

BYTE

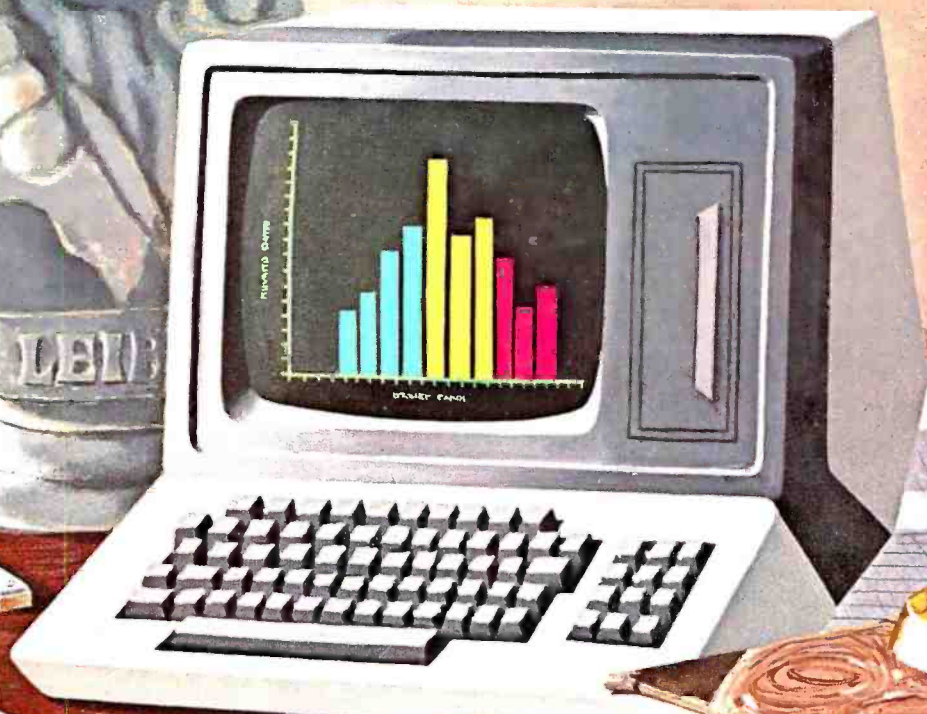

NUMERICAL ANALYSIS

ROBERT
79 LINNEY

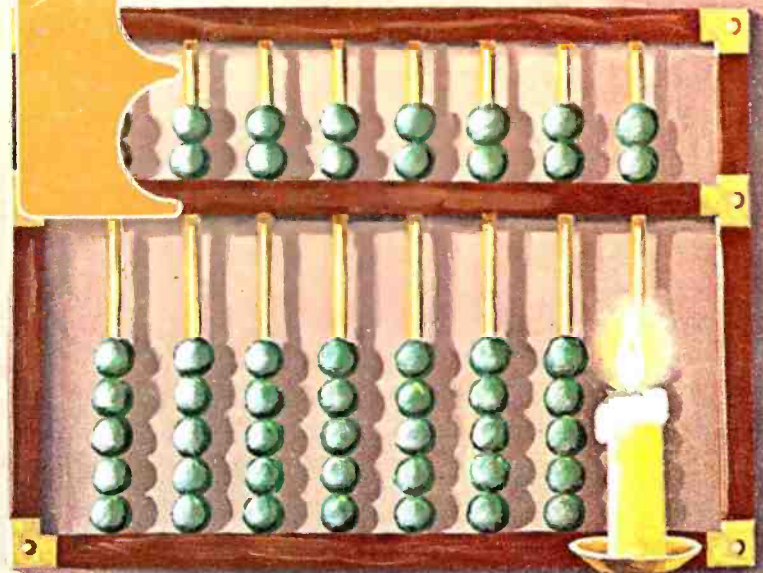
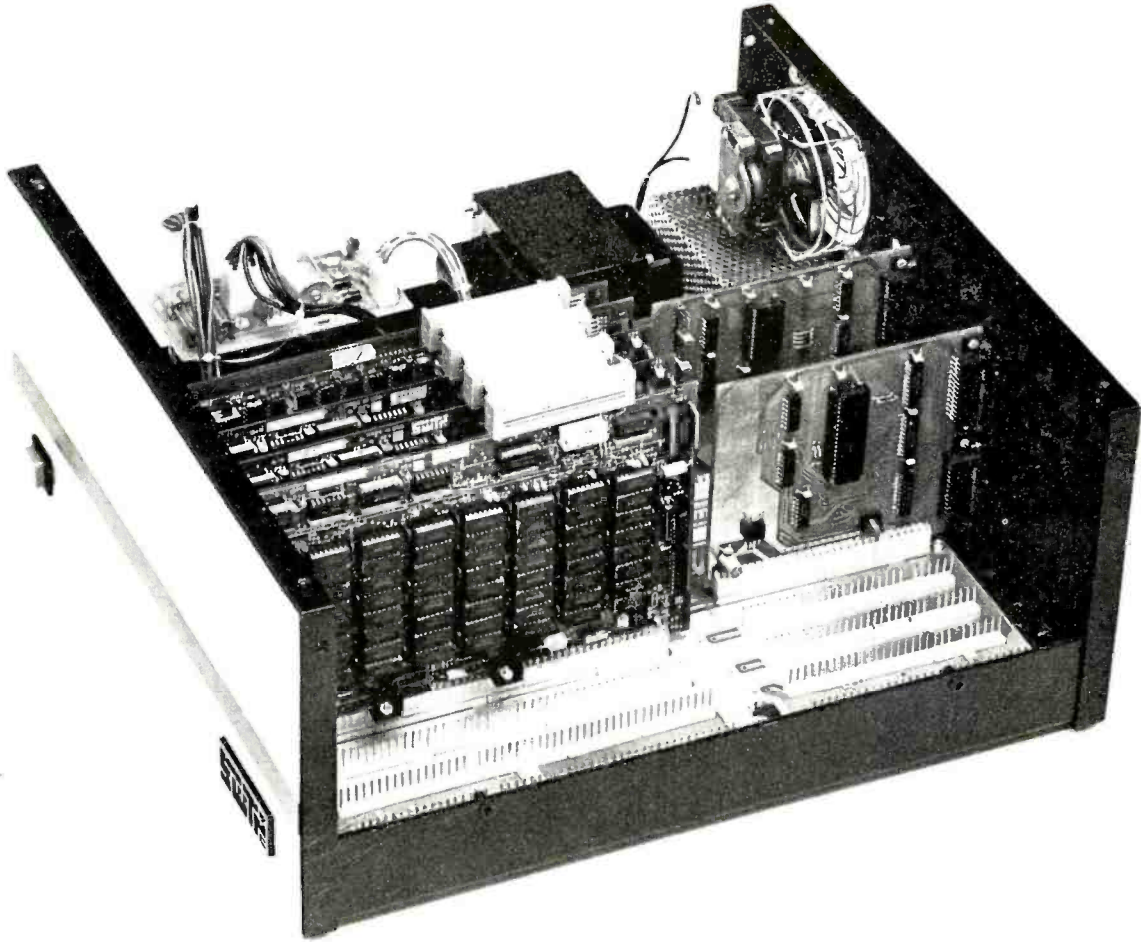

S/09 THE MIGHTY MICRO

**MC6809 PROCESSOR — 20-BIT ADDRESS BUS
DIRECTLY ADDRESSES UP TO 768K OF RAM**

Performance and capabilities never before possible are now available to you in the SWTPC S/09 Computer System. The S/09 uses the Motorola MC6809 processor, the most powerful 8-bit general purpose MPU available. It features more addressing modes than other 8-bit MPU's and an optimized consistent instruction set enhanced by powerful 16-bit instructions. This, plus 24 indexing submodes, promote the use of modern programming techniques like position independent code, re-entrancy and recursion.

The 20-bit address bus makes possible direct addressing of up to 768K of memory without any slow or clumsy processes such as bank switching. RAM memory is designed with independent control and array cards for economical expansion of memory. The DMA and the processor boards can access memory independently for different tasks.

Multuser capability is "built-in". No additional hardware is required to operate additional terminals. A dynamic memory management system can allocate available RAM in as small as 4K blocks to the various users or tasks.

The dual-bus motherboard design used in the S/09 makes adding I/O ports to the system quick and economical. I/O address decoding for all I/O slots is supplied with the system. All serial I/O cards may be quickly programmed to run at standard baud rates from 110 to 38,400.

Both multiuser and multitasking/multiuser operating systems are available for the S/09. BASIC, PASCAL and an Assembler are immediately available. Editor and Debug programs are also available for use in system development.

S/09 complete as shown with 128K bytes of RAM memory, one parallel and two serial I/O ports. . . \$2,995.00
128K memory expansion card \$1,995.00

Circle 356 on inquiry card.



SOUTHWEST TECHNICAL PRODUCTS CORPORATION
219 W. RHAPSODY
SAN ANTONIO, TEXAS 78216 (512) 344-0241



Low-cost hard disk computers are here

11 megabytes of hard disk and 64 kilobytes of fast RAM in a Z80A computer for under \$10K. Two floppy drives, too. Naturally, it's from Cromemco.

It's a reality. In Cromemco's new Model Z-2H you get all of the above and even more. With Cromemco you get it all.

In this new Model Z-2H you get not only a large-storage Winchester hard disk drive but also two floppy disk drives. In the hard disk drive you get unprecedented storage capacity at this price—11 megabytes unformatted.

You get speed—both in the 4 MHz Z80A microprocessor and in the fast 64K RAM which has a chip access time of only 150 nanoseconds. You get speed in the computer minimum instruction execution time of 1 microsecond. You get speed in the hard disk transfer rate of 5.6 megabits/sec.

EXPANDABILITY

You get expandability, too. The high-speed RAM can be expanded to 512 kilobytes if you wish.

And the computer has a full 12-slot card cage you can use for additional RAM and interface cards.

BROADEST SOFTWARE SUPPORT

With the Z-2H you also get the broadest software support in the

microcomputer field. Software Cromemco is known for. Software like this:

- Extended BASIC
- FORTRAN IV
- RATFOR (RATional FORtran)
- COBOL
- Z80 Macro Assembler
- Word Processing System
- Data Base Management

with more coming all the time.

SMALL, RUGGED, RELIABLE

With all its features the new Z-2H, including its hard disk drive, is still housed in just one small cabinet.

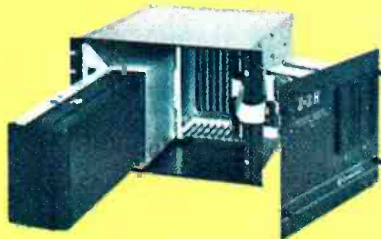

Hard disk drive at lower left can be interchanged just by sliding out and disconnecting plug. Seven free card slots are available. Z-2H includes printer interface card.

Included in that cabinet, too, is Cromemco ruggedness and reliability. Cromemco is time-proved. Our equipment is a survey winner for reliability. Of course, there's Cromemco's all-metal cabinet. Rugged, solid. And, there's the heavy-duty power supply (30A @ 8V, 15A @ +18 V, and 15A @ -18V) for circuitry you'll sooner or later want to plug into those free card slots.

CALL NOW

With its high performance and low price you KNOW this new Z-2H is going to be a smash. Look into it right now. Contact your Cromemco computer store and get our sales literature. Find out when you can see it. Many dealers will be showing the Z-2H soon—and you'll want to be there when they do.

PRESENT CROMEMCO USERS

We've kept you in mind, too. Ask about the new Model HDD Disk Drive which can combine with your present Cromemco computer to give you up to 22 megabytes of disk storage.

Cromemco
i n c o r p o r a t e d

280 BERNARDO AVE., MOUNTAIN VIEW, CA 94040 • (415) 964-7400
Tomorrow's computers now

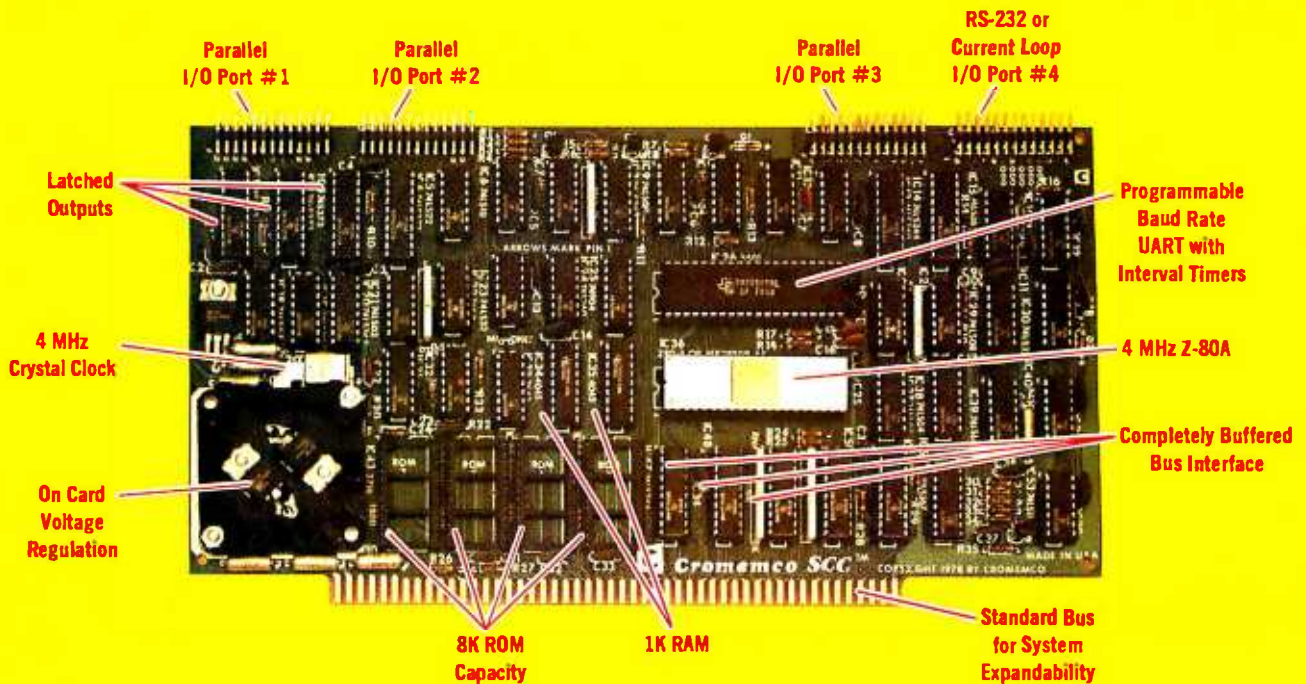

The single card computer with the features that help you in real life

COMPLETE COMPUTER

In this advanced card you get a professional quality computer that meets today's engineering needs. And it's one that's complete. It lets you be up and running fast. All you need is a power supply and your ROM software.

The computer itself is super. Fast 4 MHz operation. Capacity for 8K bytes of ROM (uses 2716 PROMs which can be programmed by our new 32K BYTESAVER® PROM card). There's also 1K of on-board static RAM. Further, you get straightforward interfacing through an RS-232 serial interface with ultra-fast speed of up to 76,800 baud — software programmable.

Other features include 24 bits of bi-directional parallel I/O and five on-board programmable timers.

Add to that vectored interrupts.

ENORMOUS EXPANDABILITY

Besides all these features the Cromemco single card computer gives you enormous expandability if you ever need it. And it's easy to expand. First, you can expand with the new Cromemco 32K BYTESAVER PROM card mentioned above. Then there's Cromemco's broad line of S100-bus-compatible memory and I/O interface cards. Cards with features such as relay interface, analog interface, graphics interface, optoisolator input, and A/D and D/A conversion. RAM and ROM cards, too.



Card Cage

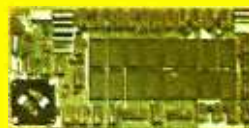

32K BYTESAVER PROM card

EASY TO USE

Another convenience that makes the Model SCC computer easy to use is our Z-80 monitor and 3K Control BASIC (in two ROMs). With this optional software you're ready to go. The monitor gives you 12 commands. The BASIC, with 36 commands/functions, will directly access I/O ports and memory locations — and call machine language subroutines.

Finally, to simplify things to the ultimate, we even have convenient card cages. Rugged card cages. They hold cards firmly. No jiggling out of sockets.

AVAILABLE NOW/LOW PRICE

The Model SCC is available now at a low price of only \$450 burned-in and tested (32K BYTESAVER only \$295).

So act today. Get this high-capability computer working for you right away.



Cromemco

incorporated

Specialists in computers and peripherals

280 BERNARDO AVE., MOUNTAIN VIEW, CA 94040 • (415) 964-7400

Foreground

- 10** FREQUENCY ANALYSIS OF DATA USING A MICROCOMPUTER *by F R Ruckdeschel*
Application of the Fast Fourier Transform (FFT)
- 36** ADD NONVOLATILE MEMORY TO YOUR COMPUTER *by Steve Ciarcia*
Using electrically alterable read-only memory as a "read-mostly" memory
- 54** FASTER AUDIO PROCESSING WITH A MICROPROCESSOR *by William J Dally*
Selected hardware circuits make possible higher-fidelity processing systems
- 120** ANALYSIS OF POLYNOMIAL FUNCTIONS WITH THE TI-59 CALCULATOR *by Pierre Chance*
A hand-held approach to numerical analysis
- 134** MINIMIZING CURVE-PLOTTING CALCULATION *by Timothy G Bowker*
Curve-plotting routine for the Hewlett-Packard 9825A computer
- 144** NONITERATIVE DIGITAL SOLUTION OF LINEAR TRANSFER FUNCTIONS *by Bryan Finlay*
The analysis of the response of dynamic systems

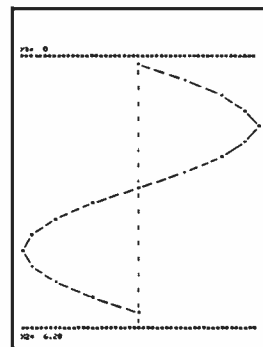

page 10

Background

- 106** TEXT COMPRESSION *by James L Peterson*
Decrease necessary storage space with Huffman codes
- 196** A USER'S LOOK AT TINY-C *by Christopher O Kern*
Commentary on tiny-c
- 222** SOME NOTES ON MODULAR ASSEMBLY PROGRAMMING *by James Lewis*
Modular programs aid design and implementation
- 241** TWENTY-FOUR WAYS TO WRITE A LOOP *by W D Maurer*
Dr Maurer takes you through a loop
- 247** MORSE CODE TRAINER *by Mark Bernstein*
Use your computer to train with Morse code recognition
- 250** THIRTY DAYS TO FASTER INPUT *by Arthur Armstrong*
Improve your touch typing skills

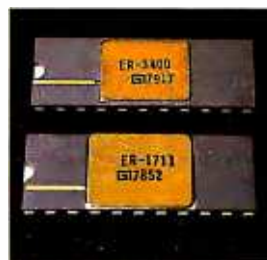

page 36



page 88

Nucleus

Editorial, On the Importance
of Casting Abstractions . . . , 6
Letters, 78
Technical Forum, 82
Programming Quickies, 87
Languages Forum, 88
BYTE's Bits, 200

BYTE's Bugs, 102, 210, 249
BYTE News, 103
Event Queue, 228
What's New?, 252
Unclassified Ads, 287
Reader Service, BOMB, 288



Cover Art: Numerical Analysis *by Robert Tinney*

BYTE is published monthly by BYTE Publications Inc, 70 Main St, Peterborough NH 03458, a wholly-owned subsidiary of McGraw-Hill, Inc. Address all mail except subscriptions to above address: phone (603) 924-7217. Address subscriptions, change of address, USPS Form 3579, and fulfillment questions to BYTE Subscriptions, PO Box 590, Martinsville NJ 08836. Second class postage paid at Peterborough NH 03458 and at additional mailing offices—USPS Publication No. 102410 (ISSN 0360-5280). Subscriptions are \$18 for one year, \$32 for two years, and \$46 for three years in the USA and its possessions. In Canada and Mexico, \$20 for one year, \$36 for two years, \$52 for three years. \$32 for one year air delivery to Europe. \$32 surface delivery elsewhere. Air delivery to selected areas at additional rates upon request. Single copy price is \$2.50 in the USA and its possessions, \$2.95 in Canada and Mexico, \$4.00 in Europe, and \$4.50 elsewhere. Foreign subscriptions and sales should be remitted in United States funds drawn on a US bank. Printed in United States of America.

Address all editorial correspondence to the editor at the above address. Unacceptable manuscripts will be returned if accompanied by sufficient first class postage. Not responsible for lost manuscripts or photos. Opinions expressed by the authors are not necessarily those of BYTE. Entire contents copyright © 1979 by BYTE Publications Inc. All rights reserved.

BYTE® is available in microform from University Microfilms International, 300 N Zeeb Rd, Dept PR, Ann Arbor MI 48106 USA or 18 Bedford Row, Dept PR, London WC1R 4EJ ENGLAND.

Subscription WATS Line: (800) 258-5485

Office hours: Mon-Thur 8:30 AM - 4:30 PM Eastern Time
Friday 8:30 AM - Noon

In This BYTE



About the Cover

This month's cover features artist Robert Tinney's concrete realization of the theme for several articles in this issue: today's tools of analysis and design are computers, both as calculating-engines and as non-traditional symbol-manipulators. By implication, if Leibniz were alive today he would be employing a friendly desk-top computer as a tool for examination of concepts ranging far beyond the calculus he helped shape.

The Fast Fourier Transform (FFT) is a unique algorithm that is necessary for the analysis and reproduction of signal waveforms. However, performing a complex mathematical derivation of the concept is not necessary. Fred Ruckdeschel has formulated a nonrigorous mathematical treatment of the FFT and demonstrates how it may be applied to synthesize a variety of waveforms in the Frequency Analysis of Data Using a Microcomputer.

Page 10

Does data evaporate from your computer's volatile programmable memory when you turn the power off? Perhaps you could benefit from having some nonvolatile memory in your machine. Steve Ciarica explores the useful properties of

electrically alterable read-only memory as he tells how to Add Nonvolatile Memory to Your Computer.

Page 36

After finding software-intensive approaches to audio processing too slow for high fidelity sound, William J Dally set out to develop a system that uses hardware to speed up processing of audio signals. He explains his ideas in Faster Audio Processing with a Microprocessor.

Page 54

Huffman code is a method for compressing text characters by exploiting their relative frequency of occurrence in text. Space savings of up to 50% can be realized using this technique.

James Peterson discusses the advantages and tradeoffs involved in this and other types of Text Compression.

Page 106

Numerical analysis techniques are quite often simplified by the use of powerful number handling algorithms available on large computer systems. A reasonable alternative to such analysis for the small-scale computer user lies in the utilization of the hand calculator. Small calculators continue to expand their capabilities as proven by Pierre Chance in his investigation of Analysis of Polynomial Functions with the TI-59 Calculator.

Page 120

Most methods of estimating a particular function and plotting it require an analysis involving calculus. Timothy Bowker has written a program that performs a simple trigonometric analysis of a function which will yield an accurate approximation of the function and then print the curve on a Hewlett-Packard 9872A plotter. See his article entitled Minimizing Curve-Plotting Calculation.

Page 134

In the analysis of system response, the utility of the transfer function is immeasurable. The transfer function will convert a time domain relationship into a frequency domain relationship, a manipulation that can prove to simplify the solution process. Bryan Finlay presents a clear picture of the concepts involved in a Noniterative Digital Solution of Linear Transfer Functions.

Page 144

The usefulness of microcomputers is increasing as more powerful and varied programming languages are implemented. Christopher Kern provides A User's Look at Tiny-c, one of the more recent languages to appear.

Page 196

Some Notes on Modular Assembly Programming presents several examples of well-written assembler programs. James Lewis feels that a structured approach to program writing helps both the design and implementation processes.

Page 222

Many people use loops in computer programs without really thinking about how they work. In Twenty-four Ways to Write a Loop, W D Maurer illustrates the endless variety of program loops and shows you how to get the most out of them.

Page 241

If you're interested in using your computer to learn Morse code, Mark Bernstein's Morse Code Trainer can help you to practice. His program translates plain text into Morse code and then outputs it through a speaker.

Page 247

Does it take you ten minutes to enter twenty lines of code at your terminal? Are your index fingers worn out from hours of hunting and pecking? Why not use your own computer to learn the useful art of touch typing. Read Arthur Armstrong's article, Thirty Days To a Faster Input.

Page 250

Publishers

Virginia Londoner
Gordon R Williamson
Associate Publisher
John E Hayes
Assistant
Jill E Callihan

Editorial Director

Carl T Helmers Jr
Executive Editor
Christopher P Morgan
Editor in Chief
Raymond G A Cote
Senior Book Editor
Blaise W Liffick

Editors

Richard S Shuford
Gregg Williams
Assistant Editor
Bob Braisted
Editorial Assistants
Gale Britton
Faith Ferry
New Products Editor
Clubs, Newsletters
Charles Freiberg
Drafting
Jon Swanson

Production Director

Nancy Estle
Production Editors
David William Hayward
Ann Graves
Faith Hanson
Warren Williamson
Robin M Moss
Anthony J Lockwood
Art Director
Eileen Bingham
Production Art
Wai Chiu Li
Christine Dixon
Holly Carmen LaBossiere
Deborah Porter

Typographers

Cheryl A Hurd
Debe L Wheeler
Sherry McCarthy
Kathy Becker

Advertising Director

Patricia E Burgess
Assistants
Ruth M Walsh
Marion Gagnon
Eileen Kindl
Adv/Prod Coordinator
Thomas Harvey
Advertising Billing
Noreen Bardsley
Don Bardsley

Circulation Manager

Gregory Spitzfaden
Assistants
Pamela R Heaslip
Agnes E Perry
Melanie Bertoni
Barbara Ellis
Dealer Sales
Ginnie F Boudrieau
Anne M Baldwin
Receptionist
Jacqueline Earnshaw

Traffic Department
Mark Sandagata
Thomas Yanni

Comptroller

Kevin Maguire
Assistant
Mary E Fluhr

National Advertising

Sales Representatives:
Hajar Associates Inc
East
280 Hillside Av
Needham Heights MA 02194
(617) 444-3946
521 Fifth Av
New York NY 10017
(212) 682-5844
Midwest
664 N Michigan Av
Suite 1010
Chicago IL 60611
(312) 337-8008
West, Southwest
1000 Elwell Ct
Suite 227
Palo Alto CA 94303
(415) 964-0706/(714) 540-3554

Officers of McGraw-Hill Publications Company: Paul F McPherson, President; Group Vice Presidents: R Bernard Alexander, Gene W Simpson, and Daniel A McMillan; Group Vice President-Planning and Development: James E Boddorf; Senior Vice President-Editorial: Ralph R Schulz; Vice Presidents: Robert B Doll, Circulation; James E Hackett, Controller; William H Hammond, Communications; Thomas H King, Manufacturing; Edward E Schirmer, International.

Officers of the Corporation: Harold W McGraw Jr, President, Chief Executive Officer and Chairman of the Board; Robert F Landes, Senior Vice President and Secretary; Ralph J Webb, Treasurer.



MICROANGELOTM

HIGH RESOLUTION INTELLIGENT GRAPHICS

Graphics boards have come and graphics boards have gone. None have really given you all the features at a competitive price that you've wanted—UNTIL NOW!

HIGH RESOLUTION 512 x 484 pixel display, from its own 32K random access memory.

INTELLIGENT Resident software emulates a terminal and also accepts high level commands for point, line, region, and variably sized and oriented character generation.

ROCK SOLID DISPLAY No snow, no jitter, no dropout. PERIOD.

INDEPENDENT Z80 driven at 4 Mhz on its own bus, so no address space from your host is used.

OBEDIENT Direct MicroAngelo via the light pen interface or high level software.

TALKATIVE High speed communication with your host over interrupting parallel ports.

EXTENSIBLE Room for up to 8K of PROM.

TIMELY 60 Hertz interrupting real time clock.

EASY TO USE Drop it into any S-100 host and you're up and running.

VERSATILE Composite or direct drive output; provision for external sync for a 512 x 512 display.

AFFORDABLE 895 dollars brings you the creative genius of MicroAngelo.

MicroAngelo is available now. Call Jim Mather at (703) 827-0888 or write us at Micro Diversions, Inc., 8455-D Tyco Road, Vienna, Virginia, 22180 and get creative!

**Look for
Shugart drives
in personal
computer systems
made by these
companies:**

Altos Computer Systems
2378-B Walsh Avenue
Santa Clara, CA 95050

Apple Computer
10260 Bandlely Dr.
Cupertino, CA 95014

Commodore Business Machines, Inc.
3330 Scott Boulevard
Santa Clara, CA 95050

Digital Microsystems Inc.
(Formerly Digital Systems)
4448 Piedmont Ave.
Oakland, CA 94611

Industrial Micro Systems
633 West Katella, Suite L
Orange, CA 92667

North Star Computer
2547 9th Street
Berkeley, CA 94710

Polymorphic Systems
460 Ward Dr.
Santa Barbara, CA 93111

Problem Solver Systems
20834 Lassen Street
Chatsworth, CA 91311

Processor Applications Limited
2801 E. Valley View Avenue
West Covina, CA 91792

Technico Inc.
9130 Red Branch Road
Columbia, MD 21045

Texas Electronic Instruments
5636 Etheridge
Houston, TX 77087

Thinker Toys
1201 10th Street
Berkeley, CA 94710

 **Shugart**

Editorial

On the Importance of Casting Abstractions in Concrete

Carl Helmers

We human beings are a conceptual species. While firmly planted in our animal evolutionary roots, our chief distinguishing characteristic is a degree of development of our mental powers. This characteristic allows us to recursively reflect upon the degree of development of our mental powers, among other things. The idea of a computer as a mental amplifier fits well within this conceptual side of human nature. In part, this explains the intellectual fascination of computing technology, which is available on a widespread basis as the modern personal computer. As a thought recording and amplification device, the computer deals with abstractions admirably. But there is also another side to the human fascination with computing which should not be ignored: the casting of abstractions in concrete forms which are understandable and emotionally gratifying. Here we find the animal side of our evolutionary heritage interacting with the cerebral side, producing a positive human value for an otherwise sterile activity.

Conceptualization exists in human beings. We do it all the time, for it is a part of our nature. Some do it better than others. Like any ability, it varies from individual to individual. Within individuals this ability varies over the course of a lifetime of growth, development and aging.

The content of our thoughts can be explicit models closely bound to the real world as perceived by human senses, abstractions like those of mathematics which are less obviously bound to real-world roots, or even total fantasies such as stories of science fiction, novels, plays, paintings and other forms of art. All innovation and progress start out as a conceptual fantasy, whether or not the fantasy is based on real-world inputs. But, if the fantasy is to be imparted to someone or made into a real-world object, it must be figuratively "cast in concrete" as a tangible and specific item. I make the claim that one tie with our evolutionary past is partly demonstrated by the emotional experience of pleasure derived by seeing concrete and specific results come from efforts directed by an abstract plan.

This is the phenomenon of emotional feedback from intellectual activities, made "real" in some way as a specific action. As I write these words at a keyboard, I am illustrating the phenomenon in the pleasure I derive from formulating my words into an essay. The concepts are certainly in my own mind. I am translating them through specific actions into a concrete form: the words printed on a piece of paper in the form of a draft I send to our copy editors.

In an analogous way, a writer of a science fiction story is a spinner of tales. Such tales are but dreams bottled up in a mind unless they are cast into a concrete form signifying meaning: as an oral or written account transmitted to another mind. We only know that the science fiction spinner of tales exists at all because of this concrete form of his or her fantasy abstractions.

For the fascination of computing, there is ample opportunity for casting abstract concepts into concrete form. Here we get the emotional feedback and confirmation of our understanding about the way a system of concepts works in a specific example. The importance of game programming on computers as a way of learning to write programs and learn about interactive sequences cannot be underestimated.

"My Shugart followed me home."

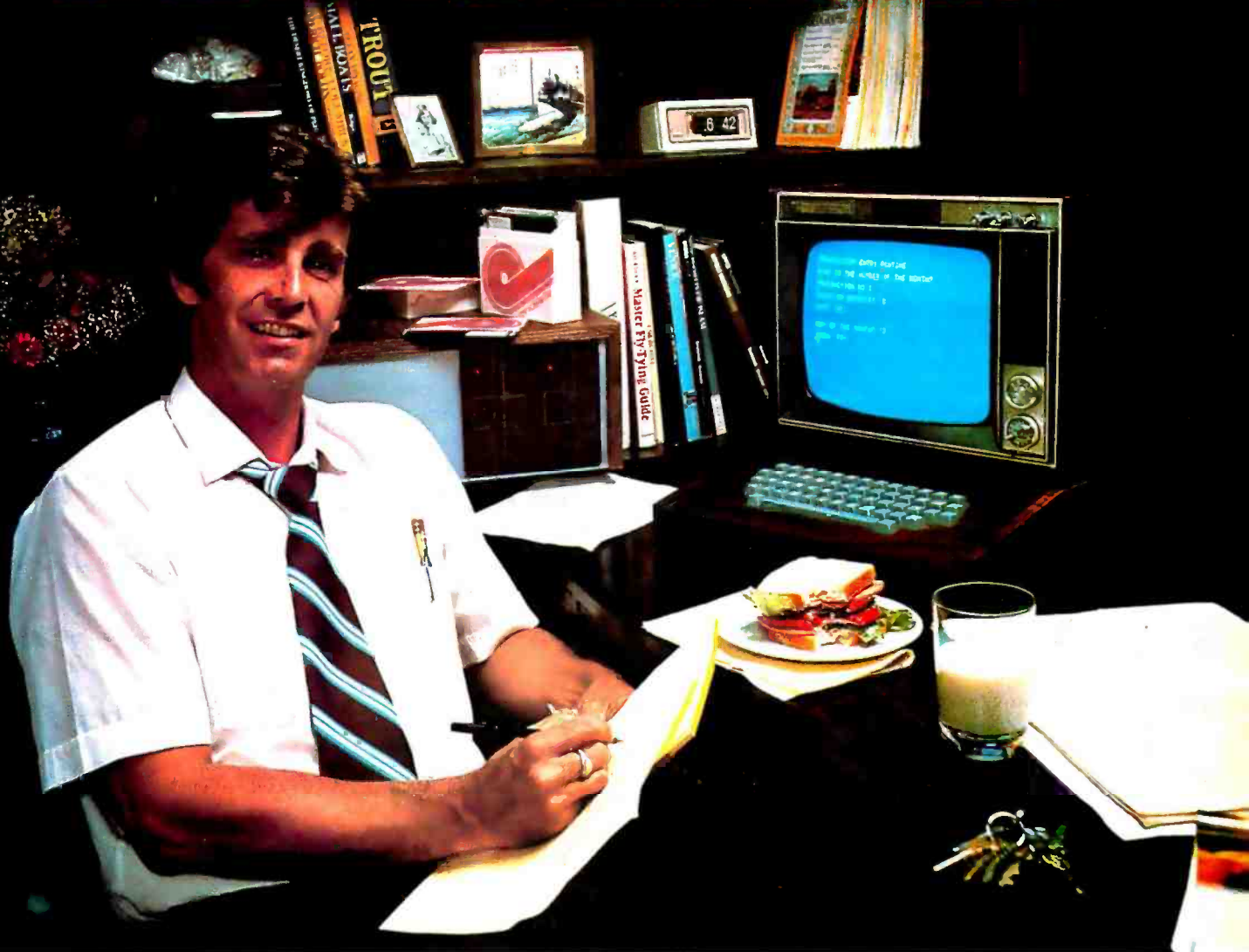

"After working all day with the computer at work, it's a kick to get down to Basic at home. And one thing that makes it more fun is my Shugart minifloppy™. We use Shugart drives at work, so when I bought my own system I made sure it had a minifloppy drive.

"Why? Shugart invented the minifloppy. The guys who designed our system at work tell me that Shugart is the leader in floppy design and has more drives in use than any other manufacturer. If Shugart drives are reliable enough for hard-working business computers, they've got to be a good value for my home system.

"When I'm working on my programs late at night, I can't wait for cassette storage. My minifloppy gives me fast random access and data

transfer. The little minidiskettes™ store plenty of data and file easily too.

"I made the right decision when I bought a system with the minifloppy. When you lay out your own hard-earned cash, you want reliability and performance. Do what I did. Get a system with the minifloppy."

If it isn't Shugart, it isn't minifloppy.

 **Shugart**

435 Oakmead Parkway, Sunnyvale, California 94086

See opposite page for list of manufacturers featuring Shugart's minifloppy in their systems.

™ minifloppy is a registered trademark of Shugart Associates

The act of defining a game as a program and making a specific implementation is this very act of casting an abstraction (the game) into concrete form (the program which allows one to interact with that abstraction).

Just as I cannot partake of the science fiction writer's tale without a concrete form of sensible representation, I cannot play some adventure game in someone else's head. I can play the game only in the concrete form of its traditional letter correspondence mode (a la Dungeons and Dragons) or the computer automated forms of a specific program (with names like Adventure, Zork, etc). This abstraction which is the concept of the game cannot be perceived emotionally except in this form of a specific implementation.

The pleasure of seeing an abstract concept transformed into a concrete representation is one of the key motivations of the experimenter. The experimenter is the person who works creatively with a technology — be it oil paints on canvas or bit patterns in memory — and sees the results at first hand. It is the spirit of the scientist as much as of the artist.

Why should I sit down and design a computer, then build it, then design my own particular style of system software? There are numerous wheels in the computer world which at first sight I do not need to reinvent in various ways. But the way to thoroughly understand an art, science or technology is to participate in it. Thus, I spend effort designing and building computer systems from time to time; I spend effort now and then designing and implementing text editors; I spend effort from time to time designing and implementing simple interactive application programs for mundane tasks. I do not do this without a return on my efforts in the form of the emotional satisfaction and pleasure which come from seeing my abstract concepts implemented in concrete form.

I partake of the pleasure of exploring the possible concepts of a design, settling on one, then working out its hidden implications and feeding that knowledge back into the design. This is the challenge of understanding which motivates our curiosity in any field. It is made quite explicit by the demands of the computer field. Programming a computer is a very abstract concept, yet when that computer program abstraction turns on a

motor in a robot arm, or sounds a note on a music synthesizer in a progression of some fugue, the program has a very real and concrete way of interacting with our senses and emotional evaluations.

This, then, is the true importance of experimentation and the resultant casting of abstract ideas into concrete form: it provides us with emotional confirmation via pleasure of an otherwise valueless thought. The human value of pleasure, or happiness, in turn feeds back into our thought processes, and the cycle continues. The act of translation, from abstract to concrete, aids us in our understanding of the world and our perceptions of it. ■

Progress Report: The 6809 Project

At this writing, September 26 1979, my 6809's central processor card design is complete in the form of a wiring diagram spread over four large sheets of drafting vellum. I have not yet begun to wire the processor, due to a heavy travel and speaking schedule in late summer and early autumn of this year. Once I have finished the actual implementation of the card, readers can expect to see photographs, wiring diagram, and hand-assembled machine language primitives for a terminal-oriented operating system. Timing? As noted earlier, I continue with this project at the sufferance of a 24-hour day. So, the next installment will come when it is ready, and no sooner. ...CH

Articles Policy

BYTE is continually seeking quality manuscripts written by individuals who are applying personal computer systems, designing such systems, or who have knowledge which will prove useful to our readers. For a more formal description of procedures and requirements, potential authors should send a large (9 by 12 inch, 30.5 by 22.8 cm), self-addressed envelope, with 28 cents US postage affixed, to BYTE Author's Guide, 70 Main St, Peterborough NH 03458.

Articles which are accepted are purchased with a rate of up to \$50 per magazine page, based on technical quality and suitability for BYTE's readership. Each month, the authors of the two leading articles in the reader poll (BYTE's Ongoing Monitor Box or "BOMB") are presented with bonus checks of \$100 and \$50. Unsolicited materials should be accompanied by full name and address, as well as return postage.

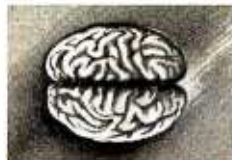

8086 Boards

CPU with Vektored Interrupts \$650.
 PROM-I/O \$495.
 RAM 8K x 16/16K x 8 \$395.

ANALOG Boards

A/D 16 Channel, \$495.
 12 Bit, High Speed
 D/A 4 Channel, \$395.
 12 Bit, High Speed



VIDEO DIGITIZATION

Real Time Video \$850.
 Digitizer and Display
 Computer Portrait System \$4950.

S-100 Boards

Video and/or Analog
 Data Acquisition
 Microcomputer Systems



The High Performance S-100 People
 TECMAR, INC.
 23414 Greenlawn • Cleveland, OH 44122
 (216) 382-7599

MORE CAPABILITIES THAN ANY OTHER PERSONAL COMPUTER UNDER \$1,000*

Compare the built-in features of the ATARI® 800™ with other leading personal computers. Whether you program it yourself or use pre-programmed cartridges or cassettes, the ATARI 800 gives you more for your money.

Run your own programs? Easy. Just plug in the 8K BASIC or optional Assembler language cartridge, and go. They're ROM based. That means more RAM for your programs.

Also included with the ATARI 800 is an internal speaker and four separate sound channels, FCC approval, a built-in RF modulator, the ATARI 410™ Program Recorder and a high speed serial I/O.

Peripherals? Add up to 48K of user installable RAM. Or up to four individually accessible floppies.

A high-speed printer. And more to come.

Graphics programs? No problem. The ATARI 800 offers 128 color variations: 16 colors in 8 luminance levels. Plus 29 keystroke graphics symbols and 8 graphics modes. All controlled from a 57 character ASCII keyboard. With upper and lower case.

Or, program it our way. There are exciting programs available and many more on the way for the ATARI 800. Business programs. Home Management programs. Entertainment. And with the 410 audio/digital recorder, you can add Atari's unique Talk & Teach™ Educational System cassettes.

Your way or our way, you'll find that the ATARI 800 is probably the most powerful computer that \$999.99* can buy.

And with that power, you get dependability. Dependability built into Atari's custom designed and fully-tested LSI circuitry and lower component count, (less components, less chance for failure).

But if anything ever does go wrong, you'll find a complete network of computer-connected Atari service facilities waiting for you throughout the country.

Make your own comparison. Hands on. Anywhere computers are sold. Or, send for a free chart that compares the features of the ATARI 800 to other leading fully-programmable computers.

*Suggested retail price \$999.99, includes computer console, program recorder and BASIC language cartridge.



ATARI
PERSONAL COMPUTER SYSTEMS

1265 Borregas Ave., Dept. C, Sunnyvale, California 94086. Call toll-free 800-538-8547
(In California 800-672-1404) for the name of your nearest Atari retailer.

Frequency Analysis of Data Using a Microcomputer

F R Ruckdeschel
773 John Glen Blvd
Webster NY 14580

Introduction

People involved with digital electronics often deal with signals in which the voltage or current changes with time. When a pulse is distorted, its shape is generally expressed in terms of *overshoot* or *rise time*.

In the design of analog electronics equipment such as audio amplifiers, great emphasis is placed on frequency response and phase shifts. The performance of consumer-oriented audio systems is not normally specified in terms of pulse rise time or pulse delay. However, such a specification would characterize the system's basic response to the *zeroth order*. The zeroth order qualifier is necessary because rise time is only an approximate (but very useful) description of a system's response to a stepped input. A complete description would be possible through comparative plots of input and output waveforms.

In communications theory both the real-time (signal versus time) and frequency (signal content versus frequency) representations are applied somewhat interchangeably since the object is to transmit real-time signals, such as pulses, over channels having bandwidth and noise limitations. The Fourier transform is used to aid in such analyses. To exercise this analysis technique it is assumed that the system response is linear. That is, if the input signal level is halved, so is the output signal, along with no change in signal shape. It is thus apparent why most digital engineers do not use Fourier transforms; their systems are highly nonlinear, and work well because of the nonlinearity. It is also apparent why audio engineers are heavily dependent on frequency analysis; their systems are highly linear.

The choice of the Fourier transform for electronics analysis is based on the properties of its "basis" functions, sinusoids. For example, in electronic systems which are composed of ideal inductors, resistors and capacitors, sinusoids have the unique property that if a pure sinusoid of a particular frequency is inserted anywhere into a circuit, examination of any other location in the circuit will show a pure sinusoid of the same frequency, though perhaps changed in amplitude and phase. There is no *mode conversion*. In real systems, however, nonlinea-

rities in response can lead to *harmonic distortion*, which is another way of saying *mode conversion*.

Vital to the application of sinusoids in Fourier analysis is a property called *linear independence*. That is, it is not possible to generate a sinusoid of angular frequency ω_2 from the addition (a linear operation) of two other sinusoids having frequencies ω_1 and ω_3 ($\omega_1 \neq \omega_2$, ω_3). A nonlinear operation such as multiplication is required for this to occur.

Mathematically speaking, the sinusoidal functions used in Fourier analysis form a complete, continuous, and infinite set of orthogonal functions spanning the space of all real numbers. This should be compared with the analogous digitally-oriented Walsh functions (See "Walsh Functions," September 1977 BYTE, page 190). The Walsh functions form a complete, discrete (but infinite) set of orthogonal functions, also capable of spanning all real space.

Having discussed the basic utility of the functions which compose the Fourier transform, we will now take a brief look at the mathematical structure that will eventually be encoded into a program to calculate frequency transforms.

The Fourier Transform

The basic definition of the Fourier transform operation is:

$$F(\omega) = \int_{-\infty}^{\infty} f(x)e^{-i\omega x} dx \quad (1)$$

where:

$F(\omega)$ = the frequency transform

$f(x)$ = the function to be transformed

ω = the frequency variable (eg: radians/second)

x = the spatial variable (eg: time in seconds)

$i = \sqrt{-1}$

The transform is performed using complex coordinate ($\sqrt{-1}$) algebra and integration. $F(\omega)$ is thus in the complex domain and is only a mathematical construct. However, $|F(\omega)|$, the absolute value (or modulus) of $F(\omega)$, is a measurable value. It is defined as:

FIDELITY ELECTRONICS

VOICE CHESS CHALLENGER[®]

THE FIRST THINKING GAME THAT SPEAKS TO YOU



A perfect chess opponent, the Challenger[®] can play against you at infinite levels of skill, from beginner to expert. And... it speaks to you... calling out all moves, catching errors and announcing game progression. The Challenger[®] is also a superb teacher and it will even suggest your best move. Be warned, however, that the Challenger[®] has 1200 classic book-opening moves and can analyze over three million board positions stored in its tiny computer brain. So, it can be very tough. It is so sophisticated, it is available in either English, Spanish, German or French language.

Other challenging computer games from Fidelity include... BRIDGE... CHECKERS... and BACKGAMMON. At fine stores everywhere.



**FIDELITY
ELECTRONICS, LTD.**
Miami, Florida 33178

The world's largest manufacturer of self-contained, microprocessor based, board games.

$$|F(w)|^2 = F^*(w) F(w) \quad (2)$$

The * operator stands for conjugation (reversing the signs of the imaginary terms). We note that:

$$F^*(w) = \int_{-\infty}^{+\infty} f(x)^* (e^{-iwx})^* (dx)^*$$

If x and $f(x)$ are real (as we will now specify), then we have $x^* = x$ and $f(x)^* = f(x)$, giving:

$$F^*(w) = \int_{-\infty}^{+\infty} f(x) e^{iwx} dx = F(-w)$$

Thus:

$$F(w) = \sqrt{F(-w) F(w)} = F(-w) \quad (3)$$

Note that, in principle, when performing the integration called for in equation (1), all values of w should be considered, both positive and negative. But since equation (3) indicates that $F(w)$ is symmetrical about $w = 0$, we need only consider (and plot) the function for $w \geq 0$.

$|F(w)|$ is called the *amplitude* or *modulus* of the transform. There is also a phase term in the transform which complements the modulus description. For the purposes of this article, however, the phase term will not be considered.

To calculate $|F(w)|$, we observe that:

$$|F(w)|^2 = \{Re F(w)\}^2 + \{Im F(w)\}^2 \quad (4)$$

The *Re* and *Im* operators denote that the real and imaginary part of $F(w)$ are to be taken respectively. These are:

$$Re F(w) = \int_{-\infty}^{+\infty} f(x) \cos(wx) dx \quad (5a)$$

$$Im F(w) = \int_{-\infty}^{+\infty} f(x) \sin(wx) dx \quad (5b)$$

To finally arrange the above equations into a structure suitable for computer calculation, we consider $f_i = f(x_i)$ to represent the data value (perhaps from an equation or experiment) at position x_i . For simplicity we consider the data points to be equally spaced; $x_{i+1} - x_i = \Delta x$.

We also consider f_i to exist only over the interval x_1 to x_N . Outside that interval, f_i will be defined to be zero. Combining the above considerations into a program-mable form we have:

$$|F(w)|^2 = \{\sum_{i=1}^N f_i \cos(w x_i) \Delta x\}^2 + \{\sum_{i=1}^N f_i \sin(w x_i) \Delta x\}^2$$

Equation (6) is the basis for the present computer calculation of the Fourier transform of the function represented by $\{f_i\}$. The computer program shown in listing 1 performs this calculation and plots the results.

Note that the number of input data points is N . For an equivalent, but not redundant frequency space description, $N/2$ transform points are required. From an inspection of equation (6) it is apparent that the number of calculations increases by N^2 if a numerical implementation of the integration is applied. Thus, if the number of data points is doubled, the computing time roughly quadruples. The Fast Fourier Transform (FFT) algorithm reduces this dependence. For limited data sets (less than fifty data points), the routine shown in listing 1 takes on the order of fifteen minutes or less in North Star BASIC on an IMSAI, which is acceptable when compared to the large programming complexities associated with implementing an FFT for an arbitrary length data set. The trade-off is between available programmer's time and processor time; my computer lost in the trade-off.

For those interested in further investigation of Fourier transform techniques, an excellent book on the subject is *The Fast Fourier Transform* by E O Brigham, published by Prentice-Hall. Brigham not only presents FFT algorithms, but also reviews continuous transform theory, as well as the errors (particularly at high frequencies) associated with discrete transforms such as the one used here. He also considers reconstruction of the original data set using the calculated frequency transform.

The Discrete Fourier Transform Program

The computer program presented in listing 1 is written in North Star BASIC and is user-oriented. It allows the scale of the automatic data and frequency plots to be adjusted to fit the available terminal width. All plots are shifted and scaled such that they use the maximum terminal width established by the user. Thus, even the owner of a thirty-two-character wide video display can use this program.

The program requires the beginning and ending coordinates (X_1 and X_2 respectively) of the data set as well as

Tremendous Savings on Refurbished AJ Couplers/Modems

Your chance to buy the best from the world leader in data communications. We have a variety of couplers and modems—formerly on lease to our customers—fully refurbished. This is a rare opportunity for you to have the same models used by the largest companies in the world.

- Some models under \$100!
- 30-day parts/labor warranty
- Nationwide AJ service network
- Fast delivery
- Variety of models—up to 1200 baud
- Limited quantities
- Use your Visa or Master Charge

Act now. First come, first served. Write Anderson Jacobson, Inc., 521 Charcot Ave., San Jose, CA 95131. Or call your nearest AJ office:

San Jose, CA Rosemont, IL Hackensack, NJ
(408) 946-2900 (312) 671-7155 (201) 488-2525



Is your "Pencil" getting dull?
Then you need

The Pencil Sharpener

from MicroDaSys

"Personalizing Form Letter Package" for your Electric Pencil 11™ under CP/M™

You:

- Create your letter or announcement using the EP II
- "Key" insertion items throughout the text
- Set up the insertion data file using EP II, BASIC, or other software
- Or use existing files (Accounts Payable, Mailing list, etc.)
- Identify the particular letter and insertion data file and RUN THE PENCIL SHARPENER

The Pencil Sharpener:

- Uses your version of the Electric Pencil II
- Loads in the designated letter
- Inserts all designated data for the appropriate "keys"
- Prints the letter using the EP II "Print Sub-System"
- Personalizes and prints letter after letter, replacing key words

SAVE TIME - FOLLOW UP OLD BUSINESS - CONTACT NEW BUSINESS

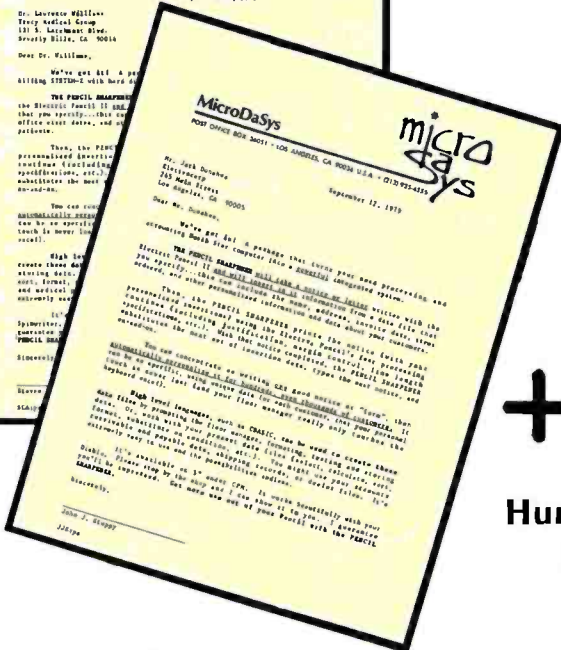
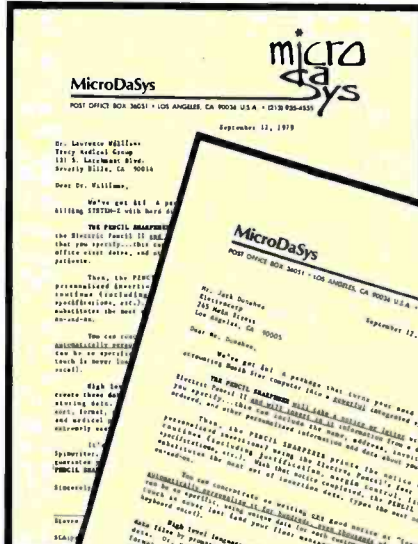
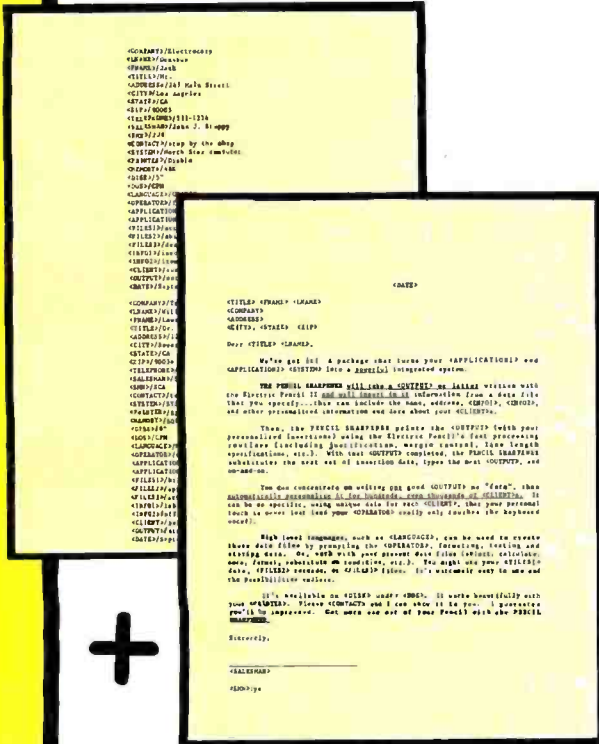

+

Hundreds More!

The PENCIL SHARPENER runs on all versions of Electric Pencil II under CP/M.
Soon available TRS-80 version and "star brightener" for Word Star.

Generous Dealer Discounts!

GET THE POINT? ... GET THE PENCIL SHARPENER!

CP/M is a trademark of Digital Research. The Electric Pencil II is a trademark of Michael Shroyer Inc.

MicroDaSys, P.O. Box 36051, Los Angeles, CA 90036
(213) 935-4555 TWX 910 321 2378

Please send me _____ copies of the PENCIL SHARPENER at \$195 each.

Payment terms:

[] Check/ M.O. Enclosed [] C.O.D. [] Charge Card
Card No. _____ Exp. _____

Name _____
Company _____
Address _____
City/State _____
Zip _____ Telephone () _____

Specify disk:
[] 8" [] North Star
[] Micropolis
[] Check here if SOL



Listing 1: This program will input and plot the data set, then determine the transform and display it graphically. The program is written in North Star BASIC, but features particular to this BASIC were avoided so that the software may be run on most BASIC interpreters.

```

10 REM ***FREQUENCY ANALYZER***
20 REM F. RUCKDESCHEL 9/20/77
30 PRINT\PRINT\PRINT
40 PRINT "****FOURIER SPECTRUM ANALYZER****"
50 PRINT\PRINT
60 PRINT"THIS PROGRAM TRANSFORMS "
70 PRINT"EQUAL INCREMENT DATA INTO "
80 PRINT"FREQUENCY SPACE "
90 PRINT\PRINT
100 PRINT"THE USER INPUTS THE STARTING "
110 PRINT"AND ENDING COORDINATES, ALONG "
120 PRINT"WITH THE NUMBER OF DATA POINTS "
130 PRINT"THE PROGRAM WILL THEN PLOT "
140 PRINT"THE DATA AND ITS SPECTRUM"
150 PRINT\PRINT
160 REM INITIALIZATION
170 PRINT "INPUT TERMINAL WIDTH: ",
180 INPUT L
190 PRINT "BEGINNING COORDINATE: ",
200 INPUT X1
210 PRINT "ENDING COORDINATE: ",
220 INPUT X2
230 PRINT "NUMBER OF DATA POINTS: ",
240 INPUT N
250 PRINT"INPUT SCALE FACTOR: ",
260 INPUT I
270 IF I<1 THEN GOTO 250
280 DIM D(N)
290 D=(X2-X1)/(N-1)
300 W1=0\W2=3.14159/(D*I)
310 W3=W2/(N-1)
320 REM DATA INPUT
330 PRINT "INPUT DATA"
340 FOR I=1 TO N
350 PRINT I,\INPUT D(I)
360 NEXT I
370 B=0
380 REM SHIFT DATA TO NON-NEGATIVE
390 FOR I=1 TO N
400 IF B>D(I) THEN B=D(I)
410 NEXT I
420 FOR I=1 TO N
430 D(I)=D(I)-B
440 NEXT I
450 B=ABS(B)
460 PRINT\PRINT\PRINT
470 REM FIND MAX. DATA VALUE
480 T=0
490 FOR I=1 TO N
500 IF T<D(I) THEN T=D(I)
510 NEXT I
520 REM PLOT DATA
530 S=L/T
540 E=S*B
550 PRINT\PRINT
560 PRINT " DATA PLOT (NORMALIZED)"
570 PRINT\PRINT
580 PRINT "X1= ",X1
590 GOSUB 1190
600 FOR I=1 TO N
610 IF S*D(I)<1 THEN GOTO 620
620 IF S*D(I)<1 THEN PRINT "*"
630 IF S*D(I)>=1 THEN PRINT TAB(S*D(I)), "*"
640 IF S*B<1 THEN GOTO 660
650 PRINT TAB(E), ":"
660 NEXT I
670 GOSUB 1200
680 PRINT "X2= ",X2
690 REM START FOURIER TRANSFORM
700 DIM F(N)

```

```

710 FOR I=1 TO N
720 W=(I-1)*W3
730 C1=0\S1=0
740 FOR M=1 TO N
750 X=X1+(M-1)*D
760 G=W*X
770 C1=C1+D(M)*COS(G)
780 S1=S1+D(M)*SIN(G)
790 NEXT M
800 F(I)=SQRT(S1*S1+C1*C1)*D
810 IF I=1 THEN GOSUB 1260
820 NEXT I
830 REM END FOURIER TRANSFORM
840 PRINT\PRINT
850 REM TRANSFORM DATA TABLE
860 PRINT " FREQ(RAD) MODULUS"
870 PRINT " -----"
880 FOR I=1 TO N
890 PRINT " ",INT(1000*W3*(I-1)+.5)/1000,
900 PRINT " ",INT(1000*F(I)+.5)/1000
910 NEXT I
920 PRINT\PRINT
930 REM TRANSFORM PLOT
940 PRINT " FREQUENCY PLOT (NORMALIZED)"
950 PRINT\PRINT
960 PRINT INT(1000*W1+.5)/1000,
970 PRINT " RADIANS/SECOND ",
980 PRINT INT(500*W1/3.14159+.5)/1000,
990 PRINT " HERTZ (CYCLES/SECOND)"
1010 GOSUB 1200
1020 T=0
1030 FOR I=1 TO N
1040 IF T<F(I) THEN T=F(I)
1050 NEXT I
1060 S=L/T
1070 FOR I=1 TO N
1080 IF S*F(I)<1 THEN GOTO 1090
1090 IF S*F(I)<1 THEN PRINT "*"
1100 IF S*F(I)>=1 THEN PRINT TAB(S*F(I)-.5), "*"
1110 PRINT " ",TAB(L-1), "."
1120 NEXT I
1130 GOSUB 1200
1140 PRINT INT(1000*W2+.5)/1000,
1150 PRINT " RADIANS/SECOND ",
1160 PRINT INT(500*W2/3.14159+.5)/1000,
1170 PRINT " HERTZ (CYCLES/SECOND)"
1180 END
1190 REM BORDER LINE PLOT
1200 FOR I=1 TO L
1210 PRINT "**",
1220 NEXT I
1230 PRINT
1240 RETURN
1250 REM CORRECT DC VALUE FOR DATA SHIFT
1260 C1=C1-N*B
1270 F(1)=ABS(C1)*D
1280 RETURN
READY

```

number of data points, N , as initial inputs. It then asks for a frequency scale factor (to be discussed shortly). After receiving this information it then asks for the N data values, f_i . These are plotted, and the computer subsequently enters the Fourier transform calculation, which may take several minutes. At the end of this calculation, the N frequency data points are printed out. This is where the effect of the frequency scale factor becomes evident. With a scale factor of unity, the Nyquist sampling criterion is used to determine the maximum frequency to be used in the transform calculation. The frequency range is divided into $N-1$ intervals, and the frequency space data points are plotted at the associated N



We're looking for the most original use of an Apple since Adam.

What in the name of Adam do people do with Apple Computers?

You tell us.

In a thousand words or less.

If your story is original and intriguing enough, you could win a one-week all-expense paid trip for two to Hawaii. Which is the closest we could come to paradise.

Win fabulous prizes for creative writing.

To enter, drop by your nearest Apple dealer and pick up an entry blank. Fill it out. Then write an article, in 1000 words or less, describing the unusual or interesting use you've found for your Apple.

A jury of independent judges will cast the deciding vote for the grand prize: a week for two, airfare included, in Hawaii.

The judges will also choose 16 additional winners, two each from eight categories:

graphics/music, entertainment, home, business, education, scientific, professional, and industrial. And each winner will choose from a long list of longed-after Apple peripherals—from Apple Disk II's to Graphics Tablets to printers. Or you can take a \$250 credit towards the purchase of any Apple product.

The contest ends March 31, 1980. All winners will be notified by May 15.

Entry forms are available at your participating Apple dealer. Call 800-538-9696, (800-662-9238 in California), for the one nearest you.

Mail the entry blank, your article and any photos to: Apple Computer, "What in the name of Adam" contest, 10260 Bandlely Drive, Cupertino, CA 95014.

And may the juiciest application win.

Circle 17 on inquiry card.

apple computer 

FOURIER SPECTRUM ANALYZER

THIS PROGRAM TRANSFORMS EQUAL INCREMENT DATA INTO FREQUENCY SPACE

THE USER INPUTS THE STARTING AND ENDING COORDINATES, ALONG WITH THE NUMBER OF DATA POINTS THE PROGRAM WILL THEN PLOT THE DATA AND ITS SPECTRUM

INPUT TERMINAL WIDTH: 751
 BEGINNING COORDINATE: 70
 ENDING COORDINATE: 76.28
 NUMBER OF DATA POINTS: 717
 INPUT SCALE FACTOR: 71

INPUT DATA

- 170
- 27.38
- 37.71
- 47.92
- 571
- 67.92
- 77.71
- 87.38
- 970
- 107.38
- 117.71
- 127.92
- 137.1
- 147.92
- 157.71
- 167.38
- 1770

Figure 1: Initializing routine for a seventeen-point approximation of a one-period sine wave. The period chosen was 2π . Thus, the characteristic frequency associated with this sine wave is one radian per second.

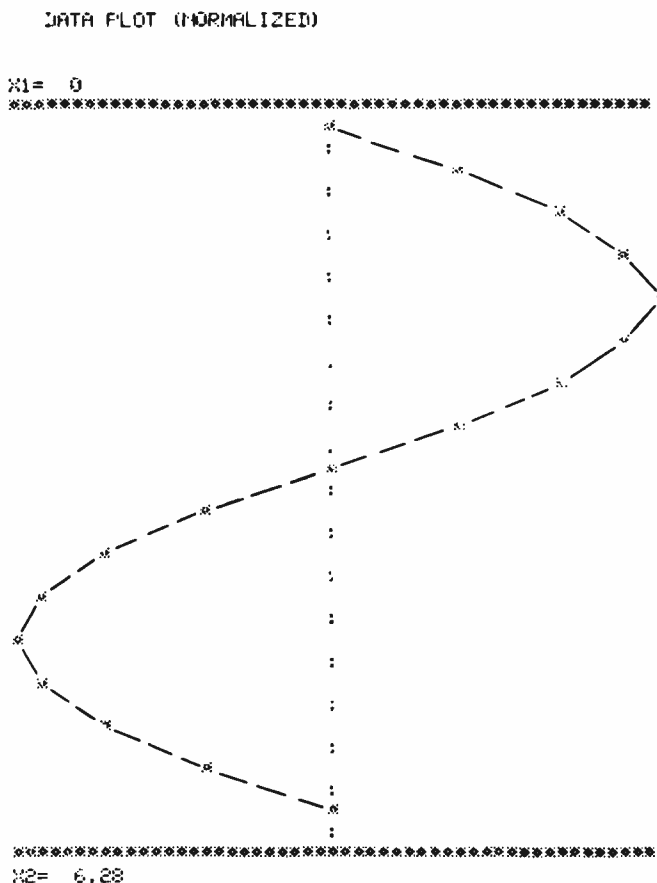

Figure 2: Computer responds with a plot of the data set. For added clarity, lines have been drawn between the plotted points on this and all subsequent figures.

boundaries. With an inputted scale factor greater than unity, the maximum frequency is reduced correspondingly. This gives better resolution for examining low frequency components. Scale factors less than unity are not permitted.

A sample run for a seventeen-point approximation of a single period of a sine wave is shown in figures 1, 2, and 3. We expect to see no "power" at $w=0$ on the frequency plot because the average value of the data set is zero. Such is the case, since the signal approximated is a discrete truncation of a continuous sine wave having a frequency of one radian per second. However, because the wave has been truncated, there are many other frequency components present which not only spread out the power around the one radian per second point, but also appear to shift the frequency spectrum maximum towards a lower frequency. The same features are apparent in figure 4 where the frequency resolution has been increased three-fold.

Truncated Sine Waves

The plots presented in the last section demonstrated that, although we intuitively expect a peak in the frequency spectrum at the sine wave frequency, none is apparent. If figure 4 is viewed with a little imagination, however, it is possible to see that the complete spectrum is composed of two parts, with one part having a peak at the sine wave frequency, thus causing the small bump at $f = 1$ radian per second in figure 4.

Since we have a computer program that allows easy evaluation of frequency spectra, consider the approxi-

mate square-wave data set shown in figure 5. The corresponding frequency plots are shown in figures 6 and 7. Mathematically we expect to see a "sinc" function, $(F(z) = \sin z/z)$, frequency response, with the exception of having a zero at $w=0$. The next zero is expected to be at 2 radians per second. From the frequency plots we see the expected characteristic shape, but with a zero at 1.9 radians per second; the input square wave is not ideal. A direct comparison of figures 3, 4, and 6, 7 indicates that the single-period sine wave has a spectrum similar to that of the single-period square wave, with the important difference that there appears to be more high frequency content in the square-wave spectrum. This is not surprising since there are sharp edges in the square-wave truncation which should lead to more high frequency components than with the sine-wave truncation.

Since the spiked-spectrum characteristic of an infinitely long wave is not very evident in the single-period wave truncation example given above, the question arises: how many sine wave periods are required before the frequency content that is characteristic of the single-period square wave is sufficiently reduced to allow the spiked spectrum to become evident? Again, we can experiment using the computer by entering a thirty-three data point representation of a two-period sine wave and observing the resulting frequency plot (see figure 8). As expected, the infinite sine-wave characteristic is much more evident

The easy way to learn about computers: BUILD ONE.



△ H8 Personal Computer with Dual Floppy System

△ H19 Smart Video Terminal

H14 Serial Printer

H11A 16-bit Computer (DEC® PDP-11/03 compatible) with Dual Floppy System ▷

△ H89 All-In-One Computer

Self-Instruction Programs for Assembly and BASIC Programming △

Yes, you can do it. Heath makes it simple with easy-to-build kits and step-by-step assembly manuals that lead you from unpacking to final plug-in.

And once you build your own computer, you'll know it inside-out. You'll know how to make it work for you.

Software, designed especially for Heathkit Computers, includes innovative programs

for running your home or business, and exciting games your kids will enjoy.

The Heathkit User's Group (HUG), made up of owners of Heathkit Computers, will share with you a library of over 400 programs that they've written to make your computer serve you in ways you never imagined.

Heathkit Computers may be low-cost kits.

But they're not playthings. They're powerful, high-capacity computers designed for complex programming. You'll find complete systems — hardware, software, accessories — within the pages of the Heathkit Catalog. And you'll find service any time you need it at 55 locations throughout the U.S. or at the Heathkit factory.

FREE CATALOG

For complete descriptions of Heathkit Computers and nearly 400 other electronic kits for your home, business or pleasure, send for the latest, free Heathkit Catalog.

If Coupon is missing write: Heath Co., Dept. 334-600, Benton Harbor, MI 49022

Heathkit Products are also sold and serviced at Heathkit Electronic Centers (units of Schlumberger Products Corp.) throughout the U.S. See your white pages. DEC is a registered trademark of Digital Equipment Corporation.



HEATH Schlumberger	Heath Company, Dept. 334-600 Benton Harbor, MI 49022
<input type="checkbox"/> YES Please send me my FREE Heathkit Catalog. I am not currently receiving your catalogs.	
Name _____	
Address _____	
City _____	State _____
CP-170	Zip _____

FREQ (RAD)	MODULUS
0	0
.5	4.778
1.001	3.16
1.501	2.076
2.001	.392
2.501	.84
3.002	.392
3.502	.522
4.002	.392
4.502	.35
5.003	.393
5.503	.232
6.003	.392
6.503	.149
7.004	.393
7.504	.079
8.004	.393

FREQUENCY PLOT (NORMALIZED)

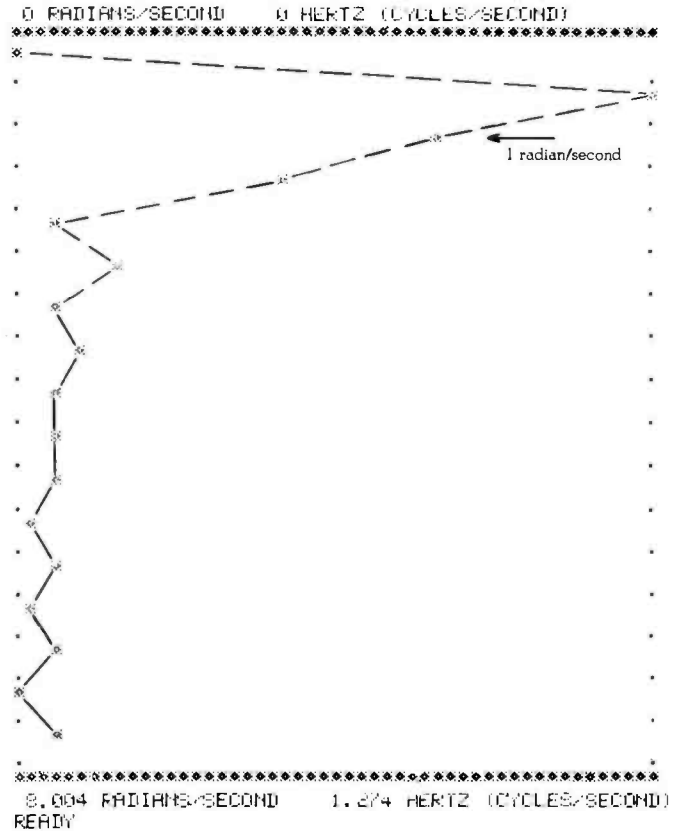

Figure 3: The program outputs a table of transformed data, as well as a frequency space plot.

because the term which appears to be related to the truncation has collapsed two-fold in the frequency span.

To those familiar with Fourier transforms of signals which have been "windowed," the first low frequency zero shown on figure 8 (other than that at $w=0$) is directly related to this "window function." This function may be considered as multiplying an infinite sine wave to give the observed truncation, thus the frequency spectrum of the resulting signal is the convolution (see convolution theory in *The Fast Fourier Transform* by Brigham) of the perfect sine wave spectrum with the spectrum of this window function, the latter having a functional form defined by $(F(z) = \sin z/z)$. As the window becomes relatively

FINALLY, Apple II® software for the discerning computerist, and the not-so-discerning beginner

AppleAids™

Little Tricks™

A series of carefully explained subroutines containing a potpourri of useful programming techniques in Integer Basic and Applesoft, such as specific key stroke identification, timing loops, disappearing question marks on input, no question marks on input, and many more.

Cassette (16K) 14.95 Disk (32K) 19.95

Scroll Control™

Have you ever wondered why you cannot list an Integer Basic or Applesoft program one screen-page at a time? So have we, and we did something about it! Our machine language Scroll Control, hidden in RAM so as not to "bump" into your program, can be engaged or disengaged at a flick of the keyboard. Why be frustrated when instead you can control the scroll? Cassette 9.95 Disk 14.95

CompuLaw™ Series

*Alitax Estimator™

This Applesoft program, prepared under the supervision of an attorney, estimates disposable income after alimony and child support payments and federal taxes. For use by laymen and attorneys. 1980 tables.

Cassette (24K) 9.95 Disk (32K) 14.95

*Pensioner™

A companion to Alitax Estimator in Applesoft designed to calculate the present value of a pension in states in which a pension is subject to division in marital dissolution cases.

Cassette (24K) 9.95 Disk (32K) 14.95

N.J. res. add 5% sales tax
Apple II and Applesoft are registered trademarks of Apple Computer, Inc.
Add \$1/item, shipping and handling professional, but not a substitute for legal advice

Form-It-Out™

A series of routines in Integer Basic and Applesoft containing detailed explanation and examples of programming techniques necessary to professionalize your screen output. Included are right and center justification, windowing, tabbing, cursor positioning among others.

Cassette (16K) 14.95 Disk (32K) 19.95

Track & Sector List™

This is the ultimate disk utility. Instead of a catalog, have you ever seen those dreaded words "I/O ERROR"? Is all lost? NO! Now your disk may be saved. Also you can eliminate bad sectors, remove control characters imbedded in file names, change the disk volume number, and more. This machine language program is supplemented by extensive tutorial documentation worth its weight in gold. Disk only (32K) 24.95

Hex and Decimal Learning Tree™

My ABC's™

An early learning Integer Basic program using over one hundred and fifty high resolution graphic letters and pictures in a drill-and-practice format designed to develop identification of capital and small letters, and association of letters with pictures. Scoring capability allows monitoring. Child tested and teacher recognized. Cassette (48K) 14.95 Disk 19.95

Now I Can Rhyme™

A companion to My ABC's in Integer Basic. The child selects those high resolution pictures which rhyme. Score-keeping capability allows monitoring. Incorporates progressive levels of difficulty.

Cassette (48K) 14.95 Disk (48K) 19.95

SOFTAGON
INCORPORATED

P.O. Box 774M
Morristown, NJ 07960
(201) 539-3770



ALTOS COMPUTER SYSTEMS PROUDLY ANNOUNCES

SUN-SERIES

ACS8000-6



THE VERY FIRST

Double Density Z80 Micro-Computer
plus Twin 8" Floppies
plus 14.5Mb Winchester Disk
for under \$9,500!

And more! 4 user CP/M® for under \$12,000!

*CP/M is a registered trademark of Digital Research, Inc.

ALTOS COMPUTER SYSTEMS, LEADER IN SINGLEBOARD TECHNOLOGY
DOES IT AGAIN WITH ITS SINGLEBOARD ACS8000-6. TOTAL BUSINESS COMPUTER

HIGH TECHNOLOGY AGAIN

The new ACS8000-6 single board computer is packed with *ultra-high* technology: Z80 double-density computer, up to 208Kb of high speed RAM, Floppy-disk and Winchester Hard Disk controllers, DMA, up to 6 serial/2 Parallel I/O, optional 32 bit floating point processor . . . All on One Board, fully socketed, fully documented reliable and maintainable.

ADVANCED MULTI-USER SOFTWARE

Our new ALTOS Multi-User Executive (AMEX) supports four independent CP/M compatible programs in any of six languages: Basic, Fortran, Cobol, Pascal, APL, C, and a wealth of complete business application packages.

WINCHESTER MASS STORAGE

We're staying with Shugart for both floppies and Winchester hard disk. Why? Simple, low price, solid reliability and they're our next door neighbor. Our single board computer supports up to 4 Mbytes of floppies and 58 Mbytes of Winchester running under AMEX.

ALTOS

COMPUTER SYSTEMS

2338-A Walsh Avenue
Santa Clara, Ca. 95050

MINI PERFORMANCE FOR 1/2 COST

Prices you will love. Entry level ACS8000-6 Hard Disk System \$9,450
2 users \$10,670, 4 users \$11,960,
AMEX separate at \$250.

AVAILABLE NOW! Circle 6 on inquiry card.
Call for your nearest Altos dealer. (408)
244-5766. Telex 171562 ALTOS SNTA.

FREQUENCY PLOT (NORMALIZED)

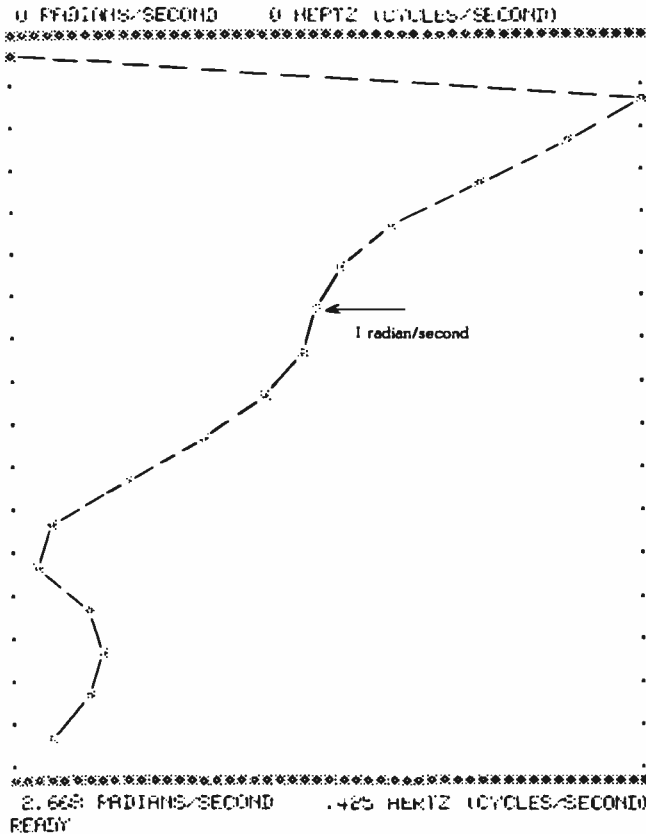

DATA PLOT (NORMALIZED)

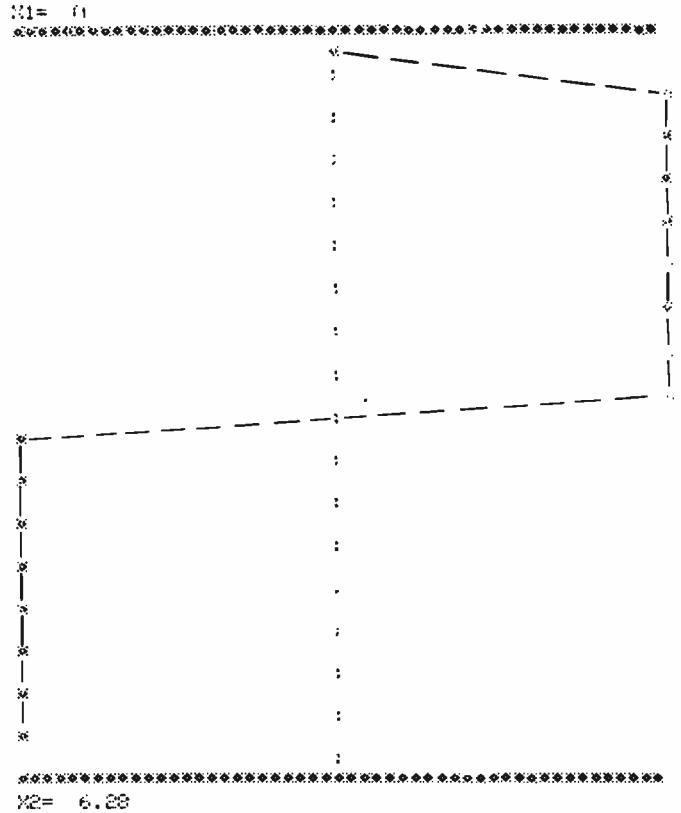

Figure 4: Same frequency plot as shown in figure 3, but with a 3.0 scale factor condition (three-fold increase in frequency resolution).

Figure 5: Plot of the seventeen-point data set used to approximate a square wave having the same period as the sine wave examined in figures 2 and 3.

wider, the sine function increasingly takes on a delta (or impulse) function characteristic which eventually leads to a spiked spectrum for the resulting transform. Figures 9 and 10 demonstrate this for approximations of four- and eight-period sine waves. The latter plot definitely shows the narrow band spectrum element that is expected for a sine wave. Note, however, that the spread in power around the sine wave frequency still remains.

Frequency-Shift Keying

One of the techniques used to encode digital information for transmission or recording is frequency-shift keying (FSK). In this method a frequency f_0 is associated with the logic state 0, and a frequency f_1 is associated with the logic state 1. Thus a message consists of a sequence of sine wave bursts, each having a characteristic frequency f_0 or f_1 . It is apparent that the ideas and plots developed in the previous section may be directly applied to the consideration of FSK encoding.

If the data-signal center frequency is 2100 Hz (which is equal to $(f_0 + f_1)/2$), and if the desired data-transfer rate is 300 bits per second, then one may expect to see (and subsequently decode) many bursts of seven-period sine waves having frequency spectra similar to that shown in figure 10, though scaled in frequency. Obviously, if the two chosen encoding frequencies are very close together it will be difficult to reliably sort out the signals using a

filter technique. If a linear filter approach is taken, then it is apparent by examination of figure 10 that a minimum frequency separation of about $(f_0 + f_1)/8$ is called for. For a 2100 Hz center frequency, a 500 Hz frequency separation is required. This gives encoding frequencies of approximately 1850 and 2350 Hz. More will be said about the significance of those frequencies later.

The above frequency separation requirement was obtained by considering several factors. These considerations included the decoding technique, filtering, and determining whether or not the frequency spectra are sufficiently separated to allow filter detection (using many dB per octave roll off). Another approach, which is more accurate, is to count sine wave periods or zero crossings. If periods are used, the minimum required frequency separation is that which gives a one-period difference (eg: seven periods versus eight periods). In this case, the required frequency separation comes out to be 300 Hz. This can be reduced to 150 Hz using zero crossings. To get better discrimination than this, a technique such as phase-locked loops must be used, and the results are highly hardware-design dependent.

For the sake of comparison, consider some of the frequencies used in the real world. The standard modem frequencies are separated by 200 Hz; 2025/2225 Hz and 1070/1270 Hz. For standard modem encoding frequencies, you must do more than simply decode by filtering.

Small business systems complete for under \$200 a month. Business software such as Inventory Control, Accounts Receivable and Word Processing available now.

The Chieftain 6800 microcomputer series with capabilities that surpass the Z-80 is made for business systems.

Smoke Signal's quality-packed Chieftain 1.5 features two double-sided 5.25-inch mini-floppy drives and Chieftain III features two 8-inch double-sided floppy drives.

Both microcomputers provide 32K static memory, two serial I/O ports, a 2 MHz processor board, a 2K RAM monitor, a nine-slot motherboard with built-in baud rate generator and gold connectors for high reliability. The Chief-

tain's stylish leather-grained enclosure has its own cooling fan and regulated power supply.

And they're expandable up to 128K memory with up to 4 megabytes floppy disk storage.

The Chieftain series is noted for extremely high reliability as well as ease of operation.

So see your nearest Smoke Signal dealer, he'll be glad to show you how to get your wampum's worth. Systems start at \$2,595.

- Send information on your Chieftain microcomputer
 Send name of nearest dealer

Name _____

Address _____

Company _____

City _____

State/Zip _____

Dealer inquiries invited.



**SMOKE SIGNAL
BROADCASTING**

31336 Via Colinas, Westlake Village,
California 91361, (213) 889-9340

**BASIC-FORTRAN
COBOL NOW
AVAILABLE**

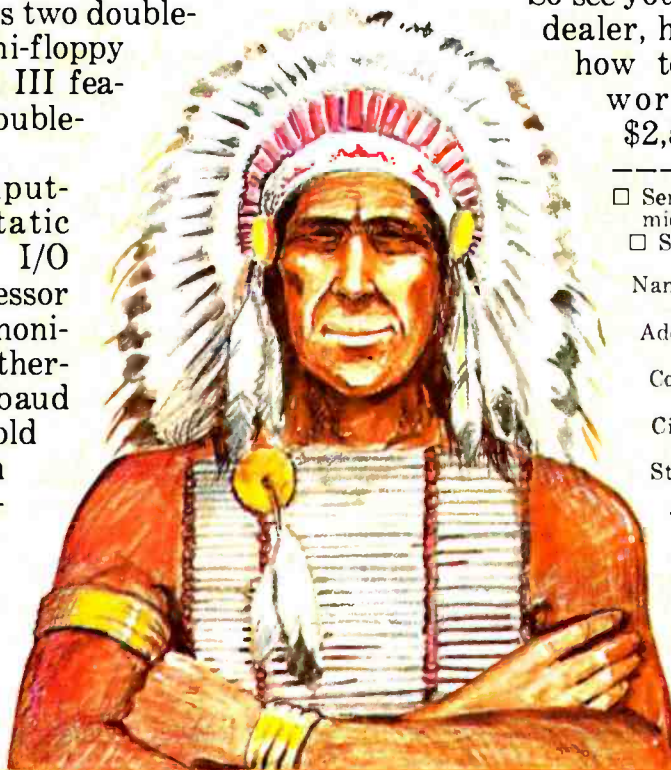

Hail to the Chieftain

Smoke Signal Broadcasting, 31336 Via Colinas, Westlake Village, CA 91361, (213) 889-9340

"Our inventory is our existence. Think we'd trust it to anything less than Scotch® Brand Diskettes?"

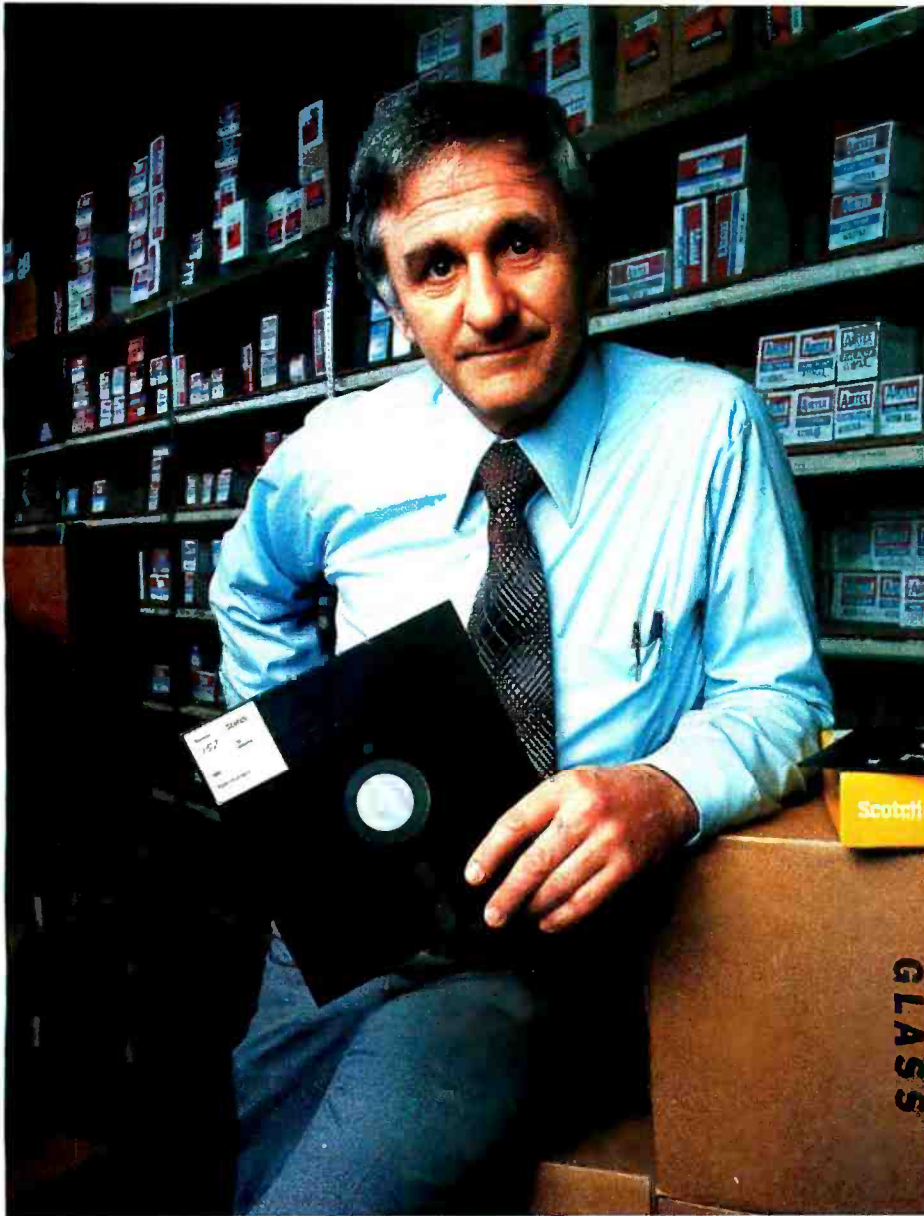

Don Stone, President,
Mass. Auto Supply Company,
Inc., Boston, Mass.

Scotch Diskettes are the diskettes you can depend upon with the information *your* business depends upon.

Each one is tested and certified error-free before it leaves our factory. Because we know nothing less than perfection is acceptable for *your* vital business data.

Scotch Diskettes are available in regular or mini sizes, compatible with almost any system.

To find out where you can purchase Scotch Diskettes, call toll free: 800-328-1300. (In Minnesota, call collect: 612-736-9625.) Ask for the Data Recording Products Division. In Canada, write 3M Canada Inc., London, Ontario, N6A 4T1.

If it's worth remembering,
it's worth Scotch
Data Recording Products.



3M

HOW TO MAKE



D I S C U S

232

D I S C U S

D I

YOUR FIRST MILLION



New 1.2 megabyte quad-density disk. \$1545.

Now you can afford to put a million bytes of memory in your S-100 system.

Introducing DISCUS 2+2™ full-size quad-density floppy disk system by Morrow. DISCUS 2+2™ gives you 1.2 megabytes per diskette (600K bytes of double-density data per side). And it's all addressable as easily as main memory with the system's exclusive BASIC-V™ virtual disk BASIC software.

Best of all, DISCUS 2+2™ comes complete, assembled, and ready to run for just \$1545. Included in the system price are an S-100 controller, factory-mounted full-size disk drive, a complete library of pre-interfaced software, even cables and connectors.

But you don't have to get your first million in one big megabyte. Morrow's DISCUS/2D™ single-side double-density floppy disk system gives you 600K per full-size diskette for just \$1149, complete and assembled. And when you want to expand to a full megabyte, just plug in a second drive... both the hardware and software are expandable.

And if economy is a real concern, you can still get started on your million with Morrow's DISCUS 1™ 250K single-density disc system. It's delivered complete and assembled for just \$995... and will accept up to 3 more drives.

All three Morrow disk systems meet the Proposed IEEE S-100 standard and are compatible with 2MHz, 4 MHz and 5 MHz S-100 systems. A dual-drive cabinet is available as an option with any density you choose.

Why set your goals low and slow with a mini-floppy system? Get started on your first million with a DISCUS™ full-size system by Morrow. See your local computer shop. Or write Thinker Toys™, 5221 Central, Richmond, California 94804. Or call (415) 524-2101, weekdays 10-5 (Pacific Time).

 Morrow Designs
Thinker Toys™

FREQUENCY PLOT (NORMALIZED)

0 RADIANS/SECOND 0 HERTZ (CYCLES/SECOND)

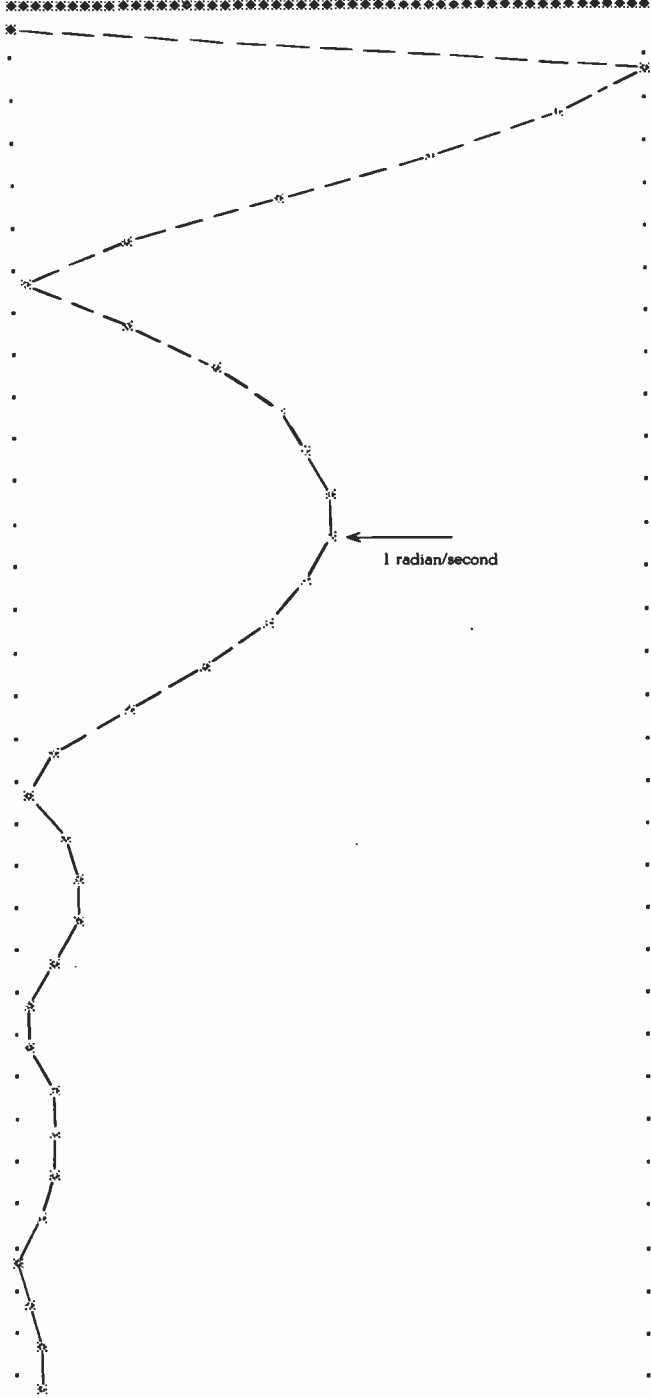

2.666 RADIANS/SECOND .424 HERTZ (CYCLES/SECOND)
READY

Figure 8: Frequency plot of a two-period sine wave approximated by a thirty-three-point data set. A frequency scale factor of 3 was used.

FREQUENCY PLOT (NORMALIZED)

0 RADIANS/SECOND 0 HERTZ (CYCLES/SECOND)

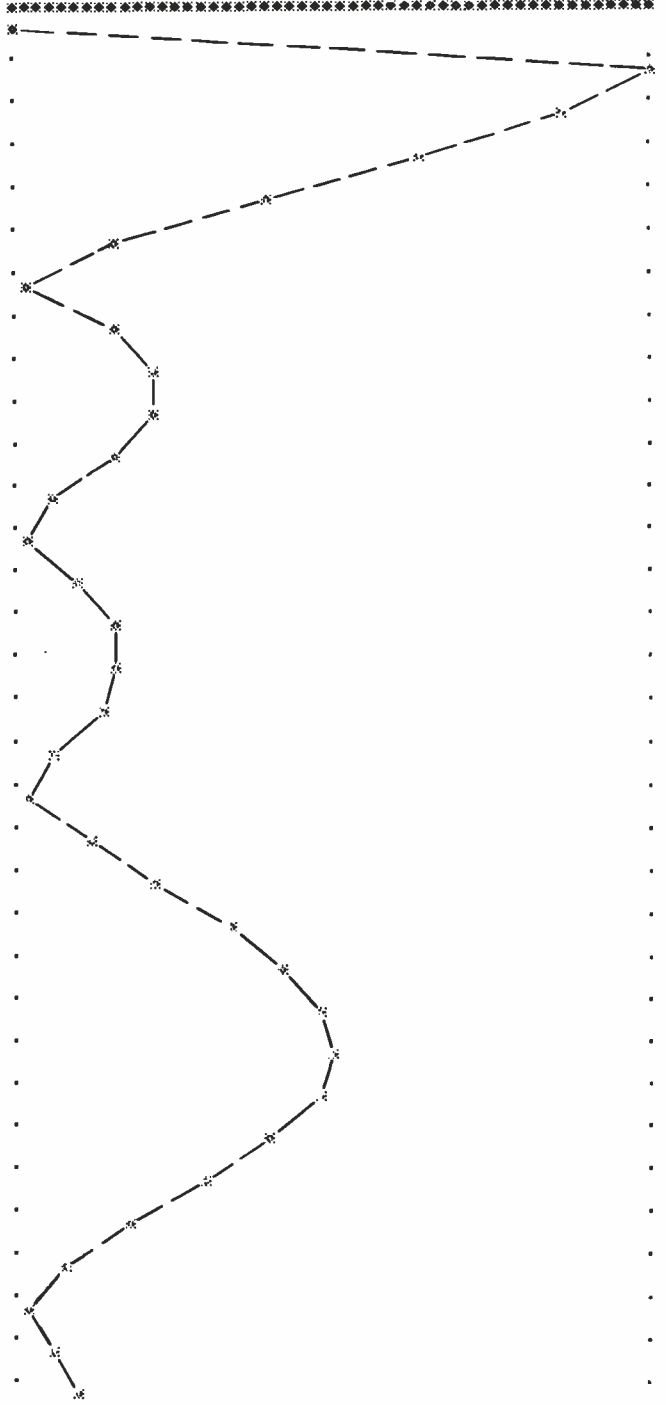

1.333 RADIANS/SECOND .212 HERTZ (CYCLES/SECOND)
READY

Figure 9: Frequency space plot of a four-period sine wave approximated by a thirty-three-point data set. A scale factor of 3 was used.

Text continued from page 22:

figure 12. Observe that there is a large value at $w=0$ which dwarfs the power at the characteristic sine-wave frequency. A high pass filter would remove the $w=0$ term.

Figure 13 shows the effect of adding uncorrelated noise to the above sine wave via the following formula:

$$f_i = 2 + \sin(x_i) + 2 \{RND [(I-1)/(N+1)] - 0.5\} \quad (8)$$

Best-selling values from Heath Data Systems



WH89
All-In-One Computer

WH14
Serial Printer



WH19
Smart Video Terminal

Complete line of best-sellers

You'll know why they're best-sellers the moment you see them. They're compact and powerful, designed especially for the needs of business and priced to pay for themselves quickly.

WH89 All-In-One Computer is a completely self-contained system. Now with its own wordprocessing software, it's the ideal choice for reliable, affordable wordprocessing. It has two Z80 microprocessors, mini-floppy storage, WH19 terminal, heavy-duty keyboard and keypad, and 16K RAM expandable to 48K. **All for only \$2295.**

WH19 Smart Video Terminal has a Z80 microprocessor, 24 x 80 display, upper and lower case, direct cursor addressing and 8 user-programmable keys. And it's DEC® VT52 and ANSI compatible. **Only \$995.**

WH14 Serial Printer is microprocessor-controlled and features 5 x 7 dot matrix, upper and lower case, variable pitch/lines per inch, tractor feed, and adjustable paper width. Uses standard ribbon and fanfold paper. RS-232 or 20 mA current loop. **Only \$895.**

Heath Data Systems best-sellers are on display now at your nearby Byte Shop, Computerland, Heathkit Electronic Center, MicroAge Dealer, and other specialty computer stores. OEM's call (616) 982-3361 for quantity discounts.

Heath data systems

CP-172

Heath Data Systems
Hilltop Road, St. Joseph, MI 49085

DEC is a registered trademark of Digital Equipment Corporation.
Prices subject to change without notice.

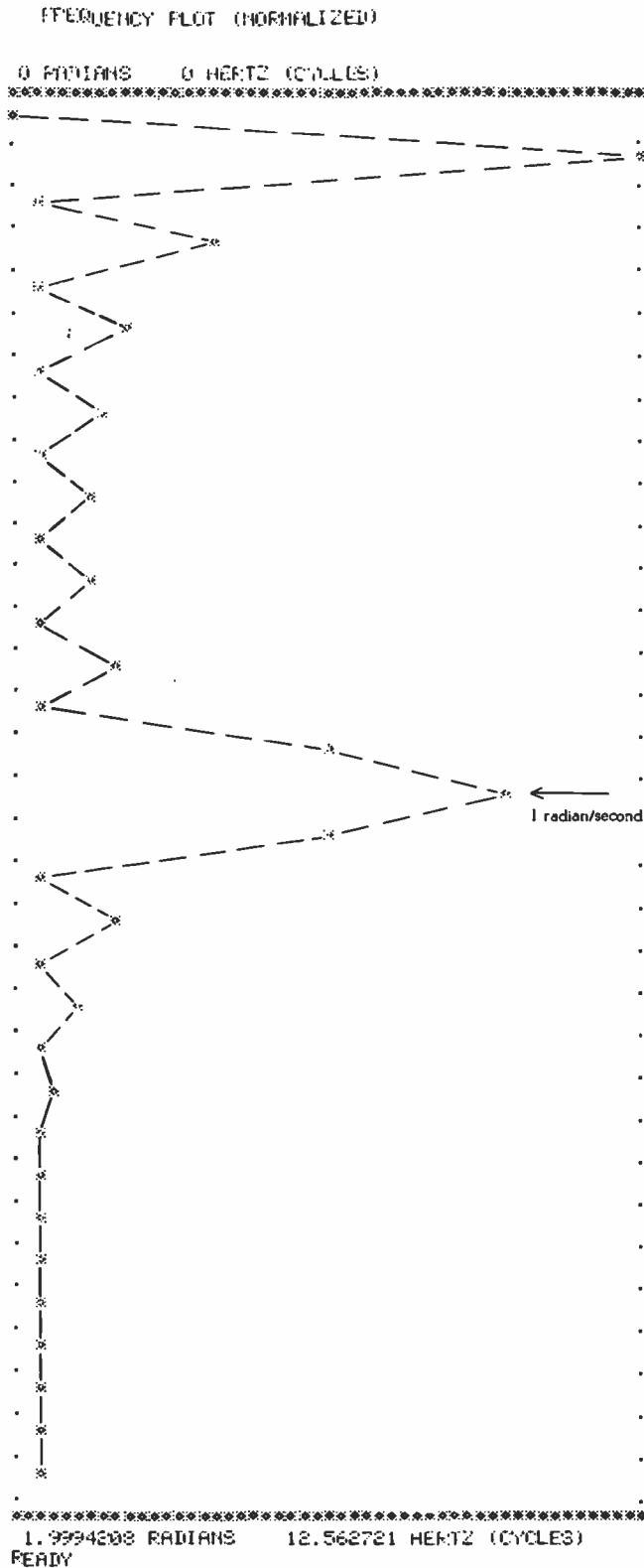

Figure 10: Frequency space plot of an eight-period sine wave approximated by a sixty-five-point data set. Normal resolution.

Observe that the average value of the noise is zero and that the noise added is uncorrelated because a new "seed" for the random number generator is chosen at each data point. This noise is not "white" or Gaussian, but rather is linearly distributed between -0.5 and +0.5.

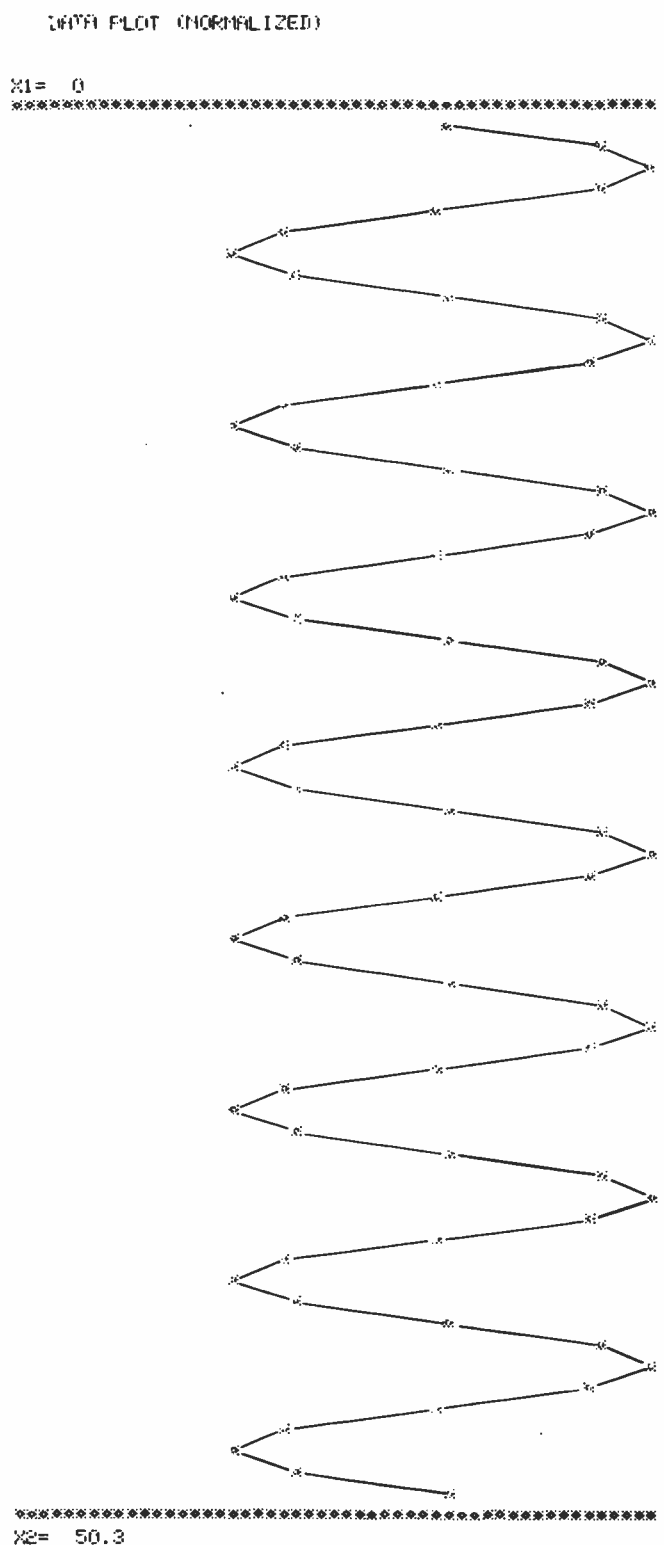

Figure 11: Eight-period sine wave as approximated by a sixty-five-point data set.

The sine wave hidden in figure 13 is not very evident, although you might guess (perhaps from an oscilloscope trace) that a repetitive signal is present.

Figure 14 shows the frequency transform of the noisy data from figure 13. Observe that, although there is noise

New from SSM.



80 Character Video

With 80 characters per line our VB3 is the perfect video interface for word processing. It produces a standard 80x24 display of upper and lower case characters or as much as 80x51 for a full page of text. The matrix for graphic display goes up to 160x204. And with optional EPROM, as many as 256 user programmed characters or symbols can be produced.

VB3 is memory mapped for rapid screen updating. But it occupies memory only when activated. So one or more VB3s can be located at the same address with a full 65K of memory still available to the user.

It generates both U.S. and European TV rates and meets the new IEEE S-100 standard. Other features include keyboard input, black on white or white on black, one level of grey, underline, strike thru, blinking char., blank-out char., and programmable cursor. Software includes a CP/M compatible driver and a powerful terminal simulator.

VB3 is available in several configurations. Retail prices start at \$375 kit, \$440 assembled.

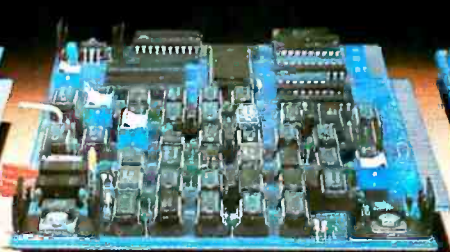

Z-80 CPU

We spent over a year designing the CB2 to assure that it will be the most fully S-100 compatible Z-80 CPU on the market.

It operates at 2MHz or 4MHz by DIP switch selection and includes two sockets for 2716/2732 EPROMs or TMS 4016 2K RAMs. Memory sockets can be disabled. Separate run/stop and single step switches allow system evaluation without the benefit of a front panel.

CB2 also features an MWRITE signal, firmware vector jump, and an output port to control 8 extended address lines (allowing use of more than 65K of memory). Jumper options generate the new IEEE S-100 signals to insure future S-100 compatibility.

Retail price—\$210 kit, \$275, assembled.

Our line. CPU, Video, I/O, RAM, EPROM, EPROM Programmer, Music, Prototyping, Terminator, Extender, and Mother boards. Available assembled or as kits.

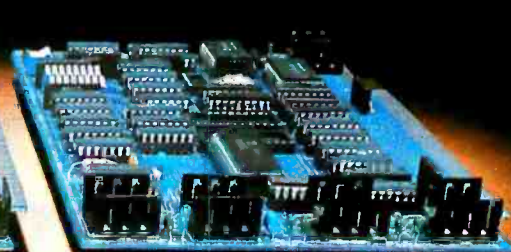

8080 CPU

Our new CB1A is identical to our popular CB1 with the exception that the on-board RAM has been increased from 256 bytes to a full 1K.

It also features an optional 2K of 2708 EPROMs, power-on/reset vector jump, MWRITE, parallel input port with status and DIP switch addressing.

Retail price—\$159 kit, \$219 assembled.



2116 Walsh Avenue
Santa Clara, CA 95050 (408) 246-2707

Send for our free brochure and find out why SSM has become the favorite of discerning Hobbyists and OEMs.



Why not kill two birds with one stone?

If you have an Apple* and you want to interface it with parallel and serial devices, we have a board for you that will do both. It's the AIO.TM

Serial Interface.

The RS-232 standard assures maximum compatibility with a variety of serial devices. For example, with the AIO you can connect your Apple* to a video terminal to get 80 characters per line instead of 40, a modem to use time-sharing services, or a printer for hard copy. The serial interface is software programmable, features three handshaking lines, and includes a rotary switch to select from 7 standard baud rates. On-board firmware provides a powerful driver routine so you won't need to write any software to utilize the interface.

Parallel Interface.

This interface can be used to connect your Apple* to a variety of parallel printers. The programmable I/O ports have enough lines to handle two printers simultaneously with handshaking control. The users manual includes a software listing for controlling parallel printers or, if you prefer, a parallel driver routine is available in firmware as an option. And printing is only one application for this general purpose parallel interface.

Two boards in one.

The AIO is the only board on the market that can interface the Apple to both serial and parallel devices. It can even do both at the same time. That's the kind of innovative design and solid value that's been going into SSM products since the beginning of personal computing. The price, including PROMs and cables, is \$135 in kit form, or \$175 assembled and tested. See the AIO at your local computer store or contact us for more information.



2116 Walsh Avenue
Santa Clara, California 95050
(408) 246-2707

*Apple is a
TM of Apple
Computers,
Inc.

AIO
Serial & Parallel
Apple Interface

FREQUENCY PLOT (NORMALIZED)

0 RADIANS/SECOND 0 HERTZ (CYCLES/SECOND)

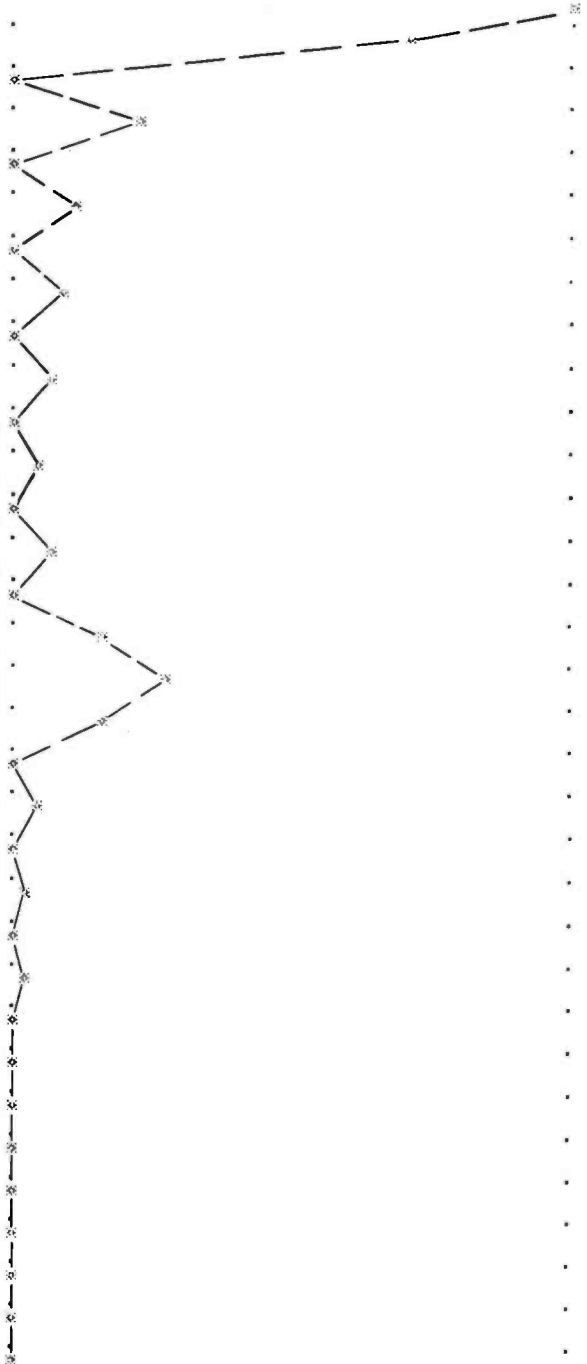

Figure 12: Frequency space plot of a raised eight-period sine wave as approximated by a sixty-five point data set.

in the frequency spectrum, the sine wave component is clearly evident. Thus, to recover information about the amplitude of the sine wave component, you could use a narrow band filter to look at the spectrum content in the vicinity of the sine-wave characteristic frequency. Using Gaussian noise in this example gives much the same result.

Noisy data sets, as above, can be created (us-

Circle 302 on inquiry card.



Beautiful "Computer Chess" Reproduction—only \$4.95!

This dramatic reproduction of the October '78 Byte cover art has been produced with the same care and quality as limited edition prints—yet it is available for the price of a poster.

The overall size is 18" x 22", which includes a 1½" border. It is printed on heavy, 80 lb., matte finish, coated stock, excellent for the finest framing if desired.

The price of this quality reproduction is \$4.95, plus \$1.00 for mailing tube, handling, and postage. In addition, the artist, Robert Tinney, will select the 100 finest prints from this first edition for his personal signature and number. These 100 signed and numbered prints will be sold on a strictly first-come basis for \$24.00 plus \$1.00 postage and handling.

See coupon below for ordering.

Send me _____ of the \$4.95 posters, and _____ of the \$24.00 signed prints. I have included \$1.00 for postage and handling.

Please charge this to my _____
 Visa/Master Charge: _____
 Visa card number: _____
 Master Charge no.: _____
 Name: _____ signature _____
 Address: _____
 City: _____ State: _____ Zip: _____

Card expires: _____

robert tinney graphics
 P.O. Box 45047
 Baton Rouge, LA 70895

DATA PLOT (NORMALIZED)

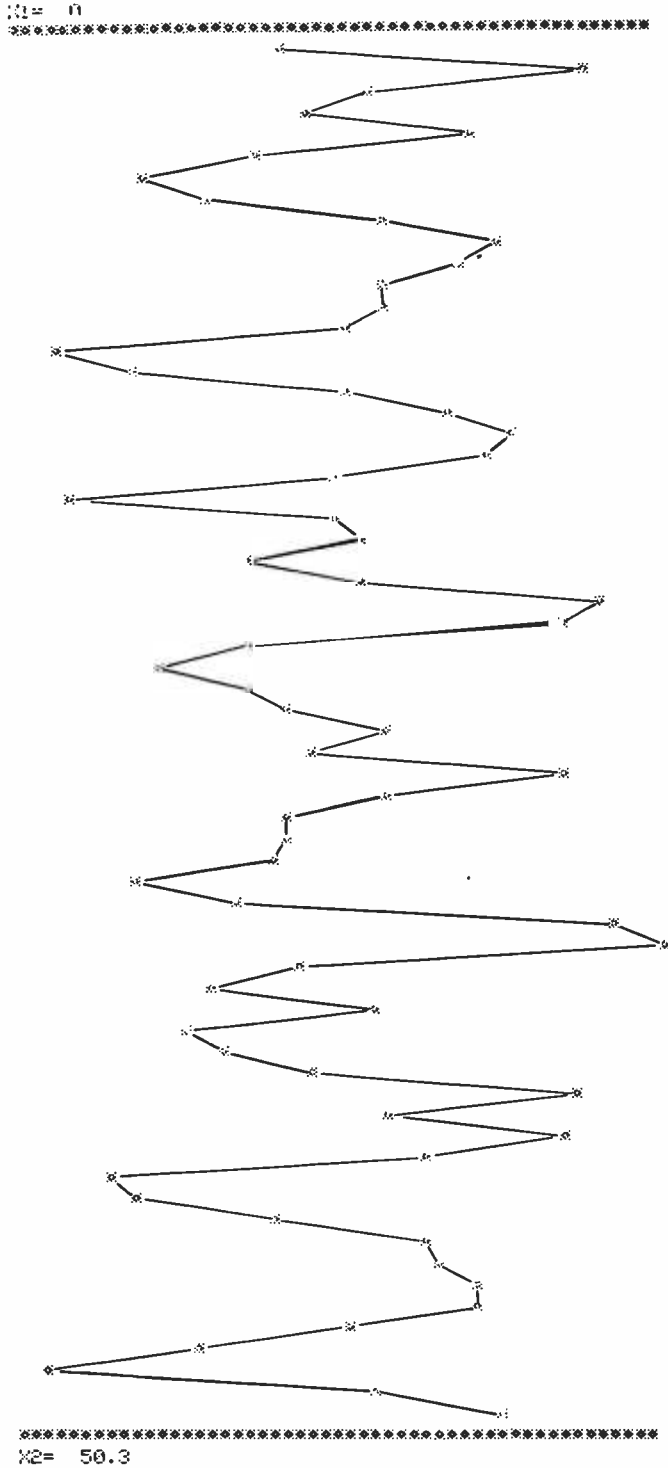

Figure 13: Same waveform as in figure 11, but with noise added.

ing a Gaussian noise distribution) many times. If this is done each time using new random number generator seeds so that there is no correlation between data sets, then the noise will on the average appear to be uniformly distributed along the frequency axis. At the sine-wave frequency that I have chosen, you can expect to see an average noise power ($|F_n(w)|^2$) of some value N_b . If we

FREQUENCY PLOT (NORMALIZED)

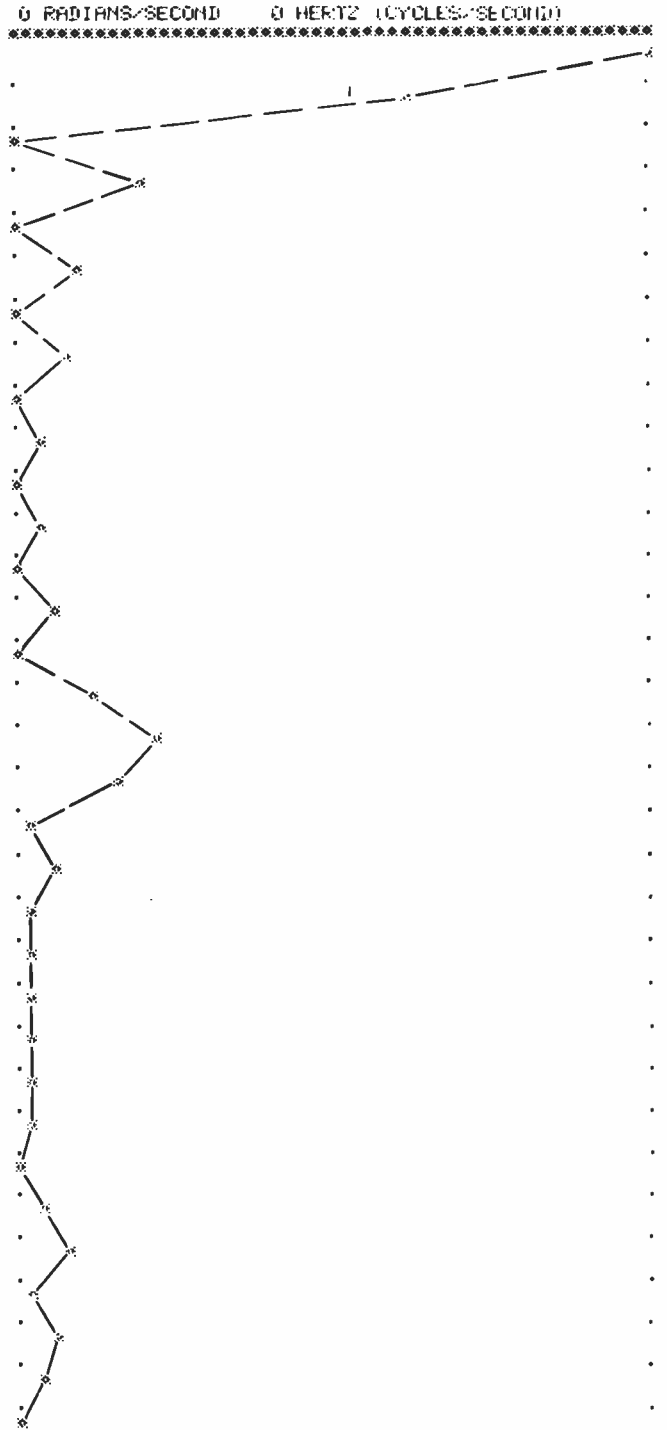

Figure 14: Frequency space plot of the transform of the noisy data set shown in figure 13.

measure the power ($|F_s(w)|^2$) at the sine-wave frequency, we can expect to see an average value S_b . The amplitude signal to noise ratio (S/N) is then:

$$(S/N)_b = S_b/N_b \tag{9}$$

If we had instead looked at a sixteen-period raised sine wave having the same characteristic frequency and the

I've finally found a personal computer I respect.

CompuColor II.

ratio available in a personal computer.

The complete system is only \$1595.* And that price includes 8K user RAM, RS-232C compatibility and random access file capabilities.

Our 8 foreground and background colors will boost your comprehension, while introducing you to an exciting new dimension in BASIC programming. The vector graphics have 16,484 individually-accessible plot blocks. And the 13" diagonal measure screen gives you 32 lines of 64 ASCII characters. You also have the flexibility that comes with 16K Extended Disk BASIC ROM.

CompuColor II offers a number of other options and accessories, like a second disk drive and expanded keyboard, as well as expandability to 32K of user RAM. Of course we also have a whole library of low-cost Sof-Disk™ programs, including an assembler and text editor.

Visit your nearest computer store for details. And while you're there, do some comparison testing. With all due respect to the others, once you see it, you'll be sold on the CompuColor II.



**CompuColor
Corporation**



Unretouched photo of screen

*U.S. Domestic price

CompuColor Corporation • Intecolor Drive • Technology Park/Atlanta • Norcross, Georgia 30092 • Telephone 404/449-5996

same impressed noise level, the average noise power would have been twice as great, or $N_{16} = 2N_8$. This conclusion is based on the noise power \times time product. The total energy in the sine wave component (the energy in the bump at $\omega =$ one radian per second) also doubles. However, we have seen in the previous examples that the width of the sine-wave component narrows as the number of periods increases (width in frequency space is proportional to the inverse of the number of periods). Thus, the power at the characteristic frequency for the sixteen-period sine-wave quadruples, or $S_{16} = 4S_8$. The power signal to noise ratio is:

$$(S/N)_{16} = 2 (S/N)_8 \quad (10)$$

It can be shown that by increasing the length of the sine wave sampled by a factor n you can improve the amplitude S/N by \sqrt{n} . (Lock-in amplifiers can also be used to improve S/N . Observe that increasing the sampling time is analogous to including more periods; S/N is proportional to $\sqrt{\text{sampling time}}$, or $1/\sqrt{\text{bandwidth}}$.)

Conclusion

The computer program presented in listing 1, although not optimal in efficiency, is reasonably universal and capable of being used in many applications. The application considered above was the evaluation of frequency-shift keying encoding method, in terms of decoder bandwidth, band separation, and noise immunity.

A simple extension of the program could be implemented by generating the phase component of the complex frequency spectrum. This can be done by placing another few statements in the program:

```
Insert: 805 P(I) = ATAN (S1/C1)
Add: DIM P(I), print and plot routines
```

$P(I)$ represents the phase in radians. Since North Star

Glossary

center frequency: 1. The mean frequency of the output wave when modulated by a symmetrical signal. 2. The center frequency in a frequency spectrum plot.

harmonic distortion: The production of undesirable harmonic frequencies at the output, due to circuit nonlinearities when a sinusoidal voltage is applied to the input.

Fast Fourier Transform: (FFT) A mathematical concept that describes the relationship between information in the time domain and the frequency domain. The Fourier transform of correlation functions will yield the power spectra.

flutter: The variations in frequency caused by irregular motion of the recording device during the recording process. Flutter usually refers to high-frequency variations, and the term "wow" denotes low-frequency deviations.

frequency compensation: A technique involving modification of a circuit to improve the linearity of its response with respect to frequency over the existing bandwidth.

BASIC, Version 6, Release 2 does not have the inverse tangent function, an additional subroutine for calculating the inverse tangent would be necessary. For the examples given above, the phase response was not an important consideration, and would have increased the computing time.

The use of the complete transform, both amplitude and phase, encourages some interesting experiments in the realm of signal recovery. For example, a low resolution signal (eg: an image scan such as that from an analog barcode reader) could be transformed, and the resulting transform could be corrected for the device response. The resulting corrected transform could then be retransformed back into signal (optical image) space. This is particularly easy (and effective) when the device response is stable and there is sufficiently little noise. For example, with a simple optical device such as a grocery store barcode reader, the unaided resolution in terms of edge response may be on the order of 0.005 inches. With correction this can be improved to 0.0005 inches, an order of magnitude improvement in edge response. Such corrections are not uncommon as most quality tape recorders have playback frequency compensation. In the latter case, an analog circuit is used instead of a computer.

The preceding resolution improvement approach is based on the assumption that the system being considered is linear. Optical systems are convenient in this respect, and much can be done with the transforms of optical images—witness the Mariner photos. The program presented here offers the opportunity to experiment with some of these techniques. ■

REFERENCES

- McGraw-Hill Dictionary of Scientific and Technical Terms, Second Edition, 1978.
 Radio Shack Dictionary of Electronics, 1974-75.
 A Dictionary of Microcomputing, Philip E Burton, Garland Publishing Inc, 1976.

frequency response: 1. A measure of how effectively a circuit or system transmits the different frequencies that are applied to it. 2. The section of the frequency spectrum which can be sensed by a device within specified amplitude error tolerances.

frequency-shift keying: (FSK) A method of frequency modulation that involves shifting the output frequency between predetermined values corresponding to the frequencies of correlated sources.

frequency spectrum: An entire range of the distribution of the intensity of an electro-magnetic or acoustic radiation as a function of frequency.

noise immunity: A measure of how sensitive a circuit is to electrical interference or other sources of noise.

overshoot: 1. An initial transient response to a unidirectional variation in input which exceeds the steady state response. 2. The maximum amount by which this transient response exceeds the 100% amplitude level.

phase-locked loop: A circuit which compares the input carrier frequency with the frequency of the voltage

FOR THE VERY BEST IN NORTHSTAR® COMPATIBLE SOFTWARE

DATA BASE MANAGERS SPECIAL!! \$10.00 OFF of Selector-III C2

Selector-III C2: SuperSoft is proud to offer the Selector-III C2 at a special \$10.00 discount. Selector III allows instant recall of any record using any information item in the record. This makes Selector-III the most powerful Data Base Management System in micro-computers today! You can define a data format and begin entering your data in minutes. Helps bring applications on line in hours instead of months. (Note: Selector-III C2 requires CP/M and C BASIC 2, not supplied - also 48K Ram required for some applications) Selector-III C2 is: \$335.00 (\$10.00 off list). (Manual alone: \$20.00)

BUSINESS

CRS - Client Record System. A complete program package for the insurance agent. CRS will provide you with very fast online access to your client records, print reports and mail labels, and give you all the information you will need to increase your sales through the use of CRS as a **MARKETING TOOL.**

CRS stores a complete record for each client that includes the name, address, telephone #, as well as provisions for customer #, salesman # and up to six policies (expandable if needed). The policy information is complete with both the type of coverage and the company that is underwriting it, as well as exp. date, premium, term, and payment schedule. You also have a remark field.

You can search the files by any field, and CRS supports a powerful 'save' search to provide you with all the information you need to increase insurance sales. CRS comes with two(2) user's manuals, one for the owner, and one for office personnel (minimal system: one drive, 40K RAM starting 2000H) \$250.00 (Manual: \$40.00)

TEXT PROCESSORS

TFS - Text Formatting System. At least a full featured text processor for NorthStar that you can rely on! TFS has left & right margin justification, page numbering, chaptering, page headings, centering, paged output & MORE. Supports powerful text manipulations including: global & local "search and change," file merges and block moves. This means that you can restructure your text file at any time to look the way you want it to, you can even "chain" files together from disk for documents larger than your current memory.

TFS is completely "load and go" therefore you can start using it at once. You get two(2) user's manuals: one is a Quick Start manual to get you going in minutes, the other is an in depth study of TFS. (TFS requires RAM from 0000H to 2000H) \$75.00 (Manual only: \$20.00)

COMPUTER AIDED INSTRUCTION

MISS - Microcomputer Instructional Support System. A complete, self-contained CAI package applicable to home, school or business education. Includes everything needed to create a sophisticated computer learning environment. MISS allows one to create any type lesson complete with wrong answer branching, re-test, and complete record keeping. The student is prompted 100% of the way and need have no special knowledge. A special feature is the optional use of a unique algorithm which separates spelling errors from incorrect responses. Absolutely no programming knowledge is required. MISS is completely interactive and maintains complete records on any number of students and lessons (limited only by disk space). MISS is a completely flexible system that will allow you to either create lessons or to purchase pre-programmed lessons which run under MISS. Complete with user's manual \$40.00. (Manual alone: \$10.00)

ASSEMBLERS

ARIAN - A complete 8080 assembler that interfaces directly to your DDS. ARIAN is completely "load and go". Features include: dynamic file and RAM allocation, custom disk and RAM command capability, several library routines directly accessible by the user. Also, a complete text editor, and system executive. ARIAN is both powerful and easy to learn and use; it is an assembler that you can grow with. Comes complete with a 51 page user's manual (ARIAN requires RAM from 0000H to 2000H) \$50.00 (Manual alone: \$10.00)

ARIAN Utility Package - Several disk based utilities. Includes a complete DEBUG Package: \$50.00

PROGRAMMING LANGUAGES

'Tiny' Pascal - This is the famous Chung/Yuen 'tiny' Pascal. FAST - ELEGANT - STRUCTURED. Local and global variables plus procedure and function independence make 'tiny' Pascal great for high speed applications. Compiles to 8080 code that executes up to 25 times faster than BASIC. You also receive SOURCE to 'tiny' Pascal written in Pascal. This means that you can compile the compiler! Add features, relocate, etc. (you will need 36K to do this) \$40.00

UTILITIES

DEBE - (Does Everything But Eat!) This is a must for NorthStar users. You can: COMPACT & EXPAND BASIC programs. Compacting removes unnecessary spaces and remarks. This saves money and makes for programs run faster. Expanding puts them back again.

Cross-reference BASIC programs by variables and transfer statements.

Global substitutions of variables and transfer statements.
Formatted print outs of BASIC programs as well. \$40.00

SPECIFY SINGLE OR DOUBLE DENSITY

FOR THE VERY BEST IN TRS-80 COMPATIBLE SOFTWARE

'Tiny' Pascal FOR TRS-80

Now you too can have Pascal! The famous Chung/Yuen 'tiny' Pascal has been specially designed for the TRS-80! The full power and elegance of 'tiny' Pascal is at your command. Programs written in 'tiny' Pascal run at least 4 times faster than the same program in BASIC! 'tiny' Pascal is also a great way to learn Pascal programming, & fun too.

Best of all, you only need a 16K Level II TRS-80! No disk is required. The 'tiny' Pascal operating system is self-contained and very easy to use.

'Tiny' Pascal is a subset of standard Pascal & includes: RECURSIVE PROCEDURE/FUNCTION, IF-THEN-ELSE REPEAT/UNTIL, 'PEEK' & 'POKE', WHILE DO, CASE, MORE! (Plus full graphics for your TRS-80).

You can save and load programs to and from tape in both source or compiled form.

You get all this and more, plus a user's manual for \$40.00
DISK VERSION NOW AVAILABLE \$45.00

Energy-Miser

Energy-Miser is a complete heating/cooling analysis program for your home, office or business! With Energy-Miser you can calculate heat loss because of poor insulation, leaky doors and windows, poor planning and more. With Energy-Miser you can predict the annual savings on your utility bills for various improvements or modifications, including: use of solar power, better insulation, opening and closing drapery, etc.

But there is even more: Energy-Miser can also calculate your Return on Investment. That is, you can find your break point for converting to solar, for insulating better, etc. Energy-Miser even takes into consideration the Energy Tax Credit! Energy-Miser is a program designed to save your money!

Energy-Miser is a proven program written by a professional and includes a complete user's manual for \$22.50. (Minimum System 16K Level II, No Disk Required)



ALL ORDERS PREPAID OR C.O.D.
ILLINOIS RESIDENTS ADD 5% SALES TAX

SUPERSOFT

P.O. Box 1628
Champaign, IL 61820
(217) 344-7596

controlled oscillator (VCO) by means of a phase detector; the output of the phase detector is fed through a loop filter and then back to the voltage controlled oscillator to keep in phase with the incoming carrier frequency.

phase shift: 1. The difference between corresponding points on the input and output signal waveforms, commonly referred to as the phase angle. 2. A change in the phase angle between two periodic signals.

processor: (CPU - central processing unit) The central control unit of the digital computer. This unit contains the memory, the Arithmetic and Logic Unit (ALU), control circuitry, and general purpose registers. The processor controls the decoding and execution of all machine instructions.

real-time operation: A computer mode of operation in which the input data is received and processed as it is

generated so that the current information may be used to control that process.

rise time: The time required for the leading edge of a pulse to rise from 10% to 90% of its steady-state value. It is proportional to the time constant and is a measure of how quickly the signal makes a transition from one state to another.

signal-to-noise ratio: (S/N ratio) A measurement of the relative quality of a signal. Precisely the ratio of the magnitude of the signal to the magnitude of the noise present.

video display: (CRT - cathode ray tube) a peripheral which presents its data visually on a television-like screen.

Add Nonvolatile Memory to Your Computer

Steve Ciarcia
POB 582
Glastonbury CT 06033

"You know, Ray, sometimes I think I see more of you than your wife does."

He grinned and retorted, "I just dropped over to see what the Circuit Cellar¹ Frankenstein was cooking up this month."

I fully deserved that. Few have seen the Circuit Cellar, and it does look a little imposing at first. The usual 20-square-foot hobby corner used by most computerists has been expanded to a 1000-square-foot computer room which vaguely resembles the bridge of the starship *Enterprise*. Accented with the eerie appearance of seven video displays and a multitude of strange black boxes emanating menacing sounds, it sometimes becomes an environment of computerized insanity. While I am not interested in creating any monsters, Baron von Frankenstein and I may have a few interests in common. His demise, I assure you, was simply a case of bad press.

"Steve?" Ray said loudly. "What are you working on?"

I was jerked back to reality somewhat abruptly. Visions of a 1932 movie set faded as I turned in my swivel chair to respond.

"I am actually working on several ideas, Ray, but the easiest is trying to put a computer in a car."

Ray quickly cast a doubtful glance

at the 64 K-byte, dual-disk, Z80-based system. Returning his attention to me he quipped, "Where do you plan to put the printer?"

"I do not mean a big computer. I mean a little one, probably a single board. I will have sensors throughout the car to monitor engine speed, temperatures, pressures, and so forth fed to a display visible to the driver. The driver will be able to calculate and keep running totals of gas mileage, monitor the engine performance, and generally maintain a comfortable feeling of safe motoring."

Ray said, "That sounds pretty good. You will obviously have to use CMOS for your computer." His observation was based on his long years of technical experience.

"Why?"

Ray seemed confused at my reply. He expected agreement. Shouldn't complementary-metal-oxide semiconductor (CMOS) components be used since the computer will be battery powered?

"Because it is battery powered. That's why!" he demanded.

"That is not necessarily true." Trying not to seem quarrelsome, I continued. "Let's think about an automobile for a minute. There are many power-consuming devices. A defroster fan or rear-window heater

can draw 100 watts each. Without the floppy-disk drives, even that big Z80 system over there does not pull that much. I am shooting to stay under 20 watts, but logic type does not make much difference."

"Yes, I know when the engine is running there is plenty of power available from the alternator." Ray seemed a bit frustrated in pointing out my misjudgement of the facts. He persisted. "At 12 volts, 20 watts is almost 2 amperes! The 12-volt car battery will not last long with the engine off."

"You do not leave the defroster fan on with the engine off, do you?" I countered.

"Of course not! But what about your program? If it is written into programmable memory such as 2102 or 2114 devices, you'll lose it when the power goes off."

"I said this computer is for automotive use. It cannot be considered as a general-purpose computer. Rather than using only programmable memory with programs loaded from tape or disk, it will have the operating system and language interpreter stored in read-only memory and application software stored in erasable, programmable read-only memory, an EPROM. The only programmable memory needed will be a

Text continued on page 40



6809 PROCESSING POWER!

The Percom SBC/9™. Only \$199.95.

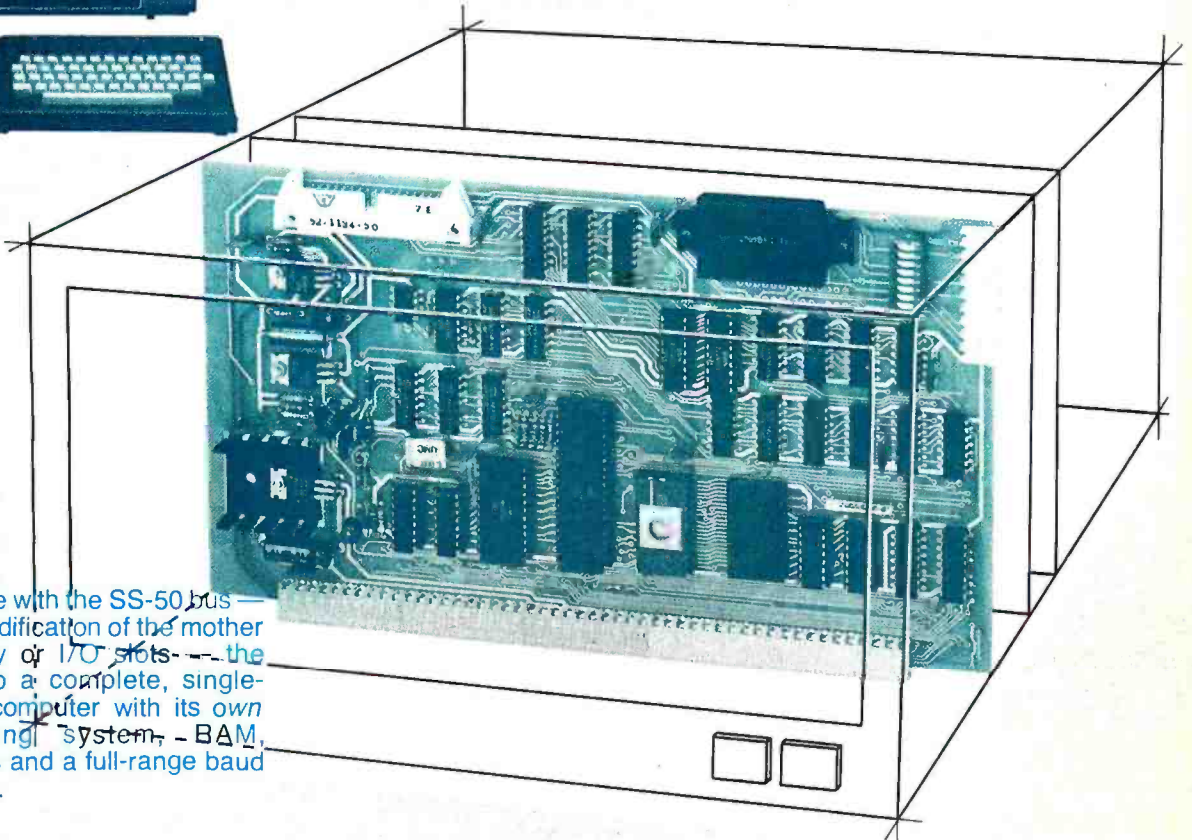

Fully compatible with the SS-50 bus — requiring *no* modification of the mother board, memory or I/O slots — the SBC/9™ is also a complete, single-board control computer with its own ROM operating system, — BAM, peripheral ports and a full-range baud clock generator.

Make the SBC/9™ the heart of your computer and put to work the most outstanding microprocessor available, the 6809.

the Mighty 6809

Featuring more addressing modes than any other eight-bit processor, position-independent coding, special 16-bit instructions, efficient argument-passing calls, autoincrement/autodecrement and more, it's no wonder the 6809 has been called the "programmer's dream machine."

Moreover, with the 6809 you get a microprocessor whose programs typically use only one-half to two-thirds as much RAM space as required for 6800 systems, and run faster besides.

And to complement the extraordinary 6809, the Percom design team has developed PSYMON™, an extraordinary 6809 operating system for the SBC/9™.

PSYMON™ — Percom SYstem MONitor

Although PSYMON™ includes a full complement of operating system commands and 15 externally callable [™] trademark of Percom Data Company, Inc.

utilities, what really sets PSYMON™ apart is its easy hardware adaptability and command extensibility.

For hardware interfacing, you merely use simple, specific device driver routines that reference a table of parameters called a Device Control Block (DCB). Using this technique, interfacing routines are independent of the operating system.

The basic PSYMON™ command repertoire may be readily enhanced or modified. When PSYMON™ first receives system control, it initializes its RAM area, configures its console and then 'looks ahead' for an optional second ROM which you install in a socket provided on the SBC/9™ card. This ROM contains your own routines that may alter PSYMON™ pointers and either subtly or radically modify the PSYMON™ command set. If a second ROM is not installed, control returns immediately to PSYMON™.

- Provision for multi-address, 8-bit bidirectional parallel I/O data lines for interfacing to devices such as an encoded keyboard.
- A serial interface Reader Control output for a cassette, tape punch/reader or similar device.
- An intelligent data bus: multi-level data bus decoding that allows multiprocessing and bus multiplexing of other bus masters.
- Extended address line capability — accommodating up to 16 megabytes of memory — that does not disable the on-board baud rate clock or require additional hardware in I/O slots.
- On-board devices which are fully decoded so that off-card devices may use adjoining memory space.
- Fully buffered address, control and data lines.

The SBC/9™, complete with PSYMON™ in ROM, 1K of RAM and a comprehensive users manual™ costs just \$199.95.

PERCOM

PERCOM DATA COMPANY, INC.
211 N. KIRBY GARLAND, TEXAS 75042
(214) 272-3421

Percom 'peripherals for personal computing'

To place an order or request additional literature call toll-free 1-800-527-1592. For technical information call (214) 272-3421. Orders may be paid by check, money order, COD or charged to a VISA or Master Charge account. Texas residents must add 5% sales tax.

Circle 304 on inquiry card.

PRICES AND SPECIFICATIONS SUBJECT TO CHANGE WITHOUT NOTICE.

Welcome to Percom's Wide World

SS-50 Bus LFD-400™ and LFD-800™ Systems

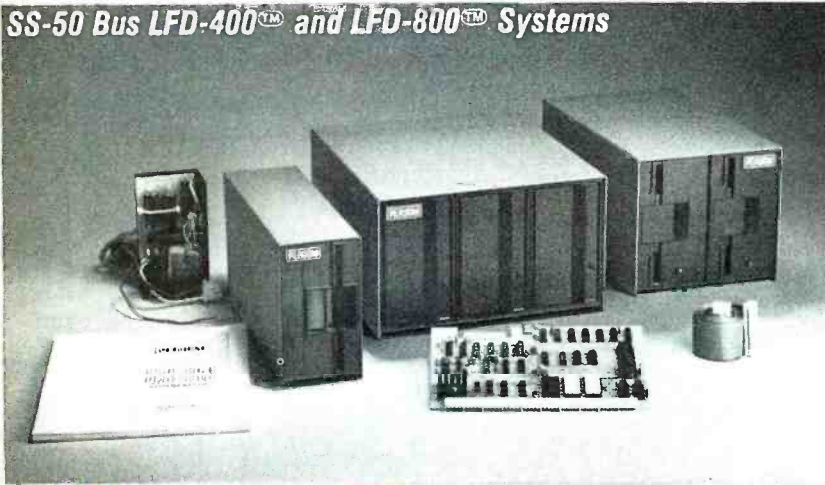

Each LFD mini-disk storage system includes:

- drives with integral power supplies in an enamel-finished enclosure
- a controller/interface with ROM operating system plus extra ROM capacity
- an interconnecting cable
- a comprehensive 80-page users manual

Low-Cost Mini-Disk Storage in the Size You Want.

Percom LFD mini-disk drive systems are supplied complete and ready to plug in the moment they arrive. You don't even have to buy extra memory. Moreover, software support ranges from assembly language program development aids to high-speed disk operating systems and business application programs.

The LFD-400™ and -400EX™ systems and the LFD-800™ and -800EX™ systems are available in 1-, 2- and 3-drive configurations. The -400, -400EX drives store 102K bytes of formatted data on 40-track disks, and data may be stored on either surface of a disk. The -800, -800EX drives store 200K bytes of formatted data on 77-track disks.

The LFD-1000™ systems (not pictured) have dual-drive units which store 800K bytes on-line. The LFD-1000™ controller accommodates two drive systems so that a user may have as much as 1.6M bytes on-line.

Mini-disk storage system prices:

MODEL	1-DRIVE SYSTEM	2-DRIVE SYSTEM	3-DRIVE SYSTEM
For the SS-50 Bus:			
LFD-400™	\$ 599.95	\$ 999.95	\$1399.95
LFD-800™	895.95	1549.95	2195.95
For the EXORciser® Bus:			
LFD-400EX™	\$ 649.95	\$1049.95	\$1449.95
LFD-800EX™	945.95	1599.95	2245.95
LFD-1000™	(dual) \$2495.00	(quad) \$4950.00	—

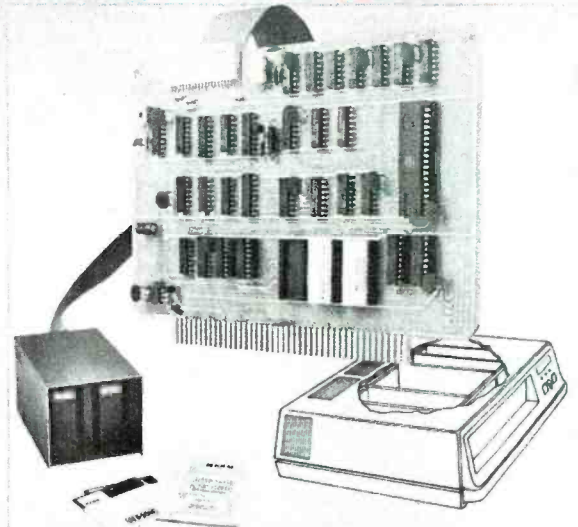

EXORciser® Bus LFD-400EX™, -800EX™ Systems

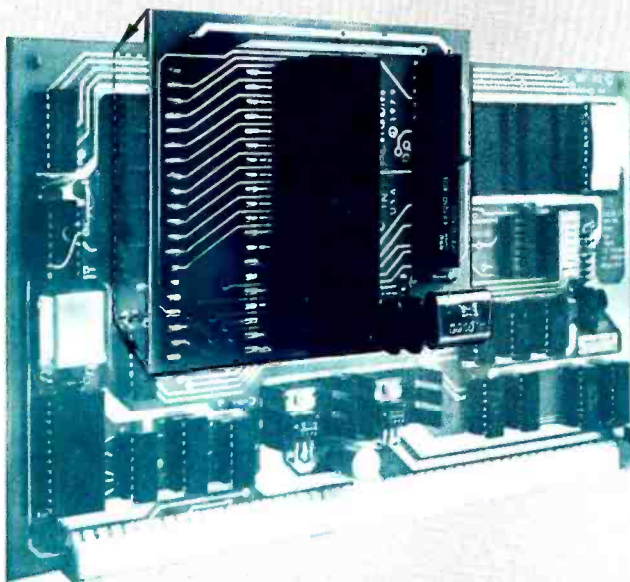

Upgrade to 6809 Computing Power. Only \$69.95

Although designed with the SWTP 6800 owner in mind, this upgrade adapter may also be used with most other 6800 and 6802 MPUs. The adapter is supplied assembled and tested, and includes the 6809 IC, a crystal, other essential components and user instructions. Restore your original system by merely unplugging the adapter and a wire-jumpered

DIP header, and re-inserting the original components. Also available for your upgraded system is PSYMON™ (Percom System MONitor), the operating system for the Percom 6809 single-board computer. PSYMON™ on 2716 ROM costs only \$69.95. On diskette (source and object files), only \$29.95.

Data Terminal & Two-Cassette Interface — the CIS-30+



- Interface to data terminal and two cassette recorders with a unit only 1/10 the size of SWTP's AC-30.
 - Select 30, 60 or 120 bytes per second cassette interfacing; 300, 600 or 1200 baud data terminal interfacing.
 - Optional mod kits make CIS-30+ work with any microcomputer. (For MITS 680b, ask for Tech Memo TM-CIS-30+-09.)
 - KC Standard/Bi-Phase-M (double frequency) cassette data encoding. Dependable self-clocking operation.
 - Ordinary functions may be accomplished with 6800 Mikbug® monitor
- Prices: Kit, \$79.95; Assembled, \$99.95. Prices include a comprehensive instruction manual. Also available: Test Cassette, Remote Control Kit (for program control of recorders), IC Socket Kit, MITS 680b mod documentation and Universal Adapter Kit (converts CIS-30+ for use with any computer).

of 6800 Microcomputing.

6800/6809 SOFTWARE

System Software

6800 Symbolic Assembler — Specify assembly options at time of assembly with this symbolic assembler. Source listing on diskette \$29.95

Super BASIC — a 12K extended random access disk BASIC for the 6800 and 6809. Supports 44 commands and 31 functions. Interprets programs written in both SWTP 8K BASIC (versions 2.0, 2.2 & 2.3) and Super BASIC. Features: 9-digit BCD arithmetic, Print Using and Linput commands, and much more. Price \$49.95

TOUCHUP™ — Modifies TSC's Text Editor and Text Processor for Percom mini-disk drive operation. Supplied on diskette complete with source listing \$17.95

Operating Systems

INDEX™ — This easy-to-use disk-operating and file management system for 6800 microcomputers is fast. VO devices are serviced by interrupt request. INDEX™ accesses peripherals the same as disk files — new devices may be added without changing the operating system. Other features: unlimited number of DOS commands may be added • over 60 system entry points • display only those files at or above user-specified file activity level • versions available for SWTP MF-68, Smoke's BFD-68 and Motorola's EXORciser*. Price \$99.95

MINIDOS-PLUSX™ — An extension of the original MINIDOS™ for LFD-400™ mini-disk systems, MINIDOS-PLUSX™ manipulates files by six-character names. Supports up to 31 files. Resident commands include Initialize, Save, Allocate, Load, Files (directory list), Rename and Delete. Supplied on 2708 ROM with a minidiskette that includes transient utilities such as Copy, Backup, Create, Pack and Print Directory. Price \$34.95

PSYMON™ — Percom SYSTEM MONitor for the Percom single-board/SS-50-bus-compatible 6809 computer accommodates user's application programs with any mix of peripherals **without** modifying programs. PSYMON™ also features character echoing to devices other than the communicating device, sophisticated register and memory dump routines and more. Price (on 2716 ROM) \$69.95

WINDEX™ — Described in detail elsewhere on this page.

Business Programs

General Ledger — For 6800/6809 computers using Percom LFD mini-disk storage systems. Requires little or no knowledge of bookkeeping because the operator is prompted with non-technical questions during data entry. General Ledger updates account balances immediately — in real time, and will print financial statements immediately after journal entries. User selects and assigns own account numbers; tailors financial statements to firm's particular needs. Provides audit trail. Runs under Percom Super BASIC. Requires 24K bytes of RAM. Supplied on minidiskette with a comprehensive users manual. Price \$199.95.

FINDER™ — This general purpose data base manager is written in Percom Super BASIC. Works with 6800/6809 computers using Percom LFD-400™ mini-disk drive storage systems. FINDER™ allows user to define and access records using his own terminology — customize file structures to specific needs. Basic commands are New, Change, Delete, Find and Pack. Add up to three user-defined commands. FINDER plus Super BASIC require 24K bytes of RAM. Supplied on minidiskette with a users manual. Price \$99.95

Mailing List Processor — Powerful search, sort, create and update capability plus ability to store 700 addresses per minidiskette make this list processor efficient and easy to use. Runs under Percom Super BASIC. Requires 24K bytes of RAM. Supplied on minidiskette with a users manual. Price \$99.95.

From the Software Works

Development and debugging programs for 6800 μCs on diskette:

Disassembler/Source Generator \$30.95
Reloc'ng Disas'mblr/Segmented Text Gen \$40.95
Disassembler/Trace \$25.95
Support Relocator Program \$25.95
Relocating Assembler/Linking Loader \$55.95
SmithBUG** (2716 EPROM) \$70.00

½-Price Special on Hemenway Software!

CP/68 disk operating system \$ 49.97
STRUBAL+ # compiler \$124.97
EDIT68 text editor \$ 19.97
MACRO-Relocating Assembler \$ 39.97
Linkage Editor (LNKEDT68) \$ 24.97
Cross Reference utility \$ 14.97

™trademark of Percom Data Company, Inc.

* trademark of Motorola Corporation

#Trademark of Hemenway Associates Company

**SmithBUG is a trademark of the Software Works Company

And 'looking into' is just what you do with the Electric Window™ as you peer right into memory space where characters are being input and manipulated. Display is memory-resident, programmable and generates up to 24 80-character lines.

Other features include:

- standard character generator plus provision for optional special character generator
- dual intensity, high-lighting alphanumeric display
- scrolling by a programmable register • programmable display positioning
- programmable interlaced or non-interlaced scan
- descenders on lower case letters • users manual with application instructions and listing of WINDEX™ driver.

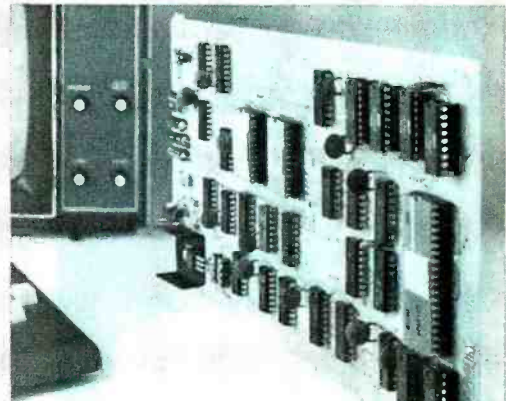

The Electric Window.™
Worth Looking Into. **\$249.95**

WINDEX™ is a fast video display driver program for the Electric Window™. WINDEX™ also features: program and keyboard control of character generators • displayable control characters — under program control • automatic scrolling • a driver routine for the parallel input keyboard feature of the Percom 6809 Single-Board Computer, the SBC/9™ • auto-linking to PSYMON™, the ROM operating system for the SBC/9™ • Prices: ROM version: \$39.95; LFD-400™ compatible diskette (source and object files): \$29.95.

Now Available! the SBC/9™ MPU/Control Computer

(Single-Board-Computer/6809) — stands alone as a control computer, but also compatible with the SS-50 bus for use as an MPU card. Includes PSYMON™ (Percom System Monitor) in a 1K ROM and provides for additional 1K of ROM. Also includes 1K of RAM. Features: Super Port — provision for multi-address, 8-bit bidirectional data lines • an intelligent data bus for multi-level data bus decoding • an on-board 110-baud to 19.2 kbaud clock generator • extended address capability — to 16 megabytes — without disabling baud clock or adding hardware. And much more. Supplied with PSYMON™ and comprehensive users manual. Price \$199.95.

See full page ad elsewhere in this magazine for all of the SBC/9™ features.

Full Feature Prototyping PC Boards

All of the features needed for rapid, straightforward circuit prototyping. Use 14-, 16-, 24- and 40-pin DIP sockets

- SS-50 bus card accommodates 34- and 50-pin ribbon connectors on top edge, 10-pin Molex connector on side edge • I/O card accommodates 34-pin ribbon connector and 12-pin Molex on top edge



I/O Bus Card: \$14.95

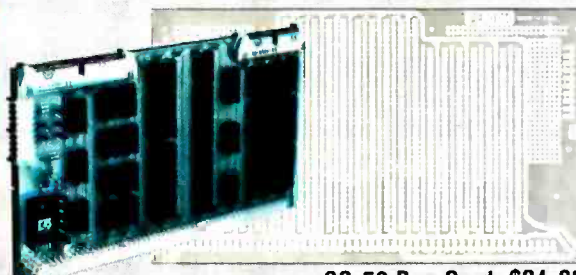
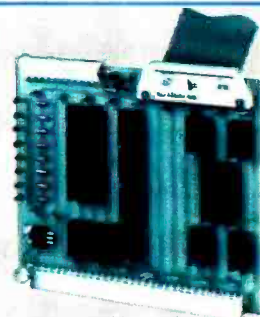

SS-50 Bus Card: \$24.95

- I/O card is 1-¼ inches higher than SWTP I/O card • interdigitated power conductors • contacts for power regulators and distributed capacitance bypassing
- use wire wrap, wiring pencil or solder wiring • tin-lead plating over 2-oz copper conductors wets quickly, solders easily
- FR4-G10 epoxy-glass substrate.

To place an order or request additional literature call toll-free 1-800-527-1592. For technical information call (214) 272-3421. Orders may be paid by check, money order, COD or charged to a VISA or Master Charge account. Texas residents must add 5% sales tax.

PRICES AND SPECIFICATIONS SUBJECT TO CHANGE WITHOUT NOTICE.

Circle 305 on inquiry card.



PERCOM DATA COMPANY, INC.
211 N. KIRBY GARLAND, TEXAS 75042
(214) 272-3421

X-RATED Revolutionary Computerized Math!

```

Enter ? SOLVE (X^3 = A^2 * X, X):
muMATH Responds
@ X = A
  X = A
  X = 0

Enter ? TAN (X) * COS (X) + 1 / CSC (X):
Response
@ 2 * SIN(X)

Symbolic Integration!
? INT (X * COS(A * X^2), X):
@ SIN(X^2 * A) / (2 * A)

Symbolic Matrix Inversion!
? | 1, X |
  | 0, A | + I:
@ | 1, X/A |
  | 0, 1/A |

Exact Arithmetic!
? 991 * 9^+(1/2) / 40^+35:
@ 296438922463401814427834899493
2562055695871443302411356128843
2033904069287504517225987785930307
497936652596433351 / 12500XXXXXXXX

```

muMATH™

- These examples illustrate only a few of the many *symbolic* math capabilities of muMATH. Note that it is not limited to *numerical* evaluation as in BASIC or PASCAL.
- Available for 8080, 8085 and Z80 processors using standard CP/M,* CDOS*, IMDOS*, and TRSDOS* operating systems.
- Engineers and scientists find it ideal for deriving or checking lengthy analytical results.
- Students and teachers agree it is superb for math education from exact arithmetic through calculus.
- Hobbyists have discovered the underlying muSIMP programming system perfect for other artificial intelligence applications.
- Also available from The Software Warehouse is a sophisticated LISP language interpreter for the above processors and operating systems.
- All software with extensive documentation is immediately available.
- Call or write directly for fast response.

* Manufacturers' registered trademarks.



Text continued from page 36:

scratch pad for calculations and a small area set aside for storage of continually updated, long-term quantities like mileage and gas consumption."

Ray was not incorrect. The language interpreter and application program *could* reside entirely in programmable memory as in most older personal computers. Memories composed of 2102A devices can, in fact, be put in a stand-by mode by dropping the power-supply voltage to 2 V. This reduces power consumption by 80% while still retaining data.

While being practical under most circumstances, stand-by operation is not a total solution. Depending upon the system configuration, memory power might have to be sequenced on and off, and perhaps be isolated from the 5-V supply of the rest of the system.

The ultimate value of this technique is dependent on efficient power conversion. A 12-V-to-2-V converter with 50% efficiency would be self-defeating. Battery power, however much reduced, is still required as long as memory data is to be retained.

Hybrid computers exist wherein high-speed, bipolar microprocessors are mated with low-power CMOS memory. Such a system could have various forms of read-only memory as before, but in the form of complementary-metal-oxide devices rather than bipolar memory chips.

Data retention time would probably be an order of magnitude longer, but there are complications associated with mixing logic families. All things considered, if it were not for the high cost of CMOS memory, I would use it.

Ray persisted, saying, "You still have to provide continuous power for *some* programmable memory if you intend to store those long-term values." Ray was convinced that I must have constant power on something. I hated to disillusion him.

I explained, "Not necessarily. I considered the usual standby-mode programmable memory, both CMOS and bipolar types, and rejected them. Bipolar standby takes too much power; and CMOS memory chips might be destroyed by physical handling. This is experimental, you know."

Ray said, "If you intend to shut off

the computer entirely, then I suppose you could write out data to an audio cassette to be reloaded when you start the car."

I said, "Well no, I want this to be automatic. I should be able to get in the car, turn the key and have the computer start too. The tape player in the car is for Bartok, not for Kansas City data." I paused slightly to allow the air to clear, and then continued. "I have been thinking of using nonvolatile programmable memory."

Ray's jaw dropped. "Nonvolatile? Do you mean *core* memory?"

While magnetic core memory is indeed nonvolatile, that was not what I meant. "No, not core, but *semiconductor, nonvolatile programmable memory!*"

Though Ray is quite technically aware, this was a new concept for him and he wasn't sure if I was serious. I have been known to play jokes like this before.

To convince him that I was serious, I began to explain, "Specifically, I am talking about *electrically alterable read-only memory*, or EAROM. You should consider it as a *read-mostly* memory."

"Well, that's different!" Ray exclaimed with relief. "You didn't say read mostly!"

All About the EAROM

EAROMs are *word-alterable* read-only memories intended for use as "read-mostly" memories. On the surface this may sound similar to an EPROM (erasable, programmable read-only memory). Once erased under ultraviolet light, an EPROM is indeed a word-alterable read-only memory.

In reality, there is very little similarity between the electrically alterable and erasable, programmable memory. An EPROM can be erased only in block mode and generally takes about 10 minutes to erase. While some can be programmed in as little as 50 seconds, an 11-minute (or more) read/write cycle-time hardly qualifies it in the category of high-speed programmable memory. An EPROM, therefore, is just a conveniently reprogrammable read-only memory.

An EAROM, on the other hand, does not rely upon ultraviolet light exposure for erasure. Clearing memory for reprogramming is done

Introducing the First CP/M Compatible Desktop Computer with Color Graphics.

The new Intecolor 8063 is the first desktop computer to combine the advantages of color alphanumeric and graphics with the versatility of CP/M. For unprecedented flexibility at a price within the reach of most small businesses, the Intecolor 8063 is the answer.

What does CP/M mean to you? An abundant selection of readily available software. There are CP/M programs for most business applications, minimizing the need for specially-prepared software.

Load the CP/M Operating System Disk and you're ready to run any CP/M program (without modifica-

tion), whether it's in BASIC, FORTRAN IV, or any other programming language. Add the superb readability and improved comprehension of color graphics and you've got unparalleled desktop performance.

Standard features of the Intecolor 8063 include a 19" color display with an 80 character x 48 line format, 32K of user RAM (expandable to 48K), and a dual 8" floppy disk drive with 591K bytes of storage (expandable to 1.1 megabytes).

Plus you get ISC's color version of Microsoft Business BASIC on floppy disk. All for just \$5995.* Incredible? Indeed, and only from ISC, the world's largest supplier of color CRT terminals.

If your application calls for it, Microsoft FORTRAN IV is available from ISC for \$150.00.*

So if you want to spend more time computing than programming, contact your ISC sales representative today. Or check out the 8063 at selected computer dealers. CP/M in color. Only from ISC.

Color Communicates Better



U.S. Domestic prices. Unretouched photo of screen. Furniture not included. CP/M is a registered trademark of Digital Research Corp.

ISC SALES REPRESENTATIVES: AL: 205/883-8660. AK: (GA) 404/449-5961. AZ: 602/994-5400. AR: (TX) 214/840-2169. CA: Alhambra 213/281-2280. Goleta 805/964-8751. Irvine 714/557-4460. Los Angeles 213/476-1241. Mountain View 415/964-9300. San Diego 714/292-8525. CO: 303/759-0809. CT: (GA) 404/449-5961. DE: (VA) 703/569-1502. FL: Orlando 305/425-5505. Ft. Lauderdale 305/776-4800. Melbourne 305/723-0766. Tallahassee 904/878-6642. GA: 404/455-1035. HI: 808/524-8633. ID: (UT) 801/973-7969. IL: (No.) 312/564-5440. (So.) (MO) 816/765-3337. IN: (IL) 312/564-5440. IA: (MO) 816/765-3337. KS: (MO) 816/765-3337. KY: 606/273-3771. LA: 504/626-9701. ME: (GA) 404/449-5961. MD: (VA) 703/569-1502. MA: (GA) 404/449-5961. MI: 313/227-7067. MN: 612/822-2119. MS: (AL) 205/883-8660. MO: 816/765-3337. MT: (CO) 303/759-0809. NB: (MO) 816/765-3337. NH: (GA) 404/449-5961. NJ: (GA) 404/449-5961. NV: (AZ) 602/994-5400. NM: 505/292-1212. NY: (GA) 404/449-5961. NC: 919/682-2363. ND: (MN) 612/822-2119. OH: Dayton 513/429-9040. Cleveland 216/464-8113. Columbus 614/436-2051. OK: (TX) 214/840-2169. OR: 503/620-5800. PA: 412/922-5110. RI: (GA) 404/449-5961. SC: 803/798-8070. SD: (MN) 612/822-2119. TN: 615/482-5781. TX: 214/840-2169. El Paso Area (Las Cruces, NM) 505/523-0601. Houston Only 713/780-2511. UT: 801/973-7969. VT: (GA) 404/449-5961. VA: 703/569-1502. WA: 206/455-9180. WY: 412/922-5110. WI: (IL) 312/564-5440. WY: (CO) 303/759-0809.

EUROPEAN EXPORT SALES: EUROPE: (MA) 617/661-9424. BELGIUM: Brussels 02-242 36-04. FRANCE: Rueil Malmaison 749-40-37. GREECE: Athens 642-1368. ITALY: Roma 805-647/872-457. THE NETHERLANDS: Poeldijk 01749-7640. SPAIN: Barcelona 204 17 43. SWEDEN: Vallingby 08-380-370. SWITZERLAND: Mutschellen 057-54655. UNITED KINGDOM: Bournemouth 0202-293-115.

WEST GERMANY: München 089-31881. **AUSTRALIA & NEW ZEALAND:** Melbourne 543-2077. Meadowbank 808-1444. Chermide 59-6436. Wellington 64-4585. Auckland 876-570. **CANADA:** Datamex Ltd. (Distributor) Dorval 514/636-9774. Ottawa 613/224-1391. Toronto 416/787-1208. Vancouver 604/684-8625. **CENTRAL & SOUTH AMERICA & CARIBBEAN:** (GA) 404/394-9603. **MEXICO:** Monterrey 564-876. **FAR EAST:** (CA) 213/382-1107. **HONG KONG:** 5-742211. **JAPAN:** Tokyo 402-8596. **TAIWAN:** Taipei 02-7026284. **MIDDLE EAST:** IRAN: Tehran 891148. **ISRAEL:** Tel Aviv 266-291. **KUWAIT:** Kuwait 438 180/172. **LEBANON:** Beirut 221731 260110. **SAUDI ARABIA:** Jeddah 27790. Riyadh 25083-39732. **UNITED ARAB EMIRATES:** Sharjah 24068.

For sales and service in other countries contact ISC headquarters in Norcross, GA, U.S.A.



Intelligent Systems Corp. □ 5965 Peachtree Corners East □ Norcross, GA 30071 □ Telephone 404-449-5961 □ TWX 810-766-1581

Circle 175 on inquiry card.

ELECTRICALLY ALTERABLE READ ONLY MEMORIES

FUNCTION	DESCRIPTION	PART NUMBER	PAGE NO.
8K BIT EAROM	8,192 bits organized 2,048 x 4	ER0082	4-5
512 BIT EAROM	512 bits organized 128 x 4	ER2051	4-16
		ER2051 HR	4-16
		ER2055	4-19
1K RAM/EAROM	1,024 bits organized 256 x 4	ER1711	4-13
1400 BIT SERIAL EAROM	1,400 bits organized 100 x 14	ER1400	4-8
		ER2401	4-22
4K EAROM	4,096 bits organized 1,024 x 4	ER2402	4-22
		ER3400	4-34
		ER2605	4-28
8K EAROM	8,192 bits organized 2,048 x 4	ER2810	4-28

Photo 1: Shown here are the General Instrument ER3400 and ER1711 electrically alterable read-only-memory (EAROM) parts. The ER3400 has only the EAROM function; the ER1711 combines the functions of programmable memory and EAROM in a single part.

ASCII encoded keyboards as low as \$65*



The RCA VP-601 keyboard has a 58 key typewriter format for alphanumeric entry. The VP-611 (\$15 additional*) offers the same typewriter format plus an additional 16 key calculator type keypad.

Both keyboards feature modern flexible membrane key switches with contact life rated at greater than 5 million operations, plus two key rollover circuitry.

A finger positioning overlay combined with light positive activation key pressure gives good operator "feel", and an on-board tone generator gives aural key press feedback.

The unitized keyboard surface is spillproof and dustproof. This plus the high noise immunity of CMOS circuitry makes the VP-601 and VP-611 particularly suited for use in hostile environments.

The keyboards operate from a single 5 volt, DC power supply, and the buffered output is TTL compatible. For more information contact RCA VIP Marketing, New Holland Avenue, Lancaster, PA. Telephone (717) 291-5848.



*Optional user price. Dealer and OEM prices available.

electrically. With a read time equivalent to a high-speed EPROM, complete or partial erasure in 10 ms, and a write time of a mere 1 ms, an EAROM fills the gap between truly programmable memory and EPROM.

EAROM can be integrated into the memory address space of practically any microcomputer. Like regular read-only memory, it retains data (for up to 10 years) when the power is removed, and is a natural choice for bootstrap program-storage applications. Should the stored program have to be changed, you can erase the chip with a 10-ms eraser routine and then rewrite the data at a rate of 1 ms per byte. This can all be done without removing the part from the system.

There are many EAROMs available, but like other types of memory devices, their architectures and capacities vary. You would not use 1 K-bit memory chips if you had to fit 64 K bytes of memory on a small printed-circuit board, nor would you choose to use an erasable programmable read-only memory requiring a 3-voltage power supply if only a 5-V supply is available.

It is important to observe that EAROMs also have limitations. Unlike regular programmable memory, the electrically alterable read-only memory cannot be erased and reprogrammed without limit. The General Instrument model ER3400 EAROM, for instance, can have each byte read 2×10^{11} times, but written only 100,000 times. If this EAROM were being used as standard programmable memory in a frequently executed loop, 100,000 erase and write cycles would take only 20 minutes.

The ER3400 is better used to store tables and calculated results that must be retained if the power fails. The specific, useful qualities of the ER3400 are high density of data storage, high speed, and long time of data retention.

A Hybrid Memory Device

Where nonvolatile memory is required to have more frequent write cycles, the General Instrument ER1711 should be used. This device combines two types of memory on a single chip: a standard 1 K-bit, static programmable memory and a 1 K-bit electrically alterable read-only memory.

Expect the Unexpected
from Micro Control's Static

32K Ram #2

S-100 Bus
Compatible

Now! Before you consider any other 32K Ram System, you've got to find out about ours. "WHY" because we can match any other system on the market for specifications and capabilities. PLUS . . . our 32K Static RAM is rigorously tested by our own Micro Control Test Equipment (there's none better) . . . PLUS! you get our exclusive 2 year warranty, a warranty that proves we stand behind our product! To top it off, its all yours at a very affordable price. You can expect to get MORE from our 32K STATIC RAM PLUS 2

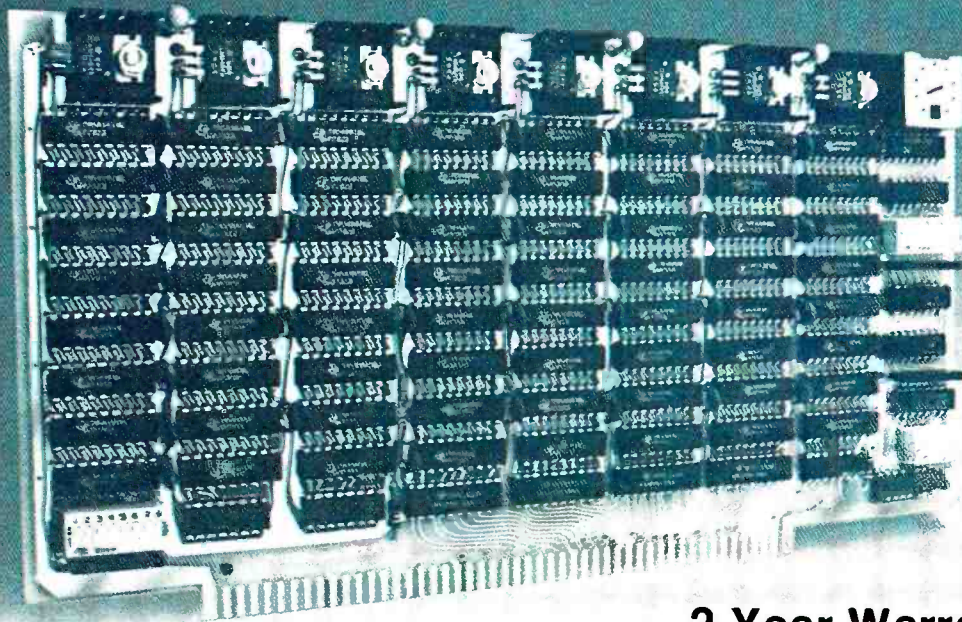

2 Year Warranty!



7956 Main Street N.E.
Minneapolis, MN 55432

(612) 786-8750

Micro Control Company	2 MHZ	4 MHZ
7956 Main St. N.E., Mpls., MN. 55432	\$695.00	\$895.00

Please send ___ 32K Static Ram Boards for a total price of _____
 Check or money order enclosed Please send more information
 OEM prices available upon request on your 32K Ram + 2

Name _____ Signature _____

Company Name _____ Position _____

Address _____ City _____ State _____ Zip _____

Yes, I would like more information on Micro Control Company and their Memory and Test Products.

A0 thru A9	10-bit word address.
D0 thru D3	Data input and output pins.
\overline{CE}	Chip enable. Chip selected when \overline{CE} is pulsed to logic 0.
C0, C1	Mode-control inputs.
\overline{WE}	Write enable. Input data read when \overline{WE} is pulsed to logic 0.
V_{SS}	Substrate supply. Normally at +5 V.
V_{G1}	Ground input.
V_{DD}	Power-supply input. Normally at +12 V.
V_{GG}	Power-supply input. Normally at -30 V.

Table 1: Functions of pins on the General Instrument ER3400 electrically alterable read-only-memory device.

The programmable memory is mapped as standard program memory. There is no limitation on write cycles. When the memory contents are to be retained, such as at the time of system power-down, a sensing circuit pulses the EAROM write line. With one pulse the entire content of the 1 K programmable memory is written in parallel to the EAROM. The EAROM section has the same write-cycle limitations as the ER3400 part.

Devices such as the ER1711 are particularly suited for storing frequently changing data. As long as power is available to the system, this data resides in the programmable memory. Only during periods when the power is off or during special events is the data transferred to non-volatile storage.

Design Choices

Each of the two EAROM devices has its good and bad features. The designer choosing EAROM parts for

a memory system will have to choose among the various positive attributes and complications. No single EAROM part necessarily fits all applications. The application must determine the choice.

Failure to understand this fact and lack of adequate knowledge of the variety of parts available are contributing factors to the absence of electrically alterable read-only memories in personal computers. The two devices I have chosen to discuss should cover most applications, but other configurations do exist.

General Instrument ER3400

The ER3400 is a 4 K-bit EAROM configured as 1024 by 4 bits. 1 K bytes of nonvolatile storage can be obtained using two chips. Figure 1a shows the pinout designations, and figure 1b shows the block diagram of the chip. Photo 1 shows the part in its dual-in-line package. Table 1 describes the functions of the pins found on the ER3400.

The ER3400 requires three power-supply voltages (+5 V, -12 V, and -30 V) for complete operation.

Because of the relatively low currents required to write data into an EAROM, the -30-V supply is usually derived from either the +5-V or -12-V supply. A previous Circuit Cellar article ("No Power for Your Interfaces? Build a 5 W DC-to-DC Converter," October 1978 BYTE, page 22, or page 1 in my book *Ciarcia's Circuit Cellar* BYTE Books, 1979) covered both theory and design procedures, should you need to make -30-V supply.

Unlike a regular programmable memory which has only read and write functions, the ER3400 has four operational modes: read; write; word erase; and block erase.

Operational Modes of the ER3400

Erase: To erase one word, both of the C0 and C1 mode-control input lines are set in the logic 1 (high) state, and the desired address location is set. A negative excursion of the voltage on the chip enable (\overline{CE}) line loads in the address and control, and initiates the erase operation. To avoid tying up the microprocessor bus, this mode is latched on the positive-going edge of the \overline{CE} signal. The erase operation will continue while \overline{CE} is high.

When it is desired to erase the entire device, the operation is the same,

Figure 1: Pinout designations of the twenty-two pins on the General Instrument ER3400 electrically alterable read-only memory (1a), and a block diagram of the major circuit sections within the part (1b).

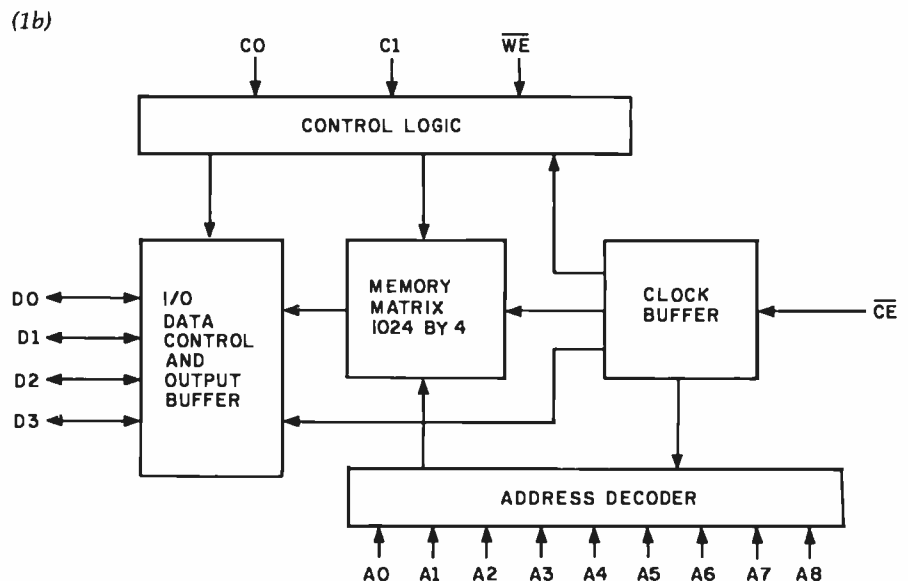
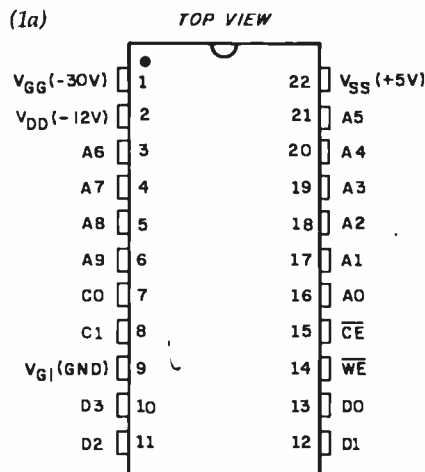

Color. VP-590 add-on Color Board allows program control of 8 brilliant colors for graphics, color games. Plus 4 selectable background colors. Includes sockets for 2 auxiliary keypads (VP-580). \$69.*

Sound. VP-595 Simple Sound Board provides 256 tone frequencies. Great for supplementing graphics with sound effects or music. Set tone and duration with easy instructions. \$24.*

Music. VP-550 Super Sound Board turns your VIP into a music synthesizer. 2 sound channels. Program control of frequency, time and amplitude envelope (voice) independently in each channel. Program directly from sheet music! Sync provision for controlling multiple VIPs, multitrack recording or other synthesizers. \$49.*

Memory. VP-570 RAM Expansion Board adds 4K bytes of memory. Jumper locates RAM in any 4K block of up to 32K of memory. On-board memory protect switch. \$95.*

EPROM Programmer. VP-565 EPROM Programmer Board comes complete with software to program, copy and verify 5-volt 2716 EPROMs—comparable to units costing much more than the VP-565 and VIP put together! Programming voltages generated on board. ZIF PROM socket included. \$99.*

EPROM Interface. VP-560 EPROM Interface Board locates two 5-volt 2716 EPROMs (4K bytes total) anywhere in 32K of memory. VIP RAM can be re-allocated. \$34.*

ASCII Keyboard.** Fully encoded, 128-character ASCII encoded alpha-numeric keyboard. 58 light touch keys including 2 user defined keys! Selectable upper and lower case. Handsomely styled. Under \$50.*

Tiny BASIC.** VP-700 Expanded Tiny BASIC Board puts this high-level language on your VIP. BASIC stored in 4K of ROM. Ready for immediate use—no loading necessary. This expanded BASIC includes the standard Tiny BASIC commands plus 12 additional—including color and sound control! Requires external ASCII encoded alpha-numeric keyboard. \$39.*

Auxiliary Keypads. Program your VIP for 2-player interaction games! 16-key keypad VP-580 with cable (\$15*) connects to sockets provided on VP-590 Color Board or VP 585 Keyboard Interface Card (\$10*).



COSMAC VIP lets you add computer power a board at a time.

With these new easy-to-buy options, the versatile RCA COSMAC VIP (CDP18S711) means even more excitement. More challenges in graphics, games and control functions. For everyone, from youngster to serious hobbyist. And the basic VIP computer system starts at just \$249* assembled and ready to operate.

Simple but powerful—not just a toy.

Built around an RCA COSMAC micro-processor, the VIP includes 2K of RAM. ROM monitor. Audio tone with a built-in speaker. Plus 8-bit input and 8-bit output port to interface relays, sensors or other peripherals. It's



easy to program and operate. Powerful CHIP-8 interpretive language gets you into programming the first evening. Complete documentation provided.

Take the first step now.

Check your local computer store or electronics parts house. Or contact

RCA VIP Marketing, New Holland Avenue, Lancaster, PA 17604. Phone (717) 291-5848.

*Suggested retail price. CDP18S711 does not include video monitor or cassette recorder.
**Available 1st Quarter, 1979.

The fun way
into computers.

C0	C1	Mode	Explanation
0	1	Block erase	Erase operation performed on all words.
1	1	Word erase	Stored data is erased at addressed location.
0	0	Read	Addresses data read after leading edge of \overline{CE} pulse.
1	0	Write	Input data written at addressed location.

Table 2: Selection of modes of operation of the ER3400 EAROM. The indicated logic levels are presented to the two mode-control inputs C0 and C1 to produce the corresponding mode of operation of the memory device.

except that the C0 mode-control input is low while C1 is kept in a high logic state.

A "dummy read" operation is required to end the erase cycle.

Write: The control code for write is for the C0 line to be high while C1 is low. The control word and address are strobed in at the occurrence of the \overline{CE} (chip enable) pulse. Data is strobed in during the write enable (\overline{WE}) signal. The timing requirements for the write enable signal are design-

ed so that \overline{WE} may be generated by combining the chip enable signal and a write signal through a logic gate.

As is the case with the erase operation, the control code and address are latched on the rising (positive-going) edge of \overline{CE} . Data is latched by the rising edge of \overline{WE} . As in erase, a dummy read is required to end the write cycle.

Read: To read out data, C0 and C1 control lines are both held low and the desired address is selected. The

chip enable signal strobes in the mode and address data, and clocks out the data.

In all modes, when \overline{CE} is high, the data input/output lines are in a high-impedance state. The control line logic levels for the several modes are summarized in table 2.

In the write and erase (both word and bulk) modes, the data, addresses, and the state of the control lines are loaded into internal registers within the ER3400 on the rising edge of the \overline{CE} pulse, and are later cleared by a dummy read pulse also strobed by \overline{CE} .

Number	Type	+5 V	GND	-12 V	-30 V
IC1	HM-7603	16	8		
IC2	ER3400	22	9	2	1
IC3	ER3400	22	9	2	1
IC4	74121	14	7		
IC5	7400	14	7		

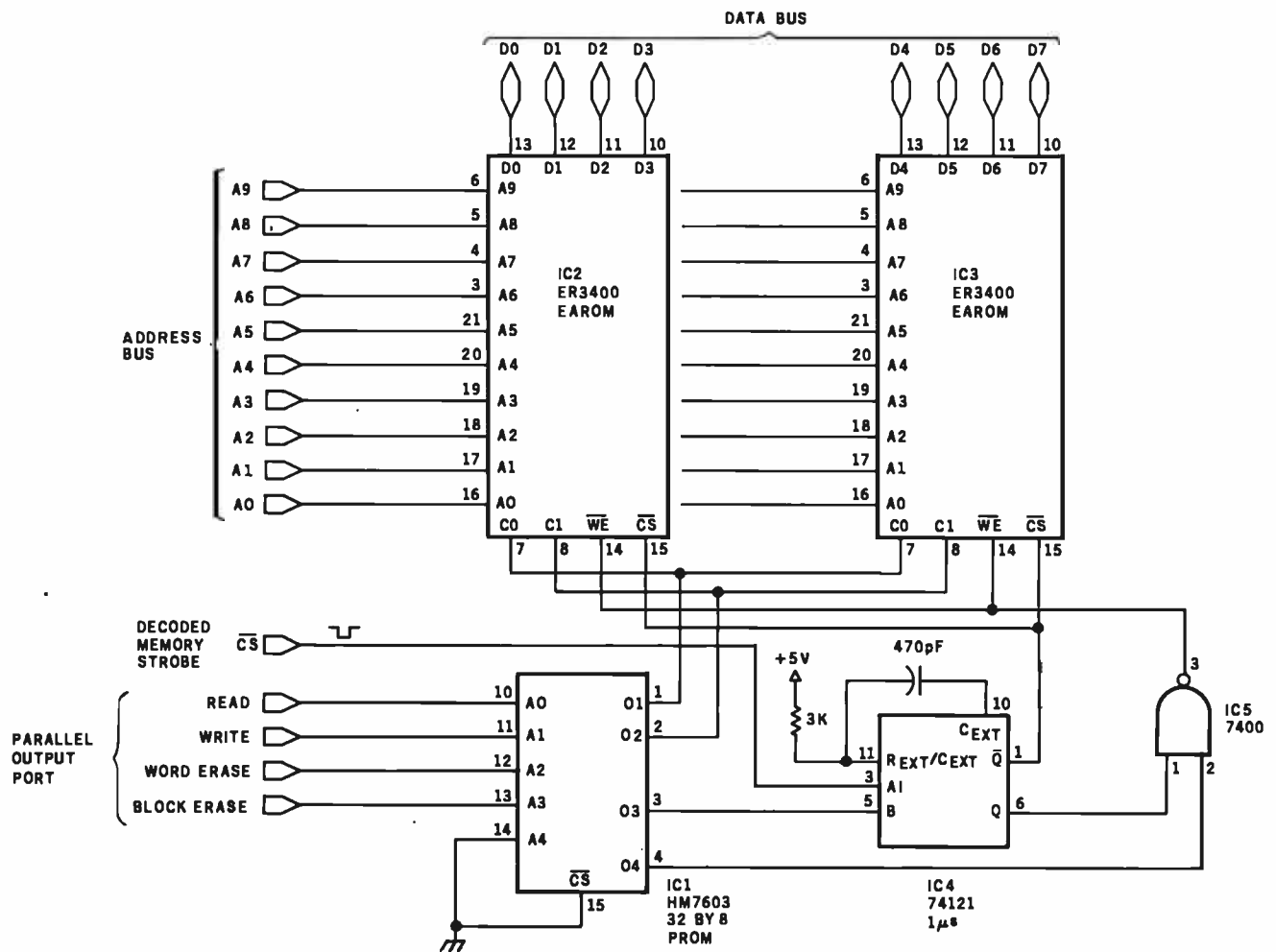

Figure 2: Schematic diagram of a circuit that uses two ER3400s to form a 1024-byte memory. Read, write, and erase functions of the ER3400 are available using this circuit. The programmable read-only memory, IC1—the Harris Semiconductor HM-7603, a 32-word-by-8-bit PROM, serves to decode mode-control inputs received from a parallel output port. The truth table for this PROM is shown in table 3.

We Need Your Help!

An International Company Called MicroDaSys has designed a dynamite solution for the small businessman seeking a computer. We call it the "millie"[™]. It's a system that combines the **absolute best business software available** with fast, dependable hardware.

The "millie" is the smartest buy a small business can make. It comes with the most powerful accounting, word processing and applications software available. And to take advantage of that power, the "millie" uses the S-100 bus, eight inch disk drives and the universal CP/M[‡] operating system. It can be programmed in BASIC, FORTRAN, Pascal and dozens of other languages. Best of all, "millie" prices start at **under \$3000**. The one illustrated includes a reproduction-quality printer and full accounting and word processing software for just \$6995. "Millie" has been in use for over a year in the US, Europe, South America and Australia. It is a **proven design**, regularly updated as the state-of-the-art advances.

But an international company can't knock on doors. Without branch offices in every city of the US (and the world) we have the same problem as dozens of other computer manufacturers. We simply can't contact all of the small businessmen who could benefit from our "millie". That's where you come in.

We seek your help. Sell our "millie" as a complete, integrated system to your neighborhood businesses, universities, writers and other professionals. If you're reading this magazine you probably

have all the expertise required to demonstrate and sell "millies". All that's really required is the **motivation to seek out prospective customers** and the **ability to present "millie's" features** to them in a way most understandable to them. Put us in your customer's place.

We offer you a piece of the exciting computer market, the chance to work with the most sophisticated software and hardware available, and best of all, a **handsome commission** and no minimum purchase requirements (not even one!).

It's easy to sell "millies". You will be supported by an **international advertising campaign**, a dependable system made by a well known manufacturer, and the best documentation available. All you need is the enterprise to seek out new customers and provide them with the support they need (perhaps earning your own consulting fees) **during and after installation**. We will even supply you with potential sales leads in your area — Reader Service Questionnaires, Direct Mail Inquiries, and Telephone Responses. These are people who want you to sell them a "millie"! All you need to do is act!

You've got nothing to lose! There are absolutely no strings, no minimum purchases, no special degrees or instruction required, no retail store necessary. All that is required is the sincere desire to earn money selling our computers. Join the fascinating field of computer sales now. The market is ready if you are! Write or call today for your introductory sales package and complete info.

millie



For distribution in the Netherlands contact:
Computer Programming International BV
Burg Penstraat 3, Postbus 288, 3740AG Baarn, Holland

[‡] CP/M is a registered trademark of Digital Research Corp.
Circle 221 on inquiry card.

**Please rush me, without obligation,
your introductory sales package.**
MicroDaSys P.O. Box 36051 Dept B-12, Los Angeles, CA
90036
Phone: (213) 935-4555 TWX: 910-321-2378
NAME _____
ADDRESS _____
CITY _____
STATE _____
ZIP _____

Operation	Address					Data							
	A0	A1	A2	A3	A4	O1	O2	O3	O4	O5	O6	O7	O8
Read	1	0	0	0	0	0	0	1	0	X	X	X	X
Write	0	1	0	0	0	1	0	1	1	X	X	X	X
Word Erase	0	0	1	0	0	1	1	1	0	X	X	X	X
Block Erase	0	0	0	1	0	0	1	1	0	X	X	X	X
All other locations						0	0	0	0	X	X	X	X

Table 3: Truth table for the mode-decoding, programmable read-only memory (PROM) that appears as IC1 in figure 2. A high logic state is represented by 1; a low logic state is represented by 0. Where the logic state does not matter, X characters appear in the table. Possible substitutes for the Harris Semiconductor HM-7603 PROM used here include the 74S288, 82S123, and AM27S09.

Observe carefully the requirement for the dummy read operation. Since there is no internal timing or sequencing, the ER3400 relies upon the user to terminate the write and erase functions by switching the EAROM into the read mode after 1 ms following a write and after 10 ms following an erase. There are various software and hardware methods to accomplish this.

For personal computer use, the circuit of figure 2 should be considered.

A parallel output port provides the flag input to the mode-decoding, programmable read-only memory (PROM) IC1. A memory map of the mode-decoding memory is shown in table 3.

With the electrically alterable read-only-memory device attached to the address and data lines, a read operation is accomplished by setting the output bit corresponding to the A0 input line of the PROM to a high logic state. Each of the four address

lines A0 thru A3 is called a flag for purposes of explanation.

Setting the read flag (A0) corresponds to a binary 10000 input code to the PROM (IC1 in figure 2). The O1 and O2 outputs will place low logic levels on both mode-control inputs C0 and C1. This places the EAROM in the read mode.

Next, the EAROM is addressed through the normal \overline{CS} line. This action fires the one-shot (monostable multivibrator, IC4 in figure 2) which clocks the data onto the computer data bus. The ER3400 has a cycle time of 1.8 μ s. Depending upon the memory speed of your computer, it may be necessary to add wait states when addressing EAROM.

The sequence is similar for write and erase operations. By setting the write flag (A1), the mode-decoding PROM causes C0 to go high while C1 stays low, placing the EAROM in the write mode. Addressing the appropriate byte and strobing the \overline{CS} line causes the ER3400 to enter a write

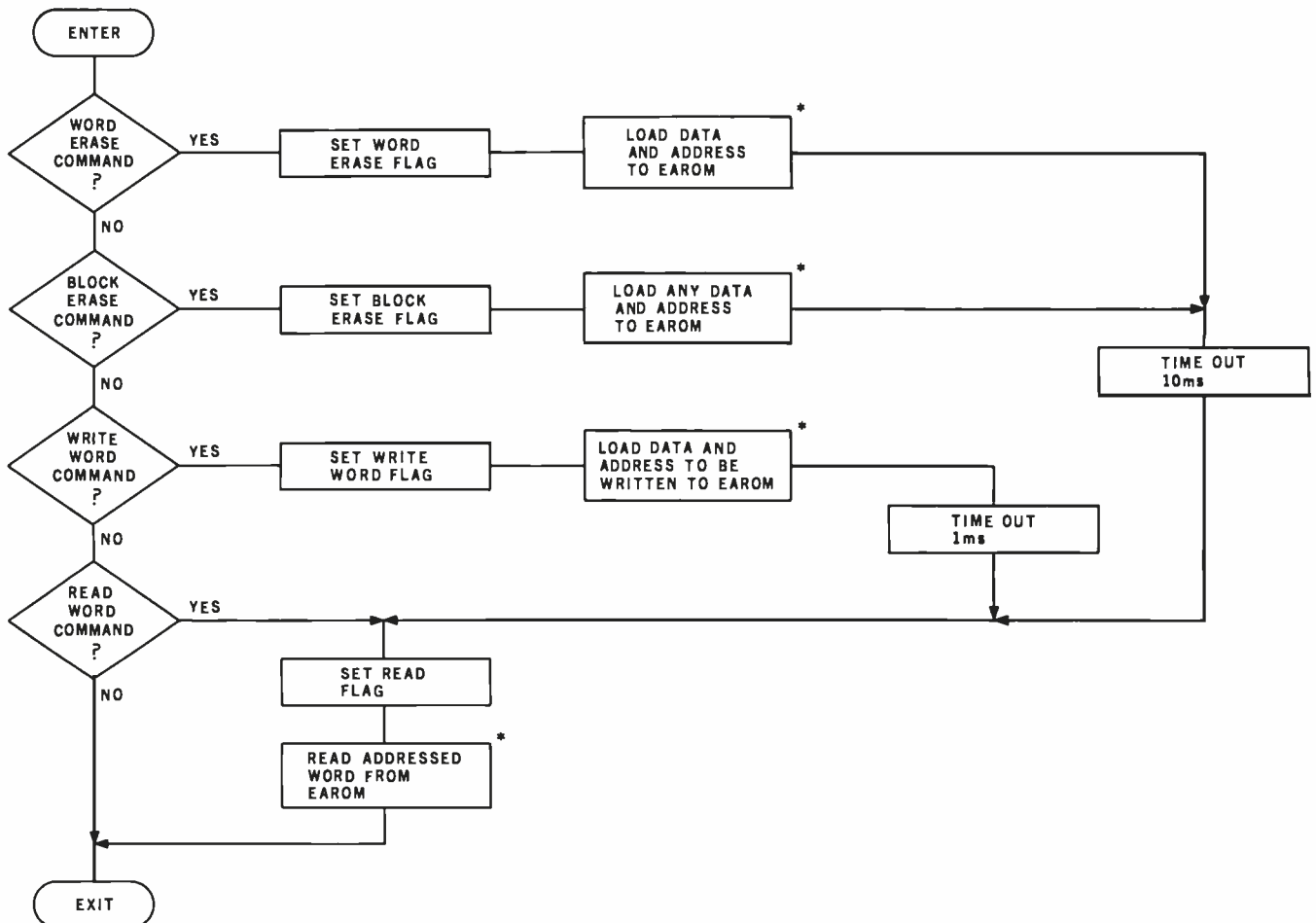

Figure 3: A flowchart of the algorithm for actuating the various operating modes of the ER3400 interface circuit of figure 2. The diagram blocks marked with asterisks refer to standard memory read or write instructions.

CCS has everything to expand your Apple II*

Friendly Frankie's roadside Apple II stand has plenty to whet your appetite for expansion. So, if you're ready to have your Apple II computer interface with the outside world, wheel around to Frankie's stand today.

Expand to your heart's content with our full range of delicious

accessories, including: prom modules, asynchronous and synchronous serial interfaces, arithmetic processors, programmable timers, parallel interfaces, A/D converters, and Apple II compatible boards galore.

Let Frankie connect your Apple II to the rest of the world

faster, and for a lot less bucks.

For all the mouth-watering details, contact our northern California headquarters or your local roadside computer store. If Frankie's out, ask for Dennis or Jerry. They'll be glad to help you.

*Apple II is a registered trademark of Apple Computers, Inc.

FRIENDLY FRANKIE'S FRESH APPLES

A/D
CONVERTER
\$149⁹⁵

PROM
MODULE
\$79⁹⁵

SERIAL
INTERFACE
\$159⁹⁵

PROGRAMMABLE
TIMER
\$159⁹⁵

PARALLEL
INTERFACE
\$119⁹⁵

ARITHMETIC
PROCESSOR
\$399⁹⁵



California Computer Systems

309 Laurelwood Road, Santa Clara, CA 95050, (408) 988-1620

So Nobody Goes Away Mad.

Table 4: Descriptions of pin functions of the General Instrument ER1711 hybrid EAROM/programmable memory part.

Pin	Description
D0 thru D3	4-bit data word
A0 thru A7	8-bit data address
V _{SS}	+5-V supply voltage
V _{DD}	-12-V supply voltage
V _{GF}	Ground
CE	Chip enable: strobed during programmable-memory cycles, held low during EAROM cycles
H	Hold: normally high, low during data-recall cycle
W	Write: high during programmable-memory write cycle
RS	Restore: normally low, pulsed high during recall cycle
E/W	Erase/Write: controls EAROM memory cells.

condition. (The byte addressed for writing should have previously been erased through either the word or block erase operations.)

After 1 ms, the read flag (A0) is set and a read sequence is executed to stop the write activity. A flowchart of the mode-selection algorithm is shown in figure 3.

Operational Modes of the ER1711

The ER1711 operates quite differently from the ER3400. Configured as 256 by 4 bits, this device combines the properties of both regular pro-

grammable memory and electrically alterable read-only memory on a single chip. Figure 4 shows the pinouts of the ER1711, and table 4 describes the pin functions.

In general, EAROM writing is rather slow. Read access time can be less than 1 ms, but writing and erasing take 1 to 50 ms (depending upon the device). As demonstrated earlier, it takes a little over 1 second to completely write the ER3400.

In applications where the EAROM is "read-mostly" memory and is used to hold infrequently changing data or

Figure 4: Pinout designations of the General Instrument ER1711 hybrid electrically alterable read-only-memory/programmable-memory device.

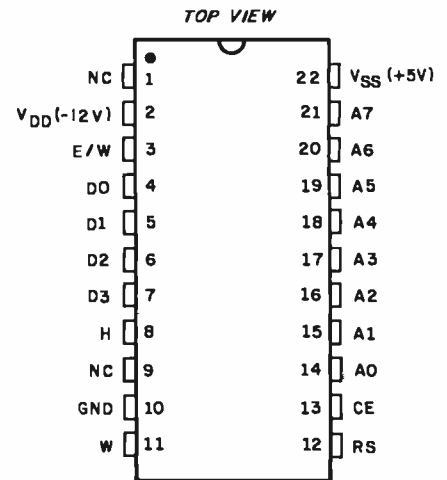

programs, slow erase and write times are no problem. However, in instances where an EAROM is used to store data or programs during power-down conditions, slow write times are objectionable. The distinctive feature of the ER1711 is its ability to store its entire contents of the programmable memory in a single write pulse.

The static programmable-memory section of the ER1711 is addressed like any other system memory. It can hold constantly changing data with no restrictions on the number of read/write cycles. The contents of this memory can be transferred to the EAROM section through one write pulse. In this way, the EAROM can instantly save all data when the power fails. When power is returned, a simple pulse sequence restores the data from the EAROM to the programmable operating memory.

ER1711 Power Requirements

The ER1711 uses +5-V and -12-V power supplies for normal programmable-memory operation. These supplies must be kept constant within a 5% tolerance. Other voltages used are as follows for EAROM operations:

V_w (-17 V to -21 V)
is used to transfer data from programmable memory to EAROM;
V_r (-8 V to -15 V)
is used to transfer data from EAROM to programmable memory; and
V_E (+25 V to +30 V)

TURN-ON!

Now have full computer control of up to 256 lights, appliances and even wall switches **without special wiring**. The SciTronics REMOTE CONTROLLER permits direct control of the inexpensive BSR remote line-carrier switches sold by Sears, Radio Shack and many others.

HOW IT WORKS: Writing 3 control words to the controller board sends one of 6 instructions over the a-c line to the desired switch. The instructions include any remote on, off, all off, any light bright, dim, or all on. Reading the board tells if busy.

FEATURES:

- ★ FULL S-100 COMPATIBILITY—all lines fully buffered, board address dip switch selectable to span 65K.
- ★ FULL TRS-80-1 COMPATIBILITY—board housed in attractive woodgrained case with power supply and connector cable allows direct connection to TRS-80-1 expansion port.
- ★ COMPATIBLE WITH OTHER SYSTEMS—combination of on-board select switches and complete connector wiring information allows ease of use with Apple II, PET, KIM, SYM, HEATH HB, plus others.
- ★ SYSTEM SELECT SWITCHES—choose active high or low inputs, addressed or I/O drive, parallel or serial entry, non S-100 inputs like VMA, clocking on any transition.
- ★ SIMPLE TO USE—sample software included for all systems listed, all IC's socketed.

APPLICATIONS:

- ★ Make your entire home, business or apartment "computer controlled"
- ★ Save energy by controlling lights and appliances
- ★ Control lights and alarms for security systems

REMOTE CONTROLLER BOARD \$159.

ENCASED SELF POWERED CONTROLLER FOR TRS-80-1 \$184.

remote switches not included

Send check or money order to:

SciTronics Inc.
523 S. Clewell St., P.O. Box 5344
Bethlehem, PA 18015
(215) 868-7220

Please list system with which you plan to use controller. Master Charge and Visa accepted. PA residents add sales tax.



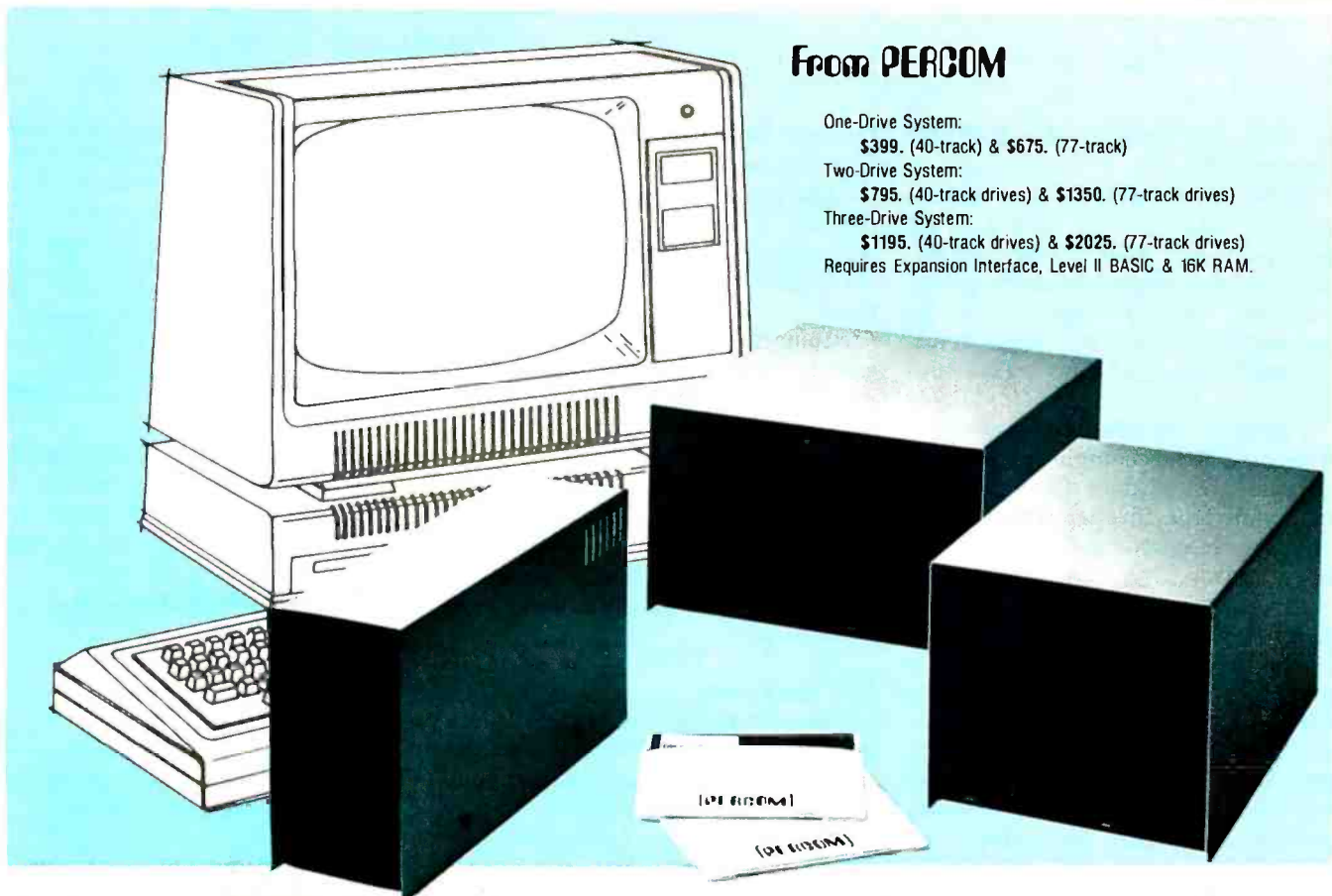

From PERCOM

One-Drive System:
\$399. (40-track) & **\$675.** (77-track)
 Two-Drive System:
\$795. (40-track drives) & **\$1350.** (77-track drives)
 Three-Drive System:
\$1195. (40-track drives) & **\$2025.** (77-track drives)
 Requires Expansion Interface, Level II BASIC & 16K RAM.

Low Cost Add-On Storage for Your TRS-80* . In the Size You Want.

When you're ready for add-on disk storage, we're ready for you.
 Ready with six mini-disk storage systems — 102K bytes to 591K bytes of
 additional *on-line* storage for your TRS-80*.

- Choose either 40-track TFD-100™ drives or 77-track TFD-200™ drives.
- One-, two- and three-drive systems immediately available.
- Systems include Percom PATCH PAK #1™, on disk, at no extra charge. PATCH PAK #1™ de-glitches and upgrades TRSDOS* for 40- and 77-track operation.
- TFD-100™ drives accommodate "flippy disks." Store 205K bytes per mini-disk.
- Low prices. A single-drive TFD-100™ costs just \$399. Price includes PATCH PAK #1™ disk.
- Enclosures are finished in system-compatible "Tandy-silver" enamel.

Whether you need a single, 40-track TFD-100™ add-on or a three-drive add-on with 77-track TFD-200™s, you get more data storage for less money from Percom.

Our TFD-100™ drive, for example, lets you store 102.4K bytes of data on one side of a disk — compared to 80K bytes on a TRS-80* mini-disk drive — and 102.4K bytes on the other side, too. Something you can't do with a TRS-80* drive. That's almost 205K bytes per mini-disk.

And the TFD-200™ drives provide 197K bytes of on-line storage per drive

— 197K, 394K and 591K bytes for one-, two and three-drive systems.

PATCH PAK #1™, our upgrade program for your TRSDOS*, not only extends TRSDOS* to accommodate 40- and 77-track drives, it enhances TRSDOS* in other ways as well. PATCH PAK #1™ is supplied with each drive system at no additional charge.

The reason you get more for less from Percom is simple. Peripherals are not a sideline at Percom. Selling disk systems and other peripherals is our main business — the reason you get more engineering, more reliability and more back up support for less money.

In the Product Development Queue . . . a printer interface for using your TRS-80* with any serial printer, and . . . the Electric Crayon™ to map your computer memory onto your color TV screen — for games, animated shows, business displays, graphs, etc. Coming PDQ!

™ TFD-100, TFD-200, PATCH PAK and Electric Crayon are trademarks of PERCOM DATA COMPANY.
 *TRS-80 and TRSDOS are trademarks of Tandy Corporation and Radio Shack which have no relationship to PERCOM DATA COMPANY.

PERCOM

PERCOM DATA COMPANY, INC.
 211 N. KIRBY • GARLAND, TX • 75042

To order add-on mini-disk storage for your TRS-80*, or request additional literature, call Percom's toll-free number: 1-800-527-1592. For detailed Technical information call (214) 272-3421.

Orders may be paid by check or money order, or charged to Visa or Master Charge credit accounts. Texas residents must add 5% sales tax.

Percom 'peripherals for personal computing'

is used for erasing the EAROM storage cells.

Since these voltages are required only as single pulses during either power-up or power-down cycles, they do not require separate power supplies. All voltages can be generated by charge-pumping circuits operated from +5-V and -12-V supplies.

Figure 5 is the schematic diagram of a circuit which accomplishes the save-data and recall-data functions and maintains the proper timing and voltages required for the various operations.

Data Restoration

The static-programmable-memory portion of the ER1711 has an access time of 900 ns. Upon initial application of power to the system, if this programmable memory is to be loaded from EAROM, the computer signals this action by pulsing the *data-recall* input line. This triggers a 300 μ s ramped voltage to the erase/write (E/W) line of the ER1711. After 300 μ s, the hold line (H) is

brought high for 150 ms, and the E/W line is set at a potential of 27 V. At the conclusion of this sequence, the ER1711's programmable memory will contain the former contents of the EAROM, and the EAROM will be erased.

Saving the data stored in the programmable memory is started by raising the *system-save* line to a logic 1. The resultant application of a -20-V pulse of a 1-to-10-ms duration to the ER1711 causes the data to be stored in the electrically alterable read-only memory. Data retention time varies according to the pulse duration, from 3 days for a 1-ms pulse to 30 days for a 10-ms pulse.

In Conclusion

I do not expect that you will immediately convert your computer memory to EAROM, but at least you now know what EAROM is. In my own case, I have chosen to use ER1711 memory devices for my automotive computer. I can only speculate on the final configuration, but at least I can count on not having

Figure 5: A circuit that allows data stored in the programmable memory of the ER1711 to be saved into and recalled from the electrically alterable read-only-memory section. Charge-pumping circuits are used to generate the relatively high voltages needed for the erase, store, and recall cycles of the ER1711. Power-down and power-up states are initiated by the System Save and Data Recall signals. 

to be concerned with standby power consumption and battery backup.

For further information on EAROMs or determination of price and availability contact:

General Instrument Corp
600 W John St
Hicksville NY 11802
Attn: John Wunner

EAROM specifications and diagrams reprinted courtesy of General Instrument Corporation.

Next Month: you will learn how to build a wireless interface that connects the Sears (alias BSR) home control system to your computer. ■

Operation of the ER1711

In normal operation the ER1711 operates as a programmable memory. Before powering down, the data can be stored in the electrically alterable, nonvolatile read-only-memory (EAROM) cells by a single, negative write pulse. When power is restored, the previously saved data can be recalled by a power-up and data-recall cycle which transfers all this saved data to the programmable memory. It is suggested that an erase cycle be performed soon after the data-recall cycle, so that the memory will be prepared in case of another power-down cycle. The EAROM cycles operate as explained here.

Erase Cycle:

1. The H line should be high and the RS and CE lines low.
2. Positively pulse the E/W line to +25 V for 100 to 200 ms.

Stored-Data Cycle:

1. The H line should be held high

and the RS and CE lines low.

2. Pulse the E/W line negative to -22 V for 1 to 10 ms to store nonvolatile data.
3. The nonvolatile EAROM memory cells must have been previously erased for valid data retention.

Power-Up and Recall Cycle:

1. Turn on power with CE and RS held to ground and the H and E/W lines biased to V_{SS} .
2. When power is on, lower H and pulse RS to precondition the EAROM cells.
3. Lower RS and ramp down the E/W line at a rate of -0.1 V/ μ s. This can be done with a series resistor of 470 K ohms in the E/W line.
4. After the E/W recovery time, bring both the E/W and H lines to V_{SS} .
5. If in the course of erasing data, the power shuts down again, the erase cycle can be terminated and a write cycle im-

mediately started without loss of data.

In normal programmable-memory operation, only the +5-V and -12-V power supplies are required. The erase-store and recall cycles require momentary high-voltage pulses to tunnel charges through the negative-metallic-oxide-semiconductor (NMOS) memory transistors. These higher voltages can be created from the +5-V and -12-V power supplies using the charge-pumping circuits shown in figure 5. This circuit will generate the sequence of RS, H and E/W pulses needed for power-down and up sequencing. The power-down and up cycles are initiated by System Save and Data Recall signals respectively. Figure 5 is a suggested circuit using standard transistor-transistor logic (TTL) parts; a similar circuit can be designed with complementary-metallic-oxide-semiconductor (CMOS) logic instead.

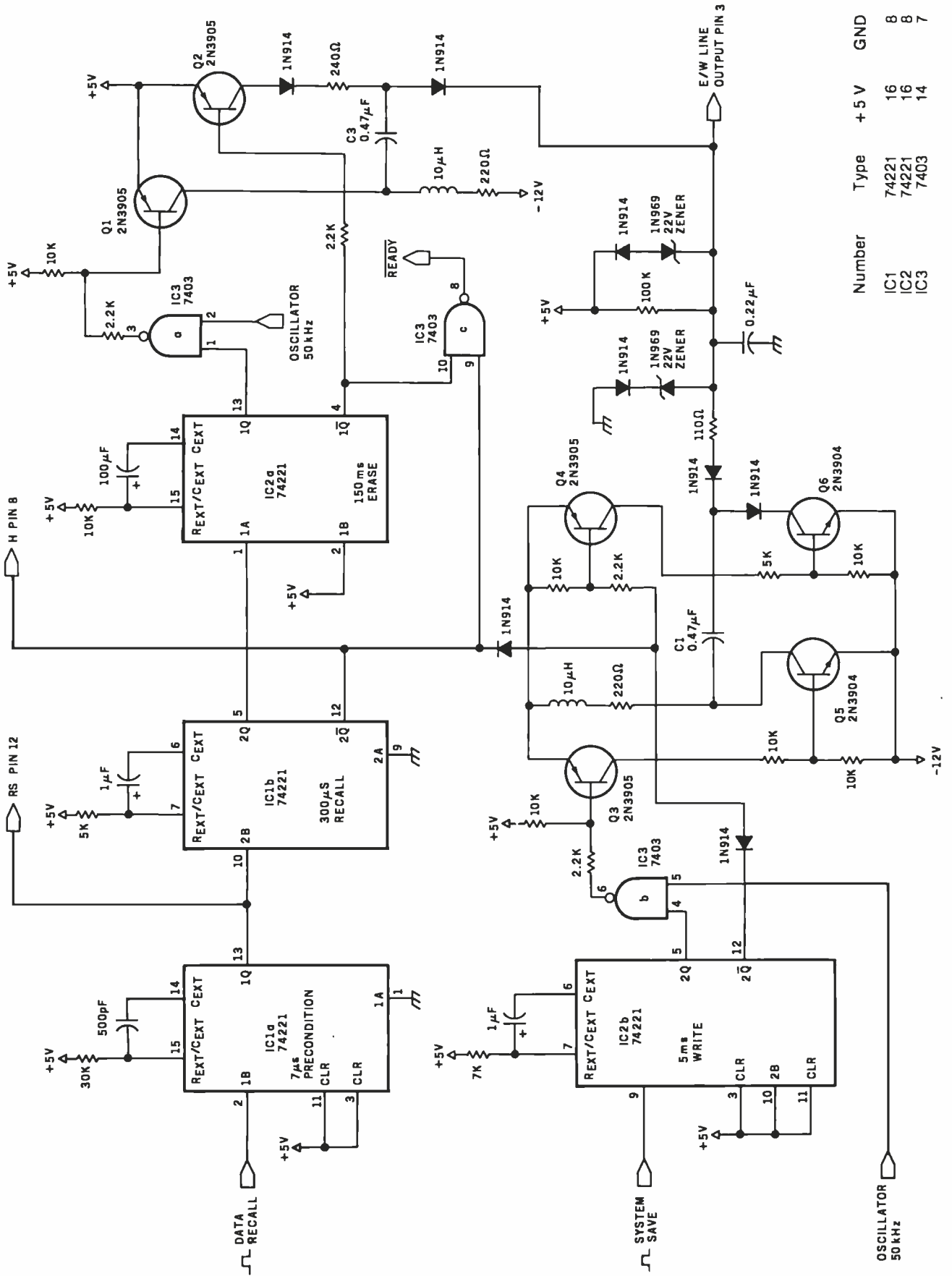

Number	Type	+5 V	GND
IC1	74221	16	8
IC2	74221	16	8
IC3	7403	14	7

Faster Audio Processing with a Microprocessor

William J Dally
Apt U-3 Dutch Village
Blacksburg VA 24060

Introduction

Audio processing involves transforming an audio signal by filtering, delay, and modulation to make the sounds more musically pleasing or to improve communication systems. Audio processing by both analog and digital methods has been performed for many years; however, these methods are expensive to implement if complete manipulation of the output signal is to be achieved.

The advent of low-cost microcomputers in recent years permits a new approach to audio processor design which has the advantage of much greater flexibility at competitive costs. T C O'Haver employed a microcomputer for audio processing using a minimum of hardware in the design, while relying upon software for signal manipulation (see "Audio Processing with a Microcomputer," June 1978 BYTE, pages 166 thru 173). With this heavy emphasis on software, the speed of the processor was not sufficient to process high fidelity audio signals (20 Hz to 20 kHz). This

article presents a different approach wherein modest amounts of hardware are incorporated into the design of the microcomputer system, reducing the demands on the processor. Flexibility in manipulating the audio signal is not sacrificed, and the cost of the additional hardware is not excessive.

Timing Analysis of Software Approach

In the microcomputer audio processing system developed by O'Haver, only an analog-to-digital (A/D) converter, a microprocessor, and a digital-to-analog (D/A) converter were used. The audio processing functions of phlanging, reverberation, and linear transformation were performed by the software of the system. In a timing analysis of the design, an 8080 processor operating at a system clock rate of 2 MHz was considered.

The processing routines used in this system are shown in listing 1, translated to 8080 assembly language. Also shown are the number of processor cycles and the execution times for these routines (28 μ s, 79 μ s, and 85 μ s respectively). Most applications will use all three of these routines, as well as system control and overhead routines. Thus, the worst-case cycle time (the time required to process one unit of data) becomes:

$$L_w = 28 + 79 + 85 + L_o > 200 \mu s$$

where L_w = worst-case cycle time
and L_o = overhead time.

To prevent distortion, the sampling frequency f_s must be twice that of the maximum signal frequency f , which is:

$$f_s < f_s/2 = 1/(2L_w) < 2.5 \text{ kHz.}$$

It is evident from this calculation that $f_s < 2.5$ kHz is too low for high-fidelity audio. Furthermore, many audio applications require more functions than linear transformation, phlanging, and reverberation. Adding more functions to a software-oriented system decreases the maximum signal frequency still further. It is apparent that a system which depends too heavily on software is too slow for comprehensive audio processing. A better approach is to use a design combining software and hardware that reduces the time demands on the processor, while maintaining flexibility.

Hardware and Software Approach

There are several methods by which hardware can be added to the system to reduce the processing load. Bit-slice processors with cycle times which are about eight times faster than an 8080 could be used for the processor. However, these bit-slice processors and the fast memories needed to support them are prohibitively expensive. Also, this system would not be capable of handling any additional functions.

A better solution is to add peripheral hardware to take some of the processing load off of the pro-

About the Author

William J Dally is an engineering consultant for a Silver Spring, Maryland electronics development firm and is an electrical engineering student at Virginia Polytechnic Institute and State University. His past projects include a programmable read-only memory programmer, a computerized traffic control system, and an intelligent tape drive. Current projects include a general purpose Z80 system and a disk-based editor plus assembler which uses only 3 K bytes of memory.

MOVING DATA AT A SNAIL'S PACE BECAUSE YOU'RE FLOPPY BOUND?

Let Corvus Systems put you back in the race!



- For TRS-80†, Apple‡ (including Apple Pascal), S-100 Bus—and now LSI-11.
- Fully compatible hardware/software.
- 10-million byte disk: IMI-7710.
- Proven Winchester technology.
- Z-80 based Corvus disk controller.
- Comprehensive disk diagnostics.
- Up to 4 disks per system.
- System \$5350, add-on disk \$2990.

Corvus offers a complete systems solution to the mass storage problem of micro computers. In a package smaller than a briefcase, we provide an intelligent controller, disk, and personality module. Call or write today for additional information. Get up to speed with Corvus.

NOW! CORVUS SPEAKS APPLE™ PASCAL™!



†TRS-80 is a registered trademark of Radio Shack, a Tandy Co.
‡Apple is a registered trademark of APPLE Computers, Inc.

CORVUS SYSTEMS, Inc.

900 S. Winchester Boulevard
San Jose, California 95128
408/246-0461

			(CLOCK CYCLES)
;	XFER	— ROUTINE FOR LINEAR TRANSFORMATIONS	
XFER:	LHLD	CONV ;GET INPUT FROM ADC	16
	STA	STRB ;STROBE ADC	13
	MVI	H, TABLE ;POINT AT TABLE	7
	MOV	A, M ;GET TRANSFORMED DATA	7
	STA	DAC ; OUTPUT TO DAC	+13
			56
	;EXECUTION TIME 28 MICROSECONDS		
;			
;	PLNG	— PHLANGING ROUTINE	
PLNG:	LHLD	DELAY ;GET STARTING DELAY	16
NEXT:	MVI	H, BUFF ;POINT AT BUFFER	13
	MOV	A, M ;GET DELAYED DATA	7
	ANI	FEH ;DIVIDE BY TWO	7
	RRC	;	4
	MOV	B, A ;SAVE FOR MIXING	5
	LDA	CONV ;GET NEW DATA	13
	STA	STRB ;STROBE ADC	13
	MOV	M, A ;PUT IN CURRENT BUFFER LOCATION	7
	ANI	FEH ;DIVIDE BY TWO	7
	RRC	;	4
	ADD	B ;MIX NEW AND DELAYED SIGNALS	4
	STA	DAC ;OUTPUT TO DAC	13
	DCR	L ;NEXT LOCATION	5
	JNZ	NEXT ;NOT DONE — NEXT LOCATION	10
	LXI	H, DELAY ;DONE — SWEEP DELAY	10
	DCR	M ;	10
	JMP	PLNG ;REPEAT	+10
			158
	;EXECUTION TIME 79 MICROSECONDS		
;			
;	RVRB	— REVERB ROUTINE	
RVRB:	XRA	A ;INITIALIZE BUFFER ADDRESS	4
	MOV	L, A ;	5
	MOV	H, A ;	5
RRST:	MVI	H, FIRST ;POINT AT BEGINNING OF BUFFER	13
RNXT:	STA	STRB ;STROBE ADC	13
	MOV	A, M ;GET DATA FROM BUFFER	7
	ANI	FEH ;DIVIDE BY TWO	7
	RRC	;	5
	MOV	B, A ;SAVE FOR MIXING	5
	LDA	CONV ;GET DATA FROM ADC	13
	ANI	FEH ;DIVIDE BY TWO	7
	RRC	;	5
	ADD	B ;MIX	4
	MOV	M, A ;STORE MIXED SIGNAL IN BUFFER	7
	STA	DAC ;OUTPUT TO DAC	13
	INR	L ;INCREMENT POINTER	5
	JNZ	RNXT ;NOT DONE — GO REVERB	10
	INR	H ;MAYBE DONE, CHECK H	5
	LDA	LAST ;	13
	CMP	H ;	4
	JZ	RRST ;DONE — START BUFFER OVER	10
	JMP	RNXT ;NOT DONE	+10
			170
	;EXECUTION TIME 85 MICROSECONDS		

Listing 1: Audio processing routines to perform linear transformation, phlanging, and reverberation, using a software-oriented approach on an 8080 system with a 2 MHz system clock frequency. Execution times of 28 μ s (linear transformation), 79 μ s (phlanging) and 85 μ s (reverberation) are too slow for high-fidelity audio applications.

cessor. This distributed hardware approach is less expensive than a fast processor, and allows more flexible software since timing is not critical. The remainder of this article will discuss this approach.

System Definition

To design an audio processing

microcomputer system, it is necessary to define the system's processing functions. These functions fall into three categories: linear transformations, time-delay functions, and gain-control functions. Functions such as distortion and clipping, where the output depends only on the input, are linear transformation. Time-delay

functions such as phlanging, phase shifting, and reverberation, involve delaying the incoming signal and mixing signals which are delayed for different amounts of time. Gain-control functions involve varying the gain of the system to control amplitude, and include sustain, vibrato, and quantization noise reduction.

SuperBrain™

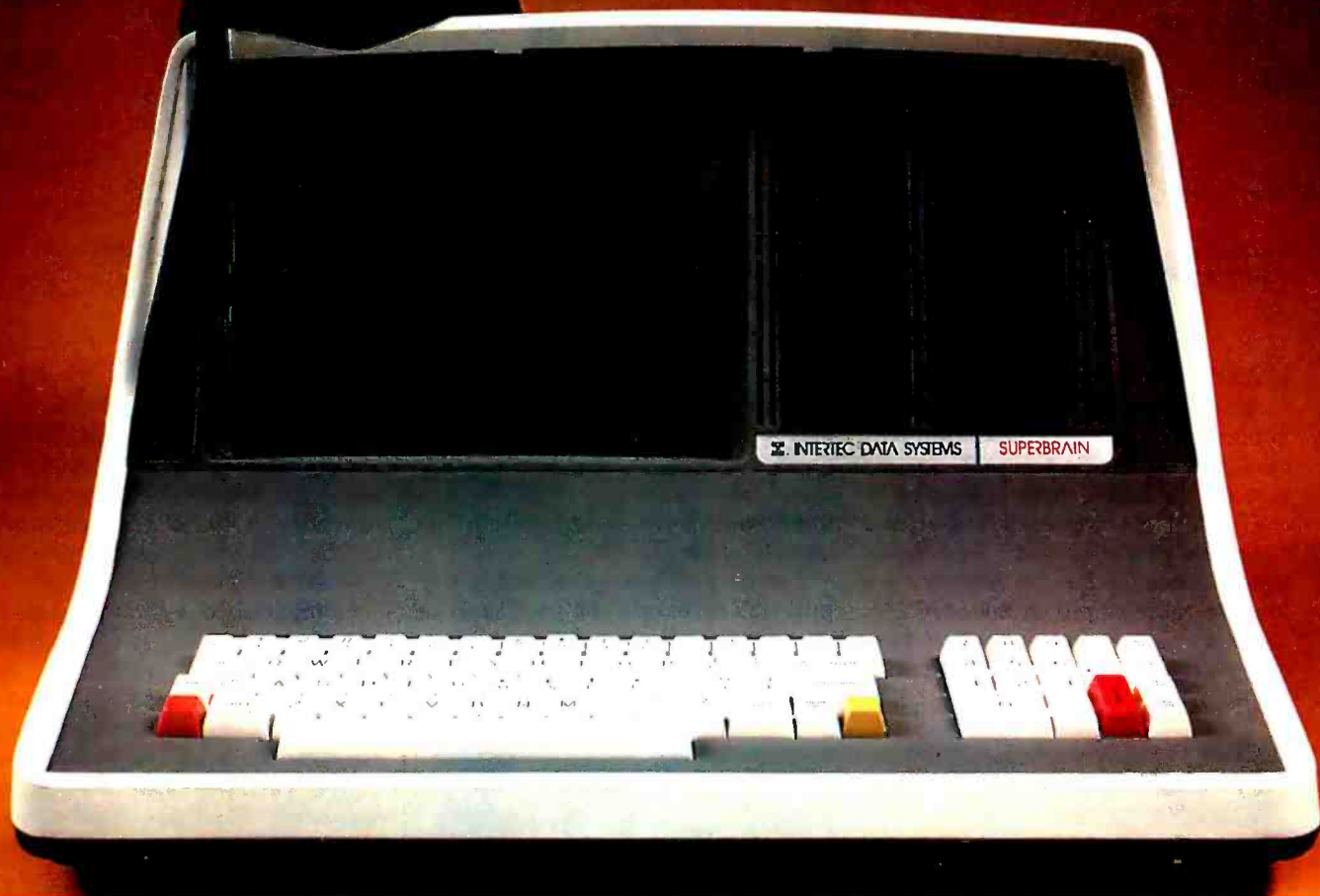

The Honor Graduate

There's been a lot of talk lately about intelligent terminals with small systems capability. And, it's always the same. The systems which make the grade in performance usually flunk the test in price. At least that was the case until the SuperBrain graduated with the highest PPR (Price/Performance Ratio) in the history of the industry.

For less than \$3,000*, SuperBrain users get exceptional performance for just a fraction of what they'd expect to pay. Standard features include: two dual-density mini-floppies with 320K bytes of disk storage, up to 64K of RAM to handle even the most sophisticated programs, a CP/M Disk Operating System with a high-powered text editor, as-

sembler and debugger. And, with SuperBrain's S-100 bus adapter, you can even add a 10 megabyte disk!

More than an intelligent terminal, the SuperBrain outperforms many other systems costing three to five times as much. Endowed with a hefty amount of available software (BASIC, FORTRAN, COBOL), the SuperBrain is ready to take on your toughest assignment. You name it! General Ledger, Accounts Receivable, Payroll, Inventory or Word Processing . . . the SuperBrain handles all of them with ease.

Your operators will praise the SuperBrain's good looks. A full ASCII keyboard with a numeric keypad and function keys. A non-glare, dynamically focused, twelve inch screen. All in an attractive desktop unit weighing less than a standard

office typewriter. Sophisticated users will acclaim SuperBrain's twin Z-80 processors which transfer data to the screen at 38 kilobaud! Interfacing a printer or modem is no problem using SuperBrain's RS-232C communications port. But best of all, you won't need a PhD in computer repair to maintain the SuperBrain. Its single board design makes servicing a snap!

So don't be fooled by all the freshman students in the small systems business. Insist on this year's honor graduate . . . the SuperBrain.

 **INTERTEC
DATA
SYSTEMS®**

2300 Broad River Road, Columbia, SC 29210
(803) 798-9100 TWX: 810-666-2115

*Quantity one. Dealer inquiries invited.

Circle 180 on inquiry card.

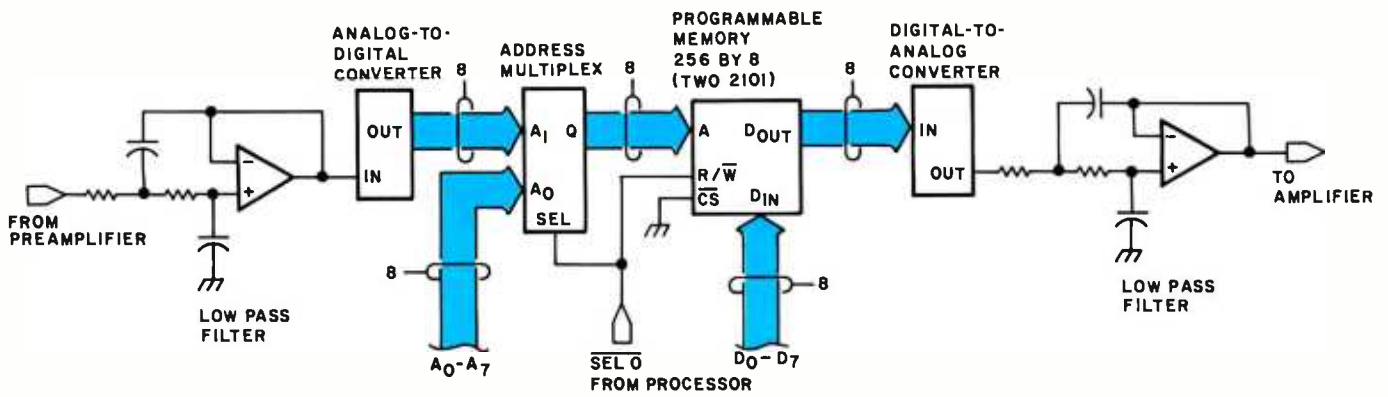

Figure 1: A simplified diagram of a hardware implementation of a linear transformation or transfer function. It requires a software routine to set up a transfer function in a look-up table stored in memory.

Linear Transformations

A simplified diagram of a hardware implementation of a linear transformation is shown in figure 1. In this system, the audio input is filtered to eliminate high-frequency noise, and converted to digital form. This digital signal is then used as the address for a look-up table stored in memory. An address multiplexer allows the processor access to the memory to set up

or change the table. The output of this table is converted to analog form and is filtered to limit it to audio frequencies. Thus, the output is an audio signal, the voltage of which forms a one-to-one correspondence with the input voltage.

The only software required to support this hardware is a routine to set up a transfer function in the look-up table. This routine is executed only

on power-up or when the transfer function is changed. Effects such as "fuzz," and harmonic distortion can be implemented in this manner, and users can define their own transfer function. A linear transfer function can be used to bypass this processing element if desired.

Compared to a software intensive approach, the only additional hardware required to implement a linear transformation is the address multiplexer. The converters and memory for a look-up table are required even with a software-oriented approach. However, the processor has much more free processing time with a hardware and software approach since data transfer takes place without processor intervention.

Time-Delay Functions

Phlanging is a time-delay function which involves delaying the input signal from 0 to 5 ms and mixing it with the current input signal to produce the output signal. The result is that of a comb filter, attenuating the frequency which has a period twice as long as the time delay and all of its odd harmonics. The time delay is varied with time over a certain range to give a sweeping effect.

Because a musician does not always want the same phlanging effect, it is necessary to give the processor control over the phlanging parameters, which include width (the difference between the longest and shortest time delay), range (the average delay), rate (the rate at which the delay changes), and depth (the amplitude of the delayed signal).

The hardware to perform the phlanging function is shown as a

NOW, FROM MOUNTAIN HARDWARE. THE 100,000 DAY CLOCK.™

Put your S-100 Computer on the clock.

A real time clock could double the utility of your computer. Time events in 100 μ S increments for up to 100,000 days (over 273 years). Program events for the same period with real time interrupts that permit pre-programmed activities to take place...without derailing on-going programs. Maintain a log of computer usage. Call up lists or appointments. Time and date printouts. Time events. An on-board battery keeps the clock running in the event of power outage.

Mountain Hardware also offers a complete line of peripheral products for many fine computers.

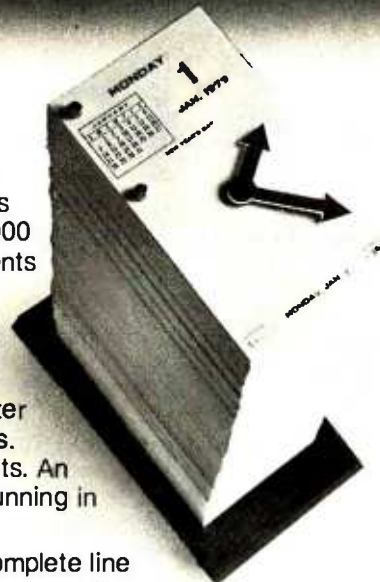

Available at your dealer's. Now.

Mountain Hardware, Inc.

300 Harvey West Blvd.
Santa Cruz, CA 95060 (408) 429-8600



A FULL NETWORK DATA MANAGEMENT SYSTEM FOR MICRO COMPUTERS



the Ultimate Software Tool:

AVAILABLE FROM

Micro Data Base Systems, inc.

MDBS IS A VERSATILE DATA BASE MANAGEMENT SYSTEM

- PROVIDES FLEXIBILITY OF A FULL NETWORK DATA BASE SYSTEM
- EFFECTIVE REPRESENTATION OF COMPLEX DATA STRUCTURES
- RECORDS CAN BE ORDERED ON VARIOUS SORT KEYS
- COMMANDS TO ADD, DELETE, UPDATE, SEARCH AND TRAVERSE THE DATA BASE
- SORTED, FIFO, LIFO, NEXT AND PRIOR SET ORDERING PROVIDED
- PROVIDES DATA PROTECTION
- STRAIGHTFORWARD USE OF ISAM-LIKE STRUCTURES
- COMPARABLE TO DATA BASE SYSTEMS PREVIOUSLY AVAILABLE ONLY ON LARGER COMPUTERS

MDBS IS CODASYL ORIENTED WITH EXTENSIONS

- EXPLICIT REPRESENTATION OF MANY-TO-MANY SETS
- RECORD TYPES MAY OWN OTHER OCCURRENCES OF THE SAME RECORD TYPE
- DIFFERENT RECORD TYPES CAN PARTICIPATE IN A SINGLE SET
- MULTIPLE LEVELS OF READ/WRITE PROTECTION
- NAMES OF DATA ITEMS, RECORDS, SETS AND FILES ARE WHOLLY USER DEFINABLE

MDBS IS FOR THE SERIOUS APPLICATIONS PROGRAMMER

- POWERFUL COMPONENT IN INFORMATION PROCESSING
- RELIEVES TEDIUM OF FILE HANDLING DETAILS
- OEMS CAN RAPIDLY AND INEXPENSIVELY DEVELOP APPLICATION SOFTWARE
- USEFUL IN DISTRIBUTED PROCESSING ENDEAVORS

SOFTWARE DELIVERED ON MINI-OR FULL-SIZED FLOPPY DISKS
USING CP/M[®], NORTH STAR, OR TRS-80[®] COMPATIBLE FORMATS

- **MDBS INTRODUCTORY OFFER \$750.00**
- **USERS MANUAL (alone) \$35.00**
- **Distributors and OEMS Contact MDBS for Special Rates**
- **Application Programming Contracts will be Considered.**

Indiana Residents Include 4% Sales Tax.



WE ACCEPT



CP/M is a registered trademark of Digital Research Corp.
TRS-80 is a registered trademark of Radio Shack/Tandy Corp.

FEATURES

- WRITTEN IN Z-80 CODE FOR MAXIMAL EXECUTION EFFICIENCY AND MINIMAL MEMORY USAGE. (8080 VERSION EXTRA).
- ROUTINES ARE CALLABLE FROM BASIC (OR OTHER HOST LANGUAGES) TO FACILITATE FAST AND EASY APPLICATION PROGRAMMING.
- ROUTINES CAN BE ORGED TO SATISFY USER REQUIREMENTS.
- SUPPORTS DATA BASES SPREAD OVER SEVERAL DISK DRIVES (MAXIMUM OF 8). DISKS MAY BE MINI- OR FULL-SIZED FLOPPIES OR HARD DISKS.
- I/O AND HOST LANGUAGE INTERFACE ROUTINES ARE ISOLATED FOR EASY ADAPTATION. PATCHES FOR MANY COMMON OPERATING SYSTEMS/HOST LANGUAGE COMBINATIONS AVAILABLE, INCLUDING CP/M[®] WITH BASIC, FORTRAN AND COBOL, NORTH STAR DOS AND BASIC, ETC.

REQUIREMENTS

- **Z-80 Based System (8080 Systems Extra, 6502 Version Forthcoming)**
- **8 to 16K Bytes (Depending on Options) in Addition to the Operating System, Host Language and Users Program.**

PACKAGE INCLUDES

MDBS-DDL DATA DEFINITION LANGUAGE ANALYZER/EDITOR. The user specifies data structures to be used in a concise Data Definition Language (DDL). The MDBS Data Definition Language Analyzer/Editor allows the user to interactively create and edit DDL specifications and to initialize the data base for use based on these specifications.

250 PAGE USERS MANUAL with extensive documentation of the MDBS System.

MDBS-DMS DATA MANAGEMENT ROUTINES. These are the routines callable from the host language (BASIC, PASCAL, etc.) which perform the data base operations of finding, adding, and deleting records; fetching and storing data items; and traversing the (possibly complex) data structure.

SAMPLE APPLICATION PROGRAMS written in North Star BASIC which illustrate various features of MDBS.

MICRO DATA BASE SYSTEMS, INC

P.O. BOX 248 LAFAYETTE, IN 47902

(317) 742-7388

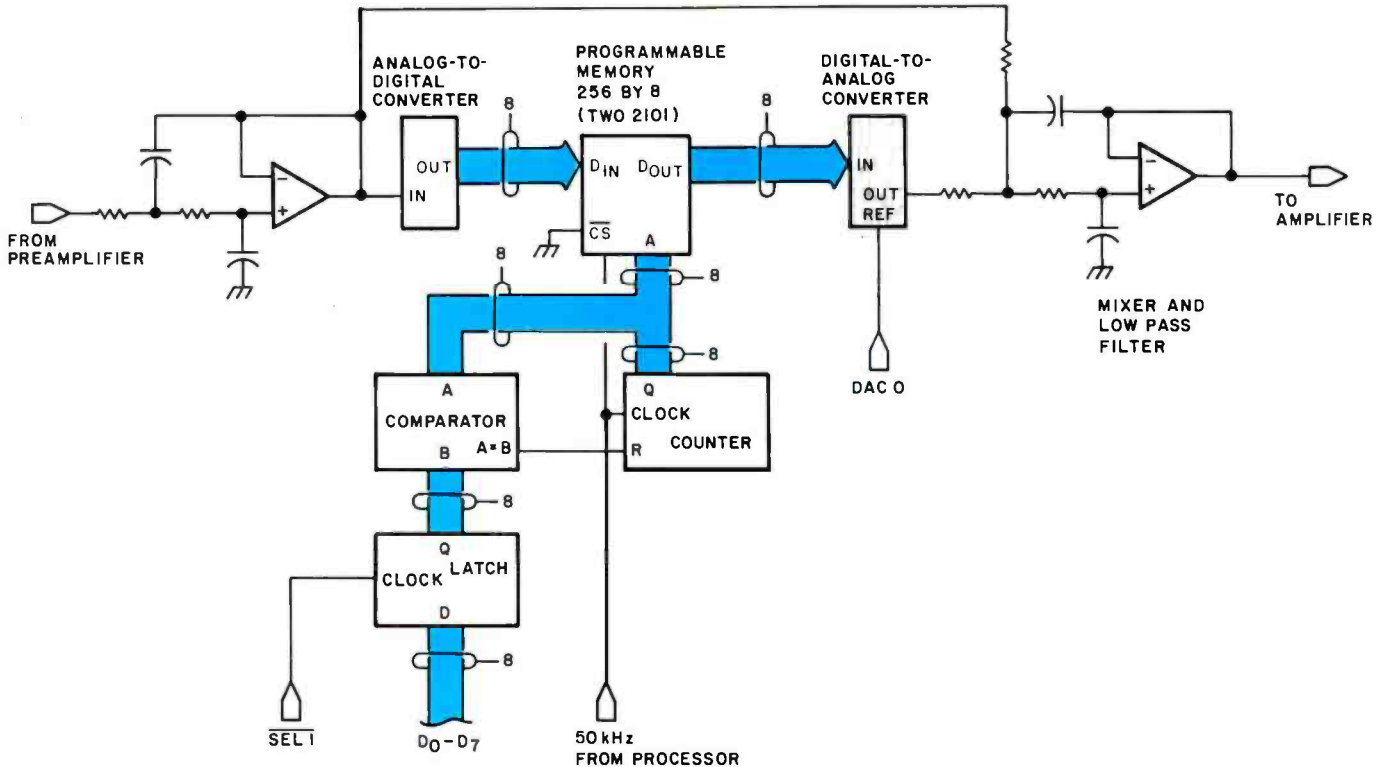

Figure 2: A diagram of hardware to perform the phlanging function. Phlanging is an audio effect originally produced by playing duplicate tape or disk recordings in almost exact synchronization. The name is derived from the practice of manipulating the phlanges of tape reels as they spin to change the degree of synchronization.

**YOU MAY ALREADY OWN
YOUR NEXT 1200 BAUD DECWRITER[®]**

**UPGRADE YOUR LA36 TO STATE-OF-THE-ART
PERFORMANCE WITH THE DS120 TERMINAL CONTROLLER**

FASTER—The DS120 prints at up to 165 cps and maintains true 1200 baud throughput. This translates into lower costs in computer time as well as time savings for you. A 1000 character internal print buffer virtually eliminates the need for fill characters.

SMARTER—Our microprocessor control intelligently optimizes carriage movement by printing bidirectionally and automatically executing high speed tabs over any blank spaces in the text.

MORE VERSATILE—We offer more standard features than any 1200 baud teleprinter currently available. A complete list of forms control and formatting features are programmable from the keyboard or via the data stream. The DS120 is equipped with both an EIA RS232-C interface and a 20 mA Current Loop interface. The unit communicates using the 128 character ASCII set at baud rates from 110 to 4800. Full-duplex, half-duplex and echo-plex modes may be selected from the keyboard. The controller supports half-duplex transmission using both coded-character turn-around and reverse channel protocol.

EASY TO INSTALL, EASY TO USE—The DS120 replaces your LA36 logic card in a matter of minutes and is fully compatible with the existing electronics. A comprehensive User's Manual provides detailed instructions for installation and operation.

RELIABLE—Our performance and reliability have been field proven in over 2500 installations.

INEXPENSIVE — BUT NOT CHEAP—Although the DS120 is just about the lowest cost way to print at 1200 baud, we don't cut corners on quality. The DS120 is built for years of service using pretested, high reliability components from leading manufacturers. Each unit undergoes a 48 hour test cycle before shipment and carries a 90 day warranty on materials and workmanship.

AVAILABLE—We can deliver ... typically within 30 days after receiving your order. Our stocking distributors are conveniently located in major cities throughout the U.S. for even better delivery.

DATASOUTH COMPUTER CORPORATION
627 F. Mifflin Lane • Charlotte, North Carolina 28210 • 704/523-8500
DECWRITER[®] is a registered trademark of Digital Equipment Corporation. Installation of the DS-120 will void any DEC warranty or service contract.

simplified diagram in figure 2. The input signal is filtered, converted to digital form, and stored in memory for a period of time controlled by the processor. After being delayed by storage in memory, the data is converted to analog form (with the gain controlled by the processor), then mixed with the current incoming signal, and filtered. The mixing of a delayed signal with a signal which has not been delayed produces the phlanging effect.







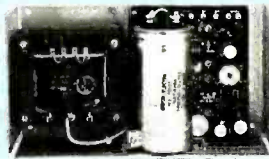

The delay in memory is accomplished by having a counter cycle through a portion of the memory, reading the delayed data and writing new data at each location. Thus, the delay is equal to the cycle length which is controlled by the processor. The processor stores the cycle length in an 8-bit latch. The contents of this latch are compared to the output of the counter; when they are equal, the counter is reset to zero. This action causes the memory to cycle from location zero to the location corresponding to the contents of the latch. Thus, the processor can add sweep to the phlanging effect, and control the width, range, and speed of the sweep by varying the contents

POWER-ONE D.C. POWER SUPPLIES

Now available for small systems applications

Power-One, the leader in quality open-frame power supplies, now offers a complete line of single, dual, and triple output models for small computer systems. Also available are special purpose models for Floppy Disk and Microcomputer applications.

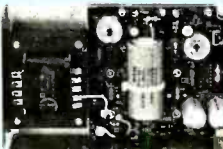
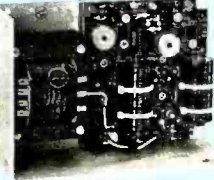
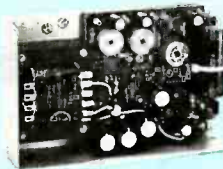
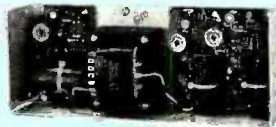
Below are just a few popular examples of the over 90 "off the shelf" models now available from stock.

<p>SINGLE OUTPUT & LOGIC POWER SUPPLIES</p> <ul style="list-style-type: none"> • 56 "off the shelf" models • 2V to 250V, 0.1A to 40A • $\pm .05\%$ regulation • 115/230 VAC input 	<p>5V @ 3A, w/OVP</p>  <p>HB5-3/OVP \$24.95 single qty.</p>	<p>5V @ 12A, w/OVP</p>  <p>HD5-12/OVP \$79.95 single qty.</p>	<p>5V @ 40A, w/OVP NEW</p>  <p>SK5-40/OVP Switching Model \$250.00 single qty.</p>
<p>FLOPPY-DISK SERIES</p> <ul style="list-style-type: none"> • 8 "off the shelf" models • Powers most popular drives • Single/dual drive applications • 2-year warranty 	<p>5V @ 0.7A, w/OVP NEW 12V @ 1.1A/1.7A PK</p>  <p>CP340 For one 5.25" Media Drive \$44.95 single qty.</p>	<p>5V @ 1A, w/OVP -5V @ 0.5A, w/OVP 24V @ 1.5A/1.7A PK</p>  <p>CP205 For one 8.0" Media Drive \$69.95 single qty.</p>	<p>5V @ 2.5A, w/OVP -5V @ 0.5A, w/OVP 24V @ 3A/3.4A PK</p>  <p>CP206 For two 8.0" Media Drives \$91.95 single qty.</p>
<p>DUAL OUTPUT MODELS</p> <ul style="list-style-type: none"> • 15 "off the shelf" models • $\pm 5V$ to $\pm 24V$, 0.25A to 6A • I.C. regulated • Full rated to $+50^{\circ}C$ 	<p>12V/15V @ 0.25A NEW</p>  <p>HAD12-.25/HAD15-.25 \$32.95 single qty.</p>	<p>5V @ 2A, w/OVP 9 - 15V @ 0.5A</p>  <p>HAA512 \$44.95 single qty.</p>	<p>$\pm 12V @ 1.7A$ or $\pm 15V @ 1.5A$</p>  <p>HBB15-1.5 \$49.95 single qty.</p>
<p>TRIPLE OUTPUT MODELS</p> <ul style="list-style-type: none"> • 10 "off the shelf" models • 5V plus $\pm 9V$ to $\pm 15V$ outputs • Models from 16W to 150W • Industry standard size 	<p>5V @ 2A, w/OVP $\pm 9V$ to $\pm 15V @ 0.4A$</p>  <p>HTAA-16W \$49.95 single qty.</p>	<p>5V @ 3A, w/OVP $\pm 12V @ 1A$ or $\pm 15V @ 0.8A$</p>  <p>HBAA-40W \$69.95 single qty.</p>	<p>5V @ 6A, w/OVP $\pm 12V @ 1.7A$ or $\pm 15V @ 1.5A$</p>  <p>HCBB-75W \$91.95 single qty.</p>



NEW 79' CATALOG!

Get Your FREE Copy Now!

Phone us direct or circle the reader service number below.

 **POWER-ONE** INC.
D.C. POWER SUPPLIES



Power One Drive • Camarillo, CA 93010 • (805) 484-2806 • TWX 910-336-1297

of the 8-bit latch. The amplitude of the output is controlled by varying the reference voltage for the digital-to-analog converter.

A flowchart of a routine which will control the phlanging effect is shown in figure 3, and the 8080 code is shown in listing 2. This routine should be supported by a control panel routine which updates the values of amplitude, width, range, and speed from external switches.

The routine initially sets the time delay equal to range plus $\frac{1}{2}$ width. This delay is then decremented at a rate proportional to speed until the delay becomes equal to the lower limit of range minus $\frac{1}{2}$ width. When this value is reached, the process is repeated with the delay being set to its initial value.

For this routine to operate efficiently, the wait period of $(1/\text{speed})$ is regulated by a real-time clock interrupt. No processing time is wasted in software timing loops using this method. Allowing a minimum wait-time of 1 ms, this software will execute during $43 \mu\text{s}$ (average) out of every 1 ms interval. Comparing this value to the impractical execution times for a software-oriented approach, it is apparent that the addition of a little hardware takes a great load off the system software.

Reverberation (or reverb), another time-delay function, has the effect of making music sound like it is being played in a large auditorium. This effect is produced by creating artificial echoes, using time delay, that simulate echoes off the walls of a concert hall. Multiple echoes, from

repeated reflections off walls, are simulated by mixing the output (delayed signal) with the input (not delayed) so that the output contains information that is delayed many times. To simulate different room acoustics, it is useful for the processor to have control over the length of the delay and the amplitude of the delayed signal.

A simplified diagram of a hardware implementation of the reverberation effect is shown in figure 4. The audio input is filtered and mixed with the delayed signal, and the output of this mixer is then converted to digital form and delayed in memory using a scheme analogous to that used in phlanging, with the processor controlling the length of the delay to simulate larger or smaller rooms. The output of the delay memory is converted back to analog form, with the amplitude controlled by the processor to determine the rate at which the echoes decay. This delayed analog signal is mixed with the input, producing the reverberation effect. The output is the current input signal mixed with echoes of an integer number of time periods with decaying amplitude.

At first the circuit described by figure 4 may appear to represent more than a little additional hardware. However, the 4 K bytes of delay memory are required even with an all software approach. Furthermore, the hardware reverberation circuit provides automatic refresh for dynamic memories, as the low-order six address bits are always cycled through

Figure 3: Flowchart of software routine to control phlanging. The code for this routine is found in listing 2. It initializes the delay time to $(\text{range} + \text{width}/2)$ and decrements the time at a rate proportional to speed until the delay time is equal to $(\text{range} - \text{width}/2)$. When this value is reached, the delay time is reinitialized and the process is repeated. The average execution time is $43 \mu\text{s}$ for each cycle.

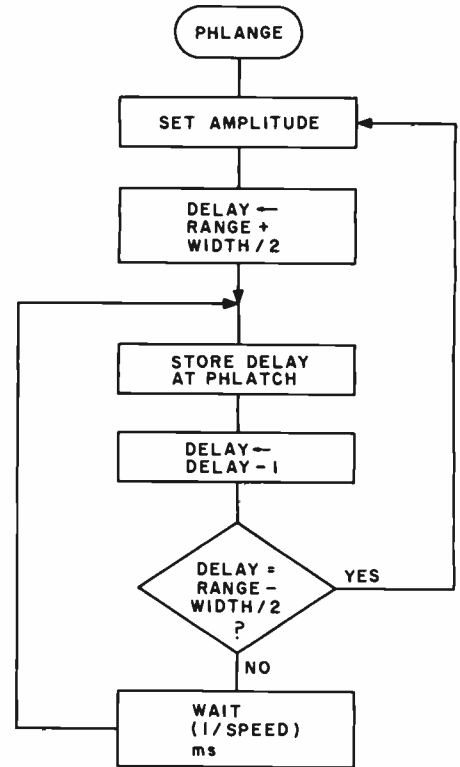

(CLOCK CYCLES)

PHLN1:	LDA	AMPL	;INITIALIZE — SET AMPLITUDE	13
	STA	DAC3	;ANALOG CHANNEL 3	13
	LDA	STDEL	;(RANGE + WIDTH/2)	13
	STA	DELAY	;DELAY ← RANGE + WIDTH/2	13
	RET		;	10
;				
PHLNG:	LDA	DELAY	;GET DELAY	13
	STA	PHLTC	;STORE AT PHLATCH	13
	DCR	A	;DECREMENT DELAY	5
	STA	DELAY	;SAVE	13
	MOV	B,A	;	5
	LDA	ENDEL	;(RANGE - WIDTH/2)	13
	CMP	B	;DELAY = RANGE - WIDTH/2?	4
	JZ	PHLN1	;YES, REINITIALIZE	10
	RET		;NO, RETURN FOR 1 MS WAIT	+10
;EXECUTION TIME 43 MICROSECONDS AVERAGE				86
				AVG

Listing 2: Assembler coding of a routine to control phlanging for the 8080 microprocessor. A flowchart of this is shown in figure 3.

Now... You, the small systems user can enjoy the advantages of HI-performance *low cost* computer graphics

HIPLØT™ Digital Plotters

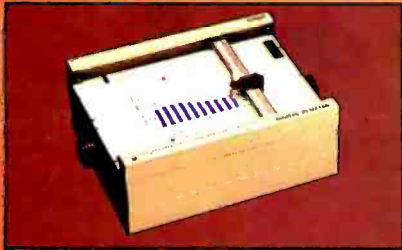

The perfect small system output device

- Displays data in easy to read graphical format
- Both serial and parallel inputs built-in.
- Used standard 8½" x 11" paper (DIN A4)
- Plotting speed up to 2.4 ips (60 mm per sec)
- Resolution of both 0.01 and 0.005 in. (0.1 mm and 0.2 mm)
- Baud rate and step size easily changed
- Completely assembled and ready to use
- Priced at \$1085*

HIPAD™ Digitizers

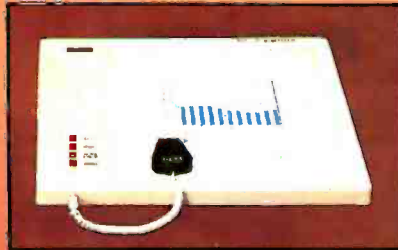

The perfect small system input device

- Resolution and repeatability of 0.005 in. (0.1 mm)
- Origin is completely relocatable
- RS232C and 8 bit parallel interface selectable at the connector
- Accuracies of ±0.015 in. (0.4 mm)
- Optional LC display shows actual values being inputted
- Digitizing surface 11" x 11" (28 mm x 28 mm)
- Priced at \$795*

For complete information contact Houston Instrument, One Houston Square, Austin, Texas 78753. (512)837-2820. For rush literature requests persons outside Texas call toll free 1-800-531-5205. In Europe contact Houston Instrument, Rochesterlaan 6, 8240 Gistel Belgium. Phone 059/27 74 45.

houston instrument | DIVISION OF BAUSCH & LÖMBE

"the graphics - recorder company"

HIPLØT - Circle Inquiry #165

HIPAD - Circle Inquiry #167

™ Trademark of Houston Instrument

*U.S. Domestic Price Only

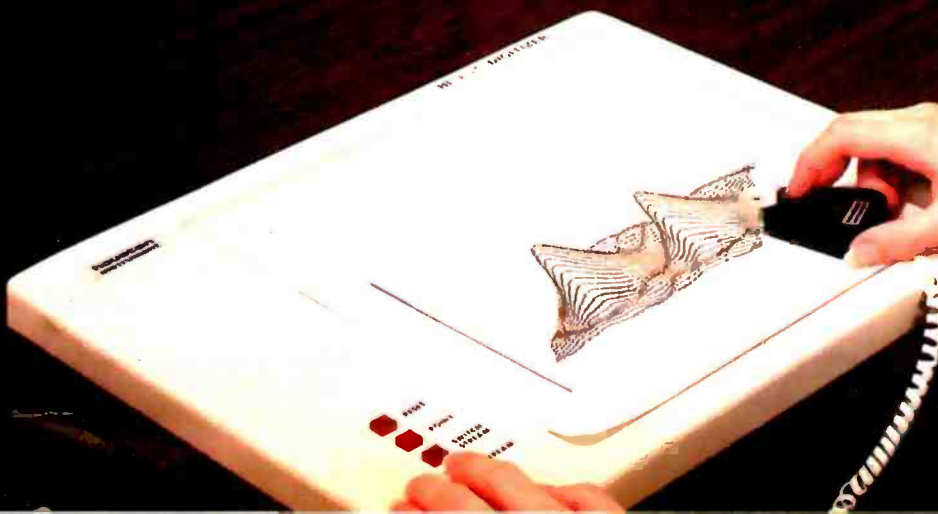
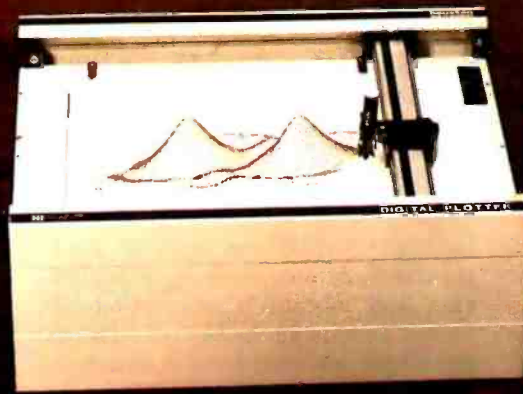
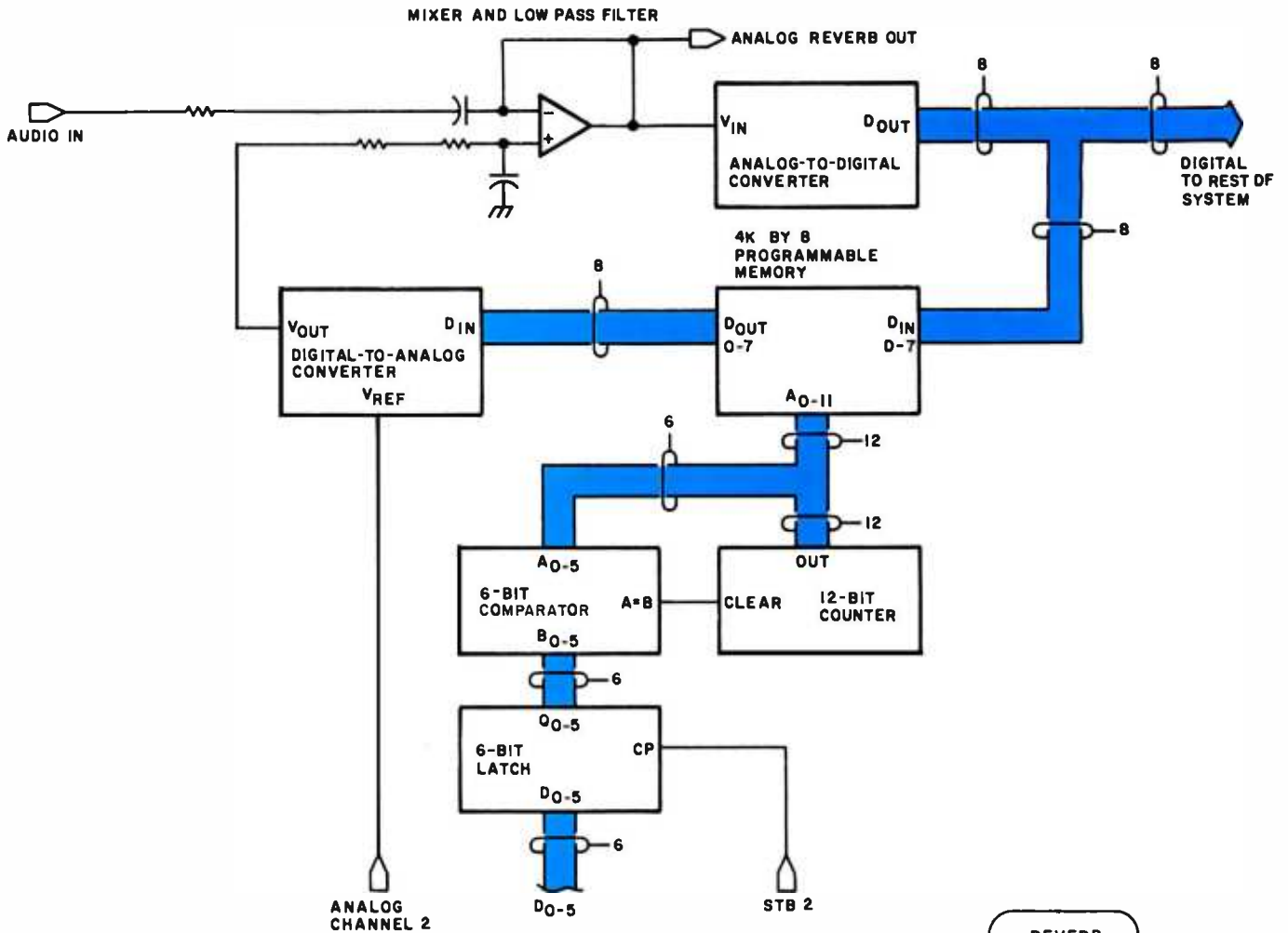

Figure 4: Simplified diagram of a hardware implementation of the reverberation effect. This circuit produces artificial echoes using a time delay.



every 1.28 ms. Thus, the circuit described by figure 4 represents a small amount of additional hardware since the dedicated 4 K memory is less expensive than adding 4 K bytes of memory to the processor unit.

The software to operate this circuit (flowchart shown in figure 5, code shown in listing 3) consists of a routine to update the length of the delay and the amplitude of the delayed signal every time the control panel routine is accessed. Again, by dedicating 4 K bytes of memory to

reverberation and adding a little additional hardware, great software savings are realized.

Gain-Control Functions

The third class of audio processing functions to be discussed is gain-control functions such as compression and vibrato. Compression involves decreasing the system's gain as the amplitude of the input signal increases, and increasing the gain as the amplitude of the input decays, to keep the output at a near constant

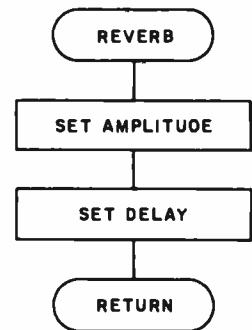

Figure 5: Flowchart of the routine to control the reverberation function. A simple procedure of setting up the desired amplitude and delay time is used. The code for this routine is found in listing 3.

```

;REVB      — ROUTINE CALLED BY CONTROL PANEL TO SET UP REVERB
REVB:     LDA    RAMP          ;SET UP AMPLITUDE
          STA    DAC2         ;ANALOG CHANNEL 2
          LDA    RDEL         ;SET UP DELAY TIME
          STA    RLTC        ;IN REVERB LATCH
          RET                ;EXIT
;EXECUTION TIME 31 MICROSECONDS
    
```

(CLOCK CYCLES)

```

13
13
13
13
+10
62
    
```

Listing 3: 8080 code of the routine to control the reverberation function. It simply sets up the desired amplitude and delay times. The flowchart is shown in figure 5.

“onComputing™ really makes personal computers easy to understand.”



Written in non-technical language, onComputing™ contains articles on the capabilities of microcomputers, getting started, latest reviews of personal computers, where to purchase and how to use your computer.

An anyone can learn the fundamentals of using a computer. **onComputing** readers receive practical advice and helpful hints on how to get the most out of a personal computer, explanations of computer terminology, and, periodically, an updated list of active computer clubs.

Benefit from the experience of other computer enthusiasts. Articles in **onComputing** are written by well known authors as well as competent amateurs. They share their ideas on how to use the computer as a tool for business, education, home entertainment, laboratory work and other applications.

Computer experts edit **onComputing** for the new user, not the computer professional. The editors combine their esoteric knowledge of computer science and equipment to produce concise, non-technical material which can be readily understood by anyone interested in using a computer—for fun or profit.

onComputing, Inc.
70 Main St., Peterborough, NH 03458

Start your subscription today.

EVERY THREE MONTHS **onComputing** will bring the latest developments in the field of personal computing: use, applications, books, selection—all in an easy-to-read style.

© onComputing, Inc. 1979

onComputing Subscription Dept. P.O. Box 307, Martinsville, NJ 08836

REGULAR subscription rate:

- U.S. 1 yr. (4 issues) @ \$8.50 Canada & Mexico, 1 yr. (4 issues) @ \$10.00
- FOREIGN (to expedite service, please remit in U.S. funds drawn on a U.S. bank.)
- Europe (and all other countries, except above), 1 yr. @ \$12.00—surface delivery.
- Start my subscription with current issue. Start with Vol. 1 No. 1
- Bill Visa Bill Master Charge Bill me (North America only)

Card Number

Expiration

Signature

Name (please print)

Street/Apartment Number

City

State/Province/Country Code

7M89

New CRT SENSATION!

You have been reading about our astounding Pascal MICROENGINE™ CPU that executes Pascal 13x faster than an LSI-11 and 3x faster than a PDP 11-34. Your orders show it! That is our Model X-90. Now meet another sensation in our X-pert Systems™ configuration. CRT Model X-920.

*Trademark Western Digital Corporation

DISPLAY/EDIT TERMINAL
Model X-920

\$968*

\$856* (Without 18 function keys)



STANDARD FEATURES (partial list)

- Microprocessor controlled
- Serial RS232C and 20 ma current loop
- 10 baud rates—75 to 19,200
- 24 lines x 80 characters
- 96 ASCII displayable characters
- Upper and lower case
- 12 x 10 character resolution
- Dual intensity display
- Clear full intensity data only
- Programmable reverse video
- Programmable underline
- 105 keys with alpha lock
- 14 key numeric pad with decimal
- 16 special function keys
- 8 edit function keys
- 2 block transmission keys
- Self test mode
- Protect mode
- Block mode
- 80 storable tabbing
- Insert/delete character and line
- Scrolling
- Addressable cursor
- A host of other features, including cursor controls and remote commands such as clear to nulls spaces, end of line, end of screen; set h.o. zero intensity; set blink etc
- Optional screen print & 2nd page memory

For our system or for yours, in commercial, technical, educational or personal applications, the Computex X-920 is unmatched in its price class. Coming soon is our Model X-8000. This high performance 16-bit CPU, using the Z-8000, addresses 8M bytes of memory directly!

All features of the Hazeltine 1400 and ADM-3A Plus: 128 ASCII characters... 7 x 10 matrix... Reverse video... Print key... Shiftlock... Transparent mode... Backspace... Tabbing... Integrated numeric pad.



\$799*

List price **\$956***

PERKIN-ELMER (Model 550)

Off the shelf delivery now on the Model X-920 and P-E Model 550. Same day shipping on all orders with certified cash payment! Specify shipping and add 40 lb cost. Any difference refunded. A \$25 connecting cable free with every CRT ordered before December 1. Customer satisfaction is guaranteed. Full refund with the return of any product within 10 days. Service contracts available. Systems catalog \$1. Pascal MICROENGINE™ owners manual \$19.95 (postpaid). *LIMITED TIME cash price. 10% down guarantees priority. IL residents add 5% sales tax. Master Charge and VISA accepted.

(312) 684-3183
COMPUTEX
The Computer Experts™
5710 Drexel Avenue
Chicago, IL 60637

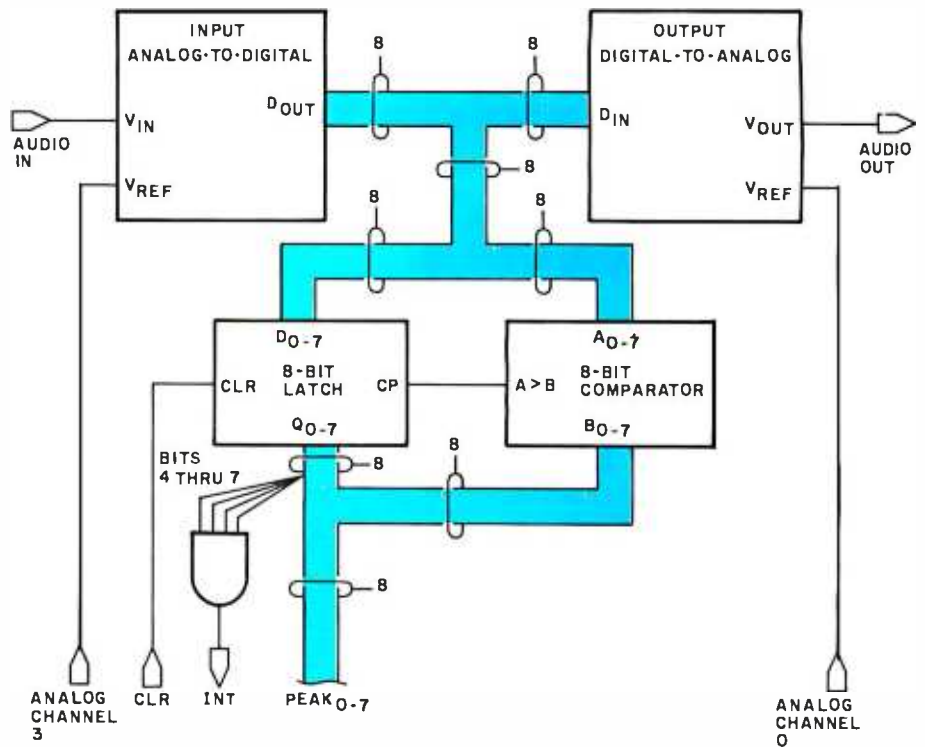

Figure 6: Simplified diagram of a gain-control function circuit. It employs a feedback system using a digital peak comparator composed of an 8-bit latch and an 8-bit comparator.

level. This effect "stretches" notes or sustains them by stopping their decay. *Vibrato* is an effect whereby the amplitude of the output is periodically varied to give a warbling sound.

The gain-control functions are implemented by means of a feedback system. The processor varies the gain of the system according to a certain rule and receives feedback on the result of its action by measuring the amplitude of the current signal. A circuit to perform these functions is shown in figure 6. The processor controls the amplitude of the signal by varying the reference voltages to the input analog-to-digital converter and output digital-to-analog converter. The processor gets feedback about the amplitude of the signal from a *digital peak detector* composed of an 8-bit latch and an 8-bit comparator.

To use the peak detector, the processor clears the latch at the beginning of a period and samples the contents of the latch at the end of the period. The comparator continuously compares the amplitude of the input signal (A) with the contents of the latch (B). When the amplitude of the incoming signal exceeds the value stored in the latch, the A>B output of the comparator goes to a *true* logic

state, strobing the amplitude of the incoming signal into the latch. Therefore the contents of the latch always reflect the greatest amplitude of the input signal from the point when the latch was last cleared, because when a signal of greater amplitude is detected by the comparator, it is clocked into the latch.

Since the attack (rising amplitude portion of waveform) of the signal may be very fast, an interrupt is provided for the processor when the amplitude exceeds hexadecimal F0. This gives the processor time to adjust gain before clipping can occur.

A flowchart and code for the compression routine are shown in figure 7 and listing 4. This compression routine attempts to keep amplitude at a constant level by subtracting the peak value of the incoming signal from a limit on this value, set by the user. The reference voltage of the input analog-to-digital converter is adjusted proportionally to the difference. Thus, if the peak amplitude is lower than the desired limit, the difference is positive, and the analog-to-digital converter reference voltage (and therefore the gain) is increased. Similarly, if the peak amplitude is greater than the limit, the gain is

TRS-80 MODEL II FORMAT NOW AVAILABLE

DIGITAL RESEARCH

- CP/M* FLOPPY DISKETTE OPERATING SYSTEM — Packages supplied on diskette complete with 8080 assembler, text editor, 8080 debugger and various utilities plus full documentation. CP/M available configured for most popular computer/disk systems including: North Star Single, Double or Quad density, Altair 8800 disks, Helios II, Exidy Sorcerer, Vector MZ, Heath H171 or H89, TRS-80, iCOM 3712 and iCOM Micro Disk plus many other configurations available off the shelf. **\$145/\$25**
CP/M version 2 (not all formats available immediately) **\$170/\$25**
- MAC — 8080 Macro Assembler. Full Intel macro definitions. Pseudo Ops include RPC, IFP, REPT, TITLE, PAGE, and MACLIB. Z-80 library included. Produces Intel absolute hex output plus symbols file for use with SID (see below) **\$100/\$15**
- SID — 8080 symbolic debugger. Full trace, pass count and break-point program listing system with back-trace and histogram utilities. When used with MAC, provides full symbolic display of memory labels and equated values **\$85/\$15**
- TEX — Text formatter to create paginated, page-numbered and justified copy from source text files, directable to disk or printer **\$85/\$15**
- DESPOOL — Program to permit simultaneous printing of data from disk while user executes another program from the console **\$60/\$5**

MICROSOFT

- BASIC-80 — Disk Extended BASIC. ANSI compatible with long variable names, WHILE/WEND, chaining, variable length file records **\$300/\$25**
- BASIC COMPILER — Language compatible with BASIC-80 and 3-10 times faster execution. Produces standard Microsoft relocatable binary output. Includes Macro-80. Also linkable to FORTRAN-80 or COBOL-80 code modules **\$350/\$25**
- FORTRAN-80 — ANSI '66 (except for COMPLEX) plus many extensions. Includes relocatable object compiler, linking loader, library with manager. Also includes MACRO-80 (see below) **\$400/\$25**
- COBOL-80 — ANSI '74 Relocatable object output. Format same as FORTRAN-80 and MACRO-80 modules. Complete ISAM, interactive ACCEPT/DISPLAY, COPY, EXTEND **\$625/\$25**
- MACRO-80 — 8080/8085 Macro Assembler. Intel and Zilog mnemonics supported. Relocatable linkable output. Loader, Library Manager and Cross Reference List utilities included **\$149/\$15**
- EDIT-80 — Very fast random access text editor for text with or without line numbers. Global and in-line commands supported. File compare utility included **\$89/\$15**

MICRO FOCUS

- STANDARD CIS COBOL — ANSI 74 COBOL standard compiler fully validated by U.S. Navy tests to ANSI level 1. Supports many features to level 2 including dynamic loading of COBOL modules and a full ISAM file facility. Also, program segmentation, interactive debug and powerful interactive extensions to support protected and unprotected CRT screen formatting from COBOL programs used with any dumb terminal **\$850/\$50**
- FORMS 2 — CRT screen editor. Automatically creates a query and update program of indexed files using CRT protected and unprotected screen formats. Output is COBOL data descriptions for copying into CIS COBOL programs. No programming experience needed. Output program directly compiled by CIS COBOL (standard). **\$200/\$20**

EIDOS SYSTEMS

- KISS — Keyed Index Sequential Search. Offers complete Multi-Keyed Index Sequential and Direct Access file management. Includes built-in utility functions for 16 or 32 bit arithmetic, string/integer conversion and string compare. Delivered as a relocatable linkable module in Microsoft format for use with FORTRAN-80 or COBOL-80, etc. **\$535/\$23**
- KBASIC — Microsoft Disk Extended BASIC with all KISS facilities, integrated by implementation of nine additional commands in language. Package includes KISSREL as described above, and a sample mail program **\$895/\$45**

MICROPRO

- SUPER-SORT I — Sort, merge, extract utility as absolute executable program or linkable module in Microsoft format. Sorts fixed or variable records with data in binary, BCD, Packed Decimal, EBCDIC, ASCII floating, fixed point, exponential, field justified, etc. Even variable number of fields per record **\$225/\$25**
- SUPER-SORT II — Above available as absolute program only **\$175/\$25**
- SUPER-SORT III — As II without SELECT/EXCLUDE **\$125/\$25**

- WORD-STAR — Menu driven visual word processing system for use with standard terminals. Text formatting performed on screen. Facilities for text pagination, page number, justify, center and underscore. User can print one document while simultaneously editing a second. Edit facilities include global search and replace, read/write to other files, block move, etc. Requires CRT terminal with addressable cursor positioning **\$445/\$25**
- WORD-MASTER Text Editor — In one mode has supersets of CP/M's ED commands including global searching and replacing, forward and backwards in file. In video mode, provides full screen editor for users with serial addressable-cursor terminal **\$125/\$25**

SOFTWARE SYSTEMS

- CBASIC-2 Disk Extended BASIC — Non-interactive BASIC with pseudo-code compiler and runtime interpreter. Supports full file control, chaining, integer and extended precision variables, etc. **\$109/\$15**

STRUCTURED SYSTEMS GROUP

- GENERAL LEDGER — Interactive and flexible system providing profit and report outputs. Customization of COA created interactively. Multiple branch accounting centers. Extensive checking performed at data entry for proof, COA correctness, etc. Journal entries may be batched prior to posting. Closing procedure automatically backs up input files. All reports can be tailored as necessary. Requires CBASIC **\$899/\$25**
- ACCOUNTS RECEIVABLE — Open item system with output for internal aged reports and customer-oriented statement and billing purposes. On-Line Enquiry permits information on Customer Service and Credit Departments. Interface to General Ledger provided if both systems used. Requires CBASIC **\$699/\$25**
- ACCOUNTS PAYABLE — Provides aged statements of accounts by vendor with check writing for selected invoices. Can be used alone or with General Ledger and/or with NAD. Requires CBASIC **\$699/\$25**
- LETTERIGHT — Program to create, edit and type letters or other documents. Has facilities to enter, display, delete and move text, with good video screen presentation. Designed to integrate with NAD for form letter mailings. Requires CBASIC **\$179/\$25**
- NAD Name and Address selection system — interactive mail list creation and maintenance program with output for full reports with reference data or restricted information for mail labels. Transfer system for extraction and transfer of selected records to create new files. Requires CBASIC **\$79/\$20**
- QSORT — Fast sort/merge program for files with fixed record length, variable field length information. Up to five ascending or descending keys. Full back-up of input files created **\$95/\$20**

GRAHAM-DORIAN SOFTWARE SYSTEMS

- PAYROLL SYSTEM — Maintains employee master file. Computes payroll withholding for FICA, Federal and State taxes. Prints payroll register, checks, quarterly reports and W-2 forms. Can generate ad hoc reports and employee form letters with mail labels. Requires CBASIC. Supplied in source code **\$590/\$35**
- APARTMENT MANAGEMENT SYSTEM — Financial management system for receipts and security deposits of apartment projects. Captures data on vacancies, revenues, etc. for annual trend analysis. Daily report shows late rents, vacancy notices, vacancies, income lost through vacancies, etc. Requires CBASIC. Supplied in source code **\$590/\$35**
- INVENTORY SYSTEM — Captures stock levels, costs, sources, sales, ages, turnover, markup, etc. Transaction information may be entered for reporting by salesman, type of sale, date of sale, etc. Reports available both for accounting and decision making. Requires CBASIC. Supplied in source code **\$590/\$35**
- CASH REGISTER — Maintains files on daily sales. Files data by sales person and item. Tracks sales, overruns, refunds, payouts and total net deposits. Requires CBASIC. Supplied in source code **\$590/\$35**
- tiny C — Interactive interpreter system for teaching structured programming technique. Manual includes full source listings **\$75/\$40**
- BDS C COMPILER — Supports most major features of language, including Structures, Array, Pointer, recursive function evaluation, linkable with library to 8080 binary output. Lacks data initialization, long & float type and static & register class specifiers. Documentation includes "C" Programming Language book by Kernighan & Ritchie **\$110/\$15**
- WHITESMITHS' C COMPILER — The ultimate in systems software tools. Produces faster code than Pascal with more extensive facilities. Conforms to the full UNIX Version 7 C language, described by Kernighan and Ritchie, and makes available over 75 functions for performing I/O, string manipulation and storage allocation. Compiler output in A-Natural format. Supplied with A-Natural (see below) requires 60K CP/M **\$630/\$30**
- A-NATURAL — Narrative assembler with linking loader, library and extensive library in A-Natural relocatable format and translators from A-Natural source to Microsoft MACRO-80 source and from A-Natural rel to source **\$330/\$15**

- POLYVUE/80 — Full screen editor for any CRT with XY cursor positioning. Inserts vertical and horizontal scrolling, interactive search and replace, automatic text wrap around for editing, optional macros for manipulating blocks **\$135/\$15**
- POLYTEXT/80 — Text formatter for word processing applications. Justifies and updates source text files. Will generate form fields and program fields and conditional processing. Supports LaserJet field printers includes variable pitch justification and motion optimization. **\$85/\$15**
- ALGOL-60 — Powerful block-structured language compiler featuring economical run time dynamic allocation of memory. Very compact (24K total RAM) system implementing almost all Algol 60 report features plus many powerful extensions including string handling direct disk address I/O etc. Requires Z80 CPU **\$199/\$20**
- Z80 DEVELOPMENT PACKAGE — Consists of: (1) disk file line editor, with global inter- and intra-line facilities; (2) Z80 relocating assembler, Zilog/Mostek mnemonics, conditional assembly and cross reference table capabilities; (3) linking loader producing absolute Intel hex disk file **\$95/\$20**
- ZDT — Z80 Debugger to trace, break and examine registers with standard Zilog/Mostek mnemonic disassembly displays. \$35 when ordered with Z80 Development Package **\$50/\$10**
- DISTEL — Disk based disassembler to Intel 8080 or TDL/Xitan Z80 source code, listing and cross reference files. Intel or TDL/Xitan pseudo ops optional. Runs on 8080 **\$65/\$10**
- DISILOG — As DISTEL to Zilog Mostek mnemonic files. Runs on Z80 only **\$65/\$10**
- TEXTWRITER III — Text formatter to justify and paginate letters and other documents. Special features include insertion of text during execution from other disk files or console, permitting recipe documents to be created from linked list segments. Has facilities for sorted index, table of contents and footnote insertions. Ideal for contracts, manuals, etc. **\$125/\$20**
- POSTMASTER — A comprehensive package for mail list maintenance. Features include keyed record extraction and label production. A form letter program is included which provides neat letters on single sheet or continuous forms. Requires CBASIC **\$150/\$25**
- WHATSI? — Interactive data-base system using associative tags to retrieve information by subject. Hashing and random access used for fast response. Requires CBASIC **\$12/\$25**
- XYBASIC Interactive Process Control BASIC — Full disk BASIC features plus unique commands to handle bytes, rotate and shift, and to test and set bits. Available in Integer, Extended and ROMable versions. Integer Disk or Integer ROMable **\$295/\$25**
Extended Disk or Extended ROMable **\$395/\$25**
- SMAL/80 Structured Macro Assembled Language — Package of powerful general purpose text macro processor and SMAL structured language compiler. SMAL is an assembler language with IF, THEN, ELSE, LOOP, REPEAT-WHILE, DO, END, BEGIN-END constructs **\$75/\$15**
- SELECTOR III-C2 — Data Base Processor to create and maintain multi key data bases. Prints formatted, sorted reports with numerical summaries or mailing labels. Comes with sample applications including Sales Activity, Inventory, Payables, Receivables, Check Register, and Client/Patient Appointments, etc. Requires CBASIC Version 2. Supplied in source code **\$345/\$20**
- CPM/374X — Has full range of functions to create or re-name an IBM 3741 volume, display directory information and edit the data set contents. Provides full file transfer facilities between 3741 volume data sets and CP/M files **\$195/\$10**
- BASIC UTILITY DISK — Consists of (1) CRUNCH-14 — Compacting utility to reduce file size and increase the speed of programs in Microsoft Basic and TRS-80 Basic. (2) DPFLUN — Double precision subroutines for computing nineteen transcendental functions including square root, natural log, log base 10, sin, arc sin, hyperbolic sin, hyperbolic arc sin, etc. Furnished in source on diskette and documentation **\$50/\$35**
- THE STRING BIT — Fortran character string handling. Routines to find, fill, pack, move, separate, concatenate and compare character strings. This package completely eliminates the problems associated with character string handling in FORTRAN. Supplied with source **\$45/\$15**
- BSTAM — Utility to link one computer to another also equipped with BSTAM. Allows file transfers at full data speed (no conversion) with CRC block automatic check for very large files. Full wildcard expansions to send ASCII baud with wire, 200 baud with phone connection. Both ends need one. Standard and M versions can talk to one another **\$150/\$5**
- Flippy Disk Kit — Template and instructions to modify single sided 5 1/4" diskettes for use of second side in single sided drives **\$12/\$50**

*CP/M is a trademark of Digital Research
*Z80 is a trademark of Zilog, Inc.
**UNIX is a trademark of Bell Laboratories
***WHATSI? is a trademark of Computer Headware

†CP/M for Heath, TRS-80 Model I and PolyMorphic 8813 are modified and must use specially compiled versions of system and applications software.
‡Modified version available for use with CP/M as implemented on Heath and TRS-80 Model I computers

§User license agreement for this product must be signed and returned to Lifeboat Associates before shipment may be made

All Micropro prices are discounted!

Structured systems prices are discounted!

Shopping list No.7

Software for most popular 8080/8085 computer disk systems including **NORTH STAR, iCOM, MICROPOLIS, DYNABYTE DB8/2, EXIDY SORCERER, SD SYSTEMS, ALTAIR, VECTOR MZ, MECCA, 8" IBM, HEATH H17 & H89, HELIOS, IMSAI VDP42 & 44, REX, INTERTEC, VISTA V80 and Y200, TRS-80 MODEL I and MODEL II, OHIO SCIENTIFIC and IMS 5000** formats.

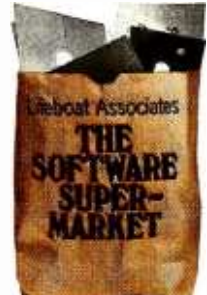

Orders must specify disk systems and formats, e.g. North Star single, double or quad density, IBM single or 20/256, Altair 8800, etc. Micropolis Mod I or II, 5 1/4" soft sector (Micro iCOM SD Systems Dynabyte), etc.
Prices F.O.B. New York. Shipping, handling and C.O.D. charges extra.
Manual cost applicable against price of subsequent software purchase.
The sale of each proprietary software package conveys a license for use on one system only.

Lifeboat Associates, 2248 Broadway, N.Y., N.Y. 10024 (212) 580-0082 Telex: 668585

```

COMPR — PERFORMS COMPRESSION                                (CLOCK CYCLES)
COMPR: LDA LIMIT ;GET LIMIT                                13
      MOV B,A ;SAVE                                        5
      LDA PKDET ;GET PEAK *                                13
      STA CLRDET ;RESET DETECTOR                          13
      SUB B ;PEAK — LIMIT                                  4
      MOV B,A ;                                           5
      LDA DAC3IM ;GET CURRENT VALUE OF DAC3                13
      SUB B ;DAC3 + LIMIT — PEAK                          4
      STA DAC3IM ;UPDATE DAC3 AND IMAGE                    13
      STA DAC3 ;                                           13
      RET ;EXIT                                           +10
                                                    = 106
;EXECUTION TIME 53 MICROSECONDS

```

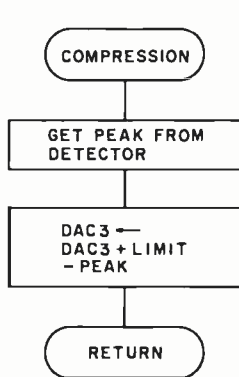

Figure 7: Flowchart of a routine to perform compression of an audio signal. It adjusts the reference voltage of the input analog-to-digital converter to keep the output signal at a constant level. The assembler code for the 8080 processor is shown in listing 4.

Listing 4: 8080 assembler code of the routine to perform compression of an audio signal by adjusting the reference voltage of the input analog-to-digital converter (ADC) to keep the output signal at a constant level. The flowchart is given in figure 7.

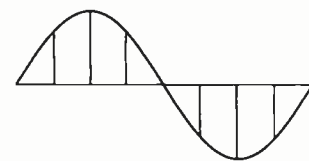
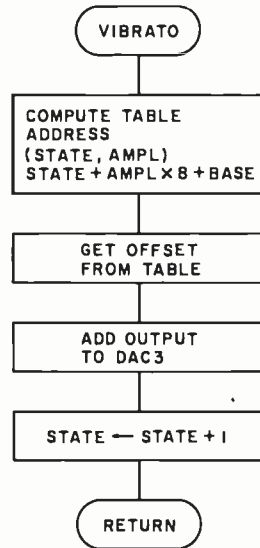

Figure 8a: Flowchart of the vibrato routine. It varies the amplitude of the audio signal in an approximately sinusoidal manner by dividing a sine wave into eight discrete parts. Each time the routine executes, it fetches an offset value from a table for the present state and amplitude. This offset value is added to the reference voltage of the input digital-to-analog converter to produce the vibrato effect. The code is given in listing 5.

decreased. This action keeps the signal at a near constant level. Reaching the maximum possible gain of the analog-to-digital converter limits this action, thereby preventing noise from being amplified to audible levels in the absence of a signal.

Vibrato is obtained by using the algorithm shown in the flowchart of figure 8a. The 8080 code is shown in listing 5. This vibrato routine varies the amplitude of the audio signal approximately sinusoidally, with a period equal to eight times the interval between executions of this routine. To simulate a sine wave, the algorithm breaks one cycle into eight parts (0 thru 7, see figure 8b). Each time the routine executes, it fetches the offset value for that part of the curve from a look-up table. Different offset values are used for different levels of vibrato. The value obtained from the look-up table is then added to the reference voltage of the input digital-to-analog converter. The frequency of the vibrato is controlled by how often the routine executes.

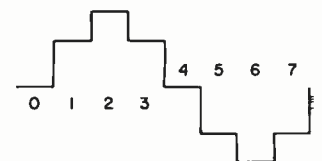

Figure 8b: Division of the sine wave into eight parts and the resulting voltage levels for each state.

```

VIBR: LXI H,AMPL ;COMPUTE TABLE ADDRESS
      MOV M,A ;GET AMPLITUDE
      RAL ;MULTIPLY BY 8
      RAL
      RAL
      INX H ;ADD TO STATE
      ADD M ;
      INR M ;INCREMENT STATE
      LXI H,BASE ;GET BASE ADDRESS
      ADD L ;ADD TO STATE + AMPL*8
      MOV L,A
      LDA DAC3IM ;GET CURRENT VALUE OF VREF
      ADD M ;ADD TO TABLE OFFSET
      STA DAC3 ;OUTPUT TO DAC
      RET ;EXIT

```

Listing 5: Routine to add vibrato coded for the 8080 processor. It uses table look-up of an 8-segment approximation of a sine curve to vary the input digital-to-analog converter (DAC) reference voltage. Figure 8a shows the flowchart.

**A computer
is only as
good as its
software.**

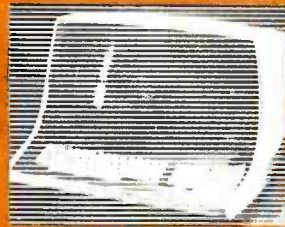

MICROSOFT

We set the standard.

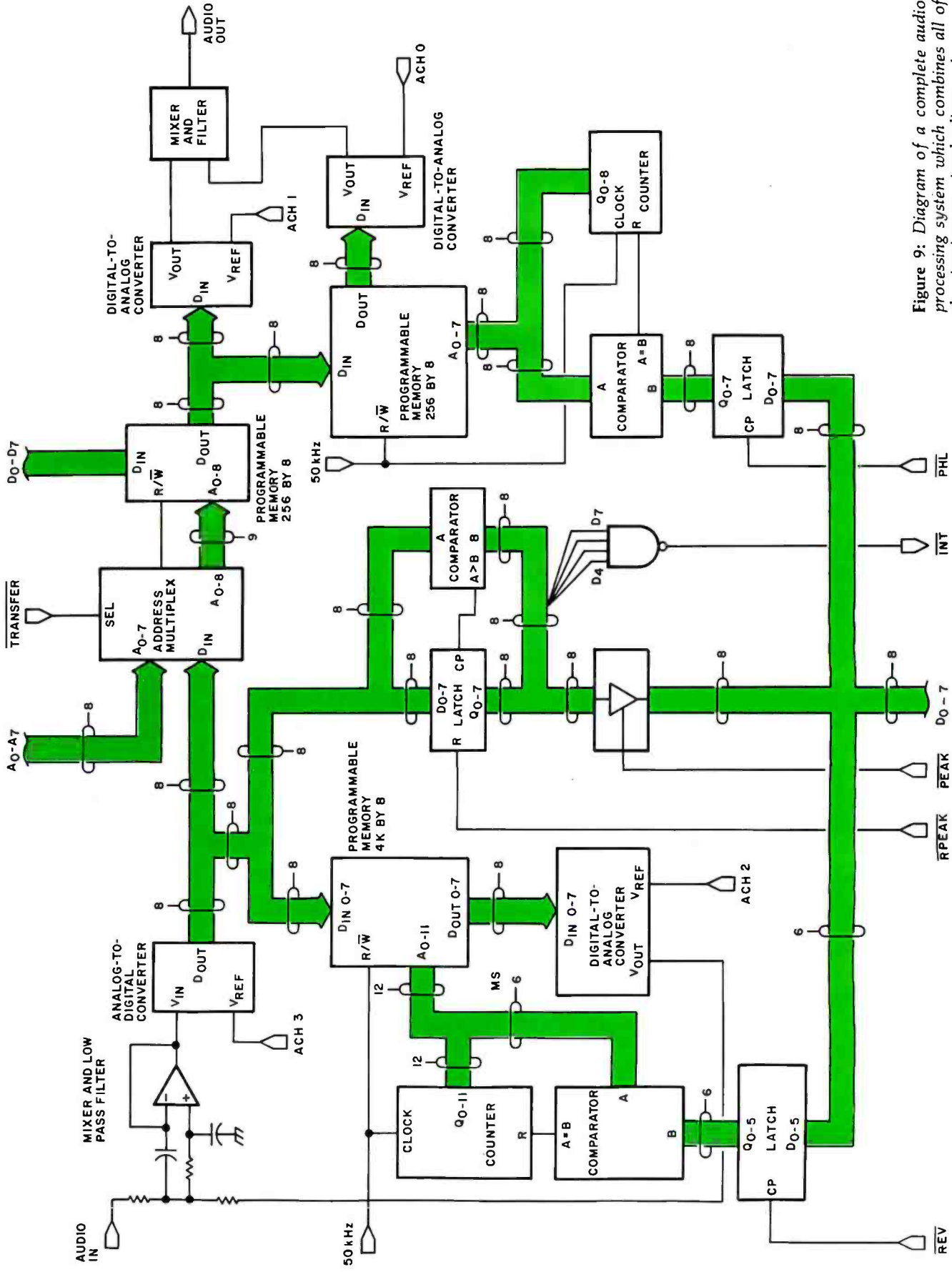

Figure 9: Diagram of a complete audio processing system which combines all of the circuitry previously discussed.

For a more precise sine wave, more states should be used to represent the curve. If the number of states is reduced, higher vibrato frequencies are possible. With eight states, the maximum vibrato frequency (with the routine executing once every ms) is 125 Hz. This is adequate for most applications. For even higher frequencies with less distortion, a voltage controlled oscillator may be added to the circuit.

The gain-control circuitry can also be used to minimize quantization noise by keeping the digital signals at near maximum levels and restoring their dynamics (amplitude variations) at the output digital-to-analog converter. However, care must be taken with this approach to restore the dynamics of delayed signals at levels that reflect the amplitude at the time that they were delayed.

Complete System

Combining the transfer, time-delay and gain-control functions into a single system saves money on hardware since all functions share the same analog-to-digital converter and processor, two of the most expensive components. Figure 9 shows a simplified diagram of the complete system which combines the circuitry described in all previous figures.

The system software is structured so that each function's routine should execute periodically, but each routine may execute with a different period. To control the calling of these function routines, the top level of the system software (shown in the flowchart of figure 10 and with code given in listing 6) is interrupt driven (by the frequency divider of figure 11), executing once every ms. This routine decrements software timers corresponding to each routine. When one of these timers reaches zero, the corresponding routine is called. On system power-up, all timers are initialized, and after executing a particular routine the timer corresponding to that routine is reinitialized.

Listing 6: The code for the interrupt service routine. The real-time clock causes this routine to be entered at intervals of 1 ms. It activates functions according to the proper schedule. Its flowchart is shown in figure 10.

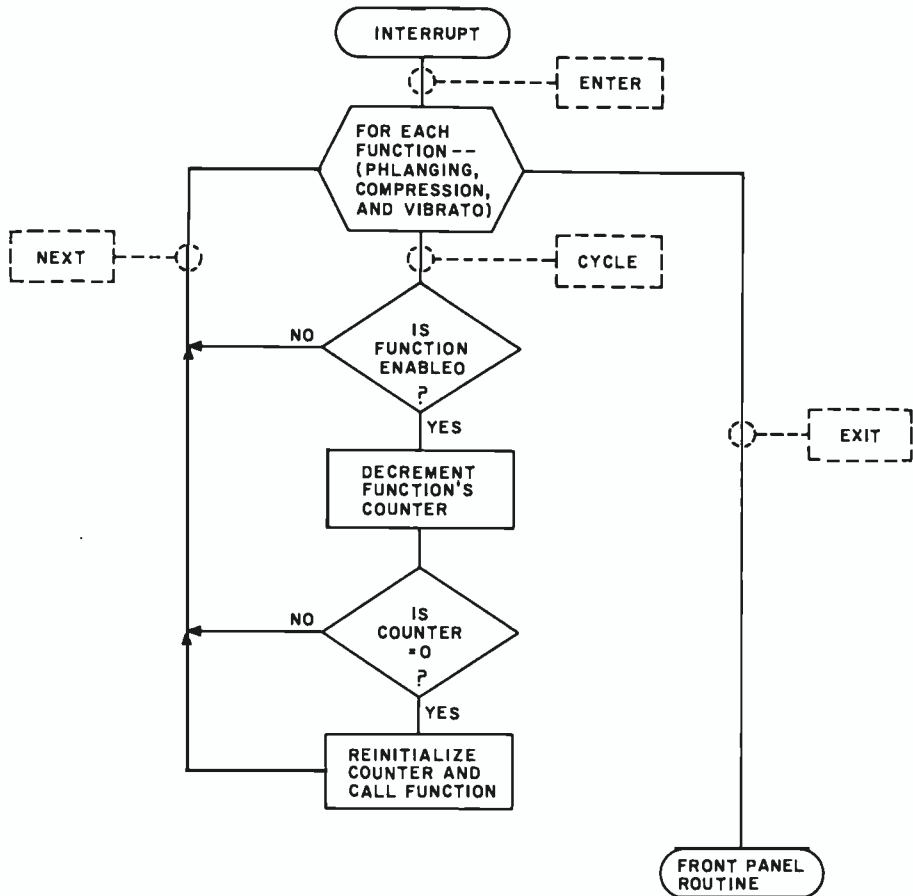

Figure 10: Flowchart of the interrupt service routine. At intervals of 1 ms, an interrupt occurs from the real-time clock, and this interrupt service routine is executed. It calls the appropriate function routines at the proper times by decrementing software counters corresponding to each routine. When one of these counters reaches zero, its software routine is called and the time is reinitialized. If the function is not selected, the counter will not be decremented. The control panel service routine executes during any free time.

```

INT:      LXI    D,ZPHLNG
          LXI    H,PLCNT      ;GET ADDRESS OF PHLANGE COUNTER
          MVI    B,3         ;3 FUNCTIONS PHLANGING,
                               ;COMPRESSION AND VIBRATO
          ;
          ;
          INTLP:  MOV    A,M      ;FOR EACH FUNCTION
                  CPI    FFH      ;IS FUNCTION ENABLED
                  JZ     INT1     ;?
                               ;NO — NEXT FUNCTION
                  DCR    M        ;YES — DECREMENT COUNTER
                  PUSH   D        ;SAVE REGISTERS
                  PUSH   H
                  CZ     ZJMP     ;CALL ROUTINE IF ZERO
                  POP    H        RESTORE REGISTERS
                  POP    D
                  INX    H        ;POINT AT NEXT FUNCTION'S
                               ;COUNTER
                  INX    D        ;POINT AT NEXT
                  INX    D        ;ENTRY IN JUMP
                  INX    D        ;TABLE
                  DCR    B        ;DECREMENT INDEX
                  JNZ    INTLP    ;ITERATE IF NOT DONE
                  RET             ;EXIT IF DONE

          ;
          ZJMP:  XCHG           ;GET ADDRESS OF ROUTINE
                  PCHL           ;JUMP THROUGH TABLE
          ;
          ZPHLNG: JMP    PHLNG
          ZCOMPR: JMP    COMPR
          ZVIBR:  JMP    VIBR
  
```

One of the best values computers is now



\$1995 SPECIAL SYSTEM PRICE

includes H8 Computer with 16K memory, four-port serial I/O and operating software, plus H17 Floppy Disk System (shown here with optional second drive) and H19 CRT Terminal — all in kit form.

Heathkit H8 Computer

- 8080A CPU has more software written for it than any other CPU
- 7 plug-in board positions for flexibility in configuring your system
- Up to 65K memory capacity
- Front panel keyboard for direct access to registers and memory

\$289 kit purchased separately. Was \$379. You save \$90.
\$349.00 assembled

Heathkit H17 Floppy Disk System

- Instant access to programs and data
- 102K bytes storage area
- 250 mS typical random access time

- Includes interface controller board
\$495.00 kit purchased separately
\$550.00 assembled

Heathkit H19 Smart Video Terminal

- Z80 microprocessor-controlled
 - 25 x 80, upper and lower case
 - Direct cursor addressing
 - 8 user-programmable keys
- \$675.00 kit purchased separately
\$995 assembled

5% discount on software, memory and interfacing

Special 5% discount applies to all software, memory and interface

boards when purchased with the H8 system.

Seven plug-in board positions on the H8 let you configure any combination of memory and I/O's that suits you. Heathkit memory boards come in 16K, 8K and 4K increments. Interface boards are available for parallel, serial and cassette I/O's.

Wide selection of software:

Software for the H8 Computer includes operating systems software, MICROSOFT™ BASIC, FORTRAN, wordprocessing, plus innovative applications software for business and pleasure.

HUG has over 400 programs

An extensive library of programs is available to owners of Heathkit Com-

in high-performance \$90 better.

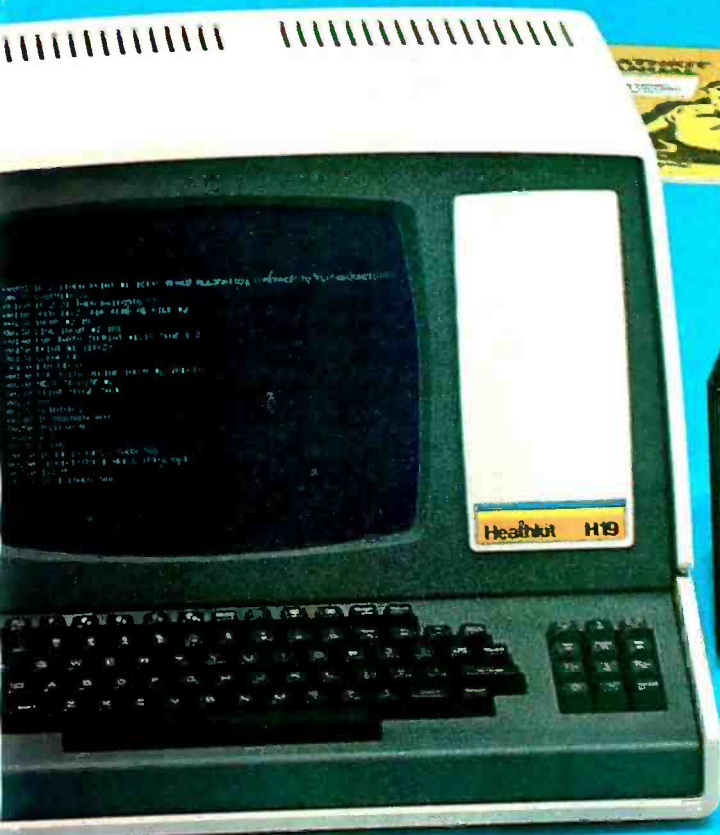

Circle 163 on Inquiry card.

puters through the Heath User's Group (HUG). The experience of this computerite group can help you get the most from your computer.

Plus Heathkit service

You get the most thorough documentation ever written when you buy your Heathkit Computer. So it's easy to get your system assembled and operating quickly.

And you get one of the most reliable service organizations after you buy. More than 55 service locations throughout the U.S., plus a factory service phone give you fast access to experts when you need them.

It's all at your Heathkit Electronic Center

Computers, peripherals, software and accessories — in kit or assembled form — you'll find them all at your Heathkit Electronic Center. You'll even find educational support like

the special self-instruction programs that teach you BASIC and Assembly languages programming.

Check the white pages in the city nearest you for the location of your Heathkit Electronic Center*:

Alexandria, VA
Anaheim, CA
Atlanta, GA
Baltimore, MD
Boston, MA
Buffalo, NY
Chicago, IL
Cincinnati, OH
Cleveland, OH
Columbus, OH
Dallas, TX
Denver, CO
Detroit, MI
El Cerrito, CA
Fair Lawn, NJ
Frazer, PA
Hartford, CT
Houston, TX
Indianapolis, IN
Jericho, NY
Kansas City, KS
Los Angeles, CA
Louisville, KY
Miami, FL
Milwaukee, WI
Minneapolis, MN

New Orleans, LA
Norfolk, VA
Ocean, NJ
Oklahoma City, OK
Omaha, NB
Philadelphia, PA
Phoenix, AZ
Pittsburgh, PA
Pomona, CA
Providence, RI
Redwood, CA
Rochester, NY
Rockville, MD
Sacramento, CA
Salt Lake City, UT
San Antonio, TX
San Diego, CA
San Jose, CA
Seattle, WA
St. Louis, MO
St. Paul, MN
Tampa, FL
Toledo, OH
White Plains, NY
Woodland Hills, CA

*Units of Schlumberger Products Corporation. Prices stated here are mail order and may be slightly higher at retail locations. CP-169

FREE CATALOG

Write for a **FREE** Heathkit Catalog containing the complete line of Heathkit Computers, plus nearly 400 other electronic kits for your home, work or pleasure.

Heath Company, Dept. 334-600
Benton Harbor, Mich. 49022



Heathkit

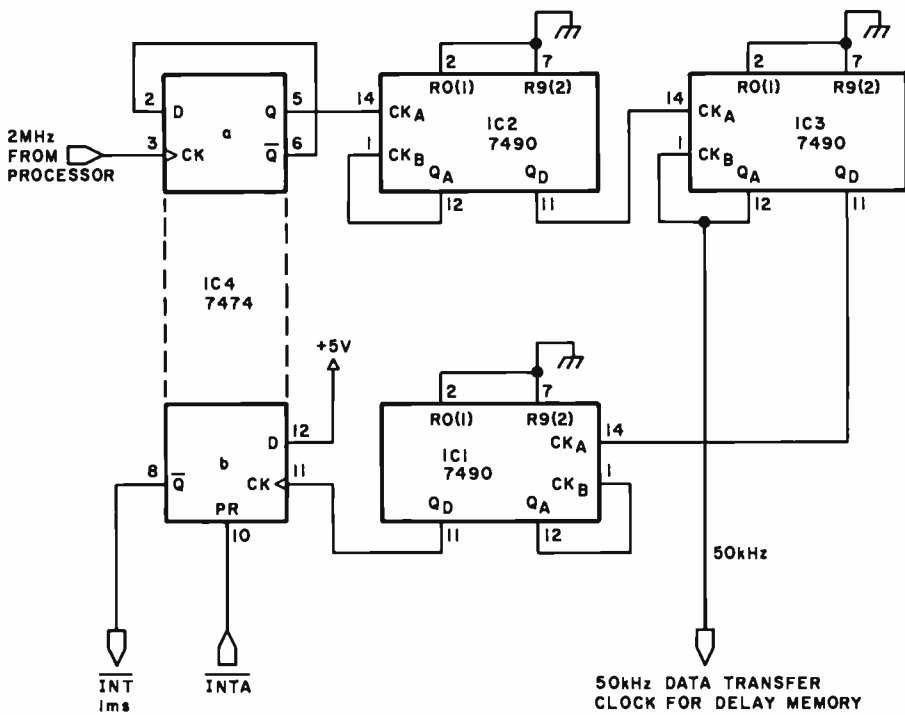

Routines that execute once per ms are called on every interrupt and do not have timers. Any time left over at the end of the millisecond is used to service the control panel.

External User Control

The control panel used with the system (the device with which the user communicates with the system, selects functions, and specifies function parameters) can take many forms. A control panel can be as simple as a few toggle switches or as elaborate as a graphics terminal. The schematic diagram for a very simple control panel interface is shown in figure 12. Two pairs of seven-segment light emitting diode (LED) displays show the user which parameter is being observed and the value of that parameter. The value of the parameter can be adjusted by pressing increment or decrement switches. A parameter select switch changes the parameter displayed. The software to operate this panel is shown as a flowchart in figure 13, and the 8080 code is given in listing 7.

Figure 11: Frequency divider for the 50 kHz data-transfer clock and the 1 ms real-time clock interrupt. The first stage divides the 2 MHz processor clock signal by forty, to obtain 50 kHz. This is further divided by fifty and sent to a flip-flop to interrupt the processor every 1 ms.



**computer mart
of new jersey**

**the
microcomputer
people®**

**THE VITAL
INGREDIENT:
EXPERTISE**

Before you buy your new microcomputer, chances are you have a lot of questions. Important questions that could mean the difference between a working system and a wasted system. The vital ingredient is expertise. The microcomputer people at Computer Mart are expert at answering your questions and helping you put together the best system for your application. Whether it's for business, the home, or the laboratory, come see the experts at Computer Mart of New Jersey. We have the vital ingredient.

Computer Mart of New Jersey
501 Route 27
Iselin, N.J. 08830
(201) 283-0600

HOURS:
Open at 10 am.
Tuesday through Saturday



**FREE - NEW
APPLE GRAPHICS
SOFTWARE-Reg. \$40⁰⁰**

with the purchase of
"The Paper Tiger"
IDS-440G Printer
W/Graphics / 2-K Buffer
at \$1194⁰⁰

**• A FULL LINE
OF APPLE
• CROMEMCO**

CHECK OUR PRICES
Small Business & Personal Computer Systems



apple computer
Authorized Dealer



**FARNSWORTH
COMPUTER CENTER**
1891 N. FARNSWORTH AVE.
AURORA, IL. 60505
(312) 851-3888
Weekdays 12 to 8; Sat. 10 to 5

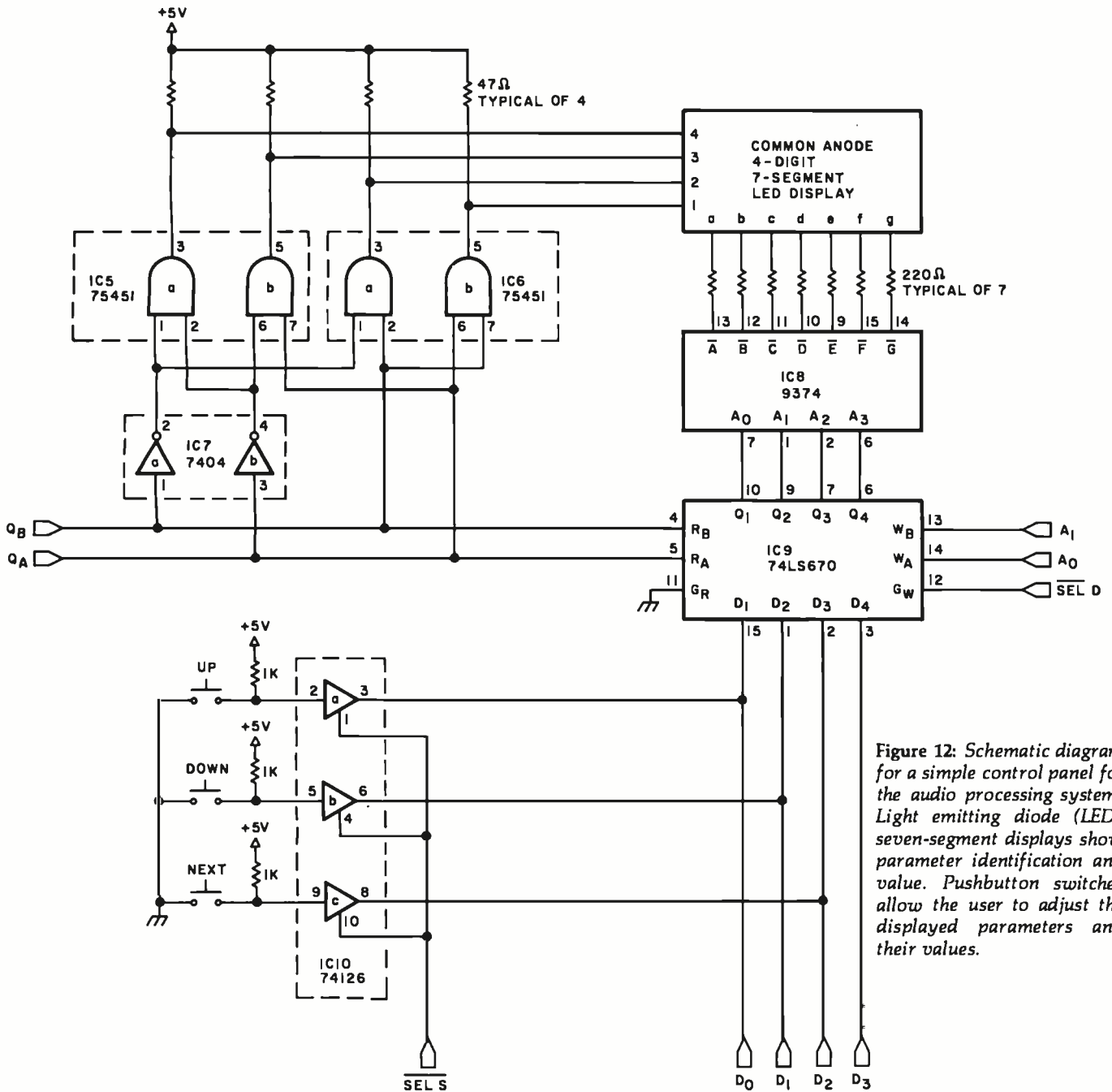

Figure 12: Schematic diagram for a simple control panel for the audio processing system. Light emitting diode (LED) seven-segment displays show parameter identification and value. Pushbutton switches allow the user to adjust the displayed parameters and their values.

This routine looks for transitions of the switches, and updates the display and parameters accordingly.

Conclusion

The interested user is by no means limited to the functions that I have described here. Tonal control, phase-shifting, and even synthesized chords are possible using digital techniques. Using a microcomputer, the possibilities are endless. The microcomputer can even generate the music it processes. There are certainly many unexplored instances where microcomputers can be applied to audio processing.

I have attempted to describe not only the design of one microcomputer audio processing system, but also the methodology used in designing any real-time microcomputer system. Before rushing into the design of a system, a top-down approach to the problem should be used, the system should be defined, a worst case timing analysis of the system should be performed and, if necessary, hardware versus software tradeoffs should be made to distribute tasks and allow reasonable execution times. An intelligent compromise between hardware and software is almost always the best solution.

Number	Type	+ 5 V	GND
IC1	7490	5	10
IC2	7490	5	10
IC3	7490	5	10
IC4	7474	14	7
IC5	75451	8	4
IC6	75451	8	4
IC7	7404	14	7
IC8	9374	16	8
IC9	74LS670	16	8
IC10	74126	14	7

Table 1: Power supply connections for integrated circuits used in the designs described in this article.

Rx AVAILABLE WITHOUT PRESCRIPTION!

THE ONLY SYSTEM OF ITS KIND YOUR MICROCOMPUTER WILL EVER NEED!

GLOBAL™ DATABASE MANAGEMENT SYSTEM

for PROGRAMMERS, ACCOUNTANTS, BOOK-KEEPERS, DOCTORS, LAWYERS, PUBLISHERS, SCIENTISTS, MANUFACTURERS, WHOLESALERS, RETAILERS, MANAGERS, LANDLORDS, REAL ESTATE AGENTS, TEACHERS, STUDENTS, ETC.

Extremely comprehensive, versatile user-oriented management system for database creation and list maintenance. Runs under CP/M* and CBASIC2** on a microcomputer system in only 40K RAM.

Completely user-defined file structure with sequential, random and linked file maintenance; user-defined number of fields; data transfer between records; automatic high speed search algorithms with global search function; built-in ISAM; fast sort/merge utility; record selectable output can be formatted (with/without headings, column titles, totals, etc.) and printed on various forms (labels, envelopes, preprinted forms, etc.); links to CP/M commands or programs with automatic return to Global; provides status reports on diskette, data file and hardware environment; disk used as extended memory.

Supplied on standard 8" IBM disk (inquire about other formats), complete with BASIC subroutine library in source code, with comprehensive manual.

\$295

MANUAL ONLY... \$25

*Trademark of Digital Research
**Trademark of Software Systems

Add { Shipping \$2.00
C.O.D. 1.00
Sales Tax where applicable

DEALER INQUIRIES INVITED

GLOBAL PARAMETERS

1505 Ocean Ave., Brooklyn, N.Y. 11230
212/252-5002

Figure 13: Flowchart of the control-panel service routine. It supports the hardware shown in schematic form in figure 12. The three pushbutton switches are polled once per ms to check for transitions. If a transition in state has occurred on the UP switch, the value of the parameter being displayed is incremented. DOWN decrements the value of the parameter, and NEXT displays the next parameter. The routine is set up to handle sixteen single-byte parameters in sequential memory locations. The 8080 code is given in listing 7.

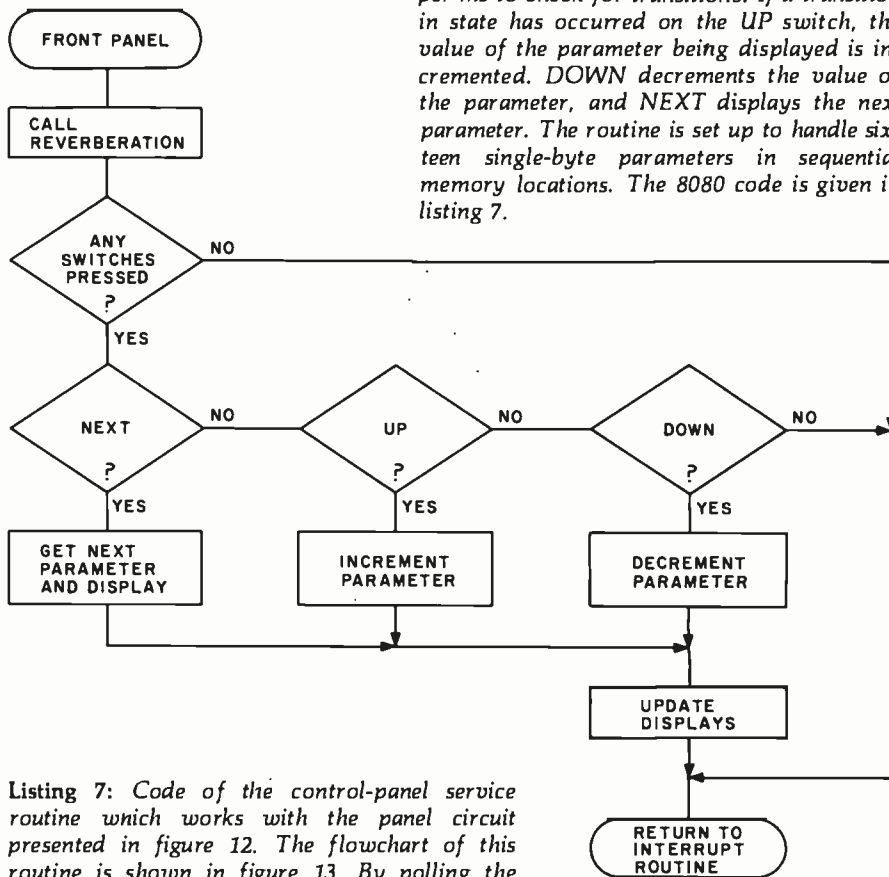

Listing 7: Code of the control-panel service routine which works with the panel circuit presented in figure 12. The flowchart of this routine is shown in figure 13. By polling the pushbutton switches, it allows the user to select function parameters and change their values. This routine is set up to handle sixteen single-byte parameters in sequential memory locations.

```

FPR:      CALL    REVB      ;UPDATE REVERB
          LDA     PBSW      ;ANY BUTTONS PUSHED?
          ANI    7         ;MASK OFF UNUSED BITS, IF NO
                               ;BUTTONS PUSHED
          JZ     FPHLT      ;HALT AND WAIT FOR NEXT INTERRUPT
          MOV    B,A        ;AND SAVE DATA
          LXI   H,PBSIM    ;LOOK FOR TRANSITIONS
          CMA
          ANA     M        ;IF 0 NOW AND WAS 1, TRANSITION
          JZ     FPHLT      ;EXIT IF NO TRANSITIONS
          MOV    M,B        ;ELSE UPDATE IMAGE
          LHLD  PARM       ;GET ADDRESS OF PARAMETER
          CPI   1          ;NEXT
          JNZ   UP         ;NO, CHECK UP
          MOV   A,L        ;GET LOW BYTE OF POINTER
          INR   A          ;YES, INCREMENT POINTER
          ANI   0FH        ;MODULO 16
          MOV   L,A        ;AND SAVE
          SHLD PARM
          FPDIS: MOV   A,M  ;GET NEW PARAMETER
          STA  PDISP      ;DISPLAY
          MOV  A,L        ;GET PARAMETER #
          STA  NDISP     ;DISPLAY
          FPHLT: HALT    ;HALT AND WAIT FOR INTERRUPT
          UP:   CPI     2  ;UP?
          JNZ  DOWN      ;NO - GO CHECK DOWN
          INR  M          ;YES - INCREMENT PARAMETER
          JMP  FPDIS     ;AND DISPLAY

          DOWN: CPI     4  ;DOWN?
          JNZ  FPHLT     ;NO - HALT
          DCR  M          ;YES - DECREMENT PARAMETER
          JMP  FPDIS     ;AND DISPLAY ■
    
```

The Source for 6800/6809 Software

Technical Systems Consultants, Inc. is The Source for your 6800/6809 systems software needs. From FLEX™, the standard disk operating system of the 680X family, to Sort/Merge, your systems requirements can be filled with the highest quality software in the industry. Nowhere else can you find such variety from a single source. Here are some of the most popular:

Program Name	6800	6809
FLEX for SWTPc	\$90	\$90
FLEX for SSB	90	90
Extended BASIC	100	100
Extended BASIC Precompiler	50	50
BASIC	65	65
BASIC Precompiler	40	40
FLEX Sort/Merge	75	75
Text Editing System	40	35
Assembler	40	40
Text Processing System	60	N/A
Debug Package	55	75
FLEX Utilities	100	60

These packages are available on either 8" or 5" soft-sectored FLEX diskettes (5" 6800 is FLEX 2.0). Price includes user's manual and object code diskette. Certain programs are available on cassette. Contact Technical Systems Consultants for pricing. All orders should include 3 percent for postage and handling (8 percent on foreign orders). Master Charge and Visa are welcome.

™FLEX is a trademark of Technical Systems Consultants, Inc.



technical systems
consultants, inc.
Box 2574, West Lafayette, IN 47906
(317) 463-2502

Letters

Problems 1 thru ten

Most publications other than BYTE print "two," not "2" in the midst of an English sentence. Now when I read BYTE I have to go through a kind of mental stuttering: "2, oh yes, that means two." It is the same sort of gear shifting I go through whenever I read text that says "hopefully" when "I hope" is meant, or spells "through" as t, h, r, u, as the *Chicago Tribune* used to do. These are all examples of manner interfering with matter.

I do not object to *all* reforms in communication (going metric suits me fine), but this one is unrewarding.

Philip Bacon
3101 NW 2nd Ave
Gainesville FL 32607

The road to truth and beauty is sometimes a convoluted one. You will notice that our humorous experiment with simplistic rules only lasted for an issue or two — and that reason and judgement

have now prevailed. We resolve 1 [sic] thing at a time. . . . CTH

S-100 Core?

I have an S-100 bus computer and would like to install core memory in it. I have been unsuccessful in locating anyone marketing such a device. I would greatly appreciate any information on the subject.

If no one is manufacturing S-100 core, where might I locate core planes that I can interface to the S-100 bus?

Larry Smith
R and L Enterprises
2901 Willens Dr #6
Melrose Park IL 60164

Removing Solder — A Comment

William Trimmer's article "Soldering Techniques" (September 1979 BYTE, page 84) covers the basics of soldering very well, but I would like to take ex-

ception to his suggestion to remove solder by "Rap(ping) the edge of the board smartly on the workbench." This practice could crack the board at worst, or the flying solder could bridge across the foil patterns, causing a short.

My technique for desoldering is to take "Solder-Wick," dip it in liquid rosin flux and wick up the solder as Mr. Trimmer mentions in his article. I find that the liquid flux improves the wicking action of the braid.

John F Roystone
4084A Birch Ct
Shaw AFB SC 29152

Weather Radio Information

There seems to be a request for information relating to Weather Satellite Receiving Equipment.

I have had a receiving set in operation since the fall of 1973, using a modified Heathkit GR-110 as a receiver, and using other ideas from the NASA SP 5079.

A much more informative and practical book is *Weather Satellite Handbook*, by Dr Ralph E Taggart of Michigan State University.

C A Bush
5538 Larch St
Vancouver British Columbia
V6M 4E1 CANADA

Subroutine Parameters Questioned

With all due respect to Professor Maurer, his D(L,L) example in "Subroutine Parameters" (July 1979 BYTE, page 228) would *always* yield strange results, without regard to the particular parameter passing technique employed. If the function of D is to zero the first parameter while doing nothing with the second, calling it with the same actual parameter in both places is a logical inconsistency, demanding that the same thing be made zero and be left alone simultaneously. The CDC 6400 program did not "work" any better than the IBM one; it simply produced a different "strange" result, which the programmer apparently found more acceptable.

I also question, on page 230, the statement that the $S = S + X$ example will not work with call-by-reference. Again, the problem here appears to be inherent in the logic of the case. The logic of the subroutine is expected to do $S = S + A(I)$ on the range $I = 1,10$, while at the

Now Build Professional Quality Printed Circuit Boards INSTANTLY With **E-Z CIRCUIT™** by **Bishop Graphics, Inc.**

PRESSURE-SENSITIVE COPPER Design Products



With E-Z CIRCUIT's revolutionary *new* pressure-sensitive Copper Design Products, you actually build "instant" professional caliber PC boards right in your own shop or home, *WITHOUT* chemicals, artwork, photography, screening or etching.

The exclusive new E-Z CIRCUIT Copper Design System contains everything you need to produce or repair a professional, printed circuit board with electrical and mechanical characteristics that simulate those of etched "production house" PC boards. Our *unique* Technical Manual, with easy-to-follow, illustrated "how to" tips and

techniques shows and tells you how.

E-Z CIRCUIT's pressure-sensitive copper products are only one dimension of the E-Z CIRCUIT family. The comprehensive E-Z CIRCUIT Technical Manual & Catalog 102 contains detailed information on the *entire* product line, including:

- *PC Drafting Aids* to help you create professional PC board artwork
- *General Purpose PC Plug Boards, DIP & SIP Sockets, Terminal Pins, Wire and Accessories* for building PC boards with today's fast, modern wire wrapping methods

E-Z CIRCUIT™
by **Bishop Graphics, Inc.**

5388 Sterling Center Drive • P.O. Box 5007AA
Westlake Village, CA 91359 U.S.A.
(213) 991-2600 • Telex: 66-2400

For your copy of this value-packed E-Z CIRCUIT Technical Manual & Catalog 102, including information on the location of your nearest E-Z CIRCUIT Distributor, send \$1.00 — plus 50¢ for postage and handling — along with your name and address to:

same time treat the formal parameter X as standing for a simple variable. I am not familiar with ALGOL 60, but most FORTRANs handle the situation by requiring an array declaration for X in the body of the subroutine's code.

Omri Serlin
POB 62138
Sunnyvale CA 94086

WD Maurer Replies:

When we CALL D(A,B), where D is defined by SUBROUTINE D(X,Y), the basic idea is that X is "really" A and that Y is "really" B. Any time we see an X in the subroutine D, we expect it to stand for A, in the context of this particular call. If, for example, we set X to U and then Y to V, that corresponds to setting A to U and B to V. If A and B are really both the same variable L, then we have set L to U and then L to V, which is perfectly acceptable. If we have set X to U and not set Y to anything, then, if the actual parameters are both L, we should set L to U. The fact that we have not set Y to anything does not mean that the old value of L should necessarily be preserved without modification, since there are many other possible ways that the variable L can have another name; for example, it can be in COMMON, referenced by both D and the program which calls D.

The second of Mr Serlin's concerns is a simple matter of confusion about ALGOL 60. If I put $S = S + X$ in a loop in ALGOL 60, it is capable of doing $S = S + A[1]$ the first time, $S = S + A[2]$ the second time, etc, through the loop. If I put $S = S + X$ in a loop in FORTRAN, it must add the same quantity X each time through the loop. In this case it will be $A(i)$, where i was the value that the variable I takes on when the subroutine is entered. Requiring an array declaration for X would make X into an array name, in which case $S = S + X$ would not be syntactically valid.

W D Maurer
George Washington University
SEAS
Washington DC 20052

Quest Comments

Thanks so much for the QUEST program listed in the July 1979 BYTE. As novices, it was fun modifying this routine to run on our TRS-80.

By placing personal references in some of the maze locations, our family has received hours of fun, often late into the night.

For any beginners who wish to do more than buy cassette games, listings such as this are well worth a BYTE subscription.

Harold and Marguerite Jenkins
10 Peaceful Ln
Norwalk CT 06851 ■

UP TO 2400 MEGABYTES OF HARD DISK CONTROL FOR THE S-100 BUS



Konan's SMC-100 is versatile, fast, cost efficient. It's the disk controller that brings S-100 bus micro computers together with large capacity hard disk drives.

Versatile

Interfaces S-100 bus micro computers with all fixed or removable media disk drives with storage module (SMD) interfaces. Each Konan SMC-100 will control up to 4 drives ranging from 8 to 600 megabytes per drive, including most "Winchester" type drives. Up to 2400 megabytes of hard disk per controller! And you can take your pick of hard disk drives: Kennedy, Control Data, Fujitsu, Calcomp, Microdata, Memorex, and Ampex, for example.

Fast

SMC-100 transfers data at fast, 6 to 10 megahertz rates, with full onboard sector buffering and sector interleaving, and a DMA that's faster than other popular S-100 DMA controllers.

Cost efficient

SMC-100 is priced right to keep your micro computer system micro-priced. It takes advantage of low-cost-per-megabyte disk drive technology to make the typical cost less than \$80 per megabyte. The OEM/Dealer single quantity price is only \$1650, with driver ROM option. Excellent quantity discounts are available.

SMC-100 availability:

Off the shelf to 30 days in small quantities. (Complete subsystems are on hand for immediated delivery.)

Konan has the answers. Talk to them today. Call direct on Konan's order number: 602-269-2649. Or write to Konan Corporation, 1448 N. 27th Avenue, Phoenix, Arizona 85009.

KONAN™
1448 N. 27th Avenue • Phoenix, Arizona 85009 • 602-269-2649

Microcomputing comes of age.

Ohio Scientific's OS-65U Level 3 operating system software brings new networking and distributed processing capabilities to microprocessor based computer systems.

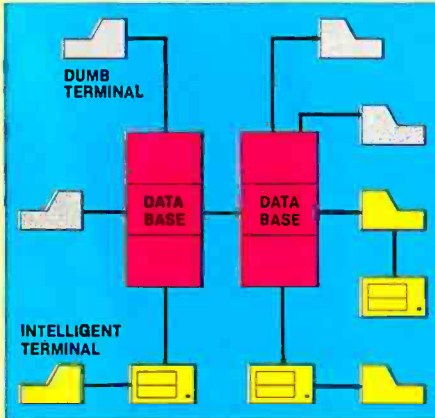

Until now, the only alternative for low cost multiple-user computer applications was time-shared systems. However, a serious drawback of microcomputer or mini-computer multi-user time-share systems is the fact that under heavy work loads they slow down to a crawl since the central processor time in such a system is shared by all of the users.

In a microprocessor based distributed processing system, using floppy based microcomputers as intelligent terminals (local systems) most of the work load is handled locally. Overall system performance does not degrade under heavy job loads. Each local system performs entry, editing and execution while utilizing the central data base for disk storage, printer output, and other shared resources.

For more demanding applications it is desirable to have several data bases, each with its own collection of local systems. Such an inter-connected set of data bases is called a network. Each data base and its local intelligent and dumb terminals is called a cluster.

Level III

OS-65U Level 3 now supports this advanced networking and distributed processing capability as well as conventional single user operation and time-sharing. Level 3 now supports local clusters of intelligent microcomputer systems as well as

dumb terminals for the purpose of utilizing a central Winchester disk data base and other shared resources. The system also has full communications capability with other Level 3 data bases providing full network capability. The system utilizes Ohio Scientific's low cost, ultra high performance computer systems throughout for intelligent terminals as well as data bases. This general systems configuration provides a cost/performance ratio never before attained in this class of computer power.

Level 3 resides in each network data base. A subset system resides in each intelligent terminal. Each data base supports up to 16 intelligent systems and up to 16 dumb terminals. However, since dumb terminals can heavily load the system, they should be kept to a minimum. Level 3 also supports a real time clock, printer management, and other shared peripherals.

Data Base Requirements

Minimal requirements for a Level 3 network data base are a C3-C or C3-B computer system with 23 or 74 megabytes respectively, console terminal, 100K bytes RAM and a CA-10X 16 port I/O board for network and cluster communications.

Intelligent Terminal Requirements

Any Ohio Scientific 8" floppy based computer with 56K RAM and one data base communications port.

Connections

Intelligent terminals and networked data bases are connected by low-cost cabling. Each link can be up to 10,000 feet long at a transfer rate of 500K bits per second, and will cost typically 30¢ a foot (plus installation).

Syntax

Existing OS-65U based software can be directly installed on the network with only one statement change!

Level 3 has the most elegantly simple programming syntax ever offered on a computer network.

File syntax is as follows:

DEV A,B,C,D.	Local Floppies	} unchanged from single user and timeshare systems
DEV E	Local hard disks	
DEV K-Z	Specific network Data Bases	

Each of up to 8 open files per user can be from 8 separate origins. Specific file and shared peripheral contentions are handled by 256 network semaphores with the syntax Wait N
Wait N, close.

The network automatically prioritizes multiple resource requests and each user can specify a time out on resource requests. Semaphores are automatically reset on errors and program completion providing the system with a high degree of automatic recovery.

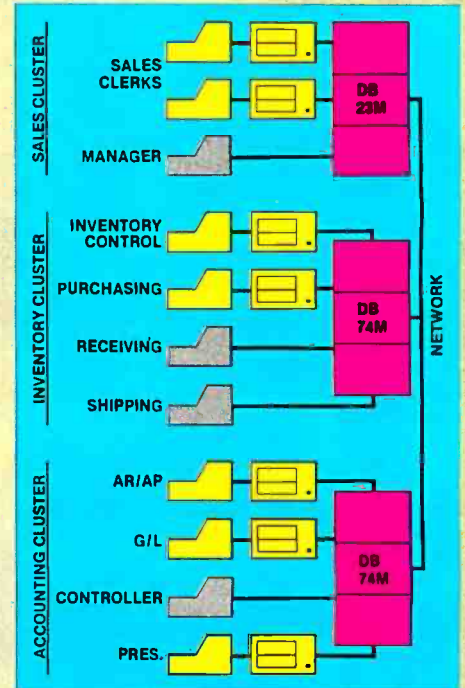

A Typical System

A typical system with two network data bases will have 148 megabytes of disk, four intelligent subsystems equipped with dual floppies, two dumb terminals, a word processing printer, a fast line printer, network data base manager software and 1000 ft. of inter-connecting cable. Utilizing .7 MIPS processors throughout it will cost less than \$50,000 plus installation. GT option computers (1.2 MIPS) can be utilized at a slightly higher cost.

One Step at a Time

Best of all, Ohio Scientific users can develop distributed processing systems economically one step at a time. A user can start with a single user floppy system, add a hard disk, then time-sharing, then a second Winchester data base for backup and finally cluster intelligent terminals to achieve a full network configuration.

For literature and the name of your local dealer, CALL 1-800-321-6850 TOLL FREE.

OHIO SCIENTIFIC
 1333 SOUTH CHILLICOTHE ROAD
 AURORA, OH 44202 • (216) 562-3101

The Microcomputers you should take seriously.

The Challenger III Series is the micro-computer family with the hardware features, high level software and application programs that serious users in business and industry demand from a computer system, no matter what its size.

Since its introduction in August, 1977, the Challenger III has become one of the most successful microcomputer systems in small business, educational and industrial development applications. Tens of thousands of Challenger III's have been delivered and today hundreds of demonstrator units are set up at systems dealers around the country.

The Challenger III systems offer features which make their performance comparable with today's most powerful mini-based systems. Some of these features are:

Three processors today, more tomorrow.

The Challenger III Series is the only computer system with the three most popular processors— the 6502A, 68B00 and Z-80. This allows you to take maximum advantage of the Ohio Scientific software library and programs offered by independent suppliers and publishers. And all Challenger III's have provisions for the next generation of 16 bit micros via their 16 bit data BUS, 20 address bits, and unused processor select codes. This means you'll be able to plug a CPU expander card with two or more 16 bit micros right in to your existing Challenger III computer.

Systems Software for three processors.

Five DOS options including development, end user, and virtual data file single user systems, real time, time share, and networkable multi-user systems.

The three most popular computer languages including three types of BASIC plus FORTRAN and COBOL with more

languages available from independent suppliers. And, of course, complete assembler, editor, debugger and run time packages for each of the system's microprocessors.

Applications Software for Small Business Users.

Ready made factory supported small business software including Accounts Receivable, Payables, Cash Receipts, Disbursements, General Ledger, Balance Sheet, P & L Statements, Payroll, Personnel Files, Inventory and Order Entry as stand alone packages or integrated systems. A complete word processor system with full editing and output formatting including justification, proportional spacing and hyphenation.

OS-DMS, the software star.

Ohio Scientific offers an Information Management system which provides end user intelligence far beyond what you would expect from even the most powerful mini-systems. Basically, it

allows end users to store any collection of information under a Data Base Manager and then instantly obtain information, lists, reports, statistical analysis and even answers to conventional "English" questions pertinent to information in the Data Base. OS-DMS allows many applications to be computerized without any programming!

The "GT" option yields sub-microsecond microcomputing.

Ohio Scientific offers the 6502C microprocessor with 150 nanosecond main memory as the GT option on all Challenger III Series products. The system performs an average of 1.5 million instructions per second executing typical end user applications software (and that's a mix of 8, 16 and 24 bit instructions!).

Mini-system Expansion Ability.

Challenger III systems offer the greatest expansion capability in the microcomputer industry, including a full line of over 40 expansion accessories.

Networking and Distributed Processing

OS-65U level 3 now provides networking capabilities as well as time sharing ability allowing Challenger III based systems to be expanded to meet the most demanding business applications.

Prices you have to take seriously.

The Challenger III systems have phenomenal performance-to-cost ratios. The C3-S1 with 48K static RAM, dual 8" floppies, RS-232 port, BASIC and DOS has a suggested retail price of under \$4000. 80 megabyte disk based systems start at under \$12,000. Our OS-CP/M software package with BASIC, FORTRAN and COBOL is only \$600, and other options are comparably priced.

For literature and the name of your local dealer, CALL 1-800-321-6850 TOLL FREE.

Circle 300 on inquiry card.

C3-B wins Award of Merit at WESCON '78 as the outstanding microcomputer application for Small Business.

The Challenger III Series from Ohio Scientific.



C3-S1

C3-OEM

OHIO SCIENTIFIC
1333 SOUTH CHILLICOTHE ROAD
AURORA, OH 44202 • (216) 562-3101

free freight

We'll pay the surface freight on all pre-paid products featured in this ad to any of 18,000 U.S. tariffed locations. No handling charges, add on costs, insurance fees or credit card fees!



TI 99/4
\$100 REBATE!
 if we fail to deliver within 30 days of your payment. Built in equation calculator, 13" color monitor, 16-bit C.P.U., TI Basic w/13 digit precision, and more!
\$1150



Soroc IQ 120
 High quality, professional text-editing terminal. 73-key board, built in 2K RAM.
\$789



Hazeltine 1500
 7X10 matrix, baud rates to 19,200; full keyboard with numeric pad, full function CRT at a new low price!
\$950



TI 810
 Basic 150 cps serial. The industry leader at a new low price! Save over \$300.
\$1589



Centronics 730
 100 cps, parallel, 3-way feed, 80-character buffer...the new leader in small printers from Centronics. Save \$100.
\$895

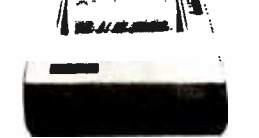

Comprint 912
 Low priced electrostatic matrix printer, 225 cps.
 Serial **\$535**
 Parallel **499**



MicroSource Software for NorthStar
 Word processing, accounts receivable, accounts payable, general ledger, time billing/management, client write-up for accountants...call toll free for features & prices!

Televideo 912 \$779
Centronics 704 \$1685
Heath WH 14 \$749

Over 2000 products from over 100 manufacturers. Prices subject to change without notice, products subject to availability. FOB Tempe, AZ (5% sales tax in Arizona)

Call now
TOLL FREE 1-800-528-1418
MICROWORLD
 1425 W. 12th Pl. • Tempe, AZ 85281 • (602) 894-1193



Technical Forum

A Proposed Graphics Software Standard Part 2

Dr Vincent C Jones, 1913 Sheely Dr, Ft Collins CO 80526

Sample Implementation

In part 1, the framework for a proposed graphics software standard was discussed.

An implementation of the 8080 assembly language protocol for use with the Cromemco Dazzler (listing 1) illustrates how the algorithms and standards presented translate into working software. Except for a few instances where the architecture of the 8080 or Dazzler allowed substantial simplification, the program code corresponds exactly to the Nassi-Schneiderman charts in part 1. The major deviations are in the handling of control characters in the routine CHAR, affected byte address calculation in DOT, and the termination condition in PAGE.

The software starts by defining the standard entry points. The Dazzler is assumed to be jumpered to use ports 16 and 17 (octal), the Cromemco default. If you own a Dazzler and it uses different ports, the I/O (input/output) commands in INITG, CHAR, and ANIMAT will need modification.

8080/Dazzler INITG

The first step in all these routines is to preserve any registers affected. In this case, HL is not saved because its contents will be replaced by the display description parameters.

The Dazzler requires the refresh buffer to start at an even multiple of 512. No test is made to check and see if the address provided is valid; instead, an algorithm that converts any address to a valid address and a valid address to itself is used. The refresh buffer address calculated is then stored in the two bytes labeled RBUF. Placing all the variables in a single section of memory is not only good programming practice, it also permits efficient setting of defaults by using register indirect addressing. The call to the CHAR routine with zero accumulator sets the display mode to MAXR and takes care of outputting the required controls to the Dazzler's Color/Mode port.

After calling PAGE to clear the screen, the Dazzler is finally turned on. The high-byte of the refresh buffer address is retrieved from memory and rotated into the bit position expected by the Dazzler. The OUT instruction starts the display, if it is not already on. The final step, before restoring register values, is to load the appropriate parameter description into HL. Hexadecimal 8AFC indi-

Text continued on page 176
 Listing on page 84

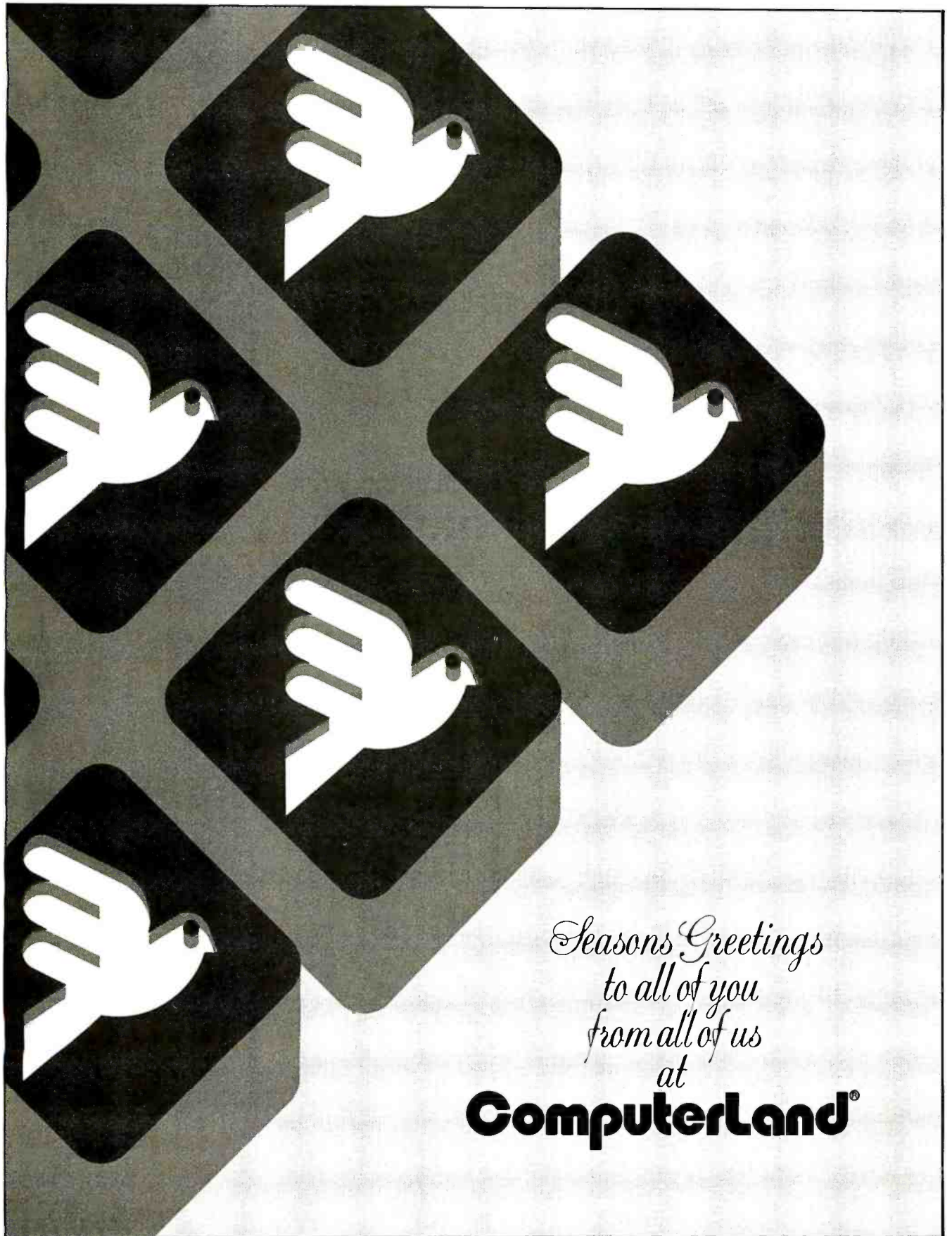

*Seasons Greetings
to all of you
from all of us
at*

ComputerLand[®]

Listing 1: Implementation of the 8080 assembly language protocol for use with the Cromemco Dazzler. With a few exceptions, the program corresponds exactly to the Nassi-Schneiderman charts in part 1.

```

;
; THE VCJ GRAPHICS PACKAGE
; 8080/DAZZLER VERSION
; VERSION 3.02B <-> AUG 25, 1977
;
***** COPYRIGHT NOTICE *****
*
*
* COPYRIGHT (C) 1977
* DR. VINCENT G. JONES
*
*
* COMMERCIAL USE OR DISTRIBUTION *
* IS PROHIBITED WITHOUT THE *
* EXPRESS WRITTEN CONSENT OF THE *
* COPYRIGHT OWNER. REPRODUCTION, *
* MODIFICATION OR ADAPTATION FOR *
* PERSONAL USE IS PERMITTED PRO- *
* VIDED THIS NOTICE IS INCLUDED. *
*
*****
;
;
; JUMP TABLE TO DEFINE STANDARD ENTRY POINTS
;
ORG 104H ;START OF STANDARD SPACE
JMP INITG ;INITIALIZE GRAPHICS
JMP PAGE ;CLEAR THE SCREEN
JMP CURSOR ;GO TO A POINT ON THE SCREEN
JMP DOT ;DISPLAY A POINT ON THE SCREEN
JMP LINE ;DRAW A LINE BETWEEN POINTS
JMP CHAR ;DISPLAY AN ASCII CHARACTER
JMP AVIMAT ;CHANGE BUFFERS WITHOUT FLICKER

;DEFINE THE DAZZLER PORTS
DAZ0 EQU 0EH ;CONTROL PORT
DAZ1 EQU DAZ0+1 ;COLOR/MODE PORT

;
; ROUTINE INITG
; INITIALIZE THE DAZZLER TO 128 BY 128 B/W MODE,
; X = 0, Y = 0, SCREEN CLEARED, AND
; CURRENT COLOR SET TO WHITE.
; H,L CONTAINS THE FIRST AVAILABLE ADDRESS
; FOR REFRESH BUFFERS.
; RETURNS DISPLAY CHARACTERISTICS IN H,L
;
INITG: PUSH PSW ;SAVE A FEW REGISTERS
        D   ;
        DCX H ;FIX REFRESH ADDR TO LEGAL
        MOV A,H ; BOUNDARY
        ADI 02H ;
        ANI 0FEH ;CLEAR 256 BIT
        MOV H,A ;
        XRA A ;CLEAR A
        LJA L,A ; AND MAKE LOW BYTE ZERO
        MOV
0104 C31901
0107 C34501
010A C35901
010D C37701
0110 C3F101
0113 C38F02
0116 C38F03

030E = ;
030F = ;

; ROUTINE INITG
; POSITION THE CURSOR AT X,Y IN H,L
; OR CONVERT THE COORDINATES IN H,L FROM
; STANDARD COORDINATES (0-255 DN EACH AXIS)
; TO THE COORDINATES CURRENTLY IN USE BY THE
; DAZZLER.
;
CURSOR: PUSH PSW ;SAVE THE WORLD
        H   ; OR AT LEAST PART
        CALL CU000 ;CONVERT TO COORD IN USE
        SHLD YPOS ;AND SAVE FOR OTHER PEOPLE
        POP H ;RESTORE THE WORLD
        POP PSW ;
        RET ;
;
; INTERNAL SUBROUTINE CU000
; CONVERT THE X,Y COORDINATE PAIR IN H,L TO

```

```

0124 22A984
0127 21AB04
012A 77
012B 23
012C 77
012D 23
012E 77
012F 23
0130 36FF
0132 CD8F02
0135 CD4501
0138 3AA804
013B 37
013C 1F
013D D30E
013F 21BC8A
0142 D1
0143 F1
0144 C9

;
; ROUTINE PAG
; CLEAR THE SCREEN
; OR CLEAR 2K OF MEMORY COMMENCING
; AT THE ADDRESS IN 'RBUF'.
;
PAGE: PUSH PSW ;SAVE THE USER WORLD
        D   ;
        PUSH H ;
        LKLD RBUF ;STARTING ADDRESS
        MVI A,08H ;(BUFFER LENGTH/256)
        ADD H ;HIGH BYTE OF LAST ADDR +1
        MOV E,L ;NEED A ZERO FOR MEMORY FILL
        MOV H,E ;NEXT THAT BYTE
        MOV H,H ;NEXT BYTE
        CMP H ;DONE YET?
        JNZ P000 ;NO. KEEP TRUCKING
        POP H ;RESTORE THE USER
        POP D ;
        POP PSW ;
        RET ;
;
; ROUTINE CURSOR
; POSITION THE CURSOR AT X,Y IN H,L
; OR CONVERT THE COORDINATES IN H,L FROM
; STANDARD COORDINATES (0-255 DN EACH AXIS)
; TO THE COORDINATES CURRENTLY IN USE BY THE
; DAZZLER.
;
CURSOR: PUSH PSW ;SAVE THE WORLD
        H   ; OR AT LEAST PART
        CALL CU000 ;CONVERT TO COORD IN USE
        SHLD YPOS ;AND SAVE FOR OTHER PEOPLE
        POP H ;RESTORE THE WORLD
        POP PSW ;
        RET ;
;
; INTERNAL SUBROUTINE CU000
; CONVERT THE X,Y COORDINATE PAIR IN H,L TO

```

Listing 1 continued:

```

;       THE COORDINATE SYSTEM CURRENTLY IN USE
;
; USES REGISTERS A, H, AND L:
;
0164 3AA7B4      LDA     MODE       WHICH MODE?
0167 F5        PUSH    PSV       WILL I NEED IT LATER
0168 AF        XRA     A         MOVE H TO A WITH CY CLEAR
0169 B4        ORA     H         DIVIDE BY 2
016A 1F        RAR     H,A      AND SAVE IT
016B 67        MOV     A         DO THE SAME FOR Y
016D B5        XRA     A         ;
016E 1F        RAR     H,A      ;
016F 6F        MOV     L,A     JALL'DONE IF 128 BY 128
0170 F1        POP     PSV     WHAT MODE ARE WE IN?
0171 3C        INR     A         128 BY 128?
0172 F8        RP      A         YES, ALL DONE
0173 AF        XRA     A         64 BY 64, PRETEND 128
0174 C367B1    JMP     CU001      AND DIVIDE AGAIN

;ROUTINE DOT
; DISPLAY THE POINT AT THE CURSOR POSITION
;
;BLOCK #1: ADDRESS CALCULATION FROM Y POSITION
;
DOT:  PUSH    PSV       SAVE THE WORLD
      PUSH    B         ;
      PUSH    D         ;
      PUSH    H         ;
0178 3A     LDA     MODE       GET THE DISPLAY MODE BYTE
017E 4F     MOV     C,A       80=MAX, 88=MAXC, 01=128, 81=64
017F 3A     LDA     YPOS      WHICH RESOLUTION
0182 8C     INR     C         ;
0183 FA8891   JM      D101      64 BY 64
0186 F5     PUSH    PSV       SAVE FOR BIT MASK TIME
0187 1F     RAR     H,A      DIVIDE BY 2
0188 2F     CMA     D,A     CONVERT TO LINE NUMBER
0189 57     MOV     D,A     SAVE A COPY
018A E61F    ANI     1FH     EACH QUADRANT IS 32 HIGH
018C 6F     MOV     L,A     MULT LINE # BY BYTES/LINE
018D 7A     MOV     A,D     BUT FIRST CORRECT FOR QUADRANT
018E 620     MOV     20H      WHICH ARE WE IN?
0190 CA97B1   JZ      D102      1ST OR 2ND, NO CORRECT REQ
0193 3E49    MVI     A,40H    MOVE DOWN TO 3RD OR 4TH
0195 85     ADD     L         WHICH IS 1K AFTER SHIFTING
0196 6F     MOV     L,A     END OF QUADRANT CORRECTION
0197 2600    MVI     H,00H    READY TO MULTIPLY BY 16
0199 29     DAD     H         TIMES 2
019A 29     DAD     H         TIMES 2
019C 29     DAD     H         TIMES 2
019D EB     XCHG     MAKE ROOM FOR BASE ADDRESS
019E 2AA9B4   LLD     WHERE DO WE START?
01A1 19     DAD     D         HALT IS FIRST BYTE ON LINE

;BLOCK #2: ADDRESS CALCULATION FROM X POSITION
;
01A2 3AADB4   LDA     XPOS      GET X CURSOR
01A5 8C     INR     C         WHICH RESOLUTION?

```

```

01A6 FAAB91   J164 BY 64
01A9 F5     J128 BY 128, SAVE FOR BLOCK #3
01AA 1F     JDIVIDE BY 2
01AB 57     JSAVE FOR LATER
01AC E620   JCHECK QUADRANT
01AE CAB501  JQUAD 1 OR 3, NO CORRECTION
01B1 3E02   JQUAD 2 OR 4, ADD 512
01B3 84     H         TO GET CORRECT ADDRESS
01B4 67     H,A      QUADRANT CORRECTION COMPLETE
01B5 7A     H,A      JX CURSOR (NORM 64)
01B6 61E    J32 TO A QUADRANT
01B8 8F     J2 POINTS PER BYTE
01B9 5F     E,A     J ADD TO LINE ADDRESS
01BA 7A     A,D     J BUT SAVE COPY OF 64 VALUE
01BB 1600   D,00H    JCLEAR D FOR A DOUBLE ADD
01BD 19     D         JNOV HAVE THE BYTE ADDRESSED

;BLOCK #3: BIT MASK GENERATION
;
01BE 1F     RAR     JEVEN OR ODD?
01BF 3E0F   MVI     A,0FH    JASSUME EVEN
01C1 D2C501  JNC     JCORRECT ASSUMPTION
01C4 2F     CMA     J WAS ODD, SWITCH HALVES
01C5 8C     C         ;
01C6 FAE291  INR     J128 BY 128?
01C9 57     JM      D,A     JSAVE MASK
01CA F1     MOV     D,A     JXPOS
01CB E691   POP     PSV     JEVEN OR ODD?
01CD 5F     ANI     01H    JSAVE LOW BIT
01CE F1     MOV     E,A     JYPOS
01CF 1F     POP     PSV     JEVEN OR ODD?
01D0 3E33   MVI     A,33H    JASSUME ODD
01D2 DAD601  JC      D302     JINVALID ASSUMPTION
01D5 2F     CMA     JNO, EVEN
01D6 A2     ANA     D         JDOWN TO 2 BITS
01D7 1D     DCR     E         JFINALLY DO X
01D8 CAE9B1  JZ      D303     JX WAS ODD
01DB E655   ANI     55H     JX WAS EVEN
01DD C3E201  JMP     D400     ;
01E0 26AA   ANI     0AAH    JX WAS ODD

;BLOCK #4: REFRESH MEMORY MODIFICATION
;
01E2 57     MOV     D,A     JSAVE THE BIT MASK
01E3 2F     CMA     JFIRST ERASE ORIGINAL CONTENTS
01EA A6     AMA     H         ;
01E5 5F     MOV     E,A     JSAVE CLEANED VERSION
01E6 3AAE04  LDA     COLOR    JGET COLOR DESIRED
01E9 A2     ANA     D         JDOWN TO DESIRED POINT
01EA B3     ORA     C         JADD TO ORIGINAL CONTENTS
01EB 77     ORA     E         JAND STUFF INTO MEMORY
01EC E1     MOV     H,A     JRESTORE THE WORLD
01ED D1     POP     D       JNOTE! THIS SERIES IS
01EE C1     POP     B       J ALSO USED BY LINE
01EF F1     POP     PSV    J AND CHAR.
01F0 C9     RET     JALLIDONE

;
;
01E2 57     MOV     D,A     JSAVE THE BIT MASK
01E3 2F     CMA     JFIRST ERASE ORIGINAL CONTENTS
01EA A6     AMA     H         ;
01E5 5F     MOV     E,A     JSAVE CLEANED VERSION
01E6 3AAE04  LDA     COLOR    JGET COLOR DESIRED
01E9 A2     ANA     D         JDOWN TO DESIRED POINT
01EA B3     ORA     C         JADD TO ORIGINAL CONTENTS
01EB 77     ORA     E         JAND STUFF INTO MEMORY
01EC E1     MOV     H,A     JRESTORE THE WORLD
01ED D1     POP     D       JNOTE! THIS SERIES IS
01EE C1     POP     B       J ALSO USED BY LINE
01EF F1     POP     PSV    J AND CHAR.
01F0 C9     RET     JALLIDONE

;
;
01A2 3AADB4   LDA     XPOS      GET X CURSOR
01A5 8C     INR     C         WHICH RESOLUTION?

```

Listing 1 continued on page 168

DELTA IS READY . . .

WITH
WITH
WITH

32K or 16K RAM



- 16K or 32K Static Memory. ● S-100 Bus Connector. ● 9 Regulators provide excellent heat distribution. ● Extended addressing (bank switching).
- Low power requirement. ● Phantom line.
- 20-Page operating manual. ● Full 1-year warranty. ● 32K version assembled and tested \$485.00. ● 16K version available assembled and tested, \$290.00.

Double Density Disk Controller 8" or 5"

This One



Works!!

- Designed for CPM®. ● On Board Boot.
- 2MHz-4MHz Operation. ● Switch Selectable Write Precomp. ● "Personality Board" to modify drive configurations (no jumper wires). ● 2 Data separators; one digital, one analog. ● Drive Diagnostic Software included. ● Complete documentation. ● Runs without occupying any system RAM. ● Transparent Density Select. \$385.00.

SOLUTIONS
SOLUTIONS
SOLUTIONS

DP Z-80 CPU



- 2MHz or 4MHz operation (jumper selectable).
 - Power on jump to On Board Eprom (2708 or 2716).
 - M1 Wait State for 160% thruput enhancement with 450ns memory. ● 3 Parallel I/O ports.
 - Two Serial RS-232 I/O ports. ● Baud rates: 50 to 19.2K. \$260.00.
- (Cable and Eprom extra)

ALL
YOU
EVER
NEED!!

DP S-100 Mainframe



- 12 slot S-100 Motherboard with power supply +8@20a, ±16@6a (nylon card guides).
- Mates with disk systems shown in center column.
- Neat, compact, extremely reliable mainframe.
- Also available with S-44 2 user, 3 CPU system with features similar to Multi-user TRS-80 Expansion Package. Kit \$295.00

Disk Drive Storage

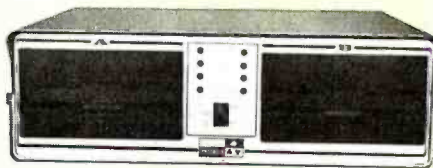

- Cabinet comes with multiple power.
- Supply to suit all popular disk drives ±5@5a, +24@6a.
- DP-1000K Twin double density Shugart SA-800B or Siemens FDD-100-8. (2 megabytes). \$1350.00
- DP-2000K Double sided, double density Shugart SA-850-R or Siemens FDD-200-8 (2 megabytes). \$1850.00
- Drive box less drives with ample power supply. Kit \$295.00

Ultimate TRS-80 Expansion Package - 340K of Double Density



- Cost effective Z-80 15 slot dual drive S-44 5" computer. Mates with TRS-80 or with terminal.
- Excellent expandable starter system for small business.
- Also an unbeatable choice for dedicated word processor applications or industrial scientific use (80 x 24 video).
- The S-44 card set ensemble is specifically designed for business engineering and technical applications.
- 50-60 Hz (110/220VAC).
- Provides expansion to 64K CPM operating system, modems, multiuser, etc. \$1775.00 (32K)

West:

DELTA PRODUCTS

1653 E. 28th Street
Long Beach, Calif. 90806
Tel: (213) 595-7505



Telex: 128-126 DELTMAR SGHL

East:

DELTA PRODUCTS

1254 South Cedar Road
New Lenox, Illinois 60451
Tel: (815) 485-9072

Circle 128 on inquiry card.

Relative Subroutines for the Z80

Dennis Bathory Kitz, Roxbury VT 05669

One of the problems associated with writing versatile, relocatable programs for microprocessors is making decisions on how to use subroutines. The main difficulty occurs when a program using subroutines is to relocate itself; every call address must be rewritten. On the other hand, avoiding subroutines wastes valuable memory space.

I faced this dilemma when developing a program to exercise the memory in my TRS-80; a bit had failed, and I needed a program that could reside in low-memory during a test of high-memory, and relocate itself to high-memory in order to test low-memory. The lengthy process had to be repeated many times (preferably while I was asleep), and leave the results displayed on the monitor the next morning. The necessary ingredients for this program were: a test of all combinations of bits in a byte; a section to identify the bad address; hexadecimal and ASCII conversion routines; a clear-screen and address display routine; and a section to relocate the program and display that fact. A further requirement was that the program reside in a single page of memory.

The identification for each bad address was written as a subroutine; nested inside were the conversions to hexadecimal and ASCII and the display section. Altogether, six separate subroutine calls were needed to identify and display each faulty address.

Self-relocation of the program could have ended with a flurry of activity, transferring the program and rewriting every CALL with a specific new address.

Instead, it was possible to write the program with "relative" subroutines which are not address-specific. This concept is not entirely new, and some late-generation processors employ many such position-independent commands. However, the current crop of popular chips does not offer any direct way of accessing a nearby subroutine. The following procedure illustrates one way it can be achieved with the Z80:

- determine the offset from the end of the subroutine back to the main program flow;
- assign this value as the operand of a relative jump placed at the end of the subroutine;

- jump to the subroutine.

Here is an example of a "relative call and return" situation — and it uses only two bytes more than a standard subroutine:

```
1000    LD IX,1080    ;CENTER POINT OF ONE PAGE
1004    [MAIN PROGRAM]
      .
      .
1040    LD (IX + 8),BD ;IDENTIFY RETURN OFFSET AND
1044    JR 20        ;PUT IN PLACE
1046    [MAIN PROGRAM] ;JUMP TO THE SUBROUTINE
      .
      .
1066    [SUBROUTINE]
      .
      .
1087    JR XX        ;RETURN TO MAIN PROGRAM
                          FLOW
```

Note that, like an absolute subroutine, this configuration may be entered at any point — only the offset value loaded into the return jump must change.

In the case of a conditional return, moreover, the circumstances gain only one step in complexity, as the return value cannot be determined by the main program before the subroutine is executed. Instead, whenever a return condition is met during subroutine execution, the conditional jump transfers control to the last instruction of the subroutine, which is the "loaded" jump. It then returns to the main program flow.

Both these procedures have one characteristic that many programmers tend to avoid, and that is their self-modifying activity. Naturally, this obviates their use in read-only memory. But if it is important to have a relocatable module, it can be achieved with only one register (IX or IY) needing a specific address.

The memory use benefits of either method can be determined quickly. If it takes 5 bytes to rewrite an address directly, and a standard CALL and return combination needs 4 bytes, then a 6-byte unconditional or an 8-byte conditional "relative call" is the obvious choice. Overall, these methods provide an efficient and versatile escape from the usual complexities of creating relocatable programs. ■

APL/S: An Alternative

Robert G Brown, 777 S Mathilda Ave Apt D148,
Sunnyvale CA 94087

About the Author

Robert G Brown is an independent consultant after having worked for IBM for 13 years. He began using APL in 1968 and structured programming in 1970. When he designed the APL/S language in 1978, he attempted to combine structured programming with APL on a small computer in a way which removes some of the common objections to both.

APL/S is a modified subset of APL plus structured-programming control figures. It is intended to be a good first language both for those who may go on to more powerful languages such as Pascal or APL, and for those whose computational needs are destined to remain modest.

Pseudocode

Structured programming is a collection of techniques that help produce demonstrably correct programs. One of the fundamental ideas is to first state the action of the program in what is sometimes called *pseudocode*, or structured English, then progressively refine the statements of the program toward the programming language being used.

With structured English, any imperative statement can be used, but alternation and repetition statements are restricted to a few well defined forms. In this case, the forms are IF-THEN-ELSE, ENDIF for alternation and WHILE-DO, ENDWHILE for repetition. Their intuitive meaning can be illustrated by a set of dieting instructions.

The instructions are to keep eating, one byte at a time, as long as you are hungry. When you are no longer hungry, ask yourself whether you want to get fat. If you do, eat some more. A structured English statement of these instructions is:

```
WHILE you are hungry
DO eat a byte
ENDWHILE
IF you want to get fat
THEN eat some more
ENDIF
```

An APL/S Program

The pseudocode for a guess-the-number-game program is shown in listing 1a. The input is a series of guesses at a

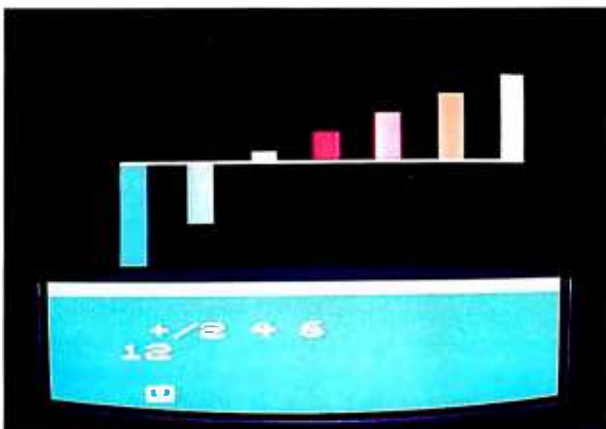

Photo 1: An immediate-mode calculation displayed on an ordinary television set. The user entered "+/2 4 6". This expression was evaluated, and the result (12) was displayed. The +/ characters indicate that the elements of the array 2 4 6 should be added. Therefore 2+4+6 gives 12 as the result. The cursor (an inverse video U, which shows up as a white square with a U inside) indicates that the keyboard is open for the next immediate-mode entry. The histogram bars are left over from a previous calculation.



Photo 2: Program AVE, which computes the average of a set of numeric observations. Input is from the keyboard as a series of numeric values — an array constant. The input, returned by the KEYB function, is assigned to OBS, thus making OBS an array. The average value is computed by adding up the elements of the array (+/OBS) and dividing the sum by the size of the array (SIZE OBS). Since the result is not assigned to a variable, it is displayed.

Listing 1a: Pseudocode for a guess-the-number-game program. This type of expression may be called Structured English. See listing 1b for the APL/S equivalent.

```
Pick a number between 1 and 100
Set the number of guesses to 1
WHILE the guess from the keyboard is not equal
  to the number picked
DO add 1 to the number of guesses
  IF the guess is higher than the number
  THEN display "Too high"
  ELSE display "Too low"
  ENDIF
  Display "Try again"
ENDWHILE
Display "Number guesses-"
Display the number of guesses
```

randomly selected number. The outputs are messages saying "too high," "too low," and "try again." When the number is correctly guessed, the number of guesses made is displayed.

The corresponding APL/S program, named GUESS, is shown in listing 1b. It is a line-for-line translation of the pseudocode. By looking at the pseudocode and the sample execution in listing 2, the programmer should be able to understand the main points of the APL/S program, although all the details may not be clear.

A Description of APL/S

A more complete and precise description of APL/S is provided by the syntax diagrams in figure 1 thru 5 and

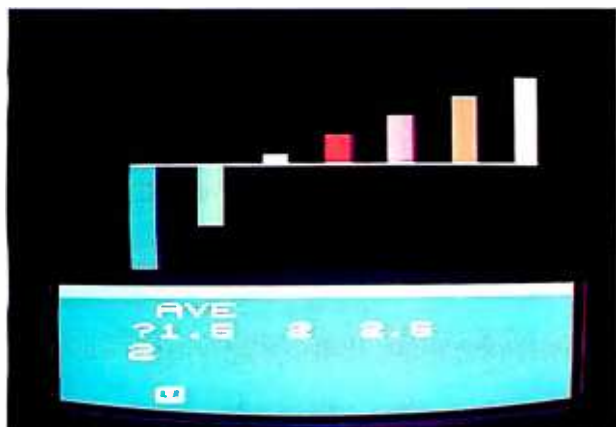

Photo 3: The program AVE is executed by keying in its name. Keyboard input is prompted by a question mark (?). The user entered the 3-element array constant 1.5 2 2.5. In the program, $+/OBS \div SIZE\ OBS$ was evaluated as $+/OBS$ (giving 6) divided by $SIZE\ OBS$ (giving 3) for a result of 2.

Listing 1b: APL/S program for the guess-the-number game. In this implementation of the language, keywords such as PROGRAM and RANDOM may be abbreviated by the first four letters. See listing 2 for an example of the execution of this routine.

```
PROGRAM GUESS
NUM=RANDOM 100
NGES=1
WHILE NUM NE GES=KEYB
DO NGES=NGES+1
  IF GES GT NUM
  THEN "TOO HIGH"
  ELSE "TOO LOW"
  ENDIF
  "TRY AGAIN"
ENDWHILE
"NUMBER GUESSES-"
NGES
ENDPROGRAM
```

Listing 2: Example execution of the program of listing 1b. Execution of a program is started by typing the name of the program, in this case GUESS. User input is prompted by a question mark (?) character.

```
GUESS
?50
TOO HIGH
TRY AGAIN
?25
TOO LOW
TRY AGAIN
?32
NUMBER GUESSES-
3
```

the function descriptions in table 1. Starting at the diagram labeled Program, a path through the diagrams defines a syntactically correct APL/S program. The diagrams do not specify APL/S action (that is, the meaning or semantics of the program).

Each circle indicates a *terminal symbol*. Terminal symbols become part of the program text exactly as shown. The boxes indicate *nonterminals*. For each nonterminal there is a diagram (or, for functions, a description in table 1). When all nonterminals have been replaced with sequences of terminals according to the diagrams (or table 1), the result is a syntactically correct APL/S program.

The syntax diagrams in figures 1 thru 5 do not cover statements for loading, saving, editing, or tracing the execution of programs. A complete description of APL/S can be found in the paper "An Introduction to APL/S" (part of the *Conference Proceedings of the Third West Coast Computer Faire*, November 1978) and the *APL/S User's Manual* by W Judd and S Cintz (available from the VideoBrain Computer Co).

HOLIDAY SPECIAL

SAN DIEGO COUNTY'S COMPUTER STORE INTL.

Presents the
COMPLETE HOME COMPUTER SYSTEM

Apple II 32k

REG. \$2,350

NOW \$1,895

- Integer or Apple Soft Basic
- 32K User Memory (RAM)
- Color Graphics
- Music and Sound Effects
- Excellent Reliability

APPLE DISK II SYSTEM

- Disk Drive with Controller
- Disk Operating System
- 110 K On Line Storage
- 10 Pre-Programmed Diskettes

13" PORTABLE T.V. SET

TO TAKE ADVANTAGE OF COLOR GRAPHICS, WITH RF TV MODULATOR



COMPUTER STORE INTL.
A DIVISION OF COMPUTER METRICS INC.

**1251 BROADWAY
EL CAJON CA. 92021
(714) 579-8066**

OFFER EXPIRES 12-31-79

	APL/S	APL	Definition
Scalar 2-argument functions	X+Y X-Y X×Y X÷Y X*Y X MAX Y X MIN Y X MOD Y X LOG Y X LT Y X LE Y X EQ Y X GE Y X GT Y X NE Y X AND Y X OR Y	X+Y X-Y X×Y X÷Y X*Y XΓY XLY X Y X⊗Y X<Y X≤Y X=Y X≥Y X>Y X≠Y X∧Y X∨Y	X plus Y X minus Y X times Y X divided by Y X to the Yth power maximum of X and Y minimum of X and Y X modulo Y X residue of Y base X log of Y X less than Y X less than or equal to Y X equal to Y X greater than or equal to Y X greater than Y X not equal to Y X and Y X or Y
Scalar 1-argument functions	+Y -Y SIGN Y +Y EXP Y CEIL Y FLOOR Y ABS Y LOG Y !Y RAND Y NOT Y	+Y -Y xY +Y *Y ΓY LY Y ⊗Y !Y ?Y -Y	Y negative of Y signum of Y reciprocal of Y e to the Yth power ceiling of Y floor of Y absolute value of Y natural log of Y factorial of Y a random integer from 1 to Y not Y
Mixed 2-argument functions	X,Y	X,Y	the concatenation of X and Y, an array
Mixed 1-argument functions	SIZE Y INDEX Y ARRAY Y .Y X(Y) X=Y ⊙/Y	ρ Y ιY Y ρ 0 .Y X[Y] X-Y ⊙/Y	number of elements in Y 1,2,...Y size Y array of zeros Y ensured a vector the element of X selected by Y X assumes the value of Y the ⊙ reduction of Y, where ⊙ is any scalar 2-argument function: Y ₁ ⊙Y ₂ ⊙...⊙Y _n
Subscribing Assignment Reduction operator	X(Y) X=Y ⊙/Y	X[Y] X-Y ⊙/Y	the element of X selected by Y X assumes the value of Y the ⊙ reduction of Y, where ⊙ is any scalar 2-argument function: Y ₁ ⊙Y ₂ ⊙...⊙Y _n
Input Output	KEYB X "X"	□ X 'X'	keyboard input display the value of X display X
Circle functions (scalar 1-argument functions in APLS)	SIN X COS X TAN X	1oX 2oX 3oX	sin X cos X tan X

Table 1: APL/S functions with equivalent APL functions shown for comparison.

Because of the limited character set available, the relational functions are denoted with alphabetic symbols (eg: NE for ≠) and assignment is denoted by = instead of the preferable ← of APL. In most other cases, functions which are denoted in APL by special characters are denoted in APL/S by the name of the function as given in descriptions of APL.

In APL/S, mathematical formulas are evaluated left to right with addition and subtraction done last. For example, 2*4+10×3-1 is evaluated as follows:

$$\begin{aligned}
 &2^4+10\times 3-1 \\
 &16+10\times 3-1 \\
 &16+30-1 \\
 &46-1 \\
 &45
 \end{aligned}$$



Figure 1: Syntax diagram showing global structure of an APL/S program.

SYNCHRO-SOUND

The ORIGINAL Computer People Who KNOW computers and offer EVERYTHING you need in Small Computer Systems

Compare PRICE, QUALITY, DELIVERY, SERVICE and you'll see why you don't have to look anyplace else!



TEXAS INSTRUMENTS
810 Multi-Copy Impact Printer
ONLY **\$1599.00**
SINGLE QUANTITY PRICE

We carry a full line of Texas Instruments products

SUPER SPECIAL!



LA 34
DECwriter IV Teleprinter
\$1095.00
SINGLE QUANTITY PRICE

TERMINALS

LEAR-SIEGLER	ADM-3A	} CALL* for prices
	ADM-31	
	ADM-42	



HAZELTINE

1400	...	} CALL* for prices
1410	...	
1500	...	

Mod 1 Edit



COMPUTERS

NORTHSTAR
Horizon II (kit) ... CALL* for price

PRINTERS

QUME
Sprint—5/45 KSR
..... **\$2995.00**
Typewriter Quality Printer Terminal



DIGITAL SYSTEMS

DSC-2 CALL* for prices
Dble Density
Dual Drive Disk



TELETYPE

43 CALL* for price



CROMEMCO
System 3 CALL* for price



CENTRONICS

Micro	} CALL* for prices
779-2	
700-2	
703-0	



MORE SPECIALS

Okidata SL 125 \$2595.00	Livermore Acoustic Coupler 249.00
Javelin 9" Monitor 159.95	Centronics Micro Printer 395.00
Persci 277 Dble Density 1395.00	5" Scotch Diskette	.. Box/34.95
Imsai PCS 80/15 599.00	8" Scotch Diskette	.. Box/39.95
Televideo 912 920 } CALL*		

* Our prices are too low to advertise. Please call or write. We now carry a full line of Alpha-Micro Products

We have a full staff of Programmers and Computer Consultants to design, configure and deliver a Turnkey Computer System to meet your specific requirements.



SYNCHRO-SOUND

The Computer People
193-25 Jamaica Avenue, Jamaica, New York 11423
TWX 710-582-5886

ENTERPRISES, INC.

PHONE ORDERS. CALL:
NEW YORK — 212/468-7067
LOS ANGELES — 213/628-1808
CHICAGO — 312/641-3010
DALLAS — 214/742-6090

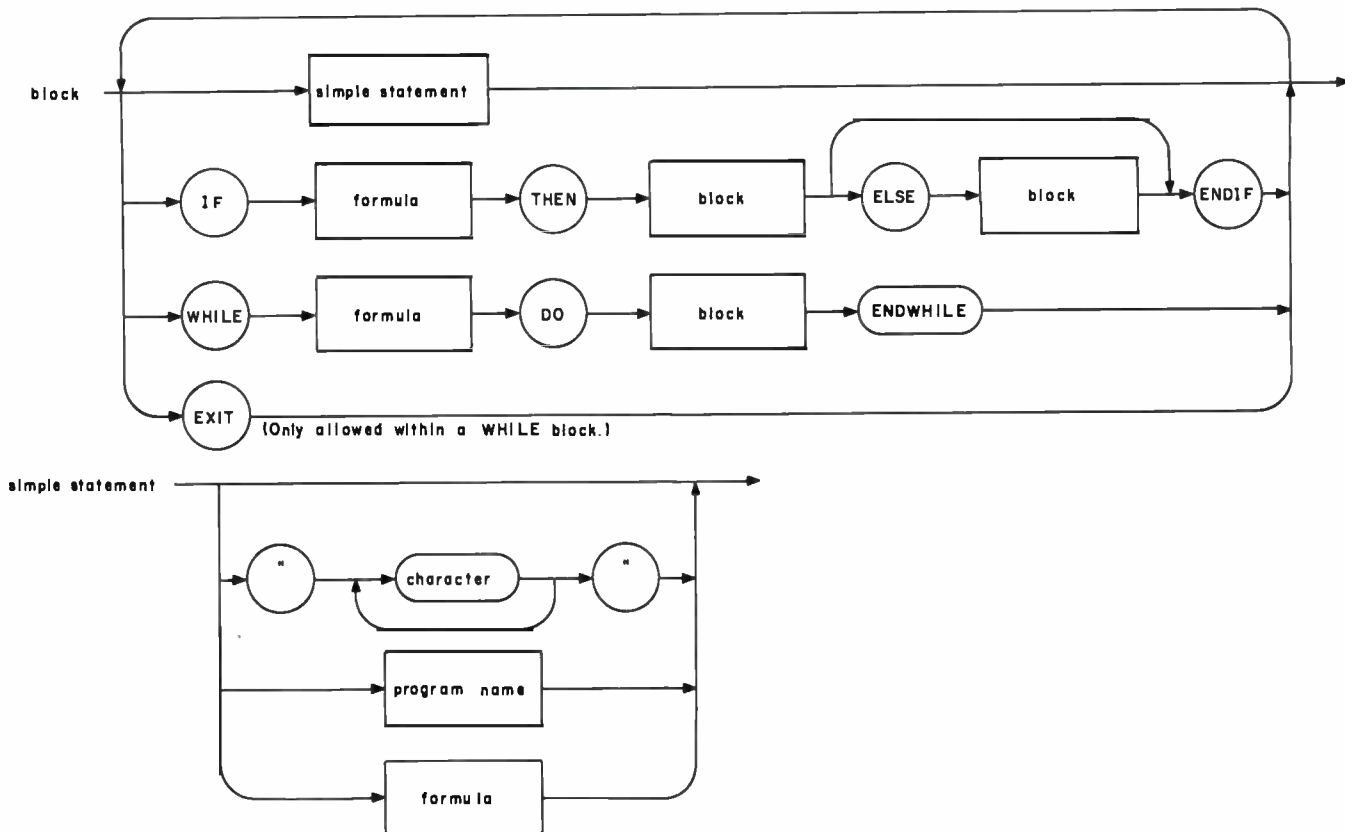

Figure 2: Syntax diagram for block and simple statement structures.

For an assignment statement, evaluation cannot be strictly left to right. For example, the statement $A = 10 + 1$ is evaluated by first adding 10 and 1 for a result of 11, then assigning the 11 to A.

Evaluating the right hand side of an assignment before performing the assignment is carried forward to the case of an assignment embedded within a formula. For example:

```

3 × A = 10 + 1
3 × A = 11
3 × 11
33

```

The use of assignment within a formula is illustrated in the program GUESS of listing 1b in the line `WHILE NUM NE GES=KEYB`. The evaluation of the line goes as follows: the KEYB function reads the keyboard and returns the value entered, the assignment operation places the value into the variable GES, and the NE function is then evaluated to 1 if NUM is not equal to GES or to 0 if NUM is equal to GES. WHILE will then have an argument of 0 or 1.

WHILE, IF, AND, OR, and all the relational functions treat 1 as true and 0 as false. APL/S makes no data type distinctions such as boolean, integer, or real — a number is a number. Functions such as AND are defined on a subset of the numbers, namely 0 and 1.

The control figures of APL/S are Sequence; IF-THEN-ELSE, ENDIF; WHILE-DO, ENDWHILE; and Sub-

programs. There is no GOTO statement, but there is an EXIT for early termination of a WHILE loop. Because all control figures are self terminating (ie: ENDIF, ENDWHILE, ENDPROGRAM), there is no need for BEGIN-END pairs to form compound statements. Anywhere a single statement can appear, so can a block of statements.

Programs can be invoked recursively. The major weakness is that all variables are global. These facilities of the language are powerful enough that the popular eight-Queens problem can be solved by an APL/S program which closely follows the recursive and well structured solution given by Dijkstra. (The differences are array bounds and local variables.)

The eight-Queens problem was discussed from a beginner's viewpoint in an article in the October 1978 BYTE ("Solving the Eight-Queens Problem," by Terry Smith, page 122) and from a more sophisticated vantage by several readers in the February 1979 BYTE ("Eight-Queens Forum," pages 132 through 148). Dr E W Dijkstra's solution is found on pages 72 thru 82 of *Structured Programming*, by Dahl, Dijkstra, and Hoare (Academic Press, 1972):

Like APL, in APL/S all scalar functions are extended element-by-element to arrays, any scalar two-argument function can be used to reduce an array, and mixed functions such as SIZE (ρ in APL) are defined. Unlike APL, in APL/S arrays are restricted to one dimension, and subscript expressions must evaluate to scalars (or one-element arrays). Some examples should help clarify the array features.

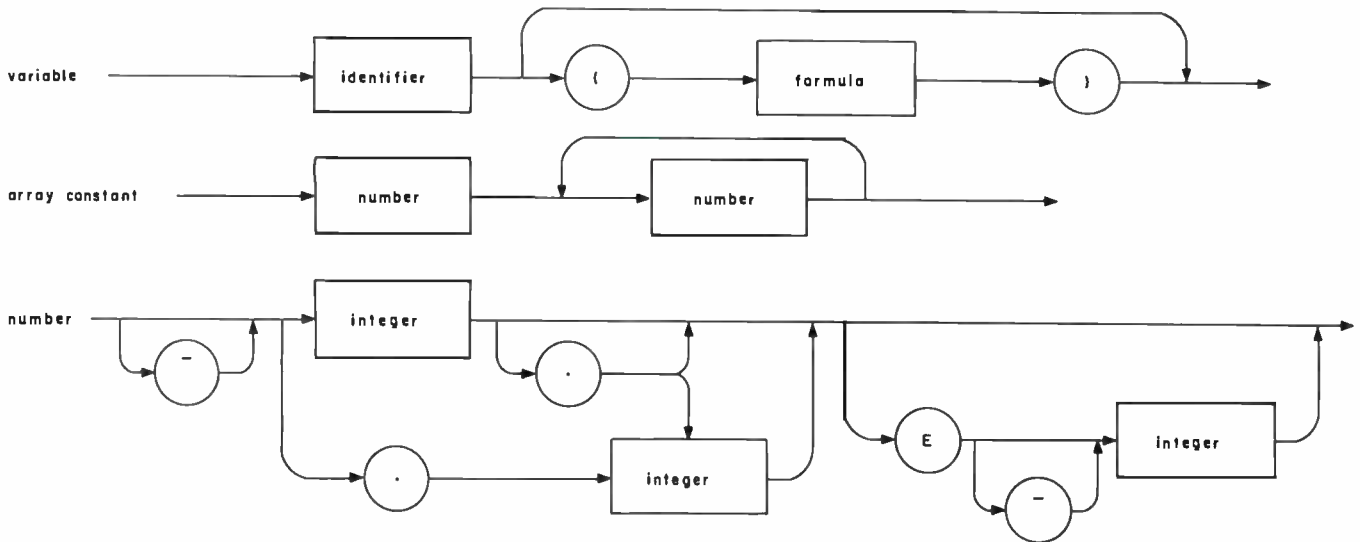

Figure 3: Syntax diagram for variable, array constant, and number structures.

Some Examples

Any simple statement (as defined in figure 2) can be entered for immediate evaluation. Photo 1 shows an example of an immediate mode calculation on the VideoBrain computer. The user entered +/2 4 6. It was evaluated and the result, 12, was displayed. The "2 4 6" is

an example of an array constant. Addition was used to reduce the array to a scalar. Reduction by addition (+/) can be visualized as: +/2 4 6 gives 2+4+6 gives 12.

A more realistic use of arrays in immediate mode is the calculation of net present value. Given the one-dimensional array of cash flows, $C=(C_1, C_2, \dots, C_n)$, the net present value (NPV) at an interest rate I , is given by:

$$NPV = \sum_{j=1}^{j=n} \frac{C_j}{(1+I)^j}$$

In APL/S, the formula for the net present value is:

$$+/(C \div ((1+I) * \text{INDEX SIZE } C))$$

For comparison, the equivalent formula in APL is:

$$+ / C \div (1+I) * \iota C$$

The two formulas are similar, differing only in function names and parentheses (to insure the same order of evaluation).

Because this kind of use of the array facilities is at the very heart of APL or APL/S programming, it is essential to understand how such formulas are evaluated. Let $I=0.1$ and $C=100\ 50\ 150$. The evaluation of the APL/S formula can be traced through its intermediate results:

$$\begin{aligned} &+/(C \div ((1+I) * \text{INDEX SIZE } C)) \\ &+/(100\ 50\ 150 \div (1.1 * \text{INDEX SIZE } 100\ 50\ 150)) \\ &+/(100\ 50\ 150 \div (1.1 * \text{INDEX } 3)) \\ &+/(100\ 50\ 150 \div (1.1 * 1\ 2\ 3)) \\ &+/(100\ 50\ 150 \div (1.1\ 1.21\ 1.331)) \\ &+/(90.909\ 41.32\ 112.7) \\ &90.909 + 41.32 + 112.7 \\ &63.111 \end{aligned}$$

Text continued on page 98

SPECIAL INTRODUCTORY OFFER



ANADEx DP-8000 LINE PRINTER

LOGON offers you this excellent small reliable printer at a low introductory price. Every DP-8000 is complete with the latest features: - Adjustable tractors and 1K input buffer. Standard features include:

- RS232C, current loop and centronics parallel
- 80 columns - 112 char/sec
- 96 char set - 9 x 7 font — Bidirectional printing
- Top of form, skip over perf, out of paper, eight vertical tabs, etc.

Only \$795

Plus \$20.00 shipping and handling.
Terms - check with order - Allow 3 weeks for delivery



Logon Inc.
246 O Lemoine Ave.
Fort Lee, N.J. 07024
201-224-6911
212-594-8202

Bringing Music Home

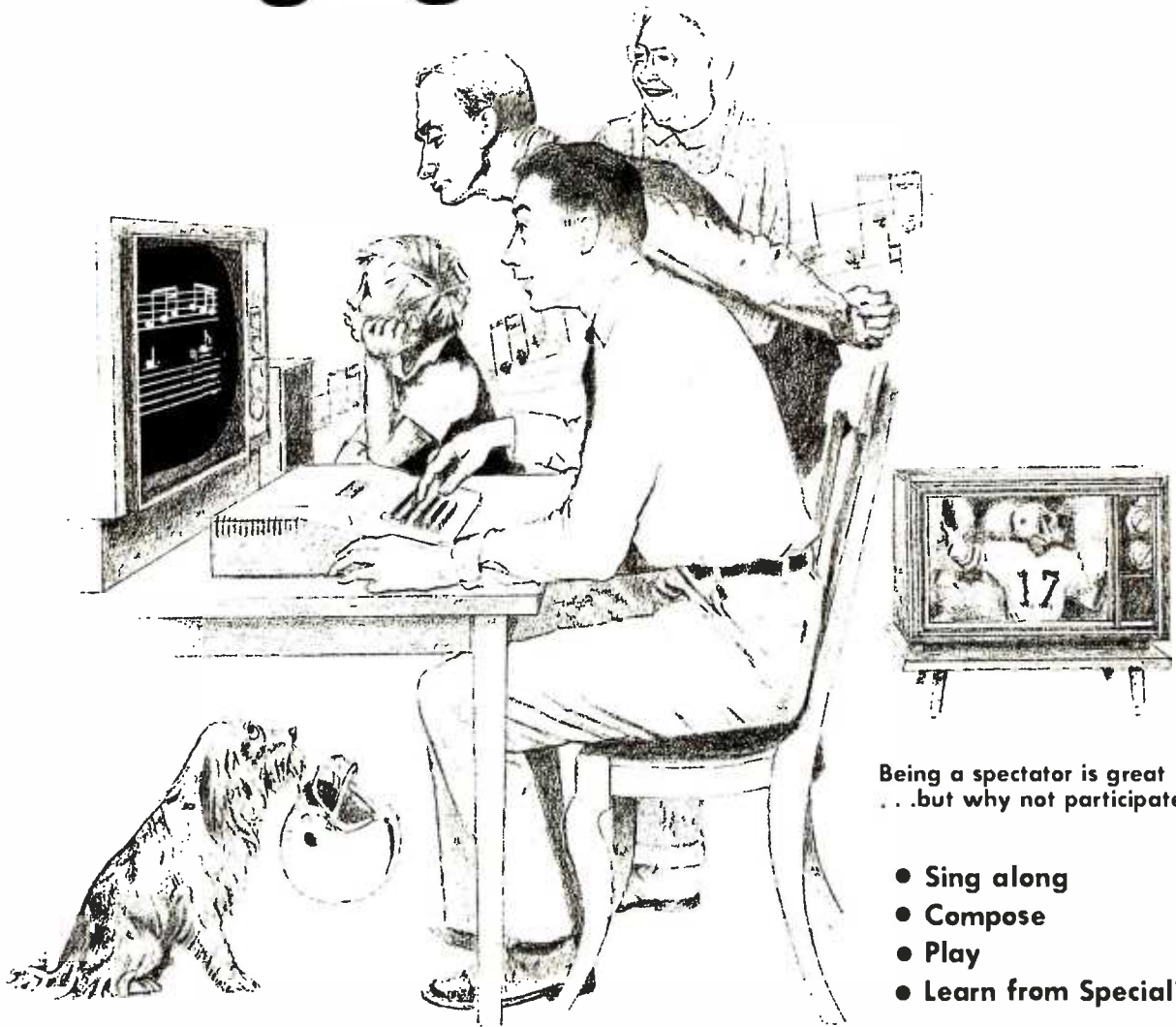

Being a spectator is great
...but why not participate?

- Sing along
- Compose
- Play
- Learn from Specialists

LET MICRO MUSIC TURN YOUR APPLE II® INTO A FAMILY MUSIC CENTER!

VISIT THE APPLE DEALER NEAREST YOU AND ASK FOR A DEMONSTRATION OF MMI'S MICRO COMPOSER™
The MICRO COMPOSER LETS YOU—

- Play up to 4 simultaneous voices
- See all 4 voices at the same time you're hearing the music—a must for music editing!
- Enter music notes by a fast, simple and well-tested coding system.
- Program the pitch, rhythm, and timbre of the music. Tempo is varied by the Apple paddle.
- Choose 7 different tone colors for each voice or create your own tone color.
- Compose, edit, display, and play music through an interactive, command-driven language that's easy to learn.
- Save your music on disk or cassette.
- Hear quality music sound at low cost through the MICRO MUSIC™ DAC card. No amplifier needed! Designed for MMI by Hal Chamberlin and Micro Technology Unlimited.
- Select from future MMI music instruction software to accompany the MICRO MUSIC DAC.

The MICRO COMPOSER is an APPLE II® compatible, low-cost music system designed by the folks at MMI. Our music software was designed by leading experts in music education. A simple step-by-step instruction manual leads you through entering, displaying, editing, and playing music with up to four voices—soprano, alto, tenor, and bass. You can change the sound of each voice to reed, brass, string, or organ sounds and you can even color your own music sounds!

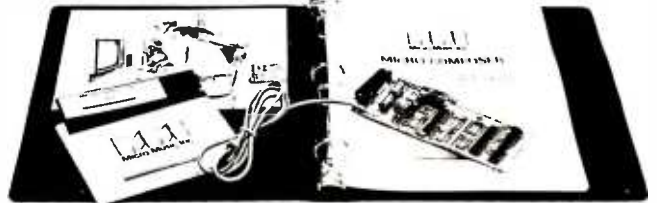

HAVE FUN! THE MICRO COMPOSER comes complete with an instruction manual, software disk or cassette—in either Integer or Applesoft ROM BASIC, and the MICRO MUSIC DAC music card. Just plug the MICRO MUSIC DAC into the APPLE extension slot and connect the audio cable to a speaker.

Suggested retail price \$220.

Ask your local dealer for information on MMI products, or contact:



Micro Music Inc 309 W. Beaufort, University Plaza, Normal, Illinois 61761 (309) 452-6991

APPLE II is a trademark of Apple Computer Inc.

SELECTOR III - C2

THE INFORMATION MANAGEMENT SYSTEM

Includes these Application Sub-Programs. . .

Sales Activity, Inventory, Payables, Receivables, Check/Expense Register, Library Functions, Mailing Labels, Appointments, Client/Patient Records

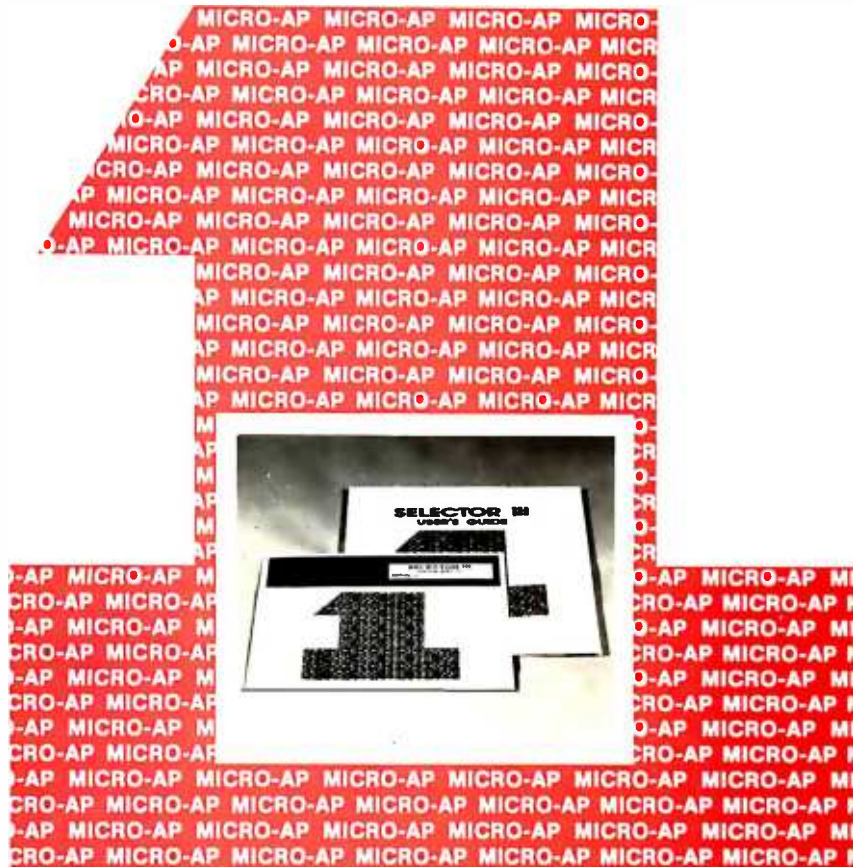

Circle 213 on inquiry card.

RANDOM, MULTI-KEY RECORD RETRIEVAL under CP/M, CDOS, IMDOS, ADOS ...

SELECTOR III-C2 ALLOWS INSTANT RECALL OF ANY RECORD USING ANY INFORMATION ITEM IN THE RECORD. That statement deserves re-reading, because that ability makes **SELECTOR III-C2** the most powerful information management system in microcomputers today!

The three major activities in business computing are...Word Processing, Financial Accounting, and the storing, processing, and reporting of information. The latter is where **SELECTOR III-C2** shines and fills the professional and personal need.

The system represents the state of the art using Micro-Ap's unique record indexing, query, and report writing methods. It's 'menu driven' and uses screen displays with all the instructions and error sensing that allow the novice to quickly learn the system and accomplish his tasks.

With **SELECTOR III-C2** you...

- define a record format assigning up to 24 fields as 'key' fields -meaning that records can be instantly recalled by name, date, quantity, ZIP Code, or whatever.
- create a file and begin entering edited and verified data immediately.
- browse through your file in key field order, making whatever changes or deletions needed.
- select collections of records meeting your exact requirements and arranged in the order wanted.
- create a unique report that contains the precise information you need - with numerical totals, averages, maxima, and minima -for any period of time and summarized by name, date...or by any item you want.
- bring an application on-line in hours instead of months.

SELECTOR III-C2 is a 'turn-key' system that can manage most applications as is. It includes source-code and pre-defined record formats and sub-programs to perform the tasks listed at top of page. Programmers can easily add other sub-programs - using the system's powerful utilities - to perform virtually any special computation or function required.

The system runs under CBASIC Vers. 2, and is priced at \$345. It's available in a variety of CP/M, disk formats including Dynabyte; North Star; Micropolis; TRS-80; Helios II; Heathkit; iCOM; Altair; Im-sai; Cromemco; and others.

Available from computer stores worldwide.

LIFEBOAT Associates

2248 Broadway, Suite 34,
New York, N.Y. 10024 • (212) 580-0082

Or order direct from

MICRO-AP

9807 Davona Drive, San Ramon, CA 94583
(415) 828-6697

Circle 58 on inquiry card.

DESKS AND STUFF

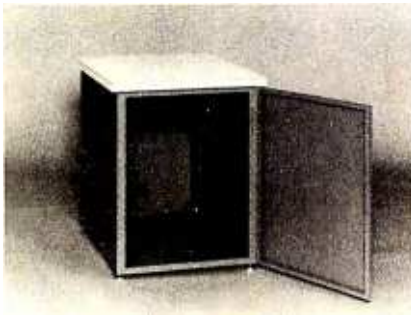

Computer terminals, business systems, lab components . . . they all need desks and enclosures. That's what we're all about. Computer Furniture and Accessories offers a standard line of furniture suitable for a wide variety of applications. Handsome, rugged, economical furniture in all shapes, sizes and colors. Basic models shipped from stock in days, not months. And we're nice people to deal with. What more could you ask for?

CF&A

**Computer Furniture and
Accessories, Inc.
1441 West 132nd Street
Gardena, CA 90249
(213) 327-7710**

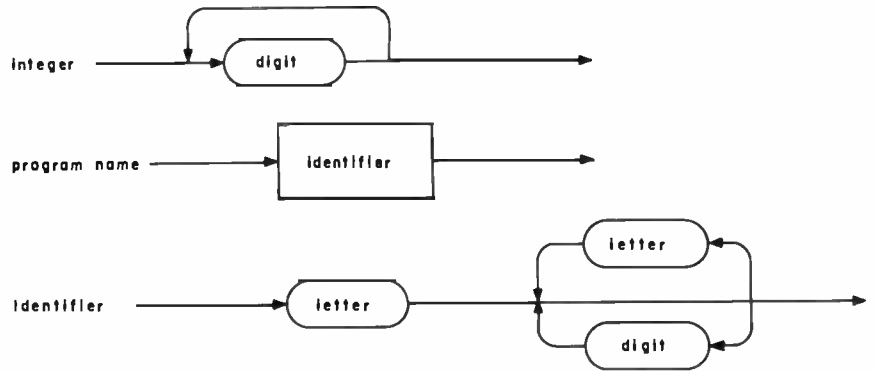

Figure 4: Syntax diagram showing integer, program name, and identifier structures.

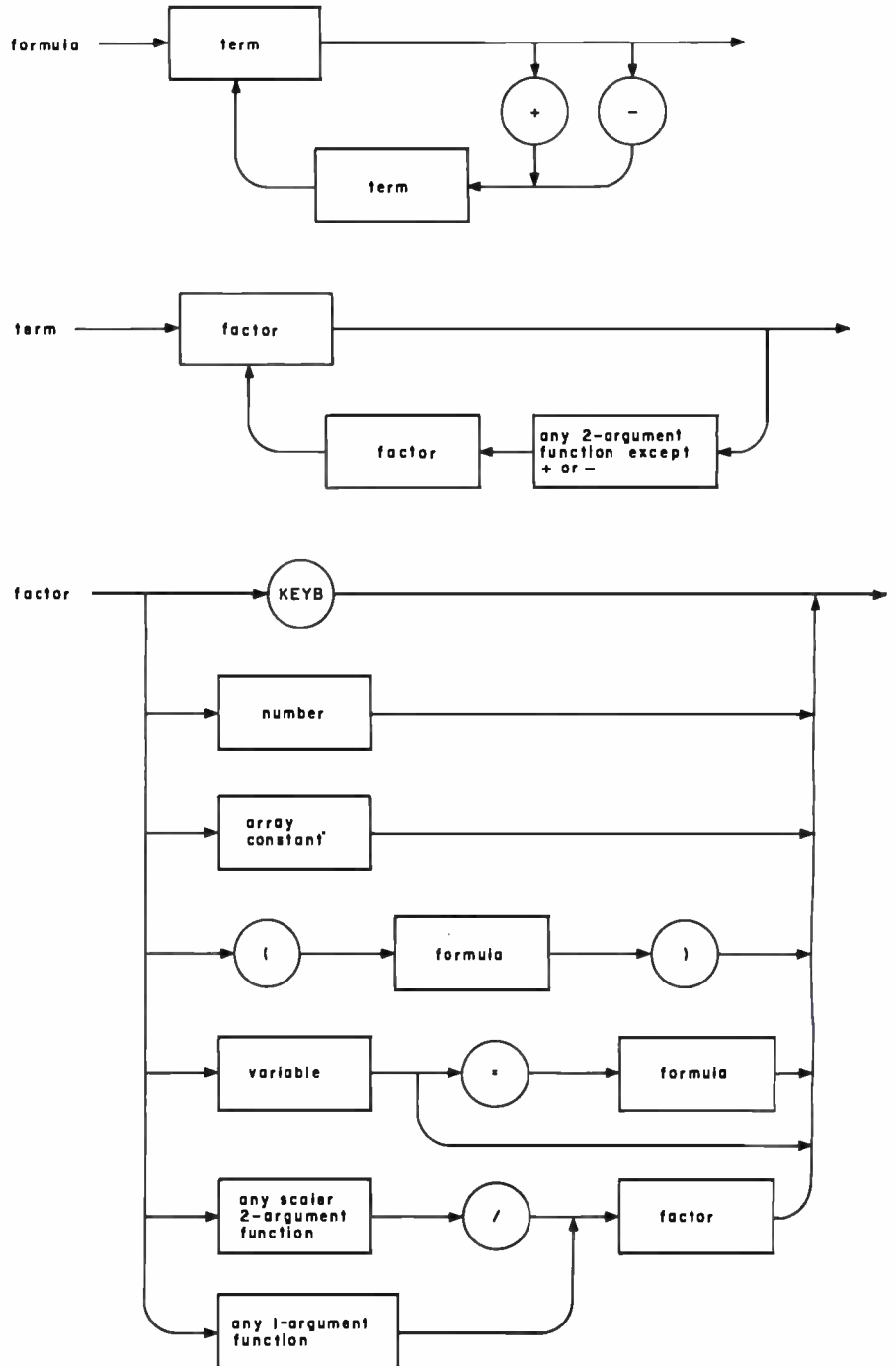

Figure 5: Syntax diagram of formula, term, and factor structures.

A Beautiful Way To Interface



IQ 140



SOROC's first and foremost concern, to design outstanding remote video displays, has resulted in the development of the IQ 140. This unit reflects exquisite appearance and performance capabilities unequaled by others on the market.

With the IQ 140, the operator is given full command over data being processed by means of a wide variety of edit, video, and mode control keys, etc.

The detachable keyboard, with its complement of 117 keys, is logically arranged into 6 sections plus main keyboard to aid in the overall convenience of operation. For example, a group of 8 keys for cursor control / 14 keys accommodate numeric entry / 16 special function keys allow access to 32 pre-programmed commands / 8 keys make up the extensive edit and clear section / 8 keys for video set up and mode control / and 8 keys control message and print.

Two Polling options available: 1) Polling compatible with Lear Siegler's ADM-2. 2) Polling discipline compatible with Burroughs.

Circle 346 on Inquiry card.

IQ 120



The SOROC IQ 120 is the result of an industry-wide demand for a capable remote video display terminal which provides a multiple of features at a low affordable price.

The IQ 120 terminal is a simple self-contained, operator / computer unit.

The IQ 120 offers such features as: 1920 character screen memory, lower case, RS232C extension, switch selectable transmission rates from 75 to 19,200 bps, cursor control, addressable cursor, erase functions and protect mode. Expansion options presently available are: block mode and hard copy capability with printer interface. The IQ 120 terminal incorporates a 12-inch, CRT formatted to display 24 lines with 80 characters per line.

 **SOROC**
TECHNOLOGY, INC.

165 FREEDOM AVE., ANAHEIM, CALIF. 92801
(714) 992-2860 / (800) 854-0147

Listing 3: An APL/S program that simulates a game of craps. The game continues until a bet of \$0 is made. Actual play is handled by the subroutine PLAY, which sets WIN to 1 to indicate a win, and to 0 for a loss. The net amount won is stored in NET.

```
PROGRAM CRAPS
  NET=0
  "BET 0 TO QUIT"
  WHILE 1
    DO "PLACE YOUR BET"
      IF 0 GE BET=KEYB
      THEN EXIT
      ELSE "COMING OUT"
        PLAY
        IF WIN
        THEN "WINNER"
          NET=NET+BET
        ELSE "YOU LOSE"
          NET=NET-BET
        ENDIF
      ENDIF
    ENDWHILE
    IF NET GE 0
    THEN "YOU'VE WON"
      NET
    ELSE "YOU'VE LOST"
      -NET
    ENDIF
    "COME.AGAIN SOON"
  ENDPROGRAM
```

Listing 4: The PLAY subroutine used by the CRAPS program of listing 3. A first roll of 7 or 11 wins; 2, 3, or 12 loses. Otherwise, a point is established (the value of the first roll). The dice are then repeatedly rolled until the point is rolled for a win, or a 7 is rolled for a loss. See listing 5 for a sample execution of CRAPS.

```
PROGRAM PLAY
  +DICE=RANDOM 6 6
  PONT=+/DICE
  IF OR/(PONT EQ 7 11)
  THEN "PASS"
    WIN=1
  ELSE WIN=0
    IF OR/(PONT EQ 2 3 12)
    THEN "CRAPS"
      ELSE "YOUR POINT IS"
        PONT
        WHILE 1
          DO +DICE=RANDOM 6 6
            IF +/DICE EQ PONT
            THEN "POINT MADE"
              WIN=1
            EXIT
          ELSE
            IF +/DICE EQ 7
            THEN "BUSTED"
              EXIT
            ENDIF
          ENDIF
        ENDWHILE
      ENDIF
    ENDWHILE
  ENDIF
  ENDPROGRAM
```

Listing 5: Sample execution of CRAPS.

```
CRAPS
BET 0 TO QUIT
PLACE YOUR BET
?250
COMING OUT
4 3
PASS
WINNER
PLACE YOUR BET
?300
COMING OUT
1 1
CRAPS
YOU LOSE
PLACE YOUR BET
?200
COMING OUT
2 4
YOUR POINT IS
6
1 4
6 2
5 5
1 5
POINT MADE
WINNER
PLACE YOUR BET
?0
YOU'VE WON
150
COME AGAIN SOON
```

Text continued from page 94:

A simple program (AVE) using the array facilities is shown in photo 2 as it would appear to the user. The program computes the average of a set of observations. An execution of AVE is shown in photo 3.

The final example uses both the structured programming and array features for a simple game of craps. The main program is shown in listing 3, a subprogram in listing 4, and a sample execution in listing 5.

Both the main program and the subprogram use an EXIT statement to end a loop based on a condition detected inside the loop. The single entry, single exit convention of structured programming is maintained by this highly restricted type of GOTO.

The subprogram PLAY (listing 4) contains examples of using the array features for logical testing, a use which is not obvious in the numeric computation context usually employed in explaining the array features. Such non-mathematical use of the array features is common in APL programming, although in APL it is used in conjunction with a kind of conditional GOTO. The evaluation of the expression IF OR/(PONT EQ 7 11) will be followed through its intermediate results.

Although the purpose of the statement is logical testing, the execution trace will show how the statement is, in its use of the array features, similar to the expression for net present value. For tracing, let PONT=9.

IF OR/(PONT EQ 7 11)
 IF OR/(9 EQ 7 11)
 IF OR/(0 0)
 IF 0 OR 0
 IF 0

The result, 0, indicates that it is false that PONT equals 7 or 11, so execution will proceed to the first statement of the ELSE block.

Summary

APL/S is one of the first high-level language alternatives to BASIC to be offered on a low-priced personal computer (under \$800). APL/S combines structured programming with an APL approach to arrays. Additional differences between APL and APL/S are due to hardware limitations and a desire to make use of the language as natural as possible. ■

An APL/S language system is available in a read-only memory cartridge for the VideoBrain home computer from VideoBrain Computer Co, 2950 Patrick Henry Dr, Santa Clara CA 95050.

REFERENCES

1. Brown, R G, "An Introduction to APL/S," *Conference Proceedings of the Third West Coast Computer Faire*, November 1978.
2. Dahl, Dijkstra, and Hoare, *Structured Programming*, Academic Press, 1972.
3. Judd, W and Cintz S, *APL/S User's Manual*, Video Brain Computer Co, Santa Clara CA, 1978.
4. Smith, Terry, "Solving the Eight-Queens Problem," October 1978 BYTE volume 3, number 10, page 122.

New Robotype™

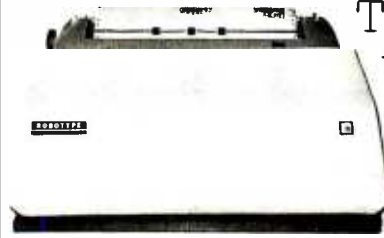

Turns your typewriter into a quality output printer!

- easily connects to any computer
- serial and parallel interface
- all electronics included—ready to use from package
- connects to IBM Selectric II typewriter in just one minute
- adapts to a variety of typewriters—no modifications
- compatible with Radio Shack TRS-80, Apple II, Pet, etc.
- Centronics interface compatible
- available from stock in 30 days

Put a Robotype to work on your typewriter for under \$1,000. Call (614) 436-3163 today!

Dealer, distributors, and word processor OEM inquiries welcome.

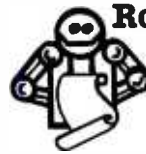

Robotype™
 (A trademark of Compu-Matics, Inc.)

Applied Computer Systems, Inc. 

77 East Wilson Bridge Road • Worthington, Ohio 43085

Low Power 32K RAM for Heath® H8 computers

DG-32D 32K RAM FEATURES:

- ✓ Plugs into Heath® H8 Computer
- ✓ Ready to use. Fully assembled, tested & burned in
- ✓ Operates with existing Heath memory
- ✓ Protected Memory Output Buffers in the event of Address error.
- ✓ Utilizes popular 4116 RAM devices
- ✓ Memory Address DIP switch changeable
- ✓ Arranged as 4 Independent 8K Blocks
- ✓ Low Power Consumption: Less than 6 watts, typical
- ✓ Transparent Refresh
- ✓ One year guarantee
- ✓ Compatible with all current H8 peripherals.

Heath® and H8 are registered trademarks of the Heath Corporation, Benton Harbor, Michigan.

D·G ELECTRONIC DEVELOPMENTS CO.

\$479

D·G Electronic Developments Co. brings you a totally compatible, fully assembled and tested 32K RAM for Heath® H8 computers. The DG-32D has less than 6 watts power consumption. This allows you to add a full 32K bytes of Random Access Memory without taxing or replacing your computer's power supply. Engineered to plug-in and run without any user modifications, the DG-32D can be used with or without existing H8 RAM without modification. Protection of the memory output buffers is provided in the event of assigning two blocks to the same address space. The DG-32D is the ideal answer to expansion of the Heath H8 computer . . . Low power consumption, low price, high capacity, total engineering and exacting production methods.

Ordering Information: DG-32D RAM available only from DG Electronic Developments Co., P.O. Box 1124, 1827 South Armstrong, Denison, Texas 75020. Check, money-order, VISA or Master Charge. Phone orders accepted on charge orders. NO COD's. Foreign orders add 30%. Texas residents add 5%. For VISA or Master Charge orders call 214-465-7805. \$479.00 freight prepaid.

32K RAM for HEATH® H8

NINE NEW KITS AVAILABLE NOW!

QK-100 Triple A · D Converter	\$36.95
QK-101 Dual Air Temperature Sensors	26.95
QK-102 Dual Ground Moisture Sensors	29.95
QK-103 Power Supply with Dual Sockets	29.95
QK-104 Dual Liquid Temperature Sensors	32.95
QK-105 Dual Photo Sensors	27.95
QK-106 Dual Water Level Sensors	34.95
QK-108 Dual Surface Temperature Sensors	30.95
QK-109 Dual Hall-Effect DC Magnetic Sensors	54.95
QK-110 Multiplier and Voltage-Controlled Amp	43.95
QK-112 Peak Sense and Hold/Sample and Hold	28.95
QK-115 8/16 Input Analog Multiplexer	38.95
QK-122 Dual Instrumentation Amplifier	24.95
QK-124 Log and Anti-Logarithmic Functions	40.95
QK-133 Multiple Audible Alarm	25.95
QK-134 Multiple Analog Comparators	39.95
QK-138 Dual "People" Sensors	34.95
QK-900 Socket and Mounting Board	8.95



ALL Q-kits AVAILABLE IN ASSEMBLED MODULES

— ask for Q-mod price information.

Q-kits use I/O ports and are not dependent on a particular bus system.

Most Q-kits offer stand-alone application capability, using a ±15 Volt Power Supply.

CALL Q-KIT
WITH YOUR CUSTOM-DESIGN
SYSTEM REQUIREMENTS!



ANALOG
PERIPHERAL FUNCTIONS

... in touch with reality!

(602) 299-9831

P.O. BOX 35879

TUCSON, ARIZONA 85740

a division of the j. r. conwell corporation



Computer Simulates State Prison System, Helps Predict Cost

Louisiana State University (LSU) has designed several computer models that simulate the operation of the state's prison system. The computer models can determine the cost of building and staffing new prison units, the costs of prisoner transfer, and the costs that any changes in duration of stay or in legislation affecting probation or sentencing might have. With the University's IBM computer at their disposal, lawmakers can propose various pieces of legislation, send it to LSU for analysis, and receive a response within 48 hours. For further information, contact IBM, 7701 Stemmons Fwy, Dallas TX 75247.

Apple Computer Introduces a Repair Service

Apple Computer Inc, 10260 Bandlely Dr, Cupertino CA 95014, has announced a nationwide repair program featuring same-day computer repairs.

Level I repair requires no special technical knowledge and will be dealt with by a local dealer using new diagnostic software and Apple's Modular Parts Exchange Program (MPEP).

The diagnostic program tests the motherboard, power supply, memories, keyboard, tape I/O, paddles, disk drive, and peripheral interface cards. When the problem is located, the diagnostic program identifies it and informs the dealer, through the video display, which component needs repair or replacement. The Level II (more complex) repairs will take place at a regional distributor, and Level III ser-

vice will originate from the Apple Service Center in Cupertino CA.

A California School District Uses Computers

Five hundred and fifty boys and girls from elementary grades and the six high schools in the Huntington Beach school system are now using a powerful IBM System/370 Model 135, which is reserved exclusively for instructional purposes. The students take courses in mathematics, science, social studies, business, English, and computer programming languages in teacher-supervised classrooms on 56 terminals. A group of high school students wrote a series of online programs to carry all scoring and results of an academic decathlon hosted by a Huntington Beach high school. One student wrote a program to survey all county school professional salaries. Another 7th grade pupil won the county science fair with a computer project. Children can develop their own academic computing programs and make any program selection they want. For further information, contact Glen Dysinger, 5201 Bolsa Ave, Huntington Beach CA 92647.

LSU Professor and Computer Develop New Ways to Deal With Environmental Problems

An IBM 3033 processor and Richard C Farmer, professor of chemical engineering, are solving complex equations devised in the 1880s that describe the motions of solid particles in fluids. Computed results may show where to deposit sediment from dredging operations that are necessary

We're about to make a new name for ourselves.

Not that the old one was so bad. As Ithaca Audio, we've made quite a name for ourselves. As the source for CPU, memory, video display and disk controller boards to upgrade other makers' mainframes and peripherals. The company that makes those neat little RAM expansion kits. And the folks behind the world's only Z-80 Pascal compiler.

But as much as we've enjoyed improving other people's equipment, we've been quietly moving towards larger endeavors, with a lot of encouragement from our customers. Listening to people's problems, as well as their needs. And, as a prime mover behind the IEEE S-100 Bus Standard, answering some really knotty questions.

One of the results is our new identity. And our first new product: the InterSystems DPS-1. An IEEE S-100 compatible mainframe with features that live up to its looks. Dependable operation to 4 MHz. Twenty-card capacity. A modular power

supply. And something no one else has — built-in breakpoints to give you a faster, more powerful tool for testing software as well as hardware. *Directly* accessible from an easy-to-use front panel that's as *reliable* as it is functional. In short, an intelligently-designed computer for the intelligent user.

There's a lot more to InterSystems. In hardware. And software. All available through the nationwide dealer network we're now assembling.

You can watch this magazine for updates. Or contact us directly for straight, friendly answers and detailed information from key staff people. Just the way you always have. Because even though we're making a new name for ourselves, we'll never forget who made it possible.

InterSystems

Ithaca Intersystems Inc.
1650 Hanshaw Road/P. O. Box 91
Ithaca, NY 14850/607-257-0190



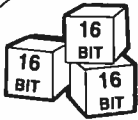

NOW... DISCOVER
16-BIT MICROPROCESSORS!

MICROPROCESSOR LEARNING PACKAGE

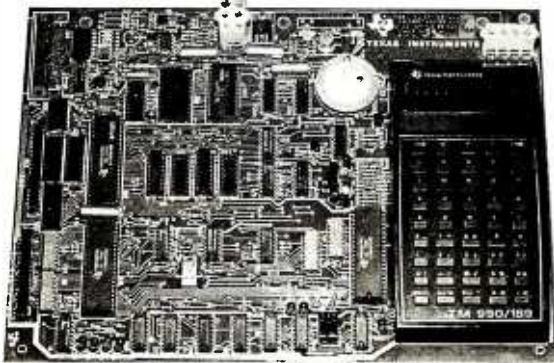

UNIVERSITY MODULE

We offer TI's 16-bit educational module and back it up with support products and services to provide a complete learning package. The University module includes: 16-bit microprocessor; on-board alphanumeric terminal and 10-character, 7-segment alphanumeric display; firmware-resident debug monitor and symbolic assembler; audio cassette interface; user-addressable LEDs; 16-bit programmable I/O controller; optional EIA and TTY interface; 4K bytes of ROM (expandable to 6K) and 1K bytes of RAM (expandable to 2K).

MEMORY AND I/O EXPANSION MODULE

To make the University module even more useful, we designed the Expansion module to provide 8K bytes of additional memory! It has sockets for 8K bytes of EPROM and sockets for 8K bytes of static RAM, which are address configurable on 1K byte boundaries. Included is an EPROM programmer for TI 2708's and 2716's. This module is the mother board for 15 additional 32-bit I/O expansion ports.

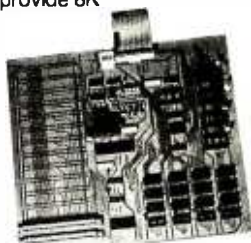

DOCUMENTATION PACKAGE



To support your hardware and software, we offer the 550-page textbook, *Introduction to Microprocessors*. Included in the book are exercises and lab experiments designed specifically for the University module. Application notes are available, along with a set of demonstration programs on audio cassettes. Courses and workshops are also offered. Write or call today for more information on dates and times.

Buy through GGA, Inc. and save! University module with demonstration programs on audio cassettes — \$299. Memory and I/O Expansion module — \$199. Power supply for University module — \$65.

Contact: Educational Products Department
12840 Hillcrest Road, Suite 113, Dallas, Texas 75230
(214) 980-0730

GGA George Goode & Associates, Inc.

to maintain shipping lanes, without endangering precious oyster beds. Professor Farmer hopes to find a way to halt the silting that blocks shipping, without creating other environmental problems. Before a computer approach was developed, marine scientists had to depend on photos and dyed water, and civil engineers used scale models to study environmental problems. The Tennessee Valley Authority uses Professor Farmer's approach to determine optimum methods, from an environmental standpoint, to dispose of the waste heat from power plants. The Louisiana State University, Office of Information Services, Baton Rouge LA 70803 has more information on computer-assisted programs in environmental studies.

Short Course Series

Integrated Computer Systems Inc, 3304 Pico Blvd, POB 5339, Santa Monica CA 90405, has announced their winter and spring schedule for their Short Course series. Courses on computer graphics, digital signal processing; troubleshooting microprocessor systems, and other topics will be covered. The courses are being held in major cities around the US. These courses are structured for technical and managerial personnel.

Computer Courses for Nonspecialists

Human Computing Resources Corp is presenting short courses on introductory programming in BASIC, programming in Pascal, introduction to computing and personal computers and microprocessors, how to buy a computer for a small business, computer graphics, word processing, computers in law and medicine, and more. For price and schedules

for the next year, contact Human Computing Resources Corp, 10 St Mary St, Toronto Ontario, CANADA M4Y 1P9.

Call for Papers

The Instrument Society of America (ISA) is sponsoring a conference on the theory, design, manufacture and use of instrumentation, computers and systems for measurement and control entitled "Instrumentation of Challenge," to be held October 20-23, 1980, in Houston. Papers concerning theory, applications, technique or innovations in the fields of aerospace, analysis, cryogenics, data handling and computation, metals, power, textiles, pulp and paper, maintenance, biomedical, and more, are welcome.

To submit a paper for consideration, request abstract forms from ISA headquarters, 400 Stanwix St, Pittsburgh PA 15222. Deadline for unsolicited papers is February 1 1980. ■



Some Refreshing Bugs

Thanks go to Steve Garcia for uncovering several bugs in his October 1979 BYTE Circuit Cellar article, "Self-Refreshing LED Graphics Display." In figures 2 (page 59) and 4 (page 62) the light-emitting diodes (LEDs) are shown with their polarities reversed. For proper operation, they should be reversed from their appearance in the figures. Also, in figure 2 the signal decode I/O write strobe is shown as a high-to-low transition. It should be a low-to-high transition for proper operation. ■

BYTE News . . .

FCC TO ALLOW ASCII COMMUNICATION VIA OSCAR: The Federal Communications Commission (FCC) has granted the American Radio Relay League (ARRL), the largest amateur radio association in the world, a waiver to allow ASCII communications via the OSCAR satellite. Radio amateurs who have personal computers will soon be able to transmit and receive ASCII anywhere in the world. The waiver covers "experimental use only," as there are still some problems. The problems involve radio frequency (RF) interference in the satellite receiver and a lack of a clear-cut protocol for the ASCII format. Progress is being made in solving these problems, and it is expected that amateurs will utilize this service heavily.

UNIX-LIKE SYSTEM AVAILABLE FOR 8080/Z80 SYSTEMS: An operating system modeled after UNIX (registered trademark of Bell Labs) is now available from the Computer Systems Design Group, 3632 Governor Dr, San Diego CA 92122. UNIX is a high-level, timeshare operating system developed by Bell Labs to run on large DEC PDP-11 systems. It has proven very popular at educational institutions, research organizations, and the like, because of its power and flexibility.

COMPUTER BULLETIN BOARDS MULTIPLY: Computerized bulletin board systems are multiplying like rabbits! These systems, which allow people to communicate with others via terminal/modems and personal computer systems, are skyrocketing in popularity. From only three computerized bulletin board systems in operation at this time last year, their number has increased to nearly 60 systems in operation across the country. These systems are run by individuals, clubs and businesses who are using the computerized bulletin board systems' software to set up computerized intelligent answering machines. Many are tailored to the special needs of the sponsors by altering the software. California has nearly twenty computerized bulletin board systems in operation and Texas approximately ten. A majority of the computerized bulletin board systems can be contacted via computer club newsletters.

NEWS BRIEFS: Bell Labs, Murray Hill NJ, has fabricated experimental bubble memory chips with 11.5 M bit density to yield working storage of at least 1 M bytes . . . Bell Labs has also announced an extension of the conventional doping methods used in manufacturing integrated circuits that could double their speed . . . National Semiconductor, Santa Clara CA, has announced a CMOS microprocessor which executes the Z80 instruction set. However, it is not pin-compatible with the Z80 . . . Texas Instruments is the leader in microprocessor production. So far they have made over 9 million TMS-1000 microprocessors. The TMS-1000 is a 4-bit processor used mostly in toys and games.

8-INCH HARD DISK DRIVE MARKET SHAPING UP: It is now apparent that manufacturers are going to use the new 8-inch hard disk drives in a big way next year. The 8-inch hard disk drives will fill a gap that exists between floppy drives and the 14-inch hard disk drives. The IMI-7710, made by International Memories Inc, Cupertino CA, is the only drive currently in production. IMI appears to have at least a 6-month, and possibly greater, lead on the rest of the manufacturers. The 7710 stores 11 M bytes and sells for under \$2000 in quantity (\$2990 for a single unit).

At least a dozen manufacturers will have 8-inch hard drives in production by the end of the first quarter of next year. They will range from 2.1 M bytes all the way up to 51 M byte units, with prices ranging from \$1900 to \$4000 in single-unit quantities. Shugart will be a late entry into this market and is keeping development efforts under wraps. However, Shugart is expected to introduce a very low-cost small storage size drive.

It is expected that manufacturers of double-sided floppy drives will have all the bugs solved in 1980 and that these drives will hinder the low-end, 8-inch hard disk drive market. On the high-end, the 14-inch hard disk drives, although physically larger, have a lower cost per bit and hence may limit the growth of 8-inch drives. It is expected that the more popular 8-inch hard disk drives will be in the 5 to 20 M byte range.

RANDOM RUMORS: General Electric is interested in the personal computing area. They have invested some money in Intelligent System Corp (ISC), the maker of Compucolor systems. But they have not decided on their approach . . . Shugart is producing 1000 5-inch floppy disk drives per day, while Micropolis, ranked second in the industry, is turning out 200 per day . . . A 2 M byte

5-inch floppy disk drive will be announced this coming spring by Tandon Magnetics, Chatsworth CA. The drive will be double-sided and double-density with 96 tracks per inch and 12,000 bits per inch.

16-BIT MULTIPROCESSOR UNIT PERIPHERAL INTEGRATED CIRCUITS BEING INTRODUCED: All of the 16-bit microprocessor manufacturers are introducing peripheral integrated circuits which increase the power and flexibility of the new 16-bit microcomputer systems. These integrated circuits will allow these microcomputers to take over applications once considered the province of mini or large computer systems. These include memory management (MMU), bus arbitration, direct memory access (DMA), and floating point arithmetic. Also being introduced for the 16-bit devices are dual-density floppy disk, bubble memory, and super fast printer controllers.

The memory management unit allows the microprocessor to partition off its own memory space. Motorola and Zilog plan to have memory management unit integrated circuits for their 68000 and Z8000 multiprocessor units, while Intel includes the memory management unit with their 8086 16-bit multiprocessor unit.

Bus arbitration controllers are used in multiprocessor systems where there is more than one master unit on the bus. The bus arbiter provides the necessary timing and control signals, including establishing priorities among masters. Intel has already announced such an integrated circuit and Motorola and Zilog are designing theirs.

AMD has released its arithmetic processor which performs single-precision (32-bit) and double-precision (64-bit) add, subtract, multiply, and divide operations with 16-bit wide data paths.

WHAT'S AHEAD FOR 1980?: This is a good time to make some predictions for next year. What can we expect? Let me stick my neck out a little. I expect to see the following:

- The first Japanese personal computer systems will become available in this country.
- Competitive pressures will increase on small manufacturers. This will cause some liquidations and several mergers, consolidations or acquisitions.
- A sizable number of audio and office equipment retailers will enter the computer retailing business. This will create pressures on conventional computer stores. We may even see the appearance of stores that sell only software, much like audio record stores.
- 16-bit microcomputer systems will be commonplace. They will have multiuser, multitasking and multiprocessing, and greater real-time operating capabilities. They will offer far more sophisticated editors, debuggers, compilers, assemblers, and other system software.
- IBM, Digital Equipment Corp, Data General, Hewlett-Packard and other minicomputer makers will introduce low-cost microcomputer systems to compete with current microcomputer systems.
- Several personal computer manufacturers will introduce "second generation" machines with significant increases in power.
- The emphasis will shift from hardware to software. BASIC will continue as the dominant language. Enhancements will continue to be made to the available BASIC interpreters. BASIC compilers will be more available. Pascal will increase in popularity, but will still be used by only a small percentage of system programmers. New COBOL compilers will also become available and increase in popularity. APL will also increase in popularity, particularly for financial and statistical applications. Also a large number of data base managers will be introduced.
- Business application software for microcomputer systems will finally "come of age" and provide the needed performance that suppliers have been promising but not delivering during the past two years.
- The first low-cost microcomputer-based robot kit will be introduced.
- Typewriters will have built-in intelligence, using microprocessors and built-in microdisks naturally, and will have many word processing features. They will be able to store 10 to 50 pages of text. The "dumb" typewriter will soon be a thing of the past.
- Personal computer time-sharing systems will proliferate. The greatest use will be for accessing data bases.

MAIL: I receive a large number of letters each month as a result of this column. If you wish a response, please include a stamped, self-addressed envelope.

**Sol Libes
Amateur Computer Group
of New Jersey (ACG-NJ)
1776 Raritan Rd
Scotch Plains NJ 07076**

The body's beautiful, but you'll love your Companion for her mind!

INTRODUCING THE PERSONAL GENIE: COMPANION I & II

Beneath her beautiful teakwood roll-top desk exterior, there beats a heart of pure Radio Shack TRS-80 Microcomputer.

But don't let her good looks fool you. Your Genie has a brain that's right at home in your office, home, classroom or laboratory.

Two versions are available, each designed around the TRS-80 system with video monitor, keyboard, cassette recorder, expansion inter-face, mini-disk system and printer.

Both include the latest version of the TRS-80 disk operating

system, disk BASIC and Level II BASIC as well as the assurance of Radio Shack's reputation, warranty and national service network.

The Companion I features 16K of memory, the TRS-80 Quick Printer I and a single mini-disk drive.

The Companion II highlights include 32K of memory, the TRS-80 tractor feed line printer and dual mini-disk drives.

Either version can be expanded to accommodate additional memory and mini-disk drives.

And we haven't forgotten her brain food either. A full set of cassettes, diskettes and paper

accompanies the clear and concise instructions of the Companion User's Manual. All this brain matter comes pre-assembled in a body you can love and live with.

The perfect Companions from PRODATA.

PRODATA, INC.

*Companion
Computer
Systems*



Companions I & II are competitively priced at \$3,495 and \$4,995 respectively, FOB Ft. Worth, Texas, and ready for immediate delivery. PRODATA will pay the air freight charges on all prepaid orders within the Continental U.S.A. For more information call Toll free 800-367-7050 Ext. 1811 or write PRODATA, Inc. 98-1122 Kahapili Street, Aiea, Hawaii 96701, Telephone 808-488-5348. Assembly Office: 3620 Lake Pontchartrain Drive, Arlington, Texas 76016.

Text Compression

James L Peterson
Dept of Computer Sciences
University of Texas
Austin TX 78712

A continuing problem on any computer system is storage. There is never enough computer memory for all the information we wish to store. This is true both for programs in main memory and for the information which resides on peripheral devices.

One solution to this problem is simply to buy more memory. Particularly in the case of storage devices with removable media such as cassettes, floppy disks, magnetic tape and even paper tape, additional media can be purchased and used as necessary. But even here economics will eventually limit the amount of storage available.

An alternative approach is to try to make better use of existing storage media. This is where *text compression* can be of great use. The idea of text compression is to reduce the amount of space needed to store a file by compressing it, making it smaller.

Compression is accomplished by changing the way in which the file is represented. The *encoding* procedure is performed in such a way that it is reversible; that is, it can later be *decoded* to produce the original uncompressed file. This is illustrated in figure 1. The hope is that the encoded version of the file will be smaller than the original file, and hence space will be saved.

The cost of this space saving is processor time. Additional processor time will be needed to encode and decode the compressed files as they are processed. However, it should be noted that microprocessors are seldom processor bound, but more commonly have extra processor cycles available. In fact, the total execute time of many programs will be less on a compressed file despite its encoded form. This is because the I/O(input/output) transfer time for a compressed file is less than the

transfer time for an uncompressed file, since there are fewer bits to read or write. Hence, I/O bound programs (like assemblers and loaders) may execute faster on compressed files.

The basic idea of text compression is to find an encoding method that takes up minimal space. Many algorithms for text compression have been invented, and we present some of them here. In general, these algorithms will work for any type of data, such as numeric, character string, and so on; but for purposes of this article we limit ourselves to text, ie: strings of characters. This will include programs, documentation, mailing lists, data, and many other files stored in computers. In fact, object programs, if considered as simply strings of bytes, can also be compressed, although this must be done carefully.

Text compression is accomplished by careful selection of the *representation* of the information in the compressed file. For many small computer systems, the ASCII code is generally used to represent characters. The main advantage of the ASCII code is that the representation is standard and easy to define. A major disadvantage is its poor space utilization. ASCII is a 7-bit code, while most processors handle 8-bit bytes. Thus, 1 bit out of 8 (12.5%) is wasted simply because a 7-bit character code is used in an 8-bit byte. Further, most control codes are seldom used, and many applications do not need both upper and lower case characters. Thus, another bit can generally be reclaimed with ease, providing at least 25% savings in storage space. Many of the algorithms presented here can turn these extra bits into even greater savings of space.

Notice, however, that this approach requires a description of how the compressed file is to be represented. This description commonly consists of the encoding and decoding routines. The savings which result from text compression must be balanced against both the additional processor time for encoding and decoding, and the storage space necessary for the encoding and decoding routines. Also, different types of files may be best encoded by different methods, so several different encoding and decoding routines may be necessary.

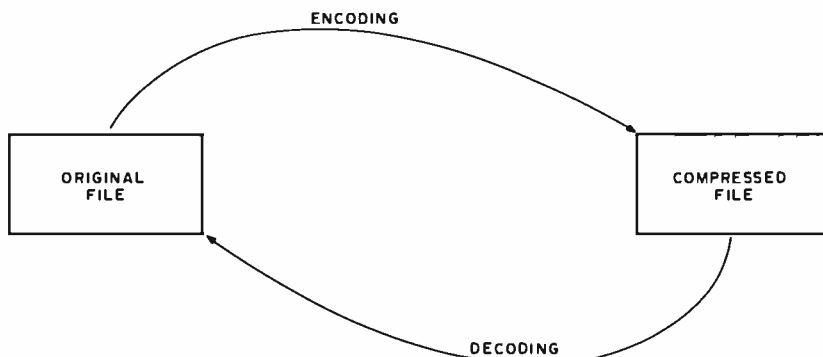

Figure 1: The text compression process.

Do TRS-80's new lower prices mean you get "cheaper" computers?

No Way!



Here's why . . .

Production costs drop and manufacturing efficiency rises when you deliver more than 100,000 TRS-80[®] Model I systems built in your own factories in less than two years. No other computer — ever — has had customer acceptance on such a scale.

Sure, TRS-80 Model I is the price leader, but then you know better than to make your decision based on price alone. You've got to be convinced you get 1) full quality and features, and that 2) our more than 100 service locations furnish faster service, and that 3) we continue to add new software and hardware for TRS-80, even though our list is already one of the industry's longest.

Level I — 4K
Ideal Starter
System

\$499

Was \$599 last year

Level II — 16K
Advanced System
with Calculator Keypad

\$849

Was \$988 last year

New Model I/II Catalog

Come in and get your copy of our new 24-page computer catalog and you'll decide that TRS-80 is your unique opportunity to own a full-featured, fully serviced, fully supported microcomputer at a really nice price.



New TRS-80 Model II

A bigger, more powerful "brother" to the TRS-80. Completely new, it's a business microcomputer with capabilities beginning where Model I approaches upper limits. Storage capacity up to 2 megabytes. Order now for early delivery.

\$3450

½-Megabyte
Basic System



These two cards honored
at most Radio Shack stores

Retail prices may vary at individual stores and dealers.

Radio Shack[®]
The biggest name in little computers[™]

A Division of Tandy Corporation • Fort Worth, Texas 76102
Over 7000 Locations in 40 Countries

```

***      /**
/*****\  *****\
*****  *****
*****'  '*****
**/      \**
..       /***\
****\    *****
****\   . . *****
\****'  ***** \**/
"      *****/
      \**** \
          \
          *
          *
          / . /****\
          ./ /*****\
/*****\  * /****/'
/**'  \**\  * /''''
      \** /
          *|||
          \|/
          \*
          \
          \
          \

```

Figure 2: A file which can benefit from simple text compression techniques. The original file is a 24 by 80 character video display image consisting of 1920 characters. Deleting trailing blanks and using tabs set for every 8 columns will reduce the size of this file to 412 characters — a savings of 78.6 percent.

Trailing Blanks and Tabs

A simple approach to compression for text files (but not for object code files) is eliminating blanks which come at the ends of lines before the carriage return and line feed characters. These are known as trailing blanks. For systems which store large amounts of assembly language, BASIC or FORTRAN programs, much of each line will be blank. Any trailing blanks can be deleted without changing the meaning of the file.

Tabs can be used to reduce the number of blanks elsewhere in a line. Particularly with block structured programs, such as ALGOL, Pascal, or PL/I, or with column oriented languages such as FORTRAN or assembly language, tabs can be quite effective in text compression. Two varieties of tabbing mechanisms can be used. One is called *fixed tab stops*. In this case, tab stops occur every *n* columns, where *n* is a system-wide constant. Typically *n*=8, although some studies have shown that *n*=4 or *n*=5 will produce additional savings.

```

$32 $3*$4 /**.@ $30 /$5* \ $6* \ @ $30 $7* $7* @ $30 $5''' '$6* @ $31 **/$6 \ *** @ $30
$3.$9 /$3* \ @ $29 $4* \ $7 $6* @ $29 $5* \ . . $6* @ $29 \ $4'' $6* \ **/ @ $31 ''
$6*/. @ $36 \ $4* \ @ $43 \ @ $43 * @ $43 * @ $43 / ./ $3* \ @ $30 . $9 ./ / $7* \ @ $27
/$6* \ $6*/$3*/ @ $26/ *** ' \ ** \ $3.*/$3' @ $26'$6 \ **/ @ $35*$3 \ @ $35 \ */ @ $36 \
* @ $37 \ @ $37 \ @

```

Figure 3: Further compression of the file shown in figure 2 done by replacing multiple identical characters with an escape sequence. The escape sequence in this case is the escape character \$ followed by the number of repetitions and the character to be repeated. This scheme is useful only when the repeat count is greater than 2. The count would normally fit into 1 byte, but is here shown in decimal. The character @ represents the carriage return and line feed. Only 287 characters are needed to represent the file in figure 2 using this representation. This reduces the file to 14.9 percent of its original size.

The other possibility is to use *variable tab stops*. In this case, tab stop positions are selected for each file separately. This would require a decision as to which tab stops are best (ie: which would produce the best compression). In addition it would be necessary to indicate with each file what tab settings are to be used. This can be done easily by appending a tab stop dictionary at the head of each file. Such a dictionary would be used to initialize tables for the decoding routine which would replace each tab with an appropriate number of blanks. This approach allows different tab settings to be used for different programming languages or data sets.

Multiple Characters

Trailing blanks and tab mechanisms are used for compressing strings of multiple blank characters. Some applications may result in strings of identical nonblank characters occurring frequently. For example, picture processing by computer often requires storing long sequences of identical characters, such as the characters which produce figure 2. The approach here is to replace a string of *n* identical characters by the number *n* and 1 character, thus saving *n*-2 characters. The count can be represented as a byte. If the count exceeds 256, it can be output as a count of 256 followed by the character, and then another count and character for the remainder.

Encoding consists of simply counting identical characters until a different one is found, and then outputting the count and character. Decoding simply expands each count and character to the appropriate number of characters.

Obviously, *n* should be greater than 2 most of the time for this approach to succeed. If *n* were generally 1, this approach would actually double the size of the file. Since this is commonly the case for text files, a more sophisticated approach is generally used.

We wish to replace sequences of identical characters by a count and character, but leave single or double characters alone. The problem is representing the multiple characters in such a way that the count is not misinterpreted as a character. A common solution is to use an *escape sequence*, which is a means of indicating that a special interpretation should be applied to the characters which follow. To create an escape sequence, choose any character which is seldom (preferably never) used. For example, in ASCII one of the control codes or special characters might be used. ASCII even provides an escape character, but if it is already being used for another purpose, any other character code can be used. Now a sequence of *n* identical characters would be represented by the escape character, the value *n*, and the character to be repeated. Figure 3 shows the text of figure 2 compressed by this method.

This allows normal text to be represented normally, except for the escape character. The problem we must now solve is how to represent the escape character if it occurs in the input (uncompressed) text. If we simply copy it to the compressed file, the decoder will (incorrectly) think it is the start of an escape sequence and interpret the following 2 characters as indicating a sequence of identical characters (this is essentially the same problem that language designers face in trying to represent a quoted string consisting of a quote). Several approaches to this problem can be used: outlaw all occurrences of the escape character; replace all escape char-

"Chess Challenger-10 Wins Microchess Tourney"

—Personal Computing Magazine
February, 1979



Genius Offspring

"Its successor, the new Chess Challenger-7, is infinitely more powerful!"

—S. Samole

President, Fidelity Electronics

**JUST RELEASED
VOICE CHALLENGER**

Chess Challenger-10 did more than win the Penrod Memorial Microchess Tournament, it literally trounced all opponents. Personal Computing Magazine, February, 1979, reports, "Chess Challenger-10 emerged as the easy victor with ten wins, two draws and no losses."

All Top Name Performers

There were no amateurs in the championship playoff. Every contender bore the brand of a well-known electronic chess game, and each was accompanied by its entourage of coaches, programmers, and engineers. After each contestant had played all of the opponents in round robin fashion, the brilliant Challenger-10, stood far ahead of its second place runner-up.

Nobody Knew

Unknown to the other companies, the undefeated tournament leader was being retired after the contest. Taking its place was a far more powerful chess computer, the Challenger "7." This new micro-computer had already beaten the official undefeated champ during a series of pre-tournament warm-up games at the factory. Its engineers explain that it is simply 14 months ahead in technology, in finer algorithm sophistication and in its superb performance.

Improve Your Game to Near Brilliant

Within its seven different levels of play, you can enjoy every degree of chess competition, from beginner to tournament skill. Its total flexibility lets you change games mid-stream or switch sides with the computer to see how it would handle your dilemma. You can add pieces to your side or take away the computer's Queen. It is a superb teacher!

Touch the PV key and the "7's" total recall memory will verify every piece position on the board. You can even set up hypothetical encounters to test its reaction at each level.

Fidelity's Challenger "7" is able to analyze over 3,024,000 board positions. It masterfully handles over one thousand book openings and will respond to any deviation. Academic openings as Sicilian, French, Ruy Lopez and Queen Gambit Declined, are just some of the challenges to keep you on your toes.

It Knows Every Rule in the Book

The Challenger "7" will permit you to castle or perform an En Passant capture or do so itself, if that is its best move. When your pawn has reached the eighth rank, it will be automatically raised to a Queen, unless you tell the computer to promote it to another piece. It will take on any player and sharpen his skills considerably... but it won't permit illegal moves.

At Level 1, its average response time is 5 seconds. At Tournament Level 7, the Challenger makes championship decisions in just 3 minutes.

Unbeatable in Price As Well As Play

Best of all, the Chess Challenger "7" is just \$89.95 complete with chessmen and UL approved 110V AC adaptor.

All pieces are magnetized, to stay where you place them on the permanent metal board. The set is mounted in a simulated wood-grained housing which measures 12 1/2" x 8" x 1". Bright, one-half inch tall LED electronic digits, provide unmistakably clear readout.

A MAJOR ADVANCE VOICE CHESS

Brand new from Fidelity—the granddaddy of them all. VOICE CHALLENGER. It may look something like the "7," but it's a great deal more. Increased microprocessor brain offers all of the 7's ability plus three additional levels beyond the seven: *Excellent* (6 minutes), *Expert* (11 minutes) and *Infinite* (from 5 seconds to days). But, you needn't wait days. You can command this level to move at any time. So many readers have asked for *maximum skill*. This is it.

Most incredible, it *TALKS*. In addition to its display, an electronic miracle of voice synthesis permits this phenomenal Challenger to speak. It's not a tape, but a computer-created voice distinctively announces each move it makes. It verbalizes your moves, too. It has a vocabulary of over 50 words which will also suggest a move for you if you take too long.

If the Voice Challenger is about to set up a mate-in-two offense, it will flash, "Mate-in-Two." From here on, you'd better be a whiz to avoid defeat. This set (same size as "7") comes in a black enamelled hardwood cabinet. Hand-carved Staunton pieces in tan and black are magnetized to stay put. The unit is complete with a durable ABS carrying case.

Both units are backed by a 90-day manufacturer's limited parts and labor warranty.

PLAY CHESS FOR 10 DAYS AT OUR EXPENSE

As a gift or for yourself, the "7" and the "Voice" are unquestionably the finest chess computers you can select... but, if within 10 days, you are not pleased, return your purchase for a prompt refund.

CREDIT CARD ORDERS CALL TOLL FREE

800-621-5809

ILLINOIS RES: 800-972-5858
24 HOURS—7 DAYS/WEEK

Please send me _____ Chess Challenger "7(s)" at \$89.95 plus \$3.00 for shipping and insurance.
 Send me _____ Voice Challenger(s) at \$259.95 plus \$3.00 shipping and insurance. Price includes case.
Ill. residents add 5% sales tax. If not satisfied, I can return it within 10 days for a refund.

Enclosed please find check or money order.
 Charge My Credit Card:
 American Express Master Charge Carte
 BankAmer/Visa Diners Club Blanche

Credit Card No. _____
Master Charge # _____ Exp. Date _____
Name _____
Address _____
City _____
State _____ Zip _____
Signature _____
B-12 *Camelot '79

Final Results

Reprinted Courtesy of Personal Computing,
February, 1979, P. 66. (Darker lines ours.)

CONTESTANTS	OPPONENTS									Games Won	Lost	FINAL SCORE	FINAL POS	
	1	2	3	4	5	6	7	8	9					
1 MICRO-CHESS 1.0 (Heath H-8)	W	X	½	0	1	0	0	0	0	1	3	8	2½	7*
2 MICRO-CHESS 1.5 (TRS-80)	W	½	X	½	0	0	0	0	0	0	5	7	2½	6*
3 MICRO-CHESS 2.0 (PET)	W	½	½	X	1	0	0	0	0	3	4	5	5	4
4 CHESS CHALLENGER (3 Level)	W	1	½	0	X	½	½	0	0	2	5	5	4½	5
5 CHESS CHALLENGER (10 Level)	W	1	1	1	1	X	1	½	0	10	2	0	11	1
6 BORIS	W	1	½	1	0	1	X	0	0	7	2	3	8	3
7 SARGON I (TRS-80)	W	1	1	1	½	½	1	X	0	6	5	1	8½	2
8 ATARI <i>Did not play</i>	W								X					

*Note: Microchess 1.5 wins 6th place over Microchess 1.0 by virtue of the tie-breaking analysis of relative strength of opponents

**Camelot
DIRECT**

801 Green Bay Rd., Lake Bluff, IL 60044

A DIVISION OF UNITED EDUCATORS, INC.

```

10 READ A
20 IF A=0 THEN 110
30 IF A>0 THEN 80
40 LET B=-A
50 LET R=SQR(B)
60 PRINT A,R," $"
70 GO TO 10
80 LET R=SQR(A)
90 PRINT A,R
100 GO TO 10
110 END

```

```

10 $5 A
20 $2 A=0 $6 110
30 $2 A>0 $6 80
40 $3 B=-A
50 $3 R=SQR(B)
60 $4 A,R," $$ "
70 $1 10
80 $3 R=SQR(A)
90 $4 A,R
100 $1 10
110 $7

```

Figure 4: Compressing a BASIC program by using keyword replacement. The keywords (1) GO TO, (2) IF, (3) LET, (4) PRINT, (5) READ, (6) THEN and (7) END have been replaced by an escape sequence consisting of an escape character \$ followed by a keyword number. Note that the escape character occurred within the original program and was replaced by a special escape sequence \$\$.

acters by a special escape sequence such as one with a 0 count; replace all escape characters by an escape character, a count of 1, and an escape character, treating it as a sequence of length 1. Any of these approaches will allow a file to be encoded and decoded easily and correctly.

Note that, in choosing an escape character, we can always use the same one (a system-wide constant) or we can select a different one for every file. If we choose a different one for every file, we must make a preliminary pass through the file to look at all characters used and find one which is not used. We should then append the escape character at the beginning of the file to allow the decoding algorithm to know what character is used as the escape character.

Keyword Replacement

A very common type of file stored in computer systems is a program file. Programs offer great possibilities for

text compression because of their stylized form and syntax. The techniques of deleting trailing blanks and using tabs to replace leading blanks can reduce storage requirements considerably. But an even larger gain can be made from keyword replacement.

Most programming languages use a number of *keywords* or *reserved words*: in FORTRAN, such words as INTEGER, FORMAT, CALL and so on; in BASIC, such words as LET, READ, PRINT, REM and so on. These words are used throughout these programs and are prime candidates for text compression.

Two techniques are commonly used. First, one can replace each keyword by an escape sequence. The escape sequence might consist of the escape code, followed by a number which indicates which keyword is being used. This has the advantage of allowing a large number of reserved words up to the number which can be held in 1 byte, and can be particularly

useful for assembly language symbolic op codes.

An alternative approach is to look through the existing character code for unused character codes. For example, if ASCII is being used, many of the control codes, some of the special characters, and perhaps the lower case characters are not normally used. If 7-bit ASCII is being used with 8-bit bytes, then the extra bit can be used to define 128 new unused codes. These unused codes are paired up with the most frequently occurring reserved words. One code should be reserved for use as an escape or quote character, in case any of the codes assumed to be unused should happen to be used in an input file.

For encoding, the input file is scanned for reserved words and each reserved word is replaced by the appropriate special code as illustrated by figure 4. If any of the special codes should show up in the input stream, they are replaced by the 2-character sequence of the escape code followed by the input character. For decoding, all special codes are replaced by their equivalent keyword, except that any character preceded by an escape code is copied directly to the output, with no replacement.

At this point, a problem may become apparent. Note that the keywords for any particular language are fixed and relatively small in number, but that the keywords vary from language to language. Hence, the appropriate correspondence between special codes and reserved words may vary greatly. In single language systems (such as those which offer only BASIC) this is not a problem, but more general systems need to consider this problem.



PET ANALOG INPUT



Analog to Digital Conversion System for the Commodore PET Computer

Give the PET the ability to sense, measure, and control the world around it with DAM SYSTEMS modules. Just plug the PETSET1 into the PET to set 16 channels of analog input. Screw terminals are provided for each channel so you can hook up joysticks, pots, or whatever appropriate sensors you have. Each of the 16 analog inputs, in the range of 0 to 5.12 volts, is converted to a decimal number between 0 and 255 (20 millivolts per count). Conversion time is 100 microseconds. In addition, the FETMOD provides two IEEE ports and one user port as well as a DAM SYSTEMS port. Software is provided. A one line program is all that is necessary to read a channel.

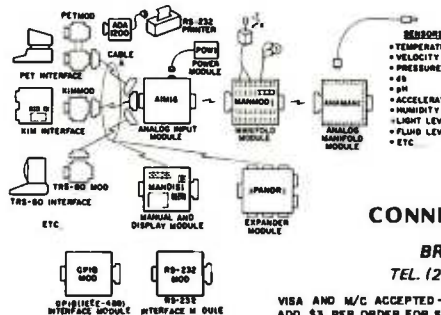

PETSET1

- 1- AIM161 - 16 ANALOG INPUTS-8 BITS-100 MICROSEC
- 1- PETMOD - PET ADAPTER-2 IEEE PORTS - 1 USER PORT-1 DAM SYSTEMS PORT
- 1- CABLE A24 - 24 INCH INTERCONNECT CABLE
- 1- MANMOD1 - MANIFOLD MODULE-SCREW TERMINALS FOR INPUTS, REFERENCE, GROUND
- 1- POW1 - POWER MODULE

PETSET1a for 110 VAC \$295
PETSET1e for 230 VAC \$305
Order direct or contact your local computer store.

CONNECTICUT microCOMPUTER, Inc.
150 POCONO ROAD
BROOKFIELD, CONNECTICUT 06804
TEL. (203) 775-4595 TWX: 710-456-0052

VISA AND M/C ACCEPTED- SEND ACCOUNT NUMBER, EXPIRATION DATE AND SIGN ORDER. ADD \$3 PER ORDER FOR SHIPPING & HANDLING - FOREIGN ORDERS ADD 10% FOR AIR POSTAGE.

Several sr
First, one c
coding f
each lp
gram
Ser
f.

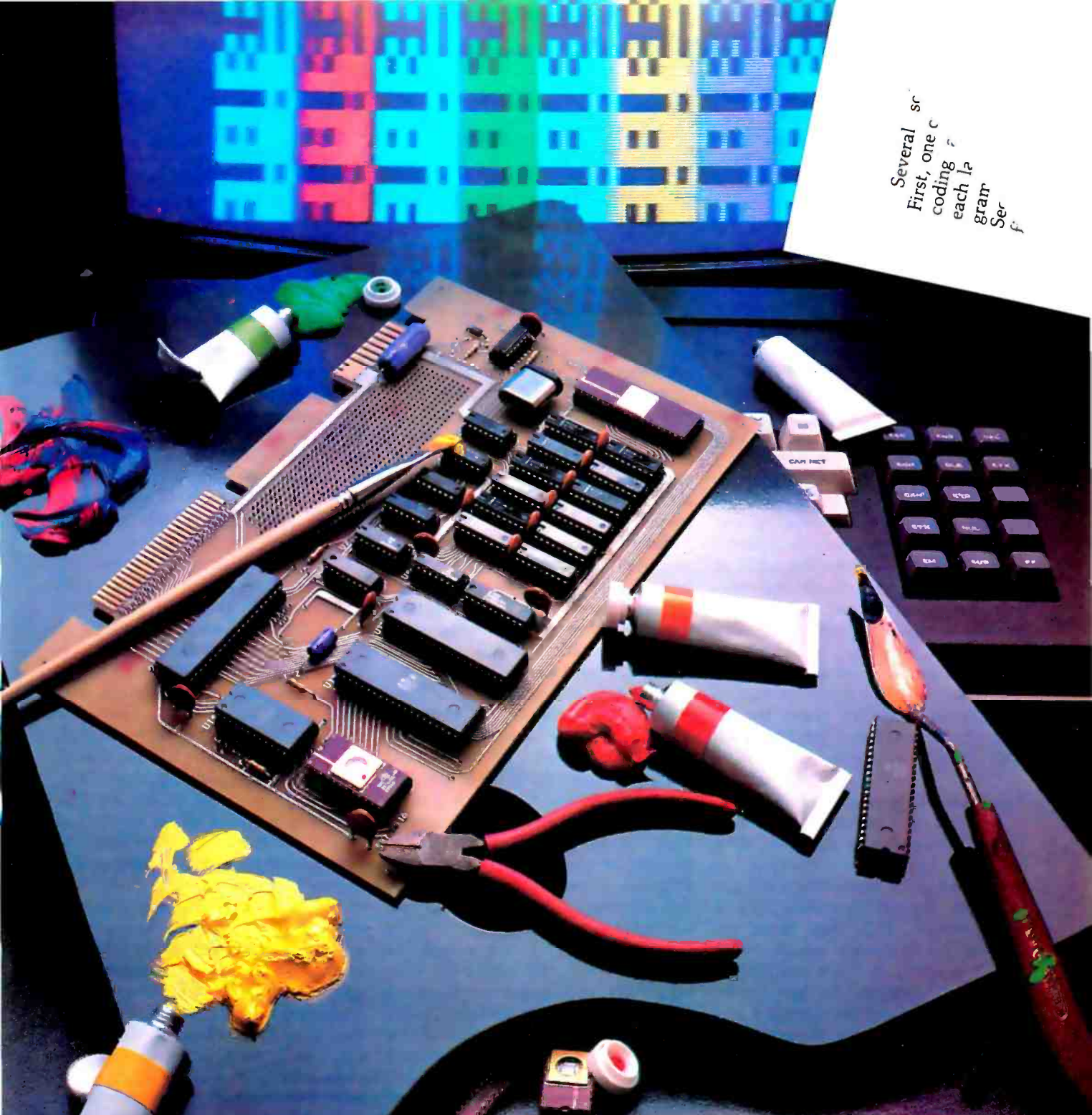

INTRODUCING THE RAINBOW 2000... THE PERIPHERAL WITH THE BRIGHTEST COLOR GRAPHICS SINCE VINCENT VAN GOGH!

The Rainbow 2000 is the first of a new generation in color peripherals providing a cost effective way to upgrade to full color and high resolution graphics.

By using standard RS 232 C communication interfacing, we made the Rainbow 2000 adaptable to any existing mini or advanced system. A Built-in 6K RAM memory allows the Rainbow 2000 to "stand alone" using just a keypad and color monitor, or it can be utilized with multi-

*TRS-80 is a registered trademark of Radio Shack, a Tandy Co.

terminal systems.

When we at Digitus designed the Rainbow 2000, we had the industrial and scientific user in mind, so we didn't skimp on the specs. We test each board extensively before it is packaged for sale, we use prime quality parts and we back each board with a full one-year guarantee.

So whether you're plotting family expenses on your *TRS-80, or monitoring a factory with an *IBM 370, let the Rainbow 2000 be your step up to color graphics.

*IBM 370 is a trademark of International Business Machine Inc.

The Rainbow 2000, Vincent would have given his right ear for one!

FOR FURTHER INFORMATION CALL OR WRITE:
DIGITUS CORPORATION
P.O. BOX 10095
TOWSON, MARYLAND
21204
800-638-4259
DEALER INQUIRIES
WELCOMED



solutions are available. One can simply use separate encoding and decoding routines for each language, leaving it to the programmer to use the appropriate one. Second, one can tag each compressed file with a byte which indicates if this is a BASIC compressed file, or a FORTRAN compressed file, or a type X compressed file. Then the encoder must either be told how to encode the file or be able to guess (or compute) that it is a FORTRAN, BASIC, or type X file and apply the appropriate compression algorithm. The compressed file is tagged as it is encoded. The decoder looks at the tag and uses the appropriate decoding scheme.

A third approach is more general, but potentially more expensive. The difference between the encoding and decoding algorithms for the different types of files is simply the table of pairings between keywords and character codes. Therefore, another approach is to prefix each compressed file with a dictionary of character code and reserved word pairs. The dictionary explains the meanings of the special character codes by indicating the reserved words for which they stand.

Substring Abbreviation

The idea of appending an abbreviation dictionary to the front of a compressed file opens the way to using the keyword replacement scheme for more general files. The idea is quite simple. Pick out those sequences of characters which occur most frequently in a file and replace them with a special character code. To allow decoding, we append a dictionary at the beginning of each file to show which special character codes

```
Dictionary:  $A "the"
              $B "text compression"
              $C "computer"
              ...
```

```
Text:        This paper is concerned with $A use of $B in $C systems, where $A amount of $C storage is
              limited.
              ...
```

Figure 5: Text compression by substring replacement. Substrings are replaced by abbreviation codes (here we use escape sequences). A dictionary is placed at the beginning of the file to define the meanings of the abbreviations.

correspond to which replaced character strings. This approach can yield very good text compression, especially for programs or natural language text, since keywords, variable names and some words (like *the*, *and*, and so on) are used very frequently.

But there are some problems with this approach also. The major problem is selecting the character strings to be abbreviated. With programs written in particular languages, keywords occur frequently and so are a safe bet for substitution, but what constitutes appropriate character strings for general replacement? These can be determined only by examining the file, since the appropriate strings will vary from file to file.

The objective, of course, is to realize the greatest savings in space. Here we are limited mainly by the number of codes available for substitution. If we use unused codes in the existing character set, we are limited to from 10 to 50 abbreviation codes, typically. If we extend the character set (say by using 8-bit codes with 7-bit ASCII) then we may have as many as 128 codes available. Using an escape sequence may provide up to 256, but at a cost of at least 2

characters per abbreviation. In all cases, the number of codes available will always be limited to, say, *m*. Thus we need to pick those *m* strings for abbreviation which will result in the greatest space savings.

We do not always want to pick merely the most frequently occurring *m* strings. Consider the 2 strings to *and text compression*. If *to* occurs 100 times and *text compression* only 15 times, which should we replace? Replacing the 2-character sequence *to* by a single abbreviation code saves only 1 character (assuming 1 byte abbreviation code) per occurrence, or a total of 100 characters. Replacing the 16-character sequence *text compression* saves 15 characters per occurrence, or 225 characters total. Thus, in general we wish to replace that character sequence whose product of length and frequency is greatest. An example of substring replacement is shown in figure 5.

The encoding problem then becomes that of finding the *m* sequences whose length-frequency product is greatest, replacing all occurrences of them with the *m* abbreviation codes, and appending the abbreviation dictionary at the front of the compressed file. The decoding problem reduces to



CHESS-8

Chess for the Heath H-8 computer. CHESS-8® transforms your computer into a challenging chess playing opponent. Multi-level play options match CHESS-8® to your playing ability. Plays full U.S. Chess Federation rules, including castling, "en passant" capture and pawn promotion. Does not permit nor make illegal moves!

Use your CRT terminal to input moves using modified chess notation, display board status or game move summary. Order today and match your skill against CHESS-8®. Supplied on disk with complete instructions, requires HDOS. Send \$24.95 to QC Systems . . .



Quantum Communications Systems
13195 - 87th Place North, Largo, Florida 33542

TARBELL VDS-II

Vertical Disk Subsystem



SYSTEM INCLUDES:

- 2 Siemens 8" Disk Drives
- 1 Cabinet with Fan and Power Supply.
- 1 Tarbell Floppy Disk Interface, assembled & tested.
- 1 CP/M Disk Operating System.
- 1 Tarbell BASIC.
- All Cables and Connectors.
- Complete User Documentation.
- Fully factory assembled and tested:

VDS-II Single Density . . . \$1888
 VDS-IID Double Density \$1999

TARBELL DOUBLE DENSITY INTERFACE FOR 8" FLOPPY DISK

Under Tarbell Double-Density CP/M, single and double density disks may be intermixed. The system automatically determines whether single or double density is in place.

- Software select single or double density.
- Phase-locked-loop and write precompensation for reliable data recovery and storage.
- On-board phantom bootstrap PROM is disabled after bootstrap operation so all 64K memory address space is available to user.
- DMA in single or double density permits multi-user operation.
- Extended addressing provides 8 extra address bits, permitting direct transfers anywhere in a 16 megabyte address range.
- Select up to 4 drives, single or double-sided.
- New BIOS for CP/M included with interface on single-density diskette.

Double Density Interface only, assembled & tested. . . . \$425.

CP/M is a registered trademark of Digital Research.

Tarbell
 Electronics

950 DOVLEN PLACE • SUITE B • CARSON, CALIFORNIA 90746
 (213) 538-4251 • (213) 538-2254

merely reading in the abbreviation dictionary and replacing all abbreviation codes with the appropriate character sequence.

The only real difficulty is finding the *m* sequences to be abbreviated. No really good solution to this problem is known. The best solution I have seen works as follows: first, make 1 pass through the file to compute the most frequently occurring pairs. There should be no more than 2500 of these, and probably many fewer. Compute the frequency of these pairs and keep only the *m* or *2m* most frequent. Now consider that any sequence of length 3 both begins and ends with a subsequence of length 2, and that these 2 subsequences of length 2 must be at least as frequent as the length 3 sequence. That is, if there are 23 occurrences of *abc*, then there must be at least 23 *ab* and at least 23 *bc*. Thus we can make another pass through the file, counting the frequency of subsequences of length 3, but limiting ourselves to those sequences which begin and end with subsequences of length 2 (which

are also frequent). Next we can make another pass for length 4 (limiting the sequences to those with frequent length 3 subsequences), another pass for length 5, and so on until we decide to stop. We can stop either when our last pass has produced no new sequences whose frequency-length product exceeds the previous set, or after a fixed number of passes.

Huffman Coding

All of the schemes for text compression discussed so far are similar in the sense that they confine themselves to working within the given character code and byte structure. Even more savings can result from recoding the character code representation itself. Almost all character code representations use a fixed code size: 6 bits for binary coded decimal (BCD), 7 bits for ASCII and 8 bits for EBCDIC. This can be very wasteful of space.

Consider the simple problem of encoding the 4 characters *A*, *B*, *C*, and *D*. If we use a fixed code size, then we could encode each character with 2 bits, as follows:

```
A 00
B 01
C 10
D 11
```

But suppose that the letter *A* occurs 50% of the time in the text, *B* occurs 25% and *C* and *D* split the remaining 25% equally. Then the following variable length character code will produce a shorter average text length.

```
A 0
B 10
C 110
D 111
```

To compute the average text length, consider that, out of *n* characters, *n*/*2* will be *A* which requires only 1 bit, *n*/*4* will be *B* for 2 bits each and the remaining *n*/*4* will be *C* or *D* for 3 bits each. Thus the total number of bits to represent *n* characters is:

$$1(n/2) + 2(n/4) + 3(n/4) = 1.75n$$

Comparing this with the *2n* bits needed for the fixed length code, we see that we have saved 12.5% of the total file size.

Variable length coding and decoding is somewhat more complex than fixed length coding, but not really difficult. It involves much more bit manipulation. To encode a string like *ABAABCDAB*, we simply concatenate the bit representations of each character, packing across byte boundaries as necessary.

```
A B A A B C D A B
0 10 0 0 10 110 111 0 10
```

To decode, we must scan from left to right, looking at each bit. For the string 01001100, we notice that the 1st bit is a 0. Only *A* starts with 0, so our 1st character is an *A*. The next bit is a 1, so it could be a *B*, *C* or *D*, but looking at the next bit we see that the next character must be a *B*. We remove the 2 bits for the *B*, and continue. The next bit is 0, so the next character is an *A*. The following bit is a 1, signifying either a *B*, *C*, or *D*. The next bit is a 1, signifying a *C* or *D*. Finally the next bit indicates a *C*. The last character is an *A*. So our decoded text is *ABACA*.

Computer stored text files can benefit greatly from Huffman coding. Huffman coding can be used anytime

Introducing...

MINI-FLEXTM

Designed Specifically
to Protect 5" Diskettes



The Newest
Member of The
Advance Access
Diskette
Protection Family

For Further Information
CALL TOLL FREE
800 323-0254



ADVANCE ACCESS GROUP
10526 W. Cermak Westchester, IL 60153 312 562-5210
"Manufacturers of Information Processing Supplies"

IDS Announces S-100 Energy Management Module

The 100-EMM Energy Management Module provides temperature measurement at four separate locations indoors or out; monitors eight (8) doors, windows, or fire sensors; controls six external devices via relay or optoisolator; and provides an intrusion alarm with battery backup (alarm operates even during primary power outages). Put the 100-EMM to use in your home or business and claim a 30% tax credit for the cost of your S-100 computer system including the 100-EMM. (Purchasing the 100-EMM can actually save you several times its cost in tax credits. Full instructions for filing are included in the 100-EMM manual.)

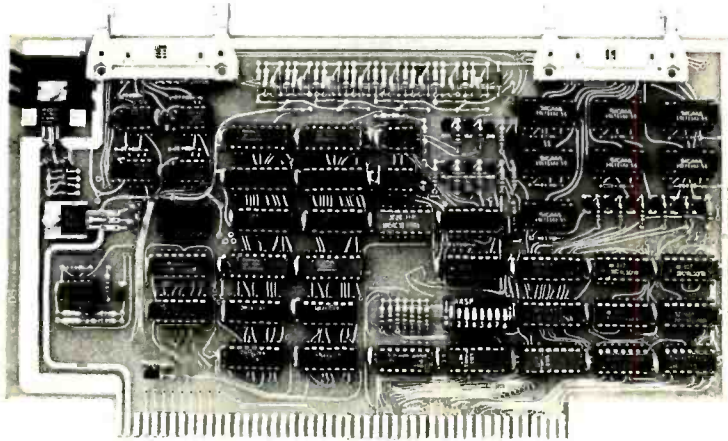

**BUY THIS S-100 BOARD
AND GET A 30% TAX
CREDIT BASED ON THE
COST OF YOUR
COMPUTER SYSTEM!**

**100-EMM Energy Management Module
Assembled and Tested \$395.00
Kit \$345.00**

Options for 100-EMM:

CP-52 Cable Panel - Terminates two 26-conductor flat cables in 26 screwplugs. Use it for convenient interconnection of the 100-EMM to the "outside world". **\$45.00**

CABL-26-STD 26-Conductor Flat Ribbon Cable - Four feet in length with connectors for 100-EMM and CP-52 above. **\$35.00** Other lengths available on special order. Add **\$1.00** per foot.

OTHER PRODUCTS FROM IDS. The most complete source of S-100 compatible modules for process control, data acquisition, energy management, and data communications.

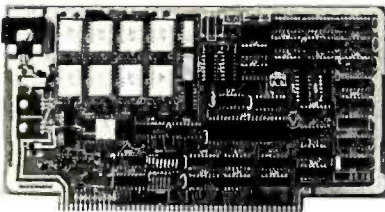

88-MODEM S-100 ORIGINATE/ANSWER MODEM WITH AUTO-DIALER. Software selectable baudrate provides any baudrate from 66-600 baud. Provides 1.5 stop bits when operated in 5-bit code mode. Auto-answer programs available for CROMEMCO CDOS, CP/M, North Star Horizon and MDS, and Alpha Micro.

Assembled and Tested \$395.00 Kit \$245.00

88-UFC UNIVERSAL FREQUENCY COUNTER

Four software selected inputs. Measure frequency from 0-650 MHz and period from .1µS to 1 Second. Extensive software included.

Assembled and Tested \$299.00 Kit \$199.00 Temperature-Compensated Crystal Oscillator option **\$145.00**

88-SAI SYNCHRONOUS/ASYNCHRONOUS INTERFACE

The most versatile serial interface on the market. Computer access/control of all data and handshake lines and provision for masked interrupts, inversion of any input or output signal, and onboard baudrate generation for 110, 134.5, 150, 300, 600, 1200, 2400, 4800, 9600, and many other baud rates. Many more features.

Assembled and Tested \$299.00 Kit \$199.00

88-SPM TIME OF DAY CLOCK with battery backup. Set the clock with three out instructions: no delays! Programs included in North Star BASIC, CBASIC, and 8080 assembly language.

Assembled and Tested with crystal option \$199.00 Kit less crystal option \$99.00 Crystal Option Kit **\$25.00**

88-RCB RELAY CONTROL BOARD

16 Relays on one board. Control appliances, production equipment, or even musical instruments (See BYTE Magazine Sept 1977 page 12)

Assembled and Tested \$299.00 Kit \$199.00

**INTERNATIONAL
DATA SYSTEMS, INC.**

Mailing Address:

Post Office Box 17269
Dulles International Airport
Washington, DC 20041
Telephone (703)661-8442

Shipping Address:

400 West Service Road, Suite 130
Dulles International Airport
Washington, DC 20041 USA
TELEX 901112 IDS CTLY

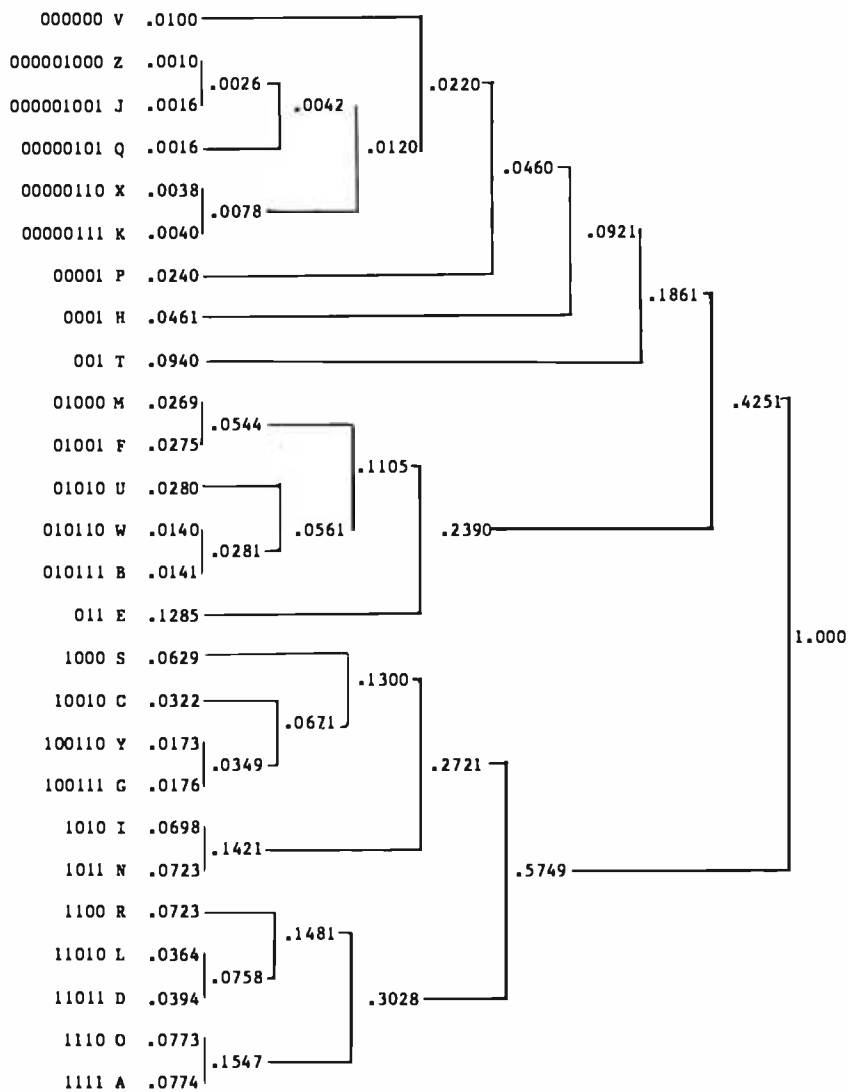

Figure 6: Huffman code for the letters of the English language, based on the probabilities (frequency of occurrence) of the letters in English. The code length is inversely proportional to the frequency of occurrence of a given letter (in much the same manner as Morse code). Code lengths vary from 9 bits (for z and j) to 3 bits (for e and t). The average length is 4.1885 bits per letter. Five bits would be necessary for a fixed length code, a space saving of 16 percent.

the probabilities of the character codes are not equal. In fact, the more unequal the probabilities, the better the compression with a Huffman coding. Looking at a table of frequencies of the letters in English, we can see that they are quite unequal, and hence can be compressed nicely with Huffman coding.

To construct a Huffman code, a very simple algorithm is used (refer to figure 6). First, it is necessary to compute the probabilities of the characters to be encoded. This requires 1 pass through some sample text, a part

of a file, the whole file or several files, as desired, counting the occurrences of different characters. Then we need to sort the characters according to their frequency. Take the 2 least frequently occurring characters, and combine them into a *super character* whose frequency is the sum of the 2 individual characters. The code for each of the 2 characters will be the code for the *super character* followed by a 0 for one character and 1 for the other. Now delete the 2 least frequently used characters from the list and insert the new *super character*

into the list at the appropriate place for its frequency. Continue this process until all characters and *super characters* are combined into 1 *super character*. The result is a Huffman code of minimal average code length. The Huffman code may best be seen as a binary tree with the terminal nodes (leaves) being the characters which are encoded.

Huffman coding can be quite successful in text compression, in extreme cases reducing the size of a file more than half. The basic technique can be improved upon in a number of ways. For example, pairs of characters, rather than single characters, can be used as the basis of encoding. This requires a much larger table of character frequencies, since now we need to compute the frequencies of character pairs, and larger tables of character pair and Huffman code associations, but can result in greater savings.

Another possibility is to use conditional Huffman coding. The objective here is to utilize the fact that the probability (frequency) of a character will vary depending upon what character precedes it. For example, compare the probability of a U following a Q (nearly 1) to the probability of a U following a U (nearly 0). So an optimal encoding should use a very short code for a U which follows a Q and can use a very long code for a U which follows a U. The encoding algorithm involves computing the frequency with which each character follows every other character. A separate Huffman code is then computed for the characters which follow each character. The encoding scheme remembers the last character encoded and uses that to select the code to be used for the next character. The decoding algorithm must also remember the last character decoded in order to be able to select the correct decoding algorithm.

Huffman codes are really quite simple, but they can be made more sophisticated to achieve increased text compression. However, even with simple Huffman codes, some problems can arise. First, notice that Huffman encoding and decoding both involve a great deal of bit manipulation, which can be very slow to program. Second, the best compression is achieved if a Huffman code can take advantage of the unequal fre-

Isn't it time you put some of your ideas in motion?

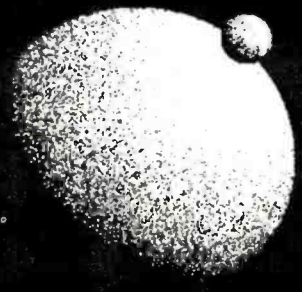
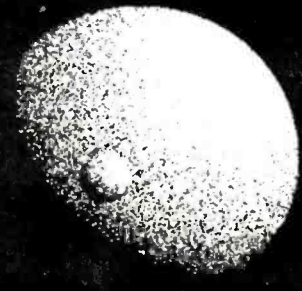

Well now you can. The Terak 8510/a was built to bring graphics to life.

This unique, completely self-contained, stand alone, desk top graphics computer gives you an animation capability that, until now, could only be obtained with a larger, more expensive system.

The nerve center, a powerful 16-bit microcomputer, allows effective animation, making it ideal for design, simulation, and modeling.

And an independently controlled 4K read/write memory allows the creation of an unlimited number of character sets.

This, coupled with the two ported main memory, allows the 8510/a to simultaneously display animated graphics and text. Until Terak, this capability could only be found in far more expensive systems.

What's more, Terak supports U.C.S.D., PASCAL, DEC RT-11, BASIC and FORTRAN IV software.

But the best part is the price. Only \$7,850. That's roughly half the cost of our nearest competitor's system—with roughly twice the competitor's capability.

So if you want to make the most of your ideas, put 'em in motion with a Terak

8510/a—the best priced performer on the market.

For more information, write Terak Corporation, 14405 North Scottsdale Road, Scottsdale, Arizona 85254. Or call (602) 991-1580.

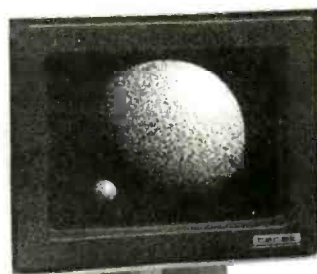

terak
CORPORATION



© 1979 Terak

Animation by Michael Smith
University of Utah
Computer Aided Instruction Group

quencies of characters in a file, but these will differ from file to file. Thus a separate encoding may be best for each file. This can be done by appending the code at the front of a file (as with the dictionaries used for abbreviations) but this increases the size of the file (significantly for small files).

Third, the variable length code nature of Huffman coding can make them extremely vulnerable to transmission or storage errors. In a fixed length code, if 1 bit is changed, only that 1 character is affected, while with Huffman codes, both that character and all succeeding characters may be decoded incorrectly because of a mistake in the assumed length of the incorrect character. (A similar problem would happen to a fixed length code if a bit were dropped or added.) Thus, for safety, it is necessary to add error detection and correction redundancy back into the file, increasing its size.

Still there are environments in which Huffman coding can be quite useful. Consider a word processing system storing files on a low speed serial device such as a cassette. Since

the system is special purpose, one can compute the expected frequencies of English characters and use 1 Huffman code for all files. Encoding and decoding would be done automatically by the tape driver routines. Alternatively the encoding and decoding could be built into the tape drive hardware itself as special purpose logic or a small processor with a read only memory encoding/decoding table. This encoding/decoding approach would be totally transparent to the user. The only effect on the user would be the ability to store a larger, but variable number of "characters" on a fixed amount of tape.

Conclusions

The amount of storage space needed to store information can be greatly reduced by simple text compression techniques like the ones we have presented here. Each of the techniques presented can save some space in many files. And many of the techniques can be used one after another to achieve more and more compression. Text compression can be a sim-

ple and effective method of increasing the amount of storage available in exchange for some processor cycles. ■

REFERENCES

1. deMaine, P A D, *The Integral Family of Reversible Compressors*, Computer Science Department, Pennsylvania State University, 1971.
2. Dishon, Y, "Data Compaction in Computer Systems," *Computer Design*, volume 16, number 4, April 1977, pages 85 to 90.
3. Huffman, D A, "Method for Construction of Minimum-Redundancy Codes," *Proceedings of the IRE*, September 1952, pages 1098 to 1101.
4. Knuth, D E, *The Art of Computer Programming: Volume 1, Fundamental Algorithms*, second edition, Addison-Wesley, Reading MA, 1973.
5. Peterson, J, Bitner, J, and Howard, J, *On the Selection of Optimal Tab Settings*, Department of Computer Sciences, University of Texas, December 1977.
6. Rubin, F, "Experiments in Text File Compression," *Communications of the ACM*, volume 19, number 11, November 1976, pages 617 to 623.

A Delicious Slice of apple® Pie.

The Standard APPLE II Business System: APPLE II PLUS personal computer with 48K RAM memory, 2-DISK II floppy Disk Drives, Video Monitor, THE CONTROLLER business software, PRINTER IIA (Centronics 779), and manuals. **\$4995.00**

**TELEX
182274**



- **APPLE II Business System:** Buy now and we'll replace the Centronics 779 with the Deluxe TEXAS INSTRUMENTS 810 Printer **AT NO EXTRA CHARGE!**
 - Add **BIG STORAGE** capacity to your Business System with the **REVOLUTIONARY SHUGART DUAL DISK DRIVE**, 2-large, 8" disks with **500K STORAGE**, Apple DOS compatible. **Only \$1795.00.**
 - **OR REPLACE** your 2-APPLE DISK II Drives (200K) with the **SHUGART DUAL DISK DRIVE** for **only \$695.00** additional (with purchase of APPLE II Business System).
 - **APPLE II Computer + the EMAKO PRINTER.** Reg. \$1972.00 **Only \$1772.00**
 - **APPLE II Computer + the New VITEK PRINTER.** Reg. \$2190.00 **Only \$2090.50**
Buy now and receive interfacing cable **FREE!**
- APPLE II JOYSTICKS** - Standard \$39.95 ea. Deluxe CR \$49.95 ea.
EXPAND-A-PORT \$49.95 ea.

JOIN NOW — Become a Member of Computerworld's **RAYGAMCO Discount Club**. As a RAYGAMCO Member, you receive **20% OFF** list price on every item you purchase. Simply send name and address to —

ComputerWorld

A RAYGAM COMPANY

6791 Westminster Ave., Westminister, CA 92683 (714) 891-2587

MICROTEK

OUTPERFORMS THEM ALL!



CHECK THESE FEATURES...

- 80 or 120 columns (software selectable)
- Double width printing
- Non-thermal paper, pin feed
- 125 CPS, 70 lines per minute
- 9 x 7 dot matrix
- Vertical format unit
- 96-character ASCII (upper and lower case)
- Adjustable forms width
- Parallel, serial (RS-232), and IEEE-488 interfaces available

CHECK THIS CHART...

Features	MICROTEK MT-80P	Anadex DP-8000	Centronics 730-1 (Radio Shack 26-1154)	Super Brain LP-80	Integral Data 440	MPI 88T
9 x 7 Dot Matrix	Yes	Yes	No	No	No	No
Sustained thruput for full lines	70 LPM	84 LPM	21 LPM	63 LPM	42 LPM	60 LPM
Selectable condensed character set	Yes	No	No	No	Yes	Yes
Full function VFU	Yes	Yes	No	No	Yes	No
Built-in self test	Yes	No	No	No	Yes	No
Graphics option	No	No	No	No	Yes	No
Accepts single sheets of paper	No	No	Yes	No	No	Yes
Ribbon costs	\$2.00	\$3.00	\$4.50	\$4.00	\$12.00	\$9.95
Cost of 2k/4k buffer	\$42/\$80	\$45/NA	NA/NA	NA/NA	\$199* /NA	\$50/NA
Unit price	\$750	\$995	\$970-\$995	\$890	\$995	\$749

* Memory buffer alone not available, includes graphics option

Comparison data from manufacturer's current (September '79) literature.

We've researched the under-\$1,000 80-column dot matrix printers currently available, and have made some key comparisons in the chart to the right. Check it out.

All the printers support the full 96-character ASCII set, print on pin feed non-thermal multi-copy paper, accept forms in various widths up to 9.5", and easily interface to all popular small computers.

If you want to print graphics or feed single sheets of paper through your printer, we can't help you. But if you want as much data buffer storage as you can get, a 9 x 7 dot matrix for better looking characters, a condensed character set that's great for printing multiple columns of numbers, a readily available low cost ribbon, and documentation that includes complete schematics and troubleshooting procedures, then we can help you a lot. And we can offer you something else that's new to the low-cost printer market. Our 30 day BUY BACK guarantee. If you buy a MICROTEK printer and are unhappy with it, for any reason, you can return it within 30 days for a full refund. It's that simple.

Does MICROTEK really outperform them all? You be the judge.

NOW CHECK THIS COUPON...



Send me more information

MICROTEK, Inc., 7844 Convoy Court, San Diego, CA 92111
(714) 278-0633

Name

Address

City

State

Zip

Phone

Dealer inquiries invited.

Analysis of Polynomial Functions with the TI-59 Calculator

Part 1

Pierre Chancé
20 Rue de Longchamp
75116 Paris FRANCE

Between the elementary functions accessible by direct calculation and higher-order equations reserved for the computer, there exists an intermediate domain where programmable calculators are useful.

Certain concrete problems sometimes lead to such equations without this creating an exceptional volume of calculation. Some have been encountered, for example, in the handling of small 6 by 6 matrices concerning medical data. Other technicians are also familiar with this type of obstacle in their fields. Consequently, the feeling is that it is worthwhile proposing a convenient program worked out on the Texas Instruments TI-59 and designed for sixth-order and lower-degree polynomial functions.

Independent of the advantages in mathematical terms, I hope that this article will give the user a meaningful introduction to this highly advanced calculator. For practical reasons, the original goals were as follows:

- calculate all the characteristic elements of the function (roots, maximums, minimums, and points of inflection where applicable)
- automatically plot the function curve
- control the program with a single key

Obtaining these conditions virtually eliminates any chance of operating error, and frees the user for other tasks once the calculation has begun. This is especially the case since the main program can be stored on a single magnetic card as can the printout program. Altogether, this provides a simplified procedure which nonetheless permits execution of the successive steps in the following

sequence:

- obtaining the appropriate boundaries of the interval to be studied
- choice of the increment
- recall of the maximum error
- calculation of roots in increasing order
- printout of correctly sampled tables of values

All of the above is applicable both for the initial polynomial and for derived polynomials. Because of the geometric significance of the derivative, these provide the maximums and minimums of the function as well as possible points of inflection.

Given that excessive automation can be inconvenient in certain cases, a manual procedure has been provided to permit using the keys to enter the lower and upper boundaries of the interval to be studied along with the value of the increment desired.

After a brief discussion of the calculation principles, the main program and then the automatic printout program for the function curve will be examined. A commentary on numerical applications will conclude the examination.

Calculation Principles

Here is the type of polynomial that will be dealt with:

$$P(x) = a_n x^n + a_{n-1} x^{n-1} + \dots + a_0 \quad (a_n \neq 0, n \leq 6)$$

where x is a real number and coefficients a_0, a_1, \dots, a_n are known real numbers.

The method used to determine the roots of $P(x) = 0$ is



MODEL 800 • WITH SUNFLOWERS

A NEW MASTERPIECE IN PRINTERS

Sometimes the true value of a product fails to relate to its selling price. Van Gogh's paintings once sold for less than \$1,000. Base 2's MODEL 800 printer sells for lots less than \$1,000, but it does more than printers costing twice its price (and a lot more than a Van Gogh painting).

Besides being beautiful to look at, the MODEL 800 prints up to six different character fonts with embedded elongation in any of five line densities (72, 80, 96, 120 and 132 characters per line), prints up to three copies and is equipped with a long-life cartridge ribbon. With such versatility as four interface modes (IEEE 488, industry standard parallel, 20ma current loop and RS232), baud rates up to 19,200, and with accommodations for 115VAC or 230VAC operation, the MODEL 800 matches any system decor.

As a note of further new world refinement, the MODEL 800 can be optionally equipped with high speed paper advance and graphics output, a versatile tractor feed mechanism, terminal buffer memory, tabs and form feed.

Requiring only a square foot of space, the MODEL 800 is smaller than its contemporaries; its rugged aluminum construction is designed to stand the test of time.

Isn't it time you added a new masterpiece to your collection?

Recommended retail price:

Standard MODEL 800	\$499
High-speed paper advance	50
Tractor mechanism	50
Terminal buffer memory	50

base 2^o inc.

P.O. BOX 3548 FULL., CAL. 92634 / (714) 992-4344

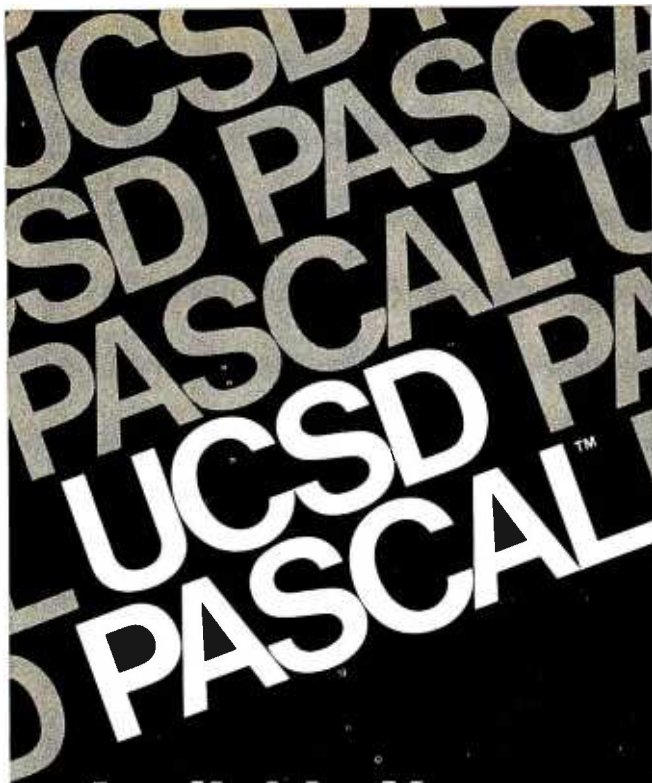

Available Now

The most widely used Pascal system. Compilers to complete development software. For most popular microcomputer systems. With full documentation and support. From one source.

SOFTech
MICROSYSTEMS
A SUBSIDIARY OF SOFTECH

9494 Black Mountain Road
San Diego, CA 92126 714/578-6105

UCSD Pascal is a trademark of the Regents of the University of California.

Find out more. Send this coupon.

- Please send UCSD Pascal description and order form.
- Please send distributor and volume license information.

Name _____

Title _____

Company _____

Address _____

City/State/Zip _____

Computer system _____

Send to: SofTech Microsystems
9494 Black Mountain Road
San Diego, CA 92126

Byte 12

bipartition. This consists of successive dichotomies of the interval (a, b) chosen with the function being continuous over this interval. The calculation is performed sequentially, and the step increment is designated by Δx .

To determine the root of the equation which belongs to the segment Δx , the latter is divided in two, and the calculator retains that half at whose extremes the function has opposite signs. The new shortened segment is further divided in two, and the process is repeated iteratively until the upper value of the residual interval is limited by the error limit. The middle of this final interval represents a root of the function to within the error.

This method provides only a single value in an interval Δx and requires more calculating time if boundaries a and b are taken too far apart. If they are taken too close together, the risk is obviously one of losing a root; the same applies if Δx is too large. Therefore we attempt to eliminate these drawbacks due to too much and too little by programming Lagrange's theorem. This replaces a subjective estimation of the boundaries by a calculation guaranteeing a reliable interval (a, b).

Let $a_0 > 0$ and a_k ($k \geq 1$) be the first of the negative coefficients of the polynomial $P(x)$. The following number as the upper limit of the positive roots of equation $P(x) = 0$ can then be used:

$$R = 1 + \sqrt[k]{\frac{B}{a_0}}$$

where B is the largest of the absolute values of the negative coefficients of the polynomial $P(x)$. Now the user no longer has to distinguish the two values of x between which the roots are supposed to fall. The calculator finds and prints them. To determine the possible limit of the negative roots of the equation, use $x = -z$. This involves changing the sign of the coefficients of the odd registers. However, if the latter equation has no positive roots, the initial equation has no negative roots and the calculator will not provide any.

Optimization of the process is completed by another method. As soon as a root is found, it serves as the lower boundary of the cycle of the following calculation. This sets the increment interval in the new segment to be explored. The correction is aimed at improving the reliability of root detection: this is an essential point.

Observe that details of the program code depend on some of the special capabilities of the TI-59 and PC-100A printing cradle. Naturally, the reader is referred to the instruction manual for full details. In passing, it is merely my intention to mention the decisive factors in my work.

The user has 960 program statements or 100 storage locations available with the possibility of adjusting their respective size as a function of the problem. Each memory block occupies eight program statements. The standard distribution adopted uses 480 program statements and sixty data-storage locations which will be filled entirely. The micromemory connects to the calculator and provides a library of twenty-five programs totalling 5000 steps.

Of the forty functions to which the OP key provides



DOUBLE DENSITY — A CAN OF WORMS?

DATASPEED believes it's time to put a long-standing rumor to rest. Double density disk recording is alive and well and living in hundreds of DATASPEED disk controllers around the world. Many companies are advertising double density disk controllers — some have even delivered a few — but hundreds of delivered AND WORKING systems prove that DATASPEED is the front-runner in double density disk systems.

½ MEGABYTE OF DISK STORAGE — \$295 ASSEMBLED

The DATASPEED CONDUCTOR™ disk controller will put ½ megabyte of storage on any standard 8" disk — reliably. It also allows DOUBLE-SIDED recording for a fantastic 1 megabyte of storage on a single flexible diskette — reliably. We guarantee it.

THE CONDUCTOR can also offer the same guaranteed reliability for 5¼" diskettes in either single or double density and single or double sided modes. THE CONDUCTOR comes fully assembled and fully tested and can even be ordered with a customized, ready to go CP/M™ that performs disk accesses almost twice as fast as most other double density CP/M's.

DRIVE SYSTEMS — FROM \$1095

DATASPEED is also offering COMPLETE DISK systems. For instance, you can order a single drive system for just \$1095 that includes:

- 1 Shugart SA800 8" disk drive (½ megabyte)
- 1 DATASPEED CONDUCTOR disk controller
- 1 cable with connectors for 2 drives
- 1 attractive horizontal cabinet with space for 2 drives
- 1 2 drive power supply

The above system also includes everything you need to upgrade to a dual drive system at a later date — just plug in any standard 8" disk drive and you've got 1 megabyte of disk storage — or you can order a double drive system from us (as above but with 2 Shugart drives) for just \$1649.

DATASPEED, INC.
1302 NOE STREET
SAN FRANCISCO, CALIFORNIA 94131
Telephone (415) 282 - 5616

REMINDER

SPECIAL OFFER EXPIRES
JANUARY 15TH

DRIVE SYSTEM — \$1095
WITH FREE SOFTWARE

FREE OSBORNE ACCOUNTING SOFTWARE

For a limited time, DATASPEED will include with any drive system — FREE — the entire Osborne accounting software package (CBASIC-2™ Version) on double density diskettes. (Requires CBASIC-2 — available from DATASPEED for \$95 — manuals available separately). The software is available elsewhere in this publication for up to \$750!!!

(OFFER EXPIRES JAN. 15, 1980)

AVAILABLE NOW!!

DATASPEED is shipping controllers and drive systems off the shelf. Not in three months or six months — NOW!!! To order, see your local computer retailer — or order directly from us. (Because of the extraordinary prices, the complete drive systems are only available directly from DATASPEED). We accept checks, Master Charge and Visa.

ASK ABOUT OUR VIDEO CONTROLLER

Also, ask about the new DATASPEED memory-mapped video controller!! It features an 80x24 character format, user programmable character set, 128 bytes of user RAM, 1 or 2K of user ROM and HARDWARE SCROLLING!!



DATASPEED

access, special mention can be made of the following:

- printout of alphanumeric characters
- sign indicator
- error indicator
- incrementing and decrementing of memories
- listing of memory content
- listing of labels

Lastly, the T register is very important. Here, it is possible to store and recall a number and test it with respect to the contents of the display register.

In the final analysis, the TI-59 has the quantitative and qualitative features which prove useful in writing a program of the type that is being presented.

Main Program

Data entry:

For reasons of efficiency, the initialization sequence and data entry is not placed at the beginning of the program but at statement 066 with the LBL A instruction and statement 073 with the LBL B instruction (see listing 1). The coefficients of the polynomial are stored by conventional indirect addressing from x^6 at R_{16} to x^0 at R_{10} with a zero introduced when a corresponding term of a power of x is missing.

Evaluation of the polynomial:

This is the role of the LBL A' instruction placed at location 000 to save calculating time, since this sequence is called frequently.

Determination of boundaries and step increment:

The calculation is monitored by LBL C which, in particular, uses subroutines RCL and STO and PGM 08 of the Solid-State Software. After execution of the sequences the following results are given:

- the lower boundary a is printed out at location 091
- the upper boundary b is printed out at location 099
- the absolute value of the interval ($b-a$) is printed out at location 117
- the step increment Δx is printed out at step 124 immediately after steps 120 thru 122 which contain the variable number of partitions of interval (a, b) or 020 in our listing

The appearance of a zero as a boundary value means the absence of roots for the interval considered, the coefficients of the polynomial being positive or zero. And by three successive calls (PGM 08 A, PGM 08 B, PGM 08 C) program C finally aligns the assignments with those of the library by storing a at R_{01} , b at R_{02} and Δx at R_{03} .

Program execution:

This discussion of the mathematical method used will save the trouble of describing the principles again. As for execution:

- LBL RCL (statement 133) changes the sign of the coefficients of the odd registers (R_{15}, R_{13}, R_{11})
- LBL STO (statement 155) plays a complex role. At statement 176, it stores the first coefficient which is

Listing 1: Main program listing of the polynomial-function analysis on the TI-59.

000	76	LEL	104	11	A	208	77	GE	312	99	PRT
001	16	A'	105	43	RCL	209	02	02	313	69	DP
002	53	r	106	18	18	210	20	20	314	18	18
003	42	STO	107	36	PGM	211	69	DP	315	87	IFF
004	17	17	108	08	08	212	31-	31	316	07	07
005	68	DP	109	12	B	213	97	D82	317	02	02
006	10	10	110	98	ADV	214	00	00	318	96	96
007	42	STO	111	43	RCL	215	02	02	319	98	ADV
008	18	18	112	18	18	216	05	05	320	18	C'
009	43	RCL	113	75	-	217	00	0	321	92	RTH
010	01	01	114	43	PCL	218	92	RTH	322	76	LBL
011	42	STO	115	17	17	219	50	1x1	323	18	C'
012	19	19	116	95	=	220	42	STO	324	24	CE
013	06	6	117	99	PRT	221	07	07	325	43	RCL
014	42	STO	118	55	+	222	43	RCL	326	02	02
015	00	00	119	68	HDP	223	00	00	327	75	-
016	01	1	120	00	0	224	42	STO	328	93	-
017	06	6	121	02	2	225	02	02	329	05	5
018	42	STO	122	00	0	226	94	+/-	330	49	FFD
019	01	01	123	95	=	227	85	+	331	03	02
020	42	RCL	124	99	PRT	228	43	RCL	332	43	RCL
021	17	17	125	36	PGM	229	20	20	333	03	U3
022	45	YX	126	08	08	230	95	=	334	65	X
023	43	RCL	127	13	C	231	42	STO	335	03	?
024	00	00	128	98	ADV	232	20	20	336	09	9
025	55	X	129	19	D'	233	43	RCL	337	95	=
026	24	CE	130	15	E	234	02	02	338	42	STO
027	73	RC*	131	92	RTH	235	42	STO	339	01	01
028	01	01	132	76	LBL	236	00	00	340	02	2
029	69	DP	133	43	RCL	237	85	-	341	01	1
030	30	30	134	01	1	238	09	9	342	42	STO
031	69	DP	135	05	5	239	95	=	343	00	00
032	31	31	136	42	STO	240	42	STO	344	03	3
033	85	+	137	01	01	241	01	01	345	09	9
034	43	RCL	138	03	3	242	29	CP	346	43	STO
035	17	17	139	42	STO	243	73	RC*	347	09	05
036	45	YX	140	00	00	244	01	01	348	42	RCL
037	43	RCL	141	01	1	245	22	INV	349	01	01
038	00	00	142	94	+/-	246	77	GE	350	72	ST+
039	65	X	143	64	FD+	247	02	02	351	00	00
040	24	CE	144	01	01	248	67	67	352	69	DP
041	42	RCL	145	02	2	249	69	DP	353	20	20
042	18	8	146	22	INV	250	31	31	354	43	RCL
043	65	8	147	44	SUM	251	97	D82	355	03	03
044	73	RC*	148	01	01	252	00	00	356	44	SUM
045	01	01	149	97	D82	253	02	02	357	01	01
046	85	+	150	00	00	254	42	42	358	97	D82
047	69	DP	151	01	01	255	01	1	359	09	09
048	31	31	152	41	41	256	85	+	360	03	03
049	97	D82	153	92	RTH	257	43	RCL	361	49	48
050	00	00	154	76	LBL	258	07	07	362	24	CE
051	00	00	155	42	STO	259	22	INV	363	02	2
052	20	20	156	07	7	260	45	YX	364	01	1
053	43	RCL	157	42	STO	261	43	RCL	365	22	INV
054	10	10	158	00	00	262	20	20	366	90	LST
055	54	+	159	01	1	263	95	=	367	24	CE
056	42	STO	160	06	6	264	42	STO	368	98	ADV
057	17	17	161	42	STO	265	02	02	369	02	2
058	43	RCL	162	01	01	266	92	RTH	370	01	1
059	19	19	163	29	CP	267	50	1x1	371	42	STO
060	42	STO	164	73	RC*	268	32	X1T	372	09	09
061	01	01	165	01	01	269	43	RCL	373	22	INV
062	43	RCL	166	22	INV	270	07	07	374	86	STF
063	17	17	167	57	E0	271	77	GE	375	07	07
064	92	RTH	168	01	01	272	02	02	376	73	PC*
065	76	LBL	169	76	76	273	49	49	377	09	09
066	11	A	170	68	DP	274	73	RC*	378	16	A'
067	01	1	171	31	31	275	01	01	379	72	ST+
068	06	6	172	97	D82	276	50	1x1	380	09	09
069	42	STO	173	00	00	277	42	STO	381	69	DP
070	00	00	174	01	01	278	07	07	382	26	29
071	92	RTH	175	64	64	279	81	STO	383	69	DP
072	76	LBL	176	42	STO	280	02	02	384	18	18
073	12	B	177	07	07	281	49	49	385	87	IFF
074	72	ST+	178	43	RCL	282	76	LBL	386	07	07
075	00	00	179	00	00	283	14	D	387	03	03
076	99	PRT	180	42	STO	284	99	PRT	388	73	73
077	69	DP	181	20	20	285	36	PGM	389	24	CE
078	30	30	182	73	RC*	286	08	08	390	02	2
079	92	RTH	183	01	01	287	14	D	391	01	1
080	76	LBL	184	55	+	288	98	ADV	392	22	INV
081	13	C	185	43	RCL	289	32	RTH	393	90	LST
082	98	ADV	186	07	07	290	76	LBL	394	98	ADV
083	71	SBR	187	55	=	291	15	E	395	98	ADV
084	42	RCL	188	72	ST+	292	36	PGM	396	98	ADV
085	71	SBR	189	01	01	293	06	05	397	92	RTH
086	42	STO	190	69	DP	294	15	E	398	76	LBL
087	68	HDP	191	31	31	295	39	PRT	399	19	D'
088	94	+/-	192	97	D82	296	22	INV	400	95	5
089	42	STO	193	00	00	297	56	STF	401	00	0
090	17	17	194	01	01	298	07	07	402	00	0
091	99	PRT	195	82	32	299	85	-	403	00	0
092	71	SBR	196	43	RCL	300	42	RCL	404	00	0
093	43	RCL	197	20	20	301	05	05	405	00	0
094	71	SBR	198	42	STO	302	65	X	406	01	1
095	42	STO	199	00	00	303	01	1	407	68	HDP
096	68	HDP	200	85	+	304	00	0	408	68	HDP
097	42	STO	201	09	9	305	95	=	409	68	HDP
098	18	18	202	95	=	306	26	PGM	410	68	HDP
099	99	PRT	203	42	STO	307	08	08	411	14	D
100	43	RCL	204	01	01	308	11	A	412	92	RTH
101	17	17	205	73	RC*	309	36	PGM	413	76	LBL
102	36	PGM	206	91	01	310	08	05	414	17	E'
103	08	08	207	22	INV	311	15	E	415	43	RCL

Listing 1 continued on page 126

PRODIGY: YOUNG AND BRILLIANT

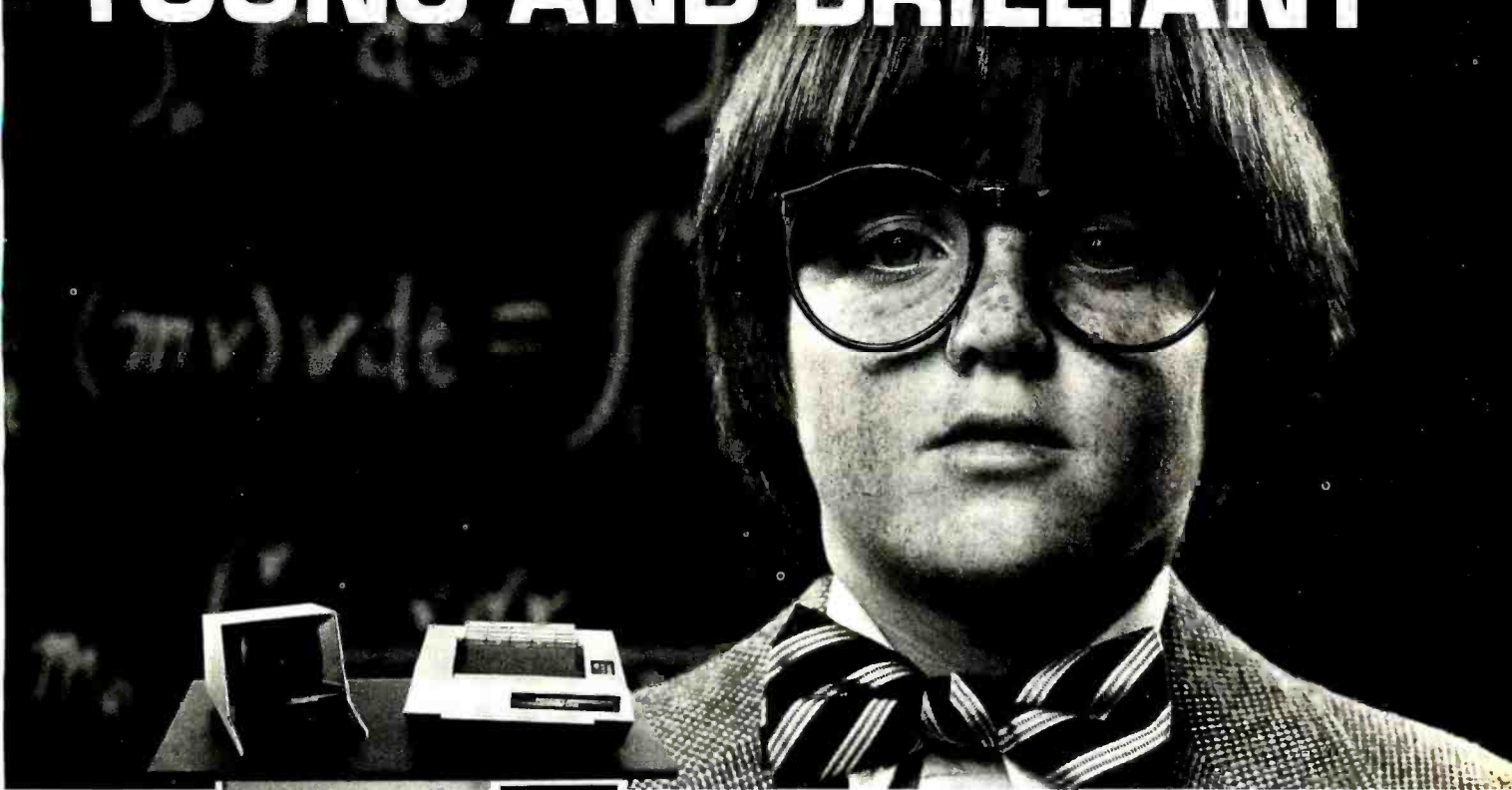

... "Though it may look like many other microcomputer systems . . . Prodigy One literally speeds away from them . . ." — Max Schindler, Software Editor-ELECTRONIC DESIGN.

Every so often an individual is born exhibiting extraordinary talent at a very early age. Often, they rise above the multitude establishing themselves as masters in their fields. These individuals are called prodigies.

The Prodigy computer is so advanced, it clearly establishes itself as a master in the field of small business computing.

Modular design and single board construction mean reliability, expandability, and ease of service.

But it is SOFTWARE which truly sets Prodigy apart. Unlike other computers, software was a major design consideration rather than an afterthought. Prodigy utilizes a highly advanced operating system and PROTEGE* to provide some very impressive features:

- | | |
|------------------------|-----------------|
| ■ DATA BASE MANAGEMENT | ■ INDEXED FILES |
| ■ VIRTUAL CODE | ■ SPOOLING |
| ■ DATA COMPRESSION | ■ MULTI-TASKING |

The result? Incredible speed and storage capacity, and economical systems development and maintenance.

Your local Prodigy dealer maintains an extensive library of field proven application software. Available applications include General Ledger, Accounts Receivable, Accounts Payable, Payroll, Medical Billing, and a remarkable system for the Personnel Placement Industry. All are easy to use yet provide a level of sophistication unheard of in its price class. And Prodigy also does word processing!

Prodigy systems are supported by a nationwide organization of thoroughly trained, experienced professionals. Your Prodigy dealer is a SINGLE source for hardware, software and a level of service that continually insures effective, trouble free operation.

Speed, sophistication, and low cost; an incredible combination for a small business computer. Would you expect less from a PRODIGY?

PRODIGY 
SYSTEMS, INC.

497 LINCOLN HIGHWAY • ISELIN, N.J. 08830 • (201) 283-2000

*Prodigy's easy to use compiler-based small business applications development language. Prodigy also supports other popular languages such as FORTRAN, COBOL, BASIC, and PASCAL.

U.S. ROBOTICS, INC.



LA34 DECwriter IV \$1199.00

- Tabs
- 132 columns
- 10, 12, 13.2, 16.5 characters/inch
- 2, 3, 4, 6, 8 or 12 lines/inch
- Optional tractor feed
- 110 or 300 baud
- RS232C/ASCII
- Friction feed/up to 15" wide paper
- 9x7 dot matrix, impact printing
- Upper/lower case

Teletype Model 43 KSR \$1049.00

- 110 or 300 baud
- RS232C/ASCII
- Pin feed/8 1/2" H x 11" W paper is perfect for filing and copying.



- Shiftlock Key
- Print Key
- Integrated Numeric Pad
- Editing Functions
- Extremely Compact: 15" W x 19" D x 14" H
- Silent fan-free operation

PENRIL 300/1200 MODEM Originate/Auto-Answer \$799.00

- RS232
- Full duplex over voice grade phone lines
- 1 year warranty
- Stand alone

USR-300 Series

USR-310 Originate



Acoustic Coupler \$159.00

- 0-300 Baud
- Bell 103/113 compatible
- Stand Alone
- RS232
- 1 Year Warranty
- Crystal Controlled
- State of the Art LSI circuitry
- 5 stage active filters

USR-330 Originate/ Auto-Answer



Modem \$339.00

FCC certified for direct connection to phone lines via standard extension phone jack.

USR-320 Auto-Answer Modem \$319.00

U.S. ROBOTICS, INC.

1035 W. LAKE ST.
CHICAGO, ILL. 60607

Sales
General Offices
Service

(312) 733-0497
(312) 733-0498
(312) 733-0499

Listing 1 continued:

416	11	11	436	04	4	456	16	16	476	40	10
417	42	STD	437	95	=	457	43	RCL	477	99	PRT
418	10	10	438	42	STD	458	16	16	478	98	ADV
419	43	RCL	439	13	13	459	99	PRT	479	92	RTH
420	12	12	440	43	RCL	460	43	RCL			
421	65	X	441	15	15	461	15	15			
422	02	2	442	65	X	462	99	PRT			
423	95	=	443	05	5	463	43	RCL			
424	42	STD	444	95	=	464	14	14	001	16	A'
425	11	11	445	42	STD	465	99	PRT	066	11	A
426	43	RCL	446	14	14	466	43	RCL	073	12	B
427	13	13	447	43	RCL	467	13	13	081	13	C
428	65	X	448	16	16	468	99	PRT	133	43	RCL
429	03	3	449	65	X	469	43	RCL	155	42	STD
430	95	=	450	06	6	470	12	12	283	14	D
431	42	STD	451	95	=	471	99	PRT	291	15	E
432	12	12	452	42	STD	472	43	RCL	323	18	C'
433	43	RCL	453	15	15	473	11	11	399	19	D'
434	14	14	454	00	0	474	99	PRT	414	17	B'
435	65	X	455	42	STD	475	43	RCL			

not zero in register R_{07} and recalls its rank in R_{00} to store it at $STO\ 20$.

At statements 182 thru 192, all the terms of the polynomial, starting with the first, are divided by the first coefficient which is not zero. This makes a_0 positive and equal to 1. This operation must be kept in mind to correctly interpret the change from one polynomial to the next when reading the results.

Location of the first negative coefficient to determine its value and rank begins at statement 196 and uses two loops, statements 203 thru 205 and 207 thru 219. Finally, if the negative coefficient exists, its absolute value is stored in register R_{07} and its rank in register R_{02} , and then its relative position with respect to the first coefficient which is not zero is stored in register R_{20} . Incidentally, the register number of a coefficient (R_{01}) can be determined easily by adding 9 to its ordinal number (R_{00}).

The calculation of the negative coefficient which has the highest absolute value starts at statement 233 and uses the T register with a relatively sophisticated process. This employs four loops, 251 thru 242, 245 thru 267, 271 thru 249 and 279 thru 249. The evaluation of R in Lagrange's formula takes place at statements 255 thru 265.

On the whole, the STO program can be considered to end with the RTN instruction of statement 218 with a long conditional branch with multiple options which operates as a subroutine and ends at the RTN of statement 266.

Maximum error:

This factor is introduced by LBL D (statement 283) which is none other than the assignment of the error ϵ in R_{03} in accordance with the assignment of PGM 08 D in the library. From experience it can be seen that repetition of the error coefficient for each calculation sequence constitutes a constraint, and that setting it at 0.01 in the absence of error entry, as provided by PGM 08, does not really spare the user from this preoccupation.

The fact is that although the precision required varies from one operator to the next, everyone generally uses a rather constant factor for a series of calculations.

It is thus practical to keep ϵ in the program, even if this means modifying it to the programming mode as soon as the need arises. This is the role of LBL D' (statement 399) where statements 400 thru 410 can contain ϵ up to 1×10^{-10} unless less precision is preferred. It is then sufficient to fill the empty spaces with NOP instructions or simply with zeros after the first significant figure. Since LBL D' calls D at statement 411 but is itself called by C at

S-100, 6-PORT COMMUNICATIONS

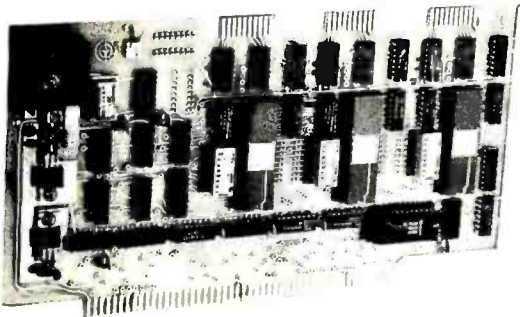

- INTERFACES MULTI TERMINALS, COMPUTERS, PRINTERS, MODEMS, ETC.
- 2, 4, OR 6 CHANNELS; 2 OPTIONAL RTC'S
- SELECTABLE I/O ADDRESS
- PROGRAMMABLE SYNC. CHARACTERS
- SYNC AND ASYNC
- HARDWARE ERROR CHECKING (CRC-16, CCITT)
- COMPLIES WITH: EIA RS-232C STANDARD; IEEE PROPOSED S-100 BUS STANDARD

FULL 6-PORT CONFIGURATION (ASSEMBLED AND TESTED) \$895.00

For information, contact: Dianne Polk (703) 893-4330 x 100



7916 Westpark Drive □ McLean, Virginia 22102

MAGSAM™

KEYED FILE MANAGEMENT SYSTEM

Sophisticated applications made simple.

Put data at your fingertips... easily accessed, displayed, and updated by key. MAGSAM™ allows your CBASIC programs to create and access sophisticated keyed file structures through simple CBASIC statements.

Powerful, affordable, and easy to use.

MAGSAM™ is now available in three versions offering an array of features and capabilities. Standard MAGSAM™ features include random by key, sequential by key, generic by key, randomly by record number, and physical sequential access techniques. Each MAGSAM™ Package includes the MAGSAM™ file manager, tutorial program, file dump utility, User Guide, Reference Card, and one year update service.

- **MAGSAM™** — Most advanced version. Secondary Indexing with any number of keys, and Record and Key Deletion with automatic reuse of freed space. \$145†
- **MAGSAM II™** — Single Key support with full Record and Key Delete capability. \$99†
- **MAGSAM I™** — Entry level version. Single Key support without Delete functions. \$75†
- **MAGSAM™ User Guide only** — comprehensive tutorial and reference manual. \$15

Available for 8" soft sector, Micropolis, and TRS-80 disk formats. Requires CP/M™ or derivative and CBASIC. Distributed as CBASIC subroutines in source form.

Visa and Mastercard welcome. Dealer and OEM inquiries invited.



MICRO APPLICATIONS GROUP
7300 CALDUS AVENUE
VAN NUYS, CA 91406

* Trademark of Digital Research. † Single site license

SYNCHRO-SOUND NOW OFFERS The Personal, Affordable Home Computer by ATARI®

Designed for education, entertainment, business and household management applications... connected to your home TV, with Color Graphics in 16 colors.



ATARI 400™ 57 key monopanel keyboard with U/L case. 8K RAM. 8K ROM expandable to 16K.



ATARI 800™ 57 fullstroke keyboard with U/L case. Cassette recorder. 8K RAM expandable to 48K. 8K ROM expandable to 16K. Printer and floppy disk accessories available.

CALL FOR LOW INTRODUCTORY PRICES



SYNCHRO-SOUND

The Computer People ENTERPRISES, INC.
193-25 Jamaica Avenue, Jamaica, New York 11423

PHONE ORDERS, CALL:

New York—212/468-7067 Chicago—312/641-3010

Los Angeles—213/628-1808 Dallas—214/742-6090

TWX 710-582-5886

HOLIDAY SALE ON TELETYPE

Good until December 31

TELETYPE MODEL 43

- 4320 AAA (TTL interface) \$945
- 4320 AAK (RS232 interface) \$1,045
with transformer to operate on 50Hz, 220v, installed
inside cabinet add \$ 75
We stock paper and ribbon for the Teletype Model 43

**PET, NEC SPINWRITER, DIABLO, CENTRONICS,
TRS-80, PER SCI also available.**

- HAZELTINE 1500 (assembled only) \$945**
- 1510 \$1,085
with 50Hz, 220v current adaptation \$100
also available with Danish, German or French
character sets add \$30

INTERTUBE II \$800

IMS 5000 SERIES, COMPLETE Z80 SYSTEM
2 I/O ports, 1 K EPROM bootstrap loader, double
density, dual 5 1/4 " disks, CP/M. S-100, 12 slot main-
frame. A new rising star! No waiting.

MARINCHIP SYSTEMS M9900

ELEGANT 16 BIT CPU, S-100 COMPATIBLE
Multi-user, multi-processor operating system. PASCAL,
Extended precision commercial BASIC, FORTH, META &
applications package. Complete kit and DISCEX soft-
ware \$550; Assembled \$700. We configure systems to
meet your budget & your needs. Hard Disk interface (with
software) available.

IMS MEMORY, 16K Fully static, 250 ns \$285

TEI S-100 Mainframes

- 12 slot — MCS 112 \$433
 - 22 slot — MCS 122 \$609
- These mainframes are completely assembled, tested
and contain everything required for plug-in operation.

TARBELL Floppy Disk Controller \$255
Other Tarbell products available.

UPGRADE DECWRITER II

For 1200 Baud operation.
Microprocessor-based Controller from Datasouth . . \$750

INNOVEX—the most reliable 8" floppy drive on the
market! MTBF greater than 8,500 hours. Head life greater
than 15,000 hours under normal operating conditions.
Shugart compatible.
Drive alone \$ 522
2 drives with power supply and cabinet \$1,565

SIEMENS DRIVES

8" Double Density, Shugart Compatible \$420

MODEM: "THE CAT" from Novation \$190
Originate/Answer. 300 baud.

TO ORDER: We ship within 24 hours after receipt of certified check, money order or cash-
iers check. Credit cards: add 4%. Personal checks: allow ten days. \$12 shipping for ter-
minals. \$3 for memories and modem. New York residents include sales tax. Prices and
availability subject to change without notice.

—WE EXPORT TO ALL COUNTRIES—
—OVERSEAS CALLERS USE (212) 448-6298 ONLY—

We have no reader inquiry number. Please call or write.

JOHN D. OWENS ASSOCIATES INC.

12 SCHUBERT STREET (New Address)
STATEN ISLAND, NEW YORK 10305
(212) 448-6283 (212) 448-6298

statement 129, it is clear that key C finally controls recall, printout and then entry of the maximum error ϵ programmed by the operator.

Calculation of roots:

The heart of this calculation is PGM 08 E from the library which we call at statements 292 and 309. Determination of the successive roots is implemented by our LBL E (statement 291). From the second root, the lower boundary a takes the value of the preceding root augmented by a minimum quantity equal to $\epsilon \times 10$. This augmentation is an artifice designed to move the calculator off the solution it has just found.

The process continues up to unsuccessful exploration of the last interval. At printout this initiates the characteristic series of 9.999...? provided by the manufacturer's PGM 08. LBL E itself is controlled by LBL C at statement 130. This is why key C in fact initiates determination of the roots at the right time.

Tables of values of τ and $P(\tau)$:

These two tables are successively printed out by LBL C' (statement 323) which samples thirty-nine suitable stored values of x from registers R_{21} thru R_{59} and replaces them immediately in the same registers with the thirty-nine corresponding values of $P(x)$. The median of x may be very close to zero. This means that the median of $P(x)$ corresponds to the value of the polynomial for $x = 0$ when $P(x) = P(-x)$.

The sequence C' starts with restoration of the lower boundary a in R_{01} and stores a new increment in R_{03} taken from forty statements between a and b . An automatic listing of the memories with loop and error-indicator control provides indexing of the values.

Sequence C' is itself controlled by LBL E at statement 320 after FLAG 07 has used the error signal from the end of root determination. Given that LBL E is subordinate to LBL C, as was stated earlier, sequence C' is finally implemented by key C also. Given the partition used, the thirty-nine sample values of x and then of $P(x)$ occupy statements 480 thru 959. Those of $P(x)$ can be recorded on a magnetic card in groups 3 and 4 for automatic printout by points of the function curve. The polynomials derived from $P(x)$ could obviously be recorded in the same manner.

Calculation of derived polynomials:

The derivation of each polynomial term of the general expression ax^n gives a term of the expression anx^{n-1} . The calculation is performed by LBL B' (statement 414) which, by depressing key B' once, prints out all the coefficients from x^n to x^0 . The sequence has been designed to provide $P'(x)$ from $P(x)$, $P''(x)$ from $P'(x)$ and so forth as long as the polynomial remains differentiable. Since the program then divides the polynomial by its first nonzero coefficient, it will come as no surprise to find a derivative divided by this term. This in no way changes the final results.

As soon as key B' has played its role, it is sufficient to depress key C for the derived polynomial to be handled in accordance with the same complete cycle as described for the initial polynomial. No other intervention is necessary, unless it is desired to return to the initial



We want you to
always have
a perfect
record.

Ours.

Maxell has the best quality control record in the industry. So we're certain to always give you the best Floppy Disks in the world.

Some reasons why Maxell is so good.

Every Maxell Floppy Disk is guaranteed to be perfect. We tolerate no ifs, ands, buts, excuses, or dropouts. It's that simple . . . and that tough.

In fact we have developed innovative manufacturing techniques that actually slow down certain processes, sacrificing speed to gain quality. And our unique binder system, developed by our own engineers, applies the magnetic oxide with amazing uniformity and surface smoothness.

Ten out of ten: a perfect record.

Of course, Maxell Floppy Disks conform to ISO and IBM specifications. They also have been recommended by major OEMs, because Maxell works best with their hardware.

So open a box, and know in advance that it holds ten perfect floppys. You're right to not settle for anything less. Neither do we.

Maxell offers the full range of Floppy Disks, from standard 8-inch to 5 1/4 -inch, plus Data Cassettes. *Dealer inquiries invited.*



Maxell Corporation of America. Data Products Group
60 Oxford Drive, Moonachie, NJ 07074 Tel. (201) 440-8020

polynomial to evaluate it as a function of the roots found for the derived polynomials. This determination is only made after all the derived polynomials that are deemed useful have been used in sequence by the automatic procedure just indicated.

When the coefficients of the initial polynomial have been reentered from R_{16} to R_{10} as at the beginning, enter each root on the keyboard, and each time depress A' . This evaluates the corresponding $P(x)$. The function curve is then completed by virtue of the geometric significance of the derivative by the following coordinates:

- to the root of $P'(x) = 0$ taken as the abscissa corresponds an ordinate by $P(x)$ which defines a maximum or minimum of $P(x) = 0$
- to the root of $P''(x) = 0$ taken as the abscissa corresponds an ordinate by $P(x)$ which defines a point of inflection of $P(x) = 0$ if there is one

Program of Function Curve

Principle:

The curve of the polynomial is automatically plotted as shown in the program in listing 2. It was necessary to conceive an algorithm that compensates for the relative weakness of the TI-59 in this area, since it accepts only twenty whole positive values on a 2.5 inch tape.

With the exception of special cases, the spacing of the plotted points is manifestly insufficient. It can be seen that to cover an 8.5 by 14 inch sheet of paper (a standard European A4 sheet, 21 by 29.7 cm), six strips of machine

Listing 2: Listing of the program that will plot the function curve.

```

000 76 LBL          105 06 6          210 00 0
001 98 ADV          106 54 >          211 00 0
002 69 DP          107 55 +          212 00 0
003 00 00          108 53 (          213 00 0
004 04 4          109 43 RCL          214 69 DP
005 00 0          110 07 07          215 01 01
006 00 0          111 85 +          216 69 DP
007 00 0          112 43 RCL          217 05 05
008 00 0          113 08 08          218 92 RTH
009 00 0          114 54 )          219 76 LEL
010 00 0          115 54 )          220 95 =
011 00 0          116 95 =          221 00 0
012 00 0          117 72 ST+          222 32 XIT
013 00 0          118 00 00          223 43 RCL
014 69 DP          119 69 DP          224 00 00
015 01 01          120 30 20          225 75 -
016 69 DP          121 97 DSZ          226 04 4
017 05 05          122 09 09          227 00 0
018 92 RTH          123 00 00          228 95 =
019 76 LBL          124 81 81          229 67 EQ
020 28 LOG          125 92 PTH          230 02 02
021 78 RC+          126 76 LEL          231 02 02
022 00 00          127 15 E          232 71 SBR
023 75 -          128 53 (          233 36 PGM
024 43 RCL          129 43 PCL          234 43 RCL
025 30 20          130 07 07          235 06 06
026 95 =          131 85 +          236 65 X
027 69 DP          132 43 RCL          237 43 RCL
028 07 07          133 08 08          238 01 01
029 43 RCL          134 54 )          239 95 =
030 06 06          135 55 +          240 32 XIT
031 65 X          136 06 6          241 92 RTH
032 07 7          137 55 +          242 76 LEL
033 95 =          138 43 RCL          243 36 PGM
034 72 ST+          139 03 03          244 32 INV
035 00 00          140 95 =          245 67 EO
036 92 RTH          141 43 STD          246 00 00
037 76 LEL          142 06 06          247 02 02
038 75 -          143 06 6          248 92 PTH
039 22 INV          144 43 STD          249 76 LEL
040 77 GE          145 05 05          250 10 E'
041 00 00          146 00 0          251 69 DP
042 21 21          147 42 STD          252 00 00
043 71 SBR          148 01 01          253 19 D'
044 95 =          149 39 CF          254 69 DP
045 92 RTH          150 02 2          255 01 61
046 76 LEL          151 01 1          256 19 D'
047 11 A          152 42 STD          257 69 DP
048 07 7          153 00 00          258 02 02
049 42 STD          154 03 3          259 19 D'
050 00 00          155 09 9          260 69 DP
051 92 RTH          156 42 STD          261 03 03
052 76 LEL          157 09 09          262 19 D'
053 12 B          158 43 RCL          263 69 DP
054 50 IXI          159 06 06          264 04 04
055 72 ST+          160 65 X          265 69 DP
056 00 00          161 43 PCL          266 05 05
057 55 +          162 01 01          267 92 RTH
058 01 1          163 95 =          268 76 LEL
059 00 0          164 42 STD          269 19 D'
060 95 =          165 20 20          270 04 4
061 74 SH+          166 69 DP          271 00 0
062 00 00          167 21 21          272 04 4
063 69 DP          168 43 PCL          273 00 0
064 20 20          169 06 06          274 04 4
065 92 RTH          170 65 X          275 00 0
066 76 LEL          171 43 PCL          276 04 4
067 13 C          172 01 01          277 00 0
068 14 D          173 99 FRT          278 04 4
069 15 E          174 98 ADV          279 00 0
070 92 RTH          175 98 ADV          280 92 RTH
071 76 LEL          176 98 ADV
072 14 D          177 95 =
073 03 3          178 32 XIT
074 09 9          179 73 PC+
075 42 STD          180 00 00
076 09 09          181 71 SBR
077 02 2          182 75 -
078 01 1          183 69 DP
079 42 STD          184 30 20
080 00 00          185 97 DSZ
081 53 (          186 09 09
082 73 RC+          187 01 01
083 00 00          188 79 79
084 55 +          189 98 ADV
085 43 RCL          190 98 ADV
086 03 03          191 10 E'
087 85 +          192 98 ADV
088 43 RCL          193 98 ADV
089 07 07          194 98 ADV
090 55 +          195 97 DSZ
091 43 PCL          196 05 05
092 03 03          197 01 01
093 54 )          198 49 49
094 65 X          199 92 RTH
095 53 (          200 76 LEL
096 53 (          201 99 PPT
097 43 RCL          202 69 DP
098 03 03          203 00 00
099 65 X          204 07 7
100 01 1          205 05 5
101 09 9          206 00 0
102 93 .          207 00 0
103 08 8          208 00 0
104 65 X          209 00 0
001 98 ADV
020 28 LOG
038 75 -
047 11 A
053 12 B
067 13 C
072 14 D
127 15 E
201 99 FRT
220 95 =
243 36 PGM
250 10 E'
269 19 D'

```

Retro-Graphics™



For your Dumb Terminal. The Retro-Graphics PC card mounts easily in the Lear Siegler ADM-3A to provide you with an affordable graphics computer terminal.

Features:

- Z-80 Based
- Point Plotting
- 512 by 250 Dot Matrix
- Automatic Vector Generation
- Simple Plug-in Interconnect
- Optional TEKTRONIX Software Compatibility

You will be impressed with the packaging, performance and price of the Retro-Graphics card. Write or phone today for complete specifications.

DIGITAL ENGINEERING, INC.

1775 Tribute Road
Sacramento, CA 95815
(916) 920-5600

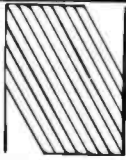

NEECO

Microcomputer Systems Division

**PROUDLY ANNOUNCES THE NEWEST
HARDWARE AND SOFTWARE FOR YOUR PET!**

**The PET is now a truly sophisticated
Business System with the announcement
of these peripherals and software packages.**



PRODUCT	DESCRIPTION	PRICE	AVAILABILITY
PET 2001—8KN (Large Keys)	8K RAM	\$ 795	DEC/JAN
PET 2001—8K	8K RAM	\$ 795	IMMEDIATE
PET 2001—16KN (Large Keys)	16K RAM*	\$ 995	IMMEDIATE
PET 2001—32KN (Large Keys)	32K RAM	\$1295	IMMEDIATE
PET 2023 PRINTER	ROLL FEED	\$ 850	IMMEDIATE
PET 2022 PRINTER	TRACTOR/ROLL	\$ 995	IMMEDIATE
ROMRETRO KIT	UPDATED O/S	\$ 90	IMMEDIATE
PET 2040	DUAL FLOPPY*	\$1295	IMMEDIATE
PET C2N	2nd Cassette	\$ 100	IMMEDIATE

*The 16K/32K (large keyboard) units do not include a cassette drive. Order C2N Cassette. 2040 Floppy Drive requires a 16K or 32K unit. 8K RAM Retrofit available July.

ALL PETS ARE FULLY TESTED BY NEECO BEFORE SHIPMENT. NEECO IS A FULL CUSTOMER-ORIENTED BUSINESS. CALL FOR OUR FREE CATALOG. SEND US A COPY OF THIS AD WITH AN ORDER AND WE WILL WARRANTEE YOUR COMMODORE PET FOR ONE FULL YEAR!

PET-DISK BASED BUSINESS SOFTWARE

SOFTWARE/APPLICATION	REQUIRES	AUTHOR	AVAILABILITY	PRICE
WORDPRO II / WORD PROCESSING	2040 + 16K PET	PRO/MICRO	IMMEDIATE	\$100
WORDPRO III / WORD PROCESSING	2040 + 32K PET	PRO/MICRO	DECEMBER	\$200
GENERAL LEDGER	2040 + 32K PET	CMS SOFTWARE	IMMEDIATE	\$295*
ACCOUNTS PAYABLE	2040 + 32K PET	CMS SOFTWARE	DECEMBER	\$295*
ACCOUNTS RECEIVABLE	2040 + 32K PET	CMS SOFTWARE	DECEMBER	\$295*
MAILING LIST	2040 + 32K PET	CMS SOFTWARE	IMMEDIATE	\$100
NEECOLEDGER	COMPUTHINK .4 M DRIVE + 32K PET	NEECO	IMMEDIATE	\$795
NEECOMAILER	COMPUTHINK .4 M DRIVE + 32K PET	NEECO	IMMEDIATE	\$150

*The CMS Software (G/L, A/R, A/P) are based on Osborne & Associates trial tested business basic software. Software is complete with full documentation and user instructions. All packages require a printer for output. Commodore recommends the NEC Spinwriter (available from NEECO) as the output printer for WORDPRO.

DEALER INQUIRIES INVITED ON SOFTWARE & NEC (PET) SPINWRITER

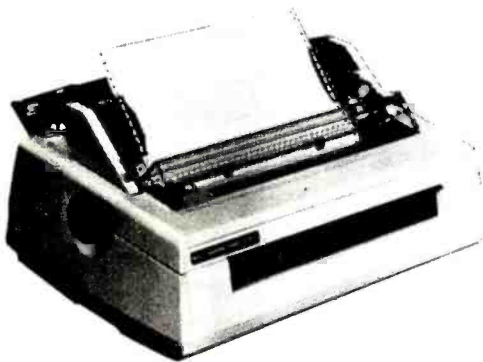

**FOR WORD PROCESSING
NEC IS BEST!**

- * 55 characters per second output speed
- * Changeable thimble for different typstyles
- * Less than 1% warranty malfunction rate
- * IBM quality letter output
- * Dealer inquiries invited

**THE NEC SPINWRITER
MODEL 5530-P** (Centronics I/O modified for PET)

\$2995

*Price includes IEEE interface to PET. IEEE Port is available for use with 2040 Dual Disk.

*The NEC 5530-P is the output printer recommended by Commodore for their Word Processing System.



NEECO

Microcomputer Systems Division

NEW ENGLAND ELECTRONICS CO., INC.
679 HIGHLAND AVE., NEEDHAM, MASS. 02194
SHOWROOM HRS.: MON. - FRI. 9:30 - 5:30. EST.

(617) 449-1760

MASTERCARD OR VISA ACCEPTED
TELEX NUMBER 951021, NEECO

paper must be juxtaposed. In practice, this means making the data positive, preparing a suitable format and then dividing it into six parts. Thus, the calculator can sequentially print the asterisks corresponding to the thirty-nine values of registers R_{21} thru R_{59} . This can be accomplished in six runs.

Since asterisks will be printed for only thirty-nine pieces of data on 39 by 6 runs, a printout arrangement by points on the base line is used to mark the nonoperation. The interval between points is equal to the increment of the table of the values of x .

Location in the plane is completed by two other arrangements:

- a sign in the shape of a triangle, in place of a point, marks the middle of the base line when there is no value on the zero abscissa
- the ordinates are marked laterally by a column of points with twenty per tape

Initialization and data entry:

These operations are performed by LBL A (statement 047) and LBL B (statement 053). The lower data item entered first is stored in register R_{07} , and the upper data item, entered second, is stored in register R_{08} . The choice of these values determines the amplitude of the graphic reproduction. If it is desired to cover a maximum field, it is necessary to determine the extremes of the values to be reproduced by concurrently consulting the table of the values of $P(x)$ and the group of values of $P(x)$ for x taken from the roots of $P'(x) = 0$.

Note that LBL B continues (statement 057) with the ad-

dition of the tenth of each value entered. This automatically provides a margin for the sheet.

Service labels:

Since there is no point in spreading signs on a page without identification, a certain number of sequences permit projections along the abscissa and ordinates. LBL ADV (statement 001) prints one point on the base line of the strip when no data appears on the corresponding abscissa. You will recognize the alphanumeric code controlled by instructions OP 00, OP 01 and OP 05.

Instead of a point, LBL PRT (statement 201) prints a small triangle in the middle of the base line. This distinctive sign marks the zero abscissa when no data item corresponds to it. This median is recognized by monitoring register R_{40} in passing and, by subtracting its ordinal number, it checks for the zero condition using the T register ($= t$ or $\neq t$). The conditional transfer is executed by means of the LBL = instruction at statement 220 and LBL PGM at statement 243 (the first being called as a subroutine at statement 043 by the LBL - instruction and the second at statement 232 by the LBL = instruction). Naturally, the T register is restored to its previous value immediately after statement 234 and before returning to the main program to serve in the test of the upper limit for the following data item.

Incidentally, it can be observed here that the user is dealing with a structure with four levels of subroutines (main program - SBR - - SBR = - SBR PGM - SBR PRT). The calculator can handle them with no difficulty, since it can accept up to six successive calls. The ordinate location is provided by LBL E' (statement 250), called at

SPECIALIZING IN QUALITY MICROCOMPUTER HARDWARE

INDUSTRIAL • EDUCATIONAL • SMALL BUSINESS • PERSONAL

BUILDING BLOCKS FOR MICROCOMPUTER SYSTEMS, CONTROL & TEST EQUIPMENT

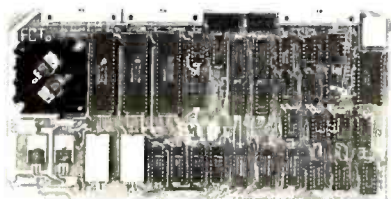

R² I/O
2K ROM
2K RAM
3 Serial Ports
1 Parallel Port
WIRED: \$295.00

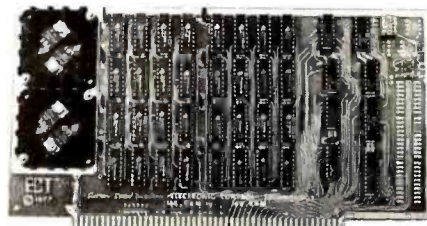

16 K RAM
FULLY STATIC
MEMORY
KIT: \$279.00
WIRED: \$310.00

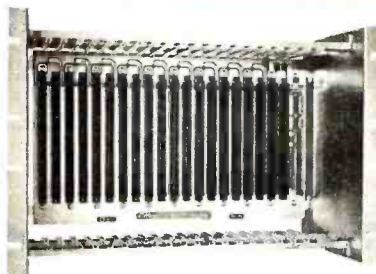

ECT-100-F
RACKMOUNT
CARD CAGES
KIT: \$200.00
WIRED: \$250.00

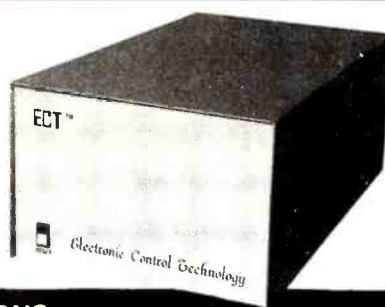

TT-10
TABLE TOP
MAINFRAMES
KIT: \$340.00
WIRED: \$395.00

POWER SUPPLIES, CPU's, MEMORY, OEM VARIATIONS

ELECTRONIC CONTROL TECHNOLOGY (201) 686-8080

763 RAMSEY AVE.
HILLSIDE, N.J. 07205

statement 181, which prints a column of points at the end of the tape. For reasons of economy, the alphanumeric characters are grouped in LBL D' at statement 269 and recalled as a subroutine whenever needed.

Data printout:

LBL LOG (statement 020) prints an asterisk when the value of R_{00} recalled by indirect addressing is between the lower and upper limits of the tape considered. Printout uses a special instruction OP 07. Conditional transfer is provided by LBL — which transfers execution to LBL LOG if the data item is acceptable after subtracting the value of the lower limit stored in register R_{20} . Finally, the data item processed is excluded from the printing field by addition of the group of seven instructions of the tape format contained in register R_{06} (statements 029 thru 035).

Data conversion:

This operation is executed by LBL D (statement 072). It assigns the thirty-nine data items collected by recording in groups 3 and 4 of registers R_{21} thru R_{59} on completion of calculation of the initial $P(x)$ polynomial. However, this could just as well be a polynomial derived for another calculation purpose. The positive value and formatting of this data for printout are obtained with a better spread by dividing them by the increment of the table of values of x contained in register R_{03} . Each converted data item replaces the previous data item term for term in the same register R_{21} thru R_{59} .

Tape printout:

Printout of the six tapes is controlled by LBL E (statement 127). This sequence begins with calculation of the tape format stored in register R_{06} . Tape indexing depends on register R_{01} , initially loaded with zero at statement 146, then incremented at statement 166 and printed at statement 173. The lower tape limit is calculated at statement 165 (STO 20) and the upper limit at statement 177 for loading in the T register.

Transfer to the test of the upper tape limit is executed by instruction SBR — at statement 181. The mechanism of LBL E uses a double loop:

- 149 thru 198 for register R_{09} for data counting loaded at 39
- 179 thru 185 for register R_{05} for tape counting loaded at 6

The entire system is actuated by simply depressing key C, since LBL C at statement 067 monitors D and E. Part 2 of this article will discuss the numerical applications of this program. Samples will be provided to illustrate the initialization and plotting procedures to be followed to output the function curve. ■

Glossary

Lagrange's method: Several theorems exist that can solve for the real root(s) of a polynomial equation by means of successive approximations. Lagrange's method obtains the real root using only integer calculations, thereby eliminating any roundoff error. This process is therefore very useful for separation of roots located in a small interval.

New for the APPLE II & TRS-80*

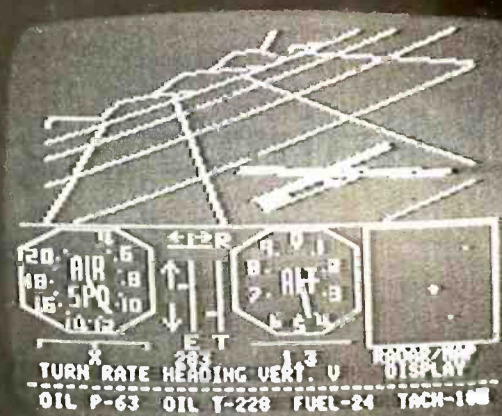

the subLOGIC FS1 Flight Simulator!

Experience the excitement of a new era in computer simulation as you make your landing approach after a practice flight in your FS1. Then return to the skies where enemy fighters are waiting to intercept you.

The FS1 is a visual flight simulator that gives you realistically stable aircraft control. And its beautifully accurate graphics are produced by a high-performance driver capable of drawing 150 lines per second.

Please DO NOT confuse the FS1 with other software claiming to offer flight simulation. The FS1's sophistication, speed, and beauty are way beyond the ordinary.

See the FS1 package demonstrated at your dealer's, or order directly from subLOGIC. Either way, it's only \$25 plus 75¢ for UPS or \$1.50 for first class mail. VISA and MasterCard accepted.

*16K required. Specify your system: Apple II or TRS-80 Level I or Level II.

(217) 359-8482
subLOGIC
Box V, Savoy, IL 61874

The engineering and graphics experts
opening a new era in computer simulation.

Minimizing Curve-Plotting Calculation

Timothy G Bowker
Systems Research Laboratories Inc
2800 Indian Ripple Rd
Dayton OH 45440

Are you plotting the results of time-consuming calculations? The efficient routine described here will give you accurate curves with fewer calculated points.

This article is written for the most common type of plotter/software combinations which draw straight lines between calculated points. Figure 1 shows superimposed curves, both of which are plots of the function 2^x as an example. The smooth curve is produced using a very small ΔX , while the other is created with a ΔX equal to 2. The marks below the X axis indicate the values of X (and ΔX , between two marks) used for the non-smooth curve. A comparison of the two curves illustrates where the greatest error occurs. When ΔX is constant and large, and straight lines are drawn between calculated points, the accuracy of a plot is less in regions of sharper curvature. The accuracy decreases in regions of greater slope (given equal curvature and constant ΔX) because the plotted line-segment length is greater at steeper slopes.

It is often desirable to have consistent accuracy throughout a plot, and yet minimize the number of points required to plot a curve (to minimize calculation and running time). In such a case, it would be more efficient to use small values of ΔX in regions of steep slope and/or sharp curvature, and large values of ΔX in regions of little slope and little curvature.

Ideally, ΔX could be adjusted so that with a minimum number of calculated points, a curve would be plotted (with discrete, straight-line segments) such that the curve appeared accurate. This result may be achieved as illustrated in figure 2. (Again, the ΔX values used are marked below the X axis.) Note the smaller number of points calculated in the low slope/low curvature ($X < 0$) area of the curve. Compare this with figure 3 which was plotted with a constant ΔX of 0.1. Figure 2 has slightly better resolution at the steepest part of the curve ($\Delta X \text{ min} \cong 0.09$) as well as having been plotted with less than half the points required for figure 3.

Figure 4 sheds additional light on the technique. The plot is identical to figure 2 except that crosses have been marked at each plotted point. Note that line-segment lengths are similar at both ends of the plot (where curvature is slight) but that the value of ΔX on both ends is

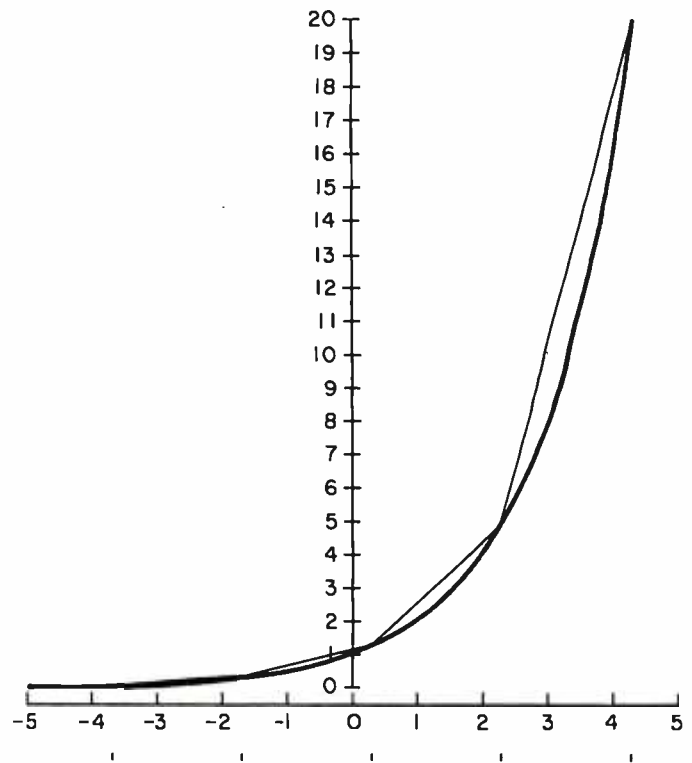

Figure 1: True curve superimposed on curve plotted with $\Delta X = 2$. Notice less accuracy in regions of greater slope or curvature using constant ΔX .

vastly different, as may be observed by the X_i markers below the X axis. Also note that where curvature is greater, ΔX is adjusted to yield shorter line-segment lengths (as around $X = 2$).

Figure 5 is a duplicate of figure 3, with crosses added at plotted points, which further emphasizes the effort wasted in low slope/low curvature areas using a constant ΔX .

The Method

ΔX may be automatically varied during the running of a plotting program by estimating the curvature and slope

Let your LSI-11* break the 28K barrier

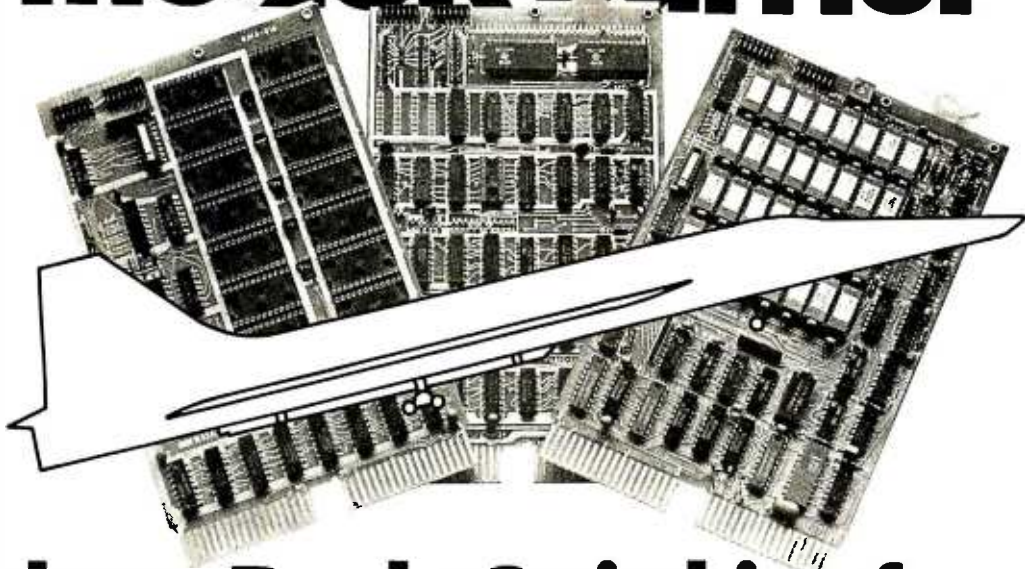

With our Bank-Switching family

In LOCAL mode our memory is functionally just like DEC memory. But when you run out of memory space you're not lost. Add an inexpensive Bank-Switch Controller (BSC-256) and you can go to **two megabytes**. Add another and go to **four megabytes**.

So don't get boxed in with other brands of LSI-11* memory. Break free. Join the family:

RMA-032	32K by 16 bit RAM. On-board refresh	\$1200 (Single qty.)
RMS-016	16K by 16 bit ROM. (Intel 2716)	\$300 (Single qty.)
BSC-256	The Bank-Switch Controller	\$300 (Single qty.)

Substantial quantity discounts are available. For a free copy of our Bank-Switching manual, call or write on your company letterhead.

*Digital Pathways Inc.
4151 Middlefield Road
Palo Alto, CA 94306
(415) 493-5544*

**Registered trademark of Digital Equipment Corporation*



DIGITAL PATHWAYS

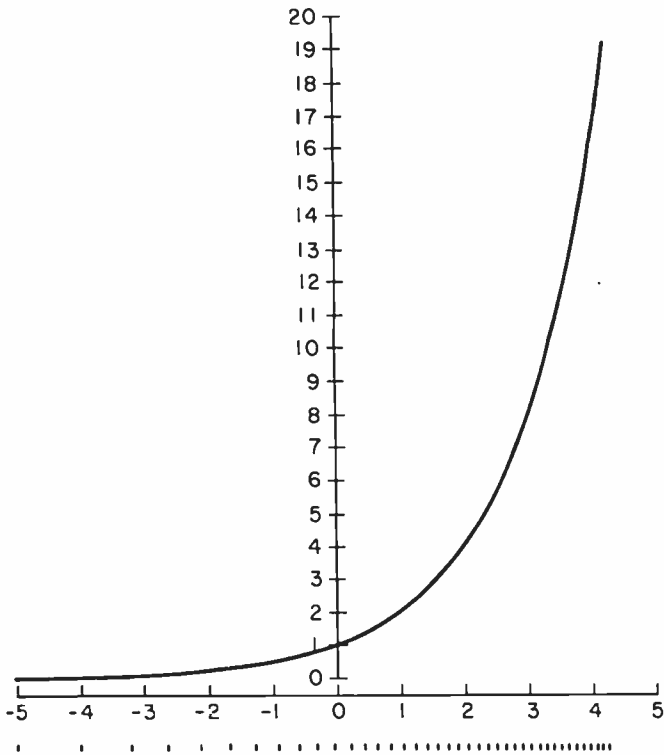

Figure 2: Accurate curve plotted with more efficiently selected ΔX values (the increments for ΔX are indicated by marks below the X axis).

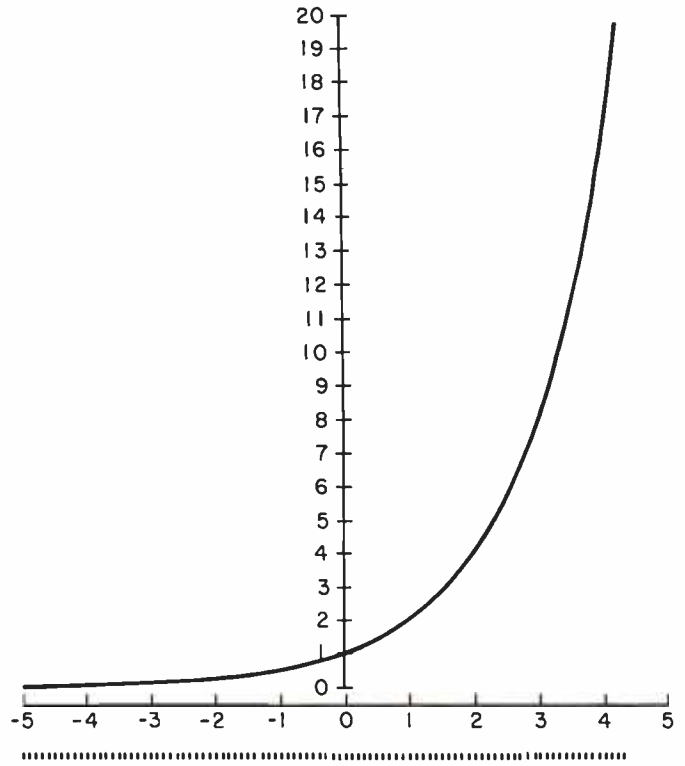
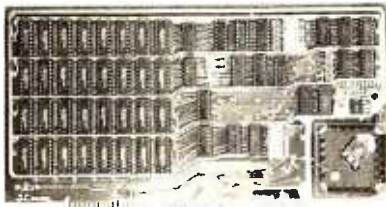

Figure 3: Accurate curve plotted with constant ΔX . Note the unnecessary points calculated and plotted in lower-left straight line portion of curve.

16K STATIC RAM



with
 \$275 450 ns
 \$300 250 ns
 memory chips

Assembled, Tested and Guaranteed

Static TMS 4044 or equivalent - Fully Static 4Kx1 Memory Chips for full DMA capability, no tricky timing problems.

Fully S-100 Bus Compatible - All lines fully buffered, Dip Switch Addressable in two 8K block, 4K increments. Write Protectable in 2 blocks, Memory Disable using Phantom, Battery back up capability.

Bank Select - Using output port 40H (Cromemco software compatible)-addressable to 512KB of Ram for time share or Memory Overlap, also has alternate ports B0H, COH.

Guaranteed - Parts and labor for one year. You may return the undamaged board within 10 days for a full refund.

Orders - You may phone for Visa, MC, COD (\$4 handling charges for COD) orders. Personal checks must clear prior to shipping. Shipping-Stock to 72 hours normally. Will notify expected shipping date for delay beyond this. Illinois residents add 5% tax. Please include phone number with order.

S.C. Digital

P.O. Box 906 Phone:
 Aurora, IL 60507 (312) 897-7749

of the upcoming curve. This is based on the slope of the last two plotted points and the curvature of the last three plotted points.

When there is no curvature, the plot segment length must still be limited, due to the look-back nature of the ΔX determination routine. In other words, the routine cannot assume that the rest of the plot is straight simply because the last portion was perfectly straight. Therefore, when dealing with a curve with no curvature, no matter what the slope, this routine will plot a line segment of approximately constant length. This length is selected by the programmer to accommodate the nature of the curve being plotted and resolution requirements.

This routine may be conveniently implemented using slope, trigonometric functions, angles, and changes in angle. A strictly geometric approach, while possibly appearing better than a trigonometric one, has serious difficulties.

The present routine stores the last two values of both X and Y and finds the appropriate "plot" slope of the last plotted curve segment. (It is necessary to be concerned with the slope as it appears plotted. The mathematical slope $(Y_i - Y_{i-1}) / (X_i - X_{i-1})$ will probably not equal the plot slope due to difference between the X and Y scales. If 1 inch on the Y axis covers a ΔY of M and 1 inch on the X axis covers a ΔX of N, then the mathematical slope, $\Delta Y / \Delta X$, should be multiplied by N/M to yield the plot slope. M and N should be fairly accurate for proper program operation.)

ITEM NO.
WK-7

CMOS SAFE

IC INSERTION/EXTRACTION KIT

KIT INCLUDES

- MOS-1416 14-16 CMOS SAFE INSERTER
- MOS-2428 24-28 CMOS SAFE INSERTER
- MOS-40 36-40 CMOS SAFE INSERTER
- EX-1 14-16 EXTRACTOR
- EX-2 24-40 CMOS SAFE EXTRACTOR



OK MACHINE & TOOL CORPORATION
3455 CONNER ST., BRONX, N.Y. 10475 U.S.A.
PHONE (212) 994-6600 TELEX NO. 125091



PRINTED IN U.S.A.

PATENT PENDING

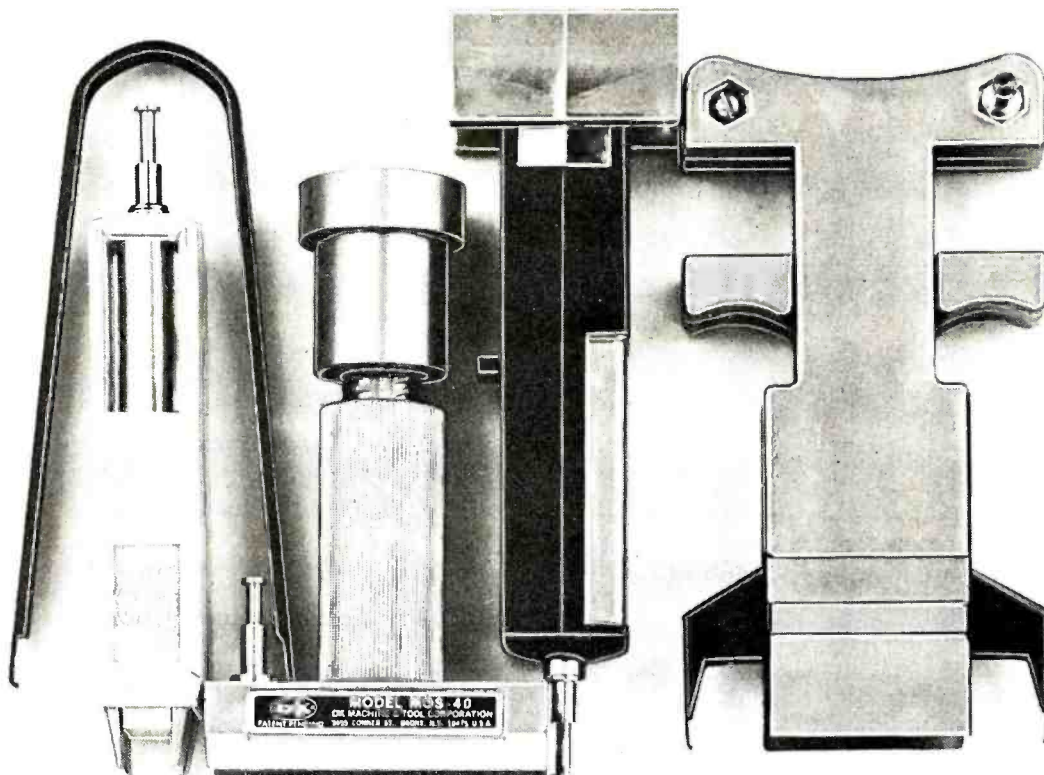

INS-1416	14-16 PIN DIP IC INSERTER	\$ 3.49
MOS-1416	14-16 PIN MOS CMOS SAFE INSERTER	\$ 7.95
MOS-2428	24-28 PIN MOS CMOS SAFE INSERTER	\$ 7.95
MOS-40	36-40 PIN MOS CMOS SAFE INSERTER	\$ 7.95
EX-1	14-16 PIN EXTRACTOR TOOL	\$ 1.49
EX-2	24-40 PIN CMOS SAFE EXTRACTOR TOOL	\$ 7.95
WK-7	COMPLETE IC INSERTER/EXTRACTOR KIT	\$29.95

MINIMUM BILLING \$25.00. ADD SHIPPING CHARGE \$2.00. NEW YORK RESIDENTS ADD APPLICABLE TAX.

OK MACHINE & TOOL CORPORATION 3455 CONNER ST., BRONX, N.Y. 10475 (212) 994-6600/TELEX 125091

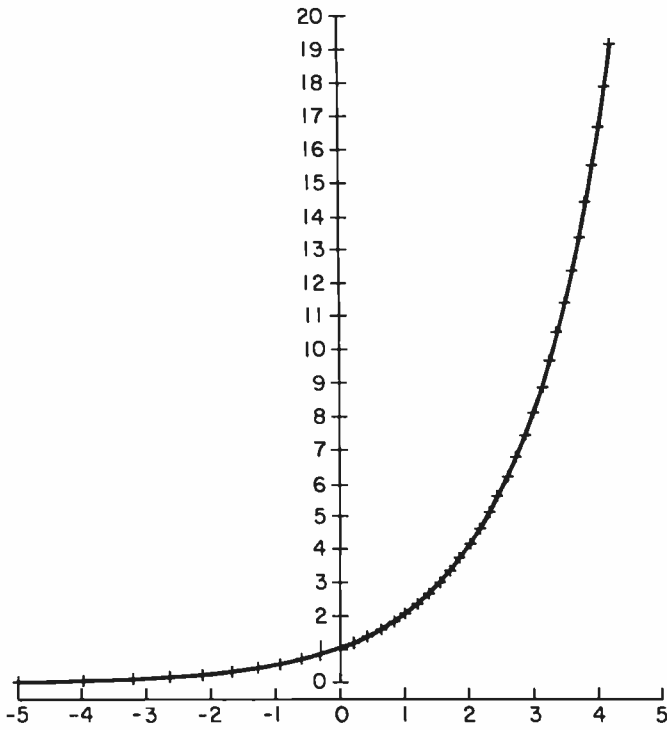

Figure 4: Identical to figure 2 except that crosses are used to indicate plotted points. Note similar line segment lengths at both ends of the curve, but vastly different ΔX s (distances between marks below X axis). Note also the shorter line segments in area of greater curvature.

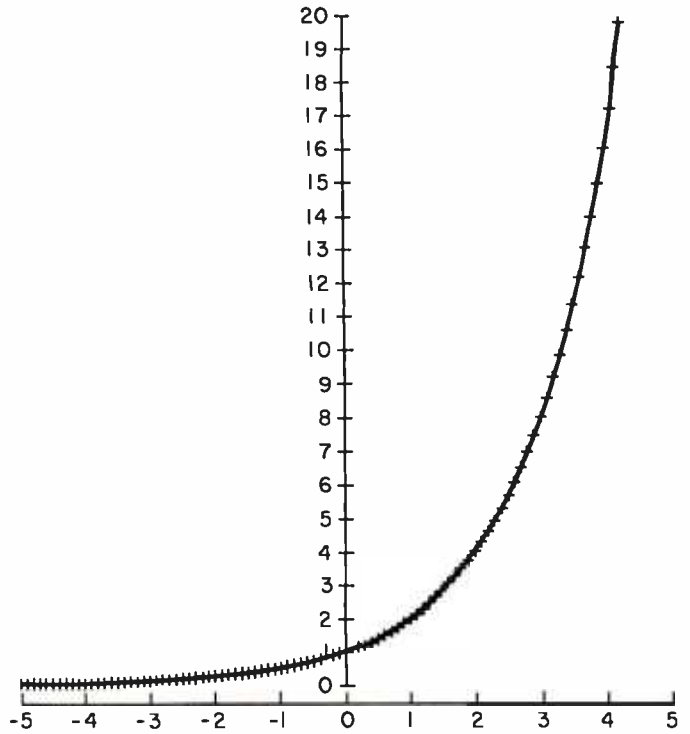

Figure 5: Same as figure 3 with the crosses at all plotted points. Note the reasonable line segment lengths in the upper-right portion of curve, but unnecessarily short line segments in the lower left portion of curve due to the use of constant ΔX .

DigiBYTE SYSTEMS CORP. **Grand Opening**

NEW YORK'S ONLY TOTAL COMPUTER CENTER

5 Complete Stores In One!

- BUSINESS • PERSONAL • HOBBY SHOP
- COMPUTER LIBRARY • REPAIR SHOP



Presenting the remarkable.

TEXAS INSTRUMENTS

TI-99/4 HOME COMPUTER

includes Console and Color Video Monitor

Complete **\$1049**

Additional accessories also available.

Write or call for information and literature.



For personal use and record keeping...
For home management and education...
For entertainment...
For every member of your family. For right now.

31 East 31st Street,
New York, N.Y. 10016
(212) 889-8130

DigiBYTE SYSTEMS CORP.

The arctangent of the last plot slope is computed to yield the last plot angle. Taking the cosine of the last plot angle and multiplying by the value of the desired line-segment length (using X axis units) yields the required ΔX estimate for the next point as illustrated in figure 6. That is, when the last two line segments' curvature is zero:

$$\Delta X_i = X_{i+1} - X_i = L \cos \left\{ \arctan \left[\frac{N(Y_i - Y_{i-1})}{M(X_i - X_{i-1})} \right] \right\} \quad (1)$$

where:

L = desired maximum line-segment length,
N/M = scale difference adjustment factor.

This determines the contribution to ΔX from the plot slope (or first derivative) effects.

Notes on Figure 6

Assume (X_4, Y_4) and (X_5, Y_5) have been plotted, and ΔX_4 and Q_4 (the corresponding slope angle) have been calculated, but that ΔX_5 , X_6 , Y_6 , and Q_5 are not yet known. It is assumed that Q_5 will be approximately equal to Q_4 , which is generally true for small line-segment

GET FREE GAMES!

...When you subscribe to SPI magazines

Subscribe to *Strategy & Tactics* The Magazine of Conflict Simulation

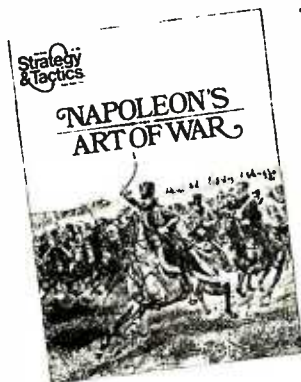

Now in its second decade of continuous publication, *S&T* is the prime magazine of strategy gaming and military history. Every issue comes complete with a full fledged simulation game — diecut cardboard playing pieces, 22" x 32" map, and rules of play bound in the magazine. Plus fascinating historical articles, reviews, and game related material. All the great battles of history are yours to fight again in the games of *Strategy & Tactics Magazine*.



YOURS FREE
When you subscribe to *S&T* you'll get *Chickamauga*, a terrific Civil War contest, normally selling for \$4.

Subscribe to *Ares* The Magazine of SF and Fantasy Gaming



The first issue of this unique science fiction/fantasy magazine will appear February 1980. Each magazine will contain a brand-new ready to play sf or fantasy game PLUS stories, illustrations, reviews, articles on game strategy, as well as science-fact material. *Ares* will be the blending of speculative fiction and gaming, bringing new excitement to both interests. Be a subscriber and get your free bonus game!



YOURS FREE
When you subscribe to *Ares* you'll get *The Creature That Ate Sheboygan*, a tongue-in-cheek simulation of Hollywood monsters threatening a typical American city. A \$4 value — FREE!

Subscribe to *MOVES* The Magazine of Gaming Technique

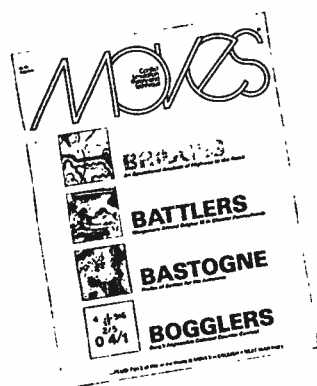

A necessary companion to *S&T* and *Ares*, *MOVES* carries analysis of play by experienced gamers, 'nuts and bolts' articles on game design and tough talking critiques of SPI games and those of other publishers.



YOURS FREE
When you subscribe to *MOVES* you'll get *Arnhem* the exciting re-creation of the Allied air-drop on Nazi occupied Holland. A \$4 game — FREE!

Send check or money order to:



Please enroll me as a subscriber to:

- Strategy & Tactics**; 1 yr. (6 issues) plus free Chickamauga game: \$16
- Ares**; 1 yr. (6 issues) plus free Creature game: \$14
- MOVES**; 1 yr. (6 issues) plus free Arnhem game: \$9.60
- SPECIAL**: All three magazines for one year plus a fourth Mystery Free Game (worth \$4) for only \$35.64 (a \$55.60 values at only two-thirds the price)

Name _____

Address _____ Apt Nr: _____

City _____ State _____ Zip _____

MasterCharge or Visa account number (check type)

Expiration Date _____

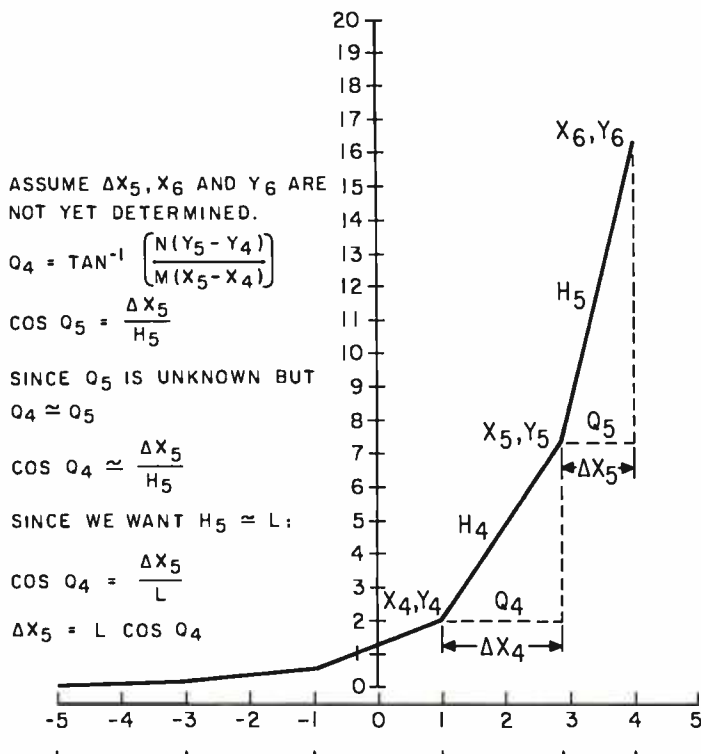

Figure 6: Illustration of the trigonometric estimation of next ΔX , with no consideration of curvature. The line segment lengths have been exaggerated for demonstration purposes. The plot was run with the listed program with $L=2$ and $C=0$.

lengths. Without considering curvature, you want H_5 to equal L , the desired line-segment length. From figure 6:

$$\frac{\Delta X_5}{H_5} = \cos Q_5$$

Assume $Q_4 \approx Q_5$ so:

$$\frac{\Delta X_5}{H_5} \approx \cos Q_4$$

Substituting L for the desired value for H_5 :

$$\frac{\Delta X_5}{L} = \cos Q_4$$

$$\Delta X_5 = L \cos Q_4$$

which is the estimate used for ΔX_5 to yield a line-segment length approximately equal to L , without consideration of curvature.

To adjust ΔX for curvature (or second derivative) effects, the plot angle of the last plotted curve segment is subtracted from the plot angle of the previously plotted curve segment to yield the change in plot angle. This value yields a direct indication of curvature, which is not, however, equal to the second derivative.

Since you are not concerned with the sign of the curvature, only its magnitude, take the absolute value of the change in plot angle. (You were not concerned with the sign of the slope either, but since this program is designed only for plots of single valued functions of "X" ($\Delta X > 0$), the cosine of the plot angle will always be positive, regardless of the sign of the slope, thus eliminating the need to take the absolute value.)

Taking equation 1 for ΔX without curvature and setting the plot angle equal to Q , you have:

$$\Delta X = L \cos Q \quad (2)$$

for ΔX without curvature.

Perhaps the simplest way to include a contribution from the change in plot angle is in the following form:

$$\Delta X = \frac{L \cos Q}{1 + C(P-Q)} \quad (3)$$

where C is a weighting factor which controls the effect of the change in plot angle (curvature) on ΔX , and P is the plot angle previous to the last plot angle, Q . Thus, $P-Q$ = the change in plot angle. It may be seen that equation 3 reduces to equation 2 when there is no curvature ($P = Q$, $P-Q = 0$). The weighting factor C is perhaps best determined by experimentation, but will probably be approximately equal to L when P and Q are in degrees.

Program Initialization and Operation

Since the program in listing 1 utilizes a look-back algorithm, some initialization is required because there are no "previous three points" at the beginning of the program.

TERMINALS FROM TRANSNET

PURCHASE FULL OWNERSHIP AND LEASE PLANS

DESCRIPTION	PURCHASE PRICE	PER MONTH		
		12 MOS.	24 MOS.	36 MOS.
LA36 DECwriter II	\$1,595	\$ 152	\$ 83	\$ 56
LA34 DECwriter IV	1,295	124	67	45
LA120 DECwriter III. KSR ...	2,295	219	120	80
LA180 DECprinter I, RO	2,095	200	109	74
VT100 CRT DECscope	1,895	181	99	66
VT132 CRT DECscope	2,295	220	119	80
DT80-1 CRT Terminal	1,895	181	99	66
T1745 Portable Terminal	1,595	152	83	56
T1765 Bubble Memory Term. .	2,795	267	145	98
T1810 RO Printer	1,895	181	99	66
T1820 KSR Printer	2,195	210	114	77
ADM3A CRT Terminal	875	84	46	31
QUME Letter Quality KSR.	3,195	306	166	112
QUME Letter Quality RO.	2,795	268	145	98
HAZELTINE 1410 CRT	895	86	47	32
HAZELTINE 1500 CRT	1,095	105	57	38
HAZELTINE 1552 CRT	1,295	124	67	45
DataProducts 2230	7,900	755	410	277
DATAMATE Mini Floppy	1,750	167	91	61

FULL OWNERSHIP AFTER 12 OR 24 MONTHS
10% PURCHASE OPTION AFTER 36 MONTHS

ACCESSORIES AND PERIPHERAL EQUIPMENT
ACOUSTIC COUPLERS • MODEMS • THERMAL PAPER
RIBBONS • INTERFACE MODULES • FLOPPY DISK UNITS
PROMPT DELIVERY • EFFICIENT SERVICE



TRANSNET CORPORATION
2005 ROUTE 22, UNION, N.J. 07083
201-688-7800

TWX 710-985-5485

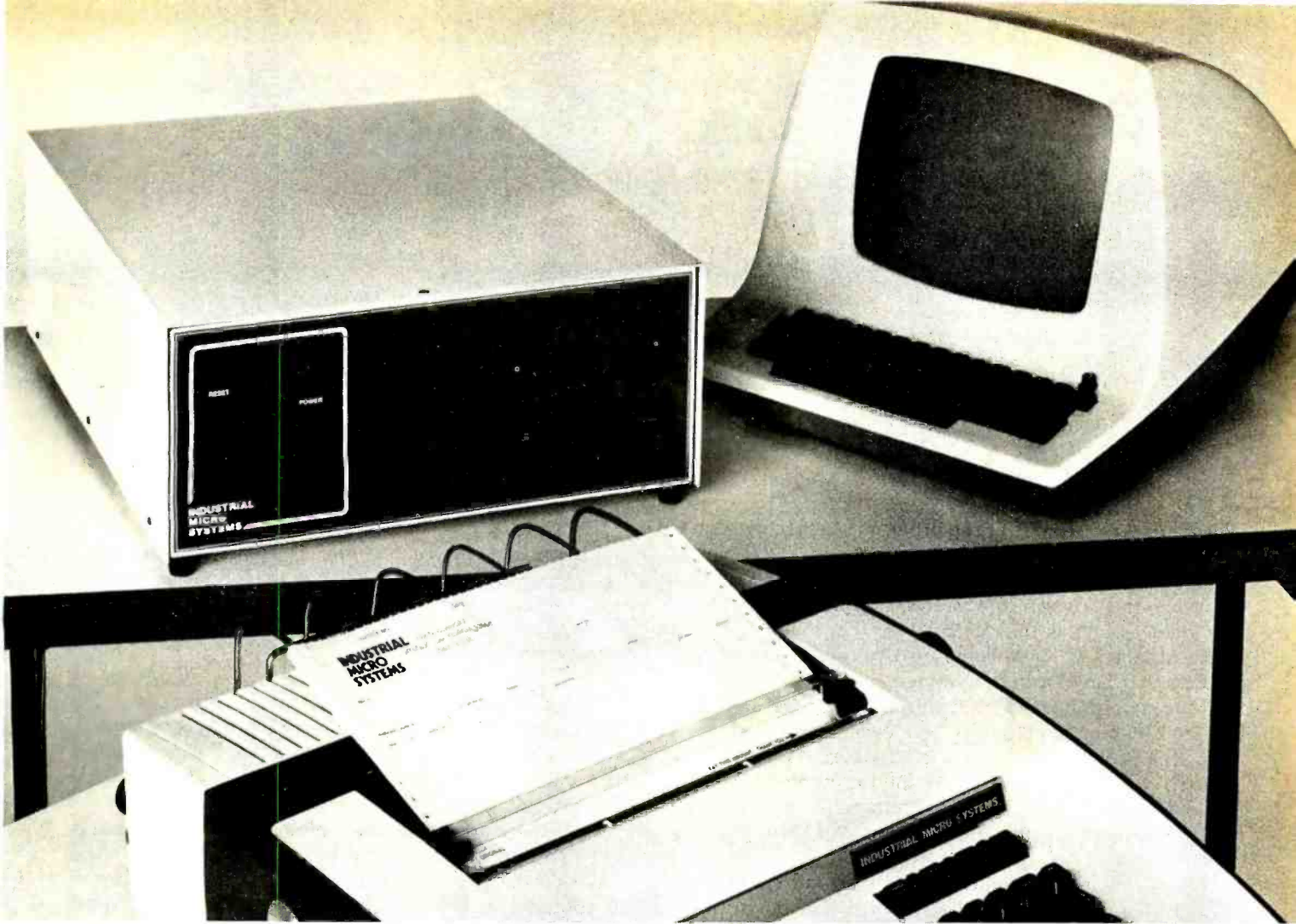

More than meets the eye.

The new Series 5000 is mighty for its size. In more than several thousand ways!

In fact, it's the first small system offering over a megabyte of integrated mini-floppy capacity. And with its super memory management, you can have better than 300k of RAM in desk or desktop versions. But hardware is just the tail of the whale...

It's the wide selection of software that really makes this system mighty.

Operating systems? Choose CP/M* with CBASIC†—the most widely accepted small computer operating system ever. Or MVT-FAMOS,** a multi-user, multi-tasking operating system with file management like the big guys. Or MICROCOBOL,††

also for multiple users, but implemented in COBOL, familiar to commercial users the world over.

And application programs for these operating systems number in the thousands. From real estate to accounting, taxes to inventory control, they're all available at low cost—ready to run.

When you add these software and hardware features to Industrial Micro Systems' reputation for rugged, reliable quality products you'll begin to see it all. A lot more system than your first glance reveals.

See even more at your dealer. Call us to find out the name of your nearest dealer. He'll tell you everything you need to know. And really open your eyes!

*Trademark of Digital Research Inc. **Trademark of MVT Microcomputer Systems Inc. †Trademark of Software Systems ††Product of CAP-CPP

INDUSTRIAL MICRO SYSTEMS

The great unknown.

628 N. Eckhoff St., Orange, CA 92668, (714) 978-6281

Variable List

C	curvature weighting factor
D	ΔX (variable X increment)
I	points counter
L	maximum line segment length
M	units per inch on the Y axis
N	units per inch on the X axis
P	slope angle previous to last slope angle
Q	last slope angle
W	last independent variable
X	independent variable
Y	dependent variable
Z	last dependent variable

Table 1: List of variable definitions that are used in the plotting routine that outputs the curve in figure 2.

Therefore, at the start of the program, an arbitrary small value (0.01 in the example) is assigned to ΔX (D in the program). I is initialized to zero and X is set to $X_{min} - D$.

When the program first starts, X is incremented by D to yield X_{min} . Y is then calculated, the point (X_1, Y_1) is plotted, and I is incremented by 1 to total the number of points that have been determined.

Since two points are needed to have a slope, I is tested to see if two or more points have been determined yet. If not, the program skips to line 15 where the first calculated Y value is stored in Z. In line 16, the first X value is stored in W. Then the program returns to line 5 where X is incremented by the initial value of D, to yield the second value of X.

Next, the second value of Y is calculated, the point (X_2, Y_2) is plotted, and I is added to I. Since two points have now been determined ($I = 2$), the test in line 10 causes the program to continue to line 11, where the first slope and first slope angle are determined.

Since three points (two plotted line segments) are needed to determine a change in slope, the test in line 12 senses that only two points have been determined, and jumps to line 14 where the first plot angle is stored in P.

```

0:  ent L,C
1:  4-M;2-N
2:  -5.01-X
3:  .01-D
4:  0-I
5:  "X=";X+D-X
6:  "Y=";21X-Y
7:  plf X,Y
8:  I+1-I
9:  if Y>20; goto "Stop"
10: if I < 1.5; goto "Y-Z"
11: stn ((N/M) (Y-Z)/(X-W))-Q
12: if I < 2.5; goto "Q-P"
13: Lcos (Q/(1+Cabs (P-Q)))-D
14: "Q-P";Q-P
15: "Y-Z";Y-Z
16: X-W
17: goto "X="
18: "Stop";stp
*32105

```

Listing 1: Essence of program listing that will run on a Hewlett-Packard 9825A desktop computer and plot a function on the Hewlett-Packard 9872A plotter. The program is written in Hewlett-Packard's HPL language. The parameters in this particular listing will plot the curve in figure 2.

X_2 and Y_2 are then stored in W and Z, respectively, and the program again returns to line 5 where X_3 is computed. Then Y_3 is calculated, (X_3, Y_3) is plotted, I is incremented to a value of three, and in line 11 the plot angle from points (X_1, Y_1) and (X_2, Y_2) is computed.

Since there are three points plotted (two line segments and two plot angles), the value of change in plot angle may be calculated. The test in line 12 allows the program to continue to line 13 where the change in plot angle ($|P-Q|$) is computed as part of the ΔX calculation equation.

The program returns to line 5 where, for the first time, X is incremented by a calculated ΔX , rather than the initialized value of ΔX .

The program continues in this way until Y_i is found to exceed Y_{max} , in line 9, and then the program stops. ■

AGENS™

LOW COST ASSEMBLY GENERATION SYSTEM

You can assemble machine language programs for any of the popular 8 and 16 bit microcomputers.

You can use this meta-assembler to generate procedures and structures that best fit your applications.

This system is hosted on your Z-80 computer using CPM and 24K or more bytes of memory.

The Works. Iterative passes for forward ref optimization, subscripts, remote names, macros, functions, externals, relocation classes and more.

BONUS: Source link loader file so you can customize your system.

\$170: AGENS on 8" diskette, Loader, sample generators and manual.

\$27: Manual only.

RBB Software Products™

P.O. BOX 2111
YORBA LINDA, CALIFORNIA 92686
(714) 837-5965

THERE IS A DIFFERENCE IN TRS-80 DISK DRIVES CAPACITY

Expansion interface – gives your TRS-80 the disk capacity it needs, and much, much more!

10 to 40 MByte, 8" Winchester drive – expands capacity far beyond Model II storage,

Single sided minifloppy – up to 150 KBytes of storage capacity.

Single or double sided 8" floppies – up to 2.5 MBytes in dual drive cabinet – for the serious TRS-80 user.



LOBO DRIVES' new family of disk memory products provides you with a choice of memory capacities you need to effectively execute the complex business software you've developed for your TRS-80*. LOBO DRIVES' selection of readily available, software compatible drives permits you to expand your inventory, payroll, customer list, and accounts receivable files as your business grows.

And LOBO DRIVES brings you more... a new plug-in expansion interface that provides an easy way to add hardware enhancements, communications capability, and programmable features... and it comes with the LOBO DRIVES famous 1 year, 100% parts/labor warranty.

Call or write for the complete LOBO DRIVES story. Find out just how competitively priced a family of high capacity drives can be...



935 Camino Del Sur Goleta,
California 93017.
(805) 685-4546

"CAN YOU REALLY AFFORD TO PAY LESS?"

Quantity discounts available – Dealer inquiries invited

Yes, I want to know more about LOBO Drives and what they can do for my TRS-80. Send me information on:

- | | |
|---|---|
| <input type="checkbox"/> 5 1/4-in. Floppy drive | <input type="checkbox"/> 8-in. Winchester hard disk, 10 Mbyte drive |
| <input type="checkbox"/> 8-in. Floppy drive
Single sided
Double sided | <input type="checkbox"/> Double density expansion interface |

Name _____

Company _____

Address _____

City _____ State _____ Zip _____

Phone No. _____

If dealer, provide resale no. _____

*TRS-80 is a registered trademark of Radio Shack, a Tandy Company.

Circle 208 on inquiry card.

Noniterative Digital Solution of Linear Transfer Functions

Bryan Finlay
Chief of Biomedical Engineering
University Hospital
POB 5339, Postal Stn A
London Ontario
CANADA N6A 5A5

Introduction

This article will develop a technique for the precise, noniterative, digital solution of the time-domain response of linear transfer functions with constant coefficients. A computer program written in BASIC is provided for use on the Hewlett-Packard 9830A desktop computer. The program is suitable for solving equations that, in the Laplace domain, exhibit up to ten roots in either the numerator or denominator.

This program is shown to be at least ten times faster than certain iterative solutions when used for checking analog simulation data.

A complex second-order transfer function is used to demonstrate the use of the program in evaluating responses to impulse, step, ramp, and sinusoidal forcing functions.

Due to the availability of desktop computers it is thought that this relatively simple program could help to enhance educational courses in automatic control theory, as well as being of interest to personal computer users.

Most digital solutions of differential equations with constant coefficients involve iterative procedures. The efficient use of such procedures requires the operator to have a good knowledge of both the solution to the equations and the iterative procedure. A "feeling" for the time-course of the solution is particularly important when the response is oscillatory, otherwise an iterative solution can become quite inaccurate.

In the design and development of a complex automatic control system it is a common practice to use an analog computer simulation. The accuracy of the initial simulation is generally checked by comparing the analog results with those obtained from a digital solution of the equations. If the differential equations can be considered to have constant coefficients, then a noniterative solution of

the time-domain response can be obtained by digital techniques.

Many automatic control theory problems present themselves in the form of the system transfer function and subsequent rearrangement to define the differential equations for iterative solution (as required by the Hewlett-Packard State Variables Pac). This can be a tedious, if not dissuading, process. It is the intention of this article to develop a technique that will permit the

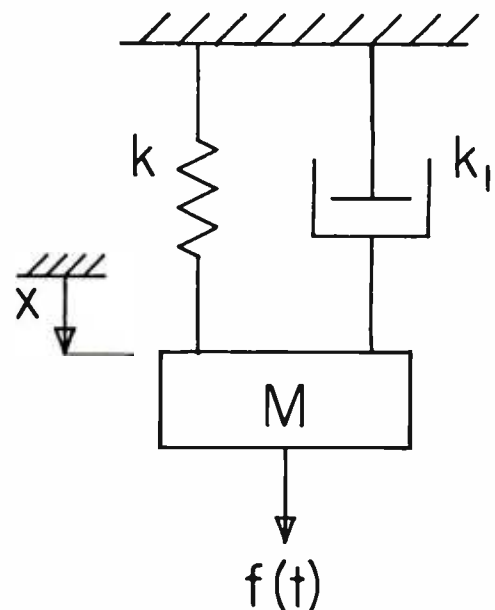
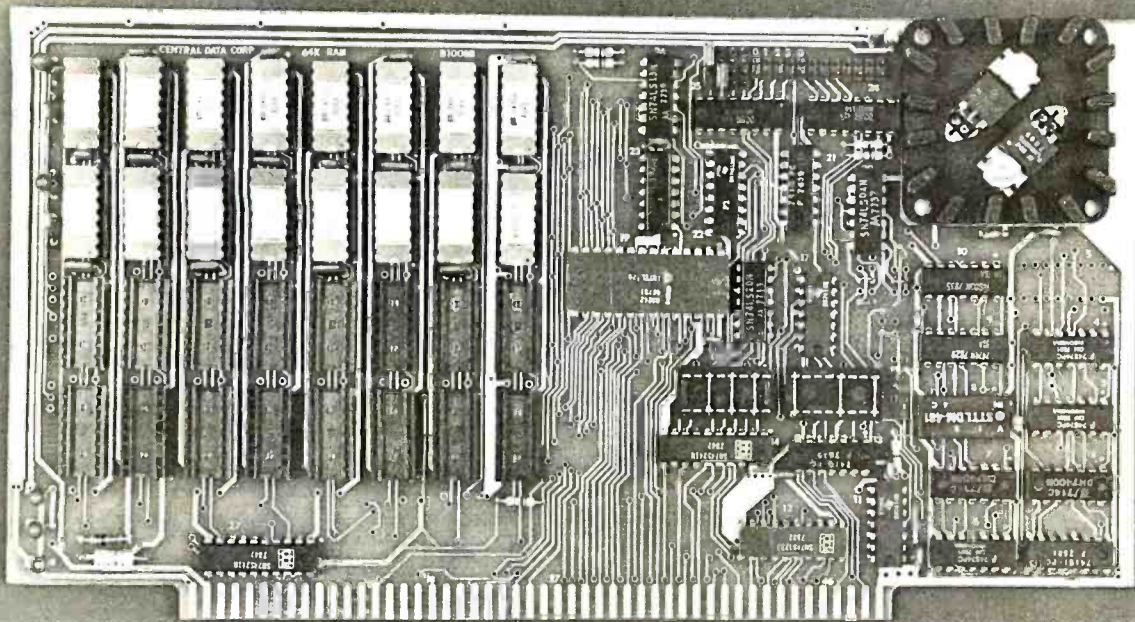

Figure 1: Spring, mass, and damper model for a door-closing mechanism.



32K Board Pictured Above

New RAM Prices.

From The Dynamic Memory Company.

16K—\$249 32K—\$375
48K—\$500 64K—\$625

Ever since we started making these memory boards over a year ago we have continued to lower our prices to stay competitive. Due to your confidence in us, we are again able to lower our prices! Our reliability has been proven by months of superior performance in thousands of installations. Our low-power boards are being used by quality-minded systems manufacturers across the country and overseas.

4MHz boards now available.

After receiving hundreds of requests, our engineering staff has come up with a new version of our board which runs on 4MHz Z-80 systems. It wasn't easy to come up with a high speed board which would operate as reliably as our 450ns version, but after months of careful design and testing, we did it. The price of the 250ns board is \$10 per 16K additional.

All of our features remain.

Our boards didn't become great sellers only because of the price. We still offer you our deselect feature which allows our RAM to overlap with any fixed memory areas in your system. Also, the RAM area of our board is fully socketed so that you can expand the board yourself.

Other standard features include: plug selectable addressing on 16K boundaries (shorting plugs are placed over wire-wrap pins to address the board — located on the top of the board for easy changes), S-100 and Z-80 compatibility and totally invisible refresh — no wait states.

Fully assembled, tested, and guaranteed.

All of our boards go through a rigorous testing procedure. They are then placed on burn-in running a series of memory tests to detect any other possible faults. After you receive the board, you are backed by us with a one year warrantee.

Low power consumption keeps your computer from "losing its cool."

The total power consumption of our 16K board is typically less than 4 watts (+8V @ 300ma, +16V @ 150ma and -16V @ 20ma). Boards with additional memory typically increase power consumption only 1 watt per 16K!

Standard S-100 Interface.

Our board is designed to interface with any standard S-100 CPU. All of the timing of the board is independent of the processor chip, and the board is set up for different processors by changing two plugs on the board.

Contact your local dealer.

To find out more about our RAM boards, contact your local dealer. If he is unable to help you, call or write us for a fast response. Central Data Corporation, 1207 North Hagan Street, Champaign, IL 61820. (217) 359-8010

Central Data

digital solution of the time-domain response of linear transfer functions (or more generally Laplace transforms) by a noniterative process.

Analyzing the Response of Dynamic Systems

In order to emphasize the power of using transfer functions to analyze the response of dynamic systems, an example is given here to cover both the derivation and use of the transfer function. Consider a relatively massless object being moved by a spring and damper (dashpot) as shown in figure 1; this type of arrangement could characterize a door closing mechanism. An idealized spring exerts a force, f_s , that is directly proportional to the compression or extension, x , applied to it:

$$f_s = k x$$

An idealized damper exhibits Newtonian viscosity such that the force, f_d , that it exerts is directly proportional to the rate of compression or extension:

$$f_d = k_1 \frac{dx}{dt}$$

The constants of proportionality in these cases are k and k_1 and have units of N/m (lb/ft) and N per m/sec (lb per ft/sec) respectively.

Figure 2 shows the three forces acting on the mass and so permits us to apply Newton's second law of motion which tells us that "the summation of forces in a given direction is equal to the product of mass and acceleration that will take place in that direction."

$$f(t) - kx - k_1 \frac{dx}{dt} = M \frac{d^2x}{dt^2}$$

If the mass-acceleration term is small in relation to the other forces then this equation can be estimated as follows:

$$k_1 \frac{dx}{dt} + kx = f(t)$$

In the simplest case this equation can be solved by separation of variables and integration. However, the problem is compounded by the fact that the applied force $f(t)$ may be a time-dependent quantity itself. A few examples of such time-dependent functions are: impulse, step, ramp, or sine wave functions.

Virtually all automatic control systems contain elements that, in mathematical terms, require the use of differential equations. Consequently, aerospace, industrial, process-control and biological investigators have latched on to a convenient and consistent technique for solving these equations. The technique is summarized in the block diagram below:

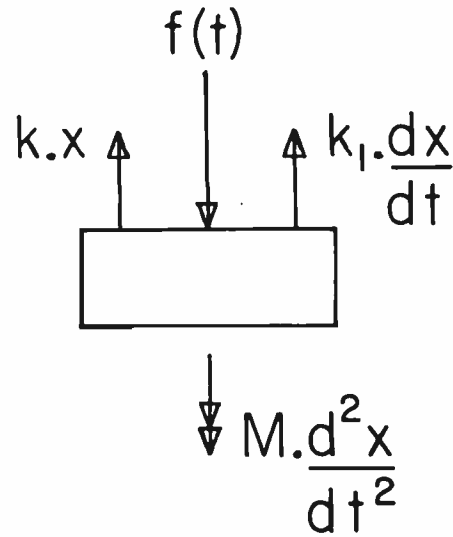

Figure 2: Free-body diagram illustrating the total forces and the resultant mass-acceleration acting on the mass M of figure 1.

Using standard tables each element in the differential equation is transformed to its Laplace transform. The transformed equation is rearranged to form the transfer function which is defined as the Laplace transform of the output divided by the Laplace transform of the input. In the example, if we consider the force $f(t)$ to be the input quantity and the displacement x to be the output then the transfer function is:

$$T(s) = \frac{X(s)}{F(s)} = \frac{1}{k_1 s + k} = \frac{1/k}{1 + \frac{k_1 s}{k}}$$

where $X(s)$ and $F(s)$ are the Laplace transforms of x and $f(t)$ respectively. The transfer function is a simple version of the Laplace transform since it assumes that all initial conditions are zero. This assumption effectively says that it does not matter whether the spring moves from 50 cm to 100 cm or moves from 150 cm to 200 cm; the resultant movement is 50 cm and the assumption of ideal springs means that the changes in forces will be the same. Note that it is the changes in forces from a steady state that will determine the dynamic behavior.

In the absence of a computer, the normal procedure to follow from this stage would be to choose an input quantity $f(t)$ and substitute its Laplace transform, $F(s)$, into the transfer function. The transfer function could then be manipulated algebraically by separating it into partial fractions to produce standard forms that may be found in a table of Laplace transforms. This set of standard equations in the Laplace domain could then be retransformed back to the time domain. For those seeking a more complete approach with detailed examples the Thaler and Brown textbook will provide good reading. The major

Say "ADI/OS"

TM - COMPCO

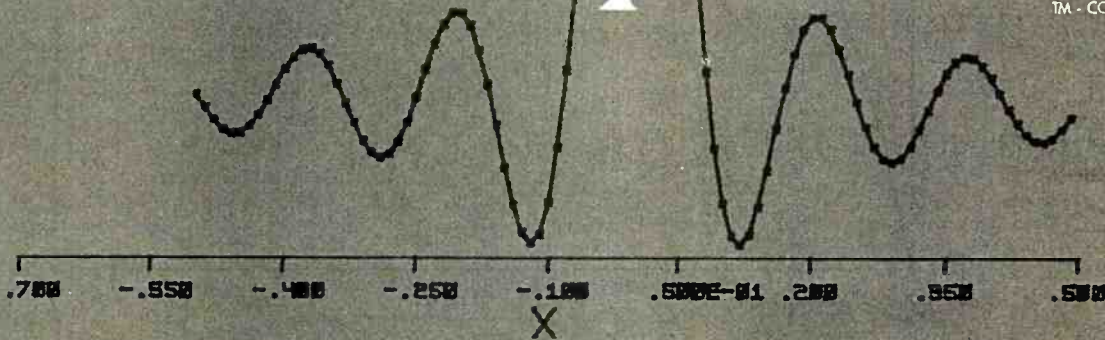

to your data acquisition and display problems with COMPCO'S Analog - Digital I/O System.

The complete ADI/OS system includes everything required for a research and development laboratory, and many OEM systems: 16 channels of single-ended analog input (or 8 differential channels); two double-buffered D/A channels for driving a X-Y display (display not included); 32 bits of programmable digital I/O; 4 completely independent RS232 serial ports with software-selectable Baud rates; a Microterm MIME-I CRT terminal; a Houston Instruments HIPLØT incremental plotter; and an ALTOS 8000-2 microcomputer system, with 4MHz Z80* processor, 64K of RAM memory, twin Shugart double-density floppy disk drives, CP/M operating system, and Microsoft FORTRAN. COMPCO's GSP interactive graphics package is included to provide graphics output on the CRT terminal, HIPLØT plotter, and/or a X-Y display. A FORTRAN-callable subroutine package is also provided to perform the analog data acquisition. In addition, two unused serial ports may be used to drive a modem (permitting the system to talk to a larger machine), an additional CRT terminal for color graphics, or a serial line printer such as a TI-810 or NEC Spinwriter. *Z80 is a trademark of Zilog † TM - Digital Research

This entire ADI/OS
system is available
from COMPCO for
\$9,995

OEM, Institutional and Dealer Inquiries Invited

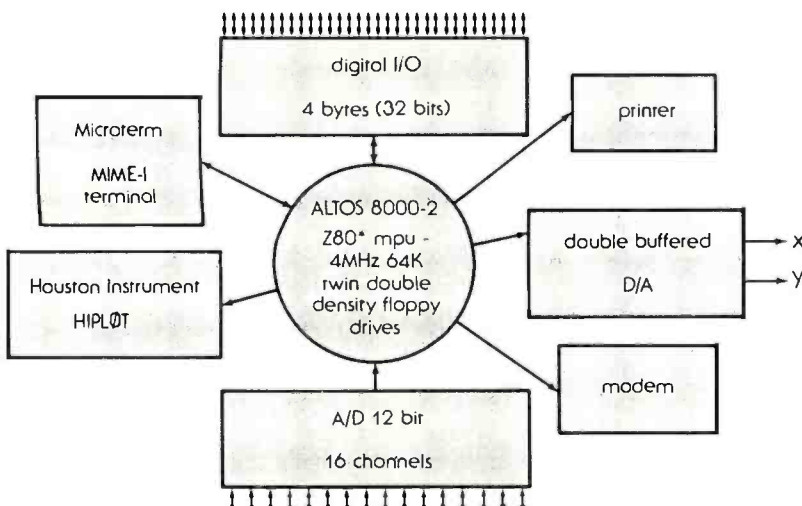

Compco

8705 North Port Washington Road
Milwaukee, Wis. 53217 414/351-3404
COMPUTER SPECIALISTS

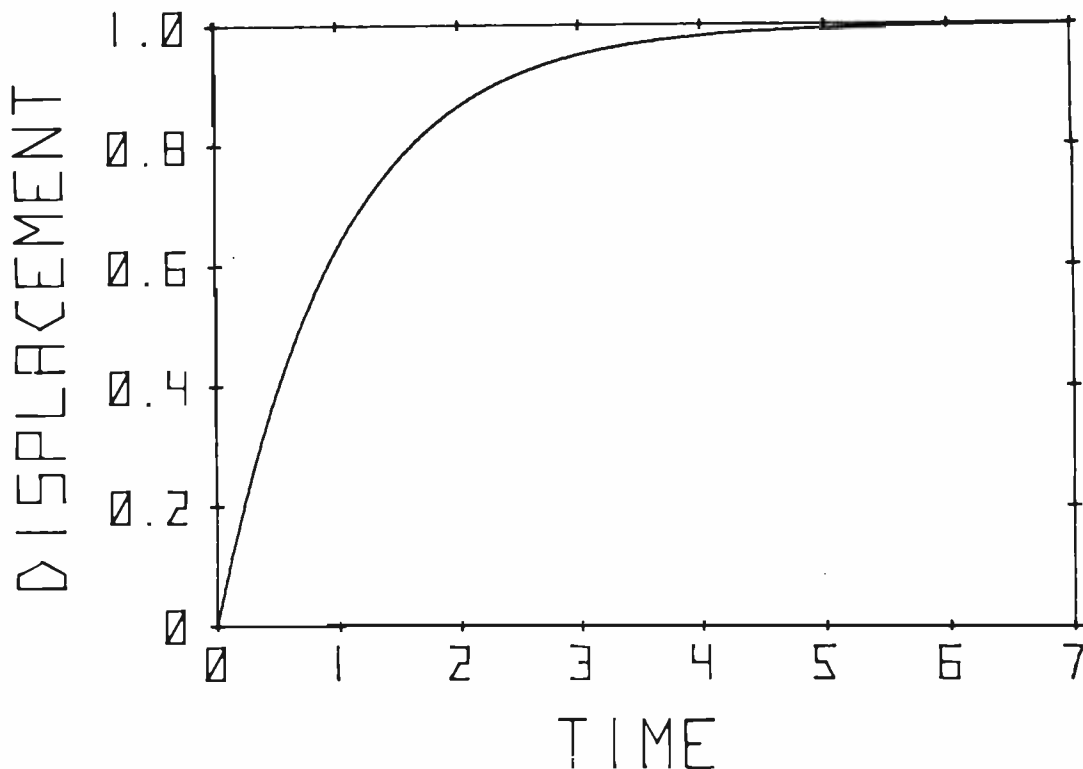

Figure 3: Time-domain response of system in figure 1 when subjected to a step change in the force $f(t)$.

portion of this article provides a computer approach to the solution of the differential equations by means of the transfer function.

If the input, $f(t)$, is a step change in force of unit value then the resulting value for $x(t)$ is given by:

$$x(t) = \frac{1}{k} (1 - e^{-t/\tau})$$

where τ is a characteristic of the system and is defined as the time constant; in fact it is the ratio k_1/k . The displacement x will be 63.2% complete after a time $t = \tau$ and will be 98% complete when $t = 4\tau$. Consequently, the facility to read a time constant from a transfer function is valuable in describing the time-domain response of a system. A typical displacement response to a step change in force for a system with a one second time constant and stiffness k of unit magnitude is shown in figure 3.

High fidelity enthusiasts will know that the performance of a system is not clearly conveyed by its response to a step change in input. The frequency response provides a more informative set of data and concerns the response of a system to the input of a sine wave. Any linear system when subjected to a sine wave input will produce a sine wave of the same frequency at its output. However, the output sine wave will have an amplitude that is dependent upon the applied frequency. The peak of the output wave may also occur at a different time to that of the applied input. This phase shift, as it is called, is also frequency dependent.

A good high fidelity system will have a constant plot of amplitude versus frequency over its desired operating range, usually around 50 Hz to 20 kHz. In practice a voltage variation of 30% is considered to be good and

would be expressed in logarithmic terms as a 3 dB variation.

The transfer function is an extremely powerful tool in the plotting of frequency response data since it can be shown mathematically that the substitution of $j\omega$ for s in the transfer function gives the amplitude and phase for a given frequency ω radians per second (note $\omega = 2\pi f$), after initial transients have decayed.

The operator j is used to indicate a vector at 90° . A vector a would lie on the x-axis of a graph and go from zero to a . The vector ja goes from zero to a on the y-axis of a graph. A vector jja would mean that the vector a had been rotated through 90° and 90° again, or 180° . This means that j^2a , as a vector, has the same meaning as $-a$. Consequently, the operator j can be looked upon mathematically as $\sqrt{-1}$ (note $j^2 = -1$).

Applying this knowledge to the transfer function for the spring and damper system yields:

$$T(j\omega) = \frac{1/k}{1 + j\omega\tau}$$

The denominator of this equation is a vector with a real part (x-axis) of unity and complex part (y-axis) of $\omega\tau$. For small values of ω this vector has a value of 1 and lies along the x-axis, indicating it has a phase of 0° . At very high frequencies the vector will have a magnitude of $\omega\tau$ and lie along the y-axis, indicating a 90° phase shift.

If we consider a system with a time constant of one second and unit stiffness of k then the resulting graphs of amplitude and phase versus frequency are shown in figures 4 and 5. When the amplitude versus frequency data are plotted on this log-log scale, the response is seen to approximate a horizontal low-frequency asymptote

Text continued on page 155; figures on pages 150-154

NEECO PROUDLY
ANNOUNCES THE
COMPUTHINK

MINIMAX

"FULLY INTEGRATED COMPUTER SYSTEM"



MINIMAX SERIES COMPUTER

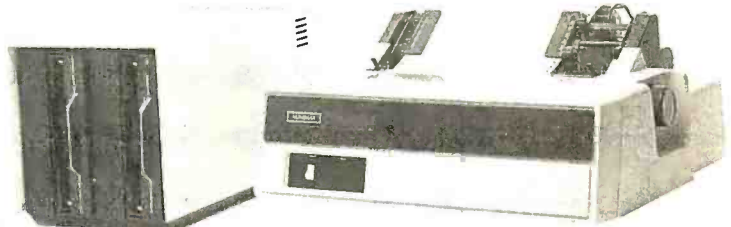

PRINTER NOT
INCLUDED IN PRICE

**THE MINIMAX SERIES WAS DESIGNED
TO OFFER THE MARKET MINICOMPUTER
CAPABILITIES AT MICROCOMPUTER PRICES.
COMPARE THE CAPABILITIES & PRICE!**

CONTACT NEECO FOR FULL SPECS - FREE MINIMAX MANUAL.

MEET THE MINIMAX COMPUTER



MINIMAX I - \$4495

**THE MINIMAX SERIES COMPUTER WAS DESIGNED BY INDUSTRY PROFESSIONALS.
COMPARE THE PRICE AND FEATURES TO ANY OTHER COMPUTER IN ITS CLASS!**

• THE MINIMAX SERIES COMPUTER IS AN INTEGRATED, COMPACT UNIT CONTAINING THE CPU, DUAL DENSITY DISK STORAGE, 12 INCH CRT, AND FULL STYLE KEYBOARD, WITH SEPARATE NUMERIC ENTRY PAD. ALL KEYS (INCLUDING CURSOR) WITH FULL REPEAT • HYBRID 2 MEGAHERTZ 6502 CPU • 108K SYSTEM RAM (48K USER) • FASTEST FLOPPY DISK ACCESS (24K LOADS IN 4.2 SECONDS) • 16K ROM CONTAINS COMPUTHINK BASIC (AN EXTENDED MICROSOFT BASIC) WITH EXTENDED PRECISION, DOS INCLUDES COMPLETE FILE I/O WITH FULL RANDOM ACCESS, COMPLETE MONITOR WITH DEBUG & TRACE, AND TINY 6502 ASSEMBLER • COMPLETE HIGH RESOLUTION GRAPHICS WITH INDIVIDUAL DOT (240 x 512) POINT SCREEN ADDRESSABILITY • FULL SCREEN TEXT EDITING WITH OVERWRITE, INSERTION OR DELETION • SPLIT SCREEN/WINDOW MODES • INDIVIDUAL FIELD EDITING WITH FIELD PROTECT AND AUTO SKIP TO NEXT FIELD • DISK STORAGE SYSTEM TRANSFERS 6K PER SECOND WITH AUTO VERIFY AND PARITY CHECK • 12 INCH CRT-64 CHARACTERS BY 30 LINES, UP TO THREE PROGRAMMABLE CHARACTER FONTS FOR LANGUAGES OR SPECIAL CHARACTERS • SWITCHABLE 110 OR 220V OPERATION • HYBRID CPU IS MICROPROGRAMMABLE WITH 64 USER DEFINABLE OPCODES, CHOICE OF 800K OR 2.4 MEGABYTE DISK STORAGE • FULL SERIAL RS-232C PORT WITH PROGRAMMABLE BAUD RATES AND MODEM CONTROL SIGNAL • DEDICATED DISK PORT • PRINTER PORT SUPPORTS PARALLEL COMMERCIAL PRINTERS • 24 PIN I/O USER PORT • PAGEMATE DATABASE AVAILABLE • PLM COMPILER AVAILABLE • BUSINESS PACKAGES AVAILABLE • COMPLETE DIAGNOSTICS & SCHEMATICS INCLUDED • COMPLETE USER MANUAL INCLUDED

MINIMAX I - .8 MEGABYTE
ON LINE MINIFLOPPY STORAGE

MINIMAX II - \$5995

MINIMAX II - 2.4 MEGABYTE
ON LINE 8" FLOPPY STORAGE

**THE MINIMAX WAS DESIGNED AND IS MANUFACTURED BY COMPUTHINK
COMPUTER CORP. DISTRIBUTED IN EUROPE AND THE EASTERN U.S. BY NEECO.**

COMPUTHINK .4 & .8 MEGABYTE DISK DRIVES FOR THE NEW 16/32K PETS!

DISK SYSTEMS INCLUDE DISKMON OPERATING
SYSTEM IN ROM AND INTERFACE TO 16/32 PETS!



FOR 8K PETS

(small keyboards)

.4 Megabytes of Disk

Storage for 8K PETS!

(Requires Expandmem)

400K-8S DISK SYSTEM INCLUDES RANDOM
ACCESS IN DOS-LOADS 20K IN 4 SECONDS!

24K Expandmem Memory \$525
32K Expandmem Memory \$615

\$1295

- Dual Minifloppy Drives with 200K per diskette side for total 400K-800K on line
- 800K model accesses all 4 diskette sides via dual read and write arm system
- Dual Density Hardware and DOS loads 20K (with verification) in 4.2 seconds complete
- DISKMON (DOS) adds 17 commands to BASIC including Random Access and printer support
- System comes complete with plug in internal board containing 8K RAM, DOS, and Disk Controller Hardware—Board plugs directly onto internal memory expansion pins
- System does not utilize IEEE or USER Port, system functions directly from memory port
- All DISKMON DOS commands reside interactively with BASIC—disk directory command and format command do not interfere with program in RAM—DOS command were designed for simplicity of use. System was manufactured for heavy commercial use
- System installs completely in less than ten minutes—immediately ready for use
- \$1295 and \$1595 prices include all hardware, DOS, complete user manual, and demo/utility diskette
- Available software includes PLM Compiler (\$250) Relocatable Assembler (\$70) Source-Editor Program (\$70), Autolink Linking Loader (\$70), and a complete Database system (Pagemate \$495)
- Call or write for complete product information and specifications—User manual \$10

(PRODUCT AVAILABILITY IS AUG/SEPT—CALL FOR INFO)

ALL 16/32K MODELS INCLUDE AN	400K-16N	\$1295
INTERNAL PLUG-IN INTERFACE	400K-32N	\$1295
BOARD CONTAINING DOS, 8K OF	800K-16N	\$1695
RAM, AND CONTROLLER	800K-32N	\$1695



NEW ENGLAND ELECTRONICS CO., INC.
679 HIGHLAND AVE., NEEDHAM, MA 02194
MON-FRI, 9:00-5:30, E.S.T.

(617) 449-1760

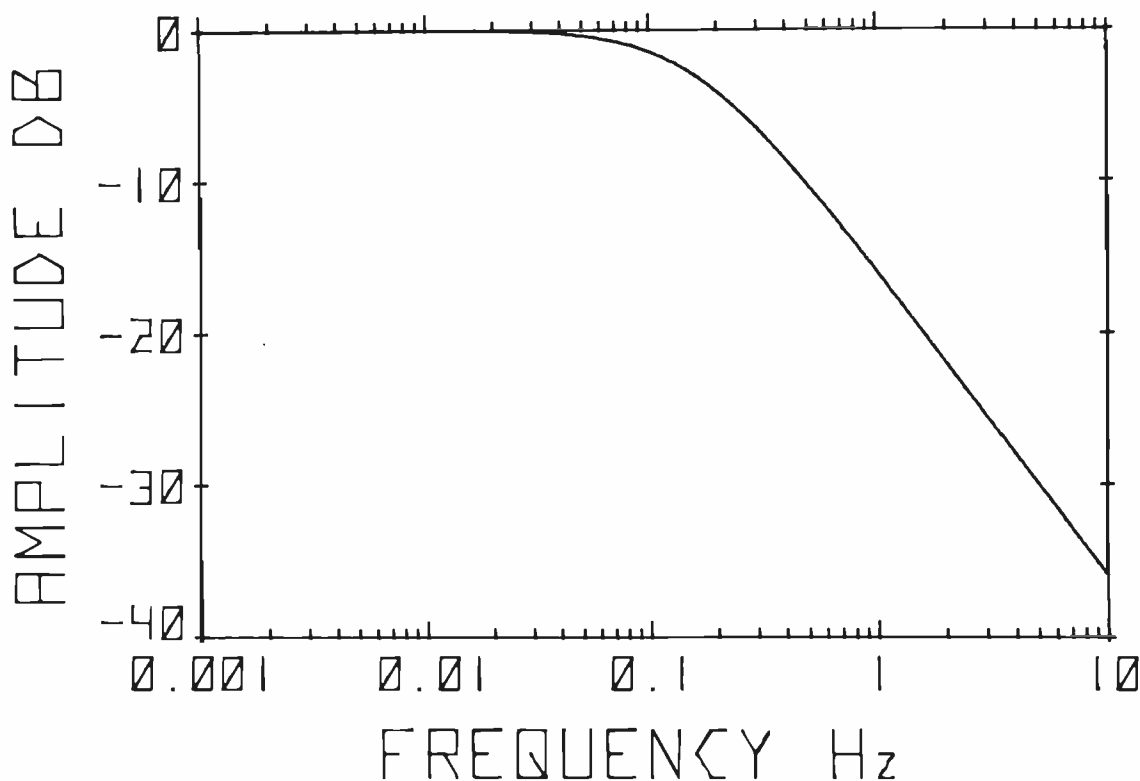

Figure 4: Amplitude versus frequency data for the system in figure 1.

DATA TERMINAL EQUIPMENT — FROM MICROMAIL



LA34 DECwriter IV

\$1,199.00

- Upper/lower case, 9x7 dot matrix
- 10, 12, 13.2, 16.5 characters/inch
- 2, 3, 4, 6, 8 or 12 lines/inch
- 22"W x 7"H x 15 1/2"D, 25 lbs.
- 110 or 300 baud, RS 232C serial ASCII
- Friction feed, paper width to 15"

New from DIABLO

DIABLO 1640 **\$2,690.00**

Receive-only **\$2,331.00**

High-quality daisywheel printing at 45 cps.

DIABLO 1650 **\$2,779.00**

Receive-only **\$2,419.00**

Metal daisywheel printing at 40 cps.

T.I. 810 printer **\$1,695.00**

- Includes upper/lower case
- 150 characters per second
- RS 232C serial interface
- Adjustable forms tractor



SOROC IQ 120 **\$795.00**

- RS 232C, upper/lower case, full ASCII
- Numeric keypad, protected fields
- Cursor keys plus addressable cursor
- Auxiliary extension port



SOROC IQ 140 **\$1,250.00**

- RS 232C and 20mA current loop
- Extensive editing features
- 25th line terminal status display
- 16 function keys (32 with shift)



NEC Spinwriter

Call or write for prices

To Order: Send certified check (personal or company checks require two weeks to clear) including handling* and 6% sales tax if delivered within California.

*Handling: Less than \$2,000, add 2%; over \$2,000, add 1%. Everything shipped freight collect in factory cartons with manufacturer's warranty.

MICROMAIL
 MICROMAIL • BOX 3297 • SANTA ANA, CA 92703
 (714) 731-4338

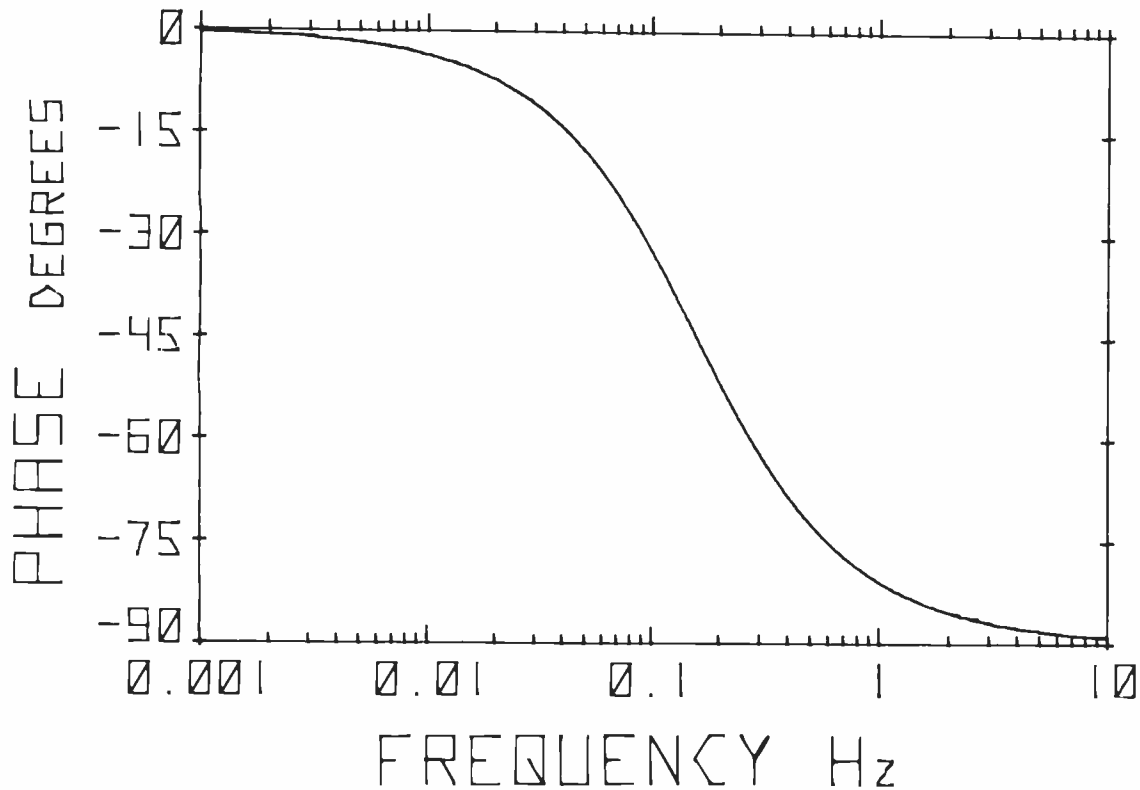

Figure 5: Phase versus frequency data for the system in figure 1.

MONITOR \$149, 12" B&W

XMAS SPECIAL
Complete Terminal plus Monitor \$439

Offer Expires Jan. 1st

Stand Alone Video Terminal

64x16 line format with 128 displayable characters
Serial ASCII or BAUDOT with multiple Baud rates
Full cursor control with scrolling and paging
On board power supply
Serial interface RS232 or current loop
Purchase SCT-100 alone or complete terminal

SCT-100 VIDEO BOARD FEATURES

- 64x16 line format with 128 displayable characters
- Serial ASCII or BAUDOT with multiple Baud rates
- \$197 Assembled or \$167 Kit (Partial Kit ~~\$140~~ \$45)
- Full cursor control with scrolling and paging
- On board power supply
- Serial interface RS232 or current loop
- Purchase SCT-100 alone or complete terminal

COMPLETE KEYBOARD TERMINAL \$375

Full Kit \$325 (includes SCT-100)

XITEX CORP. 9861 Chartwell Drive
Dallas, Texas 75243 (214) 349-2490

ORDER BY PHONE/Overseas orders & dealers welcome

MRS100 FEATURES:

- Connects directly with any ASCII or Baudot Teletype®/Terminal
- Operates from 1 to 150 WPM with Auto-Sync.
- Displays WPM rate of copied signal plus FIFO buffer status.
- Contains a built-in 80 Hz bandpass filter and sidetone oscillator.

~~\$295~~ Assembled & Tested • ~~\$245~~ Complete Kit • ~~\$95~~ Partial Kit

XITEX MORSE TRANSCIVER

XMAS SPECIAL

Full Kit \$179
Assembled \$236

NEW FROM XITEX...ABM-100

Universal Converter ASCII • Baudot • Morse
The ABM-100 is a universal code converter for translating between ASCII and Baudot, or between Morse and ASCII (or Baudot). Also used as a TTY® speed converter. Assembled and tested the ABM will operate from a single +5V supply and sells for \$129. Write for complete details

Circle 392 on inquiry card.

December 1979 © BYTE Publications Inc 151

The Comprint 912 printer. No one else can match our speed, our print quality, our quiet operation, or our reliability. Not for \$660 they can't.

Our Comprint 912 is the best printer for the money. Period. Any printer that can match our price can't even begin to match our performance. And any printer that boasts performance like ours doesn't even come close to our price. No matter what your application; computer reports, listings, CRT hard copy, message

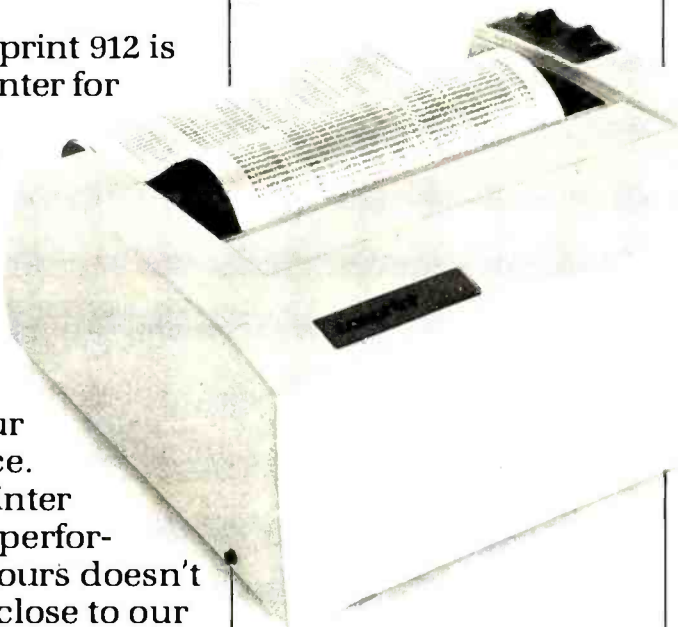

The Comprint 912 prints nearly 3 lines every second.

Speed.
At 225 characters per second (170 LPM) the Comprint 912 is up to 4 times faster

than impact printers costing hundreds of dollars more. With our printer you don't waste time and money waiting for your print-out.

Print Quality.

Our 9x12 matrix provides sharp, crisp characters. Compare that with our competition. Their very best is a 9x7 matrix, which means no lower case descenders and cramped letters. With the Comprint 912 you don't have to put up with the irritation of fuzzy, hard to read computer printing. This

receiving, scientific/ industrial data logging, or anything you can think of, the Comprint 912 is the performance leader in printers under \$1000.

First consider our performance.

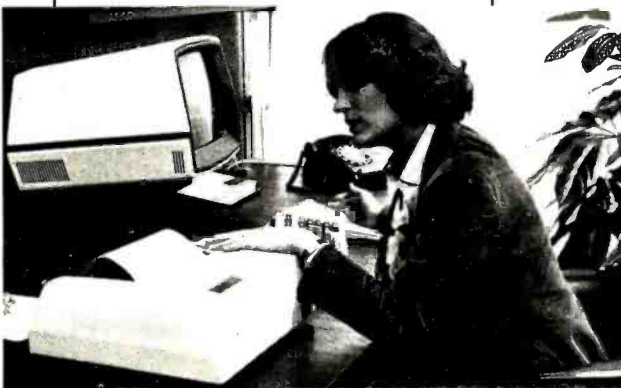

CRT hardcopy is an excellent application for the Comprint 912.

exceptional print quality in-ly by the Comprint 912 in 7-ness reliability, 6 month-parallel I/O and 8 1/2" wide-been shipped to happy custo-

offer a 6 month warranty, twice the industry standard. The key to all this superior performance is our special

need a plain bond paper copy, just run your Comprint 912 printout through your plain bond copy machine and you've got it. Even though our paper is special, it's available everywhere; from your dealer or distributor, or from us. Now consider our price.

The superior print quality provided by the Comprint 912 is obvious in this actual size sample.

means increased productivity. And because the Comprint 912 makes better originals, our originals make better Xeroxes.

Quiet Operation.

Most computer printers are irritatingly noisy. They can disrupt concentration and reduce the efficiency of anyone working near them. They're noisy because they're



The Comprint 912 is quiet because it's electronic not mechanical.

impact. The Comprint 912 has no mechanical print head banging on the paper. It's electronic. It's quiet.

Reliability.

Since the Comprint 912 prints electronically, rather than mechanically like ordinary impact printers, we have fewer moving parts and less vibration. The Comprint 912 has fewer things to go wrong and less wear. That's why we



Fewer moving parts in the Comprint 912 mean greater reliability.

paper. This aluminized "silver paper" works just like ordinary paper. It won't fade or discolor and actually costs less than plain paper and one time ribbons. For the vast majority of printing applications it's just plain better than plain paper. Especially when you consider the hidden costs of plain paper printers due to their inferior performance compared to the Comprint 912. And on those rare occasions when you really do

The Comprint 912.

\$660 with parallel interface, \$699 with serial interface.

We could talk about our other advantages, like our 80-character lines on 8-1/2" wide paper, or our compact, light-weight size, and the fact that the Comprint 912 has no ribbons to mess with, no chemicals, nothing to add but paper.

But you have to see for yourself. Before you buy any printer, insist on seeing the Comprint 912, the performance leader, at your local computer store or industrial distributor. Or contact us for a descriptive brochure, a sample print-out, and applications literature.



comprint

The performance leader.

Computer Printers International, Inc.

340 E. Middlefield Rd.
Mountain View, California 94043
415 969-6161

COMPUTER PROGRAM

LISTING #	LINE #
-----------	--------

1	80 120 140 160-220 250-310
---	--

1	330-540 <div style="display: flex; align-items: center; margin-left: 20px;"> } 370-440 </div> <div style="display: flex; align-items: center; margin-left: 20px;"> } 450-530 </div>
---	---

2	30 50 70
---	----------------

2	120-230 <div style="display: flex; align-items: center; margin-left: 20px;"> } 150-200 </div> <div style="display: flex; align-items: center; margin-left: 20px;"> } 210 </div>
---	---

2	240-420
---	---------

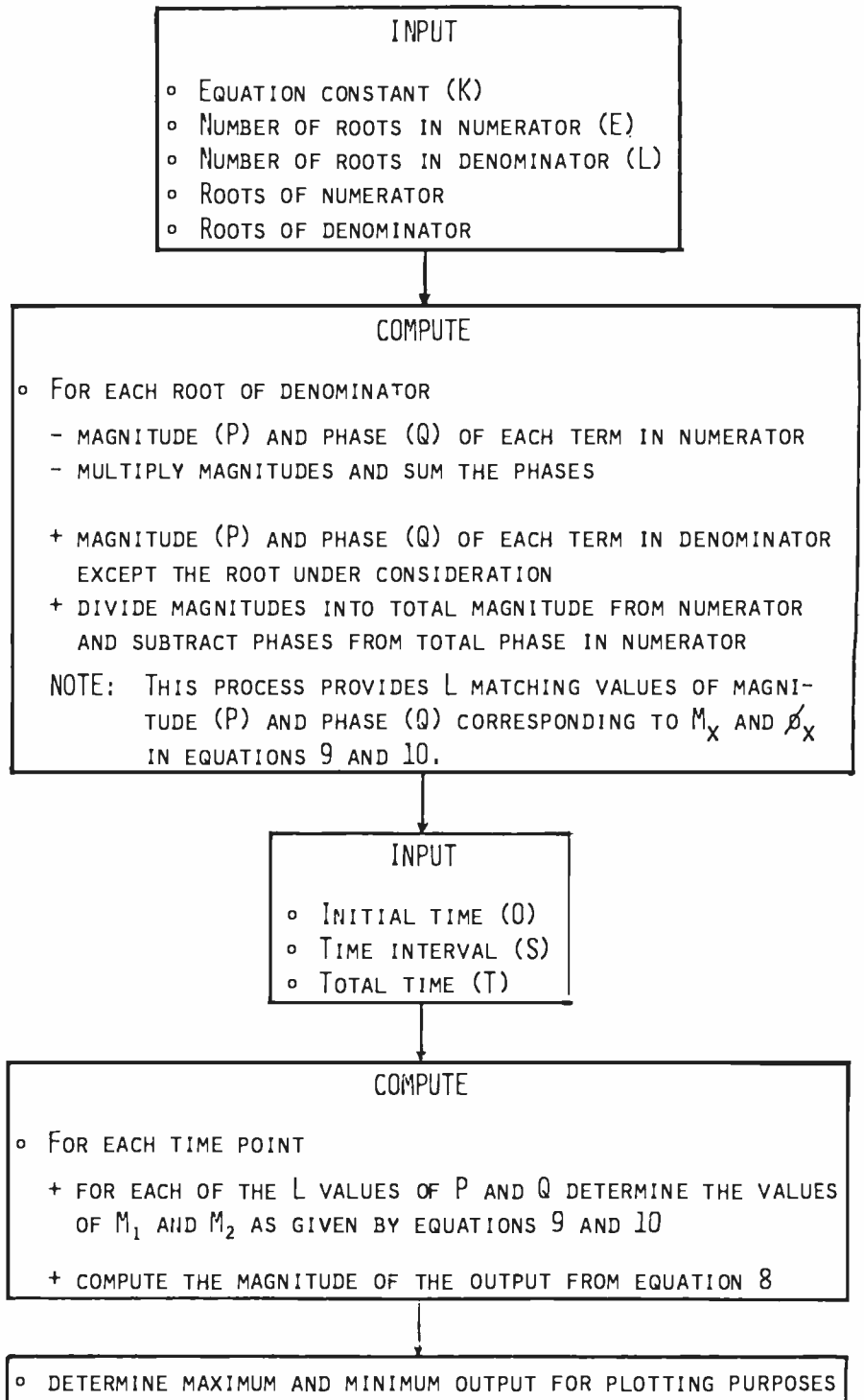

Figure 6: Flow diagram and guide to the computer program which is provided in listing 1.

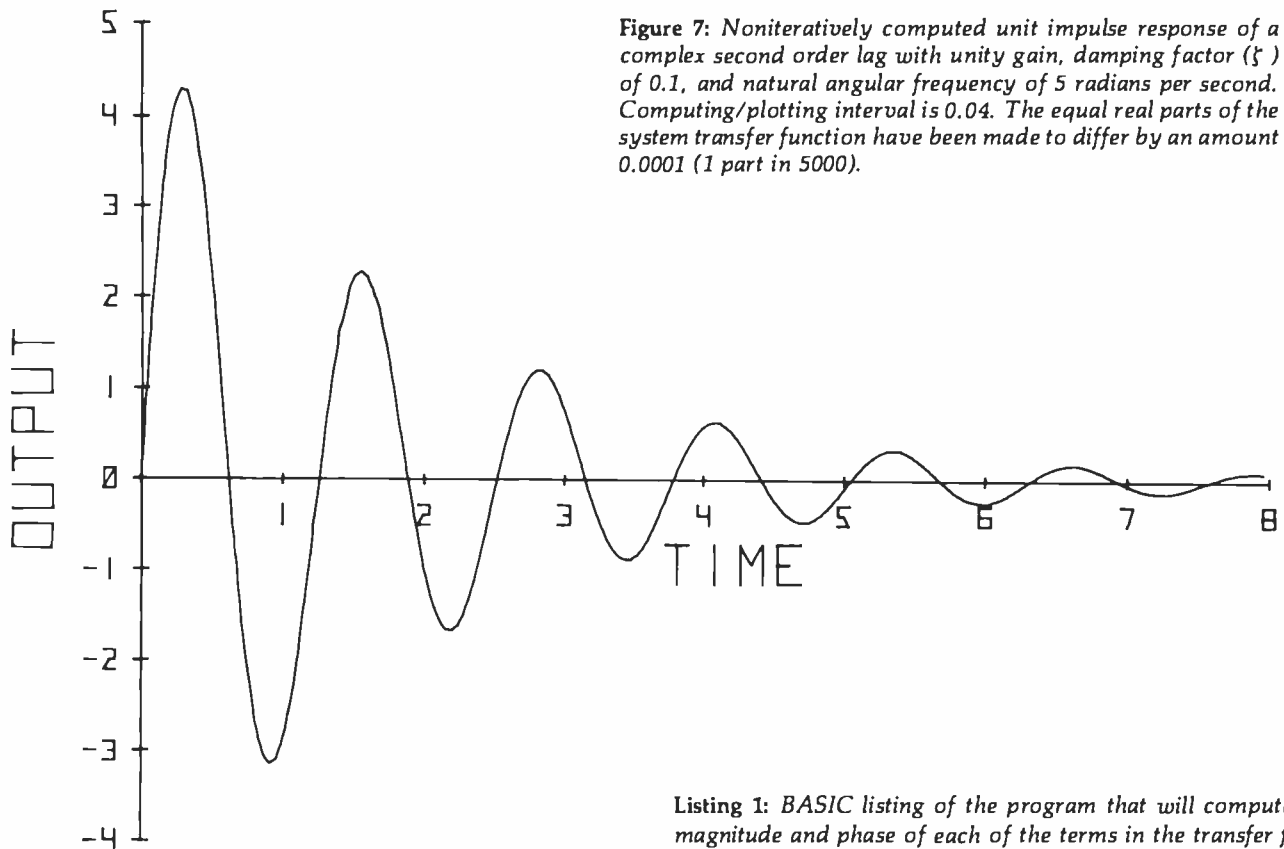

Figure 7: Noniteratively computed unit impulse response of a complex second order lag with unity gain, damping factor (ζ) of 0.1, and natural angular frequency of 5 radians per second. Computing/plotting interval is 0.04. The equal real parts of the system transfer function have been made to differ by an amount 0.0001 (1 part in 5000).

Text continued from page 148:

and a high-frequency asymptote with a slope of -20 dB/decade. The frequency at the point of intersection of these two asymptotes is 0.159 Hz in this example and, in general, is known as the break frequency and is given by:

$$\omega = \frac{1}{\tau} \quad \text{or} \quad f = \frac{1}{2\pi\tau}$$

It is at this frequency that the actual frequency response curve is 3 dB below the break point.

This simple example illustrates the use of transfer functions and helps to relate the response of a system in both the time domain and the frequency domain. The transfer function, therefore, provides a ready starting point for obtaining either time-domain or frequency-domain solutions. Since the substitution of $j\omega$ for s in the transfer function permits easy computation of the frequency response, it would be nice if a computer program was readily available to obtain plots of the time-domain response from the transfer function. It is the intent of this article to develop and illustrate the use of such a program.

General Solution of Laplace Transforms

Given a general Laplace transform $F(s)$ which is the ratio of two polynomials:

$$F(s) = \frac{P(s)}{Q(s)}$$

with the order of $Q(s)$ equal to, or greater than, the order of $P(s)$, then an inverse Laplace transform, may be

Listing 1: BASIC listing of the program that will compute the magnitude and phase of each of the terms in the transfer function.

```

10 DIM E(A(10),B(10),C(10),D(10),E1,L1,F(10),Q(10),Z(20))
20 PRINT "TRANSIENT RESPONSE PLOT FROM TRANSFER FUNCTION"
30 PRINT
40 PRINT "EXPRESS T.F. THUS:-- K(S+A1+JB1)(S+A2+JB2)(S+...)"
50 PRINT "      (S+C1+JD1)(S+C2+JD2)(S+...)"
60 PRINT
70 DISP "WHAT IS K?";
80 INPUT K
90 PRINT "K=";K
100 DIM G1,H1,F1,I(1)
110 DISP "HOW MANY ROOTS IN NUMERATOR?";
120 INPUT E
130 DISP "HOW MANY ROOTS IN DENOMINATOR?";
140 INPUT L
150 IF E=0 THEN 240
160 FOR G=1 TO E
170 DISP "WHAT IS A("G")?";
180 INPUT A(G)
190 DISP "WHAT IS B("G")?";
200 INPUT B(G)
210 PRINT "A("G")=";A(G); "B("G")=";B(G)
220 NEXT G
230 PRINT
240 IF L=0 THEN 330
250 FOR H=1 TO L
260 DISP "WHAT IS C("H")?";
270 INPUT C(H)
280 DISP "WHAT IS D("H")?";
290 INPUT D(H)
300 PRINT "C("H")=";C(H); "D("H")=";D(H)
310 NEXT H
320 PRINT
330 FOR G=1 TO L
340 F(G)=1
350 Q(G)=0
360 IF E=0 THEN 450
370 FOR H=1 TO E
380 N=SQR((A(H)-C(G))^2+(B(H)-D(G))^2)
390 N=ATH((B(H)-D(G))/(A(H)-C(G)))
400 IF (A(H)-C(G)) >= 0 THEN 420
410 N=N-PI
420 F(G)=F(G)*N
430 Q(G)=Q(G)+N
440 NEXT H
450 FOR R=1 TO L
460 IF R=G THEN 530
470 M=SQR((C(R)-C(G))^2+(D(R)-D(G))^2)
480 N=ATH((D(R)-D(G))/(C(R)-C(G)))
490 IF (C(R)-C(G)) >= 0 THEN 510
500 N=N-PI
510 F(G)=F(G)*N
520 Q(G)=Q(G)+N
530 NEXT R
540 NEXT G
550 END

```

NEW ALL PURPOSE COMPUTER DESK

by **DONTHO**

WALNUT FINISH 60Wx28Hx26D



- SILENT 50 CFM FAN FILTERS AIR AND VENTILATES DISK DRIVE AND DISKETTE STORAGE AREA.
- LEFT CABINET IS 15w x 14h x 24d HOLDS 4 DISK DRIVES AND 90 DISKETTES.
- FOUR ELECTRICAL OUTLETS INSIDE CABINET.
- SIX OUTLETS (5 USABLE) ON BACK OF DESK. ALL CONTROLLED BY MASTER SWITCH.

DESK
PRICE

\$369.00

DEALER
INQUIRIES
INVITED

Right cabinet of same dimensions is open in back to feed paper to printer. Eliminates paper on floor. Front provides storage for manuals or notebooks.

Completely assembled. Price FOB Wakarusa, Ind. Allow two weeks for shipment.

UP TO 60% TIME SAVINGS!

MAILING LIST

by **DONTHO**

ELIMINATES AT LEAST 60% OF TIME REQUIRED TO ASSEMBLE DATA IN MAILING LIST ● REPEAT KEY (@) ENTERS LAST DATA SUCH AS SURNAME, CITY AND STATE, ZIP CODE ETC. ● DOES AWAY WITH MOST TYPING ERRORS. ● SORTS 650 NAMES IN TWO MINUTES. ● PRINTS ON STANDARD LABELS BY NAME, CITY, STATE, ZIP CODE, SELECT CODE #1 OR #2, OR ANY TWO OF THESE. ● KEYBOARD ADJUSTMENT OF L & R PRINT POSITIONS.

REQUIRES 32K MEMORY, DISK DRIVE & DOS. HOLDS ABOUT 250 NAMES ON DOS, AND ABOUT 650 ON CLEAN DISKETTE.

ANY IMPROVEMENTS TO PROGRAM WITHIN ONE YEAR WILL BE FURNISHED TO PURCHASERS FREE OF CHARGE.

MAILING LIST \$79.95 delivered

ORDER BY MONEY ORDER-PERSONAL CHECK-VISA OR MASTERCARD

DONTHO SCIENTIFIC, INC.

P.O. BOX 864 MICHIGAN CITY, IN 46360

PHONE (219) 872-2364

OUR POLICY

We will ship no product we are not fully prepared to guarantee.

evaluated to define the time-domain solution.

Inversion to the time domain may be accomplished by applying a partial fraction expansion and thus expanding $F(s)$ to a sum of simpler expressions each of which may be found in tables of Laplace transforms (refer to W D Day's Tables of Laplace Transforms). This system is illustrated below for a relatively simple transform:

$$F(s) = \frac{4}{(s+2)(s+3)} = \frac{A_1}{(s+2)} + \frac{A_2}{(s+3)} \quad (1)$$

$$\text{Giving } F(s) = \frac{4}{(s+2)} - \frac{4}{(s+3)} \quad (2)$$

In equation 2, the value of A_1 has been derived by multiplying both sides of equation 1 by $(s+2)$ and letting $s = -2$. Similarly, A_2 was obtained by multiplying by $(s+3)$ and setting $s = -3$. More precisely:

$$A_1 = \left. F(s) \times (s+2) \right|_{s=-2}$$

and,

$$A_2 = \left. F(s) \times (s+3) \right|_{s=-3}$$

for a general transform with n different non-complex roots in the denominator, then:

$$A_x = \left. F(s) \times (s+r_x) \right|_{s=-r_x} \quad (3)$$

where r_x is the x th root.

The time-domain solution of equation 1 is:

$$f(t) = A_1 e^{-2t} + A_2 e^{-3t}$$

or more generally:

$$f(t) = A_1 e^{-r_1 t} + A_2 e^{-r_2 t} + \dots + A_n e^{-r_n t} \quad (4)$$

for a transform with n different non-complex roots in the denominator.

Combining equations 3 and 4, the general time-domain solution for a transform with n different non-complex roots is given by:

$$F(t) = \sum_{s=-r_1}^{-r_n} \left. (s+r_x) \times F(s) \times e^{st} \right|_{s=-r_x} \quad (5)$$

where x is assigned each value from 1 to n . This form of solution is generally referred to as the Residue Theorem solution (refer to the Thaler and Brown text for details). Equation 5 clearly lends itself to digital programming. However, when equal or repeated roots exist in the

WHEN THE FUN AND GAMES ARE OVER, you shouldn't have to gamble on your microcomputer's ability to get down to business. You won't with **Outpost 11**. It's a serious unit with quality components: **Cherry, full ASCII keyboard; Setchell-Carlson CRT, 24 x 80 characters, 7 x 9 dot matrix; inverse, grey, blink; form generation characters; Shugart floppy disk drives; M6800 CPU; 32 k bytes RAM; glass-epoxy PC boards, manufactured and tested to Mil Q 9858-A; entire unit 100-hour burn in tested; IC's tested to Mil P 883; I/O interrupt prioritizing structure; soft-sectored disk format; business BASIC; FLEX 2.0; TSC BASIC; self diagnostics; software development packages; etc; etc; etc.** All this and more at only **\$2,595,** suggested retail price. See **Outpost 11** at a dealer listed or write us for the name of a dealer near you.

TANO Corporation, 4301 Poche Court West, New Orleans, La. 70129



THE SERIOUS MICROCOMPUTER



Dealers: ATLANTA, GA, Magaro and Associates — 404-252-6609, Professional Indexing — 404-572-4177 • BEAVERTON, OR, Data Tools International — 503-645-4604 • BEND, OR, Control Industries — 503-389-1969 • COOKEVILLE, TN, Cumberland Computers — 615-526-7651 • DADE CITY, FL, Sabatelli Computer System Inc. — 904-567-7777 • DALLAS, TX, Eclectic Corp. — 214-358-1307 • DES MOINES, IA, H. Allen Hanna — 515-283-5130 • ELKGROVE VILLAGE, IL, Kramer DataPower Inc. — 312-894-0554 • GREENVILLE, SC, Plus Inc. — 803-242-9090 • HOUSTON, TX, Eclectic Corp. — 713-228-7798 • IDAHO FALLS, ID, Great Plains Computer Co. — 208-529-3210 • LONG BEACH, CA, CTI Data Systems Inc. — 213-426-7375 • MOBILE, AL, Railway Express — 205-661-8889 • NEW ORLEANS, LA, TANO Corp. — 504-254-3500 • NEWTON CENTRE, MA, Daner-Hayes Inc. — 617-969-4650 • PARKER, CO, Western Marketing Assoc. — 303-841-2788 • SALT LAKE CITY, UT, Home Computer Store — 801-484-6502 • SAN JOSE, CA, PBC Associates — 408-377-7001 • SEAFORD, DE, Robert Underwood — 302-629-8438 • SEATTLE, WA, Empire Electronics — 206-244-5200 • WALTHAM, MA, Computer Mart Inc. — 617-899-4540 • WESTFORD, MA, Thorstensen Labs — 617-692-2051 • ONTARIO, CANADA, Combined Systems — 416-549-2900 • GOUDHURST, KENT, ENGLAND, Warren Woodfield Assoc. Ltd. — 05-803-590 • DEALER INQUIRIES INVITED — 504-254-3500. TWX 810-591-5229

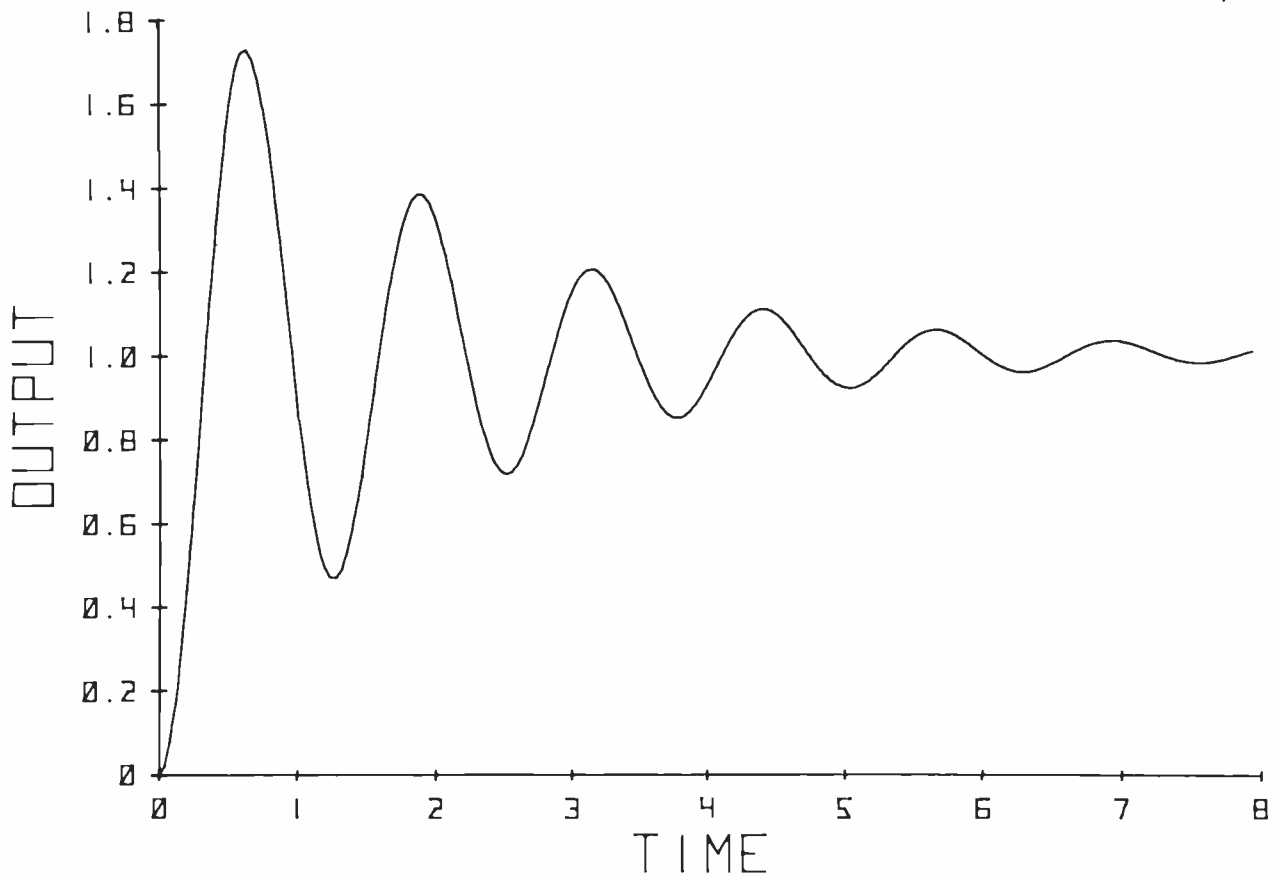

Figure 8: Computed unit step response for the transfer function in figure 7. Computing/plotting interval is 0.04.

**practical
applications**

BOOT- STRAP

TURN ON YOUR TRS-80 DISK SYSTEM AND GO RIGHT INTO YOUR BASIC PROGRAM—YOUR TRS-80 WILL LOAD AND RUN PROGRAMS—BY ITSELF! Yes, with this unbelievable program your computer will take command of itself whenever power-on or reset is pressed. Go from DOS all the way into your Basic program, execute DOS or Basic commands, load and execute any machine-language programs or subroutines you need (such as printer drivers, machine language sorts, etc.), set your file buffers and memory size, then run any Basic program you want, without lifting another finger! **BOOTSTRAP's** custom files make turn-key end-user applications simple! Requires disk system, works with DOS 2.1, 2.2 and NEWDOS, completely documented for easy implementation. **\$15.95**

PRACTICAL APPLICATIONS™ (415) 592-6633
1313 Laurel St., Suite 15, San Carlos, CA 94070

- Please send me TRS-80 BOOTSTRAP (\$15.95 each enclosed. Calif. residents add tax).
- Send your catalogs.

Name _____

Address _____

City _____ State _____ Zip _____

TRS-80 is a trademark of Tandy Corp.

BY1279

denominator of $F(s)$, the inverse transform of all the terms due to the repeated root, r_x , may be found as follows:

$$f(t) = \frac{1}{(m-1)!} \left| \frac{d^{m-1}}{ds^{m-1}} \{ (s+r_x) \times F(s) \times e^{st} \} \right|_{s=-r_x} \quad (6)$$

where m is the number of times the root appears (for example: $m=2$ for two equal roots).

Listing 2: This is a listing of the program designed to compute the total response, M , of a system as given in equation 8.

```

10 DIM K:FC(10):EC(10):CC(10):DC(10):E1,LI,FC(10):CC(10):ZS(20)
20 DISP "WHAT IS INITIAL TIME T(0)?"
30 INPUT Q
40 DISP "WHAT IS TIME INTERVAL DT?"
50 INPUT S
60 DISP "TOTAL TIME - MAX=T(0)+200*DT"
70 INPUT T
80 PRINT "INITIAL TIME=";Q
90 PRINT "TIME INTERVAL=";S
100 PRINT "FINAL TIME=";T
110 PRINT
120 FOR U=0 TO T STEP S
130 V=0
140 H=1+INT((U-Q)/S)
150 FOR G=1 TO L
160 N=FC(G)*EXP(-CC(G)*U)
170 Y=CC(G)-DC(G)*U
180 V=V+N*COS(Y)
190 N=H+G*SIN(Y)
200 NEXT G
210 ZH1=V+SIGN(V)*SQRT(V^2+N^2)
220 DISP "COMPUTING"
230 NEXT U

```

Listing 2 continued on page 160

Hard Disk Solutions

8 Slot S-100 Bus & Card Set,
Including:
4 MHz, Z80-A Processor
64K RAM
I/O
Tape Cartridge Controller
Hard Disk Controller

11 Convenient Function
Keys, Including One Spare
(for future development)

2 Serial plus 2 Parallel
I/O Ports

24 Megabyte, 8"
Winchester Technology Hard
Disk Storage

640⁺ BPI Tape Cartridge with
more than 10 Megabytes of
Storage

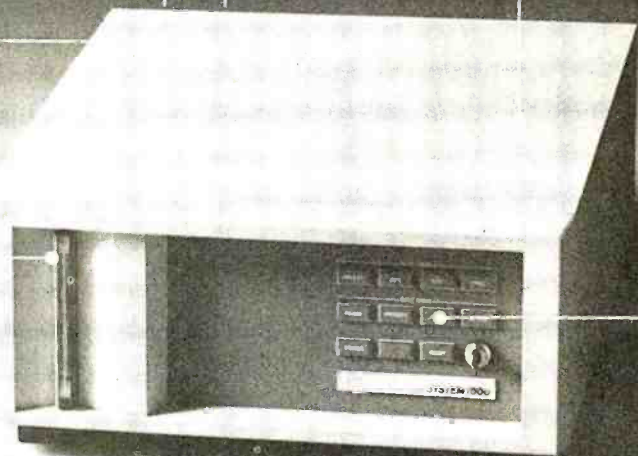

OUR GOAL . . . To provide a complete 'Solution System' to the Dealer, OEM, or anybody with a job which requires a powerful computer.

IN SHORT . . . To deliver a system which is ready to be used.

How do we do this? Very simply . . . We don't stop with just a powerful set of hardware. Instead we've integrated an intelligent package of systems level software, including:

PDOS — A Z80, CP/M (Ver 1.4) compatible Disk Operating System, Designed to equip you with large system power. Not a floppy DOS modified to accommodate hard disks!

Back-Up — A comprehensive data recovery system.

. . . And of course the entire CP/M library of programming languages & applications programs.

Our System 1000 is available **NOW**, with second sources on all components. This means we can deliver systems today and continue to support them tomorrow.

Write for more details on our —
'End to Obsolescence Plan'.

Available Options:

Floppy disk sub-systems
CP/M Ver. 2.00

NOTE: Our Back-Up system is available in special versions for CP/M & CDOS, for those who already have S-100 Hard Disk Systems.

CP/M is a TM of Digital Research

PDOS is a product of Phoenix Software
Associates Ltd.

CDOS is a TM of Cromemco

CSSN

Circle 306 on inquiry card.

COMPUTER SERVICE SYSTEMS NETWORK

120 BOYLSTON STREET • FOURTH FLOOR • BOSTON, MASSACHUSETTS 02116 • (617) 482-2343

INCORPORATED

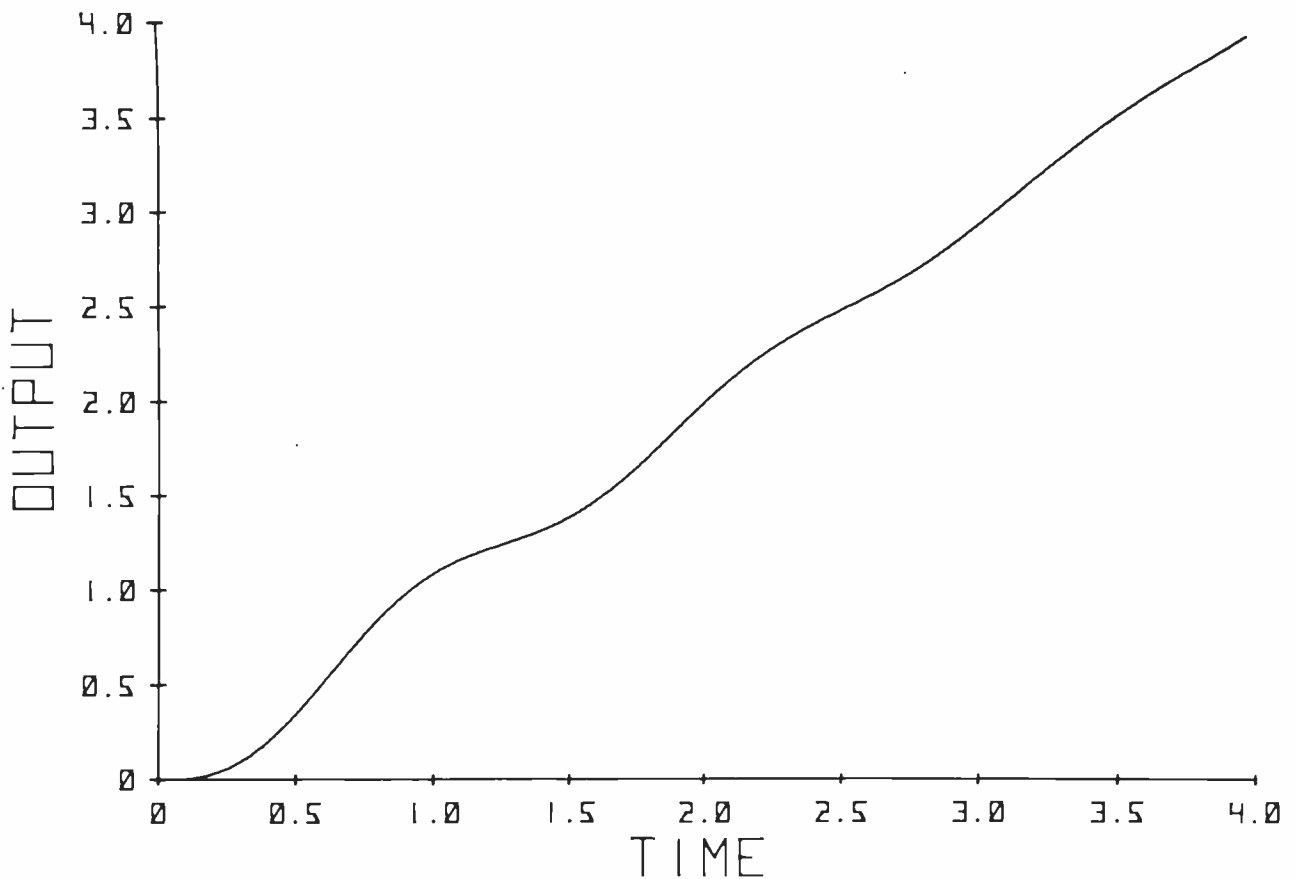

Figure 9: Unit ramp response computed for the transfer function in figure 7. Computing/plotting interval is 0.02. The equal real parts of the transfer function of the unit ramp have been set to differ by an amount 1×10^{-8} .

Listing 2 continued:

```

240 DISP "INPUT MAX & MIN (0=YES 1=AUTO)";
250 INPUT I
260 IF I=1 THEN 320
270 DISP "MAX OUTPUT";
280 INPUT M
290 DISP "MIN OUTPUT";
300 INPUT N
310 GOTO 430
320 M=N/2011
330 FOR U=0 TO T STEP S
340 H=1+(U-0)/S
350 IF (C0R) > H THEN 360
360 H=C(LH)
370 GOTO 400
380 IF (Z0I) > H THEN 400
390 H=Z(H)
400 NEXT U
410 IF H.0 THEN 430
420 H=0
430 END

```

Solution by Residue Theorem

Digital programming of the differentiation of equation 6 is not the simplest process and, in practice, is unnecessary. Due to the number crunching capacity of small-scale desktop digital computers, the problem of two equal roots can be surmounted quite readily. When inputting the data on the roots, one of the two equal roots is changed by a relatively small amount (approximately 0.1 or 1%). While electronic control systems may employ components with tolerances causing a 1% error in the roots, experience tells us that the difference in the plotted curves will be virtually indistinguishable in any practical system.

The problem of repeated roots has effectively been

solved, and it is necessary only to develop equation 5 to a form capable of handling complex roots.

If r_x is complex (of the form: $-a - jb$), then equation 5 tells us that the root r_x makes a contribution, $f_1(t)$, to the total response in the time domain at time t where:

$$f_1(t) = \left. (s+a+jb) \times F(s) \times e^{st} \right|_{s=-a-jb}$$

giving: $f_1(t) = M_x e^{j\phi} e^{-[a+jb]t}$

or rearranging: $f_1(t) = M_x e^{-at} e^{j(\phi-bt)}$ (7)

The real (Re) and imaginary (Im) parts of $f_1(t)$ are respectively:

$$f_1(t) (\text{Re}) = M_x e^{-at} \cos(\phi-bt)$$

$$f_1(t) (\text{Im}) = M_x e^{-at} \sin(\phi-bt)$$

The total system response, M , at a specific time t is given by:

$$M = \sqrt{M_1^2 + M_2^2} \quad (8)$$

Where $M_1 = \sum_{x=1}^n M_x e^{-r_x t} \cos(\phi_x - b_x t)$ (9)

and $M_2 = \sum_{x=1}^n M_x e^{-r_x t} \sin(\phi_x - b_x t)$ (10)

Bit Pad One™ is the small, low-cost digitizer that lets you add a graphics or menu capability to any data processing system. It's perfect for data entry, CRT cursor control, games, mapping and countless business applications like order entry and inventory control.

Bit Pad One is small in size, but big in reliable capability.

The 11" x 11" active area has a resolution of 0.005" which is comparable to digitizers found in expensive turnkey graphic design systems.

Best of all, Bit Pad One is designed and built by Summagraphics, the leading manufacturer and OEM supplier of data tablets and digitizers.

Bit Pad One. It's bringing digitizing down to earth.



Summagraphics
corporation

35 Brentwood Ave., Box 781
Fairfield, CT 06430
(203) 384-1344.

Central Office: 3785 Varsity Dr., Ann Arbor, MI 48104, (313) 973-1710.

Western Office: 1102 West 17th St., Santa Ana, CA 92706, (714) 541-8261.

European Office: 14 rue de l'Ancien-Port, 1201 Geneva, Switzerland, phone 022/31 39 40.

**Bit by bit,
the world is coming
to Bit Pad One.**

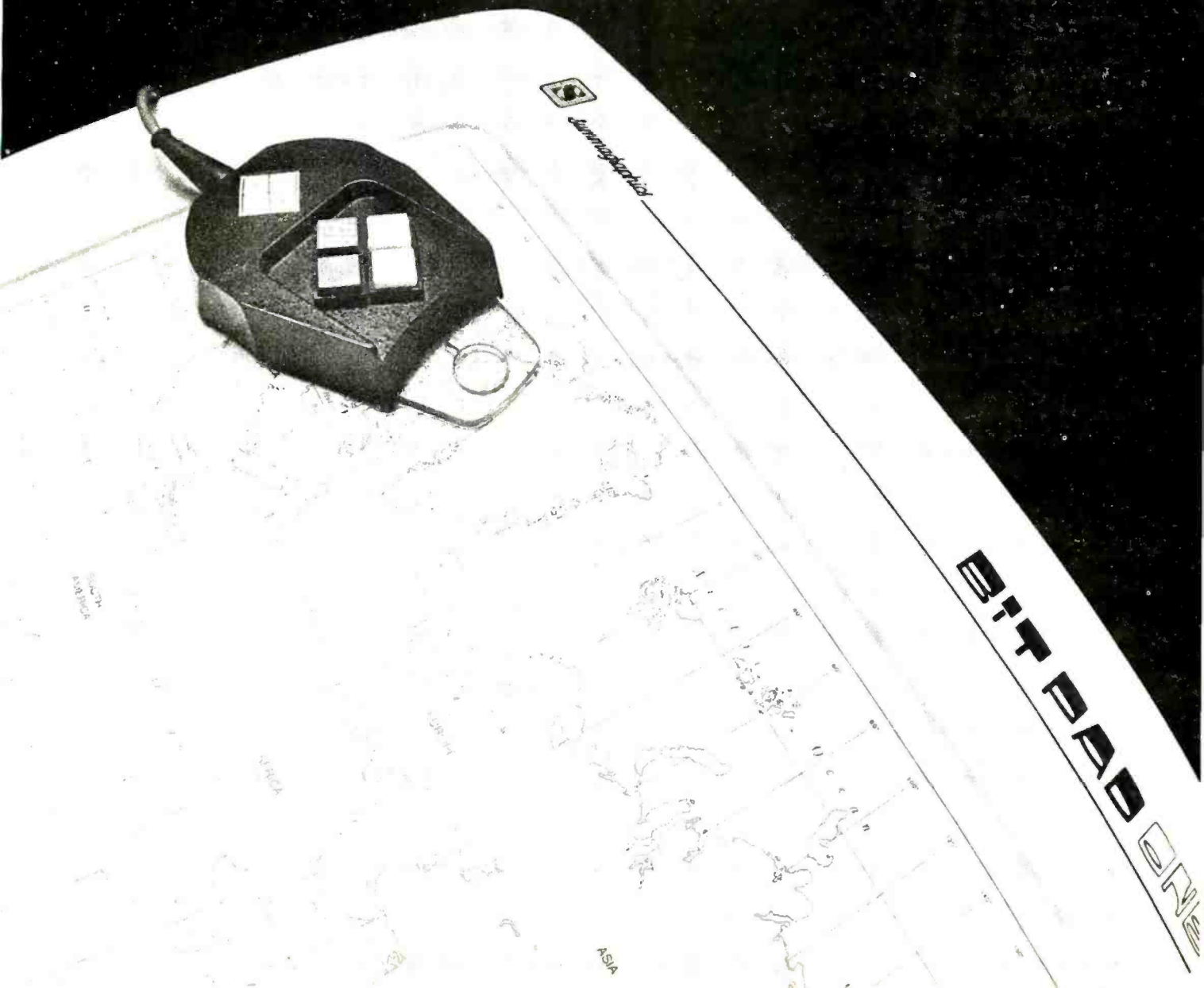

DYNACOMP

Quality software for: Altair
North Star
TRS-80 (Level II)

Sophisticated software written by recognized computer professionals. Each program is supplied with complete documentation. All programs can be run with standard terminals (32 characters or wider) and within 12K program memory space.*

FLIGHT SIMULATOR

(as described in SIMULATION, Volume II)

- Realistic and extensive three-dimensional simulation of take-off, flight and landing.
- Based on aerodynamic equations and real airfoil.
- Practice instrument approaches and navigation using radials and compass headings.

Price: \$17.95
SIMULATION, Volume II (BYTE Publications): \$6.00

VALDEZ*

- (Requires 16K of program memory)
- Exciting simulation of supertanker navigation in Prince William Sound and Valdez Narrows using radar map.
 - Detailed physical model of ship response and tidal patterns.
 - Chart course through ship and iceberg traffic.
- Price \$14.95

BRIDGE 2.0

- Complete contract and duplicate bridge game.
 - Computer both bids and plays.
 - Computer will play offense or defense according to the bid.
 - Challenging entertainment for the advance player.
 - Excellent learning tool for the bridge novice.
- Price: \$17.95

HEARTS 1.5

- An entertaining computer simulation of this popular card game.
 - Play against two computer opponents.
 - Beware the Black Maria!
- Price: \$14.95

NORTH STAR TEXT EDITOR

- (Update of program described in BYTE, June 1979)
- Designed as an easy-to-use (and remember) basic text editor.
 - Works through unmodified North Star DOS.
 - Line-oriented editing, variable line width, simple paragraph indexing.
- Price: \$10.95 (Available only on North Star diskette)

NORTH STAR COMPRESSION PROGRAM

- Removes all unnecessary spaces and remark statements from program.
 - Requires only a single disk drive.
 - Any size program may be processed.
 - Increases execution speed of programs while using less memory.
- Price: \$9.95 (Available only on North Star diskette. Requires release 4 or higher North Star BASIC.)

Except where noted, all software is available on North Star diskettes, and Altair and TRS-80 cassettes.

Additionally, Microsoft BASIC ASCII listings are available on paper tape and cassette (modem compatible, 300 baud).

All orders processed within 48 hours. Write for more detailed descriptions of these and other programs available from **DYNACOMP**.



DYNACOMP

P.O. Box 162

Webster, New York, 14580

New York residents please add 7% NYS sales tax.

Computer Program

The BASIC program developed for solving these equations is shown in listing 1. $F(s)$ is assumed to have a maximum tenth-order numerator and/or denominator of the general form:

$$F(s) = \frac{K(s+A1+jB1)(s+A2+jB2)\dots(s+A10+jB10)}{(s+C1+jD1)(s+C2+jD2)\dots(s+C10+jD10)}$$

Obviously, any complex root must have a conjugate for the equation to have any meaning.

The flow diagram for the solution of the equations is given in figure 6. The program permits 201 output data points to be evaluated, or 200 time divisions. Full four-word accuracy is employed in the intermediate computations and, to save memory, two-word accuracy is employed in the stored values of the output.

In practice, three types of output have been found useful:

- A tabular printout of time and magnitude.
- A thermal printer plot of output versus time provides crude but rapid viewing of the unknown response and so permits optimizing the time interval and total time to achieve the most informative plot.
- A digital, pen-plotted output for formal presentation.

Use of link statements on the HP9830A allowed this program to be run with 2 K words of memory. However, a 4 K word memory permitted simultaneous loading of all program files onto the key files.

Results and Discussion

Consider the complex second-order transfer function with unity gain, damping factor (ζ) of 0.1, and natural angular frequency of 5 radians per second:

$$\frac{V_o(s)}{V_i(s)} = \frac{25}{s^2 + s + 25} \quad (11)$$

For a unit impulse, $v_i(t)$, then $V_i(s) = 1$ and:

$$V_o(s) = F(s) = \frac{25}{(s+0.5+j4.975)(s+0.5-j4.975)}$$

Since the computer interprets the real parts of these roots as being equal, it is necessary to change one of them by a small amount (approximately 0.5001 in this case).

The impulse response of equation 11 is shown in figure 7. This curve was computed for 201 points from $t=0$ to 8 at 0.04 intervals.

Frequently, a digital computer solution is required as a check on the accuracy of an analog computer simulation. The efficiency of this computer program in providing such data is illustrated in table 1. The test is to compute the output at 0.5-second intervals for the first 5 seconds of figure 7. The performance of the program was compared with a standard iterative procedure employed by the Hewlett-Packard Math Pac volume 1.

a PERCOM SAMPLER



For your SS-50 bus computer — the CIS-30+

- Interface to data terminal and two cassette recorders with a unit only 1/10 the size of SWTP's AC-30.
- Select 30, 60, or 120 bytes per second cassette interfacing, 300, 600 or 1200 baud data terminal interfacing.
- Optional mod kits make CIS-30+ work with any microcomputer. (For MITS 680b, ask for Tech Memo TM-CIS-30+—09.)
- KC-Standard/Bi-Phase-M (double frequency) cassette data encoding. Dependable self-clocking operation.
- Ordinary functions may be accomplished with 6800 Mikbug™ monitor.
- Prices: Kit, \$79.95; Assembled, \$99.95.

Prices include a comprehensive instruction manual. Also available: Test Cassette, Remote Control Kit (for program control of recorders), IC Socket Kit, MITS 680b mod documentation, Universal Adaptor Kit (converts CIS-30+ for use with any computer).

MIKBUG® Motorola, Inc.

In the Product Development Queue . . .

Coming PDQ. Watch for announcements.

6809 Processor Card — With this SS-50 bus PC board, you'll be able to upgrade with the microprocessor that Motorola designers describe as the "best 8-bit machine so far made by humans."

The Electric Crayon™ — This color graphics system includes its own μ P and interfaces to virtually any microcomputer with a parallel I/O port.

Printer Interface — For your TRS-80™. Interface any serial RS232 printer to your TRS-80™ with this system.

™ELECTRIC WINDOW, ELECTRIC CRAYON, Pilon-30 and Pilon-10 are trademarks of Percom Data Company, Inc.

TRS-80 is a trademark of Tandy Corporation and Radio Shack which has no relationship to Percom Data Company.

Orders may be paid by check or money order, or charged to Visa or Master Charge credit account. Texas residents must add 5% sales tax.



For your data storage — Pilon-30™ and Pilon-10™ data cassettes

- Orders-of-magnitude improvement in data integrity over ordinary audio cassettes.
- Pilon-coated pressure pad eliminates lint-producing felt pad of standard audio cassettes.
- Smooth pilon coating minimizes erratic tape motion.
- Foam pad spring is energy absorbing. Superior to leaf spring mounted pad which tends to oscillate and cause flutter.
- Five-screw case design virtually precludes deformation during assembly.
- Price: \$2.49.



For your S-100 computer — the CI-812

- Both cassette and data terminal interfacing on one S-100 bus PC board.
- Interfaces two recorders. Record and playback circuits are independent.
- Select 30, 60, 120, or 240 bytes per second cassette interfacing, 110 to 9600 baud data terminal interfacing.
- KC-Standard/Bi-Phase-M (double frequency) encoded cassette data. Dependable self-clocking operation.
- Optional firmware (2708 EPROM) Operating System available.
- Prices: kit, \$99.95; assembled, \$129.95.

Prices include a comprehensive instruction manual. In addition to the EPROM Operating System, a Test Cassette, Remote Control Kit (for program control of recorders), and an IC Socket Kit are also available.

CASSETTE SOFTWARE

For 8080/Z-80 μ Cs . . .

BASIC ETC — Developed by the co-authors of the original Tiny BASIC, BASIC ETC is easy to use yet includes commands and functions required for powerful business and scientific programs as well as for hobby applications. 9.5K bytes of RAM. 1200-baud cassette and 42-page user's manual . . . \$35.00

Cassette Operating System — EPROM (2708) COS for the Percom CI-812 dual peripheral interfacing PC card . . \$39.95

If you're programming on a 6800 μ C, you'll want these development and debugging programs written by Ed Smith of the Software Works:

Disassembler/Source Generator — Disassembles SWTP Resident Assembler, TSC Mnemonic Assembler/Text Editor or Smoke Signal Mnemonic Assembler/Text Editor and produces compacted source code suitable for re-editing. Prints or displays full assembly-type output listing. 4K bytes of RAM. (Order M68SG) . . . \$25.00

Disassembler/Trace — Use to examine (or examine and execute) any area of RAM or ROM. "Software-single-step" through any program, change the contents of CPU or memory location at any time, trace subroutines to any depth. 2.3K bytes of RAM. (Order M68DT) . . . \$20.00

EPROM Support/Relocator Program — This program relocates a program in any contiguous area of RAM or ROM to anywhere in RAM. Use to assemble and test programs in RAM, adjust programs for EPROM operating addresses and then block move to your EPROM burner address. 952 bytes of RAM. Loads at hex 1000. (Order M68EP) . . . \$20.00

Relocating Assembler & Linking Loader (M68AS) . . . \$50.00

Relocating Disassembler & Segmented Source Text Generator (M68RS) \$35.00

Americana Plus — 14 tunes for the Newtech Model 68 Music Board in machine language ready to load and run. Cassette compatible with Percom CIS-30+ and SWTP AC-30. Order MC-1SW . . \$15.95

HARDWARE

Newtech Model 68 Music Board — Produces melodies, rhythms, sound effects, morse code, etc. from your programs. Includes manual with BASIC for writing music scores and assembly language routine to play them. Installs in SWTP I/O slot. Assembled & tested . . . \$59.95

The Percom ELECTRIC WINDOW™ — Memory-resident and programmable, this video display character generator board for your SS-50 bus displays up to 24 80-character lines. Features dual character generators, dual-intensity high-lighting. One programmable register controls scrolling. Compatible with standard video monitors . . . \$249.95

SS-50 Prototype Cards:
Large card (up to 70 40-pin ICs) \$24.95
I/O size card . . . \$14.95

PERCOM

PERCOM DATA COMPANY, INC.
DEPT. B

211 N. KIRBY • GARLAND, TX. 75042

PERCOM™ 'peripherals for personal computing'

To order products or request additional literature, call Percom's toll-free number: 1-800-527-1592. For detail technical information call (214) 272-3421.

Table 1: A measure of the efficiency of the computer program in verifying the accuracy of an analog computer simulation.

TIME (seconds)	RESIDUE THEOREM	OUTPUT			
		ITERATIVE SOLUTION			
		Integration Time (seconds)			
		0.5	0.1	0.01	0.005
0	0.000	0.000	0.000	0.000	0.001
0.5	2.381	9.375	2.054	2.378	2.380
1.0	-2.943	-43.36	-2.757	-2.940	-2.943
1.5	2.194	117.8	2.433	2.195	2.194
2.0	-0.9269	-161.9	-1.564	-0.9322	-0.9281
2.5	-0.1850	-290.8	0.5962	-0.1778	-0.1834
3.0	0.7909	2775	0.1653	0.7850	0.7895
3.5	-0.8654	-10265	-0.5901	-0.8630	-0.8648
4.0	0.5901	22981	0.6902	0.5914	0.5903
4.5	-0.2045	-15666	-0.5620	-0.2083	-0.2053
5.0	-0.1051	-130420	0.3283	-0.1010	-0.1042
Total Time for Computation and Printout (seconds)	25	10	25	200	390

It is clear from table 1 that the cumulative errors for an iterative process with integration time, δt , of 0.1 produced inadequate results at $t=5$. Accuracies of 4% and 1% are obtained at $t=5$, for integration times of 0.01 and 0.005 seconds respectively. However, the total computing times of 200 and 390 seconds respectively are drastically larger than the 25 seconds associated with the Residue Theorem approach. By employing fast memory in the HP 9830A the total computing and printout time can be reduced to 15 seconds. Use of the Infotek FP 30,

fast processor, can reduce this total time even further to approximately 8 seconds.

A unit step input (ie: $V_i(s)=s^{-1}$) in equation 11 gives $F(s)$ as:

$$F(s) = \frac{25}{(s+0+j0)(s+0.5001+j4.975)(s+0.5-j4.975)} \quad (12)$$

A unit ramp input (ie: $V_i(s) = s^{-2}$) in equation 11 gives $F(s)$ as:

$$F(s) = \frac{25}{(s+0+j0)(s+1 \times 10^{-8}+j0)(s+0.5001+j4.975)(s+0.5-j4.975)} \quad (13)$$

Figure 10: Computed initial transients of the transfer function used in figure 7, when it is subjected to a unit sinusoidal forcing function of the same frequency (five radians per second) as the natural frequency of the system under test. Computing/plotting interval is 0.05. The equal real parts of the forcing function have been made to differ by an amount 1×10^{-8} .

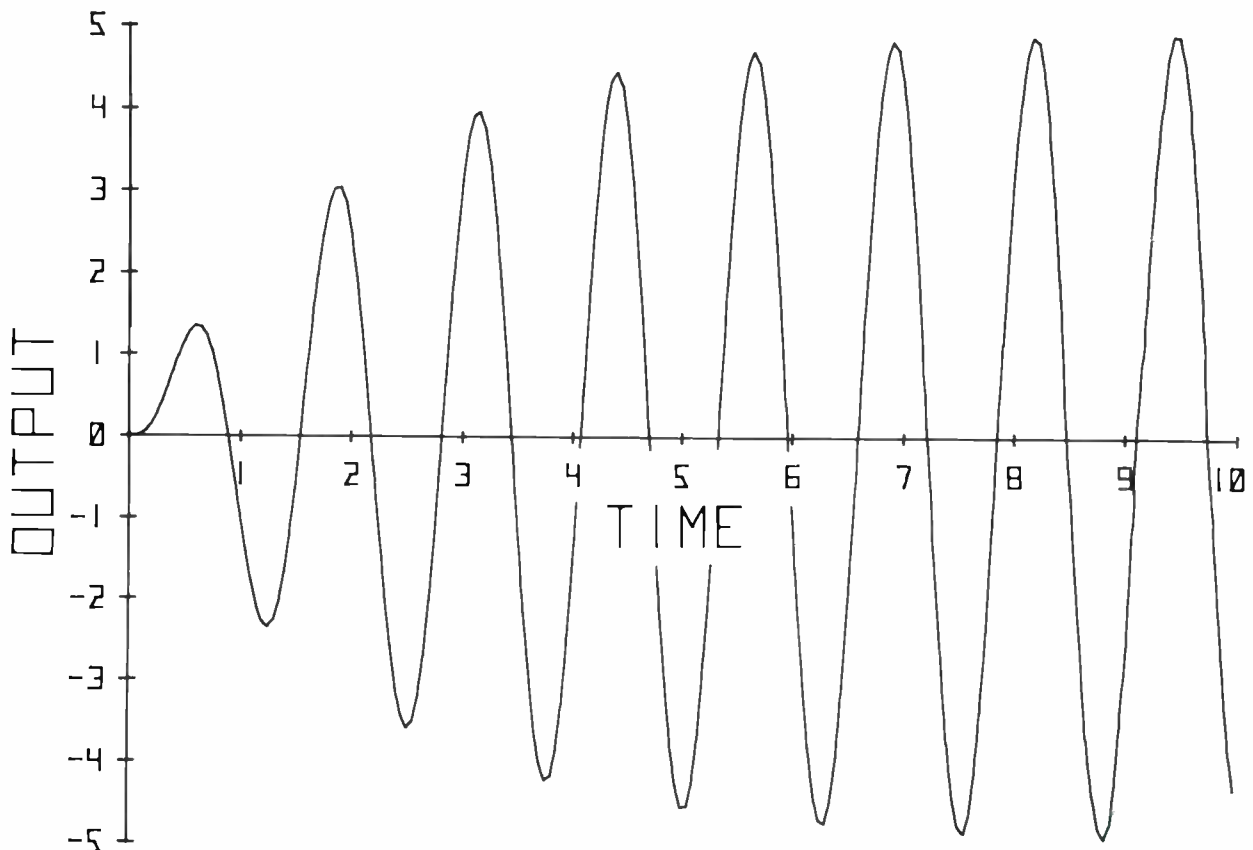

NOBUS-Z™ \$2295

for Business *and* Home

A PROFESSIONAL MICROCOMPUTER AT AN AFFORDABLE PRICE

The NOBUS-Z COMPUTER has the hardware features needed for today's sophisticated small business, scientific, educational and personal systems.

- **SINGLE BOARD TECHNOLOGY**
- **4MHZ Z80A**
- **64K 200NS RAM**
- **8-INCH DRIVE DUAL DENSITY**
- **CP/M® OPERATING SYSTEM**
- **GRAPHICS IN COLOR**
- **SOUND GENERATOR**
- **2-SERIAL PORTS**
- **2-PARALLEL PORTS**
- **4-COUNTER/TIMERS**

Order a NOBUS-Z from your local Computer Dealer or write to EXO ELECTRONICS for complete information. OEM inquiries welcome. CIRCLE 134 ON THE INQUIRY CARD



DOLLAR FOR DOLLAR YOU WON'T FIND A BETTER SYSTEM

EXO ELECTRONICS supplies complete integrated systems centered around our NOBUS-Z. Professional CRT editing terminals and line printers round out our hardware offering. Fully supported software languages and packages supply the muscle for the system. Business and Scientific Basics, FORTRAN, Pascal and COBOL are available. We offer a complete line of business systems including accounts payable/receivable, payroll, inventory, data base management, and a complete full screen edit word processing system.

VERSATILITY: A 4MHZ Z80A microprocessor and CP/M give you the most powerful processor and operating system available today. 64K RAM is provided and parity checking is standard for critical applications. Up to four single or double density, 8 or 5 inch soft-sectored floppy disk drives are handled by the on-board controller. A video output gives dazzling displays on your TV set. A separate 6K bank of memory allows up to 256x192 pixel graphics without contending for main system memory. Text and

graphics can be mixed on-screen under program control with up to 16 rows of 32 characters of text. With our optional stand-alone keyboard and your TV the NOBUS-Z can be operated without a separate terminal. All electronics are socketed and readily serviceable on a single board.

PRICES	NOBUS-Z with 8-IN. Shugart® drive ..	\$2295
	additional drive	\$610
	HAZELTINE® 1420 terminal	\$895
	CENTRONICS® 730 100 cps printer ...	\$995
	EXO stand-alone keyboard	\$95

The NOBUS-Z is also available with a 5-inch double density drive for \$1995

NOBUS
Z

EXO
ELECTRONICS
COMPANY

P.O. BOX 3571 CULVER CITY, CALIFORNIA 90230 (213) 390-6527

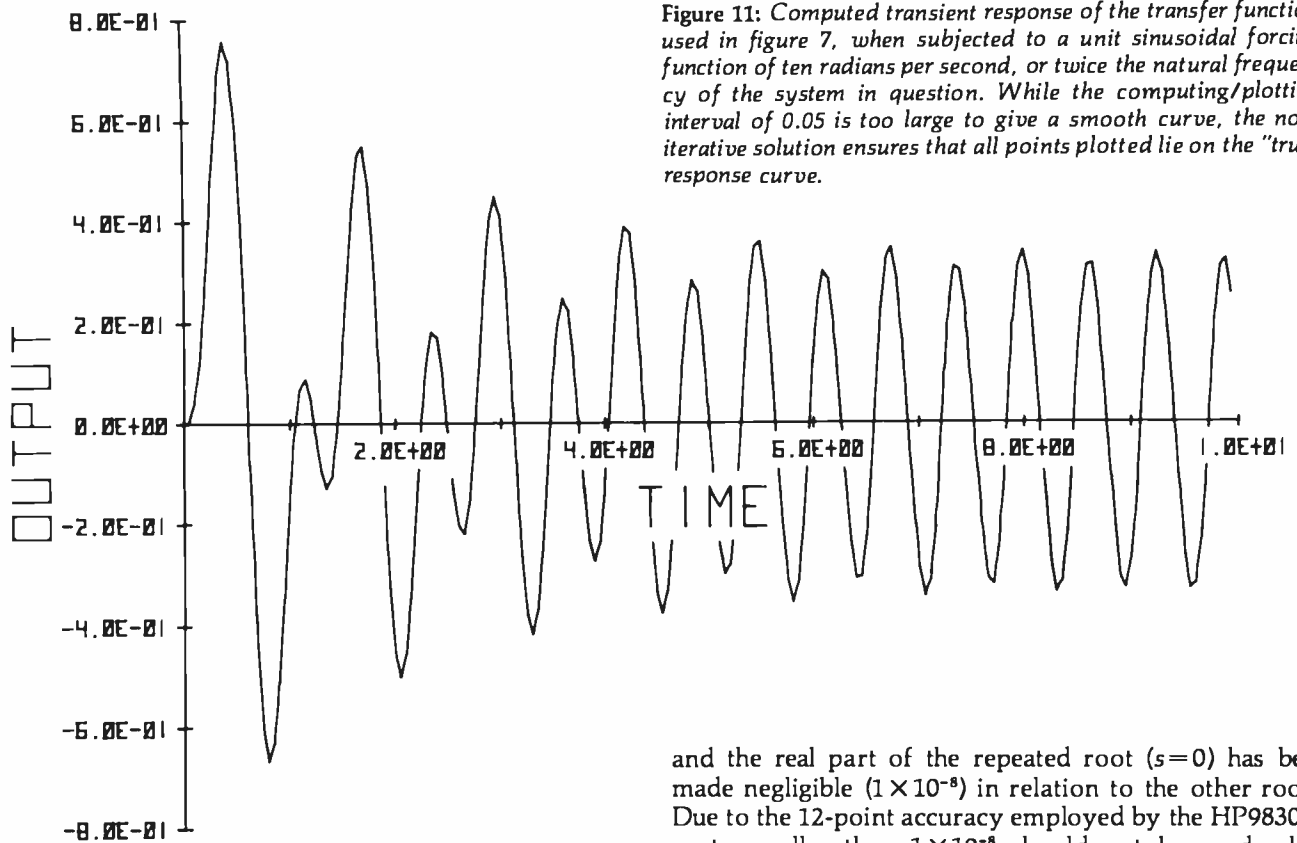

Figure 11: Computed transient response of the transfer function used in figure 7, when subjected to a unit sinusoidal forcing function of ten radians per second, or twice the natural frequency of the system in question. While the computing/plotting interval of 0.05 is too large to give a smooth curve, the non-iterative solution ensures that all points plotted lie on the "true" response curve.

and the real part of the repeated root ($s=0$) has been made negligible (1×10^{-8}) in relation to the other roots. Due to the 12-point accuracy employed by the HP9830A, roots smaller than 1×10^{-8} should not be used when handling trigonometric functions such as arctangent. Similarly, any two roots must have a difference that is greater than 1×10^{-8} . While equation 13 may be solved using a value of 1×10^{-10} for the root at $s=0$, the accuracy decreases rapidly, and the solution becomes meaningless with a value of 1×10^{-12} . However, a root of 1×10^{-8} would represent a time constant of 3.17 years. If, for any reason, the time constants are in the order of months or years, then the whole problem should be time-scaled before programming.

The solutions to equations 12 and 13 are plotted in figures 8 and 9 respectively.

In educational environments, these digital simulations help emphasize the transient behavior of systems subjected to sinusoidal forcing functions, without the possibility of causing a system overload. Figure 10 illustrates the effect of inputting equation 11 with a unit sine wave

$$v_i(t) = \sin(\omega t) \quad V_i(s) = \frac{\omega}{s^2 + \omega^2}$$

with a frequency of 5 radians per second, that being equal to the natural frequency of the system. Since $\zeta = 0.1$, this is almost the resonant frequency.

Figure 11 illustrates the effect of inputting equation 11 with a unit, 10 radians per second sine wave, which is twice the natural frequency of the system.

While the axis labels in figures 7 thru 10 are most convenient for the presentation of those results, the printout employed in figure 11 is more versatile when a great number of amplitudes and time scales are expected. ■

REFERENCES

- Day W D, Tables of Laplace Transforms, London: Iliffe, 1966.
Thaler G J and Brown R G, *Analysis and Design of Feedback Control Systems*, New York, McGraw-Hill, 1960, pages 9-29.

Main/Frames from \$200

Main/Frames from \$200

- 14 Basic Models Available
- Assembled & Tested
- Power Supply:
8v@15A, ± 16v@3A
- 15 Slot Motherboard
(connectors optional)
- Card cage & guides
- Fan, line cord, fuse, power
& reset switches, EMI filter
- 8v@30A, ± 16v@10A
option on some models



Rack mounted from \$200

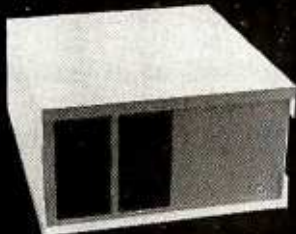

8" Floppy Main/Frame
(includes power for drives
and mainframe) from \$365

Write or call for our
brochure which includes our
application note:

'Building Cheap Computers'

INTEGRAND

8474 Ave. 296 • Visalia, CA 93277 • (209) 733-9288
We accept BankAmericard/Visa and MasterCard

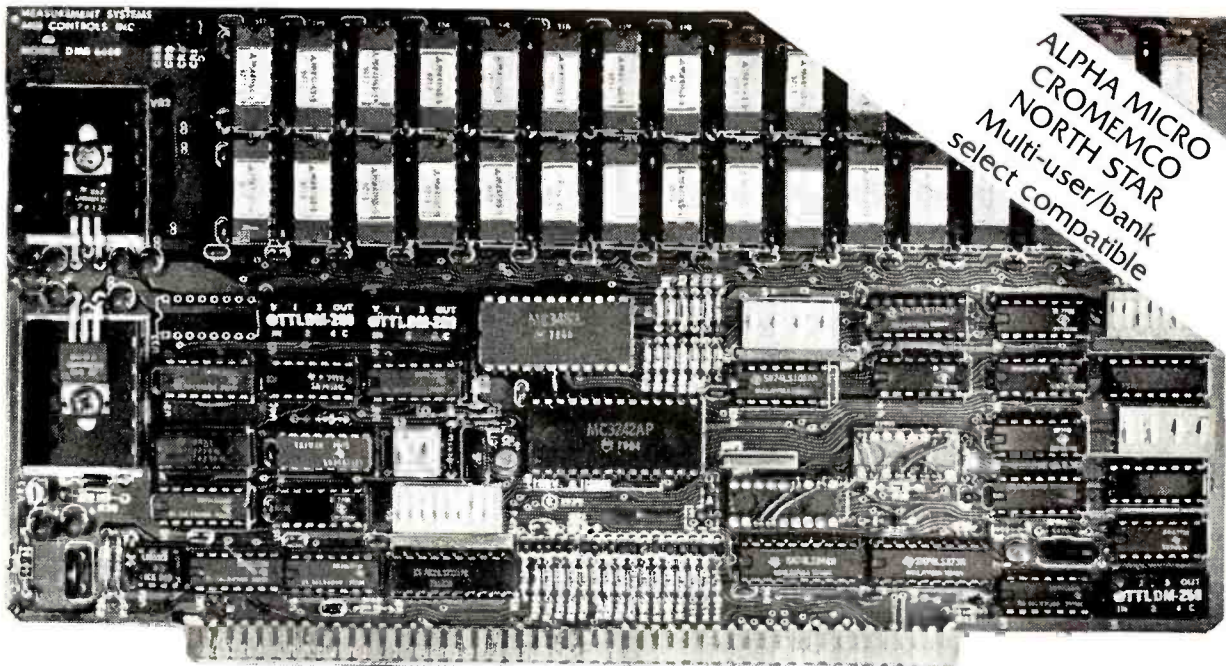

ALPHA MICRO
CROMEMCO
NORTH STAR
Multi-user/bank
select compatible

Model DMB-6400 Series dynamic 64k byte RAMS incorporate the features which are standard in the DM-6400 Series and adds bank select for multi-user-timesharing applications.

- ALPHA MICRO, CROMEMCO, and NORTH STAR output port bank select.
- Memory bank size can be incremented to 64k bytes in 16k increments.
- Four (4) 16k byte, functionally independent memory banks.
- Eight (8) 64k byte banks of memory per output port for expansion to 512k bytes for each output port.

Model DM-6400 Series dynamic 64k memory boards feature IEEE S-100 compatible timing and on board transparent refresh.

- Memory selectable and deselectable in 4k byte increments.
- 25 MHz on board crystal oscillator for independent timing.

DMB-6400 and DM-6400 Common Features:

- 4 MHz Z80 operation with no wait states.
- Tested and burned-in.
- Low power- 8 watts maximum.
- Reliable, expandable memories.

ONE YEAR GUARANTEE

THE FOLLOWING PRODUCTS ARE AVAILABLE

- | | | | |
|---|---|--|--|
| <input type="checkbox"/> DMB-6400/64K RAM | <input type="checkbox"/> DMB-3200/32K RAM | <input type="checkbox"/> DM-6400/64K RAM | <input type="checkbox"/> DM-3200/32K RAM |
| <input type="checkbox"/> DMB-4800/48K RAM | | <input type="checkbox"/> DM-4800/48K RAM | |

ATTRACTIVELY DISCOUNTED OEM AND DEALER QUANTITY PRICES AVAILABLE

U.K. & EUROPEAN REPRESENTATIVE:

ABACUS COMPUTERS LTD
62, NEW CAVENDISH STREET
LONDON, W1M 7LD U.K.
TEL: 01-580/8841 TELEX: 881-3085

AUSTRALIAN REPRESENTATIVE:

COMPUTERLAND OF MELBOURNE
555 COLLINS STREET
MELBOURNE, VIC3000
TEL: 625581

MEASUREMENT
systems & controls
incorporated

867 North Main Street ● Orange, CA 92668
Telephone: 714/633-4460

Listing 1 continued from page 85:

```

ROUTINE LINE
GENERATE THE LINE FROM THE CURRENT CURSOR
POSITION TO THE POINT X,Y IN H,L,I.
USES DOT TO ACTUALLY DISPLAY THE POINTS.
BLOCK 1: PRELIMINARIES
1.1--SECTOR DETERMINATION
LINE: PUSH PSV ;SAVE THE WORLD
PUSH B ; NOTE: ORDER IS SET BY
PUSH D ; RESTORE IN DOT
PUSH H ;
CALLI CUR00 ;COORDINATES NEED CHANGING
LDA XPOS ;GET CURRENT CURSOR POSITION
CMP H ;WHICH IS BIGGER?
JCF L100 ;XF
SUB H ;NEED A-H
MVI B,00H ;SET SECTOR CODE TO ZERO
JMP L101 ;AND CONTINUE
L100: A ; WHICH REQUIRES 2'S COMP
; AND AN ADD
MVI B,04H ;SECTOR CODE GETS 4
MOV D,A ;XP GOES IN D GETS 4
LDA YPOS ;DO THE SAME FOR Y
CMP L ;WHICH IS LARGER
JCF L102 ;YF IS
SUB L ;YC IS
MOV E,A ;SAVE IT
JMP L103 ;AND CONTINUE
L102: A ; AGAIN, GET 2'S COMPLIMENT
;
L ; TO FIND YF-YC
E,A ; AND SAVE IT
MVI A,02H ;INCR SECTOR CODE BY 2
ADD B ;
MOV B,A ;NEW SECTOR VALUE
CMP E ;IS XP < YP?
JCF L104 ;IF SO THEY NEED EXCHANGING
MOV D,E ; OK AS THEY ARE
MOV E,A ;XP = YP
INR B ;AND YP = OLD XP
; AND SECTOR CODE GETS ONE MORE
;
; 1.2--PARAMETER INITIALIZATION
L104: MVI L,00H ;XT = 0
MOV H,D ;XP, XT
PUSH H ;XP, XT
MVI H,0 ;0,0
MVI H,0 ;TA = 0
MOV L,E ;HL = YP
MOV D,Y ;DY = YP
MVI A,D ;Determine DX
; WHICH IS 2'S COMPLIMENT
; OF XP
MVI H,0FFH ; I.E. DX = -XP
INX H

```

```

0237 22A304 ;SAVE FOR L00P
023A 37 ;T0 = 1/2 DX
023B 7C ;ARITH SHIFT RIGHT
023C 1F ; OF H,L.
023D 67 ;HIGH BYTE DONE
023E 7D ;MOV DO LDW BYTE
023F 1F ;
0240 6F ;ALL'DONE
0241 85 ;SAVE T0
;
; 1.3--SET UP COORDINATE TRANSFORMATION TABLE
;
;
LXI H,MXT ;CALCULATE CORRECT MOVES
MOV A,B ;OFFSET INTO TABLE
RLC ;EACH ENTRY IS FOUR BYTES
;
MVI E,A ;ADD TO BASE ADDRESS
DAD D ;H,L IS NOW ADDRESS OF M0X
MOV E,M ;GET M0X
INX H ;AIM AT M0Y
MOV D,M ;AND GET IT TOO
XCHG ;SHIFT TO H,L
M0X ;AND STORE IN MOVE ZERO
XCHG ;NOW GET 'OME'.MOVE
INX H ;WHICH ARE THE NEXT 2 ENTRIES
MOV E,M ;
INX H ;
MOV D,M ;MIY
XCHG ;GET SET
SHLD MIX ; AND STORE
;
; BLOCK #2: THE ACTUAL LINE GENERATION LOOP
;
;
; 2.1--DISPLAY THE CURRENT POINT
;
;
L000: CALL DOT ;DISPLAY THE CURRENT POINT
;
; 2.2--TEST FOR DONE
;
;
POP B ;B,C=T0
POP D ;D,E = TA
POP H ;H,L = XP, XT
MVI A,L ;XT
CMP H ;XP
JNC D002 ;ALL DONE, GO RESTORE
INR L ;XT = XT + 1
PUSH H ;SAVE FOR NEXT ITERATION
;
; 2.3--DETERMINE NEXT MOVE
;
;
LHLD DY ;GET DY
DAD D ;TA = TA + DY
PUSH H ;SAVE FOR NEXT ITERATION
DAD B ;TA + T0
JC L040 ;IF POSITIVE
;
; 2.4--MAKE THE REQUIRED MOVE
;
;

```

Listing 1 continued on page 170

XMAS BONUS

FROM

CHRISLIN INDUSTRIES

BONUS OFFER GOOD
NOV. 15, 1979
THRU JAN. 15, 1980

\$155 CASH DISCOUNT
ON ANY OF OUR 64K BYTE
MEMORIES.



WE'RE CELEBRATING!!!!

THANKS TO YOUR SUPPORT WE HAVE BECOME
A MAJOR MANUFACTURER OF HIGH SPEED, HIGH
QUALITY, INDUSTRIAL GRADE MICROCOMPUTER MEMORIES.
TO SHOW OUR APPRECIATION WE ARE MAKING THIS LIMITED OFFER.

WITH A COPY OF THIS PAGE AND YOUR ORDER WE WILL SHIP A
64KB MEMORY TO YOU AT \$155 OFF OUR REGULAR LOW PRICE OF \$750.
THIS OFFER GOOD ONLY FOR OUR 64KB S100BUSMODULE, MOTOROLA
EXORCISOR® I MODULE, LSI 11/2® MODULE OR INTEL MULTIBUS®
MODULE. THIS OFFER NOT GOOD ON SMALLER BOARDS OR OUR **NEW**
EXORCISOR® II MODULE.



CI-6800 64K x 8



CI-S100 64K x 8

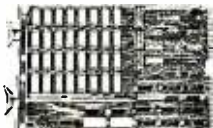

CI-1103 32K x 16



CI-8080 64K x 8

NEW!!

64KB MEMORY FOR EXORCISOR® II
OPERATES AT 2 MEGA HERTZ.
PARITY. \$995.00

Tested and burned-in. Full year warranty.



Chrislin Industries, Inc.

Computer Products Division

31352 Via Colinas • Westlake Village, CA 91361 • 213-991-2254

3rd Generation S-100: Chosen by Professionals, Supported by CompuPro™

Why S-100? Because S-100 machines are not consumer-oriented, all-in-one microcomputers — but flexible, modular, professional-level systems that are easy to upgrade, modify, and adapt to specific applications. As a result, over the years the S-100 buss has proven to be the ideal choice for commercial, industrial, and scientific applications. It doesn't obsolete itself, but simply adapts to innovation.

We use the experience we've acquired in the past, coupled with the very best technology offered by the present, to build products for the future . . . products that meet, and often exceed, the demands of the new wave of professional S-100 users. Our expanded S-100 line is the right approach at the right time; we invite you to write for further information.

NEW! HIGH-PERFORMANCE S-100 MOTHERBOARDS

19 slot: \$174 unkit*, \$214 assm
12 slot: \$129 unkit*, \$169 assm
6 slot: \$ 89 unkit*, \$129 assm

*Edge connectors and termination resistors are pre-soldered in place for assembly.
These 3rd generation motherboards, designed to work with the latest 5 and 10 MHz CPUs coming on line, exceed the latest S-100 specs and offer superior performance. Includes true active termination (with half of the termination load at each end of every buss line), grounded Faraday shield between all buss signal lines to minimize crosstalk, and edge connectors included for all slots. All sizes fit Godbout, Vector, TEI, IMSAI, and similar enclosures.

These high quality motherboards are a welcome addition to any system — or the start of a great one.

2S "Interfacer" S-100 I/O board \$189 unkit, \$249 assm, \$324 CSC

Dual serial port with 2 full duplex parallel ports for RS-232 handshake; EIA232C line drivers and receivers (1488, 1489) along with current loop (20 mA) and TTL signals on both ports. On-board crystal controlled timebase with independently selectable Baud rate generators for each port (up to 19.2 KBaud). Hardware UARTs don't tie up the CPU. And, there's much more . . . this is a no-excuses serial board that does things the others only dream about.

NEW! 3P + S "Interfacer II" S-100 I/O board \$189 unkit, \$249 assm, \$324 CSC

Incorporates 1 channel of RS-232 serial I/O (with all the features of a port from the 2S "Interfacer", including handshaking), along with 3 full duplex parallel ports. The parallel section uses LSTTL octal latches for latched input and output data with 24 mA drive current, attention/enable/and strobe bits for each parallel port (with selectable polarity), interrupts for each input port, and separate 25 pin connectors with power for each channel along with a status port for interrupt mask and port status. All in all, this is an incredibly versatile and flexible board.

2708 S-100 EROM board \$85 unkit

4 independently addressable 4K blocks, with dipswitch selectable jump start built right into the board. Includes all support chips and manual, but does not include EROMs.

Active Terminator Board \$34.50 kit

Plugs into any S-100 motherboard (although ours don't need it) to reduce ringing, noise, crosstalk, and other buss-related problems. Here is an upgrade that is simple and effective.

The Godbout Box!

By the time you read this, we will be shipping our industrial-grade enclosure. It's perfectly suited to creating a powerful system based on our line of S-100 boards (or anyone else's, if you're so inclined). It's rack mount or desk mount (with sliders for pulling it out of the rack if desired), neat-looking, heavy duty, and comes with the back panel pre-punched to accept a variety of connectors. Oh yes, and let's not forget the power supply for powering all your boards; it comes with the box, too. See your computer store for details, or write us direct.

NEW! "MEMORY MANAGER" S-100 board

\$59 kit, \$85 assm, \$100 CSC

Now you can add bank select and extended addressing to older S-100 machines like the Altair, IMSAI, Sol, Polymorphic, etc. Either use this board with our new extended addressing boards, or retrofit our high density Econorams (the ones with phantom or extra qualifier lines) for use with the Memory Manager Board to get up to 1/2 a megabyte of memory space for your computer.

We supply memory

All our Econoram* memory is fully static, zips along at 4 MHz with the Z-80 or 5 MHz with the 8085, supports a number of popular busses, is available from us through computer stores world-wide, includes a 1 year limited warranty, and comes in three configurations to suit your needs. For lowest cost, choose an "unkit" with sockets and bypass caps pre-soldered in place for an easy, one-evening assembly. When you just can't wait to get going, order our assembled and tested version. For critical systems, specify boards qualified under our **Certified System Component (CSC)** high-reliability program. These boards are extensively tested, burned in for 200 hours, and are immediately replaced in event of failure within 1 year of invoice date. Refer to chart below for pricing.

Name	Buss & Notes	Unkit	Assm	CSC
8K Econoram IIA	S-100	\$149	\$179	\$239
16K Econoram IV	S-100	\$269	\$329	\$429
16K Econoram VIIA-16	S-100	\$279	\$339	\$439
24K Econoram VIIA-24	S-100	\$398	\$485	\$605
16K Econoram IX	Dig Grp	\$319	\$379	n/a
32K Econoram IX	Dig Grp	\$559	\$639	n/a
32K Econoram X	S-100	\$529	\$649	\$789
32K Econoram XI	SBC/BLC	n/a	n/a	\$1050
16K Econoram XII	S-100 (1)	\$329	\$419	\$519
24K Econoram XII	S-100 (1)	\$429	\$539	\$649
32K Econoram XIII	S-100 (2)	\$559	\$699	\$849
16K Econoram XIV	S-100 (3)	\$289	\$349	\$448
16K Econoram XV-16	H8 (4)	\$329	\$395	n/a
32K Econoram XV-32	H8 (4)	\$599	\$729	n/a
16K Memory Expansion	(5)	\$87.20	n/a	n/a
16K x 16 or 32K x 8 Econoram XVI — coming soon!				

Notes

- (1) Bank select board — 2 independent banks addressable on 8K boundaries.
- (2) Bank select board — 2 independent banks addressable on 16K boundaries.
- (3) Extended addressing (24 address lines). Single block addressable on 4K boundaries.
- (4) Bank select option for implementing memory systems greater than 64K.
- (5) Chip set expands memory in Radio Shack-80, Apple, and Exidy Sorcerer machines.

*Econoram is a trademark of Godbout Electronics.

KEYBOARD SPECIAL:

Microswitch keyboard, already encoded with upper and lower case ASCII. Silent switches (not reed type). Requires +5 and -12V. With edge connectors; just plug in and go. Normally \$99, but order merchandise worth \$50 or more and the keyboard is yours for only \$49!

Season's Greetings and Happy New Year!

Thank you for the support that made 1979 a great year for us . . . we'll continue to earn that support in 1980.

TERMS: Cal res add tax. Allow 5% for shipping, excess refunded. VISA®/Mastercharge® call our 24 hour order desk at (415) 562-0636. COD OK with street address for UPS. Prices good through cover month of magazine.

CompuPro™

Bldg. 725, Oakland Airport, CA 94614

from **GODBOUT**
ELECTRONICS

FREE CATALOG: Send us your name and address . . . we'll take care of the rest. In return, you'll get pages and pages of technical information, pricing, specials, kits, and lots more. Include 41c in stamps for 1st class delivery.

IS YOUR Z80 HALF ASLEEP?

Don't settle for less than the total performance built into your Z80 Computer. Wake up its entire potential with an OASIS Operating System—the high-powered, professional software package that takes full advantage of Z80 power.

Utilizing optimized Z80 code, OASIS makes the system run faster. More and better tools let you develop software faster, too.

It's easy to use because all the tools you need are included: ISAM files, hard and floppy disk support, editor, user accounting with logon, password privilege level, and file security. Options: BASIC Compiler, spooler, text editor and output processor,

development package, and more.

The BASIC Compiler *is also an interpreter, complete with debugger.* It makes programs run faster, takes less memory, and provides software security. A first for micros, it's an OASIS exclusive.

FEATURES: Single- & Multi-User/ User Accounting/ Multi-Tasking/ File & Record Security/ Logon, Password & Privilege Protection/ Keyed (ISAM), Direct & Sequential Files/ Hard & Floppy Disk Support/ Extensive Documentation

OASIS PRODUCTS: Single-User Operating System/ Multi-User Operating System/ Macro Re-locating Assembler/ Debugger/ Linker/ Editor/ Output Text Formatter/ Spooler/ Communications Package/ Sort/ Diagnostic & Maintenance Utilities/ Interactive EXEC Language/ Re-entrant BASIC Compiler

OASIS IS AVAILABLE FOR: Altos/ Bilings/ Digital Microsystems/ Digital Group/ Cromemco/ Vector Graphic/ Micromation/ CompuCorp/ North Star/ Onyx/ Bell Controls/ TRS-80 Mod II/ Vortex and others

Multi-User OASIS, available for most computer configurations, gets even more performance out of your system. It has all the Single-User features, *PLUS a re-entrant BASIC Compiler*, file and record locking, variable time-slicing, user-to-user communications, and extended memory addressing. All fully upward compatible with Single-User.

Documentation?...complete and extensive. And, of course, there's plenty of application software.

OASIS operating systems, languages, development packages, system utilities — all fully integrated, all from one source.

Ask your dealer or manufacturer. Or send the coupon direct, today.

MAKES MICROS RUN LIKE MINIS.

OASIS

Order OASIS direct from:
Phase One Systems, Inc.
 7700 Edgewater Drive, Suite 830
 Oakland, CA 94621
 Telephone (415) 562-8085 TWX 910-366-7139

My computer configuration (specify make, disk system, etc.)

Name _____
 Street Address (No Box #) _____
 City _____ State _____ Zip _____

PLEASE
 SEND ME:

- OASIS (Includes Manual)
- Single-User System \$150
 - BASIC Compiler \$100
 - Multi-User System \$250
 - Re-entrant BASIC Compiler \$145

- | Manual Only | Amount |
|----------------------------------|--------|
| <input type="checkbox"/> \$17.50 | |
| <input type="checkbox"/> \$15 | |
| <input type="checkbox"/> \$17.50 | |
| <input type="checkbox"/> \$15 | |

SPECIAL WITH THIS COUPON:
 System AND BASIC Manual
 Complete Information

- | | |
|----------------------------------|--|
| <input type="checkbox"/> \$27.50 | |
| <input type="checkbox"/> \$1 | |

- Check Enclosed
 - UPS C.O.D.
 - VISA
 - Mastercharge
- Card Number: _____
 Expiration Date: _____
 Signature: _____

Shipping	\$2
\$1 for C.O.D.	
California residents add sales tax	
TOTAL	

Teratek's

POSTMASTER

Tomorrow's mail system. Today.

One package does it ALL.

Postmaster offers the most powerful and flexible mail-management system available.

Batch Entry: Entering names and addresses to a mailing list is simple. Repeated elements of a record need only be entered once.

Powerful Record Extraction: Used in conjunction with the **Optional Reference Field**, this feature allows simple creation of user specified "target-files."

Dedicated Record Editor: List, modify or delete records. Allows intact or extracted backup of original file.

Automatic "ID" Field Insertion: (optional) Key in a name, and a unique 10 character record identifier will be entered automatically to the Reference area.

Envelopes: Postmaster prepares single or continuous envelopes.

Mailing Labels: Standard or user-specified formats up to five across are supported by Postmaster. User may specify any number of labels per name.

Form Letters: Prepare and edit form letters in a variety of formats, on either single or continuous forms. Optional capability of allowing text or salutation "Inserts" for some or all letters in any print run.

Dedicated Record Sorting: Sorted files are re-written to disk. The sort may be in either ascending or descending order. Uses the FAST Shell-Metzner sorting algorithm.

Attractive Reports: Neat, paginated reports on either 80 or 132 column paper. The 80 column option allows your CRT to provide an attractive report display.

Clear, Complete Documentation: The manual will explain in simple English how to get started right away. Sample data and form-letter files are included on the disk to allow new users to experiment (learn) quickly.

Quality That's Affordable and Available: The Postmaster programs are available in a variety of 5" and 8" disk formats (40k of RAM, CP/M and CBASIC2 are required). Among the formats supported are TRS-80, North Star, Heath H8 and H89, standard 8" IBM, Vector MZ and other CP/M derivatives capable of running CBASIC.

COMPLETE PACKAGE: \$150.
MANUAL ALONE: \$15.

(Credited toward subsequent purchase)

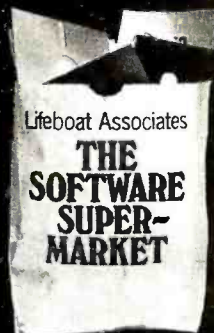

LIFEBOAT ASSOCIATES

2248 Broadway, New York, N.Y. 10024 ☐ (212) 580-0082 ☐ Telex: 668585

Text continued from page 82:

cates that double buffered animation is available, MAXC mode has 15 colors and 64 by 64 resolution, the display is in color, and MAXR mode has one color and 128 by 128 resolution.

8080/Dazzler Page

The PAGE routine takes advantage of the hardware requirement that refresh buffers start only on even page boundaries and are 2 K bytes long. The low-byte of the address is used for a free zero, while the HL register is incremented until H corresponds to the high-byte of the first address beyond the buffer.

8080/Dazzler Cursor

Since the same scaling routine is used for both CURSOR and LINE, CURSOR becomes an almost empty routine. Aside from preserving registers, all it does is call CU000 with the coordinates presented, and save the scaled result as the new software cursor position XPOS, YPOS.

The MODE byte engages in some trickery to indicate the desired mode efficiently. The numeric value associated with the mode is rotated right one bit position. The resultant value can be incremented up to 126 times and still remain negative if in MAXC or R64 mode, and positive if in MAXR or R128 mode. Since MAXR on the Dazzler is 128 by 128 resolution, and MAXC is 64 by 64, we have a simple test to determine which mode is in use.

The scale routine CU000 divides X and Y by 2, checks to see if R128 or MAXR is selected, and divides again if they are not.

8080/Dazzler DOT

This routine tends to be somewhat complex due to the convoluted mapping from bits in the byte to points on the screen used by the Dazzler in 128 by 128 resolution mode, and the dividing of the screen into four quadrants. Fortunately, if the 128 by 128 coordinates are divided by 2, the address and mask generated by applying the algorithm for 64 by 64 resolution yields the four bits corresponding to the four possible 128 by 128 points. The low-order bits of the X and Y coordinates lost in the division are then used to select the single bit corresponding to the desired point.

The four quadrant problem is similarly solved by using the high-order bit of each coordinate to determine the quadrant, and the remaining lower order bits to find the location inside the quadrant. Since these problems are unique to the Dazzler, they will not be discussed further. The interested reader is invited to trace the logic in the program listing.

One final comment on the DOT routine is appropriate. The DOT register restore sequence is also used by LINE and CHAR. If it is changed, the appropriate modifications will also be required in LINE and CHAR.

8080/Dazzler LINE

The LINE routine is almost a block-for-block encoding of the LINE algorithm. The variable name correspondence table (table 8) is provided as a cross-reference guide, since some of the variable names used in the algorithm were modified.

Because the values of XP and YP are lost when the cursor adjustments for "move 0" and "move 1" are looked up, initialization of variables is moved to immediately after sector determination. TA and T0 are both 16-bit numbers because they represent the product of two 8-bit numbers. The only 16-bit arithmetic available on the 8080 is addition. To subtract X from T0, the 16-bit two's complement of X, DX, is calculated and added. Similarly, DY is the 16-bit representation of Y.

The cursor adjustments required for a "move 0" and a "move 1" are looked up in the table MXT. Entries are indexed by sector weight. Each entry is four bytes long (MOX, MOY, M1X, and M1Y for the particular sector), so the sector weight is multiplied by 4 (two shifts left) and added to the starting address of the table. The correct cursor adjustments are then retrieved and stored where access is more convenient.

The only other significant change to the logic is the placement of the test for completion. For efficiency, x is compared to X immediately after the point is displayed. This has the added advantage of occurring at the only time the stack is free of temporary variables.

8080/Dazzler CHAR

The CHAR routine, with the exception of control character processing, also follows its Nassi-Schneiderman chart rigorously. The major change has been to convert to a SELECT construct the string of IFs used for control character processing. This avoids a multitude of tests which are guaranteed to fail once the character has been recognized. The processing of control characters with similar actions has also been consolidated to reduce redundancy.

As is obvious from its Nassi-Schneiderman chart, CHAR is really two independent routines with a common entry point. The only common code is the register saving and parity stripping. By pushing the address of the restore register routine onto the top of the stack, the return (RET) instruction will jump to the restore register sequence, restore all registers, and then return to the calling program.

The character matrix table is indexed by ASCII value minus 32, ie: the first entry is a blank. Since each entry is

Table 8: Variable name definitions for LINE.

8080 Software	Algorithm Description
XT	x
YT (not used)	y
XP	X
YP	Y
XPOS or XC	XC
YPOS or YC	YC
XF	XF
YF	YF
TA	TA
T0	T0
DX	-X
DY	+Y
MOX, MOY	Cursor adjustment for a "Move 0"
M1X, M1Y	Cursor adjustment for a "Move 1"

Note: The table numbering sequence is continued from part 1.

Up Your Output.

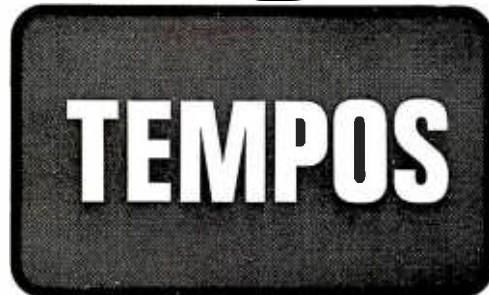

MULTI-TASKING!

The TEMPOS Operating System is quickly becoming the standard in Multi-User, Multi-Tasking operating systems for 8080 and Z80 microcomputers. Multi-Tasking means that, even with only one user at one terminal, more than one job can be running on the system *simultaneously!* If you have ever had to go get a cup of coffee while you wait for your computer to print listings, you know the advantages of a system that will handle one job while you are working on another. TEMPOS is a true time sharing system, and the maximum number of jobs is limited only by your memory.

MULTI-USER!

Want to share your computer with another user? With TEMPOS all it takes is another terminal... up to seven interactive terminals are allowed! And with Re-Entrant programs, each user does not need a complete copy in memory. We include three Re-Entrant programs (the OPUS/THREE High-Level Language, the TEXTED Text Editor, and FILES, a disc file directory/manipulator) or write your own! In addition, we include an assembler, a linking loader, over a half-dozen other utility programs and over 60 system subroutines, callable by the programmer!

PROVEN!

With TEMPOS, you get a package that has been tested in our facilities for over two years, and in the field at over 50 different installations. We have used this system ourselves for everything from writing high-level languages to developing applications to text editing to games. TEMPOS is undoubtedly the most flexible software tool on the market... and you can have it for much less than you think!

COMPATIBLE!

TEMPOS is available for many different systems; pre-written drivers may include yours. Or, using our interactive System Generation Routine, you can add your own. Call or write now for our free catalog and the name of a dealer near you. The TEMPOS Operating System is available for \$787.00, the manual set (price may be credited toward the purchase of the TEMPOS package) for \$21.50 (prices include shipping within the U.S.).



1642 S. Parker Road, Suite 300, Denver, Colorado 80231
(303) 755-9694

three bytes long, the index must be multiplied by 3 to get the offset into the table. (The format of the character table is fully defined in the comments preceding it in the listing.) The first byte of each entry contains all the flags describing the character. The width bits are masked off and the cursor value for the next character position calculated. If the width is 6 (including a blank pixel between characters) the special subroutine to generate the first column of a 5-column wide character is executed. The descender indicator flag is then checked and the cursor is adjusted if necessary.

The normal character generation code scans the character matrix row-by-row. Whenever a 1 is encountered, the DOT routine is called to display the pixel at that location. When all five rows are completed, the cursor value is set for the next character position as calculated earlier, and control returned to the calling program.

The special subroutine used for five wide characters generates only the first column. By incrementing the cursor position, the normal character generation sequence is used to generate columns 2 through 5 instead of the normal 1 through 4.

Control character handling proceeds in three phases. Phase 1 checks for any of the four mode controls and sets MODE as required. The Dazzler hardware must also be informed so it can change mode. Phase 2 is entered if the control character is not a mode control. This is an individual check for each of the carriage control characters. Note that to get to the top line, form feed must determine what resolution is in use. Phase 3, if reached, is current color selection. The value of the control character is first

checked to verify that it actually is a color select character. If it is black, the COLOR byte is set to all zeros. If any other color, a check is made to determine if the Dazzler is in a color supporting mode (MAXC or R64). If not, COLOR is set to all ones (high-resolution white). If a color mode is in use, the bright bit is set and the low-order four bits are duplicated in the high-half of the byte to yield a COLOR byte with the desired color in both pixel fields. Conveniently, the Dazzler color bit definitions match the lower three bits of the color select character.

A word of caution is in order for anyone using the compiler hexadecimal output in the listing directly, rather than the source code. The character table contains more bytes per line than the compiler used allocates for listing purposes (hence the "D" error). One must load the character table from the source code rather than from the compiler's hexadecimal output.

8080/Dazzler ANIMAT

The ANIMAT routine's implementation is adequately described in the comments on the listing. The flag byte ANIM indicates whether the first 2 K buffer or the second (auxiliary) 2 K buffer is currently being filled. Note that if the buffer swap were made as soon as vertical blanking was detected rather than as soon as vertical blanking was detected following an absence of vertical blanking, it would be possible to swap buffers, modify the display, and swap buffers again—all during one vertical blanking period. The net result, of course, would be that the one buffer would never be displayed, a clearly undesirable circumstance.

BATTERY-WRAP

WIRE WRAPPING TOOL

MODEL BW-2630

- POSITIVE INDEXING
- ANTI-OVERWRAPPING
- BITS AVAILABLE FOR AWG 26, 28 & 30
- BATTERY OPERATED
- LIGHT WEIGHT

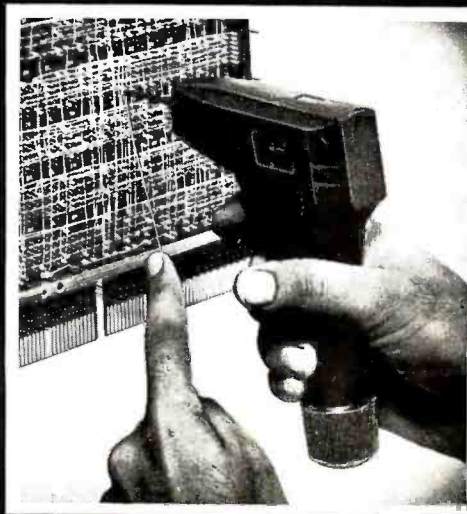

\$19⁸⁵*

BATTERIES AND BIT NOT INCLUDED

U.S.A.
FOREIGN
PATENTS
PENDING



OK MACHINE & TOOL CORPORATION

3455 CONNER STREET, BRONX, N.Y. 10475, U.S.A.

PHONE (212) 994-6600 • TELEX: 125091

BW-2630	BATTERY-WRAP TOOL	\$19.85
BT-30	BIT FOR AWG 30	\$ 3.95
BT-2628	BIT FOR AWG 26 & 28	\$ 7.95
RB-20	TWO NI-CAD BATTERIES	\$10.75

*MINIMUM BILLING \$25.00 / ADD SHIPPING CHARGE \$2.00 / NEW YORK CITY / STATE RESIDENTS ADD APPLICABLE TAX.

MICROSOFT CONSUMER PRODUCTS CONTINUING THE MICROSOFT TRADITION

Microsoft set the standard in microcomputer system software. We know more about the structure and capabilities of today's microcomputers than anyone else. And now we're using that power in a whole new way!

Announcing Microsoft Consumer Products. Distinctive software packages backed by the Microsoft name. Each is created by a top-notch programmer and comes to you fully documented, at a cost you can afford.

Microsoft Editor/Assembler-Plus.* Now get every feature of Radio Shack's Editor/Assembler and T-Bug all in one package. PLUS—many "big computer" features to simplify your programming, editing and debugging. All in a low cost cassette package. Don't waste time creating both source and object tapes—Assembler-Plus assembles directly into memory. Supports macros and conditional assembly, too. Editor-Plus simplifies editing with extra commands like Substitute, Move, Copy and Extend. And Z-Bug,** the most powerful debugger ever available for the TRS-80, has single step execution, direct execution in calculator mode and symbolic references. And, you can use up to 8 breakpoints at a time, with no need to remove a breakpoint before proceeding. For the 16K, Level II, cassette TRS-80. Priced at \$29.95.

Microsoft Adventure. Only Microsoft offers Adventure complete, as originally written for the DEC PDP-10, now implemented on personal computers. The ultimate fantasy/logic game, Adventure allows you to explore the depths of the "Colossal Cave," collecting treasures and magic, solving puzzles, avoiding hazards and adversaries—including the dreaded killer dwarves. Don't be fooled by imitation or incomplete versions. Only Microsoft has it all. Adventure fills an entire disk with everything you need for your exploration. Written by Gordon Letwin, of SOFTWIN, Associates. Adventure for the TRS-80 requires a single-disk, 32K system. For the Apple II,** a single-disk, 32K system with either the standard disk or language card system. For just \$29.95.

Microsoft Typing Tutor. There's no easier way to master your keyboard! Faster and more efficient than any other teaching method, Typing Tutor helps you if you're starting from scratch or simply building speed. The secret lies in Typing Tutor's exclusive TRM™ or "Time Response Monitoring" software. TRM monitors your keyboard 20 times per second so the computer can evaluate your skill. Your speed. Your errors. Your weakest keys. Typing Tutor tells you where you stand then automatically adjusts itself to help you improve. Written by Dick Ainsworth and Al Baker of the Image Producers, Inc. For the Apple II with 16K and Apple BASIC or the TRS-80 with 16K and Level II BASIC. Priced at \$14.95.

Microsoft Level III BASIC. Upgrade your Level II TRS-80 and increase your programming efficiency without additional hardware. Microsoft Level III loads from cassette tape on top of the Level II ROM. It gives you every feature of Disk BASIC except disk file commands. But that's not all—Level III's high-speed graphics turn your TRS-80* into a virtual electronic drawing board. And there's program renumbering, long error messages, quick shift-key entries, time-limit INPUT statements and many more features. System requirements: Level II BASIC and 16K. Occupies 5.2K RAM. Priced at \$49.95.

Where To Buy. Microsoft Consumer Products are sold by computer retailers nationwide. If your local computer store doesn't have them, call us. Phone (206) 454-1315. Or write Microsoft Consumer Products, 10800 Northeast Eighth, Suite 819, Bellevue, WA 98004.

*TRS-80 is a trademark of Radio Shack Corp. **Apple II is a trademark of Apple Computer, Inc. Editor/Assembler-Plus and Z-Bug are trademarks of Microsoft. TRM is a trademark of The Image Producers, Inc.



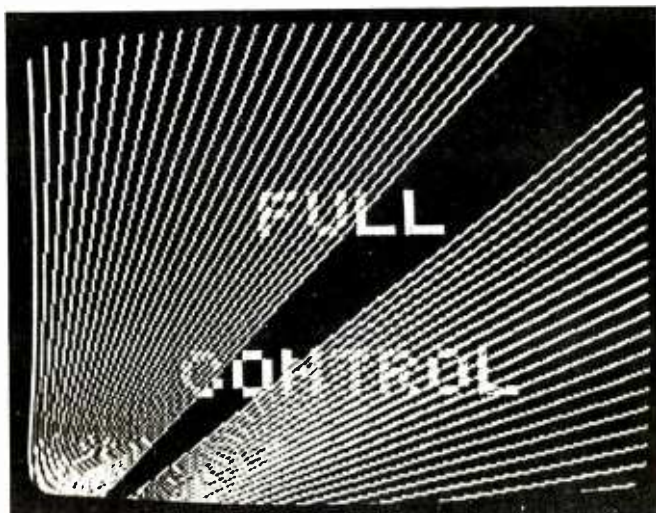

Photo 1: Display generated by demonstration program number 2 (see listing 2).



Photo 2: Display generated by demonstration program number 3 (see listing 2).

Demonstration Program

The demonstration program (see listing 2 on page 184) is provided for several purposes. Aside from demonstrating the power of the protocols, it serves as a tutorial in using the 8080 assembly language protocol and as a debugged, working user program for verifying successful implementation of the 8080 assembly language protocol. The photographs illustrating this article were all generated by this program and a Matrox ALT-256**2 display. The program contains four independent demonstrations and two utility subroutines. Equates are used to allow mnemonic references to the standard protocol's entry vectors, color controls, and display modes.

The first demonstration is a maximum-resolution exercise for the line generator. The identification message uses R64 resolution deliberately to get large characters. A series of maximum-length lines are drawn to generate the string art parabolas in each corner. The calculation of the endpoints of all the lines is simplified by the standard coordinate system. Their spacing is controlled by the value for MRSCFL returned by INITG. Because of the speed of generation, a variable delay utility subroutine, PAUSE, is used to give time to observe the display. These pauses may be extended indefinitely by setting the switch register to hexadecimal 01.

The second demonstration tests the generation of all 64 of the uppercase ASCII characters. Again, advantage is taken of the lowest resolution mode to display large characters. The 64 characters are drawn eight times, once in each color, in order to demonstrate the ability to vary the display dynamically. On the last iteration, the characters are drawn in black, leaving a clear screen. Rather than verify that the display is capable of selective erase, the PAGE routine is also called. The full range of available character sizes is then displayed using R64, MAXR, and R128 display modes for one line each. All mode changes are immediately followed by absolute cursor positioning commands to avoid erroneous results.

The third demonstration cycles through all available colors with the line generator. To avoid claiming Full Color Control on a monochrome display, the color bit in MAXCD is tested. MCCOLS is then checked to see how many colors or grey shades are available. All available colors are used, one at a time, as one end of each line is moved closer to (255,255). The attempt at mode RXXX, after shifting to R64, is ignored by the package in this article. The enhanced Dazzler package available from Cromemco uses it to select the Dazzler's 16-level grey scale mode.

The final demonstration is a short animation sequence. The header is inserted in both buffers. The auxiliary buffer must be cleared first, since this function is not included in the standard. If the display is not double buffered, this will also clear any warning messages generated by the graphics package.

The algorithm used to animate the figure will work with either double buffered displays or selectively erasable displays. For the former, the figure is backed up one step and drawn in black to erase it from the non-displaying buffer (PAGE would require too much time and erase the header). The figure is then advanced two steps to get to the position past the one currently being displayed and drawn in white. Finally, ANIMAT is called to display the updated buffer, and the whole procedure is repeated until the screen is traversed. If the display is not double buffered (tested using the ANIM field in MAXRD), the ANIMAT routine is called anyway to delay until the start of vertical blanking. While the display is busy with vertical blanking, the old figure is erased and the new one displayed. If all the changes can be made before the affected memory is displayed, there will not be any flicker, and the animation will be as smooth as when double buffering is used.

The STRING subroutine is a convenient utility for displaying text strings. It calls the CHAR routine with each successive character in a string of ASCII characters until an ASCII '\$' (hexadecimal 24) is detected.

**RADIO SHACK COMPUTER OWNERS
TRS-80 MODEL I AND MODEL II**

TRS-80TM MONTHLY NEWSLETTER

- PRACTICAL APPLICATIONS
- BUSINESS
- GAMBLING • GAMES
- EDUCATION
- PERSONAL FINANCE
- BEGINNER'S CORNER
- NEW PRODUCTS
- SOFTWARE EXCHANGE
- MARKET PLACE
- QUESTIONS AND ANSWERS
- PROGRAM PRINTOUTS
- AND MORE

PROGRAMS AND ARTICLES PUBLISHED IN OUR FIRST 12 ISSUES INCLUDE THE FOLLOWING:

- A COMPLETE INCOME TAX PROGRAM (LONG AND SHORT FORM)
- INVENTORY CONTROL
- STOCK MARKET ANALYSIS
- WORD PROCESSING PROGRAM (FOR DISK OR CASSETTE)
- LOWER CASE MODIFICATION FOR YOUR VIDEO MONITOR OR PRINTER
- PAYROLL (FEDERAL TAX WITHHOLDING PROGRAM)
- EXTEND 16-DIGIT ACCURACY TO TRS-80 FUNCTIONS (SUCH AS SQUARE ROOTS AND TRIGONOMETRIC FUNCTIONS)
- NEW DISK DRIVES FOR YOUR TRS-80
- PRINTER OPTIONS AVAILABLE FOR YOUR TRS-80
- A HORSE SELECTION SYSTEM*** ARITHMETIC TEACHER
- COMPLETE MAILING LIST PROGRAMS (BOTH FOR DISK OR CASSETTE SEQUENTIAL AND RANDOM ACCESS)
- RANDOM SAMPLING***BAR GRAPH
- CHECKBOOK MAINTENANCE PROGRAM
- LEVEL II UPDATES***LEVEL II INDEX
- CREDIT CARD INFORMATION STORAGE FILE
- BEGINNER'S GUIDE TO MACHINE LANGUAGE AND ASSEMBLY LANGUAGE
- LINE RENUMBERING
- AND CASSETTE TIPS, PROGRAM HINTS, LATEST PRODUCTS COMING SOON (GENERAL LEDGER, ACCOUNTS PAYABLE AND RECEIVABLE, FORTRAN-80, FINANCIAL APPLICATIONS PACKAGE, PROGRAMS FOR HOMEOWNERS, MERGE TWO PROGRAMS, STATISTICAL AND MATHEMATICAL PROGRAMS (BOTH ELEMENTARY AND ADVANCED) . . . AND

FREE WORD PROCESSING PROGRAM (Cassette or Disk)
For writing letters, text, mailing lists, etc., with each new subscriptions or renewal.

LEVEL II RAM TEST -
Checks random access memory to ensure that all memory locations are working properly.

SEND FOR OUR 36 PAGE SOFTWARE CATALOG (INCLUDING LISTINGS OF HUNDREDS OF TRS-80 PROGRAMS AVAILABLE ON CASSETTE AND DISKETTE), \$2.00 OR FREE WITH EACH SUBSCRIPTION OR SAMPLE ISSUE.

COMPUTRONICS
MATHEMATICAL APPLICATIONS SERVICE™

Box 149 New City, New York 10956



24 HOUR ORDER LINE
(914) 425-1535



ONE YEAR SUBSCRIPTION \$24
TWO YEAR SUBSCRIPTION \$48
SAMPLE OF LATEST ISSUE \$ 4

START MY SUBSCRIPTION WITH ISSUE _____
(#1 · July 1978 · #7 · January 1979 · #12 · June 1979)

NEW SUBSCRIPTION _____ RENEWAL _____

CREDIT CARD NUMBER _____ EXP. DATE _____

SIGNATURE _____

NAME _____

ADDRESS _____

*** ADD \$6/YEAR (CANADA, MEXICO) · ADD \$12/YEAR AIR MAIL · OUTSIDE OF U.S.A., CANADA & MEXICO ***

Conclusion

The availability of a powerful graphics protocol immensely simplifies the design and coding of graphics programs. The limitations imposed by forcing individual capabilities to meet a common protocol are more than made up by the availability of precisely defined functions and controls. Furthermore, the protocol is sufficiently flexible to allow the installation and use of unique display features without adversely affecting the ability to run programs designed to the standard. For example, the

package available from Matrox for its ALT-256**2 contains such enhancements as high-resolution positioning of low-resolution DOTs, choice of fixed or proportional character spacing, and up to 8 bits (256 combinations) color and/or grey scale for each pixel.

The author would like to thank John Rogers, Gary Johnsey, and especially Bart Schwartz for their help in making these articles possible.

Graphics Interface Standard for FORTRAN

The following FORTRAN subroutine definitions extend the flexibility and hardware independence of the proposed microcomputer graphics standard to FORTRAN.

INITG (XMRSCS, YMRSCS, MRCOLS, XMCSCL, YMCSCS, MCCOLS, LANIM, LCOLOR)

Initialize graphics hardware and software to maximum resolution mode with all options disabled. The screen is cleared and the current color is set to white. Eight variables are used to return the display parameters:

XMRSCS (REAL*4) X dimension of physical display points in standard coordinates, maximum resolution mode.

YMRSCS (REAL*4) — as above except Y dimension.

MRCOLS (INTEGER*2) — colors (grey shades) available in maximum resolution mode.

XMCSCL (REAL*4) — X dimension of physical display points maximum colors mode.

YMCSCS (REAL*4) — as above except Y dimension.

MCCOLS (INTEGER*2) — colors (grey shades) available in maximum color selection mode.

LANIM (LOGICAL*1) — TRUE if double buffered animation available.

LCOLOR (LOGICAL*1) — TRUE if display is in color, FALSE implies monochrome.

PAGE

Clear the screen

CURSOR (IX, IY)

Move the cursor to the coordinate position specified.

IX (INTEGER*2) — X (horizontal) coordinate desired. Value is in standard display coordinates (0 through 255). Out of range values are permitted but

may have unpredictable results.

IY (INTEGER*2) — as above except Y (vertical) coordinate desired. Lower left-hand corner of the screen is the point 0,0.

DOT

Display a dot at the current cursor position using the current color.

LINE (IX, IY)

Display a line from the current cursor position to the coordinate position specified. IX and IY are defined as in CURSOR.

CHAR (ICHAR)

The ASCII character defined by the low-order 7 bits of ICHAR is displayed at the current cursor position. Control characters are interpreted as defined in the standard to change display mode, current color, etc.

ICHAR (INTEGER*2) — the ASCII character to be interpreted or displayed.

ANIM

Program execution is delayed until the start of the next vertical blanking period. If double buffered animation is supported, buffers are not switched until immediately before returning.

WRITE (10, nnn) var, var, ...

The logical unit number 10 is available for formatted output to the display. Binary output will result in an I/O (input/output) error. Input attempts will return End of File. Rewind, endfile, and backspace operations are no-ops. The display must be initialized by INITG before writing to LUN 10. The first character output on each line is interpreted as a standard FORTRAN printer control character (' ' for single space, '0' for double space, '1' for new page, and '+' to overprint the same line).

Sample Program

```
C--- Example usage of FORTRAN Standard Graphics Calls
      LOGICAL*1 LANIM, LCOLOR
C--- Initialize graphics
      CALL INITG(XMRSCS, YMRSCS, MRCOLS, XMCSCL,
1 YMCSCS, MCCOLS, LANIM, LCOLOR)
C--- Title display
      WRITE (10, 100)
100  FORMAT(1H1, 'A SINE WAVE')
C--- Calculate and display a sine wave
```

```
C--- Move to starting point
      CALL CURSOR (0, 128)
C--- Determine distance between X values
      INCR = IFIX (YMRSCS + 0.5)
      IF(INCR.LE.0)INCR = 1
C--- Draw the actual curve
      DO 1000 IX = INCR, 255, INCR
        X = 3.14159*FLOAT(IX)/64.0
        Y = SIN(X)*100.0
        IY = IFIX (Y + 128.0)
1000  CALL LINE (IX, IY)
      END
```

PET / TRS-80 / APPLE: Personal Software brings you the finest!

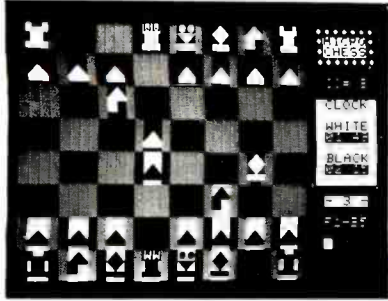

MICROCHESS

The Industry's First
Gold Cassette
Over 50,000 Sold

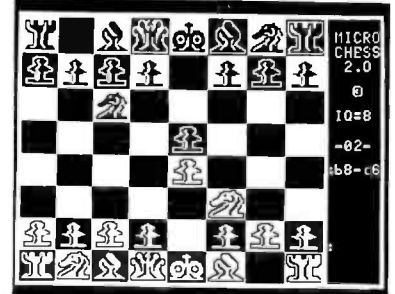

MICROCHESS is the industry's best selling computer game. And no wonder—because MICROCHESS gives you more than just a chessplaying program: A convenient, foolproof set of commands and error checks ... complete instructions in a 5½" by 8½" booklet ... a cassette that's guaranteed to load, with disk versions coming soon ... and several levels of difficulty to challenge you not just once, but time after time. It's available through well over three hundred computer stores and many mail order sources ... always

originating from Personal Software. What's more, every Personal Software product is selected to give you these same benefits of easy availability, reliable cassettes, readable documentation, a carefully thought out user interface ... and most important, continuing challenge and enjoyment, not just once but time after time. If you haven't already, order your own gold cassette: MICROCHESS, by Peter Jennings, for 8K PETs, 16K APPLEs, and 4K Level I and II TRS-80s \$19.95

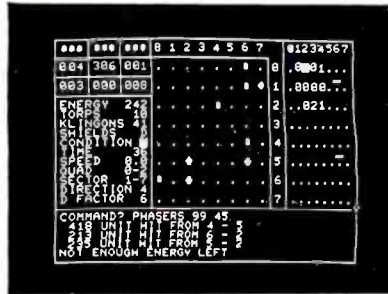

TIME TREK

A Tour De Force
In Real Time Action
Strategy Games

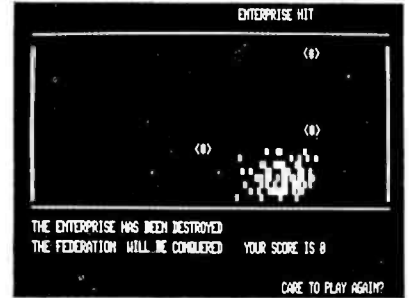

TIME TREK by Brad Templeton for 8K PETs and Joshua Lavinsky for 4K Level I and II TRS-80s adds a dramatic new dimension to the classic Star Trek type strategy game: REAL TIME ACTION! You'll need fast reflexes as well as sharp wits to win in this constantly changing game. Be prepared—the Klingons will fire at you as you move, and will move themselves at the same time, even from quadrant to quadrant—but with practice you can change course and speed, aim and fire in one smooth motion, as fast as you can press the keys. Steer under power around obstacles—evade enemy

shots as they come towards you—lower your shields just long enough to fire your phasers, betting that you can get them back up in time! With nine levels of difficulty, this challenging game is easy to learn, yet takes most users months of play to master. ADD SOUND EFFECTS with a simple two-wire hookup to any audio amplifier; the TRS-80 also produces sound effects directly through the keyboard case, to accompany spectacular graphics explosions! You won't want to miss this memorable version of a favorite computer game \$14.95

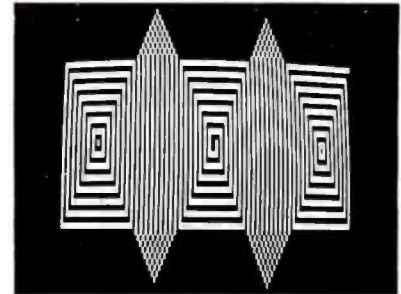
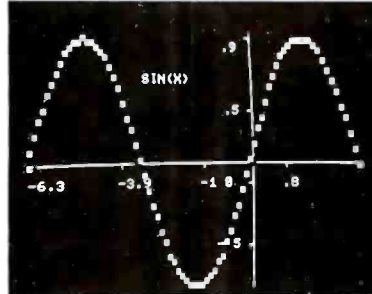
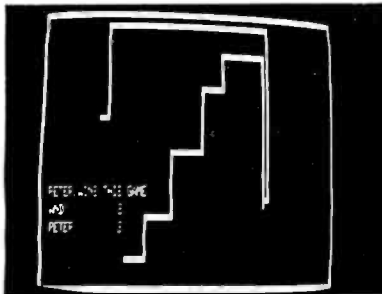

BLOCKADE by Ken Anderson for 4K Level I and II TRS-80s is a real time action game for two players, with high speed graphics in machine language. Each player uses four keys to control the direction of a moving wall. Try to force your opponent into a collision without running into a wall yourself! A strategy game at lower speeds, BLOCKADE turns into a tense game of reflexes and coordination at faster rates. Play on a flat or spherical course at any of ten different speeds. You can hear SOUND EFFECTS through a nearby AM radio—expect some razzing if you lose! \$14.95

GRAPHICS PACKAGE by Dan Fylstra for 8K PETs includes programs for the most common 'practical' graphics applications: PLOTTER graphs both functions and data to a resolution of 80 by 50 points, with automatic scaling and labeling of the axes; BARPLOT produces horizontal and vertical, segmented and labeled bar graphs; LETTER displays messages in large block letters, using any alphanumeric or special character on the PET keyboard; and DOODLER can be used to create arbitrary screen patterns and save them on cassette or in a BASIC program \$14.95

ELECTRIC PAINTBRUSH by Ken Anderson for 4K Level I and II TRS-80s: Create dazzling real time graphics displays at speeds far beyond BASIC, by writing 'programs' consisting of simple graphics commands for a machine language interpreter. Commands let you draw lines, turn corners, change white to black, repeat previous steps, or call other programs. The ELECTRIC PAINTBRUSH manual shows you how to create a variety of fascinating artistic patterns including the one pictured. Show your friends some special effects they've never seen on a TV screen! \$14.95

WHERE TO GET IT: Look for the Personal Software® display rack at your local computer store. For the name and address of the dealer nearest you, call Personal Software at (408) 745-7841. If you don't have a dealer nearby, you can call or mail us your order with your check, money order or VISA/Master Charge card number. For a free catalog, ask your dealer or use the reader service card at the back of this magazine.

PERSONAL SOFTWARE INC.
592 WEDDELL DR. • SUNNYVALE, CA 94086

December 1, 1979

Oregon Software inc. minicomputer

To the users of OMSI Pascal-1 for the PDP-11:

We are pleased to make available to you the new version (V1.2) of OMSI Pascal-1. V1.2 contains many enhancements and improvements, and you will find it easier to operate and even more reliable. The following overview outlines the most significant changes incorporated in the new version. For details, please ask for the V1.2 Language Specification and User's Guide(s).

Extended precision real arithmetic: a compiler switch causes all real calculations to be carried out with 15 digit precision (standard PDP-11 double precision four-word format). Extended precision is supported on all PDP-11 and LSI-11 processors, and on all operating systems. The precision of the library functions is also extended.

Debugger: the interactive debugger is now entirely Pascal-oriented, and is conversant with all user identifiers, types, scope rules, and the source program. The debugger has the capability, for example, to intercept a fatal error and display the last executed statements, or to accept and store commands for display of variables at a breakpoint.

Profiler: if you have ever wondered where your program spends its time, the Profiler can produce a listing and show you the number of times every line is executed.

Fatal error recovery: the system error procedure can be replaced by a Pascal-coded routine.

Direct access files: the procedure Seek(file,record) is a built-in procedure, and causes the file buffer to be positioned to any desired record.

File options: many enhancements have been made in file processing, allowing (for example) large buffers and spanned records on RSTS and RT11, and RSX file attributes including variable-length records. The RSTS file support uses 24-bit block numbers for RSTS V7 large file capability. All systems now support a full default filename when opening files.

Fast MACRO: most of the compilation time is actually spent in MACRO and the linking loader. On RSTS systems, a new utility (MAC) performs both of these functions in one-third of the time.

String package: included with V1.2 is a set of procedures and functions for handling dynamic length character strings. The package is written for portability in Standard Pascal.

Order information: to OMSI Pascal-1 licensees in warranty or extended support, V1.2 is available for the cost of handling, media, and shipping; other parties please contact Anne Smith, Vice-president for Sales.

Yours truly,



Donald Baccus

Vice-president, Software Engineering.

2340 SW Canyon Road Portland, Oregon 97201
(503) 226-7760 Cable: SOFTWARE TWX 910-464-4779

NEW!

Introduction to Low Resolution

GRAPHICS

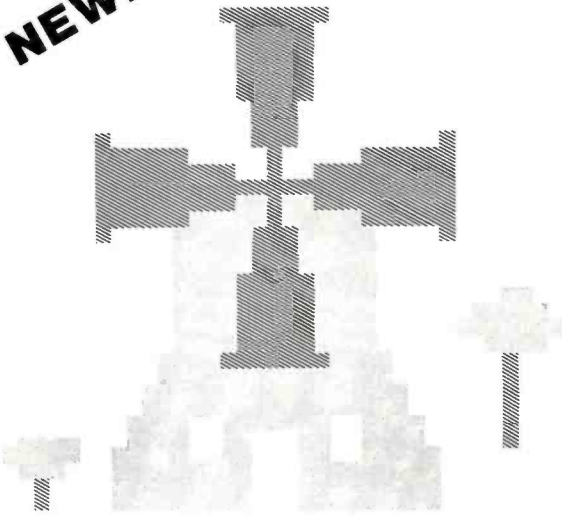

Now you can produce amazing computer graphics — even if you can't draw a straight line. Literally! Learn how to draw lines and shapes, make graphs, draw pictures and even do animations. The simple secrets of how to do all this are contained in SCELBI's new book "Introduction to Low Resolution Graphics."

Today's exciting personal and small business computing machines are generally provided with at least some kind of "low resolution" graphics capability. What is low resolution graphics? It is graphics presented on a point-by-point basis where the number of points is limited to about 8000 or less. The APPLE II by APPLE Computers, Inc., the Radio Shack TRS-80 and the Commodore PET all have low resolution graphics capability. So do many other kinds of microcomputers.

What can you do with low resolution graphics? Lots of things . . .

If you know how! You can plot plain and simple or fancy and complex graphs to consolidate data, for business or pleasure purposes. But you can do so much more than that! You can use the capability to improve the presentation and impact of almost anything you want your computer to tell people. It can be used to animate games or data, clarify and amplify educational materials, or just plain entertain people. Get started putting your computer to new and exciting uses through the world of graphics. Anyone can learn and apply these easy-to-understand techniques. Order your copy today!

Shows How to Draw

- *Straight lines*
- *Triangles*
- *Circles*
- *Elipses*
- *Borders*
- *Reverse backgrounds*
- *Deck of playing cards*
- *A clown that winks*
- *Football grid*
- *Animated football game*

In addition to these fundamentals of drawing and animation, the book tells how to synchronize computer-generated sounds to your illustrations.

\$9.95 □ No. 65 (use coupon on facing page)

NEW!

Z80 Software Gourmet Guide & Cookbook

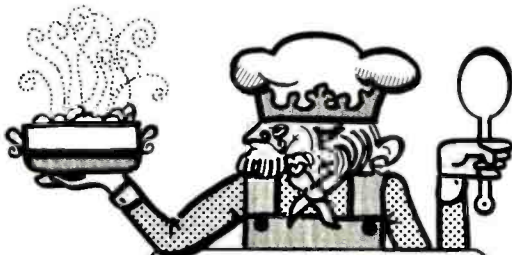

Put Together
Your Own Z80 Programs
Using These
Time-Tested Recipes

- Utility Routines —
- Stack Operations —
- Search and Sort Routines —
- Floating Point Routines —
- Z80 Instruction Set —
- And More —

You need this cookbook!

You'll be able to put together programs without having to start from scratch. You'll have the most useful routines at your command — already programmed and ready-to-use. You'll get a plain-talk explanation of how the powerful Z80 instruction set works. And that's a big value to everyone, Z80 owner or not!

Why is it called a cookbook?

Because it's a book of recipes. It contains routines, subroutines and short programs. These are the ingredients. All you do is take a pinch of this, a pinch of that. Combine the ingredients, and voila — your own masterpiece! Just the program to suit your taste.

Time tested recipes.

Check These Features

- *Handy reference to Z80 instruction set*
- *Search and sort routines*
- *Many general purpose utility routines*
- *Flow charts and source listings*
- *I/O and interrupt programming*
- *Machine codes given in both hexadecimal and octal notation*
- *How to control and manipulate Z80 stack*
- *Code and numeric conversion routines*

Although the Z80 cookbook is brand new, SCELBI's software cookbook idea has been around for years. The recipes are really time tested! Tens of thousands of our 6800 and 8080 cookbooks have been used throughout the U.S. and in countries around the world. Add the "Z80 Software Gourmet Guide & Cookbook" to your recipe filebox. Order today!

\$14.95 □ No. 75 (use coupon on facing page)



**SCELBI
Publications**

Hot to Trot... for Computers?

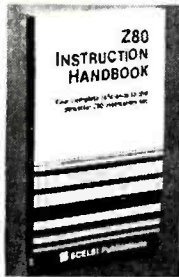

Z80 Instruction Handbook

A complete guide to the Z80 instruction set. Machine codes presented in both octal and hexadecimal format. An index lists instructions alpha-

betically along with machine codes and timing information. Industry-standard mnemonics used throughout.

\$4.95* No. 20



Personal Information Management System

Plain talk on what a computer can do for you. How to use a computer without knowledge of programming. 15 examples include

personal mailing list, accounts payable — even an intelligent ham radio log. For the TRS-80, PET and others.

\$9.95* No. 10

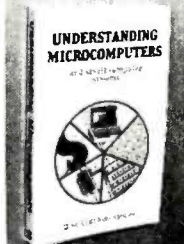

Understanding Microcomputers

300-page no-nonsense easy-reading text. Simple-to-use glossary. Extra knowledge for reading and understanding computer magazines and manufacturer's literature. Instructions for microcomputers. Machine language programming. Input/output devices. Gives an intro to BASIC.

\$9.95* No. 90

Calculating with BASIC

Calculating with BASIC

A variety of programs to help the student, scientist, engineer, technician or hobbyist apply the language to practical problems. Covers

mathematics, finance and statistics, mechanical engineering and electronics. For fun Hangman and Space Capture games are provided.

\$7.95* No. 30

MICRO COMPUTER



POTPOURRI

Microcomputer Potpourri

Reference for beginner, technician, engineer. Glossary with all the jargon. Helps beginners understand computer magazines, mfg. literature and serves as refer-

ence for the pro. Reviews microprocessor chips in detail. Complete text on understanding microcomputers.

\$2.95* No. 70



SCELBI Publications, P. O. Box 3133, Milford, CT 06460 203-874-1573

*IMPORTANT ORDERING INFO! Include \$1.00 shipping/handling for each item. Prices shown are for North American customers. Master Charge, VISA, Postal and Bank Money Orders preferred. Personal checks delay shipping up to 4 weeks.

No. 10 No. 20 No. 30 No. 65 No. 70 No. 75 No. 90

Name (please print) _____

Card No. _____ Bank No. _____ Exp. _____

Address _____

City/State _____ Zip _____

Signature _____ Amt. Enc. _____

See SCELBI books at your favorite
computer or electronics store.

Lasting 2 continued:

8531 68	L-C	MOV	8531 218AB	LXI	M-STR8	*HARD SMALL* → SHIFT TO R128
8532 C01881	L-C	CALL	8532 C09187	CALL	STR18H	
8533 68	M-B	MOV	8532 21484D	LXI	M-AD8H	
8536 68	L-C	MOV	8532 C08A81	CALL	CURSOR	
8537 C01881	CALL		8532 211358	LXI	M-STR8	*CHARACTERS*
8538 68	M-D	CALL	8532 C09187	CALL	STR18H	
8539 68	L-B	MOV	8532 881A	MVI	B-T8H	LET THAT SURE IN
853C C01881	CALL		8532 C08187	CALL	PAUSE	*FOR A WHILE
853D 2AC8B8	L-N	MOV	853D C08187	CALL	PAUSE	*CLEAR FOR NEXT DEMO
853E 7818	M-D	MOV	853E C08187	CALL	PAUSE	
8540 2C	A	MOV	8540 C08187	CALL	PAUSE	
8548 17	RAL					
855A 17	RAL					
855A 17	RAL					
855B 82	MOV					
856C 37	MOV					
856D 3A85	JNC					
8578 881A	MVI					
857E C0A187	CALL					
8580 78	MOV					
8581 82	MOV					
8582 82	MOV					
8583 82	MOV					
8584 82	MOV					
8585 82	MOV					
8586 82	MOV					
8587 82	MOV					
8588 82	MOV					
8589 82	MOV					
858A 82	MOV					
858B 82	MOV					
858C 82	MOV					
858D 82	MOV					
858E 82	MOV					
858F 82	MOV					
8590 82	MOV					
8591 82	MOV					
8592 82	MOV					
8593 82	MOV					
8594 82	MOV					
8595 D87F83	JNC					
8596 7D	MOV					
8599 8E8H	MOV					
859C 8A8383	MOV					
859F 8A	JC					
85A8 C38A83	JMP					
85AB 8882	MOV					
85A5 C0A187	CALL					
85AB 8D	BCR					
85A9 727F85	JP					
85AC C08781	CALL					
85B2 81C64D	LXI					
85B2 C08A81	CALL					
85B3 21888D	LXI					
85B4 21888D	LXI					
85B5 21888D	LXI					
85B6 21888D	LXI					
85B7 21888D	LXI					
85B8 21888D	LXI					
85B9 21888D	LXI					
85BA 21888D	LXI					
85BB 21888D	LXI					
85BC 21888D	LXI					
85BD 21888D	LXI					
85BE 21888D	LXI					
85BF 21888D	LXI					
85C0 21888D	LXI					
85C1 21888D	LXI					
85C2 21888D	LXI					
85C3 21888D	LXI					
85C4 21888D	LXI					
85C5 21888D	LXI					
85C6 21888D	LXI					
85C7 21888D	LXI					
85C8 21888D	LXI					
85C9 21888D	LXI					
85CA 21888D	LXI					
85CB 21888D	LXI					
85CC 21888D	LXI					
85CD 21888D	LXI					
85CE 21888D	LXI					
85CF 21888D	LXI					
85D0 21888D	LXI					
85D1 21888D	LXI					
85D2 21888D	LXI					
85D3 21888D	LXI					
85D4 21888D	LXI					
85D5 21888D	LXI					
85D6 21888D	LXI					
85D7 21888D	LXI					
85D8 21888D	LXI					
85D9 21888D	LXI					
85DA 21888D	LXI					
85DB 21888D	LXI					
85DC 21888D	LXI					
85DD 21888D	LXI					
85DE 21888D	LXI					
85DF 21888D	LXI					
85E0 21888D	LXI					
85E1 21888D	LXI					
85E2 21888D	LXI					
85E3 21888D	LXI					
85E4 21888D	LXI					
85E5 21888D	LXI					
85E6 21888D	LXI					
85E7 21888D	LXI					
85E8 21888D	LXI					
85E9 21888D	LXI					
85EA 21888D	LXI					
85EB 21888D	LXI					
85EC 21888D	LXI					
85ED 21888D	LXI					
85EE 21888D	LXI					
85EF 21888D	LXI					
85F0 21888D	LXI					
85F1 21888D	LXI					
85F2 21888D	LXI					
85F3 21888D	LXI					
85F4 21888D	LXI					
85F5 21888D	LXI					
85F6 21888D	LXI					
85F7 21888D	LXI					
85F8 21888D	LXI					
85F9 21888D	LXI					
85FA 21888D	LXI					
85FB 21888D	LXI					
85FC 21888D	LXI					
85FD 21888D	LXI					
85FE 21888D	LXI					
85FF 21888D	LXI					

Listing 2 continued on page 192

```
...and processors are here. Just thumb through the pages of this magazine. There are at least five different companies selling them. So, which one's for you? How do you judge the differences? And what about cost. Are you willing to pay the 300 plus dollars that some of the companies are asking?

Well go ahead and compare! AUTOTYPE comes out ahead in EVERY category!

Features? AUTOTYPE has more powerful features than ANY other Word Processor on the market. But, don't take our word. Go ahead, compare! AUTOTYPE has an exclusive MACRO programming capability. No other Word Processor can make that claim. AUTOTYPE also has a scratch Holding Buffer. Again, no one else even comes close.

Price? AUTOTYPE beats 'em all! With a price tag of $195, AUTOTYPE is well below the competition. But, again, don't just take our word. Go ahead, look for yourself. Then fill out the order form below to start processing words instead of using a word processor!

CAN I MOVE PARAGRAPHS AROUND?

YES! AUTOTYPE has a Holding Buffer that can be used to save any amount of text and then Unhold it to the location you want. AUTOTYPE even allows you to do multiple Unholds!

CAN I MERGE CUSTOMERS NAMES INTO LETTERS?

YES! AUTOTYPE contains a "merge" character that may be placed anywhere in text. Then, at the time text is printed, a separate file may be merged into the letter and then printed! Another feature that NO OTHER WORD PROCESSOR has!

CAN I ENTER TEXT IN SOME OTHER FORMAT THAN 64 CHARACTERS WIDE?

YES! AUTOTYPE has a screen redimension command. The screen can be set from 16 characters wide to 120 characters wide. There's even horizontal scrolling to view the text! Once more, we're far beyond the competition!

CAN IT HANDLE TEXT LARGER THAN MY COMPUTERS MEMORY?

YES! Most other Word Processors demand that the entire text be inside the computer. AUTOTYPE allows you to "spool" your text from the disk. This means that you can have edit files that are over 200 type written pages long!!

CAN IT UNDERLINE?
CAN IT BOLDFACE?
CAN IT INDENT?
CAN IT HYPHENATE?

YES! YES! YES! YES! AUTOTYPE has ALL the standard Word Processor features including underlining text, boldface printing and paragraph indentation. AUTOTYPE also has soft and hard hyphens. Soft hyphens are used at the end of lines and disappear if moved!

WHAT ABOUT INSERTING IN THE MIDDLE OF A WORD?

Certainly! AUTOTYPE allows inserting anything anywhere! You can move single letters or entire chapters right into the middle of any word. Now THAT'S POWER!!
```

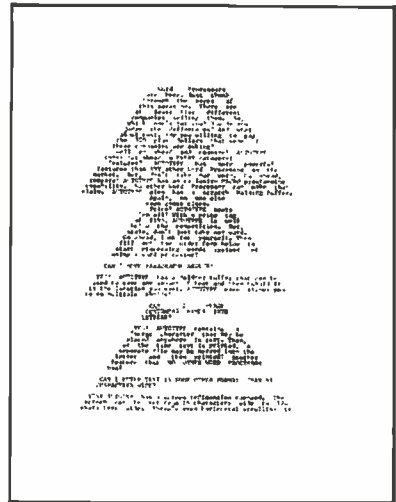
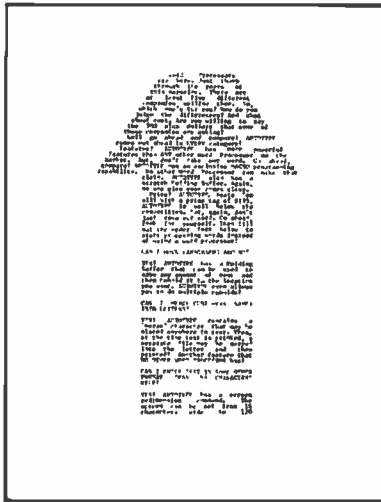

Word Processors are here. Just thumb through the pages of this magazine. There are at least five different companies selling them. So, which one's for you? How do you judge the differences? And what about cost. Are you willing to pay the 300 plus dollars that some of the companies are asking?

Well go ahead and compare! AUTOTYPE comes out ahead in EVERY category!

Features? AUTOTYPE has more powerful features than ANY other Word Processor on the market. But, don't take our word. Go ahead, compare! AUTOTYPE has an exclusive MACRO programming capability. No other Word Processor can make that claim. AUTOTYPE also has a scratch Holding Buffer. Again, no one else even comes close.

Price? AUTOTYPE beats 'em all! With a price tag of \$195, AUTOTYPE is well below the competition. But, again, don't just take our word. Go ahead, look for yourself. Then fill out the order form below to start processing words instead of using a word processor!

CAN I MOVE PARAGRAPHS AROUND?

YES! AUTOTYPE has a Holding Buffer that can be used to save any amount of text and then Unhold it to the location you want. AUTOTYPE even allows you to do multiple Unholds!

CAN I MERGE CUSTOMERS NAMES INTO LETTERS?

YES! AUTOTYPE contains a "merge" character that may be placed anywhere in text. Then, at the time text is printed, a separate file may be merged into the letter and then printed! Another feature that NO OTHER WORD PROCESSOR has!

CAN I ENTER TEXT IN SOME OTHER FORMAT THAN 64 CHARACTERS WIDE?

YES! AUTOTYPE has a screen redimension command. The screen can be set from 16 characters wide to 120 characters wide. There's even horizontal scrolling to view the text! Once more, we're far beyond the competition!

CAN IT HANDLE TEXT LARGER THAN MY COMPUTERS MEMORY?

YES! Most other Word Processors demand that the entire text be inside the computer. AUTOTYPE allows you to "spool" your text from the disk. This means that you can have edit files that are over 200 type written pages long!!

CAN IT UNDERLINE? CAN IT BOLDFACE? CAN IT INDENT? CAN IT HYPHENATE?

YES! YES! YES! YES! AUTOTYPE has ALL the standard Word Processor features including underlining text, boldface printing and paragraph indentation. AUTOTYPE also has soft and hard hyphens. Soft hyphens are used at the end of lines and disappear if moved!

WHAT ABOUT INSERTING IN THE MIDDLE OF A WORD?

Certainly! AUTOTYPE allows inserting anything anywhere! You can move single letters or entire chapters right into the middle of any word. Now THAT'S POWER!!

CAN IT SEARCH AND REPLACE?

YES! But, there's more! AUTOTYPE allows simple searches of search and replace. AUTOTYPE also allows wild card characters in the search string for probable matching! A very simple feature that AUTOTYPE makes very powerful!

CAN IT DO AUTOMATIC PAGE NUMBERING AND TITLING?

Of Course! Any length title up to the current line length. Page numbers can start anywhere. And if that's not enough, the number of blank lines below the title is adjustable!

DOES IT HAVE "DYNAMIC" PRINT FORMATTING?

OH YES! And with a flare! The pages that you see printed here were all printed from the same file. Only the print MACRO was altered! What's more, they were all printed on a standard serial printer. Complete "dynamic" print formatting can be accomplished with NO alteration of text! Let's see the competition make that claim!

CAN IT DO SUBSCRIPTS AND SUPERSSCRIPTS?

YES! Once again, AUTOTYPE has the features to be called a true processor of words and not just another word processor.

CAN IT VERTICAL TAB?

YES! And do negative vertical tabs to the top of page also! This is invaluable for two column printing.

CAN YOU ADJUST THE INDENT, LINE LENGTH AND JUSTIFICATION?

COMPLETELY! Either in the text itself, by manual formatting commands or with a print MACRO. Only AUTOTYPE gives you that kind of choice!

WILL IT EXECUTE A SERIES OF COMMANDS AUTOMATICALLY?

YES! That's one of AUTOTYPE's standard features. No other Word Processor has the ease of use or the powerful commands that AUTOTYPE has.

ARE THE TABS ADJUSTABLE?

All tab stops are displayed graphically with a simple command. Tab removal and setting are simple cursor movements and a single key command! No more "guessing" where your tabs are set. They're all laid out in front of you!

HOW MUCH DOES AUTOTYPE COST?

\$195. This question is the easiest to answer. It's simple. We want you to use your computer to its fullest extent. And we want you to be able to do it at a reasonable price. This is the one area where our competition is way ahead of us! They simply charge more than we do!

HOW DO I ORDER?

We thought you'd never ask! Just fill out the order form below and mail to INFINITY MICRO. Or call us directly and place your order. It'll be shipped the same day.

WORD PROCESSING POWER IS HERE! With AUTOTYPE®

Mail To:
INFINITY MICRO
P.O. BOX 4627
SANTA CLARA, CA 95050
(408) 988-1867

VIDEO

- Memory mapped Video at CC00 hex. as 64 characters by 16 lines. Processor Tech or equivalent.
- *Cursor addressable terminal. (ADM-3A)
- *Cursor addressable terminal. (HAZELTINE 1500)

DISK

- CP/M on IBM standard 8"
 - CP/M on Micropolis MOD I
 - CP/M on Micropolis MOD II
 - CP/M on North Star
 - CP/M on Double Density 8"
- Please specify Manufacturer.

NAME _____
ADDRESS _____
CITY _____ STATE ____ ZIP ____
PHONE _____

Please ship _____ AUTOTYPE disks and manuals immediately! Please find enclosed \$ _____ @ \$195/each.

* Available Nov-Dec of 1979
Copyright © 1979 Infinity Micro

TSE "TRS-80 USERS! Your Software Supermarket"

GAMES

Warfare I 4-game anthology, Level II, 16K \$7.95
Backgammon by Scott Adams. Level II, 16K \$7.95
X-Wing II by Chris Freund. Level II, 16K \$9.95
Talpan by Art Canfil. Level II, 16K \$9.95
Sargon Chess by Dan and Kathe Spracklen. Level II, 16K \$19.95
Chess Companion by Michael Kelleher. Level II, 16K \$7.95
Three D Tic Tac Toe by Scott Adams. Level II, 16K \$7.95
Concentration by Lance Micklus. Level II, 16K \$7.95
Amazin' Mazes by Robert Wallace. Level II, 16K \$7.95
Time Bomb by David Bohlke. Level II, 16K \$4.95

Life Two by Leo Christopherson. With sound -Level II, 16K \$14.95
Android Nim by Leo Christopherson. With sound - Level II, 16K \$14.95
Cubes by Leo Christopherson Level II, 16K \$9.95
Mastermind II by Lance Micklus \$7.95
Mastermind II - Source List -\$20.00
Robot/Breakaway Game duo by Lance Micklus. Level II, 4K \$7.95
Tycoon by David Bohlke. Level II, 16K \$7.95
Slalom by Denslo Hamlin. level II, 16K \$7.95
9 Games for Preschool Children by George Blank. Level II, 16K \$9.95
Ten Pin by Frank B. Rowlett, Jr. Level II, 16K \$7.95
Atlantic Balloon Crossing by Dean Powell. Level II, 16K \$9.95
Space Battles by Level IV, Level II, 16K Tape or 32K Disk, Tape -\$14.95, Disk -\$19.95

Star Trek III.3 by Lance Micklus Level II, 16K \$14.95
Dog Star Adventure by Lance Micklus. Level II, 16K \$9.95
Safari by David Bohlke. Level II, 16K \$7.95
Treasure Hunt by Lance Micklus. Level II, 16K \$7.95
'Round the Horn by George Blank. Level II, 16K \$9.95
Pork Barrel by George Blank. Level II, 16K \$7.95
Kamikaze by Russell Starkey. Level II, 16K \$7.95
All Star Baseball by David Bohlke. Level II, 16K \$7.95
Barricade by Small Systems Software. Machine Language -\$14.95
Journey To The Center Of The Earth by Greg Hassett. Level II, 16K Tape \$7.95
Pentominoes by James Garon. Level II, 16K \$7.95
Snake Eggs by Leo Christopherson. With sound Level II, 16K \$14.95

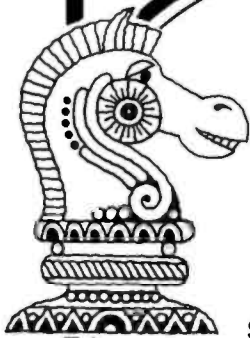

**Now
In Stock!**

SARGON was the BEST
SARGON II is MUCH
BETTER!

Seven levels of play ...
faster, better end game ...
randomized opening.

\$29.95

BOOKS

Sargon Handbook by Don & Kathe Spracklen. \$14.95 plus \$1.00 shipping and handling.
The Basic Handbook by Dr. David A. Lien. \$14.95 plus \$1
Z80 Instruction Handbook by Scelbi Publications. \$4.95
The Little Book Of BASIC Style by John Nevison. \$5.95 plus \$1
TRS-80 Assembly Language Programming by William Barden, Jr. \$3.95 plus \$1
Introduction to TRS-80 Graphics by Don Inman. \$7.95 plus \$1
Learning Level II by David A. Lien. \$15.95 plus \$1

NEW!!!

Understandable! Indexed library with 200
Assembly Language Routines.

Z80 Software Gourmet Guide And Cookbook

from Scelbi. \$14.95 + \$1 postage.

SPECIAL PURPOSE

Calculator by R. W. Robitaille, Sr. Level II, 4K \$2.95
Moving Signboard by Circle Enterprises. Level II. 4K \$9.95
Histogram/Scattergram by Gary S. Breschini. Level II, 16K \$9.95.
Simple Simon by George Blank. Level II. Written In BASIC. \$4.95
Math Drill by K. L. Brown. Level II, 16K \$4.95
RPN Calculator by Russell Starkey. Level II, 16K \$9.95
Ham Radio by Michael Kelleher. Level II, 16K \$9.95
Ham Radio ARS I.1 (32K disk) \$24.95
Electronics Assistant by John Adamson. Level II, 16K \$9.95
Preflight by Stephen Hebbler. Level II, 16K \$20.00
Basic Statistics by Steve Reisser. Level II, 16K \$20.00
Drill Masters by Computer Graphics - specify title desired. Level II, 16K \$7.95 each. German, Russian, Italian, Spanish, or Music Theory
Keyboard-80 by John Adamson. Level II, 16K \$9.95

0 TRIAL OFFER!
1 SAMPLER \$5.95
2 PIRATE'S COVE
3 ADVENTURELAND
4 VOODOO CASTLE
5 MISSION IMPOSSIBLE
6 STRANGE ODYSSEY
7 FUN HOUSE
8 BRAND NEW! PYRAMID OF DOOM
THE COUNT

SCOTT ADAMS' ADVENTURES

Cassettes \$14.95
 Combinations on disk:
 2 for \$24.95
 3 for \$39.95

ST-80D

by Lance Micklus

The STANDARD
in Smart Terminal
Programs for the TRS-80

(32K Disk)
\$79.95

IMPORTANT

- No sales tax •
- All C.O.D.'s or special •
delivery orders are a mini-
mum of \$5 for special
handling
- When ordering Percom •
please add \$5 each,
packaging and handling fee.
- PRICES DO NOT •
INCLUDE SHIPPING

BUSINESS

- Inventory II.2 by M. Kelleher and R. W. Robitaille, Sr. 16K disk systems \$59.95
- Inventory System II.3 by M. Kelleher. Improved version, \$79.95
- Inventory 'S' by Roger W. Robitaille, Sr. Level II, 16K Tape -\$24.95; 32K Disk -\$39.95
- Payroll by Stephen Hebbler. For disk systems. 32K \$59.95
- Accounts Receivable II by S. Hebbler. 32K disk systems \$79.95
- Appointment Log by Michael Kelleher. Level II, 16K \$9.95 Disk version, \$19.95
- General Ledger I by M. Kelleher, requires 32K Disk, \$79.95
- Mail List II by R. W. Robitaille, Sr. 32K disk systems \$99.95
- Small Business Bookkeeping by R. W. Robitaille, Sr. Level II, 16K. With Journal -\$22.00; Without Journal - \$15.00

UTILITIES

- NEWDOS by Apparat \$49.95
- NEWDOS+ by Apparat \$99.95
- Machine Language Monitor by Small Systems Software. Level II, 16K \$26.95
- Three Monitors for Disk by Small Systems Software. Disk for 16 through 48K (all in one) \$29.95
- KVP Extender by Lance Micklus. Tape - \$29.95; Disk - \$34.95
- KVP 232 by Lance Micklus - KVP adapted for the TRS-232. Tape - \$29.95
- ST80 Smart Terminal Level II, 16K \$49.95
- ST80D Smarter Terminal for disk systems. \$79.95
- Micro Text Editor by Don Coons. Level II, 4K or 16K \$9.95

- Text-80 by Frank B. Rowlett, Jr. For 32K disk systems \$59.95
- 8080-Z80 Conversion Level II, 16K \$15.00
- Renumber by Lance Micklus. Level II, available in 16 through 48K (specify when ordering) \$7.95
- Renumber source listing \$20.00
- Electric Pencil by Michael Shrayar. Powerful machine language word processing system. Level II, 16K tape - \$100; Disk version - \$150
- Level III BASIC by Microsoft. \$49.95
- Level I in Level II by Apparat. Level II, 16K \$15.00
- Fortran by Microsoft. 32K - 2 Disks. New low price \$195.00

PERSONAL

- Typing Tutor by Roger W. Robitaille, Sr. Level II, 16K \$19.95
- Secrets of the Tarot by John T. Phillip. Level II, 16K \$9.95
- Biorhythms by Frank B. Rowlett, Jr. Level II, 4K \$4.95
- Personal Finance by Lance Micklus. Level II, 16K \$9.95
- Advanced Personal Finance by Lance Micklus for 32K disk systems \$24.95
- Home Financial Management by Michael Kelleher. Level II, 16K \$9.95

HARDWARE ACCESSORIES

- Cassettes boxes of ten each. C-10 - \$6.50 plus \$1.00 shipping
- C-20 - \$7.50 plus \$1.00 shipping
- Diskettes Dysan, (premium quality) box of 5 -\$24.95 plus \$1.00 shipping; nationally known brand, box of 10 - \$34.95 plus \$1
- Diskette Storage Box \$5.00

Floppy Armour™ Protective envelope for shipping floppy disks, 5-pack - \$4.95 plus \$1.00 shipping and handling

NEWDOS

Eliminate 90% of the hassle of a disk system by replacing your TRS-DOS with NEWDOS! faster, more reliable, many more features \$49.95.

or

Add Superzap, Directory checks, other utilities. NEWDOS+ \$99.95

PACKAGE PRICE \$150

SEPARATELY:
MACRO ASSEMBLER \$80.
FORTRAN \$80.



WANTED

Used TRS-80 equipment! We buy and sell used equipment. Call or write for details.

SPECIAL

\$669. TRS-80
16K, LEVEL II
NO KEYPAD.

MAGAZINES

SoftSide(monthly)

\$18. 1 yr., Bulk Rate
\$30. 1 yr., Overseas Airmail
\$25. 1 yr., First Class or Overseas Surface
\$38. 6 mos. w/cassette \$68. 6 mos. w/disk

PROG/80(bi-monthly)

\$15. 1 yr., Bulk Rate
\$22. 1 yr., First Class or Overseas Surface
\$27. 1 yr. Overseas Airmail

SoftSide's AppleSeed(monthly)

\$15. 1 yr., Bulk Rate
\$22. 1 yr., First Class

SAVE \$167.

TRS-80 expansion interface with our 16K RAM, single PERCOM disk drives with cable, and NEWDOS operating system. \$830.

FREE!!

For more detailed descriptions of our software and accessories, send for the "TSE" catalog...it's FREE!

TRS 232 by Small Systems Hardware - \$49.95

Percom Disk Drives Single or dual, for TRS-80's. Single drive -\$399.00; Dual drive - \$795.00; Cable required - \$29.95

ASK ABOUT OUR FREE HARDSIDE CATALOG

TO ORDER (9AM - 5:30 PM, EST)
TOLL-FREE 1-800-258-1790

The Software Exchange

6 South Street, Box 68, Milford, NH 03055 603-673-5144

* A trademark of Radio Shack and Tandy Corp.

Build your own microcomputer as you learn computer technology at home.

New from NRI! The Most Complete and Up-to-date Home Study Course Ever Offered

As the microprocessor revolutionizes the computer world and microcomputers appear almost everywhere, NRI brings you a new, convenient, and effective way to keep up with this expanding technology. It's NRI's Computer Technology Course, created and designed exclusively for learning at home in your spare time.

Featuring NRI's Exclusive Dual Language Microcomputer

NRI goes beyond book learning to give you practical, "hands-on" experience in designing circuitry, interfacing components, programming, and troubleshooting. As you learn, you actually assemble NRI's designed-for-learning microcomputer, incorporating the latest advances in the state of the art. It looks and operates like the finest of its kind, actually does more than many commercial units. But NRI engineers have designed components and planned assembly so it demonstrates important principles, gives you working experience in detecting and correcting problems. And it's yours to keep, put to work in your own home or business.

You also build and keep your own test instruments, including a transistorized volt-ohm meter and CMOS digital frequency counter. And NRI's Discovery Lab[®] broadens your horizons with specialized experiments and theory demonstrations.

The Proven Way to Learn at Home

You don't have to worry with travel, classes, or time lost from work when you learn the NRI way. As they have for more than 60



years of teaching technical subjects, NRI brings the material to you. You study in your spare time, at your convenience, using "bite-size" lessons that program material into logical segments for easier assimilation. You perform experiments and build equipment using kits we supply. And your personal NRI instructor is always available for consultation should you have questions or problems. Over a million students have already shown the effectiveness of NRI training.

Choice of Courses

Several courses are available, depending

upon your needs and background. NRI's Master Course in Computer Technology starts with the fundamentals, explores basic electronics and digital theory, the total computer world, and the microcomputer. The Advanced Course, for students already versed in electronics and general computers, concentrates on the microprocessor and microcomputer. In both courses, you build all instruments and your own computer.

Send for Free Catalog... No Salesman Will Call

Get the details on these exciting new courses in NRI's free, 100-page catalog. Shows all kits and equipment, lesson outlines, and full information, including facts on other electronics courses. Mail the coupon today and we'll rush your catalog. No salesman will ever call. Keep up with the latest technology as you learn on your own computer. If coupon has been removed, write to NRI Schools, Computer Department, 3939 Wisconsin Ave., Washington, D.C. 20016.



NRI Schools
McGraw-Hill Continuing
Education Center
3939 Wisconsin Avenue
Washington, D.C. 20016

NO SALESMAN WILL CALL
Please check for one free catalog only:

- Computer Electronics Including Microcomputers
- TV/Audio/Video Systems Servicing
- Complete Communications Electronics with CB • FCC Licenses • Aircraft, Mobile, Marine Electronics
- CB Specialists Course
- Amateur Radio • Basic and Advanced



All career courses approved under GI Bill.
 Check for details.

- Digital Electronics • Electronic Technology • Basic Electronics
- Small Engine Repair
- Electrical Appliance Servicing
- Automotive Mechanics
- Auto Air Conditioning
- Air Conditioning, Refrigeration, & Heating Including Solar Technology

Name _____ (Please Print) Age _____

Street _____

City/State/Zip _____

Accredited by the Accrediting Commission of the National Home Study Council 170-12-9

Listing 2 continued:

```

0732 62      MOV      H,A
0733 2E14    MVI     L,20
0735 CD1001  CALL    JL,20 >> LEFT LEG
0738 2E25    MVI     L,37
073A 67      MOV      H,A
073B CD0A01  CALL    CURSOR
073E 2E30    MVI     L,48
0740 CD1001  CALL    JX+1,48 >> LEFT BOD
0743 2E26    MVI     L,38
0745 91      SUB      C
0746 67      MOV      H,A
0747 CD1001  CALL    JX+1-A5,38 >> LEFT ARM
074A 78      MOV      H,A
074B 67      MOV      H,A
074C 2E25    MVI     L,37
074E CD0A01  CALL    JSAME FOR RIGHT SIDE
0751 2E30    MVI     L,48
0753 CD1001  CALL    JX-1,37
0756 2E26    MVI     L,38
0758 81      ADD      C
0759 67      MOV      H,A
075A CD1001  CALL    JX-1-A5,38 >> RT ARM
075D 0A      INR     B
075E 2E30    MVI     L,48
075F 60      MOV      H,B
0761 CD0A01  CALL    JFINALLY DO HEAD
0764 2E34    MVI     L,52
0766 CD1001  CALL    JX,52 >> NECK
0769 78      MOV      A,B
076A D602    SUI     2
076C 67      MOV      H,A
076D CD1001  CALL    JX-2,52
0770 2E38    MVI     L,56
0772 CD1001  CALL    JX-2,56
0775 78      MOV      A,B
0776 C602    ADI     2
0778 67      MOV      H,A
0779 CD1001  CALL    JX+2,56
077C 2E34    MVI     L,52
077E CD1001  CALL    JX+2,52
0781 68      MOV      H,B
0782 CD1001  CALL    JX,52 >> END OF HEAD
0785 2E36    MVI     L,54
0787 C602    ADI     2
0789 67      MOV      H,A
078A CD0A01  CALL    JTHE NOSE1
078D CD0A01  CALL    DOT
0790 C9      RET

```

```

; COMMON SUBROUTINES
;
; EXCEPT AS NOTED... ALL REGISTERS ARE PRESERVED
;
; SUBROUTINE STRING

```

```

; DISPLAY THE STRING OF ASCII CHARACTERS POINTED
; TO BY H,L TERMINATING WITH "$".
; EXITS WITH H,L POINTING TO THE "$".
STRING: PUSH PSW
STR000: MOV A,X
        JGET CHAR
        JTERMINATOR
        JZ STR001
        CALL JOK... SO DISPLAY IT
        INX H
        JNEXT CHAR
        STR000 JMP STR000
        STR001: POP PSW
        JRESTORE A
        RET
; SUBROUTINE PAUSE
; DELAY A BIT... AS DETERMINED BY REGISTER B
; EXITS WITH B=0.
; WARNING: B = 0 IS MAX, NOT ZERO. DELAY
; SENSE SWITCHES SET TO 01H CAUSE INFINITE PAUSE
;
        PAUSE1: PUSH H
        PUSH PSW
        LXI H,0000H ;MAKE UNIT DELAY SHOR
        LDR L,JA 3 REGISTER COUNT DOWN
        PAUSE0: DCR JNZ
        DCR H
        PAUSE0: JNZ
        DCR B
        PAUSE0: JNZ
        JZ PAUSE1
        JREAD SENSE SW
        JARE THEY SET TO ONE
        POP PSW
        POP H
        RET
; STRING DEFINITIONS
;
0788 17A2595A455STR001: DB 'HI,'BYTE$$$$$'
07C7 47524150485STR011: DB 'GRAPHIC$$$$'
07D8 535A414E4A5STR02: DB 'STANDARD$$$$'
07DD 17A655AC4C5STR03: DB 'HI,'FULL$'
07E3 11A3154F145TR04: DB 'RED,'C,'YEL,'O,'GRN,'L,'CYN,'O,'BLU,'R$'
07EE 115A124F135TR04G: DB '1H,'T,'12H,'O,'13H,'N,'14H,'A,'15H,'L$'
07F9 17A34FAE545TR05: DB 'HI,'CONTROL$'
0802 17A44152475TR06: DB 'HI,'LARGE,'MAXR,'$'
080A 41A2A420535TR07: DB 'AND 'SMALL','R12B,'$'
0815 43A84152415TR08: DB 'CHARACTERS$'
0820 17A14E494D5TR09: DB 'HI,'ANIMATIONS$'
; VARIABLE STORAGE AREA
;
        MAXCD: DS 1 ;MAXC DISPLAY DISRIPTOR
        MAXRD: DS 1 ;MAXR DISPLAY DISRIPTOR
        I00H: DS 100H
        STACK: DS 1
        END
092E

```

EASYWRITER,* the 1st true Word Processor for the Apple!*

Are you looking for the best Word Processor for your Apple? Well we are so sure you'll choose **EasyWriter** that we've prepared this ad to help you make your decision **EASY**. Check out these powerful features:

- Incremental spacing to support your Qume, Diablo, or Spinwriter
- Character oriented (No line numbers to deal with)
- Menu selectable routines for all known printers and interfaces
- Word wrap around on screen for continual text entry
- Our own new high speed DOS (Twice as fast as Apple's)
- Of course full editing, disk, and printer commands
- Subscripting, Superscripting, and MORE MORE MORE . . .

The straight facts make EasyWriter the only logical choice. By the same people who brought you WHATSIT. Available at your local computer store or our new California office!

	<i>EasyWriter*</i>	<i>Dr. Memory*</i>	<i>Big Edit*</i>	<i>Apple Pie*</i>	<i>Super-Text*</i>		
Incremental Spacing	X						
Character Oriented Screen	X				X		
Printer Interface Routines	X						
Word Wrap Around	X				X		
Editing Commands	X	X	X	X	X		
High Speed Disk	X						
50 Pages of Text per Disk	X						
Subscripting & Superscripting	X				X		
Your Choice							



ORDER FORM

CUT ALONG DOTTED LINE

793 Vincente **146 N. Broad Street**
Berkeley, CA 94707 **Griffith, IN 46319**
(415) 525-4046 **(219) 924-3522**

It Isn't Software Until it Works!
A perfect Christmas gift!

***EasyWriter**
 EasyWriter is a TM of Cap'n Software

***Dr. Memory**
 Dr. Memory is a TM of Muse

***Big Edit**
 Big Edit is a TM of Gravey, Martin & Sampson, Inc.

***Apple Pie**
 Apple Pie is a TM of Programma International, Inc.

***Super-Text**
 Super-Text is a TM of Muse

Apple
 Apple is a TM of Apple Computers, Inc.

Whatsit
 Whatsit is a TM of Computer Headware

Name:			
Company:			
Address:			
City:		State:	Zip:
I would like more information on:			
ITEM	QUANTITY	PRICE	TOTAL
Easy Writer (EZ 2)		\$ 99.95	
Whatsit Model A-1 (Apple)		125.00	
Whatsit Model CP-2 (CP/M)		150.00	
Whatsit Model NS-3 (N Star)		100.00	
Whatsit Manual		25.00	
EasyWriter Manual		30.00	
Subtotal			\$
CA Residents add 6% sales tax			\$
Shipping & Handling			\$ 2.50
GRAND TOTAL			\$
Master Charge or Visa Number:			

A User's Look at Tiny-c

Christopher O Kern
201 I St SW Apt V-839
Washington DC 20024

As the microcomputer industry has responded to a rapidly growing market — a market composed of small business users and others who are less interested in computers than they are in *using* computers for particular applications — a considerable amount of good system-level software has become available. Unfortunately, any given computer hobbyist is able to use only a small portion of this software.

It is inevitable that the microprocessor that is chosen to be the central processing unit of a small computer will restrict the range of avail-

able software to the subset written for that microprocessor. But for the vast majority of computer hobbyists, there are two other impediments to using the system programs that are now on the market (assemblers, text editors and processors, language interpreters and compilers, and the like) that are far more important. First, available programs often require large amounts of memory and floppy disk storage; second, almost all of the software on the market requires that the user have a particular manufacturer's computer or, at the very least, a particular disk operating

system.

There is a simple way around these two restrictions. The software vendor can sell his product as source code for particular microprocessors, with directions for adapting the program to the end user's computer system. Given the economic pressures of the software market, this has not proved to be a popular approach. However, an intriguing experiment in selling a sophisticated system program on this basis is being carried out by tiny-c associates (the lower-case style is theirs). This program offers an interpreter (for an exceedingly modest price) for the structured programming language *tiny-c* that can be easily adapted to any 8080-family or LSI-11/PDP-11 computer.

Tiny-c is based on the C programming language, which was developed at Bell Laboratories, where it was used to write the UNIX operating system under which the C compiler can be run. As might be expected of a programming language that can be used to write operating systems, C mirrors the actual operation of a computer somewhat more closely than does a language like BASIC. Tiny-c follows C's example in this respect, as well as most others. For those familiar with C (I was not at the time I started using tiny-c on my home computer), I should point out that tiny-c is not a true subset of C. There are slight syntactical differences, and tiny-c has a comparatively restricted set of statements, fundamental data structures, and operators.

Tiny-c follows C's example in another way: a significant portion of the tiny-c language system is written in tiny-c itself. The actual interpreting of tiny-c code is done by a program that is written in 8080 or PDP-11 assembly language. But tiny-c pro-

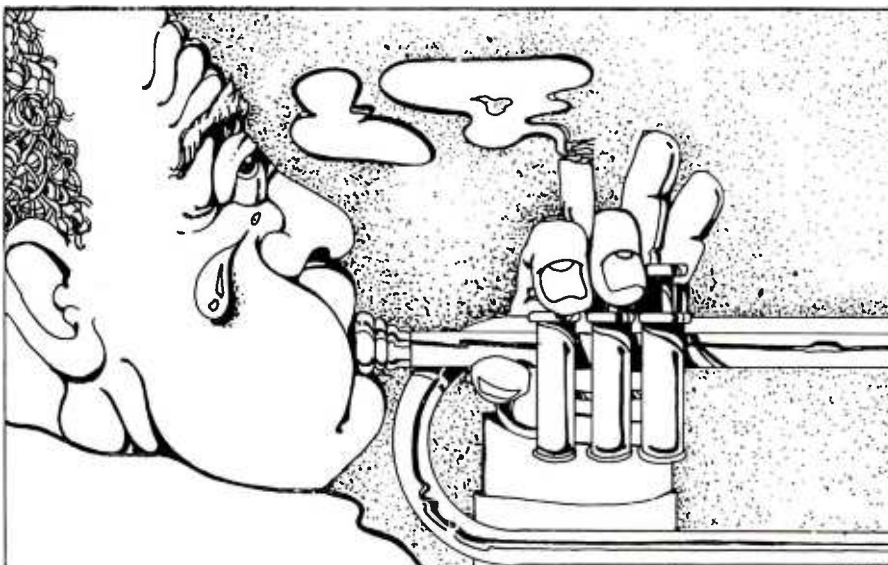

THE TRS-80* BLUES.

Do your TRS 80'S limitations hit a sour note? Our full line of business-oriented software can change that tune.

They're easy to use, modularly designed, and superiorly documented, giving you versatility and sophistication of a higher scale, at a price you'll sing about.

So write us, and we'll send you the score.

SMALL BUSINESS SYSTEMS GROUP
GROTON STREET, DUNSTABLE, MA. 01827 (617) 649-9595

*TRS-80 is a registered trade mark of Radio Shack, a division of Tandy Corp.

THE INFLATION FIGHTER



***\$749**

*Suggested retail price.
Substantial OEM and dealer
discounts available

You can't buy more
capability for less . . . But
you can buy less for more.

MPI presents the perfect answer to your inflation-riddled printer budget. THE MODEL 88T DOT MATRIX PRINTER. The first in a series of new full-capability low-cost printers designed specifically for the general use computer market. The Model 88T is a fully featured printer with a dual tractor/pressure-roll paper feed system and a serial or parallel interface. The tractor paper feed system provides the precision required to handle multi copy fanfold forms, ranging in width from 1 inch to 9.5 inches. For those applications where paper costs are important, the pressure-roll feed can be used with 8.5 inch roll paper. A long-life ribbon cartridge gives crisp, clean print without messy ribbon changing. The microprocessor controlled interface has 80, 96 or 132 column formatting capability while printing upper and lower case characters bi-directionally at 100 characters per second.

With all of these features, **plus** quality construction, continuous duty print head and attractive styling, the Model 88T would easily sell at the competition's "under \$1000" (999.⁹⁹) tag. But we are offering it for only \$749; this should make you happy and several hundred dollars richer.

Write for complete specifications and pricing information.



MICRO PERIPHERALS, INC. 2099 WEST 2200 SOUTH / SALT LAKE CITY, UTAH 84119 / (801) 973-6053

grams are written, edited, and (in most cases) run under the supervision of a *program preparation system* that is written entirely in tiny-c. The importance of this should not be underestimated. It means that it is easy to change the way the user interacts with the tiny-c system by writing a new program preparation system in tiny-c. This new program preparation system can be tested and debugged

under the old version. While any changes in the way tiny-c programs are interpreted would have to be made as alterations to the assembly language code, the type of customizing that most users will probably be interested in can be done without re-assembly. For the truly ambitious, the source code for the interpreter is available for alteration, substitution, or just general tinkering.

The Language

Before looking at the system in more detail, a description of the language is in order. Tiny-c is quite unlike BASIC. There are no line numbers. Variables can have names of any length (although only the first seven and last one letters of a variable or function name are actually used by the interpreter). Control flow is not limited to a sequence of individual

Tiny-c Program Example

Listing 1 is a tiny-c function to fill a buffer with ASCII text, such as might be required in a text processing program. The program fragment illustrates a number of features of tiny-c.

Buffer, cursor, and blockend are all global variables, which must be declared outside any function. Buffer is a pointer to an address in computer memory representing the start of the buffer. Cursor is a pointer to the address of the next byte of text to be printed. Blockend is a pointer to the address following the last byte of text that has been read from an external file; new text will be placed beginning at blockend.

The first two lines of the function declare local variables. Recordcount is an integer variable. Pointer is a character pointer, which will later be set to an address within the buffer. The byte it will point to is pointer(0).

In the third line of the function, a standard library function called movebl is called. Movebl will shift any text that is left over from the previous file record to the start of the buffer. Its arguments are a pointer to the first character to be moved, a pointer to the last character to be moved, and the distance to move the block (in this case, the negative distance represented by buffer-cursor).

Once the leftover text has been moved, the cursor and blockend pointers must be reset. The blockend pointer is moved back the same distance that the entire block was moved. In the same statement, the local pointer is set to the same address. Accomplishing the same setback, but somewhat more simply, the

address of cursor is assigned the address of the start of the buffer.

The parentheses in the sixth line of the function set the order of evaluation inside the condition of the if statement. First, another standard library function, fread, is called to read a new record from the file. Fread's arguments are a pointer to the address showing where to place the new text (blockend), and a unit number designating the mass storage device. Fread returns the number of bytes

the new text. Then a while loop is used to excise any carriage returns in the text (tiny-c files as implemented in my system do not contain separate line feeds). Note how the byte pointer(0) can be evaluated as either an ASCII integer code (13 = carriage return) or a character (' ', or blank). Note also how the local pointer is incremented through the new text. When it reaches the address of blockend, the while condition fails and the loop is terminated. As it so

```
fillbuffer [
    int recordcount
    char pointer(0)
    movebl (cursor, blockend, (buffer - cursor))
    pointer = blockend = blockend + (buffer - cursor)
    cursor = buffer
    if ((recordcount = fread (blockend, 1)) > 0) [
        blockend = blockend + recordcount
        while (pointer < blockend) [
            if (pointer(0) = 13) pointer(0) = ' '
            pointer = pointer + 1
        ]
    ]
    return recordcount
]
```

Listing 1

actually read, if any, or a negative number indicating that the end of the file has been reached (the end-of-file record, by convention, contains no data). The local variable recordcount is set to the number of bytes read.

The statement subject to the if condition, enclosed in brackets, will be executed only if recordcount is positive (ie: if the record read contains new text). If it is, the condition is fulfilled and the code that is enclosed in the brackets is executed. First the blockend pointer is moved up to the end of

happens, this is also the end of the if statement, hence the two successive closing brackets.

Now all that is left is to return control to the calling function. The return statement is entirely optional; one final bracket will do the job. But the calling function may need to know how many bytes have been placed in the buffer, so recordcount is returned. Recordcount becomes the numerical value of the function fillbuffer to the calling function. Fillbuffer could therefore be used to represent an integer in some tiny-c expression.

What's NEW

from

SOFTAPE

RACER

Slip behind the wheel, ignite the engine and get ready for a high speed race. RACER uses Hires and paddles to simulate Grand Prix excitement. Requires 24K.



ROULETTE

Roulette is a realistic duplication of the popular casino favorite using HIREs graphics and a spinning wheel. Bets can be placed with the keyboard or you can use SOFTAPE's BRIGHT Pen. One or two players can bet against the house. Requires 24K.

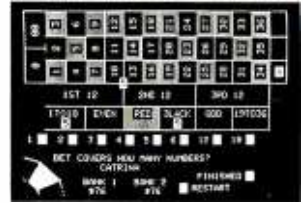

CRAZY 8's

Crazy 8's is a card game using Bill Depew's HIREs playing cards. One player can play the APPLE. The beginner can select the option of seeing the APPLE's hand while playing. Crazy 8's is an easy to learn card game. Great for all ages. Requires 24K.

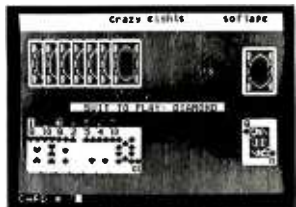

CRAPS

Play Las Vegas Craps on a high resolution playing table created by your APPLE. Place bets, play the field, passline and hardway rolls... all are possible with this detailed simulation. Dice rolls are animated on the screen. Improve your game or devise your own "system". Craps requires INTEGER BASIC and 24K or memory. BONUS!! Included on the back side of the tape is Bright Pen™ Craps for those lucky guys with the SOFTAPE Bright Pen. You will be amazed how easily moves are made and how fast the game progresses!!



MICROGAMMON 1.0

Pit your mental skill and luck against that of the Apple with this computer implemented version of the popular board game Backgammon. All the moves are displayed on the video screen along with the board layout and pieces.

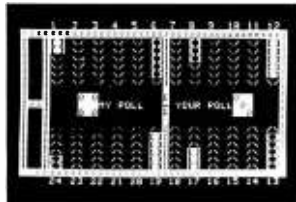

This program requires at least 16K of memory to run from cassette and 32K of memory to be stored and played from an Apple II Disk System. No additional hardware is needed.

Learn, practice, and enhance your Backgammon ability a true competitor. (To our knowledge, the Apple doesn't cheat!!!)

PRO GOLF

Now, even on rainy days, you can improve your game with PRO GOLF. With the Apple II as your caddy, you choose your own clubs and irons on each shot on this full 18-hole course. Every fairway has its own challenging sandtraps and water hazards, but distractions disappear when the screen displays only the green as you begin to putt. Your Apple-caddy keeps track of your score. Have fun, and remember... keep you eye on the ball!

SOLITAIRE POKER

The ultimate poker machine! SOLITAIRE POKER simulates the poker machines that line the Las Vegas strip. Practice your poker ability with Hires playing cards. SOLITAIRE POKER is a sure winner! Requires 24K.



Two More By Steve Baker

GOMOKU

The ancient game of five men in a row. You play against a machine language routine with three levels of excellence. A Hires board using SCREEN MACHINE gives this game the beauty and style of chess. Requires 16K.

FIGHTER PILOT

It's war, and your mother ship is under attack. The adrenalin flows as you accelerate through the launch tube and penetrate the void of space. With all systems operating, your sensors show the direction of the enemy racing to meet you. After a few bursts he explodes, and you fly through his debris to meet the next one.

FIGHTER PILOT is a fast-moving game of excitement and skill. This graphics program, written in integer basic, requires 16K of memory.

Circle 357 on inquiry card.

SOFTAPE

10432 BURBANK BLVD. • NORTH HOLLYWOOD, CA 91601

Yes! I own an Apple and I would like to receive future product announcements.

BankAmericard, Visa, MasterCharge & personal checks accepted.

Name _____	Craps	14.95	
	Racer	12.95	
Address _____	S. Poker	12.95	
	Crazy 8's	12.95	
City _____	Pro Golf	12.95	
	Roulette	14.95	
State _____ Zip _____	Microgammon	14.95	
	Fighter Pilot	12.95	
	Gomoku	14.95	

- Master Charge
 Visa
 Bank Americard

SUB TOTAL

Calif. Sales Tax (Cal. Res. only)

TOTAL:

Credit Card Number

--	--	--	--	--	--	--	--	--	--	--	--	--	--	--	--	--	--	--	--

INTERBANK NO. FOR
MASTERCHARGE

SIGNATURE														
-----------	--	--	--	--	--	--	--	--	--	--	--	--	--	--

Expiration Date MONTH YR.



statements, as is the case in BASIC, but includes the invocation of functions (the equivalent in this context to BASIC subroutines), either through explicit calls to a given function, or by using the function as an element in a more complex tiny-c expression.

All tiny-c programs are composed of functions. Tiny-c functions, in turn, are composed of other functions, tiny-c statements, and operators. The list of tiny-c statements is small but surprisingly flexible. It includes *if*, *if-else*, *while*, *return* (which provides an optional way for returning some computed value of a function to the calling function), and *break* (which terminates the innermost current *while* loop prematurely, ie: without waiting for the normal termination condition to be met).

There is no explicit "do" statement. Tiny-c functions are called directly by simply placing their names in the program text. They are invoked indirectly by their use as elements in a larger tiny-c expression. Within a logical expression, tiny-c functions take on whatever value the function returns,

although a function is not required to return any value at all (the default is zero). A series of function calls, or any other series of tiny-c statements, can be turned into a compound statement and executed as a unit by enclosing it in brackets.

Tiny-c operators include unary minus (-), multiplication (*), integer division (/), remainder following division (%), addition (+), subtraction (-), less than (<), greater than (>), less than or equal (<=), equal (=), not equal (!=), greater than or equal (>=), and assignment (=). Choosing the *single* equal (=) sign for assignment and the *double* equal (==) for testing equality may seem rather odd at first, as does the choice of !=, instead of the more common <>, as the inequality operator. In practice, both choices are easy to adapt to and soon become intuitive.

The number of primitive tiny-c data structures, like the number of statements and operators, has been kept to a minimum. There are two fundamental types of data in tiny-c: 16-bit signed *integers* (which permits numbers from -32768 to 32767), and

8-bit *characters* (which can actually represent any 8-bit quantity). These two basic structures can be combined into arrays, but tiny-c does not provide any way to deal with arrays as a single entity; this must be done with functions. You cannot, for example, write [if (answer == "Yes") then startgameover] in tiny-c because the character array "Yes" cannot be compared with anything using the equality operator. Instead you must write a function to perform a letter by letter comparison.

In addition to integers, characters, integer arrays, and character arrays, more complex data structures representing any combination of the fundamental structures can be created. On the other hand, tiny-c does not provide services to create or process these more complex data structures in the manner of the Pascal language. These must be developed and accessed by specific functions through the use of pointers, which provide an essentially convenient but rather low-level way of searching through memory.

Pointers are declared in tiny-c

What you 'C' is what you get!

C Compiler for CP/M*

New, and available now! An easily affordable compiler incorporating most of the features of the full C language.

BD SOFTWARE

System requirements: CP/M and at least 24K of RAM

Variable Types: char, int, unsigned

Composite Types: arrays, structures, unions

Pointers: to variables, structures, unions and functions

Features: is a structured language, all functions (Programs) recursive; more powerful expression operators than any other von Neuman type language; allows free-formatted source; close enough to UNIX**C to make conversions feasible.

Speed: On 2 MHz 8080, the statement for (i = 1; i < 30000; i++) x = 5; takes about 4 seconds to execute.

Package contains: compiler, linker, library manager; standard function library; sample source files include games, a terminal emulator with disk I/O plus the source for many standard library functions; BDS C User's Guide; Book—*The C Programming Language* by Dennis Ritchie and Brian Kernighan of Bell Labs.

Price: \$110

Recipient of the Computer Lib Seal of Approval

*CP/M is a trademark of Digital Research Corp

**UNIX is a trademark of Bell Laboratories

Lifeboat Associates

2248 Broadway, New York, N.Y. 10024 (212) 580-0082 Telex 668585

Pascal/MTM

DIGITAL MARKETING announces CP/M* compatible Pascal. Pascal/M brings the language power of Pascal together with the extensive file handling capabilities of CP/M.

- Pascal/M allows the user to have full access to CP/M data files written in other languages (such as BASIC) and stored under CP/M.
- All CP/M utilities are available for managing Pascal Programs.
- All I/O is fully compatible with CP/M file structure.
- Built-in procedures provide for terminal-independent cursor controls.
- Standard Pascal/M is available for the 8080/85 or Z80 CPUs.
- A special Z80 version takes advantage of the Z80's extended instruction set.

This package includes diskette with P Code Compiler, Interpreter, and Runtime Library; *Pascal User Manual and Report* by Jensen and Wirth; and *Pascal/M User's Reference Manual*. Pascal is available on 5 1/4" or 8" diskettes. The cost is \$350. For manuals only - \$35. • Visa/MC.

*CP/M is a trademark of Digital Research.

Digital Marketing

2670 CHERRY LANE
WALNUT CREEK, CA 94596
(415) 938-2880

through the declaration of an array. An array is declared by declaring its *type* (integer or character) and its *last element*. All arrays begin with element 0, so the tiny-c declaration [int arrayofintegers(10)] creates an 11-element array of integers (2-byte values), and the declaration [char arrayofcharacters(10)] creates an 11-element array of single-byte values.

In either case, the pointer is simply the array name without a subscript. Therefore, the above integer declaration has simultaneously declared a pointer, arrayofintegers, which can be aimed at the start of any 2-byte value in the array by moving it, through a tiny-c expression, in 2-byte increments. The pointer, which is aimed at the zeroth element of the array at the time of declaration, can therefore be moved to the third element (the start of the third 2-byte integer) by setting [arrayofintegers = arrayofintegers + 3] without any requirement of capturing the data in the intervening two elements of the array. Similarly, the pointer arrayofcharacters can be moved in

1-byte increments. There is no way to declare a pointer without declaring at least one element of an array, so when the array itself is not needed (eg: when the pointer is going to be used to keep track of data in a pre-existing array such as a buffer), the tiny-c convention is to declare an array whose last element is 0.

This ability to declare pointers and move them around at will makes it possible to use tiny-c pointers to address any location in the computer's available memory. The addressing is, of course, relative to where the tiny-c interpreter decides to locate the first element of the array, but with a few lines of assembly language code it is possible to add the absolute addressing that many BASIC interpreters provide through PEEK and POKE commands.

Tiny-c is quite permissive about interchanging integer and character data, thus permitting reference to characters by their numerical ASCII codes. It also provides a powerful facility for generating interesting and often complex program bugs.

It should be fairly obvious that

tiny-c is not a very sophisticated language, and there are certainly features that I miss. Boolean operators would be handy, as would multiple-precision integer and floating-point arithmetic. I don't particularly miss the rather wide variety of mathematical functions that are provided as part of my BASIC interpreter, and I can duplicate the very useful string-handling functions that are available in BASIC by either writing them in tiny-c or by adding machine language subroutines to the tiny-c system as described below.

The most important feature of tiny-c is one that is essentially unavailable in BASIC. This feature is the ability to create functions and then use or manipulate them without further thought as to what is inside. Tiny-c functions exist as independent worlds of their own. They have their own local variables, although it is also possible to define global variables and have all functions access them. They can accept arguments and manipulate them within the function, without changing the value that was passed by the calling function. In

NOW GET EVERYTHING YOU NEED
 (hardware and software) TO ADD SOUND
 TO YOUR BASIC PROGRAMS!

PET
COMPUCOLOR II
TRS-80 II

Computer games without sound effects are like TV shows without audio — flat. Now you can add the joy of sound to your entire BASIC library. Soundware™ gives you everything you need!

You get hardware — a neat speaker-amplifier unit with volume control, earphone jack and connectors. No wiring, no soldering — simply add two AA batteries and plug it in!

You get software — two programs to demonstrate and help you create your own sound effects. Make your programs come alive — add laser sounds, bird calls, bounces, clicks, sirens, music notes, tunes! Complete instructions included, one-year limited warranty, immediate shipment.

GREAT CHRISTMAS GIFT!

See your dealer for demonstrations.
 If not convenient, order direct by phone (408) 371-4120, or coupon.

Please send SOUNDWARE as follows:

<input type="checkbox"/> All PETS.	<input type="checkbox"/> All TRS-80 Level II — \$29.95	<input type="checkbox"/> All COMPUCOLOR II — \$39.95
<input type="checkbox"/> Payment enclosed (CAP pays shipping)	<input type="checkbox"/> Send C.O.D. (add 15%)	<input type="checkbox"/> MasterCard
<input type="checkbox"/> VISA/BankAmericard		

Card No. _____ Exp. Date _____ Sig _____
 Please print _____ (Callfarians add 6% sales tax)
 Name _____
 Address _____
 City _____ State _____ Zip _____

All PETS, TRS-80 II
\$29.95

COMPUCOLOR II
\$39.95

RS-80 II
PET
COMPUCOLOR II
TRS-80 II

1884 Shulman Ave. San Jose, CA 95124 (408) 371-4120 CAP Electronics, Dept. B

GTC HAS IT!



TEXAS INSTRUMENTS TI-99/4



Home Computer

- 26 K ROM extended TI BASIC.
- 16 color graphics, and music and sound effects.
- High quality 13" color monitor.
- 16 K RAM user memory.

CTC'S DISCOUNT PRICE FOR THE COMPLETE SYSTEM; CONSOLE & 13" COLOR MONITOR

\$1099

Order now. Subject to availability by manufacturer.
Price subject to change without notice. Refunds guaranteed prior to delivery.



The Computer People

San Diego's largest Discount Computer & Calculator Store. 5560 Ruffin Road. San Diego, CA 92123

Please ship me the following merchandise.

TI HOME COMPUTER PRODUCTS	
PHC004M TI-99/4 Home Computer	\$1099.00 \$ _____
PHA2000 Dual Cassette Cable	6.95 \$ _____
PHP1100 Remote Controls (Pair)	29.95 \$ _____
PHP1500 Speech Synthesizer	149.95 \$ _____
COMMAND MODULES	
PHM3000 Diagnostic	29.95 \$ _____
PHM3001 Demonstration	69.95 \$ _____
PHM3002 Early Learning Fun	29.95 \$ _____
PHM3003 Beginning Grammar	29.95 \$ _____
PHM3004 Number Magic	19.95 \$ _____
PHM3005 Video-Graphs	19.95 \$ _____
PHM3006 Home Financial Decisions	29.95 \$ _____
PHM3007 Household Budget Management	44.95 \$ _____
PHM3008 Video Chess	69.95 \$ _____
PHM3009 Football	29.95 \$ _____
PHM3010 Physical Fitness	29.95 \$ _____
Special Prices on Calculators, Micro Computers, Accessories	
TI-Programmer Calculator	49.95 \$ _____
HP-41C Programmable Calculator	249.95 \$ _____
HP-41C Card Reader	159.95 \$ _____
HP-41C Printer	319.95 \$ _____
HP-41C Memory Module	39.95 \$ _____
SOROC IQ-120	849 \$ _____
Hazeltine 1400	695 \$ _____
IMSAI VDP-42/32K	4,695 \$ _____
IMSAI PCS-44/32K	3,695 \$ _____
IMSAI I-8080	931 \$ _____
IMSAI I-8080 Kit	699 \$ _____
IMSAI IKB-1 Intelligent Keyboard	275 \$ _____
Cromemco Z-2H Computer System with 64 K. Dual Floppy, 10MB Hard Disk	8,995 \$ _____

TOTAL \$ _____
Shipping, add 3% \$ _____
Cal. residents add 6% tax \$ _____
Amount enclosed \$ _____
(check or money order)

Charge to my VISA MASTER CHARGE
 Acct # _____ Bank # _____ Exp. Date _____
 Signature: _____
 (Required if using credit card)
 Name _____
 Street or P.O. _____
 City _____ State _____ Zip _____

fact, a tiny-c function is *not* able to change the value of a variable that is passed to it (except internally) *unless* an express provision is made.

This reliance on functions as fundamental building blocks of programs has three important consequences:

- Programs are easy to read. They are not only modular, but because control flow is altered only by the invocation of other tiny-c functions or the intervention of a few simple tiny-c statements, it is easy to follow what the program is doing. Combining this with the availability of long, descriptive variable and function names makes it possible to read tiny-c programs in a way that is almost as close to reading English text as it is to reading a program written in BASIC or FORTRAN.

- Programs are easy to alter. Since functions are atomic units as far as other functions are concerned, it is possible to change or substitute a function without worrying about unanticipated effects of the change on other parts of the program. Obviously, it is not possible to change a data structure used by other functions without ill effects, or blithely alter global variables (which are therefore best kept to a minimum). It is possible to rewrite a function to make it more efficient or to add a strictly local feature without resulting in the blow-up of some other function.

- Tiny-c functions can be kept in a library, taken out in the future, and used in new programs. With a little care, it is possible to write a function in a way that maximizes its generality and its future utility. In many instances, it is convenient to think of previously written tiny-c functions, not simply as potential components of new programs, but as extensions to the language. The program preparation system and the machine language interface provided in the tiny-c system encourage this, so perhaps it is time to describe the system in detail.

The System

The program preparation system and the machine language interface are two of the six main parts of the tiny-c system. The others are the interpreter itself, a library of commonly used tiny-c functions, a library of special purpose functions that have

been coded in machine language to increase execution speed, a set of input and output routines to service a console terminal and a mass storage device, which must be coded by the user for his own installation.

Everything except the I/O (input/output) routines is provided in source-code form (8080 or PDP-11 assembly language, or tiny-c) in the *tiny-c owners manual*, which is available from tiny-c associates, POB 269, Holmdel NJ 07733, and currently sells for \$40. The programs are also available on various machine-readable media in a number of formats. The one used by my computer, a Heath H8 with cassette mass storage, is not one of these, so I rather laboriously typed in the entire 8080 source code. Fortunately, the listings in the *tiny-c owner's manual* are quite legibly printed.

The interpreter is quite compact. Including the library of special functions that are coded in machine language and loaded along with it, the interpreter occupies a scant 4244 bytes in my system. There is no limitation on recursion (functions calling themselves, either directly or indirectly, where the function calls another function which calls the original calling function). But memory allocation is static. So, for example, a program that uses an unusually large number of active variables at one time might conceivably not run, even though plenty of extra memory was available in the section allocated for the program text. This would require that you stop the interpreter and reallocate memory. In practice, I have yet to have this happen. The internal operation of the interpreter is described in considerable detail in a chapter of the *tiny-c owner's manual*, which should facilitate making alterations.

I was slightly disappointed with the speed of execution of tiny-c. It is difficult to make comparisons with BASIC, mainly because the languages are so dissimilar, but also because my BASIC interpreter includes a large number of functions that speed up program execution considerably. Many of these functions, such as string handling functions, could be added to tiny-c as machine language subroutines, so any comparison that relies on the use of these special purpose BASIC functions is somewhat unfair. Still, when running through a



EUROMICRO 80

sixth symposium on microprocessing and microprogramming LONDON, September 16-18, 1980

1. CALL FOR PAPERS 2. CALL FOR MICE

EUROMICRO 80 is the sixth annual symposium organized by EUROMICRO, the European Association for microprocessing and microprogramming. EUROMICRO has held its previous conferences in Nice, Venice, Amsterdam, Munich and Goteborg. Workers in the fields of microprocessing and microprogramming have found these international events invaluable for getting together and exchanging ideas on the latest developments.

DEADLINES

Full Paper

Authors should submit six complete copies of their papers to the Programme Chairman, no later than January 31, 1980. The papers, (no longer than 16,000 words) should include a 200-word abstract and authors' names and mailing addresses.

Authors will be notified of acceptance by May 1, 1980; final camera-ready papers will be due on June 1, 1980.

Preprints of the Proceedings will be available at the time of the Symposium; the final Proceedings will be published later.

Short Notes

Authors should submit four copies of a 1000-word summary to the Deputy Programme Chairman before May 15, 1980; they will be notified of acceptance by June 30.

Final Short-Notes will be published in a Special Issue of the EUROMICRO Journal; camera-ready papers will be due at the Symposium.

FOR FULL DETAILS

In the U.S.: Contact Dr. Rodney Zaks, **SYBEX**, 2020 Milvia Street, Berkeley, California 94704.

In Europe: Contact Prof. Lionel Thompson, **HSDE**, Hatfield AL 109LP England.

Industrial Seminars

Companies should submit two copies of a two-page summary, including title and the name of the person responsible for presenting the contribution, to the General Chairman before July 1, 1980.

They will be notified of acceptance by July 30. Industrial papers will be collected and handed out to participants at registration; they may be considered for later publication in EUROMICRO Journal.

EUROMOUSE CONTEST

A Micromouse contest, inspired by the IEEE event, will be held. Substantial prizes, trips, and other awards are available.



MICRO MOUSE

loop of simple variable assignments, tiny-c seemed to operate only a third as fast as my BASIC interpreter.

Functions in Machine Language

The machine language functions supplied with tiny-c perform a variety of tasks. One moves blocks of data around in memory, another counts the number of occurrences of a given character within a memory field, still others interface between tiny-c and the input/output routines supplied by the user. The user can add to this so-called "standard library" of machine language functions. Tiny-c provides several utility routines which are available to user-coded functions. These simplify the interface between tiny-c and machine language.

One thoughtful feature is a set of special calls to external subroutines which take place (if enabled) at the beginning of any program, at the start of every tiny-c statement within a program, and when the program finishes running. The manual suggests that these may be used to create

a *debugger*, which could allow you to single-step through a tiny-c program, set breakpoints, or enable a *profiler* which could count how often each statement is executed.

Functions in tiny-c

Aside from the standard library of machine language functions, there is a standard library of functions coded in tiny-c. These are normally loaded with the program preparation system. Like the machine language functions, this standard library of tiny-c functions is a mixed bag. Some just dress up machine language functions (which are called by number) with a descriptive name. Others convert from ASCII to binary and vice versa, read and write strings to the console terminal, and load and dump files. Continuing the parallel with the machine language functions, the user can add his own functions to the tiny-c library. This provides a convenient way to store functions that are used often at a given installation (eg: a function to drive a special device,

such as a digital plotter).

Program Preparation System

The program preparation system is the part of the tiny-c system that the user is most conscious of, because it mediates most interactions with the interpreter. As an editor, the program preparation system is quite adequate, but unexceptional. It provides commands for inserting text, moving a given number of lines up or down, locating a given line by number (tiny-c does not use line numbers, but the editor keeps count for its own purposes), locating a given string (the user may optionally specify whether the string being searched for is at the beginning or the end of a line), editing strings within a line, deleting lines, and reading and writing files (program text, plain text, or data). The one drawback to its being written in tiny-c is that the editor operates a bit slowly, but not so slowly as to be frustrating.



The program preparation system also permits you to execute any tiny-c function that is in the standard library or entered as program text. This means it is possible to run any program under the editor. For those who have floppy disks, that is not a particularly important advantage. For those, like myself, who depend on cassettes for mass storage, the freedom from having to shuttle programs in and out of memory is a big plus. The fact that the editor can be used to run a program also means that tiny-c, like BASIC, has a single operating environment. Programs can be written, tested, debugged, and run without the user having to consciously switch from one mode to another.

The program preparation system is entirely optional. It is provided in two forms. One is neatly formatted and commented, and occupies about 9000 bytes. The other is "crunched" — stripped of all of its unnecessary indentations and spaces. Because tiny-c is essentially free-form, this has no effect on program function. However, it renders the "crunched" code relatively unreadable. The saving is about 5000 bytes which, for a program that resides in memory for the amount of time that program preparation system does, is a fair trade for legibility.

Programs which do not use the

new **ECONOMICAL STD BUS* PLUGBOARDS**
FROM *Vector*
MAKE SYSTEM EXPANSION AND
INTERFACE BOARDS FAST 'N EASY

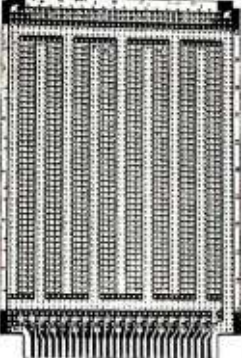
<p>4610 for soldering or wire wrapping. Mounts 20 16-pin DIPs or combinations.</p>	<p>4610-2 for wire wrapping. Mounts 35 16-pin DIPs or combinations.</p>	<p>4610-1— Hi density, wrap or solder. Mounts 59 16-pin DIPs compact, 47 spaced.</p>
---	--	---

*Card edge connector pins are connected to power and ground buses per STD BUS convention. Tinned buses and pads for easy soldering one side only.

All models have .042 holes on 0.1 inch grid. 4 1/2 x 6 1/2 x .062 plugboards, 28/56 nickelplated gold flashed contacts on .125" centers. Card Extender 3690-16 available.	<table border="0"> <tr><td>4610</td><td>\$18.95</td></tr> <tr><td>4610-1</td><td>\$15.95</td></tr> <tr><td>4610-2</td><td>\$18.95</td></tr> <tr><td>3690-16</td><td>\$25.00</td></tr> </table>	4610	\$18.95	4610-1	\$15.95	4610-2	\$18.95	3690-16	\$25.00
4610	\$18.95								
4610-1	\$15.95								
4610-2	\$18.95								
3690-16	\$25.00								

Plus full supporting line of Card Cages, mating connectors, w.w. tools, terminals, DIP Sockets. Available now thru AVID Distributors & Factory Direct.



Prices subject to change without notice.
*Pro-Log/Mostek developed.

719079

program preparation system (ie: those that operate directly under the interpreter) must begin execution with a function named "main." Other than that, any program that will operate under the program preparation system will operate directly under the interpreter, although the library functions normally loaded along with the program preparation system will probably have to be loaded with other programs.

By dispensing with the amenities provided by the program preparation system, a given system can run a tiny-c program that is roughly 5000 bytes longer than it could otherwise accept. With 24 K bytes of memory available on my system, I have approximately 8 K bytes of program space with everything loaded: the interpreter, a standard console driver, my I/O interface routines, and the program preparation system. One very useful improvement would be to provide text compression that would permit a series of spaces (which should be used liberally in a language like tiny-c for indenting) to be packed into a single byte. This, however, would require some changes to the interpreter.

Support Services

Before moving on to a brief description of the procedures for installing tiny-c, I should say a few words about the quality of the documentation and support for the tiny-c system. This is a rather low-priced item, but that fact is not reflected in the *tiny-c owner's manual*. The manual is slickly produced. As noted before, the quality of the printing is excellent. Comments in the assembly language code are a bit sparse, but the section on the internal operation of the interpreter explains each routine's purpose in acceptable detail. Since I was keystroking the entire source code anyway, I used the opportunity to merge in some of the documentation from the owner's manual text.

The manual provides a detailed description of the language, an operating guide to the program preparation system, several program examples along with comments on their style, the section on the internal operation of the interpreter, explicit installation instructions, and the various source codes. And it is written in coherent English.

Support is principally provided

through an occasional newsletter which provides fixes for program bugs, suggested improvements, and answers to commonly asked questions. When I found a minor bug in the way that the interpreter passed arguments between functions, my letter to tiny-c associates prompted a quick acknowledgement from author Tom Gibson, although he had no immediate solution.

Installation

As noted above, the user is required to code several installation

routines. These provide an interface between the computer's operating system and tiny-c. The routines write a single character to a console terminal, read a single character from the terminal, check to see if a character has been input, open files for reading from or writing to a mass storage device (such as a cassette recorder or floppy disk), read and write single records, and close files when the reading or writing is done.

Many of these functions are likely to be already available in the computer's operating system. In some



Cat Calls

How to tie your computer into the world.

All you need is a phone and a Cat™ acoustic modem. A Cat modem takes the data you type into your terminal and sends it out over standard telephone lines to any other compatible computer or terminal within reach of your phone. And it listens too.

So now you can work at home and talk by phone to your office computer. Gain access to data banks. Or swap programs with computer people

anywhere. The possibilities are endless—if you have Cat.

It's the fast, accurate, reliable modem that ties you into the world—for less than \$199.

Cat by
Novation



Call for details

(800) 423-5410

In California (213) 996-5060

Available at Hamilton/Avmet, Kierulff Electronics, Byte Shops, Computerland, and your local computer store.

Novation, Inc., 18664 Oxnard Street, Tarzana, California 91356

cases, the tiny-c interface will consist of nothing more than juggling the data left in particular registers to match up the requirements of the tiny-c interpreter and the operating system. In other cases, certain functions of the operating system may have to be substantially adapted to meet the specifications set out in the *tiny-c owner's manual*. Some users may have to write all of the input and output routines from scratch.

The user has a lot of latitude in designing the interface. He can simply meet the minimum specifications in

the manual, or he can add features that will take advantage of the particular characteristics of his computer. In my case, I decided that I wanted to have a visual indication of all magnetic tape operations on the H8's front panel (a very useful feature of Heath's system). The interface provides that function on its own, without any intervention from the tiny-c interpreter.

While the installation instructions are quite explicit, coding the input and output routines is not a trivial task. Nevertheless, it should be well

within the competence of anyone with more than nominal experience in writing programs in assembly language, as long as the programmer is familiar with the internal functioning of the computer's operating system. A few "load and go" versions of tiny-c are available for specific computers, but many users will have to provide their own interface routines. While it may not seem like a particularly interesting chore, this is what gives tiny-c its generality, thus making it available for use on a large number of computer systems.

Once the interface routines are ready, the various components of the tiny-c system are loaded and linked. A program is provided in the manual for relocating the interpreter if the address supplied (hexadecimal 2000) is unacceptable. If you have typed in all of the source code, as I did, you can assemble the interpreter anywhere you want. Those users who buy machine-readable media can load the program preparation system as easily as the other parts of the system. In my case, the editor I used to enter the program preparation source code used a format that would have been indigestible to the tiny-c interpreter, so I had to write still another routine to reformat the file. Subsequent versions of the program preparation system are written under itself, so the problem only arose once.

I had a little trouble getting tiny-c up and running the first time, but all of the problems were my own. Most, as is usually the case, were the result of inattentive reading of the manual. They were all, fortunately, easy to correct. The entire project, from first reading of the manual through writing the interface routines through keystroking the source code through debugging, took most of my spare time for about three weeks.

There is something to be said for tackling a software project of this magnitude, even if most of the real work has been done by someone else. Although I would have undoubtedly bought tiny-c in machine-readable form if it had been available for my computer, the work I did during the installation gave me a much better understanding of the way the software works. That, in turn, has reduced the sense of intimidation that I have felt in dealing with programs that are this large and this complex. ■

FORT//80™

FORTRAN

for the 8080 only \$9995

- FORT//80 is a subset of Fortran IV with many powerful enhancements!
- FORT//80 is an advanced software development tool!
- FORT//80 is AFFORDABLE!!

FEATURES

- FORT//80 directly addresses 8080 ports as FORTRAN variables
- I/O drivers accessed via FORTRAN read/write statements
- FORT//80 accepts embedded in-line machine code
- 8080 condition codes are available as FORTRAN keywords and can be operated upon
- Multiple assignment operators accepted
- Interleaved listings and object code for quick debugging
- Symbolic names up to 31 char long simplify documentation
- Constants expressible to base 2, 8, 10, 16 or as char strings
- Compact: Needs only 25K for compiler and minimum workspace

- Fast: Runs up to 10 times as fast as PLM
- FORT//80 directives specify location of code in memory at run-time
- Interrupt and interrupt control
- FORT//80 control of interrupts and interrupt service lines
- All code runs on 8080, 8085 and Z80 (upward compatibility)
- FORT//80 is a true resident compiler and generates directly executable object code. No run time package needed
- FORT//80 is very fast. It compiles quickly and produces dense highly optimized code
- Single and double precision IBM format floating point arithmetic

PRICING

FORT//80 CPM version and manual on 8" diskette	\$99.95
FORT//80 Language manual separately	20.00
FORT//80 Implementation manual	20.00
Sample diskette validation program and data	5.00

Shipping charges to US and Canada postpaid, overseas add \$5.00. Please add appropriate state sales tax. Master Charge and Visa accepted.

1. FORT//80 is supplied on a single use basis, subject to the signing of a non-disclosure agreement
2. FORT//80 can be implemented with other disc operating systems using the implementation manual or special versions available by quotation.
3. The purchase price of manuals and sample programs will be credited towards subsequent purchase of FORT//80.

ramsay electronics

BOX 4072, ROCHESTER, NY 14610
 PHONE ORDERS CALL 716-271-6487

Distributors:

- Digital Research of Texas, Box 401565, Garland, TX 75040, (214) 271-2461
- Electrolabs Inc., Box 6721, Stanford, CA 94305, (415) 321-5601
- Arkansas Systems Inc., 8901 Kanis Rd., Little Rock, KS 72205, (501) 227-8471
- Arkon Electronics Ltd., 409 Queen St. W., Toronto, ONT M5V 2A5, (416) 868-1315

Dealer inquiries invited.

™Akron Electronics Ltd.

Get Ready to Make Your Own Magic

Announcement I. The first eight Personal Programs[®] from Aladdin Automation are waiting for you now at your neighborhood computer retailer or direct from Aladdin.

Now you can get your full share of Aladdin Magic in every one of these Personal Programs[®]:

Math-Ter-Mind[®] A delightful, educational learning experience for your pre-school child. Watch the smile on your child's face as a correct answer makes the mathematician smile on the screen before you. A nursery song also serves as a reward for learning elementary addition and subtraction. With Aladdin's Math-Ter-Mind[®] your child's pathway to learning will be fun-filled . . . for both of you. Math-Ter-Mind[®]. The first release from the Aladdin Education[®] Series. (nursery song currently available only in Apple II[®] program)

Lunar Lander In a controlled descent, you're just seconds away from your first landing on the cold, forbidding surface of the moon. As you navigate your delicate spacecraft downward to the safety of Moonbase, you must be ever watchful of the dangers rising to meet you with each passing moment: a fuel level fast approaching zero; deadly meteor showers that come from any direction, at any time; sheer-faced rock cliffs and rough terrain; choosing the correct landing pattern and rate of descent. Aladdin's Lunar Lander. Your chance to reach out and touch the stars . . . without leaving the safety and comfort of your own chair. The first release from the Aladdin Simulation[®] Series.

Craps All eyes in the casino are on you. The dice are in your hands. Lady Luck sits at your shoulder, whispering . . . "Just one more time. Try your luck just one more time." You throw . . . and watch the dice tumbling on the screen. With Aladdin's Craps you play against the computer, so it's awfully tough to win. But when you do, it's an experience you're likely never to forget. Craps. An exciting, heart-pounding Personal Program[®]. The first release from the Aladdin Las Vegas[®] Series.

Mastermind A challenging game of intrigue, centuries old, that will give you full chance to test your powers of logic, deduction and reason. And test them you will, as you try and solve the computer's puzzle, using clues as they're provided one-by-one. You control the degree of difficulty in this classic Personal Program[®] that offers one simple, yet all-consuming challenge: beat the Mastermind in a direct, one-on-one battle of wits. Aladdin's Mastermind. The first release from the Aladdin Old Favorites[®] Series.

Tic-Tac-Toe Five different levels of difficulty allow a person of any age or skill to take part in this relaxing, enjoyable game that can act as a learning tool, as well. Level I, for example, is suitable for children and is excellent also for teaching simple mathematics. The computer plays just about perfectly at Level V. Just about, that is, so go ahead and take your best shot. See if you can beat the computer in this traditional favorite of young and old alike. Tic-Tac-Toe. Another first release from the Aladdin Old Favorites[®] Series.

Jungle Island[®] Shipwrecked in a raging storm at sea, miraculously you survive only to find yourself stranded on a seemingly deserted jungle island. Without food, water or supplies of any kind, you begin to try and find your way to safety. The computer will be your eyes and ears as you explore your jungle island and all the mysteries and dangers that lie in wait for you. Jungle Island[®]. A captivating first release from the Aladdin Adventure[®] Series.

Stix[®] Aladdin's Stix[®] can be played with 2 to 5 piles of sticks and between 1 and 19 sticks in each pile. The object: to be the one to pick up the last stick. Sounds simple? Yes, but you're playing against the computer. Take heart, though, because you can control the degree of difficulty in this update of the ancient game of Nim. Stix[®]. Another first release from the Aladdin Old Favorites[®] Series.

Super Pro Football[®] Here's your chance to be more than just an armchair quarterback. With Aladdin's Super Pro Football[®] you can replay any Super Bowl game, from the first, between Green Bay and Oakland, to last year's classic victory by Pittsburgh over Dallas. For once you can turn back the clock and go for that one big play that made the difference between victory and defeat in pro football's biggest game of all. Super Pro Football[®]. The first exciting release from the Aladdin Super Pro[®] Series.

Visit your neighborhood computer retailer or contact Aladdin direct to get your full share of the magic in Announcement I, the first eight Personal Programs[®] from Aladdin Automation.

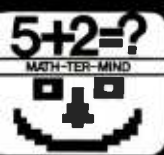

Math-Ter-Mind[®]



Lunar Lander

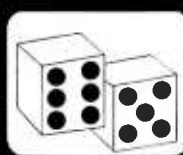

Craps



Mastermind



Tic-Tac-Toe



Jungle Island[®]

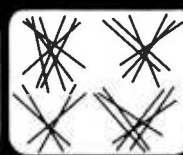

Stix[®]



Super Pro Football[®]

Welcome to the All-New World of Aladdin. And Get Ready to Make Your Own Magic

Circle 3 on inquiry card.



ALADDIN AUTOMATION, INC.
ALADDIN COMPUTER CORP.

3420 Kenyon Street, Ste. 131, San Diego, CA 92111

Clubs and Newsletters

International Computer Chess Association (ICCA)

The ICCA prints two newsletters a year about ICCA planned activities, future events of interest to its members, reviews of books or articles, interesting anecdotes, and short technical papers. The ICCA is considering establishing an international archive for organizing and storing materials on computer chess, and would be interested in hearing from potential donors of funds and materials. Membership is \$10 for one year. For more information, write to Professor B Mittman, Editor, *ICCA Newsletter*, Vogelback Computing Ctr, Northwestern University, Evanston IL 60201.

Washington Apple Pi

Washington Apple Pi, a group of Apple II owners and users, meets at George Washington University, Room 206, Tompkins Hall, 23rd and H St NW, Washington DC at 9:30 AM the fourth Saturday of each month. The meetings include discussions of available software, classes on assembly language, demonstrations and explanations of home-built and commercially available hardware, and they have had a discussion of the Apple II in Europe from a visiting Belgian owner. The group also publishes a monthly newsletter. For more information, write Washington Apple Pi, POB 34511, Washington DC 20034.

Central Ohio Apple Computer Hobbyists (COACH)

Meetings are on the third Saturday of each month from 1 to 5 PM. For more information, contact Tom Mimplitch, 1547 Cunard Rd, Columbus OH 43227, or phone (614) 237-3380.

New Canadian Apple Users Group

The Apples British Columbia Computer Society, #101-2044 W Third Ave, Vancouver British Columbia CANADA V6J 1L5, meets on the first Wednesday of every month. Dues are \$15 per year.

REDUCE Newsletter

The Symbolic Computation Group of the University of Utah publishes a quarterly newsletter devoted to REDUCE, a LISP-based computer algebra system

designed for a variety of large computers. The newsletter is available from the University of Utah computer science department for \$100. For more information, contact the Department of Computer Science, University of Utah, Salt Lake City UT 84112.

Heath Users Group (HUG)

HUG Northshore is a computer club for Heathkit computer users (H8, H11, ET3400). The club provides a forum for exchanging ideas, programs and knowledge, with the intent of developing the full potential of the computer system. The club meets the second Wednesday of each month at 7 PM at the following address: Hill Tech Building, 88 Holten St, Danvers MA 01923. For a free copy of their monthly newsletter, write HUG Northshore, POB 112, Danvers MA 01923.

NEVADA COBOL™ + PTDOS* = FAST! FAST! FAST!

NEVADA COBOL™ COMPILER

FAST COMPILE TIME Up to 650 lines per minute on a 32K RAM Sol-20/HELIOS*.

FAST RUN TIME The compiler generates efficient in-line machine language.

FAST DEVELOPMENT TIME COBOL was designed specifically to solve business problems. NEVADA COBOL™ is easy to learn & simple to use.

FEATURES Random access file support
Sequential files both fixed and variable length
Debugging capability
Copy statement
Data types: Character string, 16-bit binary and packed decimal (COMP-3)
18-digit accuracy
Hexidecimal non-numeric literals
Powerful editing with English language error messages
Interactive ACCEPT/DISPLAY
Subset of ANSI-74

WANT A CLOSER LOOK? SEND \$25 FOR THE NEVADA COBOL MANUAL AND \$275 FOR THE PTDOS/HELIOS DISKETTE.

COBOL APPLICATION PACKAGES

BUDGET PLANNING The Business Plan Generator consists of 2 COBOL programs. One is interactive menu driven for data collection and the other prints professional style reports. Both are table driven for ease in changing chart-of-accounts. Fantastic time saver and planning aid for start-up or existing businesses.

PRECOBOL The COBOL preprocessor allows the COBOL programmer to make up his own time saving mnemonics which are translated to standard COBOL reserved or user words. Old or new programs are margin aligned and structure indented for easy reading, changing or debugging.

PFR Personal Financial Reporting consists of 3 COBOL programs to record and print personal income and expenditures. The heart of the system is the easy data collection forms and interactive input program. Report shows current month, year-to-date and average figures.

LABELS Prints labels 1-up or 4-up cheshire or gunned format, and the 1-up has an option to stop for envelope feeding.

SEND \$25 FOR EACH APPLICATION PACKAGE WHICH INCLUDES THE DOCUMENTATION AND EITHER THE SOURCE CODE LISTINGS OR PTDOS/HELIOS DISKETTE. PLEASE INDICATE YOUR PREFERENCE.



Ellis Computing

1480 17th Avenue
San Francisco, CA 94122
(415) 664-1534

(* Sol, HELIOS & PTDOS are Trademarks of Processor Technology Corporation. California residents please add sales tax.

Introducing

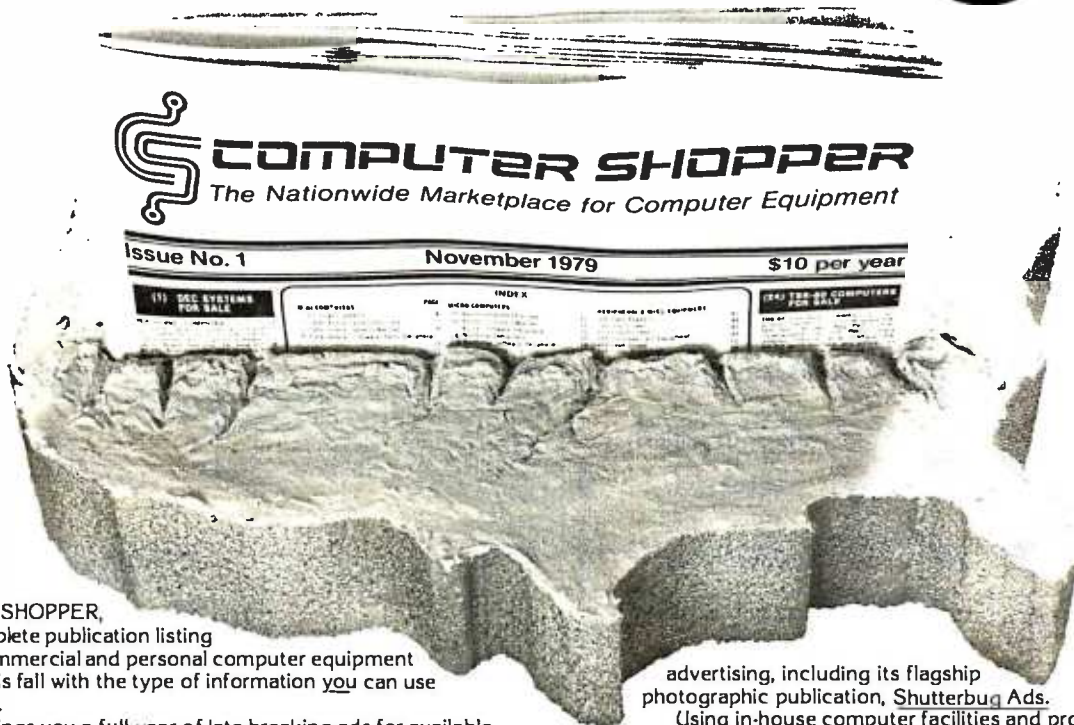

COMPUTER SHOPPER, the first complete publication listing business, commercial and personal computer equipment is coming this fall with the type of information you can use every month.

Just \$5 brings you a full year of late breaking ads for available equipment, software and accessories for mini, micro and big system computers AND you can run YOUR FIRST CLASSIFIED AD WITHOUT CHARGE under this Charter Subscription offer.

EACH ISSUE OF COMPUTER SHOPPER GIVES YOU:

- Ads from individuals, brokers and manufacturers, nationwide
- Categorized ads so you can find them instantly
- Large 11 by 14 easy-to-read format
- Low classified ad rates - 10¢ a word
- Short turn-around advertising time — your ad is in print in 10 days
- Free ad typesetting
- Nationwide circulation guaranteed

COMPUTER SHOPPER is YOUR place to buy or sell any computer equipment because it has been designed after extensive research into the needs and wants of America's computer buyers and sellers.

To reach more than 20,000 computer-owning firms each month, COMPUTER SHOPPER has been launched on a \$78,000 budget by Patch Publications, a proven specialist in reader service

advertising, including its flagship photographic publication, Shutterbug Ads.

Using in-house computer facilities and professional typesetting, Patch's experienced production team makes COMPUTER SHOPPER easily affordable for firms and individuals by using modern techniques and large-space advertising to offset normal costs.

EVEN A LIMITED-TIME COMPUTER USER can get any buy, sell or want-to-find message into this nationwide market for a most reasonable cost. . . only 10¢ a word.

And to prove how successful this ad can be for you, this Charter Subscription Offer includes your own complimentary classified ad. Use it to sell your used equipment or to find components you need.

Just select the correct category listed at left, include it, plus your ad wording on a separate sheet. . . then return it with your subscription acceptance.

DON'T MISS a single timely issue of COMPUTER SHOPPER. Send the coupon with your ad today, knowing you can cancel anytime and receive a 100% refund for all unmailed issues.

 **COMPUTER SHOPPER**
P.O. Box F-1, Titusville, FL 32780
305-269-3211, 8 a.m. - 5 p.m.

LIST OF CATEGORIES IN COMPUTER SHOPPER

Mini Computers

Burroughs Systems
Data General Systems For Sale
Data General Systems Wanted
Data General, Software, Parts, Peripheral
Datapoint Systems
Datapoint Software, Parts, Peripheral
DEC Systems For Sale
DEC Systems Wanted
DEC Software, Parts, Peripheral
IBM Systems For Sale
IBM Systems Wanted
NCR Systems
NCR, Software, Parts, Peripheral
Misc. Minicomputers (Hardware & Software)

Micro Computers

Apple Computers For Sale
Apple Computers Wanted
Apple, Software, Peripheral
Northstar Computers

Northstar, Software, Peripheral
Ohio Scientific
Ohio Scientific, Software Peripheral
PET Computers
PET Software, Peripheral
TRS-80 Computers For Sale
TRS-80 Computers Wanted
TRS-80, Software, Peripheral
Misc. Microcomputers
Misc. Microcomputer Software, Peripheral

Peripheral & Misc. Equipment

Card Readers
Disc Drives
Line Printers
Punched Card Equipment
Tape Drives
Crt's
Misc. Equipment
Misc. Large Systems
Misc. Software
Misc. Accessories & Supplies

SPECIAL Charter Subscription OFFER Save \$5.00

Yes, I want to become a charter subscriber of COMPUTER SHOPPER, the nationwide computer marketplace. Enter my Charter Subscription for the half price rate of \$5.00 for 1 year (12 issues). If I'm not totally satisfied with my first issue, I can have a full refund and I keep the first issue FREE.

Name _____

Address _____

City _____ State _____ Zip _____

Payment Enclosed Master Charge VISA

Card # _____ Exp. Date _____

I have enclosed my complimentary classified ad.

I'd like to run my ad later. Please send me a Certificate.

**Mail to: COMPUTER SHOPPER, P.O. BOX F-1
TITUSVILLE, FL 32780 or call 305-269-3211**

CP/M® SOFTWARE TOOLS



NEW ED-80 TEXT EDITOR

ED-80 offers a refreshing new approach for the creation and editing of program and data files conversationally — and it saves you money. Its powerful editing capabilities will satisfy the most demanding professional — yet it can still be easily used by the inexperienced beginner.

Look at These Outstanding Features:

- FULL SCREEN window displays with forward and backward scrolling for editing your data a page-at-a-time, rather than line-by-line.
- Provides you with all the features found on the large main-frame and minicomputer editors, such as IBM, UNIVAC, CDC, and DEC.
- Commands include forward or backward LOCATE, CHANGE, and FIND; and INSERT, DELETE, REPLACE, APPEND, SAVE, PRINT, WINDOW, MACRO, TABSET, SCALE, DUMP, and others.
- Compatible with existing CP/M edit and text formatted files, with CBASIC, and with Microsoft's MBASIC, FORTRAN, COBOL, and ASSEMBLER.
- CHANGE commands allow you to make conditional changes and to use variable length strings.
- Designed for CP/M and derivative operating systems, including LIFEBOAT, CDOS, IMDOS, DOS-A, ADOS, etc.
- GET and PUT commands for concatenating, moving, duplicating, and merging your edit files on the same or different diskettes.
- Provides you with fast memory-to-memory COPY commands, and an intermediate buffer for copying lines over-and-over.
- Repays your initial investment many times over with unique time-saving editing capabilities.
- Saves your last LOCATE, CHANGE, FIND, and APPEND command for easy re-execution.
- Simple line-oriented commands for character string editing.
- Automatically displays the results of every edit command for your verification.
- Single keystrokes for your most commonly used commands.
- Safeguards to prevent catastrophic user errors that result in the loss of your edit file.
- INLINE command for your character-oriented editing.
- Designed for today's high speed CRT's, video monitors, and teletypewriter terminals.
- Thoroughly field tested and documented with a comprehensive User's Manual and self-instructional tutorial.

And remember — in today's interactive programming environment — your most important software tool is your text editor. ED-80 is already working in industry, government, universities, and in personal computing to significantly cut program development time and to reduce high labor costs. Why not let ED-80 begin solving your text editing problems today? ORDER NOW and we'll pay the postage!

Mail to: SOFTWARE DEVELOPMENT & TRAINING, INC.
P.O. Box 4511, Huntsville, AL 35802

ED-80 is protected by copyright and furnished under a paid-up license for use on a single computer system.

Please send additional information.

Send Diskette, User's Manual and paid-up license \$99.00
Specify SINGLE DENSITY Disk Make/Model, Size, Hard/Soft Sector
Make/Model _____ 8" or 5" HS or SS

Send User's Manual (credited on purchase of paid-up license) \$10.00

Check or Money Order enclosed for \$ _____
Please charge my credit card: VISA Master Charge

Card No. _____ Bank No. _____ Exp. Date _____

NAME _____
ADDRESS _____
CITY _____ STATE _____ ZIP _____
SIGNATURE _____ PHONE _____

C-1

SOFTWARE DEVELOPMENT & TRAINING, INC.
Post Office Box 4511 — Huntsville, Alabama 35802
Dealer Inquiries Welcomed
© CP/M is a trademark of Digital Research

Personal Computing Industry Report (PCIR)

PCIR is a monthly report on personal computing in business, professional, educational, hobby and home applications. The newsletter covers such topics as the market for board-level microcomputers including market shares and trends, reviews of popular microcomputer systems, the status of computer retail stores, and other items of general interest. PCIR is available from Vantage Research Inc, 2680 Bayshore Rd, Mountain View CA 94043, for \$195 for one year.

Appleseed Newsletter

Appleseed Newsletter, c/o The Computer Shop, 6812 San Pedro, San Antonio TX 78216, covers the current and future events of this Apple users group's meetings, which center around swapping programs, discussions and the use of new products.

Sorcerer User's Newsletter (SUN)

Sorcerer User's Newsletter is published monthly by Steven J Long, 792 Laurie Ave, Santa Clara CA 95050. Included are short programs sent by users, notes on problems or fixes, comments on accessories, and anything else which is of general interest to Sorcerer users. A program

library is available for use by subscribers. The subscription rate is \$10 per calendar year.

A New Apple Users Group

There is a new users group in New York City: The Big Apple User Group, 55 Water St, c/o Bruce Brewster, Drysdale Securities, New York NY 10004. For more information, contact Tony Cerreta, (914) 636-3417 or write to the above address. ■

BYTE's Bugs

Redundancy Rules These Pages...

Readers may have noted some redundancy in text on pages 8 and 10 of the November 1979 BYTE. As Murphy would have it, this was discovered in the final printed versions of BYTE, as opposed to the more typical discovery of such effects in the "blue line" proof copies we get of each issue. So, rest assured—if the paragraph beginning on page 10 looks familiar when you read it, it is indeed an inadvertent repeat of an incomplete paragraph at the bottom of page 8....CH

**PRIORITY
ONE
ELECTRONICS**

Don't miss our
insert in the January
1980 issue of BYTE!



Put the BYTE on the IRS with Aardvark

In an era when computers are an integral part of business and entertainment, and computer software is more and more sophisticated, Aardvark is yet another breed in advanced computer software. Aardvark's Micro Tax series is a true user-oriented Federal Income Tax package. Specifically developed by qualified tax professionals for use on personal home computers, this low-cost, time-saving Aardvark Micro Tax package accurately and efficiently computes your federal income tax liability. Aardvark will display and fill in facsimile Form 1040 and related schedules and, if connected to a Centronics printer, will print out these facsimile forms auto-

matically. Each program is designed to use the appropriate tax table or rate schedule. The more advanced Micro Tax II and III also calculate Income Averaging, Maximum Tax on Earned Income, Minimum Tax and Alternative Minimum Tax. The Aardvark package is compatible with Apple II and TRS-80 users and includes an indexed instruction manual and input forms for easy input of tax data. To see how Aardvark can be tax-deductible, check the instructions in the binder of the manual. You can also use the binder to store pertinent 1979 tax records. Cure your headaches this tax season, order today...and put the BYTE on the IRS with Aardvark!

MICRO TAX I \$25
 Form 1040
 Schedule A
 Schedule B
 Schedule TC
 (will not calculate Income Averaging, Max Tax or Alternative Minimum Tax)

MICRO TAX II \$35
 Form 1040
 Schedule A
 Schedule B
 Schedule G (Inc. Avg.)
 Schedule TC
 Form 4625 (Minimum Tax)
 Form 4726 (Max Tax)
 Form 6251 (Alt. Min. Tax)

MICRO TAX III \$50
 Program 2 plus
 Schedule C
 Schedule D
 Schedule E
 Schedule SE
 Form 2119 - Sale of Personal Residence

When Ordering Specify:
 TRS-80 16K Level II Basic
 Apple II 32K with Applesoft Basic
 Apple II 16K Micro with Applesoft ROM Card

Aardvark Software

Coming Soon - Micro Tax Package for PET and TI Systems.

P.O. Box 26505 Milwaukee, WI 53213



24 hrs.

Call TOLL FREE 1-800-558-8570.
 In Wisconsin 1-414-289-9988

7 days





**REASONABLY - PRICED
QUALITY SOFTWARE**

Word processing for CP/M®

FMT Text Formatter \$75

Use FMT and your text editor to convert your CP/M system to a powerful word processor. FMT features include automatic page headings and footings, page numbering, centering, underscoring, external file merging, and in-line console input. FMT works with any video, CRT, or hardcopy terminal and printer combination. Added capabilities for daisy-wheel printers: superscripting, subscripting, and half-line spacing.

Run Cromemco Software Under CP/M

ADAPT Software Interface \$50

Now you can get Cromemco software to run on your CP/M system. ADAPT interfaces those powerful Cromemco packages (except for Multi-User BASIC) to any CP/M Version 1.4 system without patching. Adapt works without changes for any memory size.

Coming Soon - RATFOR

Watch for TSW's RATFOR (RATIONAL FORtran) precompiler that runs at more than 1000 statements per minute.

Dealer inquiries invited.
California residents
add 6% sales tax.

THE SOFTWARE WORKS
5207 Marigot Pl.
San Diego, CA. 92124

© CP/M is a trademark of Digital Research.

SUPER BASIC PROGRAM

ADAPTABLE FOR USE ON MOST SYSTEMS

DEMONS & SAINTS

SEND \$2 FOR MULTIPAGE LISTING AND PROGRAM DESCRIPTION TO

RASCAL PROGRAMS

ATTN. S. BURNS

3040 LINCOLN AV. BOX 2

E. ST. LOUIS, IL 62204

ATTENTION 2650 USERS

PROGRAMS ON CASSETTE TAPE

Machine Language Programs	(CD) 12K BASIC Programs
Memory Relocator \$6	Alphabetize \$6
relocates data in another	Bond for Deed \$6
section of memory	Loan Payment \$6
Identify Memory Location \$6	Vector Resolution \$10
for source code statements	magnitude and direction
Data Trap \$6	of two vectors in the
change all data between	plane
two specified memory loca-	Numerical Integration \$6
tions to ASCII values	Trapezoidal Rule
between 20 and 60	Cramer's Rule (2 x 2) \$6
Trap \$10	Cramer's Rule (3 x 3) \$10
game	
Super Screen Saver \$15	
saves several pages of screen	
information in a special buffer	

(CD) 8K BASIC Programs

*Demons & Saints \$15	Matrix Multiplication \$10
*Tic-Tac-Toe \$10	*Basketball Statistics Keeper
	saves and updates data —
	no disk required - 2 parts

*Program Text Uses From 28-36 Blocks of Memory
256 bytes/block

All Programs Above \$100



**North Star Horizon Timesharing
with
Hard Disk Interface**

In excess of 120 megabytes bulk storage capacity now possible. Several different hard disk units are available, interfaced to North Star DOS and BASIC.

Two to seven-user timesharing North Star Horizon integrated computer systems with: Dual density or quad capacity eight inch drives and/or hard disk units with your choice of a variety of printers.

A complete selection of innovative business application software is available for North Star* systems.

Foreign orders are our specialty. Dealerships are available. Call or write for descriptive literature, hard disk availability and/or dealer information package.

Micro Mike's, Incorporated

905 South Buchanan * Amarillo, Texas 79101 * USA
Telephone: 806-372-3633

making technology uncomplicated — for People

The **FORE**most
FORM-matter

A big friendly, forms generator package without a big system price.

A compliment to Hewlett Packard 9835 and 9845 Desktop Computers.

with FORM-matter you can...

- Create Forms
- Change Forms without Changing the Programs Using the Forms
- Simplify Input & Output on CRT Screens & Hardcopy Printers
- Use a Menu Driven Style
- Slip it into Your HP-Desktop System with 5 Simple Instructions.
- Save Money!
- Save Time!

Single Copy - \$350
Quantity & O.E.M. Discounts Available

For Further Information Call or Write:

CCS

CORPORATE COMPUTER SYSTEMS, INC.

675 Line Road, Aberdeen, New Jersey 07747 Telephone 201-583-4422

MICRO EXPO 80

THE LEADING
EUROPEAN
MICROCOMPUTER
SHOW

**CALL FOR
PAPERS**

Submissions are invited
on all aspects of
microcomputing for
presentation at the
conference. Accepted
papers will be published
in book form.

FOR FULL DETAILS:



Ref. ME80

2020 Milvia St.
Berkeley, Ca. 94704
tel: (415) 848-8233

PARIS MAY 6-8

SUPER SOFTWARE!

MICROWARE 6800 SOFTWARE IS INNOVATION AND PERFORMANCE

LISP Interpreter

The programming language LISP offers exciting new possibilities for microcomputer applications. A highly interactive interpreter that uses list-type data structures which are simultaneously data and executable instructions. LISP features an unusual structured, recursive function-oriented syntax. Widely used for processing, artificial intelligence, education, simulation symbolic, and computer-aided design. 6800 LISP requires a minimum of 12K RAM.
Price: \$75.00

A/BASIC Compiler

The ever-growing A/BASIC family is threatening old-fashioned assembly language programming in a big way. This BASIC compiler generates pure, fast, efficient 6800 machine language from easy to write BASIC source programs. Uses ultra-fast integer math, extended string functions, boolean operators and real-time operations. Output is ROMable and RUNS WITHOUT ANY RUN-TIME PACKAGE. Disk versions have disk I/O statements and require 12K memory and host DOS. Cassette version runs in 8K and requires RT/68 operating system.
Price: Disk Extended Version 2.1 \$150.00
Cassette Version 1.0 \$65.00

A/BASIC Source Generator

An "add-on" option for A/BASIC Compiler disk versions that adds an extra third pass which generates a full assembly-language output listing AND assembly language source file. Uses original BASIC names and inserts BASIC source lines as comments. SSB and SWTPC Minilix version available.
Price: \$75.00

A/BASIC Interpreter

Here it is—a super-fast! A/BASIC interpreter that is source-compatible with our A/BASIC compiler! Now you can interactively edit, execute and debug A/BASIC programs with the ease of an interpreter—then compile to super efficient machine language. Also a superb stand-alone applications and control-oriented interpreter. Requires 8K RAM. The cassette version is perfect for Motorola D2 Kits.
Price: \$75.00

RT/68 Real Time Operating System

MIKBUG—compatible ROM that combines an improved monitor/debugger with a powerful multitasking real-time operating system. Supports up to 16 concurrent tasks at 8 priority levels plus real time clock and interrupt control. Thousands in use since 1976 handling all types of applications. Available on 6830 (MIKBUG-type) or 2708 (EPROM-type) ROM. Manual is a classic on 6800 real-time applications and contains a full source program listing.
Price: RT68MX (6830) \$55.00
RT68MXP (2708) \$55.00

6800 CHESS

A challenging chess program for the 6800. Two selectable difficulty levels. Displays formatted chess board on standard terminals. Requires 8K memory. Machine language with A/BASIC source listing.
Price: \$50.00

Our software is available for most popular 6800 systems on cassette or diskette unless otherwise noted. Disk versions available on S.S.B., SWTPC, or Motorola MDOS. Please specify which you require. Phone orders are welcomed. We accept MASTERCARD and VISA. We try to ship orders within 24 hours of receipt. Please call or write if you require additional information or our free catalog. Microware software is available for OEM and custom applications.

MICROWARE
SYSTEMS CORPORATION

P.O. BOX 4865
DES MOINES, IA 50304
(515) 265-6121

Books from BITS inc PASCAL

MICROCOMPUTER PROBLEM SOLVING USING PASCAL
by Kenneth L. Bowles

This book is designed both for introductory courses in computer problem solving at the freshman and sophomore college level, and for individual self-study. Graphics is stressed in this version of the book. A complete single-user software system based on PASCAL has been developed at the University of California at San Diego, where the author is a professor in the Department of Applied Physics and Information Science. This system embodies extensions to the standard PASCAL which include the necessary functions and procedures for handling graphics and strings. 563pp.
#077 \$9.80

PASCAL USER MANUAL AND REPORT (Second Edition) by K. Jensen and N. Wirth

The manual is directed towards those who have some familiarity with computer programming and who wish to get acquainted with the PASCAL language. It is mainly tutorial and includes many helpful examples to demonstrate the various features of the language. The Report is a concise reference for both programmers and implementors. It defines Standard PASCAL, which constitutes a common base between various implementations of the language. 167pp.
#088 \$7.90

NEW A PRACTICAL INTRODUCTION TO PASCAL by I.R. Wilson and A.M. Addyman

PASCAL will soon supercede BASIC, and for good reason. It is a simple and efficient language, encouraging structured programming. Wilson and Addyman have written an introduction to PASCAL suitable for first time or experienced programmers. Describing PASCAL using syntax diagrams, the book encourages the step-wise refinement technique of structured programming. Over 60 programs are included as examples, and seven of its 14 chapters are devoted to data structures. 148pp.
#218 \$7.90

PROGRAMMING IN PASCAL by Peter Gorgono

This book is an excellent introduction to one of the fastest growing programming languages today. The text is arranged as a tutorial containing both examples and exercises to increase reader proficiency in PASCAL. Besides sections on procedures and files, there is a chapter on dynamic data structures such as trees and linked lists. These concepts are put to use in an example bus service simulation. 359pp.
#099 \$11.50

CONCURRENT PASCAL COMPILER by Alfred Hartman

This is a paper describing a seven-pass compiler for the Concurrent PASCAL programming language. It includes details about the pass structure, lexical analysis, syntax analysis, code assembly and implementation of the compiler. Concurrent PASCAL is an abstract programming language for computer operating systems. The language extends sequential PASCAL with the monitor concept for structured concurrent programming. Compilation of Concurrent PASCAL on a microcomputer is done by dividing the compiler into seven sequential passes. The passes, written in sequential PASCAL, generate virtual code that can be interpreted on any 16 bit computer. 119pp.
#137 \$8.40

AN INTRODUCTION TO PROGRAMMING AND PROBLEM SOLVING WITH PASCAL

by G. M. Schneider, S. Weingart and D. Perlman

This book introduces all aspects of the programming and problem solving process, including problem specification and organization, algorithms, coding, debugging, testing documentation and maintenance. Good programming style and how to produce a high quality finished product is brought out in numerous style examples throughout the text. PASCAL is used as a vehicle to teach various aspects of programming techniques. 359pp. #070 \$14.95

(Postage \$.75/item or \$1.00 outside U.S. to a maximum postal charge of \$3.00)

DIAL YOUR BANK CARD ORDERS

TOLL FREE 800-258-5477

BITS Inc Books to erase the impossible

25 Route 101 West, PO Box 428, Peterborough, NH 03458



∞ INFINITE BASIC ∞™

**RELOCATABLE MODULES FOR THE TRS LEVEL II AND DOS SYSTEMS
LOAD ANY OR ALL MODULES. FOR \$49.95 THE CORE PACKAGE INCLUDES:**

∞ MATRIX PACKAGE ∞

Over 30 BASIC commands including:

- ∞ Matrix Read, Inverse, Transpose, and Identity. Simultaneous Equations!!!
- ∞ Add, Subtract, or Multiply Scalars, Vectors, or Multi-dimension arrays!!!
- ∞ Dynamically Reshape, Expand, Delete Arrays, Change arrays in mid-program.
- ∞ Copy array elements, set arrays to scalar, zero arrays, move arrays.
- ∞ Tape array read and write including string arrays.

FOR \$29.95 more get the ∞ BUSINESS PACKAGE ∞

- ∞ Eliminate round-off error!! Multiple precision packed decimal arithmetic. 127-digit max. accuracy
- ∞ Binary search or sorted arrays. Insert new elements in sorted arrays!!!
- ∞ Automatic page headings, footings, and pagination. Includes forced end-of-page.
- ∞ Automatic hash for record retrieval!! And more for your professional packages.

∞ STRING PACKAGE ∞

Over 40 BASIC commands including:

- ∞ Left and right justify, truncate, rotate. Text justification. String centering.
- ∞ Delete or insert substring, Pack strings, Convert to upper or lower case.
- ∞ Translate characters, Reverse strings, Verify function, Number of occurrences.
- ∞ Masked string searches for simple or array variables. Encrypt or decrypt strings.
- ∞ Compress/uncompress character string arrays to 6 bits or less per character.
- ∞ AND the famous RACET machine language SORTS. Multi-key multivariable and string. Sort 1000 elements in 9 sec!!

**FUTURE ∞ ADD-ON PACKAGES ∞ will include
∞ STATISTICS ∞ INPUT/OUTPUT ∞ GRAPHICS ∞**

Attn: TRS Add-On OEM's: We can support your special hardware add-ons with direct BASIC commands. System Houses: We license System House usage of ∞ INFINITE BASIC ∞ modules.

COMMAND PROCESSOR 'COMPROC' for \$19.95 (DOS only)

Extend DOS-AUTO command to perform multiple steps either at power-up or as a user command. Execute a script consisting of a sequence of commands or data from a BASIC command file.

REMODEL + PROLOAD for \$34.95 (Specify 16, 32, or 48K version)

REnumber any section of a program, MOve program segments, DElete program lines. Combine programs with renumber and merge. Load or save any portion of program from tape.

DISK SORT PROGRAM 'DOSORT' for \$34.95 (Specify 32 or 48K, minimum 2 disk system)

SORT/MERGE multi-diskette sequential files. Multiple variables and keys. Includes machine language in-memory sorts, comparators and string handling.

COPY SYSTEM TAPES with 'COPSYS' for \$14.95 (Non-DOS)

Check, VISA, M/C C.O.D.
Calif. residents add 6%

Telephone Orders Accepted
(714) 637-5016

WHEN ORDERING PLEASE
ADVISE PUBLICATION SOURCE

RACET COMPUTES
702 Palmdale, Orange CA 92665

Expand the usefulness of your microcomputer

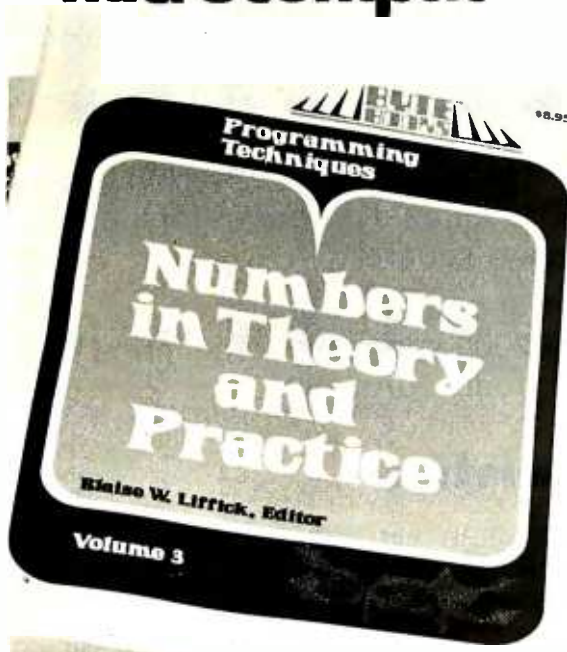

Numbers in Theory and Practice, the third volume in Byte's Programming Techniques series, is a collection of the best articles from past issues of BYTE® magazine along with the latest information on topics such as Floating Point Numbers, Random Numbers, Numerical Methods and Mathematics of Computer Graphics. This book contains numerous programs written in BASIC or assembly language and provides 192 pages of theory and practical applications along with nearly 100 illustrations, flow charts and computer art. Numbers in Theory and Practice is the next logical step for the computer user who seeks challenge and knowledge. \$8.95 ISBN: 0-07-037827-4

BYTE BOOKS Division

70 Main Street, Peterborough, New Hampshire 03458

Please send _____ copies of Numbers in Theory and Practice.

Name _____ Title _____ Company _____

Street _____ City _____ State/Province _____ Code _____

Check enclosed in the amount of \$ _____

Bill Visa Bill Master Charge

Card No. _____ Exp. Date _____

Add 60¢ per book to cover postage and handling.

Other books in the Programming Techniques series are: Program Design ISBN 0-07-037825-8 / Simulation ISBN 0-07-037826-6 / Bits and Pieces ISBN 0-07-037828-2



BOOKS OF INTEREST TO COMPUTER PEOPLE™

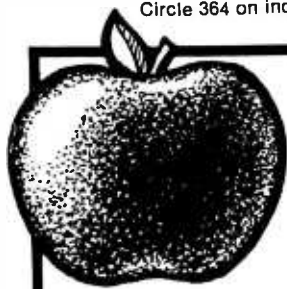

= 8080
(KIM too!)

8080 SIMULATOR on cassette

-KIM 1 version \$19.95

-APPLE II version \$19.95

turn your 6502 into an 8080

and use the wealth of 8080 software

TO ORDER:

By Phone: (415) 848-8233. Visa, MC, American Express.

By Mail: Indicate quantity desired. Include payment.

Shipping: Add \$1.50 per book (UPS), or 75c (4th class - allow 4 weeks delivery).

TAX: In California, add tax.



Dept. B-12 2020 Milvia Street,
Berkeley, California 94704

APL
APL
APL
APL
APL
APL
SOFTRONICS
μAPL for the 8080/8085/Z-80

©1979 Erik T. Mueller

APL is an interactive general-purpose programming language with powerful primitive functions. SOFTRONICS APL runs under the CP/M* operating system. It is 'ready-to-go' in ASCII, using CP/M standard I/O. The interpreter runs in a variety of character set configurations. In addition to the standard ASCII mnemonic representations, it supports typewriter and bit-pairing ASCII.APL character sets. It can run with user-supplied I/O drivers.

FEATURES:

- Most of the functions and operators of full APL, including n-dimensional inner and outer product, reduction, compression, general transpose, reversal, take, drop. Execute and format.
- The interpreter resides in 30K bytes of memory, leaving remaining memory for the workspace and disk operating system.
- Shared-variable mechanism for CP/M disk input and output, system functions and variables, system commands.
- Abrams' descriptor calculus and shared data storage are the advanced optimization techniques employed by the interpreter. This saves memory space and execution time. Values are stored internally in a variety of formats for efficient memory utilization.
- Optional driver program for video display with programmable character generator.

\$350 on CP/M* disk COMPLETE WITH USER'S MANUAL
NJ residents please add 5% sales tax.



36 Homestead Lane
Roosevelt, N.J. 08555

* CP/M is a registered trademark of Digital Research

Heuristics

SpeechLink™

2000

Talk To Your Computer . . .

- Voice data entry to the Apple® computer
- Voice control of your Apple® system
- User variable vocabulary (64 words and up)
- Applesoft & Integer Basic compatible with or without disk operating system

Useful For . . .

- Collecting inventory data
- Running the Apple® as a terminal
- Controlling production test equipment (say "test 2")
- Menu selection of programs (say "stocks")
- Entering stock market data
- Educational programs for the kids (say "square")

See your computer dealer.

Model 2000 suggested retail price \$259, model 20A \$189.



1285 HAMMERWOOD AVENUE
SUNNYVALE, CALIFORNIA 94086
408/734-8532

Apple® is a registered trademark of Apple Computer Corporation

ANOTHER FIRST FROM MOUNTAIN HARDWARE. SUPERTALKER.

GIVE VOICE TO YOUR APPLE.

SuperTalker allows you to add the dimension of human speech output in your computer programs. Add voice to games. Program verbal prompting for the operator of your business system. Use verbal warnings under program control as an enunciator in commercial security or control rooms. Create educational programs that verbally coach the student.

THE SUPERTALKER SYSTEM.

SuperTalker is a new Mountain Hardware peripheral system which allows the Apple II computer to output exceptionally high quality human speech through a loudspeaker under program control. Output may also be directed through any P.A. or stereo system. Initially, spoken words are digitized into RAM memory through the system microphone. Speech data in RAM may then be manipulated like any other stored data.

A COMPLETE PACKAGE.

The SuperTalker peripheral system consists of:
The SuperTalker peripheral card which plugs into

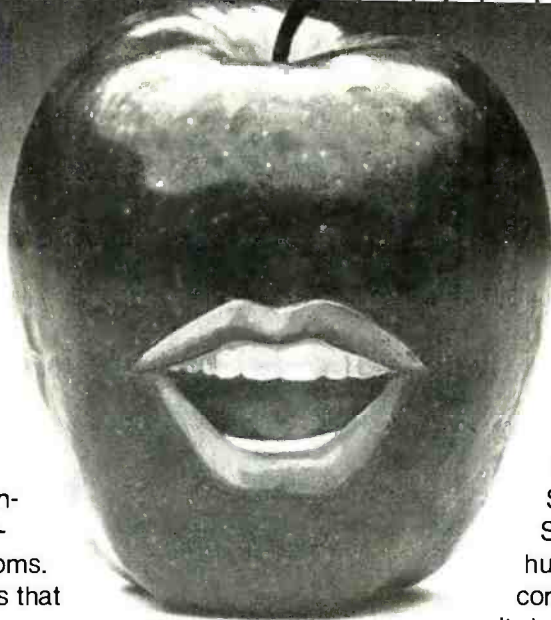

FOR YOUR APPLE II

a peripheral slot on the Apple II; a microphone; a loudspeaker; easy-to-use operating software and documentation; plus, two ready-to-run SuperTalker programs.

OPERATING SYSTEMS.

In order to achieve maximum utility using SuperTalker, the SuperTalker Disk Operating System permits output of human speech under program control with direct I/O routines.

It also provides a preparation program which permits the creation of voice files on diskette. BASIC program routines are provided

which require only one-line statements to output a word or phrase. Routines also support cassette storage.

TEACH YOUR COMPUTER TO TALK.

For \$279 assembled and tested, SuperTalker gives your Apple II a voice in the matter.

AVAILABLE NOW.

Mountain Hardware's SuperTalker, Apple Clock and 100,000 Day Clock™ (for S-100 bus computers) are available through computer dealers worldwide.

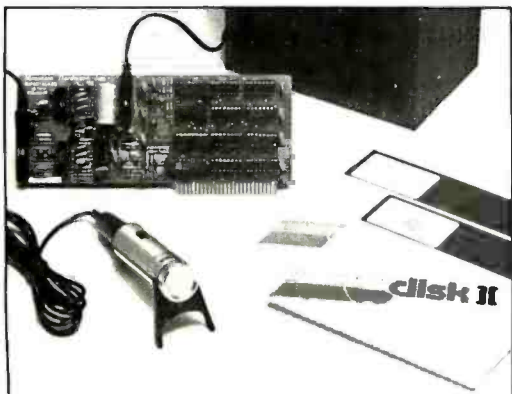

Mountain Hardware, Inc.

LEADERSHIP IN COMPUTER PERIPHERALS
300 Harvey West Blvd., Santa Cruz, CA 95060
(408) 429-8600

Sounds super.

- Send me everything I need to know about SuperTalker.
- Also information on your Real-Time clocks for Apple II and S-100.

Name _____

Address _____

City _____ State _____ Zip _____

Apple II is a trademark of Apple Computer, Inc.

Multi Variable Task

software system

FAMOS™

MULTI-TASKING DOS:

- 8080/z80
- Device independent file system
- Multi-sessioning/spooling
- Full user accounting
- All files dynamic
- Multi-user file security
- Intersystem communications

\$100 BUS SUPPORT

MVT-BASIC™

MULTI-USER COMPILER

- Powerful file, string I/O
- Chaining . . . parameter passing
- ISAM/sort facilities
- Random, sequential files
- Machine language calls
- Error trapping

HARD DISKS SUPPORTED

MVT-WORDFLOW™

MULTI-USER WORD PROCESSING SYSTEM

- Concurrent data processing
- Automatic field insertion
- Global search/replace
- Library file insertion
- "Cutting & pasting"/block moves
- Full WP printer support
- Multiple printers/concurrent
- Wordwrap/variable line spacing
- All options under user control

IMMEDIATE DELIVERY

AVAILABLE TO MANUFACTURERS/
OEM FOR PRIVATE LABEL
MARKETING

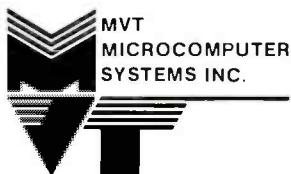

9241 Reseda Blvd., Suite 203
Northridge, CA 91324
Phone: (213) 349-9076

CASSETTE DUPLICATION

TRS-80(I & II), PET,APPLE, KIM, ATARI

Quality software duplication is more than copying cassettes. Microsette duplication uses a proprietary high speed duplicator designed specifically for computer program duplication. The finished products are of consistent quality, guaranteed to load. Minimum order is 100 with discounts for higher quantities. Call (408) 735-8832 for details.



MICROSETTE CO.
777 Palomar Avenue
Sunnyvale, CA 94086

Circle 227 on inquiry card.

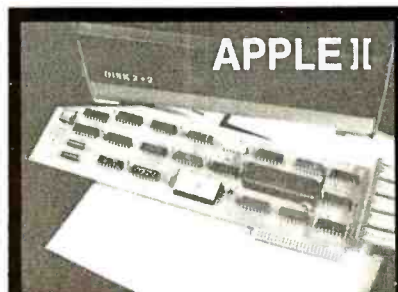

8" DISK CONTROLLER

APPLE DOS COMPATIBLE

- DOUBLES APPLE II™ STORAGE
- SHUGART 800/801 COMPATIBLE
- STANDARD IBM™ 3740 FORMAT
- CP/M™, UCSD PASCAL™ CAPABILITY

Available at your local APPLE Dealer: \$400.



SORRENTO VALLEY ASSOCIATES
11722 SORRENTO VALLEY RD.
SAN DIEGO, CA 92121

Circle 347 on inquiry card.

MAXIMUM VALUE FOR YOUR DOLLAR

NORTH STAR COMPUTER PRODUCTS

DOUBLE DENSITY	KIT	ASM
HRZ-1-32K-D	\$1590.	\$1850.
HRZ-2-32K-D	1910.	2200.
MDS-A-D	550.	640.
EXTRA DRIVE	330.	
QUAD DENSITY	KIT	ASM
HRZ-1-32K-Q	\$1750.	\$2040.
HRZ-2-32K-Q	2230.	2560.
MDS-A-Q	720.	800.
EXTRA DRIVE	480.	

All HORIZONS now come standard with 3 ports and all edge connectors and minimum 32K memory.

BOARDS-DISCS

	KIT	ASM
RAM-16K W/PARITY	\$300.	\$345.
RAM-32K W/PARITY	475.	520.
FPB-A	205.	270.

VERBATIM DISCS, BOX OF 10 . . . \$29. PP
We will try to beat any deal. Call:

A.E.I.
3851 HACKETT AVE.
LONG BEACH, CALIF. 90808
(213) 421-4815

Circle 21 on inquiry card.

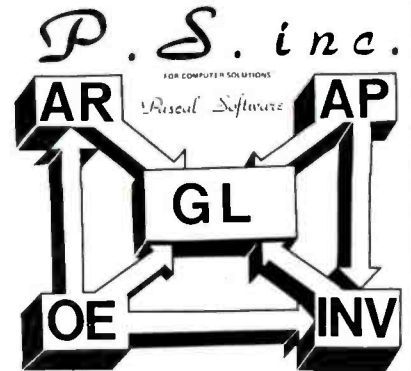

USE OUR
BUSINESS SOFTWARE
for
GREATER PROFIT
through
MORE EFFICIENT
OPERATION

INCLUDES :

- GENERAL LEDGER
- ACCOUNTS PAYABLE
- ACCOUNTS RECEIVABLE
- ORDER ENTRY
- INVENTORY CONTROL

This totally integrated, single entry system is easy to learn and easy to use because it is "Menu" oriented.

The software requires a minimum system consisting of 48K memory, CRT, Printer, dual floppy disc. It is ready to run on the following systems :

- DEC PDP - 11
- AM - 100
- PASCAL MICROENGINE
- CIT PENSEE

We are working on the following systems and feel we can install our software on them within 30 days ARO: Data General, General Automation, LSI 4/10, 4/30, Some Z80 Systems

Price for the total system is \$2995.00. Order a user manual (\$25.00 plus \$2.00 shipping & handling) or the Demo Floppy & Manual (\$65.00 plus \$2.50 shipping & handling) to reserve this price for you beyond our expected price increase Nov 1, 1979.

TO ORDER USE OUR TOLL FREE NUMBER
1-800-437-4774

VISA AND MASTERCARD WELCOME
OR SEND CHECK OR MONEY ORDER TO

P. S. INC, 619 NP AVE, BOX 2017 L
FARGO, ND 58107
(PH) 701/235-8145

P.S. Inc.

DEALER INQUIRIES INVITED

Circle 322 on inquiry card.

11 BASICs from BITS™

BASIC, From the Ground Up by David E. Simon.

This book is a good introduction to computing and the BASIC language for anyone, regardless of their background. David Simon assumes you have no previous programming experience and no familiarity with computing concepts. From the ground up, he builds on the fundamental concepts and teaches each part of the BASIC language in turn. Examples illuminate each step and six fully solved problems are included. This is the "beginner's book" in BASIC we at BITS have been looking for. 222 pages \$8.95.

THE BASIC WORKBOOK — CREATIVE TECHNIQUES FOR BEGINNING PROGRAMMERS by Kenneth Schoman, Jr.

This book contains lecture notes, exercises and problems for people learning BASIC. In a hands-on workbook style, Kenneth Schoman covers statements, loops, functions, variables, input/output and strings. Simulation and plotting are introduced. The examples and problems are runnable in virtually any version of BASIC. If you're learning BASIC, complement your studies with this book! 117 pp. \$5.95

BASIC WITH STYLE: PROGRAMMING PROVERBS by Paul Nagin and Henry Ledgard.

"Programmers can and should write programs that work the first time." This statement may sound idealistic to those accustomed to long hours of debugging. Yet, it's the theme of this book — a unique collection of "proverbs" or rules and guidelines for writing more accurate error-free programs. Newly rewritten, this book now emphasizes structured programming and all examples are in BASIC. 134 pp. \$5.95

BASIC BASIC, 2nd EDITION by James S. Coan.

If you're not already familiar with BASIC, James Coan's Basic BASIC is one of the best ways to learn about this popular computer language. BASIC (which stands for Beginner's All-Purpose Symbolic Instruction Code) is easy to learn and easy to apply to many problems. Basic BASIC gives you step-by-step instructions for using a terminal, writing programs, using loops and lists, solving mathematical problems, understanding matrices and more. The book contains a wealth of illustrations and example programs, and is suitable for beginners on many different levels. It makes a fine reference for the experienced programmer, too. 256 pp. \$8.95.

ADVANCED BASIC by James S. Coan.

Advanced BASIC is the companion volume to James Coan's Basic BASIC. In this book you'll learn about some of the more advanced techniques for programming in BASIC, including string manipulation, the use of files, plotting on a terminal, simulation and games, advanced mathematical applications and more. Many useful algorithms are covered, including some clever sorting techniques designed to reduce program execution time. As with Basic BASIC there are many illustrative example programs included. BASIC doesn't have to be basic with Advanced BASIC! 184 pp. \$8.95

BASIC AND THE PERSONAL COMPUTER by Dwyer/Critchfield.

A fascinating book covering many areas of interest to the personal computer user. After giving an in-depth course in BASIC, which can be covered in 8 hours, the book discusses microcomputer hardware, graphics, word processing, sorting, simulation and data structures. This is an easy to read text that is useful for the beginner and informative for the advanced user. 438 pp \$12.95

THE LITTLE BOOK OF BASIC STYLE by John Nevison.

Structure, style, correctness, maintainability. Attributes of good programming are getting much attention, and well they should. When one considers what we invest in programs, their manageability and efficiency become very important. Here these concepts are explained, along with 19 rules and many examples in BASIC to help improve your programming style. 151 pp. \$5.95

SOME COMMON BASIC PROGRAMS by Lon Poole and Mary Borchers, published by Osborne and Associates.

At last, a single source for all those hard to find mathematics programs! Some Common BASIC Programs combines a diversity of practical algorithms in one book: matrix multiplication regression analysis, principal on a loan, integration by Simpson's rule, roots of equations, operations on two vectors, chi-square test, check writer, geometric mean and variation, coordinate conversion and a function plotting algorithm. These are just some of the many programs included. For only \$8.50 you can buy the kind of programs previously available only as part of software math package systems for large scale computers. All the programs are written in a restricted BASIC suitable for most microcomputer BASIC packages, and have been tested and debugged by the authors. 192 pp. \$9.50

BASIC WITH BUSINESS APPLICATIONS by Richard W. Lott.

This book focuses on the BASIC language and its application to specific business problems. The book is divided into two sections. Part one introduces the BASIC language and the concept of logical flowcharting. Part two presents problems and possible solutions. Topics include: interest rate calculation, break-even analysis, loan rates, and depreciation. Exercises at the end of each chapter give a greater understanding of BASIC by actual programming. This book is a great aid to the beginner wanting to learn BASIC without having a technical or scientific background. 284 pp. \$11.95

MORE BASIC COMPUTER GAMES edited by David H. Ahl.

Here are 84 new games from David Ahland Creative Computing! Punchin Minotaur and battle with the beast; try Chuck-a-luck but bring your money; key In Eliza and unload your troubled mind to the doctor. They're all great fun. After all, what are computers for? 185 pp. \$7.50

GAME PLAYING WITH BASIC, by Donald D. Spencer.

You'll enjoy the challenge of competing with your own computer. Games described include: 3-D Tic Tac Toe, Nim, Roulette, Slot Machines, Magic Squares, Keno, Morra, Baccarat, Knight's Magic Tour, and many others. The style is non-technical, and each section gives complete rules for the game, how it works, illustrative flowcharts, and example outputs for each program. The last chapter contains 26 games for reader solution, including Hexapawn and Poker Dice. 166 pp. \$7.95.

NEW!



POSTAL CHARGES
 U.S.: \$.75/book to a max. of \$3 Foreign: \$1/book to a max. of \$4 (surface) UPS (U.S. only): \$1.75 1st book, \$.75 each additional book to a max. of \$4.

BITS™
 inc

DIAL YOUR CHARGE CARD ORDERS TOLL-FREE 800-258-5477

(in NH call 924-3355) Mon-Fri 9-5



Books to erase the impossible

POB 428, 25 Route 101 West, Peterborough, N.H. 03458

SORCERER* SOFTWARE!

All programs on cassette. Only 8k of memory required.

FASTGAMMON™ by Bob Christiansen. Backgammon players love this machine language program that provides a fast, skillful opponent. Eight-page instruction manual includes rules of backgammon. **\$19.95**

PLOT by Vic Tolomei. Now Apple owners will be envious of how easy you can get good graphics on your SORCERER. PLOT includes both a super high resolution mode and a quick low resolution mode. Both are accessible from your BASIC programs using simple commands. Hi-res & lo-res examples included on tape. **\$14.95**

SHAPE MAKER™ by Don Ursem. Construct special characters and fancy shapes with ease using this on-screen character editor. Detailed 12-page instruction booklet includes example applications. **\$14.95**

DEBUG by Bob Pierce. Debug machine language programs by stepping through one instruction at a time. Relocatable. Several display options. Multiple break points. Modify memory and registers. **\$14.95**

Z-80 DISASSEMBLER by Vic Tolomei. Decode machine language programs, including SORCERER's monitor and ROM-PAC's, with this Z-80 Disassembler written in BASIC. Prints out machine code. Zilog mnemonics, and ASCII. **\$19.95**

MAGIC MAZE™ by Vic Tolomei. A challenging maze game. Ten levels of play. Holding your lantern, you wander through a maze trying to stay on the right path and avoid pitfalls. Automatic scoring tells you how good a pathfinder you are. **\$11.95**

SOFTWARE INTERNALS MANUAL FOR THE SORCERER by Vic Tolomei. A must for anyone writing software for the SORCERER. Seven chapters: Intro to Machine Language, Devices & Ports, The Monitor, Cassette Interface, BASIC structure, Video & Graphics, The Keyboard. Indexed. Includes diagrams and software routines. 64 pages. **\$14.95**



QUALITY SOFTWARE

6660 Reseda Blvd., Suite 103, Reseda, CA. 91335
Telephone 24 hours, seven days a week: (213) 344-6599

WHERE TO GET IT: Ask your nearest Sorcerer dealer to see Quality Software's Sorcerer programs. Or, if you prefer, you may order directly from us. MasterCharge and Visa cardholders may telephone their orders and we will deduct \$1 from orders over \$19 to compensate for phone charges. Or mail your order to the address above. California residents add 6% sales tax. Orders outside North America add \$5 for registered airmail, pay in U.S. currency. * The name "SORCERER" has been trademarked by Exidy, Inc.

PET • PET • PET • PET • PET • PET • PET • PET • PET • PET • PET • PET • PET • PET • PET

PET PRODUCTS

Programs — Workbooks
for Floppy Disk — for Cassette



See your Dealer

Dealer Inquiries Invited

Put your PET to work!

T I S

PROGRAMS	WORKBOOKS	
SW-1* MAIL making list system	WB-1 Getting Started with Your PET	\$3.95
SW-2* CHECKBOOK record	WB-2 PET String and Array Handling	\$3.95
SW-3* ACCOUNTS keep track of who owes you how much	WB-3 PET Graphics	\$4.95
SW-4 MEDIT create and maintain data files	WB-4 PET Cassette I/O	\$4.95
SW-5* CALENDAR appointments, meetings at a glance	WB-5 Miscellaneous PET Features	\$3.95
	WB-6 PET Control and Logic	\$3.95

*These programs are special purpose data base management systems. They all can:
 • Sort numeric or string fields
 • Select based on numeric or string (*)
 • Select based on subrating match
 • Select based on range of entry number
 Prices: \$9.90 each for programs using cassette storage for data
 \$12.95 each using sequential floppy disk storage for data.
 Price includes 40 - 80 page instruction manual

Add \$2.00 for shipping and handling

Money back guarantee



On bank card orders, give all numbers

TIS
P.O. Box 821, Dept. B
Los Alamos, NM 87544

PET is a trademark of Commodore Business Machines

PET • PET • PET • PET • PET • PET • PET • PET • PET • PET • PET • PET • PET • PET • PET

PET Word Processor

8K
and
16/32K
PET
versions

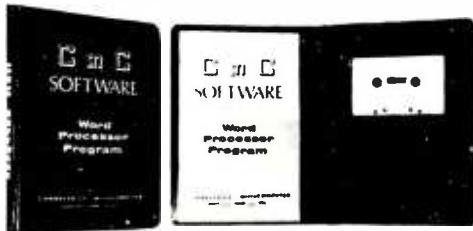

This program permits composing and printing letters, flyers, advertisements, manuscripts, etc., using the COMMODORE PET and a printer.

Printing directives include line length, line spacing, left margin, centering and skip. Edit commands allow you to insert lines, delete lines, move lines and paragraphs, change strings, save files onto and load files from cassette (can be modified for disk), move up, move down, print and type.

Added features for the 16/32K version include string search for editing, keyboard entry during printing for letter salutations, justification, multiple printing and more.

A thirty page instruction manual is included.

The CmC Word Processor Program for the 8K PET is \$29.50. The 16/32K version is \$39.50.

Order direct or contact your local computer store.

VISA AND M/C ACCEPTED — SEND ACCOUNT NUMBER, EXPIRATION DATE AND SIGN ORDER.
ADD \$1 PER ORDER FOR SHIPPING & HANDLING — FOREIGN ORDERS ADD 10% FOR AIR POSTAGE

CONNECTICUT microCOMPUTER, Inc.

150 POCONO ROAD
BROOKFIELD, CONNECTICUT 06804

TEL: (203) 775-4595 TWX: 710-456-0052

MEMOREX FLEXIBLE DISCS

Markette 1s - Single Head, Single Density

IBM Compatible (128 b/s, 26 sectors)	32013060
IBM System 6 Compatible (512 b/s)	32013066
Shugart Compatible, 32 Hard Sector	32013015
2-5-\$5.00 each — 6-9-\$4.50 each — 10-up \$3.75 each	

Markette 1d - Single Head, Double Density

IBM Compatible (128 b/s, 26 sectors)	32013090
Shugart Compatible, 32 Hard Sector	32013091
2-5-\$6.50 each — 6-9-\$6.25 each — 10-up \$5.90 each	

Markette 2d - Double Headed, Double Density

Soft Sector (Unformatted)	32013102
Soft Sector (256 b/s, 26 sectors)	32013103
Soft Sector (512 b/s, 15 sectors)	32013114
Soft Sector (1024 b/s, 8 sectors)	32013104
32 Hard Sector	32013105
2-5-\$7.00 each — 6-9-\$6.75 each — 10-up-\$6.55 each	

Mini-Markette

5 1/4" Single Head, Single Density

Soft Sector (Unformatted)	32013401
10 Hard Sector	32013403
16 Hard Sector	32013405
2-5-\$5.00 each — 6-9-\$4.50 each — 10-up \$3.75 each	

Digital Cassettes: MEMOREX E-300, usable in 90% of all applications.
5-10 \$8.00 each, 11-29 \$7.50 each, 30 or more \$6.75 each

Send check or money order or provide us with your Bank Americard or Master Charge Card number and signature. Send to DATA SALES, P.O. Box 8230, Corpus Christi, Texas 78412 (Texas Residents add 5% Sales Tax) On orders of less than \$25.00 add \$2 for shipping and handling. For more information on the complete line of MEMOREX products
Circle Reader #

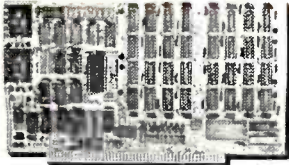

64K BYTE EXPANDABLE RAM
 DYNAMIC RAM WITH ON BOARD TRANSPARENT REFRESH GUARANTEED TO OPERATE IN NORTHSTAR, CROMEMCO, VECTOR GRAPHICS, SOL. AND OTHER 8080 OR Z-80 BASED S100 SYSTEMS *4MHZ Z-80 WITH NO WAIT STATES.
 * SELECTABLE AND DESELECTABLE IN 4K INCREMENTS ON 4K ADDRESS BOUNDARIES.
 * LOW POWER—8 WATTS MAXIMUM.
 * 200NSEC 4116 RAMS.
 * FULL DOCUMENTATION.
 * ASSEMBLED AND TESTED BOARDS ARE GUARANTEED FOR ONE YEAR AND PURCHASE PRICE IS FULLY REFUNDABLE IF BOARD IS RETURNED UNDAMAGED WITHIN 14 DAYS.

	ASSEMBLED / TESTED
64K RAM	\$595.00
48K RAM	\$529.00
32K RAM	\$459.00
16K RAM	\$389.00
WITHOUT RAM CHIPS	\$319.00

S100 MAINFRAME AND CABO CAGE

- * W/ SOLID FRONT PANEL \$239.00
- * W/ CUTOUTS FOR 2 MINI-FLOPPIES \$239.00
- * 30 AMP POWER SUPPLY \$119.00



- VISTA V-200 MINI-FLOPPY SYSTEM**
- * S100 DOUBLE DENSITY CONTROLLER
 - * 204 KBYTE CAPACITY FLOPPY DISK DRIVE WITH CASE & POWER SUPPLY
 - * MODIFIED CPM OPERATING SYSTEM WITH EXTENDED BASIC \$695.00
 - * EXTRA DRIVE, CASE & POWER SUPPLY \$395.00

16K X 1 DYNAMIC RAM
 THE MK4116-3 IS A 16,384 BIT HIGH SPEED NMOS. DYNAMIC RAM. THEY ARE EQUIVALENT TO THE MOSTEK, TEXAS INSTRUMENTS, OR MOTOROLA 4116-3.
 * 200 NSEC ACCESS TIME. 375 NSEC CYCLE TIME.
 * 16 PIN TTL COMPATIBLE.
 * BURNED IN AND FULLY TESTED.
 * PARTS REPLACEMENT GUARANTEED FOR ONE YEAR.
 \$8.50 EACH IN QUANTITIES OF 8

BETA COMPUTER DEVICES
 P.O. BOX 3465
 ORANGE, CALIFORNIA 92665
 (714) 633-7280

CALIF. RESIDENTS PLEASE ADD 6% SALES TAX. MASTERCHARGE & VISA ACCEPTED. PLEASE ALLOW 14 DAYS FOR CHECKS TO CLEAR BANK. PHONE ORDERS WELCOME.

KIM/SYM/AIM-65—32K EXPANDABLE RAM
 DYNAMIC RAM WITH ONBOARD TRANSPARENT REFRESH THAT IS COMPATIBLE WITH KIM/SYM/AIM-65 AND OTHER 6502 BASED MICROCOMPUTERS.

- * PLUG COMPATIBLE WITH KIM/SYM/AIM-65. MAY BE CONNECTED TO PET USING ADAPTOR CABLE. SS44-E BUS EDGE CONNECTOR.
- * USES +5V ONLY (SUPPLIED FROM HOST COMPUTER BUS). 4 WATTS MAXIMUM.
- * BOARD ADDRESSABLE IN 4K BYTE BLOCKS WHICH CAN BE INDEPENDENTLY PLACED ON 4K BYTE BOUNDARIES ANYWHERE IN A 64K BYTE ADDRESS SPACE.
- * BUS BUFFERED WITH 1LS TTL LOAD.
- * 200NSEC 4116 RAMS.
- * FULL DOCUMENTATION
- * ASSEMBLED AND TESTED BOARDS ARE GUARANTEED FOR ONE YEAR AND PURCHASE PRICE IS FULLY REFUNDABLE IF BOARD IS RETURNED UNDAMAGED WITHIN 14 DAYS.

	ASSEMBLED / TESTED
WITH 32K RAM	\$419.00
WITH 16K RAM	\$349.00
WITHOUT RAM CHIPS	\$279.00
HARD TO GET PARTS ONLY (NO RAMS)	\$109.00
BASE BOARD AND MANUAL	\$49.00



into the 80's

Circle 365 on Inquiry card.

program your way:



PROGRAMMING THE Z8000

By Richard Mateosian, 320 pp., Ref. C281, \$14.95

A complete and detailed introduction to the Z8000 and its specific programming techniques from basic concepts to multimicro synchronization.

Available at the end of December.

PROGRAMMING THE 8086 Available soon.

TO ORDER:

By Phone: (415) 848-8233. Visa, MC, American Express.

By Mail: Indicate quantity desired. Include payment.

Shipping: Add \$1.50 per book (UPS), or 75¢ (4th class - allow 4 weeks delivery).

Tax: In California, add tax.



SYBEX, INC.
 2020 Milvia Street,
 Berkeley, California 94704

Some Notes on Modular Assembly Programming

James Lewis
Micro Logic Corp
100 Second St #213
Hackensack NJ 07602

James Lewis is president of Micro Logic Corp, a microcomputer application firm involved in microprocessor applications ranging from LASER beam controllers to office systems.

Despite the dominance of BASIC over machine code (eg: assembly language) in the programming of personal microcomputers, a significant number of programs are written in machine code, and for many good reasons: machine programs usually run much faster than BASIC programs; machine coded programs do not require the overhead in memory space taken up by a BASIC interpreter; they often take less space than equivalent BASIC programs; and a BASIC interpreter may not be available on a given system.

The purpose here is not to further compare BASIC with machine code but rather

to discuss a good way to use machine code, given that it has been selected as the language of choice. The method to be described focuses on an important aspect of machine coding: the use of subroutines.

Example

The technique is best explained and illustrated with an example. Although 8080 code will be used (and regardless of whether or not the reader is familiar with 8080 machine code), the overall philosophy applies to other machines. The problem is to write a program that generates pseudorandom notes of music through a DAC (digital to analog converter). Incidentally, the example was implemented on a TRS-80 using a TRS-80-DAC board.

The Algorithm

The algorithm chosen to produce pseudorandom music is as follows:

1. Generate a pseudorandom number;
2. Initialize a cycle count to 32;
3. Initialize note value of 16 mV;
4. Count down from the pseudorandom number to 0 to produce a delay;
5. Output the voltage;
6. Multiply the voltage by -1;
7. Decrement the cycle count and go to 4 if not 0;
8. Return to the monitor if the shift key is down;
9. Otherwise go to 1.

This will produce random notes, each consisting of 32 square wave transitions and a voltage swing of +16 mV to -16 mV until the shift key is pressed to abort the program.

Listing 1: Nonmodular code for pseudorandom tone generator.

START	MVI	B,1	B = RUNNING RANDOM TOTAL
	MVI	C,16	C = DAC VOLTAGE
	MVI	D,32	D = CYCLE COUNT FOR A NOTE
LOOP1	MOV	A,B	A = LAST RANDOM NUMBER
	ADI	187	A = NEW RANDOM NUMBER
	MOV	B,A	B = NEW RANDOM NUMBER
	MOV	E,D	E = CYCLE COUNT FOR A NOTE
LOOP2	MOV	A,B	A = NEW RANDOM NUMBER
DLY	DCR	A	PRODUCE A DELAY BY COUNTING
	JNZ	DLY	DOWN FROM THE RANDOM NUMBER
	MOV	A,C	A = DAC VOLTAGE
	OUT	DP0RT	SET DAC VOLTAGE
	CMA		MULTIPLY BY -1 BY TAKING
	INR	A	THE 2'S COMPLEMENT
	MOV	C,A	C = NEW DAC VOLTAGE
	DCR	E	DECREMENT CYCLE COUNT
	JNZ	LOOP2	LOOP IF NOT 0
	LDA	SHKEY	A = VALUE OF SHIFT KEY
	ORA	A	TEST A
	JZ	LOOP1	NEXT NOTE IF NOT PRESSED
	JMP	MONITOR	ELSE RETURN TO MONITOR

If you need to learn assembly language read what the critics say about this book

"This book is the best and most lucid introduction to Z80 programming that we have seen."

Digital Design

"Practical Microcomputer Programming is a very powerful series. It is well written and full of essential techniques for the assembly language programmer."

Byte

"This is an EXCELLENT book. . . This book is a must for all Z80 users. . . dirt cheap for such great software and documentation."

CACHE

In 18 chapters and 4 appendices **PRACTICAL MICROCOMPUTER PROGRAMMING: THE Z80** supplies EVERYTHING you need to learn to program the Z80 at assembly level. Essential assembly language techniques are explained in clear English and documented with more than 100 working example programs. The full SOURCE text of a conversational assembler and debugging monitor are given in appendices. This software will run on any Z80 based machine. Object code on either paper tape or TRS-80 Level II cassette is sent FREE when the coupon from the book is returned.

Don't pass up this unique opportunity to add this valuable programming skill to your repertoire.

6" x 9", 481 pages, hardcover, \$32.95

TRS-80 is a trademark of Tandy Corp.

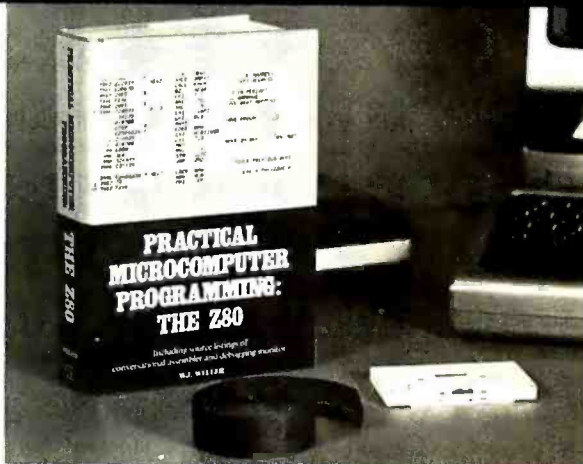

Send check or money order to:
Northern Technology Books
Box 62
Evanston, IL 60204

Name _____

Address _____

City _____ State _____ Zip _____

U.S. funds only. Illinois residents add 5% sales tax.

No COD's please.

FINALLY! SECURITY FOR CP/M FILES! With LOCKER[©] and CSPOOL![©]

LOCKER[©]

Rewrites disk files in scrambled format with a 64 character "lock code". Added parity for Self-Correcting!

CSPOOL[©]

Transfers CP/M files to/from cassette tape!

Mail to: **INFINITY MICRO**
P.O. BOX 4627
SANTA CLARA, CA 95050
(408) 988-1867

- LOCKER @ \$38
 CSPOOL for Sorcerer @ \$38
 CSPOOL for Sol/CUTS @ \$38

Please specify disk as CP/M on 8" IBM standard or 5 1/4" Micropolis.

NAME _____

ADDRESS _____

CITY _____ STATE _____ ZIP _____

Copyright © 1979 Infinity Micro.



Smoke Signal Broadcasting announces...

MULTI-USER COBOL

A powerful business language designed to run on Smoke Signal Broadcasting's 6800 based microcomputer line which offers the following capabilities:

- Handles all aspects of program development, from initial input of source programs, through compilation and testing, to the operation of a complete business system.
- Multi-user BOS (Business Operating System) allows for multiple users to interact with the computer at the same time.
- An interactive text editor, compiler, and linker and librarian.
- A wide range of application products including accounting systems, file management and report generating.

Smoke Signal Broadcasting's 'Chiefs' once again providing you with the high quality, reliable software for use on the increasingly popular Chieftain Series of 6800 based microcomputer.

Software licenses available to qualified dealers and software houses. Contact Jim Allday for further information.

We're the "CHIEF" in 6800 products software

SMOKE SIGNAL  **BROADCASTING[®]**

31336 Via Colinas, Westlake Village, CA 91361, (213) 889-9340

Listing 1 is the 8080 implementation of the above algorithm without using the modular machine code practice. For simplicity, the trivial algorithm of adding an arbitrary number like 187 to a running total is used to produce pseudorandom numbers.

The code first initializes some parameters. It then generates a simple pseudorandom number. After setting up a cycle count, it sets up a pseudorandom delay count and then executes the pseudorandom delay. It then outputs and inverts the note value, decrements the count, and loops if necessary. Next it checks for a user abort with the shift key and either loops or goes to the monitor.

This style of coding has many disadvantages over the modular style given in listing 2. It is relatively hard to follow, hard to explain, and hard to change. Compare it with the modular approach for yourself.

Listing 2: Modular code for pseudorandom tone generator. This form is better than the nonmodular form because each of the subroutines can be accessed separately and debugged more easily.

START	CALL CALL CALL JMP	RANDOM NOTE ABORT START	A = RANDOM NUMBER GENERATE NOTE USING (A) AS FREQUENCY ABORT TO MONITOR IF SHIFT KEY DOWN LOOP FOR NEXT NOTE
RANDOM	LDA ADI STA RET	RANUM 187 RANUM	A = OLD RANDOM NUMBER A = NEW RANDOM NUMBER SAVE NEW RANDOM NUMBER RETURN TO CALLING PROGRAM
RANUM	DATA	1	INITIAL RANDOM NUMBER
NOTE	PUSH MVI CALL CALL DCR JNZ POP RET	8 8,32 DELAY TOGGLE 8 LOOPN 8	SAVE 8 REGISTER VALUE 8 = 32 FOR CYCLE COUNT DELAY ACCORDING TO (A) REGISTER FLIP DAC FOR SQUARE WAVE DECREMENT CYCLE COUNT LOOP IF NOT 0 RESTORE 8 REGISTER VALUE RETURN
DELAY LOOPD	PUSH DCR JNZ POP RET	PSW A LOOPD PSW	SAVE THE (A) REGISTER DECREMENT (A) LOOP IF NOT 0 RESTORE THE (A) REGISTER
TOGGLE	PUSH LDA CMA INR STA OUT POP RET	PSW VOLTAGE A VOLTAGE DPOR PSW	SAVE THE (A) REGISTER A = CURRENT VOLTAGE MULTIPLY BY -1 8Y TAKING THE 2'S COMPLEMENT SAVE NEW VOLTAGE OUTPUT VOLTAGE TO DAC RESTORE THE (A) REGISTER GO BACK INITIAL VOLTAGE VALUE
VOLTAGE	DATA	18	INITIAL VOLTAGE VALUE
ABORT	LDA ORA JNZ RET	SHKEY A MONITOR	A = VALUE OF SHIFT KEY TEST VALUE GO TO MONITOR IF PRESSED ELSE RETURN

We now show a different approach to the coding of the same program. Even though the code that generates the pseudorandom number is only three lines, we will make a subroutine out of it called RANDOM. We will also transform the 2 line DLY loop into a subroutine called DELAY and create a subroutine called TOGGLE to invert the note value. A subroutine can also be set up to generate a note given a delay value called NOTE, which will call DELAY. Lastly we create a routine to check for a shift key abort called ABORT.

The result of modularizing the program in this way yields several advantages. Each of the subroutines is easily understood because of its simplicity, and will be useful, without changes, in more complex music synthesis programs and in unrelated programs. The code is easier to debug and modify. To be fair, it should be pointed out that the modular code in this case is longer and a bit slower. However these disadvantages are of little concern in this case; in fact, in more complex programs, the modular approach usually produces shorter code than the non-modular approach. Lastly, an important advantage of the modular style is a simplified main routine.

The main routine, START, is significantly easier to understand and modify than the original nonmodular version. Of course we still have to write the subroutines, but each one is so small that it will be simple to code.

The RANDOM routine is simple and, since it is in modular form rather than part of some nonmodular code, it can be used by other programs or extensions of the music program given here. (Actually it is a poor pseudorandom number generator, but the point of modularization still applies.)

The NOTE routine generates a note with frequency determined by the value of A. (Actually, A gives the period, but everything is random, anyway.) The NOTE routine uses both the TOGGLE and DELAY subroutines.

Although the NOTE routine is not completely general (eg: cycle count is fixed), it can be used in programs other than the random note generator. The DELAY routine which NOTE calls is also straightforward. It is applicable to numerous situations — wherever a short variable delay is needed. The next routine toggles the note value and outputs a voltage to produce the square wave. Lastly, ABORT finishes the program. This completes the modular implementation of the pseudorandom note generator program.

BITS PROGRAMMER PADS™

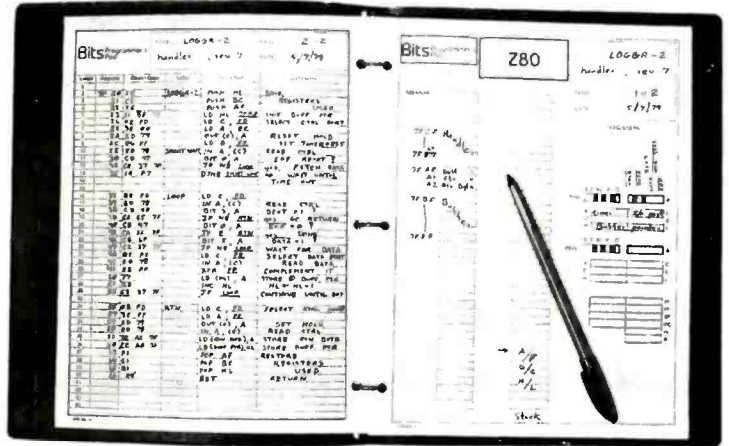

VISA



For Fastest Service

CALL TOLL FREE 800-258-5477
FOR BANK CARD ORDERS

Good programming deserves good documentation. BITS Inc. has developed a programming form to help assembly language programmers write and preserve their programs in a loose-leaf notebook format. BITS PROGRAMMER PADS™ are now available for the 8080A, Z-80, 1802, 6800, and 6502 microprocessors. On one side of the form the processor's register architecture is laid out along with continuous memory locations. This allows the details of your program's register use, stack manipulations, indexed addressing, and table and data storage to be permanently recorded. The other side is for your program or subroutine listing. Its source listing is entered in the instructions, labels and comments columns. Assembling is done next by filling in the object

code column which is wide enough for two or three byte instructions. Memory locations are assigned in the address column. If revision or relocation of the program is necessary, the address column can be renewed using typewriter correction tape (a white paper tape about 1/3" wide) and memory addresses reassigned.

BITS PROGRAMMER PADS will protect the effort you have put into your programs and take some of the pain out of hand assembly. Each 50-page pad is printed on durable stock paper, and prepunched for a standard three-ring notebook. They are available for \$2.50 each plus postage and handling (75¢ for one pad, \$1.25 for two or more domestic; \$1.00 per pad to a maximum charge of \$4.00 foreign.)

BITS Inc Books to erase the impossible 25 Route 101 West, PO Box 428, Peterborough, NH 03458

**FOR YOU
YOUR WIFE
YOUR CHILD
YOUR HOME
YOUR SCHOOL
YOUR BUSINESS**



**A Computer System Both
Practical and Affordable!**

Many uses for your computer. ■ Word Processing ■ Accounting ■ Bookkeeping ■ Games ■ Personal Records ■ Menu Planning ■ Educational Development ■ Tax Preparation ■ Homework, etc.

BYTE SHOP EAST offers a wide selection of hardware to meet your specific needs: SORCERER, PET, APPLE, NORTH STAR, IMSAI, DIGITAL, and many, many others. BYTE SHOP EAST has a complete library of books and magazines to meet your needs.

Come in to our computer stores for a FREE demonstration!

BYTE SHOP EAST, INC.

130 East 40th St.
(Corner of Lexington Ave.)
New York 10016
Tues.-Fri. 10 - 6 Sat. 10 - 5
(212) 889-4204

2721 Hempstead Turnpike
(Just East of Wantagh Pkwy)
Levittown, N.Y. 11756
Tues.-Fri. 12 - 8 Sat. 10 - 5
(516) 731-8116



Smoke Signal Broadcasting announces...

AUTO CLERK

A file maintenance and report generation system designed to run on Smoke Signal Broadcasting's Chieftain Series of microcomputers with COBOL and BOS (Business Operating Systems).

- Requires no computer experience and no special training in order to automatically handle filing problems and reporting requirements.
- Requested information is displayed immediately, at computer speed, not filing cabinet speed.
- The user defines desired reports and the information they are to contain. Then the reports can be produced at any time.
- Stored information of general interest can be made readily accessible. Confidential information can be kept secret.
- All your information is in one place, the microcomputer. The small size means the system can reside at any convenient place in the office.

Let Smoke Signal Broadcasting, the 'experts', supply you with further information on AUTO CLERK, or COBOL, or BASIC, or FORTRAN.

Software licenses available to qualified dealers and software houses. Contact Jim Allday for further information.

We're the "CHIEF" in 6800 products software

SMOKE SIGNAL BROADCASTING®

31336 Via Colinas, Westlake Village, CA 91361, (213) 889-9340

KEYED FILE ACCESS

Create Interactive Systems In Hours With--

- MULTIPLE KEY INDEXING
- OPTIMIZED RANDOM ACCESS
- SUPER FAST SEQUENTIAL ACCESS
- DUPLICATE KEY VALUES ALLOWED
- ANY NUMBER OF DATA FILES SUPPORTED
- COMPLETE REAL TIME INSERTION
AND DELETION CAPABILITIES

FAIR COM

2606 Johnson Drive
Columbia, Mo. 65201
314-445-3304

Making Micro's Work Like Maxi's

MICRO B+™ brings the state-of-the-art in file accessing—the **B TREE INDEX**—to application programmers writing in CBASIC-II under CP/M * or derivative. The **B TREE INDEX** gives unparalleled performance: fast insertion, retrieval, and deletion without the need to ever reorganize the index! Let Fair Com turn your micro on to B TREES.

Special introductory offer: Return this ad with your order and **save \$50**. Offer good through December 15, 1979.

Available on 8" soft sector disks.

MICRO B+™ in CBASIC-II source code, with manual and demonstration program...\$195*. Manual and demonstration disk in CBASIC-II intermediate code...\$25. Look for MICROSOFT and other versions soon.

To order, send check or money order. **VISA** and **MASTERCARD** welcomed, send card number, expiration date and your signature.

*Trademark of Digital Research **Single CPU License

Method Comparison

Note that the modular approach has generated several useful routines that can be used in either more complex music programs or even totally unrelated programs. This applies to every routine except the main routine, which is specific to the current application. Furthermore the main routine is easy to follow and hence modify. If one wanted to create, say, a melody generator, it would be a much easier task to do so with the subroutines than the nonmodular program. In some applications the increased size of the modular code would not be outweighed by the other advantages, but

in larger systems the modular approach usually generates less code. The modular version is also a little slower, but this is often of little concern.

Conclusion

The technique of breaking a machine language program down into very small logical subroutines yields numerous advantages and few disadvantages. It takes some practice to learn how to do this effectively and to see the benefits firsthand, but it is well worth the initial added effort.■

GIVE YOUR APPLE VISION FOR CHRISTMAS!

The DS-65 Digisector® opens up a whole new world for your Apple II. Your computer can now be a part of the action, taking pictures to amuse your friends, watching your house while you're away, taking computer portraits... the applications abound! The DS-65 is a random access video digitizer. It converts a TV camera's output into digital information that your computer can process. The DS-65 features:

- **High resolution:** 256 X 256 picture element scan
- **Precision:** 64 levels of grey scale
- **Versatility:** Accepts either interlaced (NTSC) or industrial video input
- **Economy:** A professional tool priced for the hobbyist

The DS-65 is an intelligent peripheral card with on-board software in 2708 EPROM. Check these software features:

- Full screen scans directly to Apple Hi-Res screen
- Easy random access digitizing by Basic programs
- Line-scan digitizing for reading charts or tracking objects
- Utility functions for clearing and copying the Hi-Res screen

Let your Apple see the world!

DS-65 Price: \$349.95
Advanced Video FSII Camera Price \$299.00
SPECIAL COMBINATION PRICE: \$599.00

THE MICRO WORKS

P.O. BOX 1110 DEL MAR, CA 92014 714-942-2400

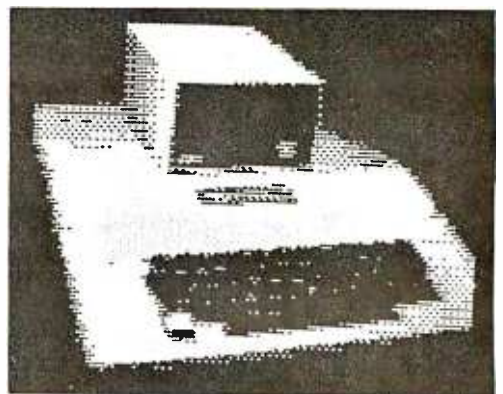

APPLE SELF-PORTRAIT



Powerful Apple/TRS 80 Software

by Systems
Design
Lab

See your dealer
Or for immediate delivery
SEND CHECK OR MONEY ORDER TO:

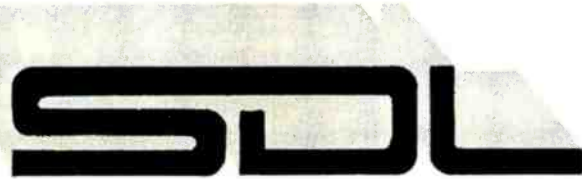

HIRES GRAPHIC PRINTER Print in Hires all the standard alphanumeric keyboard characters in addition to 16 user defined characters. Will append to yours with 2 easy call statements. (16k) \$19.95

HIRES PLAYGROUND Load a picture or any Hires screen from tape or disk and then do text editing with any of the standard keyboard or 16 user defined characters. (16k) \$24.50

THE FORECASTER II The Forecaster II does a linear regression trend analysis on your data and automatically labels the Hires graph screen for easy reading. (16k) \$17.95

DUAL RACE Dual Race is a very exciting fast paced and challenging auto race game for two players. (> 16k) .. \$14.95

MAILING LIST This versatile program has many features such as alphanumeric sort of any field, vertical spacing adjustment, printer interrupt for label adjustment, search any field and print labels, and much more. (32k) \$24.95

MULTIPLE REGRESSION ANALYSIS This program may be used in business, education, or in any field where historical data is used to predict future events. Includes the correlation matrix, the inverted matrix, the sum, mean, standard deviation and much more. (16k) \$19.95

TURF ANALYSIS Take the guesswork out of handicapping with this new and easy way to handicap horse racing on the APPLE II. This program provides incredibly accurate predictions through the use of multiple regression. (16k) * Also Available in TRS 80. 19.95

MATRIX INVERT This program will quickly find the inverse and determinant to a symmetrical matrix or solve a system of symmetrical linear equations. (16k) \$11.95

THE PLOTTER With the APPLE II, this program will allow you to easily plot equations in High Resolution Graphics in just seconds. (16k) \$12.95

MANDALA SUPREME You can now create artistic objects with the APPLE II similar to the popular Double Bessel Function within minutes. (16k) \$14.95

SOLO RACE Solo Race is a very exciting and challenging Low Resolution auto race game where you drive a race car over curvy roads and around obstacles. (> 16k) \$9.95

FUNPAK I The Funpak I is a small library of 5 programs all rolled into one. The Rat Race Maze, Mine Field, Canyon Bomber, Music Machine and Sound. (> 16k) \$9.95



PRO FOOTBALL Never before has there been a program that can predict such unbelievably accurate pointspreads with the APPLE II. You may predict any game within seconds from data saved on cassette or disk. The data file will instantly give you a complete rundown of the season's activity. Each program includes a complete prior season data file. (22k) * Also Available in TRS 80 \$19.95

COLLEGE FOOTBALL Similar to the PRO FOOTBALL program. This program contains over 78 major college football teams and a complete prior season data file. (35k) \$19.95

*Requires an Applesoft rom card

2612 Artesia Blvd., Suite B-1
Redondo Beach, CA 90278
(213) 374-4471

Javelin
Monitors
\$159.95

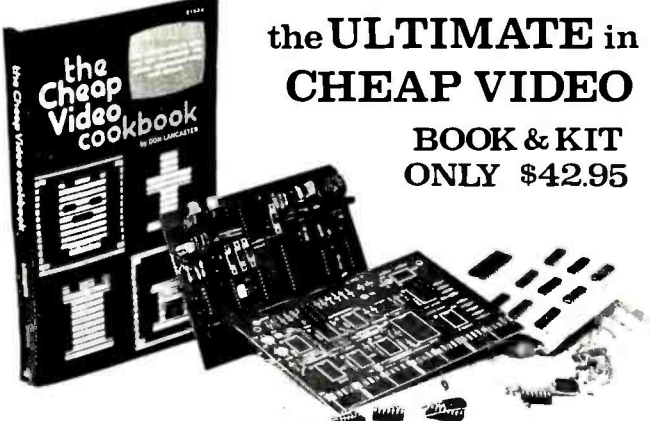

the ULTIMATE in CHEAP VIDEO

BOOK & KIT ONLY \$42.95

Don Lancaster's "Cheap Video" concept allows almost unlimited options, including:

- * Scrolling - Full performance cursor.
- * Line/Character formats of 16/32, 24/80, 32/64 or almost anything.
- * Graphics - up to 256 X 256 B&W; 96 X 128 COLOR (requires low-cost option modules)
- * Works with 6502, 6800 and other micros.

SPECIAL OFFER: Buy the Kit (upper case alphanumeric option included) & get the Book at 1/2 price.

RIA ELECTRONICS, DEPT 11-B, 1020W. WILSHIRE BLVD., OKLAHOMA CITY, OK 73116

I'm Sold, PLEASE RUSH..... () SEND FREE CATALOG

() TVT-6 5/8 Kit & CheapVideo Cookbook - \$42.95 (enclosed)

() TVT-6 5/8 Kit only (book required for assembly)-\$39.95

name: _____

address: _____

city: _____ state: _____ zip: _____

RIA ELECTRONICS DEPT. 12-B, 1020W. WILSHIRE BLVD., OKLAHOMA CITY, OK 73116



Smoke Signal Broadcasting announces... BUSINESS ACCOUNTS RECEIVABLE and INVOICE ENTRY SYSTEM

An on-line up-dating and reporting system which runs on Smoke Signal's Random DOS with 48K bytes and 500K bytes of disc storage which provide the following capabilities:

- Direct up-dating of account, invoice and payment information so that all changes are applied as entered.
- Audit records generated when account balance data is modified or an account is deleted.
- Invoice processing is used as the "front-end processor" for the accounts receivable system.
- Open invoices maintained in the system until payment is made.
- Billing information can either be printed or viewed on the CRT.
- Reports can be sorted by: account item number, account number, name, or zip code. Within each sequence, high and low ranges may be specified for each report.

Smoke Signal Broadcasting's Chieftain Series of 6800 based micro-computers has established a reputation of high quality, reliable equipment. This software package is designed to further enhance this reputation.

Software licenses available to qualified dealers and software houses. Contact Jim Allday for further information.

We're the "CHIEF" in 6800 products software

SMOKE SIGNAL BROADCASTING®

31336 Via Colinas, Westlake Village, CA 91361, (213) 889-9340

Event Queue

In order to gain optimum coverage of your organization's computer conferences, seminars, workshops, courses, etc, notice should reach our office at least three months in advance of the date of the event. Entries should be sent to: Event Queue, BYTE Publications, 70 Main St, Peterborough NH 03458. Each month we publish the current contents of the queue for the month of the cover date and the two following calendar months. Thus a given event may appear as many as three times in this section if it is sent to us far enough in advance.

DECEMBER 1979

December

WPI Programs, WPI is holding two-day courses in management skills for engineering and research and design supervisors; managing under pressure; energy conservation management; and management planning, scheduling and control.

For more information, contact Worcester Polytechnic Institute, Worcester MA 01609.

December

Computer Management in the 80s. Computer Power Management Corp, POB 1403, Rockville MD 20850, is giving one- and two-day seminars on computer management for executives. The courses cover data processing, word processing and printing, the role of data communications in data processing, and planning and supervising automated facilities and operations. The courses will be held in major cities in the US.

December

Yourdon Seminars. Yourdon Inc, 1133 Avenue of the Americas, New York NY 10036, is offering a series of seminars on software engineering, structure design and programming for microprocessors, data base modeling and design, programming in COBOL, and data base administration, throughout cities in the US during December.

December

Datapro Seminars, Datapro Research Corp, 1805 Underwood Blvd, Delran NJ 08075, is holding various seminars covering such topics as data communication, distributed systems, data processing, word processing, minicomputers and small business computers, and more. The seminars will be held in major cities around the US. They are two-day courses.

December 2-6

MUSE North American Annual Meeting, Bahia Mar Hotel and Yachting Center, Ft Lauderdale FL. This conference of Modcomp Users Exchange (MUSE) will feature technical sessions, workshops and user/manufacturer interface sessions on the use of Modcomp computers and their related software. Contact Kathy Black, MUSE, 4620 W Commercial Blvd, Suite 6C, Tamarac FL 33319.

December 3-5

Winter Simulation Conference, Holiday Inn, Em-

YOU THINK YOU'VE SEEN WORD PROCESSING SOFTWARE?

The **MAGIC WAND**TM Word Processing System offers you the best features of any system in the micro market

FEATURES INCLUDE:

- Full-screen text editor
 - Simple, control key operation
- Edit programs as well as text
 - Assemble, compile or run programs without modification
- Files larger than memory
 - Files up to 256K
- Library files
 - Merge part or all of one file with another
- Spool printing
 - Print a file while editing another
- Easy page formatting
 - Simple commands set margins, page length, etc.
- Override commands at run-time
 - Give any command from the keyboard as well as in file
- Variable pitch control
 - Change pitch in mid-line, even mid-word
- Up to 128 user-defined variables
 - String, numeric or dollar format
- Form letter generation from external data files
 - Compatible with both sequential and fixed-record files
- Conditional commands
 - Any command may be conditional
- Print to disk and/or printer
 - Save all or part of output on disk
- Switch from specialty printer to CP/M list device
 - Print the same file on either specialty or standard printer

EASE OF OPERATION

With all its power, the MAGIC WAND is remarkably easy to use. This is no accident. The command structure is designed to be flexible and logical so that you can perform basic functions with a minimum of commands.

We have included in the manual a step-by-step instructional program, for the person who has never used a word-processor before. The trainee uses sample files from the system disk and compares his work to simulated screens and printouts.

In addition to the lessons, the manual has a complete documentation of the command structure, special notes for programmers, an introduction to CP/M for non-programmers and a glossary. The manual is typeset, rather than typewritten, for greater legibility.

We have written the manual in non-technical English, because we want you to read it. We don't overload you with a bunch of jargon that could confuse even a PhD in Computer Sciences.

We send out newsletters so that users of the MAGIC WAND can learn special applications of the print commands. For example, we might show you how to create a mailing list or set up an index for a file.

In short, we've done everything we can to make things easy for you. Because the best software in the world is just a bunch of code if you can't use it.

For more information, call or write:

small business applications, inc.

3220 Louisiana • Suite 205 • Houston, Texas 77006 • 713-528-5158

CP/M is a registered trademark of Digital Research Corp

68 MICRO JOURNAL

Months ahead of all others with
6800/09 articles & new products

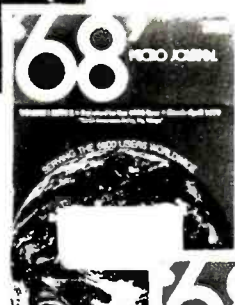
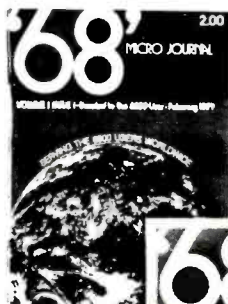

★
★
**THE
ONLY
6800/09
USER-ORIENTED
MAGAZINE**

Crunchers Corner — Bryant (A monthly programming tutorial) • Flex™ to BFD — Puckett • Tiny Music — Thompson • Semiconductor, Part 1 — Kinzer • Soup Up Your TVT — Pass • Hints & Kinks — fixes (soft & hard) • 50 pages plus Each Month!

Crunchers Corner — Bryant • A Look at the SWTPC CT-82 — Ferguson • 6800 Relative Branch Calculation (Hand) — Berenbon • Relative Calculator (Machine) — Heatherington • Maillist (Disk) — Lilly • Modems — Schuman • Semiconductor - Part 2 — Kinzer • Locate — Pigford • A20 MA, Printer-SWTPC — Perdue • AS-50 Monitor Board — Pentecost • TSC Basic for 6800 — Shirk • Plus Much-Much More!

Crunchers Corner — Bryant • A Case for the Small DOS — Mauch • MF-68 Motor Fix — Sorrels • Transfer (FLEX 1 to 2 or 5) — Womack • 6800 Delay — Berenbon • Make Like a 6809 — Feintuch • Games (Basic) — Harmon • Boot (Flex-BFD) — Puckett • Freeze Display (SSB) — Johnson • Paper Tape Reader — Adams • FLEX™ Fixes and Much More!

MAGAZINE COMPARISON (2 years) Monthly Averages 6800 Articles

KB	BYTE	CC	DOBB'S	TOTAL PAGES-
7.8	6.4	2.7	2.2	19.1 ea. mo.

Average cost for all four each month: \$5.88
(Based on advertised 1-year subscription price)

68' cost per month: \$1.21

That's Right! Much, Much More

for About

1.5 the Cost!

EFFECTIVE SEPT. 1, 1979

1-Year \$14.50 2 Years \$26.00 3 Years \$36.50

OK, PLEASE ENTER MY SUBSCRIPTION

Bill My: Master Charge — VISA

Card # _____ Exp. Date: _____

For 1-Year 2 Years 3 Years

Enclosed: \$ _____

Name _____

Street _____

City _____ State _____ Zip _____

My Computer Is: _____

68 MICRO JOURNAL

3018 Hamill Road

HIXSON, TN 37343

FOREIGN ADD:

\$9.50 Per Yr. Surface

\$29.00 Per Yr. Air Mail

★ MORE 6800 ARTICLES THAN ALL OTHERS COMBINED ★

Z_S - SYSTEMS



64K RAM BOARD

The Z_S-SYSTEMS 64K RAM board is designed to operate in any Z80 based microcomputer having S-100 bus. It uses 16K dynamic RAM chips, & features:

- Board select
- Bank select
- Transparent on-board refresh
- 2 or 4MHz operation (w/ no wait state)
- Memory disable

FLOPPY DISK CONTROLLER

Handles with no modification up to:

- * 4 standard 8" drives (Shugart or compatible) or
 - * 3 minidrives 5"
- Run with 2 or 4 MHz CPU

Compatible with Cromemco and M/PM multiuser. Fully assembled, burned in, & tested. Available from stock to 60 days

As low as \$500.00 in quantities of 100

Price of one.....\$695.00

With 16K RAM.....\$359.00
Plus shipping charges



Use CP/M Disk Operating System Using the 1771 LSI controller
Price of one.....\$245.00
PC board only.....\$35.00

SEND FOR FREE INFORMATION
6 months warranty on our boards with normal use

Z_S-SYSTEMS

PO Box 1847, San Diego, CA 92112
(714) 447-3997



Smoke Signal Broadcasting announces...

BUSINESS INVENTORY CONTROL and ORDER ENTRY SYSTEM

An on-line inquiry system which runs on Smoke Signal's Random DOS with 48K bytes and 500K bytes of disk storage which provides the following capabilities:

- All reports can be sorted several different ways. High and low ranges may be selected for each report.
- On line capability means any report can be requested at any time and will always show current status.
- Recording of sales automatically reduces inventory. Back orders are automatically generated.
- Bill of Materials function allows for automatic component updating when items are sold.
- Component list can include "comment" lines for inclusion of overhead, labor, etc.
- Projected Parts Report allows for forecasting results of producing a specific product mix.
- Where-Used Report lists every occurrence of a component and the quantities in each major item.

This business package enhances the reputation for quality and reliability established by Smoke Signal Broadcasting's Chieftain family of 6800 based microcomputers.

Software licenses available to qualified dealers and software houses. Contact Jim Allday for further information.

We're the "CHIEF" in 6800 products software

SMOKE SIGNAL  BROADCASTING®

31336 Via Colinas, Westlake Village, CA 91361, (213) 889-9340

barcadero, San Diego CA. This conference will feature papers and panel discussions on discrete and combined (discrete and continuous) simulations. Contact Professor Robert E Shannon, University of Alabama in Huntsville, School of Science and Engineering, POB 1247, Huntsville AL 35807.

December 3-5
Crime by Computer, San Francisco CA. The seminar will address the following topics of what is becoming a leading crime category: computer crime methods, changing nature of business crime, the computer criminal, vulnerability, security techniques, principles of safeguard, and the auditor's role and tools.

For more information, contact Infotech International Inc, 234 E Colorado Blvd, Pasadena CA 91101.

December 3-5
The Application of Computer Technology to Accounting Systems, Washington DC. The theme of the conference is "Information Systems as a Management Tool for the Financial Executive." The conference is sponsored by the Association of Government Accountants (AGA). Contact Ken Burroughs, DBD Systems Inc, 1500 N Beauregard St, Alexandria VA 22311.

December 3-5
Implementing Cryptography in Data Processing and Communications Systems, New York NY. Going beyond an introduction to cryptographic systems, the seminar will stress implementation of the DES and address public key implementation considerations. Contact Ms Jansen, Cryptotech, 12 Station Rd,

Bellport NY 11713, (516) 286-2626.

December 3-5
COMDEX '79, MGM Grand Hotel, Las Vegas NV. This conference and exposition for third-party sellers of computer systems, word processing systems, peripherals, software packages, and media will focus on solutions to business problems normally encountered in structuring a successful dealership and the operational aspects of the dealership from both the supplier and customer's side. Contact The Interface Group, 160 Speen St, Framingham MA 01701.

December 3-7
Pascal Programming for Mini and Microcomputers, Holiday Inn, Palo Alto CA. This course covers a general approach to the use of high-

level languages in small computers, including an intensive course in Pascal programming, a preview of ADA (the evolving Department of Defense standard real-time language), and an introduction to structured programming techniques.

For additional information, contact the Institute for Advanced Professional Studies, 1 Gateway Ctr, Newton MA 02158.

December 4-6
Understanding and Using Computer Graphics, New York NY. Computer users in business or engineering firms are invited to this conference covering computer graphics, data processing, systems analysis and design, financial management and analysis, and more. Contact Frost and Sullivan, Dept C-2 106 Fulton St, New York NY 10038.

CP/M[®] 2

CONTROL PROGRAM FOR MICROCOMPUTERS ENABLING YOU TO RUN SOFTWARE PUBLISHED FOR CP/M 1.4 ON THE TRS-80 MODEL II

for the TRS-80[®] Model II

CP/M is considered the industry standard disk operating system because it gives you the hardware-independent interface you need to make your computer work for you. CP/M 2.0 is the latest in the evolution of a proven reliable and efficient software system. FMG CORPORATION NOW OFFERS THE CP/M 2.0 FOR THE TRS-80 MODEL II. It features an enhanced upward compatible file system and powerful new random access capabilities. The CP/M 2.0 from FMG provides the ability to run software published for the CP/M system, on the TRS-80 Model II. From minidisks, floppy disks, all the way to high-capacity hard disks, the flexibility of CP/M 2.0 makes it a truly universal operating system. The package includes an 8" system disk, editor, assembler and debugger for the TRS-80 Model II.

CP/M is a registered trademark of Digital Research Corp. TRS-80 is a registered trademark of Radio Shack



PRICE \$200.00
 Manual Only \$ 25.00

NEW

VERSATILITY For Your TRS-80 Model II

FMG CORPORATION

5280 Trail Lake Drive
 Suite 14
 Ft. Worth, Tex. 76133
 (817) 294-2510

Call or Write for Complete Information

- **USER ASSIGNABLE ACCOUNT NUMBERS**
- **HIGH SPEED ASSEMBLY LANGUAGE PROGRAM**
- **18 DIGIT ACCURACY**
- **AUTOMATIC POSTING TO GENERAL LEDGER**
- **INVOICE AGING**
- **CHECK PRINTING WITH INVOICE DETAIL**

(Requires 32K, two drives and CP/M)

BUSINESS APPLICATIONS

FROM THE ORIGINATOR OF THE TRS-80 PROJECT

ACCOUNTS RECEIVABLE

Accounts receivable is a low volume invoice system. An entry may be invoiced at any time — before ready for billing, when ready, after billed, even after paid. It even has progress billing which keeps track of milestone payments made at intervals. The program allows automatic posting to the General Ledger and will interface with a future mailing list program for making bulk mailings to customers. Accounts Receivable does not print invoices. Reports:

Not billed
 Open and Closed Invoices
 Aging Analysis
 Customer Statements
 Customer Activity List

ACCOUNTS PAYABLE

Accounts Payable is an invoice linked system which means that everything revolves around the invoice. The system provides the user security through the use of a password. It allows automatic (complete or partial) payment of selected invoices, and automatic distribution of each invoice to as many as eleven different general ledger accounts. This system maintains vendor activity, automatically posts accounts payable and cash accounts, and will interface with a future mailing list program. Reports: Open and Closed Item Listing

Aging — 30/60/90 days (or user selected)
 Transaction printing for Audit Trail
 Accounts Payable Ledger

Customization is available at additional cost.

PRICE EACH \$250.00

6800 SYSTEM SOFTWARE

Unmatched • Field Proven • Documented • Industry Wide

SDOS™

A totally interrupt-driven (both disk and other peripherals) disk operating system, including type-ahead. Provides device independent, byte addressable random files. Supports any mixture of disk drives up to 2.5 BILLION bytes per drive. Disk files can grow dynamically to match application needs. Automatic, overlapped read-ahead on sequential files and LRU sector buffer pooling on random-access files optimize disk I/O. System utilities allow operator file manipulation, disk initialization, backup with wildcard file selection, and disk structure repair facilities to handle the infrequent but unavoidable disasters that occur in the real world. Turn-key application systems can be easily built, coupled with SD Business Basic. 242 pages of documentation.

IDB

A RAM or EPROM-based assembly language debugger. Provides single-step with register display, multiple real-time conditional breakpoints, memory dump, multiple data display and entry modes. Can be used to debug interrupt-driven code. 39 pages of documentation.

6800 Hardware supported:

Conrac Model 480 (AMI MDC) + ICOM floppy
WaveMate + Perci floppy (1771 + DMA)
Electronics Product Associates + ICOM floppy
Motorola EXORcisor + EXORDisk I or II
SWTP + mini or DMAF floppy (FLEX)
CMI 6800 + Winchester (16M) + Calcomp floppy (1771 + DMA)
MSI 6800 + FD-8 mini-floppy or 10M cartridge disk
Mizar Labs + double density Micropolis drives (1791 + DMA)
SSB Chieftain—mini or 8-inch floppy
Computer and Data Machines (England)

BUSINESS BASIC COMPILER

A super fast application oriented BASIC. 10 digit BCD for values to 100 million dollars with pennies. Random access to variable size, variable content records. Long, meaningful variable names, formatted output, IF-THEN-ELSE with multiple statements per line, and error-trapping make this BASIC extremely powerful. Compiled code, automatic integer optimization, and fast floating point make applications written in SD Basic run faster than on virtually any other microcomputer, and protect the source code of the application. 104 pages of documentation.

EDIT

A powerful and easy to use text editor with change, delete, insert, and remove commands. Automatic display of text or context changes, macro facilities for complex or repetitive editing. 44 pages of documentation.

ASM

A lovely 2 pass assembler with conditional assembly, long labels, symbol table dump and cross-reference, error cross-reference, extensive arithmetic and listing control. 103 pages of documentation.

Write for a free catalogue or contact the hardware manufacturer.

All SD software comes with a 1 year warranty.

INNOVATION IN SOFTWARE



SOFTWARE DYNAMICS

2111 W. Crescent, Suite G
Anaheim, CA 92804
(714) 635-4760

CP-80 COMPUTER CLOCK/CALENDAR



**A Real Time Saving Device
For Only \$149.95 + Shipping Charge**

CP-80 FEATURES:

Exact time and date on all computer printouts • Time and date not affected by computer shutdown • Time and date set by software • Functions as an elapsed timer • Compatible with all standard parallel ports • Will maintain time and date on 115V AC or optional standby power

SPECIFICATIONS:

Attractive two tone blue and white cabinet • 5¼ x 2 x 8 in. • 4 year calendar • Optional standby power • Requires one input and output parallel port TTL compatible and 115 VAC • 12 or 24 hour format • 50 or 60 HZ operation • All software and diagrams included

TERMS:

CHECK WITH ORDER • C.O.D. • VISA • MASTER CHARGE

CP Products

1427 Agnes Street
Kansas City, Mo. 64127
816-483-1000



Smoke Signal Broadcasting announces...

AUTO INDEX

A computerized automatic data storage and retrieval system designed to run on Smoke Signal Broadcasting's Chieftain Series of microcomputers with the COBOL and BOS (Business Operating System).

- Performs the same function as manual card index and file systems.
- Allows the non-computer specialist to input and edit text records with a minimum of training.
- All records in storage can be searched for particular user defined characteristics, i.e., college graduates, EE degrees, specialist in computers living in Southern California, stock records, customer names, prospect lists, membership lists, etc.
- Instant, automatic access to file information.
- Increases office efficiency.
- Assures security of confidential information.

Another example of Smoke Signal Broadcasting's popular line of high quality business software.

Software licenses available to qualified dealers and software houses. Contact Jim Allday for further information.

We're the "CHIEF" in 6800 products software

SMOKE SIGNAL BROADCASTING®

31336 Via Colinas, Westlake Village, CA 91361, (213) 889-9340

December 8-9

Data Processing for Business People, Cherry Hill Inn, Cherry Hill NJ. Management Information Corp presents this seminar to meet the needs of company management in understanding computers. The seminar includes basic concepts of data processing, alternatives (service bureaus, time-sharing), small business computer systems, program packages availability and selection, managing the computer system, and the future of data processing. Contact Management Information Corp, 140 Barclay Ctr, Cherry Hill NJ 08034.

December 10-11 and December 13-14 New York NY and Washington DC, respectively, **New User Documentation Workshops**. These two-day workshops will focus on how to write good data processing user-manuals with emphasis on analysis of specific user needs, planning

and outlining, effective writing, illustration and packaging of documentation. The program includes lectures on basic concepts followed by small group discussions.

Contact Progressive Communications Inc, The Alamo 310, 128 S Tejon St, Colorado Springs CO 80903.

December 10-11

Mini and Microcomputers in Control, Galt Ocean Mile Hotel, Ft Lauderdale FL. This symposium will cover computer architecture and hardware for control, languages for control, algorithms for control, hierarchical control, methodology, and other topics. Contact The Secretary, Computers in Control Symposium, POB 2481, Anaheim CA 92804.

December 10-12

Project Management for Computer Systems, Chicago IL. This seminar will illustrate techniques for

planning, implementing, installing, and controlling projects. Contact The University of Chicago, 1307 E 60th St, Chicago IL 60637.

December 10-13

1979 Fall DECUS US Mini/Midi Symposium, San Diego CA. This symposium is an opportunity for Digital Equipment computer users to participate in a technical exchange. Contact DECUS, One Iron Way, MR2-3, Marlboro MA 01752.

December 10-14

IEEE Computer Society's Tutorial Week 79, Hotel Del Coronado, San Diego CA. Fifteen different one-day seminars will be offered throughout the week. Contact IEEE Computer Society, POB 639, Silver Spring MD 20901.

December 10-14

Advanced Programming Workshop, Lafayette IN. Course objectives include

developing skills required to plan, prepare, test, and document software. Projects will include using assemblers and high-level language compilers and interpreters. Contact Wintek Corp, 902 N 9th St, Lafayette IN 47904.

JANUARY 1980

January 3-4

Hawaii International Conference on System Sciences, Honolulu HI. The conference will cover developments in theory or practice in software and hardware, and advanced computer systems applications in selected areas with emphasis on medical information processing and computer-based decision support systems for upper level managers in organizations. For more information, contact Perry G Patteson, Office of Management Programs, University of Hawaii, 2404 Maile Way, Honolulu HI 96822.

January 5-8

International Winter Consumer Electronics Show, Las Vegas Convention Center, Grand Ballroom of the Las Vegas Hilton and the Jockey Club Hotel, Las Vegas NV. The show will have over 850 exhibitors covering markets including audio systems, software, television and video tape and disk systems, home computers, calculators, and many more. Contact Consumer Electronics Shows, 2 Illinois Ctr, Suite 1607, 233 N Michigan, Chicago IL 60601.

January 15

Invitational Computer Conference, Orange County CA. New developments in computer and peripheral technology such as Pascal systems, 2-page printers, and streaming tape drives, will be featured in this conference directed to the quantity buyer. For more information, contact B J Johnson and Associates, 2503 Eastbluff Dr, Suite 203, Newport Beach CA 92660.

SUPERPASCAL

**5-10 times faster...
and more!**

Meet Pascal/Z™, the fast, flexible compiler with higher speed, greater efficiency and improved debugging:

- **True Z-80 native code Pascal compiler**—5-10X faster than competing P-code implementations—*no interpreter required.*

- **The only multi-tasking Pascal**—produces ROMable re-entrant code.

- **Optimized for fastest execution**—recognizes and exploits special cases.

- **Easily transportable**—all hooks to your system made through support library.

- **Includes IEEE standard floating point package.**

Single copy on CP/M-compatible disk includes compiler, companion macro-assembler & source of the library, \$275. OEM licenses available. Write or call for more information.

InterSystems™

Ithaca Intersystems Inc., 1650 Hanshaw Road/P.O. Box 91,
Ithaca, NY 14850/607-257-0190/TWX: 510255 4346

© 1979 Ithaca Intersystems Inc.

Dust Covers make neat gifts.



Here's a Holiday gift every computer can use. Cover Craft Dust Covers are currently available for hundreds of computers, CPU's and printers priced at \$6.95 and \$9.95.

CALIFORNIA
 Advanced Computer Products
 Santa Anna, CA 92704
 714-558-8813
 Computer Center, Inc.
 Berkeley, CA 94703
 415-845-6366
 Computerland of Dublin
 Dublin, CA 94566
 415-828-8090
 Hobby World
 Northridge, CA 91324
 213-886-9200
 Information Systems Assoc.
 Healdsburg, CA 95448
 707-544-9500
 Microbyte Computer Store
 San Jose, CA 95124
 408-377-4685
 Micro Sun
 Computer Center
 Walnut Creek, CA 94596
 415-933-6252
 The Byte Shop
 San Luis Obispo, CA 93401
 805-543-9310
CONNECTICUT
 Computerland of Fairfield
 Fairfield, CT 06430
 203-374-2227
 Technology Systems
 Bethel, CT 06801
 203-748-6856
FLORIDA
 Computer Age, Inc.
 Pompano Beach, FL 33317
 305-946-4999
 Computers For You
 Ft. Lauderdale, FL 33312
 305-581-8945
 Micro Computer Systems, Inc.
 Tampa, FL 33609
 813-879-4225
 Trans-Data Corp.
 Coral Gables, FL 33134
 305-446-9982

GEORGIA
 Atlanta Computer Mart
 Atlanta, GA 30340
 404-455-0647
HAWAII
 Tri-L Micro Computers, Inc.
 Honolulu, HI 86817
 808-524-3780
ILLINOIS
 Byte Shop
 Champaign, IL 61820
 217-352-2323
 Computerland of Niles
 Niles, IL 60648
 312-967-1714
 U.S. Robotics, Inc.
 Chicago, IL 60607
 312-733-0497
 Visible Computer Supply Corp.
 St. Charles, IL 60174
 800-323-0628
INDIANA
 Data Domain
 Bloomington, IN 47401
 812-334-3607
 Data Domain of Ft. Wayne
 Fort Wayne, IN 46805
 219-482-8415
KANSAS
 Dunn Electronics
 Liberal, KS 67901
 316-624-1888
MARYLAND
 The Computer Workshop
 Rockville, MD 20852
 301-468-0463
MASS.
 ComputerLand/Boston
 Wellesley, MA 02181
 617-235-6252
 CPU Shop, Inc.
 Charlestown, MA 02129
 617-242-3350

MICHIGAN
 Computerland of Southfield
 Southfield, MI 48034
 313-356-8111
 MicroComputer World
 Grand Rapids, MI 49503
 616-451-8348
MINNESOTA
 ABS Data Systems
 St. Cloud, MN 56301
 612-253-8734
 Computerland of Bloomfield
 Bloomfield, MN 55431
 612-884-1474
 Custom Computer Systems, Inc.
 Minneapolis, MN 55411
 612-588-3944
MISSOURI
 Computer Country
 Florissant, MO 63031
 314-921-4433
 Computer Country
 St. Louis, MO 63129
 214-487-2033

MONTANA
 Big Sky Byte Shop
 Billings, MT 59102
 406-252-2299
NEBRASKA
 Midwest Computer Co., Inc.
 Omaha, NE
 402-592-3597
 Omaha Computer Store
 Omaha, NE 68127
 402-592-3590
NEVADA
 JBA Associates
 Las Vegas, NV 89102
 702-382-0562
N. HAMPSHIRE
 Computerland of Nashua
 Nashua, NH 03060
 603-889-5238
 Bitzbytes
 Concord, NH 03301
 603-224-8233

NEW YORK
 Atlas Electronic Micro Dealer
 New York, NY 10028
 212-427-4040
 Computerland of Buffalo
 Buffalo, NY 14150
 716-836-6511
 The Computer Corner
 White Plains, NY 10601
 914-949-DATA
 Digi Byte Systems Corp.
 New York, NY 10016
 212-889-8130
 Digi Byte Systems Corp.
 Staten Island, NY 10301
 Great Neck Computer Corp.
 Great Neck, NY 11023
 516-466-5662

N. CAROLINA
 Byte Shop — Greensboro
 Greensboro, NC 27401
 919-275-2983
OHIO
 Astro Video Equipment
 Lancaster, OH 43010
 614-687-0629
 Computerland of Cleveland East
 Mayfield Hgts., OH 44124
 216-461-1200
 21st Century Shop
 Cincinnati, OH 45202
 513-651-2111
PENNSYLVANIA
 Alpha Computer Center, Inc.
 Lancaster, PA 17601
 717-299-0567
TEXAS
 Computer Corner
 Amarillo, TX 79109
 806-355-5618
 The Computer Shop
 San Antonio, TX 78216
 512-828-0553
 Mutex Sound & Electronics
 Big Spring, TX 79720
 915-263-8300
 Interactive Computers
 Houston, TX 77036
 713-772-5257
 Young Electronics Service
 College Station, TX 77840
 713-693-3462
VIRGINIA
 Digi Byte Systems Corp.
 Virginia Beach, VA 23452
 804-340-1977

WASHINGTON
 Computer Marketing Corp.
 Wenatchee, WA 98801
 509-662-9541
WISCONSIN
 Colertron
 Computer Division
 Racine, WI 53405
 414-637-2003
 Computerland of Madison
 Madison, WI 53711
 608-273-2020
CANADA
 Computer Mart Ltd.
 Toronto, Ontario M4M 2L2
 416-928-0730
 Kobetek Systems Ltd.
 Nova Scotia, BOP 1X0
 902-542-9100
 Orthon Holdings Ltd.
 Edmonton, Alberta T5N3N3
 403-488-2921
EUROPE
 Micro Computers Unlimited, P.V.B.A.
 Gent Belgium
 Computer Shop Janel
 Paris, France
 Electronica Top International
 Maastricht, Den Dolder Holland
 The Byte Shop Ltd.
 Ilford, Essex IG2 6HW
 Data Efficiency Ltd.
 Hemel Hempstead, Herts England

No Dealer? Contact:

COVER CRAFT
 P.O. Box 555, Amherst, NH 03031
 Telephone (603) 673-8592

NO FRILLS! NO GIMMICKS! JUST GREAT DISCOUNTS MAIL ORDER ONLY

HAZELTINE	
1400	} Call For Prices
1410	
1420	
1500	
1500(Kit)	
CENTRONICS	
779-2	995.00
700-2	1350.00
703 tractor	2195.00
Micro Printer	395.00
NORTHSTAR	
Horizon I assembled	1629.00
kit	1339.00
Horizon II assembled	1999.00
kit	1599.00
TELETYPE	
Mod 43	995.00
DIGITAL SYSTEMS	
Computer	\$4345.00
Double Density Dual Drive	2433.00
TELEVIDEO	
912	} Call For Prices
920	
DEC	
LA 34	1149.00
CROMEMCO	
System III \$1000 off ...	4990.00
10% off on Cromemco products	
TEXAS INSTRUMENTS	
810 Printer	1595.00
Optima Cabinets (New)	99.95
5" Scotch Diskette	Box/29.95
8" Scotch Diskette	Box/34.95

Most items in stock for immediate delivery. Factory-fresh, sealed cartons.

DATA DISCOUNT CENTER P.O. Box 100
 135-53 Northern Blvd., Flushing, New York 11354, 212/465-6609
 N.Y.S. residents add appropriate Sales Tax. Shipping FOB N.Y.
 BankAmericard, Master Charge add 3%. COD orders require 25% deposit.

Smoke Signal Broadcasting announces... 6809 DISC OPERATING SYSTEM

DOS 69 is Smoke Signal Broadcasting's new 6809 Disc Operating System that contains all the features of DOS 68 version 5.

- Compatible with text files created under DOS 68.
- Includes improved 6809 SMARTBUG ROM monitor on 2716.
- Includes a 6809 BASIC that is completely compatible with Smoke Signal Broadcasting's 6800 BASIC.
- 6809 Text Editor included.
- 6809 Assembler at no extra cost. This assembler will operate under either DOS 68 or DOS 69 and will both assemble new 6809 source code and translate 6800 source code to 6809 object code. (This is not the same as Smoke Signal Broadcasting's MACRO 69 Macro Assembler).

NOTE: DOS 69 is supported on Smoke Signal Broadcasting's Chieftain systems with Smoke Signal Broadcasting's 6809 CPU board; and on SWTPC systems with Smoke Signal's BFD or LFD disc system and SWTPC 6809 CPU board (I/O moved to \$E000 in accordance with SWTPC instructions). Support for other hardware configurations including consultation on operation with other CPU boards cannot be provided.

Price \$100.00 including ROM monitor.
 Specify 5" or 8" disc and Chieftain or SWTPC System.

SMOKE SIGNAL BROADCASTING®
 31336 Via Colinas, Westlake Village, CA 91361, (213) 889-9340

January 15-18

TV-Microelectronics and Microprocessing Exhibition, National Exhibition Centre, Birmingham, England. Manufacturers and suppliers of microprocessors, electronic and microcomputer games, video display units, video cameras and projection systems, and digital consumer electronics are invited to participate. Over 9000 retailers, wholesalers, distributors and government buying authorities are expected to attend this show. For more information, contact TMAC, 680 Beach, Suite 428, San Francisco CA 94109.

January 23-26

International Microcomputers Minicomputers Microprocessors (IMMM), Harumi Exhibition Centre, Tokyo Japan. This is a show for manufacturers, commercial and financial establishments, service industries and institutions, and

design engineers interested in buying computer systems, components and services. For more information, contact Industrial and Scientific Conference Management Inc, 222 W Adams St, Chicago IL 60606.

January 28-30

Communication Networks '80, Sheraton Washington Hotel, Washington DC. The program will offer 50 conference sessions in areas such as fiber optics, satellite communications, systems networks, and innovations in electronic mail and office administrative networks.

For further information on registration, speaking opportunities or exhibit space, contact William Leitch, The Conference Co, 60 Austin St, Newton MA 02160.

January 28-30

Principles of Programming Languages, Las Vegas NV. This symposium concerns practical and theoretical

aspects of principles and innovations in the design, definition, and implementation of programming languages. Some topics are algorithms and complexity bounds for language processing tasks, specification languages, error detection and recovery, and unusual or special-purpose languages that raise issues of principle. Contact Professor John Werth, Department of Mathematical Sciences, University of Nevada, Las Vegas NV 89154.

January 30-February 1

MIMI '80 Asilomar, Asilomar Conference Grounds, Pacific Grove CA. This symposium covers all aspects of mini and microcomputers including technology, hardware, software engineering, languages, education and more. Contact The Secretary, MIMI '80 Asilomar, POB 2481, Anaheim CA 92804.

FEBRUARY 1980

February 6

Invitational Computer Conference, Ft Lauderdale FL. This conference is directed to the quantity buyer and will feature the newest developments in computer and peripheral technology. Contact B J Johnson and Associates, 2503 Eastbluff Dr, Suite 203, Newport Beach CA 92660.

February 13-15

The IEEE International Solid State Circuits Conference, San Francisco CA. This conference is a forum for the presentation of advancements in all aspects of solid state circuits. It will cover design, performance, fabrication, testing, and applications in digital, analog, microwave, and other areas of new solid state circuits, device structures, phenomena and systems. For more information, contact Lewis Winner, 301 Almeria Ave, POB 343788, Coral Gables FL 33134.

February 18-21

European Information Management Exhibition and Conference, Wembley Conference Centre, London, England. This show will exhibit microcomputer systems and peripheral items with demonstrations and applications focused on problem solving for the management executive. Contact, Expoconsul, 420 Lexington Ave, New York NY 10017.

February 25-27

Communication Networks '80, Shoreham Americana Hotel, Washington DC. This conference and exposition will cover business communications. For program information, contact the Director of Program Development, The Conference Co, 60 Austin St, Newton MA 02160. For exhibit information, contact the national sales manager, Communications Networks '80, POB 96, Haddon Heights NJ 08035.

TRS-80® BUSINESS SOFTWARE
Why not buy THE GENUINE ARTICLE???

The Osborne & Associates applications (Payroll with Cost Accounting, Accounts Payable & Accounts Receivable, and General Ledger) are on their way to becoming the standard applications software in the microcomputer field.

The genuine O&A software is written in CBASIC® for the CP/M® Operating System. Any other combination of language and operating system represents a reprogramming effort... for the TRS-80, Model I, several organizations have done such a reprogramming in Disk BASIC under TRSDOS. These packages have certain drawbacks such as having some features of the application removed. In addition, the fact that they are written in a source interpreter BASIC causes the comments in the source programs (if these are distributed at all) to be removed in the interest of saving space and execution time. Since CBASIC is a compiled language, comments cost nothing (in either space or execution time) in the executable version of the file—but such comments are invaluable in the later program maintenance and modification that is always required on applications software. Without having such comments, it is easy to spend many times the cost of the software on just one modification/maintenance effort. A buyer should take this into consideration when looking at the apparent cost of the package. The CBASIC source programs we sell are heavily commented to aid the programmer.

Our programs are **THE GENUINE ARTICLE**... the CBASIC source code as developed by Osborne & Associates. We furnish the buyer BOTH the TRS-80, Model I version (requires a 48K Model I with two or more disks) AND the unmodified 8" version (for later use on the TRS-80, Model II or other 8" CP/M system)... at no extra charge. By using our DOWNLOAD program, it is possible to start using the applications on the Model I, and then when the Model II is up and running at a later date, download the data files from the Model I to the Model II and keep running the same applications without disrupting your operation.

The Osborne & Associates books have been rewritten to reflect the CP/M, CBASIC versions of the applications. These books can be purchased either from your local computer store or from us directly. We can see no percentage in your buying other than **THE GENUINE ARTICLE**... which is what we sell... the Osborne & Associates source programs in CP/M and CBASIC.

CP/M Operating System.....	\$150.00
CBASIC Compiler.....	95.00
O&A Payroll w/Cost Accounting.....	250.00
O&A Acc'ts. Rec./Acct's. Payable.....	250.00
O&A General Ledger w/Cash Journal.....	250.00
O&A CBASIC books for above (each).....	15.00
DOWNLOAD program.....	95.00

TRS-80 is a registered trademark of Radio Shack, a Tandy company
CP/M is a registered trademark of Digital Research
CBASIC is a registered trademark of Software Systems



8041 NEWMAN AVENUE • SUITE 208 • HUNTINGTON BEACH, CALIFORNIA 92647 • (714) 848-1922

TRS-80* PERIPHERALS

DISK DRIVES
40 tracks, 2 sides
with power supply & case
VERBATIM DISKETTES \$3.00
OYSAN DISKETTES \$4.60

\$349

16K MEMORY KITS
for TRS-80, APPLE, SORCERER
w/ jumpers and instructions
LIFETIME GUARANTEE!!!!

\$79

PRINTERS from
CENTRONICS, INTEGRAL
DATA, NEC SPINWRITER,
TEXAS INSTRUMENTS.
ALL AT GREAT SAVINGS!!

\$379

TRS-80 computers in stock!!

We also carry APPLE, SORCERER, PET, SO SALES products. WE WILL NOT BE UNDERSOLD.

TRS-80 SOFTWARE

GAMES	UTILITIES	BUSINESS
ANDROID NIM \$14.00 nim robots that wink and respond. Excellent graphics and sound.	NEWDOS+ \$99.00 Enhanced DOS. Contains many improvements over TRSDOS. 7 useful utilities built in. For 40 track use also.	GL, AR, AP, PAYROLL INTERAC- TIVE \$350. reports include unbilled invoices, open/closed accounts, aging, Trial balance, income statement, balance sheet Handles 200 accounts. 1750 transactions.
STAR TREK III \$14.00 Travel through the galaxy on the Enterprise and destroy klingons. New updated version.	NEWDOS \$49.00 Same as above without utilities.	Stand alone of each \$95 INVENTORY II \$99.00 activity listing, complete listing, selected listing, minimum quantity search. 1000 items per disk
AIR RAID \$14.00 Real time shooting gallery.	SYSTEM INTEGRATION TEST \$29.00 tests memory, disk drives, and printer.	ALL ABOVE PROGRAMS BY SBSG
SARGON-CHESS \$19.00 Best chess for TRS-80	MICROSOFT FORTRAN \$325.00 CPM \$150.00	ELECTRIC PENCIL \$99.00 by Michael Shryver
LIBRARY 100 \$49.00 100 games, utilities, and business programs in one package. Great value!	RENUMBER \$14.00 disk	disk \$150.00 BEST word processor for the TRS-80
	G2 LEVEL III \$49.00 FOURTH by MMS \$65.00	

The above list is just a brief summary of some of our most popular software. We have a large selection of other software for many uses and for many computers. Documentation for any of our programs is available on request. If you have any questions, please call. We would like to hear from you.

TO ORDER, CALL OR WRITE:

MIDWEST COMPUTER PERIPHERALS

1467 S. MICHIGAN AV.
CHICAGO, IL. 60605
(312) 251-5028



FALL SPECIAL
10% Discount on
all Software orders
over \$100

*TRS-80 is a Registered Trademark of Tandy Corp.

**TRS-80
LEVEL II**
\$750. COMPLETE SYSTEM

The world's most popular microcomputer, with 16K of memory and Level 11 basic for only \$750, complete with full 90 day Radio Shack warranty. We accept check, money order or phone orders with Visa or MasterCard. (Shipping costs added to charge orders).

Disk drives, printers, peripherals, software and games . . . you name it, we've got it (Both Radio Shack & other brands). Write or call for our complete price list.



**C&S
ELECTRONICS MART** Ltd.

AUTHORIZED DEALERSHIP **Radio Shack**

32 E. Main Street • Milan Michigan 48160 • (313) 439-1400

EPROM PROGRAMMER — Model EP-2A-79



SOFTWARE AVAILABLE FOR F-8, 8080, 6800, 8085, Z-80, 6502, KIM-1, 1802, 2650.

EPROM type is selected by a personality module which plugs into the front of the programmer. Power requirements are 115 VAC, 50/60 HZ at 15 watts. It is supplied with a 36 inch ribbon cable for connecting to microcomputer. Requires 1 1/2 I/O ports. Priced at \$155 with one set of software. Personality modules are shown below.

Part No.	Programs	Price
PM-0	TMS 2708	\$15.00
PM-1	2704, 2708	15.00
PM-2	2732	30.00
PM-3	TMS 2716	15.00
PM-4	TMS 2532	30.00
PM-5	TMS 2516, 2716, 2758	15.00

Optimal Technology, Inc.
Blue Wood 127, Earlysville, VA 22936
Phone (804) 973-5482



Smoke Signal Broadcasting announces...

COMMERCIAL PAYROLL SYSTEM

A Payroll system which runs on Smoke Signal Broadcasting's Random DOS with 48K bytes and a 500K byte disk which offers the following capabilities:

- Direct updating of employee information, hours worked, wages, deduction, etc., means that any inquiry for a selected employee will provide up to the minute status on that employee.
- Simultaneously handles hourly, salary and commissioned employees; weekly, bi-weekly, semi-monthly and monthly pay periods.
- Allows for payment against a cash advance.
- Vacation and sick hours accrue either as a rate per hour worked, or on anniversary dates. Time charged automatically reduces the amount available.
- Password protection maintains confidentiality of data.
- Generates ten reports including employee status, activity reports and audit report.
- All reports can be sorted several different ways. Reports can be generated for specific categories and can even be limited to ranges within the categories.
- Tax tables are easily modified with built-in routines. The system also handles state and local taxes.

Look to Smoke Signal Broadcasting to provide the high quality business software to run on the popular Chieftain Series of 6800 based microcomputers.

Software licenses available to qualified dealers and software houses. Contact Jim Allday for further information.

SMOKE SIGNAL BROADCASTING®
31336 Via Colinas, Westlake Village, CA 91361, (213) 889-9340

Guaranteed software from Data Access Corporation. . .

TRS-80 ISDMS INDEXED SEQUENTIAL DATA MANAGEMENT SYSTEM

- Interactive Data Base Definition
- Random Key Access To Any Record
- Sequential Key Access To Any Record
- Fast Assembler Sorting On Any Field
- Complete Interactive File Maintenance
- Fast In-Memory Directory Of All Records
- Automatic Blocking & Unblocking Of Records
- Loads It's Assembler Program from BASIC
- BASIC & Assembler Source Included
- Sample Data & Programs Included
- Includes Assembler Disk Sort
- INKEY\$ Data Entry Routine
- Runs On 2, 3 or 4 Drives

IF YOU'VE GOT A TRS-80* DISK SYSTEM, WE'VE GOT A FAST, FEATURE PACKED SOFTWARE SYSTEM THAT'S READY TO GO TO WORK FOR YOU NOW! INTERACTIVELY DEFINE A DATA BASE AND BEGIN USING IT IN HOURS! BUILD YOUR APPLICATION WITH ISDMS, ITS A SOLID FOUNDATION!

PRICE: \$175.

ISDMS WITH REPORT GENERATOR

The complete ISDMS Package combined with a report definition and generation program. With ISDMS and the Report Generator you can create a complete file and report system without writing a line of code!

PRICE: \$225

TRS-80 BUSINESS PROGRAMS

TRS-80 Model II conversions available soon

- Accounts Receivable, up to 1200 Accounts. . . . \$500
- On-Line Inventory, up to 1800 Items. \$600
- Point Of Sale Inventory, up to 3000 Items. \$750
- General Ledger w/Check Writer. \$500
- Payroll, All Fed., State Taxes, Tips & EIC. \$500
- Mailing List, up to 1800 names on 4 Disks. \$200

Licensed copies of Data Access 'TRS-80 programs are guaranteed to load and run on operational systems, and to be free from programming defects.

DEALER INQUIRIES INVITED

DATA ACCESS CORPORATION

4221 Ponce De Leon Blvd.
Coral Gables, FL 33146
Phone: (305) 446-0669

*TRS-80 is a registered trademark of Radio Shack

Circle 95 on inquiry card.



NOW BETTER THAN EVER

- Control Program for Microcomputers.
- Includes Editor, Assembler, Debugger, Utilities.
- Supports Floppy Disks and Hard Disks.
- For 8080, 8085, Z-80, MDS, Cromemco.
- \$150-Diskette and Documentation
- \$25-Documentation only



NEW INDUSTRY STANDARD

- Multi-terminal access.
- Multi-programming.
- CP/M-compatible.
- Real-time features.
- \$300-Diskette and Manual
- \$25-Manual only

DIGITAL RESEARCH

OPTIONAL SOFTWARE PACKAGES

MAC™ MACRO ASSEMBLER:

- Compatible with new Intel macro standard.
- Complete guide to macro applications.
- \$90-Diskette and Manual.

SID™ SYMBOLIC DEBUGGER:

- Symbolic memory reference.
- Built-in assembler/disassembler.
- \$75-Diskette and Manual.

TEX™ TEXT FORMATTER:

- Powerful text formatting capabilities
- Text prepared using CP/M Editor.
- \$75-Diskette and Manual.

DESPOOL™

- Background print utility.
- Use with CP/M
- \$50-Diskette and Manual.

DIGITAL RESEARCH®

P.O. Box 579 • Pacific Grove, California 93950
(408) 649-3896

PET Printer Adapter

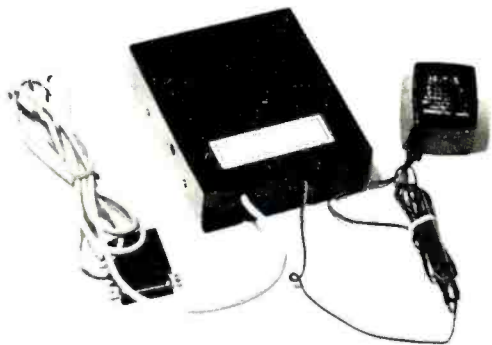

The CmC ADA 1200 drives an RS-232 printer from the PET IEEE-488 bus. Now, the PET owner can obtain hard copy listings and can type letters, manuscripts, mailing labels, tables of data, pictures, invoices, graphs, checks, needlepoint patterns, etc., using RS-232 standard printer or terminal.

A cassette tape is included with software for plots, formatting tables and screen dumps. The ADA1200 sells for \$169.00 and includes case, power supply and cable.

Order direct or contact your local computer store.

VISA AND M/C ACCEPTED — SEND ACCOUNT NUMBER, EXPIRATION DATE AND SIGN ORDER.
ADD \$3 PER ORDER FOR SHIPPING & HANDLING — FOREIGN ORDERS ADD 10% FOR AIR POSTAGE

CONNECTICUT microCOMPUTER, Inc.
150 POCOMO ROAD
BROOKFIELD, CONNECTICUT 06804
TEL: (203) 775-4595 TWX: 710-456-0052

VULCAN = DBMS

THE PROFESSIONAL DATABASE
MANAGEMENT SYSTEM

For 8080/Z80 systems under CP/M or PTDOS

- * **VULCAN** is a complete database management system that has 38 powerful, easy to learn, English-like commands to manipulate files, records, fields, and scratch-pad variables.
- * **VULCAN** has a command repertoire which includes such commands as: SORT, REPORT, APPEND, INSERT, EDIT, COPY, REPLACE, LOCATE, DISPLAY, DO, LIST, and LOOP.
- * **VULCAN** structured data records can be selectively chosen for processing using complex Boolean, string, or mathematical expressions.
- * **VULCAN** can be used in interactive or program mode. The program mode uses modern structured command programs to combine powerful DBMS operations.
- * **VULCAN** is written in assembly language for efficient information processing and requires 36K bytes CP/M system and one or more disk drives.
- * **VULCAN** can accept or store data in standard ASCII files to be compatible with BASIC, FORTRAN, etc.

* VULCAN (CP/M or PTDOS)	\$490
Manual only	\$ 25

SCDP

**Software Consultation Design
and Production**

6542 Greeley St.

Tujunga, CA 91042 (213) 352-7701

California residents add 6% sales tax.

THE ESSENCE of output quality

- *Any* IBM SELECTRIC® can be converted to produce high quality output at an affordable price!
- *Interfaces* directly to S100, Parallel, RS-232 or IEEE-488.
- *Compatible* with TRS-80, Sorcerer, Pet, Apple, Horizon, etc.
- *Why* be printer bound? Prices from \$496 to \$575.

Call
today.



Backspace and Tab
Available NOW!



Escon Products, Inc.
171 Mayhew Way, Suite 204
Pleasant Hill, Ca., 94523
(415) 935-4590



Smoke Signal Broadcasting announces...

FORTRAN

A powerful scientific programming language complete with sub routine capability designed to run on 6800 based microcomputers.

- Complete FORTRAN Compiler for the 6800.
- Produces Relocatable Object Code.

Included with the compiler is the Smoke Signal Linking Loader which loads the object code produced by the compiler into any portion of memory specified by the programmer. FORTRAN is completely integrated to operate with DOS 68, Smoke Signal's Disc Operating System and is ideal for scientific applications, number crunching and three dimensional array processing.

New updated FORTRAN includes large sub-routine library of mathematical functions.

\$149.00 on 5" disc.
(Add \$1.00 for 8" disc).

We're the "CHIEF" in 6800 products software

SMOKE SIGNAL BROADCASTING®

31336 Via Colinas, Westlake Village, CA 91361, (213) 889-9340

Learn to program your microcomputer using Assembly Language

Assembly Language Programming primers for these five microprocessors, by Lance Leventhal.

Each book explains assembly language programming, describes the functions of assemblers and assembly instructions, and discusses basic software development concepts. A special section on structured programming complements the many practical programming examples, which range from simple memory load loops to complete rudimentary design projects.

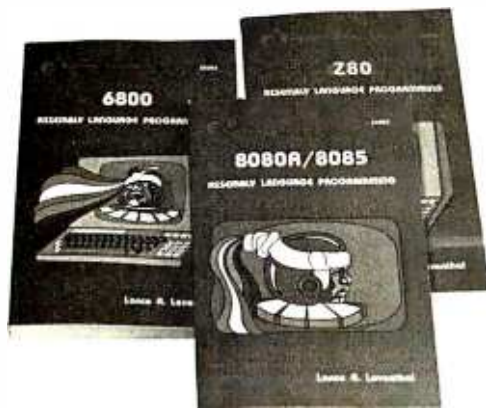

JUST ARRIVED

6502

and COMING SOON

6809

In each book you'll find:

- Over 80 programming examples tailored to your microcomputer, with source program, object code, flowcharts, and explanatory text.
- Each instruction fully explained
- Assembler conventions
- I/O devices and interfacing methods
- How to program the interrupt system
- Table of Contents: Introduction to Assembly Language Programming; Assemblers; The Assembly Language Instruction Set; Simple Programs; Simple Program Loops; Character Coded Data; Code Conversion; Arithmetic Problems; Tables and Lists; Subroutines; Input/Output; Interrupts; Problem Definition and Program Design; Debugging and Testing; Documentation and Redesign; Sample Projects.

Don't forget our other ALP Books

Z80 - 6800 - 8080A/8085

Order Form

Price increase effective January 1, 1980. If ordering after January 1, please use price in brackets.

Book	Price	Quantity	Amount
6502 Assembly Language Programming	\$9.50 [\$12.50]		
Z80 Assembly Language Programming	\$9.50 [\$12.50]		
6800 Assembly Language Programming	\$9.50 [\$12.50]		
8080A/8085 Assembly Language Programming	\$9.50 [\$12.50]		

Calif. residents add 6% sales tax.
S.F. BART residents add 6-1/2% sales tax.

SHIPPING (Shipping for large orders to be arranged)

- All foreign orders \$4.00 per item for airmail
- \$0.45 per item 4th class in the U.S. (allow 3-4 weeks)
- \$0.75 per item UPS in the U.S. (allow 10 days)
- \$1.50 per item special rush shipment by air in the U.S.

For faster shipment or credit card, phone (415) 548-2805

Please notify me when 6809 ALP is available.

Name: _____

Address: _____

City: _____ State: _____

ZIP: _____ Phone: _____

 **OSBORNE/McGraw-Hill**

630 Bancroft Way, Dept. 127
Berkeley, California 94710
(415) 548-2805 • TWX 910-366-7277



6809!

MD-690 b Single Board Computer

- 1K RAM
- 10K PROM space
- Parallel keyboard input
- Memory-mapped video firmware
- Fully S-100 compatible (including 8080 type I/O)
- MONBUG II monitor included
- 2400 baud cassette interface
- 20 I/O lines
- RS-232 level shifters
- Real time clock
- DMA
- 6809

\$299 Assembled

\$239 Kit

Please rush me the following...

MicroDasys P.O. BOX 36051, LOS ANGELES, CA 90036, USA

CPU Card (Kit) CPU Card (Assembled)

NAME _____ Exp. Date: _____

COMPANY _____

ADDRESS _____

CITY _____ STATE _____ ZIP _____

Calif. residents add 6%

CATCH THE S-100 INC. BUS!



	LIST PRICE	OUR SPECIAL CASH PRICE
Imsai "8080" Kit complete w/Front Panel	750.00	625.00
Imsai VIO-C Kit	325.00	275.00
Cromemco TU-ART Kit	195.00	165.00
Thinker Toys Switchboard A&T	259.00	220.00
Shugart SA 400 Dual Density, Bare Drive	450.00	295.00
Intertec "Intertube"	995.00	779.00

Subject to Available Quantities • Prices Quoted Include Cash Discounts. Shipping & Insurance Extra.

We carry all major lines such as S.D. Systems, Cromemco, IMSAI, Vector Graphics, North Star, Sanyo, ECT, TEI, Godbout, Thinker Toys, Hazeltine, IMC For a special cash price telephone us.

Bus... **S-100, inc.**
 Address... **7 White Place**
Clark, N.J. 07066
 Interface... **201-382-1318**

BET, YOU DIDN'T KNOW!

OAE'S new PP-2708/16 PROM Programmer is the *only* programmer with all these features:

- Converts a PROM memory socket to a table top programmer. No complex interfacing to wire—just plug it into a 2708 memory socket
- A short subroutine sends data over the address lines to program the PROM
- Programs 2 PROMS for less than the cost of a personal-ity module. (2708s and TMS 2716s)
- Connect 2 or more in parallel — super for production programming
- Complete with DC to DC switching inverter and 10 turn cermet trimmers (for precision pulse width and amplitude alignment)
- All packaged in a handsome aluminum case

PP-2708/16 . . . A & T \$325.

PP-2716 (Programs Intel's 2716) A & T \$295.

OAE

Oliver Advanced Engineering, Inc.
 676 West Wilson Avenue
 Glendale, Calif. 91203
 (213) 240-0080

*Pat's Pending

Smoke Signal Broadcasting announces...

6809 MACRO ASSEMBLER

Macro 69 is an advanced assembler designed to let the professional programmer take full advantage of the capabilities of the world's most powerful 8 bit microprocessor.

- Supports conditional assembly.
- Produces relocatable object code.
- Includes linking loader.
- Operates under DOS 68 or DOS 69.
- Assembles 6809 code and translates 6800 source code to 6809 object code.
- Cross-referenced symbol table provided.
- Very powerful macro instruction capability.

Smoke Signal Broadcasting, your number one source for high quality, reliable products.

Price — \$199.00 for 5" disc
 (add \$1.00 for 8" disc.)

We're the "CHIEF" in 6800 products software

SMOKE SIGNAL BROADCASTING®

31336 Via Colinas, Westlake Village, CA 91361, (213) 889-9340

IMMEDIATE DELIVERY

Domestic & Export

DEC LSI-11 COMPONENTS

A full and complete line with software support available.



Mini Computer Suppliers, Inc.

25 CHATHAM ROAD
SUMMIT, NEW JERSEY 07901
SINCE 1973

(201) 277-6150 Telex 13-6476

SOFTWARE TOOLS

- C compilers and cross-compilers for PDP-11's, LSI-11's, 8080's and Z/80's, with complete runtime library. **The full language is supported with efficient code generation.**
- Interface libraries giving access to all system directives for UNIX*, RT-11, RSX-11M, RSTS/E, IAS, CP/M, CDOS and ISIS-II.
- A-Natural narrative assembler for 8080's and Z/80's with librarian and linking loader.
- Over 75 installations in less than six months.

*UNIX is a trademark of Bell Laboratories.

Continuing maintenance and training available. An affordable alternative to Assembler, Fortran or Pascal, for as little as \$500 per compiler binary license. Catalogue and references available upon request.

Write to

Whitesmiths, Ltd.

127 East 59th Street · New York NY 10022 · 212 799-1200

TRS-80 disk software

DATA BASE MANAGER IOM-III 32K \$49
You can use it to maintain a data base & produce reports without any programming. Define file parameters & report formats on-line. Features key random access, multi-keys, sort, field arith, audit log. Enhanced version \$69.

ACCCOUNT manage client accounts & accounts receivable. Order entry. Print invoices, statements & reports. 32K \$69.

WORD PROCESSOR 16K \$39
Our Word-III is the first word processor specifically designed for the TRS-80 that uses disk storage for text. Written in BASIC. No special hardware and text limit. Use for letters, manuals & reports. 32K version features upper/lower case without hardware change. \$49.

MAILING LIST 16K \$35
Lets you maintain data base and produce reports & labels sorted in any field. Random access. 2-digit selection code used. 32K version fast SHELL sort \$49. Advanced version with report writer \$59.

INVENTORY 16K \$39
While others use inefficient sequential file, we use 9-digit alphanumeric key for fast on-line random access. Reports give order info, performance summary, etc. Enhanced 32K version \$49.

KEY RANDOM-ACCESS UTIL 16K \$19
Lets you access a record by specifying a key. Features hashing, blocking, buffering technique.

Send \$5 for each manual.

MOO-II, superior, integrated software available.

MICRO ARCHITECT

96 Dothan St., Arlington, MA 02174

DUNJONQUEST™ Presents



- Take your favorite character—or let the computer create one for you!
- Let the Book of Lore guide you through a DUNJONQUEST™ within the Temple.
- Decide to fight the monsters or grab the treasure and run—but don't think too long—they'll come after you!

The Temple of Apshai—for the TRS-80 (Level II, 16K) and PET (32K) microcomputers.

Ask your local dealer or send a check for \$24.95 to:

Automated Simulations-Department Y
P.O. Box 4232, Mountain View, CA 94040
California residents please add 6% sales tax.

The Vault of the Dead is but one of the many dark and fearsome mysteries within the ruined Temple of Apshai. The Temple of Apshai is your first adventure in the DUNJONQUEST™ series of fantasy role playing games. DUNJONQUEST™ is a complete game system and The Temple of Apshai is a complete fantasy adventure game for you and your microcomputer.

**OVER 200 ROOMS!
OVER 30 MONSTERS!
OVER 70 TREASURES!**

Twenty-four Ways to Write a Loop

Dr Maurer Takes You Through a Loop

W D Maurer
Professor Dept of Electrical
Engineering and Computer Science
George Washington University
Washington DC 20052

To start with, let us look at table 1. There are several things about this table that should be surprising.

All we are trying to do is move some quantities from one place to another. There are N of them, and they are called $P(1)$ thru $P(N)$. We are trying to move them to $Q(1)$ thru $Q(N)$, which we could do, of course, using a FOR statement in BASIC, as follows:

```
10 FOR J=1 TO N
20 Q(J)=P(J)
30 NEXT J
```

which should make sense even if you don't know BASIC. But we are trying to do this without a FOR statement, in order to learn how loops function; and immediately we are confronted with a wide variety of choices. Table 1 shows the first twenty-four of these. They are all different; they are all short; and they all do exactly the same thing. (Well, not quite exactly. At the end of some of them, J is equal to $N+1$; at the ends of others, J may be equal to N , or to 1, or to 0. But since we are presumably not going to use J after we finish the loop, this should make no difference.)

Why are there so many ways to write a loop? There are certain things

Actually, 124 ways (or more) illustrate the endless variety of looping — that simplest of programming techniques

we can do in either of two (or more) ways.

We can start with $Q(1)$ and go up to $Q(N)$ (first and second columns in table 1), or we can start with $Q(N)$ and go down to $Q(1)$ (third and fourth columns).

We have three things to do in the loop: setting $Q(J)$ equal to $P(J)$; increasing (or decreasing) J by one; and making a test. These three things may be arranged in any of six ways; denoting them by U, V, and W, we may arrange them as UVW, UWV, VUW, VWU, WUV, or WVU. Each of these six arrangements corresponds to one of the six rows of table 1.

What may be further surprising about table 1 are the subtle ways in which not everything is quite symmetrical. For example, in the last column, the variable J is sometimes initialized to N , and sometimes to $N+1$. The latter takes a bit more time (unless N is really a constant, such as 10). In the first column, J is

sometimes set to 1 and sometimes to 0, which on many computers takes a bit less time than setting it to 1.

It does not take much ingenuity, however, to see that in enumerating twenty-four ways to write a loop, we have really only scratched the surface. What are some of the other things we could have done?

Looking at the top of the second column, we see that we are testing whether J is less than or equal to N . We could just as easily have tested whether J is less than $N+1$. The same sort of change could have been made throughout the second and fourth columns, giving us a total of thirty-six ways to write a loop.

Most of the changes of this kind would rather obviously have been changes for the worse. It clearly takes more time testing against $N+1$ than it does testing against N , even if we set some new variable like $N1$ to $N+1$ before the loop and then test against $N1$ inside the loop. A possible exception to this is the one at the top of the last column, where we could have tested for J greater than 0. In assembly language on a 6800-based system using 8-bit signed integer data, you can do this with a branch-if-greater-than-zero (BGT) instruction directly after the decrementing.

10 J = 1 20 Q(J) = P(J) 30 J = J + 1 40 IF J < > N + 1 GOTO 20	10 J = 1 20 Q(J) = P(J) 30 J = J + 1 40 IF J < = N GOTO 20	10 J = N 20 Q(J) = P(J) 30 J = J - 1 40 IF J < > 0 GOTO 20	10 J = N 20 Q(J) = P(J) 30 J = J - 1 40 IF J > = 1 GOTO 20
10 J = 1 20 Q(J) = P(J) 30 IF J = N GOTO 60 40 J = J + 1 50 GOTO 20	10 J = 1 20 Q(J) = P(J) 30 IF J > = N GOTO 60 40 J = J + 1 50 GOTO 20	10 J = N 20 Q(J) = P(J) 30 IF J = 1 GOTO 60 40 J = J - 1 50 GOTO 20	10 J = N 20 Q(J) = P(J) 30 IF J < = 1 GOTO 60 40 J = J - 1 50 GOTO 20
10 J = 0 20 J = J + 1 30 Q(J) = P(J) 40 IF J < > N GOTO 20	10 J = 0 20 J = J + 1 30 Q(J) = P(J) 40 IF J < N GOTO 20	10 J = N + 1 20 J = J - 1 30 Q(J) = P(J) 40 IF J < > 1 GOTO 20	10 J = N + 1 20 J = J - 1 30 Q(J) = P(J) 40 IF J > 1 GOTO 20
10 J = 0 20 J = J + 1 30 IF J = N + 1 GOTO 60 40 Q(J) = P(J) 50 GOTO 20	10 J = 0 20 J = J + 1 30 IF J > N GOTO 60 40 Q(J) = P(J) 50 GOTO 20	10 J = N + 1 20 J = J - 1 30 IF J = 0 GOTO 60 40 Q(J) = P(J) 50 GOTO 20	10 J = N + 1 20 J = J - 1 30 IF J < = 0 GOTO 60 40 Q(J) = P(J) 50 GOTO 20
10 J = 1 20 IF J = N + 1 GOTO 60 30 Q(J) = P(J) 40 J = J + 1 50 GOTO 20	10 J = 1 20 IF J > N GOTO 60 30 Q(J) = P(J) 40 J = J + 1 50 GOTO 20	10 J = N 20 IF J = 0 GOTO 60 30 Q(J) = P(J) 40 J = J - 1 50 GOTO 20	10 J = N 20 IF J < = 0 GOTO 60 30 Q(J) = P(J) 40 J = J - 1 50 GOTO 20
10 J = 0 20 IF J = N GOTO 60 30 J = J + 1 40 Q(J) = P(J) 50 GOTO 20	10 J = 0 20 IF J > = N GOTO 60 30 J = J + 1 40 Q(J) = P(J) 50 GOTO 20	10 J = N + 1 20 IF J = 1 GOTO 60 30 J = J - 1 40 Q(J) = P(J) 50 GOTO 20	10 J = N + 1 20 IF J < = 1 GOTO 60 30 J = J - 1 40 Q(J) = P(J) 50 GOTO 20

Table 1: Twenty-four ways to write a loop in BASIC. These twenty-four basic methods can be expanded with a variety of small changes to produce over 124 different types of looping.

We can consider the possibility of setting $Q(J+1)$ to $P(J+1)$, or $Q(J-1)$ to $P(J-1)$, rather than $Q(J)$ to $P(J)$. In some cases, this would speed up some of the other operations in the loop. For example, at the top of the first column, we could have set J to 0 and tested J against N rather than $N+1$, if we set $Q(J+1)$ equal to $P(J+1)$. Both of these changes represent timing improvements.

It might seem that setting $Q(J+1)$ to $P(J+1)$ wastes a certain amount of time of its own, compared with setting $Q(J)$ equal to $P(J)$. This, however, is not so, or should not be so on a well-constructed system (although it might be so in some versions of BASIC). Any additive or subtractive constant in a subscript (such as $J+1$, above) does not have to be computed. To see why this is so, we need some knowledge of assembly language; those who know only BASIC may skip the following paragraph, in which the explanation is given.

Every time we make reference to $t(v)$, for an array t and a variable v , we have to add the value of v to the address of t . On the 8080, this is done explicitly; we typically do an `LXI H,t` followed by a `DAD D` where the `DE` register contains v (that is, where the `E` register contains v and the `D` register contains 0) and then we can reference $t(v)$ by doing `ADD M` or `MOV r,M` or `MOV M,r` or the like. On the 6502, it is done in the hardware; we do an `LDA t,X` or an `STA t,X` or an `ADC t,X` or the like, where the `X` register contains v , but the hardware adds the `X` register to the address given in the instruction, which effectively adds v to the address of t in this case. Every microcomputer has slightly different details, but the idea is the same in all cases. Now suppose we want to make a reference to $t(v+k)$, where k is a constant. We have to add the value of $v+k$ to the address of t — which is the same as adding the value of v to the address of t plus k . The point is

that both k and the address of t are constants; they do not change during the running of this program. Thus the address of t plus k is also a constant, and this addition can be done before the program starts. On the 8080, for instance, we would simply say `LXI H,t+k` rather than `LXI H,t`; this is a single instruction whose address field (second and third bytes of the instruction code) contains the 16-bit quantity obtained by adding k to the address of t . On the 6502, we might say `LDA t+k,X` and again we have a single instruction whose address field contains the address of t plus k . The same trick works, of course, for references to $t(v-k)$ rather than $t(v+k)$.

At any rate, by adding 1 or subtracting 1 in our subscripts, we have produced two new ways of writing a loop from every way we already have. We now have 108 ways to write a loop. Of course, theoretically, we could have set $Q(J+2)$ equal to $P(J+2)$, or $Q(J-2)$ equal to $P(J-2)$,

CP/M[®] := PASCAL;

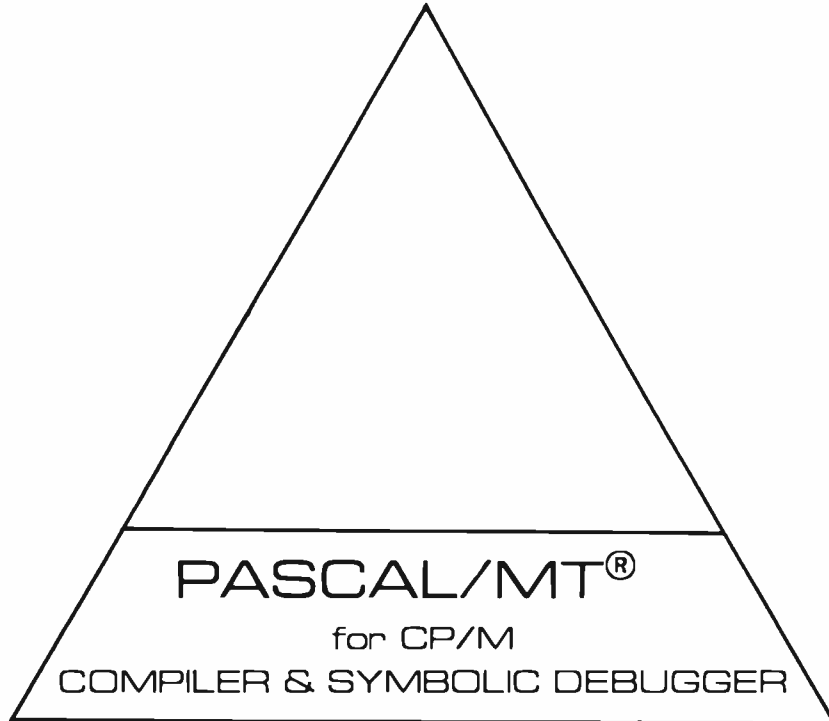

- Compiles directly to fast machine code!
- Needs only 32K CP/M system [or equivalent]!
- Includes Interactive Symbolic Debugger!
- Business arithmetic [18 digits] or Binary floating point [6.5 digits] [9511 version available]
- 8080/Z80 Now!
- 8086/Z8000 in 1980!

PMT-B [Business Arith.] 99.95
PMT-S [Source for run-time] 50.00

PMT-F [Floating Point] 99.95
PMT-M [Manual Alone] 30.00

Order Now From:



11722 D, Sorrento Valley Rd.
San Diego, Ca. 92121
[714] 223-5566, Ext. 289

We Accept:

LPS CDD,
Checks,
MC, Visa



© PASCAL/MT, trademark of MT MicroSYSTEMS
© CP/M, trademark of Digital Research

MT MicroSYSTEMS formerly MetaTech

and so on ad infinitum. There is now no bound at all (except for integer overflow considerations) on the number of new ways to write a loop we can set down.

One of these, by the way, has a certain amount of practical importance. The IM6100 microcomputer (or PDP-8) has an increment instruction, but no decrement instructions. Furthermore, the increment does a test against 0 (it is called ISZ, or increment and skip on 0). This does not correspond to anything in table 1 at all; if we are testing against 0, in table 1, we are always decrementing. However, consider the following loop:

```
10 J = -N
20 Q(J+N+1) = P(J+N+1)
30 J = J+1
40 IF J < > 0 GOTO 20
```

This time we cannot use the trick we mentioned earlier unless N is a constant. If N is a constant, however, the above loop does the same thing as all the other loops of table 1; and the last two instructions in it are meant to be executed, on the IM6100, by the single instruction ISZ J, followed by a jump to the label 20.

Are we finished with all possible speed improvements in our loop? Not at all. Consider the following loop:

```
10 J = 2
20 Q(J-1) = P(J-1)
30 Q(J) = P(J)
40 J = J+2
50 IF J <= N GOTO 20
```

Suppose that N is 100. Then, instead of going through this loop one hundred times, we would go through it fifty times. Each time, two elements of the Q array would be set to corresponding elements in the P array. The advantage is that $J=J+2$ is done only fifty times, where $J=J+1$ was done one hundred times in the loops of table 1; also, the IF statement is done only fifty times instead of one hundred times.

In practice, the improvement here is not quite as good as it looks. The assignment $J=J+2$ is generally slower than $J=J+1$. In fact, on many microcomputers, the fastest way to do $J=J+2$ is to do $J=J+1$ twice. On the 6502, the two array assignments can be done very neatly, one after the other, with:

```
LDA P-1,X
STA Q-1,X
LDA P,X
STA Q,X
```

as soon as the value of J is in the X register. On the 8080, though, assuming that the address of $P(J-1)$ is in DE and the address of $Q(J-1)$ is in HL, you would have to do something like:

```
LDAX D
MOV M,A
INX D
INX H
LDAX D
MOV M,A
INX D
INX H
```

where the second INX D and INX H set up the DE and HL registers for the next time through the loop. Thus the only improvement here is in having fewer executions of the test at the end of the loop.

Obviously the same idea as above could be implemented by increasing the variable J by 3, by 4, or however many each time, although there will be a corresponding increase in the size of program memory. Another difficulty with these schemes is that they do not work unless J is a multiple of 2, or whatever the increment is. If this is not the case, then some extra elements will be transferred from one array to the other, and this may cause unpredictable results. The general technique (known as "unrolling" a loop) does, however, have some useful applications on big computers. Even on a small system it is often useful, particularly when N is a very small number, such as 3, to write:

```
10 Q(1)=P(1)
20 Q(2)=P(2)
30 Q(3)=P(3)
```

which is better than any of the loops we have so far discussed.

Another speed improvement in loops arises from an analysis of the case in which $N=0$. If we are moving N quantities, then, if N is 0, we should be moving no quantities; that is, we should be doing nothing at all. Many of our loops, however, either become endless, or they move a single quantity ($P(1)$ or $P(N)$) in this case. In particular, this holds for all of the

loops in the first and third rows of table 1. The reason that this is a bit unsettling is that these are the only loops in table 1 which have three repeated statements in them (line numbers 20, 30, and 40). They are therefore the fastest of our loops, since all the other loops in table 1 have four repeated statements (line numbers 20, 30, 40, and 50).

It would seem that we have a choice between slowing down our loops and having a loop that doesn't work for $N=0$. In FORTRAN, in fact, the choice that was made was to disregard the case $N=0$ in favor of a faster loop. (This could be called an "institutionalized bug" in FORTRAN.) After all, the FORTRAN people reasoned, we can always check if $N=0$ just before starting the loop, if we are worried about this case. But there is a better way; we can write:

```
10 J = 1
20 GOTO 50
30 Q(J) = P(J)
40 J = J+1
50 IF J <= N GOTO 30
```

thus having only three repeated statements (line numbers 30, 40, and 50) and a loop which works properly if $N=0$.

It might seem as if the above loop is violating a sacred precept by jumping into the middle of the loop (at line number 20). In fact, however, the problems associated with jumping into the middle of a loop do not apply to the special case of jumping to one of the incrementation and testing statements at the end of the loop, provided that we know what we are doing. (If we have a FOR loop in BASIC, we still can't jump from outside the loop to the NEXT statement at the end of it; we are merely talking about ways in which the FOR loop might be implemented.)

Let us now take up the general subject of implementation of loops in machine language.

In the first place, there are a few computers that perform certain loops in hardware. That is, there is a single instruction that performs an entire loop. On the Z80, the instructions LDIR, LDDR, CPIR, CPDR, INIR, INDR, OUTIR, and OUTDR are of this type. Single instructions that perform loops are also found on certain

big computers; thus the UNIVAC 1106 and other computers of the 1100 series have block transfer, search, and masked search instructions, and the now obsolete UNIVAC 1103 had a special instruction called "repeat" that caused the instruction which followed it to be repeated a specified number of times. The trouble with such instructions is that each of them is an implementation of only one specific type of loop, although an admittedly common one. For example, on the Z80, as long as the value of N is in the double register BC, we can perform the data-moving operation of table 1 by either of the sequences:

```
LD DE,Q
LD HL,P
LDIR
```

or:

```
LD DE,QEND
LD HL,PEND
LDDR
```

assuming that the arrays P and Q end at PEND and QEND respectively. (These two sequences correspond roughly to the second and fourth columns of table 1, respectively.) While this gives a significant speed improvement in this case, it is of no help if the repeated instruction, instead of $Q(J)=P(J)$, is $Q(J)=J$ or $Q(J)=0$ or $R(J)=P(J)+Q(J)$, or if the count could have been kept in the B register while the C register is used to hold something else. The same sort of thing could also be done in one instruction on the UNIVAC 1106, using a block transfer instruction.

In the second place, even if an entire loop cannot be executed by means of a single instruction, some microcomputers have a single instruction which performs the functions associated with the loop index — that is, increasing it or decreasing it by 1 and then performing a conditional transfer. On the Z80, there is DJNZ, which decrements the B register by one and jumps (presumably back to the start of the loop) unless the B register has been decreased to 0. On the Signetics 2650, there is BDRR, which does the same thing with any specified register; there is also BDRA, which performs a jump to an absolute rather than a relative address, and BIRR and BIRA, which increment in-

stead of decrementing. The EA9002's DRJ and IRJ are also similar. The 8080, the 6800, the 6502, and the COSMAC, however, have no instructions of this kind, although it is a technique very common on big computers.

Even though there may not be a single instruction on your processor that decreases a register by 1 and also does a conditional jump, this method of ending a loop is the one that is the most common on small systems. It corresponds to the loop at the top of the third column in table 1. Typically, you use the B register on the 8080 and 6800 and the Y register on the 6502. The decrementing instruction (DCRB on the 8080, DECB on the 6800, DEY on the 6502) sets the zero flag, so that a jump on nonzero (JNZ on the 8080 and BNE on the 6800 and 6502) can immediately follow. On the COSMAC, there is no zero flag; after decrementing, the register that was decremented must be moved to the D register before the branch on nonzero (BNZ).

One important difference between the typical loop and the one at the top of the third column in table 1 is that the movement of data in that loop proceeds backwards; that is, $Q(N)$ first, then $Q(N-1)$, and so on. In many loops the logic makes this impossible, and in any event it is unnecessary. Even if we have a register which decrements to 0 during a loop, we usually have one or more further indices which are initialized at the beginning of the loop and which increase, rather than decreasing, every time we start a new iteration.

Figure 1 illustrates the progress of such a loop. The loop moves the string DATA from one place to another in memory; it is given for the 8080 by:

```
LOOP: LDAX D
      MOV M,A
      INX D
      INX H
      DCR B
      JNZ LOOP
```



FIDELITY CHALLENGER
computerized games
that challenge YOU!

Our prices are LOWER than Sears Roebuck catalog!

*Wish Book for the 1979 Holiday Season (page 658-661)

PLUS... WE PAY POSTAGE!



\$279.95

VOICE CHESS CHALLENGER®



\$89.95

BACKGAMMON
CHESS '77



\$279.95

CHECKER CHALLENGER®
\$59.95

BRIDGE CHALLENGER®

fds FACTORY DIRECT SALES
Dept. 57
1317 E. Colorado St.
Glendale, CA 91205
Phone: (213) 245-1417

ORDER TODAY

Retail Store Hours Tues - Fri 10AM to 6PM
Sat 9AM to 5PM Closed Sunday & Monday

20% deposit required on C.O.D. orders

Check Money Order VISA Master Charge

CA residents add 6% sales tax (No C.O.D. outside continental U.S.A.)

FREE SHIPPING on all prepaid orders!

SATISFACTION GUARANTEED OR YOUR MONEY BACK!

Price subject to change without notice. Refunds guaranteed. Quality Made in U.S.A. Copyright ©1979 Factory Direct Sales

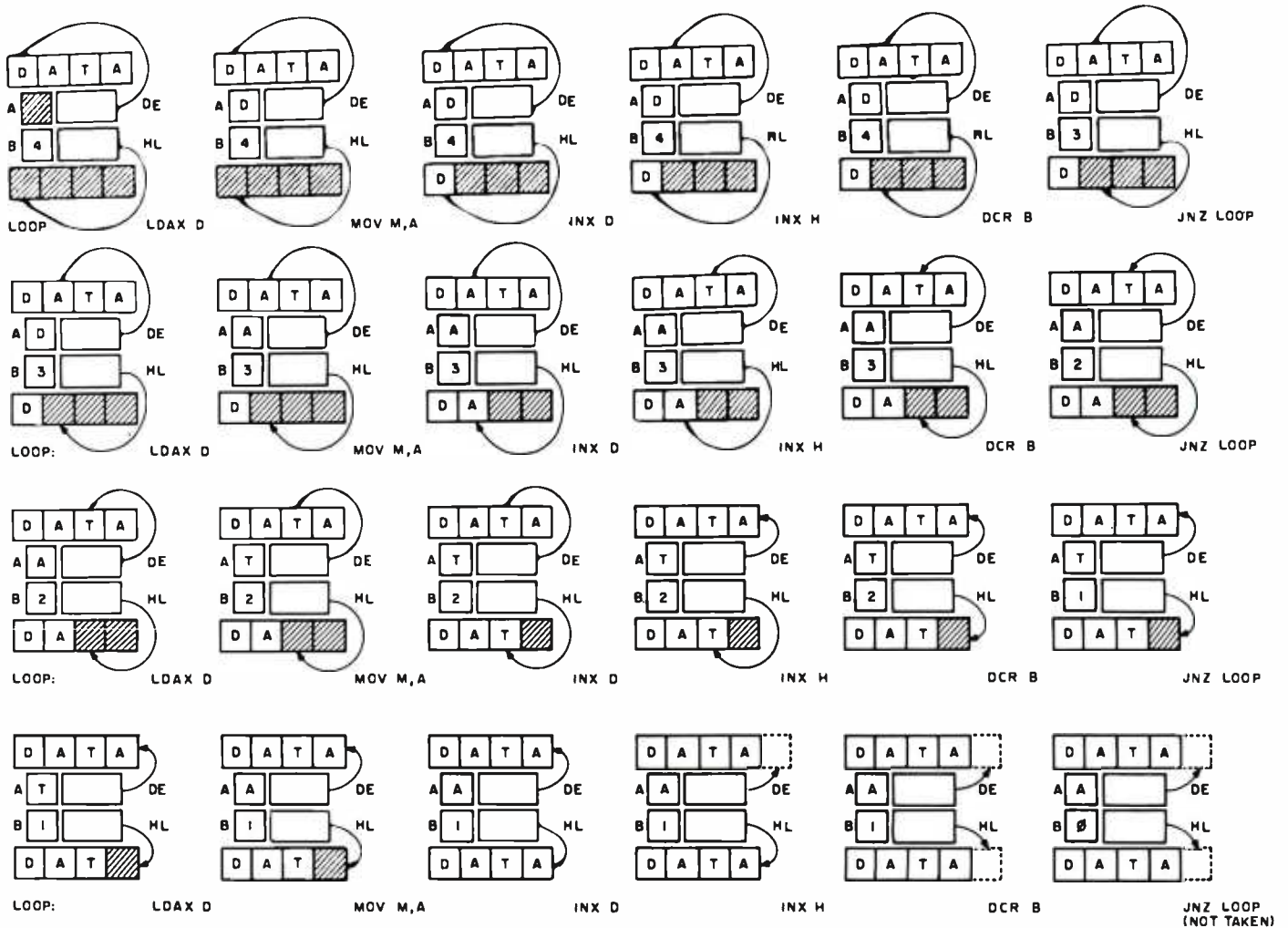

Figure 1: Progress through a loop to move the string "DATA" from one place in memory to another.

where the registers B, DE, and HL are presumed to be loaded before the loop starts. Specifically, register B is loaded with the number of characters to be moved (four, in this case); DE is loaded with the *source starting address*, or the address of the first character of the string in its old location; and HL is loaded with the *destination starting address*, or the address of the first character of the string in its new location. The six instructions of the loop are executed four times each, and the contents of the A, B, DE, and HL registers and the source and destination string area are illustrated. In the case of the DE and HL registers, an arrow is drawn from the register to the cell with address α , where the number α is currently in the given register. (We say that the register contains a *pointer* to that cell, or *points* to that cell.) The six instructions take 7, 7, 5, 5, 5, and 10 cycles respectively, giving a total

timing of $39n$ cycles for n characters to be moved; in this case it would be 156 cycles, or $78 \mu s$ if a 500 ns clock is used. To this must be added, of course, the time taken for initialization; using LXI D, α and LXI H, β and MVI B,4, the total time would become $93 \mu s$ in this case.

If you are new at writing assembly language code, do not worry if it takes you a while to get used to loops. Endless loops, and loops which are supposed to be done n times but which in fact are done either $n+1$ times or $n-1$ times, are quite commonly written by beginning programmers. The most important rules to remember are the following:

- When you jump back to the start of the loop, *never* jump back to the place where you set up the count or the starting addresses (registers B, DE, and HL in the example above). This will *always* result in

an endless loop. You should jump back to the point immediately following this initialization, as it is called.

- Remember that sometimes a loop must start with the count set to N, sometimes to $N+1$, and sometimes to $N-1$, depending on the logic. You should "walk through" your loops a few times when you are just starting out, until you are sure of the proper starting values.
- If you are using a step size greater than one, try not to test for equal or unequal. For example, if you are looping for $J=1$ to 10 by steps of two (FOR $J=1$ TO 10 STEP 2 in BASIC) then the values of J will be 1, 3, 5, 7, 9, 11, and so on; if your test at the end of the loop is a test for $J=10$, then $J=10$ will never hold and the loop will become endless. A test involving $>$ or $<$ (such as $J <= 10$) will avoid this difficulty. ■

Morse Code Trainer

Mark Bernstein
 Dept of Chemistry
 Harvard University
 Cambridge MA 02138

A commonly suggested application for microprocessors is translating text to Morse code. The subroutine described in figure 1 translates letters into Morse code and drives a speaker to serve as a Morse code trainer. Minor changes to the speaker driver routine would enable a microcomputer to key a transmitter directly.

The main entry to the routine is at hexadecimal address 0180. When the routine is called, the letter to be transmitted must be stored in register A as a number between decimal 0 and 25: 0=A, 1=B and 25=Z. By subtracting hexadecimal 41 from an ASCII letter code, this routine may be made compatible with ASCII text handling programs.

The program in listing 1 is relocatable. A data table (table 1) is expected to start at hexadecimal location 0080. The table may be relocated by changing the address stored in hexadecimal memory locations 0181 and 0182 to point at the location before the first word of the table.

Since the translation routine alters the contents of all registers, the user must write the mainline logic defensively. Registers containing important information must be saved by the user before calling the Morse code translator.

Intermediate Code

The heart of the Morse code translator is a binary representation of Morse code, illustrated in figure 2. This representation is stored in a data table for each letter, starting at hexadecimal 0080. The first letter's code is stored in the first position, the second letter's code in the next position, and so forth through the alphabet.

The intermediate code (stored as a binary coded decimal number) is very simple. The four high order bits define the number of dots or dashes in the letter. The four low order bits determine the sequence of dots and dashes for the letter. The first dot or dash is stored in the low order bit, with a 1 indicating a dash and a 0 indicating a dot.

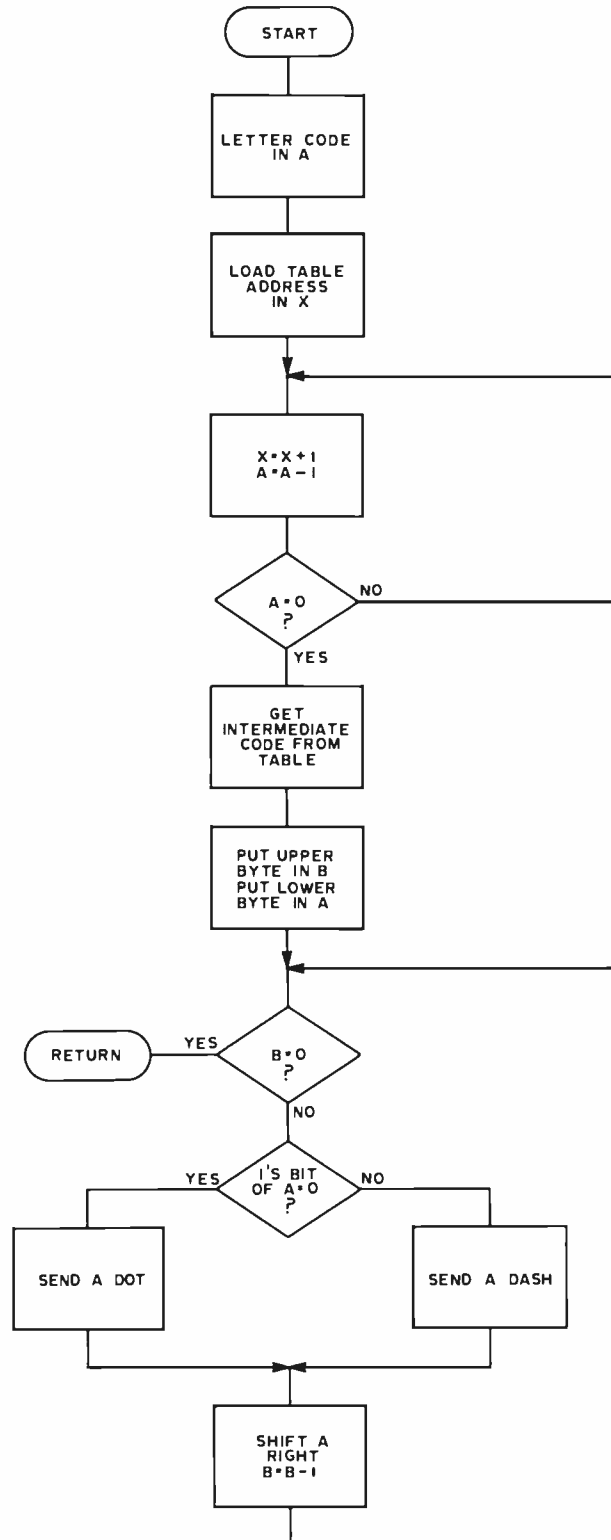

Figure 1: Flowchart for the Morse code translation routine.

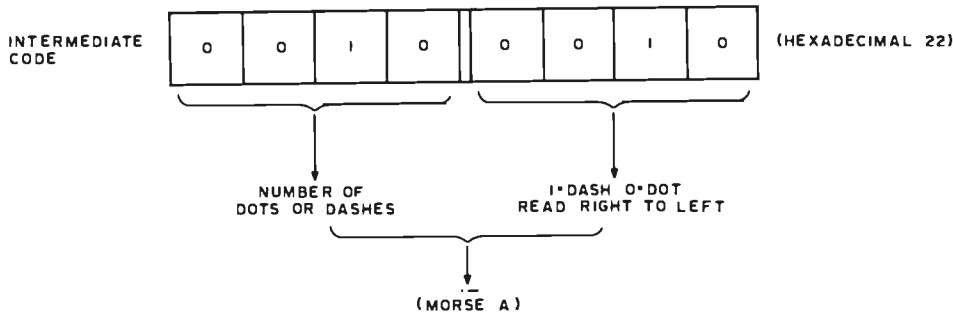

Figure 2: Intermediate code used by the ASCII-to-Morse-code translator. The data is stored in binary coded decimal (BCD) format. The high order bit indicates how many characters are in the letter; the low order bit defines whether they are dashes or dots.

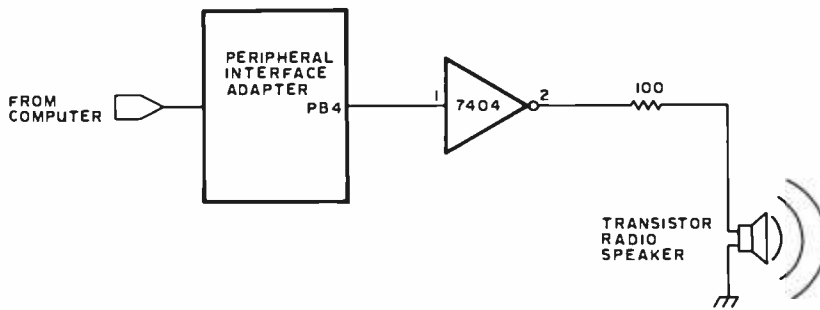

Figure 3: Simple circuit for connecting a speaker to the computer output port for listening to computer output in Morse code.

Hexadecimal Address	Hexadecimal Code	Mnemonic Op Code	Operand	Comments
0178	16	TAB		entry for byte splitter
0179	84	OF AND		get low byte
017B	54	54 LSR	LSR	shift right four times
017D	54	54 LSR	LSR	to get high order byte
017F	39	RTS		
0180	CE	00 7F LDX		main entry: point X to byte before start of data table
0183	08	INX		
0184	4A	DEC	A	point X to Ath entry
0185	2A	FC BPL		
0187	A6	00 LDA	A	fetch intermediate code
0189	8D	ED BSR		call byte splitter (0178)
018B	5D	TST	B	all signals sent?
018C	26	01 BNE		
018E	39	RTS		all done
018F	85	01 BIT	A	check lowest bit of A
0191	27	04 BEQ		jump if zero (dot)
0193	8D	08 BSR		send a dash
0195	20	02 BRA		skip
0197	8D	17 BSR		send a dot
0199	44	LSR	A	shift A to get next signal code
019A	5A	DEC	B	
019B	20	EE BRA		start another pass through loop
019D	CE	20 00 LDX		load timer for a dash
01A0	0F	SEI		start tone here
01A1	09	DEX		
01A2	27	05 BEQ		all done?
01A4	7C	80 06 INC		increment PIA
01A7	20	F8 BRA		start a new loop
01A9	CE	10 00 LDX		start a pause after tone
01AC	09	DEX		loop for a while
01AD	26	FD BNE		
01AF	39	RTS		tone finished
01B0	CE	10 00 LDX		load timer for a dot
01B3	8D	EB BSR		go to tone generator
01B5	39	RTS		

Listing 1: Morse code conversion program written in 6800 assembler code. This program can be relocated without any change.

The 2's bit gives the second dot or dash, if necessary, and so forth. For example, the code for A (- ·) is hexadecimal 22 (0010 0010).

How it Works

The subroutine in listing 1 loads the index register with the starting address of the intermediate code table. The code indicated by register A is fetched, and the four high order bits are split off by a call to the subroutine at hexadecimal 0178 and stored in register B.

The low order bit of register A, which contains the code for a dot or dash, is now tested. If a dash is to be sent, the dash generator routine is called (hexadecimal 019B). A dot is handled by the dot generator routine (hexadecimal 01B0). These routines drive a speaker. They may be rewritten to drive a transmitter interface.

The speaker driving routines begin by setting a timing value into the index register. The values given in listing 1 (dot=1000, dash=2000) result in sending speeds of about seven words per minute on my computer using a 614 kHz clock speed. Different speeds and dot-to-dash ratios may be obtained by changing these values.

The speaker is actually driven by the instruction sequence beginning at hexadecimal 01A0. This loop subtracts 1 from the index register and adds 1 to an output port. The use of a peripheral interface adapter (PIA) is assumed by this program. The address of the output port is stored in hexadecimal locations 01A5 and 01A6 until the X register is 0. The initial value of the X register determines the length of the tone. The program assumes that the appropriate output port has been initialized. By adding 1 to the output port each time the routine loops, the low order bit (PB0) changes very rapidly, the second bit (PB1) only half as quickly, and so forth; each bit gives a different tone. The speaker is connected to one output bit via a buffer, which provides sufficient drive capacity to power the speaker arrangement in figure 3. Users may select any bit to fit their own tonal preference.

After each dot or dash is sent, the main subroutine performs a logical shift right on register A. This places the next dot or dash code into the low order bit. Register B is decremented, and the program tests whether it is 0. If so, the entire letter has been sent. If register B is not 0, the program loops

until all dots and dashes have been sent. Control is then returned to the user's main-line program. ■

Hexadecimal Address	Hex Code	Letter	Morse
0080	22	A	· -
0081	41	B	- · · ·
0082	45	C	- · - ·
0083	31	D	- · ·
0084	10	E	·
0085	44	F	· · - ·
0086	33	G	- · - ·
0087	40	H	· · · ·
0088	20	I	· ·
0089	4E	J	- · - - -
008A	35	K	- · -
008B	42	L	- · · ·
008C	23	M	- -
008D	21	N	- ·
008E	37	O	- - -
008F	46	P	- · - ·
0090	4B	Q	- - - ·
0091	32	R	· - ·
0092	30	S	· · ·
0093	11	T	-
0094	34	U	· · -
0095	48	V	· · · -
0096	36	W	- · -
0097	49	X	- · · -
0098	4D	Y	- · · ·
0099	43	Z	- - · ·

Table 1: Intermediate code data table is expected by the program to start at hexadecimal memory location 0080.

BYTE's Bits

Inexpensive Communications Via Meteor Trails

The hundreds of millions of meteors that enter the earth's atmosphere every day leave in their wake a very inexpensive communications medium — the meteor trail. This band of ionized particles is an effective alternative to satellites for communication. Meteor trails can be used to relay data on icebergs, pollution, earthquakes, oil reserves, and can link remote villages and distant sources of supplies and emergency assistance.

Meteor burst transmission has proven reliable and cost-effective for the snow telemetry program operated by the US Department of Agriculture's Soil Conservation Service. By transmitting snowfall data from remote locations, the program has

eliminated costly manual measurements.

Meteor burst transmission systems work in several stages. Remote sensors gather data while a microprocessor-controlled station emits a continuous radio signal, which bounces off a meteor trail whenever one occurs within range. When this signal reaches a transceiver at a remote site, data is transmitted via the meteor trail to the central station.

For more information, contact SRI International, 333 Ravenswood Ave, Menlo Park CA 94025.

Texas Instruments Has an Award Winning Bubble Memory

Texas Instruments has been awarded the 1979 Information Product of the Year Award for its Models 763 Bubble Memory Data

Terminal and 765 Portable Bubble Memory Data Terminal. Both terminals have a full 128-character alphanumeric keyboard. Up to 80,000 characters can be collected and stored in the nonvolatile bubble memory, then transmitted at rates from 110 to 9600 bits per second (bps) to a host computer system. Both units have a quiet 30 characters per second (cps) print speed and built-in acoustic couplers.

A bubble memory is a small electromagnetic circuit that stores digital information by changing the magnetic polarity of a thin, crystalline film. The bubbles are cylindrical magnetic islands polarized in a direction opposite from that of the film. Bubble memory has no moving parts, and, because it works magnetically, retains information when the power is turned off. It offers higher access speeds, smaller size, and less weight and power consumption over paper tape, cassette and floppy disk systems. Bubble memory

terminals can access any indexed record in memory in less than 15 ms — 10 times faster than on floppy disk. If the data location is unknown, the character string search speed is 1000 cps, about 4 times the speed of a cassette search.

For more information, contact Texas Instruments, POB 1444, M/S 7784, Houston TX 77001.

Coming up in BYTE

In the January 1980 issue of *BYTE*, the theme is "The Domesticated Computer" — the idea of using computers around the home in various forms. A key part of that theme is played by Steve Ciarcia's article (written with some research aid from Ira Rampil) on adapting a widely sold and mass-produced household electrical controller to the typical personal computer.

Thirty Days to a Faster Input

Arthur Armstrong
3345 Moore St
Los Angeles CA 90066

Remember the last time you typed something into your computer? Did you look at the text to find out what to type, then at the keyboard to find out how to type it, then at the screen to see what you had typed? If you did, then it's time you learned to touch type. This is simply a means of learning the positions of the keys so well that typing becomes unconscious and automatic, and the material seems to flow directly from your mind to the page. The mechanical process becomes completely removed from the cerebral process, much like a musician playing an instrument.

Learning touch typing is not difficult. (Consider the millions of people who have mastered it.) All it takes is a convenient and permanent assignment of fingers to keys, some way of measuring progress, and a lot of systematic practice. Fortunately for you, your computer can perform all the tedious error checking and bookkeeping while you concentrate on the process. The program listed at the end of this article will help you become, if not rich and famous, at least less frustrated in your typing.

Admittedly, the traditional keyboard is not an efficient one. However, if that is what

you have, you should use the conventional finger assignment shown in figure 1. Naturally, the keys work no matter what finger you use, but this scheme seems comfortable. The important thing is to always use the same finger for each key. Otherwise the process cannot become automatic.

The program will ask you what characters you want to practice. This allows you to learn groups rather than to attempt the entire keyboard at once. One good way is to start with the group ASDFG. When you have mastered these learn HJKL;. Then combine the entire row ASDFGHJKL;. (Use lower case if your keyboard makes this easier. Don't complicate things with the shift key until later.) As you type, keep the tips of the fingers resting on the "home" keys ASDF JKL;. This gives you a fixed reference for reaching other keys. After you have gained facility with the home row, use groups that will allow you to keep a reference on the home keys. Try groups like QWASZX or TYGHBN. This gives you practice in reaching up and down the board. If you try to learn each row separately, you will lose the sense of distance between rows.

The program then asks, "How many in each word?" This means how many of the characters from your group should be presented at one time. When starting a new group of keys, use a word length of one character. When you have learned the individual characters, increase the word length using the same group: this will allow you to develop rhythm. The time interval between keystrokes should always be the same, and don't worry about speed. If you work on accuracy and rhythm, the speed will develop. As you gain facility, use long word lengths (20 to 30) and include spaces in your groups. This gives a sense of typing sets of words.

Stereotyping

The program asks if you want "echo." This means do you want to see the letters you are typing. Perhaps it is better to use echo until you have gained confidence but your goal should be to type with no echo and without looking at the keyboard. If you find yourself peeking at the board use smaller groups of letters. Learn to type while looking only at the text you are copying.

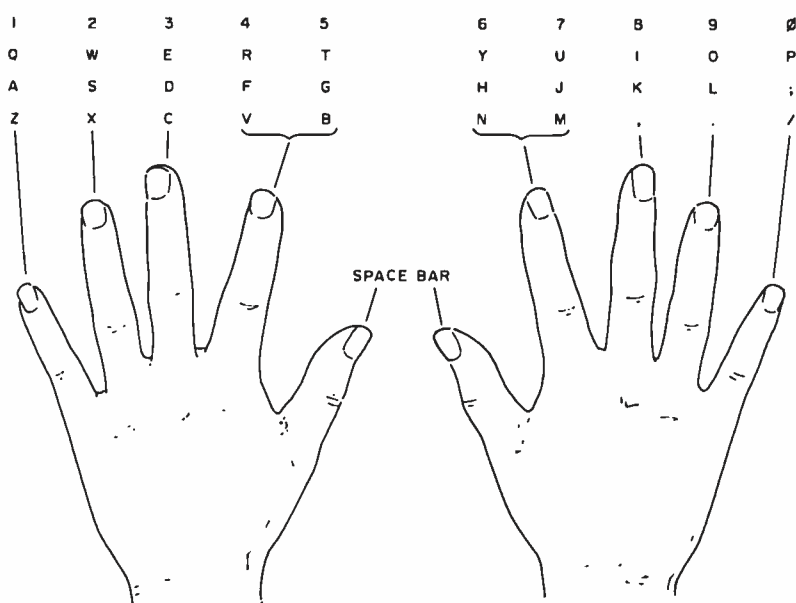

Figure 1: Standard touch typing finger assignments for the conventional typewriter keyboard.

Line Numbers	Commentary
100-130	Establishes the values for one set of trials. WL is word length. NT is number of trials. E is echo flag.
200-380	Constitutes the main loop presenting the trials. NP is the number of keystrokes possible.
220	Sets AS to a null string. 230-260 select a random set of characters and form the word, AS, to be presented.
250	A catenation of strings. MIDS(C\$,R,1) selects one character of C\$ from position R.
270	Prints the word.
300-370	The input loop.
310	Gets one character from the keyboard (decimal ASCII, no parity).
315	Converts the value to a string.
320	Checks for echo and prints the character if echo is on.
350	Compares the input character with the appropriate character in the test word. If they are not the same, the program jumps to line 500 for error processing. If the character is correct, line 360 tallies the number right (NR) and 370 returns for the next input character.
375	Checks the echo flag and prints a new line if echo is on.
400-430	Presents the results of the trials. 400 calculates the percentage of correct keystrokes based on number right and number possible.
405-410	Tabulates the characters missed.
500-540	Keeps score on wrong characters. The missed character is in AS pointed to by I. This character is compared with the characters in C\$ using J as a pointer. When a match is found, line 515 tallies the miss in array A.
520	Tells you which character you missed.
530	A delay loop to allow time to respond to the error notice.
540	Goes back to the main loop for the next trial.

```

10 REM TYPING DRILL
20 REM APT AFMSTPONG
30 REM 9/3/77
50 CLEAR200
100 INPUT"WHAT CHAFACTEPS DO YOU WANT";C$
105 L=LEN(C$):DIM A(L)
110 INPUT"HOW MANY IN EACH WORD?";WL
120 INPUT"DO YOU WANT ECHO?";A$
125 I=LEFT$(A$,1)="Y"THEN E=1
130 INPUT"HOW MANY TRIALS?";NT
200 FOR T=1 TO NT
210 NP=N*P+WL
220 AS=""
230 FOR I=1 TO WL
240 F=INT(L*RND(1)+1)
250 AS=AS+MIDS(C$,F,1)
260 NEXT
270 PPINT:PFINTAS
300 FOFI=1 TO WL
310 WAIT 0,1,1:X=INP(1)AND 127
315 E$=CHPS(X)
320 IFE=0 THEN 350
330 PRINT E$:
350 IFE<>MIDS(AS,I,1) THEN 500
360 NR=NR+1
370 NEXT
375 IFE=1 THEN PPINT
380 NEXT T
400 PPINT:PFINT"YOUR SCORE IS ";INT(100*NR/NP);"%
402 IF NP=N THEN 415
405 PPINT"ERROFS: ";FOFI:1 F A(I)=0 THEN 410
407 PFINTMIDS(C$,I,1):A(I)
410 NEXT
415 PPINT:INPUT"AGAIN?";A$
420 I=LEFT$(A$,1)="Y"THEN E=1
430 END
500 FOPJ=1 TO L
510 IF MIDS(C$,J,1)<>MIDS(AS,I,1) THEN NEXT:GOTO 520
515 A(J)=A(J)+1
520 PFINT:PFINT"ERROF ON ";MIDS(AS,I,1)
530 FOPJ=1 TO 300:NEXT
540 GOTO 380

```

Listing 1: A BASIC program designed to teach touch typing. The user inputs the subset of typing characters to be used in the drill, and the program responds with random combinations of these characters. The user then attempts to duplicate this string of characters by touch typing only (ie: without looking at the keyboard). Any mistakes are immediately signalled by the computer, and the score is printed out. The program was written for MITS 3.2 BASIC and requires 8 K of programmable memory. Any BASIC package that features numeric arrays, strings, and a random number generation capability will suffice.

```

END
WHAT CHAFACTEPS DO YOU WANT? ASDFGHJKL;
HOW MANY IN EACH WORD? 6
DO YOU WANT ECHO? YES
HOW MANY TRIALS? 3

SKFHKS
SD
EPPOR ON K

GLFGLF
GLFGLF

GFGDDA
GFGDDS
ERROP ON A

YOUR SCORE IS 66 %
EPPORS:
A I
K I

AGAIN? YES
WHAT CHAFACTEPS DO YOU WANT? ASDFGHJKL;
HOW MANY IN EACH WORD? 6
DO YOU WANT ECHO? NO
HOW MANY TRIALS? 3

AAAS;J

GLSDSF

EPPOP ON S

AAFFGF

EPPOP ON G

YOUR SCORE IS 77 %
ERPOPS:
S I
G I

AGAIN? YES
WHAT CHAFACTEPS DO YOU WANT? SG
HOW MANY IN EACH WORD? 10
DO YOU WANT ECHO? N
HOW MANY TRIALS? 2

SGSGSGSGSG

GGSGSGSGSG

YOUR SCORE IS 100 %

AGAIN? NO

```

Listing 2: A sample touch typing program.

The program then asks, "How many trials?" This is the number of times the program will present you with a word before telling you your score.

After you have finished the set, the program will indicate your score and show you a tabulation of your errors. Note that the program checks each character as it is typed in. It doesn't wait for you to finish the word. As soon as you miss a character, the program tells you which one it was and gives you another word. This is to prevent learning wrong responses.

The program was written in MITS 3.2 8 K BASIC but should be easy to modify for other dialects if necessary.

One extension would be to modify the program to select words or phrases from DATA statements. This would allow you to practice on "real" words instead of random strings.

In any event, I hope this turns out to be your type of program! ■

What's New?

SYSTEMS

C4P MF Personal Computer

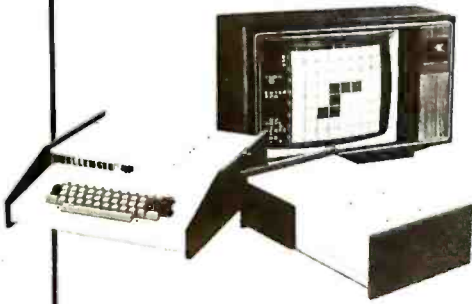

Ohio Scientific has introduced the C4P MF computer which includes a 32 by 64 character display, a 24 K byte static random access memory which is expandable to 48 K bytes and two 5-inch floppy disks. The system features a line printer and modem interface, keyboard with lowercase, and software including a word processor and library of program development tools, high-speed animation, sound output, a digital-to-analog (D/A) converter for music and voice output, joystick interfaces, a home control operating system, an AC remote control interface, and a home security and fire alarm interface.

The price is \$1695. For further information, contact Nancy M Valent, Ohio Scientific, 1333 Chillicothe Rd, Aurora OH 44202.

Circle 578 on inquiry card.



System 8000 for Small Business

This microprocessor-based small system incorporates S-100 bus architecture and up to 64 K bytes of programmable memory. Called the System 8000, this product includes a Z80-based processor, a video terminal, a dot matrix printer, and a floppy disk subsystem ranging in storage from 180 K bytes to 2 M bytes. The video terminal has a 12-inch screen displaying 80 characters

on each of 24 lines. The printer has a 7 by 7 dot matrix with bidirectional printing capability and rear tractor feed. Software used by the System 8000 consists of the CP/M operating system with an interpreted or compiled BASIC language. Some of the software options include FORTRAN, COBOL and APL. For further information, contact Computer Markets, 75 the Donway W #910, Don Mills, Ontario, CANADA M3C 2E9.

Circle 579 on inquiry card.



Z80 Microprocessor-Based System

Informer 3's hardware consists of a Z80 microprocessor; 48 K bytes of programmable memory; two RS-232 serial interface ports; one parallel interface port; a software monitor in 2 K bytes of programmable read-only memory; 8-inch floppy disk; and a 24-line by 80-character video terminal. The software includes Floppy BASIC (an extended disk BASIC); diagnostics; and basic utilities, which include file copy and disk copy for either single or multiple drive systems. The business software includes inventory management, payroll, accounts payable and receivable, word processing, customer mailing list, general ledger, program development, and others.

The Informer 3 system sells for less than \$4000. For further information, contact Digital Sport Systems, Division of Rohner Machine Works, 7th and Elm, W Liberty IA 52776.

Circle 580 on Inquiry card.

What's New?

PERIPHERALS

Percom Adds Music Board to SS-50 Product Line

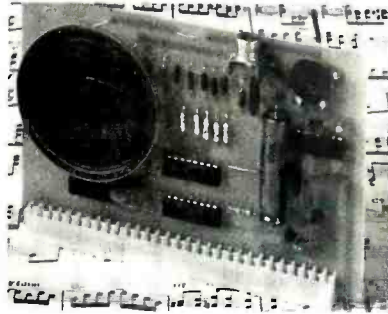

Percom Data Co has added the Newtech Model 68 Music Board to its SS-50 bus product line. The Music Board produces computer generated sounds such as melodies and rhythms, computer game sound effects, Morse code sounds, audible prompts for interactive computer operation, train sounds for model railroading, play-along and sing-along music, and sounds for many other applications.

The Music Board uses a single I/O (input/output) slot of Southwest Technical Products' 6800 computer and is supplied with a comprehensive user's manual that includes a theory of operation, a BASIC program for writing music scores, and an assembly language routine for program execution. The card includes address decoding, digital-to-analog conversion, audio amplification circuits, and its own speakers. The audio circuit includes a volume control.

An auxiliary jack for connecting the output audio to a remote speaker or audio system is mounted at the top of the card.

Also available, on either cassette or 5-inch disk, is *Americana Plus*, 14 tunes including "The Entertainer" and Chopin's "Minute Waltz." The cassette version of *Americana Plus* is compatible with Percom's CIS-30+ cassette and data terminal interface unit and the SwTPC AC-30 unit. The disk version runs on Percom's LFD-400 system using MINIDOS-PLUSX. The *Americana Plus* programs are in machine language and do not require an assembler or interpreter program.

The Music Board sells for \$59.95 assembled and tested. The cassette version of *Americana Plus* (MC-1SW) is priced at \$15.95, and the disk version (MD-1PC) is \$19.95. For further information, contact Percom Data Co, 211 N Kirby, Garland TX 75042.

Circle 533 on inquiry card.

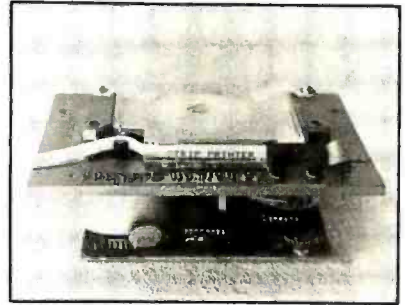

Thermal Strip Printer

The Model STSP-1 is a serial thermal strip printer which responds to an ASCII input by printing uppercase 5 by 7 dot matrix characters on a narrow paper strip. Originally designed for use with portable battery-powered items, the control circuit uses CMOS integrated circuits for low power consumption. The mechanism has only one moving part, and the printing process is silent. The last fifteen characters can be easily seen

in the viewing area of the paper cassette. The parallel input port is at 5 V CMOS level. A busy line is provided to simplify interfacing.

The STSP-1 mechanism with control interface is priced at \$225; the STSP-1E mechanism with control interface, enclosure, power supply, and input cable sells for \$295; and a package of ten thermal print tape cassettes is \$25. For further information, contact Prentke Romich Co, RD 2, POB 191, Shreve OH 44676. Circle 535 on inquiry card.

Buffered Tabletop Teleprinter



Teletype Corp has announced a tabletop buffered teleprinter featuring a microprocessor-based controller. The

teleprinter comes with a send, edit and receive buffer, and with extensive user-activated options that make it attractive for a variety of applications. The tabletop Model 43 BSR (buffered send/receive) provides 16 K characters of solid-state storage. It can automatically send and receive data via its buffer at up to 180 characters per second. Simultaneously, data can be entered and edited off-line for future transmission.

The 43 BSR is designed for switched network timesharing and message switching applications where it can reduce transmission costs and computer connect time. The 43 BSR is also ideal for data base inquiry systems where several inquiries can be entered into the buffer off-line and then automatically sent to the host computer, which sends back information after each inquiry.

The price of the 132-column pin-feed teleprinter with 16 K buffer is \$2483. In an 80-column friction feed configuration, the price is \$2505. For further information, contact Teletype Corp, 5555 Touhy Ave, Skokie IL 60077.

Circle 534 on inquiry card.

Where Do New Products Items Come From?

The information printed in the new products pages of BYTE is obtained from "new product" or "press release" copy sent by the promoters of new products. If in our judgement the information might be of interest to the personal computing experimenters and homebrewers who read BYTE, we print it in some form. We openly solicit releases and photos from manufacturers and suppliers to this marketplace. The information is printed more or less as a first in first out queue, subject to occasional priority modifications. While we would not knowingly print untrue or inaccurate data, or data from unreliable companies, our capacity to evaluate the products and companies appearing in the "What's New?" feature is necessarily limited. We therefore cannot be responsible for product quality or company performance.

What's New?

PERIPHERALS

Disk Module Doubles Disk Storage of Vector Graphic Systems

A 630,000 character dual floppy disk module has been announced by Vector Graphic Inc, 31364 Via Colinas, Westlake Village CA 91361. Called MICRO-STOR, this unit is used to expand Vector Graphic MZ and Memorite II systems from 2 to 4 disk drives. The unit features 2 Micropolis MOD II quad-density disk drives in an attractive chassis, using the standard 5-inch, 16-sector disk. The module simply plugs into the existing disk controller board. The operating systems presently in use on Vector Graphic hardware were prepared in advance to make use of 4 drives.

Tested and assembled, the MICRO-STOR is priced at \$1395.

Circle 525 on inquiry card.

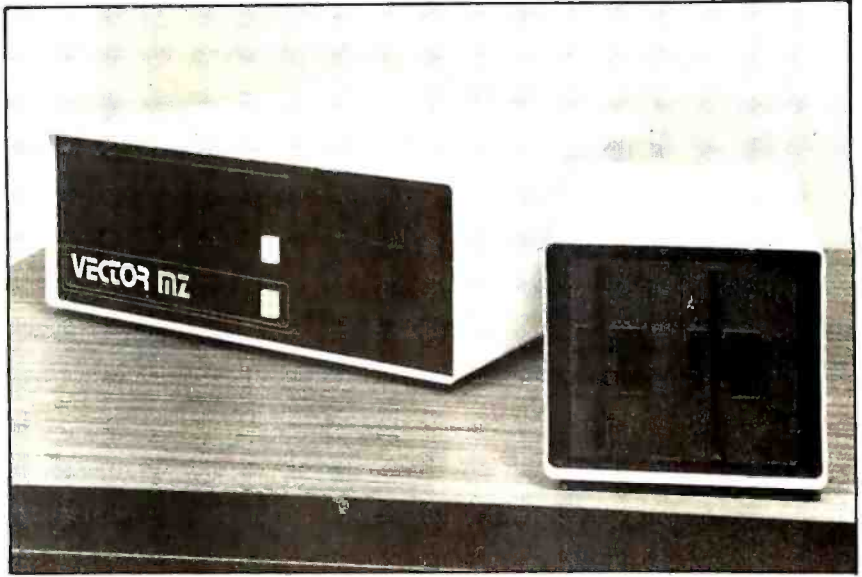

Intelligent Printer Features 96-Character Set



The Trendcom 100 Intelligent Printer provides the microcomputer user with 40-column hard copy on 4½ inch (11.43 cm) wide paper. Interfaces are available for TRS-80, Apple II, PET and Sorcerer computers. The Trendcom 100 features bidirectional 40 character per second printing with a full 96-character ASCII set, including upper and lowercase letters, numerals, and punctuation marks. The 5 by 7 dot matrix characters are printed with either black or blue images, depending upon the paper used. The microprocessor-controlled unit is quiet, since it uses no print hammers, gears, or drive belts. This new printer uses a thick film thermal printhead to eliminate wear and reliability problems.

The Trendcom 100 is fully enclosed in a metal and high-impact plastic case and is available in both 115 V and 230 V AC versions. The printer is priced at \$375. For further information, contact Trendcom, 484 Oakmead Pky, Sunnyvale CA 94086.

Circle 526 on inquiry card.

Four Printers from Dataroyal

These versions of the IPS-7000 series feature a 9-wire print head, a 7 by 9 dot matrix with full lowercase descenders, a 96 American Standard Code for Information Interchange (ASCII) character set that prints at 200 characters per second, and includes an 8-bit microprocessor. Models 7048 and 7248 feature a 500-character circular buffer, and Models 7049 and 7249 offer a 3500 character buffer. The new models include programmable vertical format control, an audible alarm, and a self-test switch.



The 7048 serial and 7248 parallel models are \$1594, and the 7049 serial and 7249 parallel models are \$1669. For further information, contact Dataroyal Inc, Main Dunstable Rd, Nashua NH 03061.

Circle 527 on Inquiry card.

New Terminal Supports Data Processing and Word Processing Applications



The Hazeltine 1420 computer terminal is designed to support small business systems using both data and word processing software. It features a typewriter-style keyboard arrangement with both upper and lowercase, making

it suitable for fast and accurate entry, and high-intensity blink or nondisplay (zero intensity) modes.

The terminal also features a program-function key mode as well as column and field tabs. All of the basic elements needed for up-to-date, fast data entry and data inquiry are included in the video terminal, including an enhanced separate numeric keypad. The Hazeltine 1420 operates with a standard EIA RS-232 interface with eight transmission rates up to 9600 bits per second (bps) which are switch selectable and accommodate all 128 ASCII codes.

The microprocessor design of the terminal permits utilization of fewer parts and increases its dependability. Its state-of-the-art design results in cool operating temperatures and makes possible the elimination of a fan.

For further information, contact Hazeltine Corp, Computer Terminal Equipment, Greenlawn NY 11740.

Circle 528 on Inquiry card.

What's New?

PERIPHERALS

Add-on Disk Drives for TRS-80

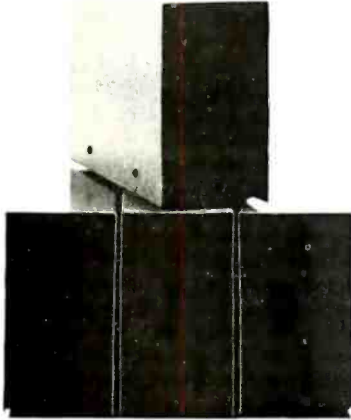

A family of add-on disk drives for the TRS-80 has been introduced by Microcomputer Technology Inc, 2080 S Grand Ave, Santa Ana CA 92705. The MTI single-head disk drive family (TF-X) offers the user a choice of MPI, Pertec, or Shugart SA400 5-inch floppy disk drives. The Shugart drive is the same device offered by Radio Shack, while the Pertec provides quieter operation and the use of both sides of the disk. The MPI unit provides additional features normally found in the 8-inch size disk drives, such as door lock and automatic disk ejection.

Prices for the TF-X single-head units start at \$379. MTI's dual-headed units (TDH-X) provide the same capacity as two single-headed drives and are priced at \$675.

Circle 529 on Inquiry card.

Light Pen for Radio Shack TRS-80



This self-contained light pen which plugs directly into the TRS-80 bus con-

Pen Plotter with Built-in Microcomputer-Based Controller

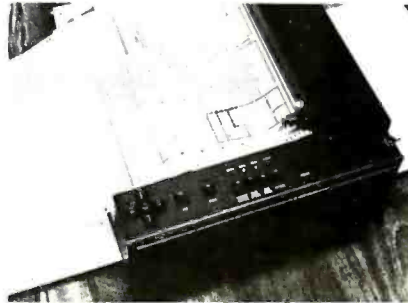

The Model 1553 is a compact, portable, desktop Digital Incremental Plotter with an integral microcomputer-based controller. The built-in RS-232 interface provides for on-line, off-line or remote operation via communication

lines, as a timeshared terminal.

The unit's high speed (10 inches per second (ips) along axes, 14.14 ips diagonal movement) and the intelligence of the controller (hardware symbol and character generation, circle and arc generation, dot and dash generation, scale and rotate), make it suited for business graphics, process control and scientific analysis plotter applications. The resolution is 0.0025 inch for excellent line quality. A universal pen holder and dynamic adjuster allow the use of ballpoint, liquid roller, and fiber tip pens. Pen type and color changes can be accomplished easily during a plot through programmable plotter pause commands.

The price of the Digital Incremental Plotter is \$5950. For further information, contact Nicolet Zeta Corp, 2300 Stanwell Dr, Concord CA 94520.

Circle 531 on Inquiry card.

Microprocessor-Based Cassette Terminal Features NCR Compatibility

This NCR-compatible, microprocessor-based cassette terminal is for applications including data communications, data logging, and program loading. The MFE Model 5450VRL Microprocessor Cassette Terminal is an 8080-based data storage system that features an optional variable record length read capability for compatibility with NCR's variable block length systems. The standard 5450 is compatible with Sweda, Texas Instruments, and all other RS-232-compatible systems. Accommodating ANSI/EMCA-compatible cassettes, all MFE terminals automatically perform read after write, cyclic redundancy check, and parity error checks to insure data integrity.

The storage capacity for the MFE 5450VRL varies with record length; for the 5450, capacity is 442 K formatted characters. The MFE product line also includes the Model 5000 (221 K characters), and the 2500 (350 K characters). All, except the 2500, incorporate high-speed skip, search, and edit capability. The terminals operate in full and half duplex modes; full duplex provides echoplex operation for each character. Dual RS-232C I/O (input/output) interfaces are standard; 20 mA current loop is optional.

MFE Microprocessor Cassette Terminals are priced from \$1995 each for the 5000 and 5450, and from \$1190 for the 2500; the VRL option for the 5450 is \$200. For further information, contact MFE Corp, Keewaydin Dr, Salem NH 03079.

Circle 532 on Inquiry card.

necter has been announced by the 3G Company Inc, Rt 3, POB 28a, Gaston OR 97119. The light pen makes it possible to bypass the TRS-80's keyboard and interact directly with the information displayed on the video screen. The light pen adds versatility to most graphics programs and makes possible unique games. A menu can be displayed on the screen, and the user can make a selection from that menu by using the light pen. This type of interaction makes it easy for the person who is not familiar with computers to use an applications program.

The light pen is completely assembled and ready to plug into the TRS-80. A sample program and programming instructions are included with the pen. The light pen sells for \$34.95 plus \$1.50 for postage and handling within the US (\$6 for foreign orders). The pen includes a 30-day unconditional money back guarantee.

Circle 530 on Inquiry card.

What's New?

PERIPHERALS



Miniature Printer Prints Text and Graphics

Called the ESP-40, this miniature printer can print images transmitted by digital facsimile equipment or can be used with any keyboard to form a low-cost printer terminal. The ESP-40 utilizes a nonimpact matrix printing process, and prints on electrosensitive paper 4 inches (10.16 cm) wide at rates up to



280 characters a second. A built-in microprocessor with a 320-character buffer memory enables the unit to print upper and lowercase characters (7 or 9 dots high) in a variety of styles and widths under program control. Between 5 and 20 characters per inch can be printed, and characters of different widths can be printed on the same line.

For plotting diagrams, the buffer output is applied directly to the printhead.

This enables up to 8 vertical dots to be printed at 240 printhead positions across the width of the paper, and in this mode the line shift is 8 dots high. The unit can plot curves and circles with great accuracy, and produce maps, drawings, and copies of photographs as well as diagrams. The printing mechanism is controlled by a timing disk which synchronizes the printhead with the data buffer. This ensures that the quality of printing is unaffected by changes in voltage or in mechanical friction.

The ESP-40 is 8 by 8.3 by 4.1 inches (20.32 by 21.08 by 10.41 cm) without the cooling fan. An electronic watchdog monitors all functions and sounds an alarm in case of impending or actual failure. Used with a hand-held keypad, test routines for fault diagnosis are provided by the on-board software. For further information, contact English Numbering Machines Ltd, Printer Div, Queensway, Enfield EN3 4SB, Middlesex, ENGLAND.

Circle 536 on Inquiry card.

New Terminal Fully Compatible with DEC VT-100



The DT80/1 video terminal offers full compatibility with Digital Equipment Corporation's VT-100. A key feature of the DT80/1 is its ability to interface with a printer in three different modes: on-line as data arrives; as a printer controller; and as a source for feeding data from the screen directly to the printer. The terminal offers a special display tube saver and self-diagnostics, and is protected by a one-year warranty.

For optimum space flexibility, the DT80/1 has a detachable keyboard. The capacity of its video screen is 24 lines by 80 or 132 characters, with light-emitting diode indicators for operator awareness and status. The DT80/1 screen also offers such functions as underline, blink, and dual-intensity. In addition, the user may employ a split screen, double-high

or double-wide characters, composite video input and output, and limited graphics. Reverse video is also keyboard selectable.

Other user convenience features include a typewriter-style keyboard, fixed and settable tabs, and bidirectional smooth scrolling. Internally, the DT80/1 houses a large-scale integrated technology video controller with two serial I/O (input/output) ports, which operate asynchronously with either RS-232C or 20 mA current loop. Communication speeds are up to 19,200 bits per second (bps).

For more information, contact Datamedia Corp, 7300 N Crescent Blvd, Pennsauken NJ 08110.

Circle 537 on Inquiry card.

New Printers from Centronics



Centronics printers, Models 730-1 through 730-7, include such features as 50 character per second print speed, 80 column line length at 10 characters per inch (3.9 characters per cm), a full line buffer, high-speed carriage return, and 7 by 7 dot matrix printing. Each unit has a built-in tear bar for paper tear off within five lines of print and is capable of making three simultaneous copies.

The printers' typewriter-like platen takes hand fed 8.5 inch (21.6 cm) wide sheets in letter, legal size or longer lengths, standard international sized A4 sheets, and the fixed pins on the platen accept standard computer grade multipart or single-part fanfold paper 9 inches (23 cm) wide from pin-to-pin. This system also allows the use of 8.5 inch (21.6 cm) wide roll paper up to 5

inches (12.7 cm) in diameter.

The Model 730s can handle payroll checks on preprinted forms, inventory listings on computer-grade fanfold paper, direct-mail letters on cut sheets and general information on roll paper. Some other applications include electronic mail, message logging, technical and scientific data logging and reservation systems.

These units weigh less than 10 pounds (4.5 kg) and measure 14.5 inches (36.8 cm) wide by less than 12 inches (30.5 cm) deep and less than 5 (12.7 cm) inches tall. The parallel printers are \$995 and the serial printers are \$1045. Contact Chuck Clemente or Sterling Hager at Centronics, Hudson NH 03051.

Circle 538 on Inquiry card.

What's New?

SOFTWARE

Pascal Business Software

A fully integrated system of Pascal business accounting packages has been announced by PS inc, Fargo ND. Standardized on the UCSD implementation of the language, the software includes a general ledger package that permits a company to name and number over 1000 of its own accounts, and to generate financial reports for the overall operation and for separate profit

centers. Accounts payable with aging and cash requirements reporting; accounts receivable with aging and sales analysis; order entry; and inventory control are all tied into the general ledger. It is menu-oriented for ease of training and use.

PS inc can supply their software on floppy disk or cartridge disk media.

For more information, contact PS inc, 619 NP Ave, Fargo ND 58102.

Circle 551 on inquiry card.

Development and Debugging Software for 6800 Micro-computer Programming

Percom Data Co has expanded its 6800 microcomputer software products line to include additional support programs for use in program development and debugging. The six programs that have been added include an assembler-linking loader, three disassemblers, a relocater, and a monitor with debugging conveniences. The programs are available on either cassette or disk, except the monitor which is in erasable read-only memory. Cassettes are Kansas City standard format at 300 bits per second (bps). The programs work with Percom operating systems. For prices and detailed description of the programs, write to Percom Data Co, 211 N Kirby, Garland TX 75042.

Circle 554 on inquiry card.

Macroassembler and Text Editor for PET, Apple II or SYM

The 6502 Macroassembler and Text Editor (ASSM/TED) is written specifically for the PET, Apple II, and SYM microcomputers. This software package was written in assembly language and occupies 8 K bytes of memory starting at hexadecimal location 2000. ASSM/TED provides 27 commands and 20 pseudo operations. Specific features include macroinstructions and conditional assembly support;

extensive text editing commands (which include automatic line numbering, and string search and replace); tape load; record and append commands; vectors for interfacing to disk systems; free format source input; source-code syntax similar to MOS Technology specifications, and other functions.

The user manual and cassette tape in either PET, Apple II or SYM (HS) format are available for \$35 plus \$2 for shipping and handling. For further information, contact C W Moser, 3239 Linda Dr, Winston-Salem NC 27106.

Circle 552 on inquiry card.

Software Packages for the UCSD Pascal Operating System

Two new software packages are available for the UCSD Pascal operating system. The first package, FORMOUT, is a collection of routines to do formatted output from Pascal programs. Included routines allow formatted printing of strings and numbers, tabbing to a specific column, and printing an arbitrary number of spaces or some other printing character. FORMOUT allows the user to easily switch from one I/O (input/output) device to another so that programs can be switched between devices during processing.

CPMREAD, the second package, translates CP/M disk files to Pascal text files. It allows the user to investigate the CP/M disk directory and choose the files to be translated. Assembler and BASIC source code can be brought across and then modified for use on the Pascal system using the standard Pascal editors. Since CPMREAD is written completely in Pascal, it can run on any machine running the UCSD Pascal system, allowing LSI-11 (and other) systems to have access to CP/M files.

FORMOUT is available as a source listing with manual for \$20. A machine-readable copy of FORMOUT is available on an 8-inch soft-sectored, single-density disk, for an additional \$10. CPMREAD is distributed as an executable code file only and is available for \$25. For further information, contact Pickles and Trout, POB 1206, Goleta CA 93017.

Circle 555 on inquiry card.

Pascal for North Star Horizon

North Star Computers Inc has announced that Pascal is now available for use with the North Star Horizon computer and Micro Disk System (MDS). North Star Pascal incorporates the complete UCSD Pascal program development system. North Star's version of Pascal includes such standard language features as the four elementary data types: real and integer numbers, boolean (true and false), and char (characters). The programmer may also define custom data types. Both elementary and programmer-defined data types may be organized into arrays, records, sets, or sequential files.

Pascal programs are easily understandable since descriptive names may be given to variables, constants, procedures, and functions within a program. Several types of loops and two conditional statements are provided to control program execution. A restricted form of GOTO is also available. In addition, North Star Pascal includes several extensions which ease the task of writing major business and personal programs.

The North Star Pascal package includes its own operating system. Pascal programs are compiled into fast executing p-code and are executed at

runtime by a program which simulates the operation of a hypothetical computer called the P-machine. The program development system is available on two single-density 5-inch disks or one double-density disk. Software provided with the system includes the P-machine simulator, Pascal operating system, Pascal compiler, and a screen-oriented text editor. A line-oriented text editor is also included with the system for use in situations where a suitable video terminal is not available.

For advanced applications, an auxiliary Pascal software package is available, containing a special assembler and numerous utility programs. With the assembler, it is possible to generate machine code procedures and functions which may be linked into compiled Pascal programs prior to execution. The auxiliary Pascal software package supplements the primary package described above.

The primary North Star package is \$49 including reference manual. The auxiliary software package is available for \$29. In ordering either package, specify whether single-density or double-density disk operation is desired. The system documentation package alone may be ordered for \$20. For further information, contact North Star Computers, 2547 Ninth St, Berkeley CA 94710.

Circle 553 on inquiry card.

What's New?

SOFTWARE

Tiny Pascal for TRS-80

A compact version of Tiny Pascal fits in the standard 16 K byte TRS-80 system and consists of the compiler, text editor, runtime routines, p-code interpreter (which saves storage space), and a system monitor. Execution speed is about 4 times faster than Level II BASIC using integer variables. This version is available from SuperSoft, POB 1628, Champaign IL 61820 for \$40.

Circle 556 on inquiry card.

Software for Texas Instruments

This software system is written in BASIC, works on floppy and hard disk systems and includes inventory control, order entry, sales analysis, general ledger, accounts payable, accounts receivable, and payroll.

Some of the capabilities of this software include invoice printing; back order reports; sales analysis by salesmen, customer, and product; purchase order journals and much more.

This system works on the Texas Instruments 990 and 771 computers. It is available from Kitzmiller Systems, 252 S Oxford Ave, Los Angeles CA 90004.

Circle 557 on inquiry card.

Digital Research Introduces CP/M 2.0 and MP/M

Digital Research has announced two new disk operating systems that are adaptable to nearly any 8080 or Z80 computer system with disk backup storage. CP/M 2.0, an enhanced version of CP/M, release 1, can run simple floppy disk systems to large-capacity hard disk drives. Configuration is accomplished through a disk definition table which drives the file management algorithms, allowing simple field alteration.

MP/M is a CP/M compatible multiterminal operating system which supports real-time multiprogramming at each terminal, along with background and foreground modes. It can serve as a complete program development environment for one or more users, or as the nucleus of clustered terminals or processors accessing a common data base. MP/M device drivers can be altered in the field to operate with interrupt driven or polled I/O (input/output) devices.

CP/M 2.0 is \$150 and MP/M is \$300, which includes documentation and floppy disk in single-density 8-inch form. Contact Digital Research, POB 579, Pacific Grove CA 93950.

Circle 558 on inquiry card.

8080 Simulator and Debug Package for Apple II

The Apple-80 is an 8080 simulator and debug package designed for the 6502-based Apple II computer. It allows any 16 K byte or larger Apple II to run programs written for the 8080, and can be used as a design and debugging aid for the development of original 8080 software.

Apple-80 provides single step, trace, and run modes, and executes all valid 8080 op codes. Illegal op codes are rejected. All 8080 registers are visible on the Apple screen and may be modified at will. 8080 I/O (input/output) port addresses are arranged in a table for ease of user modification. Up to eight

breakpoints may be set to facilitate program debugging. 6502 subroutines may be called directly from 8080 programs, allowing full access to Apple monitor and user-written functions. Conversely, 8080 routines may be embedded in 6502 programs. Vectored interrupts are also simulated.

The complete Apple-80 package includes Apple-80 routines, a manual, an 8080 program which demonstrates Apple-80 features, and an Apple-80 ready-reference card. The package is priced at \$20 plus \$1.50 for shipping and handling. For further information, contact Dann McCreary, POB 16435-B, San Diego CA 92116.

Circle 559 on inquiry card.

Text Output Processor

Script-80 is an 8080 microcomputer-based text output processing program that is compatible with the Script text processors available on most large mainframe computers. Developed to handle form letters, document files, and mailing lists, Script-80 requires an 8080 or Z80-based microcomputer with at least 16 K bytes of memory, a printer or hard copy terminal, a floppy disk drive, and CP/M or a compatible (CDOS, IMDOS, etc) operating system. The Script-80 system supports over 50 standard Script commands for the combining of multiple files, formatting and right-justifying of text, margin and line length control, centering of title lines, spacing, immediate and conditional page eject, page headings, page footings, and several formats of page numbering. Text from up to 255 files may be nested and embedded in the output text as though they are a

part of the original file. Additional features include picture (pixel) processing, automatic multidisk search for embedded files, and extended upper and lowercase conversion capabilities.

The Script-80 Professional version extends page, multiple disk, and output device handling. The user's manual explains how to use Script-80 with BASIC for selective mailing of form letters. The Commercial version goes beyond the Professional version to support mass personalized-letter mailing techniques.

The single-drive Hobbyist version is \$45; the multidrive Professional version sells for \$125; the full Commercial version with two-year update and maintenance service is \$625; the manual alone (specify version) is priced at \$25. For further information, contact J Vilkaitis Consultants, POB 26, 417 High St Ext, Thomaston CT 06787.

Circle 560 on inquiry card.

Apple Releases New Software

Apple Computer Co has released volumes 3 through 5 of the *Apple Software Bank*, a library of user-contributed programs. The new programs include File Cabinet, a personal directory and record keeping system; Character Generator, a program to label high-resolution graphic images; California Driver's Test, (a simulation of the actual exam); Integer Basic Renumber/Append; and 25 others.

Accompanying the 3 new volumes is a 90-page manual providing detailed descriptions and operating instructions for each of the programs. Called the *Bonus Issue*, the manual is an effective aid for Apple II users trying to establish or improve good programming techniques.

Apple also introduced 2 new graphics-oriented games, Apple Bowl and

Microchess. Both games use high-resolution graphics. Apple Bowl creates a life-like simulation of bowling, including ball speed and spin control capabilities to help bowlers perfect their games. Microchess is a strategy game and includes 8 levels of ability, from which the user can select the one most closely matching their playing skill.

The *Apple Software Bank* user-contributed programs are available from Apple dealers. Users must provide their own blank disk or cassette tape for copying the programs. A copy fee of \$10 per disk or \$2 per program is charged. The *Bonus Issue* manual is free with the purchase of all or any programs. Microchess is priced at \$20 on cassette and \$25 on disk, and Apple Bowl is priced at \$20 on cassette or disk. For further information, contact Apple Computer Inc, 10260 Bandlely Dr, Cupertino CA 95014.

Circle 561 on inquiry card.

The DATA-TRANS 1000

A completely refurbished
IBM Selectric Terminal with
built-in ASCII Interface.

\$1395

Features:

- 300 Baud
- 14.9 characters per second printout
- Reliable heavy duty Selectric mechanism
- RS-232C Interface
- Documentation included
- 60 day warranty - parts and labor
- High quality Selectric printing
- Off-line use as typewriter
- Optional tractor feed available
- 15 inch carriage width

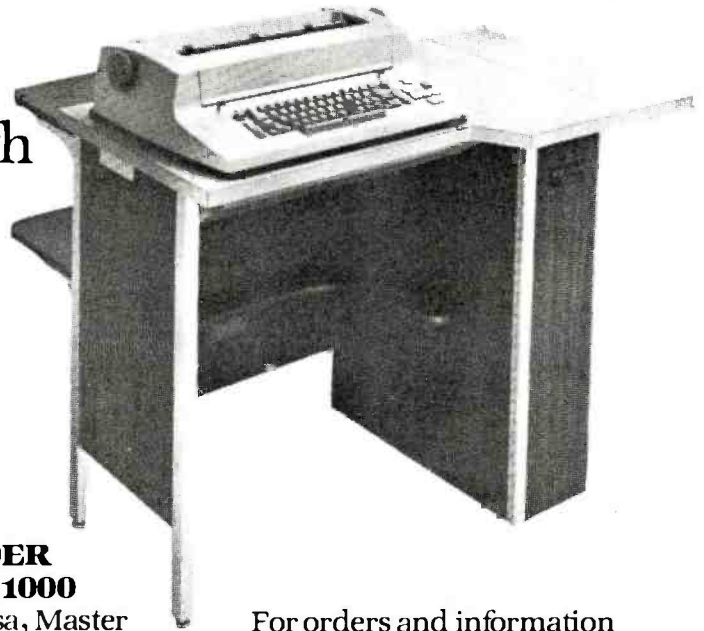

HOW TO ORDER DATA-TRANS 1000

1. We accept Visa, Master Charge. Make cashiers checks or personal check payable to:

DATA-TRANS

2. All orders are shipped F.O.B. San Jose, CA
3. Deliveries are immediate

For orders and information

DATA-TRANS
2154 O'Toole St.
Unit E
San Jose, CA 95131
Phone: (408) 263-9246

MICRO-PROCESSORS: FROM CHIPS TO SYSTEMS

This book cover all aspects of microprocessors, from the basic concepts to advanced interfacing techniques, in a progressive presentation. It is independent from any manufacturer, and presents uniform **standard** principles and design techniques, including the interconnect of a **standard** system, as well as specific components. It introduces the MPU, how it works internally, the system components (ROM, RAM, UART, PIO, others), the system interconnect, applications, programming, and the problems and techniques of system development. By R. Zaks. SYBEX. Ref. C201. \$9.95

MICRO-PROCESSOR INTERFACING TECHNIQUES

Microprocessor interfacing is no longer an art. It is a set of techniques, and in some cases just a set of components. This comprehensive book introduces the basic interfacing concepts and techniques, then presents in detail the implementation details, from hardware to software. It covers all the essential peripherals, from keyboard to floppy disk, as well as the standard buses (S100 to IEEE 488) and introduces the basic troubleshooting techniques. (2nd Expanded Edition). By Austin Lesea and R. Zaks. Ref. C207 SYBEX. \$11.95

PROGRAMMING THE 6502 PROGRAMMING THE Z80 PROGRAMMING THE 8080*

It covers all essential aspects of programming, as well as the advantages and disadvantages of the 6502 and should bring the reader to the point where he can start writing complete applications programs. For the reader who wishes more, a companion volume is available: The 6502 Applications Book. By R. Zaks. 6502: Ref. C202; Z80: Ref. C280; 8080: Ref. C208. SYBEX. Each \$10.95



44 BUS MOTHER BOARD

Has provisions for ten 44 pin (.156) connectors, spaced 3/4 of an inch apart. Pin 20 is connected to X, and 22 is connected to Z for power and ground. All the other pins are connected in parallel. This board also has provisions for bypass capacitors. Board cost \$15.00 Part No. 102. Connectors. \$3.00 each Part No. 44WP.



AN INTRODUCTION TO PERSONAL AND BUSINESS COMPUTING

No computer background is required. The book is designed to educate the reader in all the aspects of a system, from the selection of the microcomputer to the required peripherals. By Rodney Zaks. Ref. C200. SYBEX \$6.95

COMPUTER PROGRAMMING HANDBOOK

A complete guide to computer programming & data processing. Includes many worked-out examples. By Peter Staak. TAB \$9.95

DIGITAL CASSETTE

5 min. each side. Box of 10 \$9.95. Part No. C-5.

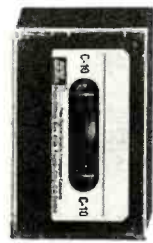

TVT COOKBOOK

Bk 1064 — by Don Lancaster. Describes the use of a standard television receiver as a microprocessor CRT terminal. Explains and describes character generation, cursor control and interface information in typical, easy-to-understand Lancaster style. \$9.95

To Order: Mention part no. description, and price. In USA shipping paid by us for orders accompanied by check or money order. We accept C.D.D. orders in the U. S. only, or a VISA or Master Charge no., expiration date, signature, phone no., shipping charges will be added. CA residents add 6.5% for tax. Outside USA add 10% for air mail postage and handling. Payment must be in U. S. dollars. Dealer inquiries invited. 24 hour order line (408) 448-0800



Send for FREE Catalog . . . a big self-addressed envelope with 41¢ postage gets it fastest!

ELECTRONIC SYSTEMS Dept. B P. O. Box 21638, San Jose, CA USA 95151

COMPUCRUISE

Put a computer in your car, which gives you the most effective and functional cruise control ever designed, plus complete trip computing, fuel management systems, and a remarkable accurate quartz crystal time system.

So simple a child can operate, the new CompuCruise combines latest computer technology with state-of-the-art reliability in a package which will not likely be available on new cars for years to come • Cruise Control • Time, E. T., Lap Timer, Alarm • Time, Distance, Fuel to Arrival • Time, Distance, Fuel to Empty • Time, Distance and Fuel on Trip • Current or Average MPG, GPH • Fuel Used, Distance since Fillup • Current and Average Vehicle Speed • Inside, Outside or Coolant Temperature • Battery Voltage • English or Metric Display. \$199.95 without cruise control \$159.95.



FLOPPY DISK STORAGE BINDER

This black vinyl three-ring binder comes with ten transparent plastic sleeves which accommodate either twenty, five-inch or ten, eight-inch floppy disks. The plastic sleeves may be ordered separately and added as needed. A contents file is included with each sleeve for easy identification and organizing. Binder & 10 holders \$14.95 Part No. 8800; Extra holders 95¢ each. Part No. 800



OPTO-ISOLATED PARALLEL INPUT BOARD FOR APPLE II

There are 8 inputs that can be driven from TTL logic or any 5 volt source. The circuit board can be plugged into any of the 8 sockets of your Apple II. It has a 16 pin socket for standard dip ribbon cable connection.

Board only \$15.00. Part No. 120, with parts \$69.95. Part No. 120A.

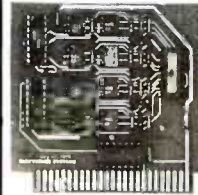

TIDMA

• Tape Interface Direct Memory Access • Record and play programs without bootstrap loader (no prom) has FSK encoder/decoder for direct connections to low cost recorder at 1200 baud rate, and direct connections for inputs and outputs to a digital recorder at any baud rate • S-100 bus compatible • Board only \$35.00 Part No. 112, with parts \$110 Part No. 112A



SYSTEM MONITOR

8080, 8085, or Z-80 System monitor for use with the TIDMA board. There is no need for the front panel. Complete with documentation \$12.95.

16K EPROM

Uses 2708 EPROMS, memory speed selection provided, addressable anywhere in 65K of memory, can be shadowed in 4K increments. Board only \$24.95 part no. 7902, with parts less EPROMs \$49.95 part no. 7902A.



ASCII KEYBOARD

TTL & DTL compatible • Full 67 key array • Full 128 character ASCII output • Positive logic with outputs resting low • Data Strobe • Five user-definable spare keys • Standard 22 pin dual card edge connector • Requires +5VDC, 325 mA. Assembled & Tested. CherryPro Part No. P70-05AB. \$119.95.



ASCII KEYBOARD

53 Keys popular ASR-33 format • Rugged G-10 P.C. Board • Tri-mode MOS encoding • Two-Key Rollover • MOS/DTL/TTL Compatible • Upper Case lockout • Data and Strobe inversion option • Three User Definable Keys • Low contact bounce • Selectable Parity • Custom Keycaps • George Risk Model 753. Requires +5, -12 volts. \$59.95 Kit.

ASCII TO CORRESPONDENCE CODE CONVERTER

This bidirectional board is a direct replacement for the board inside the Trendata 1000 terminal. The on board connector provides RS-232 serial in and out. Sold only as an assembled and tested unit for \$229.95. Part No. TA 1000C

DISK JACKET™

Made from heavy duty .0095 matte plastic with reinforced grommets. The mini-diskette version holds two 5-1/4 inch diskettes and will fit any standard three ring binder. The pockets to the left of the diskette can be used for listing the contents of the disk. Please order only in multitudes of ten. \$9.95/10 Pack.

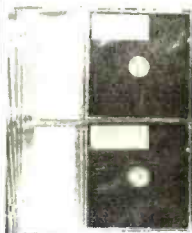

ATARI 800

Computer with 8K \$995.00, disk drive \$549.00, printer \$599.99



VIDEO TERMINAL

16 lines, 64 columns • Upper and lower case • 5x7 dot matrix • Serial RS-232 in and out with TTL parallel keyboard input • On board baud rate generator 75, 110, 150, 300, 600, & 1200 jumper selectable • Memory 1024 characters (7-21L02) • Video processor chip SFF96364 by Neculonix • Control characters (CR, LF, →, ←, ↑, ↓, non destructive cursor, CS, home, CL • White characters on black background or vice-versa • With the addition of a keyboard, video monitor or TV set with TV interface (part no. 107A) and power supply this is a complete stand alone terminal • also S-100 compatible • requires +16, & -16 VDC at 100mA, and BVDC at 1A. Part No. 1000A \$199.95 kit.



RS-232/20mA INTERFACE

This board has two passive, opto-isolated circuits. One converts RS-232 to 20mA, the other converts 20mA to RS-232. All connections go to a 10 pin edge connector. Requires +12 and -12 volts. Board only \$9.95, part no. 7901, with parts \$14.95 Part No. 7901A.



COMPUCOLOR II

Model 3, 8K \$13.95, Model 4, 16K \$15.95, Model 5, 32K \$18.95. Prices include color monitor, computer, and one disk drive.



PET COMPUTER

With 32K & monitor - \$1195. Dual Disk Drive - \$1195.



Apple II or APPLE II PLUS

16K - \$979, 32K - \$1059, 48K - \$1123. Disk & cont. \$589



CASSETTE TAPE ERASER

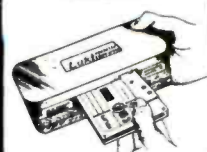

REMOVES RECORDINGS IN ONE SECOND! The process eliminates static positive / negative ions and maintains original tone quality with minimal tape hiss • To improve tone quality • To reduce hissing • For quick and easy to erase • No battery or liquid required • Powerful and effective action • Unconditional 2 year guarantee. ERASER-8 \$19.95.

16K RAMS

For the Apple, TRS-80 or Pet 85 each Part No. 4116/2117.

APPLE II HOBBY/PROTOTYPING CARD

\$14.95 Part No. 7907

T.V. INTERFACE

• Converts video to AM modulated RF, Channels 2 or 3. So powerful almost no tuning is required. On board regulated power supply makes this extremely stable. Rated very highly in Doctor Dobbs' Journal. Recommended by Apple • Power required is 12 volts AC C.T., or +5 volts DC • Board only \$76.00 Part No. 107, with parts \$13.50 Part No. 107A



PARALLEL TRIAC OUTPUT BOARD FOR APPLE II

This board has 8 triacs capable of switching 110 volt 6 amp loads (660 watts per channel) or a total of 5280 watts. Board only \$15.00 Part No. 210, with parts \$119.95 Part No. 210A.

To Order: Mention part no. description, and price. In USA shipping paid by us for orders accompanied by check or money order. We accept C.O.D. orders in the U.S. only, or a VISA or Master Charge no., expiration date, signature, phone no., shipping charges will be added. CA residents add 6.5% for tax. Outside USA add 10% for air mail postage and handling. Payment must be in U.S. dollars. Dealer inquiries invited. 24 hour order line (408) 448-0800



Send for FREE Catalog . . . a big self-addressed envelope with 41¢ postage gets it fastest!

ELECTRONIC SYSTEMS Dept. B P. O. Box 21638, San Jose, CA USA 95151

TRS-80 E.S. SERIAL I/O

- Can input into basic
- Can use LLIST and LPRINT to output, or output continuously
- RS-232 compatible
- Can be used with or without the expansion bus
- Onboard switch selectable baud rates of 110, 150, 300, 600, 1200, 2400, parity or no parity odd or even, 5 to 8 data bits, and 1 or 2 stop bits. D.T.R. line
- Requires +5, -12 VDC
- Board only \$19.95 Part No. 801Q, with parts \$59.95 Part No. 801QA, assembled \$79.95 Part No. 801QC. No connectors provided, see below.

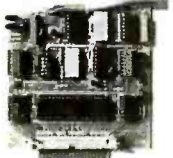

BA/RS-232 connector Part No. DB25P\$6.00, with 9', B conductor cable \$10.95 Part No. DB25P9



3' ribbon cable with attached connectors to fit TRS-80 and our serial board \$19.95 Part No. 3CAB40.

MODEM

- Type 103
- Full or half duplex
- Works up to 300 baud
- Originate or Answer
- No coils, only low cost components
- TTL input and output-serial
- Connect 8 Ω speaker and crystal mic. directly to board
- Uses XR FSK demodulator
- Requires +5 volts
- Board only \$7.60 Part No. 109, with parts \$27.50 Part No. 109A



DISKETTES



Box of 10, 5" \$29.95, 8" \$39.95. Plastic box, holds 10 diskettes, 5" - \$4.50, 8" - \$6.50.

APPLE II** SERIAL I/O INTERFACE



Baud rate is continuously adjustable from 0 to 30,000

- Plugs into any peripheral connector
- Low current drain. RS-232 input and output
- On board switch selectable 5 to 8 data bits, 1 or 2 stop bits, and parity or no parity either odd or even
- Jumper selectable address
- SOFTWARE
- Input and Output routine from monitor or BASIC to teletype or other serial printer
- Program for using an Apple II for a video or an intelligent terminal.

Also can output in correspondence code to interface with some electricics.

- Also watches DTR
- Board only \$15.00 Part No. 2, with parts \$42.00 Part No. 2A, assembled \$62.00 Part No. 2C

8K EPROM PIICEON

Saves programs on PROM permanently (until erased via UV light) up to 8K bytes. Programs may be directly run from the program saver such as fixed routines or assemblers.

- S-100 bus compatible
- Room for 8K bytes of EPROM non-volatile memory (2708's).
- On-board PROM programming
- Address relocation of each 4K of memory to any 4K boundary within 64K
- Power on jump and reset jump option for "turnkey" systems and computers without a front panel
- Program saver software available
- Solder mask both sides
- Full silkscreen for easy assembly.

Program saver software in 1 2708 EPROM \$25. Bare board \$35 including custom coil, board with parts but no EPROMS \$139, with 4 EPROMS \$179, with 8 EPROMS \$219.

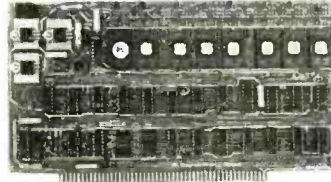

WAMECO PRODUCTS WITH

ELECTRONIC SYSTEMS PARTS

- FDC-1** FLDPPY CONTROLLER BOARD will drive shugart, pertek, remex 5" & 8" drives up to 8 drives, on board PROM with power boot up, will operate with CPM (not included). PCBD \$42.95
- FPB-1** Front Panel. (Finally) IMSAI size hex displays. Byte or instruction single step. PCBD \$42.95
- MEM-1A** 8Kx8 fully buffered, S-100, uses 2102 type RAMS. PCBD \$24.95, \$168 Kit
- QMB-12** MOTHER BOARD, 13 slot, terminated, S-100 board only \$34.95 \$89.95 Kit
- CPU-1** 8080A Processor board S-100 with 8 level vector interrupt PCBD \$25.95 \$89.95 Kit
- RTC-1** Realtime clock board. Two independent interrupts. Software programmable. PCBD \$25.95, \$60.95 Kit
- EPM-1** 1702A 4K EPROM card PCBD \$25.95 \$49.95 with parts less EPROMS
- EPM-2** 2708/2716 16K/32K EPROM card PCBD \$24.95 \$49.95 with parts less EPROMS
- QMB-9** MOTHER BOARD. Short Version of QMB-12. 9 Slots PCBD \$30.95 \$67.95 Kit
- MEM-2** 16Kx8 Fully Buffered 2114 Board PCBD \$25.95, \$269.95 Kit

T.V. TYPEWRITER

- Stand alone TVT
- 32 char/line, 16 lines, modifications for 64 char/line included
- Parallel ASCII (TTL) input
- Video output
- 1K on board memory
- Output for computer controlled cursor
- Auto scroll
- Non-destructive cursor
- Cursor inputs: up, down, left, right, home, EOL, EOS
- Scroll up, down
- Requires +5 volts at 1.5 amps, and -12 volts at 30 mA
- All 7400, TTL chips
- Char. gen. 2513
- Upper case only
- Board only \$39.00 Part No. 106, with parts \$145.00 Part No. 106A



TAPE INTERFACE

- Play and record Kansas City Standard tapes
- Converts a low cost tape recorder to a digital recorder
- Works up to 1200 baud
- Digital in and out are TTL-serial
- Output of board connects to mic. in of recorder
- Earphone of recorder connects to input on board
- No coils
- Requires +5 volts, low power drain
- Board only \$7.60 Part No. 111, with parts \$27.50 Part No. 111A



UART & BAUD RATE GENERATOR

- Converts serial to parallel and parallel to serial
- Low cost on board baud rate generator
- Baud rates: 110, 150, 300, 600, 1200, and 2400
- Low power drain +5 volts and -12 volts required
- TTL compatible
- All characters contain a start bit, 5 to 8 data bits, 1 or 2 stop bits, and either odd or even parity.
- All connections go to a 44 pin gold plated edge connector
- Board only \$12.00 Part No. 101, with parts \$35.00 Part No. 101A, 44 pin edge connector \$4.00 Part No. 44P



HEX ENCODED KEYBOARD

This HEX keyboard has 19 keys, 16 encoded with 3 user definable. The encoded TTL outputs, 8-4-2-1 and STROBE are debounced and available in true and complement form. Four onboard LEDs indicate the HEX code generated for each key depression. The board requires a single +5 volt supply. Board only \$15.00 Part No. HEX-3, with parts \$49.95 Part No. HEX-3A. 44 pin edge connector \$4.00 Part No. 44P.



RS-232/ TTL INTERFACE

- Converts TTL to RS-232, and converts RS-232 to TTL
- Two separate circuits
- Requires -12 and +12 volts
- All connections go to a 10 pin gold plated edge connector
- Kit \$ 9.95 Part No. 232A 10 Pin edge connector \$3.00 Part No. 10P.

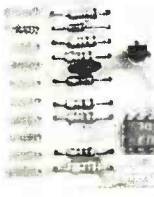

RS-232/TTY INTERFACE

This board has two active circuits, one converts RS-232 to 20mA, and the other converts 20mA to RS-232. Requires +12 and -12 volts. \$9.95 Part No. 600A Kit.



S-100 BUS ACTIVE TERMINATOR

Board only \$14.95 Part No. 900, with parts \$24.95 Part No. 900A



DC POWER SUPPLY

- Board supplies a regulated +5 volts at 3 amps., +12, -12, and -5 volts at 1 amp.
- Power required is 8 volts AC at 3 amps., and 24 volts AC C.T. at 1.5 amps.
- Board only \$12.50 Part No. 60B5, with parts excluding transformers \$42.50 Part No. 60B5A



To Order: Mention part no., description, and price. In USA shipping paid by us for orders accompanied by check or money order. We accept C.O.D. orders in the U.S. only, or a VISA or Master Charge no., expiration date, signature, phone no., shipping charges will be added. CA residents add 6.5% for tax. Outside USA add 10% for air mail postage and handling. Payment must be in U.S. dollars. Dealer inquiries invited. 24 hour order line (408) 448-0800



Send for FREE Catalog . . . a big self-addressed envelope with 41¢ postage gets it fastest!

ELECTRONIC SYSTEMS Dept. B , P. O. Box 21638, San Jose, CA USA 95151

What's New?

PUBLICATIONS

New Trackball Products Catalog



Trackball Products



MS
Measurement Systems, Incorporated
121 Water St., Norwalk, CT 06854
(203) 841-1100

Measurement Systems Inc has announced publication of their 12-page catalog of Trackball products. Trackballs are widely used for the human operator to perform positioning or contouring tasks on interactive displays either in computer peripherals or radar systems. Almost one half of the catalog contains technical and application data so that the reader gains a full understanding of this product. The balance of the catalog provides extensive data on specific standard items with options available. Fourteen trackballs are described, ranging in size from 2 to 3½ inches in diameter (5.08 to 8.89 cm). For further information, contact Measurement Systems Inc, 121 Water St, Norwalk CT 06854.

Circle 539 on inquiry card.

Free Apple Software Catalog from Rainbow

This 45-page catalog includes over 100 games of all types, fifteen business applications, twelve demonstration programs from voice recognition and speech synthesis to high-resolution and color graphics, and software

development programs. Rainbow's "Pot O' Gold" of 49 games and demonstrations is also featured.

Prices for programs on cassette and diskette average around \$10 to \$20. Write Rainbow Computing Inc at 9719 Reseda Blvd, Northridge CA 91324 or call (213) 349-5560 for your free catalog.

Circle 541 on inquiry card.

PIPS for VIPS

PIPS written by Tom Swan contains 160 pages of programs and documentation for use on the RCA COSMAC VIP, and an appendix describing modifications which can be made to allow the *PIPS* programs to be run on the ELF computers.

The first program, "Character Designer," facilitates building and editing a complete American Standard Code for Information Interchange (ASCII) and graphics character set, the remaining three programs use the display capabilities generated by the "Character Designer" to build text files. "Messenger" allows easy text and graphics display from within CHIP-8; "Text Editor-21" is a general-purpose text editor, and "Disassembler-7" is an 1802 machine language disassembler. All these programs utilize a high-resolution display method described in *PIPS*. The remaining programs in the book are a "CHIP-8 Program Editor" and two games written in CHIP-8: Space Wars and Surround.

The book is available from Aresco, POB 1142, Columbia MD 21044, for \$19.95. The price includes a companion cassette containing all the *PIPS* programs.

Circle 542 on inquiry card.

New Book Series on Computers

Academic Press Inc, 111 5th Ave, New York NY 10003, is publishing a series of books that cover a wide range of topics in the computer field.

Physics of Computer Memory Devices, Artificial Intelligence, Computer Vision Systems, Pattern Recognition and Artificial Intelligence, and *Associative Networks* are some of the books now on the market.

The prices range from \$29 to \$39.50

Circle 543 on inquiry card.

Book on Microprocessors from Texas Instruments



Written in nontechnical language, *Understanding Microprocessors* covers the aspects of microcomputer systems which use a microprocessor chip as the central unit for processing and control. This book provides the layman with the basics of what comprises a microprocessor, how it fits into the microcomputer system, what other system parts are necessary and how the microcomputer system functions. It introduces the reader to digital electronics, integrated circuit functions and includes 8- and 16-bit microprocessor applications with exercises and solutions. It is priced at \$4.95 and is available from Texas Instruments Inc, POB 3640, MS 84, Dallas TX 75285.

Circle 544 on inquiry card.

Free TIB0203 Data Book from Texas Instruments



A data book on the TIB0203 magnetic bubble memory has been announced by Texas Instruments Inc, POB 225012, Dallas TX 75265. The 48 page book, publication number LCC4430, contains complete specifications on the TIB0203 and, in addition, an 8 page discussion on the basic fundamentals and advantages of magnetic bubble memories. Also included in the manual are specification sheets for the interfacing integrated circuits which have been designed for use with the TIB0203. The additional data sheets include those for SN74LS361 function timing generator, SN75281 sense amplifier, SN75380 function driver, and SN75382 coil driver. Data sheets for standard devices which are needed for bubble memory system design, such as TSP102 thermistor and VSB53 Schottky-diode bridge, are also included.

Circle 540 on inquiry card.



HOBBY WORLD®

CALL TOLL FREE: (800) 423-5387 USA

IN CALIF: (800) 382-3651

LOCAL & OUTSIDE USA (213) 886-9200

Your one-stop mail order computer store!



SSM PB1 2708/16 EPROM BOARD

• S-100 Bus
Programs eproms. Has provisions for 4K or 8K of eprom. With test-socket sockets.
Cat No. 1440 PB1 kit \$135

SSM AIO SERIAL/ PARALLEL INTERFACE

• Apple Bus
One RS-232 serial, two bi-directional parallel. Interface your Apple to printers, plotters, terminals. With firmware, cables.
Cat No. 1918 AIO kit \$129
Cat No. 1919 AIO a&t \$169

SSM VB1B VIDEO INTERFACE

• S-100 Bus
64 x 16 video, upper and lower case, greek. Composite and parallel video. White on black, or reverse.
Cat No. 1417 VB1B kit \$129
Cat No. 1419 VB1B bbd \$ 26

SSM IO4 2 SERIAL + 2 PARALLEL PORTS

• S-100 Bus
Full handshaking, 20%0mA current loop. Dip switch address selection.
Cat No. 1411 IO4 kit \$139
Cat No. 1413 IO4 kit \$ 26

SSM CB1A 8080A CPU BOARD

• S-100 Bus
2K of PROM, 1K of RAM. Power on/reset, vector jump, parallel port with status.
Cat No. 2044 kit \$155
Cat No. 2045 bbd \$26

MARINCHIP M9900 16 BIT CPU

• S-100 Bus
Includes DOS, BASIC, word processor, text editor, assembler, linker, diagnostics and debug tools. Increases system performance by a factor of 2!

Cat No.	Description	Price
1379	M9900 CPU kit	\$550
1950	as above, a&t	\$700
1951	PROM/RAM/MSIO kit	\$275
1964	as above, a&t	\$350
1940	PASCAL	\$150
1941	META	\$ 50
1942	System generation kit	\$100
1943	Full documentation	\$ 20

SSM CB2 Z-80(A) CPU BOARD

2 or 4 MHz, dip switch selectable. 2 sockets for 2716's or 2732 eproms or TMS4016 rams. MWRITE, firmware vector jump. Allows more than 64K ram.
Cat No. 2046 kit \$199

SSM VB3 80 CHAR. VIDEO BOARD

• S-100 bus
80 char/line, 24 lines upper & lower case, plus 256 user defined symbols, plus 160 x 204 graphics. Memory mapped. US and European compatible.
Cat No. 2047 2MHz kit \$369
Cat No. 2049 4MHz kit \$395

ITHACA Z-80 CPU BOARD

• S-100 Bus
2.5MHz or 4 MHz, on board 2708, optional MWRITE, allows operation without front panel.
Cat No. 1512 bareboard \$32

ITHACA 2708/16 EPROM BOARD

Accepts up to 16 eproms. Dip switch addressable to any 1K location. Unused ROM locations may be allocated to RAM by dip switch.
Cat No. 1511 bareboard \$28

TARBELL CASSETTE INTERFACE

• S-100 Bus
Fastest transfer rate: 187 to 540 bytes/sec. Phase encoding (self-clocking). Generates Kansas City tapes.
Cat No. 1756 kit \$120

TARBELL 32K STATIC RAM

• S-100 Bus
Extended addressing (bank switching), phantom line, low power requirements. 9 on-board regulators!
Cat No. 1979 kit \$625

TARBELL FLOPPY DISK INTERFACE

• S-100 Bus
Up to 4 single drives in daisy chain. 250 bits per sec. Works with modified CPM and BASIC compiler. Build in phantom bootstrap.
Cat No. 1901 kit \$190
Cat No. 1774 bareboard \$ 40

SSM SB1 MUSIC SYNTHESIZER

• S-100 Bus
Freq range 15-20,000 Hz. Software uses only 4K RAM. Uses standard ASCII encoding, for music encoding. Includes timer. Use more than one board for chords and harmonies.
Cat No. 1408 SBT kit \$145
(with software)
Cat No. 1410 SBT bbd \$35

SD SYSTEMS VERSAFLOPPY

• S-100 Bus
Operates with Z-80, 8080(A), 8085. Controls up to four 5 1/4" or 8" drives. Dozens of features.
Cat No. 1516 kit \$159

SD SYSTEMS EXPANDORAM

• S-100 Bus
Interfaces with Sol, Altair, Imsai, Cromemco, etc. Expand dynamic memory in blocks of 8 to 64K. Dip switch selection for positioning boundaries. Write protect, phantom output disable. Uses 4116 rams.
Cat No. 1517-0 kit \$185
Cat No. 1516-C 16K RAM \$80ea

SD SYSTEMS VIDEO DISPLAY BOARD

• S-100 Bus
Interfaces a monitor and a keyboard to the S-100 Bus. On-board Z-80 controls functions. 80 x 24 display. 2K on-board RAM.
Cat No. 1599 kit \$318

WAMECO QMB-12 12 SLOT MOTHERBOARD

• S-100 Bus
Very quiet! On-board kluge area accepts up to two 40-pin sockets. Also area for 3 separate voltages.
Cat No. 1507 bareboard \$36

WAMECO FDC-1 FLOPPY DISK CONTROLLER

Controls up to eight Shugarts, Perfecos, Remex's, or VPI's. Also designed to operate with CPM software. Compatible with Z-80 or 8080 systems.
Cat No. 1377 bareboard \$48

WAMECO FPB-1 FRONT PANEL BOARD

Similar to Imsai. Controls 8080A computer. Features memory examine, memory deposit, RUN, STOP, RESET. Hex displays. BYTE or instruction single step.
Cat No. 1322 bareboard \$47

CCS 7115A APPLE II PROM MODULE

Add firmware without changing ROMs. 14K space available. Uses SV 2716 eproms.
Cat No. 1630 kit \$62
Cat No. 1631 a&t \$72

CCS 7710A APPLE II ASYNCHRONOUS SERIAL INTERFACE

Interfaces printers, etc. Features serial with full handshaking, and RS-232C (A thru E).
Cat No. 1623 kit \$90
Cat No. 1624 a&t \$145

CCS 7712A APPLE II SYNCHRONOUS SERIAL INTERFACE

RS-232C (A thru E). Standard synchronous signaling, rate per RS269/ANSI x3.1-1976.
Cat No. 1627 kit \$90
Cat No. 1628 a&t \$145

CCS 7520AK APPLE II EXTENDER BOARD

Use for debugging or testing modules in the Apple II.
Cat No. 1611 kit \$21

CCS 7720A APPLE II PARALLEL INTERFACE

Interface printers and other peripherals. Programmable interrupt, 2 bi-directional ports, full handshaking.
Cat No. 1632 kit \$62
Cat No. 1633 a&t \$105

CCS 7470A APPLE II BCD A/D CONVERTER

Single channel A/D, 12 bits. Allows conversion of -4 to +4 VDC to a BCD number, 2000usec conversion.
Cat No. 1621 kit \$115
Cat No. 1622 a&t \$135

CCS 2520A EXTENDER/ TERMINATOR BOARD

• S-100 Bus
Active and/or dynamic termination. Labeled S-100 signals.
Cat No. 1610 kit \$38

CCS MXVI 16K STATIC RAM MODULE

• S-100 Bus
Fully buffered, addressable in 4K blocks. Plugs right in most S-100 computers. 2 versions of bank select: bank byte or bank port.
Cat No. 1601A 450ns kit \$285
1601B 200ns kit \$330
1602A 450ns a&t \$330
1602B 200ns a&t \$375
1603 bbd only \$27

CCS APPLE & S-100 PROTOTYPING BOARDS

Signals labeled on-board.

Cat No.	Description	Price
1606	Apple Wirewrap	\$21
1607	Apple soldertail	\$21
1608	Apple etch	\$18
1604	S-100 soldertail	\$26
1605	S-100 wirewrap	\$23
1609	S-100 etch	\$26

CCS 7811A APPLE II ARITHMETIC PROCESSOR

Add high powered math to your Apple! Increases math power by 10x! For number crunching, graphics.
Cat No. 1635 a&t \$390

CCS GPIB IEEE 488 BUS INTERFACE

Interface test equipment (equipped with 488 bus) to the Apple! Also interfaces the PET to the Apple.
Cat No. 2051 a&t \$295

Send for FREE CATALOG

The best selection of computer accessories add-ons, factory fresh IC's, led's, semi's, software, PC aids, prototyping aids, books, test equipment, and more! Always updated! Dozens of new products every issue!

HOW TO ORDER

Pay by check, COD, VISA, or MasterCard. Charge orders include expiration date. Order by phone or mail. Minimum order \$10. Please include phone number and magazine/issue you are ordering from. USA: add \$2 for shipping/handling ground, add \$3 for air. FOREIGN: Add \$3 for shipping/handling surface, \$6 for air. COD's \$1 add'l! Guaranteed satisfaction for 120 days or your money back! Not responsible for typographical errors. We reserve the right to limit quantities.

19511 Business Center Dr. Dept. K12 Northridge, Ca. 91324

What's New?

PUBLICATIONS

New COS/MOS Integrated Circuit Manual Issued by RCA

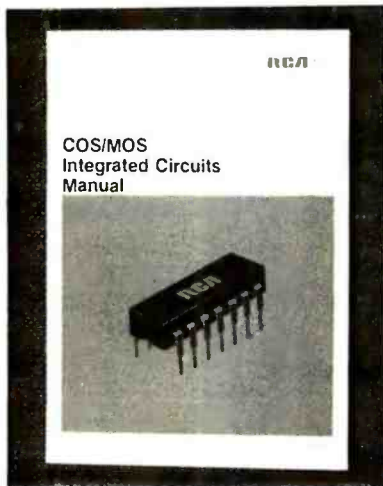

A new 168-page edition of the *RCA COS/MOS Integrated Circuits Manual*, CMS-272, is available for \$5 from RCA Solid State Division, Rt 202, Somerville NJ 08876. This manual provides detailed

information on the design, operation, and application of COS/MOS digital integrated circuits ranging from simple gates to highly complex large-scale integrated devices.

The manual begins with the basic principles of complementary symmetry MOS integrated circuits, and then describes the circuit elements from which the more complex COS/MOS integrated circuits are developed. It gives the features and characteristics of current RCA A-series and B-series types as well as device handling and operating considerations. Design examples and performance data are given for COS/MOS devices in a wide variety of circuit applications, such as, astable and monostable multivibrators, crystal oscillators for digital timekeeping, shift registers and counters, display drivers, and digital frequency synthesizers.

New material includes an introduction to microprocessors and memory interfacing, as well as guidelines to the design of custom large-scale integrated circuits. The information in this manual is presented in thirteen well-illustrated, easy-to-read text sections.

Circle 545 on inquiry card.

Management Guide to 100 Word Processors

This new report tells a manager which word processors are commonly used in different industries, which models are used in specific applications, who services the system after it is purchased, and which word processors are feasibly priced. In addition to charting this information for 100 models, the guide provides a directory of suppliers, which includes name, address, and phone number.

Word Processing Market Report is available for \$15 from Alltech Publishing Co, 212 Cooper Ctr, N Park Dr and Browning Rd, Pennsauken NJ 08109.

Circle 549 on inquiry card.

The First New England Microcomputer Resource Handbook

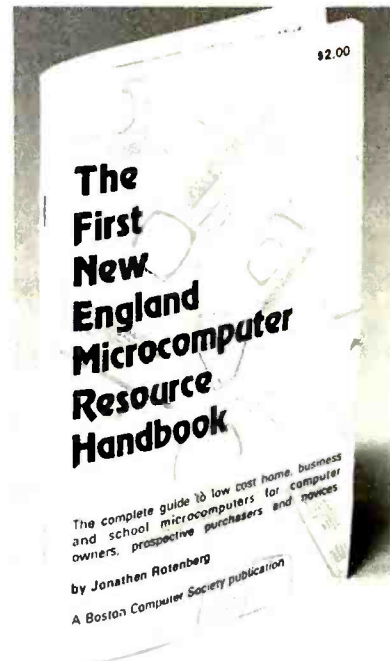

This guide to microcomputers for novices, prospective purchasers and system owners contains sections on product comparisons, application software, buying tips, support devices, computer stores, introductory information, publications, user groups, consultants, books, repair companies and a glossary which defines buzz words in terms of real-life situations. The, 115-page book is available for \$2 from New England computer stores or from The Boston Computer Society, 17 Chestnut St, Boston MA 02108.

Circle 550 on inquiry card.

Belais' Master Index to Computer Programs in BASIC

Source information and detailed reviews of 531 documented, ready-to-run programs in 72 fields covering home and business are included in this book. Updates and reprints also are listed. The book utilizes technical and layman's languages to describe the programs.

This 192-page paperback is available for \$9.95 plus \$1 shipping from Falcon Publishing, Dept G, 140 Riverside Ave, POB 688, Ben Lomond CA 95005.

Circle 546 on inquiry card.

PET Quick Reference Card

This card contains a complete summary of the Commodore PET BASIC language along with examples and definitions of every command and a table of the PET's graphic characters with their hexadecimal equivalents. Programmers will find a table of memory locations as well as information on the user port, PET sound, and the IEEE-488 interface bus.

The price is \$3.50. For more information, contact Leading Edge Computer Products, POB 3872, Torrance CA 90510.

Circle 547 on inquiry card.

Free Word Processing Supplies Guide

An 84-page illustrated *Guide to Word Processing Accessories and Supplies, 1979 Edition*, describing almost 1300 items for word and data processing installations, is available from American Word Processing Co, 18730 Oxnard St, Tarzana CA 91356. Included are many 5-inch and 8-inch disk storage systems, anti-static mats, video work stations, fireproof media safe, competitive brands of Diablo and Qume printer ribbons, various lines of durable plastic printwheels, thimbles, and ribbons for the NEC Spinwriter printers and more.

Circle 548 on inquiry card.

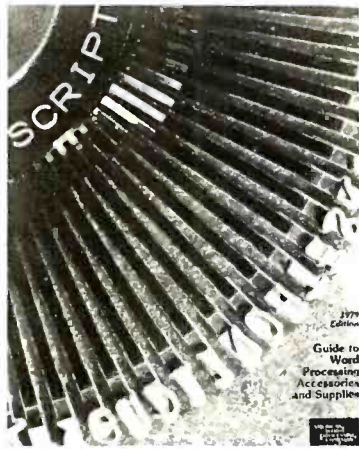



ATTENTION ELF OWNERS: QUEST SUPER BASIC

Quest, the leader in inexpensive 1802 systems announces another first. Quest is the first company worldwide to ship a full size Basic for 1802 systems. A complete function Super Basic by Ron Cenko including floating point capability with scientific notation (number range ±.17E[±]), 32 bit integer ±2 billion. Multi dim arrays, String arrays, String manipulation, Cassette I/O. Save and load. Basic, Data and machine language programs and over 75 Statements, Functions and Operators.

Easily adaptable on most 1802 systems. Requires 12K RAM minimum for Basic and user programs. Cassette version in stock now. ROM

versions coming soon with exchange privilege allowing some credit for cassette version.

Super Basic on Cassette \$40.00
Tom Pittman's 1802 Tiny Basic Source listing now available. Find out how Tom Pittman wrote Tiny Basic and how to get the most out of it. Never offered before. \$19.00

S-100 Slot Expansion \$9.95
Coming Soon: Assembler and Editor; Elf II Adapter Board. High resolution alpha/numerics with color graphics expandable up to 256 x 192 resolution for less than \$100.

16K Dynam. RAM bd. expand. 32K; less than \$150.

RCA Cosmac Super Elf Computer \$106.95

Compare features before you decide to buy any other computer. There is no other computer on the market today that has all the desirable benefits of the Super Elf for so little money. The Super Elf is a small single board computer that does many big things. It is an excellent computer for training and for learning programming with its machine language and yet it is easily expanded with additional memory, Full Basic, ASCII Keyboards, video character generation, etc.

A 24 key HEX keyboard includes 16 HEX keys plus load, reset, run, wait, input, memory protect, monitor select and single step. Large, on board displays provide output and optional high and low address. There is a 44 pin standard connector slot for PC cards and a 50 pin connector slot for the Quest Super Expansion Board. Power supply and sockets for all IC's are included in the price plus a detailed 127 pg. instruction manual which now includes over 40 pgs. of software info. including a series of lessons to help get you started and a music program and graphics target game.

Before you buy another small computer, see if it includes the following features: ROM monitor; State and Mode displays; Single step; Optional address displays; Power Supply; Audio Amplifier and Speaker. Fully socketed for all IC's. Real cost in warranty repairs. Full documentation.

Many schools and universities are using the Super Elf as a course of study. OEM's use it for training and research and development.

The Super Elf includes a ROM monitor for program loading, editing and execution with SINGLE STEP for program debugging which is not included in others at the same price. With SINGLE STEP you can see the microprocessor chip operating with the unique Qued address and data bus displays before, during and after executing instructions. Also, CPU mode and instruction cycle are recorded and displayed on 8 LED indicators.

Remember, other computers only offer Super Elf features at additional cost or not at all. Compare before you buy. Super Elf Kit \$106.95. High address option \$8.95. Low address option \$9.95. Custom Cabinet with drilled and labelled plexiglass front panel \$24.95. Expansion Cabinet with room for 4 S-100 slots \$41.00. NiCad Battery Memory Saver Kit \$6.95. All kits and options also completely assembled and tested.

An RCA 1861 video graphics chip allows you to connect to your own TV with an inexpensive video modulator to do graphics and games. There is a speaker system included for writing your own music or using many music programs already written. The speaker amplifier may also be used to drive relays for control purposes.

Questdata, a 12 page monthly software publication for 1802 computer users is available by subscription for \$12.00 per year.

Super Expansion Board with Cassette Interface \$89.95

This is truly an astounding value! This board has been designed to allow you to decide how you want it optioned. The Super Expansion Board comes with 4K of low power RAM fully addressable anywhere in 64K with built-in memory protect and a cassette interface. Provisions have been made for all other options on the same board and it fits neatly into the hardwood cabinet alongside the Super Elf. The board includes slots for up to 6K of EPROM (2708, 2758, 2716 or TI 2716) and is fully socketed. EPROM can be used for the monitor and Tiny Basic or other purposes.

subroutines allowing users to take advantage of monitor functions simply by calling them up. Improvements and revisions are easily done with the monitor. If you have the Super Expansion Board and Super Monitor the monitor is up and running at the push of a button.

A 1K Super ROM Monitor \$19.95 is available as an on board option in 2708 EPROM which has been preprogrammed with a program loader/editor and error checking multi file cassette read/write software. (relocatable cassette file) another exclusive from Quest. It includes register save and readout, block mode capability and video graphics driver with blinking cursor. Break points can be used with the register save feature to isolate program bugs quickly, then follow with single step. The Super Monitor is written with

Other on board options include Parallel Input and Output Ports with full handshake. They allow easy connection of an ASCII keyboard to the input port. RS 232 and 20 ma Current Loop for teletype or other device are on board and if you need more memory there are two S-100 slots for static RAM or video boards. Also a 1K Super Monitor version 2 with video driver for full capability display with Tiny Basic and a video interface board. Parallel I/O Ports \$9.85, RS 232 \$4.50, TTY 20 ma I/F \$1.95, S-100 \$4.50. A 50 pin connector set with ribbon cable is available at \$12.50 for easy connection between the Super Elf and the Super Expansion Board.

Multi-volt Computer Power Supply

8v 5 amp, ±18v .5 amp, 5v 1.5 amp, ±5v 5 amp, 12v 5 amp, -12 option ±5v, ±12v are regulated. Kit \$29.95. Kit with punched frame \$37.45, \$4.00 shipping. Woodgrain case \$10.00, \$1.50 shipping.

Power Supply Kit for the complete system (see Multi-volt Power Supply below).

60 Hz Crystal Time Base Kit \$4.40

Converts digital clocks from AC line frequency to crystal time base. Outstanding accuracy Kit includes: PC board, IC, crystal, resistors, capacitors and trimmer.

79 IC Update Master Manual \$35.00

Complete IC data selector, 2500 pg. master reference guide. Over 50,000 cross references. Free update service through 1979. Domestic postage \$3.50. No foreign orders.

INTERGATED CIRCUITS

7400TTL	LM320K-5	1.50	CD4021	1.25
7400N	LM320K-5	1.50	CD4022	1.10
7401N	LM320K-1P	1.50	CD4023	1.20
7401N	LM320K-1S	1.50	CD4024	1.25
7402N	LM320T-15	1.60	CD4025	2.60
7402N	LM320T-15	1.60	CD4026	2.60
7403N	LM320T-12	1.50	CD4027	6.6
7403N	LM320T-12	1.50	CD4028	8.5
7404N	LM320K-1P	1.50	CD4029	1.02
7404N	LM320K-1S	1.50	CD4030	5.0
7405N	LM320K-5	1.35	CD4031	1.02
7405N	LM320K-5	1.35	CD4040	1.02
7406N	LM320K-12	1.35	CD4042	8.5
7406N	LM320K-12	1.35	CD4043	8.5
7407N	LM320K-15	1.25	CD4046	1.67
7408N	LM320T-15	1.25	CD4049	4.5
7408N	LM320T-15	1.25	CD4050	4.9
7409N	LM320T-15	1.25	CD4051	1.1
7409N	LM320T-15	1.25	CD4060	1.42
7410N	LM320K-12	1.25	CD4066	7.1
7410N	LM320K-12	1.25	CD4068	4.0
7411N	LM320K-5	1.35	CD4069	4.0
7411N	LM320K-5	1.35	CD4070	2.5
7412N	LM320K-12	1.25	CD4071	2.8
7412N	LM320K-12	1.25	CD4072	2.8
7413N	LM320K-15	1.25	CD4073	2.8
7413N	LM320K-15	1.25	CD4074	2.8
7414N	LM320K-5	1.35	CD4075	2.8
7414N	LM320K-5	1.35	CD4076	2.8
7415N	LM320K-12	1.25	CD4077	2.8
7415N	LM320K-12	1.25	CD4078	2.8
7416N	LM320K-15	1.25	CD4079	2.8
7416N	LM320K-15	1.25	CD4080	2.8
7417N	LM320K-5	1.35	CD4081	2.8
7417N	LM320K-5	1.35	CD4082	2.8
7418N	LM320K-12	1.25	CD4083	2.8
7418N	LM320K-12	1.25	CD4084	2.8
7419N	LM320K-15	1.25	CD4085	2.8
7419N	LM320K-15	1.25	CD4086	2.8
7420N	LM320K-5	1.35	CD4087	2.8
7420N	LM320K-5	1.35	CD4088	2.8
7421N	LM320K-12	1.25	CD4089	2.8
7421N	LM320K-12	1.25	CD4090	2.8
7422N	LM320K-15	1.25	CD4091	2.8
7422N	LM320K-15	1.25	CD4092	2.8
7423N	LM320K-5	1.35	CD4093	2.8
7423N	LM320K-5	1.35	CD4094	2.8
7424N	LM320K-12	1.25	CD4095	2.8
7424N	LM320K-12	1.25	CD4096	2.8
7425N	LM320K-15	1.25	CD4097	2.8
7425N	LM320K-15	1.25	CD4098	2.8
7426N	LM320K-5	1.35	CD4099	2.8
7426N	LM320K-5	1.35	CD4100	2.8
7427N	LM320K-12	1.25	CD4101	2.8
7427N	LM320K-12	1.25	CD4102	2.8
7428N	LM320K-15	1.25	CD4103	2.8
7428N	LM320K-15	1.25	CD4104	2.8
7429N	LM320K-5	1.35	CD4105	2.8
7429N	LM320K-5	1.35	CD4106	2.8
7430N	LM320K-12	1.25	CD4107	2.8
7430N	LM320K-12	1.25	CD4108	2.8
7431N	LM320K-15	1.25	CD4109	2.8
7431N	LM320K-15	1.25	CD4110	2.8
7432N	LM320K-5	1.35	CD4111	2.8
7432N	LM320K-5	1.35	CD4112	2.8
7433N	LM320K-12	1.25	CD4113	2.8
7433N	LM320K-12	1.25	CD4114	2.8
7434N	LM320K-15	1.25	CD4115	2.8
7434N	LM320K-15	1.25	CD4116	2.8
7435N	LM320K-5	1.35	CD4117	2.8
7435N	LM320K-5	1.35	CD4118	2.8
7436N	LM320K-12	1.25	CD4119	2.8
7436N	LM320K-12	1.25	CD4120	2.8
7437N	LM320K-15	1.25	CD4121	2.8
7437N	LM320K-15	1.25	CD4122	2.8
7438N	LM320K-5	1.35	CD4123	2.8
7438N	LM320K-5	1.35	CD4124	2.8
7439N	LM320K-12	1.25	CD4125	2.8
7439N	LM320K-12	1.25	CD4126	2.8
7440N	LM320K-15	1.25	CD4127	2.8
7440N	LM320K-15	1.25	CD4128	2.8
7441N	LM320K-5	1.35	CD4129	2.8
7441N	LM320K-5	1.35	CD4130	2.8
7442N	LM320K-12	1.25	CD4131	2.8
7442N	LM320K-12	1.25	CD4132	2.8
7443N	LM320K-15	1.25	CD4133	2.8
7443N	LM320K-15	1.25	CD4134	2.8
7444N	LM320K-5	1.35	CD4135	2.8
7444N	LM320K-5	1.35	CD4136	2.8
7445N	LM320K-12	1.25	CD4137	2.8
7445N	LM320K-12	1.25	CD4138	2.8
7446N	LM320K-15	1.25	CD4139	2.8
7446N	LM320K-15	1.25	CD4140	2.8
7447N	LM320K-5	1.35	CD4141	2.8
7447N	LM320K-5	1.35	CD4142	2.8
7448N	LM320K-12	1.25	CD4143	2.8
7448N	LM320K-12	1.25	CD4144	2.8
7449N	LM320K-15	1.25	CD4145	2.8
7449N	LM320K-15	1.25	CD4146	2.8
7450N	LM320K-5	1.35	CD4147	2.8
7450N	LM320K-5	1.35	CD4148	2.8
7451N	LM320K-12	1.25	CD4149	2.8
7451N	LM320K-12	1.25	CD4150	2.8
7452N	LM320K-15	1.25	CD4151	2.8
7452N	LM320K-15	1.25	CD4152	2.8
7453N	LM320K-5	1.35	CD4153	2.8
7453N	LM320K-5	1.35	CD4154	2.8
7454N	LM320K-12	1.25	CD4155	2.8
7454N	LM320K-12	1.25	CD4156	2.8
7455N	LM320K-15	1.25	CD4157	2.8
7455N	LM320K-15	1.25	CD4158	2.8
7456N	LM320K-5	1.35	CD4159	2.8
7456N	LM320K-5	1.35	CD4160	2.8
7457N	LM320K-12	1.25	CD4161	2.8
7457N	LM320K-12	1.25	CD4162	2.8
7458N	LM320K-15	1.25	CD4163	2.8
7458N	LM320K-15	1.25	CD4164	2.8
7459N	LM320K-5	1.35	CD4165	2.8
7459N	LM320K-5	1.35	CD4166	2.8
7460N	LM320K-12	1.25	CD4167	2.8
7460N	LM320K-12	1.25	CD4168	2.8
7461N	LM320K-15	1.25	CD4169	2.8
7461N	LM320K-15	1.25	CD4170	2.8
7462N	LM320K-5	1.35	CD4171	2.8
7462N	LM320K-5	1.35	CD4172	2.8
7463N	LM320K-12	1.25	CD4173	2.8
7463N	LM320K-12	1.25	CD4174	2.8
7464N	LM320K-15	1.25	CD4175	2.8
7464N	LM320K-15	1.25	CD4176	2.8
7465N	LM320K-5	1.35	CD4177	2.8
7465N	LM320K-5	1.35	CD4178	2.8
7466N	LM320K-12	1.25	CD4179	2.8
7466N	LM320K-12	1.25	CD4180	2.8
7467N	LM320K-15	1.25	CD4181	2.8
7467N	LM320K-15	1.25	CD4182	2.8
7468N	LM320K-5	1.35	CD4183	2.8
7468N	LM320K-5	1.35	CD4184	2.8
7469N	LM320K-12	1.25	CD4185	2.8
7469N	LM320K-12	1.25	CD4186	2.8
7470N	LM320K-15	1.25	CD4187	2.8
7470N	LM320K-15	1.25	CD4188	2.8
7471N	LM320K-5	1.35	CD4189	2.8
7471N	LM320K-5	1.35	CD4190	2.8
7472N	LM320K-12	1.25	CD4191	2.8
7472N	LM320K-12	1.25	CD4192	2.8
7473N	LM320K-15	1.25	CD4193	2.8
7473N	LM320K-15	1.25	CD4194	2.8
7474N	LM320K-5	1.35	CD4195	2.8
7474N	LM320K-5	1.35	CD4196	2.8
7475N	LM320K-12	1.25	CD4197	2.8
7475N	LM320K-12	1.25	CD4198	2.8
7476N	LM320K-15	1.25	CD4199	2.8
7476N	LM320K-15	1.25	CD4200	2.8
7477N	LM320K-5	1.35	CD4201	2.8
7477N	LM320K-5	1.35	CD4202	2.8
7478N	LM320K-12	1.25	CD4203	2.8
7478N	LM320K-12	1.25	CD4204	2.8
7479N	LM320K-15	1.25	CD4205	2.8
7479N	LM320K-15	1.25	CD4206	2.8
7480N	LM320K-5	1.35	CD4207	2.8
7480N	LM320K-5	1.35	CD4208	2.8
7481N	LM320K-12	1.25	CD4209	2.8
7481N	LM320K-12	1.25	CD4210	2.8
7482N	LM320K-15	1.25	CD4211	2.8
7482N	LM320K-15	1.25	CD4212	2.8
7483N	LM320K-5	1.35	CD4213	2.8
7483N	LM320K-5	1.35	CD4214	2.8
7484N	LM320K-12	1.25	CD4215	2.8
7484N	LM320K-12	1.25	CD4216	2.8
7485N	LM320K-15	1.25	CD4217	2.8
7485N	LM320K-15	1.25	CD4218	2.8
7486N	LM320K-5	1.35	CD4219	2.8
7486N	LM320K-5	1.35	CD4220	2.8
7487N	LM320K-12	1.25	CD4221	2.8
7487N	LM320K-12	1.25	CD4222	2.8
7488N	LM320K-15	1.25	CD4223	2.8
7488N	LM320K-15	1.25	CD4224	2.8
7489N	LM320K-			

A low cost Modem for your APPLE that lets you be a part of it all.

Complete with software on cassette **\$284⁹⁵**

Keep up with the latest information, share your ideas and programs with other hobbyists, time-share clubs, colleges, businesses, friends . . . anywhere, everywhere across the country.

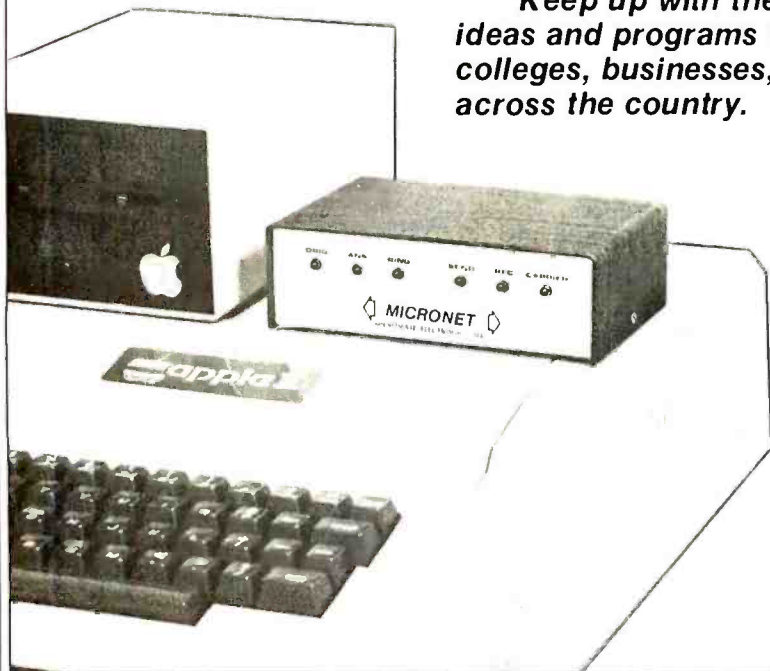

The MICRONET MODEM, an originate-answer and auto-answer modem, part of the Automodem II series, is furnished with an FCC registered coupler and two inter-connecting cables and plugs into any standard telephone jack.

MICRONET . . . enhanced by a handsomely styled and coordinated enclosure with a simple inexpensive interface to the APPLES' game jack, allows you to make full use of all the input/output slots provided for other peripherals. Full compatability with *Bell, Westinghouse 103, and Westinghouse 113.*

Don't be left behind . . .
Order the MICRONET MODEM today!
 Manufactured by Micromate Electronics, Inc.
Dealer's Inquiries Invited

ASCII KEYBOARD * KIT \$79.95



ASCII KEYBOARD KIT — Assembled and Tested **\$95.95**
 • Single +5V Supply • Full ASCII Set (Upper and Lower Case) • Parallel Output • Positive and Negative Strobe • 2-Key Rollover • 3 User Definable Keys • P.C. Board Size: 17-3/16" x 5" • Control Characters Molded on Key Caps • Optional Provision for Serial Output. **OPTIONAL:** Metal Enclosure \$27.50 • Edge Con. \$2.00 • Sockets \$4.00 • Upper Case Lock Switch \$2.50 • Shift Register (for Serial Output) \$2.00. Dealer inquiries invited.

APPLE II I/O BOARD * KIT \$49.00

APPLE II I/O BOARD KIT — Plugs into Slot of Mother Board
 • 1 8-Bit Parallel Output Port (expands to 3 Ports) • 1 Input Port • 15mA Output Current Sink or Source • Can be used for peripheral equipment such as printers, floppy discs, cassettes, paper tapes, etc. • 1 Free Software Listing for SWTP PR40 or IBM selectric. **PRICE:** 1 Input and 1 Output Port \$49.00, 1 Input and 3 Output Ports \$60.00. Dealer inquiries invited.

VENUS 2001 VIDEO BOARD kit \$199.95

Assembled and Tested \$259.95 • Complete Unit with 4K Memory and Video Driver on Eprom assembled and tested **\$339.95**. **OPTIONAL:** • Sockets \$10.00 • 2K Memory \$30.00 • 4K Memory \$50.00 • Video Driver Eprom \$20.00.

S-100 Plug-in • Parallel Keyboard Port — On board 4K Screen Memory (optional). On board Eprom (optional) for Video Driver or Text Editor Software. **Up and down scrolling through video memory** — Reverse Video, Blinking Characters. **Display:** 128 ASC 11 Characters 64x32 or 32x16 Screen Format (Jumper Selectable). 7 by 11 Dot Matrix Characters.

American or European TV Compatible (CRT Controls Programmable). Dealer inquiries invited.

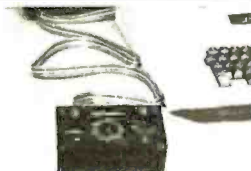

THE APPLESTICK™ \$49⁹⁵

Just plug it into your game connector and make your present games more enjoyable.

The APPLESTICK is a wonderful add-on for your Apple II. With an APPLESTICK you can enjoy the smooth, easy control of a true 360° joystick.

Manufactured by Micromate.

Not recommended for scientific applications requiring linearity.

new! A DREAM COME TRUE!

Introducing: **30 MZH**

DUAL TRACE PORTABLE SCOPE

for an **\$555.**

amazing



MODEL MS 230

• Dual trace 2-channel; separate, chopped or alternate modes • 30 megahertz bandwidth • External and internal trigger • Time base -0.05, Microseconds to 0.2 SEC/div 21 settings • Battery or line operation • Line synchronization mode • Power consumption less than 50W • Vertical gain 0.1 to 50 volts/div-12 settings • Size: 2.9" H, 6.4" W, 8.5" D • Weighs only 3.5 lbs with batteries • Complete with input cable and rechargeable batteries and charger unit. **OPTIONAL:** Leather case \$45.00 • 10:1 probe \$27.00 (2 for \$49.00)

MS-215 — 15 MHZ DUAL TRACE PORTABLE SCOPE — \$399⁰⁰
MS-15 15 MHZ SINGLE TRACE SCOPE — \$299⁰⁰

SHIPPING \$3.50 / California residents add 6% sales tax
ELECTRONICS WAREHOUSE Inc.

15820 Hawthorne Boulevard
 Lawndale, CA 90260
 (213) 370-5551



CALIFORNIA DIGITAL

Post Office Box 3097 B • Torrance, California 90503

FREE Paper Tiger

With Purchase of The INTEGRAL DATA 440

Your Choice, \$200 Value

- 1) Graphics Option Package
 - 2) Interface for APPLE II
 - 3) TRS-80 Printer Interface
- California Digital has recently researched the complete low cost printer market. It is our opinion that the IDS 440 Paper Tiger is, without doubt, the most versatile and offers the best value of any printer costing under \$1,000.

This quality dot matrix printer incorporates such features as software selectable character size to allow print densities up to 132 characters per line. Full forms handling capabilities and tractor feed mechanism adjustable to 9.5". The Paper Tiger is engineered to accept either parallel or RS232 serial ASCII. 110/220V.50/60Hz.

**** \$995.00 plus shipping ****

S-100 Mother Board

Quiet Buss

\$2995
8803-18
18 slot
MSAI

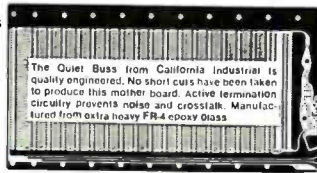

The Quiet Buss from California Industrial is quality engineered. No short cuts have been taken to produce this mother board. Active termination circuitry prevents noise and crosstalk. Manufactured from extra heavy FR-4 epoxy Buss.

TELETYPE MODEL 43

Even if we have to give them away, we're going to ship more 43's in 1979 than the aggregate of all our competitors.

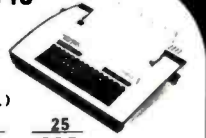

Model 43AAA TTL)

EACH 3 10 25
\$925. 875. 850. 825.
RS-232 Interface "K" Add \$7500 plus shipping

Minidisk Drive for TRS-80

your choice
Lobo
or
Vista

\$388.
Includes
Interface Cable

FREE PLASTIC LIBRARY CASE with purchase of each box of ... Verbatim mini-diskettes. \$5 value.

\$24.95
BOX of 10
DISKETTES

CONNECTORS

your choice
DB25P male plug & hood
or
DB25S female
\$395

Qty.	fe.	male	hd.
25	3.45	2.45	1.15
25	3.15	2.25	1.05
100	2.85	1.90	.95
500	2.25	1.60	.85
1K	1.97	1.37	.75

Edge Connectors

GOLD 100 PIN
MSAI/ALTAIR

msai solder .125x.250	\$3.95	3/4 9.00
msai w/.125centers	\$4.95	3/4 13.00
Altair solder tail .140row	\$5.95	3/4 15.00

SPECIALS

22/44 Kim eyelet .156"	\$1.95	3/4 5.00
25/50 solder tab .156"	\$1.09	3/4 2.00
36/72 wide post w/.156	\$1.95	3/4 5.00

TEN \$39 for 50+ \$65 Scotch CASSETTES

Certified Digital
Wont drop a BIT!

DISKETTES \$550

8inch Soft (IBM)
8inch 32 sector
Mini Soft sec.
Mini 10 sector
Mini 16 sector

CALIFORNIA INDUSTRIAL is an Authorized Dealer of Scotch Brand Data Products

Shugart Associates SA800-R Floppy Disk Drive

The most cost effective way to store data processing information, when random recall is a prime factor. The SA800 is fully compatible with the IBM 3740 format. Write protect circuitry, low maintenance & Shugart quality.

\$449.50

\$85 KEYBOARD ASCII ENCODED

KEYTRONIC ASCII & ASCII complement.

- *Ten key data pad
- *Cursor controls
- *Six user switches
- *Alpha Lock
- *Auto repeat
- *Single 5 volt.
- *Glass reed.

NEW

MEMORY TRS-80 \$ APPLE II 65

16k memory (8) 4116's

Installation is simple. Anyone who has ever changed a spark plug should be able to up-grade his microcomputer.

How can California Digital offer these memory up-grade sets at 25% below our competition? Simple, we buy in volume, wholesale to dealers and sell the balance directly to owners of personal micro-systems. These 16K dynamic memory circuits are factory prime and unconditionally guaranteed for one full year. NOW, before you change your mind, pick up the telephone and order your up-grade memory from the California Digital. Add \$3 for TRS80 jumpers.

STATIC	1-31	32-99	100-5C	-999	1K+
21L02 450nS.	1.19	.99	.95	.90	.85
21L02 250nS.	1.49	1.39	1.25	*	*
2114 1Kx4 450	5.95	5.50	5.25	4.75	4.50
2114 1Kx4 300	8.95	8.50	8.00	*	*
4044 4Kx1 450	5.95	5.50	5.25	*	*
4044 4Kx1 250	9.95	9.50	9.00	*	*
4045 1Kx4 450	8.95	8.50	8.00	*	*
4045 1Kx4 250	9.95	9.50	9.00	*	*
5257 low pow.	5.95	5.50	5.00	4.80	4.60

SPECIAL CIRCUITS

Z80A 4MHz.	24.95	AY5-1013A UART	4.95
8080A CPU	9.95	Floppy Disc Controllers	
8085	22.50	WD 1771 single D.	39.95
8086 intel 16 bits	85.00	WD 1781 Double D	65.00
TMS9900 16 bits	49.95	WD 1791 D/D 3740 *	

E PROMS	1-15	16-63	64+
1702A 2K	4.95	4.50	4.00
2708 8K	8.95	9.50	9.00
2716 5v 16K	39.95	35.00	*
2716 T 1	24.88	20.00	*
2532	85.00	*	*

Regent 25 from APPLIED DIGITAL DATA SYSTEMS



Well if you really insist upon purchasing one of the above terminals, sure, we'll sell it to you. But when the keyboard starts to double bounce, the screen fades and the power supply just craps out don't call us, complain to the manufacturer.

The alternative, take a serious look at the ADDS Regent 25, we have, and concluded that this terminal offers the best value in todays market. Through years of research the ADDS Company has evolved a low maintenance, extremely durable CRT terminal capable of withstanding an abusive 24 hour duty cycle. The Regent 25 features Intel 8085 microprocessor controlled circuitry along with the Cherry Switch long-life capacitance keyboard.

18 key cursor and numeric pad doubles to allow for user definable special functions. True descending lower case characters along with a fully addressable cursor makes the Regent 25 the ideal word processing terminal.

High-resolution screen is capable of displaying 96 upper and lower case ASCII characters and 32 control codes. This unique feature assist in the debugging of programs. The Regent 25 is switch selectable to display six European languages along with Katakana.

Clearly the Regent 25 is not your average terminal, but than, ADDS is not your average terminal company.

Portable Data Entry System

\$1395.00

These used data terminals were originally designed for chain store inventory control and order entry systems. The operator enters the inventory control number, merchandise on hand and the unit price. After all pertinent data has been entered into the recorder, the main warehouse is telephoned, the handset is placed in the acoustic coupler and all the recorded information is transmitted back to the master computer. With a little imagination and one of these portable entry systems, you should be able to exclude programs and computer information with associates across the country. All units were removed from service in working condition. Original cost \$2,500.

Each system comes complete with:

- *Portable Cassette Drive Unit
- *Removable Entry Keyboard with LED Display
- *Five Gould "D" Modems
- *Acoustical Coupler
- *Battery Charger
- *DB25 Cable
- *Shoulder strap
- *Full Documentation

Buying a CRT Terminal? Hazeltine • Soroc • Lear Siegler

MINIATURE SWITCHES

your choice

\$.98	10	20	100	1K
	88	88	81	73.66

SPDT Miniature Toggles

- 7101 C&K ON-NONE-ON
- 7107 jbt ON-OFF (mnt.ON)
- 7108 CK ON-(moment.ON)
- Rocker JBT OPDT
- Rotary 3P-4-Pos.
- Rotary 3P-6-Pos.
- Push B (N.O.) \$39ea./4/\$1

DIP Switch

\$129	10	25	100	1K
ea.	\$119	109	97	83

specify 4 for 8pos.

SP5T

Wire Wrap Center

DISCOUNT

IC SOCKETS

pin	wire wrap	low profile
	ea. 25 50	ea. 25 50
8	17-16	15 15
14	37-36 35	18 17 16
16	38 37 36	19 18 17
24	99 93 85	36 35 34
40	169 155 139	63 60 58

50H KYNAR WIRE WRAP \$98

\$98	500	1,000	11,000
	\$9.	\$15.	\$105.

Battery wire wrapping tool \$295

\$2995 BW 630

OR HOBBY WRAP-30 wire wrap & strip tool \$545

(213)679-9001

All merchandise sold by California Digital is premium grade. Sorry, no COD's. Orders are shipped the same day received. California residents add 6%. Foreign orders add 10%. Orders over \$25, when accompanied by payment, are shipped at our expense. Otherwise, please add \$2.

Circle 39 on inquiry card.

JADE Computer Products

As JADE enters its fourth year, we would like to express our appreciation to all our friends and customers who have supported us through the years. We could not have grown from a ten-employee, half-million dollar company into a fifty-employee, eight-million dollar company without your continuing support. We at JADE thank YOU for being part of our family and wish you a joyous Holiday Season.

S D SYSTEMS EXPANDORAM

EXPANDABLE TO 64K USING 4116 RAMS



Interfaces with most popular S-100 boards
Bank selectable; PHANTOM provision
Draws only 5 watts fully populated
Designed to work with Z-80, 8080, and 8085 systems
No wait states required
16K boundaries & protect via dip switches
Kits come with sockets for full 64K
Invisible refresh

MEM-16130K (16K KIT)	\$199.00
MEM-16130A (16K A&T)	\$249.00
MEM-32131K (32K KIT)	\$265.00
MEM-32131A (32K A&T)	\$315.00
MEM-48132K (48K KIT)	\$339.00
MEM-48132A (48K A&T)	\$389.00
MEM-64133K (64K KIT)	\$394.00
MEM-64133A (64K A&T)	\$444.00

S D SYSTEMS PROM-100

VERSATILE EPROM PROGRAMMER

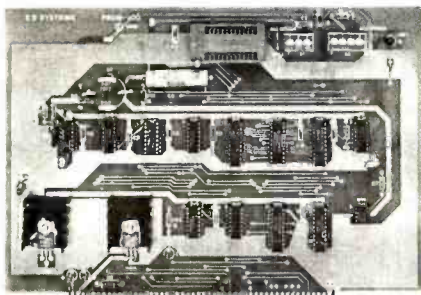

S-100 bus compatible (note: board height 7")
Dip switch selects 2708, 2716, 2732, 2758, or 2516's
25 VDC programming pulse generated on board
Programming time only 100 seconds for 16K bits
Support-software listing provided in manual
Program and erasure verification
Software provides for reading of object file from CP/M and programming into EPROM

MEM-99520K (KIT)	\$145.00
MEM-99520A (A&T)	\$215.00

S D SYSTEMS EXPANDOPROM

EXPANDABLE TO 32K USING 2716 EPROMS

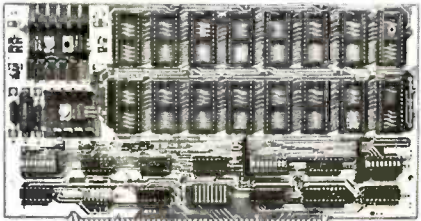

S-100 bus compatible, uses 2708 or 2716 EPROMs
Dip switches allow selection of: each EPROM, 16K or 32K boundary, wait states

MEM-32220K (KIT)	\$135.00
MEM-32220A (A&T)	\$199.00

GET THE INSIDE TRACK JADE DOUBLE-D

DOUBLE DENSITY DISK CONTROLLER

Read/write single or double density, 8" or 5 1/4" drives
On board Z-80 insures reliable operation
CP/M compatible in either single or double density
Density is software selectable
Up to 4 single or double sided, single or double density drives may be mixed on the same system
EIA level serial printer interface on board-up to 9600 baud (perfect for despooling operations)
All the hard work of disk access is done by the on board Z-80A and 2K memory, leaving your host CPU free for its normal duties
Uses IBM standard formats for proven reliability
THIS BOARD REALLY WORKS!!!!!!
IOD-1200K (DOUBLE-D KIT)

IOD-1200K (DOUBLE-D KIT)	\$285.00
IOD-1200A (DOUBLE-D A&T)	\$349.00
IOD-1200D (MANUAL ONLY)	\$15.00

S D SYSTEMS VERSAFLOPPY II

DOUBLE DENSITY DISK CONTROLLER

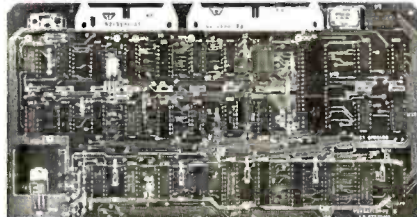

Single or double density floppy disk controller
985600 bytes on 8" double sided diskettes
259840 bytes on double sided 5 1/4" diskettes
S-100 bus (IEEE) standard compatible
IBM 3740 format in single density
8" and 5 1/4" drives controlled simultaneously
Operates with Z-80, 8080, and 8085 CPU's
Controls up to 4 drives
Vectored interrupt operation optional
IOD-1160K (KIT)

IOD-1160K (KIT)	\$305.00
IOD-1169A (A&T)	\$399.00

S D SYSTEMS VERSAFLOPPY

VERSATILE FLOPPY DISK CONTROLLER

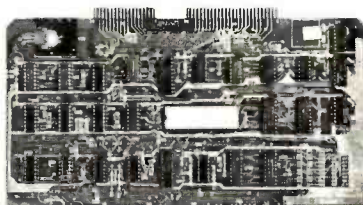

IBM 3740 soft sectored format
S-100 Z-80 or 8080 compatible
Controls up to 4 single or double sided drives
Compatible with all popular disk drives
CP/M compatible
Listings for control software included

IOD-1150K (KIT)	\$139.00
IOD-1150A (A&T)	\$229.00

DECEMBER SPECIAL JADE P/S I/O KIT

1 PARALLEL, 2 SERIAL I/O PORTS

One bi-directional parallel I/O port and two serial ports; one is RS232/TTL, the other is RS232/Kansas City Standard cassette interface

IOI-1040K (KIT)	\$89.95
IOI-1040A (A&T)	\$159.95
IOI-1040B (BARE BOARD)	\$20.00

S D SYSTEMS EXPANDORAM II

4 MHz RAM BOARD EXPANDABLE TO 256K

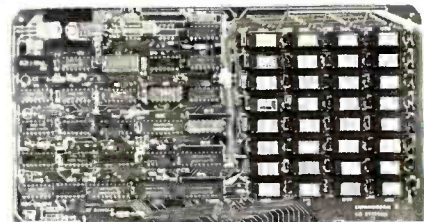

S-100 bus compatible, up to 4 MHz operation
Expandable memory from 16K to 256K
Dip switch selectable boundaries
Page-mode allows up to 8 boards on the same bus
Invisible refresh; PHANTOM output disable
Designed to operate in Z-80 based systems

MEM-16631K (16K KIT)	\$275.00
MEM-16631A (16K A&T)	\$325.00
MEM-32632K (32K KIT)	\$359.00
MEM-32632A (32K A&T)	\$410.00
MEM-48632K (48K KIT)	\$445.00
MEM-48632A (48K A&T)	\$495.00
MEM-64632K (64K KIT)	\$529.00
MEM-64632A (64K A&T)	\$579.00

S D SYSTEMS VDB-8024

80 X 24 I/O MAPPED VIDEO BOARD



80 character by 24 line display, 7 X 10 dot matrix
Composite or separate TTL video outputs
On-board keyboard interface with power
On-board Z-80 and 2K RAM

Blink, underline, reverse, protect, up/down scroll
Upper/lower case characters, 32 special characters
Optional 128 user-programmable characters
IOV-1020K (KIT)

IOV-1020K (KIT)	\$295.00
IOV-1020A (A&T)	\$459.00

S D SYSTEMS SBC-100/200

2 OR 4 MHz SINGLE BOARD COMPUTER

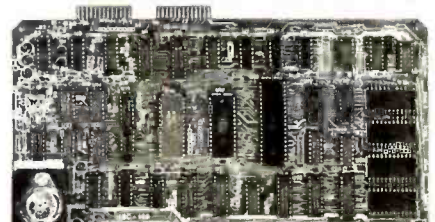

S-100 bus compatible Z-80 CPU
1K of on-board RAM
4 EPROM sockets accommodates 2708, 2716, or 2732
One parallel and one serial I/O port
4-channel counter timer chip (Z-80 CTC)
Software programmable serial baud rates

CPC-30100K (2 MHz KIT)	\$215.00
CPC-30100A (2 MHz A&T)	\$345.00
CPC-30200K (4 MHz KIT)	\$255.00
CPC-30200A (4 MHz A&T)	\$365.00

SALE PRICES GOOD THRU JANUARY 5, 1980

PRICES SLASHED FOR DECEMBER !!!! CALL TOLL-FREE AND SAVE

800-421-5809 CONTINENTAL U.S.

800-262-1710 INSIDE CALIFORNIA

SD SYSTEMS Z-80 STARTER KIT COMPLETE Z-80 MICROCOMPUTER

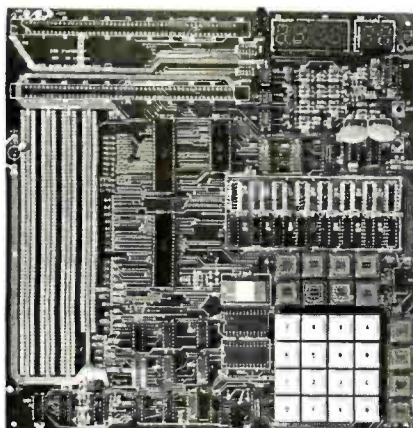

On-board keyboard, display, EPROM programmer, and cassette interface
On-board S-100 interface
Wire-wrap area and room for 2 S-100 connectors
Two 8-bit parallel I/O ports, 4-channel CTC, 5 programmable breakpoints
Examine and change memory, I/O ports, or register
CPS-30010K (KIT) \$219.00
CPS-30010A (A&T) \$365.00

CP/M 2.0

Digital Research has done it again! This new release of their industry standard disk operating system is bound to be an even bigger hit than the original version. All of the fundamental file-size restrictions of release 1 have been eliminated, while maintaining full compatibility with the earlier versions. This new release can be field-configured by the user for a single mini-disk up through a multiple drive hard-disk system with 128 megabyte capacity. Field configuration can be accomplished easily through use of the Macro Library (DISKDEF) provided with CP/M 2.0.

A powerful operating system for only ... \$150.00

JADE'S NEW MOTHERBOARDS THE ISO-BUS

WE'RE PROUD OF OUR MOTHER!
6-SLOT

BARE BOARD	\$24.95
KIT	\$49.95
ASSEMBLED & TESTED	\$59.95
12-SLOT	
BARE BOARD	\$39.95
KIT	\$89.95
ASSEMBLED & TESTED	\$99.95
18-SLOT	
BARE BOARD	\$59.95
KIT	\$129.95
ASSEMBLED & TESTED	\$149.95

SPECIAL PACKAGE PRICE ROCKWELL AIM-65 THE HEAD-START IN MICROCOMPUTERS

KIM-1 compatible
On-board printer
Full ASCII keyboard

AIM-65 w/1K RAM..\$375.00
AIM-65 w/4K RAM..\$450.00
8K BASIC ROM..\$100.00
POWER SUPPLY..\$59.95
CASE for AIM-65..\$49.95

4K Assembler/Editor..\$80.00
Special Package Price \$599.00
4K AIM-65, 8K BASIC ROM, Power Supply, and Case.

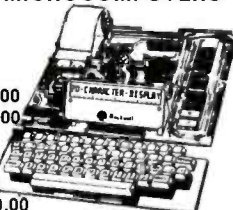

SALE ENDS JANUARY 5, 1980

JADE MEMORY EXPANSION KITS FOR TRS-80 APPLE EXIDY

Everything you need to add 16K of memory to your computer. Your kit comes neatly packaged with easy to follow instructions. In just minutes your computer is ready to tackle more advanced software.

\$75.00

NEW REVISION C BOARD THE BIG Z

Z-80 CPU BOARD WITH SERIAL I/O PORT

Features include ● S-100 Compatible available in 2MHz or 4MHz versions. ● On-board 2708, 2716, or 2532 EPROM can be addressed on any 1K, 2K or 4K boundary with power-on jump to EPROM. ● On-board EPROM may be used in SHADOW mode, allowing full 64K RAM to be used. ● Automatic MWRITE generation in front panel is not used. ● On-board USART for synchronous or asynchronous R232 operation (on-board baud rate generator). ● Reverse channel capability on USART allows use with buffered peripherals or devices with not-ready signal.

CPU-30200K (2 Mhz KIT)	\$149.95
CPU-30200A (2 Mhz A&T)	\$199.95
CPU-30201K (4 Mhz KIT)	\$159.95
CPU-30201A (4 Mhz A&T)	\$209.95

MICROPROCESSORS	6800 PRODUCT
F8 \$16.95	6821P \$5.25
Z80 (2MHz) \$10.95	6828P \$12.00
Z80A (4MHz) \$14.95	6834P \$16.95
CDP1802CD \$24.95	6850P \$4.80
6502 \$11.95	6852P \$7.50
6800 \$12.50	6860P \$9.25
6802 \$20.00	6862P \$12.00
8008-1 \$15.95	6875L \$7.30
8035 \$24.00	6880P \$2.50
8035-B \$24.00	CHARACTER GENERATORS
8080-A \$10.00	2513 Upper \$7.95
8085 \$23.00	2513 Lower (5 volt) \$6.75
TMS9900TL \$49.95	2513 Upper (5 volt) 9.75
8080A SUPPORT DEVICES	2513 Lower (5 volt) \$13.00
8212 \$5.00	MCM6571 up scan \$13.00
8214 \$4.65	MCM6571A down scan \$10.95
8216 \$2.95	PROMS
8224 (2MHz) \$4.30	1702A
8226 \$2.75	2708 \$8.95
8228 \$6.40	2716 \$39.95
8238 \$6.40	2716 (5v) \$39.95
8243 \$8.00	2758 (5v) \$30.00
8251 \$7.50	DYNAMIC RAMS
8253 \$20.00	4116/416D 8 for \$74.95
8255 \$6.40	2104/4096 \$4.75
8257 \$19.95	2107B-4 \$3.95
8259 \$19.95	TMS4027/4096 \$4.75
8275 \$69.95	STATIC RAMS
8279 \$17.70	21102 (450ns) \$1.50
USRT	21102 (250ns) \$1.75
S2350 \$10.95	2101-1 \$2.95
UARTS	2111-1 \$3.25
AY5-1013A \$5.25	2112-1 \$2.95
AY5-1014A \$8.25	2114L (450ns) \$5.75
TR1602B \$5.25	2114L (300ns) \$5.95
TMS6011 \$5.95	TMS4044 (450ns) \$8.00
IM6403 \$9.00	TMS4044 (300ns) \$9.95
BAUD RATE GENERATORS	410D (200ns) \$9.95
MC14411 \$10.00	4200A (200ns) \$9.95

JADE Computer Products

4901 W ROSECRANS, HAWTHORNE, CA 90250
213-679-3313

PLACE ORDERS TOLL FREE

800-262-1710 800-421-5809
INSIDE CALIFORNIA CONTINENTAL U.S.

WRITE FOR OUR FREE 1979 CATALOG
FOR CUSTOMER SERVICE OR TECHNICAL INQUIRIES
CALL 213-679-3317

TERMS OF SALE: Cash, checks, money orders, and credit cards accepted. Minimum order \$10.00. California residents add 6% sales tax. Minimum shipping and handling charge \$2.50. Prices are for U.S. and Canadian delivery only and are subject to change without notice. For export prices and information send for a JADE INTERNATIONAL CATALOG.

INTEGRAL DATA SYSTEMS THE PAPER TIGER 132 COLUMN DOT MATRIX PRINTER

Up to 198 CPS
1.75 to 9.5 inch adjustable tractor and friction feed.
Parallel and serial interface.
98 character ASCII set.
80 to 132 columns.
6 or 8 lines per inch.
Eight software selectable character sizes.
110, 300, 600, or 1200 baud.

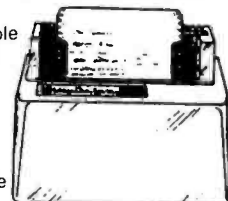

PRM-33440 \$995.00
PRM-33441(with graphics & 2K buffer) .. \$1195.00

DISKETTE SPECIAL

5.25" SOFT, 10, OR 16 SECTOR
10 for \$29.95
8" SOFT SECTOR IBM COMPATIBLE
10 for \$34.95

S-100 CONNECTOR SALE

100 PIN IMSAI TYPE SOLDER-TAIL CONNECTOR
6 for \$15.00 12 for \$25.00

SPST DIP SWITCHES

PART NUMBER	NUMBER OF SWITCHES	PRICE
SWD-103	3	\$1.00 \$1.18
SWD-104	4	\$1.05 \$1.20
SWD-105	5	\$1.10 \$1.24
SWD-106	6	\$1.15 \$1.28
SWD-107	7	\$1.20 \$1.30
SWD-108	8	\$1.25 \$1.34
SWD-109	9	\$1.30 \$1.36
SWD-110	10	\$1.35 \$1.38

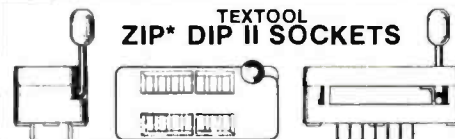

16 PIN ZIP* DIP II \$5.50
24 PIN ZIP* DIP II \$7.50
40 PIN ZIP* DIP II 10.25

* ZERO INSERTION PRESSURE

SPECIAL HOLIDAY PRICE! NOVATION CAT ACOUSTIC COUPLER/MODEM

\$157.50

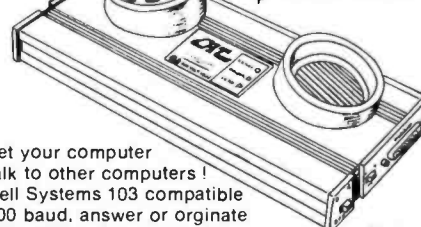

Let your computer talk to other computers!
Bell Systems 103 compatible
300 baud, answer or originate
IOM-5200A (SALE PRICED) \$157.50

SALE ENDS JANUARY 5, 1980

Introducing . . .
Graphic Golf
 TRS-80* Trademark of Tandy Corp **Level II 16K**

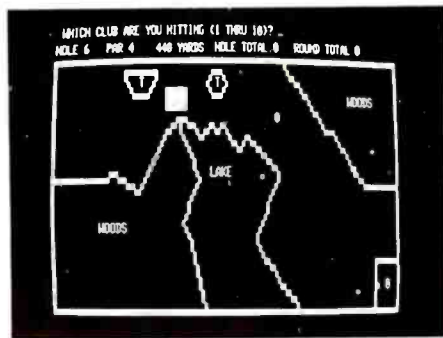

Welcome to "Small Woods Country Club," where you can play on our scenic 18 hole, par 72, 6,840 yard course. Will you make it over the lake, or take the long way? You choose the club and angle, 80% skill, 20% chance. A challenge to all. Plays like a real course. Instruction tape included. Easy to order . . . **15⁹⁵**

Send check or money order to . . . Ken Smallwood
 (Calif. residents add 6%) 389 Coral St.
 Visa or Mastercharge accepted Santa Cruz, Ca. 95060
 Bank Card order for 1 day delivery (408) 688-4187

Dealer inquiries invited

CIRCLE 336 ON READER SERVICE CARD

T.D.Q.
TAPE DATA QUERY
 THE IDEAL SOLUTION FOR PERSONAL AND VERY-SMALL BUSINESS DATA MANAGEMENT

PET-8K

TRS-80-LVL II

- * COMPLETE CASSETTE FILE MANAGEMENT SYSTEM
- ENGLISH-LIKE COMMAND LANGUAGE
- REPORT GENERATOR
- UTILITY PACKAGE
- NO PROGRAMMING KNOWLEDGE REQUIRED
- REQUIRES 2 CASSETTE RECORDERS
- * T.D.Q. APPLICATION CASEBOOK

- COMPLETE DIRECTIONS TO MICRO-COMPUTERIZE:
- INVENTORY CONTROL
 - ACCOUNTS RECEIVABLE
 - ACCOUNTS PAYABLE
 - ORDER PROCESSING
 - LABEL PRINTING
 - CHECK PRINTING
 - INVOICE PRINTING
 - CUSTOMER DIRECTORY
 - APPOINTMENT SCHEDULING
 - VENDOR MASTER FILE
 - PAYROLL JOURNAL
 - CHECKBOOK JOURNAL
 - TELEPHONE BOOK
 - RENT COLLECTION

SPECIAL YEAR-END SALE PRICE - \$100.00
 INCLUDES:

CASEBOOK; 2 CASSETTES, 3 USER'S MANUALS & REF. CARDS
 ORDERS MUST BE RECEIVED BY JAN 31, 1980
 SEND CHECK OR MONEY-ORDER TO:

H. GELLER COMPUTER SYSTEMS
 P.O. BOX 350
 NEW YORK, N.Y. 10040
 (N.Y. RESIDENTS ADD SALES TAX)

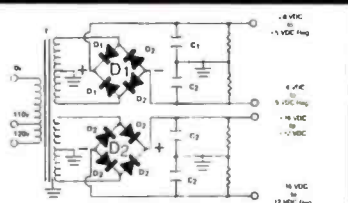

**BUILD YOUR OWN LOW COST
 MICRO-COMPUTER
 POWER SUPPLIES
 FOR S-100 BUS, FLOPPY DISCS, ETC.**



POWER TRANSFORMERS (WITH MOUNTING BRACKETS)

ITEM NO.	USED IN KIT NO.	PRI. WINDING TAPS	SECONDARY WINDING OUTPUTS			SIZE W x D x H	UNIT PRICE
			2x8 Vac	2x 14 Vac	2x24 Vac		
T ₁	1	0V, 110V, 120V	2x 7.5A	2x2.5A	—	3 3/4" x 3 5/8" x 3 1/8"	19.95
T ₂	2	0V, 110V, 120V	2x 12.5A	2x3.5A	—	3 3/4" x 4 3/8" x 3 1/8"	25.95
T ₃	3	0V, 110V, 120V	2x9A	2x2.5A	2x2.5A	3 3/4" x 4 3/8" x 3 1/8"	27.95
T ₄	4	0V, 110V, 120V	2x4.5A	—	2x4.5A	3 3/4" x 3 5/8" x 3 1/8"	19.95

POWER SUPPLY KITS (OPEN FRAME WITH BASE PLATE, 3 HRS. ASSY. TIME)

ITEM	USED FOR	@ +8 Vdc	@ -8 Vdc	@ +16 Vdc	@ -16 Vdc	@ +28 Vdc	SIZE WxDxH	UNIT PRICE
KIT 1	18 CARDS SOURCE	15A	—	2.5A	2.5A	—	12" x 6" x 4 7/8"	46.95
KIT 2	SYSTEM SOURCE	25A	—	3A	3A	—	12" x 6" x 4 7/8"	54.95
KIT 3	DISC SYSTEM	18A	1A	2A	2A	4A	14" x 6" x 4 7/8"	62.95
KIT 4	DISC SOURCE	8A	1A	—	—	8A	10" x 6" x 4 7/8"	44.95

EACH KIT INCLUDES: TRANSFORMER, CAPACITORS, RESIS., BRIDGE RECTIFIERS, FUSE & HOLDER, TERMINAL BLOCK, BASE PLATE, MOUNTING PARTS AND INSTRUCTIONS.

REGULATED POWER SUPPLY "R2" ASSY. & TESTED, OPEN FRAME, SIZE: 9" (W) x 5" (D) x 5" (H) \$69.95

SPECS: +5V ± 1%, @ 5A, +24V, ± 1%, @ 5A. OVERCURRENT PROTECTION AND +5% ADJ. FOR BOTH VOLTAGES.
 REMARK: IDEAL FOR ROCKWELL AIM-65 MICROCOMPUTER. ALSO -5V, @ 1A OPTIONAL, \$5.00 ADDITIONAL.

SHIPPING FOR EACH TRANSFORMER: \$4.75. FOR EACH POWER SUPPLY: \$5.00 IN CALIF. \$7.00 IN OTHER STATES. CALIF. RESIDENTS ADD 6% SALES TAX. OEM WELCOME

SUNNY INTERNATIONAL
 (TRANSFORMERS MANUFACTURER)
 Telephone: (213) 633-8327

STORE:
 7245 E. ALONDRA BLVD.
 PARAMOUNT, CA 90723
 STORE HOURS: 9 AM - 6 PM



MAIL ORDER:
 P.O. BOX 4296
 TORRANCE, CA 90510



16K EPROM CARD-S 100 BUSS



\$59.95
KIT

OUR
BEST
SELLING
KIT!

USES 2708's!

Thousands of personal and business systems around the world use this board with complete satisfaction. Puts 16K of software on line at **ALL TIMES!** Kit features a top quality soldermasked and silk-screened PC board and first run parts and sockets. All parts (except 2708's) are included. Any number of EPROM locations may be disabled to avoid any memory conflicts. Fully buffered and has WAIT STATE capabilities.

OUR 450NS 2708'S
ARE \$8.95 EA. WITH
PURCHASE OF KIT

ASSEMBLED
AND FULLY TESTED
ADD \$25

8K LOW POWER RAM KIT-S 100 BUSS SALE



PRICE
CUT!

\$119.50
KIT

(450 NS RAMS!)

Thousands of computer systems rely on this rugged, work horse, RAM board. Designed for error-free, NO HASSLE, systems use.

KIT FEATURES:

1. Doubled sided PC Board with solder mask and silk screen layout. Gold plated contact fingers.
2. All sockets included.
3. Fully buffered on all address and data lines.
4. Phantom is jumper selectable to pin 67.
5. FOUR 7805 regulators are provided on card.

Blank PC Board w/Documentation
\$29.95
Low Profile Socket Set...13.50
Support IC's (TTL & Regulators)
\$9.75
Bypass CAP's (Disc & Tantalums)
\$4.50

ASSEMBLED AND FULLY
BURNED IN ADD \$30

16K STATIC RAM KIT-S 100 BUSS

PRICE CUT!

\$279 KIT

FOR 250NS
ADD \$10

FULLY
STATIC, AT
DYNAMIC PRICES



WHY THE 2114 RAM CHIP?

We feel the 2114 will be the next industry standard RAM chip (like the 2102 was). This means price, availability, and quality will all be good! Next, the 2114 is FULLY STATIC! We feel this is the ONLY way to go on the S-100 Bus! We've all heard the HORROR stories about some Dynamic Ram Boards having trouble with DMA and FLOPPY DISC DRIVES. Who needs these kinds of problems? And finally, even among other 4K Static RAM's the 2114 stands out! Not all 4K static Rams are created equal! Some of the other 4K's have clocked chip enable lines and various timing windows just as critical as Dynamic RAM's. Some of our competitor's 16K boards use these "tricky" devices. But not us! The 2114 is the ONLY logical choice for a trouble-free, straightforward design.

KIT FEATURES:

1. Addressable as four separate 4K Blocks.
2. ON BOARD BANK SELECT circuitry (Cromemco Standard!). Allows up to 512K on line!
3. Uses 2114 (450NS) 4K Static Rams.
4. ON BOARD SELECTABLE WAIT STATES
5. Double sided PC Board, with solder mask and silk screened layout. Gold plated contact fingers.
6. All address and data lines fully buffered.
7. Kit includes ALL parts and sockets.
8. PHANTOM is jumpered to PIN 67.
9. LOW POWER: under 2amps TYPICAL from the +8 Volt Bus.
10. Blank PC Board can be populated as any multiple of 4K.

BLANK PC BOARD W/DATA—\$33

LOW PROFILE SOCKET SET—\$12
SUPPORT IC'S & CAPS—\$19.95

ASSEMBLED & TESTED—ADD \$30

16K STATIC RAM SS-50 BUSS

PRICE CUT!

\$275 KIT

FULLY STATIC
AT DYNAMIC PRICES

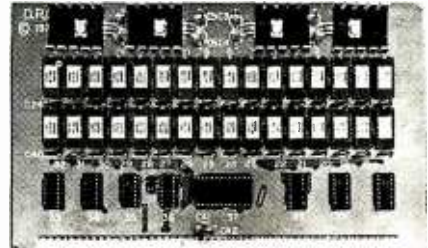

KIT FEATURES:

1. Addressable on 16K Boundaries
2. Uses 2114 Static Ram
3. Runs at Full Speed
4. Double sided PC Board. Solder mask and silk screened layout. Gold fingers.
5. All Parts and Sockets included
6. Low Power: Under 2 Amps Typical

FOR SWTPC
6800 BUSS!

ASSEMBLED AND
TESTED - \$30

BLANK PC BOARD—\$33

COMPLETE SOCKET SET—\$12

SUPPORT IC'S AND CAPS—\$19.95

S-100 Z80 CPU CARD

ASSEMBLED AND TESTED! READY TO USE! Over 3 years of design efforts were required to produce a TRUE S-100 Z80 CPU at a genuinely bargain price! **4 MHZ! \$159.95**

FEATURES:

- * 2 or 4 MHZ Operation.
- * Generates MWRITE, so no front panel required.
- * Jump on reset capability
- * 8080 Signals emulated for S-100 compatibility.
- * Top Quality PCB, Silk Screened, Solder Masked, Gold Plated Contact Fingers.

Perfect For
OEM's

LOW POWER - 250NS 2114 RAM SALE!

4K STATIC RAM'S MAJOR BRAND, NEW PARTS. These are the most sought after 2114's. LOW POWER and 250NS FAST. **\$7.50 ea. or 8 For \$55**
SPECIAL SALE: (We reserve the right to limit quantities.)

NOT ASSOCIATED WITH DIGITAL RESEARCH OF CALIFORNIA. THE SUPPLIERS OF CPM SOFTWARE.

PROC. TECH. QUILTS THE MICROPROCESSOR BUSINESS! FACTORY CLOSE OUT - SPECIAL PURCHASE!

#16KRA

16K S-100 Dynamic Ram Board - \$149.95

ORIGINALLY PRICED AT \$429 each!

We purchased the remaining inventory of PT's popular 16K Ram Board when they recently closed their plant. Don't miss the boat! These are brand new, fully tested, ASSEMBLED and ready to go. All are sold with our standard 90 day limited warranty!!

72 Page Full Manual, Included Free!

Digital Research: Computers

(OF TEXAS)

P.O. Box 401565 • GARLAND, TEXAS 75040 • (214) 494-1505

TERMS: Add \$1.00 postage, we pay balance. Orders under \$15 add 75c handling. No C.O.D. We accept Visa, MasterCard, and American Express cards. Tex. Res. add 5% Tax. Foreign orders except Canada add 20% P & H. 90 Day Money Back Guarantee on all items.

STATISTICAL DATA & SOFTWARE FOR TRS80

DATABANK programs contain 10 years of monthly statistical data on ten related subjects. Includes graphs, tables, trends, internal/external comparison, and capacity for data file expansion/update.

Six **DATABANK** programs now available for TRS-80 16K Level II Cassette.

- * General Economy
- * Manufacturing & Trade
- * Industrial Production
- * Money & Credit
- * Money Rates & Yields
- * Commodity Spot Prices

\$29.95 each 3 for \$84.95
Free cassette storage album with order for all six programs. Money orders speed delivery.

DATABANK

POB 9283, Ft Lauderdale, FL 33310

Circle 90 on inquiry card.

a TRS-80 basic renumbering program that does more

Renumber a program in any desired manner in one pass • rennumbers even the longest programs in seconds • changes all line number references • rearranges program order • easily repeated use because commands are BASIC remarks • returns original BASIC program on errors • called from BASIC. returns to BASIC • specify 4 or 16K Level II or 32 or 48K DOS

Tested cassette/program both sides \$20

TRS-80 acting up? • check your RAM with our versatile RAM check • runs until interrupted - finds permanent and intermittent bad memory • memory size Independent

Tested cassette/program both sides \$10

MICROBIOTIC COMPUTING, INC.
6515 ROSS AVENUE S.E. 
ALBUQUERQUE, NEW MEXICO 87108



- **APPLE II or APPLE II PLUS** \$995.00
- **DC HAYES MODEMS** 339.95
- **FLOPPY DISK W/CONT.** 529.95
- **APPLE SOFT CARD** 159.95
- **PASCAL CARD** 459.95
- **ALF MUSIC SYNTHESIZER** 249.95
- **10 MEGA-BYTE DISK DRIVE (for APPLE)** 4695.00

UCATAN COMPUTER STORE

across from Ramada Inn

PO Box 1000

Destin, Florida 32541

(904) 837-2022 or (904) 243-8565

Circle 309 on inquiry card.

C-10 SHORT CASSETTES 50 FT.

Qty.	Price
1	\$1.00
10	\$0.75
50	\$0.65

Premium tape and cassettes acclaimed by thousands of repeat order microcomputer users. Price includes labels, cassette box and shipping in U.S.A. VISA and M/C orders accepted. California residents add sales tax. Phone (408) 735-8832.

MICROSETTE CO.
777 Palomar Avenue
Sunnyvale, CA 94086

Circle 228 on inquiry card.



The best choice in mainframes !

- S100 CARD FRAME
- 22 MHz 12" CRT MONITOR
- 18 AMP POWER SUPPLY
- UPPER & LOWER CASE
- ASCII KEY BOARDS
- AXIAL BLOWER
- ASSEMBLED & TESTED
- READY FOR YOUR CARDS
- \$995.00

VERY ATTRACTIVE O.E.M. AND
DEALER DISCOUNTS AVAILABLE.

INFINITE INCORPORATED

Celebrating Our 11th Year.

819 E. STRAWBRIDGE, MELBOURNE, FL 32901 - (305) 724-1588

Circle 170 on inquiry card.

TRS-80, PET, APPLE, SORCERER Hardware/Software Systems

Available now:

- **HAM INTERFACE**—including the most sophisticated RTTY systems money can buy.
- **Baudot and ASCII printer interfaces.**
- **Electra Sketch®**, **ANIMATION GRAPHICS Compiler**

Write or call for free catalog

MACROTRONICS, inc..

P.O. Box 518 (A) Keyes, CA 95328

(209) 634-8888 / 667-2888 (R) (S)

We are experiencing telephone difficulties, please keep trying.

Circle 203 on inquiry card.

Dial: 402-987-3771

HOTLINE

YOU NEED CRISP, HIGH CONTRAST BLACK-WHITE and VIVID COLOR ALPHA-NUMERICS/GRAPHICS CAPABILITIES FROM YOUR VIDEO MONITOR IF YOU WANT REALLY SUPER-LOOKING IMAGES FROM YOUR COMPUTER!!

AS SPECIALISTS IN VIDEO IMAGING...we think we have the right monitor or modulator for your system. Our product line includes the popular "Micro-Verter" (OSI and Apple Inc. approved UHF color modulator), a variety of color and B-W monitors, color cameras, B-W cameras, Audio subcarrier kits and parts. FREE CATALOG UPON REQUEST. Dealers welcomed. Well established program with over 400 dealers.

GET FREE DETAILS VIA OUR HOTLINE!!!

ATV Research 13-B BROADWAY DAKOTA CITY, NE. 68731

Circle 19 on inquiry card.

SURPLUS ELECTRONICS

ASCII ASCII



**IBM SELECTRIC®
BASED I/O TERMINAL
WITH ASCII CONVERSION
INSTALLED \$645.00**

- Tape Drives • Cable
 - Cassette Drives • Wire
 - Power Supplies 12V15A, 12V25A, 5V35A Others, • Displays
 - Cabinets • XFMRs • Heat Sinks • Printers • Components
- Many other items. SEND \$1.00 FOR CATALOG REFUNDABLE FIRST ORDER
WORLDWIDE ELECT. INC.
130 Northeastern Blvd.
Nashua, NH 03060

Phone orders accepted using
VISA or MC
Call 603-889-7661

Circle 391 on inquiry card.

BYTE's New Toll-free Subscriber W.A.T.S. Line (800) 258-5485

To further improve service to our customers we have installed a toll-free WATS line in our Peterborough, New Hampshire office. If you would like to order a subscription to BYTE, or if you have a question related to a BYTE subscription, you are invited to call (800) 258-5485 between 8:30 AM and 4:30 PM Eastern Time. This applies to calls from within the continental US only.

We thank you and look forward to serving you.

10-DAY FREE TRIAL

Send for our
FREE Catalog

WE BUY USED PET, APPLE and TRS-80 COMPUTERS



\$100 FREE ACCESSORIES WITH 16K or 32K PET

Buy our 16K or 32K PET and we'll give you your first \$100 worth of accessories, FREE. Just indicate on your order that you have reduced the cost of your accessories by \$100.

FREE Terminal Package with 8K PETs

SAVE \$69

4K - Keyboard C	\$ 95
8K - Keyboard C	\$ 75
16K - Keyboard B	\$ 95
16K - Keyboard N	\$ 95
32K - Keyboard C	\$125
32K - Keyboard B	\$125
32K - Keyboard N	\$125
C — calculator keyboard (only version with tape deck)	
B — Large Keyboard (graphics not on keys)	
N — large keyboard with graphics symbols	
Used 8K PET with 90-day warranty	\$650



Hazeltine 1400

LIST SALE

~~\$850~~ ~~\$740~~

SUPER SALE PRICE TOO LOW TO ADVERTISE

Immediate Delivery — 2-Year Factory Warranty

You may have seen the Hazeltine advertised at \$850. You may have seen it sale prices at \$749 or even \$699 but our new price is so low that we can't even advertise it. Call us for a quote. Hurry, we have a limited quantity at this price. The 8048-based Hazeltine 1400 has a 12" screen, 24 x 80 display, TTY-style keyboard, addressable cursor, and RS-232 I/O from 110 to 9600 baud.

Hazeltine 1410 — \$835	Hazeltine 1510 — \$1195
Hazeltine 1500 — \$1069	Hazeltine 1520 — \$1499

PET ACCESSORIES

Commodore Dual Floppy Disk Drive	\$ SALE!
Commodore Printer (tractor feed)	\$995.00
Commodore Printer (friction feed)	\$995.00
Second Cassette — from Commodore	\$95.00
Commodore PET Service Kit	\$30.00
Beeper - Tells when tape is loaded	\$24.95
Petunia - Play music from PET	\$29.95
Video Buffer - Attach another CRT	\$29.95
Combo - Petunia and Video Buffer	\$49.95
New Serial Printer Interface for PET	\$79.95
Call for Availability	
PET - Compatible Selectric in Desk	\$895.00

SAVE \$195 COMMODORE DISK DRIVES
Reg. \$1,295 Sale \$1,100

SPECIAL



apple II plus

\$200 FREE ACCESSORIES

The new Apple II with Applesoft BASIC built-in! Eliminates the need for a \$200 Firmware Card and includes new Autostart ROM for easy operation. This combined with the FREE accessories from NCE could save you up to \$400 on a 48K Apple II system!

16K Apple II Plus — \$1195 (take \$100 in free accessories)
32K Apple II Plus — \$1345 (take \$150 in free accessories)
48K Apple II Plus — \$1495 (take \$200 in free accessories)

Apple II Accessories	
Centronics Printer Interface	\$225
Disk and Controller	Call for Availability. \$595
Second Disk Drive	\$495
Parallel Printer Card	\$180
Communications Card	\$225
Hi-Speed Serial Card	\$195
Firmware Card	\$200
Hobby/Proto Card	\$24
Microverter RF Mod.	\$35
Sanyo M2544 Recorder	\$55

Call for Availability

IN STOCK NOW!

EVERY ITEM IN THIS ADVERTISEMENT IS IN STOCK AND READY TO SHIP, EXCEPT WHERE NOTED.

Graphics printer for Apple II **NOW \$1,098**

Now you can print high resolution graphics from your Apple using the IP-225 printer and graphics option from IDS. The IP-225 is a tractor feed printer with 96 possible characters. Line length is 80/132 col. with a speed of 50/80 cps.

PET OWNERS ...

REMOTE TERMINAL for only \$69

A self-contained module and program cassette enables your PET to function as a 300 baud terminal. Supports Upper/Lower case, Rubout, Escape & all control functions. Output is TTL.

FREE WITH 8K PET PURCHASE

NEW! 800K DISK & MEMORY EXPANSION

You can instantly turn your PET into a speedy and efficient professional computer. Its easy with the new 400K Disk Drive and Memory Expansion from CompuMart Add up to 32K internally then load 20K program in only 3 seconds!

800K Disk Drive	\$1,295.00
Memory Expansion 16K	\$425.00
24K	\$525.00
32K	\$615.00

NEW

from Heath Systems

The All-In-One Computer

Dual Z-80 Processors • Built-in 102K Floppy Disk • 16K to 48K RAM • 25 x 80 Character Display • Upper/Lower Case and Line Graphics • 80 Character Keyboard with Keypad • 8 User-definable Keys • Two BASIC's and Auto-Scribe Word Processing available • Can support CP/M

Heath's third generation of computers is a compact, hi-style desktop unit which includes a complete terminal, a computer and a disk All-in-One! System includes Bootstrap in ROM, other programs available separately. HDOS operating system includes Heath's BASIC, an assembler and text editor along with important disk utilities. Microsoft language requires HDOS.

WH89 with 16K RAM	\$2,295
WH89 with 32K RAM	\$2,445
WH89 with 48K RAM	\$2,595
WH17 Second Disk Drive	\$550
Dual-port Serial Interface	\$85
HDOS Operating System	\$100
Microsoft BASIC	\$100
Word Processing	\$395

CAT COUPLER

New 300 baud Originate Answer Acoustic Coupler. Looks good, works great

priced at \$189

This is a completely refurbished Teletype KSR-33 terminal ready to use as a printer.

IN STOCK NOW

IN STOCK NOW

ZENITH

NEW

COLOR VIDEO MONITOR

The answer to the TV problem

Zenith's first color video display designed specially for computers. Your Apple won't have to force a signal through an RF-modulator and a TV tuner before it goes up on the screen. Zenith gives you the direct video connection through a standard RCA-type phono jack. A separate tip-type input jack is provided for high-impedance input to the audio system. This 13-inch monitor uses a vertical black stripe guardband with in-line tri-potential electron gun and includes automatic, color level, color processing and degaussing circuits. The 100% solid-state circuitry also takes care of the vertical and horizontal hold adjustments. Black high-impact styrene case with chrome trim.

Zenith Color Monitor \$499.00

SANYO MONITOR

\$169 \$279

9-Inch ~~\$240~~ 15-Inch ~~\$480~~



CompuMart

SINCE 1971

Department BYC9

270 THIRD ST., CAMBRIDGE, MA 02142

To Order: 1(800)343-5504

In Mass: 1(617)491-2700

In Mich: 1(313)994-3200



Member: Computer Dealers Association

IMPORTANT ORDERING INFORMATION

All orders must include 4% shipping and handling. Massachusetts residents add 5% for state sales tax. All foreign orders (except Canada) need an additional 10% for shipping and handling.

Phones open from 8:30 a.m. to 5:30 p.m. EST Monday-Friday, • P.O.'s accepted from D & B rated companies — shipment contingent upon receipt of signed purchase order • All prices subject to change without notice • Most items in stock for immediate shipment — call for delivery quotation • Sorry, no C.O.D.'s • In the Ann Arbor area? Retail store open 11:00 a.m. to 7:00 p.m. Tuesday-Friday, 10:00 a.m. to 5:00 p.m. Saturdays (Closed Sunday and Monday)

If not satisfied, return your purchase with-in 10 days for full refund of purchase price!

SUPPLIES



- FLOPPY DISKS, MINI OR STANDARD MEMOREX OR 3M
- 3M DATA CARTRIDGES OC300A, OC100A
- 3M DIGITAL CASSETTES
- 3M OR MEMOREX AUDIO CASSETTES, C-60
- 3M DISK CARTRIDGES

- WE OFFER:
- COMPETITIVE PRICING
 - IMMEDIATE DELIVERIES (Any Quantity)
 - UNCONDITIONAL GUARANTEE

BETA BUSINESS SYSTEMS
8369 VICKENS ST., #G
SAN DIEGO, CA 92111
(714) 565-4505

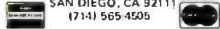

Circle 25 on inquiry card.

TEXAS INSTRUMENT COMP	
TI 99-4 COMPUTER	\$ 995.
TI 810 BASIC PRINTER	\$1790.
TI 820 BASIC PRINTER	\$1990.
TI SOFTWARE	\$5AVE
CENTRONICS PRINTERS	
779-2 TRAC. FD	\$949.
779-1 FRIC. FD	\$890.
730-1 NEW PRNTR	\$799.
730-3	\$849.
MICRO PI #390. MICRO 51	\$475.
COMMODORE BUSINESS MACHINES	
PET 2001-BK	\$675.
PET 2001-1AN.R	\$859.
PET 2001-32N.R	\$1070.
PET 2040 DUAL FLOPPY	\$1090
PET 2022 TRAC.FD PRINTER	\$849.
PET 2023 FRIC.FD PRINTER	\$749.
NORTH STAR COMPUTERS	
BIG 88 SAVINGS	
INTERTEC SUPERKRAIN	
THE HONOR GRADUATE COMPUTER	\$2990
DISPLAY TERMINALS	
INTERTUBE II	\$775
HAZELTINE 1400	\$690.
	\$785
	\$950.
	\$1149.
MULTI-BUSINESS COMPUTER SYSTEMS	
28 MARLBOROUGH STREET	
PORTLAND, CONN. 06480	
(203) 342-2747	

Circle 262 on inquiry card.

SOLOS/CUTER + CP/M USERS

Processor Technology Extended Cassette BASIC on CP/M

- Easy to install - no knowledge of assembly language needed.
- All tape functions have been converted to use disk.
- All tape-disk-tape transfer utility program is included.
- Program will relocate to any 32K or larger CP/M system.
- Supplied on a 1200 Baud CUTS cassette.
- User must supply a copy of Basic (Rev.A)
- Cassette plus users manual \$49.95:
- Manual only - \$5.00.
- Dealer inquiries invited.

This program will modify basic to run under CP/M as a disk basic with all tape file commands converted to use disk files. Program overlays CCP portion of CP/M. "For Maximum Memory Utilization."

Send check or money order to: (Ill. residents add 5% tax)

TAD ENTERPRISES
PO Box 257
Hazelcrest, IL 60429

SOLOS/CUTER are registered trademarks of Processor Technology Corp. CP/M is a registered trademark of Digital Research

Circle 366 on inquiry card.

FLOPPY DISK REPAIR



- PerSci and Shugart
- Quick turnaround
- Eight inch and minis



National Computer Service
1023 N. LaBrea
Hollywood, CA. 90038
213-851-2226

Circle 68 on inquiry card.

Memorex Floppy Discs

Lowest prices. WE WILL NOT BE UNDERSOLD!! Buy any quantity 1-1000. Visa, Mastercharge accepted. Call free (800)235-4137 for prices and information. All orders sent postage paid.

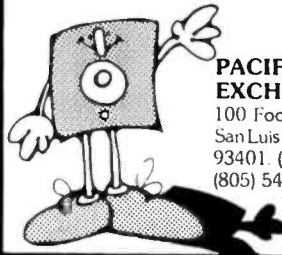

PACIFIC EXCHANGES
100 Foothill Blvd.
San Luis Obispo, CA
93401 (In Cal. call
(805) 543-1037.)

Circle 294 on inquiry card.

COMPUTER CASE COMPANY

Introduces
the



ATTACHE STYLE CASE FOR CARRYING AND PROTECTING THE APPLE COMPUTER. CONSTRUCTED OF THE HIGHEST QUALITY LUGGAGE MATERIAL. WILL ACCOMMODATE COMPUTER, TAPE RECORDER, OR DISC DRIVES PLUS TAPES, OR DISCS AND ALL MANUALS. NEVER A NEED TO REMOVE COMPUTER FROM CASE. SIMPLY REMOVE LID, CONNECT POWER AND MONITOR CABLES, AND OPERATE. LID CAN BE REPLACED AND LOCKED FOR SECURITY AND PROTECTION WITHOUT DISCONNECTING CABLES.

DELUXE CASE \$ 99.00
DELUXE CASE/2 DISC DRIVES 108.00
STANDARD CASE 79.00



EXCELLENT CHRISTMAS GIFT
FOR THE APPLE LOVER

COMPUTER CASE COMPANY
5650 INDIAN MOUND CT., COLUMBUS, OHIO 43213
(614) 868-9464

Circle 51 on inquiry card.

OPTICAL PAPER TAPE READER

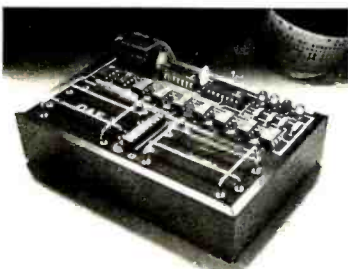

Simply connect the OP-80A Paper Tape Reader to any 8-bit parallel port and pull the tape thru (0-5,000 cps). A custom optical sensor array eliminates read errors found in lower cost units. (This is the one that works!) Complete with manual and interface cable. \$84.50 Kit and \$99.95 A & T.

Oliver Advanced Engineering, Inc.
676 W. Wilson Ave
Glendale, CA 91203
(213) 240-0080

Circle 288 on inquiry card.

Learn the Psychological secrets of how to beat most people and computers at chess

SECRETS OF A GRANDPATZER

by
Kenneth Mark Colby
Professor of Psychiatry
and Computer Science,
UCLA

Price \$20.00
MALIBU CHESS PRESS
DEPT BY
25307 Malibu Road
Malibu, CA 90265

checks, money orders, or C.O.D.
California residents add 6% sales tax

Circle 210 on inquiry card.

CROMEMCO SYSTEMS DISCOUNTED

System 2 with 64k RAM—\$3195
System 3 with 32k RAM—\$4795
with 64k RAM—add \$ 595

Discounts up to 20% on most Cromemco hardware. We carry the full Cromemco line.

TORREY PINES BUSINESS SYSTEMS

14260 Garden Rd., Suite 8A
Poway, California 92064
(714) 486-3460

California residents add 6% sales tax

Circle 374 on inquiry card.

The COMPUTER FACTORY

TO ORDER CALL (212) 687-5001

SUPERBRAIN™

INTERTEC
DATA
SYSTEMS

32K
ONLY
\$2995



More than an intelligent terminal, the SuperBrain outperforms many other systems costing three to five times as much. Endowed with a hefty amount of available software (BASIC, FORTRAN, COBOL), the SuperBrain is ready to take on your toughest assignment! You name it! General Ledger, Accounts Receivable, Payroll, Inventory or Word Processing... the SuperBrain handles all of them with ease.

Features Include:

- two dual-density minifloppies with 320K bytes of disk storage
- 32K of RAM to handle even the most sophisticated programs
- a CP/M Disk Operating System with a high-powered text editor, assembler and debugger.

SPECIAL COMBINATION SALE!

Superbrain & Centronics 704 only **\$4595**

Available Software
Accounts Receivable/Payable \$ 125
General Ledger \$ 125
Payroll with cost accounting \$ 125



NEW!



APPLE II PLUS ONLY \$1195

A complete self-contained computer system with APPLESOFT floating point BASIC in ROM, full ASCII keyboard in a light weight molded carrying case.

Features Include:

- auto-start ROM • Hi-Res graphics and 15 color video output.
- Expandable to 48K.

Supertalker.....	\$ 279	Micromodem.....	\$ 379
Disk.....	595	Programmer's Aid.....	50
Add-on Disk.....	495	Speechlab.....	229
Pascal Card.....	495	Lightpen.....	250
Business Software.....	625	Communication Card.....	225
Monitor.....	159	Modem.....	200
Printer Card.....	180	EPROM Programmer.....	100



- 16-bit microprocessor
- 16K RAM
- 13" color monitor (24 lines of 32 chrs.)
- 26K ROM operating system (Includes 14K BASIC)
- Sound - 3 tones, 5 octaves
- 16 colors, 192 x 256 res.
- Large TI library of ROM programs available.

FINALLY TEXAS INSTRUMENTS TI-99/4 Home Computer

Many Peripherals. Coming soon!

only **\$1150** Includes 13" Color Monitor!

Over 1000 software tapes, books, disks on display. Come in and browse.



NEW! MINIMAX

The Minimax Series Computer Is an integrated, compact unit containing the CPU, Disk Storage, 12 inch CRT, and Full Style Keyboard.

Features Include:

- 2 Megahertz 6502 CPU
 - 108K System RAM
 - High Res. Graphics (240x512)
 - Switchable 110 or 220V Operation
 - Choice of 800K or 2.4 Megabyte Disks
 - Business Packages Available \$395 ea
 - Serial and Parallel I/O
- MINIMAX I - 8 Megabyte on line minifloppy storage **\$4495**
MINIMAX II - 2.4 Megabyte on line 8" floppy storage **\$5995**

NEW! \$1995 List \$2500

CENTRONICS 704

- 180 cps Bi-Directional
- Upper/Lower Case
- 9 x 9 Matrix
- Tractor Feed
- Up to 15" Paper Width
- RS-252 Serial Interface



CENTRONICS 753

- New Word Processing Dot Matrix Printer
 - 130-150 cps • Proportional Spacing
 - Tractor Feed • N x 9 Matrix
- \$ 2895**

\$ 1595 Complete!

- 16K model **\$ 1895**
- 32K model **\$ 2195**



CompuColor II

COMPUCOLOR II Disk-Based Model 3 Advanced hardware and software technology gives you:

- 13" Color Display
- Advanced Color Graphics.
- 51K Disk Built-In
- 16K ROM Operating System
- 8K RAM User Memory
- 4K RAM Refresh
- 8080A Microcomputer
- RS-232 I/O

Commodore Computer

These low cost Commodore PET Business Computers have virtually unlimited business capabilities: Accounts Receivable, Inventory Records, Payroll, and other accounting functions.

PET 16N & 32N COMPUTERS

- Full size keyboard
- 16 or 32,000 Bytes Memory
- Level III Operating System
- Full Screen Editor
- Upper/lower case & 64 graphic characters

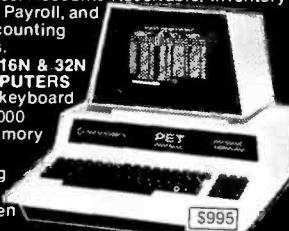

PET DUAL FLOPPY DISK

- Stores 360,000 Bytes on-line
- Microprocessor controlled
- Uses single or dual sided floppies



HI-SPEED PRINTER

- 150 characters per second • Up to 4 copies 8 1/2" wide
- Microprocessor Controlled • Prints All Graphics
- Full Formatting Capability

PERIPHERALS FOR PET

• 24K Memory Expansion.....	\$499
• 16K Memory Expansion.....	399
• PET to RS232 Serial.....	169
• 2 Way Serial/Communication.....	229
• Modem Board for PET.....	375
• Analog to Digital Board for 16 Devices.....	275
• Second Cassette Drive.....	95
• Parallel Printer Interface.....	169

CENTRONICS 730

Parallel \$995
Serial \$1045

- 100 CPS - MICROPROCESSOR CONTROLLED!
- Tractor & Friction Feed • Uses Single Sheets, Roll, Fanfold • Upper & Lower Case • Light Weight



ANDERSON JACOBSON

- 84 I/O Terminal
 - Ideal for word processing and small business.
 - ASC II Code
 - 15 cps Printout
 - High Quality Selective Printing
 - Use Keyboard for PET
 - Reliable heavy duty Mechanism
 - Completely Refurbished by A.J.
 - Service in 15 Major Cities
 - Plus \$35 Freight-In Charge
- NOW IN STOCK**
- Parallel **\$1095**
Serial **\$1195**



DATA GENERAL micro NOVA

The ultimate in small Business Computers when matched with COMPUTER FACTORY's minicomputer. Software: Accounts Receivable/Payable, Inventory Control/ Order Entry, General Ledger, Payroll Systems, from \$12,140 for 64K computer



Data General

10 Megabyte System \$17,040

with cabinet, printer terminal, video terminal dual disk and multi-user operating system!

FREE

\$35 of Software with purchase of any computer on this page.



Min Credit Card Order \$75



Open Mon.-Fri. 10-6 Sat. 10-4

RADIO SHACK • PET • SORCERER • APPLE • COMPUCOLOR • ETC. PRINTERS • PRINTERS • PRINTERS

The COMPUTER FACTORY'S extensive inventory and wide selection of computer printers assures you of finding the printer best suited for your needs and specifications. The following printers work well with all known personal computers

CENTRONICS 779.....	\$ 945
TRENDGOM 100.....	375
TRENDGOM 200.....	595
PAPER TIGER 440.....	5995
(New) Remington Selectric w/int.....	\$1895

N.Y. residents add 8% sales tax
• Same day shipment on prepaid and credit card orders • Add \$5 shipping for computers; \$3 for boards; \$1 each cassette tape.

TO ORDER CALL (212) 687-5001

(46th St.)

The COMPUTER FACTORY

485 Lexington Avenue 750 Third Avenue New York, N.Y. 10017
Foreign order desk - Telex 640055

ETCON AC/DC Voltage Tester

- High visibility voltage indicator: 120, 208 to 240, 277, 440 to 600 VAC; 120, 240, 400, 600 VDC.
- Positive or negative DC pole identified by neon lamps.
- Provision for quick prod storage in case.
- Case serves as prod holder for one-hand operation. Self-extinguishing, high-impact case for long life.
- Continuous duty rated thru 480V.
- Dimensions: 4-9/16" x 2-1/16" x 7/8". Color: Orange.



VT200 \$12.95

Custom Cables & Jumpers

NEW **NEW**

DS 25 Series Cables

Part No.	Cable Length	Connectors	Price
DB25P-4-P	4 Ft.	2-DP25P	\$15.95 ea.
DB25P-4-S	4 Ft.	1-DP25P/1-25S	\$16.95 ea.
DB25S-4-S	4 Ft.	2-DP25S	\$17.95 ea.

Dip Jumpers

DJ14-1	1 ft.	1-14 Pin	\$1.59 ea.
DJ16-1	1 ft.	1-16 Pin	1.79 ea.
DJ24-1	1 ft.	1-24 Pin	2.79 ea.
DJ14-1-14	1 ft.	2-14 Pin	2.79 ea.
DJ16-1-16	1 ft.	2-16 Pin	3.19 ea.
DJ24-1-24	1 ft.	2-24 Pin	4.95 ea.

For Custom Cables & Jumpers, See JAMECO 1979 Catalog for Pricing!

25 PIN-D SUBMINIATURE CONNECTORS (Meets RS232)

PART NO.	DESCRIPTION	PRICE
DB25P	PLUG (as pictured)	\$2.95
DB25S	SOCKET	3.50
DB251226-I	CABLE COVER for DB25P or DB25S.	1.75
DB25P-831	PLUG - Right Angle - P.C. Mount	4.95
DB25S-831	SOCKET - Right Angle - P.C. Mount	5.25

Printed Circuit Connectors

.156 Spacing-Tin-Double Read-Out Bifurcated Contacts Fits .054 to .070 P.C. Boards

PART NO.	DESCRIPTION	PRICE
15/30 SE	15/30 Contacts - solder eyelet	\$1.95
18/36 SE	18/36 Contacts - solder eyelet	2.49
22/44 SE	22/44 Contacts - solder eyelet	2.95
22/44 WW	22/44 Contacts - wire wrap	3.95
50/100 WW	50/100 Contacts - wire wrap (R681-1). (125 Spacing)	6.95

Jumbo 6-Digit Clock Kit

- Four .630" ht. and two .300" ht. common anode displays
- Uses MM5314 clock chip
- Switches for hours, minutes and hold functions
- Hours easily viewable to 30 feet
- Simulated walnut case
- 115VAC operation
- 12 or 24 hour operation
- Includes all components, case and wall transformer
- Size: 6 1/2" x 3 1/4" x 1 1/4"

JE747 \$29.95

JE701

- Bright .300 ht. comm. cathode display
- Uses MM5314 clock chip
- Switches for hours, minutes and hold modes
- Hrs. easily viewable to 20 ft.
- Simulated walnut case
- 115 VAC operation
- 12 or 24 hr. operation
- Incl. all components, case & wall transformer
- Size: 6 1/2" x 3-1/8" x 1 1/4"

6-Digit Clock Kit \$19.95

Micro-Miniature Joystick

- 2 each 100K pots (Linear Taper)
- Printed Circuit Board Mount
- Size: 1" x 1-3/16" x 1-3/16"

Micro-Miniature Joystick \$4.95

Digital Stopwatch Kit

- Use Intersil 7205 Chip
- Plated thru double-sided P.C. Board
- LED display (red)
- Times to 99 min. 59.99 sec. with auto reset
- Quartz crystal controlled
- Three stopwatches in one: single event, split (cumulative) & tay/or (sequential timing)
- Uses 3 penlite batteries
- Size: 4.5" x 2.15" x .90"

JE900 \$39.95

MICROPROCESSOR COMPONENTS

8080/8080A SUPPORT DEVICES		MICROPROCESSOR MANUALS	
8080A CPU	\$ 5.95	M-280 User Manual	\$7.50
8-Bit Input/Output	3.25	M-COP1802 User Manual	7.50
8214 Priority Interrupt Control	5.95	M-2650 User Manual	5.00
8216 Clock Generator/Driver	3.49		
8224 Bus Driver	3.95		
8226 System Controller/Bus Driver	4.95		
8231 Prog. Comm. 1/0 (USART)	5.95		
8253 Prog. Interval Timer	14.95		
8255 Prog. Periph. 1/0 (PPI)	14.95		
8257 Prog. DMA Controller	19.95		
8259 Prog. Interrupt Controller	19.95		

8080/8080A SUPPORT DEVICES		MICROPROCESSOR MANUALS	
MC6800 MPU	\$14.95	1101 256K1 Static	\$1.49
MC6802CP MPU with Clock and Ram	24.95	1103 1024K4 Dynamic	3.99
MC6801ADP 128K8 Static Ram	5.95	2101(8101) 256K4 Static	1.75
MC6821 Periph. Inter. Adap. (MC6820)	7.49	2102 1024X1 Static	1.95
MC6803B 1024X8 Bit ROM (MC6803B)	12.95	2112 256K4 Static	4.95
MC6850 Asynchronous Serial Data Adap.	14.95	2114 1024X4 Static 450ns	7.95
MC6852 Synchronous Serial Data Adap.	7.95	2114L 1024X4 Static 450ns low power	10.95
MC6860 0-600 bps Digital MODEM	12.95	2114-3 1024X4 Static 300ns low power	11.95
MC6862 2400bps Modulator	14.95	2501 256K4 Static	7.95
MC6880A Quad 5-State Bus. Trans. (MC6826)	2.25	5280/2707 4096K1 Dynamic	4.95
		7469 16K4 Static	1.75
		74S200 256K1 Static Tristate	4.95
		82421 256K1 Static	2.95
		UPD414 4K Dynamic 16 pin	4.95
		UPD416 16K Dynamic 16 pin 250ns	9.95
		TMS4044 4K Static	14.95
		TMS4045 1024X4 Static	14.95
		T117 16,384X1 Dynamic 350ns (house marked)	9.95
			41/00

MICROPROCESSOR CMPS.-MISCELLANEOUS		PROM'S	
7807/780D CPU	\$14.95	1702A 2048 FAMOS	\$5.95
Z80A/780-1 CPU	16.95	2708TCL 16K EPROM	59.95
CDP1602 CPU	19.95	2708TCL 32K EPROM	49.95
2850 MPU	19.95	2716 16K EPROM	89.95
6502 CPU	11.95	2716T-1 16K EPROM	29.95
6035 8-Bit MPU w/lock, RAM, 1/0 lines	19.95		
P8085 CPU	19.95		
TMS9900L 16-Bit MPU w/hardware multiply & divide	49.95		

JE600 HEXADECIMAL ENCODER KIT

FEATURES:

- Full 8 bit latched output for micro-processor use
- 3 User Define keys with one being bistable operation
- Debounce circuit provided for all 19 keys
- LED readout to verify entries
- Easy interfacing with standard 16 pin IC connector
- Only +5VDC required for operations

FULL 8 BIT LATCHED OUTPUT—19 KEYBOARD

The JE600 Encoder Keyboard provides two separate hexadecimal digits produced from sequential key entries to allow direct programming for 8 bit microprocessors or 8 bit memory circuits. Three (3) additional keys are provided for user operations with one having a bistable output available. The outputs are latched and monitored with LED readouts. Also included is a key entry strobe.

JE600 \$59.95
Hexadecimal Keypad only \$14.95

62-Key ASCII Encoder Keyboard Kit

FEATURES:

- 60 Keys generate the full 128 characters, upper and lower case ASCII set
- Fully buffered
- 2 user-define keys provided for custom applications
- Caps lock for upper case only alpha characters
- Utilizes a 2376 (40 pin) encoder read only memory chip
- Outputs directly compatible with TTL, DTL or MOS logic arrays
- Easy interfacing with a 16-pin dip or 18-pin edge connector

JE610 \$79.95
62-Key Keyboard only \$34.95

REGULATED POWER SUPPLY

JE200 5V-1 AMP POWER SUPPLY

- Uses LM309K
- Heat sink provided
- PC Board construction
- Provides a solid 1 amp @ 5 volts
- Can supply up to ±5V, ±5V and ±12V with JE205 Adapter
- Includes components, hardware & instructions
- Size: 3 1/2" x 5" x 2" H

JE200 \$14.95

JE205 ADAPTER BOARD - Adapts to JE200 - ±5V, ±12V and ±12V

- DC/DC converter w/ +5V input
- Toroidal hi-speed switching XMPFR
- Short circ. protection
- PC Brd. construction
- Piggy-back to JE200 board
- Size: 3 1/2" x 2" x 9/16" H

JE205 \$12.95

\$10.00 Min. Order - U.S. Funds Only
Spec Sheets - 25¢
1980 Catalog Available - Send 41¢ stamp
Postage - Add 5% plus \$1 Insurance (if desired)

FREE 1980 CATALOG

Jameco ELECTRONICS

MAIL ORDER ELECTRONICS - WORLDWIDE
1021 HOWARD AVENUE, SAN CARLOS, CA 94070
ADVERTISED PRICES GOOD THRU DECEMBER

PHONE ORDERS WELCOME
(415) 592-8097

The Incredible "Pennywhistle 103" Kit Only

\$139.95

The Pennywhistle 103 is capable of recording data to and from audio tape without critical speed requirements for the recorder and fits audio communications directly with any other modern terminal for telephone "hamming" and communications. In addition, it is free of critical adjustments and is built with non-precision, readily available parts.

Data Transmission Method Frequency Shift Keying, full-duplex (half-duplex selectable)
Maximum Data Rate 300 Baud
Data Format Asynchronous Serial (return to mark level required between each character)
Receive Channel Frequencies 2025 Hz for space, 2225 Hz for mark
Transmit Channel Frequencies Switch selectable: Low (normal) = 1070 space, 1270 mark. High = 025 space, 225 mark
Receive Sensitivity 45 dbm acoustically coupled
Transmit Level 15 dbm nominal. Adjustable from -6 dbm to +20 dbm
Receive Frequency Tolerance Frequency reference automatically adjusts to a low frequency reference at 1800 Hz and 2400 Hz.
Digital Data Interface EIA RS-232C or 20 mA current loop (receiver is optoisolated and non-polluting)
Power Requirements 120 VAC, single phase, 10 watts
Physical All components mount on a single 5" by 9" printed circuit board. All components included
Requires a VOM, Audio Oscillator, Frequency Counter and/or Oscilloscope to align



TRS-80 16K Conversion Kit

Expand your 4K TRS-80 System to 16K.
Kit comes complete with:
• 8 each UPD416-1 (16K Dynamic Rams) 250NS
• Documentation for conversion

TRS-16K \$75.00

JUST WRAP

• 30 AWG wire
• Daisy chain or point-to-point
• No stripping or slitting required - just wrap

Part No.	Color	Wire	Price
JW-1-B	Blue	50 ft. roll	\$14.95
JW-1-W	White	50 ft. roll	14.95
JW-1-Y	Yellow	50 ft. roll	14.95
JW-1-R	Red	50 ft. roll	14.95

JUST WRAP Replacement Wire

Part No.	Color	Wire	Price
R-JW-B	Blue	50 ft. roll	\$2.98
R-JW-W	White	50 ft. roll	2.98
R-JW-Y	Yellow	50 ft. roll	2.98
R-JW-R	Red	50 ft. roll	2.98

JUST WRAP Unwrap Tool \$3.49

• JUST WRAP Tool
• Unwrapping Tool

JWK-6 \$24.95

Vacuum Vise

Vacuum-based light-duty vise for small components and assemblies. ABS construction. 1 1/2" jaws. 1 1/4" travel. Can be permanently installed.

VV-1 \$3.49

EPROM Erasing Lamp

- Erases 2708, 2716, 1702A, 5203Q, 5204Q, etc.
- Erases up to 4 chips within 20 minutes.
- Maintains constant exposure distance of one inch
- Special conductive foam liner eliminates static build-up
- Built-in safety lock to prevent UV exposure
- Compact - only 7-5/8" x 2-7/8" x 2"
- Complete with holding tray for 4 chips

UVS-11E \$69.95

IDEAL FOR TRS 80 CASSETTE CONTROLLER

"Plug/Jack interface to any computer system requiring remote control of cassette functions"

The CC100 controls cassette motor functions, monitors tape location with its internal speaker and requires no power. Eliminates the plugging and unplugging of cables during computer loading operation from cassette.

#CC-100 \$29.50



FLOPPY SYSTEMS



8" Siemens FDD120-8
All Siemens options included in this drive may be configured hard or soft and single or double density. We find this to be an extremely reliable drive. \$399.00



5 1/4" BASF Magical Miniature Mini drive only 2/3 the size of others is reliable and durable and quickly gaining in popularity with our customers. Single or dual density fast access times \$274.00



Tarbell Controller may be re-configured to control 5 1/4" drives and includes short cable for one drive. KIT \$179.00, ASM \$265, but only \$219 with purch. of 2 drives.



Cable Kits For 8" Drives with 10' 50 cond. cable and connectors. Also power cable and connectors. Flat cable assem if you wish. For one drive 27.50, two 33.95, three 38.95

Cable Kits for 5 1/4" Drives as above, but 34 cond. For one drive 24.95, two 28.95.



"Power One" Model CP206 Power Supply adequate for at least two drives. 2.8A/24V 2.5A/5V, 0.5A/-5V beautiful quality. \$99.00



CABINETS for FDD120 and 801R drives, or CP206 supply. Matte finish in mar resistant black epoxy paint and stacking design 29.95

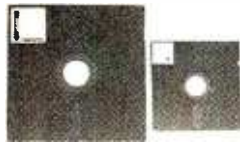

DISKETTES (3M, MRX, BASF, Georgia Magnetics, & Victor Borge)
8" \$39.95/10
5 1/4" \$29.95/10

32K / 16K Static RAM, 4MHz.

(Showing Amazing Similarity to Tarbell's unit) (16K Shown in photo)

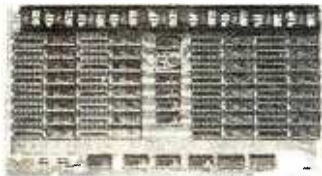

32K - \$549.00 16K - \$349.00

"BACK TO SCHOOL" KEYBOARD SPECIAL



CHERRY "PRO" Keyboard \$119.00
Streamlined Custom Enclosure \$34.95
BOTH ONLY \$124.95 !!!!!!!

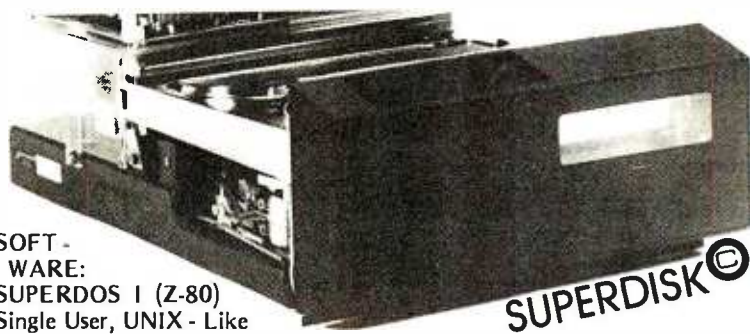

10MBy DRIVE \$3300
S-100 DMA CONTROL \$495
POWER UNIT \$395.00

SOFTWARE:
SUPERDOS I (Z-80)
Single User, UNIX - Like File System, AND Totally Upward Compatible From "XX/X" (What did you say, Digital Research??)

PS: SUPERDOS -I runs on the TRS-80, and can transform it from a toy computer to a real business machine !!!

For the first time in something like 10 years, a new STANDARD in removable media has evolved. Selected by Datapoint, and others who have not yet announced, this drive is beautifully simple and easy, if not trivial to maintain. 920kBy/sec. transfer rate, 3600 RPM 39 lbs and only 125 Watts.

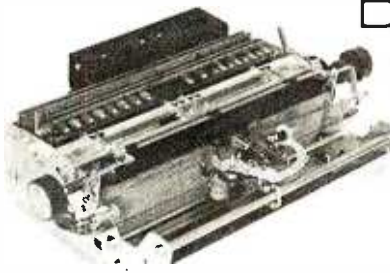

Daisy Wheel Printers Qume Sprint 3\45

PRINTER (factory warr.) \$1199.00
POWER SUPPLY (Boschert) \$349.00 (shown mounted on rear of printer)
COMBINATION SPECIAL \$1499.00

DATA DISPLAY MONITORS

Used 12" Sylvania monitors. Composite Video, 15 MHz, 120VAC. Re-built with NEW P39 anti-glare tube \$119.00
New P4, 109.00, used P4 79.00.



"OEM STYLE" as above, will fit any case. (Both versions serviced by qualified tech). Identical to above but subtract \$12.00



Doppler Motion Sensor Intrusion Detector

Extremely effective microwave motion detector for detecting unwanted visitors. Ignores mice and other non-larcenous creatures. Operates on 12VDC or from small transformer supplied. Output is relay closure for alarm control interface, or to switch on lights annunciators. Will operate THROUGH door of closet or thin wall. Best application seems to be to turn on outside lights to help invited guests, and to intimidate unwanted ones. \$159.00
Water Repellent Cover \$24.95

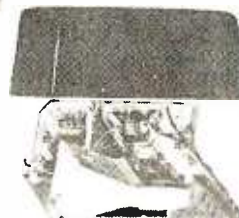

Electrolabs

POB 6721, Stanford, CA 94305
415-321-5601 800-227-8266
Telex: 345567 (Electrolab Pla)
Visa MC Am. Exp.



ESAT 200B

BI-LINGUAL 80x24 COMMUNICATING TERMINAL

Scrolling, full cursor, bell, 8x8 matrix, 110 - 19,200 baud, Dual Font Applications. Arabic & Hebrew, Multilingual Data Entry Forms Drawing, Music, & Switchyards. \$349.00



SOCKET SPECIAL

BURNDY



"Won't Let Go"

Low Profile

Solder Tail

1 CENT/ Pin !! (0.75/1000's)

8 14 16 18 20 22 24 28 40

CP/M* Source Code -- FREE! when you purchase "OS-1"
 Electrolabs' new operating system for the Z-80 designed to have exactly
 the appearance of UNIX**, including virtual I/O, "set TTY", a tree and a
 shell, filters and pipes PLUS total compatability with CP/M software!

OS-1

FEATURES

(Because OS-1 is truly a comprehensive "OS", and not merely a file handling "DOS", we have changed the name from "Superdos" to "OS-1")

- VIRTUAL I/O - copy with a single command between floppy and hard disk, or from TTY to printer to tape to disk... etc., etc.
 No messy I/O routines to write, & no awkward transfers.
- SECURITY - 9 modes of file protection. user and login protection.
- MULTI-USER - up to 256 passwords. (non-simultaneous users)
- 16MBy FILE SIZE - but no limit to no. of directories per device, thus allowing EASY implementation of gigantic storage devices.
- "SET TTY" - for printer or crt: tabs, page width, buffer, cursor, UC/LC, fonts, formfeed, arbitrary control characters etc., etc.
- "LOGIN" - automatically executes user selected programs and "set TTY".
- OCCUPIES 12KBy - only 50% larger than CP/M, but 500% more features.
- CP/M & CDOS COMPATABLE - your library is guaranteed to run!

* (Naturally, we are not giving away the version of CP/M written by Digital Research, Please pardon our pun, but they might object. What we ARE giving you is a greatly enhanced version of CP/M which resides on OS-1, and allows the user of OS-1 to run any and all of his programs, packages or system utilities which are already running on CP/M. We give you the source code at no charge so that you may modify any part of the CP/M to suit your own system requirements. At no charge, you also receive the enhancement allowing 4MBy files instead of 256K.)

OS-1 (with debugger, linker and screen oriented editor)	\$199.00
Update service, per year	29.00
Symbolic Debugger	150.00
MACRO-Assembler (Creates relocatable code)	150.00
"C" Compiler	660.00
FORTRAN Compiler	100.00
BASIC Compiler (very fast)	150.00

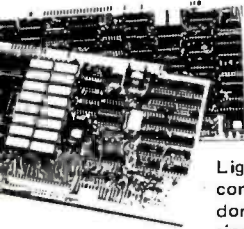

Graphics

High Resolution 480 x 512
 for B&W and Color Imaging and Graphics

Light pen, A-D, D-A, TV synchro (needs no time base correction or adjustment with anything between random interface & NTSC commercial standard). T.V. single frame grabber ("snapshot"). Up to 1 Byte of attributions per pixel.

LSI-100 & S-100 applied to:

Graphic Presentation — such as computer generated animation & other graphic displays up to 256 colors & up to 256 b&w gray scales. **Image Analysis** — using built-in FRAME GRABBER, for medical image enhancement, contour analysis, & pattern recognition. **Commercial TV Tilting & Advertising** — using synchronization capability. **Interactive graphics** — using light pen accessory.

BASIC CONFIGURATION —

LSI-11 \$1995. S-100 \$1265.
 For TRS-80/Exidy Add \$595.00
 Includes: Data Board - 32K (480 x 512 x 1 pixel) D-A 16 level video generator. Video Synchronization Circuitry. Address Control & Timing Board.

FEATURES — High speed. DMA or 2KBy window memory mapped interface. Full NTSC commercial color capability. Low power consumption. Excellent Software
Options — Accessories — Software
 Options include: light pen, auxiliary outputs, text mode, memory and much more. Accessories include: b&w and color cameras and monitors. Software: "Plot" 2D or 3D, "Tilting", "Contour", "Image Enhancement", "Vector Curve Generation".

Call for price and details

*CPM and **UNIX trademarks of Digital Research and Western Electric respectively.

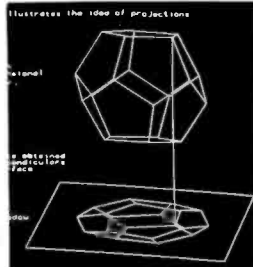

A NEW System CONCEPT!!

BRAND NEW POWER!!
 BRAND NEW OPERATING SYSTEM!!
 UN-INTERRUPTABLE POWER CAPABILITY!!
 DON'T LOSE YOUR DATA!!

FEATURING: Expandability — hardware and OS expand — up to 16 users. Double density — (it works!!!) UNIX like operating system (OS-1). Supports all CP/M utilities and programs. Time sharing capability. Turnkey software included.

BUSINESS DATA WORK SAVER®!!!

Standard features: Enclosure, 10 slot backplane, Z-80 CPU, 32K RAM, I/O and controllers, Bantam terminal, Paper Tiger Printer, OS-1, Two floppies (8" or 5 1/4"). Basic compiler with application programs for accounts payable, accounts receivable, general ledger and payroll **\$6495.00**

WORD SAVER®!!!

MULTI-USER

UP TO EIGHT STATION WORD PROCESSING

Standard features: Enclosure, 10 slot backplane, Z-80 CPU, 48K RAM, Daisy Wheel Printer, ESAT Terminal with two fonts (Arabic, Hebrew, Cyrillic, Greek, Catakana, any custom font for \$50.00) Three floppies: (8" or 5 1/4") OS-1. Word processor package with additional memory which is expandable up to eight users (each extra terminal \$900.00) **\$8695.00**

ELECTROLABS

POB 6721 Stanford, CA 94305
 415-321-5601 800-227-8266
 Telex: 345567 (Electrolab Pla)

OPTIONS: 10 MBy hard disk (available now!!!) Extra memory, graphics, etc. Call or write for further details. This is the most advanced microcomputer system available at this time.

Electrolab's System Switcher Model SP04



\$349.00

Tames

RAW POWER

for the

LSI-11/23 *

And Hard Disks

FEATURES:

- * Brown-Out Proof
- Line Frequency Indifferent
- Very Low EMI
- U.L. Approved
- 20 KHz
- High Efficiency
- Soft Start
- Extremely Lightweight
- Open Frame Design
- Short Circuit and OV Protection
- 20,000 Hour MTBF (MIL 217B)
- Adaptable to Un-Interruptable Power applications.
- and Low Cost!! (just look at DEC's price)

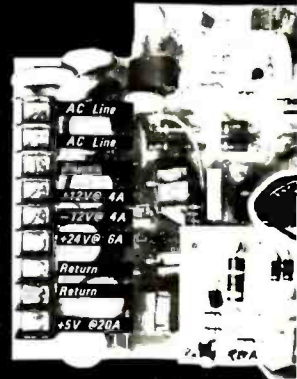

Electrolabs



HARTMANN LANG

TRS-80™ HARDWARE/SOFTWARE
 DUMP-IN BASIC LEV2 \$5.00
 MONITOR-IN BASIC LEV2 \$10.00
 HEX TO DEC/DEC TO HEX
 CONVERSION-IN BASIC LEV2 \$5.00
 HEX DUMP ASSEMBLY LANG.
 OBJECT \$5.00
 SOURCE \$10.00
 SOME LEV2 BUGS, ISSUE 1 \$3.00
 WRITE FOR COMPLETE LIST

**AUTHORS:
 WE BUY SOFTWARE
 WRITE FOR INFO
 CHECK OR MONEY ORDER TO:
 HARTMANN LANG
 BOX 693
 CHATHAM, NJ 07928**

Circle 152 on inquiry card.

save more than 20% NORTH STAR-INTERTUBE THINKER TOYS--MICROTEK

The smartest computers at the smartest price
 QUAD & DOUBLE DENSITY

	LIST	ONLY
HORIZON 1-32K-0 kit	\$1999	\$1585
HORIZON-2-32K-0 kit	2399	1905
Assembled & tested	2765	2195
HORIZON 2-32K kit QUAD	2799	2225
Assembled & tested	3215	2555
PASCAL for NORTH STAR on Disk		49
Powerful NORTH STAR BASIC		FREE
TEL PT 212 COMPUTER 5 mHz	8000	6250
THINKER TOYS DISCUS/20 A&T	1149	949
DISCUS/2 + 2 1.2 megabytes A&T	1549	1299
MEASUREMENT SYSTEM MEMORY		
A&T 4mHz 64K		640
INTERTUBE II SMART TERMINAL	995	745
MARYELLEN WORD PROCESSOR Your Best Buy	750	38
MICROTEK PRINTER	750	675
ANADEX PRINTER	995	875
FLORIDA DATA PRINTER 600 cps	4300	3440
POS for NORTH STAR Better than CP/M		95
COMPILER for HORIZON Secret Superfast Code		95
VERBATIM the best DISKETTES Box of 10		29
Which Computers are best? BROCHURE		FREE

AMERICAN SQUARE COMPUTERS
 KIVETT DR * JAMESTOWN NC 27282
 (919) 883-1105

Circle 13 on inquiry card.

APPLE™ REFERENCE CARD

SAVE TIME: Access the calls, keystrokes, and JSR's to those APPLE sub-routines that you know are there.

PLUS: Screen memory layout, Op-code Table, Character Table, Schematic of transfer operations, and **MUCH MORE.**

To Order: Send check for \$1.95 and stamped, self-addressed envelope to:
R&D PRESS

885 N San Antonio Road
 Los Altos, Ca 94022

Circle 314 on inquiry card.



SPRINT 68 MICROCOMPUTER CONTROL COMPUTER DEVELOPMENT SYSTEM

6800 MPU, serial I/O, 48K RAM, dual 8" drives, WIZRD multitasking DOS, Editor, Assembler, 12K BASIC all for \$3995.

SOFTWARE OPTIONS
 C compiler, PL/W compiler, PASCAL
HARDWARE OPTIONS
 EROM Programmer, analog I/O, parallel I/O, 488 GPIB

WINTEK Corp

1801 South Street
 Lafayette, IN 47904
 Phone: (317) 742-8428

Circle 389 on inquiry card.

TEACHERS!

THE ELECTRONIC ROLLBOOK ©

is a plush, disk-based program that maintains your class rolls in a disk file; allows you to enter grades, add, delete or edit, compute class averages, alphabetize, line-print, assign grades, display a histogram, and much more.

You can enter new grades without having to alphabetize your papers or enter the student's names or look up anything in a directory!

For TRS-80* with one disk and 32K: \$39.95.

Order from:

**Report Card
 Box 15
 Narberth, PA 19072**

Circle 323 on inquiry card.

16 K RAMS & RAM CONTROLLERS

- 16 K X 1 DYNAMIC RAMS MK4116P3
- 200 NSEC ACCESS/375 NSEC CYCLE TIMES
- 16 PIN/TTL COMPATIBLE
- ALL CHIPS BURNED IN AND FULLY TESTED
- PRICE WITH DATA SHEET \$68.00 IN QTY OF 8/THAT'S \$8.50 EACH

6800/6502 64K BYTE RAM & CONTROLLER SET
 MAKE 64K BYTE MEMORY FOR YOUR 6800 OR 6502
 THIS SET INCLUDES:
 • 32 M5K 4116-3, 16K X 1, 200 NSEC RAMS
 • 1 MC3480 MEMORY CONTROLLER
 • 1 MC3242A MEMORY ADDRESS MULTIPLEXER AND COUNTER
 • DATA & APPLICATION SHEETS, PARTS TESTED AND GUARANTEED.
 \$295.00 PER SET

DYNAMIC MEMORY CONTROLLER MC3480
 • GENERATES RAS/CAS & REFRESH TIMING FOR 16K TO 64K BYTE MEMORIES
 • PRICE WITH DATA SHEET \$13.95 EACH

MEMORY ADDRESS MUX/COUNTER MC3242AP
 • MUX ADDRESS & REFRESH COUNTER FOR 16K TO 64K BYTE MEMORIES
 • PRICE WITH DATA SHEET \$12.50 EACH

QUANTITY DISCOUNTS AVAILABLE
 ALL ORDERS POSTPAID U.S. HANDS ON INTERNATIONAL
 ORDERS CHECK OR MONEY ORDER. VISA B.A.M.C. ALSO ACCEPTED SEND ACC. NO. EXPIRATION DATE & AVERBANK NO WITH SIGNED ORDER CALIF. RESIDENTS PLEASE ADD 6% SALES TAX PHONE ORDERS (714) 633-4460
MEASUREMENT SYSTEMS & CONTROLS, INC.
 MEMORY DEVICES DIVISION
 857 NORTH MAIN ST. ORANGE, CA 92668

8048 Family

A one board microcomputer utilizing the 8035 geared toward stand alone applications with:

- one 8-bit input port
- one 8-bit output port
- one 8-bit bidirectional port
- fully programmable hand shake lines on each port
- crystal based timer
- 64 bytes RAM, expandable to 1k bytes
- provisions for program memory to 4k bytes
- single supply capability [+5V]
- low cost [64.95 - singles]

Money order, Check, or C.O.D.
 Send orders to:

Adroit Electronics, Inc.
 5 East Long Street
 Suite 1012
 Columbus, Ohio 43215
 614-221-3060

Circle 5 on inquiry card.

... add the sound dimension to your system **NOISEMAKER!**

Soundboard uses two GI AY 3-8910 I.C.'s to generate sound effects under software control. PCB only \$34.95.

Send for additional information, check or money order to:

**Ackerman
 Digital Systems, Inc.**
 110 North York Road • Suite 208
 Elmhurst, Illinois 60126
 Tel. 312-530-8992
 (Illinois residents add 5% state sales tax.)

Circle 7 on inquiry card.

tinyFORTH

tinyFORTH is a powerful interactive programming system for the TRS-80. **tinyFORTH** combines the structured high-level language, text editor, and assembler of FORTH with the graphics and cassette I/O of the TRS-80.

tinyFORTH programs are quickly developed by defining new modules in terms of previously defined modules. Each new module is compiled for fast execution and compact memory space.

tinyFORTH is easy to learn. The user's manual contains hundreds of examples to teach you **tinyFORTH** in a hands-on style. Special chapters explain graphics, applications, the text editor, and the assembler.

tinyFORTH cassette for 16k level II TRS-80 and full documentation \$29.95
 Documentation only \$9.95

All orders are fully guaranteed. Add \$1.50 for postage and handling. Order with check, money order, Visa, or MasterCard.

The Software Farm
 Box 2304 Dept. A9 Reston, VA 22090

Circle 333 on inquiry card.

Micro Computer

DISCOUNT Company

COMPARE PRICE, QUALITY, DELIVERY, SERVICE, and you'll know why you don't have to look anywhere else!

Most Items in Stock for Immediate Delivery.
All Merchandise is Fresh and in Factory Sealed Containers.

APPLE

16K Apple II or Plus.....	\$ 995
48K Apple II or Plus.....	1159
Disk w/Controller.....	539
Disk.....	450
Pascal.....	505

ATARI

400.....	\$ 469
800.....	845
Disk.....	639

CENTRONICS PRINTERS

730-1 Parallel.....	\$ 879
730-1 Serial.....	927
*779-2 Tractor.....	1035
*704 Serial.....	1895
*753-1.....	2595

COMMODORE PET

8K "N".....	\$ 795
Plus \$90 Free Merchandise	
16K "N" or "B".....	995
Plus \$130 Free Merchandise	
32K "N" or "B".....	1295
Plus \$170 Free Merchandise	

2040 Floppy.....	1295
Plus \$170 Free Merchandise	
2022 Printer.....	995
Plus \$130 Free Merchandise	
C2 "N" Cassette.....	add \$89.90

COMPUCOLOR

8K.....	\$1439
16K.....	1660
32K.....	1895

CROMEMCO

System 3.....	\$5445
Z-2H.....	9445

EXIDY SORCERER

16K.....	\$1115
32K.....	1240
48K.....	1375

HAZELTINE

1210.....	\$ 825
1500.....	1095

INTEGRAL DATA

440 (Paper Tiger).....	\$ 880
440-Graphics.....	1049

INTERTEC

Intertube.....	\$ 859
Superbrain 32K.....	2845

NEC SPINWRITER

*5530 RO.....	\$2695
*5520 KSR.....	2990
*5510 RO.....	2795
Tractor add.....	200

PERKIN-ELMER

550 Bantam.....	\$ 895
-----------------	--------

TEXAS INSTRUMENTS

99/4 Computer.....	\$1039
810 Printer.....	1695

XEROX TERMINALS

*1740 RO.....	\$2550
*1740 KSR.....	2925
*1750 RO.....	2650
Tractors add.....	215

MAIL ORDER ONLY

To Order:

Send Certified Check (Personal or Company Checks require 2 weeks to clear.)

VISA, MasterCharge add 3%

N.Y.S. Residents add appropriate sales tax.

We pay all shipping and insurance charges except items marked with asterisk.

*(DENOTES ITEMS SHIPPED F.O.B. NYC)

Your One Stop For...Quality and Huge Savings

DISCOUNT

Micro Computer Discount Company

60 E. 42nd St., Suite 411, New York, N.Y. 10017

Telephone (212) 986-7690

APPLE II PLUS**

(limited offer)
16K only \$990.00

Disk I	475.00	Firmware Card	175.00
Disk II w/Controller	575.00	Proto Card	22.00
Pascal Card	475.00	M & R Modulator	29.95
Parallel Printer Card	165.00	Sanyo Cassette	54.96
Communications Card	210.00	16K Upgrade Kit	74.95
Business Software Pkg.	625.00	Apple Radio Car	159.00
10 Megabyte Hard Disk	695.00	8" Floppy Controller	350.00
D.C. Hayes Modem	349.95	Heuristics Speechlab	179.95



ADVANCED COMPUTER PRODUCTS

FLOPPY DISK DRIVES

MPI B51-5 1/4": 40 tracks	279.00	PERSCI Model 277 Dual	1195.00
Shugart SA400-5 1/4": 35 tracks	295.00	WANGO/SIEMENS 5 1/4" Drive	290.00
Siemens/GSI FDD120-B 8"	375.00	MPI B52 5 1/4" Dual	395.00
Shugart 800/801R 8"	495.00	WANGO/SIEMENS 282 Dual 5 1/4"	395.00

ENTER InterSystems

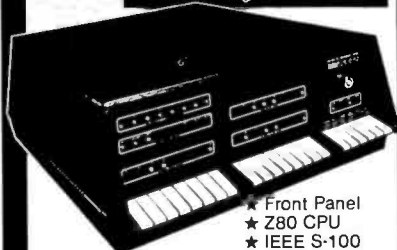

\$1150

- ★ Front Panel
- ★ Z80 CPU
- ★ IEEE S-100
- ★ 22 Cards
- ★ Modular Supply

Z80 Starter Kit

\$249

A Complete Microcomputer on a Board

- ★ Z80 Central Processing Unit with 158 Instructions.
- ★ On-Board Keyboard and Display.
- ★ Kansas City Standard Cassette Interface.
- ★ PROM Programmer Built on-board.
- ★ Expansion provision for two S-100 Connectors.
- ★ Wire Wrap area for custom circuitry.

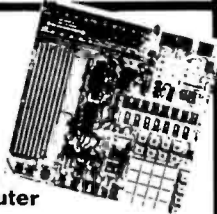

TRS-80/APPLE

MEMORY EXPANSION KITS

4116's
16K (200/250 ns.)
8 pcs. for **\$74.95**
w/instructions & jumpers.



HICKOK LX303
\$74.95

.5%, 3/2 digit 19 Range DVM, 1/2" LCD displays runs 200 hrs on 1 battery. 10 Meg Ohm Input. 1 yr. guarantee, made in U.S.A., test leads included.

Available Accessories

RC-3 115V AC Adapter	\$7.50
CC-3 Deluxe Padded Vinyl Carrying Case	\$7.50
VP-10 X 10 DCV Probe Adapter/ Protector 10 Kv	\$14.95
VP-40 40 Kv DC Probe	\$35.00
CS-1 10 Amp Current Shunt	\$14.95

SOL-20 WITH CP/M



We are proud to offer the SOL-20 with a dual floppy subsystem all operating under CP/M. Now you can use the SOL-20 and take advantage of the unlimited CP/M based software that is available.

A. MINI-DISK SYSTEM	B. STANDARD FLOPPY SYSTEM
INCLUDES:	INCLUDES:
<ul style="list-style-type: none"> • SOL-20 w/22K • VISTA V-200 controller • (2) double density drives • CP/Mw/documentation • Assembled & tested 	<ul style="list-style-type: none"> • SOL-20 w/24K • VISTA controller • (2) 8" disk drives • CP/Mw/documentation • Assembled & tested
\$2995.00	\$3295.00

SOL nKRA (expandable to 65K) RAM boards. Assembled and socketed w/o memory, data delay and proms.
Only..... \$139.95

Sol-20 Keyboards..... Only \$139.95

EXIDY SORCERER ONLY \$799.00



\$799 w/8K
\$1099 w/16K
\$1249 w/32K
\$1449 w/48K

User programmable or use cartridges. Combines the desirable features of the PET, APPLE and TRS-80 into a complete expandable computer system.
★ I/O expansion kit..... \$149.00
★ Vista V-200 add-on mini-floppy for Exidy. (requires exp module) w/CPM..... \$699.00

- ★★ New Word Processing Pac Keyboard & enclosure 90 day Warranty..... \$299.00
- ★ INCLUDES: MICROSOFT BASIC Video & Cassette Cable Complete Documentation
- ★★ S100 Expansion Module..... Add \$299.00
- ★★ Cassette recorder..... Add \$44.95
- ★★ Sanyo 9" Monitor..... Add \$169.95

... and it's COLOR SALE \$100.00 OFF

"The CompuColor II"

... a personal colorgraphics system for the modern computer man...

- ★ Color Graphics 13" Color CRT
- ★ Proven 8080A CPU System
- ★ 16K Extended Disk Basic
- ★ Up to 117" Key Keyboard
- ★ Up to 32K* RAM
- ★ Minidisk Drive 5.12K Bytes/Side



Model 3 w/8K, 72 Key Keyboard, RS232	SALE TAKE OFF	\$1495.00
Model 4 w/16K, 72 Key Keyboard, RS232	\$100.00	\$1695.00
Model 5 w/32K, 72 Key Keyboard, RS232	OFF	\$2295.00
Options: 101 Key Keyboard	Add	\$150.00
117 Key Keyboard	Add	\$225.00
Formatted Diskettes	2/\$	199.5
Programmed Diskettes		\$19.95
Diskette Library Inc. Hangman, Othello, Math, Chess, Startrek, Blackjack, Cubic Tic Tac Toe, Finance Vol. I, Finance Vol. II, Bonds and Securities, Assembler, Text Editor, Personal Data Base.		

TI 99/4



Finally! We've heard so much about it and we are proud to offer:
• Color • Up to 72K • 16 Color Graphics • Music • Sound • Solid State Software

LIMITED QTY: **\$1150.00**

VDB-8024 Video Display Board \$319 KIT

- With On-Board Z80 Microprocessor
- ★ Full 80 Characters by 24 lines display.
 - ★ Characters displayed by High Resolution 7 x 10 Matrix.
 - ★ Keyboard Power and Interface.
 - ★ Composite Video Output.
 - ★ Separate TTL Level Synchronization and Video Outputs.
 - ★ 2K Bytes Independent On-Board Memory.
 - ★ On-Board Z80 Microprocessor.
 - ★ Glitch Free Display.

KIM-1 Now only \$179.00

- ★ Power Supply
- ★ Cassette Recorder
- ★ Sanyo 9" Monitor
- Add enclosure \$29.95.

AIM 65

- \$375.00**
- ★ On Board 20 column alphanumeric printer
- | | |
|---------------------|--------------|
| w/1K RAM | \$375.00 |
| w/4K RAM | \$450.00 |
| Assembler ROM | Add \$85.00 |
| BASIC IN ROM | Add \$100.00 |
| Power Supply | Add \$69.95 |
| Enclosure | Add \$49.95 |

SYM-1 IN STOCK

- Reg. \$269.00
Now **\$219.00**
- ★ KIM-1 Compatible
 - ★ 4K ROM Monitor
 - ★ 1K Bytes 2114 RAM
 - ★ 65K Memory Expansion
 - ★ Uses EPROM 2718
 - ★ Power Supply
 - ★ Cassette Recorder
 - ★ Sanyo 9" Monitor
 - ★ School & group discounts available.
- Buy now and receive \$100.00 worth of discount coupons. (e.g.)
★ SRV1 1K Static RAM exp. reg. \$42.00

reg. \$50.00
- ★ PEK1 I/O Port
- ★ SYM BAS-1 Basic ROM (Microsoft) reg. \$159.00
- ★ KIM-2 CRT/TV Keyboard reg. \$349.00

SBC-100

- Z-80 based singleboard computer by SD Systems
- ★ 1K RAM
 - ★ RS232 port
 - ★ 4 channel counter/timer
 - KII
 - Assembled

TK80A

- ★ 8080A
 - ★ Monitor ROM
 - ★ DMA Display
 - ★ 25 Key Keyboard
 - ★ Cassette I/O
- \$299.00**

RCA COSMAC VIP

- NEW LOW PRICE **\$249.00**
Assembled. Regular price \$299.95
w/Sanyo 9" Monitor

Widen the ability of your TRS-80

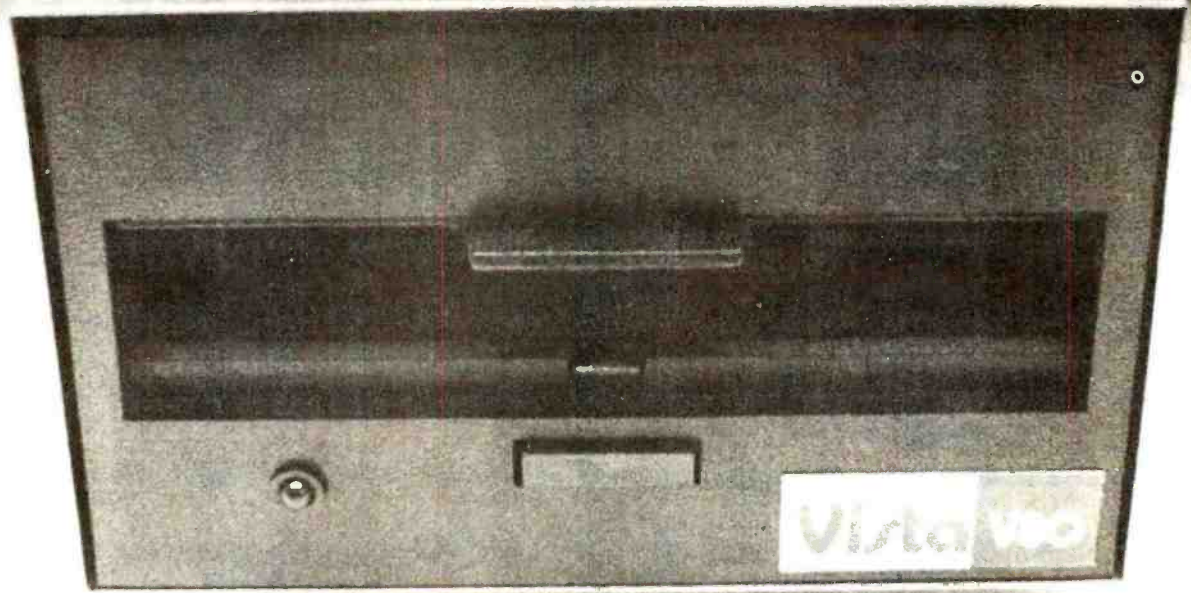

The Vista V80: \$395

The Vista V80 Mini Disk System is the perfect way to widen the capabilities of your TRS-80* Micro-computer. Quickly and inexpensively. Our \$395 price tag is about \$100 less than the Radio Shack equivalent. Our delivery time is immediate (24 hour turn-around from our Santa Ana, Ca. factory). And our system is fully interchangeable. That's just the start.

It will give you 23% more storage capacity by increasing useable storage from 55,000 to 65,000 bytes per drive with our new software patch.

It can work 8 times faster than the TRS-80 Mini-Disk system, because track-to-track access is 5ms versus 40ms for the TRS-80. You can realize this added speed

once the new double disk expansion interface is available without expensive modification of the existing unit.

It has a better warranty than any comparable unit warranty available – a full 120 days on all parts and service. When you consider how much more goes into the Vista V80, that shows a lot of faith in our product.

A full 3 amp power supply means you have 2½ times the power necessary to operate the V80, and full ventilation insures that there will be no problems due to overheating.

The Vista V80 Mini Disk System requires Level II Basic with 16K RAM Expansion interface (it operates from the Radio Shack interface system. It

comes complete with a dependable MPI Minifloppy disk drive, power supply, regulator board and vented case. It's shipped to you ready to run – simply take it out of the box and plug it in. You're in business. From the company that means business – Vista Computer Company.



The Vista Computer Company.
Manufacturers of Quality
Computer Systems
and Software.

714/953-0523
1401 Borchard
Santa Ana, Ca. 92705



Radio Hut
201 LOCHWOOD MALL • DALLAS, TEXAS 75218
ORDER BY PHONE—214-324-5509

PLEASE WRITE FOR CATALOG OR WHILE IN DALLAS, VISIT OUR RETAIL STORE AT 201 LOCHWOOD MALL, DALLAS, TEXAS 75218 (GARLAND ROAD AT JUPITER).

ORDERING INFORMATION & TERMS: Orders under \$15.00 add 75¢ handling. No C.O.D. We accept Visa, MasterCard, and American Express cards. Tex. Res. add 5% tax. Foreign orders (except Canada) add 20% P&H. 90 Day Money Back Guarantee on all items. Add 5% P&H, maximum \$5.00. ORDER BY PHONE—(214) 324-5509

The EXPANDORAM is available in versions from 16K up to 64K, so for a minimum investment you can have a memory system that will grow with your needs. This is a dynamic memory with the invisible on-board refresh, and IT WORKS!

- Bank Selectable
- Phantom
- Power 8VDC, +16VDC, 5 Watts
- Lowest Cost Per Bit
- Uses Major Brand 16K RAMS
- PC Board is doubled solder masked and has silk-screened parts layout
- Extensive documentation clearly written

SD EXPANDORAM

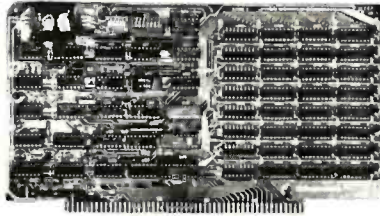

- Complete kit includes all Sockets for 64K
- Memory access time: 375ns, Cycle time: 500ns.
- No wait states required
- 16K boundaries and Protection, via Dip Switches
- Designed to work with Z-80, 8080, 8085 CPU's

EXPANDORAM 64K Kit (16K Ram)

WITHOUT MEMORY	\$139.00
16K	209.00
32K	275.00
48K	340.00
64K	405.00

SD'S PROM 100 PROM Programmer Board
The PROM-100 Programmer is a development tool for S-100 Bus computer systems. The Zero Insertion Force Programming Socket extends above the card cage height for easy access to PROM devices. Software verifies PROM erasure, verifies program loading and provides for reading of object file from Disk or PROM and programming into PROM/EPROM. Features include: On-board generated 25vdc Programming pulse, TTL compatible, maximum programming time for 16,389 bits is 100 seconds. Programs: 2708, Intel 2758, 2716, 2732 and TI 2516. DIP Selectable EPROM type.

PROM-100 Board Kit \$149.95

SD'S MPB-100 Z80 CPU BOARD KIT

The MPB-100 provides, a Z80 microprocessor based CPU for S-100 Bus systems. Front panel usage is optional, making the MPB-100 suitable for upgrading existing systems to Z80 level. A PROM socket is provided on-board which makes the MPB-100 adaptable to process control applications. Features include: Power-on Jump to 4K boundaries, 2 Megahertz or 4 Megahertz operation, optional wait states, on-board PROM socket.

MPB-100 KIT \$199.00

SD'S VERSAFLOPPY II
• IBM 3740 Compatible Soft Sector Format for Single Density Drives • Operates with Single and Dual Sided Drives. Single or Double Density Drives and 5" & 8" Drives — in any combination of four simultaneously • Drive Select and Side Select Circuitry • S-100 Bus Compatible • Vectored Interrupt Operation Optional • Phase Locked Loop Data Recovery Circuit • Operates with Z80 CPU's • Uses FD1791-1 Controller Chip • The Versafloppy II incorporates all the possible features of a flexible disk drive controller into one board. Capable of handling four drives simultaneously, combinations of any variety are possible, such as 5" single sided, 8" dual density dual sided, 5" dual density single sided. Most popular drives are controlled directly with the Versafloppy II. The operating system for the Versafloppy II is the extremely powerful SDOS available for SD Systems. Diagnostic and control software available to complete your disk system.
\$290 KIT, \$385.00 ASSEMBLED & TESTED



SD'S VDB-8024 VIDEO DISPLAY BOARD

The VDB-8024 features its own on-board Z80 microprocessor. This gives the capability of using software (included in ROM) to control functions and enhancements without interference with the computer's CPU. Included in the special features: 80 characters by 24 lines display, keyboard power and interface, composite and separate video output, 2K on-board RAM, a total of 256 available characters, full cursor control, forward and reverse scrolling, underlining, field reverse, field protect enhancements, programmable characters.
VDB-8024 KIT \$289.00

SD'S "VERSAFLOPPY I" KIT

FEATURES: IBM 3740 soft sector compatible, S-100 BNS Compatible for Z-80 or 8080. Controls up to 4 drives (single or double sided). Directly controls the following drives: Sugart SA400/450 Mini Floppy • Shugart SA800/850 Standard Floppy • PERSCI 70 and 277 • MFE 700/750 • CDC 9404/9406
\$135.00



SD'S SBC-100 SINGLE BOARD COMPUTER

The SBC-100 provides a complete micro-computer on a single board! The Z80 microprocessor is used as the heart of the SBC-100. The SBC-100 meets all the requirements of a Z80 CPU board with the added features of I/O ports, counter/timer channels, on board RAM, provisions for PROM/ROM and a software programmable baud rate generator. S-100 Bus compatible, the SBC-100 features are: 8K bytes of available PROM. 1024 bytes on-board RAM, Serial I/O with both synchronous and asynchronous operation, Parallel I/O ports, Operational Vectored Interrupts, and Four Counter/Timer Channels. SD Monitor available for RS-232 and Video Terminals. Disk based system software also available.
SBC-100 KIT \$209.00

TARBELL FLOPPY DISK INTERFACE
Compatible with Z80 & 8080. S-100 Bus. Uses CPM operating system. Plugs directly into your IMSAI or ALTAIR • Fastest transfer rate
KIT \$190.00 Assembled & Tested \$260.00

TARBELL CASSETTE INTERFACE
Plugs directly into your IMSAI or ALTAIR • Fastest transfer rate • Extremely reliable • Phase encoded • 4 extra status & control lines
KIT \$99.95

COMPUTER CORNER CPU'S

Z80	\$10.99
RELATED CHIPS	
2114 (300ns)	\$5.99
Z80 PIO	\$9.95
2708	\$7.99
4115	8/\$34.95
4116	8/\$80.00
DISC CONTROLLER	
1771	\$29.95
1791	\$37.95

IC SOCKETS

SOLDER TIN		LOW PROFILE	
PIN		PIN	
8	.12	16	.17
14	.15	18	.24
24	.32	40	.54
28	.39	20	.26

Z80 STARTER KIT

Kit: \$219.95 Assembled & Tested \$369.95
SD System's Z80 Starter Kit enables the novice to build a complete microcomputer on a single board. Featuring the powerful Z80 microprocessor, the Z80 Starter Kit features • Keyboard and Display • Audio Interface • PROM Programmer • Expansion and Wire Wrap Area • On Board RAM • 4 Channel Counter/Timer • Z-BUG Monitor in PROM • I/O Ports.

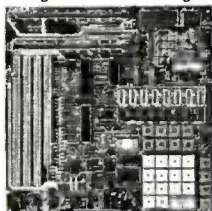

DIP SWITCHES		LEDS AND READOUT	
3 Pos.	\$1.10	Jumbo Red LED's	8/1.00
4 Pos.	\$1.12	Jumbo Green LED's	4/ .95
5 Pos.	\$1.16	Jumbo Yellow LED's	4/ .95
6 Pos.	\$1.20	Jumbo Amber LED's	4/ .95
7 Pos.	\$1.22	MV Red	10/1.00
8 Pos.	\$1.26	FND 70CC	.50
9 Pos.	\$1.36	DL 707	.95
10 Pos.	\$1.30	DL 747CA	.65
		DL 726CC	1.19
		FND 800CC	1.50
		Red Filter 4" Bezel	2.50
		Green Filter 4" Bezel	2.50
		Amber Filter 4" Bezel	2.50
		4N25	1.60
		4N26	1.25
		4N27	1.10
		4N28	.95
		4N31	1.20

S-100 CONNECTORS
High-Quality Gold Pins
\$2.99 EACH

FLOPPY DISK SPECIAL
5.25" SOFT, 10 OR 16 SECTOR
10 FOR \$29.95
8" SOFT SECTORED IBM COMPATIBLE
10 FOR \$34.95

- S-100 Bus Compatible
- Up to 4Mhz Operation
- Expandable Memory from 16K to 256K
- DIP Switch Selectable Boundaries
- Uses 16K (4116) or 64K (4164) Memory Devices
- Page Mode Operation Allows up to 8 Memory Boards on Bus
- Operates with Z80 CPU's
- Phantom Output Disable
- Invisible Refresh (Synchronized with Wait States)

SD'S EXPANDORAM II The Random Access Memory

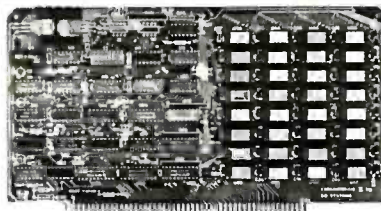

SD Systems' ExpandoRAM II is a dynamic RAM board with capacities from 16K bytes (4116) to 256K bytes (4164). It operates on the industry S-100 Bus. The design allows 8 boards to operate from the same S-100 Bus. The ExpandoRAM II is compatible with most S-100 CPU's based on the Z80 microprocessor.

EXPANDORAM II KIT

W/O	\$195.00
16K	285.00
32K	375.00
48K	465.00
64K	555.00

HOLIDAY SPECIALS For Orders Received BEFORE December 31, 1979

HOLIDAY SPECIALS For Orders Received BEFORE December 31, 1979

BECKIAN ENTERPRISES



All Prime Quality — New Parts Only
Satisfaction Guaranteed

EDGE CARD CONNECTORS: GOLD PLATED. (Not Gold Flash)
BODY: Non brittle. Solvent res., G.E. Valox.
CONTACTS: Bifurcated; Phos/Bronze; Gold over Nickel.
ABBREVIATIONS: S/T Solder Tail; S/E Solder. Eyelet.
W/W Wire Wrap 3; SW/W Short W/Wrap.

PART #	Description	Row Sp.	1-4	5-9	10-24
5010	50/100 S/T ALTAIR	140	3.75	3.50	3.30
5020	50/100 S/T IMSAI	250	3.95	3.75	3.50
5030	50/100 W/W IMSAI	250	4.10	3.90	3.70
5040	50/100 S/E ALT/IMSAI	140	5.00	4.50	4.25
5050	50/100 S/T CROMCMCO	250	6.25	6.00	5.75
1450	IMSAI CARD GUIDES		0.16	0.14	0.12

100" Contact Center Connectors.

1020	13/26 S/E IMSAI MIO:	140	2.10	1.85	1.75
1040	2.5/50 S/E	140	2.95	2.75	2.50
1050	2.5/50 S/T	140	3.00	2.80	2.60
1060	36/72 W/W Vector.	200	4.80	4.60	4.30
1065	36/72 S/T Vector.	200	4.00	3.75	3.50
1070	40/80 S/E PET	140	4.80	4.50	4.30
1075	40/80 W/W PET	200	5.00	4.65	4.35
1080	40/80 S/T PET	140	4.90	4.60	4.25
1085	43/85 S/E Cos.ELF	140	5.00	4.75	4.50
1090	43/86 S/T Cos.ELF	140	5.10	4.85	4.60
1093	43/86 S/T Cos.ELF	200	4.95	4.70	4.45
1095	43/86 W/W Cos.ELF	200	5.50	5.20	4.90
POLARIZING KEYS: For Above					

156" Contact Center Connectors.

1550	6/1 S/E PET, Etc	140	1.30	1.10	0.90
1560	6/1 S/T PET-NSC.	140	1.35	1.15	0.95
1575	12/24 S/E PET	140	2.15	1.95	1.75
1580	12/24 S/T PET	140	2.10	1.90	1.70
1590	15/30 S/E GRI Keybd.	140	2.25	2.05	1.85
1620	18/36 S/E	140	2.40	2.20	2.00
1650	22/44 S/E KIM, VECTOR	140	2.20	2.00	1.80
1660	22/44 S/T KIM, VECTOR	140	2.00	1.80	1.70
1670	22/44 W/W KIM, VECTOR	200	2.40	2.20	2.00
1690	36/72 W/W	200	3.90	3.75	3.50
1710	36/72 S/E	140	3.50	3.30	3.10
1720	36/72 S/T	200	3.30	3.10	2.90
1730	43/86 S/T Mot. 6800	140	4.40	4.15	3.90
1740	43/86 S/T Mot. 6800	200	4.35	4.10	3.85
1750	43/86 W/W Mot. 6800	200	4.45	4.25	4.10
POLARIZING KEYS: For Above					

RS232 & 'D' TYPE SUBMINIATURE CONNECTORS:

QUANTITY	1-4	5-9	10-24	I.C. SOCKETS. GOLD WIRE WRAP 3 TURN.
DE9P Male	1.45	1.35	1.25	14 pin \$0.36 ea.
DE9S Female	1.93	1.80	1.70	16 pin 0.38 ea.
DE110963-1 2pc. Grey Hood	1.20	1.10	1.00	
DA15P Male	1.95	1.80	1.70	
DA15S Female	2.80	2.60	2.40	
DA51211-1 1pc. Grey Hood	1.25	1.15	1.10	
DA110963-2 2pc. Grey Hood	1.22	1.10	1.05	
DB25P Male	2.20	2.10	1.90	I.C. SOCKETS. Dip Solder. Tin.
DB25S Female	3.20	3.00	2.70	14 pin \$0.15 ea.
DB51212-1 1pc. Grey Hood	1.30	1.20	1.10	16 pin 0.17 ea.
DB51226-1A 2pc. Black Hood	1.40	1.30	1.20	
DB110963-3 2pc. Grey Hood	1.35	1.25	1.15	
DC37P Male	3.70	3.50	3.35	
DC37S Female	4.90	4.70	4.40	
DC110963-4 2pc. Grey Hood	1.95	1.85	1.75	
DD50P Male	4.40	4.30	4.10	
DD50S Female	4.90	4.70	4.50	
DD51216-1 1pc. Grey Hood	2.30	2.10	1.90	
DD110963-5 2pc. Grey Hood.	2.40	2.20	2.00	
D20418-2 Hardware Sets	0.75	0.70	0.65	

CONNECTORS FOR CENTRONICS 700 SERIES:

Amphenol 57-3036 For Back of Centronics '700' Series:
Price: \$9.00ea. 5 pcs. \$7.50ea.

WHISPER FANS: Excellent for Computer cabinet cooling. Extremely quiet.
Dim. 4-3/4" x 1-1/2" thick. U.L. Listed. 1-4 \$1.00 5-9 \$1.00 10-24 \$1.00
\$22.00 \$19.00 \$18.00

WRITE FOR LARGER QUANTITY DISCOUNTS. DEALER INQUIRIES ARE WELCOME.

WE ARE CONNECTOR (EDGE CARD) SPECIALISTS. IF YOU DO NOT SEE WHAT YOU NEED IN THIS ADVERTISEMENT, PLEASE WRITE US. WE WILL REPLY.

TERMS: Minimum Order \$10.00. Add \$1.25 for handling and shipping. All orders over \$25.00 in USA and Canada: WE PAY THE SHIPPING.

NOTE: CA residents please add 6% sales tax.
NO C.O.D. SHIPMENTS OR ORDERS ACCEPTED.

MAIL ORDERS TO:
Beckian Enterprises
P.O. Box 3089
Simi Valley, CA 93063

C/MOS (DIODE CLAMPED)

4011	22	4024	75	4069	45	74C33	95
4002	22	4025	27	4031	30	74C151	131
4003	27	4027	45	4032	25	74C153	136
4005	45	4028	80	4033	22	74C160	130
4010	95	4029	95	4034	100	74C163	130
4011	22	4030	35	4035	22	74C165	125
4012	27	4035	97	74C027	27	74C113	130
4013	40	4047	85	74C168	30	74C174	130
4014	120	4044	85	74C169	27	74C178	120
4015	100	4045	45	74C14	120	74C192	130
4016	45	4046	195	74C16	27	74C193	140
4017	105	4048	75	74C17	80	74C201	50
4018	90	4050	45	74C73	75	74C992	50
4019	45	4051	110	74C43	50	74C914	190
4020	110	4053	130	74C43	130		
4021	110	4055	125	74C86	50		
4022	70	4056	70	74C90	95		
4023	70						

PRINTED CIRCUIT BOARD

4" x 6" DOUBLE SIDED EPOXY
S 60 mil thickness 5/32.60

EPOXY glass vector board
1/16" thick with 1/10" spacing. \$1.95

VERIPAX PC BOARD.
Our new Prototyping board is a hi density 4x4 x 6 1/4" single sided 1/16" G-10 board. It will hold 40, 24, 16 (34 units), 14 + 8 pin IC's. There are three buses, +5V, ground and a floating bus. There is a pad for a TO-220 regulator. There is a 22 pin edge connector with 156" spacing.

7 WATT LD-65 LASER DIODE IR \$8.95
25 watt Infra Red Pulse (SG 2006 equiv.)
Laser Diode (Spec sheet included) \$24.95

MINIATURE MULTI-TURN TRIM POTS
10K, 2K, 5K, 10K, 20K, 50K,
200K, 1M Ohm, 2M Ohm, \$75 each 3/52.00

TRANSISTOR SPECIALS

2N6233 NPN SWITCHING POWER \$ 1.95
MRF-8004 C BF RF Transistor NPN \$.75
2N3772 NPN Si TO 18 \$ 1.00
2N1548 PNP GE TO-3 \$.75
2N4194 NPN Si TO 3 \$ 1.00
2N5086 NPN Si TO 92 \$ 1.00
2N3137 NPN Si HF \$.55
2N3919 NPN Si TO 3 RF \$ 1.50
2N1420 NPN Si TO 5 \$ 3/5 1.00
2N3167 NPN Si TO 60 \$.70
2N2722 NPN Si TO 18 \$ 5 1.00
2N3055 NPN Si TO 3 \$.60
2N3904 NPN Si TO-92 \$ 6/5 1.00
2N3906 NPN Si TO 92 \$ 6/5 1.00
2N5296 NPN Si TO 220 \$.50
2N6109 NPN Si TO 270 \$ 5 1.00
2N3638 NPN Si TO 5 \$ 1.00
MPSA 13 NPN Si TO 18 \$ 4/5 1.00

Full Wave Bridges

PRV	2A	6A	25A	DIP SOCKETS
100	1.40	1.40	1.40	8 PIN .17 24 PIN .35
200	1.30	2.20	2.20	14 PIN .20 28 PIN .40
400	1.00	1.85	3.30	16 PIN .22 40 PIN .60
600	1.30	1.90	4.40	18 PIN .25

SANKEN AUDIO POWER AMPS

Si 1019 G 10 WATTS \$ 7.80
Si 1020 G 10 WATTS \$15.70
Si 1050 G 60 WATTS \$28.50

TANTALUM CAPACITORS

22UF 35V \$1.00	6.8UF 35V \$1.00
47UF 35V \$1.00	10UF 10V \$.25
68UF 35V \$1.00	22UF 25V \$.40
1UF 35V \$1.00	15UF 35V \$1.00
2.2UF 50V \$1.00	30UF 6V \$1.00
3.3UF 20V \$1.00	150UF 16V \$.95
4.7UF 15V \$1.00	68UF 15V \$.50

8" DISKETTES — HARD SECTOR
\$1.75, 10/\$16.00

CRYSTALS \$3.45 ea.

2.000 MHz 6.144 MHz	
4.000 MHz 8.000 MHz	26 cond. — .50/pair foot
3.57 MHz 10.000 MHz	15 cond. — .75/pair foot
3.57 MHz 20.000 MHz	50 cond. — .90/pair foot
6.000 MHz	

UNIVERSAL 4Kx8 MEMORY BOARD KIT \$69.95
32-2102 1 fully buffered, 16 address lines, on board decoding for any 4 of 64 pages, standard 44 pin bus, may be used with F-B & KIM.

SILICON SOLAR CELLS
4" diameter, 4V at 1 AMP \$10.00

LED READOUTS

FCS 8024, 4 digit	DL-7007 C.A. 3"	\$ 75
C.C. B' display	DL 737 C.A. 6"	\$150
FND 503 C.C. 5"	HP3400 8" CA	\$195
FND 510 C.C. 5"	HP3405 8" CC	\$195
DL 704 3" C.C. 5"		

Silicon Power Rectifiers

PRV	1A	3A	12A	50A	125A	700A
100	06	14	35	80	370	6.00
200	07	20	40	130	375	6.50
400	09	25	65	150	650	9.50
600	11	30	80	200	850	12.50
800	15	35	100	250	1050	16.50
1000	20	45	125	300	1250	20.00

SA-1024 & 1024-1024 stage analog "Bucket Brigade" shift register. \$14.95

IN 4148 (IN914) \$15/500
1 or .01 uf 25V ceramic disc caps. 16/\$1.00, 55/001.00

RS232 DB 25P male \$2.95
CONNECTORS DB 25S female \$3.50
HOODS \$1.50

REGULATORS

323K - 5V 3A	\$ 5.75	340K - 12, 15 or 24 V.	\$ 1.50
309K	\$ 1.60	340T - 5, 6, 8, 12	\$ 1.50
323T	\$.50	340T - 5, 6, 8, 12	\$ 1.50
		15, 18 or 24V 1.30	
		5, 12, or 15 V	79M \$1.35
			\$ 1.30 78M05 \$ 1.75

TTL IC SERIES

7400	17	7450	17	74155	75
7401	17	7472	25	74159	85
7402	17	7473	35	74160	85
7403	17	7474	42	74161	80
7404	24	7475	47	74162	120
7405	24	7476	45	74163	80
7406	33	7480	45	74164	85
7408	27	7483	60	74165	85
7409	24	7485	75	74173	130
7410	17	7486	42	74174	85
7411	22	7489	160	74175	75
7412	22	7490	50	74176	75
7413	42	7491	55	74177	75
7414	90	7492	50	74180	75
7416	33	7493	50	74181	190
7417	31	7494	60	74190	120
7419	12	7495	60	74191	130
7425	35	7496	60	74192	70
7426	33	74107	36	74193	70
7427	35	7421	25	74194	85
7430	17	7422	38	74195	85
7432	27	7423	42	74196	85
7437	27	7425	45	74197	85
7438	27	7426	45	74279	75
7440	17	7445	78	74368	85
7441	15	7448	110	74375	235
7442	50	74490	110	74471	105
7445	70	7451	65	74547	105
7447	60	7453	65		
7448	75	73154	110		

14 pin headers 3/\$1.00

MMS387AA CLOCK CHIPS . . . \$5.95
M7001 201A 206 DPDT . . . \$7.50
MM5311A \$3.75

NO. 30 WIRE WRAP WIRE SINGLE STRAND 100' \$1.50

ALCO MINIATURE TOGGLE SWITCHES

MTA 106 SPD	\$ 1.05
MTA 206 DPDT	\$ 1.70
MTA 206 P-DPDT CENTER OFF	\$ 1.85
MTA 206 P-DPDT CENTER OFF LEVER SWITCH	\$ 1.85

74LS SERIES

74LS00	74LS151	74LS245
74LS01	74LS152	74LS246
74LS02	74LS153	74LS247
74LS04	74LS154	74LS248
74LS05	74LS155	74LS249
74LS10	74LS156	74LS250
74LS11	74LS157	74LS251
74LS12	74LS158	74LS252

Three great new products for

TRS-80* Owners

MS-80 MINI DISK SYSTEM



Each add-on drive includes one minifloppy disk drive, case, power supply and regulator board.

- More Storage Capacity
- Fastest Access
- Does Not Void TRS-80 Warranty
- Shipped To You Ready To Run

2-DRIVE INTERFACE CABLE

\$24.50

4-DRIVE INTERFACE CABLE

\$34.50

INTRODUCTORY PRICE: **\$395** PER DRIVE

SUGGESTED RETAIL PRICE \$445

MATCHLESS FEATURED PRINTERS

Features:

- Documentation Included
- 80 Columns, 63 Lines Per Minute, Bi-Directional, Nominal Thruput
- High Reliability — Heavy Duty Cycle, 100 Million Characters Print Head Life
- Sprocket Feed
- 5 x 7 Dot Matrix Character Font

CABLE—\$34.50



INTRODUCTORY PRICE: **\$749**

SUGGESTED RETAIL PRICE \$777

APPARAT NEW DOS+ \$99

Features:

- Modified Editor Assembler with Disk I/O and new cross reference feature. User Information is obtained from Radio Shack's Editor Assembler documentation.
- Super-fast machine language Disassembler program, with cross reference feature.
- Apparat's own Superzap, a Hex dump utility to examine or modify disk or memory locations.
- Transfer machine language tapes directly to disk.
- Enhancements including built-in key-debounce (eliminating double entry); option under DOS or BASIC to print the screen to your MATCHLESS featured line printer; execution of a BASIC program.

MATCHLESS
SYSTEMS













NOBODY CAN BEAT OUR MS-80 WARRANTY: 90 days on labor, One Year on parts.

Dealer Inquiries Welcome

*TRS-80 is a Radio Shack product.

Prices subject to change without notice.

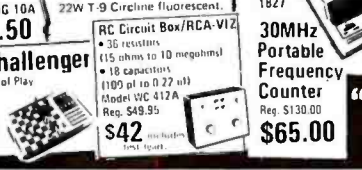
18444 South Broadway, Gardena, CA 90248 • (213) 327-1010

HICKOK 3 1/2 Digit Mini-Multimeter MODEL LX 303 \$69.50 	GOULD 15 MHz Dual Trace • Triggers in excess of 25 MHz Model DS255 \$795 including probes 	SENCORE TV-VTR-MATV and Video Analyzer Model VA48 \$945.75 Reg. \$1095.00 	CONTINENTAL SPECIALTIES 100 MHz 8-Digit Counter \$127.50 • 20 Hz - 100 MHz Range • 6" LED Display • Fully Automatic Reg. \$150.00 • Includes 100 IPC chip-load input cable-processor NOW AVAILABLE PS500 500MHZ Prescaler \$59.95 	
Sinclair PDM35 digital MultiMeter Reg. \$69.95 \$49.95 	BK PRECISION 3 1/2-Digit Portable DMM • Overhead Protected • Battery or AC operation • 3" high LED Display • Auto Zeroing Model 2800 comes complete with test leads, operating manual and spare fuse \$269.95 	Weller Controlled Output Soldering Station \$49.95 Reg. \$77.50 Model WICP-A 	BK PRECISION Digital Capacitance Meter Model 820 \$249.95 Model 1500 	CODE-A-PHONE Telephone Answering Devices Wremote Command Model 1400 \$199.95 BSR Changer Accessories \$29.95 Model BSR-129 
NLS 15 MHz Mini Oscilloscope Model MS 15 Reg. \$318.00 \$269.95 • Battery or line operation • Automatic and line sync. modes • Power consumption less than 15 W NOW AVAILABLE • 15MHz Dual Trace - Model MS 215 Reg. \$435.00 ... \$369.95 • 30 MHz Dual Trace - Model MS 230 Reg. \$559 ... \$479.95 	Weller Xcelite Service Master Attache Style Tool Kit Tool Cases Model 99SM \$47.50 Reg. \$69.95 Model TC 100/ST \$279.95 Reg. \$449.00 Model 99P Roll Kit \$19.95 Reg. \$37.95 	Logic Monitor • Automatically displays static and dynamic logic • Works with DTL TTL and CMOS • 16 LED display • Circuit governed display Reg. \$69.95 Model LM-1 \$59.95 complete 	WAHL NEW ISO-TIP "Quick Charge" \$29.95 Model 7500 Cordless Soldering Iron \$17.95 Model 5800 Thermal Solder Circuit Tester \$29.95 	
ESSE Logic Probe Model LP-1 \$44.95 • Compact, circuit powered • Detects pulses as short as 50 nSec • Multi-family compatibility DTL TTL HTL CMOS complete 	Miniature High Fidelity Stereo Speaker System. 3-Way Reg. \$139.00 \$69.50 	ESSE SYSTEM X-1000 Remote Control for Lights & Appliances 4 Piece Starter Kit Reg. \$87.95 \$79.50 One (1) Command Console Lamp Modules \$14.95 Two (2) Lamp Modules Appliance Modules 14.95 One (1) Appliance Module Command Consoles 36.95 	HICKOK Function Generator Model 270 \$181.90 • 2000 Hz maximum frequency • Peak-to-peak 250V • Impedance 50 Ohms • 10-1000 Hz BP 2000-6914 	
LEADER 30MHz Dual Trace with Delay Line Reg. \$1100.00 \$892.50 with probes 	Magnifier LAMP Model MG 10A \$49.50 Precision ground and polished magnification lens. Uses 22W T-9 Circline fluorescent. 	BK PRECISION SUPER SPECIAL Bearcat Scanner Model 250 \$299.95 Touch K 100 Scanner \$199.95 Reg. \$269 • 10 channel, computer controlled 	In-Dash AM/FM 8 Track Stereo C-777 \$52.50 AM/FM Cassette Stereo CAS 888 \$57.50 Stereo Power Booster POW-40 \$24.95 THE BIG SHOT 40 WATTS STEREO 20 WATTS PER CHANNEL BASS BOOST 	
Function Generator Model 2001 \$127.50 Sine, square, triangle and separate TTL Square wave output 	Chess Challenger Model BCC \$74.95 • Seven Levels of Play 	RC Circuit Box/RCA-VIZ • 30 resistors (15 ohms to 10 megohms) • 18 capacitors (100 pF to 0.22 uF) Model VIC 412A Reg. \$49.95 \$42 	30MHz Portable Frequency Counter Reg. \$130.00 \$65.00 	

"We Will Beat Any Advertised Price"

FORDHAM
855R ConkIn St. Farmingdale, N.Y. 11735

micro squared

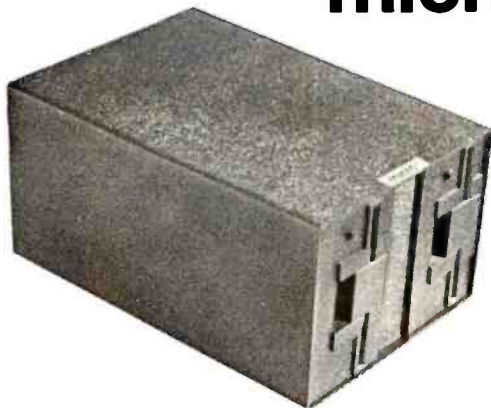

DOUBLE HEADED DUAL DISC DRIVES

TRS-80 USERS — SAVE \$800.00!!

- On line capacity of 140 tracks
- transfer rate of 125K bytes/sec.
- Up to 358.4K byte capacity

Offers TRS-80 users the capacity of 4 drives costing nearly \$2000.00

\$1195.00

Shipped ready-to-run. Price includes everything—chassis, power supply, cable and 2 drives. Just unpack and plug in. Does not require any modification to TRS-80 or TRS-80 DOS. Also available for S-100 systems. Single or double density. 140 tracks. Up to 875K byte capacity. transfer rate of up to 250K bytes/sec.

IMMEDIATE DELIVERY

Calif. residents add 6% sales tax. All orders add \$5.00 delivery costs. Master Chg/Visa/BoFA

Suite 5B, 7131 Owensmouth Avenue, Canoga Park, CA 91303 (213) 883-1993

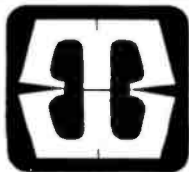

MICRO BUSINESS WORLD MAIL ORDER

Immediate response to your orders (verbal or written). Phone (213) 371-1660

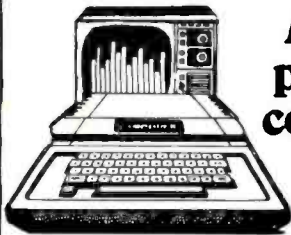

Apple II personal computer.

16K **\$920.**
Regular or Plus

- Disk II with controller **\$495.**
- Disk II without controller **\$425.**
- PASCAL Language Card **\$399.**

ALL Apple made boards
25% off list price
European Apple models available

CRAIG. M100

Electronic Language Translator

\$179.95

- French
- Spanish
- Italian
- German
- Japanese



Language Modules **\$22.95**

DYSAN DISKETTES

THE CADILLAC OF THE FLOPPY DISKS
AT LOW LOW PRICES
8" (BOX OF 10)

3740/1 sgl side/
sgl density **\$4.00 ea**

3740/1D sgl side/
dbl density **\$6.50 ea**

5" (BOX OF 5)

104/1 soft sector **\$4.00 ea**

107/1 10 sectors **\$4.00 ea**

105/1 16 sectors **\$4.00 ea**

For each 2 boxes of 8" or 4 boxes of 5" you get one plastic storage case, but hurry — supply is limited.

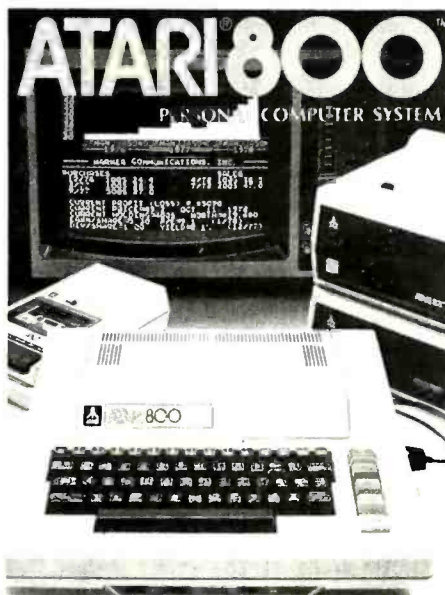

ATARI 800 Personal Computer System

Packed with: Computer Console, Basic Language Card, Education System Master Cartridge, Cassette Recorder, TV Modulator, 8K Memory (expandable to 48K), Power Supply & all Books and Manuals **\$849.99**

ATARI 400 Personal Computer System for less

Packed with: Computer Console, Basic Language cartridge, Power Supply, TV Modulator, and all Books and Manuals **\$469.99**

ATARI Program Recorder \$69.99

ATARI Software, Roms, Cassettes
25% off list price

ATARI Expansion Memory:
8K Module **\$99.99**
16K Module **\$199.99**



commodore pet

A truly professional computer system

16K **\$849.** 32K **\$1095.**

Dual Floppy Disk Model 2040 **\$1095.**

Single Disk Drive **\$795.**

Tractor Feed Printer
Model 2022* **\$849.**

Friction Feed Printer
Model 2023* **\$749.**

*need a IEEE to PET cable — 45.00
or an IEEE to IEEE cable — 35.00

Plastic Floppy Disk Holder
(up to 10) 8" **\$3.95**

Plastic Floppy Disk Holder
(up to 10) 5" **\$3.25**

16K RAM set of 8 4116's
200 ns or better **\$65.00**

HEATH DATA SYSTEMS

Smart Video Terminal
WH-19 Has a Z80 micro processor numeric keypad **\$795.00**



EPSON (A SEIKO COMPANY) TX-80 Printer
with Graphics Capabilities. 7x6 dotmatrix, Parallel (Centronics) standard 80 cols, Tractor Feed Model **\$695.**
Friction Feed Model **\$595.** Popular Computer Interfaces available for only **\$79.** (including cables)

APPLESTICK • MORE FUN AND GAMES!
2 in 1: a Joystick and Game Paddles all in one box **\$49.50**

Prices subject to change without notice. VISA and MASTER CHARGE WELCOME.

Allow 2 weeks for cashiers check to clear, 4 weeks for personal checks. Add 2% for shipping and handling. Calif. residents add 6% sales tax.

U.S. and International dealer inquiries invited.



MICRO BUSINESS WORLD

15818 Hawthorne Boulevard
Lawndale, California 90260 (213) 371-1660



CALIFORNIA COMPUTER SYSTEMS

16K RAM BOARD Fully buffered addressable in 4K blocks. IEEE standard for bank addressing 2114's PCB
\$26.95
Kit 450 NSEC \$259.95
PT-1 PROTO BOARD. Over 2,600 holes 4" regulators. All S-100 buss functions labeled, gold fingers. PCB \$25.95
PT-2 PROTO BOARD. Similar to PT-1 except set-up to handle solder tail sockets. PCB \$25.95



FORMERLY CYBERCOM/SOLID STATE MUSIC.

PB-1 2708 & 2716 Programming Board with provisions for 4K or 8K EPROM. No external supplies require textool sockets. Kit \$124.95
CB-1A 8080 Processor Board. 2K of PROM 256 BYTE RAM power on/rest Vector Jump Parallel port with status. Kit TBD PCB \$30.95
MB-6B Basic 8Kx8 ram uses 2102 type rams. S-100 buss. Kit 450 NSEC \$139.95 PCB \$26.95
MB-7 16Kx8. Static RAM uses μ P410 Protection, fully buffered. Kit \$299.95
MB-8A 2708 EROM Board. S-100. 8Kx8 or 16Kx8 kit without PROMS \$75.00 PCB \$28.95
VB-3 80x55 VIDEO BOARD
 Graphic included TBD
IO-2 S-100 8 bit parallel /IO port. 1/2 of boards is for kludging. Kit \$46.00 PCB \$26.95
IO-4 Two serial I/O ports with full handshaking 20/60 ma current loop: Two parallel I/O ports. Kit \$130.00 PCB \$26.95
VB-1B 64 x 16 video board. upper lower case Greek, composite and parallel video with software, S-100. Kit \$125.00 PCB \$26.95
Altair Compatible Mother Board. 11 x 11 1/2 x 1/2". Board only \$39.95. With 15 connectors \$94.95
Extended Board full size. Board only \$ 9.49
With connector \$13.45
SP-1 Synthesizer Board S-100
 PCB \$42.95 KIT \$135.95



WAMECO INC.

FDC-1 FLOPPY CONTROLLER BOARD will drive shugart, pertek, remic 5" & 8" drives up to 8 drives. on board PROM with power boot up. will operate with CPM™ (not included). PCB \$42.95
FPB-1 Front Panel. IMSAI size. hex displays. Byte. or instruction single step. PCB \$47.50
MEM-1A 8Kx8 fully buffered, S-100, uses 2102 type rams. PCB \$25.95
QM-12 MOTHER BOARD. 13 slot, terminated. S-100 board only \$34.95
CPU-1 8080A Processor board S-100 with 8 level vector interrupt PCB \$26.95
RTC-1 Realtime clock board. Two independent interrupts. Software programmable. PCB \$23.95
EPM-1 1702A 4K Eprom card PCB \$25.95
EPM-2 2708/2716 16K/32K EPROM CARD PCB \$25.95
QM-9 MOTHER BOARD. Short Version of QM-12. 9 Slots PCB \$30.95
MEM-2 16K x 8 Fully Buffered 2114 Board PCB \$26.95
PTB-1 POWER SUPPLY AND TERMINATOR BOARD PCB \$25.95
 8080A \$9.95 2708 \$ 9.49
 8212 2.49 2114 (450 NS) low pwr... 7.25
 8214 4.49 2114 (250 NS) low pwr... 7.99
 8224 3.49 2102A-4L 1.20

DEC. SPECIAL SALE ON PREPAID ORDERS

(Charge cards not included on this offer)

5% XMAS SALE

5% off on prepaid orders on SSM, WAMECO and CCS boards and kits. Mikos parts assortments included.

MIKOS PARTS ASSORTMENT WITH WAMECO AND CYBERCOM PCBDS

MEM-2 with MIKOS #7 16K ram with L2114 450 NSEC \$249.95
MEM-2 with MIKOS #13 16K ram with L2114 250 NSEC \$279.95
MEM-1 with MIKOS #1 450 NSEC 8K RAM \$119.95
CPU-1 with MIKOS #2 8080A CPU \$94.95
MEM-1 with MIKOS #3 250 NSEC 8K RAM \$144.95
QM-12 with MIKOS #4 13 slot mother board \$89.95
RTC-1 with MIKOS #5 real time clock \$54.95
EMP-1 with MIKOS #10 4K 1702 less EPROMS \$49.95
EPM-2 with MIKOS #11 16-32K EPROMS less EPROMS \$59.95
QM-9 with MIKOS #12 9 slot mother board \$79.95
FPB-1 with MIKOS #14 all parts for front panel \$134.95

MIKOS PARTS ASSORTMENTS ARE ALL FACTORY PRIME PARTS. KITS INCLUDE ALL PARTS LISTED AS REQUIRED FOR THE COMPLETE KIT LESS PARTS LISTED. ALL SOCKETS INCLUDED.

VISA or MASTERCHARGE. Send account number, interbank number, expiration date and sign your order. Approx. postage will be added. Check or money order will be sent post paid in U.S. If you are not a regular customer, please use charge. cashier's check or postal money order. Otherwise there will be a two-week delay for checks to clear. Calif. residents add 6% tax. Money back 30 day guarantee. We cannot accept returned IC's that have been soldered to. Prices subject to change without notice. \$10 minimum order. \$1.50 service charge on orders less than \$10.00.



(415) 592-1800

P. O. Box 424 • San Carlos, California 94070

Please send for IC, Xistor and Computer parts list

WAMECO

THE COMPLETE PC BOARD HOUSE EVERYTHING FOR THE S-100 BUSS

- * **FPB-1 FRONT PANEL BOARD.** Hex Displays, IMSAI Replaceable. PCB \$54.95
- * **FDC-1 FLOPPY DISC CONTROLLER BOARD**
Controls up to 8 Discs. PCB \$45.00
- * **MEM-1A 8K BYTE 2102 RAM BOARD**
PCB \$31.95
KIT 450 NSEC \$141.95
- * **MEM-2 16K BYTE 2114 RAM BOARD**
PCB \$31.95
KIT 450 NSEC \$299.95
- * **CPU-1 8080A CPU BOARD** with Vector Interrupt.
PCB \$31.95
KIT \$124.95
- * **EPM-1 4K BYTE 1702A EPROM**
PCB \$29.95
KIT LESS PROMS \$59.95
- * **EPM-2 16K or 32K BYTE EPROM 2708 or 2176**
Interchangeable.
PCB \$30.00
KIT LESS PROMS \$74.95
- * **QMB-9 9 SLOT MOTHER BOARD**
Terminated. PCB \$35.00
KIT \$89.95
- * **QMB-12 12 SLOT MOTHER BOARD**
Terminated. PCB \$45.00
KIT \$115.95
- * **RTC-1 REALTIME CLOCK**
Programmable Interrupts \$27.95
KIT \$79.95
- * **PTB-1 POWER SUPPLY BOARD**
PCB \$30.95
KIT LESS REGULATORS \$55.95

FUTURE PRODUCTS: 80 CHARACTER VIDEO BOARD,
IO BOARD WITH CASSETTE INTERFACE.

DEALER INQUIRIES INVITED, UNIVERSITY DISCOUNTS AVAILABLE
AT YOUR LOCAL DEALER



WAMECO INC. 111 GLENN WAY #8, BELMONT, CA 94002 (415) 592-6141

Take the mystery out of programming

with the latest from **BYTE Bookstm**

You Just Bought a Personal What?

by *Thomas Dwyer and Margot Critchfield*
Whether you are a novice programmer or an experienced computer user, this book is filled with practical ideas for using a personal computer at home or work. It will take you through the steps necessary to write your own computer programs, and then show you how to use structured design techniques to tackle a variety of larger projects. The book contains over 60 ready-to-use programs written in Radio Shack TRS-80 Level II BASIC in the areas of educational games, financial record keeping, business transactions, disk-based data file and word processing. \$11.95 pp. 184
ISBN 0-07-018492-5

Beginners Manual for the UCSD Pascal System

by *Kenneth Bowles*
Written by the originator of the UCSD Pascal System, this highly informative book is designed as an orientation guide for learning to use the UCSD Pascal System. Once familiar with the system, you will find the guide an invaluable reference tool for creating advanced applications. This book features tutorial examples of programming tasks in the form of self-study quiz programs. \$11.95 pp. 256
ISBN 0-07-006745-7



70 Main Street, Peterborough, NH 03458

The BYTE Book of Pascal

Edited by *Blaise W. Liffick*
Based on the growing popularity of Pascal as a programming language, numerous articles, language forums and letters from past issues of BYTE magazine have been compiled to provide this general introduction to Pascal. In addition, this book contains several important pieces of software including two versions of a Pascal compiler - one written in BASIC and the other in 8080 assembly language; a p-code interpreter written in both Pascal and 8080 assembly languages; a chess playing program; and an APL interpreter written in Pascal. \$25.00 Hardcover pp. 342
ISBN 0-07-037823-1
Circle 36 on inquiry card.

These books will be available in January 1980 at your favorite computer bookstore or direct from BYTEtm

BYTE BOOKS, BYTE BOOKS logo, and PAPERBYTE are trademarks of BYTE Publications, Inc.
Please allow 6-8 weeks for processing your order.

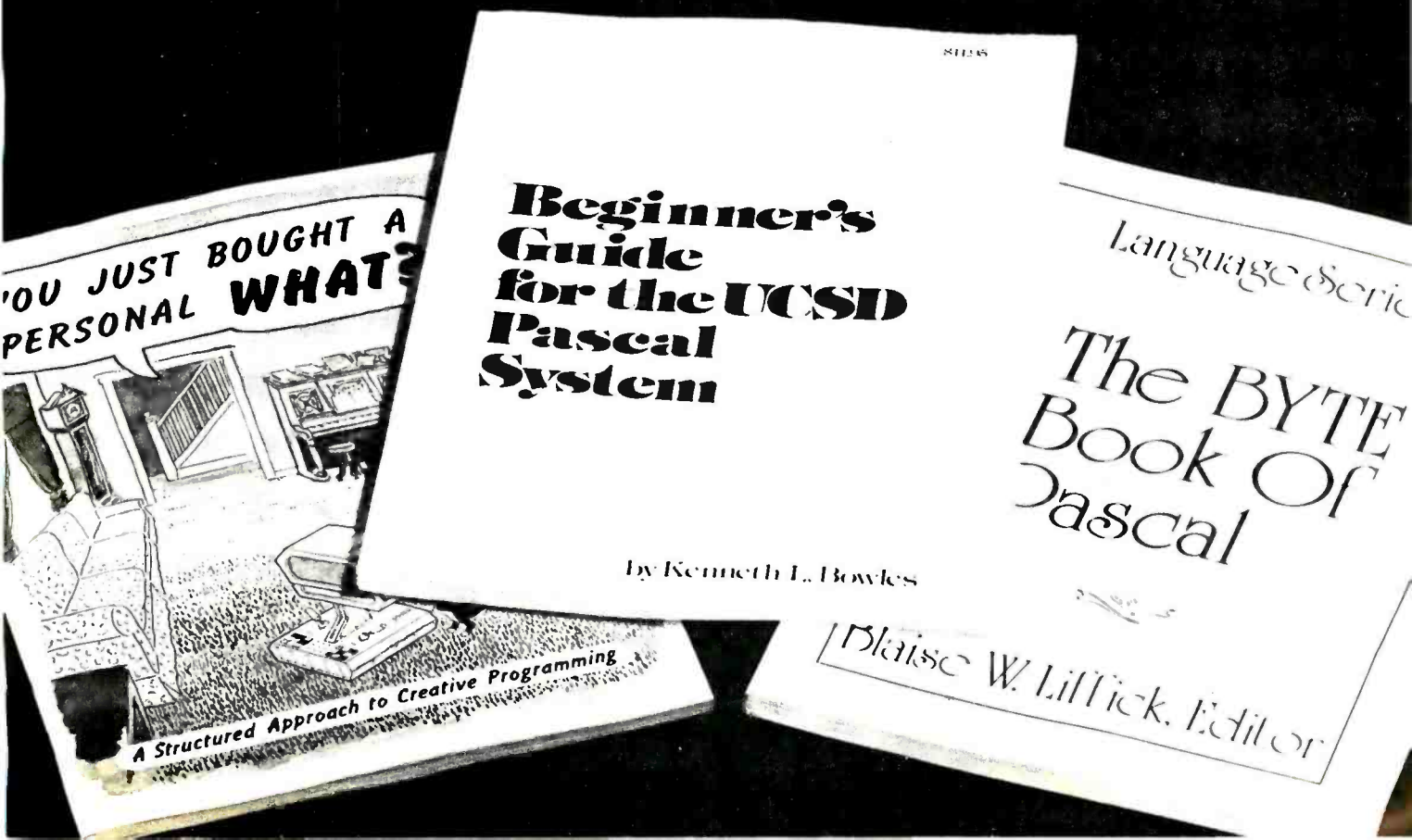

DISCOUNT PRICES

NORTH STAR
APPLE II
POLYMORPHIC
INTERACT
HAZELTINE
SOROC
CENTRONICS
MICROTEK
INTERTUBE
& Others

Call for Prices
(301) 694-8884

FREDERICK COMPUTER PRODUCTS

Municipal Airport
Frederick, MD. 21701

Circle 140 on inquiry card.

COMPUTER SUPPLIES AND ACCESSORIES

DYSAN THE CADILLAC OF THE FLOPPY DISKS AT LOW LOW PRICES

8" (BOX OF 10)

3740/1 sgl side/sgl density 4.00 ea.
3740/1D sgl side/dbl density 6.50 ea.

5" (BOX OF 5)

104/1 soft sector 4.00 ea.
107/1 10 sectors 4.00 ea.
105/1 16 sectors 4.00 ea.

For each 2 boxes of 8" or 4 boxes of 5" you get one plastic storage case, but hurry-supply is limited.

MICRO BUSINESS WORLD

15818 Hawthorne Blvd.
Dept. B12
Lawndale, CA 90260
(213) 371-1660

DEALER INQUIRIES INVITED
TERMS AVAILABLE

Circle 55 on inquiry card.

TRS SALE

ALL BRAND NEW 16K LEVEL 2
FULL WARRANTY \$699.00

ALSO:

16K MEMORY UPGRADE \$59.
TRS80 3SPEED KIT UPGRADES
TRS80 TO FAST, SLOW AND
NORMAL SPEEDS \$19.
5V-EPROM 2716 \$35.
2708 EPROMS \$7.
MICROTEK PRINTERS \$725.
SOFTWARE AND INTEGRATED
CIRCUITS(TTL'S, MOS, CMOS)
SEND FOR FREE CATALOG

DES-MAR ELECTRONICS
POST OFFICE BOX 4482
AGNEW STATION
SANTA CLARA, CA. 95054

©CALIF. ADD 6.5% TAX

Tandy Corporation

Circle 129 on inquiry card.

\$ MINI FLOPPY AT \$
\$ STORE DISCOUNT \$

SINGLE SIDED-\$225.00
DOUBLE SIDED-\$345.00

CABINETS-CABLES AND
POWER SUPPLIES ARE
ALSO AVAILABLE

INTERFACE, INC
20932 CANTARA ST
CANOGA PARK, CA 91304

(213) 341-7914

Circle 179 on inquiry card.

LOWECO DECEMBER DISCOUNTS ON TRS-80 PROGRAMS

(1) TELEPHONE/ADDRESS/MAILING — Name & zip sort. Even retrieves name from phone #. Very quick access of over 140 listings per 16K RAM.

(2) CHECKBOOK — Keep up with, or ahead of, the bank. With 45 account categories, vendor names, & easy access. Holds about 170 checks per 16K RAM.

(3) TAX AUDIT — Offers 40 dedicated tax deduction column expenses with room for 5 more of your own. Keeps track of vendors and saves pencils. 200 listings per 16K RAM.

(4) MANDALAS FOR THE CYBERNETIC AGE — WARNING: highly hypnotic graphics. 2 sets of 4 interweaving designs. \$15

All level II 16K cassettes, for December, \$20 or as noted

Loweco also carries Microsoft, TSE and TB5 for the Tandy trademark TRS-80. Our 12/31/79 "Welcome to the 80's!" mailing will be full of TRS tips, peeks and pokes. If you circle reader service number 207 or are already on our list, then you'll receive it, else you won't.

Loweco Computer
1803 Rodney
Los Angeles CA 90027
213-660-7530

Money order, cashier check speeds delivery 6% sales tax for Californians

Circle 207 on inquiry card.

ELECTRONIC CONNECTION

2708	8K (1K x 8)	450 ns	\$ 8.49
2716	Intel 16K	450 ns	\$38.49
8080A	CPU		\$ 7.99
C-2109-3			\$ 4.99
2107	MOS/RAM		\$ 3.99

SOUND/MUSIC IC SYNTHESIZER
TI-\$2.89

THE EXIDY SORCERER...

Flexibility... The Sorcerer computer gives you the flexibility of using ready-to-run, pre-packaged programs or doing your own thing and personalizing the programs for yourself.

8K RAM \$975.00
16K RAM. \$1,119.00

RESISTORS 5% CARBON FILM 1/4WATT
100 pcs—\$2.35 500 pcs—\$9.95

Minimum order \$10.00. Calif. residents add 6% sales tax. All shipped or acknowledged in 24 hours.

WESCO ELECTRONICS
831H Sierra Vista Avenue
Mountain View, Calif. 94043

Circle 386 on inquiry card.

Come Help Us Celebrate The Child

St. Jude Children's Research Hospital continues its search for life-saving knowledge about catastrophic childhood disease. And this search continues because people care. There's no charge to patients or their families, once admitted to its research studies by physician referral. The cost of drugs, equipment, and research programs is met primarily by public contributions. Help us celebrate the child by sending your tax-deductible check or request for further information to St. Jude Children's



Research Hospital,
539 Lane Ave.,
Memphis, TN 38105.

ST. JUDE CHILDREN'S RESEARCH HOSPITAL
Denny Thurman, founder

MICROLEASE!

A unique nationwide leasing program designed to facilitate the purchase and sale of computers and peripherals.

Whether you are buying or selling, **MICROLEASE** is your best leasing choice.

Excellent Rates. Fast Service by Computer Professionals.

EVERGREEN

22 Concord Avenue
Cambridge, MA 02138
(617) 868-3425

Circle 133 on inquiry card.

APPLE II® DISK SOFTWARE DATA BASE MANAGER - IFO PROGRAM

The IFO (Information File Organizer) can be used for many applications such as sales activity, inventory, check registers, balance sheets, client/patient records, billing and much more. This can be accomplished easily and quickly without prior programming knowledge.

Up to 1000 records with a maximum of 20 headers and 10 report formats can be stored on a diskette. Information can be sorted and searched (3 levels). Mathematical functions can be performed to manipulate the information. Subtotals and totals can be calculated on any numeric field.

Requires 48K and Applesoft II on ROM (or Apple II Plus). Accommodates serial/parallel printers. Error protection devices provided. Program diskette and instruction manual - \$100.
MAILING LIST PROGRAM - Print labels sorted or searched by 6 fields. On-screen editing. Line up routine. \$34.99

INVENTORY, TAX PROGRAM AND
PAYROLL DUE FOR RELEASE
IN DECEMBER.

Send check/money order to:
SOFTWARE TECHNOLOGY for
COMPUTERS (STC)
P.O. Box 428
Belmont MA 02178

Circle 362 on inquiry card.

page

Precut Wire Wrap Wire

PRECUT WIRE SAVES TIME AND COSTS LESS THAN WIRE ON SPOOLS

Kynar precut wire. All lengths are overall, including 1" strip on each end. Colors and lengths cannot be mixed for quantity pricing. All sizes listed are in stock for immediate shipment. Other lengths available. Choose from colors: Red, Blue, Yellow, Orange, Black, White, Green and Violet. One inch tubes are available at 50¢. State second choice on colors when possible.

Length	100	500	1,000	Length	100	500	1,000
2.5 inches	1.04	2.98	5.16	6.5 inches	1.60	5.37	9.84
3	1.08	3.22	5.65	7	1.66	5.63	10.37
3.5	1.13	3.46	6.14	7.5	1.73	5.89	10.91
4	1.18	3.70	6.62	8	1.78	6.15	11.44
4.5	1.23	3.95	7.12	8.5	1.82	6.41	11.97
5	1.28	4.20	7.61	9	1.87	6.76	12.51
5.5	1.32	4.48	8.10	9.5	1.92	6.93	13.04
6	1.37	4.72	8.59	10	1.99	7.26	13.57

Kit #1	\$7.95	Kit #2	\$19.95	KIT #3	\$24.95	Kit #4	\$44.95	#30 Spools
Less than 2.7¢/ft. (#30)		Less than 2¢/ft. (#30)		Less than 1.7¢/ft. (#30)		Less than 1.6¢/ft. (#30)		1-4 5-9 10+
250 3"	100 4"	250 2½"	250 5"	500 2½"	500 4½"	1000 2½"	1000 4½"	50 ft. 1.75 1.60 1.40
250 3"	100 5"	500 3"	100 5½"	500 3"	500 5"	1000 3"	1000 5"	100 ft. 3.00 2.75 2.50
100 4"	100 6"	500 3½"	250 6"	500 3½"	500 5½"	1000 3½"	1000 5"	250 ft. 4.75 4.50 4.25
		500 4"	100 6½"	500 4"	500 6"	1000 4"	1000 6"	500 ft. 8.50 8.00 7.50
		250 4½"	100 7"					1000 ft. 14.50 12.50 10.50

Wire Wrap Tool

BATTERY HOBBY TOOL*

- Auto Indexing
- Anti-Overwrapping
- Modified Wrap

BW2630	Tool	\$19.85
BT30	#30 Bit	3.95
BT2628	#26 Bit	7.95
BC1	Batteries & Charger...	11.00

*Requires 2 "C" Nicad Batteries



DECEMBER SALES!

Solderless Breadboarding

SK10 2/\$25.00 ~~\$16.60~~

The SK10's unique matrix configuration is embedded in a high temperature plastic molding. It gives you 64 pairs of 5 common spring contacts for principle circuit construction and a series of common buss strips (8) of 25 connections each.

Dimensions: .33"h x 2.2"w x 6.5"l

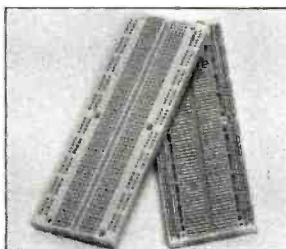

TI Edge Card Connectors

44 pin ST	(.156" centers)	Gold	1.95
100 pin ST	(.125" centers)	Gold	2.50
100 pin WW	(.125" centers)	Gold	2.95

All are Gold 100 pin, IMSA1 spacing.

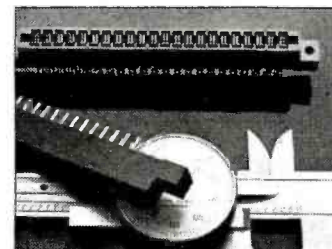

RNIC Sockets

RN HIGH RELIABILITY eliminates trouble. "Side-wipe" contacts make 100% greater surface contact with the wide, flat sides of your IC leads for positive electrical connections.

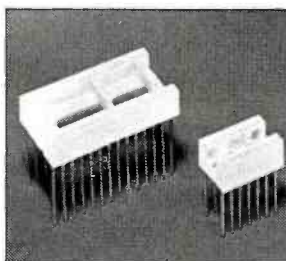

WIRE WRAP SOCKETS	Size	Quant./Tube	Price Ea.	Price/Tube
3-level Gold	08 pin WW	52	.31	\$16.12
Closed Entry Design	14 pin	60	.32	\$19.20
	16 pin	52	.34	\$17.68
All prices include Gold	18 pin	23	.50	\$11.50
	20 pin	21	.65	\$13.65
	22 pin	19	.70	\$13.30
Sockets sold at these prices by the tube only.	24 pin	10	.70	\$7.00
	28 pin	10	.95	\$9.50
	40 pin	7	1.20	\$8.40

ORDERING INFORMATION

- Orders under \$25, add \$2 handling
- Blue Label or First Class, add \$1 (up to 3 lbs.)
- CODs, VISA & MC orders will be charged shipping
- Most orders shipped next day

AVAILABLE AT SELECTED LOCAL DISTRIBUTORS

page

135 E. Chestnut Street 5A, Monrovia, California 91016 Phone (213) 357-5005

save TRS-80

on add-on products for.....

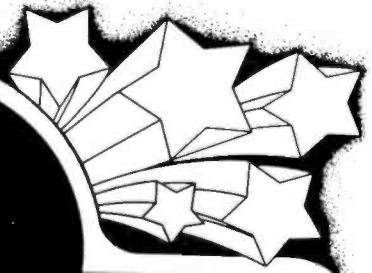

SUPER DISK

\$695

TF-7D Micropolis Largest capacity mini floppy, up to 195 Kbytes on 77 tracks with 77TKDOS+

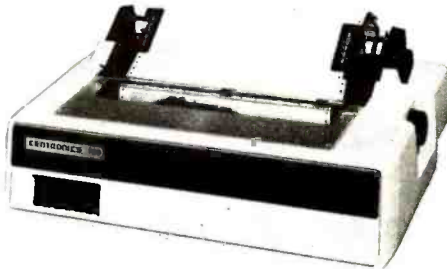

PRINTERS

- LP779 Centronics 779 w/tractors \$1099
- LP700 Centronics 700 \$1495
- LP701 Centronics 701 \$1759
- NEC Spinwriter \$2499
- LP702 Centronics 702 \$1899
- DP8000 Anadex Printer \$ 990
- LP1 Centronics P1 \$ 399
- Centronics cables \$ 39

SOFTWARE

Improve TRS-80 Performance With
NEW DOS+

- Over 200 modifications, corrections and enhancements to TRS DOS. Includes utilities. Available in two versions.
- 35 Track Version \$ 99
 - 40 Track Version \$110
 - Accounts Receivable \$ 39
 - Inventory Control \$ 39
 - Electric Pencil \$150
 - Job Entry/Status \$75
 - General Ledger \$79
 - Game Diskette \$19
 - AJA Word Processor \$75
 - Radix \$99

SEND FOR FREE CATALOG

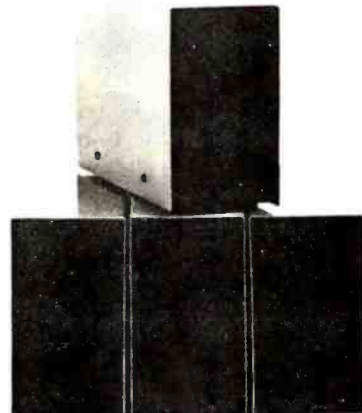

Choose From A Complete Family Of DISK DRIVES...IN STOCK

ALL DISK DRIVE SYSTEMS COME COMPLETE WITH POWER SUPPLY AND CHASSIS.

- TF-1 Pertec FD200, 5 1/4", 40 track use both sides \$382
- TF-3 Shugart SA400, 5 1/4", 35 tracks same as tandy \$389
- TF-5 MPI 5 1/4", 40 track door lock and auto diskette ejection \$379
- TDH-1 Pertec dual head 35 track same capacity as 2 drives..... \$499
- Four Drive Cable..... \$35. Two Drive Cable \$25.

220 volt versions available.

ALL PRICES CASH DISCOUNTED • FREIGHT FOB/FACTORY

NEW PRODUCTS

- Small System RS232 Interface \$ 49.00
- Expansion Interface w/32K \$499.00
- AC Line Interference Eliminator \$ 18.95
- AC Isolator (6 connectors) \$ 45.95
- Telephone Interface \$179.95
- Verbatim 5" soft sector Diskettes \$ 3.39
- 16KM 16K RAM Kit Computer \$ 82.00
- 16 Key Pad Kit \$ 68.00

ADD-ON DISK DRIVES

DOES NOT INCLUDE POWER SUPPLY OR CHASSIS

- Pertec FD200 \$282.00
- Shugart SA400 (unused) \$286.00
- Pertec FD250 (Dual Head) \$399.00
- MPI B-51 \$349.00
- MP B-52 (Dual Head) \$349.00



**MICROCOMPUTER
TECHNOLOGY
INCORPORATED**

2080 South Grand Ave.
Santa Ana, CA 92705
(714) 979-9923

VISA



6000 E. Evans Ave., Bldg. 2
Denver, CO 80222
(303) 758-7275

Apparat, Inc.

FREE! UP TO \$170 IN MERCHANDISE WITH THE PURCHASE OF ONE OF THE FOLLOWING PET-CBM ITEMS!!



PET SPECIALS

PET 16N 16K full size graphics keyboard	\$ 995	\$130
PET 16B 16K full size business keyboard	\$ 995	\$130
PET 32N 32K full size graphics keyboard	\$1295	\$170
PET 32B 32K full size business keyboard	\$1295	\$170
PET 8K 8K full size graphics keyboard	\$ 795	\$100
PET 2040 Dual Disk Drive - 343,000 bytes	\$1295	\$170
PET 2022 Tractor Feed Printer	\$ 995	\$130
PET 2023 Pressure Feed Printer	\$ 849	\$110
PET C2N External Cassette Deck	\$ 95	\$ 12
Used 8K PETs (limited quantities)	\$ 495	

*Amount of Free Merchandise with Purchase of PET-CBM Item.

***FREE**

KIM-1 \$159 (Add \$30 for Power Supply) SYM-1	\$209
BAS-1 Microsoft ROM Basic for SYM	\$ 85
Memory Plus	\$195
SYM Assembler in ROM	\$ 85
SEA-16 New 16K Static RAM	\$325
Seawell Motherboard-4K RAM	\$139
KTM-2 Synertek Video Board	\$290
S-100 16K Static RAM kit SALE	\$219
2716 EPROM (5 volt)	\$ 39
6550 RAM (for 8K PET)	\$12.70
6502 \$9.75	
6522 \$9.25	
6520 \$5.50	
2114 L 450ns \$5.35 24 @ \$4.95 100 @ \$4.45	

Axiom EX-801 PET Printer (with graphics)	\$ 475.00
Axiom EX-820 PET Plotter	\$ 749.00
Anderson Jacobson 841 Selectric RS232 Parallel	\$1095.00
Leedex Video 100 12" Monitor	\$ 119.00
Heath WH19 Terminal (factory asm.)	\$ 770.00
Heath WH14 Printer (factory asm.)	\$ 735.00
IEEE - RS 232 Printer Adaptor for PET	\$ 79.50
BETSI PET to S-100 Interface & Motherboard	\$ 119.00
PET Connectors-Parallel or IEEE	\$ 1.95
Cassette Port	\$ 1.45
Hands on Basic with a PET	\$ 9.45
Programming the 6502 (Zaks)	\$ 9.45
6502 Applications Book (Zaks)	\$10.90
6500 Manuals (MOS Technology)	\$ 6.50
Programming a Microcomputer: 6502	\$ 8.45
6502 Assembly Language (Osborne) NEW!	\$ 8.10

FREE!
UP TO \$170 IN MERCHANDISE

A B Computers

115 E. Stump Road
Montgomeryville, PA 18936
(215) 699-8386

WRITE FOR COMPLETE CATALOG

Add \$1.00 per order for shipping.
We pay balance of UPS surface charges on all prepaid orders.

3M "Scotch" 8" disks	10/\$31.00
3M "Scotch" 5" diskettes	10/\$31.50
Verbatim 5" diskettes	10/\$26.50
Diskette Storage Pages	10/\$3.95

(Write for quantity prices)

TIS PET Workbooks	6/21.50
Protect-A-Pet dust cover	\$ 9.50
Programmers Toolkit - PET ROM Utilities	\$ 45.00
Sargon II NEW! (TRS-80 or Apple)	\$ 24.90
Microchess for PET (Peter Jennings)	\$ 17.90
PET 4 Voice Music Board	\$ 29.00
4 Voice Music Monitor for PET	\$ 15.90
CmC Word Processor program for PET	\$ 25.00
Adventures by Scott Adams	15% off
7 Adventures for TRS-80 - 2 Adventures for PET	
Tunnel Vision/Kat & Mouse-maze - PET (great)	\$ 7.95
Personal Software programs	15% off
Hayden Books and Software	15% off
Osborne Books and Software	15% off
Word Processor for PET - Machine Language version.	
Auto scroll, insert, delete, form letter append, etc.	
8K version \$24.00 16K or 32K with disk	\$ 89.00

Cassettes (all tapes guaranteed) AGFA PE611

Premium quality, high out put lownoise in 5 screw housing with labels:

C-10	10/5.95	50/25.00	100/48.00
C-30	10/7.00	50/30.00	100/57.00

GREAT PET SOFTWARE

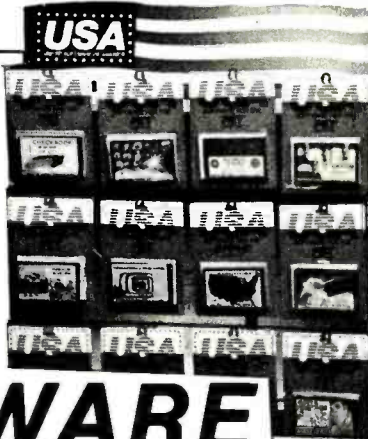

"Precise, humanized, well documented an excellent value" are the applauds now being given to United Software's line of software. These are sophisticated programs designed to meet the most stringent needs of individuals and business professionals. Every package is fully documented and includes easy to understand operator instructions.

DATABASE MANAGEMENT SYSTEM - A comprehensive, interactive system like those run on mainframes! Six modules comprising 42K of programming allow you to: create, edit, delete, display, print, sort, merge, etc., etc. - databases of up to 10,000 records. Printer routines automatically generate reports and labels on demand. 60 pages of concise documentation are included. Requirements - 16-32K PET and 2040 Dual Disk (printer optional). . . .Cost \$125

ACCOUNTS RECEIVABLE/PAYABLE - A complete, yet simple to use accounting system designed with the small businessman in mind. The United Software system generates and tracks purchase orders and invoices all the way through posting "controlled" accounts payable and accounts receivable subsystems. Keyed Random Access file methods makes data access almost

instantaneous. The low-cost solution for the first time computer user with up to 500 active accounts. Requirements - 32K PET, Dual Disk, any 80-column printer. . . .Cost \$175

CASH RECEIPTS & DISBURSEMENTS - Makes it a breeze to track all outgoing payments made by any type of business operation. Checks are tracked by number and categorized by type of expense. Sorting, summary, and audit trails make it easy to post to general ledger. This system also categorizes incoming receipts. Uses KRAM file access method. Requirements - 32K PET, Dual Disk (printer optional). . . .Cost \$99.95

KRAM - Keyed Random Access Method - The new, ultra-fast access method for the PET Disk, provides keyed retrieval/storage of data, in either direct or sequential mode, by either full or partial key values. Written by United Software in 6502 machine code, and designed with the PET in mind, it exploits all the benefits of the PET Disk, allowing full optimization of your system. Eliminates the need for "Sort" routines! KRAM provides flexibility never seen on a micro before. KRAM is modeled after a very powerful access method used on large-scale IBM Virtual Storage mainframes. So "KRAM" all you can into your PET - it will love you for it. . . .Cost \$79.95

(Sublicenses available to software houses.)

PROGRAMS FOR ENTERTAINMENT	Super Startrek 14.95
Space Intruders	PET Music Box 29.95
("Best Game of 1979") . . \$19.95	
Jury/Hostage 12.50	
Kentucky Derby/Roulette 9.95	UNITED SOFTWARE PROGRAMS FOR BUSINESS
Alien I.Q./Tank 9.95	Checkbook \$15.95
Tunnelvision/Maze Chase 14.95	Mortgage 15.95
Submarine Attack 9.95	Finance 12.95
Battle of Midway 7.95	Bonds 12.95
Laser Tank Battle 9.95	Stock Analyzer 22.95
Swarm 14.95	Stock Options 24.95
	6502 Macro Assembler . . . 49.95

Look for the RED-WHITE-BLUE United Software Display at your local computer dealer, or send check or moneyorder, plus \$1.00 shipping to:

UNITED SOFTWARE OF AMERICA
750 Third Ave.
New York, N.Y. 10017
Dealer inquiries invited

HARD DISK.... Back-Up

Winchester disk technology brings a new generation of lo-cost, hi-capacity multi-megabyte fixed storage to mini and micro-computer systems. And a new set of problems...how to back up valuable data. Saving a 10 Mbyte hard disk on floppy disks can require 10-20 floppies and can take an hour or more.

Our Back-Up software solves the problem...with Alloy Engineerings DEI cartridge tape system. Compared to floppy disks, the cartridge tape system typically saves 75% of the time and saves 75% of the media cost. And without the confusion of filing 10-20 disks.

Cartridge tapes excell even with fixed/removable disks and cartridge disks. Media costs for cartridge tapes are typically only one-quarter the cost of removable disk modules. And cartridge tapes require only about 10% of the space of removable disk packs/cartridges.

Put your valuable data on-line with a hard disk...save it off-line with an Alloy/DEI cartridge tape system. And save time, money, space, confusion and aggravation.

The hardware is £-100, and Back-Up is compatible with CP/M, CDOS, IMDOS, & PDOS. Contact us for details.
DEALER INQUIRES INVITED

CP/M is a TM of Digital Research
CDOS is a TM of Cromemco Inc
IMDOS is a TM of IMSAI Mfg

PDOS is a product of Pheonix Software Associates Ltd.
Back-Up is a product of CSSN

CSSN

COMPUTER SERVICE SYSTEMS NETWORK

120 BOYLSTON STREET • FOURTH FLOOR • BOSTON, MASSACHUSETTS 02116 • (617) 482-2343

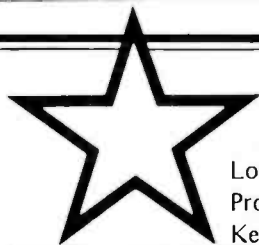

SORCERER

Serial and Parallel Port, Upper and Lower Case, Graphics Character Set, Programmable Characters. Numeric Keypad. 16K memory. \$849.95

OHIO SCIENTIFIC

C1P— 6502-chip based micro with 4K memory . . .349.00
8K Socketed memory expansion board, plugs into the C1P. With 4K of memory installed110.00
Same 8K board, with 8K of memory installed.160.00

PRINTERS

Centronics 730 899.98
COMprint 200 479.95
NEC Spinwriter 5510T. 2599.95
NEC Spinwriter 5520T. 2799.95
Paper Tiger IDS 440 1099.95
Paper Tiger w/o Graphics 899.95

ATARI

Atari 800. 949.95
Atari 400. 499.95

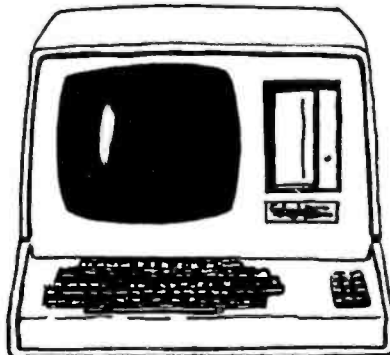

HEATH

H89 Computer, with single 5" disc drive, numeric keypad 1999.95
HDOS 69.95
Device Drivers (Manual) 19.95
CP/M (H89) 149.95
CBasic (for H89) 99.95
MicroSoft Basic (for H89) 99.95

Heath 11A System and Software
call or write for prices

OTHER COMPUTER STUFF

Scotch 5" Disks 45.00/10 And write about—
CAT Coupler 195.00 JimPak Electronics Parts
16K Dynamic RAM 79.95 OK Wire Wrap Parts
★★★ All prices plus shipping. Call or write ★★★
★ about big stuff or special deals ★

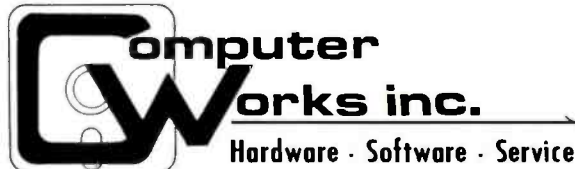

124 E. Beaufort, Normal, IL 61761 (309) 452-4424

		11542-1 Knott St. Garden Grove, CA 92641 (800) 854-6411 (714) 891-2663		SHUGART	TRS-80
MICROBYTE 16K RAM BOARD <ul style="list-style-type: none"> FULLY S-100 COMPATIBLE USES LOW POWER MM5257 4K x 1 STATIC RAMS 2MHZ OR 4MHZ OPERATION 4K BANK ADDRESSABLE EXTENDED MEMORY MANAGEMENT NO DMA RESTRICTIONS ASSEMBLED & TESTED 2MHZ \$280.00 4MHZ \$300.00		4116's (250NS) FOR APPLE OR TRS-80 8 for 64.00 16 for 120.00 FULLY GUARANTEED		SA800 DISK DRIVE INSTALLED IN DUAL CABINET W/PWR SUPPLY. ASSEMBLED & TESTED (1) DRIVE INSTALLED \$695.00 (2) DRIVES INSTALLED \$1125.00	FLOPPY DISK DRIVE WITH CABINET & POWER SUPPLY, COMPATIBLE WITH RADIO SHACK INTERFACE. ASSEMBLED & TESTED. 1 YR. WARRANTY. \$425.00 INTERFACE CABLES (\$35.00)
MICROBYTE 32K RAM BOARD <ul style="list-style-type: none"> FULLY S-100 COMPATIBLE USES LOW POWER MM5257 4K x 1 STATIC RAM 2MHZ OR 4MHZ OPERATION 4K BANK ADDRESSABLE EXTENDED MEMORY MGMT. ON BOARD 8-BIT OUTPUT PORT NO DMA RESTRICTIONS ASSEMBLED & TESTED 2MHZ \$580.00 4MHZ \$595.00		SPECIAL •1@12VOLTS CERAMIC CAPS 10¢ each OR 100/\$9.00	2708's LOW POWER 450 NANO SEC. \$8.25 each OR 8 for \$64.00	18-PIN LOW-PROFILE SOCKETS 17¢ ea.	CABLE ASSEMBLY (2) 50 PIN CARD-EDGE CONNECTORS ON 4 FT. RIBBON CABLE \$15.00 ea. REGULATORS 320T-575 340T-565 320T-1275 340T-1265
ORDERING INFORMATION NAME, ADDRESS, PHONE SHIP BY: UPS OR MAIL SHIPPING: ADD \$2.50 UP TO (5) LBS. CREDIT CARDS CHARGED APPROPRIATE FRT.		TERMS WE ACCEPT CASH, CHECK MONEY ORDERS, VISA & MASTER CHARGE CARDS. (U.S. FUNDS ONLY) TAX: 6% FOR CALIF. RESIDENTS ONLY.		8251 TESTED @ 4 MHZ U-ART \$4.50 ea	2716's 5 VOLT ONLY LOW PWR 450 NS. \$35.00 ea.
				IMSAI CONN. 100 PIN • SOLDER TAIL \$3.00 each OR 10 for \$2.60 ea. 74 L\$ 244 \$3.00 each	

EXCITING MAIL ORDER DISCOUNTS

 <p>NOVATION CAT ACOUSTIC MODEM</p> <ul style="list-style-type: none"> ANSWER, ORIGINATE 300 BAUD BELL 103 LOW PROFILE DESIGN <p>\$179.00</p>	<p>PORTABLE MINISCOPES LOW POWER CONSUMPTION</p> <p>MS-15 SINGLE TRACE 15 MHz \$289 MS-215 DUAL TRACE 15 MHz \$389 MS-230 DUAL TRACE 30 MHz \$519</p>  <p>2.9" HIGH 6.4" WIDE 8.5" DEEP</p>										
 <p>Apple II 16k OR APPLE II PLUS \$975</p> <p>APPLE II 32K *1050 APPLE II 48K *1125</p> <p>•COLOR •GRAPHICS •SOUND •APPLE II ACCESSORIES•</p> <p>APPLE SOFT BASIC CARD.....\$155 DC HAYES MICROMODEM.....\$335 ALF MUSIC SYNTHESIZER.....\$240 CORVUS 10 MEGABYTE DRIVE \$4,650</p> <p>APPLE DISK II.....\$440 WITH CONTROLLER CARD....\$495 PASCAL LANGUAGE SYSTEM...\$450 INTEGER BASIC CARD.....\$155</p>	<p>SOROC IQ 120</p> <ul style="list-style-type: none"> SERIAL RS 232C FULL ASCH II UPPER/LOWER CASE NUMERIC KEYPAD CURSER KEYS SCREEN CONTROL & PROTECTED FIELDS <p>\$775.00</p> <p>•ALSO AVAILABLE• SOROC IQ 140 \$1,225.00</p> 										
<p>SD EXPANDORAM</p> <table border="0"> <tr> <td>*64K S-100 DYNAMIC RAM BOARD</td> <td>WITHOUT MEMORY.....\$149.00</td> </tr> <tr> <td>*WORKS WITH Z-80, 8080 & 8085</td> <td>16K KIT.....215.00</td> </tr> <tr> <td>*POWER CONSUMPTION 5 WATTS</td> <td>32K KIT.....269.00</td> </tr> <tr> <td>*BANK SELECT • PHANTOM REFRESH</td> <td>48K KIT.....349.00</td> </tr> <tr> <td>*NO WAIT STATES REQUIRED</td> <td>64K KIT.....409.00</td> </tr> </table> <p>ADD \$50 FOR ASSEMBLED & TESTED</p>	*64K S-100 DYNAMIC RAM BOARD	WITHOUT MEMORY.....\$149.00	*WORKS WITH Z-80, 8080 & 8085	16K KIT.....215.00	*POWER CONSUMPTION 5 WATTS	32K KIT.....269.00	*BANK SELECT • PHANTOM REFRESH	48K KIT.....349.00	*NO WAIT STATES REQUIRED	64K KIT.....409.00	<p>LEEDEX VIDEO 100</p> <p>12" BLACK & WHITE MONITOR •VIDEO BANDWIDTH 12 MHz±3db •COMPOSITE VIDEO INPUT</p> <p>\$129.00</p> <p>• TO ORDER •</p>   <p>Phone orders invited, using credit cards. Or send personal check or money order. Add 1% for packing and handling. California resident add 6% sales tax. All equipment is shipped freight collect in factory carton with manufacturers warranty. All equipment subject to availability and price change without notice.</p>
*64K S-100 DYNAMIC RAM BOARD	WITHOUT MEMORY.....\$149.00										
*WORKS WITH Z-80, 8080 & 8085	16K KIT.....215.00										
*POWER CONSUMPTION 5 WATTS	32K KIT.....269.00										
*BANK SELECT • PHANTOM REFRESH	48K KIT.....349.00										
*NO WAIT STATES REQUIRED	64K KIT.....409.00										

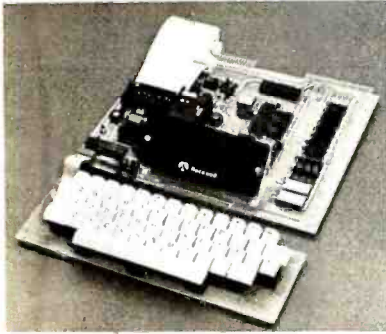

AIM 65

AIM 65 is fully assembled, tested and warranted. With the addition of a low cost, readily available power supply, it's ready to start working for you. It has an addressing capability up to 65K bytes, and comes with a user-dedicated 1K or 4K RAM.

- Thermal Printer
- Full-Size Alphanumeric Keyboard
- True Alphanumeric Display
- Proven R6500 Microcomputer System Devices
- Built-In Expansion Capability
- TTY and Audio Cassette Interfaces
- ROM Resident Advanced Interactive Monitor
- Advanced Interactive Monitor Commands

PRICE: \$375.00 (1K RAM)

Plus \$4.00 UPS (shipped in U.S. must give street address), \$10 parcel post to APO's, FPO's, Alaska, Hawaii, Canada, \$25 air mail to all other countries

We manufacture a complete line of high quality expansion boards. Use reader service card to be added to our mailing list, or U.S. residents send \$1.00 (International send \$3.00 U.S.) for airmail delivery of our complete catalog.

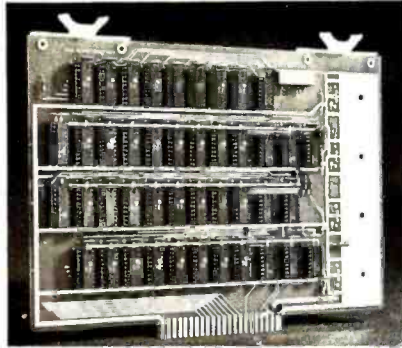

VAK-4 16K STATIC RAM BOARD

- Designed specifically for use with the AIM-65, SYM-1, and KIM-1 microcomputers
- Two separately addressable 8K-blocks with write protect.
- Designed for use with the VAK-1 or KIM-4* motherboards
- Has provisions for mounting regulators for use with an unregulated power supply
- Made with 1st quality 2114 static ram chips
- All IC's are socketed
- Completely assembled, burned-in, and tested

We manufacture a complete line of high quality expansion boards. Use reader service card to be added to our mailing list, or U.S. residents send \$1.00 (International send \$3.00 U.S.) for airmail delivery of our complete catalog.

**Product of MOS Technology*

VAK-4 DUAL 8K-RAM \$379.00
VAK-2 8K-RAM (1/2 populated) \$239.00



2967 W. Fairmount Avenue • Phoenix, AZ 85017 • (602) 265-7564

UP TO 25% OFF

YOUR OWN TRS-80 SYSTEM AT TREMENDOUS SAVINGS

① TRS-80 Complete System

Includes: CPU/Keyboard, Power Supply, Video Monitor, Cassette Recorder, Manual, and Game Cassette.

② Line Printer

③ Mini Disk System

④ C-10 Cassettes

⑤ Verbatim Diskettes



DISK DRIVES IN STOCK!

ITEM	REG. PRICE	OUR PRICE
Level II—4k	\$619.00	\$575.70
Level II—16k	\$849.00	\$789.60
Expansion Interface	\$299.00	\$278.00
Mini Disk Drive	\$ 495.00	\$ 385.00
Centronics 779 Printer	\$1599.00	\$1175.00
Centronics 101 Printer	\$1595.00	\$1400.00
Anadex DP-8000 Printer	\$1295.00	\$ 995.00
Memory Kit (16K) FREE INSTALLATION	\$ 149.00	\$ 98.00
Verbatim Diskettes ea.	\$ 5.95	\$ 4.95
3	\$ 17.89	\$ 12.00
10	\$ 59.00	\$ 37.00
C-10 Cassettes	\$ 4.95	\$ 4.50
25	\$ 24.75	\$ 18.75
Paper (9 1/2" x 11" fanfold, 3500 sheets)	\$ 35.00	\$ 29.95

MINI DISK DRIVES NOW \$385

Over \$100 less than Radio Shack's!



There are new developments every day—write or call for the latest information.

Centronics 730 \$850.00
Same as Line Printer II

TRS-80 MODEL II \$3208.50

- 32K RAM
- 1/2 MEG DISK
- ADDITIONAL 32K RAM \$ 418.50
- ADDITIONAL DISK DRIVE (1ST) \$1069.50
- ADDITIONAL DISK DRIVE (2ND + 3RD) \$ 558.00

VRData corp
777 Henderson Boulevard N-6
Folcroft Industrial Park
Folcroft PA 19032
(215) 461-5300



TOLL FREE
1-(800) 345-8102 *Orders only!

FOREIGN and DOMESTIC DISTRIBUTORSHIPS AVAILABLE . . .

WE WILL NOT BE UNDERSOLD

16K MEMORY UPGRADE KITS

- 300 NS for TRS-80* **\$69.00**
- 250 NS for TRS-80*, Apple II, Sorcerer (specify) **\$75.00**
- 200 NS for TRS-80*, Apple II, Sorcerer (specify) **\$99.00**

All kits complete with jumpers and instructions.
90 DAY WARRANTY

LETTER QUALITY HIGH SPEED PRINTER

NEC Spinwriter
\$2679.00



Includes TRS-80* interface software, quick change print fonts, 55 cps, bidirectional, high resolution plotting, graphing, proportional spacing. 90 DAY WARRANTY.

Complete inventory:

TRS-80* Apple PET TI

Most Radio Shack software available at discount. Call for special Christmas Prices.

DISK OPERATING SYSTEMS

- Radio Shack DOS 2.2—No key bounce **\$14.95**
- NEWDOS by Apparat+—No key bounce **\$49.95**
- NEWDOS "PLUS" by Apparat+ **\$99.95**

NEWDOS plus the following functions: enhanced DIRCHECK command, improved EDITOR, ASSEMBLER, DISASSEMBLER, SUPERZAP. Machine language RELOCATOR, LEVEL I on disk. Numerous enhancements to TRSDOS 2.1

- DOS 3.0 by the original author of 2.1 **\$49.95**
- MICRODOS by Percom Data **\$29.95**

User-modifiable, comprehensive operating system written in BASIC.

- PATCH PAK #1 by Percom Data **\$9.95**

Patches and enhances TRSDOS for 40 and 77-track drives.

TRS-80* COMPATIBLE HARDWARE

DISK DRIVES

More capacity than Radio Shack 35 track (80K Bytes) drives. Fully assembled and tested. Ready to plug-in and run the moment you receive it. Can be intermixed with each other and Radio Shack drive on same cable. TRS-80* compatible silver enclosure. 90 DAY WARRANTY.

- CCI-100 40 Track (102K Bytes) **\$324.00**
- CCI-200 77 Track (197K Bytes) **\$594.00**
- 2 Drive Cable **\$25.00**
- 4 Drive Cable **\$35.00**

PRINTERS

- 779 CENTRONICS TRACTOR FEED PRINTER **\$995.00**

Same as Radio Shack line printer

- 701 CENTRONICS TRACTOR FEED PRINTER **\$1499.00**

2½ times faster than line printer, full 132 characters, carriage bell tone.

- P1 CENTRONICS PRINTER **\$349.00**

Same as Radio Shack quick printer.

- CENTRONICS CABLE for TRS-80* **\$39.00**

For use with above printers.

- PAPERTIGER (IP440) Up to 198 cps **\$ 994.00**
- With 2K Buffer and Graphics **\$1189.00**

- HIPILOT DIGITAL PLOTTER by Houston Instrument **\$ 995.00**

X-Y Plotter, RS-232-C or Parallel Interface.

7" x 10" plot size. Multi-colored pens included.

TRS-80* COMPLETE SYSTEMS

- TRS-80* LEVEL II-4K reg. \$540.00 **\$494.00**
- TRS-80* LEVEL II-16K with 10 key keypad reg. \$779.00 **\$679.00**
- TRS-80* Expansion Interface **\$254.00**
- TRS-80* RS-232-C Interface **\$84.00**

MISCELLANEOUS

- TRS-232 by SMALL SYSTEMS SOFTWARE RS-232-C or Teletype Current Loop output from cassette port. **\$49.00**

- CAT MODEM **\$169.00**

Originate and answer same as Radio Shack Telephone Interface II.

DISKETTE TRS-80* BUSINESS SOFTWARE BY SBSG

Free enhancements and upgrades to registered owners for the cost of media and mailing. 30 day free telephone support from vendor. User references supplied upon request.

Fully Interactive Accounting Package: Requires 2,3, or 4 drives. Includes General Ledger, Accounts Payable, Accounts Receivable, and Payroll. Report generating. Well documented and fully tested by accountants.

- Complete package (Requires 3 or 4 drives) **\$389.00**
- Individual Modules (Require 2 or 3 drives) **\$99.00**

Inventory II: Requires 2 or 3 drives. Handles up to 1000 items per disk drive. Reports include complete activity, inventory, listing, and minimum quantity search. **\$95.00**

Mailing List Name & Address II System: Requires 2 drives. Use with Electric Pencil files for automatic insertion of name, address and greetings in letters. Has ability to print envelopes. Menu driven. Includes enter, delete, update, search, extract, merge and print. Up to 1250 names per diskette. Will sort up to 600 names in 7 minutes. 40 page manual. Zip code sort is excellent for bulk mail applications. **\$129.00**

Intelligent Terminal System ST-80 III: Enables a TRS-80* to act as a dial-up terminal on any standard time sharing network. Provides a TRS-80* with control key, ESC Key, Repeat Key, Rub Out Key, Break Key, full upper and lower case support, selectable printer output and program selectable transmission rates. **\$150.00**

Note: SBSG maintains a time-sharing computer where you can dial-up and leave your problems, 24 hours, 7 days a week.

Word Processing System: The Electric Pencil from Michael Shrayer. **Cassette \$99.00 Diskette \$150.00**

File Management System: For specialized storage needs. Sorts files in ascending or descending order on 3 separate fields. Scannable. Some applications have been fixed assets, phone numbers, names, slides, albums. Selectively totals numeric and dollar fields. Display and print capability. **\$49.00**

- Budget Control Program II by CSA** **\$49.95**

Monthly and annual budget versus actual by department.

- Cash Register System II by CSA** **\$99.00**

Tracks sales for direct entry into inventory control system and generates sales slips.

The CPU SHOP

TO ORDER CALL TOLL FREE 1-800-343-6522

Massachusetts residents call 617/242-3350

For detailed technical information, call 617/242-3350

Hours: 10 AM - 6 PM (EST) Monday - Saturday

TRS-80 is a Tandy Corporation Trademark † Requires Radio Shack TRSDOS

39 Pleasant Street, Dept. B-12
Charlestown, Massachusetts 02129

Freight collect, F.O.B.
Charlestown

Massachusetts residents add
5% sales tax

Dealer Inquiries Invited



Memory War Shop and Compare

SPECIAL

HICKOK LX303

~~\$74.95~~
\$69.95*

before X-mas

RS232 & "D" TYPE CONNECTORS*

P = Plug-Male S = Socket-Female C = Cover-Hood

PART NO.	DESCRIPTION	PRICE
DE-9P	9 Pin Female	1.4 5.9 10.24
DE-9C	9 Pin Cover	1.50 1.30 1.15
DA15P	15 Pin Male	2.20 2.00 1.80
DA15S	15 Pin Female	3.20 3.00 2.80
DA15C	15 Pin Cover	1.60 1.45 1.30
DB-25P	25 Pin Male	2.90 2.60 2.50
DB-25S	25 Pin Female	3.75 3.65 3.40
DB5121-1	1 pc. Gray Hood	1.65 1.40 1.20
DB1226-1A	2 pc. Black Hood	2.20 1.80 1.50
DB1109S-3	2 pc. Gray Hood	1.60 1.55 1.35
OC37P	37 Pin Male	3.95 3.80 3.60
OC37S	37 Pin Female	5.75 5.50 5.20
DC37C	37 Pin Cover	2.20 1.95 1.75
DD50P	50 Pin Male	4.95 4.75 4.50
DD50S	50 Pin Female	7.50 7.20 6.90
DD50C	50 Pin Cover	2.50 2.20 2.10
D20416 S	Hardware Set (2 pair)	1.00 80 .70

Connect for CENTRONICS 700 SERIES:
Amphenol 57-30360 for back of Centronics 700 Series printers
1-4-\$9.00 5-ur-\$7.50

3 LEVEL GOLD WIRE WRAP SOCKETS*

Sockets purchased in multiples of 50 per type may be combined for best price.

	1-9	10-24	25-99	100-249	250-999
8 pin	.40	.36	.34	.31	.27
14 pin	.44	.43	.41	.39	.37
16 pin	.55	.47	.45	.41	.39
18 pin	.70	.60	.55	.50	.45
20 pin	.90	.80	.75	.65	.62
22 pin	.95	.85	.80	.70	.65
24 pin	.95	.85	.80	.70	.65
28 pin	1.25	1.15	1.00	.95	.90
40 pin	1.65	1.45	1.35	1.20	1.10

All sockets are GOLD 3 level closed entry. 2 level Tall Low Profile. Tin Sockets and Dip Plugs available. CALL FOR QUOTATION.

SALE S-100 BUS EDGE CONNECTORS • SALE

S100-WWG 50/100 Cont. 125 ctrs. 3 LEVEL WIRE WRAP 025" sq. posts on 250 spaced rows. GOLD PLATED	1-4	5-9	10-24	25-99	100-249	250-999
	\$4.75	\$4.00	\$3.75	\$3.40	\$3.50	\$3.50

S100SE 50/100 Cont. 125 ctrs. PIERCED SOLDER EYELET TAILS GOLD	1-4	5-9	10-24	25-99	100-249	250-999
	\$5.00	\$4.50	\$4.00	\$3.75	\$3.50	\$3.50

Other Popular Edge Connectors

D2244-SWW 22/44 Cont. 156 ctrs. WIRE WRAP Tails GOLD.	1-4	5-9	10-24	25-99	100-249	250-999
	\$3.95	\$3.70	\$3.40	\$3.00	\$2.80	\$2.20

CG 1 (MSA) Style Card Guides 5/1/80
See our July Ad for many other connectors.

APPLE PLUGBOARD

Vector 4609 Peripheral Interface Plugboard for construction of custom circuits. Plug compatible with Apple II, Commodore PET and Super Kim microcomputers. Three connectors, in addition to the standard 25/50 system bus, are available for input/output. A 20/40 contact card-edge connector, fabricated on the rear of the board, mates with a 3-M type ribbon connector. Alternatively, a right-angle solder-tail header may be positioned in this same location. The Model 4609 also accommodates the miniature SIP-type connectors which may be placed on the periphery or in mid-board.

	1-4	5-9	10-24
\$21.50	\$19.36	\$17.26	

7520 APPLE EXTENDER CARD \$24.95

.5%, 3 1/2 digit 19 Range DVM. 1/2" LCD displays runs 200 hrs on 1 battery. 10 Meg Ohm Input. 1 yr. guarantee, made in U.S.A., test leads included.

Available Accessories

- RC-3 115V AC Adapter \$7.50
- CC-3 Deluxe Padded Vinyl Carrying Case \$7.50
- VP-10 X10 DCV Probe Adapter/ Protector 10Kv \$14.95
- VP-40 40Kv DC Probe \$35.00
- CS-1 10 Amp Current Shunt \$14.95

***FREE**
Just for Asking.
FREE BATTERY with your meter.

8803 MOTHER BOARD FOR S100 BUS MICRO-COMPUTERS

Price: **\$29.50**

- All includes 12 16Kbit capacitors for +5, +12
- 12 Drivers and timer
- Latest timing capacitors
- Wiring Sideshow. Component side bare epoxy
- Glass with white markings for component locations
- 20 Dip sockets board with 20vdc copper solder plated and 0380dram in resistors
- 5 Solder mask with solder mask on printed circuit board and additional short circuit
- Mounts 11 receptacles with 100 contacts (2 rows) 12 centered with 220vdc timing
- Vector part number 881-2 removes 12 receptacles and connectors to smaller mother board format
- Includes checked circuit and instructions for assembly of PCB, pull up of floating resistors
- Large sockets - 2Vdc (S100) AMPS, \$2.20 (15V) AMPS) Current ratings are: Will. STD 275 vdc 100c rise
- Fits in Vector 8800 microcomputer and expansion board
- Fits in MSA 8800 microcomputer and expansion board

Vector Plugboards

Part No.	Description	Price
8800V	Universal Microcomputer/processor plugboard, use with S-100 bus. Complete with heat sink & hardware 5" x 10" x 1/16"	1-4 \$19.95, 5-9 \$17.95, 10-24 \$15.95
8801-1	Same as 8800V except plain; less power buses & heat sink	1-4 \$15.22, 5-9 \$13.79, 10-24 \$12.18
3682	9.6" x 4.5" Hi-Density Dual-In-Line Plugboard for Wire Wrap with Power & Grd. Bus Epoxy Glass 1/16" 44 pin con. spaced 156	\$12.97, \$9.81
3677	9.6" x 4.5" Gen. Purpose D.I.P. Boards with Bus Pattern for Solder or Wire Wrap. Epoxy Glass 1/16" 44 pin con. spaced 156	\$10.90, \$9.74
3662	6.5" x 4.5" P pattern plugboards for IC's Epoxy Glass 1/16" 44 pin con. spaced 156	\$8.95, \$11.45

CARD EXTENDER

Card Extender has 100 contacts 50 per side on .125 centers-Attached connector-is compatible with S-100 Bus Systems. \$25.83 3690 6.5" 22/44 pin .156 ctrs. Extenders . . . \$13.17

1/16 Vector BOARD

.042 dia holes on 0.1 spacing for IC's

Phenolic	Part No.	Size	1-9	10-19
	64P44XXXP	4.5x6.5"	\$1.56	\$1.40
	169P44XXXP	4.5x17"	\$3.69	\$3.32

Epoxy Glass	Part No.	Size	1-9	10-19
	64P44	4.5x6.5"	\$1.79	\$1.61
	84P44	4.5x8.5"	\$2.21	\$1.99
	169P44	4.5x17"	\$4.52	\$4.07
	169P84	8.5x17"	\$8.83	\$7.95

TRS-80/APPLE MEMORY EXPANSION KITS

1,000's SETS SOLD!

4116's RAMS from Leading Manufacturers

(16Kx1 200/250ns)

8 for \$75.00

Add \$3.00 for programming Jumpers for TRS-80 Keyboard

100% GUARANTEED

3M SCOTCH* BRAND DISKETTES

Part No.	Density	Sectoring	Price
740-OP	1/2single	Soft/IBM	\$39.95
740-SP	2/single	Soft/IBM	\$75.00
740-32P	2/single	32	\$39.95
741-0	1/2single	Soft/IBM	\$75.00
741-1	1/2single	Soft/IBM	\$59.00
744-OK	1/2single	Soft/IBM	\$51.00*
744-OK	1/2single	Soft/IBM	\$51.00*
744-16K	1/2single	Soft/IBM	\$51.00*

*Price Includes Kas etter 10 Storage Box a \$5.00 Value (TRS-80) "DON'T SETTLE FOR ANYTHING LESS THAN SCOTCH"

14 & 16 PIN GOLD 3 LEVEL WIRE WRAP SOCKETS*

14 - G3 100 for \$36.00
16 - G3 100 for \$37.00
50 of each for \$38.00

PANAVISE

PC BOARD HOLDER

315-5 same as 315 but with 14" bar to accommodate "S100" boards. PRICE \$19.98

STANDARD VISE HEAD PRICE: \$14.49

HORIZONTAL JAW VISE HEAD PRICE: \$14.49

PANAVISE TILTS, TURNS, AND ROTATES TO ANY POSITION. IT HOLDS YOUR WORK EXACTLY WHERE YOU WANT IT.

DEALERS CALL FOR PRICING

LOW-PROFILE BASE PRICE: \$13.49

STANDARD BASE PRICE: \$13.49

VACUUM BASE PRICE: \$18.49

WIDE OPENING VISE HEAD PRICE: \$14.49

MEMORY MEMORY

2102LIPC Low Power 450ns in lots of 25	\$1.10
2102AL-2 Low Power 250ns in lots of 25	\$1.25
2114-3L 1Kx4 300 ns Low Power	8/\$50.00
5257-3L 4Kx1 300ns Low Power	8/\$50.00
2708 8K 450ns EPROM	8/65.00 \$9.00
2716 16K 5 Volt Only EPROM	\$40.00

CALL FOR QUANTITY PRICES

ORDER TOLL FREE

1-800-423-5633

except CA, AK, HI, Call (213) 894-8171

PRIORITY ONE ELECTRONICS

16723K Roscoe Blvd. Sepulveda, CA 91343

Terms: Visa, MC, BAC, Check, Money Order, C.O.D. U.S. Funds Only. CA residents add 6% sales tax. Minimum order \$10.00 Prepaid U.S. orders less than \$75.00 include 5% shipping and handling, MINIMUM \$2.50. Excess refunded. Just in case . . . please include your phone no. Prices subject to change without notice. We will do our best to maintain prices thru Dec. 1979 phone orders welcome (213) 894-8171, (800) 423-5633

OEM and Institutional inquiries invited.

HICKOK LX303 \$74.95

HICKOK LX303 \$74.95

MEMORY WAR SHOP AND COMPARE

The Vista V80: widen the ability of your TRS-80 \$395.00



The Vista V80 Mini Disk System is the perfect way to widen the capabilities of your TRS-80[®] Micro-computer. Quickly and inexpensively. Our \$395 price tag is about \$100 less than the Radio Shack equivalent. Our delivery time is immediate. And our system is fully interchangeable. That's just the start.

It will give you 23% more storage capacity by increasing useable storage from 55,000 to 65,000 bytes per drive with our new software patch.

It can work 8 times faster than the TRS-80 Mini-Disk system, because track-to-track access is 5ms versus 40ms for the TRS-80. You can realize this added speed once the new double disk expansion interface is available without expensive modification of the existing unit.

It has a better warranty than any comparable unit warranty available - a full 120 days on all parts and service. When you consider how much more goes into the Vista V80, that shows a lot of faith in our product.

A full 3 amp power supply means you have 2 1/2 times the power necessary to operate the V80, and full ventilation insures that there will be no problems due to overheating.

The Vista V80 Mini Disk System requires Level II Basic with 16 K RAM Expansion interface (it operates from the Radio Shack interface system. It comes complete with a dependable MP1 Minifloppy disk drive, power supply, regulator board and vented case. It's shipped to you ready to run-simply take it out of the box and plug it in. You're in business. From the company that means business - Vista Computer Company.

DATA CABLES, VC80-2 (2 drive) \$29.95
DATA CABLES, VC80-4 (4 drive) \$39.95
SPECIAL: Box of 10 diskettes - \$20.00 with Purchase of VISTA 80

SAVE \$100.00 DM2700S DISK & CABINET with POWER SUPPLY

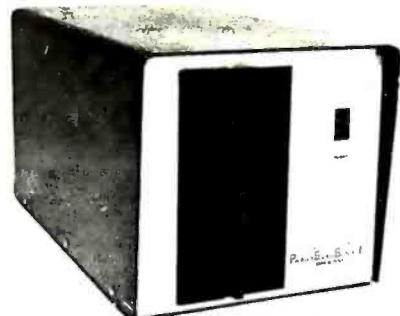

DM2700S includes Siemens FD120-B[®] Disk Drive with the following features:

- Single or Double Density
 - Hard or Soft Sector
 - Door Interlock
 - Write Protect
 - Hard Sector Detection
 - 500 KB/S Transfer
 - 800 KB unformatted
 - Bit density 6536 BP1
 - Shugart 800 Series Compatible
- Cabinet includes:
- 110V to 125V 60 Hz power supply
 - Data Cable
 - Fan
 - Accepts per SCL Shugart, Siemens B[®] Drives

SHOP AND COMPARE
DM2700S Disk Drive & Cabinet
Reg. \$750 Sale Priced \$650

FDD120-8 \$449.00
DM2700 Cabinet, less Drive
Reg. \$249 Sale Priced \$225.00

GENERAL DESCRIPTION:

Versafloppy II is a flexible disk drive controller that incorporates a wide range of capabilities into one board. It operates with double density soft sector format which provides 955,500 bytes of storage on a double sided 8 inch diskette and 179,520 bytes per side on a five inch mini-diskette. The Versafloppy II directly controls many popular disk drives. These include Shugart SA450 and SA450, Shugart SA850 and SA850, Mayflower MF8500 and MF700, Per Se 70 and 277, and Siemens DS100.

• 5 1/8 inch IEEE Standard Compatible

• IBM 3740 Compatible Soft Sector Format for Single Density Drives

• Operates with both Standard (8") and Mini (5") Drives

• Simultaneous Operation

• Provides Control for Double Sided Operation

• Operates with 280, 8080, and 8085 Central Processing Unit

• Controls up to four drives

• Vectorized Interrupt Operation

• Optional Control and Diagnostic Software Available in PROM

• SDS/DC Operating System Compatible

NEW VERSAFLOPPY II NEW

DOUBLE DENSITY, DOUBLE SIDED, DISC CONTROLLER

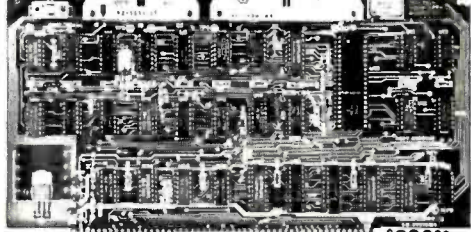

SDS-VERSAFLOPPY II KIT \$290.00
SDS-VERSAFLOPPY II A&T \$390.00

M-XVI

The true 16K Static Ram module for S-100 bus systems.



SHOP & COMPARE SPECIAL

California Computer Systems

The M-XVI gives you unbelievable expansion capability for your S-100 bus system-even beyond 64K. Manufactured to the highest quality standards documented and designed to make assembly, use, and programming a snap. The M-XVI board is a true revelation for the serious hobbyist and use in practical business or in digital applications.

FEATURES:

- Fully static
- Uses popular 2114 static RAMS
- 45 volt operation only
- Bank Select available by bank port and bank byte
- Phantom line capability
- Addressable in 4K blocks
- 4K blocks can be addressed anywhere within 64K in 4K increments
- Meets IEEE proposed S-100 signal standards
- LED indicators for board selection and bank selection
- FR8 epoxy PC boards
- Solder masked on both sides
- Silk screen of part number and part designator

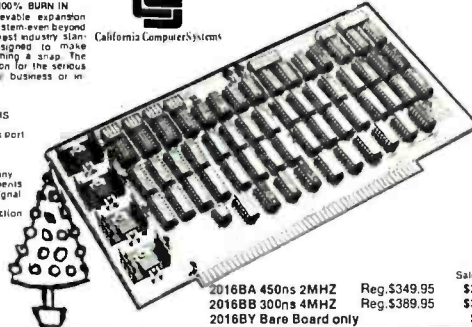

2016BA 450ns 2MHZ Reg. \$349.95 Sale Priced \$295.00
2016BB 300ns 4MHZ Reg. \$389.95 \$329.00
2016BY Bare Board only \$29.95

THE MICROBYTE M32KSS 32K STATIC MEMORY BOARD ASSEMBLED & TESTED

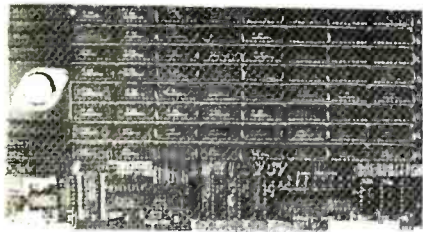

SAVE \$120.00

SALE PRICED
M32 KSS-L (2 MHz) List \$650
SALE \$530.00
M32 KSS-H (4 MHz) List \$680
SALE \$560.00

- Fully S100 Bus Compatible, IMSAI, SOL, ALTAIR, ALPHA MICRO. • Uses National's Low Power 5257 4K x 1 Static Rams. • 2 MHz or 4MHz operation. • Gold contacts for higher reliability. • On board single 5 amp regulator. • On board single 5 amp regulator. • Thermally designed heat sink (board operating temperature 0° - 70°C). • Commercially designed power bus, 7 ground bus bars, 0.1 uf decoupling capacitors. • Fully tri-state buffered. • Inputs fully low power Schottky Schmitt. Trigger buffered on all address and data lines. • Phantom is jumper selectable to pin 67. • Each 4K hardware or software selectable. • One on board 8-bit output port enables or disables the 32K in 4K blocks. • Selectable port address. • 4K banks can be selected or disabled on power on clear or reset. • Will operate with or without front panel. • Compatible with ALPHA MICRO, with extended memory management for selection beyond 64K. • No DMA restriction. • Low power consumption 2.3 - 2.5 amps. • Fully warranted for 120 days from date of shipment.



DISC DRIVES

SHUGART SA 400 5 1/4" 100 32100
SHUGART SA 450 5 1/4" 100 32100
with aluminum metal case with 1/2" thick metal diskette with door and power cord
LIST \$400.00 \$325.00

SHUGART SA 400 5 1/4" 100 32100
with aluminum metal case with 1/2" thick metal diskette with door and power cord
LIST \$400.00 \$325.00

SHUGART SA 450 5 1/4" 100 32100
with aluminum metal case with 1/2" thick metal diskette with door and power cord
LIST \$400.00 \$325.00

SHUGART SA 450 5 1/4" 100 32100
with aluminum metal case with 1/2" thick metal diskette with door and power cord
LIST \$400.00 \$325.00



VERSAFLOPPY II KIT \$290.00
VERSAFLOPPY II A&T \$390.00

DISC CONTROLLER SD "VERSAFLOPPY" KIT
The Versatile Floppy Disk Controller
Reg. ONLY \$145.00

MARRY CHRISTMAS FROM
PRIORITY ONE ELECTRONICS \$1
OUR BEST SELLING BOOK
With a purchase of \$50.00 or more
OUR BEST SELLING BOOK
Limit 1 Book per customer

Portable Miniscopes for Electronic Professionals on the Go!!! The Standout Oscilloscope development of the decade!!! Now 30MHz, dual trace model. Compare the performance, then compare the price.

Reg. \$598.15 MS-230 \$579.00
1" sale Probes 1" with purchase of scope

- 30-Megahertz bandwidth • Accuracy 3% full scale • Internal, line or external trigger
- Batteries and charger/transformer unit included • Graticule: 4 x 5 divisions, each division 0.25"
- Time base: 1 micro sec. to 0.5 sec/div 21 settings • Vertical Gain: 0.01 to 50 Volts/div, 12 settings. • Size 2.9" H x 6.4" W x 8.5" D, 3.5 lbs. • TEST MOST DIGITAL LOGIC CIRCUITS INCLUDING MICROPROCESSORS.
- *41-141 Deluxe 10tol probe with 4 interchangeable tips \$27.00
- 41-37 Deluxe 10tol/1tol probe with 4 interchangeable tips \$38.50
- 41-180 leather carrying case \$45.00
- MS-15 Single trace 15 MHz \$349.80
- MS-215 Dual trace 15 MHz \$465.45

X-MAS SPECIAL NOVATION CAT ACOUSTIC MODEM



\$159.00

- 0-300 Baud
- Bell 103
- Answer, Originate

Regular \$198.00

PRIORITY ONE ELECTRONICS
16723K Roscoe Blvd. Sepulveda, CA 91343
Terms: Visa, MC, BAC, Check, Money Order, C.O.D. U.S. Funds Only. CA residents add 6% sales tax. Minimum order \$10.00 Prepaid U.S. orders less than \$75.00 include 5% shipping and handling. MINIMUM \$2.50. Excess refunded. Just in case please include your phone no.
Prices subject to change without notice.
We will do our best to maintain prices thru Dec. 1979 OEM and Institutions phone orders welcome (213) 894-8171, (800) 423-5633 Inquiries invited.

JUST WRAP TOOL WITH ONE 50 FT. ROLL OF WIRE

COLOR	PART NO.	U.S. LIST PRICE
BLUE	JW-1-B	14.95
WHITE	JW-1-W	14.95
YELLOW	JW-1-Y	14.95
RED	JW-1-R	14.95

REPLACEMENT ROLL OF WIRE 50 FT.

BLUE	R-JW-B	2.98
WHITE	R-JW-W	2.98
YELLOW	R-JW-Y	2.98
RED	R-JW-R	2.98

JUST WRAP KIT CONTAINS

- JUST WRAP Tool
- Roll of Blue Wire, 50 ft.
- Roll of White Wire, 50 ft.
- Roll of Yellow Wire, 50 ft.
- Roll of Red Wire, 50 ft.
- Unwrapping Tool
- JWK-5 JUST WRAP KIT \$24.95

Why Cut? Why Strip? Why Silt? Why NOT...
JUST WRAP
• 1/8" 30 Wire
• .025 Square Posts
• Daisy Chain or Point to Point
• No Stripping or Slicing Required - JUST WRAP TM

• Built In Cut off
• Easy Loading of Wire
• Available Wire Colors: Blue, White, Red & Yellow

800-423-5633 EXCEPT CA, AK, HI. (213) 894-8171

ORDER TOLL FREE 1-800-423-5633 ORDER TOLL FREE 1-800-423-5633

Circle 312 on Inquiry card.

4 MHZ EXPANDORAM II KIT

The S-100 Memory Board for the 80's

SD SYSTEMS' ExpandoRAM II is a state-of-the-art dynamic RAM board with capacities from 16K bytes (4116) to 256K bytes (4164). It operates on the industry S-100 Bus. The ExpandoRAM II's design allows eight boards to operate from the same S-100 Bus. Page mode operation provides the system with the capability of servicing multiple users without RAM interference. Invisible refresh and synchronization with wait states provide greater reliability, and processing speeds up to 4 Mhz.

The ExpandoRAM II is compatible with most S-100 CPU's based on the Z80 microprocessor. When other SD SYSTEMS 200 series boards are combined with the ExpandoRAM II, they create a microcomputer with exceptional capabilities and features.

- S-100 Bus Compatible
- Up to 4Mhz Operation
- Expandable Memory from 16K to 256K
- DIP Switch Selectable Boundaries
- Uses 16K (4115) or 64K (4164) Memory Devices
- Page Mode Operation Allows up to 8 Memory Boards on Bus
- Operates with Z80 CPU's
- Phantom Output Disable
- Invisible Refresh (Synchronized with Wait States)

NEW

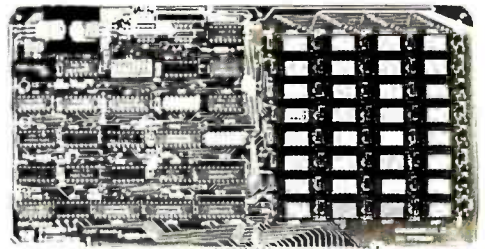

Sale Price

SDS - EXPANDORAM II KIT (4116)

16K	\$280.00	48K	\$450.00
32K	\$365.00	64K	\$535.00

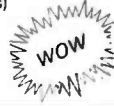

LOOK FOR OUR HUGE AD IN JANUARY BYTE

LOOK FOR OUR HUGE AD IN JANUARY BYTE

The EXPANDORAM is available in versions from 16K up to 64K, so for a minimum investment you can have a memory system that will grow with your needs. This is a dynamic memory with the invisible on-board refresh, and IT WORKS!

- Interfaces with Altair, IMSAI, SOL-8, Cromemco, SBC-100, and others.
- Bank Selectable
- Phantom
- Power 8VDC, ± 16VDC, 5 Watts
- Lowest Cost Per Bit
- Uses Popular 4116 RAMS
- PC Board is doubled solder masked and has silk-screen parts layout.
- Extensive documentation clearly written
- Complete Kit includes all Sockets for 64K
- Memory access time: 375ns, Cycle time: 500ns.
- No wait states required.
- 16K boundaries and Protection via Dip Switches
- Designed to work with Z-80, 8080, 8050 CPU's

SD EXPANDORAM The Ultimate S-100 Memory

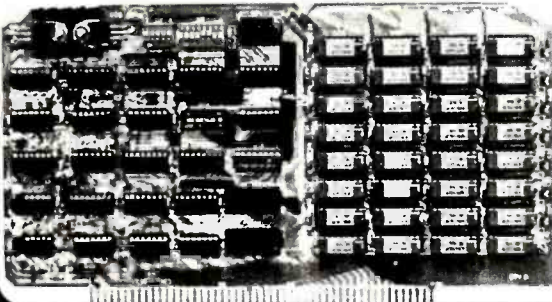

EXPANDO 64 KIT (4116)

	Reg. Price	Sale Price
16K	\$249	\$219
32K	\$324	\$285
48K	\$399	\$355
64K	\$474	\$415

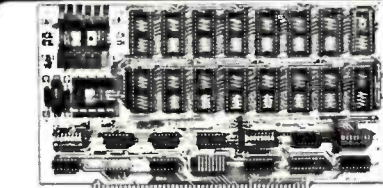

EXPANDOPROM

The ExpandoPROM can be populated with either the 2708 (1K) or the 2716 (2K) EPROMS, and may be located on either 16K or 32K boundaries.

- S-100 Bus Compatible
- Expandable Read Only Memory from 1K to 32K
- Each EPROM is Dip Switch Selectable
- Dip Switch for Addressing on 16K/32K Boundaries
- Dip Switch Selectable Wait States
- Interfaces with Imsai, Altair, Sol-20 Cromemco and SD SYSTEMS' Z80 CPU Cards

SDS-EXPANDOPROM KIT	\$136.00
SDS-EXPANDOPROM KIT	\$210.00

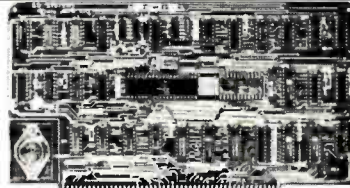

Z80 CENTRAL PROCESSING UNIT

- S-100 Bus Compatible
- 2 Mhz or 4 Mhz Operation
- Power-On Jump to any 4K Boundary
- On-Board Socket for up to 2K PROM
- Front Panel Usage Optional
- Z80 Microprocessor
- Optional Wait States

The MPB-100 can upgrade an existing S-100 8080 System with little or no necessary modifications. The MPB-100 is additionally suited for some control applications. The PROM socket will accommodate a 1K or 2K PROM plus the single voltage 4K PROM.

SDS-MPB-100 KIT	\$199.00
SDS-MPB-100 A&T	\$289.00

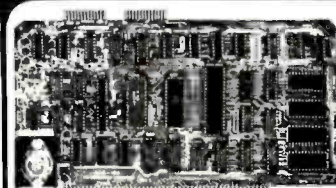

SINGLE BOARD COMPUTER

With On-Board RAM, PROM, CTC

- S-100 Bus Compatible
- Z80 Central Processing Unit
- 1024 Bytes of Random Access Memory
- 8K Bytes of PROM using 2716
- Parallel Input and Output Ports
- Four Channel Counter/Timer (Z80-CTC)
- Software Programmable Baud Rate Generator
- No Front Panel Required for Operation

SDS-SBC-100 2MHZ KIT	\$219.00
SDS-SBC-100 2MHZ A&T	\$349.00
SDS-SBC-200 4MHZ KIT	\$259.00
SDS-SBC-200 4MHZ A&T	\$369.00

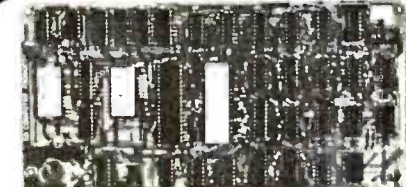

VDB-8024 VIDEO DISPLAY BOARD

With on-board Z80 Microprocessor

- S-100 bus Compatible
- Full 80 Characters by 24 Lines Display
- Characters Displayed by High Resolution 7 x 10 Matrix
- Composite or TTL Video Output
- Keyboard Power and Interface
- Forward and Reverse Scrolling Capability
- Blinking, Underlining, Field Reverse, Field Protect and Combinations
- Full Cursor Control
- 96 Upper and Lower Case Characters
- 32 Special Character Set
- 128 Additional User Programmable Characters (Optional)
- On-Board Z80 Microprocessor
- 2K Bytes Independent On-Board RAM Memory
- Glitch-Free Display

SDS-VDB-8024 KIT	\$315.00
SDS-VDB-8024 A&T	\$469.00



PROM-100

Programming Board for PROM Development

NEW

SD SYSTEMS' PROM-100 is a versatile PROM programming board offering complete EPROM programming capability. The board operates on the industry standard S-100 Bus. Support software verifies the erasure of EPROM and verifies the loaded program. SD SYSTEMS' PROM-100 offers a support-software listing with its operations manual.

- S-100 Bus Compatible
- Programs the Following EPROM s: 2708, Intel 2758, 2716, 2732 and Texas Instruments 2516
- Dip Switch Selection of EPROM type
- 25 VDC Programming Pulse Generated On Board
- Maximum Programming time: 16,384 Bits in 100 Seconds
- Power Requirement: +8VDC at 300 ma.; +16 VDC at 100 ma.; -16 VDC at 60 ma.
- TTL compatible
- Software Provides for Reading of Object File from SDOS, CP/M or PROM and Programming into EPROM
- Program Verification
- Verification of Erasure
- Zero Insertion Force Socket

SDS-PROM-100 KIT	\$149.00
SDS-PROM-100 A&T	\$219.00

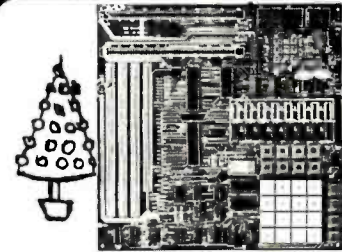

Z80 STARTER KIT

A Complete Microcomputer On A Board

- Z80 CPU with 158 Instructions
- On-Board Keyboard and Display
- On-Board PROM Programmer for Single Voltage PROMS (2716, 2758, TI2516)
- Kansas City Standard Cassette Interface
- Simple Key Controlled Audio Cassette Load and Dump
- Expansion Provision for Mounting Two S-100 Connectors (Sockets Not Included)
- Wire Wrap Area for Custom Circuitry
- Single Step through RAM or PROM
- Memory Examine and Change
- Port Examine and Change
- Z80 CPU Register and Change
- 2K Byte ZBUG Monitor in ROM
- 1K Bytes of RAM (Expandable to 2K Bytes)
- A 4 Channel Hardware Counter/Timer (Z80-CTC)
- Two Bi-Directional 8-Bit I/O Ports (Z80-P10)
- Up to 5 Programmable Breakpoints
- Switch Selectable PROM or Monitor Restart
- Vectored Interrupts provided by Z80-CTC and

SDS-Z80 STARTER KIT	\$219.00
SDS-Z80 STARTER A&T	\$369.00



PRIORITY ONE ELECTRONICS

16723K Roscoe Blvd. Sepulveda, CA 91343
 Terms: Visa, MC, BAC, Check, Money Order, C.O.D. U.S. Funds Only. CA residents add 6% sales tax.
 Minimum order \$10.00 Prepaid U.S. orders less than \$75.00 include 5% shipping and handling.
 MINIMUM \$2.50. Excess refunded. Just in case ... please include your phone no.

Prices subject to change without notice.
 We will do our best to maintain prices thru Dec. 1979
 phone orders welcome (213) 894-8171, (800) 423-5633

OEM and Institutional Inquiries Invited.

800-423-5633

EXCEPT CA, AK, HI.
 (213) 894-8171

ORDER TOLL FREE 1-800-423-5633 ORDER TOLL FREE 1-800-423-5633

Unclassified Ads

FOR SALE: Programmatic Flexwriter, paper-tape reader punch, upper/lower case, input/output (I/O) connectors. Some schematics. \$370. Bill Fujitsu, 1506 Sandcastle Dr, Corona del Mar CA 92625.

WANTED: Assembled and working SwTPC PR-40 printer to use with my PET computer. Peter Oakes, 2235 Lakeshore Dr, Muskegon MI 49441.

FOR SALE: Shugart SA3900 dual diskette subsystem. Includes two SA900 drives, SA910 controller electronics, and large enclosure with fan and power supply. 256 K bytes/8 inch drive. Full documentation. Can be used as is, or replace the transistor-transistor logic (TTL) controller with an 8271 chip and your own microcomputer. Cabinet will hold six 8 by 10 inch boards. Original cost \$2400, will sell for \$750. Roger Cox, 1050 Westmoreland Rd Apt B, Colorado Springs CO 80907, (303) 599-9274.

FOR SALE: New Processor Technology 16 K programmable-memory board with battery backup capability. Never been used. Factory assembled and tested. \$250 or best offer. Cromemco Tu-Art, assembled and tested. \$200 or best offer. Cromemco Bytesaver, assembled with or without read-only memories (2708), not tested. \$175 without read-only memories, \$275 with read-only memories including Bytemover Z80 monitor read-only memory. David Brown, 2219 Teresa Dr, Savannah GA 31406.

FOR SALE: Solid State Music MB3 4 K erasable read-only memory board with sixteen clean 1702A read-only memories. Perfect condition, with documentation. \$110. George Saum, 4371 W 82 Av, Westminster CO 80030, (303) 429-6646.

FOR SALE: A 2201 Flexwriter made by Friden. The automatic typewriter can be programmed. It has a 5610 Compu data processor mounted in table unit. Has tape punch and reader. Has 18 inch carriage. In good condition. It is a real buy for \$800 FOB Newton. Weight 350 to 400 lbs. Jack Harrison, 810 Ridge, Newton NC 28658, (704) 464-0145.

FOR SALE: Alpha-Micro computer system, AM-100, 64 K programmable memory, 10MB CDC Hawk disk drive, AMOS operating system, Accounts Receivable, General Ledger, Payroll Software. Chester Hayes, 82 S Franklin St, Wilkes-Barre PA 18773, (717) 823-3101.

FOR SALE: Litton ABS/1252 accounting computer. System includes 80 K programmable memory, paper-tape reader and punch, keyboard, printer, buffer, rewind stand, and forms stand. Ideal for needs of a small to moderate-size business. David M Martin, 501 Webster, Mishawaka IN 46544, (219) 259-8578 (office) or (219) 259-1123 (home).

FOR SALE: BYTE magazine #1 to current, inclusive. Mint condition. Best offer. K J Dabb, 2045 Robins Av, Ogden UT 84401.

FOR SALE: SOL with 5-slot S-100 cage, 16 K Dynabyte dynamic, 4 K MITS dynamic, 8 K Bytesaver, iCOM minifloppy with controller, cassette recorder, monitor Datel 30 Selectric-based terminal, USART for parallel port, PT Extended Cassette BASIC, iCOM FDOS and DEBBIE, ALS8, Editor, Disassembler, TRK80, and more. Asking minimum \$2500. Albert Boulanger, 820 NE 2 Pl, Hialeah FL 33010, (305) 888-6220.

FOR SALE: Parallel ASCII to serial ASCII converter with 20 mA current loop drive, \$20; 5 V at 3 A power supply with 45 K μ F filtering, \$30; miscellaneous power supply components (capacitors, transformers, etc) Robert Watson, 2853 Pebble Beach, Flagstaff AZ 86001, (602) 526-2312.

FOR SALE: Micromation Megabox System, dual drive, 8 inch, double density, with controller card, \$1600. Thinker Toys, 16 K static programmable memory, 4 MHz, \$275. Both items brand new. Full documentation. James R Fatz, 293 Indiana Av, Ft Wood MO 65473, (314) 368-5880.

WANTED: I have eight 1702A erasable read-only memories which I bought used on a printed circuit board. I would like to erase them, verify the erasure, program every bit, verify the programming, then erase the read-only memories, verifying the erasure. Finally, I need to have one read-only memory programmed for a keyboard encoder. Robert Heller, POB 51A Star Rt, Wendell MA 01379.

FOR SALE OR TRADE: For LSI-11, Heath H11, 11A owners. 4 K core (MMV11) used as small disk, keep loader, or BASIC in nonvolatile residence. \$450, or trade for on board refreshed 16 K programmable memory module. C Chi, (617) 369-4000 ext 340 work; (617) 842-6326 home.

FOR TRADE: Have BYTE issues #1 and #4 in mint condition. Will trade for January, February, and May 1976 issues of BYTE in comparable condition. Will Hobbs, 1917 NE 8th #3, Portland OR 97212, (503) 284-5150.

WANTED: Ran out of space in my H11 system. I would like to trade my one each or two each H11-1, 4 K x 16 memory board plus reasonable cash for a single board 16 K x 16 memory board for H11. Must be in working condition. P Reyes, 86-115 Puhawai Rd, Waianae HI 96792, (808) 696-9329.

FOR SALE: Four Heath 4 K by 16 static-memory modules. Assembled and guaranteed working. Specify bank number and I will program before shipping. \$200 each or \$700 for all four. Harold Bula, 111 NW 8th Av #B4, Hallandale FL 33009.

FOR SALE: Heathkit ET-3400 microprocessor trainer in excellent condition with all manuals and programmed learning notebooks. Many additional chips and accessories. Nathan Coates, Rt 1 POB 44, Abilene TX 79601.

FOR SALE: 16 K, Level II TRS-80. Also, Tektronix type RM35A oscilloscope with type CA dual-trace plug-in unit and type D differential-input plug-in unit. TRS-80, \$645. Oscilloscope with both plug-in units, \$295. Richard J Aspey, 234 Beachwood Dr, Burbank CA 91506, (213) 842-7947.

ZILOG USERS: Zilog user seeks an exchange of ideas. Frank Light, 64 Errwood Rd, Manchester M19 2QH, ENGLAND.

FOR SALE: S&D Sales 4 K programmable memory, \$50. Shugart SA-400 with power supply and cabinet, \$290. Micromation PerSci double density, \$2200. MITS serial input/output (I/O) board, \$100. Vector Graphics read-only memory/programmable memory, \$75. Ten 1702A read-only memories, \$35. S&D cassette interface, \$14. 3P + S I/O board, \$130. Flexwriter with S-100 interface, punch, and reader, \$375. Fred Manthey, POB 619, Mullian ID 83846, (208) 744-1143.

FOR SALE: S-100 boards: IA, Z80, Jade input/output (I/O), \$100 each. SD 4 K programmable memory, \$50. Digital cassette drive with control electronics, \$50. PAIA 400 synthesizer, \$300. Anthony Lassiter, 630 S Hermitage #402, Chicago IL 60612, (312) 942-4837.

WANTED: New or used dumb terminal and acoustic coupler, or a microcomputer with RS-232 interface and terminal capability. Lee Hayden, 5018 San Jose Blvd, Jacksonville FL 32207.

Unclassified Policy

Readers who are soliciting or giving advice, or who have equipment to buy, sell or swap should send in a clearly typed notice to that effect. To be considered for publication, an advertisement must be clearly noncommercial, typed double spaced on plain white paper, contain 75 words or less, and include complete name and address information.

These notices are free of charge and will be printed one time only on a space available basis. Notices can be accepted from individuals or bona fide computer users clubs only. We can engage in no correspondence on these and your confirmation of placement is appearance in an issue of BYTE.

Please note that it may take three or four months for an ad to appear in the magazine.

FOR SALE: Heath H8, H9, 24 K, dual cassettes, fully assembled and operational. Includes all assembly manuals, reference manuals, software (plus Extended BH BASIC with files), Space Wars game, HUG library manual and tape, and back issues of REMark Magazine. \$1450/offer. J Scheip, 6487 Silver Ridge Cir, Alexandria VA 22310, (703) 971-9619.

FOR SALE: Micropolis 1043 Mod II, 315 K bytes formatted meta floppy disk. Complete with manual, newsletters, and S-100 bus-controller board. Moving up to larger system. First check for \$950 takes all. Paul E Feick, 1105 Maia Dr, Layton UT 84041, (801) 376-9515 home, 524-4140 work.

WANTED: Newly formed computer club wants free games and/or other programs to run on a Level II TRS-80 system. Any consideration will be greatly appreciated. Bruce Caldwell, Draughon's Computer Club, Draughon's Junior College, 131 8th Av, Nashville TN 37203.

FOR SALE: Two Godbout Econoram II boards (static 8 K, 450 ns, S-100 bus) plus four spare 2102 memory integrated circuits. \$90 each or nearest offer. I have switched to a 64 K Expandoram. Ron Subler, 25 First Parish Rd, Scituate MA 02066, (617) 545-6578.

FOR SALE: SwTPC CT-64, \$275 and AC-30, \$65. Professionally assembled, working, in as-new condition with documentation. R P Felton, 4803 Neblina Dr, Carlsbad CA 92008, (714) 729-5519.

FOR SALE: Digital Development Corp Model 12750 fixed head disk. 196 K bytes, 8.5 ms high-speed access. High reliability helium pressurized system with sixteen external track protect switches. Full documentation. Ideal for computer graphics database, or timeshare swapping storage. 19 inch side, 150 lbs, 115 VAC single phase; \$500 plus shipping. J Zeglinski, 32 Aldgate Av, Toronto Ontario, CANADA M8Y 3L6.

FOR SALE: IMSAI 8080 or Cromemco Z2. Both contain full sockets and are equipped with North Star disk drive, Processor Tech 3P + S, and 8 to 32 K of memory. ADM3 terminals available and all my software for free. Best reasonable offer. J Roehrig, 7 Wildwood Dr, Dix Hills NY 11746, (516) 643-1931.

FOR SALE: Digital Group Z80 system. 26 K 21L02. Maxi-BASIC, Assembler, four input/output (I/O) ports, 64-character video board, power supply. Great system for Assembly or BASIC. \$650. Preston Marshall, 8525 Monticello Av, Alexandria VA 22308, (703) 780-3768.

FOR SALE: Atari video computer system. Very good condition. Cartridges include Surround, Indy 500, Breakout, Outlaw, Air Sea Battle, Combat, Street Racer, Starship, Video Olympics, and Homerun. All handles for games come with system. System is worth \$400, best offer takes it. Jody Wear, Rt 1 POB 83A, New Egypt NJ 08533, (609) 758-7193 after 3:30 PM.

Reader Service

To get further information on the products advertised in BYTE, fill out the reader service card with your name and address. Then circle the appropriate numbers for the advertisers you select from the list. Add a 15-cent stamp to the card, then drop it in the mail. Not only do you gain information, but our advertisers are encouraged to use the marketplace provided by BYTE. This helps us bring you a bigger BYTE. *Correspond directly with company.

Inquiry No.	Page No.	Inquiry No.	Page No.	Inquiry No.	Page No.	Inquiry No.	Page No.
9	Aardvark Software 211	96	DG Electronic Development 99	217	Micro DaSys 239	341	SC Digital 136
1	AB Computers 295	87	Digibyte Systems Corp 136	222	Micro Data Base Systems 59	326	SCDP 237
7	Ackerman Digital Systems 280	88	Digital Engineering 130		Micro Diversions 5	329	Scelbi 186, 187
8	Administrative Systems 177	84	Digital Marketing 200	223	Micromall 150	330	Scitronics 50
5	Adroit Electronics 280	86	Digital Pathways 135	204	Micro Mike's 212		Shugart Associates 6, 7
2	Advanced Access Group 114	95	Digital Research Corp (CA) 236	226	Micro Music 94	327	Simulations Pub Inc (SPI) 139
4	Adv Computer Products 282, 283	97	Digitus Corp 111	227	Microsette 218	337	'68 Micro Journal 229
3	Aladdin Automation 207	98	Dontho Scientific 156	228	Microsette 272	287	Small Business Applications 228
6	Altos 19	100	DRC (TX) 271	232	Microsoft 69	334	Small Business Sys Group 196
13	American Square Computers 280	105	Dynacomp 162	233	Micro Soft (Consumer Prod/Div) 179	336	Ken Smallwood & Associates 270
12	Anderson Jacobson 12	115	Electrolabs 278, 279	229	Micro Squared 288	328	Smoke Signal Broadcasting 21
16	Apparat Inc 294	120	Electronic Control Technology 132	209	Microtek 119	338	Smoke Signal Broadcasting 223
17	Apple Computer 15	125	Electronic Systems 259, 260, 261	234	Microware 214	339	Smoke Signal Broadcasting 225
10	Applied Computer Systems Inc 99	130	Electronics Warehouse 266	231	The Micro Works 226	342	Smoke Signal Broadcasting 227
11	ASAP Computer Products 297	131	Ellis Computing 208	237	Micro World 82	343	Smoke Signal Broadcasting 229
23	Atari Personal Computers 9	124	Escon 237	235	Midwest Computer Peripherals 235	344	Smoke Signal Broadcasting 231
19	ATV Research 272	132	Euro-Micro 80 203	230	Mikos 290	345	Smoke Signal Broadcasting 233
18	Automated Simulations 240	133	Evergreen 292	236	Mini Computer Suppliers 240	348	Smoke Signal Broadcasting 235
21	Avionic Enterprises (A.E.I.) 218	134	EXO Electronics 165	255	Morrow/Thinker Toys 24, 25	351	Smoke Signal Broadcasting 237
22	base 2 Inc 121		Factory Direct Sales 245	257	Mountain Hardware 58, 217	352	Smoke Signal Broadcasting 239
24	Becklan Enterprises 286	135	FAIRCUM 226	283	mpi 197		Softagon Inc 18
25	Beta Business Systems 274	136	Farnsworth Computer 74	260	MT Micro Sys (formerly MetaTech) 243	357	Softape 199
	Beta Computer Devices 221	138	Fidelity Electronics 11	262	Multi Bus Computer Systems 274	358	SoftTech Microsystems 122
20	Bishop Graphics 78	141	FMG Corp 230	278	MVT Microcomputer Systems 218		Softronics 216
	BITS Inc 214, 219, 225	137	Fordham Radio Supply 288	272	NEECO 131		Software Dev & Training 110
36	BYTE Books 215, 291	140	Frederick Computer Products 292	281	NEECO 149	359	Software Dynamics 231
	BYTE WATS Line 272	139	H Geller Computer Systems 270	279	Netronics 173	380	The Software Exchange 190, 191
33	Byte Shop East 225	145	Global Parameters 78	280	Netronics 173	333	The Software Farm 280
34	C & S Electronics Mart 235	150	Godbout Electronics 171		Northern Technology Books 223		The Soft Warehouse 40
35	California Computer Systems 49	153	George Goode & Associates 102	283	Novation 205	361	The Software Works 212
39	California Digital 267	151	Graham Dorian Gill	299	NRI Schools 193	302	SSM 29
38	Camelot Direct 109	106	H & E Computronics 181	300	Ohio Scientific Instrument CIV	335	SSM 30
40	CAP Electronics 201	152	Hartmann-Lang 280	300	Ohio Scientific Instrument 80, 81	340	Solid State Sales 286
44	Central Data 145	163	Health Company 17, 72, 73	291	OK Machine and Tool 137, 178	346	Soroc 97
47	Christal Industries 169		Health Company 27	288	Oliver Adv Engineering 239, 274	347	Sorrento Valley Associates 218
49	COMPCO 147	161	Heuristics 216	289	onComputing 65	356	Southwest Technical Prod Corp CII
52	COMPRINT (Comp Printers Intl) 152, 153	162	Hobby World 263	290	Optimal Technology 235	362	Software Tech for Comp (STC) 292
53	Compucolor 33	165	Houston Instrument 63	292	Oregon Software 185	353	SubLOGIC 133
54	CompuMart 273	167	Houston Instrument 63	294	Osborne/McGraw-Hill 238	363	Summagraphics 161
51	Computer Case Co 274	166	Inco Inc 127	292	Owens Associates Inc 128	354	Sunny International 270
55	Computer Components of South Bay 289	169	Industrial Micro Systems 141	294	Pacific Exchanges 274	359	Supersoft 35
	Computer Factory 275	170	Infinite Inc 272	293	Page Digital 293	349	Sybox 213
58	Computer Furniture & Accessories 96	174	Infinity Micro 189, 223	297	PAIA Electronics 227	364	Sybox 216
75	Computerland 83	173	Information Unlimited 195	304	PerCom Data 37	365	Sybox 221
77	Computer Mart of NJ 74	175	Intecolor (Div Intelligent Sys) 41	305	PerCom Data 38, 39	355	Synchro Sound 91
88	Computer Service Center 274	177	Integrand 166	307	PerCom Data 51	377	Synchro Sound 127
66	Computer Service Sys Ntwk (CSSN) 159	179	Interface Inc 292	308	PerCom Data 163	350	System Design Lab 227
60	Computer Service Sys Ntwk (CSSN) 296	176	International Data Systems 115	301	Personal Software 183	366	TAD Enterprises 274
56	Computer Shopper 209	180	Intertec Data Systems 57		Phase One Systems Inc 175	367	Tano 157
67	Computer Specialties 297		Ithaca Intersystems Inc 101, 232	303	Power One Inc 61	372	Tarbell Electronics 113
71	Computer Store International 90	196	Jade Co 268, 269	324	Practical Applications 158	369	Technical Systems Consultants 77
69	Computer Works 296	200	Jameco 276, 277	312	Priority I 300, 301, 302	370	Tecmar Inc 8
70	Computer World 118	205	Konan Corp 79	315	Prodata Inc 105	371	Terak Corp 117
73	Computex 66		Lifeboat Associates 67, 176, 200	322	PS Inc 218	368	3M Company 23
76	CT Micro Computer 110, 220, 237	208	Lobo Drives International 143	321	The Q-Kit (Div JR Conwell Corp) 100	380	Robert Tinney Graphics 31
74	Corporate Computer Systems (CCS) 212	206	Logon Inc 93	286	Quality Software 220	374	Torry Pines Business Systems 274
83	Corvus Systems 55	207	Loweco Computer 292	313	Quantum Communications Sys 112	375	Total Information Serv (TIS) 220
79	Cover Craft 233	203	Macrotronics 272	311	Quest Electronics 265	376	TransNet Corp 140
78	CP Products 231	210	Mallbu Chess Press 274	314	R & D Press 280	309	Ucatan Computer Store 272
81	The CPU Shop 299	211	Matchless Systems 287	310	RACET Computers 215		United Software of America 295
80	Cromemco 1, 2	212	Maxell Data Products 129	317	Radio Hut 285	379	US Robotics 126
85	CTC 202		Meas Sys & Controls 167, 280	318	Radio Shack 107	378	Vector Electronics 204
	Cybernetics Inc 234	213	Micro Ap 95	319	Ramsey Electronics 206	381	Vista Computer Company 284
89	Data Access Corp 236	218	Micro Applications Group 127	320	Rascal Programs 212	387	V R Data 288
90	DATABANK 272	214	Micro Architect 240	295	RBB Software Products 142	388	Wameco 290
91	Data Discount Center 233		Microbiotic Computing Inc 272	325	RCA 42, 45	386	WESCO Electronics 292
92	Data Sales 220	216	Micro Business World 292	323	Report Card 280	390	Whitesmith's Ltd 240
93	DataSouth Computer Corp 60	224	Micro Computer Discount Co 281	325	RNB Enterprises 298	389	Wintek Corp 280
94	Data Speed 123	238	Microcomputer Tech Inc (MTI) 294	316	S-100 239	391	Worldwide Electronics 272
126	Data-Trans 259	225	Micro Control 43		St Jude 292	392	Xitex 151
128	Delta Products 86	220	Micro DaSys 13			401	Zs Systems 229
129	DES-MAR Electronics 292	221	Micro DaSys 47				

BOMB — BYTE's Ongoing Monitor Box

Article No.	ARTICLE	Page
1	Ruckdeschel: Frequency Analysis of Data Using a Microcomputer	10
2	Ciarcia: Add Nonvolatile Memory to Your Computer	36
3	Dally: Faster Audio Processing with a Microprocessor	54
4	Peterson: Text Compression	106
5	Chancé: Analysis of Polynomial Functions with the TI-59 Calculator	120
6	Bowker: Minimizing Curve-Plotting Calculation	134
7	Finlay: Noniterative Digital Solution of Linear Transfer Functions	144
8	Kern: A User's Look at Tiny-C	196
9	Lewis: Some Notes on Modular Assembly Programming	222
10	Maurer: Twenty-Four Ways to Write a Loop	241
11	Bernstein: Morse Code Trainer	247
12	Armstrong: Thirty Days to Faster Input	250

September BOMB Homebrewing: Soft Touch for Software

Congratulations to Mark Dahmke for his first place winning article "Introduction to Multiprogramming," September, page 20. An extremely close second place was taken by Steve Ciarcia's "Joystick Interfaces," page 10 with third place being awarded to William Powers, "The Nature of Robots," Part 4, page 96. ■

For fastest service transfer mailer label from wrapper to coupon provided at the right. Requests cannot be honored unless zip code is given. This card valid for 90 days only.

NOTE—If label is missing or defaced fill out coupon carefully —PLEASE PRINT—this is only way to get requested material to you.

Name _____

(Title) _____

(Company) _____

Address _____

City _____ State _____ Zip _____

1 21 41 61 81 101 121 141 161 181 201 221 241 261 281 301 321 341 361 381 401 421 441 461 481 501 521 541 561 581 601 621 641
 2 22 42 62 82 102 122 142 162 182 202 222 242 262 282 302 322 342 362 382 402 422 442 462 482 502 522 542 562 582 602 622 642
 3 23 43 63 83 103 123 143 163 183 203 223 243 263 283 303 323 343 363 383 403 423 443 463 483 503 523 543 563 583 603 623 643
 4 24 44 64 84 104 124 144 164 184 204 224 244 264 284 304 324 344 364 384 404 424 444 464 484 504 524 544 564 584 604 624 644
 5 25 45 65 85 105 125 145 165 185 205 225 245 265 285 305 325 345 365 385 405 425 445 465 485 505 525 545 565 585 605 625 645
 6 26 46 66 86 106 126 146 166 186 206 226 246 266 286 306 326 346 366 386 406 426 446 466 486 506 526 546 566 586 606 626 646
 7 27 47 67 87 107 127 147 167 187 207 227 247 267 287 307 327 347 367 387 407 427 447 467 487 507 527 547 567 587 607 627 647
 8 28 48 68 88 108 128 148 168 188 208 228 248 268 288 308 328 348 368 388 408 428 448 468 488 508 528 548 568 588 608 628 648
 9 29 49 69 89 109 129 149 169 189 209 229 249 269 289 309 329 349 369 389 409 429 449 469 489 509 529 549 569 589 609 629 649
 10 30 50 70 90 110 130 150 170 190 210 230 250 270 290 310 330 350 370 390 410 430 450 470 490 510 530 550 570 590 610 630 650
 11 31 51 71 91 111 131 151 171 191 211 231 251 271 291 311 331 351 371 391 411 431 451 471 491 511 531 551 571 591 611 631 651
 12 32 52 72 92 112 132 152 172 192 212 232 252 272 292 312 332 352 372 392 412 432 452 472 492 512 532 552 572 592 612 632 652
 13 33 53 73 93 113 133 153 173 193 213 233 253 273 293 313 333 353 373 393 413 433 453 473 493 513 533 553 573 593 613 633 653
 14 34 54 74 94 114 134 154 174 194 214 234 254 274 294 314 334 354 374 394 414 434 454 474 494 514 534 554 574 594 614 634 654
 15 35 55 75 95 115 135 155 175 195 215 235 255 275 295 315 335 355 375 395 415 435 455 475 495 515 535 555 575 595 615 635 655
 16 36 56 76 96 116 136 156 176 196 216 236 256 276 296 316 336 356 376 396 416 436 456 476 496 516 536 556 576 596 616 636 656
 17 37 57 77 97 117 137 157 177 197 217 237 257 277 297 317 337 357 377 397 417 437 457 477 497 517 537 557 577 597 617 637 657
 18 38 58 78 98 118 138 158 178 198 218 238 258 278 298 318 338 358 378 398 418 438 458 478 498 518 538 558 578 598 618 638 658
 19 39 59 79 99 119 139 159 179 199 219 239 259 279 299 319 339 359 379 399 419 439 459 479 499 519 539 559 579 599 619 639 659
 20 40 60 80 100 120 140 160 180 200 220 240 260 280 300 320 340 360 380 400 420 440 460 480 500 520 540 560 580 600 620 640 660

MENTION **BYTE** WHEN WRITING TO ADVERTISERS

BYTE SUBSCRIPTIONS

41C9

For a subscription to BYTE, please complete this card.

Name _____

Address _____

City _____

State _____ Zip _____ Country _____

USA **Canada**
Mexico

- 1 year \$18 \$20
- 2 years \$32 \$36
- 3 years \$46 \$52

- \$32 Europe (air freight) payment enclosed
- \$32 Elsewhere (surface mail) payment enclosed
(Air mail rates available upon request)

*Please remit in US funds drawn on a US bank.
Thank you.*

- Check enclosed (Bonus: one EXTRA issue
— receive 13 issues for the price of 12)

-   Bill me (North America only)

Card No. _____

Expiration date _____

Four digits above name — Master Charge only _____

Signature _____ Date _____

Please allow eight weeks for processing.

Thank you

BOMB: BYTE's Ongoing Monitor Box

41C9

BYTE's BOMB is your direct line to the editor's desk. Each month, the two top rated authors receive bonuses based on your votes. To use this card, refer to the list of authors, titles, and corresponding BOMB article numbers on the opposite page. Then rate each article on a scale from 0 to 10 below by circling the appropriate rating number to the right of each BOMB article number. Your feedback helps us produce the best possible magazine each month.

BOMB Article Number Rating										
	Poor	Fair	Good	Very Good	Excellent	Wow!					
1	0	1	2	3	4	5	6	7	8	9	10
2	0	1	2	3	4	5	6	7	8	9	10
3	0	1	2	3	4	5	6	7	8	9	10
4	0	1	2	3	4	5	6	7	8	9	10
5	0	1	2	3	4	5	6	7	8	9	10
6	0	1	2	3	4	5	6	7	8	9	10
7	0	1	2	3	4	5	6	7	8	9	10
8	0	1	2	3	4	5	6	7	8	9	10
9	0	1	2	3	4	5	6	7	8	9	10
10	0	1	2	3	4	5	6	7	8	9	10
11	0	1	2	3	4	5	6	7	8	9	10
12	0	1	2	3	4	5	6	7	8	9	10
13	0	1	2	3	4	5	6	7	8	9	10
14	0	1	2	3	4	5	6	7	8	9	10
15	0	1	2	3	4	5	6	7	8	9	10
16	0	1	2	3	4	5	6	7	8	9	10
17	0	1	2	3	4	5	6	7	8	9	10
18	0	1	2	3	4	5	6	7	8	9	10
19	0	1	2	3	4	5	6	7	8	9	10
20	0	1	2	3	4	5	6	7	8	9	10

Comments _____

PLACE
STAMP
HERE

BYTE READER SERVICE

PO Box 1911 GPO
New York NY 10001
USA

PLACE
STAMP
HERE

BYTE SUBSCRIPTIONS

PO Box 590
Martinsville NJ 08836
USA

PLACE
STAMP
HERE

BYTE Publications Inc

70 Main St
Peterborough NH 03458
USA

BOMB
BYTE's Engineering Monitor Box



WORLD OF DIFFERENCE

In Business Software!

Graham-Dorian's Integrated, On-Line Programs Are Fast, Efficient, And Easy To Use.

Rely on Graham-Dorian, a full-line computer software manufacturer, for sophisticated programs — the most detailed on the market today. They're ready to go to work immediately or to be tailored for even more specific needs.

On-line capabilities enable you to make a single entry and update all affected files. An inquiry into a file at any time provides up-to-date information — no batching or sorting of input data.

The programs are easy to use. Messages on the video display guide you each step of the way. Programs make use of indexed sequential and chained files for fast and convenient retrieval of data with efficient use of disk space.

Order on standard eight-inch disk or various mini-floppy formats. Each program contains a free user's manual and hard copy source listing.

- **Accounts Receivable** — Records invoices, prepares statements and trial balance reports, etc. Automatically reports aging of accounts in periods of 30, 60, and 90 days, with each item listed separately.
- **Accounts Payable** — Vendor lookup and change, entering vendor invoices, writing checks (many options), cash flow analysis, accounts payable check register, and vendor list. Ideal for analyzing expenditures by vendor and by due date.

- **General Ledger** — Includes lookup and change, making journal entries, trial balance, transaction register, chart of accounts, financial statements, and monthly closing.

- **Job Costing** — Provides work order lookup, enters labor transactions, material set-up, progress report of hours, labor distribution report, weekly labor reset, actual versus estimated cost per job.

- **Inventory** — Can be connected with cash register for point of sale inventory control. Number of on-line items limited only by disk space available.

- **Cash Register** — Creates daily sales reports containing information on gift certificates, payouts, overrings, refunds, and how much in each category a salesperson sold.

- **Payroll** — Handles 100% of all necessary payroll functions including state income tax tables for your state. Ideally suited for both large and small companies.

- **Apartment** — Said one user, "Obviously, this was developed by apartment owners." The package fills virtually all the needs of apartment owners and managers. Ideal for projects with 75 units or more.

- **CBASIC-2** — The most comprehensive and powerful commercially oriented BASIC available today. Enhancements over CBASIC-1: integer variables, multiple line functions, CHAINing with COMMON variables, additional predefined functions, etc.

Compatible with many computers: Northstar, IMSAI, Altos, Cromenco, Industrial Micro Systems, Radio Shack TRS-80 Model II, SD Systems, Digital Microsystems, Dynabyte DB8/2, Micropolis MOD II, Vector MZ, and other 8080, 8085, and Z-80-based systems.

See your GDSS dealer or send for information packet and sample runs.



Circle 151 on inquiry card.

Graham-Dorian Software Systems, Inc.
A Division of Graham-Dorian Enterprises
211 N. Broadway / Wichita, KS 67202 / (316) 265-8633

The Personal Computer Line by OHIO SCIENTIFIC



Personal Computers

C1P: \$349 A dramatic breakthrough in price and performance. Features OSI's ultra-fast BASIC-in-ROM, full graphics display capability, and large library of software on cassette and disk, including entertainment programs, personal finance, small business, and home applications. It's a complete programmable computer system ready to go. Just plug-in a video monitor or TV through an RF converter, and be up and running. 15K total memory including 8K BASIC and 4K RAM—expandable to 8K.

C1P MF: \$995 First floppy disk based computer for under \$1000! Same great features as the C1P plus more memory and instant program and data retrieval. Can be expanded to 32K static RAM and a second mini-floppy. It also supports a printer, modem, real time clock, and AC remote interface, as well as OS-65D V3.0 development disk operating system.

Professional Portables

C4P: \$698 The professional portable that has over three times the display capability of C1Ps. Features 32 x 64 character display in up to 16 colors, graphics, audio output, a DAC for voice and music generation, key pad and joystick interfaces, AC remote control interface and much more. Utilizes a 4-slot BUS (2 used in base machine), 8K BASIC-in-ROM, 8K of static RAM and audio cassette interface. Can be directly expanded to 32K static RAM and two mini-floppy disks.

C4P MF: \$1695 The ultimate portable computer has all the features of the C4P plus real time clock, home security system interface, modem interface, printer interface, 16 parallel lines and an accessory BUS. The standard machine operates at twice the speed of currently available personal computers (with GT option it runs even faster!). The C4P MF starts with 24K RAM and a single mini-floppy and can be directly expanded to 48K and two mini-floppies. Available software includes games, personal, business, educational and home control applications programs as well as a real time operating system, word processor and a data base management system.



*Monitors and cassette recorders not included. Ohio Scientific offers a combination TV/Monitor (AC-3P) for \$115.

Home/Small Business Systems

C8P: \$895 Same great features as the C4P in a tremendously expandable "main-frame package." Features over three times the expansion capability of the C4P for advanced home and demanding business applications. Can be expanded to 48K RAM, dual 8" floppies, hard (Winchester) disks and multiple I/O devices such as Voice I/O and a universal telephone interface.



C8P DF: From \$2597 The ultimate Home/Very Small Business Computer at a personal computer price. Features 32K RAM (expandable to 48K) and dual 8" floppy disks (stores eight times as much information as a mini-floppy). Has all personal computer capabilities including 32 x 64 display, color graphics, sound, DAC, joystick interfaces, home features including real time clock, AC remote interface, home security and fire detection interface and can be expanded to include voice I/O and a universal telephone system for answering and initiating calls! Its large memory capability and 8" floppies allow it to run most Ohio Scientific business system software including a complete accounting system, word processor and information management system.

For literature and the name of your local dealer, CALL 1-800-321-6850 TOLL FREE.

OHIO SCIENTIFIC
1333 SOUTH CHILLICOTHE ROAD
AURORA, OH 44202 • [216] 562-3101