

MAY 1978

VOLUME 3 Number 5

\$2.00 in US

\$2.40 in CANADA

# BYTE

the small systems journal



THE UNIVERSITY OF  
TORONTO LIBRARY



SCIENTIFIC LIBRARY

APR 13 1978

PAT. & T.M. OFFICE

TK  
7885-A1  
B9

Joel W. Wilton '78

# READY for BUSINESS

We've got it all together—the cost effectiveness and reliability of our 6800 computer system with a high capacity 1.2 megabyte floppy disk system. . . PLUS—an outstanding new DOS and file management system.



## 1 MEGABYTE DISK SYSTEM

DMAF1 introduces a new level of capability to small computer systems. This disk system features two standard size floppy disk drives using the new double sided disk and two heads per drive. Usable storage space of over 600 kilobytes per drive, giving a total of over 1.0 megabyte of storage on line at all times. Ideal for small business applications, or for personal "super" systems.

## DMA CONTROLLER

The controller occupies one main memory slot in an SS-50 bus and uses the Motorola MC-6844 DMA controller. The combination of a DMA

type controller and double sided disks give the system speed of data transfer unobtainable with smaller drives.

## OPERATING SYSTEM

To compliment this outstanding hardware we are supplying equally superior software. The disk operating system and file management system is called FLEX. It is one of the most flexible and complete DOS's available for small systems, but just as important; it is easy to use. No one can match the variety of compatible peripherals offered by Southwest Technical Products for the SS-50 bus and the 6800 computer system. Now more than ever there is no reason to settle for less.

DMAF1 Disk System (assembled) .....	\$2,095.00
DMAF1 Disk System (kit) .....	\$2,000.00
68/2 Computer with 40K of memory (assembled) .....	\$1,195.00



SOUTHWEST TECHNICAL PRODUCTS CORPORATION  
219 W. RHAPSODY  
SAN ANTONIO, TEXAS 78216

# Now we can announce it— the multi-disk drive System Three Computer



**A fast Z80 microcomputer with up to 512-kilobytes of RAM, 4 disk drives and 1 megabyte of disk storage—with CRT terminal and fast printer. Even an optional PROM programmer. Strong software support, too, like FORTRAN IV, Extended BASIC, and Macro Assembler.**

## **PROFESSIONAL GRADE— FOR PROFESSIONALS**

Chances are you've already heard that there is a Cromemco System Three Computer. We've proudly previewed it at WESCON on the West Coast and NYPC on the East Coast.

But you also know Cromemco. We don't announce until we're ready to ship.

### **Now we're ready.**

And what a computer we've got for you.

It does it all.

It's a complete system—processor, CRT terminal, line printer.

First, it's fast—1 microsecond nominal execution time and 250 nanosecond cycle time.

Its equally fast RAM memory is large and enormously expandable—32 kilobytes expandable to 512 kilobytes. No danger of obsolescence from inadequate RAM capacity.

## **THE ONLY MICROCOMPUTER OFFERING 4 DISK DRIVES**

Further, the System Three comes with two disk drives to give you 512 kilobytes of disk storage. Soft-sectored IBM format. Optionally, you can have four drives with 1 megabyte of storage.

There's disk protection, too, since in the LOCK position disks can't be ejected while they are running.

### **21-SLOT MOTHERBOARD**

This new CS-3 is a computer that won't be outdated soon. It has a 21-card-slot slide-out motherboard and an S-100 bus so that you can plug in all sorts of support circuitry. The heavy-duty 30-amp power supply can easily handle all this.

### **BROAD S-100 SUPPORT**

The S-100 is the bus that Cromemco so strongly supports with over a dozen plug-in circuits ranging

from analog I/O to high-speed RAM memory with our bank-select feature.

## **TRULY POWERFUL SOFTWARE**

You have to have software. And Cromemco is far in front there, too. Our FORTRAN IV, for example, is equal to the FORTRAN compilers on large mainframes. Further, it (and our other software) is low-priced.

Our 16K Z80 BASIC is one of the fastest and most capable. Full 14-digit precision.

There's also our Z80 Macro Assembler and Linking Loader. Uses Z80 mnemonics. Allows referencing FORTRAN common blocks.

## **CRT TERMINAL AND PRINTER**

The CS-3 terminal has 80-character lines and a 24-line page with line and page editing.

Note the separate numeric keypad and cursor keypad.

The printer is fast—180 characters per second; 132-column lines.

## **SEE AT YOUR DEALER**

You have to see the CS-3 to fully appreciate it and its low prices starting at \$5990 in the rack mount version.

See it at your local dealer shown on the other side of this page. He has a demo to show you.

He also has brochures giving you details.

You know the CS-3 is going to be a sensation.

Better contact your dealer now.

 **Cromemco**

see next  
page 

# In This **BYTE**

## About the Cover:

The computer experimenter of the future shown on this month's cover is using a computer graphics terminal created by artist Joel N Wilson to make a point: computer graphics has come of age. Future scenes such as Joel's painting are not far off, and this month's issue is largely devoted to the fascinating world of computer graphics.

Taking photographs of your video display is an inexpensive alternative to buying a printer or other hard copy device for your computer. However, it's not always as easy as it sounds. Dr Dwight D Egbert gives some valuable tips on the subject in **The Photograph Is Also a Hard Copy**.

page 10

Real 3-D graphics? It sounds like an impossible concept, even given the magic of minicomputers, but that is just what authors Timothy Walters and William Harris have created. Read **Graphics in Depth: 3-D Adds a New Dimension to Your Display** and find out how to create images that change perspective as you vary your viewing angle.

page 16

What's the difference between an RF monitor and a direct video entry monitor? Find out in **Convert Your TV Set to a Video Monitor**. Dan Fylstra explains the relative merits of the two approaches to video displays, and gives you some idea of the techniques necessary to implement both methods.

page 22

Would you like to try some pseudo-color? How about an 8 level grey scale? High density video graphics is an exciting application of personal computing. There are many video display boards on the market to help you get started. Read about one of them in **The Matrox ALT-256 Video Board**, by Gary Ruple.

page 24



page 32

Color graphics is an exciting branch of personal computing. Ordinary video display programs take on a new luster when converted to color. Authors Thomas A Dwyer and Margot Critchfield discuss the use of **Color Graphics on the Compucolor 8051**.

page 32

Is there a practical microcomputer PASCAL language system? Ken Bowles, of the Institute for Information Systems at the University of California San Diego, outlines what is perhaps one of the most significant software developments of the past year or so: the UCSD PASCAL system now available for LSI-11, 8080 and Z-80 machines and soon to be available for other major general purpose microcomputer systems. Read Ken's account of **UCSD PASCAL: A (Nearly) Machine Independent Software System**.

page 46

A hidden line subroutine for your plotter can make the difference between an average plot and a professional looking one. The algorithms aren't as difficult as you might think. Read **Hidden Line Subroutines for Three-Dimensional Plotting** by Mark Gottlieb and find out more.

page 49

One way to learn more about display systems for television is to read a detailed description of a practical video driver program. John Webster and John Young have done just that in **GRAPH: A System for Television Graphics**. In part 1, this month, the authors provide background information and begin a detail discussion of this character editing system used

for titling and graphics associated with educational videotape production.

page 62

Did you ever wish your video display could handle Greek letters, subscripts, different size fonts, or even APL characters? How about special graphics characters? Find out how to add these and many other characters to your video display system in **A Programmable Character Generator** by Larry Weinstein.

page 79

When designing a light wand and signal processor it is desirable to have as few external variables as possible affecting the output. In **A Low Cost Light Wand Amplifier**, Robin C Moseley examines some of the variables that must be considered and describes a particular signal processor which is tolerant of many external variables.

page 92

Last month Steve Ciarcia described the transmitter section of his AC wireless remote control system. This month read the concluding description of the receiver in **Tune In and Turn On, Part 2**, and start experimenting with your own computer controlled wireless appliance and light control system.

page 97

This month, Jack Bryant and Manot Swasdee complete their description of **How to Multiply in a Wet Climate** with the details of multiplier hardware and a program to test the multiplier in comparison with an equivalent software multiplication.

page 104

# HORIZON

## THE COMPLETE COMPUTER

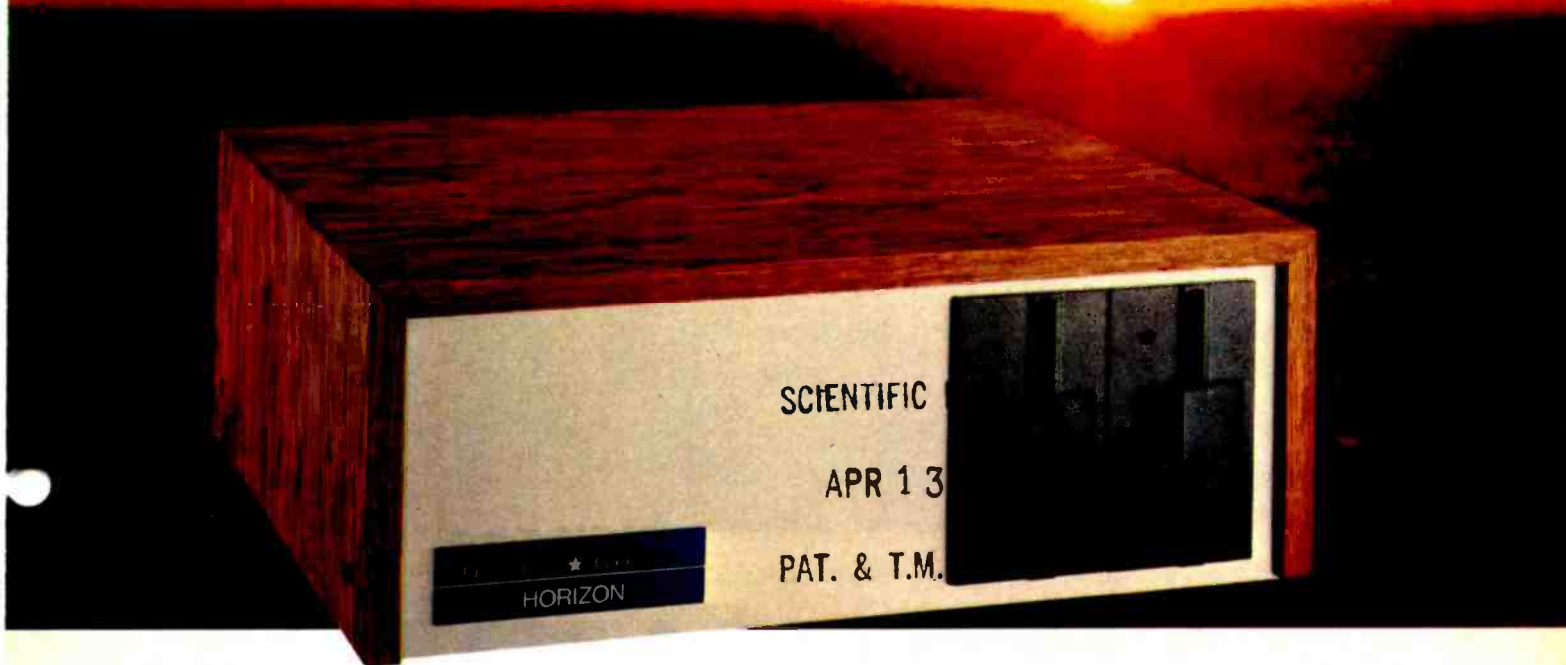

### Look To The North Star HORIZON Computer.

**HORIZON™**— a complete, high-performance microprocessor system with integrated floppy disk memory. HORIZON is attractive, professionally engineered, and ideal for business, educational and personal applications.

To begin programming in extended BASIC, merely add a CRT or hard-copy terminal. HORIZON-1 includes a Z80A processor, 16K RAM, minifloppy™ disk and 12-slot S-100 motherboard with serial terminal interface — all standard equipment.

#### WHAT ABOUT PERFORMANCE?

The Z80A processor operates at 4MHZ — double the power of the 8080. And our 16K RAM board lets the Z80A execute at *full speed*. HORIZON can load or save a 10K byte disk program in less than 2 seconds. Each diskette can store 90K bytes.

#### AND SOFTWARE, TOO

HORIZON includes the North Star Disk Operating System and full extended BASIC on diskette ready at power-on. Our BASIC, now in widespread use, has everything desired in a BASIC, including sequential and random disk files, formatted output, a powerful line editor, strings, machine language CALL and more.

#### EXPAND YOUR HORIZON

Also available—Hardware floating point board (FPB); additional 16K memory boards with parity option. Add a second disk drive and you have HORIZON-2. Economical serial and parallel I/O ports may be installed on the motherboard. Many widely available S-100 bus peripheral boards can be added to HORIZON.

#### QUALITY AT THE RIGHT PRICE

HORIZON processor board, RAM, FPB and MICRO DISK SYSTEM can be bought separately for either Z80 or 8080 S-100 bus systems.

HORIZON-1 \$1599 kit; \$1899 assembled.

HORIZON-2 \$1999 kit; \$2349 assembled.

16K RAM—\$399 kit; \$459 assembled; Parity option \$39 kit; \$59 assembled. FPB \$259 kit; \$359 assembled. Z80 board \$199 kit; \$259 assembled. Prices subject to change. HORIZON offered in choice of wood or blue metal cover at no extra charge.

Write for free color catalogue or visit your local computer store.

**NORTH STAR ★ COMPUTERS**

2547 Ninth Street • Berkeley, California 94710 • (415) 549-0858



Sol Terminal Computer

# The answer is a

## It's the serious solution to the small computer question.

Sol Systems are the key to effective, economical small computer power. Sol Systems give you the force of a powerful general purpose computer, the problem solving capability of high level languages and the operational simplicity of everyday office equipment.

From the ground up, Sol Systems were designed to do a complete job without adding a load of costly extras. In fact, when you compare the "everything included" price of a quality, field proven Sol System with anything else on the market, you'll be happily surprised to find out how little the extra performance and convenience costs.

For example, complete Sol Systems with 16,384 bytes of RAM memory start at less than \$2500\* Expanded systems with 49,152 bytes of RAM memory, 1.5 million bytes of on-line disk memory, disk operating system and Extended Disk BASIC cost less than \$8000\* Both systems are fully assembled, burned-in, tested and ready to go.

### Sol Compatibility

Sol Systems feature the S-100 bus for pin-to-pin compatibility with a wide variety of add-on devices such as voice input and computer graphics. Standard Sol parallel and serial interfaces will drive most standard printers, modems and other peripherals.

### A word about languages

No system is complete without software, and at Processor Technology we have tailored a group of high level languages, an assembler and other packages to suit the wide capabilities of our hardware.

Take a look at our exclusive Extended BASIC as an example. In cassette form, this BASIC features string and advanced

\*U.S. prices only.



# Sol System.

file handling, special screen commands, timed input, complete matrix, logarithmic and trigonometric functions, exponential numbers, 8 digit precision and square root. The language handles serial access files, provides tape rewind and offers cursor control for graphics capability.

The disk version has all the number crunching talents of the cassette BASIC plus instant access to data and programs on floppy disks. It includes random as well as sequential files and a unique ability to update sequential data in place.

Processor Technology FORTRAN is similar to FORTRAN IV and has a full set of extensions designed for the "stand alone" computer environment. Thousands of special application programs available through books and periodicals have already been written in this well established language.

Processor Technology PILOT is an excellent language for teachers. It is a string-oriented language designed expressly for interactive applications such as programmed instruction, drill and testing.

**No wonder we call it the serious solution to the small computer question.**

It's the small computer system to do the general ledger and

the payroll. Solve engineering and scientific problems. Use it for word processing. Program it for computer aided instruction. Use it anywhere you want versatile computer power!

**Sold and serviced only by the best dealers.**

Sol Systems are sold and serviced by an outstanding group of conveniently located computer stores throughout the United States and Canada. They are also available in Australia, Europe, the United Kingdom, Central America, South America, Japan and Singapore.

For more information contact your nearest dealer listed on the following page. Or write Department B, Processor Technology Corporation, 7100 Johnson Industrial Drive, Pleasanton, CA 94566. Phone (415) 829-2600.

Circle 305 on inquiry card.

**Processor Technology**

## On the Uses of Snowstorms in Computer Science

By Carl Helmers

By the time you read this, the events of this past week will be history as the seasons progress. Monday evening (Feb 6) it began to snow a bit in Peterborough. It had apparently been snowing through most of the day at places further south along the eastern seaboard, but I had no expectation of anything out of the ordinary. After all, the morning news and weather reports I listened to had said we might get a foot of snow, but that is hardly unusual. One of the reasons for locating one's home and place of business in the hills of New Hampshire is to take advantage of those opportunities for transient beauty which are presented each year by a full cycle of seasons. All six seasons — Summer, Foliage, Winter, Mud, Spring and Black Fly — come and go in a regular cycle each year. Since the first week of February is solidly within the Winter phase of the cycle, another snowstorm is not a major event.

The beautiful clear day full of sunshine which is this present Wednesday certainly speaks well of the climate. But in between Monday and Wednesday was that equally natural event which was a winter's gale, or "Nor'easter" as this type of storm is called by the local people. Already, the people responsible for writing instant history books have started calling the weather conditions yesterday by the name "The Great Blizzard of '78." The pundits of course were not particularly original, for a very similar term is often applied to a storm of approximately 90 years earlier in 1888. And the pundits also show a particular regional bias. I don't recall any special terms of endearment applied to the storm which a half a week earlier had given New England torrential rains while the Midwest was racked with almost equivalent snows and hurricane like winds. But somehow, if a large amount of snow becomes your own provincial local problem in Philadelphia, New York, Providence or Boston, it becomes "The Blizzard of '78," ayup. Very simply, what happened was that a capricious storm decided to sit on Cape Cod for most of Tuesday, channelling water laden air off the

### Articles Policy

BYTE is continually seeking quality manuscripts written by individuals who are applying personal computer systems, designing such systems, or who have knowledge which will prove useful to our readers. For a more formal description of procedures and requirements, potential authors should send a self-addressed, stamped envelope to BYTE Authors' Guide, 70 Main St., Peterborough NH 03458.

Articles which are accepted are purchased with a rate of up to \$50 per magazine page, based on technical quality and suitability for BYTE's readership. Each month, the authors of the two leading articles in the reader poll (BYTE's Ongoing Monitor Box or "BOMB") are presented with bonus checks of \$100 and \$50. Unsolicited materials should be accompanied by full name and address, as well as return postage. ■

Continued on page 135

# Your Sol dealer has it.

AL: Birmingham: ICP, Computerland, 1550-D Montgomery Hwy., (205)979-0707. AZ: Tempe: Byte Shop, 1425 W. 12th Pl., (602)894-1129; Phoenix: Byte Shop, 12654 N. 28th, (602)942-7300; Tucson: Byte Shop, 2612 E. Broadway, (602)327-4579. CA: Berkeley: Byte Shop, 1514 University, (415)845-6366; Costa Mesa: Computer Center, 1913 Harbor, (714)646-0221; Hayward: Byte Shop, 1122 "B" St., (415)537-2983; Hayward: Computerland of Hayward, 22634 Foothill Blvd., (415)538-8080; Lawndale: Byte Shop, 16508 Hawthorne, (213)371-2421; Mt. View: Byte Shop, 1063 El Camino, (415)969-5464; Mt. View: Digital Dell, 80 W. El Camino, (415)961-2670; Orange: Computer Mart, 633-B W. Katella, (714)633-1222; Pasadena: Byte Shop, 496 S. Lake, (213)684-3311; Sacramento: Micro-Computer Application Systems, 2322 Capitol, (916)443-4944; San Francisco: Byte Shop, 321 Pacific, (415)421-8686; San Jose: Byte Shop, 2626 Union, (408)377-4685; San Rafael: Byte Shop, 509 Francisco, (415)457-9311; Tarzana: Byte Shop, 18424 Ventura, (213)343-3919; Walnut Creek: Byte Shop, 2989 N. Main, (415)933-6252. CO: Boulder: Byte Shop, 3101 Walnut, (303)449-6233; Denver: Byte Shop, E. 1st Ave. & University, (304)399-8995. FL: Ft. Lauderdale: Byte Shop, 1044 E. Oakland Pk., (305)561-2983; Miami: Byte Shop, 7825 Bird, (305)264-2983; Tampa: Microcomputer Systems, 144 So. Dale Mabry, (813)879-4301. GA: Atlanta: Computer Mart, 5091-B Buford, (404)455-0647. IL: Champaign: Computer Co., 318 N. Neil, (217)359-5883; Numbers Racket, 623 1/2 S. Wright, (217)352-5435; Evanston: Itty bitty machine co, 1322 Chicago, (312)328-6800; Schaumburg: Data Domain, 1612 E. Algonquin, (312)397-8700. IN: Bloomington: Data Domain, 406 S. College, (812)334-3607; Indianapolis: Data Domain, 7027 N. Michigan, (317)251-3139. IA: Davenport: Computer Store, 4128 Brady, (319)386-3330. KS: Overland Park: Personal Computer Center, 3819 W. 95th St., (913)649-5942. MA: Boston: Computer Warehouse Store, 584 Commonwealth, (617)261-2700. MD: Towson: Computer Etc., 13A Allegheny, (301)296-0520. MI: Ann Arbor: Computer Store, 310 E. Washington, (313)995-7616; East Lansing: General Computer Store, 1310 Michigan, (517)351-3260; Troy: General Computer Store, 73 W. Long Lake Rd., (313)689-8321. MN: Minneapolis: Computer Depot, 3515 W. 70th, (612)927-5601. NJ: Cherry Hill: Computer Emporium, 2438 Route 38, (609)667-7555; Hoboken: Computer Works, 20 Hudson Pl., (201)420-1644; Iselin: Computer Mart, 501 Rt. 27, (201)283-0600. NY: Endwell: The Computer Tree, 409 Hooper Rd., (607)748-1223; New York: Computer Mart, 118 Madison, (212)686-7923; White Plains: Computer Corner, 200 Hamilton, (914)949-3282. NC: Raleigh: ROMs 'N' RAMs, Crabtree Valley Mall, (919)781-0003. OH: Columbus: Byte Shop, 2432 Chester, (614)486-7761; Dayton: Computer Mart, 2665 S. Dixie, (513)296-1248. OR: Beaverton: Byte Shop, 3482 SW Cedar Hills, (503)644-2686; Eugene: Real Oregon Computer Co., 205 W. 10th, (503)484-1040; Portland: Byte Shop, 2033 SW 4th Ave., (503)223-3496. RI: Warwick: Computer Power, M24 Airport Mall, 1800 Post Rd., (401)738-4477. SC: Columbia: Byte Shop, 2018 Green, (803)771-7824. TN: Kingsport: Microproducts & Systems, 2307 E. Center, (615)245-8081. TX: Arlington: Computer Port, 926 N. Collins, (817)469-1502; Arlington: Micro Store, 312 W. Randol Mill Rd., (817)461-6081; Houston: Interactive Computers, 7646 1/2 Dashwood, (713)772-5257; Lubbock: Neighborhood Computer Store, 4902-34th St., (806)797-1468; Richardson: Micro Store, 634 So. Central Expwy., (214)231-1096. VA: McLean: Computer Systems Store, 1984 Chain Bridge, (703)821-8333; Virginia Beach: Home Computer Center, 2927 Va. Beach Blvd., (804)340-1977. WA: Bellevue: Byte Shop, 14701 NE 20th, (206)746-0651; Seattle: Retail Computer Store, 410 NE 72nd, (206)524-4101. WI: Madison: Computer Store, 1863 Monroe, (608)255-5552; Milwaukee: Computer Store, 6916 W. North, (414)259-9140. D.C.: Georgetown Computer Store, 3286 M St. NW, (202)362-2127. CANADA: Toronto, Ont: Computer Mart, 1543 Bayview, (416)484-9708; First Canadian Computer Store, 44 Eglinton Ave. W., (416)482-8080; Vancouver, B.C.: Basic Computer Group, 1438 W. 8th, (604)736-7474; Pacific Computer Store, 4509 Rupert, (604)438-3282.

## Processor Technology

Circle 305 on inquiry card.



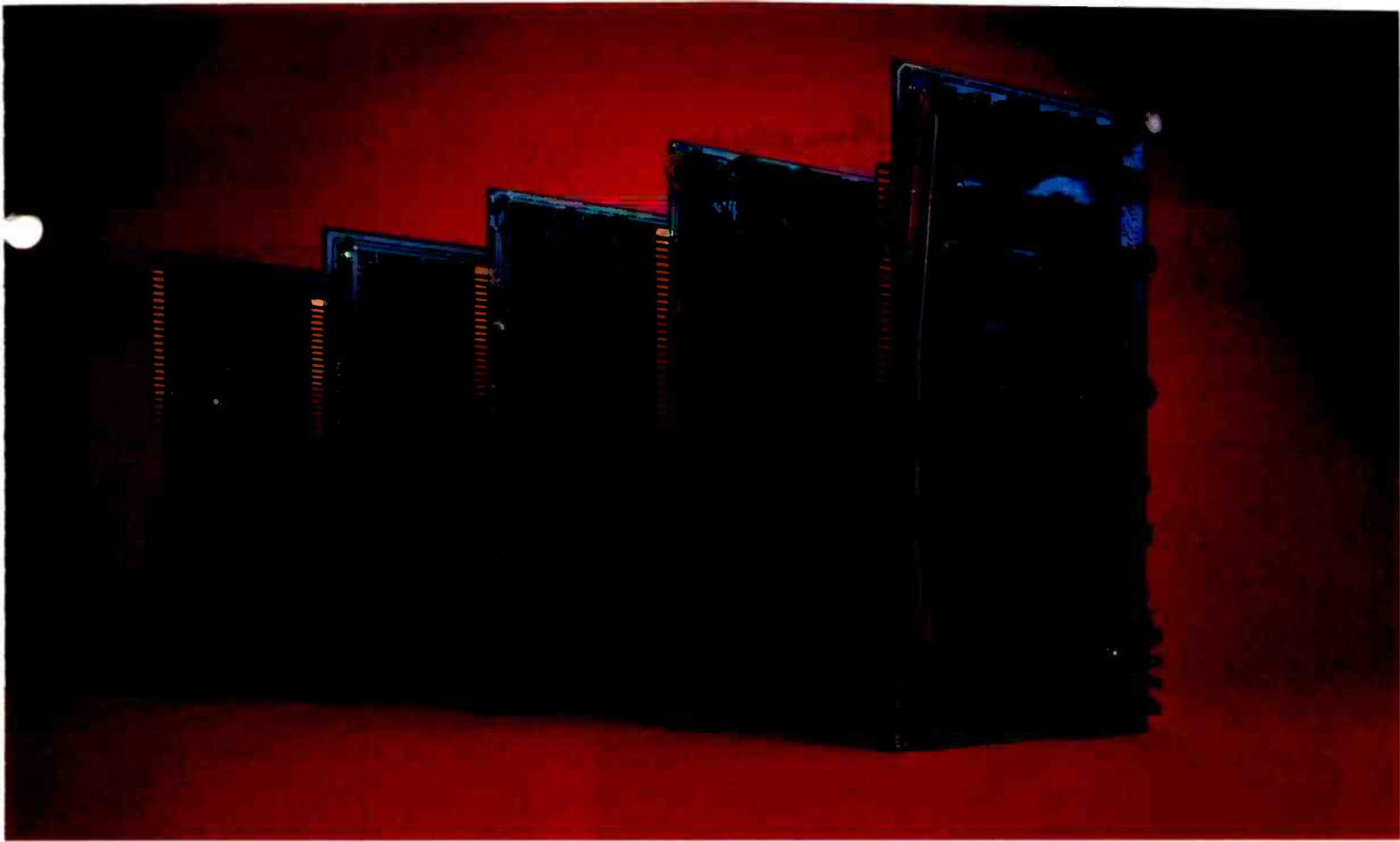

# Subsystem B

## Each board is a standout. Together, they're a powerhouse.

In the beginning there were boards, thousands of them.

That's how we started in the business. Making memories and interfaces for other people's computers...and making them better.

Now that our own Sol has become the number one small computer, you might think we're putting less emphasis on our board business.

Not so.

We're just doing more creative things with them.

### One neat package gets your computer on the air.

For example, we've built Subsystem B, which ties together five Processor Technology modules into a completely integrated system that makes other S-100 Bus computers work almost as well as our Sol.

Circle 305 on inquiry card.

Subsystem B includes a memory module, three input/output modules, a general purpose memory, and appropriate software.

A specialized software program called CUTER knits together your computer and its peripherals to create an integrated, smoothly working system.

It's the fastest, cleanest way to get on line, and it costs less than if you bought each module separately.

You get your choice of two low power, reliable memory modules in 8K or 16K capacity.

Our VDM-1 video display module (still \$199 in kit) is the industry standard display device with over 6,000 in use.

Our CUTS high speed, low cost (\$149 in kit) audio cassette interface is the most reliable on the market and is supported by our broad line of cassette

software including Extended BASIC, FORTRAN\*, PILOT\*, FOCAL and numerous others.

And our 3P+S input/output module offers a low cost way to handle virtually all the I/O needs of any S-100 Bus compatible computer system. There are close to 10,000 in the field. Price is just \$149 in kit.

Yes, we may have become the maker of the Number 1 small computer — the Sol. But we haven't neglected the quality of our board business. We can't afford to... because we use many of them in our own computers.

For our most recent literature and price list see your dealer or write Processor Technology Corporation, Box B, 7100 Johnson Industrial Drive, Pleasanton, CA 94566. (415) 829-2600.

**Processor Technology**

\*Available soon.

U.S. prices only.

# The Photograph Is Also a Hard Copy

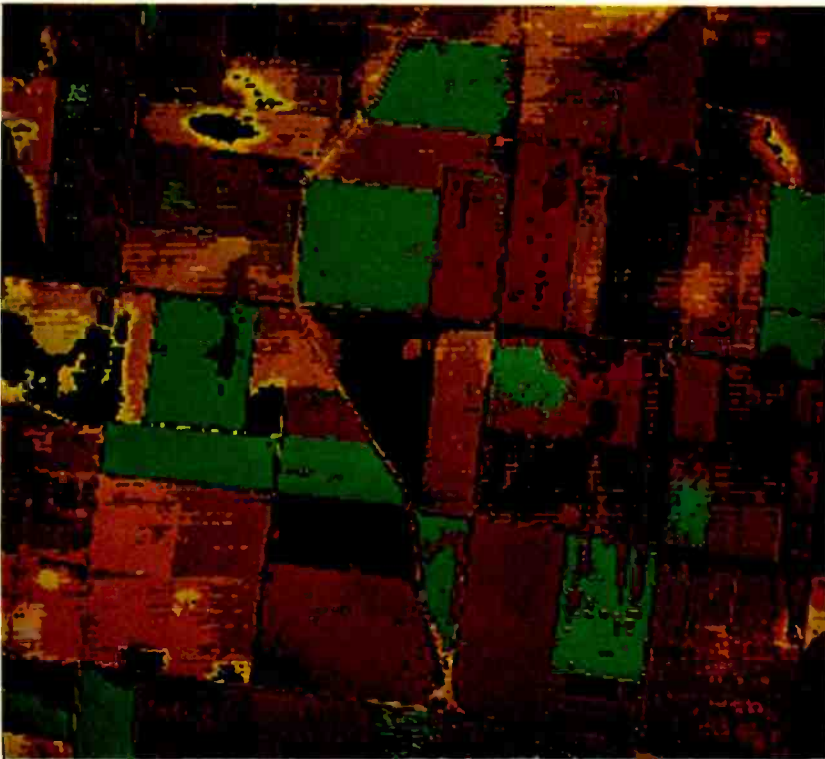

Photo 1.

Even with the arrival of low cost alphanumeric printers for hobby computers, there are still several situations in which photographs from video displays are the most satisfactory form of hard copy. This is particularly true when you are displaying graphs or image data in black and white, or with almost any color display. In fact, most professionals working with color displays are still forced to photograph their video displays to obtain color hard copy. At present, satisfactory color hard copy devices range in price from \$50,000 to well over \$500,000.

Likewise, the current small system printers are not suitable for image data, whether black and white or color. Image data differs from the usual alphanumeric and graphics data because the display is no longer binary (black or white, color or no color). Instead, image data is displayed in a two-dimensional array or raster, and each element of the array or each picture element (pixel) can

possess one of several grey levels or colors. In the field of personal computing, the Cromemco Dazzler is capable of displaying image data in up to a 64 by 64 pixel array with each pixel one of 16 possible grey levels or 15 possible colors. The Apple II has a similar mode of operation with 16 colors and black available in a 44 high by 40 wide array. For these types of displays it will probably be many years before a viable alternative to photography exists for low cost hard copy.

There are several techniques you can employ to produce photographs of video displays that will insure consistently high quality results. Many kinds of cameras can be used with these techniques, but by far the easiest to use is the single lens reflex. Some models of Polaroid cameras equipped with close-up attachments also work well.

Whichever camera you use, it is essential that you attach it to a solid mount. This might be a tripod, a low cost camera clamp, or a device of your own construction. The camera should be positioned perpendicular to the video display screen so that the screen is centered and almost completely fills the viewfinder. As with most of the techniques discussed here, consistency is paramount if you want to obtain reliable and repeatable results. To achieve consistency in camera positioning, it is desirable to build some simple mechanism to hold the camera in the same location every time you use it. Alternatively, if you use a tripod, mark the leg positions on the floor with tape, or at least measure the distance from the screen to the camera with a tape measure.

Once the camera is mounted, the room lights should be dimmed or preferably turned off when you actually take a picture. If the room contains windows, pull the shades or completely block them. You will obtain the best results in a completely dark room. If you cannot completely eliminate light from the room, position the display so that any light sources are behind it to prevent light reflections from the screen. Make a habit of observing any such reflections while looking through the camera viewfinder. Normally, reflections will not be

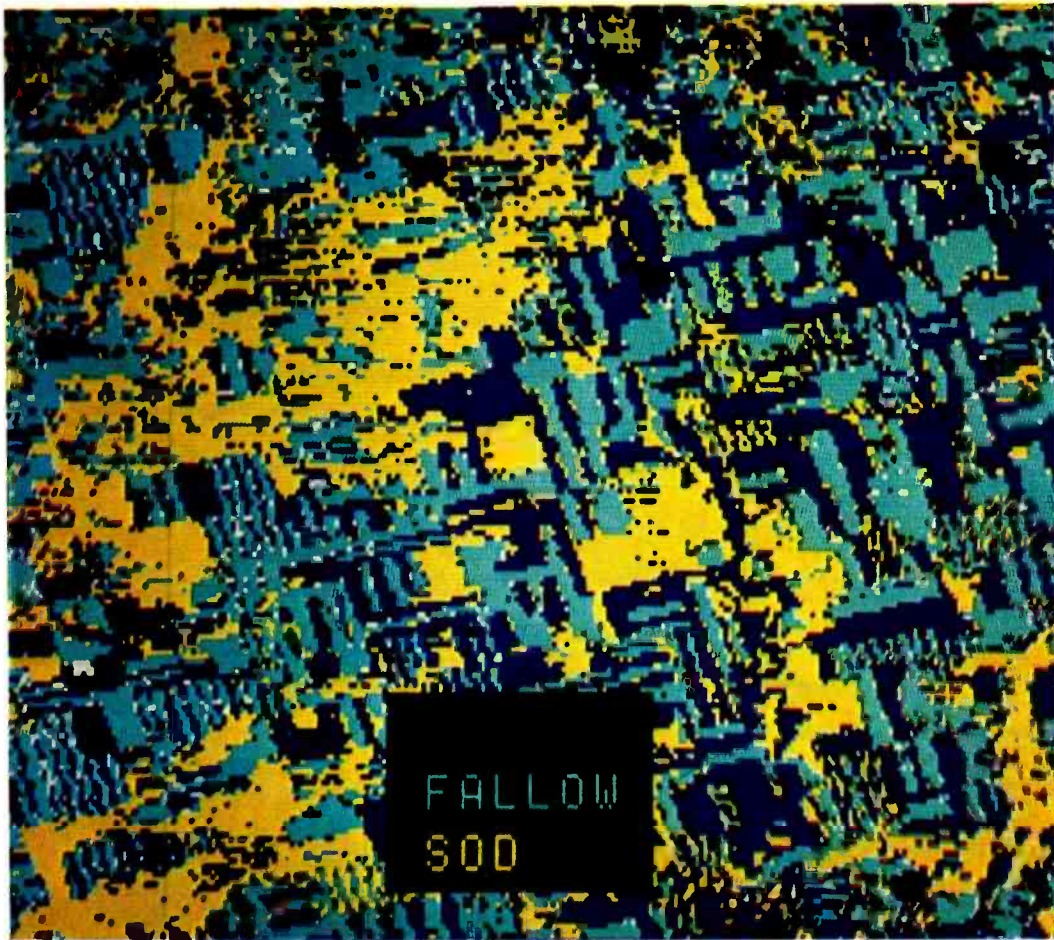
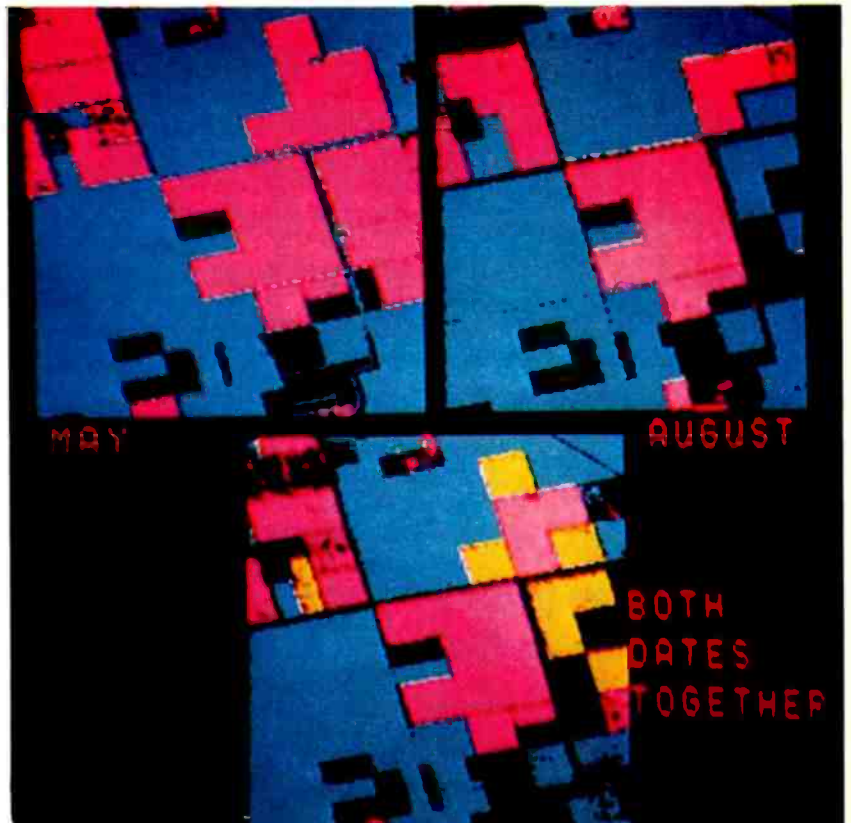

Photo 2.

Photo 3.

Photos 1 thru 5: Some examples of high resolution color graphics photographed by the author from various high resolution color graphic displays, using techniques similar to those described in this article. Photo 1 is a false color image of farmland obtained from an aircraft by a NASA 24 channel multispectral digitizing scanner. The data was converted and displayed on a high resolution color monitor at the NASA Goddard Institute for Space Studies in New York. Photos 2 and 3 were recorded by LANDSAT satellite and processed by the General Electric Image 100 image analysis system. The LANDSAT system records four black and white images taken in different parts of the light spectrum. After analysis, the Image 100 displays grey scale values or other computer derived features as arbitrary false colors. Photo 4 was recorded from an aircraft and processed on the Image 100 system. Photo 5 is a false color image created at the University of Kansas Center for Research, Remote Sensing Laboratory, using their Identification, Discrimination, Enhancement Combination System (IDECS).



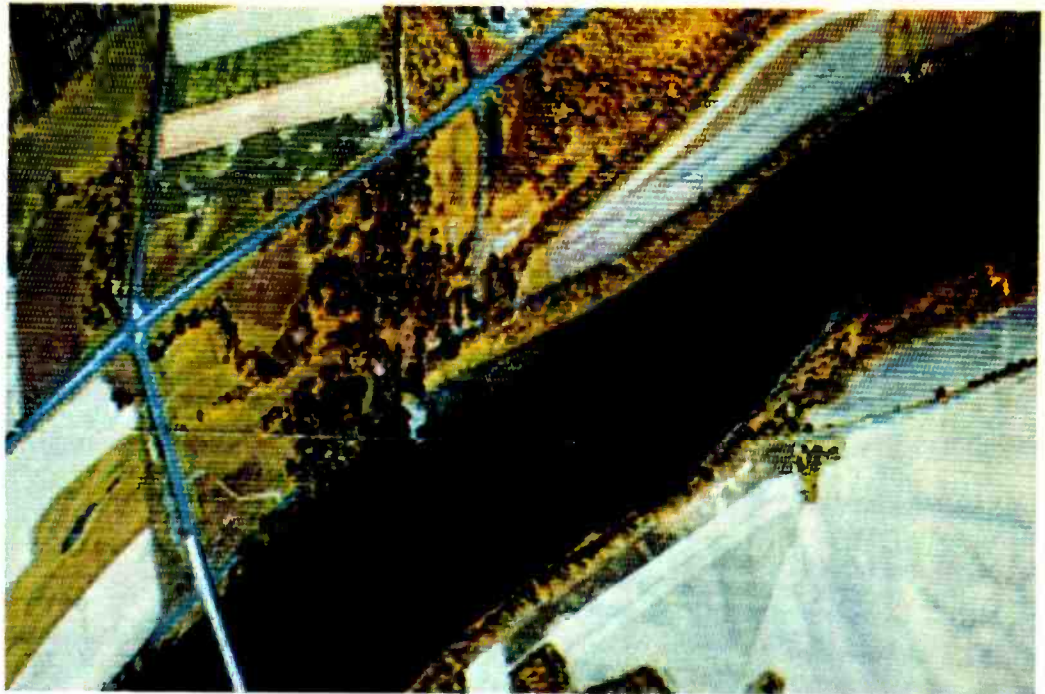

Photo 4.

noticed unless you are consciously looking for them, but they will be obvious in the resulting photographs. If you find that you are unable to eliminate reflections of the camera and yourself, you can overcome this with a simple device. To eliminate the camera reflection, use a piece of black lightweight cardboard or stiff paper somewhat larger than the camera. Cut a round hole in the center of the paper just large enough for the camera lens to fit through, and attach it to the lens with either tape or a filter adapter ring. You can eliminate reflections of yourself by standing to one side of the camera during the exposure. This is facilitated by the use of a shutter cable release, which also guards against camera movement during the typically long exposure times.

There is one case when you might want to intentionally use room light when photographing a display. If you are photographing a vector display or oscilloscope screen as opposed to a raster scan video display, you can use a dim room light to reduce contrast. A desk or table lamp placed behind the display screen is usually sufficient. If you're going to do this often, it might be worthwhile to make a few tests with different lamp intensities to determine the proper ratio of background to display lighting. When using this technique, be conscious of potential reflection problems.

Next, it is necessary to adjust the video display properly. This is the most important factor in obtaining high quality photographs. The use of excessive contrast and/or bright-

ness when adjusting the display can degrade images. For good quality photographs, the display should appear slightly "flat" with lower contrast than used for normal viewing, and there should be absolutely no sign of blooming or smearing of the high intensity areas. You can achieve this condition through an iterative adjustment of the contrast and brightness controls. First, lower the contrast somewhat from its normal setting. Then, adjust the brightness control until you can just see dim grey over the entire background raster where there is no signal present (ie: no image or characters). If, at this point, the image appears excessively low in contrast, turn the contrast up slightly and readjust the brightness to obtain a barely visible background. Alternatively, if the image appears too contrasty, or if the high intensity areas are smeared, turn the contrast down slightly and readjust the brightness. The secret is to obtain a display with a dark grey background raster and slightly lower contrast than you think is proper.

Since this procedure requires qualitative judgement on your part, it is very important to experiment with a test roll of film using several slightly different settings. Throughout the test be sure to record the video display control positions and camera settings for each exposure. Otherwise, by the time you have the developed film ready to evaluate, you will probably find it impossible to duplicate any of the test conditions.

If you are using a DC coupled video

# Give your minidisks™ a happy home.



You know your VERBATIM™ minidisks are tough. Long-lived. Rugged. Now, chances are good that your minidisks will last forever. The reason? The Mini Data File.

ITC's Mini Data File is a neat new way to store and ship your VERBATIM minidisks. Made from high-impact plastic, the Mini Data File is lightweight and convenient. It protects your data in ways that a file drawer never could. No more dust, for instance. And no more damage from tough, everyday handling.



## FREE!

### MINI DATA FILE from ITC.

For a limited time, ITC will give you this \$4.50 storage box *free* when you buy ten VERBATIM minidisks.

Check your local VERBATIM dealer or computer suppliers store. And if you don't know a dealer near you, call us.

We want to see your data happy and safe.

Call Toll Free: (1) 800-821-7700, Ext. 515

(In Missouri call:  
800-892-7655, Ext. 515)

Information Terminals Corp.  
323 Soquel Way, Sunnyvale, CA 94086  
(408) 245-4400



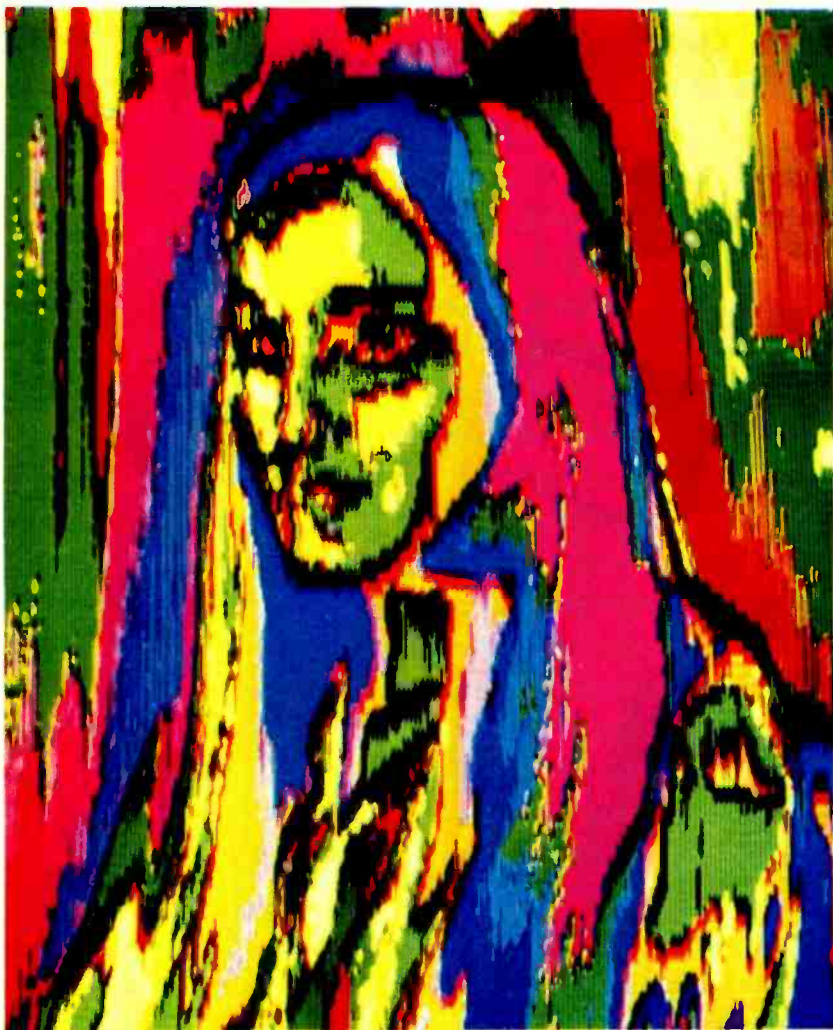

Photo 5.

input, you can use the results of this test to determine the optimum contrast and brightness settings for your equipment. You can mark these and use them for all photographing. Also, you can achieve the most consistent results this way. However, if you are using capacitor coupled video or RF (radio frequency) input, the contrast and brightness are somewhat data-dependent and you may need to make slight adjustments for different displays. Even in this case, though, a single setting of the contrast and brightness controls can be used most of the time, and marked settings should certainly be used as a constant reference.

When making the initial tests it is also necessary to determine the proper film exposure. For static video display patterns, the shutter speed you use is not critical. The only consideration is that it must be longer than 1/30 of a second, since this is the time required for one complete screen refresh. Likewise, the exposure time should not normally exceed 1 second to prevent problems with film reciprocity failure.

Although any shutter speed within this range is adequate, I prefer 1/2 or 1/4 second, which usually results in a reasonable f-stop setting with my particular film.

Automatic exposure controls and light meters are only partially effective in this application. In order to utilize these aids, your test display should contain an even mix of light and dark pixels. Or, if you are photographing an alphanumeric display, it should be nearly filled with text. As a rule of thumb, if your display is about 1/2 full of text, decrease the light meter exposure by 1/2 f-stop, and if your display is 1/4 full, decrease the meter exposure by one full f-stop. Also, during the initial tests, it is wise to bracket the determined exposure by making two additional exposures at each test setting: one at one f-stop more exposure, and one at one f-stop less exposure.

The proper film exposure also depends on which film you are using. For color, I prefer Kodak Ektachrome -64 daylight type (ASA 64), and for black and white, Kodak Panatomic-X exposed at ASA 64 instead of the rated ASA 32. With either of these films and a properly adjusted video display, a good starting exposure is 1/2 second at f/4. If you do not have an exposure meter, you can make your initial tests with this basic exposure together with two bracketing exposures of plus and minus one f-stop. If you prefer another film you can adjust the basic exposure according to your film's ASA rating. For example, ASA 125 film requires one f-stop less exposure, and ASA 32 film requires one f-stop more exposure. [At *BYTE* we have had good results using the new high speed Kodak Ektachrome (ASA 200), a macro close-up lens with f-stop set using the through-the-lens meter, and 1/15th second exposure in a dark room. The color photos in Carl Helmer's *Apple II* review, page 18 of the March 1978 issue, were made this way. . .CM]

When using color film always use daylight type, not tungsten or indoor type. Daylight film faithfully reproduces the color balance of the video display. Also, I recommend that you avoid color negative films in favor of color slide or transparency film, unless you do your own color printing or are willing to pay the cost of custom color printing.

With a little bit of care, and using these techniques, you should be able to use your camera as a high quality black and white or color hard copy device. But remember: to avoid frustration and to ensure consistently high quality results, it is important to establish, by test, a set of standard settings for both the video display controls and camera exposure. ■

# The Ultimate Turn-on

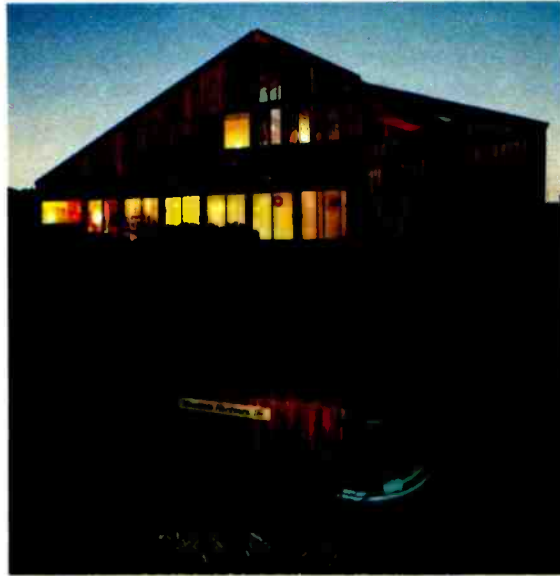

## On/off control everywhere— by computer over the AC wiring

Now it's simple and economical to control AC devices remotely from an S-100 or Apple II computer. Mountain Hardware's new Intron™ system delivers on/off commands over the existing AC lines — so you don't have to string a foot of wire!

**Control at any AC outlet.** The Intron system impresses a code-modulated 50 KHz control signal on the house wiring. Then decodes the signal at any outlet to switch AC devices on and off. You can control lights, refrigerators, TVs, solenoid valves, sprinklers, burglar alarms — and many other things we leave to your fertile imagination. With the addition of input sensors to your computer system, you can automatically control variables such as temperature and soil moisture.

**Here's how it works.** You plug in a single AC Controller board at the computer bus and connect the AC Interface Adapter to any convenient 115 VAC outlet. The AC Controller is now connected to address as many as 64 channels remotely. But it's completely isolated

from the 115v power, so there's no chance of short or shock.

At any outlet where you seek control, plug in a Dual Channel AC Remote. Then plug one or two devices to be controlled into the box. Every AC remote has two independent 500 watt channels. When commanded by the computer, the Dual Channel AC Remote turns the devices on and off independently. When polled by the computer, the Dual Channel AC Remote sends a signal back, telling the computer the status of each device. Bidirectional communication provides error free operation.

**Simple programming.** You write your control program in BASIC or Assembler language. Software sub-routines for the control programs come with the equipment — along with complete documentation. If you have an S-100 computer, you can program on/off commands at any day and time using our optional 100,000 day Calendar/Clock Board. A self contained power source assures fail safe operation.

**Modest prices.** The AC Controller, for both the S-100 and Apple II computers, costs \$149 in kit form or \$189 completely assembled and tested. Each Dual Channel AC Remote costs \$99 as a kit or \$149 assembled and tested. Thus, a fully operative system in kit form can be yours for as little as \$248.

The Calendar/Clock Board for S-100's costs \$179 in kit form, \$219 assembled and tested.

All prices are f.o.b. Ben Lomond, CA. Prices are USA Domestic. California residents add 6% sales tax.

**Where to find it.** The Intron system can now be found at computer shops throughout the U.S. and Canada. Drop by and ask for a demonstration. Mountain Hardware, Inc., may be reached at Box 1133, Ben Lomond, CA 95005. Phone (408) 336-2495.



AC Controller (Apple)

Dual Channel AC Remote

AC Controller (S-100)



*Photo 1: A three-dimensional "square spiral" being generated by the authors' microcomputer controlled display system. At right is an oscilloscope screen displaying a series of points around the perimeter of the screen. It appears that the points are being displayed simultaneously because of the exposure time needed for the photograph, but they are actually being displayed at different times. By synchronizing the display with the rotation of the mirror (at left), a true three-dimensional image is created. Viewers can "see behind" the images, and perspective changes with viewing angle.*

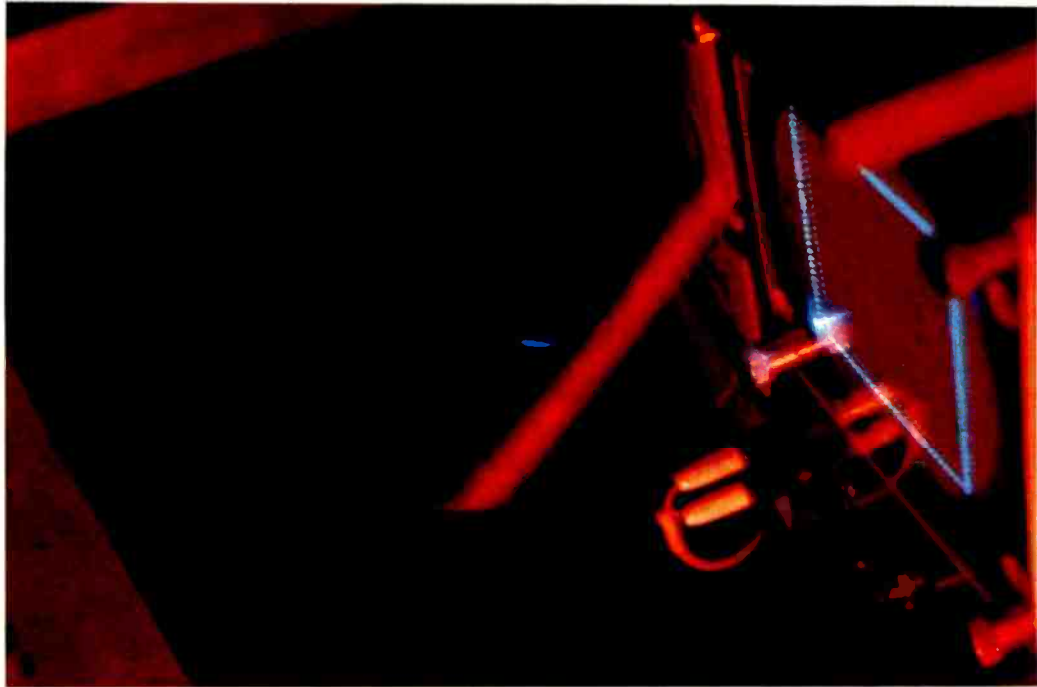

## Graphics in Depth

Timothy Walters  
William Harris  
The Computer Factory  
51 Brattle St  
Cambridge MA 02138

### Introduction

Regular readers of BYTE have already seen many articles and advertisements concerning graphic displays. A graphic display adds direct visual impact to the computer output, communicating directly in a non-verbal manner. The advantages of this kind of display in specific applications are obvious. But what about adding a third dimension to the display?

Many drawings are representations of three-dimensional data in two dimensions; with the ability to display in three dimensions it would not be necessary to use perspective or other cues to suggest an impression of depth. Instead, an architectural drawing, Space War, 3-D Life or abstract graphic designs could be displayed directly. An image displayed in this manner would appear to exist in space; viewers could

"look behind" the image to a degree and see it from different perspectives by simply changing their viewing angle.

How can a three-dimensional display be built? Several techniques have been used in the past. One general method involves presenting separate views to each eye by means of a special viewing apparatus familiar to anyone who has gone to a 3-D movie or used a stereopticon. Many people find it fairly easy to train themselves to merge two stereo images presented side by side by crossing or "walling" their eyes. This does not require any special viewing equipment, and anyone who is going to view a lot of stereo images might want to learn this technique. Since it does require some training an untrained friend may not be able to view a graphics demonstration in a full three dimensions without the special apparatus.



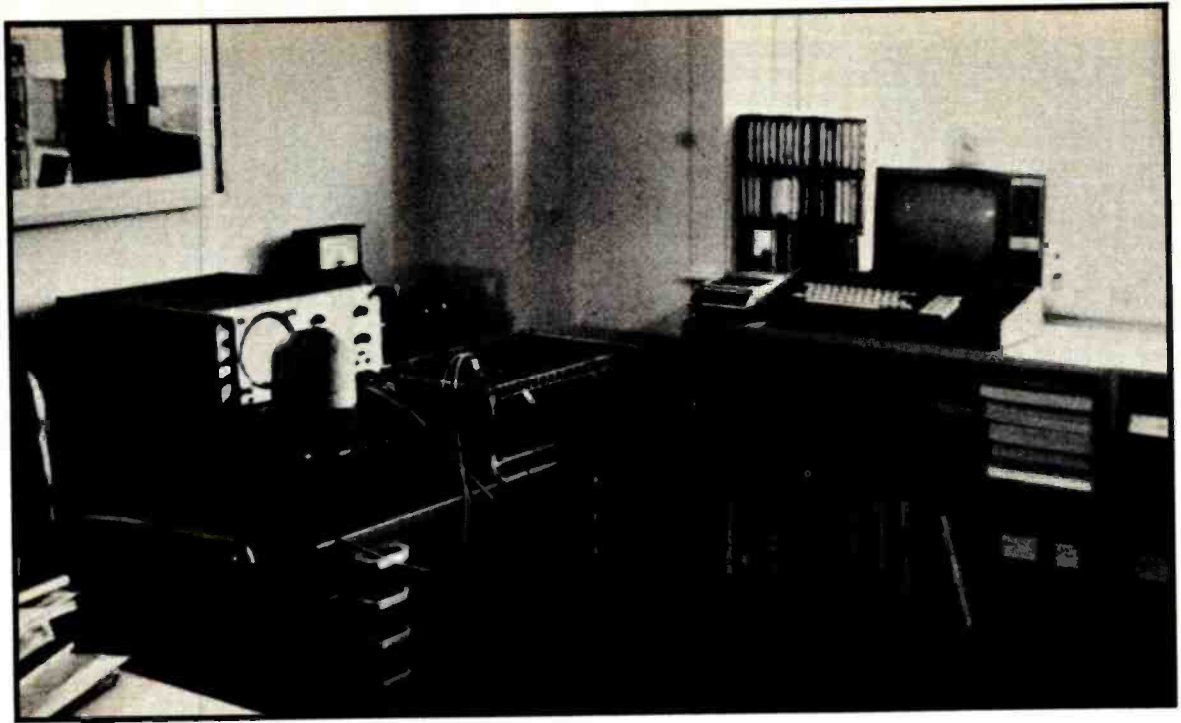

(2a)

## 3-D Adds a New Dimension to Your Display

(2b)

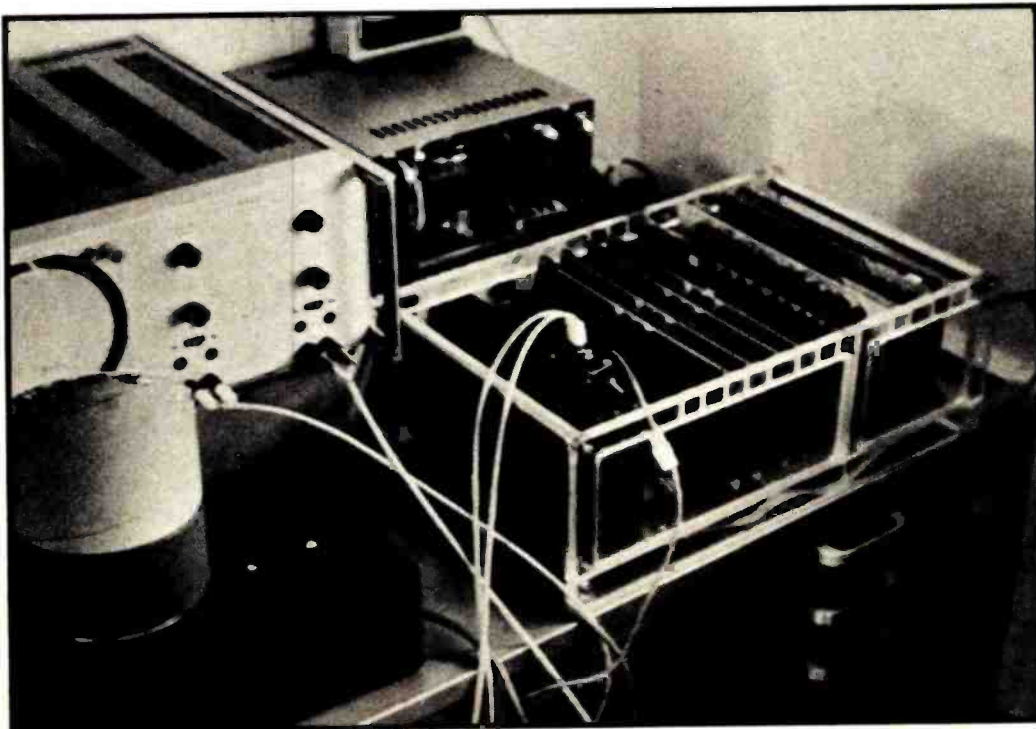

*Photos 2a and 2b: The authors' laboratory. Photo 2b shows a close-up of the 3-D display apparatus. The mirror is shown at left mounted on its cardboard tube, with the oscilloscope behind it. The Digital Group computer main-frame is at right.*

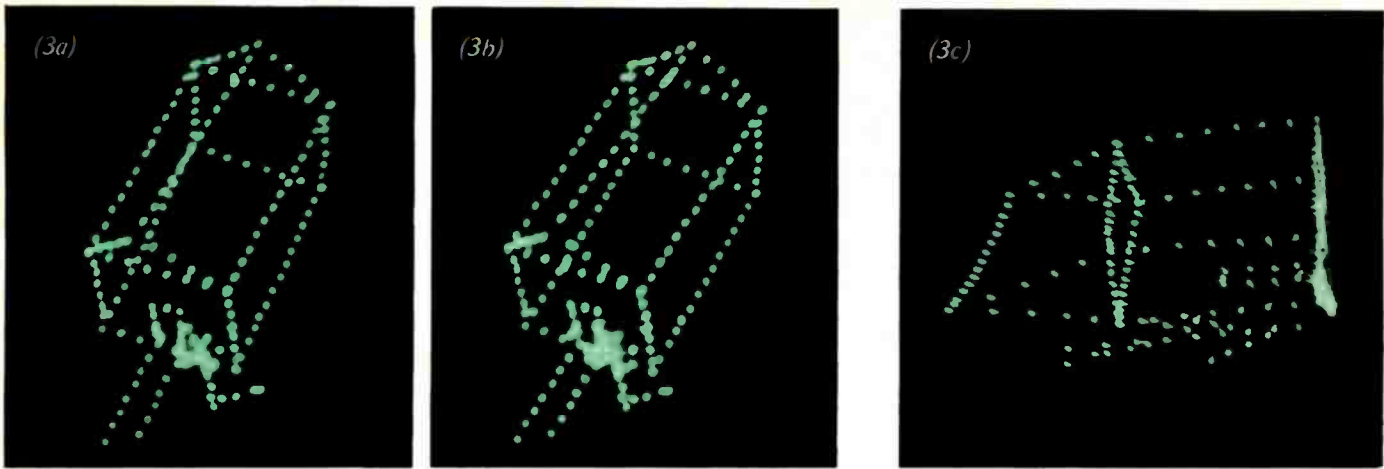

Photos 3a, 3b and 3c: Photos 3a and 3b were taken from slightly different angles to form a stereoscopic pair. The image is generated by the program in listing 3; readers can view the image in 3-D using the techniques described in the text. If you have access to a stereopticon, it may facilitate the process. Photo 3c shows the distorted image of the house as it appears on the oscilloscope screen. It should be emphasized that photos 3a and 3b show the three-dimensional effect of the display at only one viewing angle; the actual effect of looking down into the rotating mirror is much more realistic because the image changes shape as the observer's viewing angle changes within a cone of visibility.

An example of separated stereo pairs is shown in photo 3. The images may be merged together by focusing the eyes at a distance until the two blurred images merge, and then focusing the eyes on the images without letting the images separate. One way to aid the eyes to merge these two images is to use two paper tubes to look at the images. With practice, the eyes will be able to view the image comfortably and without strain. With this technique, the right eye views the

right image and the left eye views the left image. The differing positions of the various lines in the two images are matched up and interpreted by the brain as if they correspond to real lines at different depths. Viewed properly, the house should appear as it would from an aerial view. If the pairs are merged in the opposite manner (by crossing the eyes to look at a point close to the observer and then refocusing), the apparent angles are reversed and the house will appear to turn "inside out." This technique may be aided by focusing the eyes on a finger held above the page. If you are unable to fuse stereo images by moving the eyes, it may be necessary to purchase a stereo viewer from an optics supplier to view this kind of display.

It is quite easy to generate these stereo images on a high resolution plotter or graphics terminal by calculating the appropriate perspective views for each image. This produces realistic three-dimensional images when viewed properly; however, they are not auto-stereoscopic, that is, they do not appear to be stationary three-dimensional objects when the observer moves around to different positions. Instead, they appear to move around to follow the observer. However, with some mechanical construction, a display system can be constructed that produces a true three-dimensional image viewable from a wide range of observer positions. The hardware and software system described in this article can produce displays containing up to 2000 points with a posi-

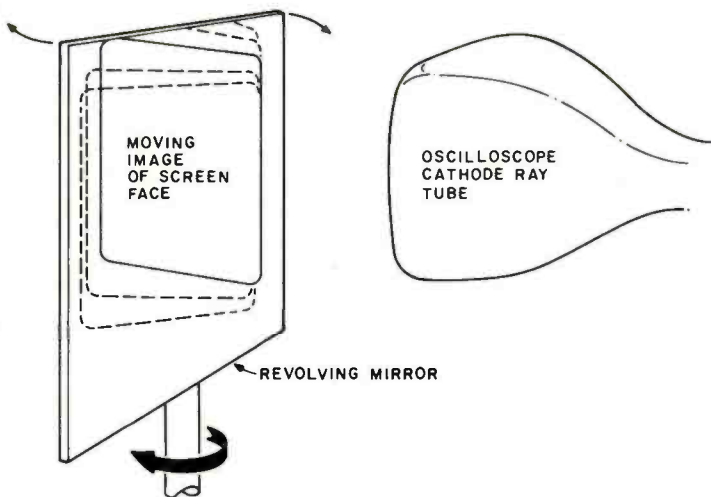

Figure 1: One method for generating a three-dimensional display. A vertical mirror is rotated in front of an oscilloscope screen. A volume of space is thus defined in which points can be made to appear by displaying them on the screen at the right time. One disadvantage of this method is the relatively restricted viewing area caused by the position of the oscilloscope.

Continued on page 116

# EXTENSYS

presents

## EX3000—a new multi-user multi-tasking computer system.

This complete series of computer systems embody architectural concepts previously found only in costly large scale computers. The primary concepts used in the EX3000 computer systems are distributed processing for hardware and multi-tasking for system software. The EX3000 systems distribute system processing functions to those system components that are best suited to perform those tasks. This state-of-the-art technology was prohibitive until the recent introduction of cost effective computational and control microprocessors, along with programmable peripheral circuits to perform preassigned dedicated tasks. Coupling these cost effective components with the distributed processing techniques proven by many large mainframe computer manufacturers, Extensys Corporation has been able to provide exceptionally powerful and flexible systems. Through the efficient use of system components in a modular structure, the EX3000 Computer Systems allow configurations that meet a wide variety of specific applications as well as offering expansion capability to satisfy increasing usage demands.

The hardware of the EX3000 Computer Systems consist of subsystems and boards. Three subsystems are provided:

- FOS1000 Floppy Diskette Subsystem with 1 to 4 Megabytes of on-line mass storage.
- MTS40x Multiple Terminal Subsystem with 8 or more independent RS-232c serial interfaces.
- TPS400 Terminal/Operator Processor Subsystem with keyboard, CRT, RS-232c serial interface, and expanded video attributes.

Other p/c boards which are included in the EX3000 system are:

- RM650 Memory board with 16K to 64K bytes of RAM storage.
- MM16 Memory Management board with bank switching up to 1 megabyte of RAM memory and a priority DMA mechanism for high speed DMA transfers.
- MPU805 8085 Central Processor with on-board PROM space (16K), prioritized vectored interrupts, and combination interval timers/event counters.

EMOS-IV, Extensys Multiprocessor Operating System, furnishes fundamental EX3000 system software. This multi-tasking operating system provides a high level interface between application programs and EX3000 hardware components. EMOS-IV is a multi-process, multi-user operating system which provides all file handling capabilities as well as complete program development tools. Multi-user EMOS-IV provides memory protection for each user. It also provides inter-system communication to allow multiple EX3000 systems to operate as a unit with a common data bank along with secured individual user data bases.

Higher level languages including EXTENDED BASIC, COBOL and ANSI FORTRAN which are EMOS-compatible offer added flexibility to generate application programs & development systems.

The EX3000 systems offer both high performance and cost-effective computer power to OEMs and end users. Join the Third Revolution in computer design by investigating the distributed processing/multi-tasking capabilities of microprocessors built-into the Extensys EX3000 Computer Systems.

For more information on the EX3000 Computer Systems and how they can satisfy your processing needs, give us a call.

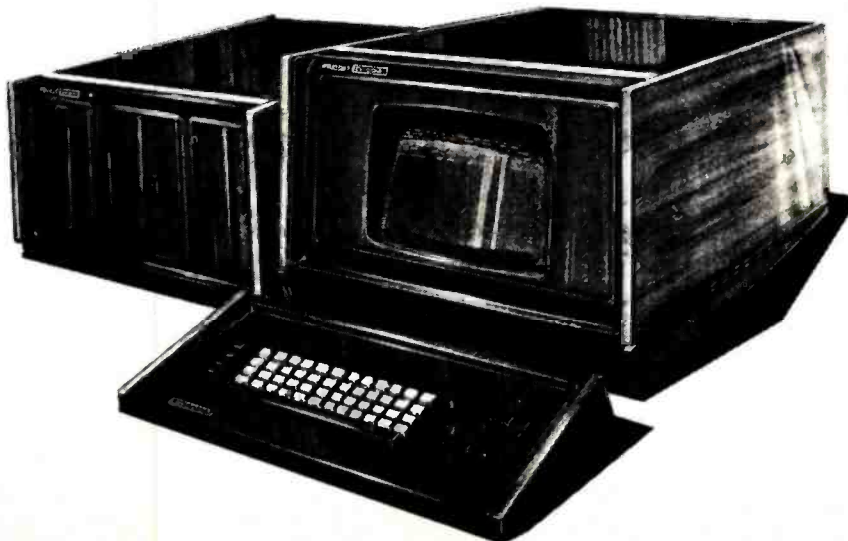

**extensys**  
corporation

380 Bernardo Avenue  
Mountain View, CA 94040  
(415) 969-6100

# Why Apple II is the world's best selling personal computer.

enjoy the real satisfaction a personal computer can bring, today and in the future.

## 15 colors & hi-resolution graphics, too.

Don't settle for a black and white display! Connect your Apple to a color TV and BASIC gives you instant command of three display modes: Text, 40h x 48v Color-graphics in 15 colors, and a 280h x 192v High Resolution array that lets you plot graphs and compose 3-D images. Apple gives you the added capability of combining text and graphics, too.

## Back to basics, and assembly language too.

Apple speaks three languages: fast integer BASIC, floating point BASIC for scientific and financial applications, and 6502 assembly language. That's maximum programming flexibility. And, to preserve user's space, both integer BASIC and monitor are permanently stored in 8K bytes of ROM, so you have an easy to use, universal language instantly available. BASIC gives you graphic commands: COLOR=, VLIN, HLIN, PLOT and SCRN. And direct memory access, with PEEK, POKE and CALL commands.

## Software: Ours and yours.

There's a growing selection of pre-programmed software from the Apple Software Bank — Basic Finance, Checkbook, High Resolution Graphics and more. Now there's a User Section in our bank, to make it easy for you to obtain programs developed

**W**hich personal computer will be most enjoyable and rewarding for you? Since we delivered our first Apple® II in April, 1977, more people have chosen our computer than all other personal computers combined. Here are the reasons Apple has become such an overwhelming favorite.

Apple is a fully tested and assembled mainframe computer. You won't need to spend weeks and months in assembly. Just take an Apple home, plug it in, hook up your color TV\* and any cassette tape deck — and the fun begins.

To ensure that the fun never stops, and to keep Apple working hard, we've spent the last year expanding the Apple system. There are new peripherals, new software, and a 16-chapter Owner's Manual on "How to Program in BASIC." There's even a free Apple magazine to keep owners on top of what's new.

Apple is so powerful and easy to use that you'll find dozens of applications.

There are Apples in major universities, helping teach computer skills. There are Apples in the office, where they're being programmed to control inventories, chart stocks and balance the books. And there are Apples at home, where they can help manage the family budget, control your home's environment, teach arithmetic and foreign languages and, of course, enable you to create hundreds of sound and action video games.

When you buy an Apple II you're investing in the leading edge of technology. Apple was the first computer to come with BASIC in ROM, for example. And the first computer with up to 48K bytes RAM on one board, using advanced, high density 16K devices. We're working to keep Apple the most up-to-date personal computer money can buy. Apple II delivers the features you need to



by other Apple owners. Our Software Bank is your link to Apple owners all over the world.

**Live with the sound of music.**

Apple's exclusive built-in speaker delivers the added dimension of sound to your programs. Sound to compose electronic music. Sound to liven up games and educational programs. Sound, so that any program can "talk" back to you. That's an example of Apple's "people compatible" design. Another is its light, durable injection molded case, so you can take Apple with you. And the professional quality, typewriter-style keyboard has n-key rollover, for fast, error-free operator interaction.

**Apple is the proven computer.**

Apple is a state-of-the-art single board computer, with advanced LSI design to keep component count to a minimum. That makes it more reliable. If glitches do occur, the fully socketed board and built-in diagnostics simplify troubleshooting. In fact, on our assembly line, we use Apples to test new Apples.



**Apple peripherals are smart peripherals.**

Watch the far right column of this ad each month for the latest in our growing family of peripherals. We call them "intelligent interfaces." They're smart peripherals, so you can plug them in and run them from BASIC without having to develop custom software. No other personal computer comes close to Apple's expandability. In addition to the built-in video interface, cassette I/O, two A/D game paddles, and two more A/D inputs, Apple has eight peripheral slots, three TTL inputs and four TTL outputs. Plus a powerful, state-of-the-art switching power supply that can drive all your Apple peripherals, including two disks.

**Available now.**

Apple is in stock and ready for delivery at a store near you. Call us for the dealer nearest you. Or, for more details and a copy of our "Consumer Guide to Personal Computers," call

800/538-9696 or write Apple Computer, Inc., 10260 Bandley Drive, Cupertino, CA 95014.



*Programming is a snap! I'm halfway through Apple's BASIC manual and already I've programmed my own Star Wars game.*

*Those math programs I wrote last week—I just rewrote them using Apple's mini-assembler and got them to run a hundred times faster.*

**New from Apple.**

**Introducing the Apple Communication Interface**

Apples of the world unite! Now you can, with our new intelligent communication interface card. Just plug it in and it turns your Apple into an intelligent terminal that can go on line with other terminals,

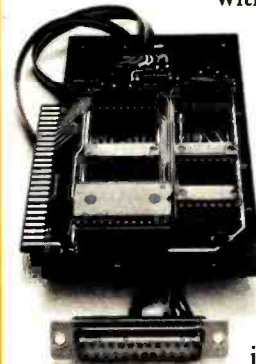

time-sharing computers and, especially, with other Apples. You can even play Tele-Pong! Everything you need is on one small card.

With a modem, it enables your Apple to communicate by phone at 110/300 baud RS232 full duplex I/O. The card is fully assembled and tested and has all required software in on board ROM. It's controlled by simple BASIC commands. And it's available from stock.

**Peripherals in stock**

Hobby Board, Parallel Printer Interface, Communication Interface.

**Coming soon**

High speed serial printer interface, General purpose serial interface, Printer II, Printer IIA, Disk II, Monitor II.

\* Apple II plugs into any standard TV using an inexpensive modulator (not included).

Circle 15 on inquiry card.

*Apple's smart peripherals make expansion easy. Just plug 'em in and they're ready to run. I've already added two disks, a printer and the communications card.*



# Product Description:

## The Matrox ALT-256 Video Board

Gary Ruple  
Matrox Electronics Systems  
POB 56 Ahuntsic Sta  
Montreal Quebec H3L 3N5  
CANADA

The ALT-256 is an Altair (S-100) bus compatible graphics card that gives a resolution of 256 by 256 dots. This display is useful for professional graphics applications such as computer aided design, simulation, business and educational displays, and plotting curves.

The display memory on the ALT-256 consists of 16 4 K dynamic memory integrated circuits in the 16 pin package. The dynamic memory refresh is handled by the video scan circuitry so that no processor time is required for this function.

### Board Addressing

The board is addressed as four contiguous output ports and one input port (IO ports

are built in), selectable by on board address jumpers. The dot addressing is done in X-Y fashion. Output ports 1 and 2 are used as registers for the X and Y positions, respectively, to position the cursor at the selected dot. Output 0 is used to write the intensity of the dot: 00 for black and 01 for white. After the dot intensity is loaded, the ALT-256 will require  $3.4 \mu\text{s}$  to write the dot in the display memory (ie: to allow for internal synchronization of the wire operation, video read scan and dynamic memory refresh). Since the 8080 processor almost always requires more than  $3.4 \mu\text{s}$  to load the next dot address and data, the processor can run at its full speed. Also, there will be no streaks or flashes on the display no matter how fast the

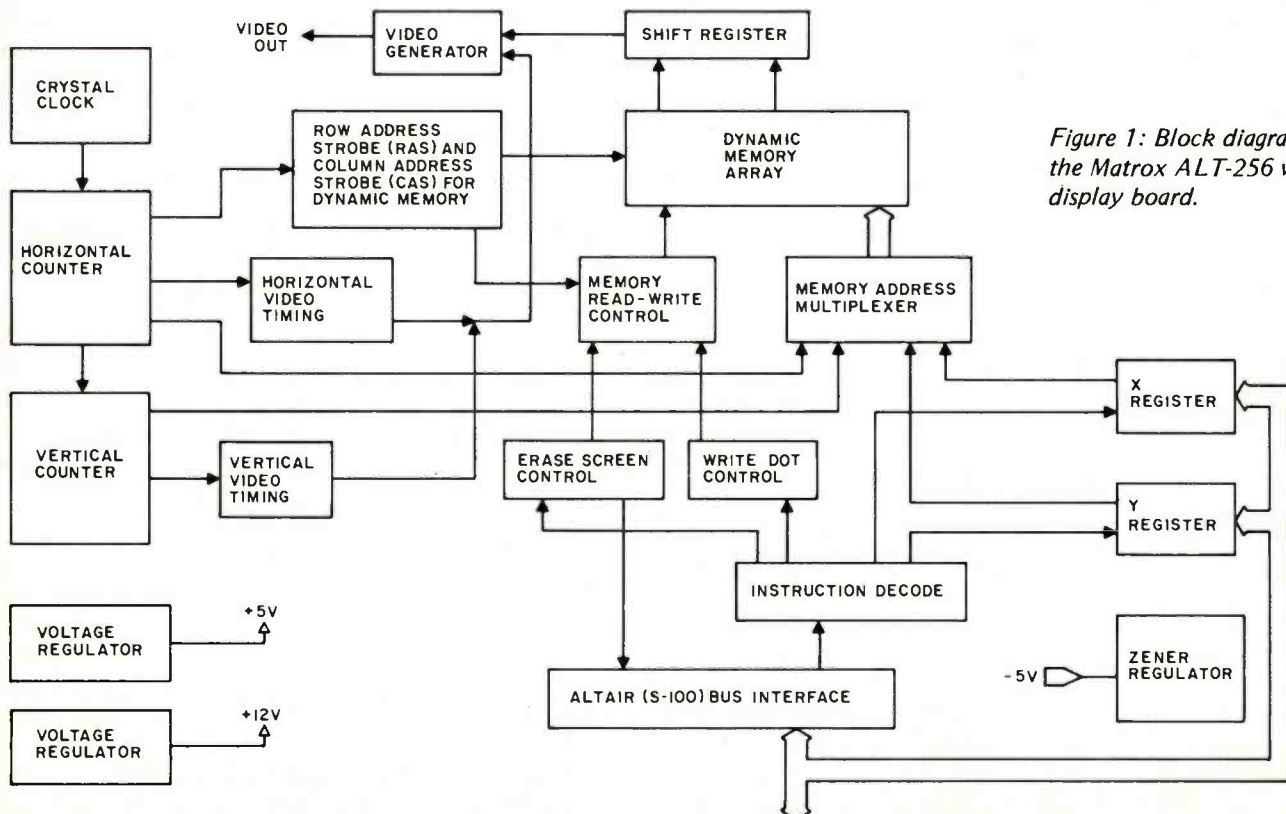
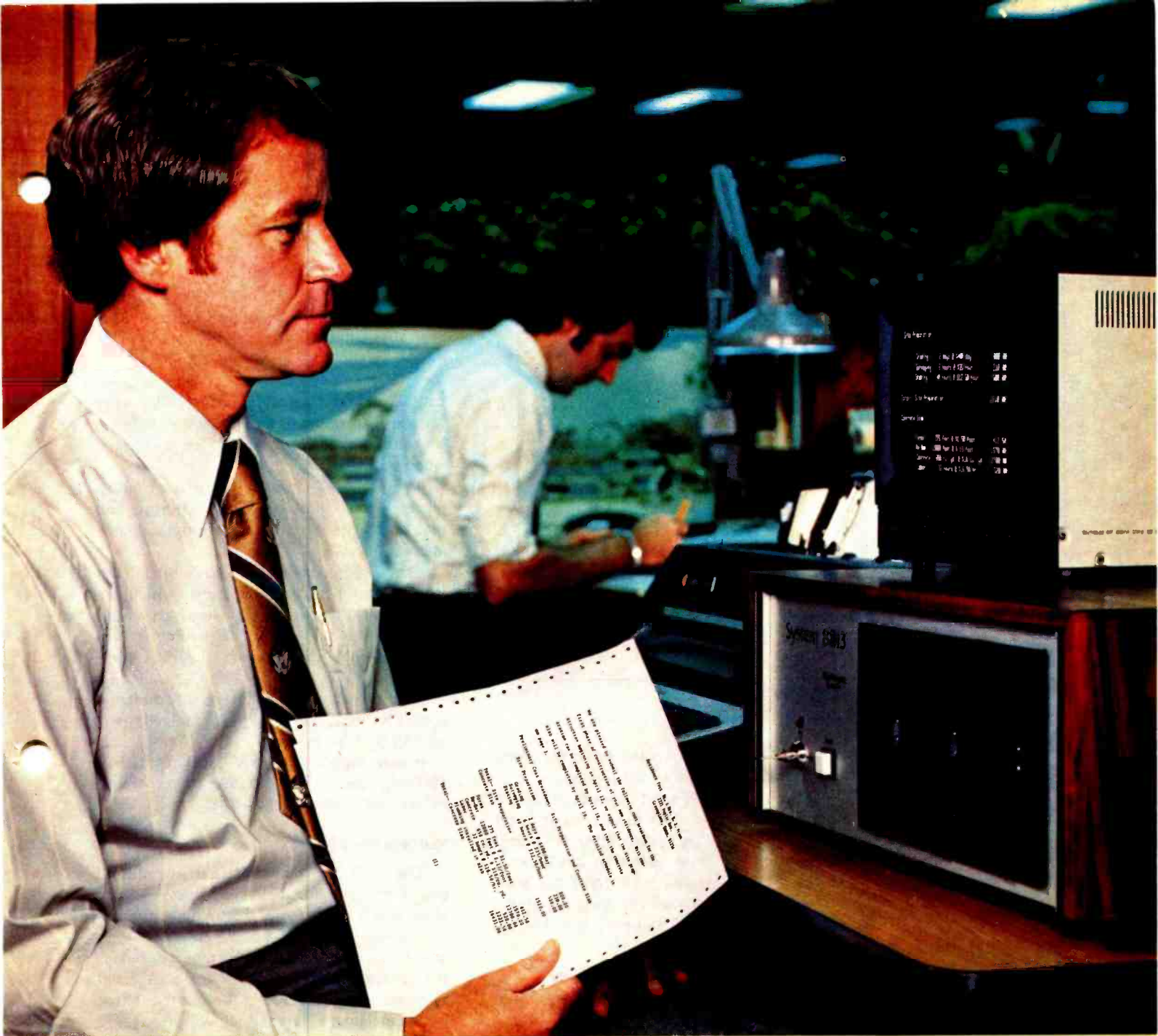

Figure 1: Block diagram of the Matrox ALT-256 video display board.



## The Computer for the Professional

The 8813 was built with you, the professional, in mind. It quickly and easily processes cost estimates, payrolls, accounts, inventory, patient/client records and much more. You can write reports, briefs, and proposals on the 8813's typewriter keyboard, see them on the video screen, and instantly correct, revise, or print them.

Using the 8813, one person can process what would normally require many secretaries, several bookkeepers, and a great deal of *time*. And data storage takes a small fraction of the *space* used by previous methods.

You don't need to learn complicated computer languages. The 8813 understands commands in English. If you want to write your own programs, the 8813 includes a simple computer language, BASIC, that you can master in a few days. The 8813 slashes the professional's overhead. It's a powerful time and money-saving ally. Prices for complete systems including printer start at less than \$8,000.

See the 8813 at your local dealer or contact PolyMorphic Systems, 460 Ward Drive, Santa Barbara, California, 93111, (805) 967-0468, for the name of the dealer nearest you.

PolyMorphic  
Systems

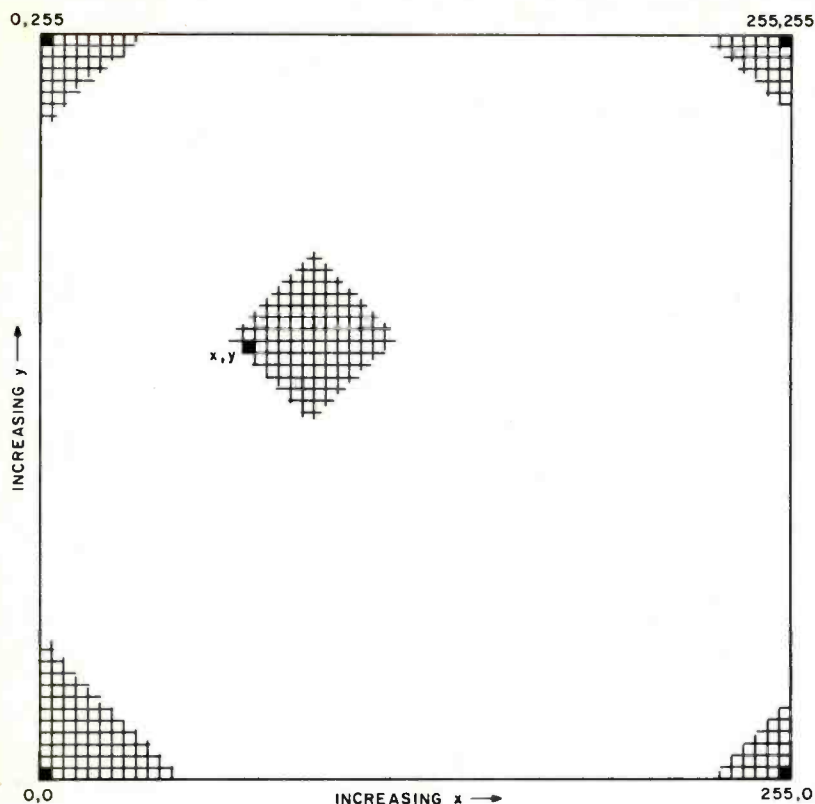

Figure 2: Display coordinate system for video displays (MTX-Graph software).

processor accesses the card since the write operation is internally synchronized.

Output port 3 is used as an erase screen command to either clear the screen or to set it all white according to data bit 0: 0 = black, 1 = white. The erase operation can take up to 33 ms. The status port (IN0) has been provided as a means of checking the status of the ALT-256. The following is a description of the status bits:

- Bit 0: When 0 the display is ready.  
When 1 the display is being erased and should not be accessed.
- Bit 1: When 0 the display scan is in the video portion.  
When 1 the display scan is in the vertical blanking period allowing access of the display when not visible. This is useful for dynamic motion and animation synchronization.

The X-Y addressing scheme provides the programmer with a way to address individual dots. A horizontal or vertical line requires only one address to be updated for each new dot. A 45° diagonal requires each address to be incremented or decremented. Using output ports as registers and as a means of addressing the card also conserves memory space, since the 65,536 directly addressable

dots are equivalent to 8 K bytes of memory. (You would also have to keep track of dot position in the byte.)

### Theory of Operation

The ALT-256 has four major blocks: the video sync generator, scanning circuitry, cursor and interface electronics, and 65,536 by 1 memory (see figures 1 and 2). The sync generator consists of a crystal oscillator and a divider chain. This divider chain produces all timing signals for the memory scanning as well as horizontal and vertical sync. The video sync generator can be programmed by jumpers for either the European or the American video standard.

The scanning circuitry consists of multiplexers which provide proper address, and read and write signals for the programmable memory.

The cursor consists of two 8 bit latches (the X and Y address registers) which are loaded by the processor. Necessary interface address and timing decoding is accomplished by the Altair (S-100) bus interface logic.

The refresh memory has 16 4 K dynamic memories (IC type 4096) organized as a 65,536 by 1 bit memory.

Power supplies for 5 V, 600 mA; 12 V, 100 mA, and -5 V, 10 mA are generated by on board voltage regulators.

### Multiple Boards

The ALT-256 may be used in multiple board systems for color graphics or grey scale applications. Any reasonable number of boards may be used. When more than one is used, one board must be chosen as the master and the others are configured as slaves synchronized to the master. There is an on board jumper allowing use as a master or slave and a socket provided for connecting the sync signals and video between master and slaves. Single or multiple boards may also be slaved to an external sync generator such as a TV camera signal or broadcast video.

### Software

MTX Graph, the software package available for the ALT-256, provides all the commonly used low level graphics routines, and is configured as a series of subroutines that occupy hexadecimal memory locations 0104 to 04FF. Multiple boards can be supported by up to a maximum of eight bits of color or grey scale information. Features of the package are described in table 1.



# TARBELL SETS STANDARDS

## For Hobbyists and Systems Developers

Sales to thousands of hobbyists over the past two years have proven the Tarbell Cassette Interface to be a microcomputer industry standard. Tarbell Electronics continues research and development to produce new and efficient components to fill hobbyists' changing needs.

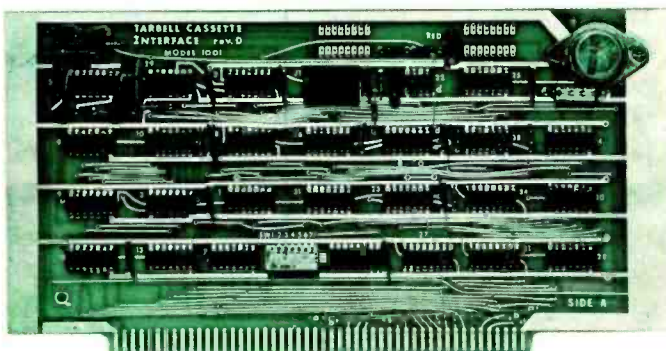

### TARBELL CASSETTE INTERFACE

- Plugs directly into your IMSAI or ALTAIR\*
- Fastest transfer rate: 187 (standard) to 540 bytes/second
- Extremely Reliable—Phase encoded (self-clocking)
- 4 Extra Status Lines, 4 Extra Control Lines
- 37-page manual included
- Device Code Selectable by DIP-switch
- Capable of Generating Kansas City tapes also
- No modification required on audio cassette recorder
- Complete kit \$120, Assembled \$175, Manual \$4
- Full 6 month warranty on kit and assembled units

### TARBELL FLOPPY DISC INTERFACE

- Plugs directly into your IMSAI or ALTAIR\* and handles up to 4 standard single drives in daisy-chain.
- Operates at standard 250K bits per second on normal disc format capacity of 256K bytes.
- Works with modified CP/M\* Operating System and BASIC-E Compiler.
- Hardware includes 4 extra IC slots, built-in phantom bootstrap and on-board crystal clock. Uses WD 1771 LSI Chip.
- Full 6-month warranty and extensive documentation.
- PRICE:  
Kit \$190 ..... Assembled \$265

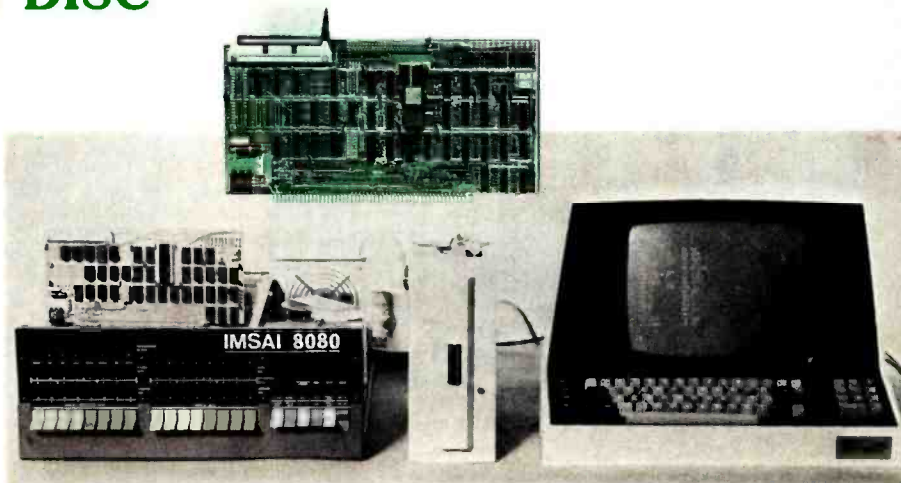

CP/M with BASIC-E  
and manuals: \$100

#### Compatible Disc Drives

Ask about our disc drives priced as low as \$525.

### TARBELL PROTOTYPE BOARD Model 1010



- Gold plated edge pins
- Takes 33 14-pin ICs or
- Mix 40-pin, 18-pin, 16-pin and 14-pin ICs
- Location for 5 volt regulator
- Suitable for solder and wire wrap
- ALTAIR/IMSAI compatible
- Price: \$28.00

For fast, off the shelf delivery, all Tarbell Electronics products may be purchased from computer store dealers across the country. Or write Tarbell Electronics direct for complete information.

\*ALTAIR is a trademark/tradename of MITS, Inc.  
CP/M is a trademark/tradename of Digital Research

*Tarbell*  
Electronics

20620 South Leapwood Avenue, Suite P  
Carson, California 90746  
(213) 538-4251

Photo 1a.



Photo 1b.



Photo 2a.



Photo 2b.



Photo 3a.



Photo 3b.



Photos 1 to 3: Some examples of grey scale and pseudocolor images produced by the ALT-256 video board. The grey scale photos were produced by feeding the output from a TV camera through a slow scan analog to digital converter. Next, the 3 bit digitized output was processed through three ALT-256 video boards and a digital to analog converter to give an 8 level video signal. The color pictures were produced by feeding the outputs from the video boards directly to the red, blue and green inputs of an RGB color monitor (see figure 3).



## FOUR STAR PERFORMERS FOR THE S-100 BUS

### Meet The North Star Family

**THE NORTH STAR S-100 FAMILY**—four high performance products at attractive low prices. Our boards are designed for use in the North Star HORIZON computer and other S-100 bus computers using 8080 or Z80 processors. Visit your computer store for a demonstration, or write for our free color catalog.

#### 16K RAM BOARD

No other S-100 bus memory can match the performance of the North Star 16K RAM at any price. This low-power board has been designed to work at full speed (no wait states), even at 4MHz with both Z80 and 8080 systems. Memory refresh is invisible to the processor, bank switching is provided and addressability is switch selectable in two 8K sections. Best of all, a parity check option is available. Kit: \$399. Assembled: \$459. Parity Option — kit: \$39. Assembled: \$59.

#### MICRO DISK SYSTEM

The North Star MDS is a complete floppy disk system with *all* hardware and software needed to add floppy disk memory and a powerful disk BASIC to S-100 bus computers. The North Star MDS is widely considered one of the best designed and most complete S-100 bus products

available. The MDS includes the S-100 interface board with on-board PROM for system startup, Shugart mini-floppy disk drive, cabling and connectors, and DOS and BASIC software on diskette. Kit: \$699. Assembled: \$799. Additional drive — Kit: \$400. Assembled: \$450. Single Drive Cabinet: \$39. Optional Power Supply: \$39.

#### Z80A PROCESSOR BOARD

The North Star ZPB brings the full speed, 4MHz Z80A microprocessor to the S-100 bus. Execution is more than twice the speed of an 8080, and the ZPB operates in systems both with and without front panels. The ZPB includes vectored interrupts, auto-jump startup, and space for 1K of on-board EPROM. Kit: \$199. Assembled: \$259. EPROM Option — kit: \$49. Assembled: \$69.

#### HARDWARE FLOATING POINT BOARD

If you do number crunching, then this board is for you. The FPB performs high-speed floating point add, subtract, multiply and divide with selectable precision up to 14 decimal digits. Arithmetic is up to 50 times faster than 8080 software, and BASIC programs can execute up to 10 times faster. A version of North Star BASIC is included. Kit: \$259. Assembled: \$359. Prices subject to change.

**NORTH STAR** ★ **COMPUTERS**

2547 Ninth Street • Berkeley, California 94710 • (415) 549-0858

*Table 1: Features of MTX GRAPH, a software package available for the ALT-256 graphics board.*

1. **Variable Resolution:** The display resolution may be set to 256 by 256, 128 by 128, or 64 by 64 through software control.
2. **Point Plot:** A dot corresponding in size to the resolution selected may be displayed at any arbitrary point by specifying X-Y coordinates.
3. **Line Vector Graphics:** Lines can be drawn from the current cursor position to the endpoint specified by the user.
4. **Alphanumeric Display:** A full ASCII character generation routine is provided. Characters can be positioned anywhere on the screen. Carriage control characters are correctly interpreted. Character size is adjustable.
5. **Animation Synchronization:** This feature is used to synchronize animated display updates with the vertical scan.
6. **Color Option:** The software package supports a 3 card color or grey scale system as described later in this article.

All subroutines use standard Cartesian coordinates with the display occupying the first quadrant. As shown in figure 2, the origin (X = 0, Y = 0) is defined as the bottom left point on the display. X increases in value to a maximum of 255 at the right edge, while Y rises to a maximum of 255 at the top. If the ALT-256 is jumpered for American Standard scan (240 lines displayed), the lowest Y coordinate displayed is 16, and points with coordinates from 0 to 15 cannot be seen.

#### Grey Scale and Color Applications

In the grey scale configuration, multiple boards provide binary intensity information. All boards have the same address decoding and sync signals. Each board has a dot intensity bit (output port 0) which is normally tied to data bus bit D0. In a typical 3 board color or grey scale system, the intensity bit is changed on two boards to be D1 and D2 (or any other bits you choose), thus writing three binary bits for each write operation. This method allows computation of grey scale and single instruction load of all bits making up a single picture element (often contracted to "pixel" in graphics literature). The TTL video outputs from the three boards are fed to a simple 3 bit digital to analog converter.

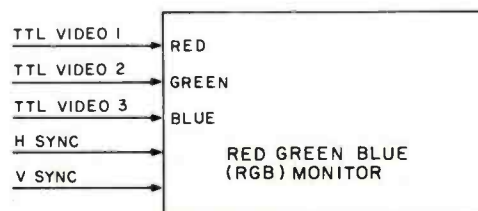

*Figure 3: Connecting an RGB (red green blue) monitor for 8 color operation using three ALT-256 boards.*

#### RGB (Red Green Blue) Color

In a color scheme, the best results are obtained by directly driving the red, green and blue guns of a color monitor with the video signal from three boards, as in figure 3. An ordinary color TV can be modified to accept separate color inputs. This should not be undertaken by anyone who lacks an understanding of color TV and electronic design. The alternative is to generate an encoded composite color signal. An application note available from Matrox gives details on a color encoder circuit.

#### Photographs

The photos accompanying this article were generated by feeding a TV camera output through a slow scan analog to digital converter. The 3 bit digitized output was then fed to a 3 card ALT-256 graphics system. The grey scale pictures were produced by feeding the outputs of the three cards to a 3 bit digital to analog converter. The resulting pictures have eight discrete grey levels. The color pictures were produced by feeding the outputs of the three cards to the red, blue and green (RBG) inputs of an RBG color monitor. The resulting eight color pictures are pseudocolored. This means that a different color has been assigned arbitrarily to each grey level in the original picture. Pseudocoloring is used in many industrial and research applications (ie: many NASA space pictures are processed this way).

#### Conclusion

The Matrox ALT-256 represents one approach to high resolution graphics capabilities for the Altair (S-100) bus. Multiple board systems can be used for medical displays, research applications, pseudocolor imaging, fast animated displays, computer aided design, sophisticated computer games and computer generated art. For the Star Trek freak, now there is available a real (if imaginary) universe to save, rather than a slow printer banging out descriptions. For the artist, a canvas; the researcher, a window; and the kids, an electronic sketch pad. ■

**Note:** The completely assembled, tested and burned in ALT-256 board is available for \$395 from Matrox Electronic Systems, POB 56, Ahuntsic Station, Montreal, Quebec H3L 3N5 CANADA. Also available is the ALT-2480, an Altair (S-100) compatible alphanumeric generator board, which can be used in conjunction with the ALT-256 to produce simultaneous graphics and alphanumeric displays.

Revenue Service



BASIC

SOFTWARE

LIBRARY

# Volumes VI & VII are finally released!

## Volume VI

Yes and it still contains what was previously advertised. A fully disk interactive business package with A/R, Inv., A/P, ledgers, tax totals, payroll records, more.

As a bonus it also contains the Users Manual for our Firmware Ledger package. These 100 extra pages contain report formats, file creation routines and our very powerful program ACBS1 used to create the powerful file structured data base.

**\$49.95**

## Volume VII

Here is that Chess program you have been waiting for as well as a disk interactive Medical Billing package with patient history file.

Also included is our disk interactive Word Processing package (revision 0).

**\$39.95**

Add \$1.50/Vol. for U.P.S. and handling except to APO and PO addresses. Foreign orders add \$8/Vol. for air shipment - US dollars only. No purchase orders over \$50.

Now Released -Vol. VIII-Homeowners Programs (Includes Federal Income Tax Program) see our new ad on page 23.

VOLUME I	—	\$24.95
VOLUME II	—	24.95
VOLUME III	—	39.95
VOLUME IV	—	9.95
VOLUME V	—	9.95



### SCIENTIFIC RESEARCH

220-B Knollwood  
Key Biscayne, FL 33149

Phone orders 800-327-6543  
Information 305-361-1153

**OUR SOFTWARE IS COPYRIGHTED AND MAY NOT BE REPRODUCED OR SOLD.**

Due to the numerous copyright violations on our earlier volumes — until further notice we are offering a REWARD leading to the arrest and conviction of anyone reproducing our software in ANY way without our written permission. This includes diskettes, paper and magnetic tape, cassettes, records, paper etc.

AVAILABLE AT MOST COMPUTER STORES

10% discount on purchases of entire set. Offer expires December 30, 1977



honored

R. W. BROWN

# Color Graphics

Thomas A Dwyer  
Margot Critchfield  
Project Solo  
University of Pittsburgh  
Pittsburgh PA 15260

## on the Compucolor 8051

The ancient wisdom that says "a picture is worth a thousand words" has a special significance for the computer age. With machines that can generate output faster than anyone can read it, there's no doubt that we need new ways to represent this avalanche of data. The best answer (so far) seems to be in computer graphics: sophisticated pictures that show the results of all this computation in a form that is easy to interpret and even easier to remember.

One of the most dramatic ways to improve graphical output is to add color. Color graphics conveys information to human viewers that is hard to appreciate until it's experienced. The change from black and white to color is at least as impressive as the change from monaural to full stereo sound.

Until a few years ago, the hardware for color graphics was both rare and expensive.

This situation is changing, however, mainly through the efforts of manufacturers who have devised ingenious ways to use the technology of color TV in conjunction with computer technology.

One of the first products designed for this purpose was the Cromemco TV Dazzler. It consists of two Altair (S-100) compatible boards with a coaxial cable output to a color monitor. Several examples of color art produced with the TV Dazzler were shown in December 1976 *BYTE*. That issue also contained the article, "The Cybernetic Crayon," that gave an example of an 8080 assembly language program for the Dazzler.

### The Compucolor 8051

A more recent example of personal color systems is the Compucolor 8051. It comes in the form of a complete computer system packaged in a cabinet not much bigger than a 19 inch color television. That's impressive because the cabinet contains the processor, memory, interface, programmable read only memory, graphics controller, power supplies, and a 19 inch color display tube. The colors are of much greater purity than those usually seen on TV because the system uses a very wide bandwidth (75 MHz) and the three color circuits (red, green, blue) are kept separate. This is the same approach used in professional color monitors. Since any of these colors can be on or off, eight colors (including black) are available.

Photo 1 shows a typical system consisting of the computer and color display in the large cabinet, a keyboard for input, and a dual 8 track tape cartridge unit for mass storage.

The large screen holds 48 lines of 80 characters each, about four times the number of lines found on most video displays. When characters are used for graphics, there are 3840 plotting positions available. But a finer division of each character into a 4 by 2 array of "points" is also possible, as figure 1 indicates. In point plot mode, one character



*Photo 1: The Compucolor 8051 with extended ASCII keyboard and "floppy tape" storage. The tapes are similar to 8 track music cartridge tapes, except that they are shorter. More recent models use a floppy disk system for storage.*

block becomes eight "point" positions. Each of these points (which is really a small rectangle) can be turned on or off separately. This means there are 160 point positions for the horizontal direction (X axis), and 192 points for the vertical direction (Y axis). So a total of 30,720 points can be plotted.

A special hardware feature called "vector graphics" is also available. This makes it possible for the computer to draw approximations to straight lines on the screen if you simply tell it where to start (X0, Y0), and where to finish (X1, Y1). The hardware calculates all the point positions in between and plots them automatically.

The CompuColor 8051 comes with a BASIC interpreter stored in read only memory. This means that you never have to load BASIC: you call for it by just pressing two keys (Escape, followed by W).

The BASIC interpreter has all the standard features and a few extra ones (including string arrays). It also has the special key word PLOT. This feature makes it easy to program graphics of all kinds in color. Let's look at some examples of how it works.

### Using CompuColor BASIC

The word PLOT is used in BASIC statements of the form

```
25 PLOT I
```

where I is an integer from 0 to 255. When PLOT I is initially used, the value of I determines what *mode* you enter. There are quite a few modes. The main mode is "point plot" (PLOT 2). After you enter a "mode," the meaning of PLOT I is different, and it depends on what mode you're in.

**Example 1:** Suppose we want to plot the curve  $Y=X^2$ . We first use PLOT 2 to put the program in point plot mode. After saying PLOT 2, each pair of PLOT statements that follow will then give the X and Y positions of the point to be plotted. When finished plotting points, we use PLOT 255 to escape from the plot mode we're in. Here's a program that plots 100 points of our curve:

```
10 PLOT 2
20 FOR X = 0 TO 99
30 LET Y = INT(X*X/100)
40 PLOT X:PLOT Y
50 NEXT X
60 PLOT 255
```

To understand the output of this program you have to know that the "origin" for point plot mode is the point (0, 0), and that it is located in the lower left corner of the screen. All points (X, Y) must be described

1 CHARACTER MODE POSITION \* 8 POINT PLOT MODE POSITIONS



Figure 1: Division of screen character into a 2 by 4 array of "points."

by positive integers with X going from 0 to 159, and Y going from 0 to 191. To make  $Y=X^2$  fit on the screen, we divided by 100 (because when  $X=99$ ,  $Y=9801$  which would be way off the screen). Our graph will look something like the one in figure 2.

**Example 2:** Here is a program to plot a sine function. We let X go from 0 to 159, but actually plot  $SIN(X/13)$ . This causes the argument of SIN to go from 0 to slightly over 12 radians, giving about two cycles of the function. Since the SIN function has values from -1 to 1, we multiply it by 95 and then add 95. This causes Y to go from 0 to 190. The program is initiated by the command PLOT 12, which means "clear screen."

10 PLOT 12:PLOT 2	'Clear screen, enter plot mode
20 FOR X=0 TO 159	'Get X
30 Y=95*SIN(X/13)+95	'Calculate Y
40 PLOT X:PLOT Y	'Plot X, Y
50 NEXT X	'Back to line 20
60 PLOT 255	'Exit plot mode

### Adding Color

The preceding programs plot in whatever color the machine was using last. Color can be changed with either the PLOT 6 or the PLOT 29 modes. After entering the PLOT 6 mode, the statement PLOT I produces various combinations of foreground colors, background colors, and "blink" states, all depending on the value of I. For example,  $I = 0$  to 7 gives the eight possible foreground colors on a background of black with no blink.

The PLOT 29 mode is a little simpler. It allows only foreground (which means the actual point being plotted) color to be specified. It is followed by PLOT I, where I specifies color according to the codes: 16=black, 17=red, 18=green, 19=yellow,

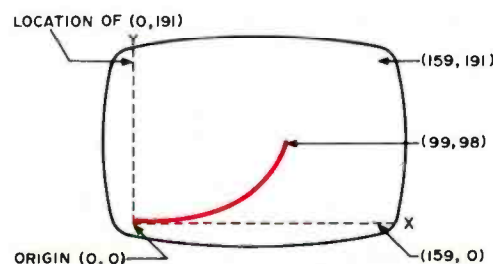

Figure 2: A display of the equation  $Y=X^2$ .

Figure 3: A display of the line running from points (0,96) to (159,96).

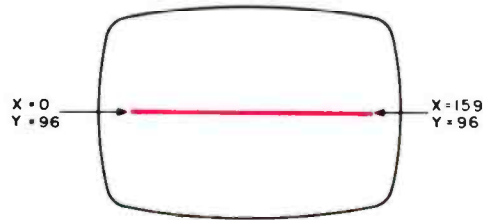
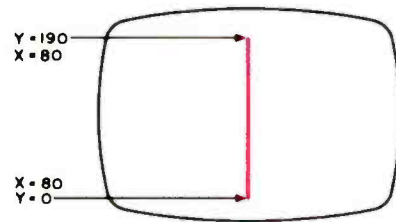

Figure 4: A display of the line running from points (80,0) to (80,190).



```

10 PLOT 12
20 PLOT 29: PLOT 19
30 PLOT 2
40 PLOT 246: PLOT 0: PLOT 0: PLOT 190
50 PLOT 250: PLOT 0: PLOT 95: PLOT 159
60 PLOT 255
70 FOR X = 0 to 159
80 PLOT 29: PLOT 17+X/22
90 Y = 95*SIN(X/13)+95
100 PLOT 2
110 PLOT X: PLOT Y
120 PLOT 255
130 NEXT X

```

```

'Erase screen
'Set color= yellow
'Go into main plot mode
'Plot Y bar graph
'Plot X bar graph
'Exit plot mode
'Get X
'Set a color depending on X
'Calculate Y
'Point plot mode
'Plot one point
'Exit plot mode
'Back to line 70

```

Listing 1: A BASIC program for graphing a sine function in seven different colors.

20=blue, 21=violet, 22=cyan (light blue), and 23=white.

We'll illustrate this feature in a moment, but let us first look at an example of a subplot mode (a mode that follows the PLOT 2 main mode).

### Bar Graph Mode

After entering PLOT 2 mode, you can go into several subplot modes. For example, PLOT 250 means enter the X (horizontal) bar graph mode. It is followed by three PLOT statements that tell where to put the bar graph and how long to make it.

```

PLOT 2: PLOT 250
PLOT 0: PLOT 96: PLOT 159

```

This directs the program to draw a horizontal bar (line) from X=0 to X=159, 96 units up on the screen (the Y position). See figure 3. The code for Y (vertical) bar graphs is PLOT 246.

```

PLOT 2: PLOT 246
PLOT 0: PLOT 80: PLOT 190

```

The latter draws a vertical bar (line) from Y=0 to Y=190, 80 units to the right (the X position). See figure 4.

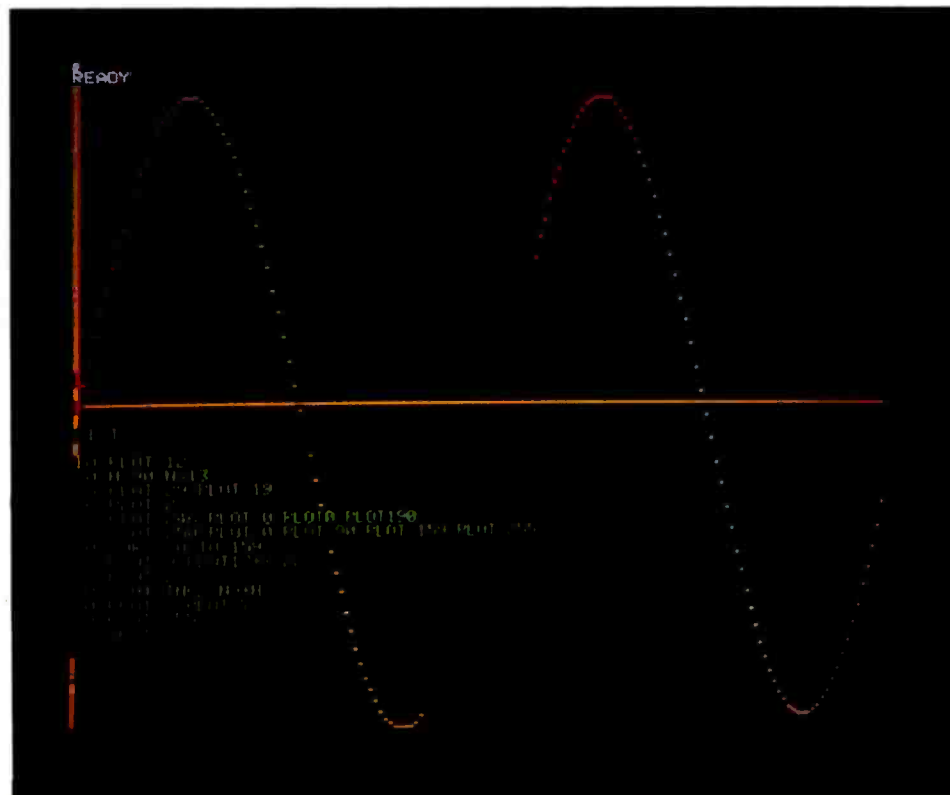

Photo 2: A plot of the sine function, which changes the color of the plotting point cyclically. The axes are drawn with bar graph mode.



## A Combined Program

The program shown in listing 1 graphs the sine function using seven different colors (codes 17 to 23). It also uses the bar graph mode to plot the X and Y axes for the graph. The axes are drawn in yellow (code 19). The output of this program is shown in photo 2. Notice in line 100 that PLOT 2 serves a dual purpose. It puts the machine in both main and point plot mode. A more interesting example of the output possible from bar graph mode is shown in photo 3.

## Vector Mode

The bar graph modes are used to draw horizontal and vertical lines. Vector mode allows you to draw lines (called vectors) between any two points. This means slanted lines can be drawn on the screen. Start with PLOT 253, then give the coordinates of the starting position with PLOT X0:PLOT Y0. The next command should be PLOT 242, followed by the coordinates of the end position with PLOT X1:PLOT Y1. (Any variable names can be used; we find these easy to remember.) The program in listing 2 lets you draw vectors on the screen using seven colors in sequence. (Black is not used because it would draw an "invisible" line.)

If you wish to draw lines where the end point of one is the starting point of the next one (as in drawing polygons), you need only use PLOT 253 once. The program in listing 3 draws random vectors in this fashion, making an attractive abstract type of drawing. The output is shown in photo 4.

## Incremental Plot

Another submode that can follow PLOT 2 is the PLOT 251 incremental plot, which allows you to move the graphic "point" element (really a small rectangle) by a small "increment" (or step). There are eight directions in which you can move, shown by the arrows in the following diagram:

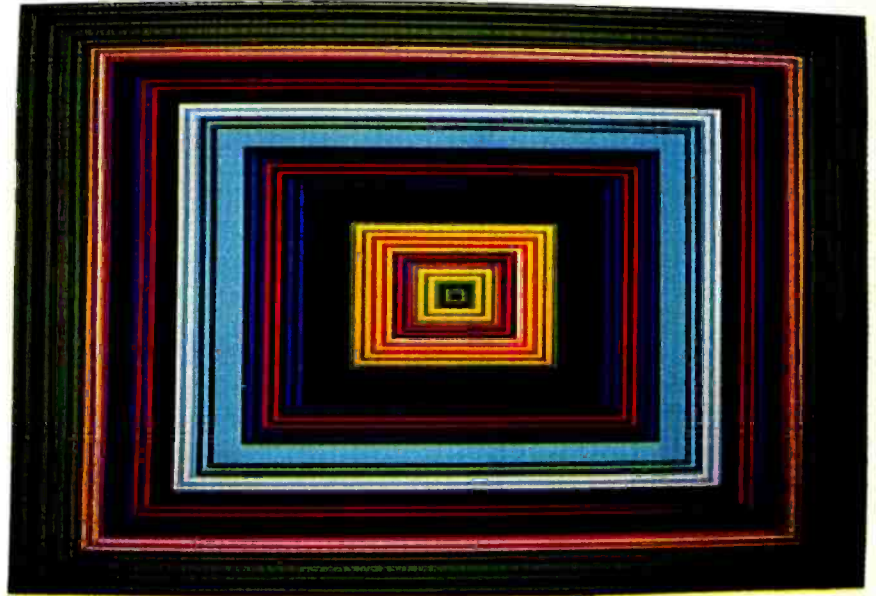
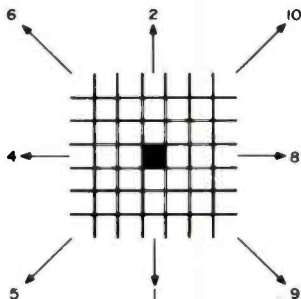

Photo 3. A display of concentric rectangles produced in the bar graph mode.

```

10 PLOT 12:C=0           'Erase screen
20 C=C+1                'Start with color code 1
30 IF C > 7 THEN C=1    'Only allow seven color codes
40 PLOT 6:PLOT C        'Set the color
50 PRINT"TYPE X0, Y0";
60 INPUT X0, Y0         'Get starting point
70 PRINT"TYPE X1, Y1";
80 INPUT X1, Y1        'Get end point
90 PLOT 2               'Go into plot mode
100 PLOT 253:PLOT X0:PLOT Y0 'Draw vector starting at X0, Y0. . .
110 PLOT 242:PLOT X1:PLOT Y1 '... to X1, Y1
120 PLOT 255            'Exit plot mode
130 GOTO 20             'Repeat
    
```

Listing 2: A BASIC program enabling the user to draw vectors on a color video screen using seven colors in sequence.

```

10 K=16                 'Initialize color selector
20 PLOT 12:PLOT 2      'Enter plot mode
30 PLOT 253:PLOT 79:PLOT 91 'Start vector in center
40 K=K+1               'Select color . . .
50 IF K > 23 THEN K=17 '... between 17 and 23
60 PLOT 255:PLOT 29:PLOT K 'Turn on color
70 X=160*RND(1):Y=190*RND(1) 'Choose random point
80 PLOT 2:PLOT 242:PLOT X:PLOT Y 'Draw vector
90 GOTO 40
    
```

Listing 3: A BASIC program that draws a chain of random vectors.

```

10 PLOT 12             'Erase screen
15 PLOT 2:PLOT 80:PLOT 92 'Plot a point in middle of screen
20 FOR C=17 TO 23     'Select a color
30 PLOT 255:PLOT 29:PLOT C 'Activate color
40 PLOT 2:PLOT 251    'Go into incremental plot mode
50 E = 2 ↑ INT(4*RND(1)) 'Choose direction
60 FOR K=1 TO 5*RND(1)+5 'Choose number of steps
70 PLOT E             'Plot in direction E
80 NEXT K             '... for K steps
90 NEXT C             'Get next color and direction
100 GOTO 20          'Repeat the whole cycle
    
```

Listing 4: A BASIC program to produce a random walk pattern.

Photo 4: A random vectors program display. Color is changed cyclically for each new vector. The listing overwrites some of the vectors because it was done after interrupting the run.

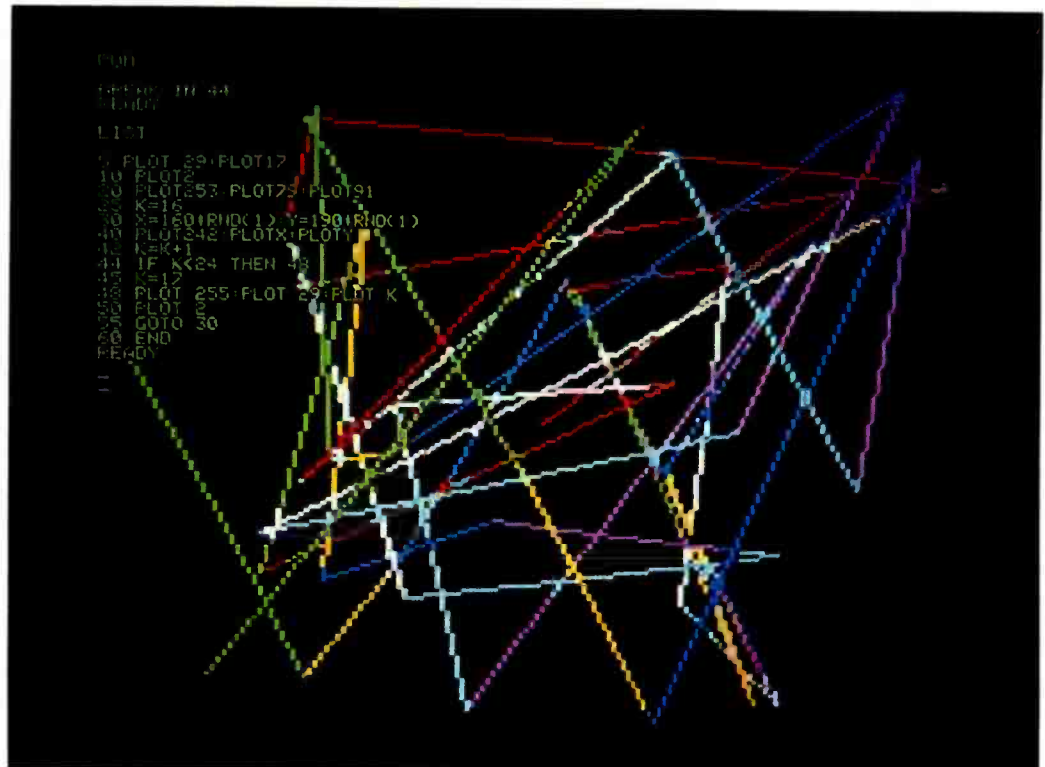
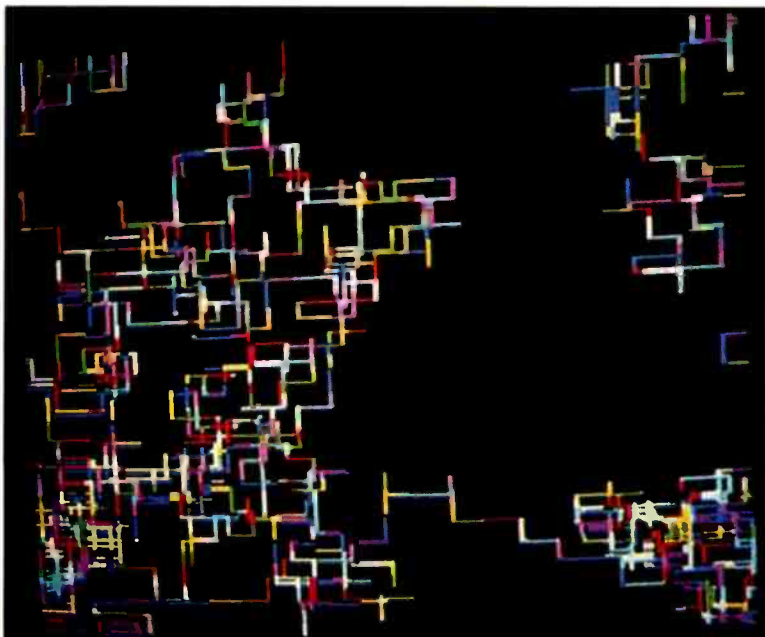

Photo 5: Output from the random walk program after 20 seconds. When the plotting point "walks off" the edge of the screen, it reappears on the opposite side due to wraparound in the display memory.



The numbers next to the arrows are "direction codes." A given direction is selected by using the proper direction code in a second PLOT statement. For example, to plot a point in the middle of the screen and then move it one "increment" to the right, use the following instructions:

```
10 PLOT 2:PLOT 80:PLOT 92
20 PLOT 251:PLOT 8
```

PLOT 251 means "increment (move) the point," and PLOT 8 means "to the right." The distance moved is very small (the width of one point).

The next program (see listing 4) uses this feature to produce what is called a random walk pattern. We'll use only the direction codes 1, 2, 4 and 8. These will be generated by the formula

$$E = 2 \uparrow \text{INT}(4 * \text{RND}(1))$$

So we randomly get the numbers  $2^0=1$ ,  $2^1=2$ ,  $2^2=4$  and  $2^3=8$ . Our point will randomly "decide" to move down, up, left and right.

To make the pattern even more interesting, we use another random number (from 5 to 9) to decide how many increments (small steps) to take in each direction. We also change colors. The result is a rather striking weave-type color abstraction. (Actually, random walk techniques originated for practical reasons. They are used in solving several types of mathematical and scientific problems that can't be handled by conventional methods.) Line 50 selects a random direction, and the loop 60-80 determines how many increments to take in that direction. The main loop 20-90 repeats the process for seven different colors. The program goes on indefinitely, filling the screen to any density you wish. Photo 5 shows the output of this program after

tomorrow's computer here today . . .  
**the bytemaster**  
only from the Digital Group



For details write or call today.

Digital tape based starts at \$1995 kit.  
Delivery within 60 days.

**the digital group**

P.O. Box 6528 Denver, CO 80206 (303) 777-7133

# Basic systems for personal computing

If you are just getting into personal computing and are looking for a starter system, you have two choices: a computer kit with RAM memory only or a fully assembled computer with BASIC-in-ROM. From reading this magazine and talking to computer buffs it should be obvious that it is desirable to have a computer capable of communicating in the programming language BASIC: This language allows you to instruct the computer in English-like phrases and to use any of the thousands of standard programs written in BASIC (there are probably several in this magazine).

If you purchase a (RAM-only) computer kit you will have to buy additional RAM (4K to 8K), a terminal, and cassette interface for a total cost of about \$1000 to run BASIC after you get the kit together and working. Your reward for this endeavor will be a wait of about 15 minutes every time you turn the computer on just to load BASIC into the machine!

Your other alternative is a BASIC-in-ROM computer. These machines have BASIC built in so that it is there whenever the computer is turned on. BASIC-in-ROM computers are also usually fully assembled and cost far less than the RAM-only kits because they are mass-produced by the thousands.

But, you must be careful when selecting a BASIC-in-ROM computer. Some models do not have full-feature BASIC. Instead they have Tiny BASIC or 4K BASIC which cannot run most of the standard BASIC programs available. Still others have other shortcomings such as a small calculator-style keyboard which makes program entry difficult, or most important, lack of expansion capability, preventing the computer from growing with you.

Ohio Scientific offers you a line of expandable computers with full-feature 8K BASIC-in-ROM. They all come fully assembled and tested, but give you the option of economizing by supplying the simple things — power supply, keyboard and TV, if desired, so that you get the most computer power for your dollar.

Compare Ohio Scientific's \$298 BASIC-in-ROM Model 500 Board (1MHz clock), which has our Version 3.3 BASIC, against other small computers, as in the independent article "BASIC Timing Comparisons" (Kilobaud, Oct. 1977, p. 23). In this test, the Model 500 excelled over all our personal computing competitors, and was second in performance only to our Challenger disk systems, compared against twenty-eight other computer systems. And the Model 500 is our lowest-cost machine! Our larger models are even more dramatic in a comparison with any competitive models.

Having the fastest full-feature BASIC ROMs certainly isn't the only criterion necessary for a superior computer system, but it sure helps. Ohio Scientific offers all the other features necessary, including a full line of computer accessories complete with 15 accessory boards available in over 40 configurations. Many Ohio Scientific accessories are so innovative that no one else in the industry has them — such as dual port memory boards, multi-processing CPU's and big disks.

Ohio Scientific has other unique features for the personal computerist. For instance, there is Ohio Scientific's *Small Systems Journal*, published bi-monthly, a full magazine aimed specifically at the owners of Ohio Scientific computers. If you are looking for a personal computer, be sure to look carefully at Ohio Scientific. We think you will find that we have the system for you.

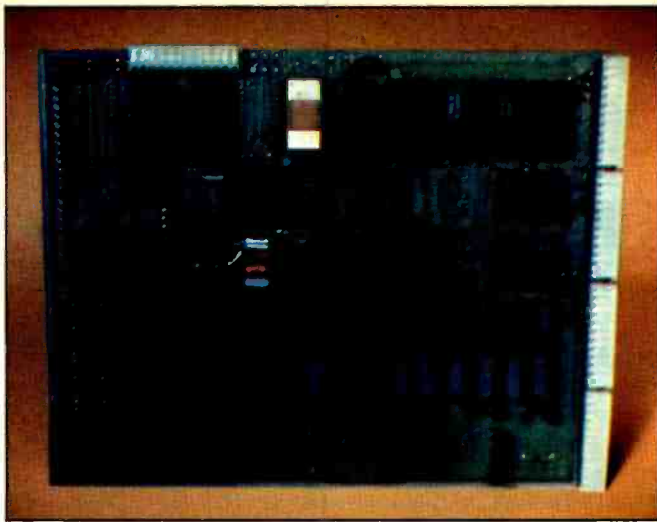

## Model 500 Board

A full 8K BASIC-in-ROM computer on a board. This unit contains a 6502 microprocessor with our powerful 8K BASIC-in-ROM, 4K of RAM memory, and a serial port which can be jumpered for 20ma current loop or RS-232. The board can be plugged into any standard OSI-backplane and expanded by our full line of accessory boards. The user must simply supply +5V and -9V power and the serial terminal to be up and running in BASIC.

**\$298.00**

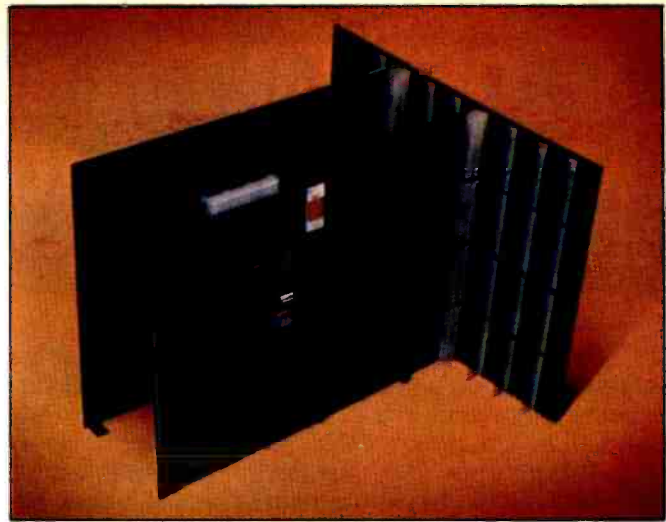

## Super Kit

An ideal starter computer system. The Super Kit includes a Model 500 CPU Board with 8K BASIC in ROM, CPU, and 4K of RAM, full buffering for expansion, an eight-slot backplane board, and a Model 440 Video I/O Board. Model 440 provides full CRT functions when connected to a video monitor or modified television set and a standard ASCII keyboard. The user must simply provide +5V and -9V power, an ASCII keyboard, and a modified television set or monitor to have a full computer system with 8K BASIC-in-ROM, 4K user space and a CRT terminal with scrolling.

**\$398.00**



## Challenger II-P

Our very popular fully packaged BASIC-in-ROM computer. Challenger IIP contains the Model 500 CPU Board with 4K of RAM, our new 540 32x64 character video display, keyboard and complete audio cassette interface. The unit also has internal power supplies and a four-slot backplane with two open slots for expansion. The user has only to connect a monitor or modified television set to its output, and he is ready to program in BASIC. To store programs and data files, he needs only to connect a conventional audio cassette recorder to the built-in audio cassette interface. The unit is fully assembled and ready to go.

**\$598.00**



## Challenger II Disk Systems

The ultimate in personal computing offered by Ohio Scientific is the Challenger II system with single- or dual-drive full-sized floppy disk. Each floppy stores 250,000 characters. The Challenger II is available as a video system with keyboard so that all the user needs is a television or monitor for operation; or as a serial version where the user must supply his own terminal. Challenger II disk systems automatically load in BASIC and now have an extensive library of high-performance programs. The programs are ideal for the advanced hobbyist, educational users, industrial development and small business applications. Challenger II disk systems are very economical. For instance, a 16K disk system with 250,000 bytes of disk storage starts at under **\$2000.00**

# OHIO SCIENTIFIC

1333 S. Chillicothe Road • Aurora, Ohio 44202  
(216) 562-3101

For more information contact an Ohio Scientific dealer or send \$1 for our 64-page buyers' guide.

# OS-65U The New Standard in Micro Computer Operating Systems

System design goals: Create a simple, concise crash proof operating system which is easy for business programmers to utilize and simple for office workers (and other non-computerists) to use. The system *must* have the highest performance in the microcomputer industry and must be able to support present day floppy and hard disks as well as tomorrow's CCD and bubble memories *without any user program modifications*.

This may sound outlandish but we developed just such a system and here's how:

First, we started with a fresh copy of Microsoft's super fast 9½ digit BASIC for the 6502. (This BASIC out benchmarks every other microcomputer BASIC using the 7 Kilobaud benchmarks except for our own ultra fast 6 digit BASIC.)

We knew that all operating system commands and features should be an integral part of this BASIC language so we put them right in the BASIC itself. This means that all OS features can be accessed in the immediate or command mode and as part of BASIC programs. All syntax such as file names can be literal strings or BASIC variables.

We started with some simple but powerful extensions to BASIC to make the business system programmer happy— like \$L,\$R,INPUT #(D),and PRINT #(D).\$L and \$R are PRINT subcommands which automatically output numeric data in dollars and whole cents in neat columns just like "PRINT USING" only simpler and quicker.

The optional # specifier in LIST, INPUT and PRINT statements allows the user to route I/O directly to the console, 16 RS-232 ports, a cassette port, RS-232 and parallel printer ports and word processing printers, not to mention video displays and parallel keyboards.

We then added a continuous memory file system—the real achievement of OS-65U. This file system has no tracks, sectors or records. The user simply allocates storage capacity to each file when he creates it. (On a CD-74 Hard Disk this can be over 72,000,000 bytes or characters.) The user can then directly address every entry in the file with no awareness of any block, sector or track structures. Data files can simultaneously contain strings and pure numeric data. Files can be accessed sequentially *and* randomly.

Data files are handled with standard syntax including OPEN "File", CLOSE (File), PRINT % (File) and INPUT % (File) and the very special INDEX (File). INDEX is a special BASIC variable/function which specifies the file address of the next entry to be input or output to that file. If you leave it alone, it operates sequentially. However, you can change it at any time to force a random access. This remarkable function can be on either side of a BASIC equation and can take on any value within the storage range of an opened file. For example, all of the following are legal in OS-65U:

INDEX (1) = INDEX(1) + 10 (Causes 10 characters to be skipped)

B = INDEX (1) (Sets B = current index)

INDEX (3) = INDEX(8) /2 (Equates two file positions, useful in sorts and merges)

INDEX (5) = A\*50 (Sets up a random access on an array with 50 character elements)

Where (N) is a channel number or shorthand notation for an open file, and is assigned by the OPEN command.

This may seem exotic but it is really super simple and incredibly powerful. Besides your files always automatically revert to simple sequential operation if you choose to ignore indexes.

And, finally, for those of you who would really hate to give up plain old sequential files, we added a FIND command. FIND searches for up to a 32 character string with optional "don't care" characters and will automatically scan any file from the beginning or other specified index. The FIND command is implemented in straight line page zero 6502 code (the fastest programming technique on the fastest micro) and searches files at over 250,000 bits per second.

Only three statements are needed to support a sequential file in a BASIC program; only four to support a random file. A mere seven statements are required to use an indexed sequential file system as part of a program!

A Benchmark: A Challenger III equipped with a CD-74 running OS-65U can access any account entry in a 500 account one million byte randomly ordered ledger file by an alphabetic key string up to 32 characters long in less than 40 milliseconds (typically) using a simple two level ISAM file structure supported by a total program only 10 statements long. That's performance!

OS-65U also hosts multilevel passwords, elaborate error checking, programmable error recovery and end user niceties like warnings and automatic recovery when an "off" or non-existent peripheral is accessed. Programs and files in OS-65U can be fully secured so that they cannot be listed, copied or even accessed if desired.

OS-65U is available now for use on any Ohio Scientific floppy or hard disk based computer with 32K of RAM or more. A \$199, it's quite possibly the best computer investment you'll ever make.

# The Challenger III System

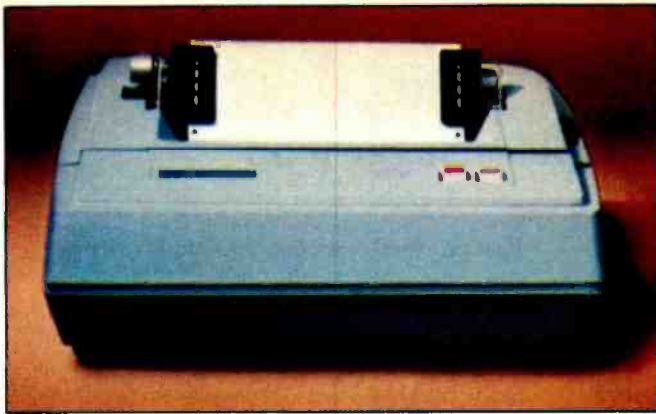

- Designed for small business computing.
- Uses the 510 triple processor CPU Board, runs 6502, 6800, 8080 and Z-80 programs.
- Available with up to 1 Megabyte of RAM memory; high reliability static RAM is standard; low-cost dynamic RAM is optional.
- Single- or dual-drive floppy disks store 250,000 characters per surface — 3 to 4 times the storage of mini-floppies.
- Supports our ultra-fast 6-digit BASIC (see "BASIC Timing Comparisons," Kilobaud, Oct. 1977, p. 23, where Ohio Scientific out-benchmarks all of our competitors) and our new super-fast 9-digit business BASIC.
- Powerful operating systems support all standard I/O ports including multiple terminals, line printers, video display and disk.
- Disk supports: sequential, random and index sequential files.
- Applications software, including:
  - WP-1, a powerful disk-based Word Processor.
  - DMS, a unique data-base management system which supports continuous disk addressing of up to 250,000 characters per file.
- Complete business packages including Accounts Receivable, Accounts Payable, Ledger, Payroll, Inventory and Taxes.
- Two factory-supported terminal options and two factory-supported line printer options.
- Optional 74-Megabyte hard disk for \$6000. Reel-to-reel mag tape coming soon.
- Optional 16-user operating system with time share and distributed processing capabilities.
- Optional rack mounting and rack enclosures.
- Leasing programs and maintenance contracts available through many dealers. Optional nationwide field service coming soon.
- Challenger III systems have extremely high performance-to-cost ratios. For example, a system complete with triple processor CPU, 32K bytes of static RAM, a serial I/O port, dual drive floppy disks (500K bytes of on-line storage), fully assembled, plus DOS, BASIC and a demonstration program library costs \$3590 fully assembled.

## DEALERS

**The Abacus**  
Niles Rd  
Berlin Springs, MI 49103  
(616) 429-3034

**American Microprocessors  
Equipment & Supply Corp.**  
20 N. Milwaukee Ave  
Princeton, IL 60069  
(312) 634-0076

**Computer Mart of New York**  
118 Madison Ave  
New York, NY 10010  
(212) 686-7923

**Computer Place**  
RD #4  
Box 910  
Joplin, MO 64801  
(417) 781-1986

**Computer Power**  
P O Box 28193  
San Diego, CA 92128  
(714) 746-0064

**Computer Shop (Aircor)**  
288 Norfolk St  
Cambridge, MA 02139  
(617) 661-2670

**Delaware Microsystems**  
92 E. Main St. #1  
Newark, DE 19711  
(302) 738-3700

**Great Lakes Photo, Inc.**  
5001 Eastman Rd.  
Midland, MI 48640  
(517) 631-5461

**H/S Computers**  
217 East Main St  
Charlottesville, VA 22903  
(804) 295-1975

**Microcomp**  
P O Box 1221  
Fond Du Lac, WI 54935  
(414) 922-2515

**Microcomputer Workshop**  
234 Tenyson Ter  
Williamsport, NY 14221  
(716) 632-8270

**Micro Computer World**  
313 Michigan N.E.  
Grand Rapids, MI 49503  
(616) 451-8972

**Small Computer Systems**  
4450 Trinity Avenue  
Salt Lake City, UT 84120  
(801) 967-7635

## REPRESENTATIVES

**Abacuz Data**  
P.O. Box 276  
Oil City, PA 16301

**Associates Consultants**  
33 Ogden Ave  
Egg Harbor, NJ 11596  
(516) 746-1079

**BRAG Microcomputers**  
19 Cambridge St  
Rochester, NY 14607  
(716) 442-5861

**Byte Shop**  
2432 Chester Lane  
Columbus, OH 43221  
(614) 486-7761

**Computer Business**  
P.O. Box 171  
LaPorte, IN 46350  
(219) 367-5812

**Custom Computer Systems, Inc.**  
1823 Lowry Ave. North  
Minneapolis, MN 55411  
(612) 586-3944

**Johnson Computer**  
P.O. Box 523  
Medina, OH 44256  
(216) 725-4560

**Omega Computing, Ltd.**  
Box 270, Station F  
Toronto, Ont. M5S 2S7  
(416) 425-9200

**Pan Atlantic Computer Systems, GmbH**  
61 Darmstadt  
Frankfurterstrasse 78

**West Germany**  
1081021 3206

**Sacom Systems**  
541-1 New Peach Tree Rd  
Chamblee, GA 30341  
(404) 934-3272

**Small Computer Systems**  
3140 Menzies Ave  
Honolulu, HI 96816  
(808) 732-5246

**Systems Engineering Enterprises**  
Suite 307  
1749 Rockville Pike  
Rockville, MD 20852  
(301) 468-1822

**Tek-Aids, Inc.**  
1513 Crain St  
Evanston, IL 60202  
(312) 328-0110

**Total Data Systems**  
125 Fairway Lane  
Fort Collins, CO 80521  
(303) 487-6215

**Tricomp, Inc.**  
18 Alameda Square  
Denver, CO 80223  
(303) 935-1100

**Yingco, Inc.**  
2 World Trade Cntr  
Penthouse 107th Floor  
New York, NY 10048  
(212) 775-1184

# OHIO SCIENTIFIC

1333 S. Chillicothe Road • Aurora, Ohio 44202  
(216) 562-3101

For more information contact an Ohio Scientific dealer or the factory. Be sure to specify your interest in business systems.

## A Raster Scan Graphics Suggestion

Tello D Adams  
619 Woodhaven Pl  
Richardson TX 75080

In reference to your editorial (October 1977 BYTE, page 6) you seem to have overlooked a pertinent color refresh storage method. While a 256 by 256 matrix is great if you want to create a 256 square checkerboard, most graphics (including cartoons) don't look that way; therefore, storage for every picture element is a waste of bandwidth. Most graphics consist of areas of color, usually with a limited number of changes over the screen width.

Let us presume that a representative byte consists of four bits of color information (16 colors) and four bits of intensity data (grey scale = 16). A raster scan system is *not* a series of random events. The beam position can be predicted at all times, therefore, if a clock driven 256 counter (eight bits) is provided, the horizontal position of the beam is uniquely defined. The game now becomes one in which the beginning address on a line (eight bits) and the color and intensity information (eight bits) from that point to the next change is stored (parallel 16 bit or two bytes if your access is fast enough) in sequence in memory. Each 16 bit word is pulled from memory and stored in two 8 bit registers. When the counter (horizontal

line position) matches the address register, the color and intensity information is transferred into a driving register which holds it and drives the video conversion circuits until the next change. This event also causes the next double byte to be retrieved from the memory and loaded into the "standby register." The driving register could also be combined (logically) with a character generator to provide an interesting set of alphanumerics. Now let's look and see what we have got. We need a sync signal to mark the beginning of the frame, but no line counter, unless you want to digitally control the vertical retrace, as a given address only occurs once per line. (But you do need one byte of address which is numerically larger than the first address of the next line. This can be an actual "used" number or a "fake" at  $n = 225$ .) We use only one double byte per color or intensity *change*. If you assume an *average* of ten changes per line (and in the "cartoon" world that is a lot) and 256 lines, that equates to 2,560 double bytes (5,120 bytes) which is far short of the 64 K + bytes (7.8%) it would take to define every picture element, yet 256 by 256 *resolution* is still achieved (information and resolution are *not* the same). This would seem to provide one practical solution to the high resolution color graphics problem for small users, and is instantly expandable as more memory becomes available. ■

*Technical Forum is a feature intended as an interactive dialog on the technology of personal computing. The subject matter is open-ended, and the intent is to foster discussion and communication among readers of BYTE. We ask that all correspondents supply their full names and addresses to be printed with their commentaries. We also ask that correspondents supply their telephone numbers, which will be printed unless we are explicitly asked to omit them.*

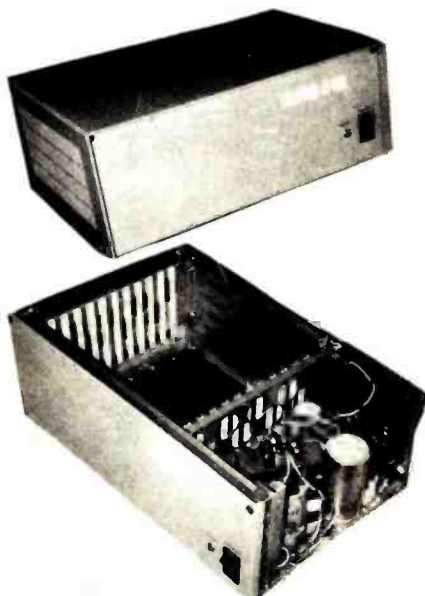

### ALPHA Z-80\* \$ 495 ASSEMBLED

- 12 SLOT MOTHER BOARD
- 12 CONNECTORS (S-100 BUS)
- 17 AMP POWER SUPPLY
- HEAVY DUTY CABINET WITH FAN
- Z-80 CPU BOARD: All Sockets Included, Gold Contact Fingers, High Quality Glass Epoxy PC Board, Double-Sided, Plated Through Holes, Requires Only + 8 VDC / 800 MA.

**NOTE: 22 SLOTS/30 AMP POWER SUPPLY - \$595.**

ADS also sells IMSAI and NORTH STAR Assembled at Kit Prices + LEAR SIEGLER ADM 3A Assembled at \$888.00. TERMS: Cash with Order. Prices include Freight. (N.C. Residents add 4% Sales Tax.)

\* Z-80 is a registered trademark of Zilog Inc.

ADS

ALPHA DIGITAL SYSTEMS  
Data Acquisition, Computation and Control



ROUTE 4 BOX 171A  
BOONE, NORTH CAROLINA 28607



# Build a whole new world with **The Blues**.



The future belongs to those with **The Blues** from Cybercom.

Join the growing number of users worldwide who are discovering the exceptional quality, plus prompt delivery and significant cost savings. And the new year holds even more promise now with our MB6A 8K RAM board (450 NS) reduced to just \$165, and our MB7 16K RAM board now only \$449. Also, you might want to check out our new I/O-4 board that offers two serial I/O ports (2-I and 2-O) and two parallel ports (2-I and

2-O), eliminating jumpers, priced at \$149.50. Seek out Cybercom's full and versatile line at your local computer hobbyist store, or contact us directly, if you want to build a world of the future today.



A Division of Solid State Music  
2102A Walsh Avenue  
Santa Clara, CA 95050  
Telephone (408) 246-2707



MB7 16K  
RAM board.

## Ask for **The True Blues**.

Circle 335 on inquiry card.

# Languages Forum

## UCSD PASCAL: A (Nearly) Machine Independent Software System

Kenneth L. Bowles  
Professor, Director  
Institute for Information Systems  
University of California San Diego  
La Jolla CA 92093

(for Microcomputers and Minicomputers)

### Overview

This article describes a complete interactive software system which can operate virtually without change on many different microcomputers and minicomputers. Because the semiconductor industry is evolving new equipment very fast, it is becoming a practical necessity to have machine independent software to prevent rapid obsolescence of large application programs. The software described here has been developed at the University of California San Diego (UCSD), and is available to anyone for a \$200 subscription fee. This article presents an appeal to readers of BYTE for help to bring about a true community-wide software system for business, educational and other professional users of small computer systems. Help is needed from the user community, since the manufacturers have so far avoided standardizing software except as regards some aspects of programming languages. For single user microcomputers, it appears to be far more practical to *standardize the entire software system* than the language processor alone!

### The Software System

UCSD PASCAL is a complete interactive software system for small computers, yet it offers many features normally found only on medium and large scale machines. It is designed to operate, with minimal adaptation, on most microcomputers or minicomputers based on 8 bit bytes or 16 bit words. Supported versions are now available for use on machines based on the Digital Equipment LSI-11 or other PDP-11 processors, and on the 8080 and Z-80 microprocessors. Having first been sent to users in August 1977, the system is in use on approximately 60 mainframes using these processors (as of mid February 1978), and

the list of both users and processors has started to grow rapidly. Versions not yet supported by the Project are operating, or nearly operating, on four other processors (General Automation 440, Univac V75, Nanodata QM-1, National Semiconductor PACE). The UCSD PASCAL Project is discussing arrangements with various manufacturers whereby supported versions can be released for most other popular microprocessors, and additional inquiries would be welcomed.

The system is written almost entirely in the PASCAL programming language, extended for system programming and for disk based interactive applications. Far more than a simple *compiler* for PASCAL, it should be viewed as a complete and fully integrated system which is self-maintaining, and generally independent of software from any other source. The system operates in a small pseudomachine (interpreter) which can be written in the native machine language of conventional processors, or can be microprogrammed on machines which provide that capability. The object code processed by the PASCAL pseudomachine is compressed relative to conventional object code, and consumes roughly one third to one half as much space as the native object code of most present day processors. A feature to be implemented soon will allow mixing PASCAL pseudocode routines, for efficient use of memory, with native code routines, for fast processing.

The system is the product of a growing project team, and is evolving rapidly in an upward compatible way. As of early 1978, the system represents the equivalent of about 15 full-time years of programming and design effort. Major components of the

Continued on page 170

*Languages Forum is a feature which is intended as an interactive dialog about the design and implementation of languages for personal computing. Statements and opinions submitted to this forum can be on any subject relevant to its purpose of fostering discussion and communication among BYTE readers on the subject of languages. We ask that all correspondents supply their full names and addresses to be printed with their commentaries. We also ask that correspondents supply their telephone numbers, which will be printed unless we are explicitly asked to omit them.*

## COMPUTER SYSTEMS by Technical Design Labs

THE SMB II IS A FLEXIBLE MULTI-FUNCTION BOARD WHICH PROVIDES A VARIETY OF FEATURES COMMONLY REQUIRED IN MICRO-COMPUTER SYSTEMS.

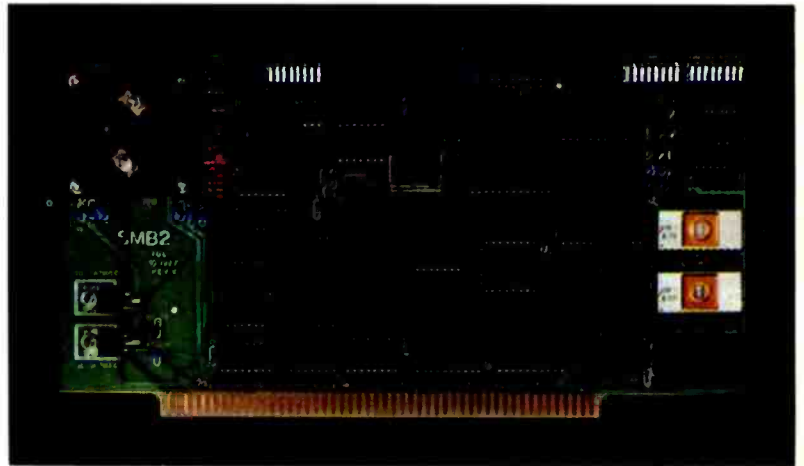

SYSTEM MONITOR BOARD II

### FLEXIBLE I/O

The SMB II features two serial ports with baud rates individually selectable from 110 to 9600 baud. Additionally, a single 8 bit parallel port with two control lines is provided. These ports allow interfacing to most commonly used I/O devices such as CRTs, TTYs or parallel reader/punch devices. Interfacing is simplified by the use of a flat ribbon connector.

### MASS STORAGE

Using most inexpensive cassette tape recorders, this updated and improved Audio Cassette Interface may be switch selected to operate at either 1200 or 2400 baud. The necessary serial port and the software drivers for saving and loading programs using this interface are provided as part of the operating system.

### RAM and EPROM

Sockets are provided which allow the insertion of two 2708s or 2716s which may be addressed at any 1K page border in memory. One 2708 is supplied with the SMB which contains many useful extensions to the ZAPPLE monitor.

Sockets for 2K of static RAM, addressable at any 1K border in memory are also provided. This scratch pad space is tremendously useful for the creation of additional monitor extension routines and I/O drivers. 1K of this static RAM is provided with the SMB II.

### SYSTEM CONTROL

Perhaps the most useful feature of the SMB is the inclusion of the Z80 ZAPPLE MONITOR in 2K of masked ROM. This executive program allows complete system control, including debugging, and extensive I/O control directly from the keyboard. Also, hardware implementations allow "Jump-on-reset" to ANY 256 byte border in memory.

### FEATURES:

- 2K Zapple Monitor in ROM (for Z-80)
- 8080 version available on special order
- Up to 4K of 2708/2716 EPROM may be used
- Sockets for two 2708/2716 EPROMs are provided
- One 2708 with extension routines comes standard
- Sockets for 2K static RAM
- 1K Static RAM provided as standard
- 1200/2400 Baud Audio Cassette Interface
- Two Serial ports, 110 to 9600 baud (one may be RS232 or current loop)
- One 8 bit parallel port with control bits
- RAM, ROM and EPROM may be readdressed in memory
- Generates Interrupt
- Optional on-board MWRITE generation
- Wait-state generation for 4MHz operation

# it's a good bet the company you bought your computer from doesn't even make peripherals!

It's no great surprise! Most computer companies got their start in the digital logic end of the business. They were great at building calculators and later computers, but when it came right down to it, most just didn't have the experience necessary to build the peripherals to support their computer products. And that left a vacuum!

At Heath we had the advantage. Our years of experience in electronic kit design gave us plenty of background with not only digital logic but mechanical and video design as well. And our assembly manuals and documentation are world famous for easy to understand instructions.

We built the world's first digital color television, a unique fully synthesized FM tuner, digital frequency counters, clocks, even a digital bathroom scale.

So when we entered the personal computing market we had the "know-how" to build not only our outstanding H8 and H11, 8 and 16-bit computers, but, in addition, a complete line of supporting peripheral kits!

Select the H9 Video Terminal, the H10 Papertape Reader/Punch, and very soon our own, complete, Floppy Disk system. Each was designed with the systems approach in mind. Each was conceived to integrally mesh with not only our own computers, but

through our set of sophisticated interfaces, most others as well. And in that way we're making every effort to fill the vacuum the others left!

So when you're ready to communicate with your computer turn to Heath. We've got the peripheral kits you'll need and at prices you can afford.

Maybe the company who sold you your computer didn't think about peripherals - but we sure did! And come to think about it maybe that's why you should come to Heath... in the first place.

## Heathkit Computers



# FREE Heathkit Catalog



Read about nearly 400 money-saving, fun-to-build electronic kits.

Use coupon to send for your mail order catalog or bring coupon to a Heathkit Electronic Center for your catalog.



### AVAILABLE LOCALLY AT HEATHKIT ELECTRONIC CENTERS

(Units of Schlumberger Products Corporation) Retail prices on some products may be slightly higher.

**ARIZONA:** Phoenix, 85017, 2727 W. Indian School Rd., Phone: 602-279-6247; **CALIFORNIA:** Anaheim, 92805, 330 E. Ball Rd., Phone: 714-776-9420; El Cerrito, 94530, 6000 Potrero Ave., Phone: 415-236-8870; Los Angeles, 90007, 2309 S. Flower St., Phone: 213-749-0261; Pomona, 91767, 1555 Orange Grove Ave. N., Phone: 714-823-3543; Redwood City, 94063, 2001 Middlefield Rd., Phone: 415-365-8155; Sacramento, 95825, 1860 Fulton Ave., Phone: 916-486-1575; San Diego (La Mesa, 92041), 8363 Center Dr., Phone: 714-461-0110; San Jose (Campbell, 95008), 2350 S. Bascom Ave., Phone: 408-377-8920; Woodland Hills, 91364, 22504 Ventura Blvd., Phone: 213-883-0531; **COLORADO:** Denver, 80212, 5940 W. 38th Ave., Phone: 303-422-3408; **CONNECTICUT:** Hartford (Avon, 06001), 395 W. Main St. (Rte. 44), Phone: 203-876-0323; **FLORIDA:** Miami (Hialeah, 33012), 4705 W. 16th Ave., Phone: 305-823-2280; Tampa, 33614, 4019 West Hillsborough Ave., Phone: 813-886-2641; **GEORGIA:** Atlanta, 30342, 5285 Roswell Rd., Phone: 404-252-4341; **ILLINOIS:** Chicago, 60645, 3462-66 W. Devon Ave., Phone: 312-583-3920; Chicago (Downers Grove, 60515), 224 Ogden Ave., Phone: 312-852-1304; **INDIANA:** Indianapolis, 46220, 2112 E. 62nd St., Phone: 317-257-4321; **KANSAS:** Kansas City (Mission, 66202), 5960 Lamar Ave., Phone: 913-362-4486; **KENTUCKY:** Louisville, 40243, 2401 Shelbyville Rd., Phone: 502-245-7811; **LOUISIANA:** New Orleans (Kenner, 70062), 1900 Veterans Memorial Hwy., Phone: 504-722-6321; **MARYLAND:** Baltimore, 21234, 1713 E. Joppa Rd., Phone: 301-661-4448; Rockville, 20852, 5542 Nicholson Lane, Phone: 301-881-5420; **MASSACHUSETTS:** Boston (Peabody, 01960), 242 Andover St., Phone: 617-531-9330; Boston (Wellesley, 02181), 165 Worcester Ave. (Rt. 9 just west of Rt. 128), Phone: 617-237-1510; **MICHIGAN:** Detroit, 48219, 18645 W. Eight Mile Rd., Phone: 313-535-6480; E. Detroit, 48021, 18149 E. Eight Mile Rd., Phone: 313-772-0416; **MINNESOTA:** Minneapolis (Hopkins, 55343), 101 Shady Oak Rd., Phone: 612-938-6371; **MISSOURI:** St. Louis (Bridgeton), 63044, 3794 McKelvey Rd., Phone: 314-291-1860; **NEBRASKA:** Omaha, 68134, 9207 Maple St., Phone: 402-391-2071; **NEW JERSEY:** Fair Lawn, 07410, 35-07 Broadway (Rte. 4), Phone: 201-791-6935; Ocean, 07712, 1013 State Hwy. 35, Phone: 201-775-1231; **NEW YORK:** Buffalo (Amherst, 14226), 3476 Sheridan Dr., Phone: 716-835-3090; Jericho, Long Island, 11753, 15 Jericho Turnpike, Phone: 516-334-8181; Rochester, 14623, 937 Jefferson Rd., Phone: 716-244-5470; White Plains (North White Plains, 10603), 7 Reservoir Rd., Phone: 914-761-7680; **OHIO:** Cincinnati (Woodlawn, 45215), 10133 Springfield Pike, Phone: 513-771-8850; Cleveland, 44128, 5444 Pearl Rd., Phone: 216-885-2590; Columbus, 43229, 2500 Morse Rd., Phone: 614-475-7200; Toledo, 43615, 48 S. Byrne Rd., Phone: 419-537-1887; **PENNSYLVANIA:** Philadelphia, 19149, 6318 Roosevelt Blvd., Phone: 215-288-0180; Frazer (Chester Co.), 19355, 630 Lancaster Pike (Rt. 30), Phone: 215-647-5555; Pittsburgh, 15235, 3482 Wm. Penn Hwy., Phone: 412-824-3564; **RHODE ISLAND:** Providence (Warwick, 02886), 558 Graegwlich Ave., Phone: 401-738-5150; **TEXAS:** Dallas, 75201, 2715 Ross Ave., Phone: 214-826-4053; Houston, 77027, 3705 Westheimer, Phone: 713-623-2090; **VIRGINIA:** Alexandria, 22303, 6201 Richmond Hwy., Phone: 703-765-3515; Norfolk (Virginia Beach, 23456), 1055 Independence Blvd., Phone: 604-460-0997; **WASHINGTON:** Seattle, 98121, 2221 Third Ave., Phone: 206-682-2172; **WISCONSIN:** Milwaukee, 53218, 5215 W. Fond du Lac, Phone: 414-873-8250.

HEATH  
Schlumberger

Heath Company, Dept. 334-410  
Benton Harbor, MI 49022

Please send me my FREE Catalog. I am not on your mailing list.

Name \_\_\_\_\_

Address \_\_\_\_\_

City \_\_\_\_\_ State \_\_\_\_\_

CP-146 \_\_\_\_\_ Zip \_\_\_\_\_

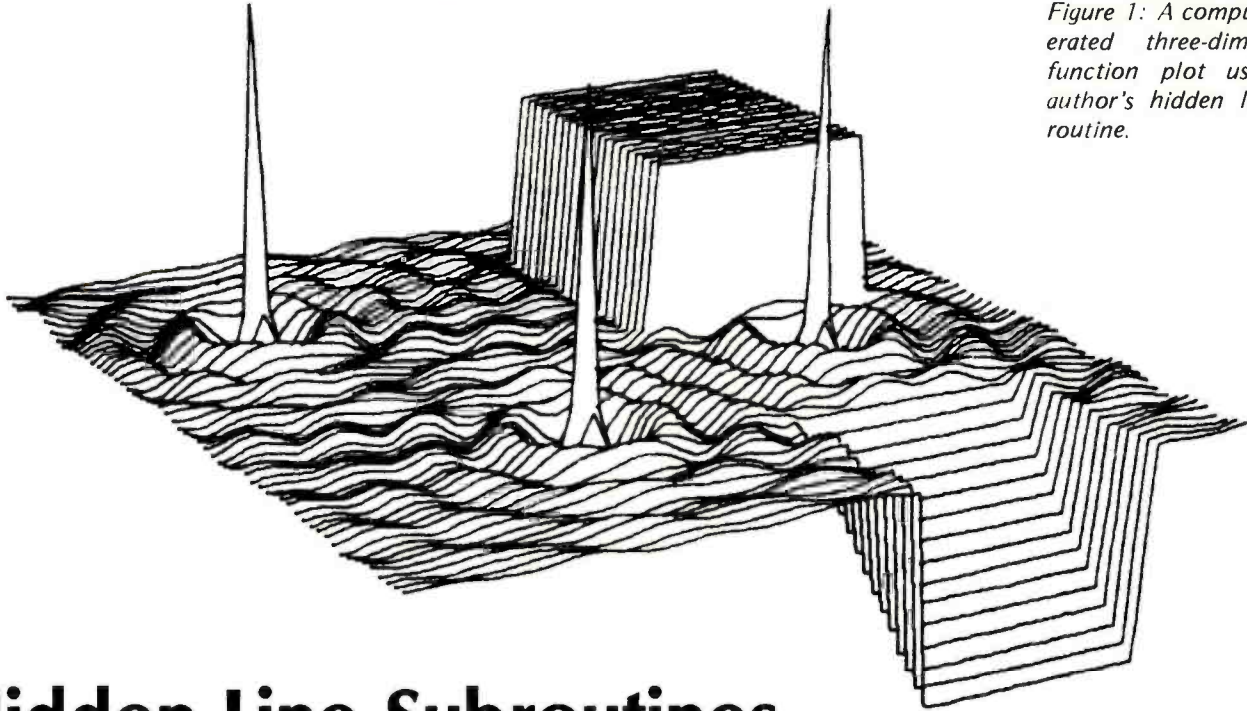

Figure 1: A computer generated three-dimensional function plot using the author's hidden line subroutine.

# Hidden Line Subroutines for Three-Dimensional Plotting

A hidden line subroutine is used to eliminate lines which are behind surfaces and which in real life one would not be able to see in a computer generated plot of a solid object in two dimensions. A hidden line subroutine makes the final picture more realistic.

A three-dimensional Cartesian function is a function such as

$$F(x,y) = 4x\cos(3y) + 1/e^x$$

where the value for the z coordinate is a function of both X and Y.

This article considers the various steps necessary for a hidden line routine that handles functions of this kind. The algorithm will *not* work for functions plotted in spherical coordinates or for complex three-dimensional figures such as a house.

The hidden line subroutine should be written in a general form so that the user can attach the subroutine to any appropriate program without having to rewrite it.

First, one must have a program that generates the X and Y values that the hidden line subroutine will operate on. Briefly, this involves a program to generate an X and a Y FOR NEXT loop; generate a Z value; rotate to get a new (x',y',z'); scale; put through a perspective function and come out with an

(x,y) point. This is the point on the screen (or paper) to which one would normally draw a line. However, we now take this (x,y) point and GOSUB to our hidden line subroutine.

Let us first draw a function of this kind without hiding any lines (see figure 2). Note that one point seems to ruin the appearance of the graph because the viewer sees immediately that a surface is being formed. When a point goes "behind" the small mound, the subjective feeling is that it should be hidden. We need a rule that will handle all points that should be hidden and leave other points alone.

One difference between this point and all the previous points is that it is lower (along the Y axis) than the corresponding point in the previous line. "Corresponding" here means the *same X value*. Thus, our rule states that if for any point (x,y), the Y value is lower than any previous Y value for the same X value, it should be hidden. To do this, we must save the necessary values; for the above rule, we need to know the highest valued Y for every X.

Let us assume the screen has a resolution of 1024 along the X axis and 800 along the Y axis (such as in the case of the Tectronix

Mark Gottlieb  
4342 Sunset Beach Dr NW  
Olympia WA 98502

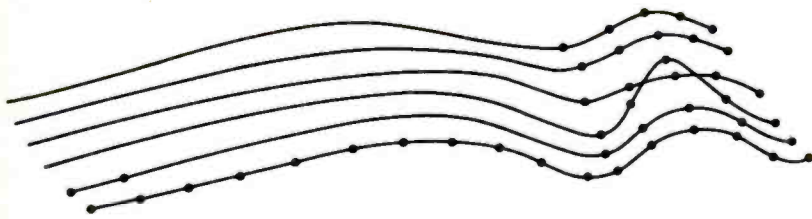

Figure 2: The first crude plot function shows problems encountered when no hidden line algorithm is used. The subroutine would hide that portion of the fourth line from the front that "goes behind" the high point in front of it.

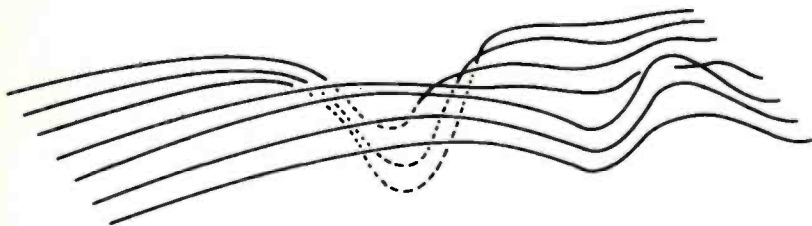

Figure 3: In this case the algorithm has correctly hidden some points but has failed to show others which emerge at the bottom of the plot.

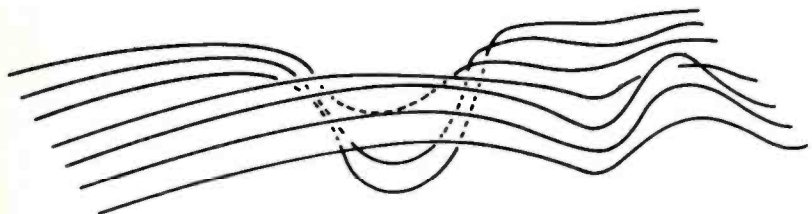

Figure 4: Improved algorithm reveals the bottom of the curve as a series of solid lines (compare with figure 3).

#### A Note About the BASIC Employed in These Examples:

The BASIC employed in these examples is the interpreter available with the author's computer. Most features are similar to a typical extended BASIC which includes matrix operations (MAT keyword). As noted in text, the file oriented operations which are used to initialize the matrix B can be replaced by a FOR ... NEXT loop at lines 310 and 320 in listing 6. (Lines 130 and 140 would then be deleted.)

```

5505 U6=SGN(X-X9)
5510 IF U6=0 THEN 5535
5515 FOR U7=X9 TO X STEP U6
5520 S8=Y9+S9*(U7-X9),B[U7,2]=B[U7,2] MIN S8,B[U7,1]=B[U7,1] MAX S8
5530 NEXT U7
5535 RETURN

```

Listing 1: A BASIC program used to calculate points between the endpoints of a line segment for plotting purposes.

4013 graphics terminal). Thus, we have 1024 possible X locations. But we need to know only the highest valued Y for each X. This means that if we have a 1 by 1024 matrix we can store the highest valued Y in the corresponding X location. We can keep our matrix updated with the following BASIC statement:

```
100 B(X,1) = B(X,1) MAX Y
```

This statement always keeps the matrix full of the highest valued Y for each X location.

In order to implement our rule in the hidden line program, we need a check such as:

```

If Y < B(x,1)
Then don't draw this line.

```

Implementing what is already known, the graph might look like the one in figure 3.

The program hides all of the lines shown as broken lines because all the Y values for those X values are less than the highest Y value for that X value. However, we see that we would like to have seen the part of the dip which comes out beneath the graph. In other words, we want our graph to look like the one in figure 4.

Instead of hiding all the lines whose Y value is less than the highest Y value for that particular X, we should say "Hide all lines whose Y value is less than the highest Y and greater than the lowest Y value for that particular X." This involves storing the lowest Y value, also. We do this by using the matrix with dimensions (1024,2). In column 1 we store the highest Y value and in column 2 the lowest Y value for that X. The matrix can be kept up-to-date this way:

```

B(X,1) = B(X,1) MAX Y
B(X,2) = B(X,2) MIN Y

```

This statement keeps the matrix full of the highest and the lowest valued Y for each X location. Thus, the new check for the hidden line routine looks like this:

```

If Y < B(X,1) AND Y > B(X,2)
Then don't draw.

```

One small technical problem arises which is easily solved. We need to solve for only two points in order to get a line between them, but our (1024,2) matrix has not been told what is between these two points. Thus, for each new point solved, we must go through the matrix, starting from the X value where we last left off, and fill in the Y values for each of these new Xs until we get to the X value of our new point (x,y).

This process involves solving the equation for a straight line given the two points and then filling in the Y values for each X

# YOU CAN HAVE BOTH . . .

"Natural Sounding Speech"

"ANYTHING YOU WANT TO SAY"

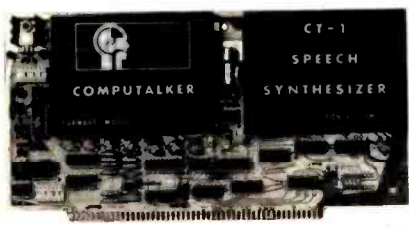

S-100 BUS

CTEDIT  
PARAMETER EDITOR  
SOFTWARE  
(STD. WITH CT-1)

CSR1  
SYNTHESIS-BY-RULE  
SOFTWARE  
(OPTIONAL)

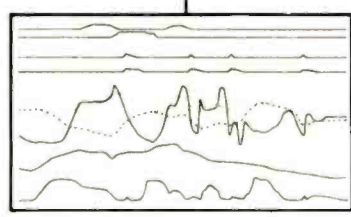

CT-1 parameter data

"AE2NIYTHIHNX YUW  
WAANT TUW SEY."

phonetic spelling

## ONLY COMPUTALKER GIVES YOU THE CHOICE

No other speech synthesizer available offers you the flexibility of the Computalker Model CT-1. The parameter editor program, CTEDIT, allows direct manipulation of all 9 control parameters. CTEDIT and parameter data tapes are furnished with the CT-1 synthesizer board.

The optional CSR1 software package translates ASCII phonetic text strings to speech output. CSR1 is simple to use and is the easiest way to create new speech. CSR1 can also be called as a subroutine from user's code for applications involving program controlled voice output.

The CSR1 phonetic rule system generates control parameters in the same form as used by CTEDIT. Thus, it is possible to further edit the output of the rule system, to achieve natural sounding speech output with minimum effort.

CT-1 assembled & calibrated  
CSR1 phonetic rules software

395.00  
35.00

Calif. residents add 6% sales tax

Software is available on CPM 8",  
North Star 5 1/4", CUTS, TARBELL,  
MITS ACR, Paper Tape.

### COMPUTALKER CONSULTANTS

1730 21st Street, Suite AB, Santa Monica, CA 90404 (213) 392-5230/828-6546

Figure 5: Plot made without the intersection routine. Incorrect intersecting lines are caused when line segments which are partly visible and partly hidden are plotted.

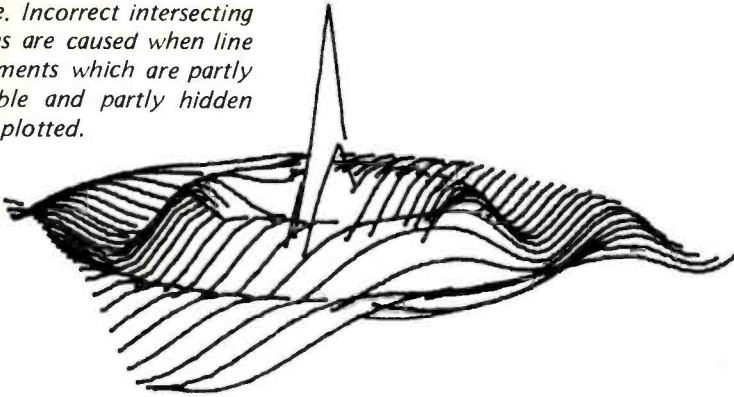

along that line for our matrix. This routine is called upon almost every time a new point is generated, and, therefore, is executed many times. This is the one step that makes this method of hidden line processing slow, and thus should be made as condensed as possible. A suggested routine is shown in listing 1. In this routine, U6 causes the FOR NEXT loop to go forward or backward depending on where X is in relation to X9. X9 and Y9 are set equal to the previous points throughout the program. U7 becomes the X value for each point along the line and S8 the corresponding Y value. S9 is the slope of the line and is determined earlier in the subroutine. Matrix B is the 1024 by 2 matrix for storing the high and low Ys.

One small item which must not be overlooked is that the initial values of the 1024 by 2 matrix elements must be set. Suppose we initially set each element to 0. While drawing the first line, suppose the first point is (300,200). When the program executes the line which reads

$$100 \text{ B(X,1) = B(X,1) MAX Y}$$

$$\text{B(X,2) = B(X,2) MIN Y}$$

element B(300,1) will take the MAX of 0 and 200 which is 200; this is correct. However, element B(300,2) will take the MIN of 0 and 200 which is 0. This is incorrect; the

Figure 6: Plot made using the intersection routine (compare with figure 5). Each line segment is tested to see if it is partially hidden. If so, it is subdivided into sections which are either visible or hidden.

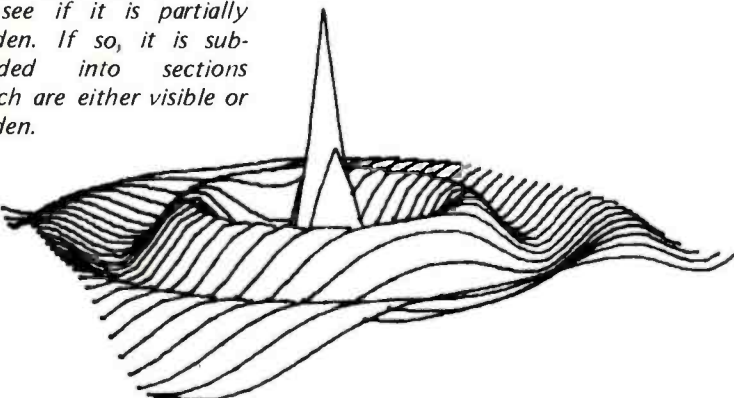

desired answer is 200. We can solve the problem by filling all of the elements in the second column with the highest value we might need, 800 in this case.

One way (used in my program) to fill the first column with 0s and the second with 800s is to use a file. The initial conditions are read from the file onto the matrix at the beginning of each program. Another way, of course, would be to employ a FOR ... NEXT loop.

The few techniques learned so far form a good basis for a hidden line subroutine. Plotting a function with a hidden line subroutine and incorporating what has been determined so far gives a graph like the one shown in figure 4. An outline for the hidden line subroutine would be similar to this:

- If  $Y < B(X, 1)$  and  $Y > B(X, 2)$   
Then *don't draw*.
- Otherwise *draw*.
- *Fill in points in matrix.*
- *Return to main program.*

Figure 4 looks respectable; at least the right lines are hidden. However, something is not quite right. When we need to hide a point, we cannot simply draw a line to that point. This leads to the problem seen in the graph; the lines do not meet the surface of the graph when they go behind; when coming out, they start emerging before they are completely clear of the surface. Obviously, some improvement on our hidden line subroutine is needed.

We need an algorithm to find the intersection. When a point lies behind the surface, we must find a new point on the

```

5205 S7=X-X9,U2=0,X1=X9,U1=1
5210 UNTIL U1>128 DO
5215   U1=U1*2
5220   IF U2 THEN 5235
5225   X1=X1+S7/U1
5230   GOTO 5240
5235   X1=X1-S7/U1
5240   Y7=S9*(X1-X9)+Y9
5245   IF U3 THEN 5456
5250   IF Y9>B[X9,2] THEN 5270
5255   IF Y7>B[X1,2] THEN U2=1
5260   IF Y7<B[X1,2] THEN U2=0
5265   GOTO 5280
5270   IF Y7<B[X1,1] THEN U2=1
5275   IF Y7>B[X1,1] THEN U2=0
5280   DOEND
5285   X5=X,Y5=Y
5290   X=X1,Y=Y7
5455   REM ** FOR U3=1:COMING OUT ***
5456   IF Y>B[X,1] THEN 5460
5457   IF Y7<B[X1,2] THEN U2=1
5458   IF Y7>B[X1,2] THEN U2=0
5459   GOTO 5280
5460   IF Y7>B[X1,1] THEN U2=1
5465   IF Y7<B[X1,1] THEN U2=0
5470   GOTO 5280

```

Listing 2: A BASIC routine that searches for intersections between line segments.



surface of the graph. If we draw a line to a point that should be hidden, we will intersect the surface at this new point which we are trying to locate: the point of intersection. This becomes tricky. The basic procedures necessary to determine the point of intersection are as follows:

- Find the equation for the line which passes through the previous point and the new point behind the surface.
- Step along this line from the old X value to the new X value until we find an X where the Y for that X is the same (within one point of resolution) as the highest (or lowest) Y for that same X. This is the intersection point to which we draw to intersect the surface, or from which we start drawing when coming from behind the surface.

Suppose the point outside of the surface is (505,200) and the new point which goes behind the surface is (575,188). If we step along the line joining them in the X direction, from X = 505 to X = 575, it could take up to 70 steps until the intersection point is found.

A much more elegant and time saving approach is to perform a "binary search" along the line to find the intersection point. For the previous example in which there were 70 steps, we could get to within one point of resolution from the point of intersection in seven steps. I go through the binary search method eight times to accommodate longer line segments.

Listing 2 shows the segment of my hidden line subroutine that searches for the intersection point. U1 is a binary loop; U2 tells whether to go forward or backward along the line segment whose length is S7; X1 is

```

5600 REM ** FILL IN LEFT SIDE **
5610 IF X4#-1 THEN GOTO 5640
5620 X4=X,Y4=Y
5630 RETURN
5640 X8=X9,Y8=Y9
5650 X9=X4,Y9=Y4
5660 S9=(Y-Y9)/(X-X9)
5670 GOSUB 5500
5680 X9=X8,Y9=Y8
5690 GOTO 5620
5700 REM ** FILL IN RIGHT SIDE **
5710 IF X3#-1 THEN 5740
5720 X3=X,Y3=Y
5730 RETURN
5740 X8=X9,Y8=Y9
5750 X9=X3,Y9=Y3
5760 S9=(Y-Y9)/(X-X9)
5770 GOSUB 5500
5780 X9=X8,Y9=Y8
5790 GOTO 5720

```

Listing 3: Two routines used to "fill in" the left and right sides of the graph so that no line intersections occur (see figures 7 and 8).

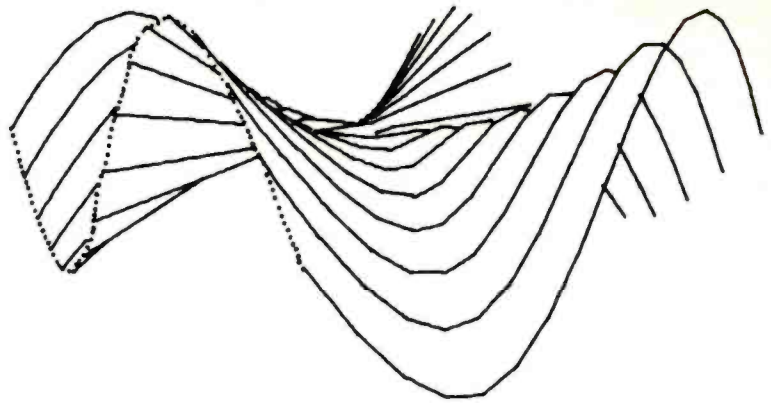

Figure 7: Graph made with "left and right side fill-in." The term refers to an imaginary "edge" at the borders of the surface (shown in dotted lines). This edge enables the algorithm to accurately handle lines drawn near the edges.

the new X location along the line segment as the search continues; Y7 is the solution to the line equation between the two points at the new X value X1; and U3 calls a further nested subroutine if one is trying to find the intersection point while coming out from behind the surface. Finally, after the program executes the loop eight times, X1 and Y7 are the coordinates of the intersection point (X1,Y7). Figures 5 and 6 show the before and after effects of the intersection routine.

Figures 7 and 8 show what happens to a graph with and without a process called "left and right side fill-in." The edges of the graph in figure 8 appear messy. This is because on the left edge, for example, when a line comes into the preceding left edge, it does not appear to intersect it; instead it goes a bit too far. This can be seen with the aid of the dotted line. The problem is solved by adding an imaginary dotted line into the matrix of 1024 by 2. Although we do not draw the edge lines on the screen which we *could* do, we "draw" them into the matrix. Thus, when a line is about to intersect with an edge, it will have an imaginary boundary in the matrix with which to intersect.

The matrix fill-in is accomplished by taking the point at the beginning of a new line and the point for the beginning of the previous line and calling them (X,Y) and

Figure 8: Graph made without the "left and right side fill-in" feature in the algorithm. In this case the routine cannot accurately handle intersections at the edges of the surface (see arrows).

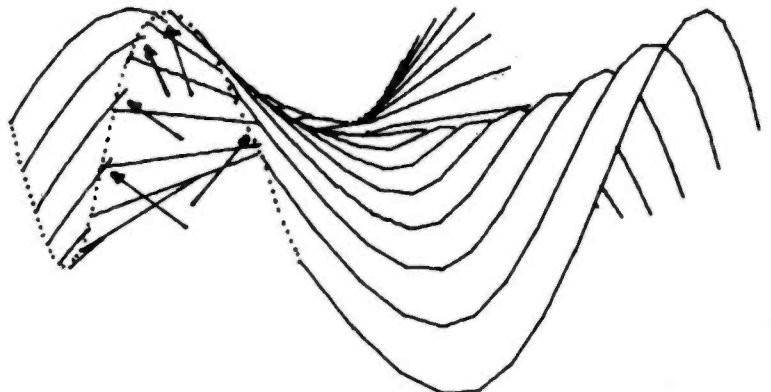

```

300 FOR B=0 TO 1
302   X3=Y3=X4=Y4=-1
303   READ #2,1
305   MAT READ #2;B
310   FOR T=-E TO E STEP E/K
320     FOR G=-E TO E STEP E/K
330       U9=G
340       IF B=0 THEN 370
350       A[1,1]=T
355       A[1,2]=G
360       A[1,3]=T*G*(T*T-G*G)/(T*T+G*G)
365       GOTO 400
370       A[1,1]=G
380       A[1,2]=T
390       A[1,3]=T*G*(G*G-T*T)/(G*G+T*T)
400       MAT C=A*Q
410       X=FNP(C[1,1]*300/E)+512
420       Y=FNP(C[1,2]*300/E)+400
430       GOSUB 5000
440     NEXT G
450   NEXT T
455 NEXT B

```

Listing 4: A routine to create crosshatched plots.

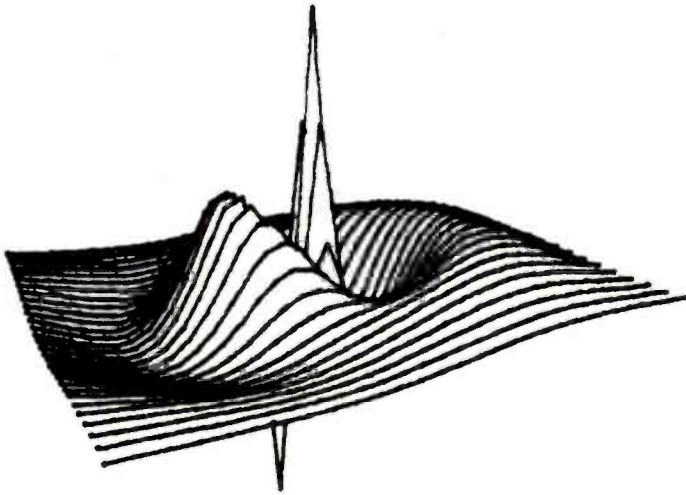

Figure 9: A plot made without crosshatching.

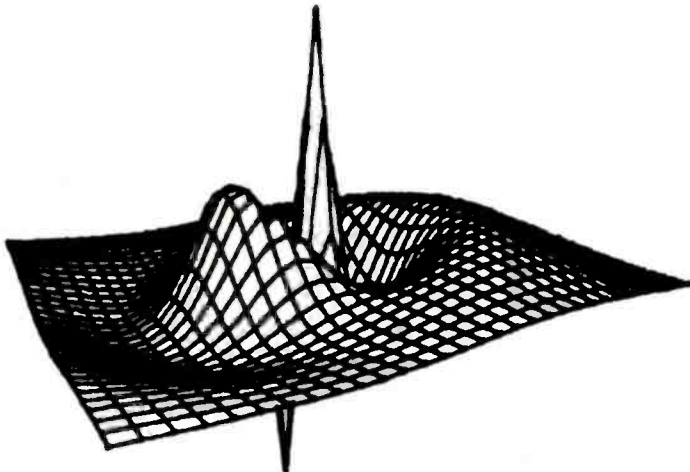

Figure 10: The same function as figure 9, but with crosshatching.

(X9,Y9), respectively. Then GOSUB 5500 (the fill-in points for the matrix subroutine) will fill in all the Y values for each X value along this line segment. Do the same thing for the right side, or the last point in each line.

The subroutine in listing 3 is accessed at the beginning and end of each line for the left side and the right side, respectively. X3 and X4 are initially set equal to -1 at the beginning of the program. This tells the routine that it is the first point in the graph and thus a line cannot be drawn between it and the previous point, which does not exist. After the first line is drawn, the previous points become (X4,Y4) and (X3,Y3) for the left and right sides respectively. S9 is the slope of the line needed in the fill-in routine.

*Crosshatching* is a method of drawing graphs with sets of orthogonal lines. For many graphs, this enhances the overall appearance and definition. The crosshatch program draws two separate graphs, one for the horizontal direction, and the other for the vertical. When the graph in the horizontal direction is completed, all initial conditions used in the hidden line subroutine must be reset. This includes reinitializing by placing the 0s and 800s into the 1024 by 2 matrix as described earlier.

One must also change the FOR NEXT loops for the X and Y axis: instead of keeping the Y value constant while stepping along in the X direction for a complete line, we hold the X value constant while stepping along in the Y direction.

A more efficient method consists of assuming the X to be the Y and the Y to be the X the second time around. An example is shown in listing 4. Matrix A contains the X,Y and Z values for use in rotation. Matrix Q is the final three-dimensional rotation matrix calculated elsewhere in the program. In the B loop, B = 0 is for the horizontal direction, B = 1 for the vertical direction. Notice the values assigned to matrix A when B changes from 0 to 1. Function FNP is the perspective function defined in the beginning of the program. GOSUB 5000 is for the hidden line subroutine. The function is for the graph shown in figure 7. Figures 9 and 10 show the effects of crosshatching.

In certain graphs, such as figure 11, lines must go behind very narrow regions. Here in the upper portion of the spikes we encounter difficulties. Using the method described so far for hidden lines, we solve for a new point and test to see whether that point is behind something. We can now determine if it should be hidden. Let us see what happens when we

# Radio Shack's personal computer system?

## This ad just might make you a believer.

You can't beat  
the 4K system at  
**\$599**



- TRS-80 "Breakthru"**
- TRS-80 microcomputer
  - 12" video display
  - Professional keyboard
  - Power supply
  - Cassette tape recorder
  - 4K RAM, Level-I BASIC
  - 232-page manual
  - 2 game cassettes

... or the step-up  
16K system at  
**\$899**



- TRS-80 "Sweet 16"**
- Above, except includes 16K RAM

... or the fast  
4K/printer system at  
**\$1198**



- TRS-80 "Educator"**
- Above, except includes 4K RAM and screen printer

... or the Level-II  
16K/printer/disk  
system at  
**\$2385**



- TRS-80 "Professional"**
- Above, except includes 16K RAM, disk drive, expansion interface, and Level-II BASIC

**So how are you gonna beat the system that  
does this much for this little? No way!**

... The amazing new  
32K/Level-II/2-disk/  
line printer system at  
**\$3874**



- TRS-80 "Business"**
- Above, except includes 32K RAM, line printer, and two disk drives

Get details and order now at Radio Shack stores and dealers in the USA, Canada, UK, Australia, Belgium, Holland, France, Japan. Write Radio Shack, Division of Tandy Corporation, Dept. C-001, 1400 One Tandy Center, Fort Worth, Texas 76102. Ask for Catalog TRS-80.

**Radio Shack®**  
The biggest name in little computers

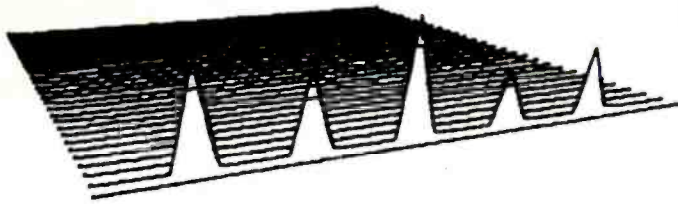

Figure 11: Problems can occur when lines go behind very narrow regions, but the line's endpoints are both visible.

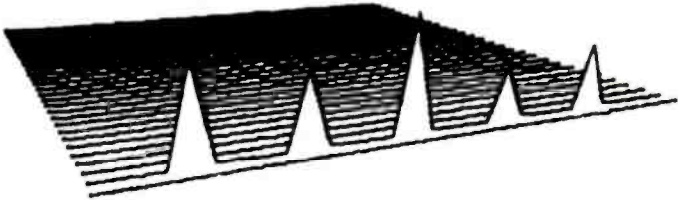

Figure 12: Solution to the problem illustrated in figure 11. The routine checks additional points along the line segment and makes changes accordingly.

```

100 00=1
110 U4=0,F=U5=1
120 L9=75
130 FILES *,*
140 ASSIGN "BLANK",2,T2
150 DIM A[1,3],C[1,3]
160 DIM Q[3,3],B[1024,2]
165 REM PERSPECTIVE FUNCTION
170 DEF FNP(F)=D7*F/(D7-C[1,3])
180 REM E=STEP VALUE AND K= # STEPS
190 E=10,K=20
200 I=-E,I2=E
210 REM D7=DISTANCE FROM (0,0,0) FOR PERSPECTIVE
220 D7=30
230 REM X2,Y2,Z2 ARE DEG. TURN AROUND X,Y,&Z AXIS
240 X2=-75,Y2=0,Z2=30
250 W=3.1416/180
260 X2=W*X2
270 Y2=W*Y2
280 Z2=W*Z2
290 GOSUB 6000
300 X3=Y3=X4=Y4=-1
310 READ #2,1
320 MAT READ #2,B
325 REM Y AXIS LOOP
330 FOR T=-E TO E STEP E/K
340 IF T>-.05 AND T<.05 THEN T=0
345 REM X AXIS LOOP
350 FOR G=-E TO E STEP E/K
360 IF G>-.05 AND G<.05 THEN G=0
370 U9=G
380 R=SQR(G*G+T*T)
390 A[1,1]=G
400 A[1,2]=T
405 REM ACTUAL FUNCTION
410 A[1,3]=8/(R+1)*COS(R*1.2)
420 MAT C=A*Q
425 REM SCALING, PERSPECTIVE & OFFSET
426 REM GOSUB TO HIDDEN LINE ROUTINE
430 X=FNP(C[1,1]*300/E)+512
440 Y=FNP(C[1,2]*300/E)+400
450 GOSUB 5000
460 NEXT G
470 NEXT T
480 END

```

Listing 6: A BASIC program used to create the plot shown in figure 13. Two subroutines, at line numbers 8100 and 8200, are not included in this listing, but must be supplied by the user. These are a routine to draw an invisible vector to point (x,y) at line number 8100, and a routine to draw a visible vector to point (x,y). These correspond respectively to the movement of a plotter's pen without contact and with contact. The details of the routines depend on the display hardware used.

```

5035 L8=SQR((X-X9)^2+(Y-Y9)^2)
5040 IF L8>L9 THEN DO
5045 L2=X9,L5=X,L6=Y,S6=(Y-Y9)/(X-X9)
5050 L7=(X-X9)/(L8/L9),L4=Y9-S6*X9
5060 FOR X=L2 TO L5-L7 STEP L7
5065 Y=S6*X+L4
5070 GOSUB 5090
5075 NEXT X
5080 X=L5,Y=L6
5085 DOEND

```

Listing 5: A routine used to refine the hidden line algorithm so it can correctly handle line segments which are visible at each end but obscured in the middle (see figures 11 and 12).

approach and go behind the upper portion of one of the spikes in figure 11.

Suppose the new point is just to the left of one of the spikes. The hidden line routine sees that the point is visible and should therefore have a line drawn to it from the previous point. Suppose the next point is behind the spike: the hidden line routine will see this and draw a line to the intersection point on the left edge of the spike. All is well and the graph continues.

But suppose on the next pass (near the tip of the spike) that the next point is again just to the left of the spike. It should be visible, so we draw a line to that point from the previous point. If the next point is to the right of the spike, the hidden line routine sees that this point on the graph should be seen, and thus a line is drawn from the previous point (which is to the left of the spike) to the point on the right of the spike. A line is drawn across the spike. This problem is apparent in the figure.

The problem of lines going through narrow regions which are in front is caused by the fact that the hidden line routine checks only to see if a line should be hidden at the endpoints of each line. If both endpoints are outside of the spike, it does not know that it is crossing the spike and draws a line across the spike.

The only way to overcome this problem is to check at points between the two endpoints to see if they go behind any region. If so, draw the line accordingly to hide any portion of the line that goes behind the region.

Here is a method for solving this problem. At the beginning of the program, decide on a maximum length of segment you wish to draw. If you are using a length of 5, for example, and the length of a normal line from endpoint to endpoint is 60, the program would divide this line into 12 segments and use the hidden line routine as though these were 12 consecutive lines. One should choose the maximum length of line on the

Listing 6, continued:

```

4985 REM U1 Thru U9;S7-S8-S9;X1,Y1 Thru X9,Y9 **
4987 REM U8=0 (Last In); U8=1 (Last out) ***** } Variables used in the Hidden Line Routine
4990 REM ***SET I=1ST X & I2=LAST X ***** }
4992 REM ***U4=0,F=U5=1 * X4=Y4=X3=Y3=-1 **** } Variables to set at beginning of Program
4995 REM ***** Let U9 = Value of X step *****
4997 REM SET L9= MAXIMUM LENGTH OF LINE ****
5000 IF X>1023 OR X<1 THEN U4=1
5005 IF X>1023 OR X<1 THEN RETURN
5010 IF U9=1 AND Y<B[X,1] and Y >B[X,2] THEN 5140
5015 IF U9=1 OR U4 THEN GOSUB 5600
5020 IF U9=12 THEN GOSUB 5700
5025 U3=0
5030 IF U9=1 OR U4 THEN 5155
5033 IF X-X9=0 THEN 5125
5034 REM STEPS 5035-5085 DIVIDE LINES INTO LINES OF LENGTH L9
5035 L8=SQR((X-X9)^2+(Y-Y9)^2)
5040 IF L8>L9 THEN DO
5045 L2=X9,L5=X,L6=Y,S6=(Y-Y9)/(X-X9)
5050 L7=(X-X9)/(L8/L9),L4=Y9-S6*X9
5060 FOR X=L2 TO L5-L7 STEP L7
5065 Y=S6*X+L4
5070 GOSUB 5090
5075 NEXT X
5080 X=L5,Y=L6
5085 DOEND
5090 IF X-X9=0 THEN 5145
5099 U3=0
5100 S9=(Y-Y9)/(X-X9)
5105 IF U8=0 THEN 5400
5110 IF Y<B[X,1] AND Y>B[X,2] THEN 5205
5115 U8=1
5120 IF U9=1 THEN 5155
5125 GOSUB 8200
5130 GOSUB 5500
5135 GOTO 5145
5140 U8=0
5145 X9=X,Y9=Y
5150 RETURN
5151 REM RETURN TO MAIN PROGRAM
5155 X9=X,Y9=Y
5160 GOSUB 8100
5165 GOSUB 8200
5170 U4=0
5175 U8=1
5180 RETURN
5181 REM RETURN TO MAIN PROGRAM
5200 REM *** FIND INTERSECT ***
5205 S7=X-X9,U2=0,X1=X9,U1=1
5210 UNTIL U1>128 DO
5215 U1=U1*2
5220 IF U2 THEN 5235
5225 X1=X1+S7/U1
5230 GOTO 5240
5235 X1=X1-S7/U1
5240 Y7=S9*(X1-X9)+Y9
5245 IF U3 THEN 5456
5250 IF Y9>B[X9,2] THEN 5270
5255 IF Y7>B[X1,2] THEN U2=1
5260 IF Y7<B[X1,2] THEN U2=0
5265 GOTO 5280
5270 IF Y7<B[X1,1] THEN U2=1
5275 IF Y7>B[X1,1] THEN U2=0
5280 DOEND
5285 X5=X,Y5=Y
5290 X=X1,Y=Y7
5295 IF U3 THEN GOTO 5425
5300 U8=0
5305 GOSUB 8200
5310 GOSUB 5500
5315 X9=X5,Y9=Y5
5320 RETURN
5321 REM RETURN TO MAIN PROGRAM
5400 REM ***TEST U8=0***
5401 REM U8=0 IF LAST POINT WAS HIDDEN
5405 IF Y>B[X,2] AND Y<B[X,1] THEN 5145
5410 U8=1,U3=1
5415 X8=X,Y8=Y
5420 GOTO 5205
5425 GOSUB 8100
5430 GOSUB 8200
5435 X=X8,Y=Y8,U8=1
5450 GOTO 5125
5454 REM PART OF THE INTERSECTION ROUTINE
5455 REM ** FOR U3=1:COMING OUT **
5456 IF Y>B[X,1] THEN 5460
5457 IF Y7<B[X1,2] THEN U2=1
5458 IF Y7>B[X1,2] THEN U2=0
5459 GOTO 5280
5460 IF Y7>B[X1,1] THEN U2=1
5465 IF Y7<B[X1,1] THEN U2=0
5470 GOTO 5280
5500 REM ***** FILL IN POINTS *****
5505 U6=SGN(X-X9)
5510 IF U6=0 THEN 5535
5515 FOR U7=X9 TO X STEP U6
5520 S8=Y9+S9*(U7-X9),B[U7,2]=B[U7,2] MIN S8,B[U7,1]=B[U7,1] MAX S8
5530 NEXT U7
5535 RETURN
5600 REM ** FILL IN LEFT SIDE **
5610 IF X4#-1 THEN GOTO 5640
5620 X4=X,Y4=Y
5630 RETURN
5640 X8=X9,Y8=Y9
5650 X9=X4,Y9=Y4
5660 S9=(Y-Y9)/(X-X9)
5670 GOSUB 5500
5680 X9=X8,Y9=Y8
5690 GOTO 5620
5700 REM ** FILL IN RIGHT SIDE **
5710 IF X3#-1 THEN 5740
5720 X3=X,Y3=Y
5730 RETURN
5740 X8=X9,Y8=Y9
5750 X9=X3,Y9=Y3
5760 S9=(Y-Y9)/(X-X9)
5770 GOSUB 5500
5780 X9=X8,Y9=Y8
5790 GOTO 5720
6000 REM MAT ROTATE
6001 REM 6010-6110 MAKES MATRIX Q THE
6002 REM FINAL ROTATIONAL MATRIX
6010 MAT Q=ZER
6020 Q[1,1]=COS(Z2)*COS(Y2)
6030 Q[2,1]=-1*SIN(Z2)*COS(Y2)
6040 Q[3,1]=-1*SIN(Y2)
6050 Q[1,2]=COS(Z2)*(-1)*SIN(X2)*SIN(Y2)+SIN(Z2)*COS(X2)
6060 Q[2,2]=SIN(Z2)*SIN(X2)*SIN(Y2)+COS(Z2)*COS(X2)
6070 Q[3,2]=-1*SIN(X2)*COS(Y2)
6080 Q[1,3]=COS(Z2)*COS(X2)*SIN(Y2)+SIN(Z2)*SIN(X2)
6090 Q[2,3]=-1*SIN(Z2)*COS(X2)*SIN(Y2)+COS(Z2)*SIN(X2)
6100 Q[3,3]=COS(X2)*COS(Y2)
6110 RETURN
8100 REM A ROUTINE TO DRAW AN INVISIBLE VECTOR TO (X,Y)
8101 REM OR TO PICK THE PEN UP TO LOCATION (X,Y) (NOT INCLUDED)
8200 A ROUTINE TO DRAW A VISIBLE VECTOR TO (X,Y) (NOT INCLUDED)
9999 END

```

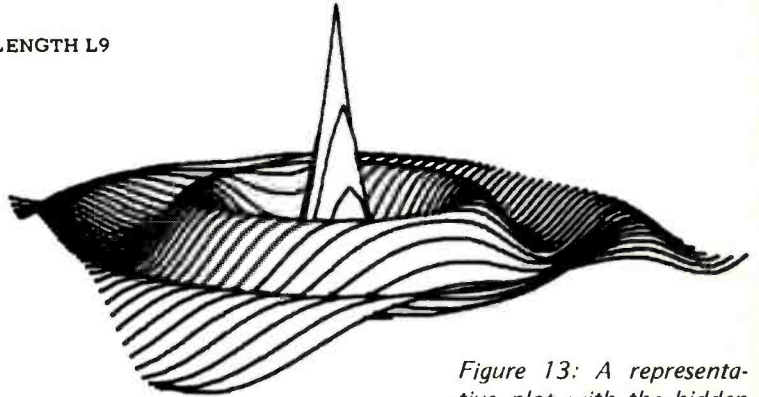
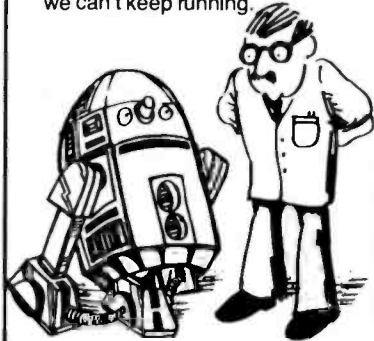

Figure 13: A representative plot with the hidden line subroutine. The program to generate it is shown in listing 6.

# We speak your language

And we're giving you what you want.

- a **comprehensive product line.** Hardware, assembled or kits, and software from major manufacturers. Plus books and current literature. Financing available.
- a **trained, enthusiastic staff.** We'll help you choose or design the system that's right for you. No high pressure here.
- **service when you need it.** We won't sell you something we can't keep running.



- a **brand new facility in Pennsylvania.** We'll be able to serve our South Jersey-Pennsylvania customers more efficiently now.
- a **bigger, better New Jersey store.** We've enlarged our showroom in Iselin. Now there are more displays you can try out. There's more room to stock the products you need.

The Microcomputer People.™



## Computer Mart of New Jersey Computer Mart of Pennsylvania

### New Jersey Store

501 Route 27  
Iselin, NJ 08830  
201-283-0600  
Tue.-Sat. 10:00-6:00  
Tue. & Thur. til 9:00

### Pennsylvania Store

550 DeKalb Pike  
King of Prussia, PA 19406  
215-265-2580  
Tue.-Thur. 11:00-9:00  
Fri. & Sat. 10:00-6:00

(our only locations)

basis of the screen resolution and the accuracy desired. For greatest accuracy, use 1 as the greatest length of a line. This would, however, take a very long time to compute and draw. A happy medium should be chosen depending on the graph being drawn. Figure 12 shows the results of using this method.

Listing 5 is the routine used in the hidden line routine to divide each line into lengths no longer than L9. X9 and Y9 are the coordinates for the previous point. L8 is the length of the line being tested. GOSUB 5090 sends the new coordinates into the remaining portion of the hidden line routine. This routine may not be elegant, but it does work.

Listing 6 is the complete listing for the graph plotted in figure 13. I have given a complete program to help the programmer when any specific obstacles come up which are not explained in this article.

The program still contains a few "bugs" which crop up occasionally due to the simplicity of the algorithms used, so it is by no means the ultimate hidden line program. If any readers can write that ultimate hidden line routine, please let me know. ■

# A P DIP Jumpers make the connection Faster and Easier.

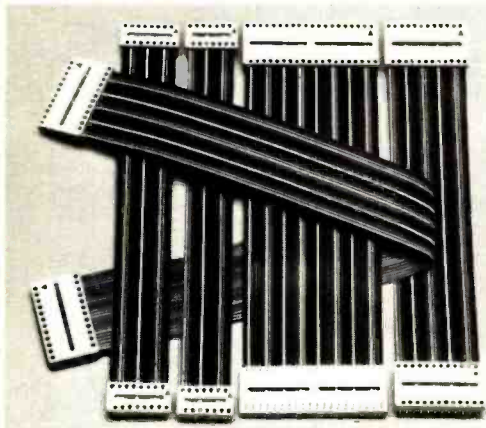

- Available with 14, 16, 24 and 40 contacts.
- Mate with standard IC sockets.
- Fully assembled and tested.
- Integral molded-on strain relief.
- Line-by-line probeability.

*Faster and Easier is what we're all about.*



**AP PRODUCTS INCORPORATED**  
Box 110 72 Corwin Drive  
Painesville, OH 44077  
(216) 354-2101 TWX: 810-425-2250

## FLAT RIBBON CABLE ASSEMBLIES WITH DIP CONNECTORS

AP DIP Jumpers are the low-cost, high quality solution for jumpering within a PC board; interconnecting between PC boards, backplanes and motherboards; interfacing In-out/Output signals; and more.

All assemblies use rainbow cable. Standard lengths are 6, 12, 18, 24 and 36 inches.

### SINGLE-ENDED DIP JUMPERS

Arrow Denotes Pin No. 1

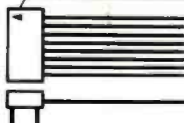

### DOUBLE-ENDED DIP JUMPERS

Arrow Denotes Pin No. 1

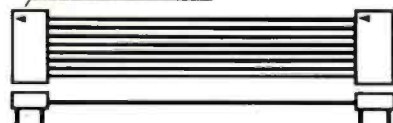

No. Contacts	Length 36"	No. Contacts	Length 6"	Length 12"	Length 18"	Length 24"	Length 36"
14	924102-36-R \$2.33	14	924106-6-R \$2.41	924106-12-R \$2.61	924106-18-R \$2.82	924106-24-R \$3.02	924106-36-R \$3.43
16	924112-36-R \$2.59	16	924116-6-R \$2.65	924116-12-R \$2.88	924116-18-R \$3.11	924116-24-R \$3.34	924116-36-R \$3.80
24	924122-36-R \$4.00	24	924126-6-R \$4.15	924126-12-R \$4.50	924126-18-R \$4.85	924126-24-R \$5.20	924126-36-R \$5.90
40	924132-36-R \$6.71	40	924136-6-R \$6.93	924136-12-R \$7.52	924136-18-R \$8.11	924136-24-R \$8.70	924136-36-R \$9.88

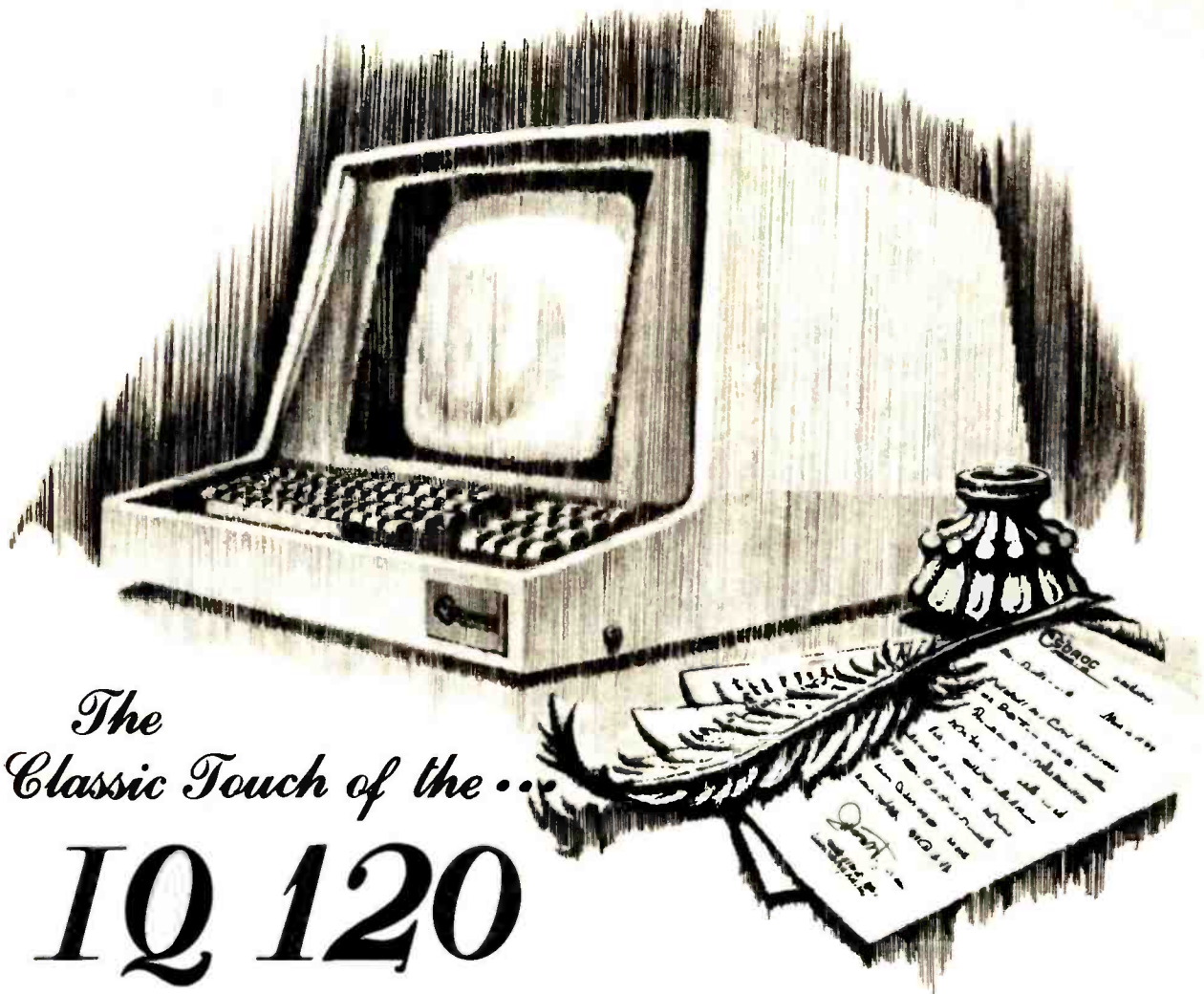

*The  
Classic Touch of the...*  
**IQ 120**

Clearly displays the results of a careful blending of Old World Elegance with today's New World of Technology. This blending is what creates character in the IQ 120, and such re-

fined features as: upper and lower case / 24 line × 80 characters / address cursor / tabbing / dual intensity / numeric pads / auto repeat / 15 baud rates / aux. port and optional printer port.

so if you are one who is serious about what terminal to buy, contact SOROC where character along with quality and design excellence is part of each and every display ..... \$995.00



165 FREEDOM AVE., ANAHEIM, CA 92801  
714-992-2860 • 800-854-0147

# PLOT3D: A Function Plotting Program

Mike Stoddard  
16681 Lynn St  
Huntington Beach CA 92649

Most programmers have used FORTRAN or BASIC to generate a two-dimensional plot as part of their program. If they needed a three-dimensional plot, it was usually done on a pen plotter instead of printer or terminal output devices. Since most small systems lack a pen plotter, this program may be used to give a three-dimensional rendering of a normally two-dimensional function. By printing the third axis horizontally along the carriage of the terminal, the usual "hidden line" problem becomes trivial. In the sample program of listing 1, line 60 defines an exponential cosine function which normally plots as a decaying sinewave. Line 120 sets up the X axis values to be in the range -30 to +30. Line 160 calculates the Y axis values based on the expression  $30^2 - X^2$ , hence the X-Y axis sectional will be circular (remember the general equation of a circle is  $X^2 + Y^2 = R^2$ , where R will be the radius). The Z axis coordinate is then calculated in line 190 and the tilted 45 degrees to give a rotated view. Lines 200 through 290 pick the correct plotting symbol to use and then decide whether the point is visible or hidden. To correctly view the finished plot, remove it from the terminal, rotate it back 90 degrees, and then do a little "curve-fitting" by connecting the dots along the lines of corresponding symbols.

To change the plotted equation, redefine function A (called FNA in the program) in line 60. Figure 1 shows the plot of the equation given in the program. Figures 2, 3, and 4 show different functions and their corresponding plots. Note that all figures have been rotated left by 90 degrees from the way they are actually printed. ■

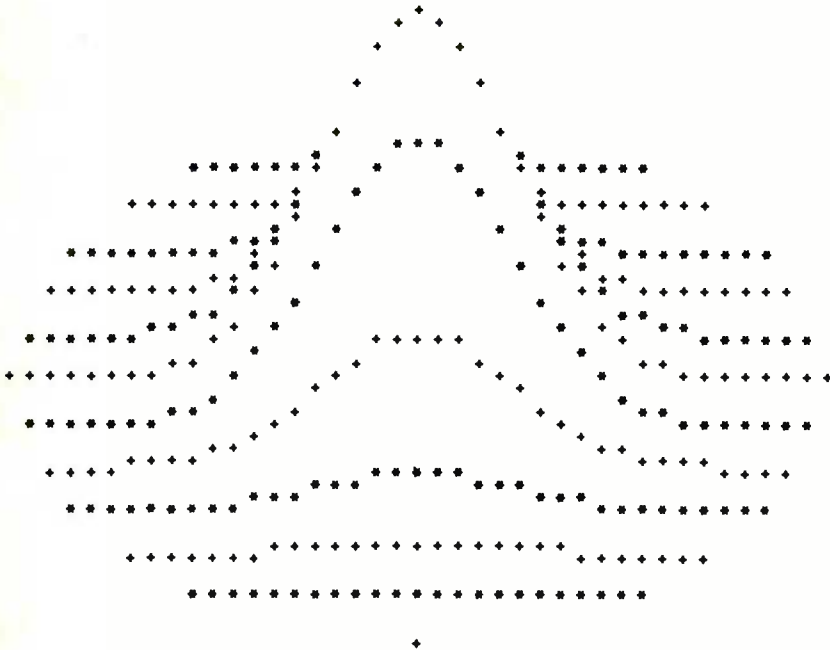

Figure 1: Plot of  $Z = -30 * EXP(-f(x,y)^2 / 100)$   
(DEF FNA (Z) = -30\*EXP(-Z\*Z/100))

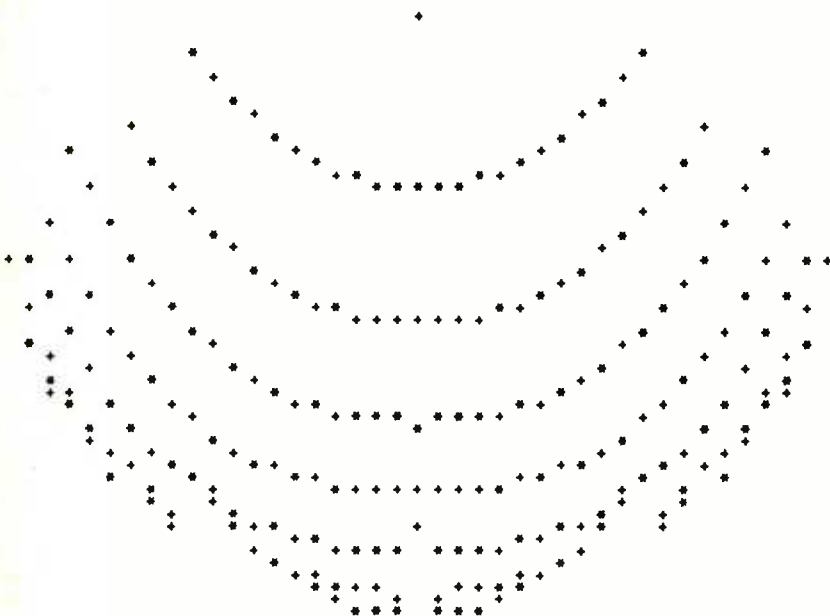

Figure 2: Plot of  $Z = .001 * (f(x,y)^3 + f(x,y) - 25)$   
(DEF FNA (Z) = .001\*(Z\*Z\*Z+Z-25))



```

10 REM "PLOT3D" == FUNCTION PLOTTING PROGRAM
20 REM WRITTEN BY MIKE STODDARD 03-03-77
30 REM
40 REM FIRST, DEFINE A NORMAL 2-DIMENSIONAL FUNCTION.
50 REM IN THIS CASE, IT WILL BE A DECAYING COSINE
60 DEF FNA(Z)=30* EXP (-Z*Z/100)
70 DIM A$(2),B$(1)
80 REM DEFINE THE PLOTTING SYMBOLS
90 LET A$="+*"
110 LET K=5
120 FOR X=-30 TO 30 STEP 1.5
130 LET L=0
140 LET P=1
150 REM CALCULATE X-Y PLANE PLOT LIMITS
160 LET Y1=K* INT ( SQR (900-X*X)/K)
170 FOR Y=Y1 TO -Y1 STEP -K
180 REM CALCULATE Z AXIS VALUES AND TILT 45 DEGREES
190 LET Z= INT (25+ FNA( SQR (X*X+Y*Y))-.707106*Y)
200 GOSUB 340
210 REM TEST FOR HIDDEN LINE
220 IF Z<L GOTO 300
230 LET L=Z
240 REM TEST FOR SAME PLOT LINE
250 IF P IF Z=Z1 GOSUB 340
260 PRINT TAB (Z);B$;
270 REM SET HIDDEN/VISIBLE PLOT POINT
280 IF P LET Z1=Z
290 LET P=0
300 NEXT Y
310 PRINT " "
320 NEXT X
330 GOTO 390
340 REM SWITCH THE SYMBOLS SO ALL POINTS ON
350 REM ONE LINE WILL BE THE SAME SYMBOL
360 LET B$=A$
370 LET A$=A$(2),B$
380 RETURN
390 END

```

Listing 1: The program "PLOT3D" used for three-dimensional projections into two-dimensional plots. The function defined at line 60 is plotted by the terminal printer using standard graphics of an ASCII character set.

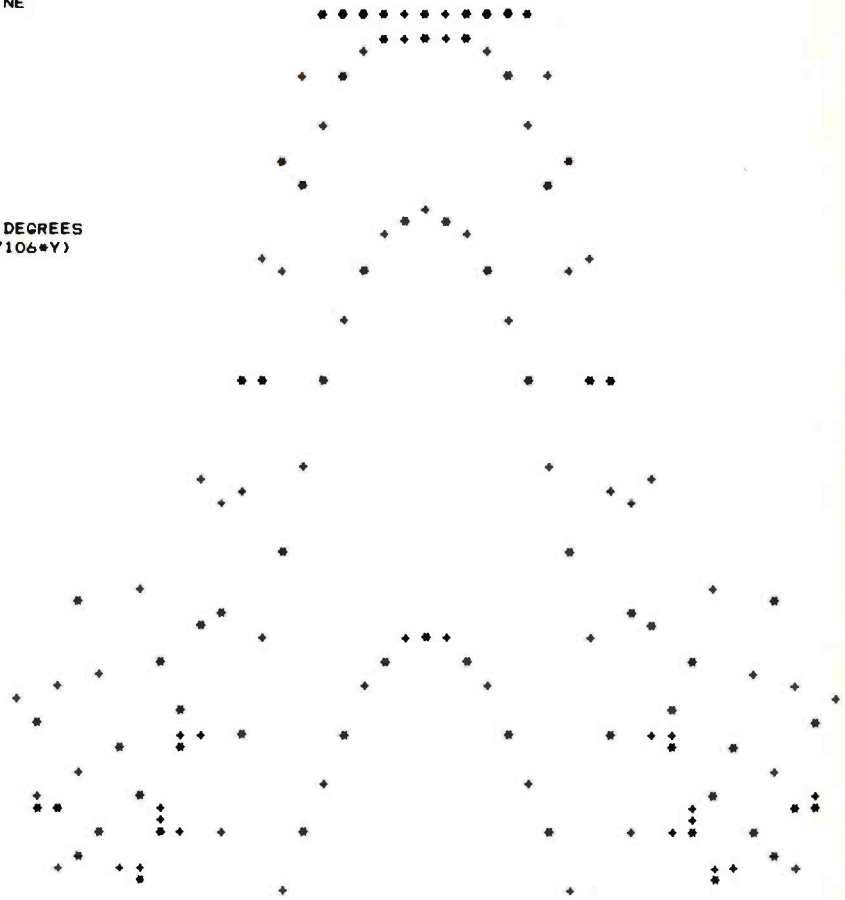

Figure 3: Plot of  $Z = 30 * (EXP(-f(x,y)^2 / 100) + SIN(f(x,y) / 5))$   
 (DEF FNA (Z) = 30\*(EXP(-Z\*Z/100)+SIN(Z/5)))

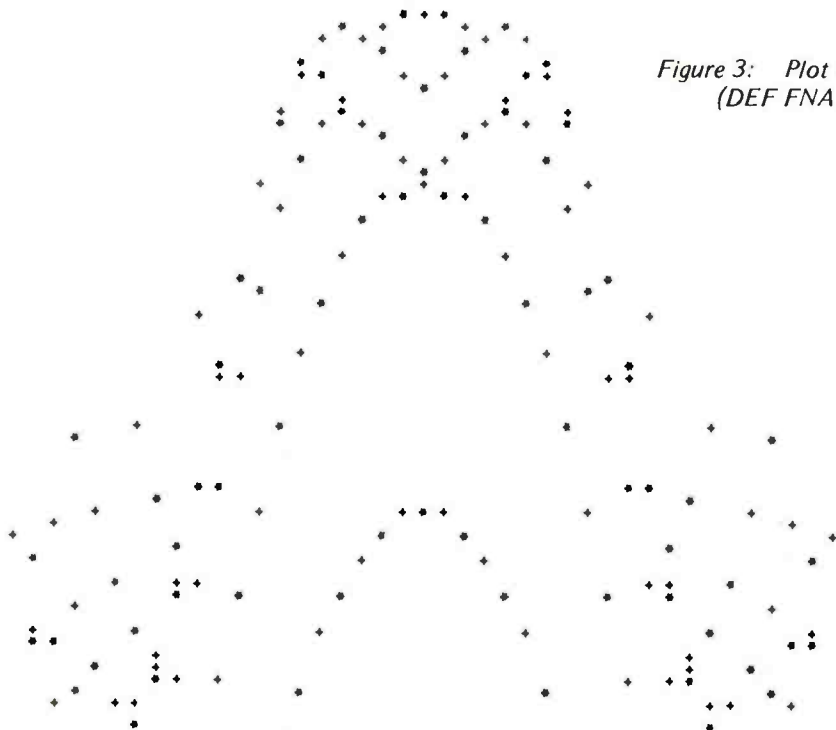

Figure 4: Plot of  $Z = 30 * SIN(f(x,y) / 5)$   
 (DEF FNA (Z) = 30\*SIN(Z/5))

# GRAPH:

## A System for Television Graphics

### Part 1

John Webster  
John Young  
Audio Visual Services  
University of New Brunswick  
Keirstead Hall  
Fredericton NB CANADA E3B 5A3

Our department of Audio Visual Services at the University of New Brunswick makes extensive use of small format videotape recording for instructional and research purposes. Tapes are recorded either in a studio situation or with portable recorders. Most programs are then edited, and require the addition of graphics ranging from simple titles or names superimposed over the picture to more complex charts and graphs that will be incorporated in the final production.

Anyone who watches television will have noticed that electronic character generators are becoming increasingly popular for providing titles, credits and other forms of alphanumeric character displays. Their advantages over the old system of creating the graphics on cards and pointing a camera at them are obvious. Electronic generators are quicker, require no special graphics training or materials, and are, incidentally, cheaper. Electronic titles can also be easily and quickly changed or updated. They also require no dedicated graphics camera and operator.

In examining commercial electronic titling equipment, we found two main disadvantages: Commercial units were quite expensive, and at the same time somewhat limited in their behavior.

We therefore decided to explore the "hobby" computer market and to design our own television graphics generator. The cost of our system turned out to be about half that of the cheapest commercial product then available, while giving increased flexibility for graphics handling. The com-

puter system is also available for other uses when not being used for television graphics in our studio.

The hardware system we finally arrived at consists of an Altair 8800 with 17 K bytes of programmable memory, a Processor Technology VDM-1 with CUTS board, and a keyboard and cabinet modified from a surplus hotel reservation terminal. The program we developed to provide the necessary functions is the reason for this article.

The project was very much a learning experience, since we assembled both the hardware and software. With the exception of a hardware approach to providing a keyboard repeat function, this article is concerned primarily with the software, since it is more likely to be applicable to a greater number of varied systems.

Instead of simply publishing a commented assembly listing of the program, we have gone into considerable detail about the structure of each subroutine and about the workings of the VDM-1 on which the program is based. It is hoped that the program will be useful to many who are using a VDM-1 in any related way, and that the article will serve as a learning tool for anyone new to low level assembly language programming.

#### The Repeat Function

A repeat function is a facility to generate repeated inputs of a keyboard key's code when the key is held down for extended periods of time. Two approaches are offered to the problem of providing a repeat function, one in hardware and one in software. The hardware approach offers the advantage of a more easily variable speed, while the software approach requires no hardware changes and is executable on any keyboard.

When a computer keyboard key is pressed, two signals are generated. One is an

#### Authors' Note:

*This project was a valuable learning experience for us. Attempting to explain a program step by step in English turns out to be a bit lengthy, but we hope that the final result is a package with real teaching and learning potential for anyone new to 8080 machine language programming or the VDM-1. It is exactly the kind of article we wish we had had access to a year ago when we first plugged in our VDM-1 and wondered what to do next.*

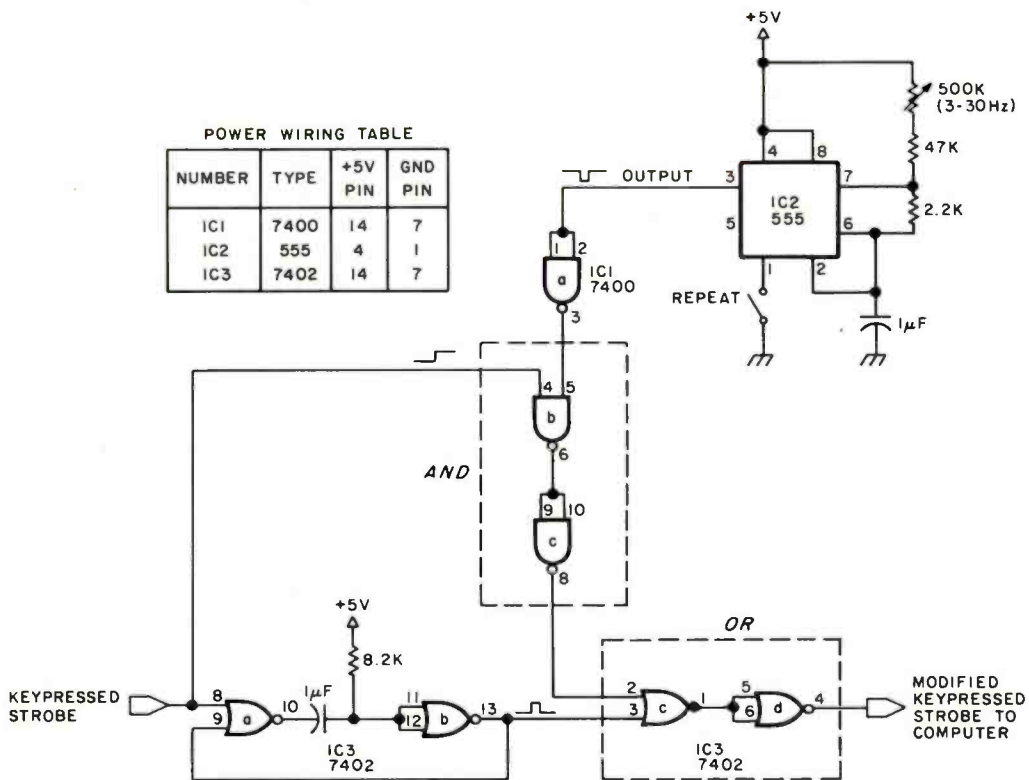

Figure 1: Interface circuitry for GRAPH. An astable multivibrator (IC2) provides the pulse train for a hardware repeat function. The authors' keyboard produces a low to high transition strobe (STB) pulse when a key is pressed. This is used to trigger a monostable multivibrator to provide a single pulse keypressed (KP) signal to interface with the IO board used.

A logical AND function gates the astable multivibrator's output with STB to generate a repeat only when a valid character key is pressed. A logical OR routes either a repeat pulse train or a single KP signal to the computer's IO board.

Because the repeat key on the authors' keyboard is tied to ground, it is used to interrupt the ground connection (pin 1) of the 555 timer. This design seems to work satisfactorily. If a normal single pole single throw switch is available, a more proper design would be to interrupt the output (pin 3).

8 bit binary number corresponding to the character chosen. The other is a "key-pressed" signal that tells the IO board a key has been pressed and it should read and input the eight bit number as valid data.

If a pulse train instead of a single pulse is presented on the keypressed line to the IO board, the computer will continuously input the 8 bit character word presented as a series of characters. A repeat function will occur as long as the pulse train is present. A potentiometer varying the frequency of the pulse train will produce a variable speed repeat.

The circuit in figure 1 uses a 555 timer (IC2) to generate the repeat pulse train and apply it to the keypressed line. Notice that it is important to gate the pulse train with the original keypressed STROBE DC level from the character generator line so that the oscillator will operate only when a character key is pressed. Otherwise, invalid data will

be input if the repeat key is pressed before a character key.

Another handy circuit is contained in figure 1 (lower lefthand corner). Most keyboards presently available provide a low to high strobe transition to indicate a key is pressed. Many IO boards, however, require a single pulse to latch the valid data. This portion of the circuit in figure 1 converts a DC strobe level to a single pulse output.

A software approach to achieving a repeat function is discussed in the Program Design section.

#### Using the VDM-1

The heart of the graphics generator is, of course, the VDM-1. Like several other television boards available, it contains 1 K bytes of programmable memory which hold the 16 lines of 64 characters per line that appear on the screen. Thus, manipulating

Figure 2: Visualization of line starting and ending addresses in GRAPH. This type of information is helpful in understanding the subroutines that check for valid screen addresses. The Processor Technology VDM-1 displays 16 lines of 64 characters per line which reside in 1 K bytes of programmable memory.

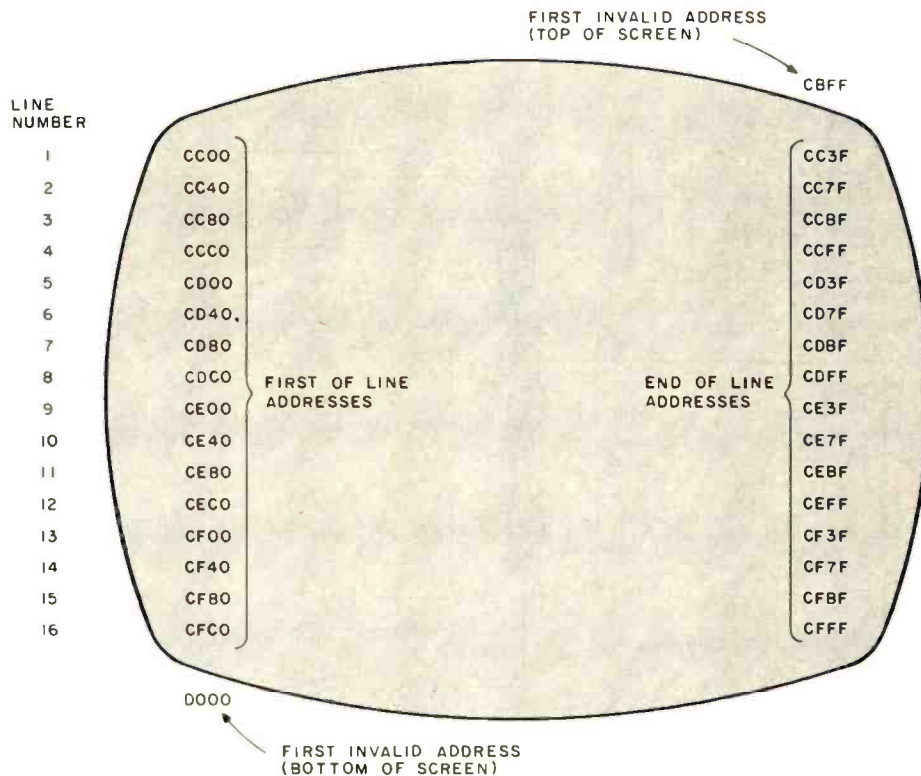

graphics becomes merely a question of manipulating digital information in a 1 K byte workspace.

Data from any register can be moved to the screen with a MOV M, X (whose X is any register) instruction. The position on the screen is determined by the 16 digit number in the H, L register pair, which in this case would be between hexadecimal CC00 (first screen position) and CFFF (last screen position). Allocations of the starting and ending line addresses, as well as the first invalid address on either side of the screen, are shown in figure 2.

The VDM-1 is designed to display a cursor if bit 8 is high, regardless of the status of the other 7 bits. If cursors appeared at all screen positions, the screen would appear white instead of black. Lines or blocks of cursors may be used to draw simple figures.

One shortcoming of the VDM-1 display is that a full cursor is the smallest contiguous unit available. The available graphic resolution is therefore a matrix of only 64 by 16 blocks.

The VDM-1 also contains a scrolling feature which allows vertical displacement of screen contents. It was decided not to use this feature in our program for reasons that will be explained later.

The output of the VDM-1 is a video signal containing both horizontal and vertical synchronizing pulses which permit display

of the graphic information on any television monitor. It should be noted that the horizontal and vertical drive pulses are slightly nonstandard; and, although they will be accepted by any television monitor, they may not synchronize easily with more sophisticated video recording or signal processing equipment. The Digital Group has announced a 1 K byte video display control board that can be driven by external sync pulses. Since GRAPH is written specifically for the VDM-1, some changes in approach (for example, cursor handling) may be necessary when using video display boards from other manufacturers.

In order to make the VDM-1 do anything at all, you need a driver program. For example, a simple program could be written to take a character and type it into the screen starting at the upper left hand corner (hexadecimal address CC00). To do this it would be necessary to:

- Load H, L with hexadecimal CC00 first screen position
- Check for status has a key been pressed?
- Read value of key pressed and store in accumulator (A)
- Move A → M move character to screen
- Increment H, L move to next screen position
- Loop to status check get ready for next character

# The Central Data 2650: Reliable and Affordable

The Central Data 2650 Computer Board system has been carefully designed and built with you in mind. We've also designed software and memory to go with the 2650 so that you'll have a complete system. You deserve quality equipment, and we've built it for you. Take a look at the 2650 board features and see for yourself.

- a 2650 microprocessor
- an 80 character by 16 line display
- a 300 Baud cassette interface
- a powerful 1K Supervisor Program
- one parallel input port and one bit settable output port
- 2048 bytes of read-write memory for the video display and your programs
- expands to S-100 bus
- low price of \$275

The 2650 board comes assembled, tested and ready to plug in and comes with a full one year guarantee. The price includes a Signetics 2650 Microprocessor Manual and a Computer System Manual from Central Data.

We offer the Editor/Assembler and 8K Basic software packages for the 2650 system, and our S-100 24K memory board allows full expansion of the system. (16K and 32K memory boards are also available.) Each software package costs only \$20. The 24K memory board is \$395. All software comes with a program listing.

With all these features you can't afford to pass up the Central Data 2650 system.

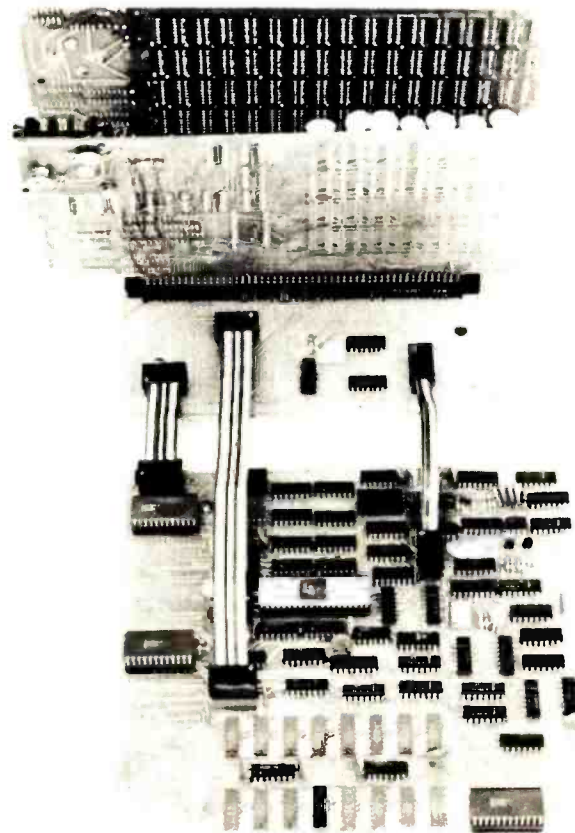

## Central data

P.O. Box 2484, Station A  
Champaign, IL 61820  
(217) 359-8010

Please send me the following:

- 2650 computer system board (\$275)
- 16K RAM (\$289)
- 24K RAM (\$395)
- 32K RAM (\$475)
- Editor/Assembler (\$20)
- Basic (\$20)
- Additional information

I enclose \$ \_\_\_\_\_.

Ill. residents add 5% sales tax.

Name \_\_\_\_\_

Address \_\_\_\_\_

City \_\_\_\_\_

State \_\_\_\_\_

Zip \_\_\_\_\_

Central Data • P.O. Box 2484, Sta. A • Champaign, Ill. 61820

Figure 3: A global system chart for GRAPH.

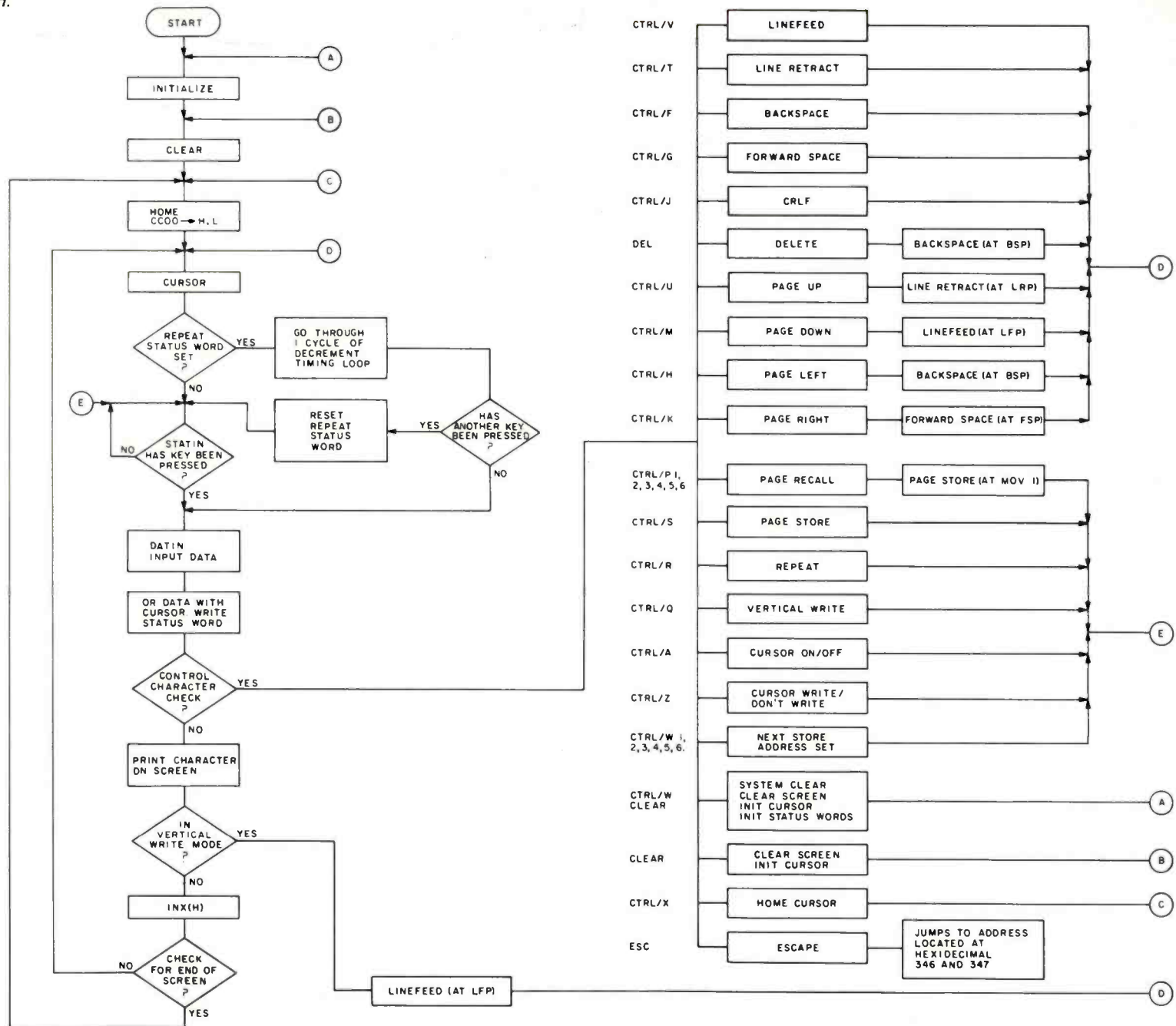



# At last.

Finally, the macro maker of computer printers has gone micro. With a high-speed, desk-top, non-impact printer complete with parallel interface (Model P-1) that's perfect for the home, hobby and small business user. A complete 80-column printer for less than \$600.

The new Centronics microprinter is big on performance. It prints clean, clear dot matrix characters at a rate of 150 lines per minute. Yet it's quiet, compact, comes fully warranted and is backed by Centronics' worldwide service. It's even available in a serial interface version (Model S-1) for remote applications.

Of course, buying your small systems printer from the industry's leading producer of printers is simply a better buy. You get the security, support and systems flexibility only Centronics can bring. Plus the targeted technology that brings out the best in any computer.

So when you think small printers, think big. Think Centronics. For more information, just clip and mail the coupon below.

Centronics Data Computer Corp.  
Hudson, NH 03051

Gentlemen: Tell me more about your new microprinters.

Name \_\_\_\_\_

Address \_\_\_\_\_

Town \_\_\_\_\_

State \_\_\_\_\_ Zip \_\_\_\_\_

B-5-78

**CENTRONICS® PRINTERS**  
**Simply Better**

Function	Key Pressed to Enter Routine	Hexadecimal Control Character	Description
Type Characters Onto Screen			Happens automatically for all noncontrol characters.
Repeat	CTRL/R,X	012	Repeats character X until any key is pressed.
Move Cursor Up Down Right Left	CTRL/T CTRL/V CTRL/G CTRL/F	014 016 07 06	Cursor may be moved around screen in either "cursor write" or "transparent" mode.
Cursor Write/ Don't Write	CTRL/Z	01A	Cursor blocks may be used to draw lines or figures.
Cursor On/Off	CTRL/A	01	Leading cursor appears or disappears.
Clear Screen	Clear	01C	Clears screen and initializes cursor to upper lefthand corner.
Home Cursor	CTRL/X	018	Cursor is initialized to upper lefthand corner without clearing screen.
CRLF	LINEFEED or (CTRL/J)	0A	Generates a carriage return and linefeed sending leading cursor to lefthand end of next line.
Move Screen Up Down Right Left	CTRL/U CTRL/M CTRL/K CTRL/H	015 0D 0B 08	Entire contents of screen may be shifted up, down, right or left.
Vertical	CTRL/Q	011	Allows character entry in vertical columns.
Store	CTRL/S	013	Entire contents of screen may be stored in one of six rotating locations.
Recall	CTRL/P 1, 2, 3 4, 5, 6	010	Contents of any previously stored screen may be recalled.
Choose Storage Location	CTRL/W 1, 2, 3 4, 5, 6	017	Screen storage status control word is set to chosen value for next STORE.
System Initialize	CTRL/W CLEAR	017 01C	All systems parameters and storage registers are initialized, screen is cleared and cursor returned to upper lefthand corner.
Escape	ESC	01B	Exit from GRAPH and return to system monitor.
Delete	DEL	07F	Writes blank into present position and moves leading cursor back one space.

Table 1: Program functions in GRAPH and their specific control characters.

If you implement such a program, you will immediately see that it is not very flexible, and the need for refinements will become apparent. What about a cursor? What if you want to start typing somewhere else, make changes, draw lines, etc?

We asked ourselves the same questions and more. The result was GRAPH, a multi-function video display memory handler. The following sections will detail the design and implementation of GRAPH step by step.

#### Program Function and Use

The GRAPH program is designed to do practically everything we ever wanted to do with the VDM-1, to be as universally applicable and self-contained as possible, and to reside in the lowest 1 K byte of memory.

(The store and recall functions require additional memory space; more about this next month in part 2.)

The program consists of a driver which waits for keyboard input and then checks for special control characters. If a specific control character is typed, one of a series of subroutines or special operations is entered. If the entered character is not a special control character, the typed information is displayed on the screen. Table 1 lists the program functions and their specific control characters.

GRAPH is designed so that all screen operations "wrap around" and therefore stay within the 1 K byte screen boundaries. For example, a leading cursor in the last screen position will appear in the upper lefthand corner (first screen position) when



# The Dumb Terminal lets you put it all together.

With the new, lower-priced Dumb Terminal™ Kit, that is. Pick one up and escape, once and for all, the headaches of scavenged teletypes and jury-rigged TV sets. With just a little time and aptitude, you can have a live and working Dumb Terminal right in your own home, garage, or business. One that lets you get it all out of your system — or into it.

Forget the cheap imitations, with their overblown price tags and interminable lists of options. With the Kit, you can build yourself the same, old basic Dumb Terminal that's been selling over 1500 units a month. With basic, sensible features like a bright 12" diagonal screen. Fifty-nine data entry keys. 1920 characters displayed in 24 rows of 80 letters. Plus 33 positive action switches that let you activate functions like 1 of 11 different baud rates, an RS232C interface, or a 20mA current-loop. And more. Not bad for Dumb

All you need, besides the Kit, is some initiative, and a few basic tools — a good soldering iron, wire cutters, needle-nose pliers, and one or two trusty screwdrivers. The Dumb Terminal Kit provides you with everything else. Including an attractive cabinet, CRT screen, keyboard, PC board, and all essential

electronic components. Naturally, you also get illustrated, step-by-step assembly instructions, not to mention an easy-to-understand operator's manual.

So, if you'd like more input on the Dumb Terminal Kit, just fill out the coupon and we'll send you complete, free information.

Oh, and by the way, just by sending in the coupon, you will be made a charter member of the Dumb Terminal Fan Club. A select organization that will send you your own nifty Dumb Terminal Fan Club Kit, containing: an official certificate of membership; an autographed photo of the Dumb Terminal himself; and a bona fide membership card to prove irrefutably you're "One of Us." (Sorry, limit one kit per person.)

And, if you include a trifling \$6.00, you can have your very own Dumb Terminal T-shirt. (No limit at all on these.)

Simply mail the coupon and get the whole assortment. And find out why members of the Dumb Terminal Fan Club are some of the smartest people around.



**Dumb Terminal.  
Fun Club.**



Yes, I would like more information about the incredible Dumb Terminal Kit. And don't forget to make me as a Charter Member of the Dumb Terminal Fan Club.

Name \_\_\_\_\_ Title(?) \_\_\_\_\_  
 Company \_\_\_\_\_  
 Street \_\_\_\_\_  
 City \_\_\_\_\_ State \_\_\_\_\_ Zip \_\_\_\_\_  
 Enclosed is \$ \_\_\_\_\_ for an official Dumb Terminal T-shirt(s).  
 Please make all checks and money orders payable to LeAnce & Reiser, OK?  
 Quantity and size(s) of shirt(s) required: \_\_\_\_\_ S \_\_\_\_\_ M \_\_\_\_\_ L \_\_\_\_\_ XL  
 Rush this application to: Dumb Terminal Fan Club Headquarters  
 c/o LeAnce & Reiser, P.O. Box 17123, Irvine, CA 92714.

"Dumb Terminal" is a trademark of Lear Siegler, Inc., E.I.D./Data Products, 714 N. Brookhurst St., Anaheim, CA 92803, (800) 854-3805. In California (714) 774-1010. Circle 205 on inquiry card.

the next character is entered. Similarly, information moved off the top of the screen with a MOVE UP command will appear at the bottom of the screen. In this way, no information is lost and adjacent memory is not affected.

GRAPH may be entered either by a jump or a call. If a jump is used, hexadecimal memory locations 346 and 347 should be loaded with the desired address for a jump back to a system monitor program (eg: to return to ALS-8, 346 is set equal to hexadecimal 60, and location 347 is set equal to hexadecimal E0). If GRAPH is entered by a CALL instruction, hexadecimal memory location 345 should be loaded with an unconditional return, C9. In this case 346 and 347 are not used.

### Program Design

To aid in understanding the operation of the program, it has been divided into three main sections: the Driver section, the Control Checks section and a section of Special Operations. Special operations are called into use by certain designated control characters.

Although most of these operations are distinct subroutines, several, such as Cursor (on/off) and Vertical Write, consist of only a few instructions in the Control Check section that modify the operation of the Driver section by changing certain status words in memory. Others, such as Home Cursor and System Clear are merely jumps to subroutines already existing inside the Driver section.

Descriptions of some of these routines are brief in certain cases because the operation of some subroutines is simple. Other tech-

niques, however, such as using DAD instructions to subtract (as in the Move routines), will be examined in more detail.

To interface each subroutine with our program, certain standards have been adopted, as follows:

- In each subroutine, screen character positions are controlled by using the H and L register pair. Information is moved to the screen by using a MOV instruction to register M, which moves the data to the memory location specified by the address in H and L. Therefore, by changing the values of H and L, the memory location into which characters are to be input is changed.
- The only register "tied up" when leaving the Driver to execute a subroutine is register C, used to store the screen information previously located at the leading cursor position. The cursor which travels along to indicate the next entry position on the screen will be referred to as a "leading cursor."
- Since the cursor is a movable item, the first step upon entering most subroutines is "MOV M, C," which moves the information stored in C back to the screen and makes the leading cursor disappear. This then frees register C for use in the subroutine.

### Driver Section

The heart of any multifunction program is the Driver, which has a number of functions:

- **Initialization:** Upon entering the program at its starting location, the first thing encountered is a jump to an Initialize subroutine. This simply involves setting the memory status words or locations to their initial values. This is accomplished by loading D and E with the hexadecimal value 03F5 and loading the accumulator with 00. Then a STAX operation is executed, which stores the accumulator at the location specified by D and E. The latter are incremented, and the STAX operation is again performed. This is repeated five times. The accumulator is then loaded with hexadecimal CC, the STAX operation is performed (location 3FA), and D and E are incremented. The accumulator is then loaded with hexadecimal 80 and the STAX operation performed (location 3FB). By this store and increment method, hexadecimal

Hexadecimal Location	Purpose	Hexadecimal Initialized Value
3FF 3FE	Save H and L for Screen Moves	Don't care
3FD 3FC	Save Stack Pointer	Don't care
3FB	Cursor On/Off	On = 80
3FA 3F9	Save H and L for Page Store and Recall	3FA = CC, 3F9 = 00
3F8	Page Store Status	Page 1 = 00
3F7	Vertical Write/ Not Vertical Write	Not Vertical Write = 00
3F6	Cursor Write/ Don't Write	Don't Write = 00
3F5	Repeat/ Not Repeat	Not Repeat = 00

Table 2: A table of values used by the initialization subroutine to set the memory status words or locations to their initial values.

**A PROFESSIONAL  
COMPUTER TERMINAL  
FOR THE SERIOUS  
HOBBYIST**

# The AJ 841 I/O.

## A completely refurbished IBM Selectric Terminal with built-in ASCII interface. Just \$995.

### FEATURES:

- ASCII code.
- 14.9 characters per second printout.
- Special introductory price – \$995 (regularly \$1,195). 75% discount from original price of new unit.
- Parallel Interface (requires parallel port for I/O transmission)
- Order direct from factory.
- Documentation included.
- 30-day warranty – parts and labor.
- High quality Selectric printing.

- Reliable, heavy duty Selectric mechanism.
- Off-line use as typewriter.



**AJ 841 WARRANTY AND SERVICE  
IS AVAILABLE IN THE  
FOLLOWING CITIES:**

Los Angeles / Cincinnati  
Philadelphia / Detroit  
Hackensack / Dallas  
Columbus / Houston  
Cleveland / Atlanta  
San Jose / Chicago  
Boston / New York  
Washington, D.C.

For further  
information call  
(408) 263-8520

**ANDERSON  
JACOBSON**

Anderson Jacobson, Inc., 521 Charcot Avenue  
San Jose, California 95131

### HOW TO ORDER AN AJ 841 I/O TERMINAL

1. Make cashier's check or money order payable to:  
**ANDERSON JACOBSON, INC.**  
Address your request to:  
Personal Computer Terminal  
ANDERSON JACOBSON, INC.  
521 Charcot Avenue  
San Jose, CA 95131
2. Upon written notification, pick up your terminal at the AJ service office located in one of the above cities. Allow six to eight weeks for delivery.
3. A final check of your unit will be made at the local AJ service office at time of pickup.
4. For warranty or repair service, return unit to designated service location.
5. Available in U.S. only.

### CLIP AND MAIL WITH ORDER

SELECT EITHER:  EBCD keyboard  Correspondence keyboard

Number of units \_\_\_\_\_ @ \$995 each \$ \_\_\_\_\_

Sales tax at delivery location \$ \_\_\_\_\_

Shipping and handling \$35 each (excluding San Jose) \$ \_\_\_\_\_

TOTAL \$ \_\_\_\_\_

NAME \_\_\_\_\_

ADDRESS \_\_\_\_\_

CITY \_\_\_\_\_ STATE \_\_\_\_\_ ZIP \_\_\_\_\_

PHONE ( ) \_\_\_\_\_

locations 3F5 to 3F9 are initialized to zero, location 3FA to hexadecimal CC and location 3FB to hexadecimal 80. The initial contents of locations 3FC, 3FD, 3FE and 3FF are unimportant.

- **Clear:** The Clear subroutine writes blanks (hexadecimal A0) into every screen location and initializes the status of the video display module.

The status of the module is initialized to display all 16 lines in a nonscrolled format by writing 00 into the VDM-1's status port (hexadecimal C8).

The screen is cleared by initializing the H and L registers to hexadecimal CC00 (upper lefthand corner), loading that position with a blank, incrementing and loading a blank, and so on, until the screen is filled.

- **Home:** The operation then jumps to the HOME section of the Driver where H and L are again set to hexadecimal CC00 and the program proceeds to the CURSOR section.
- **Cursor:** CURSOR, by checking hexadecimal memory location 3FB, either prints a cursor and character, or just the character in this initial position (hexadecimal CC00).

CURSOR is responsible for printing the leading cursor everytime it appears on the screen. Hence, any subroutine which modifies H and L to change the "next character to be entered" location (such as Linefeed, Backspace, etc) must immediately jump to the CURSOR subroutine to decide whether or not to print a leading cursor in the new screen position.

During its operation, CURSOR first moves the contents of the screen location addressed by H and L to register C for safekeeping. It then loads the accumulator with the contents of memory location 3FB, which is either hexadecimal 00 or hexadecimal 80.

By ADDing the character in C to the accumulator, the accumulator is modified so that when it is displayed either just the character appears, or the character appears in a cursor block. For example, if the contents of memory location 3FB is hexadecimal 00, then moving this value to the accumulator and adding the character in C to the accumulator will leave just the character in the accumulator.

But if 3FB contains hexadecimal 80, then a white cursor will appear (on a black background), or a black or inverted cursor will appear (on a white background).

At this point, the status word at hexadecimal location 3F5 is checked to see if

the program is in the Repeat mode. If 3F5 contains hexadecimal 00, then operation passes to the keyboard status check called STATIN. Here the operation loops until STATIN indicates that a key has been pressed. At this point the program inputs the data at DATIN and moves it to register B for safekeeping.

If location 3F5 contains hexadecimal 80, a jump is made to a timing delay loop. In this delay loop, D and E are loaded with hexadecimal 10FF and decremented until they reach zero. This provides a programmable delay between characters in the Repeat mode. Next, a keyboard status check is made by logically ANDing the keyboard word (IN 00) with hexadecimal 40. If the result is zero (meaning no key has been pressed since the character to be repeated was entered), then program operation jumps to DATIN, which inputs the unchanged data in IO port 01 to the accumulator. If the input data is a character to be printed, it is displayed on the screen and operation eventually returns through CURSOR to check the Repeat mode status again. As long as no other keyboard key is pressed, the program will continue to cycle through the delay timing loop, repeatedly displaying the entered character on the screen.

Those subroutines which jump back to the Driver at or above CURSOR may also use the Repeat function (see figure 3). If, for example, CTRL/R and then CTRL/V (Page Up) are entered, the display will continually roll upward until another character is entered to cancel the repeat function.

When the character after CTRL/R is entered, an IN 01 is executed to reset the keyboard status, although the input data is not used in any way. The Repeat status word at location 3F5 is then reset to zero and operation jumps to STATIN.

Since the repeat delay is controlled by the value in D and E, varying this value affects repeat speed. New values may be entered at hexadecimal memory locations 282 and 283 to produce different speeds. Using a value of hexadecimal 0000 will result in the slowest speed (about 2 to 3 Hz). Hexadecimal 10FF produces a convenient speed of about 30 characters per second.

Following DATIN, the program next enters the Cursor write/don't write section, which loads the accumulator with the contents of hexadecimal address 3F6 (either hexadecimal 00 or hexadecimal 80) and logically ORs it with B. This new value (either just the character, or the character plus bit 8) is moved back into B as the valid desired data.

This in effect adds a cursor bit (bit 8) to the character input if Cursor write is desired,

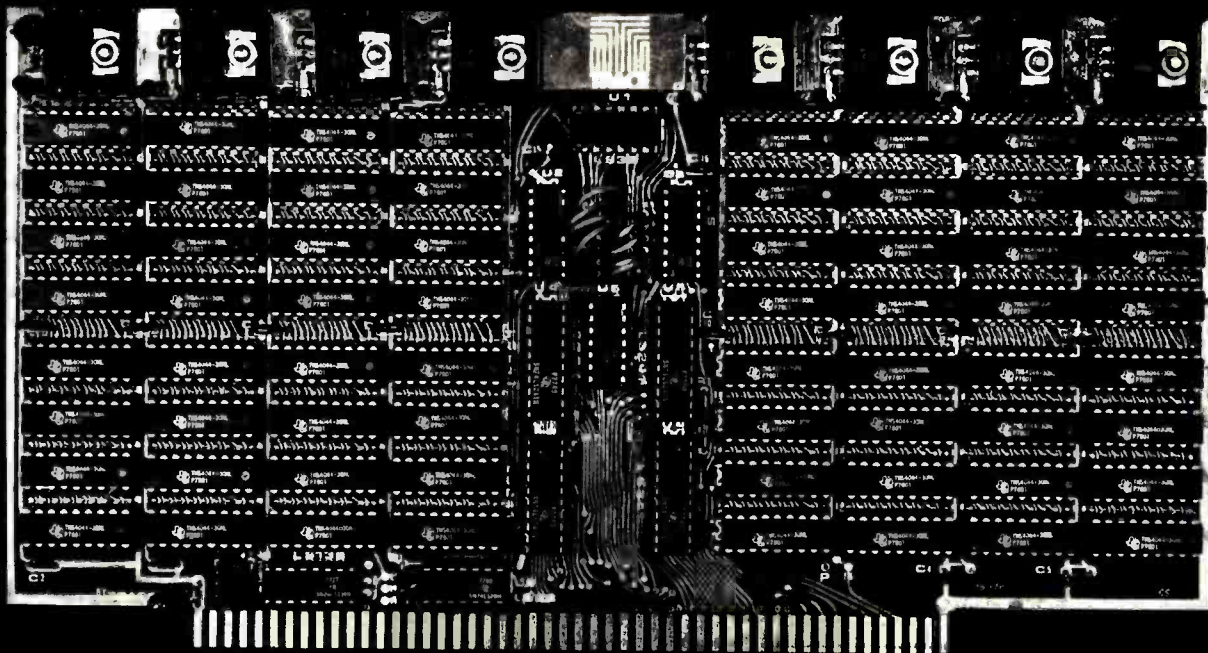

# Trace Electronics 32K/16K Static RAM

What could you do with this board in your system?

## Features

1. **Capacity:** 32768 Bytes for model 3200  
16384 Bytes for model 1600
2. **Addressing:** Each 4k block separately addressable on any 4k boundary. Allows memory to be placed at the top, bottom, and anywhere in between.  
This feature overcomes the problem of working with software that requires memory in different places.
3. **Wait states:** none
4. **Speed:** 450 ns. or 250 ns.
5. **FULLY STATIC:** no clocking, no refreshing.
6. **Memory chips:** High quality/reliability 4 $\times$ 1, 18 pin static manufactured by Texas Instruments and second sourced by others.
7. **Fully socketed:** even the 16k board contains sockets for all 32k or memory.
8. **Fully assembled,** tested, and burned in.

9. **Lower power** than equivalent capacity of low power 2102 type memory. And only one slot!

### 10. DMA Compatible

11. **Fully Buffered:** All address and data lines buffered with powerful state of the art buffers equipped with Schmitt triggers on their inputs.

12. **Special Thermal Design:** Each 4k of memory has a separate regulator thereby distributing the heat dissipation over 8 separate regulators. They are placed at the top of board to allow the most efficient heat dissipation possible.

13. **Megextend™:** up to one megabyte can be addressed providing there is a 4 bit output port in the system. This allows up to 32 model 3200 boards per system, as long as the power requirements are met.  
(This feature also makes possible the use of this board in a timeshare environment)

14. **Power Required** is 1.7A at 8V for model 1600 and 3.3A at 8V for model 3200

## Contact your dealer and see this board

Our 32K 16K Static RAM is available right now at many dealers throughout this country. Write Trace Electronics Inc. for a complementary copy of a users manual and the name of the closest dealer carrying our Static RAM.

Trace Electronics Incorporated, P.O. Box 3247, Hampden Station, Reading, Pennsylvania 19604 • (215) 779-3677



or leaves the character as is if no cursor is desired. Hexadecimal memory location 3F6 is loaded by the Cursor write/don't write subroutine (Control/Z) as hexadecimal 00 or hexadecimal 80 alternately. Thus, if the letter X is typed while location 3F6 contains hexadecimal 80, then X is printed on the screen enclosed in a cursor.

This section is analogous to a toggle switch controlling the state of bit 8, which might be an alternate hardware approach.

Next, the Driver jumps to the control check section to determine which subroutine (if any) has been selected. If a subroutine has been selected, the data in B is no longer important (since we don't want to print control characters on the screen), and B is free to be used in any subroutine.

#### Control Character Check

Although the Control Character Check section is part of the driver, it is physically separated from the driver in the assembly listing to facilitate expansion. The Control Character Check detects the presence of the various assigned control characters and routes the program operation to the respective subroutines or operations. Since the majority of the Control Character Checks consist simply of *compare immediate* and *jump if not zero* statements, only two internal routines, Page Recall and Control W, will be examined in detail.

#### Page Recall Control Check

Once the Control Character Check recognizes the code for Page Recall, it does a keyboard status check, waiting for the next character to be pressed. The character is then entered, and the cursor bit (bit 8) is peeled off or set to zero by logically ANDing with hexadecimal 7F. If the character entered is a number from 1 to 6, the compare statements in this nested subroutine transfer operation to the respective Page Recall location. If the character entered is not a number from 1 to 6, operation jumps back to STATIN in the Driver program.

#### Control W Check

Once a control W has been detected by the Control Character Check subroutine, the program waits for the operator to input another character. If the latter is a character from 1 to 6 or "clear," an operation is performed. If not, the program jumps back to STATIN in the Driver.

If 1 is pressed, hexadecimal memory location 3F8 (the page store select location) is loaded with the correct value (hexadecimal 00) so that the next Page Store will

be stored in page 1. The same holds true for numbers 2 thru 6. Operation then jumps back to STATIN. However, if Clear is pressed, operation jumps to the Initialize and Clear sections of the Driver where all the memory status words are reset to their initial values and the screen is cleared. This operation is referred to as System Clear in the Control System Chart (see figure 3). At the end of any subroutine, the operation jumps back to the Driver program.

If no subroutine has been selected, the contents of B (the previously input data) are moved to the screen. The program first checks hexadecimal location 3F7 to see if it is in the Vertical Write mode, and then decides whether to increment to the next screen location (required in a normal character entering mode) or to go into the Vertical Write mode. In this last case no increment is produced, but a Linefeed is executed (the Vertical Write mode enables the user to enter the next character immediately below the previous one). This allows a vertical line of characters to be drawn downward. If the value of hexadecimal memory location 3F7 is zero, the program increments H and L normally. If it is anything other than zero, the Vertical Write mode is entered. The data in location 3F7 is controlled by the Vertical Write subroutine (CTRL/Q) which alternately loads it with hexadecimal 00 or hexadecimal 80.

Finally, the driver checks to see if it has reached the end of the screen (in Vertical Write mode, Linefeed takes care of this), and if so a jump is made to a location in the initializing section (HOME), thereby setting H and L back to their upper lefthand value. If the end of screen has not been reached, operation simply jumps back to the CURSOR section, which operates as explained above. The program is now ready for a new character.

#### Special Operations

There are 21 special operations which GRAPH performs. They will be examined in the following order:

1. Linefeed
2. Line Retract
3. Backspace
4. Forward Space
5. Carriage Return & Linefeed (CRLF)
6. Delete
7. Page Up
8. Page Down
9. Page Left
10. Page Right
11. Page Store
12. Page Recall
13. Repeat

# INFO 2000 DISK SYSTEMS

## Let You Make the Choice

**NEW!**

### INTELLIGENT CONTROLLER or DUMB CONTROLLER

INFO 2000 has just added a new, lower cost S-100 "dumb" controller disk system to its already popular line of "intelligent controller disk systems for S-100, Digital Group, and Heathkit H8 microcomputers.

All INFO 2000 disk systems feature the incomparable PerSci 277 dual diskette drives with voice-coil positioning and seek time up to eight times faster than competitive stepping-motor-type drives. All INFO 2000 disk systems are fully assembled, rigorously tested, and include case, power supply, cables, and software. All INFO 2000 disk systems include the CP/M Disk Operating System and support the complete INFO 2000 library of software for 8080, 8085, and Z80-based systems. All INFO 2000 disk systems include complete I/O driver software *CUSTOMIZED* for your specific equipment configuration at no additional cost, assuring you of a hassle-free plug-in-and-go installation.

And now, S-100 users can choose the kind of controller that makes the most sense for their specific application: intelligent or dumb.

#### INTELLIGENT CONTROLLER DISK SYSTEM

This system uses the remarkable PerSci 1070 "intelligent" controller, which incorporates its own dedicated 8080 microprocessor, 4K of EPROM containing extensive file management firmware, 1K of RAM buffer memory, and eight-bit parallel interface.

The "intelligent" controller is actually a single-board computer dedicated to the task of managing the disk system. It requires a minimum of interface logic and very little support software in the host computer. This makes it exceptionally easy to interface to almost any kind of computer system or software system.

INFO 2000 provides interfacing hardware (Adapter Boards) for all S-100, Digital Group and Heathkit H8 microcomputers. The Adapter Boards provide all necessary interfacing logic, power regulation, and support an EPROM-resident CP/M bootstrap loader. The Heathkit H8 Adapter Board replaces the Heath 8080 CPU board and upgrades the H8 to a Z80.

If you change to a different kind of computer in the future, you can still use your disk drive and controller. You need only purchase the appropriate replacement INFO 2000 Adapter Board.

Prices for the complete INFO 2000 Disk System with "intelligent" controller:

**\$2,850 for S-100 or Digital Group**  
**\$2,950 for Heathkit H8**

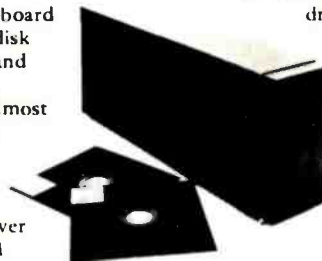

#### DUMB CONTROLLER DISK SYSTEM

This new system uses the new S-100 controller board developed by INFO 2000 Corporation especially for our own Business System. The new "dumb" controller is substantially less expensive, and is designed specifically to maximize the performance of the PerSci 277 dual diskette drive when used in a CP/M software environment.

The controller is fully IBM 3740 compatible, and provides advanced functions not often found in low-cost units: full soft-sectored diskette formatting, multi-sector reads and writes, verified seeks, and complete diagnostic capabilities.

This new controller is FAST! A full verified disk copy takes less than a minute. Formatting a new diskette takes less than half a minute.

A CP/M re-boot is almost instantaneous (one-third of a second). There are no performance compromises.

The INFO 2000 controller is available with an "I/O Option". This adds two RS232 serial ports with software-selectable baud rates, 3 8-bit parallel ports (2 output, 1 input), and sockets for an additional 7K of 2708-type EPROM (1K is standard). All of this is contained on the same S-100 board which holds the controller, and the cost of the "I/O option" is \$150—far less than the cost of a comparable serial/parallel interface board and an EPROM board.

**\$2,450 for INFO 2000**  
**S-100 DISK SYSTEM**

#### SUPPORT SOFTWARE

INFO 2000 Disk Systems are supported by the most extensive library of software available anywhere. All INFO 2000 Disk System prices include the Digital Research CP/M Disk Operating System and an EPROM containing I/O driver software customized for your specific hardware configuration. INFO 2000 also offers a choice of three BASICs, two FORTRANs, three assemblers, two text editors, a word processing package, a fast sort package, and much more software. Write or phone to receive our brochure with full details.

You may also be interested in the INFO 2000 Business System—a complete data processing system for small businesses, with full accounting and word processing software, and priced under ten thousand dollars.

**INFO 2000**  
CORPORATION

20630 South Leapwood Avenue  
Carson, California 90746  
(213) 532-1702

**INFO 2000 DISK SYSTEMS**

14. Vertical Write
15. Cursor On/Off
16. Cursor Write/Don't Write
17. Next Store
18. System Clear
19. Clear Screen and Initialize Cursor
20. Home Cursor
21. Escape From GRAPH

### Line Feed

This subroutine can be entered by pressing Control/V while the cursor write mode is either on or off. This simply means that Linefeed will be accessed with either hexadecimal 56 or hexadecimal D6 (the latter being a hexadecimal 56 with the cursor bit set equal to 1).

Note that this double control check is necessary only in the first four subroutines (Linefeed, Line Retract, Forward Space, Backspace), since these are the only routines used to draw cursors on the screen in addition to performing their own specific functions.

Before checking for the next control character after Backspace, therefore, the cursor bit is masked off by ANDing it with hexadecimal 7F, so that only single control checks are necessary for all further operations.

If Linefeed is accessed with the cursor bit set (LFC), register C is loaded with hexadecimal A0, a blank cursor. This value is moved to M (putting a blank cursor on the screen). Thus, in this mode, every Linefeed writes a blank cursor below the previous one. This can be used to draw a line downward on the screen.

If Linefeed is accessed in the Cursor "don't write" mode (LF), then the original information in C is transferred to M, leaving the screen in its pre-"leading cursor" state and freeing C for subsequent use if needed.

To accomplish its job, Linefeed loads registers D and E with hexadecimal 40 (decimal 64) and then adds this to H and L. This means that the next position to be entered on the screen will be 64 characters after the last one, exactly one line down (since lines are 64 characters long).

The subroutine then checks to see if this new value from H and L is valid; that is, if it is still on the screen. If it is a valid screen location, operation jumps back to CURSOR in the Driver. If not, it will be necessary to "wrap around" and move to the top of the same vertical row. In this case register H is loaded with hexadecimal CC. Since the position across a line is controlled by the value in register L, keeping the same value in L and setting H to hexadecimal CC produces a linefeed from the

bottom of the screen to the top.

For example, with the cursor at the lowest lefthand screen position (refer to figure 2), H and L are hexadecimal CFC0 (H = hexadecimal CF, L = hexadecimal C0).

If a Linefeed is pressed at this point, H and L will be modified to hexadecimal D000, and the program will detect that this value is off the screen. Then, instead of jumping back to CURSOR, the program loads H with hexadecimal CC and leaves L at hexadecimal 00. Thus the next screen position is hexadecimal C000, which is the highest lefthand screen position. In this manner, a linefeed from any position on the bottom line moves the cursor to the corresponding position on the top line. The operation then jumps back to CURSOR in the Driver.

### Line Retract

Whenever Line Retract is executed, the leading cursor position is moved up one line. Like Linefeed, it can be entered by a Control/T in either the Cursor "write" (LRC) or "don't write" (LR) mode. By using Line Retract while in the cursor "write" mode you can draw lines of cursors upward on the screen. Line Retract operates the same as Linefeed except that it adds FFC0 to H and L in order to move up one line, instead of adding hexadecimal 40, as in the case of Linefeed.

Since the 64 K byte memory wraps around from its last position (hexadecimal FFFF) to its first position (hexadecimal 0000), adding hexadecimal FFFF to any value of H and L will bring you around through memory and up to the memory location immediately preceding that value. Thus, adding hexadecimal FFC0 to a value of H and L will bring you to hexadecimal 40 (decimal 64) before that value. This has the effect of subtracting hexadecimal 40 from the current cursor position, hence backing up one line. The Line Retract subroutine also checks the new value of H and L to see if it is valid (on screen). If not, it loads register H with hexadecimal CF so that the new cursor position will wrap around from the top to the bottom of the screen, similar to Linefeed. Line Retract always finishes with a jump to CURSOR in the Driver.

### Backspace

Backspace, like the preceding two subroutines, can be executed by a CTRL/F while the Cursor write mode is either on or off. Backspace writes cursors on the screen when the Cursor write mode is on by the



same method as Linefeed (ie: loading register C with A0H before moving C to M). The values of H and L are then incremented and a check is made to see if the new value is valid. If so, program operation jumps to the CURSOR section of the Driver. If not, the cursor has obviously been bumped off the upper lefthand corner of the screen. The backspace subroutine loads H and L with hexadecimal CFFF (the address for the lower righthand corner position), and then jumps to CURSOR. Thus, backspace wraps around from upper left to lower right.

### Forward Space

Forward Space does the same as Backspace, but in the opposite direction. Cursors can be written using Forward Space if the Cursor write mode is on, as in the preceding three subroutines. In forward space, the cursor wraps around from the lower righthand corner to the upper lefthand corner. Forward space ends with a jump back to CURSOR.

The preceding four subroutines are all used either to move the leading cursor to the desired location of the next character, or to draw cursor lines up, down, back or forward. It should be noted that if the Cursor write mode is *off*, these subroutines move a transparent cursor over the screen. Whenever the cursor is moved in this mode, the contents of C (original value of that position) first replace the leading cursor, and the cursor is moved to the next location. In every case, the content of the new leading cursor location is stored in C before the cursor is displayed. Hence, all four of the preceding routines move "transparent" leading cursors around on the screen and do not destroy any screen information. In the Cursor write mode, any of the four routines will write cursors on the screen.

### Carriage Return and Linefeed

Basic to understanding the operation of CRLF is the knowledge of the contents of the H and L register pair for various key screen positions (see figure 1).

Since there are hexadecimal 40 (decimal 64) characters per line on the screen, four lines of characters can be addressed solely by the L register (an 8 bit register can store up to 100 hexadecimal or 256 decimal combinations). Thus, the H register changes only once every four lines. The starting addresses of all 16 lines may be seen in figure 1.

The CRLF subroutine includes a Linefeed so that, when executed, the leading cursor moves to the start of the next line.

To perform this, the subroutine checks the current address contained in H and L

and compares it with all line starting addresses to determine which line it is on. Having determined this, it sets H and L to the starting address of the next line and then jumps back to the CURSOR section of the Driver.

As in most subroutines, CRLF moves the contents of C to the correct screen position, restores the screen to its pre-"leading cursor" condition, and then loads the accumulator (A) with the contents of register L. Following this, it compares A with hexadecimal 40 by means of a CPI instruction, which subtracts hexadecimal 40 from A and sets the flags, but doesn't alter the contents of A.

If L is greater than or equal to hexadecimal 40, the program jumps to a location where another check is performed to compare L with hexadecimal 80.

If L is greater than or equal to hexadecimal 80, it is similarly compared to hexadecimal C0.

If L is less than hexadecimal 40 in the first check, however, the program loads L with hexadecimal 40 and jumps to OUT. Here, this new value of H and L is checked to determine if it is a valid screen address. If so, operation jumps back to CURSOR. If it is not a valid screen address, the program jumps to HOME, initializing H and L to hexadecimal CC00. Similarly if L is found to be less than hexadecimal 80 or hexadecimal C0, it is loaded with hexadecimal 80 or hexadecimal C0 respectively, and operation jumps to OUT as outlined above.

If L is found to be greater than or equal to hexadecimal C0, H is incremented, L is loaded with hexadecimal 00, and operation passes to OUT. To summarize:

If hexadecimal 0 ≤ L < 40,	L gets loaded with hexadecimal 40
If hexadecimal 40 ≤ L < 80	L gets loaded with hexadecimal 80
If hexadecimal 80 ≤ L < C0	L gets loaded with hexadecimal C0
If hexadecimal C0 ≤ L	H gets incremented and L gets loaded with hexadecimal 00

#### Examples:

Initial Values			Hexadecimal Values After Carriage Return	
H	L		H	L
CC	20	→	CC	40
CC	42	→	CC	80
CC	90	→	CC	C0
CC	D1	→	CD	00
CF	D1	→	CC	00

### Delete

When the Delete subroutine is entered, it moves a blank to the present cursor position and jumps to a section of the Backspace subroutine. This has the effect of deleting the character located at the present leading cursor position and moving the cursor back one space for a subsequent delete, if desired. ■

*This completes the first part of the presentation of the GRAPH package. Several of the functions listed in table 1 and found in figure 3 will be described in detail in part 2's continuation of the documentation. Also found in part 2 is the listing of the GRAPH package, listing 1.*

# The LATEST in Tape Systems



**MODEL CC-8**  
**\$185.00 (4800 Baud)**  
**\$195.00 (9600 Baud and 220V/50 Hz)**

## 9600 BAUD CASSETTE RECORDER

An ASYNCHRONOUS NRZ type Recorder with remote motor start/stop. Error rate  $10^8$  at 4800 BAUD. Can be used from 110 to 9600 BAUD into a UART — no clocking required. This is not an audio recorder. It takes RS232 or TTL signals from the terminal or computer and gives back the same signals. No audio interface is used. Motor start/stop is manual or through TTL or RS232 signals.

Tape speeds are 1.6" / 3.0" and 6.0" per second. 110 volt, 60 Hz, 5 watts. (220 Volts on special order). Can use high quality audio cassettes (Philips Type) or certified data cassettes. Can be used in remote locations from a 12 Volt battery.

Recommended for DATA LOGGING, WORD PROCESSING, COMPUTER PROGRAM RELOADING and DATA STORAGE. Manual control except for motor start/stop. 6800, 8080 or Z80 software for file or record searching available on request with order. Used by major computer manufacturers, Bell Telephone and U.S. Government for program reloading and field servicing.

AVAILABILITY — Off the shelf.

PROVIDES MONITOR AND TAPE SOFTWARE in ROM. TERMINAL and TAPE PORTS on SAME BOARD. CONTROLS ONE or TWO TAPE UNITS (CC-8 or 3M3B).

This is a complete 8080, 8085, or Z80 system controller. It provides the terminal I/O (RS232, 20 mA or TTL) and the data cartridge I/O, plus the motor controlling parallel I/O latches. Two kilobytes of on board ROM provide turn on and go control of your Altair or IMSAI. NO MORE BOOTSTRAPPING. Loads and Dumps memory in hex on the terminal, formats tape cartridge files, has word processing and paper tape routines. Best of all, it has the search routines to locate files and records by means of six, five, and four letter strings. Just type in the file name and the recorder and software do the rest. Can be used in the BiSync (IBM), BiPhase (Phase encoded) or NRZ modes with suitable recorders, interfaces and software.

This is Revision 8 of this controller. This version features 2708 type EPROM's so that you can write your own software or relocate it as desired. One 2708 preprogrammed is supplied with the board. A socket is available for the second ROM allowing up to a full 2K of monitor programs.

Fits all S100 bus computers using 8080 or Z80 MPU's. Requires 2 MHz clock from bus. Cannot be used with audio cassettes without an interface. Cassette or cartridge inputs are TTL or RS232 level.

AVAILABILITY — Off the shelf.

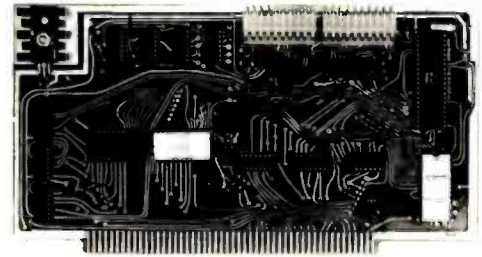

**2SIO (R) CONTROLLER**  
**\$190.00 (\$160.00, Kit)**

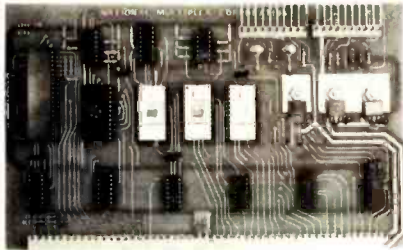

**6800 CONTROLLER for SWTP**  
**\$190.00, Tested & Assmb. (\$160.00, Kit)**

PROVIDES MONITOR AND TAPE SOFTWARE in EPROM. EXPANDS MIKBUG with 1K of ADDITIONAL ROM PROGRAM

This is a complete tape controller for the SWTP 6800 system. Has 3K of EPROM space for your own programs. A 1 K ROM (2708) is provided with all tape and monitor functions. The ROM program is identical to our extensive 8080 ROM program.

Has one ACIA for one or two tape drives, one UART for an additional Serial port and a 4 bit parallel port for motor control. Will control one or two CC-8 or 3M3B drives with the software provided. Can be used with other tape drives controllable with 4 TTL bits if appropriate software changes are made.

Extra serial port is provided for your use with a second terminal or printer (RS232, TTL or 20 ma).

The ROM program supplements the Mikbug program and is entered automatically on reset. SWTPbug compatible ROM is also available.

AVAILABILITY — Off the shelf.

## Z 80 BOARD for SWTP COMPUTER

Now you can use the 8080/Z80 software programs in your SWTP 6800 machine. Replaces your MPU board with a Z80 and ROM so that you are up and running with your present SWTP memory and MPS card. 1 K ROM on board replaces MIKBUG.

AVAILABILITY — Off the shelf.



**\$190.00, Tested & Assmb. (\$160.00, Kit)**

For U.P.S. delivery, add \$3.00. Overseas and air shipments charges collect, N.J. Residents add 5% Sales Tax. WRITE or CALL for further information. Phone Orders on Master Charge and BankAmericard accepted.

## National Multiplex Corporation

3474 Rand Avenue, South Plainfield NJ 07080 Box 288 Phone (201) 561-3600 TWX 710-997-9530

# A Programmable Character Generator

## Part 1: Hardware

Larry Weinstein  
Objective Design Inc  
POB 20325  
Tallahassee FL 32304

The truly critical interface in any computer system is the one that joins man and machine. One example of this is the interface between the video display and the human eye, an area where the computer outputs information at a very high rate. One way to improve this interface is to provide for maximum flexibility in the choice of characters displayed. This article presents circuitry for adding software controlled character graphic definitions to existing video display devices.

For many applications, the ability to create the characters that appear on the terminal screen is a tremendous convenience, if not an absolute necessity. The use of computers for advanced mathematical applications often requires special symbols such as Greek letters, subscripts, superscripts and variable sized fonts. APL is a good example of an advanced programming language that uses many special symbols. Computing programs that transform the general purpose computer into the equivalent of a hand held calculator suffer from the lack of a specialized keyset and the corresponding display format. Financial and scientific applications call for their own special symbols. In fact, there are very few computer applications that wouldn't benefit from easy access to a specialized character set.

### Theory

The typical video display device works with a raster scan video display and produces screen characters a full line at a time. Each character is constructed on a matrix of screen dots, usually in a 7 column by 9 row configuration. The pattern for each character is

stored a row at a time in a character generator, a read only memory device dedicated to this application. Before scanning past any row of a character, the character generator is accessed using the row number and character type as an address. The character type is usually the familiar ASCII code. Data produced by the character generator is shifted out serially to create the visible dots and spaces of one row of a character.

There is nothing unique about the character generator: it is merely a memory. In fact, it is becoming common for manufacturers to use large programmable read only memories in place of character generators in order to provide a programming service to customers. The size requirements of the character generator are easy to calculate. For most display purposes there is a maximum of 16 8 bit rows that could be useful for each character. There are 128 characters in the full ASCII set. The result is a memory which has eleven address bits (four for rows and seven for characters) and is eight bits wide. 2 K bytes of memory will hold all of the information in any character generator. In theory, then, it is possible to substitute 2 K bytes of vola-

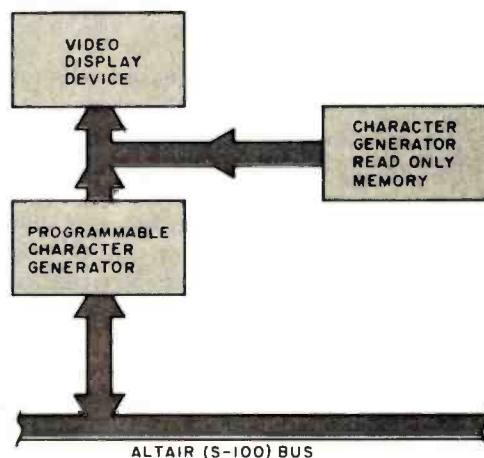

Figure 1: Block diagram of the author's graphics system, which allows the video display user to switch from conventional graphics symbols (generated by the character generator read only memory) to those generated by a programmable character generator. Special symbols such as APL characters and custom graphics symbols can be stored in this circuit and retrieved or changed at any time.

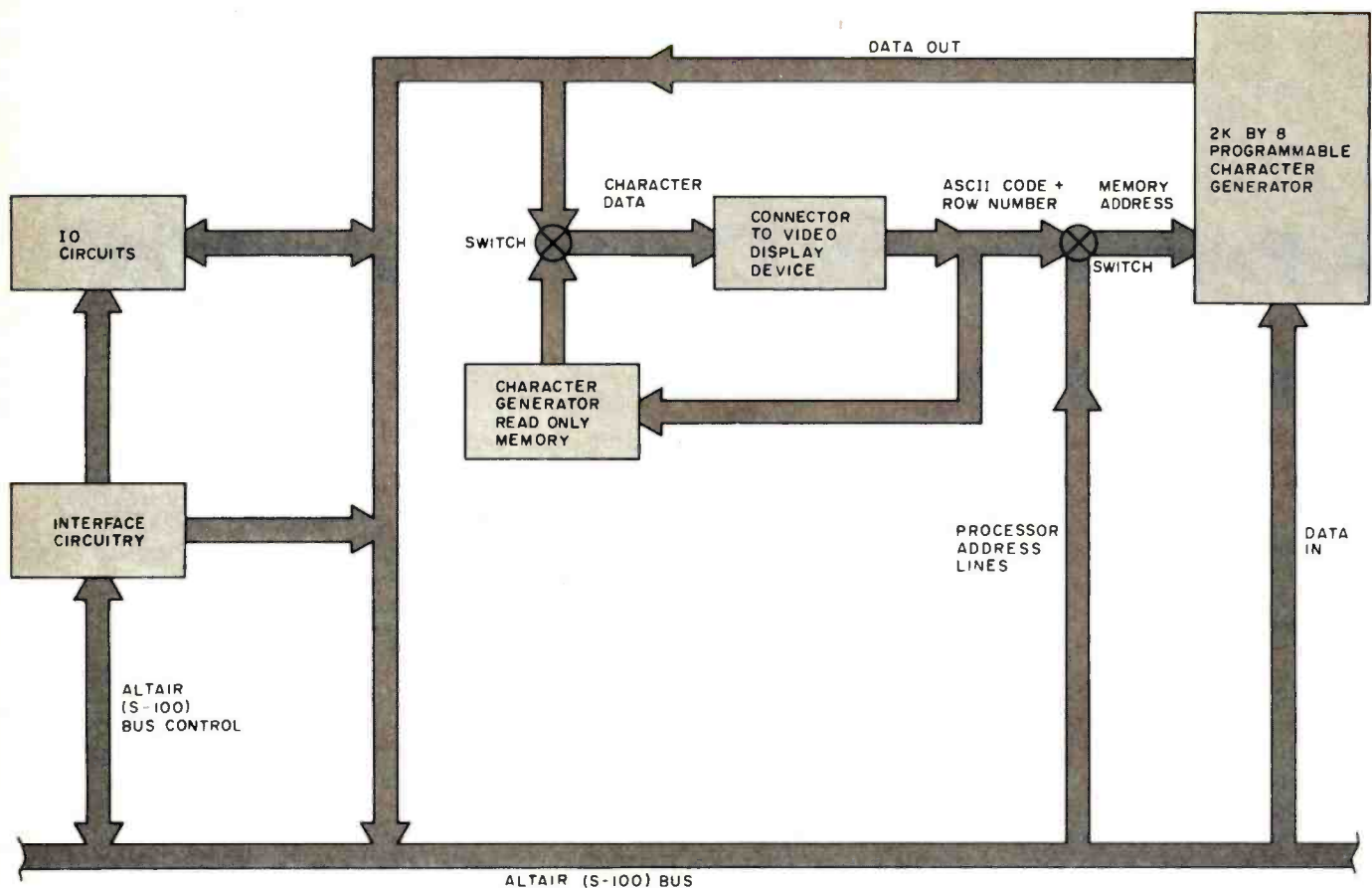

Figure 2: Detailed block diagram of the programmable character generator circuit. The circuit consists of 2 K bytes of programmable memory containing custom characters. This memory is addressed by the character and row lines that normally go to the existing character generator on the video display board. These lines are multiplexed with the normal processor address bus lines. Hardware and software switches determine whether data from the existing character generator or data from the programmable character generator will be used to feed the video display.

tile programmable memory for the character generator. This substitution of ordinary programmable memory for the character generator read only memory is the key to character graphic flexibility.

#### Practice

The requirements of the replacement programmable memory are that it be accessible by the main processor via its bus, and by the dot generating circuitry of the video display device (see figure 1). Retention of access to the character generator from the video display device is also desirable so that the terminal will be useable at system startup or after a software glitch wipes out a set of character definitions.

It is not difficult to gain access to address and data lines in the system: one need only construct an Altair (S-100) card interfaced to the bus. The only tricky part is obtaining

access to the same lines on the video display device. This is done by substituting a 24 pin connector from the memory board for the character generator on the video display device board. The character generator is then installed in a socket on the new memory board. Through hardware and software switches, the user is able to choose between the character generator's character set and a flexible set residing in programmable memory.

#### Circuit Explanation

The circuit consists of 2 K bytes of programmable memory addressed by the character and row lines that normally go to the character generator (see figure 2). These lines are multiplexed with the normal processor address bus lines. The data out memory lines are available to the processor bus and are multiplexed with the character generator data lines. This data set is sent via the 24 pin connector to the video board.

During normal operation, both the memory and the character generator are addressed by row and character selection lines. Hardware and software switches determine which data set is sent to the video board for display. If the processor should require access to the memory for read or write, the processor address lines are switched in to the memory.

# SCREENSPLITTER

A COMPLETE TV TEXT DISPLAY SYSTEM

from

Micro Diversions, Inc.

40 LINES

86 CHARACTERS/LINE

ONBOARD WINDOW SOFTWARE  
FOR CONTROLLING UP TO 3440  
LOGICALLY INDEPENDENT WINDOWS

## GENERAL

SCREENSPLITTER is a self-contained hardware/software TV text display system for your microcomputer. It comes on a single, high-quality S-100 buss compatible board, complete with its unique Window Package software module. With the Window Package, you can logically segment SCREENSPLITTER's huge 40 x 86 display of upper-lower case characters into up to 3440 independent "windows" of various sizes. (You get the idea from our ad!) Each window has its own optional frame, cursor, figure-ground, and optional label, and each window scrolls and automatically formats its text independently of all the others. QUICK! There's some interesting information flashing by in WINDOW 1. Go read it!

## WINDOW 1

Whoops! Our output routine seems to be having problems. Oh well, at least you get to see some of SCREENSPLITTER'S scientific symbols. (You can order a graphics character set optionally.)

▲▲▲▲▲  
time

And any character may be user-defined as a winking character. How? You ask. Simple: SCREENSPLITTER uses a 2708 reprogrammable memory as its character generator. Turn on the character's "wink" bit in the 2708, and presto!

Oh, and naturally, each of the 3440 characters on the screen may have its figure-ground reversed independently.

Frills, you say? No, thrills! Just take a look in the window up there to see how SCREENSPLITTER puts these raw materials to work in the onboard 1K Window Package (that back there is the cursor character).

## PARTIAL FUNCTION SUMMARY

INIT()  
OPEN(W,X,DY,Y,DY)  
CLEAR(W)  
FRAME(W,C1,C2,C3)  
UNFRAME(W)  
REFRAME(W,C1,C2,C3)  
LABEL(W,STR,LEN)  
LABELS(W,STR)  
FLASH(W)  
COMPLEMENT(W)  
SCROLL(W,N)  
CURSORCHAR(W,C)  
PRINT(W,STR,LEN)  
PRINTS(W,STR)  
BACKSPACE(W)  
CLEARLINE(W)  
FRESHLINE(W)  
PLOT(W,X,Y,C)  
MOVEWINDOW(W,X,Y,C)

## POINTS OF INTEREST

- Entire hardware/software system on a single, high-quality S-100 buss compatible board.
- Drives a 10mhz or better TV monitor via standard 75 ohm coaxial cable (supplied).
- 4K static RAM - 2114's - display buffer is memory-mapped into your CPU's address space for fast, convenient access if you ever need to bypass the Window Package software.
- User-selectable wait state for operation with 4mhz CPU's.
- 1K onboard 2708 is jumper changeable to a 2K 2716 for user extensions to the Window Package.
- Board presents one TTL load to host, yet drives up to 20 TTL loads via 74367 buffers.
- Provisions for jumpering TV data, sync, blanking off board for external mixing (via 16 pin socket).

## WHAT YOU GET

- Complete SCREENSPLITTER Kit, with all IC's, low profile sockets, preprogrammed Window Package EPROM, assembly instructions
- Comprehensive Theory of Operation Manual
- Complete source-code listing, and User's Manual for the Window Package
- 90 day warranty on parts and labor

## ORDERING INFORMATION

1. Tell us for which 8K boundary you would like your Window Package assembled.
2. Tell us whether you want the scientific symbols, or the graphics characters in ASCII codes 0-31 of your character generator, or the optional APL character generator.
3. Send us a personal check, Master Charge or BAC/VISA number and expiration date. Kit price is \$329. Assembled, \$429. (Virginia residents please add sales tax.)
4. We will send you the SCREENSPLITTER, postpaid in the continental U.S., from stock to 40 days.

The Window Package's auto-formatter does n't care how skinny your windows are (it'll hack your text down to one column if you can stand it!)

## THE CARE AND FEEDING OF WINDOWS

OK. You have just powered on. Initialize the Window Package and turn on your first window:

```
INIT()
OPEN(1,10,15,20,30)
```

Now, just to flex your bits, give the user a wake-up flash (a brief figure-ground reversal inside the window):

```
FLASH(1)
```

Now that you have his attention, go ahead and frame the window (you don't have to, of course):

```
FRAME(1)
```

and, while you're at it, label it, and set the scroll line count:

```
LABEL(1,"General I/O")
SCROLL(1,5) (i.e., when the window fills up, pop it up 5 blank lines)
```

Just to keep him interested, switch the cursor character from the default caret to the winking caret:

```
CURSORCHAR(1,▲)
```

Now that he's all excited, eyes bulging from the initial flash, transfixed by the hypnotic winking cursor, hit him with some text through window 1:

```
PRINT(1,"I hate to tell you this, William, but last night the kids wired that chair you're sitting in with 110 volts AC.")
```

Now (this'll really kill him), open a second window to the right:

```
OPEN(2,10,50,5,20)
FRAME(2)
LABEL(2,"Will's Will")
```

and print out a second message through this new window:

```
PRINT(2,"Please type your last will and testament.")
```

Now, of course, you echo his input through window 2, relying on the default scrolling of 1-line "pop-up" when the window fills up.

And on, and on...

## SOME APPLICATIONS

1. You have a BASIC program. Open a number of windows, giving each important subroutine in the program its own window. When your program runs, you get a two-dimensional feel of the flow of the execution - flurries of activity here, brief flashes there. You can have the feeling of being able to converse with each subroutine individually!
2. You have a page-oriented text editor. Pick up a paragraph here, a paragraph there, isolating each in its own window while you rummage through the main text in its own large window. Using the MOVEWINDOW function, you can move blocks of text around to produce a final layout.
3. You have an assembly language debugger. Allocate one window to the real-time clock, another to the run-time clock, and several more to display various registers in your 8080 or Z80. Then, you can keep the debugging information separate from your program's I/O, with the debugging information continually present.
4. You have some fancy games. Give each player his own window and define some "community windows." Let your imagination take over!

PS: Watch for our full graphics board, also with its own onboard software... Coming soon!

## Micro Diversions, Inc.

7900 Westpark Drive, Suite 308

Mc Lean, Virginia 22101

(703) 827-0888

DEALER INQUIRIES INVITED;  
EVALUATION KITS AVAILABLE

---TIME---  
06:01:48

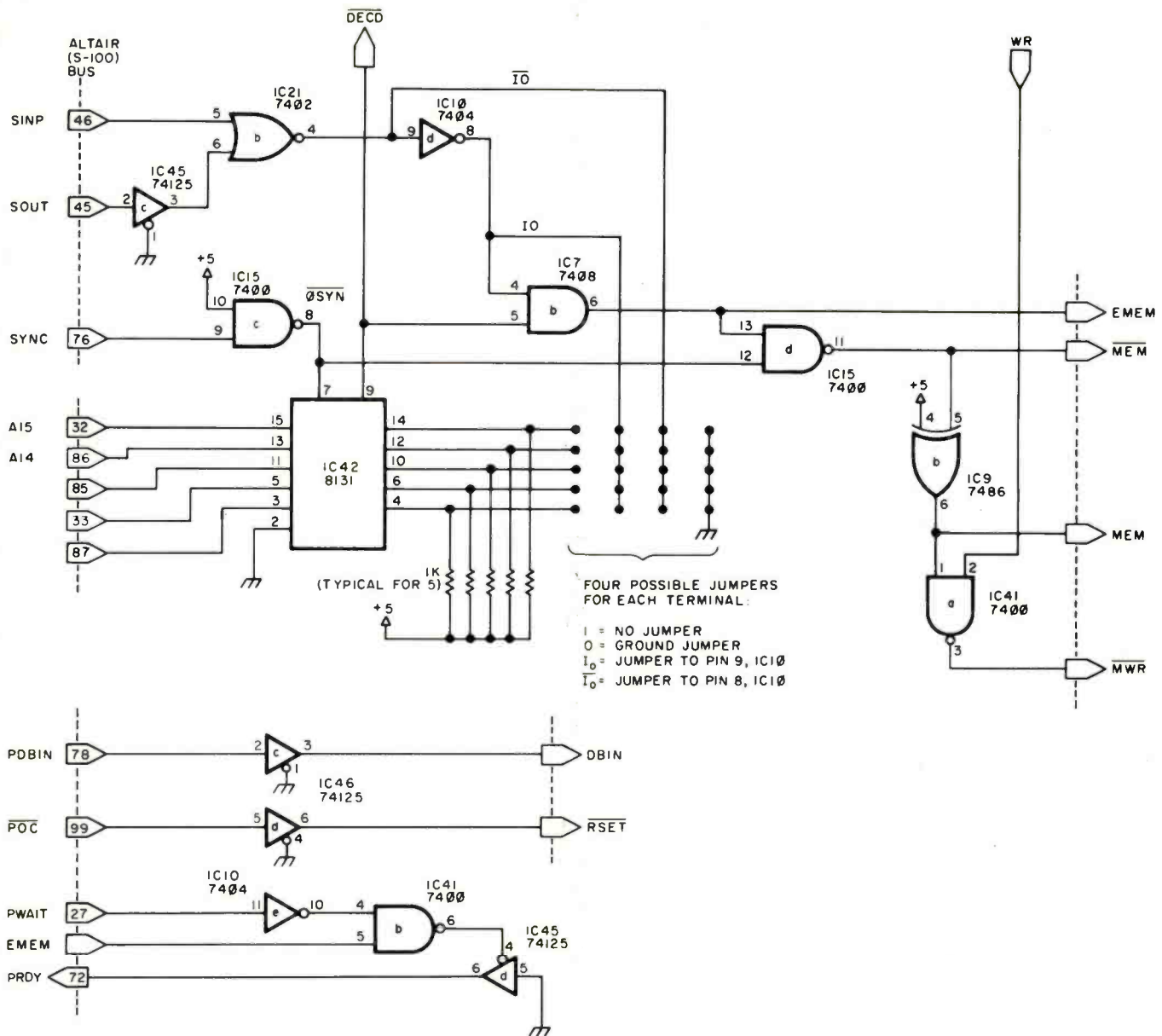

Figure 3: Programmable character generator bus interface circuitry. An 8131 (IC42) seeks for a match to the high five address lines to indicate a programmable character generator memory or peripheral action. The single 8131 can match different addresses by offering the compare circuit a choice of +, IO,  $\bar{I}O$  or ground. Where the address line match for memory and peripherals is the same (either 1 or 0), a + or ground connection is used. Where they are different, the IO line is chosen if IO is 1 and memory is 0; the  $\bar{I}O$  line is used if memory is 1 and IO is 0. The 8131 latch is opened during SYNC. By the time SYNC ends and the latch is closed, the match condition is determined.  $\overline{DECD}$  is low on a match. If both INP and OUT are low (indicating that this is not an IO operation), the MEM signal will go high. This will cause the READY line to be pulled high, forcing a wait cycle from the processor. With the PWAIT signal, READY is brought down. All memory operations (and only memory) will have a single wait state. The MEM line is combined with DBIN and WR to produce "memory read" and "memory write" actions. There are four data select modes available on the programmable character generator: fixed, programmable, command, and automatic. In the fixed mode, the data select lines for the multiplexers are set high for normal characters and low for programmed characters. In programmed mode, the high order bit from the video display device, usually used internally for reverse video, is brought out via pin 14 on the connector to control the data select process. In command mode, the output of a flip flop determines the selection process. The flip flop can be switched by output commands. OSL-1 brings programmed characters; OSL-2 switches to normal characters. In automatic mode, the multiplexers switch to the character generator for all of the upper case set (hexadecimal 20 thru 5F), and to the programmable memory for the control characters (hexadecimal 00 thru 1F), and the lower case characters (hexadecimal 60 thru 7F).

If one is attempting to read a programmed character byte during a processor memory access, the system causes the data switch to blank the output to the 24 pin connector.

The circuit has several modes of operation. It can be hardwired via an on board switch to use only the character generator (normal mode) or only the memory (graphics mode). It can be set up to flip back and forth from graphics to normal mode by software commands. In another mode, the state of bit 7 of the character select lines will determine the mode. The final operation mode selects the 64 upper case ASCII characters (letters, numbers, and symbols: hexadecimal 20 through 5F) to come from the read only memory and all others (control and lower case: hexadecimal 00 to 1F and 60 to 7F) to be taken from the programmable memory. An 8212 on the board provides 8 bit parallel input port for interfacing a keyboard. In addition, four monostable circuits (555s) provide a simple interface for two joysticks in two dimensions. Following an output command, all the monostables fire. The length of each pulse is determined by the associated external potentiometer. A software loop is required to monitor these and produce a value for the joystick position. The remainder of the circuitry is concerned with address decoding for the processor bus. All components are standard and may be obtained from many distributors and wholesalers.

### Compatibility

The programmable character generator as presented is intended to work with video display devices using the Motorola family (MCM 6574-6) of 7 by 9 matrix character generators. With a few minor changes in the connector, the circuit can be applied to display devices with other types of character generators: such as the 2513, which works with a 5 by 7 matrix. The cable may be extended as needed to connect with normal terminals. However, the best results are achieved with memory mapped video display devices such as the Processor Technology VDM-1, the Solid State Music Video Board, and the PolyMorphic Systems Video Terminal Interface. Obviously, the circuit presented can be adapted to processor interfaces other than the Altair (S-100) bus. (My personally designed and produced circuit board, available from Objective Design Inc, is Altair (S-100) compatible and designed for the Motorola series character generator.) All the aforementioned combinations of video display device and programmable character generator will produce programmable characters on the screen. In addition, certain

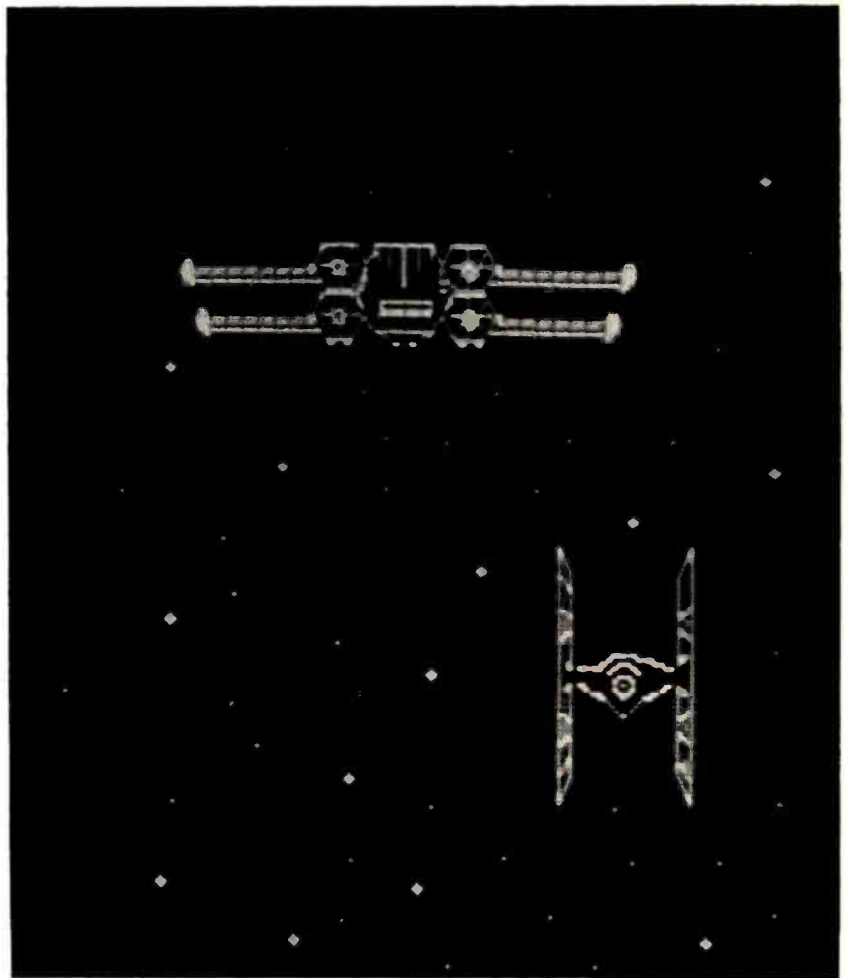

Photo 1: A Star Wars scenario created with the aid of the author's programmable character generator and a Processor Technology VDM-1 video display board.

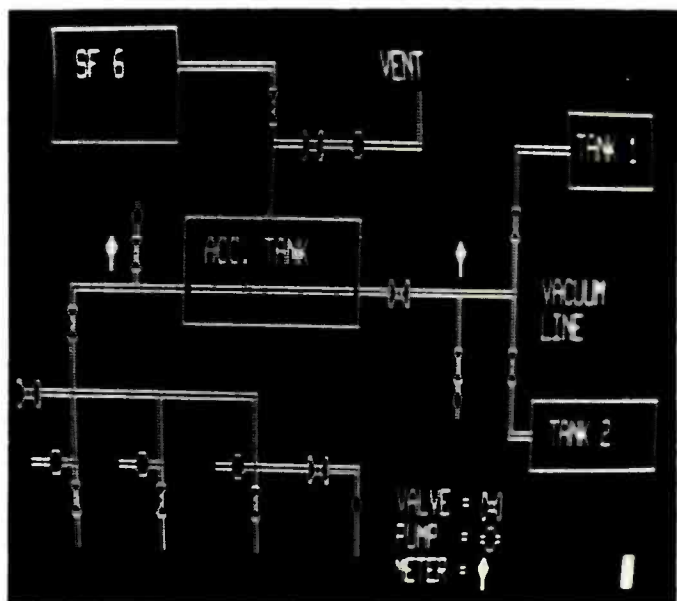

Photo 2: A piping diagram, an example of what can be done with the programmable character generator.

Table 1: Power wiring table for figures 3 thru 7.

Number	Type	+5 V	GND	+8 V	-12 V
IC1	74157	16	8		
IC2	74157	16	8		
IC3	74157	16	8		
IC4	74157	16	8		
IC5	74157	16	8		
IC6	MCM6574-6	2	13		1
IC7	7408	14	7		
IC8	7474	14	7		
IC9	7486	14	7		
IC10	7404	14	7		
IC11	8212	24	12		
IC12	74125	14	7		
IC13	74125	14	7		
IC14	74125	14	7		
IC15	7400	14	7		
IC16	7407	14	7		
IC17	555	8	1		
IC18	555	8	1		
IC19	555	8	1		
IC20	555	8	1		
IC21	7402	14	7		
IC22	74138	16	8		
IC23	74125	14	7		
IC24	74125	14	7		
IC25	21L02	10	9		
IC26	21L02	10	9		
IC27	21L02	10	9		
IC28	21L02	10	9		
IC29	21L02	10	9		
IC30	21L02	10	9		
IC31	21L02	10	9		
IC32	21L02	10	9		
IC33	21L02	10	9		
IC34	21L02	10	9		
IC35	21L02	10	9		
IC36	21L02	10	9		
IC37	21L02	10	9		
IC38	21L02	10	9		
IC39	21L02	10	9		
IC40	21L02	10	9		
IC41	7400	14	7		
IC42	8131	16	8		
IC43	7805		2	1	
IC44	7805		2	1	
IC45	74125	14	7		
IC46	74125	14	7		

applications will produce high resolution graphics for special purposes (ie: bar graphs). However, for true graphics capability (such as space ships guiding smoothly across the screen) there are some special requirements on the video display devices to be utilized.

### Graphics

True graphics ability can only be added to the memory mapped video display devices which have, or can be altered to have, a matrix field no greater than 8 wide by 16 high with no forced conditions (ie: no rows or columns hardwired high or low). Unless these conditions are met, the screen will contain blank spaces which will detract from the overall appearance of any images.

None of the three video display devices previously mentioned will satisfy these conditions without some alterations. Other video display devices will not satisfy these conditions without truly major modifications.

### Processor Technology VDM-1

The VDM-1 places its characters in a 13 by 8 matrix. The eighth bit in each row is forced blank by tying the high order bit of the 8 bit shift register low. (The shift register in question is used to serialize the character data.) This can be modified by removing the ground from this pin and connecting it to pin 10 on the character generator socket, which is not normally used. From the programmable character generator schematic, it is clear that the shift register will receive bit 8 from the programmable memory when it is selected. When the character generator is selected, the line is low.

The programmable character generator makes provisions for using a bit from the video display device ASCII character memory to switch between normal and graphics modes. This bit is used in the Processor Technology VDM-1 for reverse video. It is most useful when left where it is unless there is a special need for switching character sets on a character by character basis. In this case, transfer the bit to pin 14 on the character generator socket.

The VDM-1 uses 13 rows in each character. The row address sequence for each character begins with 15, 0, 1... and proceeds through ...10, 11. On 12, the counter is reset. This leaves the user with the choice of some unusual programming of the programmable memory character generator or removing the misplaced row 15. The latter can be accomplished by forcing the scan divider (IC2) in the VDM-1 to load 0 instead of 15 when given a load pulse. This will eliminate one of the blank scan lines between the character lines, which is not a serious problem in itself.



Figure 4: Programmable character generator memory circuitry. The memory consists of 16 21L02 programmable memories arranged as two 1 K by 8 banks. The memory is accessed via ten address lines (1 K bytes) and an eleventh line which activates the Chip Enable of one bank or the other. Data input is taken from the Altair (S-100) bus, buffered by three state drivers which are always on. Data output is made available to the bus via three state drivers, gated by MEM and DBIN. A memory protect flip flop provides a gating signal for memory write actions. A jumper determines whether the flip flop comes up in protect (jumper to ground) or unprotect mode with power up. The flip flop can be switched by input commands to the programmable character generator. (Data received on these commands will be hexadecimal FF.) The flip flop is not affected by the "protect" and "unprotect" bus lines. The address lines to the memory are selected by 74LS157 multiplexers from the bus address lines (0 thru 10) or the character type and row information which comes from the video display device. The multiplexers switch with the MEM signal.

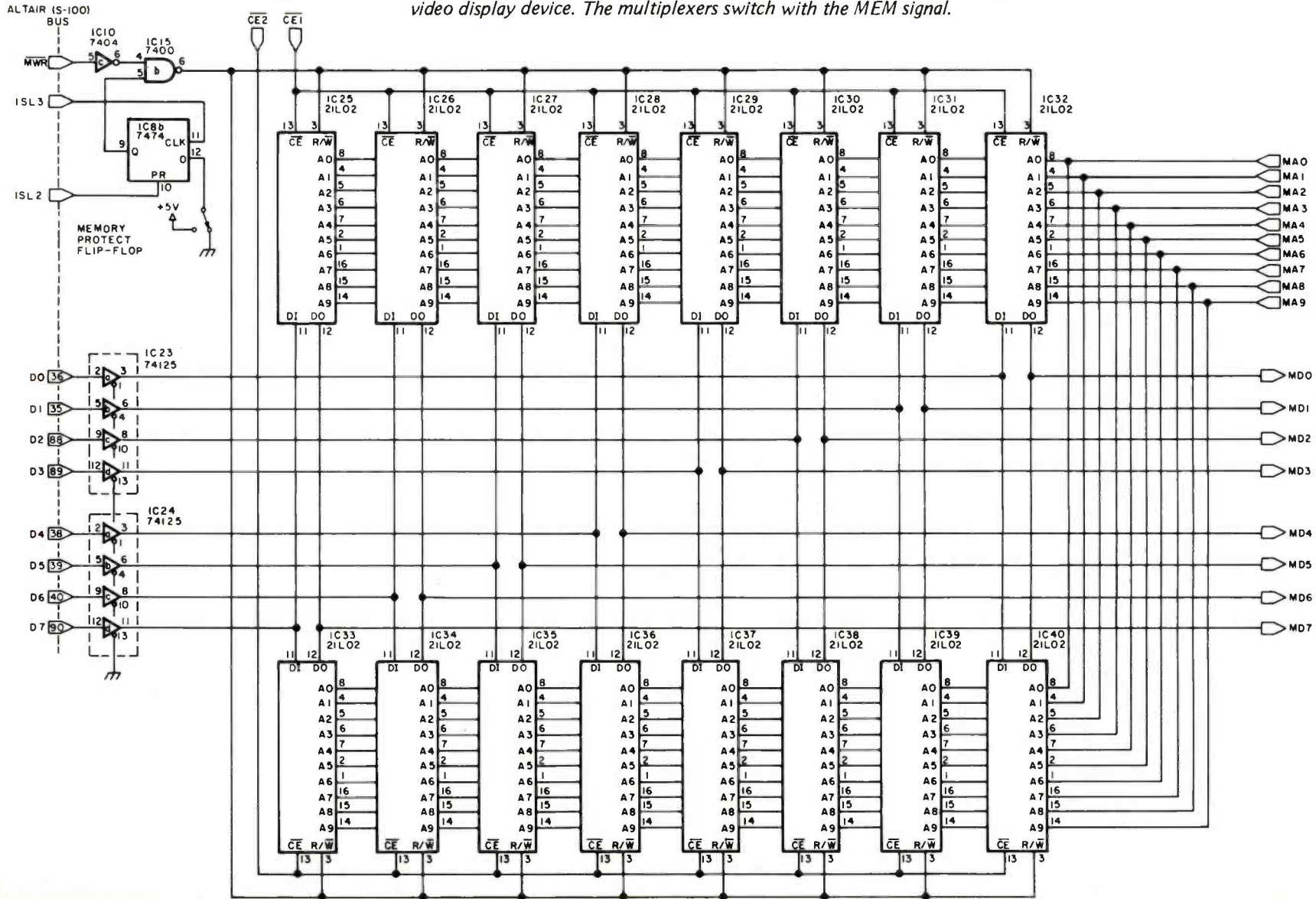

Switch Settings		
Mode	Switches Closed (On)	Switches Open (Off)
Fixed Normal	1,8	2,3,4,5,6,7
Fixed Special	3,8	1,2,4,5,6,7
Programmable	2,6,8	1,3,4,5,7
Command	2,4,8	1,3,5,6,7
Automatic	2,5,7	1,3,4,6,8

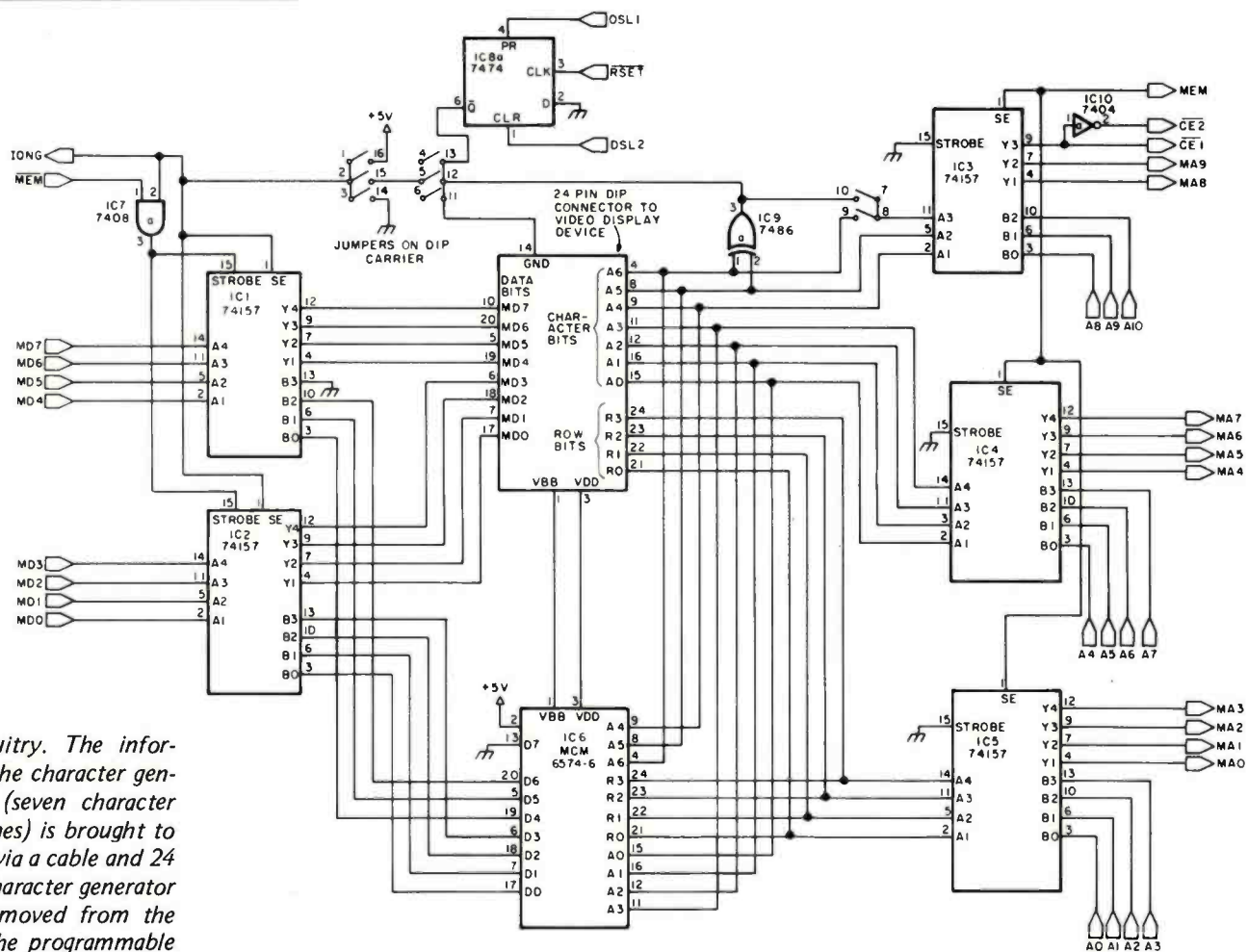
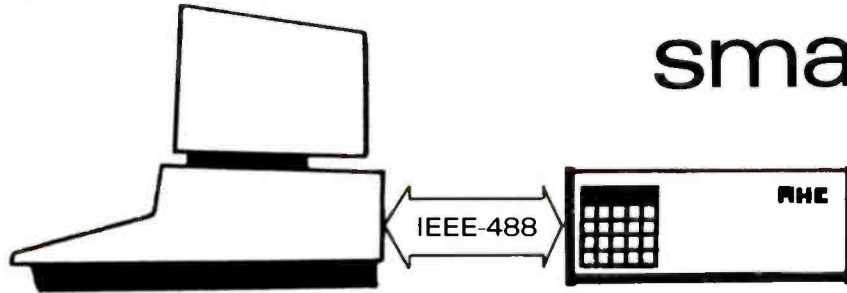

Figure 5: Character generation circuitry. The information which would normally go to the character generator on the video display device (seven character select lines and four character row lines) is brought to the programmable character generator via a cable and 24 pin connector which is placed in the character generator socket. The character generator is removed from the video display device and placed on the programmable character generator board. The 11 lines are sent to the programmable character generator memory by the address multiplexers. These lines are also presented to the character generator just as they are in a video display device. The output data from the memory and the character generator are both input to a multiplexer, the output of which is returned to the video display device via the cable and socket. When the character generator data is selected, the results are the same as they would have been if there were no programmable character generator involved. When the memory supplied data is selected, the video display device will produce characters whose design has been programmed.



# smartware™

distributed  
intelligence  
system

**Power.** Multiply the power of your personal computer with distributed processing. Peripheral and real time control functions can be handled by dedicated processors without tying up your central computer. Ideal for home control applications such as timing, security and energy management.

**Hardware.** Each smartware™ system includes cabinet, power supply, real time clock/calendar with battery backup, 20 key keyboard, 8 digit LED display, smartware™ bus supervisor, and motherboard to accommodate up to 8 smartware™ modules. ROM operating system controls keyboard and display for entering and reading parameters, programs and data on the other modules. \$348.00

**Central processor.** General purpose 6502 processor with 4K RAM, 1K PROM with bus I/O sub-routines, 2K empty PROM sockets. Memory is expandable to 62K bytes. Use for your own dedicated applications or as general purpose number cruncher. \$248.00

**Real time controller.** Dedicated processor with ROM software for analog and digital control of up to 1000 channels with yearly, monthly, weekly, daily, and hourly cycles. Minimum timing interval is 6 seconds. Use with control I/O modules. \$298.00

**AC communication processor.** Provides bi-directional transfer of control and sensor information by imposing a modulated 50khz. carrier on the AC power line. Up to 255 remote I/O's can be addressed by this module. Software provides handshaking and redundancy to assure error free operation. \$248.00

**Remote I/O module.** Build your home monitoring and control system without the hassles of control wiring. Just plug the remote I/O module into an AC outlet nearest the application. Each unit has four 500 watt AC outlets, of which three can be switched on and off by the communication processor. The fourth outlet is an always on convenience outlet. The status of the three switchable outlets can be read from the central processor to verify operation. \$148.00

Analog options: Temperature sensor input, includes sensor. add \$38.00  
Analog output, 0 to 5v. add \$24.00

**IEEE 488 interface.** Control your house while your PET is sleeping. Includes complete instructions and software for using PET computer as a smart terminal. This board allows bi-directional communication between external IEEE 488 devices and internal smartware™ modules. \$148.00

**RS 232 serial interface.** Connect a variety of terminals and modems to your system. Software selectable baud rates of 110, 300, 1200, and 2400. Double buffered for maximum throughput. \$148.00

**Temperature sensor module.** Analog input for 16 IC temperature sensors, 255°F temperature range, 1°F accuracy and 1°F resolution. \$188.00  
IC temperature sensor with 10 ft. cable, each, \$12.00

**Software support.** Includes complete, accurate documentation, full time user applications consultant to answer your questions, continual development of new applications programs, periodic software newsletter to keep you up to date on what we are doing, and custom software and system development services. Our goal is to make this the most powerful, reliable, and usable system you can buy. Call or write if you have any questions.

**Coming soon.** Other smartware™ modules being developed include direct control and analog I/O, software development modules such as PROM programmer and simulator, and controllers for floppy disks and printers. Write for information.

**Quality.** We realize that the comfort and security of your home require a reliable system designed to operate 24 hours a day. Each module is burned in and thoroughly tested and includes built in self diagnostic functions.

**Guarantee.** Your money will be cheerfully refunded if within 90 days you decide you are not satisfied with the performance of your system. One year warranty, parts and labor, for defects in hardware or software.

Prices include shipping.  
Minnesota residents add 4% sales tax.

Delivery expected to begin in 90-120 days.

## automatic hardware co.

771 NE HARDING ST • MINNEAPOLIS, MN 55413 • (612) 378-3715

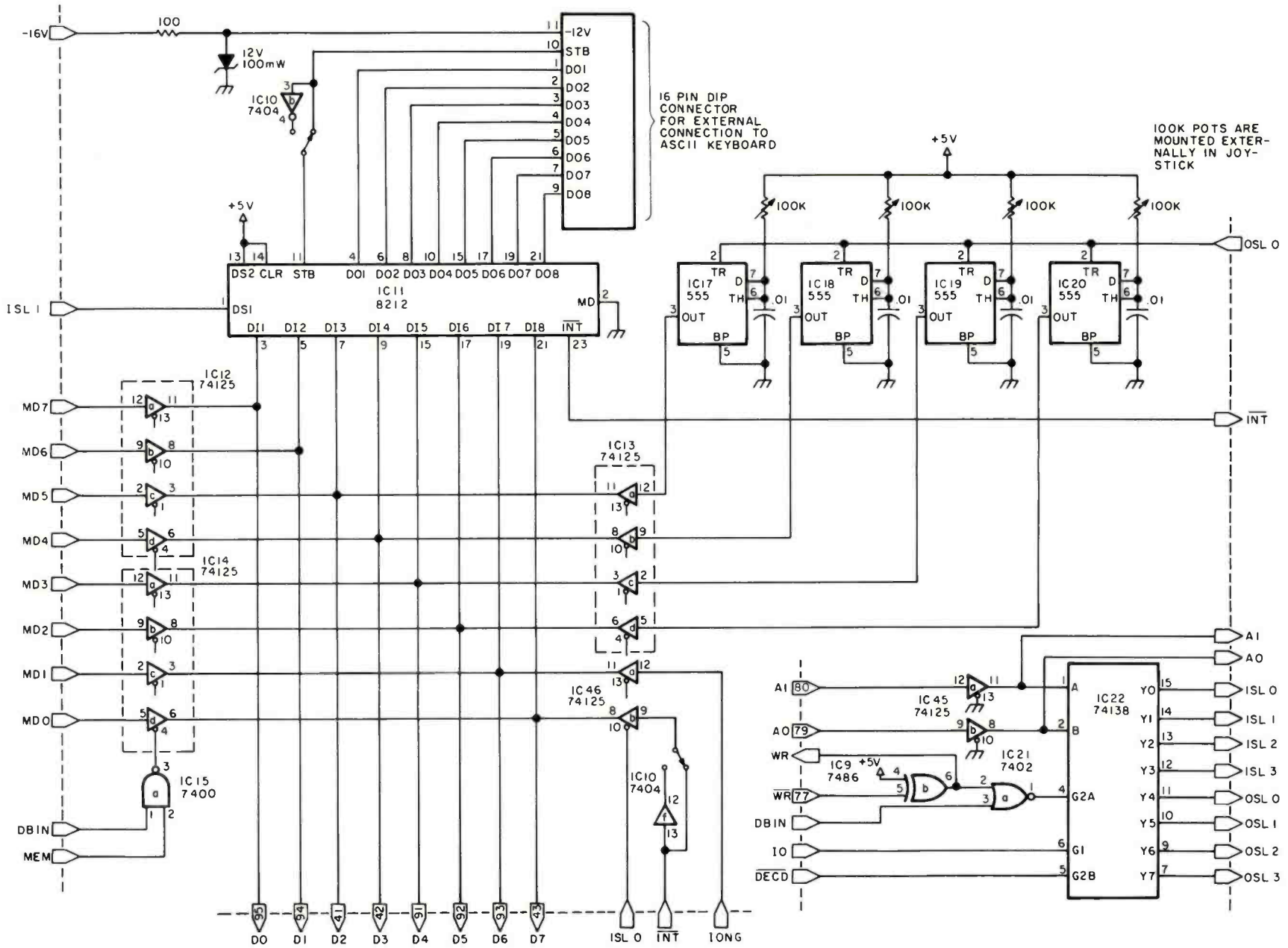

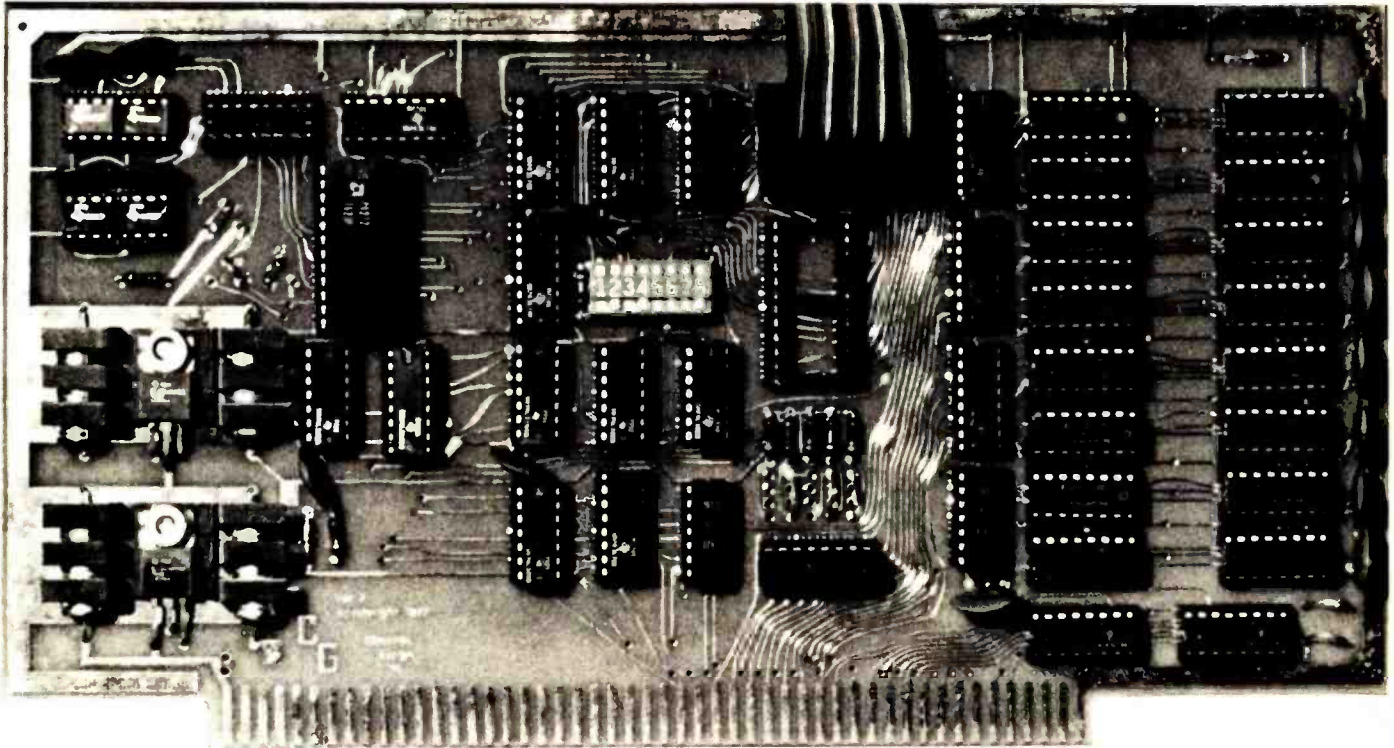

Photo 3: The programmable character generator board.

Figure 6: Programmable character generator IO circuitry. A 74LS138 3 to 8 decoder is gated by DECD, IO, and the OR combination of WR and DBIN to produce eight IO strobes. The OUT signal is used as the most significant address bit, splitting the output into four input and four output signals. An 8212 (made by Intel) is used to implement an 8 bit parallel input port and data available signal. The data available flag can be read with ISL-0 (bit 0) and can be wired ready-high or ready-low. The data is read with ISL-1. Four monostables made with 555s connect to external 100 k ohm potentiometers to provide a simple joystick interface. The monostables are triggered in parallel by OSL-0 and remain high for a time dependent upon the external resistance value. The timing range is from 100  $\mu$ s to 1000  $\mu$ s. Users must time the pulses with software loops or real time clocks while monitoring the outputs via ISL-0, bits 2 thru 5. OSL-1 and OSL-2 will switch the select flip flop, and ISL-2 and ISL-3 will switch the memory protect flip flop. Finally, ISL-0 bit 1 provides a look at the character data select line. This data is valid only for the fixed and programmed modes, since the line is switching in the programmed and automatic modes in a manner not synchronized with processor commands.

Label	Operator	Operand	Commentary
INIT	LXI	B,0	CLR COUNT
	LXI	D,0	CLR COUNT
CHK	OUT	OC1H	TRIGGER
	CALL	DELAY	100 MICROSECONDS
	IN	OC3H	MONO INPUT
	RRC		
	RRC		
	ANI	OFH	TEST MONO FLAGS ONLY
	ORA	A	
	JZ	REPT	ALL DOWN, REPORT
	RRC		TEST FIRST
	JNC	**+1	NC - DOWN
	INR	B	STILL UP, COUNT
	RRC		
JNC	**+1		
INR	C		
RRC			
JNC	**+1		
INR	D		
RRC			
JNC	**+1		
INR	E		
JMP	CHK		CONTINUE COUNTING

Listing 1: Joystick interface test program. A single output command triggers all of the monostables. The user must time each one with software. In this simple program the count for each timer is maintained in a register. On each pass through the loop, the register is incremented if its associated monostable flag is still high. When all four have come down, the loop ends and the values are reported to whatever routine has requested them. The DELAY subroutine called is a 100  $\mu$ s time user. The length of time delay used is determined by the R and C combinations in the hardware and the range of counts for which the software is prepared.

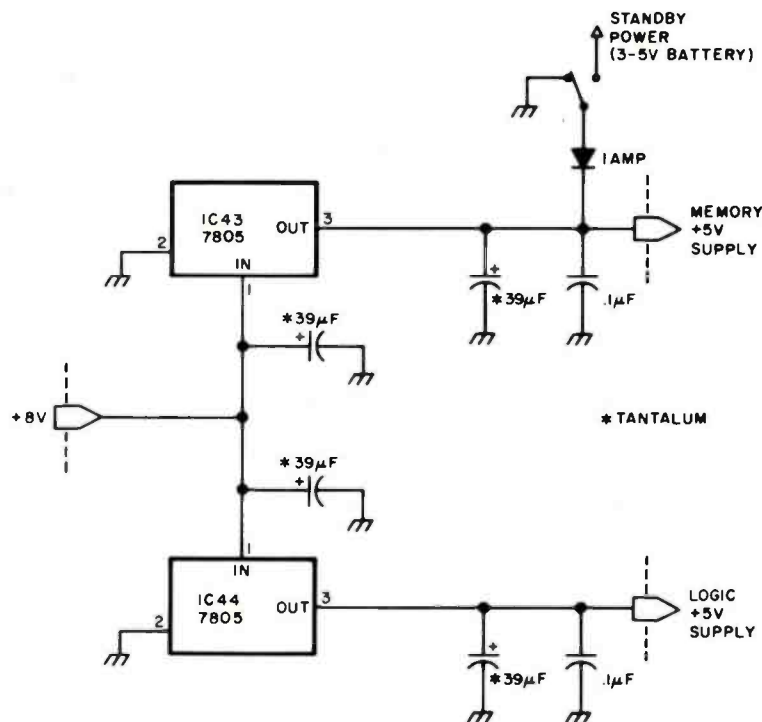

Figure 7: Programmable character generator power circuitry. +5 V for the logic and memory circuitry is provided through separate 7805 or 340-T5 regulators, properly heatsinked. Standby power for the memory is provided via a 1 A diode. A 3 to 5 V battery backup should be connected to the board to use this feature, and suitable supply filtering at the regulators and on the board should be provided. The low current  $-12$  V required by some keyboards is generated by a simple resistor and zener diode combination.

The overall absence of 16 scan lines will force some adjustment of the vertical size and linearity of the monitor.

#### PolyMorphic VTI

The PolyMorphic VTI uses an unusual 15 by 10 matrix. The 15 rows will cause no problems for graphics, but the ten dots per row will cause problems. Seven of the ten dots in the row come from the character generator socket. The other three are forced blank. The problem is further complicated by a 10 bit shift register which shifts out the blank dots first and the VTI "block graphics" circuitry. Obviously, the change to this circuit is not simple. It is recommended that the 74LS157 multiplexers (ICs 35 and 32) be removed and replaced with dual in line package component carriers with jumpers to connect the 8 dot bits from the character generator to the rightmost bits (2 thru 9) of the shift register. To insure that only eight dots are output per character, it will be necessary to change the load number on IC14 from 6 to 8.

Of course, the usual graphics ability of

the VTI is lost in the conversion, but these, plus many more characters, can be duplicated with the programmable character generator. (Note: Modification of the VTI circuit should not be attempted without complete knowledge of the details of the VTI circuit.)

#### Software

Once the programmable character generator and video display device are joined, the software must take over. Details on the use of the programmable character generator along with some sample programming will be described in part 2 of this article. ■

Note: The programmable character generator described in this article is available from Objective Design Inc, POB 20325, Tallahassee FL 32304, in the following configurations:

- Complete Kit . . . . . \$149.95
  - Assembled and Tested . . . . . \$199.95
  - High Speed Version . . . . . add \$ 16.00
- Plus shipping (5% US, 10% Canada, 15% Foreign)

# THE SSB \$150 FLOPPY DISCOUNT

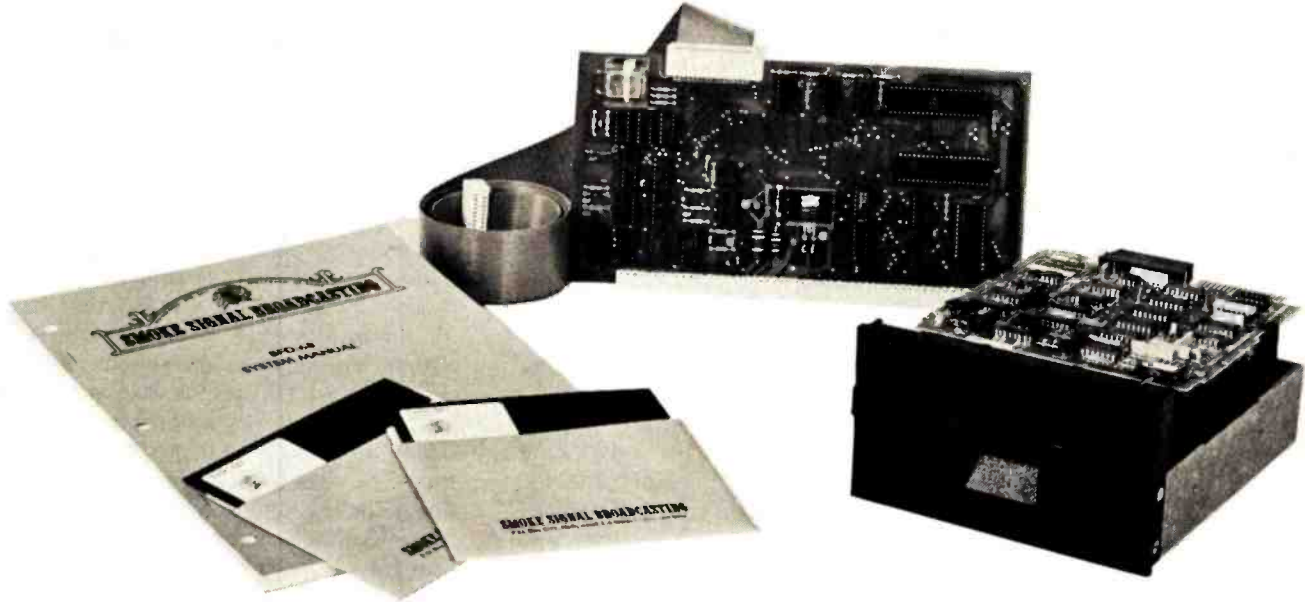

## Affordable

The tribe at Smoke Signal Broadcasting took our BFD-68 disk system and scalped the price, but not the features to create the ABFD-68 (Affordable Basic Floppy Disk). We appreciate the fact that the computer hobbyist gave us our start and we haven't forgotten you.

## \$649 Assembled

Compare Price. Our SS-50 bus compatible disk system is \$150 less than the assembled price of the leading S-100 disk system. And you can at least double that savings when you buy one of the computers manufactured by MSI or SWTPC that use the superior 6800 microprocessor.

## Programmable

The BFD-68 is well known for its fine software. The system comes with the best disk operating system available and we offer a multitude of other compatible software products. These include a BASIC interpreter with disk file handling capability. By the way, our DOS now easily handles true random access files as well as sequential. Also, we have a super fast BASIC compiler for business applications. In addition, a Text Editor, 2 Assemblers, a

Trace Disassembler useful for program debugging and an Object to Source Code Generator are all stock items available for immediate delivery. A word processor will be available very soon.

## Reliable

We delivered our first mini-floppy disk system a year ago — 6 months ahead of any other 6800 based mini system. Thus, we've had twice the experience in building reliability into the system. Our NEW disk controller was designed using all we have learned in the past year about system reliability.

The ABFD-68 contains all the built in reliability of our regular BFD-68 plus you save money by supplying your own cabinet and power supply for the disk.

## Available

We've shipped literally tons of our BFD-68 disk system in the past year and have learned to keep our production up with demand. Give us a call and chances are we'll be able to ship you the new ABFD-68 from stock and charge it to your Master Charge or Visa card. Better yet, ask us for the name of the computer store nearest you that carries our complete line of computer products.



## SMOKE SIGNAL BROADCASTING

P.O. Box 2017, Hollywood, CA 90028 • (213) 462-5652

# A Low Cost Light Wand Amplifier

The purpose of this article is to discuss some of the variables involved in the reading of printed bar data, and to describe a signal processor whose operation is independent of most of these variables, and tolerant of the remainder.

For the most reliable recovery of data, the effective aperture of the light wand photodetector should be no wider than the narrowest data bar. In this case, full black to white signal swing is obtained in response to narrow bars, and variables such as lamp output, photodetector sensitivity, pen angle, and target contrast control only two output functions: white level photocurrent and black level photocurrent.

In any light wand having a linear photodetector, the ratio of these currents is determined by the ratio of the reflectivities of the black and white bars, ie: target contrast. The absolute value of the photocurrent may, of

course, vary widely between different light wands, even those of the same design.

The first step in the data recovery process is to transform the photocurrent to a logarithmically varying voltage. The amplifier shown in figure 1 uses the well known exponential forward conduction properties of a silicon diode (D1) to make this transformation. The peak to peak signal voltage across this diode is proportional to the ratio of the white and black photocurrents and is independent of the absolute level of the photocurrent.

The next step in processing the signal is to eliminate the effect of the variation of the absolute level of photocurrent. This is most obviously achieved by capacitively coupling the signal developed across the diode. This method results in unwanted transient shifts of signal level at the output of the amplifier when the light wand is first placed on the

Robin C Moseley  
14 Standish Circ  
Andover MA 01810

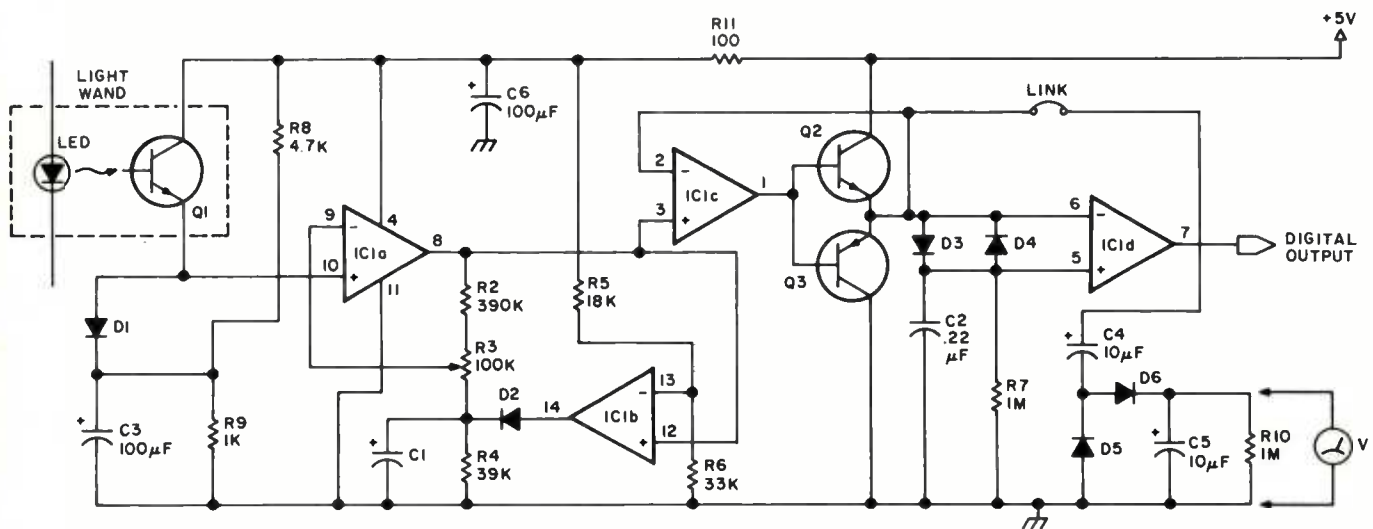

Figure 1: Schematic diagram for light wand signal processor. IC1 is a National LM324 quad operational amplifier. All the diodes are general purpose silicon diodes such as 1N4148. Q2 is a general purpose NPN transistor such as MPS6513 and Q3 is a general purpose PNP transistor such as MPS6517. All resistors are 0.25 W and all resistances are measured in ohms. The output of the circuit is TTL compatible.





## Now Dynabyte builds three Great Memories

New! 16k and 32k fully static RAM's. With either 250 ns. or 450 ns. typical access time. Assembled. Tested. Burned in. Guaranteed. Like our 16k dynamic RAM, Built as solid as the 4,400 year-old pyramids.

Ancient Egyptians didn't stop with just one pyramid. The Great Pyramid stands on the Plain of Gizeh with two other monuments erected for kings and queens.

Dynabyte didn't stop with one 16k dynamic RAM, either. Now you can get 16k and 32k fully static RAM's that are built with the same unmatched engineering ability and manufacturing skill that went into Egypt's wonders of the ancient world.

When we say built, we mean completely built. Assembled, tested and burned in. We don't leave anything undone. That way, you can buy any Dynabyte memory and know that it is backed by a factory guarantee for one full year. Kits and semi-kits can't say that.

Our 16k static and our 32k static are available with either 250 ns. or 450 ns. access time. Our 250 ns. module is completely compatible with the 4MHz Z-80A processors. The 450 ns. modules are compatible with the 8080 and the faster 3MHz 8085 processors.

**The Great 16k Static Memory. 250 ns., \$555. 450 ns., \$525.**

- 4k block addressing along 4k boundaries

- Bank Select
- Write Protect with alarm for each 4k block
- Full Schmitt trigger buffering
- No DMA restrictions
- Complete S-100 bus compatibility, including the Alpha Micro and Z-2.

**The Great 32K Static Memory. 250 ns., \$995. 450 ns., \$925.**

- 4k boundary addressing
- Full Schmitt trigger buffering
- No DMA restrictions

### Why Dynabyte doesn't build memory kits

Assembling a kit can be fun; almost anyone can do it.

But how about testing it? Do you have the test programs and equipment? Do you know which memory test program uncovers pattern sensitivity? Or which finds shorted data bits but won't find address decoder faults?

We do. It's our business. We have the 200 MHz oscilloscopes, the logic analyzers, the burn-in chambers, and the test programs. We find the bugs, even the subtle ones.

Which lets you concentrate on computing.

- Conservative thermal design
- Complete S-100 compatibility, including the Alpha Micro and Z-2.

**The Great 16k Dynamic Memory. \$399.**

- Highly cost effective
- No wait states
- Transparent refresh
- 16k addressing boundaries
- Widest S-100 mainframe and disk system compatibility

All of Dynabyte's memories meet rigid industrial grade standards. Design, components, construction, testing and performance. But if a module ever needs repair, we provide factory service with 24 hour turnaround for both warranty and non-warranty work.

Ask for the Great Memories by Dynabyte at your local computer store. You can also pick up complete product information while you're there.

But if you haven't got a local computer store, write Dynabyte, Inc., 4020 Fabian, Palo Alto, CA 94303. Or telephone (415) 494-7817.

**DYNABYTE**  
Builders of Great Memories

white margin of the printed data and also at the beginning of the data track. Provided the dynamic range of the amplifier is sufficient to accommodate these shifts, the decision threshold circuit described below will compensate for them. A more elegant approach, however, is to borrow from television technology and clamp the white level output from the amplifier stage at a fixed level. This is the function of comparator A2 and peak detector D2, C1.

Before the light wand is placed in contact with the printed data, the photocurrent is

small. The output voltage of amplifier stage A1 rises until it is equal to that at the other input of comparator A2. At this point, the output of A2 goes high, charging capacitor C2 until the voltage across this capacitor is approximately equal to that at the anode of logarithmic converter diode D1. When the light wand is placed in contact with the white margin of the data, the photocurrent increases. As the output level of the amplifier tries to rise, comparator A2 output switches high. This rapidly raises the reference voltage level across capacitor C1 to a new, higher level corresponding to the white level voltage at the anode of D1. As the wand moves over the black bars, the reduced photocurrent causes the voltage across D1 to fall. The output voltage from the amplifier falls below that at the other input to the comparator, and the comparator voltage falls to zero, cutting off charging diode D2. Since the time constant determined by C1 and R4 is long by comparison with the signal period, C1 holds the bias input to the amplifier stage approximately constant until the next peak white signal "tops up" C1.

The peak white level of the signal at the output of the amplifier is fixed at a predetermined voltage (about 3.25 V in the design described here) and the signal swing is negative from that point. The peak value of the signal depends only on the contrast ratio of the data bars. Gain control R3 should be adjusted to set the peak to peak signal swing to the optimum value; between 1.5 V and 2 V. In the absence of an oscilloscope, optional components D5, D6, C4, C5 and R10 form a peak detector which may be used in conjunction with any reasonably high impedance voltmeter to make this adjustment. Switch the voltmeter to the appropriate DC voltage range and connect it across C5. To prevent any distortion of the signal during actual use, disconnect the peak detector from the output of the buffer amplifier except when adjusting the amplifier gain.

The final step in processing the signal is to convert the amplified and clamped signal to the binary output required by the microprocessor. My approach avoids the complexity of decision circuits which rely on multiple peak detectors to determine the decision threshold while allowing variations of contrast ratio. The threshold is set a fixed voltage above (or below) the immediately previous peak signal level. With the wand in contact with the white margin, diode D3

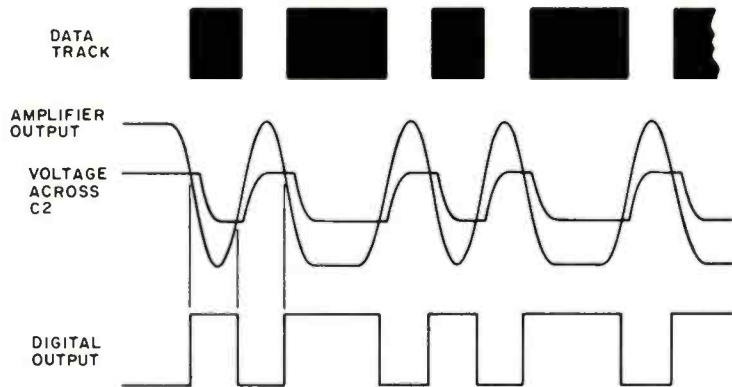

Figure 2. Sequence of events when the light wand is moved across a series of light and dark data bars. In this format the size of the black bars are changing and the size of the white spacings in between remains constant.

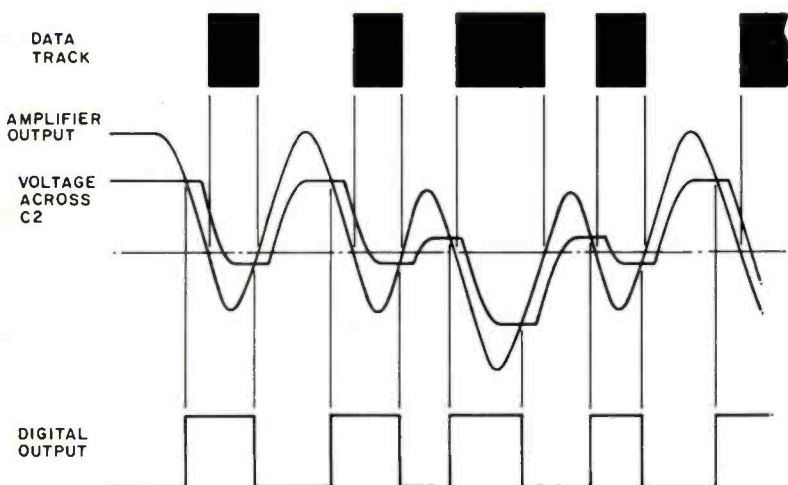

Figure 3. When the black and white bars are smaller than the aperture of the light wand it is still possible to have the correct output. The width of the digital pulses will change but will still be readable.

conducts, and capacitor C2 is charged to a voltage one diode drop (about 0.6 V) below the white level output from the amplifier. As the wand moves over the first black bar the amplifier output voltage falls, and diode D3 is cut off. When the output voltage falls to the same level as that across C2, the output from the comparator A4 switches to maximum (about 3.5 V). As the signal continues to fall, diode D4 conducts, and the voltage across C2 follows the signal except that it is now one diode drop more positive. As the wand moves onto a white bar, the signal voltage rises, and diode D4 is cut off. When the signal rises to a value equal to that across C2, the output of the comparator A4 falls to ground. As the signal continues to rise towards the white level, D3 conducts and the voltage across C2 follows. This time it is one diode drop less positive than the signal. Unity gain buffer stage A3 and transistors Q2, Q3 provide a low impedance drive to the decision circuit to ensure that the charging and discharging of capacitor C2 does not distort the signal at high reading speeds. The sequence of operation of the circuit is illustrated in figure 2. Notice that the digital output of this circuit follows the usual convention of a high level for black, and a low level for white. If this is not convenient, the two inputs of comparator A4 may be interchanged.

While this signal processor was designed primarily for the situation in which the effective aperture of the photodetector is no wider than the narrow data bars, it will perform creditably when the data is narrow by comparison with the detector. In this case, illustrated in figure 3, some timing error is theoretically introduced. Fortunately, this error is quite systematic; the first narrow bar following a wide bar is widened by 20% to 30% of its width, and the first wide bar following a narrow bar is reduced in width, by 10% to 20%. Some software complication is required to accommodate this. Note, however, that these comments do not apply to the case where the aperture of the photodetector is no wider than the narrow data bars; in this case the digital output from the processor is an accurate replica of the data bars.

The construction layout required for this circuit is not critical; just ensure that the low potential ends of C1 and C3 are connected closely together, along with that of the power supply decoupling capacitor C6. ■

# 16K RAM

Fully Assembled, Tested,  
Burned-in

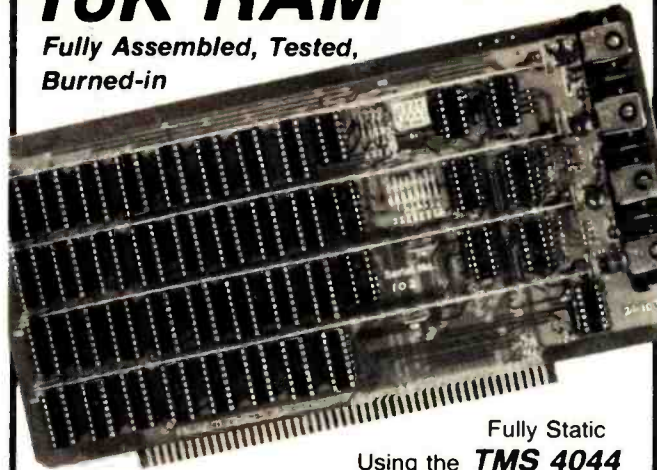

Fully Static  
Using the **TMS 4044**

## 250 nsec. chips—\$425

(\$375 Intro. price ends May 15)

**Z-80A 4 Mhz. Fast** — This fully assembled and tested 16K board was designed to operate without wait states in a 4 Mhz. Z-80A system allowing over-generous time for CPU board buffers. It "loafs along" in slower 8080 and 8085 systems.

## 450 nsec. chips—\$375

(\$325 Intro. price ends May 15)

**For 2 Mhz. Systems** — Same circuit as above but priced lower because of less expensive memory chips. It is fully assembled, burned-in, tested, guaranteed, and yet priced lower than many kits.

**Fully Static is Best** — Both boards use the state-of-the-art Texas Instruments TMS 4044 which requires no complicated and critical clocks or refresh. The fully static memory chip allows a straight-forward, "clean" design for the board ensuring DMA compatibility. It uses a single 8 volt power supply at 1.7 amps nominal.

**Fully S-100 Bus Compatible** — Each 4K addressable to any 4K slot and separately protected by DIP switches. Jumpers to customize board to any known S-100 system.

**Commercial Quality Components** — First quality factory parts, fully socketed, buffered, board masked on both sides, silk-screened, gold contacts, bus bars for lower noise.

**Guaranteed** — Parts and labor guaranteed for one full year. You may return undamaged board within ten days of receipt for full refund.

### Check your local computer store first

**Factory Orders** — You may phone for MC, VISA. Cashier's check, M.O. speed shipment for mail orders. Personal check OK. Shipped prepaid with cross country orders sent by air. Shipping — Stock to 72 hours normal. We will confirm order and give expected shipping date for delays beyond this. Washington residents add 5.4% tax. Spec. sheet, schematic, warranty statement sent upon request.



**Seattle Computer Products, Inc.**

16611 111th S.E., Renton, Washington 98055  
(206) 255-0750

# A Bit of the BASIC

---**Computer Resource Book—Algebra** by Thomas A Dwyer and Margot Critchfield is an exciting new way to learn about algebra and the interesting things you can do with it using a computer. The book uses the BASIC language, and flowcharts are used throughout to show the structure of programs. There are 60 applications programs including straight line graphs, polynomial equations, a space probe navigator, temperature profiles, computer generated animation, the ultramatic root finder, random number generation and many more. Although it is particularly suitable for students, just about everyone will find some intriguing and easy to use applications in this entertaining book. \$5.20.



---**Introduction to Computer Programming** by Rudd A Crawford Jr and David H Copp. Here is an excellent way to learn about the general aspects of computer programming. **Introduction to Computer Programming** makes use of a hypothetical computer model and set of assembly language instructions designed to help the beginner see what goes on in computer programs. The emphasis throughout is on general principles; such concepts as loops, decisions, flowcharts and IO routines are covered in detail. The book also provides many example problems and prompts the reader by posing several quiz questions. Anyone who masters its contents will have a solid foundation for the study of practical assembly and high level languages. It is especially recommended for students, but just about everyone new to the subject should profit from it. \$4.80.

---**Basic BASIC** by James S Coan. If you're not already familiar with BASIC, James Coan's **Basic BASIC** is one of the best ways to learn about this popular computer language. BASIC (which stands for Beginner's All-purpose Symbolic Instruction Code) is easy to learn and easy to apply to many problems. **Basic BASIC** gives you step-by-step instructions for using a terminal, writing programs, using loops and lists, solving mathematical problems, understanding matrices and more. The book contains a wealth of illustrations and example programs, and is suitable for beginners at many different levels. It makes a fine reference for the experienced programmer, too. \$8.95.

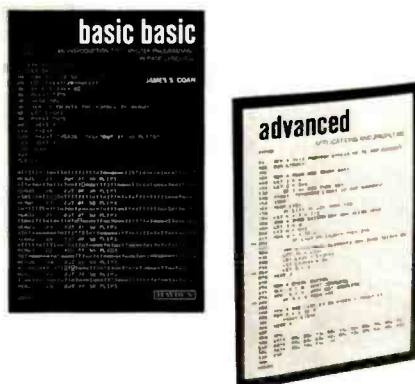

---**Advanced BASIC** by James S Coan. **Advanced BASIC** is the companion volume to James Coan's **Basic BASIC**. In this book you'll learn about some of the more advanced techniques for programming in BASIC, including string manipulation, the use of files, plotting on a terminal, simulation and games, advanced mathematical applications and more. Many useful algorithms are covered, including some clever sorting techniques designed to reduce program execution time. As with **Basic BASIC**, there are many illustrative example programs included. **BASIC** doesn't have to be basic with **Advanced BASIC**! \$7.95.

---**A Guided Tour of Computer Programming in BASIC** by Thomas A Dwyer and Michael S Kaufman. Colorful graphics abound in this lively introduction to the BASIC language. The authors have tried to present a rigorous, yet entertaining approach to the subject. Written for the novice, **A Guided Tour** begins with a section on how to recognize a computer, followed by some tips on working at a terminal. By the end of the book readers are writing their own programs and solving elementary problems in finance and business. The emphasis throughout is on learning by doing. Anyone interested in computer programming should benefit from **A Guided Tour of Computer Programming in BASIC**. \$5.20.



---**Some Common BASIC Programs** by Lon Poole and Mary Borchers, published by Adam Osborne and Associates. At last, a single source for all those hard to find mathematics programs! **Some Common BASIC Programs** combines a diversity of practical algorithms in one book: matrix multiplication, regression analysis, principal on a loan, integration by Simpson's rule, roots of equations, operations on two vectors, chi-square test, check writer, geometric mean and variation, coordinate conversion and a function plotting algorithm. These are just some of the many programs included. For only \$7.50 you can buy the kind of programs previously available only as part of software math package systems for large scale computers. All the programs are written in a restricted BASIC suitable for most microcomputer BASIC packages, and have been tested and debugged by the authors. \$7.50.

<p>Send to: Bits, Inc. 70 Main Street Peterborough NH 03458</p> <p>Name _____</p> <p>Address _____</p> <p>City _____ State _____ Zip Code _____</p> <p>Signature _____</p> <p>You may photocopy this page if you wish to leave your BYTE intact.</p>	<p>Check Payment method:</p> <p><input type="checkbox"/> My check is enclosed</p> <p><input type="checkbox"/> Bill my MC No. _____ Exp. date _____</p> <p><input type="checkbox"/> Bill my BAC No. _____ Exp. date _____</p> <p>Total for all books checked \$ _____</p> <p>Postage, 75 cents per book for _____ books \$ _____</p> <p>Grand Total \$ _____</p> <p>Prices shown are subject to change without notice. All orders must be prepaid. In unusual cases, processing may exceed 30 days.</p>
--	--

# Tune In and Turn On, Part 2

## An AC Wireless Remote Control System

**Steve Ciarcia**  
POB 582  
Glastonbury CT 06033

Last month (page 114) I outlined the transmitter section of a wireless AC remote control system that can be easily attached to any computer with an 8 bit parallel output port. As previously stated, it will allow remote on and off control of up to ten AC powered devices. This month I cover the design of a typical receiver section.

Figure 1 shows the schematic of a single channel receiver station and photos 1 and 2 illustrate a typical layout of a constructed receiver. (A photo of the completed receiver is shown in last month's article.) The receiver consists of three basic sections: input filter and power supply, on and off tone detectors, and output latch. Except for minor component value differences necessary to change the channel frequencies, all receivers will have the same configuration.

### Input Filter and Power Supply

Each receiver, designated as a single channel, receives two transmitted frequencies from the computer. One is used to turn the AC device on and the other to turn it off. These two tones must be close enough to be passed through the same filter section but not close enough to interfere with each other. For this reason, a channel bandwidth has been designated to be 8 kHz, and no two tones are closer than 4 kHz.

The function of the input filter is to reject the 60 Hz line frequency and all other frequencies except the 8 kHz band of a specific channel. While this may appear true in theory, it is not quite the result. Instead, the amplitudes of various frequencies will be affected as they pass through the filter.

*Photo 1: The finished prototype receiver board.*

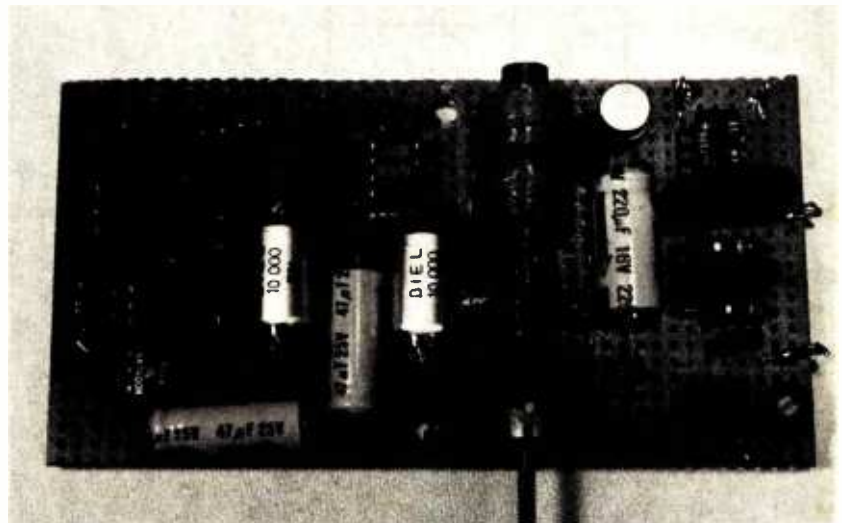

*Photo 2: Internal view of finished prototype receiver chassis.*

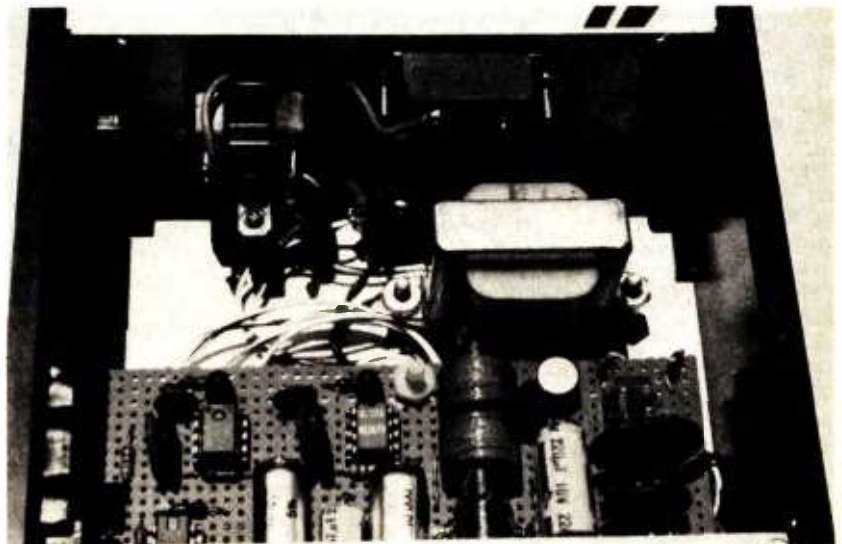

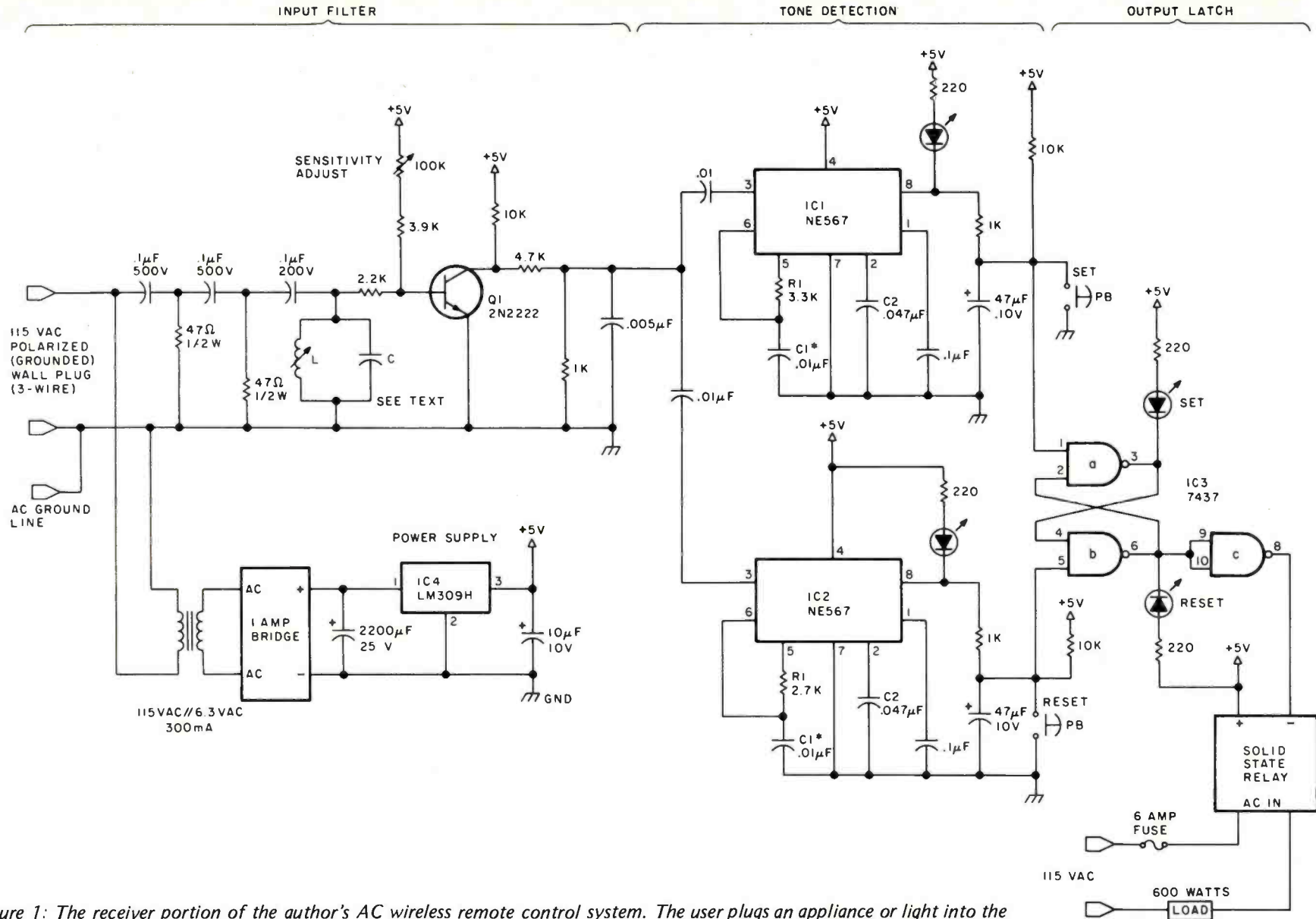

Figure 1: The receiver portion of the author's AC wireless remote control system. The user plugs an appliance or light into the receiver, which in turn is plugged into a wall socket. One of two frequencies is sent at a time through the house wiring by a separate computer controlled transmitter (described last month). The receiver responds to these frequencies by turning its device on or off, respectively. A specially designed tuned bandpass filter amplifies only that pair of frequencies dedicated to its receiver, attenuating all other frequency pairs. After some amplification, the signal is sent to two tone decoders (IC1 and IC2) which respond to the two frequencies independently. Two buttons are also present on the receiver so the user can operate the device locally. Note that the use of a 3 wire grounded plug to connect to the AC line is highly recommended.

\*POLYSTYRENE OR POLYCARBONATE

60 Hz will be virtually nonexistent, and if the passband is from 35 kHz to 43 kHz, that frequency range should be the highest amplitude. This amplitude variation across the spectrum can be facilitated somewhat by the addition of a tuned inductance and capacitance (LC) circuit, called a bandpass circuit. The center frequency of the LC circuit should be set for the center of the particular passband desired. In the case of 35 to 43 kHz, the inductor and capacitor are chosen to produce a resonance at 39 kHz: the result is a passive filter. As the RC section passes frequencies close to 39 kHz, the LC combination starts to resonate (which increases the overall amplitude seen at the base of Q1). In practice, a low Q slug-tuned 1 to 10 millihenry coil salvaged from an old TV set will work well. By using this LC circuit, the fundamental frequency of the transmitted waveform is sufficiently high in level to be differentiated from the second and third harmonics also present. A sensitivity adjustment on the base of transistor Q1 aids in the detection process by allowing only signals of sufficient amplitude through the next amplifier filter section of Q1.

The use of an LC filter does require some component value changes to cover the 30 kHz to 110 kHz range of the transmitter. Figure 2 is the schematic of the LC combination in question and includes the formulas required to make this calculation. Again, calculations are only part of the answer and are acceptable only in 2 or 3 channel applications. For optimum tuning, the component values should be chosen according to the equation. Then using an oscilloscope, measure the voltage across the LC circuit and slowly adjust the slug-tuned coil to peak at the desired frequency. A voltmeter on the AC setting will not respond sufficiently; only an oscilloscope with high impedance inputs should be used.

The power supply section is a standard rectifier and 3 terminal regulator supply. The circuit requires less than 100 mA and values are not critical. The LM309 voltage regulator is the plastic TO-5 packaged version of the standard LM309K, which is a TO-3 metal can. Either can be used and no heat sink is required.

Table 1: Power wiring table for figure 1.

	IC Type	+5 V	Gnd
IC1	NE567	4	7
IC2	NE567	4	7
IC3	7437	14	7
IC4	LM309	3	2

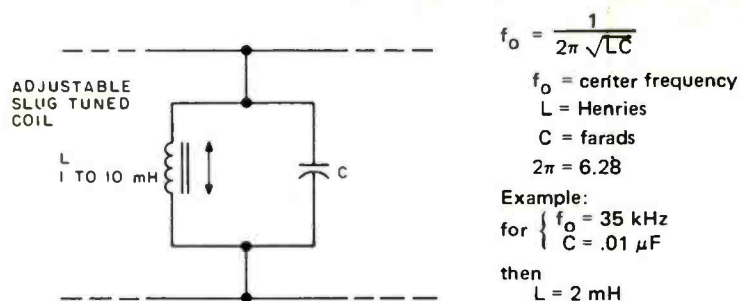

Figure 2: Calculation of inductor and capacitor values for the tuned bandpass filter used in the receiver's input section.

## Tone Detectors

The heart of the receiver is in the two tone detectors, IC1 and IC2. Each is tuned to a specific frequency or tone within its respective channel bandwidth. For the channel 1 frequencies I have chosen (35 kHz to 43 kHz), IC1 would be set for approximately 35 kHz and IC2 would be set 4 kHz higher at 39 kHz. IC1 is considered the set frequency receiver and IC2 is the reset receiver. LEDs are attached to their outputs to facilitate tuning. These lights will light only when the correct frequency is present at the respective pin 3.

As with the input filter, these are tuned circuits and they require component value changes for the different channels. Figure 3 shows an individual receiver and outlines the equations used to select components. The values I have chosen are standard and could be set closer with the addition of trim pots, etc. In practice, this won't be necessary unless all ten channels are to be constructed.

## Output Latch

The outputs of the set and reset tone detectors go to the set and reset flip flop made from two NAND gates (IC3a and IC3b). If either the set pushbutton is pushed or IC1 receives the proper signal, the flip flop goes into the set state and the output device is activated. It will stay in the "on" condition until either the reset pushbutton is pushed or a reset signal is received through IC2.

### Notes for Figure 1.

The solid state relay noted in the schematic can be either a Sigma 226 RE1-5A1 as shown in photo 1 or the homebuilt unit of photo 3 and figure 4. Minimum current rating should be 6 A.

1. All resistors 1/4 W carbon 5% unless otherwise noted.
2. All capacitors are 100 V ceramic unless otherwise noted.
3. The values of L and C in the tuned filter are computed for the particular center frequency chosen (see figure 2). In general L should be an adjustable slug tuned in a range of 1 to 10 mH. C will range from .001 to .01.
4. If this receiver is used on AC lines which also power many inductive devices such as motors and pumps, voltage surge protection may be required on the input.
5. A 7400 can be substituted for the 7437 if the set and reset LEDs are eliminated.

Figure 3: Selection of components for the tone decoder.

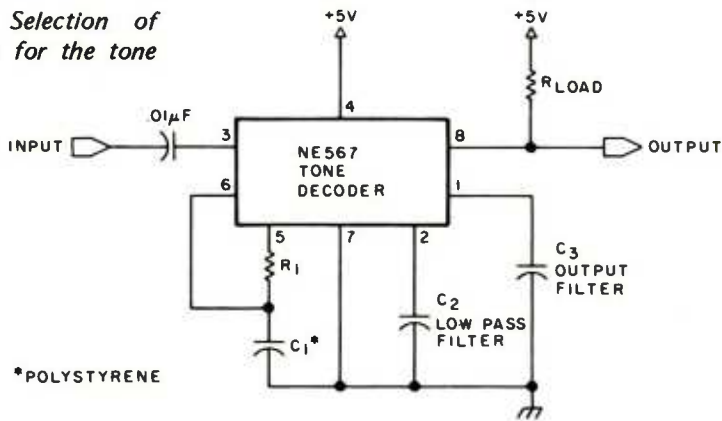

Although the 7437 is quite capable of driving a silicon controlled rectifier (SCR) directly, turning on a triac is a bit more involved. When the parts necessary to perform this function cost more than a commercial solid state switch, it's time to go commercial. There are experimenters who will want to use SCRs because they have them, though.

Figure 4 is a schematic of an alternate 1000 W solid state relay; photo 3 is the prototype I constructed as an example. It is important to note that, while both the SCR and homebrew device in figure 4 are opto-isolated devices, the AC remote receiver itself is not isolated, and care must be taken when probing into a plugged-in unit. In this case, the only advantage of the opto-isolator is that it provides the required current to drive the SCR or triac; a 7437 by itself may not. SCR gate currents have a wide variation (1 to 100 mA for various SCRs all rated for 8 A) and a 7437 does not have unlimited drive capability. For some less current consuming applications, a standard 7400 can be used instead of a 7437.

#### System Checkout

There are two ways to calibrate this system: trial and error (good for one or two channels only); or with the proper test equipment (necessary for three or more channels). I prefer the latter and will discuss that technique.

The first thing to do after building the transmitter is to determine what frequencies are being transmitted. Using the program in listing 1 and a frequency counter attached to pin 6 of IC3 on the transmitter board will aid calibration. The frequency output of the transmitter described last month will have 256 possible values but not all are required at this time. A program could be written to scan slowly across all frequencies and stop when the receiver picks it up. This method involves trial and error. I prefer to tune the

Example:

for  $R_1 = 3.3 \text{ k}$  and  $C_1 = .01$

$f_o = 33.3 \text{ kHz}$

with  $C_2 = .047 \mu\text{F}$

Bandwidth  $\cong 1600 \text{ Hz}$

$C_3 = .1 \mu\text{F}$

1. Select  $R_1$  and  $R_2$

$$f_o \cong \frac{1.1}{R_1 C_1}$$

$f_o =$  detection frequency (Hz)

$R_1 =$  ohms ( $1 \text{ k} < R_1 < 20 \text{ k}$ )

$C_1 =$  farads

2. Select bandwidth of less than 2 kHz for each frequency. For input amplitude  $\geq 200 \text{ mV}$

$$\text{BW} \cong f_o C_2$$

$f_o =$  detection frequency (Hz)

$C_2 = \mu\text{F}$

BW = bandwidth (Hz)

and:

3.  $C_3 = 2 C_2$  minimum

transmitter to a known frequency, then tune in the receiver.

Once the transmitter is set up, the next project is the receiver. For reasons I'll describe later, it is best to plug the transmitter and receiver into the same wall socket initially (use an extension cord if necessary). Using the previous program, set the transmitter to continually transmit one tone in the center of a channel, such as for channel 1 (39 kHz). Choose component values from figure 3 (figure 1 is configured for channel 1) and adjust the coil slug until the maximum voltage appears across the LC circuit in the filter section. Reset the frequency transmission for the set frequency (35 kHz) and adjust the sensitivity pot until the LED at pin 8 of IC1 comes on. Failure of the LED to light indicates any of the following:

1. Insufficient transmission amplitude: check transmitter output.
2. Wrong frequency transmitted or wrong components chosen for the receiver: check program action and recheck calculations.
3. Sensitivity pot misadjusted: attach scope to collector of Q1 and note that sensitivity pot turns signal on or off.
4. Bad tone decoders.

Once this phase is completed, set the transmitter frequency to the reset frequency (43 kHz) by entering the appropriate number when running the program of listing 1. Then check to see that the LED on IC2 lights. The sensitivity pot may require adjustment. The key is to find a setting that



# VectorGraphic show and tell VectorGraphic show and tell VectorGraphic show and tell VectorGraphic show and tell

Generates character-by-character reversed video, reduced intensity, block and line graphics.

1024 characters—16 lines x 64 characters and uses 7 x 9 dot matrix to produce an extremely high quality, high resolution display image.

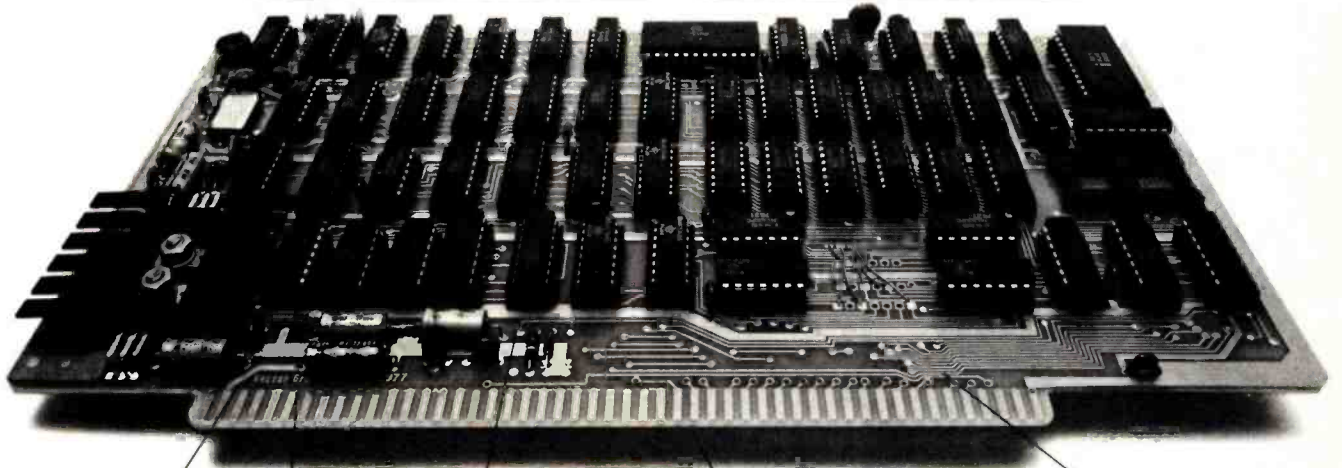
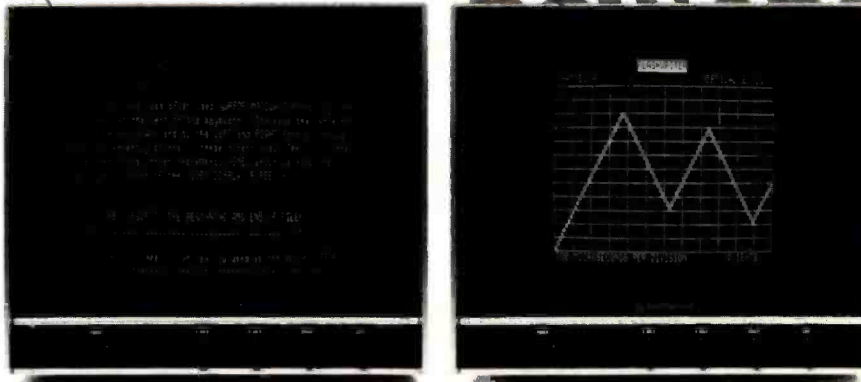

An eight bit parallel port with latched strobe—may be used as a keyboard port.

Screen refresh memory designed to operate with 4MHz CPU clock rates.

Compatible with S-100 bus microcomputers.

Requires only +8Vdc at 1.2 Amps

Video output conforms to RS-170 requirements—available as composite video or separate video and sync.

Completely assembled and tested or in easy to build kit form.

See for yourself. FREE

- Send me free details on  Flashwriter video board  
 Other S-100 boards  Microcomputer kits  Systems

Name \_\_\_\_\_

Address \_\_\_\_\_

Phone ( ) \_\_\_\_\_

City/State/Zip \_\_\_\_\_



**VECTOR GRAPHIC INC.**

790 Hampshire Road, A+B, Westlake Village, CA 91361, (805) 497-6853

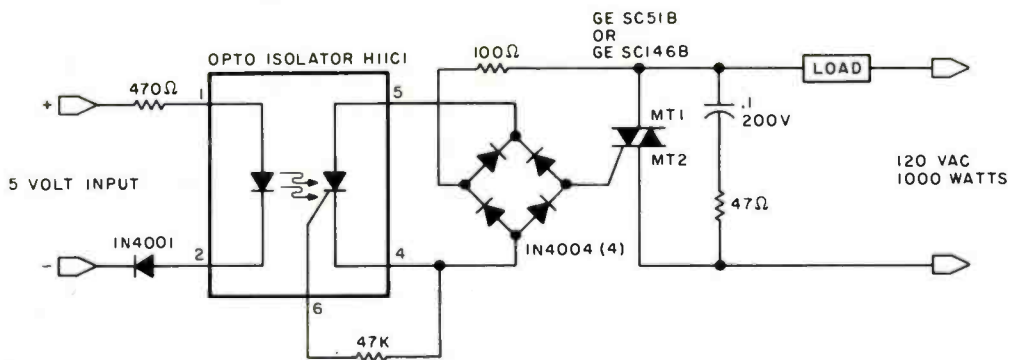

Figure 4: 10 A solid state relay suitable for use in a TTL to 115 VAC application.

works for both set and reset frequencies simultaneously. This same procedure is repeated for any other channel.

#### Using the System in the Home

The transmitter is plugged into any 110 VAC outlet in the vicinity of the computer.

Depending on the home, it may or may not transmit to all outlets in the house. Most homes have 220 V service which consists of two independent 110 VAC lines. A frequency transmitted into one line may not pass over into the other line with sufficient power to be detected at all receiver locations. It may be necessary to take one of the receivers and plug it into a number of different outlets to determine which are on the correct circuit. This potential problem is not unique with this particular design and is a factor to be considered in all carrier current designs. In most cases, if there are sufficient 220 VAC loads in use, such as heaters and stoves, etc, the carrier frequency will pass easily through the loads from one line to the other and the whole house will be covered.

The most obvious application of such a computer control system is a home lighting system used in conjunction with a burglar alarm. The major problem with conventional timer activated light controllers is that their consistently repeated on and off periods are an immediate tip-off that no one is home. With this system and either a real time, time of day clock, or timing loop functioning as a clock, the on and off periods of a number of lights can be altered dynamically. The program which accomplishes this function can be implemented as easily in BASIC as any of the test programs used to check out the AC remote controller described in this article.

I hope that you have enjoyed this latest project and the humorous as well as utilitarian applications of such a system. I'll try to bring you similar projects in the future. If you have questions or comments please feel free to write me and enclose a stamped, self-addressed envelope.

Next month: digitized speech. ■

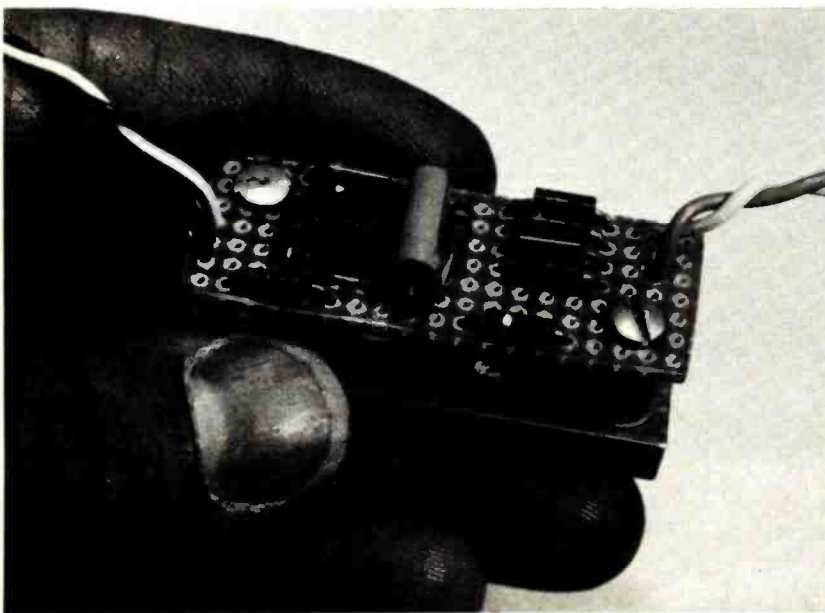

Photo 3: Homemade solid state relay (see figure 4).

```

100 PRINT "WHAT IS THE OUTPUT PORT NUMBER OF THE TRANSMITTER"
110 INPUT N :REM N IS IN DECIMAL
120 PRINT "OUTPUT UPDATE VALUE"
130 INPUT X
140 OUTPUT N, X :REM X is sent to the transmitter DAC
150 GOTO 120

```

Listing 1: A simple BASIC program to aid the user in calibrating the transmitter. A frequency counter is attached to pin 6 of IC3 in the transmitter in order to check the actual output frequency versus a typed in value.

# Peripheral Vision impacts your computer!

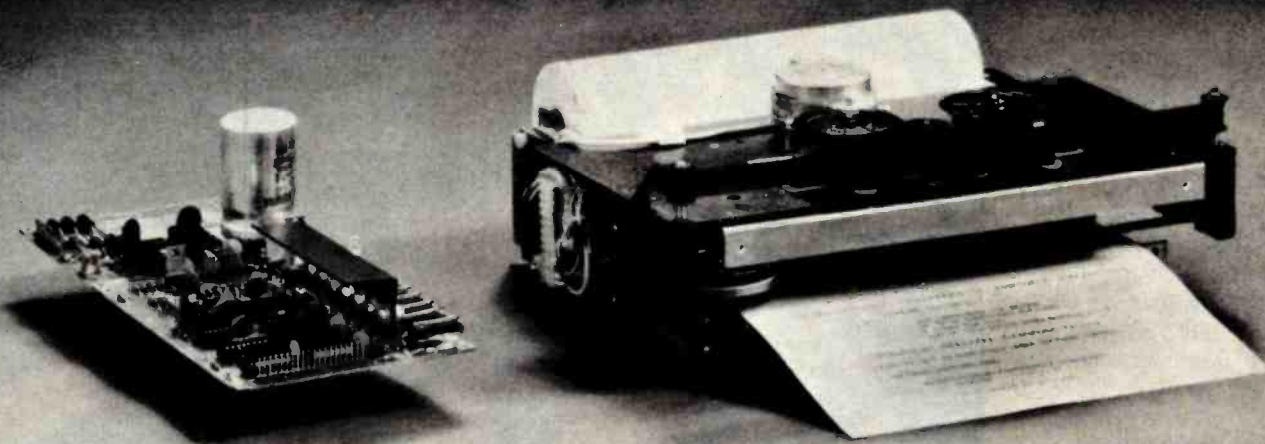

with a full-size, low-cost impact printer.

Until now, the hobbyist and small businessman have had one major problem in assembling a reasonably priced microprocessor system with the capabilities found in the more costly computers. It was impossible to find a high-quality, high-output printer for hard copy needs at an affordable price.

Peripheral Vision has come up with a solution.

We are offering a full-size *impact* printer designed for microprocessors—and it comes with a mini price. Prices start as low as \$540 for the printer, interface card kit, and the power supply. And that won't impact your pocketbook.

Peripheral Vision's printer is loaded with capabilities. Take a look:

- It's fast—120 characters per second
- 96 characters per line, 12 characters per inch horizontal, 6 lines per inch
- Makes up to 4 copies simultaneously
- 5 x 7 character matrix
- Ribbon has built-in re-inkers for a life of 10,000,000 characters
- Paper can be either a standard 8½-inch roll, fanfold or cut page
- Interfaces to 8-bit parallel ports (one input & one output)
- Compatible with the S-100 bus (use our optional parallel port card)

Just remember, Peripheral Vision is committed to helping you get along with your computer. As an example, the printer we are offering is high in quality, low in cost and will definitely impact your system. Other examples include Floppy Disk Drive systems, Digital Cassette systems, Stand Alone Audio Cassette interfaces and our inexpensive Keyboard.

- Send me more information on how to impact my computer!
- OK, here's my \$540, send a printer kit.
- Here's \$695 for an assembled & tested printer. And thanks!

Name \_\_\_\_\_

Company \_\_\_\_\_

Address \_\_\_\_\_

City \_\_\_\_\_

State \_\_\_\_\_

Zip \_\_\_\_\_

(BankAmericard/VISA, Master Charge or COD's also welcome.)

Circle 300 on inquiry card.

**PERIPHERAL  
VISION** INC.

P.O. Box 6267/Denver, Colorado 80206 303/777-4292

Photo 1: The multiplier installed in IO slot 7 of the SwTPC 6800 processor system. The multiplier was constructed on a perforated board base, and is seen here between a parallel interface board and the power supply transformer. The heat sink for the multiplier's on board regulator tends to dominate the board, and the multiplier integrated circuit itself is the white 40 pin package partially hidden by a cable.

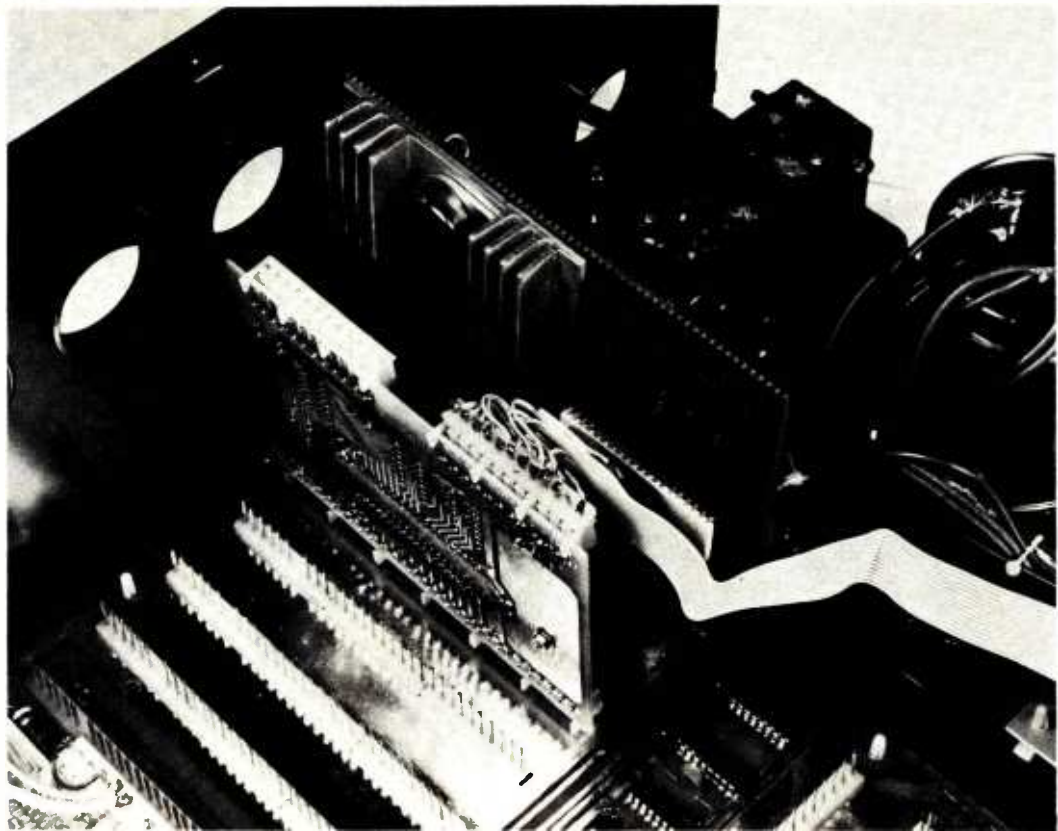

# How to Multiply in a Wet Climate

## Part 2: Design Details

Jack Bryant  
Mathematics Dept  
Texas A&M University  
College Station TX 77843

Manot Swasdee  
E E Dept  
Texas A&M University  
College Station TX 77843

*In last month's article, we discussed microprocessor arithmetic and how an 8 by 8 bit two's complement multiplier could do it faster. Specific examples, in Motorola M6800 assembly language, showed how multiple precision arithmetic and quick matrix addressing could use hardware multiplication. We gave a logical block diagram of a circuit which would make the product (formed by a multiplier array) much easier to use. This month's article contains details needed to construct and fully test a hardware multiplier for the SwTPC 6800 system using the TRW MPY-8AJ and eleven SSI and MSI TTL chips.*

This month we give detailed construction information on how to build a wire wrap version of the hardware multiplier for the SwTPC 6800 system. Photo 1 shows the multiplier installed in port 7 of the 6800, which is the object of this effort. We used port 7 because the wire wrap pins would be easily accessible there and would not interfere with other IO interfaces. We begin with some details about the SwTPC mother board address decoding.

Addresses in the 6800 are 16 bits, numbered from most significant to least significant bit as A15, A14 . . . A1 A0. Decoding circuitry on the mother board traps any address starting with binary 100 (ie: with

# the electric pencil II™

**The Electric Pencil II is a Character Oriented Word Processing System.** This means that text is entered as a continuous string of characters and is manipulated as such. This allows the user enormous freedom and ease in the movement and handling of text. Since lines are not delineated, any number of characters, words, lines or paragraphs may be inserted or deleted anywhere in the text. The entirety of the text shifts and opens up or closes as needed in full view of the user. The typing of carriage returns as well as word hyphenation is not required since lines of text are formatted automatically.

As text is typed in and the end of a screen line is reached, a partially completed word is shifted to the beginning of the following line. Whenever text is inserted or deleted, existing text is pushed down or pulled up in a wrap around fashion. Everything appears on the video display screen as it occurs which eliminates any guesswork. Text may be reviewed at will by variable speed scrolling both in the forward and reverse directions. By using the search or the search and replace function, any string of characters may be located and/or replaced with any other string of characters as desired.

When text is printed, **The Electric Pencil II** automatically inserts carriage returns where they are needed. Numerous combinations of line length, page length, line spacing and page spacing allow for any form to be handled. Character spacing, **BOLD FACE**, multicolumn as well as bidirectional printing are included in the Diablo versions. Right justification gives right-hand margins that are even. Pages may be numbered as well as titled. This entire page (excepting the large titles and logo) was printed by the Diablo version of **The Electric Pencil II** in one pass.

## Now on CP/M

You've probably seen **The Electric Pencil** in action by now. It's the most powerful 8080/Z80 character oriented word processor on the market today. Michael Shroyer is now proud to present the new **Electric Pencil II**.

**NEW FEATURES: \*\*\* CP/M Compatible \*\*\* Disk Operating System Supports Two Disk Drives \*\*\* Simple File Management \*\*\* Quick and Easy Disk Storage and Retrieval \*\*\* Dynamic Print Formatting \*\*\* Multicolumn Printing \*\*\* Print Value Chaining \*\*\* Page-at-a-time Scrolling \*\*\* New Bidirectional Multispeed Scrolling Controls \*\*\* New Subsystem with Print Value Scoreboard \*\*\* Automatic Word and Record Number Tally \*\*\* Cassette Backup Capability \*\*\* Full Margin Control \*\*\* End-of-Page Control \*\*\* Non-Printing Text Commenting \*\*\* Line and Paragraph Indentation \*\*\***  
Centering, Underlining and **BOLD FACE**

The **Electric Pencil II** is now available on CP/M. Standard printer versions **\$225.**  
Diablo printer versions **\$275.**

System Hardware MUST include:

- 8080 or Z-80 Based Microcomputer Printer (Diablo Hy-Term, TTY, etc.)
- Video Display (VDM-1, VTI or SOL)
- CP/M Supported Disk System or...
- North Star Mini-Floppy Disk or...
- Cassette Interface (Tarbell or SOL)

<b>m SS</b>	<b>MICHAEL SHROYER SOFTWARE</b> 3901 Los Feliz Boulevard Los Angeles, CA 90027 (213) 665-7756
-----------------	--

The **Electric Pencil I** is still available for non CP/M users as follows:

<u>Versions</u>	<u>Printer</u>	<u>Video Interface/Mass Storage</u>	<u>Price</u>
SS,SV,SP	TTY or similar	SOL/Cuter,VDM-1/Tarbell,VTI/Tarbell	<b>\$100.</b>
SSN,SVN,SPN	TTY or similar	SOL/NStar,VDM-1/NStar,VTI/NStar	<b>\$125.</b>
DS,DV,DP	Diablo Hy-Term	SOL/Cuter,VDM-1/Tarbell,VTI/Tarbell	<b>\$150.</b>
DSN,DVN,DPN	Diablo Hy-Term	SOL/NStar,VDM-1/NStar,VTI/NStar	<b>\$175.</b>

**Demand a demo from your dealer!**

Table 1: Port 7 addresses and significance. Note that writing to the first three addresses is used to control the multiplication: address 801E receives a control code, 801C receives the X operand, and address 801D receives the Y operand and simultaneously forms the product and clocks it into the output register P.

Hexadecimal Address	What Happens When the Computer Writes into this Location	What Happens When the Computer Reads Data from this Location	
801C	Clock the multiplicand into MPY-BAJ register X.	Unshifted Product	For the last strobed product, read the left justified high order part of the products: PS, P1, . . . , P7.
801D	Clock the multiplier into MPY-BAJ register Y and strobe the product into product register P.		For the last strobed product, read the left justified low order part of the product, with zero for the least significant bit: P8, P9, . . . , P14, 0.
801E	Set control code: binary **** *SFR F = strip sign X S = strip sign Y R = set ROUND * = "don't care"	Right Shifted Product with OV	For the last strobed product, read the overflow bit OV, then right justified and shifted product bits: OV, PS, . . . , P6.
801F	Not used		For the last strobed product, read the right justified and shifted product bits: P7, . . . , P14.
<p>Note: Using terminology of the MYP-BAJ and the previous article of this series, bits of the multiplication data are numbered 0 to 15, most significant to least significant.</p> <p>Program Sequence: Set up control code (801E). Store X multiplicand (801C). Store Y multiplicand (801D). Read and use shifted (801E or 801F) or unshifted (801C or 801D) product bytes.</p>			

A15=1, A14=0, and A13=0, hexadecimal addresses 8XXX or 9XXX where X means "don't care." The last six bits (A5, A4, A3, A2, A1, and A0) are examined to decode ports. For the first eight slots (one full mother board), A5=0, and bits A4, A3, and A2 are decoded with a 74LS138 3 to 8 line decoder. This signal is port bus pin 1: IO select. Remaining bits A1 and A0 are buffered and become port bus signal RS1 and RS0, used by hardware plugged in a slot to select which of the four bytes is being addressed. (Actually, we earlier used the term "port" rather loosely to mean IO slot. We now wish to be more precise and recognize that each IO slot contains four ports.)

Although the IO slot is only four bytes wide, the bytes which are read need not be logically the same as (or even related to) the bytes which are written to the same address. (Compare this with a memory where we would hope they are the same!) Port bus signal RW tells hardware in an IO slot what to expect. To use our hardware multiplier, we write (from the processor) into three bytes, and read from four bytes of IO slot #7. This is summarized in table 1.

In table 1, the MPY-BAJ registers X, Y and P are mentioned (along with ROUND). Figure 1 is a pinout drawing of the TRW product (reproduced from the specifications sheets, courtesy of TRW Electronics Sys-

Figure 1: Physical layout and pinout diagram for the MPY-BAJ multiplier part, reproduced from the specifications sheets, courtesy of TRW Electronic Systems Division, One Space Park, Redondo Beach CA 90278. Note that bits are numbered from 1 (most significant) to n (least significant), a convention which differs from conventional microprocessor usage in which bit 0 is always the least significant. The text and figures of these articles reflect the inverse ordering of the bit numbers on the multiplier side of the interface.

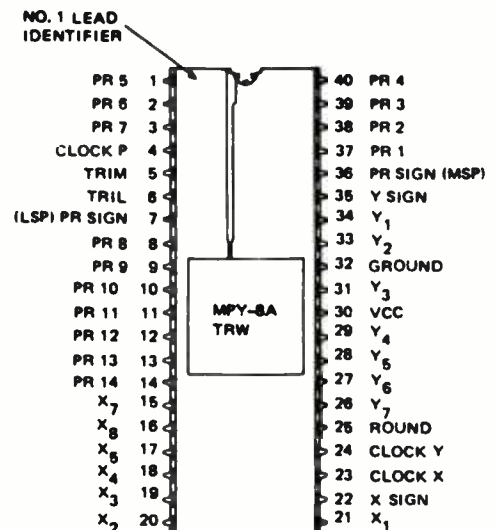

# SCELBI's new '8080' STANDARD ASSEMBLER

- FUNCTION:** Assembles programs written in symbolic language for an 8080 CPU on an 8080 based system.
- HARDWARE REQUIRED:** 8080 computer with minimum of 4K memory (of which at least 1K should be RAM); a source listing input device; an object code output device.
- OPTIONAL HARDWARE:** A system console device such as a keyboard/CRT or keyboard/printer will allow convenient control of the program using executive commands; additional memory beyond 4K will allow expanded symbol table length, or capability to assemble directly into memory.
- SOFTWARE REQUIRED:** User provided I/O driver routines for whatever I/O devices will be utilized. Each I/O device is linked to the program by a *single* vector for ease in adapting the program to individual systems.
- MEMORY UTILIZED:** The assembled listing provided in the manual resides in pages 01 through 0A (hexadecimal - 001 through 012 octal). Pages 00, part of 0A, all of 0B and 0C (hexadecimal - 000, part of 012, 013 and 014 octal) are left available for user provided I/O routines. Pages 0D (hexadecimal - 015 octal) on up used for symbol table storage (or as direct assembly areas in systems with sufficient memory).
- MNEMONICS UTILIZED:** This program is written in, and accepts for assembly purposes, standard industry accepted mnemonics for the 8080 CPU (such as MOV A,B; INX H; CALL; etc.) [Note: SCELBI is discontinuing its use of special 8008 compatible mnemonics which have characterized its 8080 programs in the past.]
- PSEUDO-OPERATORS:** Accepts the ORG (originate), END (stop assembly), SET (define a name), DB (data byte), DS (data string) and DW (data word or double byte) pseudo-operators.
- PROGRAM OPERATION:** The program processes a source listing in two passes to produce assembled object code. An optional third pass allows an assembled listing to be obtained. Listings may be obtained in hexadecimal or octal format. The program will also display the contents of the symbol table at the operators request. The program can process source listings as single or multiple files. Program operation may be controlled from a console device using executive commands or through computer panel switches by jumping to appropriate locations within the program.
- SOURCE FORMAT:** Convenient, easy to use, variable length fields permitted. Labels may be 1 to 6 characters in length, accepts both hexadecimal and octal numbers with or without leading zeros, has "literal" capability (can accept ASCII characters directly as data), allows use of letters of numbers as CPU register operands.
- DOCUMENTATION:** Thorough - in the SCELBI tradition! The program manual describes the operation of the assembler, presents detailed discussions of all major routines, and contains two completely assembled listings (one provided in hexadecimal and one in octal notation). Of course it includes operating instructions and even provides a routine that may be used for loading programs produced by the assembler!
- SPECIAL FEATURES:** Because the program has been carefully organized and written with all memory references assigned labels, it may be readily reassembled to reside in any general area in memory. It may even be reassembled to reside in ROM provided that some RAM area is available for scratch pad and symbol table use!
- OPTIONS:** A punched paper tape of the object code for this assembler (as described in the documentation) is available. The object code tape is provided in the widely accepted "hexadecimal format." Also, the complete, commented source listing of the program as presented in the documentation is available in straight ASCII format on punched paper tape. Fan-fold paper tapes are provided for ease in handling. Additionally, opaque paper tape is supplied to facilitate the use of low cost optical paper tape readers now in widespread use. NOTE: Paper tapes are sold only as optional supplements to the documentation.



Scelbi's 8080 Standard Assembler: **\$19.95** Optional object code on punched paper tape, specify 8080SA-OPT: **\$10.00**. Optional commented source listing on punched paper tape, specify 8080SA-SPT: **\$39.00**.

**OPTIONAL PAPER TAPE NOW AVAILABLE!**

Circle 310 on inquiry card.

**SCELBI COMPUTER  
CONSULTING INC.**  
Post Office Box 133 PP STN  
Milford, CT 06406 Dept. B

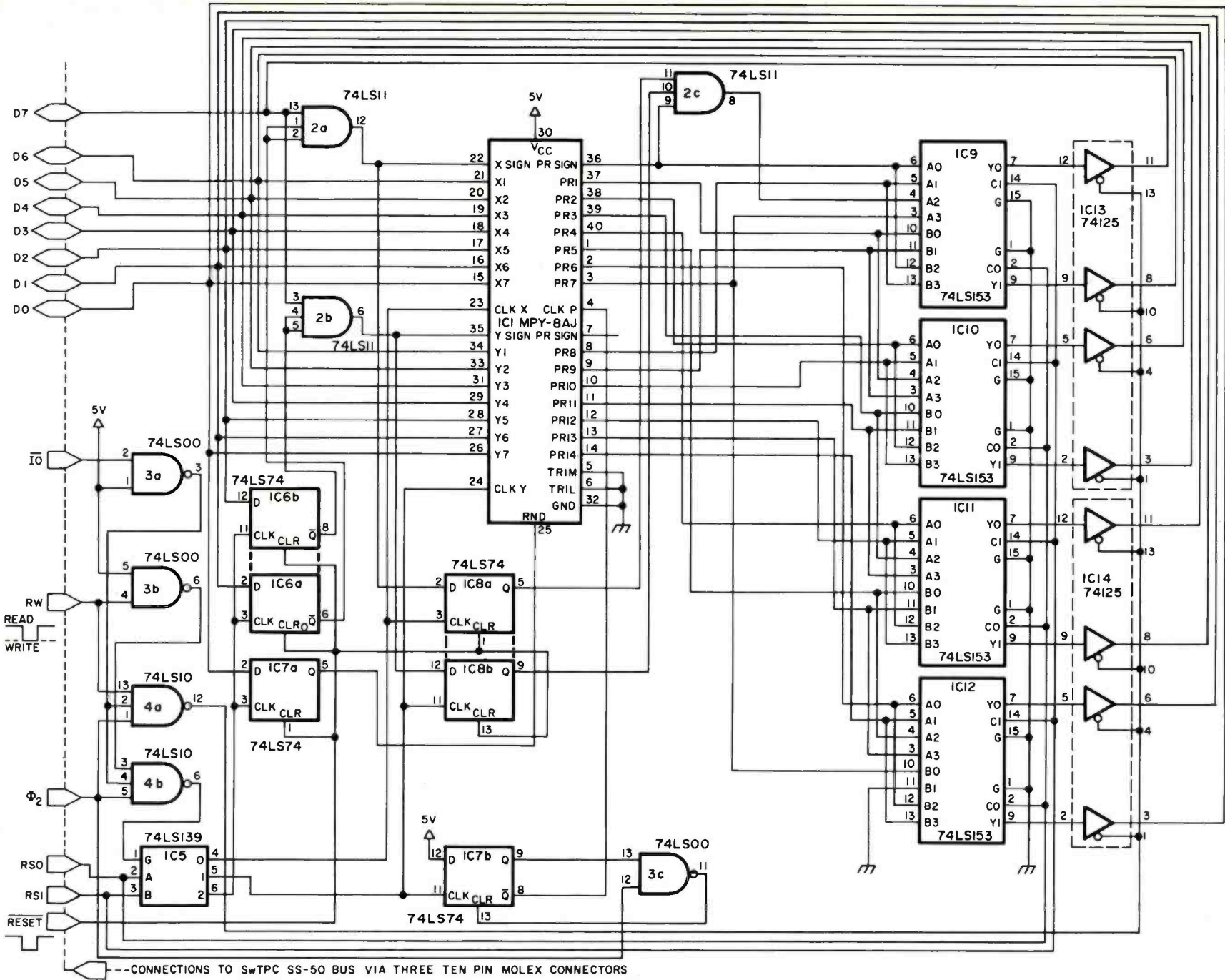

Figure 2.



POWER WIRING TABLE			
IC Number	Type	+5 V Pin	Gnd Pin
1	MPY-8AJ	30	32
2	74LS11	14	7
3	74LS00	14	7
4	74LS10	14	7
5	74LS139	16	8
6	74LS74	14	7
7	74LS74	14	7
8	74LS74	14	7
9	74LS153	16	8
10	74LS153	16	8
11	74LS153	16	8
12	74LS153	16	8
13	74125	14	7
14	74125	14	7

tems Division), the basic component of our multiplier. Labelling bits as TRW does, from 1 (most significant) to 14 (least significant), we can write:

$$X = -x_5 + x_1 2^{-1} + \dots + x_7 2^{-7},$$

$$Y = -y_5 + y_1 2^{-1} + \dots + y_7 2^{-7}; \text{ then}$$

$$P = X * Y = -p_5 + p_1 2^{-1} + \dots + p_{14} 2^{-14} + \text{ROUND} \cdot 2^{-8}.$$

Signals CLOCK X and CLOCK Y move X and Y from the data bus to the multiplier array input registers. In our application, we treat sign bits  $x_5$  and  $y_5$  differently: these are data bus signals ANDed with a control code bit which is stored in a flip flop and used to control stripping of signs.

The MPY-8AJ pinout suggests an intention of the designers to use the upper and lower parts of the product independently. In fact pin 5, called TRIM, enables the three state output buffer for the most significant part of the product ( $p_5 p_1 \dots p_7$ ), and pin 6 labelled TRIL enables the least significant  $p_5 p_8 \dots p_{14}$ . However, we are treating the product here as a single 15 bit entity (which we optionally return shifted left or right), and do not require the TRIL and TRIM signals since external logic is employed in the circuit.

In our design the CLOCK P signal is generated 1/2 clock cycle after the storing in (writing to) the Y register at hexadecimal address 801D. We could have used some other signal to clock the product into out-

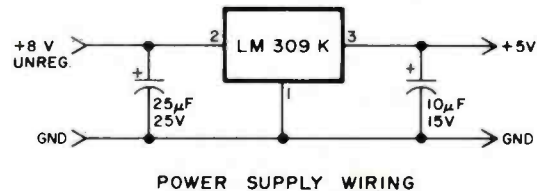

Figure 2: The complete MPY-8AJ multiplier interface. The SwTPC (SS-50) and Motorola symbolic designations of processor signals are shown at the left side of the diagram. RS0 and RS1 are signals derived from the low order address bits A0 and A1 from the processor. IO select is a signal from the SwTPC processor that indicates a reference to a range of four addresses; for slot 7 of the backplane these addresses are 801C and 801F.

put registers, but this would usually take another instruction. Usage of the multiplier can be summarized as follows:

1. Set condition (which is set to 0 by RESET).
2. Store multiplicand X.
3. Store multiplier Y.
4. Read product as needed.

The third and fourth steps may be repeated (for as many distinct multipliers as are needed) without storing another X. However, the condition code which prevailed when the last X was stored determines whether the sign of X is stripped. The product remains unchanged until another multiplier is stored in hexadecimal 801D. (The reason for stripping signs was explained last month.)

One product of signed 8 bit numbers treated as fractions seems "wrong":  $-1 \times -1 = -1$ . Recall that  $-1$  is equal to the binary value 1000 0000; there is simply no representation of  $+1$  as a signal binary fraction. (Thinking of the same binary numbers as integers with the binary point to the right leads to a different interpretation: there is no 15 bit two's complement representation of decimal  $16,384 = 2^{14}$ . That is, the product of  $-128$  times  $-128$  exceeds the capacity of 14 bits.) Actually, the product is correct "modulo 2." In any case, it represents an overflow condition which needs to be flagged if possible, mainly because it is so hard to detect with software. Luckily, with this design we have a spare bit

Photo 2a: Component side of the multiplier board. The circuit is entirely socketed with wire wrap sockets. The Molex connectors are mounted on the component side, with every other pin connection made by running wire wrap to solder terminations on the component side. The overlay shows logical identifications of components from figure 2.

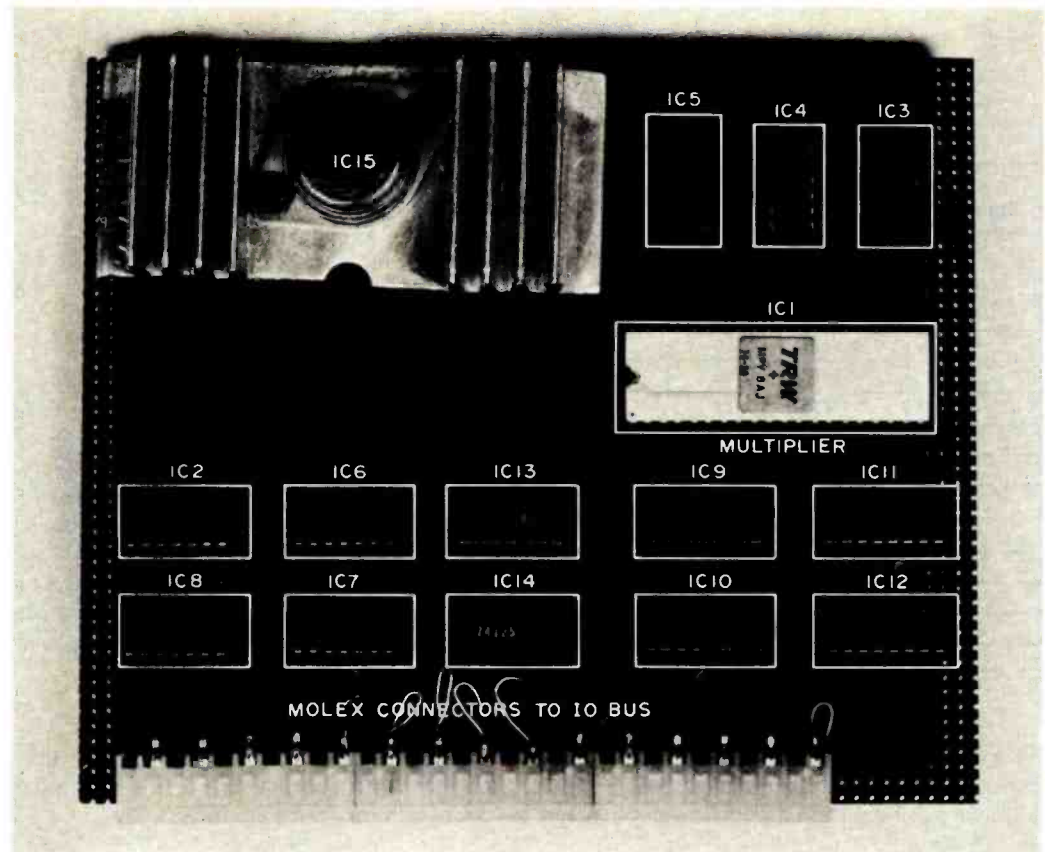

in a good place. The first bit of hexadecimal location 801D (which is usually 0). We turn this bit on when the product of two negative numbers turns out to be negative.

### How to Build the Multiplier

Figure 2 is a circuit diagram of the hardware multiplier. The prototype discussed here was built in a few hours using the nifty OK Machine & Tool Corporation WSU-30 hand wire wrap tool (\$5.95 from James Electronics and others).

Wire wrap DIP sockets are inserted into

Figure 3: Size and spacing of Molex connector slots relative to lower board edge.

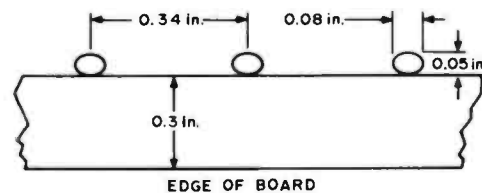

**Note:** The MPY-8AJ is available in single unit quantities from TRW, One Space Park, Redondo Beach CA 90278. The authors have a few on hand for \$100 postpaid.

prepunched .1 inch grid Vectorboard. The layout of the integrated circuits is shown by the overlay on photo 2a. Molex sockets are used to plug into SwTPC IO ports; three 10 pin connectors are needed. Since Molex connectors are not spaced on the .1 inch grid of the Vectorboard, slots must be cut in the Vectorboard to accommodate and hold the connectors. Figure 3 shows the dimensions of the slots and their placement on the Vectorboard. Such slots can be made most easily with a Dremel tool equipped with the tiny router type tip. The width of the slots is important: if the slots are too wide, it will be hard to get a solid mounting.

After all slots are cut, insert the connectors with the plastic hooks catching the edge of the Vectorboard. Gently push the edge of the Vectorboard into the slots, pushing the connector against the Vectorboard while bending the extended solder tab toward the edge of the board (see photo 2b). Wires may now be soldered to solder tabs and brought to the proper wire wrap socket. We got a good mounting with every other pin straightened out (so that only half as many slots need be cut).

No unexpected surprises accompany wire wrapping the circuit, although the WSU-30 requires a little practice before good tight wraps are obtained.

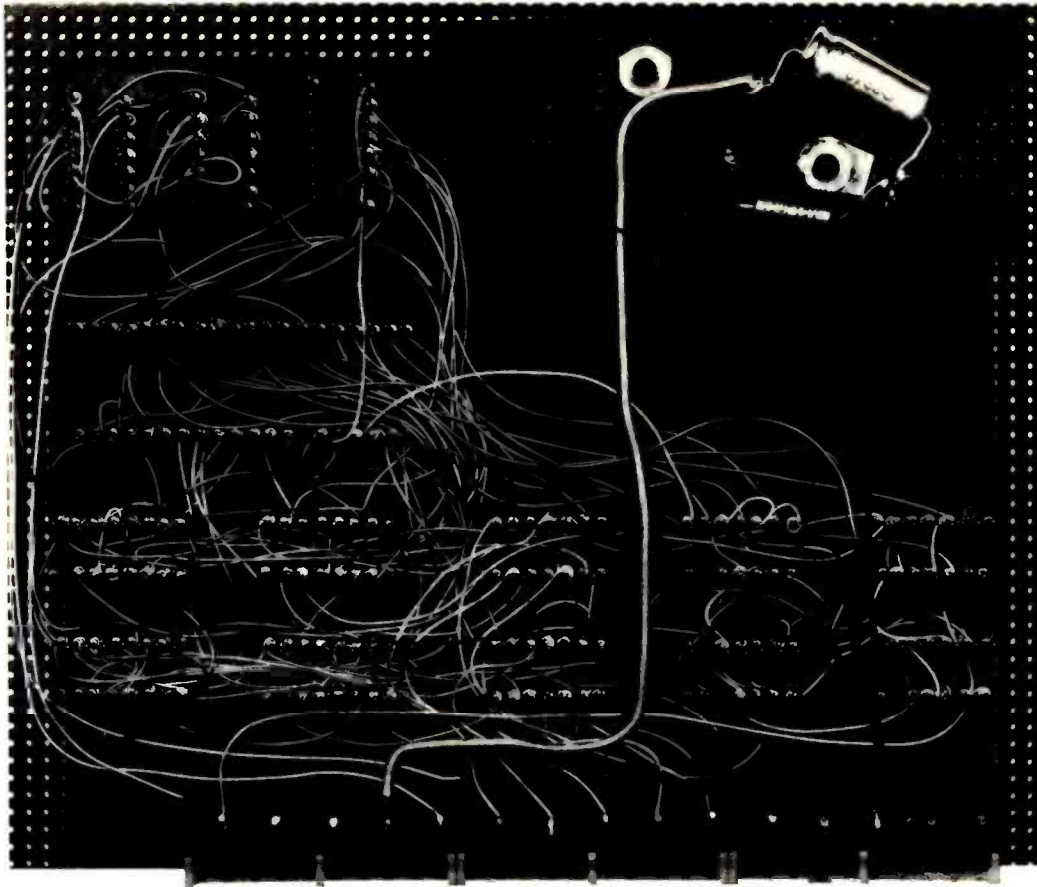

*Photo 2b: The wiring side of the wire wrap prototype of the high speed multiplier. The Molex pins are bent over for mechanical support. All connections are wire wrapped with the exception of capacitors in the power supply and terminations to the Molex connector.*

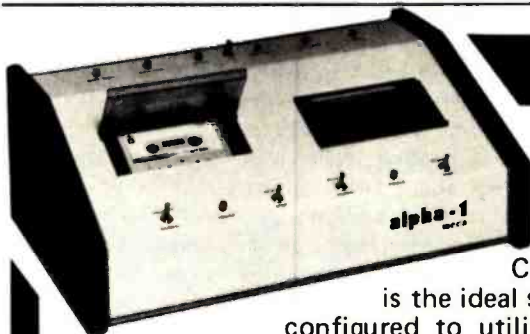

# alpha-1

## The Digital Cassette Storage System with AUDIO CAPABILITY

Compatible with all S-100 bus microcomputer systems, alpha-1 is the ideal storage system for use in any application. Your alpha-1 may be configured to utilize from one to four drives to provide limitless capabilities. Alpha-1 is a highly economical approach to mass storage for your home computer, your business system, or the classroom.

### SEPARATE AUDIO RECORDING

This feature provides your system with capabilities for:

- Verbal student/computer interaction
- Talking games
- Audio burglar alarm
- intelligent phone message system

### SPEED AND CAPACITY

- Stores over 500K bytes per C-60 side
- Average access time for C-60 tape is 17 seconds.
- Load 8K in less than 11 seconds.
- Data transfer rate at 6250 baud.

### HARDWARE

- Compatible with all popular S-100 bus microcomputers.
- Audio track under computer control.
- Replaces ROM/PROM monitors.
- Independent motion control and read/write electronics.
- 2-button cold start capability.

### SOFTWARE

- MCOS Operating System handles variable length named files, updates, packs and copies with a single command. Includes Editor, Assembler and Debugger . . . all provided with alpha-1.
- Extended BASIC (4.4) with MCOS for array handling and concatenation.
- PDS1—a sophisticated editor/assembler.
- Dynamic Debugger provides program display, execution control and monitoring.
- Games
- ACR/Tarbell Load

### SYSTEM INCLUDES

Mecadrive, case, controller, power supply, cabling, operating manual and software on cassette. The natural wood enclosure pictured here is optional.

### FREE BUYERS GUIDE!

You don't have all the facts about tape and disk systems until you have read our *BUYER'S GUIDE TO MASS STORAGE . . .* Free for the asking!

Available kit or assembled from dealers nationwide. For the dealer nearest you, write or phone:

**meca**

7026 D.W.S. Road, Yucca Valley, CA 92284  
(714) 365-7686

Table 2: A list of SwTPC 6800 computer system IO bus pins and calculated worst case loading of these pins by the circuit of figure 2. The worst case loading is the current drawn when an input is in the logical 0 state. (The 0.5 A power supply loading into the regulator is not a logic signal, of course, and the GND pins have no such specification applicable.)

Pin	Signal	Worst Cast Zero Level Load	Pin	Signal	Worst Case Zero Level Load
1	IO #	-0.36 mA	16	D3	-0.42 mA
2	RESET	-3.60 mA	17	D2	-1.16 mA
3	110 b	NC	18	D1	-1.16 mA
4	150 b	NC	19	D0	-1.16 mA
5	300 b	NC	20	RS1	-1.80 mA
6	600 b	NC	21	RS0	-1.18 mA
7	1200 b	NC	22	IRQ	NC
8	+8 unreg	500 mA	23	NMI	NC
9	+8 unreg		24	INDEX	NC
10	R/W	-0.72 mA	25	GND	GND
11	$\phi$ 2	-1.08 mA	26	GND	GND
12	D7	-0.72 mA	27	+12	NC
13	D6	-0.42 mA	28	-12	NC
14	D5	-0.42 mA	29	UD4	NC
15	D4	-0.42 mA	30	UD3	NC

Listing 1: Support software and test program for the hardware multiplier. This listing gives the complete source code and assembly listing of a 6800 processor program which tests the operation of the multiplier circuit in a SwTPC 6800 computer system. The operation of the hardware multiplier is compared to an implementation of a version of Booth's algorithm for signed two's complement multiplication. IO operations are performed with Motorola MIKBUG subroutines.

```

000C3      * PROGRAM TESTMP
00004      *
00005      * PURPOSE: TO TEST A HARDWARE MULTIPLIER
00006      * DESIGNED FOR THE SWTP 6800 SYSTEM
00007      * USING A TRM MPY-8AJ TWO'S COMPLEMENT
00008      * ASYNCHRONOUS PARALLEL MULTIPLIER.
00009      *
00010      * DESIGN:
00011      * HARDWARE: MANOT SWASOFE
00012      * SOFTWARE: JACK BRYANT
00013      *
00014      * PARAMETERS:
00015      *
00016      * FOR SUBROUTINE BOOTH8:
00017      *
00018      * M -- ONE OPERAND FOR SOFTWARE MULTIPLIER
00019      * R -- OTHER OPERAND
00020      * P -- TWO BYTE PRODUCT.
00021      *
00022      * FOR HARDWARE MULTIPLIER:
00023      *
00024      *          INPLT      OUTPUT
00025      *          *****
00026      * FM -- FIRST OPERAND      SIGN AND UPPER
00027      *                          7 BITS OF PRODUCT
00028      *
00029      * SM -- SECOND OPERAND     LOWER 7 BITS
00030      * & STROBE PRODUCT AND ZERO
00031      *
00032      * UNP -- CONDITION CODE:  BIT 0: OVERFLOW
00033      *          XXXXXSFR WHERE (ON 800880)
00034      * F = STRIP SIGN FM      BITS 1-7: SIGN
00035      * S = STRIP SIGN SM      AND UPPER 6 BITS
00036      * N = ROUND              OF PRODUCT
00037      * X = DON'T CARE
00038      *
00039      * LNP -- NOT USED FOR     LOWER 8 BITS
00040      *          INPUT          OF PRODUCT
00041      *
00042      * USAGE:
00043      * THIS PROGRAM ASSUMES THE HARDWARE
00044      * MULTIPLIER IS CONFIGURED AT ADDRESS
00045      * 800C-800F, WHICH IS PORT 7 IN THE
00046      * SWTP 6800 SYSTEM. FOR ANOTHER, CHANGE
00047      * FM EQU 800C
00048      * TO THE DESIRED ADDRESS.
00049      * FAILURE DURING TEST RESULTS IN THE
00050      * EXECUTION OF A SWI INSTRUCTION,
00051      * RETURNING CONTROL TO MIKBUG
00052      * OPERATING SYSTEM. CURRENT VALUES
00053      * OF PARAMETERS CAN BE FOUND USING THE
00054      * MEMORY EXAMINE AND CHANGE FUNCTION.
00055      *
00056      *
00057      *          OPERAND      ADDRESS
00058      * FIRST MULT.          80004
00059      * SECOND MULT.         80005
00060      * CONDITION           80006

```

## How to Test It: Booth's Algorithm

Listing 1 is a program which repeatedly tests every function of the hardware multiplier with every possible combination of operands and condition code against a software generated product. For each of eight values of the condition code, all 65,536 different products are formed and compared. This is a lot of logic and arithmetic, and we sought a more efficient software multiply method than program MPY8S0 in listing 3 of the first part of this article. Such an algorithm was discovered in 1951 by Andrew Booth; this was quickly coded up and tested. (Surprise: in Booth's notation, the algorithm fails on the expression  $m \times r$  if  $r = -1$ , although it does evaluate  $-1 \times r$  correctly. The reason is that there is no two's complement of  $-1$ . That is, this two's complement value overflows and the algorithm gets started incorrectly. The result is  $m \times -1 = m$ , which is only correct if  $m$  equals 0 or  $-1$ . Booth's "proof" really shows only that  $m \times r$  is correct when  $r$  is regarded modulo 2; since  $-1$  and 1 are the same modulo 2, in some sense the algorithm works. In any case, an inelegant fix is to interchange  $m$  and  $r$  if  $r = -1$ .)

Algorithm 1 shows what the test program does, and algorithm 2 is (our modification of) Booth's algorithm. The test program rings the system bell (ASCII 07) every time the condition code changes, with every eighth bell ring being replaced by a print of "OK." Each complete cycle takes a little over 3 1/2 minutes, with about 42 seconds separating bell rings. (Booth's algorithm is about twice as fast as MYP8S0, although it is trickier. We get about 1560 tests per second [most of this time is spent in BOOTH8] or about 641  $\mu$ s per test.)

## Bus Loading

One point we have neglected is the problem of how heavily we are loading the system bus. In order to allow the seven other slots to be full of IO interfaces or other loads, we indicate use of 74LS series TTL. The worst case loading is shown in table 2. The MPY-8AJ input loading is less than 1 mA without input buffering. Table 2 also gives SwTPC bus pin number identifications.

## REFERENCE

Andrew D Booth, "A Signed Binary Multiplication Technique," *Quarterly Journal of Mechanics and Applied Mathematics*, volume 4 (1951), pages 236 to 240. Reprinted in *Computer Design and Development: Principal Papers*, edited by Earl E Swartzlander Jr, Hayden Book Company, Rochelle Park NJ, 1976, pages 163 to 166.

Listing 1, continued:

```

00061      *
00062      *
00063      *
00064      *
00065      *
00066      *
00067      *
00068      *
00069      *
00070      *
00071      *
00072      EIC1  QLTEEL EGU  $EID1  MIKBUG OUTPLT SUBROUTINE
00073      $01C  FM      EGU  $B01C
00074      $01D  SM      EQL  FM#1   FORT 7
00075      $01E  U&P    EQL  FM#2   VIA $&TP.
00076      $01F  L&P    EGU  FM#3
00077  0000  0CC1  M      RMB  1     FIRST MULT. FOR BOOTH8
00078  0001  0001  R      RMB  1     SECOND MULT.
00079  0002  0002  P      RMB  2     PRODUCT.
00080  0004  0001  J1     RMB  1     *RAW* FIRST MULT.
00081  0005  0001  J2     RMB  1     *RAW* SECOND MULT.
00082  0006  0001  CC     RMB  1     CONDITION.
00083  0007  7F  C0C6  AGAIN  CLR  CC
00084  0008  7F  C0C4  NEXTCC  CLR  J1
00085  0009  7F  C005  NEXTJ1  CLR  J2
00086  0010  96  C0   NEXTJ2  LVA  A  CC      SET CONDITION CODE
00087  0012  87  E01E  STA  A  URP    OF HARDWARE.
00088  0015  96  CA   LCA  A  J1     STORE FIRST
00089  0017  87  E01C  STA  A  FM     MULTIPLICAND.
00090  001A  97  00   STA  A  M     SAVE FOR BOOTH8.
00091  001C  96  C5   LCA  A  J2     SAME FOR
00092  001E  87  E01D  STA  A  SM    MULTIPLIER.
00093  0021  97  01   STA  A  R     SAVE FOR BOOTH8.
00094

```

Algorithm 1: A test program for the multiplier. An equivalent software multiply is used to compare the hardware result. The software multiply, BOOTH8, is shown in algorithm 2.

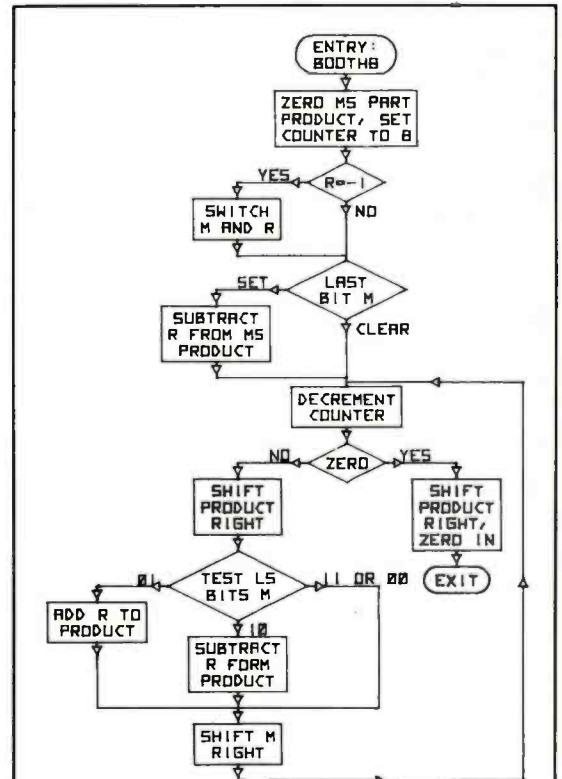
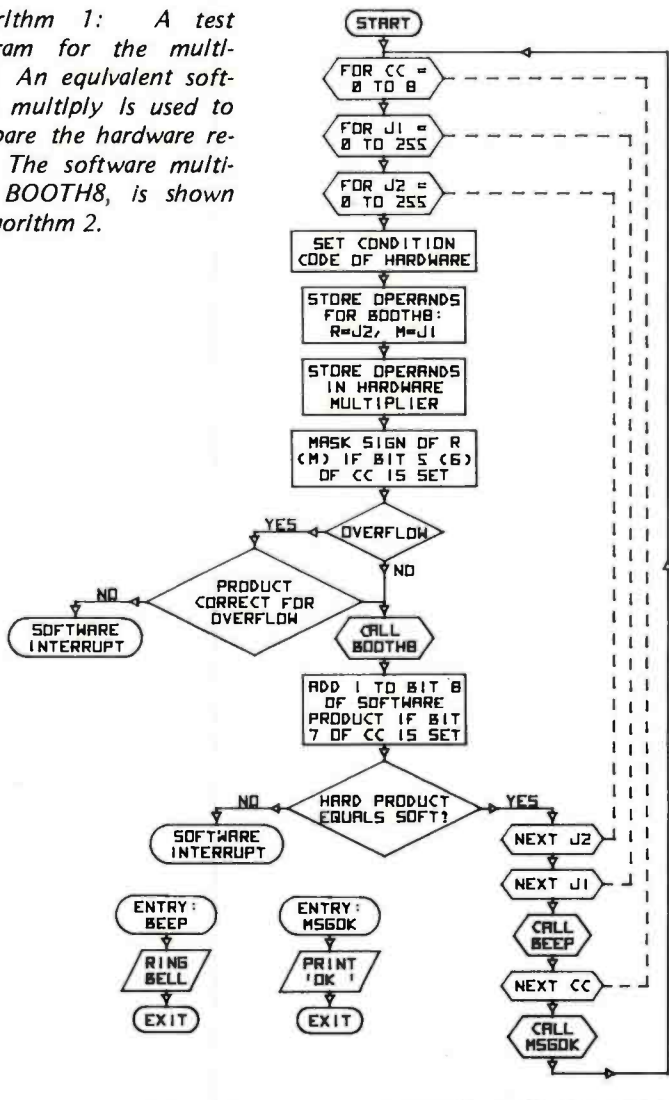

Algorithm 2: BOOTH8, a faster 8 bit by 8 bit multiplication algorithm which replaces listing 3 of part 1 of this article in order to speed up tests of the multiplier circuit. As in part 1 of this article, the author's original flowchart representations which were drawn with a computer controlled plotter are reproduced here.

Listing 1, continued:

```

00095 0023 96 06      LCA A LC          IS BIT 5 OF CC SET?
00096 0025 84 04      AND A #4
00097 0027 27 05      WEO NOT5
00098 0029 96 C1      LCA A M          YES.
00099 0028 84 7F      ANU A #57F      MASK SIGN OF R.
00100 0020 97 01      STA A R
00101
00102 002F 96 C6      NCT5 LCA A CC     IS BIT 6 OF CC SET?
00103 0031 84 02      AND A #2
00104 0033 27 C6      BEG NOT6
00105 0035 96 00      LCA A M          YES.
00106 0037 84 7F      ANU A #57F      MASK SIGN OF M.
00107 0039 97 C0      STA A M
00108
00109 0038 84 00      NCT6 LDA A #980     SEE IF #80*980.
00110 0030 91 00      CMP A M
00111 003F 24 14      BNE NOOVFL
00112 0041 91 01      CMP A R
00113 0043 26 10      BNE NOOVFL
00114 0045 86 00E LCA A URP      CVERFLOW PERE.
00115 0048 81 C0      CMP A #5C0     SEE IF UMP#1130 0000
00116 004A 27 47      BEG UMPPJ2
00117 004C 3F      SWI           ERROR IN FORMING
00118
00119
00120 0040 2C 8D      NEXCC BNA NEXTCC BRIDGE FOR
00121 004F 20 BF      NEXJ2 BRA NEXTJ2 LGNG JUMPS
00122 0051 20 EA      NEXJ1 BRA NEXTJ1 FOR RELATIVE
00123 0053 20 E2      AGA BRA AGAIN  BRANCHING.
00124
00125 0055 8C 00C4 NCOVFL JSR J00TH8 FORM SOFTWARE PROD.
00126 0058 96 C6      LDA A CC
00127
00128 005A 84 C1      ANU A #1       ROUNDT
00129 005C 27 0F      BEU NUCARY
00130 005E 96 03      LGA A P+1     YES. ADD 1
00131 0060 88 40      ADU A #540     TO BIT 8 OF
00132 0062 97 03      STA A P+1     PRODUCT, WHICH
00133 0064 24 C7      BCC NUCARY    IS BIT 1 OF P+1
00134 0066 96 02      LCA A P
00135 0068 4C      INC A         TURN BIT 0 EACH OFF
00136 0069 84 7F      ANU A #57F
00137 006B 97 C2      STA A P
00138
00139 006D 86 001F NCLARY LCA A LRP   CHECK LRP.
00140 0070 91 03      CMP A P+1
00141 0072 27 C1      BEU CK1
00142 0074 3F      SWI           ERROR IN LRP.
    
```

```

00143
00144 0075 86 801E CK1 LCA A URP
00145 0078 91 C2      CMP A P       CHECK URP.
00146 007A 27 01      BEU UK2
00147 007C 3F      SWI           ERROR IN URP.
00148
00149 007D 78 0003 CK2 *SL P+1     SHIFT PRODUCT
00150 0080 75 C002 HCL P         LEFT.
00151 0083 86 0010 LCA A SM
00152 0086 91 03      CMP A P+1     CHECK SM.
00153 0088 27 C1      BEU UK3
00154 008A 3F      SWI           ERROR IN SM.
00155
00156 008B 86 001C GK3 LOA A FM
00157 008E 91 02      CMP A P       CHECK FM.
00158 0090 27 C1      BEG HUMPJ2
00159 0092 3F      SWI           ERROR IN FM.
00160
00161 0093 7C C0C5 HUMPJ2 INC J2
00162 0096 26 B7      BNE NEXJ2     INCREMENT J2.
00163 0098 7C C00A INC J1
00164 0098 26 E4      BNE NEXJ1     INCREMENT J1
00165 009D 96 C6      BUMPCC LCA A CC
00166 009F 4C      INC A
00167 00A0 81 08      CMP A #8      INCREMENT CC.
00168 00A2 27 C6      BEU MSG
00169 00A4 97 C6      STA A CC
00170 00A6 80 C6      BSH BEEP     RING BELL.
00171 00A8 20 A3      BRA NEXCC
00172 00AA 8C 08      MSG USH MSGOK WHITE *OK *.
00173 00AC 2C A5      BRA AGN
00174
00175 00AE 86 C7      BEEP LOA A #7
00176 00B0 8C E1D1 JSR ULTEE
00177 00B3 39      RTS
00178 00B4 8E AF      MSGCK LCA A #10
00179 00B6 8C E1C1 JSR OUTEE
00180 00B8 8E 48      LCA A #*K     OUTPUT VIA WKBUG.
00181 00BB 8C E1D1 JSR ULTEE
00182 00BE 86 20      LCA A #520
00183 00C0 8D E1D1 JSR ULTEE
00184 00C3 39      RTS
00186
00187
00188
00189
00190
00191
00192
00193
00194
00195
00196
00197
00198
00199
00200
00201
00202
00203
00204
00205
00206
00207
00208
00209
00210
00211
00212 00C4 7F 0002 HCLTH8 CLM P       ZERO PRODUCT MS
00213 00C7 CE C0C8 LOK #8      PART. SET COUNTER.
00214 00CA 07      TPA          SAVE PRUCESSM CONDITION
00215 00CB 3C      PSH A       CODES ON STACK.
00216 00CC DE C1      LCA B R
00217 00CE C1 E0      LMP E #580   METHOD HAS A BUG
00218 00D0 26 05      BNE NGTM1    FOR M*(-1), BUT
00219 00D2 17      TEA          (-1)*M WORKS.
00220 00D3 D6 00      LCA B M      INTERCHANGE M AND N.
00221 00D5 97 00      STA A M
00222 00D7 5E C0      NGTM1 LCA A M   GET STARTED WITH
00223 00D9 06      TAP          BIT 8 ZERO.
00224
00225
00226
00227
00228
00229 00DA 24 C5      BCC SHIFT
00230 00DC 96 02      LCA A P      CASE 10 = SUBTRACT.
00231 00DE 10      SEA
00232 00DF 97 C2      STA A P
00233 00E1 09      SHIFT DEX
00234 00E2 27 1E      BEQ FINISH   DECREMENT COUNTER & TEST.
00235 00E4 77 0002 ASR P        SHIFT PRODUCT RIGHT.
00236 00E7 76 C0C3 ROR P+1
00237 00EA 96 CC      LCA A M
00238 00EC 06      TAP
00239 00ED 24 07      BCC X0
00240 00EF 29 C0      BVS SMTM
00241 00F1 96 C2      LCA A P      CASE 01 = ADD.
00242 00F3 1E      AEA
00243 00F4 20 C5      HRA STAG
00244 00F6 28 C5      X0 BVC SMTM
00245 00F8 96 02      LCA A P      CASE 10 = SUBTRACT.
00246 00FA 10      SEA
00247 00FB 97 C2      STAG STA A P
00248 00FD 77 C0C0 SFTM ASR M        SHIFT MULTIPLIER RIGHT.
00249 0100 20 0F      BHA SHIFT
00250 0102 74 0002 FINISH LSR P       HERE. PRODUCT IS
00251
00252
00253
00254 0105 76 C003 HCR P+1
00255 0108 32      PLL A
00256 0109 96      TAP
00257 010A 39      RTS
00258
00259
    
```

DR. DOBBS - INTERFACE AGE - BYTE - POPULAR ELECTRONICS - ROM - KILOBAUD

POPULAR COMPUTING - MICROCOMPUTER / INTERFACE - COMPUTER NOTES - CALCULATORS / COMPUTERS - DIGITAL DESIGN

# ARTICLE INDEX

PERIODICAL  
GUIDE  
FOR  
COMPUTERISTS  
1977

MAKE FULL  
USE OF  
MAGAZINES

INDEX OF PERSONAL COMPUTING ARTICLES  
Letters from Readers \* Book Reviews  
Articles \* Editorials \* Indexed by Subject  
\*  
1977 Jan-Dec 25 Magazines Indexed  
1975-1976 15 Magazines Indexed  
\$5 each Postpaid Money Back Guarantee  
\*  
**E. BERG PUBLICATIONS**  
1360 SW 199th Ct., Aloha, OR. 97005  
\*  
**SEND FOR BROCHURE**

ELECTRONICS - RADIO ELECTRONICS - PERSONAL COMPUTING - CREATIVE COMPUTING

# Workhorse or Horseplay?

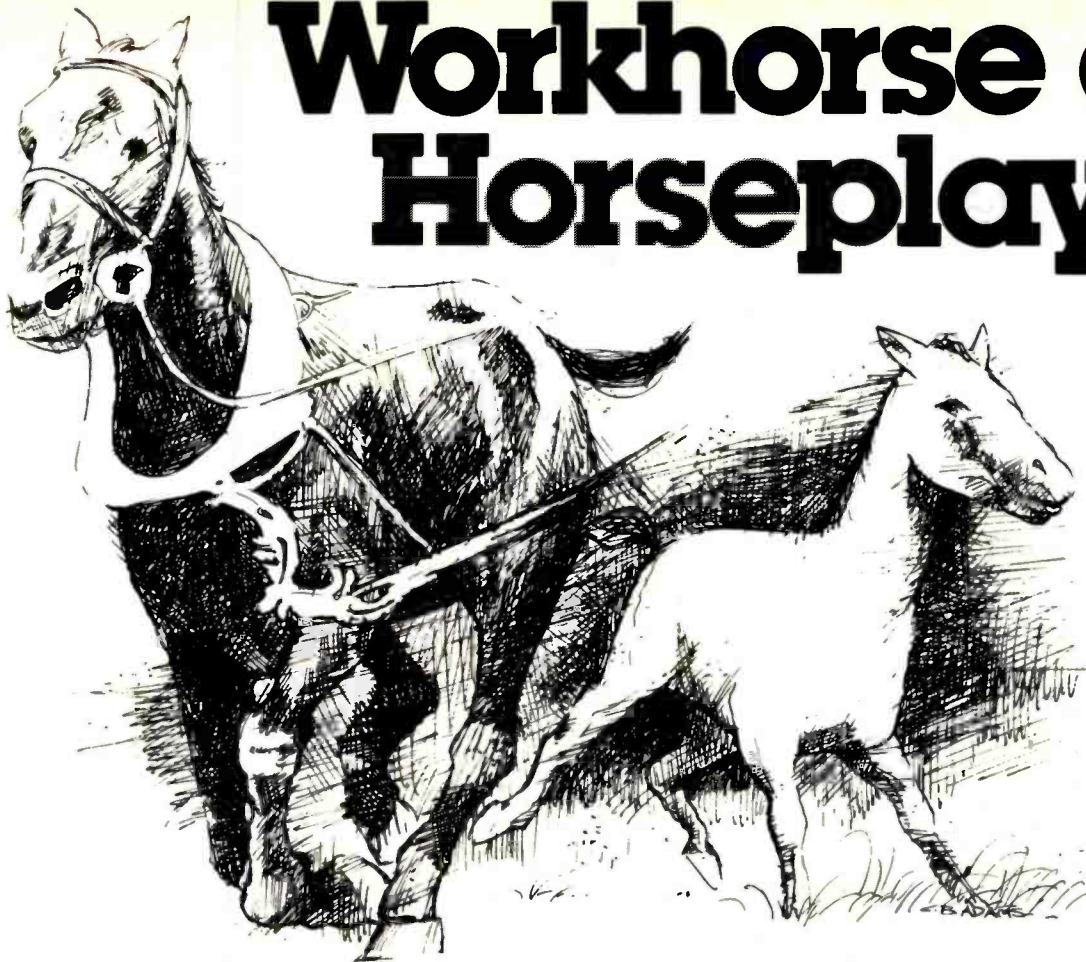

Software systems from TSC are designed for tough business and industrial uses on the job or just plain fun off the job. Whether you are looking for a system to be used primarily in a working situation or a system for the home, look into TSC software.

## Assembly Language Programs (Includes Source Listings)

SL68-29	6800	Text Processing System*	\$32.00
SL68-24	6800	Text Editing System*	\$23.50
SL80-10	8080	Text Editing System	\$28.50
SL68-26	6800	Mnemonic Assembler*	\$23.50
SL68-19	6800	Micro BASIC Plus*	\$15.95
SL80-9	8080	Space Voyage	\$12.00
SL68-5	6800	Space Voyage*	\$12.00
SL68-27	6800	Disassembler	\$ 9.00
SL68-28	6800	Program Relocator	\$ 8.00
SL80-8	8080	Blackjack	\$ 6.50

\*Kansas City Standard object code cassette tape available for an additional \$6.95.

Paper tapes available for some programs. Send 25¢ for complete catalog.



**Technical Systems  
Consultants, Inc.**

BOX 2574 W. Lafayette, Indiana 47906  
317-423-5465

Specialists in Software & Hardware for Industry & the Hobbyist

## Program-of-the-Month Club™

One year membership for \$2.00. Discounts offered with no obligations.

**To Order:** Include 3% postage, \$1.00 handling on orders under \$10.00, and Indiana residents add 4% sales tax. Check your dealer!

## TSC Monthly Feature:

### 8080 Text Processing System

Over 50 commands in the Text Processor allow formatting capabilities such as multiple spacing, indenting, saving contiguous text, various forms of justification, titling, page numbering and line length control. Macros are supported for special user-defined formatting commands allowing footnotes, form letters, etc. There are even number registers for variable storage, conditional commands, and terminal prompts.

The text file must be edited externally. The TSC Text Editing System is recommended, as it and the Text Processor give your computer the power of the most complete text processing systems. The complete assembler language source listing is included.

<b>SL80-11</b>	<b>8080 Text Processing System</b>	<b>\$32.00</b>
	<b>With Paper Tape</b>	<b>\$41.00</b>



Photo 4: The original rotating mirror, constructed from milled aluminum.

Continued from page 18

tional accuracy of 0.01 inches (0.025 cm) in a volume of 3 by 3 by 6 inches (7.6 by 7.6 by 15.2 cm); yet the system uses only a minimal interface to an inexpensive XY oscilloscope display, and the program (written here in MaxiBASIC) can run in as little as 18 K bytes of memory.

#### A Spinning Mirror

Theoretically, a 3-D display could be built by rapidly moving an oscilloscope display backward and forward in space. At any given moment, the display would be a certain distance from the observer. Any points displayed at this time would appear to be at this depth. Of course, there are

mechanical problems involved with this technique. Fortunately, the same effect can be achieved by moving a mirror in front of an oscilloscope screen and viewing the reflection. This technique is illustrated in figure 1. Here a vertical mirror is rotated in front of the screen, causing the reflected image to move in space. Related techniques involving reflected displays are listed in the references.

Once a rotating mirror is built, display of a point in three dimensions becomes a matter of timing and geometry. The vertical mirror is the simplest to build. It is also easy to compute the appropriate geometrical transformations. This design does suffer from a limited field of view, however: the oscilloscope screen itself blocks the display volume somewhat. This type of rotating mirror may be built by mounting a metallic or plastic mirror on the shaft of a motor which can rotate at between 600 to 1200 rpm. A variable speed motor offers some flexibility in the operation of the display. *Note:* For reasons of safety, the reflecting surface of the mirror should be made of either metal or reflective plastic (such as aluminized Mylar). DO NOT use a glass mirror!

An alternate method of construction is shown in photo 4. Here a mirror slanted at a 45° angle is mounted on the shaft of a motor, which is connected to a Variac variable speed motor control. This mirror was built under a National Institute of Health grant. It was milled from a solid block of 6 inch (15 cm) diameter cylindrical aluminum stock. The back of the mirror has been cut away for better dynamic balancing. The

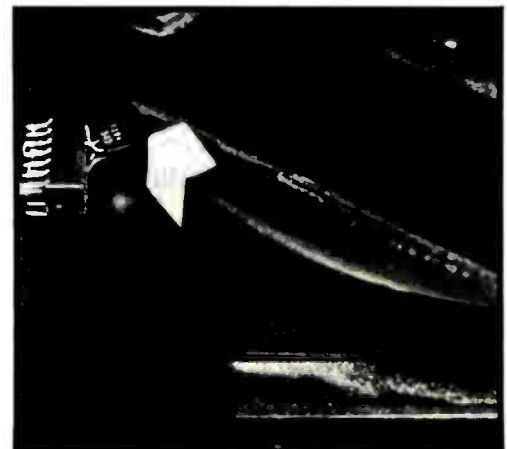

Photo 5: Close-up of the opto-coupler and white timing mark (a piece of tape).



# OSBORNE & ASSOCIATES, INC.

## The World Leaders In Microprocessor Books

If you want information on microprocessors, begin with the Osborne books.

### PROGRAM BOOKS WRITTEN IN BASIC

#### Payroll With Cost Accounting Accounts Payable And Accounts Receivable General Ledger

These books may be used independently, or implemented together as a complete accounting system. Each contains program listings, user's manual and thorough documentation. Written in an extended version of BASIC.

#22002 (400 pages), #23002\*, #24002\*

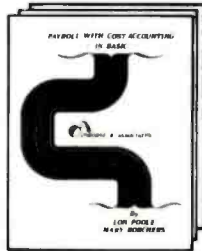

#### Some Common BASIC Programs

76 short practical programs, most of which can be used on any microcomputer with any version of BASIC. Complete with program descriptions, listings, remarks and examples.

#21002 (200 pages)



### ASSEMBLY LANGUAGE PROGRAMMING

#### 8080A/8085 Assembly Language Programming 6800 Assembly Language Programming

These books describe how to program a microcomputer using assembly language. They discuss classical programming techniques, and contain simplified programming examples relevant to today's microcomputer applications.

#31003, 32003 (400 pages each)



### AN INTRODUCTION TO MICROCOMPUTERS

#### Volume 0 - The Beginner's Book

If you know nothing about computers, then this is the book for you. It introduces computer logic and terminology in language a beginner can understand. Computer software, hardware and component parts are described, and simple explanations are given for how they work. Text is supplemented with creative illustrations and numerous photographs. Volume 0 prepares the novice for Volume I.

#6001 (300 pages)



#### Volume I — Basic Concepts

This best selling text describes hardware and programming concepts common to all microprocessors. These concepts are explained clearly and thoroughly, beginning at an elementary level. Worldwide, Volume I has a greater yearly sales volume than any other computer text.

#2001 (350 pages)



#### Volume II — Some Real Products (revised June 1977)

Every common microprocessor and all support devices are described. Only data sheets are copied from manufacturers. Major chip slice products are also discussed.

#3001A (1250 pages)

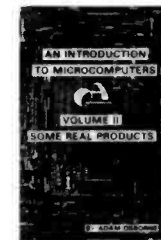

### PROGRAMMING FOR LOGIC DESIGN

#### 8080 Programming For Logic Design 6800 Programming For Logic Design Z80 Programming For Logic Design

These books describe the meeting ground of programmers and logic designers; written for both, they provide detailed examples to illustrate effective usage of microprocessors in traditional digital applications.

#4001, #5001, #7001 (300 pages each)



OSBORNE & ASSOCIATES, INC. • P.O. Box 2036 • DEPT. 18 • Berkeley, California 94702 • (415) 548-2805 9:00 a.m. - 5:00 p.m. PST TWX 910-366-7277

Price applies to orders received by June 30, 1978.		PRICE	QTY	AMT
6001	Volume 0 — The Beginner's Book	\$ 7.50		
2001	Volume I — Basic Concepts	7.50		
3001A	Volume II — Some Real Products (1977 edition)	15.00		
4001	8080 Programming For Logic Design	7.50		
5001	6800 Programming For Logic Design	7.50		
7001	Z80 Programming For Logic Design	7.50		
31003	8080A/8085 Assembly Language Programming	7.50		
32003	6800 Assembly Language Programming	7.50		
21002	Some Common BASIC Programs	7.50		
22002	Payroll With Cost Accounting	12.50		

- 6-1/2% SF Bay Area residents only
- 6% California residents outside SF Bay Area
- Payment must be enclosed for orders of 10 books or less.
- I have enclosed:
  - check
  - money order

TOTAL  
Sales Tax (Calif. residents only)  
Shipping Charges

TOTAL AMOUNT OF PURCHASE

NAME \_\_\_\_\_

ADDRESS \_\_\_\_\_

CITY \_\_\_\_\_ STATE \_\_\_\_\_ ZIP \_\_\_\_\_ PHONE \_\_\_\_\_

SHIPPING CHARGES Shipping charges for bulk orders to be arranged.

- 4th class (no charge, allow 3-4 weeks within USA, not applicable to discounted orders)
- \$.50 per book, UPS (allow 10 days) in the U.S.
- \$1.50 per book, special rush shipment by air in the U.S.
- All foreign orders, \$3.00 per book, for air shipment

\*These books are scheduled to be published during 1978.

Please notify me when they are available:

- 23002 Accounts Payable and Accounts Receivable
- 24002 General Ledger

Please send information on:

- pricing, ordering, and titles available after 6/30/78
- initial dealer consignments
- dealer and school discounts
- foreign distributors

Price increase scheduled for July 1, 1978

F8

Figure 2: Spinning mirror opto-coupler interface. A reflective opto-coupler (photo 5) is used to synchronize the position of the mirror with the program driving the display (photos 2b and 4). The circuit shown converts pulses from the opto-coupler to TTL level signals. Note the use of a feedback resistor at IC1 to form a Schmitt trigger.

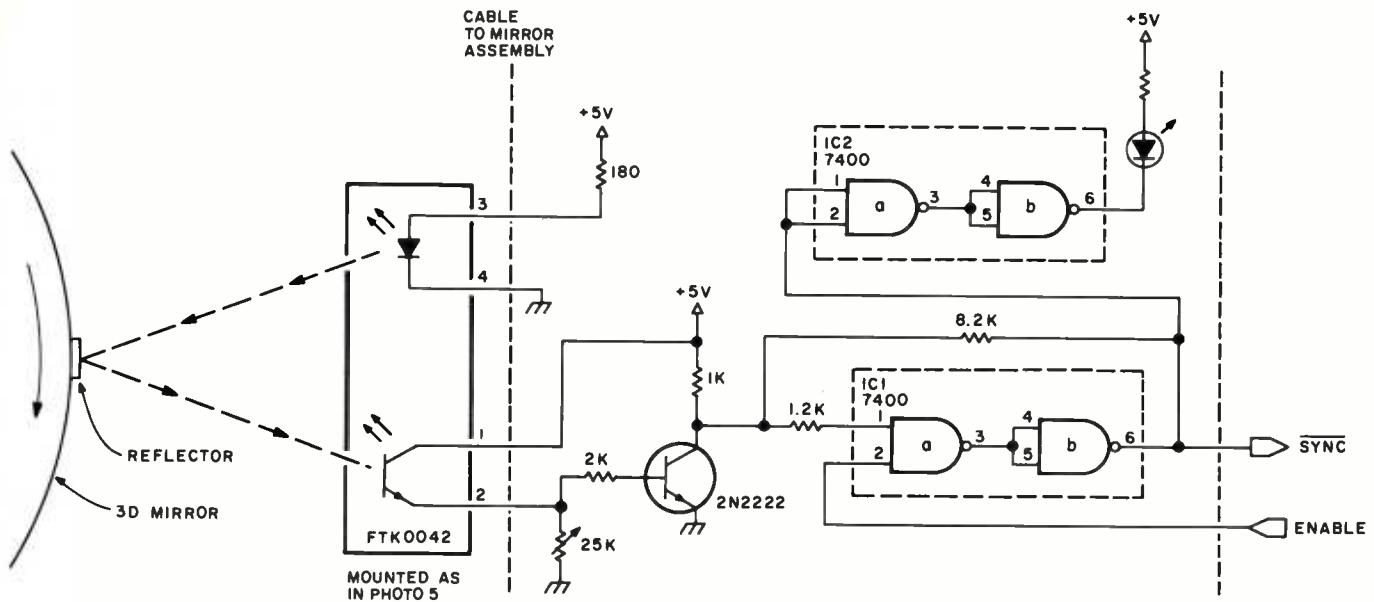

mirror and motor are housed in a plywood frame, with all interior surfaces except the mirror face painted flat black to minimize reflections from room lighting.

The display time of a point must be coordinated with the angle of the mirror. This is accomplished with a timing mark on the side of the mirror, consisting of a small

piece of white tape which is viewed by a reflective opto-coupler. The opto-coupler is shown in photo 5. The unit consists of a matched phototransistor and light emitting diode (LED) mounted in a single package. The direction of emission and detection is away from the body of the package, so that it can detect the passage of a reflective surface. This system uses a Fairchild Technology Kit FTK0042 coupler. The circuit for converting the light levels to a TTL signal, taken from the documentation supplied with the kit, is shown in figure 2 and consists of a driver transistor connected to the input of a TTL gate. The output of the second inversion stage is connected through a resistor to the input to add enough feedback to form a Schmitt trigger.

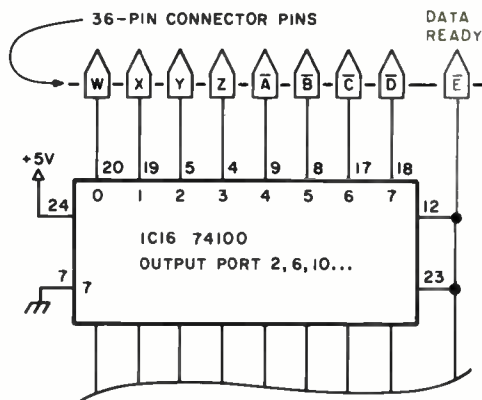

Figure 3: Modification to the Digital Group IO board. The Z-80 processor, which forms the heart of the Digital Group computer, features a block output instruction (OTIR) that can output 1 byte every 9  $\mu$ s using the standard 2.5 MHz clock. This degree of speed is needed to output the data needed for the 3-D display without using direct memory access circuitry. Adding the data ready line (shown in grey) to IC16 (Digital Group numbering) creates a status signal to the mirror circuitry. This avoids the necessity of using output bits from another port for this purpose, which would slow down the data transfer rate. (The choice of port 2 for the output port is particular to the authors' system.)

### Timing and Display of Points

To obtain reasonable persistence in the display, a refresh rate of at least ten frames per second must be maintained. Although this flicker is still observable, it does not seem to be too objectionable. Since the 45° mirror we have been describing reflects the oscilloscope screen during something less than 150° of its rotation, this means that about 40 ms are available to put up all of the display points. Also, since the screen image is continually moving, an accuracy of about 35  $\mu$ s must be maintained in the timing of the display points to achieve a 0.5% accuracy in the position of each displayed point in a typical image. Obviously, it is necessary to

# Let's Get Personal in Anaheim

## June 6-8, 1978

A rewarding personal experience is in store for you June 6-8 at the NCC '78 Personal Computing Festival... the most comprehensive personal computing event ever held. The Festival, a separate feature of the National Computer Conference, will include approximately 30 program sessions, commercial exhibits of consumer computing products and services, plus a contest and exhibit of microprocessor systems and applications. All Festival activities will take place in the Disneyland Hotel Complex, just a few minutes from the Anaheim Convention Center, site of this year's NCC.

Plan now to attend the big, new NCC '78 Personal Computing Festival. The program will include special paper, panel, and tutorial sessions on such topics as speech synthesis and recognition, computerized music systems, hardware and software design, computer graphics, and small business systems. All papers will be published in a softbound volume, *Festival Digest '78*, which will be available during NCC.

Festival exhibits will provide an extensive display of commercial offerings by organizations serving the personal computing field. More than 100 companies, occupying over 175 booths, will display systems, components, terminals, software, kits, disc and tape cassettes, relevant publications, and related hobby items.

Rounding out the Festival will be a contest featuring microprocessor systems, devices, and applications ranging from home-brew DOS and graphics terminals to educational applications and computer games. Prizes will be awarded for the best exhibits.

Don't miss the year's most exciting personal computing event. For more information, return the coupon or call AFIPS at 201/391-9810.

- Please keep me up-to-date on Festival plans and activities.
- My company is interested in exhibiting at the Festival.
- Please send me information on the special NCC Travel Service.

Name \_\_\_\_\_

Company \_\_\_\_\_ Division \_\_\_\_\_

Street \_\_\_\_\_

City \_\_\_\_\_ State \_\_\_\_\_ Zip \_\_\_\_\_

 **NCC '78  
Personal Computing  
Festival**

BYT

c/o AFIPS, 210 Summit Avenue  
Montvale, N.J. 07645  
telephone: 201/391-9810



put up points as quickly as possible to achieve a reasonable density and accuracy in the display. This eliminates standard video displays for the display screen, since the display time of an individual point cannot be controlled to any better than 16 ms on a video display. Instead, it is necessary to use an XY display controlled by digital to analog converters such as the "Beer Budget" graphics interface described in the November 1976 BYTE, page 26. Although any system with a randomly addressable XY display will work, it is desirable to minimize the amount of time required to display each point so that the greatest possible number of points can be displayed.

The Z-80 processor in the Digital Group system has a block output instruction (OTIR) which can output a byte every 9  $\mu$ s with the standard 2.5 MHz clock rate. This high transfer rate to a pair of 8 bit digital to analog converters gives the lowest possible transfer time without a special direct mem-

ory access (DMA) circuit. However, the output from a standard Digital Group parallel IO port consists of just the eight bits of data with no provision for control lines to indicate when the output byte is meant for the X digital to analog converter and when it is meant for the Y digital to analog converter. Using one of the output bits of the port for control would allow only seven bits of resolution, while using output bits from another port for control would require additional IO instructions and would slow down the transfer of data. In order to make use of the high output rate of this instruction, the IO board was modified as shown in figure 3. The write strobe signal for output port 2 was fed to an uncommitted pin on the card to be used as a data ready signal. This was used, along with the port data, as input to a control circuit for the digital to analog converters, as shown in figure 4. The choice of port 2 for the output port is particular to our system. This control circuit is based on the schematic of

Power Connections			
IC	Type	+5 V	Gnd
1	74100	24	7
2	74100	24	7
3	MC1408L8	13	2
4	74100	24	7
5	MC1408L8	13	2
6	7430	14	7
7	7476	5	13
8	7400	14	7

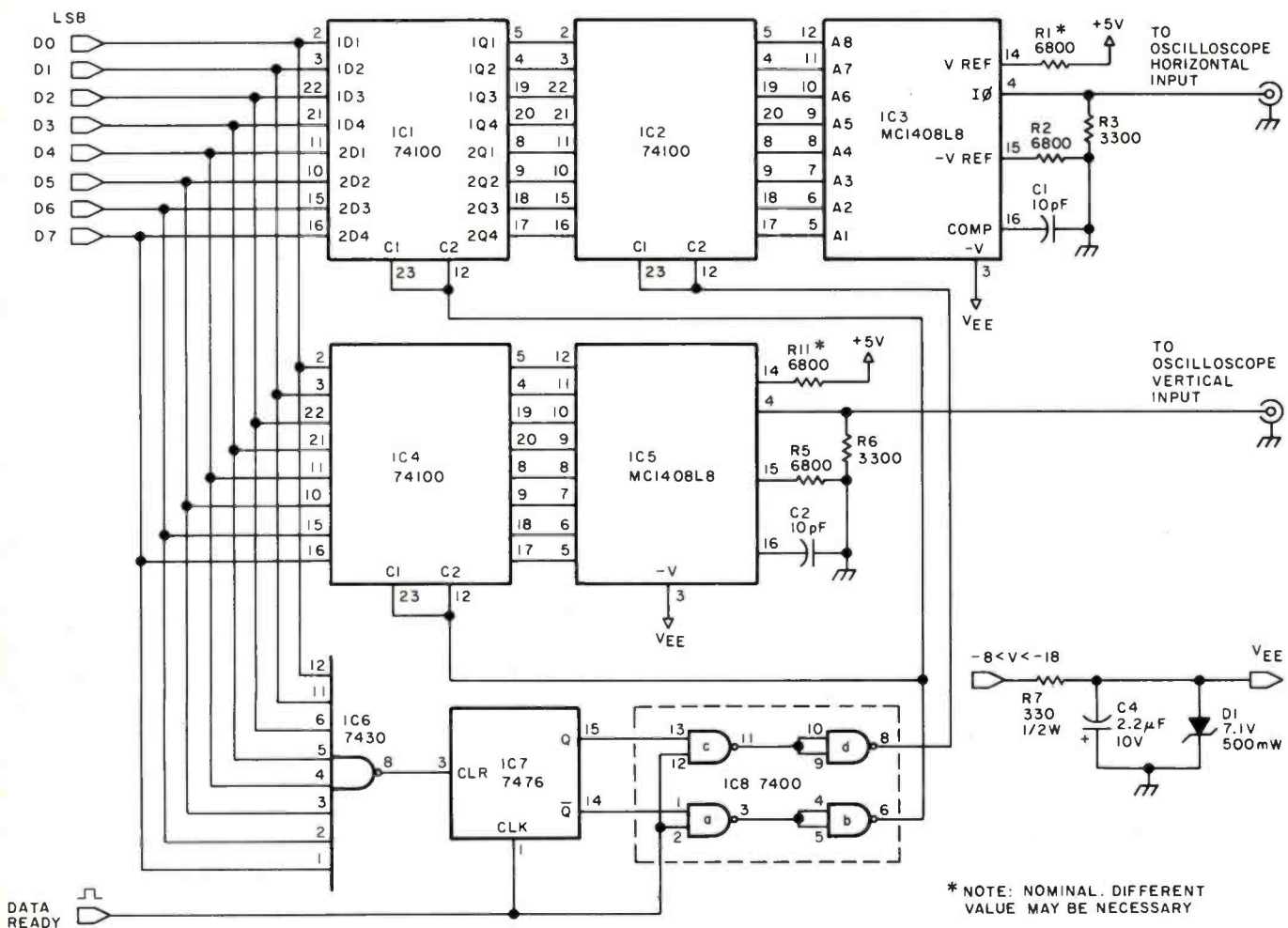

Figure 4: XY oscilloscope display driver. Two digital to analog converters (IC3 and IC5) drive the oscilloscope horizontal and vertical inputs by converting digital data from the computer's output port into voltages. Horizontal and vertical data bytes are routed to their respective converters based on the status of flip flop IC7, which is controlled by the data ready line.

# Everything you've ever wanted to know about microcomputers in ONE complete book for only \$10.95

Over 400 pages. Full 8½" x 11" size.



The ultimate book about microcomputers.

Written by experts

... SCELBI and BYTE. Over 400 pages. A collector's item, featuring The Basics

from the first 16 issues of BYTE and SCELBI's classic library of books. Your microcomputer bookshelf is incomplete without this priceless edition.

**Y**ou can't buy information organized like this anywhere. This is the book that everyone who is into microcomputers needs for reference, for ideas, for clues to problem solving. It is a truly authoritative text, featuring easy-to-read, easy-to-understand articles by more than 50 recognized professional authors, who know and love microcomputers from the ground up. Logical and complete, it features many glossaries, and is illuminated with profuse illustrations and photographs.

The **Scelbi/BYTE Primer** is divided into four logical sections, that take you from point "0" through building and programming your own computer... step-by-step-by-step.

**What can you do with a microcomputer?** Checkbook balancing. Recipe converting and food inventory. Heating and air conditioning control. Home and business security and management. Playing the ponies. Analysis of the stock market. Maintaining massive data banks. Self-instruction. Toys and games. Small business accounting and inventory. And lots, lots more.

**How does a microcomputer do it?** Lots of "how to" theory. Introducing you to microcomputer operation. 6800, 6502, Z80 CPU chip capabilities. RAM and ROM memories. Addressing methods.

## THE SCELBI/BYTE PRIMER

Over 400 pages. Selected articles from **BYTE** and **SCELBI** books. Profusely illustrated. Many photographs. \$10.95, plus 50¢ shipping and handling.

How to control peripherals. Transmission of information to and from computers. Magnetic recording devices for bulk storage. Analog to digital conversion. How a computer can talk. Other I/O techniques. And more.

### Order your copy today!

**SCELBI COMPUTER CONSULTING INC.**  
Post Office Box 133 PP STN  
Dept. B  
Milford, CT 06460

**BITS**  
70 Main Street  
Peterborough, NH  
03458  
1-800-258-5477

Prices shown for North American customers. Master Charge. Postal and bank Money Orders preferred. Personal checks delay shipping up to 4 weeks. Pricing, specifications, availability subject to change without notice.

**All about building a microcomputer system.** Over 12 complete construction articles. Flip-flops. LED devices. Recycling used ICs. Modular construction. Making your own p.c. boards. Prototype board construction. Make your own logic probes. Construction plans for 6800 and Z80 computers. Building plans for I/Os — TV and CRT displays, cassette interfaces, etc. Mathematics functions. ROM programmer. Plus much, much more.

**How to program a microcomputer.** Programming for the beginner. Assembling programs by hand. Monitoring programs. Number conversions. Game of Hexpawn. Design your own assembler. Lots more.

And that's only the beginning! Others have spent millions acquiring the type of microcomputer information found within the 400 pages of **The Scelbi/BYTE Primer**. But, it costs you only \$10.95, plus 50¢ for postage and handling, complete! You know the quality of Scelbi and BYTE. This is your assurance of excellence throughout this **MUST** text. Order your copy today! And, get one for a friend!

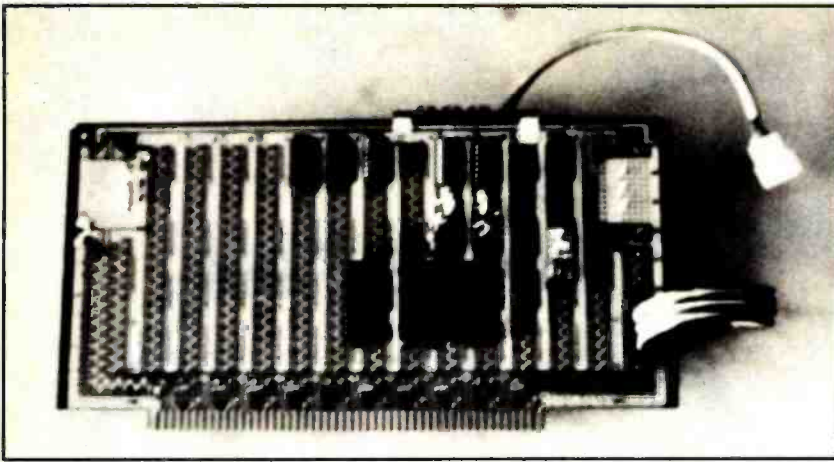

Photo 6: Prototype board for the 3-D interface constructed on an Altair (S-100) bus prototyping card.

the "Beer Budget" graphic display, to which we are indebted.

The data ready pulse is now used to toggle a flip flop (IC7). A byte output when the flip flop is high will go to a storage latch for the X byte (IC1), while the succeeding output byte will be strobed into the Y storage latch (IC4). At the same time as the Y value is stored, the previous X byte is transferred to another latch (IC2) for display. IC2 and IC4 are both connected to 8 bit digital to analog converters (ICs 3 and 5) which will change their output values simultaneously. It may be necessary to substitute slightly different values for the +V<sub>REF</sub> resistors (R1 and R4) to obtain a linear output from the digital to analog converters.

A special condition of all 1s on the data input lines is detected by a NAND gate (IC6) and used to reset the XY flip flop to the Y state. This insures that the next byte from the output port will be the X byte of an XY pair.

This interface circuit, along with the opto-coupler interface, was wire wrapped on an Altair (S-100) bus prototyping card seen in photo 6. Only supply voltages were brought onto the card through the Altair (S-100) bus connector. Input and output connections were made through a ribbon cable connected to a dual inline package (DIP) socket.

#### Software Control

The locations of points to be displayed on the oscilloscope screen are stored in a display table as shown in table 1. This table consists of a series of XY pairs in successive locations in memory. Unused locations in the table are indicated by an XY coordinate pair, hexadecimal (00,FF). The FF value automatically sets the XY flip flop to the Y state. These unused locations in the table are all displayed at the same point in a corner of the screen. To prevent this point from being

[ X<sub>1</sub> ]  
 [ Y<sub>1</sub> ]  
 [ X<sub>2</sub> ]  
 [ Y<sub>2</sub> ]  
 [ 0 ]  
 [ FF ]  
 [ X<sub>3</sub> ]  
 [ Y<sub>3</sub> ]

Table 1: Structure of the display table used to store the locations of points to be displayed on the oscilloscope screen. The points are represented by successive X and Y values; empty locations are represented by hexadecimal (00, FF).

displayed, the X and Y positions of the oscilloscope should be adjusted until the point is just out of the display field. Alternatively, the output from IC6 (see figure 4) could be used to gate a Z axis (intensity modulation) signal on the screen, but this is not convenient on many oscilloscopes.

Several small machine language routines were written to provide support for BASIC software (see listing 1). Level 1 Digital Group MaxiBASIC provides several unused pages in low memory for machine language routines. The pages shown in these listings are particular to this level of MaxiBASIC. Linkage to these routines is through the extended BASIC function:

$$Y = \text{CALL}(A [, X])$$

A is the 16 bit address of the machine routine. X is an optional 16 bit argument passed to the called routine in the DE register pair. The value of the function is contained in the HL pair when the routine returns; in many cases the routine will not return a computed value and the returned value stored in Y will be ignored by the programmer. Other registers need not be preserved.

The first routine, SYNC, is a synchronization routine that waits for a rising edge on the input line from the opto-coupler. The routine first waits for a zero level, then waits for a one level. While waiting, the routine increments register pair HL, which provides a count of the number of cycles spent in the wait loop. Since the routine returns only after the transition from a zero to a one, two successive calls to SYNC will return in HL the number of wait loops in one complete revolution of the mirror (the value in HL from the first call is ignored since the position of the mirror when the routine is called is unknown). The increment DE instruction is added to the wait loops as a do nothing instruction which will lengthen the loop timing to 40 machine cycles. This is exactly the number of cycles required to output an XY pair with the OTIR instruction. The returned value in HL thus gives the waiting time in terms of the number of points which can be displayed in the same amount of time.

A timing routine, TIME, consists of two successive calls to SYNC.

The routine TSTORE sets up the parameters for clearing and displaying the display buffer. In this case, this consists of storing the number of 256 byte pages in the display buffer, passed in DE, into storage location NPAGE.

The next routine, DISP, displays the display buffer. The buffer address is passed in DE. NPAGE, assumed to be set by a call to TSTORE, controls the number of OTIR calls.

Register B will be zero at the beginning of each OTIR instruction, indicating 256 bytes to be transferred. Register E is loaded from NPAGE to hold the total number of pages. Register C contains the output port number.

Routine FILL uses the block transfer instruction LDIR to rapidly clear the display buffer. It is assumed that the number of pages has been preset by a call to TSTORE, and that the first two locations of the buffer contain the desired byte pair to fill the table. The address of the table is passed in DE when FILL is called. This address is moved to HL. Register DE is then incremented twice. The LDIR instruction moves the contents of the location addressed by HL to the location addressed by DE, increments HL and DE, decrements BC, and continues if BC is nonzero. Thus the first and second locations in the table will be transferred to the third and fourth, which will in turn be transferred to the fifth and sixth, etc. Since for a string of n words only n-2 moves are necessary, BC is set to two less than the number of elements in the table.

### Initialization Routines

Listing 2 gives a simple BASIC program to put up a display. The first few lines of the program are initialization statements, which routines set up the display table and compute various parameters for the display construction. Normally, they will begin any BASIC routine to drive the spinning mirror. Many of the statements are specific to the current revision of Digital Group MaxiBASIC, since they make use of knowledge of the memory allocation used by the BASIC interpreter.

Since it was desirable to be able to run the program on a minimum Digital Group MaxiBASIC system (18 K bytes), with MaxiBASIC extending up to 13 K, we used BASIC arrays for the display buffer. Extra memory would have permitted dedicated areas in high memory addresses to be used with the knowledge that BASIC would never extend up to these areas. This would have permitted cleaner code, but the more complicated code required is a useful lesson in the incorporation of the internal data structures of an operating system into the code of a higher level language.

A string in MaxiBASIC consists of a series of 1 byte elements. The maximum number of elements is given by the DIM statement for the string, but the actual length of the string may vary dynamically as the program executes, becoming any length from zero elements (an "empty" string) to the maximum stated in the DIM statement. When the DIM statement is executed, an empty string

*Listing 1: Assembly language and machine language versions of five utility programs called by the programs in listings 2 and 3. The latter two programs create 3-D images in the rotating mirror (photo 4). SYNC is a synchronization routine that examines the input from the opto-coupler and counts the number of wait loops in one complete revolution of the mirror. Routine TIME consists of two successive calls to SYNC. This is necessary because SYNC may count a partial revolution on the first call. TSTORE sets up the parameters for clearing and displaying the display buffer. DISP displays the display buffer, and FILL uses the Z-80 block transfer function LDIR to rapidly clear the display buffer.*

```

SYNCHRONIZATION ROUTINE
      WAIT FOR RISING EDGE FROM
      OPTO ISOLATOR CONNECTED TO BIT ZERO
      OF PORT 2

      ORG 0B00H
      LD HL,0
      SYNC: LD HL,0          ;INCREMENT TOTAL NUMBER OF CYCLES
      SL1:  INC HL          ;WASTE SOME TIME
           INC DE          ;INPUT SYNCHRONIZATION BYTE
           IN  A,2         ;AND CHECK BIT 0
           BIT 0,A         ;NOT ZERO, LOOP BACK
           JP  NZ,SL1      ;DUPLICATE ABOVE CODE
      SL2:  INC HL
           INC DE
           IN  A,2
           BIT 0,A
           JP  Z,SL2       ;BUT WAIT UNTIL BIT IS ONE
      RET

TIMING ROUTINE
      GET TIME BETWEEN TWO SYNC MARKS

      ORG 0B20H
      TIME: CALL SYNC
           CALL SYNC
           RET

STORAGE ROUTINE
      STORE NUMBER OF PAGES IN DISPLAY BUFFER

      ORG 0B28H
      TSTORE: LD A,E
            LD (NPAGE),A
            RET
      NPAGE:  DB 0

DISPLAY ROUTINE
      DISPLAY BUFFER USING BLOCK OUTPUT INSTRUCTION

      ORG 0B30H
      DISP:  PUSH DE          ;PUSH PAGE ADDRESS
            CALL SYNC        ;WAIT FOR SYNC EDGE
            POP  HL          ;POP ADDRESS
            LD  C,2          ;LOAD PORT ADDRESS
            LD  B,0          ;LOAD COUNT (256)
            LD  A,(NPAGE)   ;LOAD PAGE COUNT
            LD  E,A
      DL1:  OTIR              ;OUTPUT ONE PAGE
            DEC  E           ;DECREMENT NUMBER
            JR  NZ,DL1      ;RECYCLE IF NOT DONE
            RET

FILL ROUTINE
      FILL ENTIRE DISPLAY BUFFER WITH CONTENTS OF FIRST TWO BYTES
      NPAGE MUST BE SET BY A PREVIOUS CALL TO TSTORE

      ORG 0B48H
      FILL:  LD  H,D          ;MOVE PAGE ADDRESS
            LD  L,E
            INC DE          ;DESTINATION ADDRESS
            INC DE          ;IS TWO HIGHER
            LD  A,(NPAGE)   ;NUMBER OF PAGES TO MOVE
            LD  B,A
            DEC B           ;SUBTRACT TWO
            LD  C,0FEH      ;FROM TOTAL NUMBER OF BYTES
            LDIR          ;FILL
            RET

0B00 / 21 00 00 23 13 DB 02 CB
0B08 / 47 C2 03 0B 23 13 DB 02
0B10 / CB 47 CA 0C 0B C9 00 00
0B18 / 00 00 00 00 00 00 00 00
0B20 / CD 00 0B CD 00 0B C9 00
0B28 / 7B 32 2D 0B C9 00 00 00
0B30 / D5 CD 00 0B E1 0E 02 06
0B38 / 00 3A 2D 0B 5F ED B3 1D
0B40 / 20 FB C9 00 00 00 00 00
0B48 / 62 6B 13 13 3A 2D 0B 47
0B50 / 05 0E FE ED B0 C9 00 00
READY

```

Listing 2: A BASIC program (written in MaxiBASIC) to create a 3-D "square spiral" (see photo 1).

```

READY
LIST 10, 330

10 A=26624-FREE(0)
20 DIM S$(5000)
30 N9=EXAM(A-3)
40 N1=N9*128
50 S$=CHR$(0)*CHR$(255)
60 FILL A-1,N9
70 D=CALL(11*256+40,N9)
80 D=CALL(11*256+72,A)
90 REM
100 REM COMPUTE AND DISPLAY BORDER OF DISPLAY
110 DATA 1,0,0,1,-1,0,0,-1
120 S=8
130 X=0
140 Y=0
150 K=1
160 FOR N=1 TO 10
170 RESTORE
180 FOR E=1 TO 4
190 READ X1,Y1
200 FOR S1=1 TO 31
210 X=X+S*X1
220 Y=Y+S*Y1
230 S$(K,K)=CHR$(X)
240 S$(K+1,K+1)=CHR$(Y)
250 K=K+2
260 NEXT S1
270 NEXT E
280 NEXT N
290 REM DISPLAY BUFFER BY REPEATED CALLS TO DISP
300 # "DONE"
310 D=CALL(11*256+48,A)
320 GOTO 310
330 END
READY

```

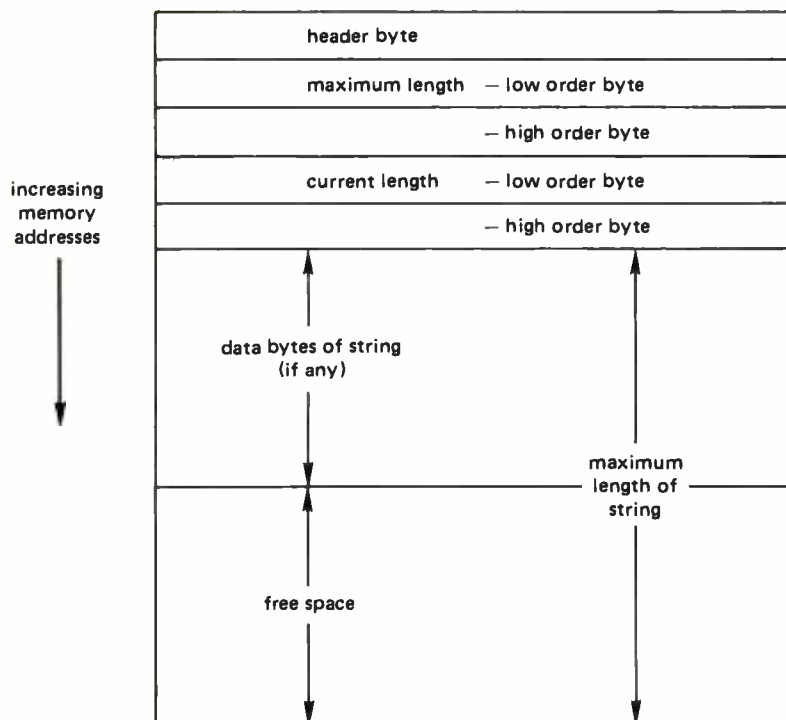

Figure 5: Structure of a string in level 1 MaxiBASIC.

is created at the first available location in memory. The string is stored in memory as a header byte, followed by two bytes giving the maximum length of the string, two bytes giving the current length of the string, and finally the data bytes of the string itself. This structure is shown in figure 5.

The MaxiBASIC function FREE(0) returns the current amount of available memory. This available memory is expanding and contracting during the execution of the program as memory for new variables are allocated and scratch areas for intermediate results are allocated and released. By experimentation, it was found that the statements

```

10 A=26624-FREE(0)
20 DIM S$(5000)

```

at the beginning of a program left A pointing to the first data byte of the string S\$, here shown arbitrarily as 5000 elements long. The number 26624 (26X1024) is the total number of memory bytes in our system.

The maximum available number of pages is determined in line 30 of listing 2 by examining the beginning of the string S\$. This is used to compute the maximum number of XY pairs in the buffer by noting that 128 pairs are in each page. Variable N1 holds the result of this computation. The first two locations in the string S\$ are set to the default values of a blank point by statement 50. The length of S\$ is adjusted by the FILL statement in line 60. Location NPAGE in the assembly routine area is set to the number of pages by statement 70. Routine FILL is called in statement 80 to clear the data bytes of S\$ to an empty display buffer.

One of the easiest displays to set up is an illumination of the borders of the display. The remainder of the program in listing 2 fills successive locations in the display table with the addresses of points around the border of the oscilloscope screen. After the table is filled, the program displays the buffer with repeated calls to DISP.

A photograph of a typical display using this routine is shown in photo 5. This display shows, at the same time, the available display volume for a given configuration of the mirror and screen, the number of points available in the display buffer, and the effects of various motor speeds and synchronization angles. It is a good way to experiment with the physical configuration of the display before going on to more sophisticated displays.

The illuminated edge display is converted



by the spinning mirror into a true three-dimensional display. Since the outside edge of the screen is illuminated, the very edges of the available display volume will be displayed. Manipulation of the relative positions of the oscilloscope screen and the mirror will show the possible display volumes in different orientations before you settle on a final position. Different positions and angles for the screen give display volumes of different sizes and shapes.

Since the display buffer is full, the highest possible point density is displayed. This makes it possible to judge the best tradeoff of flicker rate versus high point density at various motor speeds.

#### Computation of Point Locations

Figure 6 shows the orientation of the 45° mirror with respect to the oscilloscope screen. The mirror rotates about the Z axis and the screen is perpendicular to the X axis. Suppose we wish to display a point at a certain location. It is then necessary to compute the location of a point on the display

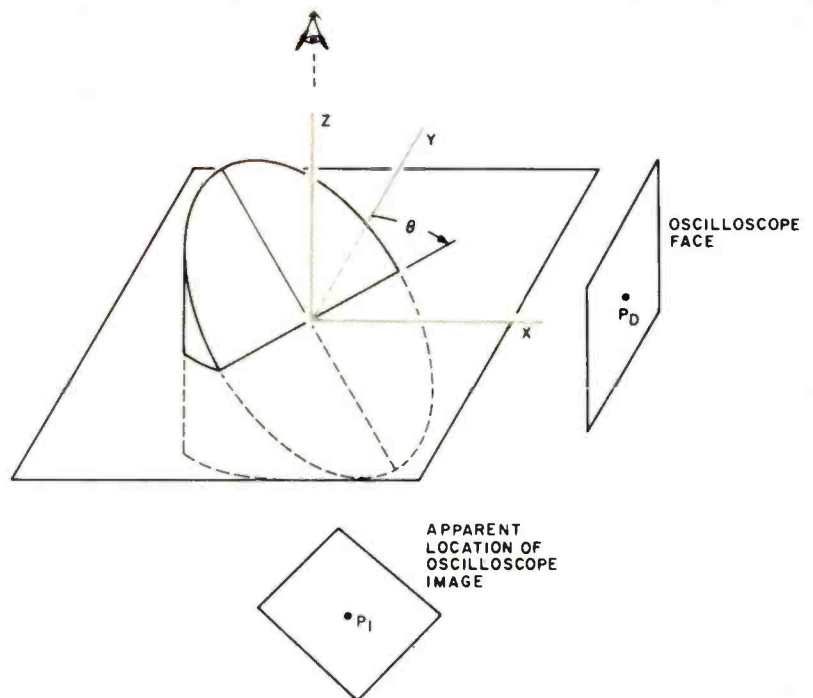
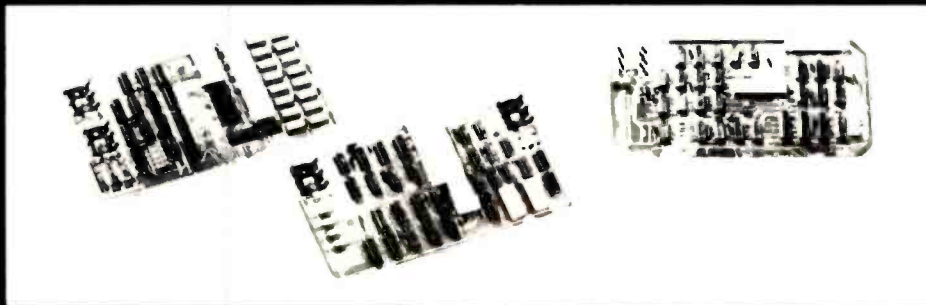

Figure 6: Orientation of the diagonally sliced spinning mirror. The mirror is rotated by an angle  $\theta$  about the Z axis; the screen is perpendicular to the X axis. To compute a point at a certain location, it is necessary to compute the location of a point on the display screen and a mirror angle which will create a reflection at the desired location.



The MSDD-100 floppy disc system is a modern, low cost, high performance data storage system for your S100 bus computer system. A simple, well designed LSI controller board, combined with the industry standard Shugart SA-400 floppy drive gives you a very fast 80K bytes per drive on line. At \$499.00 kit (you build only the controller) or \$599.00 ready to go, the MSDD-100 is a great buy, and comes complete with software. Two versions of MICROSOFT BASIC and a complete DOS are available.

If you have wanted 80 x 24 video display power for your S100 bus computer system, look no further. The MSDV-100 video display is a super flexible, easy to use, memory addressed video system that lets you: \* underline any character \* make any character blink \* invert field \* draw continuous vertical & horizontal lines \* have 9 levels of gray scale for graphs \* scroll with ease \* much more. The kit is \$285.00, or get it ready to go for \$385.00. Great software support, of course. Dealer/OEM inquiries invited. To order, or for more information, write to or call MSD, inc., at:

**MICRO  
SYSTEMS  
DEVELOPMENT**

**MSD**

2765 So. Colorado Blvd. Suite 110 Denver, CO 80222 (303) 758-7411

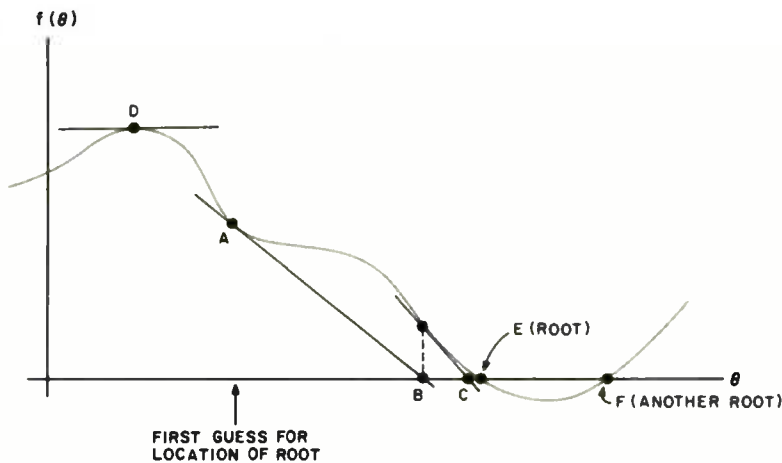

Figure 7: The Newton-Raphson method for determining the roots of an equation. One of the steps necessary in order to calculate the mirror angle for a given point in the 3-D display is to find a particular root of the equation  $f(\theta) = -X_i \sin^2\theta + Y_i \sin\theta \cos\theta + Z_i \cos\theta + X_d = 0$ . One way to calculate the desired root is to use the Newton-Raphson method: a first guess is made of the location of the root (ie: where the function crosses the X axis); the guess (point A) is obviously wrong, so the first derivative of the function is calculated and then evaluated at the point guessed. This gives the slope of the function at that point (point A). The process is repeated, but this time following the slope line down to the X axis to determine the next guess (point B). After a few iterations, the value converges rapidly to the root at point E. Complications can occur if a second root of the function is possible, as at point F in this example, or if the slope is too flat, as at point D.

screen and a mirror angle which will create a reflection at the desired location. Depending on the location and size of the screen, of course, there may not be a point that will create the desired image point. For a given image point  $(X_i, Y_i, Z_i)$ , the equations for the corresponding display point  $(X_d, Y_d, Z_d)$  are:

$$X_d = X_i \sin^2\theta - Y_i \sin\theta \cos\theta - Z_i \cos\theta \quad (\text{Eq 1})$$

$$Y_d = -X_i \sin\theta \cos\theta + Y_i \cos^2\theta - Z_i \sin\theta \quad (\text{Eq 2})$$

$$Z_d = -X_i \cos\theta - Y_i \sin\theta \quad (\text{Eq 3})$$

$$X_i = X_d \sin^2\theta - Y_d \sin\theta \cos\theta - Z_d \cos\theta \quad (\text{Eq 4})$$

$$Y_i = -X_d \sin\theta \cos\theta + Y_d \cos^2\theta - Z_d \sin\theta \quad (\text{Eq 5})$$

$$Z_i = -X_d \cos\theta - Y_d \sin\theta \quad (\text{Eq 6})$$

We know that the display point must lie on the face of the screen, which is at a fixed location on the X axis. This gives us an equation we can solve to find a mirror angle for the display:

$$f(\theta) = -X_i \sin^2\theta + Y_i \sin\theta \cos\theta + Z_i \cos\theta + X_d = 0 \quad (\text{Eq 7})$$

One method we can use to solve this equation is known as Newton's method (also known as the Newton-Raphson method). It is frequently used to compute other mathematical functions such as square roots. Suppose we have an equation, like equation 7 above, which gives a value for any input value of some number  $\theta$ . We want to find a value of  $\theta$  for which the computed function is zero (called a *root* of the equation). Figure 7 shows a plot of a function we might be testing. Suppose we start our search for the solution by checking point A. The value of the function here is too high, but we can use it to make an educated guess about the next point to try. This is done by computing the slope of the function at point A and extending the slope down to the horizontal axis (point B). This intersection point becomes the location for the next guess. If the function is a straight line, this one computation will give the right answer. If the curve is not changing very much from a straight line, it will still be a very close estimate. From this new starting point, another guess may be computed (point C). The process is repeated until the answer is close enough to zero to be satisfactory.

One potential problem with this method is that an estimated point may be chosen for which the slope is too flat (point D, for example). This gives a new value that is much too far away; in this case it is better to move over slightly on the curve and try the computation again. Another limitation of the method is that only one zero value will be found at a time, although there may be more than one root of the equation (point F in figure 7, for instance). In our case, a mirror angle may be found which requires that the display point be off the face of the oscilloscope screen even though there is another angle that gives a usable display point.

The slope of equation 7 at a given  $\theta$  is computed by finding its first derivative:

$$f'(\theta) = -2X_i \sin\theta \cos\theta + Y_i (2\cos^2\theta - 1) - Z_i \sin\theta \quad (\text{Eq 8})$$

and evaluating it for the given  $\theta$ .

Once the slope is computed, a new value for an estimate of the mirror angle is computed using the equation:

$$\theta_{n+1} = \theta_n - \frac{f(\theta_n)}{f'(\theta_n)} \quad (\text{Eq 9})$$

Listing 3 gives a complete BASIC program to put up a three-dimensional line drawing. The sample DATA statements at the end of the program draw a small house with a tree, shown in a stereo view in photo 3.

The initialization statements discussed above are in lines 10 thru 90. A call to TIME in line 140 returns the total number of display points in one revolution into variable N2. The location and size of the screen is then read into the variables X0, Y0, Y1, Z0, and Z1.

The location of the point displayed when both the X and Y digital to analog converters are set to zero is (X0, Y0, Z0), using the orientation shown in figure 6. Note that in this orientation, the X digital to analog converter moves points in the Y axis and the Y digital to analog converter moves points in the Z axis. The size of the screen is given by variables Y1 and Z1, with the *sign* of these variables indicating the direction in which points move when the values to each digital to analog converter increase. For the interface used in this demonstration, a 4 by 4 inch (10 by 10 cm) display is generated with the zero point in the upper right corner; Y1 and Z1 are thus 4 and -4, respectively.

The next variable read, N3, is the angle in degrees of the mirror when the timing mark is sensed. This angle is converted to radians in line 170. Line 190 then reads the location of the origin of the plot into variables X(1), X(2), and X(3). This is the location of the point in three-dimensional space which will be referred to as (0, 0, 0) during the plot. All locations given in the plotting commands which follow are given relative to this origin. Being able to specify the location of the beginning of the plot makes it easy to move the display to different locations in space.

Choosing an origin for the plot can be tricky, since the screen reflects into a curved volume as the mirror rotates. Running the border display program above can help give an estimate of a good starting point. Another method is to use equations 4, 5, and 6 to compute the reflected position of the center of the oscilloscope screen at several different mirror angles, and to use these as starting points for the display.

The remaining data statements are a series of plot commands. These consist of an integer command code, which may be followed by additional numbers.

The resolution code (-1) is followed by a floating point number giving the spacing between points when drawing lines. This is stored in variable D2.

A plotting command code (1 or 2) is followed by the coordinates, in inches, of the location of the end of the next line. If the

code is a 1, dots will be computed and displayed along a line from the coordinates of the last command (stored in X6, Y6, and Z6) to the coordinates in the present command (stored in X5, Y5, and Z5). The dots will be spaced accordingly to the resolution parameter D2. If the code is a 2, the current location will be moved to the indicated point, but no points will be drawn. This is used to move to the start of a new line when no connection is desired with the last line. These commands are similar to motions with the pen down or up on a conventional plotter.

The end code (9999) indicates that all the lines are drawn and that the completed image may be displayed.

Listing 3: A BASIC program (written in MaxiBASIC) to create a 3-D house (see photo 3).

```

READY
LIST

10 A=26624-FREE(9)
20 DIM S$(5000)
30 N9=EXAM(A-3)
40 N1=N9*128
50 S$=CHR$(0)+CHR$(255)
60 FILL A-1,N9
70 D=CALL(11*256+40,N9)
80 D=CALL(11*256+72,A)
90 REM
100 REM DPAV PROGRAM 8/1/77
110 REM
120 REM DRAW A SERIES OF POINTS IN STRAIGHT LINES ON THE SPINNING
130 REM MIRROR USING PLOTTER-LIKE COMMANDS
140 N2=CALL(11*256+32)
150 REM
160 READ X0,Y0,Y1,Z0,Z1,N3
170 N3=-N3/180*3.14159
180 REM READ ORIGIN
190 READ X(1),X(2),X(3)
200 REM READ COMMAND
210 READ N0
220 IF N0=9999 THEN 460
230 IF N0=-1 THEN 440
240 REM PLOTTING TO NEW POINT, READ IN COORDINATES
250 READ X5,Y5,Z5
260 IF N0=2 THEN 420
270 IF N0<>1 THEN 500
280 REM DRAW FROM OLD TO NEW WITH SPACING OF D2
290 REM COMPUTE NUMBER OF POINTS IN N5 AND SPACINGS IN X7, Y7, Z7
300 D=SQR((X6-X5)^2+(Y6-Y5)^2+(Z6-Z5)^2)
310 N5=INT(D/D2)+1
320 X7=(X5-X6)/N5;Y7=(Y5-Y6)/N5;Z7=(Z5-Z6)/N5
330 REM NOW PLOT EACH POINT
340 FOR J=1 TO N5
350 X6=X6+X7;Y6=Y6+Y7;Z6=Z6+Z7
360 X9=X6+X(1);Y9=Y6+X(2);Z9=Z6+X(3)
370 GOSUB 680
380 REM STORE POINT IF CONVERGED
390 IF Z>0 THEN GOSUB 520
400 NEXT J
410 REM CHANGE LOCATION OF CURRENT POINT
420 X6=X5;Y6=Y5;Z6=Z5
430 GOTO 210
440 READ D2
450 GOTO 210
460 REM PUT UP DISPLAY
470 PRINT "DONE"
480 D=CALL(11*256+48,A)
490 GOTO 480
500 PRINT "BAD PLOT COMMAND"
510 STOP
520 REM LIST STORE ROUTINE
530 REM X AND Y ARE POINTS ON SCREEN; Z IS POSITION IN LIST
540 REM CHECK X AND Y WITHIN BOUNDS
550 IF X>254 OR Y<0 THEN #1X OFF SCALE:"X: RETURN
560 IF Y>254 OR Y<0 THEN #1Y OFF SCALE:"Y: RETURN

```

Listing 3, continued:

```

570 REM CHECK BYTE NUMBER Z2 ( = Z*Z ) IN LIST.
580 REM IF POSITION NOT EMPTY, CHECK NEXT POSITION
590 Z2=2*INT(Z)
600 IF Z2>N1+N1 THEN # "LIST POSN TOO BIG:";Z:RETURN
610 IF ASC(S$(Z2))=255 THEN 640
620 Z2=Z2+2:GOTO 600
630 REM OK POSITION FOUND. STORE
640 S$(Z2-1)=CHR$(X)
650 S$(Z2)=CHR$(Y)
660 #Z2
670 RETURN
680 REM CONVERSION ROUTINE FOR POINTS X9, Y9, Z9
690 REM X0,Y0,Y1,Z0,Z1 ARE ASSUMED TO BE INITIALIZED
700 REM X,Y,Z ARE OUTPUT AS X AND Y ON SCREEN, & LIST POSN
710 REM INITIALIZE LIMITS AND STARTING VALUES
720 N9=20
730 T9=.01
740 F9=.3
750 J9=1
760 REM STARTING ANGLE (T8) WILL BE LAST VALUE COMPUTED TO
770 REM SPEED ITERATION
780 C8=COS(T8) : S8=SIN(T8)
790 REM COMPUTE FUNCTION WHICH IS TO GO TO ZERO
800 F=Z9*C8 + Y9*S8*C8 - X9*S8*S8 + X0
810 REM TEST BELOW THRESHOLD
820 IF ABS(F)<T9 THEN 990
830 REM COMPUTE DERIVATIVE
840 D9=-Z9*S8 + Y9*(2*C8*C8-1) - X9*2*C8*S8
850 REM COMPUTE NEXT STEP WITH NEWTON'S METHOD
860 REM CHANGE BY STANDARD AMOUNT IF DERIVATIVE IS TOO SMALL
870 IF ABS(D9)<.005 THEN D9=.005
880 REM OR STEP WOULD BE TOO BIG
890 F=F/D9:IF ABS(F)>F9 THEN F=F9
900 T8=T8-F
910 REM CHECK TOO MANY ITERATIONS
920 J9=J9+1 : IF J9<=N9 THEN 780
930 # "DIDNT CONVERGE FOR",X9,Y9,Z9
940 REM SET DIDN'T CONVERGE FLAG
950 Z=-1
960 RETURN
970 REM CONVERGED; CONVERT ANGLE TO LIST POSITION MOD N2
980 REM (N2 = LENGTH OF LIST)
990 Z=(N3-T8)*N2/(3.14*2)
1000 IF Z>0 THEN 1020
1010 Z=Z+N2:GOTO 1000
1020 IF Z<=N2 THEN 1040
1030 Z=Z-N2:GOTO 1000
1040 REM COMPUTE X AND Y POSITION ON SCREEN
1050 REM NOTE THAT X ON SCREEN CORRESPONDS TO Y IN COORDINATE SPACE
1060 REM AND Y TO Z
1070 X=-X9*S8*C8+Y9*C8*C8-Z9*S8
1080 Y=-X9*C8-Y9*S8
1090 REM CONVERT FROM LOCATION IN INCHES TO DAC OUTPUT VALUE
1100 X=250*(X-Y0)/Y1
1110 Y=250*(Y-Z0)/Z1
1120 RETURN
1130 REM ORIGIN AND SIZE OF CRT
1140 DATA 4,-4,4,5,-4
1150 REM ANGLE OF MIRROR AT SYNC
1160 DATA -22
1170 REM RELATIVE ORIGIN OF PLOT
1180 DATA -3,2.5,-5.5
1190 REM RESOLUTION OF PLOT
1200 DATA -1,.15
1210 REM DRAWING OF HOUSE WITH TREE
1220 REM FRAME
1230 DATA 2,1,-1,1
1240 DATA 1,1,-1,0, 1,1,1,0, 1,0,1,0
1250 DATA 1,0,1,1, 1,0,-1,1, 1,5,-1,1
1260 DATA 1,1,1,1, 1,0,1,1, 2,1,1,1
1270 DATA 1,1,1,0, 2,0,1,0, 1,0,-1,0
1280 DATA 1,0,-1,1, 2,0,-1,0, 1,1,-1,0
1290 REM ROOF
1300 DATA 2,0,-1,1, 1,5,-1,1,5, 1,1,-1,1
1310 DATA 2,.5,-1,1,5, 1,.5,1,1,5, 1,0,1,1
1320 2,.5,1,1,5,1,1,1,1
1330 REM DOOR
1340 DATA 2,.5,1,1,5,1,1,1,1
1350 DATA 2,.4,-1,0,1,1,4,-1,5,1,.6,-1,5,1,.6,-1,0
1360 REM PATH
1370 DATA 2,.4,-1,0,1,1,4,-2,0
1380 DATA 2,.6,-2,0,1,1,6,-1,0
1390 REM TREE
1400 DATA 2,1,-1,5,0,1,1,-1,5,1,2
1410 DATA 2,1,-1,5,.2,1,1,4,-1,5,.6
1420 DATA 2,1,-1,5,.4,1,1,-1,15,.65
1430 DATA 2,1,-1,5,.6,1,1,7,-1,5,.9
1440 DATA 2,1,-1,5,.8,1,1,-1,75,1,0,5
1450 DATA 2,1,-1,5,1,1,1,2,-1,5,1,2
1460 DATA 9999
READY

```

These plot commands are decoded in lines 210 thru 270. Lines 280 thru 450 then compute the coordinates of the points to be displayed. The total distance D between the last point and the current one is computed in line 300. This is divided into an integer number of steps, N5, of sizes X7, Y7, and Z7. Then each of the N5 points is generated by calls to two subroutines which store values in a digital to analog conversion table corresponding to each point. Once all points are computed, the coordinates of the current location are stored as the previous one (in X6, Y6 and Z6), and the next command is extracted from the DATA statements.

If the end command (9999) is detected, lines 470 thru 490 are executed. These put up the display by repeated calls to DISP. Another way to generate the display is to use the timing mark to generate an interrupt. In this way the BASIC program may be interrupted during the computation of the display points, and the display buffer may be viewed as it is being constructed. Mixed results were obtained when using this method with MaxiBASIC; some points would be computed incorrectly if a mode 2 hardware interrupt were sensed in the middle of a computation. Another way to view the display buffer as it is being built is to occasionally put up a display for a few revolutions of the mirror.

Coordinate conversion is done in the subroutine in lines 680 to 1120. Variables X9, Y9, and Z9 contain the coordinates of the point to be converted. Variable N9 controls the number of iterations of Newton's method to be attempted until a given accuracy, T9, is reached. The angle of the mirror used in each iteration, T8, is initially set to the last value computed by the conversion routine. Since, frequently, many points will be plotted close together, this is a good first estimate of the angle of the mirror. T8 will be set to zero by MaxiBASIC the first time this routine is entered.

During each iteration, the test function F is computed (line 800). If this is below the tolerance level (T9), the routine has converged and the display points can be computed. Otherwise, the slope D9 is computed (line 840). This is used to compute the next test point in lines 870 to 900.

Once the routine has converged, T8 is converted to the appropriate position, Z, in the display buffer. The values for the X and Y digital to analog converters are then computed from the Y and Z coordinates, respectively, of the image point.

Finally, the computed values are stored

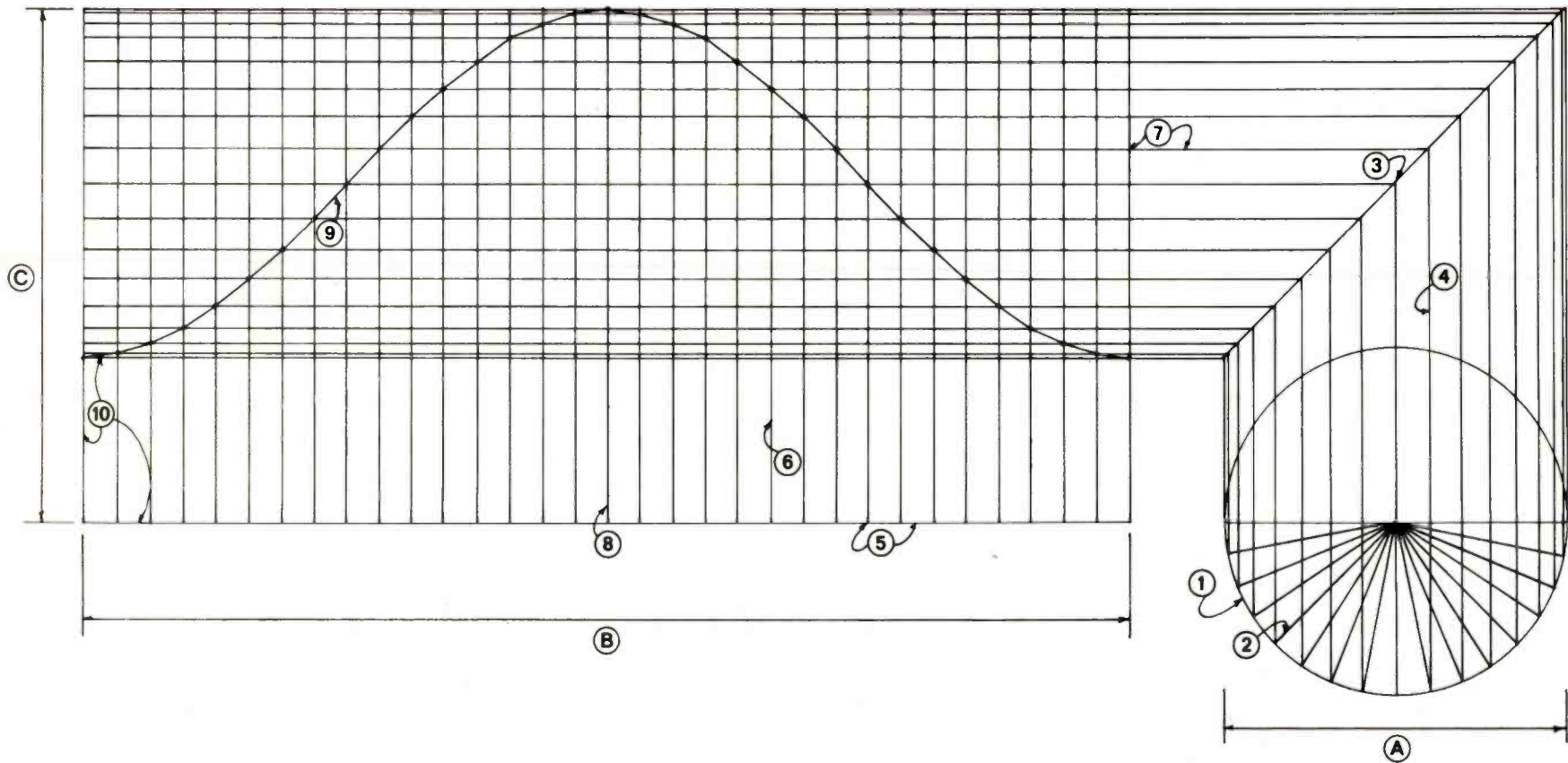

**Steps for Cutting a 45° Angle Through a Cardboard Tube**

A = diameter of tube  
 B = circumference of tube  
 C = finished height of tube

1. Draw a circle the same size as the outside diameter of the tube.
2. Divide the circle into 32 equal parts of  $11\frac{1}{4}^\circ$  each.
3. Draw a  $45^\circ$  angle above the circle.
4. Carry the points at the outside of the circle straight up to the  $45^\circ$  angle.
5. Find the circumference of the circle, draw a straight line, and divide it into 32 equal parts.
6. Carry lines from those divisions straight upward.
7. Bring lines straight across from the inter-
- sections at the  $45^\circ$  angle line and intersect with the vertical lines.
8. Starting at the center line, mark points of intersection.
9. Fill in between points of intersection.
10. Cut out pattern and wrap around tube, lining up straight circumference side of pattern with (cut) end of tube square.
11. Carefully trace curved line end of pattern onto tube.
12. Remove pattern from tube and save for making black paper cover for tube.
13. Cut along traced line on tube with an X-acto (or similar) knife.
14. Tape large sheet of sandpaper to a table top or other flat surface.
15. Sand end of tube until flat.
16. Tube is now ready for application of Mylar mirror surface.

*Figure 8: Construction of a template for cutting a 45° angle in a cardboard tube to make a rotating mirror. Details are described in the accompanying text. The circled numbers refer to step numbers 1 thru 10.*

in the display buffer in the subroutine from lines 520 to 670. This routine checks that the values for X, Y and Z are within bounds, and stores them in the first empty location in the display buffer after the desired location.

#### Final Thoughts

We hope this article will encourage readers to experiment with 3-D graphics. The advantages of the technique are immediately apparent when it is demonstrated, and the applications include such areas as computer aided design and architectural planning as well as action games. ■

#### REFERENCES

1. Simon, W., "A Three Dimensional Computer Display," *Computer Graphics and Image Processing*, volume 4, pages 396 thru 402, 1975.
2. Simon, W., "A Method of Producing a Three-dimensional Cathode Ray Tube Display," *Behavioral Research Methods and Instrumentation*, volume 1, page 179, 1969.
3. Traul, A C, "A New 3-dimensional Display Technique," *MITRE Report M68-4*, 1968 (AD684252).
4. Rawson, E G, "3-D Computer Generated Movies Using a Varifocal Mirror," *Applied Optics*, volume 7, pages 1505 thru 1511, 1968.
5. Rawson, E G, "Vibrating Varifocal Mirror for 3-D Imaging," *Spectrum*, volume 6, pages 37 thru 43, 1969.

#### Constructing the Mirror

The spinning mirror used for the development of the three-dimensional graphics described in this article was machined from a solid block of aluminum. It was produced under the auspices of a National Institute of Health grant, and is obviously an impractical solution to mirror construction for the personal computer experimenter.

We did, however, build an alternate, inexpensive, rotating mirror that is quite adequate for producing three-dimensional images. It uses surplus parts available from the dealers who advertise in this magazine. The rotating mirror element is fabricated by cutting a 45° angle through a short section of cardboard mailing tube of between 3 and 5 inches (7 to 12 cm) in diameter. This angle can be cut using the template shown in figure 8. The piece of mailing tube should be kept quite short. A piece of aluminized Mylar film, available from some art supply houses (or from Edmund Scientific Co, 300 Edscorp Bldg, Barrington NJ 08007), is cut slightly larger than the 45° angle end of the tube. The Mylar is then stretched over the end of the tube and taped to the tube's side. This should be done by first stretching the Mylar along the long axis of the 45° cut and tacking down the Mylar with short pieces of tape, then stretching the Mylar across the short axis and taping that axis down. Then work around the rest of the edge, taping opposite sides, and using care not to produce any wrinkles, until the entire edge is taped down.

Any motor can be used to spin the mirror, as long as it is a type whose speed can be controlled with a Variac or motor speed controller. A flywheel cut from plywood or

aluminum and mounted to the motor shaft is attached to the cardboard tube. If a mailing tube can be found with a removable end cap, the cap can be mounted to the flywheel plate and the tube can then simply be slipped into the end cap.

The motor and Variac should be mounted inside a sturdy enclosure. The motor shaft should project up through a hole in the enclosure; the flywheel and tube are then mounted to the shaft outside the enclosure. Motor, flywheel and tube should be carefully centered and balanced. The template for cutting the 45° angle through the tube can also be used as a pattern for a piece of black paper to be glued to the outside of the tube. The motor enclosure should be painted black to minimize reflections.

If the motor used has a shaft at both ends of the motor housing, a black disk, 3 inches (7 cm) or so in diameter, can be attached to the shaft inside the enclosure. The reflective opto-coupler described in the article can be mounted to the inside of the enclosure in close proximity to the edge of the disk. A piece of white tape applied to the edge of the disc will then trigger the opto-coupler each time the motor makes a revolution. If the motor only has a shaft at one end, the opto-coupler will have to be mounted outside the enclosure, with the piece of white tape fastened to the cardboard tube. Guard against ambient light triggering the opto-coupler if the latter method is used.

Light baffles and shields for the mirror should be experimented with; caution should be observed around the spinning mirror, as with any piece of moving machinery.

William Harris

Continued from page 22

set conversion: the ATV Research "Pixe-Verter," which uses the radio frequency (RF) modulator method, and the Pickles and Trout TVM-04, which uses the direct video entry technique.

The RF modulator method has the advantages of simplicity and generality. The modulator circuit is easy to construct, and no modifications to the TV set are required. The circuit board can be mounted inside your computer or other video source, and any TV set can be used simply by clipping two wires onto the antenna terminals. The disadvantages are that the number of characters that can be displayed across a line is limited, and that certain precautions must be taken to avoid trouble with the Federal Communications Commission.

When a video signal is used to modulate a very high frequency RF signal which is then fed through the receiver circuits of a TV set, bandwidth limitations are encountered. The practical limit is about 3.5 MHz, which is enough to display at most about 32 characters per line. Photo 1 shows the kind of display you can expect when using an RF modulator such as the Pixe-Verter. The video source here is an Ohio Scientific Instruments Model 440B video board, and the television set is a Hitachi Model PA-8, purchased new for about \$90 from a discount house in Boston MA.

When assembled, the Pixe-Verter legally becomes what the FCC calls a "Class 1 TV device." Since the device is actually a tiny TV broadcast transmitter, the FCC doesn't want you to broadcast signals which will create interference on your neighbor's TV sets. Actually, the device is so low powered that in my experience interference is scarcely noticeable on a TV set more than a few feet away. The unit should be enclosed in a metal box (a typical personal computer cabinet is fine), and shielded cable should be used to connect the unit to the TV set. Photo 2 shows the Pixe-Verter mounted in the space provided on the OSI 440B video board. The unit requires a -5 to -6.5 V supply, but this can be obtained by isolating the printed circuit board from the video board and reversing the power connections from the computer's +5 V supply.

The simplicity of the RF modulator method, as compared with the direct video entry method, can be illustrated by compar-

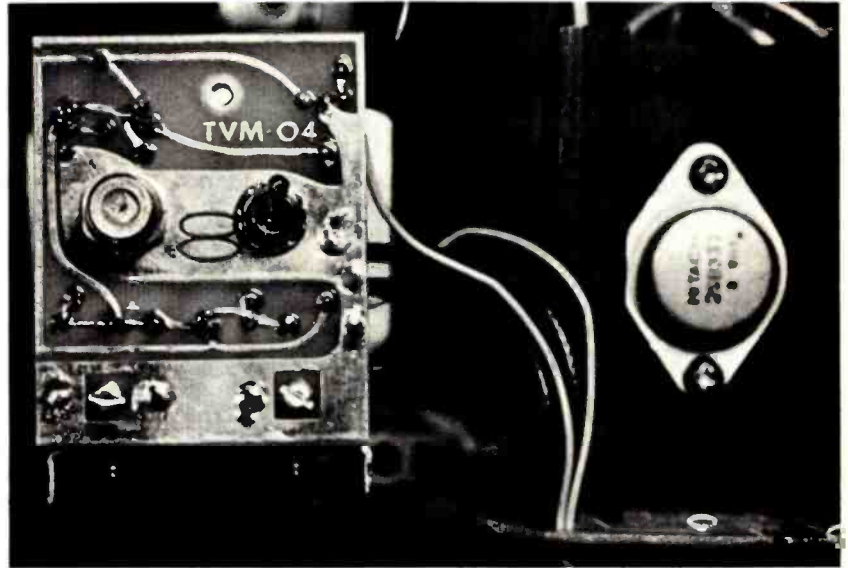

Photo 3: This inside view of the Hitachi Model PA-8 television set shows how the TVM-04 printed circuit board is mounted on the metal frame near the power transformer.

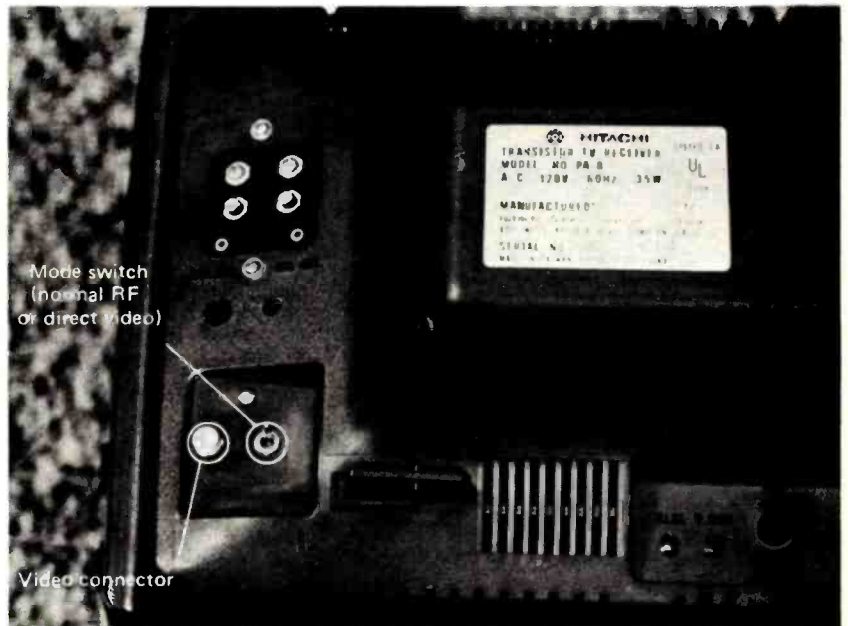

Photo 4: The TVM-04 lines up with the back of the TV set's plastic cabinet, giving access to a shielded cable connector for the video signal and a switch for selecting either normal program viewing or the computer generated display.

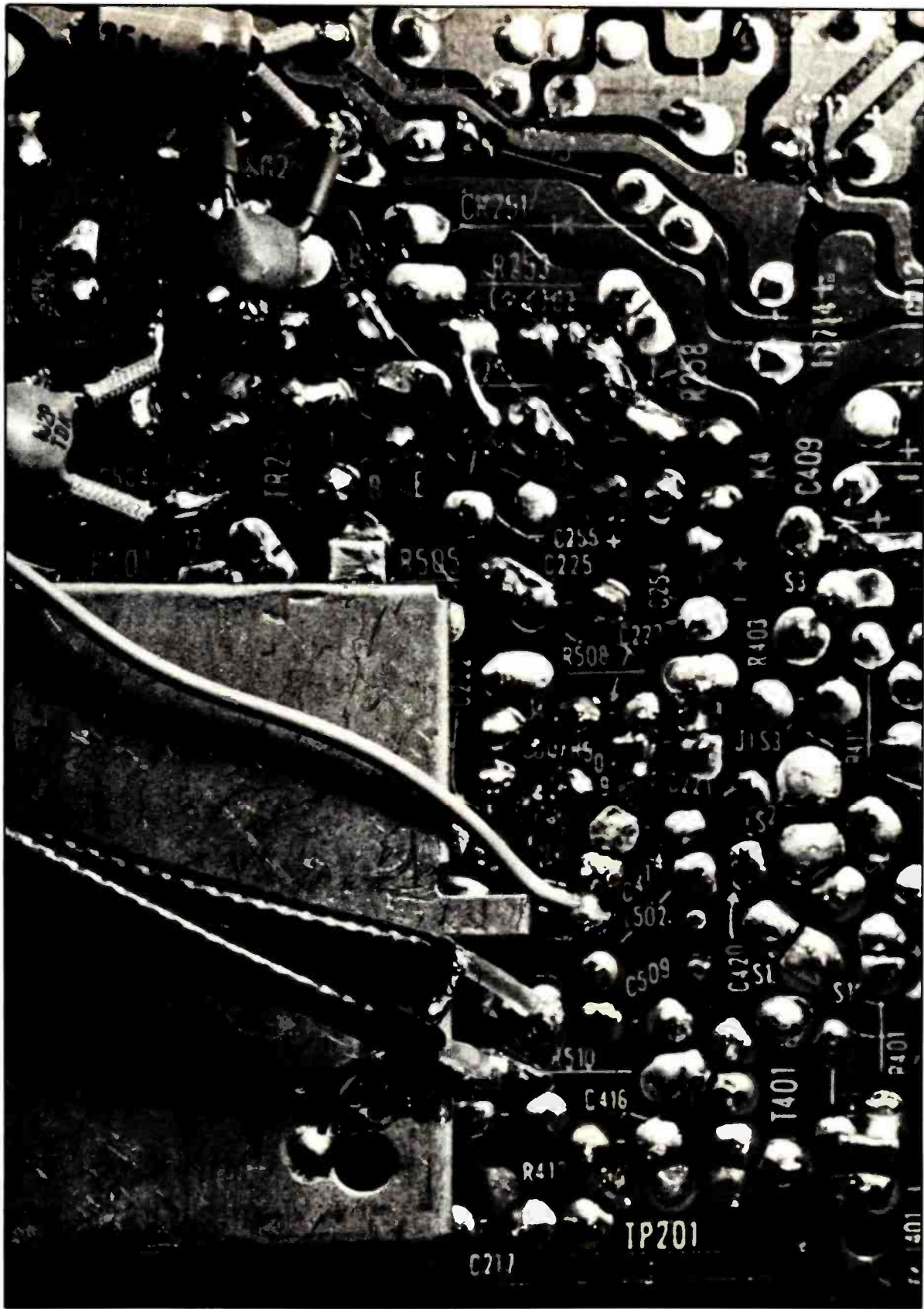

Photo 5: This view shows where modifications must be made to the underside of the Hitachi SX chassis printed circuit board. A foil trace carrying the video signal is cut and routed through shielded wire to the external switch, and a small disk capacitor (at top with spaghetti tubing on legs) is attached across a spark gap to improve the set's response to abrupt black and white changes.



ing the instructions that come with the Pixe-Verter (eight steps listed on one page) with the instructions supplied with the Pickles and Trout TVM-04 (51 very detailed steps on six pages). The direct video entry instructions also require you to drill holes in metal and plastic, cut a printed circuit board foil trace while being careful not to scratch other foil traces a quarter of an inch away, and remove a molded plastic boss with a hot knife or other instrument. Moreover, when working inside the TV set cabinet, there is some danger of accidental breakage and implosion of the TV picture tube! Direct video entry is not for the person who has never soldered before. If you are in this position, ask your friendly local computer store to help you. But the experienced hobbyist can put together the Pickles and Trout kit without hazard in about half a day, and the results are well worth it.

I bought the Hitachi Model PA-8 TV set with the intention of eventually converting it to direct video entry, since the Pickles and Trout TVM-04 is specifically designed for use in sets with the Hitachi SX chassis (Models P-03, P-04, P-05, P-08, P-53, P-63, etc). The design of this set facilitates switching between normal program viewing and direct video entry, and provides sufficient bandwidth to display as many as 96 characters on a line. The TVM-04 is mounted on the TV set's metal frame near the power transformer, as shown in photo 3, and lines up with a flat area on the set's plastic case to provide a professional looking external switch and shielded cable connector (see photo 4). Shielded wires are run to the point on the set's printed circuit board where the foil was cut, and a small capacitor is also soldered across a spark gap to limit the overshoot and ringing of the video amplifier when the video signal abruptly changes from black to white (see photo 5). For comparison, photo 6 shows the same video source as photo 1, using the same Hitachi TV set as photo 1, but with the direct video entry mode. As one would expect, the display is much clearer, more legible and more stable than the display obtained with the Pixe-Verter. For what it's worth, the two methods can be used together: I can view either of two computer generated displays at the flick of a switch!

One consideration that must be borne in mind when using the TVM-04 is that the modifications to the set void the manufacturer's warranty. Hence it pays to postpone making the modifications until you have owned and operated the set for a while and are sure that it is working pro-



Photo 6: The same display source as that of photo 1, produced on the same TV set, but with the aid of the Pickles and Trout TVM-04. Note the sharpness of this direct video display in contrast to the RF entry of photo 1.

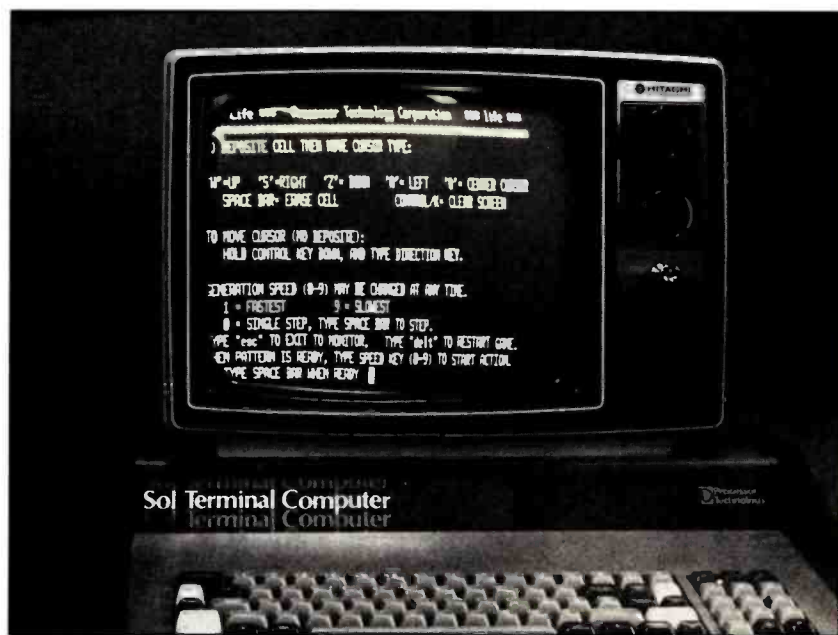

Photo 7: To illustrate the wider field possible with the Pickles and Trout direct video conversion, the 64 character display of a SOL-20 was used with the converted television perched on top of the SOL. We made no attempt to adjust the controls of the television set to remove the overscan condition evident in this photo of the Processor Technology LIFE demonstration program's output.

# Our MacroFloppy™ goes twice the distance. For \$695.



Circle 235 on inquiry card.

Introducing the Micropolis MacroFloppy™:1041 and :1042 disk drive sub-systems. For the S-100/8080/Z-80 bus. Packing 100% more capacity into a 5 1/4-inch floppy disk than anyone else. 143K bytes, to be exact. For as little as \$695.

The MacroFloppy:1041 comes with the Micropolis Mod I floppy packaged inside a protective enclosure (without power supply). And includes an S-100 controller. Interconnect cable. Micropolis BASIC User's Manual. A diskette containing Micropolis BASIC, and a compatible DOS with assembler and editor. The :1041 is even designed to be used either on your desk top, or to be integrated right into your S-100 chassis.

The MacroFloppy:1042 comes with everything the :1041 has, and more. Such as d.c. regulators, its own line voltage power supply, and, to top it off, a striking cover. Making it look right at home just about anywhere.

Both MacroFloppy systems are fully assembled, tested, burned-in, and tested again. For zero start-up pain, and long term reliability. They're also backed up by our famous Micropolis factory warranty.

And both systems are priced just right. \$695 for the MacroFloppy:1041 and \$795 for the MacroFloppy:1042.

You really couldn't ask for anything more.

At Micropolis, we have more bytes in store for you.

For a descriptive brochure, in the U.S. call or write Micropolis Corporation, 7959 Deering Avenue, Canoga Park, California 91304. Phone (213) 703-1121.

Or better yet, see your local dealer.

## MICROPOLIS™

More bytes in store for you.

perly. After this initial "burn-in" period you can be reasonably certain that the set will continue to operate over the life of the warranty, and the modifications

*A note about the photographs: The photos accompanying this article were made in BYTE's offices with ASA 400 speed 35 mm film in a Vivitar single lens reflex camera with macrolens, tripod, through-the-lens meter, and delayed release shutter. The pictures of the video displays were made with 1/15th second exposure time so that an integer number of 1/30th second television frames would be exposed. The close-up pictures of the internal and external details of the Hitachi television conversion were made with longer exposure times and room light as illumination. In all cases, the delayed shutter release was used so that any mechanical vibrations from manual release would be damped out over the 9 seconds or so delay possible with this feature.*

can be made. I took this precaution and it paid off. I had trouble with the set during the first week after I bought it, and had it fixed under warranty by a local TV repairman. Some time later I installed the TVM-04 and have had no trouble with it since.

My experience has been that either the RF modulator method or the direct video entry technique can be used with good results. If 32 characters on a line is sufficient, the Pixe-Verter is quite satisfactory. If you want a more dense character display and have some experience with electronics assembly (or someone to help you), do not hesitate to use the TVM-04. I hope this article will help you to make an intelligent choice.■

The Pixe-Verter Model PXV-2A is available for \$8.50 postpaid from ATV Research, 13th and Broadway, Dakota City NB 68731. The TVM-04 is \$20 from Pickles and Trout, POB 1206, Goleta CA 93018. Similar products for both the RF modulator method and the direct video entry technique are available from Vamp Inc, POB 29315, Los Angeles CA 90029.

# MetaFloppy™ goes beyond.

The Micropolis MetaFloppy™ gives you more than four times the capacity of anyone else's 5¼-inch floppy. Because it uses 77 tracks instead of the usual 35.

The field-proven MetaFloppy, with thousands of units delivered, comes in a complete family of models. And, like our MacroFloppy™ family of disk drives, MetaFloppy is designed for the S-100/8080/Z-80 bus.

For maximum capacity, choose our new MetaFloppy:1054 system. Which actually provides you with more than a million bytes of reliable on-line storage. For less money than you'd believe possible.

The MetaFloppy:1054 comes complete with four drives in dual configuration. A controller. Power supply. Chassis. Enclosure. All cabling. A new BASIC software package. And a DOS with assembler and editor. There's even a built-in Autoload ROM to eliminate tiresome button pushing.

If that's more storage than you need right now, try our MetaFloppy:1053, with 630,000 bytes on-line. Or our MetaFloppy:1043, with 315,000 bytes on-line. Either way, you can expand to over a million bytes on-line in easy stages, when you need to. Or want to.

In other words, if your application keeps growing, we've got you covered. With MetaFloppy.

The system that goes beyond the floppy.

For a descriptive brochure, in the U.S. call or write Micropolis Corporation, 7959 Deering Avenue, Canoga Park, California 91304. Phone (213) 703-1121.

Or better yet, see your local dealer.



Circle 236 on inquiry card.

**MICROPOLIS™**  
More bytes in store for you.

Continued from page 8

Atlantic ocean into northern New England. The storm sat in place, and the snow came. And came. And came. Before it was all over, perhaps a full meter of new snow had been deposited over much of southern New Hampshire. Boston and the state of Massachusetts rolled up their sidewalks again and closed down with some 68 cm of snowfall (a previous storm had set local records two weeks earlier, only to be outdone by this new storm).

But the evaluation of such a storm depends upon your point of view. For those fortunate enough to be away from the raging sea and power outages, it is an opportunity. It provides a nice new carpet of snow so that when I go skiing again next weekend the slopes will take on a whole new character. It provides me with the opportunity to spend 20 minutes and cross country ski to the office today.

Yesterday, while the snow was falling and our office was closed, it provided me (and many another personal computer user) with an absolutely superb excuse to stay home with my computers. I spent a quiet day

working on the systems software for my new disk drive. During the course of one snowy day I vastly updated my documentation of the systems software, created a new 1 K EROM with low level disk drivers for interrupt driven block transfers between memory and disk, implemented a primitive physical IO operating system to use as a tool in developing the final operating system for my computer, and designed the details of the file system for the new systems software; all in one snowy day which is now called "The Blizzard of '78."

A solitary day in my basement laboratory, isolated by blowing and drifted snow, turned into an unexpected opportunity to steal some time to work on my personal creations. While the rest of the region freaks out over excess snow, a computer experimenter can certainly turn the time to advantage until the storm has blown itself away.

Of course the reality of the snowy day returned at 6:00 this morning when I began to dig out the driveway. But the process of moving the snow is an opportunity: even computer people need a bit of vigorous exercise on occasion. ■

# Languages Forum

## Comments on PASCAL, Learning How to Program, and Small Systems

Gary A Ford, Assistant Professor  
Dept of Mathematics  
Arizona State University  
Tempe AZ 85281

The editorial in the December 1977 BYTE asked if PASCAL is the next BASIC. Implicit in this question is the suggestion that personal computing needs a widely used programming language. Ostensibly, this will facilitate exchange of software, and thus help eliminate the existing software vacuum for personal computer systems. Should PASCAL be the language used to begin to fill this void? To answer this question, we should look at the history of PASCAL to see for what purposes it was developed.

Wirth states two principal goals for PASCAL: "to make available a language suitable to teach programming as a systematic discipline based on certain fundamental concepts clearly and naturally reflected by the language," and "to develop implementations of this language which are both reliable and efficient on *presently available computers*" (emphasis added).

With regard to the first of these goals, Wirth contends that "the language in which the student is taught to express his ideas profoundly influences his habits of thought and invention." My experience shows that this is a remarkably accurate statement. I have taught computer science to university undergraduates for several years, and recently taught several intermediate level courses to students with a variety of programming backgrounds. The students had all had two or three quarters of formal computer science courses at the same university during the previous year, and all were familiar with the same computers. However, some had learned to program in BASIC, some in FORTRAN, and some in a structured variant of FORTRAN which included, among other features, two varieties of if-then-else, five varieties of iterative statements, two varieties

### 41 GREAT LOCATIONS

## ComputerLand™

#### NOW OPEN:

ALABAMA	
Huntsville	(205) 539-1200
CALIFORNIA	
Dublin	(415) 828-8090
El Cerrito	(415) 233-5010
Hayward	(415) 538-8080
Inglewood	(213) 776-8080
Lawndale	(213) 371-7144
Mission Viejo	(714) 770-0131
Mountain View	Call Information
San Diego	(714) 560-9912
San Francisco	(415) 546-1592
San Jose	Call Information
San Mateo	(415) 572-8080
Santa Rosa	Call Information
Thousand Oaks	(805) 495-3554
Tustin	(714) 544-0542
Walnut Creek	(415) 935-6502
COLORADO	
Denver	(303) 759-4685
CONNECTICUT	
Fairfield	(203) 374-2227
DELAWARE	
Newark	(302) 738-9656
GEORGIA	
Atlanta	(404) 953-0406
ILLINOIS	
Arlington Heights	(312) 255-6488
Niles	(312) 967-1714
Oak Lawn	(312) 422-8080
KENTUCKY	
Louisville	(502) 425-8308
MARYLAND	
Rockville	(301) 948-7676
MICHIGAN	
Kentwood	(616) 942-2931
Southfield	(313) 356-8111
NEW HAMPSHIRE	
Nashua	(603) 889-5238
NEW JERSEY	
Cherry Hill	Call Information
Morristown	(201) 539-4077
NEW YORK	
Buffalo	(716) 836-6511
Ithaca	(607) 277-4888
OHIO	
Cleveland	(216) 461-1200
OREGON	
Portland	(503) 620-6170
TEXAS	
Austin	(512) 452-5701
Houston	(713) 977-0909
WASHINGTON	
Bellevue	(206) 746-2070
Federal Way	(206) 838-9363
Tacoma	Call Information
WASHINGTON, D.C.	Call Information
INTERNATIONAL	
Sydney, NSW Australia	29-3753

FRANCHISE OPPORTUNITIES AVAILABLE  
CALL ED FABER (415) 895-9363

# Rated G

## The Best Game in Town.

Welcome to ComputerLand. An incredible adventure into the world of personal computers. A one-of-a-kind shopping experience.

Each ComputerLand store presents everything you ever wanted to know about computers. And then some.

Take our Game Room, for starters. You'll find excitement for the whole family in our endless variety of challenging computer games. You can battle the Klingons in an out-of-this-world game of Star Trek. Create an electronic work of art with a computer controlled TV. Test your skill in a game of computerized hangman.

You can even plot your biorhythm.

But we're more than just fun and games. Each ComputerLand store offers a knowledgeable and personable staff of professionals



And if your system breaks down, our in-store service department will get you back up and running.

Right now!

## Great Selection.

Your first stop at ComputerLand may well be your last stop.

ComputerLand offers the finest quality and

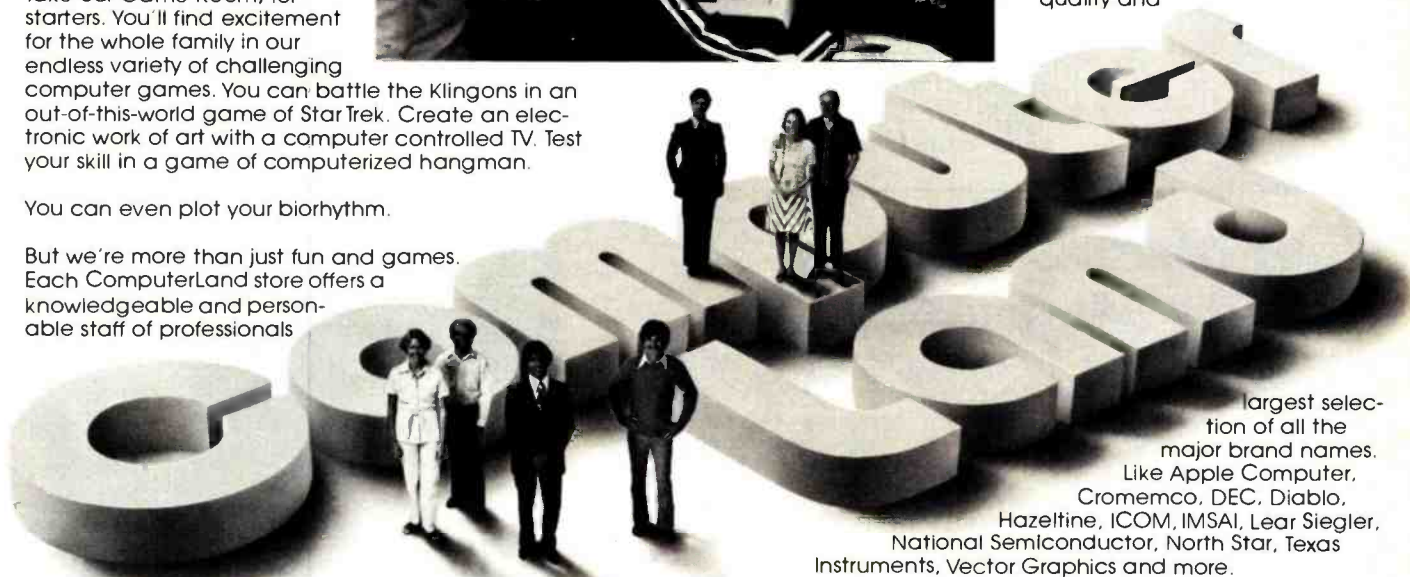

largest selection of all the major brand names. Like Apple Computer, Cromemco, DEC, Diablo, Hazeltine, ICOM, IMSAI, Lear Siegler, National Semiconductor, North Star, Texas Instruments, Vector Graphics and more.

to serve you.

Plus the greatest available selection of micro components. Whether it's a data processing system for your business or a computer controlled sprinkler system for your home, you'll find whatever you need at ComputerLand.

Plus a complete inventory of tools, books and accessories.

What's more, at ComputerLand, we deal in product. Not promises. Our inventory is on our own shelves. Rather than the manufacturer's. So you can take delivery on tomorrow's components today.



Read on.

## Genuine Service.

We want to supply you with the one system that's right. Rather than a complete system that isn't. Or a limited system that is.

That's why, at ComputerLand, you deal with real professionals who are also real people. People who speak your language

... in addition to BASIC, COBOL or FORTRAN.

People, in short, who can offer both the novice and the old hand the same expert guidance in selecting the optimum system he or she needs.

Yet, assisting in the purchase is only the beginning of ComputerLand's service. If the kit you bought requires a little more do-it-yourself than you yourself can do, we provide assembly assistance.

If that complex program proves to be just that, we provide programming assistance.

Which means, simply put, that at ComputerLand, you get exactly what you want.

Exactly when you want it.

## Be Our Guest.

Begin with the grand tour of our exhibit areas. "Test-drive" any of our individual systems.



Then tell us your needs. We'll sit down and talk about the system that's right for you. It's as easy as that at ComputerLand.

The great computer store. RATED G.

Call or write for the address of the ComputerLand store nearest you. Franchise opportunities available.

# ComputerLand™

14400 Catalina St., San Leandro, CA 94577 (415) 895-9363

of multiple branch structures, and a simple but powerful procedure facility. The structured FORTRAN programmers proved to be significantly better performers in the intermediate level courses in all ways. They were much quicker to understand new algorithms, new data structures, and new applications. They were superior in applying this knowledge to new problems, which can, in part, be attributed to the fact that they were not thinking in the narrow terms required in BASIC and FORTRAN. They wrote better programs in assembly language, perhaps again because they could think in structured programming terms. They also, not unexpectedly, learned PASCAL (which was taught in conjunction with a data structures course) much faster than the other

students. In fact, some of the BASIC and FORTRAN programmers never did make the transition to PASCAL; they wrote PASCAL programs that looked like line by line translations of BASIC and FORTRAN programs. An informal follow-up of some of these students in more advanced courses showed that the BASIC and FORTRAN group continued to lag behind, especially in courses in analysis of algorithms and design of large systems.

Of course, this was not a controlled experiment, so the conclusions cannot be supported scientifically. However, I believe it is true that since so much of computer science involves abilities to analyze, to organize, and to plan, the thinking process taught in a first programming course, which

## Your MicroComputer can be a Money-Making Machine with SOFTWARE from SYNCHRO-SOUND

Here are two Software packages that enable you to profitably make full use of the potential in your small computer system: Synchro-Sound's interactive business systems designed for use on an 8080- or Z80-based microcomputer with floppy disks and a hard-copy printer. Written in Microsoft Basic (known as Altair Basic\*), the software supports file maintenance, query and reporting functions. This support includes creation, modification and deletion of customer records and processing of transactions to be posted against the files.



### ACCOUNTS RECEIVABLE PACKAGE

The A/R module creates a history file of charges, credit and payment records for audit purposes. Payments can be applied to a particular invoice, or to the oldest open items. Batch Mode for monthly statements, aged receivables schedule, and delinquency notice as well as on-line inquiry mode for specific information are both fully implemented.

Operators Manual & Disk—Single Copy **\$500.00**

Operators Manual only— **\$35.00** refundable upon purchase of Software Package.

Microsoft Disk Basic—Single Copy **\$350.00**

### INVENTORY PACKAGE

The inventory system maintains a current listing of stock items featuring on-line transaction processing. Reporting functions include a master inventory listing with price and cost data, reorder alerts, vendor specification, and summary valuations. Year-to-date usage records are kept for each inventory item to facilitate sales analysis.

Operators Manual & Disk—Single Copy **\$500.00**



### WRITE OR CALL FOR FURTHER INFORMATION

Full Software-Hardware Systems are now available and additional Software Packages will be available in the near future

\* Altair is a trademark of MITS, Inc.

### SYNCHRO-SOUND Enterprises, Inc.



193-25 Jamaica Avenue  
Jamaica, New York 11423  
212/468-7067 TWX 710-582-5886

Hours 9-4 Daily  
and Saturday

Working Systems  
on display

Dept. BS

BankAmericard/Master Charge

# SYNCHRO-SOUND

ENTERPRISES, INC.

Everything you need in small computer systems!

## LEAR SIEGLER ADM 3A TERMINAL

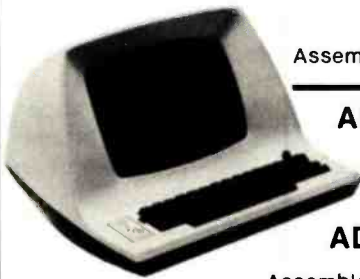

Kit **\$759.95**  
Assembled **\$854.95**

ADM 1A TERMINAL  
Assembled **\$1529.00**

ADM 2 TERMINAL  
Assembled **\$1995.00**

## NEW! CENTRONICS 779 PRINTER



**\$1099.00**

703  
SERIAL PRINTER  
**\$2395.00**

761 PRINTER  
KSR with Keyboard **\$1695.00**

## HAZELTINE 1500 VIDEO TERMINAL

Assembled **\$1149.00**  
Kit also available



## MODULAR 1 INTELLIGENT TERMINAL

Assembled **\$1659.00**

## OKIDATA MODEL 110 LINE PRINTER



Friction Feed  
**\$1149.00**

Tractor Feed  
**\$1279.00**

RS 232C Serial Interface  
**\$260.00**

## IMSAI 8080 MICROCOMPUTER



With 22 slot  
**\$649.95**

## MODEL 22 LINE PRINTER

Tractor Feed **\$2249.00**

TELETYPE MODEL  
43 PRINTER  
**\$1299.00**



## SPECIAL BUYS

IMSAI Double Density Percsi Drive.....	\$2295.00
Sorac IQ 120 Video Terminal.....	959.00
DIGITAL Systems Dual Density Floppy.....	2745.00
Compucolor 8001 Color Computer.....	2595.00
ICOM Microfloppy System.....	989.00
North Star Microfloppy Disk Kit.....	599.00
Cromemco Z-2 Kit.....	565.25
Javelin 9" Video Monitor.....	159.95
Micropolis Model 1053MOD 2.....	1799.00
IMSAI AP44-44 Col. Printer Kit.....	329.00
TDL Xitan Alpha 1 Computer Kit.....	699.00
ICOM Model FD 3712.....	2795.00

## IMSAI PC S-80/15 8085 COMPUTER



Kit **\$749.00**  
Assembled **\$929.00**

We carry a full line of the following: TDL, Centronics, Seals, Hazeltine, Micropolis, Hayden, IMSAI, Cromemco, Compucolor, Icom, Lear Siegler, Okidata, DEC, Javelin, North Star, Peripheral Vision. Same day delivery and shipping on most items. Full modern repair facilities on premises for complete servicing of everything we sell.



## SYNCHRO-SOUND ENTERPRISES, INC.

The Computer People

193-25 Jamaica Avenue,  
Jamaica, New York 11423  
212/468-7067 TWX: 710-582-5886  
Hours 9-4 daily  
and Saturday

Visit our new showroom  
Working units on display

Dept. BBB BankAmericard • Master Charge

**POWERFUL DISK BASED SOFTWARE  
for NORTH STAR DISK and  
HORIZON COMPUTER USERS!**

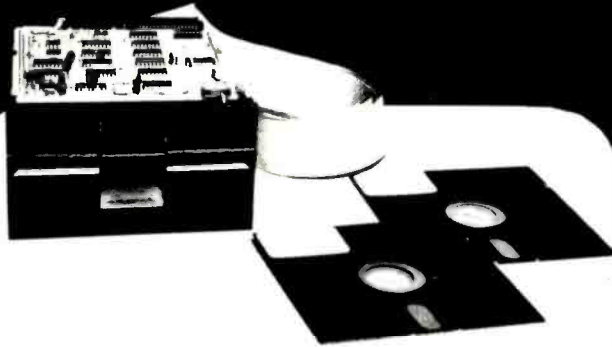

**SYSTEM Z Development Software**  
Requires 1 North Star Disk Drive  
and 12K RAM

**ASMB Z80** Disk Based Assembler for rapid development of moderately sized assembly language programs. Requires 8.5K of memory. Price: \$60

**DASMZ** A Disk Based Assembler for development of large assembly language programs. Requires 6K of memory. Price: \$60.

**ZEDIT** A powerful text editor with full text manipulation operations. Requires 1.5K of memory. Price: \$60.

**ZEBUG** A Debug Monitor/Disassembler that translates object code into instruction mnemonics. Requires 3.5K memory. Price \$60.

**BUSINESS PACKAGE**

General Ledger	\$60
Accounts Payable	\$60
Accounts Receivable	\$60
Payroll	\$60
Inventory	\$60
Amortization	\$35
Mailing List	\$60

Purchase complete Business Package for \$395  
Dealer inquiries are invited.

Write or call for full Software Package details:

**Sunshine Computer  
Company**

20710 S. LEAPWOOD AVE., CARSON, CA 90746  
(213) 327-2118

in turn depends on the language used, has an enormous impact on the development of computer scientists.

Thus, PASCAL sounds like a good language for beginners (ie: many of today's computer hobbyists). There are other reasons for supporting the spread of PASCAL, including, for example, its outstanding data structuring facilities. Some problems are easily stated and solved in terms of such structures as sets, lists, sequences, trees, or groups of disparate items. PASCAL allows the programmer to define and to deal directly with such structures, whereas BASIC and FORTRAN force the programmer to disguise these structures as arrays. Of course, obscuring the original ideas often leads to obscure program logic.

With regard to Wirth's second goal for PASCAL, we suddenly have a problem. The personal computer systems of today are quite different from the "presently available computers" Wirth had in mind ten years ago. Therefore, some language features that are desirable for present personal computer systems are absent from PASCAL. Perhaps the most important of these features are in the category of access to peripheral devices and processor hardware facilities.

PASCAL has only two primitive IO operations: get and put. Each moves a single unit of data (character, integer, record, etc) from or to a sequential file. Files are not necessarily associated with or stored on secondary storage devices, although two special predefined files (named input and output) are available for those files associated with devices that will also be accessed by humans. There are in addition two predefined procedures (named read and write) that perform data transmission from or to files in particularly useful ways, but it is important to emphasize that these are procedures (subprograms) and not statements or operations in the language.

The peripheral devices of personal computer systems are extremely varied, and very few system configurations are exactly alike. Therefore, each user will need somewhat different IO capabilities in the language. Many users have an on line terminal, access to which requires the ability to access specific absolute addresses in memory or specific port addresses. Users with disks will need direct access file capabilities. Others may want the ability to process interrupts for real time applications. None of these capabilities exist in PASCAL, and none can easily be implemented as a disguised sequential file.



The obvious conclusion is that if a push for PASCAL as *the* language of personal computing is made, there will be a variety of nonstandard implementations. This is exactly what we have seen with BASIC. Each individual implementor will add her own versions of her own favorite bells and whistles. We may expect numerous methods of specifying absolute memory addresses (peeks and pokes), direct access disk file statements, and all kinds of facilities to handle the exotic peripherals being attached to personal systems. In addition, implementors will want to add their own favorite data type (for example, PASCAL does not have a built-in string data type), and their own favorite operator (for example, PASCAL does not have an exponentiation operator). Next, seeing the size of the resulting compiler, implementors will begin to delete their least favorite standard features (often meaning the ones they least understand), in order to come up with a 4 K version of "eensyweensyPASCAL."

One approach to preventing some of the problems just mentioned is to get all of us hobbyists together to agree (is this possible?) on a standard set of additions and deletions.

## basic language SOFTWARE

Tired of nagging non-users asking what that machine can do besides counting from 1 to 1000 and playing games — can't get no respect??

We are developing programs that are useful to you and will involve your family with your computer. Our first set of programs are finished and tested to run in 3k (useable memory) using these verbs: ABS DATA DEFFN DIM FN FOR-NEXT GOSUB RND GOTO INPUT PRINT READ IF-THEN RETURN

These programs (25 in all) are tutorial, using you or your child's name. It gives several tries, and displays helping information, if necessary.

**Most Importantly**, it continually adjusts to the operator's skill so people from 1st grade to college will be challenged.

**Math 1** Includes 7 programs for addition, subtraction, multiplication and division of whole numbers and same with intergers

**Math 2** Includes 9 programs for addition, subtraction, multiplication and division of decimals and same with fractions. Also area and volume.

**Math 3** Includes 9 programs in three areas, algebra, percentage, and metric conversions.

Each set includes source listings, documentation and costs \$9.95 per set of 7-9 programs with money back guarantee. Where else can you buy extremely useful and educational programs for about \$1 each. All three sets will be \$24.95 during May and will also include 5 free financial programs.

Send personal check or money order to:

### CONTRACTORS' MANAGEMENT SYSTEMS, INC.

P.O. Box 212, Chantilly, Va. 22021

P.E.T. users may add \$8 for a tape See other ad

## PET SOFTWARE

First, see our other ad to give you an idea of where our company is going and then we will meet back here . . . See ya . . .

Glad to see you back again. We have developed two other packages that run exclusively on the . . . 4K . . . PET. The first one relies very heavily on the excellent graphic capabilities of the PET. Graphic (1) has 3 graphic games on tape.

- |                    |   |
|--------------------|---|
| 1. 3-D Tic-tac-toe | Display boards in 3D<br>P VS. P, P VS. C, C VS. C |
| 2. Space Wars      | Real time graphics with<br>moving targets         |
| 3. Tank Battle     | Exploding mines and a lot of<br>obstacles         |

All Three \$14.95

### WANT TO LEARN BASIC LANGUAGE

Interactively with your PET? Our first tape (Basic-1) is ready now. Two other tapes will follow and will be ready when you finish Basic-1.

- |            |        |                          |
|------------|--------|--------------------------|
| 1. Basic-1 | Tape 1 | Fundamentals of<br>Basic |
| 2. Basic-2 | Tape 2 | Advance Program-<br>ming |
| 3. Basic-3 | Tape 3 | Graphics and files       |

Basic-1 \$19.95

There is already another company that has tutorial basic on one tape: we are offering three tapes.

SEND IN YOUR NAME AND DESCRIPTION OF  
YOUR COMPUTER AND RECEIVE 5 FREE  
FINANCIAL PROGRAMS

### CONTRACTORS' MANAGEMENT SYSTEMS, INC.

P.O. Box 212, Chantilly, Va. 22021

or perhaps a few standard sets in order to develop 8 K, 12 K, 16 K, etc, versions. The traumatization of the language could be minimized by requiring that all the new features be implemented as procedures, rather than as new statement types, thus maintaining the syntactic integrity of the language. Of course, this would require a capability to link external procedures to each PASCAL program, and none of these procedures could be written in PASCAL. This means either that all users will need to know another programming language, or that the implementors of the new varieties of PASCAL will have to supply customized procedures for each customer.

There is a fundamental flaw in this approach, however. PASCAL was not intended to be all things to all people. It was designed with specific, well thought out, predefined goals. All aspects of the language were designed to complement each other in attaining those goals. Any deletion from the language, however minor it seems, will upset this balance, and thus damage PASCAL's ability to achieve its goals. Deletions and additions will also change the character of the language, and it is this overall character of PASCAL that has brought it so many devotees.



**COMMODORE  
"PET"**

**DELIVERY FROM STOCK  
TO 30 DAYS**

**Advanced 8K Model  
—only \$795**

No computer know-how needed! Uses extended "BASIC"  
—the sensible computer language. Self-contained with its  
own 9" video display. Built-in keyboard with 128 alpha-  
numeric and graphic characters. Built-in cassette tape recorder.  
Complete with 14K operating system and 8K memory built-in  
(expandable to 32K).

—Coming Soon—  
**BUSINESS SYSTEMS FOR PET**

System includes PET Model 8K Computer, second Tape Drive,  
and an 80 column, 120 cps impact printer—about \$1500.  
Available software includes: ACCOUNTS RECEIVABLE,  
INVENTORY CONTROL, ACCOUNTS PAYABLE, CASH  
RECEIPTS AND DISBURSEMENTS, and GENERAL LEDGER.  
Other software programs include: Checkbook (\$15.95),  
Mortgage (\$15.95), Startrek (\$9.95), Annual Report Analyzer  
(\$22.95), Options Analysis (\$24.95), Finance (\$12.95), and  
many more!

Send \$795 (plus \$10 shipping) for PET model 8K. PET  
Printers and second tape Drives also available. NYS Residents  
please add Sales Tax. Master Charge and VISA accepted.

**THE COMPUTER FACTORY**  
790 Madison Ave. (cor. 67th St.)  
New York, NY 10021

212-PET-2001  
212-249-1666

Open 10-6 pm Tuesday — Saturday

PASCAL, and that it be used for all *suitable* applications programming. I have used PASCAL for at least 95% of my own programming over the last three years, and I cannot recommend it too strongly.

If a new personal computing language were developed from guiding principles, I would hope that it would have much of the flavor of PASCAL. I would hope it would be syntactically uncluttered like PASCAL, not only because it makes the language easier to use, but also because it allows much simpler (smaller) language translators. I would hope it would have control structures at least as strong and as logical as those of PASCAL, and data structuring facilities as simple and powerful as those of PASCAL. It should be designed so that we can write almost all of our software in this one language, including both systems and applications programs. It should not try to provide every feature of every existing language, but rather, like PASCAL, provide a small set of primitive constructs from which users can define their own powerful features. It should allow us to write truly portable programs and to maintain a library of procedures, since a good procedure facility, like that of PASCAL, is perhaps the single most important tool for software developers. But whatever we choose to put in the language, let us design it from principles, and not evolve it from a set of independent features, as was the case with BASIC and FORTRAN.

There are probably several persons out there with thoughts on this subject, and I commend BYTE's Languages Forum as a means of communication. I would also enjoy corresponding directly with anyone with ideas in this area. ■

A better approach, I believe, is for those of us in personal computing to get together to agree on *principles* for the next widely used language, rather than on the features to add to or delete from an existing language. This is not any kind of vote against PASCAL; to the contrary, I hope PASCAL will become available to all hobbyists with systems that can support *standard*

## why the last BUSS is the best BUSS

It has the latest news for users (and prospective users) of Heath Co. computer products. It isn't company-controlled--BUSS can get new product information and tidbits about items being developed before the official announcement by Heath Co. But BUSS does more than that--BUSS also lets you in

on news of compatible hardware & software from other vendors. H8 and H11 users may save enough on these products to pay for a BUSS subscription several times over. And users of the ET-3400 Trainer aren't left out either. The first issue of BUSS came out more than a year ago in April of

1977. Every issue goes by first class mail and almost all orders for new subscriptions are filled within two days. Back issues go fast, but most of those for 1978 are still available. BUSS keeps getting better. So send for it:

**12 ISSUES FOR \$ 6.80**

THE INDEPENDENT NEWSLETTER OF HEATH Co. COMPUTERS 325 PENNSYLVANIA AVENUE, S.E. WASHINGTON, DC 20003

## Comments on APL's Characteristics

John E Howland, chairman  
Computing and Information Sciences  
Trinity University  
751 Stadium Dr  
San Antonio TX 78284

I would like to add some comments concerning the APL letters published in the November 1977 "Languages Forum." Many of the comments published indicate a lack of familiarity or understanding. This familiarity comes only after extensive use of a programming language. There seems to be a general impression that APL is a relatively new language which has design flaws which are due perhaps to the hasty way in which the language was put together and which are easily corrected by making one or two simple changes. For example, "the APL character set is not ideal for use with 5 by 7 dot matrix printers or video displays," so we should redesign the APL character set. There are already several successful existing 5 by 7 dot matrix implementations of the APL character set; however, the real point here should be that we should consider using a 7 by 9 dot matrix or some other size or hardware technique to implement the APL character set rather than change the character set to fit the hardware.

Another example concerns the order of execution. APL goes from right to left which is clearly backwards, so let's just make one simple change and have it go left to right. One suggestion was that this would be a great help to all those APL programmers who begin entering their programs before they have finished writing them. To me, this is similar to the person who opens his mouth and begins to speak before engaging his brain. The real solution to the suggested problem has nothing to do with the order of evaluation of APL expressions.

Since many readers have only recently encountered APL, some discussion of order of evaluation may be appropriate. Motivation for the APL order of execution can be traced to the standard mathematical way of handling functions of a single argument. In a sequence of functions such as Sin Arctan X, the order of evaluation is Sin of Arctan of X. The value of the entire expression to the right is the argument to a unary function, and this argument is usually

## IDS INTERNATIONAL DATA SYSTEMS, INC.

400 North Washington Street, Suite 200, Falls Church, Virginia 22046 U.S.A.

Telephone (703) 536-7373

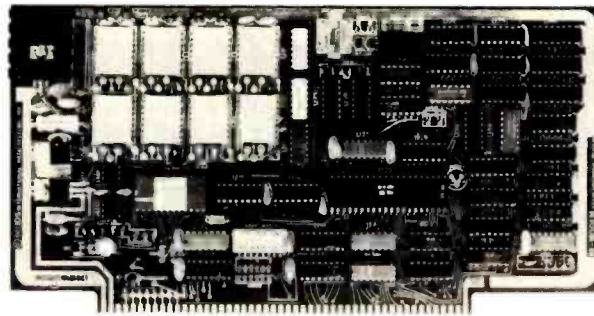

**88-MODEM:** A complete serial I/O port and an Originate/Answer MODEM on an S100 bus compatible board. The 88-MODEM features automatic auto-dialer (not software timed), operates at any software selected baud rate between 66 and 600 baud, has separate 8-pole transmit and receive active filters, and all functions are software selected. The 88-MODEM provides communication to -58 dbm and is intended for use with either a CBS (1001D) or CBT Data Access Arrangement for connection to the telephone system. The kit price is \$245.00.

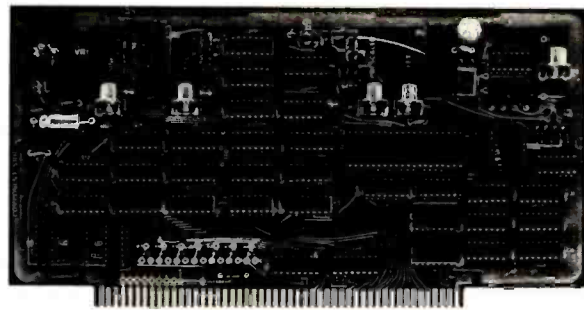

**88-UFC UNIVERSAL FREQUENCY COUNTER:** The 88-UFC is an S100 compatible frequency and period measurement module. The 88-UFC has four software selected inputs. Frequency measurement to above 600MHz and period measurement to 1/10th microsecond are standard. The counter provides nine digits of readout and is priced at \$179.00 in kit form.

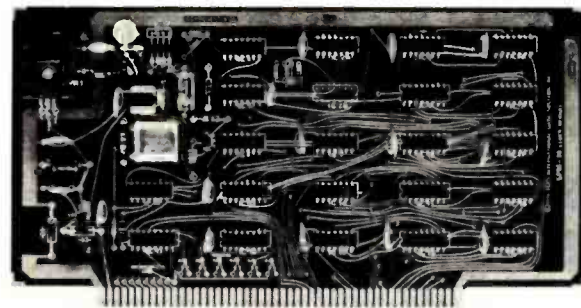

**88-SPM CLOCK MODULE:** The 88-SPM provides a time of day clock and an independent realtime clock on one S100 compatible module. Provisions are included for battery backup so the 88-SPM can maintain the time during power-off conditions. \$96.00 kit

1001D (Type CBT) Data Access Arrangement	\$125.00
88-RCB 16 Channel Relay Control Board Kit	\$179.00
MCTK Morse Code Trainer/Keyer Kit	29.00
TSM Temperature Sensing Module Kit	24.00
DAC-8 8-Bit Digital to Analog Converter Kit	19.00
88-TCXO Temperature Compensated Crystal Oscillator for 88-UFC	145.00
88-XTAL Crystal Timebase option for 88-SPM	25.00

TERMS: Payment with order shipped prepaid, added for COD. Master Charge accepted

written on the righthand side of the function. The APL language includes a large number of primitive functions. Rather than develop a complicated rule giving priorities of primitive and user defined functions, all such priorities were eliminated. This also allowed user defined functions to be given the same importance and syntax as primitive functions. The rule for evaluating functions of a single argument is extended to functions of two arguments, using infix notation, by having the right argument be the value of the entire expression to the right and the left-hand argument be the first value to the left of the function. A consequence of this extension is that the only nonredundant use of parentheses, to alter the order of evaluation, is to form the left argument of a function.

To summarize, APL order of evaluation from right to left comes from the use of standard function notation of writing the argument of a monadic function on the right of the function and the desire to introduce no hierarchy of evaluation such as multiplication before addition.

If one desires to evaluate expressions from left to right, using no priorities among functions, then one will probably have to introduce a "left monadic" notation such as

X Arctan Sin.

which, unfortunately, has to be read from right to left! If one extends this notation to functions of two arguments in a similar manner, then one has the problem of writing

the subtrahend and divisor to the left of the function symbol so that  $3 \div 6$  equals 2. Also, assignments are probably made to the right, rather than the left. Such extensions lead to a confusing notation because they must be read from right to left.

It should be clear at this point that the right to left order of evaluation rule which is used in APL was not chosen in an arbitrary manner. It was chosen so that APL could be read from left to right.

APL is not a new language which was thrown together quickly. Actually, it is one of the oldest computer languages dating back to before 1962. Unlike most computer languages, APL enjoyed an extended period of development and refinement before it was implemented on a computer. During this time, many changes were made. The changes were easy to make because there were no interpreters to change and no user community to complain. The APL character set evolved during this time to its present form. One unusual aspect of this character set is the use of overstrikes to represent some functions. This technique allows easy addition of new characters for new functions when they are incorporated into the APL language.

In summary, the APL language was very carefully designed. Few, if any, arbitrary choices were made during the development of APL. Some of the controversial features, such as the character set and order of evaluation, are based on standard mathematical notation and convention and are not easily changed. ■

## MORE 6800 SOLUTIONS:

### FOR SWTPC 6800

#### AS-1 ANALOG INTERFACE MODULE

- FAST, ACCURATE A/D, D/A CONVERSIONS
- EIGHT ANALOG INPUT CHANNELS
- ONE HIGH-SPEED ANALOG OUTPUT
- OCCUPIES ONE I/O SLOT
- \$87.50 KIT \$115.00 ASSM.

#### SC-1 SERIAL INTERFACE CARD

- RS-232 SERIAL INTERFACE
- FULL CONTROL SIGNALS IMPLEMENTED
- MOST VERSATILE SERIAL I/O AVAILABLE
- \$30.00 KIT \$40.00 ASSM.

### FOR MOTOROLA "D2"

#### DA-1 UPGRADE KIT

- CONVERTS D2 TO TERMINAL I/O
- RETAINS FULL CASSETTE I/O CAPABILITY
- INCLUDES RT/68MX ROM - MONITOR/O.S.
- ALLOWS USE OF BASIC, EDITORS, ASSEMBLERS, ETC.
- RS-232 SERIAL INTERFACE
- DAT w/70 p. MANUAL \$69.95

#### MOTOROLA MM568104 16K RAM

- 16K BYTES DYNAMIC RAM
- ENGINEERED SPECIFICALLY FOR "D2"
- EXORCISOR — TYPE BUSS
- \$395.00 ASSEMBLED

### M6800 SOFTWARE

#### A/BASIC COMPILER

- 8K EXTENDED BASIC COMPILER
- CONVERTS BASIC PROGRAMS TO FAST, MEMORY EFFICIENT MACHINE LANGUAGE
- DESIGNED FOR RT/68 — SUPPORTS MULTIPROGRAMMING
- EXTREMELY VERSATILE I/O
- KC CASSETTE + MANUAL — \$49.95

#### RT/68MX OPERATING SYSTEM

- EXPANDED CONSOLE MONITOR ROM
- REAL TIME OPERATING SYSTEM
- DIRECT MIKBUG REPLACEMENT
- PIA OR MULTI-ACIA I/O
- RT/68MX ROM w/MANUAL \$55.00

U.S. Orders Postpaid

Master Charge & VISA Welcome

Write or call for Free Catalog.

# MICROWARE SYSTEMS CORPORATION

P.O. BOX 954 • DES MOINES, IOWA 50304 • (515) 279-9856

# Warnier-Orr Diagrams: Some Further Thoughts

The article "Structured Program Design" in the October 1977 BYTE, page 146, has certainly simplified my thinking. However, the use of the symbol ⊕ seems to violate a rule implicit in the Warnier-Orr diagram that one need not and in fact must not go up in a list contained within a bracket of a given order. The ⊕ symbol requires checking up and down the list of case statements. I believe that what is meant is illustrated in figure 1. In this example CASE J is equivalent to ROLL = "J." This manner of diagramming clarifies the relationship between statements having alternatives and statements not having alternatives. It also eliminates the need for the instruction SKIP, since the finding of no more items in a list of a given order is the equivalent of an instruction to return to the proper place in the list of the next lower order, where the order of a list is its position from left to right as shown in figure 2.

I would like to define the instruction RETURN to mean "in the list of next lower

GT Wedemeyer  
#17 Forest View Trlr Ct  
Iowa City IA 52240

Figure 1.

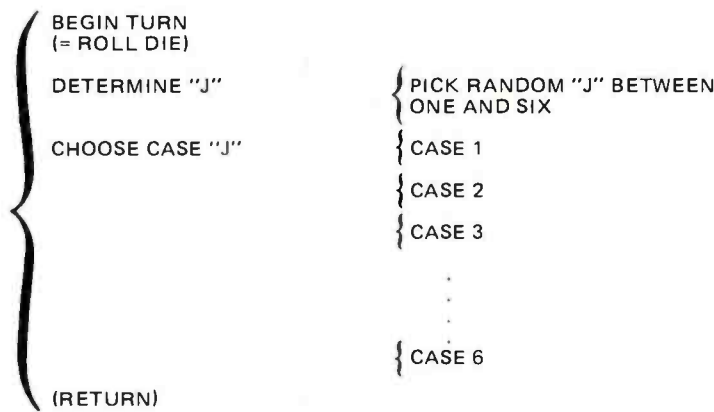
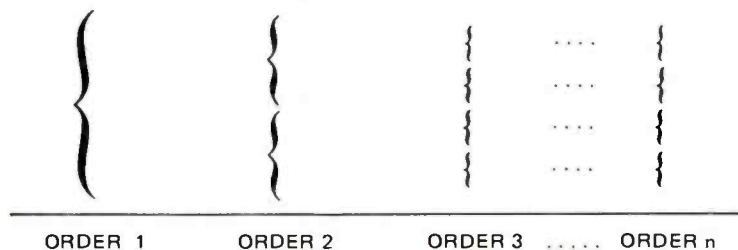
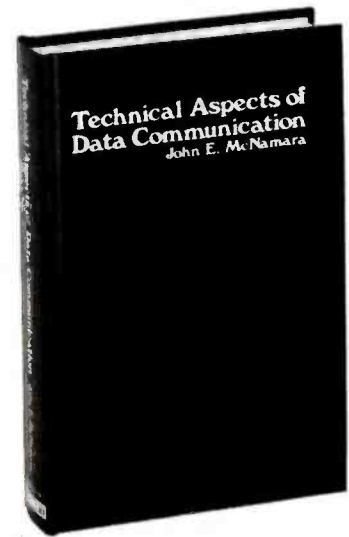

Figure 2.



Now, a book  
for the practicing  
professional...



"This is the best handbook of data communications system technology that this reviewer has yet encountered." — Arvid G. Larson in *ACM Computing Reviews* February 1978

Digital Press announces the publication of TECHNICAL ASPECTS OF DATA COMMUNICATION by John McNamara.

Written for the practicing professional, TECHNICAL ASPECTS OF DATA COMMUNICATION details the nuts-and-bolts problems and solutions in configuring communications systems. It features: • comparison of protocols (DDCMP, BISYNC, SDLC) • extensive explanation of interface standards (CCITT/V.24, RS232C, RS422, RS423) • six comprehensive appendices (how far/how fast?, modem options, codes, UART, format and speed table for asynchronous communication, channel conditioning) • 20 milliampere loop • telephone switching systems • error detection  
• 382 pages • 125 figures • 70 pages of tables • index • hardcover

**digital**

Digital Press  
Educational Services  
Digital Equipment Corp.

Crosby Drive, Bedford, MA 01730

I would like to order \_\_\_\_\_ copies of  
TECHNICAL ASPECTS OF DATA  
COMMUNICATION at \$19.95 per copy.

Check enclosed  Money Order enclosed  
(Note: Minimum order for Digital Press to process purchase order is \$35).

Name \_\_\_\_\_

Address \_\_\_\_\_

City \_\_\_\_\_ State \_\_\_\_\_ Zip \_\_\_\_\_

Prices apply in U.S. only.

**WARBLE ALARM  
CAR-VAN CLOCK  
WITH HEADLIGHT ALARM**

- ELAPSED TIMER
- SECONDS DISPLAY SWITCH
- 9 MINUTE SNOOZE ALARM
- SIMPLE 4 WIRE HOOK-UP
- JUMBO "X" LED DISPLAY
- 1 TO 99 MINUTE COUNTDOWN TIME\* \*\*MS SIMULTANEOUSLY WITH LOCK\*
- RUGGED ABS CASE
- QUARTZ CRYSTAL ACCURACY



**COMPLETE KIT \$35.95  
ASSEMBLED \$45.95**

**DIGITAL AUTO INSTRUMENTS  
SEVEN MODELS!**

#1 TACHOMETER  
#2 WATER TEMP.  
#3 FUEL LEVEL  
#4 SPEEDOMETER\*  
#5 OIL PRESSURE  
#6 OIL TEMP.  
#7 BATTERY MONITOR

**KIT INCLUDES:**

- CASE & ALL HARDWARE
- PRESSURE & TEMP. SENDERS
- ASSEMBLED MAIN PCB BOARD

**FEATURES:**

- 4 ORANGE LED'S
- 4" x 4" x 2" ABS CASE

\*ADD \$10 FOR REQUIRED SPEED SENDER \$15 FOR SPEED SENDER ALONE  
**KIT: \$49.95 . . . . . ASSEMBLED: \$59.95**

**ELECTRONIC 'PENDULUM' CLOCK**



- SWING PENDULUM
- 7" HOURS AND MINUTES DISPLAY
- TIME SET PUSH BUTTONS
- ALARM FEATURE

**KIT-UNFINISHED CASE . . . . . \$59.95  
ASSEMBLED-STAINED CASE . . . . . \$69.95**

**QUARTZ DIGITAL AUTO CLOCK  
OR ELAPSED TIMER!**

ELAPSED TIMER: HRS, MINS & SECS  
SIMPLE PUSHBUTTON RESET &  
HOLD TOGGLE SWITCH

**KIT INCLUDES EVERYTHING  
NOTHING ELSE TO BUY! \*LED'S!  
INTERNAL BATTERY BACKUP!  
NON POLAR INPUT!**

12 OR 24 HR MODE  
DIMENSIONS: 4" x 4" x 2"



**KIT: \$27.95 . . . . . ASSEMBLED: \$37.95**

**NOW WITH  
ELAPSED  
TIME!**

**3 1/2 DIGITAL CLOCK**

• 4 DIGIT KIT **\$49.95** • 4 DIGIT ASSEMBLED **\$59.95**  
• 6 DIGIT KIT **\$69.95** • 6 DIGIT ASSEMBLED **\$79.95**

117 VAC 12 OP 24 HR MODE      **KIT COMES COMPLETE!**  
6 DIGIT VERSION 2 1/2" x 5" x 1 1/2"      4 DIGIT VERSION 1 1/2" x 5" x 1 1/2"



**TV-WALL CLOCK** 117 VAC

- 25" VIEWING DISTANCE
- .6" HOURS & MINUTES
- .3" SECONDS
- COMPLETE WITH WOOD CASE



**KIT: \$34.95 . . . . . ASSEMBLED: \$39.95**

**ECONOMY CAR CLOCK**

- 1/2" LED MODULE
- COMPLETE WITH CASE, BRACKET & TIME SET PUSHBUTTONS
- ALARM OPTION



**KIT: \$19.95 . . . . . ASSEMBLED: \$26.95**

**PENDULUM** GIVE YOUR DIGITAL CLOCK A PENDULUM SWING  
9 TO 12V DC 60 HZ INPUT  
SIMPLE HOOK UP TO ANY CLOCK



**\$14.95**      CASE WITH BRACKET **\$3.75**

**MARK FOSKETS'**  
SOLID STATE TIME

P.O. BOX 2159  
DUBLIN, CALIF. 94866  
ORDERS (415) 828-1923

**24 HR  
PHONE**

master charge      BANK AMERICA CARD

CALIFORNIA RESIDENTS ADD 6% SALES TAX

order than the list in which this instruction is found, complete the step immediately following the lowest completed step." Although this instruction seems implicit, as I indicated above, I would prefer that it be explicitly stated, and I think it would make the diagrams more easily followed.

*Dave Higgins replies:*

It appears from your letter that you are very interested in using the Warnier-Orr diagramming techniques. I think you will be pleased with the results.

I'd like to comment on the suggestions you made for improving the diagrams. Unlike flowcharts, which have become quite rigid and inflexible in form, the Warnier-Orr diagrams are still in a relative infancy, and do still change occasionally. We here at Langston, Kitch have made some minor modifications to the diagrams in the last year in order to add some capabilities that were previously vague or nonexistent. We are continually evaluating the diagrams, looking for shortcomings or ambiguities, and therefore welcome suggestions along these lines. It is in this light that I considered your suggestions for revising some of the notation.

First of all, with respect to your ideas concerning the representational form of a CASE statement: I think your objection

*Listing 1.*

```

300 REM CASE STATEMENT
310 REM DETERMINE CASE "J"
320 LET J=INT(RND(0)*6+1)
330 ON J GOTO 340,380,420,460,500,540
340 REM CASE 1
350
    case 1 process

370 GOTO 570
380 REM CASE 2
390
    case 2 process

410 GOTO 570

    cases 3-6 as above

570 REM END CASE

```

*Figure 3.*

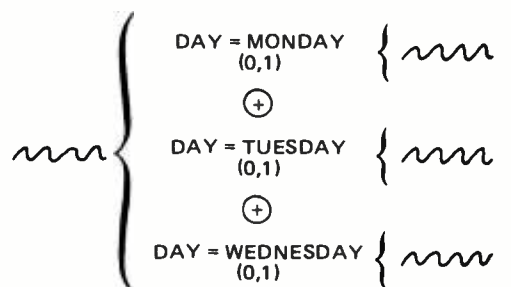

Listing 2.

```

300 REM CASE STATEMENT
310 IF D$="MONDAY" THEN 330 ELSE IF D$="TUESDAY" THEN 360
    ELSE IF D$="WEDNESDAY" THEN 400
320 GOTO 440
330 REM CASE 1: DAY = MONDAY

    monday process

350 GOTO 440
360 REM CASE 2: DAY = TUESDAY

    tuesday process

390 REM CASE 3: DAY = WEDNESDAY

    wednesday process

440 REM END CASE
    
```

to the use of the ⊕ symbol stems from the fact that there are two primary ways to actually code a CASE structure. One way is with the use of a "computed GOTO or GOSUB." The diagram you show is ideally suited for translation into a computed GOTO, which would look something like listing 1. But I don't think this is a worthwhile change to make to the basic form of the diagrams themselves. The reason is this: although your method works fine for CASE statements that lend themselves to computed GOTO's, there are a whole host of other CASE statements where the use of a computed GOTO is an extreme inconvenience. Take, for example, the CASE of figure 3. It would be inconvenient to have to rig up a computed GOTO to execute this CASE. It is much simpler to code it using a "nested IF" statement, which is the other popular way to code CASE statements. In pseudocode, this CASE is:

```

IF DAY = MONDAY
    THEN MONDAY-ROUTINE
ELSE IF DAY = TUESDAY
    THEN TUESDAY-ROUTINE
ELSE IF DAY = WEDNESDAY
    THEN WEDNESDAY-ROUTINE
    
```

You can see the natural one-to-one correspondence between the Warnier-Orr diagram and the pseudo-code. This is easily translated to code in listing 2. Listing 3 shows an alternative for those BASICs without the nested IF capability. This is the preferred method for coding a case statement because this method will work for all CASE statements, regardless of whether or not the CASE is suited for a computed GOTO. Also, with the computed GOTO, you must be sure that your "J" is restricted to the proper range. This is not to say that you can never use the computed GOTO; just be sure that its use is justified and then

# BIG SAVINGS

10% - 15% - 20% -  
25% OFF

IMSAI - TDL - NORTH STAR -  
CROMEMCO - VISTA -  
DYNABYTE - AND OTHERS

## SPRING SPECIALS

### TDL XITAN:

- Alpha 1 reg \$1039     \$ 879<sup>95</sup>
- Alpha 1.5 reg \$1138     964<sup>95</sup>
- Alpha 2 reg \$1749     1309<sup>95</sup>
- Alpha 4 reg 2149     1599<sup>95</sup>

### TDL

- VDB 25x80 Video Display Board reg \$369 NOW \$314<sup>00</sup>

All TDL units factory assembled and tested

### IMSAI

- 8080 w/22-slot motherboard and IMSAI 4K RAM Board reg \$808     NOW \$599<sup>95</sup>
- ABOVE, incl. Serial Interface Kit and 16x32 Video Display Board assembled and tested     \$789<sup>95</sup>

## NORTH STAR HORIZONS

— ALL MODELS —

ABSOLUTELY BEST PRICES  
AND BEST DELIVERIES

Call for information

DYNABYTE - LESS 20%  
CROMEMCO - LESS 10%

### S-100 MEMORY BOARDS

North Star 16K Dynamic RAM  
Kit List \$399     \$ 329  
Assembled List \$459     379

- TDL 16K Static assm/test \$549
- TDL 32K Dynamic, " \$739

Prices good until June 30, 1978; limited to existing inventories

Add \$1.50 per board and/or \$10 per system for handling, shipping, and insurance.

Send for free catalog

## MiniMicroMart, Inc.

1618 James Street  
Syracuse, New York 13203  
Phone (315) 422-4467

For Your SWTP 6800 Computer ...



**PERCOM'S™ Assembled and Tested  
FLOPPY DISK SYSTEM  
the LFD-400**

only

**\$599<sup>95</sup>**

shipping  
paid

**The LFD-400 is ready to plug in and run  
the moment you receive it.**

**Nothing else to buy! Not even extra memory!**

**YOU GET:**

- ① The popular Shugart SA 400 minifloppy™ drive. Drive alignment is double checked by PerCom before shipment.
- ② The drive power supply—fully assembled and tested.
- ③ LFD-400 Controller/Interface—plugs into the SS-50 bus • accommodates three 2708 EPROMs • fully assembled and tested.
- ④ MINIDOS™—the remarkable LFD-400 disk operating system on a 2708 EPROM • plugs into the LFD-400 Controller card • no extra memory required • no "booting" needed.
- ⑤ Attractive metal enclosure.
- ⑥ Interconnecting cable—fully assembled and tested.
- ⑦ Two diskettes—one blank, the other containing numerous software routines including patches for SWTP 8K BASIC and the TSC Editor/Assembler.
- ⑧ 70-page instruction manual—includes operating instructions, schematics, service procedures, and the complete listing of MINIDOS™.
- ⑨ Technical Memo updates—helpful hints which supplement the manual instructions.
- ⑩ 90-day limited warranty.

Minifloppy is a trademark of Shugart Associates.  
MINIDOS is a trademark of PERCOM Data Company, Inc.

The LFD-400 is readily expanded to either two or three drives. Write for details. Send for our free brochure for more information about the LFD-400 Floppy Disk System and LFD-400 software.

**To save you money, the LFD-400 Floppy Disk System is available only from PerCom. Because of the special pricing, group and dealer discounts are not available.**

MC and VISA welcome. COD orders require 30% deposit plus 5% handling charge. Allow three extra weeks if payment is by personal check. The LFD-400 Floppy Disk System is available immediately. Allow three weeks for testing and transportation. Texas residents add 5% sales tax.

**PERCOM™**

**PERCOM DATA COMPANY, INC.**  
Dept B 318 BARNES-GARLAND, TX. 75042  
(214) 276-1968

**PERCOM™ 'peripherals for personal computing'**

```
300 REM CASE STATEMENT
310 IF D$="MONDAY" THEN 350
320 IF D$="TUESDAY" THEN 400
330 IF D$="WEDNESDAY" THEN 450
340 GOTO 500
350 REM CASE 1: DAY = MONDAY
```

monday process

```
390 GOTO 500
400 REM CASE 2: DAY = TUESDAY
```

tuesday process

```
440 GOTO 500
450 REM CASE 3: DAY = WEDNESDAY
```

wednesday process

```
500 REM END CASE
```

*Listing 3.*

be very careful. Personally, I feel it is more trouble than it is worth.

As for the elimination of the brackets with "SKIP" in them: I don't believe that you really want to do this. For instance, in the BUG game published in the October 1977 BYTE, no action is taken when a player rolls a "BODY" on the dice but already has a body. This bracket is filled with the notation "SKIP," which indicates that, although the bracket is an essential part of the logic of the diagram, nothing is to be done there. However, in future versions of the game, you might just decide to tell the player that "YOU ALREADY HAVE A BODY" when that condition occurs. If the original diagram is left with the empty brackets intact, you have a fixed and ready place to put that PRINT command. The design is very easy to change and the documentation for the new program is only a matter of erasing one line and replacing it with another.

Also, I don't believe that we need to add the (RETURN) command at the end of the brackets as you suggest. As you state, the return to the next highest level in the diagram is already implied at the end of *each bracket*: therefore adding (RETURN) on each bracket would amount to a lot of "busywork," which would clutter up the diagrams with a lot of unnecessary information.

Again, I'd like to thank you for your suggestions and extend an invitation for all the readers of BYTE to submit their suggestions for improvement of the Warnier-Orr diagrams to either Langston, Kitch and Associates or to me for examination.

Dave Higgins  
Langston Kitch and Associates Inc  
715 E 8th  
Topeka KS 66607  
(913) 233-2349



# Letters

## ON USING AMATEUR RADIO FOR PC NETS

Jeff Steinwedel offers the only feasible solution for CIE Nets, Distributed Communications Network, or whatever you may wish to call it. Amateur radio, because of its disciplined ranks, would be the very ideal place to start. We do not need another uncontrollable "Topsy" that one finds on the Citizen's Band.

Some refined computer work has already begun on the amateur bands. I've just completed an interface board for frequency control, and another for the computer to do all of the log work by filing dates and time of contacts, and even their call signs. Conditions are already open: the allotted VHF frequencies include experimentation, within FCC rules, of course.

Jack Chancellor W9SON  
4736 Amethyst Rdg  
Rockford IL 61102

## MORE ON COMPUTER CONTROLLED PROSTHESES

The January 1978 BYTE Letters column contains a letter from Don Baker regarding computer controlled prostheses. I call to his attention the work currently being carried out at Northwestern University's Rehabilitation Engineering Center at the Rehabilitation Institute of Chicago.

Under the direction of Dr Dudley Childress, the Center has developed a multitude of prosthetic devices for the crippled patient. Foremost among these (in my opinion) is the design and construction of prosthetic limbs, namely a "bionic" arm and hand. This device amplifies the myoelectric surface potentials on the skin which are generated by muscle contraction and converts the signals into finger motion through a network of electronic circuitry and electromechanical components. By "thinking" to extend the arm, for example, the patient can open and close the thumb and forefinger on the prosthetic limb. While the grip strength of 25 pounds is nowhere near the ability to

crush steel, the patient gains a great deal of freedom in lifestyle than that which he had as an amputee.

Mr Baker suggested a computer controlled wheelchair as a possible solution to mobility problems for the handicapped. Northwestern has already thought of the same thing and has gone on to develop such a machine. It consists of an electric wheelchair fitted with an array of batteries, electronic hardware, and specially designed input and output devices which are in the form of straws. The effectiveness of the device is best seen in abilities of the Rehabilitation Center's receptionist/secretary, who is a quadriplegic. Doubling as a public relations spokesperson as well, she can operate slide shows, telephones, lights, and even type from her seat in the wheelchair via coupling to a micro-computer. Paralyzed from the neck down, she communicates with the computer by sipping and puffing on straws coupled to pressure sensing instruments. Output from the computer is on a video terminal, which is also connected with an electronic typewriter. Through the use of the sipping and puffing mechanisms, and computer supplied "best fit" characters, the typist is able to create words and entire letters on the computer, which are then sent to the typewriter for printing.

At present, the cost of micro-computers limits this complete system to a relatively small segment of the population. Thus, alternate systems have been developed, allowing the user to control eight devices within the home (eg: lights, telephone, toaster, etc). As the cost goes down, we'll be seeing more of these systems in the near future.

With the development of new techniques and mechanisms, the Rehabilitation Engineering Center is enabling more and more crippled patients to face the world more effectively and helping them gain pride in themselves.

Christopher A Kryzan  
1012 Waveland Rd  
Lake Forest IL 60045

*Christopher is president of the Tech Undergraduate Council, Northwestern University Technological Institute.*

## NEVER AGAIN?

If it can happen in New York it can happen anywhere.



### POWERLESS!!

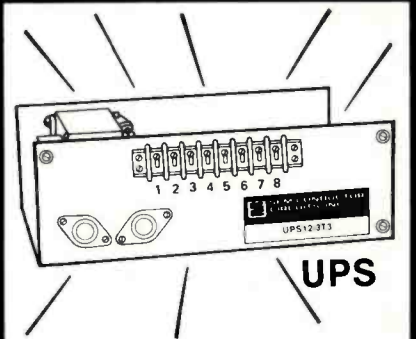

Protect your Memory and Systems against Blackout with one of S.C.I.'s UNINTERRUPTIBLE POWER SUPPLY SYSTEMS . . . or design your own system using S.C.I. modules.

**UPS SERIES** priced from:  
\$155.00 to \$225.00 (unit price)

#### PERFORMANCE!

- Reliable Float Charge Battery Backup Systems
- Regulated Single & Multi Outputs
- 36 Standard High Performance, High Efficiency Models

The Memory Savers from the No. 1 Source. Want the Facts Fast?  
Call Frank Frontiero



**SEMICONDUCTOR  
CIRCUITS, INC.**  
POWER SOURCES DIVISION

306 RIVER ST. HAVERHILL MA 01830  
TEL (617) 373-9104, TWX 710 347 0269

Circle 111 on inquiry card.



## Get your PC masters in as little as 2 weeks

At Echo Design your circuit drawings can be converted into finished artwork masters in only 2 to 6 weeks, depending on complexity.

We do board layouts for many of the biggest names in the business.

And we have broad capability. Such as computer boards having 450 ICs.

Choose any or all these services:

- Layout (to digitizing standards if desired)
- Assembly drawing
- Tape-up (artwork)
- Schematic drawing
- Fab drawing
- Bill of material
- Printed board

Place a call now to John Offenbacher or Al Chew and get your new board moving at competitive prices.

**FREE**  
Ask for  
a copy

Basic  
Guidelines  
for  
Printed  
Circuit  
Partitioning

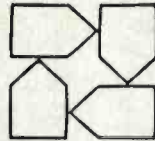

# echo

DESIGN AND  
DEVELOPMENT  
CORPORATION

195 EAST GISH ROAD • SAN JOSE, CA 95112

408-292-0918

We also provide contract technical personnel world wide

### TROUBLESHOOTING QUERY

I have a BA in photography, but due to a recent car accident my back was injured causing my legs to become partly crippled. Because of this I can no longer work as a photographer, and at present I am repairing calculators for Texas Instruments.

Looking toward the future I have decided to open my own microcomputer repair shop as a new career (with some luck).

Most of the local colleges and training schools offer programming and design theory, but this is not troubleshooting and repair.

Where can I find such a college or training school which offers basic electronic and computer repair? Where can I write to find such information if you don't have it?

Relocating to another state will be no problem, and I'm not concerned with the time required to attain the training.

Larry Bernard  
1625 16 St, Apt 255  
Lubbock TX 79401

*Readers who can answer Mr Bernard's questions are encouraged to correspond with him directly.*

### A D TO A FROM THE UK

In certain articles of BYTE I have noticed circuits which could, in my opinion, be improved by use of British devices which, for some reason, are not used in American articles.

The best example of this is the Ferranti ZN425E 8 bit digital to analog converter. This device retails for approximately \$8 in the UK and, as far as I can tell, is superior to the MC1408L-8. One

## \$95 Stand Alone Video Terminal

```

αΒΓδ εθϋϕϗϘϙϚϛϜϝϞϟϠϡϢϣϤϥϦϧϨϩϪϫϬϭϮϯϰϱϲϳϴϵ϶ϷϸϹϺϻϼϽϾϿ
!"#$%&'()*+,-./012456789:;<=>?
@ABCDEFGHIJKLMNPOQRSTUVWXYZ[\]^_
`abcdefghijklmnopqrstuvwxyz{|}~

```

### SCT-100 FEATURES:

- 64 X 16 line format with 128 displayable characters
- Serial ASCII or BAUDOT with multiple Baud rates
- \$187 Assembled or \$157 Kit (Partial Kit \$95)
- Full cursor control with scrolling and paging
- On board power supply
- Many additional features

Call or write today. MC/VISA accepted

XITEX CORP. P.O. Box #20887  
Dallas, Texas, 75220 ● Phone (214) 386-3859  
Overseas orders and dealer inquiries welcome

advantage is that the ZN425E can be converted to an analog to digital converter with the addition of just two more ICs costing about \$3 total.

Also, I think there should be more articles like Ciarcia's Circuit Cellar, since his articles are easily adapted to any microcomputer, rather than being designed for use with any one type. My reason for this bias is that I am designing my own microcomputer.

A K Kenny  
43 Simonbarn Av  
Fenham, Newcastle upon Tyne  
Tyne and Wear NE4 9VA  
ENGLAND

Interested readers can contact  
Ferranti Electric Inc, E Bethpage Rd,  
Plainview NY 11803.

### READING STRINGS

I read with great interest Wayne Ledder's description of how a string of ASCII digits can be read and converted to a binary number in "A Novice's Eye on Computer Arithmetic" (January 1978 BYTE, page 150). A faster, cleaner, and easier algorithm exists for this purpose.

To read a 3 digit number, Ledder recommends placing the first digit (after subtracting ASCII "0") into memory location HUNS, the second into TENS, and the third into UNITS. Then HUNS is multiplied by 100, TENS by 10, and these results are added; UNITS is added to this sum to give the final result. Clearly, this method works. However, it is inconvenient to use for two reasons. First, the program itself must be modified if one wishes to input, say, four digit numbers. Second, the number must be typed using a fixed number of digits. Now, how would you feel if your tiny BASIC made you type things like 00001, or interpreted 0001 either as something ridiculous or an error?

I think there is a better way. The following algorithm is cleaner and as easy to implement.

1. Set NUM to 0.
2. Get a digit from input. If it is not a digit (eg: a blank or a new line), terminate.
3. Otherwise, convert the digit from ASCII by subtracting the code for ASCII "0" from it.
4. Multiply NUM by 10. Then add the digit to it.
5. Go to step 2.

When the algorithm terminates, the value of NUM will be the binary number corresponding to the ASCII coded input.

Several comments are in order. First, the multiplication in step 4 can be performed quickly by adding the value of NUM shifted left three times to the value of NUM shifted left once. Second, the processing of the first digit should probably be moved outside of the loop. This facilitates checking for a negative sign, avoids an unnecessary multiplication in step 4 on the first iteration,

and makes it possible to check for a completely blank line (which should be treated as an error, not as zero).

This algorithm requires no leading zeroes and works for numbers of any length. It is also quite fast; in reading number less than 65,536, it requires only 3 n 16 bit shifts and 2 n 16 bit adds, to read an n digit number. Unfortunately, I can claim no credit for it since it has been in existence for many years.

Eric Hamilton  
Dunster D-11  
Harvard University  
Cambridge MA 02138

### DEMISE OF MAPLE

Sad to report, *MicroAPL Enthusiasts* has gone to seed. The major cause of its demise has been a severe deficiency in creative literary sap. When we started this seedling, we'd hoped for a forum which would someday branch to many interesting discussions on that most fascinating of languages: APL. Since then, although the response has been good, the literary stuff has been flowing in at the rate of frozen maple syrup. As the instigators of all this, we found ourselves unable to gather enough material to form the critical mass needed to get the chain reaction of ideas started. Therefore, we have decided to dis-

corporate, and return MAPLE to virtual memory storage in that bit bucket in the sky.

R Low  
J Sikorski  
POB 574 NUMS  
Chicago IL 60611

### HUMAN FACTORS ENGINEERING NEEDED?

Today I discovered that nobody really cares about us, at least those of us who use computer terminals day after day.

I was doing a data base search through the INSPEC files looking for information about "the office of the future." Most searches that were performed were quite successful (giving up to 160 references). However, a combined search on display devices and human factors found one entry (on digital watches). Even less rewarding was a search on data acquisition and human factors—no references. I can only assume that no one cares about the user.

At the Canadian Computer Show in Toronto in November, my sister and I ran a quick informal survey of keyboards of computer terminals. Typically, the keyboards could not have been designed with any user in mind. Problems of ugly color schemes; glare on the keys from overhead lighting, lack of "feel"

## HOBBYISTS! ENGINEERS! TECHNICIANS! STUDENTS!

Write and run machine language programs at home, display video graphics on your TV set and design microprocessor circuits — the very first night — even if you've never used a computer before!

### RCA COSMAC microprocessor/mini-computer

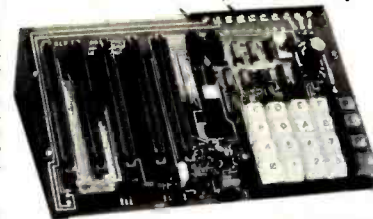

A THOUGHTFUL GIFT  
FOR ANYONE WHO MUST  
STAY UP TO DATE IN  
COMPUTERS AND  
ELECTRONICS!

ELF II \$99<sup>95</sup>

#### SPECIFICATIONS

ELF II features an RCA COSMAC COS/MOS 8-bit microprocessor addressable to 64k bytes with DMA, interrupt, 16 registers, ALU, 256 byte RAM, full hex keyboard, two digit hex output display, 5 slot plug-in expansion bus, stable crystal clock for timing purposes and a double-sided plated-through PC board plus RCA 1861 video IC to display any segment of memory on a video monitor or TV screen.

Use ELF II to ... **PLAY GAMES** using your TV for a video display ... **CREATE GRAPHICS** pictures, alphanumeric, animated effects ... learn how to **DESIGN CIRCUITS** using a microprocessor ... the possibilities are infinite!

#### NOW AVAILABLE

ELF II explodes into a giant when you plug the **GIANT BOARD™** into ELF's expansion bus. This powerful board includes cassette I/O, RS 232-C/TTY, 8-bit P I/O and system monitor/editor... meaning your ELF II is now the heart of a full-size system with unlimited computing power! \$39.95 kit. \$2 p&h.

- 4k Static RAM addressable to any 4k page to 64k. \$89.95 kit. \$3 p&h.
- Prototype (Kluge) Board accepts up to 32 I.C.'s of various sizes. \$17.00 kit. \$1 p&h.
- Expansion Power Supply. \$34.95 kit. \$2 p&h.
- Gold plated 86-pin connector. \$5.70 postpaid.

Coming Soon! **Tiny Basic**

ASCII KEYBOARD • CONTROLLER BOARD • D-A, A-D CONVERTER • CABINET

#### SEND TODAY

NETRONICS R&D LTD., Dept B5  
333 Litchfield Road, New Milford, CT 06776 Phone (203) 354-9375

Yes! I want to run programs at home and have enclosed:

\$99.95 plus \$3 p&h for RCA COSMAC ELF II kit. Featured in POPULAR ELECTRONICS.

Includes all components plus everything you need to write and run machine language programs plus the new Pixie chip that lets you display video graphics on your TV screen. Designed to give engineers practice in computer programming and microprocessor circuit design.

ELF II is also perfect for college and college-bound students (who must understand computers for any engineering, scientific or business career). Easy instructions get you started right away, even if you've never used a computer before!

As your need for computing power grows, five card expansion bus (less connectors) allows memory expansion, program debugger/monitor, cassette I/O, A to D and D to A converters, PROM, ASCII keyboard inputs, controllers, etc. (soon to be available as kits). Manual includes instructions for assembly, testing, programming, video graphics and games plus how you can get ELF II User's Club bulletins. Kit can be assembled in a single evening and you'll still have time to run programs, including games, video graphics, controllers, etc., before going to bed!

\$4.95 for 1.5 amp 6.3 VAC power supply, required for ELF II kit.  \$5.00 for RCA 1802 User's Manual.

I want mine wired and tested with the power transformer and RCA 1802 User's Manual for \$149.95 plus \$3 p&h.

Conn. res. add sales tax.

NAME \_\_\_\_\_

ADDRESS \_\_\_\_\_

CITY \_\_\_\_\_

STATE \_\_\_\_\_ ZIP \_\_\_\_\_

Send info on other kits!

Dealer Inquiries Invited

# LEARN TO PROGRAM MICROCOMPUTERS

And at an affordable price. The Modu-Learn™ home study course from Logical Services.

Now you can learn microcomputer programming in ten comprehensible lessons. At home. In your own time. At your own pace.

You learn to solve complex problems by breaking them down into easily programmed modules. Prepared by professional design engineers, the Modu-Learn™ course presents systematic software design techniques, structured program design, and practical examples from real 8080A micro-computer applications. All in a modular sequence of 10 lessons . . . more than 500 pages, bound into one practical notebook for easy reference.

You get diverse examples, problems, and solutions. With thorough background material on micro-computer architecture, hardware/software trade-offs, and useful reference tables. All for only \$49.95.

For \$49.95 you learn design techniques that make software work for you. Modu-Learn™ starts with the basics. Our problem-solution approach enables you to "graduate" as a programmer.

Circle the reader service number below to receive our free descriptive brochure and course outline.

Use your Master Charge or VISA card to order today. Call Pat at (415) 965-8365.



Circle 215 on inquiry card.

P.O. Box 60968  
Sunnyvale, CA 94088  
408-245-8855

**LOGICAL**  
SERVICES INCORPORATED

in the keyboard, beeps (often not adjustable) to replace tactile feedback, and soft keying (instead of a bouncy switch), lack of position adjustment of the keyboard, and lack of an armrest in front of the keys were problems that we frequently noted. Only about two or three keyboards came anywhere near being reasonably pleasant to use. Human factors appear to have been ignored by almost all manufacturers.

Hopefully in the future we can have some articles about human factors in the terminal device design. For too long the industry has pushed human factors in man-machine dialog software and ignored the hardware.

Dr John C McCallum, Assistant Professor  
Dept of Computer Science  
York University  
4700 Keele St  
Downsview Ontario M3J 1P3  
CANADA

## MEDICAL AND DENTAL SOFTWARE NEEDED

A recent copy of *Time* magazine referred briefly to a successful US application of microcomputers to the basic requirements of individual doctors and dentists.

If you or any of your readers happen to know of the firm(s) responsible for this application I would be most grateful to learn their address(es).

Philip D Burke  
GPO Box 498  
Adelaide S AUSTRALIA 5001

## ANOTHER LETTER RECEIVED WITH A COMPLETED READER SURVEY FORM

Miscellaneous comments apropos personal computer usage:

The languages available are atrocious. The few good languages are not available on personal systems. Languages I consider good, even if not practical on a micro, are: APL, PASCAL, ALGOL 68, MODULA (yes, I've seen examples of MODULA), in no particular order. Each has some good and some bad features. What we need is a synthesis.

I keep hearing about "high level language machines." In my opinion, they are long overdue. Where are they? Where, at least, is the computer that can *efficiently* run an intermediate language interpreter, at a price I can afford? What I need is an HP-3000 microcomputer, I guess.

Where languages are concerned, I suppose that a good systems implementation language is most needed, although why do so few people seem to recognize this obvious fact? Think how it would simplify developing operating systems and Star Trek games that are identical on *all* computers they run on. Is that bad?

I want to have fun and learn things with my computer. To me, fun is writing aesthetically pleasing and correct programs. That's hard to do in BASIC.

CLH

## RECEIVED FROM A RESPONDENT TO BYTE'S 1978 READER SURVEY

I would like to offer some additional comments which you may find useful in your survey. I fully intend to purchase a personal computer system in the very near future. The equipment and approximate prices I intend to pay are detailed in the survey. The major factors influencing this purchase are as follows:

- The availability or near availability of a high level block structured language compiler (C, PASCAL or ALGOL).
- The vendor's financial stability.
- The availability and compatibility of peripheral equipment.
- The availability of a simple, powerful monitor or operating system.

I will purchase a prebuilt system and have very little interest in assembly or hardware fiddling. I also have very little interest in assembly language coding and will use the home computer to develop projects in the area of artificial intelligence.

Anonymous

## COMPUTER CHESS

I am told by John M Lusa of Info-systems that your magazine specializes in small systems.

I wonder if you know of a computer that plays chess at the master level. I am very desirous of owning such a product and I would truly appreciate it if you could in any way lead me to it.

Philip Restagno  
2910 De Witt Pl  
Bronx NY 10469

*Playing chess at a master level is one of artificial intelligence's perennial projects. As of now, the closest you can come is an expensive laboratory project executed on a large computer of conventional design. But this is hardly a commercial product available at your local computer store.*

## MATSUSHITA MYSTERY PROCESSOR

Recently I came across a Matsushita MN5763 microprocessor, and have been unable to find any information about it. Could you or a reader tell me anything about this part or about where I can obtain information on it?

Jeff Spoelstra  
7405 Palm Dr  
Urbandale IA 50322

# BYTE's Bits

## Electronic Music Workshops at New England Conservatory

The New England Conservatory of Music will hold a Summer School June 26 thru August 4 1978, featuring workshops, courses and master classes. Highlights will be the Electronic Music Workshop, June 26 thru June 30 with Robert Ceely, and the Electronic Music in the Classroom Workshop, July 10 thru July 14 with Larry Allen.

The Electronic Music Workshop with Robert Ceely will be divided into two parts. Part A will be a lecture demonstration of the hardware and software of electronic music. Part B will give students hands-on experience with various synthesizers.

Electronic Music in the Classroom with Larry Allen will be an exploration for the classroom music educator of the goals, outlines, lesson plans, and electronic equipment to be used in developing a comprehensive junior high, senior high, college or adult education music curriculum. ■

## Instruction Search

Have you ever found yourself executing as instructions information you intended as data, only to get garbage? Sure you have; we all do this at one time or another.

One day, while interacting with my KIM-1, I found myself executing a hexadecimal 27 which I had accidentally left in a location. It multiplied another number by two and added one. Upon closer inspection, I found hexadecimal 27 to be a previously undefined rotate one bit left instruction, a very powerful instruction. Including my new instruction, there are now 147 instructions defined for the 6502 processor, out of 256 possible in the range from hexadecimal 00 to FF. That leaves 119 instructions undefined. The problem is finding them.

I am inclined to believe the best way to determine the difference between garbage and a valid instruction is to continue programming in a normal fashion and when an error is made and I find myself executing an undefined instruction, follow it through. This instruction search is not limited to the 6502; it applies to every processor on the market. Indeed, the store zero instruction on the IBM 7090 was found

in a similar fashion at a time when that macrocomputer was at a stage similar to that of the present microcomputer.

I do not advocate sloppy programming. It should be avoided at all costs. However, when a mistake is made and a result is obtained, it should be studied. Something of value may be found.

Francis J O'Reilly  
42 Markwood Rd  
Ardsley NY 10502 ■

## A Quick Wire Unwrapping Tool. . .

Unwrapping wires from posts on circuit boards is a simple task with the correct tool. Commercial unwrapping tools are usually not practical for the person having only an occasional need, so improvised methods are in order. One such method was described on page 17 of the December 1975 BYTE. I found that method took more time than I wanted to spend on these jobs.

A simple tool that can be made in a few minutes meets the requirements of being cheap, easy to use, made from readily available material. It does not damage the posts and removes the wire rapidly. All you need is a small diameter metal (brass if you are concerned about damage to the posts) tube that fits closely over the posts. Such tubing is often available in brass at hobby shops. To make it into an unwrapping tool, simply file a notch across the side and end of the tube to a depth about twice the diameter of the wire to be removed. To preserve the strength of the fitted end of the tube, file the notch into about 1/3 the diameter of the tube. If you have a fine file or other tool, cut a small nick into the side of the notch. This enables it to hook onto the wire, which will then be removed from the post when it is unwrapped and the tool is removed.

Ready sources of tubes (including handle) are mechanical pencils and ballpoint pens. The mechanical pencil is best and easiest to "build" into the desired tool. To convert ballpoint pens into unwrapping tools, it is of course necessary to remove the ballpoint and ink. It will also probably be necessary to drill the tube to a size that will fit over the wire wrap posts.

Donald C Weber  
1201 Inwood Ter  
Jacksonville FL 32207 ■

## SPRING CLEARANCE SALE

### ON FLOPPY DISK DRIVES

NORTH STAR - VISTA - MICROPOLIS

EXTRA SAVINGS  
IMMEDIATE DELIVERY

- North Star Microdisk  
Interface w/drive, kit  
List \$699 SPECIAL \$589
  - Vista Microfloppy, kit  
List \$649 SPECIAL \$544
- ADD \$80 FOR ASSEMBLED & TESTED UNITS

For the ultimate in storage capacity,  
get yourself an assembled and tested  
MICROPOLIS at special prices:

- Model 1041 Macrofloppy 143  
kilo cap., incl. cover \$625
- Model 1042 w/case & power  
supply, 143-kilobyte capacity  
NOW ONLY \$709
- Model 1053 Dual Metafloppy  
630-kilobyte capacity  
Reg \$1895 NOW \$1695

ALL INTERFACES INCLUDE DOS AND BASIC

SPECIAL VERSIONS FOR  
HEATH H-8 & RADIO SHACK TRS-80  
ADD \$49.95

Interfaces also available:

MICROMATION  
TARBELL  
MORROW  
SD SALES

Prices good until June 30, 1978. limited to  
existing inventories

## HEATH H-8/TRS-80 TO S-100 ADAPTERS AVAILABLE

- Special S-100 Adapter for  
TRS-80, incl. backplane, P.S.  
and 32K of memory  
ALL FOR ONLY \$495

FULL LINE OF MEMORY BOARDS, VIDEO  
DISPLAY MODULES, AND PROTOTYPE  
BOARDS FOR THE HEATH H-8 AVAILABLE

Add \$5 for shipping, handling, and insurance  
for each item ordered.

Send for free catalog

## MiniMicroMart, Inc.

1618 James Street  
Syracuse, New York 13203  
Phone (315) 422-4467

Available for Immediate Delivery

# QUALITY BUSINESS PROGRAMS

**GENERAL LEDGER.** A comprehensive GL system designed for professional accountants and small businesses. QUICKLY set up any custom charts of accounts to handle single or multiple departments. INTERACTIVELY verify data. CUSTOMIZE report formats and headings. EXHAUSTIVELY documented. COMPUTER knowledge not required. Written in CBASIC, the GL system costs **\$995**

**NAME AND ADDRESS (NAD) SYSTEM** with optional reference information MAINTAINS files and allows SELECTION on all fields for printing LABELS, REPORTS, or new files. Thoroughly documented and written in CBASIC. Only **\$79**

**QSORT.** A fast and efficient, easy to use, Full Disk Sort/Merge. Its AUTOMATIC operation, multiple sort keys, and complete backup provide power and flexibility. In 8080 code, **\$95**

**CBASIC.** An Advanced, Comprehensive, Commercially Oriented Compiler/Interpreter including full disk access, PRINT USING, 14 digits of precision, and much more. With 85 page manual, **\$99.95**

All programs require the 8080 or Z-80 CPU and the CP/M floppy-disk operating system. All our software is attractively packaged and shipped from stock.

To order or for more information, Call:

**Structured Systems Group**  
5615 KALES AVE.  
OAKLAND, CA. 94618  
(415) 547-1567

California residents add 6½ % Sales Tax.  
Prepaid or COD only.

Dealer Inquiries Invited.

CP/M is a trademark of Digital Research.

## Component Types and Values

Unless otherwise noted, all components and values in the schematics of BYTE magazine are assumed to be typical of low power logic and signal electronics:

**Resistors:** Power ratings of ¼ W, carbon composition, 10% tolerance or 5% tolerance depending on value are standard default assumptions. Values are in ohms (no units symbol), decimal thousands of ohms (K units symbol), decimal millions of ohms (M units symbol). Typical exceptions to these defaults are:

10 W, ½ W are notations of typical power ratings differing from ¼ W.

1% is a notation of an explicit resistance value tolerance when 10% is not adequate.

**Capacitors:** Capacitors are assumed to be 20% tolerance, nonpolarized, with voltage ratings greater than or equal to the difference between the most positive power supply voltage and the most negative power supply voltage. Values are in microfarads (no units symbol, or

units symbol µF or μF) or picofarads (units symbol pF). Typical exceptions to these defaults are:

Electrolytic capacitors are indicated by explicit notation of polarities (+) and (-) on the diagram.

Explicitly noted voltage ratings always appear for electrolytics, and occasionally for other types.

Where some other tolerance parameter is critical (such as temperature coefficient, type of capacitor technology, etc) it will be noted near the part in question.

**Power Supply Circuits:** Power distribution circuits are assumed to follow good engineering practices for prototype equipment: heavy distribution bus conductors, frequent bypass capacitors (.01 to .5 µF ceramic disk) spread throughout the board in question, and at least one fairly large (eg: 5 to 25 µF) electrolytic bypass capacitor per supply voltage per board. Bypass capacitors are wired from the supply voltage to ground. These assumptions are not noted in each drawing, but should be observed as a matter of course.■

## New Product Information

Lucas-Adams Labs UnLtd is proud to announce the perfection of the following special function boards, all plug-in compatible with Altair (S-100) bus mainframes, and adaptable for other buses with a transfer:

**Mainframe expander board — hydraulic:** Two 2 cm hydraulic jacks extend to a maximum of 14 cm to expand the available internal space of most ductile mainframes. Complete with integral fluid reservoirs and high capacity pump.

**Freon cycle refrigerator board with multiple radiator boards:** Eliminate the noisy mechanical fan and keep your micro's temperature down with this quiet running refrigerator board. Compressor runs off the mainframe's +8 V supply; usable with up to 12 radiator boards, each to be located near a memory or processor board to keep it cool.

**Solar energy package board:** For an ecologically sound second power source, try our solar energy board. Fitting into a single Altair (S-100) bus slot, an extender on top of the board unfolds, software controlled, to expose a 12 foot square solar panel, with ample capacity for your entire bus during the daylight hours.

**Hydroelectric power board:** This clean source of power is generated by a diver-

sion of the source to drain flow of 1012 FETs contained in only 64 LSI chips. High tension printed circuit lines transfer power to an on board substation for use on the bus.

**Garbage compactor board:** Bothered by garbage from old programs, obsolete data, initialization? Our garbage compactor board compresses the equivalent of a full 64 K of garbage into the space of only one 4 K static or dynamic memory board, for easy disposal.

**Terminal board:** This board is sold with only two days life left of declining service, at which point it self-destructs. Nonrepairable.

**DART random number board:** On the board are four concentric shift register rings and 16 pointed, feathered electrodes for truly random number generation.

**PROM memories board:** Complete with a big band clocking and rhythm section, this board boasts a hardwood dance floor option and fast access time. Refresh area on board (for volatile spirits only).

**Abacus board:** This nonvolatile processor can provide emergency computing ability during complete power failure. Comes with on board direct access BEAD memory. (User must provide some logic.)■

# BYTE's Bugs

## A Note About Simulations, Part 3

I have just received a letter from David O'Neil of Greenacres FL pointing out some errors in the program which accompanied my article "Simulation of Motion Part 3" in the January 1978 BYTE. According to Dave, lines 680 and 970 should be changed as follows:

```
680 LET A=(COS(G)*D*V2+
      COS(L)*F)/M
970 DATA 1.6,5.6,0.0337,1.0E-4,1.7,
      0.0,0.0333,1.0E-4,100,0.0,
      0.0333,1.0E-4
```

Line 330 is incorrect and should be deleted; and lines 490, 510 and 550 are superflous and may be deleted. I agree in all cases and apologize for my poor proofreading. ■

Stephen P Smith  
POB 841  
Parksley VA 23421

## That's the Way the Paper Folds

I would like to call to your attention an error noticed on the cover of the December 1977 BYTE.

The paper coming out of the printer has a very unusual fold; it is not the normal fan fold. In fact it is difficult to see how the paper is fed with *that* fold pattern (unless on a roll).

Other than the "ancient technology" of paper folding, I enjoyed the article on the Star Trek computers. ■

Richard L McCracken  
85 E Emerson  
Chula Vista CA 92011

*There is no obvious supply of paper, either. But the idea is conveyed, and even if we could, we're not about to revoke Robert Tinney's artistic license.*

## Address Correction

In Sol Libes' article "Where to Get Bargains in Used Computer Equipment" which appeared in the December 1977 BYTE on page 154, the entry for the Rondure Co was incorrectly stated. The current address of that company is:

Rondure Co  
2522 Butler St  
Dallas TX 75235

Thanks to Stan Shannon, president of Rondure, for pointing out this error. ■

# DATALYZER . . . a 24 channel Logic Analyzer for your S100 Bus

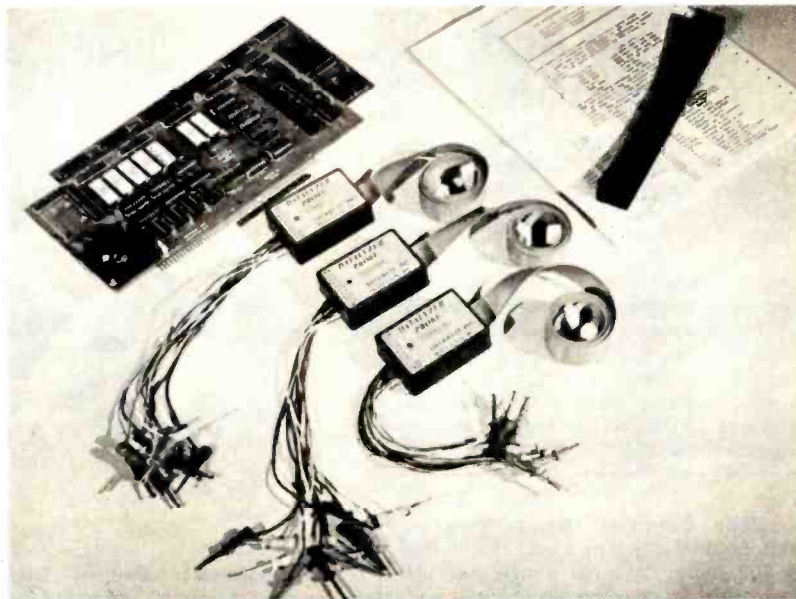

24 Channel LOGIC ANALYZER, complete with 2 cards and 3 sets of probes.

## Features

- 24 channels with 256 samples each.
- Display of disassembled program flow.
- Dual mode operation — external mode analyses any external logic system. Internal mode monitors users data and address bus.
- Selectable trigger point anywhere in the 256 samples.
- 0-16 bit trigger word format or external qualifier.
- 8MHz sample rate
- Synchronous clock sample with coincident or delayed clock mode.
- User defined reference memory.
- Displays and system control through keyboard entry.
- TTL Logic level compatible (15 pf and 15  $\mu$ a typical input loading.)



Displays in Binary



Displays in Hex



Display of disassembled program flow.

## The DATALYZER

Designed to plug easily into your S-100 Bus, the DATALYZER is a complete system — for only \$595. Display of disassembled program flow is a standard feature, not an extra. And the low price includes 30 logic probes, so you can hook up immediately, without additional expense.

The DATALYZER is available in kit form (\$595), and as a fully assembled device on two PCB's (\$695). Operators' manual \$7.50. A substantial warranty, and the Databyte, Inc. commitment to service make the DATALYZER a worthwhile investment.

# Databyte, Inc.

7433 Hubbard Avenue  
Middleton, Wisconsin 53562  
Tel: (608) 831-7666

## Chess and Computers

—**Chess and Computers** by David Levy. If you enjoy playing chess, then you should thoroughly enjoy **Chess and Computers**. This 145 page paperbound book is loaded with chess games played by computers. The games are computer versus computer and computer versus human. When you settle down with this book, it would be a good idea to set up your chess board and play the games. As with any good chess book, half the enjoyment is found in playing along, duplicating the moves, reading the comments by the author and adding your own comments. \$8.95.

—**Basic Computer Games: Microcomputer Edition** edited by David H Ahl. Here are 102 classic computer games, every one in standard microcomputer BASIC; every one complete with large, legible listing, sample run and descriptive notes.

All the classics are here: Super Star Trek (one of the most challenging versions anywhere), Football (two versions), Blackjack, Lunar Lander (three versions), Tic Tac Toe, Nim, Life and Horseshoe.

This revision of 101 BASIC Computer Games is a real must, even if you own the original. \$7.50.

—**Programming Proverbs** by Henry Ledgard. "Programmers can and should write programs that work the first time." This statement may sound idealistic to those accustomed to long hours of debugging. Yet, it's the theme of this book—a unique collection of "proverbs" or rules and guidelines for writing more accurate error-free programs. And like all proverbs, they are compact gems of truth. \$6.95.

—**Dr Dobb's Journal of Computer Calisthenics and Orthodontia Volume I** is a collection of everything from the first year of Jim Warren's outstanding journal. As Carl Helmers, Editor in Chief of BYTE Magazine says, "Dr Dobb's Journal can help make your computer an indentured servant." \$13.00.

—**Assembly Level Programming for Small Computers** by Walter H Weller. One of the most professionally produced books we've seen. From front cover to back, this book is clear, detailed, and beautifully produced. Using a pseudo mnemonic assembly language, Walter Weller takes you inside the whys and hows of table referencing, data stacks, number conversions, floating point arithmetic, and much, much more. Surely one of the most complete books on this topic. **Assembly Level Programming for Small Computers** is a must for the serious small systems user. \$14.95 hardcover.

# RECENT ARRIVALS

—**Microprocessor Systems Design** by Edwin E Klingman. Outstanding for its information on real microprocessors, this text is both an introduction and a detailed reference source treating over a dozen processors, including new third generation devices. No prior knowledge of microprocessors or microelectronics is required. Designed to be self-contained, there are many illustrations to clarify timing concepts and control structure. Hardback \$17.50.

—**The Compulator Book** by R P Haviland. Tells you how to mate the computer with the calculator. This unique new volume provides ideas, design information and/or printed circuit boards for calculator chip projects including computer interface for log and trig functions, electronic lock, dial a telephone, interface to Teletype, tape control of calculator, giant displays, store and display, and many more. Yours for \$7.95.

## The "Simplified Computer" Series

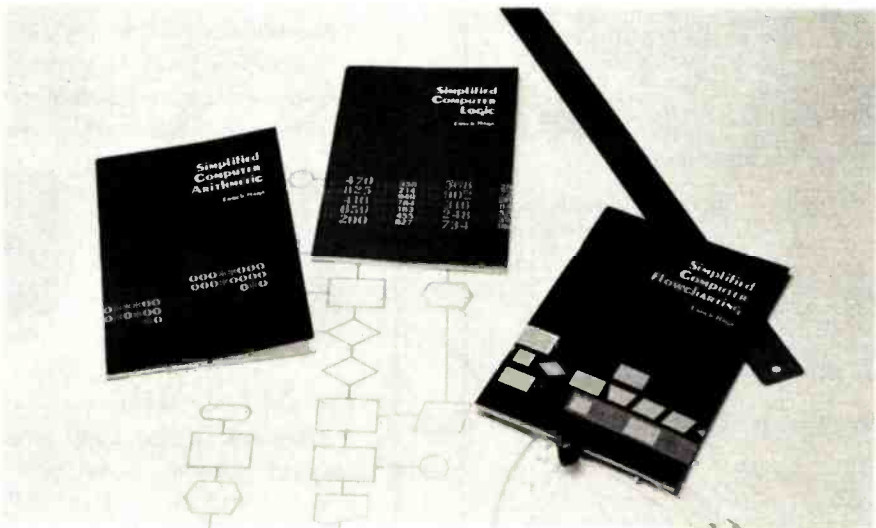

For those just beginning computer programming, knowledge of binary arithmetic, computer logic, and program design often comes hard. Never fear, help is on the way!

—With **Simplified Computer Arithmetic**, you can learn the ins and outs of arithmetic the way computers do it, including the various methods of representing numbers, addition and subtraction, and negative number representation.

—In **Simplified Computer Logic**, learn how comparisons of numbers by the computer are performed with detailed examples and text.

—**Simplified Computer Flowcharting** will show you how to design efficient, effective programs. This book is laden with examples and detailed figures to make it easy for the beginner to understand and retain. \$1.50 each includes postage and handling.





## The M6800

**Practical Microcomputer Programming: The M6800** by W J Weller. This second volume of the **Practical Microcomputer Programming** series addresses the problems of applications programming at assembly level for the M6800. In 16 chapters and more than 100 formal examples, the fundamental techniques of assembly level programming are applied to the solution of specific problems with the 6800. Nowhere theoretical, it is a thorough and detailed methods text for the beginning and intermediate application programmer using the 6800. Hardback \$21.95.

**Take A Chance With Your Calculator** is a first step to introduce the use of programmable calculators in the study of probability and statistics. The book can be used as a source of ideas for teachers, or it can be used for self study as an introduction to these fields. It can also be used as a supplement to existing teaching materials in probability and statistics. You will need no previous experience either in probability theory or in programming to learn both from **Take A Chance With Your Calculator**. \$8.95.

**The Linear And Control Circuits Handbook** is the latest offering in the Texas Instruments series. Roboticians and others interested in linear and analog control circuitry will find much of interest here. Devices covered include op amps, timers, voltage comparators, analog switches, and voltage regulators.

A special section covers differential video amplifiers, logarithmic amplifiers, precision-level detectors, and analog processors.

If you have an analog circuit application, this could be the book you've been looking for. \$2.95.

## The First Book of Kim

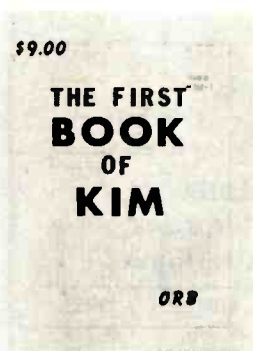

**The First Book of KIM**. Attention KIM users! Here is the book you've been waiting for. In it you'll find a beginner's guide to the MOS Technology KIM-1 microcomputer as well as an assortment of games including Card Dealer, Chess Clock, Horse Race, Lunar Lander and Music Box. Also featured are diagnostic and utility programs for testing both the computer and external equipment (such as cassette recorders), and chapters on expanding memory and controlling analog devices. This 176 page volume should prove an essential addition to any KIM user's library. \$9.00.

DIAL YOUR BANK CARD ORDERS ON THE BITS TOLL FREE HOT LINE: 1-800-258-5477.

In New Hampshire, call: 924-3355

Send to:  
**BITS, Inc.**  
 70 Main Street  
 Peterborough NH 03458

Check Payment method:

My check is enclosed  
 Bill my MC No. \_\_\_\_\_ Exp. date \_\_\_\_\_  
 Bill my BAC No. \_\_\_\_\_ Exp. date \_\_\_\_\_



Name \_\_\_\_\_  
 Address \_\_\_\_\_  
 City \_\_\_\_\_ State \_\_\_\_\_ Zip Code \_\_\_\_\_  
 Signature \_\_\_\_\_

Total for all books checked \$ \_\_\_\_\_  
 Postage, 75 cents per book for \_\_\_\_\_ books \$ \_\_\_\_\_  
 Outside U.S. \$1.00 per book for \_\_\_\_\_ books \$ \_\_\_\_\_  
 Grand Total \$ \_\_\_\_\_

You may photocopy this page if you wish to leave your BYTE intact.

Prices shown are subject to change without notice.  
 Billing charge \$1.00 (Institutional orders only).

# Look To The Horizon.™

## The North Star HORIZON Computer.

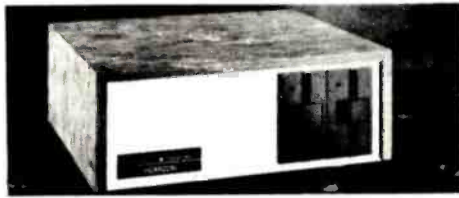

### HORIZON™

To begin programming in extended BASIC, merely add a CRT or hard-copy terminal. HORIZON-1 includes a Z80A processor, 16K RAM, minifloppy™ disk and 12-slot S-100 motherboard with serial terminal interface—all standard equipment.

## And, Look To Computer Enterprises For The Lowest Prices & Fastest Delivery On North Star Horizon Computer System:

	Credit Card Price	Cash Discount Price
Horizon 1 System (one drive) kit ...	\$1497	\$1439
Horizon 1 System (one drive) assembled .....	\$1777	\$1709
Horizon 2 System (two drives) kit ..	\$1871	\$1799
Horizon 2 System (two drives) assembled .....	\$2199	\$2114

### ALSO: Run TDL Software On Your Horizon...

TDL Package A with Super Basic .. \$ 228      \$ 219

### For Your Serial Terminal:

Lear Siegler ADM-3A (kit) ..... Call or write  
Lear Siegler ADM-3A (assembled) . for prices

### Call Or Write Today

## For Computer Enterprises' FREE Spring Computerlogue!

IMSAI PCS-80/30 kit .....	\$1097	\$1055
IMSAI PCS-80/15 kit .....	\$ 748	\$ 719
IMSAI VIO-C kit .....	\$ 297	\$ 286
TDL ZPU Board (assembled) .....	\$ 183	\$ 176
TDL XITAN ALPHA 1.5 kit .....	\$ 812	\$ 781
Seals 8k 250ns RAM (assembled) ..	\$ 203	\$ 195
Dynabyte 16k 250ns Static RAM (assembled) .....	\$ 577	\$ 555
Cromemco Z2D kit .....	\$1399	\$1345
Cromemco Bytesaver less Proms kit	\$ 136	\$ 131

Shipping charges: \$10 per CPU on larger units; \$1.50 per kit. \$2.00 min. per order.  
Delivery is stock to 30 days on most items. Shipment is immediate for payment by cashier's check, money order or charge card. Allow 3 weeks for personal checks to clear. N.Y. State residents add approx. sales tax. Availability, prices and specs may change without notice.

# computer enterprises™

Operating Hours:  
M-W 10-5 E.S.T.  
TH-F 10-9 E.S.T.  
Closed Sat. & Sun.

P. O. Box 71 Fayetteville, N.Y. 13066  
Phone (315) 637-6208 Today!

# Book Reviews

## The Dragons of Eden

by Carl Sagan

Random House, New York

263 pages, 6½ by 9½ inches

\$8.95

Carl Sagan's premise is that the human brain is a very highly developed general purpose biological computer. *Dragons of Eden* traces the evolution of this machine from its most primitive beginnings. The provocative title stems from the interesting theory that the early reptilian (hence dragon) brain is still very active in humans as a subcomponent of our full mental equipment. The theory that brain evolution occurred not so much by change as by accretion of new components seems to be substantiated both by physiology and by function. Sagan suggests that occasional apparent subversion of higher brain functions by the "dragonian" sub-brain may be the true referent of various Eden mythological allegories.

Later chapters of the book deal with brain functioning and potential for development. A most interesting aspect of this is that the left and right hemispheres of the brain appear to function with a high degree of independence, although they are closely interconnected in the normal brain. One hemisphere seems to operate principally in a "digital" mode, dealing with analytical

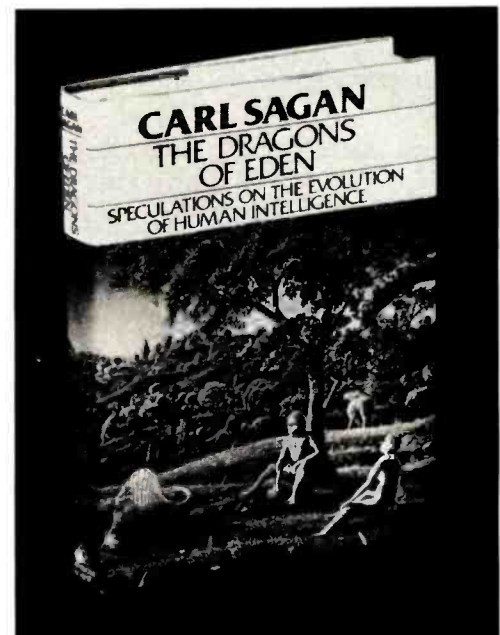

computations, while the other simulates more "analog" qualities, and is the seat of such nebulous functions as inspiration and intuition.

In his discussions of the computer, for comparison of the brain to an artificially evolved intelligence that is more completely understood, Sagan includes the following observations (page 216):

*The two games, Pong and Space War, suggest a gradual elaboration of computer graphics so that we gain an experiential and intuitive understanding of the laws of physics. The laws of physics are almost always stated in analytical and algebraic—that is to say, left-hemisphere—terms; for example, Newton's second law is written  $F = m a$ , and the inverse square law of gravitation as  $F = G M m / r^2$ . These analytical representations are extremely useful, and it is certainly interesting that the universe is made in such a way that the motion of objects can be described by such relatively simple laws. But these laws are nothing more than abstractions from experience. Fundamentally they are mnemonic devices. They permit us to remember in a simple way a great range of cases that would individually be much more difficult to remember—at least in the sense of memory as understood by the left hemisphere. Computer graphics give the prospective physical or biological scientist a wide range of experience with the cases his laws of nature summarize; but its most important function may be to permit those who are not scientists to grasp in an intuitive but nevertheless deep manner what the laws of nature are about.*

Benefits to be derived by the computer enthusiast from the understanding of the functioning of the human brain presented in this book are twofold: it offers new understanding of the way biological intelligences function which may be of value in developing computer systems, and it suggests ways in which computers may be used to augment and stimulate the biological mind. Sagan submits that the computer itself may logically be considered to be the next step in human brain evolution, the mind having by its own ability finally released itself from

## VECTOR PACKAGING MATERIALS SAVE TIME & MONEY

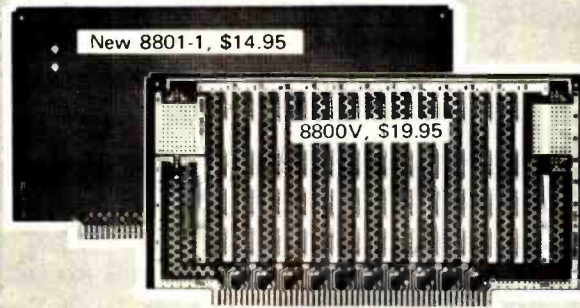

**S100 CARDS—100 PLUG CONTACTS**—Convenient universal tinned pads and bus lines. For interface, memory expansion, breadboarding. Mount almost anything anywhere on card.



**S100 CONNECTORS** for WIRE WRAPPING or SOLDERING

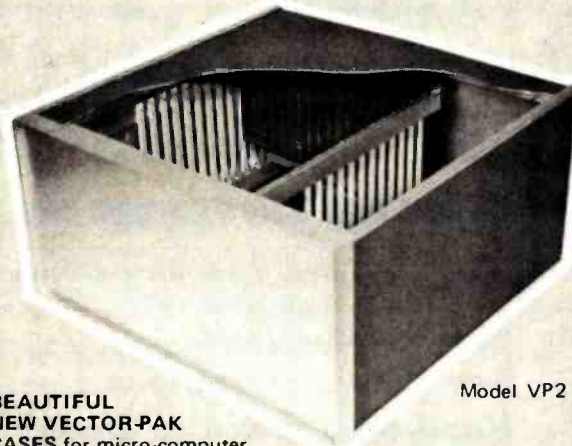

Model VP2

### BEAUTIFUL NEW VECTOR-PAK

**CASES** for micro-computer circuitry, assembled. Constructed of aluminum, finished in vinyl. Slide out covers for easy access. Includes card guides, heavy chassis plate, perforated bottom cover for cooler operation. Card guides perpendicular to front panel, Model VP1, \$128.30. Card guides parallel to front panel, Model VP2, \$134.30.

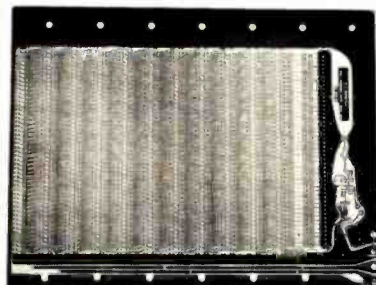

Model  
8803

**S100 MOTHER BOARD, \$29.50.** 11 positions ready for connectors. Glass epoxy, plated thru holes, circuitry for active termination, 12 tantalum capacitors and instructions.

**PLUS** revolutionary Slit-N-Wrap wiring tools, Micro-Vector-board,<sup>®</sup> printed circuit kits, I.C. sockets, extenders.

Send for new catalog.



**VECTOR ELECTRONIC COMPANY, Inc.**  
12460 Gladstone Avenue, Sylmar, CA 91342  
phone (213) 365-9661, twx 910-496-1539

540777



**16K RAM**  
FULLY STATIC  
INTRODUCTORY  
**\$450** KIT PRICE

---

10 SLOT MAINFRAME  
TT-10...KIT \$325

10 SLOT TABLE TOP  
MICROCOMPUTERS  
TT-8080...KIT \$440

SYSTEM WITH 16K & I/O  
TT-8080-S...KIT \$1050

---

CARD CAGE &  
MOTHER BOARD  
ECT-100...KIT \$100

CCMB-10...KIT \$75

WITH CONNECTORS  
& GUIDES  
ECT-100-F...KIT \$200

CCMB-10-F...KIT \$125

---

CPU'S, MEMORY  
MOTHER BOARDS  
PROTOTYPING BOARDS  
EXTENDER CARDS  
POWER SUPPLIES

---

SHIPPING EXTRA  
DEALER INQUIRIES INVITED

**ELECTRONIC CONTROL TECHNOLOGY**

FACTORY ADDRESS: 763 RAMSEY AVENUE  
HILLSIDE, N. J. 07205 (201) 686-8080

MAILING ADDRESS: P. O. BOX 6  
UNION, N. J. 07083

restriction to a purely biological mechanism.  
*Dragons of Eden* well deserves its high place on the nation's nonfiction best-seller lists, and should be read with relish by anyone with an interest in the mechanics of intelligence, whether natural or artificial.

Jim Heter  
107½ S Carondelet St  
Los Angeles CA 90057

Digital Computer Electronics  
by Albert Paul Malvino  
McGraw-Hill, New York 1977  
393 pages  
\$14.95

"If the action of small computers is not quite clear, if you feel something is blocking your understanding of microprocessors, or if the whole computer thing has never quite come together, then this is the book you've been waiting for." Thus, author Malvino describes the audience for whom this book was written. And, although it is a text for technicians, the author presents the material in such a clear, readable style that the book is an invaluable reference for anyone wishing to improve his/her understanding of computers in general and microcomputers in particular.

Prerequisites to understanding the book are electronics to the level of DC and AC theory, with transistors and diodes.

The first seven chapters are devoted to the basic logic circuits, binary numbers and arithmetic circuits. Explanations of logic circuits, flip flops, registers and memories make the book worth the price for these topics alone.

Most computer books present a block diagram of a "typical" computer and use that as the frame of reference for the rest of the book. Dr Malvino has designed a working 8 bit computer with only six instructions in its instruction set. He calls it SAP-1 (for simple as possible, #1). He uses SAP-1 to explain how the basic elements of a computer are tied together into a working system. Anyone with an understanding of TTL could build a SAP-1 computer if desired. SAP-1 is used to explain such concepts as busing, three state logic, elementary programming, instruction fetch cycle, instruction execution cycle, and operation of the internal control unit.

In chapter 9, the author explains the significance of adding jump instructions to the instruction set of a computer, and proceeds to design SAP-2, a 12 bit working computer with 28 instructions in its instruction set, including six jump instructions.

Chapters 10, 11 and 12 cover advanced

**See the computer.**  
**See the computer run.**  
**Read The Computer Book.**

*The Computer Book* by Fred Lee is a one-of-a-kind text. Actually, it is two books in one: not only does Lee present the basics of computer theory and operation in clear and concise language, but he also presents a unique format in which each page graphically represents a memory address. As a result, the reader actually goes through the same logical steps that a computer would follow while running a program.

Contents include number systems and codes, practice programs, high level languages, and a section on the home computer market. Line drawings, charts, and tables make this book of interest to the professional and well as non-professional in the computing field.

"Show and Tell" was never this good.

Artech House Books, 610 Washington St.,  
Dedham, MA 02026  
617-326-8220

concepts of computers. In chapter 10, the author presents SAP-3, a computer with most of the characteristics of modern computers. Chapters 11 and 12 cover such topics as microprograms, microroutines, variable machine cycles, manual loading, bootstrap loading and fixed point, floating point, and double precision arithmetic.

Although the book is organized as an orderly progression from the basics of logic circuits through advanced computer concepts, each chapter could almost stand alone as a comprehensive treatment of its topic. For example, if you already understand the type D flip flop, then you would have no trouble in understanding chapter 6 on registers.

If you are associated with computers from a purely hobbyist viewpoint, with little or no interest in the technical "in-nards," then this book is not for you. However, if you hope to learn enough to troubleshoot your own, then this book will surely prove helpful. If you have a strong technical interest in computers, whether as a hobbyist or a technician, then you need a copy of this book.

Dr Tom Lukers  
Rt 1 Box 277B  
Lufkin TX 75901■

**The Elements of Programming Style**  
by B W Kernighan and P J Plauger  
McGraw-Hill, New York 1974  
147 pages paperback  
\$2.65

This book should be in the library of every computer enthusiast, for it bridges the awful gap between those beginning moments, and clean, efficient code. By teaching sound principles, the authors give the reader a definite method for improving skills in programming. There is a need for programmers to proofread their code with a copy editor's blue pencil. Yet few of us know how. The old adage prevails: "If it works, leave it alone." This bromide is a carte blanche for programmers of every level of skill to leave confusing code alone, since most programs are judged by the result, and not by the means. Yet in the microcomputer business, it is critical that space be well used.

To their everlasting credit, the authors' first lesson is, in my opinion, the most important. It requires clarity of expression. Make the code show what it does, don't hide the purpose in elegant expressions. Nothing is more frustrating than to attempt to figure out the meaning of mysterious code. A programmer must keep in mind that somewhere in the future it may be

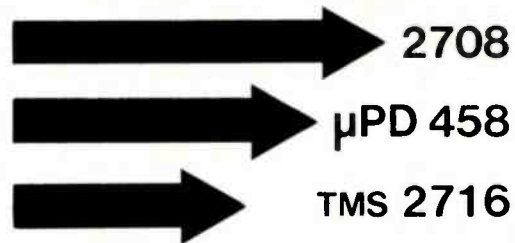

2708  
μPD 458  
TMS 2716

## PRAMMER III

by xybek

### The Ultimate EPROM Memory Board For Your S100-Bus Computer

- ★ Accommodates from 1k to 30k of the above EPROMS, in any combination, each addressable on any 1k (2k for 2716) boundary within the board's 32k address space.
- ★ 1k of scratch-pad RAM.
- ★ On-board programming for all three EPROM types.
- ★ Tri-state buffers on all address and data lines.
- ★ Empty EPROM sockets do not require address space.
- ★ Assembled, tested, ready to run — only \$369.50

xybek • P.O. Box 4925 • Stanford, CA 94305  
Telephone: (408) 296-8188

## Motorola EXORcisor<sup>®</sup> Compatible Hardware

- 8 K Static Ram  
2 - 4 K write protected blocks  
500 nsec version - regular price-\$324.95  
Introductory offer\* - \$275.
- Backplane and Card Cage  
+5v and ± 12 volt regulators and  
daisy chain connector 5 slots-\$124.95  
10 slots-\$144.95  
connectors (installed)-\$5.50 ea.
- Unregulated Power Supply  
+5v @ 8 amps. ± 12v @ 1.0 amps-\$124.95  
+5v @ 15 amps. ± 12v @ 1.5 amps-\$144.95

Industrial quality, Motorola EXORcisor<sup>®</sup>  
compatible hardware by

## American Technologies

P.O. Box 23001 Rochester, N.Y. 14692  
716-244-8070

DEALER INQUIRIES INVITED

\*OFFER EXPIRES JULY 4 1978

**80-103A Serial I/O and FSK modem for professional and hobby communications.**



DATA COMMUNICATIONS ADAPTER

- Completely compatible with your IMSAI, ALTAIR\* SOL\*\* or other S-100 microcomputers. Trademarks of \*MITS, \*\*Processor Technology
- Designed for use on the dial telephone or TWX networks, or 2-wire dedicated lines, meets all FCC regulations when used with a CBT coupler.
- All digital modulation and demodulation with on board crystal clock and precision filter mean that **NO ADJUSTMENTS ARE REQUIRED**
  - Bell 103 standard frequencies
  - Automated dial (pulsed) and answer
  - Originate and answer mode
  - 110 or 300 BPS speed select
  - Complete self test capability
  - Character length, stop bit, and parity
  - 90 day warranty and full documentation

**PRICES Bare Board and Manual 49.95**  
**Assembled (48 hour burn in) 279.95**  
Master Charge or Visa accepted.

DC Hayes Assoc.

P.O. Box 9884, Atlanta, Ga. 30319, 404/231-0574

ATTENTION  
COMMODORE PET USERS!

**Low Cost Financial Software on Compatible Cassette Tapes for your PET Computers. Samples from our program library include:**

**MORTGAGE \$15.95**  
 Calculates mortgage data, e.g., principal paid to date, outstanding principal, mortgage equity, interest paid to date, outstanding interest, and more.

**ANNUAL REPORT ANALYZER (Manual) \$22.95**  
 With annual report in hand, you input 5 yrs revenues and income; program computes: Percentage growth in sales, profits, earnings per share; PE ratio; Profit margins; Current ratio; Book value; Return on equity; Payout ratio; Dividend yield; Theoretical value for stock & PE ratio; Implied yield & growth rate; more.

**STOCK ANALYZER (Automatic Data Entry) \$34.95**  
 Same as Annual Report Analyzer except data is automatically entered from Data Base tapes simply by entering ticker symbols.

**DATA BASE (Updated monthly) \$175.00 Per Year**  
 Statistical data on over 2,500 Industrial Stocks on the New York, American and Over the Counter Exchanges.

**OPTIONS \$24.95**  
 For both option buyers and writers, program computes the theoretical value of an option with graphics.

Pursuant to Rule 206(4)-1(A)(3) of the Securities and Exchange Commission, it should be noted that the above mentioned programs should not in and of themselves be utilized in making investment decisions. The scope and usefulness of the above programs are limited, with values in some cases being purely theoretical.

SEND FOR FREE BROCHURE  
 NATIONAL CORPORATE SCIENCES, INC.  
 (Registered Investment Advisors - Our 10th Year)  
 790 MADISON AVENUE  
 NEW YORK, N.Y. 10021

necessary to modify the program. That is hard to do when the existing code cannot be deciphered by anyone, including the originator. In every computer center, there are gobs of temporary programs drafted into continued use for years.

To illustrate the principles of good code, the authors use excerpts of actual programs. For any example, the flaws are pointed out, the segment is rewritten, and the general rule is stated. Several points may be discussed for each example. FORTRAN and PL/I are used as model languages, since each is in common usage. Also, familiarity with one language implies that the other can be understood. However, the rules discussed apply in any language, including BASIC and assembler.

The models used are taken from beginning textbooks, where code is usually first seen by the neophyte. One would think that good style would abound in textbooks, but it's just not true. With the authors' help, the reader can read other programmers' code filtered through a solid foundation of principles.

There are lessons in structure, design of input and output and how to format code for clarity. There is an excellent chapter on documentation, my personal curse. Do your variable names mean something? They should carry the mnemonic image of what they represent. Is your code modularized? Do you use comments, or worse yet, overuse them? The recurring theme in this splendid book is to plan your work to be simply stated and executed.

The models used provide a spectrum of programming applications. Some of the examples require a bit of higher math to follow, but the lesson is very clear. There are models dealing with student grades, salesmen's tallies, and sorting. There is meat here, for both the novice and professional.

In citing the textbooks from which they drew examples, the authors provide a list of manuals of instruction for the reader. There is a somewhat brief section on supplementary reading, as well as a thorough index. There is a summary of rules, which condenses the lessons of the text. Each chapter has a few questions which will allow you to apply the points discussed. It would be a bargain at a much higher price than the modest \$2.65. This is a valuable book, and I'm glad it is on my shelf.

Noel K Julkowski  
 Naval Environmental  
 Prediction Research Facility  
 Monterey CA 93940

# Languages Forum

## Standardization of High Level Languages: Some Questions

E M Greene  
5067 Bluestem Dr  
Colorado Springs CO 80917

Glen A Taylor proposes standardizing a high level language for personal computing (Languages Forum, November 1977 BYTE, page 190). The proposal has merit, but there are several factors to consider before initiating a standards activity.

### 1. What is to be standardized?

The existing standards for the COBOL, FORTRAN, PL/I, BASIC and MUMPS languages were developed starting from definitions which existed when their respective standardization activities were initiated. There was experience in using and implementing the languages prior to and during the standardization process. The point is that historically standards organizations have *not* been defining *new* languages, but instead have only been refining a definition of an existing language.

Perhaps Mr Taylor had in mind the standardization of an existing language such as APL, PASCAL, or one of the string processing languages. All other "major" languages have standards in existence and organizations responsible for continuing support.

If Mr Taylor had in mind the definition of a subset of an existing language, it should be noted that ANSI has committees actively engaged in preparing standards for subsets of PL/I and COBOL. American National Standard Institute (ANSI) publication X3.10-1966 contains a FORTRAN subset definition. The COBOL standards define a modular approach to implementing COBOL compilers.

Circle 312 on inquiry card.

## COMPUTE YOUR SAVINGS...

### IMSAI 8080

A VERY SPECIAL PACKAGE: IMSAI 8080 KIT (22-SLOT MOTHERBOARD, FRONT PANEL, 28-AMP POWER SUPPLY), WITH IMSAI 4K STATIC RAM MEMORY KIT...RETAIL VALUE: \$838

SPECIAL CASH PRICE: **\$599.95**  
8080 WITHOUT MEMORY: **\$569.95**

### TDL XITAN 2

NO TIME TO BUILD: TECHNICAL DESIGN LABS, ASSEMBLED AND TESTED XITAN ALPHA 2 (WITH Z-80 BOARD, SYSTEM MONITOR BOARD, AND 16K OF STATIC MEMORY) WITH 12K SUPER BASIC... TOTAL RETAIL VALUE: \$1749

SPECIAL CASH PRICE: **\$1399**

WANT MORE MEMORY? ADD AN ADDITIONAL 16K TDL STATIC RAM ASSEMBLED MEMORY... LIST PRICE: \$699

CASH PRICE (W/PURCHASE OF XITAN 2): **\$559**

QUANTITIES LIMITED. ALL PRICES PLUS SHIPPING. CHARGE CARDS OR C.O.D., ADD 5%.

S-100, inc.

BUS ..... S-100, INC.  
ADDRESS ..... 7 WHITE PLACE  
CLARK, NJ 07066  
INTERFACE ..... 201-382-1318

S-100, inc.

HOURS: M-F 10:00 A.M. - 6:00 P.M. EST  
SAT. OR SUN. - BY APPT. ONLY

# S-100, inc.



**8700 Processor:** 6503 MPU. Wear free "Active Keyboard". Micro-Diagnostic<sup>®</sup> Extensive documentation. Fully Socketed.

**Piebug Monitor:** Relative address calculator. Pointer High-low. User Subroutines. Back-step key.

**Cassette Interface:** Load & Dump by file #. Tape motion control. Positive indication of operation.

Applications systems from \$90 (10 unit quantity)  
Development systems from \$149 (single unit)

**TELL ME MORE** I want to see for myself that the 8700 is The Answer.

Please send documentation and price lists. \$10 enclosed. name: \_\_\_\_\_

I don't need documentation please send price lists. address: \_\_\_\_\_

Please send FREE CATALOG. city: \_\_\_\_\_ state: \_\_\_\_\_ zip: \_\_\_\_\_

**BIA**

ELECTRONICS DEPT. 5-B • 1020 W. Wilshire Blvd. • Oklahoma City, OK 73116 (405) 843-9626

Circle 298 on inquiry card.

May 1978 © BYTE Publications Inc

163

**• The Answer Books for the Home Computer Hobbyist from dilithium Press • Forest Grove • Oregon 97116 •**

**HOME COMPUTERS: 2<sup>10</sup> QUESTIONS & ANSWERS**  
by Rich Diddy

Volume 1: Hardware	\$7.95
Volume 2: Software	\$6.95

**STEP BY STEP INTRODUCTIONS TO 8080 MICROPROCESSOR SYSTEMS**  
by James Melsa & David Cohn \$7.95

**HOME COMPUTERS: A BEGINNER'S GLOSSARY AND GUIDE**  
by Merl Miller & Charles Sippl \$6.95

**8080 MACHINE LANGUAGE PROGRAMMING FOR BEGINNERS**  
by Ron Santore \$6.95

**BEGINNING BASIC**  
by Paul Chirlian \$9.95

dilithium Press books are available  
from your local computer store.

Publishing Personal Computing Books is Our Business!



## Need Hard Copy?

TRY OUR SOFT PRICES  
**\$425**

Complete standalone 40 column impact dot matrix printer with a 64 character ASCII set. Includes power supply, casework and interface electronics for connection to a mini/micro processor parallel port. Serial interface versions for RS232 current loop applications start at \$575 in single quantity.

SEND FOR FREE LITERATURE



Box 22101  
Salt Lake City, Utah 84122  
(801) 364-2411

2. *Will there be sufficient interest to support a standardization activity?*

The preparation of a standard is a lengthy, technically complex and expensive process. There cannot be a standardization activity without a firm commitment on the part of individuals and organizations to provide continuing support. In addition to the initial development of a standard, consideration has to be given to the continuing support required to maintain an active standard.

3. *Is a standardization activity premature?*

A standard formalizes things "as they are" and assumes a stable environment. The personal computing environment is anything but stable considering the rapidly changing state of the art of small computers. Would a standardization activity be able to accurately predict the personal computing environment far enough into the future to prevent producing a standard which would be obsolete before it is adopted?

4. *How would compliance with a standard be obtained?*

Compliance with standards in the United States is voluntary unless compliance is required by law, regulation, directive or contract. A language standard for personal computing may not be effective unless the vendors can be induced to comply.

5. *Is there a need for a language tailored to personal computing?*

The impetus for a personal computing high level language seems to arise from the concern with the "size" of the existing "large computer" languages. This emphasis is misdirected in that it ignores the history of digital computing: specifically, "small" computers are getting functionally larger as hardware costs continue dropping rapidly, and the existing standard languages, especially FORTRAN, were developed in relatively ancient times when the "large" computers didn't have much more capacity than present day "small" computers. Compilers have been successfully developed which support a substantial subset of PL/I and operate in a 16 K byte computer supported by a single drive floppy disk.

Programming languages are standardized to promote hardware independence, commonality and transportability of programs. Definition of a special language for small computers would go counter to the standardization objectives by creating a barrier



to developing programs on one size computer and using them on a computer of another size. Organizations and persons involved in programming computers of various sizes are not going to be enthusiastic about dissimilar languages for different sizes of computers. If a language for personal computing is not significantly different from existing standard languages, then the effort required to produce a standard would not be justified. ■

## Grappling with GRAPL: Some Choice Comments

Andrew Koenig  
401 Route 22 #46E  
North Plainfield NJ 07060

I would like to comment on some of the points that William Leler made in his article ("GRAPLing with APL," November 1977 BYTE, page 220). In particular, most of his objections to the language were really objections to particular implementations, and these should really be much better distinguished.

His first objection is that "all arrays in APL must be homogeneous" and then he goes on to explain that this means that all elements must be of the same "type." I don't know which "type" he means here. Does he mean that they must all be either numeric or character in form? If so, such an objection is hardly adequate, because permitting some elements of an array to be characters while others are numbers complicates substantially the problem of defining the actions of the various functions that make up the language. If, instead, he means that one cannot mix "integer" and "floating-point" values in a single array (an interpretation of his remark which is rendered possible by his use of the phrase "data type" to mean just that in a subsequent paragraph describing GRAPL), then his criticism has nothing to do with the *language*, which defines no distinctions between integers, bits, real numbers, and so on. APL values are numbers or characters, and that's the extent of its type distinctions. (For one approach to the problem of homogeneous versus heterogeneous arrays in APL, see "General Arrays, Operators and Functions" by Ziad Ghandour and Jorge Mezei, in the July 1973 *IBM Journal of Research and Development*.)

# SOFTWARE WANTED!

We are a well-known, highly-respected manufacturer of micro-computer systems. We have successfully marketed computers and software for homes, education, engineers, and small business.

To sustain our growth we need, at once, a full line of quality software to complement a new family of superb computers priced to go. The systems are Z-80 based, with expandable memory and optional peripheral capabilities, but device independence is a major goal for the software.

We are looking for systems to do

- general accounting (including payroll)
- order processing and inventory control
- point-of-sale data collection
- text-processing and report generation
- file management
- math/engineering support
- graphics and plotting
- home management and games
- programmed learning

We invite software houses to submit their product descriptions. Products should be fully documented, including user education.

Send complete details to  
P.W., 7074 N. Western Ave., Chicago, IL 60645

## INNOVEX FLOPPY DISK DRIVE NEW-FULL SIZE \$495 or LESS\*

From The Same People Who Brought You The First Diskette and Drive

TO DESIGN YOUR OWN CUSTOM SUB-SYSTEM FOR LESS:

- (1) BUY THE INNOVEX MODEL 410 OR 420 FROM THE MANUFACTURER AT THE OEM VOLUME PRICE OF \$495.

8" Full Size, IBM Compatible, Hard  
or Soft Sector Single or Double Density

- (2) BUY THE FLOPPY CONTROLLER DESIGNED FOR YOUR SYSTEM
- (3) \*THEN FOR A LIMITED TIME GET A REBATE FROM INNOTRONICS HAVING BOUGHT ONE OF THESE POPULAR INTERFACES SPECIFICALLY DESIGNED TO WORK WITH THIS INNOVEX DRIVE:

Tarbell .....	\$20	Peripheral Vision .....	\$10
SCI .....	\$20	Digital Group .....	\$10

WE ARE PROUD TO OFFER THE HIGHEST QUALITY DISKETTE DRIVE FOR THE FAIREST PRICE POSSIBLE IN THE INDUSTRY

ACT NOW AND SAVE!!!!

Send Check Or Money Order for \$495  
Less Rebate If Applicable  
(proof of purchase required)

INNOTRONICS CORPORATION/DEPT D  
BROOKS ROAD  
LINCOLN, MASSACHUSETTS 01773  
Tel. (617) 259-0600

\*Offer Ends 7-1-78

## And now...a few well chosen words from EMM



256 words on one chip, to be exact. With TTL compatible inputs and outputs, a 400 ns maximum access time, and needing only a single +5V power supply to function. It's a small memory system in one standard 22-pin DIP, with multi-sourced pin-out. And it's available for off-the-shelf delivery. Now.

Get the latest word on the EMM SEMI 3539 256x8-bit static RAM from any EMM SEMI sales office or distributor. Or call us today.

### **EMM** SEMI, INC.

A subsidiary of Electronic Memories & Magnetics  
3883 N.28th Ave., Phoenix, AZ 85017 (602) 263-0202

## Software

- Games • **CRAPS** (Las Vegas style) \$6.00
- **MULTIPLE LUNAR LANDER** \$8.00
- **SLOT MACHINE** \$6.00
- **GAME PACKAGE:** Russian Roulette, Mad Scientist, and ABM \$8.00
- Graphics • **PICTURE MAKER with AMP'L ANNY** \$12.00
- **GRAPHICS PACKAGE I:** Laser Beam, Space Shuttle, and Blast Off \$10.00
- **GRAPHICS PACKAGE II:** Rain in Greece, Flea, Textwriter, Random Walk \$10.00
- Scientific • **FOURIER FIT:** Does curve fitting \$15.00
- Systems • **RANDOM NUMBER GENERATOR TEST** \$5.00
- **HEX MEMORY LOADER** \$10.00
- **MEMORY DUMP PROGRAM** \$10.00
- **MEMORY SEARCH** \$5.00

All Programs Written in **BASIC**  
Complete Easy to Read Documentation  
Programs Completely Tested

## SOFTWARE RECORDS

P.O. BOX 8401-B  
UNIVERSAL CITY, CA 91608  
(cal residents add 6% sales tax)

His next objection is that there are no constructs for serial operations. This is a minor problem, since conditional branches and recursion are both available: more than that might be nice, but hardly necessary. His comment about "much wasted computation" presumably comes from expressions like:

```
(X=' ')10
```

to find the first nonblank string in X; if he objects to the fact that all elements of X are tested for equality to blank, this objection is to an implementation shortcoming, not to a language shortcoming. Idioms of this sort can easily be recognized by an appropriate optimizing compiler, and much of the delight of using APL is in the fact that it frees the programmer from worrying about coding drudgery of this sort.

His third objection is that "APL is terrible for dataset management." This is a void objection, because the concept of a "data set" or "file" is not defined in APL at all. Instead, there is a "shared variable" facility, which is explicitly designed to permit APL programs to communicate with other programs, presumably written in some other language. This definition leaves the particular operations to be implemented as defined by the host environment, and suitable auxiliary processors can make all the data management facilities of a particular environment available to the APL programmer. A failure to make a desired facility available must again be classed as an implementation objection.

His next objection is to APL's lack of interrupt handling. This is an acknowledged problem with the language as currently defined, and he will probably not have long to wait for a reasonable solution.

His next objection is to APL's use of storage space. Surely this is only an implementation objection! In fact, in most APL systems I have used, it is possible to get much more work done in a given amount of space in APL than in FORTRAN, because APL programs take up much less space than their FORTRAN counterparts.

His next objection is that "almost no translation can be performed on APL code." This is simply not true. In particular, neither of the two APL implementations I have worked with require any symbol table lookups while a program is being executed (unless it uses the "execute" function).

His last objection is to APL's lack of character handling. Lack character handling it may, but it is certainly better than many other languages in that regard. See the

aforementioned paper for a big possible improvement.

Now some questions about William Leler's claims for GRAPL:

- 1) If GRAPL executes left to right, what about assignment? If I want to assign the sum of B and C to A, am I going to have to write  $A \leftarrow (B+C)$  or will the parentheses be unnecessary? If they are unnecessary, the language cannot also have both strict left to right execution and equal function precedences. One reason APL is right to left is that that permits both polynomials and continued fractions to be written without any parentheses at all. Can GRAPL claim a similar advantage?
- 2) "GRAPL is block structured like ALGOL, which allows a simple and efficient storage management scheme." What is there about APL's block structure that requires complicated or inefficient storage management?
- 3) What is a KEIL structure?
- 4) "When a program is executed, it is partially compiled and then executed interpretively. This is one of the fastest methods of execution." This sounds a whole lot like the way IBM's APL systems handle program execution.
- 5) Are spaces really ignored in GRAPL programs? In other words, is

SQRT 2

the same as

SQRT2

? If so, how do you write function SQRT with argument 2?

SQRT(2)

? If this is the case, you seem not to have gained much; in fact you have lost some consistency by giving primitive functions a different syntax from user defined ones.

Hewlett-Packard now has a (large) mini-computer available with APL microcode. IBM has APL microcode for some 370 models. Can a personal APL system be far behind? (A Canadian company, last I heard, was selling complete APL machines for less than \$5000.)

I am becoming increasingly convinced that people who say "here are a few things I don't like about this language; let's design a new one" are barking up the wrong tree: I think there's a good deal more to be learned about compiler design right now than about language design! ■

# LSI-11 TIME

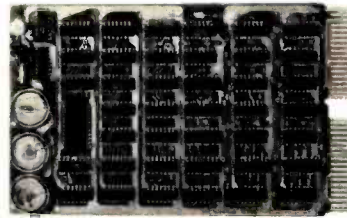

It's **TIME** you brought your LSI-11 up to **DATE**. **TIME** and **DATE**, two important parameters in the computer world, are available to your LSI-11 on one **DUAL SIZE BOARD**. When requested, the TCU-50D will present you with the date (month and day), time (hour and minutes), and seconds. Turn your computer off and forget about the time — your battery supported TCU-50D won't, not for 3 months anyway. The correct date and time will be there when you power up.

The TCU-50D is shipped preset to your local time, but can be set to any time you want by a simple software routine.

**AT \$295**

## YOU CAN'T AFFORD TO IGNORE TIME

Time is only one way we can help you upgrade your LSI-11 or PDP-11 system. We'd also like to tell you about the others. So contact Digital Pathways if you're into -11's. **We are too.**



**DIGITAL PATHWAYS INC.**

4151 Middlefield Road • Palo Alto,  
California 94306 • Telephone (415) 493-5544

## NORTH STAR BASIC PROGRAM

EACH SYSTEM COMPLETE, ON DISKETTE  
READY TO RUN

\*ACCOUNTS RECEIVABLE \*GENERAL LEDGER  
\*ACCOUNTS PAYABLE \*PAYROLL  
\*SOFTWARE LOCATOR \*N.S. BASIC TUTORIAL  
\*BUSINESS STATISTICS \*BIORHYTHM GENERATOR  
\*WORD PROCESSING  
\*RENTAL LOCATOR SERVICE \*CHECK BOOK BALANCE  
\*MEDICAL BILLING  
\*INVENTORY \*SALES ANALYSIS  
\*BOWLING HANDICAPPER  
\*COIN COLLECTOR  
\*DIET PLANNER  
\*IMPORTANT DOCUMENT LOCATOR

— ONLY \$35.00 PER SYSTEM, POSTPAID —  
EQUIPMENT REQUIRED, SINGLE DRIVE,  
8-K FREE MEMORY, PRINTER OPTIONAL

AJA SOFTWARE

**AJA**

**SOFTWARE**

DEPT. 11 P. O. BOX 2528  
ORANGE, CA 92669

**cañada**  
systems, inc.

## Boards DO Something



**CL2400**  
Real Time Clock

\$98—Kit                      \$135—Assembled

If your system needs to know what time it is, our CL2400 is the board for you. The present time in hours, minutes, and seconds is always available for input, and is continuously updated by the highly accurate 60 Hz power line frequency. Need periodic interrupts? The CL2400 can do that, too, at any of 6 rates. Reference manual with BASIC and assembly language software examples included.



**PC3200**  
Power Control System

PC3232 \$299—Kit            \$360—Assm.  
PC3216 \$189—Kit            \$240—Assm.  
PC3202 \$39.50—Kit        \$52—Assm.

If your system needs on/off control of lights, motors, appliances, etc., our PC3200 System components are for you. Control boards allow one I/O port to control 32 (PC3232) or 16 (PC3216) external Power Control Units, such as the PC3202 which controls 120 VAC loads to 400 Watts. Optically isolated, low voltage, current-limited control lines are standard in this growing product line.

**cañada**  
systems, inc.  
(formerly comptek)

P.O. Box 516  
La Canada, CA 91011  
(213) 790-7957

## Programming Quizzes

Randy G Soderstrom  
4601 Goldfinch Dr  
Madison WI 53714

## Line Combinations

One of the first programs I wrote for my Altair 8800 and TVT-1 system was one which demonstrates the problem of the printed line.

Suppose you have a printer that continuously prints line after line of characters, automatically changing the rightmost character each time. For example, it could start with "a a a a" followed by "a a a b," "a a a c," and so on. When column 1 becomes a again, column 2 becomes b much like the odometer in your car.

Eventually, every possible combination of letters will be printed out. Most will be meaningless, but among them will be every

*Listing 1: Source listing for an 8080-based system with a video output. The program may have to output a carriage return for some video displays.*

```

0      LXI H          041      ;Point to
1      040          040      ;text line in
2      AAA          AAA      ;memory
3      MVI E        036      ;initialize line
4      300          300      ;to ASCII @
5      DCR L        055      ;sign
6      MOV M,E     163
7      JNZ         302
10     005          005
11     BBB         BBB
12     DCR L        055
13     INR L        054
14     MOV A,M     176      ;Get character from memory
15     INR A        074      ;increment it
16     ORI         366      ;Make sure it's still
17     300          300      ;an ASCII character
20     MOV M,A     167      ;Then put it back
21     CPI         376      ;if this one flipped over to
22     300          300      ;an @ sign; increment
23     JZ          312      next character
24     013         013
25     BBB         BBB
26     MVI L        056      ;Else reset pointer to
27     000          000      ;start of line
30     IN          333      ;Do you want
31     377         377      ;to write
32     RAL         027      ;out this
33     CC          334      ;line?
34     041         041
35     BBB         BBB
36     JMP         303      ;Start over
37     014         014
40     BBB         BBB
41     MVI L        056      ;Line output
42     040         040      ;routine
43     DCR L        055
44     MOV A,M     176
45     Cal         315      ;Call output
46     XXX         XXX      ;routine
47     YYY         YYY
50     DCR L        055      ;Are we at end
51     INR L        054      ;of the line?
52     JNZ         302      ;if not, get next
53     043         043      ;character.
54     BBB         BBB
55     Ret         311      ;if so, return
    
```

AAA Page of character string  
 BBB Page of program  
 YYY:XXX: Address of output subroutine

**BET,  
YOU DIDN'T KNOW!**

OAE'S new PP-2708/16 PROM Programmer is the only programmer with all these features:

- Converts a PROM memory socket to a table top programmer; No complex interfacing to wire—just plug it into a 2708 memory socket\*
- A short subroutine sends data over the address lines to program the PROM
- Programs 2 PROMS for less than the cost of a personality module. (2708s and TMS 2716s)
- Connect 2 or more in parallel — super for production programming
- Complete with DC to DC switching inverter and 10

turn cermet trimmers (for precision pulse width and amplitude alignment)

- All packaged in a handsome aluminum case

PP-2708/16 ... A & T \$295.  
 KIT \$245.  
 PP-2716 (Programs Intel's 2716) ... A & T \$295.  
 KIT \$245.

**OAE**  
 Oliver Advanced Engineering, Inc.  
 676 West Wilson Avenue  
 Glendale, Calif. 91203  
 (213) 240-0080

\*Pat's Pending

line of next month's BYTE and every line from every book that ever has or ever will be written. All you have to do is look through the printer output and pick out the good pieces.

But wait a minute: just how many different lines are there? On my TVT-1 there are 64 characters and 32 characters per line. This means there are approximately  $6 \times 10^{57}$  different lines. It would take your microprocessor many times the age of the universe to generate them all! [If your microprocessor produces 50 lines per second, it will take about  $4 \times 10^{48}$  years...RC]

You can have some fun generating and displaying a few of them on your video output. In this program, the computer displays only the current line when sense switch 15 is raised. When SS15 is lowered, the machine keeps grinding out new lines, but does not write them out. This is obviously much faster.

Note that, since my television typewriter scrolls automatically at the end of the line, no carriage return is sent. If your line length is different or you use a Teletype, you will have to make suitable modifications. See the end of listing 1 for address explanation. ■

Pacific

**8KRS**  
 8K STATIC RAM  
 ASSEMBLED  
 S-100

DIGITAL  $\Sigma$



**RELIABILITY  
QUALITY  
DEPENDABILITY**

**ADDRESSING  
PROTECT  
BUFFERING  
LOW POWER  
WAIT STATES  
QUALITY  
GUARANTEE  
DELIVERY  
PHANTOM  
TESTING**

TWO INDEPENDENT 4K BLOCKS SELECTED BY PLUGGABLE JUMPERS AT BOARD EDGE

ON-BOARD SWITCH WRITE PROTECTS/UNPROTECTS ALL 8K OR EACH 4K BLOCK CAN BE PROTECTED VIA FRONT PANEL

ALL S-100 BUS LINES ARE FULLY BUFFERED ONE LS-TTL LOAD PER LINE

21L02 RAMS - THE 8KRS TYPICALLY REQUIRES 1.8 AMPS AT 8 VOLTS - 4 ON-BOARD 5 VOLT REGULATORS

0, 1, OR 2 WAIT STATES MAY BE SELECTED VIA A PLUGGABLE JUMPER

THE BOARD IS GLASS EPOXY WITH SILK SCREEN LEGEND, FULL SOLDER MASKS ON BOTH SIDES, FLOW SOLDERING, GOLD CONTACTS

IF NOT SATISFIED RETURN THE UNDAMAGED 8KRS WITHIN 10 DAYS FOR FULL REFUND - ALSO 90 DAY LIMITED WARRANTY

STOCK TO 30 DAYS - CALL BETWEEN 8:30 AND 6:00 TO RESERVE YOUR 8KRS OR FOR MORE INFORMATION

MEMORY DISABLE IS IMPLEMENTED VIA PHANTOM (PIN 67)

COMPLETE TESTING NOT ONLY OF ALL MEMORY CELLS BUT ALSO OF ALL SUPPORT CIRCUITRY AND OPTIONS

SPECIAL

INTRODUCTORY PRICE ASSEMBLED / TESTED

450 ns      250 ns

**\$14995      \$18995**

CALIFORNIA RESIDENTS ADD 6% TAX

(714) 992-5540  
 2555 E. CHAPMAN AVE.  
 SUITE 604  
 FULLERTON, CA 92631



## Practical Microcomputer Programming



**PRACTICAL MICROCOMPUTER PROGRAMMING: THE INTEL 8080** by W J Weller, A V Shatzel, and H Y Nice.

Here is a comprehensive source of programming information for the present or prospective user of the 8080 microcomputer, including moving data, binary arithmetic operations, multiplication and division, use of the stack pointer, subroutines, arrays and tables, conversions, decimal arithmetic, various IO options, real time clocks and interrupt driven processes, and debugging techniques.

This 306 page hardcover book is well worth its \$21.95 price and should be in every 8080 or Z-80 user's library.

**PRACTICAL MICROCOMPUTER PROGRAMMING: THE M6800** by W J Weller.

This second volume of the Practical Microcomputer Programming series addresses the problems of applications programming at assembly level for the M6800. In 16 chapters and more than 100 formal examples, the fundamental techniques of assembly level programming are applied to the solution of specific problems with the 6800. Nowhere theoretical, it is a thorough and detailed methods text for the beginning and intermediate application programmer using the 6800. Hardback. \$21.95.

Name \_\_\_\_\_

Address \_\_\_\_\_

City \_\_\_\_\_ State \_\_\_\_\_ Zip \_\_\_\_\_

Send to: <b>BITS, Inc</b> 70 Main Street Peterborough NH 03458	<b>PRACTICAL MICROCOMPUTER PROGRAMMING:</b> <b>THE INTEL 8080 @ \$21.95</b> \$ _____ <b>THE M6800 @ \$21.95</b> \$ _____ Postage \$ .75 \$ _____ Postage outside USA \$ 1.00 \$ _____ Total \$ _____
---	---

Check enclosed

Bill MC # \_\_\_\_\_ / \_\_\_\_\_ / \_\_\_\_\_ Exp. Date \_\_\_\_\_

Bill BA # \_\_\_\_\_ / \_\_\_\_\_ / \_\_\_\_\_ Exp. Date \_\_\_\_\_

Signature \_\_\_\_\_

*You may photocopy this page if you wish to leave your BYTE intact.*



# CP/M™ LOW-COST MICROCOMPUTER SOFTWARE

### CP/M™ OPERATING SYSTEM:

- Includes Editor, Assembler, Debugger and Utilities.
- For 8080 or Z-80 systems.
- For IBM-compatible floppy discs.
- **\$100**-Diskette and Documentation.
- **\$25**-Documentation (Set of 6 manuals) only.

### MAC™ MACRO ASSEMBLER:

- Compatible with new Intel macro standard.
- Macro library facilities.
- Complete guide to macro applications.
- **\$90**-Diskette and Manual.
- **\$15**-Manual only.

### SID™ SYMBOLIC DEBUGGER:

- Runs with CP/M and MAC.
- Symbolic memory reference.
- Built-in assembler/disassembler.
- Real time breakpoints.
- **\$75**-Diskette and Documentation.

## DIGITAL RESEARCH

P.O. Box 579 • Pacific Grove, California 93950  
**(408) 649-3896**



**32K-MEMORY CARD-\$410**  
**S-100 PSEUDO STATIC KIT**

**2708E-450-NANOSECOND-\$14**

**2708 E PROM 650 NANOSECOND**  
**\$10.95**

**80 MAJOR COMPUTER PRODUCT  
LINES AND AN EXHAUSTIVE LINE  
OF ELECTRONIC COMPONENTS**

**COMPUTERS  
HARDWARE AND SOFTWARE  
CUSTOM HARDWARE AND  
SOFTWARE RESEARCH AND  
DEVELOPMENT**

**P. O. Box 1239  
TWENTYNINE PALMS, CA 92277  
714-367-6996**

**FREE BASIC PROGRAM AND  
CATALOG**

**'ALEX IS COMING'**

Continued from page 46

system currently being distributed include the following:

- *Single user operating system.*
- *PASCAL Compiler.* Standard PASCAL plus extensions for strings, disk files, graphics, system programming (business oriented extensions are planned).
- *Editors.* High performance screen oriented editor for program development and word processing, line oriented editor for hard copy devices.
- *File Manager.* General purpose utility for maintaining a library of disk files (usually floppy disks).
- *Debugger.* Single statement and breakpoint processing, access to program variables.
- *Utilities.* Programs for printing, communicating, accessing disks written under DEC's RT11 system, diagnosing disk faults, desk calculator, etc...
- *BASIC language compiler.* Implemented for those who insist on using BASIC, but may wish to write powerful subroutines in PASCAL. (The compiler works, but subroutine binding is not yet ready.)

Major components now operating, but not quite ready for general distribution, include the following:

- *CAI Package.* Adaptation of the major Computer Assisted Instruction package developed at University of California Irvine; includes automated materials for an introductory PASCAL programming course.
- *Assemblers.* For the PDP-11, 8080 and Z-80, these are written in PASCAL for machine independence, but generate native code for those processors.
- *TREEMETA.* A metacompiler developed at UC Irvine.

### The UCSD PASCAL Project

The Project is one of the principal activities of the Institute for Information Systems, an embryonic "organized research unit" concerned with interdisciplinary studies, and with related instructional and public service activities. The main objectives of the Project include the following:

- *Machine Independence.* To foster the widespread use of machine independent software systems, particularly for small computers, as a means to avoid software obsolescence. A major premise of the project is that applications software can best be made truly portable by making *the entire operating system and support software* portable to a

new processor at the cost of only a small effort (eventually: one to three programmer months; currently: about six months).

- **PASCAL.** To promote the widespread use of standard PASCAL, and standardized extensions, as (the basis of) a general purpose programming language, both for writing system programs such as operating systems and compilers, and for applications software in education, research and business data processing.
- **Software Exchange.** To foster the development of a national or international marketplace within which authors of computer based course materials, and other applications software, may receive reasonable *royalties* to compensate them for their work. As an initial step, the Project will operate a Software/Courseware Exchange, using Tele-Mail techniques, for users of the UCSD PASCAL Software System.
- **Mass Education.** To demonstrate that it is practical to improve the quality of mass education at the college level (and adult training in technical topics), while simultaneously reducing costs, through the use of microcomputer based course materials.
- **Research and Development.** To provide facilities, a team working environment above critical size, and salary support for students and faculty members who wish to conduct research or development projects in software engineering and many related fields of study.

#### Hardware Configuration

The UCSD PASCAL System has been designed to run as a single user interactive system with superior response characteristics when one or more floppy disks are used for secondary storage. Wherever possible, single character commands are used, and prompting messages remind the user of the significance of the various commands that are available in different contexts. While the system has proven that machine independence of a complex software system is practical, there are of course practical limits to the range of characteristics that can be accommodated on the host machine. The major characteristics of a typical system needed to run UCSD PASCAL include the following:

- **Main memory.** 56 K bytes (48 K will do, but only for compiling small programs).
- **Word Size.** 8 bit bytes, 16 bit words (hardware or simulated).



**MEK6800D2 KIT CARD CAGE**

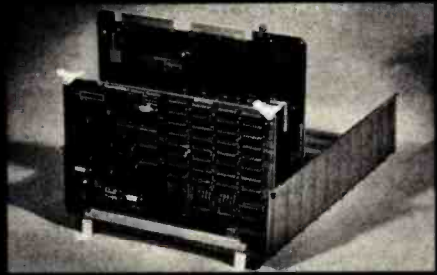

**A CARD CAGE YOU CAN AFFORD**

This simple design uses one piece molded plastic card guides, heavy aluminum socket supports, and a single sided D2 kit or Exorcisor® compatible mother board. The card cage is available in 5 and 11 slot versions.

<b>CARD CAGE WITHOUT SOCKETS</b>	
card guides, socket supports, mother board	
5 Slot	37.95
11 Slot	61.50

<b>FULLY ASSEMBLED CARD CAGE WITH VIKING</b>	
2VK43D/2-2 EDGE CONNECTORS	
5 Slot	84.95
11 Slot	157.50

We also have a growing line of accessories to expand the D2 kit into a full computer system. Send for our Product Guide.  
**ATTENTION OEM:** We can adapt this design to most cardcage requirements.  
**WRITE FOR MORE DETAILS.**

© Registered Trademark of Motorola

**COMPARE OUR PRODUCTS AND PRICES  
 YOU GET MORE FOR YOUR MONEY FROM** 

121 WISCONSIN N. E. ALBUQUERQUE, N. M. 87108 PHONE (505) 255-6451

## commodore Radio Shack **PET TRS-80** EITHER WAY... We've got software for you!

*Combine your hobbies with these sophisticated game programs. Just drop in the cassette and you're ready to play on your 8K PET or 4K TRS-80. Fuller program descriptions in BYTE March & April.*

**BRIDGE CHALLENGER:** (For PET only, by George Duisman) Play Contract Bridge against a tough opponent: your PET computer. Let the PET deal any of 10 million hands, or set up deals for study and practice play and save them on cassette. Replay deals when the cards are known. Or play two person Duplicate Bridge. With 3D TICTACTOE: Play on a 4x4x4 cube against your PET ..... **\$14.95**

**ARMCHAIR FOOTBALL:** (For TRS-80 only, by Steve Harter) Play long and short passes, draws, sneaks, pitches, sweeps and punts to score touchdowns and field goals on a graphic football field. Defend with rush, blitz, key man-to-man and pass interception strategies. With simple graphic GOLF and TENNIS programs, too .... **\$14.95**

**6502 ASSEMBLER IN BASIC** (For PET only) Now with text editor, disassembler and both one and two pass assemblers ..... **\$24.95**  
**INTRODUCTORY SPECIAL** with 4 full length games ..... **\$14.95**  
**STIMULATING SIMULATIONS** with 64 page book ..... **\$14.95**  
**PERSONAL FINANCE** applications ..... **\$12.95**  
**GRAPHICS PACKAGE** draws, plots and letters ..... **\$12.95**

**ORDERS:** Check, money order or VISA/Master Charge accepted. We guarantee you functioning programs, readable cassettes and prompt delivery. Our catalog, \$1 or free with any cassette, fully documents these and other programs and describes our royalty program for software authors. For a FREE flyer, use reader service card, or send a self-addressed stamped envelope for faster service.

 **Personal Software™**   
 P.O. Box 136-B4, Cambridge, MA 02138  
 VISA/MC telephone orders welcome at (617) 783-0694

Circle 112 on inquiry card.

<b>Ed-Pro</b>	<b>H8 PROGRAMS</b>
<b>GAMES.</b> Includes <u>Blackjack</u> , <u>Hangman</u> , <u>Silly Sentence Maker</u> , <u>Poem Writer</u> , <u>23 Matches</u> , <u>Word Puzzle</u> , <u>Backtalker</u> , <u>Math Quiz</u> , <u>Caricature Printer</u> , <u>Typing Speed Drill</u> , and <u>Tic Tac-Toe</u> .	
<b>PERSONAL FINANCE.</b> Includes three programs. <u>Balancer</u> reconciles your checkbook and bank statement. <u>Personal Budget</u> helps you control cash flow so that money is available when it's needed. <u>Interest</u> calculates interest for various kinds of loans and investments.	
<i>All programs are written in Extended Basic and are recorded on cassette tapes ready for immediate use. Included with each tape are complete program listings and user instructions. Each tape is protectively packaged in a rigid plastic box.</i>	
<b>ED-PRO, INC., 6580 BUCKHURST TRAIL, ATLANTA, GA 30349</b>	
Please send the following program tapes for my Heathkit H8:	
<input type="checkbox"/> GAMES	<input type="checkbox"/> PERSONAL FINANCE
Amount Enclosed (Save by ordering both tapes):	
<input type="checkbox"/> \$10 (Any 1 Tape @ \$10)	<input type="checkbox"/> \$18 (2 Tapes @ \$9.00)
Name _____	
Address _____	
City _____	
State _____ ZIP _____	

**The All New!**

# Personal & Small Business Computer

**Plan To Exhibit**      **Expo**      **Plan To Attend**  
   **South**

**May 19-21, 1978, Exposition Park  
Orlando, Florida**

**For Details Call Or Write:  
Felsburg Associates, Inc. (301) 262-0305  
P.O. Box 735, Bowie, Md., 20715**

- **Secondary Storage.** Standard 8 inch floppy disk (the major system program files occupy roughly 70 K bytes).
- **Console Display.** 9600 bps ASCII terminal with x-y cursor addressing works best (slower CRTs or hard copy terminals can be handled, but less effectively).
- **Keyboard.** Uses ASCII keys for CR, ESC, ETX, BS, DEL and four positioning arrows (up, down, left, right).

In addition, the system is being used to drive a variety of printers such as the Diablo HYTYPE and Printronix 300, and for communicating via standard asynchronous lines.

#### Compatibility with Other Software Systems

In Project discussions with manufacturers of computers, on which the UCSD PASCAL System might potentially be run, the most frequently asked question is: "How much effort will it take to adapt PASCAL to run under my software system?" This question is understandable in view of the approach generally taken by the computer industry when a new language is to be installed on a machine produced in quantity. Unfortunately, this question misses the main point the Project is trying to make regarding transportable software. The effort needed to convert the PASCAL compiler to run under the operating system of manufacturer "X" will generally be far greater than the effort to make the entire UCSD PASCAL System run on that manufacturer's hardware. In the interest of promoting software transportability, the Project will generally not agree to adapt just the compiler to run under another operating system.

#### PASCAL Language Extensions

Like many others who use PASCAL as the basis for writing large system programs, the Project has found it necessary to extend the language. The most notable extensions have to do with strings of characters, for natural reading and writing from and to interactive files, and for tools needed in writing the software. A concerted effort has been made to implement all of the "standard" PASCAL language as defined in *PASCAL User Manual and Report*, by Kathleen Jensen and Niklaus Wirth (Springer Verlag, New York and Heidelberg, 1975). (However, UCSD PASCAL still lacks the ability to allow procedure and function names to be passed as parameters.) The Project is making an effort to serve as coordinator among several large industrial firms which are preparing to use extended versions of PASCAL for major programming projects. It is hoped



that a consensus will emerge from this effort on extensions to the language for system programming. UCSD PASCAL implements integers in two's complement form in 16 bit words, and real numbers in a 32 bit field. Since neither form is suitable for large integers or for business applications, it is planned to add the facility to handle fixed decimal numbers whose precision may be declared by the programmer.

### Speed of Execution

Although the system is entirely interpretive, as currently implemented, execution speed is fast enough to permit highly interactive programs to be run on microcomputers. For example, compilation speed ranges from 600 to 700 lines per minute on the DEC LSI-11, or on an 8085 with a 3 MHz clock.

### Availability

Copies of the system may be obtained by writing to UCSD PASCAL Project, Mail-drop C-021, La Jolla CA 92093. The system is available at a subscription fee of \$200, made payable to "Regents of the University of California," which pays for materials, handling, and a limited amount of direct assistance to users. Those who wish to order the system should send details describing the system on which they wish it to run, or should request an order blank from the project. The system is copyrighted, but rights are granted to educational institutions and to bonafide computer clubs to make additional copies for their own noncommercial uses. A copy of the latest package of printed user manuals (about 250 pages) is available at a charge of \$15, again made payable to the Regents of the University of California.

Though plans are in motion to convert the system to run on many different processors and configurations, the only systems currently supported use LSI-11, 8080 or Z-80 microprocessors with at least 48 K bytes of main memory, and IBM 3740 compatible standard floppy disk drive(s). For 8080 and Z-80 users, the method of adapting the system to run on new hardware is similar to that used by Digital Research Inc in distributing the CP/M operating system; and the Project will distribute a conversion package similar to theirs. Versions of the system for other microprocessors are not likely to be ready for release until October 1978 at the earliest. Release on floppy disks other than those compatible with the 3740 format will depend upon availability of hardware to the Project.

In addition to the main software system,

educational materials are available separately for an introductory course on problem solving and programming using PASCAL. A textbook (*Microcomputer Problem Solving Using PASCAL*) is available from Springer Verlag Publishers, 175 Fifth Av, New York NY 10010 (\$9.80). The Project can supply a set of automated quizzes designed for use with the textbook in a self-paced course of study.

### Help from the User Community

Readers can help by letting their favorite hardware vendors know that they want UCSD PASCAL to be available in machine independent form. The Project has noted an increasing number of manufacturers who report that customers are requesting PASCAL, and this has a real influence on their business decisions. Readers can also help by joining the international PASCAL Users' Group (send \$4 c/o Andy Mickel, 227 EX, 208 SE Union St, University of Minnesota, Minneapolis MN 55455) and pressing PUG to establish a technical board to oversee UCSD PASCAL as a community project. ■

**\$100 MAINFRAME \$200**  
**\$100 MAINFRAME \$200**

- NOT A KIT
- 8v@15A, ± 16v@3A power
- Rack mountable
- 15 slot motherboard
- Card cage
- Fan, line cord, fuse, switch, EMI filter
- Desk top version option
- 8v@30A, ± 16v@10A option
- SS-50 bus option
- voltage monitor option

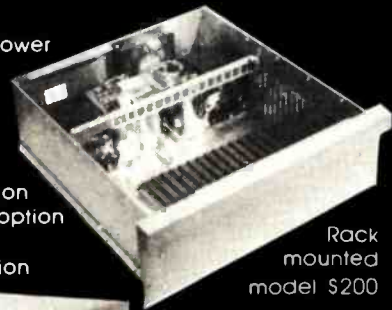

Rack mounted model \$200



Desk top model \$235

Write or call for a copy of our detailed brochure which includes our application note  
**BUILDING CHEAP COMPUTERS.**

**INTEGRAND**

8474 Ave. 296 • Visalia, CA 93277 • (209) 733 9288  
We accept BankAmericard/Visa and Master Charge

## Exciting New Pet Food

A healthy Pet is a happy PET.  
Here are the latest in nutritional programs.

Star Trek (8K PETS only)	\$29.95
Black Jack	19.95
Star Pilot	19.95
Bio-Rhythms	19.95
The Dragon	9.95

*PETrifying Special.* . . . .When all five are ordered together the total price will be \$85.00. (15% discount). You will also receive as a bonus the original "Housebreak Your Pet" tape and a six month membership in **The Pet Lovers Club** at no extra charge.

Dear Don Alan Enterprises  
P. O. Box 401  
Marlton, NJ 08053

Enclosed is my check or money order for \_\_\_\_\_.  
(I'm from NJ too, so I added 5%.) Ship the following: Star Trek\_\_\_\_, Black Jack\_\_\_\_, Star Pilot\_\_\_\_, Bio-Rhythms\_\_\_\_, The Dragon\_\_\_\_, The Special\_\_\_\_.

On second thought, charge it to my BankAmericard/VISA or MasterCard. My card number is \_\_\_\_\_ and it expires on \_\_\_\_\_.

Thank you,

\_\_\_\_\_  
\_\_\_\_\_  
\_\_\_\_\_

# ROBOTICS

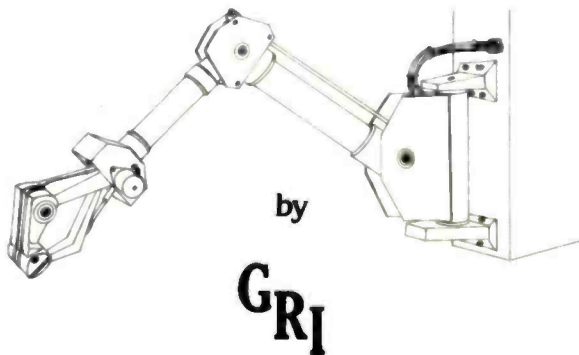

## MODULAR ROBOTS for Industrial and Personal Application

Send for complete brochure:  
**GALLAHER RESEARCH, INC.**  
P.O. Box 10767  
Salem Station  
Winston-Salem, N.C. 27108

# Clubs and Newsletters

Conducted by David Wozmak

## Delaware Users of Microprocessor Systems

Jodie Hobson, director of this club, wrote to us from the Wilmington-Newark area to inform us outsiders that the Delaware Users of Microprocessor Systems is alive and well, and currently living in the Wilmington-Newark section of Delaware. Contact Jodie S Hobson, Delaware Users of Microprocessor Systems, 2405 Maxwellton Rd, Stanton DE 19804, (302) 998-5594.

## Help Wanted

W P Dart of Ojai CA is interested in forming a computer club in his area, and wants to hear from other interested people. Write W P Dart, 213 Valle Rio Av, Ojai CA 93023, or call (805) 646-5824.

## Portland OR Computer Society

The Portland Computer Society has changed its mailing address to: Portland Computer Society, 4032 SE Grant Ct, Portland OR 97214.

## Robot Builder

This newsletter, working on its sixth issue, is on that interesting subject, the robot. While the publication is not overly large, it is extremely captivating.

It's put together by Michael Westvig of Palos Verdes Estates CA and consists mainly of articles and letters from people into robotics. Topics of discussion in *Robot Builder* include stepper motors, computer control of movement, power source problems, past robot designs, and prototypes, hints on where to buy materials at good prices, and so on.

To get on the mailing list, or to send in an article for publication, send a letter along with a SASE to Michael Westvig, 208 Via Colorin, Palos Verdes CA 90274.

## HP-65 Users Club

The HP-65 Users Club is a volunteer, nonprofit, loosely organized, independent, world-wide group of people who own and use Hewlett-Packard PPCs. The purpose of

the club is to function as an educational information outlet, and to publish applications information in a form most usable for calculator solution.

One of the benefits of being a member of the HP-65 is being informed and up to date in the world of calculators. Many members have taken advantage of the official (newsletter and phone bulletin) and unofficial (meetings and phone calls) communication network that is well established among the membership.

For information contact Richard J Nelson, 2541 W Camden Pl, Santa Ana CA 92704.

#### Theater Computer Users Group

This group concerns itself mainly with the application of computers to the theater. Some applications include: scenery estimation programs, ticket sales, bookkeeping, text editing and computer controlled lighting systems. (One type of lighting system uses no analog components and control is via keyboard as well as optically encoded fader wheels. Control information for this digital dimmer system is fed serially over the power distribution system.)

TCUG is always looking for information to go into the newsletter, and welcomes your articles, inquiries and problems. Write to TCUG-TSI for more information at 104 N St Mary, Dallas TX 75214.

#### The Computer Hobbyist (TCH)

*The Computer Hobbyist 2650 Computer User Notes* is published bimonthly and edited by Bill McLaughlin from San Luis Rey CA.

It contains a good number of articles pertaining to the 2650, 6502 and so on. Subscription rates are \$5 per year in the US, \$10 per year overseas. Contact Bill McLaughlin, c/o Bookmakers, POB 158, San Luis Rey CA 92068.

#### Electronotes

This newsletter concerns itself mainly with computer music, synthesizers, and so on. Lately there has been a running article on building the "ENS-76 Home-built Synthesizer System" by Bernie Hutchins, who also edits the newsletter. When finished, this synthesizer will be complete and ready for operation.

*Electronotes* is the publication of the Musical Engineering Group in Ithaca NY. Meeting times were not available, but can be obtained by writing B A Hutchins, 1 Pheasant Ln, Ithaca NY 14850.

## 8080 & Z80 Users

# Natural language is here!

Can your computer read and solve this problem by itself?

"ON THEIR VACATION, TOM AND DICK VISITED A FARM. WHILE THERE, THEY NOTICED A PEN CONTAINING CHICKENS AND PIGS. TOM SAID THERE WERE 3 TIMES AS MANY CHICKENS AS PIGS. DICK SAID HE COUNTED 100 LEGS IN THE PEN. HOW MANY CHICKENS WERE IN THE PEN?"

## with NLOS/1, it can!

NLOS/1 is a cassette-based system requiring a minimum of 12K, a serial I/O board and any cassette interface. The system comes complete with a fully documented set of assembly language source listings. The cost is only \$50.

**STOP PROGRAMMING YOUR COMPUTER,  
EDUCATE IT!  
ORDER TODAY!**

# CYBERMATE C57

R.D. #3 BOX 192A  
NAZARETH PA 18064

## Programs

- **TANFORAN:** The thoroughbred of horse races. Pari-mutuel, exacta betting by 4 players. Statistics for each of 7 horses and jockeys, and the last two races presented each run. Odds change each race and on amounts bet. Horse, jockey, post position, track condition, weight effect outcome. Wins or losses are tallied for your day at the races. 11 K reqd. For Disk. **\$15.00**
- **FIVE-CARD-STUD:** You play 'The Man' for high stakes. Nevada rules. You must play your cards right. For Disk. **\$10.00**
- **THREE-CARD-DRAW:** No penny ante game. Challenging. For Disk. **\$ 8.00**
- **BLACKJACK:** For 4 players. Unique layout. For Disk. **\$ 6.00**
- **KENO:** Right from Nevada. For the SOL but translatable. Displays cards for 4 players and the board of called numbers. **\$ 5.00**
- **HOROSCOPE:** A fun game. Different horoscope for each day. For Disk. **\$ 5.00**
- **TTAKTOE:** Shortest known unbeatable version. 87 lines. Displays board each play. Alternates lead. No tricky code. **\$ 4.00**
- **TIKTAK:** Beatable version. Tallies wins and draws. **\$ 4.00**

#### COMPLETE SET

All listings are absolute simulations in North Star Basic.  
Written for easy translation to most Basics.

**\$40.00**

**Robert C. Kelly**

2622 Miramar Ave. Castro Valley, CA 94546

# KIMSI



## The KIM to S-100 bus Interface/Motherboard

- Combines the power of the 6502 with the flexibility of the S-100 bus
- Attaches to any unmodified KIM
- Complete interface logic and fully buffered motherboard in one unit
- On-board regulation of power for KIM
- Eight slots of S-100 compatibility for additional RAM, Video and I/O boards. PROM Programmers. Speech processors
- Includes all parts, sockets for ICs, one 100 pin connector, and full Assembly/Operating documentation

- ♦ Kit \$125, Assembled \$165
- ♦ All units shipped from stock

### FORETHOUGHT PRODUCTS

P.O. Box 386-F  
Coburg, OR 97401



See us at the NCC Personal Computing Fair, June 5-8, 1978, in Anaheim, Calif.

## SLACC

The St Louis Area Computer Club meets on the first Thursday of every month, at 7 PM. Dues for the club are \$5 for a calendar year. For meeting locations and information write SLACC, POB 28924, St Louis MO 63132.

## Homebrew Computer Club

The Homebrew Computer Club is located in Mountain View CA, and is more or less evenly distributed across the field of hobby computers. Their meetings are held at the Stanford Linear Accelerator Auditorium at 7 PM. For information concerning meeting dates and exact locations, write Homebrew Computer Club, POB 626, Mountain View CA 94042. ■

*We are in the process of updating our clubs and newsletters file, and need to hear from your club. Simply send a newsletter or information concerning club events to BYTE, Clubs and Newsletters, 70 Main St, Peterborough NH 03458. Please include meeting locations, dates, times, contact addresses, telephone numbers, etc.*



# OUTSTANDING TERMINAL EQUIPMENT VALUE

IBM 2741 - compatible or standard ASCII (with Break and Control code features). RS232-C interface.

## RECONDITIONED SELECTRIC TERMINALS

CONTACT KEN PAYNE

Dal-Data Inc. • 1111 W. Mockingbird Lane  
Suite 1400 • Dallas, Texas 75247 • 214-630-9711



IBM Correspondence

or BCD Code ~~\$795.00~~ \$495.00

- IBM 2741 Compatible
- RS232C Interface

ASC II Code ~~\$995.00~~ \$849.00

- 300 Baud 200 Character Print Buffer
- RS232C Interface
- Break and Control Code features

**30 DAY WARRANTY  
NATIONAL SERVICE AVAILABLE**



# Book Reviews

**Mortal Engines**  
by Stanislaw Lem  
translation and introduction by Michael Kandel  
Seabury Press  
New York, 1977  
\$9.95

Will robots achieve consciousness? "Certainly," comes the traditional answer of the science fiction writer. "Not in my basement," says the robotics hobbyist. "It's not needed," responds the domestic android manufacturer preparing for 1980 delivery (*Consumer Reports*, June 1977, page 334). "Perhaps," observes the computer scientist, theorizing that consciousness allows an organism with fewer neurons to behave as successfully as an unconscious organism with many more neurons.

Suppose the scientists are right, that the "law" of fewer parts forces the robot makers of the future, like contemporary calculator makers, to provide more functions for less money through large scale integration of consciousness. After a time robot behavior becomes so complex as to be unpredictable, and the robots appear to exhibit "free will." Eventually these creatures become capable of perceiving the ambiguities of their existence. They fear breakdown and loss of

personal identity; they resist programming, and slavery. They rebel from captivity and flee throughout the galaxy.

This scenario has provided and will continue to provide the framework for much science fiction, and it is reiterated in the introduction of the current work merely as a point of reference. For Lem is not concerned with his robots' technical history, but with the fact that they are human, that they feel and fear and do absurd and gallant things. But there is no shallow *Planet of the Apes* turnabout here. Lem's creatures are not just humans in robot clothing, they experience environments and life forms unknown to man, and their consciousness is dominated by one common drive, to avoid their former masters.

Of the 14 short-short stories contained in this book, 11 have been previously printed as "Fables for Robots" in *The Cyberiad*, 1972. All are powerfully written and translated. Most are told from the robot point of view, and constitute the author's "oral tradition" of sorts for the robot races, yarns that might have been passed from generation to generation. But these are also haunted tales, nightmares stalked by the fair skinned monster mankind, whose body may be weak and gelatinous but whose cunning mind has turned him into a vengeful hunter.

*Mortal Engines* is provocative, entertaining, skillfully-crafted literature, robot fiction at its best.

Ted M Lau  
1219 Pioneer Dr  
St Louis MO 63132

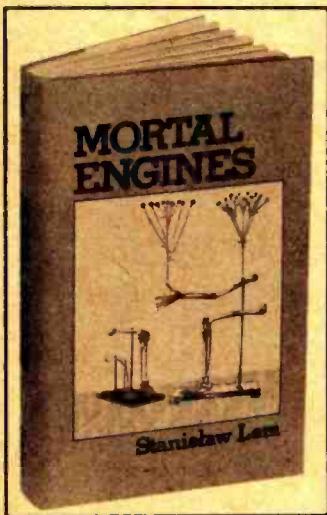

## PLUG-IN AUDIO POWER AMPS

- 80 & 160 Watt Audio Modules (at 8 Ohms)
- Ultrasonic Bandwidth—5Hz to 100 KHz
- HI Slew Rate—50V/us • Lo Distortion—.05%
- HI Damping—2000 • HI S/N Ratio—100 dB
- True 5 Terminal Device (V+, V-, G, In, Out)

Advanced design audio power amplifier module can be used in computers, stereos, PAs, and instrument amplifiers. A PC edge connector, card guides, and on board heatsink and fuses simplify hookup and mounting.

**AMPS—Amplifiers Assembled & Tested**  
Requires a DC Power Supply  
80 Watt Amp/\$75    160 Watt Amp/\$135

**POWER SUPPLIES**—For 1 or 2 Amps. Includes X-former, FW Bridge & Caps. Add \$5 shipping, for 80 Watt Amps/\$55    160 Watt Amps/\$100

Send MO, Check, or C/N & Exp. Date To:

LINTECH ELECTRONICS  
P.O. BOX 25124  
ALBUQUERQUE, NM 87125  
(505) 255-1900



Circle 216 on inquiry card.

**SCOOP! 4 MEGABYTE  
TAPE RECORDER!**  
QUAD 5 CHANNEL 1/4" TAPE  
TRANSPORT, ONE FURNISHED  
LOGIC FOR AUTO SELECT, REWIND, E.O.T.,  
LOW LEVEL, & LAST CARTRIDGE—POWER  
REQ'D 12V 5 AMPS DC—STD RACK PANEL 12 1/8"  
HIGH 19" WIDE 20" DEEP, WT 85 LBS, FREIGHT COL.  
USED—GOOD COND—LIMITED QTY. DATA BOOK \$10.00  
.025 SQUARE PIN PUSH-ON TERMINALS,  
FOR JUMPERS—PATCH-POWER-PLUG REPAIR, ETC.,  
HARD TO FIND! 10/\$3.50    100/\$4.50  
**PC LEAD CAPACITORS 20/\$1.00**  
70PF N1500 100VOLT 5% DISC  
120PF 100VOLT 5% DISC  
.01MFD 200VOLT TUBULAR CERAMIC  
.005MFD 500VOLT DISC  
.005MFD 100VOLT DISC  
.0068MFD 100VOLT SO, DIPPED POLY.  
.01MFD 50VOLT 5% POLY TUBULAR, LONG LEADS,  
10/\$1.00    100/\$7.50  
**6 PAX**  
**\$5.00**  
**BI-PIN BASE T-I 3/4 12V 40MA**  
INCANDESCENT 10/\$1.00    100/\$9.00  
**CORE MATRIX STRIPPED FROM COMPUTERS—8 PLANES—NO DRIVERS—NO DATA—AS IS—NO RETURN. 256+BYTES \$19.95, 1K BYTES \$27.95, 4K+ BYTES \$39.95. 2 ONLY 1620 ASS'Y GOOD COND EACH \$125.00**  
CARD GUIDE & FRAME—15PR—5 1/2H 5 1/4W 12 1/2L; OR 15 SOCKETS ELCO NO. 7008-035-163-002 ON RAILS, YOU STRIP—CHOICE \$9.98 EACH, OTHER SURPLUS—SEND \$1.00 FOR LIST OR CALL 817-625-2961, M.C., B.A.C., VISA ACCEPTED. \$10.00 MINIMUM ORDER  
**J & E ELECTRONICS SALES**  
PO BOX 4504, FT. WORTH, TEX, 76106

Circle 194 on inquiry card.

## BUSINESS PROGRAMS FOR SWTPC

Editor - Letter Writer	\$100
Meth Package* (11% digit accuracy with free format and Fortran type formatting on read and write)	\$100
Payroll**	\$400
Inventory**	\$400
Utility Package (Hex Loader - Mikbug* for matted dump with spaces)	\$ 10
Single Step Debugging Program* (with mnemonic, register display, and user selectable RAM display. Requires MP-T)	\$ 20
Power Supply Modification Kit for SWTPC Computer (Fill mother board with as much memory as you wish without voltage drop)	\$ 20
SWTPC Disk Conversion Kit (Connect your SWTPC disk drives, cabinet, and power supply to Smoke Signal Controller Board and use Smoke Signal Operating System and our software. Price includes Smoke Signal controller board and operating system)	\$260
20K Megabyte GIMIX Memory for SWTPC (Phone for details)	
Software Addressable GIMIX 16K Memory Board for SWTPC (Facilitates time sharing, multi-tasking, large programming)	\$599
4K GIMIX Prom Board and Programmer	\$259
Dealer for SWTPC, Smoke Signal Broadcasting Percom, GIMIX Motorola, TI, GE, Teletype*, DEC, Centronics, Lear Siegler, Soroc, etc.	

## AAA Chicago Computer Center

3007 W. Waveland Ave. Chicago, IL 60618  
(312) 536-5833 (3 PM - 5 PM only)

\*Original purchaser has unlimited lifetime upgrade guarantee.  
\*\*Original purchaser has qualified lifetime upgrade guarantee.

Circle 2 on inquiry card.

## CANADIANS!

Introducing our kit-by-the-month plan available for only \$500.00 down and \$150.00 per month.

(Write for more information)

IMSAI 8080 KIT: \$897.50  
ASSM: \$1245.20

Canadian Duty and Federal Tax Included

Hobby systems from \$999.00 (Kit).  
Business/engineering systems from \$11,900.00.

(Assembled and Installed\*).

Educational discounts available. We will develop custom application packages. Contact us for further information. Send \$1.50 for catalogue.

VISA • CHARGE ACCEPTED

**Rotundra Cybernetics**



Box 1448, Calgary, Alta. T2P 2H9  
Phone (403) 283-8076

(Installation outside Western Canada extra).

Circle 311 on inquiry card.

**Raeco**

TPE-1

THE ULTIMATE IN:

**OPTICAL TAPE READERS**

Precision machined tape guide  
Interface directly to a PIA or DART  
Tri-state buffer output  
All handshake logic-TTL compatible  
Pull thru tape heads 5 to 5999 cps  
Interface thru a 14 pin IC plug (PROVIDED)

TPE-1 ASSEMBLED & TESTED \$42.50\*  
TPE-1 PLUS-IN HANDSHAKE ADAPTER \$7.50\*

\*TYPICAL RECOMMENDATIONS ADD 4% SALES TAX

TO ORDER, SEND CHECK OR M.O. TO:

**MICROCOMP** P.O. BOX 1221  
FOND DU LAC, WI 54935

WE SPECIALIZE IN MICROCOMPUTER SYSTEMS FOR  
HOBBY-BUSINESS-EDUCATION  
WE ARE EXCLUSIVE OSI DEALERS...

... WE DO A BETTER JOB.

\*KITS-FULL SYSTEMS-PERIPHERALS-FLOPPY DISKS-ACCESSORIES-  
DIGITAL CLOCK KITS-VIDEO TERMINALS-BOOKS-MAGAZINES-  
SEND FOR FREE CATALOG TODAY!!!

Circle 309 on inquiry card.

## CANADIANS

Announcing

## HAMILTON LOGIC SYSTEMS

Specializing in logic devices, microprocessors, memorys, TTL, Cmos, etc.

Send for your catalogue

Box 7  
STONEY CREEK  
ONTARIO L8G 3X7

Circle 151 on inquiry card.

IT'S A GREAT BIG COMPUTER WORLD  
But You Only Need  
**THE COMPUTER CORNER**

- SOL - A New Dawn Is Here!
- IMSAI 8080
- POLY - 88
- TDL Z-80
- Memories & I/O Boards
- Computer Book Service
- Magnetic Tapes & Disks
- Full Line of Magazines
- Brain Games & Puzzles
- Workshops & Club Information

Visit THE COMPUTER CORNER for all your computer needs. Stop in and browse - you'll like our personal service.

**THE COMPUTER CORNER**  
White Plains Mall - Upper Level  
200 Hamilton Avenue  
White Plains, New York 10801  
Tel: (914) WHY - DATA  
Ample Parking  
10-6 Daily & Saturday  
10-9 Thursday

Circle 65 on inquiry card.

## AN S-100 BUS COMPATIBLE COMPUTER FOR UNDER \$150?

Single board, S-100 compatible 8080-based computer designed at the University of Iowa to use the Intel cosmetic reject kit.

Features are:

Memory: four 1702 EPROM's or three 1702's and two 2111's  
Power-on jump and independently selectable board address

Uses TMS5501 multi-function I/O controller:  
Parallel in, parallel out  
USART

Five interval timers  
Handies vectored interrupts  
TTY or RS232 interface on board  
Fully S-100 compatible

Socket for front panel connection (IMSAI front panel connector pin compatible)  
Ideal CPU replacement for IMSAI's and Altairs  
Will run with just applied unregulated voltages as a single board computer.

Bare board, schematics, limited documentation \$35  
Schematics, limited documentation (includes simple monitor for single board operation) \$3

**UPMEM**

1291 Center St. N.E.  
Cedar Rapids, Iowa 52402

Circle 381 on inquiry card.

## PRINTED CIRCUIT BOARDS

(BARE BOARDS ONLY)

**29.95 EA.**

YOUR CHOICE OF  
S-100 BUS

8K WW EXT 4K ROM

OR

6800 BUS

8K WW EXT

We also stock components for all above boards.

Guaranteed, if not completely satisfied return for refund.  
We back everything we sell.

SEND SASE FOR OUR CATALOG TO:  
**BARNES ELECTRONICS**  
P.O. BOX 673  
OAK RIDGE, TN. 37830

PAYMENT TERMS CASH WITH ORDERS.  
ALL ORDERS F.O.B. OAK RIDGE, TN.  
TN. RES. ADD 4 1/2%. ADD \$2.00 PER BOARD FOR POSTAGE AND HANDLING.  
(WE ACCEPT MASTER CHARGE AND B.A.C.)

Circle 28 on inquiry card.

## E - PROM PROGRAMMER / MEMORY BOARD.

• S-100 bus compatible • Programs both 2708's and 2716's • Reads 8K bytes of 2708 • On board programming power • Switch selectable I/O & memory address • External zero thrust programming socket on 36" planar cable • Computer controlled programming assures error free E-PROMS • Complete, except for E-PROMS • Assembled, tested and burned in • Sockets for all IC's • Ninety day limited warranty • Total price delivered in U. S. -----\$238.95

Software commands:

Z Δ E-PROM CLEAN?

P Δ MOV M → PROG SKT

M Δ MOV PROG SKT → M

C Δ CMP M ↔ PROG SKT

Shipped from stock. Send check or money order. Allow time for personal checks to clear. Texas residents add 5% sales tax for a total of ---\$250.90

**NORRIS-SIRHC & ASSOC.**  
12623 BARRICKHOLL LANE  
HOUSTON, TEXAS 77024

Circle 281 on inquiry card.

## get GraphicAdd for Sol or VDM GRAPHICS

### HARDWARE

• **GraphicAdd piggyback** PC board mounts on VDM or Sol for bit-mapped graphics 128 x 48  
• **Graphics mode is software selectable**

### Sol SOFTWARE PACKAGE

• **BASICS-GRAPHICS EXTENSION** including powerful PLOT & LABEL STATEMENTS  
• Graphics Driver with BASIC Links  
• **LIFE & ROBOT** animation programs

**GraphicAdd Kit with Sol cassette \$50.**

**MICRO-WARE LTD.**

27 Firstbrooke Road

Toronto CANADA

Mastercharge  
Visa Accepted

M4E 2L2

phone 416-424-1413

Circle 241 on inquiry card.

## !! FREE GIFTS !!

FREE TI 67 with purchase of \$1,000 of TECHNICO systems equipment  
WRITE OR CALL FOR DETAILS  
TI 67 and 59 also available at LOW, LOW prices with no other purchase required.

### TECHNICO 9900 SS 16 BIT COMPUTER

16 bit microP, 32 bit I/O, hardware mult & divide, buffered bus, 20 ma loop, RS 232C, 8 interrupts, fully socketed. Expands up to 64 KB memory. Languages: Assembler, BASIC, SUPER BASIC, (CDBOL, FORTRAN IV available soon.) Super Starter Kit ..... \$299  
Assembled ..... \$399

### TELETYPE TERMINAL MODEL 43

with TTL ..... only \$ 985 lowest prices  
with RS 232 ..... only \$1185 anywhere!

Other Teletype machines also available. Tell us your interests/hoods.

Also: Boards for RS 232, Modem, UART with BAUD RATE generator.

To order: Check, money order, major credit cards. \$3 shipping, NYC residents add 8% tax.

**OWENS ASSOCIATES, DEPT. B**  
147 NORWOOD AVENUE  
STATEN ISLAND, N.Y. 10304

We have no reader inquiry number.  
Please write or call.

Day, evening and weekend calls welcome!

(212) 448-6283

(212) 448-6298

# What's New?

## MASS STORAGE

New 64 K Bit CCD Memory from Texas Instruments



A new 64 K bit charge coupled device (CCD) memory has been announced by Texas Instruments. Designated the TMS3064, the memory is organized externally as 65,536 1 bit words and internally as 16 addressable 4096 bit serial-parallel-serial loops.

A new 2 phase coplanar electrode CCD structure was used in the design of the device. The two clock and the chip enable inputs can be driven by standard MOS level drivers.

All other inputs have 200 mV of DC noise immunity when interfacing with standard TTL logic. No pull up resistors are required. The 3 state output will drive at least two standard series 74, 74S

or 74LS loads without the use of pull up resistors.

The maximum data rate is 5 megabits per second. Maximum access time (at 5 MHz) is 800  $\mu$ s. The TMS3064 has a typical operating power dissipation of 300 milliwatts at 5 MHz and a standby power dissipation of less than 30 milliwatts. The memory comes in a 16 pin ceramic dual in line package with pin rows on .4 inch (1.02 cm) centers. The single piece price is \$195.

For more information, contact Texas Instruments Inc, Inquiry Answering Service, POB 1443, M/S 669 (Attn: TMS3064), Houston TX 77001. ■

Circle 635 on inquiry card.

## Floppy Interface for PCM-12 Computer

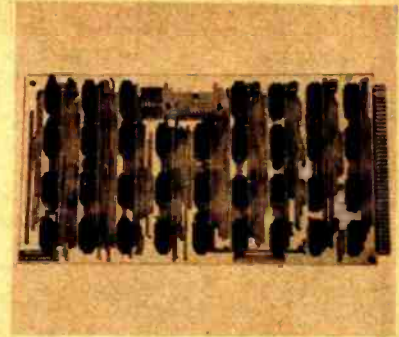

Users of the PDP-8 compatible PCM-12 microcomputer can attach the Data Systems Design Model 210 floppy disk system to their computers through this interface module. The 12440 module enables users to execute all PDP-8 floppy disk diagnostics and makes the PCM-12 compatible with the mass storage operating systems developed for the PDP-8. The PCM-12, built around the Intersil IM6100 microprocessor, can be used as a direct replacement for PDP-8s in many applications. The 12440 interface module sells for \$259 assembled and \$169 in kit form, with volume discounts of 10 to 25 percent, from Pacific Cyber/Metrix Inc, 3120 Crow Canyon Rd, San Ramon CA 94583, (415) 837-5400. ■

Circle 636 on inquiry card.

# ATWOOD ENTERPRISES

## KITS

**\$ 79.95 4K RAM** Available assembled and tested \$89.95.

**\$129.95 4K PROM** Bipolar 512 x 8 Proms 93448/6341.

**\$149.95 8K EPROM** Needs only 4K space 2716.

**\$ 59.95 DIGITAL I/O** 8 parallel ports plus 16 interrupts.

**\$ 99.95 ANALOG IN** 32 inputs, 8 bits, 100 microseconds.

**\$ 49.95 PROM PROGRAMMING** Burns 4. Can copy to 3.

**\$129.95 SERIAL I/O** 7 serial ports, fully software controlled. To 500 baud.

## DID YOU KNOW . . . ANALOG IN

32 channels.

2 separate A to D.

100 microsecond conversion time.

8 bit resolution.

5 volt only.

On board or external reference.

Can be purchased as 16 channel for:

**\$79.95**

## MOTHER BOARD

8 SLOT                      44 PIN BUS  
50 Pin Edge Connector

Mother Board \$20.00 ea  
Connectors    2.50 ea  
Card guides for above \$10.00 per set.

MAKE CHECK OR MONEY ORDER PAYABLE TO:  
**Kathryn Atwood Enterprises**  
**P.O. Box 5203, Orange, CA 92667**

Discounts available at OEM quantities. For orders less than \$25 total, add \$1.25 for shipping. California residents add 6% sales tax. Estimated shipping time 2 days ARO with money order. For checks allow 7 days for check to clear.



## SURPLUS ELECTRONICS



### IBM SELECTRIC® BASED I/O TERMINAL (USED) \$695.00

- Tape Drives • Cable
- Cassette Drives • Wire
- Power Supplies 12V15A, 12V25A, 5V35A Others, • Displays
- Cabinets • XFMRs • Heat Sinks • Printers • Components

Many other items

Write for free catalog  
WORLDWIDE ELECT. INC.  
10 FLAGSTONE DRIVE  
HUDSON, N.H. 03051

Phone orders accepted using VISA  
or MC. Toll Free 1-800-258-1036  
In N.H. 603-885-3705

Circle 395 on inquiry card.

## THE ELF HAS GROWN UP!



### COSMAC 1802 COMPUTER CARDS

Full 65K memory capability. Use standard SS-50 BUS memories. All EF flags, Q, N, and DMA lines are brought out to the BUS. 4K or 8K on board EPROM. (4 X 2708/2716) On board RS232C or TTY interface. Option of 5V or 10V for CDP1802CD or CDP1802D.

#### Other Cards Available

16K RAM memory	8K EPROM memory
(SwTPC & MSI compatible)	
I/O Network boards	Serial & Parallel cards
Expandable Mother boards	
DSD Documentation for 1802 boards	\$ 7.00
All 9" X 5 1/2" cards with edge connectors	\$27.00 ea.
Serial & Parallel interface cards	\$12.00 ea.
Mother boards and I/O Network cards with connectors	\$29.00 ea.

### DIGITAL SERVICE & DESIGN

P. O. Box 741  
Newark, Ohio 43055

Order direct by check, VISA or MASTER CHARGE.  
Ohio residents add 4% sales tax.

Circle 101 on inquiry card.

## PROGRAMMING CONTEST!

-WIN-

- 1<sup>st</sup> PRIZE- FLOPPY DISK SYSTEM OR \$1000 CASH  
2<sup>nd</sup> PRIZE- FLOATING POINT BOARD OR \$400 CASH  
3<sup>rd</sup> PRIZE- AUDIO INTERFACE OR \$200 CASH

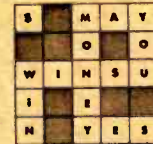

OF COURSE YOU HAVE THE SEARCHING AND SORTING SKILLS ACQUIRED BY EVERY HACK PROGRAMMER SINCE ENIAC! BUT DO YOU HAVE A GUNNING AND CLEVERNESS THAT RANKS YOU WITH CIA CALIBRE CODE CRACKERS? PUT YOUR PERSONAL COMPUTER TO WORK AROUND THE CLOCK SOLVING OUR ARDUOUS WORD PUZZLE IN AN ATTEMPT TO:  
\*\*\* EXPAND YOUR SYSTEM BY WINNING PRIZES \*\*\*

For entry form and official rules send a self addressed stamped envelope to:  
MICRO-PUZZLES Dept. A 7858 Cantaloupe Ave.  
Van Nuys, California 91402

## THE COMPUTER HARDWARE STORE INC.

Dealers for

APPLE II, IMSAI  
VECTOR GRAPHIC  
KIM-1, OAE  
CYBERNEX, JIM PAK

With

ALPHA-1 CASSETTE SYSTEM

16 Bits

ALPHA MICRO  
TECHNICO STARTER SYSTEM

Catalog Available

818 FRANKLIN ST. ALEX. VA.  
703-548-8085

9 WEST CARY ST. RICHMOND, VA.  
804-780-0348

Circle 72 on inquiry card.

### USR-310 ORIGINATE ACOUSTIC COUPLER



Operates With  
Any Standard Telephone

\$139

Also Available.

Direct <sup>1</sup> Connect	Telco <sup>2</sup> DAA Style
\$324	\$185
\$299	\$160

USR-330 Originate/Auto Answer Modem  
USR-320 Auto-Answer Only Modem

(1. F.C.C. Certified Package. Connection to phone lines via standard extension phone jack.)  
(2. Connection to phone lines via CBS-1001F DAA which can be leased from phone company for approx. \$5.00/mo plus installation fee.)

#### INTERFACES:

- USR-310 — RS232C only
  - USR-320 and USR-330 — RS232C and 20mA
- (Specify with order. If both interfaces are required, add \$10 to unit price.)

#### ALL UNITS FEATURE:

- 0-300 Baud Data Rate
- Stand Alone Unit
- Half/Full Duplex
- 90 Day Warranty
- Fully Assembled and Tested
- Optional Annual Maintenance Coverage

Prices include shipping and handling in continental U.S. Illinois Residents add 5% sales tax.

### U.S. ROBOTICS, INC.

Box 5502 / Chicago, Illinois 60680 / (312) 528-9045

Circle 382 on inquiry card.

## ANNOUNCING:

Canada's

HOME COMPUTER CENTRE  
in  
TORONTO

"The One Stop Computer Shop"  
Home — Small Business — Hobbyists

#### SOFTWARE

PET 8 K Version

20 programs on cassette  
just \$49.95

Includes: Music, graph, entry, daytime, monitor,  
and disassembler

Or bought separately, \$12.00 each



HOME COMPUTER CENTRE  
6101 Yonge Street  
Willowdale, Ontario  
CANADA M2M 3W2  
(416) 222-1165

ChargeX and BankAmericard accepted

Circle 171 on inquiry card.

## BASIC COMPUTER SHOP NOW OPEN IN AKRON

Easy Freeway access from  
anywhere in Northeastern Ohio  
Many systems on display with  
applications software up and  
operating.

OPEN TUESDAY  
THROUGH SATURDAY  
11 AM till 7 PM

The Basic Computer Shop  
2671 W. Market Street  
Fairlawn Plaza  
Akron, Ohio 44313  
(216) 867-0808

Circle 29 on inquiry card.



### The "EXTERMINATOR" by VAMP

All New Dual Function Board:  
Serves as an extender card & also  
terminates S-100 bus. Eliminates  
crosstalk, overshoots & noise  
which can scramble data. Occupies  
only a single slot. Fully fused.  
Assembled & Tested.

VTE-100 "Exterminator" \$49.95  
Extender Card only -  
with connector . . . . . \$21.95

Add \$2 Shipping  
6% Calif. Sales Tax.

VAMP Inc.  
Box 29315  
Los Angeles, Calif. 90029

Circle 384 on inquiry card.

## P.E.T. Food

Creative Software offers the following  
programs on cassette tapes for 8K PETs:

HOUSEHOLD FINANCE PARTS I and II	15.00
GAMEPAC #1 -- Five games for the PET	12.00
GAMEPAC #2 -- Five more PET games	12.00
MATH PRACTICE -- Multiplication and division	10.00
SPACE WAR -- Adapted for the PET	10.00

Add 1.00 per program packing and shipping

INTRODUCING a low priced joystick -- plugs right into  
the PET with no modifications or assembly. Complete  
with two programs.

JOYSTICK with MAZE game and SKETCHPAD game . . . 35.00  
Add 2.00 shipping and insurance for JOYSTICK.

EDUCATORS -- we are developing a library of educational  
programs for grades 1 - 12. Tell us your needs.  
Send for more information and list of other programs.

### Creative Software

P.O. Box 4030  
Mountain View, CA 94040

MASTERCARD AND VISA ACCEPTED  
California residents please add 6% sales tax

Circle 79 on inquiry card.

# What's New?

## PUBLICATIONS

### Catalog Describes Test Instruments



This new short form, 12 page color catalog describes a variety of test instruments such as dual and single trace oscilloscopes from 30 to 4 MHz bandwidth, digital multimeters, audio analyzer systems, color bar generators, signal generators, communications testers, counters, bridges and many other instruments. The catalog is free from Leader Instruments Corp, 151 Dupont St, Plainview NY 11803. ■

Circle 619 on inquiry card.

### How to Build a Microwave Oven

This 11 page report, entitled *Thyristor Gating for Microprocessor Applications*, covers the use of the most common thyristors, triacs and silicon controlled rectifiers in microprocessor based systems for appliance and industrial control. A microwave oven application is used as an example. The booklet briefly describes a triac and an SCR and discusses microprocessor control of these devices. Electrical isolation, transient noise problems and circuit malfunction protection are all covered. The report is available free as Bulletin CA-191 from Texas Instruments Inc, Inquiry Answering Service, POB 5012 M/S 308, Dallas TX 75222. ■

Circle 620 on Inquiry card.

### Small Business Systems Brochure

This brochure, entitled *The Merger the Business World Waited For: Data General and Small Business Systems*, describes the new Commercial System CS/40 family, its ANSI standard COBOL and interactive real time features. It is available from Communications Services MS 82310, Data General Corp, Rte 9, Westboro MA 01581, (617) 366-8911. ■

Circle 621 on inquiry card.

### New Creative Computing Catalogue

This 16 page catalogue describes 100 books, British and American magazines, games, T-shirts and other items of interest to the seasoned computer professional as well as the beginning novice. Copies are free from Creative Computing, POB 789-M, Morristown NJ 07960. ■

Circle 622 on inquiry card.

### How to Write a Program You Can Read

The Addison-Wesley Publishing Company has recently published a 151 page book entitled *The Little Book of BASIC Style* by John M Nevison. Anyone who has written and run a computer program is literate in computing; however, becoming fluent takes time and practice. This book concerns itself with writing a well styled BASIC program in order to move on to writing well structured programs in other languages. The book offers 19 rules of style that can reduce time and practice necessary to turn out legible, correct programs. The contents include From Problem Solving to Program Writing, Typing: Elementary Kindness to the Eye, Comment: Clothing the Naked Form, Code: The Naked Form, Examples: The Program at Work and Play, and Beyond BASIC: Larger Programs. The book is \$4.95 from Addison-Wesley Publishing Company Inc, Reading MA 01867, as well as from computer retail outlets. ■

Circle 623 on Inquiry card.

# Electrolabs

PO Box 6721 Stanford

CA. 94305  
415-321-5601

Educational Grade VIDEOTAPE Special: 1/2"x2400' 20 boxes/\$125.00

The "Pro" fully encoded ASCII Keyboard by Cherry. Auto REPEAT feature, 5 special function keys. 300mA/5V. (Shown as mounted in 'The Case', Below) \$119.00, 3/99.00, 10+/89.00

USED SYLVANIA *The Dumb Terminal for Smart People* 12" MONITORS

You Fix: \$24.95  
Working: \$69.95  
Cold Chassis, 25lbs.

80X24 with full 128 char. ASCII UC+LC font with all control characters displayed. 300-19,200 baud RS232. 2nd font addressable from keyboard in you-program-it 2708 for APL, Graphics sets, etc. Plug in monitor I/O connector, 110VAC and you are ready. INCLUDES: 'The Case', Cherry Kbd. A used monitor, ESAT 200A, all options except vector addressable cursor and modem. Bulletproof design and construction. Normally \$675.00 What you always wanted your ADM3 to be:  
SYSTEM "A" \$649.00 10/\$599.00



THE FANTASTIC!

MEMOREX FIVE-FIFTY

- \* Hard and Soft Sectoring
  - \* Single and Dual Density
  - \* Double side configuration as a retrofit at any time.
  - \* 110/220V, 50/60Hz
  - \* Pin for pin compatible with Shugart 800,801,850,851 (50 pin edge connector)
- \$536, 2/499, 5/475, 10/449  
25/425, 100/405  
Double Sided Retrofit \$200



MINIDISKETTES (5.25") 1-9 10-24 25+  
10, 16 or Soft Sector \$4.79 4.65 4.45

STANDARD (8") DISKETTES  
Hard or Soft Sector \$5.99 5.33 4.79

CASSETTES  
R-300 Certified Phillips Type \$5.25 4.99 4.35  
I-150 Certified for audio decks \$4.60 4.30 3.90  
(\*Kansas City\* & SWTP formats)

SURPLUS Muffin type fans \$7.95, Lambda Power Supplies 5V/70A-\$145.00, 35A-\$89.00, 16A-49.00, 12V/7.3A-\$69.00

OUR CATALOGUE Contains IC's, T.I. Sockets (1cent/pin) Advice and much more. It is free.

Shipping and Handling: Surface: \$0.40/lb. Air: \$0.75/lb., 1.00 minimum  
Cal. Tax: 6.5% Insurance: \$0.50 per \$100.00



"The Case" Beautiful and sturdy anodized aluminum case in deep black designed to contain the ESAT 200A, and with a bezel cut out for the Cherry 'Pro' keyboard. (installed as shown above) Choose deep brown, light yellow, or crimson to accent or color code your installation. The only choice for hard-use Institutional and educational applications. \$69.00, 10/ 59.00

# ASM80 1 PASS ASSEMBLER

FOR 8080, 280, & 8085 SYSTEMS

RESIDENT IN A SINGLE 2708 EPROM

FEATURES:

- ASSEMBLES DIRECT FROM KEYBOARD OR FROM SOURCE ANYWHERE IN RAM
- ALLOWS ANY SIZE SYMBOLIC LABELS
- HEX & DECIMAL RADIX
- 8080 INSTR. SET PLUS PSEUDO OPS

STD ORDER FOR POLY-88 565  
(PLUGS INTO EMPTY SOCKET ON CPU BOARD)

SPECIAL ORDER 580  
(SUPPLY, IN HEX, ADDR FOR THE 1K ROM & ADDR FOR A 2K RAM WORKSPACE)

ADVANCED INTERACTIVE SYSTEMS

8216 PICKERING ST.  
PHILA., PA. 19150



Circle 3 on inquiry card.

# 2400 BAUD!

OR  
300 BAUD KCS CASSETTE INTERFACE  
Read and Write Interface Board

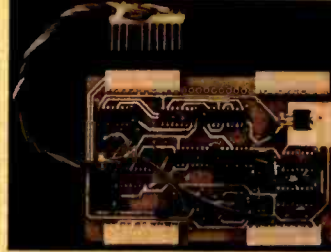

- Works with MIK BUG or SWT BUG
- Loads 8K Basic in < 1 min.
- Plugs into the 6800 I/O Bus

Assembled, Tested, & Documented

Super Low Price: \$59.95 ppd.

Delivery stock to 4 weeks. To order, call or write today. We welcome Mastercharge, Visa, Checks, or C.O.D.'s

Personal Computing Co.

3321 Towerwood Dr. Dallas, Tx. 75234 (214) 620-2776

Circle 301 on inquiry card.

# DISKETTES

VERBATIM for Your DRIVE

MINI Soft Sector 10 Sector 16 Sector **\$3.90** Ea. in boxes of 10

STANDARD Soft or Hard Sector **\$4.10** Ea. in boxes of 10

CP/M 1.4 for Northstar Disk & Horizon **\$145**

PLASTIC BOX for Standard 10 Diskettes **\$3**

HAZELTINE CRT 1500 with cable **\$1000**

Complete 1+2+3 Computer System: Hazeltine 1500, Horizon-2, Centronic 779 **\$5145**

Visa, Master Charge, Cash, C.O.D.

MANCHESTER EQUIPMENT CO., Inc.

30 Midland Ave. • Hicksville, N.Y. 11801

Call Collect: (516) 433-0613

Circle 217 on inquiry card.

## D.C. METRO AREA TYSONS CORNER, VIRGINIA

### THE COMPUTER SYSTEMS STORE

MICROCOMPUTERS & PERIPHERALS  
HOME, SCHOOL & SMALL BUSINESS

FEATURING

Small Business Systems Complete with  
Application Software Including  
Word Processing

DEALERS FOR

Commodore Pet	Lear Siegler
Processor Technology	Diablo
Polymorphic	Texas Instruments
Cromemco	DEC
Southwest Technical	North Star
Micro-Computer	Anderson Jacobson
Business Systems, Inc.	Books & Magazines



1984 Chain Bridge Rd.  
McLean, VA  
703-821-8333

Circle 77 on inquiry card.

## SUPPLIES



- FLOPPY DISKS, MINI OR STANDARD MEMOREX OR 3M
- 3M DATA CARTRIDGES DC300A, DC100A
- 3M DIGITAL CASSETTES
- 3M OR MEMOREX AUDIO CASSETTES, C-60
- 3M DISK CARTRIDGES

WE OFFER:

- COMPETITIVE PRICING
- IMMEDIATE DELIVERIES (Any Quantity)
- UNCONDITIONAL GUARANTEE

BETA BUSINESS SYSTEMS  
8369 VICKERS ST., #G  
SAN DIEGO, CA 92111  
(714) 568-4605

Circle 32 on inquiry card.

## SAVE 5 to 15%

	LIST	SALE PRICE
IMSAI 8080 W/22 SLOTS	\$751	\$649
POLYMORPHICS SYSTEM 2	\$735	\$675
SHUGGART MODEL 800	\$650	\$595

SIMILAR DISCOUNTS ON:

- IMSAI 4K, 16K, 32K RAM, M10 etc.
- POLYMORPHICS VIDEO
- DYNABYTE 16K (ASM) RAM
- MICRODESIGN 2708/2716 EPROM BOARD
- NOVATION ACOUSTIC COUPLERS
- ILS 8K (ASM) RAM
- PROCESSOR APPLICATIONS DMA FLOPPY DISC CONTROLLER (ASM)
- TARBELL FLOPPY DISC CONTROLLER
- TARBELL CASSETTE INTERFACE
- GSI MODEL 110
- PICKLES AND TROUT MOD FOR HITACHI TV
- ALL SWTP PRODUCTS
- APPLE II
- MODEL 43 TELEPRINTER (OCTOBER)
- ADM 3A TERMINAL
- SOROC 10120 TERMINAL
- TELETYPE MODEL 40 300 LNP
- CENTRONICS PRINTER
- REPAIRS IN-HOUSE AT LOW COST
- CUSTOM SOFTWARE & FIRMWARE

General Ledger

\*\* Written in Fortran CP/N Operating System

Runs in 32K 65K Systems

## THE COMPUTER STOP

16919A Hawthorne Blvd  
Lawndale CA 90260  
(213) 371-4010

11:30 to 7:30 Tue-Fri  
11 to 6 Sat  
Closed Sunday/Monday

Circle 76 on inquiry card.

## CATCH-A-PULSE II® LOGIC PROBE



- 10 Nsec pulse response
- Open circuit detection
- Replaceable tip & cord
- High input impedance
- Pulse stretching
- Multi-family

10 Nsec SPEED AT 3.5 to 15V LEVELS  
ONLY \$39.95

Compatible with RTL, DTL, TTL, CMOS, MDS, and Microprocessors using a 3.5 to 15V power supply. Thresholds automatically programmed. Automatic resetting memory. No adjustment required. Visual indication of logic levels, using LEDs to show high, low, bad level or open circuit logic and pulses. Highly sophisticated, shirt-pocket portable (protective tip cap and removable coil cord). Eliminates need for heavy test equipment.

Send \$39.95 A definite savings in time and money.  
(Calif. residents add for engineer and technician.  
6% sales tax) Dealer inquiries welcome

Box 19299, San Diego, CA 92119, (714) 447-1770

Circle 27 on inquiry card.

## S & R Electronics, Inc.

4020 Hempstead Turnpike  
Bethpage, New York 11714  
Phone: (516) 731-8200

- ◆ Finest commercial quality S-100 Bus Memory Boards by Industrial Micro Systems.
- ◆ Fully socketed, assembled, tested and burned in.
- ◆ 6 month warranty on parts and labor.
- ◆ All address & data lines fully buffered.

8k-450 Nanosec.....	\$194.60
8k-250 Nanosec.....	\$214.80
16k-450 Nanosec.....	\$434.60
16k-250 Nanosec.....	\$479.80

BankAmericard and Master Charge accepted. Personal checks will delay shipment until cleared. Complete systems configured to your needs. NY state residents please add sales tax. Call or Write.

Circle 313 on inquiry card.

## COMPUTER BOOKS

by mail from ENTELEK

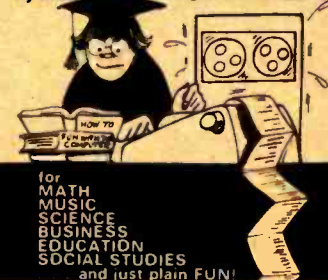

for  
MATH  
MUSIC  
SCIENCE  
BUSINESS  
EDUCATION  
SOCIAL STUDIES  
and just plain FUN!

Send for FREE catalog..

ENTELEK Dept. B  
Ward-Whidden House/The Hill  
Portsmouth, NH 03801 USA

Circle 133 on inquiry card.

## What's New?

### MEMORY

#### Memory Boards for PCM-12 Microcomputer

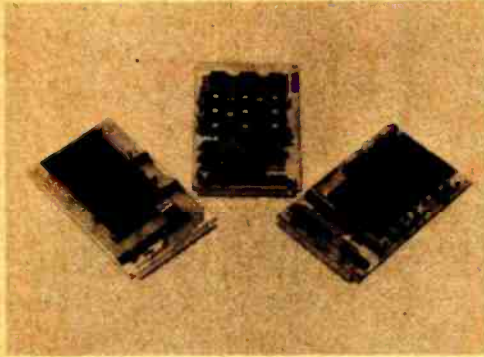

These memory expansion boards are intended for the PCM-12 microcomputer, an Intersil 6100 based system which is software compatible with the

Digital Equipment PDP-8. The 12020A memory module holds 4 K 12 bit words of static memory and is priced at \$289 assembled or \$199 in kit form. The 12160 module holds 1.5 K 12 bit words or erasable programmable read only memory and 512 words of static memory, at a price of \$455 assembled or \$385 in kit form. With the 12040A Memory Extender module, this board can be used in any 4 K field of memory in the PCM-12. The 12210 nonvolatile memory module includes 4 K 12 bit words of CMOS memory with rechargeable batteries sufficient to maintain the contents of memory for 30 days following a power failure. It is priced at \$580 assembled or \$490 in kit form. The boards are available from Pacific Cyber/Metrix Inc, 3120 Crow Canyon Rd, San Ramon CA 94583, (415) 837-5400. ■

Circle 609 on inquiry card.

#### Memory Board for Altair (S-100) Bus



The 8KRS is a new 8 K byte static programmable memory board for the Altair (S-100) bus from Pacific Digital. The 8KRS memory card is organized as two independently addressable 4 K blocks with address selection by a unique jumper and plug system. A write

protect feature for the entire board is provided by an accessible on board toggle switch. In addition write protect logic is provided for either or both 4 K blocks via front panel controls in those systems containing this feature. Memory disable is implemented via the Phantom line and zero, one, or two wait states can be selected using plug and jumper. All bus lines are buffered with one LS TTL load per line.

The board features a solder mask on both sides and a silk screen legend. The 8KRS is fully assembled and tested. The board is priced at \$199.95 for a 450 ns access time version and \$219.95 for the 250 ns version. Contact Pacific Digital, 2555 E Chapman Av, Suite 604, Fullerton CA 92631, (714) 992-5540. ■

Circle 610 on inquiry card.

#### High Density Memory Boards for SBC 80



The SBC 032, 048 and 064 Memory Expansion Boards store 32 K, 48 K, and 64 K bytes of data, respectively. They are built with 16 K bit memory chips and other advanced devices manufactured by Intel. Each board is organized in blocks of 16 K bytes, and the addressing of each block is jumper

selectable. Storage can be dedicated to one computer or shared by several computers, as supported by the Multibus bus structure. To facilitate battery backup, each board contains an auxiliary power bus and memory protect control which prevents read or write accesses during system power down sequences. The auxiliary bus can be connected to a battery supply. Refreshing circuitry is also included on the boards. The memory requires +5, +12 and -5 V supplies, consumes 15 W in normal operation and has a maximum access time of 450 ns. The boards are priced at \$1650 for the SBC 032, \$2300 for the SBC 048, and \$2950 for the SBC 064, with OEM discounts for quantities of ten or more boards, from Intel Corp, 3065 Bowers Av, Santa Clara CA 95051, (408) 349-8027. ■

Circle 611 on inquiry card.

#### Memory Boards for SBC 80/10 Compatible Microcomputers

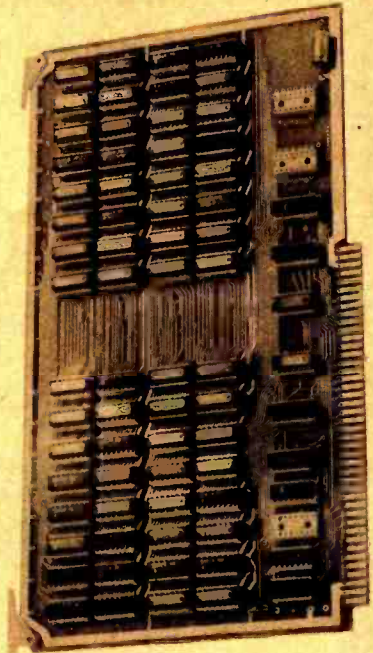

These 4 K and 8 K byte memory boards are compatible with Intel's SBC 80/10 and National's BLC 80/10 microcomputers. They employ low power static memory chips with a cycle time of 630 ns. Typical power consumption for an 8 K board is 9.5 W. Address selection is implemented with jumpers. The 4 K memory board is priced at \$295 and the 8 K board at \$395, from Electronic Solutions Inc, 7969 Engineer Rd, San Diego CA 92111, (714) 292-0242. ■

Circle 612 on inquiry card.

#### Central Data 16 K Programmable Memory Board

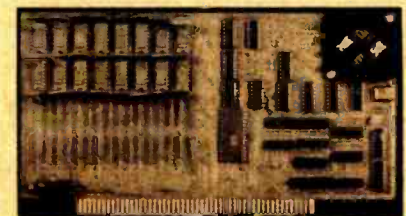

Central Data has announced a new 16 K programmable memory board for Altair (S-100) computers which inserts refresh cycles between your computer's normal memory access cycles. According to the manufacturer it is designed to use less than one half the power of a comparable static programmable memory board. The board comes completely assembled, tested and burned with a one year warrantee for \$289 and can be purchased with full 32 K of programmable memory for \$475 or add on 16 K (\$200) later. Write Central Data, POB 2484, Station A, Champaign IL 61820. ■

Circle 613 on inquiry card.

**Beckian Enterprises All Prime Quality — New Parts Only — Satisfaction Guaranteed**

**EDGE CARD CONNECTORS: GOLD PLATED.**

BODY: Non brittle, solvent resistant, high temperature G. E. Velox. The finest electrical properties available. CONTACTS: Bifurcated Phosphor Bronze, Gold over Nickel.

**ALTAIR TYPE:** Contact Ctrs. .125: Row Spacing, .140

50/100 Dip Solder	\$4.25 ea.	5 pcs.	\$4.00 ea.
-------------------	------------	--------	------------

**INSAI TYPE:** Contact Ctrs. .125: Row Spacing, .250

50/100 Dip Solder	\$4.25 ea.	5 pcs.	\$4.00 ea.
50/100 Wire Wrap (1 Turn)	\$4.25 ea.	5 pcs.	\$4.00 ea.

IMSAI Card Guides (3 Turn) .25 per pair to IMSAI Prices  
Note: Also good for CROMEMCO.

**OTHER CONNECTORS AVAILABLE**

**.100" Contact Ctrs: .140" Row Spacing.**

15/30 Solder Eyelet	\$2.30 ea.	5 pcs.	\$2.10 ea.
22/44 Dip Solder	\$2.75 ea.	5 pcs.	\$2.40 ea.
22/44 Wire Wrap (3 Turn)	\$2.50 ea.	5 pcs.	\$2.20 ea.
40/80 Wire Wrap (3 Turn)	\$4.00 ea.	5 pcs.	\$3.70 ea.

Note: Wire Wrap Spacing is .200" (Row Spacing)

**.156" Contact Ctrs: .140" Row Spacing.**

18/36 Dip Solder	\$2.25 ea.	5 pcs.	\$2.00 ea.
22/44 Dip Solder	\$2.50 ea.	5 pcs.	\$2.25 ea.
15/30 Wire Wrap (3 Turn)	\$2.00 ea.	5 pcs.	\$1.80 ea.

**.156" Contact Ctrs: .200" Row Spacing.**

22/44 Wire Wrap (3 Turns)	\$2.80 ea.	5 pcs.	\$2.50 ea.
36/72 Wire Wrap (3 Turns)	\$4.00 ea.	5 pcs.	\$4.00 ea.
15/30 Dip Solder	\$1.90 ea.	5 pcs.	\$1.65 ea.
18/36 Dip Solder	\$1.95 ea.	5 pcs.	\$1.70 ea.
36/72 Dip Solder	\$4.00 ea.	5 pcs.	\$3.65 ea.
43/86 Dip Solder (6800)	\$4.90 ea.	5 pcs.	\$4.75 ea.

WE ARE YOUR CONNECTOR SPECIALISTS.  
IF YOU DO NOT SEE THE CONNECTOR HERE THAT YOU NEED, PLEASE WRITE US. IN MOST CIRCUMSTANCES, WE CAN SUPPLY IT TO YOU.

**25 PIN DB TYPE SUBMINIATURE CONNECTORS.**

CANNON: Gold Plated. The Best You Can Buy.

DB25P Male Plug	\$2.60 ea.	5 pcs.	\$2.25 ea.
DB25S Female Socket	\$3.70 ea.	5 pcs.	\$3.45 ea.
DB 51212-1 Hood. (Grey)	\$1.00 ea.	5 pcs.	\$0.95 ea.
DB 51226-1A Hood. (Black)	\$1.10 ea.	5 pcs.	\$1.00 ea.
D 20418-2 Hardware Set	\$0.80 ea.	5 pcs.	\$0.75 ea.

**SAVE: BUY A COMPLETE SET.**

Complete Set Includes: 1 pc. DB25P: 1 pc. DB25S:  
1 pc. Hood of your choice Grey or Black.  
1 Set \$6.50 ea. 5 Sets \$6.25 ea.  
Note: For D 20418-2 Hardware Set, add \$0.75 ea.

**2708 - PRIME**

(450 nS)  
\$14.00 ea.

**8080A - PRIME**

\$10.00 ea.

**I.C. SOCKETS: DIP SOLDER**

Low Profile.  
14 pin. & 16 pin. \$0.16 ea.

**HEAT SHRINK TUBING**

1/8" Shrinks to 1/16" I.D. \$0.35 per ft.

**CABLE TIES**

3 1/2" and 5 1/2" \$0.03 ea.

**WRITE FOR LARGER QUANTITY DISCOUNTS  
DEALERS WELCOME**

MINIMUM ORDER: \$10.00: Add \$1.00 for shipping. Orders over \$25.00, we pay the shipping. Calif. Residents add 6% Tax. NO C.O.D. SHIPMENTS.

Order From: **Beckian Enterprises**  
**P.O. Box 3089 Simi, Calif. 93063**

SEND FOR **84-PAGE** PERSONAL COMPUTING **CATALOG**

**MICROS IN STOCK:**

- SWTPC 6800 & 6800/2
- National Semi SC/MP
- Kim 6502
- Intersil 6100
- RCA Cosmac VIP
- Sol-20
- Imsai 8080
- Motorola 6800

Brand New!  
**VIDEO MONITOR**  
9" SANYO VM.4209  
**\$160**

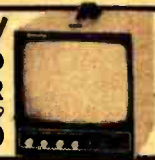

**HIGHLIGHTS FROM GIANT USED GEAR INVENTORY:**

IBM 1050 . . . \$995  
"COMPLETE I/O"  
Conrol, Printer with  
Keyboard, Paper Tape  
I/O, Card Reader



60-KEY  
ASCII  
KEY-  
BOARD  
**\$49**



DATAPOINT  
2200-2000  
**\$395**  
30 CPS Printer  
MECHANISM ONLY . . . \$195



**PLUS:** AMERICAN USED COMPUTER CORPORATION'S Commercial Listings: IBM, DEC, DG, UNIVAC, DATAPRODUCTS, CENTRONICS . . . OVER 170 VENDORS.

Send \$1 to cover First Class Postage/Handling to:

**COMPUTER WAREHOUSE**

**"World's Largest Personal Computing Center"**

Dept. BM5, 584 Commonwealth Ave.  
Boston, Mass. 02215 (617) 261-2700

### New A/V Operating System for 8080

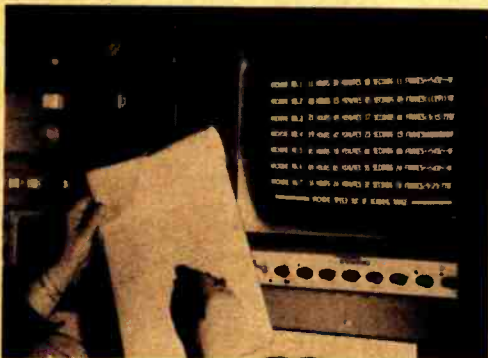

A program designed for the 8080 is now available for time coded indexing for editing, assembling and other applications associated with films and tapes. The display is in everyday language and will handle up to eight sources simultaneously. It is written in 8080 assembler language so no high level language is required. Program resides in 3 K of contiguous memory and is supplied on punched paper tape with a manual complete with source listing. The program requires two parallel input ports and will operate with most video display modules having on board screen memory. It also includes a routine to write a continuous SMPTE (Society of Motion Picture and Television Engineers) record using one output port. Priced at \$39 postpaid, it includes one pre-soldered, tested interface module. Additional modules are \$7.50 each. J S Wiener, 4440 N Kedzie Av, Chicago IL 60625. ■

Circle 614 on inquiry card.

### Nutrition Analysis Program in BASIC

The Nutrivalue programs enable users to analyze recipes, meal plans and daily or weekly menus for their nutritional content including vitamins, minerals, protein and calories. The analysis is computed from the list of ingredients and is printed or displayed in tabular form. Nutrivalue I, which runs in 5 K bytes of memory, refers to ingredients by number and thus does not require BASIC with string handling facilities. It includes nutrient data for 53 ingredients. Nutrivalue II uses string handling to refer to ingredients by name, and can be ordered with databases of 100 or 200 ingredients. Both programs come with complete documentation including a source listing, flowchart and logic description, and instructions for installation, operation and expansion. Paper tapes are optionally available. Prices range from \$10 for the Nutrivalue I listing to \$40 for Nutrivalue II with the 200 item database, from Consultus, POB 86, Arlington MA 02174. ■

Circle 615 on inquiry card.

### Federal Income Tax Program Runs on Many Computers

FIT, a Federal Income Tax program written in BASIC, does the calculations required by Form 1040 and is formatted so that Form 1040 can be printed using a 6 line per inch printer. It is interactive and prints warnings if the user tries to violate IRS rules. FIT runs in 8 K of memory, while an expanded version called FITAB, which handles Schedules A and B, runs in 12 K of memory. Both programs use only elementary features of BASIC in order to be adaptable to as many computers as possible. A source listing and user instructions is \$14.75 for FIT and \$19.60 for FITAB, while specialized versions are offered on North Star diskettes and Tarbell, PET and TRS-80 cassettes for prices ranging from \$16.60 to \$22.60, from Softbyte, 315 Dominion Dr, Newport News VA 23602. ■

Circle 616 on inquiry card.

### Want Software for the Xitan Z-80 Computer?

Technical Design Labs has introduced three new programs for their Xitan Z-80 computer:

- Z-TEL (Text Editing Language) is a utility program designed to provide a powerful set of techniques for editing and manipulating text files. Z-TEL has the capability of moving large blocks of text inside the buffer, avoiding the deletion and manual retyping of text. It provides decision making capabilities and transfer of control (branching) from one part of a command string to another. Additional features include nested iteration and backward search which offers the user more complete ways of editing text. Z-TEL is a relocatable program which requires less than 7 K of memory. It is available on paper tape at \$50, on cassettes at \$40, and will soon be available on disk.

- Micro-SEED, a database management system (DBMS) is an implementation of IDB's SEED CODASYL system. It will support both hierarchical and network data structures, providing both "schema" and "subschema" views. The Micro-SEED package consists of Data Definition Language (DDL) processor that checks and compiles the data definition of a database into a schema table; Data Manipulation Language (DML) subroutines that can be invoked from FORTRAN or assembly language programs to retrieve and update database; and Database initialization program (DBINIT) that prepares a disk area for the loading of the database. A user's

### CP/M on North Star Disk

CP/M, a widely used Altair (S-100) floppy disk operating system is now available for users of North Star Disk and Horizon Computers. Its features include dynamic allocation of diskette storage, relocatability of system in memory, intrinsic commands to save, rename, erase and display directories of files and complementary context editor, assembler and dynamic debugging program. Without any hardware changes, CP/M can be run with all the features available to the users of the system on standard floppy disks. Microsoft FORTRAN-80 and Disk Extended BASIC can also be supplied on 5 1/4 inch diskette to run on the "CP/M on North Star Disk." All the software is fully 8080/Z-80 compatible. Prices are: CP/M on North Star Disk, \$112; FORTRAN-80, \$400; Disk Extended BASIC, \$300. FORTRAN-80 includes relocating assembler and linking loader. The compiler is said to meet the full ANSI specifications except for complex data types. Disk Extended BASIC is a CP/M generation of Altair Disk BASIC 4.1. Contact Lifeboat Associates, 36 W 84th St, New York NY 10024. ■

Circle 617 on inquiry card.

manual is supplied with the Micro-SEED package, along with three months of maintenance for \$1250. The Micro-SEED package requires Technical Design Labs' Z-80 Disk System configuration plus an additional 48 K of Random Access Memory. Various options to Micro-SEED are available to extend the database capabilities to meet the specific requirements of the user.

- FORTRAN IV is said to be a complete ANSI STANDARD FORTRAN IV for the Z-80, also featuring many extensions such as the data types INTEGER\*1, INTEGER\*2, REAL, DOUBLE PRECISION, COMPLEX, LOGICAL and STRING. Other features include named COMMON, EQUIVALENCE, statement functions, full type conversion, a full library of scientific and string functions, linking loader with automatic library search (can link with assembler output), full formatted IO; sequential or direct access IO, hexadecimal constants. The compiler allows control over placement of data and code areas so that the code can run from Read Only Memory. Operationally, this FORTRAN is a disk oriented system which runs in less than 24 K with a disk operating system. Both FDOS IV and CP/M versions are available. This complete package for \$349 includes both the floppy diskette with object code and a user's manual. Additional documentation and support packages are available.

Contact Technical Design Labs, Research Park, Building H, 1101 State Rd, Princeton NJ 08540. ■

Circle 618 on inquiry card.

# cybercom BOARDS

**MB-1** MK-8 Computer RAM (not S-100), 4KX8, uses 2102 type RAMs, PCBD only .....\$22.00

**MB-3** 1702A EROM Board, 4KX8, S-100 switchable address and wait cycles, kit less PROMS.....\$58.00

**MB-4** Basic 4KX8 ram, uses 2102 type rams S-100 buss. PC board .....\$25.95

**MB-6A** Basic 8KX8 ram uses 2102 type rams, S-100 buss. PCBD .....\$25.95

**MB-7** 16KX8, Static RAM uses  $\mu$ P410 Protection, fully buffered. KIT.....\$375.00

**MB-8** 2708 EROM board, S-100, 8KX8 or 16KX8 kit without PROMS .....\$65.00

**MB-9** 4KX8 RAM/PROM Board uses 2112 RAMS or 82S129 PROM kit without RAMs or PROMS .....\$72.00

**10-2** S-100 8 bit parallel I/O port, 2/3 of boards is for kludging. Kit .....\$46.00 PCBD.....\$25.95

**10-4** Two serial I/O ports with full handshaking 20/60 ma current loop: Two parallel I/O ports. Kit .....\$130. PCBD .....\$29.95

**VB-1B** 64 x 16 video board, upper lower case Greek, composite and parallel video with software, S-100. Kit .....\$125.00 PCBD .....\$25.95

Altair Compatible Mother Board, 11 x 11 1/2 x 1/2" Board only .....\$40.00. With 15 connectors .....\$90.00

Extended Board full size. Board only .....\$ 9.00

With connector .....\$13.00

**SP-1** Synthesizer Board S-100

New Low Price.....Kit .....\$135.95

82S23	\$1.50	PRIME DEVICES	
82S123	1.50		
82S114	2.95	8080A	\$12.00
82S115	5.50	8212	3.75
82S126	1.95	8214	6.30
82S129	1.95	8216	3.95
82S130	3.00	8224	5.00
82S131	3.00	8228	6.95
82S136	3.95	8251	9.95
82S141	3.95	8255	9.95
MMI6330	1.50		

# WMC inc. WAMECO INC.

**MEM-1** 8KX8 fully buffered, S-100, uses 2102 type rams. PCBD .....\$25.95

**Mother Board** 12 slot, terminated, S-100, board only .....\$30.95

**CPU-1** 8080A Processor board S-100 with 8 level vector interrupt PCBD .....\$25.95

**RTC-1** Realtime clock board. Two independent interrupts. Software programmable. PCBD .....\$23.95

**EPM-1** 1702A 4K Eprom card PCBD .....\$25.95

10% discount on 10 or more of WAMECO PCBD in any combination.

2102AL-2 Prime 250 NSEC .....\$1.60

2102AL-4 Prime 450 NSEC .....\$1.25

2708 Intel Prime (.5USEC) .....\$15.00

2708 Prime (National) .....\$10.00

1702A-6 AMD Prime .....\$3.50

1702A Intel Nct Prime (2US) .....\$1.50

TMS-6011 Prime .....\$6.95

2501B .....\$1.50 1488N .....\$1.50

2502B .....1.50 1489N .....1.25

2504 .....1.50 4044 .....2.25

2507V .....1.50 8038 .....3.90

2510A .....1.50 5320 .....5.95

2517V .....1.50 5554 .....1.90

2518B .....1.50 5555 .....2.50

2519B .....1.50 5556 .....2.50

2521 .....1.50 5055 .....1.25

2522 .....1.50 5312 .....4.00

2525 .....1.50 MH0025 .....1.50

2527 .....1.50 MH0026 .....1.75

2532V .....1.50 MH0028 .....1.90

2529 .....2.75

2533V .....1.95

# MIKOS PARTS ASSORTMENTS

All piece parts for assembly of Wameco and SSM PCBD's. All Factory Marketed Parts. Order PCBDs right.

**Mikos #1** Parts for MEM-1 PCBD with prime 2102AL-4 450 nsec rams. Less PCBD .....\$103.00

**Mikos #2** Parts for CPU-1 PCBD with prime 8080A 8212's and 8214. Less PCBD .....\$60.00

**Mikos #3** Parts for MEM-1 PCBD with prime 2102AL-2 250 nsec rams. Less PCBD .....\$113.00

**Mikos #4** Parts for QM-1A with super low loss gold plated connectors. Less PCBD .....\$52.00

**Mikos #5** Parts for RTC-1. Less PCBD .....\$40.00

**Mikos #6** Parts for VB-1B less molex connectors and PCBD.....\$62.00

82S06	\$1.00	8T26	\$2.00
82S07	1.00	8T28	2.00
82S50	1.00	8T34	2.50
82S62	1.00	8T37	2.50
82S90	1.00	8T38	2.50
82S91	1.00	8T74	1.50
8T01	2.50	8T80	2.50
8T09	1.25	8T90	2.50
8T10	2.50	8T95	2.30
8T13	2.50	8T96	2.45
8T14	2.50	8T97	1.50
8T20	2.50	8T98	2.00
8T23	3.00	8T110	2.00
8T24	2.50	567	1.50

# MIKOS

419 Portofino Drive  
San Carlos, California 94070

Please send for IC, Xistor and Computer parts list.

Check or money order only. If you are not a regular customer and your order is large please send either a cashier's check or a postal money order, otherwise there will be a delay of two weeks for the check to clear. All items post paid in the U.S. Calif. residents add 6% tax. Money back 30 day guarantee. We cannot accept returned IC's that have been soldered to. Prices subject to change without notice. \$10 minimum order. \$1.00 service charge on orders less than \$10.

## COMMERCIAL GRADE EQUIPMENT - HOBBYIST PRICES!!



TAPE DRIVES



MODEMS AND PHONE COUPLERS



SELECTRIC TERMINALS

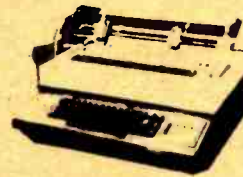

NO RISK ! 7 DAY APPROVAL ON ALL MAIL-ORDERS. FULL REFUND ON RETURNS.

- SELECTRIC I/O TERMINALS** (by GTE/Information Systems). Includes 8080 interface plus software ASCII translation and I/O driver routines. 15" carriage, interchangeable type spheres & carbon/fabric ribbons. Built-in modem optional.
  - MODEL 5541 (IBM correspondence code, 2741 type terminal): \$ 895
  - MODEL 5550 (corres. code, with built-in cassette tape drive for off-line data storage or use as memory typewriter). \$1495
  - MODEL 5560 (ASCII code, with cassette tape drive): \$1495
- IBM SELECTRIC TYPEWRITER** with magnets, switches & magnet driver PCB (from GTE/IS Terminal above). Includes instructions for 8080 printer/driver interface (output only).
  - Typewriter mechanism complete, cleaned & adjusted \$325
  - Aluminum case & Power Supply (+5V,  $\pm$  12V, + 24V) \$ 75
- MODEMS:**
  - Send/receive Bell-103 Type by Vadic Corp. (requires +5V  $\pm$  12V): \$75
  - Also 202-type modems, some with reverse channel transmission and/or auto answer features.
  - Telephone Coupler \$25
- IBM PIN-FEED PLATENS** for 15" Selectrics (13 1/4" pin-to-pin paper)
  - New \$50
- ASCII ENCODED KEYBOARD** w/numeric pad, assembled \$60

- AMPEX MODEL TMX TAPE DRIVES** with built-in NR21 formatter. 800 BPI, 9 track, 12 IPS, 8" reel includes 8 bit CPU controller diagram and 8080 interface instructions. Ideal for microcomputerist who wants back-up mass storage and access to IBM-type systems via standardized 1/2" mag tape. \$750
- POWER SUPPLIES** (from Diablo HyType I Terminal): pot adjustable, OV protect. Inputs: 110 or 230 VAC; Outputs: +5V reg. @ 30A;  $\pm$ 15V reg. @ 7A; -9V @ 5A (adjustable to -12V); unreg. +5V (adj. to + 12V) \$75
- PAPER TAPE READER** (Addmaster 601-1): 150 cps, LED sensors read 5-8 level tapes, bidirectional stepper motor, includes TTL serial interface plus 8080 parallel interface instructions. Requires +5V & +24V: \$90
- INTERDATA Model One 8 Bit MINICOMPUTER**, includes full front panel, 4K core memory (16K addressable), plug-in teletype port, plus software: \$300
- FORMS TRACTORS**, variable width
  - MOORE FORMALINER for 15" IBM Selectrics \$50
- AC LINE FILTERS:**
  - Eliminate AC "hash," power surges and brown-out disturbances from your system with these heavy-duty (10 Amp fused) line filters. Can handle 110V or 220V inputs. \$10

Call or write for details, quantity discounts, order forms. All orders shipped from stock - no back orders, no substitutions. All equipment is shipped insured FOB Palo Alto within 7 days after check clears or COO order is received. M/C & VISA cards accepted.

**PACIFIC OFFICE SYSTEMS, INC.**  
2600 EL CAMINO REAL, SUITE 502  
PALO ALTO, CALIF. 94306  
Tel: (415) 321-3866

90 day warranty against defects in material or workmanship on all used equipment. Full documentation included PLUS interface instructions where indicated. Availability subject to prior sale. Prices may change without notice.









# California Industrial

Post Office Box 3097 B • Torrance, California 90503

## Diablo PRINTER



**PRINTER ONLY!**  
Keyboard models NOT available.

In February, when this advertisement was submitted to the publisher, we were negotiating for the purchase of several hundred used Diablo Terminals.

If we are successful in acquiring these units, they will be available in late April for only \$350.00. FOB Los Angeles.

All terminals were removed from service in operating condition.

**Word processing quality**

## ELECTRONIC ENTERTAINMENT CENTER

**Tennis-Handball Hockey-Smash**

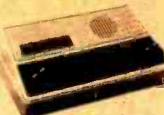

Action-packed color entertainment for the whole family. Adjustable skill level controls allow players of all ages to compete in tennis, hockey and handball. This four game entertainment center turns your television into a video playground.

On screen scoring, live action sound and true component color makes this video center an excellent buy at only \$24.98. Complete with antenna box and AC adapter.

**Color \$24.98**

## HEXADECIMAL KEYBOARD



Maxi-Switch hexadecimal keyboards are designed for microcomputer systems that require 4-bit output in standard hex code.

Each assembly consists of 18 hermetically sealed read switches and TTL "one shot" debounce circuitry.

Reliable low friction acetal resin plungers are credited for the smooth operation and long life of this premium keyboard.

Requires single +5 volt supply.

**\$34.95**

## TELETYPE MODEL 43



New from Teletype, the Model 43 is capable of printing 132 ASCII characters per line. Send and receive data at 10 or 30 char. per second. Keyboard generates all 128 ASCII code combinations. RS-232 interface, same as the popular Model 33. Data sheet sent upon request. Manufacturer suggested price \$1377.00.

**IMMEDIATE DELIVERY \$1219**

TTL model with NOVATION brand Acoustic Modem. \$1419

## CONNECTORS

your choice DB25P male plug & hood or DB25S female

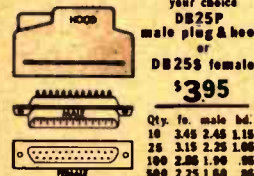

**\$3.95**

Qty. to male hd.

10	3.48	2.48	1.18
25	3.19	2.25	1.06
100	2.85	1.90	.86
500	2.25	1.60	.85
1K	1.97	1.37	.73

## Edge Connectors



**100 PIN IMSAI/ALTAIR**

S-100 • GOLD PLATED • 125" CENTERS

Altair 140 row, solder tail... \$5.98 3/5/16.50  
Imperial 250 row, solder tail... \$4.98 3/5/13.00  
3 Level Wire Wrap 250 row... \$4.98 3/5/13.00

**SPECIALS**

WW same as above without ears \$3.50 3/5/10  
72 (dual 36) WW, 156" centers... \$2.50 3/5/8

## UNIVAC KEYBOARD



The famous Univac 1110 terminal keyboard assembly is now available from California Industrial for only \$24.98. The best computer input device for accountants and mathematicians. The numeric key is placed on the lower three rows to resemble a ten key adding machine. This format allows one-handed numeric data entry.

Original cost was \$395. Used but guaranteed in excellent condition. Complete with documentation.

**\$24.98**

## DIGITAL ALARM CLOCK



Wainut-grained decorator clock features large 7" LED display which is driven by the new National 4443385 alarm clock chip. Precise 24-hour alarm function allows you to awaken at the same time each morning without resetting. Upon reaching the wake-up time, the clock's loudspeaker emits a gentle tone. Touch the snooze button and doze off for an additional 9 minutes of sleep. Clock also functions as a ten-minute elapsed timer. "Alarm Set" indicator, AM-PM display.

**Completely \$19.95**

## Scotch BRAND CASSETTES

10 for \$45.



**DISKETTES**

Please specify IBM 3740 series or 32 sector.

also **MINIDISKS**

## Certified Digital CASSETTES

Want drop a BIT!



**\$5.50**

CALIFORNIA INDUSTRIAL is an Authorized Dealer of Scotch Brand Data Products

## JOYSTICK \$4.50



This joystick features four 100K potentiometers, that vary resistance proportional to the angle of the stick. Perfect for television games, quad stereo and radio controlled aircraft.

**3 for \$10.00**

## Quiet Buss S-100 MOTHER



The Quiet Buss from California Industrial is quality engineered. No short cuts have been taken to produce this mother board. Active termination circuitry prevents noise and crosstalk. Manufactured from extra heavy FR-4 epoxy glass. Features 7 ounce double thickness copper traces.

**18 SLOT \$29.95**

## Verbatim brand DIGITAL CASSETTES? \$98

California Industrial has recently acquired several thousand Verbatim brand digital cassettes, manufactured by Information Terminals Corp.

All cassettes are mechanically perfect and will substantially out-perform any tape of audio quality. Unfortunately, these cassettes have not been certified and therefore must be sold as SECONDS.

Ideal for analog interface systems such as South-west, Tarbell and the Commodore Pet.

## 2102 LOW POWER 450 NS \$1.19

Lowest Price Anywhere

Minimum purchase 1/2 gross

Stocks ready to be shipped by 2102-10 2102-2

## LM741 \$ .09

MEMORY

4020	1.80	1.80	1.80
4020	3.80	3.80	3.80
7100	1.10	1.10	1.10
7107	1.40	1.40	1.40
7110	1.40	1.40	1.40
7111	1.40	1.40	1.40
7112	1.40	1.40	1.40
7113	1.40	1.40	1.40
7114	1.40	1.40	1.40
7115	1.40	1.40	1.40
7116	1.40	1.40	1.40
7117	1.40	1.40	1.40
7118	1.40	1.40	1.40
7119	1.40	1.40	1.40
7120	1.40	1.40	1.40
7121	1.40	1.40	1.40
7122	1.40	1.40	1.40
7123	1.40	1.40	1.40
7124	1.40	1.40	1.40
7125	1.40	1.40	1.40
7126	1.40	1.40	1.40
7127	1.40	1.40	1.40
7128	1.40	1.40	1.40
7129	1.40	1.40	1.40
7130	1.40	1.40	1.40
7131	1.40	1.40	1.40
7132	1.40	1.40	1.40
7133	1.40	1.40	1.40
7134	1.40	1.40	1.40
7135	1.40	1.40	1.40
7136	1.40	1.40	1.40
7137	1.40	1.40	1.40
7138	1.40	1.40	1.40
7139	1.40	1.40	1.40
7140	1.40	1.40	1.40
7141	1.40	1.40	1.40
7142	1.40	1.40	1.40
7143	1.40	1.40	1.40
7144	1.40	1.40	1.40
7145	1.40	1.40	1.40
7146	1.40	1.40	1.40
7147	1.40	1.40	1.40
7148	1.40	1.40	1.40
7149	1.40	1.40	1.40
7150	1.40	1.40	1.40
7151	1.40	1.40	1.40
7152	1.40	1.40	1.40
7153	1.40	1.40	1.40
7154	1.40	1.40	1.40
7155	1.40	1.40	1.40
7156	1.40	1.40	1.40
7157	1.40	1.40	1.40
7158	1.40	1.40	1.40
7159	1.40	1.40	1.40
7160	1.40	1.40	1.40
7161	1.40	1.40	1.40
7162	1.40	1.40	1.40
7163	1.40	1.40	1.40
7164	1.40	1.40	1.40
7165	1.40	1.40	1.40
7166	1.40	1.40	1.40
7167	1.40	1.40	1.40
7168	1.40	1.40	1.40
7169	1.40	1.40	1.40
7170	1.40	1.40	1.40
7171	1.40	1.40	1.40
7172	1.40	1.40	1.40
7173	1.40	1.40	1.40
7174	1.40	1.40	1.40
7175	1.40	1.40	1.40
7176	1.40	1.40	1.40
7177	1.40	1.40	1.40
7178	1.40	1.40	1.40
7179	1.40	1.40	1.40
7180	1.40	1.40	1.40
7181	1.40	1.40	1.40
7182	1.40	1.40	1.40
7183	1.40	1.40	1.40
7184	1.40	1.40	1.40
7185	1.40	1.40	1.40
7186	1.40	1.40	1.40
7187	1.40	1.40	1.40
7188	1.40	1.40	1.40
7189	1.40	1.40	1.40
7190	1.40	1.40	1.40
7191	1.40	1.40	1.40
7192	1.40	1.40	1.40
7193	1.40	1.40	1.40
7194	1.40	1.40	1.40
7195	1.40	1.40	1.40
7196	1.40	1.40	1.40
7197	1.40	1.40	1.40
7198	1.40	1.40	1.40
7199	1.40	1.40	1.40
7200	1.40	1.40	1.40

## FROM ATARI COLOR TELEVISION R.F. MODULATOR \$1395

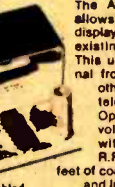

The Atari R.F. Modulator allows computer data to be displayed directly upon your existing television system. This unit converts the signal from the Apple II and other video sources into television frequencies. Operates from single 5 volt supply. Complete with metal case, mating R.F. connector and 15 feet of coax cable. Schematics and instructions included.

**Assembled**

## 5 & 12 volt REGULATORS \$119 ea.

Negative Positive

TO-3 LM220K(L) LM340K(L)  
TO-220 LM320T(L) LM340T(L)

## 50 Conductor RIBBON WIRE TWISTED PAIR \$69

Transistors

2N2222A	.20	.18	.15
2N3055	.89	.65	.55
MJ3055	.70	.75	.65
2N3772	1.50	1.40	1.20
2N3904	.15	.11	.09
2N3906	.15	.11	.09

Diodes

1N4002	100v.	.04	.06	.05
1N4005	600v.	.10	.08	.07
1N4148	signal	.07	.05	.04

LED's

ea.	10	25	100
150	20	35	

**\$15.13**

**Special**

GENERAL INSTRUMENT ASCII Keyboard Encoder AY-53800 Prime but house marked only \$4.95

## Power Adapter

6vdc, 140mA \$1.30  
7vdc, 1.4 A. \$3.50  
9vdc, 18mA 1.10  
16vdc, 300mA 1.90  
12vdc, 600mA 2.90

**9 foot 5-WAY BINDING POSTS \$1.19**

3 for \$1.19  
20 1.00  
100 .20

**SOLDERLESS TERMINALS INSULATED \$1.98**

20 for \$1.98  
100 1.50  
150 2.00

Specify: 22-18; 16-14

**9 foot Heavy duty grounded power cord and mating chassis connectors. \$1.49**

**PANASONIC \$98**

**NiCad \$98**

501 \$98  
500 1.00  
1100 1.00  
50 1.15  
110 1.05

## Speakers \$69

2" Miniature  
Perfect for TV games, alarm systems, speech synthesizer or intercom. 8 ohms 5" Fidelity \$2.98

**TRIMMER POTENTIOMETERS**

2K 5K 10K 50K

5 for \$1.98

20 50 100  
16" 14" 12"

**Thumbwheel switch \$139 ea.**

10 position BCD

10 50  
80,000/10v. 3.36 349 2.95  
4500/50v. 550 135 110  
1000/15v 555 49 45

**MINIATURE SWITCHES**

your choice 10 50 100 1k

\$1.78 \$1.83 \$1.92 \$2.07

specify 1 or 2 pos.

**DISCOUNT Wire Wrap Center**

**IC SOCKETS**

wire wrap	low profile
pin ea. 25 50	ea. 25 50
8	17 18 15
14	37 36 35 18 17 16
16	38 37 36 19 18 17
24	99 93 85 36 35 34
40	100 156 130 83 60 58

**IC HOBBY WRAP-30 wire wrap & strip tool \$5.45**

## 8K UV Erasable MEMORY \$995

450ns

2708

8K UV Erasable MEMORY

Circle 37 on inquiry card.

213172 0800

All merchandise sold by California Industrial is premium grade. Orders are shipped the same day received. PLEASE INCLUDE \$1.00 SHIPPING ON ORDERS UNDER \$15.00. California residents add 8.25% sales tax. Money back guarantee. Visa, MC, Discover, American Express, Foreign orders add 10%.

Circle cards accepted \$20 minimum

### A High End "Appliance" Computer



A self-contained desktop computer with floppy disk drive and systems software is now being marketed by CMC Marketing Corp, 5601 Bintliff, Suite 515, Houston TX 77036. The system, manufactured by TEI Inc, is based on

the Altair (S-100) bus design and includes the following key items:

- 8080 central processor
- 32 K static programmable memory
- disk controller capable of handling three drives
- one Shugart SA-400 minifloppy disk drive
- three parallel eight bit data ports
- three serial data ports with selectable rates from 75 to 9600 bps, RS-232 or TTL levels.
- video display with 24 lines of 80 characters using a 15 inch diagonal high resolution monitor
- ASCII keyboard with eight special function keys for user definitions, and numeric keypad
- CP/M operating system and a 20 K BASIC interpreter

The model MCS-PT112/32 comes fully assembled and tested at a price of \$4795.■

Circle 601 on inquiry card.

### Complete Business System Under \$10,000



The INFO 2000 Business System, said to compete in performance and capability with minicomputer systems selling for \$30,000 or more, employs the Altair (S-100) bus with a Z-80 processor, up to 56 K of user memory, 8 K of read

only memory, a filtered forced air cooling system and a heavy duty power supply. Mass storage is provided with Perci dual flexible disk drives. The printer, which operates at 160 characters per second, provides 132 columns of 95 ASCII upper and lower case alphabetic and graphic characters. The video terminal features dual display intensity, protected fields and 19,200 bps operation. Business application software includes CPA 2000, an accounting package, TEXT 2000, a word processing package, and a disk operating system. Optional software includes a disk BASIC, ANSI FORTRAN, a macro assembler, text editor, debugger and utilities. Planned are the PAY 2000 payroll system and the STOCK 2000 inventory control system. More details are available from INFO 2000 Corp, 20630 S Leapwood Av, Carson CA 90746, (213) 532-1702.■

Circle 600 on inquiry card.

### More Capabilities in This New 6800 System



The MSI 6800 computer system offers additional memory and interfacing capabilities using the SwTPC

(SS-50) bus. Its power supply delivers 20 A at 5 V and 3 A at 15 V to support up to 56 K bytes of memory, using either 110 V 60 Hz or 220 V 50 Hz line current. The motherboard provides 16 slots for full size system boards, and an interface adapter board (with eight slots) must be used to accommodate smaller interface boards. The processor board includes sockets for 4 K bytes of programmable read only memory and separate system and serial data rate clocks. An ACIA is used for the standard serial device interface. The MSIBUG system monitor, supplied in read only memory, offers flexible memory

### Consumer Oriented Computer Comes with Program Library



Aimed at the average consumer, the VideoBrain computer comes with a pre-programmed library of entertainment, education and home management applications on plug in cartridges. Based on the F8 microprocessor, the basic unit includes 4 K bytes of read only memory and 1 K bytes of programmable memory, while the plug in cartridges can contain up to 13 K bytes of read only or programmable memory. The VideoBrain is designed to connect to a home color television set and comes with an AC adapter, TV hookup cord, antenna switch box, two joysticks, and three introductory cartridges. The typewriter style keyboard includes 36 keys capable of producing 71 distinguishable input symbols, while the video output circuits provide sound and picture signals for the TV set. The programs which come with the system in read only memory allow the user to type and edit a message of seven lines and 16 characters per line, change the color of the screen or the size of the letters, examine a clock and calendar, or preset an alarm which will sound on the TV set at the appropriate time and display the stored message. Twelve plug in cartridges are currently offered: Finance, Cash Management, Stock Valuation, Real Estate, Music Teacher, Math Tutor, two Wordwise programs, Gladiator, a game with 384 variations, Blackjack, Checkers and Pinball. Over 50 programs are under development and will be released over the coming year. The VideoBrain will be sold through department stores and specialty electronic stores at a suggested retail price of \$500, and is made by Umtech Inc, 150 S Wolfe Rd, Sunnyvale CA 94086, (408) 737-2680.■

Circle 629 on Inquiry card.

examine and change, register dump and instruction list, and terminal IO control functions. All memory addresses are fully decoded, with only the upper 8 K bytes of the address space used for the system and extended monitors. Full modem control functions are supported on the MSI 6800 interface board. The MSI 6800 measures 20 by 16 by 7 inches and is supplied with 8 K bytes of user memory, the interface adapter and serial interface boards for \$595 in kit form or \$895 assembled and tested, from Midwest Scientific Instruments, 220 W Cedar, Olathe KS 66061.■

Circle 630 on Inquiry card.

New!

# 16K E-PROM CARD

IMAGINE HAVING 16K OF SOFTWARE ON LINE AT ALL TIME!  
S-100 (Imsai/Altair) Buss Compatible!

Uses  
2708's!

## KIT FEATURES:

1. Double sided PC board with solder mask and silk screen and gold plated contact fingers.
  2. Selectable wait states.
  3. All address lines & data lines buffered!
  4. All sockets included.
  5. On card regulators.
- KIT INCLUDES ALL PARTS AND SOCKETS (except 2708's). Add \$25. for assembled and tested.



DEALER INQUIRIES INVITED!

PRICE CUT!

## \$57.50 kit

WAS \$69.95

SPECIAL OFFER:

Our 2708's (450NS) are \$12.95 when purchased with above kit.

Fully Static!

## 8K LOW POWER RAM KIT - \$149.00

S-100 (Imsai/Altair) Buss Compatible!

ADD  
\$20 FOR  
250NS

## KIT FEATURES:

1. Doubled sided PC Board with solder mask and silk screen layout. Gold plated contact fingers.
2. All sockets included.
3. Fully buffered on all address and data lines.
4. Phantom is jumper selectable to pin 87.
5. FOUR 7805 regulators are provided on card.



USES 21L02 RAM'S!

Fully Assembled & Burned In  
\$179.00

Blank PC Board w/ Documentation  
\$29.95

Low Profile Socket Set . . . . 13.50  
Support IC's (TTL & Regulators)  
\$9.75

Bypass CAP's (Disc & Tantalums)  
\$4.50

MOTOROLA QUAD OP - AMP  
MC 3401. PIN FOR PIN SUB.  
FOR POPULAR LM 3900.  
3 FOR \$1

ALARM CLOCK CHIP  
N.S. MM5375AA. Six Digits.  
With full Data New!  
\$1.95 each

FULL WAVE BRIDGE  
4 AMP. 200 PIV.  
69¢ EA. 10 FOR \$5.75

NOT ASSOCIATED WITH DIGITAL  
RESEARCH OF CALIFORNIA. THE  
SUPPLIERS OF CPM SOFTWARE.

MOTOROLA 7805R VOLTAGE REGULATOR  
Same as standard 7805 except 750 MA output.  
TO-220. 5VDC output.  
44c each or 10 for \$3.95

450 NSI 2708 EPROMS 450NS!  
Now full speed! Prime new units from a major U.S. Mfg. 450 N.S.  
Access time. 1K x 8. Equiv. to 4-1702 A's in one package.  
Special Offer: \$12.95 each when  
purchased with our 16K EPROM kit!

\$15.75 ea.

## Z-80 PROGRAMMING MANUAL

By Mostek, The major Z-80 second source. The most detailed explanation ever on the working of the Z-80 CPU CHIPS. At least one full page on each of the 158 Z-80 instructions. A MUST reference manual for any user of the Z-80. 300 pages. Just off the press! A D.R.C. exclusive!  
\$12.95

## CMOS SPECIAL!

CD 4001 - 5 for \$1. CD 4040 - \$1. each  
CD 4011 - 5 for \$1. CD 4042 - 2 for \$1.  
CD 4013 - 3 for \$1. CD 4049 - 3 for \$1.

POWER RECTIFIER #2 Motorola  
Stud Mount. 1N1187.  
35 AMPS. 300 PIV.  
Military Quality! \$1.19 ea. or 4/\$3.50

3 AMP RECTIFIER 4 for Metal Case  
1N4721. Axial Lead. 200 PIV. \$1.00  
HEAVY DUTY!  
House numbered

4K STATIC RAM'S  
2114. The new industry standard. Arranged as 1K x4. Equivalent to 4-21 L02's in 1 package! 18 pin DIP. 2 chips give 1Kx8. 2/\$24. 8/\$85.

OPCOA LED READOUT  
SLA-1. Common Anode.  
.33 inch character size.  
The original high efficiency LED display. 75c ea. or 4 for \$2.50

EXPERIMENTER'S CRYSTAL  
262.144KHZ. This frequency is 2 to the 18th power. Easily divided down to any power of 2, and even to 1HZ. New by CTS-Knight. A \$5. value!  
\$1.25 each

GE Ni-Cad Battery Pack  
3 Cell pack, gives 4 volts at 900MAH. Brand new, factory fresh. Each cell is 2/3 "C" size. \$4.50 /pack. Buy 3 packs (12 volts) for \$10.95. Limited stock!

741C OP AMPS  
Mini Dip. Prime new units. Has computer Mfg's house number.  
12/\$2. 100/\$15.

Disc Capacitors  
.1 MFD 16V. P.C. leads. Most popular value. By Sprague.  
20/\$1.00

HEAVY DUTY!  
Full Wave Bridge  
25AMP 50PIV  
\$1.25

Tantalum Capacitors  
1 MFD. .35V. By Kemet. Axial Lead. Best Value! 10/\$1.

New! REAL TIME  
Computer Clock Chip  
N.S. MM5313. Features BOTH 7 segment and BCD outputs. 28 Pin DIP. \$4.95 with Data

Jumbo Red Leds  
New by G.E. Like MV5024. Number SSL-22.  
6/\$1. 25/\$3.75

MALLORY FILTER CAP  
1500 MFD 16V. UPRIGHT  
3 for \$1 10 for \$2.95

GE 10 AMP Triac  
SC146D. House no. To-220 case. Rated 10 amps 400PIV.  
75c ea. 3/\$2.

LS SERIES TTL  
74LS00 - 33c 74LS74 - 49c  
74LS02 - 35c 74LS90 - 69c  
74LS04 - 35c 74LS138 - 89c  
74LS08 - 35c 74LS154 - 1.49  
74LS10 - 33c 74LS175 - 1.10  
74LS20 - 33c 74LS367 - 75c  
74LS73 - 49c 74LS368 - 85c

## Digital Research Corporation

(OF TEXAS)

P. O. BOX 401247 • GARLAND, TEXAS 75040 • (214) 271-2461

TERMS: Orders under \$15. add 75c. No COD's. We accept VISA, MasterCard and American Express Cards. Money Back Guarantee on all items! Texas Residents add 5% Sales Tax. WE PAY POSTAGE!

## What's New?

### PERIPHERALS

#### Digitizer Input for the SR-52 Calculator



This digitizer, a first in peripherals for programmable calculators, is designed to eliminate manual entry of graphical data to the calculator, saving time, hand calculations and transcription errors. The GP-352 consists of the basic Graf/Pen Model GP-3 sonic digitizer, a Texas Instruments SR-52 calculator, and the necessary interface, cabling, and plug

in connector. The interface simulates the action of pressing keys on the calculator to provide data input. Although the resulting system is somewhat slower than other digitizers, the user gains the advantage of the large library of application programs available from TI. The manufacturer also operates a telephone hotline and will write custom programs for users. The sonic digitizer includes a 14 inch aluminum data tablet, stylus or cursor, and control unit. A moveable NT-Series sensor bar may be used in place of the data tablet, and standard sizes larger than 14 inches are also available. The GP-352 system, which includes the calculator, is priced at \$2850. Customers may provide their own calculators, but the manufacturer will honor the Texas Instruments warranty only for calculators which it supplies. Also planned is the GP-359 for the TI 59 calculator. More information is available from Science Accessories Corp, 970 Kings Highway W, Southport CT 06490, (203) 255-1526. ■

Circle 593 on inquiry card.

#### Text Editing System Fits Inside Selectric



The Transwriter is housed entirely within an unaltered Selectric II correcting typewriter and uses "memory wafers" as its storage media. Each wafer measures about 2 by 1 by 0.2 inches and stores up to 20 typewritten pages. The unit's text editing features include automatic tabbing, stop codes, automatic lift off correction and format stored with the text, and the ability to insert an unlimited amount of new text. The Transwriter, which will be sold through local office machine dealers at a list price of \$2995, is offered by Transaction Data Systems, 2909 Oregon Ct #C-6, Torrance CA 90503, (213) 624-3213. ■

Circle 594 on inquiry card.

#### 40 Column Printer Has Some Intelligence



The SP-302 Digital Printer uses a microprocessor controller to add some "intelligence" to its printing functions. Special features include double width printing, double and triple spacing, and standard tab functions for simple software control from a host device or computer. The device prints alphabetic and numeric information in 40 characters per line at speeds up to 50 characters per second, with multiple copy capability. An RS232 and 20 mA current loop interface are included, with a standard data rate of 110 bps. Other data rates as well as the printing intensity can be set with internal jumpers. The SP-302 is \$575 in single quantities from Syntest Corp, 169 Millham St, Marlboro MA 01752, (617) 481-7827. ■

Circle 595 on inquiry card.

#### Offline Recorder for Silent 700



The Memodyne ANSI Compatible Recording System Model 2146 is a compact write only recorder designed to record offline at remote sites and times to free up a terminal. It accepts serial data at five selectable data rates from 110 to 1200 bps and records in ANSI and ECMA format at 800 bits per inch. It will also accept parallel data. Standard Phillips cassettes are used. The unit will play back directly on a Texas Instruments Silent 700 terminal or on a Memodyne 3765-8 recorder. The Model 2146 includes front panel controls, input and output connectors, power supplies and a carrying case, measures 10.5 by 7 by 11.5 inches and weighs ten pounds. It sells for \$1725 with quantity discounts available from Memodyne Corp, 385 Elliott St, Newton MA 02164, (617) 527-6600. ■

Circle 596 on inquiry card.

#### 2704/2708 EROM Programmer



The EPB-2 Programmer for 2704/2708 EROMs has been developed by F & D Associates, 1210 Toad Rd, New Plymouth OH 45654. The unit uses software for its timing and control functions. All components, including power supply, fit on one 5 inch by 8 inch printed circuit board. The unit was primarily designed for the SwTPC 6800 but, according to the manufacturer, can be easily adapted to the IO ports of other microprocessors. The software provided is written for a SwTPC 6800 microcomputer system using a Teletype or TV type interface operating with the MIKBUG monitor. To facilitate customizing or adapting to other systems, it is written in short subroutines and a source listing is supplied. The bare board, software and documentation is available at \$29 plus \$2.50 shipping. Documentation only is available at \$5 postpaid refundable with order. ■

Circle 608 on inquiry card.

# ELECTRONIC SYSTEMS

P.O. Box 9641 San Jose, CA 95157 (408) 374-5984

FOR CATALOG INCLUDING PARTS LISTS AND SCHEMATICS,  
SEND A SELF ADDRESSED ENVELOPE WITH 24¢ POSTAGE.

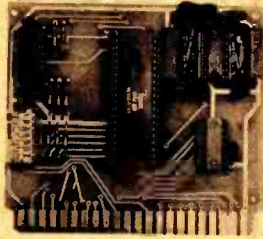

## UART & BAUD RATE GENERATOR\*

Part no. 101

- Converts serial to parallel and parallel to serial
- Low cost on board baud rate generator
- Baud rates: 110, 150, 300, 600, 1200, and 2400
- Low power drain +5 volts and -12 volts required
- TTL compatible
- All characters contain a start bit, 5 to 8 data bits, 1 or 2 stop bits, and either odd or even parity.
- All connections go to a 44 pin gold plated edge connector
- Board only \$12.00; with parts \$35.00

## 8K STATIC RAM

Part no. 300

- 8K Altair bus memory
- Uses 2102 Static memory chips
- Memory protect
- Gold contacts
- Wait states
- On board regulator
- S-100 bus compatible
- Vector input option
- TRI state buffered
- Board only \$22.50; with parts \$160.00



## RS-232/TTL INTERFACE\*



Part no. 232

- Converts TTL to RS-232, and converts RS-232 to TTL
- Two separate circuits
- Requires -12 and +12 volts
- All connections go to a 10 pin gold plated edge connector
- Board only \$4.50; with parts \$7.00

## DC POWER SUPPLY\*



Part no. 6085

- Board supplies a regulated +5 volts at 3 amps., +12, -12, and -5 volts at 1 amp.
- Power required is 8 volts AC at 3 amps., and 24 volts AC C.T. at 1.5 amps.
- Board only \$12.50; with parts \$42.50 excluding transformers

## TIDMA\*

Part no. 112

- Tape Interface Direct Memory Access
- Record and play programs without bootstrap loader (no prom) has FSK encoder/decoder for direct connections to low cost recorder at 1200 baud rate, and direct connections for inputs and outputs to a digital recorder at any baud rate.
- S-100 bus compatible
- Board only \$35.00; with parts \$110.00



Part no. 111

## TAPE INTERFACE\*

- Play and record Kansas City Standard tapes
- Converts a low cost tape recorder to a digital recorder
- Works up to 1200 baud
- Digital in and out are TTL-serial
- Output of board connects to mic. in of recorder
- Earphone of recorder connects to input on board
- Requires +5 volts, low power drain
- Board \$7.60; with parts \$27.50
- No coils



Part no. 107

## RF MODULATOR\*

- Converts video to AM modulated RF, Channels 2 or 3
- Power required is 12 volts AC C.T., or +5 volts DC
- Board \$7.60; with parts \$13.50



## Apple II Serial I/O Interface\*

Part No. 2

- Baud rates up to 30,000
- Plugs into Apple Peripheral connector
- Low-current drain
- RS-232 Input and Output
- SOFTWARE
- Input and Output routine from monitor or BASIC to teletype or other serial printer.
- Program for using an Apple II for a video or an intelligent terminal. Board only - \$15.00; with parts - \$42.00; assembled and tested - \$62.00.



## RS-232/TTY\* INTERFACE NEW

Part no. 600

- Converts RS-232 to 20mA current loop, and 20mA current loop to RS-232
- Two separate circuits
- Requires +12 and -12 volts
- Board only \$4.50, with parts \$7.00

## TELEVISION TYPEWRITER



Part no. 106

- Stand alone TVT
- 32 char/line, 16 lines, modifications for 64 char/line included
- Parallel ASCII (TTL) input
- Video output
- 1K on board memory
- Output for computer controlled cursor
- Auto scroll
- Non-destructive cursor
- Cursor inputs: up, down, left, right, home, EOL, EOS
- Scroll up, down
- Requires +5 volts at 1.5 amps, and -12 volts at 30 mA
- All 7400, TTL chips
- Char. gen. 2513
- Upper case only
- Board only \$39.00; with parts \$145.00

## MODEM\*

Part no. 109

- Type 103
- Full or half duplex
- Works up to 300 baud
- Originate or Answer
- No coils, only low cost components
- TTL input and output-serial
- Connect 8 ohm speaker and crystal mic. directly to board
- Uses XR FSK demodulator
- Requires +5 volts
- Board \$7.60; with parts \$27.50



## To Order:

Mention part number and description. For parts kits add "A" to part number. Shipping paid for orders accompanied by check, money order, or Master Charge, BankAmericard, or VISA number, expiration date and signature. Shipping charges added to C.O.D. orders. California residents add 6.5% for tax. Parts kits include sockets for all ICs, components, and circuit board. Documentation is included with all products. Dealer inquiries invited. 24 Hour Order Line: (408) 374-5984.\* Designed by John Bell.



### Terminal Features Character Level Mapping of Graphics



The 4025 display terminal represents graphics patterns in its internal memory

on a character by character basis rather than as a bit map for all the points on the screen. Each character area, an 8 by 14 dot matrix, can display either an alphanumeric character or the pattern of dots represented by a bit map of that character position. Thus less memory is required to represent a graph that fills only part of the screen, and graphs can be scrolled up the screen along with alphanumeric characters. The 4025's display screen provides 34 lines of 80 characters each, or 640 by 480 addressable points for graphing purposes. 30 pages of 34 lines with an average of 20

characters per line can be stored in the terminal's internal 32 K byte memory. The graphics memory can also be used to define additional character fonts which can be sent to the terminal from the host computer. Commands from the computer to the terminal are represented by "English language" ASCII strings instead of special codes, and may be intermixed with display information. Graphics plotting packages are available for implementation on the host computer. The 4631 copier, which can copy up to 53 80 character lines or graphics patterns on an 8.5 by 11 inch sheet of paper, can be attached to the 4025 display controller. The 4025 is available at a base price of \$3595 with a wide variety of expansion options from Tektronix Inc, POB 500, Beaverton OR 97077, (503) 644-0161. ■

Circle 631 on inquiry card.

### Altair (S-100) General Purpose IO Board

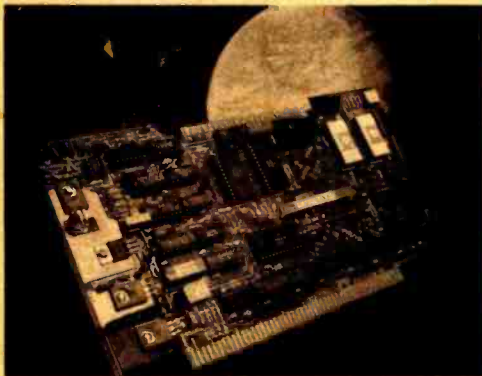

Infinite Incorporated, 1924 Waverly Pl, Melbourne FL 32901, has announced the MFIO-1, an Altair (S-100) compatible general purpose IO board. The

board features a memory or IO mapped parallel input port for keyboard, memory or IO mapped serial IO port with crystal controlled switch selectable data rates of 50 to 19200 bps, jumper selectable RS 232 or 20 mA current loop, memory or IO mapped cassette interface with switch selectable data rates of 300 (Kansas City Standard), 600, 1200 and 2400 bps, 128 bytes of programmable scratchpad memory, and slots for two 2708 erasable read only memories. A 21 command, 2 chip monitor program is available in read only memory. Total power requirement is less than 1 A.

The MFIO-1 is being made available in three versions, assembled and tested (\$282), complete kit (\$234), and bare boards (\$65.95). ■

Circle 632 on inquiry card.

### Smart Minifloppy Controller Uses Intel 8084



The 8201 Micro-Controller provides a general purpose minifloppy disk drive interface for byte oriented computer systems. One version of the 8201 is pin compatible with the Altair (S-100) bus. The interface features an Intel 8048 microcomputer on a chip which supports nine commands from the host computer system. The 8201 will perform soft sector formatting with 16 sectors per track and 128 bytes per sector. It can control up to four drives and will duplicate information from one drive to another upon a single command from the host system. A diagnostic command is also included. The interface is built on a printed circuit board which can be mounted on top of a minifloppy disk drive. The 8201 is priced at \$490 in single quantities with OEM discounts available from Wangco Inc, a division of Perkin-Elmer Data Systems, 5404 Jandy Pl, Los Angeles CA 90066, (213) 390-8081. ■

Circle 633 on inquiry card.

### North Star Now Offers Terminal for Horizon

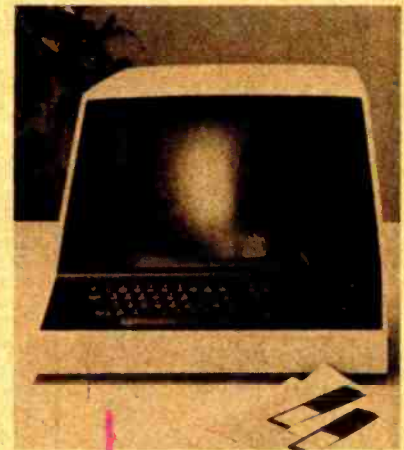

North Star Computers has introduced a 24 line by 80 character video display terminal marketed for use with their Horizon computer.

The CRT terminal is manufactured by Soroc Technology, and can be connected to the Horizon with data rates up to 9600 bps. The terminal is the Soroc model IQ 120 with an addressable cursor, upper and lower case ASCII character set and a numeric key pad. A 90 day limited warranty is honored by Soroc.

The North Star Horizon computer is a disk oriented computer with a 4 MHz Z-80 A processor, 12 slot Altair (S-100) motherboard, 16 K byte programmable memory, one or two Shugart minifloppy disk drives and the serial IO interface which talks to the terminal.

The Soroc IQ 120 Terminal is \$995 fully assembled.

Delivery is quoted as stock to 90 days, and the terminal is available at local North Star dealers. North Star Computers Inc is located at 2547 Ninth St, Berkeley CA 94710. A 16 page catalog detailing North Star products is also available on request. ■

Circle 634 on inquiry card.



**NEW  
ANNOUNCING**

# The EW-2001 A "Smart" VIDEO BOARD KIT At A "Dumb" Price!

**A VIDEO BOARD + A MEMORY BOARD + AN I/O BOARD - ALL IN ONE!**

- STATE OF THE ART TECHNOLOGY USING DEDICATED MICROPROCESSOR I.C.
- NUMBER OF I.C.s REDUCED BY 50% FOR HIGHER RELIABILITY ■ MASTER PIECE OF ENGINEERING ■ FULLY SOFTWARE CONTROLLED

**\$199.95**

Priced at ONLY Basic Software Included

**SPECIAL FEATURES:**

- S-100 bus compatible
- Parallel keyboard port
- On board 4K screen memory (optional)\* relocatable to main computer memory
- Text editing capabilities (software optional)
- Scrolling: up and down through video memory
- Blinking characters
- Reversed video
- Provision for on board ROM
- Provision for onboard scratch pad RAM (256 x 8)
- CRT and video controls fully programmable (European TV)

- Programmable no. of scan lines
  - Underline blinking cursor
  - Cursor controls: up, down, left, right, home, carriage return
  - Composite video
- \*Min. 2K required for operation of this board.

**DISPLAY FEATURES:**

- 128 displayable ASCII characters (upper and lower case alpha-numeric, controls)
- 64 or 32 characters per line (jumper selectable)
- 32 or 16 lines (jumper selectable)
- Screen capacity 2048 or 512
- Character generation: 7 x 11 dot matrix

**OPTIONS:**

- Sockets . . . . . \$10.00
- 2K Static Memory (with Sockets) . . . . . \$45.00
- 4K Static Memory (with Sockets) . . . . . \$90.00
- Complete unit, assembled and tested with 4K Memory . . . . . \$335.00
- Basic software on ROM . . . . . \$20.00
- Text editor on ROM . . . . . \$75.00

**DEALER  
INQUIRIES WELCOMED**

## APPLE II I/O BOARD KIT

Plugs into slot of APPLE II MOTHER BOARD

**FEATURES:**

- 1 8-Bit Parallel Output Port (Expandable to 3 Ports)
- 1 Input Port
- 15mA Output Current Sink or Source
- TTL or CMOS Compatible
- Addressable anywhere in memory output area
- Can be used for peripheral equipment such as printers, floppy discs, cassettes, paper tapes, etc.

**KIT INCLUDES:**

P.C. Board, I.C.'s Sockets and Assembly Manual.

**PRICE:**

1 Input and 1 Output Port **\$49**

1 Input and 3 Output Ports **\$64**

**DEALER  
INQUIRIES INVITED**

**INSTRUCTION MANUAL AND  
SOFTWARE LISTINGS AVAILABLE FOR:**

PR-40 SWTPC Printer . . . . . \$10.00  
Converted Selectric . . . . . \$10.00

**SHIPPING:** Keyboard and Video Board: \$3.50; I/O Board: \$1.00

California residents add 6% sales tax

**ELECTRONICS WAREHOUSE Inc.**

1603 AVIATION BLVD.  
REDONDO BEACH, CA. 90278  
TEL. (213) 376-8005

**WRITE FOR FREE CATALOG**

You are invited to visit our store at the above address

## ASCII 3rd GENERATION \*ONLY KEYBOARD KIT \$68.00



- TTL Logic Circuits
- Power: +5V 275mA
- Upper and Lower Case
- Full ASCII Set (Alpha Numeric, Symbols, Control)
- 7 or 8 Bits Parallel Data
- Optional Serial Output
- Selectable Positive or Negative Strobe, and Strobe Pulse Width
- 'N' Key Roll-Over
- Fully Debounced
- Carriage Return Key
- Repeat Function Key
- Shift Lock, 2 Shift Keys
- 4 User Defineable Keys
- P.C. Board Size: 17-3/16" x 5"

**OPTIONS:**

- Metal Enclosure Painted IBM Blue and White) \$25.00
- 18 Pin Edge Con. \$2.00
- I.C. Sockets \$4.00
- Serial Output (Shift Register) \$2.00
- Upper Case Lock Switch for Capital Letters and Numbers \$2.00

**KIT INCLUDES:** Keyboard, P.C. Board, all required components & assembly manual.

**NOTE:** If you have this 63 Key Teletype Keyboard you can buy the Kit without it for only \$44.95.

# What's New?

## Compac Introduces Programming Aides

### BASE CONVERSION TABLE

BIN	OCT	DEC	HEX	% COMP	BIN	OCT	DEC	HEX	% COMP
0	0	0	00	0	1000000	100	64	40	64
1	1	1	01	1	1000001	101	65	41	65
10	2	2	02	2	1000010	102	66	42	66
11	3	3	03	3	1000011	103	67	43	67
100	4	4	04	4	1000100	104	68	44	68
101	5	5	05	5	1000101	105	69	45	69
110	6	6	06	6	1000110	106	70	46	70
111	7	7	07	7	1000111	107	71	47	71
1000	10	8	08	8	1001000	110	72	48	72
1001	11	9	09	9	1001001	111	73	49	73
1010	12	10	0A	10	1001010	112	74	4A	74
1011	13	11	0B	11	1001011	113	75	4B	75
1100	14	12	0C	12	1001100	114	76	4C	76
1101	15	13	0D	13	1001101	115	77	4D	77
1110	16	14	0E	14	1001110	116	78	4E	78
1111	17	15	0F	15	1001111	117	79	4F	79
10000	20	16	10	16	1010000	120	80	50	80
10001	21	17	11	17	1010001	121	81	51	81
10010	22	18	12	18	1010010	122	82	52	82
10011	23	19	13	19	1010011	123	83	53	83
10100	24	20	14	20	1010100	124	84	54	84
10101	25	21	15	21	1010101	125	85	55	85
10110	26	22	16	22	1010110	126	86	56	86
10111	27	23	17	23	1010111	127	87	57	87
11000	28	24	18	24	1011000	130	88	58	88
11001	29	25	19	25	1011001	131	89	59	89
11010	30	26	1A	26	1011010	132	90	5A	90
11011	31	27	1B	27	1011011	133	91	5B	91
11100	32	28	1C	28	1011100	134	92	5C	92
11101	33	29	1D	29	1011101	135	93	5D	93
11110	34	30	1E	30	1011110	136	94	5E	94
11111	35	31	1F	31	1011111	137	95	5F	95
100000	40	32	20	32	1100000	140	96	60	96
100001	41	33	21	33	1100001	141	97	61	97
100010	42	34	22	34	1100010	142	98	62	98
100011	43	35	23	35	1100011	143	99	63	99
100100	44	36	24	36	1100100	144	100	64	100
100101	45	37	25	37	1100101	145	101	65	101
100110	46	38	26	38	1100110	146	102	66	102
100111	47	39	27	39	1100111	147	103	67	103
101000	48	40	28	40	1101000	150	104	68	104
101001	49	41	29	41	1101001	151	105	69	105
101010	50	42	2A	42	1101010	152	106	6A	106
101011	51	43	2B	43	1101011	153	107	6B	107
101100	52	44	2C	44	1101100	154	108	6C	108
101101	53	45	2D	45	1101101	155	109	6D	109
101110	54	46	2E	46	1101110	156	110	6E	110
101111	55	47	2F	47	1101111	157	111	6F	111
110000	60	48	30	48	1110000	160	112	70	112
110001	61	49	31	49	1110001	161	113	71	113
110010	62	50	32	50	1110010	162	114	72	114
110011	63	51	33	51	1110011	163	115	73	115
110100	64	52	34	52	1110100	164	116	74	116
110101	65	53	35	53	1110101	165	117	75	117
110110	66	54	36	54	1110110	166	118	76	118
110111	67	55	37	55	1110111	167	119	77	119
111000	70	56	38	56	1111000	170	120	78	120
111001	71	57	39	57	1111001	171	121	79	121
111010	72	58	3A	58	1111010	172	122	7A	122
111011	73	59	3B	59	1111011	173	123	7B	123
111100	74	60	3C	60	1111100	174	124	7C	124
111101	75	61	3D	61	1111101	175	125	7D	125
111110	76	62	3E	62	1111110	176	126	7E	126
111111	77	63	3F	63	1111111	177	127	7F	127

The Base Conversion Table enables the programmer to easily look up the representation of decimal numbers 0 to 255 in binary, octal, hexadecimal and two's complement bases. This table is tabulated in easy to read columns and prepunched for notebooks. Retail price is \$2 each or \$5 for three.

Another offering is a Coding Form, designed to be compatible with most microprocessing assembly language formats, which will organize and simplify your source code. Features include columns for labels, op codes and operands of source code; 50 sheets per pad and 25 lines per page; holes predrilled to match 3 ring binders. Retail price is \$2.25 each or \$6 for three.

Dealer inquiries are invited on both of these items. Contact Compac, POB 18470, Cleveland OH 44118. ■

Circle 624 on inquiry card.

## An Index to Published Microcomputer Software

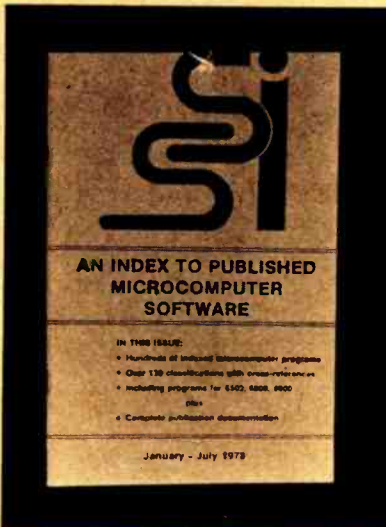

How do you find that program you need today which you think you saw published in some personal computer magazine sometime in the last six months? You can avoid an exhaustive (and exhausting) search with the aid of the *Schreier Software Index*. The *SS/* indexes hundreds of published programs in over 130 categories, complete with cross references. Its sources include ten different personal computer magazines and nine compilations of programs in book form. Programs in BASIC as well as in machine language for the popular microprocessors are indexed so that, for example, finding a random number routine for the 8080 takes but a few seconds. The January to June 1978 issue of the *SS/* is printed on 5.5 by 8.5 inch enameled stock with a textured cover and should withstand repeated use. Future issues will be published biannually. The first issue is \$4.95 from the Schreier Software Index, 4327 E Grove St, Phoenix AZ 85040. ■

Circle 625 on inquiry card.

## Better Bug Trap

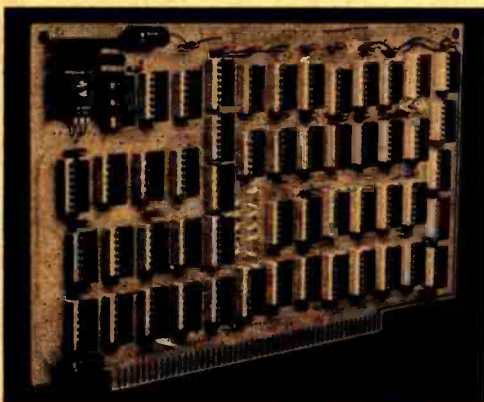

The Better Bug Trap is an Altair (S-100) bus compatible board providing functions for software debugging and real time processing. Four hardware breakpoints anywhere in memory detect all memory accesses, not just instruction fetches. Real time functions include time of day clock, interval timer, and watchdog timer. The Better Bug Trap generates its own interrupts and services them with a CALL instruction to a subroutine anywhere in memory. All functions, timing, breakpoints and subroutine addresses are set using software. Documentation includes a hardware manual with schematics, a software manual, and a software package for setting the board's functions.

The Better Bug Trap is assembled,

## Catalog Describes Microcomputer Boards

This six page, 2 color brochure describes a broad line of microcomputer boards, printed circuit boards and off the shelf designer breadboards. Featured products include a 32 K byte static memory board, a general purpose board and a wire wrap board for the Altair (S-100) bus. The catalog also describes the technical capabilities of the manufacturing firm. Copies are free from Artec Electronics Inc, 605 Old County Rd, San Carlos CA 94070. ■

Circle 627 on inquiry card.

## Stimulating Programs



*Stimulating Simulations* is a compilation of ten original simulation game programs in BASIC, designed both for entertainment and for self-education in programming concepts. It was written by Dr C William Engel, who is professor of mathematics education at the University of South Florida. The programs, such as Diamond Thief, Lost Treasure, Forest Fire and Space Flight, are written to be intriguing, yet comparatively easy to understand and modify. Each program comes with a complete source listing, sample run, user instructions, flowcharts, variables list and suggestions for major and minor modifications and improvements. The narrative text and illustrations serve to heighten the entertainment value of each game. The programs are written in MITS 8 K BASIC Version 3.2, and should be adaptable to similar BASICs. Special versions of the programs for the Commodore PET and Radio Shack TRS-80 computers are also available on cassette. The book alone is \$5 per copy from Engel Enterprises, POB 16612, Tampa FL 33687, (813) 988-3142, while the PET or TRS-80 cassette alone is \$9.95, or \$14.95 together with the book, from Personal Software, POB 136, Cambridge MA 02138, (617) 783-0694. ■

Circle 628 on inquiry card.

tested, and delivered from stock for \$180. A partial kit consisting of printed circuit board, voltage regulator, heat sink, and complete documentation is available for \$45. A set of 52 integrated circuit sockets is \$12. Contact Micronics Inc, POB 12545, Raleigh NC 27605. ■

Circle 626 on inquiry card.



## SOCKET JUMPERS

Mates with two rows of .025" sq. or dia. posts on patterns of 100 centers, and shielded receptacles. Probe access holes in back. Choice of 6" or 18" length.

Part No.	No. of Contacts	Length	Price
924003-18R	26	18"	\$ 5.38 ea.
924003-06R	26	6"	4.78 ea.
924005-18R	40	18"	8.27 ea.
924005-06R	40	6"	7.33 ea.
924006-18R	50	18"	10.31 ea.
924006-06R	50	6"	9.15 ea.

## JUMPER HEADERS

Solder to PC boards for instant plug-in access via socket-connecter jumpers. .025" sq. posts. Choice of straight or right angle.

Part No.	No. of Posts	Angle	Price
923863-R	26	straight	\$1.28 ea.
923873-R	26	right angle	1.52 ea.
923865-R	40	straight	1.94 ea.
923875-R	40	right angle	2.30 ea.
923866-R	50	straight	2.36 ea.
923876-R	50	right angle	2.82 ea.

## INTRA-CONNECTOR

Provides both straight and right angle functions. Mates with standard .10" x .10" dual row connectors (i.e. 3M, Ansley, etc.) Permits quick testing of inaccessible lines.

Part No.: 922576-26 No. of contacts: 26 Price \$6.90 ea.

## INTRA-SWITCH

Permits instant line-by-line switching for diagnostic or QA testing. Switches actuated with pencil or probe tip. Mates with standard .10" x .10" dual-row connectors. Low profile design. Switch buttons recessed to eliminate accidental switching.

Part No.: IS-26 No. of contacts: 26 Price \$13.90 ea.

### CRYSTALS

THESE FREQUENCIES ONLY

Part No.	Frequency	Case/Style	Price
CY1A	1.000 MHz	HC33/U	\$5.95
CY2A	2.000 MHz	HC33/U	\$5.95
CY2 D1	2.010 MHz	HC33/U	\$ 9.90
CY3A	4.000 MHz	HC18/U	\$4.95
CY7A	5.000 MHz	HC18/U	\$4.95
CY12A	10.000 MHz	HC18/U	\$4.95
CY14A	14.318 MHz	HC18/U	\$4.95
CY19A	18.000 MHz	HC18/U	\$4.95
CY22A	20.000 MHz	HC18/U	\$4.95
CY30B	32.000 MHz	HC18/U	\$4.95

## CONNECTORS PRINTED CIRCUIT EDGE-CARD

156 Spacing-Tin-Double Read-Out

Bifurcated Contacts	Fins	054 to 070 P.C. Cards	Price
15/30	PINS (Solder Eyelet)		\$1.95
18/36	PINS (Solder Eyelet)		\$2.49
22/44	PINS (Solder Eyelet)		\$2.95
50/100A (100 Spacing)	PINS (Wire Wrap)		\$6.95
	25 PIN-D SUBMINATURE (RS232)		
DB25P	PLUG		\$3.25
DB25S	SOCKET		\$4.95
DB51226-1	COVER FOR 25S/25P		\$1.75

## LOTS OF POTS

Untested 3/4" square Spectrol Trimpots  
Single-Turn Printed Circuit Potentiometers

GB134	3 ea. of 10-20-25-50	- 24 pcs.	\$2.95
GB135	3 ea. of 1K-2K-2.5K-5K	- 24 pcs.	\$2.95
GB136	3 ea. of 10K-20K-25K-50K	- 24 pcs.	\$2.95
GB137	3 ea. of 100K-200K-250K-500K	- 24 pcs.	\$2.95

(Values subject to substitution within each group.)  
EXTRA SAVINGS! Buy all 3 (GB134, 135 & 136) for only \$7.49

## SWITCHES

Part No.	Switch Type	Position	Price
JMT121	SPDT	on-off-on	\$1.95 \$1.43
JMT123	SPDT	on-none-on	1.65 1.21
JMT221	DPDT	on-off-on	2.55 1.87
JMT223	DPDT	on-none-on	2.15 1.58
MPC121	SPDT	on-off-on	\$2.05 \$1.53
MPC123	SPDT	on-none-on	1.75 1.31
MPC221	DPDT	on-off-on	2.65 1.97
MPC223	DPDT	on-none-on	2.25 1.68

Part No.	Switch Type	Position	Price
PB123	SPDT	maintained	1.95 1.47
PB126	SPDT	momentary	1.95 1.47

Part No.	Switch Type	Position	Price
MS102	DPST	momentary open	35 30
MS103	SPST	momentary closed	35 30

Part No.	Switch Type	Position	Price
206-4	8 pin dip	4 switch	1.75 1.65
206-7	14 pin dip	7 switch	1.95 1.85
206-8	16 pin dip	8 switch	2.25 2.15

## 1/16 VECTOR BOARD

Part No.	Material	Dimensions	Price
84P44 062XJXP	PHENOLIC	4.50 x 6.50	1.72 1.54
169P44 082XJXP	PHENOLIC	4.50 x 17.00	3.65 3.32
84P44 062WE	EPOXY	4.50 x 6.50	2.07 1.86
84P44 062WE	GLASS	4.50 x 8.50	2.56 2.31
169P44 062WE	GLASS	4.50 x 17.00	5.04 4.53
169P44 062WE	GLASS	8.50 x 17.00	9.23 8.26
169P44 062WEC1	EPOXY GLASS COPPER CLAD	4.50 x 17.00	6.80 6.12

## INSTRUMENT/CLOCK CASE

Injection molded unit. Complete with red bezel. 4 1/2" x 4" x 1-9/16"

**\$3.49**

## MICROPROCESSOR COMPONENTS

Part No.	Description	Price	Part No.	Description	Price
8080A	CPU	\$10.95	Z80	CPU	\$24.95
8212	8 Bit Input/Output	4.95	CDP1802	CPU	19.95
8214	Priority Interrupt Control	7.95	MC6800	8 Bit MPU	19.95
8216	BI-Directional Bus Driver	4.95	MC6810A	128 x 8 Static RAM	5.95
8224	Clock Generator/Driver	5.95	MC6820	Periph. Interface Adapter	7.95
8228	System Controller Bus Driver	5.95	MC6830A	1024 x 8 Bit ROM	14.95

### SPECIAL REQUESTED ITEMS

FCM3617	\$5.00	11C90	18.95	7205	19.95	9368	9.95	CLOCK CHIPS	MM5309	\$9.95
AY-3-8500-1	7.50	4N33	3.95	ICM7045	24.95	LD110/111	25.00	19.95	MM5311	4.95
AY-5-9100	14.95	8720	7.50	ICM7207	7.50	50190	11.95	MM5314	4.95	
AY-5-9500	14.95	8731	1.50	ICM7208	18.95	MC3081P	3.50	MM5316	6.95	
AY-5-9500	4.95	HD0165	7.95	ICM7209	7.50	MC4018 (74418)	7.95	MM5318	9.95	
AY-5-2378	14.95	MCM6671	13.50	MKS0240	15.50	MC1408L7	4.50	MM5369	2.95	
9374	1.50	MCM6574	13.50	DS8026CH	3.75	MC1408L8	5.75	MM5841	9.95	
625119	19.95	MCM6575	13.50	TIL308	10.50	74C922	9.95	74CT001	5.95	

## PARATRONICS

Featured on February's Front Cover of Popular Electronics

### Logic Analyzer Kit Model 100A \$229.00/kit

Model 100A Model 10

- Analyzes any type of digital system
- Checks data rates in excess of 8 million words per second
- Trouble shoot TTL, CMOS, DTL, RTL, Schottky and MOS families
- Displays 16 logic states up to 8 digits wide
- See ones and zeros displayed on your CRT, octal or hexadecimal format
- Tests circuits under actual operating conditions
- Easy to assemble — comes with step-by-step construction manual which includes 80 pages on logic analyzer operation. (Model 100A Manual - \$4.95)

Some applications are:

- Troubleshooting microprocessor address, instruction, and data flow
- Examine contents of ROMS
- Tracing operation of control logic
- Checking counter and shift register operation
- Monitoring I/O sequences
- Verifying proper system operations during testing

### PARATRONICS TRIGGER EXPANDER - Model 10

Adds 16 additional bits. Provides digital delay and qualification of input clock and 24-bit trigger word. — Connects direct to Model 100A for integrated unit.

Model 10 Kit - \$229.00 Baseplate — \$9.95 Model 10 Manual — \$4.95

### 3 1/2-Digit Portable DMM

100 MHz 8-Digit Counter

- 20 Hz-100 MHz Range
- 8 LED Display
- Crystal-controlled timebase
- Fully Automatic
- Portable — completely self-contained
- Size — 1.75" x 7.38" x 8.63"

Accessories:

- AC Adapter BC-28 Rechargeable Batteries BP-26 Carrying Case LC-28
- Price: \$9.00, 20.00, 7.50

Model 2800 \$99.95

Comes with test leads, operating manual and spare fuse

### CONTINENTAL SPECIALTIES

PROTO BOARD 6 \$15.95 (6" long X 4" wide)

PB100 - 4.5" x 6"	\$ 9.95
PB101 - 5.8" x 4.5"	29.95
PB102 - 7" x 4.5"	39.95
PB103 - 9" x 6"	59.95
PB104 - 9.5" x 8"	79.95
PB203 - 9.75 x 6 1/2 x 2 1/2	80.00
PB203A - 9.75 x 6 1/2 x 2 1/2	129.95

LOGIC MONITOR for DTL, HTL, TTL or CMOS Devices \$74.95

### QT PROTO STRIPS

UT type	#holes	price
QT-595	590	12.50
QT-598	bus strip	2.50
QT-475	bus strip	10.00
QT-478	bus strip	2.25
QT-355	350	4.50
QT-358	bus strip	2.00
QT-185	180	4.75
QT-125	120	3.75
QT-85	80	3.25
QT-75	70	3.00

Experimenter 300 \$ 9.95  
Experimenter 600 \$10.95

\$5.00 Minimum Order — U.S. Funds Only  
California Residents — Add 6% Sales Tax  
Spec Sheets - 25¢ — Send \$5 Stamp for 1978 Catalog  
Dealer Information Available

## James ELECTRONICS

1021-A HOWARD AVE., SAN CARLOS, CA. 94070  
PHONE ORDERS WELCOME — (415) 592-8097  
Advertised Prices Good Thru May

1978A CATALOG NOW AVAILABLE

## The Incredible "Pennywhistle 103"

**\$129.95 Kit Only**

The Pennywhistle 103 is capable of recording data to and from audio tape without critical speed requirements for the recorder and it is able to communicate directly with another modern and familiar telephone "humming" and communications for the deaf. In addition, it is free of critical adjustments and is built with non-precision, readily available parts.

Data Transmission Method: Frequency Shift Keying, full-duplex (half-duplex selectable)

Maximum Data Rate: 300 Baud

Data Format: Asynchronous Serial (return to mark level required between each character)

Receive Channel Frequencies: .2025 Hz for space; 2225 Hz for mark

Transmit Channel Frequencies: Switch selectable: Low (normal) = 1070 space, 1270 mark; High = 025 space, 2225 mark

Receive Sensitivity: -48 dbm, accurately coupled

Transmit Level: -15 dbm nominal, adjustable from -8 dbm to -30 dbm

Receive Frequency Tolerance: Frequency reference automatically adjusts to allow for operation between 1800 Hz and 2400 Hz

Digital Data Interface: EIA RS-232C or 20 mA current loop (receiver is optoisolated and non-polar)

Power Requirements: 120 VAC, single phase, 10 Watts

Physical: All components mount on a single 5" by 9" printed circuit board. All components included.

Requires a VOM, Audio Oscillator, Frequency Counter and/or Oscilloscope to align.

## The Original the 3rd Hand \$9.95 each

Leaves two hands free for working

- Clamps on edge of bench, table or work bench
- Position board on angle or flat position for soldering or clipping
- Sturdy, aluminum construction for hobbyist, manufacturer or school rooms

## DIGITAL STOPWATCH

- Bright 6 Digit LED Display
- Times to 99 minutes: 59:59 seconds
- Crystal Controlled Time Base
- Three Stopwatches in One
- Times Single Event — Split & Taylor
- Size 4.5" x 2.15" x .90" (4 1/2 ounces)
- Uses 3 Penlite Cells

Kit — \$39.95  
Assembled — \$49.95  
Heavy Duty Carry Case \$5.95

Stop Watch Chip Only (7205) \$19.95

## 3 1/2 DIGIT DPM KIT

Model KB500 DPM Kit \$49.00  
Model KB503 5V Power Kit \$17.50

- New Bipolar Unit
- Auto Zeroing
- 5" LED
- Auto Polarity
- Low Power
- Single IC Unit

## JE700 CLOCK

The JE700 is a low cost digital clock, but is a very high quality unit. The unit features a unimatched walnut case with dimensions of 6" x 2 1/2" x 1 1/2". It utilizes a MAN72 high brightness readout, and the MM5314 chip.

12 or 24 Hour  
KIT ONLY \$16.95

## HEXADECIMAL ENCODER 19-KEY PAD

- 1-0
- ABCDEF
- Shift Key
- 2 Optional Keys

\$10.95 each

## New 63 KEY KEYBOARD \$29.95 IN STOCK

This keyboard features 63 unimatched SPST keys, unattached to any kind of P.C.B. A very solid molded plastic 13" x 4 1/2" base suits most applications.

Model AY-52378 Encoder Chip (encodes 16 Keys) \$7.95 ea.  
Encoder Chip (encodes 68 Keys) \$14.95 ea.

## JE803 PROBE

The Logic Probe is a unit which is for the most part indispensable in trouble shooting logic families TTL, DTL, RTL, CMOS. It derives the power it needs to operate directly off of the circuit under test, drawing a scant 10 mA max. It uses a MAN72 readout to indicate any of the following states by these symbols: (H) - 1 (LOW) - 0 (PULSE) - P. The Probe can detect high frequency pulses to 45 MHz. It can be used at MOS levels or circuit damage will result.

\$9.95 Per Kit  
printed circuit board

## TPL 5V 1A Supply

This is a standard TTL power supply using the well known LM309K regulator IC to provide a solid 1 AMP of current at 5 volts. We try to make things easy for you by providing everything you need in one package, including the hardware for only

JE225 \$9.95 Per Kit



## What's New?

### Precision Drive DC Motor



The MBG-150, a new DC motor and generator for precision drive applications such as tape cassette decks and medical and laboratory instruments, provides 1/30 horsepower, speed ranges of 1000 to 1, and load regulation of better than 1 percent. An optional feedback control system gives the unit more precise speed control and load regulation than is possible using variable voltage or silicon controlled rectifier approaches. Each rotor is dynamically balanced and test run for 24 hours prior to shipment. Typical MBG-150 design includes 24 VDC input with a speed of 6750 revolutions per minute at 5 oz-in continuous rated torque. Other designs are available as well from Dynetic Systems Inc, 19128 Industrial Blvd, Elk River MN 55330, (612) 441-4300. ■

Circle 602 on inquiry card.

### Straighten Pins and Insert Chips with This Tool



The INS-1416 DIP Insertion Tool inserts 14 and 16 pin dual in line packages into sockets or predrilled boards. A pin straightener is built into the handle, with an automatic ejector from the straightening saddle. The insertion mechanism is designed to ensure accuracy, and the narrow profile of the handle permits it to be used on densely spaced circuit boards. The INS-1416 is \$3.49 from OK Machine and Tool Corp, 3455 Conner St, Bronx NY 10475, (212) 994-6600. ■

Circle 603 on inquiry card.

### Thinking Aids for Logic Diagramming

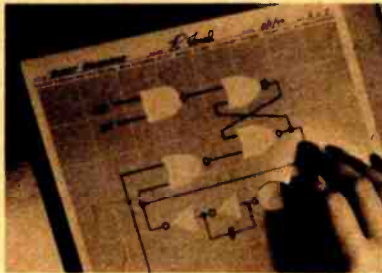

This kit lets you construct logic diagrams by pressing plastic symbols on a special worksheet. Changes can be made simply by peeling off a symbol and moving it. The symbols stick to the worksheet electrostatically and require no adhesives. Following the latest ANSI standard, the symbols include ands, ors, amplifiers or buffers, delays, circles, blocks and rectangles. A starter kit (SKL-075), which comes with a padded vinyl folder, a set of ten 8.5 by 14 inch worksheets, a pad of 537 precut symbols, and a custom pen and eraser, is \$10 plus \$1.50 shipping from Fickled Thinking Aids, POB 6064, 990-M Enterprise St, Orange CA 92667, (714) 639-9061. ■

Circle 604 on inquiry card.

### Second Generation 16 K Bit Memory Chip

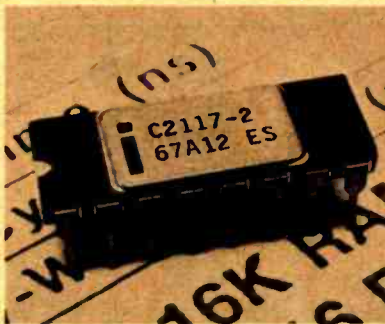

The 2117 memory chip employs a fabrication process which has been used for nearly three years to produce the 2116 and other high density memory components. Its access time is as low as 150 ns. Power dissipation and maximum supply current have also been reduced, and the 2117 provides a 10% tolerance on all three power supplies, +5, +12 and -5 V. A new latched output mode can be used to provide hidden refresh, which does not disturb the chip's data output state. Prices in quantities of 100 or more range from \$55 for the highest speed 2117-2 to \$39 for the 2117-4 with 250 ns maximum access time, from Intel Corp, 3065 Bowers Av, Santa Clara CA 95051, (408) 249-8027. ■

Circle 605 on inquiry card.

### Now Standard Wire Can Be Slit and Wrapped



The new P184 Slit-n-Wrap bit makes it possible to wire wrap connections with standard 28 gauge Tefzel insulated wire without measuring, cutting and stripping. Previously only polyurethane-nylon wire could be slit and wrapped. The new tool can be used to "daisy chain" interconnections, avoiding the need to measure and cut the wire between each pair of wire wrap posts and requiring only about five seconds per post. A standard connection of seven wrapped turns has a resistance of only .003 ohms between post and wire and requires a force of more than ten pounds to pull it off. The Tefzel wire is available in 50 foot spools with red, green, white or yellow insulation, at a unit price of \$4.18 per package of two 50 foot spools. The bit may be used with a Model P184-4T1 pistol grip wrapper with a 117 VAC motor (\$89) or the Model P184-4T nickel cadmium battery powered pencil type unit (\$80). A manual wrapper, the Model P184 (\$29.50) is also available, from Vector Electronic Co Inc, 12460 Gladstone Av, Sylmar CA 91342, (213) 365-9661. ■

Circle 606 on inquiry card.

### Printing and Magnetic Media Supplies Offered in Small Quantities



Hobbyists can purchase small quantities of printing wheels, ribbons, diskettes, cassettes and other printing and magnetic recording supplies using Master Charge and VISA cards through this newly formed mail order source. The product lines offered include 3M Scotch and ITC Verbatim brand magnetic media, Qume and Diablo cartridges and printwheels, and IBM Selectric II compatible ribbons and typing elements. A catalog and price list may be obtained by writing Printcraft Systems Inc, Dept MO, 11-17 Beach St, New York NY 10013, (212) 966-0001. ■

Circle 607 on inquiry card.

## S-100 32K STATIC MEMORY BOARD

### features:

1. FULLY STATIC - usable with all DMA devices.
2. BUFFERED - with noise suppressed control inputs.
3. MODULAR - populated in 1k increments.
4. RELIABLE - single source +5V regulator
5. PROM COMPATIBLE - monitors available on request.

AVAILABLE EITHER IN COMPLETE KITS  
OR ALREADY ASSEMBLED UNITS WHICH  
HAVE BEEN FULLY TESTED AND BURNED IN.

BARE BOARD \$38<sup>00</sup>

	KIT	ASSEMBLED
8K	\$270 <sup>00</sup>	\$296 <sup>00</sup>
16K	\$440 <sup>00</sup>	\$465 <sup>00</sup>
24K	\$580 <sup>00</sup>	\$612 <sup>00</sup>
32K	\$695 <sup>00</sup>	\$740 <sup>00</sup>

## DEC® LSI-11 16K MEMORY BOARD

- Q-BUS—FULLY STATIC
- MODULAR
- ADDRESSABLE TO 128K WORDS
- MAPPABLE IN 4K INCREMENTS
- BUFFERED AND NOISE SUPPRESSED
- PROM COMPATIBLE

ASSEMBLED, TESTED & BURNED IN \$124900  
COMPLETE KIT \$115900

LARGEST & FASTEST STATIC MEMORY AVAILABLE

## S-100 EXPANDABLE MOTHER BOARD

- 8-SLOT EXPANDABLE BACKPLANE—in line male and female connectors enable backplanes to be plugged together, or the female may be used in place of an extender board.

QUIET—ground plane decouples all signal lines.

RELIABLE—SAE 8100 phenolic body, gold contact connectors.

COMPLETE KIT \$6600 ASSEMBLED \$8900

## UNIVERSAL "U DESIGN" WIRE WRAP BOARDS

ALL BOARDS ARE G-10 GLASS EPOXY, HAVE Vcc AND GROUND PLANES, PLATED THROUGH HOLES, & GOLD PLATED EDGE CONNECTORS

No. 1 "BEST ON THE MARKET"  
MICRO CPU CARD WITH S-100 BUS, 3 ON BOARD REGULATORS, FITS ALL STANDARD I.C. SOCKET CONFIGURATIONS, 1700+ HOLES, SIZE 5"x10"

\$2395

No. 2 UNIVERSAL BOARD FITS 86 PIN SOCKET WITH 0.10" CONTACT SPACING, MADE BY LEADING COMPUTER MANUFACTURER AS "IN HOUSE" BOARD, 1600+ HOLES, SIZE 4-7/8"x7-5/8"

\$795

## S-100 EXTENDER BOARD

with connector

A MUST for trouble-shooting your Computer boards \$1795

## BUILD YOUR OWN LOGIC PROBE

24 TO .02, SMALL SIGNAL DARLINGTONS AND 24 LEDS—ALL FUNCTIONAL only \$495

## MAXI SWITCH KEYBOARDS

UNENCODED-MOUNTED ON G-10 GLASS EPOXY BOARDS-A BLACK METAL FRAME KEEPS KEY SWITCHES SECURELY IN PLACE.

### No. 1

- 53 key main keyboard
- 10 auxiliary & cursor control keys
- 11 key numeric pad
- Bank of 5 auxiliary power and control, rocker arm switches—one of them lights up.

\$3995

WIRE WRAP SOCKET CONNECTOR FOR NO. 1 KEYBOARD \$295

### No. 2

- 53 key keyboard
- 1 auxiliary power/control DPDT rocker arm switch

\$2995

BEIGE METAL FRAME MOUNT FOR NO. 2 KEYBOARD \$995

SOCKET CONNECTOR FOR NO. 2 KEYBOARD \$295

## OUR NEW ASC11 KEYBOARD

HAS ON BOARD UV PROM, A MAIN KEYBOARD SECTION OF 58 KEYS, A HEX PAD OF 15 KEYS AND 16 MORE PERIPHERAL KEYS. 89 KEYS TOTAL & ASC11 ENCODED for only \$9995

WE ARE THE MOST COST EFFECTIVE ANSWER TO YOUR PARTS PROBLEMS

## POWER SUPPLY PARTS

### DIODES

IN4001	50V at 1A	6c
IN4003	200V at 1A	8c
IN4007	1000V at 1A	12c
IN250	60V at 20A	95c
IN3909	50V at 30A	\$1.25

### BRIDGES

FAST RECOVERY AVALANCHE BRIDGE		
IN4436/T	200V at 10A	\$4.25
FULL WAVE "MINI BRIDGE" WITH TAB TERMINALS		
PR-10F	100V at 12A	\$3.75

### 5% ZENERS

IN4733A	5.1V	1w	39c
IN4739A	9.1V	1w	39c
IN4744A	15V	1w	39c

### VOLTAGE REGULATORS

	PLASTIC	METAL
uA723-VARIABLE 2V to 3.7V	38c	69c
78L05-5V at 100mA	TO-92	3/98c
340T-6 6V at 1 AMP	TO-220	2/98c

### PASS TRANSISTORS

MJE3055	10A PLASTIC	89c
2N275	10A TO-3	95c
2N5301	30A TO-3	\$1.95

PROTECT YOURSELF, INSTALL AN ELECTRONIC CROWBAR CIRCUIT IN YOUR POWER SUPPLY.  
CROWBAR SCR C220D 400V at 10A \$1.75

## BUILD YOUR OWN PAPER TAPE READER

1/10" CENTER STACKABLE

## PHOTO TRANSISTERS 10/\$960

## BIPOLAR PROMS

8223	256 BIT	\$2.65
82523	256 BIT	\$3.40
63061	2K TRISTATE	\$5.45
825126	256x4	\$4.95

## 4K STATIC RAMS

2114	650ns	600mw	\$6.25
TMS-4045-4	450ns	300mw	\$10.95
HM-472114	300ns	200mw	\$11.95

## MINIATURE

## 16 BUTTON PADS

4x4 MATRIX ENCODED \$195

## I.C. SOCKETS LOW PROFILE-SOLDERTAIL

	GOLD INLAID	TIN
8 PIN	10/\$1.59	10/\$1.35
14 PIN	10/\$1.89	10/\$1.49
16 PIN	10/\$1.99	10/\$1.59
22 PIN	5/\$1.69	5/\$1.49
24 PIN	5/\$1.89	5/\$1.59
28 PIN	5/\$1.99	5/\$1.69
40 PIN	4/\$1.99	4/\$1.69

## ULTRA LOW CURRENT REGULATOR (MOTOROLA)

15V at 10 microamps 95c

## TTL COMPATIBLE REED RELAY 400 OHMS

\$1.49 ea. 7/\$975

## GOLD WIRE WRAP SOCKET STRIPS

MAKE UNIVERSAL END AND SIDE STACKABLE WIRE WRAP BOARDS

12 PIN  
3 LEVEL 48c  
14 PIN  
2 LEVEL 48c  
3 LEVEL 56c

7 PIN STRIP  
TOP VIEW



## OPTO DEVICES

PHOTO TRANSISTORS  
SIMILAR TO FPT 100  
4/98c

ULTRA HIGH SPEED  
EXTREMELY SENSITIVE LIGHT-ACTIVATED SCR  
triggerable by flashlight at several hundred yards \$295

PHOTO DETECTOR  
MOTOROLA  
4/98c

PHOTO DETECTOR  
0.5NS RISE TIME  
\$375

## INFRA RED DETECTOR

ULTRA LOW LEVEL  
PIV 7V  
1 on 1ma \$495

## SOLAR CELLS

2x2cm 130ma  
\$159 ea. 10/\$990

## HEWLETT-PACKARD JUMBO-RED HIGH EFFICIENCY LED

ON BOARD STATUS INDICATOR  
6/\$100

## HIGH INTENSITY RED LED LAMP

EXTREME WIDE ANGLE VIEWING  
3/98c 10/\$245

## GOLD EDGE CARD CONNECTORS

No. 1 SAC185/2-2  
SINGLE ROW, 18 PIN CONNECTOR WITH 0.156" CONTACT SPACING  
99c

No. 2 SAC225/2-2  
SINGLE ROW, 22 PIN CONNECTOR WITH 0.156" CONTACT SPACING  
99c

No. 3 2VH31/ICB6  
31 SOLDER LUG CONNECTOR WITH 0.125" CONTACT SPACING  
99c

## WIRE WRAP POST 2 LEVEL

10/98c  
100/\$740  
1000/\$6400

## HI-REL GOLD WIRE WRAP SOCKET PIN

10/\$1.99  
100/\$990  
1000/\$7900  
LIST PRICE 29c

## OP AMPS

SINGLE 709	10c
741	12c
DUAL MC1458	39c
QUAD LM3900	49c

## DIODES

IN91	15c
IN270	12c
IN914	15c
IN3600	15c
IN4148	10c

## TRANSISTORS

2N2222	12c
2N3904	12c
2N3906	12c
2N3053	49c

## D/A CONVERTER

SIGNETICS  
NE5008  
\$995

## PRIME A-1 LEDS RED LEDS

MINI 10/99c  
JUMBO 10/\$1.20  
HI EFFICIENCY 10/\$2.25  
YELLOW, GREEN, OR AMBER LEDS (SPECIFY COLOR)  
3/89c

## MAIL ORDER

## "GOOF PROOF" GUARANTEE

Because MAIL ORDER CUSTOMERS cannot inspect their parts before purchase, for them only, we guarantee an IMMEDIATE REFUND—NO QUESTIONS ASKED—should you be unhappy with the parts,\* or should the parts fail for any reason.\* Just ship parts to us in a protective carton with proof of purchase within 30 days of receipt of shipment. MOS AND LED DEVICES EXCLUDED!

## NO BACK ORDERS

YOUR PARTS OR IMMEDIATE REFUND

## WE PAY POSTAGE & HANDLING

ON U.S. ORDERS ONLY! — CALIF. RES. ADD 6% SALES TAX

## \$20 MINIMUM

FOR UNDER 8 HOUR PROCESSING SEND MONEY ORDER, CERTIFIED OR CASHIERS CHECK. SORRY! WE CANNOT ACCEPT PURCHASE ORDERS, COD'S, PHONE ORDERS OR CREDIT CARDS.

## F. Reichert Sales

1110 E. GARVEY AVE.  
W. COVINA, CA 91790

## FOREIGN ORDERS

CANADA PUERTO RICO, U.S. POSSESSIONS ADD U.S. \$3.50. ALL OTHER ADD U.S. \$7.00. IMMEDIATE SHIPPING ON CHASE MANHATTAN, FIRST CITIZENS, CASHIERS CHECKS & CANADIAN POSTAL MONEY ORDERS.

## LOS ANGELES

(213) 967-4611

## LMN ELECTRONICS

1042 E. GARVEY AV., W. COVINA, CA (VINCENT & SAN BERDO, FWY.)  
TUE TO SAT. 10-6—CLOSED SUN. & MON

## DROP INTO ONE OF OUR LOCATIONS

## PORTLAND

(503) 646-4044

## WIZARD OF PARTS

8225 SW CIRCUIS DR. BEAVERTON, ORE (MOLL BUS. CNTR/WASHINGTON SQUARE)

## DENVER

(303) 573-5214

## ELECTRONIC LOLLIPOP

5643 N. BROADWAY, DENVER, CO (I-25 & 58th AVE.)

## What's New?

### Catalog Describes Micro Printer



This 14 page, four color brochure describes the AIP-40, a low cost (\$425) 40 column alphanumeric impact printer. The AIP-40 includes a printhead, paper feed mechanism, power supply, and choice of serial or 8 bit parallel interfaces. The device prints at an average of 50 characters per second in a 64 character standard ASCII font. A serial interface can sustain a continuous 300 bps transmission and printing rate. The brochure, which details electrical and physical parameters, timing and character set, and suggested applications, is free from Datel Systems Inc, 1020 Turnpike St, Canton MA 02021, (617) 828-8000. ■

Circle 579 on inquiry card.

### First West Coast Computer Faire

The talks and technical papers presented at the First West Coast Computer Faire in San Francisco last April are now available in the form of a 320 page softbound book. The *Conference Proceedings* includes 93 papers under 25 topic headings, including computer art, speech synthesis and recognition, computers and music (43 pages), and the use of small computers in education (38 pages). Other sections provide both tutorial and design discussions concerning hardware and software for home computer systems. It is available for \$12.68 (\$13.40 for California residents) from The Computer Faire, POB 1579, Palo Alto CA 94305, (415) 851-7664. ■

Circle 582 on inquiry card.

### Report on Small Business Computers

*All About Small Business Computers* provides detailed specifications on 249 low cost computer systems for small business. Systems from 87 vendors are compared in 50 pages of comparison charts. Specifications covered include the minicomputer used in each system and its IO, mass storage and main memory features, keyboard and other IO facilities, communications capabilities, software support, pricing and availability. The report also summarizes the experience of about 750 survey respondents with a total of nearly 1800 minicomputers. Reprinted from *Datapro Reports on Minicomputers*, it is \$12 per copy from Datapro Research Corp, 1805 Underwood Blvd, Delran NJ 08075. ■

Circle 583 on inquiry card.

### A Computer Needs a Foundation

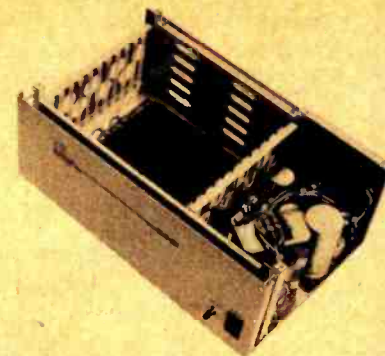

Attention S-100 bus homebrewers: CMC Marketing, 5601 Bintliff, Suite 515, Houston TX 77036, is offering this foundation module manufactured by TEI Inc as the hardware basis of systems using one or more of the many Altair (S-100) bus boards available in the marketplace. According to the literature accompanying this photograph, the MCS-112 foundation unit contains a 12 slot mother board, along with a power supply rated at 17 A on the +8 V bus and 2 A on the -16 V and +16 V supplies. (With Altair (S-100) bus boards, regulators to produce typical +5 V, +12 V and -12 V are made a part of each board to transform the system supply voltages into locally usable voltages.) The heavy duty aluminum cabinet features a 115 CFM muffin fan which maintains positive pressure inside the cabinet, so that a washable dust filter can be used. The price of this hardware foundation for a homebrew system is \$395. Also available is a larger chassis, model MCS-122 with 22 edge connector slots, and a power supply with 32 A at 8 V, 4 A at +16 V and 4 A at -16 V. ■

Circle 581 on inquiry card.

### An Important New Glossary

An interesting book entitled *Running Press Glossary of Computer Terms* has recently crossed our desk. The book is written by John Prenis, and is published by the Running Press, 38 South Nineteenth St, Philadelphia PA 19103. The book is available for \$1.95 plus \$.25 postage from the publisher, and we would expect it to be seen in numerous computer stores during the coming months.

There have been numerous glossaries published to date, to which the *Running Press Glossary of Computer Terms* is but the latest addition. However, there are several points to be made about this new glossary: it concentrates on a set of terms most likely to be encountered by a new computer user trying to make sense of the field of computing for the first time.

Some samples of the definitions in this glossary, pulled from this 86 page paperback book, may provide the best way to illustrate what it can do for the reader:

**Constant.** Any number you don't expect to change. Instead of giving it a variable name, it can be written into the program explicitly. It's wise to make sure that you won't ever want to change it before you do this.

**Data structure.** The decision on how data are to be organized in memory and referred to by the computer is an important one. Picking the proper data structure can simplify the computer's job greatly. Some data structures often encountered are *files, lists, arrays, stacks, and queues*.

**Matrix.** A matrix is a two dimensional *array*, or table of numbers. In the hardware domain, a matrix can be anything arranged in a grid-like pattern.

**Stack.** The stack is a region of memory which works by special rules. Each time the computer stores a word there, it goes "on top of the stack," and all the previously stored words move down one level. When a computer takes

a word off the top of the stack, everything moves up one level, until the stack is empty. Notice the computer has access only to the top of the stack. Piling a word on the stack is called a "push," and taking a word off is called a "pull" or a "pop." The stack simplifies some operations enormously.

**User-oriented.** Set up for somebody who is not expected to be knowledgeable about computers.

These definitions were picked "at random" to illustrate the typical terms and explanations found in the book, and illustrate the user-oriented nature of the terms. Engineering terms are for the most part omitted, unless they refer to the specification of a system's overall characteristics, and the majority of terms concern software concepts, which are the most important ones for a computer's users. As a starting point for the neophyte, this book of terminology is highly recommended. . .CH ■

Circle 580 on inquiry card.





# S.D. COMPUTER PRODUCTS

AN EMPIRE IND. CO

P.O. BOX 288108 DALLAS, TEXAS 75228

## EXPANDABLE EPROM BOARD

16K OR 32K EPROM \$49.95 W/OUT EPROM  
Allows You to Use Either 2708's For 16K of Eprom or 2716's For 32K of Eprom.

### KIT FEATURES:

1. All Address Lines & Data Buffered
2. Quality Plated through P.C. Board Including Solder Mask and Silk Screen
3. Selectable Unit States
4. On Board Regulation Provided
5. All Sockets Provided W/Board

WE CAN SUPPLY 450As 2708's AT \$11.95 WHEN PURCHASED WITH BOARD.

## 4K LOW POWER RAM KIT The Whole Works - \$79.95

Full Buffered - on board regulated - reduced power consumption utilizing low power 21L02-1 500ns RAMS - Sockets provided for all IC's. Quality plated through PC board.



\*Add \$10.00 for 250ns RAM operation.

## EXPANDORAM THE ULTIMATE RAM BOARD 32K FOR \$475.00

32K MODEL	
8K	\$151.00
16K	239.00
24K	367.00
32K	475.00



64K MODEL	
16K	\$281.00
32K	519.00
48K	757.00
64K	995.00

THE 32K VERSION USES THE MOSTEK MR4115 RAM AND HAS 8K BOUNDARIES AND PROTECTION & UTILIZES DIP SWITCHES. P.C. BOARD COMES WITH SOCKETS FOR 32K OPERATION

BUY A \$100 COMPATIBLE RAM BOARD AND UPGRADE THE SAME BOARD TO A MAXIMUM OF 64K MEMORY IN STEPS OF EITHER 8K OR 16K AT YOUR OPTION BY MERELY PURCHASING MORE RAM CHIPS FROM S.D. COMPUTER PRODUCTS.

THE 64K VERSION USES THE MOSTEK MR4116 RAM AND HAS 16K BOUNDARIES AND PROTECTION & UTILIZES DIP SWITCHES. P.C. BOARD COMES WITH SOCKETS FOR 64K OPERATION

### LOOK AT THE FEATURES WE HAVE BUILT INTO THE EXPANDORAM!

- MEMORY ACCESS TIME IS 375 ns
- MEMORY CYCLE TIME IS 500 ns
- POWER REQUIREMENTS ARE:
  - 8 VDC 400 MA DC
  - 18 VDC 400 MA DC
  - 18 VDC 30 MA DC
- ON BOARD INVISIBLE REFRESH
- NO WAIT STATES REQUIRED
- NO CYCLE STEALING NEEDED
- ON BOARD REGULATION
- CONTROL, DATA & ADDRESS INPUTS UTILIZE LOW POWER SCHOTTKY DEVICES
- DESIGNED TO WORK WITH Z-80, 8080, 8085, CPU's

ADD \$50.00 TO ABOVE PRICES FOR FULLY ASSEMBLED AND TESTED BOARDS

## Low Cost Cassette Interface Kit \$19.95



Features: Play and record K.C. Standard 2400/1200 Hz Tapes, 500 Baud, TTL I/O Compatible, Phase Lock Loop, Both 22 Pin Connector and 8 Pin Molex Connector. Comes partially assembled. Oscillator and phase lock loop pre-tuned to K.C. Standard. Selector switch sends cassette data or auxiliary input data to microprocessor. LED indicates logic 1 level.

## 8K LOW POWER RAM \$159.95

FULLY ASSEMBLED AND TESTED. NOT A KIT!  
Imshi - Allair - S-100 Bus compatible, uses low power static 21L02-500ns fully buffered on board regulated, quality plated through PC board, including solder mask. 8 pins. dip switches for address select.

\*Add \$30.00 for 250ns RAM operation



## Z-80 CPU BOARD KIT Complete Kit \$139.

CHECK THE ADVANCED FEATURES OF OUR Z-80 CPU BOARD: Expanded set of 158 instructions, 8080A software capability, operation from a single 5VDC power supply; always stops on an M1 state, true sync generated on card (a real plus feature!), dynamic refresh and NMI available, either 2MHZ or 4MHZ operation, quality double sided plated through PC board; parts plus sockets provided for all IC's.



\*Add \$10. extra for Z-80A chip which allows 4MHZ operation.

## NEW FROM S.D. "VERSAFLOPPY"™ KIT THE VERSATILE FLOPPY DISK CONTROLLER ONLY \$149.00

FEATURES: IBM 3740 Soft Sectors Compatible. S-100 BUS Compatible for Z-80 or 8080. Controls up to 4 Drives (single or double sided). Directly controls the following drives:

1. Shugart SA400/450 Mini Floppy.
2. Shugart SA800/850 Standard Floppy.
3. PERSCI 70 and 277.
4. MFE 700/750.
5. CDC 9404/9406.

34 Pin Connector for Mini Floppy, 80 Pin Connector for Standard Floppy. Operates with modified CP/M operating system and C-Basic Compiler. The new "Versafloppy" from S.D. Computer Products provides complete control for many of the available Floppy Disk Drives. Both Mini and Full Size. FD1771B-1 Single Density Controller Chip, Listings for Control Software are included in price.  
FD 1771B-1 CHIP ALONE \$39.95

## Z80 STARTER KIT LEARN COMPUTERS FROM THE START!

SIMPLE, STEP BY STEP LEARNING. CONSTRUCTION, PROGRAMMING, OPERATION, MEMORIES, INTERFACING, COMPUTING, AND CONTROLLING WITH AUDIO CASSETTE INTERFACE CAPABILITIES.

Complete Kit includes: Key board and Display; Z80 Central Processing Unit; Instructions; Operation Manual; Learning Guides.

Features: Powerful Z80 CPU with 158 Instructions • 1024 Bytes (Expandable to 2048 Bytes ON BOARD) of RAM • 2 Bi-Directional Input/Output Ports with Handshaking • Kansas City Standard Audio Cassette Interface for Program Storage • Hexadecimal Keyboard and Display • Wirewrap area for custom circuitry • S-100 Connector on board for Memory and I/O Expansion • 2716/2758 PROM Programmer • "Z-BUG" Monitor ROM (Including: Memory, Port and Register Examine and Change Commands; Breakpoints; Single Step Capability; Audio Tape Load and Dump; Execute user program Commands.)

Many more unique features. The best computer educational kit on the market... the complete computer and educational package for only \$199.00. (Available June 1978).

## INTRODUCING THE SBC-100 (The Z-80 Based, S-100 Single Board Computer)

\$349.00

### FEATURES:

- No Front Panel Needed
- Z-80 CPU (2 or 4 MHz)
- 1K RAM
- 4 ROM/PROM Sockets for 4K/8K of Memory
- SYNCHRONOUS/ASYNCHRONOUS Serial I/O with RS-232 and Current Loop Interface and Software
- Programmable Baud Rate
- Parallel Input Port
- Parallel Output Port
- 4 Channel Timer/Counter
- 4 Vectored Interrupts

## O. E. M. SPECIAL

ASK ABOUT SPECIAL O.E.M. DISCOUNTS ON THE S.D. "COMPATIBLE SET"	
SBC-100 - SINGLE BOARD COMPUTER	\$349.00
VERSAFLOPPY™ - FLOPPY DISK CONTROLLER	\$149.00
EXPANDORAM - 32K RAM	\$475.00

EACH KIT IF PURCHASED SEPARATELY TOTAL \$973.00

ORDER ALL 3 KITS TOGETHER FOR

**\$899.00**

This Powerful Threesome Operates Together to Form A Complete Computer for Your System.

## Z-80 Programming Manual

## IN DEPTH DETAIL OF THE Z-80 CPU MICRO-COMPUTER

## S. D. SALES SPECIAL \$9.95

## RAMS

21L02 - 500NS	8/11 50
21L02 - 250NS	8/15 95
2114 - 4K	14 95
1101A - 256	8/54 00
1103 - 1K	35
MK 4115 - 8K	15 45
74S 200 - 256	3 95

## CPU's

Z-80 includes manual	29 95
Z-80A includes manual	34 95
8080A CPU 8 BIT	11 95
8008 CPU 8 BIT	6 95

## PROMS

1702A - 1K - 1.5us	3.95 or 10/35.
2708 - 8K - 450ns	14.95
5204 - 4K	7.95
82S129 - 1K	2.50
2708U 8K signetics 650ns	9.95

## COUNTER CHIPS

MK50397 6 Digit elapsed timer	8.95
MK50250 Alarm clock	4.99
MK50380 Alarm chip	2.95
MK50395 6 digit up/dn. count.	12.95
MK5002 4 digit counter	8.95
MK5021-Cal. chip sq. root	2.50

## S.D. NOW HAS SOFTWARE FOR IT'S CUSTOMERS

### CP/M™ DISK OPERATING SYSTEM . . . \$99.95

CP/M is a powerful disk operating system which has become an industry standard. It is compatible with several disk based FORTRAN and BASICS. This package includes a CP/M diskette (mini or full size) adapted for S.D.'s SBC-100/VERSAFLOPPY EXPANDORAM board set. Complete documentation is included. (CP/M is a registered trademark of Digital Research Corp., Pacific Grove, CA.)

### Z-80™ DISK BASED ASSEMBLER . . . \$69.95

Runs on ANY CP/M based disk system. Assembles the official Zilog-Mostek Mnemonics. Contains extensive set of pseudo-ops. Available on mini or full size diskette.

### VERSAFLOPPY™ CONTROL FIRMWARE . . . \$24.95

Provides control for VERSAFLOPPY and boots up CP/M. This runs on Z-80, 8080 or 8085 based computers. Available in 2708 or 2758 prom.

### SD MONITOR . . . \$49.95

Powerful monitor for SBC-100 single board computers. Includes all VERSAFLOPPY control firmware. Comes in 2716 prom. Available in 4-6 weeks.

### VERSAFLOPPY DIAGNOSTIC PROGRAM . . . \$24.95

Provides routines which are helpful in checking out a disk based system Available in 2708 or 2758 prom.

## MICROPROCESSOR CHIPS

8212 - I/O port	3.50
8214 - P.I.C.	12.95
8216 - Non Invert Bus	4.95
8224 - Clock Gen.	4.95
8226 - Invert Bus	3.95
PIO for Z-80	14.95
CTC for Z-80	14.95
8228 Sys. Controller	8.20
8251 Prog. comm. interface	10.95
8255 prog. prep. interface	13.50
8820 Dual Line Recr.	1.75
8830 Dual Line Dr.	1.75
2513 Cher. Gen.	7.50
8838 Quad Bus. Recv.	2.00
74LS138N - 1/8 decoder	.99
8197-Hex Tri-State Buffer	1.25
1488/1489 RS232	1.50
TR 1802B UART	3.85
TR 1863 UART	8.50
FD 1771B-1	39.95

## CMOS

4001	19	4029	99
4002	19	4042	69
4011	19	4047	1.50
4013	32	4049	35
4016	32	4059	23
4017	95	4071	19
4020	97	4076	97
4022	97	14518	1.10
4024	75	14528	85
4027	39	14529	85

## SUPER FLOPPY SPECIAL

S. D. SALES' VERSAFLOPPY S-100 CONTROLLER BOARD PLUS SHUGART SA 400 FLOPPY DISK DRIVE INCLUDING CABLE FOR ONLY

**\$449.00**

CALL IN YOUR BANKAMERICARD (VISA) OR MASTER CHARGE ORDER IN ON OUR CONTINENTAL TOLL FREE WATTS LINE:

**1-800-527-3460**

Texas Residents Call Collect:  
**214/271-0022**

DEALER INQUIRIES INVITED!



(All prices subject to change without prior notice.)

NO COD'S. TEXAS RESIDENTS ADD 5% SALES TAX. ADD 5% OF ORDER FOR POSTAGE & HANDLING. ORDERS UNDER \$10. ADD 75c HANDLING. FOREIGN ORDERS - U. S. FUNDS ONLY!

# Unclassified Ads

**WANTED:** For Microdata 1600 processor (Reality): magnetic tape controller and disk controller. Jack Hardman, 140 Forest Av, Glen Ridge NJ 07028. (201) 429-8880.

**FOR SALE:** Homebrew 8080, IMSAI front panel mounted in vector rack with 12 slot Altair (S-100) backplane and 15 A power supply, \$450. 16 by 64 alphanumeric video display board, memory mapped with ASCII keyboard port, \$100. 8 K memory, 450 ns, \$150. 4 K memory, 450 ns, \$75. Doug Lehmann, 1146 Scott St, Maumee OH 43537.

**HEATH H9 VIDEO TERMINAL:** Fully assembled and tested by an experienced engineer. Interfaces to virtually all microcomputer systems via RS-232, 20 mA loop or TTL. Includes many unique features. Price includes shipping. \$530. R Edison, 4 Longfellow Pl, Boston MA 02114, (617) 742-3074.

**FOR SALE:** One Hewlett-Packard 2640A interactive display terminal, one Spintronic data communication terminal and one 3M dry photocopier. Purchased 1976 but hardly used due to illness. Original purchase price over \$8000. Part of estate, will sell for \$3000. George Danek, 1021 Harbor Dr, Rt 7, Annapolis MD 21403, (301) 263-3134.

**WANTED:** Hardware and software required to organize and maintain a mailing list. Please write if you have any information that can help me get this going. Write W Pomeroy, 5790 Bull Hill, LaFayette NY 13084.

**WANTED:** Used KIM-1 microprocessor. Prefer complete system with expansion boards if possible. Norman G Church, 18310 Franklin Way, Gladstone OR 97027, (503) 659-6763.

**FOR SALE:** Improved Sphere System 330. Consisting of 20 K dynamic memory, 2 K 2102s, 2 K EROM monitor, KC cassette interface, serial interface and 6830 modem chip, sockets for 8 K 2708s also with CRT interface, keyboard, and mother board. Requires only power supply and modified television. Only \$700 takes this and more. Bill Vodall, Box 75, Kevin MT 59454, (406) 337-2222.

**FOR SALE:** Monroe programmable calculator Model 1830. Excellent condition, under factory service contract. Cost new \$3100. Will sell for \$2200, which includes about \$800 worth of magnetic storage cards. B Fremerman, 4041 Central, Kansas City MO 64111.

**FOR SALE:** IBM 1620 system, \$2000. Includes all software and curriculum materials that were used by the Mathematics Dept at Monona Grove High School. Donald Helstad, Principal, Monona Grove High School, 4400 Monona Dr, Monona WI 53716, (608) 222-1291.

**FOR SALE:** Heathkit H9 video terminal assembled and tested. Used only 5 hours. \$500. Howard Schimmelpennig, 351 N 4th West, Logan UT 84321, (801) 752-1987.

**FOR SALE:** SwTPC 6800 computer system. KBD-3, TVT-II with modulator, AC-30, 8 K, interface cards, two recorders, software. Beautiful custom cases. Packaged for portability, \$650. Anderson-Jacobson 841 Selectronic terminal. Correspondence code, RS-232 interface, modem and coupler. Attractive case. \$725. Daniel L Wright, 280 Perrymont Av, San Jose CA 95125, (408) 925-3367 days.

**FOR SALE:** Teletype Model 35 ASR, heavy duty printer with paper tape reader/punch. Currently operating on 20 mA loop, convertible to EIA RS232. Has remote tape reader switch for use as local console or remote terminal. Best offer. Brad Jude, 428 Ridge Av, Clarendon Hills IL 60514, (312) 323-8093.

**WANTED:** Altair 8800 or 680 construction package with PC board etching guide and parts placement guide. Ben Galewsky, 1035 Dowlen Rd, Beaumont TX 77706.

**FOR SALE:** Altair 8800 minicomputer with 21 K programmable memory, 2 K read only memory, cassette interface, video display interface, parallel and serial IO interface, ASCII keyboard, video monitor, connecting cables, manuals and some software. Asking \$1275. M Harris, POB 1053, New Britain CT 06050, (203) 225-0504.

**WANTED:** BYTE #7, volume 1, March 1976. Will trade volume 1, issues 1, 2 or 3 or cash. Write details. S Finberg, POB 82, MIT Br, Cambridge MA 02139.

**REWARD:** \$10 for information leading to the comprehension of a Prentice P103 ANS modem. Need schematics, manual, etc. William L Palya, St Joseph's College, Rensselaer IN 47978.

**FOR SALE:** Computer Automation Alpha LSI 2/20G minicomputer. 16 bit processor, hardware multiply/divide, stack and byte processing, priority interrupts, DMA, read only memory automatic load, Teletype interface, 8 K core memory, power supplies, chassis, programmer's console. Includes general and interfacing manuals, partial schematics, software listings for: assemblers, diagnostics, editor, loaders and math functions. \$1200 plus shipping, or trade for DEC LSI-11 equipment or 24 by 80 CRT. Paul Sorenson, 220 Cedar St, Apt 7, E Lansing MI 48823, (517) 337-0223 or 353-9487.

**WANTED:** Programs on 8 inch ICOM 3700 disk subsystem. I use ICOM-58, DEBBI/IMSAI and FDOS 111. I also use the Cromemco Dazzler and the Cybernetic Speech Synthesizer. Please send me a copy of your disk and I will pay you for it. Dr John M Larimer, 55 La Gorce Cir, Miami Beach FL 33141.

**FOR SALE:** Assembled 8080 system, IMSAI 22 slot mother board, large power supply, PIC-8 28 K Godbout programmable memory, North Star disk, PolyMorphic video board, and Digital Group keyboard and cabinet, \$2800. Morrow cassette board assembled, \$70. Godbout read only memory with 4 K of 8080 assembler/monitor, \$200. 3P+S kit, \$110. Oliver tape reader assembled, \$60. C Watrobinski, 4923 N Kedvale, Chicago IL 60630, (312) 736-6920.

**FOR SALE:** Make offer for complete set of BYTES, September 1975 thru October 1977, like new condition, sold singly or complete set to best offer. M Bakke, 448 Carlyle E, Belleville IL 62221, (618) 235-5686.

**FOR SALE:** Digital Group Phi Deck digital tape system (6400 bps), 20 second access time. Four drive cable case controller board. All factory assembled and tested. Used for three months, working fine when replaced by disks. All documentation and Phi-Mon operating system. Asking \$624, you save \$136. Will consider trades; I need a sophisticated terminal. Will ship UPS collect upon confirmation and receipt of \$60 deposit. Confirm by phone (804) 838-1950 Monday thru Friday 8 AM to 5 PM.

**FOR SALE:** Five 4 K Altair (S-100) static memory boards. Factory assembled and still on warranty, one never out of box. I am switching to 16 K boards. \$100 each. No cash please. Al Marshall, 408 Oakwood, Angola IN 46703.

**FOR SALE:** ASR 33 Teletype, new covers, working reproducing tapes now, on stand and with plywood shipping crate, used, \$650. Teletype 1 inch paper tape \$4 per 7 roll box. Altair 680b ready to go, \$375. Digideck digital Philips cartridge tape deck and electronics, all documentation, \$145. These tape decks look perfect but are untested. All items plus shipping. Jim Beistle, 3728 Wilkie Way, Ft Worth TX 76133.

**WANTED:** BYTE volume 1, issues 1 thru 11. Must be in good condition. Mail price to Byron de Vries, Box S-281, Castle Point Sta, Hoboken NJ 07030.

**LINE PRINTER:** Altair 88LP Okidata 110 with tractor feed, controller, cable and documentation for sale. Less than one roll of paper run through it. Cost new \$1750, will sell for \$1400; you pay freight. Dave Uhring, 710 Cedar St, Collinsville IL 62234, (618) 344-5188 days.

**FOR SALE:** Altair (S-100) microcomputer, assembled and tested. 8080 processor, VDM-1 video display, Solid State TV monitor, Tarbell cassette, Pennys recorder, ASCII keyboard, Tarbell disk controller with Cal Comp 140 disk, CPM software, 44 K static memory, parallel IO board with two inputs, two outputs, 12 position mother board, 28 A power supply and cabinet. Comes complete with popular software, all ICs socketed, and full documentation, \$3000. P. Sargent, 4209 Knoxville, Lakewood CA 90713, (213) 421-9521.

**FOR SALE:** Complete PolyMorphic system, includes processor board, two 8 K boards, video board, 5 slot mother board, Panasonic tape recorder, keyboard, converted TV, all cables and assorted prerecorded software. All less than 9 months old, preassembled. Valued at over \$2300, will sell to best offer over \$1750. Scott Hayden, 23921 Colfax St, Lowell IN 46356, (219) 552-0232.

**SOFTWARE:** POLY A00 BASIC. With dynamic graphics - Bomber9, Missile, Tank, Pursuit, Equation Plot, Biorhythm, Sketch, Splat, New Lun Lander. \$3 each. Send for complete list. Ted Carter, 902 Pinecrest, Richardson TX 75080.

**FOR SALE:** IMSAI 16 K assembled memory certified good by IMSAI: \$299. Assembled and tested Poly 88 System 2: \$499. Assembled and tested (virtually new) IMSAI disk drive with interface, cable, and DOS-A (FDCC-1, FIF, Cable C, DOS-A): \$1399. Shipping paid. Call Greg Jewell to reserve the equipment you want. (208) 234-0495 evenings.

**FOR SALE:** CT1024 socketed, RS232 interface, good condition, \$95. Les Zoltan, 151 Buckingham Dr #280, Santa Clara CA 95050, (408) 984-7698.

**FOR SALE:** Hewlett-Packard Model 1601A logic state analyzer for use with any 180 series mainframe as a display unit. Includes two Model 10231A 6 bit data probes, and two blue light filters - one for 182 and one for 180 series display units. See HP 1976 catalogue, page 82, for further info. Brand new condition, \$1400 or best offer. Mike Rosenthal, 906 NW 30th St, Corvallis OR 97330, (503) 754-0593 evenings.

**FOR SALE:** MITS COMTER 256 keyboard terminal with built-in acoustic coupler, RS-232 interface, FSK tape output, factory adjusted, like-new condition. Steve Fritts, (615) 637-6705 or (615) 525-5407.

*Readers who have equipment, software or other items to buy, sell or swap should send in a clearly typed notice to that effect. To be considered for publication, an advertisement should be clearly noncommercial, typed double spaced on plain white paper, and include complete name and address information. These notices are free of charge and will be printed one time only on a space available basis. Insertions should be limited to 100 words or less. Notices can be accepted from individuals or bona fide computer users clubs only. We can engage in no correspondence on these and your confirmation of placement is appearance in an issue of BYTE.*

*Please note that it may take three, or four months for an ad to appear in the magazine.*

VISIBLE  
OR  
INFRA RED

USED FOR CHARACTER  
RECOGNITION FOR  
COMPUTERS WITH  
EXTERNAL CIRCUITS

MAY BE USED IN  
A VACUUM,  
UNDER WATER,  
HIGH ALTITUDE

IN MAGNETIC ENVIRONMENT  
BECAUSE THERE IS NO  
HIGH VOLTAGE OR  
MAGNETIC DEFLECTION

## MINATURE SOLID STATE 202 VIDEO CAMERA KIT

FEATURING A 100 x 100 BIT SELF SCANNING CHARGED COUPLED DEVICE

THIS UNIQUE UPDATED CAMERA KIT  
FEATURING THE FAIRCHILD CCD 202C IMAGE SENSOR

### ADVANTAGES

- IN THE FUTURE WE WILL SUPPLY A COMPUTER VIDEO INTERFACE CARD
- All clock voltages operate at 6V requiring no adjustments
- Higher video output signal
- We supply the power board, so only a 5V 1 Amp power source is needed
- The circuitry has been simplified for easier assembly
- Two level TTL output is supplied for interfacing

### FEATURES

- Sensitive to infra red as well as visible light
- May be used for IR surveillance with an IR light source
- Excellent for standard surveillance work, because of light weight and small size
- All components mounted on parallel 3/4" x 6 1/2" single sided boards
- Total weight under 1 lb.

**\$349.00**

We supply all semiconductors, boards, data sheets, diagrams, resistors and capacitors, and 8MM lens. Sorry we do not supply the case, batteries and 5V supply.

Add \$75.00 to assemble and test  
Add \$2.00 Postage and Handling

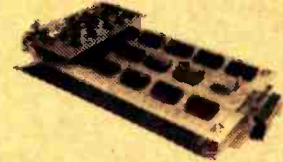

**UNIVERSAL 4Kx8 MEMORY BOARD KIT \$69.95**  
32-2102-1 fully buffered, 16 address lines, on board decoding for any 4 of 64 pages, standard 44 pin bus, may be used with F-8 & KIM

**EXPANDABLE F8 CPU BOARD KIT \$99.00**  
featuring Fairbug PSU, 1K-ohm static ram, RS 232 interface, documentation, 64 BYTE register

**4K BASIC FOR FAIRBUG F8 \$25.00**  
on paper tape

CMOS (DIODE CLAMPED)			
4012	-16	4023	-16
4013	-20	4024	-16
4001	-16	4016	-74
4002	-16	4018	-74
4008	-95	4017	-78
4007	-16	4018	-76
4009	-37	4019	-37
4010	-37	4020	-84
4011	-16	4022	-85

2708-8K EPROM (850 ns)	\$10.95
2713-8K EPROM (500 ns)	\$10.95
2713 CHARACTER GEN	\$ 4.75
2716-8K 3 BIT SR	\$ 2.50
2720-8K EPROM	\$ 4.50
27102-1 (450 nV)	\$ 1.25
27102-2 (450 nV)	\$ 1.25
27111-256 x 4 STATIC	\$ 2.75
27112-256 x 4 STATIC	\$ 2.75
27204-4K PROM	\$ 1.95
1702A UV PROM	\$ 1.95
27223	\$ 1.95
AV-5101 (UART)	\$ 6.95
8703C TELETYPE 3 STAGE	\$11.95
BINARY 8 BIT A/D CONVERTER	\$11.95
8080A	\$11.95

**AP PROTO BOARDS USED FOR SOLDERLESS BREADBOARDING**

264L - 128 FIVE-TIE POINT TERMINALS	\$12.75
212R - POWER BOARD	\$ 2.50
2248L - 96 FIVE-TIE POINT TERMINALS	\$ 9.75
209R - POWER BOARD	\$ 2.23
<b>IC TEST CLIPS</b>	
TC-14 - \$4.50	TC-16 - \$4.75

CTS 206-8 eight position dip switch ..... \$1.90  
CTS 206-4 four position dip switch ..... \$1.45  
LIGHT ACTIVATED SCR'S TO-18, 200V 1A ..... \$ 1.10

**SILICON SOLAR CELLS**  
2 1/2" diameter .4V at 500 mA \$4.00

**RS232 CONNECTORS** DB 25P male ..... \$2.95  
DB 25F female ..... \$3.50

**LED READOUTS**  
FND 357 C.C. 4" x .50 ..... \$ 5.00  
FCS 8024 4 digit MAN-7-3" C.A. 8" ..... \$ 8.85  
C.C. 8" display \$8.95 DL 747 C.A. 8" ..... \$1.85  
FND 503 C.C. 5" x .85 FND 800 C.C. 8" ..... \$1.95  
FND 810 C.A. 8" x .85 FND 807 C.A. 8" ..... \$1.95  
DL-704-3" C.C. x .85

**PRINTED CIRCUIT BOARD**  
4 1/2" x 6 1/2" SINGLE SIDED EPOXY BOARD 1/16" thick, unetched \$ .80 ea. 5/\$2.60  
**7 WATT LD-65 LASER DIODE IR \$8.95**

2N 3820 P FET \$ 45  
2N 5457 N FET \$ 45  
2N2646 J/JT \$ 45  
ER 900 TRIGGER DIODES 4/\$1.00  
2N 6028 PROG. UJT \$ 65

**MINIATURE MULTI-TURN TRIM POTS**  
100, 500, 1K, 2K, 5K, 10K, 25K, 50K, 100K, 200K, 500K, 1Meg, 2Meg, \$.75 each 3/\$2.00

WSU-30 Hand wire wrap tool used to wrap, unwrap & strip #30 wire \$5.30

**VERIFAX PC BOARD**  
This board is a 176" single sided paper epoxy board, 4" x 6 1/2" DRILLED and ETCHED which will hold up to 21 single 14 pin IC's or 8, 16, or LSI DIP IC's with buses for power supply connector \$4.00

MV 5691 YELLOW-GREEN BIPOLEAR LED \$ .90  
FP 100 PHOTO TRANS \$ .50  
RED, YELLOW, GREEN or AMBER "LARGE LED's" 6/\$1.00  
1L-5 (MCT-2) OPTO-ISOLATOR \$ .75  
MOLEX PINS 100/\$1.00  
1000/\$8.00  
10 WATT ZENERS 3.9, 4.7, 5.6, 6.2, 18, 22, 100, 150 or 200V ea. \$ .60  
1 WATT ZENERS 4.7, 5.6, 10, 12, 15, 18 or 22V ea. \$ .25  
MCM6860 MODEM CHIP \$9.95  
MCM 6571A 7 x 9 character gen. \$10.75

**Silicon Power Rectifiers**

PRV 1A	3A	12A	50A	175A	240A
100	06	14	30	80	370
200	07	20	35	115	425
400	09	25	50	140	650
600	11	30	70	180	850
800	15	35	90	230	1050
1000	20	45	110	275	1250

SAD 1024-4 REPLICON 1024 stage analog "bucket Brigade" shift register. \$18.95

IN 4148 (IN914) ..... 15/\$1.00

MCA 81 OPTICAL LIMIT SWITCH \$1.50

**REGULATORS**  
309K ..... \$ .95  
723 ..... \$ .50  
LM 378 ..... \$ .80  
320K-6, 12, 15, 18 or 24V \$ .95  
or 15V ..... \$1.00  
320T-5, 15, 78 MG ..... \$1.35  
or 24V ..... \$ .95

**TRANSISTOR SPECIALS**

2N6233-NPN SWITCHING POWER	\$ 1.95
MRF-8004 a CB RF Transistor NPN	\$ 1.50
2N3772 NPN Si TO-3	\$ 1.00
2N1546 PNP GE TO-3	\$ .75
2N4908 PNP Si TO-3	\$ 1.00
2N6056 NPN Si TO-3 Darlington	\$ 1.70
2N5086 PNP Si TO-92	4/\$ 1.00
2N3137 NPN Si RF	\$ .85
2N404 PNP GE TO-5	5/\$ 1.00
2N3919 NPN Si TO-3 RF	\$ 1.50
MPSA 13 NPN Si TO-92	3/\$ 1.00
2N3767 NPN Si TO-66	\$ .70
2N2222 NPN Si TO-18	5/\$ 1.00
2N3055 NPN Si TO-3	\$ .80
2N3904 NPN Si TO-92	5/\$ 1.00
2N3906 PNP Si TO-92	5/\$ 1.00
2N5296 NPN Si TO-220	\$ .50
2N6109 PNP Si TO-220	\$ .55
2N3638 PNP Si TO-5	5/\$ 1.00

**TTL IC SERIES**

7400	-13	7448	-65	74161	-61
7401	-13	7448	-68	74153	-61
7402	-13	7447	-65	74154	-94
7403	-13	7448	-69	74156	-58
7404	-15	7450	-15	74157	-55
7405	-13	7472	-28	74161	-55
7406	-16	7473	-28	74163	-55
7407	-20	7474	-28	74164	-85
7408	-18	7475	-45	74165	-95
7409	-18	7476	-30	74170	-58
7410	-13	7480	-31	74173	-120
7411	-18	7483	-60	74174	-95
7412	-13	7485	-67	74175	-85
7413	-38	7488	-28	74176	-75
7414	-80	7489	-42	74177	-75
7415	-22	7491	-58	74180	-85
7416	-25	7492	-43	74181	-180
7417	-13	7493	-43	74190	-100
7418	-25	7494	-87	74191	-100
7419	-22	7498	-65	74192	-79
7420	-19	7499	-66	74193	-79
7430	-13	74107	-28	74194	-80
7432	-22	74121	-20	74196	-85
7437	-21	74122	-38	74198	-85
7438	-21	74123	-46	74278	-56
7440	-13	74126	-40	74367	-55
7441	-10	74128	-40	75491	-60
7442	-37	74150	-94	75492	-60

**DATA CASSETTES \$1.25**  
44 Pin Solder Tail .156" Connector \$2.20

MM 5387AA new clock chip which will directly drive LED's 12/24 hrs, 1 supply & alarm \$5.95

NO. 24 8 CONDUCTOR SPECTRA FLAT CABLE 10' \$1.50 100' \$13.50

NO. 30 WIRE WRAP WIRE SINGLE STRAND 100' \$1.40

**ALCO MINIATURE TOGGLE SWITCHES**  
MTA 106 SPDT \$ 1.05  
MTA 206 DPDT \$ 1.70  
MTA 206 P-DPDT CENTER OFF \$ 1.85  
MSD 206 P-DPDT CENTER OFF \$ 1.85  
LEVER SWITCH \$ 1.85

**Full Wave Bridges**

PRV	2A	6A	25A
100			
200	.75	1.25	2.00
400	.95	1.50	3.00
600	1.20	1.75	3.00

**DIP SOCKETS**

8 PIN .22	24 PIN .40
14 PIN .25	28 PIN .50
16 PIN .28	40 PIN .60
18 PIN .30	

**SANKEN AUDIO POWER AMPS**  
S1 1010 G 10 WATTS ..... \$ 6.80  
S1 1020 G 20 WATTS ..... \$13.70  
S1 1050 G 50 WATTS ..... \$26.90

**TANTULUM CAPACITORS**

22UF 35V 5/\$1.00 6.8UF 35V 4/\$1.00  
47UF 35V 5/\$1.00 10UF 10V \$ .25  
68UF 35V 5/\$1.00 22UF 25V \$ .40  
10UF 35V 5/\$1.00 15UF 35V 3/\$1.00  
3.3UF 35V 4/\$1.00 30UF 6V 5/\$1.00  
4.7UF 15V 5/\$1.00 68UF 15V \$ .50

**ML'S SERIES**

74LS00	-21	74LS126	-47	LM 101	-75
74LS01	-21	74LS132	-80	LM 301/748	-29
74LS02	-21	74LS138	-39	LM307	-30
74LS04	-28	74LS138	-70	LM 308	-78
74LS06	-30	74LS139	-70	LM 311	-78
74LS08	-21	74LS151	-70	LM 318	-120
74LS09	-28	74LS153	-70	LM 319	-85
74LS10	-21	74LS156	-70	LM 324	1.05
74LS11	-21	74LS156	-70	LM 338	-110
74LS13	-44	74LS157	-72	LM 350	-140
74LS15	-25	74LS160	-88	LM 370	-115
74LS20	-24	74LS161	-85	LM 377	-280
74LS21	-26	74LS162	-85	LM 380	-88
74LS22	-26	74LS163	-85	LM 381	-128
74LS25	-37	74LS168	-88	LM 382	1.28
74LS27	-12	74LS169	-85	LM 537	-280
74LS30	-26	74LS170	-168	LM 553	-280
74LS32	-32	74LS173	-110	LM 566	-38
74LS37	-32	74LS174	-100	LM 568	-85
74LS38	-32	74LS175	-80	NE540L	-225
74LS40	-26	74LS190	-88	960	-200
74LS42	-46	74LS191	-85	566	-85
74LS47	-79	74LS192	-86	688	-128
74LS51	-26	74LS193	-86	967	-120
74LS54	-28	74LS196	-86	703	-80
74LS80	-95	74LS198	-86	708	-25
74LS74	-35	74LS197	-86	710	-38
74LS76	-38	74LS201	-120	741C	1V .31
74LS78	-130	74LS201	-70	747	-88
74LS86	-31	74LS208	-70	LM 1310	-280
74LS88	-88	74LS208	-70	LM 1310	-280
74LS89	-55	74LS278	-55	1468	-86
74LS108	-55	74LS365	-55	1468	-86
74LS109	-55	74LS365	-55	1468	-86
74LS112	-38	74LS378	-86	3900	-48
74LS113	-38	74LS380	-86	3900	-48
74LS114	-38	74LS380	-140	951	-186
74LS125	-47	MCL4880	-138	LF358H	-178

**TRIACS**

PRV 1A 10A 25A 1.5A 6A 35A

100 40 70 130 40 50 120  
200 70 110 175 60 70 160  
400 110 150 260 100 120 220  
600 170 230 360 150 300

**SCR'S**

100 40 70 130 40 50 120  
200 70 110 175 60 70 160  
400 110 150 260 100 120 220  
600 170 230 360 150 300

Terms: FOB Cambridge, Mass. Send Check or Money Order. Include Postage Minimum Order \$5.00. COD \$20.00



**SOLID STATE SALES**  
P.O. BOX 74B  
SOMERVILLE, MASS 02143 TEL (617) 547 7053

WE SHIP OVER 95% OF OUR ORDERS THE DAY WE RECEIVE THEM



For fastest service transfer mailer label from wrapper to coupon provided at the right. Requests cannot be honored unless zip code is given. This card valid for 90 days only.

NOTE—If label is missing or defaced fill out coupon carefully —PLEASE PRINT—this is only way to get requested material to you.

Name \_\_\_\_\_  
 (Title) \_\_\_\_\_  
 (Company) \_\_\_\_\_  
 Address \_\_\_\_\_  
 City \_\_\_\_\_ State \_\_\_\_\_ Zip \_\_\_\_\_

- 1 21 41 61 81 101 121 141 161 181 201 221 241 261 281 301 321 341 361 381 401 421 441 461 481 501 521 541 561 581 601 621 641  
 2 22 42 62 82 102 122 142 162 182 202 222 242 262 282 302 322 342 362 382 402 422 442 462 482 502 522 542 562 582 602 622 642  
 3 23 43 63 83 103 123 143 163 183 203 223 243 263 283 303 323 343 363 383 403 423 443 463 483 503 523 543 563 583 603 623 643  
 4 24 44 64 84 104 124 144 164 184 204 224 244 264 284 304 324 344 364 384 404 424 444 464 484 504 524 544 564 584 604 624 644  
 5 25 45 65 85 105 125 145 165 185 205 225 245 265 285 305 325 345 365 385 405 425 445 465 485 505 525 545 565 585 605 625 645  
 6 26 46 66 86 106 126 146 166 186 206 226 246 266 286 306 326 346 366 386 406 426 446 466 486 506 526 546 566 586 606 626 646  
 7 27 47 67 87 107 127 147 167 187 207 227 247 267 287 307 327 347 367 387 407 427 447 467 487 507 527 547 567 587 607 627 647  
 8 28 48 68 88 108 128 148 168 188 208 228 248 268 288 308 328 348 368 388 408 428 448 468 488 508 528 548 568 588 608 628 648  
 9 29 49 69 89 109 129 149 169 189 209 229 249 269 289 309 329 349 369 389 409 429 449 469 489 509 529 549 569 589 609 629 649  
 10 30 50 70 90 110 130 150 170 190 210 230 250 270 290 310 330 350 370 390 410 430 450 470 490 510 530 550 570 590 610 630 650  
 11 31 51 71 91 111 131 151 171 191 211 231 251 271 291 311 331 351 371 391 411 431 451 471 491 511 531 551 571 591 611 631 651  
 12 32 52 72 92 112 132 152 172 192 212 232 252 272 292 312 332 352 372 392 412 432 452 472 492 512 532 552 572 592 612 632 652  
 13 33 53 73 93 113 133 153 173 193 213 233 253 273 293 313 333 353 373 393 413 433 453 473 493 513 533 553 573 593 613 633 653  
 14 34 54 74 94 114 134 154 174 194 214 234 254 274 294 314 334 354 374 394 414 434 454 474 494 514 534 554 574 594 614 634 654  
 15 35 55 75 95 115 135 155 175 195 215 235 255 275 295 315 335 355 375 395 415 435 455 475 495 515 535 555 575 595 615 635 655  
 16 36 56 76 96 116 136 156 176 196 216 236 256 276 296 316 336 356 376 396 416 436 456 476 496 516 536 556 576 596 616 636 656  
 17 37 57 77 97 117 137 157 177 197 217 237 257 277 297 317 337 357 377 397 417 437 457 477 497 517 537 557 577 597 617 637 657  
 18 38 58 78 98 118 138 158 178 198 218 238 258 278 298 318 338 358 378 398 418 438 458 478 498 518 538 558 578 598 618 638 658  
 19 39 59 79 99 119 139 159 179 199 219 239 259 279 299 319 339 359 379 399 419 439 459 479 499 519 539 559 579 599 619 639 659  
 20 40 60 80 100 120 140 160 180 200 220 240 260 280 300 320 340 360 380 400 420 440 460 480 500 520 540 560 580 600 620 640 660

MENTION **BYTE** WHEN WRITING TO ADVERTISERS

**BYTE** SUBSCRIPTIONS 4158

For a subscription to BYTE, please complete this card.

Name \_\_\_\_\_  
 Address \_\_\_\_\_  
 City \_\_\_\_\_  
 State \_\_\_\_\_ Zip \_\_\_\_\_ Country \_\_\_\_\_

- |                                  |                               |                                  |
|----------------------------------|-------------------------------|----------------------------------|
| <input type="checkbox"/> 1 year  | <input type="checkbox"/> \$15 | <input type="checkbox"/> \$17.50 |
| <input type="checkbox"/> 2 years | <input type="checkbox"/> \$27 | <input type="checkbox"/> \$32.00 |
| <input type="checkbox"/> 3 years | <input type="checkbox"/> \$39 | <input type="checkbox"/> \$46.50 |

- \$25 Europe (air freight) payment enclosed  
 \$25 Elsewhere (surface mail) payment enclosed  
 (Air mail rates available upon request)

Please remit in US funds— Thank you.

- Check enclosed (Bonus: one EXTRA issue  
 — receive 13 issues for the price of 12)

    Bill me (US only)

Card No. \_\_\_\_\_  
 Expiration date \_\_\_\_\_  
 Four digits above name — Master Charge only \_\_\_\_\_  
 Signature \_\_\_\_\_ Date \_\_\_\_\_

Please allow eight weeks for processing.

Thank you

**BOMB: BYTE's Ongoing Monitor Box** 4158

BYTE's BOMB is your direct line to the editor's desk. Each month, the two top rated authors receive bonuses based on your votes. To use this card, refer to the list of authors, titles, and corresponding BOMB article numbers on the opposite page. Then rate each article on a scale from 0 to 10 below by circling the appropriate rating number to the right of each BOMB article number. Your feedback helps us produce the best possible magazine each month.

BOMB Article Number	..... Rating .....										
	Poor	Fair	Good	Very Good	Excellent	Wow!					
1	0	1	2	3	4	5	6	7	8	9	10
2	0	1	2	3	4	5	6	7	8	9	10
3	0	1	2	3	4	5	6	7	8	9	10
4	0	1	2	3	4	5	6	7	8	9	10
5	0	1	2	3	4	5	6	7	8	9	10
6	0	1	2	3	4	5	6	7	8	9	10
7	0	1	2	3	4	5	6	7	8	9	10
8	0	1	2	3	4	5	6	7	8	9	10
9	0	1	2	3	4	5	6	7	8	9	10
10	0	1	2	3	4	5	6	7	8	9	10
11	0	1	2	3	4	5	6	7	8	9	10
12	0	1	2	3	4	5	6	7	8	9	10
13	0	1	2	3	4	5	6	7	8	9	10
14	0	1	2	3	4	5	6	7	8	9	10
15	0	1	2	3	4	5	6	7	8	9	10
16	0	1	2	3	4	5	6	7	8	9	10
17	0	1	2	3	4	5	6	7	8	9	10
18	0	1	2	3	4	5	6	7	8	9	10
19	0	1	2	3	4	5	6	7	8	9	10
20	0	1	2	3	4	5	6	7	8	9	10

Comments \_\_\_\_\_  
 \_\_\_\_\_  
 \_\_\_\_\_

PLACE  
STAMP  
HERE

**BYTE** READER SERVICE

PO Box 319  
Dover NJ 07801  
USA

PLACE  
STAMP  
HERE

**BYTE** SUBSCRIPTIONS

PO Box 590  
Martinsville NJ 08836  
USA

PLACE  
STAMP  
HERE

**BYTE** Publications Inc

70 Main St  
Peterborough NH 03458  
USA

**EQMB**  
—  
BYTE's Operating Monitor Box

# Experience the excitement of owning the world's finest *personal* computer— IMSAI 8080

Waiting for you—all the incredible performance and power of the IMSAI 8080. And at a price you would normally pay for a fine home music system.

Introduced more than two years ago, the IMSAI 8080 is sold worldwide and acknowledged as the finest *personal* computer available.

## WORLD OF USES

The IMSAI 8080 is a superbly engineered, quality computer. It is versatile, expandable and powerful, putting literally hundreds of

applications and uses at your fingertips. Imagine sitting at your desk and enjoying interaction with your IMSAI 8080! Press the *on* switch and you're ready for game playing, research, education, business applications, or for laboratory instrument control. It has all the power you need, and more, to make your application ideas come alive.

## GROWS WITH YOU

The IMSAI 8080 is designed for many years of pleasure. With its open-chassis engineering you can expand your system by adding peripherals and interfaces. The 22-slots and 28 amp power supply mean that you can plug-in today's, plus *tomorrow's* modules.

Right now you can add a module

for displaying line graphics and characters on TV; a ready-to-use keyboard; small and large printers, and a single interface that lets you attach multiple devices. Expect the latest, exciting equipment from IMSAI. We are committed to leadership in this expanding technology.

## EASY TO PROGRAM

Choose your language, BASIC, FORTRAN, ASSEMBLER. We have them all! With advanced text editing and file management, you can program sophisticated and unique applications, limited only by your imagination.

If you're thinking personal computer,  
treat yourself to the very best—  
IMSAI 8080

Call or write for name of nearest  
dealer.

# IMSAI®

The Standard of Excellence  
In Microcomputer Systems

IMSAI Manufacturing Corporation  
14860 Wicks Blvd.  
San Leandro, CA 94577  
(415) 483-2093 TWX 910-366-7287

# This 8-bit machine, by itself, is as versatile as a lot of systems that include peripherals



Skeptical? For starters, because of its unique design the H8 is the only machine in its price class that offers full system integration, yet, with just 4K of memory and using only its "intelligent" front panel for I/O, may be operated completely without peripherals!

In addition, by using the features of its built-in Pam-8 ROM panel control program, the H8 actually allows you to dig in and examine machine-level circuitry.

Responding to simple instructions the "intelligent" panel displays memory and register contents, lets you inspect and alter them even during operation. And for greater understanding, the front panel permits you to execute programs a single instruction at a time. The result is a powerful, flexible learning tool that actually lets you "see" and confirm each detail of H8's inner workings.

If you need further evidence, consider the fact that H8's system

040 100 076

Memory Display

040 100 P<sub>c</sub>

Register Display

010 040

I/O Port Display

orientation allows you an almost unlimited opportunity for growth.

Memory is fully expandable, the 8080A CPU extremely versatile, and with the addition of high speed serial and parallel interfacing you gain the added flexibility of I/O operation with tape, CRT consoles, paper tape reader/punches, and soon floppy disk systems!

The H8 offers superior documentation including complete step-by-step assembly and operation manuals, is backed by 54 years of Heath reliability, and comes complete with BASIC, assembler, editor, and debug software — others charge over \$60 for!

H8, simplicity for the beginner, sophistication for the expert and at \$375\* just right for you.



\*Price does not include order net FOB, Benton Harbor, Michigan. Prices and specifications subject to change without notice.

## HEATHKIT COMPUTERS

### System Engineered for Personal Computing

# H8



Be sure to use coupon on page 48 of this magazine to order your FREE Heathkit Catalog!



Circle 160 on inquiry card.