

Are "18-Bit" CD Players Better?

# HIGH FIDELITY

AUDIO • VIDEO • TEST REPORTS • MUSIC



**YAMAHA**

Audio-Video Receiver

**DBX**

Loudspeaker

**MITSUBISHI**

Compact Disc Player

**NEC**

Compact Disc Player

**FOSGATE**

Surround-Sound Decoder

**MAGNAT**

Loudspeaker

**KENWOOD**

Integrated Amplifier

**SONY**

Portable 8mm VCR

**ALTEC LANSING**

Car Stereo Power Amp

**PANASONIC**

FM Radio-Headphones



#131C\*\*\*\*\*5-DIGIT 13903  
#032//CHA39# 11 JUN88  
2LBR3 12888 CHA99 HIF  
ENGRG LIBRARY  
MCMINTOSH LAB INC  
2 CHAMBERS ST  
BINGHAMTON NY 13903



# TAKE OUT T



## THE ELITE M-90 AND C-90 REFERENCE COMPONENTS

Hum, hiss, crosstalk, vibration: distortion in your audio signal.

Graininess, specks, flecks, jitter: extraneous noise in your video image.

Garbage.

The Elite C-90 pre-amp and M-90 power amp are no-compromise components designed to get rid of it. By keeping critical signal paths as short as possible. By offering you direct CD connection. By introducing motorized volume control separate audio and video power

transformers, and unique video processing controls like noise reduction, sharpness and detail. By giving you the purest possible audio and video that digital technology has to offer.

In the words of audio critic Julian Hirsch in *Stereo Review*, "The C-90's signal to noise ratio is considerably better than that of any CD player...that makes the C-90 the *true peer* of any digital sound source—the only pre-amplifier we have tested that can make that claim!"

The C-90 also cleans up your video. Because it

\*Measured by EIA method. \*\*Based on FTC rules regarding measurement of amplifier power ratings.



# THE GARBAGE.



not only controls up to six video components, its video-enhancing circuits actually improve your video image. Now, even rented videotapes take on a whole new look.

But what good is a complete A/V system without remote capabilities? The C-90's "SR"<sup>™</sup> System Remote gives you complete control, plus a unique Motor-Drive Volume Control that eliminates the noise created by typical electronic volume controls.

Where the C-90 leaves off, the M-90 takes over. With 800 watts/channel into 2 ohm loads; 200 watts into 8 ohms; and remarkably high current capability (47 amps) for low impedance

driving, the M-90 delivers the kind of performance digital signals demand. And for unprecedented purity, the M-90 even includes its own volume control for direct connection to your CD player.

The Elite M-90 and C-90 working together. There's just no better way to take out the garbage. For more information, call 1-800-421-1404.

ELITE  
BY PIONEER

# UNLEASH THE POWER



## Radio Shack's New High-Power Receiver With Infrared Remote



Wireless 18-Key Infrared Remote Control

Powerhouse performance with the luxury of wireless remote operation! The all-new Realistic® STA-2700 has the power and features to serve as the heart of today's sophisticated digital audio and video systems. Rated 100 watts per channel, minimum rms into 8 ohms from 20 to 20,000 Hz, with no more than 0.05% THD. The 18-key remote gives you total control from across the room. And

the digitally synthesized tuning system features a fluorescent frequency display, a programmable memory for storage of six FM and six AM stations for instant recall, plus search and manual tuning modes. The tape control center puts you in command of 2-way dubbing and 2-deck monitoring. Upgrade your system and unleash the power of the STA-2700. Only \$499.95, and only at Radio Shack.

**Radio Shack®**  
A DIVISION OF TANDY CORPORATION

Send for Your FREE 1988 Catalog!

Mail to Radio Shack, Department 88-A-307  
300 One Tandy Center, Fort Worth, TX 76102

NAME \_\_\_\_\_  
STREET \_\_\_\_\_  
CITY \_\_\_\_\_ STATE \_\_\_\_\_ ZIP \_\_\_\_\_

Remote batteries extra. Price applies at participating Radio Shack stores and dealers

**ULTRA**  
 A special new section for the advanced audiophile (Follows page 40)

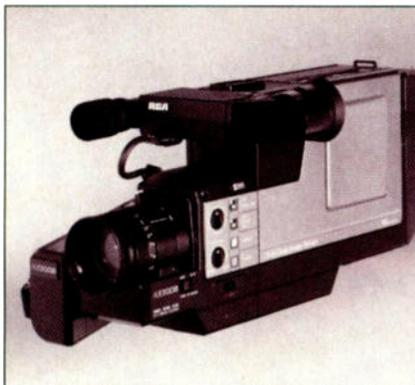

RCA's Super VHS camcorder

10



Tested: NEC CD player, 9 more

19

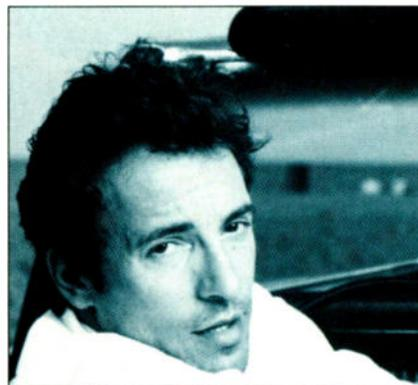

Bruce Springsteen, still anxious

65

## TEST REPORTS

NEC CD-810 Compact Disc player	19
Panasonic RF-HX7 FM radio-headphones	23
Sony EV-S1 portable 8mm VCR	24
Fosgate DSM-3602 surround-sound processor	26
Magnat MSP-60 loudspeaker	32
Kenwood KA-3300D integrated amplifier	37
Altec Lansing ALA-435 car-stereo power amplifier	41
Mitsubishi DP-311R Compact Disc player	44
DBX Soundfield SF-50 loudspeaker	48
Yamaha RX-1100U AM/FM receiver	50

On the cover: Yamaha's RX-1100U receiver (top) and Fosgate's DSM-3602 surround-sound processor.



Cover design: Joanne Goodfellow  
 Cover photo: David Wagner

## COLUMNS

Front Lines Is HDTV finally on its way?/MICHAEL RIGGS	6
Bits & Pieces The real reason to want an 18-bit CD player. DAVID RANADA	13
The Audiophile Should you upgrade to a component speaker system? CHRISTOPHER J. ESSE	14

## DEPARTMENTS

Letters	8
Currents Philips launches Philips; Nakamichi aims lower.	10
The CD Spread Ozawa's Carmina Burana; Mravinsky's Tchaikovsky symphonies; Gould's Goldberg Variations	55
Classical Reviews Inbal's Mahler cycle continues; two perspectives on Previn's return to Walton's First.	57
Pop Reviews The Seventies are alive in Pink Floyd, Jethro Tull, Yes, and Rush; Kathy Mattea; Doors.	65
Jazz Reviews Three LPs from Steve Lacy; Charlie Haden.	77
In Short Order 10,000 Maniacs; Scott Hamilton; Dave McKenna.	79
Advertising Index	77

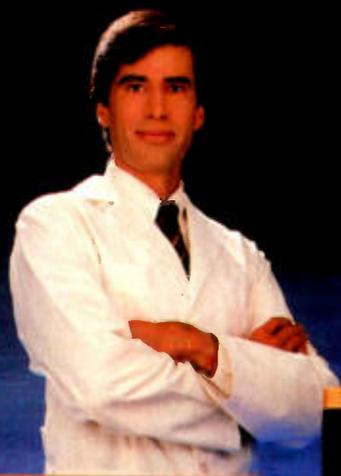

**SDA 2B**  
**\$599.95 ea.**

**SDA 1C**  
**\$798.95 ea.**

*Digital Disc Ready*

**Matthew Polk and his extraordinary new Signature Edition SDA 1C and SDA 2B.**

# “Matthew Polk Has a Passion for Perfection!”

## Experience the Awesome Sonic Superiority of His New Signature Edition SDA 1C and SDA 2B.

The genius of Matthew Polk has now brought the designer styling, advanced technology and superb sonic performance of his award winning SDA Signature Reference Systems into the new Signature Edition SDA 1C and SDA 2B.

**“They truly represent a breakthrough.”**

*Rolling Stone Magazine*

Polk's critically acclaimed, 5 time AudioVideo Grand Prix Award winning SDA technology is the most important fundamental advance in loudspeaker technology since stereo itself. Listeners are amazed when they hear the huge, lifelike, three-dimensional sonic image produced by Polk's SDA speakers. The nation's top audio experts agree that Polk SDA loudspeakers always sound better than conventional loudspeakers. Stereo Review said, "Spectacular... the result is always better than would be achieved by conventional speakers." High Fidelity said, "Astounding... We have yet to hear any stereo program that doesn't benefit." The new SDA 1C and SDA 2B utilize new circuitry which allows the drivers to more effectively utilize amplifier power at very low frequencies. This results in deeper, more powerful bass response, greater dynamic range and higher efficiency. In addition, the new circuitry makes these new speakers an extremely easy load for amplifiers and receivers to drive. Lastly, the imaging, soundstage and depth are more precise and dramatically realistic than ever.

### Why SDAs Always Sound Better

Stereo Review confirmed the unqualified sonic superiority of Matthew Polk's revolutionary SDA Technology when they wrote, "These speakers *always* sounded different from conventional speakers — and in our view better — as a result of their SDA design.

Without exaggeration, the design principals embodied in the SDAs make them the world's first true stereo speakers. The basic concept of speaker design was never modified to take into account the fundamental difference between a mono and stereo signal. The fundamental and

basic concept of mono is that you have one signal (and speaker) meant to be heard by both ears at once. However, the fundamental and basic concept of stereo is that a much more lifelike three-dimensional sound is achieved by having 2 different signals, each played back through a separate speaker and each meant to be heard by only one ear apiece (L or R). So quite simply, a mono loudspeaker is designed to be heard by two ears at once while true stereo loudspeakers should each be heard by only one ear apiece (like headphones). The revolutionary Polk SDAs are the first TRUE STEREO speakers engineered to accomplish this and fully realize the astonishingly lifelike three-dimensional imaging capabilities of the stereophonic sound medium.

**“A stunning achievement”**

*Australian HiFi*

Polk SDA Technology solves one of the greatest problems in stereo reproduction. When each ear hears both speakers and signals, as occurs when you use conventional (Mono) speakers to listen in stereo, full stereo separation is lost. The undesirable signal reaching each ear from the "wrong" speaker is a form of acoustic distortion called interaural crosstalk, which confuses your hearing.

**“Literally a New Dimension in the Sound**

*Stereo Review Magazine*

The Polk SDA systems eliminate interaural crosstalk distortion and maintain full, True Stereo separation, by incorporating two completely separate sets of drivers (stereo and dimensional) into each speaker cabinet. The stereo drivers radiate the normal stereo signal, while the dimensional drivers radiate a difference signal that acoustically and effectively cancels the interaural crosstalk distortion and thereby restores the stereo separation, imaging and detail lost when you listen to normal "mono" speakers. The dramatic sonic benefits are immediately audible and remarkable.

**“Mindboggling, astounding, flabbergasting”**

*High Fidelity Magazine*

Words alone cannot fully describe how much more lifelike SDA TRUE STEREO reproduction is. Reviewers, critical listeners and novices alike are overwhelmed by the magnitude of the sonic improvement achieved by Polk's TRUE STEREO technology. You will hear a huge sound stage which extends not only beyond the speakers, but beyond the walls of your listening room itself. The lifelike ambience revealed by the SDAs makes it sound as though you have been transported to the acoustic environment of the original sonic event. Every instrument, vocalist and sound becomes tangible, distinct, alive and firmly placed in its own natural spatial position. You will hear instruments, ambience and subtle musical nuances (normally masked by conventional speakers), revealed for your enjoyment by the SDAs. This benefit is accurately described by Julian Hirsch in Stereo Review, "...the sense of discovery experienced when playing an old favorite stereo record and hearing, quite literally, a new dimension in the sound is a most attractive bonus..." Records, CDs, tapes, video and FM all benefit equally as dramatically.

**“You owe it to yourself to audition them.”**

*High Fidelity Magazine*

SDAs allow you to experience the spine tingling excitement, majesty and pleasure of live music in your home. You must hear the remarkable sonic benefits of SDA technology for yourself. You too will agree with Stereo Review's dramatic conclusion: "the result is *always better* than would be achieved by conventional speakers...it does indeed add a new dimension to reproduced sound."

**polk audio**  
The Speaker Specialists®

5601 Metro Drive, Baltimore, Md. 21215



## New Hope For HDTV?

By Michael Riggs

**T**he world's three major broadcast-television standards—PAL, SECAM, and our own NTSC—have begun to show their age. Indeed, in certain basic respects, television has not changed since the dawn of commercial broadcasting, and NTSC television has not changed at all (except for the addition of stereo sound) since the early '50s. We can do better today. Systems that deliver large, wide-screen images with near-photographic sharpness and superb color fidelity have been demonstrated many times over the last few years.

The main stumbling blocks to higher-fidelity television are price, bandwidth, and compatibility. Because of more complicated electronics and a large, unusually shaped picture tube, a set designed to receive high-definition television (HDTV) broadcasts would cost much more than a conventional set of similar quality, especially in the beginning. But how much more are people willing to pay to get a better picture? Hundreds of dollars? Thousands? And how much better does the picture have to be before a substantial number of people will pay anything at all for it?

A second major bugaboo is bandwidth. A conventional HDTV broadcast might require a channel twice as wide as the ones now used for NTSC television. In an increasingly cluttered radio-frequency spectrum, this is no small consideration.

A number of solutions have been proposed. One is Direct Broadcast from Satellite (DBS). In this scheme, as many as three channels of HDTV might be beamed from satellites in synchronous orbits to small (approximately three-foot) rooftop dishes. The frequencies used for this purpose would not cut into the ones in heavy demand for terrestrial communications. Unfortunately, DBS is itself an expensive and financially risky proposition, and in the U.S., at least, it appears to be languishing.

Other possibilities include opening up some of the currently underutilized UHF TV band for high-definition broadcasts and using shortcuts to reduce the required bandwidth. The latter approach warrants particular scrutiny, since it bears on the third issue—compatibility—as well.

When I say compatibility, I mean the ability of current television sets to receive HDTV broadcasts in some limited form. Television in this country is supported almost exclusively by advertising revenues, and broadcasts that can be viewed in only a few thousand households just won't be able to make enough money. A signal that could deliver high-resolution, wide-screen images on special receivers and standard NTSC images on old sets would neatly sidestep this difficulty.

Recently, NBC announced details of Advanced Compatible Television (ACTV), which it is developing in collaboration with RCA and the David Sarnoff Research

Center. In many ways, ACTV will be a dream come true. Data-compression techniques enable an ACTV broadcast to squeeze into a conventional 6-MHz NTSC channel. Equally important, all the extra information needed to deliver a 1,050-line picture with more than 400 lines of horizontal resolution and a 5:3 aspect ratio is piggy-backed onto a standard NTSC signal. As far as a conventional receiver is concerned, the additional material simply doesn't exist; it picks up the broadcast and gives you a regular NTSC color picture. An ACTV receiver recognizes the extra information and uses it to double the number of scan lines, increase resolution, and add "wings" to the picture that widen the aspect ratio (width to height) from 4:3 to 5:3.

But those who have seen the system demonstrated confirm what the technical description and specifications suggest: Although ACTV is significantly better than NTSC, it is no match for a full-blown HDTV system, such as the one developed by NHK in Japan. Most obvious is ACTV's lower horizontal resolution. There may be other shortcomings as well, arising mainly from the NTSC base on which the system is built.

At its best, NTSC television is remarkably good, especially when you consider that it is almost 40 years old. A couple of months ago, I had an opportunity to tour Laserdisc Corporation of America's recently revamped videodisc mastering and manufacturing facilities in California. There I saw, for the first time, playback of 1-inch videotapes on professional monitors, and my eyes practically jumped out of my head. The picture quality was startlingly superior to anything I've ever seen on any consumer set, regardless of price or sophistication. (On the other hand, such professional monitors usually sell for upwards of \$7,000.) Nonetheless, NTSC television does have inherent limitations. For example, its color-encoding technique tends to generate small but annoying artifacts under some conditions. ACTV presumably will do nothing to overcome most of these difficulties.

So what team should we root for? It is tempting to say that we should hold out for the best that modern technology has to offer. I fear, however, that such a choice will lead nowhere, given the poor commercial prospects for any system that completely locks out the current universe of receivers. ACTV, for all its compromises, has a far better chance of actually getting higher-quality television pictures to those who care enough to pay for the privilege. And despite the recent hoopla about HDTV and its derivatives, it may be quite a while before any flavor of enhanced television hits the consumer market.

For now, we should demand that manufacturers start building monitors and VCRs that can take full advantage of our old buddy NTSC. That alone would be a big step in the right direction. ■

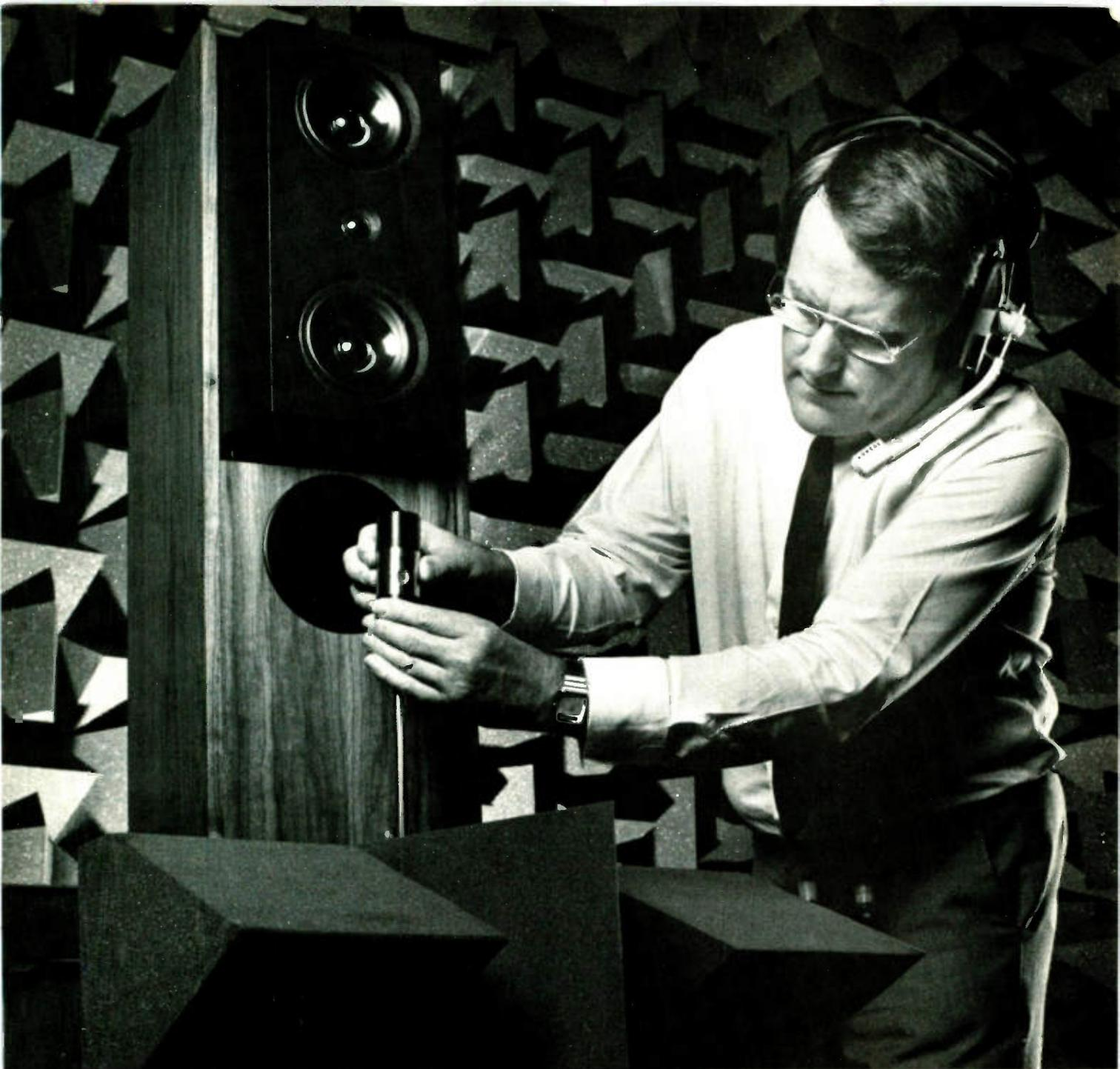

**'Before we could make our speakers better,  
we had to invent a better speaker test!'**

—Laurie Fincham, DIRECTOR OF KEF RESEARCH AND DEVELOPMENT

#### ONE STEP IN THE MAKING OF A KEF

'A speaker is usually measured by frequency response sweeps. But their proper interpretation is difficult at best — misleading at worst.

'So in 1971, KEF joined forces with Hewlett Packard and Bradford University to develop a more reliable test: computerised Fast Fourier Transform (FFT). Our computer

analyzes a series of pulse tones to produce a far more accurate, more detailed picture of frequency, phase, and transient time-domain behaviour.

'FFT testing has already spurred us to major advances in phase integrity and production consistency. It's certainly easier to make progress when you can see where you're going.'

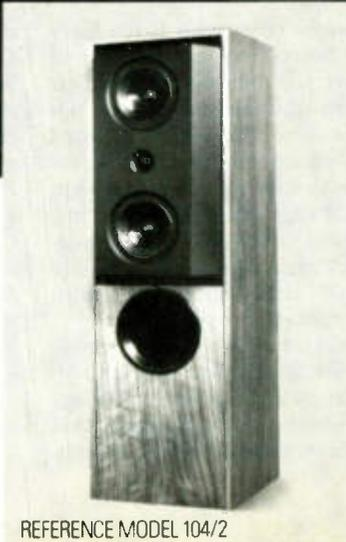

REFERENCE MODEL 104/2



*The Speaker  
Engineers*

## TALKIN' 'BOUT OUR GENERATIONS

As I sit in my room listening to the Compact Disc of *Crosby, Stills & Nash* and reading your August issue, I begin to wonder what music will be like in another 20 years. In a letter to the editor, John Nagy defends the music of the late '60s, especially the Rolling Stones album *Their Satanic Majesties Request*. I read the letter and agree with what he is saying.

Mark Moses, who replies to the letter, says the following: "The irony about pop records is that they physically outlast the moment they were meant to encapsulate." If this statement is indeed true, then how very ironic pop music is today. I am only seventeen, don't "vomit beer and ludes out of the back window of a car" while listening to *Led Zeppelin IV* (Mr. Moses's words), and have only six CDs (out of a collection of 45) that were recorded after 1980—and each of the six artists did something else before 1980.

Now that the summer of '87 is upon us, I find it interesting that music recorded 20 years ago is getting all the attention (i.e., the Beatles). Such groups as the Moody Blues, Pink Floyd, and Crosby, Stills & Nash are now on tour. It looks as if the summer of '67 is beginning to envelop the summer of '87 as well.

Mr. Nagy says that anyone under the age of thirty-seven can't truly appreciate the music of the '60s. Yet it doesn't take age to understand music. It takes intelligence and feeling. Maybe 20 years from now, when the bands of today finally learn how to play their instruments and *Led Zeppelin IV* is still playing on the radio, the Pepsi generation will have finally grown up and figured out what real music is all about: intelligence and feeling, two things that today's music doesn't have.

*John W. Gosney*  
Greenfield, Ind.

I couldn't agree more with Brian Cary Sokolow's observations on the state of contemporary pop radio and its mindless preoccupation with the music of the '60s and '70s ["Medley," August]. It is indeed ironic that rock acts of that era, however mundane, receive more airplay today than they did when they were viable concerns. What is perhaps more disturbing is the degree to which contemporary acts getting the "big push" either sound like—or in fact are—retreads from bygone days.

All of the clamor about what constitutes "real rock 'n' roll" serves only to divert attention away from what often appears to be an absence of creativity and innovation. Should the current trend con-

tinue, we'll no doubt witness the hailing of '70s AOR rock as "roots music." Frightening, when you think about it. But then, I never thought I'd have to endure the Monkees again. While the listening public collectively retrogresses, it might spare a passing thought to the plight of young artists trying to break into the business.

And all of this at the tail end of a decade that began with such promise. To paraphrase someone else's line, I've seen the future of rock 'n' roll, but not lately.

*Robert Woods*  
Chicago, Ill.

*For more on the '70s as transplanted to the '80s, see this month's BACKBEAT for reviews of new albums by Pink Floyd, Jethro Tull, Yes, and Rush.—Ed.*

## POP AND JAZZ INFORMATION, PLEASE

As a musician, I can tell from Michael Ullman's review of *Trumpet Kings* [July] that he, too, is a musician and knows what he is talking about. Now where can I get a VHS copy of the videocassette, and what is the cost? Thanks for your help.

*Wayne M. Shipe*  
Reading, Pa.

*Trumpet Kings should now be available at your local video store. If not, you may buy a copy (either Beta or VHS) directly from Video Artists International, P.O. Box 153, Ansonia Station, New York, N.Y. 10023. The cost is \$39.95 plus \$2.75 for shipping and handling. (New York residents, add sales tax.)—Ed.*

I have a CD of songs by various artists. Included is a track by Vangelis. Can you advise me if there are any solo recordings by Vangelis in any format? Please help.

*Harry Miklasz*  
Chicago, Ill.

*According to the SCHWANN COMPACT DISC CATALOG, five solo recordings by Vangelis are available on CD: Ignacio (on the Barclay label, through Polygram Special Imports) and China, The Mask, Opera Sauvage, and Soil Festivities (all on Polydor). Also on CD are Vangelis's soundtracks to La Fête Sauvage (Barclay) and Chariots of Fire (Polydor). Five more recordings are available on LP and cassette from RCA: Albedo, Beaubourg, Heaven and Hell, Spiral, and To the Unknown Man. Polydor's Earth is on LP only.—Ed.*

*Letters should be addressed to The Editor, HIGH FIDELITY, 825 Seventh Ave., New York, N.Y. 10019. All letters are subject to editing for brevity and clarity.*

# HIGH FIDELITY

**Editor** Michael Riggs  
**Art Director** Joanne Goodfellow  
**Managing Editor** Kathleen Green

**Copy Editor** David Browne  
**Assistant Managing Editor** Jonathan Tesser  
**Assistant to the Publisher** Darleen D. Edwards  
**Editorial Assistants** Judith Nichols, Arinda J. Segarra

**TECHNICAL DEPARTMENT**  
**Technical Editor** David Ranada  
**Associate Technical Editor** Christopher J. Esse  
**Consulting Technical Editors** Edward J. Foster, Robert Long  
**Contributing Editor** Larry Klein

**MUSIC DEPARTMENT**  
**Classical Music Editor** Theodore W. Libbey, Jr.  
**Popular Music Editor** Ken Richardson  
**Associate Classical Music Editor** Patricia Reilly  
**Contributing Editors** Robert E. Benson, Leslie Berman, Jim Bessman, Pamela Bloom, Francis Davis, Rev. Thomas L. Dixon, Thor Eckert, Jr., Steve Futterman, Edward Greenfield, Thomas Hathaway, Paul Hume, Paul Moor, John Morthland, Jeff Nesin, Robert R. Reilly, Thomas W. Russell III, Terry Teachout, Noah André Trudeau, Michael Ullman, Richard C. Walls, James Wierzbicki

**ART DEPARTMENT**  
**Assistant Art Director** Laura Sutcliffe  
**Technical Art** Roy Lindstrom

**PRODUCTION DEPARTMENT**  
**Director of Production** Angelo Puleo  
**Advertising Production Manager** Marina Paruolo  
**Atex System Manager** Mildred Richardson

**CIRCULATION DEPARTMENT**  
**Circulation Director/Newsstand** Jim Roberts  
**Circulation Subscription Staff** Ora Blackmon-DeBrown, Joseph DeFalco, Mitch Frank, Tom Link, James J. Smith  
**Customer Service** Kay Harris

**Vice-President**  
**Group Publisher/Editorial Director** William Tynan

**ABC CONSUMER MAGAZINES, INC.**  
**Senior Vice-President, Advertising** Richard J. Marino  
**Vice-President, Circulation** Barbara H. Marks  
**Vice-President, Operations** Lucian A. Parziale  
**Vice-President, Finance** Marc Reisch  
**Vice-President, Production** Ilene Berson Weiner

ONE OF THE **ABC PUBLISHING** COMPANIES

**President** Robert G. Burton  
1330 Avenue of the Americas, New York, N.Y. 10019

**HIGH FIDELITY** is published monthly by ABC Consumer Magazines, Inc. a division of ABC Publishing Inc. a Capitol Cities/ABC Inc. company © 1987 ABC Consumer Magazines, Inc. Member Audit Bureau of Circulations. Indexed in Reader's Guide to Periodical Literature. Current and back copies of **HIGH FIDELITY** are available on microfilm from University Microfilms, Ann Arbor Mich. 48106. Microfiche copies (1973 forward) are available from Bell & Howell Micro Photo Div. Old Mansfield Rd. Wooster Ohio 44691.

## ADVERTISING OFFICES

**New York:** ABC Consumer Magazines, Inc., 825 Seventh Ave., 8th Fl., New York, N.Y. 10019. Tel. (212) 265-8360. Peter T. Johnsmeyer, Group Advertising Director. Andrew Eisenberg, Associate Advertising Director. James R. McCallum, Advertising Director. Music/Books: Maria Mana, Classified Advertising Director. Angelo Puleo, Director of Production. Marina Paruolo, Advertising Production Manager.  
**Midwest:** **HIGH FIDELITY**, 580 Waters Edge, Lombard, Ill. 60148. Tel. (312) 691-1165/77. Starr Lane, Midwest Advertising Director.  
**Los Angeles:** ABC Consumer Magazines, Inc., 1888 Century Park East, Suite 1900, Los Angeles, Calif. 90067. Tel. (213) 284-3132. Howard Berman, Western Advertising Director.

**Editorial correspondence** should be addressed to The Editor, **HIGH FIDELITY**, 825 Seventh Ave., New York, N.Y. 10019. Editorial contributions will be welcomed and payment for articles accepted will be arranged prior to publication. Submissions must be accompanied by return postage and will be handled with reasonable care, however, the publisher assumes no responsibility for return of unsolicited photographs or manuscripts.



Magazine Publishers Association

# Now we do for Amadeus what we've always done for Mozart.

For years you've relied on Yamaha to faithfully reproduce the vibrancy and clarity of your music.

Now, innovative Yamaha technology does the same for your favorite movie videos as well.

Introducing the RX-1100U. The Yamaha receiver that combines our legendary audio quality with broadcast quality video. A major enhancement to our long line of successful receivers.

In fact, the RX-1100U contains so many exciting features, you might want to visit your authorized Yamaha dealer and spend a few minutes exploring them for yourself.



Start by playing a video cassette through the RX-1100U. And watch the results on the finest video monitor.

The powerful new video-enhancing circuitry restores clarity and sharpness to even the weakest, noisiest video signal. So any prerecorded tape looks network crisp.

Then grab a camera, shoot a few minutes of tape on your own, and use the video enhancer while making a third generation dub.

You'll have a hard time telling the dub from the original.

While you're at it, experiment with the new video Rec Out Selector feature. Use it to mix your video with different audio sources to create original music backgrounds and sound effects.



Just like a post-production shop. Next, take the most musically demanding CD, crank open the 125 watt/channel\* amplifier, and listen to what's missing.

Distortion.

It's not there because the RX-1100U boasts our new Absolute Linear Amplification (ALA) circuitry.



This advanced amplifier technology injects a mirror image of the output distortion back into the input stage. The distortion component drops virtually to zero.

What's more, this receiver has plenty of headroom—up to 360 watts/channel into a 2 ohm load—so it's never cramped by the wider dynamic range and varying speaker impedances associated

with digital sources.

Now, walk to the other side of the room, where you can appreciate the new RS interactive remote control to its fullest.

Notice how it packs fingertip operation of the receiver, as well as other Yamaha RS-remote CD players, cassette decks and turntables, into one slim hand-held unit that ends coffee table clutter forever.

Home entertainment has certainly changed. It had to. You started out as an audiophile and find yourself becoming a videophile as well. Or vice versa.



But you can still trust Yamaha to satisfy your needs.

Because when you want to know what's new in top performing equipment, we've always been the ones to listen to.

Now, with our RX-1100U, we're the ones to keep an eye on as well.

\*125 watts RMS per channel, both channels driven into 8 ohms, from 20 to 20,000 Hz, at no more than 0.015% Total Harmonic Distortion.

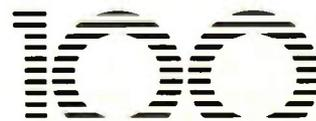

**YAMAHA 1887-1987**

Yamaha Electronics Corporation, USA, P.O. Box 6660, Buena Park, CA 90622

## TECHNICS TECHNICAL REPORT



**WHY DISC JOCKEYS, RADIO STATIONS AND JUST PLAIN MUSIC FREAKS WILL BE TECHNICALLY CRAZY ABOUT TECHNICS CD PLAYERS.**

### HIGH-RESOLUTION DIGITAL FILTER

The high-resolution digital filter contributes to the excellent sound quality of Technics CD Players. The 88.2 kHz double oversampling circuit "moves" the unwanted noise components farther away from the music than they might otherwise be. As a result, the filter circuit can be more gentle with the critical musical signal than a system using analog filters and no oversampling. This helps reduce "phase shift" or "group delay" for an accurate musical sound.

### HIGH-SPEED TRANSPORT

Every Technics home CD player uses a "linear motor" to drive the laser pickup across the traverse mechanism. This means that you can go from one track to any other in less than one second.

### CLASS AA CIRCUITRY (MODELS SL-P420, 520, 720, 1000, 1200, 1200X)

Technics Class AA circuitry isolates the voltage amplifier and current gain function in critical CD player circuitry. This is designed to help improve the ability of the amplifier to drive difficult loads.

#### TECHNICAL SPECIFICATIONS FOR SL-P720

Frequency Response	4-20,000 Hz $\pm$ 0.2 dB
Dynamic Range	94 dB
Total Harmonic Distortion	0.0025% (1kHz)
Channel Separation	98 dB (1kHz)
Wow & Flutter	0.0009%

**Technics**  
The science of sound

## C U R R E N T S

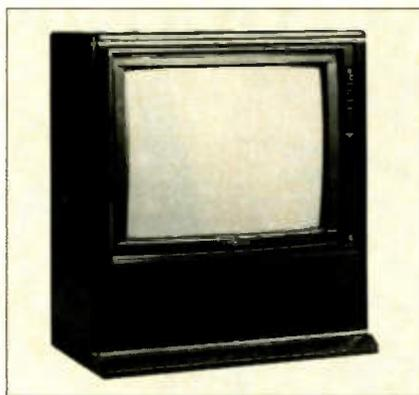

*Philips's black-ash cabinet has rosewood accents.*

### Act Three

Philips-brand audio and video products are here—again. Now that consumers should be familiar with the European electronics giant as the co-developer of the Compact Disc format, name recognition should not be an obstacle to sales (as it may have been in two previous introductions). The Philips equipment is being handled by North American Philips, the parent company's existing U.S. subsidiary, which also sells products under the Magnavox, Sylvania, and Philco names.

Of the 19 components making up the initial Philips audio line, two CD players and two integrated amplifiers rank at the top. The FA-960 integrated amp (\$549), rated at 100 watts (20 dBW) per channel, includes a recording-out selector that enables you to monitor a different source while recording. In the CD Direct mode, noise is minimized by routing the signal around the switching and tone-control circuitry. The FA-860 (\$439) is a similar 65-watt (18.1-dBW) model without the separate recording-out selector.

Philips's best CD player is its new CD-960 (\$949), which features dual 16-bit digital-to-analog (D/A) converters and an optical digital output. It can be used optionally with the DAC-960 (\$949), an outboard D/A converter with multiple digital connections for future digital components (such as DAT decks and signal processors). Both the CD-960 and the \$549 CD-770 include Philips's Favorite Track Selection (FTS) feature, previously seen on certain Magnavox CD players. FTS enables you to store playback sequences for as many as 227 CDs for subsequent recall.

The Philips label will also adorn a line of direct-view and rear-projection TV sets as well as four VCRs. Included among them are a handsomely crafted 31-inch direct-view console TV set (Model 31H-

331SB, \$2,299) and a Super VHS Hi-Fi VCR (Model VPH-733TS, \$1,099). Each new monitor has a built-in amplifier with surround-sound circuitry and outputs for a pair of back-channel speakers. For more information, contact NAP Consumer Electronics Corp., 1-40 & Straw Plains Pike, Knoxville, Tenn. 37914.

### Behind the Lens

RCA's new line of Super VHS products includes two camcorders, both with auto-focus, an electronic viewfinder, and recording and playback compatibility with regular VHS tapes. The CPR-350 (\$1,700) uses full-size cassettes and can record for as long as two hours in S-VHS mode (us-



*RCA's compact CPR-175 S-VHS-C camcorder*

ing an ST-120 tape) or two hours, 40 minutes in regular VHS mode (using a T-160 tape). You must use an S-VHS cassette for the improved-resolution S-VHS recordings, but you can use either type of tape for regular VHS recordings. The camera section has a  $\frac{1}{2}$ -inch solid-state image pickup and an f/1.2 lens with two-speed 8:1 power zoom. The macro lens-setting enables you to focus on objects as close as  $\frac{1}{4}$  inch. As is the case with nearly all of today's camcorders, the CPR-350 has automatic white-balance and iris (exposure) settings that can also be controlled manually for unusual light conditions. Connecting cables for playback on a monitor or a conventional television are supplied, as is the special S connector for use with the S-video input on the newest TV monitors and S-VHS VCRs. (An S-video connection keeps the luminance and chrominance signals separated, preventing the various side effects caused by their mutual interference; picture resolution, though, is the same as with a composite-video input.) The CPR-350 weighs about 5 $\frac{1}{2}$  pounds.

Most of the operating features in the full-size unit appear in the 2.9-pound CPR-175 (\$1,500), which records on S-VHS-C cassettes for as long as 20 minutes at SP speed or 60 minutes at EP speed. Ap-

*(Continued on page 80)*

# TECHNICS CD PLAYERS. FOR DISC JOCKEYS, RADIO STATIONS AND JUST PLAIN MUSIC FREAKS.

Designed with Class AA circuitry, precision search cueing  
and anti-vibration construction.

Technics offers two home CD players more advanced than  
the CD players many radio stations use. The Technics SL-P720  
and the SL-P520.

Innovative Class AA circuitry provides you with silky highs,  
spectacular mid-range and chest-thumping bass. Precision  
2-speed search dial cueing—a Technics exclusive—enables  
you to move precisely to any point on any track on the disc.  
Both forward and backward. And anti-vibration construction  
minimizes the effects of external shock and vibration.\*

These CD players offer a high-resolution digital filter for the  
cleanest possible sound. For programming ease, you can  
access any track in under a second. There's even 20-selection  
random access programming and wireless remote.

So if you're a disc jockey, a radio station owner or a music  
freak, you'll be crazy about the Technics CD players.

**Technics**  
The science of sound



\*SL-P720 recommended for higher vibration applications.



BOUNDARIES DISAPPEAR. SPACE EXPANDS. EVERYWHERE,  
OPENNESS. AND THAT'S ONLY WHAT IT SOUNDS LIKE. HEAR AND SEE  
THE NEC 46" PROJECTION TV WITH DOLBY SURROUND SOUND.  
CERTAIN THINGS IN LIFE SIMPLY CANNOT BE COMPROMISED.

**NEC**



## The Two-Bit Difference

By David Ranada

**T**he latest round of bit battles has just begun. Several recently announced high-end players now sport 18-bit digital-to-analog converter (DAC) integrated circuits. That's right: Despite the 16-bit data stream encoded on a Compact Disc, player manufacturers are designing in chips that, at least in theory, are four times more precise than needed. Furthermore, these units are receiving their share of digital-filter technology, with several companies promising eight-times-oversampling filters to feed their newfangled DACs. But before you pronounce your first-generation 16-bit analog-filter CD player hopelessly obsolete and rush out to plunk down hundreds of dollars on a new machine, you should be aware of how an 18-bit DAC can—and cannot—improve performance.

An entire 18-bit industry has sprung up around a specific device—the PCM-64 18-bit D/A integrated circuit from Burr-Brown, a Phoenix-based company that is probably the world's largest supplier of 16-bit audio DACs. At least half of the CD players tested by HIGH FIDELITY in the last couple of years have used Burr-Brown DACs. As of this writing, the PCM-64 is the only 18-bit DAC being mass-produced for audio use, although it was originally developed for other applications. Burr-Brown's Joel M. Halbert (co-author with Mark A. Shill of a paper describing the DAC that was presented at last fall's Audio Engineering Society convention) told me the chip was developed as part of a very fast, very accurate *analog-to-digital* converter. He says applications such as medical full-body scanners using X rays require this sort of device: The varied absorption properties of bone and tissue, plus the necessity of reducing X-ray exposure time, require a fast converter with the very wide dynamic range an 18-bit system can span (approximately 108 dB, in theory).

The chip is a superb piece of engineering, with performance approaching the theoretical ideals. The Halbert/Shill paper cites harmonic distortion of an 18-bit-encoded 1-kHz sine wave as around 0.0008 percent, when the chip is used with its full factory-recommended trimming circuit. Even without trimming, the device can be expected to produce performance linear to within 16 bits.

That level of performance is a clue as to what you can expect from the new 18-bit CD players. For the moment, you can safely ignore any and all claims to "18-bit resolution and accuracy" you may see. What the Burr-Brown chips will be used to obtain is, in effect, true 16-bit resolution with 16-bit linearity. This is only proper, considering that a CD contains, at best, a 16-bit signal—and you can't get more information out of a CD than was put in. This is important because, until recently, such 16-bit performance was rarely available with most so-called 16-bit CD players.

A digression is in order here, since "resolution," "accuracy," and "linearity" are commonly mistaken for each other and consequently misused. A DAC can be thought of as containing an internal scale or ruler. The number of gradations on the ruler is the converter's *resolution* or *precision*. Going from 16 to 18 bits of resolution is equivalent to a fourfold increase in the fineness of the gradations. The actual placement of each gradation compared to where it should be is the ruler's *accuracy*, and the evenness of the spacing is its *linearity*. The latter is the most important characteristic of a DAC in audio applications.

From this analogy, you can see why a DAC with 16-bit resolution can have only 14- or 15-bit linearity and, therefore, higher distortion than theory predicts: The gradations don't all fall where they should. You can also sense why an 18-bit converter will give better 16-bit performance: In order to fit four times as many gradations on the ruler, the ones already there must be moved closer to their ideal locations. To obtain 16-bit linearity with the new Burr-Brown device, the two extra bits don't even have to be connected!

For the most part, the move from quasi-16- to true-16-bit performance made possible by 18-bit DACs will result in an inaudible gain in sound quality, since the improvements will be masked by noise and distortion far earlier in the recording chain. Measured distortion and linearity performance should improve remarkably, however, as will signal-to-noise ratio. But the latter specification should be viewed with suspicion, since methods for obtaining it are quite unrepresentative of playing an actual music disc.

The Halbert/Shill paper does hold out some hope for improved music performance using 18-bit converters—but not with presently existing technology. Halbert and Shill point out that if the audio signal remains considerably below the Compact Disc system's upper limit of about 22 kHz, the signal is being oversampled by the original 44.1 kHz sampling rate and contains information below the 16-bit level, which can be extracted by as yet undeveloped digital signal processing (DSP). "To take full advantage of 18-bit converters in a 16-bit CD or DAT player, more sophisticated, signal-adaptive DSP hardware will be required. Although particular specifications can be improved this way, the subjective benefits with real musical signals are yet to be documented. It is also quite possible that the extra bits can be used to produce effects which subjectively improve the sound quality, even if the measured total error power is not reduced." How nice it is to see a concise engineering prediction about a possible avenue of progress in digital audio—stated in phraseology as yet uncontaminated by commercial hyperbole. ■



## Component Speakers

By Christopher J. Esse

**F**ace it: Buying an autosound system isn't as easy as buying a system for the home. You can spend \$10,000 on a home system and find it just as straightforward to set up as one that costs \$500. In contrast, even a modest system for the car will likely involve the services of a professional installer. In fact, it may be difficult just to remove your existing system: Some new cars offer very little working space, and matters are further complicated when the system is tied into the car's other electrical functions (an increasingly common situation). In most cases, autosound is not really a do-it-yourself prospect, which is an obstacle for many of us who like to play with our toys right after we unwrap them.

When I visited Andy Petite, president of Boston Acoustics (BA for short), to talk about his company's

component car speakers, we also discussed why the do-it-yourself image persists. I blamed the mass-market mentality of some autosound manufacturers, who sell their wares through outlets that don't offer an installation service. Their customers are thereby inclined to perceive car stereo as an "over-the-counter" product. Petite pointed out that, not too long ago, aftermarket components were limited to such items as add-on FM tuners and cassette players; back then, you really *could* do it yourself. But when you walk into an autosound showroom nowadays, you're looking at a display board filled with car CD players, removable radio/cassette-players, equalizers, four-channel power amps, coaxial speakers, triaxial speakers, component speakers, crossover networks, and more—the system-design options are endless. Most of us would have difficulty properly installing this equipment in the display board, never mind in our cars.

If this sounds like a complaint, it's not. The joys of a high fidelity autosound system far outweigh the time and effort it may take to put one together. I know some people who have spent fortunes on good stereo systems for their homes, only to find that most of their listening is done while driving. And when they get home from work, the kids want "quality time," the lawn needs mowing, and the new issue of *HIGH FIDELITY* has just arrived—no time for listening now. Quick, back to the car!

All of this leads into our central topic: component car speakers. In last month's "Autophile," you may have read about a contest for the best-sounding car-audio systems in the country. Those systems all used component speakers as opposed to the more commonly used coaxial, triaxial, and single- and dual-cone speaker systems. There's a good reason for this: A component speaker

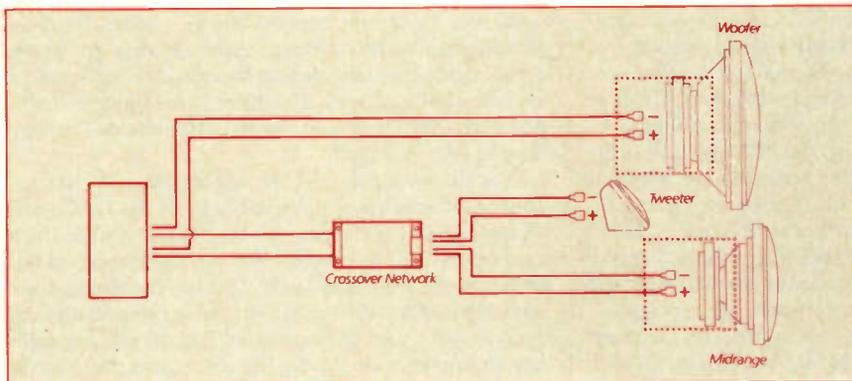

Fig. 1. In a basic setup using component car speakers, the radio's back-channel amplifier drives the woofers, which contain a "choke" that passes only the appropriate bass frequencies. A crossover determines which front-channel signals go to the midranges and tweeters. (Only one of the two stereo channels is shown.)

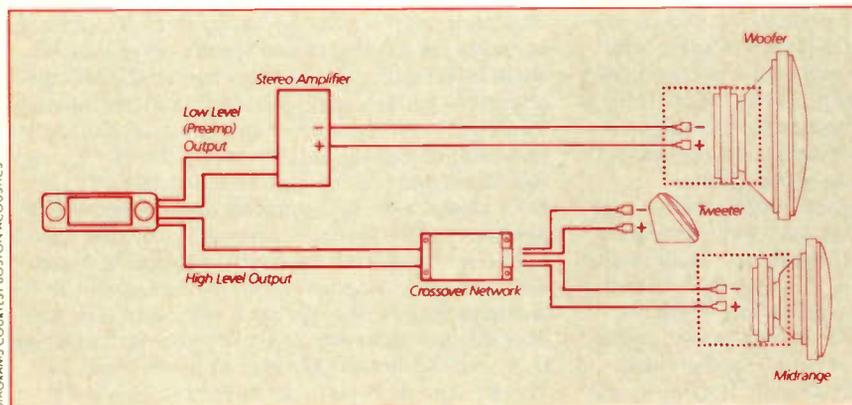

Fig. 2. Here, a separate, more powerful amplifier is used to drive the woofers. The amplifier is connected to the radio's preamp outputs; alternatively, it could run as a booster amp, fed by the radio's speaker outputs.

system offers the best chance of getting smooth, full-range music reproduction in a car. A three-way component car-speaker system houses the bass, midrange, and treble drivers in separate enclosures that can be placed within the car in locations that give the best results. (A two-way system uses just two drivers.) As in a home loudspeaker, a crossover divides the amplifier's music signal so that each speaker gets only the frequencies it is designed to reproduce.

Since speakers are the last active elements in the chain of sound reproduction, it's a safe bet that simply installing better ones will improve the sound of your system. The good news is that, in contrast to replacing your entire system, speaker installation is something you can do yourself. Richard Frank, director of marketing for Boston Acoustics, used this approach in upgrading the factory sound system in his car. So far, he's pleased with the performance of his car's "high-power" radio/cassette-player; however, the speakers that came with it, and their less-than-optimal locations, are the apparent weak link. Speakers are the bane of most factory systems, the best of which are otherwise a reasonable alternative to an aftermarket system. We'll use Frank's situation as a case study for upgrading with component speakers—in this instance, models from Boston Acoustics (a wise choice on his part).

In Frank's car, a pair of 5¼-inch full-range speakers are mounted in the lower portion of the front-door panels, and a pair of full-range 6-by-9s are mounted on the back shelf. For now, he decided to replace the front speakers with a Boston Acoustics two-way component system and to put only woofers in the back (Fig. 1 illustrates the basic connections). Having the high-frequency drivers only in the front will result in a forward sound image, rather than the all-around image delivered by the factory system. BA's Model 751 is a two-way system that includes a separate pair of tweeter modules and two 5¼-inch midrange/woofers (the perfect size for the now vacant mounting holes). The Varimount tweeters, which have removable angled enclosures, can be mounted in a variety of ways. Frank chose to attach them to the upper part of each door panel, angled in toward the listener. For the woofers, he used 6-by-9-inch bass drivers (also a part of BA's three-way 793 system) that fit the mounting holes on the back shelf. The fader control on Frank's radio now balances the sound between the higher-frequency drivers in the front and the woofers in the back. Some people prefer to be immersed in sound; had Frank been one of them, he could have simply mated the back-channel woofers with their midrange and tweeter companions.

Frank immediately noticed two related improvements provided by the new speaker system: Placing the tweeters higher on the door (and angling them in toward the listener) extended and smoothed the response and yielded a wider, more stable stereo soundstage. Previously, the high frequencies from the factory speakers were unable to escape absorption by the carpeting and the bottom cushions of the front seats.

Frank's approach is very conservative, yet it enables him to judge the benefits at each stage of upgrading. The better sound of the new speakers has encouraged him to play the system louder, quickly revealing the limits of the

radio's amplifier. Accordingly, the next step would be to drive the woofers with a separate amplifier, a more powerful one that would enable the system to play louder while still maintaining a good overall sound balance (a bass driver usually requires more power to play at a given level than do midrange drivers or tweeters). Fig. 2 shows the setup for using a separate woofer amplifier. Note that this diagram shows a radio with a back-channel preamp (low-level) output that connects directly to the amplifier. Frank's radio doesn't have a preamp output (few if any factory models do); he would have to use his radio's back-channel speaker outputs, either connecting them directly to the booster (high-level) inputs on an amplifier or to an adapter for connection to an amp's line inputs.

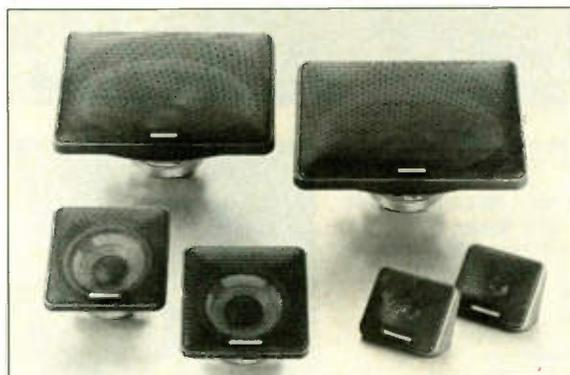

*The Boston Acoustics 793 is a three-way component car-speaker system consisting of 6-by-9-inch woofers, 4-inch midrange drivers, Varimount tweeters, and a separate crossover (not shown).*

Shopping for car speakers is tough, since listening is usually done only in a store's showroom. As you know, a home loudspeaker can sound vastly different in your living room from the way it did in the store. The acoustic environment is even more of a factor with car speakers. It would be ideal if you could listen to the speakers installed in a car, but this is rarely the case. BA's Petite offers a good suggestion: When listening to speakers in a store's display board, stand closer than you normally would, since, in a car, the front speakers are located quite close to you.

Boston Acoustics is not the only company that makes component car speakers, but it was among the first to do so. The company's philosophy is that a car system can sound only as good as its speakers. True enough. All of the company's component systems use the same Varimount tweeter with the angled enclosure, and the midrange/woofer and woofer units come in standard mounting sizes (depending on the model): 4-inch, 5¼-inch, 6½-inch, and 6-by-9-inch. These sizes make it more feasible for do-it-yourself installation, although I'm not one to recommend this, having had my share of installation disasters. The 6-by-9 woofers (which the company actually considers subwoofers) and the tweeter can be bought separately to extend the lower and upper ranges, respectively, of existing speaker systems. A guide to BA's component speaker systems (and its single-enclosure two-way system) can be obtained by writing to Boston Acoustics, Dept. HF, 247 Lynnfield St., Peabody, Mass. 01960. ■



**Horowitz in Moscow** The historic return! Music by Scarlatti, Mozart, Rachmaninov, Liszt, Chopin, Scriabin, Schumann, others. DG DIGITAL 125264

**Handel, Water Music** The English Concert/Pinnock. "Quite the best performance... now on the market."—Gramophone Archiv DIGITAL 115306

**Holst, The Planets** Montreal Symphony Orchestra/Dutoit. "[A] stunning performance... The best available on both LP and CD."—Gramophone London DIGITAL 115448

**Andrew Lloyd Webber, Variations; more** Julian Lloyd Webber, cello. London Philharmonic Orchestra/Maazel. Philips DIGITAL 115473

**Dvořák, Symphony No. 9 (New World)** Chicago Symphony Orchestra/Solti. "The playing is superlatively good."—Gramophone London DIGITAL 115168

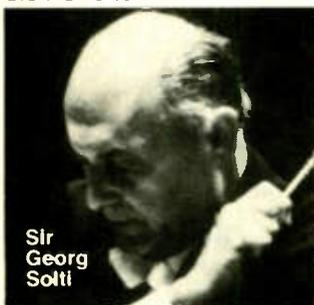

Sir Georg Solti

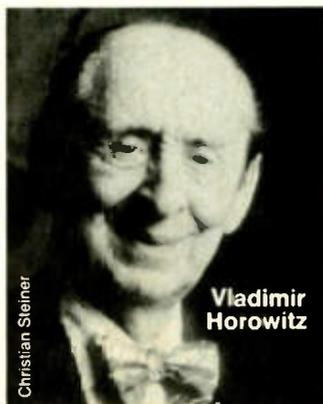

Christian Steiner

Vladimir Horowitz

**Handel, Messiah (Highlights)** Musica Sacra/Westenburg. *Hallelujah Chorus, I Know That My Redeemer Liveth*, more. RCA DIGITAL 153586

**James Galway & The Chieftains: In Ireland** *Danny Boy; When You And I Were Young, Maggie; Down By The Sally Gardens*; more. RCA DIGITAL 124344

**Ravel, Daphnis et Chloé (Complete)** Montreal Symphony/Dutoit. "An absolute dream performance."—Stereo Review London DIGITAL 115520

**Mozart, Clarinet & Oboe Concertos** Pay, basset clarinet; Piguët, oboe. Academy of Ancient Music/Hogwood. L'Oiseau-Lyre DIGITAL 115523

**Brahms, Cello Sonatas** Yo-Yo Ma, cello; Emanuel Ax, piano. "Distinguished... handsomely recorded."—Stereo Review RCA DIGITAL 154044

**Richard Stoltzman: Begin Sweet World** Title song, *Amazing Grace, Clouds, Abide With Me/Blue Monk*, more. RCA DIGITAL 150414

**Mozart, Requiem** Leipzig Radio Choir; Dresden State Orchestra/Schreier. "Exceptionally satisfying."—High Fidelity Philips DIGITAL 115039

**Rimsky-Korsakov, Scheherazade** Vienna Philharmonic/Previn. "A fresh and spacious reading."—Gramophone Philips DIGITAL 115415

**Pops In Love** The Boston Pops/Williams. *Clair de lune, Gymnopédies Nos. 1 & 2, Albinoni Adagio, Fantasia On Greensleeves, Pachelbel Canon*, more. Philips DIGITAL 125230

**Galway & Yamashita: Italian Serenade** Flute & guitar works by Paganini, Ciaramosa, Giuliani, Rossini & Bazzini. RCA DIGITAL 173824

**Horowitz in London** Recorded live! Schumann, Kinderscenen; Chopin, *Polonaise-Fantaisie & Ballade No. 1*; more. RCA DIGITAL 162507

**Mozart, The Piano Quartets** Beaux Arts Trio; Bruno Giuranna, viola. "Absolutely indispensable."—Stereo Review Philips DIGITAL 115271

**Wagner, Orchestral Highlights From The Ring** Vienna Philharmonic/Solti. *Ride Of The Valkyries*, more. London DIGITAL 115426

**The Canadian Brass: High, Bright, Light & Clear** *Air On The G String, Masterpiece Theatre Theme*, others. RCA DIGITAL 144529

**Pops In Space** John Williams leads The Boston Pops in music from *Star Wars, Close Encounters, Superman*, more. Philips DIGITAL 105392

**Pachelbel, Canon in D** Also includes other works by Pachelbel & Fasch. Maurice André, trumpet; Pallard Chamber Orchestra. RCA 133877

**Gershwin, Rhapsody In Blue; An American In Paris; Concerto** Pittsburgh Symphony/Previn (pianist & conductor). Phillips DIGITAL 115437

**Vivaldi, The Four Seasons** The English Concert/Pinnock. "The finest recording of [it] I've heard."—High Fidelity Archiv DIGITAL 115356

**Sousa, Stars & Stripes Forever** Philip Jones Ensemble. Plus *Semper Fidelis, Washington Post*, more. London DIGITAL 115051

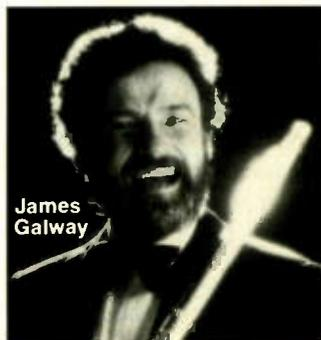

James Galway

**Michael Feinstein: Remember** Irving Berlin standards include title song, *Alexander's Ragtime Band, Puttin' On The Ritz*, more. Elektra 153947

**Tchaikovsky, Symphony No. 6 (Pathétique)** Chicago Symphony Orchestra/Levine. "A sound that dazzles and sings."—Milwaukee Journal RCA DIGITAL 153939

**Teresa Stratas Sings Kurt Weill** *Havana-Lied, Foolish Heart, Lonely House, Surabaya-Johnny, One Life To Live*, more. Nonesuch 124748

**Rudolf Serkin: Mozart, Piano Concertos Nos. 12 & 20** "He makes every phrase glow with life."—Stereo Review DG DIGITAL 115062

**Rossini, Overtures** Orpheus Chamber Orchestra. *The Barber Of Seville, The Turk In Italy, Tancredi*, 5 others. DG DIGITAL 115527

**Gregorian Chant** Schola of the Hofburgkapelle, Vienna. 10 Propers from *Graduale Romanum*; more. Philips DIGITAL 115434

**Alicia de Larrocha: Falla, Nights In The Gardens Of Spain** Plus rhapsodies with Albéniz & Turina. London DIGITAL 115410

**Tomita: The Mind Of The Universe (Live At Linz, 1984)** *One To Joy, Also Sprach Zarathustra (opening)*, more. RCA 173829



# The International Preview Society

# 3 COMPACT DISCS, RECORDS OR CASSETTES \$100 for just

plus shipping  
and handling with  
Club membership

## with No Obligation to Buy Anything...Ever!

**Fiddler On The Roof** Zero Mostel & original cast. *Matchmaker Matchmaker, Sunrise Sunset, If I Were A Rich Man*, more. RCA 100051

**Mozart, Posthorn Serenade; 2 Marches** Academy of St. Martin-in-the-Fields/Marriner. "Gracious, warm musicmaking."—*The New York Times* Phillips DIGITAL 115151

**Pavarotti: Anniversary** *Che gelida manina, E lucevan le stelle, Vesti la giubba, Cielo e mar, Addio alla madre*, 11 more. London 115344

**Bach, Goldberg Variations** Trevor Pinnock, harpsichord. "This is a definitive performance."—*Stereo Review* Archiv 105318

**Kathleen Battle: Salzburg Recital** With James Levine, piano. Purcell, Mozart, Strauss, Handel, Fauré, & more. DG DIGITAL 115292

**Mendelssohn, A Midsummer Night's Dream** Ambrosian Singers. Philharmonia Orchestra Marriner. Philips DIGITAL 115546

**Artur Rubinstein: Chopin, 14 Waltzes** "[His] playing is relaxed, assured, and wonderfully controlled."—*American Record Guide* RCA 101987

**Kiri te Kanawa: Blue Skies** With Nelson Riddle: Title song, *Speak Low, How High The Moon, So In Love*, 8 more. London DIGITAL 115035

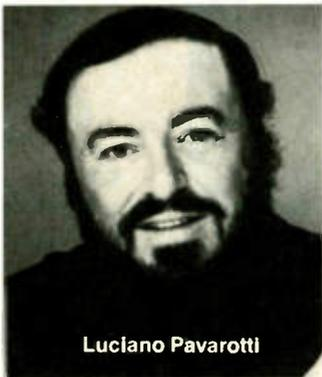

Luciano Pavarotti

**Strike Up The Band—The Canadian Brass Plays George Gershwin** Title song, *The Man I Love, Porgy & Bess Suite, 3 Preludes*, more. RCA DIGITAL 160640

**The King And I** Yul Brynner, Constance Towers & revival cast. *Getting To Know You, Hello Young Lovers, Shall We Dance*, more. RCA 123742

**Tchaikovsky, Symphony No. 4** Chicago Symphony Orchestra/Solti. "Eminently successful: powerful, fluent and virtuosic."—*Ovation* London DIGITAL 125038

**Mozart, Symphonies Nos. 40 & 41 (Jupiter)** James Levine conducts the Chicago Symphony Orchestra. RCA DIGITAL 104810

**Beethoven, Symphony No. 3 in E-Flat (Eroica)** Academy of Ancient Music/Hogwood. L'Oiseau-Lyre DIGITAL 115535

**Rubinstein Plays Rachmaninoff** Piano Concerto No. 2 & Rhapsody On A Theme Of Paganini. RCA 170232

**Debussy, La Mer; Nocturnes** Boston Symphony Orchestra/Davis. "The BSO is in tip-top form throughout."—*Ovation* Philips DIGITAL 115068

**Bach, Organ Works** Daniel Chorzempa plays the *Tocatta & Fugue In D Minor; the Prelude, Largo & Fugue In C*, more. Philips DIGITAL 115193

**Plácido Domingo Sings Tangos** *Mi Buenos Aires Querido, Alma de Bohemlo, Nostalgias, El Día Que Me Quieras*, 6 more. DG 105302

**Kiri te Kanawa: Ave Maria** *Jesu, Joy Of Man's Desiring; Let The Bright Seraphim; O Divine Redeemer*, more. Philips DIGITAL 115213

**Perlman: Mozart, Violin Concertos Nos. 3 & 5** Vienna Philharmonic/Levine. "Radiantly sumptuous."—*High Fidelity* DG DIGITAL 115146

**Barry Douglas: Tchaikovsky, Piano Concerto No. 1** London Symphony Orchestra/Slatkin. *Ovation's* Debut Recording Artist Of The Year! RCA DIGITAL 164293

This remarkable \$1 offer is being made to introduce you to an outstanding classical music membership—with never any obligation to buy.

You'll find hundreds of outstanding albums in each issue of the Society's magazine, which will be sent to you every 4 weeks. You will also receive 6 special sale issues, giving you 19 opportunities a year to shop for fine music at home. But there is no obligation to accept any offering at any time.

### You choose only the music you want!

If you'd like to accept the Main Selection, you need not do a thing. It will be sent automatically. If you'd prefer an alternate selection or none at all, just mail back the Notification Card by the specified date. You'll always have at least 10 days to decide.

### Substantial savings with our half-price bonus plan.

For every regular purchase you do make, you may choose a bonus album for only half of the members' club price! A shipping/handling charge is added to each shipment.

### 3 Compact discs or records or cassettes for just \$1!

Begin your membership now by choosing any 3 albums shown here for just \$1 plus shipping and handling. Send no money now. We want you to judge for yourself before you decide to buy. If not delighted, return your 3 albums at the end of 10 days without obligation.

## Values up to \$47.94

### The International Preview Society

P.O. Box 91406 • Indianapolis, IN 46291

YES! Please accept my membership in The International Preview Society and send me, for 10 days' FREE examination, the 3 albums I have indicated below. I may return them after 10 days and owe nothing, or keep them and pay only \$1 plus shipping & handling.

Please send all selections on:  Compact Disc  Cassette  Record

Write Selection Numbers Here:

--	--	--

Mr.  Mrs.  Miss

First Name	Initial	Last Name	(PLEASE PRINT)
------------	---------	-----------	----------------

Address \_\_\_\_\_ Apt. \_\_\_\_\_

City \_\_\_\_\_ State \_\_\_\_\_ Zip \_\_\_\_\_

Telephone (\_\_\_\_\_) \_\_\_\_\_  
Area Code

**NOTE:** Members who select compact discs will be serviced by the Compact Disc Club. Full membership details will follow with the same 10-day, no-obligation, no-minimum purchase privilege.

Limited to new members, continental USA only; one membership per family. We reserve the right to request additional information or reject any application. Local taxes, if any, will be added.

XATC4 (BF) PXH (PJ)

# Challenging Design.

## FOR UNDER \$600 YOU CAN OWN AN AMPLIFIER JUDGED TO HAVE THE EXACT SOUND CHARACTERISTICS OF AN ESOTERIC \$3000 MODEL.

Bob Carver recently shocked the staid audiophile world by winning a challenge that no other amplifier designer could ever consider.

The new M-1.0t was judged, in extensive listening tests by one of America's most respected audiophile publications, to be the sonic equivalent of a PAIR of legendary, esoteric mono amplifiers which retail for \$3000 each!

### CARVER'S GREAT AMPLIFIER CHALLENGE.

Last year, Bob Carver made an audacious offer to the editors of *Stereophile Magazine*, one of America's exacting and critical audio publications. He would make his forthcoming amplifier design sound exactly like ANY high-priced, esoteric, perfectionist amplifier (or amplifiers) the editors could choose. In just 48 hours. In a hotel room near *Stereophile's* offices in New Mexico! As the magazine put it, "If it were possible, wouldn't it already have been done? Bob's claim was something we just couldn't pass up unchallenged."

What transpired is now high fidelity history. From the start, the *Stereophile* evaluation team was skeptical ("We wanted Bob to fail. We wanted to hear a difference"). They drove the product of Bob's round-the-clock modifications and their nominees for "best power amplifier" with some of the finest components in the world. Through reference speakers that are nothing short of awesome. Ultimately, after exhaustive listening tests with carefully selected music ranging from chamber to symphonic to high-impact pop that led them to write, "...each time we'd put the other amplifier in and listen to the same musical passage again, and hear exactly the same thing. On

the second day of listening to his final design, we threw in the towel and conceded Bob the bout. According to the rules... Bob had won."

**BRAIN CHALLENGES BRAUN.** Below is a photo of the 20-pound, cool-running M-1.0t. Above it are the outlines of the pair of legendary mono

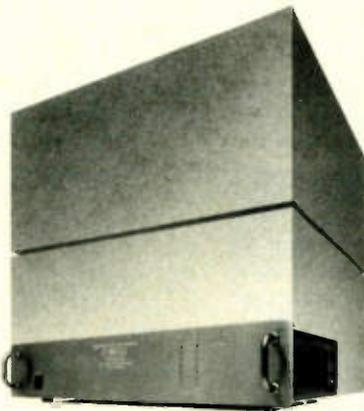

amplifiers used in the *Stereophile* challenge. Even individually, they can hardly be lifted and demand stringent ventilation requirements. And yet, according to some of the most discriminating audiophiles in the world, Bob's new design is their sonic equal.

The M-1.0t's secret is its patented Magnetic Field Coil. Instead of increasing cost, size and heat output with huge storage circuits, Magnetic Field Amplification delivers its awesome output from this small but powerful component. The result is a design with the dynamic power to reproduce the leading edge attacks of musical notes which form the keen edge of musical reality.

**A DESIGN FOR THE CHALLENGES OF MODERN MUSIC REPRODUCTION.** The M-1.0t's astonishingly high voltage/high current output and exclusive operation features make it perfect for the demands of compact digital discs, video hi-fi and other wide dynamic range playback media. The M-1.0t:

- Has a continuous FTC sine-wave output conservatively rated at 200 watts per channel.
- Produces 350-500 watts per channel of RMS power and, bridged, 800-1100 watts momentary peak power (depending on impedance).
- Delivers 1000 watts continuous sine wave output at 8 ohms in bridging mode without switching or modification.
- Is capable of handling unintended 1-ohm speaker loads without shutting down.
- Includes elaborate safeguards including DC Off-set and Short Circuit Power Interrupt protection.

**SHARE THE RESULTS OF VICTORY.** We invite you to compare the new M-1.0t against any and all competition. Including the very expensive amplifiers that have been deemed the M-1.0t's sonic equivalent. You'll discover that the real winner of Bob's remarkable challenge is you. Because world class, superlative electronics are now available at reasonable prices simply by visiting your nearest Carver dealer.

**SPECIFICATIONS:** Power, 200 watt/channel into 8 ohms 20Hz to 20KHz, both channels driven with no more than 0.15% THD. Long Term Sustained RMS power, 500 watts into 4 ohms, 350 watts into 8 ohms. Bridged Mono power, 1000 watts into 8 ohms. Noise, -110dB IHF A-weighted. Weight, 20 lbs.

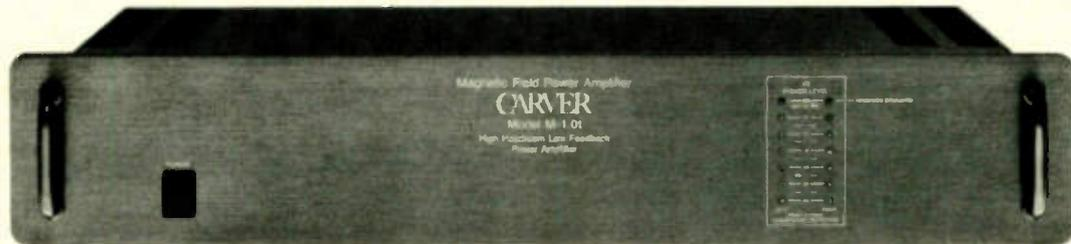

# CARVER

P.O. Box 1237, Lynnwood, WA 98046

POWERFUL

MUSICAL

ACCURATE

Distributed in Canada by evolution technology

Report preparation supervised by Michael Riggs, David Ranada, Christopher J. Esse, Robert Long, and Edward J. Foster. Laboratory data (unless otherwise indicated) is supplied by Diversified Science Laboratories.

**T**he no-nonsense quality that characterizes NEC designs is much in evidence in the CD-810. It's a solid performer that is dignified in both styling and behavior. The features appear to have been soberly considered, and, despite the unusual nature of some of them, the impression is not one of glitziness. Also typical of NEC—which is as well known for its sophisticated integrated circuits and computers as it is for home entertainment components—are the high-tech touches with which it seeks an ever-closer approach to sonic perfection.

Of all these touches, NEC seems most proud of its proprietary output filtering system. Two filters are involved: In the digital domain, there is a 73-tap ND (non-delay) filter, which is supplemented by an FDNR (frequency-dependent negative resistance) low-pass filter. (Impressive as it sounds, FDNR is just a way—uncommon in audio—of hooking up common operational amplifiers, resistors, and capacitors into a filter circuit.) The filters, in combination with two-times oversampling and dual digital-to-analog converters, are credited with exceptional accuracy in waveform reconstruction.

Similarly high-tech is the optical internal coupling that helps minimize the possibility of interference between analog and digital sections, as do the separate power supplies for the digital and analog sections. The CD-810 also is among the NEC models incorporating a phase-inverter (or polarity-inverter) switch so you can maintain absolute phase even when the recording—or the remainder of your system—flips it. This, however, presumes that either you can discern an audible difference between polarities and can tell which setting is correct (not easy) or that you have some previous knowledge of the polarity of the original recording.

There are a number of unusual operational features as well. Of these, the most striking are certainly the editing modes used for making cassette dubs of CDs. In the automatic editing mode, you use the keypad to punch in the time available on each side of the cassette (45, for example, to stipulate one side of a C-90). The CD-810 programs itself for all of the tracks, beginning at the first track and continuing until there's not enough time left for

the next unprogrammed track. If you press the editing button a second time, the player will program the second side, beginning where the first left off and inserting a pause between sides in the sequence, to give you time to turn over the cassette.

If you already have something recorded on Side A of the tape, you can set the player to program for just the re-



maining time on that side, then the full time on Side B. If you don't want to start at the beginning of the disc, you can cue up the track you want to start with before beginning automatic programming. You can also use a manual editing mode and program the sequence yourself in any order. As you do, the display keeps track of the time still available on the tape so you can tell which tracks will fit and which won't. When the editing is done, you simply start the recorder and the 810 together. For programmed playback only (without taping), a 24-selection memory is provided.

Also unusual, though without the obviously broad application of the editing functions, is timer search. When this function is invoked, the keypad can be

## NEC CD-810 Compact Disc Player

**Dimensions:** 17 by 4 inches (front); 12 inches deep plus clearance for connections.

**Price:** \$629.

**Warranty:** "Limited," two years parts and labor, except one year on the laser pickup.

**Manufacturer:** NEC (Nippon Electric Co., Ltd.), Japan.

**U.S. Distributor:** NEC Home Electronics (U.S.A.), Inc., 1255 Michael Dr., Wood Dale, Ill. 60191.

# THE AMPLIFIER THAT CHANGES THE MEANING OF THE WORDS "PEAK PERFORMANCE IN AN AUTOMOBILE"

With our new Phase Linear PLT 150 Turbo amplifier, the mere act of sitting in your car can become an exhilarating experience.

Because we build into each one the uncanny ability to boost its power, and sustain that power, during those crucial moments when your music makes inordinate demands on your stereo system.

Thus, the Turbo ensures that every musical peak, every rousing crescendo, comes through flawlessly.



**OUR TURBO AMP INCREASES YOUR CAR'S DYNAMIC HEADROOM.**

Our new Turbo amp achieves its power boost—its dynamic headroom—with what we call a "smart" power supply.

A reservoir of energy on which it can instantly draw, in times of need, to swell from a normal 30 Watts per Channel to an awesome 150 Watts per Channel.

And because our amp sustains this burst of power 25 times longer than the industry standard, it produces a truer sound than any amplifier in its class.

Even truer than larger, costlier amps that depend totally on their brawn for lack of our turbocharged brain.

## OUR AMP PROVIDES PLENTY OF POWER TO PLENTY OF SPEAKERS.

The new Phase Linear PLT 150 is stable to 2 Ohms. Which means it can continue to deliver its awesome power should you find yourself using it with more than two speakers.

And if you need even more power, (rare as the case may be), whether for speakers or subwoofer applications, we've planned for this as well.

We've designed our PLT 150 Turbo

to be bridgeable with the flick of a switch. In this monobridged mode each amp then produces a significantly beefed up 90 Watts RMS, 180 Watts Peak, to one speaker through one channel. Supplying you not only with a tremendous source of power, but tremendous proof that the only thing better than one PLT Turbo amp is two of them.

## AN AMP THIS POWERFUL DESERVES A STRONG SPEAKER.

Luckily, at Phase Linear we build speakers rugged enough to handle the power of our amps.



Our Phase Linear Graphite speakers.

Each one, built with rigid graphite cones, responds more quickly and accurately than paper cone models to intense fluctuations in peak performance music. And because they tend to "break up" less at higher volumes, you can blast away all day without the slightest hint of distortion.

So if you've been thinking of buying a car stereo amp, we suggest you try our new PLT 150 Turbo. It may not help the way your car drives. But with the right equipment, it will definitely get you going.

DIGITAL READY  
©1987 Phase Linear® a Division of International Jensen Inc.  
Phase Linear® is a registered trademark of International Jensen Inc.

**phase linear**  
GRAPHITE™

Making the best of sound technology.

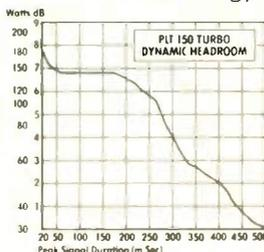

used to stipulate an elapsed time from the beginning of a track to the point at which you want playback to begin. This function is available only via the supplied AR-810 wireless remote control. So is the polarity-inversion function, though activation of both functions is indicated by pilot lights on the player's front panel. The remote, which is powered by two AA cells, also incorporates basic transport controls (even an open/close for the disc drawer) and those for the memory-playback and repeat functions.

Whether set at the remote or at the front panel, the CD-810 offers the usual repeat-mode options: full disc, programmed sequence, or A-to-B looping. The transport functions include audible search, bidirectional seek (skip), index seek, and (on the front panel only) intro scan. The ability to cue up to index points on CDs that are indexed is always welcome. The intro scan is set to sample the first 10 seconds of each track as a default but can be adjusted (once again, using the front-panel keypad) to any sample length from 1 to 60 seconds—a feature we haven't seen before on a Compact Disc player (or anything else for that matter).

There is also a spacing function to add a few seconds between tracks (handy if you're going to be playing a dub on a programmable cassette deck that needs good, clean spaces in order to pick up its cues) and timer playback. For the latter, simply leave a disc in the drawer and the power switch on; when power is restored via the timer, the disc automatically begins playing from the beginning.

The display is exceptionally neat, considering the large amount of information it imparts. The left side is the increasingly common calendar-style display that indicates available or programmed tracks (as many as 20, with an extra element that lights when a higher number is involved) and extinguishes the track numbers as they are played. Down the middle are indicators for major functions (memory, editing modes, et al.) and the four time-display options (elapsed in the current track, total elapsed, remaining in the current track, and total remaining). The time display itself is to the right, above the indicators for the repeat modes, intro scan, and the spacing function. Track and index numbers (or item number, in programming) are displayed at the top of this section. The front panel's headphone output has its own volume control.

The first thing we looked at in Diversified Science Laboratories' data was the frequency-response curves. NEC claims

exceptional freedom from ripple in its filter design; indeed, even the lab's expanded traces show no aberration that could be attributed to ripple. The efficiency of the filter design is further confirmed by the well-controlled ringing in the square-wave and pulse waveforms. Curiously, the slight rolloff at the very top of the audio band doesn't assume quite the same contour in the two channels, but response is too flat and smooth to lend any importance to such quibbles. Response with de-emphasis is more accurate than usual.

Distortion figures are excellent: below our reporting threshold (0.01 percent) in all the intermodulation measurements and in all the harmonic distortion measurements at 0 dB. And at -24 dB, THD was only marginally above the threshold, meaning that it's far below the audibility threshold. The linearity fig-

All data were obtained using the Sony YEDS-7, Technics SH-CD001, Philips 410 055-2, and Philips 410 056-2 test discs.

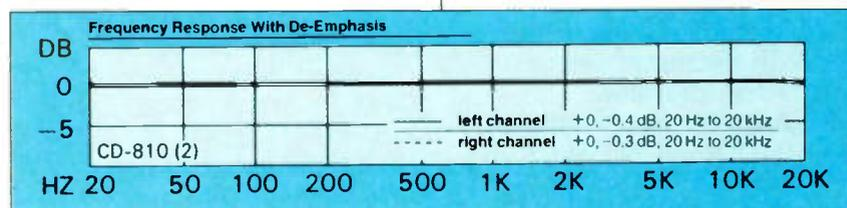
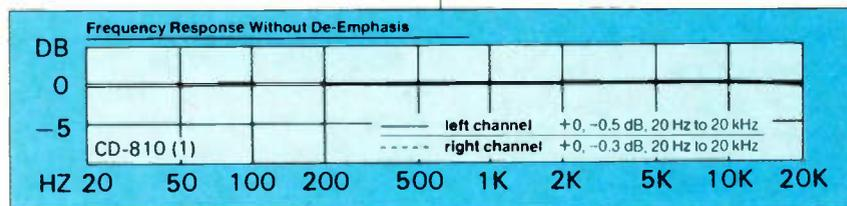

ures go slightly awry at extremely low levels (-80 dB, in particular), but not by as much as we often encounter. In any event, the discrepancies are not great enough to be of audible consequence.

The CD-810 negotiated all of the tracking tests flawlessly, as most (but certainly not all) players do these days. Headphone output clipped at a generous 7.63 volts into an open circuit, although with the standard 50-ohm load (which is more representative of actual headphone loading), it clipped at just under 1 volt, which is somewhat low. The importance of this limit obviously will depend on the impedance and sensitivity of the headset you use with the player, but we wouldn't expect it to pose a problem under most circumstances.

The CD-810 is unquestionably a fine performer, and it's clear that care and ingenuity have gone into its many features. Less apparent is the quiet ergonomic grace with which it performs its functions. Using it is a pleasure in every respect. ■▶

Channel Separation (at 1 kHz)	103 3/4 dB
Channel Balance (at 1 kHz)	± < 0.1 dB
<b>S/N Ratio (re 0 dB; A-weighted)</b>	
without de-emphasis	100 dB
with de-emphasis	100 3/4 dB
<b>Harmonic Distortion (THD+N; 40 Hz to 20 kHz)</b>	
at 0 dB	< 0.01%
at -24 dB	≤ 0.026%
<b>IM Distortion (70-Hz difference; 300 Hz to 20 kHz)</b>	
0 to -30 dB	< 0.01%
<b>Linearity (at 1 kHz)</b>	
0 to -40 dB	no measurable error
at -50 dB	+0.1 dB
at -60 dB	+0.3 dB
at -70 dB	+0.8 dB
at -80 dB	+2.3 dB
at -90 dB	+1.7 dB
<b>Tracking &amp; Error Correction</b>	
maximum signal-layer gap	> 900 μm
maximum surface obstruction	> 800 μm
simulated-fingerprint test	pass
<b>Maximum Output Level</b>	
line output	2.14 volts
headphone output (adjustable)	see text
<b>Output Impedance</b>	
line output	300 ohms
headphone output	160 ohms

# REDEFINITION.

## THE CARVER RECEIVER

Redefines your expectations of receiver performance with the power you need for Digital Audio Discs plus virtually noise-free stereo FM reception. A receiver with astonishing performance incorporating two highly significant technological breakthroughs: Bob Carver's Magnetic Field Power Amplifier and his Asymmetrical Charge Coupled FM Detector.

**ESSENTIAL POWER:** Your system needs an abundance of power to reproduce, without distortion, the dynamic range of music on Digital Audio Discs and fine analog recordings.

The Magnetic Field Amplifier in the CARVER Receiver gives you **150 watts per channel (continuous sine-wave output)** of pure, clean power with superbly defined, high fidelity reproduction.

The Magnetic Field Amplifier produces large amounts of power (absolutely necessary for the accurate reproduction of music at realistic listening levels) without the need for heavy heat sinks, massive transformers, and enormous power capacitors required by conventional amplifier design.

Unlike conventional amplifiers which produce a constant, high voltage level at all times, irrespective of the demands of the ever-changing audio signal (Even when there is no audio signal in the circuit at all!), the Magnetic Field Amplifier's power supply is signal responsive. Highly efficient, it produces *exactly and only* the power needed to carry the signal with complete accuracy and fidelity.

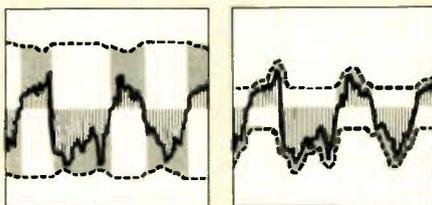

Solid line: audio output signal. Broken line: power supply voltage. Shaded area: wasted power. Vertical lines: power to speakers.

The **150 watts-per-channel (continuous sine-wave output)** CARVER Receiver is about the same size and weight of conventional receivers having merely 30 watts per channel!

**NOISE-FREE RECEPTION:** The AM-FM CARVER Receiver gives you FM stereo performance unmatched by that of any other receiver.

As it is transmitted from the station, the stereo FM signal is extremely vulnerable to distortion, noise, hiss and multipath interference.

However, when you engage CARVER's Asymmetrical Charge Coupled FM Detector circuit, the stereo signal arrives at your ears virtually noise-free. You hear fully sepa-



Reflected multi-path signals cause audible distortion.

Asymmetrical Charge Coupled FM Detector gives your ears a true sonic image.

rated stereo with space, depth and ambience!

The Asymmetrical Charge Coupled FM Detector was first introduced in CARVER's TX-11 Stereo Tuner, receiving unparalleled critical acclaim:

*"A major advance...its noise reduction for stereo reception ranged from appreciable to tremendous. It makes the majority of stereo signals sound virtually as quiet as mono signals, yet it does not dilute the stereo effect."*

Julian D. Hirsch, STEREO REVIEW

*"Separation was still there; only the background noise had been diminished, and with it, much of the sibilance and hissy edginess so characteristic of multipath interference."*

Leonard Feldman, AUDIO

*"What distinguishes the TX-11 is its ability to pull clean, noise-free sound out of weak or multipath ridden signals that would have you lunging for the mono switch on any other tuner we know of!"*

HIGH FIDELITY

*"The Carver Receiver is, without question, one of the finest products of its kind I have ever tested and used."*

Leonard Feldman, AUDIO

The CARVER Receiver has been designed for fidelity, accuracy and musicality. You will want to visit your CARVER dealer for a personal audition of this remarkable instrument.

**SPECIFICATIONS: 150 watts per channel RMS into 8 ohms, 20 Hz to 20 kHz with no more than 0.05% total harmonic distortion.**



# CARVER

P.O. Box 1237, Lynnwood, WA 98046

POWERFUL

MUSICAL

ACCURATE

Distributed in Canada by: *evolution technology*

One-piece radio-headphones are a tangle-free alternative to typical portable designs. Although the added weight of the radio may not appeal to joggers, anyone who's ever snagged a doorknob or lassoed the arm of a chair with a portable stereo's headphone cord will surely be pleased by its absence. The Panasonic RF-HX7 offers an even bigger advantage: It can be used as a full-range headphone set when connected to other music sources.

The RF-HX7 weighs 5.3 ounces without the two AAA cells (not supplied) that power its built-in stereo FM tuner. It comes with a seven-foot headphone cord (with a full-size adapter plug for the business end) and a 28-inch antenna wire, both detachable. (Unlike a conventional portable, the RF-HX7 does not use the headphone cord as an antenna.) The weight of the two earpiece/radio assemblies is balanced: The left earpiece holds the batteries and contains the power switch (with an LED indicator) and the input for the headphone cord (labeled INPUT/CD); the right one contains the FM section with tuning dial, mono/stereo switch, volume control, and antenna input. FM station frequencies show through a small porthole on the outside of the tuner.

Before we get to audio performance, we should note that the RF-HX7 is very comfortable and uncommonly well-built. The headband is not adjustable; instead, the 2½-inch-diameter earpieces swivel along a curved path, an arrangement we found very effective for getting a good fit. The spongy cushions on the earpieces yield to the shape of your ears, rather than enveloping or simply resting against them. The knurled tuning dial turns with just the right resistance, and the power and mono/stereo switches click reassuringly into place. Even the battery compartment opens with ease. Most important, though, the layout of the controls makes it easy to operate the unit by feel: Volume is "up" or "down," and tuning is "forward" or "back." Another nice touch is that the headphone cord connects to only one earpiece, reducing the possibility of getting into a choke-hold if you roll over on the couch. However, we would have preferred a longer cord.

Since the headphones are designed for use with external sources, we expected them to sound better than other radio-headphones—and they certainly did not disappoint us. Panasonic's literature suggests that the RF-HX7 be used with a portable Compact Disc player, which would be especially practical if your model doesn't have a built-in tuner.

Sound quality compares well with that of similarly priced conventional headphones, although it falls a bit shy in richness of bass and has a hint of steeliness in the treble.

Although we couldn't measure the tuner, we could compare it directly with a good home receiver by tuning both to the same stations and switching between radio and headphone on the RF-HX7. The Panasonic was able to pull in a wide range of stations; on strong signals, we could discern hardly any difference in sound quality between it and the receiver, which attests to the prowess of both the model's tuner and its amplifier. Of



**Price:** \$100.

**Warranty:** "Limited," two years parts and labor.

**Connections:** Minijack for headphone cord; threaded terminal for antenna.

**Manufacturer:** Matsushita Electrical Industrial Co., Japan.

**U.S. Distributor:** Panasonic Co., One Panasonic Way, Secaucus, N.J. 07094.

course, when you move around and reorient the dangling antenna (which can be tied into a shorter length but is nevertheless a bit awkward), reception will vary even on strong stations. The mono setting is quite effective in reducing noise on distant stations. Incidentally, the station display on the RF-HX7, which is marked in 4-MHz increments (88, 92, etc.), is remarkably accurate.

In contrast to most two-piece portable stereos, listening to the RF-HX7's FM radio—while you read, ride an exercise bike, iron your shirt, or cast a line into the lake—is like being plugged into a good home system. And when you do plug it in, you'll find that the presence of a radio does not detract from its comfort or sound quality. Whether you're after a portable FM radio or a nice set of headphones, the Panasonic RF-HX7 is certainly worth considering. ■▶

## Panasonic RF-HX7 FM Radio- Headphones

## Sony EV-S1 Portable 8mm VCR



**Dimensions:** Without handle, 11 by 2¾ inches (front), 8¼ inches deep plus clearance for controls and connections; with handle, 13¼ by 2¾ inches (front), 8¾ inches deep.

**Price:** \$900.

**Warranty:** "Limited," 90 days parts and labor.

**Manufacturer:** Sony Corp., Japan.

**U.S. Distributor:** Sony Corporation of America, Sony Dr., Park Ridge, N.J. 07656.

Anyone accustomed to conventional home VHS or Beta VCRs will be amazed by the minuscule size of Sony's EV-S1 8mm deck, which the manufacturer bills as a "transportable" VCR. The EV-S1 weighs a mere 5¼ pounds, comes with a detachable handle and a carrying case, and operates either from a 120-volt power line or (via the optional DCC-S1 cable) from a 12- or 24-volt car cigarette lighter.

Sony has packed an incredible number of features into this tiny package: a cable-compatible MTS (stereo TV) tuner with SAP (secondary audio program) reception, a three-event/two-week program timer, high-quality mono record-

control) and for a stereo microphone.

The least-often-used controls—hidden beneath a top-panel lid—include the channel-preset controls, which double as automatic or manual fine-tuning adjustments. The EV-S1's tuner covers VHF channels 2 through 13, UHF channels 14 through 69, and cable channels 1, 14 to 36, and 66 to 125—that's 152 channels in all. Of these, as many as 99 channels can be preset into memory, scanned via the channel buttons on the front panel or the remote, or tuned directly by number via the remote's numerical keypad. In addition to duplicating the VCR's transport controls, the remote is the only way to access the super-slow mode (1/10 normal-speed playback) and the frame-advance and theater-sound features.

Also beneath the top-panel lid is an antenna-select switch. Its automatic setting is recommended for use with conventional TV sets, which will receive the video and monophonic audio on Channel 3 or 4. The antenna-select's manual setting is recommended for use with a monitor, but this setting precludes recording one program while viewing another (since the monitor will be receiving only the channel the EV-S1 is set to). To the right of the antenna-select switch are three rather difficult-to-manipulate rotary knobs, one for adjusting sharpness and the other two for tracking in the slow-motion and still-frame modes. The 8mm system automatically adjusts tracking during normal playback. A switch turns the sound on or off when scanning through a tape using the double-speed playback feature.

ing using a frequency-modulation system similar to Beta Hi-Fi, stereo recording using the 8mm PCM (digital) recording system, double-speed playback with sound, a comprehensive wireless remote control that also fits in the carrying case, and a "theater sound" system said to produce three-dimensional sound effects. Furthermore, the EV-S1 is quite easy to use, thanks to a less daunting array of controls than is typical of VCRs with an equivalent number of features.

The EV-S1 is a top-loading design with controls on the top and front panels. Transport controls and the eject button are on top. Programming controls, which are unusually simple to decipher, are behind the front-panel door beneath the display area. There are front-panel minijacks for a headphone (with volume

Additional top-panel controls include an edit switch for copying tapes from the EV-S1. Other switches select between the main and SAP audio channels, turn automatic-stereo reception on and off (which permits mono listening), and select among PCM, AFM, and mixed PCM/AFM audio playback. When this last switch is in its PCM (Auto) position, the deck plays the stereo digital-audio tracks; if nothing has been recorded in the PCM mode, the deck reverts to the monophonic AFM track. When the switch is in its STD position, the AFM track plays. You can also record the SAP portion of a broadcast on the AFM track and the main stereo broadcast on the PCM tracks. An input selector cycles among three audio-video input possibilities: audio and video from the tuner, audio and video from the line inputs, or audio from the line inputs and video from the tuner (for simulcast recording).

For avid home-video buffs, an insert button facilitates editing by placing the

deck in "insert standby" mode from which it immediately begins recording when you release PAUSE—you don't have to wait through the 8mm tape-threading procedure. AUDIO DUB permits the rerecording of the PCM stereo tracks without affecting the video or the AFM track.

The yellow-green indicators (clock time, tape counter, various mode indicators, etc.) on the front panel are rather dimly lit and are located behind what seems to be a magnifying lens, restricting their visibility. However, this will be a problem only under very bright light or from off-axis.

On the rear panel are a pair of F connectors for the antenna or cable inputs and outputs and a set of video/stereo-audio inputs and outputs. Also on the rear panel are a special DC input jack for external battery operation, a stereo minijack for headphones or a pair of powered speakers, and a minijack input labeled CONTROL-S that connects the EV-S1 with another Sony VCR or, via a Sony RM-E100V Video Editing Controller, with an appropriate Sony camcorder for easy editing. This connection enables recording start/stop on the EV-S1 to be synchronized with playback start/stop on the ancillary VCR. For ultra-accurate edits, a multipin transport control jack on the EV-S1 also connects to the E100V editing controller.

The EV-S1 operates at two speeds: The fast speed provides two hours of recording on a P6-120 cassette, and the slow speed gives you four hours. According to Diversified Science Laboratories' data, video performance at the two speeds differs mainly in horizontal resolution and chroma noise, both of which are naturally better at the faster speed. On SP recordings, video response is down 6 dB at 2.0 MHz, implying a horizontal resolution of 160 lines—equivalent to that of a good conventional VCR operated at its fastest speed. In the slower LP mode, response is down by 5 1/4 dB at 1.5 MHz and 9 dB at 2.0 MHz for a calculated resolution of approximately 130 lines.

Luminance level is almost the same at both speeds and very close to the mark. Gray-scale linearity is slightly better at the faster speed but is well within acceptable bounds at either. Chroma differential gain (change in color saturation with brightness) and chroma differential phase (change in tint with brightness) are negligible, and there is no measurable chroma phase error. Chroma level is slightly low but closer to the mark than we usually find on full-size VCRs.

The EV-S1 sets audio recording level

automatically on both the AFM and PCM tracks. While this makes the deck easy to use and appears to be the de facto standard for recent 8mm home decks, it precludes the recording quality possible with careful manual level setting. Following its new practice, DSL established the point of 3-dB compression as a refer-

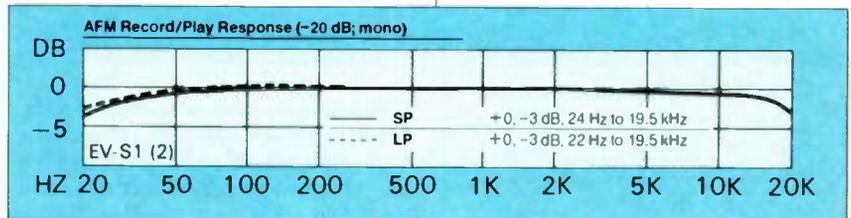
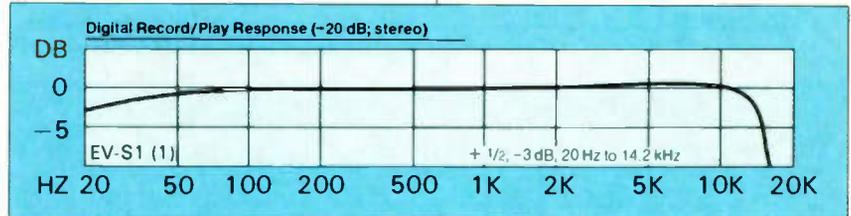

ence level. Above this point, a very "tight" ALC (automatic level control) comes into play and prevents higher recording levels except on brief bursts.

Audio output at the reference level depends on whether you're playing the PCM or AFM track. In either case, it should be adequate to drive an amplifier. Audio output from the tuner is close to that from the deck; hence, there are no substantial shifts in level regardless of the source. Output impedance is low enough to drive reasonable cable lengths and should cause just a minor drop in level when driving a conventional amplifier. The audio input impedance is high enough so as not to tax any conventional source.

The audio line-input sensitivities for reference level suggest that the ALC will rarely come into play with most program sources. We view this as an advantage, since the ALC cannot be defeated. The overload point of the microphone input is a mere 8.2 mV, suggesting that you use a low-output microphone with the EV-S1 (and even then, don't hold it too close to the sound source).

As we've found with other 8mm VCRs, audio performance is at least as good on the monophonic AFM track as on the stereo PCM track. Although the latter is digital, the relatively low sampling rate and small number of bits used to characterize the data preclude full CD sound quality. At the reference level, the monaural AFM system shows signs of overload above 4 kHz due to the pre-emphasis used. But considering the ener-

### VCR Section

Except where otherwise indicated, the recording data shown here apply to both speeds—SP and LP. All measurements were made at the direct audio and video outputs, with test signals injected through the direct audio and video inputs. The 0 dB reference input level is the voltage at which the automatic level control (ALC) produces 3 dB of compression at 315 Hz. The 0-dB reference output level is the output voltage from a 0-dB input.

#### Audio S/N Ratio (re 0-dB output; R/P; A-weighted)

	digital	AFM
SP	75 3/4 dB	70 1/2 dB
LP	75 3/4 dB	70 dB

#### Distortion (THD at -10 dB input; 50 Hz to 5 kHz)

digital	≤ 1.15%
AFM	≤ 0.29%

#### Channel Separation (315 Hz; digital)

46 dB
-------

#### Flutter (ANSI weighted peak; R/P; average)

digital	+0.017%
AFM	* < 0.01%

#### Sensitivity (for 0-dB output; 315 Hz)

	mike	line
digital	1.3 mV	785 mV
AFM	1.9 mV	1,100 mV

#### Audio Output Level (from 0-dB input; 315 Hz)

digital	0.55 volt
AFM	0.42 volt

#### Audio Input Impedance (line)

47k ohms
----------

#### Video Record/Play Response

	SP	LP
at 500 kHz	-1/4 dB	-1 dB
at 1.5 MHz	-2 3/4 dB	-5 1/4 dB
at 2.0 MHz	-6 dB	-9 dB
at 3.0 MHz	-21 dB	-23 1/2 dB
3.58 to 4.2 MHz	too low to measure	

#### Sharpness Control Range

at 500 kHz	± 1 dB
at 1.5 MHz	+4, -4 3/4 dB
at 2.0 MHz	+3 1/4, -4 dB
3.0 to 4.2 MHz	no measurable effect

#### Luminance Level

SP	7% high
LP	8% high

#### Gray-Scale Nonlinearity (worst case)

SP	≈ 8%
LP	≈ 13%

#### Chroma Level

≈ 2 dB low
------------

#### Chroma Differential Gain

≈ 10%
-------

#### Chroma Differential Phase

SP	≈ ± 2°
LP	≈ ± 3°

#### Median Chroma Phase Error

0°
----

## TV Tuner Section

All measurements were taken at the direct audio and video outputs.

### Audio S/N Ratio (mono; A-weighted)

best case (no video)	61 3/4 dB
worst case (multiburst signal)	25 dB

### Residual Horizontal-Scan Component (15.7 kHz)

-57 dB

### Audio Output Level (100% modulation)

0.39 volt

### Audio Output Impedance

1,500 ohms

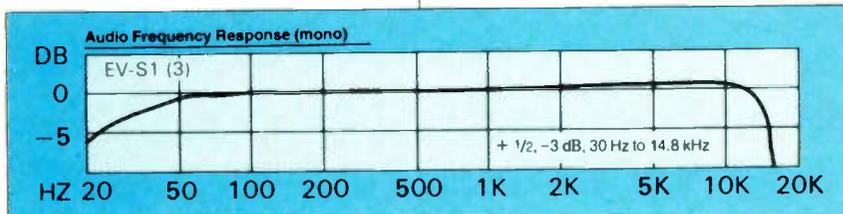

### Video Frequency Response

at 500 kHz	+ 1/4 dB
at 1.5 MHz	+ 3/4 dB
at 2.0 MHz	+ 1/2 dB
at 3.0 MHz	flat
at 3.58 MHz	-1 1/4 dB
at 4.2 MHz	-14 1/4 dB

Luminance Level 10% high

Gray-Scale Nonlinearity (worst case) none

Chroma Differential Gain  $\approx 16\%$

Chroma Differential Phase  $\approx \pm 5^\circ$

### Chroma Error

	level	phase
red	- 1/2 dB	+2°
magenta	- 1/2 dB	+3°
blue	- 1/4 dB	0°
cyan	standard	+6°
green	standard	+5°
yellow	standard	+6°
median error	- 1/4 dB	+3°
uncorrectable error	$\pm 1/4$ dB	$\pm 3^\circ$

gy distribution of typical program material, this should be of little concern.

AFM distortion at 10 dB below reference level remains well under 0.5 percent from 50 Hz to 6.3 kHz and just approaches 0.8 percent at 10 kHz. On the digital stereo tracks, distortion is somewhat higher, and rather strong aliasing components (approaching 30 percent distortion) are generated as the recording frequency approaches the theoretical

high-frequency limit at around 15 kHz. Stereo separation measures a respectable if not stellar 46 dB at 315 Hz. Flutter is below reporting limits at both speeds on the AFM track and quite negligible (+0.017 percent) with PCM recording.

Tuner audio response matches the fine response of the AFM track very closely, while tuner signal-to-noise ratio is an excellent 61 3/4 dB with the video suppressed. The noise remains quite low except under the worst video test-pattern conditions. The horizontal-scan whistle is well-suppressed by a sharp notch filter at 15.7 kHz.

The tuner's video performance is excellent, with very flat response to 3.58 MHz (implying a resolution in excess of

300 lines), near-perfect chroma level and phase accuracy, and absolutely perfect gray-scale linearity. Luminance level is just slightly high, while chroma differential phase is adequately low. The 16-percent chroma differential phase reported by DSL occurs entirely at the brightest scene level and should therefore be of minor concern.

In the viewing room, performance was eminently satisfying. Resolution at the SP speed was at least on a par with that of a good half-inch standard-format VCR; luminance and chrominance noise were, if anything, better than we've come to expect from standard VCRs. Noise bars appear during the cue and review modes (operated by pressing rewind or fast-forward during playback), but double-speed and still-frame playback were perfect on an SP-recorded tape. On an LP tape, there was a certain amount of vertical jitter with double-speed playback, yet still-frame remained excellent. Jitter in the slow mode is unlikely to be objectionable on tapes recorded at either speed.

From a technical standpoint, we have few complaints about the Sony EV-S1. Its video performance is at least equivalent to that of a conventional half-inch VCR (and better than on many). Its tuner section would be superb even in a high-resolution monitor/receiver, let alone in a VCR. Sony has managed to cram a lot of hardware into a tiny and effective package. But what else would you expect from the folks who brought us the Walkman? ■

## Fosgate DSM-3602 Surround-Sound Processor

**F**osgate made its reputation in the autousound field, but an early tie-in between Jim Fosgate and Peter Scheiber (one of the pioneers of matrixed four-channel sound) has made Fosgate's company one of the leaders in the bustling Dolby Surround market. The latest and greatest of Fosgate's processors is the DSM-3602 "360° Digital Space Matrix," which uses a refined version of the circuitry developed for the original Fosgate/Scheiber Space Matrix.

To derive ambience information, every surround-sound processor relies upon the phase and amplitude differences between signals in the left and right channels. Circuit complexity can range from a simple matrix (which, by suitable addition and subtraction of phase-shifted signals, can provide 3 dB of separation at best) to a system that uses voltage-controlled amplifiers (VCAs) in each channel with the channel gains controlled by "steering logic"

to electronically enhance the separation. Such complex systems, of which the Fosgate DSM-3602 is one, can work very effectively. But there's a trade-off to be made between the degree of "enhancement" and the audible side effects that such manipulation can introduce. In developing a side-effect-free system, the choice of the attack and release times of the VCAs and the selection of the band of energy used to derive the steering signals are the key elements—and Fosgate is an acknowledged master in these aspects of design.

With four main audio-video inputs and a fifth input for a tape deck, the DSM-3602 serves as a system switcher as well as a Dolby Surround Processor. Stereo pairs of gold-plated pin jacks are provided for the four main audio inputs, with additional gold-plated jacks for the corresponding video inputs. These are selected via a bank of pushbuttons on the front panel, each with its own indicator

# How Denon turned receiver design inside out.

Audio companies must have a fairly low opinion of the receiver customer. How else to explain the bewildering array of buttons, lights and winking fluorescent displays that festoon so many of today's receivers? These outward trappings may impress the innocent, but they contribute not one iota to better sound.



THE SAME ENGINEERS WHO DESIGN DENON PRO EQUIPMENT DESIGN DENON HOME AUDIO.

With their rugged anodized metal front panels, Denon receivers are certainly as handsome as any on the market. But Denon never forgets that it's inside, among the transistors, power supplies and heat sinks, that sound quality is determined. That's why Denon takes the typical priorities of receiver design... and turns them inside out.

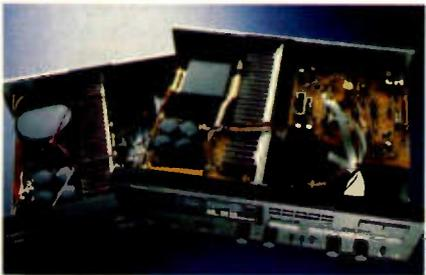

DENON RECEIVER VS. DENON INTEGRATED AMP. ANY RESEMBLANCE IS STRICTLY INTENTIONAL.

For the results, look inside any Denon receiver. You'll find discrete output transistors, not cheap IC "power packs." You'll notice ample power supplies that handle the most demanding

dynamic passages. In fact, the Pure Current Power Supply of the DRA-95VR reduces dynamic IM distortion by an impressive 60 dB.

***"Distortion is, in a word, negligible."***

*High Fidelity Magazine*

The circuit topology of every Denon receiver truly epitomizes the Denon credo, "Simple is Best." For example,

*Of equal importance, though, is the fact that much of the circuitry used in the DRA-95VR was developed for the company's exotic components, and the result is a full featured receiver that will delight even the most ardent component separatists.*

integration a practical reality. Anyone with an easy chair will enjoy the remote control supplied with Denon's top two models. It operates not only the receiver, but also a choice of Denon cassette decks and CD players.

While you might expect to pay more for a Denon, our receivers start at under \$300\*



AS BEAUTIFUL AS OUR DRA-95VR IS ON THE OUTSIDE, IT'S EVEN BETTER ON THE INSIDE.

the DRA-95VR conquers distortion without resorting to the negative feedback that can degrade transient performance. And Denon's Non-Switching Class A output stage combines the purity of Class A with the efficiency of Class B.

Anyone with a Hi-Fi VCR will appreciate Denon's video switching. It makes audio/video

***"The amplifier section is the 95VR's highlight."***

*High Fidelity Magazine*

If they seem different from similarly-priced competitors, there's a good reason. At Denon, we pay more attention to the laws of acoustics than the dictates of fashion.

# DENON

DESIGN INTEGRITY

\*Suggested retail price. Clipping reprinted with permission from Audio/Video Buyers' Guide

light. The audio tape-monitor loop is activated by a push-on/push-off button (with indicator) and has stereo pairs of inputs and outputs as well as a video input. Thus, it can serve as a fifth audio-video input or as a means of connecting the DSM-3602 into the tape-monitor loop of an external amplifier.

However, video dubbing with the Fosgate arrangement can be problematic: There's only one video output jack. Normally, this would be used to feed the TV monitor. So unless your signal sources have multiple video outputs, there's no way to dub between them

Also inside the unit is a switch to activate a 100-Hz high-pass filter in the center-front circuit. If you're using a small center-front speaker, this helps prevent overload on heavy bass.

To the right of the front-panel source selector switches are a pair of buttons that activate the Dolby Surround system and the center-channel output, respectively. Next come four mutually exclusive buttons that determine the width of the front stereo-soundstage (with Mono, Regular, Medium, and Wide settings). Each button has its own illuminated indicator, and there are additional lamps that monitor dialogue (center-channel), surround, and input levels.

As best we can determine from Fosgate's manual, the Dolby Surround (back-channel) information remains basically the same whether Regular, Medium, or Wide stage width is selected. In the Regular mode, the Dolby Surround signal is fed to the side speakers as well as to the back channels. In the Medium mode, "random phase information" is fed to the side speakers. In the Wide mode, the front signals are fed to the side speakers, and random-phase information is fed to the front speakers and also blended into the side channels. Speaker matching and placement are apparently most critical in the Wide mode.

Other front-panel controls include input level (used to prevent input-circuit overload), input balance (which corrects for left/right program imbalances that shift front sounds to the back), bass EQ (which boosts the low end in all channels), surround level, and surround delay (which varies the delay to the back speakers from 12 to 30 milliseconds). From the wireless remote, you can raise and lower volume, adjust front-to-back balance, return to the reference settings, and mute the system completely.

Bench testing can only scratch the surface of the merits of surround-sound processors; ideally, these devices should be carefully auditioned before purchase. Nonetheless, the DSM-3602 acquitted itself very well in Diversified Science Laboratories' tests. Input clipping occurs 3.5 dB above the point at which the red input-level LED lights; therefore, if you adjust the input level so that the LED flashes rarely (as Fosgate suggests), you should have no overload problems. With minimum input level, the overload point is greater than 10 volts, so there should be no problem with any common audio source. DSL also reports that the input circuit clips before any of the line outputs do: If that red LED stays off (or flashes rarely), the entire system is "clean."



**Dimensions:** 17¼ by 3 inches (front), 11 inches deep.

**AC Accessory Outlets:** Two unswitched (300 watts maximum).

**Price:** \$1,000.

**Warranty:** "Limited," one year parts and labor.

**Manufacturer:** Fosgate, P.O. Box 70, Heber City, Utah 84032.

through the Fosgate. And, since video outputs should not drive parallel-connected inputs (as audio signals can using a Y connector), you're stuck. In our view, the best way out is to connect your sources to a separate switcher (with taping facilities), route its main audio-video output through one of the DSM-3602 inputs, and leave the DSM-3602 set permanently for that input.

What the Fosgate DSM-3602 lacks in video flexibility, it more than makes up for in audio. There are eight line-level audio outputs as well as a built-in stereo power amplifier. The line-level outputs are for the left-, right-, and center-front channels, left and right side channels, left and right back channels, and a sub-woofer (should you want one in the system). The built-in power amp is factory-set to drive the rear channels, but you can change an internal jumper to switch it over for side-channel operation by following instructions given in the manual.

With the front/back balance switched to the reference settings and the remote volume and the front-panel surround-level settings raised to maximum, channel gain is just under +15 dB to the front and back outputs. The side and center-front output levels are set 6 dB and 9½ dB, respectively, below the front and back levels (these ratios can be changed by internal trim pots to match the needs of different amplifiers). Naturally, the absolute gain of all channels varies with the input-level setting.

Since maximum output level is determined by input clipping and since the



The DSM-3602's remote-control handset

gains to the various outputs differ, the maximum output level varies from output to output. Higher maximum output levels would be ideal, but the ones obtained should be adequate with power amplifiers of typical sensitivity.

A-weighted noise is admirably low at the front, center, and side channels. Back-channel signals pass through a delay line and can be expected to be noisier, but even here the figure is quite good—74 dB below the 0.5-volt reference. The measured delay time ranges from 10 to 30 milliseconds depending upon the setting of SURROUND DELAY. Front-channel separation is adequate.

For most measurements, DSL centered the input-level, surround-level, and surround-delay knobs, adjusted the input-balance control for minimum side-channel output with a mono input, reset the remote balance to the reference setting, and raised the remote volume to maximum. With these settings in the Dolby Surround/Medium-width mode, DSL measured distortion with a 1-volt input. To the front outputs, distortion remains less than 0.04 percent from 20 Hz to 6 kHz, rising smoothly to 0.13 percent at 20 kHz. The distortion is composed entirely of second- and third-order harmonics, which are relatively unobtrusive. On the back channels, distortion is 0.20 percent at 20 Hz, half that at 1 kHz, and 0.06 percent at 4 kHz and 6

kHz (the decrease is due primarily to the Dolby-required band-limiting of the back outputs).

The response is adequately flat to all outputs, but even with the bass EQ control set at minimum, exhibits a slight low-end rise to all but the center-front output. Front channel response is +3 dB (at 20 Hz), -¼ dB from 20 Hz to 20 kHz. Center-channel response is down 5½ dB at 20 Hz (probably to protect a TV monitor's built-in speaker, if you were to use it) and up 1½ dB at 20 kHz.

Back-channel response follows the Dolby Surround standard quite closely: It is up 2 dB at 20 Hz (probably because of the residual effect of the bass EQ circuit) and 3 dB down at 7.6 kHz. The side channels exhibit a smoothly drooping response (+3¼ dB at 20 Hz, -3¼ dB at 20 kHz) perhaps because of the phase-shift circuit used to derive the side information. Fully advancing the bass EQ produces an additional boost of 17 dB at 45 Hz, below which response falls off rapidly (again, to prevent speaker overload).

Fosgate rates the internal power amplifier at 40 watts (16 dBW) into 4 ohms but does not give a full set of FTC specifications. DSL found its clipping point at 12 dBW (15.8 watts) with 4-ohm loads, but distortion is very low (less than 0.005 percent at 1 kHz) at both 1 and 10 watts. A-weighted noise is an adequately low -77 dB.

In our viewing/listening room, we used six identical powered loudspeakers for the front, side, and back channels. Since that exhausted our supply of identical speakers, we used an external power amp and conventional speaker for the center front. A powered subwoofer might have been nice, but none was available to us at the time of our test. Nonetheless, with seven woofers woofing, we had adequate bass for our taste.

We tried all the stage widths and settled on Medium as the most useful. Normal was fine: Its effect was at least equivalent to that achieved with other good surround-sound processors we have used. The Wide mode was also interesting but a little less precise in image definition and placement in our room. In a wider room than ours, and with a projection TV, Wide might be the mode of choice. The Medium setting provided a wider and more continuous display than we have heard before—there were fewer "holes" in the interspeaker sonic image. And the steering logic responsible for such good performance only rarely betrayed its *modus operandi* with unnaturally "pumped" dynamics. In a word: impressive. ■

(Continued on page 31)

### Processor Section

#### Output at Clipping (at 1 kHz)

main channels	2.0 volts
center channel	0.7 volt
side channels	1.0 volt
rear channels	1.5 volts
Maximum Input Level	> 10 volts

#### S/N Ratio (re 0.5 volt; A-weighted)

main channels	81 dB
center channel	81 dB
side channels	81 dB
rear channels	74 dB

#### Distortion (THD; 20 Hz to 20 kHz; 1-volt input)

main channels	≤ 0.133%
rear channels	≤ 0.200%

#### Frequency Response

main channels	+3, -1/4 dB, 20 Hz to 20 kHz
center channel	+1 1/4, -3 dB, 30 Hz to 20 kHz
side channels	±3 3/4 dB, 20 Hz to 20 kHz
rear channels	+2, -3 dB, 20 Hz to 7.6 kHz

#### Channel Separation (1 kHz; main channels)

	62 3/4 dB
Input Impedance	35k ohms
Output Impedance	≤ 685 ohms

### Power Amplifier Section

#### Output At Clipping (at 1 kHz; 8-ohm load)

	12.0 dBW (15.8 watts)/channel
S/N Ratio (re 0 dBW; A-weighted)	77 dB

#### Distortion (THD at 1 kHz)

at 10 dBW (10 watts)	< 0.01%
at 0 dBW (1 watts)	< 0.01%

# YOU'LL NEVER HAVE TO SIT THROUGH ANOTHER AMATEUR NIGHT AGAIN.

How can you really enjoy professional entertainment when your equipment isn't professional?

You can't. And dbx can prove it to you. Here and now. And with a dbx dealer demo later.

For over 15 years, the greatest moments in entertainment have come through us. Today, you'll find dbx professional equipment at work at most every important recording studio, broadcast facility and live performance in the world.

With 75 patents and a recent Emmy

for co-developing stereo TV, our list of firsts and onlies puts us in a class all our own.

The results are ready for you to take home now. Professional equipment with all the clarity, impact, nuance and range you couldn't get before. Even in the most expensive amateur systems.

The differences you'll see and hear are audible, visible and phenomenal.

For example, our Soundfield psychoacoustic-imaging speaker systems sound spectacular in any room. Anywhere you sit in that room.

Our audio/video preamplifier incorporates Dolby® Pro Logic surround sound using dbx proprietary technology. For the most thrilling home-theater performance you can get.

Our incomparable configurable 2/3/4-channel amplifier provides over 800 watts per channel in actual use. With a flatter response than amateur amps costing twice as much.

Add to these one-of-a-kind components our FM/AM tuner with Schotz® noise reduction, uncanny clarity and a noise floor way below what you're probably listening to now.

And a CD player that's so good, *Stereo Reviews*' Julian Hirsch wrote: "Even without its special circuits [proprietary sonic enhancements], the dbx DX5 would rank as one of the best available."

Complete your home studio/theater with our superlative digital-processing VCR with VHS Hi-Fi and our own MTS stereo TV sound. And bring your video enjoyment up to where it should be.

A visit to your dbx dealer will convince you that your amateur days, and nights, are over.

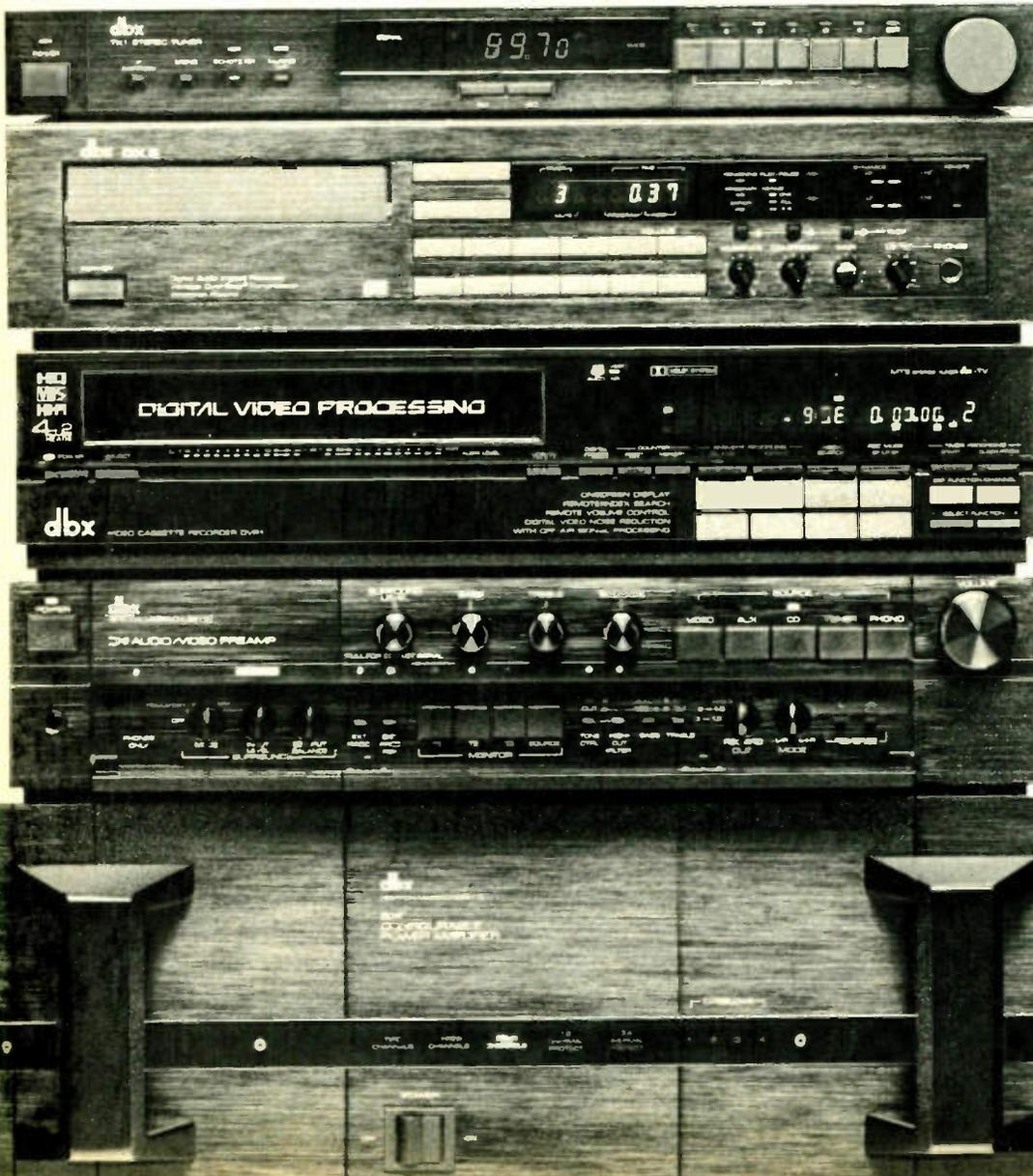

## dbx

Audio and Video  
at its professional best.

## Magnat MSP-60 Loudspeaker

**T**he Magnat name is associated with Magnasphere speakers, in which tweeter and midrange assemblies are housed in round wire-mesh cages that suggest old-style radio microphones rather than speakers. Actually, Magnaspheres are made by a subsidiary of Magnat ("a daughter company," as Magnat's German language literature puts it). As befits a parent, the MSP-60 is much more conventional and, perhaps, practical. Its relatively unobtrusive appearance will blend in better with the decor of typical American homes than might be the case with Magnaspheres.

The handsome case, made of heavy "wood solids" on the sides (and covered with a very convincing black-vinyl grain), houses a three-way bass reflex system with a ducted port that opens at the back. Recessed into the back and angled to ease cable attachment are color-coded heavy-duty binding posts drilled to accept direct input of oversize bared wiring, as well as heavy spade lugs or banana plugs. The latter will protrude somewhat beyond the back plane of the enclosure. In any event, the vents require backup-wall clearance, so the plug clearance presents no problem.

The woofer is a 7-inch polypropylene-cone driver that is centered near the bottom of the front baffle—assuming you stand the speakers vertically, which is the logical orientation (though Magnat does suggest horizontal placement as an alternative). The other two drivers are offset about 1 inch to the left of the front axis. The midrange driver is a 2-inch soft-plastic dome; the tweeter is a 1-inch "soft metal" (aluminum-based composite) dome fabricated to keep its resonance above the audible band (at 25 kHz) and to make the resonance less pronounced than it would be with a more conventional rigid dome. The coil windings of the drivers are made from oxygen-free copper wire on aluminum cores. The wire has a rectangular cross-section that, according to Magnat, permits up to 40 percent more copper in a given area than is possible with conventional windings. Nominal crossovers are at 800 Hz and 2.5 kHz.

Impedance is rated by Magnat at 4 to 8 ohms, with the measured values going only slightly beyond this range at certain narrow frequency bands. The impedance peak at woofer resonance (near 70 Hz) measures 11 ohms; the port resonance, though below 20 Hz, appears to have a similar impedance value. Other maxima are near the crossovers: 13.8 ohms at about 700 Hz and 9.0 ohms in the range around 3.5 kHz. There is a minimum of 3.9 ohms between the port and woofer

resonances and another dip to 3.3 ohms in the woofer range proper. The minima at higher frequencies are all above 4 ohms. Overall, the pattern is not extreme in any sense; the MSP-60 should present a relatively easy load for typical amplifiers to drive, though you should be circumspect about paralleling speaker pairs



from amplifiers that dislike very low impedances.

The aural personality of the speaker is quite attractive: forward and lively, though noticeably on the bright side (a natural concomitant of the first two characteristics). The sense of immediacy and presence is particularly exciting in vocal and chamber music, though some listeners may judge it even more of an ad-

*(Continued on page 36)*

**Dimensions:** 11½ by 20 inches (front), 10½ inches deep.

**Price:** \$650 per pair.

**Warranty:** "Limited," five years parts and labor.

**Manufacturer:** Magnat Elektronik GmbH & Co. KG, West Germany.

**U.S. Distributor:** Magnat America, 70 Atlantic Ave., Marblehead, Mass. 01945.

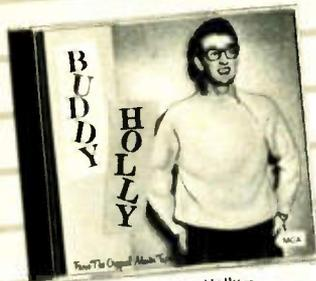

348110. Buddy Holly—From the Original Master Tapes. (MCA)



358507. Madonna—Who's That Girl (Orig. Soundtrk.) (Sire)



359901. Mick Jagger—Primitive Cool. (Columbia)



359208. Loverboy—Wildside. (Columbia)



359521. The Cars—Door To Door. (Elektra)

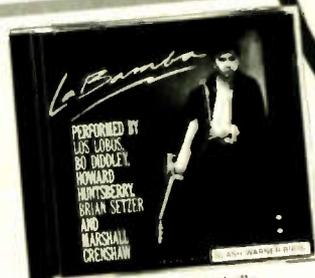

357939. "La Bamba"—Orig. Soundtrk. (Slash/Warner Bros.)

# From Buddy to The Boss

- 337659. U2—The Unforgettable Fire (Island)
- 347955. Huey Lewis & The News—Fore! (Chrysalis)
- 349985. Johnny Mathis/Henry Mancini—The Hollywood Musicals (Columbia)
- 348979. Tina Turner—Break Every Rule (Capitol)
- 352633. Dolly Parton/Linda Ronstadt/Emmylou Harris—Trio (Warner Bros.)
- 336396-396390. Billy Joel's Greatest Hits, Vol. 1 & 2. (Columbia)
- 349324. South Pacific. K. Te Kanawa, J. Carreras, etc. (Digital—CBS)
- 347153. Cyndi Lauper—True Colors. (Portrait)
- 347039. Billy Idol—Whiplash Smile. (Chrysalis)
- 346643. Andreas Vollenweider—Down To The Moon. (CBS)
- 346478. Madonna—True Blue. (Sire)
- 356576. John Adams: The Chairman Dances—DeWart, SonFron. Sym. (Digital—Nonesuch)
- 356675. Beverly Hills Cop II—motion picture soundtrack album. (MCA)
- 361980. Roger Hodgson—Hai Hai. (A&M)
- 356196. The Cure—Kiss Me, Kiss Me, Kiss Me. (Elektra)
- 343319. Janet Jackson—Control (A&M)
- 349571. Boston—Third Stage (MCA)
- 356287. Suzanne Vega—Solitude Standing. (A&M)

- 344721. Lionel Richie—Dancing On the Ceiling. (Motown)
- 355156. Vladimir Horowitz Plays Favorite Chopin. (Digitally Remastered—CBS Masterworks)
- 352948. Wynton Marsalis—Carnaval. Hunsberger, Eastman Wind Ensemble (Digital—CBS Masterworks)
- 353946. Bryan Adams—Into The Fire. (A&M)
- 234062. West Side Story—Original Cast (Columbia)
- 354985. Billie Holiday—From the Original Decca Masters. (Digitally Remastered—MCA)
- 323899. The Best Of The Alan Parson's Project. (Arista)
- 352666. REO Speedwagon—Life As We Know It. (Epic)
- 355115-395111. Prince—Sign 'O' The Times. (Paisley Park)
- 354951. Mozart: Flute Quartets—Rostropovich, Rompol, Stern, Accardo (Digital—CBS Masterworks)
- 356329. Randy Travis—Always & Forever. (Warner Bros.)
- 355990. Motley Crue—Girls, Girls, Girls. (Elektra)
- 355529. Philip Glass—Dance Pieces. (Digital—CBS)
- 357871. Tchaikovsky: Waltzes—S. Commission and Houston Symphony (Digital—Pro Arte)
- 319996-399998. Motown's 25 #1 Hits From 25 Years. (Motown)

- 355776. Stravinsky: The Firebird (1910 version); Song Of The Nightingale—Boulez, New York Phil. (Digitally Remastered—CBS Masterworks)
- 355834. David Bowie—Never Let Me Down. (EMI America)
- 346536. The Monkees—Then & Now...The Best Of The Monkees (Arista)
- 345785. Top Gun—Soundtrack. (Columbia)
- 355362. Whitesnake. (Geffen)

- 319541. Elton John—Greatest Hits. (MCA)
- 318089. Michael Jackson—Thriller (Epic)
- 340323. Sade—Promise. (Portrait)
- 339903. The Cars—Greatest Hits. (Elektra)
- 321307. Air Supply—Greatest Hits. (Arista)
- 342105. Bangles—Different Light. (Columbia)
- 357889. Copland, Billy The Kid; Appalachian Spring; etc.—Bernstein, NY Phil. (Digitally Remastered—CBS Masterworks)

- 355958-395954. Beethoven: Symphonies Nos. 8 & 9 (Choral)—Michael Tilson Thomas. English Chamber Orch. (Digital—CBS Masterworks)
- 290916. The Best Of Earth, Wind & Fire, Vol. 1 (Columbia/ARC)
- 343715. Vivaldi: Four Seasons—Maazel cond. (Digital—CBS Masterworks)
- 323261. Lionel Richie—Can't Slow Down (Motown)
- 346809. Dvorak: Symphony No. 9 (New World); Carnival Overture—Botz. London Philharm. (Digital—Verese/Sarabande)

- 345777. Peter Gabriel—So. (Geffen)
- 246868. Jim Croce—Photographs And Memories—His Greatest Hits. (Sajal)
- 334391. Whitney Houston. (Arista)
- 314443. Neil Diamond's 12 Greatest Hits, Vol. 2. (Columbia)
- 343582. Von Halen—5150. (Warner Bros.)
- 326629. Bruce Springsteen—Born In The U.S.A. (Columbia)
- 342097. Barbra Streisand—The Broadway Album. (Columbia)
- 219477. Simon & Garfunkel's Greatest Hits. (Columbia)

## Classic Rock from the Sixties and Seventies

- 300095. Electric Light Orchestra—Greatest Hits. (Jel)
- 279133. Meat Loaf—Bat Out Of Hell. (Epic)
- 358887. Grateful Dead—Workingman's Dead. (Warner Bros.)
- 358358. Joe Cocker—Classics. (A&M)
- 357277. The Who—Who's Next. (MCA)
- 345157. Jethro Tull—Aqualung. (Chrysalis)
- 327742. The Best Of Kansas. (CBS Assoc.)
- 291864—391862. Original Soundtrack—Woodstock. (Atlantic)
- 290171. The Steve Miller Band—Greatest Hits 1974-78. (Capitol)
- 291526. Emerson, Lake & Palmer—Brain Salad Surgery. (Atlantic)

- 286914. Fleetwood Mac—Rumours (Warner Bros.)
- 244459. Santana's Greatest Hits (Columbia)
- 257279. Bruce Springsteen—Born to Run (Columbia)
- 231670. Janis Joplin's Greatest Hits (Columbia)
- 214650. Blood, Sweat & Tears Greatest Hits (Columbia)
- 287003. Eagle's Greatest Hits 1971-1975 (Asylum)
- 293597. Led Zeppelin—Houses Of The Holy. (Atlantic)
- 350736. Rolling Stones—Rewind. (Rolling Stones Records)
- 269209. Boston—Boston. (Epic)
- 291021. Supertramp—Breakfast In America. (A&M)

- 291278. The Doobie Brothers—Best of the Doobies. (Warner Bros.)
- 308049. Creedence Clearwater Revival Featuring John Fogerty/Chronicle. 20 greatest hits. (Fantasy)
- 260638. Chicago's Greatest Hits (Columbia)
- 341073. Steely Dan—A Decade of Steely Dan. (MCA)
- 292243. Jackson Browne—The Pretender (Asylum)
- 351957. Yes—Fragile. (Atlantic)
- 286740. Lindo Ronstadt's Greatest Hits. (Asylum)
- 357616-397612. The Best Of The Doors. (Digitally Remastered—Elektra)
- 353102. Jimi Hendrix—Are You Experienced. (Reprise)

- 348649. Pachelbel Canon & Other Digital Delights—Toronto Chamber Orch. (Digital—Fantare)
- 353771. Bolling/Rampal: Suite #2 for Flute & Jazz Piano Trio (Digital—CBS)
- 348318. The Police—Every Breath You Take—The Singles (A&M)
- 346312. Billy Joel—The Bridge. (Digital—Columbia)
- 337519. Heart. (Capitol)
- 336222. Dire Straits—Brothers In Arms. (Warner Bros.)
- 314997-394999. Stevie Wonder's Original Musiquarium I. (Tomto)
- 348987-398982. Lindo Ronstadt—Round Midnight (Asylum)
- 353789. Sly & The Family Stone's Greatest Hits. (Epic)
- 351122. Europe—The Final Countdown. (Epic)
- 346544. Kenny G—Duotones. (Arista)

# ANY 6 COMPACT DISCS FOR \$1

plus shipping and handling, with membership

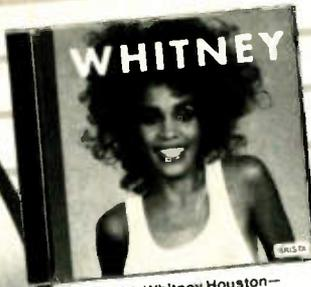

356154. Whitney Houston—  
Whitney. (Arista)



360115. Bruce Springsteen—  
Tunnel Of Love. (Columbia)

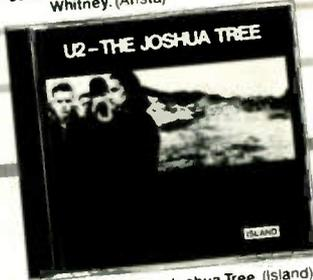

354449. U2—The Joshua Tree. (Island)

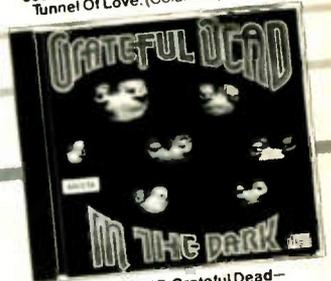

357087. Grateful Dead—  
In the Dark. (Arista)



359075. Aerosmith—  
"Permanent Vacation". (Geffen)

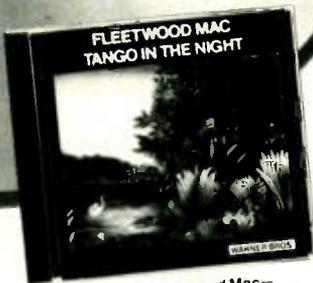

354902. Fleetwood Mac—  
Tango In The Night. (Warner Bros.)



356667. Heart—Bad Animals. (Capitol)

337402. The Manhattan  
Transfer—Vocalese.  
(Atlantic)

346957. Steve Winwood  
—Back In The High Life.  
(Island)

344622. Anita Baker—  
Rapture. (Elektra)

138586. Bob Dylan's  
Greatest Hits (Columbia)

343954. Paul Winter—  
Canyon. (Living Music)

357657. Beethoven:  
Piano Concerto No. 5—  
Murray Perahia.  
(Digital—CBS Masterworks)

357640. Wynton  
Marsalis—Marsalis  
Standart Time.  
(Columbia)

357186. Hooters—One  
Way Home. (Columbia)

353920. Simply Red—  
Men and Women. (Elektra)

352229. Carly Simon—  
Coming Around Again.  
(Arista)

356444. Dianne  
Warwick—Reservation  
For Two. (Arista)

354829. Lisa—Lisa And  
Cult Jam With Full  
Force—Spanish Fly.  
(Columbia)

356501. Benson/Klugh—  
Collaboration.  
(Warner Bros.)

361022. Tchaikovsky:  
Symphony No. 6—  
Claudia Abbada, Chicago  
Symph. Orch. (Digital—CBS  
Masterworks)

357350. The Duke  
Ellington Orchestra—  
Digital Duke. (Digital—GRP)

356741. Bach: Preludes  
And Fugues For Organ,  
Vol. 1. (Digital—Newport  
Classics)

354100. Crowded House.  
(Capitol)

354035. Dwight Yoakam  
—Hillbilly Deluxe. (Reprise)

345751. Paul Simon—  
Graceland. (Warner Bras.)

356279. Gloria Estefan  
And Miami Sound Machine  
—Let It Loose. (Epic)

358077. Hank Williams,  
Jr.—Born To Boogie.  
(Warner Bras./Curb)

357863. Barbra  
Streisand... "One Voice."  
(Columbia)

357574. Original  
Soundtrack—The Lost  
Boys. (Atlantic)

357467. Sammy Hagar.  
(Geffen)

336669. Sting—The  
Dream Of The Blue  
Turtles. (A&M)

357806. Mussorgsky:  
Pictures At An Exhibition,  
Night On Bald  
Mountain—Leonard  
Slatkin, St. Louis Symphony  
Orchestra. (The Mass Music  
Group)

360974. Squeeze—  
Babylon And On. (A&M)

360149. Echo & The  
Bunnymen. (Sire)

360016. Spyra Gyro  
—Stories Without Words.  
(Digital—MCA)

357798. The Art Of  
Beverly Sills, Album 2.  
(Digitally Remastered—  
Angel)

357145. Richard Goode  
Plays Brahms Piano  
Pieces, Op. 76 & 119/  
Fantasies Op. 116.  
(Digital—Nonesuch)

357103. Baccherini: Cello  
Concerto—Yo Yo Ma;  
Zukerman, St. Paul  
Chamber Orch.  
(Digital—CBS Masterworks)

357079. Michael Brecker.  
(Digital—MCA/Impulse)

354993. Judy Garland  
—America's Treasure.  
(Dunhill CD Classics)

291385. America—  
History/America's  
Greatest Hits. (Warner  
Bras.)

## Now it's easy to add the best of yesterday and today to your CD collection.

As a special introduction to the CBS Compact Disc Club, you can pick any six CDs for \$1.00. All you do is fill in and mail the application—we'll send your six CDs and bill you \$1.00, plus shipping and handling. You simply agree to buy four more CDs (at regular Club prices) in the next two years—and you may then cancel your membership anytime after doing so.

**How the Club works.** About every four weeks (13 times a year) you'll receive the Club's music magazine, which describes the Selection of the Month for your musical interest... plus many exciting alternates. In addition, up to six times a year, you may receive offers of Special Selections, usually at a discount off regular Club prices, for a total of up to 19 buying opportunities.

If you wish to receive the Selection of the Month, you need do nothing—it will be shipped automatically. If you prefer an alternate selection, or none at all, fill in the response card always provided and mail it by the date specified. You will always have at

least 10 days in which to make your decision. If you ever receive any Selection without having 10 days to decide, you may return it at our expense.

The CDs you order during your membership will be billed at regular Club prices, which currently are \$14.98 to \$15.98—plus shipping and handling. (Multiple-unit sets may be somewhat higher.) After completing your enrollment agreement you may cancel membership at any time; if you decide to continue as a member, you'll be eligible for our money-saving bonus plan. It lets you buy one CD at half price for each CD you buy at regular Club prices.

**10-Day Free Trial:** We'll send details of the Club's operation with your introductory shipment. If you are not satisfied for any reason whatsoever, just return everything within 10 days and you will have no further obligation. So why not choose 6 CDs for \$1 right now?

**ADVANCE BONUS OFFER:** As a special offer to new members, take one additional Compact Disc right now and pay only \$6.95. It's a chance to get a seventh selection at a super low price!

CBS COMPACT DISC CLUB, 1400 N. Fruitridge  
P.O. Box 1129, Terre Haute, Indiana 47811-1129

Please accept my membership under the terms outlined in this advertisement. Send me the 6 Compact Discs listed here and bill me \$1.00 plus shipping and handling for all six. I agree to buy four more selections at regular Club prices in the next two years—and may cancel my membership at any time after doing so.

SEND ME THESE 6 CDS FOR \$1.00.

My main musical interest is (check one). (But I may always choose from either category.)

ROCK/POP  CLASSICAL

Mr. \_\_\_\_\_  
Mrs. \_\_\_\_\_  
Miss \_\_\_\_\_  
Print First Name Initial Last Name

Address \_\_\_\_\_ Apt. \_\_\_\_\_

City \_\_\_\_\_

State \_\_\_\_\_ Zip \_\_\_\_\_

Do you have a VCR? (Check one)  Yes  No 771/588

Do you have a credit card? (Check one)  Yes  No

ADVANCE BONUS OFFER: Also send me a seventh CD right now at the super low price of just \$6.95, which will be billed to me.

This offer is not available in APO, FPO, Alaska, Hawaii, Puerto Rico. Please write for details of alternative offer. Canadian residents will be serviced from Toronto.

SMH/RX SMJ/RY Note: We reserve the right to reject any application or cancel any membership.

Selections with two numbers contain 2 CDs and count as 2—so write in both numbers. © 1988 Columbia House

**CBS COMPACT DISC CLUB: Terre Haute, IN 47811**

# Why it took a to invent the Q



## AKAI'S QUICK START: THE MOST SIGNIFICANT ADVANCEMENT IN TAPE HANDLING SINCE THE VHS CASSETTE.

Today's VHS cassettes may give you eight hours of programs. But today's VHS decks make locating those programs a real bore. That's because conventional decks must slowly thread the tape around the head drum every time you go from Fast Forward or Rewind into Play. And slowly pull the tape back into the cassette whenever you return to Fast Forward or Rewind.

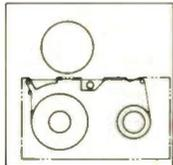

Unloading for conventional VCR

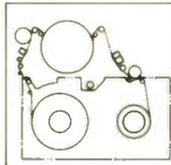

Full-loading for Quick Start

Of course, most VCRs have visible scan. But can you imagine scanning through a two-hour movie? Pass the aspirin.

Akai's exclusive Quick Start system gives you fast, fast, fast relief. For the first time, the VHS tape remains fully threaded—even during Fast Forward and Rewind. So switching between functions is more than *five times faster* than conventional VHS decks.

There's more. To make locating programs even easier, Akai searches and scans recorded segments automatically. Best of all, this revolution in tape handling is found not just on our top model—but on every new Akai VCR.

Sound great? Seem simple? Wonder why no one ever did it before?

## WHY IT TOOK AKAI TO PERFECT VHS TAPE HANDLING.

Simply stated, Akai has been building tape recorders for over 35 years. And what is a VCR if not a tape recorder? People may forget that it



Akai has over  
35 years of experience building  
tape recorders of all kinds.

# hi-fi company Quick Start VCR.



was Akai that built the first home video tape recorder in 1965 and the first lightweight helical-scan portable video tape recorder in 1969. Compared to Akai, even the biggest names in video recording seem like "Johnnies-come-lately."

To invent Quick Start, Akai invented a completely new tape transport with better tape tension control, more precise guide poles and specially conductive fine ceramic tape guides. The entire transport is under the intelligent control of a micro-processor that only years of tape deck experience could develop. The Akai Quick Start Transport. Sure it's simple... when you know how.

## AT AKAI, SOPHISTICATION MEANS SIMPLICITY.

Akai, a leader in on-screen programming, now takes ease-of-operation one step further. On our new decks, most programming functions require no more than one touch. Nothing *could* be simpler.

Or more sophisticated. Take Akai's new top-of-the-line VS-M930U-B. It offers digital special effects with memory; VHS Hi-Fi stereo; four heads; HQ circuitry with CCD noise reduction; editing; universal wireless remote control with LCD readout; on-screen programming and naturally, Akai's Quick Start system with Index and Address Search, as well as Intro Scan. Not just bells and whistles, but features any serious recordist would deem essential.

Akai. Original thinking from a true original.



Universal Wireless Remote is programmable independently of the VCR. You can "download" programmed information.

# AKAI

Where audio and video are one.

vantage in big orchestral scores, where it helps to highlight textures within the sonic impasto.

To some extent, credit for this property may be attributed to Magnat's frequency-balancing design techniques. Instead of using a single speaker and adjusting for flat anechoic response at 1 meter (which, according to the company, fails to take into account the natural attenuation of highs that occurs in listen-

ever, some listeners surely will prefer the somewhat heavier bass resulting from placement near the backup wall; imaging is still good in that position. On the other hand, we considered the bass exceptionally solid for the enclosure size even without the reinforcement of a nearby wall.

Magnat's amplifier-power rating of 90 to 130 watts, printed on a label affixed to the speakers, strikes us as reasonable on the basis of the lab tests, which indicate that a sound pressure level (SPL) of around 110 dB—as high as most home listeners will ever want—can be achieved without flinching. In many home installations, in fact, 90 watts (19.5 dBW) is considerably more than you'll really need for comfortable listening levels in moderate-size rooms, given the fairly high sensitivity figure.

Distortion is quite low, averaging about ¼ percent over the working frequency range at the lowest test level (85 dB SPL). There were no measurements significantly above 1 percent down into the deep bass, which is very unusual. The figures creep up only gradually as the test level is raised to 100 dB, where the average still is near 1 percent and almost all measurements are below 2 percent.

We were pleased by this first encoun-

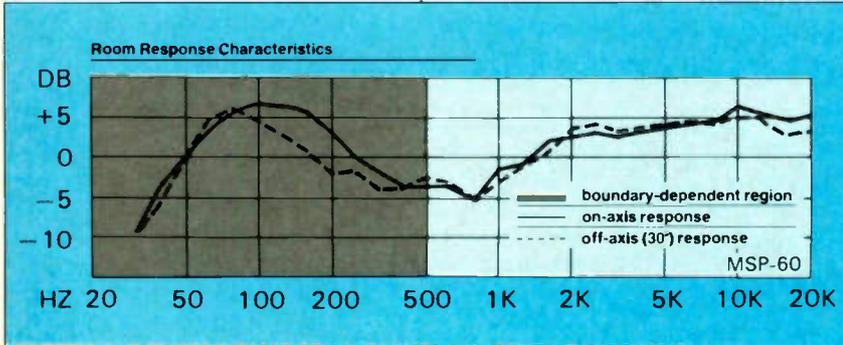

Sensitivity (at 1 meter; 2.8-volt pink noise)

91 dB SPL

Average Impedance (250 Hz to 6 kHz)

8.6 ohms

ing rooms), the measurements are made at 3 meters using a pair of speakers. When factored into the design, this method results in greater prominence being given to the highs.

In DSL's frequency-response measurements, the balance appears to be less a question of treble prominence than one of midrange reticence. Some (but not all) of the midrange dip might be cancellation from floor reflections. The graph shows response with the speaker on an 8-inch stand and 8 inches away from the backup wall. With respect to average "music band" output, on-axis response lies within about  $+6\frac{1}{4}$ ,  $-5\frac{1}{2}$  dB from the 40-Hz band up. Off-axis response is very similar, with virtually no evidence of beaming at the top end.

When DSL measured the speaker moved out into the room, the results were similar. However, the frequency range of greatest bass response was pushed almost an octave higher, yielding a gentler rolloff in the deep bass and a narrower midrange dip. Magnat's "Important Instructions" manual applies to all models in the line and covers sources of potential malfunction in good detail, but it makes no mention of placement. Instructions appended to the warranty folder that accompanied the test samples, though, recommend putting the speakers against the short wall of an oblong room but away from the corners.

We followed this recommendation for the listening tests, except that we frequently moved the speakers out from the wall for best stereo imaging and, we thought, most natural balance. How-

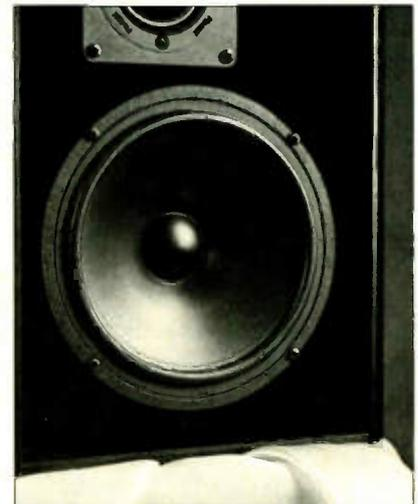

The MSP-60's 7-inch woofer has a polypropylene cone.

ter with Magnat speakers. Rarely have we experienced such a sense of musical color and liveliness without any obtrusive artificiality in the sound. Admittedly, we do perceive some coloration, but we expect many listeners will overlook this factor or see it as being outweighed by the unusual vividness with which the music is reproduced—a quality that, in some music, makes mere accuracy of timbre sound a little "flat." ■

**T**he KA-3300D is a showpiece of the Kenwood line—or, more specifically, of the company's Digital Series Audio Components. It's also the first component we've tested that boasts a built-in digital-to-analog (D/A) converter that accepts and decodes the direct-digital bit-stream output from components such as Compact Disc players and digital audio tape (DAT) decks with appropriate outputs. With this integrated amp, therefore, we take one more step toward an all-digital future.

There are actually three digital inputs and one digital output, all on the back panel. The first input is a fiber-optic coupler that mates via an optical cable with the digital-output jack on the Kenwood DP-3300D CD player. The second input is a standard gold-plated pin jack, as are the direct-digital recording and playback connections for a DAT deck. Since there is still no standard for audio-system fiber-optic connectors, Kenwood sensibly uses the optical link for hooking up its own CD player. Presumably, the standard pin jacks are employed for other digital connections so that you can mix brands. The D/A section automatically adopts the sampling frequency of the data stream (32, 44.1, or 48 kHz, depending on the source).

To choose a direct-digital input, you first push **DIGITAL DIRECT**, located next to the volume knob. This overrides not only the analog input selectors, but also the balance, mode (stereo/mono), and infrasonic-filter controls. The volume control continues to function, however, as do the loudness, muting (which attenuates output by almost the full 30 dB specified by Kenwood), and tone controls—rather a lot of processing for a “direct” feed, it seems.

Final selection of the digital source is handled by three small buttons at the bottom right of the front panel. The first chooses between the digital and analog modes; the second switches between the two non-DAT inputs; and the third chooses the DAT input. Each has a pilot light—a welcome feature, since Kenwood is inconsistent about what the switch positions represent, and the wording of the manual (not one of Kenwood's best efforts, though we've certainly seen much worse) on this matter isn't as clear as it could be. The manual also leaves us unconvinced of the utility of the back-panel D/A direct-out connections. They are provided so that the KA-3300D “can be used as [a] stand-alone D/A converter unit by connecting the line-input jacks of another amplifier to [the D/A direct-out jacks].” Therefore, the digital controls and routing

could be improved. This will probably occur in future products once analog/digital cohabitation becomes the norm.

The analog input selectors occupy most of the narrow band between the upper panel and the bottom rank of controls. The main selectors are for phono, CD, tuner, aux, and monitor. Under the large volume knob is a button to select MC (moving-coil) or MM (fixed-coil) phono options. To the left of the monitor button are three smaller ones to select Tape 1, 2, or 3 as the monitored deck. A button that chooses between Aux 1 and 2 is located above the front-panel Aux 2 input jacks, which are nestled in the base. The Aux 1 inputs are on the back panel, as are all the remaining inputs.

Tucked under the left end is the headphone jack, which aesthetically balances

## Kenwood KA-3300D Integrated Amplifier

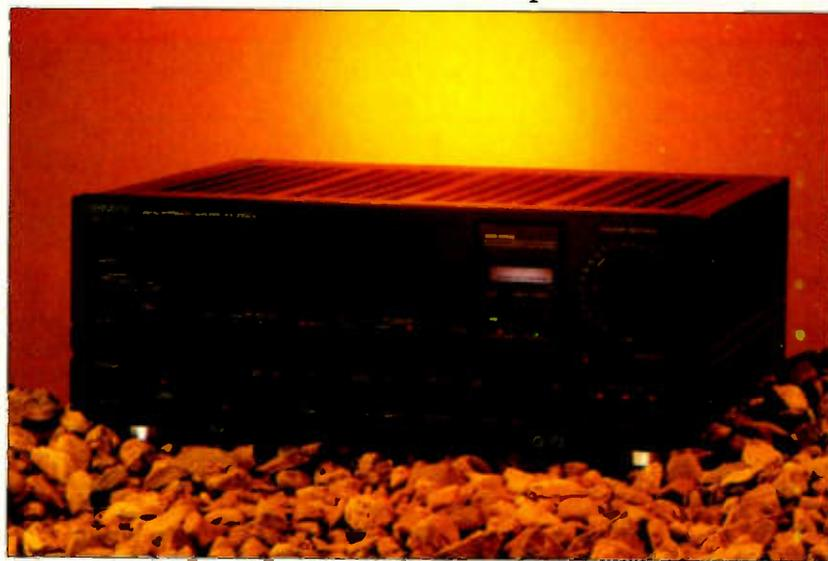

the Aux 2 inputs. Above the jack and along the bottom rank of the front panel proper are the power switch, the mode switch, the bass and treble controls (each with a turnover-frequency switch), the infrasonic filter, and the loudness controls (a combination of an on/off switch and a level knob that sets the degree of compensation).

At the upper left are rotary controls for the speakers (the A pair, the B pair, both, or neither) and the tape outputs, the switching for the latter being unusually complex. The off position interrupts all feeds to the tape decks, preventing unnecessary loading of the signal fed to the power amp. There are also two dubbing positions: Tape 1 feeding 2 and 3, and Tape 2 feeding 1 and 3. The remaining three knob positions determine which signal—from the digital input, the CD analog input, or the tuner input—will

**Dimensions:** 17 by 6 inches (front), 12 inches deep plus clearance for controls and connections.

**AC Convenience Outlets:** One unswitched (400 watts max.), two switched (100 watts max. total).

**Price:** \$1,199.

**Warranty:** “Limited,” two years parts and labor.

**Manufacturer:** Kenwood Corp., Japan.

**U.S. Distributor:** Kenwood U.S.A. Corp., 1315 E. Watsoncenter Rd., Carson, Calif. 90745.

<b>Rated Power</b>	21.8 dBW (150 watts)/channel
<b>Output at Clipping (at 1 kHz; both channels driven)</b>	
8-ohm load	22.3 dBW (170 watts)/channel
4-ohm load	24.7 dBW (295 watts)/channel
<b>Dynamic Power (at 1 kHz)</b>	
8-ohm load	22.5 dBW
4-ohm load	25.1 dBW
2-ohm load	26.2 dBW
<b>Dynamic Headroom (re rated power; 8-ohm load)</b>	
	+0.7 dB
<b>Harmonic distortion (THD; 20 Hz to 20 kHz)</b>	
at 21.8 dBW (150 watts)	≤ 0.016%
at 0 dBW (1 watt)	< 0.01%
<b>Frequency Response</b>	
	+0, -1/2 dB, < 10 Hz to 23.9 kHz
	+0, -3 dB, < 10 Hz to 62.9 kHz

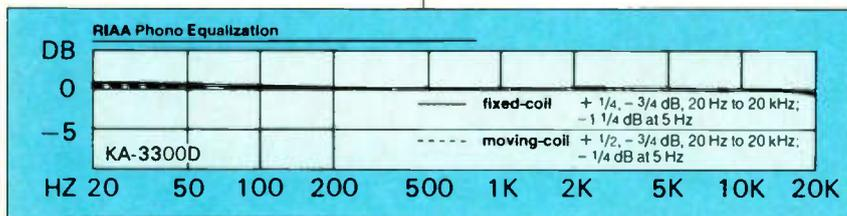

<b>Sensitivity &amp; Noise (re 0 dBW; A-weighting)</b>		
	<b>sensitivity</b>	<b>S/N ratio</b>
aux input	12 mV	78 1/4 dB
fixed-coil phono	0.20 mV	75 1/2 dB
moving-coil phono	8.3 μV	77 1/4 dB
<b>Phono Overload (1-kHz clipping)</b>		
fixed-coil phono	225 mV	
moving-coil phono	9.3 mV	
<b>Input Impedance</b>		
aux input	45k ohms	
fixed-coil phono	48k ohms, 285 pF	
moving-coil phono	100 ohms	
<b>Output Impedance (to tape)</b>		
from aux input	direct	
from phono inputs	220 ohms	
<b>Damping Factor (at 50 Hz; re 8 ohms)</b>	1.950	
<b>Channel Separation (at 1 kHz)</b>	69 1/2 dB	
<b>Infrasonic Filter</b>	-3 dB at 16 Hz, ≈ 7 dB/octave	

feed to Tape 2 and 3. Tape 1 receives whatever signal is chosen with the main input selectors.

You can thus record digital signals from any of the three digital inputs, the analog CD signal, or the tuner to any of the decks. But only Tape 1 can be used for phono and aux signals. At first, this struck us as a mite odd, but it works well enough in practice. The switching evidently doesn't affect the digital feed to the DAT, which presumably also receives whatever is chosen at the main selectors. We could find no elucidation in the manual, and without a DAT deck on hand, we were unable to check.

The D/A subsystem itself incorporates a four-times oversampling digital filter and a seven-pole Butterworth analog filter. Separate converters are provided for the two channels. Further contrib-

ness compensation be adjustable so that it won't boom when the amplifier is driven way below full capability—as it must be most of the time in typical home environments. The 3300's loudness control is exceptionally well behaved; it supplies reasonably consistent increments of bass boost as the knob is rotated and shelves predictably below a turnover frequency that depends on the degree of boost.

In a sense, however, this precision is redundant: The dual-turnover bass control doesn't shelf (and hence doesn't boost infrasonics as much) and can be switched to put its maximum boost near either 25 or 50 Hz for the 200- and 400-Hz turnover options, respectively. This will deliver subjectively more pleasing loudness compensation for some listeners than the loudness control itself. Maximum bass boost or cut runs a hair over 10 dB at either setting, and the increments are even more regularly spaced than are those of the loudness control. Treble adjustment is comparable, with the 3- and 6-kHz turnover frequencies yielding response maxima near 20 kHz and in the ultrasonic range, respectively.

The infrasonic filter is quite gentle—a little too gentle, though, if you haven't taken sufficient care with your choice of tonearm and pickup and hence have warp-output problems. There is almost no infrasonic rolloff built into the phono-input section. Though there are no separate inputs, Kenwood gives you separate phono circuitry for MM and MC cartridges, rather than just an extra gain stage to boost an MC signal. The intent is to match the load requirements of each cartridge type more precisely than permitted by the usual shortcuts. Frequency response is very smooth in both sections, with a slight rolloff at the extreme top and a minute rise in the midbass. In the deep bass, MM response continues to rise (though still not to a significant degree), while the MC curve tails back to the 1-kHz reference level.

All of this is very impressive. Were it not for the digital connections, switching, and decoding, we'd view the KA-3300D simply as a superior integrated amplifier. But the real story lies in the way Kenwood has addressed the first stages (technical and conceptual) of the coming digital takeover. The internal D/A conversion and the use of optical coupling are just two results of this. Although we hope for simpler, more straightforward—if you will, more traditional—control schemes in future analog-digital hybrids, we're satisfied that Kenwood has succeeded electrically—and optically—with its first effort in a brand-new field. ■▶

uting to purity of output is the independent construction and shielding of the amplifier's three sections (digital, analog, and output) and the proprietary Sigma Drive that seeks to siphon off to ground any digital noise picked up within the analog and output sections.

Two other special Kenwood circuits are built into the power amp. DLD (Dynamic Linear Drive) acts as a buffer between the power-supply and amplifier sections to prevent line-voltage fluctuations from affecting performance. VIG (Voltage Interface Gate) similarly acts to prevent the extra current drawn to reproduce musical peaks from influencing the power supply voltage. As in some other premium amps, Kenwood uses separate circuitry to handle high and low levels.

As you can see from the lab data, the amplifier delivers comfortable but not extreme headroom and handles low-impedance loads with equanimity. Going from 4 ohms to 2 delivers less extra power than switching from 8 ohms to 4 (just over 1 dB, as opposed to almost 2). But there's also no evidence that the amplifier is running out of the considerable head of steam it has developed at that point—the equivalent of over 400 watts per channel on a dynamic basis into 2 ohms.

The availability of so much peak power makes it obligatory that the loud-

# When you've arrived. Proton.

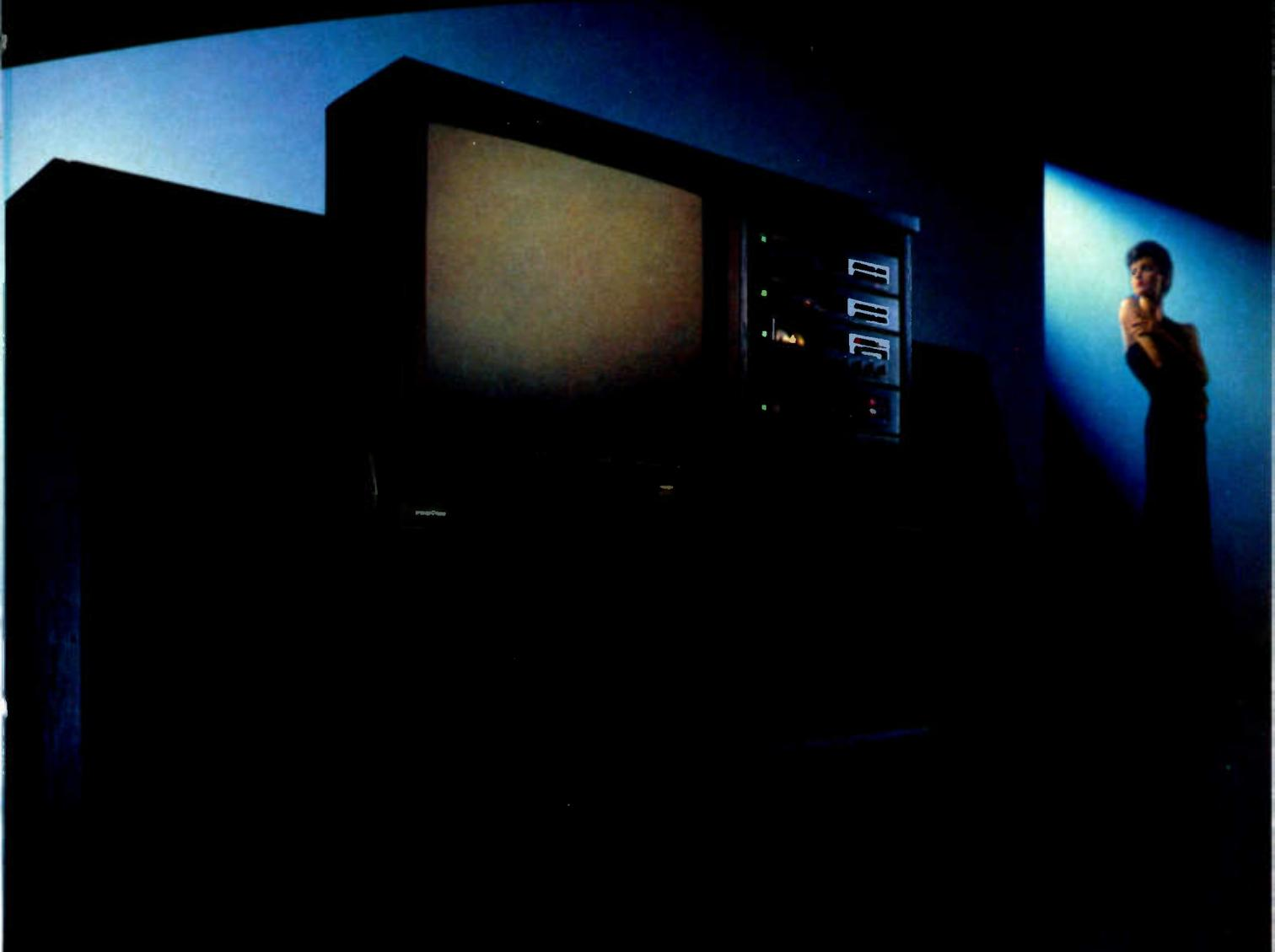

Proton's AV27 audio-video system.



300 Series Remote-Controlled Components with Dynamic Power on Demand™ (top to bottom) AM-300 Stereo Amplifier, AT-300 Stereo Tuner, AD-300 Cassette Deck, 830R CD Player.

Your audio-video system should be a reflection of your lifestyle. That's why you'll want the ultimate in picture, sound and design.

Introducing Proton's new AV27 audio-video system.

At the heart of the system is our superb, remote-controlled 300 Series audio components with exclusive Dynamic Power on Demand™ (DPD™). Since its introduction, DPD has received the highest acclaim. It does what no other technological innovation has for CD, other digital recordings, or hi-fi video listening pleasure. DPD boosts the amp's output up to four times its rated power, to let you hear even the highest musical peaks clearly, without distortion.

When you put the 300 Series together with our new matching speakers, you'll have a combination that sounds as extraordinary as it

looks. And, it's the perfect complement to Proton's stunning new 27" flat screen stereo monitor/receiver.

The Proton AV27 audio-video system. Once you own it, you'll know you've arrived.

**The ultimate audio/video guide is yours free for the asking.**

Proton's Ultimate System Guide for Audio/Videophiles tells you everything about the innovative technology and design that go into creating the renowned Proton line.

For your copy, which includes a list of the Proton retailers near you, call (800) 772-0172. In California, (800) 428-1006.

## **PROTON**

CLEARLY THE BEST  
737 W. Artesia Blvd., Compton, CA 90220



# THIS LINE-UP LOVES THE TDK LINE-UP.



## **TYPE I (Normal Position)**

**AD-X** You'll get exceptional sound throughout the entire frequency range with the first normal-bias Avilyn formulation designed for wider dynamic range with superior MOL. Record on home components.

**AD-S** For cleaner, sharper sound AD-S delivers wider dynamic range with lower tape noise. A special rigid plastic C-Thru™ mechanism provides resonance control for clear undistorted recordings. Record on home component systems, integrated systems.

**AD** Hot high-end performance is the earmark of AD. Linear ferric oxide particles for smooth, natural reproduction provide for extreme sensitivity and wider dynamic range. For use with rack systems and auto decks.

When you want premium performance at an economical price, TDK D cassettes deliver. Available in the widest assortment of lengths. Record on home tape deck systems or battery powered portables.

## **TYPE II (High Position)**

**SA-XG** This is the ultimate Type II performer that meets or exceeds professional recording standards. A superior RS-II three-layer mechanism, plus TDK's exclusive dual coated Super Avilyn formulation make it the world's quietest tape, in any class. Perfect for all professional and high-end home equipment recording.

**HX-S** When you want extended dynamic range and digital capability, HX-S is the premier metal particle tape to use. Record on home component systems.

**SA-X** The world's quietest tape formulation—a dual coating of Super Avilyn—plus a unique DLM (Dual Layer Mechanism) delivers improved frequency response with virtually no noise. Record on home component systems, high-end portables.

**SA** Greater dynamic range and high energy sound have made SA the world's most popular high bias cassette. Record on home component systems, boom boxes and other portables.

## **TYPE IV (Metal Position)**

**MA-XG** Capture the full dynamics of digitally-sourced material on MA-XG. The ultimate metal tape features TDK's new three-layer RS-II vibration dampening mechanism, which virtually eliminates vibration—delivering the purest, clearest sound. Record on high-end metal compatible decks.

**MA-X** Our Super Finavinx metal tape formulation and new DLM (Dual Layer Mechanism), which virtually eliminates vibration, allows MA-X to deliver a richer, wider dynamic range with clearer sound. Record on all metal compatible decks.

**MA** Superior sound reproduction with super-wide dynamic range are the characteristics of MA. It delivers true metal tape performance at an affordable price. Great for digitally sourced music, too. Record on all metal compatible decks.

**TDK.**  
THE ART OF PERFORMANCE.



**ULTRA**  
HIGH FIDELITY

For The  
Advanced  
Audiophile

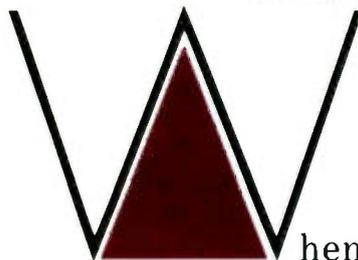

When HIGH FIDELITY began publication back in 1951, it catered to a relatively small group of devotees. Equipment capable of full-bandwidth, low-distortion music reproduction still was scarce, and enthusiasts often built some of their own gear (especially loudspeakers). The diversity of products and sophistication of design we now take for granted were still far in the future.

Today's audio-video market is astonishingly broad, ranging from \$60 portable tape players to \$40,000 speaker systems, from \$300 VCRs to \$5,000 projection television sets. But for those who really care, the goal is still the same. ULTRA HIGH FIDELITY will focus its coverage on equipment, manufacturers, and recordings that remain true to the impulse that started it all by striving for the finest possible reproduction of sound and image, regardless of cost.

*Michael Riggs/Editor*

AN INTERVIEW  
WITH  
CHRIS RUSSELL  
OF  
BRYSTON, LTD.

ULTRA  
HIGH FIDELITY

# Sounding Off

BY GORDON BROCKHOUSE

With this issue, **ULTRA HIGH FIDELITY** presents the first of a series of interviews with high-end manufacturers. The first company represented—Bryston, Ltd., of Toronto, Canada—is unique for its success in both the professional and audiophile markets. In both fields, Bryston makes preamplifiers and power amplifiers as well as accessories like moving-coil transformers, speaker switchboxes, and electronic crossovers.

Design and engineering are the responsibilities of vice-president Christopher Russell, who oversees a staff of four. **HIGH FIDELITY** contributor Gordon Brockhouse spoke with Russell at Bryston's head office in Toronto. The thirty-nine-year-old designer discussed his company's products and the philosophy behind them as well as his approach to audio in general. Russell's interest in audio started in his teens, when he listened to the Stones and the Beatles and attended live concerts of every kind of music.

**CR:** I realized that the sound systems of the day [1960s] were approaching the kind of feeling you get at a live performance, but there was still an emotional response you couldn't recapture. It became a challenge to look into things that would elicit the same response music generates in a live setting.

**GB:** *When did Bryston start building audio equipment?*

**CR:** In 1972. I had been with the company for three or four years, as a student—a boss's-son type of thing. It occurred to me that we ought to have a line of products that featured Bryston's name prominently.

My own interests were in audio and high fidelity amplification. For approximately a year, we did research, testing, and prototyping. We came up with something we thought was an improvement on available products and gave it to a Toronto sound studio to test. They found that our amplifier was more musically ac-

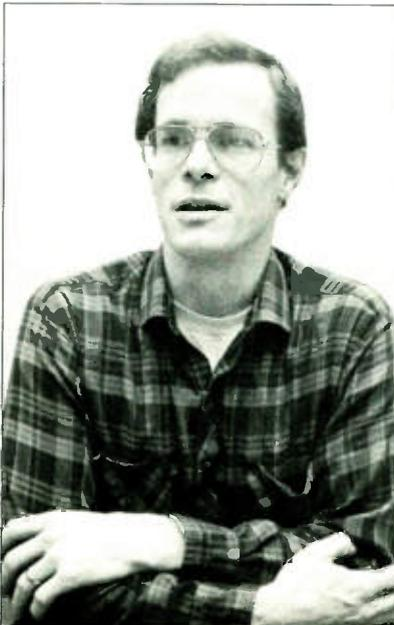

*Christopher Russell, vice president of design and engineering for Bryston.*

curate than what they'd been using. It was actually giving them more information and hiding less of the detail they needed to hear for mixing and mastering.

That, of course, was very encouraging, because it told us that our ideas had a lot of merit. Some of them were sizable departures from the philosophies of amplification at the time. So, we accepted their order for some monitoring amplifiers and built them in a very short production run; then we approached other studios. It grew pretty quickly from there. It seemed to us that perhaps we had an application in high fidelity home amplifiers as well. In 1974, we started with one store in Toronto.

**GB:** *How did the design of your products differ from those then available?*

**CR:** At the time, no one had really thought about slew-rate limiting. We felt that available amplifiers couldn't deliver the power at high frequencies



## Only Sony offers the most advanced headsets for every mindset.

Look to the company that listens to digital audio four different ways.

If you're going to invest in the world of digital audio, then only the right kind of headphones will do.

That's why you'd be most comfortable with headphones made by Sony, The Leader in Digital Audio. Like our best digital equipment, Sony's advanced headphones are designed to let you realize the full potential of digital sound reproduction.

Each Sony model is built with sensitivity, utilizing the most precise technology available. For example, cobalt diaphragm drivers for superior musical resolution

and wider dynamic range; linear crystal, oxygen-free copper wiring for less signal path resistance, and gold-plated contacts for the finest possible conductivity.

And if all that sounds good to you, listen to this: Sony offers more types of advanced headphones for the widest variety of digital audio applications. So try one on and see what it's like to get the most from your music.

After all, once you've paid for the finest digital audio components, anything less than Sony wouldn't be a sound investment.

**Headphones. SONY**

they could at midband. Back in the early '70s, transient intermodulation distortion hadn't been considered much. Square-wave performance of most amplifiers was severely limited. Low-power rise time was much different from high-power rise time. We thought that might be important when amplifiers were used at high sound levels.

Another departure was complementary circuit design. Amplifiers did not use the same circuitry on both ends [positive and negative halves] of the waveform. That added second-harmonic distortion that was causing high-order problems, sort of gritty and harsh-sounding mechanisms. So we adopted the concept of complementarity.

We also felt that much of the blurring in some solid-state amplifiers resulted from power-supply interaction between channels. We felt that an amplifier should have a separate power supply for each channel, an approach that has since become extremely popular. We found it improved imaging drastically. In addition, it was unusual [then] to have regulation within the power supply. We felt that at least the low-level voltage supplier to the gain stages ought to be strongly regulated so that they were essentially imperturbable.

We also wanted to make sure the amplifier had open-loop linearity, as opposed to a lot of feedback that would correct inherent distortion. This also has become popular. We felt that we'd wind up with a more musically accurate product, one that would sound easier, less strained.

**GB:** *What refinements have you added since then?*

**CR:** Our newest amplifiers have four-way complementarity within the output section. The same kind of transistors operate on both halves of the waveform, so that the "bottom" half of the amplifier hands the signal over to the "top" half with exactly the same amplification circuitry, not just a complementary inverse of it. The complementarity is so extreme that it linearizes the output transfer function, almost eliminating low-level crossover artifacts. There appears to

be a highly audible improvement.

Bryston doesn't make new-product announcements until after product has been shipped. Invariably when we make improvements, we receive an unsolicited reaction from our dealers. It's quite startling sometimes. When we began using the output circuit I've been describing, some dealers said the amplifiers they had on their shelves were obviously defective, because the new ones sounded so much better. But we're not head-in-the-clouds tweekophiles. Any improvement we make has to be backed up with audible and electrical



*Bryston's TF-1 moving-coil transformer.*

improvements that we can document.

**GB:** *Among both press and enthusiasts, there seem to be two extremely different approaches to amplification. One is that amplifiers sound no different if traditional measurements such as bandwidth, signal-to-noise ratio, and harmonic and intermodulation distortion are similar. At the other extreme is a subjective approach with a very exotic vocabulary used to describe perceived differences. Where do you stand here?*

**CR:** It's a funny thing—we can easily prove both philosophies correct. Suppose you subject someone to a blind test of two products, where he doesn't know what he's listening to. If you correlate data over enough trials, his choices boil down to pure guesswork.

At the same time, you can't argue with the results we've had shipping improved products and waiting for unsolicited responses. The guy gets a new amplifier with a circuit improvement. He hasn't any reason to suspect a circuit improvement but imme-

diately notices something and asks us why the amplifier sounds so much better in one specific area.

True, that's anecdotal evidence, which is almost invariably rejected by any scientific study. But you can't argue with the same thing happening again and again. Every time we do something that we can document as an improvement, people prove they can hear it.

I've whimsically come to refer to this as my "Zen" perception of the art of audio listening. It's a dual-reality kind of thing. You can prove scientifically that no one can hear the difference between an amplifier with one-percent distortion and one with one-thousandth of one percent. But at the same time, when you await people's unsolicited responses to a documentably better product, they almost always choose the thing that can be proven to be better.

**GB:** *What other factors do you believe make an amplifier or preamplifier sound better?*

**CR:** It comes down to making the amplification very linear, with very low distortion in the uncorrected condition (in the absence of feedback or feed-forward correction). Because music is almost all transients, linear amplification of transient signals really is our most basic criterion.

That takes us into several areas. Amplification is quite subject to non-linear distortions based on changes in the power supply. If the supply is changed in response to the musical waveform, it's going to cause some kind of intermodulation or cross-modulation effect. So one of the things we do is make sure that the amplification is fed from a stiff, imperturbable power supply.

**GB:** *There's a trend toward loose power supplies to give the amp very high instantaneous-current capabilities. Do you feel that's an error?*

**CR:** As an alternative to clipping, I don't disagree with it. But I do disagree if the power supply is jumping all over the place. A loose power supply doesn't really give high current output; it gives high idling voltage capability. The amplifier tends to idle at a relatively high power-supply volt-

*(Continued on page A8)*

# How a 77-year-old became the first name in digital audio.

Denon has been involved in every phase of music reproduction since the days of wind-up record players. So after seven decades of breakthroughs in studio recording, disc pressing, home audio and professional recording equipment, we were uniquely prepared to take the next step. A tape recorder so fundamentally different, it would ob-



DENON STUDIO A. ALL OUR COMPONENTS REFLECT LESSONS LEARNED IN THE RECORDING STUDIO

solete every previously accepted notion of how good recorded sound could be.

In 1972, Denon researchers achieved their goal. The world's first digital recorder worthy of commercial record production, the legendary Denon DN-023R. We quickly put our digital innovation to use, producing digital processors, digital editors, digital



WHAT OTHER AUDIO COMPANY HAS THESE CREDENTIALS?

mixers, and the world's first digitally-recorded LPs.

Today, Compact Disc players, regardless of brand, reflect the influence of the original Denon DN-023R. But this heritage runs strongest in CD players from

Denon. Because the same engineers who design Denon pro machines design Denon home audio. And the same ears that guide Denon recording sessions evaluate the sound of Denon playback components.

***"One of the most finely engineered pieces of audio gear on the planet."***

Ken Pohlmann,  
Digital Audio, on the DCD-3300

For example, the digital-to-analog converter found in every

they've variously hailed our CD players as "a winner on every count," "the player I recommend most highly," "superlatives have to be used," and "in several respects, the best I've ever heard."

Reactions which simply demonstrate one point. It's a lot easier to make audio sound like music

But Denon occupies an unusual position in the digital audio world. They (Nippon Columbia, in Business-Speak) are one of the few companies to engage in all three industries that bring digitally-mastered recording to your ears: digitally-mastered recording (on their own label), digital post production and Compact Disc pressing (on their own label). While other companies, including other CD players, similarly pursue schemes that turn their own recordings into quite as finely-tuned as possible, Denon is a Denon recording studio that listens to a Denon recording on a Denon disc through a Denon player... and hears exactly what Denon intended.

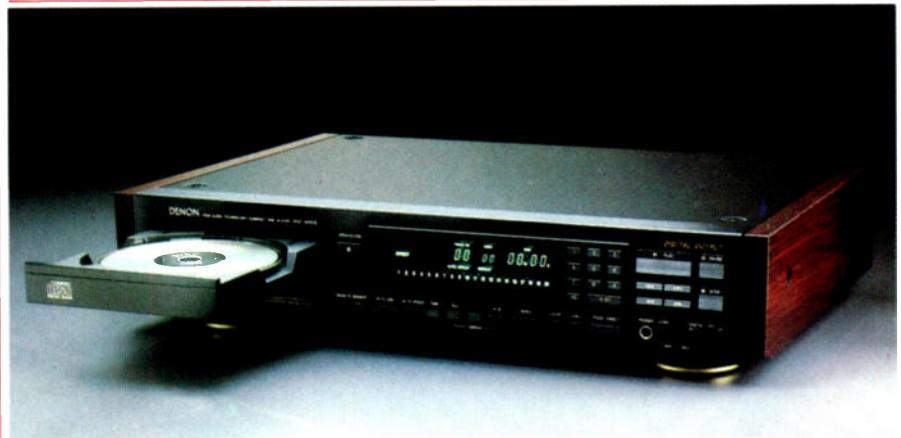

THE NEW DCD-1500!! ITS SUPER LINEAR CONVERTER COMES STRAIGHT OUT OF DENON STUDIO RECORDERS.

Denon CD player comes directly from Denon studio recorders. Unlike conventional designs, Denon's Super Linear Converter detects and corrects D/A transfer distortion.

Perhaps that's why each succeeding generation of Denon CD players is eagerly anticipated by the world's audio critics. And why

***"A look into the interior of this player reveals that Denon engineers were not taking any shortcuts whatsoever."***

Germany's Hi-Fi Vision,  
on the DCD-1500

when you really know what music sounds like.

# DENON

DESIGN INTEGRITY

# TURBOCHARGE YOUR CD PLAYER.



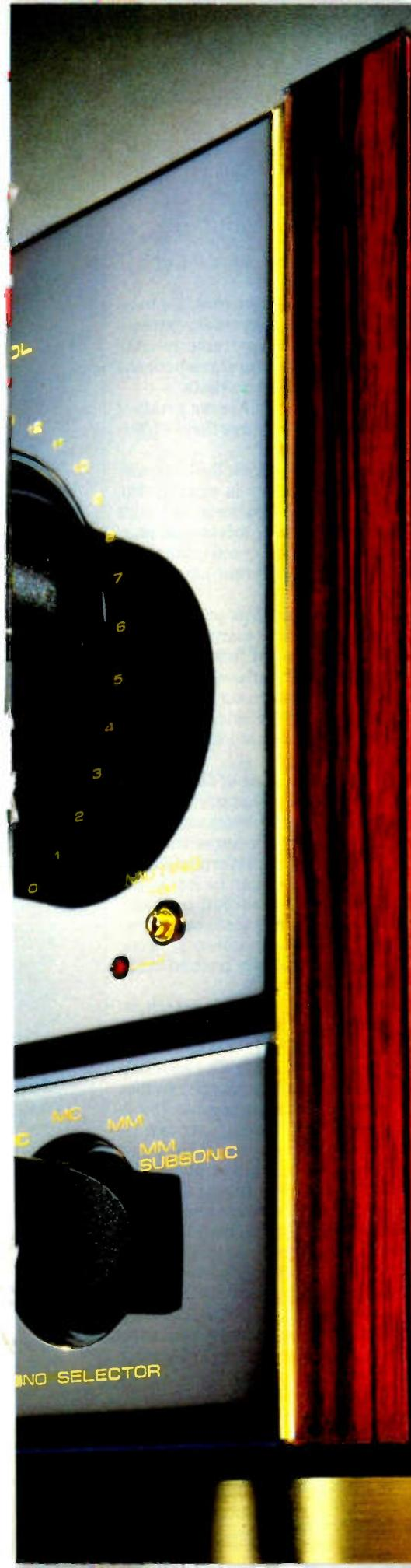

## THE ELITE A-91D INTEGRATED AMPLIFIER.

Now that the compact disc has taken the world by storm, ordinary amplifiers are failing their driving test. Because ordinary amplifiers simply can't handle the dynamic range and purer signal that digital sound delivers.

Fortunately, the A-91D is far from ordinary. Because the A-91D is built with one thought in mind—to maximize the performance of digital sound.

With 170 watts per channel into 4 ohm speaker loads, and 120 watts into 8 ohms, the A-91D unleashes digital's full dynamic range. Extra-large capacitors and huge finned cast-iron enclosed transformers further contribute to the A-91D's high current capacity and stability into speaker loads as low as 2 ohms.

Along with all this power comes unprecedented purity. You can plug the latest CD players with optical outputs directly into the A-91D, and reap the rewards of independent digital conversion circuitry—with twin, glitch-free D/A converters, a digital filter with four-times oversampling, and an analog low pass filter made from quality discrete parts. The A-91D also uses Pioneer's exclusive Non-Switching™ Type III amplifier circuit to totally eliminate switching

distortion. What's more, critical signal paths are kept extraordinarily short for less electronic interference and cleaner sound.

When it comes to digital sound, there's no such thing as good vibrations. That's why the A-91D uses a special anti-vibration honeycomb design in the chassis frame. In isolation barriers between electronic sections. Even in all five insulator feet. A large aluminum volume control knob with a specially balanced brass shaft also absorbs distortion-causing vibration, and printed circuit boards are mounted in rubber for the same reason.

The A-91D is not only ready for digital, it's ready for the future. With six digital inputs (2 optical), and three digital outputs (1 optical).

So if you want your digital sound to drive you to new heights, you need to drive your digital components with the Elite A-91D.

For more information, call 1-800-421-1404.

⊖ **ELITE** ⊖  
BY PIONEER

*(Continued from page A4)*

age. When the amplifier is delivering substantial current—perhaps when a low-frequency waveform is being fed to a woofer—the impedance can fall to low levels to the point where the power supply collapses. We consider that dangerous, because the amplification is being sourced from a modulated power supply. This makes the amplifier sound mushier. The imaging tends to wander, and you wind up with a soundstage that isn't as obviously three-dimensional.

In terms of sizing up its acoustical environment, the ear is remarkably proficient at listening to low-level artifacts. Suppose you were taken blindfolded into a large space such as a symphony hall or gymnasium, and had no previous knowledge of where you were being taken. Within seconds, you'd be able to describe the space in close detail simply by listening to the echoes that come back from your breathing, from your footsteps, from your voice.

Think of that in terms of listening to a musical reproduction. Most of what you're listening to, in terms of placing the music in the acoustical environment where it was recorded, involves interpreting low-level echoes and reverberations dying away into the background. That happens at remarkably small acoustical levels.

When you start changing the linearity of transient application into an amplifier, low-level information gets blurred, distorted, and, in many cases, lost. So we're wary of throwing a flaccid power supply into an amplifier to give the illusion of high transient-output capability.

**GB:** *What other factors do you find influencing sound quality?*

**CR:** We consider the quality of the actual components—active or passive—very important. Individual component distortions, though very low, have an audible effect.

A few years ago, we were using carbon-film resistors throughout our amplifiers. In one particular location in the feedback loop, the nonlinearities of a resistor have a direct effect on total distortion. Over a low-frequency waveform, a carbon film resistor heats and cools twice per cycle

as it goes through positive and negative peaks and a zero crossing. This inserts an extremely low-level, but still measurable, second-harmonic distortion component onto the signal.

We were able to eliminate that by substituting a metal-film resistor with a vanishingly low temperature coefficient. Although it's a very simple distortion mechanism, it appears to have been something that people were aware of in its absence. When we shipped the new amplifiers, we received a lot of phone calls.

We now use metal-film resistors throughout all of the amplifiers—even though, in many cases, the distortion mechanisms generated by carbon-film resistors might be hidden in the background. We also use polystyrene capacitors and controls with 1/4-dB tracking. You might as well use the best components. That way, you have no excuses, and you don't end up second-guessing yourself.

Very happily, we've also had tremendous success with component reliability. Our original amplifiers used off-the-shelf computer-grade filter capacitors. They had a relatively good reliability record, but we saw them as an inherent limitation in the long-term reliability of the amplifier.

So we conducted a design study, which we can now take to component manufacturers. For instance, the [capacitor's] tab root has to be welded to the internal foil. In times past, it was riveted, a potential source of unreliability. The electrolyte must be extremely pure, because we found that low-level contaminants could cause long-term reliability problems. Heat-sinking the foil within the [capacitor] improves reliability by reducing heat buildup. We now have been able to describe this component to the degree that we essentially have almost perfect reliability.

We're doing that with all components. We look for causes of breakdown problems in the field and correlate them with construction methods, even things like the compound we apply to internal screws, nuts, and bolts. Anything that goes together to build the amplifier is sealed so that the amplifiers will be vibration-resistant when they're used for live sound

reinforcement, which a lot of our stuff is.

These are things we consider to be our forte, our stock-in-trade: extreme sound quality with extreme reliability. That's how we can serve both the pro- and home-audio markets.

**GB:** *Do you build the same product for both markets, or are there different design criteria?*

**CR:** As a matter of fact, the basic amplification circuitry is exactly the same for the two markets, but with adaptations for the professional marketplace such as balanced inputs, level controls, and different kinds of input jacks.

There are very few professional sound-equipment manufacturers who have any kind of following in the audiophile marketplace. You could probably count them on the thumbs of one hand. We consider it a lovely thing that we are able to have that kind of following.

**GB:** *What's your view of the current state of the art? What are the most promising areas of endeavor?*

**CR:** The goal is to preserve the emotion of the original performance. It's startling how much can be lost in the translation to a recorded medium. Capturing the things that your ear responds to in a live environment is one of the most potentially fruitful areas of research.

A promising area of research involves adapting the listening environment. This is largely unexplored in most people's systems. The listening environment can be arranged so that it is, to some extent, ignorable. If it is made innocuous enough, it can be processed out by the ear. That's one of the wonderful things about the hearing mechanism: It is able to perceive through things and listen through to the original recording.

The original recording is at least as important, in terms of disturbing critical low-level signals and in terms of the description of the original environment. I'm very excited about the possibilities that are approaching very quickly. ■

*Gordon Brockhouse was an editor of Canadian audio and computer industry trade publications.*

CELEBRATING  
A CENTURY  
OF INNOVATION  
IN MUSIC



YAMAHA

---

 **YAMAHA PIANOS**

# Why it took a to invent the Q



## AKAI'S QUICK START THE MOST SIGNIFICANT ADVANCEMENT IN TAPE HANDLING SINCE THE VHS CASSETTE.

Today's VHS cassettes may give you eight hours of programs. But today's VHS decks make locating those programs a real bore. That's because conventional decks must slowly thread the tape around the head drum every time you go from Fast Forward or Rewind into Play. And slowly pull the tape back into the cassette whenever you return to Fast Forward or Rewind.

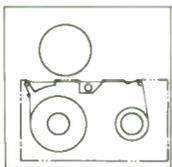

Unloading for conventional VCR

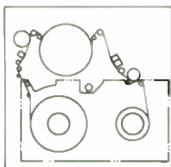

Full-loading for Quick Start

Of course, most VCRs have visible scan. But can you imagine scanning through a two-hour movie? Pass the aspirin.

Akai's exclusive Quick Start system gives you fast, fast, fast relief. For the first time, the VHS tape remains fully threaded — even during Fast Forward and Rewind. So switching between

functions is more than *five times faster* than conventional VHS decks.

There's more. To make locating programs even easier, Akai searches and scans recorded segments automatically. Best of all, this revolution in tape handling is found not just on our top model — but on every new Akai VCR.

Sound great? Seem simple? Wonder why no one ever did it before?

## WHY IT TOOK AKAI TO PERFECT VHS TAPE HANDLING.

Simply stated, Akai has been building tape recorders for over 35 years. And what is a VCR if not a tape recorder? People may forget that it



Akai has over  
35 years of experience building  
tape recorders of all kinds.

# hi-fi company Quick Start VCR.



was Akai that built the first home video tape recorder in 1965 and the first lightweight helical-scan portable video tape recorder in 1969. Compared to Akai, even the biggest names in video recording seem like "Johnnies-come-lately."

To invent Quick Start, Akai invented a completely new tape transport with better tape tension control, more precise guide poles and specially conductive fine ceramic tape guides. The entire transport is under the intelligent control of a micro-processor that only years of tape deck experience could develop. The Akai Quick Start Transport. Sure it's simple... when you know how.

## AT AKAI, SOPHISTICATION MEANS SIMPLICITY.

Akai, a leader in on-screen programming, now takes ease-of-operation one step further. On our new decks, most programming functions require no more than one touch. Nothing *could* be simpler.

Or more sophisticated. Take Akai's new top-of-the-line VS-M930U-B. It offers digital special effects with memory; VHS Hi-Fi stereo; four heads; HQ circuitry with CCD noise reduction; editing; universal wireless remote control with LCD readout; on-screen programming and naturally, Akai's Quick Start system with Index and Address Search, as well as Intro Scan. Not just bells and whistles, but features any serious recordist would deem essential.

Akai. Original thinking from a true original.



Universal Wireless Remote is programmable independently of the VCR. You can "download" programmed information.

Akai Division, Mitsubishi Electric Sales America, Inc. 225 Old New Brunswick Road, Piscataway, NJ 08854  
For the location of your nearest Akai dealer, call Toll-Free: 1-800-421-1140

# AKAI

Where audio and video are one.

# NOW TECHNICS LETS YOU CREATE AN AUDIO/VIDEO EMPIRE AND CONTROL IT FROM FAR, FAR AWAY.

Start with the new 100W A/V remote control receiver that puts you in complete control.

Imagine. Commanding an audio/video empire with just one remote control device.

Imagine. Controlling a compact disc player. And a cassette deck. And a turntable. All from across the room.

Then imagine expanding this remote control empire to include compatible Panasonic TV's, VCR's and even other brands.\*

Now it is all a reality. With the new Technics 100W AM/FM stereo remote control receiver (100 watts per channel at 8 ohms, 20Hz-20kHz with 0.007% THD) and compatible components.

The new SA-R510 has also been engineered with a built-in electronic graphic equalizer/spectrum analyzer.\*\* So you can make precise adjustments to bass, treble and mid-range sound. There are even 24 AM/FM station random access presets for instant recall.

The new Technics remote control receiver. The beginning of an audio and video empire you can control from far, far away.

**Technics**  
The science of sound



\* See dealer for details.  
\*\* Equalizer not operable by remote.



# Philips's Best

If you've read "Currents" elsewhere in this issue, you already know that Philips has introduced a new line of audio and video products under its own brand name (it already sells some of its CD players under the Magnavox label). Leading the attack on the audio front is the company's best consumer-model CD player, the CD-960, which can be used in tandem with the DAC-960 outboard digital-to-analog (D/A) converter to provide the foundation for a more complete digital audio system.

First, the player. At its heart is a pair of Philips's latest 16-bit D/A converters with new four-times-over-sampling digital filters. The new filters are said to improve attenuation of out-of-band frequencies, as well as to offer complete muting of uncorrectable errors caused by severe soiling or damage to a disc. Performance specifications are given as follows: 101-dB signal-to-noise ratio, 96-dB dynamic range, and 100-dB stereo separation (at 1 kHz).

The CD-960 weighs nearly 21 pounds; its die-cast chassis alone accounts for 4½ pounds. The laser assembly—the same as that used in Philips's professional CD players—is said to be highly resistant to the bumps and vibrations that cause mistracking. Separate motors are used for disc loading and clamping, and the disc drawer closes when you press the play button or the door itself.

In addition to a conventional analog output, the CD-960 delivers the unconverted digital signals through one of two outputs: optical (via a fiber-optic cable) or electrical (over a coax cable with regular pin jacks). Either digital output can be fed to the DAC-960 for conversion to analog, although the optical path of-

fers complete freedom from signal loss and electrical interference.

Operating features are highlighted by Favorite Track Selection (FTS), previously seen in the well-received Magnavox CDB-650 player (test report, April 1987). FTS enables you to program a sequence of track numbers, index points, and time segments

## Philips is the co-developer of the Compact Disc format.

for a particular disc and to store that information along with the disc's identification code. Thereafter, when a disc is loaded, its FTS program is immediately available. Memory capacity varies depending on the type of programming information. For example, if you program an average of five tracks per disc, the FTS memory will hold as many as 155 discs. A wireless remote control duplicates most of the front-panel operating controls.

If the CD-960 is so good, why would you want to bypass it and instead use the converter circuitry in the DAC-960 outboard converter?

The DAC-960 does have internal optical coupling to carry the output of the digital filters to the D/A converters, although that difference is unlikely to improve the sound. But the DAC-960 is more than just a companion for the CD player; it's a multi-input converter for use with future digital components such as DAT decks, digital equalizers, and other digital signal processors. In that light, it offers a choice of three digital inputs (one specifically for the CD-960's optical output) plus a digital monitor loop for a DAT deck or a digital signal processor. The correct sampling rate for the incoming digital signal is selected automatically: 48 kHz for DAT, 44.1 kHz for CD, and 32 kHz for DBS (Direct Broadcast from Satellite, not yet available in the U.S.). There is also a choice of three outputs for the analog signal: fixed, variable, or balanced (using XLR connectors typical of professional equipment). The variable output, controlled by a front-panel knob, can deliver a 4-volt signal—a level high enough to directly drive a power amplifier, making the DAC-960 a highly specialized preamplifier. A switch on the front panel reverses the polarity of the analog output signal so you can switch back and forth and listen for any difference (there's almost no way of finding out the absolute phase of the source signal, but we have yet to detect with music an audible consequence of reversed phase). In addition to the variable line output, a headphone jack with its own volume control is included.

Both the CD-960 and the DAC-960 have a suggested retail price of \$949. For further information, contact NAP Consumer Electronics Corp., I-40 & Straw Plains Pike, Knoxville, Tenn. 37914. ■



Top: The Philips CD-960 features newly designed digital filters. Bottom: The DAC-960 outboard digital-to-analog converter has multiple direct digital inputs.



# “The most significant advance in the control of auditory space since stereo.”

*David Ranada, Technical Editor  
High Fidelity Magazine*



“The ultimate audio and video sound experience.”

“Produces an uncanny sense of being somewhere else listening to live music.”

“Sound improvement ranged from substantial to mind-boggling.”

The accolades are for Yamaha's DSP-1 Digital Soundfield Processor. Created by Yamaha, the DSP-1 is a truly unique component that digitally recreates the actual live acoustic properties of the world's great concert halls and performance venues right in your own living room.

So you can listen to any type of music in the very environment it is intended to be enjoyed in. A jazz ensemble in a small club. A choir in a cathedral. Rock in an outdoor stadium.

There are 16 pre-set acoustic environments on

the DSP-1, including two Yamaha surround-sound modes and Dolby® Surround for incredible enhancement of movies on videotape or laser disc. In addition, you can modify any setting, and store it on any of 16 user program memories.

The DSP-1 is the heart of an experience called Yamaha Digital Home Theatre. A system of components that elevates home entertainment to a new, unparalleled level. Whether it's audio or video. Regardless of the format. No matter what the source.

The Yamaha DSP-1 Digital Soundfield Processor. Come feel a demonstration at a Yamaha dealer near you.



Yamaha Electronics Corporation, P.O. Box 6660, Buena Park, CA 90622.

Dolby® is a Registered Trademark of Dolby Labs Licensing Corp.

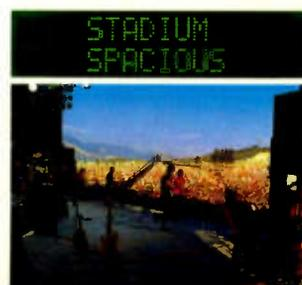
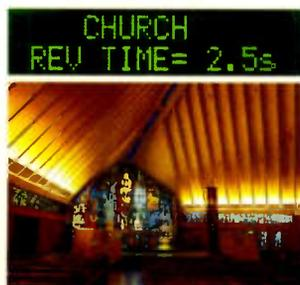



The best sound, the  
best performances

# Compact Disc Classics

BY THEODORE W. LIBBEY, JR.

**BACH: Orchestral Suites (4).** *English Baroque Soloists, Gardiner. RCA Erato ECD 88048/49 (2).*

Superb renditions of these lively, beautifully written suites. The interpretations are gutsy and expressive, and the playing is wonderfully accomplished. First-rate sound.

**BERG: Violin Concerto. BARTÓK: Violin Concerto No. 1.** *Chung; Chicago Symphony Orchestra, Solti. London 411 804-2.*

Excellent accounts of both works, with expressive but not overwrought playing from Chung and powerful support from Solti and the Chicago.

**COPLAND: "Billy the Kid"; "Rodeo."** *St. Louis Symphony Orchestra, Slatkin. Angel EMI CDC 47382.*

Lusciously recorded accounts of Copland favorites, vividly interpreted and smartly played. There have been many recordings of the two ballets, but none more effective than these.

**DVORÁK: Symphony No. 8; Scherzo capriccioso.** *Cleveland Symphony Orchestra, Dohnányi. London 414 422-2.*

Rousing performances of these ebullient scores, notable for the virtuoso playing. Dohnányi leads with authority, and the sonics are magnificent.

**HAYDN: Symphonies Nos. 94\*, 96\*, 100†, 101†.** *Academy of Ancient Music, Hogwood. Oiseau-Lyre 414 330-2\*, 411 833-2†.*

Fine Haydn for the connoisseur of the Classical style. The accounts are lean and spirited, the textures often biting crisp. Good balance and admirable sound.

**HOLST: "The Planets."** *Montreal Symphony Orchestra, Dutoit. London 417 553-2.*

The best-ever performance and recording of the suite. In this characterful reading, Dutoit goes to the core of the music and elicits a stirring performance from the Montrealers. It is all captured in state-of-the-art sound.

**MAHLER: Symphony No. 8.** *Various artists; London Philharmonic Orchestra and Chorus, Tennstedt. Angel EMI CDC 47625 (2).*

A towering yet surprisingly intimate account of this sprawling work. Tennstedt achieves a minor miracle with the complex textures, and he shapes the climaxes with unerring skill. Breathtaking sonics and splendid playing from the London Philharmonic combine to make this the most successful recording of the Eighth to date.

**MONTEVERDI: "Vespro della Beata Vergine."** *Kirkby, Rogers; Taverner Consort and Chorus, Parrott. Angel EMI CDC 47077 (2).*

One of the gems in the catalog. An appealingly energetic realization of the score, superbly played and sung. The sound is exceptional.

**MOZART: Clarinet Concerto\*;** **Oboe Concerto, K. 314†.** *Pay\*, Pignett; Academy of Ancient Music, Hogwood. Oiseau-Lyre 414 339-2.*

The preferred recordings of both works. The Clarinet Concerto is played on a basset clarinet, as Mozart wrote it; the effect is meltingly pure. Both soloists are excellent, and Hogwood delivers handsome accompaniments.

**MOZART: Symphonies: No. 36, K. 425; No. 38, K. 504.** *Prague Chamber Orchestra, Mackerras. Telarc CD 80148.*

Vigorous and muscular accounts of these symphonies, interpreted with a sure sense for the style but played on modern instruments and given full-bodied sound by Telarc.

**PROKOFIEV: Symphony No. 5; Waltz Suite, Op. 110, Nos. 1, 3, 4.** *Scottish National Orchestra, Järvi. Chandos CD 8450.*

A strongly etched interpretation that projects the darker side of the symphony. The Scots play very well and are idiomatic to boot. The recording

has enormous impact and dynamic range.

**RACHMANINOFF: Symphonies (3); "The Isle of the Dead"; "The Rock."** *Berlin Philharmonic Orchestra, Maazel. Deutsche Grammophon 419 314-2 (3).*

Sharply chiseled, powerfully played, and insightfully conducted performances that—in the case of the Third, at least—recall the composer's own.

**RESPIGHI: "Pines of Rome"; "Fountains of Rome"; "Feste romane."** *Philadelphia Orchestra, Muti. Angel EMI CDC 47316.*

Muti is just right for this music, and he has the Philadelphians playing at the peak of their form. The sound is big, bold, and reverberant, accurately conveying the way the orchestra sounds in its new recording venue, Memorial Hall in Fairmount Park.

**SCHUMANN: "Dichterliebe"; "Liederkreis."** *Bär, Parsons. Angel EMI CDC 47397.*

Striking interpretations by the young East German baritone, harking back to Fischer-Dieskau. Bär's distinctive timbre and intensity are well captured. Excellent recording.

**SIBELIUS: "Kullervo" Symphony; "The Origin of Fire"; "Our Native Land."** *Saarinén, Hynninen; Helsinki Philharmonic Orchestra, Helsinki University Male Choir, Academic Choral Society, Estonian State Academic Male Choir, Berglund. Angel EMI CDC 47496 (2).*

Winner of a HIGH FIDELITY/International Record Critics Award in 1987. Sibelius's granitic, powerful *Kullervo* Symphony is brilliantly realized, with Berglund presenting the results of many years' thought. The wealth of inner detail and the coherence of the account are both admirable, as is the playing of the Helsinki Philharmonic. Two rarely heard choral works fill out the set. Magnificent recorded sound. ■

# Where to feel the Yamaha Digital Home Theatre.

**ALABAMA** Long's Electronics Inc.—Birmingham (two locations) • Sound Distributors, Inc.—Huntsville • The Record Shop Inc.—Montgomery • Kincaid TV & Stereo—Tuscaloosa **ARIZONA** Hi-Fi Sales—Mesa • Emporium Audio Video—Tucson • Jerry's Audio Video and More—Tucson **ARKANSAS** Stereo Buff/Fayetteville—Fayetteville • Audio Visions—Ft. Smith • Leisure Electronics—Little Rock **CALIFORNIA** Honkers Sound Company—Berkeley • Kustom Hi-Fi Music House—Burlingame • Sound Goods—Campbell • The Federated Group—Canoga Park • Rogersound Lab—Canoga Park • Shelley's Stereo Video CT—Canoga Park • Dow Stereo/Video—Carlsbad • Sounds by Dave—Chico • Dow Stereo Video—Chula Vista • Sound Distinction—Concord • Pacific Coast Audio—Corona del Mar • Audio Video Specialists—Downey • Dow Stereo/Video—El Cajon • The Federated Group—El Cajon • Genesis Audio—El Toro • Rogersound Lab—El Toro • The Federated Group—Hollywood • Tubes N Tunes—Livermore • Act Electronics TV & Hi-Fi—Long Beach • Sound Goods—Mountain View • Pro Audio Electronics—Oakland • Western Audio—Palo Alto • Rogersound Lab—Pasadena • The Federated Group—Riverside • Stereo Showcase, Inc.—Sacramento • Dow Stereo/Video—San Diego (two locations) • Harmony Audio Video—San Francisco • Maybrun's Hi-Fi Video Ctr—San Francisco • The Stereo Store—San Francisco • Tubes N Tunes—San Ramon • The Federated Group—Santa Ana • Burdick's—Santa Cruz • Rogersound Lab—Santa Monica • Shelley's Stereo Video CT—Santa Monica • Golden Ear Hi-Fi Video Ct—Santa Rosa • The Federated Group—Torrance • Rogersound Lab—Torrance • Stereo Showcase, Inc.—Vallejo • Rogersound Lab—Van Nuys • Thrifty Electronics—Van Nuys • Visalia Sight & Sound, Inc.—Visalia • Rogersound Lab—Westminster **COLORADO** SoundTrack—Arvada • SoundTrack—Aurora • Listen Up—Boulder • SoundTrack—Boulder • Sunshine Audio—Colorado Springs • Listen Up—Denver • SoundTrack—Denver • SoundTrack—Highlands Ranch • SoundTrack—Littleton • Sunshine Audio—Pueblo • SoundTrack—Thornton **CONNECTICUT** Tweeter, Etc.—All Locations **DISTRICT OF COLUMBIA** AudioKrafters—Washington **DELAWARE** Sound Studio Inc.—Dover • Sound Studio Inc.—Newark • Bryn Mawr Stereo—Wilmington • Sound Studio Inc.—Wilmington **FLORIDA** Audio Spectrum, Inc.—Altamonte Springs • Sound Advice—Boca Raton • Sound Advice—Clearwater • Sound Advice—Coral Gables • Stereotypes—Daytona Beach • Sound Advice—Ft. Lauderdale • Stereo World—Ft. Myers • Sound Advice—Hialeah • Sound Advice—Hollywood • Electronics World—Gainesville • Audio Tech—Jacksonville • House of Stereo—Jacksonville • Sound Source—Marathon • Audio Trend Inc.—Melbourne • Southern Audio—Merritt Island • Sound Advice—Miami • Sound Advice—N. Miami Beach • Stereo World—Naples • Audio Spectrum, Inc.—Orlando • Audio Spectrum, Inc.—Orlando • Sound Advice—Sarasota • Sound Advice—St. Petersburg • Sound Advice—Tampa • The Audiohouse—Vero Beach • Electronic Connection—West Palm Beach • Sound Advice—W. Palm Beach **GEORGIA** Hi-Fi Buys—Atlanta (five locations) • Stereo City of Georgia—Agusta • Custom Sound—Albany • Custom Sound—Athens • Merit TV & Sound City—Columbus • Hi-Fi Buys—Duluth • Hi-Fi Buys—Kennesaw • Ken's Stereo Junction—Macon • Hi-Fi Buys—Morrow • The Music Room—Rome • Hi-Fi Buys—Tucker **HAWAII** Audio Center—Honolulu • Honolulu Audio & Video—Honolulu • The Audio Shoppe—Honolulu **IOWA** Audio Labs Inc.—Des Moines • Sound World—Fort Dodge **IDAHO** Music West—Nampa **ILLINOIS** Columbia Audio Video—Arlington Heights • United Audio Centers—Aurora • Alan's Creative Stereo—Bloomington • Glenn Poor's Audio Video—Champaign • Good Vibes—Champaign • United Audio Centers—Chicago (two locations) • United Audio Centers—Deerfield • LaSalle Electronics Inc.—Galesburg • Columbia Audio Video—Highland Park • Barrett's Entertainment—Kankakee • Unitek Electronics, Inc.—Lansing • United Audio Centers—Niles • Glenn Poor's Audio Video—Normal • Gill Custom House—Palos Hills • Columbia Audio Video—Rockford • H.F. Hutch—Schaumburg • United Audio Centers—Schaumburg • United Audio Centers—Vernon Hills • H.F. Hutch—Villa Park • Alan's Creative Stereo—Waukegan **INDIANA** Sound Pro—Carmel • Sound Pro—Greenwood • Ovation Audio Video Spec.—Indianapolis • Good Vibes—Lafayette • Sight & Sound/Wolo Conn—Michigan City • Classic Stereo—South Bend • Stereo Crafters—Terre Haute **KANSAS** Kieff's Gramophone Shop—Lawrence • Brands Mart Stereo—Overland Park • Audio Plus—Wichita • Custom Sound Inc.—Wichita **KENTUCKY** Ovation Audio Video Spec.—Lexington **LOUISIANA** Art Colby's Audio Special—Baton Rouge • Lake Charles Music—Lake Charles • Sound Trek—Metairie • Specialty Sound Co., Inc.—Monroe • Wright's Sound Gallery—Shreveport • Wright's Sound Gallery—Shreveport **MARYLAND** Soundscape—Baltimore • Soundscape—Baltimore • Stansbury Stereo—Baltimore • Stansbury Stereo—Baltimore • Professional Products—Bethesda • Gramophone Ltd.—Ellicott City • Hunt Audio—Frederick • Hunt Audio—Hagerstown • Audio Associates—Langley Park • Audio Associates—Laurel • Gramophone Ltd.—Lutherville • Stansbury Stereo—Perry Hall • Audio King—Rochester • Audio Associates—Rockville • AudioKrafters—Rockville • Sound Studio Inc.—Salisbury • Stansbury Stereo—Timonium **MAINE** The Great Northern Sound—South Portland **MASSACHUSETTS** Soundtrak Audio—Brookton • Fitchburg Music—Fitchburg • Waltham Camera—Waltham • Tweeter, Etc.—All Locations **MICHIGAN** The Stereo Shoppe—East Lansing • Stereo Center Inc.—Flint • Classic Stereo Ltd.—Grand Rapids • Classic Stereo Ltd.—Kalamazoo • The Stereo Shoppe—Lansing **MINNESOTA** Audio King—Brooklyn Center • Audio King—Burnsville • Audio King—Edina • Audio King—Mankato • Audio King—Minneapolis • Audio King—Minnetonka • Audio King—Roseville • Audio King—St. Paul **MISSOURI** Flips Stereo Place—Ballwin • Stereo One, Inc.—Cape Girardeau • The Sound Room—Chesterfield • The Sound Room—Creve Coeur • Brands Mart Stereo—Kansas City • Best Sound Inc.—St. Louis • Stereo Buff—Springfield • Flips Stereo Place—St. Louis **MISSISSIPPI** Sound Trek—Biloxi • Hooper Sound—Columbus • Hooper Sound—Hattiesburg • Hooper Sound—Jackson • Hooper Sound—Meridian **MONTANA** Video Sat & Sound—Billings • Rocky Mountain Hi-Fi—Great Falls • Electronic Parts—Missoula **NORTH CAROLINA** Stereo Sound—Chapel Hill • Tart's TV Furn. & Applian.—Fayetteville • Tart's TV Furn. & Applian.—Goldboro • Stereo Sound—Greensboro • Stereo Village/Greenville—Greenville • Stereo Sound—Raleigh • Tart's TV Furn. & Applian.—Rocky Mount • Tart's TV Furn. & Applian.—Wilmington • Stereo Sound—Winston-Salem **NEBRASKA** Center Stage Audio Video—Kearney • Stereo West—Lincoln • Custom Electronics—Omaha • Stereo West—Omaha (two locations) **NEW HAMPSHIRE** Tweeter Etc.—Manchester • Tweeter Etc.—Nashua • Tweeter Etc.—Nashua • Tweeter Etc.—Newington **NEW JERSEY** Stuart's Audio—Englewood • Hal's Stereo and Video—Lawrenceville • Bryn Mawr Stereo—Maple Shade • Perdue Radio—Montclair • Sight & Sound—Morristown • Rand's Camera & Hi-Fi—Toms River • Stuart's Audio—Westfield **NEW MEXICO** West Coast Sound—Albuquerque • Towne Crier Inc.—Clovis • Trend Tech—Farmington • West Coast Sound—Santa Fe **NEW YORK** Mom's Music Systems—Albany • Musical Designs Ltd.—Albany • Speaker Shop—Amherst • Audio Genesis Inc.—Glens Falls • Long Player Stereo—Goshen • Audio/Video Den. Ltd.—Lake Grove • Auto Sound Plus—Latham • Audio Breakthroughs—Manhasset • Audio Video Exchange—New York City • Electronic Workshop Inc.—New York • Grand Central Radio—New York • Audio Breakthroughs—New York City • Audio/Video Exchange—New York City • Cosmophonic Sound, Inc.—New York City • Rabson's 57—New York City • Continental Sound—Queens • J.B. Sound Systems, Inc.—Rochester • Gordon Electronics—Syracuse • Sound Odyssey Inc.—Wappinger Falls • Happy Ear Stereo—Watertown • Video Breakthrough—The Media Room—Watermill • Audio Video Exchange—Westbury • Harvey Electronics—All Locations • Perdue Radio—Both Locations • Stereo Warehouse—All Locations **OHIO** Audio Corner Inc.—Canton • Audio Craft Company Inc.—Cleveland • Custom Stereo Electronics—Columbus • Palme Stereo Center—Columbus • Audio Craft Company Inc.—Fairlawn • Audio Craft Company Inc.—Findlay • Carlin Audio & Video—Kettering • Audio Craft Company Inc.—Mayfield Hts. • Audio Craft Company, Inc.—Toledo • Audio Craft Company Inc.—Westlake • Far East Audio—Wooster **OKLAHOMA** The Sound Station—Bartlesville • Audio Tech—Lawton • Soundtrak—Oklahoma City (four locations) • Soundtrak—Tulsa (two locations) • The Phonograph Ltd.—Tulsa **OREGON** Stereo Plant—Bend • Bradford's Hi-Fidelity—Eugene • Sheckells Stereo—Medford • Chelsea Audio Video—Portland **PENNSYLVANIA** Hi-Fi House—Abington • Bryn Mawr Stereo—Bryn Mawr • Bryn Mawr Stereo—Camp Hill • Hi-Fi House—Camp Hill • Bryn Mawr Stereo—Frazier • Listening Post—Gibsonia • Hi-Fi House—Harrisburg • Jannen Systems—Hazelton • Bryn Mawr Stereo—Jenkintown • Gary's Sight & Sound Exp.—Johnstown • D.S. Audio—Lancaster • Listening Post—Monroeville • Bryn Mawr Stereo—Montgomeryville • Stereo Land—Natrona Heights • Bryn Mawr Stereo—Philadelphia • David Mann Audio—Philadelphia • Listening Post—Pittsburg (two locations) • Bryn Mawr Stereo—Quakertown • The Stereo Connection, Inc.—Scranton • D.S. Audio—West Reading • Bryn Mawr Stereo—Whitehall • Robert M. Sides Audio—Williamsport • Audio Clinic—York • Bryn Mawr Stereo—Langhorne **RHODE ISLAND** Sounds Unlimited—Cumberland • Soundings—Newport • Tweeter, Etc.—All Locations **SOUTH CAROLINA** Music Machine—Anderson • Audio Warehouse, Inc.—Charleston • Music Machine—Columbia • Tart's TV Furn. & Applian.—Florence • Music Machine—Greenville **SOUTH DAKOTA** Audio King—Sioux Falls **TENNESSEE** Audition Hi-Fi Inc.—Kingsport • Modern Music Audio—Memphis • Audio Systems—Nashville (two locations) **TEXAS** Sound Effects—Abilene • High Fidelity, Inc.—Austin (two locations) • Brock Audio—Beaumont • Audio Video—College Station • Tape Tone Audio Video—Corpus Christi • Custom Video—Dallas • The Federated Group—Dallas, Preston Royal • Hillcrest High Fidelity—Dallas (two locations) • Home Entertain, Dallas Gal.—Dallas • Howell Electronics—El Paso • Marvin Electronics Co.—Fort Worth • Home Entertainment, Inc.—Houston (four locations) • B & M Electronics, Inc.—Houston • Jett Sales—Lardo • Audio Techniques—Longview • Harold's Electronics—Midland • Branch Patton Superstore—Nacogdoches • Harold's Electronics—Odessa • Sound Box—San Angelo • Audio Concepts—San Antonio • Bjorns Audio Video—San Antonio • Audio Tech—Temple • Sound Towne—Texarkana • Stereo & Record Center—Tyler • Audio Tech—Waco • Tom Padgett, Inc.—Waco • Audio Tech—Wichita Falls **UTAH** Lynn's Audio & Video—Logan • Broadway Music—Salt Lake City • Arrow Audio—St. George **VIRGINIA** Audio Associates—Arlington • Holdrens—Charlottesville • The Sound Machine—Charlottesville • Sounds Unlimited—Danville • Audio Associates—Fairfax • AudioKrafters—Fairfax • Audio Showroom—Franklin • Sound Approach—Newport News • Audiotronics—Richmond (two locations) • Gary's Stereo & Video—Richmond (two locations) • Audiotronics—Roanoke • Holdrens—Roanoke (two locations) • Audio Associates—Springfield • Audio Connection, Inc.—Virginia Beach **WASHINGTON** Magnolia Hi-Fi & Video—Bellevue • Q.C. Stereo—Bellingham • Magnolia Hi-Fi & Video—Lynnwood • Magnolia Hi-Fi & Video—Tacoma **WISCONSIN** American TV—Appleton • Eme Audio—Eau Claire • Team Electronics #88—Janesville • Sound World—LaCrosse • Flanner & Hafsoos Music—Mequon • Flanner & Hafsoos Music—Milwaukee • American TV—Oak Creek • American TV—Waukesha **WEST VIRGINIA** The Sound Post—Princeton **WYOMING** Murphy Sight and Sound—Gillette • The New Music Box—Laramie

Y A M A H A D I G I T A L H O M E T H E A T R E

**A**mong the first car-stereo electronics introduced by Altec Lansing Consumer Products (or by its predecessor, Altec Lansing of California, which offered some electronics, but none for cars) is a power amplifier that impresses us by the maturity of its conception and the elegance of its execution. In other words, the ALA-435 seems like anything but a first-generation product. It is exceptionally versatile—designed to fit neatly into a wide variety of automotive applications that demand more than minimum amplifier power—but also achieves its many possible configurations with a minimum of fuss and without jury-rigging.

All controls and connections are on the same panel. Four gold-plated pin jacks accept the inputs from the front and back low-level (preamp) outputs of your front end. If you have no such outputs and prefer to use the Altec to boost your front end's built-in power amp, Altec supplies two four-pin chassis connectors with mating plugs and short (22-inch) color-coded wire harnesses. None of these conductors is connected to each other or to ground; instead, the ALA-435's floating-input design ensures that it will accept the output from a bridged amplifier without endangering that amp.

Nearby switches choose between high and low levels independently for each set of connectors (front and back). If you have only two channels of built-in amplification, for example, you can run the Altec's front channels as a booster for that amp and the back channels as a full-scale amp working off the fader output. Individual screwdriver-adjusted level controls for each of the four channels fine-tune the resulting balances.

Further increasing the amplifier's versatility are two switches (again for front- and back-channel pairs, at least nominally) that bridge or unbridge the outputs. You could, for example, bridge Channels 1 and 2 to drive a left-plus-right subwoofer and drive the back mid-range and tweeter from Channels 3 and 4, unbridged. In such a setup, the front channels might work off an existing amp, or you might want a second ALA-435 to biamp front-channel woofers and tweeters—the possibilities are almost endless. The connections for speaker leads are made via spring-loaded clips; bridged outputs use only the red (hot) ones.

Power connections are made up of three color-coded sockets that hold matching cables in place by means of a setscrew, for which an allen wrench is also supplied. The red connector accepts

an extra-heavy power lead (more than 16 feet is supplied) intended for connection directly to the battery's hot terminal or some wiring point close to it. The 25-amp fuse in this line suggests why you won't want to run the line via an ignition switch. To turn the amplifier on and off, there's a wire of similar length (but much lighter gauge) that fits a yellow socket and ties it to the accessory switching connection on the front end. A black socket is for the short (20-inch), heavy

## Altec Lansing ALA-435 Car-Stereo Power Amplifier

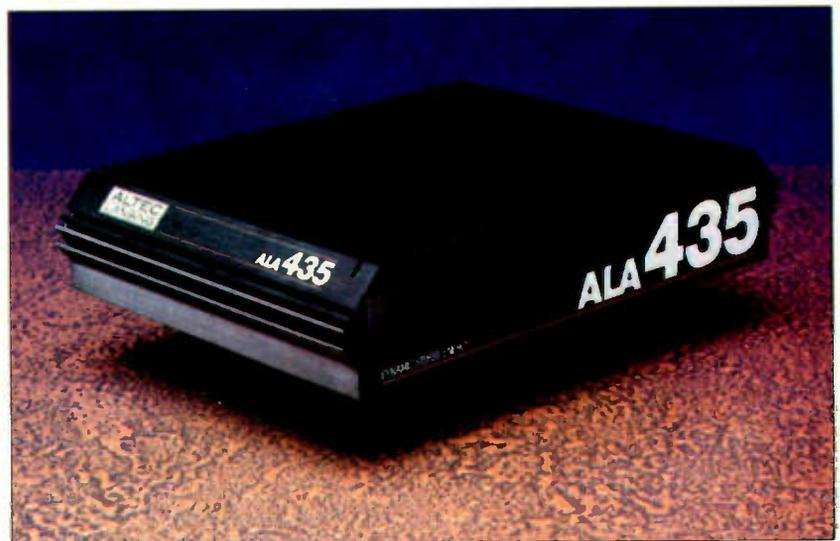

wire whose spade lug attaches to any convenient grounding point.

No matter how you bridge it, four 35-watt (15.4-dBW) channels—Altec's rating into the standard automotive 4-ohm load—is a lot of power. As Diversified Science Laboratories' data show, 1-kHz clipping is comfortably above Altec's rating by about 1 dB. Dynamic head-

*(Continued on page 44)*

**Dimensions:** 12 by 2¼ inches (front), 8¾ inches deep plus clearance for connections.

**Connections:** Pin jacks for low-level inputs; special harnesses for high-level inputs; bared wires for battery and switching from front end; spade lug for ground.

**Fuse:** 25-amp in battery line.

**Price:** \$400.

**Warranty:** "Limited," one year parts and labor.

**Manufacturer:** Altec Lansing Consumer Products, Millford, Pa. 18337.

# After four years at Hewlett-Packard, we w

In 1983, Dr. Godehard Guenther, President of a/d/s/, issued an injunction to our engineers and designers. "Guys," he said, "somebody's got to come up with a new loudspeaker standard. Let's make sure it's us."

Understand: he wasn't suggesting our existing loudspeakers weren't good. Rather, he was challenging us to address the shortcomings present even in the very best speakers, ours included. Shortcomings made all the more apparent by the sonic demands of the compact disc.

What we sought to build were speakers that didn't sound like a set of drivers stuffed in a box. Our goal was to create speakers characterized by a stable sound stage, pinpoint imaging and sound that seemed to emanate from free space.

It was a tall order. But the technology that has resulted—Unison™ . . . of one voice—is the kind other speaker makers will be emulating for years to come.



At a/d/s/, we make our own drivers. Our high definition woofers feature new cones, magnets, baskets and voice coil assemblies—painstakingly crafted to eliminate coloration.

## We finally had the tools to be as critical as we were inclined to be.

Our first task was to take a long, hard look at the limitations inherent in loudspeaker drivers. That required a powerful "microscope." And, fortunately, we had one—a high-resolution, super-fast computer from Hewlett-Packard, supported by a sophisticated mathematical program of our own devise.

Housed in a specially designed a/d/s/ acoustics laboratory, the computer gave us the ability to generate and analyze driver performance data with an accuracy, thoroughness and detail never attainable before.

High technology enclosure materials enable us to make the new CM7 (left) and CM5 extremely compact without sacrificing interior volume. How compact? Consider that the CM5 measures a mere 9<sup>5</sup>/<sub>8</sub>" x 5<sup>3</sup>/<sub>4</sub>" x 6<sup>7</sup>/<sub>8</sub>".

Unison is a trademark of Analog and Digital Systems, Inc.

In this veritable mountain of information, acoustic truths resided.



The CM7's 4th-order, 24dB/octave crossover network. Complex, sophisticated and expensive to manufacture, it's a major reason why the speaker produces such a stable image.

## If the drivers aren't flawless, no amount of camouflaging will hide the flaws.

One fact was obvious: the traditional materials used to construct woofers, tweeters and midranges—polypropylene, metal, cellulose compounds—were simply inadequate. So we set about to discover new ones ideally suited *at the molecular level* to the jobs they're required to do.

For the domes of our tweeters, we selected a proprietary copolymer that's exceedingly rigid, yet has superb internal damping and freedom from ringing. For the voice coil formers in our midranges, we adopted stainless

# the keyboard of a ere ready for a Steinway.

steel. Strong and non-magnetic, it enabled us to produce a motor quick enough to resolve the finest detail, even at the highest volume level. And so our research went, until our drivers were as perfect as the laws of physics allow.

## **The crossover network. You don't see it. You shouldn't hear it, either.**

When most speaker makers design crossover networks, their primary concern is the interaction of the drivers. We were more ambitious. We sought crossovers that optimize the relationship between the drivers and their

enclosure, even with the room in which the system is played.

And we had an advantage: the excellence of our drivers allowed us to use *ideal* crossover points. Using these points, all the fundamental tones of the human voice can be reproduced by a single driver. With the computer, we evaluated countless prototypes of crossovers. A 4th-order network of the Linkwitz-Riley type proved the most appropriate. This type alone yields the response that satisfied our requirements for neutrality and realistic imaging. On a frequency response plot, the crossover points aren't even detectable.

## **How good it ultimately sounds depends on the box you put it in.**

That's why we employed a polymer material filled with an



With its stainless steel coil former and copolymer cone, the Unisōn midrange does something a cone midrange has never done before: span the fundamental range of the human voice—from 200 to 2,000 Hz.



Our tweeters' domes are made of yet another proprietary copolymer, giving them the unique ability to provide smooth, detailed, high frequency response at even the highest levels.

extremely high mass compound to produce the rigid, aurally "invisible" enclosures of our Compact Monitor Series. You'll be amazed by the weight of these little beauties—they're heavy. You'll be floored by the sound.

To our ears, our new speakers—the M Series and compact CM Series—offer convincing proof that Unisōn technology does indeed define a new era in speaker performance. For more information about a/d/s/ products, phone a/d/s/ toll-free, at 1-800-345-8112. (In PA, call 1-800-662-2444.)



The M12 is the instrument on the right.

a/d/s/



<b>Rated Power (4-ohm load)</b>	15.4 dBW (35 watts)/channel
<b>Output at Clipping (at 1 kHz; all channels driven)</b>	16.3 dBW (43 watts)/channel
<b>4-ohm load</b>	
<b>Dynamic Power (4-ohm load)</b>	20 dBW
<b>Dynamic Headroom (re rated power; 4-ohm load)</b>	+4.6 dB
<b>Harmonic Distortion (THD; 20 Hz to 20 kHz)</b>	
at 15.4 dBW (35 watts)	≤ 0.034%
at 0 dBW (1 watt)	≤ 0.013%
<b>Frequency Response</b>	
	+0, -1/2 dB, 14 Hz to 23.8 kHz
	+0, -3 dB, < 10 Hz to 72.4 kHz
<b>S/N Ratio (re 0 dBW; A-weighted)</b>	≥ 79 1/2 dB*
<b>Sensitivity (re 0 dBW)</b>	27-133 mV*
<b>Input Impedance</b>	9.3k ohms
<b>Damping Factor (at 50 Hz; re 8 ohms)</b>	200
<b>Channel Separation (at 1 kHz)</b>	≥ 52 3/4 dB

\*Depends on setting of channel gain control.

room, at more than 4½ dB, doesn't quite realize Altec's published spec, but it is outstanding nonetheless and rare even for a home amplifier. In fact, this aspect of the ALA-435, which delivers a total of as much as 400 watts on musical peaks with all channels driven, is crucial to the design. Altec calls it DSE (dynamic stored energy). Since DSE is essentially a matter of charging up storage capacitors so that the energy is there when it's needed, it isn't fundamentally a new idea. But with the power supply limited to the 12 volts of an automobile electrical system, the ability to draw current when it isn't needed—in order to deliver that current on demand—takes on new meaning.

Frequency response is quite flat within the audio passband: down ½ dB only beyond the limits of audibility. Distortion is very low. At the 0-dBW (1-watt) test level, it exceeds our reporting threshold of 0.01 percent only at the fre-

quency extremes; even then, it contains no discernible components beside the least onerous—the second harmonic. At rated power, distortion is only marginally higher, though it does contain some third harmonic—and, in one measurement, even the fourth. But none of this comes even close to worrisome behavior.

As handsome as this performance is, the thoughtfulness of the design remains the ALA-435's most attractive quality. If you like to upgrade your system frequently, you'll be particularly grateful for the way the easily accessible connections and controls facilitate amplifier reconfiguration and for the way the wiring details have been thought out in advance, with appropriate connectors supplied with the amp. Even the straightforward layout of the main panel and the concise manual add to the feeling that Altec is at your side, quietly seeing to your needs before you're even quite sure what they are. ■

## Mitsubishi DP-311R Compact Disc Player

**M**itsubishi has not been the most visible name in audio during its years in the U.S. market, but the company has been responsible for

convert the laser-beam pulses into electrical signals and an amplifier to strengthen those signals immediately.

A glance at the widely spaced output jacks on the back panel makes it evident that Mitsubishi (like a number of other companies, at least in their premium products) is taking care to keep signals pristine by adopting a "dual mono" approach. That is, each channel is given its own circuit elements to minimize crosstalk. Another visible indication of extra care is the unit's hefty structure (given its slim profile) and vibration-isolation feet. Avoidance of mechanical resonances that can encourage mistracking is attracting increasing attention for premium designs, and the 311 is indeed exceptionally impervious to external shock.

Even more interesting are the controls. All the usual functions—play, pause, stop, and fast-scan and seek (skip) in both directions, as well as the disc-drawer control—are activated by large slanted buttons near the lower center of the front panel. Above them are small buttons for programming and repeat and for polarity (absolute phase) of the output—an extremely rare feature. Atop this center section is the numerical keypad.

To the right are the displays. First is a panel that shows whether repeat is on and whether start and stop points have been programmed for repeat of a hand-picked portion of the disc (A-B repeat). The next panel shows, calendar style, which tracks (up to 20) are available on the disc and, after programming, which



**Dimensions:** 16¾ by 2¼ inches (front), 13 inches deep plus clearance for connections.

**Price:** \$740.

**Warranty:** "Limited," two years parts, one year labor.

**Manufacturer:** Mitsubishi Electric Corp., Japan.

**U.S. Distributor:** Mitsubishi Electric Sales America, Inc., 5757 Plaza Dr., Cypress, Calif. 90630.

some startlingly original models. One of these, the DP-311R CD player, features a striking design that sets it apart in a world of lookalikes. It contains some of the company's most advanced technology: namely, the single Photo-Direct chip, which acts as both a transducer to

are included in your program. Then comes a display for time, track, and index number—with this last display converting to a selection number indicator during programming.

At the extreme right are pilots for various functions (including phase inversion) and a display switch. The latter steps from elapsed time in the current track (the default mode) to time remaining on the disc or programmed sequence, to . . . nothing! That's right, you can shut off the display altogether (once the programming chores are complete) and revel in the dark gleam of the panel, uncluttered by glowing numbers. All that remains lit in the display area are the pilots—including one to show that the display-off mode has been chosen. Elegant.

The supplied wireless remote repeats all of these controls—even that for the drawer—and adds seek (by index as well as track number) and a button (CALL) that steps through the programmed selection numbers so that you can double-check the sequence. The only control it doesn't repeat is the on/off power



The DP-311R's remote-control handset

switch, which is located at the left end of the front panel.

All of the performance measurements are excellent and have not been significantly bettered by any competitor, even in this hair-splitting field. Frequency response is very flat, with no appreciable rolloff even at the very top end of the spectrum. From this—and the symmetrical (and very well controlled) ringing in the square-wave and pulse traces—it is clear that digital filtering is employed.

Moreover, our listeners professed to hear subtle virtues in the DP-311R above and beyond the routine call of digital perfection. Clarity, transparency,

and warmth seem in slightly more abundant supply than usual. This may be due in part to our fascination with the absolute-phase switch, which seems to make an appreciable difference with some recordings and consequently adds piquancy to the listening process.

Some recording setups (and recordings, for that matter) invert polarity so that transients begin with an acoustic rarefaction rather than with the normal pressure front. Some playback electron-

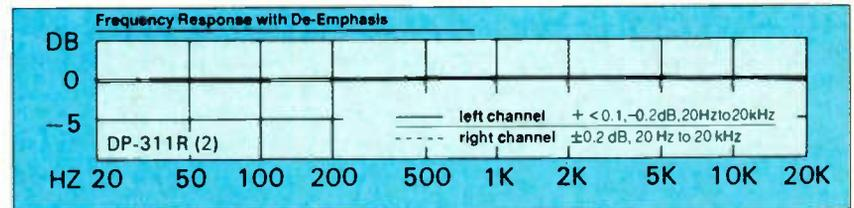
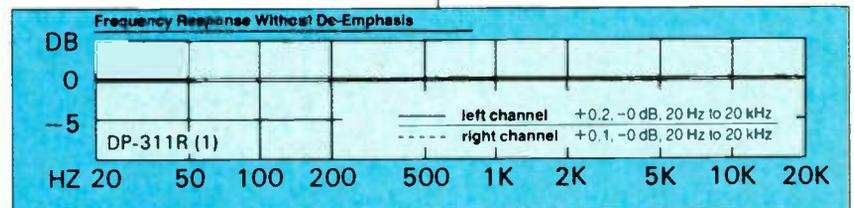

All data were obtained using the Sony YEDS-7, Technics SH-CD001, Philips 410 055-2, and Philips 410 056-2 test discs.

ics reverse it as well, which for once makes a right out of two wrongs—but not of three, which will again leave you with inverted phase. Even when a difference is clearly audible, however, it's not necessarily clear which option is the "correct" one, unless you've done some preparatory homework. We suspect most home listeners will find investigating the difference interesting at first and finally settle on a standard position for most recordings. You can always investigate the options more thoroughly and make a note of those discs you prefer to play "upside down" from the rest.

Clearly, we are impressed with the DP-311R. Beneath its handsome exterior lies a reproducer of unusual excellence. Well done, Mitsubishi.

(Continued on page 48)

Channel Separation (at 1 kHz)	113 1/2 dB
Channel Balance (at 1 kHz)	± < 0.1 dB
<b>S/N Ratio (re 0 dB; A-weighted)</b>	
without de-emphasis	105 3/4 dB
with de-emphasis	109 dB
<b>Harmonic Distortion (THD+N; 40 Hz to 20 kHz)</b>	
at 0 dB	< 0.01%
at -24 dB	≤ 0.048%
<b>IM Distortion (70-Hz difference; 300 Hz to 20 kHz)</b>	
0 to -20 dB	< 0.01%
at -30 dB	0.016%
<b>Linearity (at 1 kHz)</b>	
0 to -50 dB	no measurable error
at -60 dB	+0.1 dB
at -70 dB	+0.4 dB
at -80 dB	+1.4 dB
at -90 dB	+4.0 dB
<b>Tracking &amp; Error Correction</b>	
maximum signal-layer gap	> 900 μm
maximum surface obstruction	> 800 μm
simulated-fingerprint test	pass
Maximum Output Level	2.11 volts
Output Impedance	100 ohms

#### REPORT POLICY

Equipment reports are based on laboratory measurements and controlled listening tests. Unless otherwise noted, test data are provided by Diversified Science Laboratories. The choice of equipment to be tested rests with the editors of High Fidelity. Samples normally are supplied on loan from the manufacturer. Manufacturers are not permitted to read reports in advance of publication, and no report or portion thereof may be reproduced for any purpose or in any form without written permission of the publisher. All reports should be construed as applying to the specific samples tested. High Fidelity and Diversified Science Laboratories assume no responsibility for product performance or quality.

*Power. Precision. Performance. The new generation of Citation separates goes far beyond its predecessors to create the ultimate listening experience.*

*Designed and developed by Harman Kardon, one of the most respected names in audio, every generation of Citation has earned a reputation of excellence with audiophiles around the world. A true testing and proving ground for the most revolutionary audio concepts, Citation's innovations have ultimately been featured in all Harman Kardon components.*



Dr. Sidney Harman, Founder and Chairman of Harman Kardon.

*Steeped in audio breakthroughs and advanced designs, Harman Kardon's Citation division introduced the world's first Ultrawideband amplifier in 1963—the Citation 2 vacuum tube amplifier. In 1972, the Citation 14, the first FM stereo tuner with Phase Locked Loop (PLL) MPX decoding*

*was introduced. In 1977, the 150-Watt-per-channel Citation 19 became the first power amplifier to feature low negative feedback. 1981 saw the introduction of the Citation XX. Its exclusive High instantaneous Current Capability (HCC) design provided the instantaneous current required to precisely drive and control any loudspeaker system.*

*Now, just as the original Citation separates established design innovations that were years ahead of their time, the new Citation series sets the standards for the decade to come.*

*The new Citation twenty-three makes tuner design history as the world's first Active Tracking tuner and the world's first synthesized tuner with Analog Fine Tuning. This patented system delivers two aspects of tuner performance that were previously mutually exclusive: high selectivity and high fidelity. Its superior adjacent and alternate channel rejection lets you tune in more stations with more fidelity than was ever before possible.*



*A thorough analysis of internal layout and a strict code of symmetrical circuitry ensure rapid, accurate reproduction of the music signal.*

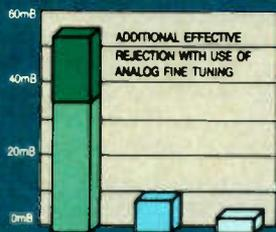

ADJACENT CHANNEL SELECTIVITY  
 ■ CITATION TWENTY-THREE ■ TYPICAL SINGLE IF TUNER  
 ■ NARROW MODE OF TYPICAL WIDE/NARROW TUNER

*In contrast to traditional methods, the Citation twenty-three's Active Tracking circuitry provides previously unheard of adjacent channel selectivity, with little or no sacrifice in stereo separation or THD.*

*As the world's first High Voltage/High Current power amplifiers, the 200-Watt-per-channel\* Citation twenty-two and the 100-Watt-per-channel\* Citation twenty-four redefine amplifier design. With just the flick of a switch, their exclusive High Voltage/High Current technology lets you select the optimum mode for driving either 8-Ohm or 4-Ohm loudspeakers. The result is higher power output and cleaner, clearer sound than any traditional design, without distortion, overheating or current limiting.*

*In an area where the smallest interference can result in the biggest problems, the new Citation twenty-one preamplifier further ensures accurate signal reproduction. Its symmetrical circuitry and many design refinements offer the most precise amplification, for a difference you can hear.*



*Gold-plated input jacks on the Citation twenty-one preamplifier provide reduced signal loss and improved long-term conductivity.*

*Citation's attention to detail can be seen as well as heard. The heavy rolled-steel, rubber-mounted chassis creates a solid, vibration-free environment that combines world class styling with sophisticated American industrial design.*

*The new Citation series from Harman Kardon. The next generation of the world's premier high fidelity components.*

*For more information and your nearest dealer call toll free 1-800-525-7000 Ext. 125 or write 240 Crossways Park West, Box 9125, Woodbury, New York 11797.*

**Citation**  
 harman/kardon

\*20Hz-20kHz = 0.08% THD into 8 Ohms and into 4 Ohms

**Citation. The next generation.**



## DBX Soundfield 50 Loudspeaker



**Dimensions:** 20½ by 48½ inches (front), 16 inches deep.

**Price:** \$2,000 per pair.

**Warranty:** "Limited," five years parts and labor.

**Manufacturer:** DBX, 71 Chapel St., Newton, Mass. 02195.

**S**temming from a short but distinguished lineage, the Soundfield 50 is the tallest and most visually distinctive of DBX's Soundfield Imaging loudspeakers. Since they were first introduced, Soundfield speakers have had as their primary design goal the production of a stable stereo image audible from a wide listening area. Listen Anywhere, goes the DBX trademark.

The principle behind Soundfield Imaging (another trademark) is quite simple: In order to maintain the stereo im-

tion directed at the other's.

The Soundfield One generated the required radiation pattern directly by use of a phased array of drivers to create an oval omnidirectional response. DBX's most recent models, such as the Soundfield 50, are simpler (the company calls them "180°" models) and take advantage of the reflective properties of the wall behind the speaker to help generate the "back" half of the Soundfield radiation pattern.

Also assisting with that task in the Soundfield 50 is the striking new-wave, new-age, postmodern, high-tech, fashion-statement enclosure. Trapezoidal in its horizontal cross section, the widest of the four panels is actually the black-painted back of the speaker, which carries the unit's multiway binding-post connectors. The second-widest panel holds most of the drivers (one 10-inch woofer, one 6½-inch midrange, a 4-inch upper-midrange, and a 3-inch wide-dispersion tweeter). Rather than facing forward, this panel instead faces the other speaker. The narrow front panel carries only a 3-inch tweeter while the slightly wider, outward-facing panel has yet another 3-inch tweeter and the system's vent.

The Soundfield 50's "extra" side and front tweeters, which are necessary to maintain the Soundfield radiation pattern at high frequencies, are driven through carefully designed phase-shifting networks to achieve that end. The crossover is thus unusually complex for what is essentially a three-way system. Crossover points are 200, 800, and 3,150 Hz.

DBX rates the Soundfield 50 at 4 ohms nominal impedance (with a 2.5-ohm minimum), which is precisely what Diversified Science Laboratories found. The actual impedance curve has several minor peaks (7.6, 5.9, and 5.3 ohms at 40, 1,500, and 5,000 Hz, respectively) and dips (2.7, 2.8, 2.9, and 2.5 ohms at 120, 700, 2,500, and 16,000 Hz), but they are arrived at smoothly and average out to about 4 ohms. As with other Soundfield speakers, sensitivity is relatively high and allows the 50s to generate substantial amounts of sound with moderate-power amplifiers.

In DSL's 300-Hz pulse test, the speaker accepted the full output of the test amplifier (465 watts, or 26.7 dBW) and delivered therewith a calculated peak sound pressure level (SPL) of an extremely loud 119.7 dB at 1 meter. Harmonic distortion was very low and can be disregarded as a major contributor to the speaker's sonic character. Distortion remained well below 1 percent at most

age as the listener approaches one loudspeaker, the other loudspeaker becomes louder. In this way, even though the sound from the nearer loudspeaker is the first to arrive at the listener's ears (and thereby would shift the image toward that speaker), the louder sound from the farther loudspeaker "pulls" the image back to where it should be. DBX's innovation with its Soundfield speakers was to perform the time/intensity trade-off using a deliberately offset, oval-shaped loudspeaker radiation pattern, with each speaker's most intense radia-

test frequencies with the three lower test levels (85, 90, and 95 dB SPL). At 100 dB SPL, bass distortion was still low (less than 1/2 percent from 80 Hz on down), but high-frequency distortion started inching past 1 percent above 1 kHz.

The lab tested the Soundfield 50 placed 8 inches from the wall behind it. In this position, the speaker's room-corrected 1/3-octave response was extremely flat—with one notable exception—when measured at one meter on-axis (for this speaker, that means directly in front of the enclosure, not in front of the main speaker panel). Were it not for the approximately 6-dB dip around 400 Hz visible in our graph, possibly caused by interference from a floor reflection, the speaker's response could be rated as a very flat  $\pm 2\frac{1}{2}$  dB from 50 Hz to 20 kHz. The off-axis measurement was quite similar to the on-axis response. However, the lower-midrange dip moved down to 250 Hz in the off-axis measurement.

We started our listening tests with the speakers placed according to DBX's recommendation (which is 1 to 1 1/2 feet from the backing wall and 8 to 12 feet apart). Our initial impression of the sound balance was one of forwardness and brightness. This quality is usually found only in speakers with a raised lower-treble response. But since the Soundfield 50s are unusually flat in their response above 1 kHz, we must attribute the perceived balance to the relative lack of energy being produced in the 400-Hz region—the area responsible for musical "body"—abetted by a gradual rise at the very top frequencies (visible in both on- and off-axis responses). Some of the forwardness disappeared when we moved the speakers up against the wall, a position which also makes for a much less cluttered listening room.

As can be expected from a speaker with a relatively flat response over a wide angle of radiation, the Soundfield 50 does not have a trace of the "boxiness" typically associated with highly colored off-axis radiation. Indeed, the Soundfield 50 is among the least boxy-sounding speakers we have tested since we examined the Soundfield One.

The skewed-radiation Soundfield Imaging techniques again succeed with the Soundfield 50. It is a strange sensation to walk right up to one speaker and have the speaker of the opposite channel seem to increase in relative volume. The effect on the stereo image is startlingly minor: It remains where it was. There is a *slight* shift toward the nearer speaker when listening very far from the center line between the enclosures, but the image usually stays put.

Although not razor-sharp, the image is at least as good as that obtained from typical forward-radiating speakers. The image also has the distinct advantage of not sounding as if it originates with the two enclosures—it seems to float at one end of the listening room with no audible means of support (the Soundfield One was even more striking in this respect). Image depth, as befits this sound quality, can be very great—depending, naturally, on the recording. All these effects are available from other speakers that radi-

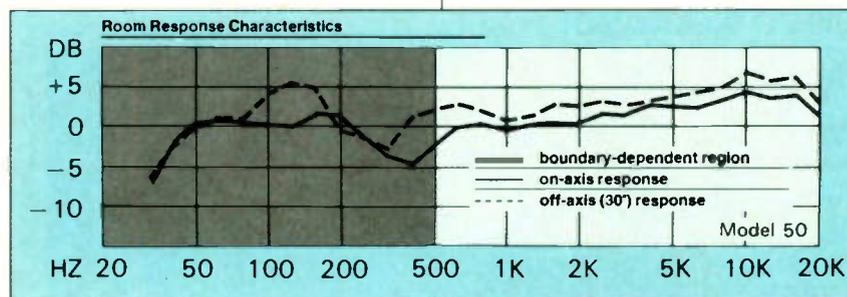

ate substantial amounts of energy away from the listener, but are usually accompanied by an imaging precision inferior even to that of conventional speakers.

While moving around our listening room testing the Listen Anywhere imaging, we realized that the wide listening area provided by the Soundfield 50 has a benefit unacknowledged by DBX's literature on the speaker: You can choose a listening position that provides the best frequency response while keeping the speakers in a conventional location and while maintaining image quality. Specifically, you can locate the prime listening position where the conjunction of the room's standing waves allow the flattest bass response. This is usually *not* along one of a rectangular room's three center axes. With normal forward-radiating speakers placed symmetrically in the room, you'd have to sit along one of these lines to obtain the best imaging. With the Soundfield 50s, movement away from a room axis, even by only a few inches, can have a noticeable and beneficial effect on bass reproduction without the accompanying change in image that can occur with conventional speakers.

In sum, we recommend the Soundfield 50s for serious auditioning, especially if, like us, you don't stay absolutely put during a listening session or if your listening-room layout prevents the traditional equilateral-triangle speaker/listener arrangement. Listen Anywhere is more than an advertising slogan: It accurately describes one of this speaker's strongest traits.

Sensitivity (at 1 meter; 2.8-volt pink noise) 93 dB SPL  
Average Impedance (250 Hz to 6 kHz) 4 ohms

## Yamaha RX-1100U AM/FM Audio- Video Receiver



**Dimensions:** 17¼ by 6 inches, 15 inches deep plus clearance for controls and connections.

**AC Convenience Outlets:** Two switched (60 watts max. total), one unswitched (200 watts max.).

**Price:** \$949.

**Warranty:** "Limited," two years parts and labor.

**Manufacturer:** Nippon Gakki Co., Ltd., Japan.

**U.S. Distributor:** Yamaha Electronics Corp., U.S.A., 6660 Orangethorpe Ave., Buena Park, Calif. 90622.

**O**f all the audio-video receivers we've tested to date, the Yamaha RX-1000U is arguably the most sophisticated. It is certainly a far cry from the typical models that combine mediocre audio behavior with basic video switching, all in the hope that the novelty of the combination will obscure the lack of high fidelity performance and features. Instead, Yamaha has taken an essentially no-compromise audio receiver and built into it not only the switching for video and its associated audio, but for a video processor as well.

are provided for two tape decks, a CD player, and a turntable. The phono jacks have a pushbutton nearby to choose between the MM (fixed-coil) and MC (moving-coil) modes.

A supplied loopstick antenna mounts on the back panel and feeds the AM inputs, which are the insert-and-lock type intended for bared wires. For FM, there's just a 75-ohm coaxial input—which, unfortunately, is the incompatible slip-on type rather than the threaded F connector common on other U.S. equipment. However, a slip-on male RF-cable plug (a pseudo-F connector, to coin a phrase) will mate to the unthreaded female chassis socket. Yamaha supplies a slip-on balun transformer to match a 300-ohm twinlead to this input, and the usual floppy dipole antenna to match the balun.

There also are control cables to interconnect the RX-1100U with other Yamaha components in the RS Series so that the receiver's supplied wireless remote can control them, too. As many as three pairs of speakers can be connected to the heavy-duty binding posts, which accept bared wires or banana plugs. The switching is arranged so that when the B and C pairs are both in use, they are connected in series with each other and in parallel with the A pair (if it, too, is on), making the latter the output of choice for critical listening. The only other back-panel feature, aside from the AC convenience outlets, is a pair of jumpers that can be removed if you want to insert a component (say, a surround-sound processor or an equalizer) between the preamp and power sections of the receiver.

The front panel's main audio controls run horizontally across the middle of the unit. The less-used audio controls are hidden behind a typical Yamaha-style door, the inside of which is labeled with the control identifications. Video processing controls and pilot lights for related functions (simulated stereo and a noise processor) are at the top center of the unit. All audio level controls (volume, loudness, and "muting"—actually, a 20-dB attenuator) are at the right end. The 1100's volume knob is motor-driven, and its index is a short fluorescent orange line that makes the setting visible from across the room.

The supplied RS-RX11 wireless remote, which is powered by two AA cells, includes a main on/off button, all of the selectors of the RX-1100U's front panel, steppers to select station presets, the 20-dB "muting," and volume. If you have matching RS Series components in the rest of the system, the remote can cue the turntable, control basic CD-player func-

The only major function that is omitted is TV tuning. But many audio-video installations these days depend on a cable decoder to select and tune stations, while the tuners built into VCRs perform the same function during recording. Therefore, the absence of a TV tuner in the RX-1100U cannot be considered a loss.

The back-panel audio-video connections are groups of three pin jacks: one each for left and right audio and one (with a yellow insulator) for composite video. There are sets of inputs and outputs for two VCRs, and an input for a videodisc player. A lone composite-video output feeds a TV receiver or monitor. As for audio components, connections

tions, and cause the selected audio deck or VCR to play, cue, or record tapes—or even switch between transports on dual-cassette audio models.

The main front-panel selectors, which choose the signals for monitoring and include all of the inputs plus the built-in AM/FM tuner, are large square buttons. If you press one that represents an A/V source, its pilot light glows red and its audio signal will go to the speakers. If you then press one representing an audio-only source, its pilot glows red and the first pilot turns green, which indicates that the video is still supplied by the A/V source even though the audio comes from another input. This makes possible simulcast (TV/FM) reception or recording.

Among the less-used controls are two recording selectors, one for video and one for audio. The one for video offers a source position that will feed the monitor settings (including those for simulcasts) to both VCRs or permit them to dub from each other or from the video-disc player. The audio recording output takes its primary cue from the source position of the video selector, again accepting whatever is chosen on the main (monitoring) selector. If the video selector is on any position other than source, however, the audio selector becomes live and can choose videodisc, either of the VCRs, audio Tape 1, CD, or phono (but not the tuner) as its source and record it independently. This complicated design isn't aided by an owner's manual that, while often clearly written as far as it goes, seems unwilling to admit that the RX-1100U is as complex as it is. Thus, the manual glosses over many points that could profit from fuller elucidation.

Next to the recording selectors are three switches for audio modes. The mono/stereo button can be used, among other things, to feed the output of a mono VCR to both channels of the preamp. The simulated-stereo option is a pair of complementary comb filters (nulls are at 150 Hz and 4.6 kHz in the left channel and just above 1 and 20 kHz in the right, according to the lab tests). Like most of the breed, Yamaha's system creates a sort of fuzzy openness that fails to enthrall us. The proprietary DNC (Dynamic Noise Canceller) circuit is a dynamic filter that cuts highs to attenuate hiss exposed by low signal levels but opens up to pass the full bandwidth as the signal level rises. In our experience, no filter of this sort operates completely unobtrusively; the Yamaha design is perhaps better than most, though this is a very subjective matter. The DNC may be most useful with substandard audio

from video program sources.

Also located on the subpanel behind the door are the balance control and the three tone controls (bass, midrange, and treble), plus a tone-defeat switch. Filling out the sub-panel are the three speaker-pair selector buttons and the headphone jack.

The tuner controls run in a narrow band just above this subpanel, stretching from the main power switch almost to the volume control. In manual/mono tuning, the tuning bar steps up or down by half-channel (0.1-MHz) increments on FM, by full-channel (10-kHz) increments on AM. In addition, there's a fine-tuning bar that microsteps by 0.01 MHz

### FM Tuner Section

All data measured in the wideband IF mode except as indicated.

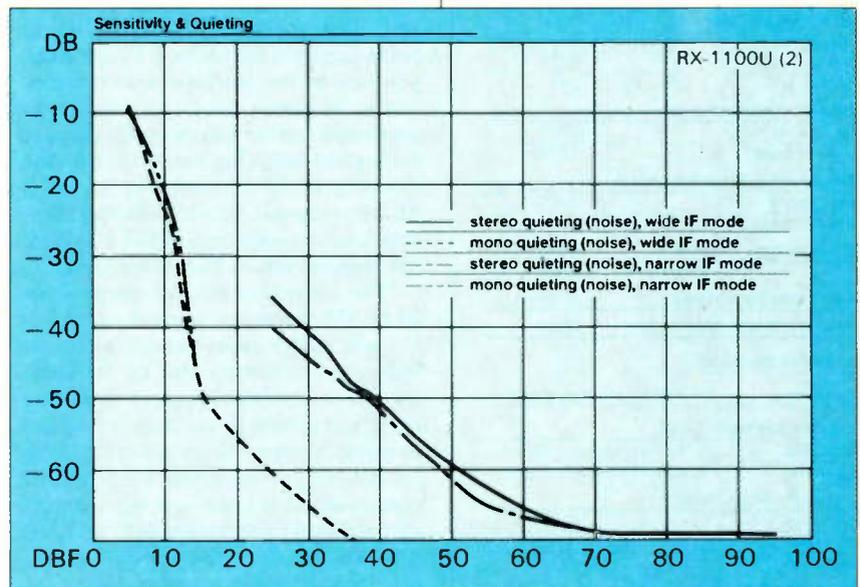
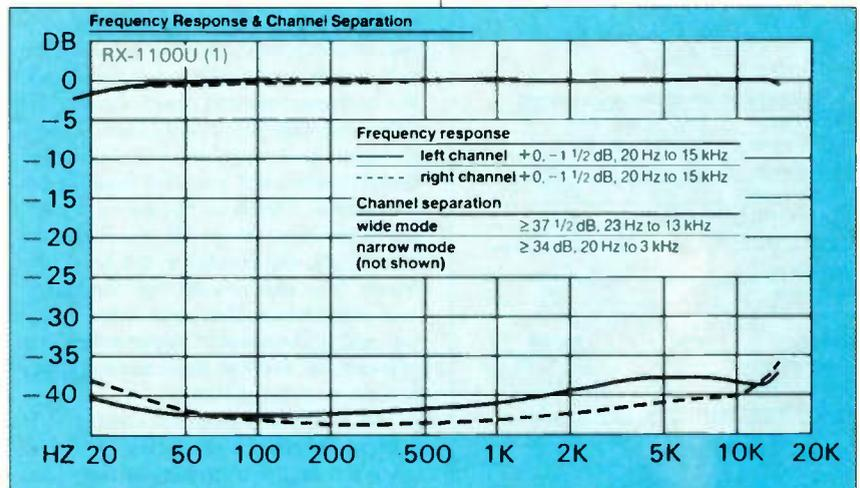

### Stereo sensitivity (for 50-dB noise suppression)

<b>wide</b>	39 1/4 dBf at 98 MHz, with 0.46% THD + N (40 1/4 dBf at 90 MHz, 39 1/4 dBf at 106 MHz)
<b>narrow</b>	38 dBf at 98 MHz, with 1.2% THD + N

on FM and 1 kHz on AM. Tuning can also be automatic/stereo, seeking out the nearest receivable station in either direction. The automatic-mode button is also used to restore stereo reception once you've tuned an FM station manually. ▶

For FM, there is an IF (intermediate frequency) stepper that offers three options: wideband operation for maximum signal quality on stations that suffer no interference from others nearby on the dial; narrowband for those that suffer from undue competition; and automatic, which chooses electronically between the first two on the basis of reception conditions. You'll probably leave the receiver in the latter mode most of the time. When you place a station in the preset memory bank, the reception mode is memorized along with the frequency. There are eight preset buttons, holding a total of 16 stations—AM or FM, in any mix—in two banks.

Video enhancement, which can be bypassed with a nearby pushbutton, consists of two rotary controls, one each for video signal level (brightness) and detail. We have encountered some commercial videotapes that could profit from the level control, though most videophiles probably will use it less often than the detail control. The latter has only a moderate adjustment range (if you forget to turn it off, the results won't be disastrous). You can smooth out the harshness or graininess that some cable operators add in the name of improvement, or you can add some of those same characteristics to other pictures.

As is typical of such controls, it achieves its effect by boosting or attenuating the high frequencies in the video signal. In Diversified Science Laboratories' measurements, there is a slight boost (up to 1/4 dB above 3 MHz) when you turn on the processor with this control at its center detent. Turning it to maximum further increases this effect in the highest bands but boosts the 1.5- and 2.0-MHz bands the most—by 3 1/4 and 3 dB, respectively. Turning the control to minimum introduces a dip of 2 and 1 1/4 dB, respectively, in these same bands.

The luminance control ranges from 83 to 155 percent of normal signal level—not nearly great enough to create fadeouts in dubbing but, by the same token, not extreme enough to give you a really bad picture if you leave the control at either extreme. There is a slight boost (to 108 percent) even with the processor turned off. There also is a slight rise in chroma level (color saturation), which is up 1/2 dB with the processor off and up 1 dB across the entire spectrum with it on. Outside of this minor vagary, chroma performance is essentially perfect.

FM tuner performance is in the ballpark with that of other high fidelity receivers—and therefore notably better than in some quite expensive audio-video models. The losses in separation and

distortion with the narrow IF bandwidth are to be expected; they are the price that must be paid for the added selectivity. However, as is usually the case, the actual selectivity figures aren't as clearly ascertainable. In the narrowband adjacent-channel test, the tuner tended to jump to the interfering carrier and wasn't consistent about the level at which this happened, preventing a single-number evaluation. In the alternate-channel test, the wideband setting proved asymmetrical in response and the figure shown is for



The RX-1100U's remote handset can be used to control other Yamaha components as well.

that reason only approximate.

We particularly appreciated what Yamaha calls the "signal quality" indicator, which registers signal strength minus multipath in five steps. The thresholds range from 27 to 43 dBf in increments of approximately 4 dB. This is precisely where the information is most needed for antenna orientation (if you have a rotator), and the steps are close enough to permit fine-tuning. The layout and calibration (0–100 percent) of the indicator suggest that nothing beyond its range in either direction could possibly be of interest. That isn't true, though the outer fringes do represent diminishing returns.

The rolloff at the low end of the FM response, which is less severe than we see in many receivers and tuners, isn't entirely due to the tuner itself. Yamaha seems to have deliberately delimited the receiver's frequency response, possibly

#### Mono sensitivity (for 50-dB noise suppression)

wide IF mode	15 1/2 dBf at 98 MHz
narrow IF mode	15 1/4 dBf at 98 MHz
Scan threshold	27 dBf
Stereo threshold	25 dBf
Stereo S/N ratio (at 65 dBf)	68 dB
Mono S/N ratio (at 65 dBf)	75 1/2 dB

#### Capture Ratio

wide IF mode	1.0 dB
narrow IF mode	1.5 dB

Selectivity	wide	narrow
alternate-channel	≈40 dB	67 1/2 dB
adjacent-channel	4 1/4 dB	see text

#### Harmonic Distortion (THD+N)

wide IF mode	stereo	mono
at 100 Hz	0.22%	0.08%
at 1 kHz	0.20%	0.10%
at 6 kHz	0.24%	0.23%
narrow IF mode		
at 100 Hz	4.2%	0.11%
at 1 kHz	3.1%	0.72%
at 6 kHz	2.15%	2.4%

#### Stereo Pilot Intermodulation

wide IF mode	0.04%
narrow IF mode	0.57%

#### Intermodulation Distortion (mono)

wide IF mode	0.08%
narrow IF mode	0.30%

AM Suppression	wide	narrow
	62 1/4 dB	56 dB

Pilot (19 kHz) Suppression	46 1/2 dB
----------------------------	-----------

Subcarrier (38 kHz) Suppression	82 dB
---------------------------------	-------

#### Amplifier Section

Rated Power	21.0 dBW (125 watts)/channel
-------------	------------------------------

#### Output At Clipping (at 1 kHz)

8-ohm load	21.8 dBW (150 watts)/channel
4-ohm load	23.6 dBW (230 watts)/channel

#### Dynamic Power (at 1 kHz)

8-ohm load	22.4 dBW
4-ohm load	24.4 dBW
2-ohm load	25.1 dBW

Dynamic Headroom (re rated power; 8-ohm load)	+1.4 dB
---	---------

#### Harmonic Distortion (THD; 20 Hz to 20 kHz)

at 21.0 dBW (125 watts)	≤0.20%
at 0 dBW (1 watt)	≤0.011%

#### Frequency Response

	+0, -1/2 dB, 20 Hz to 26.2 kHz
	+0, -3 dB, 10 Hz to 70.0 kHz

WE'LL CHANGE YOUR IDEAS

DM  
1600 1800

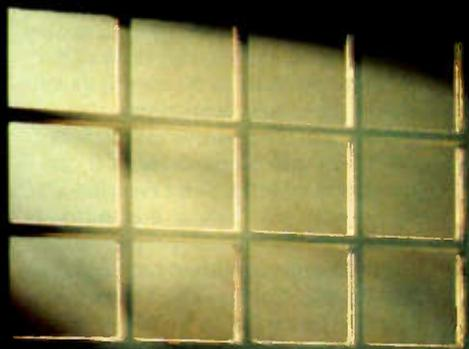

B&W sensitively shape a new generation of audio excellence. DM1600/DM1800 – veritable giant killers. Two systems incorporating all the benefits of simplified Matrix technology. Providing super-stereo imagery in modest enclosure dimensions. DM1600 – An instrument so supersensitive, so acoustically sophisticated. But blessed with the alternative facility for either stand or shelf mounting – the home-loving miracle. DM1800 has even more. Additional volume – a new powerhouse of a motor system. Delivering superb attack with transient performance. Elegant in real wood veneers and perfectly attuned to the design-conscious roomscape. DM1600/DM1800 speak of, and with, scientific elegance.



*The* **MATRIX**  
*Revolution*

to reduce the opportunities for intermodulation with so much going on in its circuitry. In particular, a useful infrasonic filter is built in (and even listed in the specifications), rolling off at about 12 dB per octave below 10 Hz. The result of the bandlimiting is a slight droop at both ends of the audible spectrum: to  $-1/4$  dB at 20 Hz and to almost  $-1/2$  dB at 20 kHz. Only under very unusual conditions will these deviations become audible.

With the tone controls engaged but set at their "defeat" detents, the droops

chosen. The output to tape from the aux inputs (actually measured through the CD jacks) is substantially direct, as you would expect with a separate recording selector. Still, the receiver does add an ignorable 50 ohms to the output impedance of the source component.

Rating of the power amp at 125 watts (21 dBW) into a minimum of 6 ohms proves conservative. Some receivers that supposedly will handle 4-ohm loads quake at the 2-ohm test, putting out less power (because of current limiting) than they do into 4 ohms. The Yamaha continues to pump out more power as impedance and duty cycle are reduced. We don't recommend taking undue advantage of this forgiving trait, but it's good to know that if you observe Yamaha's caveats (no less than 12 ohms per speaker in the parallel hookups or 3 ohms per speaker in series), you will stay well away from any ragged edges.

While the RX-1100U is not completely equivalent to its best sibling audio-only models, it comes closer to that ideal than do many top audio-video models in other lines. Its range of features—particularly the handling of FM IF bandwidth and the tone controls—is far above the call of audio-video duty and is rivaled by relatively few audio-only models. The switching, though complex, is more straightforward than that for comparable features in some of the competing gear we've tested. And the basic audio capabilities and performance are better than you're likely to find in any audio-video receiver.

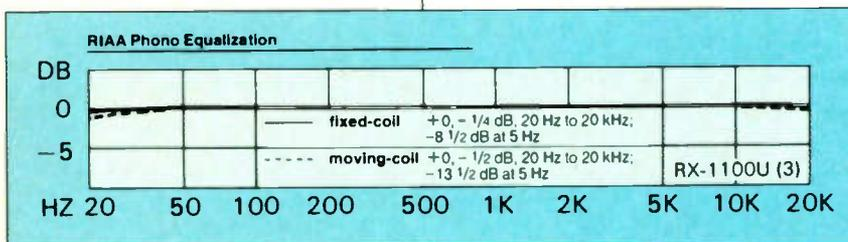

#### Sensitivity & Noise (re 0 dBW; A-weighting)

	sensitivity	S/N ratio
aux input	12.5 mV	80 3/4 dB
fixed-coil phono	0.22 mV	75 1/4 dB
moving-coil phono	15 $\mu$ V	73 dB

#### Phono Overload (1-kHz clipping)

fixed-coil phono	115 mV
moving-coil phono	7.8 mV

#### Input Impedance

aux input	31k ohms
fixed-coil phono	48k ohms; 250 pF
moving-coil phono	220 ohms

#### Output Impedance (to tape)

from aux input	see text
from tuner section	95 ohms
from phono inputs	95 ohms

#### Damping Factor (at 50 Hz; re 8 ohms)

90
----

#### Channel Separation (at 1 kHz)

73 dB
-------

#### Video Section

##### Video Frequency Response (enhancer on)

Detail	minimum	detent	maximum
500 kHz	-1 dB	flat	+1 1/4 dB
1.5 MHz	-2 dB	flat	+3 1/4 dB
2.0 MHz	-1 3/4 dB	+1/4 dB	+3 dB
3.0 MHz	flat	+1/2 dB	+1 dB
3.58 MHz	flat	+3/4 dB	+1 1/4 dB
4.2 MHz	flat	+3/4 dB	+2 dB

#### Luminance Level

Enhancer on	15% low to 55% high
Enhancer off	8% high

increase to about  $-1$  dB at both extremes, which still isn't severe enough to induce most users to turn off the tone controls. The tone controls themselves are well-behaved, with fairly even increments per calibration mark. BASS has maximum effect of about  $\pm 11$  dB near 30 Hz, with almost no effect above 1 kHz. MIDRANGE reaches from about 100 Hz to 10 kHz and achieves the surprisingly wide adjustment range of  $+13 1/2$ ,  $-12$  dB just above 1 kHz. TREBLE starts at about 1 kHz and peaks near 13 kHz, with a range of roughly  $+11$ ,  $-10$  dB.

Loudness compensation is unusually complex. As in many of its most sophisticated models, Yamaha has provided a loudness adjustment ring outside the main volume control. The idea is that you set the volume (with the loudness all the way up) for "full" listening level, based on your listening habits, room acoustics, and speaker sensitivity. Then, when you want loudness compensation, you reduce output by turning down the ring rather than the main control. This attenuates frequencies around 1 kHz more than the bass or the extreme treble, though the exact curve depends, to a considerable (and, in some ways, unpredictable) extent, on the setting of the loudness control in this instance. Of course, the tone controls give you unusual flexibility in tailoring the supplied compensation if you don't like it.

Phono response is exceptionally flat between the frequency extremes, where rolloff is slightly greater in the moving-coil mode than through other inputs and slightly flatter in the fixed-coil mode. Impedances and levels are generally well

#### ABOUT THE dBW

We currently are expressing power in terms of dBW—meaning power in dB with a reference (0 dBW) of 1 watt. The conversion table will enable you to use the advantages of dBW in comparing these products to others for which you have no dBW figures.

WATTS	dBW	WATTS	dBW
1.0	0	32	15
1.25	1	40	16
1.6	2	50	17
2.0	3	63	18
2.5	4	80	19
3.2	5	100	20
4.0	6	125	21
5.0	7	160	22
6.3	8	200	23
8.0	9	250	24
10.0	10	320	25
12.5	11	400	26
16.0	12	500	27
20.0	13	630	28
25.0	14	800	29



## MINI-REVIEWS OF THE LATEST COMPACT DISCS

By Robert E. Benson, David Hurwitz, Robert R. Reilly, and Terry Teachout

 **STRAUSS "ALPENSINFONIE":  
LOS ANGELES, MEHTA**

In the face of formidable competition, Strauss's musical travelogue of the Alps receives its finest CD representation on this London Jubilee disc featuring Zubin Mehta and the Los Angeles Philharmonic. Haitink's excellent Concertgebouw account on Philips is thinly recorded, Karajan's Berlin Philharmonic version on Deutsche Grammophon is magnificently played but is marred by disappointing sonics, and Solti's Bavarian Radio Symphony Orchestra performance on London is out of the running on all counts. The present performance is superb in detail and impulse; Mehta keeps this colorful score moving at a convincing pace, and the Philharmonic is in top form. Recorded in 1975 at UCLA's Royce Hall, this is an example of London's finest sonics, combining opulence with clarity and impact. There are some particularly splendid moments here: the horn interplay in "The Ascent" (Band 3) and the rich sonorities of "Sunset" (Band 17). Many listeners feel that this vast Alpine tapestry of sound is the most vivid of Strauss's symphonic poems, but if you enjoy the piece, you surely will find great pleasure in this recording. Unlike its full-price competitors, this budget-line disc is a terrific buy. Playing time: 48:09. (London 417717-2.) *R.E.B.*

 **ORFF:  
"CARMINA BURANA"**

As part of its new midprice Papillon Collection, RCA has released Seiji Ozawa's wonderful performance of Orff's perennial favorite *Carmina Burana*. This Boston Symphony Orchestra account, featuring the New England Conservatory Chorus and Children's Chorus, always was one of the finest recorded versions and is doubly so now that it has been digitally remastered for CD. Soloists Evelyn Mandac, Stanley Kolk, and Sherrill Milnes sing well, but the palm goes to the New England Conservatory Chorus, whose brash and gutsy youthfulness suits this music perfectly. Finally, special praise to RCA for being the only company to date to offer *Carmina Burana* at midprice, with complete texts and translations. This is the kind of quality product the CD public deserves. Playing time: 63:11. (RCA 6533-2.) *D.H.*

 **TCHAIKOVSKY SYMPHONIES:  
LENINGRAD, MRAVINSKY**

Evgeny Mravinsky and the Leningrad Philharmonic recorded Tchaikovsky's Symphonies Nos. 4, 5, and 6 (*Pathétique*) for Deutsche Grammophon during a 1960 tour of Great Britain. These performances have now been digitally remastered and reissued as a two-CD set. The remastering is outstanding, and Mravinsky's interpretations are authentic to the last degree. The line separating agitation from hysteria is regularly and fearlessly approached but never crossed. Though the orchestra plays crudely in places, Mravinsky's absolute control over his musicians is something to hear. A more moderate approach to Tchaikovsky may be preferred for everyday listening, but these performances are indispensable all the same. The Fifth Symphony is divided between the two discs. Playing time: 128:55. (Deutsche Grammophon 419 745-2.) *T.T.*

 **GERSHWIN WORKS:  
GERSHWIN; THOMAS**

This wonderful Gershwin CD is filled with brilliant performances—one of them Gershwin's own. In 1925, a year after the premiere of *Rhapsody in Blue*, Gershwin recorded the work on Duo-Art piano rolls, playing not only the solo piano part but the original jazz-band part as well. Through much painstaking effort, the producers of this CBS Masterworks recording were able to eliminate the accompaniment, preserving the composer's solo performance. To this was added the live performance of the Columbia Jazz Band led by Michael Tilson Thomas, playing the original arrangement rather than the orchestration typically heard today. The result is a modern stereophonic recording of Gershwin playing his most famous work. This has been laudably accomplished by all concerned, and though many listeners may wish to have the *Rhapsody* in its fuller orchestration, what is heard here is fascinating indeed. Another attraction is Thomas's account of *An American in Paris* with the New York Philharmonic, which is among the finest recordings ever made of this work. The CD is filled out with overtures to six of Gershwin's Broadway shows, played by the Buffalo Philharmonic under Thomas. With excellent sound throughout and

near-maximum playing time, this disc is highly recommended. Playing time: 71:27. (CBS Masterworks MK 42240.) *R.E.B.*

 **DEBUSSY PIANO MUSIC:  
JACOBS**

Pianist Paul Jacobs, who died of AIDS in 1983, left a substantial recorded legacy, which Nonesuch is now transferring to Compact Disc. The first Jacobs recording to appear on CD is his 1976 performance of the Debussy *Études*, the most satisfying account of these beautiful, elusive works on record. To fill out the disc, Nonesuch has exhumed a 1982 radio-broadcast tape of Jacobs and Gilbert Kalish performing Debussy's two-piano suite *En blanc et noir* at an outdoor festival in California. The sound is barely adequate, with plenty of audience noise and the odd birdcall here and there, but the performance is staggering—the *En blanc et noir* of a lifetime. Jacobs's original notes are augmented by a thoughtful essay on *En blanc et noir* by Ned Rorem and appreciations of Jacobs by Kalish, Teresa Sterne, Pierre Boulez, Elliott Carter, William Bolcom, and David Hamilton. This is a generous reissue, with, one hopes, many more to come. Jacobs's Busoni recordings, for instance, would fill a CD nicely. Playing time: 66:50. (Nonesuch 9 79161-2.) *T.T.*

 **RAVEL ORCHESTRAL WORKS:  
MINNESOTA, SKROWACZEWSKI**

Stanislaw Skrowaczewski and an energized Minnesota Orchestra turn in performances of Ravel's complete orchestral works that are superior, in both interpretation and sound, to all other contenders. In comparison, the acclaim given to Charles Dutoit's cycle on London amounts to nothing less than a critical embarrassment. Skrowaczewski, conductor laureate of the Minnesota and currently principal conductor of the Hallé Orchestra, has long been one of our most underrated podium masters. He is equally at home in Bruckner, Ravel, and Stravinsky, and is himself a composer of substance.

These three CDs, available separately at Vox Prima's bargain prices, are simply a steal. MWCD 7144 contains the finest *Boléro* on disc (at the correct, hypnotically slow tempo) as well as a luxurious *La valse*, a fiery *Rapsodie espagnole*, and a haunting *Pavane pour une infante défunte*. ▶

MWCD 7142 features the most magical and enchanting *Ma mère l'oye* ever offered, as well as sumptuous renditions of the two *Daphnis et Chloé* suites. MWCD 7140 includes everything else: *Alborada del gracioso*, *Le tombeau de Couperin*, *Valses nobles et sentimentales*, *Menuet antique*, the tiny fanfare from *L'éventail de Jeanne*, and the rarely performed *Une barque sur l'océan*. Don't miss this opportunity to hear these stunningly atmospheric and idiomatic performances in demonstration-quality sound. This is what the CD medium is all about, and it's encouraging to see such intelligent planning from Vox. What other gems lie under those lousy \$3.99 pressings? Playing times: 60:57 (Vox Prima MWCD 7140); 62:49 (MWCD 7142); 53:23 (MWCD 7144).

D.H.

### LORD BERNERS WORKS: ROYAL LIVERPOOL

To say that Lord Berners was an eccentric is to put it mildly. Born in 1883, Gerald Hugh Tyrwhitt-Wilson inherited the title of 14th Baron Berners in 1919. He was a painter, author, diplomat, and composer—largely self-taught, though he was encouraged by Casella and Stravinsky. Like Sir Thomas Beecham, Lord Berners' wealth permitted him to dabble as he wished; it is said he kept a miniature clavichord in his Rolls Royce. His gift for humor, satire, and parody is evident in the music heard on this new recording. The polka movement of *The Triumph of Neptune*, for example, includes a drunken sailor singing "The Last Rose of Summer." Barry Wordsworth leads the Royal Liverpool Philharmonic Orchestra in a performance of this work that is as delightful as the Beecham/Philadelphia account recorded in the early 1950s.

Also featured on this CD is an expertly crafted Fugue for orchestra, *Fantaisie espagnole*, *Three Pieces*, and two excerpts from film music for *Nicholas Nickleby*. The excellent performances capture the wit of the scores, and Angel EMI's digital recording is wide-ranging and natural. Lord Berners composed other intriguing works that have never been recorded; let's hope the present issue will at least be followed by a second volume. Playing time: 53:01. (Angel EMI CDC 47668.) R.E.B.

### ALBRECHTSBERGER: CONCERTOS FOR JEW'S HARP AND MANDORA

Performances and recording are excellent, but this is basically a party record. The Jew's harp—which is, to put it kindly, a reticent instrument—wears out its welcome pretty quickly in these two charming rococo concertos. And \$15 or so is a lot to spend for a laugh. Although the playing time on this CD may seem skimpy, another 20 minutes of Jew's harp would not necessarily

enhance this release's claim on your purse. Dieter Kirsch, on the mandora, and Fritz Mayr, on Jew's harp, are accompanied by the Munich Chamber Orchestra, Hans Stadlmair conducting. Playing time: 38:58. (Orfeo C 035821 A.) D.H.

### PETER CHRIST, CRYSTAL SOLOISTS: CHAMBER WORKS

Oboist Peter Christ is featured on a new Crystal CD (assembled from several analog LPs) that exemplifies this label's commendable practice of utilizing the storage capacity of Compact Discs, not simply replicating LP programs. Christ and his Crystal Chamber Soloists ably essay the works on this disc; it is one's interest in the material that will determine the release's appeal. The longest piece, Randall Thompson's *Suite* for oboe, clarinet, and viola (15:39), is also the best. This distinctly American music is fresh, folkish, infectiously delightful and direct, and simply moving. It adds to the mystery of why Thompson's wonderful music remains neglected. The second-longest contribution is William Grant Still's *Miniatures* for flute, oboe, and piano (12:14). The five miniatures, which are taken directly from folk melodies, are light, conventional Americana—pleasant enough, though not in the same league as the Thompson *Suite*. Alberto Ginastera's *Duo* for flute and oboe is quite sprightly, energetic, and concise, and it creates more of an impression than its eight-minute length would lead one to expect.

William Schmidt's hybrid, *The Sparrow and the Amazing Mr. Avaunt*, is puzzling. Two poems by William Pillin are recited to oboe accompaniment: The first is a melancholic reflection on Edith Piaf, the second a brief parody of avant-garde compositional techniques used to spoof "Mr. Avaunt." For this listener, these two pieces do not work together, or, rather, work too hard together. In any case, I would have preferred to have heard the texts and the music separately. Also included is Vincent Persichetti's short *Parable III*, for solo oboe, which is on the somber side.

The liner notes are full of well-deserved accolades from the composers for the superb playing by Christ and his colleagues. The digitally remastered sound is excessively bright but otherwise fine. Playing time: 49:32. (Crystal CD 321.) R.R.R.

### RACHMANINOFF WORKS: LONDON SYMPHONY, PREVIN

André Previn's exceptional sympathy for Rachmaninoff's music has never been better documented than in these excellent performances of *The Isle of the Dead* and *Symphonic Dances*, recently reissued on CD. Previn is especially successful in the

*Dances*, heeding the composer's non allegro injunction in the first movement, keeping the luscious waltz moving along in the second, and letting it all hang out in the orgasmic finale. As a bonus, the disc includes the orchestral version of the *Vocalise*, Op. 34, No. 14, and excerpts from the opera *Aleko*. Sound and performance on this midprice CD easily outclass the London disc bearing Vladimir Ashkenazy's interpretive approximations. Playing time: 71:05. (Angel EMI CDM 69025.) D.H.

### BERNSTEIN STAGE WORKS: NEW YORK, BERNSTEIN

For most listeners, the music heard on this CD is Leonard Bernstein, the youthful composer who wrote catchy, imaginative tunes, brilliantly orchestrated, far removed from his pretentious "major" works of later years. The content of the disc was originally recorded in 1960–61, with the composer conducting the New York Philharmonic. The recording of the *Symphonic Dances* from *West Side Story* has a stunning electric quality that far surpasses any other recorded version of the music, and the suite from *On the Waterfront* becomes, in this eloquent performance, a major 20th-century American symphonic poem. The dances from *On the Town* and the overture to *Candide* are dazzling. John McClure produced the original recording and remastered it for the CD reissue, which boasts sonics as big and bold as the performance. Highly recommended. Playing time: 54:42. (CBS Masterworks MK 42263.) R.E.B.

### PROKOFIEV, KODÁLY: CLEVELAND, SZELL

This coupling of Prokofiev's *Lieutenant Kijé* and Kodály's *Háry János* suites has been definitive since the day it was issued. George Szell's conducting and the Cleveland Orchestra's playing are beyond praise. The only direct competition, Klaus Tennstedt's identical coupling on Angel EMI, is a nonstarter. This is a good value at midprice, in bright but perfectly acceptable sound. Playing time: 42:26. (CBS Masterworks MYK 38527.) D.H.

### BACH "GOLDBERG": GOULD

Glenn Gould's 1955 debut recording of Bach's *Goldberg Variations* has been digitally remastered and transferred to CD as part of CBS's "Great Performances" budget line. The sound is dated, the splices audible, and the disc only half full, but who cares? This magnetic performance is without question one of the great recordings of the century. Each variation is separately banded, and Gould's original liner notes are included. An essential recording. Playing time: 38:25. (CBS Masterworks MYK 38479.) T.T.

Classical

## FROM STRENGTH TO STRENGTH

# INBAL'S MAHLER



**MAHLER: Symphony No. 6, in A minor.**

Frankfurt Radio Symphony Orchestra, Inbal.  
● Yoshiharu Kawaguchi, prod. Denon CO 1327/28  
(2, D).

**MAHLER: Symphony No. 7, in E minor.**

Frankfurt Radio Symphony Orchestra, Inbal.  
● Yoshiharu Kawaguchi, prod. Denon CO 1553/54  
(2, D).

**MAHLER: Symphony No. 9, in D; Adagio from  
Symphony No. 10, in F sharp.**

Frankfurt Radio Symphony Orchestra, Inbal.  
● Yoshiharu Kawaguchi, prod. Denon CO 1566/67  
(2, D).

With the release of Symphonies Nos. 6, 7, and 9 (the latter paired with the Adagio of No. 10), Elihu Inbal's Mahler cycle on Denon awaits only the monumental Eighth for completion. [*The Eighth was due for release as this review was going to press; it will be reviewed in a forthcoming issue.—Ed.*] Provocative as it may sound, these are the only recorded performances fit to stand beside Leonard Bernstein's in their total comprehension of, and identification with, Mahler's sound world. The interpretations are exciting, lucid, and, above all, idiomatic. In achieving this quality, Inbal succeeds where so many other participants in the Mahler boom have failed—and that success is brilliantly illustrated by these recordings.

The Sixth Symphony, Mahler's most frightening creation, is also one of his most unified and disciplined. Inbal understands the need to keep the music under control right up to the catastrophe of the tragic closing bars. His account of the symphony's opening movement perfectly balances the relentless march music with the surging lyricism of the theme depicting Mahler's wife Alma. The tempo is moderate, the

rhythm rock-solid. The Scherzo receives a knotty reading that highlights its grotesqueness, and the two trios have a real *grazioso* lilt that pointedly fails to conceal the menace lurking beneath the stylized façade.

In Inbal's rendition, the Andante for once attains a genuine walking tempo without sacrificing the element of repose so necessary at this point in the drama. Suddenly, the reason behind Inbal's slower-than-average tempos for the first two movements becomes clear: In approaching the Andante this way, he softens the contrast between it and the rest of the symphony. The music of this brief idyll sufficiently sets it apart from the rest of the work; meanwhile, Inbal maintains the dramatic momentum. Such insights typify Inbal's grasp of Mahlerian architecture and his ability to view each symphony as a whole. (In his Deutsche Grammophon recording, Herbert von Karajan disrupts the symphony's larger balance by taking the third movement at a comatose crawl.) The magical central episode with alpine horns and cowbells has never sounded so sensuous and evanescent as it does in Inbal's hands.

Correctly opting for two hammer blows in the finale instead of three, Inbal realizes the shattering effect better than anyone else has. Also impressive is the way in which he balances Mahler's brilliant polyphony in the movement's extended recapitulation. Inbal creates the utmost tension between the musical lines without producing the sense of noise run amok that characterizes Tennstedt's performance on Angel EMI. The final chord is shattering.

The Seventh Symphony is Mahler's concerto for orchestra. In fact, comparison with Bartók's *Concerto for Orchestra* reveals many similarities. Both pieces employ a five-movement "arch" form, with the sec-

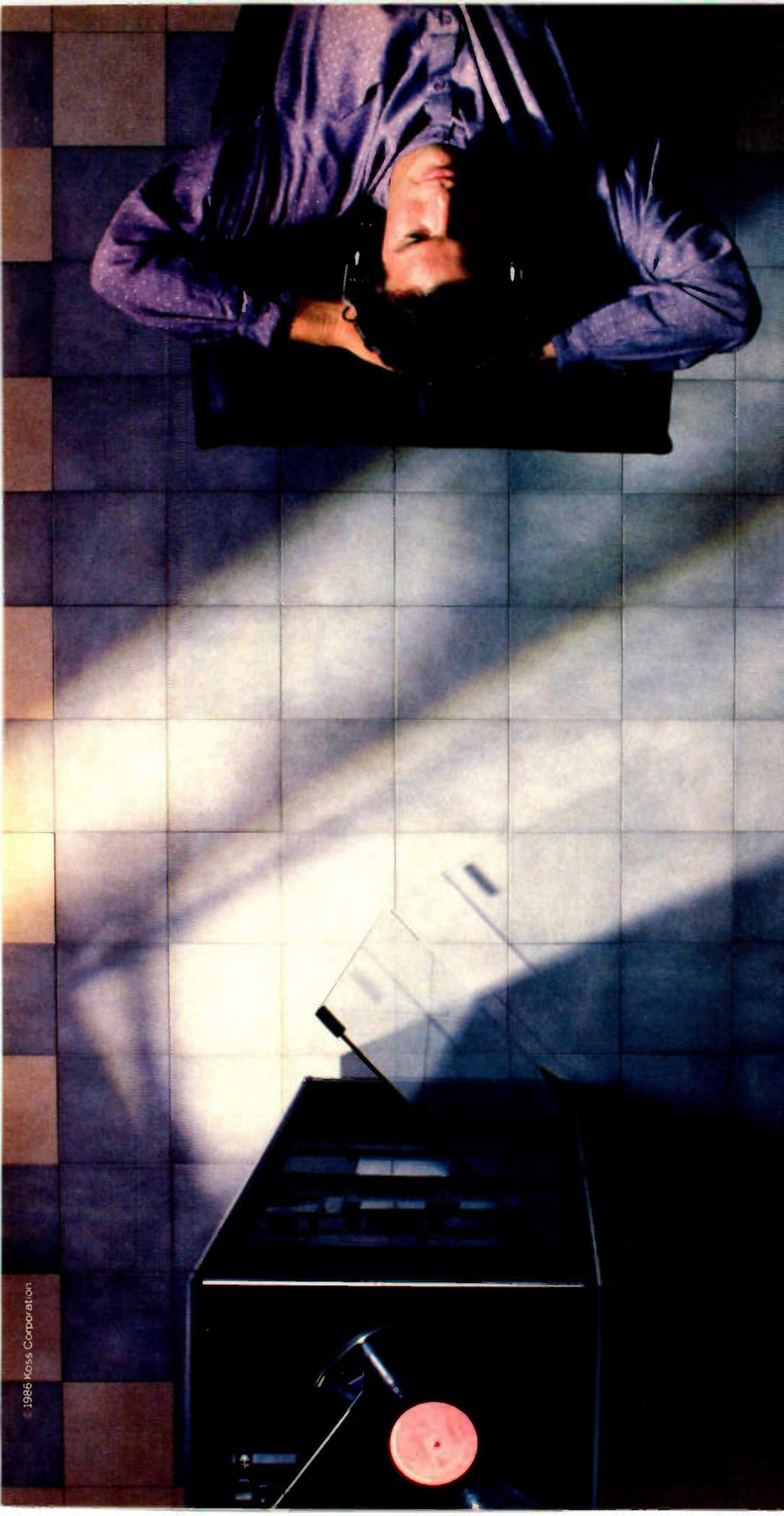

Still don't see it? That's the whole idea behind Koss' revolutionary infrared stereophone system. The Koss Kordless™ Stereophone. Now, you can enjoy all the benefits of stereophone listening with no strings attached. And while the cord may be missing, the great Sound of Koss isn't. The Kordless system is so advanced it provides a full 20-20KHz frequency response at less than 1% distortion. Plus enough signal to fill a large room. Yet it's as easy to use as conventional stereophones. Just plug the Kordless transmitter into virtually any receiver or amplifier and turn it

## CAN YOU FIND THE STEREOPHONE CORD IN THIS PICTURE?

on. Roam around the room listening to a record. Dance to a CD. Enjoy stereo or mono TV broadcasts and videos in bed. Or whatever else moves you. Sound impressive? You bet it does. And the best way to appreciate this major advance in technology is to visit your nearest Koss Kordless™ Stereophone dealer. One listen, and you'll never sit still for ordinary headphones again.

• Koss Stereophones, 4129 N. Port Washington Rd., Milwaukee, WI 53212. Koss Limited, 4112 S. Service Rd. Burlington, Ontario L7L4X5. Koss-Europe: CH-6855, Stabio-Switzerland.

 **KOSS**<sup>®</sup>  
stereophones



*Classical*

ond and fourth movements serving as intermezzi. Both composers begin with slow introductions and depict a musical progression from darkness to light, making special use of nocturnal imagery and bird-song. And in this symphony, Mahler invented what later became known as the "Bartók pizzicato"—plucking a string so hard that it snaps against the wood of the fingerboard. Successful performances of the Seventh require perfect balance between the four coequal sections of the orchestra, a steadfast refusal to prettify Mahler's often intentionally raucous textures (so much for Abbado on Deutsche Grammophon), and, most importantly, a sense of humor (which eliminates Solti and Tennstedt).

Inbal demonstrates his understanding of the Seventh most graphically in his treatment of the landler-like scherzo and the finale. Mahler marked the creepy scherzo "not fast," an injunction both Solti and Abbado blithely ignore. Inbal realizes every ghoulish twist at a moderate tempo that lets the details register properly. The finale—a delightful glorification of the banal—is simply one of the most hilarious compositions in existence; Mahler himself marked it "*allegro ordinario*." In sum, Inbal and his orchestra play the pants off the piece; only Bernstein's new Deutsche Grammophon recording is more fun.

Mahler's Ninth has not lacked for great interpretations, three of which are available on CD—Bernstein's first account for CBS, his new one on Deutsche Grammophon, and Karajan's on DG. Inbal now adds his name to the list while imparting his unique vision to the account. Throughout his cycle, Inbal has lavished extraordinary attention on string phrasing. Nowhere does this prove more important than in the string-dominated textures of the Ninth's first movement. Every musical strand seems to stand out as if it were being sung by a single voice. A particularly striking example comes in the orchestral response to the ghostly chamber-music cadenza that ushers in the coda, following the movement's third and final collapse. The violins appear to be on the verge of articulate speech, and the effect is a revelation.

The remaining movements of the Ninth proceed equally well. Inbal's rendition of the virtuosic Rondo *Burleske* may be the finest on record. He alone accurately gauges each successive acceleration to the finish, keeping the frenzy building to

the final bar. While Karajan's Berlin Philharmonic and Bernstein's Concertgebouw Orchestra can play faster, they generate less cumulative excitement.

Both Karajan and Bernstein treat the finale as an almost transcendent experience, Mahler's last attempt to come to terms with mortality. Inbal prefers a gentler approach, making this sublime Adagio a noble culmination purged of strain and torment. The perspective is similar to Bernstein's first recording of the score for CBS. The Adagio from the unfinished Tenth Symphony seems to grow naturally out of this finale, and the performance is equally satisfying.

None of these interpretive insights would matter were it not for the superlative Frankfurt Radio Symphony Orchestra. The German radio orchestras are truly a precious musical asset. Because they receive liberal rehearsal time and give relatively few public concerts, they are capable—especially under such conductors as Inbal and Günter Wand—of playing at a level that puts even the orchestras of Berlin, Chicago, and Vienna to shame. The Frankfurt ensemble is one of the best: What can be heard in this recording of the Ninth, taped live in Frankfurt, is in many ways superior to what Solti and the Chicago Symphony managed at Carnegie Hall last season.

Denon's recorded sound has improved as this Mahler series has progressed. It is now warm and immediate, with no audience noises intruding on the rather high playback level required for maximum impact. These are remarkable performances that belong in every collection. Playing time for CO 1327/28: 83:54. Playing time for CO 1553/54: 77:53. Playing time for CO 1566/67: 104:21. *David Hurwitz*

**BEETHOVEN: Concertos for Piano and Orchestra: No. 1, in C, Op. 15; No. 2, in B flat, Op. 19.**

Perahia: *Amsterdam Concertgebouw Orchestra*. Haitink. Steven Epstein, prod. CBS Masterworks IM 42177 (D). Ⓢ

**BEETHOVEN: Concerto for Piano and Orchestra No. 5, in E flat, Op. 73 ("Emperor").**

Perahia: *Amsterdam Concertgebouw Orchestra*. Haitink. Stan Goodall, prod. CBS Masterworks MK 42330 (D). Ⓢ

When Murray Perahia and Bernard Haitink recorded Beethoven's Third and Fourth Piano Concertos as the first in-

stallment in a complete cycle for CBS, the performances were of such surpassing musicality, intelligence, and technical mastery that one assumed—provided the other three concertos were realized on the same level—that this would become the recorded cycle of reference, as Artur Schnabel's has been since the 1940s. CBS has now issued the recordings of the First, Second, and Fifth Concertos, and as it turns out, things are not quite as promising as one might have hoped.



Perahia's Beethoven concerto cycle offers up an ethereal Emperor.

The reservations one has stem from Perahia's playing in the First and Second Concertos, which does not equal the seemingly unconstrained inspiration of his accounts of the Third and Fourth. In the present readings, there is an atmosphere if not of contrivance, then of reserve. Perahia's sedate tempo for the last movement of the First Concerto, for instance, exemplifies what has accurately been described as his tendency to be "overpolite."

There is, however, enough illuminating insight in Perahia's phrasing to place this cycle in a class with such notable renditions as Fleisher's, Pollini's, and Rubinstein's (especially his 1960 set with the Boston Symphony Orchestra). And Perahia's *Emperor* Concerto is one of the best on record. In all five of the concertos, the adroitness of Haitink's accompaniment and the playing of the Concertgebouw Orchestra are virtually unparalleled. The sound of the orchestra and piano in the deeply resonant Concertgebouw is reproduced with accuracy and clarity, although knob-turning in some passages causes certain instruments to predominate one mo-

VISA, MASTERCARD, DISCOVER,  
AMERICAN EXPRESS CARDS WELCOME



120 W. 31 St. (bet. 6th & 7th Ave.)  
N.Y., N.Y. 10001

CALL TOLL FREE 800-223-7323  
IN N.Y. STATE CALL 212-947-5290

### TECHNICS

#### COMPACT DISC PLAYERS

SL-P220 Programmable w/Remote	199.00
SL-P320 w/Versatile 10-Key Operation	249.00
SL-P420 w/ Multi-function Remote	299.00
SL-P600C Player w/6 Disc Changer	349.00

#### RECEIVERS

SA-180 Quartz AM/FM Stereo Receiver	129.00
SA-290 50 Watts Receiver	169.00
SA-R210 Stereo Receiver w/Remote	199.00
SA-R310 Receiver w/40 Key Remote	279.00

#### CASSETTE DECKS

RS-T11 Stereo Double Cassette	129.00
RS-T22 Double Cassette w/Peak Readout	149.00
RS-T33R Quick Reverse Double Cassette	249.00

FOR OTHER TECHNICS COMPONENTS CALL

#### COMPONENT SYSTEMS

SC-A610 100 Watts System	599.00
SC-A630 Same as Above With	
SL-P117 Compac Disc Player	799.00
SC-A640 Same As The SC-A630	
With A 32 Key Wireless Remote	999.00

### WALKMANS

SONY D-10 Disc Player	279.95
SONY D-3 Disc Player	189.90
SONY DT-3 AM/FM Disc Player	219.90
PANASONIC SLNP-P10 Disc Player	229.90
SONY WMD-6 PRO	279.95
SONY WMF-73	89.95
SONY WMF-76	99.90
SONY WMF-77	79.95
SONY WMF-100II	119.95
SONY WMF-200II	169.90
NEW! AIWA HS-PX700 Ultra Compact	IN STOCK
AIWA HSJ-700 AM/FM Recorder	IN STOCK
AIWA HSG-700 Auto Reverse Player	IN STOCK
PANASONIC RX-SA78	79.95
TOSHIBA KT-4087	129.95

### VIDEO CAMCORDERS & VCR's

#### VHS CAMCORDERS

MINOLTA MASTER CR-1400	IN STOCK
PANASONIC PV-320	1049.90
RCA CPR-300	IN STOCK
HITACHI VM-3000	IN STOCK

#### VHS-c CAMCORDERS

MINOLTA MASTER CR-3300	IN STOCK
PANASONIC PV-110	IN STOCK
ZENITH 6200	839.95
JVC GR-C25U	CALL

#### 8mm CAMCORDERS

MINOLTA MASTER CR-8100	IN STOCK
NIKON VN-810 Action 8	CALL
CANON VM-E2N Canonvision8	1199.90
OLYMPUS VX-802	IN STOCK
SONY CCD-V5	969.90
SONY CCD-V9	CALL
SONY CCD-V110	1229.90

#### VCR's

PAN. PV-3720 On Screen Display	289.90
PAN. PV-3770 Digital Special Effects	379.90
PAN. PV-4700 4 Head	279.90
PAN. PV-4722 Bar Code Programmable	399.90
PAN. PV-4750 MTS-Stereo	419.95
PAN. PV-4768 w/Built-in Amplifier	699.90
PAN. PV-4780 HiFi	IN STOCK
JVC HR-S7000 Super VHS	CALL
JVC HRD-570 HiFi	699.90

WRITE FOR  
**FREE**  
VIDEO CATALOG  
INCLUDES  
CAMERAS  
DARKROOM  
COMPUTERS  
ELECTRONICS  
& TELEPHONES



Licensed By Dept. of Consumer Affairs #800193  
Shipping & Handling Extra  
Call For Exact Quote  
Not Responsible For Typographical Errors

ment and others the next. Playing time for the First and Second Concertos: 69:28. Playing time for *Emperor* Concerto: 38:39. *Thomas Hathaway*

### BEETHOVEN: Symphony No. 9, in D minor, Op. 125.

*Wiens, Lewis, Hermann, Hartwig;*  
● *Hamburg State Opera Chorus, North German Radio Chorus and Orchestra, Wand, Ulf Thomson, prod. Angel EMI CDC 47741 (D).*

Beethoven's Ninth has acquired an almost mythical reputation for sublimity. It is, after all, the work that determined the storage capacity of the Compact Disc, even though a 90-minute CD might have made greater sense. Interpretations of the Ninth abound on CD, so it's only fair to ask whether Günter Wand has anything of value to tell us about Beethoven's ultimate symphonic statement. On the basis of this release, the answer is surely yes. In fact, this may well be the most generally recommendable account of the Ninth on CD.

In common with conductors like Bernard Haitink and Otto Klemperer, Wand has a powerful sense of musical architecture, which he communicates in performances that invariably highlight the logic that binds together a work's various movements. His approach to the Ninth is typical, yet unlike anyone else's. The first movement has a drive and drama reminiscent of Toscanini, with particularly impressive trumpets and timpani. The scherzo, which is almost exhaustingly intense, moves like the wind, with hardly any relaxation in the trio. After so much passion and frantic activity, the Adagio achieves precisely the sense of supernal calm and unearthly tranquility it must have, without becoming an exercise in Brucknerian stasis. Wand never loses the cantabile line and achieves a repose that refreshes rather than oppresses.

The finale keeps in sight the fact that its principal emotion is joy, not hysteria. No eccentricities of tempo mar the sense of mounting jubilation, as the movement proceeds. The chorus sings superbly, as do the soloists. The tenor's march variation moves with more uninhibited swagger than in any other performance I know. It's a superb moment, fully demonstrating the validity of Wand's approach: What other rendition has allowed such shameless prominence to bass drum and cymbals to such happily proletarian effect? Wand's performance exudes the serene confidence of a man who, having spent a lifetime with this music, trusts the composer to make his points simply and naturally. Aided in no small degree by the highly proficient North German Radio Orchestra and lovely recorded sound, both Beethoven and Wand succeed. Playing time: 66:17.

*David Hurwitz*

### BLISS: "A Colour Symphony"; "Checkmate" Suite.

● *Ulster Orchestra, Handley, Brian Couzens, prod. Chandos CHAN 8503 (D).* ● *ABRD 1213. □ ABTD 1213.*

Sir Arthur Bliss (1891-1975) was yet another distinguished member of the English musical renaissance that Edward Elgar launched and that composers as diverse as Michael Tippett, George Lloyd, and Peter Maxwell Davies continue. *A Colour Symphony* (1922) was Bliss's first major orchestral work. The colours (to adopt the British spelling) assigned to each of the work's four movements—purple, red, blue, and green—evoke heraldic symbolism and pageantry. Musically, the symphony sounds like a cross between Elgar and Walton: opulently scored and harmonically pungent, with a touch of jazz here and there. It's a beautiful work that sounds rather larger than its 30-minute playing time would suggest.

*Checkmate*, a 1937 ballet that follows the progress of a chess game, takes its subject very seriously. It also shows something of the moody, tragic qualities common to much British music written between the two World Wars—Walton's First Symphony (1935-36) and Vaughan Williams's Fourth (1932-35) come to mind. Like *A Colour Symphony*, *Checkmate* makes excellent musical use of its subject's traditional associations with royalty, conquest, and epic splendor. The ability to evoke these associations served Bliss well in his later role as Master of the Queen's Music.

Although both works have been recorded before, this CD marks the first time they have been coupled. In any case, not one of the earlier recordings was generally available in America, a fact that makes the current release all the more welcome. Vernon Handley and the Ulster Orchestra turn in expert performances that easily equal past accomplishments in this music, and the Chandos recording is typically splendid. Playing time: 56:11.

*David Hurwitz*

### CHADWICK: Symphony No. 2, in B flat. PARKER: "A Northern Ballad."

● *Albany Symphony Orchestra, Hegyi, Elizabeth Ostrow, prod. New World NW 339-2 (D).* ● □

It was once fashionable to deride the music of the Second New England School, a circle of late 19th-century Boston composers that included John Knowles Paine, Horatio Parker, and George W. Chadwick. At a time when American music education was in its infancy, Paine, Chadwick, and Parker all went to Germany to study composition, in the process absorbing the prevailing German Romantic idiom. Yet, despite the derivative and conservative nature of their own works, the

**ANNOUNCING**

MUSICAL AMERICA'S

# Festivals '88

A CONSUMER'S GUIDE TO 1,000 MUSIC FESTIVALS AROUND THE WORLD

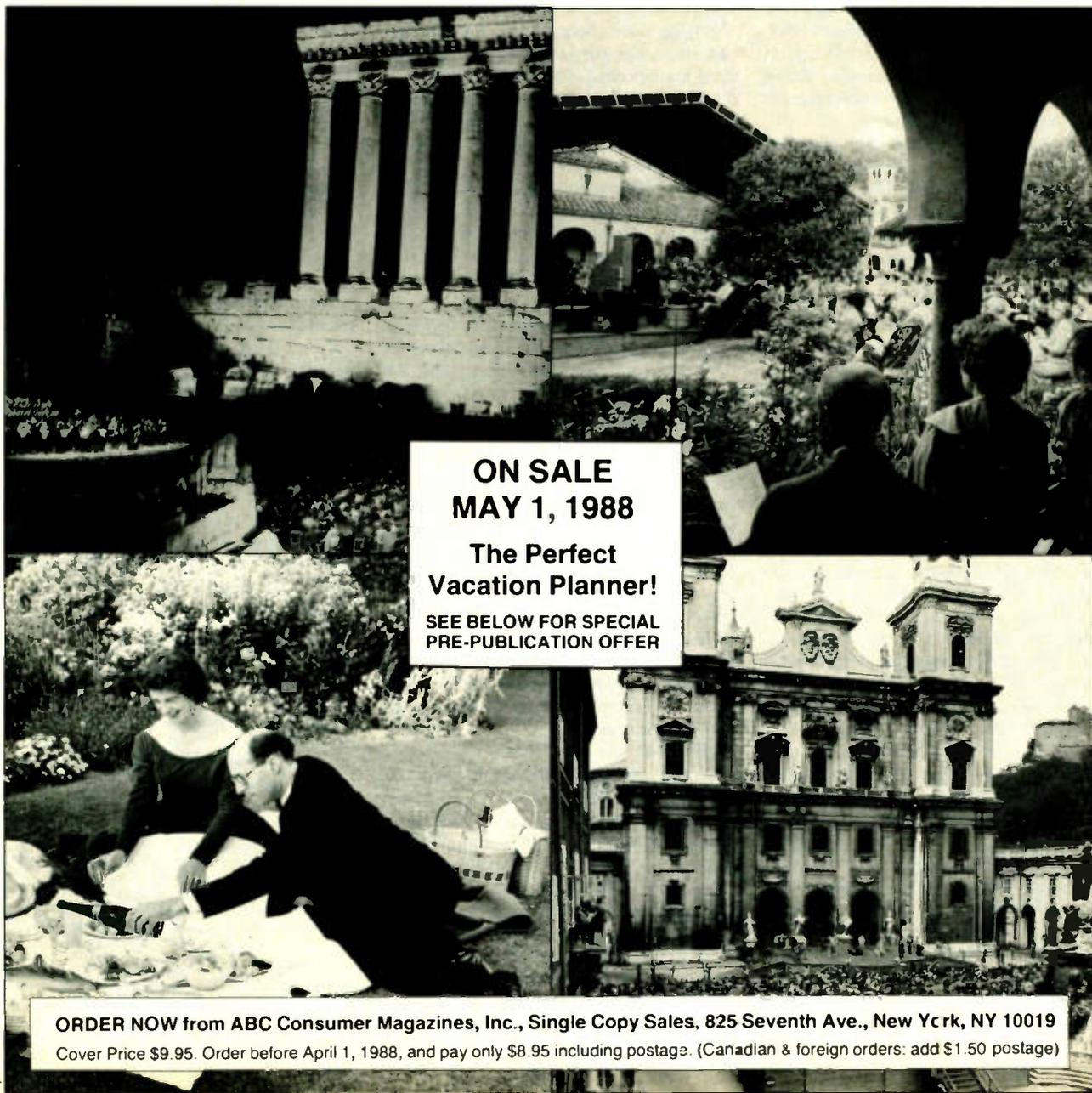

**ON SALE  
MAY 1, 1988**

**The Perfect  
Vacation Planner!**

**SEE BELOW FOR SPECIAL  
PRE-PUBLICATION OFFER**

**ORDER NOW from ABC Consumer Magazines, Inc., Single Copy Sales, 825 Seventh Ave., New York, NY 10019**  
Cover Price \$9.95. Order before April 1, 1988, and pay only \$8.95 including postage. (Canadian & foreign orders: add \$1.50 postage)

Balbeck

Carimoor

Glyndebourne

Salzburg

Bostonians performed no small service to American music. Like the European nationalists who were their contemporaries (in particular Smetana, Dvůřák, and Tchaikovsky), the Bostonians introduced their countrymen to the advanced harmonic language and the solid musical craftsmanship of the German school. Without that necessary first step, a truly native American music could never have developed in the ensuing generation.

Chadwick (1854–1931), whose Symphony No. 2 dates from 1883–86, was no avant-gardist, and his symphony is closer to the spirit of Dvůřák than to the chromaticism of Wagner. Equally evocative of Dvůřák is Chadwick's incorporation of pentatonic folk-like melodies, fully a decade before the Czech composer's *New World* Symphony provided the model for such treatment of indigenous material. Parker (1863–1919), Chadwick's student and himself the teacher of Ives and Sessions, imbued his *Northern Ballad* (1899) with a sentimental chromaticism that lends the tone poem a somewhat dated cast. Yet both works are formally coherent and effectively orchestrated.

The Albany Symphony Orchestra, under Julius Hegyi, is not equal to the demands of the Chadwick: The strings are thin in tone and ragged in ensemble, and the winds have occasional lapses in intonation. But the orchestra is eager, energetic, and deeply committed to this music. And one can have nothing but praise for the Albany Symphony's single-minded diligence in unearthing American music's long-buried treasures. Playing time: 50:44.

K. Robert Schwarz

**DRUCKMAN:** "Prism."

**ROCHBERG:** *Concerto for Oboe and Orchestra*.\*

*Robinson\**; New York Philharmonic, Zubin Mehta. Elizabeth Ostrow, prod. New World NW 335-2 (D). ◉ ◻

In *Prism* (1980), Jacob Druckman has produced an exercise in musical time travel. However, unlike Stravinsky in *Pulcinella* or Respighi in any number of works, Druckman deliberately avoids complete assimilation of his musical sources—in this case, 17th- and 18th-century operas by Charpentier, Cavalli, and Cherubini, all based on the myth of Medea. Instead, Druckman strains the music through a 20th-century filter. The result is quite entertaining, much like reflections in a fun-house mirror, but not all the reflections are amusing. As one might expect, some of the juxtapositions of 20th-century technique with 17th-century themes prove jarring. What Druckman wishes to express through this deliberate discontinuity, or through the Medea theme, is unclear. Perhaps it is that looking upon the past from a modern vantage point often distorts it.



HIGH FIDELITY ARCHIVES

Mehta meets the moderns.

George Rochberg—who, in referring to the styles of Beethoven, Mahler, and other composers in recent works, has done much to make the past respectable—shows in his plaintive *Concerto for Oboe and Orchestra* (1984) that historical pastiche and stylistic collage are no longer necessary excuses for tonality: One can just go ahead and write real music without worrying about Schoenberg. For this lesson alone, the musical world owes Rochberg a great deal. The concerto is a relatively subdued, melancholic, and meditative work, with most of the thinking done by the oboe, here very capably played by Joseph Robinson.

Zubin Mehta and the New York Philharmonic seem to have both works well in hand and are accorded good sound. But why not more music on the CD? Playing time: 40:47. Robert R. Reilly

**VERDI:** "Messa da Requiem"; *Te Deum*.

*Milanov, Castagna, Björling, Moscona*; orchestra and chorus, Toscanini. Arturo Toscanini Recordings Association ATRA 240 (A, 2). (Distributed by Music and Arts Programs of America, P.O. Box 771, Berkeley, Calif. 94701.)

Here at last is an agreeable-sounding release of a justly celebrated 1940 performance of Verdi's *Messa da Requiem* that, until now, has circulated privately in assorted less listenable editions. The acetate sources are remarkably well preserved and quiet, and the transfer to Compact Disc is as faithful as one could wish. Furthermore, the performance dates from a period when both Arturo Toscanini and the NBC Symphony Orchestra (unnamed on the label) were at a peak.

By 1940, the NBC Symphony, which had been a remarkable assemblage of excellent young players from the start, had attained a homogeneity that made it equal in most respects to the orchestras of Boston, New York, and Philadelphia. As for Toscanini, many of his broadcasts and recordings after he left the New York Philharmonic in 1936 had been less expansive in tempo and more energy-charged than before. But by 1940, he was again conducting with the breadth and freedom of tempo (always controlled by his sense for formal

coherence) and the dramatic accentuation and inflection of line that had been characteristic of his performances with the Philharmonic. As a consequence, his 1940 concert of the *Requiem* was at once relaxed and powerful, and it remains one of the greatest on record.

However, rating the 1940 performance as highly as it deserves should not cause one to underrate the 1951 RCA recording, which will be reissued soon on CD. In his liner notes for this album, Toscanini biographer Harvey Sachs wonders why Toscanini never approved the 1940 broadcast for commercial release: "The recording contains some superb singing, especially from Milanov and Björling," he writes. "... Castagna and Moscona also sing well, although not at their partners' level. ... Orchestra and chorus are outstanding. ... The sound [in Carnegie Hall] has none of the unpleasantly tinny quality that mars many of the NBC broadcasts." The few errors by the soloists that may have bothered Toscanini "occupy in all less than a minute of the *Requiem's* total length" and are of a kind that "we, nearly half a century later, can easily put into perspective."

However, I hear other flaws that occupy more than a minute, although I can still put them in perspective: The orchestra and chorus do not sound consistently together until the "Recordare." The offstage trumpet notes in the "Tuba mirum" are cracked repeatedly. The soloists do not relax and sing at their best until well into the "Kyrie" (and, as Sachs observes, Milanov later becomes nervous again and ruins her high B flat in the "Libera me"). Moreover, the microphone picked up only enough of Carnegie Hall's reverberation to give most sections of the score clarity and amplitude, but not enough to prevent the violent sec-

## FORMAT KEY

- ◉ LP
- ◻ Cassette
- Compact Disc
- ◻ Videocassette
- ◻ Videodisc
- ⊗ Open reel

### RECORDING INFORMATION

- (A) analog original
- (D) digital original

Large symbol beneath title indicates reviewed format. Small symbols following catalog number of reviewed format indicate other available formats (if any).

Catalog numbers of all formats of a particular recording usually are identical except for differing prefixes or suffixes. Catalog numbers of formats other than the reviewed format are printed only if their basic numbers differ substantially from that of the reviewed format.

Arabic numeral in parentheses indicates number of items in multi-item set. Unless otherwise indicated, all multi-LP sets are in manual sequence.

tions from sounding hard and shallow. In addition, the biggest climaxes are cut back by a volume limiter not compensated for in the transfer to CD.

In contrast, the 1951 RCA recording was assembled largely from rehearsal tapes. With no audience or radio transmission to worry about, the soloists, chorus, and orchestra made fewer mistakes than the 1940 forces did during their live broadcast. The soloists in 1951 did not include a Milanov or a Björling, but the quartet was better balanced: The beautiful singing of the soprano (Herva Nelli) and the tenor (Giuseppe di Stefano, who sang well until after the "Ingemisco") were matched this time by the superb voices and musicianship of contralto Fedora Barbieri and bass Cesare Siepi. The NBC Symphony was playing marvelously in those years, and the chorus was the wonderful Robert Shaw Chorale. Like the performances of 1940, the 1951 recording took place in Carnegie Hall. But the empty auditorium and better microphones produced a more spacious and resonant sound in 1951 than had been possible 11 years before.

The differences in these two interpretations are not an instance of a relaxed early performance being followed by a tense, less expansive one in Toscanini's last years. They are an instance of the sort of changes in expressive detail that occurred in many of Toscanini's performances from one year to the next but that did not diminish the overall impact of those performances. The isolated 1951 passages are faster for dramatic effect, and some passages are more expansively treated in the later version than in the earlier one. Rarely has more than one version of a Toscanini interpretation been made commercially available. The proper response in this case, it seems to me, is to recommend both. It remains only to add that ATRA's CD of the 1940 *Requiem* also contains Toscanini's wonderfully clear and eloquent performance of Verdi's *Te Deum* from the same broadcast. Playing time: 99:50.

Thomas Hathaway

**WAGNER: "Der fliegende Holländer."**

● *Balslev, Schunk, Estes, Salminen; Bayreuth Festspiele Orchestra and Chorus, Nilsson. Philips 416 300-2 (2, D). © 416 300-1 (3).*

The postwar Bayreuth tradition of Wagner performance has been extensively documented on commercial recordings, beginning with the London releases of the old Knappertsbusch *Parsifal* and Keilberth's *Lohengrin* and *Der fliegende Holländer*. Philips was given the honor of creating a stereo document of the '60s and '70s, including the later Knappertsbusch *Parsifal* and the dazzling Karl Böhm *Ring*. In light of that often illustrious lineage, it is discouraging to have to greet this

*Holländer* in less than glowing terms.

Philips has done a predictably splendid job of harnessing the Bayreuth acoustic and seeing to it that the voices and orchestra emerge in pristine balance. But one can say little for the performance. Production values were always of primary consideration at Bayreuth, but when the casts included the likes of George London, Hans Hotter, Theo Adam, Astrid Varnay, Leonie Rysanek, Birgit Nilsson, and so on, one experienced aural thrills as well. The present recording, taped in 1985, captured

the last revival of seven of Harry Kupfer's now legendary production. It put Simon Estes on the vocal map once and for all, and he was heralded by all who saw him as the Dutchman of the day.

How soon critics and public forget, it seems, the greats of the past (even as recent as Theo Adam). I heard Estes in the role in Boston in the late '70s and found him stolid and remarkably dull. My memories were not altered by listening to this Bayreuth performance. Devoid of the trappings—Kupfer's concept is that the

# Impressive, says Stereo Review.

## Signet SL-100 Definitive Image™ Loudspeaker



“Compared with many other speakers, on first hearing the Signet SL-100 had a warm character, with an impressively deep bass output. At higher frequencies the sound was seamlessly blended and well dispersed.

Overall, the Signet SL-100 impressed us with its superb bass, especially for its size, and its ability to provide clean, well dispersed sound at high volume levels.

Altogether, a very nice job!”

• Julian Hirsch, Hirsch-Houck Laboratories, *Stereo Review*, July 1987

For your copy of the complete review, literature, and the name of your nearest Signet dealer, write today.

**signet.**

4701 Hudson Drive, Stow, OH 44224

### Signet's Exclusive Ferralipse® Acoustic Lens†

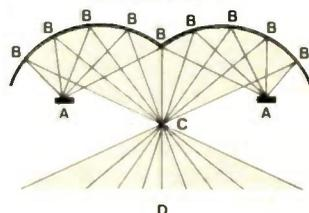

Sound from two matched 1" tweeters (A) is directed at the Ferralipse Acoustic Lens. Highs are then reflected (B) to a central focal point (C), which radiates through a 120° horizontal angle (D) with far greater uniformity and efficiency than traditional designs.

“We listened for any signs of beaming or comb-filtering effects as we walked past the front of the speakers, using both music and pink-noise signals, but we could find none.”

• *Stereo Review*, July, 1987

†U.S. Patent No. 4,421,200.

Ferralipse is a registered trademark of Phase Coherent Audio, Inc.

story is but the deluded hallucination of a hysterical Senta—it is a rather dispiriting affair. There is a staunch reliability in the way Estes plows through the role, but there is no attempt to project the *meaning* of the words or to shade and inflect the line. Lisbeth Balslev's wiry voice has no particular color, and its core melts under the pressure of the performance's intensity. There is a certain excitement in the way she handles the *Ballad*, but in the big duet with the Dutchman, "*Wie aus der Ferne*," a raucous quality creeps in that makes the tone altogether ugly. From that point on, Balslev never quite recovers her poise.

Matti Salminen makes a sonorous, suitably boisterous Daland, Graham Clark a small-voiced but musical Steuermann, Anny Schlemm a characterful Mary, and Robert Schunk a rather pedestrian Erik. Woldemar Nelsson conducts a fleet, energetic, slightly lightweight but very exciting reading of the score, and hearing the music in that Bayreuth acoustic is always a thrill.

Unfortunately, Kupfer's production is based on the original Dresden version that omits the Redemption motif. And at score's end, some of the repeated chords are deleted, replaced by frightening crunches that sound like a preplanned collapsing of parts of the set. This should have been corrected in a patch-up session. Playing time: 133:58. *Thor Eckert, Jr.*

## THEATER AND FILM

**CONTI: "The Right Stuff" Symphonic Suite; "North and South" Symphonic Suite.**

*London Symphony Orchestra, Conti.*  
 ① *Bill Conti, prod. Varese Sarabande VCD 47250 (D).* ② 704.310. ③ C704.310.

Certainly one of the most successful film composers in the business, Bill Conti may also be one of the most important. I said *maybe*. While his best efforts reveal a solid command of the orchestra and an ability to find new ways of approaching clichéd subjects, his worst can be banal in the extreme. Something of both sides is represented in suites from two recent Conti scores, *The Right Stuff* and *North and South*. The score to *The Right Stuff* walks a dangerous line, masterfully evoking Holst's *The Planets* and Tchaikovsky's Violin Concerto, yet never quite wallowing in them to the point of plagiarism. *North and South* dishes up gobs of sugary pap, all dominated by an inane main theme—*Gone with the Wind* it ain't. For once, the London Symphony is underserved by Varese Sarabande's digital sonics. Those interested in catching Conti in a more imaginative vein are directed to his score for *F/X*, currently available only on vinyl (Varese Sarabande TV 81276). Playing time: 37:22. *Noah André Trudeau*



*Previn follows his own tough act, 20 years later.*

**WALTON: Symphony No. 1, in B flat minor; Crown Imperial; Orb and Sceptre.**

*Royal Philharmonic Orchestra, Previn.*  
 ① *James Mallinson, prod. Telarc CD 80125 (D).*

André Previn's 1967 RCA recording of Sir William Walton's turbulent First Symphony with the London Symphony Orchestra has long been regarded as the benchmark performance of this 20th-century British masterpiece. Unaccountably, though, it disappeared from the catalog only a few years after it was issued. That regrettable situation has been rectified by the release of Previn's new recording of the symphony with the Royal Philharmonic Orchestra on Telarc.

Fortunately, Previn's interpretation has changed very little over the past two decades. A few passages (notably the climaxes of the first and fourth movements) are treated somewhat more spaciously than before, but this doesn't interfere with the conductor's prevailing dynamic approach, which shows that this symphony is music still very much of our own time. Moreover, Previn acutely defines the basic mood of the piece—the threat of impending war and the eventual triumph by the forces of good against evil. The only thing that keeps this version from being definitive is the slightly disappointing recording: It's full, powerful, and resonant enough, but the crucial timpani part booms more than it hits, keeping the in-

strument's sound from striking one's solar plexus as it should. That aside, Walton's finest orchestral work has never received a finer recording on disc. Walton's two popular coronation marches—*Crown Imperial* and *Orb and Sceptre*—are likewise brilliantly done (and somewhat better recorded), though I would have liked a broader overall tempo in the former.

*Bill Zakariasen*

André Previn's 1967 Walton First on RCA was justly acclaimed as the touchstone for all subsequent recordings. It combined hair-trigger precision with smoldering lyricism in a way that truly enhanced the stature of this wonderful symphony. Under any circumstances, it would have been a tough act to follow. How sad, then, that Previn doesn't even seem to have tried: His new performance on Telarc utterly lacks the punch of the old. The Royal Philharmonic sounds tired—it plods through the Waltonian rhythmic thicket, never once attaining the bite of Alexander Gibson's Scottish National Orchestra in a far more gripping performance on Chandos (CD 8313), to say nothing of the way the London Symphony sounds in Previn's earlier version.

The coda of the finale reveals just how seriously Previn has gone wrong. The all-important writing for antiphonal timpani sounds soggy, and the tam-tam part is mostly inaudible. The elegiac trumpet solo, with its jazz inflections, utterly lacks atmosphere and tenderness. In the closing pages, the orchestra seems to have trouble staying together even at the leaden tempo Previn adopts. As in his recent Telarc recording of Vaughan Williams's *A London Symphony*, Previn seems to have withdrawn into himself as an interpreter, pulling back from every major climax and allowing the tension to seep away. The two coronation marches come off better, though it was a mistake to opt for the abridged version of *Crown Imperial*, especially on disc.

Telarc's recording, as seems to be its custom these days, offers a plush sound that is short on treble information. Though the climaxes are well balanced, especially in the symphony, they lack visceral impact. The marches demonstrate Telarc's trademark mike-in-the-bass-drum sonics—vulgar in the best sense and undeniably effective. (Although the symphony does not employ a bass drum, this brighter sound would have been better suited to it.) The symphony's second movement, "*Andante con malinconia*," has become "*Andante con maunconia*" in Telarc's rendering. Somehow, this lapse seems representative of the whole boring enterprise. Playing time: 59:04. *David Hurwitz*

Backbeat®

# Ring In the Old

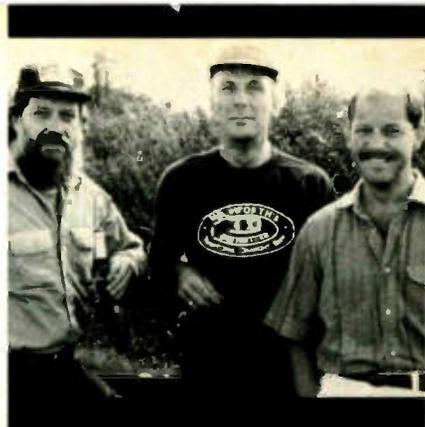

DINO SAFARI

**PINK FLOYD: A Momentary Lapse of Reason.**

Bob Ezrin and David Gilmour, prods.  
 ① Columbia CK 40599. ◯◻

**JETHRO TULL: Crest of a Knave.**

Ian Anderson, prod. *Chrysalis* VK  
 ① 41590. ◯◻

In the late Sixties and early Seventies, bands like Pink Floyd and Jethro Tull seemed to anticipate the future of rock. Who would have thought that by the Eighties, art rock—once deemed progressive—would widely be considered pretentious and passé? Notwithstanding, both Floyd and Tull have survived to the brink of the Nineties, and though their music has evolved considerably over the last 20 years, both remain tied to (somewhat com-

promised) progressive traditions.

The unmistakably Floydian *A Momentary Lapse of Reason* smashes ex-member Roger Waters's absurd claims that a band without him cannot justifiably call itself Pink Floyd. Moreover, the David Gilmour-dominated songs are a lot less boring than the self-indulgent drivel on *The Final Cut*. Liberated from Waters's endless whining about alienation and squelched postwar dreams, Gilmour dwells on sorrows of his own but introduces a drop or two of hopefulness in "Learning to Fly" and "On the Turning Away," which, along with the instrumental "Terminal Frost," happen to be the album's best cuts. A conspicuous repetition  
*(Continued on page 68)*

*Pink Floyd relearns to fly (from left): Nick Mason, David Gilmour, and Richard Wright. What's more, Jethro Tull proves it's definitely not too old to you—now what (w.p.): Ian Anderson, David Pegg, and Martin Barre. For an update on Yes and Rush, turn the pages.*





**Stereo Headphones**



**Beyerdynamic DT-990**  
Audiophile Stereo Headphones  
• Open style headphone with an unexcelled  
frequency response of 5-35kHz • Unique  
moving coil assembly • Exceptional detail  
Sale Price **\$159<sup>95</sup>** LIST \$185

- Beyerdynamic DT-880 Studio**  
The choice of pro recording studios **\$179<sup>95</sup>**
- Beyerdynamic DT-770**  
Closed ear headphones **\$139<sup>95</sup>**
- Beyerdynamic DT-330**  
Lightweight open air headphones **\$54<sup>95</sup>**
- Beyerdynamic DT-880**  
Wide frequency response **\$119<sup>95</sup>**
- Koss JCK-200**  
New wireless headphones **\$117<sup>95</sup>**
- Koss Pro4AAA +**  
Closed ear headphone **\$49<sup>95</sup>**
- Sennheiser HD-414SL**  
Open air digital ready **\$54<sup>95</sup>**
- Sennheiser HD-430**  
Wide response open air **\$84<sup>95</sup>**
- Sony MDR-CD6**  
New lightweight digital ready **\$89<sup>95</sup>**
- Sony MDR-V6**  
Closed ear digital ready **\$89<sup>95</sup>**
- Sony MDR-M33**  
Lightweight digital ready **\$44<sup>95</sup>**
- Sony MDR-31A**  
Lightweight walkman style **\$19<sup>95</sup>**

**Compact Disc Player Specials**



**Sharp DX-650**  
Programmable Compact Disc Player  
• 3-beam laser • 20-selection random access  
program memory • 3-way repeat • Forward/  
reverse search • Low profile black finish  
Sale Price **\$129<sup>95</sup>** LIST \$199

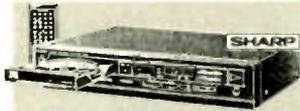

**Sharp DX-R750**  
Remote Compact Disc Player  
• Programmable music search • Wireless  
remote control • Digital display • Low profile  
front loading design • Black finish  
Sale Price **\$169<sup>95</sup>** LIST \$279



**Technics SL-P320**  
Remote Compact Disc Player  
• Direct access keypad on the front panel  
and wireless remote • 20-track memory • High  
resolution digital filter • 3-way repeat • Black  
Sale Price **\$219<sup>95</sup>** LIST \$449



**Teac PD-100**  
Programmable Compact Disc Player  
• 32 selection random memory programming  
• 3 beam laser • Double oversampling digital  
filter • DiscTrack repeat • Black  
Sale Price **\$149<sup>95</sup>** LIST \$349



**Technics SL-P520**  
Advanced Technology CD Player  
• Class AA circuitry • 2-speed dial search  
cueing • Hires digital filter • 20-track random  
programming • Wireless remote with volume  
Sale Price **\$299<sup>95</sup>** LIST \$599



**Technics SL-P720**  
Hi-Performance Compact Disc Player  
• 2-speed dial search cueing • High speed  
transport • Wireless remote with volume control  
• Double-oversampling • Class AA circuitry  
Sale Price **\$349<sup>95</sup>** LIST \$599

**Audio Accessories**



**Parsec 7403-II**  
Electronic Indoor  
FM Antenna  
• Now you can enjoy  
better FM reception  
today • Adjustable gain  
control • Amplifies  
incoming FM signal  
• AC operated • Full  
one-year warranty  
Sale Price **\$29<sup>95</sup>** LIST \$89



**dbx 400XG**  
Active Program Route Selector  
• Connect up to 3-tape decks 3-sound  
processors and a noise reduction unit • LED  
illuminated push button selectors  
Sale Price **\$149<sup>95</sup>** LIST \$299

**dbx Audio Specials**

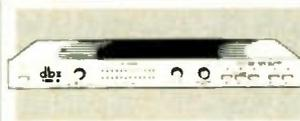

**dbx 1B8-DS**  
Dynamic Range Controller  
• Special impact recovery system adds  
"punch" to LP's or video tapes • Stereo focus  
& ambience control • Overeasy compression  
Sale Price **\$179<sup>95</sup>** LIST \$280



**dbx 224X-DS**  
Type II Noise Reduction System  
• Rack mountable NR system which effectively  
doubles tape deck's dynamic range • 40db  
min. noise reduction • 2-deck switching  
Sale Price **\$179<sup>95</sup>** LIST \$299

**Sony Audio Tape Specials**



**Sony Metal-ES 90**  
Metal Bias Audio Cassettes  
• Enjoy the finest sound from your stereo  
cassette deck • Whether your recording from  
compact disc, records or radio  
Sale Price **\$34<sup>90</sup>** 10-Pack



**Sony UX-PRO 90**  
High Bias Audio Cassette Special  
• The ultimate high bias cassettes from Sony  
• Clear cassette shell • Professional reference  
tape designed for digital audio or live music  
Sale Price **\$22<sup>99</sup>** 10-Pack

**VHS Video Movie Specials**



The Egg And I Your Choice



Morocco



Mirage

And Many More Titles Available:  
• Your Can't Cheat An Honest Man • Top Hat • Against All Flags  
• Gunga Din • The Buccaneer • Citizen Kane • Shall We Dance?  
• Lover Come Back • It's A Gift • Follow The Fleet • King Kong  
• Never Give A Sucker An Even Break • She Ware A Yellow Ribbon  
• Botany Bay • Carefree • A Time To Love And A Time To Die

**14<sup>95</sup>** Each

**Stereo Receiver Specials**

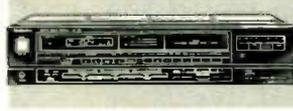

**Technics SA-180**  
Digital AM/FM Stereo Receiver  
• Quartz synthesizer digital tuning • 16-presets  
• Solid 35 watts per channel with low distortion  
• 3-LED signal meter • Black  
Sale Price **\$129<sup>95</sup>** LIST \$240

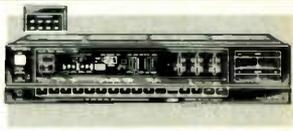

**Technics SA-R210**  
Remote Control Stereo Receiver  
• AM/FM quartz synthesizer tuner • 40-watts  
per channel • 30-key wireless AV remote  
control • 24-presets • 3-band EQ • Black  
Sale Price **\$199<sup>95</sup>** LIST \$349



**Akai AAV-205B**  
Remote Audio/Video Receiver  
• 60 watts/channel • Versatile A/V control  
features 3-video & 5-audio inputs • Surround  
sound system • 5-band EQ • 16-presets • Black  
Sale Price **\$249<sup>95</sup>** LIST \$399



**JVC RX-750VBK**  
Remote Control Digital Receiver  
• 100 watts/channel • 7-band electronic EQ  
with 5 presets • AM/FM digital tuner/Juner with  
16 presets • Wireless remote • Black finish  
**CALL FOR PRICE**

**HOW TO ORDER BY MAIL: SEND MONEY ORDER, CERTIFIED OR CASHIER'S CHECK, MASTERCARD, VISA or AMERICAN EXPRESS (Include card number, Interbank No, expiration date and signature.) TO: J&R MUSIC WORLD, 59-50 QUEENS-MIDTOWN EXPRESSWAY, MASPEH, NY 11378, DEPT. HFO188. DO NOT SEND CASH. Personal and business checks must clear our Authorization Center before processing. \$25 Minimum Order. Shipping, Handling & Insurance Charge Is 5% of Total Order with a \$3.95 minimum. (Canadian Orders Add 15% Shipping, with a \$9.95 minimum charge.) For shipments by air, please double these charges. SORRY, NO C.O.D.'s. NEW YORK RESIDENTS PLEASE ADD SALES TAX. ALL MERCHANDISE SHIPPED BRAND NEW, FACTORY FRESH, AND 100% GUARANTEED. WE ARE NOT RESPONSIBLE FOR ANY TYPOGRAPHICAL OR TRANSPOSITIONAL ERRORS.**



(Continued from page 65)

of oneness (one world, one slip, one sound, one kiss, one soul) seems to be more coincidence than unifying theme, making this Pink Floyd's first non-Concept Album in many years, and that is indeed refreshing. The dramatic *Wall*-like production wears thin after a while, however, and Gilmour's ever-peaking, comfortably numbing guitar solos could use a bit more variety.

By the way, there are no extra tracks on the Floyd CD, but the package does contain extra artwork. In contrast, Jethro Tull's *Crest of a Knave* CD offers two non-LP cuts, both every bit as good as the rest of this surprisingly excellent collection. Purportedly put together with the help of a 600-fan survey (smells like a PR gimmick to me), this is easily Tull's best album since the 12-year-old *Minstrel in the Gallery*: Ian Anderson's writing has a renewed sharpness, his distinctive flute attacks are as vigorous as ever, and what's left of his band sounds fresh and limber. True, Anderson's voice is beginning to

wear: On "Budapest" he comes across more like a raspy Mark Knopfler than the robust Anderson of old. But his aging vocal cords belie a fertile creativity, which will probably be fueling some descended form of progressive rock well into the 21st century.

Andrew Nash

**YES: Big Generator.**

Yes, Trevor Rabin, Paul De Villiers, and Trevor Horn, prods. Atco 90522-1.

CD

**RUSH: Hold Your Fire.**

Peter Collins and Rush, prods. Mercury 832 464-1. CD

A thirtyish man in a business suit points to the album I'm carrying. "Good record," he smiles. Old Springsteen? No: new Yes. Later the same day, a teenager washing his car blasts music from his bedroom. New Springsteen? No: old Rush. As Donovan once put it, welcome to the 7-Tease.

The refitted Yes has survived a lot better than most warhorses. Its 1983 surprise comeback, *90125*, was a radiant, high-

spirited marriage of old-fashioned art rock and newfangled pop economy, kept ever new by the impressive Adventures in Studioland conducted by producer Trevor Horn. This time out, Horn is the last listed of four producers, and though the full band is credited first, it's really guitarist Trevor Rabin who calls the shots—which means that *Big Generator* is more guitar-heavy, more ponderous, and therefore less interesting than *90125*. At the same time, the band seems to enjoy the relative freedom from Horn's machines, so that whereas "Big Generator" at first sounds like blatant self-plagiarism of the riff, solo, and effects from "Owner of a Lonely Heart," the song ultimately hits home as wonderful self-parody, with lyrics suggesting how completely the mechanical can replace the human: "Even if you close your eyes/We exist through this strange device." Besides, it's great to hear Yes sound so *mean*. And there's more to like: the sinister chorus of "Shoot High Aim

(Continued on page 72)

## Honesty. It's been a rare virtue in sound.

### Until now. Introducing the new Design Acoustics PS-103 3-Way Loudspeaker



While other speakers attempt to make their mark with bombast and sizzle, the Design Acoustics PS-103 loudspeaker system has been created to accurately reflect the actual sonic drama of the music. No more. And certainly no less.

**Hear the original acoustic space**

The PS-103 starts with smooth, uniform response for every octave of music. That's basic. Dispersion at the higher frequencies is also enhanced by a tapered, sealed, independent Point Source enclosure for the 6" mid-range and 3/4" tweeter. The result of this combination is an appropriate spaciousness to the reproduced sound... neither collapsed, nor overextended. With the PS-103, the illusion of a live performance is more accurate, making possible a more intense reaction to the music.

**Bass you can feel**

The illusion is enhanced by the extended bass performance from the 10" down-firing woofer, housed in its own cabinet with unique multi-element baffles that stiffen the enclosure while smoothing and extending useful sound output. You both hear and feel the deepest bass, while sensing the original room acoustics all around you.

**Honestly superior**

Before you settle for an artificial sounding speaker, give our spectacular honesty a chance. Audition the Design Acoustics PS-103 loudspeaker system today. Write for the names of Design Acoustics dealers in your area. Like you, they are very serious about very good sound.

**DCI** DESIGN®  
ACOUSTICS  
An Audio-Technica Company  
1225 Commerce Drive, Stow, OH 44224

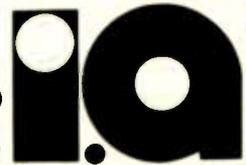
**SAVE MONEY · TIME · FREIGHT****illinois audio**12 EAST DELAWARE PLACE, CHICAGO 60611  
312-664-0020 • 800-621-8042**LOUDSPEAKERS****TECHNICS**

- SB-L35 10" 2-WAY ..... \$ 41.00 ea.  
SB-L55 10" 3-WAY ..... \$ 57.75 ea.

**PORTABLES/AUTOS****SONY PORTABLES**

- D-10 New! Programmable CD . CALL  
WM-F100 II Super Walkman w/AM-FM, Dolby & Auto. Rev. .... \$125.00  
WM-F77 AM/FM, Cassette w/dolby ..... \$ 84.95  
DD-100 Famous "Boodo Khan" cassette player! . CALL

**TOSHIBA PORTABLE**

- KT-4046 AM/FM, Cass., A/R, EQ, w/Dolby ..... \$ 59.95

**AIWA PORTABLE**

- CA-W75 AM/FM, Dubbing W/Dolby ..... \$115.00

**SHARP PORTABLE**

- WQ-CD15BK AM/FM, Cassette W/CD ..... \$349.00

**PANASONIC PORTABLES**

- RX-FD80 AM/FM, Cassette W/CD ..... \$305.00  
RX-HD10 Mini-AM/FM, Dubbing Cassette w/HD ..... \$155.00

**JVC PORTABLE**

- PC-37JBK AM/FM Cassette w/Auto-Rev., 5 Bd. Eq. & 2-way Spkr. .... \$ 99.00

**SONY AUTO.**

- ES-R12 Hi-Powered, Dolby, In-Dash ..... \$159.95

**JVC AUTO.**

- XLC-30 AM/FM, CD, 15 TK Prog ..... CALL  
KS-RX305 AM/FM, Cass., W/Dolby, Auto Reverse ..... \$219.95

**JENSEN AUTO.**

- JTX-300 6x9 Tri-axial Speakers (pr) ..... \$ 59.00  
JS-6200 12 Preset Digital AM-FM Cassette Player w/Auto-Reverse, Seek & Scan Tuning & CD Input \$145.00

**SHERWOOD AUTO.**

- CRD-210 Digital AM/FM w/Dolby B & C ..... \$165.00  
CRD-350 AM/FM w/Dolby B, C & Tape Scan ..... \$189.00

**CASSETTE DECKS****TECHNICS CASSETTE DECKS**

- RSB-915 Soft touch controls w/Dolby B ..... \$ 95.00  
RST-922 Dolby B & C w/Hi-Speed Dubbing ..... \$145.00  
RST-55R Dolby B, C, & dbx dbl Deck w/Reverse Edit. .... CALL

**TEAC CASSETTE DECKS**

- R-888X 3 Mtr, 3 HD, B, C & dbx ..... \$379.00  
R-606X Dolby B, C & dbx w/Auto-Reverse ..... \$219.00  
V-770 3 HD, 2 Mtr. with Dolby B, C & HX PRO ..... \$289.00

**SONY CASSETTE DECK**

- TCW-223 Hi-Speed Dubbing w/Dolby B & C ..... \$149.95

**JVC CASSETTE DECK**

- DDVR77J Quick Rev., Dolby B & C ..... \$239.00

**TEAC VIDEO**

- MV-350 HQ Circuitry, Mono, w/Remote ..... \$239.95

**RECEIVERS/TUNERS/AMPS/PROCESSORS**

- KENWOOD KR-V56R (55x2), AM/FM Audio-Video Receiver, 20 Presets, 5 Bd., CD Ready w/Remote ..... CALL

- KENWOOD KR-V86R (80x2) W/Remote ..... CALL

- SONY STR-AV31 (40x2) AM/FM Digital &/Remote ..... CALL

- TECHNICS SA-290 (50x2) Quartz Digital Receiver, Video & CD Inputs, 16 Presets ..... \$155.00

- TECHNICS SA-R310 (55x2) Audio/Video Receiver w/Remote ..... \$255.00

**RECEIVERS/TUNERS/AMPS/PROCESSORS**

- TECHNICS SA-R410 (100x2) 7bd Eq w/Remote ..... \$360.00

- TECHNICS ST-G40 AM/FM Qtz. Dig. Tuner w/16 Presets ..... \$119.00

- TECHNICS SU-V60 (90x2) Class AA Integrated Amp., Video & CD Inputs ..... \$247.00

**SURROUND SOUND DECODER**

- SHURE AVC20 Video/HiFi system expander with Dolby surround sound ..... \$389.00

**EQUALIZERS**

- TECHNICS SH-8046 14 Bd. w/Analyzer ..... \$150.00

- TEAC EQA-20B 10 Bd. per Channel w/Tape Dubbing \$ 99.95

- ADC SS-415X 10 Bd. per Ch., w/Computer Memory ..... \$169.95

- ADC SS-525X NEW! Computerized, 12 Bd per Ch., w/Spectrum Analyzer & Remote ..... CALL

**TURNTABLES/CDs****TECHNICS**

- SL-BD35K Fully Auto, Belt Drive ..... \$ 99.00

- SL-QD35K Above w/Quartz Direct Drive ..... \$121.00

- SL-QD22 Semi-Auto, Quartz, Direct Drive ..... \$116.00

- SL-L20K Full-Auto, Linear Tracking ..... \$124.00

**illinois audio**12 East Delaware Place  
Chicago 60611**16 YEARS OF MEETING THE NATION'S STEREO NEEDS!****10 to 5 MONDAY—SATURDAY**  
**312-664-0020 • 800-621-8042**Price & Availability Subject to Change  
Clearance Time Required on Personal & Company Checks  
Freight charges not included in these prices.

SHURE

JENSEN

JVC

Technics

Qual

TEAC

TDK

# MITSUBISHI DRIVES THE

Mitsubishi believes that mobile electronics shouldn't take a back seat to home electronics. For that reason, we've created our Diamond Collection® — an exclusive group of advanced components that puts future technology at your fingertips.

We spend more time listening to music in our cars than we do at home. Our DiamondAudio™ products put high-performance audio

on the road... from high-powered, in-dash models specifically designed for most GM\* domestic cars to the ultimate in auto sound — Compact Disc.

There's features you'd only expect from a company on the leading edge of electronic innovation. Our exclusive 3-Stage Tuner, FM Signal Processor and audible mode-confirmation of functions for ease

of use and safety while driving. Even AM stereo on selected models.

It's no surprise that a company that was at the forefront of cellular communications technology has developed another technological coup: The DiamondTel® 55 cellular telephone. We dramatically reduced the transceiver, and integrated



# FUTURE.

it into the base of the phone. This exclusive design allows you to use it mobile or transportable. But don't be fooled by its compact size. It's packed with intelligent features that make it the industry leader.

Mitsubishi's DiamondSentry™ auto security systems share Diamond Collection's common denominator of quality and reliability.

They're much more than just alarms. DiamondSentry is a complete integrated security system with custom LSI circuitry that provides maximum features and compact size. DiamondSentry is easy to use and delivers superior protection for your vehicle.

Drive the future with Mitsubishi's Diamond Collection Mobile Electronics Products. Experience what's down the road. Today.

 **MITSUBISHI**  
MOBILE ELECTRONICS

© 1987 MITSUBISHI ELECTRIC SALES AMERICA, INC.  
800 Biermann Court • Mount Prospect, IL 60056  
(312) 298-9223  
8885 Woodbine Avenue • Markham, Ontario L3R 5G1  
(416) 475-7728



(Continued from page 68)

Low," the nutty humor of "Almost Like Love," the segue from strings to the inescapably hummable riff of "Love Will Find a Way," and the Yes-of-yore workout in "I'm Running." It's no match for the inventive 90125, but *Big Generator* isn't bad for a bunch of veterans taking refuge in young man's pleasure.

Rush isn't as strange a review-fellow for Yes as one might think: At its best, the Canadian trio has always drawn more from the intricacies of progressive Brits than from the stomp of hard rock. Rush did start out as a screeching metal act on its 1974 debut, but the band matured remarkably over its next eight studio LPs, along the way mastering long-form instrumental gymnastics (*Hemispheres*), successfully condensing its material into shorter songs (*Permanent Waves*), and re-vamping its sound with intelligent synthesizers (*Signals*). How disappointing, then, were the tiredly chugging *Grace Under Pressure* and *Power Windows*, the latter more Rut than Rush. Fortunately, *Hold Your Fire* is an improvement. This, not *Permanent Waves*, is Rush's first true pop record: The band fits ten songs on one LP, with more than the usual hooks and catchy tunes, especially in the one-two-three opening of "Force Ten," "Time Stand Still," and "Open Secrets." Co-producer Peter Collins's sound is brighter than last time, too—though occasionally to the point of thinness. (Then again, each side runs a vinyl-stretching 25 minutes, and as the group admits, the album was conceived with the Compact Disc in mind.) There are genuine problems: Side 2 drags, guitarist Alex Lifeson doesn't make enough noise, and the production still begs for former co-producer Terry Brown's sonic boom. Nevertheless, *Hold Your Fire* is a healthy rebound for a band still worth following.

Ken Richardson

#### BRUCE SPRINGSTEEN: *Tunnel of Love*.

Bruce Springsteen, Jon Landau, and Chuck Plotkin, prods. Columbia OC 40999. □

Though not nearly as extreme an excursion as *Nebraska*, Bruce Springsteen's *Tunnel of Love* is certainly a departure after *Born to Run* and the famous boxed live set, two releases that featured the E Street Band as, respectively, powerful well-oiled studio machine and loose-limbed in-concert juggernaut. The music accompanying Bruce on this one is, for the most part, restrained: acoustic guitars, soothing keyboards, discrete percussion (with saxophonist Clarence Clemons absent except for a backing vocal on one cut). The hard-driving country blues of "Spare Parts" and Nils Lofgren's solo on the title cut are notable exceptions. If not *Nebraska*-stark, this album still takes its cue from

the cover photo: Looking, for the first time, middle-aged, the Boss tells us in a thoughtful, level gaze that this ain't no party.

But though it's a musical change-up, *Tunnel of Love* is the same old message millions have responded to—and the same dark vision. There's a slight shift of emphasis to the vagaries of romance, yet the weary realism, the wary perseverance are intact. Springsteen remains an anxious man, and the album is infused with the fear of being alone, fear of having a relationship go bad because of one's own imperfections or another's perfidy, fear of making the wrong commitment, fear of not doing things right or for the right reasons, fear of slipping back into the old ways you hope you've grown out of—the usual Brucean depictions without the catharsis of the E Street Band to lift us above the troubling material. What there is, though—and this will be enough for some—is the compassion the singer imparts through his vocals and through the careful balancing in his vignettes of hope and despair. It's an album of closely observed parts whose sum is quite moving.

Richard C. Walls

#### KATHY MATTEA: *Untasted Honey*.

Allen Reynolds, prod. Mercury 832 793-1. □



During her short career in country music, Kathy Mattea has continually broadened her range and strengthened her vocal prowess. She picks material with great care, and her backup musicians are always the very best; moreover, she has an uncanny ear for adapting her voice to the specific requirements of each arrangement. At her best, Mattea has shown promise of devel-

oping into the kind of singer who is beyond category—someone who, like Ray Charles, perhaps, can sing country, pop, and blues with equal authenticity. Her last album, *Walk the Way the Wind Blows*, had enough good material to stretch into five records for any lesser singer, and if you liked it as much as I did, you probably couldn't wait to sample this new opus.

The same thought, I'm sure, occurred to the folks at Mercury, and though *Untasted Honey* is far from being a clone, it does draw heavily on the earlier best-seller for inspiration, a career tactic that usually doesn't succeed very well but is entirely understandable here. Fiddle, harmonica, and steel guitar have been dropped in favor of a more basic, acoustic sound, which is real "folksy" when it works and rather bland when it doesn't. Otherwise, most of the musicians are the same crackerjacks, and the production is again excellent. Material continues to be varied, including a female drinkin'-and-thinkin' song ("Late in the Day"), a tough blues ("Like a Hurricane"), and a highly poetic lyric co-authored by Janis Ian ("Every Love"). Some of these will undoubtedly become great big radio hits, and everyone will be happy—including me, I guess, although I do hope Mattea plays it less safe next time around.

Joe Blum

#### VARIOUS ARTISTS: *The Sound of Deep Ellum*.

Various prods. Island 90637-1. □

Just off downtown Dallas, in the Depression-era black jook-joint district known as Deep Ellum, one of America's most unlikely music/arts warehouse scenes has been maturing for the last three years. *The Sound of Deep Ellum* demonstrates that the music spawned there has followed no particular party line, instead bringing out the best in a bunch of people looking for a way to bust loose—what the best rock scenes have always done.

This one is rooted strongly in the Sixties, though there are notable exceptions, such as Reverend Horton Heat's "The Devil's Chasin' Me," a loopy take on hopped-up roots rock, and the Decadent Dub Team's arty "Six Gun," white punks on dub/rap, edgy and unnerving in the most positive sense. For my money, they share the spotlight with the Buck Pets' "Snatch Rap," classic garage-band agro; the amiably footloose and ripped Mod energy of the Trees' "Cattle Car"; and End Over End's "My Dark Earth Edge," Bo Diddley meets Arthur Lee's Love. Only "Sales Tax" by the Legendary Revelations—elderly swing-jazz vets of the original Deep Ellum scene and included for historical balance, I guess (though it feels more like tokenism)—seems out of place.

The New Bohemians, meanwhile, are as

(Continued on page 77)

# COMPARE PRICE AND SERVICE!

WDS RATED #1

WE SELL MOST MAJOR BRANDS OF ELECTRONICS

## DISC PLAYER SPECIALS

<b>SANYO CP10</b> <b>\$159</b>  <b>BELOW DEALER COST</b> ★ PORTABLE DISC PLAYER ★ 16 TRACK PROGRAMMING	<b>TOSHIBA XRV22</b> <b>\$189</b>  <b>SPECIAL PURCHASE</b> ★ DUAL DISC PLAYER ★ BEST BUY - WAS \$499	<b>SONY D10</b> <b>\$269</b>  <b>SPECIAL PURCHASE</b> ★ SMALLEST PORTABLE DISC MAN ★ 21 SONG PROGRAMMING	<b>TEAC ZD 1000</b> <b>\$329</b>  ★ ZD (ZERO DISTORTION) CIRCUITRY ★ DUAL D / A CONVERTORS
---	---	--	--

## CASSETTE DECK SPECIALS

<b>TEAC V550X</b> <b>\$185</b>  ★ DOLBY B + C + dbx ★ 2-MOTOR, AUTO BIAS	<b>SHERWOOD S289RDR</b> <b>\$199</b>  ★ AUTO REVERSE DUBBING ★ HIGH SPEED, DOLBY B + C	<b>JVC DDVR77BK</b> <b>\$219</b>  ★ QUICK AUTO-REVERSE ★ DOLBY B + C, 2 MOTOR	<b>TEAC V770</b> <b>CALL!</b>  ★ DOLBY B + C + HX PRO ★ 3-HEAD, FINE BIAS
--	--	--	---

## CAR STEREO SPECIALS

<b>JENSEN JTX300</b> <b>\$58 PR.</b>  ★ 6 x 9 TRIAX ★ HIGH POWER HANDLING	<b>CLARION 700 EQA</b> <b>\$99</b>  ★ 7 BAND AMP / EQ ★ IMAGE RESTORATION	<b>CLARION 8401RT</b> <b>\$149</b>  ★ DIGITAL, 18 PRESETS ★ PRSET SCAN, CLOCK	<b>CLARION 8825RT</b> <b>\$239</b>  ★ DIGITAL, DOLBY, 18 PRESETS ★ REMOVABLE CHASSIS
---	---	--	--

## VIDEO SPECIALS

<b>PANASONIC PV2700</b> <b>\$219</b>  ★ 12 FUNCTION REMOTE ★ HQ, MULTI EVENT TIMER	<b>RCA 3-HEAD</b> <b>\$269</b>  ★ JITTER-FREE SPECIAL EFFECTS ★ ON SCREEN PROGRAMMING	<b>ZENITH MTS HIFI</b> <b>\$389</b>  ★ RANDOM ACCESS TUNER ★ 4 / 14 DAY TIMER, HQ	<b>GE 97885</b> <b>\$769</b>  ★ TOP OF THE LINE DIGITAL ★ 4-HEAD MTS HIFI
--	---	--	---

## MISCELLANEOUS SPECIALS

<b>CELESTION DL4</b> <b>\$99 EA.</b>  <b>BELOW DEALER COST</b> ★ 2-WAY BOOKSHELF ★ TOP RATED BRITISH SPEAKER	<b>BOSE 501 IV</b> <b>CALL!</b>  <b>SPECIAL PURCHASE</b> ★ DIRECT / REFLECTING ★ GREAT PERFORMANCE	<b>CELESTION DL10</b> <b>\$269 EA.</b>  <b>BELOW DEALER COST</b> ★ 3-WAY FLOOR STANDING ★ ALUMINUM DOME TWEETER	<b>JVC RX9VBK</b> <b>\$399</b>  ★ 120 WATTS / CH, WIRELESS ★ 32 PRESETS, 10 MEMORY EQ
<b>VHS FORMAT CAMCORDER</b> <b>\$589</b>  ★ 10 LUX, CCD ★ PAN FOCUS SYSTEM	<b>SHARP VCC20</b> <b>\$988</b>  ★ STEREO CAMCORDER ★ HIGH SPEED SHUTTER	<b>WIRELESS 100</b> <b>\$199 PR.</b>  <b>AC POWERED SPEAKER</b> ★ EXTEND YOUR STEREO TO ANY ROOM IN THE HOUSE	<b>ATUS AM300E</b> <b>\$209</b>  <b>WITH ECHO</b> ★ HIGH PERFORMANCE MIXER ★ 2 PHONO + 6 INS, 5 BAND EQ

THIS IS ONLY A PARTIAL LISTING OF PRODUCTS FOR SALE. PLEASE CALL FOR QUOTES ON ITEMS NOT LISTED.

**DISCOUNT  
HOTLINE**

**1-800-356-9514**

OR CALL 1-608-271-6889



**HOURS**  
M-T 8-8 FRI 9-8  
SAT 9-5

**YOUR SATISFACTION MEANS EVERYTHING TO US:**

1. WE CHOOSE ONLY QUALITY PRODUCTS
2. ALL PRODUCTS BRAND NEW FACTORY SEALED WITH FULL MANUFACTURER'S WARRANTY
3. SPEEDY SERVICE—MOST ORDERS SHIPPED WITHIN 48 HOURS.
4. A FAIR APPROACH TO SOLVING WHATEVER PROBLEMS ARISE.

**WDS**  
1ST IN SERVICE  
1ST IN PRICE

WISCONSIN  
DISCOUNT STEREO  
2417 W. BADGER RD.  
MADISON, WI 53713  
ESTABLISHED 1954

# HIGH FIDELITY CLASSIFIED

**MAIL TO:** 825 7th Ave., 7th floor, New York, N.Y. 10019  
Phone **1-800-ABC-MAGS.** In New York call (212) 887-8458 **GENERAL:** all copy subject to publisher approval  
Users of P.O. Box **MUST** supply permanent address and telephone number before ad can run

**CLOSING DATE:** 1st of second month preceding cover date **15 Word minimum** No charge for Zip Code

**CLASSIFIED RATES:** regular type, per word 1x—\$2.75, 3x—\$2.65, 6x—\$2.55, 12x—\$2.45 Words in caps—15¢ extra each **IMPERIAL type, per word: 1x—\$3.75; 3x—\$3.65; 6x—3.55; 12x—\$3.45. Words in caps—15¢ extra each.** Minimum 15 words Box numbers \$3.00 additional per insertion to cover cost of handling and postage Display, per inch 1x—\$350, 3x—\$340, 6x—\$330, 12x—\$315 **PAYMENT WITH ORDER:** Send check, M.O., MASTERCARD or VISA No. and expiration date to Maria Manaseri, Classified Dept., HIGH FIDELITY, 825 7th Ave., 7th Floor, New York, NY 10019

## AUDIO/VIDEO SPECIALTY SHOPS

**AUDIOPHILES/VIDEOPHILES!** We have the widest selection of audio/video equipment available Adcom, Infinity, Harmon Kardon, Kyocera, JVC Video, Canton, Klipsch, Luxman, Sony ES, Yamaha, NEC Call for information CONTINENTAL SOUND, 98-77 Queens Blvd., Rego Park, NY 11374 (718) 459-7507 Immediate delivery MC/VISA/AMEX/ DISCOVER

## BUSINESS OPPORTUNITIES

**START YOUR OWN SPEAKER COMPANY IN YOUR garage. It's easier than you think. Our advice is free. AMS Enterprises, 1007 Capello Way, Ojai, CA 93023.**

## ATTENTION! ATTENTION!

Join hundreds of other successful reps earning big money in their spare time Start your own audio, video, car stereo sales and marketing business with a \$2 representative's catalog We'll teach you how In business for 37 years For 35¢ you can call 301-488-9600, 9 to 9, leave your name and phone number and we'll call you back immediately with full information Or write to:

**INTERNATIONAL HI FI DISTRIBUTORS**  
Moravia Center Industrial Park  
Baltimore, Maryland 21206

## GENERATE UNLIMITED INCOME, EASILY!

**Expert reveals proven insiders' homeworking methods. Results guaranteed! Information FREE. INFOMART, Box 7637-HF1, St. Thomas, V.I., 00801-7637.**

**INTERESTED PROFIT PRODUCING ADVERTISERS!** Get FREE INFORMATION on rates and how to create your own classified ad, similar to those on these pages TOLL FREE 1-800-222-6247, or 212-887-8458

## BOOKS/PUBLICATIONS

**HIGH FIDELITY—BACK ISSUES** only \$3.00 each (including postage & handling) \$24.00 for complete years (1981 to 1986 inclusive) Prepaid only Back Issues Dept., 825 Seventh Avenue, 8th Floor New York, NY 10019

## COMPACT DISCS

low COMPACT DISC prices—LARGE inventory—mini-Catalogs \$1—DUWARS, PO BOX 6662-F, GREENVILLE, SC 29606

FREE COMPACT DISC CATALOG New CD's starting \$9.49 Wide selection LAZER SOUNDS, P.O. Box 2595, Dept. H, Kirkland, WA 98083 206-822-5513

**COMPACT DISC—at low warehouse prices. Now in our fourth year. Over 6,000 titles available. Free Catalog plus regular updates and monthly specials starting at \$10.99. OZ Warehouse, 1575P Hwy. 29 Lawrenceville, Ga 30245.**

PREVIOUSLY-OWNED CD's! Buy, Sell, Trade. Free Catalog. Information. THE CD LINK, P.O. Drawer 5596-HF Greenville, SC 29606

**WE'VE SLIPPED OUR DISC PRICES TO FIT your budget, prices start at \$8.99! Write: Laser Locker Box 8611 Somerville, N.J. 08876.**

## CD INTERNATIONAL

**We carry more POPULAR and RARE DISCS than anyone in the country. Also players and accessories. Send for monthly catalog or call (800) 356-DISC. Major credit cards accepted. 779-K W. 19th Street, Costa Mesa, CA 92627.**

## CABLE TV

CABLE TV CONVERTERS Scientific Atlanta, Jerrold, Oak, Zenith, Hamlin Many others "NEW" VIDEO HOPPER "The Copy Killer" Visa, M/C & AMEX 1-800-826-7623 B&B Inc., 10517 Upton Circle, Bloomington, MN 55431

## CLUBS/SINGLES

CLASSICAL MUSIC LOVERS' EXCHANGE Nationwide Link Between Unattached Music Lovers CMLE, Box 31, Pelham, NY 10803

## EQUIPMENT FOR SALE

**CABLE TV**  
Converters / Descramblers  
GUARANTEED LOWEST PRICES IN U.S.

Jerrold, Hamlin, Zenith—Many Others! Lowest Dealer Prices! Orders shipped within 24 hours! Complete illustrated catalog, \$2.00. MasterCard-VISA-COD accepted  
**PACIFIC CABLE CO., INC.** (800) 345-8927  
7325 1/2 Reseda Blvd., #815 Reseda, CA 91335

HIGH END AUDIO, PA AND PRO SOUND equipment at cost or below New, Used and Demo equipment available Lowest prices Call or write for list. Sound Equipment Company, 4132 Kincaid Drive, Raleigh, N.C. 27604 919-876-8432

DISCO LIGHTING, DJ SUPPLIES, EFFECTS AT wholesale prices Send \$1.00 for catalog P.O.B. 20395, Bowling Green, KY 42101

## Audio Den Ltd.

*Authorized Sales and Service*  
**AUDIO AND VIDEO COMPONENTS**

- ADCOM
- DUAL
- HAFLER
- KLIPSCH
- MAGNEPAN
- NAD
- NAKAMICHI
- N.F.C.
- PARADIGM
- SHURE ULTRA
- THORENS

2021 SMITH HAVEN PLAZA  
LAKE GROVE, N.Y. 11755  
**(516) 360-1990**

EAGLE 2 AMPLIFIERS SALE \$899.00 Charge VISA or Mastercard, factory direct, for information call 9 to 6 (Pacific Time) 1-602-453-2949

## ELECTRONICS FOR SALE

"STEREO WORLD" is your discount mailorder source with super deals on Audio/Video & Car Stereo. Lines like: Magnovox, JVC, TEAC, Technics, Pyle, Pioneer, Toshiba, Sennheiser, TDK, Maxell, Whistler, Panasonic. Car Stereo: Alpine, Clarion, Sherwood, Kenwood, Sony, Pioneer & more! Call or write for FREE catalog! Call for closeout specials! Call for Holiday Sale Items! FREE shipping each order! P.O. Box 709, Edison, NJ 08818. 201-494-0099, M-F till 6:00 pm. C.O.D. accepted.

High-end and hard-to-find audio components. Low, low prices! AUDIO AMERICA (Virginia). Call 1-804-797-5861.

## MUSICAL INSTRUMENTS

WE BUY USED BRASS & WOODWINDS Top \$ Send INF Rayburn Music, 263 Huntington, Boston, MA 02115. (617) 266-4727 Emilio or David

## FOR SALE

**EXCEPTIONAL AUDIO REPRODUCTION SYSTEMS... REASONABLY PRICED!! E.A.R.S. P.O. BOX 658-H, WEST COVINA, CA 91790. 818/961-6158, EVENINGS, WEEKENDS. STAMP BRINGS MONTHLY SPECIALS. MC/VISA.**

**BANG & OLUFSEN FULL LINE, ADS, B&W AND BOSE SPEAKERS AND OTHER QUALITY PRODUCTS AT REASONABLE PRICE, SOUNDCREST, INC., (201) 756-4856**

CALL TOLL FREE 1-800-826-0520 FOR ACOUSTAT, DAHLQUIST, NAD, HAFLER, DENON, dbx, 3D, PROTON, TANDBERG, BELLES, ORACLE, M&K, GRADO, NITTY GRITTY, AUDIOQUEST, NEC, DUNTEC, MONSTER, SUMIKO PERREAUX, CWD, SNELL, B&W, DEM, THORENS, VSP, STAX, SOTA, GRACE, ASTATIC, DYNAVECTOR. THE SOUND SELLER, 1706 MAIN STREET, MARINETTE, WI 54143, (715) 735-9002.

CALL US LAST !!!!!!!!!!!!!!!!!!!!!!!!!!!!!!!  
Shop around, Get your best price, Then call THE SOUND APPROACH. Guaranteed LOWEST PRICES on all HOME and CAR STEREO. Factory fresh, Fully warranted. For FAST DELIVERY and GUARANTEED LOWEST PRICES, call THE SOUND APPROACH, 6067 Jericho Tpke., Commack, New York, 11725 (516) 499-7680. Visa/MC/Amex.

UPGRADES FOR THORENS TURNTABLES-GRADO pick ups Corktone Platter Mat, cables and other products. For information catalog \$3.00 refundable. CHADWICK MODIFICATIONS, Dept. HF, 1925 Massachusetts Ave Boston, MA 02140 (617) 354-8933

EXPERIENCED FRIENDLY ADVICE! ACOUSTAT, HAFLER, SONY ES, CWD, THORENS, FRIED, GRADO, MONSTER CABLE, PS, SPICA, MIRAGE, STRAIGHTWIRE, QUAD, more. Immediate, FREE shipping. READ BROTHERS STEREO, 593-C King Street, Charleston, South Carolina 29403. (803) 723-7276.

DIRECT SIGHT AND SOUND, America's best kept audio and video secret, continues to please. . . . Five years and over 40,000 customers later, we still offer the best in audio, video, and auto sound including esoterics at incredible prices! We sell and service only U.S. warranty merchandise! Our staff is not only knowledgeable, but helpful and courteous in choosing the right component for you. Become one of the ELITE! Call 404-351-6772. Direct Sight and Sound, 3095 Bolling Way, Dept. H, Atlanta, Ga. 30305. MC/VISA/AMEX. COD with deposit.

GET LOW PRICES ON ALL TYPES of audio equipment — including high-end and esoteric products not normally discounted. Now we can SAVE YOU MONEY on the equipment you really want. Extensive selection — no need to settle for second choice. Thousands of satisfied customers worldwide. FAST DELIVERY available. All products feature USA manufacturer's warranty. Call us for price quotes or friendly, expert advice. Catalog \$1.00 616-451-3868  
VISA/MC/AMEX/DISCOVER/OPTIMA

audio  
advisor, inc  
225 OAKES SW • GRAND RAPIDS, MI 49503

FIND OUT WHY WE SELL MORE HIGH PERFORMANCE speaker kits than anyone in the U.S. For free catalog call 1-800-356-2255 ext 1122 AUDIO CONCEPTS INC 1631 Caledonia St La Crosse, WI 54601

**SINGERS!**  
REMOVE VOCALS  
FROM RECORDS AND CDs!

**SING WITH THE WORLD'S BEST BANDS!**  
An Unlimited supply of Backgrounds from standard stereo records! Record with your voice or perform live with the backgrounds. Used in Professional Performance yet connects easily to a home component stereo. This unique product is manufactured and sold Exclusively by LT Sound - Not sold through dealers. Call or write for a Free Brochure and Demo Record.  
**LT Sound, Dept. HF-3, 7980 LT Parkway**  
Lithonia, GA 30058 (404) 482-4724  
Manufactured and Sold Exclusively by LT Sound  
24 HOUR PHONE DEMO LINE: (404) 482-2485

HAPPY HOLIDAYS FROM THE # 1 DEALER IN THE U.S.A.!!! REVOX, PS AUDIO, HAFLER, COUNTERPOINT, JSE, B&K, FOSGATE, TEAC, ORACLE, THORENS, VPI, DUAL, PROTON, ONKYO, SAE, SONY, INFINITY, JBL, KLIPSCH, DAHLQUIST, DCM, OHM ACOUSTICS, HARMAN/KARDON, DBX SOUNDFIELD, MAGNUM DYNA LAB, MEITNER, JSE, MAGNAVOX, FOSTEX, AUDIOPRO, CELESTION, RAUNA, BOSE, NITTY GRITTY, AUDIOQUEST, STAX, GRADO, TALISMAN, AKG, STRAIGHTWIRE, MONSTER CABLE, NILES, PARSEC, AND MORE! AUTOMOTIVE: SONY, PROTON, HARMAN/KARDON, JBL, ROCKFORD/FOSGATE, ZAPCO, UNGO BOX, MORE! CD EXPERTS! FRIENDLY, EXPERT CONSULTATION. FAST SHIPPING! MC/VISA/AMEX. REFERENCE AUDIO SYSTEMS: 18214 DALTON AVENUE, GARDENA, CA 90248. (213) 398-4205, (213) 391-2679. HOURS: M-F 9-6 PDT. SAT. 9-1. \*MEMBER—BETTER BUSINESS BUREAU\*

FACTORY ORIGINAL DIAMOND NEEDLES & PHONO CARTRIDGES. MOST POPULAR LINES AT DISCOUNT PRICES. FOR FREE CATALOG SEND SELF ADDRESSED STAMPED ENVELOPE. LYLE CARTRIDGES, DEPT. H, BOX 158, VALLEY STREAM, NY 11582. CALL TOLL FREE (800) 221-0906, N.Y. (516) 599-1112. VISA/MC.

EXPERIENCE INTEGRITY AND THE LOWEST PRICE anywhere Authorized dealers for Denon, McIntosh Canton, Tandberg M&K, Sumo Infinity and many more Audio/Video Exchange Since 1951 57 Park Place NY 10007 Call 212-964-4570

WE SELL SECOND HAND HIGH QUALITY AUDIO-VIDEO with money back guarantee! Send your name and address for FREE monthly inventory Ross Stereo, 2423 Morena Blvd., San Diego, CA 92110 (619) 275-3632

CARVER, NAKAMICHI, BANG & OLUFSEN, A.D.S., CROWN, REVOX, HAFLER, ADCOM, MISSION, MERIDIAN, N.A.D., HARMAN/KARDON, KYOCERA, YAMAHA, LUXMAN, DENON, KLIPSCH, B & W, POLK, KEF, D.C.M., E-V, J.B.L., INFINITY, D.B.X., AKG, BEST PRICES PROFESSIONAL CONSULTATION, AMERISOUND SALES, INC. EAST: (904) 262-4000; WEST (818) 243-1168.

CAUTION, YAMAHA BUYERS!! Some dealers are offering Yamaha products for sale that are not designed for use or sale in the U.S.A. These units may not carry the UL approval for safety nor are they designed for usage on 110 volt U.S. current. YAMAHA ELECTRONICS CORPORATION, USA CANNOT BE HELD RESPONSIBLE FOR THESE UNITS MEETING U.S. PERFORMANCE SPECIFICATIONS NOR ARE WE RESPONSIBLE FOR WARRANTY SERVICING. For the name and location of your nearest authorized Yamaha dealer write, Yamaha Electronics Corporation, USA, P.O. Box 6660, Buena Park, CA 90622.

## INVENTIONS

Inventors! AIM wants—Ideas, Inventions, New Products Improvements on existing products. We present ideas to manufacturers Confidentiality Guaranteed Call Toll Free 1-800-225-5800 for information kit

## MISCELLANEOUS

IS IT TRUE JEEPS FOR \$44 THROUGH THE GOVERNMENT? Call for facts! 1-312-742-1142 Ext. 4671

ASIAN WOMEN SEEK AMERICAN AND Canadian men for friendship, marriage Write GRE, Box 555, Elmont, N Y 11003

FRIENDSHIP WORLDWIDE! 160,000 Members 153 Nations Free Details INTERNATIONAL PENFRIENDS, BOX 443(HF), LINDSBORG, KANSAS 67456

CADILLACS, MERCEDES, PORSCHE, etc direct from Government Seized in drug raids. Available your area. Save \$thousands\$ 216-453-3000, Ext. A9830

## SCHOOL & INSTRUCTION

BE A RECORDING ENGINEER! New classes quarterly Institute of Audio/Video Engineering, 1831 Hyperion Ave., Hollywood, Ca 90027 213-666-2380 or outside Ca 800-551-8877 - approved by NATTS

## STEREO EQUIPMENT

"GOLDSTANDS"  
FULLY ASSEMBLED SPEAKER STANDS  
Very Effective, Superior Quality.  
many models, angles, straights, spikes, sand-filled, custom stands readily available Fast delivery and remember completely assembled Free Catalog Goldstands, 229 Nassau Road, Huntington, NY 11743 516-427-4813



(Continued from page 72)

unfocused and meandering as ever on "Jamaican Lady." What does it say that they're still the only band here with a major-label deal?

Right now the trendy boutiques and theme-restaurant developers threaten to take over this gritty grass-roots scene. I'd hate to think they could drive these bands out, but anyone who knows how things work in Dallas—and most other major American cities—understands that's the most likely result, so get it while you can.

John Morthland

**THE DOORS: The Best of the Doors.**

Paul A. Rothchild, Bruce Botnick, and the Doors, prods. Elektra 60345-2 (2).

Ⓢ (2) Ⓜ

This 19-track collection offers Top 40 hits, underground classics, and a few relatively overlooked gems; there are no gratuitous selections. The real story, however, is the digitally remastered fidelity: You can't imagine how thrilling this Compact Disc sounds until you hear it. A staggering clarity unveils the complexity of the Doors' arrangements, and the sequence of songs heightens the intensity. Bluntly put, the CD version of *Sgt. Pepper's Lonely Hearts Club Band* should sound this good.

Instrumental highlights abound: the untangled swirling arrangement of

"Strange Days," the potent punch of "Love Me Two Times" and "Waiting for the Sun," and a pack of improvements to Robby Krieger's guitar, from the crisper-than-ever flamenco work in "Spanish Caravan" and the cutting electric leads of "Five to One" to the raging climaxes of "When the Music's Over" and "The End," which are certain to mess with your psyche. But even more important, the Compact Disc delineates the tremendous emotional energy in Jim Morrison's vocals. He croons ("The Crystal Ship," "Touch Me") and wails ("Roadhouse Blues," "Break On Through") with equal confidence and pleasure—sometimes in the same song ("Light My Fire"). The CD further reveals the blustery blues of Morrison's voice as recorded live for "L.A. Woman" and the close hard echo of the bathroom in which his vocals were taped for "Love Her Madly."

Available only as an import CD for the past two years, *The Best of the Doors* replaces all four of the band's previous Elektra collections: *13* (1970), *Weird Scenes Inside the Goldmine* (1972), the quadriphonic *Best of the Doors* (1973), and *The Doors' Greatest Hits* (1980). The domestic release has been issued on LP and cassette as well but deserves the clean longevity of the CD, which alone contains the bonus track "Alabama Song." Richard Price

**STEVE LACY: Only Monk.**

Giovanni Bonandrini, prod. Soul Note  
Ⓢ SN 1160. (Distributed by Polygram Special Imports.) Ⓜ

**MAL WALDRON/STEVE LACY: Sempre Amore.**

Giovanni Bonandrini, prod. Soul Note  
Ⓢ SN 1170. Ⓜ

**STEVE LACY: Momentum.**

Ed Michel, prod. Novus 3021-1. (Distributed by RCA.) Ⓜ

Soprano saxophonist Steve Lacy, an American living in Europe these past two decades, has been a prolific recording artist for at least half that period: Rare is the time when a couple of his current sides can't be found in the import bins. Though he at times makes more recondite music, his latest LPs on Italy's Soul Note are, in a way, typical, their spare, probing quality reflecting some of his essential concerns.

*Only Monk* is the saxist alone, and though he has rooted around in these nine Thelonious Monk songs before, this solo horn album almost demands a full-palette tour de force—something in which Lacy, with his deliberately paced thematic improvs, doesn't seem interested. And while the stripped-down Monk lines retain a special flavor, the rhythmic and harmonic

**A D V E R T I S I N G I N D E X**

Many advertisers will send you additional product literature free of charge. Write them care of Dept. 1/88, unless otherwise noted, at the address below. If no address appears, literature is available only through dealers. Bold-face numbers by company names are page numbers for ads in this issue.

**Akai America, Ltd. (34,35)**

225 Old New Brunswick Road  
Suite 101  
Piscataway, NJ 08854  
201/562-8500  
ATTN: Dept. HF 1 88

**B&W Loudspeakers (53)**

Misobank Int'l. Inc.  
P.O. Box 653  
Buffalo, NY 14240  
416 297-0595  
ATTN: Dept. HF 1 88

**Carver Corporation (18,22)**

20121 48th Avenue West  
P.O. Box 1237  
Lynnwood, WA 98036  
206 775-1202  
ATTN: Dept. HF 1 88

**Denon America (27)**

222 New Road  
Parsippany, NJ 07054  
201/575-7810  
ATTN: Dept. HF 1/88

**Design Acoustics (68)**

1225 Commerce Drive  
Stow, OH 44224  
216 686-2600  
ATTN: Dept. HF 1/88

**Illinois Audio (69)**

12 E. Delaware Place  
Chicago, IL 60611  
800 621-8042  
ATTN: Dept. HF 1/88

**J&R Music World (66,67)**

23 Park Row  
New York, NY 10038  
212/732-8600  
ATTN: Dept. HF 1/88

**KEF Electronics of America, Inc. (7)**

14120-K Sullyfield Circle  
Chantilly, VA 22021  
703/631-8810  
ATTN: Dept. HF 1/88

**Technics (10,11)**

One Panasonic Way  
Secaucus, NJ 07094  
201 348-7000  
ATTN: Dept. HF 1 88

**Phase Linear/Jenson (20)**

4136 N. United Parkway  
Schiller Park, IL 60176  
1-800-323-4815  
ATTN: Dept. HF 1 88

**Polk Audio (4,5,80)**

5601 Metro Drive  
Baltimore, MD 21215  
301 358-3600  
ATTN: Dept. HF 1/88

**Radio Shack (2)**

300 One Tandy Center  
Ft. Worth, TX 76102  
817/390-3672  
ATTN: Dept. HF 1 88

**Pioneer Electronics (Cover II, 1)**

2265 E. 220th Street  
Long Beach, CA 90810  
213 835-6177  
ATTN: Dept. HF 1 88

**Signet (63)**

4701 Hudson Drive  
Stow, OH 44224  
216 688-9400

**Wisconsin Discount (73)**

2417 W. Badger Road  
Madison, WI 53713  
800 356-9514  
ATTN: Dept. HF 1 88

**TDK (40,78,79)**

12 Harbor Park Drive  
Port Washington, NY 10050  
516/625-0100  
ATTN: Dept. HF 1/88

**Yamaha Electronics Corp. (9)**

6660 Orangethorpe Avenue  
Buena Park, CA 90620  
714 522-9105  
ATTN: Dept. HF 1 88

witticisms (and profundities) can only be suggested. Monk inferred resembles pleasure withheld. More successful, or at least more pleasurable, is *Sempre Amore*, which features Lacy and longtime collaborator Mal Waldron dueting on various Duke Ellington and Billy Strayhorn themes. This is a sheer delight from beginning to end, with Waldron's piquant piano chording and Lacy's slowly unfolding ideas complementing each other beautifully.

*Momentum* has the distinction of being Lacy's first domestic recording in a quarter-century. It's a good set by his working sextet, containing four original compositions, two of them featuring poems sung by Irene Aebi. The dubious poetry/music match is overshadowed by Lacy and fellow saxophonist Steve Potts's improvs and the nonstop interplay of the rhythm section. Though there are free passages here, at least one cut, "The Bath," swings in an upbeat but mellow way and would be totally suitable even for commercial airplay. And Lacy on the radio would be a *real* homecoming. *Richard C. Walls*

#### CHARLIE HADEN: *Quartet West*.

Ⓢ Hans Wendl, prod. Verve 831 673-1.

This is a change of pace for bassist Charlie Haden: Most of the records he has made as

## FORMAT KEY

- Ⓢ LP/EP
- Ⓜ Cassette
- Ⓛ Compact Disc
- Ⓥ Videocassette
- Ⓦ Videodisc

Large symbol beneath title indicates reviewed format. Small symbols following catalog number of reviewed format indicate other available formats (if any).

Catalog numbers of all formats of a particular recording usually are identical except for differing prefixes or suffixes. Catalog numbers of formats other than the reviewed format are printed only if their basic numbers differ substantially from that of the reviewed format.

Arabic numeral in parentheses indicates number of items in multi-item set.

leader or group member have represented some aspect of jazz's progressive edge. But *Quartet West* is more oriented toward the acoustic mainstream, a gathering of four pros making solid, unearthing music.

In fact, three of the cuts—Pat Metheny's "Hermitage" and the standards "Body and Soul" (the melody stated by Haden's larger-than-life bass) and "My Foolish Heart"—seem designed to be commercial jazz radio fare, pleasant ro-

mantic background music that, despite pianist Alan Broadbent's penchant for pretty chording, stays on the right side of sugary. The rest is mostly modish bop, with standout contributions from saxophonist Ernie Watts, here sticking mainly to tenor. Watts, freed from his routine studio gigs, really cuts loose on the Haden original "In the Moment" and Charlie Parker's "Passport" and seems inspired by Haden and the always alert drummer Billy Higgins. The influence of John Coltrane is obvious, but Watts has a personal locution, too, and one would like to hear more of him in an ungimmicked context.

Haden's fans may find the album's conservative configuration—blues, bop, and ballads—a little disappointing, while those weary of experimentation may appreciate for the first time the bassist's imaginative and commanding presence. But both types should dig the solo bass signoff "Taney County," a pastiche in the manner of the folk songs Haden sung as a child on the *Haden Family Radio Show* from 1939 to 1953. Listening to his bass articulate a deeper emotion than expected from the instrument as he recalls these sad and hopeful melodies, one realizes the source of the strength Haden has evinced in both his playing and his personal life.

*Richard C. Walls*



# I N S H O R T O R D E R

POP AND JAZZ MINI-REVIEWS

## 10,000 MANIACS: *In My Tribe*.

⊙ Elektra 60738-1.

Despite the departure of one player since 10,000 Maniacs' last LP, *In My Tribe* is a much fuller, more diverse collection. Natalie Merchant still sounds a little like Debbie Harry with a Gaelic accent (she's from upstate New York), but her lyrics are far more intelligible this time around. For all the ambitious character sketches, exotic settings, and heavy messages, the tastiest song is the most trivial, "Like the Weather." The album's other irony is the winningness of Merchant's very pretty "Verdi Cries": Since the cut's simple piano and strings are played by guest musicians, the vocalist is the only Maniac in evidence.

*Andrew Nash*

## SCOTT HAMILTON QUINTET: *Right Time*.

⊙ Concord Jazz CJ 311.

It's difficult to talk about Scott Hamilton without referring to earlier tenor saxophonists: He has a breathy Lester Young tone and, like Stan Getz, a lightly swinging approach to the ballads he plays. But he doesn't have the weight of the earlier

musicians, and that tone, pleasant in itself, is not inflected as eloquently. *The Right Time* is nonetheless a good album, with clever solos by pianist John Bunch and with a tight rhythm section long associated with Hamilton, who is livelier than usual on the near-boppish "Dropsy," his own line. There's nothing wrong with the playing elsewhere, except that it sounds too comfortable. The best tenors have more bite.

*Michael Ullman*

## DAVE MCKENNA: *My Friend the Piano*.

⊙ Concord Jazz CJ 313.

Dave McKenna is an amazingly versatile pianist. In a men's club in Boston recently, he sized up the elderly audience with a glance and played, to everyone's delight, a series of tunes from the Twenties, "Japanese Sandman" to "Sugar." On *My Friend the Piano* he plays a "Summer Medley" of "Guess I'll Go Back Home This Summer" and "Indian Summer." And a medley of tunes with "always" in the title. He specializes in popular songs: that way, he told me, the audience will hear something good even if he's at a loss.

But he never is. McKenna has a variety of left-hand techniques: the oom-pah of stride, the darting chords of bop, and his own walking bass lines, all on show during "Margie" and "Mean to Me," the highlights of this typically vibrant set. No single album can capture all of his talents, but *My Friend the Piano* is a fine showcase for his swinging, melodic styles.

*Michael Ullman*

## ALEXANDER O'NEAL: *Hearsay*.

⊙ Tabu FZ 40320.

Smoldering, lustful, upbeat, down: Alexander O'Neal's debut LP two years ago was one of the most awesome beginnings in recorded music. Its follow-up, *Hearsay*, is equally satisfying. Contents: full-blown funk symphonies, soulful drama, and a voice that always goes in for the kill. O'Neal has said that this LP is about his life and times following "Saturday Love," his duet with Cherrelle that made him a star. There are allusions to partying, women, dope, and becoming born again. And there's not one clunker.

*Havelock Nelson*

## PERFECT MARRIAGE

New SA-XG is TDK's exclusive SA-X formulation—the world's quietest tape—technomiously joined together with TDK's most sophisticated mechanism ever—the RS-II.

Our unique 3-layer RS-II mechanism is specifically designed to suppress the generation of modulation noise. A precision die-cast alloy frame and molded tape guide block are sandwiched between two transparent precision-molded shell halves made of a special hard plastic, which also incorporate 4 precisely machined metal guide pins. The RS-II's rigidity of construction, accuracy of fit and superior thermal resistance assure unerring tape travel, optimum tape-to-head contact and reduced modulation noise. The result is virtually true-to-source sound quality.

So whether you choose the outstanding SA-XG, or SA-X, with its new vibration-dampening Dual Layer Mechanism (DLM), you can be assured of one thing: An everlasting high bias honeymoon—till decibels do you part.



**TDK** THE ART OF PERFORMANCE.





# YOUNG CHANG

## Made in Korea, Germany, England, Japan and Vermont.

Young Chang pianos are precision crafted in Korea. But our search for the best materials in the world takes us to the ends of the earth.

It takes us to the Royal George feltworks in England because only the finest felt will do for Young Chang hammers.

It takes us to Germany and Japan for our premium core wire. From that, we make the finest piano strings possible.

It takes us to the forests of North America for our Sitka spruce. Lightweight but extremely strong, solid Sitka spruce is universally acknowledged as the ideal material for piano soundboards. And we go one better than most other piano manufacturers by using this remarkably durable wood for our keys and backposts as well.

Solid maple pin blocks and action parts are another hallmark of the best pianos. And Young Chang's maple comes from only the best sources: Vermont, Michigan and Japan.

But a great piano is more than the sum of its parts. Each Young Chang piano is expertly assembled in Korea. Our combination of exacting precision and cost-effective operation can't be found anywhere else. The result is a high-quality line of pianos without the high prices. And to reinforce our commitment to quality, we offer a 12-year *full* warranty on every piano.

To find out why people think the world of our pianos, visit your Young Chang dealer. Or contact us at Young Chang America, 13336 Alondra Boulevard, Cerritos, CA 90701.



## Sometimes you just have to be there.

If you have never experienced it, you cannot believe the beauty of a sunrise in the mountains—or the fresh scent of clean mountain air.

Few have ever experienced the effect of superbly reproduced music of their choice played in the private environment of their automobile. Music, reproduced with lifelike quality, has the power to touch our deepest emotions and to elevate our moods. And this to an extent that is not expected.

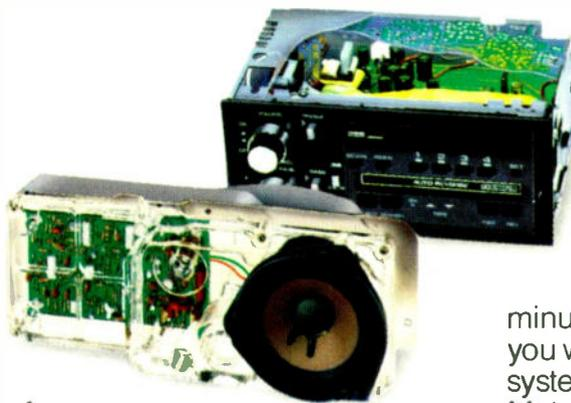

Our experience has convinced us that, regardless of your interest in music, you will require less than one minute of listening to know that you want the Delco/Bose music system in your next General Motors\* car.

Through this listening experience you will also appreciate why the Delco/Bose system is the most

highly reviewed music system available.



Sound so real, it will change how you feel about driving.

\* Available in selected models.

**BOSE**  
Better sound through research.

**Delco Electronics**  
Subsidiary of GM Hughes Electronics  
*It's who we are.*