

ITEM ID:
LEGACY:
DEV12895

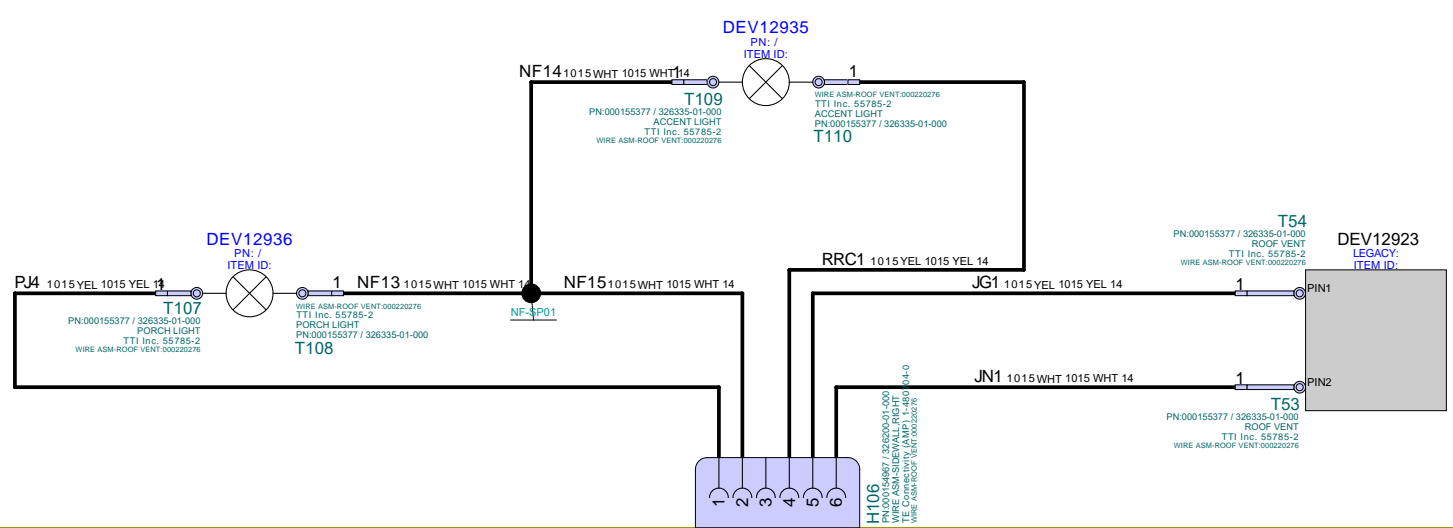

REFERENCE
WIRE ASM-IP MAIN
000187270 / 335229-01-000

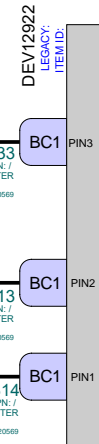
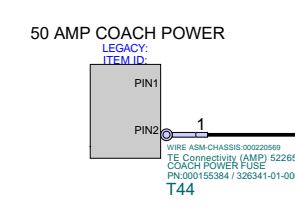
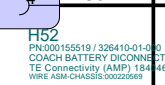
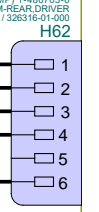
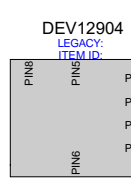
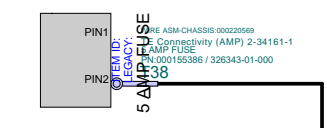
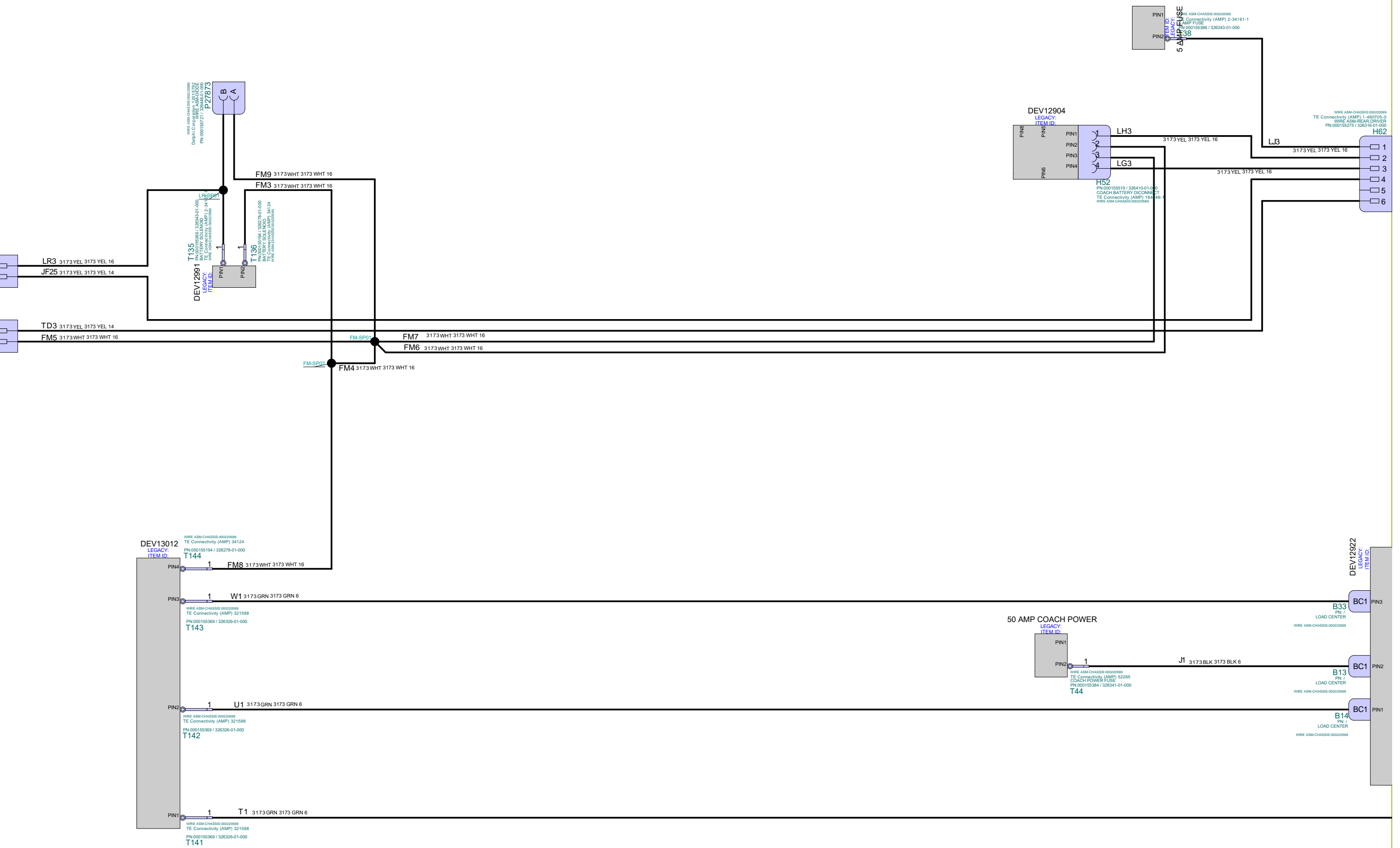

WIRE ASM-REAR DRIVER
000220935 / 342385-01-000



- 1) LJ2 1015 YEL 1015 YEL 16
- 2) LH2 1015 YEL 1015 YEL 16
- 3) LG2 1015 YEL 1015 YEL 16
- 4) JF5 1015 YEL 1015 YEL 14
- 5) TD1 1015 YEL 1015 YEL 14
- 6)

H61
PN:000154867 / 326200-01-000
WIRE ASM-CHASSIS
TE Connectivity (AMP) 1-480704-0
WIRE ASM-REAR DRIVER:000220935

- NM BC1 WIRE ASM-REAR DRIVER:000220935
LOAD CENTER
PN / B12
- VB BC1 WIRE ASM-REAR DRIVER:000220935
LOAD CENTER
PN / B10
- E BC1 WIRE ASM-REAR DRIVER:000220935
LOAD CENTER
PN / B3
- JA BC1 WIRE ASM-REAR DRIVER:000220935
LOAD CENTER
PN / B11
- ET BC1 WIRE ASM-REAR DRIVER:000220935
LOAD CENTER
PN / B4
- B BC1 WIRE ASM-REAR DRIVER:000220935
LOAD CENTER
PN / B9
- JS BC1 WIRE ASM-REAR DRIVER:000220935
LOAD CENTER
PN / B5
- J BC1 WIRE ASM-REAR DRIVER:000220935
LOAD CENTER
PN / B6
- D BC1 WIRE ASM-REAR DRIVER:000220935
LOAD CENTER
PN / B7
- JC BC1 WIRE ASM-REAR DRIVER:000220935
LOAD CENTER
PN / B8

H88
PN:00015277 / 326318-01-000
TE Connectivity (AMP) 1-480703-0
WIRE ASM-REAR DRIVER:000220935

T123
PN:00015277 / 326324-01-000
TE Connectivity (AMP) 1-480703-0
WIRE ASM-REAR DRIVER:000220935

T138
PN:00015277 / 326324-01-000
TE Connectivity (AMP) 1-480703-0
WIRE ASM-REAR DRIVER:000220935

T125
PN:00015277 / 326324-01-000
TE Connectivity (AMP) 1-480703-0
WIRE ASM-REAR DRIVER:000220935

T124
PN:00015277 / 326324-01-000
TE Connectivity (AMP) 1-480703-0
WIRE ASM-REAR DRIVER:000220935

H90
PN:000154457 / 326137-01-000
TE Connectivity (AMP) 1-480711-0
WIRE ASM-SIDEWALL RIGHT
WIRE ASM-REAR DRIVER:000220935

WIRE ASM-SIDEWALL RIGHT
000220408 / 342182-01-000

WIRE ASM-SIDEWALL RIGHT:000220408
TE Connectivity (AMP) 1-480710-0
PN:000155271 / 326275-01-000

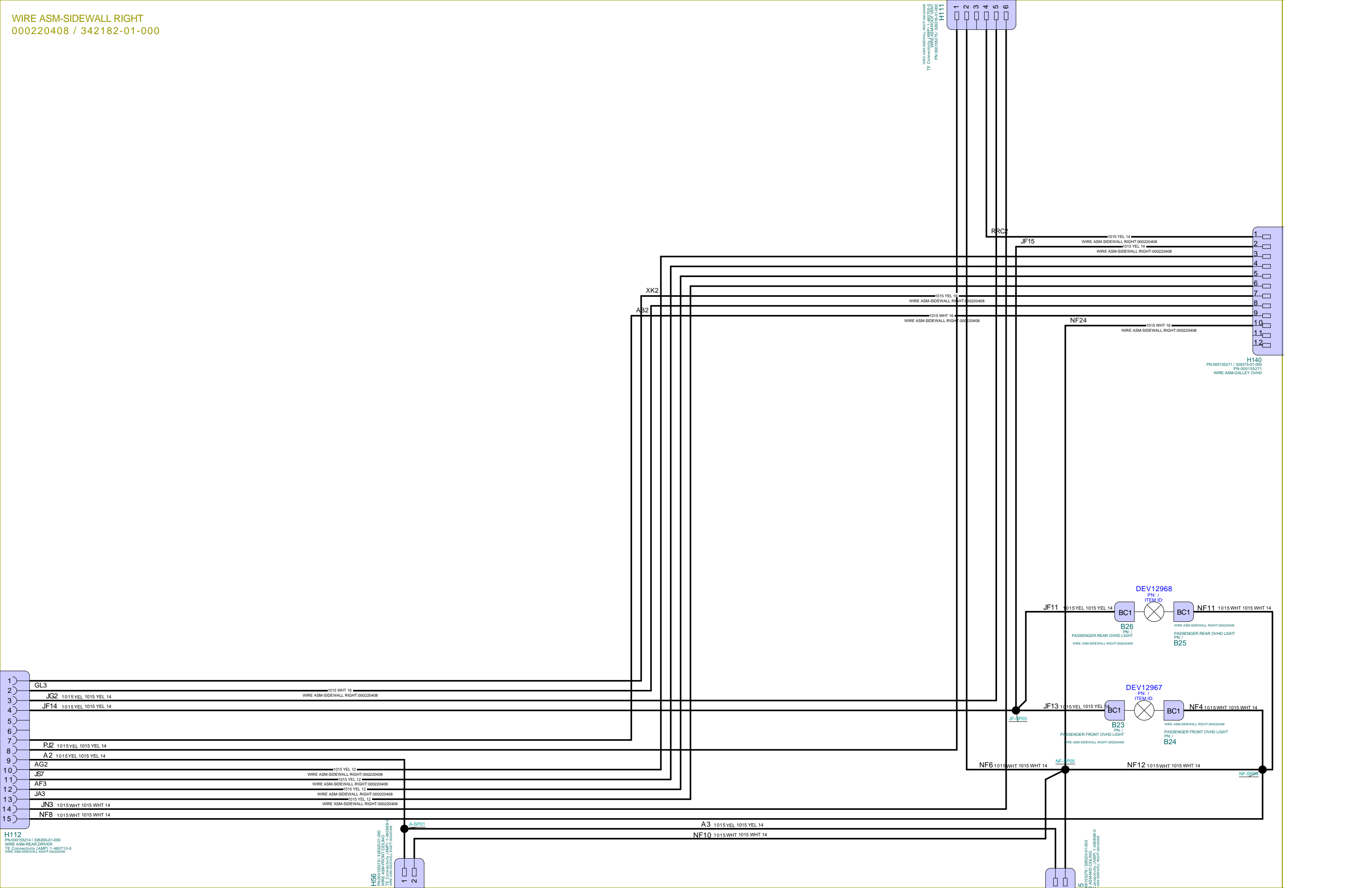
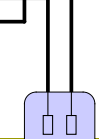
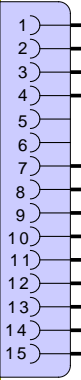
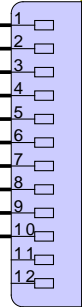
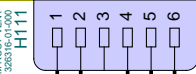

H140
PN:000155271 / 326275-01-000
PN:000155271
WIRE ASM-GALLEY OVHD

DEV12968
PN: /
ITEM ID:

DEV12967
PN: /
ITEM ID:

H112
PN:000155214 / 326265-01-000
WIRE ASM-REAR DRIVERS
TE Connectivity (AMP) 1-480710-0
WIRE ASM-SIDEWALL RIGHT:000220408

H56
PN:000155271 / 326275-01-000
WIRE ASM-REAR DRIVERS
TE Connectivity (AMP) 1-480710-0
WIRE ASM-SIDEWALL RIGHT:000220408

PN:000155271 / 326275-01-000
WIRE ASM-REAR DRIVERS
TE Connectivity (AMP) 1-480710-0
WIRE ASM-SIDEWALL RIGHT:000220408

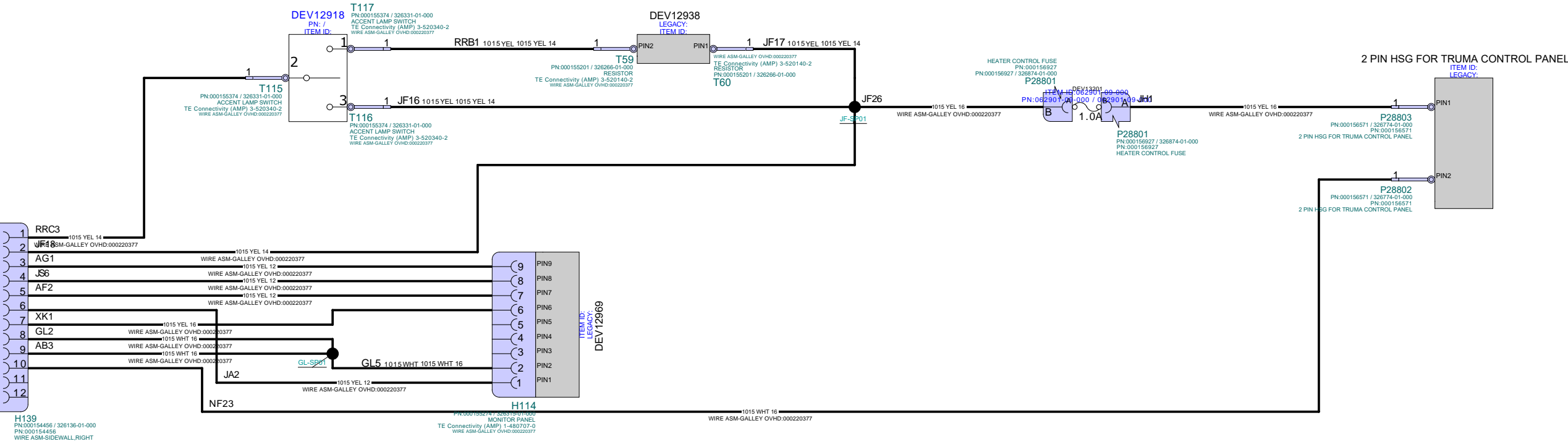

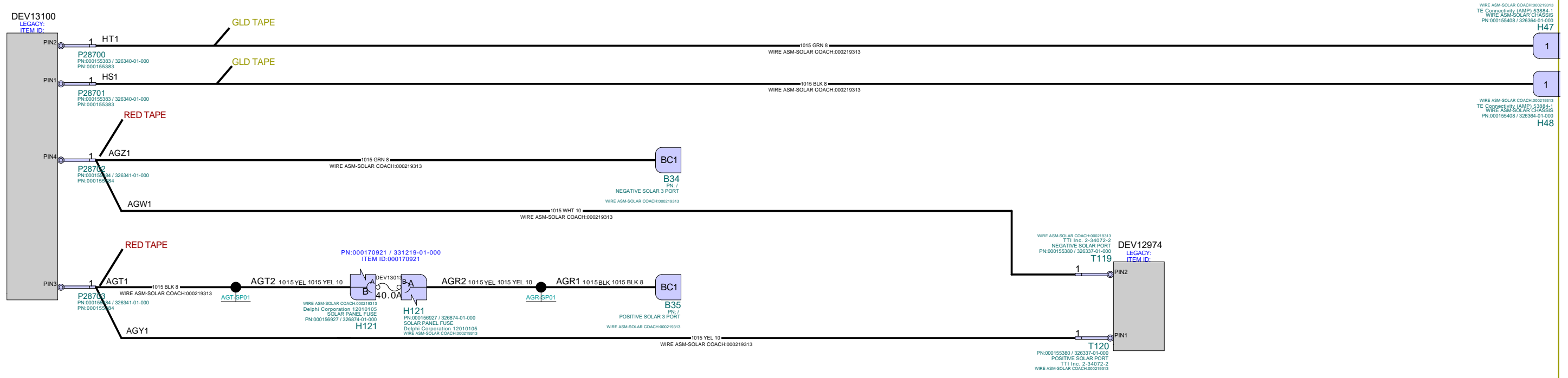

WIRE ASM-SOLAR COACH:000219313
TE Connector (AMP) 53884-1
WIRE ASM-SOLAR CHASSIS
PN:000155408 / 326364-01-000
H47

WIRE ASM-SOLAR COACH:000219313
TE Connector (AMP) 53884-1
WIRE ASM-SOLAR CHASSIS
PN:000155408 / 326364-01-000
H48

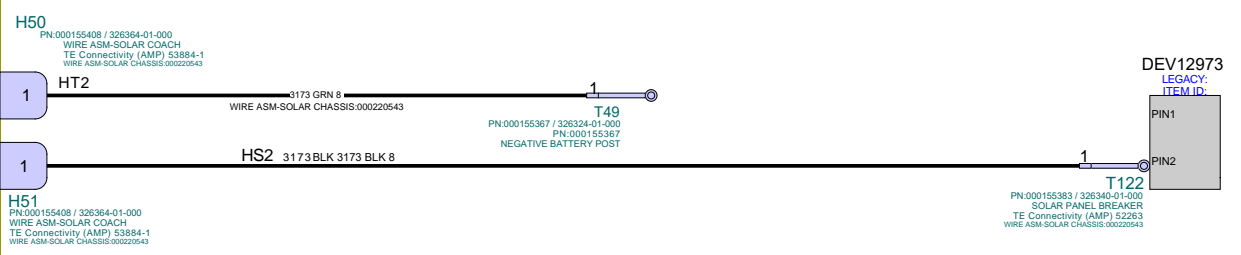

WIRE ASM-SIDEWALL LEFT
000220852 / 342343-01-000

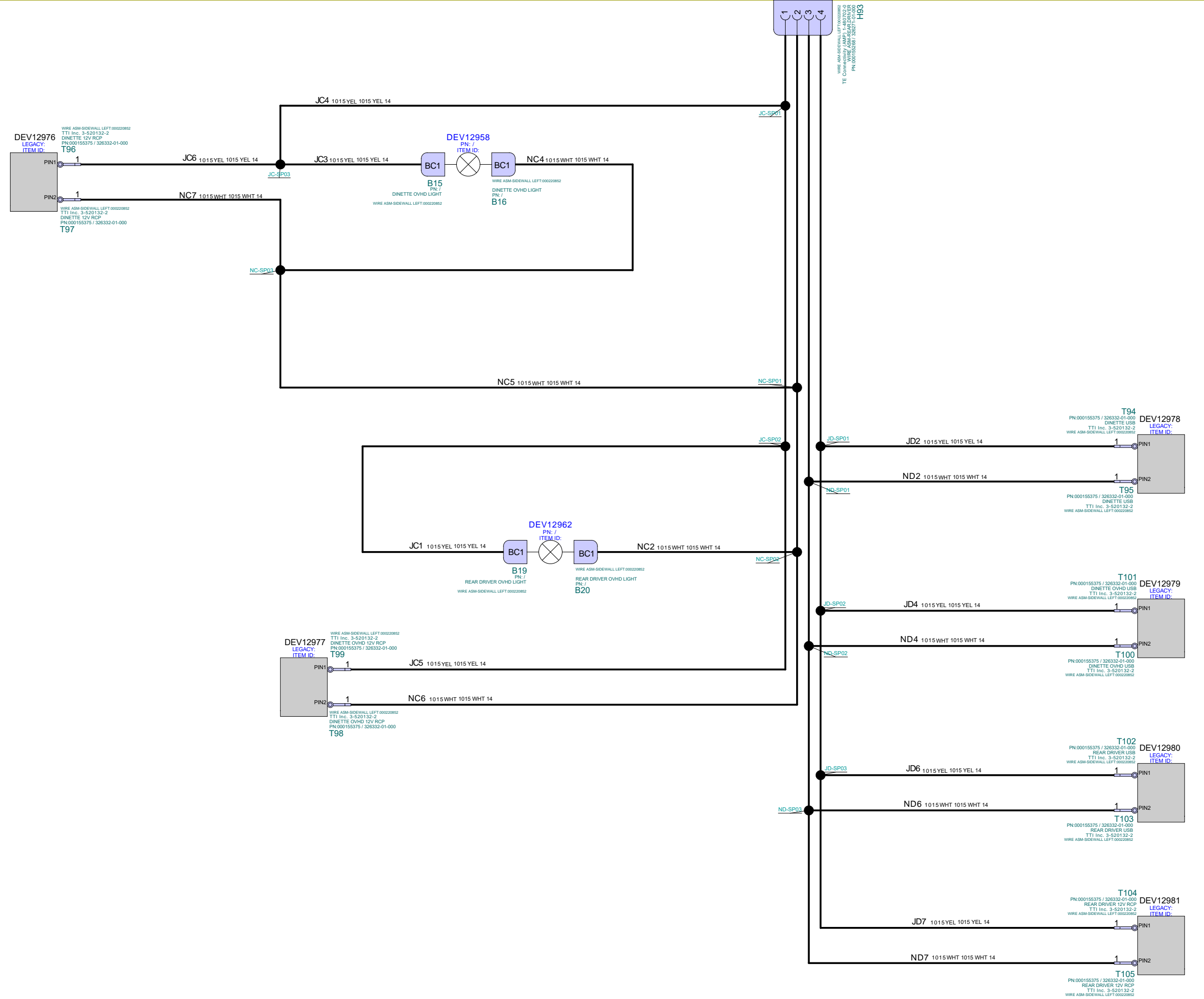

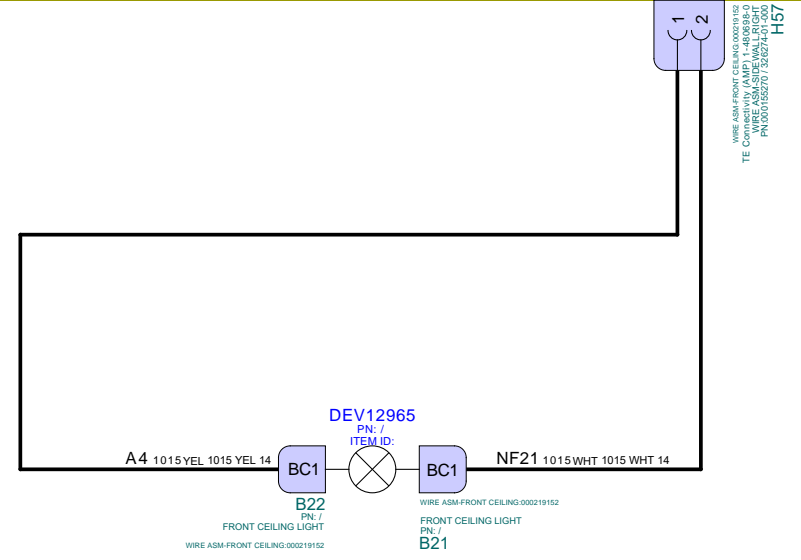

WIRE ASM-MID CEILING
000219087 / 341864-01-000

