

DrayTek

Vigor2960 Series

Dual-WAN Security Firewall



Quick Start Guide

V1.0

Vigor2960 Series Dual-WAN Security Firewall Quick Start Guide

Version: 1.0

Firmware Version: V1.0.5_RC7

(For future update, contact DrayTek)

Date: 13/07/2012

Copyright Information

Copyright Declarations

Copyright 2012 All rights reserved. This publication contains information that is protected by copyright. No part may be reproduced, transmitted, transcribed, stored in a retrieval system, or translated into any language without written permission from the copyright holders.

Trademarks

The following trademarks are used in this document:

- Microsoft is a registered trademark of Microsoft Corp.
- Windows, Windows 95, 98, Me, NT, 2000, XP and Explorer are trademarks of Microsoft Corp.
- Apple and Mac OS are registered trademarks of Apple Computer Inc.
- Other products may be trademarks or registered trademarks of their respective manufacturers.

Safety Instructions and Approval

Safety Instructions

- Read the installation guide thoroughly before you set up the router.
- The router is a complicated electronic unit that may be repaired only by authorized and qualified personnel. Do not try to open or repair the router yourself.
- Do not place the router in a damp or humid place, e.g. a bathroom.
- Do not stack the routers.
- The router should be used in a sheltered area, within a temperature range of +5 to +40 Celsius.
- Do not expose the router to direct sunlight or other heat sources. The housing and electronic components may be damaged by direct sunlight or heat sources.
- Do not deploy the cable for LAN connection outdoor to prevent electronic shock hazards.
- Keep the package out of reach of children.
- When you want to dispose of the router, please follow local regulations on conservation of the environment.

Warranty

We warrant to the original end user (purchaser) that the router will be free from any defects in workmanship or materials for a period of two (2) years from the date of purchase from the dealer. Please keep your purchase receipt in a safe place as it serves as proof of date of purchase. During the warranty period, and upon proof of purchase, should the product have indications of failure due to faulty workmanship and/or materials, we will, at our discretion, repair or replace the defective products or components, without charge for either parts or labor, to whatever extent we deem necessary to restore the product to proper operating condition. Any replacement will consist of a new or re-manufactured functionally equivalent product of equal value, and will be offered solely at our discretion. This warranty will not apply if the product is modified, misused, tampered with, damaged by an act of God, or subjected to abnormal working conditions. The warranty does not cover the bundled or licensed software of other vendors. Defects which do not significantly affect the usability of the product will not be covered by the warranty. We reserve the right to revise the manual and online documentation and to make changes from time to time in the contents hereof without obligation to notify any person of such revision or changes.

Be a Registered Owner

Web registration is preferred. You can register your Vigor router via <http://www.draytek.com>.

Firmware & Tools Updates

Due to the continuous evolution of DrayTek technology, all routers will be regularly upgraded. Please consult the DrayTek web site for more information on newest firmware, tools and documents.

<http://www.draytek.com>

European Community Declarations

Manufacturer: DrayTek Corp.
Address: No. 26, Fu Shing Road, HuKou Township, HsinChu Industrial Park, Hsin-Chu County,
Taiwan 303
Product: Vigor2960 Series Router

DrayTek Corp. declares that Vigor2960 Series of routers are in compliance with the following essential requirements and other relevant provisions of R&TTE Directive 1999/5/EEC.

The product conforms to the requirements of Electro-Magnetic Compatibility (EMC) Directive 2004/108/EEC by complying with the requirements set forth in EN55022/Class B and EN55024/Class A.

The product conforms to the requirements of Low Voltage (LVD) Directive 2006/95/EEC by complying with the requirements set forth in EN60950-1.

Regulatory Information

Federal Communication Commission Interference Statement

This equipment has been tested and found to comply with the limits for a Class A digital device, pursuant to Part 15 of the FCC Rules. These limits are designed to provide reasonable protection against harmful interference in a residential installation. This equipment generates, uses and can radiate radio frequency energy and, if not installed and used in accordance with the instructions, may cause harmful interference to radio communications. However, there is no guarantee that interference will not occur in a particular installation. If this equipment does cause harmful interference to radio or television reception, which can be determined by turning the equipment off and on, the user is encouraged to try to correct the interference by one of the following measures:

- Reorient or relocate the receiving antenna.
- Increase the separation between the equipment and receiver.
- Connect the equipment into an outlet on a circuit different from that to which the receiver is connected.
- Consult the dealer or an experienced radio/TV technician for help.

This device complies with Part 15 of the FCC Rules. Operation is subject to the following two conditions:

- (1) This device may not cause harmful interference, and
- (2) This device may accept any interference received, including interference that may cause undesired operation.

<http://www.draytek.com/user/AboutRegulatory.php>



Table of Contents

1. Introduction.....	1
1.1 Panel Explanation	2
1.2 Package Content.....	4
2. Installing Your Router.....	5
2.1 Hardware Installation.....	5
2.2 Wall-Mounted Installation	6
2.3 Printer Installation.....	7
3. Configuring Web Pages	13
3.1 Accessing Web Page	13
3.2 Changing the Password	14
3.3 Quick Start Wizard.....	15
3.4 Check the Connection Status.....	22
4. Trouble Shooting	23
4.1 Checking If the Hardware Status Is OK or Not.....	23
4.2 Checking If the Network Connection Settings on Your Computer Is OK or Not	24
4.3 Pinging the Router from Your Computer	26
4.4 Checking If the ISP Settings are OK or Not	28
4.5 Backing to Factory Default Setting If Necessary.....	29
4.6 Contacting Your Dealer	30

1. Introduction

Vigor2960 series, a firewall broadband router with dual-WAN interface, can connect to xDSL/cable/VDSL2/Ethernet FTTx. The WAN and 4-port gigabit LAN switch facilitates unified communication applications in business CO/remote site to handle large data from subscribed fatter pipe. The state-of-art routing feature, VPN security, and Dual-WAN provide integrated benefits for professional users and small offices.

Vigor2960 series provides policy-based load-balance, fail-over and BOD (Bandwidth on Demand), also it integrates IP layer QoS, NAT session/bandwidth management to help users control works well with large bandwidth.

By adopting hardware-based VPN platform, hardware encryption of AES/DES/3DS and hardware key hash of SHA-1/MD5, the router increases the performance of VPN greatly, and offers several protocols (such as IPSec/PPTP/L2TP) with up to **200** VPN tunnels.

The Object-based design used in SPI (Stateful Packet Inspection) firewall allows users to set firewall policy with ease. CSM (Content Security Management) provides users control and management in IM (Instant Messenger), P2P (Peer to Peer), URL Content Filter and Web Content Filter more efficiency than before. By the way, DoS/DDoS prevention and URL/Web content filter strengthen the security outside and control inside.

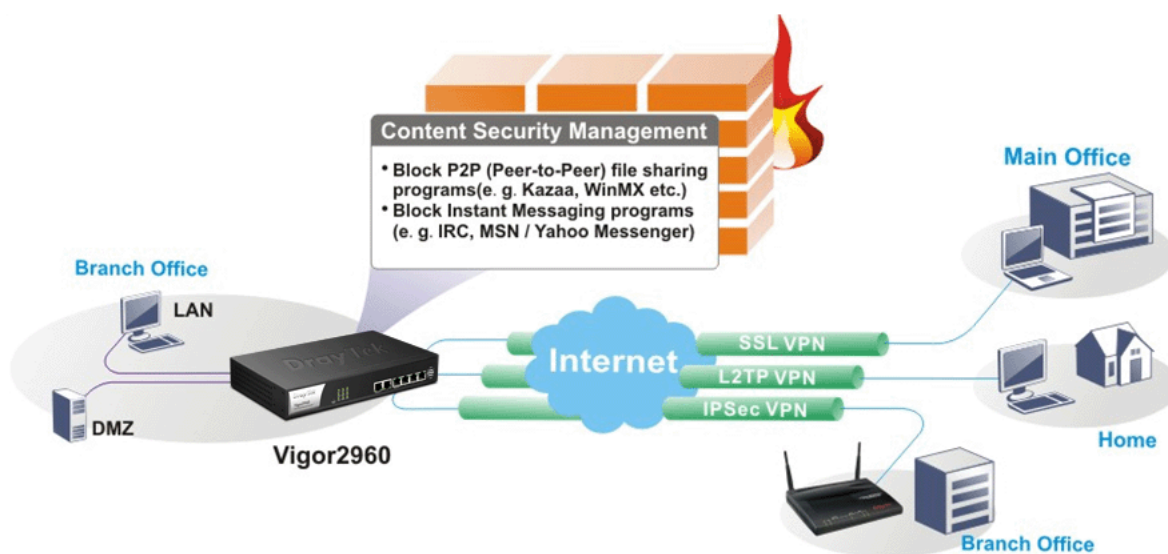

1.1 Panel Explanation



LED	Status	Explanation	
ACT (Activity)	Blinking	The router is powered on and running normally.	
	Off	The router is powered off.	
CSM	On	The profile(s) of CSM (Content Security Management) for IM/P2P, URL/Web Content Filter application can be enabled from Firewall >>General Setup . (Such profile must be established under CSM menu).	
VPN	On	The VPN tunnel is active.	
	Off	No VPN tunnel is active.	
DoS	On	The DoS/DDoS function is active.	
	Blinking	It will blink while deleting an attack.	
WAN1/2	On	The WAN1 or WAN2 connection is ready.	
	Blinking	It will blink while transmitting data.	
QoS	On	The QoS function is active.	
	Off	The QoS function is disabled.	
USB1/2	On	The USB device is connected and ready for use.	
	Blinking	The data is transmitting.	
<i>LED on Connector</i>			
GigaWAN 1/2	Left LED (Green)	On	The port is connected.
		Off	The port is disconnected.
		Blinking	The data is transmitting.
GigaLAN 1/2/3/4	Right LED (Green)	On	The port is connected with 1000Mbps.
		Off	The port is connected with 10/100Mbps.
GigaLAN 1/2/3/4	Left LED (Green)	On	The port is connected.
		Off	The port is disconnected.
		Blinking	The data is transmitting.
GigaLAN 1/2/3/4	Right LED (Green)	On	The port is connected with 1000Mbps.
		Off	The port is connected with 10/100Mbps.



Interface	Description
Factory Reset	Restore the default settings. Usage: Turn on the router (ACT LED is blinking). Press the hole and keep for more than 5 seconds. When you see the ACT LED begins to blink rapidly than usual, release the button. Then the router will restart with the factory default configuration.
GigaWAN 1/2	Connecters for remote networked devices.
GigaLAN 1/2/3/4	Connecters for local networked devices.
USB1/2	Connector for Mobile HDD, 3G Modem or printer.
	Connector for a power cord. ON/OFF - Power switch.

1.2 Package Content



1 Quick Start Guide

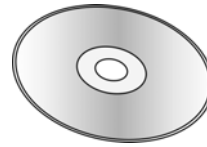

2 CD



3 RJ-45 Cable (Ethernet)

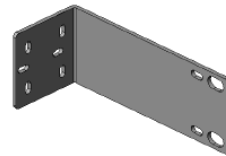

4 Rack mount kit (brackets)

5 The type of the power adapter depends on the country that the router will be installed:

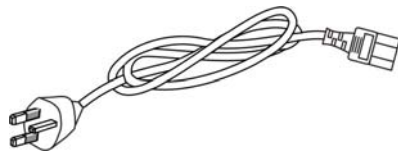

UK-type power cord



EU-type power cord



USA/Taiwan-type power cord



AU/NZ-type power cord

* The maximum power consumption is *20 Watt*.

2. Installing Your Router

This section will guide you to install the router through hardware connection and configure the router's settings through web browser.

2.1 Hardware Installation

Before starting to configure the router, you have to connect your devices correctly.

1. Connect one end of an Ethernet cable (RJ-45) to one of the **LAN** ports of Vigor2960s.
2. Connect the other end of the cable (RJ-45) to the Ethernet port on your computer (that device also can connect to other computers to form a small area network). The **LAN LED** for that port on the front panel will light up.
3. Connect the cable Modem/DSL Modem/Media Converter to any WAN port of router with Ethernet cable (RJ-45).
4. Connect the power cord to Vigor2960's power port on the rear panel, and the other side into a wall outlet.
5. Power on the device by pressing down the power switch on the rear panel. The **PWR** LED should be **ON**.
6. The system starts to initiate. After completing the system test, the **ACT** LED will light up and start blinking.

(For the detailed information of LED status, please refer to section 1.1.)

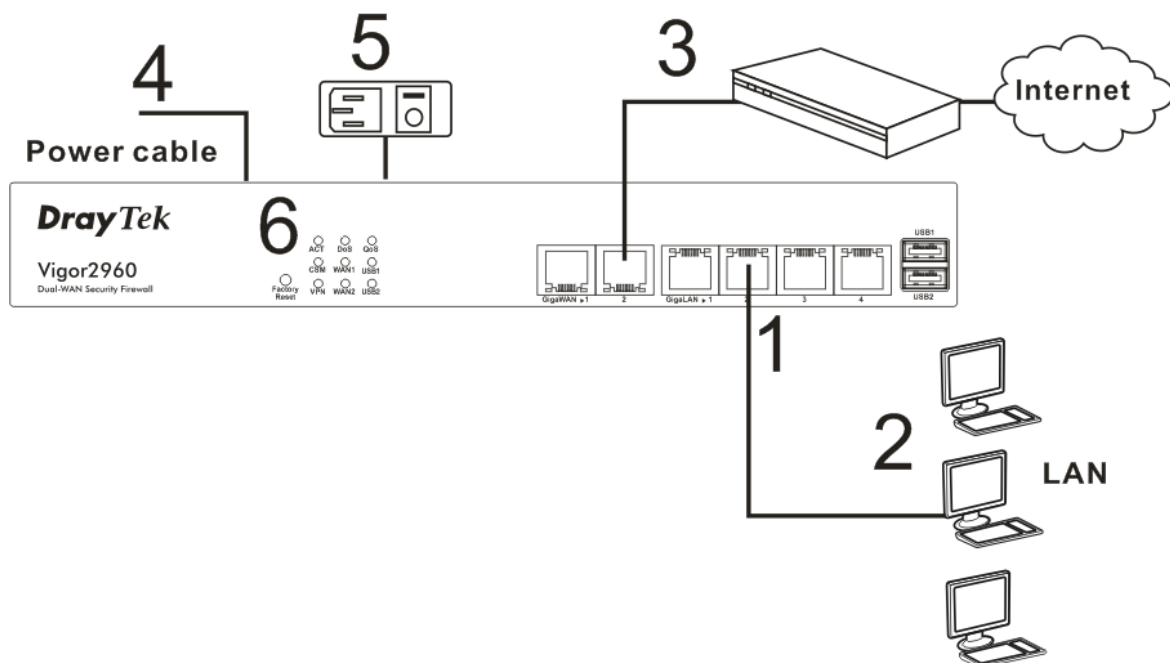

2.2 Wall-Mounted Installation

The Vigor2960 Series can be mounted on the wall by using standard brackets shown below.

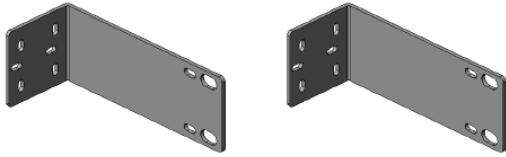

Choose a flat surface (on the wall) which is suitable for placing the router. Make the screw holes on the short side of the bracket aim at the screw holes on the router. Next, fasten both the bracket and the router with two screws; and fasten both the wall and the bracket with another two screws. Refer to the following figure.

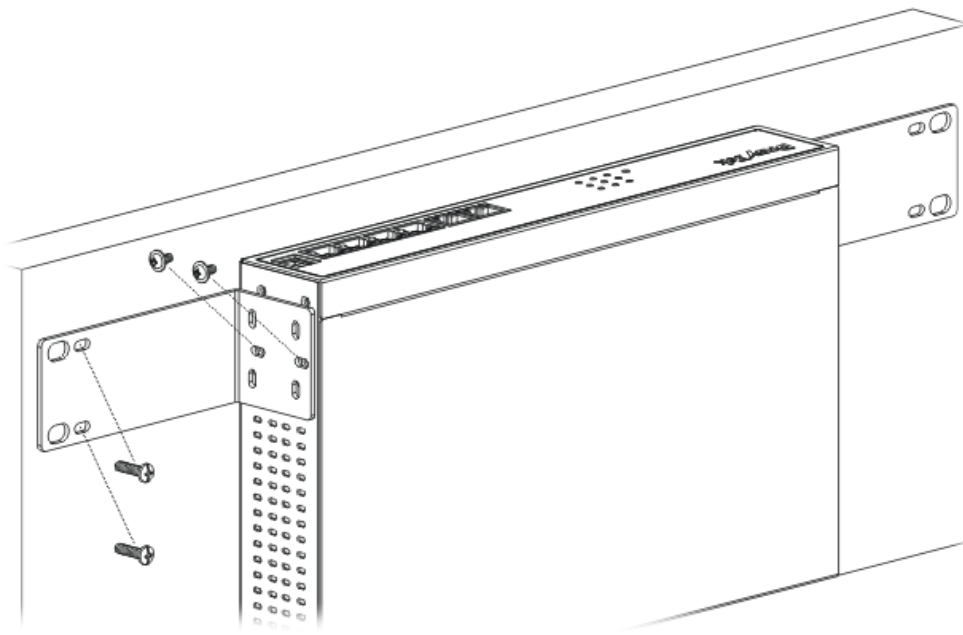

Then, continue to fasten the screws on the other side of the router and the wall with other screws.

When you finished about procedure, the router has been mounted on the wall firmly.

2.3 Printer Installation

You can install a printer onto the router for sharing printing. All the PCs connected this router can print documents via the router. The example provided here is made based on Windows XP/2000. For Windows 98/SE/Vista, please visit www.draytek.com.

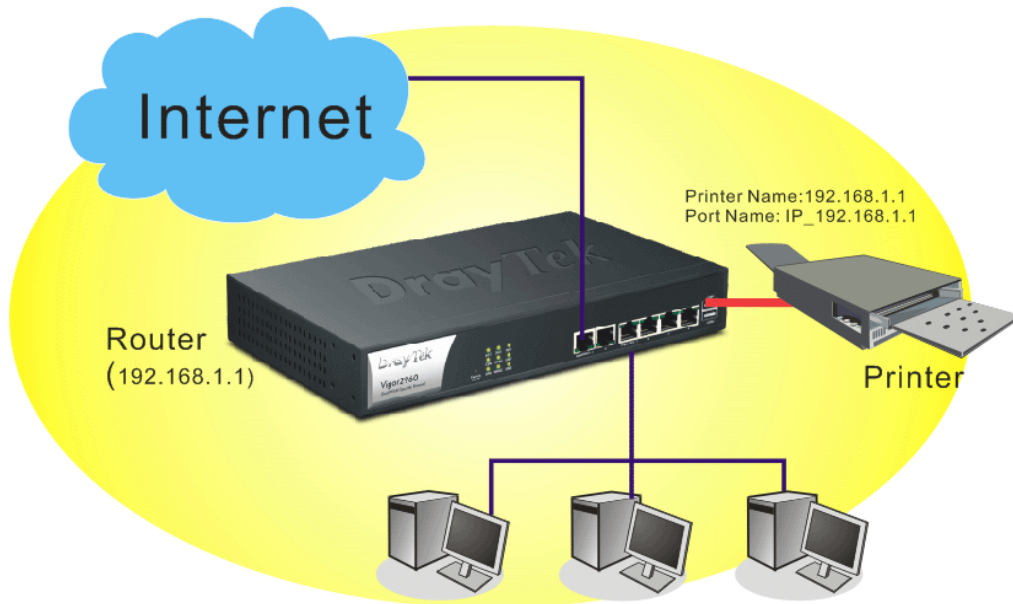

Before using it, please follow the steps below to configure settings for connected computers (or wireless clients).

1. Connect the printer with the router through USB port.
2. Open **Start->Settings-> Printer and Faxes**.

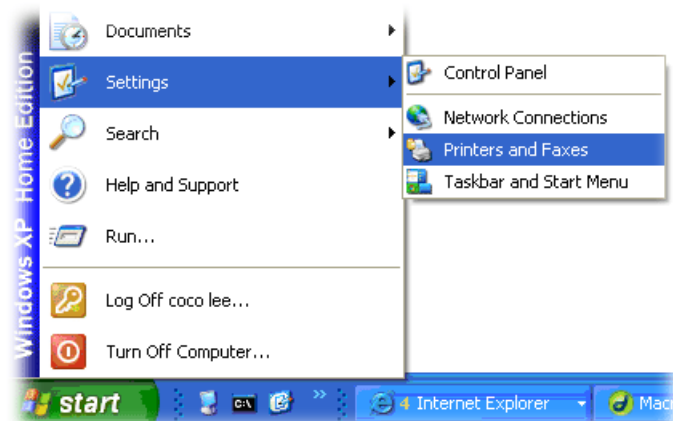

3. Open **File->Add a New Computer**. A welcome dialog will appear. Please click **Next**.

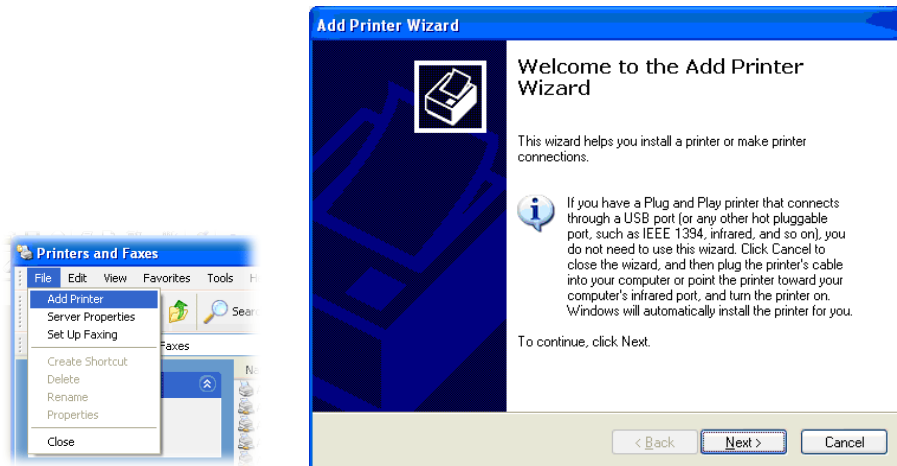

4. Click **Local printer attached to this computer** and click **Next**.



5. In this dialog, choose **Create a new port Type of port** and use the drop down list to select **Standard TCP/IP Port**. Click **Next**.

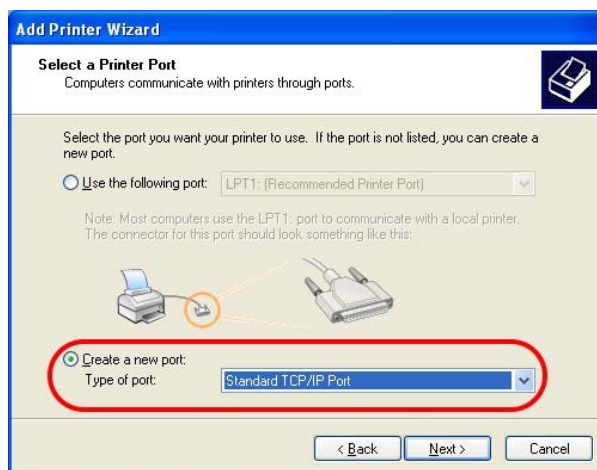

6. In the following dialog, type **192.168.1.1** (router's LAN IP) in the field of **Printer Name or IP Address** and type **IP_192.168.1.1** as the port name. Then, click **Next**.

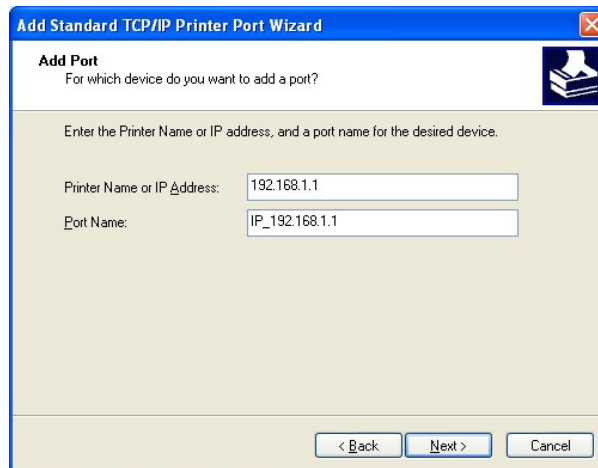

7. Click **Standard** and choose **Generic Network Card**.

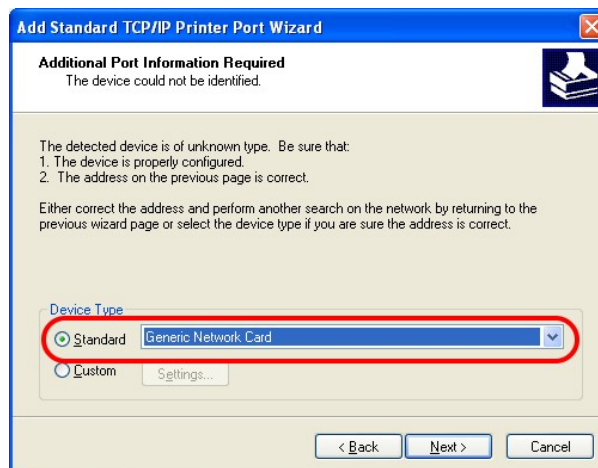

8. Then, in the following dialog, click **Finish**.



9. Now, your system will ask you to choose right name of the printer that you installed onto the router. Such step can make correct driver loaded onto your PC. When you finish the selection, click **Next**.

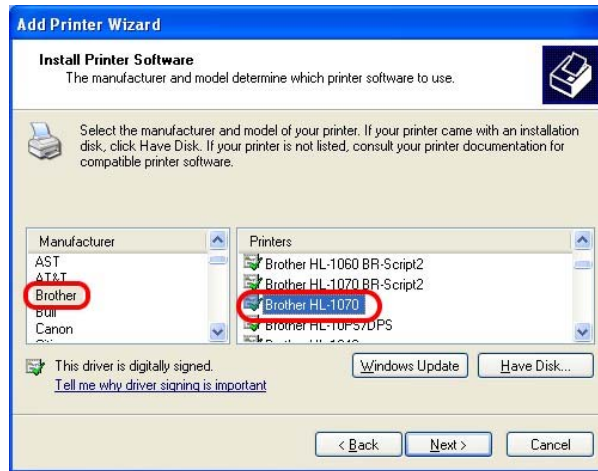

10. For the final stage, you need to go back to **Control Panel-> Printers** and edit the property of the new printer you have added.

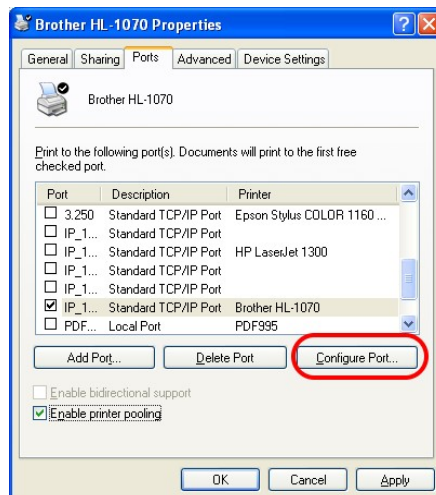

11. Select "**LPR**" on Protocol, type **p1** (number 1) as Queue Name. Then click **OK**. Next please refer to the red rectangle for choosing the correct protocol and LPR name.

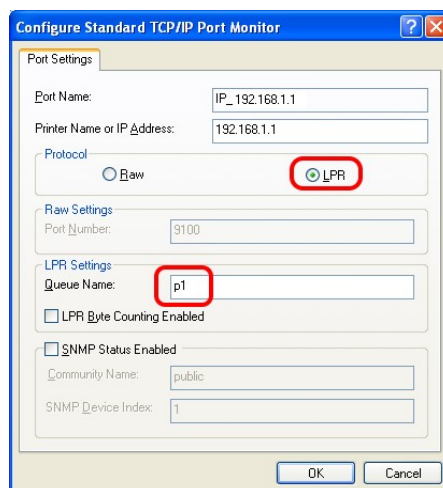

The printer can be used for printing now. Most of the printers with different manufacturers are compatible with vigor router.

Note 1: Some printers with the fax/scanning or other additional functions are not supported. If you do not know whether your printer is supported or not, please visit www.draytek.com to find out the printer list. Open **Support >FAQ**; find out the link of **Printer Server** and click it; then click the **What types of printers are compatible with Vigor router?** link.

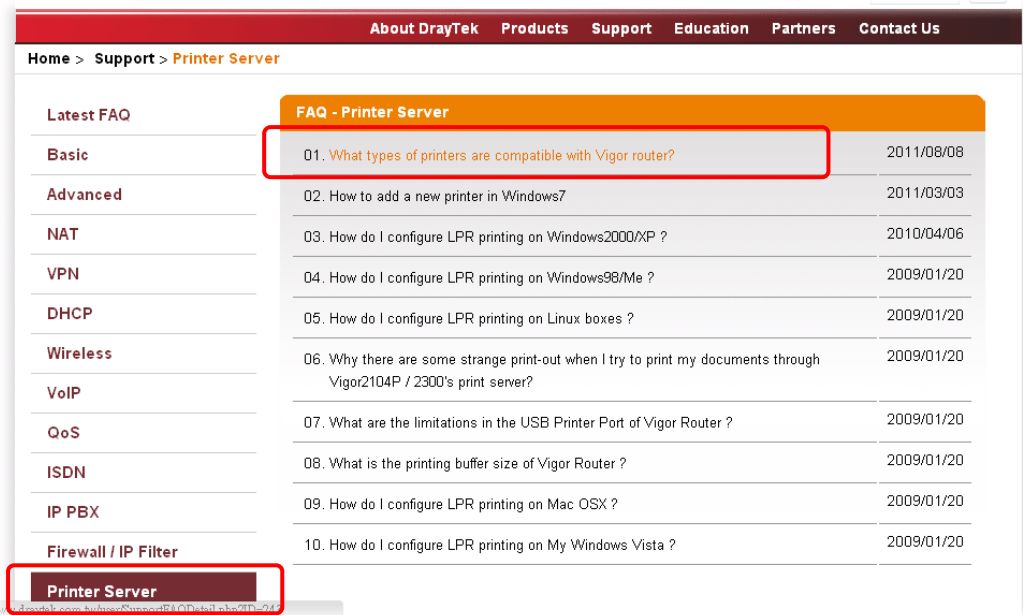

Note 2: Vigor router supports printing request from computers via LAN ports but not WAN port.

This page is left blank.

3. Configuring Web Pages

To access Internet, please finish basic configuration after completing the hardware installation.

3.1 Accessing Web Page

1. Make sure your PC connects to the router correctly.



Notice: You may either simply set up your computer to get IP dynamically from the router or set up the IP address of the computer to be the same subnet as **the default IP address of Vigor router 192.168.1.1**. For the detailed information, please refer to the later section - Trouble Shooting of the guide.

2. Open a web browser on your PC and type **http://192.168.1.1**. The following window will be open to ask for username and password.

The screenshot shows the login interface for the DrayTek Vigor2960 Series. The header is red with 'DrayTek' in white and 'Vigor2960 Series' in white. Below the header is a black bar with 'Login' in white. The main content area is white and contains a login form with fields for 'User' (containing 'admin'), 'Password' (containing six dots), and a language dropdown menu set to 'English'. A 'Login' button is located to the right of the language dropdown.

3. Please type “admin/admin” on Username/Password and click **Login**.



Notice: If you fail to access to the web configuration, please go to “Trouble Shooting” for detecting and solving your problem.

4. The web page can be logged out according to the chosen condition. The default setting is **5Min**, which means the web configuration system will logout after five minutes without any operation. Change the setting for your necessity.

The screenshot shows a dropdown menu for 'Auto Logout'. The menu is open, showing options: 5Min, Off, 1Min, 3Min, 5Min, and 10Min. The '5Min' option is currently selected.

- Now, the **Main Screen** will pop up.



3.2 Changing the Password

The first job that you have to do is changing the user password. Follow the steps below to modify:

- Go to **System Maintenance** page and choose **Administrator Password**.

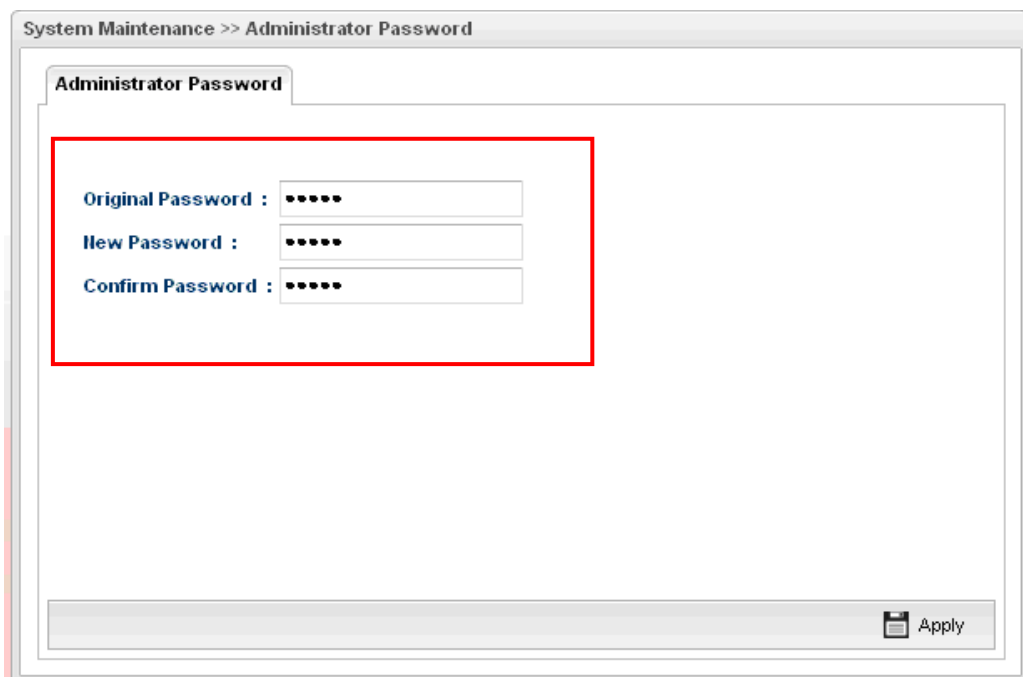

- Enter the login password on the field of **Original Password**. Type a new one in the field of **New Password** and retype it on the field of **Confirm Password**. Then click **Apply** to continue.
- Now, the password has been changed. Next time, use the new password to access the Web Configurator for this router.

3.3 Quick Start Wizard

Quick Setup is a wizard which is designed for configuring your router accessing Internet with simply steps. In the **Quick Setup** group, you can configure the router to access the Internet with different modes such as Static, DHCP, PPPoE, or PPTP modes.

Step 1

In the first page of Quick Start Wizard, please create a WAN profile.

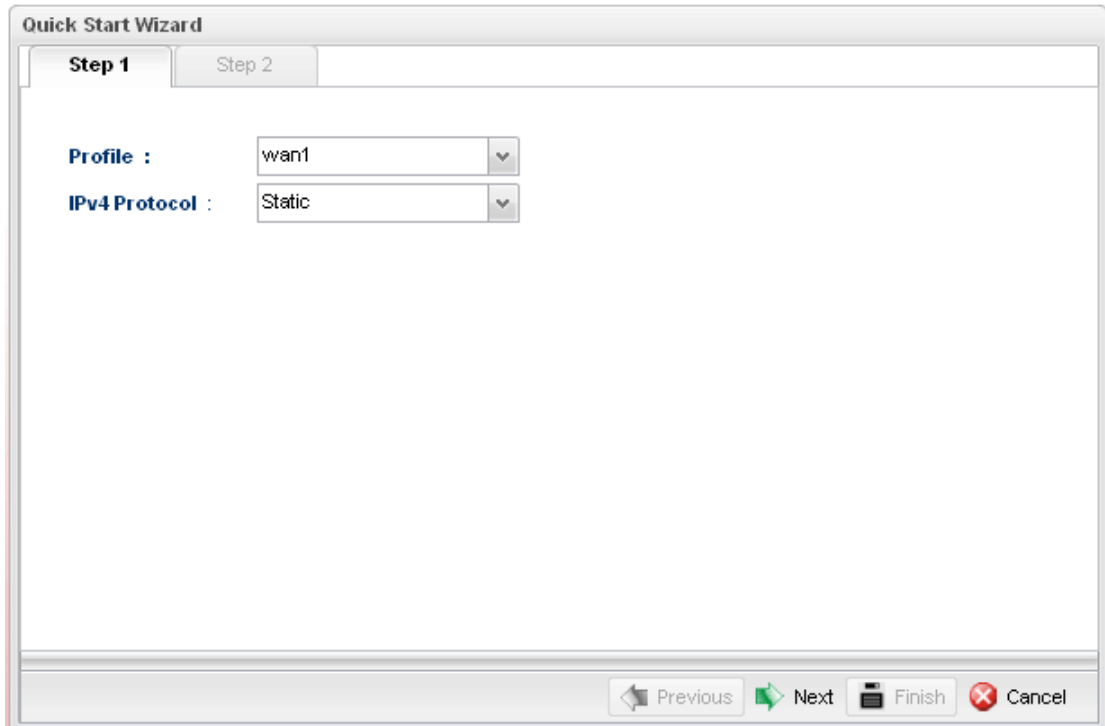

Available settings are explained as follows:

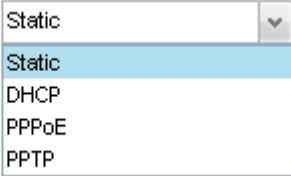
Item	Description
Profile	Use the drop down list to choose one WAN profile.
IPv4 Protocol Type	<p>Use the drop down list to choose a connection mode for such WAN profile.</p> <p>IPv4 Protocol : </p> <p>Static - If Static is selected, you can manually assign a static IP address to the WAN interface and complete the configuration by applying the settings and rebooting your router. Please type in values for IP address, Subnet Mask, Gateway IP Address and DNS Server IP Address specified by your ISP, and then click Next.</p> <p>DHCP - It allows a user to obtain an IP address automatically from a DHCP server on the Internet. If</p>

Item	Description
	<p>you choose DHCP mode, the DHCP server of your ISP will assign a dynamic IP address for Vigor2960 automatically. It is not necessary for you to assign any setting. (Host Name and Domain Name are required for some ISPs).</p> <p>PPTP - This mode lets user get the IP group information by a DSL modem with PPTP service from ISP. Your service provider will give you user name, password, and authentication mode for a PPTP setting. Click PPTP as the protocol. Type in all the information that your ISP provides for this protocol.</p> <p>If your ISP offers you PPTP (Point-to-Point Tunneling Protocol) mode, please select PPTP for this router. Next, enter the required information provided by your ISP on the web page.</p> <p>PPPoE - PPPoE stands for Point-to-Point Protocol over Ethernet. It relies on two widely accepted standards: PPP and Ethernet. It connects users through an Ethernet to the Internet with a common broadband medium, such as a single DSL line, wireless device or cable modem. All the users over the Ethernet can share a common connection.</p> <p>PPPoE is used for most of DSL modem users. All local users can share one PPPoE connection for accessing the Internet. Your service provider will provide you information about user name, password, and authentication mode.</p> <p>If your ISP provides you the PPPoE (Point-to-Point Protocol over Ethernet) connection, please select PPPoE for this router to get the following page. Enter the username and password provided by your ISP on the web page.</p>

When you finish the above settings, please click **Next** to go to next page.

Step 2

After clicking **Next**, you can see the following page which will vary according to the IPv4 protocol type selected in Step 1.

- For **Static type**, the page will be displayed as follows:

The screenshot shows the 'Quick Start Wizard' interface at 'Step 2'. The configuration fields are as follows:



- IP Address :** 172 . 16 . 3 . 103
- Subnet Mask :** 255.255.0.0
- Gateway IP Address :** 172 . 16 . 1 . 1 (Optional)
- DNS Server IP Address :** A table with the following structure:

DNS Server IP Address			
No items to show.			

At the bottom of the wizard, there are navigation buttons: 'Previous', 'Next', 'Finish', and 'Cancel'.

Available settings are explained as follows:

Item	Description
IP Address	Type the IP address of the router for the WAN profile.
Subnet Mask	Type the network mask of the router for the WAN profile.
Gateway IP Address	Use the default setting (0.0.0.0). Such IP address is ready for matching with the function of Virtual System.
DNS Server IP Address	Type a public IP address as the primary DNS (Domain Name Server). To add a new IP address, simply Add . Four boxes will appear for you to type the IP address. When you finish the settings, click Save .

Item	Description
	 <p>Add – Click this button to have a field for adding a new IP address.</p> <p>Save – Click this button to save the configuration.</p> <p> – click the icon to remove the selected entry.</p>
Previous	Click it to return to previous setting page.
Finish	Click it to save the configuration and exit the dialog.
Cancel	Click it to discard the settings configured in this page.

After finishing the above configuration, click **Finish**.

- For DHCP type, the page will be displayed as follows:

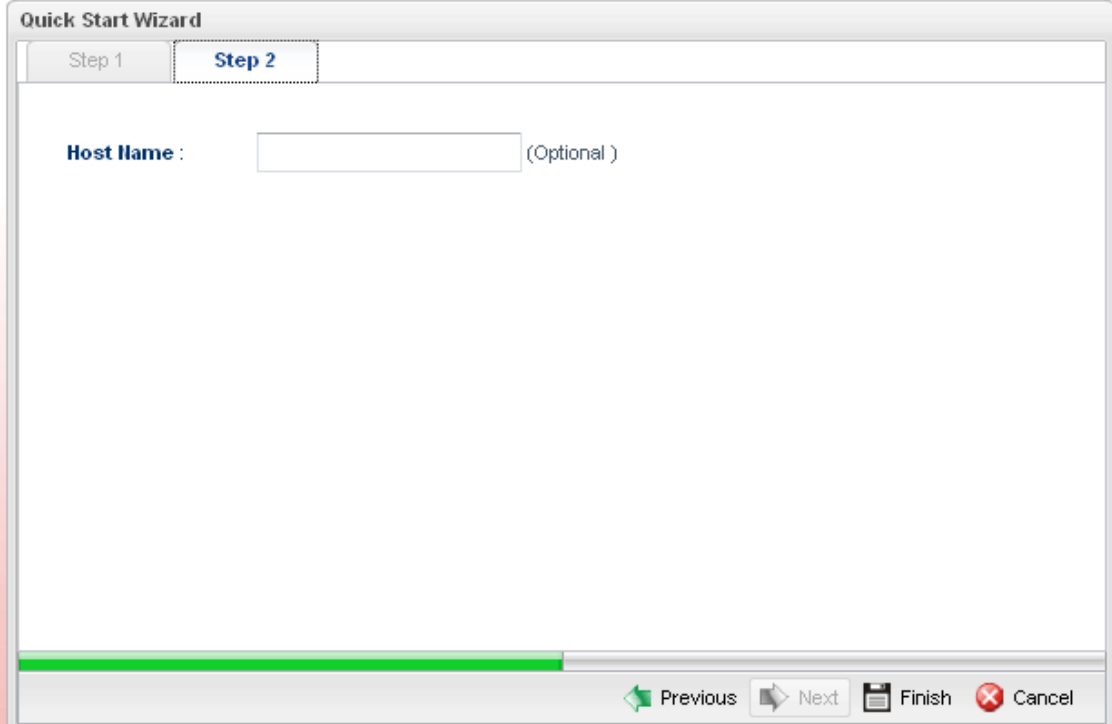

Type a name as the host name for identification (optional) for identification. Click **Finish**.

- For PPPoE type, the page will be displayed as follows:

Available settings are explained as follows:

Item	Description
Username	Type in the username provided by ISP in this field
Password	Type in the password provided by ISP in this field.
Previous	Click it to return to previous setting page.
Finish	Click it to save the configuration and exit the dialog.
Cancel	Click it to discard the settings configured in this page.

After finishing the above configuration, click **Finish**.

- For PPTP type, the page will be displayed as follows:



The screenshot shows the 'Quick Start Wizard' at 'Step 2'. The configuration fields are as follows:

- PPTP Over :** Static
- Server Address :** 0.0.0.0
- Username :** (empty)
- Password :** (empty)
- IP Address :** 172 . 16 . 3 . 103
- Subnet Mask :** 255.255.0.0
- Gateway IP Address :** 172 . 16 . 1 . 1 (Optional)

Below these fields is a section for 'DNS Server IP Address' with 'Add' and 'Save' buttons. The table below it is empty, showing 'No items to show.' At the bottom, there are 'Previous', 'Next', 'Finish', and 'Cancel' buttons.

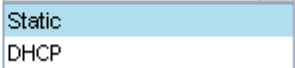
Available settings are explained as follows:

Item	Description
PPTP Over	<p>Usually ISP dynamically assigns IP address to you each time you connect to it and request. In some case, your ISP provides service to always assign you the same IP address whenever you request. In this case, you can fill in this IP address in the Fixed IP field. Please contact your ISP before you want to use this function.</p> <p>PPTP Over : </p> <p>Server Address : </p> <p>Static – Specify the IP address. DHCP - Obtain the IP address automatically.</p>
Server Address	Type a remote IP address of PPTP server.
Username	Type in the username provided by ISP in this field.
Password	Type in the password provided by ISP in this field.
Gateway IP Address	Use the default setting (0.0.0.0).
DNS Server IP Address	Type a public IP address as the primary DNS (Domain Name Server). To add a new IP address, simply Add . Four boxes will appear for you to type the IP address. When you finish the settings, click Save .

Item	Description
	 <p>Add – Click this button to have a field for adding a new IP address.</p> <p>Save – Click this button to save the configuration.</p> <p> – click the icon to remove the selected entry.</p>
Previous	Click it to return to previous setting page.
Finish	Click it to save the configuration and exit the dialog.
Cancel	Click it to discard the settings configured in this page.

After finishing the above configuration, click **Finish**.

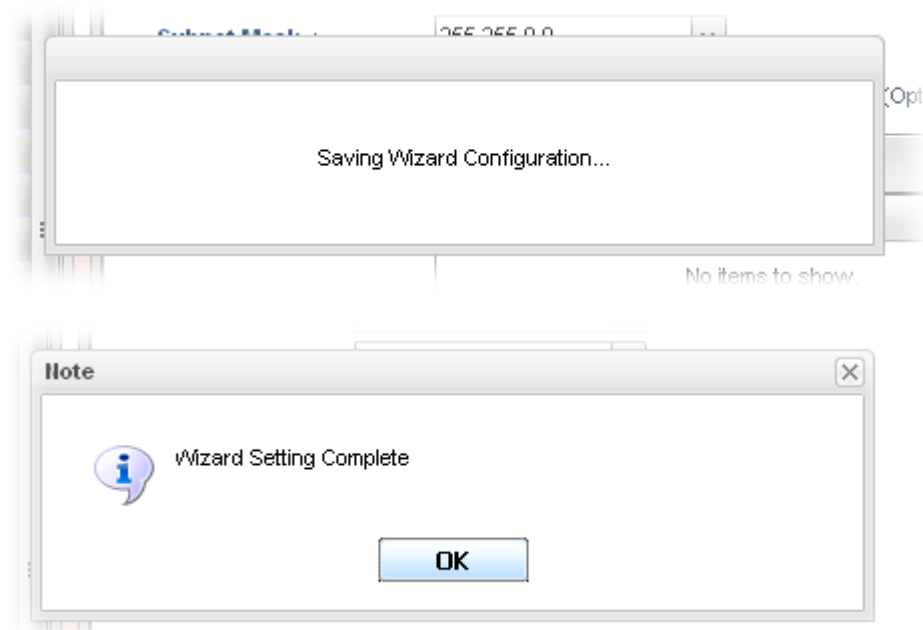

Later, you can surf the Internet at any time.

3.4 Check the Connection Status

After finishing the WAN connection, please check the connection status to ensure the network connection has been made successfully.

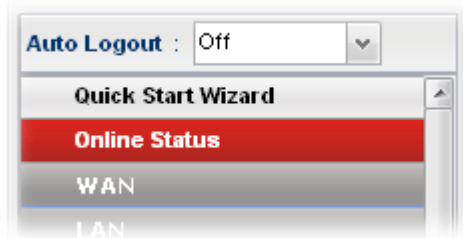

Please open **Online Status** to display the information for all the WAN interfaces at the same time, including Device Information, System Information and IPv4/IPv6 configurations.

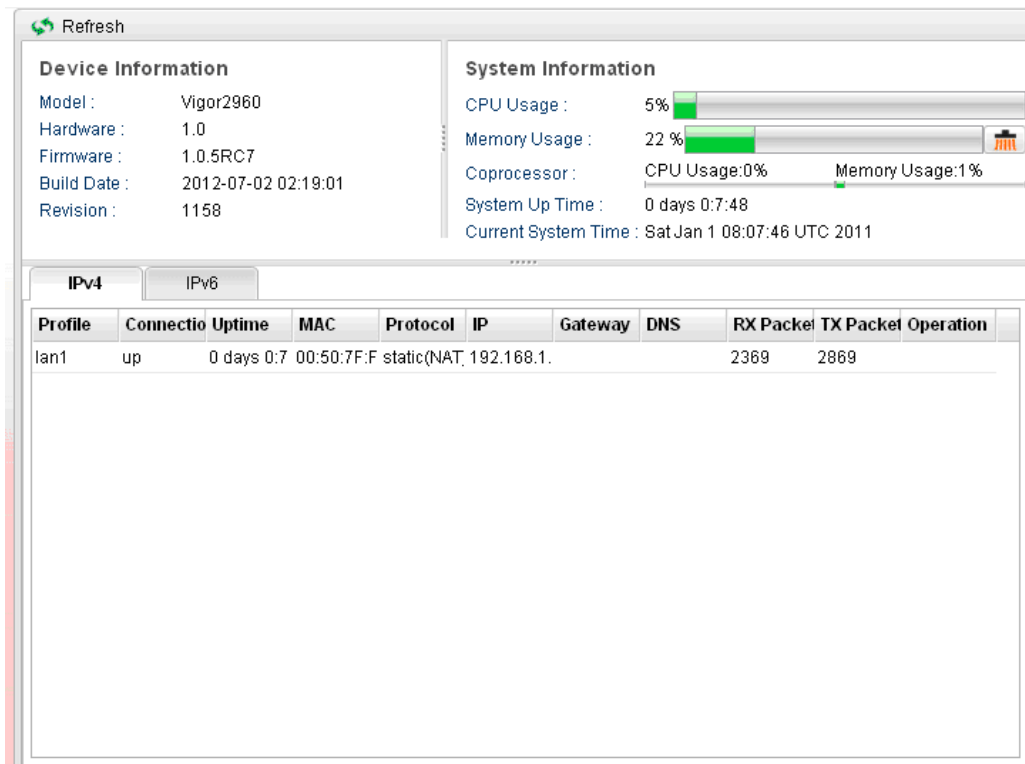

The screenshot displays the 'Online Status' page. At the top left, there is a 'Refresh' button. The page is divided into two main sections: 'Device Information' and 'System Information'.

Device Information:

- Model : Vigor2960
- Hardware : 1.0
- Firmware : 1.0.5RC7
- Build Date : 2012-07-02 02:19:01
- Revision : 1158

System Information:

- CPU Usage : 5% (with a green progress bar)
- Memory Usage : 22 % (with a green progress bar)
- Coprocessor : CPU Usage:0% Memory Usage:1%
- System Up Time : 0 days 0:7:48
- Current System Time : Sat Jan 1 08:07:46 UTC 2011

Below these sections, there are tabs for 'IPv4' and 'IPv6'. The 'IPv4' tab is active, showing a table of WAN connections.

Profile	Connectio	Uptime	MAC	Protocol	IP	Gateway	DNS	RX Packet	TX Packet	Operation
lan1	up	0 days 0:7	00:50:7F:F	static(NAT)	192.168.1.			2369	2869	

From the above figure, wan1 connection for Internet has been built successfully for the word – ***up*** has been displayed on the field of **Connection**.

4. Trouble Shooting

This section will guide you to solve abnormal situations if you cannot access into the Internet after installing the router and finishing the web configuration. Please follow sections below to check your basic installation status stage by stage.

- Checking if the hardware status is OK or not.
- Checking if the network connection settings on your computer are OK or not.
- Pinging the router from your computer.
- Checking if the ISP settings are OK or not.
- Backing to factory default setting if necessary.

If all above stages are done and the router still cannot run normally, it is the time for you to contact your dealer for advanced help.

4.1 Checking If the Hardware Status Is OK or Not

Follow the steps below to verify the hardware status.

1. Check the power line and LAN cable connections. Refer to “**2.1 Hardware Installation**” for details.
2. Turn on the router. Make sure the **ACT LED** blink once per second.

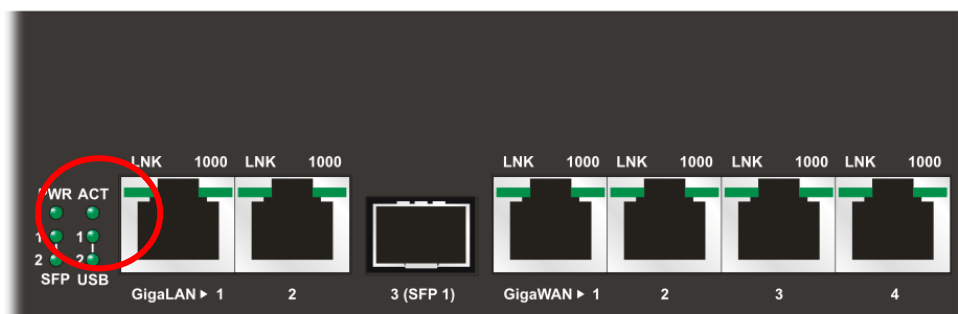

3. If not, it means that there is something wrong with the hardware status. Simply back to “**2.1 Hardware Installation**” to execute the hardware installation again. And then, try again.

4.2 Checking If the Network Connection Settings on Your Computer Is OK or Not

Sometimes the link failure occurs due to the wrong network connection settings. After trying the above section, if the link is still failed, please do the steps listed below to make sure the network connection settings is OK.

For Windows



The example is based on Windows XP. As to the examples for other operation systems, please refer to the similar steps or find support notes in www.draytek.com.

1. Go to **Control Panel** and then double-click on **Network Connections**.



2. Right-click on **Local Area Connection** and click on **Properties**.

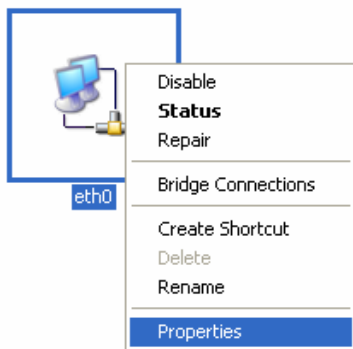

3. Select **Internet Protocol (TCP/IP)** and then click **Properties**.

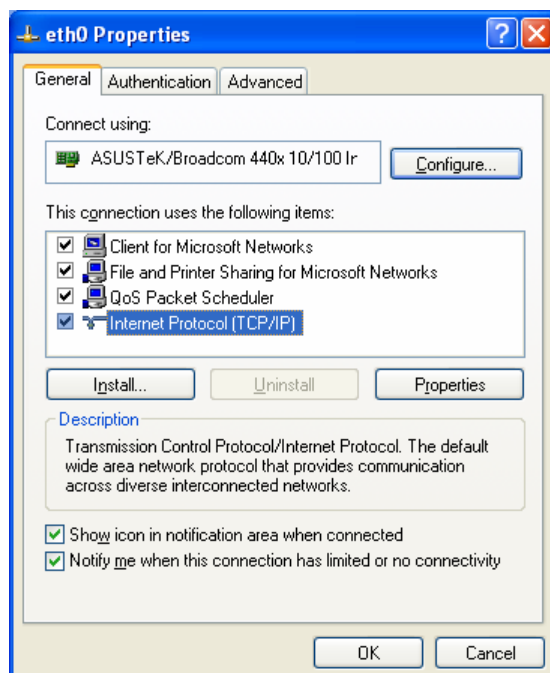

4. Select **Obtain an IP address automatically** and **Obtain DNS server address automatically**.

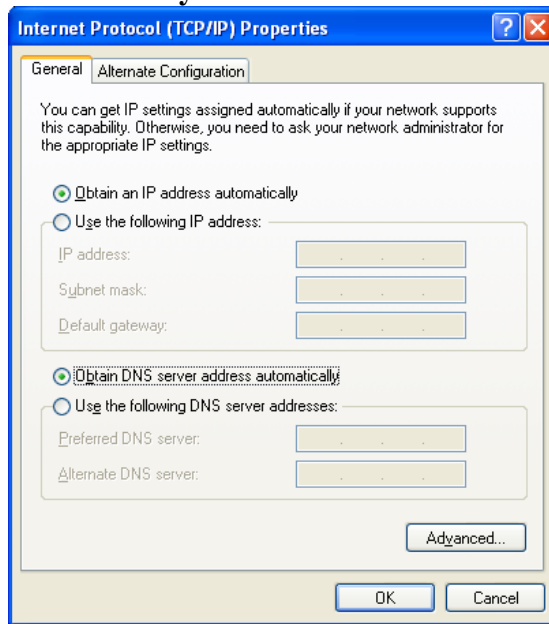

For Mac OS

1. Double click on the current used Mac OS on the desktop.
2. Open the **Application** folder and get into **Network**.
3. On the **Network** screen, select **Using DHCP** from the drop down list of Configure IPv4.

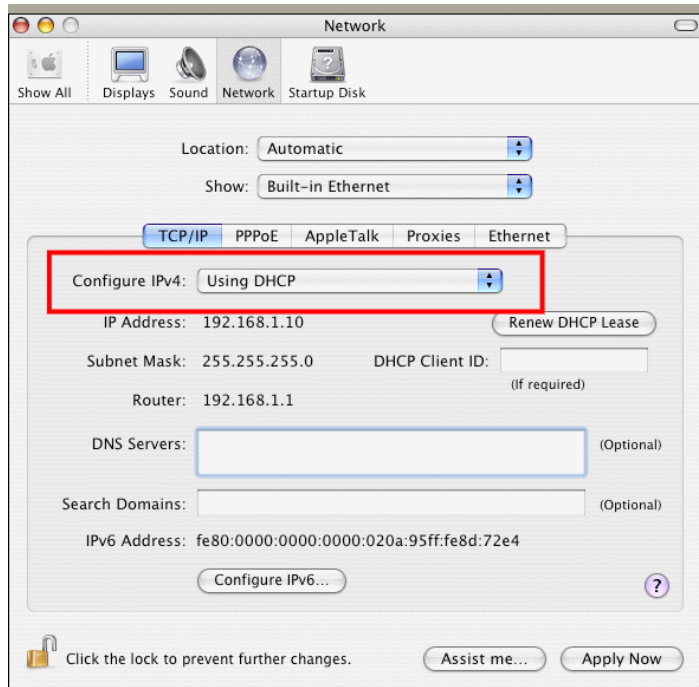

4.3 Pinging the Router from Your Computer

The default gateway IP address of the router is 192.168.1.1. For some reason, you might need to use “ping” command to check the link status of the router. **The most important thing is that the computer will receive a reply from 192.168.1.1.** If not, please check the IP address of your computer. We suggest you setting the network connection as **get IP automatically**. (Please refer to the section 4.2)

Please follow the steps below to ping the router correctly.

For Windows

1. Open the **Command Prompt** window (from **Start menu> Run**).
2. Type **command** (for Windows 95/98/ME) or **cmd** (for Windows NT/2000/XP/Vista/7). The DOS command dialog will appear.

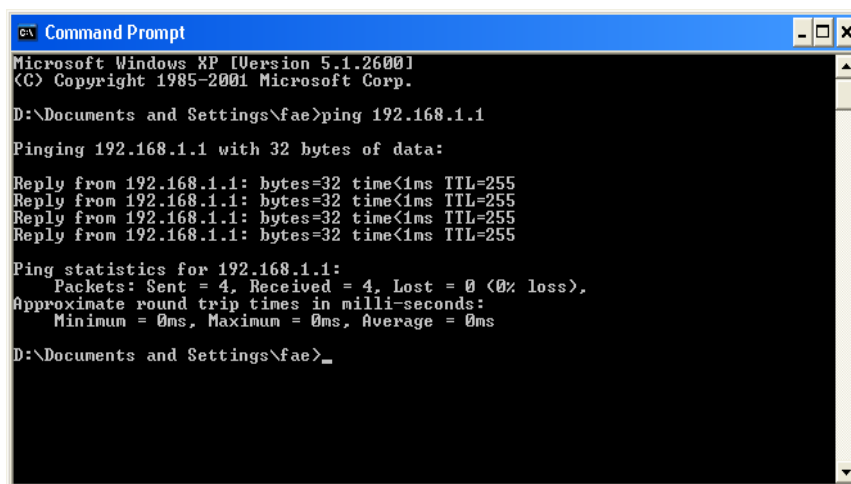

```
Microsoft Windows XP [Version 5.1.2600]
(C) Copyright 1985-2001 Microsoft Corp.

D:\Documents and Settings\fae>ping 192.168.1.1

Pinging 192.168.1.1 with 32 bytes of data:

Reply from 192.168.1.1: bytes=32 time<1ms TTL=255
Reply from 192.168.1.1: bytes=32 time<1ms TTL=255
Reply from 192.168.1.1: bytes=32 time<1ms TTL=255
Reply from 192.168.1.1: bytes=32 time<1ms TTL=255

Ping statistics for 192.168.1.1:
    Packets: Sent = 4, Received = 4, Lost = 0 (0% loss),
    Approximate round trip times in milli-seconds:
        Minimum = 0ms, Maximum = 0ms, Average = 0ms

D:\Documents and Settings\fae>_
```

3. Type **ping 192.168.1.1** and press [Enter]. If the link is OK, the line of “**Reply from 192.168.1.1:bytes=32 time<1ms TTL=255**” will appear.
4. If the line does not appear, please check the IP address setting of your computer.

For Mac OS (Terminal)

1. Double click on the current used Mac OS on the desktop.
2. Open the **Application** folder and get into **Utilities**.
3. Double click **Terminal**. The Terminal window will appear.
4. Type **ping 192.168.1.1** and press [Enter]. If the link is OK, the line of “**64 bytes from 192.168.1.1: icmp_seq=0 ttl=255 time=xxxx ms**” will appear.

```
Terminal — bash — 80x24
Last login: Sat Jan  3 02:24:18 on ttty1
Welcome to Darwin!
Vigor10:~ draytek$ ping 192.168.1.1
PING 192.168.1.1 (192.168.1.1): 56 data bytes
64 bytes from 192.168.1.1: icmp_seq=0 ttl=255 time=0.755 ms
64 bytes from 192.168.1.1: icmp_seq=1 ttl=255 time=0.697 ms
64 bytes from 192.168.1.1: icmp_seq=2 ttl=255 time=0.716 ms
64 bytes from 192.168.1.1: icmp_seq=3 ttl=255 time=0.731 ms
64 bytes from 192.168.1.1: icmp_seq=4 ttl=255 time=0.72 ms
^C
--- 192.168.1.1 ping statistics ---
5 packets transmitted, 5 packets received, 0% packet loss
round-trip min/avg/max = 0.697/0.723/0.755 ms
Vigor10:~ draytek$
```

4.4 Checking If the ISP Settings are OK or Not

Open **Online Status** to check current network status. Be careful to check if the settings coming from your ISP have been typed correctly or not.

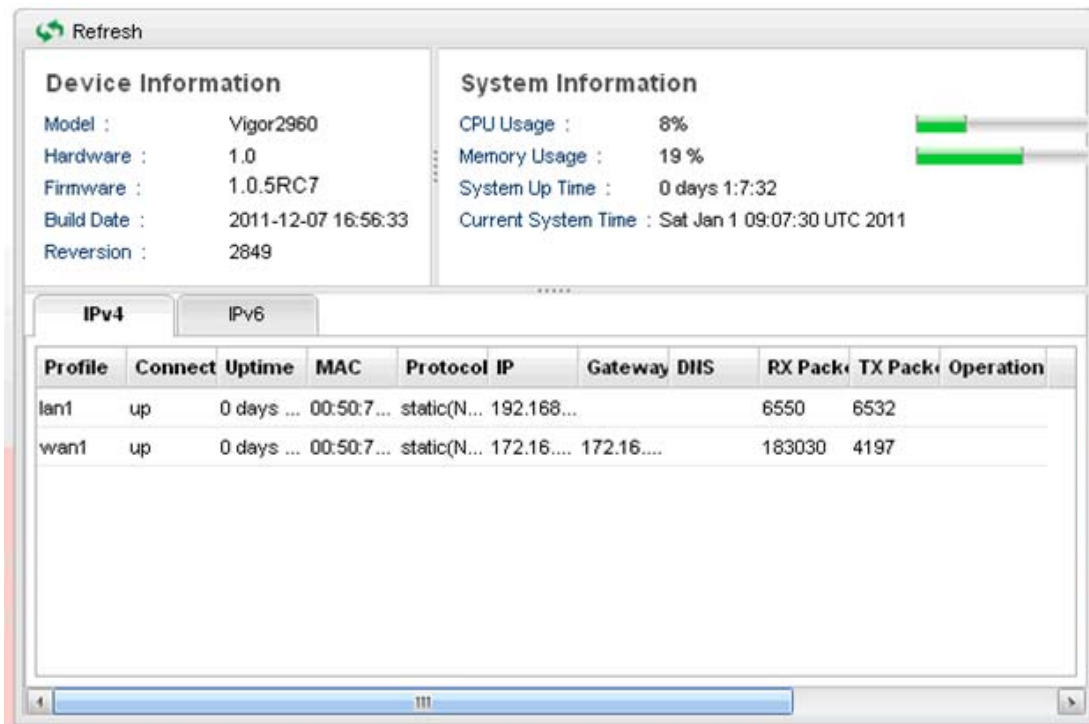

The screenshot displays the 'Online Status' page. At the top left is a 'Refresh' button. The page is divided into two main sections: 'Device Information' and 'System Information'. Below these are tabs for 'IPv4' and 'IPv6'. A table lists network profiles with columns for Profile, Connect, Uptime, MAC, Protocol, IP, Gateway, DNS, RX Pack, TX Pack, and Operation.

Profile	Connect	Uptime	MAC	Protocol	IP	Gateway	DNS	RX Pack	TX Pack	Operation
lan1	up	0 days ...	00:50:7...	static(N...	192.168...			6550	6532	
wan1	up	0 days ...	00:50:7...	static(N...	172.16....	172.16....		183030	4197	

If there is something wrong with the configuration, please go to **WAN** page and choose **General Setup** again to modify the WAN connection.

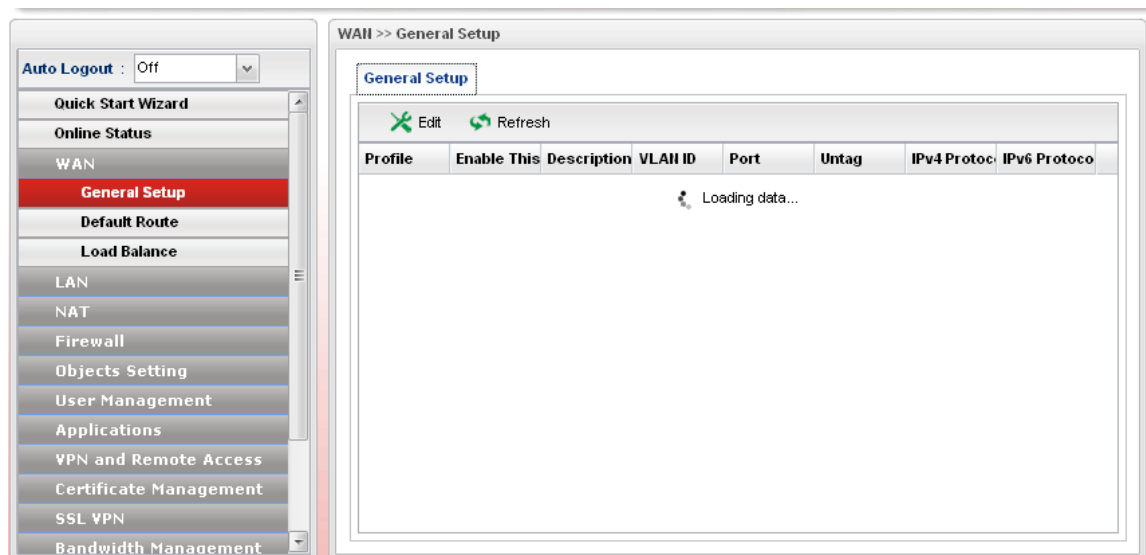

The screenshot shows the 'WAN >> General Setup' page. On the left is a sidebar menu with options like 'Auto Logout', 'Quick Start Wizard', 'Online Status', 'WAN', 'General Setup' (highlighted), 'Default Route', 'Load Balance', 'LAN', 'NAT', 'Firewall', 'Objects Setting', 'User Management', 'Applications', 'VPN and Remote Access', 'Certificate Management', 'SSL VPN', and 'Bandwidth Management'. The main content area has 'Edit' and 'Refresh' buttons and a table with columns: Profile, Enable This, Description, VLAN ID, Port, Untag, IPv4 Protoc, and IPv6 Protoco. The table content is currently 'Loading data...'.

4.5 Backing to Factory Default Setting If Necessary

Sometimes, a wrong connection can be improved by returning to the default settings. Try to reset the router by software or hardware.



Warning: After pressing **factory default setting**, you will lose all settings you did before. Make sure you have recorded all useful settings before you pressing. The password of factory default is null.

Software Reset

You can reset the router to factory default via Web page.

Go to **System Maintenance** and choose **Reboot System** on the web page. The following screen will appear. Choose **Reboot with Factory Default Configuration** and click **Reboot**. After few seconds, the router will return all the settings to the factory settings.

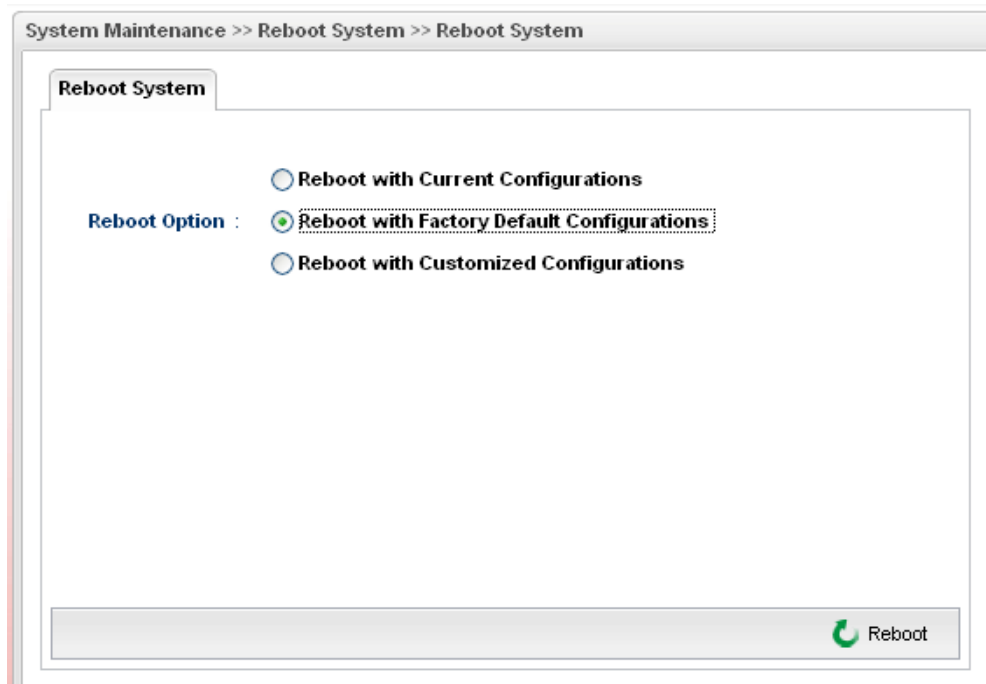

Hardware Reset

While the router is running (ACT LED blinking), press the **Factory Reset** button and hold for more than 5 seconds. When you see the **ACT LED** blinks rapidly, please release the button. Then, the router will restart with the default configuration.



After restore the factory default setting, you can configure the settings for the router again to fit your personal request.

4.6 Contacting Your Dealer

If the router still cannot work correctly after trying many efforts, please contact your dealer for further help right away. For any questions, please feel free to e-mail to support@draytek.com.