

KRUUSE Digital Thermometer
تيرموميتر

- n Temperature range: 32°C - 43.9°C
- n Measuring accuracy: 0.1°C between 35.5°C to 42.0°
- n Latest measuring result stored
- n Turns off automatically after use
- n Long temperature sensor for large animals

Cat. No	Description
291102	KRUUSE Digital Thermometer DIGI-Vet SC 12

KRUUSE DIGI-TEMP Express Thermometer
تيرموميتر للحيوانات الكبيرة

- n Fast measuring: 10-15 sec.
- n Temperature measurement between 32-42 ° C
- n Accuracy: +/- 0.10 ° C
- n Long temperature sensor for large animals

Cat. No	Description
291114	KRUUSE DIGI-TEMP Express Thermometer



- n Temperature range: 32°C - 43°C



KRUUSE Urine Strips

شرائط اختبار بول

Inexpensive and easy-to-read test. Coloured indicator squares on the strip can be compared with the colour chart on the label. Results appear in 60 seconds. Parameters: pH, nitrites, protein, glucose, ketones, bilirubin, urobilinogen, blood, leukocytes, specific gravity (For specific gravity we advise to use our refractometers).

Cat. No	Description
290798	KRUUSE Urine Strips 100/pk



Ketostix Ames

اختبار كيتوزيز في البول

Urine stix, measures ketosis in urine. 50/pk
Measuring ketosis in the urine is more accurate than measuring ketosis in milk.

Cat. No	Description
290837	Ketostix ames 2880 50/pk



BHB milk

اختبار كيتوزيز في اللبن

The test strip shows the concentration of BHB in milk.

BHB (Beta Hydroxy Butyrate) is a substance that in higher concentration is an indicator for ketosis.

Cat. No	Description
290839	BHB milk, 25/pk

KRUUSE Refractometers

اختبار كولوستروم



KRUUSE Colostrum Refractometer will very rapidly give a reliable colostrum measurement result, thus an indication if the colostrum quality is good enough to feed the newborn. Colostrum quality is measured in percentages with a cut-off value of 22%. Test the colostrum before feeding it to the newborn and use only good quality colostrum.

Cat. No	Description
290015	Colostrum refractometer, digital
290017	Colostrum refraktometer, Brix scale

CMT Test Paddle

طبق اختبار كاليفورنيا



A four-well plastic paddle. Place milk from each quarter into each section. Add test liquid, agitate gently and evaluate. Marks indicate 2 and 3 ml.

Cat. No	Description
170365	CMT test paddle

Squeeze the handle and new test liquid comes out automatically.

Cat. No	Description
170390	CMT test paddle, X-spurt multitest, blue
170392	CMT test paddle, X-spurt multitest, white

CMT Test Liquid

اختبار كاليفورنيا ١ لتر



Test liquid for the detection of mastitis. To be used with CMT test paddle. The test liquid indicates the cell count in milk.

Cat. No	Description
170366a	CMT liquid 1 l
170367	CMT liquid 5 l
170374	CMT liquid 10 l

KRUUSE Colostrum Densimeter

اختبار كولوستروم



For quick evaluation of IgG content in bovine colostrum. A quick way of measuring the quality of the colostrum is by using the KRUUSE colostrum densimeter. The densimeter measures the specific gravity of the colostrum.

Cat. No	Description
290855	KRUUSE colostrum densimeter complete with measuring Cylinder
290856	Spare densimeter
290857	Spare measuring cylinder, 250 ml



KRUTEX Nitrile Clinic Gloves - Powder Free

جاوانتي نايتر ايل

A strong and durable glove. Non-sterile. Provides excellent protection against the most common drugs and chemicals used in animal production. Thickness at the fingers: 0.15 mm. Thickness at the palm: 0.13 mm. AQL: 1.5

Features and Benefits:

- n Easy donning and removal
- n Cuff strengthened by a rolled cuff
- n Micro textured providing good wet and dry grip properties
- n Extra thin for increased sensitivity and feel
- n Good viral barrier properties
- n Latex like stretch and comfort
- n Softer than standard nitrile and vinyl
- n Free of latex
- n Free of powder
- n Free of protein
- n Easy size recognition on box
- n Colour coded for easy recognition

Cat. No Description

261131	KRUTEX nitrile examination gloves, powder free, XS, 100/pk
261132	KRUTEX nitrile examination gloves, powder free, S, 100/pk
261133	KRUTEX nitrile examination gloves, powder free, M, 100/pk
261134	KRUTEX nitrile examination gloves, powder free, L, 100/pk
261135	KRUTEX nitrile examination gloves, powder free, XL, 100/pk



KRUTEX AGRO disposable examination gloves

جوانتي فحص

Armlength examination gloves for rectal examinations, artificial insemination and obstetrics.

Thickness 20 µ, Length 90 cm, 100% polyethylene.

Cat. No	Description
260718	KRUTEX AGRO disposable examination gloves, large, 100/pk



KRUTEX Obstetric Gown

بدلة ولادة

Green, 69% PVC and 31% nylon polyamide.

Waterproof, with welded seams, lightweight quality gown, Velcro closing, rubber cuff ring in the sleeves. Comfortable to wear and individually adjustable. Size indicates length of the gown.

Cat. No	Description
260010	KRUTEX obstetric gown with Velcro, 120 cm
260020	KRUTEX obstetric gown with Velcro, 130 cm
260030	KRUTEX obstetric gown with Velcro, 140 cm
260040	KRUTEX obstetric gown with Velcro, 150 cm
260045	KRUTEX obstetric gown with Velcro, 160 cm



KRUTEX Obstetric Combi Suit

بدلة ولادة

KRUTEX Obstetric Suit is shaped like a boiler suit. Green, 69% PVC and 31% nylon polyamide. Waterproof, with welded seams, lightweight quality, Velcro closing on the back and rubber cuff ring in the sleeves. Comfortable to wear.

Cat. No	Description
260050	KRUTEX obstetric combi suit, S, size 46
260051	KRUTEX obstetric combi suit, M, size 50
260052	KRUTEX obstetric combi suit, L, size 54
260053	KRUTEX obstetric combi suit, XL, size 58





KRUTEX Obstetric Jacket and Trousers

بدلة ولادة

Green, 69% PVC and 31% nylon polyamide. Waterproof, with welded seams, lightweight quality. Velcro closing on the back and rubber cuff ring in the sleeves. Comfortable to wear.

Cat. No	Description
260055	KRUTEX obstetric jacket, XS
260056	KRUTEX obstetric jacket, S
260060	KRUTEX obstetric jacket, M
260070	KRUTEX obstetric jacket, L
260075	KRUTEX obstetric jacket, XL
260078	KRUTEX obstetric trousers, XS
260079	KRUTEX obstetric trousers, S
260080	KRUTEX obstetric trousers, M
260090	KRUTEX obstetric trousers, L
260095	KRUTEX obstetric trousers, XL



KRUTEX Obstetric Overalls

افرول ولادة

Green, 69% PVC and 31% nylon polyamide. Waterproof, with welded seams, lightweight quality. Comfortable to wear with adjustable braces.

Cat. No	Description
260096	KRUTEX obstetric overalls, S, size 46
260097	KRUTEX obstetric overalls, M, size 50
260098	KRUTEX obstetric overalls, L, size 54
260099	KRUTEX obstetric overalls, XL, size 58

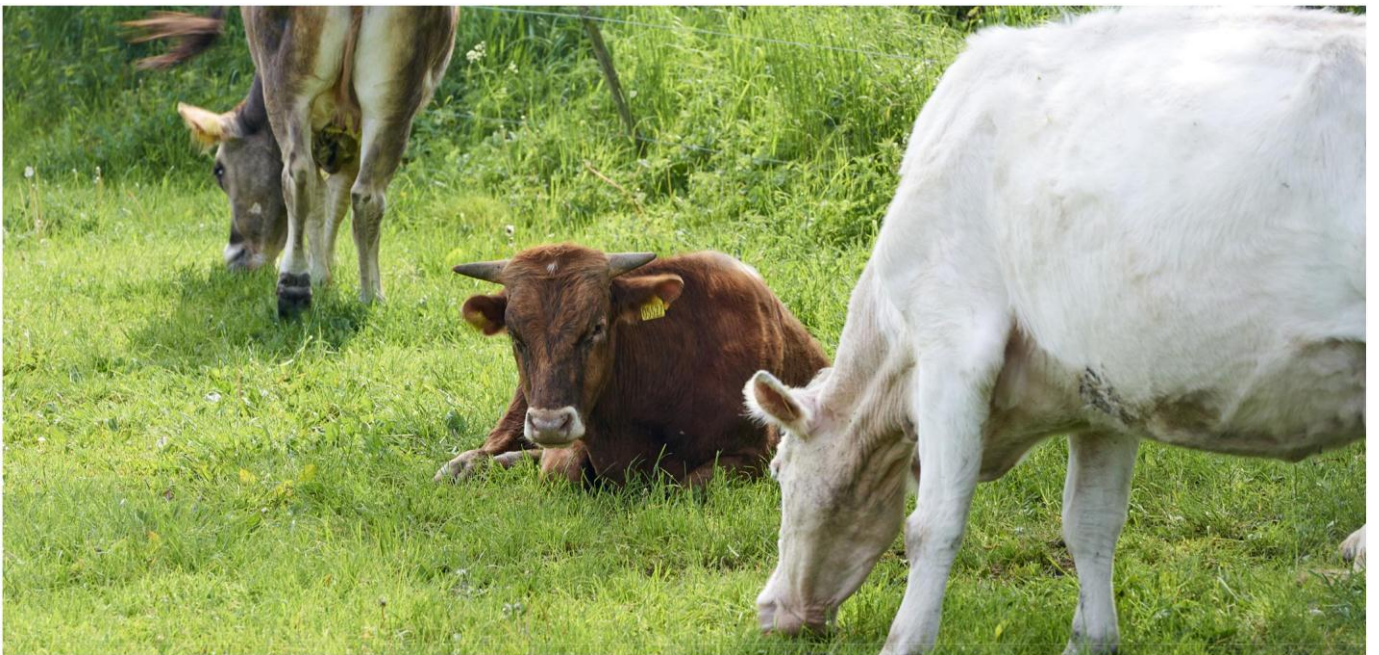

KRUTEX Obstetric Apron
ابرون ولادة

Green, 69% PVC and 31 % nylon polyamide.
Waterproof, with welded seams, lightweight
quality, tape closure in the neck.

Cat. No	Description
260450	KRUTEX obstetric apron 110 cm, green
260460	KRUTEX obstetric apron 120 cm, green
260470	KRUTEX obstetric apron 130 cm, green

KRUTEX Shoulder Protector
كثافة فحص

Green, 69% PVC and 31% nylon polyamide.
Waterproof, with welded seams, lightweight quality with rubber cuff ring.
Heavy duty and unisize.

Cat. No	Description
260560	KRUTEX shoulder protector, rubber sleeve plate, long version
260561	KRUTEX shoulder protector, rubber sleeve plate, short version

KRUTEX Obstetric Sleeve
كثافة ولادة

Green, 69% PVC and 31% nylon polyamide.
Waterproof, with welded seams, lightweight quality with rubber cuff ring.
Heavy duty and unisize.

Cat. No	Description
260570	KRUTEX obstetric sleeve, short



KRUTEX Disposable Obstetric Gown

بدلة استخدام مرة واحدة

The Obstetric gown can be used for any obstetric procedure.
A great protective gown.
5 selling points beavares

- n Light green
- n 0.03 mm thickness
- n Waterproof
- n Sleeves to be cut to desired length
- n Available in 2 sizes

Cat. No	Description
260589	KRUTEX disposable obstetric gown, S, 25/pk
260609	KRUTEX disposable obstetric gown, L, 25/pk



KRUUSE Disposable Coveralls

بدلة استخدام مرة واحدة

Made of PP-spun bonded non-woven material with a hood.
Ideal for farm visits.

Cat. No	Description
260608	KRUTEX disposable coveralls, green, S
260611	KRUTEX disposable coveralls, green, M
260612	KRUTEX disposable coveralls, green, L
260613	KRUTEX disposable coveralls, green, XL
260614	KRUTEX disposable coveralls, green, XXL
260607	KRUTEX disposable coveralls, green, XXXL



KRUTEX Disposable Polyethylene Gown, Green

بدلة استخدام مرة واحدة

The KRUTEX Disposable Gown is made of 100% polyethylene.
Green, length 135 cm, with long sleeves.

Cat. No	Description
260615	KRUTEX disposable polyethylene gown, green, 20/pk



121559



121582



121634



121556



121568



121647



121574



121575

BD Vacutainers and Needles
انابيب تحاليل دم

Cat. No	Description
121559	BD Vacutainer 2 ml plain, 100/pk
121582	BD Vacutainer 4 ml plain, 100/pk
121634	BD Vacutainer serum clot activator 10 ml (367896), 100/pk
121556	BD Vacutainer 2 ml EDTA, 100/pk
121568	BD Vacutainer 6 ml EDTA, 100/pk
121647	BD Vacutainer 10 ml EDTA, 100/pk
121600	BD Vacutainer Heparin Hemogard w/sodium 5 ml, 100/pk
121587	BD vacutainer, natrium heparin, 10 ml, 100/pk
121574	BD Vacutainer needle 18Gx1 S/S, 100/pk
121575	BD Vacutainer needle 20Gx1 M/S, 100/pk
121525	BD Vacutainer needle holder, 25/pk



KRUUSE Hoof Glue

صمغ حافر

Fast setting two-component polyurethane adhesive for cattle

KRUUSE Hoof Glue has been designed as a treatment for bovine hoof pathologies. It is used for bonding a wooden orthopedic block under the healthy hoof. Thus, the injured hoof is raised clear of the ground. That allows an immediate recovery of the mobility, a fast healing and the resumption of the normal milk yield in a short term.

Cat. No	Description
220600	KRUUSE Hoof Glue, 200 ml

Accessories for KRUUSE Hoof Glue

- It is highly recommended to use protective gloves ex. KRUTEX Nitrile Gloves

Cat. No	Description
220601	KRUUSE Hoof Glue mixing tips, 10/pk
220602	KRUUSE Hoof Glue application gun for 200 ml
220490	Demotec wooden blocks, 110 mm
220491	Demotec wooden blocks XL, 130 mm

Demotec 90

Convenient and inexpensive kit for hoof treatment on bovines. Simple to use. Fast reduction of lameness, no reduction of milk production or weight of animal.

Complete set for 2 treatments including: wooden blocks, powder, liquid, measuring cups and spatulas.



Cat. No	Description
220450	Demotec kit 2 sets
220455	Demotec kit 12 sets
220460	Demotec 90 liquid 500 ml
220470	Demotec powder, 1000

Demotec 95

Same excellent features as for DEMOTEC 90. But DEMOTEC 95 offers in ad-tition a superior moulding consistency that does not stick to your hands and can be used immediately after being mixed. Supplied as a complete set for 2 treatments. Easy to use. Complete sets for 2 or 14 treatments including: wooden blocks, powder, liquid, measuring cups and spatulas.



Cat. No	Description
220492	Demotec 95 kit 2 sets
220493	Demotec 95 kit 14 sets
220494	Demotec 95 liquid 500 ml
220495	Demotec 95 powder, 1000 g

Demotec Easy Bloc

A new system for which the design is based on the anatomy of the claw. Minimizes lameness. Fast, safe and easy to use. Demotec Easy Bloc hoof shoes 4 or 12 sets (2 or 6 right and 2 or 6 left). Not available in UK.

Clean the healthy hoof removing dirt and loose horn. Pour the liquid into the hoof shoe and sprinkle powder onto the liquid. Mix the two components and then apply the hoof shoe. Pressure can be applied to the hoof in less than 10 minutes. The process can be accelerated by using a heat gun.



Cat. No	Description
220530	Demotec Easy Bloc hoof shoes 4 sets (2 right, 2 left)
220531	Demotec Easy Bloc hoof shoes 12 sets (6 right, 6 left)
220535	Demotec Easy Block XXL 12 units, 6 right, 6 left
220532	Demotec Easy Bloc powder 500 g
220533	Demotec Easy Bloc liquid 250 ml

Demotec Futura Pad

FuturaPad is unique. One surface of the wooden block employed is covered with a flexible reactive Pad, which overcomes any unevenness of the sole and maximises adhesion over the full surface area. The reactive Pad is shaped correctly according to anatomy and the function of the claw and is affixed to the wooden block in the optimal position. FuturaPad is reactive. Pad is activated by a special glue.



Cat. No	Description
220550	Demotec Futura Pad hoof shoes, 2/pk
220551	Demotec Futura Pad hoof shoes, 10/pk
220552	Demotec Futura Pad hoof shoes, left, 10/pk
220553	Demotec Futura Pad hoof shoes, right, 10/pk

Demotec Hoof Check

Used as control in connection with hoof trimming. Used to control the five following parameters: Controlling the angle between the sole and the anterior hoof wall, measuring the length of the anterior hoof wall, comparing the height of the inside and outside hooves, ensuring that optimum contact between the sole and the ground can be achieved and controlling the slope of the sole.



Cat. No	Description
220565	Demotec hoof check

Demotec Wooden Blocks

To be fastened with SureBond. To be glued on the healthy part of the claw for immobilization of the sick part of the claw.



Cat. No	Description
220490	Demotec wooden blocks, 110 mm, 150/pk
220491	Demotec wooden blocks XL, 130 mm, 125/pk



BOVIVET Hoof Bandage

رباط طبي للحافر

BOVIVET hoof bandage is a complete bandage ready to apply. It is made from a water-repellent material that keeps liquids out. Its shape and elastic materials are designed to keep the stocking in place. A treatment pad placed inside the stocking makes dosing easy, such as salicylic acid, once the stocking is put in place. Applying additional doses is possible and the effect of the treatment can be checked during the process. The stocking remains in place, and you can be sure there will be no complications. The stocking is easy to remove and is available in 2 sizes: XL- fits most types of cows · L - fits heifers and small cow breeds.

Cat. No	Description
220411	BOVIVET Hoof Bandage, L, 10/pk
220412	BOVIVET Hoof Bandage XL, 10/pk

BOVIVET Hoof-Dressing

ضمادات للحافر



Dressing for the treatment of digital dermatitis and other hoof ailments. Used ideally in conjunction with e.g. Kruise Hoof Gel with salicylic acid. Fixate the dressing on the hoof to help the preparation to work in a clean environment.

Cat. No	Description
220405	BOVIVET protective hoof-dressing, 50/pk

Hoof Rasps

اسطوانة حافر



For treatment of approximately 1000 cows. Reduces dust and heat generation.

Cat. No	Description
220064	Hoof rasp disc tungsten 115 mm, coarse
220065	Hoof rasp disc tungsten 115 mm, fine



Demotec Hoof Discs

اسطوانة حافر

This hoof milling cutter plate has been developed in cooperation with hoof specialists.

Cat. No	Description
220067	Demotec DL hoof trimming disc
220068	Knife for Demotec DL hoof trimming disc
220069	Mounting unit for Demotec hoof trimming disc



Hoof Knives

سكاكين حافر

Broad-bladed stainless steel, length of blades 80 mm. Standard quality.

Cat. No	Description
220052	Hoof knife standard right
220053	Hoof knife standard left
220054	Hoof knife standard double edge



KRUUSE Hoof Knives

سكاكين حافر

Stainless, very sharp, length of blades 80 mm. With hard wood handle.

Cat. No	Description
220035	KRUUSE hoof knife narrow bladed, right
220042	KRUUSE hoof knife broad bladed right
220043	KRUUSE hoof knife broad bladed left
220044	KRUUSE hoof knife broad bladed, double
220045	KRUUSE hoof knife, narrow bladed, left



Aesculap Hoof Knives

سكاكين حافر

High quality for professional users.

Cat. No	Description
220007	Aesculap hoof knife right
220008	Aesculap hoof knife left



Swiss hoof knife

سكاكين حافر

With wooden handle.

Cat. No	Description
220026	Swiss hoof knife

Sharpening Tools

مبرد سكاكين



For hoof knives and scrapers.

Cat. No	Description
220070	Sharpening stone standard
220075	Sharpening stone Hauptner
220077	Sharpening steel for hoof knife knife, pocket model

Hoof Trimmer

مقص حوافر



Double action, for easy use.

Cat. No	Description
220211	Hoof trimmer short, standard 41 cm
220216	Spare blades with screws (for 220211), 2/pk

Hoof Cutter

مقص حوافر

High quality for professional users. Double action.



Cat. No	Description
220230	Hoof cutter, 60 cm

Hoof Rasp

مبرد للحوافر

Straight, 35 cm, extra deep and sharp rasp blow.



Cat. No	Description
220130	Hoof rasp straight 350 mm

Hoof Tar

Used in connection with hoof treatment. Makes the bandage water-repellant. In metal bucket with handle.

Cat. No	Description
220430	Hoof tar 2.5 L

Tar Bandage

رباط للحافر



5 cm x 25 m, waterproof, double adhesive, for hoof treatment.

Cat. No	Description
160990	Tar bandage 4.5 cm x 25 m

BOVIVET Nylon Hoof Bandage

رباط طبي للحافر

Bandage for inter-digital cleft with Velcro fastening.



Cat. No	Description
220058	BOVIVET hoof bandage for inter-digital cleft



Drenchers, Feeding Tubes, Trocars, Magnets and Infusion

KRUUSE offers veterinarians in large animal practice well known and thoroughly tested products such as the BOVIVET Calf Drencher, BOVIVET Magnets, different types of trocars and several different feeding tubes as well as other products to help in the daily work with livestock.

BOVIVET Calf Drencher

تجريع للعجول ؛ لتر

The BOVIVET Calf Drencher is available with a rigid and a flexible probe and the container holds 4 litres.

The Calf Drencher is a quick and safe method to administer liquid therapy of calves and for electrolytic calf treatment and it can be operated by one person.

The large container is primarily used when initially administering 4 l colostrum to the calf.

Two-position valve for adjusting the flow of raw milk:

- n If the valve is in position 1, the liquid runs slowly.
- n If the valve is in position 2, the liquid runs faster.

The 4 litre container will empty on average in 2 minutes.

Cat. No Description

- | | |
|--------|--|
| 230553 | BOVIVET calf drencher, 4 litre, with rigid tube, 5/pk |
| 230554 | BOVIVET calf drencher, 4 litre, with flexible tube, 5/pk |
| 230601 | BOVIVET flexible tube for calf drencher, 4 litre |
| 230602 | BOVIVET rigid tube for calf drencher, 4 litre |
| 230603 | Bottle cap for calf drencher, 4 litre |
| 230559 | BOVIVET teat for calf drencher bottle, 4 litre |



230548 / 230554



230545 / 230553

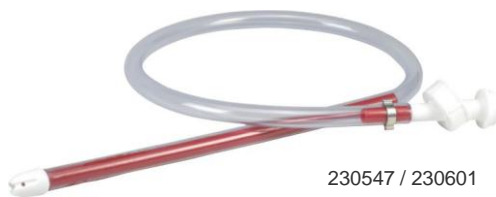

230547 / 230601



230549 / 230603



230558 / 230559

Calf Fluid Feeder

تجريع للمعجول ٣ لتر

With 3 l bag and flexible probe. The bag is made of non-toxic, heavy grade plastic. Tear-shaped ball is designed so that the oesophageal probe cannot be inserted into the trachea. Smooth plastic tube prevents needless irritation. The reusable feeder has convenient loop for hanging.

Cat. No	Description
230550	Calf Fluid Feeder with 3 litres bag and flexible probe



170823



170825



170822



170826



170835



170821

Plastic Buckets With Feeding Teats

لاکور و جرادل رضاعة و حلمات

Cat. No	Description
170823	Plastic bucket with 5 feeding teats
170825	Plastic bucket with 1 feeding teat
170822	Teat for plastic bucket (170823)
170821	Plastic valve for 170823 and 170825
170826	Extra feeding teat for 170825 and 170823, calves
170835	Bottle teat medium

BOVIVET Ruminal Magnet
مغناطيس

Our well-known BOVIVET ruminal magnets are recommended by veterinarians worldwide due to their excellent function.

The magnets have the correct size, shape and weight to offer maximum protection against and treatment of traumatic indigestion in cattle. The correct length and deep grooves in the plastic cage provide extra protection from sharp, uneven pieces.

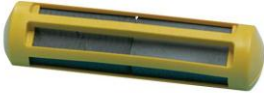

Cat. No	Description
142030	BOVIVET ruminal magnet, 10/pk
142035	BOVIMINI ruminal magnet, 10/pk



KRUUSE Ceramic Magnets

مغناطيس

Presented in a strong Styrofoam box with each magnet in a separate compartment for maximum protection. Magnets are easy to pick up as they do not stick.



Cat. No	Description
142037	KRUUSE Ceramic magnets 60 x 20 x 15 mm, 12/pk

BOVIVET Magnet Introducer

مسدس تجريع مغناطيس

For use with BOVIVET magnets for cows.



Cat. No	Description
142045	BOVIVET magnet introducer metal
142050	BOVIVET magnet introducer plastic, diameter 3 cm
142070	BOVIMINI magnet introducer metal

Metal Detector

كاشف معادن

The AF 103 is developed for security checks, but it is also eminently suitable for many other purposes, such as finding wall ties, pipes and cables in walls and other structures, scanning luggage, and especially for finding swallowed objects.

One control operation incorporating on/off and tuning 6" (15 cm) waterproof loop

Audio output with built-in speaker

Lightweight and strong mechanical

construction Pinpointing ability

Uses one PP3 9 volt battery

Detects all metals



Cat. No	Description
141753	Metal detector AF 103 incl. battery 9 V

Grymer Sterner Suture Set

توجول



To be used for non-surgical fixation of the left displaced abomasum.

Cat. No	Description
152180	Suture set Grymer Sterner 2/pk
152185	Trocar with cannula for inserting Grymer Sterner toggle suture
152190	Pressure relieving plates for Grymer Sterner toggle suture, 6/pk

Castrators for Bloodless Castration

بارديزو



With cord stop and double action handles.

Cat. No	Description
200151	Bloodless castrator 23 cm standard quality, Burdizzo type
200131	Bloodless castrator 30 cm standard quality, Burdizzo type
200136	Bloodless castrator 40 cm standard quality, Burdizzo type
200141	Bloodless castrator 48 cm standard quality, Burdizzo type



Obstetrics

To help our customers we have assembled the KRUUSE Obstetric Set including chain, ropes, handles, hook, calving belt as well as gloves and gel. Delivered in a sturdy and practical metal box.

You may also wish to have a look at some of the other products in the obstetrics range, such as our embryotome, uterine forceps and uterine pump.

KRUUSE Obstetric Set

عدة ولادة



Consists of:

- 180235: 2 x Nylon handles
- 180290: 1x Endless chain with 2 Harms eye hooks
- 180576: 1 x Pair of calving ropes 1 loop
- 180577: 1 x Pair of calving ropes 2 loops
- 180270: 2 x Eye hooks, blunt
- 180203: 1 x Calving belt with hook
- 180315: 1 x Obstetric hook Krey Schöttler
- 180426: 1 x Finger knife
- 180520: 2 x BOVIVET gel 500 ml
- 260700: 1 x KRUTEX Super Sensitive gloves
- 250170: 1 x Metal box with removable shelf and lid

Cat. No	Description
180600	KRUUSE obstetric set in metal box

Embryotome and Accessories

تقطيع جنين

Thygesen model, nickel-plated with handle for fixation of obstetric chain.



Cat. No	Description
180003	Embryotome Thygesen, dismountable, 85 cm
180006	Embryotome Thygesen, 100 cm
180011	Embryotome Thygesen, 85 cm
180055	Jointed threader for Thygesen embryotome, 80 cm
180061	Jointed threader for Thygesen embryotome 1 m
180030	Tube end bush
180020	Spare head for embryotome
180040	Handle with groove for OB chain
180050	Clamping piece



Curved Snare Director

ماسك سلك

With screw clamp to hold saw wire.

Cat. No	Description
180120	Curved snare director

180146



Saw Wire Handle

ماسك سلك

The Danish saw wire handle and the Thygesen handle are made of stainless steel, while the squeezing type handle is chrome-plated and forged brass.

Cat. No	Description
180140	Danish saw wire handle
180146	Saw wire handle squeezing type
180145	Saw wire handle Thygesen

180140



180145



Saw Wire

سلك تقطيع

Saw wire for embryotomy and dehorning.



Cat. No	Description
180150	BOVIVET saw wire 3.6 m, 12/pk
180165	BOVIVET saw wire 10 m
180160	BOVIVET saw wire 12 m
180170	JACO-VET saw wire 3.6 m
180171	JACO-VET saw wire 10 m

180160

180150

180171



BOVIVET Calving Belt

حبل ولادة

Calving belt with stainless hook. Simple and strong calving belt to be used together with obstetric chains or rope.

Cat. No	Description
180203	BOVIVET calving belt with hook
180202	BOVIVET Obstetric hook for calving belt

Obstetrical Chains

سلاسل ولادة

Made of stainless steel.

Cat. No	Description
180210	KRUUSE Obstetric chain 1 m, premium quality
180225	KRUUSE Obstetric chain 1.5 m, standard quality
180220	KRUUSE Obstetric chain 1.5 m, premium quality
180227	KRUUSE Obstetric chain with two handles, 1.3 m nickel-plated

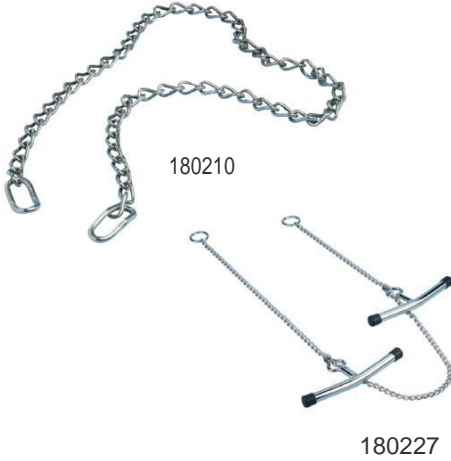
KRUUSE Handles for Obstetric Chains

Cat. No	Description
180235	KRUUSE Nylon handle, 30 x 300 mm, with groove
180265	KRUUSE Handle with hook, 10 cm
180266	KRUUSE Handle with hook, 25 cm

Eye Hook

Made of stainless steel.

Cat. No	Description
18020	Harms eye hook blunt 8 cm
18025	Harms eye hook sharp 8 cm
18020	Harms obstetric stainless steel chain with single hook

Calfpullers

جهاز ولادة

Cat. No	Description
180565	HK calf puller E11 with 2 angle pieces
180570	Calf puller
180575	Rope for calf puller model E11 2/pk
180571	Calving rope/helper (Vink)





180310



180315

KRUUSE Obstetric Hooks

خطاف

Cat. No	Description
180310	Krey-Schottler obstetric hook, sharp
180315	Krey-Schottler obstetric hook, standard



KRUUSE Calving Rope

حبل ولادة

Cat. No	Description
180576	Calving rope with 1 loop pair, Ø=5 mm, length 150 cm
180577	Calving rope with 2 loops pair, Ø=5 mm, length 150 cm

BOVIVET Vaginal Suture Tape

خيـط عمليات



Cat. No	Description
152130	BOVIVET vaginal tape 5 m roll
152135	BOVIVET vaginal tape 0.8 m sterile, 12/pk

Vulva Suture Needles

Complete with hose as well as large and small connector.

152120

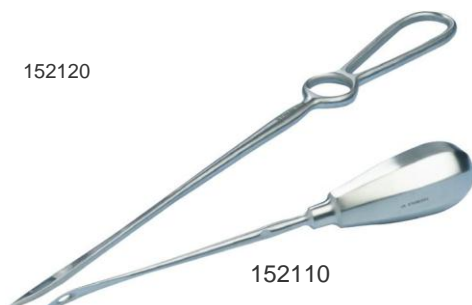

152110

Cat. No	Description
152120	Bühner suture needle, stainless steel, 30 cm
152110	Gerlach suture needle, stainless steel, 19 cm

KRUUSE | Obstetrics-teat instruments and calf rearing

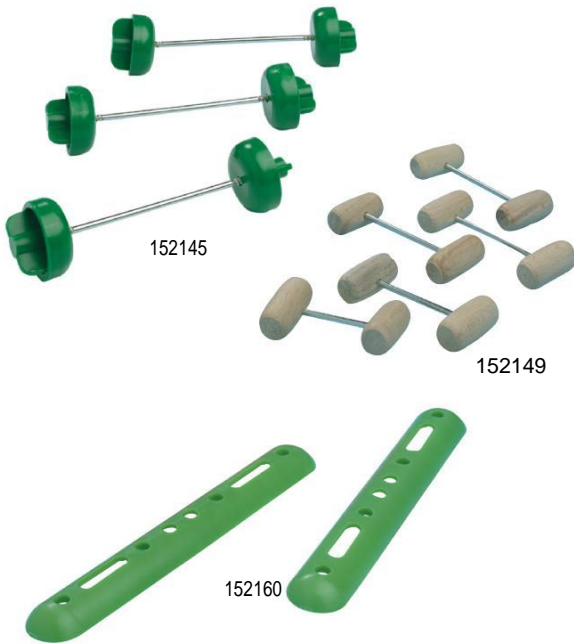

BOVIVET Prolapse Pins

With plastic or wooden finger grip, adjustable or fixed.

Cat. No	Description
152145	BOVIVET prolapse pins 55-75 mm, 12/pk
152149	BOVIVET prolapse pins with wooden balls 40 mm, 12/pk
152150	BOVIVET prolapse pins with wooden balls 50 mm, 12/pk
152151	BOVIVET prolapse pins with wooden balls 60 mm, 12/pk
152152	BOVIVET prolapse pins with wooden balls 65 mm, 12/pk
152153	BOVIVET prolapse pins with wooden balls 70 mm, 12/pk
152160	Plastic splints for prolapse pins, 12 pairs
152170	Plastic splints for prolapse pins with thread, 10 x 1 pair



BOVIVET Silicone Teat Insert

بوجیه حلامات



The Bovivet silicone teat insert is a gentle teat insert designed with a handle for easy and hygienic insertion. The conical shape of the teat insert prevents the teat insert from falling out.

Cat. No	Description
170230	BOVIVET silicone teat insert, sterile, 20/pk

BOVIVET Teat Dilator

بوجیه حلامات



Diam. 5.5 mm, length 35 mm, individually packed in plastic tube with vaseline, red obturator to be removed when milking. For cows with damaged teats, the drain can be inserted for an extended period.

Cat. No	Description
170270	BOVIVET teat dilators, 5 x 10/pk
170275	BOVIVET teat dilators, 25 x 10/pk
170280	BOVIVET teat dilators thin, 5 x 10/pk

BOVIVET Wax Teat Plugs

بوجيه حلامات



Smooth and flexible wax teat plug with head for easy and sterile application. This teat plug will slowly dissolve in the teat canal. Recommended by leading specialists.

Cat. No	Description
170283	BOVIVET wax teat plugs with head, sterile, 20/pk

BOVIVET Teat Plugs Long

بوجيه حلامات



For single use, extra long, very flexible. Packaged in a 5 cm diameter box with vaseline. Universal connector. Red pin can be removed before milking.

Cat. No	Description
170290	BOVIVET teat plugs long, 7 cm, 10/pk

KRUUSE Columbus Teat Plugs in Box

بوجيه حلامات



Single use. Box with vaseline. Each plug placed in its separate chamber.

Cat. No	Description
170300	KRUUSE Columbus teat plugs in plastic box, 20/pk

BOVIVET Teat Dilators

بوجيه حلامات



Single use. Bengen model, diameter 2.5 mm, length 4.5 cm, with vaseline. Use to open blocked teat channel.

Cat. No	Description
170315	BOVIVET teat dilators, 6 x 20/pk

BOVIVET Teat bandage

رباط طبي للحلمات



Unique polyester bandage. Protects wound against dirt, easy to mold and apply, cohesive. Can be applied to wet teats. Allergy tested.

Cat. No	Description
160954	BOVIVET Teat bandage, 6 cm x 4.5 m

BOVIVET Milking Tube

Yellow, 3.3 mm. Sterile milking tube in blister pack. Luer lock for easy ad-ministration of e.g. antibiotics.

Cat. No	Description
170193	BOVIVET milking tube luer lock, yellow, 3.3 mm, 20/pk, sterile

BOVIVET Syringe Mount Strips

Used for administration of medication from a syringe into the teat. Luer fitting.

Cat. No	Description
170260	BOVIVET syringe mount strips, luer, 100/pk, sterile



Milk Catheter

Complete with stiletto, with olive hub, nickel-plated.



Cat. No	Description
170165	Milk catheter 2.0 mm x 9 cm
170170	Milk catheter 2.5 mm x 9 cm
170180	Milk catheter 3.0 mm x 9 cm
170190	Milk catheter 4.0 mm x 9 cm

KRUUSE Teat Drainage Tubes

With stilet and teat obturator.



Cat. No	Description
170250	KRUUSE teat drainage tubes, 7 cm, 25/pk

KRUUSE Teat Dipper

مطهر حلمات

For disinfection of the teats before milking. Consists of two chambers. Pressure on the lower chamber forces the liquid into the upper cup, and the teat is easily washed.



Cat. No	Description
170339	KRUUSE teat dipper - non return valve

BOVIVET Milk Sucking Preventer

مانع رضاعة

Aluminium, with spikes.



Cat. No	Description
170380	BOVIVET sucking preventer spiked

KRUUSE Plastic Sucking Preventer

مانع رضاعة

Nylon, made of flexible plastic. Easy to apply.



170385

170386

Cat. No	Description
170385	KRUUSE Plastic sucking preventer, S
170386	KRUUSE Plastic sucking preventer, M

BOVIVET Anti Kick Hobble

With variable release catches, to keep hind legs in place after calving or milk fever.

Cat. No	Description
210058	BOVIVET nylon anti kick hobble

Styrko Kick Stopper

Extra strong, adjustable with spring lock, prevents kicking at milking and udder treatment.

Cat. No	Description
210060	Styrko cow kick stopper
210080	Replacement springs - D 9 mm

Bull Holder

شنافة



Cat. No	Description
210315	Bull holder, Harms model standard quality, with rolling adjuster, 19 cm
210316	Bull holder, Harms model standard quality, with slide adjuster, 19 cm

Nose Clamp

شنافة



With spring. Easy to attach and remove.

Cat. No	Description
210380	Nose clamp for bull 11 cm

Sheaths for Universal Inseminator

شيث تلقیح

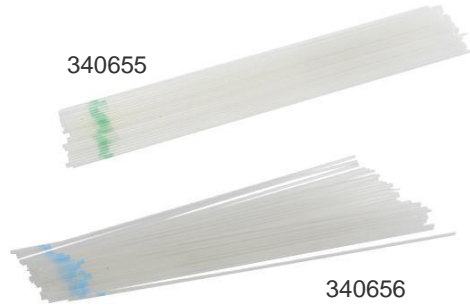

For insemination gun. Fits mini and medium straws.

Cat. No	Description
340655	Sheaths, split, universal for insemination gun, 50/pk
340656	Sheaths, non-split, universal for insemination gun, 50/pk

Straw Tweezers

The stainless steel straw tweezers secure easy handling of mini and medium straws.

Cat. No	Description
340315	Straw tweezers, 15 cm, stainless steel

Straw Cutter

Designed to quickly cut off the sealed end of straws. After insertion of straw a push on the button cuts the straw at the proper length.

Cat. No	Description
340320	Straw cutter

KRUUSE Insemination Catheter

شيث تلقیح



Cat. No	Description
230830	KRUUSE Insemination Catheter 53.5 cm, sterile, 25/pk
230831	KRUUSE Insemination Catheter 60 cm, sterile, 25/pk
230832	KRUUSE Insemination Catheter 70 cm, sterile, 25/pk
230840	KRUUSE Insemination Catheter 53.5 cm, non-sterile, 25/pk
230841	KRUUSE Insemination Catheter 60 cm, non-sterile, 25/pk
230842	KRUUSE Insemination Catheter 70 cm, non-sterile, 25/pk

340127



340131

Semen Container GT

نقل سيمين

Nitrogen container for storage and transport of semen.

Cat. No	Description
340127	Container for semen GT2, 2 l Max. capacity of 0.25 ml straws - 330, max. capacity of 0.5 ml straws – 50. Static holding time 25 days, dynamic holding time 15 days.
340131	Container for semen GT 9, 9.3 l Max. capacity of 0.25 ml straws - 1560, max. capacity of 0.5 ml straws – 720. Static holding time 84 days, dynamic holding time 50 days.
340133	Container for semen GT11, 12.2 l Max. capacity of 0.25 ml straws - 1560, max. capacity of 0.5 ml straws – 720. Static holding time 130 days, dynamic holding time 80 days.
340136	Container for semen GT21, 21.5 l Max. capacity of 0.25 ml straws - 1560, max. capacity of 0.5 ml straws – 720. Static holding time 225 days, dynamic holding time 140 days.
340141	Container for semen GT35, 33.6 l Max. capacity of 0.25 ml straws - 7380, max. capacity of 0.5 ml straws – 3285. Static holding time 90 days, dynamic holding time 56 days.
340150	Container for semen GT40, 40 l Max. capacity of 0.25 ml straws - 16400, max. capacity of 0.5 ml straws –7300. Static holding time 140 days, dynamic holding time 88 days.



340147



340149

Nitrogen Container TR

نقل نيتروجين

Container for storage and transport of nitrogen.

Cat. No	Description
340147	Container for transport TR7, 7,2 l Static holding time 36 days.
340148	Container for nitrogen TR11, 12.2 l Static holding time 67 days.
340149	Container for nitrogen TR26, 26.0 l Static holding time 130 days.

Semen Container Voyageur

Nitrogen container especially designed for difficult transports. The containers are equipped with a material which absorbs the liquid nitrogen and therefore the containers cannot leak.



340126



340137

Cat. No	Description
340126	Nitrogen container Voyageur 2, 1.75 l Max. capacity of 0.25 ml straws - 220, max. capacity of 0.5 ml straws – 100. Static holding time 13 days, dynamic holding time 8 days.
340137	Nitrogen container Voyageur 5, 6.5 l Max. capacity of 0.25 ml straws - 1040, max. capacity of 0.5 ml straws –400. Static holding time 37 days, dynamic holding time 23 days.

KRUUSE Ovi-mark Marking Sprays

سبراي



Special marking spray for sheep. Colours remain visible 5-6 months.
Fully scourable. Approved by The British Wool Marketing Board.

Cat. No	Description
240460	KRUUSE Ovi-mark, red, 400 ml, 12/pk
240461	KRUUSE Ovi-mark, blue, 400 ml, 12/pk
240462	KRUUSE Ovi-mark, green, 400 ml, 12/pk

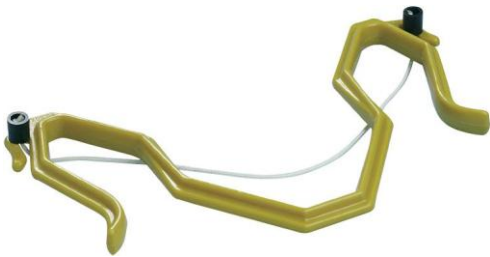
Sheep Restrainer

Unique plastic restrainer to aid the shepherd in his everyday tasks. Easy to fit, causes the ewe minimum discomfort. Ideal for lambing, transport and during treatment.

Cat. No	Description
247090	Sheep restrainer plastic large

Lambing Instrument

Useful tool for assisting lambing. Snare can be put over head or leg, pulled tightly, and the lamb is then pulled out gently. Plastic, length 37 cm.

Cat. No	Description
247080	Lambing instrument plastic

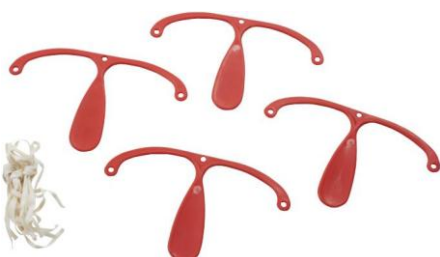
Uterine Support

This plastic support is used to prevent prolapse around the time of lambing. Once inserted into the vagina it can be tied to the fleece. Sterilize and use a lubricant before insertion.

Cat. No	Description
247000	Uterine support, plastic 3/pk



Nursing Bottle Lamb

Ideal for new born or very small lambs.

Cat. No	Description
247545	Nursing bottle for lamb with teat and valve



Feeding Buckets and Teats

جرادل للغنم

10 l, the buckets are complete with valve, hanger and feeding teats.

Cat. No	Description
170823	Plastic bucket with 5 feeding teats
170822	Teats for 170823



Hoof Knives

سكاكين حافر

Broad-bladed stainless, length of blades 80 mm. Standard quality.

Cat. No	Description
220052	Hoof knife standard right
220053	Hoof knife standard left
220054	Hoof knife standard double edge



22224

Hoof Cutters

مقص حافر

For sheep, 23 cm. Heavy, duty model.

Cat. No	Description
220224	Hoof cutter, toothed, for sheep
220225	Hoof cutter, for sheep

220525

Sheep Shears

مقص



Standard sheep shears for wool cutting.

Cat. No	Description
247010	Sheep shears 29.5 cm, 6/pk

Tally Counter

An easy way to count your animals. 4 digits, counts 0-9999, chrome-plated.



Cat. No	Description
247135	Tally counter

Applicator and Castration Rings

For docking and tailing of lambs.



Cat. No	Description
200170	Applicator for castration rings
200180	Castration rings 100/pk, 50/pk

Trocar

The trocar ensures quick relief of pressure of rumen gas.



Cat. No	Description
190368	Trocar 4 x 120 mm with metal handle and cannula

KRUUSE Disposable Needles

سنون بلاستيك معقمة

A range of sizes specially designed for the veterinary profession.
Extra sharp facet shaped needles with plastic hub, luer slip.
Paper-film peel pack.



Cat. No	Description	Colour
121288	Disp. Needle 0.4 x 20 mm, 27G x 3/4", 100/pk	●
121289	Disp. Needle 0.45 x 25 mm, 26G x 1", 100/pk	●
121293	Disp. Needle, 0.5 x 10mm, 25Gx3/8", 100/pk	●
121270	Disp. Needle 0.5 x 16 mm, 25G x 5/8", 100/pk	●
121290	Disp. Needle 0.55 x 25 mm, 24G x 1", 100/pk	●
121271	Disp. Needle 0.6 x 16 mm, 23G x 5/8", 100/pk	●
121272	Disp. Needle 0.6 x 25 mm, 23G x 1", 100/pk	●
121286	Disp. Needle 0.6 x 30 mm, 23G x 1 1/4", 100/pk	●
121291	Disp. Needle 0.7 x 20 mm, 22G x 3/4", 100/pk	●
121287	Disp. Needle 0.7 x 30 mm, 22G x 1 1/4", 100/pk	●
121275	Disp. Needle 0.8 x 10 mm, 21G x 3/8", 100/pk	●
121276	Disp. Needle 0.8 x 16 mm, 21G x 5/8", 100/pk	●
121273	Disp. Needle 0.8 x 25 mm, 21G x 1", 100/pk	●
121274	Disp. Needle 0.8 x 40 mm, 21G x 1 1/2", 100/pk	●
121292	Disp. Needle 0.9 x 13 mm,, 20G x 1/2", 100/pk	●
121277	Disp. Needle 0.9 x 25 mm, 20G x 1", 100/pk	●
121278	Disp. Needle 0.9 x 40 mm, 20G x 1 1/2", 100/pk	●
121281	Disp. Needle 1.1 x 16 mm, 19G x 5/8", 100/pk	○
121279	Disp. Needle 1.1 x 25 mm, 19G x 1", 100/pk	○
121280	Disp. Needle 1.1 x 40 mm, 19G x 1 1/2", 100/pk	○
121282	Disp. Needle 1.2 x 40 mm, 18G x 1 1/2", 100/pk	○
121283	Disp. Needle 1.25 x 25 mm, 18G x 1", 100/pk	○
121284	Disp. Needle 1.6 x 25 mm, 16G x 1", 100/pk	○
121285	Disp. Needle 1.6 x 40 mm, 16G x 1 1/2", 100/pk	○



KRUUSE-Vet Needles

سنون معدن

Reusable needles, made of stainless steel, sterilisable.
With extra strong luer lock hub for increased safety.



Cat. No	Description
120768	Vet Needles 0.7 x 4mm 22G x 1/6" luer lock, 12/pk
120607	Vet needles 0.8 x 10 mm 21G x 3/8", luer lock, 12/pk
120766	Vet Needles 0.9 x 6 mm 20G x 1/4" luer lock, 12/pk
120602	Vet needles 0.9 x 13 mm 20G x 1/2", luer lock, 12/pk
120827	Vet Needles 1.0 x 6 mm 19G x 1/4" luer lock, 12/pk
120603	Vet needles 1.0 x 10 mm 19G x 3/8", luer lock, 12/pk
120613	Vet needles 1.0 x 15 mm 19G x 5/8", luer lock, 12/pk
120614	Vet needles 1.0 x 20 mm 19G x 3/4", luer lock, 12/pk
120615	Vet needles 1.0 x 25 mm 19G x 1", luer lock, 12/pk
120612	Vet needles 1.0 x 30 mm 19G x 1 1/4", luer lock, 12/pk
120829	Vet Needles 1.2 x 6 mm 18G x 1/4" luer lock, 12 pk
120767	Vet Needles 1.2 x 10 mm 18G x 3/8" luer lock, 12/pk
120765	Vet Needles 1.2 x 13mm 18G x 1/2" luer lock, 12/pk
120722	Vet needles 1.2 x 15 mm 18G x 5/8", luer lock, 12/pk
120624	Vet needles 1.2 x 20 mm 18G x 3/4", luer lock, 12/pk
120723	Vet needles 1.2 x 25 mm 18G x 1", luer lock, 12/pk
120828	Vet Needles 1.2 x 30 mm 18G x 1 1/4" luer lock, 12/pk
120625	Vet needles 1.2 x 35 mm 18G x 1 3/8", luer lock, 12/pk
120622	Vet needles 1.2 x 40 mm 18G x 1 1/2", luer lock, 12/pk
120735	Vet needles 1.4 x 20 mm 17G x 1/2", luer lock, 12/pk
120728	Vet needles 1.4 x 25 mm 17G x 1", luer lock, 12/pk
120729	Vet needles 1.4 x 35 mm 17G x 1 3/8", luer lock, 12/pk
120732	Vet needles 1.4 x 40 mm 17G x 1 1/2", luer lock, 12/pk
120733	Vet needles 1.4 x 50 mm 17G x 2", luer lock, 12/pk
120743	Vet needles 1.6 x 13 mm 16G x 1/2", luer lock, 12/pk
120736	Vet needles 1.6 x 20 mm 16G x 3/4", luer lock, 12/pk
120744	Vet needles 1.6 x 25 mm 16G x 1", luer lock, 12/pk
120742	Vet needles 1.6 x 30 mm 16G x 1 1/4", luer lock, 12/pk
120745	Vet needles 1.6 x 40 mm 16G x 1 1/2", luer lock, 12/pk
120752	Vet needles 1.8 x 25 mm 15G x 1", luer lock, 12/pk
120753	Vet needles 1.8 x 40 mm 15G x 1 1/2", luer lock, 12/pk
120755	Vet needles 2.0 x 13 mm 14G x 1/2", luer lock, 12/pk
120759	Vet needles 2.0 x 20 mm 14G x 3/4", luer lock, 12/pk
120763	Vet needles 2.0 x 30 mm 14G x 1 1/4", luer lock, 12/pk
120824	Vet needles 2.0 x 40 mm 14G x 1 1/2", luer lock, 12/pk
120826	Vet needles 2.0 x 50 mm 14G x 2", luer lock, 12/pk



KRUUSE Disposable Syringes

KRUUSE disposable syringes are available in 2 and 3 component versions and with centric or eccentric luer slip and luer lock attachment. We also offer a range of disposable syringes with silicone O-ring as well as disposable syringes with attached needles for easy use.

KRUUSE Disposable Syringe

سيرنجات

Complete range of high quality disposable syringes, 2- and 3-component.

The disposable syringes are available as centric and eccentric
Sterilised by ethylene oxide
Paper-film peel pack
Extended graduation for added value
Luer slip adaptor

Cat. No	Description
112380	Disp. Syringe centric 2-comp. 2-2,4 ml, 100/pk
112381	Disp. Syringe centric 2-comp. 5-5,8 ml, 100/pk
112382	Disp. Syringe eccentric 2-comp. 10-11 ml, 100/pk
112383	Disp. Syringe eccentric 2-comp. 20-23 ml, 50/pk
112372	Disp. Syringe centric 3-comp. 1 ml, 100/pk
112373	Disp. Syringe centric 3-comp. 2-3 ml, 100/pk
112374	Disp. Syringe centric 3-comp. 5-6 ml, 100/pk
112375	Disp. Syringe eccentric 3-comp. 10-12 ml, 100/pk
112376	Disp. Syringe eccentric 3-comp. 20-24 ml, 50/pk
112377	Disp. Syringe eccentric 3-comp. 30-34 ml, 50/pk
112378	Disp. Syringe eccentric 3-comp. 50-60 ml, 25/pk



ECCENTRIC

EXTENDED GRADUATION

VALUELINE Disposable Syringes

سيرنجات

The range of VALUELINE syringes is an economic alternative to the other KRUUSE syringes.

Sterilised by ethylene oxide
Luer slip adaptor

Cat. No	Description
112442	Disp. Syringe centric 3-comp. 1 ml, 100/pk
112443	Disp. Syringe centric 3-comp. 2 ml, 100/pk
112444	Disp. Syringe centric 3-comp. 5 ml, 100/pk
112445	Disp. Syringe centric 3-comp. 10 ml, 100/pk
112446	Disp. Syringe eccentric 3-comp. 20 ml, 100/pk

**KRUUSE Disposable Syringes Luer Lock**

سيرنجات

KRUUSE offers a complete range of high quality luer lock disposable syringes, 3-component.

- n Sterilised by ethylene oxide
- n Paper-film peel pack
- n Extended graduation for added value
- n Luer lock adaptor
- n Centric tip

Cat. No	Description
112384	Disp. Syringe 3-comp. luer lock 2-3 ml, 100/pk
112385	Disp. Syringe 3-comp. luer lock 5-6 ml, 100/pk
112386	Disp. Syringe 3-comp. luer lock 10-12 ml, 100/pk
112387	Disp. Syringe 3-comp. luer lock 20-24 ml, 50/pk
112388	Disp. Syringe 3-comp. luer lock 30-34 ml, 50/pk
112389	Disp. Syringe 3-comp. luer lock 50-60 ml, 25/pk

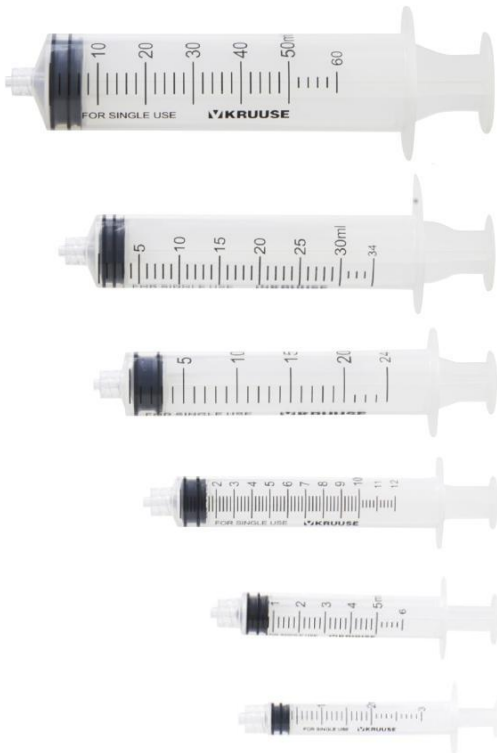



KRUUSE Reusable Syringes

Our range of high quality reusable syringes. Careful cleaning and maintenance will ensure a long life span.

KRUUSE Plexi Syringe

فايبر جلاس بليكسي

Unbreakable, high quality syringe with TPX plexiglass material. Sterilisable up to 130°C. Exchangeable metal luer lock nozzle.



Cat. No	Description
112318	Plexi syringe, luer lock, 5 ml
112280	Plexi syringe, luer lock, 10 ml
112285	Plexi syringe, luer lock, 20 ml
112286	Plexi syringe, luer lock, 30 ml
112290	Plexi syringe, luer lock, 50 ml
112281	Plexi syringe, luer lock, 10 ml, with graduated piston rod
112287	Plexi syringe, luer lock, 20 ml, with graduated piston rod
112295	Plexi syringe, luer lock, 30 ml, with graduated piston rod
112289	Plexi syringe, luer lock, 50 ml, with graduated piston rod
112321	Washer for Plexi syringe 5 ml
112291	Washer for Plexi syringe 10 ml
112292	Washer for Plexi syringe 20 ml
112298	Washer for Plexi syringe 30 ml
112293	Washer for Plexi syringe 50 ml
112326	Silicone oil 18 ml for plexi syringe
112325	KRUUSE Oral Cannula f/ Plexi Syringe

BOVIVET PLUS Plexi Revolver Syringe

مسدس ٥٠ مل اوتوماتيك



Semi-automatic revolver syringe, 50 ml, with unbreakable plexi-glass barrel and luer lock

Made of polyamide and fiberglass
Weighs only 280 g, ergonomic design
Supplied in a strong plastic case
Dosing: 1-2-3-4-5 ml

Cat. No	Description
112650	BOVIVET PLUS plexi revolver syringe luer lock 50 ml

HSW ECO-MATIC® Automatic Multi-dose Syringe**مسدس حقن اوتوماتيك**

Durable high strength plastic syringe. Perfect ergonomically designed. Accurate dosage. Can be disinfected in boiling water without loss of performance or accuracy. Each Syring is supported with sparepart kit

Cat. No	Description
113121	automatic syringe with bottle attachment, 0.3 ml, luer lock
113138	automatic syringe 1 ml, LL, w/bottle attachment
113122	automatic syringe with bottle attachment 2 ml, luer lock
113125	automatic syringe with bottle attachment 5 ml, luer lock
113139	automatic syringe 1 ml, LL, w/tube attachment
113112	automatic syringe 2ml, LL incl. tubing
113115	automatic syringe 5ml, LL incl. tubing

HSW ECO-MATIC® with Bottle Mount Universal Collars**مسدس حقن اوتوماتيك**

Color coded bottle collars for easy reference and identification of the right adapters for the different sized bottles Easy use, durable design, safe and secured bottle fitting For use with all medication bottles of different sizes and shapes (10, 50, 100, 200, 250 or 500 ml and larger) depending on the collar used: white 20 mm, blue 30 mm, green 33 mm

Cat. No	Description
113181	1 ml Luer Lock with bottle attachment for thread bottles
113182	2 ml Luer Lock with bottle attachment for thread bottles
113183	5 ml Luer Lock with bottle attachment for thread bottles
113184	Set of Draw-off Caps Ø 20, 30, 33 mm white, blue, green

HSW ECO-MATIC® TWIN – Automatic self-filling syringe with two separate barrels**مسدس حقن اوتوماتيك زوجي**

Premium-quality plastic syringe with durable plastic barrels. Ergonomic, light weight design for ease of use. Simultaneous vaccination of two products independently. Bottle mount and/or tubing connection. Adjustable barrel orientation for comfort. Easy adjustable barrel position. Various fixed dose barrel combinations available

Cat. No	Description
113104	HSW ECO-MATIC TWIN® 0,5ml/0,5ml
113106	HSW ECO-MATIC TWIN® 1ml/1ml
113107	HSW ECO-MATIC TWIN® 2ml/2ml
113108	HSW ECO-MATIC TWIN® 1ml/2ml
113109	HSW ECO-MATIC TWIN® 0,5ml/2ml

Marking

Correct and clear identification and marking of livestock is important. KRUUSE offers several options for this purpose: Marking sticks, marking sprays, tattooing equipments.



BOVIVET Superior Marking Stick

أقلام ألوان

Superior marking sticks made of special waxes, paraffin oil and high quality dyes. Temperature resistant and highly colour intensive. With screw bottom.

Cat. No	Description
240300	BOVIVET superior marking stick, blue, 10/pk
240301	BOVIVET superior marking stick, red, 10/pk
240302	BOVIVET superior marking stick, green, 10/pk
240303	BOVIVET superior marking stick, black, 10/pk
240304	BOVIVET superior marking stick, purple, 10/pk



KRUUSE Marking Stick

أقلام ألوان

An economic alternative to the well-known BOVIVET Superior marking sticks. KRUUSE marking sticks contain approx. 20% more wax than average sticks on the market. The KRUUSE marking sticks do not contain animal fat. With screw bottom.

Cat. No	Description
240313	KRUUSE marking stick green 10/pk
240314	KRUUSE marking stick red 10/pk
240315	KRUUSE marking stick blue 10/pk
240316	KRUUSE marking stick black 10/pk



KRUUSE FDA Marking Spray

سبراي ألوان

Quick and convenient marking of animals in all weather conditions. Dries instantly and has long durability.

Spray at a distance of 30-40 cm by pressing the nozzle lightly. Approved according to Danish Food Safety Regulations.

Cat. No	Description
240393	KRUUSE FDA marking spray, red, 400 ml, 12/pk
240394	KRUUSE FDA marking spray, green, 400 ml, 12/pk
240395	KRUUSE FDA marking spray, blue, 400 ml, 12/pk

KRUUSE | Wound care - Bandages

Wound Care - Bandages

KRUUSE Vet-Flex

رباط طبي

High quality flexible cohesive bandage. Strong, comfortable and user-friendly. Easy to tear. The Vet-Flex bandage has minimal shrinkage. Each roll is wrapped individually. Dispenser box of 4 or 10 rolls.



Cat. No	Description
160728	KRUUSE Vet-Flex 2.5 cm x 4.5 m, red, 10/pk
160729	KRUUSE Vet-Flex 5 cm x 4.5 m, white, 10/pk
160730	KRUUSE Vet-Flex 5 cm x 4.5 m, red, 10/pk
160744	KRUUSE Vet-Flex 5 cm x 4.5 m, green, 10/pk
160745	KRUUSE Vet-Flex 5 cm x 4.5 m, blue, 10/pk
160746	KRUUSE Vet-Flex 5 cm x 4.5 m, black, 10/pk
160731	KRUUSE Vet-Flex 7.5 cm x 4.5 m, green, 10/pk
160747	KRUUSE Vet-Flex 7.5 cm x 4.5 m, red, 10/pk
160748	KRUUSE Vet-Flex 7.5 cm x 4.5 m, blue, 10/pk
160749	KRUUSE Vet-Flex 7.5 cm x 4.5 m, black, 10/pk
160732	KRUUSE Vet-Flex 7.5 cm x 4.5 m, white, 10/pk
160733	KRUUSE Vet-Flex 10 cm x 4.5 m, white, 10/pk
160734	KRUUSE Vet-Flex 10 cm x 4.5 m, red, 10/pk
160735	KRUUSE Vet-Flex 10 cm x 4.5 m, blue, 10/pk
160736	KRUUSE Vet-Flex 10 cm x 4.5 m, green, 10/pk
160737	KRUUSE Vet-Flex 10 cm x 4.5 m, yellow, 10/pk
160738	KRUUSE Vet-Flex 10 cm x 4.5 m, black, 10/pk
160739	KRUUSE Vet-Flex 10 cm x 4.5 m, ass. of neon colours, 10/pk
160742	KRUUSE Vet-Flex 15 cm x 15 m, red, 4/pk
160743	KRUUSE Vet-Flex 15 cm x 15 m, blue, 4/pk
160726	KRUUSE Vet-Flex 15 cm x 15 cm, black, 4/pk

VALUELINE Cohesive Flex Bandage

رباط طبي

Economy range of flexible, cohesive and comfortable bandages. Easy to tear, no scissors needed. Suitable for all species. An alternative to our KRUUSE Vet-Flex bandages.



Cat. No	Description
164010	VALUELINE cohesive flex bandage, 5 cm x 4.5 m, red, 10/pk
164000	VALUELINE cohesive flex bandage, 5 cm x 4.5m, white, 10/pk
164100	VALUELINE cohesive flex bandage 7.5 cm x 4.5 m, white, 10/pk
164120	VALUELINE cohesive flex bandage 7.5 cm x 4.5 m, green, 10/pk
164200	VALUELINE cohesive flex bandage 10 cm x 4.5 m, white, 10/pk
164210	VALUELINE cohesive flex bandage 10 cm x 4.5 m, red, 10/pk
164220	VALUELINE cohesive flex bandage 10 cm x 4.5 m, green, 10/pk
164230	VALUELINE cohesive flex bandage 10 cm x 4.5 m, blue, 10/pk
164240	VALUELINE cohesive flex bandage 10 cm x 4.5 m, black, 10/pk