

Liebert® ITA™

User Manual – 5-6kVA UPS



Safety Precautions

This manual contains the information concerning the installation and operation of Liebert® ITA 5kVA and 6kVA UPS (hereinafter referred to as UPS).

Please carefully read this manual prior to installation.



1. The UPS must be installed and commissioned by engineers designated by the manufacturer or its agent. Failure to observe this could result in personnel safety risk, UPS malfunction and invalidation of warranty.
2. The UPS has been designed for commercial and industrial use only, and is not recommended for use in life support applications.
3. This is a Class A UPS product. In a residential environment, this product may nevertheless cause radio interference, in which case, the user is required to take additional measures to reduce the interference.
4. Never dispose of the battery module in a fire because it may explode and endanger personnel safety when exposed to flame.



1. The standard UPS has the external battery module, therefore, the output terminals of the UPS may carry live voltage even when the UPS is not connected to the AC mains.
2. Before moving or re-wiring the UPS, please disconnect all the inputs and make sure the UPS is completely shutdown. Or else, the output end may carry live voltage.
3. The operating environment and the saving method affect the life and reliability of the UPS, don not use the UPS in the following environments:
 - Places where the temperature and relative humidity are outside the technical specification (temperature: 0°C ~ 40°C, relative humidity: 5%RH ~ 95RH).
 - Places where direct sunlight and near heat source are present.
 - Places where vibrations or shocks are present.
 - Places where the dusty, corrosive substances, salts, or flammable gases are present.
4. Keep the air inlet and outlet well-ventilated. Poor ventilation will increase the internal temperature, which will shorten the life of the UPS components and that of the UPS.
5. Liquid or other irrelevant external objects are prohibited inside the UPS.
6. In case of fire, a dry chemical fire extinguisher is essential. Using a foam fire extinguisher will cause electric shock.
7. The life of the battery module will be shortened with the rise of the ambient temperature. To ensure normal UPS operation and enough back-up time, the battery module should be replaced periodically. Only the Emerson-authorized technicians are permitted to replace the battery module.
8. If the UPS will remain idle for a long time, it must be stored in a dry environment. The storage temperature should range between -20°C and +55°C for standard UPS (with battery module), between -40°C and +70°C for long back-up UPS (with no battery module).
9. The UPS is a professional equipment with a total rated power greater than 1kW. The equipment complies with IEC 61000-3-12 provided that the short-circuit ratio R_{sce} is greater than or equal to 250 at the interface point between the user's power supply and the public system. It is the responsibility of the installer or user of the equipment to ensure, by consultation with the distribution network operator if necessary, that the UPS is connected only to a power supply with a short-circuit ratio R_{sce} greater than or equal to 250.
10. The UPS output cable must be not longer than 10m.
11. The backfeed protection unit is external. For the using method, refer to *UF-BFP-63A Backfeed Protection Unit User Manual*.
12. Normal mode, the output neutral line of the UPS is connected with the input neutral line. Upon the mains failure, the output neutral line will be suspended, which results in the output neutral line unconnected.



Conformity and standards

1. The UPS complies with 2006/95/EC (LV Safety) and 2004/108/EC (EMC), and with the following product standards for UPS:

- IEC62040-1: 2008 General and safety requirements
- IEC62040-2: EMC requirements, Class C2 compliant
- IEC62040-3: Performance requirements and test methods

2. The UPS installation should follow the above instructions and use the accessories specified by manufacturer.



Warning: high leakage current

1. Reliable earth connection is essential before the input power (AC mains and battery included) is connected.
2. Earth leakage current is bigger than 3.5mA, and less than 5% of the input current.
3. Transient and steady-state earth leakage currents, which may occur when starting the equipment, should be taken into account when selecting instantaneous residual current circuit breaker (RCCB) or residual current detector (RCD).
4. Note that the earth leakage current of the load will be carried by RCCB or RCD.
5. This equipment must be earthed in accordance with the local electrical codes.



Warning: backfeed voltage

Before operating the circuit, isolate the UPS firstly, and then check the dangerous voltage between the ports, and that between the ports and earth.



Maintainable components

1. All internal maintenance and servicing procedures of the equipment should be carried out only by trained personnel with a tool. Components behind the protective cover which can only be removed by using a tool are restricted to service personnel.
2. The UPS meets the safety requirements completely in operator access area. Only service personnel can contact the hazardous voltage inside the UPS. However, the risk of contacting these voltages is minimized because the components with hazardous voltage may be contacted only by using a tool to remove the protective cover. No risk will exist if you follow the general norms and the procedures recommended in this manual on equipment operation.



Warning: battery high voltage

1. All the service and maintenance of the battery are performed by the trained technicians.
2. Operation on the battery will result in electric shock and high short-circuit current, therefore, before operating the battery, the following should be observed:
 - Remove the watches, rings and other metal objects.
 - Use the tools with insulation handle.
 - Wear rubber glove and shoes.
 - Avoid placing the tools and metal objects on the battery surface.
 - Cut off the charge power supply before connecting or disconnecting the battery terminals.
 - Check whether the battery is grounded accidentally, if yes, please disconnect the grounding. Contacting any grounded battery parts will result in electric shock. Therefore, make sure that the battery is not grounded during installation and maintenance.
3. Battery manufacturers provide the details of the precautions to be observed when working on, or in the vicinity of the batteries. These precautions should be followed implicitly at all times. Attention should be paid to the recommendations concerning local environmental conditions and the provision of protective clothing, first aid and fire-fighting facilities.

Contents

Chapter 1 Product Introduction	1
1.1 Features.....	1
1.2 Model Configurations	1
1.3 Appearance And Components.....	2
1.3.1 Appearance	2
1.3.2 Components	2
1.4 Operating Principle	3
1.5 UPS State And Operation Mode	3
1.5.1 Normal Mode	4
1.5.2 Bypass Mode.....	4
1.5.3 Battery Mode	5
1.5.4 ECO Mode.....	5
1.5.5 Fault State	5
1.5.6 Maintenance Bypass Mode	6
1.6 Specifications.....	6
Chapter 2 Single UPS Installation And Commissioning	8
2.1 Unpacking Inspection.....	8
2.2 Installation Preparation	8
2.2.1 Location	8
2.2.2 Environmental Requirements	8
2.2.3 Installation Tools.....	10
2.3 External Protective Devices	10
2.3.1 Battery Input	10
2.3.2 UPS Output	10
2.4 Mechanical Installation.....	10
2.4.1 Tower Installation	10
2.4.2 Rack Installation	12
2.5 Connecting Power Cables	15
2.5.1 Connecting I/O Cables.....	16
2.5.2 Connecting Battery Cables.....	18
2.5.3 Connecting 10A Charger Cables	21
2.6 Single UPS Commissioning	23
2.6.1 Check Before Startup	23
2.6.2 Single UPS Parameters Setting.....	23
2.6.3 Normal Mode Startup.....	23
2.6.4 Battery Mode Startup.....	24
Chapter 3 Parallel UPS Installation And Commissioning	26
3.1 Features.....	26
3.2 Requirements	26
3.3 Mechanical Installation.....	26
3.4 Connecting Cables.....	27

3.4.1 Connecting I/O Cables.....	27
3.4.2 Connecting Parallel Cables	28
3.5 Setting Parallel Address.....	28
3.6 Commissioning Parallel System.....	29
3.6.1 Check Before Startup	29
3.6.2 Startup Commissioning For Parallel System	29
Chapter 4 Display Panel.....	31
4.1 LED Display Panel	31
4.1.1 UPS State Indicators	31
4.1.2 UPS Load Battery Capacity And Fault Orientation Indicator.....	32
4.1.3 Control Keys	33
4.2 LCD Display Panel.....	33
Chapter 5 UPS Operation Instructions	36
5.1 Check Before Power-On	36
5.2 UPS Power-on	36
5.3 Turning On UPS.....	37
5.4 Battery Self-Test	37
5.4.1 Battery Power-on Self-Test.....	37
5.4.2 Battery Manual Self-Test	38
5.4.3 Battery Periodic Self-Test	38
5.5 Turning Off UPS.....	39
5.6 Powering Off UPS.....	40
5.7 Transferring UPS Operation Modes.....	40
5.7.1 Transferring UPS To Bypass Mode From Normal Mode Manually	40
5.7.2 Transferring UPS To Bypass Mode From Overload Protection	40
5.7.3 Transferring UPS To Inverter Mode From Bypass Mode Manually	40
5.7.4 Transferring UPS To Battery Mode From Mains Failure.....	40
5.7.5 Transferring UPS To Bypass Mode From Inner Overheating Protection	40
5.7.6 Transferring UPS To Fault State From Output Short Protection	41
5.7.7 Transferring UPS To Maintenance Bypass Mode From Inverter Output	41
5.7.8 Transferring UPS To Inverter Mode From Maintenance Bypass	41
5.8 UPS Complete Turn-off.....	41
5.9 Auto Restart.....	42
5.10 UPS Monitoring.....	42
Chapter 6 Communication.....	43
6.1 Connecting USB Communication Cable	43
6.2 Installing Communication Assembly (Optional).....	43
6.2.1 SIC Card.....	43
6.2.2 JBUS/MODBUS Adapter Card	43
6.2.3 RS485 Card.....	43
6.2.4 RS232 Card.....	44
6.2.5 Dry Contact Card.....	44
6.2.6 Extended Dry Contact Card	44

Chapter 7 Maintenance And Troubleshooting	45
7.1 Fan Maintenance	45
7.2 Battery Maintenance	45
7.3 Cleaning UPS	46
7.4 Checking UPS Status	46
7.5 Checking UPS Functions	46
7.6 Troubleshooting	46
Chapter 8 Options	48
8.1 Option List.....	48
8.2 Battery Module.....	48
8.2.1 List Of Battery Module Options.....	48
8.2.2 Appearance Of Battery Module	49
8.2.3 Back-Up Time Of Standard Battery Module For Single UPS.....	50
8.3 POD.....	50
8.3.1 1-In 1-Out 1 + 1 Parallel POD.....	50
8.3.2 1-In 1-Out 3 + 1 Parallel POD.....	51
8.3.3 3- In 1-Out 3 + 1 Parallel POD.....	52
8.3.4 Output Power Distribution POD	53
8.4 Complete Set Of Cables	54
8.4.1 Parallel Communication Cables.....	54
8.4.2 Battery Cable.....	54
8.5 Guide Rail For Rack Installation	54
8.6 Communication Options And Monitoring Options	55
8.7 10A Charger	55
8.8 LCD Display Panel Assembly	56
8.9 UF-BSO-0050 ITA UPS Battery Shared Module.....	57
Appendix 1 Glossary	59

Chapter 1 Product Introduction

Liebert® ITA 5kVA and 6kVA UPS (UPS for short) is an intelligent online UPS system with sine wave output developed by Emerson Network Power Co., Ltd (Emerson for short). The UPS offers reliable and high quality AC power to the precision instrument.

The UPS uses modular design, and rack/tower installation can be used depending on your requirements. It is applicable to supplying AC power to small scale computer center, network, communication system, automatic control system and precision instrument.

This chapter expands the features, model configuration, appearance, components, operating principle, operation status, operation mode and specification of the UPS.

1.1 Features

The UPS features include:

- Compatible with two mains input modes: 3-phase and single-phase input mode, with automatic input recognition function
- Capable of parallel connection to achieve up to 3 + 1 parallel redundant power
- High-frequency double conversion topology structure, with high input power factor, wide input voltage range, and output immune to power grid interference, thus adaptable to areas with unstable mains supply
- High power density
- Full digital control technology based on digital signal processor (DSP) to achieve high system reliability with self-protection and fault diagnosis functions
- Excellent intelligent battery management to extend the battery life
- Display panel with both LCD and LED indication to help you learn about the UPS operation status and operating parameters
- 2U thickness. Tower installation and rack installation are optional to meet different installation requirements
- Capable of ECO power supply mode, which helps you save energy to the maximum extent
- Flexible network management with Emerson monitoring software
- Fan fault self-test and automatic recognition functions
- SNMP card optional, providing network communication function
- Capable of connecting multiple battery strings, extending the power supply time of battery mode

1.2 Model Configurations

Two types are available for 5kVA and 6kVA UPS: standard model and long back-up model. The model configurations are listed in Table 1-1.

Table 1-1 Model configurations

	Model	Type	Product number	Net weight	Size (W × H × D, unit: mm)	Description
5kVA	Standard model	UHA1R-0050	01200580	17kg	435 × 85 × 640	Configured with battery modules. See 8.2 <i>Battery Module</i> for the structure and connection of the battery modules
	LCD Standard model	UHA1R-0050	01201056	17kg	435 × 85 × 640	
	Long back-up model	UHA1R-0050L	01200582	17.8kg	435 × 85 × 640	You need to select battery modules according to the requirement or connect the external battery modules by yourself
	LCD long back-up model	UHA1R-0050L	01201057	17.8kg	435 × 85 × 640	

Model	Type	Product number	Net weight	Size (W × H × D, unit: mm)	Description	
6kVA	Standard model	UHA1R-0060	01200456	17kg	435 × 85 × 640	Configured with battery modules. See 8.2 <i>Battery Module</i> for the structure and connection of the battery modules
	LCD Standard model	UHA1R-0060	01200858	17kg	435 × 85 × 640	
	Long back-up model	UHA1R-0060L	01200461	17.8kg	435 × 85 × 640	You need to select battery modules according to the requirement or connect the external battery modules by yourself
	LCD long back-up model	UHA1R-0060L	01200859	17.8kg	435 × 85 × 640	

1.3 Appearance And Components

1.3.1 Appearance

The UPS appearance is shown in Figure 1-1.



Figure 1-1 UPS appearance

1.3.2 Components

Front panel

As shown in Figure 1-2, the UPS front panel provides ventilation holes and display panel.



Figure 1-2 UPS front panel

Rear panel

As shown in Figure 1-3, the UPS rear panel provides parallel port, DIP switch, input MCB (Miniature Circuit Breaker), battery port, USB port, ventilation holes, 10A charger control port, intelligent card slot and I/O terminal block.

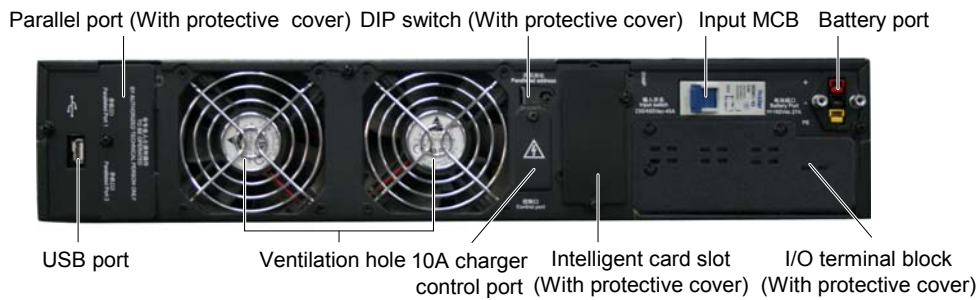

Figure 1-3 UPS rear panel



Note

Non-authorized personnel are prohibited from opening the UPS chassis cover.

1.4 Operating Principle

The operating principle of the UPS is shown in Figure 1-4.

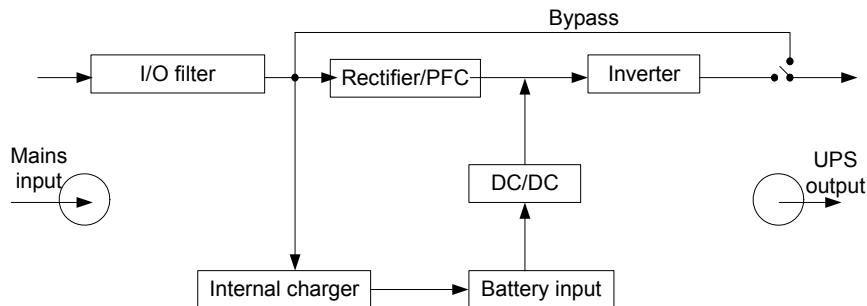

Figure 1-4 UPS operating principle

1. The UPS is composed of mains input, I/O filter, rectifier/PFC, DC/DC boost, inverter, bypass, internal charger, battery input and UPS output.
2. When the mains is normal, close the bypass MCB, and the internal charger will charge the battery. Before turning on the UPS, the output voltage is zero. After the UPS is turned on, the electronic transfer switch connects the inverter to the load, and the mains supplies DC power to the inverter through the rectifier/PFC circuit. The inverter then converts DC power into pure sine wave AC power, and supplies the AC power to the load through the electronic transfer switch.
3. When the mains is abnormal, the rectifier/PFC circuit boosts the battery voltage and supplies it to the inverter. The inverter then converts it into pure sine wave AC power, and supplies the AC power to the load through the electronic transfer switch.
4. After the mains restores, the UPS will automatically transfer from Battery mode to Normal mode, the mains supplies DC power to the inverter through the rectifier/PFC circuit, and then the electronic transfer switch supplies the AC power to the load.

1.5 UPS State And Operation Mode

The UPS state and operation mode include: Normal mode, Bypass mode, Battery mode, ECO mode, Fault state and Maintenance Bypass mode.

The operation schematic diagrams of Normal mode, Bypass mode, Battery mode and Maintenance Bypass mode are shown in Figure 1-5.



Note

Only when the UPS output power distribution unit (POD for short) is configured, can the Maintenance Bypass mode be valid.

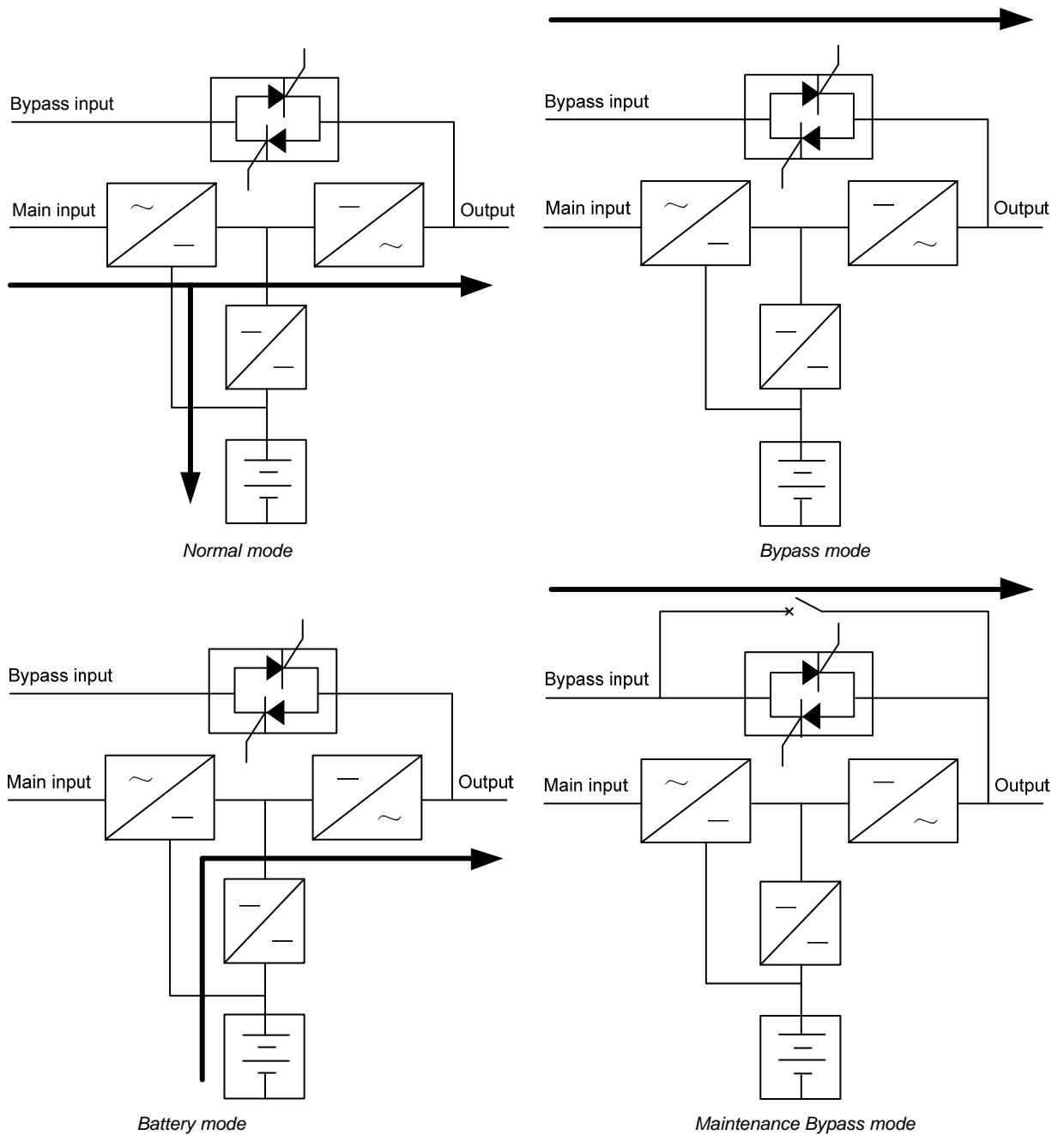

Figure 1-5 Operation schematic diagram

For the LED indicators introduced in this section, refer to 4.1.1 UPS State Indicators.

1.5.1 Normal Mode

When the mains input is normal, the load is supplied with voltage-stabilizing and frequency-stabilizing power by the mains after processing of the rectifier and the inverter, and meanwhile, the charger is charging the battery, the operation mode is Normal mode. In Normal mode, the MAINS indicator and the INVERTER indicator are on.

1.5.2 Bypass Mode

If the overload overtime, inverter or rectifier failure appears during the UPS operation in Normal mode, the UPS will transfer to Bypass mode, that is, the load is powered by the bypass source, which comes directly from the mains input. If the rectifier is normal, the internal charger will charge the battery. In Bypass mode, the INVERTER indicator is off; the MAINS indicator and the INVERTER indicator are on.



Note

In case of mains failure or mains voltage out of range (120Vac ~ 253Vac/265Vac/276Vac) in Bypass mode, the UPS will turn off and stop the output.

1.5.3 Battery Mode

Upon mains failure, rectifier overload or mains voltage out of range (120Vac ~ 276Vac), the rectifier and the internal charger will stop running, and the battery will supply power to the load through the inverter. The BATTERY indicator and INVERTER indicator are on, and the buzzer alarms every 3.3 seconds, notifying you that the UPS is in Battery mode.



Note

1. The battery has been fully charged before delivery. However, transportation and storage will inevitably cause some capacity loss. Therefore, it is required to charge the battery for eight hours before putting the UPS into operation for the first time, to ensure the adequate back-up time for battery.
2. The battery cold start can also be used to start the UPS from the Battery (charged) mode upon mains failure. Therefore, the battery power can be used independently for improving the system availability to some extent.
3. In Battery mode, when the battery voltage is low, the buzzer beeps rapidly (once per second), and the corresponding measures must be done in time.

1.5.4 ECO Mode

In ECO mode, when the bypass voltage is 220Vac/230Vac/240Vac \pm 10% and the frequency is within 50Hz/60Hz \pm 2Hz, the load is supplied by the bypass AC source and the BYPASS indicator is on. When the bypass voltage is abnormal, the load is supplied by the inverter. ECO mode is an energy-saving operation mode. For power equipment insensitive to power grid quality, you can use the ECO mode for power supply through bypass to reduce the power loss.

When the bypass voltage is normal, the inverter is in no-load state, the load is supplied by the bypass AC source and the BYPASS indicator is on.



Note

1. In ECO mode, if the bypass failure or abnormal bypass voltage appears when the output is not overloaded, the UPS will transfer to Normal mode. However, if the bypass failure or abnormal bypass voltage appears when the output is overloaded, the UPS will not transfer to Normal mode, and the bypass will be turned off.
2. In ECO mode, the efficiency of the UPS is up to 97%.

1.5.5 Fault State

In Normal mode, the UPS will transfer to Bypass mode if the inverter failure or UPS overtemperature appears. In Battery mode (with no bypass mains), the UPS will turn off and stop the output if the inverter failure or UPS overtemperature appears. In Fault state, the FAULT indicators will turn on, the buzzer will keep beeping, and the corresponding indicator will blink.



Note

In Fault state, if the bypass fails or bypass voltage is abnormal when the output is not overloaded, except for the faults which can cause turn-off, the UPS will transfer to the inverter input, such as radiator over-hot. However, if the bypass fails or bypass voltage is abnormal when the output is overloaded, the UPS will not transfer to the inverter input, and will turn off the bypass.

The UPS provides the relay card UF-DRY310 (optional) for user to realize the EPO function, refer to *UPS Extended Relay Card User Manual*. The user should install the EPO function circuit at the UPS output port for the remote emergency shutdown function if the relay card UF-DRY310 is not used.

1.5.6 Maintenance Bypass Mode

If maintenance and repair for UPS are needed, you can transfer the load to the Maintenance Bypass through maintenance bypass MCB, and the power to the load is not interrupted. The maintenance bypass MCB is located on the front panel of the POD, and the capacity meets the requirements of total load capacities. Refer to *Liebert® ITA 5kVA And 6kVA UPS Parallel Power Distribution Unit User Manual* for the detailed introductions of the POD.



Note

When the UPS has malfunctions and cannot working normally, please get in touch with the nearest Emerson branch office or local service center. It is prohibited to repair the UPS by yourself, otherwise the personnel injury and damage to the equipment will occur.

1.6 Specifications

The specifications are listed in Table 1-2.

Table 1-2 Specifications

Item		5kVA		6kVA	
		Standard model	Long back-up model	Standard model	Long back-up model
		UHA1R-0050	UHA1R-0050L	UHA1R-0060	UHA1R-0060L
Input	Rated voltage	Single-phase: 220/230/240Vac, 3-phase: 380/400/416Vac			
	Voltage range	Single-phase: 176Vac ~ 276Vac, 3-phase: 305Vac ~ 478Vac, at full load Single-phase: 120Vac ~ 176Vac, 3-phase: 210Vac ~ 305Vac, linear derating Single-phase: 120Vac, 3-phase: 210Vac, at half load			
	Frequency	50Hz/60Hz ± 5Hz			
	Power factor	Single-phase: ≥ 0.99, 3-phase: ≥ 0.95			
Output	Rated power	4.5kW		4.8kW	
	Voltage	220/230/240Vac ± 3%			
	Frequency	In Normal mode: the output tracks the bypass frequency when the bypass frequency is within 50Hz/60Hz ± 5Hz			
	Frequency track rate	0.2Hz/s (default), 1Hz/s			
	Power factor	0.9		0.8	
	Crest factor	3: 1			
	Voltage harmonic distortion	≤ 3% (linear load), ≤ 5% (non-linear load)			
	Load regulation rate	2%			
	Dynamic response recovery time	60ms			
	Overload capacity	105% ~ 125% rated load for 1min, 125% ~ 150% rated load for 100ms			
	Bypass voltage	120Vac ~ 253/265/276Vac			
	Mains efficiency	91%			
Battery	Type	Sealed, lead-acid, maintenance-free battery (12V/7Ah)			
	Cell No.	16 (12V/7Ah)	Depended on external battery capacity (the battery capacity should be bigger than 56Ah)	16 (12V/7Ah)	Depended on external battery capacity (the battery capacity should be bigger than 56Ah)
	Rated voltage	192Vdc			
	Recharge duration	Four hours to 90% rated capacity	Depended on external battery capacity	Four hours to 90% rated capacity	Depended on external battery capacity
	Charge current	2A	4A	2A	4A
Transfer time	Mains ↔ Battery	0ms			
	Inverter ↔ Bypass	≤ 4ms			
Noise	≤ 50dB				
Panel display mode	LED/LCD (optional)				
Safety	CCEE (GB4943-1995)/GB4943				

Item		5kVA		6kVA	
		Standard model	Long back-up model	Standard model	Long back-up model
		UHA1R-0050	UHA1R-0050L	UHA1R-0060	UHA1R-0060L
EMC	Conduction emission	IEC/EN 62040-2			
	Immunity	I ≤ 16A, IEC/EN61000-3-3; 16A < I ≤ 75A, IEC/EN61000-3-11			
	Harmonic current	I ≤ 16A, IEC/EN61000-3-2; 16A < I ≤ 75A, IEC/EN61000-3-12 YD/T1095-2001 level 2 15%			
Surge protection		IEC/EN-61000-4-5, endurance level 4 (4kV) (live line to earth), level 3 (2kV) (during live lines)			
Protection level		IP20			
Ambient condition	Operating temperature	0°C ~ 40°C			
	Storage temperature	-40°C ~ +70°C (battery excluded); -20°C ~ +55°C (battery included)			
	Relative humidity	5% ~ 95%, non-condensing			
	Altitude	< 1500m, derating in accordance with GB/T3859.2 when higher than 1500m			
Size	W × H × D (mm)	435 × 85 × 640			
Net weight (kg)		17	17.8	17	17.8

Chapter 2 Single UPS Installation And Commissioning

This chapter introduces the installation, cable connection and commissioning of the single UPS.

Each site has its peculiarity, so this chapter provides the guidance with general installation procedures and methods for the installation engineer who should conduct the installation according to the actual conditions.



Warning: professional installation

1. The UPS should be installed by a qualified engineer according to the information contained in this chapter. If any problem is found, please get in touch with Emerson local service center immediately.
2. The UPS shall not be powered on without approval of the commissioning engineer.
3. The UPS installation must be carried out by professionals strictly. For other equipment which is not introduced in this manual, the detailed information about mechanical installation and electrical installation are delivered with the equipment.

2.1 Unpacking Inspection

After the UPS arrival, you should unpack it and check the following items:

1. Visually inspect the UPS appearance for transportation damage. If any problem is found, please notify the carrier immediately.
2. Check the accessories and models against the delivery list. If any problem is found, please notify the dealer immediately.

2.2 Installation Preparation

2.2.1 Location

To extend the UPS life, the chosen place must offer:

- Convenient wiring
- Adequate operator access area
- Good ventilation to meet the heat dissipation requirements
- No corrosive gas, such as sulfur dioxide and so on
- No excessive moisture or heat source
- No excessive dust
- Compliance with fire-fighting requirements
- Operating temperature compliant with the specifications, see Table 1-2 for details

2.2.2 Environmental Requirements

UPS room

The UPS is designed for indoor installation, which should be installed in a clean and well-ventilated environment, to keep the environmental temperature within the specifications.

The internal fans provide forced air cooling for the UPS. Cooling air enters the UPS through the ventilation holes on the rear panel, and exhausts the hot air through the front ventilation holes. Therefore, do not obstruct the ventilation holes. Maintain at least 200mm clearances between the front, rear, top, bottom, side panels of the UPS and the wall or adjacent equipment (see Figure 2-1), to avoid obstructing the UPS ventilation and heat dissipation. Otherwise, the UPS internal temperature will rise, which will shorten the UPS life.

If necessary, an indoor exhaust fan should be installed to keep the indoor temperature from rising. An air filter should be used in a dusty environment where the UPS is to be operated.

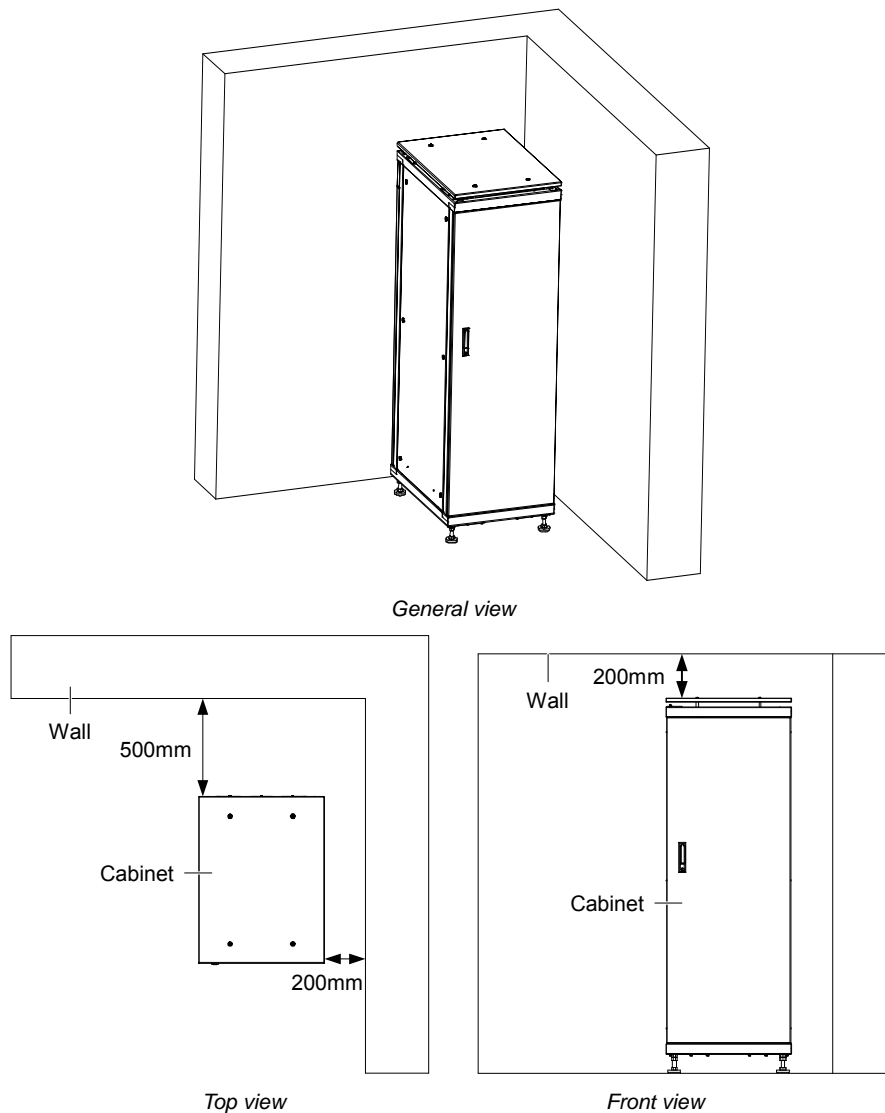

Figure 2-6 Installation clearances



Note

1. The UPS should be installed only on the concrete surface or other non-flammable surfaces.
2. As shown in Figure 2-1 (top view), the clearance between the rear panel of the cabinet and the wall is 500mm, however, this clearance also needs to be considered for the sake of maintenance.

Battery room

A small amount of hydrogen and oxygen will be generated at the end of battery charging, therefore, you must ensure that the fresh air ventilation of battery installation environment meets the EN50272-2001 requirements.

The battery environmental temperature should keep constant, because the environmental temperature is the main factor to affect the battery capacity and life. The battery standard operating temperature is 20°C, operation above this temperature will shorten the battery life, and operation below this temperature will reduce the battery capacity. If the battery average temperature in operation rises from 20°C to 30°C, the battery life will be reduced by 50%; if the battery temperature in operation exceeds 40°C, the battery life will be decreased exponentially. In general, the allowable environmental temperature of the battery is 15°C ~ 25°C. The battery should be kept away from heat and ventilation holes.

When the UPS uses an external battery, you must install a battery protective device (such as a fuse or a circuit breaker) in areas near the battery, and use the shortest wiring distance for the connection between the protective device and the battery.

Storage environment

When the UPS does not need to be installed immediately, the UPS must be stored indoors to be protected from the excessive moisture or overtemperature environment. The battery requires dry and low temperature, well-ventilated environment for storage, and the most suitable storage temperature is 20°C ~ 25°C.

 Warning: battery hazards
During the battery storage, the battery must be periodically charged according to the battery instructions. When charging the battery, you can connect the UPS to the mains temporarily to charge and activate the battery.

2.2.3 Installation Tools

Prepare installation tools according to Table 2-1. The tools must be insulated and ESD-proof processed prior to use.

Table 2-3 Installation tools list

Installation tool	Specification	Application
Cross screwdriver	EJ5100mm	Remove the screws of the top protective cover of the UPS, or open the chassis
Wire-pressure plier	YT-12	Press wires for I/O terminal block
Diagonal plier	MTC3C	Make I/O cables
Slotted screwdriver	EJ375mm	Connect I/O cables

2.3 External Protective Devices

The circuit breaker or other protective devices must be installed at the external AC input end of the UPS. This section provides the general guidance for qualified installation engineer. The qualified installation engineer should learn about the local wiring regulations and other related information.

2.3.1 Battery Input

If the battery module option is provided by Emerson, the battery module has a built-in overcurrent protective device. Otherwise, the external battery cabinet should equip a DC compatible circuit breaker to provide overcurrent protection for the UPS and its batteries.

2.3.2 UPS Output

The protective device must be installed for the UPS output power distribution. The protective device must be different from the input power distribution protection air breaker, and provide the overload protection (see Table 2-4).

2.4 Mechanical Installation

Two installation modes are available: tower installation and rack installation. You can select an appropriate installation mode according to the actual conditions.

2.4.1 Tower Installation

1. Adjust the display panel.
 - 1) Remove the fixing screws (two pieces), and hold the left side of the display panel to pull it out.
 - 2) Rotate the display panel 90° counter clockwise, and then put it to its original place.
 - 3) Tighten the fixing screws.

The operation procedures of the display panel are shown in Figure 2-2 when the mode is changed from rack installation to tower installation.

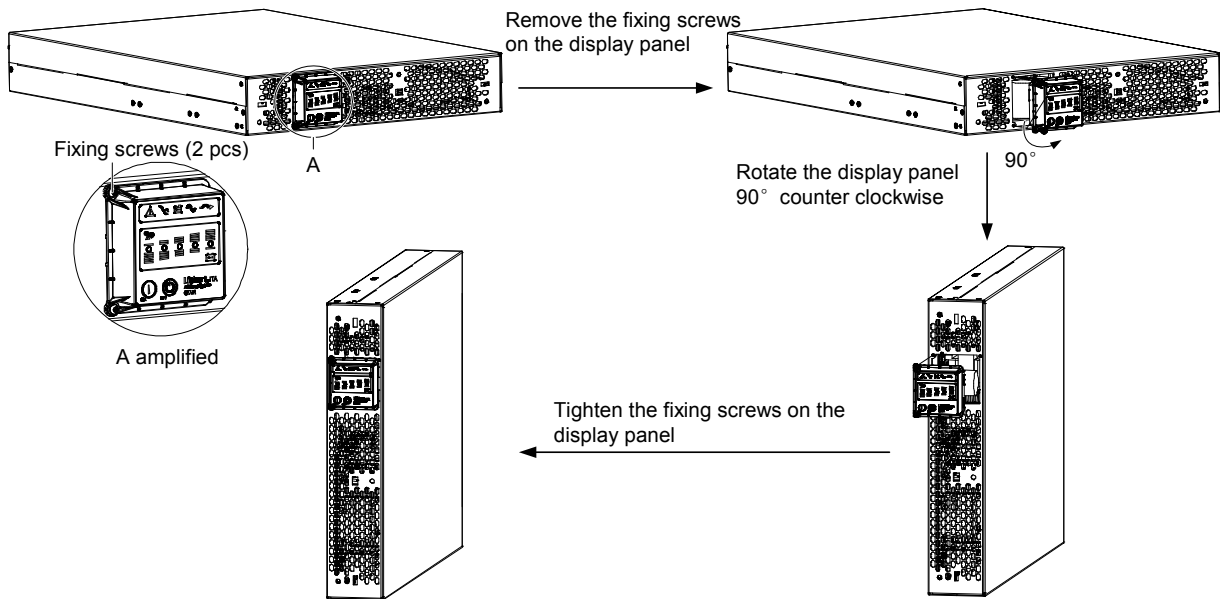

Figure 2-7 Adjusting the display panel



Note

1. For the tower installation, you need to adjust the display panel; for the rack installation, ignore this step.
2. When adjusting the display panel, you do not need to open the chassis of the UPS.

2. Install the plastic panel.

1) Take out the plastic panel from the UPS package.

2) Align the plastic panel with the UPS display panel, and gently press the metal buckles on both sides of the plastic panel into the square holes on the UPS front panel according to the direction shown in Figure 2-3.

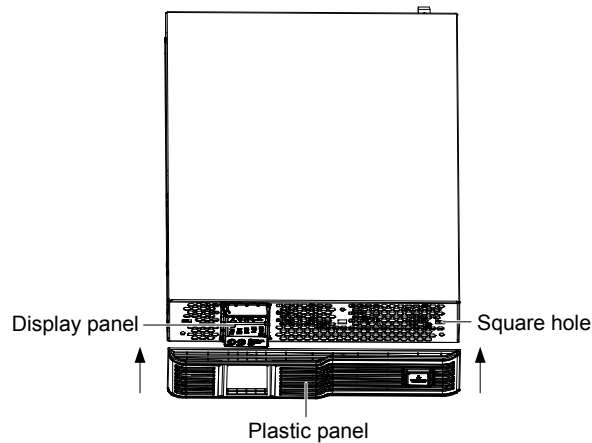

Figure 2-8 Installing the plastic panel



Note

You do not need to uninstall the UPS when the plastic panel is removed. Press the two ends of the plastic panel with hands, and gently pull down the plastic panel to remove it, as shown in Figure 2-4.

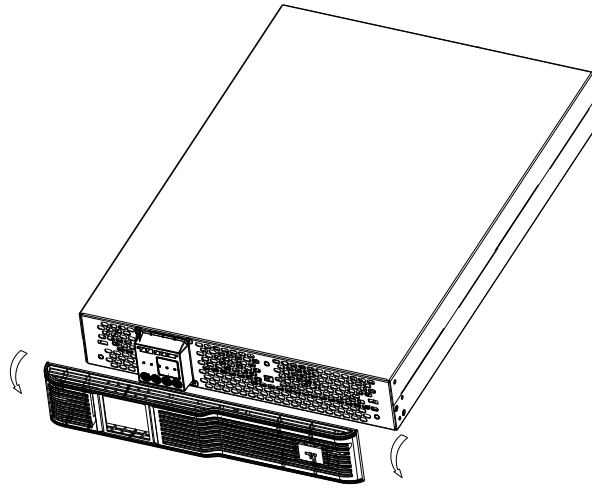

Figure 2-9 Removing the plastic panel

3. Take out the support bases from the accessories, assemble a pair of support bases together through the fastenings, as shown in Figure 2-5, and put them onto the flat installation table.

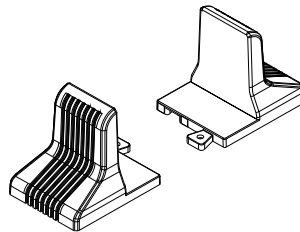

Figure 2-10 Installing the support base

4. If battery module installation is necessary, take out other support base extensions delivered with the battery module, and then assemble the support base extensions and the support bases through the fastenings, as shown in Figure 2-6.

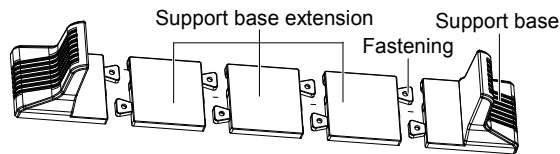

Figure 2-11 Installing the support base with support base extension

5. Place the UPS and battery module (if applicable) on the support bases and support base extensions. Each UPS needs four support bases to install, as shown in Figure 2-7.

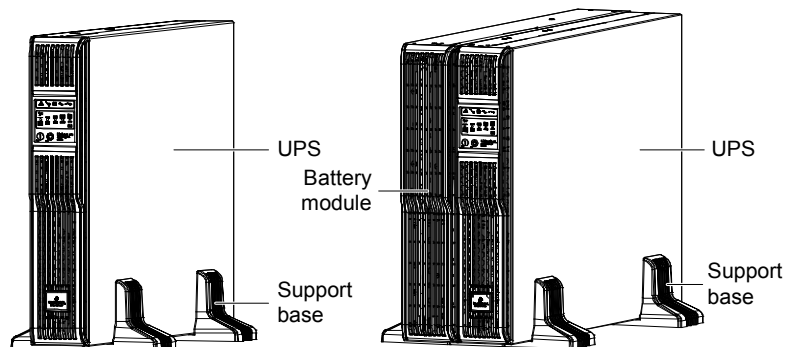

Figure 2-12 Installing the UPS and battery module

2.4.2 Rack Installation

Installation procedures for UPS

1. Install the plastic panel, refer to 2.4.1 Tower Installation for the procedures.

2. Take out the brackets and six M4 × 10 screws from the accessories, and fix the two brackets onto the two sides of the front panel of the UPS using the screws through installation hole 1, as shown in Figure 2-8.

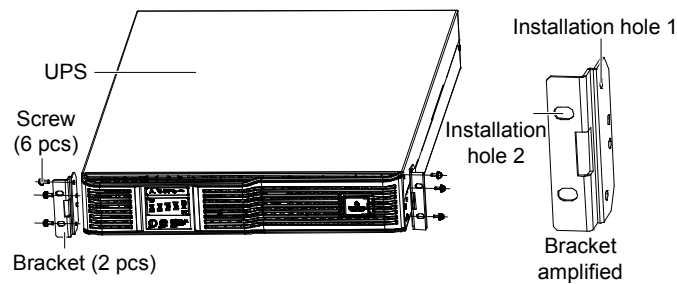

Figure 2-13 Installing the brackets



Note

It is prohibited to move the UPS through the brackets.

3. Install the guide rails.

You need to use guide rails when you select Liebert® ITA series UPS and its options, and select the rack installation. The installation procedures of the guide rails are as follows:

1) Take out the guide rails (one left guide rail and one right guide rail), guide rail screws and panel screws from the package, distinguish the left guide rail and right guide rail according to Figure 2-9, and confirm its retractable function respectively.

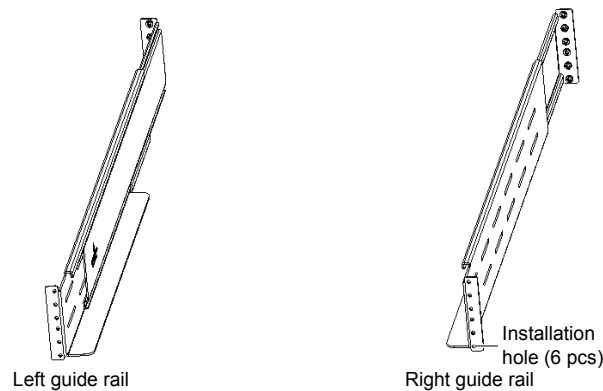

Figure 2-14 Appearance of the guide rail

Distinguish the guide rail screw and the panel screw according to Figure 2-10.

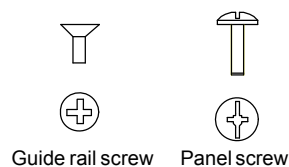

Figure 2-15 Appearance of the screw

2) Adjust the length of the guide rail according to the dimensions of the rack.

3) Align the installation holes of the guide rail with the square holes of the rack, fix the guide rail on the rack with the guide rail screws (eight pieces), each left guide rail and right guide rail need four guide rail screws, as shown in Figure 2-11.

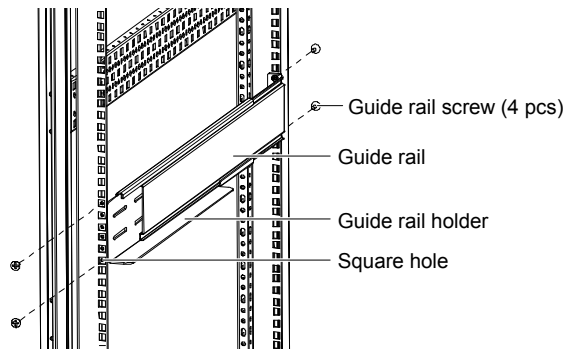

Figure 2-16 Installing the guide rail



Note

1. The guide rail holder must be close to the front of the rack.
2. Any end of one guide rail has six installation holes (see Figure 2-9), do not use the two installation holes in the middle when fixing the guide rail. It is recommended to use the top and bottom installation hole (from top to bottom, installation hole 1 and installation hole 6).

The guide rail installation is finished, as shown in Figure 2-12.

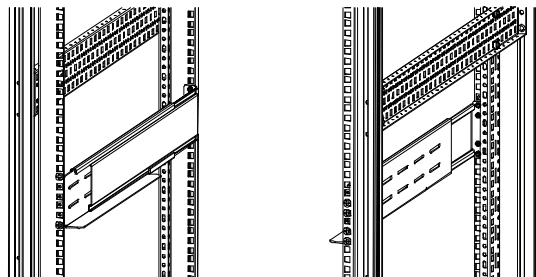

Figure 2-17 Guide rail installation complete

4. Place the UPS on the guide rails in the rack, and push it completely into the rack. Use four panel screws (M4 × 16) to fix the UPS in the rack through the installation hole 2 of the brackets, as shown in Figure 2-13.

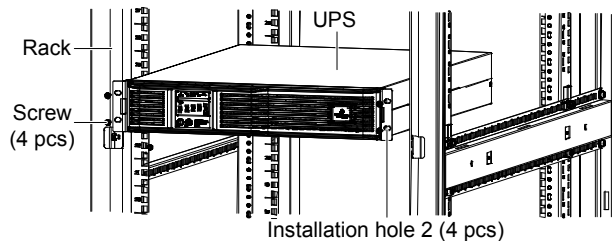

Figure 2-18 Installing the UPS

Installation procedures for UPS with battery modules

The installation method of the battery module is the same as that of the UPS. Repeat the installation procedures of the UPS to install and fix the battery modules and the UPS in the rack one by one, as shown in Figure 2-14.

Because the battery module is heavy, you should pay attention to the following items in installation:

- Install the battery modules first, start the installation from the bottom, and then place the UPS onto the top, as shown in Figure 2-14.
- It is prohibited to move the UPS and battery modules through the brackets.
- Two persons or more are required for the installation.

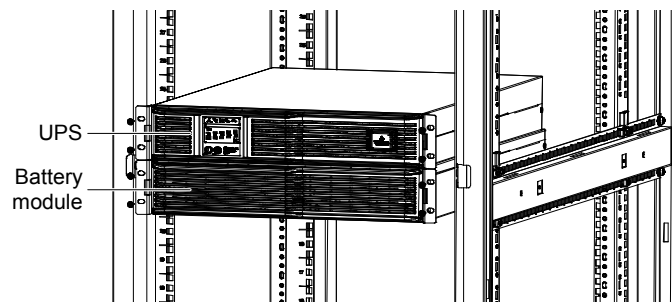

Figure 2-19 Installing the UPS with battery modules

2.5 Connecting Power Cables

I/O cables, battery cables and 10A charger cables (optional) are required for connection. When connecting the cables, you should follow the local wiring regulations, take the environment situation into account, and refer to Table 3B of IEC60950-1.

The maximum current in different operating modes is listed in Table 2-2, the recommended minimum cable CSA (Cross-Sectional Area) is listed in Table 2-3. Select the appropriate cables according to Table 2-2 and Table 2-3.

Table 2-4 Max. steady state AC and DC current

UPS rated power (kVA)	Rated current (A)						Battery discharging current upon min. battery voltage
	Mains input current ^{1,2} upon battery charging with max. ability			Gross output current ² at full load			
	220V	230V	240V	220V	230V	240V	
5 (1-in 1-out)	27	27	27	23	22	21	32
5 (3-in 1-out)	12	12	12	23	22	21	32
6 (1-in 1-out)	31	31	31	27	26	25	38
6 (3-in 1-out)	13	13	13	27	26	25	38

Note:
 When the battery cables are selected, according to the current value shown in this table, the max. allowable voltage drop is 4Vdc. Do not ring the cables to avoid increasing the electromagnetic interference (EMI).
 1: The input mains current of the rectifier and the bypass.
 2: Non-linear load (switch mode power) affects the neutral cable design of the output and the bypass. The neutral cable current may exceed the rated phase current, up to 1.732 times as large as the rated current

Table 2-5 Single UPS cable CSA (unit: mm², environmental temperature: 25°C)

Model	Input	Output	Neutral cable	PE	Battery
5/6kVA (1-in 1-out)	6	6	6	6	6
5/6kVA (3-in 1-out)	6	6	6	6	6

The recommended I/O MCB capability of the UPS is listed in Table 2-4. Select the MCBs according to your requirements.

Table 2-6 UPS I/O MCB selection

Model	Input interface	Recommended capability of input external MCB	Battery MCB	Output interface	Recommended capability of output external MCB
5/6kVA (1-in 1-out)	Terminal block	63A	DC63A	Terminal block	40A
5/6kVA (3-in 1-out)	Terminal block	63A	DC63A	Terminal block	40A

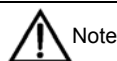

Note

- The UPS is high leakage current equipment, it is not recommended to configure the MCB with leakage current protection function.
- To ensure the reliable connection, the pipe type connection terminal (accessory of the UPS) is required for all cable connections.

2.5.1 Connecting I/O Cables

The power cables of the UPS should be connected through the I/O terminal block located on the UPS rear panel. Remove the protective cover A of the I/O terminal block shown in Figure 2-15 to reveal the I/O terminal block.

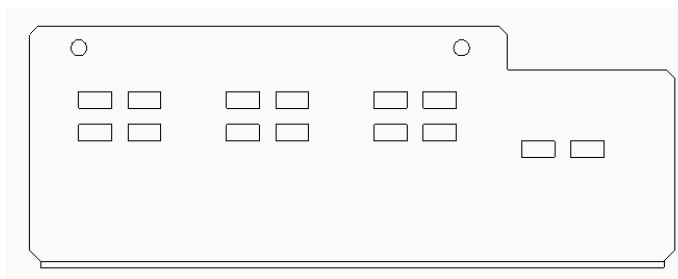

Figure 2-20 Protective cover A of the I/O terminal block

Figure 2-16 gives the terminal layout of the I/O terminal block.

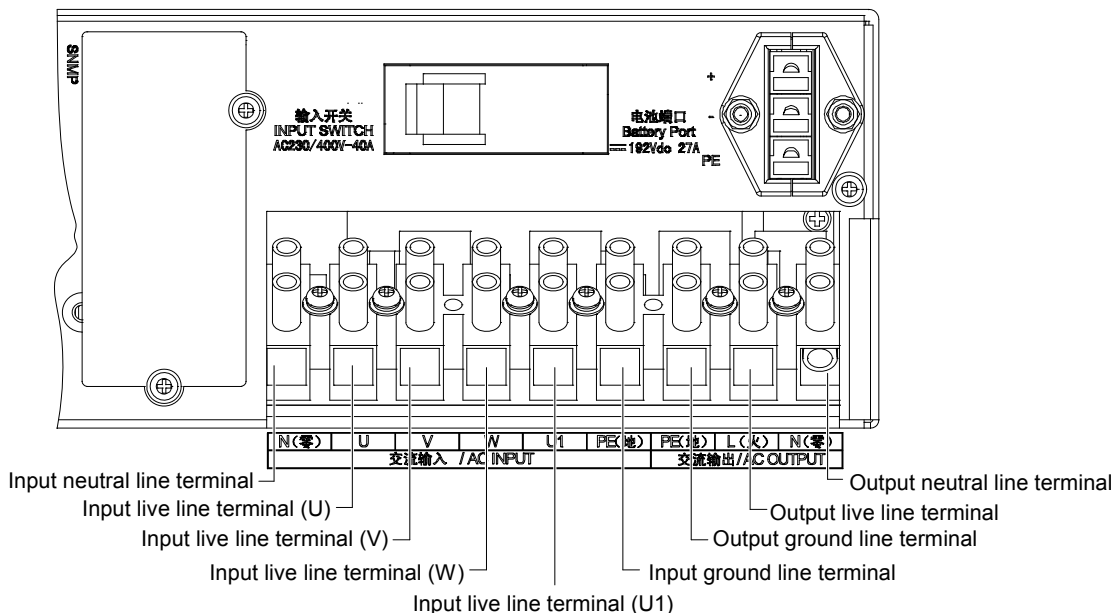

Figure 2-21 Terminals layout of the I/O terminal block

Note

1. Do not reverse the input neutral line and live line.
2. Do not use a wall socket to feed power to the UPS. Otherwise, the socket may be burned.
3. Connect the output neutral line and live line and ground line correctly and reliably. For the sake of safety, the ground line must be connected firstly.
4. Install a three-pole or quadrupole linkage breaker on the mains input neutral line and live line to facilitate cutting power under emergency conditions. Use correct power distribution method (see Figure 2-17) to ensure safety of the UPS and user equipment.

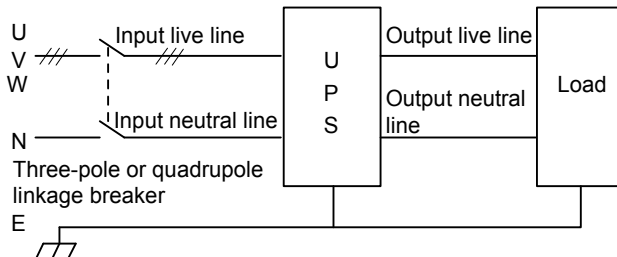

Figure 2-22 Correct power distribution method

After the cable connection, install the protective cover B of the I/O terminal block to protect the I/O terminal block. The protective cover B of the I/O terminal block is shown in Figure 2-18.

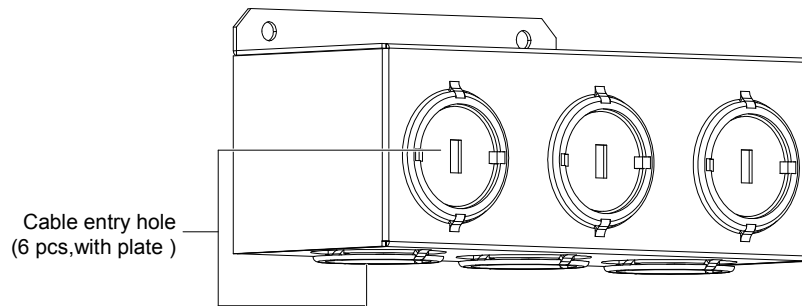

Figure 2-23 Protective cover B of the I/O terminal block

Before installing the protective cover B of the I/O terminal block, remove the iron plates on the cable entry holes, and install the bushings (label: 21101494, accessories). After the cable connection, fix the protective cover B of the I/O terminal block.

According to user's requirements, the I/O cable connections are divided into two types: 1-in 1-out (factory default) and 3-in 1-out.

The I/O cable connection procedures of the self-distribution for the two types are described in the following.

● 1-in 1-out (factory default)

1. Make sure that all the external I/O MCBs of the UPS are open.
2. Remove the protective cover A of the I/O terminal block.
3. Remove the plates on three cable entry holes of the protective cover B according to the cable direction.
4. Pass all the cables to be connected to the I/O terminal block through the cable entry holes of the protective cover B according to the actual situation.
5. Connect the main input N line, L line and PE line respectively to the input neutral line terminal, input live line terminal (U), input ground line terminal of the UPS I/O terminal block, and tighten the fixing screws. Short the input live line terminal (V), input live line terminal (W) and input live line terminal (U1) using the shorting wire (label: W01), as shown in Figure 2-19.
6. Connect the output L line, N line and PE line respectively to the output live line terminal, output neutral line terminal and output ground line terminal of the UPS I/O terminal block, and tighten the fixing screws, as shown in Figure 2-19.
7. Install the protective cover B of the I/O terminal block.

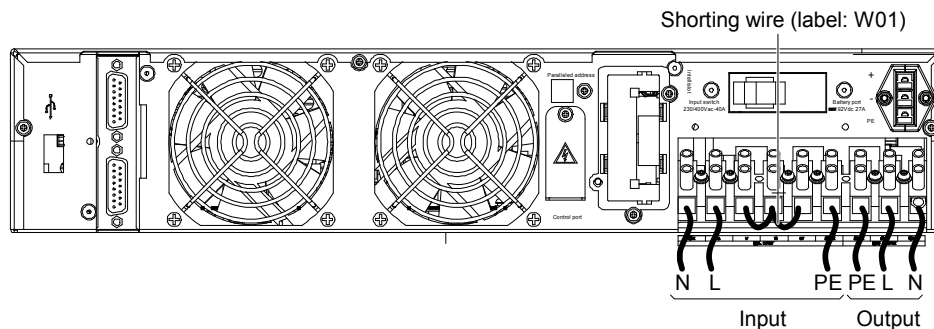

Figure 2-24 Cable connection for 1-in 1-out

● 3-in 1-out



The default power distribution mode of this UPS is 1-in 1-out. If 3-in 1-out is needed, you should switch from 1-in 1-out to 3-in 1-out according to the following steps, and then continue the installation and commissioning.

1. Make sure that all the external I/O MCBs of the UPS are open.
2. Remove the protective cover A of the I/O terminal block.
3. Remove the plates on three cable entry holes of the protective cover B according to the cable direction.
4. Pass all the cables to be connected to the I/O terminal block through the cable entry holes of the protective cover B according to the actual situation.
5. Remove the shorting wire (label: W01, see Figure 2-19) from the UPS I/O terminal block.

6. Connect the main input live line (phase A, phase B and phase C), N line and PE line respectively to the input live line terminal (U), input live line terminal (V), input live line terminal (W), input neutral line terminal and input ground line terminal of the UPS I/O terminal block. The input live line terminal (U1) is not connected, as shown in Figure 2-20.
7. Connect the output L line, N line and PE line respectively to the output live line terminal, output neutral line terminal and output ground line terminal of the UPS I/O terminal block, as shown in Figure 2-20.
8. Install the protective cover B of the I/O terminal block.

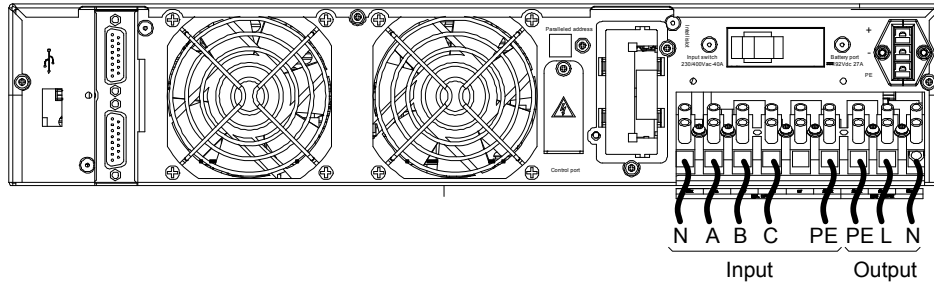

Figure 2-25 Cable connection for 3-in 1-out

2.5.2 Connecting Battery Cables

External battery module connection principle diagram of the self-distribution

The default battery number of the UPS is 16 cells. The principle diagram is shown in Figure 2-21.

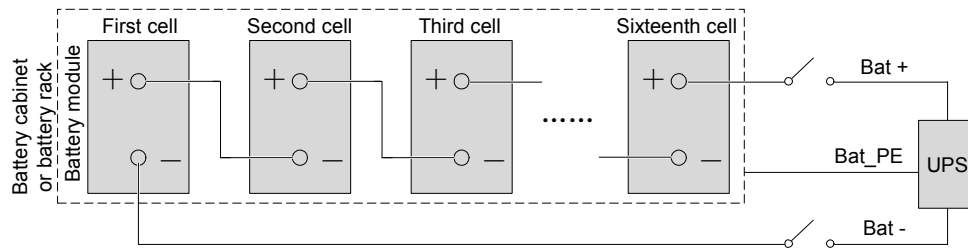

Figure 2-26 Battery module connection principle diagram

Warning
<ol style="list-style-type: none"> 1. As shown in Figure 2-21, DC battery MCBs must be added between the battery string and the UPS. 2. The bat_PE of the UPS must be connected to the metal enclosure of the battery cabinet directly and reliably, and the wiring of the Bat + and the Bat - should be laid side by side and be the same direction to make sure that only one point for the system is grounded.

Notes

Before connecting the battery cable, check that:

1. The battery string comprises batteries of the same manufacturer, same model, and same use state.
2. The battery number complies with the UPS specifications, that is, sixteen 12V batteries are connected in series.
3. Confirm with a voltmeter that the battery string voltage is about 200Vdc after the series connection.

Note
<ol style="list-style-type: none"> 1. Non-professionals are prohibited from connecting the battery cables. 2. It is prohibited to reverse the positive pole and negative pole of the battery. 3. Different UPSs cannot use the same battery module. Otherwise, the UPS will be damaged. 4. The battery cable length of the standard UPS is 0.5m, and that of the long back-up UPS is 1.5m. It cannot be extended unlimitedly ($\leq 3m$). 5. Turn off the UPS before replacing the battery and connecting the battery cables.

Battery cable connection for standard UPS (battery module is used)

The standard UPS provides a battery cable A, which is used to connect the battery module with the UPS, as shown in Figure 2-22.

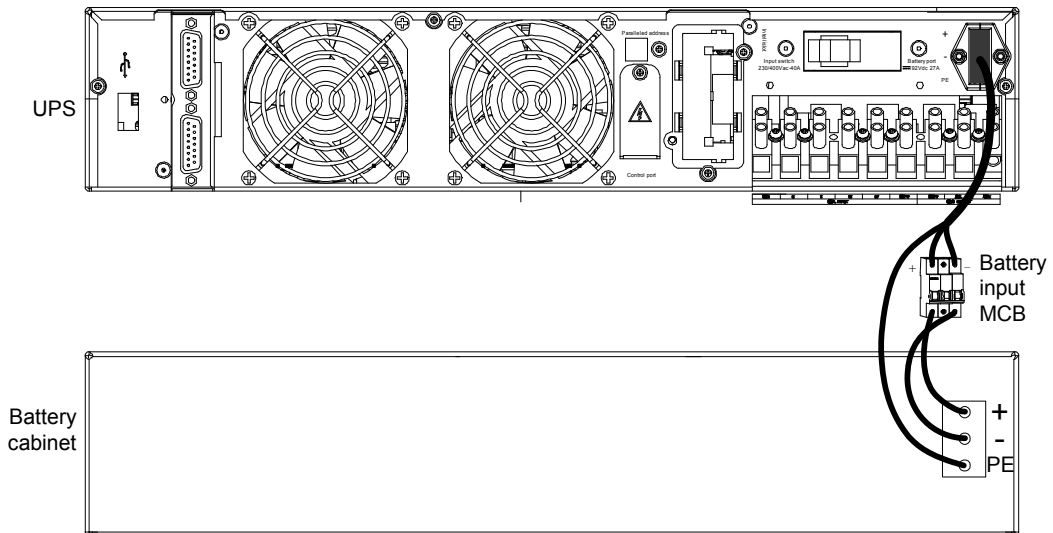

Figure 2-30 Battery cable connection for long back-up UPS

Connecting the long back-up UPS and the battery module

When you need to connect the long back-up UPS and the battery module, a battery cable A (standard UPS accessory) is necessary, as shown in Figure 2-22. The battery cable A is used to connect the battery module and the long back-up UPS.

The connection procedures are as follows:

1. Make sure that all the external input MCBs and output MCBs of the UPS are open.
2. Use voltmeter to measure and confirm that there is no DC voltage on the battery port on the UPS rear panel (see Figure 1-3).
3. Connect the red, black and yellow terminal of one end of the battery cable A to the corresponding terminal of the battery port on the rear panel of the UPS, and connect the other end of the battery cable A to one of the battery ports of the battery module 1, as shown in Figure 2-26.
4. Connect one end of the accessory cable of the battery module to the other battery port of the battery module 1, and connect the other end of the accessory cable of the battery module to one of the battery ports of the battery module 2. Follow this step to connect other battery modules.

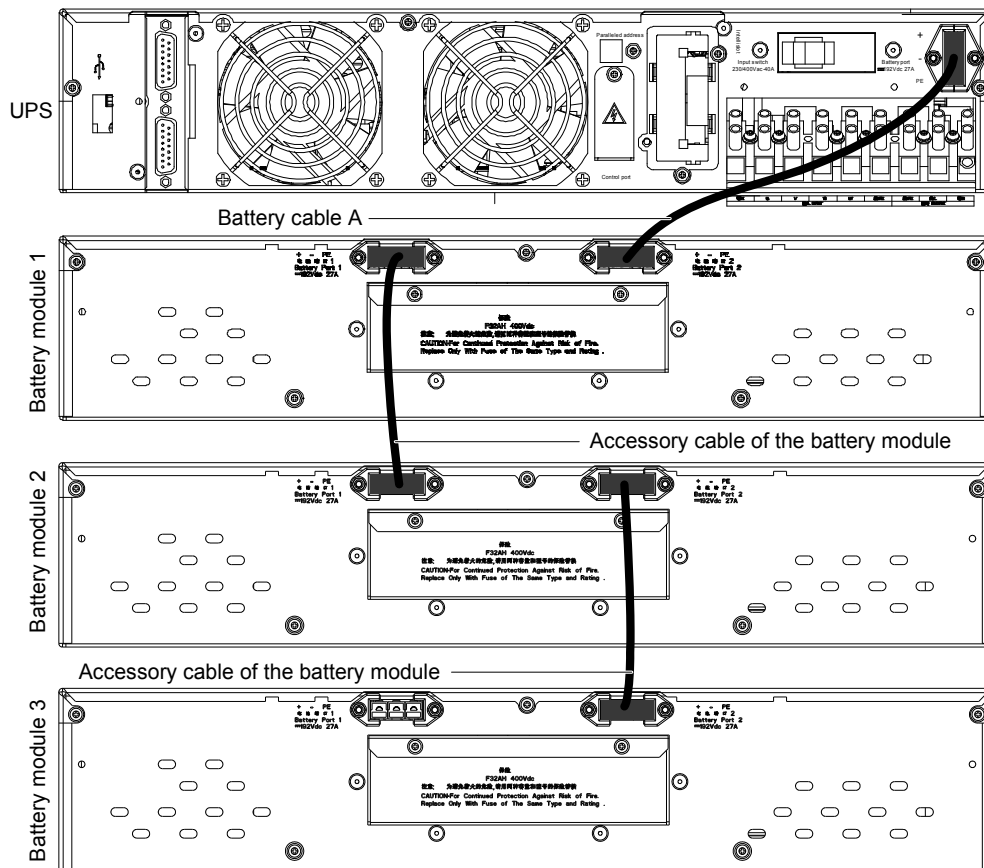

Figure 2-31 Cable connection for the long back-up UPS and the battery module



Note

1. If the battery cable is not essential, you can plug the battery cable. After that, please restore the protective cover of the battery port on the UPS to its original place immediately to avoid electrical shock;
2. The battery cable A is not only the accessory of the standard UPS, but also the option of the long back-up UPS;
3. The maximal allowable charge current of the standard battery module is 2.16A, and the maximal allowable charge current of the long back-up UPS is 4A, therefore when the standard battery module is used to connect with the long back-up UPS, the number of the standard battery modules is not less than 3.

2.5.3 Connecting 10A Charger Cables

The 10A charger is optional; its cable connection procedures are as follows:

1. Take out the 10A charger cable (DB9) from its package, remove the protective cover of the control port on the rear panel of the 10A charger (see Figure 2-27), and insert one end of the cable into the control port.
2. Remove the protective cover of the control port on the rear panel of the UPS, and insert the other end of the cable into the control port of 10A charger, as shown in Figure 2-27.

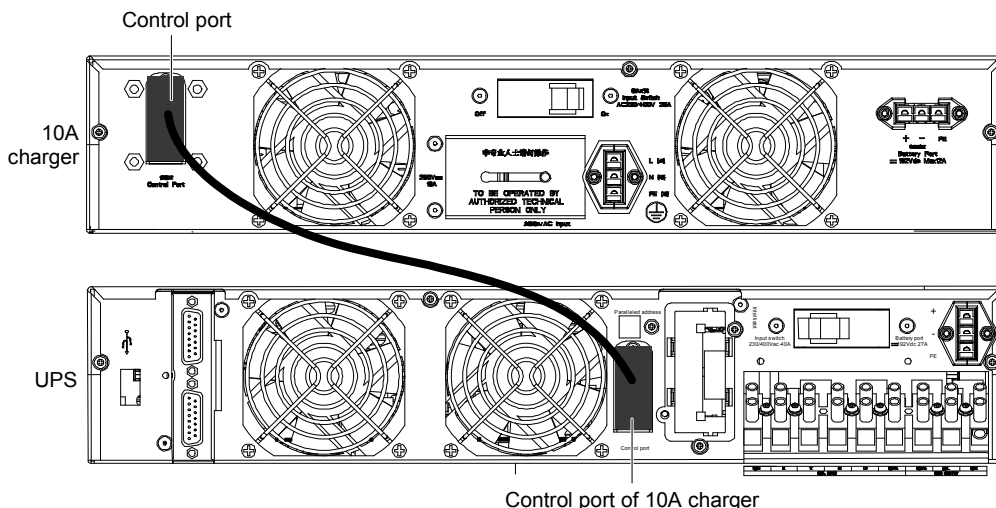

Figure 2-32 10A charger cable connection

3. Use a screwdriver to tighten the fixing screws of the cable ports.

Note
<ol style="list-style-type: none"> 1. Refer to <i>UF-BCH192/10 Charger Module User Manual</i> for other connections between the 10A charger and the UPS. 2. After removing the protective cover of the control port, please keep the protective cover appropriately. When the control port is not used, restore the protective cover to its original place to avoid electrical shock. 3. The maximal allowable charge current of the battery module is 2.16A, and the maximal allowable charge current of the 10A charger is 10A, therefore when the standard battery module is used to connect with the long back-up UPS, the battery shared module should be connected, and the number of the battery shared modules is not less than 8.

After the cable connection, find the label shown in Figure 2-28 or Figure 2-29 on the enclosure of the UPS and click “√” after “AC INPUT” according to the actual situation for easy maintenance.

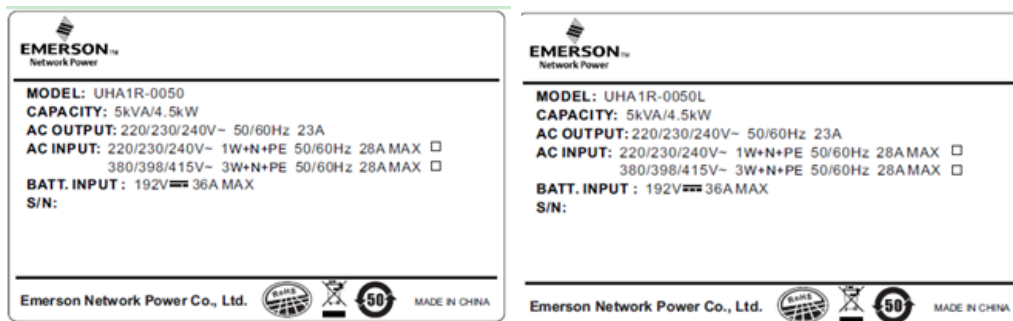

Figure 2-33 ITA 5kVA UPS labels

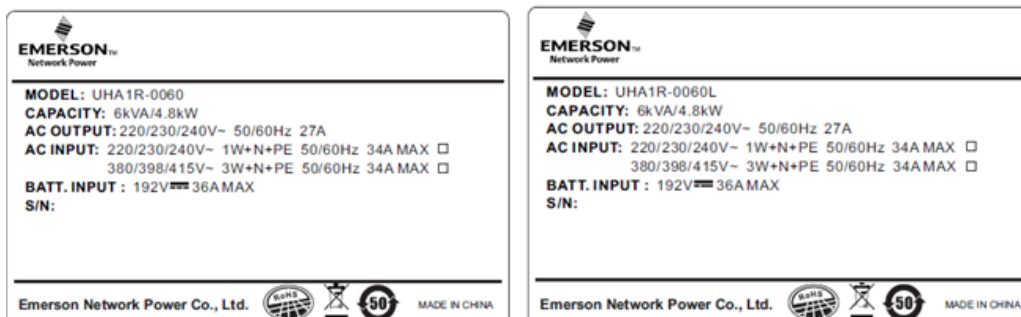

Figure 2-34 ITA 6kVA UPS labels

2.6 Single UPS Commissioning

2.6.1 Check Before Startup

1. Check and confirm that the power distribution mode of the UPS and the POD (if configured) is correct, that the connection of the power cables and signal cables is correct and there is no short circuit.
2. Check that the battery installation and the cable connection are correct, that the positive pole and the negative pole of the battery are correct.
3. Measure and confirm that the mains voltage and frequency are normal.
4. The output terminals of the UPS and the POD (if configured) are energized upon the startup. If the load is connected with the output terminals, make sure that the power to the load is safe.

2.6.2 Single UPS Parameters Setting

Parameters setting of the standard LED display panel

1. Output voltage level setting

The UPS can set the level of the output voltage (220V, 230V and 240V are optional), and the default value is 220V. It is prohibited from setting the value yourself. If the setting needs to be changed, please contact the agents.

2. Other settings

Set other parameters through SiteMonitor monitoring software. Refer to the SiteMonitor guideline attached in the VCD for its installation and usage. The settable parameters are listed in Table 2-5.

Table 2-7 Settable parameters

Parameter	Description	Default
Self-test cycle	Set the self-test cycle of the battery	Disabled
ECO function	Set whether ECO function is enabled	Enabled
EOD startup	Set whether startup is automatic	Enabled

Parameters setting of the optional LCD display panel

The parameters of the single UPS can be set through the LCD display panel; the parameters are listed in Table 2-6.

Table 2-8 Setting parameter of the single UPS

Parameter	Description	Default
Output voltage	Set the level of the output voltage (220V/230V/240V)	220V
Self-test cycle	Set the self-test cycle of the battery	Disabled
ECO function	Set whether the ECO function is active	Disabled
EOD startup	Set whether startup is automatic	Enabled
Language	Set the LCD displayed language	Chinese

2.6.3 Normal Mode Startup

1. Close the UPS external I/O MCBs and the input MCB on the rear panel of the UPS (see Figure 1-3) one by one, and make sure that the battery connection is reliable.

 Warning
After the external output MCB is closed, the output terminal block of the UPS and the power distribution end of the load will be live, pay attention to the personnel safety to avoid electrical shock. Check whether the power supply to the load is safe.

2. Power on the UPS to enter the self-test status (including the battery self-test), all the LED indicators blink, and the buzzer beeps at intervals. After the self-test, the UPS enters the standby mode, and the mains indicator turns on, as shown in Figure 2-30.

 Note
The figures in this chapter show the panel of 5kVA UPS, the 6kVA UPS panel is the same with that of the 5kVA UPS panel except that the capacity silkscreen is 6KVA.

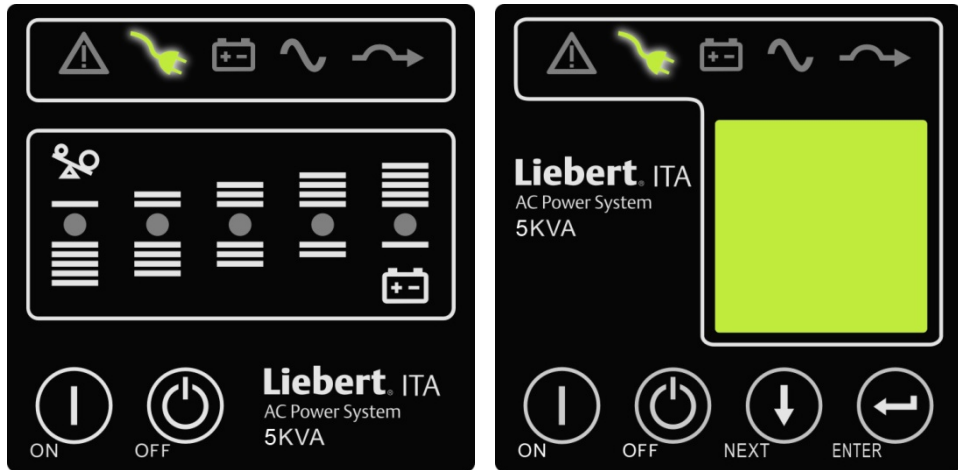

Figure 2-35 Indicators status

3. Press the ON/SILENCE key for more than one second, and wait for thirty seconds, the UPS will enter the inverter standby mode automatically, at this time, the inverter indicator blinks. After the UPS has output, the inverter indicator will turn on, as shown in Figure 2-31.

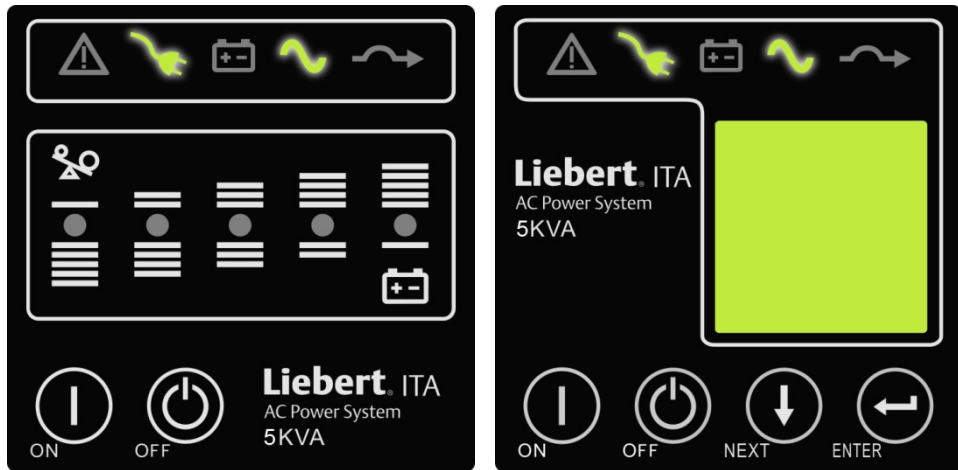

Figure 2-36 Indicators status

4. Measure whether the inverter output voltage is normal.

2.6.4 Battery Mode Startup

1. Close the battery MCB, press the ON/SILENCE key for more than one second, the UPS will start up and enter the self-test status (including the battery self-test). All LED indicators blink, the buzzer beeps at intervals. After the self-test, the UPS will enter the standby mode.
2. Press the ON/SILENCE key for more than one second, and wait for thirty seconds, the UPS will enter the inverter standby mode automatically, the inverter indicator blinks. After the UPS has output, the inverter indicator will turn on, as shown in Figure 2-32.

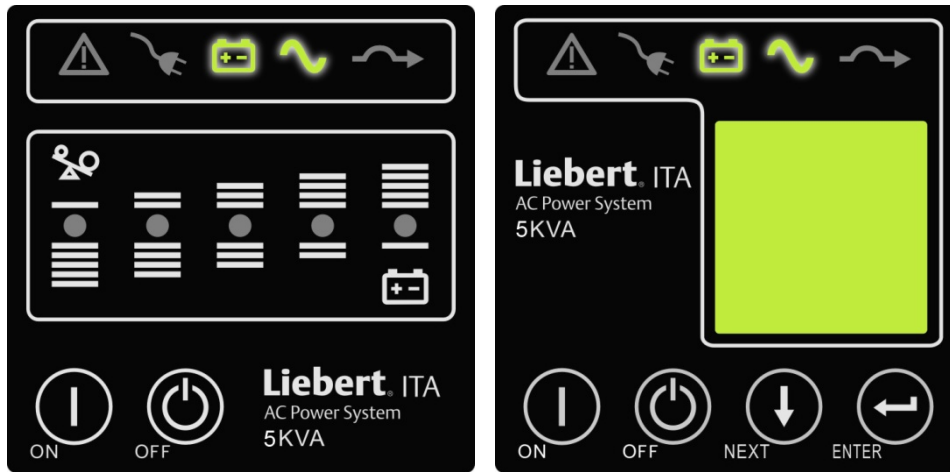

Figure 2-37 Indicators status

Chapter 3 Parallel UPS Installation And Commissioning

The UPS parallel system provides the user with $N + 1$ ($1 \leq N \leq 3$) parallel configuration, N stands for the basic parallel sets, 1 stands for the redundant sets.

The parallel power distribution unit (POD for short) which can provide safe and reliable power distribution function is compulsory for the UPS parallel system. The UPS parallel system provides the user with 1 + 1 parallel POD and 3 + 1 parallel POD.

This chapter introduces the mechanical installation, setting parallel address, connecting parallel cables and POD cables.

3.1 Features

1. The software and the hardware of each UPS in parallel system are the same as those of the single UPS. The detailed parameters can be set through the background software (for service engineers only). For all UPSs of the parallel system, the requirements of the parameter settings are same.
2. The parallel cables form a ring connection to provide reliability and redundancy for the system.

3.2 Requirements

A UPS system composed of multiple parallel-connected UPSs is equivalent to a large UPS system. Nevertheless, it provides increased system reliability. To ensure equal utilization of all UPSs and compliance with relevant wiring regulations, the following requirements must be met:

1. All single UPSs must have the same capacity and must be connected to the same main and bypass source.
2. The bypass input power and the rectifier input power must be connected to the same input terminal.
3. The outputs of all single UPSs must be connected to the same output bus.

3.3 Mechanical Installation

Taking the rack installation of the 3 + 1 parallel system with battery module for example, the mechanical installation of the parallel system is as follows:

1. The UPS installation method of the 3 + 1 parallel UPS is the same as that of the single UPS. Refer to 2.4 *Mechanical Installation* for details.
2. As shown in Figure 3-1, to facilitate the cable connection and operation, the battery module should be installed at the bottom; the UPS and the battery module should be installed one after another, and the 3 + 1 parallel POD should be installed on the top.
3. The installation method of 3 + 1 parallel POD is the same as that of the UPS.

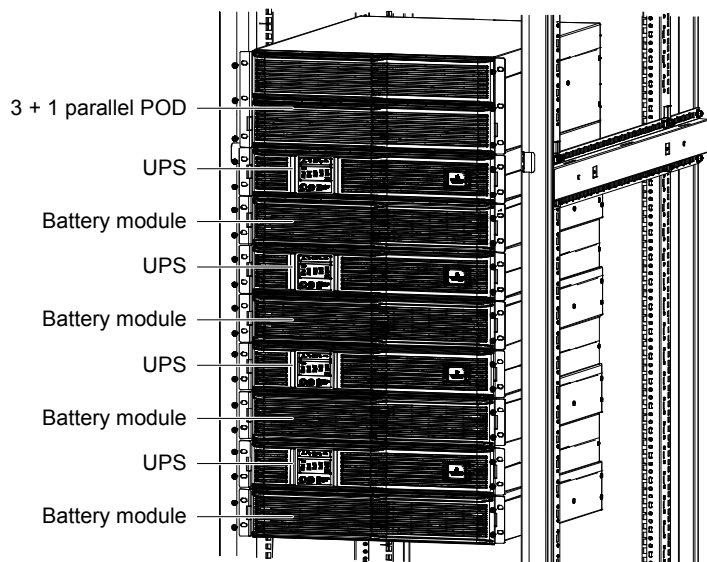

Figure 3-38 Installation of the 3 + 1 parallel system with battery modules

3.4 Connecting Cables

In the UPS parallel system, each single UPS needs to configure the MCBs and power cables respectively, refer to Table 2-3 and Table 2-4 for the specifications.

3.4.1 Connecting I/O Cables

There are two modes for UPS parallel power distribution: using the parallel POD (optional) provided by Emerson and self-distribution.

According to the user requirements, the I/O cable connections are divided into two types: 1-in 1-out (default) and 3-in 1-out.

Using the parallel POD power distribution

In the UPS parallel system, it is recommended to use POD provided by Emerson to perform power distribution. Refer to *Liebert® ITA 5kVA And 6kVA UPS Parallel Power Distribution Unit User Manual* for the power cable connection.

Self-distribution

The block diagram of four-UPS parallel system is shown in Figure 3-2. Refer to 2.5.1 *Connecting I/O Cables* for the cable connection of each UPS. When using the self-distribution, refer to Table 2-3 and Table 2-4 for the selection of the MCBs and power cables.

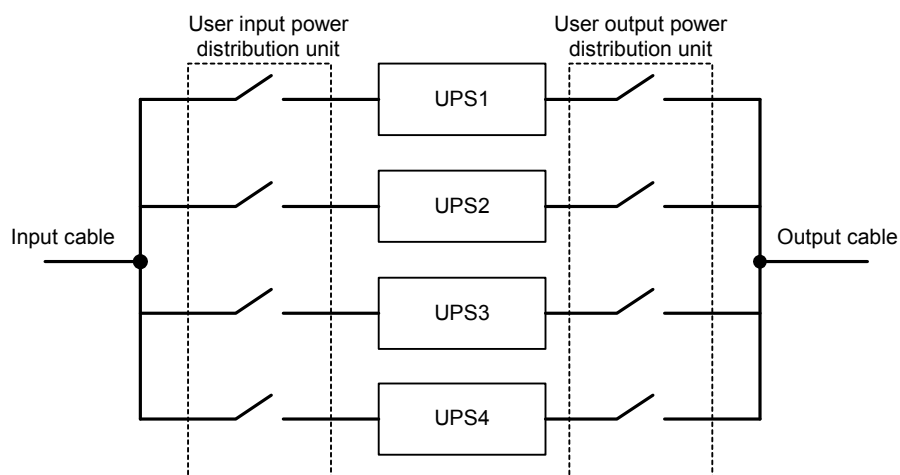

Figure 3-39 Block diagram of four-UPS parallel system

3.4.2 Connecting Parallel Cables

The parallel system provides parallel cables (option). The parallel cables form a ring connection through the parallel ports on the rear panel of the UPS. The cable connection schematic diagram of the 3 + 1 parallel system is shown in Figure 3-3. The parallel port of the UPS is DB15 male port (pin shape), and the parallel cable port is DB15 female port (hole shape).

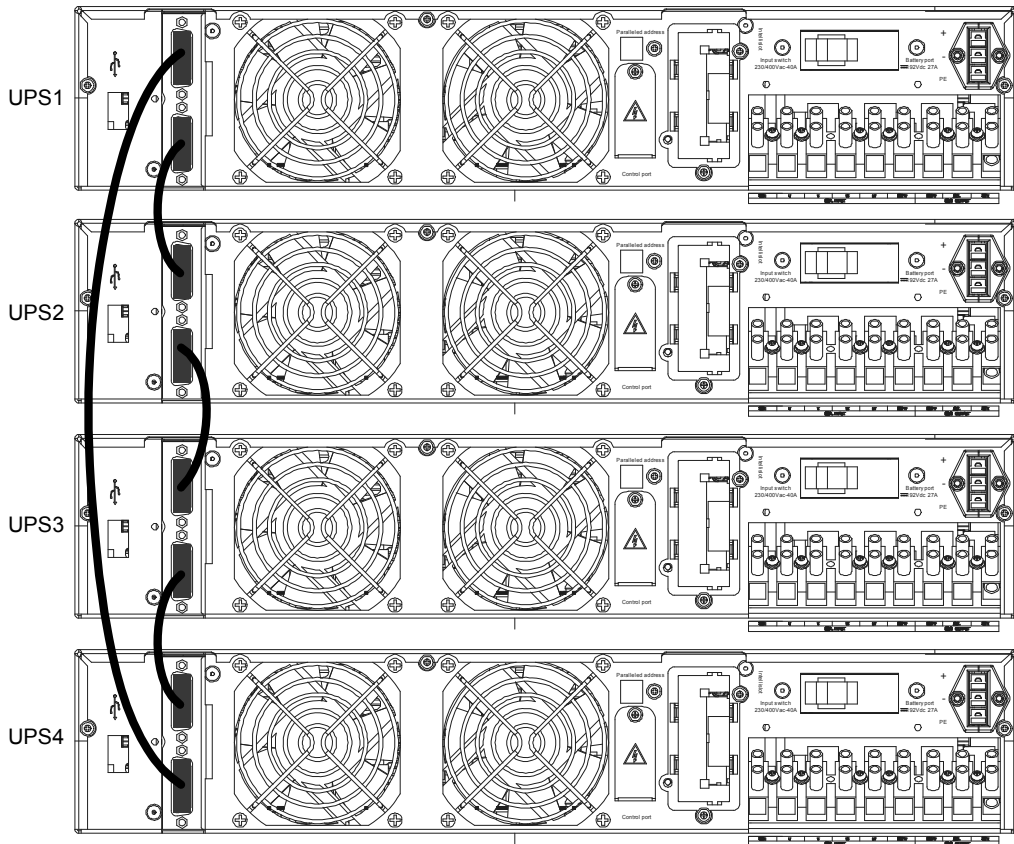

Figure 3-40 Parallel cable connection schematic diagram of 3 + 1 parallel system



Note

The parallel cables provided by Emerson must be used for the parallel system.

3.5 Setting Parallel Address

The parallel addresses for all UPSs in the parallel system should be set. The parallel addresses can be set through the DIP switch on the rear panel of the UPS (see Figure 1-3). Remove the cover of the DIP switch, and set the DIP switch according to Table 3-1.

Table 3-9 DIP switch settings

Parallel address	Parallel 1#	Parallel 2#	Parallel 3#	Parallel 4#
DIP switch position	<div style="display: flex; justify-content: space-around;"> <div style="text-align: center;">DIP3 <input type="checkbox"/></div> <div style="text-align: center;">DIP2 <input type="checkbox"/></div> <div style="text-align: center;">DIP1 <input checked="" type="checkbox"/></div> </div> <p style="text-align: center;">ON</p>	<div style="display: flex; justify-content: space-around;"> <div style="text-align: center;">DIP3 <input type="checkbox"/></div> <div style="text-align: center;">DIP2 <input checked="" type="checkbox"/></div> <div style="text-align: center;">DIP1 <input type="checkbox"/></div> </div> <p style="text-align: center;">ON</p>	<div style="display: flex; justify-content: space-around;"> <div style="text-align: center;">DIP3 <input type="checkbox"/></div> <div style="text-align: center;">DIP2 <input checked="" type="checkbox"/></div> <div style="text-align: center;">DIP1 <input checked="" type="checkbox"/></div> </div> <p style="text-align: center;">ON</p>	<div style="display: flex; justify-content: space-around;"> <div style="text-align: center;">DIP3 <input checked="" type="checkbox"/></div> <div style="text-align: center;">DIP2 <input type="checkbox"/></div> <div style="text-align: center;">DIP1 <input type="checkbox"/></div> </div> <p style="text-align: center;">ON</p>



Warning

1. The parallel address for each UPS must be unique.
2. The default setting of all the DIP switches are OFF. However, you should set the DIP switch position for the parallel system according to the descriptions listed in Table 3-1. Otherwise, a UPS fault will occur.
3. When one group of batteries supply power to several UPSs at the same time, the UF-BSO-0050 ITA UPS battery shared module is essential, or else, the UPSs cannot share the battery. For the details of the battery shared module, refer to *UF-BSO-0050 ITA UPS Battery Shared Module User Manual*.

3.6 Commissioning Parallel System

3.6.1 Check Before Startup

1. Check and confirm that the power distribution mode of the main UPS is correct; that the connections of the power cables and signal cables are correct and there is no short circuit. Check that the power distribution mode of the POD and the cable connection are correct and there is no short circuit.
2. Check that the battery installation and cable connection are correct and there is no short circuit, and that the positive pole and negative pole of the battery are correct.
3. Check that the phase sequence of the main, bypass and output of each UPS is correct and accordant. Ensure that the parallel cable connection is reliable, and that the user load is not connected during power-on, to check all the working status of the parallel system.
4. Measure and confirm that the mains voltage and frequency are normal.
5. The output terminals of the UPS and the POD are energized upon power-on. If the load is connected with the output terminals, make sure that it is safe to feed power to the load.

3.6.2 Startup Commissioning For Parallel System

1. Power on and commission each UPS of the parallel system respectively, namely power on one UPS each time, and other UPSs are in the turn-off status, the specific commissioning procedures are as follows:

- 1) Close the external input MCB, output MCB, battery MCB and input MCB of one UPS, the UPS is powered on. Ensure that other UPSs are in the turn-off status. (If POD is configured, close the corresponding input MCB and output MCB of the POD).



Warning

After the POD output MCB is closed, the UPS output terminal block, the POD output terminal block and the load will be live, pay attention to personnel safety to avoid electrical shock. Confirm that it is safe to feed power to the load.

- 2) Power on the UPS to enter self-test status (including battery self-test), all LED indicators blink, and the buzzer beeps at intervals. After the self-test, the UPS will enter the standby mode, and the mains indicator will turn on.
- 3) Press the ON/SILENCE key for more than one second, and wait for about thirty seconds, the UPS will transfer to the inverter standby mode automatically, the inverter indicator blinks. After the UPS has output, the inverter indicator will turn on.
- 4) Measure that the inverter output voltage is normal.
- 5) If the UPS is working normally, turn off the UPS.
- 6) Repeat the preceding step1) ~ step5) to power on and commission the other UPSs respectively.



Note

Carry out the parallel commissioning after each UPS is working normally.

2. After confirming that each UPS has been powered on and is working normally, you can commission the parallel system. The specific procedures are as follows:

- 1) Close the external input MCB, output MCB, battery MCB and input MCB of one UPS (if POD is configured, close the corresponding input MCB and output MCB of the POD), the UPS is powered on, at the same time, make sure that other UPSs are in the turn-off status. After the self-test, press the ON/SILENCE key for one second, and wait for about

thirty seconds, after the UPS has output, the inverter indicator will turn on. Measure that the inverter output voltage is normal.

2) Close the input MCB, external input MCB, output MCB and battery MCB of the second UPS (if POD is configured, close the corresponding input MCB and output MCB of the POD). Follow the preceding steps to start the inverter of the second UPS, check that there is no alarm on the LCD display screen, and confirm that the UPS parallel works normally.

3) Follow the preceding methods to start up the inverter of the third or the fourth UPS to connect the UPS into the parallel system.



During the parallel startup, confirm that the external output MCB of each UPS has been closed, and that all the inverter output of the UPSs are parallel connected.

Chapter 4 Display Panel

This chapter introduces the functions and use of the components on the UPS display panel, and provides LED display information, control keys, indicators and LCD display information, including LCD screen types, detailed menu messages, prompt windows message and UPS alarm list.

 **Note**

The figures in this chapter show the panel of 5kVA UPS, the 6kVA UPS panel is the same with that of the 5kVA UPS panel except that the capacity silkscreen is 6KVA.

4.1 LED Display Panel

The LED display panel provides LED indicators and control keys, as shown in Figure 4-1.

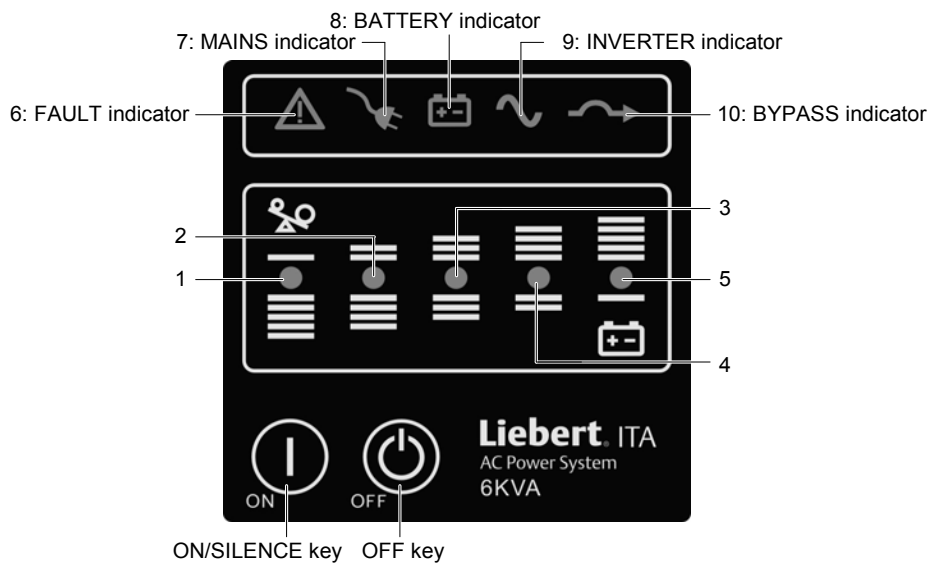

Figure 4-41 LED display panel

The ten indicators are divided into two groups according to the applications.

1. UPS state indicators: FAULT indicator, MAINS indicator, BATTERY indicator, BYPASS indicator and INVERTER indicator. The FAULT indicator is red and the other indicators are green.

2. UPS load battery capacity and fault orientation indicator: includes five indicators, of which four indicators are green and one indicator is yellow. The yellow indicator indicates UPS load over-capacity or battery capacity extra-low.

4.1.1 UPS State Indicators

The UPS state indicators (see Figure 4-1) indicate the UPS operation and fault state, as described in Table 4-1.

Table 4-10 UPS state indicators

Indicator No.	Definition	Color	Description
6	FAULT indicator	Red	On in the event of fault, and off otherwise
7	MAINS indicator	Green	On when the mains is normal, off during mains failure, and blinks when mains voltage outside specifications
8	BATTERY indicator	Green	On when the battery is supplying power, and off otherwise
9	INVERTER indicator	Green	On when the inverter is supplying power, and off otherwise
10	BYPASS indicator	Green	On when the bypass is supplying power, and off otherwise

4.1.2 UPS Load Battery Capacity And Fault Orientation Indicator

The UPS load battery capacity and fault orientation indicator indicates the load situation of the UPS. In Battery mode, it indicates battery capacity. Upon UPS failure, it works with the UPS state indicators to indicate the fault type of the UPS.

Ten indicators cooperate to indicate the operation state and fault type of the UPS, as described in Table 4-2.

Table 4-11 Indicators combining to indicate the fault type of the UPS

Operation state		Indicator No. (see Figure 4-1)										Alarm
		1	2	3	4	5	6	7	8	9	10	
Normal mode	5% ~ 25% load capacity	●						●		●		
	26% ~ 50% load capacity	●	●					●		●		
	51% ~ 75% load capacity	●	●	●				●		●		
	76%~ 95% load capacity	●	●	●	●			●		●		
	96% ~ 105% load capacity	●	●	●	●	●		●		●		
	> 105% load capacity	●	●	●	●	●		●		●		□2Hz
Battery mode	0% ~ 25% battery capacity					●			●	●		□1Hz
	26% ~ 50% battery capacity				●				●	●		□1/3Hz
	51% ~ 75% battery capacity			●	●				●	●		□1/3Hz
	76% ~ 95% battery capacity		●	●	●				●	●		□1/3Hz
	> 96% battery capacity	●	●	●	●				●	●		□1/3Hz
Bypass mode	< 105% load capacity	○	○	○	○	○		●			●	
	> 105% load capacity	●	●	●	●	●		●			●	□2Hz
Inverter standby	< 105% load capacity	○	○	○	○	○		●		◐	●	
	> 105% load capacity	●	●	●	●	●		●		◐	●	□2Hz
Non-operation mode								○				
Short fault						◐	●	○	○			◇
Charger failure					◐		●	○	○	○	○	◇
fan/over-temperature fault				◐			●	○	○	○	○	◇
Parallel current sharing failure			◐				●	○	○	○	○	◇
Rectifier failure (bus high fault)		◐					●	○	○	○	○	◇
Battery fault (high voltage)		○	○	○	○	○		○	◐	○	○	
Battery fault (no battery, reverse connection)		○	○	○	○	○	●	○	◐	○	○	◇
Other failures (auxiliary supply failure and inverter failure)		○	○	○	○	○	●	○	○	○	○	◇

Note: ○: off; ●: on; ◐: flashes; ◎: ensures according to the current operation mode of the UPS; ◇: alarm lasting; □: alarm; when the UPS is in normal mode, the MAINS indicator and INVERTER indicator are on

 Note

Indicator 5 is yellow, indicator 6 is red and other indicators are green.

4.1.3 Control Keys

The two control keys include ON/SILENCE key and OFF key. Their functions are given in Table 4-3.

Table 4-12 Functions of the control keys

Control key	Function
ON/SILENCE key	1. Starting the inverter: Pressing and holding this key for one second starts the inverter. 2. Silencing alarm: In Battery mode, or upon overload or fault, the UPS has an audible alarm, pressing and holding this key for one second silences the alarm. 3. Initiating battery manual test: When the UPS is in Normal mode, pressing and holding this key for four seconds initiates battery manual test
OFF key	1. Turning off the inverter: When the UPS is in Normal mode or Battery mode, pressing and holding this key for one second turns off the inverter, and the UPS output transfers to Bypass mode. 2. UPS accessing to standby state: When the UPS is in Bypass mode, pressing and holding this key for ten seconds turns off UPS bypass output, then the UPS accesses to the standby state

!	Note
Pressing and holding the ON/SILENCE key for one second silences the alarm, and do the same operation can resume the alarm beep.	

4.2 LCD Display Panel

The LCD display panel provides LED indicators, a LCD display screen and control keys, as shown in Figure 4-2.

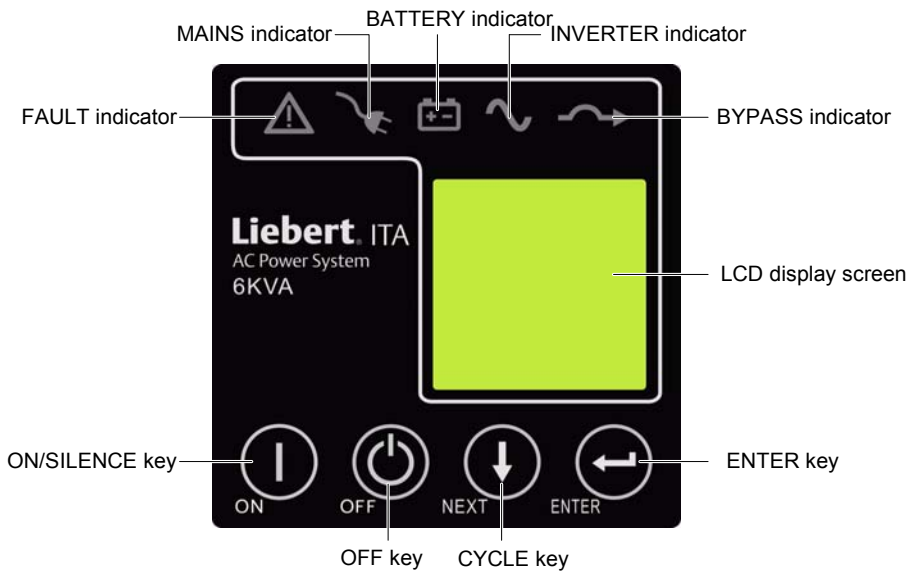

Figure 4-42 LCD display panel

The functions of the control keys are listed in Table 4-4.

Table 4-13 Functions of the control keys

Control keys	Functions
ON/SILENCE key	1. Starting the inverter: When the inverter is off, pressing and holding this key for one second starts the inverter. 2. Silencing alarm: When the UPS has an audible alarm, pressing and holding this key for one second silences the alarm. 3. Initiating battery manual test: When the UPS is in Normal mode, pressing and holding this key for four seconds initiates battery manual test
OFF key	1. Turning off the inverter: When the UPS is in Normal mode or Battery mode, pressing and holding this key for one second turns off the inverter, and the UPS output transfers to Bypass mode. 2. UPS accessing to standby state: When the UPS is in Bypass mode, pressing and holding this key for ten seconds turns off UPS bypass output, then the UPS accesses to standby state

Control keys	Functions
CYCLE key	Pressing and holding this key for less than one second shifts between menu items on the same level and selects parameters. Pressing and holding this key for more than one second turns on/turns off the backlight on the LCD
ENTER key	Pressing and holding this key for less than one second enters the selected menu. Pressing and holding this key for more than one second returns to previous menu

The interfaces of the LCD display screen include power-on interface and menu interface.

1. Power-on interface

The power-on interface displays the UPS series, product type and company name for about 20 seconds. The power-on interface of the 6kVA UPS is shown in Figure 4-3, the interface of the 5kVA UPS is the same as the interface shown in Figure 4-3 except the capacity.

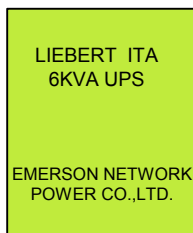

Figure 4-43 Power-on interface

2. Menu interface

The menu interface includes running interface, alarm message interface and setting interface, the main menu interface is shown in Figure 4-4.

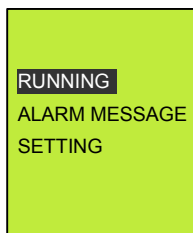
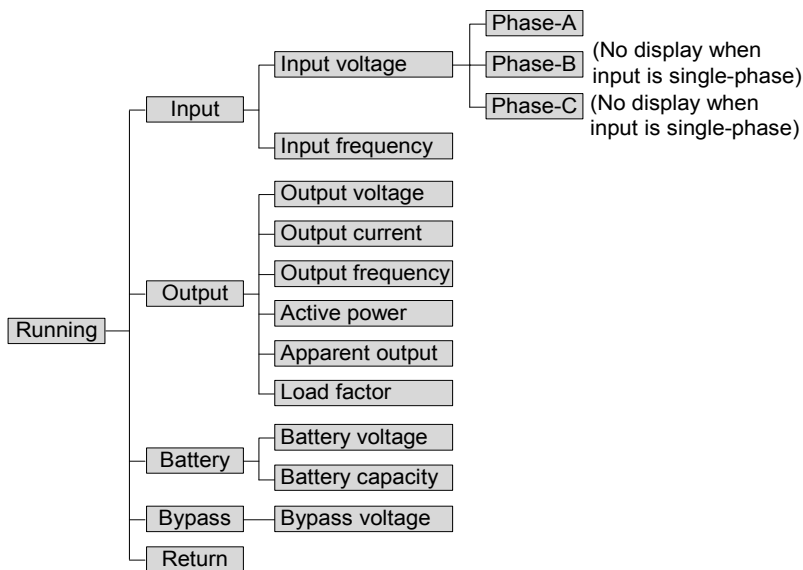

Figure 4-44 Main menu interface

You can enter the corresponding interfaces through the functional keys on the LCD display panel. The structure diagrams of each level menu are shown in Figure 4-5. The interfaces are refreshed every other second.



Running menu

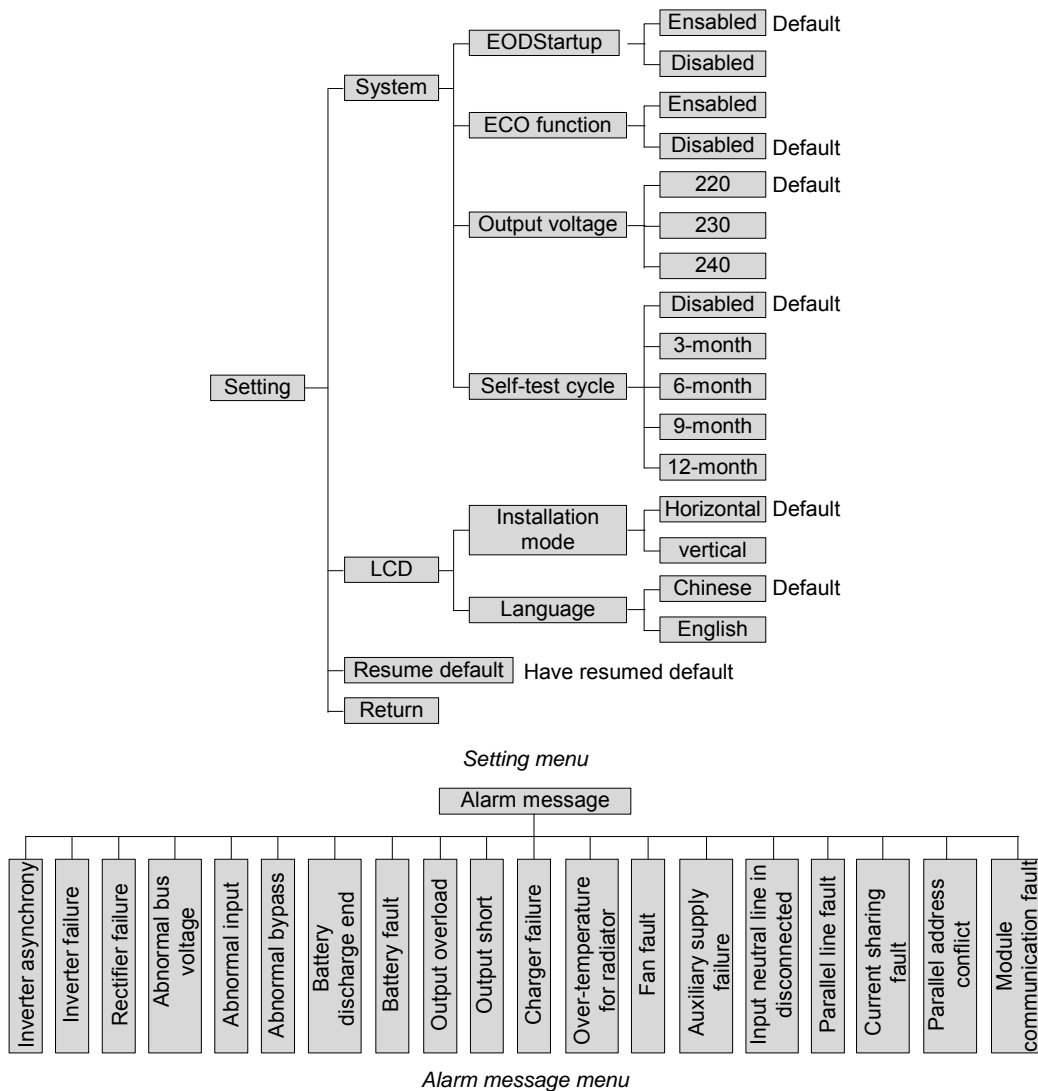

Figure 4-45 Structure diagram of the menu interface

The parameters of the single UPS can be set through the LCD display panel; the parameters are listed in Table 4-5.

Table 4-14 Setting parameter of the single UPS

Parameter	Description	Default
Output voltage	Set the level of the output voltage (220V/230V/240V)	220V
Self-test cycle	Set the self-test cycle of the battery	Disabled
ECO function	Set whether the ECO function is active (The ECO can be set in the parallel mode, but the setting is not active)	Disabled
EOD startup	Set whether the startup is automatic	Enabled
Language	Set the LCD displayed language	Chinese

Chapter 5 UPS Operation Instructions

This chapter describes UPS check before power-on, and the UPS power-on, turning on and routine operation procedures.



During the operation, the buzzer alarm may appear, at this point, press the ON/SILENCE button for one second to silence the audible alarm, and press this button for one second again to resume the alarm beep.

 Note
<p>1. If the UPS is fed from a generator, follow the following instructions to switch on the UPS: 1) Start up the generator; and do not start up the load of the UPS. 2) Connect the UPS to the generator. When the generator operates stably, switch on the loads one by one. To ensure reliable generator operation, it is recommended that the UPS load should be less than 30% of the generator capacity. It is recommended that the generator capacity should be 1.5 times ~ 2 times of the UPS rated capacity.</p> <p>2. The battery has been fully charged before delivery. However, storage and transportation will inevitably cause some charge loss. It is required to charge the battery for eight hours before putting the UPS into first operation to ensure adequate back-up time.</p> <p>3. The display panel of the 6k VA UPS is the same with that of the 5kVA UPS except the silkscreen. Take the display panel of the 5kVA UPS for example in this chapter.</p>

5.1 Check Before Power-On

Before power-on, check the following items:

1. Check that the UPS input cables and output cables are connected properly and reliably, and the UPS input cable connections are not reverse.
2. Check that the polarities of the battery cables are correct.
3. Check that the communication cables are connected properly.

  Warning
<p>The UPS output terminals will be live due to the UPS power-on procedure. If the load is connected to the output terminals of the UPS, make sure whether it is safe to feed power to the load. Ensure that the load is isolated with the UPS output terminal if the load is not ready for accepting the power.</p>

5.2 UPS Power-on

After connecting the UPS input cables and output cables, the UPS will start up if the mains input voltage is within 120Vac ~ 276Vac, and the UPS conducts self-test (including battery self-test). When the self-test is complete, the UPS enters the standby state and the MAINS indicator turns on, as shown in Figure 5-1.

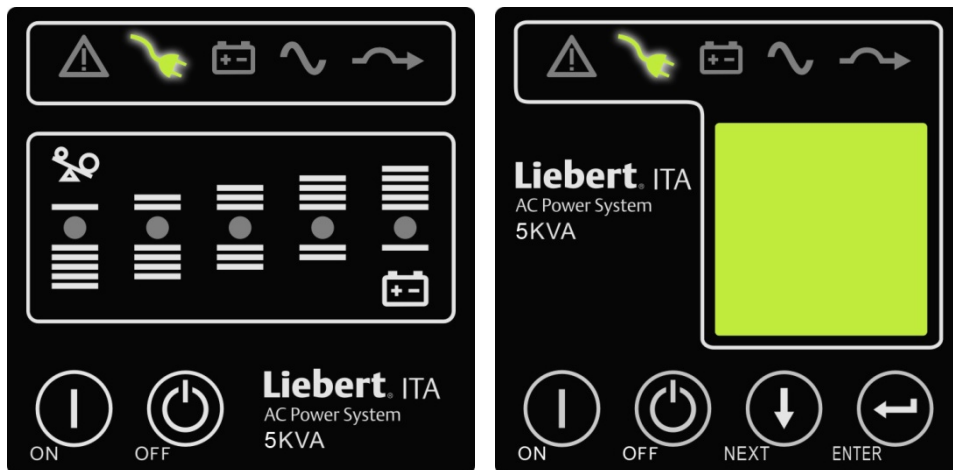

Figure 5-46 Indicators state

5.3 Turning On UPS

After the UPS power-on, press the ON/SILENCE key for more than one second. After about 30 seconds, the UPS will transfer to Normal Standby mode automatically and the INVERTER indicator will blink.

When the UPS has output, the INVERTER indicator will turn on, as shown in Figure 5-2.

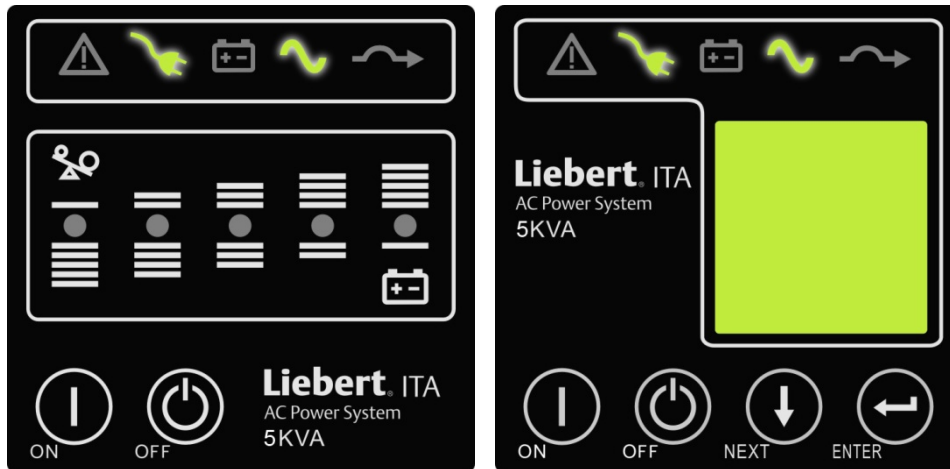

Figure 5-47 Indicators state

Pressing the OFF key for one second to confirm that the UPS is in Bypass mode, the interface is shown in Figure 5-3.

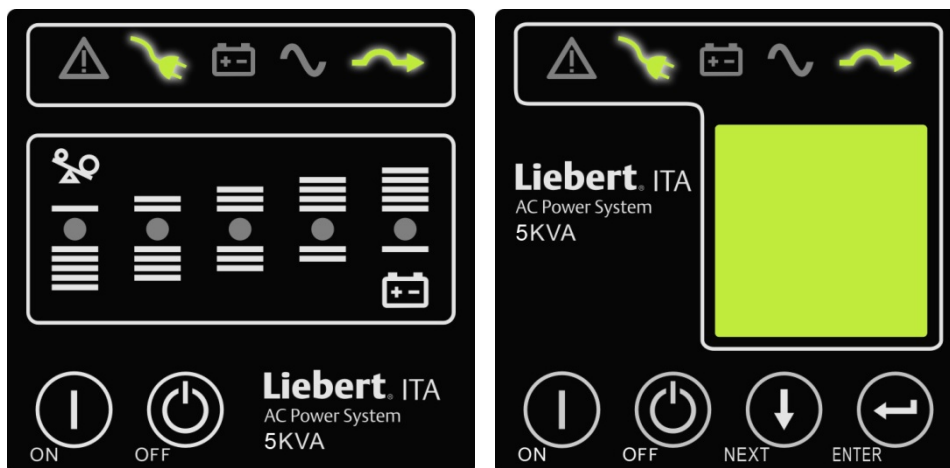

Figure 5-48 Indicators state

It is recommended that the load should be less than 70% of the rated load to ensure normal operation of the UPS in the event of short time extra-load, and prolong the lifetime of the UPS at the same time.



Note

1. If the UPS transfers from Normal mode to Bypass mode three times within one hour due to overload, it will remain in Bypass mode for one hour afterwards and cannot transfer back to Normal mode until the overload fault is removed.
2. Single UPS can start up in Normal mode and Bypass mode, refer to 2.6.3 *Normal Mode Startup* and 2.6.4 *Battery Mode Startup* for details.
3. Refer to 3.5.2 *Startup Commissioning For Parallel System* to start up the parallel UPS.
4. In Bypass mode, the load is powered directly by the mains instead of pure power of the inverter output.

5.4 Battery Self-Test

Battery self-test includes battery power-on self-test, battery manual self-test and battery periodic self-test.

5.4.1 Battery Power-on Self-Test

To ensure normal battery connection, the UPS will conduct self-test for the battery connection each time the UPS is powered-on. If the battery is reverse-connected, the FAULT indicator will turn on and the BATTERY indicator will blink

to remind you to inspect the battery connection. At this moment, the UPS cannot start up. After the battery connection fault is removed, press and hold the ON/SILENCE key for more than four seconds to silence the alarm and start up the UPS. The indicators states are shown in Figure 5-4. If the battery voltage is extra high, only the BATTERY indicator will blink.

 Note

1. When the battery is not connected, the UPS can start up normally, but the FAULT indicator will turn on and the buzzer will beep to prompt the user to check the battery connection. Press the ON/SILENCE key for four seconds to silence the alarm.
2. If the working status of the UPS is changed, the alarm will be triggered, the user should power off the UPS to deal with the battery connection fault, and the alarm will be removed.

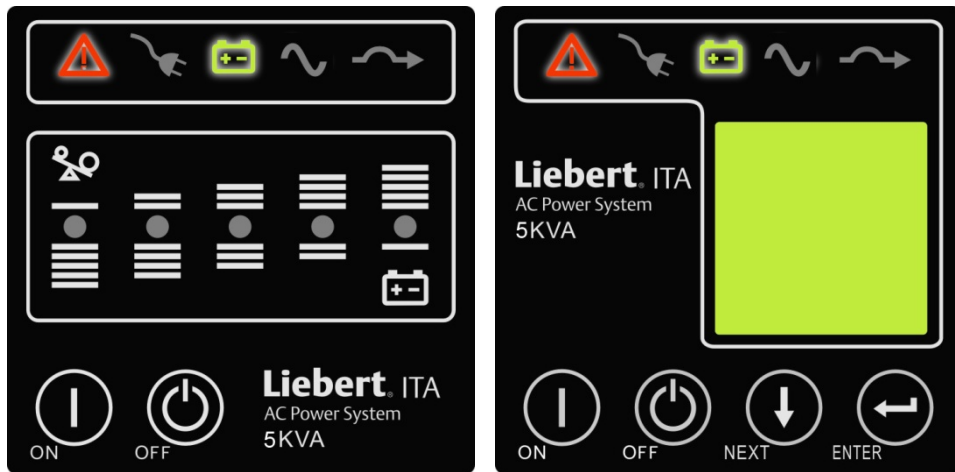

Figure 5-49 Indicators states

5.4.2 Battery Manual Self-Test

Battery manual self-test includes battery in-position test and battery state test.

In normal state, when the mains is normal, the rectifier output is not overloaded, meanwhile, the battery voltage is not less than 12V, press and hold the ON/SILENCE key for four seconds, the battery will start self-test, the BATTERY indicator will turn on. After the self-test, the BATTERY indicator will turn off. Upon battery fault (battery not connected or battery failure), the FAULT indicator will turn on and BATTERY indicator will blink, as shown in Figure 5-5.

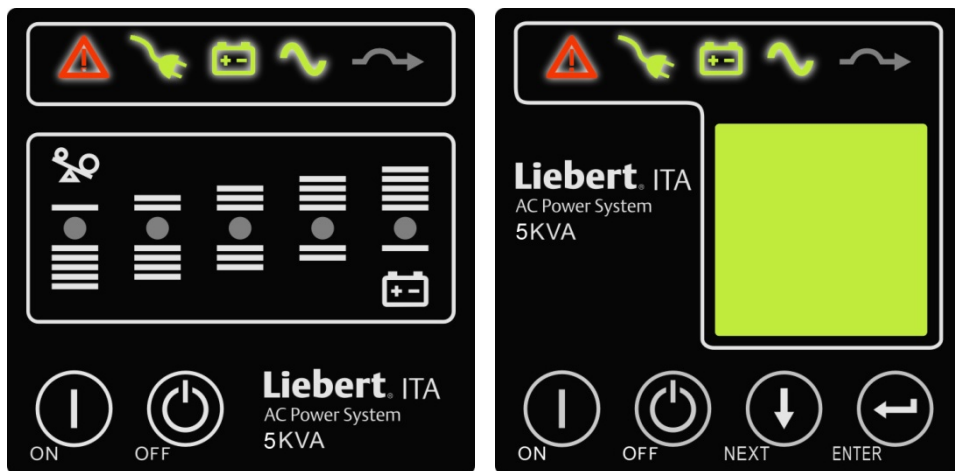

Figure 5-50 Indicators states

5.4.3 Battery Periodic Self-Test

You can set self-test period of the battery through the monitoring software, which includes disabled, 3-month, 6-month, 9-month and 12-month.

In normal state, when the mains input is over 176V, the rectifier operates normally, and single cell voltage is not lower than 12V, the battery will conduct periodic self-test if the set self-test periodic time arrives. The BATTERY indicator will

turn on when the battery self-test starts; upon battery fault (battery not connected or battery failure), the FAULT indicator will turn on and the BATTERY indicator will blink, as shown in Figure 5-5.

⚠ Note
1. The battery state information will be refreshed after each time of battery self-test. Confirm the battery fault information of the self-test upon battery undercharge by conducting another time of self-test after the battery has been fully charged.
2. Follow the order to start up the UPS: connect the battery, connect the mains and then press the ON/SILENCE key.

5.5 Turning Off UPS

Turning off UPS includes turning off UPS from Normal mode, turning off UPS from Battery mode and turning off UPS from Bypass mode.

Turning off UPS from Normal mode

Press and hold the OFF key for one second until the buzzer beeps, the UPS inverter stops operating, and transfers to Bypass mode. At this moment the MAINS indicator and BYPASS indicator will turn on; press and hold the OFF key for ten seconds, the UPS enters standby state. At this moment, the UPS is not powered off completely, and the MAINS indicator is on, as shown in Figure 5-6. If you need to power off the UPS completely, disconnect the mains input of the UPS.

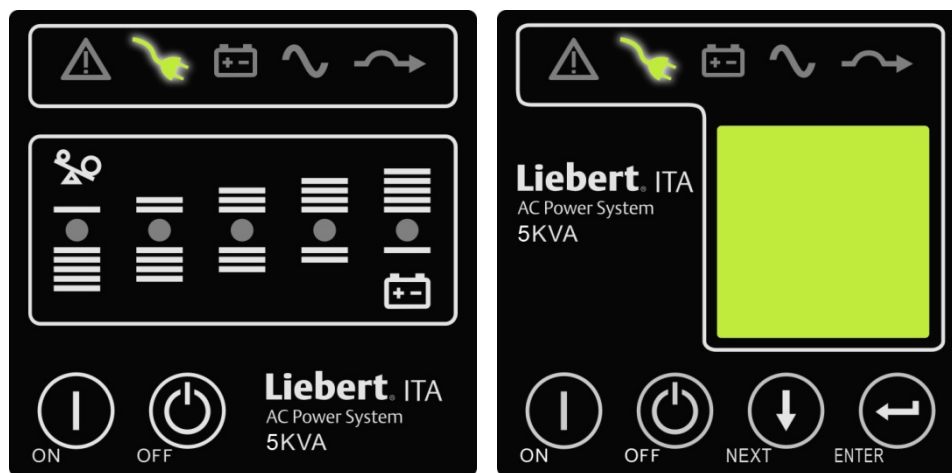

Figure 5-51 Indicators states

Turning off UPS from Battery mode

Press and hold the OFF key for one second, then the UPS is turned off, the output is terminated, the load is powered off and the BATTERY indicator is off, as shown in Figure 5-7. If you need to power off the UPS completely, press and hold the OFF key for ten seconds.

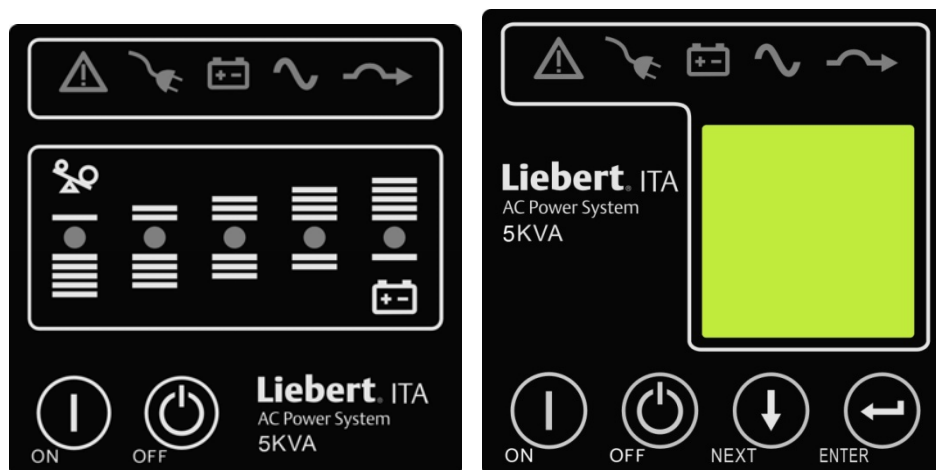

Figure 5-52 Indicators states

Turning off UPS from Bypass mode

Press and hold the OFF key for ten seconds, then the UPS stops output and enters standby state. At this moment the UPS is not powered off completely. If you need to power off the UPS completely, disconnect the mains input of the UPS.

5.6 Powering Off UPS

The power-off procedures are as follows:

1. Disconnect input cable plug or open the UPS upstream switch after turning off the UPS. At this moment, all indicators will turn off, the fan will stop (if battery is configured, the fan will stop 20 seconds later), and the power-off is complete.
 2. Set the external battery switch to OFF position if the UPS has an external battery.
- After the UPS is powered off, the output will terminate and the load will be powered off.

5.7 Transferring UPS Operation Modes

In normal state, set the UPS to Normal mode. In the event of mains failure, the UPS will transfer to Battery mode automatically and will not terminate output. In the event of overload, the UPS will transfer to Bypass mode and will not terminate output. In the event of inverter fault and overtemperature in the UPS, the UPS will transfer to Fault state automatically.

5.7.1 Transferring UPS To Bypass Mode From Normal Mode Manually

In normal state, press and hold the OFF key for one second to transfer the UPS to Bypass mode.

Refer to 1.5 *UPS State And Operation Mode* for detailed introduction of Normal mode, Bypass mode, Battery mode and Maintenance Bypass mode.

5.7.2 Transferring UPS To Bypass Mode From Overload Protection

When the UPS load exceeds the rated value and preset time, it will transfer to Bypass mode from Normal mode and send out rapid alarm sound every 0.5 second. At this moment, the UPS output voltage is the mains voltage, and redundant loads must be removed until the UPS does not generate overload alarm. Wait for five minutes and the output will transfer to Normal mode automatically. To protect the load and UPS, transferring to Bypass mode from overload protection cannot occur for more than three times within one hour, otherwise the output will remain in Bypass mode and can transfer back one hour later.



Note

In Bypass mode, the load is powered directly by mains instead of pure power of the inverter output.

5.7.3 Transferring UPS To Inverter Mode From Bypass Mode Manually

In Bypass mode, press and hold the ON/SILENCE key for two seconds. After the inverter operates normally, the UPS will transfer to Inverter mode.

5.7.4 Transferring UPS To Battery Mode From Mains Failure

The UPS transfers to Battery mode in the event of mains failure. If the UPS operates until the battery power is depleted, it will turn off automatically. When the mains recovers, the UPS will turn on automatically and enter Normal mode. This function is designed for unattended operation. If the UPS is turned off manually when working in Battery mode, then it needs to be turned on manually when the mains recovers, and it cannot turn on automatically.

5.7.5 Transferring UPS To Bypass Mode From Inner Overheating Protection

Keep proper environmental temperature and favorable ventilation for the UPS. Otherwise, the UPS internal temperature will rise. At this moment, the UPS will transfer to Bypass, the FAULT indicator will turn on, indicator 3 will blink (see Figure 4-1) and the UPS will beep for a long time. You should cut off the UPS input supply, remove the

obstacle at the airduct or increase the clearance between the UPS and the wall. After the UPS is cooled, connect it to the mains and restart it.

5.7.6 Transferring UPS To Fault State From Output Short Protection



If the UPS load is short connected, the UPS will terminate output, the FAULT indicator will turn on, the yellow indicator of the load indicator will blink and the UPS will beep for a long time. At this moment, you should disconnect the short connected load from the UPS, cut off the input power supply and wait for ten minutes until the UPS turns off automatically (or turn off the UPS by pressing the OFF key manually after 10 seconds). After removing the short connecting fault, connect the UPS to the mains and restart it.

5.7.7 Transferring UPS To Maintenance Bypass Mode From Inverter Output

When the UPS is operating in inverter output mode, follow the procedures below to transfer load to Maintenance Bypass mode from Inverter Output.

 Note
<ol style="list-style-type: none"> 1. Before transferring the UPS, ensure that the bypass is normal and synchronizes with the inverter. Failure to meet these requirements may cause power supply interrupt of the load in short time. 2. To realize this function, you need to select a POD or configure a maintenance bypass MCB.



1. Press and hold the OFF key for one second. The INVERTER indicator turns off and the buzzer beeps. The load transfers to static bypass, and the inverter turns off.
2. Close the maintenance bypass MCB on the front panel of the POD, the load power is supplied by the maintenance bypass.

  Warning
If you need to maintain the UPS, wait for 10 minutes approximately until the capacitance and voltage of the internal DC bus finish discharging.

3. Open the UPS input MCB and output MCB.

5.7.8 Transferring UPS To Inverter Mode From Maintenance Bypass

After maintaining the UPS, follow the procedures below to transfer the load to inverter output from maintenance bypass.

  Warning
Because no auxiliary contact information of the maintenance bypass MCB is introduced in the UPS, UPS operation restoration after maintenance must be carried out strictly following the procedures below. Failure to observe these procedures may cause damage to the equipment.

1. Close the output MCB on the front panel of the POD.
2. Close the main input MCB and bypass input MCB on the front panel of the POD.
3. Wait until the UPS starts to operate in Bypass mode, and open the maintenance bypass MCB on the front panel of the POD.
4. Press and hold the ON/SILENCE key for more than one second, the UPS will transfer to the Inverter mode.

5.8 UPS Complete Turn-off

For the UPS system with POD, if you need to turn off the UPS completely, transfer the UPS from Inverter mode to Maintenance Bypass mode according to the procedures in 5.7.7 *Transferring UPS To Maintenance Bypass Mode From Inverter Output*, to ensure that the use of the load during UPS power-off will not be affected. If the load needs no power supply, open the maintenance bypass MCB directly, as shown in Figure 5-8.

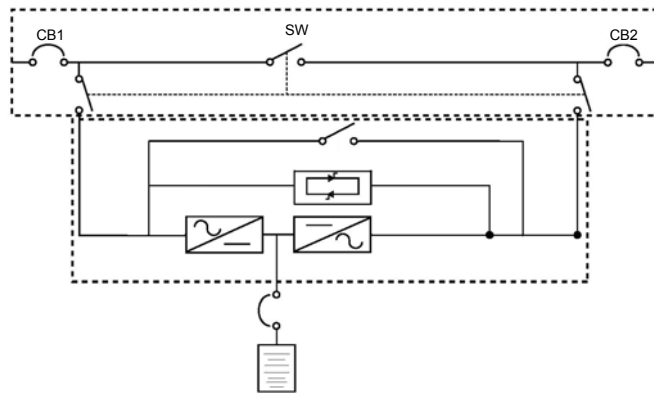



Figure 5-53 Configuration of the single UPS with external maintenance bypass

For the UPS system which requires the power distribution to be accomplished by user, if you need to isolate the UPS from AC power, disconnect the external input MCB.

 Warning
Cut off the maintenance power to prevent physical injury.

5.9 Auto Restart

Upon mains failure, the UPS supplies power to the load through battery until the battery power is depleted, and the UPS will terminate output.

Meet the following conditions, the UPS will automatically restart and recover output power supply.

- The mains restores after battery EOD;
- The UPS EOD Auto Restart function is enabled.

 Note
1. The UPS EOD Auto Restart function is enabled by default if there is no customized requirement. 2. If the Auto Restart function is not enabled, you can start the UPS manually by pressing the ON/SILENCE key.

5.10 UPS Monitoring

For the methods of the UPS background monitoring, refer to *SiteMonitor Monitoring Software User Manual* delivered with the UPS.

Chapter 6 Communication

This chapter briefly introduces the UPS communication.

The communication ports include: USB port and intelligent card port, which cannot be used at the same time.

6.1 Connecting USB Communication Cable

See Figure 1-3 for the position of the USB port.

The procedures for connecting the USB communication cable are as follows:

1. Take out the USB communication cable from the accessories.
2. Insert one end of the USB communication cable to the USB port on the rear panel of the UPS.
3. Insert the other end to the USB port of the computer.

Install the USB driver in the installation disk before communication.

The USB port can be connected to the single SiteMonitor software. For the installing, configuring and using methods of the SiteMonitor software, refer to the user manual in the installation disk.

6.2 Installing Communication Assembly (Optional)

The UPS provides an intelligent card port (see Figure 6-1), which is used to install the communication assembly, including SIC card, dry contact card, extended dry contact card, RS485 card, RS232 card and JBUS/MODBUS adapter card.

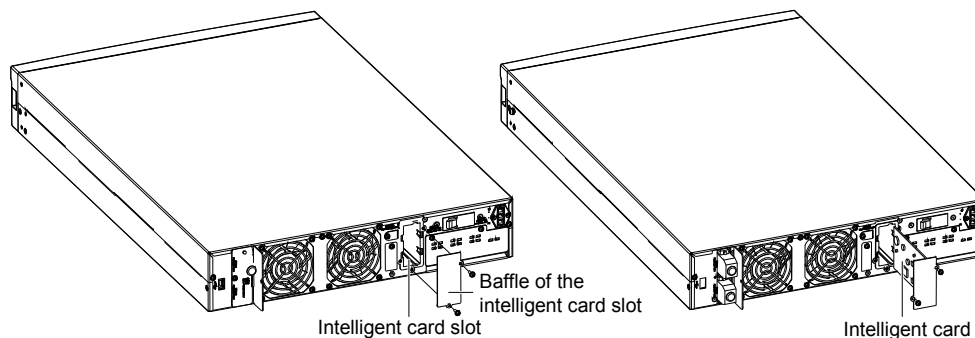

Figure 6-54 Intelligent card installation

6.2.1 SIC Card

SIC-SNMP card is a network management card, which provides the UPS, air conditioner, static transfer system (STS), server power management system (SPM), and other intelligent devices produced by Emerson with network communication capability. The SIC card can also be used with the Network Shutdown program designed by Emerson to provide safe automatic shutdown function for the computer, thus protecting data and reducing loss.

Refer to the corresponding user manual for the installation and operation guide.

6.2.2 JBUS/MODBUS Adapter Card

Through the background monitoring software, JBUS/MODBUS adapter card (adapter card for short) can use JBUS/MODBUS (RTU) protocol to manage the UPS and the field lighting power system (FLP) devices of Emerson. The adapter card obtains various electrical parameters, running state and fault type of the devices to be aware of the operation status of the devices.

Refer to the corresponding user manual for the installation and operation guide.

6.2.3 RS485 Card

RS485 card should be used together with Liebert® ITA series UPS of Emerson to realize the signal transform from RS232 to RS485.

Refer to the corresponding user manual for the installation and operation guide.

6.2.4 RS232 Card

RS232 card should be used together with Liebert® ITA series UPS of Emerson. It only supports RS232 protocol communication, and the maximum length of communication cable cannot exceed 15 meters.

6.2.5 Dry Contact Card

Dry contact card provides the remote with four routes of relay digital signal output: UPS on Battery, Battery Low, UPS on Bypass or in Standby, UPS Faulty. Each dry contact output provides both normally open and normally closed ports for user. The dry contact card can also receive three routes digital signal inputs, two of which control the UPS turn-on and turn-off respectively, the third is reserved.

Refer to the corresponding user manual for the installation and operation guide.

6.2.6 Extended Dry Contact Card

Besides the functions of the UPS dry contact card, the extended dry contact card provides RS232 and RS485 communication function to support the JBUS/MODBUS (RTU) communication protocol, and provides four routes analog signal acquisition function.

Refer to the corresponding user manual for the installation and operation guide.

Chapter 7 Maintenance And Troubleshooting

This chapter introduces the UPS maintenance, including fan maintenance, battery maintenance, cleaning UPS, checking UPS status, checking UPS functions and troubleshooting.

7.1 Fan Maintenance

The UPS fans are intended to run for 20000 hours ~ 40000 hours continuously. The higher the environmental temperature is, the shorter the fan life will be.

During UPS operation, verify the fan status once every half a year by confirming that the airflow can blow out from the ventilation holes on the rear panel of the UPS.

7.2 Battery Maintenance



Note

1. Never short connect the battery, otherwise a fire will occur.
2. Never open the battery to prevent physical injury because of the electrolyte. If you accidentally touch the electrolyte, wash the area immediately with plenty of clean water and go to hospital.

The internal battery of the UPS is sealed, lead-acid, maintenance-free battery. The battery life depends on the environmental temperature, charge and discharge times. High environmental temperature and deep discharge shortens the battery life.

To ensure the battery life, it is required to:

- Maintain the environmental temperature between 15°C and 25°C.
- Prevent small current discharge. Continuous battery operation time exceeding 24 hours is strictly prohibited.
- Charge the battery for at least 12 hours when the UPS is not in use for a long time or the battery has not been charged or discharged for three months continuously. In high temperature environment, charge the battery for at least 12 hours when the battery has not been charged or discharged for two months continuously.



Note

1. Check the screws that fix the battery connecting components periodically. If the screws are loose, tighten them immediately.
2. Ensure that all safety equipment is complete and that the function is normal, especially that the settings of the battery management parameters are correct.
3. Measure and record the temperature of the battery room.
4. Check whether the battery ports are damaged or hot, and whether the enclosure and the covers are damaged.

If liquid leakage and damage to the battery are found, place the battery in the anti-vitriol tank, and deal with it according to the local regulations.

The waste lead-acid battery is dangerous waste material. It is one of the national emphases to control the waste battery pollution. Its storage, transportation, usage and disposal must follow the national and local law and other criterions about the dangerous waste material and the waste battery pollution prevention.

According to the related regulations, recycle the waste lead-acid battery, and other disposal methods are prohibited. Throwing away randomly the waste lead-acid battery and other improper disposal methods can result in serious environment pollution, which will be investigated the legal responsibility.

As the provider of the lead-acid battery, Emerson has built perfect service network and recycle system for the waste battery to assist users to deal with the waste battery by law. Contact Emerson or the nearest service center for the detailed information of the recycle system about the waste battery.

Emerson is not liable for the environment results caused by failure to comply with the notices in this section or to use the waste battery recycle system provided by Emerson.

7.3 Cleaning UPS

Clean the UPS periodically, especially the ventilation holes or the dust filters, to ensure free airflow inside the UPS. If necessary, clean the UPS with a vacuum cleaner. Confirm that the ventilation holes are unobstructed.

7.4 Checking UPS Status

It is recommended to check the UPS operation status once every half a year.

Check the following items:

1. Check whether the UPS is faulty: Is the FAULT indicator on? Is the UPS giving any alarm?
2. Check whether the UPS is operating in Bypass mode. Normally, the UPS operates in Normal mode; if it operates in Bypass mode, find out the reason, such as operator intervention, overload, internal fault, and so on.
3. Check whether the battery is discharging: When mains is normal, the battery should not discharge; if the UPS operates in Battery mode, find out the reason, such as mains failure, battery test, operator intervention, and so on.

7.5 Checking UPS Functions

 Note
Procedures for checking the UPS functions may cause power interrupt to load.

It is recommended to check the UPS functions once every half a year.

Backup the load data before conducting the UPS functions check. Procedures are as follows:

1. Press the OFF key to check whether the buzzer, the indicators and the LCD are normal.
2. Press the ON/SILENCE key to check again whether the indicators and the LCD are normal, the UPS has been transferred to the Inverter mode.
3. After the UPS starts to operate in Inverter mode (INVERTER indicator is on), press and hold the ON/SILENCE key for four seconds, the battery self-test will start to check whether the battery is normal. If any battery problem is found, find out the reason immediately and take measures to solve the problem.

7.6 Troubleshooting

In the event of UPS abnormality and fault, shoot the trouble according to the instructions in Table 7-1. If the fault persists, seek technical support and service from the local service center of Emerson.

Table 7-15 Troubleshooting table

No.	Fault	Possible cause	Action to take
1	The mains MCB is closed; however the display panel does not display, and the UPS does not conduct self-test	Input power not connected to the UPS	Check that the UPS input cables are connected properly
		Input voltage extra low	Use a voltmeter to confirm that the UPS input voltage is within specifications
2	The mains is normal; however the MAINS indicator is off, and the UPS is in Battery mode	UPS mains MCB open	Close the UPS mains MCB
		Input cables improperly connected	Connect the UPS input cables properly
3	No UPS alarm is generated; however the UPS has no output voltage	Output cables improperly connected	Make sure the output cables are properly connected
4	After the ON/SILENCE key is pressed, the UPS does not start up	Time of holding the key too short	Press and hold the ON/SILENCE key for more than one second till the buzzer beeps
		Overload	Remove all loads and restart the UPS
5	The MAINS indicator blinks	Mains voltage or frequency beyond the UPS input range	If the UPS is operating in Battery mode, note the battery back-up time
6	The buzzer beeps every 0.5 second, and the LED displays OVERLOAD	Overload	Remove some non-priority loads
7	The FAULT indicator is on, and	External battery switch open	Close the external battery switch

No.	Fault	Possible cause	Action to take
	the LED displays BATTERY FAIL	External battery cables improperly connected	Check that the external battery cables are properly connected
		External battery reversely connected	Check that the external battery cables are not reversely connected
		Battery damaged	Contact the local service center of Emerson to replace the battery
8	The FAULT indicator is on, and the LED displays CHARGER FAIL	Charger failed	Contact the local service center of Emerson to replace or repair the charger
9	Battery discharge time is shorter than the standard time obviously	Battery not fully charged	When the mains is normal, charge the battery for more than eight hours, and then test the battery discharge time
		Battery capacity depleted	Contact the local service center of Emerson to replace the battery
10	The buzzer beeps, the FAULT indicator is on, and the LED displays TEMP OVER	UPS internal overtemperature	<ol style="list-style-type: none"> 1. Check that airflow blows out from the ventilation holes on the rear panel. 2. Check that the clearances on both sides and at the back of the UPS are greater than 200mm. 3. Check that the ventilation holes on the front panel, side panels, base plate and rear panel of the UPS are unobstructed. 4. Wait for ten minutes and restart the UPS
11	The buzzer beeps for a long time, the FAULT indicator is on, and the LED displays OUTPUT SHORT	UPS output short circuit	Remove the load short circuit fault and restart the UPS
12	The buzzer beeps for a long time, the FAULT indicator is on, and the LED displays RECTIFIER FAIL, INVERTER FAIL, AUX SUPPLY FAIL, or OUTPUT FAIL	UPS internal fault	The UPS needs repair. Seek technical assistance from the local service center of Emerson
13	Abnormal noise or smell in UPS	UPS internal fault	Turn off the UPS and cut off the power input immediately. Seek technical assistance from the local service center of Emerson
14	The UPS is about to turn off due to battery capacity shortage	Battery capacity low, UPS turn-off imminent, and load power lost imminent	<ol style="list-style-type: none"> 1. Save the load data immediately and turn off the priority load to avoid losing or damaging data. 2. Connect the UPS input terminal to standby AC power
15	The FAULT indicator is on and the buzzer beeps for a long time	Parallel address incorrect	<ol style="list-style-type: none"> 1. Open the UPS mains switch. 2. Reset the parallel address
16	The FAULT indicator is on, the buzzer beeps for a long time, and the LED displays RECTIFIER FAIL, ABNOR BUS VOLT	Overload	Remove some loads and restart the UPS in approximately five minutes
		UPS internal fault	Turn off the UPS, cut off the input power and contact the local service center of Emerson

When reporting UPS fault to Emerson or dealer, please inform the UPS model and machine number (the bar code on the rear panel of the UPS). If the UPS is a long back-up UPS, you should also provide battery configuration information.

Chapter 8 Options

This chapter introduces the options of the UPS product.

8.1 Option List

The options are listed in Table 8-1.

Table 8-16 Option list

Name	Model	Remark	ROHS
Battery module	U16-07C1	Battery module with built-in 16-cell 12V batteries	ROHS
	U20-24C2	You need to select a battery cabinet with two layers (dimension: 460 × 820 × 810, unit: mm)	ROHS
	U20-38C3	You need to select a battery cabinet with three layers (dimension: 460 × 790 × 1090, unit: mm)	ROHS
	U20-65C3	You need to select a battery cabinet with three layers (dimension: 660 × 1000 × 1090, unit: mm)	ROHS
	U20-100C3	You need to select a battery cabinet with three layers (dimension: 660 × 1000 × 1270, unit: mm)	ROHS
POD	UF-POD112U11	1-in 1-out rack model 5kVA and 6kVA UPS 1 + 1 parallel POD	ROHS
	UF-POD314U11	1-in 1-out rack model 5kVA and 6kVA UPS 3 + 1 parallel POD	ROHS
	UF-POD314U31	3-in 1-out rack model 5kVA and 6kVA UPS 3 + 1 parallel POD	ROHS
	UF-POD-0050	Rack model 5kVA and 6kVA POD	R5
Guide rail/bracket	UF-RMKIT2438	Slide guide rail assembly for ITA series UPS	R5
LCD assembly	UF-LCD-ITA-0050	LCD assembly for 5kVA UPS (only for 5kVA UPS)	R5
	UF-LCD-ITA-0060	LCD assembly for 6kVA UPS (only for 6kVA UPS)	R5
Complete set of cables	UH62SA1SL3	Parallel cable for Liebert® ITA 5kVA/6kVA/10kVA UPS	ROHS
	UH62SA1SL2	Battery cable for Liebert® ITA 5kVA/6kVA UPS (optional only for long back-up UPS, standard UPS is configured with the battery cable)	ROHS
Communication options	UF-SNMP810	SIC card assembly for Intellislot UPS	ROHS
	UF-DRY320	Extended dry contact card assembly for UPS	R5
	UF-DRY310	Dry contact card and its options for UPS	R5
	UF-MODBUS210	MODBUS assembly for Liebert NX and ITA UPS	R5
	UF-RS485	232 to 485 communication assembly for ITA UPS	R5
	UF-RS232	RS232 communication card options for Liebert® ITA UPS	R5
Monitoring options	UPS02R100	SiteMonitor network monitoring software (number of users ≤ 5)	ROHS
	UPS03R100	SiteMonitor network monitoring software (number of users ≤ 20)	ROHS
	UPS04R100	SiteMonitor network monitoring software (limitless)	ROHS
Charger module	UF-BCH192/10	10A charger (only for long back-up UPS)	R5
Battery shared assembly	UF-BSO-0050	Battery shared module (optional only for long back-up 5kVA UPS)	R5

8.2 Battery Module

8.2.1 List Of Battery Module Options

The battery module options are listed in Table 8-2.

Table 8-17 Battery module options

Model	Name	Description
U16-07C1	Battery module (2U)	Built-in 16-cell 12V 7.2A batteries, used to prolong the system running time. Note: It is recommended to extend four battery modules, at least two. The accessory of the battery module is a cable, used to connect the extended battery module



Note

1. The battery loop and the AC input are not insulated, therefore hazardous voltage may exist between the battery port and the earth. Never touch them by hand to avoid electrical shock.
2. Refer to 2.5.2 *Connecting Battery Cables* for the method to connect the battery module. If the longer cables are needed, please consult the dealers.
3. The maximal allowable charge current of the standard battery module is 2.16A, the maximal allowable charge current of the standard UPS is 4A, and the maximal allowable charge current of the 10A charger is 10A, therefore the number of the standard battery modules should be based on the charge capacity when you build the system.

8.2.2 Appearance Of Battery Module

Adjust the direction of the plastic panel on the battery module according to actual requirement. The appearance of the battery module is shown in Figure 8-1.

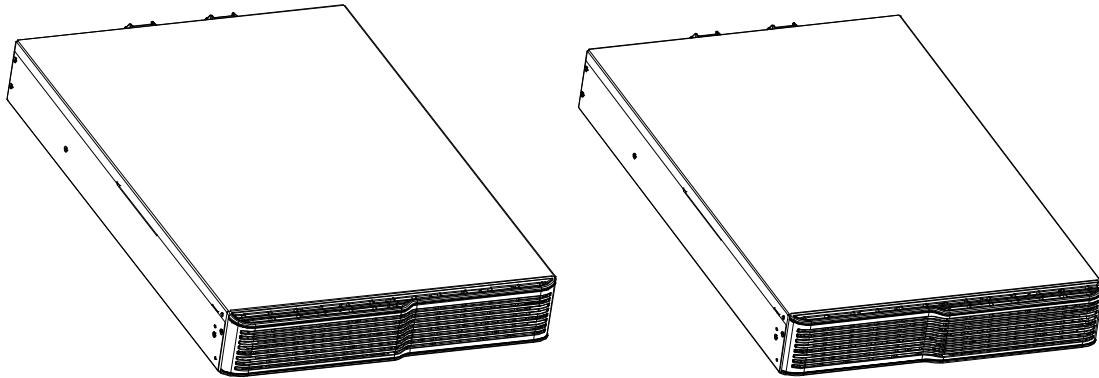

Figure 8-55 Appearance of the battery module

There is no display panel on the front panel of the battery module. The plastic panel can be removed, as shown in Figure 8-2.

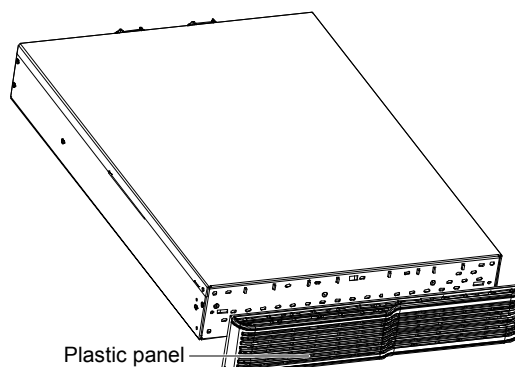

Figure 8-56 Removing the plastic panel

The battery module provides battery ports, battery fuse box and ventilation holes on the rear panel, as shown in Figure 8-3.

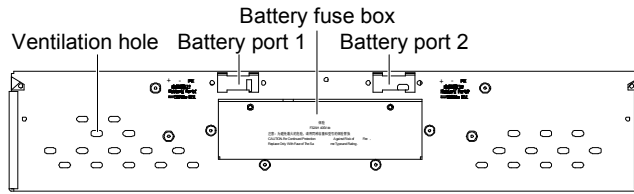

Figure 8-57 Rear panel of the battery module

8.2.3 Back-Up Time Of Standard Battery Module For Single UPS

In battery mode, the back-up time of a standard battery module (7AH/192V) upon full load is five minutes approximately. Adding the number of battery modules can prolong the back-up time; see Table 8-3 for the back-up time of different battery modules upon full load.

Table 8-18 Back-up time of standard battery module for single UPS

No. of the battery module	Battery module capacity	4800W	3800W	2800W	1800W	1300W	1000W
1	7.2AH	4.2m	6.7m	11.7m	25m	45.8m	1h7m
2	15AH	9.2m	13.3m	23.3m	50m	1h32m	2h13m
3	22AH	20m	28.3m	43.3m	1h26m	2h30m	4h1m
4	30AH	30m	38.3m	1h7m	2h5m	3h11m	5h16m
5	36AH	35m	43.3m	1h15m	2h20m	3h43m	5h55m
6	43AH	40m	55m	1h26m	2h45m	4h40m	6h21m
7	50AH	44m	58.3m	1h32m	3h4m	4h43m	6h40m
8	56AH	58m	83.3m	1h57m	3h16m	4h51m	7h05m
9	65AH	1h10m	1h32m	2h13m	3h45m	5h41m	8h11m
10	72AH	1h23m	1h57m	2h30m	4h18m	6h31m	9h27m



Note

The data in Table 8-3 is only for your reference, because the back-up time of batteries is affected by battery parameters, factories and models, aging degree and other factors.

8.3 POD

UPS parallel POD is an option of the UPS. It provides safe and reliable power distribution function for the user. The POD options are listed in Table 8-4.

Table 8-19 POD options

Model	Name	Dimension (Height × Width × Depth)
UF-POD112U11	1-in 1-out 1 + 1 parallel POD	430mm × 85mm × 625mm
UF-POD314U11	1-in 1-out 3 + 1 parallel POD	430mm × 170mm × 625mm
UF-POD314U31	3-in 1-out 1 + 1 parallel POD	430mm × 170mm × 625mm
UF-POD-0050	Output power distribution POD	430mm × 85mm × 80mm

8.3.1 1-In 1-Out 1 + 1 Parallel POD

The appearance of the 1-in 1-out 1 + 1 parallel POD is show in Figure 8-4.

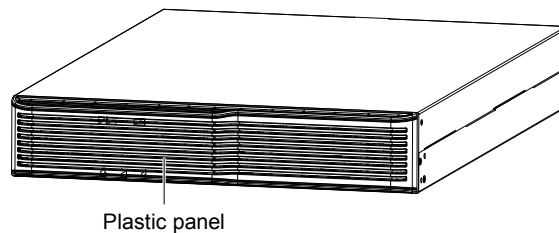

Figure 8-58 Appearance of 1-in 1-out 1 + 1 parallel POD

Remove the plastic panel to reveal the front panel of the 1-in 1-out 1 + 1 parallel POD, as shown in Figure 8-5.

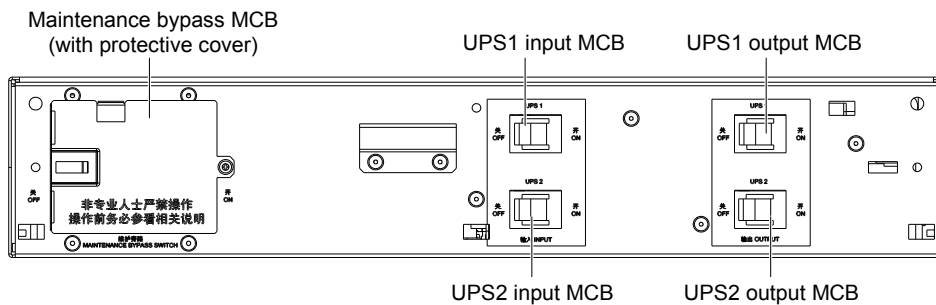

Figure 8-59 Operation panel of the 1-in 1-out 1 + 1 parallel POD

The rear panel of the 1-in 1-out 1 + 1 parallel POD is shown in Figure 8-6.

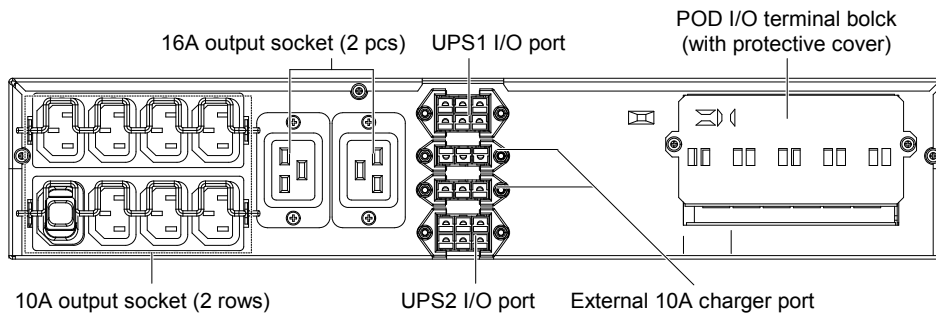

Figure 8-60 Rear panel of the 1-in 1-out 1 + 1 parallel POD

8.3.2 1-In 1-Out 3 + 1 Parallel POD

The appearance of the 1-in 1-out 3 + 1 parallel POD is show in Figure 8-7.

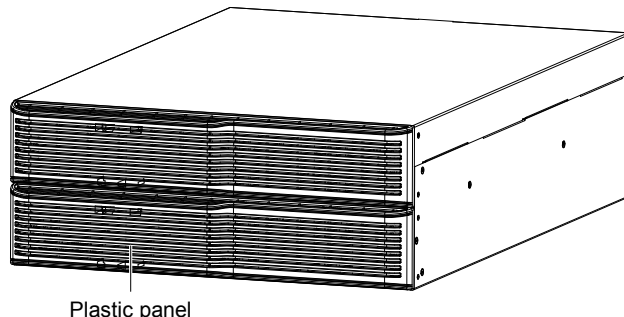

Figure 8-61 Appearance of 1-in 1-out 3 + 1 parallel POD

Remove the plastic panel to reveal the front panel of the 1-in 1-out 3 + 1 parallel POD, as shown in Figure 8-8.

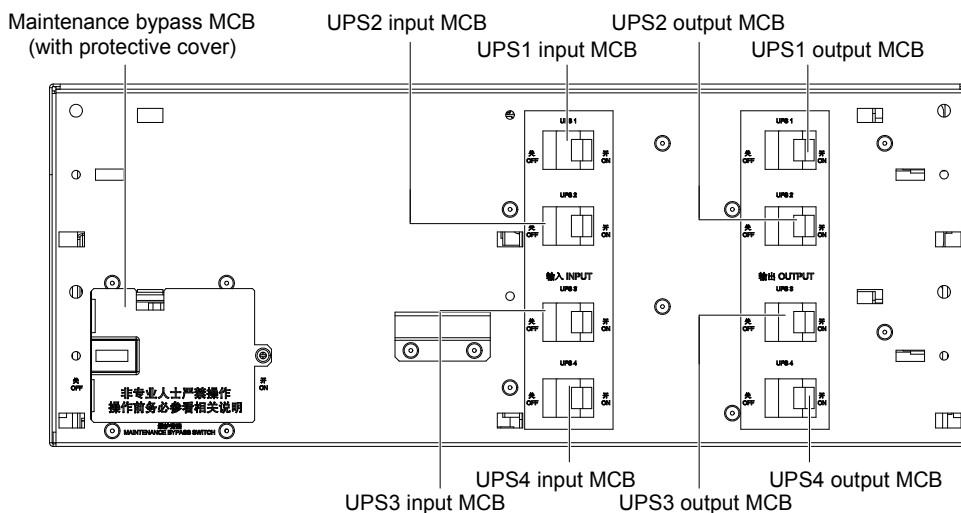

Figure 8-62 Operation panel of the 1-in 1-out 3 + 1 parallel POD

The rear panel of the 1-in 1-out 3 + 1 parallel POD is shown in Figure 8-9.

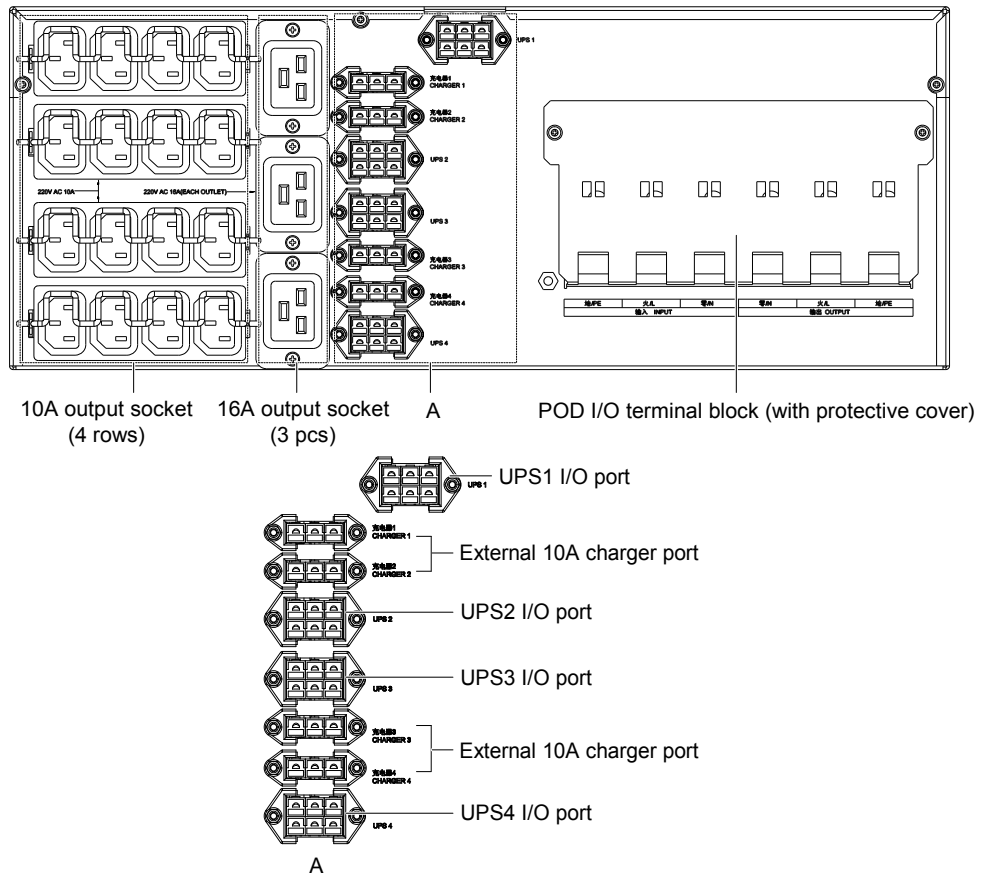

Figure 8-63 Rear panel of the 1-in 1-out 3 + 1 parallel POD

8.3.3 3- In 1-Out 3 + 1 Parallel POD

The appearance of the 3-in 1-out 3 + 1 parallel POD is show in Figure 8-10.

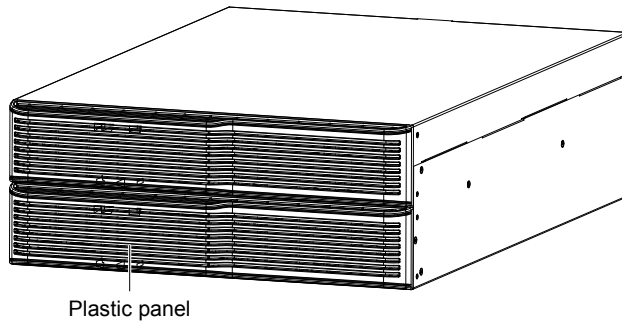

Figure 8-64 Appearance of 3-in 1-out 3 + 1 parallel POD

Remove the plastic panel to reveal the front panel of the 3-in 1-out 3 + 1 parallel POD, as shown in Figure 8-11.

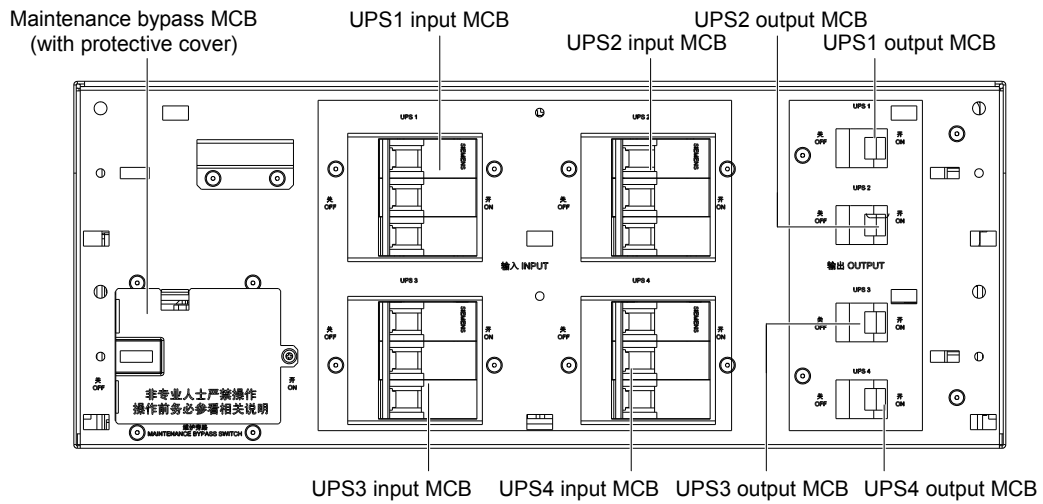

Figure 8-65 Operation panel of the 3-in 1-out 3 + 1 parallel POD

The rear panel of the 3-in 1-out 3 + 1 parallel POD is shown in Figure 8-12.

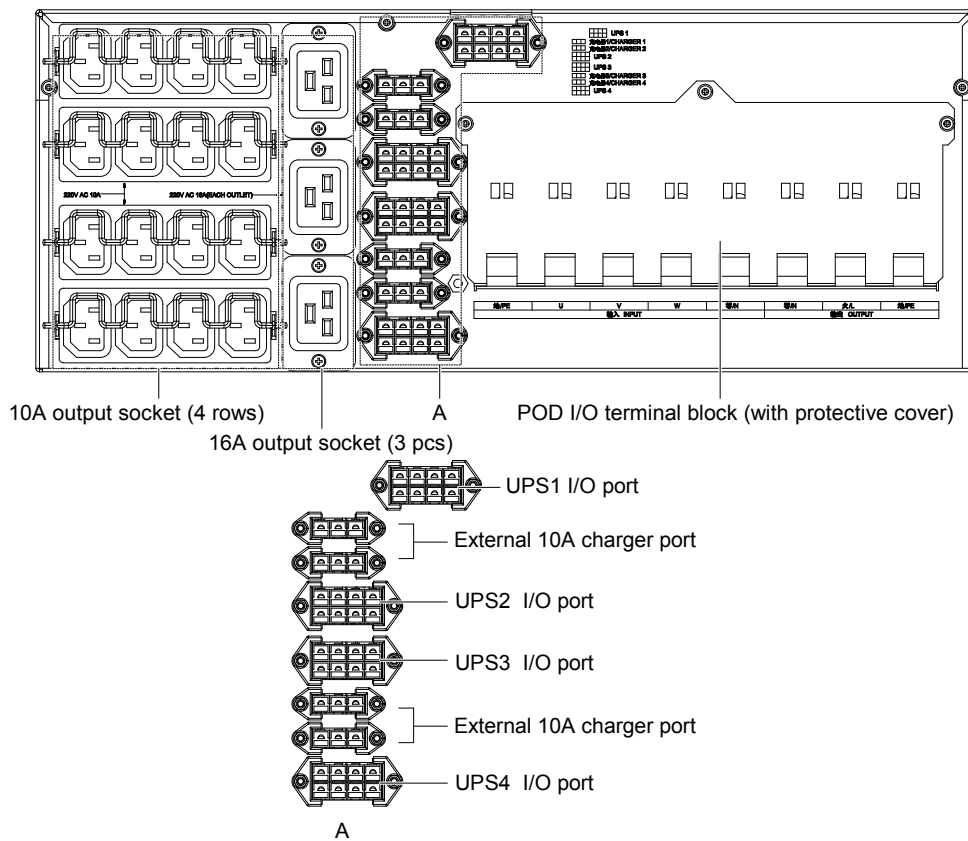

Figure 8-66 Rear panel of the 3-in 1-out 3 + 1 parallel POD

8.3.4 Output Power Distribution POD

The appearance of the output power distribution POD is show in Figure 8-13.

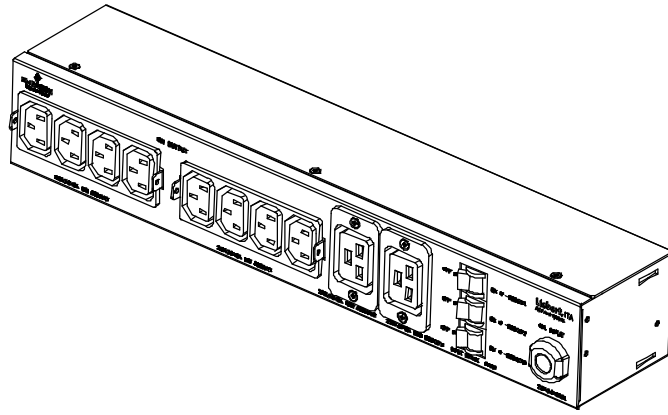

Figure 8-67 Appearance of the output power distribution POD

The operation panel of the output power distribution POD is shown in Figure 8-14.

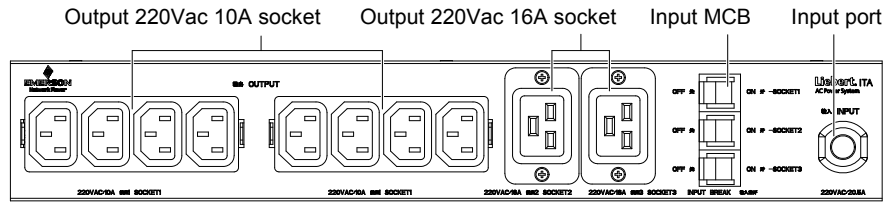



Figure 8-68 Operation panel of the output power distribution POD

8.4 Complete Set Of Cables

8.4.1 Parallel Communication Cables

The communication cable is compulsory in parallel system. See Table 8-5 for its description. Refer to 3.4.2 *Connecting Parallel Signal Cables* for connecting the parallel cables.

Table 8-20 Description of the communication cable

Model	Name	Description	Appearance
UH62SA1SL3	Communication cable	For N + 1 parallel system, N + 1 communication cables are required. For example, two communication cables are required in 1 + 1 parallel system; three communication cables are required in 2 + 1 parallel system; four communication cables are required in 3 + 1 parallel system	

8.4.2 Battery Cable

The battery cable is optional when the long back-up UPS is selected. The battery cable is an accessory of the standard UPS when the standard UPS is selected. See Table 8-6 for its description. Refer to 2.5.2 *Connecting Battery Cables* for detailed information.

Table 8-21 Description of battery cable

Model	Name	Description	Appearance
UH62SA1SL2	Battery cable	When standard UPS is selected, battery cable is configured in UPS accessories, there is no need to select it again; When long back-up UPS is selected, and the UPS is required to configure with a standard battery module U16-07C1, the battery cable needs to be selected	

8.5 Guide Rail For Rack Installation

The guide rail for rack installation is used in rack installation of UPS, POD (option) and battery module (option). See Table 8-7 for its description. Refer to 2.4.2 *Rack Installation* for rack installation procedures.







Table 8-22 Guide rail for rack installation

Model	Name	Description	Appearance
UF-RMKIT2438	Guide rail for rack installation	A set of guide rail includes a left guide rail and a right guide rail, and its bearing is 50kg. Use the guide rail in the rack installation. It is applicable to the various server cabinets with standard size, UPS, modular battery and POD	

8.6 Communication Options And Monitoring Options

The communication options and the monitoring options are listed in Table 8-8.

Table 8-23 Communication options and monitoring options

Name	Model	Description	Appearance
SIC card (can be connected to net port temperature and humidity sensor)	UF-SNMP810	Support Web remote monitor to the UPS through TCP/IP protocol and Internet; Support remote safe shutdown; Provide an extended net port, cascade-connect at most eight temperature humidity sensors	
RS485 card	UF-RS485	Be used to connect UPS to RDU-A monitoring unit, or connect to the cascade-communication in parallel system	
MODBUS card	UF-MODBUS210	Select it when the UPS is connected to the monitoring system of building	
Dry contact card	UF-DRY310	Provide four routes relay signal outputs and three routes digital signal inputs	
Extended dry contact card	UF-DRY320	Provide four routes relay signal outputs, three routes digital signal inputs, RS232 and RS485 communication function and four routes analog signal acquisition function	
RS232 card	UF-RS232	Only support RS232 protocol communication, communication cable cannot be longer than 15m	
Remote monitoring software	SiteMonitor	SiteMonitor PC monitoring software (used in single and parallel UPS at the site server, delivered as a CD with the UPS, and the Network Shutdown program is included in it)	
		SiteMonitor network monitoring software (number of users ≤ 5)	
		SiteMonitor network monitoring software (number of users ≤ 20)	
		SiteMonitor network monitoring software (limitless)	

8.7 10A Charger

The 10A charger is an option for the long back-up UPS. See Table 8-9 for its description.

Table 8-24 Description of 10A charger

Model	Name	Description	Dimension (Height × Width × Depth)	Weight
UF-BCH192/10	10A charger	Used to charge the battery of large capacity, shorten the charging time together with 5kVA, 6kVA and 10 kVA UPS	435mm × 380mm × 85mm	12kg

The appearance of the 10A charger is shown in Figure 8-15.

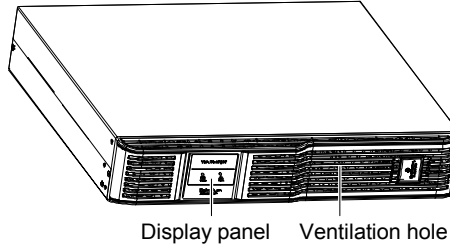

Figure 8-69 Appearance of 10A charger

The rear panel of the 10A charger is shown in Figure 8-16.

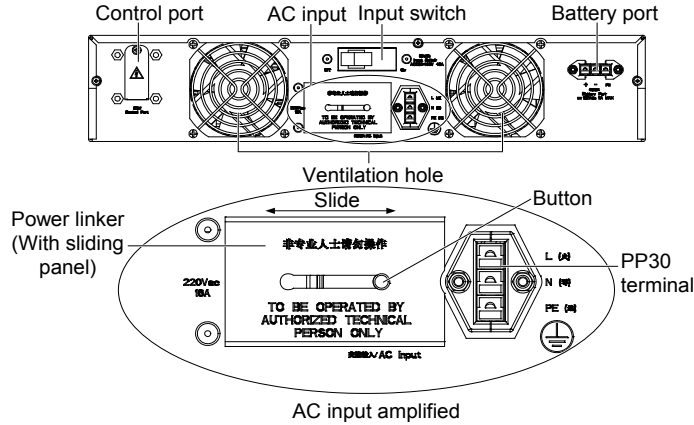

Figure 8-70 Rear panel of 10A charger

Note

Non-authorized personnel are prohibited from opening the 10A charger cover.

8.8 LCD Display Panel Assembly

UF-LCD-ITA-0050 and UF-LCD-ITA-0060 are LCD display panel options for 5kVA and 6kVA UPS respectively. The commissioning has been completed before delivery. You need to install the LCD display panel in accordance with the UPS. Refer to 4.2 LCD Display Panel for its menu structure, function description and interface .The appearance of the LCD display panel assembly is shown in Figure 8-17.

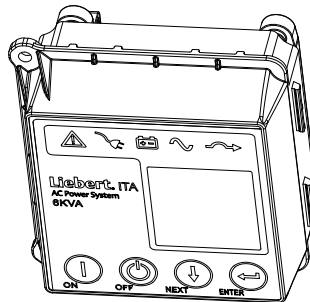

Figure 8-71 Appearance of LCD display panel assembly

Note

Never open the LCD display panel during installation.

The detailed procedures are as follows:

1. Confirm that the UPS is powered off, the bypass and I/O MCBs are open, and the battery cable is disconnected.
2. Press two ends of the UPS plastic panel with hands, gently pull out the plastic panel, as shown in Figure 8-18 (a).

3. Use a screwdriver to remove the two M3 × 8 screws, which fix the LED display panel and the UPS chassis. Pull out the LED display panel and cables from the chassis, as shown in Figure 8-18 (b). Disconnect the three cables connecting to the LED display panel, and remove the LED display panel.
4. Connect the three cables to the LCD display panel, and fix the LCD display panel with two M3 × 8 screws, as shown in Figure 8-18 (c).
5. Install the plastic panel to its position, as shown in Figure 8-18 (d).

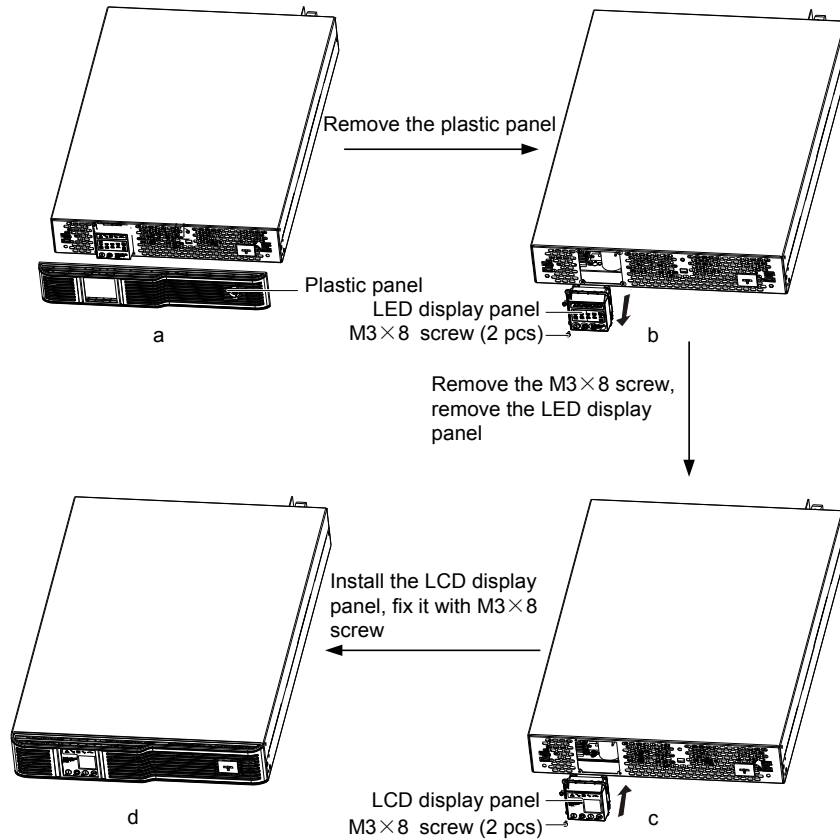

Figure 8-72 Installing the LCD display panel



Note

1. There is no need to open the USP chassis cover in process of replacing the LCD display panel.
2. Note the screw position and clip on the other side when installing and removing the display panel assembly. During installation, first put the clip on the side of the display panel into the UPS chassis, then fix the screws; when removing the display panel, reverse the procedures.
3. The rotation method of the LCD display panel is the same as that of the LED display panel, please refer to 2.4.1 *Tower Installation*.

8.9 UF-BSO-0050 ITA UPS Battery Shared Module

The UF-BSO-0050 ITA UPS battery shared module (battery shared module for short) is only applicable to 5kVA long back-up UPS parallel system. Through the battery shared module, a battery string of large capacity can supply power to several 5kVA UPSs at the same time.

The appearance of the battery shared module is shown in Figure 8-19. See Table 8-10 for its description.

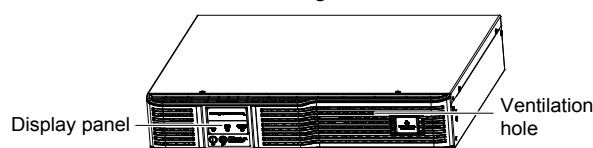

Figure 8-73 Appearance of battery shared module

Table 8-25 Description of battery shared module

Model	Name	Description	Dimension (Height × Width × Depth)	Weight
UF-BSO-0050	Battery shared module	When a battery string of large capacity supplies power to several 5kVA UPSs at the same time, the battery shared module is needed	377mm × 435mm × 85mm	6kg

For the details of the battery shared module, refer to *UF-BSO-0050 ITA UPS Battery Shared Module User Manual*.

Appendix 1 Glossary

AC	Alternating current
CSA	Cross-sectional area
DC	Direct current
DSP	Digital signal processor
EMC	Electromagnetic compatibility
EMI	Electromagnetic interference
ESD	Electrostatic discharge
ECO	Economic
EOD	End-of-discharge
FLP	Field lighting power system
I/O	Input/output
MCB	Miniature circuit breaker
PE	Protective earth
PFC	Power factor correction
POD	Parallel power distribution unit
RCCB	Residual current circuit breaker
RCD	Residual current detector
SPM	Server power management system
STS	Static transfer switch
UPS	Uninterruptable power system

Emerson Network Power, a business of Emerson

(NYSE:EMR), a global company that leads by applying a unique combination of industry expertise, technology, and resources to make the future of our customers' enterprises and networks possible.

Emerson Network Power provides innovative solutions and expertise in areas including AC and DC power and precision cooling systems, embedded computing and power, integrated racks and enclosures, power switching and controls, infrastructure management and connectivity. All solutions are supported globally by local Emerson Network Power service technicians.

While every precaution has been taken to ensure the accuracy and completeness of this literature, Emerson Network Power assumes no responsibility and disclaims all liability for damages resulting from use of this information or for any errors or omissions.

All rights reserved throughout the world.

Specifications subject to change without notice.

All names referred to are trademarks or registered trademarks of their respective owners