

INNOVATIONS
2023 | 02 | METRIC

KenTIP™ FS

Modular Drilling

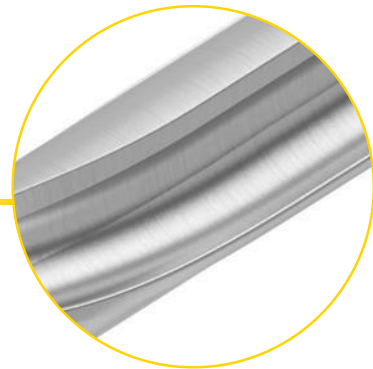
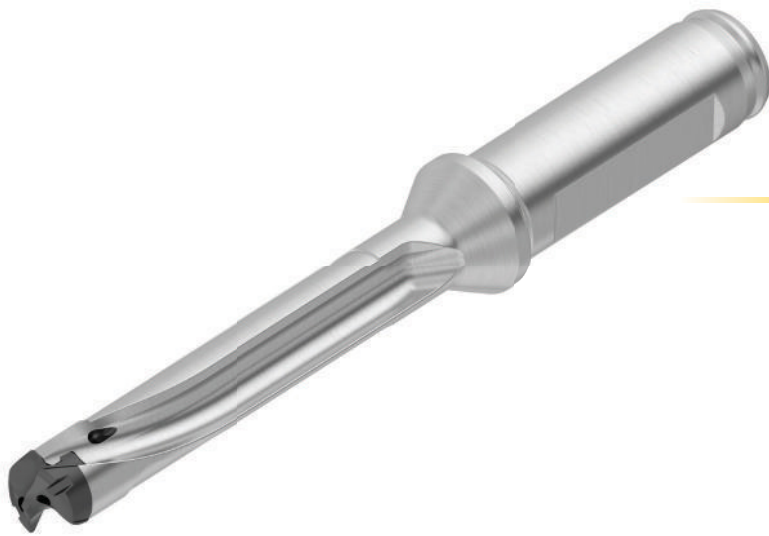

Straight fluted holders for static drilling applications.



GTP Insert for universal applications. GDrill geometry with 140° point angle. Excellent centering capabilities and low axial forces.

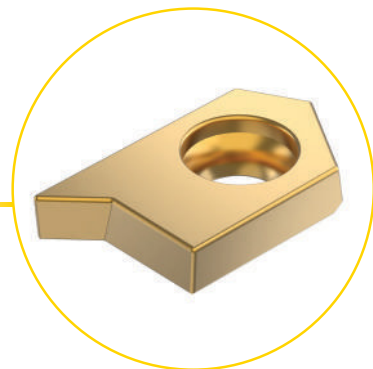
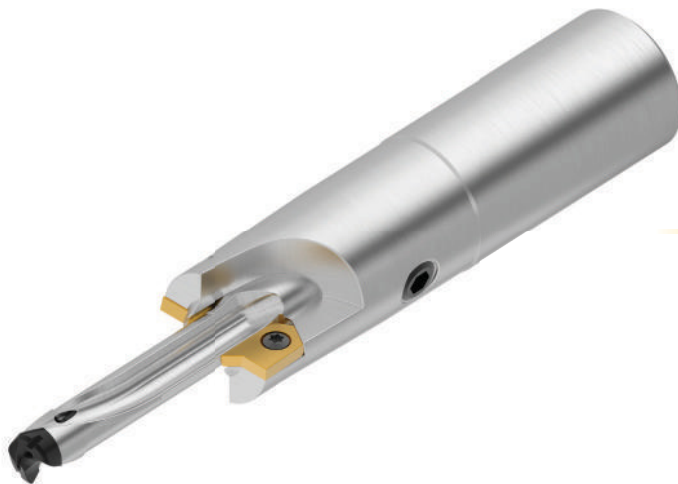

Straight fluted holders for combined drilling and countersinking applications.

INNOVATIONS

Services & Support	2-5
Contact Information	2-3
Spare Parts & Accessories Information • Online Catalog.....	4-5
Holemaking	6-87
KenTIP FS • Modular Drill	6-49
Kenna Universal • Solid Carbide Drill	50-77
KenReam S • Solid Carbide Reamer	78-87
High-Performance Solid Carbide End Milling	90-105
Dynamic Milling.....	89-105
High-Performance Modular End Milling	106-147
Roughing & Finishing with One Tool.....	106-107, 110-121
Roughers and Finishers	107-108, 110-111, 122-125
Aluminum Machinings.....	108, 110-111, 126-128
Specific Applications	109-111, 129-140
Adapters and Wrenches	141-144
Nomenclatures.....	145-147
General Information	148-153
Grades and Grade Descriptions	148-151
Key to Column Headings	152
Material Cross Reference.....	153

CAS — Customer Application Support

Get Fast and Reliable Answers to Your Toughest Problems

Our CAS Team is the metalworking industry's leading help desk resource for tooling application solutions and problem resolution.

Easy Access to Proven Metalworking Expertise!

Kennametal Application Engineers assist customers and engineering groups throughout the world with expert tool selection and application recommendations for the entire range of Kennametal tooling.



Region	Originating Country	Language	CAS Hotline	Email
North America	USA	English	800 835 3668	na.techsupport@kennametal.com
	Mexico	Spanish	1800 253 0758	na.techsupport@kennametal.com
Africa	South Africa	English	+27117489300	na.techsupport@kennametal.com
Europe	Austria	German	0223 63181360	eu.techsupport@kennametal.com
	Belgium	English/French	0279 06 540	eu.techsupport@kennametal.com
	Denmark	English	808 89298	na.techsupport@kennametal.com
	Finland	English	0800 919412	na.techsupport@kennametal.com
	France	French	01 60 12 83 00	eu.techsupport@kennametal.com
	Germany	German	06003 8277110	eu.techsupport@kennametal.com
	Israel	English	—	na.techsupport@kennametal.com
	Italy	Italian	028 95 96 212	eu.techsupport@kennametal.com
	Netherlands	English	076 79 95 220	eu.techsupport@kennametal.com
	Norway	English	800 10080	na.techsupport@kennametal.com
	Poland	Polish	616 656 553	eu.techsupport@kennametal.com
	Russia	English	—	eu.techsupport@kennametal.com
	Sweden	English	0207 99246	na.techsupport@kennametal.com
UK	English	0138 44 08 095	na.techsupport@kennametal.com	
Ukraine	English	—	eu.techsupport@kennametal.com	
Asia Pacific	Australia	English	1800 666 667	ap-kmt.techsupport@kennametal.com
	India	English	1 800 103 5227	in.techsupport@kennametal.com
	Japan	English	03 3820 2855	ap-kmt.techsupport@kennametal.com
	Korea (South)	English	+82 2 2100 6100	ap-kmt.techsupport@kennametal.com
	Malaysia	English	1800 812 990	ap-kmt.techsupport@kennametal.com
	New Zealand	English	0800 450 941	ap-kmt.techsupport@kennametal.com
	Singapore	English	1800 6221031	ap-kmt.techsupport@kennametal.com
	Taiwan	English	0800 666 197	ap-kmt.techsupport@kennametal.com
Thailand	English	1800 4417820	ap-kmt.techsupport@kennametal.com	

Numbers shown only serve the originating country listed.

Service & Sales Centers Around the World

Region	Country	Sales Hotline	Email
North America	United States	+1 800 446 7738	FtMill.Service@kennametal.com
	Canada	+1 800 446 7738	toronto.service@kennametal.com
	Mexico	+1 888 402 4963	k-mx.service@kennametal.com
Central/South America	Argentina	+54 11 4719 0700	buenos-aires.ventas@kennametal.com
	Brazil	+55 19 3936 9200	bra.marketing@kennametal.com
	Chile	+56 2 2264 1177	kennametalchile@kennametalchile.cl
Africa	Egypt	+44 1384 408060	na.techsupport@kennametal.com
	South Africa	+27 11 748 9300	na.techsupport@kennametal.com
Europe	Austria	+43 2236 3798980	brunn.sales@kennametal.com
	Belgium	+32 0800 81 372	belgium.sales@kennametal.com
	Czech Republic	+420 800 900 840	k-prha.sales@kennametal.com
	France	+33 1 60 12 81 00	info.fr@kennametal.com
	Germany	+49 6003 8277 0	rosbach.sales@kennametal.com
	Great Britain	+44 1384 408060	kingswinford.service@kennametal.com
	Hungary	+36 96 618 150	gyoer.sales@kennametal.com
	Ireland	+44 1384 408060	na.techsupport@kennametal.com
	Italy	+39 02 895 961	milano.vendite@kennametal.com
	Luxemborg	+32 4 248 48 48	liege.sales@kennametal.com
	Netherlands	+31 0800 44 33 201	netherlands.sales@kennametal.com
	Poland	+48 61 6656501	poland.service@kennametal.com
	Portugal	+351 22 4119 400	porto.service@kennametal.com
	Russia	+7 495 4115386	moscow.information@kennametal.com
Slovakia	+421 0800 044 053	k-eu-zilina.sales@kennametal.com	
Spain	+34 93 586 03 50	barcelona.service@kennametal.com	
Turkey	+90 216 574 4780	tr.information@kennametal.com	
Asia Pacific	Australia	+61 800 666 667	k-au.service@kennametal.com
	China	+86 400 889 2135	k-cn.service@kennametal.com
	India	+91 800 103 5138	k-bngl.information@kennametal.com
	Indonesia	+65 6265 9222	k-sg.sales@kennametal.com
	Japan	+81 3 3820 2855	k-jp.service@kennametal.com
	Korea (South)	+82 2 2109 6100	k-kr-service@kennametal.com
	Malaysia	+60 3 5569 9080	k-sg.sales@kennametal.com
	New Zealand	+64 0800 536626	k-nz.service@kennametal.com
	Singapore*	+65 62659222	k-sg.sales@kennametal.com
	Taiwan	+886 4 2350 1920	taiwan.service@kennametal.com
Thailand	+66 2 642 3455	k-sg.sales@kennametal.com	

*Vietnam and Philippines individuals should contact the Singapore office.

Visit kennametal.com to find local Authorized Kennametal Distributors.



Spare Parts & Accessories Information

Lost a screw? Have to replace worn-out clamping wedges?
Need to find and re-order those spare parts?

Are you in need of some accessories, like a torque wrench or coolant shower plate? These tools are at your fingertips!
Go to kenametal.com and find what you need in seconds. Enter the catalog number of the corresponding tool, and it will display.

STEP 1 Enter the tool catalog number here

The screenshot shows the Kennametal website interface. At the top, there is a search bar with a magnifying glass icon. Below the search bar, there are navigation tabs for PRODUCTS, INDUSTRIES, SERVICES, RESOURCES, SUPPORT, and ABOUT US. The main content area displays the product details for a Mill 16 shell mill. The product title is "Mill 16™ • Shell Mill • Screw-On Clamping • Fine Pitch • Metric". Below the title, there is a sub-heading "Face Mill • Cast Iron Machining". The "Features and benefits" section lists: "Milling cutters for cast iron and compacted graphite iron (CGI) machining.", "Ideal for roughing of engine heads and blocks, housings, gear boxes, etc.", "Insert pocket numbering system.", and "High feed rate capability to boost productivity and reduce cycle time." The "Uses and application" section includes icons for various materials. The "Workpiece Materials" section shows icons for P, M, K, and S. Below the product details, there is a table with columns for SAP Material Number, ISO Catalog Number, Effective Cutting Diameter, Maximum Cutting Diameter, Adapter / Shank / Bore Diameter, Bolt Circle 4, and Hub Diameter. The table shows the following values: SAP Material Number: 6159026, ISO Catalog Number: MILL16D0632050N08SC, Effective Cutting Diameter: 63.0000, Maximum Cutting Diameter: 75.0200, Adapter / Shank / Bore Diameter: 22.0, Bolt Circle 4: [D4], and Hub Diameter: 50.0000.

STEP 2 Select the spare parts & accessories

The screenshot shows the "Spare Parts for Mill 16™ • Shell Mill • Screw-On Clamping • Fine Pitch • Metric" section. It displays four spare parts and accessories, each with an image and a "Get Price" button:

- Spare Part ANTI-SEIZE LUBRICANT (Image of a spray nozzle)
- WRENCH (Image of a torque wrench)
- INSERT SCR M5-08 x 14 IP20 (Image of a screw)
- SOCKET HEAD SCREW DIN 912 M10X25 (Image of a screw)



Digitally access spare parts and accessories information to ensure you keep your operation running.

Visit kenametal.com/novo and log into the web app.
It's free!



Online Catalog

Can't find your paper copy of our catalog anymore?
No worries. Go to catalogs.kennametal.com to see what's out there.

Search for what you need, watch a video, and share pages with others, all from one site! Go to catalogs.kennametal.com, and if you want to check it out on your mobile device, just download the FREE app for iOS or Android™.

1 Search for what you need

2 Watch videos



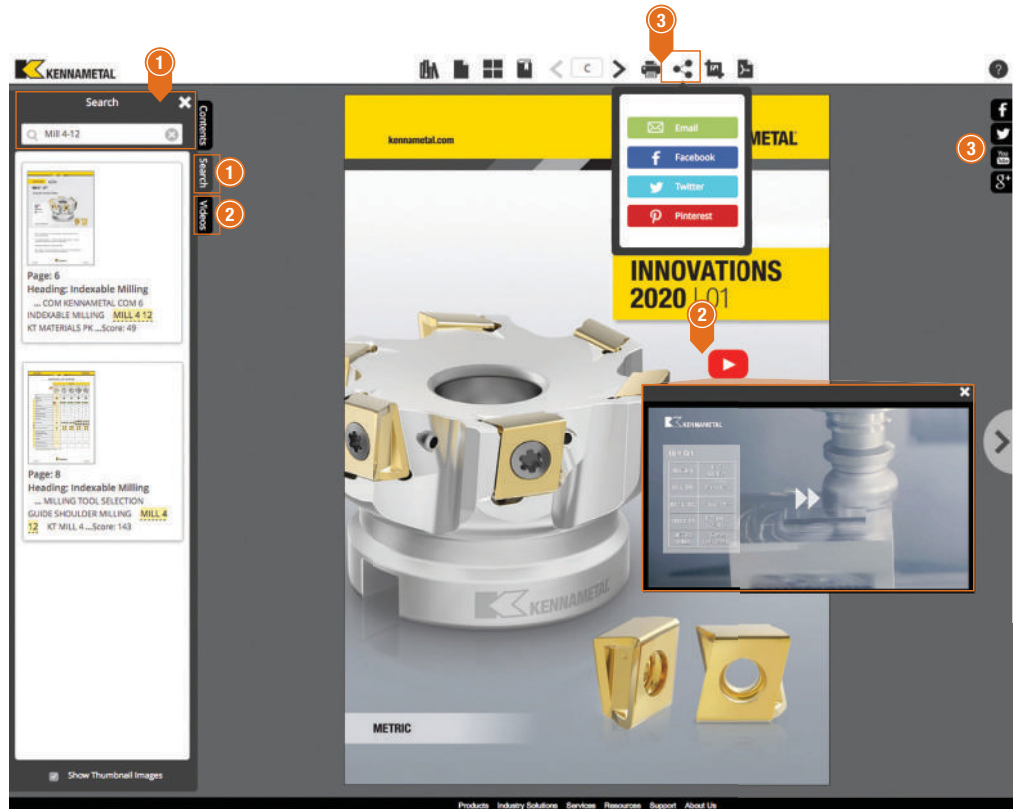











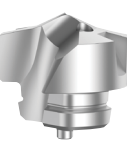



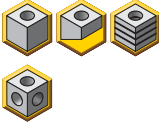

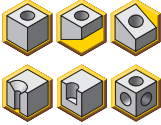



3 Share with others



Check out our new catalog app.
Available in the Google Play™ Store or
the App Store®.

Modular Drills • Tool Selection Guide • KenTIP™ FS



KenTIP FS							
	GTP	HPG	HPC	HPL	FEG	DAV	SPF
	NEW! 						
Page	12-14	15-19	23-25	20-22	27	26	26
Workpiece material							
Primary	P M K	P	K	M	P K	N C	C
Secondary	S	K	P	S	M	S	
Main operation							
Point angle	140°	143°	143°	140°	145°/180°	128°/155°	128°/90°
Cutting diameter [D1]	6,0-26,0mm	6,0-26,0mm	6,0-26,0mm	6,0-26,0mm	6,0-26,0mm	6,35-12,7mm	6,35-12,7mm
Flutes and margin							
Corner chamfer							

Modular Drills • Tool Selection Guide • KSEM



	KSEM™						
	FEG	HP	HPG	HPCCL	HPL	SPL	PC
Page	H29*	H26*	H8*	H48*	H14*	H52*	H56*
Workpiece material							
Primary	P K	P	P	K	M	M S	P K
Secondary	M S	K	M K			P N	M
Main operation							
Point angle	150°/180°	140°	140°	140°	140°	140°	150°
Cutting diameter [D1]	12,5–40,0mm	12,5–40,0mm	12,5–40,0mm	12,5–40,0mm	12,5–40,0mm	12,5–40,0mm	12,5–40,0mm
Flutes and margin							
Corner chamfer							

*See page in the Kennametal Master Catalogue 2018 • Volume Two • Rotating Tools, A-16-05217.

Modular Drills • Tool Selection Guide • KSEM PLUS™ — A1 Heads

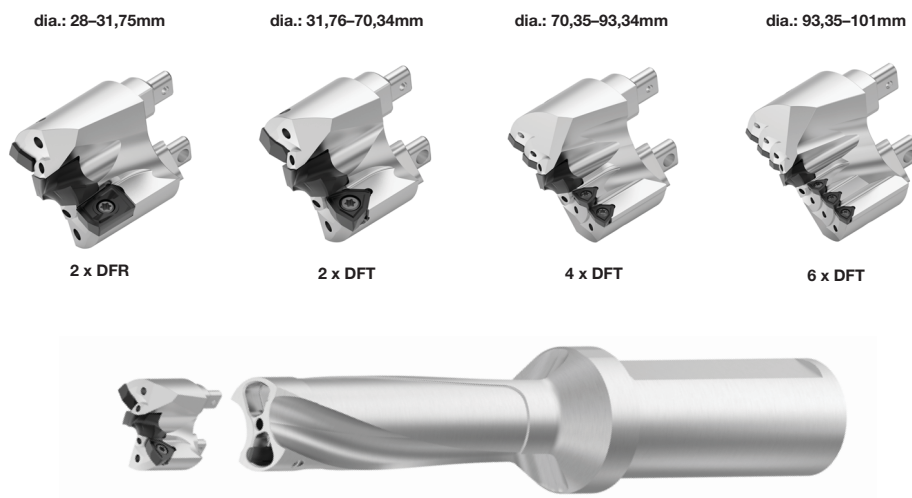

KSEM PLUS A1 Heads						
Drill head style						
Center insert	HPG			FEG		
Outboard insert	DFR-GD	DFR-MD	DFR-LD	DFT-HP	DFT-MD	DFT-DS
Page	H89-J84*			H90-J87*		
Workpiece material	P K S	P M		K N		P K S
	M N	K N S		P M S		M N
Main operation						
Cutting diameter [D1]	28,0-31,75mm			31,75-101,40mm		
Flutes and margin						

*See page in the Kennametal Master Catalogue 2018 • Volume Two • Rotating Tools, A-16-05217.

Modular Drills • Tool Selection Guide • KSEM PLUS™ — B1 Heads

dia.: 28-70,34mm

dia.: 70,34-93,34mm

dia.: 93,35-101mm



2 x DFC



4 x DFC



6 x DFC

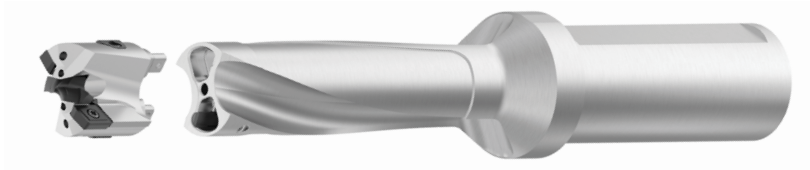

KSEM PLUS B1 Heads				
Drill head style				
Center insert	HPG		FEG	
Outboard insert	DFC-HP	DFC-MD	DFC-DS	DFC-HPF
Page	H90*			40**
Workpiece material				
Primary	P K S	P M	P M	
Secondary	M N	K N S	N S	M K N
Main operation				
Cutting diameter [D1]	28,0-101mm			
Flutes and margin				

*See page in the Kennametal Master Catalogue 2018 • Volume Two • Rotating Tools, A-16-05217.

** See page in the Kennametal Innovations 2020 • 02, A-19-06096.

KenTIP™ FS

Modular Drilling

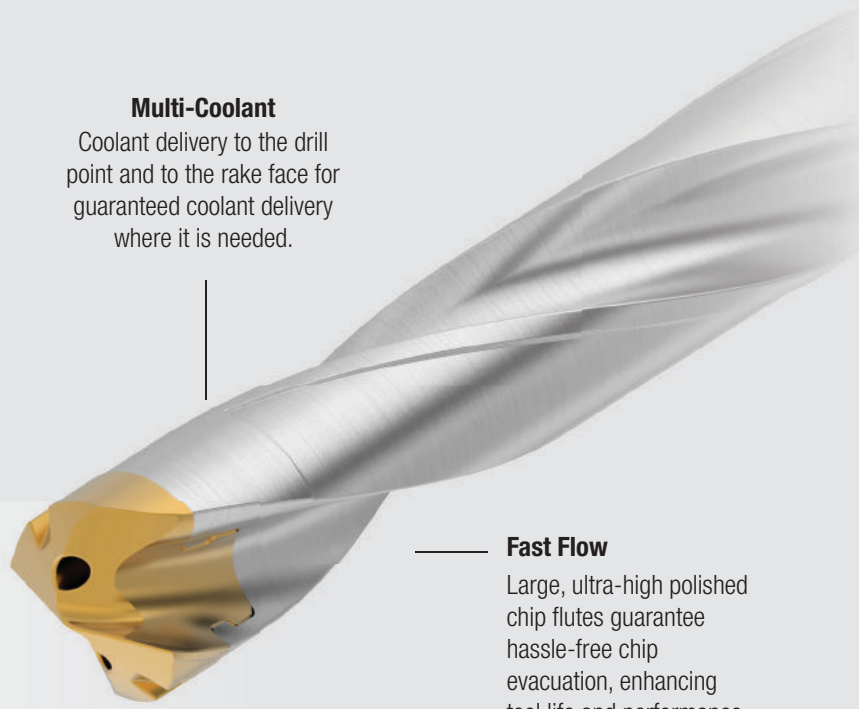

Multi-Coolant

Coolant delivery to the drill point and to the rake face for guaranteed coolant delivery where it is needed.

Fast Flow

Large, ultra-high polished chip flutes guarantee hassle-free chip evacuation, enhancing tool life and performance.

Quick Release

Every drill body comes with a KenTIP smart wrench. Insert exchange in the machine becomes easy and saves idle time. And that saves money.

Materials



Applications



Counterboring



Countersinking/
Stroke Chamfering



Drilling



Drilling:
Inclined Entry



Drilling:
Stacked Plates



Drilling:
Flat Bottom



Drilling:
Inclined Exit



Drilling:
Cross Hole



Drilling:
Vibration Assisted

KenTIP FS covers more applications and provides better performance than any other modular system, delivering substantial cost savings and process simplifications on your shop floor.

KenTIP FS inserts cover the entire front part of the drill. The coupling is completely protected from chip flow and contact with the workpiece. Carbide where it matters.

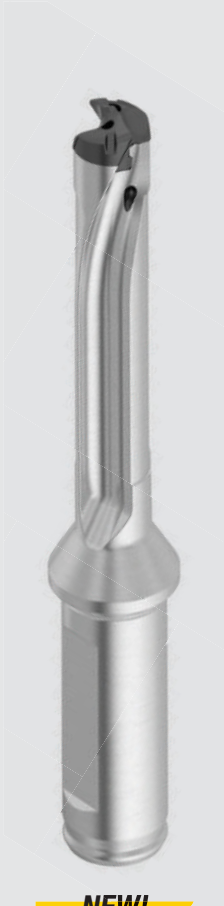

NEW!

For static drilling applications.



NEW!

For combined drilling and countersinking applications.

NEW!



KenTIP™ FS GTP insert with the GDrill™ point design.

- GTP insert for universal applications.
- For steel, stainless steel, and cast iron.
- GDrill geometry with 140° point angle.
- Excellent centering capabilities and low axial forces.
- Through coolant.

KenTIP™ FS • Insert • GTP Geometry

- first choice
- alternate choice

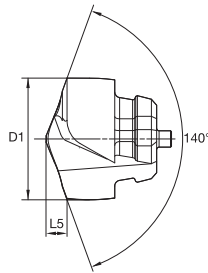

P	●
M	●
K	●
N	●
S	○
H	●
C	●

order number	ISO catalogue number	D1	L5	SSC	KC7325
7001867	KTFST06000GTPM	6,00	0,95	A	●
7001868	KTFST06350GTPM	6,35	1,00	B	●
7001869	KTFST06500GTPM	6,50	1,03	B	●
7001870	KTFST06746GTPM	6,75	1,07	C	●
7002021	KTFST06800GTPM	6,80	1,08	C	●
7002022	KTFST07000GTPM	7,00	1,11	D	●
7002023	KTFST07500GTPM	7,50	1,19	E	●
7002024	KTFST07938GTPM	7,94	1,27	E	●
7002025	KTFST08000GTPM	8,00	1,28	F	●
7002026	KTFST08100GTPM	8,10	1,29	F	●
7002027	KTFST08204GTPM	8,20	1,31	F	●
7002028	KTFST08300GTPM	8,30	1,33	F	●
7002029	KTFST08334GTPM	8,33	1,33	F	●
7002030	KTFST08500GTPM	8,50	1,36	G	●
7002051	KTFST08600GTPM	8,60	1,38	G	●
7002052	KTFST08700GTPM	8,70	1,39	G	●
7002053	KTFST08733GTPM	8,73	1,40	G	●
7002054	KTFST08800GTPM	8,80	1,41	G	●
7002055	KTFST08900GTPM	8,90	1,43	G	●
7002056	KTFST09000GTPM	9,00	1,44	H	●
7002057	KTFST09100GTPM	9,10	1,46	H	●
7002058	KTFST09300GTPM	9,30	1,49	H	●
7002059	KTFST09347GTPM	9,35	1,50	H	●
7002060	KTFST09400GTPM	9,40	1,51	H	●
7002071	KTFST09500GTPM	9,50	1,53	I	●
7002072	KTFST09525GTPM	9,53	1,53	I	●
7002073	KTFST09558GTPM	9,56	1,54	I	●
7002074	KTFST09600GTPM	9,60	1,54	I	●
7002075	KTFST09700GTPM	9,70	1,56	I	●
7002076	KTFST09800GTPM	9,80	1,58	I	●
7002077	KTFST09900GTPM	9,90	1,59	I	●
7002078	KTFST09921GTPM	9,92	1,60	I	●
7002079	KTFST10000GTPM	10,00	1,61	J	●
7002080	KTFST10100GTPM	10,10	1,63	J	●
7002081	KTFST10200GTPM	10,20	1,64	J	●
7002430	KTFST10300GTPM	10,30	1,66	J	●
7002511	KTFST10320GTPM	10,32	1,66	J	●
7002512	KTFST10400GTPM	10,40	1,68	J	●
7002513	KTFST10500GTPM	10,50	1,69	K	●
7002514	KTFST10600GTPM	10,60	1,71	K	●
7002515	KTFST10700GTPM	10,70	1,73	K	●
7002516	KTFST10716GTPM	10,72	1,73	K	●
7002517	KTFST10800GTPM	10,80	1,74	K	●
7002518	KTFST10900GTPM	10,90	1,76	K	●
7002519	KTFST11000GTPM	11,00	1,78	L	●
7002520	KTFST11100GTPM	11,10	1,79	L	●
7002521	KTFST11113GTPM	11,11	1,79	L	●
7002522	KTFST11200GTPM	11,20	1,81	L	●
7002523	KTFST11300GTPM	11,30	1,83	L	●
7002524	KTFST11500GTPM	11,50	1,86	M	●
7002525	KTFST11509GTPM	11,51	1,86	M	●
7002526	KTFST11600GTPM	11,60	1,88	M	●
7002527	KTFST11700GTPM	11,70	1,89	M	●
7002528	KTFST11800GTPM	11,80	1,91	M	●
7002529	KTFST11900GTPM	11,90	1,93	M	●
7002530	KTFST11908GTPM	11,91	1,93	M	●

148-151	152	47-49	88, 156



KenTIP™ FS • Insert • GTP Geometry

(continued)

- first choice
- alternate choice

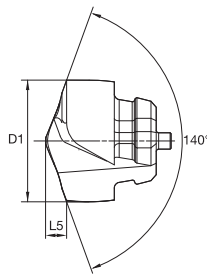

P	●
M	●
K	●
N	●
S	○
H	●
C	●

order number	ISO catalogue number	D1	L5	SSC	KC7325
7002531	KTFST12000GTPM	12,00	1,94	N	●
7002532	KTFST12100GTPM	12,10	1,96	N	●
7002533	KTFST12200GTPM	12,20	1,98	N	●
7002535	KTFST12304GTPM	12,30	1,99	N	●
7002536	KTFST12400GTPM	12,40	2,01	N	●
7002538	KTFST12474GTPM	12,47	2,02	N	●
7002539	KTFST12500GTPM	12,50	2,03	O	●
7002540	KTFST12600GTPM	12,60	2,04	O	●
7002541	KTFST12700GTPM	12,70	2,06	O	●
7002542	KTFST12800GTPM	12,80	2,08	O	●
7002543	KTFST12900GTPM	12,90	2,09	O	●
7002544	KTFST13000GTPM	13,00	2,11	P	●
7002545	KTFST13096GTPM	13,10	2,13	P	●
7002546	KTFST13200GTPM	13,20	2,14	P	●
7005301	KTFST13300GTPM	13,30	2,16	P	●
7005302	KTFST13400GTPM	13,40	2,18	P	●
7005304	KTFST13492GTPM	13,49	2,19	P	●
7005305	KTFST13500GTPM	13,50	2,19	Q	●
7005306	KTFST13600GTPM	13,60	2,21	Q	●
7005307	KTFST13700GTPM	13,70	2,23	Q	●
7005308	KTFST13800GTPM	13,80	2,24	Q	●
7005309	KTFST13891GTPM	13,89	2,26	Q	●
7005310	KTFST13940GTPM	13,94	2,27	Q	●
7005311	KTFST14000GTPM	14,00	2,28	R	●
7005312	KTFST14100GTPM	14,10	2,29	R	●
7005313	KTFST14200GTPM	14,20	2,31	R	●
7005314	KTFST14288GTPM	14,29	2,32	R	●
7005315	KTFST14300GTPM	14,30	2,33	R	●
7005316	KTFST14400GTPM	14,40	2,34	R	●
7005317	KTFST14500GTPM	14,50	2,36	S	●
7005318	KTFST14600GTPM	14,60	2,38	S	●
7005319	KTFST14684GTPM	14,68	2,39	S	●
7005320	KTFST14800GTPM	14,80	2,41	S	●
7005321	KTFST15000GTPM	15,00	2,44	T	●
7005322	KTFST15083GTPM	15,08	2,46	T	●
7005323	KTFST15100GTPM	15,10	2,46	T	●
7005324	KTFST15200GTPM	15,20	2,48	T	●
7005325	KTFST15300GTPM	15,30	2,49	T	●
7005326	KTFST15479GTPM	15,48	2,52	T	●
7005327	KTFST15500GTPM	15,50	2,53	T	●
7005328	KTFST15600GTPM	15,60	2,54	T	●
7005329	KTFST15700GTPM	15,70	2,56	T	●
7005330	KTFST15800GTPM	15,80	2,58	T	●
7005331	KTFST15875GTPM	15,88	2,59	T	●
7005332	KTFST16000GTPM	16,00	2,61	U	●
7005333	KTFST16100GTPM	16,10	2,63	U	●
7005334	KTFST16200GTPM	16,20	2,65	U	●
7005335	KTFST16300GTPM	16,30	2,66	U	●
7005336	KTFST16400GTPM	16,40	2,68	U	●
7004192	KTFST16500GTPM	16,50	2,70	U	●
7004193	KTFST16600GTPM	16,60	2,71	U	●
7004194	KTFST16670GTPM	16,67	2,72	U	●
7004195	KTFST16700GTPM	16,70	2,73	U	●
7004196	KTFST16800GTPM	16,80	2,75	U	●
7004197	KTFST16900GTPM	16,90	2,76	U	●
7004198	KTFST17000GTPM	17,00	2,78	V	●

148-151	152	47-49	88, 156

KenTIP™ FS • Insert • GTP Geometry

(continued)

- first choice
- alternate choice

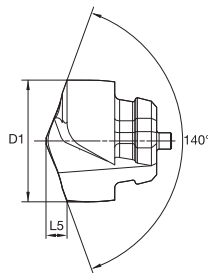

P	●
M	●
K	●
N	●
S	○
H	●
C	●

order number	ISO catalogue number	D1	L5	SSC	KC7325
7004199	KTFST17066GTPM	17,07	2,79	V	●
7004200	KTFST17100GTPM	17,10	2,80	V	●
7004221	KTFST17200GTPM	17,20	2,81	V	●
7004222	KTFST17300GTPM	17,30	2,83	V	●
7004223	KTFST17400GTPM	17,40	2,85	V	●
7004224	KTFST17463GTPM	17,46	2,86	V	●
7004225	KTFST17500GTPM	17,50	2,86	V	●
7004226	KTFST17600GTPM	17,60	2,88	V	●
7004227	KTFST17700GTPM	17,70	2,90	V	●
7004228	KTFST17800GTPM	17,80	2,91	V	●
7004229	KTFST17859GTPM	17,86	2,92	V	●
7004230	KTFST17900GTPM	17,90	2,93	V	●
7004231	KTFST18000GTPM	18,00	2,95	W	●
7004232	KTFST18100GTPM	18,10	2,96	W	●
7004233	KTFST18258GTPM	18,26	2,99	W	●
7004234	KTFST18300GTPM	18,30	3,00	W	●
7004235	KTFST18400GTPM	18,40	3,01	W	●
7004236	KTFST18500GTPM	18,50	3,03	W	●
7004237	KTFST18600GTPM	18,60	3,05	W	●
7004238	KTFST18700GTPM	18,70	3,07	W	●
7004239	KTFST18800GTPM	18,80	3,08	W	●
7004240	KTFST18900GTPM	18,90	3,10	W	●
7004241	KTFST19000GTPM	19,00	3,12	X	●
7004242	KTFST19050GTPM	19,05	3,12	X	●
7004243	KTFST19100GTPM	19,10	3,13	X	●
7004244	KTFST19200GTPM	19,20	3,15	X	●
7004245	KTFST19253GTPM	19,25	3,16	X	●
7004246	KTFST19279GTPM	19,28	3,16	X	●
7002302	KTFST19300GTPM	19,30	3,17	X	●
7002303	KTFST19500GTPM	19,50	3,20	X	●
7002304	KTFST19700GTPM	19,70	3,23	X	●
7002305	KTFST19800GTPM	19,80	3,25	X	●
7002306	KTFST19845GTPM	19,85	3,26	X	●
7002307	KTFST19900GTPM	19,90	3,27	X	●
7002308	KTFST20000GTPM	20,00	3,28	Y	●
7002309	KTFST20100GTPM	20,10	3,30	Y	●
7002310	KTFST20200GTPM	20,20	3,32	Y	●
7002451	KTFST20300GTPM	20,30	3,33	Y	●
7002452	KTFST20500GTPM	20,50	3,37	Y	●
7002453	KTFST20600GTPM	20,60	3,38	Y	●
7002454	KTFST20638GTPM	20,64	3,39	Y	●
7002455	KTFST21000GTPM	21,00	3,45	Z	●
7002456	KTFST21100GTPM	21,10	3,47	Z	●
7002457	KTFST21200GTPM	21,20	3,49	Z	●
7002458	KTFST21500GTPM	21,50	3,54	Z	●
7002459	KTFST21800GTPM	21,80	3,59	Z	●
7002460	KTFST22000GTPM	22,00	3,62	ZA	●
7002461	KTFST22200GTPM	22,20	3,65	ZA	●
7002462	KTFST22225GTPM	22,23	3,66	ZA	●
7002463	KTFST22500GTPM	22,50	3,70	ZA	●
7002464	KTFST22800GTPM	22,80	3,75	ZA	●
7002465	KTFST23000GTPM	23,00	3,79	ZB	●
7002466	KTFST23200GTPM	23,20	3,82	ZB	●
7002467	KTFST23500GTPM	23,50	3,87	ZB	●
7002468	KTFST23813GTPM	23,81	3,93	ZB	●
7002469	KTFST24000GTPM	24,00	3,96	ZC	●
7002470	KTFST24500GTPM	24,50	4,04	ZC	●
7002471	KTFST24700GTPM	24,70	4,07	ZC	●
7002472	KTFST25000GTPM	25,00	4,13	ZD	●
7002473	KTFST25400GTPM	25,40	4,19	ZD	●
7002474	KTFST25500GTPM	25,50	4,21	ZD	●
7002475	KTFST25679GTPM	25,68	4,24	ZD	●
7002476	KTFST26000GTPM	26,00	4,29	ZD	●



KenTIP™ FS • Insert • HPG Geometry

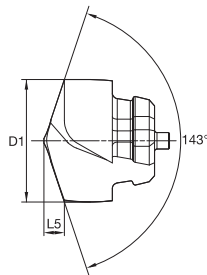

- first choice
- alternate choice

P	●
M	○
K	○
N	○
S	○
H	○
C	○

order number	ISO catalogue number	D1	L5	SSC	KCP15A
6388539	KTFSS06000HPGM	6,00	1,37	A	●
6388541	KTFSS06100HPGM	6,10	1,38	A	●
6388543	KTFSS06200HPGM	6,20	1,40	A	●
6388545	KTFSS06300HPGM	6,30	1,44	B	●
6388547	KTFSS06350HPGM	6,35	1,45	B	●
6388551	KTFSS06500HPGM	6,50	1,47	B	●
6388553	KTFSS06530HPGM	6,53	1,48	B	●
6388555	KTFSS06600HPGM	6,60	1,49	C	●
6388559	KTFSS06700HPGM	6,70	1,51	C	●
6388561	KTFSS06746HPGM	6,75	1,52	C	●
6388563	KTFSS06800HPGM	6,80	1,53	C	●
6388565	KTFSS06900HPGM	6,90	1,54	C	●
6388567	KTFSS06909HPGM	6,91	1,54	C	●
6388569	KTFSS07000HPGM	7,00	1,59	D	●
6388571	KTFSS07100HPGM	7,10	1,61	D	●
6388573	KTFSS07145HPGM	7,15	1,61	D	●
6388576	KTFSS07200HPGM	7,20	1,62	D	●
6388578	KTFSS07366HPGM	7,37	1,65	D	●
6388580	KTFSS07400HPGM	7,40	1,66	D	●
6388582	KTFSS07500HPGM	7,50	1,68	E	●
6388584	KTFSS07541HPGM	7,54	1,69	E	●
6388586	KTFSS07600HPGM	7,60	1,70	E	●
6388588	KTFSS07700HPGM	7,70	1,71	E	●
6388590	KTFSS07800HPGM	7,80	1,73	E	●
6388592	KTFSS07900HPGM	7,90	1,75	E	●
6388594	KTFSS07938HPGM	7,94	1,75	E	●
6388596	KTFSS08000HPGM	8,00	1,80	F	●
6388598	KTFSS08100HPGM	8,10	1,82	F	●
6388599	KTFSS08164HPGM	8,16	1,83	F	●
6388602	KTFSS08204HPGM	8,20	1,84	F	●
6388604	KTFSS08300HPGM	8,30	1,85	F	●
6388606	KTFSS08334HPGM	8,33	1,86	F	●
6388608	KTFSS08400HPGM	8,40	1,87	F	●
6388610	KTFSS08433HPGM	8,43	1,87	F	●
6388611	KTFSS08500HPGM	8,50	1,89	G	●
6388613	KTFSS08600HPGM	8,60	1,91	G	●
6388615	KTFSS08611HPGM	8,61	1,91	G	●
6388617	KTFSS08700HPGM	8,70	1,92	G	●
6388620	KTFSS08733HPGM	8,73	1,93	G	●
6388622	KTFSS08800HPGM	8,80	1,94	G	●
6388624	KTFSS08839HPGM	8,84	1,95	G	●
6388626	KTFSS08900HPGM	8,90	1,96	G	●
6388628	KTFSS09000HPGM	9,00	2,01	H	●
6388630	KTFSS09093HPGM	9,09	2,03	H	●
6388642	KTFSS09100HPGM	9,10	2,03	H	●
6388644	KTFSS09129HPGM	9,13	2,03	H	●
6388646	KTFSS09200HPGM	9,20	2,04	H	●
6388648	KTFSS09300HPGM	9,30	2,06	H	●
6388650	KTFSS09347HPGM	9,35	2,07	H	●
6388652	KTFSS09400HPGM	9,40	2,08	H	●
6388654	KTFSS09500HPGM	9,50	2,10	I	●
6388656	KTFSS09525HPGM	9,53	2,11	I	●
6388658	KTFSS09558HPGM	9,56	2,11	I	●
6388660	KTFSS09600HPGM	9,60	2,12	I	●
6388662	KTFSS09700HPGM	9,70	2,13	I	●
6388664	KTFSS09800HPGM	9,80	2,15	I	●

148-151	152	47-49	88, 156

KenTIP™ FS • Insert • HPG Geometry

(continued)

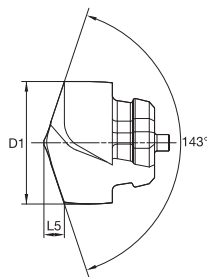

- first choice
- alternate choice

P	■	●
M	■	○
K	■	○
N	■	○
S	■	○
H	■	○
C	■	○

order number	ISO catalogue number	D1	L5	SSC	KCP15A
6388666	KTFSS09900HPGM	9,90	2,17	I	●
6388668	KTFSS0921HPGM	9,92	2,17	I	●
6388670	KTFSS10000HPGM	10,00	2,22	J	●
6388672	KTFSS10023HPGM	10,02	2,22	J	●
6388674	KTFSS10084HPGM	10,08	2,23	J	●
6388676	KTFSS10100HPGM	10,10	2,24	J	●
6388678	KTFSS10200HPGM	10,20	2,25	J	●
6388680	KTFSS10262HPGM	10,26	2,26	J	●
6388682	KTFSS10300HPGM	10,30	2,27	J	●
6388684	KTFSS10320HPGM	10,32	2,27	J	●
6388686	KTFSS10400HPGM	10,40	2,29	J	●
6388688	KTFSS10490HPGM	10,49	2,30	J	●
6388690	KTFSS10500HPGM	10,50	2,31	K	●
6388692	KTFSS10600HPGM	10,60	2,33	K	●
6388694	KTFSS10700HPGM	10,70	2,34	K	●
6388696	KTFSS10716HPGM	10,72	2,35	K	●
6388698	KTFSS10800HPGM	10,80	2,36	K	●
6388700	KTFSS10900HPGM	10,90	2,38	K	●
6388702	KTFSS11000HPGM	11,00	2,43	L	●
6388704	KTFSS11100HPGM	11,10	2,45	L	●
6388706	KTFSS11113HPGM	11,11	2,45	L	●
6388708	KTFSS11200HPGM	11,20	2,46	L	●
6388710	KTFSS11300HPGM	11,30	2,48	L	●
6388712	KTFSS11400HPGM	11,40	2,50	L	●
6388714	KTFSS11500HPGM	11,50	2,52	M	●
6388716	KTFSS11509HPGM	11,51	2,52	M	●
6388718	KTFSS11600HPGM	11,60	2,54	M	●
6388720	KTFSS11700HPGM	11,70	2,55	M	●
6388722	KTFSS11800HPGM	11,80	2,57	M	●
6388724	KTFSS11900HPGM	11,90	2,59	M	●
6388726	KTFSS11908HPGM	11,91	2,59	M	●
6388728	KTFSS12000HPGM	12,00	2,64	N	●
6388730	KTFSS12100HPGM	12,10	2,65	N	●
6388732	KTFSS12200HPGM	12,20	2,67	N	●
6388734	KTFSS12304HPGM	12,30	2,69	N	●
6388736	KTFSS12400HPGM	12,40	2,70	N	●
6388738	KTFSS12474HPGM	12,47	2,72	N	●
6388740	KTFSS12500HPGM	12,50	2,73	O	●
6388742	KTFSS12600HPGM	12,60	2,74	O	●
6388744	KTFSS12700HPGM	12,70	2,76	O	●
6388746	KTFSS12800HPGM	12,80	2,78	O	●
6388749	KTFSS12900HPGM	12,90	2,79	O	●
6388751	KTFSS13000HPGM	13,00	2,85	P	●
6388753	KTFSS13096HPGM	13,10	2,86	P	●
6388755	KTFSS13200HPGM	13,20	2,88	P	●
6388757	KTFSS13280HPGM	13,28	2,89	P	●
6388759	KTFSS13300HPGM	13,30	2,90	P	●
6388761	KTFSS13380HPGM	13,38	2,91	P	●
6388763	KTFSS13400HPGM	13,40	2,91	P	●
6388765	KTFSS13492HPGM	13,49	2,93	P	●
6388767	KTFSS13500HPGM	13,50	2,93	Q	●
6388769	KTFSS13600HPGM	13,60	2,95	Q	●
6388771	KTFSS13700HPGM	13,70	2,97	Q	●
6388773	KTFSS13800HPGM	13,80	2,98	Q	●
6388775	KTFSS13891HPGM	13,89	3,00	Q	●
6388777	KTFSS13896HPGM	13,90	3,00	Q	●

148-151	152	47-49	88, 156

KenTIP™ FS • Insert • HPG Geometry

(continued)

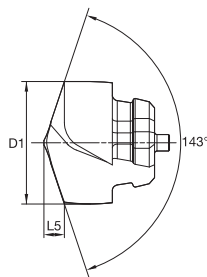

- first choice
- alternate choice

P	■	●
M	■	○
K	■	○
N	■	○
S	■	○
H	■	○
C	■	○

order number	ISO catalogue number	D1	L5	SSC	KCP15A
6388779	KTFSS13940HPGM	13,94	3,01	Q	●
6388781	KTFSS14000HPGM	14,00	3,05	R	●
6388784	KTFSS14100HPGM	14,10	3,07	R	●
6388786	KTFSS14200HPGM	14,20	3,09	R	●
6388787	KTFSS14288HPGM	14,29	3,10	R	●
6388789	KTFSS14300HPGM	14,30	3,10	R	●
6388791	KTFSS14400HPGM	14,40	3,12	R	●
6388792	KTFSS14500HPGM	14,50	3,14	S	●
6388793	KTFSS14600HPGM	14,60	3,16	S	●
6388794	KTFSS14666HPGM	14,67	3,17	S	●
6388795	KTFSS14684HPGM	14,68	3,17	S	●
6388796	KTFSS14700HPGM	14,70	3,17	S	●
6388798	KTFSS14800HPGM	14,80	3,19	S	●
6388799	KTFSS14900HPGM	14,90	3,21	S	●
6388800	KTFSS15000HPGM	15,00	3,26	T	●
6388821	KTFSS15083HPGM	15,08	3,27	T	●
6388822	KTFSS15100HPGM	15,10	3,28	T	●
6388823	KTFSS15200HPGM	15,20	3,29	T	●
6388824	KTFSS15300HPGM	15,30	3,31	T	●
6388825	KTFSS15380HPGM	15,38	3,32	T	●
6388826	KTFSS15400HPGM	15,40	3,33	T	●
6388828	KTFSS15479HPGM	15,48	3,34	T	●
6388829	KTFSS15500HPGM	15,50	3,34	T	●
6388830	KTFSS15600HPGM	15,60	3,36	T	●
6388831	KTFSS15700HPGM	15,70	3,38	T	●
6388832	KTFSS15800HPGM	15,80	3,39	T	●
6388833	KTFSS15875HPGM	15,88	3,41	T	●
6388834	KTFSS15900HPGM	15,90	3,41	T	●
6388420	KTFSS16000HPGM	16,00	3,48	U	●
6388531	KTFSS16027HPGM	16,03	3,49	U	●
6388532	KTFSS16080HPGM	16,08	3,49	U	●
6388534	KTFSS16100HPGM	16,10	3,50	U	●
6388533	KTFSS16104HPGM	16,10	3,50	U	●
6388535	KTFSS16200HPGM	16,20	3,51	U	●
6388536	KTFSS16271HPGM	16,27	3,53	U	●
6388537	KTFSS16300HPGM	16,30	3,53	U	●
6388538	KTFSS16400HPGM	16,40	3,55	U	●
6388540	KTFSS16500HPGM	16,50	3,57	U	●
6388542	KTFSS16600HPGM	16,60	3,58	U	●
6388544	KTFSS16670HPGM	16,67	3,59	U	●
6388546	KTFSS16700HPGM	16,70	3,60	U	●
6388548	KTFSS16800HPGM	16,80	3,62	U	●
6388550	KTFSS16900HPGM	16,90	3,63	U	●
6388552	KTFSS17000HPGM	17,00	3,66	V	●
6388554	KTFSS17066HPGM	17,07	3,67	V	●
6388556	KTFSS17100HPGM	17,10	3,67	V	●
6388558	KTFSS17200HPGM	17,20	3,69	V	●
6388560	KTFSS17300HPGM	17,30	3,71	V	●
6388562	KTFSS17400HPGM	17,40	3,72	V	●
6388564	KTFSS17463HPGM	17,46	3,74	V	●
6388566	KTFSS17480HPGM	17,48	3,74	V	●
6388568	KTFSS17500HPGM	17,50	3,74	V	●
6388570	KTFSS17600HPGM	17,60	3,76	V	●
6388572	KTFSS17700HPGM	17,70	3,77	V	●
6388574	KTFSS17800HPGM	17,80	3,79	V	●
6388575	KTFSS17859HPGM	17,86	3,80	V	●

148-151	152	47-49	88, 156

KentIP™ FS • Insert • HPG Geometry

(continued)

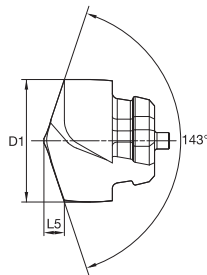

- first choice
- alternate choice

P	●
M	○
K	○
N	○
S	○
H	○
C	○

order number	ISO catalogue number	D1	L5	SSC	KCP15A
6388577	KTFSS17900HPGM	17,90	3,81	V	●
6388579	KTFSS18000HPGM	18,00	3,89	W	●
6388581	KTFSS18100HPGM	18,10	3,91	W	●
6388583	KTFSS18200HPGM	18,20	3,93	W	●
6388585	KTFSS18258HPGM	18,26	3,94	W	●
6388587	KTFSS18300HPGM	18,30	3,94	W	●
6388589	KTFSS18400HPGM	18,40	3,96	W	●
6388591	KTFSS18500HPGM	18,50	3,98	W	●
6388593	KTFSS18600HPGM	18,60	3,99	W	●
6388595	KTFSS18654HPGM	18,65	4,00	W	●
6388597	KTFSS18700HPGM	18,70	4,01	W	●
6388600	KTFSS18800HPGM	18,80	4,03	W	●
6388601	KTFSS18900HPGM	18,90	4,04	W	●
6388603	KTFSS19000HPGM	19,00	4,07	X	●
6388605	KTFSS19050HPGM	19,05	4,08	X	●
6388607	KTFSS19100HPGM	19,10	4,09	X	●
6388609	KTFSS19200HPGM	19,20	4,10	X	●
6388612	KTFSS19228HPGM	19,23	4,11	X	●
6388614	KTFSS19253HPGM	19,25	4,11	X	●
6388616	KTFSS19279HPGM	19,28	4,12	X	●
6388618	KTFSS19300HPGM	19,30	4,12	X	●
6388619	KTFSS19355HPGM	19,36	4,13	X	●
6388621	KTFSS19400HPGM	19,40	4,14	X	●
6388623	KTFSS19446HPGM	19,45	4,14	X	●
6388625	KTFSS19460HPGM	19,46	4,15	X	●
6388627	KTFSS19500HPGM	19,50	4,15	X	●
6388629	KTFSS19600HPGM	19,60	4,17	X	●
6388641	KTFSS19700HPGM	19,70	4,19	X	●
6388643	KTFSS19800HPGM	19,80	4,20	X	●
6388645	KTFSS19845HPGM	19,85	4,21	X	●
6388647	KTFSS19900HPGM	19,90	4,22	X	●
6388649	KTFSS20000HPGM	20,00	4,31	Y	●
6388651	KTFSS20100HPGM	20,10	4,32	Y	●
6388653	KTFSS20200HPGM	20,20	4,34	Y	●
6388655	KTFSS20241HPGM	20,24	4,35	Y	●
6388657	KTFSS20300HPGM	20,30	4,36	Y	●
6388659	KTFSS20500HPGM	20,50	4,39	Y	●
6388661	KTFSS20600HPGM	20,60	4,41	Y	●
6388663	KTFSS20638HPGM	20,64	4,41	Y	●
6388665	KTFSS20700HPGM	20,70	4,42	Y	●
6388667	KTFSS20800HPGM	20,80	4,44	Y	●
6388669	KTFSS20900HPGM	20,90	4,46	Y	●
6388671	KTFSS20990HPGM	20,99	4,47	Y	●
6388673	KTFSS21000HPGM	21,00	4,48	Z	●
6388675	KTFSS21100HPGM	21,10	4,50	Z	●
6388677	KTFSS21200HPGM	21,20	4,51	Z	●
6388679	KTFSS21300HPGM	21,30	4,53	Z	●
6388681	KTFSS21400HPGM	21,40	4,55	Z	●
6388683	KTFSS21433HPGM	21,43	4,55	Z	●
6388685	KTFSS21500HPGM	21,50	4,56	Z	●
6388687	KTFSS21700HPGM	21,70	4,60	Z	●
6388689	KTFSS21800HPGM	21,80	4,61	Z	●
6388691	KTFSS21829HPGM	21,83	4,62	Z	●
6388693	KTFSS21900HPGM	21,90	4,63	Z	●
6388695	KTFSS22000HPGM	22,00	4,72	ZA	●
6388697	KTFSS22100HPGM	22,10	4,73	ZA	●

148-151	152	47-49	88, 156

KenTIP™ FS • Insert • HPG Geometry

(continued)

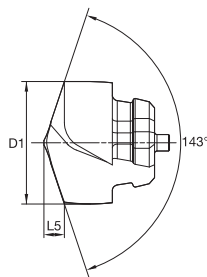

- first choice
- alternate choice

P	■	●
M	■	○
K	■	○
N	■	○
S	■	○
H	■	○
C	■	○

order number	ISO catalogue number	D1	L5	SSC	KCP15A
6388699	KTFSS22200HPGM	22,20	4,75	ZA	●
6388701	KTFSS22225HPGM	22,23	4,75	ZA	●
6388703	KTFSS22400HPGM	22,40	4,78	ZA	●
6388705	KTFSS22500HPGM	22,50	4,80	ZA	●
6388707	KTFSS22600HPGM	22,60	4,82	ZA	●
6388709	KTFSS22700HPGM	22,70	4,83	ZA	●
6388711	KTFSS22800HPGM	22,80	4,85	ZA	●
6388713	KTFSS22900HPGM	22,90	4,87	ZA	●
6388715	KTFSS23000HPGM	23,00	4,89	ZB	●
6388717	KTFSS23100HPGM	23,10	4,91	ZB	●
6388719	KTFSS23200HPGM	23,20	4,92	ZB	●
6388721	KTFSS23300HPGM	23,30	4,94	ZB	●
6388723	KTFSS23400HPGM	23,40	4,96	ZB	●
6388725	KTFSS23416HPGM	23,42	4,96	ZB	●
6388727	KTFSS23500HPGM	23,50	4,98	ZB	●
6388729	KTFSS23600HPGM	23,60	4,99	ZB	●
6388731	KTFSS23700HPGM	23,70	5,01	ZB	●
6388733	KTFSS23800HPGM	23,80	5,03	ZB	●
6388735	KTFSS23813HPGM	23,81	5,03	ZB	●
6388737	KTFSS23900HPGM	23,90	5,04	ZB	●
6388739	KTFSS24000HPGM	24,00	5,13	ZC	●
6388741	KTFSS24100HPGM	24,10	5,14	ZC	●
6388743	KTFSS24200HPGM	24,20	5,16	ZC	●
6388745	KTFSS24300HPGM	24,30	5,18	ZC	●
6388747	KTFSS24400HPGM	24,40	5,19	ZC	●
6388750	KTFSS24500HPGM	24,50	5,21	ZC	●
6388752	KTFSS24600HPGM	24,60	5,23	ZC	●
6388754	KTFSS24608HPGM	24,61	5,23	ZC	●
6388756	KTFSS24700HPGM	24,70	5,24	ZC	●
6388758	KTFSS24800HPGM	24,80	5,26	ZC	●
6388760	KTFSS24900HPGM	24,90	5,28	ZC	●
6388762	KTFSS25000HPGM	25,00	5,30	ZD	●
6388764	KTFSS25100HPGM	25,10	5,32	ZD	●
6388766	KTFSS25200HPGM	25,20	5,33	ZD	●
6388768	KTFSS25250HPGM	25,25	5,34	ZD	●
6388770	KTFSS25300HPGM	25,30	5,35	ZD	●
6388772	KTFSS25400HPGM	25,40	5,37	ZD	●
6388774	KTFSS25500HPGM	25,50	5,38	ZD	●
6388776	KTFSS25540HPGM	25,54	5,39	ZD	●
6388778	KTFSS25600HPGM	25,60	5,40	ZD	●
6388780	KTFSS25679HPGM	25,68	5,41	ZD	●
6388782	KTFSS25700HPGM	25,70	5,42	ZD	●
6388783	KTFSS25800HPGM	25,80	5,44	ZD	●
6388785	KTFSS25806HPGM	25,81	5,44	ZD	●
6388788	KTFSS25900HPGM	25,90	5,45	ZD	●
6388790	KTFSS26000HPGM	26,00	5,47	ZD	●

148-151	152	47-49	88, 156

KenTIP™ FS • Insert • HPL Geometry

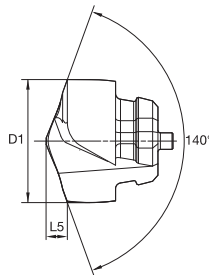

- first choice
- alternate choice

P	Blue	●
M	Yellow	●
K	Red	●
N	Green	●
S	Orange	○
H	Grey	●
C	Brown	●

order number	ISO catalogue number	D1	L5	SSC	KCMS15
6370956	KTFST06000HPLM	6,00	1,34	A	●
6370971	KTFST06350HPLM	6,35	1,40	B	●
6370974	KTFST06500HPLM	6,50	1,43	B	●
6370977	KTFST06629HPLM	6,63	1,46	C	●
6370980	KTFST06800HPLM	6,80	1,49	C	●
6370983	KTFST07000HPLM	7,00	1,53	D	●
6370986	KTFST07500HPLM	7,50	1,63	E	●
6370987	KTFST07800HPLM	7,80	1,68	E	●
6370990	KTFST07938HPLM	7,94	1,71	E	●
6370992	KTFST08000HPLM	8,00	1,72	F	●
6370994	KTFST08100HPLM	8,10	1,74	F	●
6370997	KTFST08204HPLM	8,20	1,76	F	●
6371000	KTFST08334HPLM	8,33	1,79	F	●
6371003	KTFST08400HPLM	8,40	1,80	F	●
6371006	KTFST08500HPLM	8,50	1,82	G	●
6371009	KTFST08600HPLM	8,60	1,84	G	●
6371012	KTFST08700HPLM	8,70	1,86	G	●
6371015	KTFST08800HPLM	8,80	1,88	G	●
6371018	KTFST08900HPLM	8,90	1,90	G	●
6371031	KTFST09000HPLM	9,00	1,93	H	●
6371033	KTFST09100HPLM	9,10	1,95	H	●
6371035	KTFST09200HPLM	9,20	1,97	H	●
6371037	KTFST09400HPLM	9,40	2,00	H	●
6371039	KTFST09500HPLM	9,50	2,03	I	●
6371040	KTFST09558HPLM	9,56	2,04	I	●
6371041	KTFST09600HPLM	9,60	2,05	I	●
6371042	KTFST09700HPLM	9,70	2,07	I	●
6371043	KTFST09800HPLM	9,80	2,09	I	●
6371044	KTFST09900HPLM	9,90	2,11	I	●
6371045	KTFST10000HPLM	10,00	2,13	J	●
6371046	KTFST10100HPLM	10,10	2,15	J	●
6371047	KTFST10200HPLM	10,20	2,17	J	●
6371048	KTFST10300HPLM	10,30	2,19	J	●
6371049	KTFST10320HPLM	10,32	2,19	J	●
6371050	KTFST10400HPLM	10,40	2,21	J	●
6371051	KTFST10500HPLM	10,50	2,23	K	●
6371052	KTFST10600HPLM	10,60	2,25	K	●
6371053	KTFST10700HPLM	10,70	2,27	K	●
6371054	KTFST10800HPLM	10,80	2,29	K	●
6371055	KTFST10900HPLM	10,90	2,31	K	●
6371056	KTFST11000HPLM	11,00	2,34	L	●
6371057	KTFST11100HPLM	11,10	2,35	L	●
6371058	KTFST11113HPLM	11,11	2,36	L	●
6371059	KTFST11200HPLM	11,20	2,37	L	●
6371060	KTFST11400HPLM	11,40	2,41	L	●
6371061	KTFST11500HPLM	11,50	2,44	M	●
6371062	KTFST11600HPLM	11,60	2,46	M	●
6371063	KTFST11800HPLM	11,80	2,49	M	●
6371064	KTFST11908HPLM	11,91	2,52	M	●
6371065	KTFST12000HPLM	12,00	2,54	N	●
6371066	KTFST12200HPLM	12,20	2,58	N	●
6371067	KTFST12304HPLM	12,30	2,60	N	●
6371068	KTFST12500HPLM	12,50	2,64	O	●
6371069	KTFST12700HPLM	12,70	2,68	O	●
6371070	KTFST12800HPLM	12,80	2,70	O	●
6371071	KTFST12900HPLM	12,90	2,72	O	●

148-151	152	47-49	88, 156



KentIP™ FS • Insert • HPL Geometry

(continued)

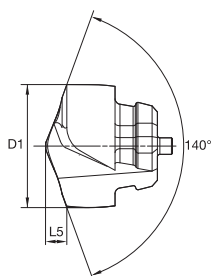

- first choice
- alternate choice

P	■	●
M	■	●
K	■	●
N	■	●
S	■	○
H	■	●
C	■	●

order number	ISO catalogue number	D1	L5	SSC	KCMS15
6371072	KTFST13000HPLM	13,00	2,74	P	●
6371073	KTFST13096HPLM	13,10	2,76	P	●
6371074	KTFST13200HPLM	13,20	2,78	P	●
6371075	KTFST13492HPLM	13,49	2,84	P	●
6371076	KTFST13500HPLM	13,50	2,84	Q	●
6371077	KTFST13800HPLM	13,80	2,90	Q	●
6371078	KTFST13891HPLM	13,89	2,92	Q	●
6371079	KTFST13896HPLM	13,90	2,92	Q	●
6371080	KTFST14000HPLM	14,00	2,95	R	●
6371081	KTFST14100HPLM	14,10	2,96	R	●
6371082	KTFST14200HPLM	14,20	2,98	R	●
6371083	KTFST14288HPLM	14,29	3,00	R	●
6371084	KTFST14300HPLM	14,30	3,00	R	●
6371085	KTFST14400HPLM	14,40	3,02	R	●
6371086	KTFST14500HPLM	14,50	3,05	S	●
6371087	KTFST14684HPLM	14,68	3,08	S	●
6371088	KTFST14800HPLM	14,80	3,10	S	●
6371089	KTFST15000HPLM	15,00	3,15	T	●
6371090	KTFST15100HPLM	15,10	3,17	T	●
6371111	KTFST15200HPLM	15,20	3,19	T	●
6371112	KTFST15500HPLM	15,50	3,24	T	●
6371113	KTFST15875HPLM	15,88	3,31	T	●
6370906	KTFST16000HPLM	16,00	3,35	U	●
6370907	KTFST16104HPLM	16,10	3,37	U	●
6370911	KTFST16150HPLM	16,15	3,38	U	●
6370913	KTFST16271HPLM	16,27	3,40	U	●
6370916	KTFST16500HPLM	16,50	3,45	U	●
6370918	KTFST16670HPLM	16,67	3,48	U	●
6370920	KTFST17000HPLM	17,00	3,55	V	●
6370922	KTFST17463HPLM	17,46	3,64	V	●
6370924	KTFST17480HPLM	17,48	3,64	V	●
6370926	KTFST17500HPLM	17,50	3,65	V	●
6370927	KTFST17700HPLM	17,70	3,69	V	●
6370929	KTFST18000HPLM	18,00	3,76	W	●
6370931	KTFST18258HPLM	18,26	3,80	W	●
6370933	KTFST18500HPLM	18,50	3,85	W	●
6370935	KTFST18654HPLM	18,65	3,88	W	●
6370937	KTFST19000HPLM	19,00	3,96	X	●
6370939	KTFST19050HPLM	19,05	3,97	X	●
6370941	KTFST19200HPLM	19,20	3,99	X	●
6370942	KTFST19228HPLM	19,23	4,00	X	●
6370944	KTFST19253HPLM	19,25	4,00	X	●
6370947	KTFST19279HPLM	19,28	4,01	X	●
6370949	KTFST19355HPLM	19,36	4,02	X	●
6370951	KTFST19446HPLM	19,45	4,04	X	●
6370955	KTFST19500HPLM	19,50	4,05	X	●
6370957	KTFST19845HPLM	19,85	4,12	X	●
6370972	KTFST20000HPLM	20,00	4,16	Y	●
6370975	KTFST20500HPLM	20,50	4,25	Y	●
6370978	KTFST20638HPLM	20,64	4,28	Y	●
6370981	KTFST21000HPLM	21,00	4,36	Z	●
6370982	KTFST21150HPLM	21,15	4,39	Z	●
6370985	KTFST21500HPLM	21,50	4,45	Z	●
6370988	KTFST22000HPLM	22,00	4,56	ZA	●
6370991	KTFST22225HPLM	22,23	4,60	ZA	●
6370993	KTFST22500HPLM	22,50	4,66	ZA	●

148-151	152	47-49	88, 156
---------	-----	-------	---------

KenTIP™ FS • Insert • HPL Geometry

(continued)

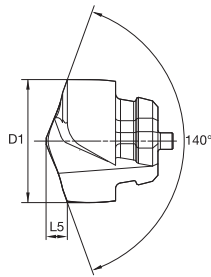

- first choice
- alternate choice

P	Blue	
M	Yellow	●
K	Red	
N	Green	
S	Orange	○
H	Grey	
C	Brown	

order number	ISO catalogue number	D1	L5	SSC	KCMS15
6370996	KTFST23000HPLM	23,00	4,76	ZB	●
6370999	KTFST23500HPLM	23,50	4,86	ZB	●
6371002	KTFST23813HPLM	23,81	4,92	ZB	●
6371005	KTFST24000HPLM	24,00	4,96	ZC	●
6371008	KTFST24500HPLM	24,50	5,06	ZC	●
6371011	KTFST25000HPLM	25,00	5,17	ZD	●
6371014	KTFST25400HPLM	25,40	5,24	ZD	●
6371017	KTFST25500HPLM	25,50	5,26	ZD	●
6371020	KTFST25600HPLM	25,60	5,28	ZD	●
6371032	KTFST25650HPLM	25,65	5,29	ZD	●
6371034	KTFST25679HPLM	25,68	5,29	ZD	●
6371036	KTFST25806HPLM	25,81	5,32	ZD	●
6371038	KTFST26000HPLM	26,00	5,37	ZD	●

148-151	152	47-49	88, 156

KenTIP™ FS • Insert • HPC Geometry

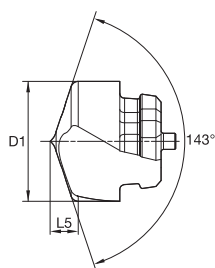

● first choice

○ alternate choice

P	Blue	○
M	Yellow	○
K	Red	●
N	Green	○
S	Orange	○
H	Grey	○
C	Brown	○

order number	ISO catalogue number	D1	L5	SSC	KC7410
6370700	KTFST06000HPCM	6,00	1,38	A	●
6370871	KTFST06200HPCM	6,20	1,41	A	●
6370872	KTFST06350HPCM	6,35	1,46	B	●
6370873	KTFST06500HPCM	6,50	1,48	B	●
6370874	KTFST06530HPCM	6,53	1,49	B	●
6370876	KTFST06700HPCM	6,70	1,53	C	●
6370875	KTFST06746HPCM	6,75	1,54	C	●
6370877	KTFST06800HPCM	6,80	1,55	C	●
6370878	KTFST07000HPCM	7,00	1,62	D	●
6370879	KTFST07145HPCM	7,15	1,64	D	●
6370880	KTFST07300HPCM	7,30	1,67	D	●
6370881	KTFST07500HPCM	7,50	1,73	E	●
6370882	KTFST07600HPCM	7,60	1,74	E	●
6370883	KTFST07800HPCM	7,80	1,78	E	●
6370884	KTFST07938HPCM	7,94	1,80	E	●
6370885	KTFST08000HPCM	8,00	1,85	F	●
6370886	KTFST08100HPCM	8,10	1,87	F	●
6370887	KTFST08204HPCM	8,20	1,88	F	●
6370888	KTFST08500HPCM	8,50	1,96	G	●
6370889	KTFST08600HPCM	8,60	1,98	G	●
6370890	KTFST08700HPCM	8,70	1,99	G	●
6370891	KTFST08733HPCM	8,73	2,00	G	●
6370892	KTFST09000HPCM	9,00	2,08	H	●
6370893	KTFST09100HPCM	9,10	2,10	H	●
6370894	KTFST09500HPCM	9,50	2,19	I	●
6370895	KTFST09525HPCM	9,53	2,20	I	●
6370896	KTFST09600HPCM	9,60	2,21	I	●
6370897	KTFST09700HPCM	9,70	2,23	I	●
6370898	KTFST09800HPCM	9,80	2,24	I	●
6370899	KTFST09921HPCM	9,92	2,27	I	●
6370900	KTFST10000HPCM	10,00	2,32	J	●
6370901	KTFST10023HPCM	10,02	2,32	J	●
6370902	KTFST10200HPCM	10,20	2,35	J	●
6370903	KTFST10300HPCM	10,30	2,37	J	●
6370904	KTFST10320HPCM	10,32	2,27	J	●
6370905	KTFST10500HPCM	10,50	2,43	K	●
6370908	KTFST10600HPCM	10,60	2,45	K	●
6370910	KTFST10700HPCM	10,70	2,46	K	●
6370912	KTFST10716HPCM	10,72	2,46	K	●
6370914	KTFST10800HPCM	10,80	2,48	K	●
6370915	KTFST11000HPCM	11,00	2,55	L	●
6370917	KTFST11100HPCM	11,10	2,57	L	●
6370919	KTFST11113HPCM	11,11	2,57	L	●
6370921	KTFST11400HPCM	11,40	2,62	L	●
6370923	KTFST11500HPCM	11,50	2,66	M	●
6370925	KTFST11800HPCM	11,80	2,71	M	●
6370928	KTFST11908HPCM	11,91	2,73	M	●
6370930	KTFST12000HPCM	12,00	2,78	N	●
6370932	KTFST12304HPCM	12,30	2,84	N	●
6370934	KTFST12500HPCM	12,50	2,90	O	●
6370936	KTFST12700HPCM	12,70	2,93	O	●
6370938	KTFST13000HPCM	13,00	3,02	P	●
6370940	KTFST13096HPCM	13,10	3,03	P	●
6370943	KTFST13200HPCM	13,20	3,05	P	●
6370945	KTFST13300HPCM	13,30	3,07	P	●
6370946	KTFST13492HPCM	13,49	3,10	P	●

148-151	152	47-49	88, 156



KenTIP™ FS • Insert • HPC Geometry

(continued)

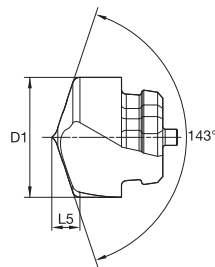

● first choice
○ alternate choice

P	■	○
M	■	○
K	■	●
N	■	○
S	■	○
H	■	○
C	■	○

order number	ISO catalogue number	D1	L5	SSC	KC7410
6370948	KTFST13500HPCM	13,50	3,13	Q	●
6370950	KTFST13600HPCM	13,60	3,15	Q	●
6370952	KTFST13800HPCM	13,80	3,18	Q	●
6370954	KTFST13891HPCM	13,89	3,19	Q	●
6370958	KTFST14000HPCM	14,00	3,25	R	●
6370960	KTFST14100HPCM	14,10	3,27	R	●
6370973	KTFST14288HPCM	14,29	3,30	R	●
6370976	KTFST14500HPCM	14,50	3,36	S	●
6370979	KTFST14600HPCM	14,60	3,38	S	●
6370984	KTFST14684HPCM	14,68	3,39	S	●
6370989	KTFST14800HPCM	14,80	3,41	S	●
6370995	KTFST15000HPCM	15,00	3,49	T	●
6370998	KTFST15083HPCM	15,08	3,50	T	●
6371001	KTFST15100HPCM	15,10	3,50	T	●
6371004	KTFST15200HPCM	15,20	3,52	T	●
6371007	KTFST15300HPCM	15,30	3,54	T	●
6371010	KTFST15500HPCM	15,50	3,57	T	●
6371013	KTFST15600HPCM	15,60	3,59	T	●
6371016	KTFST15800HPCM	15,80	3,62	T	●
6371019	KTFST15875HPCM	15,88	3,63	T	●
6370147	KTFST16000HPCM	16,00	3,73	U	●
6370149	KTFST16100HPCM	16,10	3,74	U	●
6370148	KTFST16104HPCM	16,10	3,74	U	●
6370150	KTFST16200HPCM	16,20	3,76	U	●
6370351	KTFST16271HPCM	16,27	3,80	U	●
6370352	KTFST16300HPCM	16,30	3,78	U	●
6370353	KTFST16500HPCM	16,50	3,81	U	●
6370354	KTFST16550HPCM	16,55	3,82	U	●
6370355	KTFST16600HPCM	16,60	3,83	U	●
6370356	KTFST16670HPCM	16,67	3,87	U	●
6370357	KTFST17000HPCM	17,00	3,95	V	●
6370358	KTFST17066HPCM	17,07	4,00	V	●
6370359	KTFST17100HPCM	17,10	3,96	V	●
6370360	KTFST17200HPCM	17,20	3,98	V	●
6370361	KTFST17300HPCM	17,30	4,00	V	●
6370362	KTFST17463HPCM	17,46	4,02	V	●
6370363	KTFST17500HPCM	17,50	4,03	V	●
6370364	KTFST17550HPCM	17,55	4,04	V	●
6370365	KTFST17600HPCM	17,60	4,05	V	●
6370366	KTFST17700HPCM	17,70	4,06	V	●
6370367	KTFST17800HPCM	17,80	4,08	V	●
6370368	KTFST18000HPCM	18,00	4,19	W	●
6370369	KTFST18100HPCM	18,10	4,21	W	●
6370370	KTFST18258HPCM	18,26	4,24	W	●
6370381	KTFST18500HPCM	18,50	4,28	W	●
6370382	KTFST18600HPCM	18,60	4,29	W	●
6370383	KTFST18700HPCM	18,70	4,31	W	●
6370384	KTFST19000HPCM	19,00	4,41	X	●
6370385	KTFST19050HPCM	19,05	4,42	X	●
6370386	KTFST19279HPCM	19,28	4,46	X	●
6370387	KTFST19446HPCM	19,45	4,49	X	●
6370388	KTFST19500HPCM	19,50	4,50	X	●
6370389	KTFST19800HPCM	19,80	4,55	X	●
6370390	KTFST20000HPCM	20,00	4,66	Y	●
6370401	KTFST20241HPCM	20,24	4,70	Y	●
6370402	KTFST20300HPCM	20,30	4,71	Y	●

148-151	152	47-49	88, 156

KentIP™ FS • Insert • HPC Geometry

(continued)

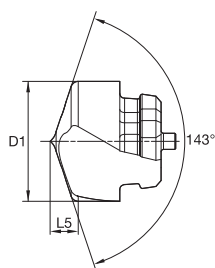

- first choice
- alternate choice

P	■	○
M	■	
K	■	●
N	■	
S	■	
H	■	
C	■	

order number	ISO catalogue number	D1	L5	SSC	KCT410
6370403	KTFST20500HPCM	20,50	4,74	Y	●
6370404	KTFST20638HPCM	20,64	4,77	Y	●
6370405	KTFST21000HPCM	21,00	4,88	Z	●
6370406	KTFST21433HPCM	21,43	5,00	Z	●
6370407	KTFST21500HPCM	21,50	4,97	Z	●
6370408	KTFST22000HPCM	22,00	5,13	ZA	●
6370409	KTFST22225HPCM	22,23	5,20	ZA	●
6370410	KTFST22440HPCM	22,44	5,20	ZA	●
6370411	KTFST22500HPCM	22,50	5,21	ZA	●
6370412	KTFST23000HPCM	23,00	5,35	ZB	●
6370413	KTFST23416HPCM	23,42	5,42	ZB	●
6370414	KTFST23500HPCM	23,50	5,43	ZB	●
6370415	KTFST23813HPCM	23,81	5,49	ZB	●
6370416	KTFST24000HPCM	24,00	5,63	ZC	●
6370417	KTFST24500HPCM	24,50	5,72	ZC	●
6370418	KTFST24608HPCM	24,61	5,70	ZC	●
6370419	KTFST25000HPCM	25,00	5,87	ZD	●
6370420	KTFST25070HPCM	25,07	5,88	ZD	●
6370421	KTFST25400HPCM	25,40	5,88	ZD	●
6370422	KTFST25500HPCM	25,50	5,95	ZD	●
6370423	KTFST25679HPCM	25,68	5,93	ZD	●
6370424	KTFST25806HPCM	25,81	5,95	ZD	●
6370425	KTFST26000HPCM	26,00	6,03	ZD	●

148-151	152	47-49	88, 156

KenTIP™ FS • Insert • DAV Geometry

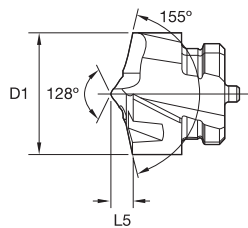
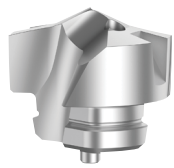

- first choice
- alternate choice

P	■	■
M	■	■
K	■	■
N	■	●
S	■	○
H	■	■
C	■	●

order number	ISO catalogue number	D1	L5	SSC	KN15
6957701	KTFST06350DAVM	6,35	1,12	B	●
6957702	KTFST07938DAVM	7,94	1,38	E	●
6957703	KTFST09525DAVM	9,53	1,69	I	●
6957704	KTFST11113DAVM	11,11	1,96	L	●
6957705	KTFST12700DAVM	12,70	2,24	O	●

KenTIP FS • Insert • SPF Geometry

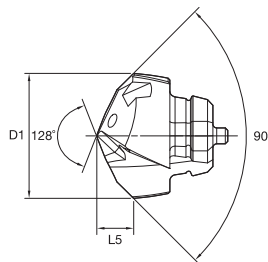

- first choice
- alternate choice

P	■	■
M	■	■
K	■	■
N	■	■
S	■	■
H	■	■
C	■	●

order number	ISO catalogue number	D1	L5	SSC	KCC10
6773154	KTFST06350SPFM	6,35	1,54	B	●
6773155	KTFST07938SPFM	7,94	1,94	E	●
6773160	KTFST09525SPFM	9,53	2,38	I	●
6773171	KTFST11113SPFM	11,11	2,46	L	●
6773172	KTFST12700SPFM	12,70	3,10	O	●

148-151	152	47-49	88, 156

KenTIP™ FS • Insert • FEG Geometry

- first choice
- alternate choice

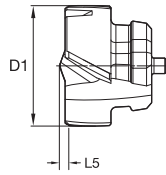

P	●
M	○
K	●
N	●
S	●
H	●
C	●





order number	ISO catalogue number	D1	L5	SSC	KCP15A
6771074	KTFSS06000FEGM	6,00	0,53	A	●
6771075	KTFSS06500FEGM	6,50	0,56	B	●
6771076	KTFSS06800FEGM	6,80	0,58	C	●
6771077	KTFSS07000FEGM	7,00	0,60	D	●
6771078	KTFSS07500FEGM	7,50	0,64	E	●
6771079	KTFSS07938FEGM	7,94	0,65	E	●
6771080	KTFSS08000FEGM	8,00	0,67	F	●
6771111	KTFSS08500FEGM	8,50	0,71	G	●
6771112	KTFSS08520FEGM	8,52	0,71	G	●
6771113	KTFSS09000FEGM	9,00	0,74	H	●
6771114	KTFSS09500FEGM	9,50	0,78	I	●
6771115	KTFSS09525FEGM	9,53	0,78	I	●
6771116	KTFSS10000FEGM	10,00	0,81	J	●
6771117	KTFSS10200FEGM	10,20	0,82	J	●
6771118	KTFSS10500FEGM	10,50	0,84	K	●
6771119	KTFSS10800FEGM	10,80	0,85	K	●
6771120	KTFSS11000FEGM	11,00	0,88	L	●
6771121	KTFSS11113FEGM	11,11	0,88	L	●
6771122	KTFSS11500FEGM	11,50	0,91	M	●
6771123	KTFSS11800FEGM	11,80	0,92	M	●
6771124	KTFSS12000FEGM	12,00	0,94	N	●
6771125	KTFSS12304FEGM	12,30	0,95	N	●
6771127	KTFSS12500FEGM	12,50	0,98	O	●
6771128	KTFSS12700FEGM	12,70	0,98	O	●
6771129	KTFSS13000FEGM	13,00	1,01	P	●
6771130	KTFSS13500FEGM	13,50	1,04	Q	●
6771131	KTFSS14000FEGM	14,00	1,07	R	●
6771132	KTFSS14288FEGM	14,29	1,08	R	●
6771133	KTFSS14500FEGM	14,50	1,10	S	●
6771134	KTFSS15000FEGM	15,00	1,14	T	●
6771135	KTFSS15300FEGM	15,30	1,14	T	●
6771136	KTFSS15500FEGM	15,50	1,15	T	●
6771137	KTFSS15875FEGM	15,88	1,15	T	●
6771138	KTFSS16000FEGM	16,00	1,20	U	●
6771139	KTFSS16500FEGM	16,50	1,21	U	●
6771140	KTFSS16670FEGM	16,67	1,21	U	●
6771151	KTFSS17000FEGM	17,00	1,26	V	●
6771152	KTFSS17463FEGM	17,46	1,27	V	●
6771153	KTFSS17500FEGM	17,50	1,27	V	●
6771154	KTFSS17700FEGM	17,70	1,27	V	●
6771155	KTFSS18000FEGM	18,00	1,32	W	●
6771156	KTFSS18500FEGM	18,50	1,33	W	●
6771157	KTFSS19000FEGM	19,00	1,38	X	●
6771158	KTFSS19050FEGM	19,05	1,39	X	●
6771159	KTFSS19200FEGM	19,20	1,39	X	●
6771160	KTFSS19500FEGM	19,50	1,39	X	●
6771161	KTFSS20000FEGM	20,00	1,45	Y	●
6771162	KTFSS20500FEGM	20,50	1,45	Y	●
6771163	KTFSS20638FEGM	20,64	1,46	Y	●
6771164	KTFSS21000FEGM	21,00	1,51	Z	●
6771165	KTFSS21500FEGM	21,50	1,51	Z	●
6771166	KTFSS22000FEGM	22,00	1,57	ZA	●
6771167	KTFSS22225FEGM	22,23	1,57	ZA	●
6771168	KTFSS22500FEGM	22,50	1,57	ZA	●
6771169	KTFSS23000FEGM	23,00	1,63	ZB	●
6771170	KTFSS23500FEGM	23,50	1,63	ZB	●
6771171	KTFSS24000FEGM	24,00	1,69	ZC	●
6771172	KTFSS24500FEGM	24,50	1,69	ZC	●
6771173	KTFSS25000FEGM	25,00	1,74	ZD	●
6771174	KTFSS25400FEGM	25,40	1,75	ZD	●
6771175	KTFSS26000FEGM	26,00	1,76	ZD	●

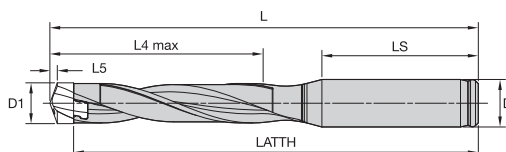

KentIP™ FS • Drill Body • 1.5 x D • SS Shank • Metric





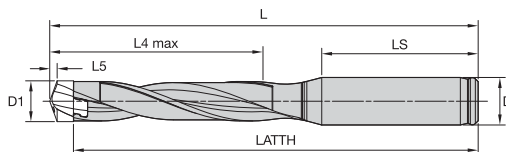

order number	ISO catalogue number	D1	D1 max	L4 max	L	LATTH	LS	D	SSC
6389570	KTFS060R01SS08M	6,00	6,299	9,00	57,00	53,50	37,00	8,00	A
6389571	KTFS063R01SS08M	6,30	6,599	10,00	58,00	54,30	37,00	8,00	B
6389572	KTFS066R01SS08M	6,60	6,999	11,00	60,00	56,20	37,00	8,00	C
6389573	KTFS070R01SS08M	7,00	7,499	11,00	60,00	55,90	37,00	8,00	D
6389574	KTFS075R01SS08M	7,50	7,999	12,00	61,00	56,60	37,00	8,00	E
6389575	KTFS080R01SS10M	8,00	8,499	13,00	68,00	63,40	41,00	10,00	F
6389576	KTFS085R01SS10M	8,50	8,999	14,00	69,00	64,10	41,00	10,00	G
6389577	KTFS090R01SS10M	9,00	9,499	14,00	69,00	63,80	41,00	10,00	H
6389578	KTFS095R01SS10M	9,50	9,999	15,00	70,00	64,50	41,00	10,00	I
6389448	KTFS100R01SS12M	10,00	10,499	16,00	78,00	72,20	46,00	12,00	J
6389449	KTFS105R01SS12M	10,50	10,999	17,00	79,00	72,90	46,00	12,00	K
6389450	KTFS110R01SS12M	11,00	11,499	17,00	79,00	72,60	46,00	12,00	L
6389471	KTFS115R01SS12M	11,50	11,999	18,00	80,00	73,30	46,00	12,00	M
6389472	KTFS120R01SS14M	12,00	12,499	19,00	83,00	76,00	46,00	14,00	N
6389473	KTFS125R01SS14M	12,50	12,999	20,00	84,00	76,80	46,00	14,00	O
6389474	KTFS130R01SS14M	13,00	13,499	20,00	84,00	76,50	46,00	14,00	P
6389475	KTFS135R01SS14M	13,50	13,999	21,00	85,00	77,20	46,00	14,00	Q
6389476	KTFS140R01SS16M	14,00	14,499	22,00	90,00	81,90	49,00	16,00	R
6389477	KTFS145R01SS16M	14,50	14,999	23,00	91,00	82,60	49,00	16,00	S
6389478	KTFS150R01SS16M	15,00	15,999	24,00	92,00	83,30	49,00	16,00	T
6389479	KTFS160R01SS16M	16,00	16,999	26,00	94,00	84,70	49,00	16,00	U
6389480	KTFS170R01SS20M	17,00	17,999	27,00	100,00	90,10	51,00	20,00	V
6389566	KTFS180R01SS20M	18,00	18,999	29,00	102,00	91,60	51,00	20,00	W
6389567	KTFS190R01SS20M	19,00	19,999	30,00	103,00	92,00	51,00	20,00	X

			
148-151	152	47-49	88, 156

KenTIP™ FS • Drill Body • 3 x D • SS Shank • Metric





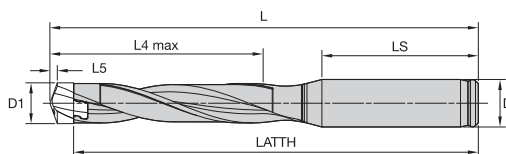

order number	ISO catalogue number	D1	D1 max	L4 max	L	LATTH	LS	D	SSC
6389361	KTFS060R03SS08M	6,00	6,299	19,00	67,00	63,50	37,00	8,00	A
6389362	KTFS063R03SS08M	6,30	6,599	20,00	68,00	64,30	37,00	8,00	B
6389363	KTFS066R03SS08M	6,60	6,999	21,00	70,00	66,20	37,00	8,00	C
6389364	KTFS070R03SS08M	7,00	7,499	23,00	72,00	67,90	37,00	8,00	D
6389365	KTFS075R03SS08M	7,50	7,999	24,00	73,00	68,60	37,00	8,00	E
6389366	KTFS080R03SS10M	8,00	8,499	26,00	81,00	76,40	41,00	10,00	F
6389367	KTFS085R03SS10M	8,50	8,999	27,00	82,00	77,10	41,00	10,00	G
6389368	KTFS090R03SS10M	9,00	9,499	29,00	84,00	78,80	41,00	10,00	H
6389369	KTFS095R03SS10M	9,50	9,999	30,00	85,00	79,50	41,00	10,00	I
6371340	KTFS100R03SS12M	10,00	10,499	32,00	94,00	88,20	46,00	12,00	J
6371961	KTFS105R03SS12M	10,50	10,999	33,00	95,00	88,90	46,00	12,00	K
6371962	KTFS110R03SS12M	11,00	11,499	35,00	97,00	90,60	46,00	12,00	L
6371963	KTFS115R03SS12M	11,50	11,999	36,00	98,00	91,30	46,00	12,00	M
6371964	KTFS120R03SS14M	12,00	12,499	38,00	102,00	95,00	46,00	14,00	N
6371965	KTFS125R03SS14M	12,50	12,999	39,00	103,00	95,80	46,00	14,00	O
6371966	KTFS130R03SS14M	13,00	13,499	41,00	105,00	97,50	46,00	14,00	P
6371967	KTFS135R03SS14M	13,50	13,999	42,00	106,00	98,20	46,00	14,00	Q
6371968	KTFS140R03SS16M	14,00	14,499	44,00	112,00	103,90	49,00	16,00	R
6371969	KTFS145R03SS16M	14,50	14,999	45,00	113,00	104,60	49,00	16,00	S
6371970	KTFS150R03SS16M	15,00	15,999	48,00	116,00	107,30	49,00	16,00	T
6371971	KTFS160R03SS16M	16,00	16,999	51,00	119,00	109,70	49,00	16,00	U
6371972	KTFS170R03SS20M	17,00	17,999	54,00	127,00	117,10	51,00	20,00	V
6389147	KTFS180R03SS20M	18,00	18,999	57,00	130,00	119,60	51,00	20,00	W
6389148	KTFS190R03SS20M	19,00	19,999	60,00	133,00	122,00	51,00	20,00	X

			
148-151	152	47-49	88, 156

KenTIP™ FS • Drill Body • 5 x D • SS Shank • Metric



order number	ISO catalogue number	D1	D1 max	L4 max	L	LATTH	LS	D	SSC
6389370	KTFS060R05SS08M	6,00	6,299	32,00	80,00	76,50	37,00	8,00	A
6389381	KTFS063R05SS08M	6,30	6,599	33,00	81,00	77,30	37,00	8,00	B
6389382	KTFS066R05SS08M	6,60	6,999	35,00	84,00	80,20	37,00	8,00	C
6389383	KTFS070R05SS08M	7,00	7,499	38,00	87,00	82,90	37,00	8,00	D
6389384	KTFS075R05SS08M	7,50	7,999	40,00	89,00	84,60	37,00	8,00	E
6389385	KTFS080R05SS10M	8,00	8,499	43,00	98,00	93,40	41,00	10,00	F
6389386	KTFS085R05SS10M	8,50	8,999	45,00	100,00	95,10	41,00	10,00	G
6389387	KTFS090R05SS10M	9,00	9,499	48,00	103,00	97,80	41,00	10,00	H
6389388	KTFS095R05SS10M	9,50	9,999	50,00	105,00	99,50	41,00	10,00	I
6371973	KTFS100R05SS12M	10,00	10,499	53,00	115,00	109,20	46,00	12,00	J
6371974	KTFS105R05SS12M	10,50	10,999	55,00	117,00	110,90	46,00	12,00	K
6371975	KTFS110R05SS12M	11,00	11,499	58,00	120,00	113,60	46,00	12,00	L
6371976	KTFS115R05SS12M	11,50	11,999	60,00	122,00	115,30	46,00	12,00	M
6371977	KTFS120R05SS14M	12,00	12,499	63,00	127,00	120,00	46,00	14,00	N
6371978	KTFS125R05SS14M	12,50	12,999	65,00	129,00	121,80	46,00	14,00	O
6371979	KTFS130R05SS14M	13,00	13,499	68,00	132,00	124,50	46,00	14,00	P
6371980	KTFS135R05SS14M	13,50	13,999	70,00	134,00	126,20	46,00	14,00	Q
6371981	KTFS140R05SS16M	14,00	14,499	73,00	141,00	132,90	49,00	16,00	R
6371982	KTFS145R05SS16M	14,50	14,999	75,00	143,00	134,60	49,00	16,00	S
6371983	KTFS150R05SS16M	15,00	15,999	80,00	148,00	139,30	49,00	16,00	T
6371984	KTFS160R05SS16M	16,00	16,999	85,00	153,00	143,70	49,00	16,00	U
6371985	KTFS170R05SS20M	17,00	17,999	90,00	163,00	153,10	51,00	20,00	V
6389149	KTFS180R05SS20M	18,00	18,999	95,00	168,00	157,60	51,00	20,00	W
6389150	KTFS190R05SS20M	19,00	19,999	100,00	173,00	162,00	51,00	20,00	X

			
148-151	152	47-49	88, 156

KenTIP™ FS • Drill Body • 8 x D • SS Shank • Metric

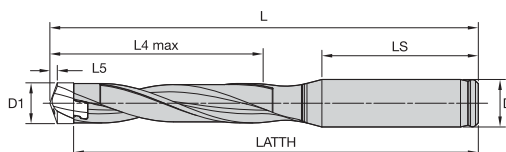

order number	ISO catalogue number	D1	D1 max	L4 max	L	LATTH	LS	D	SSC
6389389	KTFS060R08SS08M	6,00	6,299	50,00	98,00	94,50	37,00	8,00	A
6389390	KTFS063R08SS08M	6,30	6,599	53,00	101,00	97,30	37,00	8,00	B
6389391	KTFS066R08SS08M	6,60	6,999	56,00	105,00	101,20	37,00	8,00	C
6389392	KTFS070R08SS08M	7,00	7,499	60,00	109,00	104,90	37,00	8,00	D
6389393	KTFS075R08SS08M	7,50	7,999	64,00	113,00	108,60	37,00	8,00	E
6389394	KTFS080R08SS10M	8,00	8,499	68,00	123,00	118,40	41,00	10,00	F
6389395	KTFS085R08SS10M	8,50	8,999	72,00	127,00	122,10	41,00	10,00	G
6389396	KTFS090R08SS10M	9,00	9,499	76,00	131,00	125,80	41,00	10,00	H
6389397	KTFS095R08SS10M	9,50	9,999	80,00	135,00	129,50	41,00	10,00	I
6371986	KTFS100R08SS12M	10,00	10,499	84,00	146,00	140,20	46,00	12,00	J
6371987	KTFS105R08SS12M	10,50	10,999	88,00	150,00	143,90	46,00	12,00	K
6371988	KTFS110R08SS12M	11,00	11,499	92,00	154,00	147,60	46,00	12,00	L
6371989	KTFS115R08SS12M	11,50	11,999	96,00	158,00	151,30	46,00	12,00	M
6371990	KTFS120R08SS14M	12,00	12,499	100,00	164,00	157,00	46,00	14,00	N
6371991	KTFS125R08SS14M	12,50	12,999	104,00	168,00	160,80	46,00	14,00	O
6371992	KTFS130R08SS14M	13,00	13,499	108,00	172,00	164,50	46,00	14,00	P
6371993	KTFS135R08SS14M	13,50	13,999	112,00	176,00	168,20	46,00	14,00	Q
6371994	KTFS140R08SS16M	14,00	14,499	116,00	184,00	175,90	49,00	16,00	R
6371995	KTFS145R08SS16M	14,50	14,999	120,00	188,00	179,60	49,00	16,00	S
6371996	KTFS150R08SS16M	15,00	15,999	128,00	196,00	187,30	49,00	16,00	T
6371997	KTFS160R08SS16M	16,00	16,999	136,00	204,00	194,70	49,00	16,00	U
6371999	KTFS170R08SS20M	17,00	17,999	144,00	217,00	207,10	51,00	20,00	V
6389271	KTFS180R08SS20M	18,00	18,999	152,00	225,00	214,60	51,00	20,00	W
6389272	KTFS190R08SS20M	19,00	19,999	160,00	233,00	222,00	51,00	20,00	X

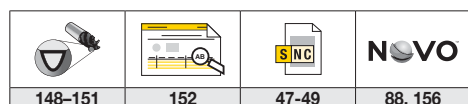

148-151

152

47-49

88, 156



KenTIP™ FS • Drill Body • 12 x D • SF Shank • Metric

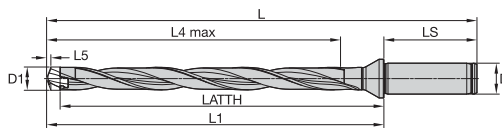

order number	ISO catalogue number	D1	D1 max	L4 max	L	LATTH	L1	LS	D	SSC
6389579	KTFS060R12SF12M	6,00	6,299	76,00	141,00	92,50	96,00	45,00	12,00	A
6389580	KTFS063R12SF12M	6,30	6,599	79,00	144,00	95,30	99,00	45,00	12,00	B
6389581	KTFS066R12SF12M	6,60	6,999	84,00	150,00	101,20	105,00	45,00	12,00	C
6389582	KTFS070R12SF12M	7,00	7,499	90,00	156,00	106,90	111,00	45,00	12,00	D
6389583	KTFS075R12SF12M	7,50	7,999	96,00	162,00	112,60	117,00	45,00	12,00	E
6389584	KTFS080R12SF12M	8,00	8,499	102,00	168,00	118,40	123,00	45,00	12,00	F
6389585	KTFS085R12SF12M	8,50	8,999	108,00	174,00	124,10	129,00	45,00	12,00	G
6389586	KTFS090R12SF12M	9,00	9,499	114,00	180,00	129,80	135,00	45,00	12,00	H
6389587	KTFS095R12SF12M	9,50	9,999	120,00	186,00	135,50	141,00	45,00	12,00	I
6389481	KTFS100R12SF16M	10,00	10,499	126,00	198,00	144,20	150,00	48,00	16,00	J
6389482	KTFS105R12SF16M	10,50	10,999	132,00	204,00	149,90	156,00	48,00	16,00	K
6389483	KTFS110R12SF16M	11,00	11,499	138,00	210,00	155,60	162,00	48,00	16,00	L
6389484	KTFS115R12SF16M	11,50	11,999	144,00	216,00	161,30	168,00	48,00	16,00	M
6389485	KTFS120R12SF16M	12,00	12,499	150,00	222,00	167,00	174,00	48,00	16,00	N
6389486	KTFS125R12SF16M	12,50	12,999	156,00	228,00	172,80	180,00	48,00	16,00	O
6389487	KTFS130R12SF16M	13,00	13,499	162,00	234,00	178,50	186,00	48,00	16,00	P
6389488	KTFS135R12SF16M	13,50	13,999	168,00	240,00	184,20	192,00	48,00	16,00	Q
6389489	KTFS140R12SF16M	14,00	14,499	174,00	246,00	189,90	198,00	48,00	16,00	R
6389490	KTFS145R12SF16M	14,50	14,999	180,00	252,00	195,60	204,00	48,00	16,00	S
6389501	KTFS150R12SF20M	15,00	15,999	192,00	269,00	210,30	219,00	50,00	20,00	T
6389502	KTFS160R12SF20M	16,00	16,999	204,00	281,00	221,70	231,00	50,00	20,00	U
6389503	KTFS170R12SF20M	17,00	17,999	216,00	293,00	233,10	243,00	50,00	20,00	V
6389568	KTFS180R12SF25M	18,00	18,999	228,00	314,00	247,60	258,00	56,00	25,00	W
6389569	KTFS190R12SF25M	19,00	19,999	240,00	326,00	259,00	270,00	56,00	25,00	X

148-151	152	47-49	88, 156

KentIP™ FS • Drill Body • 1.5 x D • SCF Shank • Metric

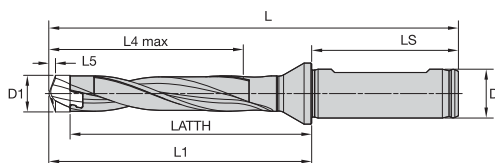



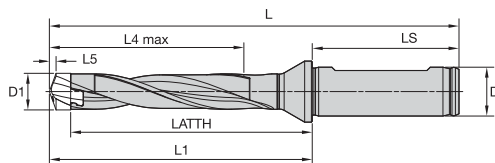

order number	ISO catalogue number	D1	D1 max	L4 max	L	LATH	L1	LS	D	SSC
6389504	KTFS200R01SCF25M	20,00	20,999	32,00	118,00	50,40	62,00	56,00	25,00	Y
6389505	KTFS210R01SCF25M	21,00	21,999	33,00	119,00	50,80	63,00	56,00	25,00	Z
6389506	KTFS220R01SCF25M	22,00	22,999	35,00	121,00	52,20	65,00	56,00	25,00	ZA
6389507	KTFS230R01SCF25M	23,00	23,999	36,00	122,00	52,70	66,00	56,00	25,00	ZB
6389508	KTFS240R01SCF25M	24,00	24,999	38,00	124,00	54,10	68,00	56,00	25,00	ZC
6389509	KTFS250R01SCF25M	25,00	26,000	39,00	125,00	54,50	69,00	56,00	25,00	ZD

148-151	152	47-49	88, 156

KenTIP™ FS • Drill Body • 3 x D • SCF Shank • Metric





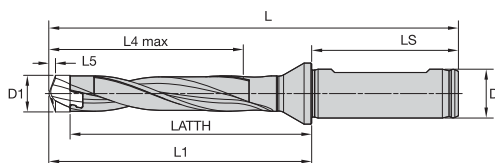

order number	ISO catalogue number	D1	D1 max	L4 max	L	LATH	L1	LS	D	SSC
6389436	KTFS080R03SCF12M	8,00	8,499	26,00	92,00	42,40	47,00	45,00	12,00	F
6389437	KTFS085R03SCF12M	8,50	8,999	27,00	93,00	43,10	48,00	45,00	12,00	G
6389438	KTFS090R03SCF12M	9,00	9,499	29,00	95,00	44,80	50,00	45,00	12,00	H
6389439	KTFS095R03SCF12M	9,50	9,999	30,00	96,00	45,50	51,00	45,00	12,00	I
6372514	KTFS100R03SCF16M	10,00	10,499	32,00	104,00	50,20	56,00	48,00	16,00	J
6372515	KTFS105R03SCF16M	10,50	10,999	33,00	105,00	50,90	57,00	48,00	16,00	K
6372516	KTFS110R03SCF16M	11,00	11,499	35,00	107,00	52,60	59,00	48,00	16,00	L
6372517	KTFS115R03SCF16M	11,50	11,999	36,00	108,00	53,30	60,00	48,00	16,00	M
6372518	KTFS120R03SCF16M	12,00	12,499	38,00	110,00	55,00	62,00	48,00	16,00	N
6372519	KTFS125R03SCF16M	12,50	12,999	39,00	111,00	55,80	63,00	48,00	16,00	O
6372520	KTFS130R03SCF16M	13,00	13,499	41,00	113,00	57,50	65,00	48,00	16,00	P
6372591	KTFS135R03SCF16M	13,50	13,999	42,00	114,00	58,20	66,00	48,00	16,00	Q
6372592	KTFS140R03SCF16M	14,00	14,499	44,00	116,00	59,90	68,00	48,00	16,00	R
6372593	KTFS145R03SCF16M	14,50	14,999	45,00	117,00	60,60	69,00	48,00	16,00	S
6372594	KTFS150R03SCF20M	15,00	15,999	48,00	125,00	66,30	75,00	50,00	20,00	T
6372595	KTFS160R03SCF20M	16,00	16,999	51,00	128,00	68,70	78,00	50,00	20,00	U
6372596	KTFS170R03SCF20M	17,00	17,999	54,00	131,00	71,10	81,00	50,00	20,00	V
6389279	KTFS180R03SCF25M	18,00	18,999	57,00	143,00	76,60	87,00	56,00	25,00	W
6389280	KTFS190R03SCF25M	19,00	19,999	60,00	146,00	79,00	90,00	56,00	25,00	X
6389281	KTFS200R03SCF25M	20,00	20,999	63,00	149,00	81,40	93,00	56,00	25,00	Y
6389282	KTFS210R03SCF25M	21,00	21,999	66,00	152,00	83,80	96,00	56,00	25,00	Z
6389283	KTFS220R03SCF25M	22,00	22,999	69,00	155,00	86,20	99,00	56,00	25,00	ZA
6389284	KTFS230R03SCF25M	23,00	23,999	72,00	158,00	88,70	102,00	56,00	25,00	ZB
6389285	KTFS240R03SCF25M	24,00	24,999	75,00	161,00	91,10	105,00	56,00	25,00	ZC
6389286	KTFS250R03SCF25M	25,00	26,000	78,00	164,00	93,50	108,00	56,00	25,00	ZD

 148-151	 152	 47-49	 88, 156
--	--	--	--

KenTIP™ FS • Drill Body • 5 x D • SCF Shank • Metric



order number	ISO catalogue number	D1	D1 max	L4 max	L	LATTH	L1	LS	D	SSC
6389440	KTFS080R05SCF12M	8,00	8,499	43,00	109,00	59,40	64,00	45,00	12,00	F
6389441	KTFS085R05SCF12M	8,50	8,999	45,00	111,00	61,10	66,00	45,00	12,00	G
6389442	KTFS090R05SCF12M	9,00	9,499	48,00	114,00	63,80	69,00	45,00	12,00	H
6389443	KTFS095R05SCF12M	9,50	9,999	50,00	116,00	65,50	71,00	45,00	12,00	I
6372597	KTFS100R05SCF16M	10,00	10,499	53,00	125,00	71,20	77,00	48,00	16,00	J
6372598	KTFS105R05SCF16M	10,50	10,999	55,00	127,00	72,90	79,00	48,00	16,00	K
6372599	KTFS110R05SCF16M	11,00	11,499	58,00	130,00	75,60	82,00	48,00	16,00	L
6372600	KTFS115R05SCF16M	11,50	11,999	60,00	132,00	77,30	84,00	48,00	16,00	M
6372601	KTFS120R05SCF16M	12,00	12,499	63,00	135,00	80,00	87,00	48,00	16,00	N
6372602	KTFS125R05SCF16M	12,50	12,999	65,00	137,00	81,80	89,00	48,00	16,00	O
6372603	KTFS130R05SCF16M	13,00	13,499	68,00	140,00	84,50	92,00	48,00	16,00	P
6372604	KTFS135R05SCF16M	13,50	13,999	70,00	142,00	86,20	94,00	48,00	16,00	Q
6372605	KTFS140R05SCF16M	14,00	14,499	73,00	145,00	88,90	97,00	48,00	16,00	R
6372606	KTFS145R05SCF16M	14,50	14,999	75,00	147,00	90,60	99,00	48,00	16,00	S
6372607	KTFS150R05SCF20M	15,00	15,999	80,00	157,00	98,30	107,00	50,00	20,00	T
6372608	KTFS160R05SCF20M	16,00	16,999	85,00	162,00	102,70	112,00	50,00	20,00	U
6372609	KTFS170R05SCF20M	17,00	17,999	90,00	167,00	107,10	117,00	50,00	20,00	V
6389287	KTFS180R05SCF25M	18,00	18,999	95,00	181,00	114,60	125,00	56,00	25,00	W
6389288	KTFS190R05SCF25M	19,00	19,999	100,00	186,00	119,00	130,00	56,00	25,00	X
6389289	KTFS200R05SCF25M	20,00	20,999	105,00	191,00	123,40	135,00	56,00	25,00	Y
6389290	KTFS210R05SCF25M	21,00	21,999	110,00	196,00	127,80	140,00	56,00	25,00	Z
6389311	KTFS220R05SCF25M	22,00	22,999	115,00	201,00	132,20	145,00	56,00	25,00	ZA
6389312	KTFS230R05SCF25M	23,00	23,999	120,00	206,00	136,70	150,00	56,00	25,00	ZB
6389313	KTFS240R05SCF25M	24,00	24,999	125,00	211,00	141,10	155,00	56,00	25,00	ZC
6389314	KTFS250R05SCF25M	25,00	26,000	130,00	216,00	145,50	160,00	56,00	25,00	ZD

			
148-151	152	47-49	88, 156

KenTIP™ FS • Drill Body • 8 x D • SCF Shank • Metric

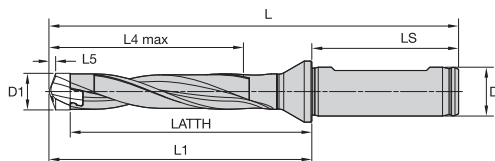

order number	ISO catalogue number	D1	D1 max	L4 max	L	LATTH	L1	LS	D	SSC
6389444	KTFS080R08SCF12M	8,00	8,499	68,00	134,00	84,40	89,00	45,00	12,00	F
6389445	KTFS085R08SCF12M	8,50	8,999	72,00	138,00	88,10	93,00	45,00	12,00	G
6389446	KTFS090R08SCF12M	9,00	9,499	76,00	142,00	91,80	97,00	45,00	12,00	H
6389447	KTFS095R08SCF12M	9,50	9,999	80,00	146,00	95,50	101,00	45,00	12,00	I
6372610	KTFS100R08SCF16M	10,00	10,499	84,00	156,00	102,20	108,00	48,00	16,00	J
6372611	KTFS105R08SCF16M	10,50	10,999	88,00	160,00	105,90	112,00	48,00	16,00	K
6372612	KTFS110R08SCF16M	11,00	11,499	92,00	164,00	109,60	116,00	48,00	16,00	L
6372613	KTFS115R08SCF16M	11,50	11,999	96,00	168,00	113,30	120,00	48,00	16,00	M
6372614	KTFS120R08SCF16M	12,00	12,499	100,00	172,00	117,00	124,00	48,00	16,00	N
6372615	KTFS125R08SCF16M	12,50	12,999	104,00	176,00	120,80	128,00	48,00	16,00	O
6372616	KTFS130R08SCF16M	13,00	13,499	108,00	180,00	124,50	132,00	48,00	16,00	P
6372617	KTFS135R08SCF16M	13,50	13,999	112,00	184,00	128,20	136,00	48,00	16,00	Q
6372618	KTFS140R08SCF16M	14,00	14,499	116,00	188,00	131,90	140,00	48,00	16,00	R
6372619	KTFS145R08SCF16M	14,50	14,999	120,00	192,00	135,60	144,00	48,00	16,00	S
6372620	KTFS150R08SCF20M	15,00	15,999	128,00	205,00	146,30	155,00	50,00	20,00	T
6372621	KTFS160R08SCF20M	16,00	16,999	136,00	213,00	153,70	163,00	50,00	20,00	U
6372622	KTFS170R08SCF20M	17,00	17,999	144,00	221,00	161,10	171,00	50,00	20,00	V
6389315	KTFS180R08SCF25M	18,00	18,999	152,00	238,00	171,60	182,00	56,00	25,00	W
6389316	KTFS190R08SCF25M	19,00	19,999	160,00	246,00	179,00	190,00	56,00	25,00	X
6389317	KTFS200R08SCF25M	20,00	20,999	168,00	254,00	186,40	198,00	56,00	25,00	Y
6389318	KTFS210R08SCF25M	21,00	21,999	176,00	262,00	193,80	206,00	56,00	25,00	Z
6389319	KTFS220R08SCF25M	22,00	22,999	184,00	270,00	201,20	214,00	56,00	25,00	ZA
6389320	KTFS230R08SCF25M	23,00	23,999	192,00	278,00	208,70	222,00	56,00	25,00	ZB
6389331	KTFS240R08SCF25M	24,00	24,999	200,00	286,00	216,10	230,00	56,00	25,00	ZC
6389332	KTFS250R08SCF25M	25,00	26,000	208,00	294,00	223,50	238,00	56,00	25,00	ZD

148-151	152	47-49	88, 156

KenTIP™ FS • Drill Body • 12 x D • SCF Shank • Metric

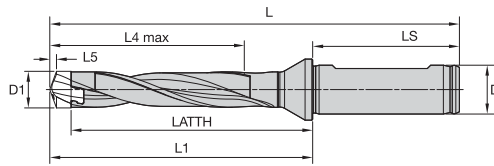

order number	ISO catalogue number	D1	D1 max	L4 max	L	LATTH	L1	LS	D	SSC
6389510	KTFS200R12SCF25M	20,00	20,999	252,00	338,00	270,40	282,00	56,00	25,00	Y
6389561	KTFS210R12SCF25M	21,00	21,999	264,00	350,00	281,80	294,00	56,00	25,00	Z
6389562	KTFS220R12SCF25M	22,00	22,999	276,00	362,00	293,20	306,00	56,00	25,00	ZA
6389563	KTFS230R12SCF25M	23,00	23,999	288,00	374,00	304,70	318,00	56,00	25,00	ZB
6389564	KTFS240R12SCF25M	24,00	24,999	300,00	386,00	316,10	330,00	56,00	25,00	ZC
6389565	KTFS250R12SCF25M	25,00	26,000	312,00	398,00	327,50	342,00	56,00	25,00	ZD



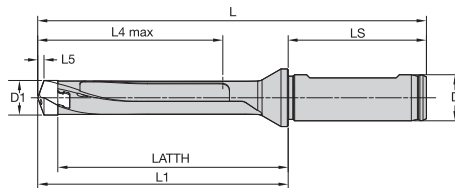

148-151	152	47-49	88, 156

KenTIP™ FS • Drill Body • 5 x D • Straight Fluted • SCF Shank • Metric

NEW!



order number	ISO catalogue number	D1	D1 max	L4 max	L	LATTH	L1	LS	D	SSC
6953931	KTFS080S05SCF12M	8,00	8,499	43,00	109,00	64,00	64,00	45,00	12,00	F
6953932	KTFS085S05SCF12M	8,50	8,999	45,00	111,00	66,00	66,00	45,00	12,00	G
6953933	KTFS090S05SCF12M	9,00	9,499	48,00	114,00	69,00	69,00	45,00	12,00	H
6953934	KTFS095S05SCF12M	9,50	9,999	50,00	116,00	71,00	71,00	45,00	12,00	I
6953935	KTFS100S05SCF16M	10,00	10,499	53,00	125,00	77,00	77,00	48,00	16,00	J
6953936	KTFS105S05SCF16M	10,50	10,999	55,00	127,00	79,00	79,00	48,00	16,00	K
6953937	KTFS110S05SCF16M	11,00	11,499	58,00	130,00	82,00	82,00	48,00	16,00	L
6953938	KTFS115S05SCF16M	11,50	11,999	60,00	132,00	84,00	84,00	48,00	16,00	M
6953939	KTFS120S05SCF16M	12,00	12,499	63,00	135,00	87,00	87,00	48,00	16,00	N
6953940	KTFS125S05SCF16M	12,50	12,999	65,00	137,00	89,00	89,00	48,00	16,00	O
6953941	KTFS130S05SCF16M	13,00	13,499	68,00	140,00	92,00	92,00	48,00	16,00	P
6953942	KTFS135S05SCF16M	13,50	13,999	70,00	142,00	94,00	94,00	48,00	16,00	Q
6953943	KTFS140S05SCF16M	14,00	14,499	73,00	145,00	97,00	97,00	48,00	16,00	R
6953944	KTFS145S05SCF16M	14,50	14,999	75,00	147,00	99,00	99,00	48,00	16,00	S
6953945	KTFS150S05SCF20M	15,00	15,999	80,00	157,00	107,00	107,00	50,00	20,00	T
6953946	KTFS160S05SCF20M	16,00	16,999	85,00	162,00	112,00	112,00	50,00	20,00	U
6953947	KTFS170S05SCF20M	17,00	17,999	90,00	167,00	117,00	117,00	50,00	20,00	V
6953948	KTFS180S05SCF25M	18,00	18,999	95,00	181,00	125,00	125,00	56,00	25,00	W
6953949	KTFS190S05SCF25M	19,00	19,999	100,00	186,00	130,00	130,00	56,00	25,00	X
6953950	KTFS200S05SCF25M	20,00	20,999	105,00	191,00	135,00	135,00	56,00	25,00	Y
6953951	KTFS210S05SCF25M	21,00	21,999	110,00	196,00	140,00	140,00	56,00	25,00	Z
6953952	KTFS220S05SCF25M	22,00	22,999	115,00	201,00	145,00	145,00	56,00	25,00	ZA
6953953	KTFS230S05SCF25M	23,00	23,999	120,00	206,00	150,00	150,00	56,00	25,00	ZB
6953954	KTFS240S05SCF25M	24,00	24,999	125,00	211,00	155,00	155,00	56,00	25,00	ZC
6953955	KTFS250S05SCF25M	25,00	25,999	130,00	216,00	160,00	160,00	56,00	25,00	ZD

			
148-151	152	47-49	88, 156

KenTIP™ FS • Drill Body • 3 x D • Straight Fluted • BF Shank • Metric

NEW!

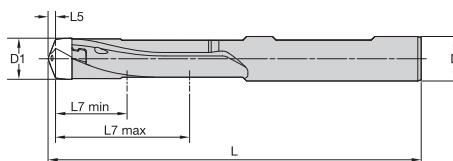



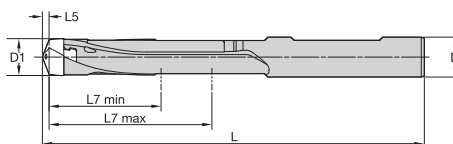

order number	ISO catalogue number	D1	D1 max	L7 min	L7 max	L	D	SSC
6953861	KTFS080S03BF08M	8,00	8,499	11,50	25,50	81,00	8,00	F
6953862	KTFS085S03BF09M	8,50	8,999	12,50	27,00	82,00	9,00	G
6953863	KTFS090S03BF10M	9,00	9,499	13,50	28,50	91,00	10,00	H
6953864	KTFS095S03BF10M	9,50	9,999	15,00	30,00	93,00	10,00	I
6953865	KTFS100S03BF10M	10,00	10,499	16,00	31,50	94,00	10,00	J
6953866	KTFS100S03BF11M	10,00	10,499	16,00	31,50	94,00	11,00	J
6953867	KTFS105S03BF11M	10,50	10,999	17,00	33,00	95,00	11,00	K
6953868	KTFS110S03BF12M	11,00	11,499	18,50	34,50	107,00	12,00	L
6953869	KTFS115S03BF12M	11,50	11,999	19,50	36,00	108,00	12,00	M
6953870	KTFS120S03BF12M	12,00	12,499	20,50	37,50	109,00	12,00	N
6953871	KTFS120S03BF13M	12,00	12,499	20,50	37,50	109,00	13,00	N
6953872	KTFS125S03BF13M	12,50	12,999	22,00	39,00	110,00	13,00	O
6953873	KTFS130S03BF14M	13,00	13,499	23,00	40,50	112,00	14,00	P
6953874	KTFS135S03BF14M	13,50	13,999	24,50	42,00	113,00	14,00	Q
6953875	KTFS140S03BF14M	14,00	14,499	25,50	43,50	114,00	14,00	R
6953876	KTFS140S03BF15M	14,00	14,499	25,50	43,50	118,00	15,00	R
6953877	KTFS145S03BF15M	14,50	14,999	26,50	45,00	119,00	15,00	S
6953878	KTFS150S03BF15M	15,00	15,999	29,00	48,00	121,00	15,00	T
6953879	KTFS150S03BF16M	15,00	15,999	29,00	48,00	122,00	16,00	T
6953880	KTFS160S03BF16M	16,00	16,999	31,50	51,00	124,00	16,00	U
6953891	KTFS170S03BF18M	17,00	17,999	34,00	54,00	127,00	18,00	V
6953892	KTFS180S03BF18M	18,00	18,999	36,50	57,00	129,00	18,00	W

KenTIP FS • Drill Body • 4 x D • Straight Fluted • BF Shank • Metric

NEW!



order number	ISO catalogue number	D1	D1 max	L7 min	L7 max	L	D	SSC
6953893	KTFS080S04BF08M	8,00	8,499	24,00	38,00	93,50	8,00	F
6953894	KTFS085S04BF09M	8,50	8,999	25,50	40,00	95,00	9,00	G
6953895	KTFS090S04BF10M	9,00	9,499	27,00	42,00	104,50	10,00	H
6953896	KTFS095S04BF10M	9,50	9,999	28,50	43,50	106,50	10,00	I
6953897	KTFS100S04BF11M	10,00	10,499	30,00	45,50	108,00	11,00	J
6953898	KTFS105S04BF11M	10,50	10,999	31,50	47,50	109,50	11,00	K
6953899	KTFS110S04BF12M	11,00	11,499	33,00	49,00	121,50	12,00	L
6953900	KTFS115S04BF12M	11,50	11,999	34,50	51,00	123,00	12,00	M
6953921	KTFS120S04BF13M	12,00	12,499	36,00	53,00	124,50	13,00	N
6953922	KTFS125S04BF13M	12,50	12,999	37,50	54,50	125,50	13,00	O
6953923	KTFS130S04BF14M	13,00	13,499	39,00	56,50	128,00	14,00	P
6953924	KTFS135S04BF14M	13,50	13,999	40,50	58,00	129,00	14,00	Q
6953925	KTFS140S04BF15M	14,00	14,499	42,00	60,00	134,50	15,00	R
6953926	KTFS145S04BF15M	14,50	14,999	43,50	62,00	136,00	15,00	S
6953927	KTFS150S04BF16M	15,00	15,999	46,50	65,50	139,50	16,00	T
6953928	KTFS160S04BF16M	16,00	16,999	49,50	69,00	142,00	16,00	U
6953929	KTFS170S04BF18M	17,00	17,999	52,50	72,50	145,50	18,00	V
6953930	KTFS180S04BF18M	18,00	18,999	55,50	76,00	148,00	18,00	W

			
148-151	152	47-49	88, 156

BF Combination Tool • Toolholder • SS Shank • Metric

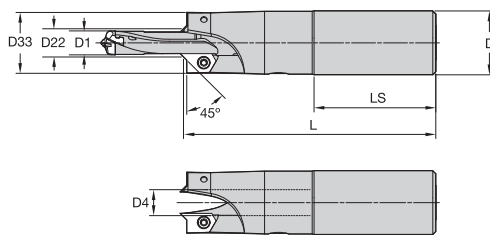



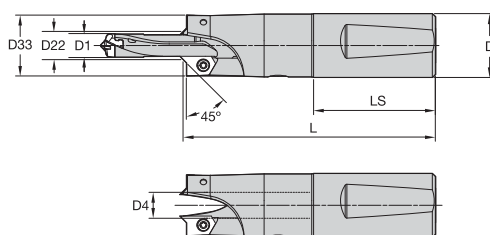

order number	ISO catalogue number	D33	D22	D1	D1 max	D4	L	LS	D
1245716	3.37042R320	14,90	9,00	3,40	4,00	4,00	87,50	50,00	20,00
1245718	3.37051R320	15,40	9,50	4,10	4,50	5,00	87,50	50,00	20,00
1191046	3.37052R320	15,90	10,00	4,60	5,00	5,00	87,50	50,00	20,00
1191048	3.37061R320	16,40	10,50	5,10	5,50	6,00	87,50	50,00	20,00
1245720	3.37062R320	16,90	11,00	5,55	6,00	6,00	87,50	50,00	20,00
1191050	3.37071R320	17,40	11,50	6,10	7,00	7,00	97,30	50,00	20,00
1245722	3.37081R320	18,40	12,60	7,30	8,00	8,00	97,30	50,00	20,00
1191052	3.37091R320	19,40	13,60	8,10	9,00	9,00	97,30	50,00	20,00
1245724	3.37101R332	27,90	14,70	9,10	10,00	10,00	117,40	60,00	32,00
1191056	3.37111R332	28,90	15,70	10,10	11,00	11,00	117,40	60,00	32,00
1245725	3.37121R332	29,90	16,70	11,10	12,00	12,00	127,40	60,00	32,00
1191060	3.37131R332	31,00	17,70	12,20	13,00	13,00	127,40	60,00	32,00
1245727	3.37141R332	31,50	18,20	13,10	14,00	14,00	127,10	60,00	32,00
1191063	3.37151R332	32,50	19,30	14,10	15,00	15,00	127,40	60,00	32,00
1245729	3.37161R332	33,50	20,30	15,50	16,00	16,00	127,10	60,00	32,00
1245731	3.37171R332	34,50	21,30	16,50	17,00	17,00	127,10	60,00	32,00
1245733	3.37181R332	35,50	22,30	17,50	18,00	18,00	127,10	60,00	32,00

BF Combination Tool • Toolholder • WN Shank • Metric



order number	ISO catalogue number	D33	D22	D1	D1 max	D4	L	LS	D
1245717	3.37042R820	14,90	9,00	3,40	4,00	4,00	87,50	50,00	20,00
1245719	3.37051R820	15,40	9,50	4,10	4,50	5,00	87,50	50,00	20,00
1191047	3.37052R820	15,90	10,00	4,60	5,00	5,00	87,50	50,00	20,00
1191049	3.37061R820	16,40	10,50	5,10	5,50	6,00	87,50	50,00	20,00
1245721	3.37062R820	16,90	11,00	5,55	6,00	6,00	87,50	50,00	20,00
1191051	3.37071R820	17,40	11,50	6,10	7,00	7,00	97,30	50,00	20,00
1245723	3.37081R820	18,40	12,60	7,30	8,00	8,00	97,30	50,00	20,00
1191053	3.37091R820	19,40	13,60	8,10	9,00	9,00	97,30	50,00	20,00
2951632	3.37092R820	19,40	13,70	8,10	9,00	9,00	97,30	50,00	20,00
1191055	3.37101R832	27,90	14,70	9,10	10,00	10,00	117,40	60,00	32,00
1191057	3.37111R832	28,90	15,70	10,10	11,00	11,00	117,40	60,00	32,00
1191059	3.37121R832	29,90	16,70	11,10	12,00	12,00	127,40	60,00	32,00
1245726	3.37131R832	31,00	17,70	12,20	13,00	13,00	127,40	60,00	32,00
1191062	3.37141R832	31,50	18,20	13,10	14,00	14,00	127,40	60,00	32,00
1245728	3.37151R832	32,50	19,30	14,10	15,00	15,00	127,10	60,00	32,00
1245730	3.37161R832	33,50	20,30	15,50	16,00	16,00	127,10	60,00	32,00
1245732	3.37171R832	34,50	21,30	16,50	17,00	17,00	127,10	60,00	32,00
1245734	3.37181R832	35,50	22,30	17,50	18,00	18,00	127,10	60,00	32,00

			
148-151	152	47-49	88, 156

BF Combination Tool • Insert Blank • R900



NEW!

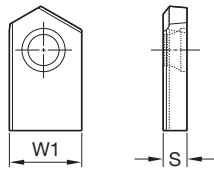

- first choice
- alternate choice

P	■	■	■
M	■	■	●
K	■	○	●
N	■	■	●
S	■	■	●
H	■	■	■

order number	ISO catalogue number	S	W1	KMF	KMT
1208627	3.41020R900	3,00	6,10	●	—
1208648	3.41220R900	3,50	10,10	●	—
1208679	3.41299R900	3,50	11,30	—	●

BF Combination Tool • Insert • R900SF



NEW!

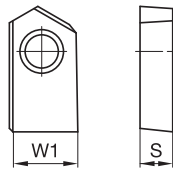

- first choice
- alternate choice

P	■	■	■
M	■	■	■
K	■	○	■
N	■	■	●
S	■	■	■
H	■	■	■

order number	ISO catalogue number	S	W1	KMF
1801129	3.41220R900SF	3,50	10,10	●

BF Combination Tool • Insert • R900STF





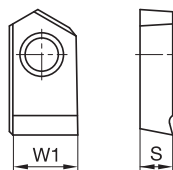

NEW!



- first choice
- alternate choice

P	■	■	■
M	■	■	●
K	■	■	●
N	■	○	■
S	■	■	■
H	■	■	■

order number	ISO catalogue number	S	W1	CS5
1801125	3.41020R900STF	3,00	6,10	●
1801126	3.41220R900STF	3,50	10,10	●

			
148-151	152	47-49	88, 156

BF Combination Tool • Insert • R901



NEW!

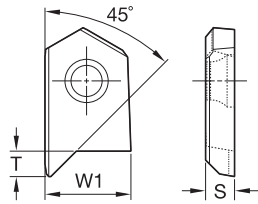

- first choice
- alternate choice

P	●	●
M	●	●
K	●	●
N	●	●
S	●	●
H	●	●

order number	ISO catalogue number	S	W1	T	CS5	KC7315
1208579	3.41020R901	3,00	6,10	2,90	●	●
2613791	3.41020R901	3,00	6,10	2,90	—	●
1208601	3.41220R901	3,50	10,10	3,05	●	—
2615045	3.41220R901	3,50	10,10	3,05	—	●

BF Combination Tool • Insert • R902





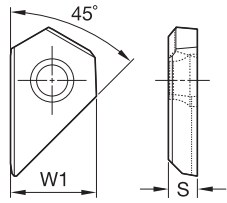

NEW!



- first choice
- alternate choice

P	●	●
M	●	●
K	●	●
N	●	●
S	●	●
H	●	●

order number	ISO catalogue number	S	W1	CS5	KC7315
1208588	3.41020R902	3,00	6,10	●	—
2613792	3.41020R902	3,00	6,10	—	●
1208606	3.41220R902	3,50	10,10	●	—
2615046	3.41220R902	3,50	10,10	—	●

			
148-151	152	47-49	88, 156

BF Combination Tool • Insert • R903



NEW!

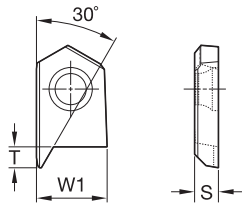

- first choice
- alternate choice

P	●	●
M	●	●
K	●	●
N	●	●
S	●	●
H	●	●

order number	ISO catalogue number	S	W1	T	CS5	KC7315
1208594	3.41020R903	3,00	6,10	2,90	●	●
2615043	3.41020R903	3,00	6,10	2,90	—	●
1208615	3.41220R903	3,50	10,10	3,05	●	—
2615047	3.41220R903	3,50	10,10	3,05	—	●

BF Combination Tool • Insert • R904



NEW!

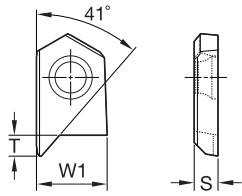

- first choice
- alternate choice

P	●	●
M	●	●
K	●	●
N	●	●
S	●	●
H	●	●

order number	ISO catalogue number	S	W1	T	KC7315
2613790	3.41020R904	3,00	6,10	2,90	●
2615044	3.41220R904	3,50	10,10	3,05	●

148-151	152	47-49	88, 156

KenTIP™ FS • GTP & FEG • Tolerances

Tolerance • Metric	
D1 metric	tolerance S8
6	0,019/+0,037
>6-10	0,023/+0,045
>10-18	0,028/+0,055
>18-26	0,035/+0,068

KenTIP FS • Tolerances

Tolerance • Metric	
D1 metric	tolerance k8
6	0,000/+0,018
>6-10	0,000/+0,022
>10-18	0,000/+0,027
>18-26	0,000/+0,033

KenTIP FS • GTP • Application Data

Material Group	Cutting Speed – vc			Metric									
	Range – m/min			Recommended Feed Rate per Rev									
	min	Starting Value	max		6,0	8,0	10,0	12,0	16,0	20,0	24,0	26,0	
P	0	70	125	175	mm/r	0,09–0,18	0,10–0,21	0,12–0,24	0,14–0,30	0,18–0,36	0,23–0,42	0,27–0,48	0,28–0,50
	1	70	120	170	mm/r	0,09–0,18	0,10–0,22	0,12–0,24	0,14–0,30	0,18–0,36	0,23–0,42	0,27–0,48	0,28–0,50
	2	90	135	180	mm/r	0,09–0,18	0,10–0,25	0,12–0,27	0,14–0,33	0,18–0,39	0,23–0,45	0,27–0,51	0,28–0,50
	3	60	95	130	mm/r	0,09–0,16	0,10–0,28	0,11–0,29	0,13–0,33	0,17–0,37	0,22–0,41	0,28–0,45	0,30–0,46
	4	50	90	130	mm/r	0,09–0,16	0,10–0,28	0,11–0,29	0,13–0,33	0,17–0,37	0,22–0,41	0,24–0,45	0,25–0,46
	5	30	65	100	mm/r	0,09–0,15	0,10–0,18	0,10–0,22	0,11–0,27	0,15–0,32	0,19–0,37	0,23–0,42	0,24–0,43
M	6	40	60	80	mm/r	0,09–0,15	0,09–0,18	0,10–0,22	0,10–0,27	0,15–0,32	0,19–0,37	0,23–0,42	0,24–0,43
	1	20	55	90	mm/r	0,07–0,12	0,08–0,13	0,08–0,14	0,10–0,18	0,12–0,22	0,15–0,26	0,18–0,27	0,19–0,28
	2	30	60	90	mm/r	0,07–0,12	0,08–0,13	0,08–0,16	0,10–0,18	0,12–0,22	0,15–0,26	0,18–0,27	0,19–0,28
K	3	20	40	60	mm/r	0,07–0,12	0,08–0,12	0,08–0,14	0,10–0,16	0,12–0,22	0,15–0,26	0,18–0,27	0,19–0,28
	1	80	140	200	mm/r	0,11–0,26	0,13–0,32	0,15–0,44	0,18–0,49	0,25–0,58	0,29–0,64	0,35–0,70	0,36–0,75
	2	80	130	180	mm/r	0,11–0,26	0,13–0,31	0,15–0,36	0,18–0,40	0,25–0,48	0,29–0,60	0,35–0,70	0,36–0,75
S	3	70	95	120	mm/r	0,10–0,22	0,12–0,25	0,15–0,35	0,16–0,40	0,20–0,48	0,26–0,60	0,30–0,63	0,32–0,65
	1	10	20	30	mm/r	0,05–0,09	0,06–0,10	0,07–0,12	0,08–0,13	0,10–0,15	0,11–0,17	0,12–0,19	0,13–0,21
	2	10	20	30	mm/r	0,05–0,09	0,06–0,10	0,07–0,12	0,08–0,13	0,10–0,15	0,11–0,17	0,12–0,19	0,13–0,21
	3	15	25	35	mm/r	0,05–0,09	0,06–0,10	0,07–0,12	0,08–0,13	0,10–0,15	0,11–0,17	0,12–0,19	0,13–0,21
	4	20	30	40	mm/r	0,04–0,07	0,05–0,09	0,05–0,10	0,07–0,12	0,08–0,13	0,08–0,13	0,09–0,15	0,10–0,17

KenTIP FS • HPG • Application Data

Material Group	Cutting Speed – vc			Metric										
	Range – m/min			Recommended Feed Rate per Rev										
	min	Starting Value	max		6,0	8,0	10,0	12,0	14,0	16,0	20,0	24,0	26,0	
P	0	95	125	175	mm/r	0,10–0,19	0,11–0,22	0,13–0,30	0,15–0,37	0,17–0,41	0,19–0,45	0,24–0,52	0,28–0,60	0,29–0,62
	1	90	130	170	mm/r	0,10–0,19	0,11–0,22	0,13–0,30	0,15–0,37	0,17–0,41	0,19–0,45	0,24–0,52	0,28–0,60	0,29–0,62
	2	100	140	180	mm/r	0,10–0,19	0,11–0,26	0,13–0,34	0,15–0,41	0,17–0,45	0,19–0,49	0,24–0,56	0,28–0,64	0,29–0,62
	3	60	100	130	mm/r	0,10–0,17	0,11–0,31	0,12–0,36	0,14–0,41	0,16–0,44	0,18–0,46	0,23–0,51	0,30–0,56	0,31–0,58
	4	60	100	130	mm/r	0,10–0,17	0,11–0,31	0,12–0,36	0,14–0,41	0,16–0,44	0,18–0,46	0,23–0,51	0,25–0,56	0,26–0,58
	5	60	80	100	mm/r	0,09–0,16	0,10–0,22	0,11–0,28	0,12–0,34	0,14–0,37	0,16–0,40	0,20–0,46	0,24–0,52	0,25–0,54
K	6	60	70	80	mm/r	0,09–0,16	0,10–0,22	0,11–0,28	0,12–0,34	0,14–0,37	0,16–0,40	0,20–0,46	0,24–0,52	0,25–0,54
	1	80	120	170	mm/r	0,12–0,21	0,14–0,34	0,16–0,39	0,19–0,45	0,23–0,50	0,26–0,58	0,30–0,64	0,36–0,76	0,37–0,79
	2	80	110	120	mm/r	0,12–0,21	0,14–0,34	0,16–0,39	0,19–0,45	0,23–0,50	0,26–0,58	0,30–0,64	0,36–0,76	0,37–0,79
	3	50	80	100	mm/r	0,11–0,19	0,13–0,27	0,15–0,33	0,17–0,37	0,19–0,42	0,21–0,46	0,28–0,54	0,32–0,63	0,33–0,66



KenTIP™ FS • HPL • Application Data

Material Group	Cutting Speed – vc			Metric										
	Range – m/min			Recommended Feed Rate per Rev										
	min	Starting Value	max		6,0	8,0	10,0	12,0	14,0	16,0	20,0	24,0	26,0	
M	1	50	60	90	mm/r	0,07–0,13	0,08–0,15	0,09–0,18	0,11–0,20	0,12–0,22	0,13–0,24	0,16–0,28	0,19–0,32	0,20–0,33
	2	30	60	90	mm/r	0,07–0,13	0,08–0,15	0,09–0,18	0,11–0,20	0,12–0,22	0,13–0,24	0,16–0,28	0,19–0,32	0,20–0,33
	3	20	50	60	mm/r	0,07–0,13	0,08–0,15	0,09–0,18	0,11–0,20	0,12–0,22	0,13–0,24	0,16–0,28	0,19–0,32	0,20–0,33

KenTIP FS • HPC • Application Data

Material Group	Cutting Speed – vc			Metric										
	Range – m/min			Recommended Feed Rate per Rev										
	min	Starting Value	max		6,0	8,0	10,0	12,0	14,0	16,0	20,0	24,0	26,0	
K	1	100	175	200	mm/r	0,12–0,29	0,14–0,34	0,16–0,39	0,19–0,45	0,23–0,50	0,26–0,58	0,30–0,64	0,36–0,76	0,37–0,79
	2	100	160	180	mm/r	0,12–0,29	0,14–0,34	0,16–0,39	0,19–0,45	0,23–0,50	0,26–0,58	0,30–0,64	0,36–0,76	0,37–0,79
	3	70	85	120	mm/r	0,11–0,23	0,13–0,27	0,15–0,33	0,17–0,37	0,19–0,42	0,21–0,46	0,28–0,54	0,32–0,63	0,33–0,66

KenTIP FS • DAV • Application Data

Material Group	Cutting Speed – vc			Metric							
	Range – m/min			Recommended Feed Rate per Rev							
	min	Starting Value	max		6,0	8,0	10,0	12,0	16,0	20,0	
S	4	10	13	20	mm/r	0,02–0,08	0,03–0,10	0,04–0,12	0,05–0,16	0,05–0,18	0,06–0,20
N	1	100	230	270	mm/r	0,13–0,22	0,16–0,24	0,20–0,28	0,24–0,32	0,28–0,40	0,32–0,48
	2	100	220	270	mm/r	0,14–0,23	0,16–0,28	0,20–0,32	0,24–0,36	0,28–0,40	0,32–0,52
	3	90	180	230	mm/r	0,13–0,22	0,16–0,24	0,20–0,28	0,24–0,32	0,28–0,40	0,32–0,48
	4	90	130	200	mm/r	0,10–0,18	0,16–0,28	0,20–0,32	0,24–0,36	0,28–0,40	0,32–0,52
C	2	70	110	140	mm/r	0,03–0,10	0,04–0,12	0,05–0,15	0,05–0,18	0,06–0,21	0,07–0,23
	3	10	13	20	mm/r	0,02–0,08	0,03–0,10	0,04–0,12	0,05–0,16	0,05–0,18	0,06–0,20
	4	10	20	40	mm/r	0,02–0,08	0,03–0,10	0,04–0,12	0,05–0,16	0,05–0,18	0,06–0,20



KenTIP™ FS • SPF • Application Data

Material Group		Cutting Speed – vc			Metric							
		Range – m/min			Recommended Feed Rate per Rev							
		min	Starting Value	max		6,0	8,0	10,0	12,0	16,0	20,0	
C	1	80	100	150	mm/r	0,05–0,20	0,05–0,20	0,05–0,20	0,05–0,20	0,05–0,20	0,05–0,20	0,05–0,20

KenTIP FS • FEG • Application Data

Material Group		Cutting Speed – vc			Metric									
		Range – m/min			Recommended Feed Rate per Rev									
		min	Starting Value	max		6,0	8,0	10,0	12,0	14,0	16,0	20,0	24,0	26,0
P	0	110	140	170	mm/r	0,10–0,19	0,11–0,22	0,13–0,24	0,15–0,26	0,17–0,29	0,19–0,31	0,21–0,34	0,23–0,38	0,24–0,40
	1	110	140	170	mm/r	0,10–0,19	0,11–0,22	0,13–0,24	0,15–0,26	0,17–0,29	0,19–0,31	0,21–0,34	0,23–0,38	0,24–0,40
	2	100	120	140	mm/r	0,10–0,19	0,11–0,22	0,13–0,24	0,15–0,26	0,17–0,29	0,19–0,31	0,21–0,34	0,23–0,38	0,24–0,40
	3	80	100	120	mm/r	0,10–0,17	0,11–0,20	0,12–0,22	0,14–0,24	0,16–0,26	0,18–0,28	0,20–0,31	0,21–0,35	0,22–0,36
	4	70	90	110	mm/r	0,10–0,17	0,11–0,20	0,12–0,22	0,14–0,24	0,16–0,26	0,18–0,28	0,20–0,31	0,21–0,35	0,22–0,36
	5	60	80	100	mm/r	0,09–0,16	0,10–0,18	0,11–0,20	0,13–0,22	0,15–0,24	0,16–0,26	0,18–0,29	0,19–0,33	0,20–0,34
M	1	40	60	80	mm/r	0,07–0,12	0,08–0,14	0,09–0,16	0,11–0,18	0,12–0,20	0,13–0,22	0,14–0,24	0,15–0,26	0,16–0,27
	2	35	55	70	mm/r	0,07–0,12	0,08–0,14	0,09–0,16	0,11–0,18	0,12–0,20	0,13–0,22	0,14–0,24	0,15–0,26	0,16–0,27
K	1	90	120	175	mm/r	0,12–0,21	0,14–0,24	0,16–0,28	0,18–0,32	0,20–0,36	0,22–0,40	0,25–0,44	0,28–0,48	0,29–0,50
	2	80	110	140	mm/r	0,12–0,21	0,14–0,24	0,16–0,28	0,18–0,32	0,20–0,36	0,22–0,40	0,25–0,44	0,28–0,48	0,29–0,50
	3	70	80	100	mm/r	0,11–0,19	0,13–0,22	0,14–0,25	0,16–0,28	0,18–0,32	0,21–0,36	0,23–0,40	0,26–0,44	0,27–0,46



KenTIP™ FS and KSEM™ • Bodies • Catalog Numbering System

Each character in our catalog number signifies a specific trait of that product. Use the following key columns and corresponding images to easily identify which attributes apply.

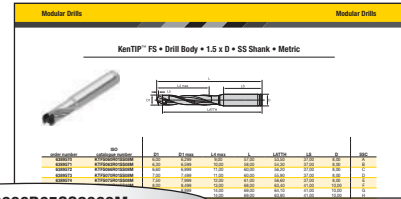

KTFS2000R05SS2000M

KTFS	2000	R	05	SS	2000	M
Series	Cutting Diameter D1	Flute Style	Length to Diameter Ratio	Shank Style	Shank Diameter	Unit of Dimensions
<p>KTFS</p>	<p>Metric = D1 in mm Inch = D1 in decimal inch</p>	<p>R = Right spiral S = Straight</p>	<p>05 = 5 x D</p>	<p>SS = Straight shank SF = Straight shank with flange SCF = Side lock shank with flange BF = With side lock for BF adapter</p>	<p>Metric = D in mm Inch = D in decimal inch</p>	<p>M = Metric Blank = Inch</p>
<p>KSEM</p>	<p>Metric = D1 in mm Inch = D1 in decimal inch</p>	<p>R = Right spiral</p>	<p>05 = 5 x D</p>	<p>WN = Whistle Notch™ shank WD = Whistle Notch with flange</p>	<p>Metric = D in mm Inch = D in decimal inch</p>	<p>M = Metric Blank = Inch</p>

KSEM PLUS™ • Heads • Catalog Numbering System

Each character in our catalog number signifies a specific trait of that product. Use the following key columns and corresponding images to easily identify which attributes apply.

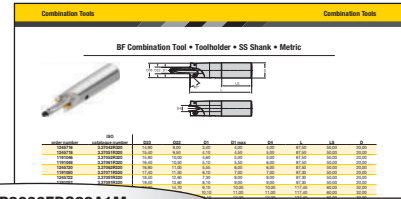

KSEMP2000FDS28A1M

KSEMP	2000	FDS28	A1	M
Series	Cutting Diameter D1	Connection Style Machine Side – CSMS	Head Style	Unit of Dimensions
KSEMP	Metric = D1 in mm Inch = D1 in decimal inch	FDS28 = Connection size 28	A1 = Modular drill head for lowest cost per hole. B1 = Modular drill head for challenging conditions like stacked plates, cross holes, and inclined exits.	M = Metric Blank = Inch

KSEM PLUS • Bodies • Catalog Numbering System

Each character in our catalog number signifies a specific trait of that product. Use the following key columns and corresponding images to easily identify which attributes apply.

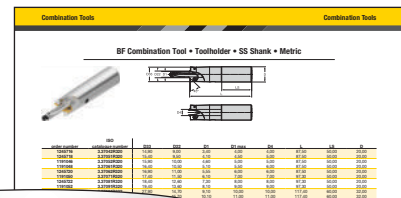

WD32FDS28190M

WD	32	FDS28	190	M
Shank Style	Shank Diameter	Connection Style Workpiece Side – CSWS	Drill Body Length L1	Unit of Dimensions
WD = Drill body with Whistle Notch™ shank SSF = Drill body with flanged shank with flat	Metric = D in mm Inch = D in decimal inch	FDS28 = Connection size 28	Metric = L1 in mm Inch = L1 in decimal inch	M = Metric Blank = Inch

KenTIP™ FS • Inserts • Catalog Numbering System

Each character in our catalog number signifies a specific trait of that product. Use the following key columns and corresponding images to easily identify which attributes apply.

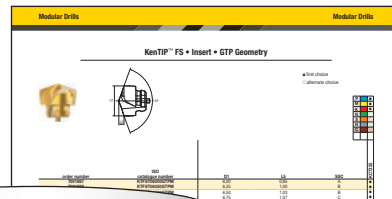

KTFST2000HPGM

KTFS	T	2000	HPG	M
Series	Coolant Type	Cutting Diameter D1	Point Geometry	Unit of Dimensions
<p>KTFS = KenTIP FS</p>	<p>T = Through coolant S = No through coolant</p>	<p>Metric = D1 in mm Inch = D1 in decimal inch</p>	<p>HPG = Steel HPL = Stainless steel HPC = Cast iron FEG = Flat bottom SPF = CFRP DAV = Vibration assisted applications in stacks, titanium, aluminum DAL = Stacks, titanium, aluminum</p>	<p>M = Metric Blank = Inch</p>

KSEM™ • Inserts • Catalog Numbering System



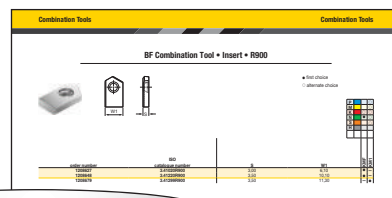





































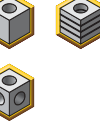











Each character in our catalog number signifies a specific trait of that product. Use the following key columns and corresponding images to easily identify which attributes apply.



KSEM2000HPGM

KSEM	2000	HPG	M
Series	Cutting Diameter D1	Point Geometry	Unit of Dimensions
<p>KSEM KSEMP = KSEM Plus</p>	<p>Metric = D1 in mm Inch = D1 in decimal inch</p>	<p>HP = Long chipping steels HPG = Steel HPL = Stainless steel HPCCCL = Cast iron FEG = Flat bottom PC = Piloting in all materials SPL = High-temperature alloys, non-ferrous materials</p>	<p>M = Metric Blank = Inch</p>

Tool Selection Guide • Material Specific Drills

	HPR Drills	HPX Drills	HPX Drills	SGL Drills	HPS Drills	Y-TECH™ Drills	KMH Drills	KMH Drills
								
								
Series	B254_HPR B255_HPR B256_HPR	B221_HPX B222_HPX	B224_HPX B225_HPX B226_HPX	B210_SGL B211_SGL B212_SGL	B284_HPS B285_HPS B286_HPS	B291_YPL B292_YPL	B941A	B951A
Page	11***	11, 14**	16, 18, 21**	G38*	G88*	G94*	G126*	G127*
Workpiece material								
Primary	K	P	P	M S	N	M S	H	H
Secondary		K		P		P	P K	P K
Hole tolerance	IT9-IT10	IT9-IT10	IT9-IT10	IT9-IT10	IT9-IT10	IT9-IT10	IT9-IT10	IT9-IT10
Standard range								
Cutting diameter [D1]	3,0-20,0mm	3,0-20,0mm	3,0-20,0mm	2,5-20,0mm	3,0-20,0mm	3,0-20,0mm	2,5-14,0mm	3,0-16,0mm
Drill length [L4 max]	14,0-160,0mm	14,0-85,0mm	14,0-160,0mm	12,0-160,0mm	14,0-124,0mm	14,0-77,0mm	14,0-43,0mm	14,0-45,0mm
Drilling depth L/D1	3-8 x D	3-5 x D	3-8 x D	3-8 x D	3-8 x D	3-5 x D	3 x D	3 x D
Point angle	143°	140°	140°	140°	135°	140°	142°	140°
Flute angle	30°	30°	30°	30°	30°	30°	15°	30°
Coolant								
Operations								
Flutes and margin								
Corner chamfer								
Shank								

















































* See page in the Kennametal Master Catalog 2018 • Volume Two • Rotating Tools, A-16-05217.

**See page in the Kennametal Innovations 2021 • 01, A-20-06200.

***See page in the Kennametal Innovations 2021 • 02, A-20-06262.

- Primary
- Secondary

Tool Selection Guide • Versatile Drills

	GOdrill™	GOdrill	Kenna Universal™ Drills	Kenna Universal Drills	Kenna Universal Step Drills
					
					
Series	B041A_CPG B042A_CPG	B051A_CPG B052A_CPG B053A_CPG	B966A B967A	B976A B977A B978A B979A	B731A B732A
Page	G8*	G14*	54-57	58-71	72-73
Workpiece material					
Primary					
Secondary					
Hole tolerance	IT9-IT10	IT9-IT10	IT9-IT10	IT9-IT10	IT9-IT10
Standard range					
Cutting diameter [D1]	1,0-20,0mm	1,0-20,0mm	3,0-20,0mm	2,4-20,0mm	3,0-20,0mm
Drill length [L4 max]	5,0-77,0mm	5,0-124,0mm	14,0-85,0mm	12,0-124,0mm	—
Drilling depth L/D1	3-5 x D	3-8 x D	3-5 x D	3-12 x D	—
Point angle	140°	140°	140°	140°/132°	140°
Flute angle	30°	30°	30°	30°	30°
Coolant			 	 	 
Operations			   	   	   
Flutes and margin					
Corner chamfer					
Shank	 	 	 	 	

* See page in the Kennametal Master Catalog 2018 • Volume Two • Rotating Tools, A-16-05217.

- Primary
- Secondary

Kenna Universal™

High-Performance
Solid Carbide Drill



Materials



Applications



Countersinking/
Stroke Chamfering



Drilling



Drilling:
Stacked Plates



Drilling:
Inclined Exit



Drilling:
Cross Hole

Versatile solid carbide drill generates excellent hole quality in multiple materials.

The Kenna Universal drill series covers a diameter range from 2,383–21 mm and provides 12 x D drilling capability.

Applicable in many materials for cross hole drilling, inclined exit drilling, deep hole drilling, and chamfer hole drilling. The Kenna Universal drill series offers long tool life, fewer tool changes, and requires less tool inventory, making it an excellent alternative to other high-performance, material-specific drills.

The cone point design is ideal for piloting applications.

B979



NEW!

12 x D drilling without a pilot drill in multiple materials.

Four-margin land design for stability, hole straightness, and high productivity.

Ultra-high polished flutes provides minimum friction, improving chip evacuation and tool life.

B731



NEW!

Combines two applications in one process step, reducing machining time and cost.

Excellent hole quality, roundness, ovality, and position accuracy.

B96/B97



NEW!

KCU15 grade provides longer tool life.
Cost-effective alternative to other high-performance, material-specific solid carbide drills.

Applicable as pilot drill for deep hole drilling applications.

- A four-margin land design provides hole straightness and roundness, even when drilling cross holes.
- The low-thrust drill point design has excellent centering capabilities, ideal for less stable machining conditions.
- Easy to recondition, delivering extended tool life.
- MQL-ready! All shanks fulfill the DIN 6535 and 69090-03 requirements for minimum quantity lubrication.

Kenna Universal™ • B966 • 3 x D • Straight Shank

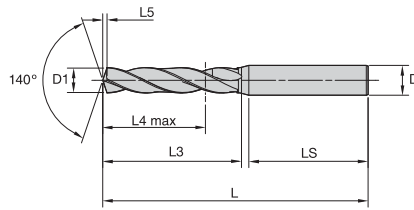

- first choice
- alternate choice

P	●
M	○
K	●
N	○
S	○
H	○

order number	catalogue number	D1	L	L3	L4 max	L5	LS	D	KC7315
1913052	B966A03000	3,00	62	20	14	0,5	36	6	●
2273318	B966A03100	3,10	62	20	14	0,5	36	6	●
1961108	B966A03200	3,20	62	20	14	0,5	36	6	●
2213696	B966A03300	3,30	62	20	14	0,5	36	6	●
2408266	B966A03400	3,40	62	20	14	0,6	36	6	●
1913458	B966A03500	3,50	62	20	14	0,6	36	6	●
2425117	B966A03600	3,60	62	20	14	0,6	36	6	●
1913459	B966A03700	3,70	62	20	14	0,6	36	6	●
1913460	B966A03800	3,80	66	24	17	0,6	36	6	●
2040682	B966A03900	3,90	66	24	17	0,6	36	6	●
2266804	B966A03960	3,96	66	24	17	0,7	36	6	●
1913461	B966A04000	4,00	66	24	17	0,7	36	6	●
2425113	B966A04100	4,10	66	24	17	0,7	36	6	●
1913462	B966A04200	4,20	66	24	17	0,7	36	6	●
2213700	B966A04300	4,30	66	24	17	0,7	36	6	●
2213701	B966A04400	4,40	66	24	17	0,7	36	6	●
1913473	B966A04500	4,50	66	24	17	0,7	36	6	●
1913474	B966A04600	4,60	66	24	17	0,8	36	6	●
2256916	B966A04700	4,70	66	24	17	0,8	36	6	●
1913475	B966A04800	4,80	66	28	20	0,8	36	6	●
2425114	B966A04900	4,90	66	28	20	0,8	36	6	●
1913476	B966A05000	5,00	66	28	20	0,8	36	6	●
2391925	B966A05040	5,04	66	28	20	0,8	36	6	●
1995000	B966A05100	5,10	66	28	20	0,8	36	6	●
2250824	B966A05200	5,20	66	28	20	0,9	36	6	●
2045222	B966A05300	5,30	66	28	20	0,9	36	6	●
2425115	B966A05400	5,40	66	28	20	0,9	36	6	●
1913477	B966A05500	5,50	66	28	20	0,9	36	6	●
2242390	B966A05600	5,60	66	28	20	0,9	36	6	●
1913478	B966A05700	5,70	66	28	20	1,0	36	6	●
1913479	B966A05800	5,80	66	28	20	1,0	36	6	●
1957789	B966A05900	5,90	66	28	20	1,0	36	6	●
1913480	B966A06000	6,00	66	28	20	1,0	36	6	●
2038613	B966A06050	6,05	79	34	24	1,0	36	8	●
2220855	B966A06100	6,10	79	34	24	1,0	36	8	●
1982397	B966A06200	6,20	79	34	24	1,0	36	8	●
2404438	B966A06300	6,30	79	34	24	1,1	36	8	●
2391902	B966A06350	6,35	79	34	24	1,1	36	8	●
2037058	B966A06400	6,40	79	34	24	1,1	36	8	●
1913481	B966A06500	6,50	79	34	24	1,1	36	8	●
2220856	B966A06600	6,60	79	34	24	1,1	36	8	●
1985037	B966A06700	6,70	79	34	24	1,1	36	8	●
1913482	B966A06800	6,80	79	34	24	1,1	36	8	●
1988099	B966A06900	6,90	79	34	24	1,2	36	8	●
1913483	B966A07000	7,00	79	34	24	1,2	36	8	●
2425118	B966A07100	7,10	79	41	29	1,2	36	8	●
2231579	B966A07200	7,20	79	41	29	1,2	36	8	●
2425119	B966A07300	7,30	79	41	29	1,2	36	8	●
1913484	B966A07400	7,40	79	41	29	1,3	36	8	●
1913485	B966A07500	7,50	79	41	29	1,3	36	8	●
2425120	B966A07600	7,60	79	41	29	1,3	36	8	●
2217005	B966A07700	7,70	79	41	29	1,3	36	8	●
1913486	B966A07800	7,80	79	41	29	1,3	36	8	●
1988100	B966A07900	7,90	79	41	29	1,3	36	8	●
1913487	B966A08000	8,00	79	41	29	1,4	36	8	●
1997389	B966A08100	8,10	89	47	35	1,4	40	10	●
1985038	B966A08200	8,20	89	47	35	1,4	40	10	●
2403807	B966A08300	8,30	89	47	35	1,4	40	10	●
2203486	B966A08400	8,40	89	47	35	1,4	40	10	●
1913488	B966A08500	8,50	89	47	35	1,4	40	10	●

148-151	152	76-77	88, 156

Kenna Universal™ • B966 • 3 x D • Straight Shank

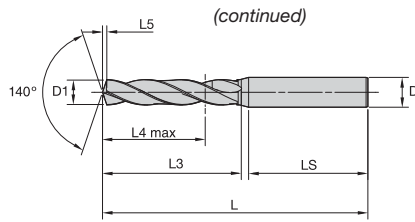

- first choice
- alternate choice

P	●
M	○
K	●
N	○
S	○
H	○

order number	catalogue number	D1	L	L3	L4 max	L5	LS	D	KC7315
1995002	B966A08600	8,60	89	47	35	1,5	40	10	●
2425143	B966A08700	8,70	89	47	35	1,5	40	10	●
1913489	B966A08800	8,80	89	47	35	1,5	40	10	●
2425145	B966A08900	8,90	89	47	35	1,5	40	10	●
1913490	B966A09000	9,00	89	47	35	1,5	40	10	●
2425146	B966A09100	9,10	89	47	35	1,5	40	10	●
2273321	B966A09200	9,20	89	47	35	1,6	40	10	●
1913491	B966A09300	9,30	89	47	35	1,6	40	10	●
1995073	B966A09400	9,40	89	47	35	1,6	40	10	●
1913492	B966A09500	9,50	89	47	35	1,6	40	10	●
1998947	B966A09600	9,60	89	47	35	1,6	40	10	●
2425149	B966A09700	9,70	89	47	35	1,7	40	10	●
1913493	B966A09800	9,80	89	47	35	1,7	40	10	●
2256252	B966A09900	9,90	89	47	35	1,7	40	10	●
1913494	B966A10000	10,00	89	47	35	1,7	40	10	●
1995074	B966A10100	10,10	102	55	40	1,7	45	12	●
1913495	B966A10200	10,20	102	55	40	1,7	45	12	●
2227338	B966A10300	10,30	102	55	40	1,8	45	12	●
1992232	B966A10400	10,40	102	55	40	1,8	45	12	●
1913496	B966A10500	10,50	102	55	40	1,8	45	12	●
2043136	B966A10600	10,60	102	55	40	1,8	45	12	●
1913497	B966A10700	10,70	102	55	40	1,8	45	12	●
2229055	B966A10800	10,80	102	55	40	1,8	45	12	●
2425151	B966A10900	10,90	102	55	40	1,9	45	12	●
1913498	B966A11000	11,00	102	55	40	1,9	45	12	●
2425173	B966A11100	11,10	102	55	40	1,9	45	12	●
1913499	B966A11200	11,20	102	55	40	1,9	45	12	●
2214926	B966A11300	11,30	102	55	40	1,9	45	12	●
1995075	B966A11400	11,40	102	55	40	2,0	45	12	●
1913500	B966A11500	11,50	102	55	40	2,0	45	12	●
2043137	B966A11600	11,60	102	55	40	2,0	45	12	●
1913501	B966A11700	11,70	102	55	40	2,0	45	12	●
1997391	B966A11800	11,80	102	55	40	2,0	45	12	●
2425176	B966A11900	11,90	102	55	40	2,0	45	12	●
1913502	B966A12000	12,00	102	55	40	2,1	45	12	●
1995076	B966A12100	12,10	107	60	43	2,1	45	14	●
2425178	B966A12200	12,20	107	60	43	2,1	45	14	●
2231830	B966A12300	12,30	107	60	43	2,1	45	14	●
2425203	B966A12400	12,40	107	60	43	2,1	45	14	●
1913503	B966A12500	12,50	107	60	43	2,1	45	14	●
1991229	B966A12600	12,60	107	60	43	2,2	45	14	●
1913504	B966A12700	12,70	107	60	43	2,2	45	14	●
2425205	B966A12800	12,80	107	60	43	2,2	45	14	●
2425206	B966A12900	12,90	107	60	43	2,2	45	14	●
1913505	B966A13000	13,00	107	60	43	2,2	45	14	●
3024745	B966A13100	13,10	107	60	43	2,3	45	14	●
1972376	B966A13200	13,20	107	60	43	2,3	45	14	●
2204116	B966A13300	13,30	107	60	43	2,3	45	14	●
3757726	B966A13400	13,40	107	60	43	2,3	45	14	●
1913506	B966A13500	13,50	107	60	43	2,3	45	14	●
1913507	B966A13700	13,70	107	60	43	2,4	45	14	●
1913508	B966A14000	14,00	107	60	43	2,4	45	14	●
2425233	B966A14200	14,20	115	65	45	2,5	48	16	●
2248306	B966A14300	14,30	115	65	45	2,5	48	16	●
1913509	B966A14500	14,50	115	65	45	2,5	48	16	●
1913510	B966A14700	14,70	115	65	45	2,5	48	16	●
2220857	B966A14800	14,80	115	65	45	2,6	48	16	●
1913511	B966A15000	15,00	115	65	45	2,6	48	16	●
1913512	B966A15500	15,50	115	65	45	2,7	48	16	●
1913513	B966A15700	15,70	115	65	45	2,7	48	16	●
1913514	B966A16000	16,00	115	65	45	2,8	48	16	●
2641904	B966A16500	16,50	123	73	51	2,9	48	18	●
4003520	B966A17000	17,00	123	73	51	2,9	48	18	●
4003521	B966A17500	17,50	123	73	51	3,0	48	18	●
4003522	B966A18000	18,00	123	73	51	3,1	48	18	●
3505952	B966A20000	20,00	131	79	55	3,5	50	20	●

Kenna Universal™ • B966 • 3 x D • Whistle Notch™ Shank

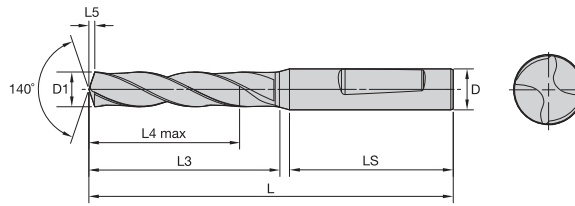

● first choice
○ alternate choice

P	●
M	○
K	●
N	○
S	○
H	○
	○
	○

order number	catalogue number	D1	L	L3	L4 max	L5	LS	D	KC7315
1913652	B966F03000	3,00	62	20	14	0,5	36	6	●
2428793	B966F03300	3,30	62	20	14	0,5	36	6	●
2264867	B966F03400	3,40	62	20	14	0,6	36	6	●
1913653	B966F03500	3,50	62	20	14	0,6	36	6	●
2264869	B966F03600	3,60	62	20	14	0,6	36	6	●
1913656	B966F04000	4,00	66	24	17	0,7	36	6	●
1913657	B966F04200	4,20	66	24	17	0,7	36	6	●
1913661	B966F05000	5,00	66	28	20	0,8	36	6	●
2264973	B966F05100	5,10	66	28	20	0,8	36	6	●
2251799	B966F05300	5,30	66	28	20	0,9	36	6	●
1913662	B966F05500	5,50	66	28	20	0,9	36	6	●
2265006	B966F05600	5,60	66	28	20	0,9	36	6	●
1913665	B966F06000	6,00	66	28	20	1,0	36	6	●
2265002	B966F06300	6,30	79	34	24	1,1	36	8	●
1969942	B966F06400	6,40	79	34	24	1,1	36	8	●
1913666	B966F06500	6,50	79	34	24	1,1	36	8	●
2264990	B966F06700	6,70	79	34	24	1,1	36	8	●
1913667	B966F06800	6,80	79	34	24	1,1	36	8	●
1913668	B966F07000	7,00	79	34	24	1,2	36	8	●
2265022	B966F07100	7,10	79	41	29	1,2	36	8	●
2265003	B966F07300	7,30	79	41	29	1,2	36	8	●
1913669	B966F07400	7,40	79	41	29	1,3	36	8	●
2265023	B966F07600	7,60	79	41	29	1,3	36	8	●
1913672	B966F08000	8,00	79	41	29	1,4	36	8	●
2251802	B966F08200	8,20	89	47	35	1,4	40	10	●
1970003	B966F08400	8,40	89	47	35	1,4	40	10	●
1913673	B966F08500	8,50	89	47	35	1,4	40	10	●
1913675	B966F09000	9,00	89	47	35	1,5	40	10	●
2264958	B966F09100	9,10	89	47	35	1,5	40	10	●
1913677	B966F09500	9,50	89	47	35	1,6	40	10	●
1913679	B966F10000	10,00	89	47	35	1,7	40	10	●
1913680	B966F10200	10,20	102	55	40	1,7	45	12	●
2264985	B966F10400	10,40	102	55	40	1,8	45	12	●
1913681	B966F10500	10,50	102	55	40	1,8	45	12	●
2264986	B966F10600	10,60	102	55	40	1,8	45	12	●
1913682	B966F10700	10,70	102	55	40	1,8	45	12	●
2264936	B966F10800	10,80	102	55	40	1,8	45	12	●
1913683	B966F11000	11,00	102	55	40	1,9	45	12	●
2264988	B966F11800	11,80	102	55	40	2,0	45	12	●
1913687	B966F12000	12,00	102	55	40	2,1	45	12	●
2428802	B966F12100	12,10	107	60	43	2,1	45	14	●
2428856	B966F12200	12,20	107	60	43	2,1	45	14	●
1913688	B966F12500	12,50	107	60	43	2,1	45	14	●
1913689	B966F12700	12,70	107	60	43	2,2	45	14	●
1913690	B966F13000	13,00	107	60	43	2,2	45	14	●
1913691	B966F13500	13,50	107	60	43	2,3	45	14	●
1913693	B966F14000	14,00	107	60	43	2,4	45	14	●
1913694	B966F14500	14,50	115	65	45	2,5	48	16	●
1913696	B966F15000	15,00	115	65	45	2,6	48	16	●
1913699	B966F16000	16,00	115	65	45	2,8	48	16	●
2264918	B966F16500	16,50	123	73	51	2,9	48	18	●
2264892	B966F17000	17,00	123	73	51	2,9	48	18	●
2264920	B966F17500	17,50	123	73	51	3,0	48	18	●
2264893	B966F18000	18,00	123	73	51	3,1	48	18	●

148-151	152	76-77	88, 156

Kenna Universal™ • B967 • 5 x D • Straight Shank

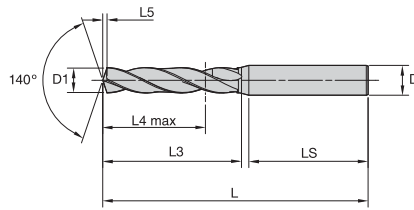

- first choice
- alternate choice

P	●
M	○
K	●
N	○
S	○
H	○
	○
	○

order number	catalogue number	D1	L	L3	L4 max	L5	LS	D	KC7315
6172513	B967A03000	3,00	66	28	23	0,5	36	6	●
6172514	B967A03100	3,10	66	28	23	0,5	36	6	●
6172515	B967A03200	3,20	66	28	23	0,5	36	6	●
6172516	B967A03300	3,30	66	28	23	0,5	36	6	●
6172517	B967A03500	3,50	66	28	23	0,6	36	6	●
6172518	B967A03800	3,80	74	36	29	0,6	36	6	●
6172519	B967A04000	4,00	74	36	29	0,7	36	6	●
6172520	B967A04200	4,20	74	36	29	0,7	36	6	●
6172531	B967A04300	4,30	74	36	29	0,7	36	6	●
6172532	B967A04500	4,50	74	36	29	0,7	36	6	●
6172533	B967A04800	4,80	82	44	35	0,8	36	6	●
3773323	B967A05000	5,00	82	44	35	0,8	36	6	●
6172534	B967A05100	5,10	82	44	35	0,8	36	6	●
6172535	B967A05200	5,20	82	44	35	0,9	36	6	●
6172536	B967A05500	5,50	82	44	35	0,9	36	6	●
6172537	B967A05800	5,80	82	44	35	1,0	36	6	●
3956013	B967A06000	6,00	82	44	35	1,0	36	6	●
6172538	B967A06100	6,10	91	53	43	1,0	36	8	●
3598188	B967A06500	6,50	91	53	43	1,1	36	8	●
6172539	B967A06600	6,60	91	53	43	1,1	36	8	●
3956018	B967A06700	6,70	91	53	43	1,1	36	8	●
6172540	B967A06800	6,80	91	53	43	1,1	36	8	●
3956014	B967A07000	7,00	91	53	43	1,2	36	8	●
3956017	B967A07400	7,40	91	53	43	1,3	36	8	●
3890197	B967A07500	7,50	91	53	43	1,3	36	8	●
6172541	B967A07800	7,80	91	53	43	1,3	36	8	●
2435131	B967A08000	8,00	91	53	43	1,4	36	8	●
6172542	B967A08100	8,10	103	61	49	1,4	40	10	●
2425073	B967A08500	8,50	103	61	49	1,4	40	10	●
6172543	B967A08600	8,60	103	61	49	1,5	40	10	●
3876021	B967A08700	8,70	103	61	49	1,5	40	10	●
6172544	B967A08800	8,80	103	61	49	1,5	40	10	●
2425000	B967A09000	9,00	103	61	49	1,5	40	10	●
5548378	B967A09300	9,30	103	61	49	1,6	40	10	●
3117503	B967A09500	9,50	103	61	49	1,6	40	10	●
4114696	B967A09800	9,80	103	61	49	1,7	40	10	●
2037059	B967A10000	10,00	103	61	49	1,7	40	10	●
4080356	B967A10200	10,20	118	71	56	1,7	45	12	●
2649486	B967A10500	10,50	118	71	56	1,8	45	12	●
2658075	B967A10700	10,70	118	71	56	1,8	45	12	●
2425052	B967A10800	10,80	118	71	56	1,9	45	12	●
3005898	B967A11000	11,00	118	71	56	1,9	45	12	●
4089831	B967A11300	11,30	118	71	56	1,9	45	12	●
3877827	B967A11500	11,50	118	71	56	2,0	45	12	●
4114713	B967A11800	11,80	118	71	56	2,0	45	12	●
2627240	B967A12000	12,00	118	71	56	2,1	45	12	●
4080362	B967A12300	12,30	124	77	60	2,1	45	14	●
2424997	B967A12500	12,50	124	77	60	2,1	45	14	●
3955980	B967A12700	12,70	124	77	60	2,2	45	14	●
4080393	B967A12800	12,80	124	77	60	2,2	45	14	●
4071037	B967A13000	13,00	124	77	60	2,2	45	14	●
3005899	B967A13500	13,50	124	77	60	2,3	45	14	●
2613858	B967A14000	14,00	124	77	60	2,4	45	14	●
3559794	B967A14500	14,50	133	83	63	2,5	48	16	●
4080395	B967A15000	15,00	133	83	63	2,6	48	16	●
4078132	B967A15300	15,30	133	83	63	2,6	48	16	●
3848433	B967A15500	15,50	133	83	63	2,7	48	16	●
2658685	B967A16000	16,00	133	83	63	2,8	48	16	●
5897007	B967A16500	16,50	143	93	71	2,9	48	18	●

148-151	152	76-77	88, 156

Kenna Universal™ • B976 • 3 x D • Internal Coolant • Straight Shank

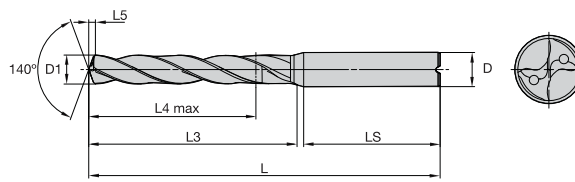

- first choice
- alternate choice

P	●
M	○
K	●
N	○
S	○
H	○

order number	catalogue number	D1	L	L3	L4 max	L5	LS	D	KC7315
4042538	B976Z02383	2,38	50	16	11	0,4	28	3	●
4042539	B976Z02400	2,40	50	16	11	0,4	28	3	●
4042540	B976Z02439	2,44	50	16	11	0,4	28	3	●
4042541	B976Z02489	2,49	50	16	11	0,4	28	3	●
4042542	B976Z02500	2,50	50	16	11	0,4	28	3	●
4042543	B976Z02578	2,58	50	16	11	0,4	28	3	●
4042544	B976Z02600	2,60	50	16	11	0,4	28	3	●
4042545	B976Z02642	2,64	50	16	11	0,4	28	3	●
4042546	B976Z02705	2,71	50	16	11	0,4	28	3	●
4042547	B976Z02779	2,78	50	16	11	0,4	28	3	●
4042548	B976Z02800	2,80	50	16	11	0,5	28	3	●
4042549	B976Z02820	2,82	50	16	11	0,5	28	3	●
4042550	B976Z02870	2,87	50	16	11	0,5	28	3	●
4042551	B976Z02900	2,90	50	16	11	0,5	28	3	●
4042552	B976Z02947	2,95	50	16	11	0,5	28	3	●
2878592	B976A03000	3,00	62	20	14	0,5	36	6	●
3005956	B976A03100	3,10	62	20	14	0,5	36	6	●
4054494	B976A03175	3,18	62	20	14	0,5	36	6	●
3528124	B976A03180	3,18	62	20	14	0,5	36	6	●
3110522	B976A03200	3,20	62	20	14	0,5	36	6	●
2878591	B976A03300	3,30	62	20	14	0,5	36	6	●
4054495	B976A03454	3,45	62	20	14	0,6	36	6	●
3528125	B976A03500	3,50	62	20	14	0,6	36	6	●
3110544	B976A03600	3,60	62	20	14	0,6	36	6	●
2890223	B976A03700	3,70	62	20	14	0,6	36	6	●
4054496	B976A03734	3,73	62	20	14	0,6	36	6	●
4054497	B976A03797	3,80	66	24	17	0,6	36	6	●
2392360	B976A03800	3,80	66	24	17	0,6	36	6	●
2392361	B976A03900	3,90	66	24	17	0,6	36	6	●
2649363	B976A03970	3,97	66	24	17	0,7	36	6	●
1913515	B976A04000	4,00	66	24	17	0,7	36	6	●
4054498	B976A04039	4,04	66	24	17	0,7	36	6	●
2599887	B976A04100	4,10	66	24	17	0,7	36	6	●
1913516	B976A04200	4,20	66	24	17	0,7	36	6	●
2276088	B976A04300	4,30	66	24	17	0,7	36	6	●
4054499	B976A04366	4,37	66	24	17	0,7	36	6	●
4054500	B976A04496	4,50	66	24	17	0,7	36	6	●
1913517	B976A04500	4,50	66	24	17	0,7	36	6	●
1913518	B976A04600	4,60	66	24	17	0,8	36	6	●
3528126	B976A04620	4,62	66	24	17	0,8	36	6	●
4054501	B976A04700	4,70	66	24	17	0,8	36	6	●
2649364	B976A04763	4,76	66	28	20	0,8	36	6	●
1913519	B976A04800	4,80	66	28	20	0,8	36	6	●
2397687	B976A04900	4,90	66	28	20	0,8	36	6	●
1913520	B976A05000	5,00	66	28	20	0,8	36	6	●
2385356	B976A05100	5,10	66	28	20	0,9	36	6	●
4054502	B976A05106	5,11	66	28	20	0,8	36	6	●
1984183	B976A05200	5,20	66	28	20	0,9	36	6	●
3528127	B976A05250	5,25	66	28	20	0,9	36	6	●
1988932	B976A05300	5,30	66	28	20	0,9	36	6	●
2264538	B976A05400	5,40	66	28	20	0,9	36	6	●
4054503	B976A05410	5,41	66	28	20	0,9	36	6	●
1913521	B976A05500	5,50	66	28	20	0,9	36	6	●
2541535	B976A05530	5,53	66	28	20	0,9	36	6	●
4086429	B976A05558	5,56	66	28	20	0,9	36	6	●
2649365	B976A05575	5,58	66	28	20	0,9	36	6	●
2224587	B976A05600	5,60	66	28	20	0,9	36	6	●
6962060	B976A05650	5,65	66	28	20	0,9	36	6	●
1913522	B976A05700	5,70	66	28	20	1,0	36	6	●
4054504	B976A05791	5,79	66	28	20	1,0	36	6	●

148-151	152	76-77	88, 156

Kenna Universal™ • B976 • 3 x D • Internal Coolant • Straight Shank

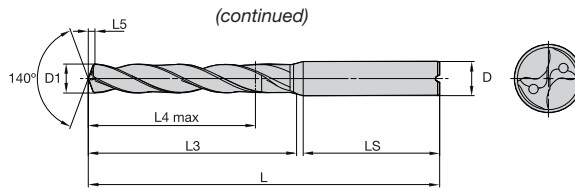

- first choice
- alternate choice

P	●
M	○
K	●
N	○
S	○
H	○

order number	catalogue number	D1	L	L3	L4 max	L5	LS	D	KC7315
1913523	B976A05800	5,80	66	28	20	1,0	36	6	●
4054505	B976A05944	5,94	66	28	20	1,0	36	6	●
1913524	B976A06000	6,00	66	28	20	1,0	36	6	●
2455054	B976A06100	6,10	79	34	24	1,0	36	8	●
1986773	B976A06200	6,20	79	34	24	1,0	36	8	●
2649366	B976A06350	6,35	79	34	24	1,1	36	8	●
1913525	B976A06500	6,50	79	34	24	1,1	36	8	●
4054506	B976A06528	6,53	79	34	24	1,1	36	8	●
3528128	B976A06530	6,53	79	34	24	1,1	36	8	●
2231776	B976A06600	6,60	79	34	24	1,1	36	8	●
3121287	B976A06700	6,70	79	34	24	1,1	36	8	●
2649367	B976A06746	6,75	79	34	24	1,1	36	8	●
3528129	B976A06750	6,75	79	34	24	1,1	36	8	●
1913526	B976A06800	6,80	79	34	24	1,1	36	8	●
2579622	B976A06900	6,90	79	34	24	1,2	36	8	●
4054507	B976A06909	6,91	79	34	24	1,2	36	8	●
1913527	B976A07000	7,00	79	34	24	1,2	36	8	●
2614817	B976A07100	7,10	79	41	29	1,2	36	8	●
2649368	B976A07145	7,15	79	41	29	1,2	36	8	●
3110545	B976A07200	7,20	79	41	29	1,2	36	8	●
2455056	B976A07300	7,30	79	41	29	1,2	36	8	●
4054508	B976A07366	7,37	79	41	29	1,2	36	8	●
1913528	B976A07400	7,40	79	41	29	1,3	36	8	●
1913529	B976A07500	7,50	79	41	29	1,3	36	8	●
2649369	B976A07541	7,54	79	41	29	1,3	36	8	●
3553503	B976A07600	7,60	79	41	29	1,3	36	8	●
2455057	B976A07700	7,70	79	41	29	1,3	36	8	●
1913530	B976A07800	7,80	79	41	29	1,3	36	8	●
2397689	B976A07900	7,90	79	41	29	1,3	36	8	●
2649370	B976A07938	7,94	79	41	29	1,3	36	8	●
1913531	B976A08000	8,00	79	41	29	1,4	36	8	●
3830321	B976A08020	8,02	89	47	35	1,4	40	10	●
2036154	B976A08100	8,10	89	47	35	1,4	40	10	●
2390961	B976A08200	8,20	89	47	35	1,4	40	10	●
2231777	B976A08300	8,30	89	47	35	1,4	40	10	●
2649371	B976A08334	8,33	89	47	35	1,4	40	10	●
6962061	B976A08400	8,40	89	47	35	1,4	40	10	●
3528131	B976A08430	8,43	89	47	35	1,4	40	10	●
4054509	B976A08433	8,43	89	47	35	1,4	40	10	●
1913532	B976A08500	8,50	89	47	35	1,4	40	10	●
2222651	B976A08600	8,60	89	47	35	1,5	40	10	●
1988983	B976A08700	8,70	89	47	35	1,5	40	10	●
2649372	B976A08733	8,73	89	47	35	1,5	40	10	●
1913533	B976A08800	8,80	89	47	35	1,5	40	10	●
4054510	B976A08839	8,84	89	47	35	1,5	40	10	●
1913534	B976A09000	9,00	89	47	35	1,5	40	10	●
4054511	B976A09093	9,09	89	47	35	1,5	40	10	●
2224588	B976A09100	9,10	89	47	35	1,5	40	10	●
2649373	B976A09129	9,13	89	47	35	1,6	40	10	●
2408308	B976A09200	9,20	89	47	35	1,6	40	10	●
1913535	B976A09300	9,30	89	47	35	1,6	40	10	●
3615883	B976A09400	9,40	89	47	35	1,6	40	10	●
1913536	B976A09500	9,50	89	47	35	1,6	40	10	●
2649374	B976A09525	9,53	89	47	35	1,6	40	10	●
2231778	B976A09600	9,60	89	47	35	1,6	40	10	●
1961106	B976A09700	9,70	89	47	35	1,7	40	10	●
3528132	B976A09750	9,75	89	47	35	1,7	40	10	●
1913537	B976A09800	9,80	89	47	35	1,7	40	10	●
2649375	B976A09921	9,92	89	47	35	1,7	40	10	●
1913538	B976A10000	10,00	89	47	35	1,7	40	10	●

148-151	152	76-77	88, 156

Kenna Universal™ • B976 • 3 x D • Internal Coolant • Straight Shank

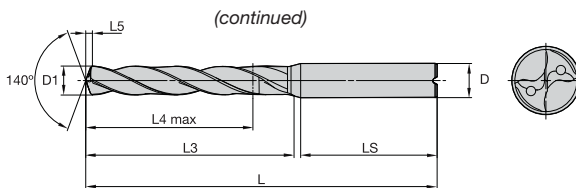

- first choice
- alternate choice

P	●
M	○
K	●
N	○
S	○
H	○

order number	catalogue number	D1	L	L3	L4 max	L5	LS	D	KC7315
1913539	B976A10200	10,20	102	55	40	1,7	45	12	●
4054512	B976A10262	10,26	102	55	40	1,8	45	12	●
3119977	B976A10300	10,30	102	55	40	1,8	45	12	●
2649376	B976A10320	10,32	102	55	40	1,8	45	12	●
2884170	B976A10400	10,40	102	55	40	1,8	45	12	●
1913540	B976A10500	10,50	102	55	40	1,8	45	12	●
5057900	B976A10600	10,60	102	55	40	1,8	45	12	●
1913541	B976A10700	10,70	102	55	40	1,8	45	12	●
2649377	B976A10716	10,72	102	55	40	1,8	45	12	●
2388784	B976A10800	10,80	102	55	40	1,8	45	12	●
1913542	B976A11000	11,00	102	55	40	1,9	45	12	●
2649378	B976A11113	11,11	102	55	40	1,9	45	12	●
1913543	B976A11200	11,20	102	55	40	1,9	45	12	●
2490989	B976A11300	11,30	102	55	40	1,9	45	12	●
1913544	B976A11500	11,50	102	55	40	2,0	45	12	●
2649379	B976A11509	11,51	102	55	40	2,0	45	12	●
3791545	B976A11600	11,60	102	55	40	2,0	45	12	●
1913545	B976A11700	11,70	102	55	40	2,0	45	12	●
3873028	B976A11800	11,80	102	55	40	2,0	45	12	●
2649380	B976A11908	11,91	102	55	40	2,0	45	12	●
1913546	B976A12000	12,00	102	55	40	2,1	45	12	●
2419790	B976A12300	12,30	107	60	43	2,1	45	14	●
2649381	B976A12304	12,30	107	60	43	2,1	45	14	●
1913547	B976A12500	12,50	107	60	43	2,1	45	14	●
1913548	B976A12700	12,70	107	60	43	2,2	45	14	●
2227984	B976A12800	12,80	107	60	43	2,2	45	14	●
1913549	B976A13000	13,00	107	60	43	2,2	45	14	●
2217898	B976A13300	13,30	107	60	43	2,3	45	14	●
4054513	B976A13495	13,50	107	60	43	2,3	45	14	●
1913550	B976A13500	13,50	107	60	43	2,3	45	14	●
1913551	B976A13700	13,70	107	60	43	2,4	45	14	●
1913552	B976A14000	14,00	107	60	43	2,4	45	14	●
2226630	B976A14100	14,10	115	65	45	2,4	48	16	●
2404108	B976A14200	14,20	115	65	45	2,5	48	16	●
2649382	B976A14288	14,29	115	65	45	2,5	48	16	●
1913553	B976A14500	14,50	115	65	45	2,5	48	16	●
1913554	B976A14700	14,70	115	65	45	2,5	48	16	●
1913555	B976A15000	15,00	115	65	45	2,6	48	16	●
1913556	B976A15500	15,50	115	65	45	2,7	48	16	●
2649383	B976A15875	15,88	115	65	45	2,7	48	16	●
1913558	B976A16000	16,00	115	65	45	2,8	48	16	●
2882164	B976A16200	16,20	123	73	51	2,8	48	18	●
1913559	B976A16500	16,50	123	73	51	2,9	48	18	●
4054514	B976A16670	16,67	123	73	51	2,9	48	18	●
2045867	B976A16800	16,80	123	73	51	2,9	48	18	●
1913560	B976A17000	17,00	123	73	51	2,9	48	18	●
2397289	B976A17100	17,10	123	73	51	3,0	48	18	●
2649384	B976A17463	17,46	123	73	51	3,0	48	18	●
1913561	B976A17500	17,50	123	73	51	3,0	48	18	●
1913562	B976A18000	18,00	123	73	51	3,1	48	18	●
1913563	B976A18500	18,50	131	79	55	3,2	50	20	●
1913564	B976A19000	19,00	131	79	55	3,3	50	20	●
2649385	B976A19050	19,05	131	79	55	3,3	50	20	●
1913565	B976A19500	19,50	131	79	55	3,4	50	20	●
2044834	B976A19700	19,70	131	79	55	3,4	50	20	●
4006503	B976A19840	19,84	131	79	55	3,5	50	20	●
1913566	B976A20000	20,00	131	79	55	3,5	50	20	●

148-151	152	76-77	88, 156

Kenna Universal™ • B976 • 3 x D • Internal Coolant • Whistle Notch™ Shank

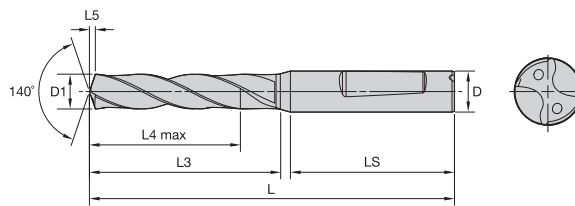

● first choice
○ alternate choice

P	●
M	○
K	●
N	○
S	○
H	○

order number	catalogue number	D1	L	L3	L4 max	L5	LS	D	KC7315
4006482	B976F03000	3,00	62	20	14	0,5	36	6	●
3681262	B976F03900	3,90	66	24	17	0,6	36	6	●
1913701	B976F04200	4,20	66	24	17	0,7	36	6	●
1913702	B976F04500	4,50	66	24	17	0,7	36	6	●
1913703	B976F04600	4,60	66	24	17	0,8	36	6	●
1913705	B976F05000	5,00	66	28	20	0,8	36	6	●
2209877	B976F05100	5,10	66	28	20	0,8	36	6	●
2215328	B976F05200	5,20	66	28	20	0,9	36	6	●
1913706	B976F05500	5,50	66	28	20	0,9	36	6	●
2264996	B976F05600	5,60	66	28	20	0,9	36	6	●
1913708	B976F05800	5,80	66	28	20	1,0	36	6	●
1913709	B976F06000	6,00	66	28	20	1,0	36	6	●
2264976	B976F06300	6,30	79	34	24	1,1	36	8	●
2264977	B976F06400	6,40	79	34	24	1,1	36	8	●
1913711	B976F06800	6,80	79	34	24	1,1	36	8	●
1913712	B976F07000	7,00	79	34	24	1,2	36	8	●
2264978	B976F07100	7,10	79	41	29	1,2	36	8	●
1913715	B976F07800	7,80	79	41	29	1,3	36	8	●
1913716	B976F08000	8,00	79	41	29	1,4	36	8	●
2264941	B976F08300	8,30	89	47	35	1,4	40	10	●
1913717	B976F08500	8,50	89	47	35	1,4	40	10	●
2264897	B976F08600	8,60	89	47	35	1,5	40	10	●
2264898	B976F08700	8,70	89	47	35	1,5	40	10	●
1913718	B976F08800	8,80	89	47	35	1,5	40	10	●
1913719	B976F09000	9,00	89	47	35	1,5	40	10	●
1913723	B976F10000	10,00	89	47	35	1,7	40	10	●
1913724	B976F10200	10,20	102	55	40	1,7	45	12	●
1913725	B976F10500	10,50	102	55	40	1,8	45	12	●
1913726	B976F10700	10,70	102	55	40	1,8	45	12	●
2264912	B976F10800	10,80	102	55	40	1,8	45	12	●
1913727	B976F11000	11,00	102	55	40	1,9	45	12	●
1913730	B976F11700	11,70	102	55	40	2,0	45	12	●
1913731	B976F12000	12,00	102	55	40	2,1	45	12	●
1913732	B976F12500	12,50	107	60	43	2,1	45	14	●
1913733	B976F12700	12,70	107	60	43	2,2	45	14	●
1913734	B976F13000	13,00	107	60	43	2,2	45	14	●
1913735	B976F13500	13,50	107	60	43	2,3	45	14	●
1913736	B976F13700	13,70	107	60	43	2,4	45	14	●
1913737	B976F14000	14,00	107	60	43	2,4	45	14	●
1913738	B976F14500	14,50	115	65	45	2,5	48	16	●
1913740	B976F15000	15,00	115	65	45	2,6	48	16	●
6133107	B976F15400	15,40	115	65	45	2,7	48	16	●
1913743	B976F16000	16,00	115	65	45	2,8	48	16	●
1913744	B976F16500	16,50	123	73	51	2,9	48	18	●
1913745	B976F17000	17,00	123	73	51	2,9	48	18	●
5118592	B976F17500	17,50	123	73	51	3,0	48	18	●
1913747	B976F18000	18,00	123	73	51	3,1	48	18	●
1913748	B976F18500	18,50	131	79	55	3,2	50	20	●

148-151	152	76-77	88, 156

Kenna Universal™ • B977 • 5 x D • Internal Coolant • Straight Shank

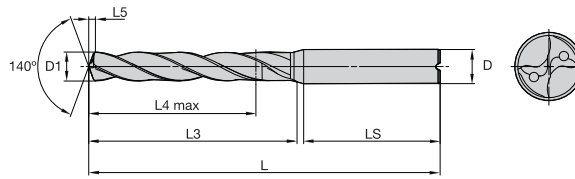

- first choice
- alternate choice

P	●
M	○
K	●
N	○
S	○
H	○

order number	catalogue number	D1	L	L3	L4 max	L5	LS	D	KC7315
2425285	B977A03000	3,00	66	28	23	0,5	36	6	●
2425288	B977A03100	3,10	66	28	23	0,5	36	6	●
4054515	B977A03175	3,18	66	28	23	0,5	36	6	●
2425290	B977A03200	3,20	66	28	23	0,5	36	6	●
3480435	B977A03250	3,25	66	28	23	0,5	36	6	●
1959665	B977A03300	3,30	66	28	23	0,5	36	6	●
2425292	B977A03400	3,40	66	28	23	0,6	36	6	●
4086430	B977A03454	3,45	66	28	23	0,6	36	6	●
2425303	B977A03500	3,50	66	28	23	0,6	36	6	●
2425304	B977A03600	3,60	66	28	23	0,6	36	6	●
2425305	B977A03700	3,70	66	28	23	0,6	36	6	●
4054516	B977A03734	3,73	66	28	23	0,6	36	6	●
4054517	B977A03797	3,80	74	36	29	0,6	36	6	●
2425306	B977A03800	3,80	74	36	29	0,6	36	6	●
2203489	B977A03900	3,90	74	36	29	0,6	36	6	●
2649386	B977A03970	3,97	74	36	29	0,7	36	6	●
1913567	B977A04000	4,00	74	36	29	0,7	36	6	●
4054518	B977A04039	4,04	74	36	29	0,7	36	6	●
2416279	B977A04100	4,10	74	36	29	0,7	36	6	●
1913568	B977A04200	4,20	74	36	29	0,7	36	6	●
2040680	B977A04300	4,30	74	36	29	0,7	36	6	●
4054519	B977A04366	4,37	74	36	29	0,7	36	6	●
2425309	B977A04400	4,40	74	36	29	0,7	36	6	●
4054520	B977A04496	4,50	74	36	29	0,7	36	6	●
1913569	B977A04500	4,50	74	36	29	0,7	36	6	●
2649387	B977A04580	4,58	74	36	29	0,8	36	6	●
1913570	B977A04600	4,60	74	36	29	0,8	36	6	●
2649388	B977A04623	4,62	74	36	29	0,8	36	6	●
2965409	B977A04650	4,65	74	36	29	0,8	36	6	●
2425310	B977A04700	4,70	74	36	29	0,8	36	6	●
2649389	B977A04763	4,76	82	44	35	0,8	36	6	●
1913571	B977A04800	4,80	82	44	35	0,8	36	6	●
2396971	B977A04900	4,90	82	44	35	0,8	36	6	●
1913572	B977A05000	5,00	82	44	35	0,8	36	6	●
2049487	B977A05100	5,10	82	44	35	0,8	36	6	●
4054521	B977A05106	5,11	82	44	35	0,8	36	6	●
1975006	B977A05200	5,20	82	44	35	0,9	36	6	●
2202510	B977A05300	5,30	82	44	35	0,9	36	6	●
2425311	B977A05400	5,40	82	44	35	0,9	36	6	●
2649390	B977A05410	5,41	82	44	35	0,9	36	6	●
1913573	B977A05500	5,50	82	44	35	0,9	36	6	●
2649391	B977A05558	5,56	82	44	35	0,9	36	6	●
1959664	B977A05600	5,60	82	44	35	0,9	36	6	●
1988931	B977A05700	5,70	82	44	35	1,0	36	6	●
4054522	B977A05791	5,79	82	44	35	1,0	36	6	●
1913574	B977A05800	5,80	82	44	35	1,0	36	6	●
2228362	B977A05900	5,90	82	44	35	1,0	36	6	●
4054523	B977A05944	5,94	82	44	35	1,0	36	6	●
1913575	B977A06000	6,00	82	44	35	1,0	36	6	●
2043779	B977A06100	6,10	91	53	43	1,0	36	8	●
4132877	B977A06150	6,15	91	53	43	1,0	36	8	●
2425323	B977A06200	6,20	91	53	43	1,0	36	8	●
2425324	B977A06300	6,30	91	53	43	1,1	36	8	●
2383552	B977A06350	6,35	91	53	43	1,1	36	8	●
2383778	B977A06400	6,40	91	53	43	1,1	36	8	●
1913576	B977A06500	6,50	91	53	43	1,1	36	8	●
2658213	B977A06528	6,53	91	53	43	1,1	36	8	●
2425325	B977A06600	6,60	91	53	43	1,1	36	8	●
2230539	B977A06700	6,70	91	53	43	1,1	36	8	●
1913577	B977A06800	6,80	91	53	43	1,1	36	8	●

148-151	152	76-77	88, 156

Kenna Universal™ • B977 • 5 x D • Internal Coolant • Straight Shank

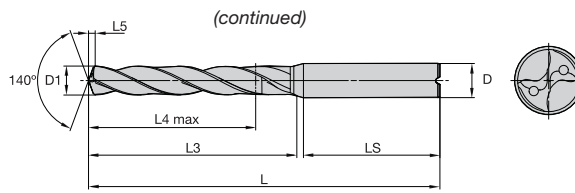

● first choice
○ alternate choice

P	●
M	○
K	●
N	○
S	○
H	○

order number	catalogue number	D1	L	L3	L4 max	L5	LS	D	KC7315
1959666	B977A06900	6,90	91	53	43	1,2	36	8	●
2658215	B977A06909	6,91	91	53	43	1,2	36	8	●
1913578	B977A07000	7,00	91	53	43	1,2	36	8	●
2203579	B977A07100	7,10	91	53	43	1,2	36	8	●
2658216	B977A07145	7,15	91	53	43	1,2	36	8	●
2264019	B977A07200	7,20	91	53	43	1,2	36	8	●
2425326	B977A07300	7,30	91	53	43	1,2	36	8	●
4054524	B977A07366	7,37	91	53	43	1,2	36	8	●
1913579	B977A07400	7,40	91	53	43	1,3	36	8	●
1913580	B977A07500	7,50	91	53	43	1,3	36	8	●
2658217	B977A07541	7,54	91	53	43	1,3	36	8	●
2425330	B977A07600	7,60	91	53	43	1,3	36	8	●
1992230	B977A07700	7,70	91	53	43	1,3	36	8	●
1913581	B977A07800	7,80	91	53	43	1,3	36	8	●
2425328	B977A07900	7,90	91	53	43	1,3	36	8	●
2658218	B977A07938	7,94	91	53	43	1,3	36	8	●
1913582	B977A08000	8,00	91	53	43	1,4	36	8	●
3102669	B977A08020	8,02	103	61	49	1,4	40	10	●
2244229	B977A08100	8,10	103	61	49	1,4	40	10	●
1986652	B977A08200	8,20	103	61	49	1,4	40	10	●
2390123	B977A08300	8,30	103	61	49	1,4	40	10	●
2658219	B977A08334	8,33	103	61	49	1,4	40	10	●
2236065	B977A08400	8,40	103	61	49	1,4	40	10	●
2658220	B977A08433	8,43	103	61	49	1,4	40	10	●
1913583	B977A08500	8,50	103	61	49	1,4	40	10	●
2425331	B977A08600	8,60	103	61	49	1,5	40	10	●
2203834	B977A08700	8,70	103	61	49	1,5	40	10	●
2658221	B977A08733	8,73	103	61	49	1,5	40	10	●
1913584	B977A08800	8,80	103	61	49	1,5	40	10	●
4054525	B977A08839	8,84	103	61	49	1,5	40	10	●
1971763	B977A08900	8,90	103	61	49	1,5	40	10	●
1913585	B977A09000	9,00	103	61	49	1,5	40	10	●
4054526	B977A09093	9,09	103	61	49	1,5	40	10	●
2425332	B977A09100	9,10	103	61	49	1,5	40	10	●
2658222	B977A09129	9,13	103	61	49	1,6	40	10	●
2218492	B977A09200	9,20	103	61	49	1,6	40	10	●
1913586	B977A09300	9,30	103	61	49	1,6	40	10	●
2658223	B977A09347	9,35	103	61	49	1,6	40	10	●
2408209	B977A09400	9,40	103	61	49	1,6	40	10	●
1913587	B977A09500	9,50	103	61	49	1,6	40	10	●
2658224	B977A09525	9,53	103	61	49	1,6	40	10	●
2425344	B977A09600	9,60	103	61	49	1,6	40	10	●
1939528	B977A09700	9,70	103	61	49	1,7	40	10	●
2658214	B977A09746	9,75	103	61	49	1,7	40	10	●
1913588	B977A09800	9,80	103	61	49	1,7	40	10	●
2245191	B977A09900	9,90	103	61	49	1,7	40	10	●
2658226	B977A09921	9,92	103	61	49	1,7	40	10	●
1913589	B977A10000	10,00	103	61	49	1,7	40	10	●
2407294	B977A10100	10,10	118	71	56	1,7	45	12	●
1913590	B977A10200	10,20	118	71	56	1,7	45	12	●
4054527	B977A10262	10,26	118	71	56	1,8	45	12	●
2240351	B977A10300	10,30	118	71	56	1,8	45	12	●
2658227	B977A10320	10,32	118	71	56	1,8	45	12	●
2425455	B977A10400	10,40	118	71	56	1,8	45	12	●
1913591	B977A10500	10,50	118	71	56	1,8	45	12	●
2043417	B977A10600	10,60	118	71	56	1,8	45	12	●
1913592	B977A10700	10,70	118	71	56	1,8	45	12	●
2658228	B977A10716	10,72	118	71	56	1,8	45	12	●
2256918	B977A10800	10,80	118	71	56	1,8	45	12	●
2425457	B977A10900	10,90	118	71	56	1,9	45	12	●

148-151	152	76-77	88, 156

Kenna Universal™ • B977 • 5 x D • Internal Coolant • Straight Shank

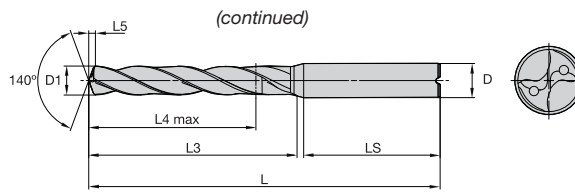

- first choice
- alternate choice

P	●
M	○
K	●
N	○
S	○
H	○

order number	catalogue number	D1	L	L3	L4 max	L5	LS	D	KC7315
1913593	B977A11000	11,00	118	71	56	1,9	45	12	●
2264020	B977A11100	11,10	118	71	56	1,9	45	12	●
2658229	B977A11113	11,11	118	71	56	1,9	45	12	●
1913594	B977A11200	11,20	118	71	56	1,9	45	12	●
2425456	B977A11300	11,30	118	71	56	1,9	45	12	●
2425381	B977A11400	11,40	118	71	56	2,0	45	12	●
1913595	B977A11500	11,50	118	71	56	2,0	45	12	●
2658230	B977A11509	11,51	118	71	56	2,0	45	12	●
2045822	B977A11600	11,60	118	71	56	2,0	45	12	●
1913596	B977A11700	11,70	118	71	56	2,0	45	12	●
2049488	B977A11800	11,80	118	71	56	2,0	45	12	●
2272493	B977A11900	11,90	118	71	56	2,0	45	12	●
2658231	B977A11908	11,91	118	71	56	2,0	45	12	●
1913597	B977A12000	12,00	118	71	56	2,1	45	12	●
2384430	B977A12100	12,10	124	77	60	2,1	45	14	●
2049489	B977A12200	12,20	124	77	60	2,1	45	14	●
2045820	B977A12300	12,30	124	77	60	2,1	45	14	●
2658232	B977A12304	12,30	124	77	60	2,1	45	14	●
2425380	B977A12400	12,40	124	77	60	2,1	45	14	●
1913598	B977A12500	12,50	124	77	60	2,2	45	14	●
2203577	B977A12600	12,60	124	77	60	2,2	45	14	●
1913599	B977A12700	12,70	124	77	60	2,2	45	14	●
1941189	B977A12800	12,80	124	77	60	2,2	45	14	●
2226662	B977A12900	12,90	124	77	60	2,2	45	14	●
1913600	B977A13000	13,00	124	77	60	2,2	45	14	●
2658234	B977A13096	13,10	124	77	60	2,3	45	14	●
2401853	B977A13100	13,10	124	77	60	2,3	45	14	●
2655215	B977A13200	13,20	124	77	60	2,3	45	14	●
2229138	B977A13300	13,30	124	77	60	2,3	45	14	●
4054528	B977A13495	13,50	124	77	60	2,3	45	14	●
1913601	B977A13500	13,50	124	77	60	2,3	45	14	●
1913602	B977A13700	13,70	124	77	60	2,4	45	14	●
2251639	B977A13800	13,80	124	77	60	2,4	45	14	●
1913603	B977A14000	14,00	124	77	60	2,4	45	14	●
3180571	B977A14100	14,10	133	65	45	2,4	48	16	●
2230406	B977A14200	14,20	133	83	63	2,5	48	16	●
2658235	B977A14288	14,29	133	83	63	2,5	48	16	●
1913604	B977A14500	14,50	133	83	63	2,5	48	16	●
2043418	B977A14600	14,60	133	83	63	2,5	48	16	●
1913605	B977A14700	14,70	133	83	63	2,5	48	16	●
2606867	B977A14800	14,80	133	83	63	2,6	48	16	●
1960078	B977A14900	14,90	133	83	63	2,6	48	16	●
1913606	B977A15000	15,00	133	83	63	2,6	48	16	●
1960079	B977A15100	15,10	133	83	63	2,6	48	16	●
2506705	B977A15200	15,20	133	83	63	2,6	48	16	●
2635436	B977A15300	15,30	133	83	63	2,6	48	16	●
1913607	B977A15500	15,50	133	83	63	2,7	48	16	●
1913608	B977A15700	15,70	133	83	63	2,7	48	16	●
1941190	B977A15800	15,80	133	83	63	2,7	48	16	●
2658236	B977A15875	15,88	133	83	63	2,7	48	16	●
2245263	B977A15900	15,90	133	83	63	2,8	48	16	●
1913609	B977A16000	16,00	133	83	63	2,8	48	16	●
2658237	B977A16078	16,08	143	93	71	2,8	48	18	●
2203787	B977A16200	16,20	143	93	71	2,8	48	18	●
5309298	B977A16300	16,30	143	93	71	2,8	48	18	●
2416198	B977A16400	16,40	143	93	71	2,8	48	18	●
1913610	B977A16500	16,50	143	93	71	2,9	48	18	●
2233364	B977A16600	16,60	143	93	71	2,9	48	18	●
4086431	B977A16670	16,67	143	93	71	2,9	48	18	●
2264017	B977A16700	16,70	143	93	71	2,9	48	18	●

148-151	152	76-77	88, 156

Kenna Universal™ • B977 • 5 x D • Internal Coolant • Straight Shank

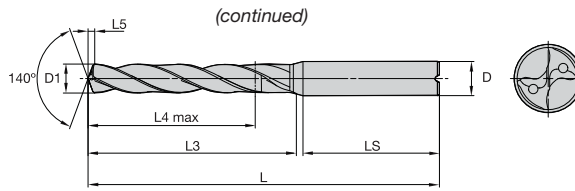

- first choice
- alternate choice

P	●
M	○
K	●
N	○
S	○
H	○

order number	catalogue number	D1	L	L3	L4 max	L5	LS	D	KC7315
1913611	B977A17000	17,00	143	93	71	2,9	48	18	●
2658239	B977A17463	17,46	143	93	71	3,0	48	18	●
1913612	B977A17500	17,50	143	93	71	3,0	48	18	●
2391872	B977A17700	17,70	143	93	71	3,1	48	18	●
1913613	B977A18000	18,00	143	93	71	3,1	48	18	●
2276090	B977A18400	18,40	153	101	77	3,2	50	20	●
1913614	B977A18500	18,50	153	101	77	3,2	50	20	●
2276698	B977A18600	18,60	153	101	77	3,2	50	20	●
2244276	B977A18800	18,80	153	101	77	3,3	50	20	●
1913615	B977A19000	19,00	153	101	77	3,3	50	20	●
2658240	B977A19050	19,05	153	101	77	3,3	50	20	●
2229054	B977A19200	19,20	153	101	77	3,3	50	20	●
2658241	B977A19253	19,25	153	101	77	3,3	50	20	●
2658242	B977A19446	19,45	153	101	77	3,4	50	20	●
1913616	B977A19500	19,50	153	101	77	3,4	50	20	●
2386665	B977A19700	19,70	153	101	77	3,4	50	20	●
4006504	B977A19840	19,84	153	101	77	3,5	50	20	●
1913617	B977A20000	20,00	153	101	77	3,5	50	20	●
2818063	B977A21000	21,00	167	112	85	3,7	50	20	●

148-151	152	76-77	88, 156

Kenna Universal™ • B977 • 5 x D • Internal Coolant • Whistle Notch™ Shank

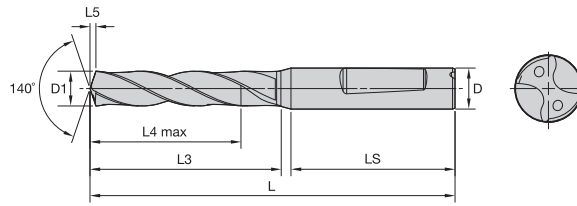

● first choice
○ alternate choice

P	●
M	○
K	●
N	○
S	○
H	○
	○
	○

order number	catalogue number	D1	L	L3	L4 max	L5	LS	D	KC7315
2605709	B977F03000	3,00	66	28	23	0,5	36	6	●
3861272	B977F03100	3,10	66	28	23	0,5	36	6	●
3043177	B977F03200	3,20	66	28	23	0,5	36	6	●
1962706	B977F03300	3,30	66	28	23	0,5	36	6	●
2643468	B977F03400	3,40	66	28	23	0,6	36	6	●
2544251	B977F03500	3,50	66	28	23	0,6	36	6	●
3594438	B977F03600	3,60	66	28	23	0,6	36	6	●
2041877	B977F03700	3,70	66	28	23	0,6	36	6	●
2499960	B977F03800	3,80	74	36	29	0,6	36	6	●
2647585	B977F03900	3,90	74	36	29	0,6	36	6	●
1913752	B977F04000	4,00	74	36	29	0,7	36	6	●
2264981	B977F04100	4,10	74	36	29	0,7	36	6	●
1913753	B977F04200	4,20	74	36	29	0,7	36	6	●
2264903	B977F04300	4,30	74	36	29	0,7	36	6	●
1913754	B977F04500	4,50	74	36	29	0,7	36	6	●
3594435	B977F04550	4,55	74	36	29	0,8	36	6	●
1913755	B977F04600	4,60	74	36	29	0,8	36	6	●
2543238	B977F04650	4,65	74	36	29	0,8	36	6	●
2264931	B977F04700	4,70	74	36	29	0,8	36	6	●
1913756	B977F04800	4,80	82	44	35	0,8	36	6	●
2264885	B977F04900	4,90	82	44	35	0,8	36	6	●
1913757	B977F05000	5,00	82	44	35	0,8	36	6	●
1970761	B977F05100	5,10	82	44	35	0,8	36	6	●
2264921	B977F05200	5,20	82	44	35	0,9	36	6	●
2213726	B977F05300	5,30	82	44	35	0,9	36	6	●
2264932	B977F05400	5,40	82	44	35	0,9	36	6	●
1913758	B977F05500	5,50	82	44	35	0,9	36	6	●
2049505	B977F05550	5,55	82	44	35	0,9	36	6	●
3496233	B977F05558	5,56	82	44	35	0,9	36	6	●
1962705	B977F05600	5,60	82	44	35	0,9	36	6	●
2264983	B977F05700	5,70	82	44	35	1,0	36	6	●
1913759	B977F05800	5,80	82	44	35	1,0	36	6	●
2264952	B977F05900	5,90	82	44	35	1,0	36	6	●
1913760	B977F06000	6,00	82	44	35	1,0	36	6	●
2001853	B977F06100	6,10	91	53	43	1,0	36	8	●
2001854	B977F06300	6,30	91	53	43	1,1	36	8	●
2265008	B977F06400	6,40	91	53	43	1,1	36	8	●
1913761	B977F06500	6,50	91	53	43	1,1	36	8	●
2263756	B977F06600	6,60	91	53	43	1,1	36	8	●
2204114	B977F06700	6,70	91	53	43	1,1	36	8	●
1913762	B977F06800	6,80	91	53	43	1,1	36	8	●
1962704	B977F06900	6,90	91	53	43	1,2	36	8	●
1913763	B977F07000	7,00	91	53	43	1,2	36	8	●
5175059	B977F07100	7,10	91	53	43	1,2	36	8	●
1913764	B977F07400	7,40	91	53	43	1,3	36	8	●
1913765	B977F07500	7,50	91	53	43	1,3	36	8	●
1913766	B977F07800	7,80	91	53	43	1,3	36	8	●
1913767	B977F08000	8,00	91	53	43	1,4	36	8	●
1988291	B977F08100	8,10	103	61	49	1,4	40	10	●
2227264	B977F08200	8,20	103	61	49	1,4	40	10	●
1913768	B977F08500	8,50	103	61	49	1,4	40	10	●
2047751	B977F08600	8,60	103	61	49	1,5	40	10	●
2260660	B977F08700	8,70	103	61	49	1,5	40	10	●
1913769	B977F08800	8,80	103	61	49	1,5	40	10	●
1913770	B977F09000	9,00	103	61	49	1,5	40	10	●
2251337	B977F09100	9,10	103	61	49	1,5	40	10	●
1913771	B977F09300	9,30	103	61	49	1,6	40	10	●
1913772	B977F09500	9,50	103	61	49	1,6	40	10	●
1913773	B977F09800	9,80	103	61	49	1,7	40	10	●
2264915	B977F09900	9,90	103	61	49	1,7	40	10	●

148-151	152	76-77	88, 156

Kenna Universal™ • B977 • 5 x D • Internal Coolant • Whistle Notch™ Shank

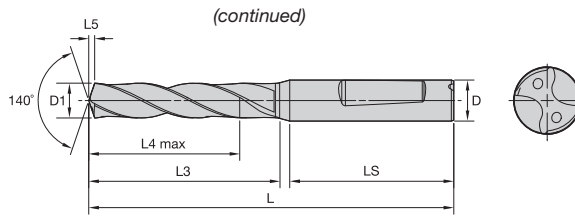

- first choice
- alternate choice

P	●
M	○
K	●
N	○
S	○
H	○

order number	catalogue number	D1	L	L3	L4 max	L5	LS	D	KC7315
1913774	B977F10000	10,00	103	61	49	1,7	40	10	●
2251340	B977F10100	10,10	118	71	56	1,7	45	12	●
1913775	B977F10200	10,20	118	71	56	1,7	45	12	●
2264876	B977F10300	10,30	118	71	56	1,8	45	12	●
2264905	B977F10400	10,40	118	71	56	1,8	45	12	●
1913776	B977F10500	10,50	118	71	56	1,8	45	12	●
1913777	B977F10700	10,70	118	71	56	1,8	45	12	●
1989874	B977F10800	10,80	118	71	56	1,8	45	12	●
1913778	B977F11000	11,00	118	71	56	1,9	45	12	●
1913779	B977F11200	11,20	118	71	56	1,9	45	12	●
1913780	B977F11500	11,50	118	71	56	2,0	45	12	●
1913781	B977F11700	11,70	118	71	56	2,0	45	12	●
1959586	B977F11800	11,80	118	71	56	2,0	45	12	●
1913782	B977F12000	12,00	118	71	56	2,1	45	12	●
2428859	B977F12300	12,30	124	77	60	2,1	45	14	●
1913783	B977F12500	12,50	124	77	60	2,1	45	14	●
1913784	B977F12700	12,70	124	77	60	2,2	45	14	●
1913785	B977F13000	13,00	124	77	60	2,2	45	14	●
1913786	B977F13500	13,50	124	77	60	2,3	45	14	●
2264881	B977F13800	13,80	124	77	60	2,4	45	14	●
1913788	B977F14000	14,00	124	77	60	2,4	45	14	●
2046287	B977F14200	14,20	133	83	63	2,5	48	16	●
1913789	B977F14500	14,50	133	83	63	2,5	48	16	●
1913791	B977F15000	15,00	133	83	63	2,6	48	16	●
2038795	B977F15200	15,20	133	83	63	2,6	48	16	●
1913792	B977F15500	15,50	133	83	63	2,7	48	16	●
1913793	B977F15700	15,70	133	83	63	2,7	48	16	●
2264864	B977F15800	15,80	133	83	63	2,7	48	16	●
1913794	B977F16000	16,00	133	83	63	2,8	48	16	●
1913795	B977F16500	16,50	143	93	71	2,9	48	18	●
1913796	B977F17000	17,00	143	93	71	2,9	48	18	●
1913797	B977F17500	17,50	143	93	71	3,0	48	18	●
1913798	B977F18000	18,00	143	93	71	3,1	48	18	●
1913799	B977F18500	18,50	153	101	77	3,2	50	20	●
1913800	B977F19000	19,00	153	101	77	3,3	50	20	●
1913801	B977F19500	19,50	153	101	77	3,4	50	20	●
1913802	B977F20000	20,00	153	101	77	3,5	50	20	●
2204113	B977F21000	21,00	167	112	85	3,7	50	20	●

148-151	152	76-77	88, 156

Kenna Universal™ • B978 • 8 x D • Internal Coolant • Straight Shank

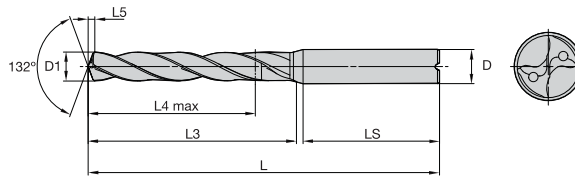

- first choice
- alternate choice

P	●
M	○
K	●
N	○
S	○
H	○

order number	catalogue number	D1	L	L3	L4 max	L5	LS	D	KC7315
3782458	B978A03000	3,00	78	40	33	0,6	36	6	●
3903498	B978A03300	3,30	78	40	33	0,7	36	6	●
5059278	B978A03400	3,40	78	40	33	0,7	36	6	●
5132051	B978A03600	3,60	78	40	33	0,7	36	6	●
3057117	B978A03700	3,70	78	40	33	0,8	36	6	●
5006833	B978A03800	3,80	87	49	41	0,8	36	6	●
2658393	B978A03970	3,97	87	49	41	0,8	36	6	●
2888306	B978A04000	4,00	87	49	41	0,8	36	6	●
3858210	B978A04200	4,20	87	49	41	0,9	36	6	●
3593089	B978A04500	4,50	87	49	41	0,9	36	6	●
2620169	B978A04600	4,60	87	49	41	1,0	36	6	●
2658394	B978A04763	4,76	94	56	48	1,0	36	6	●
4025911	B978A04800	4,80	94	56	48	1,0	36	6	●
1913618	B978A05000	5,00	94	56	48	1,0	36	6	●
2264933	B978A05100	5,10	94	56	48	1,1	36	6	●
2264934	B978A05200	5,20	94	56	48	1,1	36	6	●
2264889	B978A05300	5,30	94	56	48	1,1	36	6	●
1913619	B978A05500	5,50	94	56	48	1,1	36	6	●
2658395	B978A05558	5,56	94	56	48	1,2	36	6	●
3592190	B978A05600	5,60	94	56	48	1,2	36	6	●
2043415	B978A05700	5,70	94	56	48	1,2	36	6	●
2875584	B978A05800	5,80	94	56	48	1,2	36	6	●
2979048	B978A05900	5,90	94	56	48	1,2	36	6	●
1913620	B978A06000	6,00	94	56	48	1,3	36	6	●
2261701	B978A06100	6,10	105	67	57	1,3	36	8	●
2264928	B978A06200	6,20	105	67	57	1,3	36	8	●
2264970	B978A06300	6,30	105	67	57	1,3	36	8	●
2658396	B978A06350	6,35	105	67	57	1,3	36	8	●
2264971	B978A06400	6,40	105	67	57	1,3	36	8	●
1913621	B978A06500	6,50	105	67	57	1,4	36	8	●
2242780	B978A06600	6,60	105	67	57	1,4	36	8	●
2264972	B978A06700	6,70	105	67	57	1,4	36	8	●
2658397	B978A06746	6,75	105	67	57	1,4	36	8	●
1913622	B978A06800	6,80	105	67	57	1,4	36	8	●
1913623	B978A07000	7,00	105	67	57	1,5	36	8	●
2658398	B978A07145	7,15	113	74	64	1,5	36	8	●
3057121	B978A07400	7,40	113	74	64	1,6	36	8	●
1913624	B978A07500	7,50	113	74	64	1,6	36	8	●
2658399	B978A07541	7,54	113	74	64	1,6	36	8	●
2407297	B978A07700	7,70	113	74	64	1,6	36	8	●
1913625	B978A07800	7,80	113	74	64	1,6	36	8	●
2647029	B978A07900	7,90	113	74	64	1,7	36	8	●
2658400	B978A07938	7,94	113	74	64	1,7	36	8	●
1913626	B978A08000	8,00	113	74	64	1,7	36	8	●
2264953	B978A08100	8,10	135	92	80	1,7	40	10	●
2940518	B978A08200	8,20	135	92	80	1,7	40	10	●
2658401	B978A08334	8,33	135	92	80	1,8	40	10	●
6962062	B978A08400	8,40	135	92	80	1,8	40	10	●
1913627	B978A08500	8,50	135	92	80	1,8	40	10	●
2264954	B978A08600	8,60	135	92	80	1,8	40	10	●
2264955	B978A08700	8,70	135	92	80	1,8	40	10	●
2658402	B978A08733	8,73	135	92	80	1,8	40	10	●
2255896	B978A08800	8,80	135	92	80	1,9	40	10	●
1913628	B978A09000	9,00	135	92	80	1,9	40	10	●
2442642	B978A09100	9,10	135	92	80	1,9	40	10	●
2658403	B978A09129	9,13	135	92	80	1,9	40	10	●
3057122	B978A09300	9,30	135	92	80	2,0	40	10	●
1913629	B978A09500	9,50	135	92	80	2,0	40	10	●
2658404	B978A09525	9,53	135	92	80	2,0	40	10	●
2249180	B978A09700	9,70	135	92	80	2,1	40	10	●

148-151	152	76-77	88, 156

Kenna Universal™ • B978 • 8 x D • Internal Coolant • Straight Shank

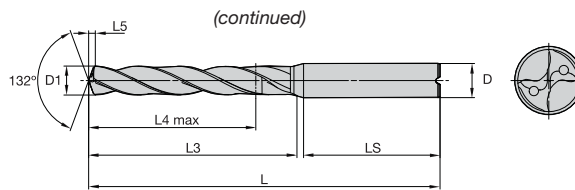

- first choice
- alternate choice

P	●
M	○
K	●
N	○
S	○
H	○

order number	catalogue number	D1	L	L3	L4 max	L5	LS	D	KC7315
1971584	B978A09750	9,75	135	92	80	2,1	40	10	●
2050230	B978A09800	9,80	135	92	80	2,1	40	10	●
2264956	B978A09900	9,90	135	92	80	2,1	40	10	●
2658405	B978A09921	9,92	135	92	80	2,1	40	10	●
1913630	B978A10000	10,00	135	92	80	2,1	40	10	●
2264938	B978A10100	10,10	158	110	96	2,1	45	12	●
1913631	B978A10200	10,20	158	110	96	2,2	45	12	●
2264939	B978A10300	10,30	158	110	96	2,2	45	12	●
2658406	B978A10320	10,32	158	110	96	2,2	45	12	●
1913632	B978A10500	10,50	158	110	96	2,2	45	12	●
2658407	B978A10716	10,72	158	110	96	2,3	45	12	●
1985985	B978A10800	10,80	141	94	79	2,3	45	12	●
1913633	B978A11000	11,00	158	110	96	2,3	45	12	●
2658408	B978A11113	11,11	158	110	96	2,4	45	12	●
1984545	B978A11200	11,20	158	110	96	2,4	45	12	●
2436719	B978A11300	11,30	158	110	96	2,4	45	12	●
2045616	B978A11400	11,40	158	110	96	2,4	45	12	●
1913634	B978A11500	11,50	158	110	96	2,4	45	12	●
2658409	B978A11509	11,51	158	110	96	2,4	45	12	●
2404433	B978A11700	11,70	158	110	96	2,5	45	12	●
2044606	B978A11800	11,80	158	110	96	2,5	45	12	●
2658410	B978A11908	11,91	158	110	96	2,5	45	12	●
1913635	B978A12000	12,00	158	110	96	2,6	45	12	●
2658411	B978A12304	12,30	176	128	112	2,6	45	14	●
1913636	B978A12500	12,50	176	128	112	2,7	45	14	●
2658412	B978A12700	12,70	176	128	112	2,7	45	14	●
1942450	B978A12800	12,80	176	128	112	2,7	45	14	●
1913637	B978A13000	13,00	176	128	112	2,8	45	14	●
3491692	B978A13100	13,10	176	128	112	2,8	45	14	●
1913638	B978A13500	13,50	176	128	112	2,9	45	14	●
1913639	B978A14000	14,00	176	128	112	3,0	45	14	●
2658413	B978A14288	14,29	197	146	128	3,1	48	16	●
1913640	B978A14500	14,50	197	146	128	3,1	48	16	●
1913641	B978A15000	15,00	197	146	128	3,2	48	16	●
2263727	B978A15100	15,10	197	146	128	3,2	48	16	●
2214237	B978A15200	15,20	197	146	128	3,2	48	16	●
2428744	B978A15300	15,30	197	146	128	3,3	48	16	●
1913642	B978A15500	15,50	197	146	128	3,3	48	16	●
2264901	B978A15800	15,80	197	146	128	3,4	48	16	●
2658414	B978A15875	15,88	197	146	128	3,4	48	16	●
1913643	B978A16000	16,00	197	146	128	3,4	48	16	●
2658415	B978A16078	16,08	214	163	144	3,4	48	18	●
2436798	B978A16200	16,20	214	163	144	3,5	48	18	●
1913644	B978A16500	16,50	214	163	144	3,5	48	18	●
1913645	B978A17000	17,00	214	163	144	3,6	48	18	●
2658416	B978A17463	17,46	214	163	144	3,7	48	18	●
1913646	B978A17500	17,50	214	163	144	3,8	48	18	●
1913647	B978A18000	18,00	214	163	144	3,9	48	18	●
1913648	B978A18500	18,50	234	181	160	4,0	50	20	●
1913649	B978A19000	19,00	234	181	160	4,1	50	20	●
2658417	B978A19050	19,05	234	181	160	4,1	50	20	●
2658418	B978A19253	19,25	234	181	160	4,1	50	20	●
1913650	B978A19500	19,50	234	181	160	4,2	50	20	●
2275452	B978A19800	19,80	234	181	160	4,3	50	20	●
2235124	B978A19840	19,84	234	181	160	4,3	50	20	●
1913651	B978A20000	20,00	234	181	160	4,3	50	20	●

148-151	152	76-77	88, 156

Kenna Universal™ • B978 • 8 x D • Internal Coolant • Whistle Notch™ Shank

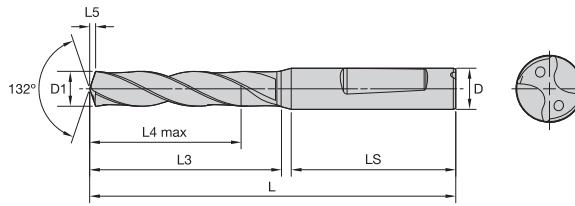

● first choice
○ alternate choice

P	●
M	○
K	●
N	○
S	○
H	○

order number	catalogue number	D1	L	L3	L4 max	L5	LS	D	KC7315
3855740	B978F03000	3,00	78	40	33	0,6	36	6	●
6594089	B978F03300	3,30	78	40	33	0,7	36	6	●
3636818	B978F03600	3,60	78	40	33	0,7	36	6	●
5686551	B978F04000	4,00	87	49	41	0,8	36	6	●
6594090	B978F04200	4,20	87	49	41	0,9	36	6	●
5686555	B978F04500	4,50	87	49	41	0,9	36	6	●
3398461	B978F04700	4,70	87	49	41	1,0	36	6	●
3364974	B978F05000	5,00	94	56	48	1,0	36	6	●
5419957	B978F05100	5,10	94	56	48	1,1	36	6	●
6184978	B978F05200	5,20	94	56	48	1,1	36	6	●
6594101	B978F05300	5,30	94	56	48	1,1	36	6	●
6236092	B978F05500	5,50	94	56	48	1,1	36	6	●
6594102	B978F05700	5,70	94	56	48	1,2	36	6	●
3658546	B978F06000	6,00	94	56	48	1,3	36	6	●
5409793	B978F06100	6,10	105	67	57	1,3	36	8	●
6594103	B978F06200	6,20	105	67	57	1,3	36	8	●
3394029	B978F06500	6,50	105	67	57	1,4	36	8	●
6098864	B978F06600	6,60	105	67	57	1,4	36	8	●
1950974	B978F06800	6,80	105	67	57	1,4	36	8	●
3398487	B978F07000	7,00	105	67	57	1,5	36	8	●
3127866	B978F07400	7,40	113	74	64	1,6	36	8	●
3398489	B978F07500	7,50	113	74	64	1,6	36	8	●
6594104	B978F07700	7,70	113	74	64	1,6	36	8	●
2392134	B978F08000	8,00	113	74	64	1,7	36	8	●
2656831	B978F08500	8,50	135	92	80	1,8	40	10	●
3690693	B978F08800	8,80	135	92	80	1,9	40	10	●
5589965	B978F09000	9,00	135	92	80	1,9	40	10	●
3398457	B978F09500	9,50	135	92	80	2,0	40	10	●
3398458	B978F09700	9,70	135	92	80	2,1	40	10	●
5583078	B978F09800	9,80	135	92	80	2,1	40	10	●
5325630	B978F10000	10,00	135	92	80	2,1	40	10	●
1950975	B978F10200	10,20	158	110	96	2,2	45	12	●
3365518	B978F10300	10,30	158	110	96	2,2	45	12	●
6594105	B978F10500	10,50	158	110	96	2,2	45	12	●
5617574	B978F11000	11,00	158	110	96	2,3	45	12	●
6236911	B978F11300	11,30	158	110	96	2,4	45	12	●
2463308	B978F11500	11,50	158	110	96	2,4	45	12	●
6594106	B978F11700	11,70	158	110	96	2,5	45	12	●
2230052	B978F12000	12,00	158	110	96	2,6	45	12	●
5996610	B978F12500	12,50	176	128	112	2,7	45	14	●
3040265	B978F13000	13,00	176	128	112	2,8	45	14	●
3061071	B978F14000	14,00	176	128	112	3,0	45	14	●
5161475	B978F14500	14,50	197	146	128	3,1	48	16	●
2047587	B978F15000	15,00	197	146	128	3,2	48	16	●
6594107	B978F15500	15,50	197	146	128	3,3	48	16	●
5178669	B978F16000	16,00	197	146	128	3,4	48	16	●
5622502	B978F16500	16,50	214	163	144	3,5	48	18	●
6165212	B978F17000	17,00	214	163	144	3,6	48	18	●
6098863	B978F17500	17,50	214	163	144	3,8	48	18	●
3795311	B978F18000	18,00	214	163	144	3,9	48	18	●
6165214	B978F20000	20,00	234	181	160	4,3	50	20	●

148-151	152	76-77	88, 156

Kenna Universal™ • B979 • 12 x D • Internal Coolant • Straight Shank

NEW!

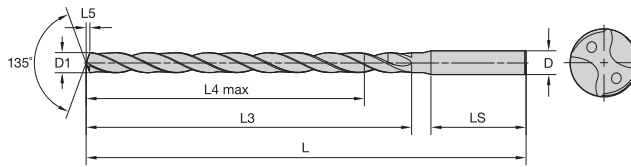

- first choice
- alternate choice

P	●
M	○
K	●
N	○
S	○
H	○

order number	catalogue number	D1	L	L3	L4 max	L5	LS	D	KCU15A
7038955	B979A02400	2,400	75	42	35	0,5	28	4	●
7038956	B979A02500	2,500	75	42	35	0,5	28	4	●
7038958	B979A02800	2,800	75	43	36	0,6	28	4	●
7038959	B979A02900	2,900	75	43	36	0,6	28	4	●
7038960	B979A03000	3,000	93	52	44	0,6	36	6	●
7038971	B979A03175	3,175	93	52	44	0,7	36	6	●
7038972	B979A03264	3,264	93	53	44	0,7	36	6	●
7038974	B979A03500	3,500	93	53	44	0,7	36	6	●
7038975	B979A03970	3,970	107	66	56	0,8	36	6	●
7038976	B979A04000	4,000	107	66	56	0,8	36	6	●
7038979	B979A04500	4,500	107	67	56	0,9	36	6	●
7038980	B979A04600	4,600	107	68	57	1,0	36	6	●
7038983	B979A04800	4,800	125	82	69	1,0	36	6	●
7038984	B979A05000	5,000	125	83	70	1,1	36	6	●
7038985	B979A05100	5,100	125	83	70	1,1	36	6	●
7038986	B979A05200	5,200	125	83	70	1,1	36	6	●
7038987	B979A05300	5,300	125	84	71	1,1	36	6	●
7038989	B979A05500	5,500	125	84	71	1,2	36	6	●
7038990	B979A05558	5,558	125	84	71	1,2	36	6	●
7038991	B979A05600	5,600	125	85	72	1,2	36	6	●
7038992	B979A05700	5,700	—	85	72	1,2	—	—	●
7038993	B979A05800	5,800	125	85	71	1,2	36	6	●
7038994	B979A06000	6,000	125	86	72	1,3	36	6	●
7038995	B979A06200	6,200	139	97	82	1,3	36	8	●
7038996	B979A06350	6,350	139	98	83	1,3	36	8	●
7038997	B979A06500	6,500	139	98	83	1,4	36	8	●
7038998	B979A06600	6,600	139	99	84	1,4	36	8	●
7039000	B979A06800	6,800	139	99	83	1,4	36	8	●
7039002	B979A07000	7,000	139	100	84	1,5	36	8	●
7039003	B979A07145	7,145	153	111	94	1,5	36	8	●
7039004	B979A07500	7,500	153	112	95	1,6	36	8	●
7039005	B979A07800	7,800	153	113	95	1,7	36	8	●
7039006	B979A07938	7,938	153	114	96	1,7	36	8	●
7039007	B979A08000	8,000	153	114	96	1,7	36	8	●
7039008	B979A08100	8,100	185	136	116	1,7	40	10	●
7039010	B979A08500	8,500	185	137	117	1,8	40	10	●
7039011	B979A08700	8,700	185	138	118	1,9	40	10	●
7039012	B979A08733	8,733	185	138	117	1,9	40	10	●
7039013	B979A09000	9,000	185	139	118	1,9	40	10	●
7039014	B979A09500	9,500	185	140	119	2,0	40	10	●
7039015	B979A09525	9,525	185	140	119	2,0	40	10	●
7039017	B979A10000	10,000	185	142	120	2,1	40	10	●
7039018	B979A10200	10,200	218	164	140	2,2	45	12	●
7039019	B979A10500	10,500	218	165	141	2,2	45	12	●
7039020	B979A11000	11,000	218	167	142	2,4	45	12	●
7039021	B979A11113	11,113	218	167	142	2,4	45	12	●
7039022	B979A11500	11,500	218	168	143	2,5	45	12	●
7039023	B979A11800	11,800	218	169	143	2,5	45	12	●
7039025	B979A12000	12,000	218	170	144	2,6	45	12	●
7039026	B979A12500	12,500	246	193	165	2,7	45	14	●
7039027	B979A12700	12,700	246	194	166	2,7	45	14	●
7039029	B979A13000	13,000	246	195	166	2,8	45	14	●
7039030	B979A13500	13,500	246	196	167	2,9	45	14	●
7039031	B979A14000	14,000	246	198	168	3,0	45	14	●
7039033	B979A15000	15,000	277	223	190	3,2	48	16	●
7039035	B979A16000	16,000	277	226	192	3,4	48	16	●
7039038	B979A18000	18,000	305	253	216	3,9	48	18	●

148-151	152	76-77	88, 156

Kenna Universal™ • B731 • Short • Internal Coolant • Straight Shank

NEW!

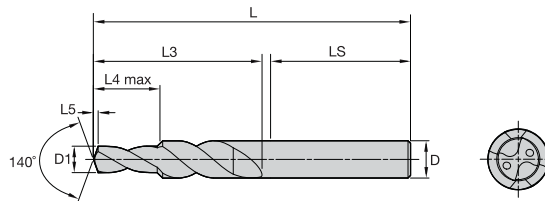

- first choice
- alternate choice

P	●
M	○
K	●
N	○
S	○
H	○
	○

order number	catalogue number	D1	L	L3	L4 max	L5	LS	D	KCU15
7039044	B731A03300KMG	3,30	66	21	10	0,5	36	6	●
7039046	B731A03734KMG	3,73	66	21	11	0,6	36	6	●
7039047	B731A04200KMG	4,20	66	26	13	0,7	36	6	●
7039048	B731A04496KMG	4,50	79	28	15	0,7	36	8	●
7039049	B731A05000KMG	5,00	79	28	15	0,8	36	8	●
7039050	B731A05106KMG	5,11	79	29	16	0,9	36	8	●
7039051	B731A05410KMG	5,41	79	30	17	0,9	36	8	●
7039052	B731A06528KMG	6,53	89	34	19	1,1	40	10	●
7039053	B731A06800KMG	6,80	89	38	18	1,1	40	10	●
7039054	B731A06909KMG	6,91	89	38	20	1,2	40	10	●
7039055	B731A07938KMG	7,94	89	38	21	1,3	45	12	●
7039056	B731A08433KMG	8,43	102	40	22	1,4	45	12	●
7039057	B731A08500KMG	8,50	102	45	21	1,4	45	12	●
7039058	B731A09921KMG	9,92	107	45	26	1,7	45	14	●
7039059	B731A10200KMG	10,20	107	52	25	1,7	45	14	●
7039060	B731A10500KMG	10,50	107	52	25	1,8	45	14	●
7039061	B731A10716KMG	10,72	107	54	29	1,8	45	14	●
7039062	B731A12000KMG	12,00	115	54	30	2,1	48	16	●
7039063	B731A12304KMG	12,30	115	55	31	2,1	48	16	●
7039064	B731A12500KMG	12,50	115	61	30	2,2	48	16	●
7039065	B731A13096KMG	13,10	115	62	34	2,3	48	16	●
7039066	B731A13495KMG	13,50	123	62	35	2,3	48	18	●
7039067	B731A14000KMG	14,00	123	66	33	2,4	48	18	●
7039068	B731A17463KMG	17,46	131	72	44	3,0	50	20	●

148-151	152	76-77	88, 156

Kenna Universal™ • B732 • Long • Internal Coolant • Straight Shank

NEW!

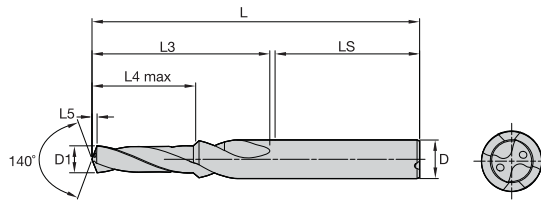

- first choice
- alternate choice

P	●
M	○
K	●
N	○
S	○
H	○
	○

order number	catalogue number	D1	L	L3	L4 max	L5	LS	D	KCU15
7039095	B732A03000KMG	3,00	66	27	16	0,5	36	6	●
7039069	B732A03300KMG	3,30	66	27	17	0,5	36	6	●
7039070	B732A03734KMG	3,73	66	28	18	0,6	36	6	●
7039096	B732A04000KMG	4,00	66	28	18	0,7	36	6	●
7039071	B732A04200KMG	4,20	66	28	18	0,7	36	6	●
7039072	B732A04496KMG	4,50	79	32	19	0,7	36	8	●
7039073	B732A05000KMG	5,00	79	34	21	0,8	36	8	●
7039074	B732A05106KMG	5,11	79	34	21	0,9	36	8	●
7039075	B732A05410KMG	5,41	79	36	23	0,9	36	8	●
7039098	B732A06000KMG	6,00	79	36	23	1,0	36	8	●
7039076	B732A06528KMG	6,53	89	41	26	1,1	40	10	●
7039077	B732A06800KMG	6,80	89	42	27	1,1	40	10	●
7039078	B732A06909KMG	6,91	89	42	27	1,2	40	10	●
7039099	B732A07000KMG	7,00	89	44	28	1,2	40	10	●
7039079	B732A07938KMG	7,94	102	47	30	1,3	45	12	●
7039100	B732A08000KMG	8,00	102	48	30	1,4	45	12	●
7039080	B732A08433KMG	8,43	102	49	32	1,4	45	12	●
7039081	B732A08500KMG	8,50	102	55	32	1,4	45	12	●
7039101	B732A09000KMG	9,00	102	55	34	1,5	45	12	●
7039082	B732A09921KMG	9,92	107	56	36	1,7	45	14	●
7039102	B732A10000KMG	10,00	107	57	37	1,7	45	14	●
7039084	B732A10200KMG	10,20	107	60	38	1,7	45	14	●
7039085	B732A10500KMG	10,50	107	60	38	1,8	45	14	●
7039086	B732A10716KMG	10,72	107	61	40	1,8	45	14	●
7039087	B732A12000KMG	12,00	115	65	43	2,1	48	16	●
7039089	B732A12304KMG	12,30	115	65	44	2,1	48	16	●
7039090	B732A12500KMG	12,50	115	65	43	2,2	48	16	●
7039091	B732A13096KMG	13,10	123	71	47	2,3	48	16	●
7039092	B732A13495KMG	13,50	123	72	48	2,3	48	18	●
7039093	B732A14000KMG	14,00	123	74	50	2,4	48	18	●
7039094	B732A17463KMG	17,46	153	86	58	3,0	50	20	●

148-151	152	76-77	88, 156

Kenna Universal™ Drill • B966, B967 Series • Application Data • Metric

Material Group	Cutting Speed – vc			Metric									
	Range – m/min			Recommended Feed Rate per Rev									
	min	Starting Value	max		3,0	4,0	6,0	8,0	10,0	12,0	16,0	20,0	
P	0	70	90	115	mm/r	0,05–0,11	0,08–0,14	0,09–0,19	0,11–0,22	0,13–0,26	0,15–0,30	0,19–0,36	0,24–0,46
	1	60	70	100	mm/r	0,06–0,13	0,09–0,16	0,11–0,22	0,13–0,26	0,15–0,31	0,18–0,35	0,22–0,42	0,28–0,54
	2	80	90	100	mm/r	0,06–0,13	0,08–0,16	0,12–0,22	0,14–0,26	0,17–0,31	0,20–0,35	0,24–0,42	0,31–0,53
	3	50	70	90	mm/r	0,07–0,15	0,09–0,17	0,13–0,23	0,15–0,28	0,19–0,33	0,22–0,38	0,26–0,47	0,34–0,59
	4	50	70	100	mm/r	0,06–0,15	0,08–0,17	0,12–0,23	0,14–0,28	0,17–0,33	0,19–0,38	0,23–0,47	0,29–0,59
	5	40	50	70	mm/r	0,06–0,12	0,08–0,14	0,10–0,18	0,12–0,22	0,16–0,26	0,18–0,28	0,22–0,36	0,26–0,42
M	6	30	40	60	mm/r	0,05–0,07	0,06–0,10	0,08–0,14	0,10–0,18	0,12–0,22	0,14–0,24	0,18–0,32	0,23–0,41
	1	30	40	50	mm/r	0,04–0,07	0,05–0,09	0,08–0,11	0,09–0,12	0,10–0,14	0,12–0,16	0,14–0,18	0,16–0,20
	2	40	50	60	mm/r	0,04–0,08	0,06–0,10	0,08–0,12	0,09–0,14	0,10–0,16	0,12–0,18	0,14–0,20	0,16–0,22
K	3	30	40	50	mm/r	0,04–0,07	0,06–0,09	0,08–0,11	0,09–0,12	0,10–0,14	0,12–0,16	0,14–0,18	0,16–0,20
	1	80	120	160	mm/r	0,11–0,22	0,12–0,24	0,16–0,31	0,20–0,38	0,23–0,44	0,25–0,49	0,31–0,60	0,38–0,74
	2	80	100	130	mm/r	0,10–0,17	0,12–0,19	0,16–0,25	0,20–0,31	0,23–0,36	0,25–0,40	0,31–0,48	0,38–0,60
N	3	70	80	100	mm/r	0,07–0,15	0,09–0,19	0,12–0,25	0,14–0,30	0,17–0,35	0,19–0,40	0,25–0,48	0,30–0,60
	1	90	230	270	mm/r	0,08–0,14	0,10–0,16	0,12–0,20	0,16–0,24	0,20–0,28	0,24–0,32	0,28–0,40	0,32–0,48
	2	90	220	270	mm/r	0,08–0,16	0,10–0,20	0,12–0,24	0,16–0,28	0,20–0,32	0,24–0,36	0,28–0,44	0,32–0,52
	3	90	180	225	mm/r	0,12–0,14	0,13–0,16	0,14–0,20	0,16–0,24	0,20–0,28	0,24–0,32	0,28–0,40	0,32–0,44
S	4	90	130	270	mm/r	0,08–0,16	0,10–0,20	0,12–0,24	0,16–0,28	0,20–0,32	0,24–0,36	0,28–0,40	0,32–0,48
	1	10	20	30	mm/r	0,03–0,08	0,04–0,09	0,06–0,11	0,07–0,12	0,09–0,14	0,10–0,15	0,12–0,17	0,14–0,19
	2	10	20	30	mm/r	0,03–0,08	0,04–0,09	0,06–0,11	0,07–0,12	0,09–0,14	0,10–0,15	0,12–0,17	0,14–0,19
	3	15	25	35	mm/r	0,03–0,08	0,04–0,09	0,06–0,11	0,07–0,12	0,09–0,14	0,10–0,15	0,12–0,17	0,14–0,19
	4	20	30	40	mm/r	0,03–0,05	0,03–0,05	0,04–0,08	0,05–0,09	0,05–0,11	0,07–0,12	0,08–0,13	0,09–0,14

Kenna Universal Drill • B97*/B73* Series • Application Data • Metric

Material Group	Cutting Speed – vc			Metric										
	Range – m/min			Recommended Feed Rate per Rev										
	min	Starting Value	max		2,0	3,0	4,0	6,0	8,0	10,0	12,0	16,0	20,0	
P	0	80	120	160	mm/r	0,04–0,10	0,06–0,12	0,07–0,14	0,09–0,19	0,11–0,22	0,13–0,26	0,15–0,30	0,19–0,36	0,24–0,46
	1	70	100	140	mm/r	0,05–0,12	0,07–0,14	0,08–0,16	0,11–0,22	0,13–0,26	0,15–0,31	0,18–0,35	0,22–0,42	0,28–0,54
	2	90	120	140	mm/r	0,05–0,12	0,07–0,14	0,08–0,16	0,12–0,22	0,14–0,26	0,17–0,31	0,20–0,35	0,24–0,42	0,31–0,53
	3	60	80	100	mm/r	0,06–0,13	0,08–0,15	0,09–0,17	0,13–0,23	0,15–0,28	0,19–0,33	0,22–0,38	0,26–0,47	0,34–0,59
	4	50	80	100	mm/r	0,06–0,13	0,07–0,15	0,08–0,17	0,12–0,23	0,14–0,28	0,17–0,33	0,19–0,38	0,23–0,47	0,29–0,59
	5	50	60	80	mm/r	0,06–0,12	0,08–0,13	0,10–0,15	0,12–0,19	0,16–0,24	0,20–0,27	0,24–0,30	0,28–0,38	0,32–0,44
M	6	40	50	70	mm/r	0,04–0,06	0,05–0,08	0,06–0,10	0,08–0,14	0,10–0,18	0,13–0,22	0,14–0,24	0,18–0,32	0,23–0,41
	1	30	40	50	mm/r	0,03–0,07	0,04–0,07	0,05–0,09	0,08–0,11	0,09–0,12	0,10–0,14	0,12–0,16	0,14–0,18	0,16–0,20
	2	40	50	60	mm/r	0,03–0,07	0,04–0,08	0,06–0,10	0,08–0,12	0,09–0,14	0,10–0,16	0,12–0,18	0,14–0,20	0,16–0,22
K	3	30	40	50	mm/r	0,03–0,06	0,04–0,07	0,05–0,09	0,08–0,11	0,09–0,12	0,10–0,14	0,12–0,16	0,14–0,18	0,16–0,20
	1	90	130	170	mm/r	0,09–0,17	0,11–0,22	0,12–0,24	0,16–0,31	0,20–0,38	0,23–0,44	0,25–0,49	0,31–0,60	0,38–0,74
	2	80	120	150	mm/r	0,11–0,15	0,12–0,16	0,13–0,19	0,16–0,25	0,20–0,31	0,23–0,36	0,25–0,40	0,31–0,48	0,38–0,60
N	3	70	90	110	mm/r	0,07–0,15	0,08–0,17	0,09–0,19	0,12–0,25	0,14–0,30	0,17–0,35	0,19–0,40	0,24–0,48	0,30–0,60
	1	90	230	315	mm/r	0,06–0,13	0,08–0,14	0,10–0,16	0,12–0,20	0,16–0,24	0,20–0,28	0,24–0,32	0,28–0,40	0,32–0,48
	2	90	225	270	mm/r	0,06–0,12	0,08–0,16	0,10–0,20	0,12–0,24	0,16–0,28	0,20–0,32	0,24–0,36	0,28–0,44	0,32–0,52
	3	90	180	270	mm/r	0,11–0,14	0,12–0,14	0,13–0,16	0,14–0,20	0,16–0,24	0,20–0,28	0,24–0,32	0,28–0,40	0,32–0,44
S	4	90	135	180	mm/r	0,06–0,12	0,08–0,16	0,10–0,20	0,12–0,24	0,16–0,28	0,20–0,32	0,24–0,36	0,28–0,40	0,32–0,48
	1	10	20	30	mm/r	0,02–0,07	0,03–0,08	0,04–0,09	0,06–0,11	0,07–0,12	0,09–0,14	0,10–0,15	0,12–0,17	0,14–0,19
	2	10	20	30	mm/r	0,02–0,07	0,03–0,08	0,04–0,09	0,06–0,11	0,07–0,12	0,09–0,14	0,10–0,15	0,12–0,17	0,14–0,19
	3	15	25	35	mm/r	0,02–0,07	0,03–0,08	0,04–0,09	0,06–0,11	0,07–0,12	0,09–0,14	0,10–0,15	0,12–0,17	0,14–0,19
	4	20	30	40	mm/r	0,02–0,04	0,03–0,05	0,03–0,05	0,04–0,08	0,05–0,09	0,05–0,11	0,07–0,12	0,08–0,13	0,09–0,14



Kenna Universal™ Drill • B979 Series • Application Data • Metric

Material Group	Cutting Speed – vc			Metric									
	Range – m/min			Recommended Feed Rate per Rev									
	min	Starting Value	max		3,0	4,0	6,0	8,0	10,0	12,0	16,0	20,0	
P	0	80	110	140	mm/r	0,06–0,12	0,07–0,14	0,09–0,19	0,11–0,22	0,13–0,26	0,15–0,30	0,15–0,30	0,24–0,46
	1	70	100	130	mm/r	0,07–0,14	0,08–0,16	0,11–0,22	0,13–0,26	0,15–0,31	0,18–0,35	0,18–0,35	0,28–0,54
	2	70	100	110	mm/r	0,07–0,14	0,08–0,16	0,12–0,22	0,14–0,26	0,17–0,31	0,20–0,35	0,20–0,35	0,31–0,53
	3	60	80	100	mm/r	0,08–0,15	0,09–0,17	0,13–0,23	0,15–0,28	0,19–0,33	0,22–0,38	0,22–0,38	0,34–0,59
	4	50	60	70	mm/r	0,07–0,14	0,08–0,17	0,12–0,23	0,14–0,28	0,17–0,33	0,19–0,38	0,19–0,38	0,29–0,59
	5	50	60	70	mm/r	0,03–0,11	0,04–0,11	0,05–0,11	0,05–0,14	0,08–0,18	0,11–0,21	0,14–0,24	0,16–0,26
M	6	40	50	60	mm/r	0,03–0,08	0,04–0,10	0,05–0,11	0,05–0,14	0,08–0,18	0,11–0,21	0,14–0,24	0,16–0,26
	1	30	40	50	mm/r	0,04–0,07	0,05–0,09	0,07–0,11	0,09–0,12	0,10–0,14	0,12–0,16	0,14–0,18	0,16–0,20
	2	40	50	60	mm/r	0,04–0,07	0,06–0,10	0,07–0,11	0,09–0,12	0,10–0,14	0,12–0,16	0,14–0,18	0,16–0,20
K	3	30	40	50	mm/r	0,03–0,07	0,05–0,09	0,06–0,11	0,08–0,12	0,09–0,13	0,11–0,15	0,13–0,17	0,15–0,19
	1	80	120	160	mm/r	0,10–0,15	0,12–0,20	0,16–0,28	0,20–0,34	0,23–0,40	0,25–0,44	0,31–0,54	0,38–0,68
	2	70	110	140	mm/r	0,10–0,14	0,12–0,19	0,16–0,25	0,20–0,31	0,23–0,36	0,25–0,40	0,31–0,48	0,38–0,60
N	3	60	80	100	mm/r	0,07–0,15	0,09–0,17	0,12–0,23	0,14–0,29	0,17–0,34	0,19–0,38	0,24–0,44	0,30–0,56
	1	90	200	300	mm/r	0,08–0,14	0,10–0,16	0,12–0,20	0,16–0,24	0,20–0,28	0,24–0,32	0,28–0,40	0,32–0,48
	2	90	180	270	mm/r	0,08–0,16	0,10–0,20	0,12–0,24	0,16–0,28	0,20–0,32	0,24–0,36	0,28–0,44	0,32–0,52
	3	90	160	230	mm/r	0,12–0,14	0,13–0,16	0,14–0,20	0,16–0,24	0,20–0,28	0,24–0,32	0,28–0,40	0,32–0,44
S	4	80	120	160	mm/r	0,08–0,16	0,10–0,20	0,12–0,24	0,16–0,28	0,20–0,32	0,24–0,36	0,28–0,40	0,32–0,48
	1	10	20	30	mm/r	0,03–0,08	0,04–0,09	0,06–0,11	0,07–0,12	0,09–0,14	0,10–0,15	0,12–0,17	0,14–0,19
	2	10	20	30	mm/r	0,03–0,08	0,04–0,09	0,06–0,11	0,07–0,12	0,09–0,14	0,10–0,15	0,12–0,17	0,14–0,19
	3	15	25	35	mm/r	0,03–0,08	0,04–0,09	0,06–0,11	0,07–0,12	0,09–0,14	0,10–0,15	0,12–0,17	0,14–0,19
	4	20	30	40	mm/r	0,03–0,05	0,03–0,05	0,04–0,08	0,05–0,09	0,05–0,11	0,07–0,12	0,08–0,13	0,09–0,14

Kenna Universal Drill • B97 Series • Application Data • Metric

Material Group	Cutting Speed – vc			Metric										
	Range – m/min			Recommended Feed Rate per Rev										
	min	Starting Value	max		2,0	3,0	4,0	6,0	8,0	10,0	12,0	16,0	20,0	
P	0	80	120	160	mm/r	0,04–0,10	0,06–0,12	0,07–0,14	0,09–0,19	0,11–0,22	0,13–0,26	0,15–0,30	0,19–0,36	0,24–0,46
	1	70	100	140	mm/r	0,05–0,12	0,07–0,14	0,08–0,16	0,11–0,22	0,13–0,26	0,15–0,31	0,18–0,35	0,22–0,42	0,28–0,54
	2	90	120	140	mm/r	0,05–0,12	0,07–0,14	0,08–0,16	0,12–0,22	0,14–0,26	0,17–0,31	0,20–0,35	0,24–0,42	0,31–0,53
	3	60	80	100	mm/r	0,06–0,13	0,08–0,15	0,09–0,17	0,13–0,23	0,15–0,28	0,19–0,33	0,22–0,38	0,26–0,47	0,34–0,59
	4	50	80	100	mm/r	0,06–0,13	0,07–0,15	0,08–0,17	0,12–0,23	0,14–0,28	0,17–0,33	0,19–0,38	0,23–0,47	0,29–0,59
	5	50	60	80	mm/r	0,06–0,12	0,08–0,13	0,10–0,15	0,12–0,19	0,16–0,24	0,20–0,27	0,24–0,30	0,28–0,38	0,32–0,44
M	6	40	50	70	mm/r	0,04–0,06	0,05–0,08	0,06–0,10	0,08–0,14	0,10–0,18	0,13–0,22	0,14–0,24	0,18–0,32	0,23–0,41
	1	30	40	50	mm/r	0,03–0,06	0,04–0,07	0,05–0,09	0,08–0,11	0,09–0,12	0,10–0,14	0,12–0,16	0,14–0,18	0,16–0,20
	2	40	50	60	mm/r	0,03–0,07	0,04–0,08	0,06–0,10	0,08–0,12	0,09–0,14	0,10–0,16	0,12–0,18	0,14–0,20	0,16–0,22
K	3	30	40	50	mm/r	0,03–0,06	0,04–0,07	0,05–0,09	0,08–0,11	0,09–0,12	0,10–0,14	0,12–0,16	0,14–0,18	0,16–0,20
	1	90	130	170	mm/r	0,09–0,17	0,11–0,22	0,12–0,24	0,16–0,31	0,20–0,38	0,23–0,44	0,25–0,49	0,31–0,60	0,38–0,74
	2	80	120	150	mm/r	0,11–0,15	0,12–0,16	0,13–0,19	0,16–0,25	0,20–0,31	0,23–0,36	0,25–0,40	0,31–0,48	0,38–0,60
N	3	70	90	110	mm/r	0,07–0,15	0,08–0,17	0,09–0,19	0,12–0,25	0,14–0,30	0,17–0,35	0,19–0,40	0,24–0,48	0,30–0,60
	1	90	230	315	mm/r	0,06–0,13	0,08–0,14	0,10–0,16	0,12–0,20	0,16–0,24	0,20–0,28	0,24–0,32	0,28–0,40	0,32–0,48
	2	90	225	270	mm/r	0,06–0,12	0,08–0,16	0,10–0,20	0,12–0,24	0,16–0,28	0,20–0,32	0,24–0,36	0,28–0,44	0,32–0,52
	3	90	180	270	mm/r	0,11–0,14	0,12–0,14	0,13–0,16	0,14–0,20	0,16–0,24	0,20–0,28	0,24–0,32	0,28–0,40	0,32–0,44
S	4	90	135	180	mm/r	0,06–0,12	0,08–0,16	0,01–0,20	0,12–0,24	0,16–0,28	0,20–0,32	0,24–0,36	0,28–0,40	0,32–0,48
	1	10	20	30	mm/r	0,02–0,07	0,03–0,08	0,04–0,09	0,06–0,11	0,07–0,12	0,09–0,14	0,10–0,15	0,12–0,17	0,14–0,19
	2	10	20	30	mm/r	0,02–0,07	0,03–0,08	0,04–0,09	0,06–0,11	0,07–0,12	0,09–0,14	0,10–0,15	0,12–0,17	0,14–0,19
	3	15	25	35	mm/r	0,02–0,07	0,03–0,08	0,04–0,09	0,06–0,11	0,07–0,12	0,09–0,14	0,10–0,15	0,12–0,17	0,14–0,19
	4	20	30	40	mm/r	0,02–0,04	0,03–0,05	0,03–0,05	0,04–0,08	0,05–0,09	0,05–0,11	0,07–0,12	0,08–0,13	0,09–0,14

Tolerances • Kenna Universal Drills

nominal size range	Tolerance • Metric	
	D1 tolerance m7	D tolerance h6
>3–6	0,004/0,016	0,000/-0,008
>6–10	0,006/0,021	0,000/-0,009
>10–18	0,007/0,025	0,000/-0,011
>18–25,4	0,008/0,029	0,000/-0,013

Solid Carbide Drills • Catalog Numbering System

Each character in our catalog number signifies a specific trait of that product. Use the following key columns and corresponding images to easily identify which attributes apply.

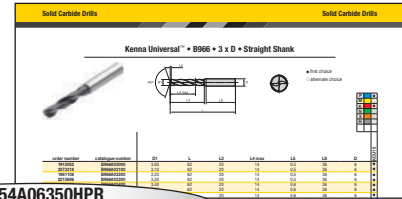

B254A06350HPR
K254A02500HPR

B
K

Tool Type

B = Metric (metric shank with 2mm steps)
K = Inch (inch shank)

25
25

Series

04 = GOdrill™
05 = GOdrill Internal Coolant
06 = Microdrills Internal Coolant
10 = TF Drill
21 = HP Drill Internal Coolant for stainless steel
22 = HP Drill for steel
25 = HP Drill Internal Coolant for cast iron
26 = HP Drill Internal Coolant
07 = Micro Deep-Hole Drills Internal Coolant
27 = Deep-Hole Drill Internal Coolant
28 = HP Drill Internal Coolant for non-ferrous materials
29 = Y-TECH™ Drill Internal Coolant for difficult-to-machine materials
34 = BF Drill Internal Coolant
41 = TX Drill Internal Coolant
42 = TX Light Drill Internal Coolant
50 = Non-Coolant Spotdrill
51 = SPF PCD Drill Internal Coolant
53 = SPF Drill
55 = DAL Drill
56 = DAL PCD Drill Internal Coolant
70 = Flat Bottom Drill Internal Coolant
72 = Step Drill
73 = Step Drill Internal Coolant
94 = Hard Drill
95 = Hard Drill Internal Coolant
96 = Kenna Universal™ Drill
97 = Kenna Universal Drill Internal Coolant

4
4

Length to Diameter Ratio

1 = 3 x D
2 = 5 x D
3 = 8 x D
8 = 2 x D
5 = 5 x D
0 = 3 x D
1 = 5 x D
2 = 8 x D
1 = 3 x D
2 = 5 x D
4 = 3 x D Internal Coolant
5 = 5 x D Internal Coolant
6 = 8 x D Internal Coolant
4 = 3 x D
5 = 5 x D
6 = 8 x D
9 = 12 x D
0 = 7 x D
1 = 15 x D
2 = 20 x D
3 = 25 x D
4 = 30 x D
5 = 40 x D
6 = 50 x D
4 = 3 x D
5 = 5 x D
6 = 8 x D
1 = 3 x D
2 = 5 x D
3 = Medium Length
1 = 5 x D
1 = 120°
5 = 90°
1 = 3 x D
2 = 5 x D
6 = 3 x D Internal Coolant
7 = 5 x D Internal Coolant
7 = 3 x D
1 = Short
2 = Long
1 = 3 x D
2 = 5 x D
6 = 3 x D
7 = 5 x D
8 = 8 x D
9 = 12 x D

A
A

Shank Style

A = Straight Shank
F = Whistle Notch™ Shank
Z = Straight Shank (1mm steps)

S = Straight Shank (1mm steps)
H = Extended Shank for HIPACS

Solid Carbide Drills • Catalog Numbering System

(continued)

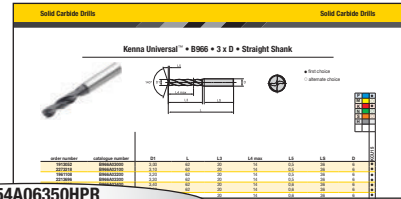

B254A06350HPR
K254A02500HPR

06350

HP

R

02500

HP

R

Cutting Diameter D1

Point Style

Corner Style

Other Features



















Metric = D1 in mm
Inch = D1 in decimal inch

CP = Cone Point
SG = Smooth Gashing
HP = Highly Positive
YP = Uneven Flute Design
SP = Split Point
DA / DAL = Double Angle
KM = Kenna Universal Cone Point

G = General Purpose
L = Light Hone
X = Next Generation for Steel
C = Corner Chamfer
R = Corner Radius
S = Sharp
F = Fiber
H = Curved Cutting Edge Shape

P = Body with Flat Surface for HiPACS Insert

Tool Selection Guide • Reamers

	Solid & Brazed Reamers		Brazed Reamers, PCD		Expandable Reamers		Indexable Reamers	
	KenReam™ S	KenReam MS	KenReam Q	KenReam MQ	KenReam E	KenReam ME	KenReam X	
								
Series	RMS / KRS / RMR / RMB	RHR / RHM	R215 / R225	R420	RMB-E	RHM-E	RIR	RIQ
Page	kennametal.com	kennametal.com	kennametal.com	kennametal.com	kennametal.com	kennametal.com	kennametal.com	kennametal.com
Tool type	Solid & Brazed Reamers	Modular Reamers	Brazed Reamers, PCD	Modular Reamers, PCD	Expandable Reamers, Brazed	Expandable Reamers, Modular	Indexable Reamers	Indexable Reamers
Main operations								
Workpiece material								
Primary	P M K N	P M K	N	N	P M K	P M K	P M K N S	P M K N S
Secondary	S	S			S	S	H	H
Cutting diameter D1	5–20mm	14–42mm	6–20mm	20–42mm	14–20mm	14–42mm	6–300mm+	16–300mm+
Accuracy	IT7	IT7	IT6	IT6	IT6	IT6	IT5	IT5
Cylindricity 	7µm	7µm	5µm	5µm	7µm	7µm	4µm	4µm
Position 	10µm	10µm	7µm	7µm	10µm	10µm	10µm	10µm
Surface roughness (Ra)	0,5–1,5µm	0,5–1,5µm	0,1–0,8µm	0,1–0,8µm	0,5–1,5µm	0,5–1,5µm	0,1–1,8µm	0,1–1,8µm
Cost / Part	low	low	extremely low	extremely low	low	low	low	low
Cycle time	low	low	extremely low	extremely low	low	low	moderate	moderate
Number of flutes [ZU]	4–8	6–8	2–4	4–6	6	6–8	1	1 or more
Coolant								



Cylindricity

NOTE: Process and application-dependent.

Highly depending on the premachine hole accuracy.

Use of high-performance drilling/premachining tools mandatory to reach values.



Position

NOTE: Process and application-dependent.



























Highly depending on the premachine hole accuracy.

Use of high-performance drilling/premachining tools mandatory to reach values.

Ra Surface roughness

NOTE: Surface roughness values are guidelines and depend on the application, workpiece material, coolant situation, machine, and cutting data applied.

Tool Selection Guide • KenReam™ S

Solid Carbide Reamers						
KenReam S						
	NEW! 	NEW! 	NEW! 	NEW! 		
Series	KRS102	KRS103	KRS104	KRS105	RMS SF	RMS HF
Page	82	82	83	83	*K8	*K9
Main operations	 	 	 	 	 	 
Workpiece material						
Primary	P M	P M	K	K	P M K N	P M K
Secondary	K S	K S	P M	P M	S	S
Cutting diameter D1	5–14mm				5–14mm	
Accuracy	IT7				IT7	
Cylindricity 	7µm				7µm	
Position 	10µm				10µm	
Surface roughness (Ra)	0,5–1,5µm				0,5–1,5µm	
Cost / Part	low				low	
Cycle time	low				low	
Number of flutes [ZU]	4–6	6–8	4–6	6–8	4–6	4–6
Coolant						

* See page in the Kennametal Master Catalog 2018 • Volume Two • Rotating Tools, A-16-05217.

 **Cylindricity**
NOTE: Process and application-dependent.
 Highly depending on the premachine hole accuracy.
 Use of high-performance drilling/premachining tools mandatory to reach values.

 **Position**
NOTE: Process and application-dependent.
 Highly depending on the premachine hole accuracy.
 Use of high-performance drilling/premachining tools mandatory to reach values.

Ra Surface roughness
NOTE: Surface roughness values are guidelines and depend on the application, workpiece material, coolant situation, machine, and cutting data applied.

KenReam™ S

High-Performance
Solid Carbide Reamer



Materials



Applications



Reaming:
Blind Hole



Reaming:
Through &
Cross Holes



Reaming:
Through Hole



Reaming:
Blind & Cross Holes

Solid carbide reamers for highest feed rates, maximum chip control, and best surface quality in steels and cast iron.

The KenReam S solid carbide reamer series is designed for long tool life and highest metal removal rates in blind hole and through hole applications up to 5 x D.

Unique design features deliver excellent process reliability and consistent hole quality of IT7 at lowest cost per part.



NEW!

KenReam™ S102

Proprietary chip former and right-hand helical flutes for excellent chip control and chip evacuation in blind hole applications.

Increased flute length separates chips and avoids chip tangling.



NEW!

KenReam S103 & KenReam S105

Unique front gash design with increased number of teeth for excellent chip forming and hassle-free chip evacuation to the front.



NEW!

KenReam S104

Double lead for high speed and feeds plus best surface quality.

Through hole reamers with proprietary front gash design deliver highest feed rate capability and productivity for any steel or cast iron parts.

The right-hand helical fluted blind hole reamers deliver maximum chip control and reliability.

Advanced substrate and coating for superior tool life and productivity.

KenReam™ S102 • Helical Fluted • 5 x D • Internal Coolant • Straight Shank

NEW!

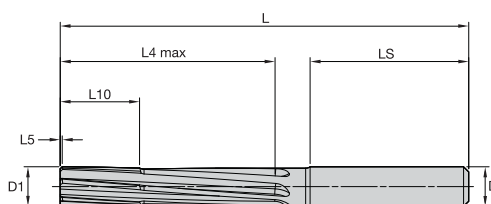

● first choice

○ alternate choice

P	●
M	●
K	○
N	○
S	○
H	○

order number	catalogue number	D1	L5	L10	L4 max	L	LS	D	Z	KCU05A
7029804	KRS102A050000H7	5,00	0,40	12,00	30,00	74,00	36,00	6,00	4	●
7029805	KRS102A055000H7	5,50	0,40	12,00	30,00	74,00	36,00	6,00	4	●
7029806	KRS102A060000H7	6,00	0,40	12,00	30,00	74,00	36,00	6,00	4	●
7029807	KRS102A065000H7	6,50	0,40	16,00	45,00	91,00	36,00	8,00	4	●
7029808	KRS102A070000H7	7,00	0,40	16,00	45,00	91,00	36,00	8,00	4	●
7029809	KRS102A080000H7	8,00	0,40	16,00	45,00	91,00	36,00	8,00	6	●
7029810	KRS102A090000H7	9,00	0,50	20,00	53,00	103,00	40,00	10,00	6	●
7029831	KRS102A100000H7	10,00	0,50	20,00	53,00	103,00	40,00	10,00	6	●
7029832	KRS102A110000H7	11,00	0,60	20,00	63,00	118,00	45,00	12,00	6	●
7029833	KRS102A120000H7	12,00	0,60	20,00	63,00	118,00	45,00	12,00	6	●
7029834	KRS102A130000H7	13,00	0,60	25,00	77,00	132,00	45,00	14,00	6	●
7029835	KRS102A140000H7	14,00	0,60	25,00	77,00	132,00	45,00	14,00	6	●

KenReam S103 • Front Gash • 5 x D • Internal Coolant • Straight Shank

NEW!

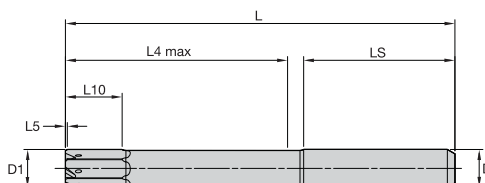

● first choice

○ alternate choice

P	●
M	●
K	○
N	○
S	○
H	○

order number	catalogue number	D1	L5	L10	L4 max	L	LS	D	Z	KCU05A
7029836	KRS103A050000H7	5,00	0,70	9,00	32,00	74,00	36,00	6,00	6	●
7029837	KRS103A055000H7	5,50	0,70	9,00	32,00	74,00	36,00	6,00	6	●
7029838	KRS103A060000H7	6,00	0,70	9,00	32,00	74,00	36,00	6,00	6	●
7029839	KRS103A065000H7	6,50	0,70	12,00	49,00	91,00	36,00	8,00	6	●
7029840	KRS103A070000H7	7,00	0,70	12,00	49,00	91,00	36,00	8,00	6	●
7029841	KRS103A080000H7	8,00	0,80	12,00	49,00	91,00	36,00	8,00	6	●
7029842	KRS103A090000H7	9,00	0,80	15,00	57,00	103,00	40,00	10,00	6	●
7029843	KRS103A100000H7	10,00	0,80	15,00	57,00	103,00	40,00	10,00	6	●
7029844	KRS103A110000H7	11,00	0,90	18,00	67,00	118,00	45,00	12,00	8	●
7029845	KRS103A120000H7	12,00	0,90	18,00	67,00	118,00	45,00	12,00	8	●
7029846	KRS103A130000H7	13,00	0,90	21,00	81,00	132,00	45,00	14,00	8	●
7029847	KRS103A140000H7	14,00	0,90	21,00	81,00	132,00	45,00	14,00	8	●

148-151	152	85-87	88, 156

KenReam™ S104 • Helical Fluted • 5 x D • Internal Coolant • Straight Shank

NEW!

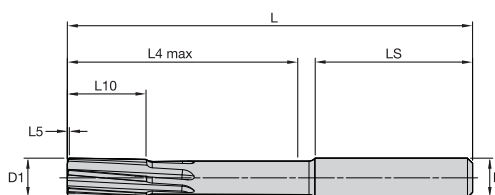

● first choice

○ alternate choice

P	●	○
M	●	○
K	●	○
N	●	○
S	●	○
H	●	○

order number	catalogue number	D1	L5	L10	L4 max	L	LS	D	Z	KCU05A
7029848	KRS104A050000H7	5,00	0,40	12,00	32,00	74,00	36,00	6,00	4	●
7029849	KRS104A055000H7	5,50	0,40	12,00	32,00	74,00	36,00	6,00	4	●
7029850	KRS104A060000H7	6,00	0,40	12,00	32,00	74,00	36,00	6,00	4	●
7029862	KRS104A065000H7	6,50	0,40	16,00	49,00	91,00	36,00	8,00	4	●
7029863	KRS104A070000H7	7,00	0,40	16,00	49,00	91,00	36,00	8,00	4	●
7029864	KRS104A080000H7	8,00	0,50	16,00	49,00	91,00	36,00	8,00	6	●
7029865	KRS104A090000H7	9,00	0,50	20,00	57,00	103,00	40,00	10,00	6	●
7029866	KRS104A100000H7	10,00	0,50	20,00	57,00	103,00	40,00	10,00	6	●
7029867	KRS104A110000H7	11,00	0,60	20,00	67,00	118,00	45,00	12,00	6	●
7029868	KRS104A120000H7	12,00	0,60	20,00	67,00	118,00	45,00	12,00	6	●
7029869	KRS104A130000H7	13,00	0,60	25,00	81,00	132,00	45,00	14,00	6	●
7029870	KRS104A140000H7	14,00	0,60	25,00	81,00	132,00	45,00	14,00	6	●

KenReam S105 • Front Gash • 5 x D • Internal Coolant • Straight Shank

NEW!

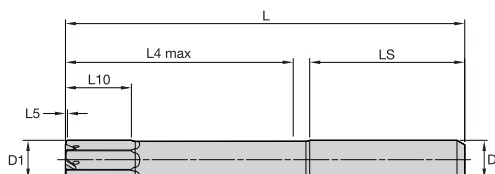

● first choice

○ alternate choice

P	●	○
M	●	○
K	●	○
N	●	○
S	●	○
H	●	○

order number	catalogue number	D1	L5	L10	L4 max	L	LS	D	Z	KCU05A
7029872	KRS105A050000H7	5,00	0,40	9,00	32,00	74,00	36,00	6,00	6	●
7029873	KRS105A055000H7	5,50	0,40	9,00	32,00	74,00	36,00	6,00	6	●
7029874	KRS105A060000H7	6,00	0,40	9,00	32,00	74,00	36,00	6,00	6	●
7029875	KRS105A065000H7	6,50	0,40	12,00	49,00	91,00	36,00	8,00	6	●
7029876	KRS105A070000H7	7,00	0,40	12,00	49,00	91,00	36,00	8,00	6	●
7029877	KRS105A080000H7	8,00	0,50	12,00	49,00	91,00	36,00	8,00	6	●
7029878	KRS105A090000H7	9,00	0,50	15,00	57,00	103,00	40,00	10,00	6	●
7029879	KRS105A100000H7	10,00	0,50	15,00	57,00	103,00	40,00	10,00	6	●
7029891	KRS105A110000H7	11,00	0,60	18,00	67,00	118,00	45,00	12,00	8	●
7029892	KRS105A120000H7	12,00	0,60	18,00	67,00	118,00	45,00	12,00	8	●
7029893	KRS105A130000H7	13,00	0,60	21,00	81,00	132,00	45,00	14,00	8	●
7029894	KRS105A140000H7	14,00	0,60	21,00	81,00	132,00	45,00	14,00	8	●

148-151	152	85-87	88, 156
---------	-----	-------	---------

KenReam™ S • Application Data

Material Group	Cutting Speed – vc			Recommended feed per tooth (fz = mm/th)							
	Range – m/min			Tool Diameter (mm)	4,000–7,000		7,001–10,000		10,001–14,000		
	min	Starting Value	max		Feed/Tooth	min	max	min	max	min	max
P	1	90	130	160	mm/z	0,06	0,12	0,08	0,15	0,08	0,20
	2	90	130	160	mm/z	0,06	0,12	0,08	0,15	0,08	0,20
	3	90	130	160	mm/z	0,06	0,12	0,08	0,15	0,08	0,20
	4	80	120	160	mm/z	0,06	0,12	0,08	0,15	0,08	0,20
	5	20	40	60	mm/z	0,06	0,12	0,08	0,15	0,08	0,15
	6	20	40	60	mm/z	0,06	0,12	0,08	0,15	0,08	0,15
M	1	20	40	50	mm/z	0,08	0,12	0,08	0,15	0,08	0,15
	2	20	40	50	mm/z	0,08	0,12	0,08	0,15	0,08	0,15
	3	20	40	50	mm/z	0,08	0,12	0,08	0,15	0,08	0,15
K	1	80	160	240	mm/z	0,06	0,15	0,08	0,20	0,08	0,20
	2	80	140	200	mm/z	0,06	0,15	0,08	0,20	0,08	0,20
	3	60	90	120	mm/z	0,06	0,15	0,08	0,15	0,08	0,15
S	1	15	20	30	mm/z	0,06	0,12	0,06	0,15	0,06	0,15
	2	15	20	30	mm/z	0,06	0,12	0,06	0,15	0,06	0,15
	3	20	30	40	mm/z	0,06	0,12	0,06	0,15	0,06	0,15
	4	20	30	40	mm/z	0,06	0,12	0,06	0,15	0,06	0,15

Recommended Reaming Allowance in Diameter						
Tool Diameter (mm)	4,000–7,000		7,001–10,000		10,001–14,000	
2 x ap	min	max	min	max	min	max
mm	0,20	0,30	0,20	0,30	0,20	0,40

KenReam™ S • KRS Series • Catalog Numbering System

Each character in our catalog number signifies a specific trait of that product. Use the following key columns and corresponding images to easily identify which attributes apply.

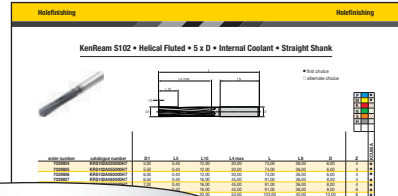

KRS100A05000H7

KRS100

KenReam S KRS Series

KRS102 = Solid Carbide Reamer for Blind Holes in Steel
KRS104 = Solid Carbide Reamer for Blind Holes in Cast Iron
KRS103 = Solid Carbide Reamer for Through Holes in Steel
KRS105 = Solid Carbide Reamer for Through Holes in Cast Iron

A

A = Straight Shank

A = Straight Shank

050000

Cutting Diameter D1

Metric = D1 in mm
Inch = D1 in decimal inch

H7

ISO Tolerance Class

H7

KenReam S • RM Series • Catalog Numbering System

Each character in our catalog number signifies a specific trait of that product. Use the following key columns and corresponding images to easily identify which attributes apply.

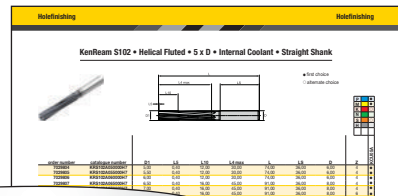

RSM05000H7SF

RMS

KenReam S/E Series

RMS = Solid Carbide Reamer
RMR = Monoblock Reamer with Solid Head
RMB = Monoblock Reamer with Tips
RMBE = Monoblock Reamer with Tips, Expandable

05000

Cutting Diameter D1

Metric = D1 in mm
Inch = D1 in decimal inch

H7

ISO Tolerance Class

H6
H7

SF

Flute Style

SF = Straight Flute
HF = Helical Flute



KenReam™ MS • Catalog Numbering System

Each character in our catalog number signifies a specific trait of that product. Use the following key columns and corresponding images to easily identify which attributes apply.

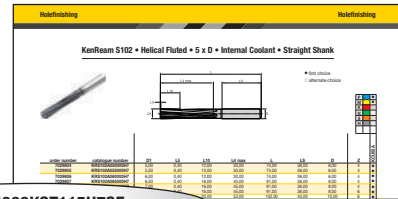

RHR14000KST115H7SF

RHR	14000	KST115	H7	SF
KenReam M Series	Cutting Diameter D1	Connection Style Machine Side – CSMS	ISO Tolerance Class	Flute Style
<p>RHR = Modular Reamer with Solid Head</p> <p>RHM = Modular Reamer with Tips</p> <p>RHME = Modular Reamer with Tips, / Expandable</p>	<p>Metric = D1 in mm</p> <p>Inch = D1 in decimal inch</p>	<p>KST115 = Kennametal short taper, dia. 11,5mm</p>	<p>H6</p> <p>H7</p>	<p>SF = Straight Flute</p> <p>HF = Helical Flute</p>

KenReam Q • Catalog Numbering System

Each character in our catalog number signifies a specific trait of that product. Use the following key columns and corresponding images to easily identify which attributes apply.

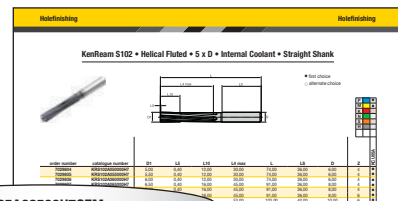

R225A08500H7SFM

R	2	2	5	A	08500	H7	SF	M
Tool Type	Series	Coolant	Length to Diameter Ratio	Shank Style	Cutting Diameter D1	ISO Tolerance Class	Flute Style	Unit of Dimensions
<p>R = Reamer</p>	<p>1 = Solid carbide</p> <p>2 = Tipped</p> <p>3 = Tipped expandable</p> <p>4 = Modular</p> <p>5 = Modular expandable</p>	<p>0 = Without coolant</p> <p>1 = Without central coolant</p> <p>2 = With radial coolant</p>	<p>4 = 3 x D</p> <p>5 = 5 x D</p> <p>6 = 8 x D</p>	<p>A = Cylindrical Shank</p>	<p>Metric = D1 in mm</p> <p>Inch = D1 in decimal inch</p>	<p>H6</p>	<p>SF = Straight Flute</p> <p>HF = Helical Flute</p>	<p>M = Metric</p> <p>Blank = Inch</p>

Modular Reamer Bodies • Catalog Numbering System

Each character in our catalog number signifies a specific trait of that product. Use the following key columns and corresponding images to easily identify which attributes apply.

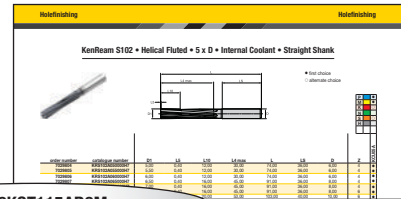

SS16KST115AR3M

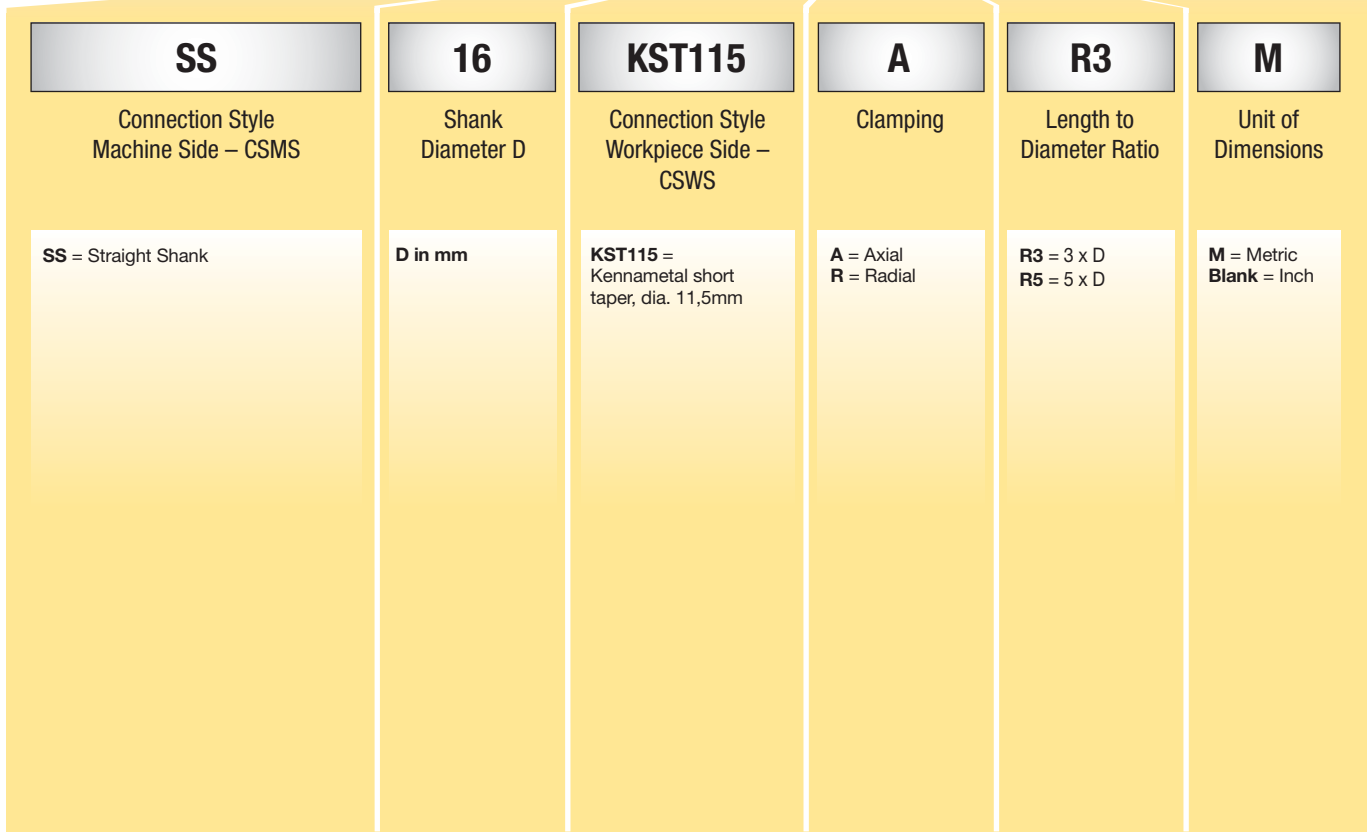

NOVOTM

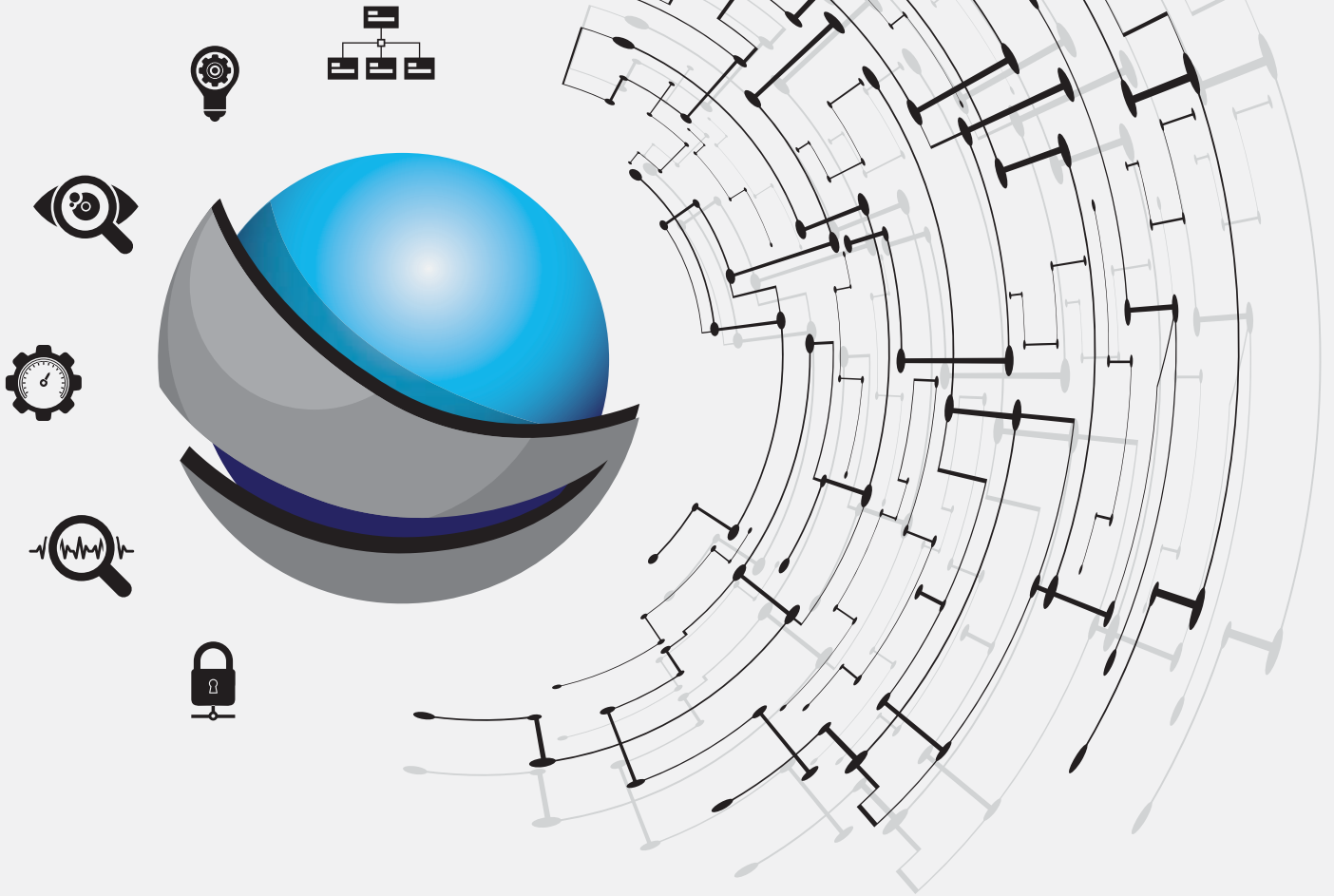

**Digitally access and leverage product data and knowledge
to connect systems and processes throughout
the entire manufacturing lifecycle.**

VISIT KENNAMETAL.COM/NOVO.

Tool Selector

DYNAMIC MILLING							
	KOR5™ DS		KOR5™ DA			KOR6™ DT	
				NEW! 			
Series	KOR5..R..	KOR5..L..	KOR5..R..I	KOR5..L..I..	KOR5..R..C	KOR6..R..	KOR6..L..
Page	92	93	94-95	97-99	95-97	99-100	101-101
Tool type							
Rougher	●	●	●	●	●	●	●
Finisher	○	○	○	○	○		
Chamfering							
Main operation							
Workpiece material							
Primary	P M	P M	N	N	N	S	S
Secondary	K S H	K S H				P M K H	P M K H
Corner style							
Corner radius [R _ε]	0,50–1mm	0,50–1mm	0,20–2,50mm	0,20–2,50mm	0,20–2,50mm	0,05–1mm	0,50–1mm
Corner chamfer width [BCH]	–	–	–	–	–	–	–
Cutter diameter [D1]	8–25mm	8–25mm	10–25mm	10–25mm	10–25mm	8–25mm	8–25mm
Length of cut	3 x D	5 x D	3 x D	5 x D	3 x D	3 x D	5 x D
Maximum cutting depth [A _{p1} max]	24–75mm	40–125mm	30–60mm	50–125mm	30–60mm	24–75mm	40–125mm
Flute helix angle	40°	40°	35°	35°	35°	38°	38°
Number of flutes [ZU]	5	5	5	5	5	6	6
Coolant							
Additional operations							

- Primary
- Secondary

KOR™ Series

High-Performance Dynamic Milling



Materials



Applications



Ramping



Trochoidal Milling



Side Milling/Shoulder
Milling: Roughing



Side Milling/Shoulder
Milling: Finishing

KOR Series

Designed for dynamic milling with low radial engagement and full length of cut. Maximizes capabilities of 5-axis machines, using CAM tool path generation software.

KOR5^{DA} — Dynamic Rougher for Aluminum

With chip splitters for near-perfect chip management.

Safe-Lock™ shanks available for pullout protection.

With and without internal coolant.

NEW!

5 x D length of cut with internal coolant for a broader application range.

KOR5™ DA



Proprietary flute forms reduce vibrations and improve tool life.

KOR5^{DS}



Helix angles tailored to target material to minimize vibration and optimize tool life.

KOR6™ DT



Front end geometries for maximum tool life in helical and ramping operations.

KOR5^{DS} — Dynamic Rougher for Steel and Stainless Steel

With chip deformers for near-perfect chip management at high surface quality.

Safe-Lock™ and Weldon® shanks for pullout protection.

3 x D and 5 x D with plain and Weldon shanks.

KOR6^{DT} — Dynamic Rougher for Titanium

With chip splitters for optimized chip management.

3 x D and 5 x D with plain and Weldon shanks.

KOR5™ DS • Radiused • 5 Flutes • 3 x D • Plain Shank • Metric

- first choice
- alternate choice

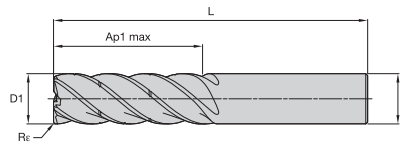

P	●
M	●
K	○
N	○
S	●
H	○

order number	catalogue number	D1	D	Ap1 max	L	Re	KC643M
6763959	KOR5RA0800R024HAR050CM	8,00	8,00	24,00	67,00	0,50	●
6763960	KOR5RA1000R030HAR050CM	10,00	10,00	30,00	80,00	0,50	●
6763981	KOR5RA1200R036HAR075CM	12,00	12,00	36,00	100,00	0,75	●
6763982	KOR5RA1600R048HAR100CM	16,00	16,00	48,00	110,00	1,00	●
6763984	KOR5RA2000R060HAR100CM	20,00	20,00	60,00	125,00	1,00	●
6763985	KOR5RA2500R075HAR100CM	25,00	25,00	75,00	150,00	1,00	●

KOR5 DS • Radiused • 5 Flutes • 3 x D • Weldon® Shank • Metric

- first choice
- alternate choice

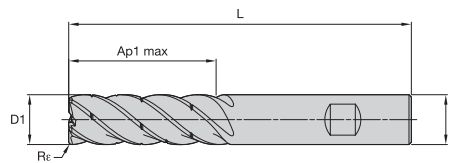

P	●
M	●
K	○
N	○
S	●
H	○

order number	catalogue number	D1	D	Ap1 max	L	Re	KC643M
6763986	KOR5RA0800R024HBR050CM	8,00	8,00	24,00	67,00	0,50	●
6763987	KOR5RA1000R030HBR050CM	10,00	10,00	30,00	80,00	0,50	●
6763988	KOR5RA1200R036HBR075CM	12,00	12,00	36,00	100,00	0,75	●
6763989	KOR5RA1600R048HBR100CM	16,00	16,00	48,00	110,00	1,00	●
6763992	KOR5RA2000R060HBR100CM	20,00	20,00	60,00	125,00	1,00	●
6763993	KOR5RA2500R075HBR100CM	25,00	25,00	75,00	150,00	1,00	●

148-151	152	105	88, 156

KOR5™ DS • Radiused • 5 Flutes • 5 x D • Plain Shank • Metric

● first choice
○ alternate choice

order number	catalogue number	D1	D	Ap1 max	L	Re	
6768036	KOR5RA0800L040HAR050CM	8,00	8,00	40,00	87,00	0,50	●
6768037	KOR5RA1000L050HAR050CM	10,00	10,00	50,00	100,00	0,50	●
6768038	KOR5RA1200L060HAR075CM	12,00	12,00	60,00	125,00	0,75	●
6768039	KOR5RA1600L080HAR100CM	16,00	16,00	80,00	141,00	1,00	●
6768040	KOR5RA2000L100HAR100CM	20,00	20,00	100,00	170,00	1,00	●
6768042	KOR5RA2500L125HAR100CM	25,00	25,00	125,00	200,00	1,00	●

KC643M

P	●
M	●
K	○
N	○
S	●
H	○

KOR5 DS • Radiused • 5 Flutes • 5 x D • Weldon® Shank • Metric

● first choice
○ alternate choice

order number	catalogue number	D1	D	Ap1 max	L	Re	
6768043	KOR5RA0800L040HBR050CM	8,00	8,00	40,00	87,00	0,50	●
6768044	KOR5RA1000L050HBR050CM	10,00	10,00	50,00	100,00	0,50	●
6768045	KOR5RA1200L060HBR075CM	12,00	12,00	60,00	125,00	0,75	●
6768046	KOR5RA1600L080HBR100CM	16,00	16,00	80,00	141,00	1,00	●
6768047	KOR5RA2000L100HBR100CM	20,00	20,00	100,00	170,00	1,00	●
6768048	KOR5RA2500L125HBR100CM	25,00	25,00	125,00	200,00	1,00	●

KC643M

P	●
M	●
K	○
N	○
S	●
H	○

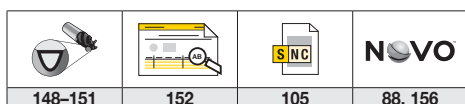

KOR5™ DA • Radiused • 5 Flutes • 3 x D • Internal Coolant • Plain Shank • Metric

- first choice
- alternate choice

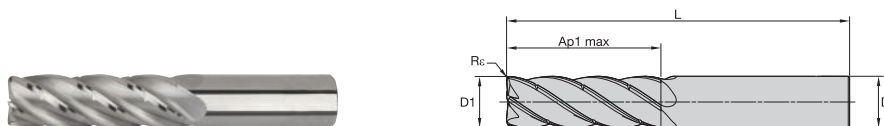

P	■
M	■
K	■
N	●
S	■
H	■

order number	catalogue number	D1	D	Ap1 max	L	R _c	K600
6754973	KOR5RA1000R030HAR020IM	10,00	10,00	30,00	75,00	0,20	●
6754974	KOR5RA1000R030HAR050IM	10,00	10,00	30,00	75,00	0,50	●
6754975	KOR5RA1000R030HAR100IM	10,00	10,00	30,00	75,00	1,00	●

KOR5 DA • Radiused • 5 Flutes • 3 x D • Internal Coolant • Safe-Lock™ Shank • Metric

- first choice
- alternate choice

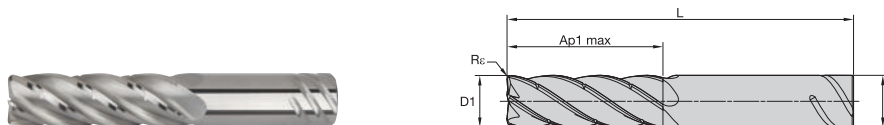

P	■
M	■
K	■
N	●
S	■
H	■

order number	catalogue number	D1	D	Ap1 max	L	R _c	K600
6754977	KOR5RA1200R036SLR020IM	12,00	12,00	36,00	87,00	0,20	●
6754978	KOR5RA1200R036SLR050IM	12,00	12,00	36,00	87,00	0,50	●
6754979	KOR5RA1200R036SLR150IM	12,00	12,00	36,00	87,00	1,50	●
6754980	KOR5RA1200R036SLR250IM	12,00	12,00	36,00	87,00	2,50	●
6755002	KOR5RA1600R048SLR050IM	16,00	16,00	48,00	104,00	0,50	●
6755003	KOR5RA1600R048SLR200IM	16,00	16,00	48,00	104,00	2,00	●
6755004	KOR5RA1600R048SLR250IM	16,00	16,00	48,00	104,00	2,50	●
6755006	KOR5RA2000R060SLR050IM	20,00	20,00	60,00	120,00	0,50	●
6755007	KOR5RA2000R060SLR250IM	20,00	20,00	60,00	120,00	2,50	●
6755009	KOR5RA2500R075SLR050IM	25,00	25,00	75,00	144,00	0,50	●
6755010	KOR5RA2500R075SLR250IM	25,00	25,00	75,00	144,00	2,50	●

148-151	152	105	88, 156

KOR5™ DA • Square End • 5 Flutes • 3 x D • Internal Coolant • Plain Shank • Metric

- first choice
- alternate choice

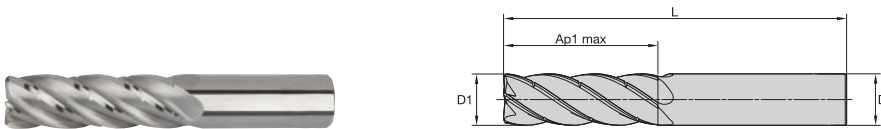

P	■
M	■
K	■
N	●
S	■
H	■
	■

order number	catalogue number	D1	D	Ap1 max	L	K600
6754972	KOR5SE1000R030HAIM	10,00	10,00	30,00	75,00	●

KOR5 DA • Square End • 5 Flutes • 3 x D • Internal Coolant • Safe-Lock™ Shank • Metric

- first choice
- alternate choice

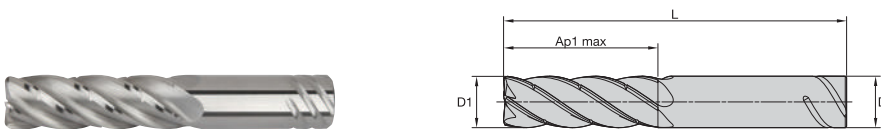

P	■
M	■
K	■
N	●
S	■
H	■
	■

order number	catalogue number	D1	D	Ap1 max	L	K600
6754976	KOR5SE1200R036SLIM	12,00	12,00	36,00	87,00	●
6755001	KOR5SE1600R048SLIM	16,00	16,00	48,00	104,00	●
6755005	KOR5SE2000R060SLIM	20,00	20,00	60,00	120,00	●
6755008	KOR5SE2500R075SLIM	25,00	25,00	75,00	144,00	●

KOR5 DA • Radiused • 5 Flutes • 3 x D • Plain Shank • Metric

- first choice
- alternate choice

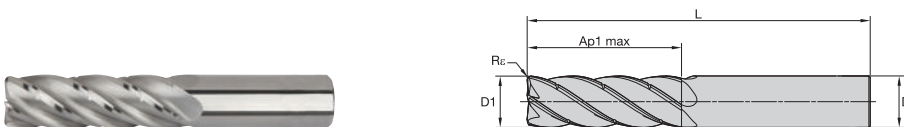

P	■
M	■
K	■
N	●
S	■
H	■
	■

order number	catalogue number	D1	D	Ap1 max	L	Rε	K600
6755013	KOR5RA1000R030HAR020CM	10,00	10,00	30,00	75,00	0,20	●
6755014	KOR5RA1000R030HAR050CM	10,00	10,00	30,00	75,00	0,50	●
6755015	KOR5RA1000R030HAR100CM	10,00	10,00	30,00	75,00	1,00	●

KOR5™ DA • Radiused • 5 Flutes • 3 x D • Safe-Lock™ Shank • Metric

- first choice
- alternate choice

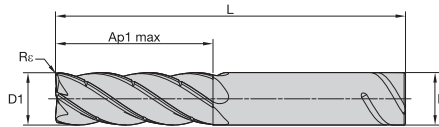

P	■	■
M	■	■
K	■	■
N	■	●
S	■	■
H	■	■

order number	catalogue number	D1	D	Ap1 max	L	Rc	K600
6755017	KOR5RA1200R036SLR020CM	12,00	12,00	36,00	87,00	0,20	●
6755018	KOR5RA1200R036SLR050CM	12,00	12,00	36,00	87,00	0,50	●
6755019	KOR5RA1200R036SLR150CM	12,00	12,00	36,00	87,00	1,50	●
6755020	KOR5RA1200R036SLR250CM	12,00	12,00	36,00	87,00	2,50	●
6755032	KOR5RA1600R048SLR050CM	16,00	16,00	48,00	104,00	0,50	●
6755033	KOR5RA1600R048SLR200CM	16,00	16,00	48,00	104,00	2,00	●
6755034	KOR5RA1600R048SLR250CM	16,00	16,00	48,00	104,00	2,50	●
6755036	KOR5RA2000R060SLR050CM	20,00	20,00	60,00	120,00	0,50	●
6755037	KOR5RA2000R060SLR250CM	20,00	20,00	60,00	120,00	2,50	●
6755039	KOR5RA2500R075SLR050CM	25,00	25,00	75,00	144,00	0,50	●
6755040	KOR5RA2500R075SLR250CM	25,00	25,00	75,00	144,00	2,50	●

KOR5 DA • Square End • 5 Flutes • 3 x D • Plain Shank • Metric

- first choice
- alternate choice

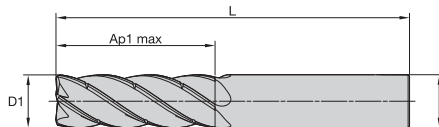

P	■	■
M	■	■
K	■	■
N	■	●
S	■	■
H	■	■

order number	catalogue number	D1	D	Ap1 max	L	K600
6755012	KOR5SE1000R030HACM	10,00	10,00	30,00	75,00	●

148-151	152	105	88, 156

KOR5™ DA • Square End • 5 Flutes • 3 x D • Safe-Lock™ Shank • Metric

- first choice
- alternate choice

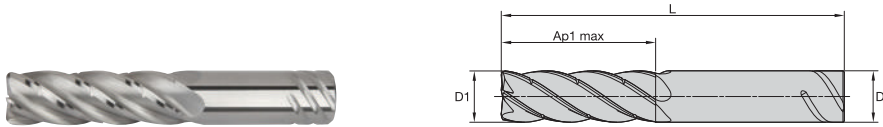

P	■
M	■
K	■
N	●
S	■
H	■

order number	catalogue number	D1	D	Ap1 max	L	K600
6755016	KOR5SE1200R036SLCM	12,00	12,00	36,00	87,00	●
6755031	KOR5SE1600R048SLCM	16,00	16,00	48,00	104,00	●
6755035	KOR5SE2000R060SLCM	20,00	20,00	60,00	120,00	●
6755038	KOR5SE2500R075SLCM	25,00	25,00	75,00	144,00	●

KOR5 DA • Radiused • 5 Flutes • 5 x D • Internal Coolant • Plain Shank • Metric

- first choice
- alternate choice

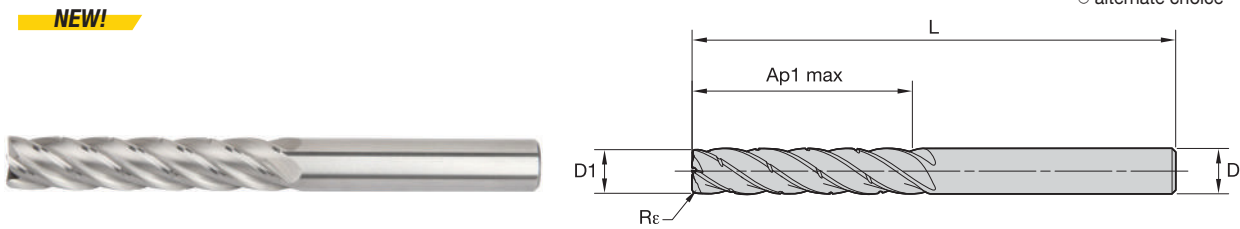

P	■
M	■
K	■
N	●
S	■
H	■

order number	catalogue number	D1	D	Ap1 max	L	Rc	K600
6974931	KOR5RA1000L050HAR020IM	10,00	10,00	50,00	100,00	0,20	●
6974932	KOR5RA1000L050HAR050IM	10,00	10,00	50,00	100,00	0,50	●
6974933	KOR5RA1000L050HAR100IM	10,00	10,00	50,00	100,00	1,00	●

148-151	152	105	88, 156

KOR5™ DA • Radiused • 5 Flutes • 5 x D • Internal Coolant • Safe-Lock™ Shank • Metric

NEW!

- first choice
- alternate choice

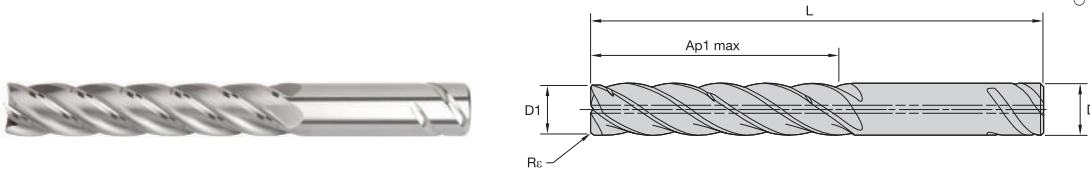

P	■
M	■
K	■
N	■ ●
S	■
H	■

order number	catalogue number	D1	D	Ap1 max	L	Re	K600
6974935	KOR5RA1200L060SLR020IM	12,00	12,00	60,00	115,00	0,20	●
6974936	KOR5RA1200L060SLR050IM	12,00	12,00	60,00	115,00	0,50	●
6974937	KOR5RA1200L060SLR150IM	12,00	12,00	60,00	115,00	1,50	●
6974938	KOR5RA1200L060SLR250IM	12,00	12,00	60,00	115,00	2,50	●
6974940	KOR5RA1600L080SLR050IM	16,00	16,00	80,00	141,00	0,50	●
6974941	KOR5RA1600L080SLR200IM	16,00	16,00	80,00	141,00	2,00	●
6974942	KOR5RA1600L080SLR250IM	16,00	16,00	80,00	141,00	2,50	●
6974944	KOR5RA2000L100SLR050IM	20,00	20,00	100,00	166,00	0,50	●
6974945	KOR5RA2000L100SLR250IM	20,00	20,00	100,00	166,00	2,50	●
6974947	KOR5RA2500L125SLR050IM	25,00	25,00	125,00	200,00	0,50	●
6974948	KOR5RA2500L125SLR250IM	25,00	25,00	125,00	200,00	2,50	●

KOR5 DA • Square End • 5 Flutes • 5 x D • Internal Coolant • Plain Shank • Metric

NEW!

- first choice
- alternate choice

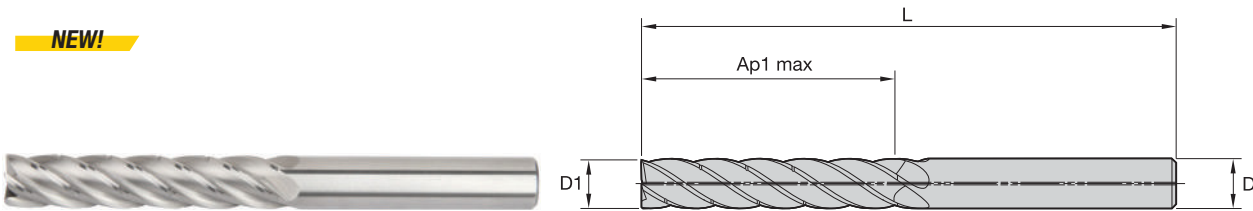

P	■
M	■
K	■
N	■ ●
S	■
H	■

order number	catalogue number	D1	D	Ap1 max	L	K600
6974934	KOR5SE1000L050HAIM	10,00	10,00	50,00	100,00	●

148-151	152	105	88, 156

KOR5™ DA • Square End • 5 Flutes • 5 x D • Internal Coolant • Safe-Lock™ Shank • Metric

NEW!

- first choice
- alternate choice

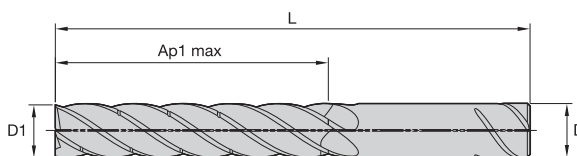

P	■
M	■
K	■
N	●
S	■
H	■

order number	catalogue number	D1	D	Ap1 max	L		K600
6974939	KOR5SE1200L060SLIM	12,00	12,00	60,00	115,00	●	●
6974943	KOR5SE1600L080SLIM	16,00	16,00	80,00	141,00	●	●
6974946	KOR5SE2000L100SLIM	20,00	20,00	100,00	166,00	●	●
6974949	KOR5SE2500L125SLIM	25,00	25,00	125,00	200,00	●	●

KOR6™ DT • Radiused • 6 Flutes • 3 x D • Plain Shank • Metric

- first choice
- alternate choice

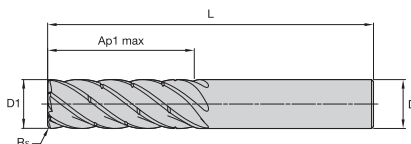

P	■
M	○
K	○
N	○
S	●
H	○

order number	catalogue number	D1	D	Ap1 max	L	Re	KCSM15
6767693	KOR6RA0800R024HAR050M	8,00	8,00	24,00	67,00	0,50	●
6767694	KOR6RA1000R030HAR050M	10,00	10,00	30,00	80,00	0,50	●

148-151	152	105	88, 156

KOR6™ DT • Radiused • 6 Flutes • 3 x D • Weldon® Shank • Metric

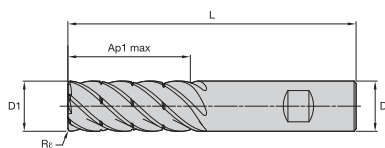

- first choice
- alternate choice

P	<input checked="" type="checkbox"/>	<input type="checkbox"/>
M	<input type="checkbox"/>	<input type="checkbox"/>
K	<input type="checkbox"/>	<input type="checkbox"/>
N	<input type="checkbox"/>	<input type="checkbox"/>
S	<input checked="" type="checkbox"/>	<input type="checkbox"/>
H	<input type="checkbox"/>	<input type="checkbox"/>

order number	catalogue number	D1	D	Ap1 max	L	Re	KCSM15
6767699	KOR6RA0800R024HBR050M	8,00	8,00	24,00	67,00	0,50	●
6767700	KOR6RA1000R030HBR050M	10,00	10,00	30,00	80,00	0,50	●
6767701	KOR6RA1200R036HBR075M	12,00	12,00	36,00	100,00	0,75	●
6767702	KOR6RA1600R048HBR100M	16,00	16,00	48,00	110,00	1,00	●
6767703	KOR6RA2000R060HBR100M	20,00	20,00	60,00	125,00	1,00	●
6767705	KOR6RA2500R075HBR100M	25,00	25,00	75,00	150,00	1,00	●

KOR6 DT • Radiused • 6 Flutes • 3 x D • Safe-Lock™ Shank • Metric

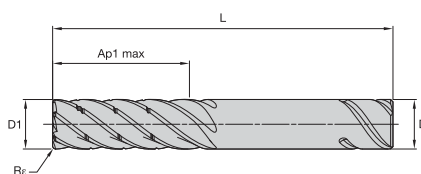

- first choice
- alternate choice

P	<input checked="" type="checkbox"/>	<input type="checkbox"/>
M	<input type="checkbox"/>	<input type="checkbox"/>
K	<input type="checkbox"/>	<input type="checkbox"/>
N	<input type="checkbox"/>	<input type="checkbox"/>
S	<input checked="" type="checkbox"/>	<input type="checkbox"/>
H	<input type="checkbox"/>	<input type="checkbox"/>

order number	catalogue number	D1	D	Ap1 max	L	Re	KCSM15
6767695	KOR6RA1200R036SLR075M	12,00	12,00	36,00	100,00	0,75	●
6767696	KOR6RA1600R048SLR100M	16,00	16,00	48,00	110,00	1,00	●
6767697	KOR6RA2000R060SLR100M	20,00	20,00	60,00	125,00	1,00	●
6767698	KOR6RA2500R075SLR100M	25,00	25,00	75,00	150,00	1,00	●

KOR6 DT • Radiused • 6 Flutes • 5 x D • Plain Shank • Metric

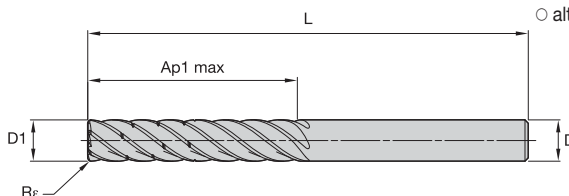

- first choice
- alternate choice

P	<input checked="" type="checkbox"/>	<input type="checkbox"/>
M	<input type="checkbox"/>	<input type="checkbox"/>
K	<input type="checkbox"/>	<input type="checkbox"/>
N	<input type="checkbox"/>	<input type="checkbox"/>
S	<input checked="" type="checkbox"/>	<input type="checkbox"/>
H	<input type="checkbox"/>	<input type="checkbox"/>

order number	catalogue number	D1	D	Ap1 max	L	Re	KCSM15
6767641	KOR6RA0800L040HAR050CM	8,00	8,00	40,00	87,00	0,50	●
6767642	KOR6RA1000L050HAR050CM	10,00	10,00	50,00	100,00	0,50	●

KOR6™ DT • Radiused • 6 Flutes • 5 x D • Weldon® Shank • Metric

● first choice
○ alternate choice

order number	catalogue number	D1	D	Ap1 max	L	Re		KCSM15
6767647	KOR6RA0800L040HBR050CM	8,00	8,00	40,00	87,00	0,50	●	●
6767648	KOR6RA1000L050HBR050CM	10,00	10,00	50,00	100,00	0,50	●	●
6767649	KOR6RA1200L060HBR075CM	12,00	12,00	60,00	125,00	0,75	●	●
6767650	KOR6RA1600L080HBR100CM	16,00	16,00	80,00	141,00	1,00	●	●
6767651	KOR6RA2000L100HBR100CM	20,00	20,00	100,00	166,00	1,00	●	●
6767652	KOR6RA2500L125HBR100CM	25,00	25,00	125,00	190,00	1,00	●	●

KOR6 DT • Radiused • 6 Flutes • 5 x D • Safe-Lock™ Shank • Metric

● first choice
○ alternate choice

order number	catalogue number	D1	D	Ap1 max	L	Re		KCSM15
6767643	KOR6RA1200L060SLR075CM	12,00	12,00	60,00	125,00	0,75	●	●
6767644	KOR6RA1600L080SLR100CM	16,00	16,00	80,00	141,00	1,00	●	●
6767645	KOR6RA2000L100SLR100CM	20,00	20,00	100,00	166,00	1,00	●	●
6767646	KOR6RA2500L125SLR100CM	25,00	25,00	125,00	190,00	1,00	●	●

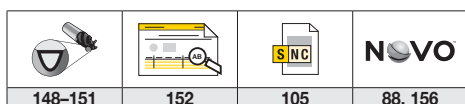

KOR5™ DS & KOR6™ DT • 3 x D • Application Data • Metric

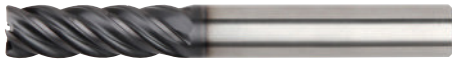

KOR5 DS 3 x D



KOR6 DT 3 x D

Material Group			KC643M			Recommended feed per tooth (fz = mm/th) for side milling (A).							
	A		Cutting Speed – vc m/min			mm	D1 – Diameter						
	ap	ae	min	–	max		8,0	10,0	12,0	16,0	20,0	25,0	
P	0	3 x D	0,1 x D	150	–	440	fz	0,072	0,086	0,099	0,121	0,137	0,149
	1	3 x D	0,1 x D	150	–	440	fz	0,072	0,086	0,099	0,121	0,137	0,149
	2	3 x D	0,1 x D	140	–	418	fz	0,072	0,086	0,099	0,121	0,137	0,149
	3	3 x D	0,1 x D	120	–	352	fz	0,060	0,073	0,084	0,105	0,121	0,137
	4	3 x D	0,1 x D	90	–	330	fz	0,054	0,065	0,075	0,092	0,106	0,117
	5	3 x D	0,1 x D	60	–	220	fz	0,048	0,058	0,067	0,084	0,097	0,109
M	6	3 x D	0,1 x D	50	–	165	fz	0,040	0,048	0,056	0,068	0,078	0,085
	1	3 x D	0,1 x D	90	–	253	fz	0,060	0,073	0,084	0,105	0,121	0,137
	2	3 x D	0,1 x D	60	–	176	fz	0,048	0,058	0,067	0,084	0,097	0,109
K	3	3 x D	0,1 x D	60	–	154	fz	0,040	0,048	0,056	0,068	0,078	0,085
	1	3 x D	0,1 x D	120	–	330	fz	0,072	0,086	0,099	0,121	0,137	0,149
	2	3 x D	0,1 x D	110	–	308	fz	0,060	0,073	0,084	0,105	0,121	0,137
S	3	3 x D	0,1 x D	110	–	286	fz	0,048	0,058	0,067	0,084	0,097	0,109
	1	3 x D	0,1 x D	50	–	198	fz	0,060	0,073	0,084	0,105	0,121	0,137
	2	3 x D	0,1 x D	25	–	88	fz	0,032	0,038	0,045	0,056	0,065	0,074
	3	3 x D	0,1 x D	25	–	88	fz	0,032	0,038	0,045	0,056	0,065	0,074
H	4	3 x D	0,1 x D	50	–	132	fz	0,044	0,053	0,062	0,077	0,089	0,100
	1	3 x D	0,1 x D	80	–	308	fz	0,054	0,065	0,075	0,092	0,106	0,117
	2	3 x D	0,1 x D	70	–	264	fz	0,040	0,048	0,056	0,068	0,078	0,085

NOTE: Lower value of cutting speed is used for high stock removal applications or for higher hardness (machinability) within group.

Higher value of cutting speed is used for finishing applications or for lower hardness (machinability) within group.

Side milling applications – for longest reach (L3) tools, reduce Ae by 30%.

For better surface finish, reduce feed per tooth.

KOR5™ DS & KOR6™ DT • 5 x D • Application Data • Metric



KOR5 DS 5 x D



KOR6 DT 5 x D

Material Group	A		Cutting Speed – vc m/min			Recommended feed per tooth (fz = mm/th) for side milling (A).							
	A		Cutting Speed – vc m/min			D1 – Diameter							
	ap	ae	min	–	max	mm	8,0	10,0	12,0	16,0	20,0	25,0	
P	0	5 x D	0,05 x D	150	–	540	fz	0,097	0,117	0,134	0,163	0,185	0,200
	1	5 x D	0,05 x D	150	–	540	fz	0,097	0,117	0,134	0,163	0,185	0,200
	2	5 x D	0,05 x D	140	–	513	fz	0,097	0,117	0,134	0,163	0,185	0,200
	3	5 x D	0,05 x D	120	–	432	fz	0,081	0,098	0,114	0,141	0,164	0,184
	4	5 x D	0,05 x D	90	–	405	fz	0,073	0,087	0,101	0,124	0,143	0,158
	5	5 x D	0,05 x D	60	–	270	fz	0,065	0,078	0,091	0,113	0,131	0,147
M	6	5 x D	0,05 x D	50	–	202,5	fz	0,054	0,065	0,075	0,092	0,105	0,115
	1	5 x D	0,05 x D	90	–	310,5	fz	0,081	0,098	0,114	0,141	0,164	0,184
	2	5 x D	0,05 x D	60	–	216	fz	0,065	0,078	0,091	0,113	0,131	0,147
K	3	5 x D	0,05 x D	60	–	189	fz	0,054	0,065	0,075	0,092	0,105	0,115
	1	5 x D	0,05 x D	120	–	405	fz	0,097	0,117	0,134	0,163	0,185	0,200
	2	5 x D	0,05 x D	110	–	378	fz	0,081	0,098	0,114	0,141	0,164	0,184
S	3	5 x D	0,05 x D	110	–	351	fz	0,065	0,078	0,091	0,113	0,131	0,147
	1	5 x D	0,05 x D	50	–	243	fz	0,081	0,098	0,114	0,141	0,164	0,184
	2	5 x D	0,05 x D	25	–	108	fz	0,043	0,052	0,060	0,075	0,087	0,099
H	3	5 x D	0,05 x D	25	–	108	fz	0,043	0,052	0,060	0,075	0,087	0,099
	4	5 x D	0,05 x D	50	–	162	fz	0,060	0,072	0,084	0,104	0,120	0,135
	1	5 x D	0,05 x D	80	–	378	fz	0,073	0,087	0,101	0,124	0,143	0,158
H	2	5 x D	0,05 x D	70	–	324	fz	0,054	0,065	0,075	0,092	0,105	0,115

NOTE: Lower value of cutting speed is used for high stock removal applications or for higher hardness (machinability) within group.
 Higher value of cutting speed is used for finishing applications or for lower hardness (machinability) within group.
 Side milling applications – for longest reach (L3) tools, reduce Ae by 30%.
 For better surface finish, reduce feed per tooth.

KOR5 DS & KOR6 DT • Adjustment Factor for Feed and Speed Calculation • Metric

	Ae/D	2%	4%	5%	8%	10%	12%	20%	30%	40%	50%	100%
Speed factor	Kv	2,1–3,6	1,6–3	1,6–2,5	1,6	1,4	1,38	1,3	1,2	1,1	1	0,9
Feed factor	KFz	3,58	2,56	2,3	1,84	1,67	1,54	1,25	1,09	1,02	1	1

NOTE: For an Ae/D ratio of 5% or less there is a range given for speed factor Kv, which allows the user to either be more conservative at the lower value or more aggressive with the higher value.
 This can also be considered based on the machinability of the material, from difficult to free cutting.
 These calculations are for roughing/semi-finishing cuts when used with the recommended base Fz.
 For light finishing cuts requiring improved surface quality it is recommended to reduce the base Fz approximately 50% and then apply these factors.

To calculate application specific cutting data, please use KV coefficient table to the right for adaptation of cutting speed and KFz for feed respectively.

Vc new = Vc * Kv
 Fz new = IPT * KFz

Calculation example:

Application: D1 = 25mm, KOR5^{DS} / KOR6^{DT} 3 x D;
 P5 material group;
 Ae 2,5mm (Ae = 10% of D1)
 Cutting data recommendation: 220m/min;
 Fz = 0,109 mm/z
 Adjustment coefficients: Ae = 2,5mm equals 10%;
 Kv = 1,4; KFz = 1,67

Final cutting data recommendation:

Vc new = 220 * 1,4 = 308mm/min
 Fz new = 0,109 * 1,67 = 0,182mm/z

KOR5™ DA • Application Data • Metric



Material Group	A		B		K600			Recommended feed per tooth (fz = mm/th)					
	ap		ae		Cutting Speed – vc m/min			D1 – Diameter					
	ap	ae	ap	min	max	mm	10,0	12,0	16,0	20,0	25,0		
N	1	0,5 x D1	0,5 x D1	0,25 x D1	200	–	2000	fz	0,080	0,120	0,160	0,200	0,225
	2	0,5 x D1	0,5 x D1	0,25 x D1	200	–	1500	fz	0,070	0,110	0,140	0,180	0,213

NOTE: These guidelines may require variations to achieve optimum results. For better surface finish, reduce feed per tooth.

For cutting aluminum with high silicon, TiCN coating is recommended.

Ap for milling machine with ceramic bearings spindle, multiply by 0,5.

Above parameters are based on ideal conditions. For smaller taper machining centers, please adjust parameters accordingly on >12mm diameter.

KOR5™ DA • Adjustment Factor Table for Feed Calculation • Metric

Ae/D1	2%	5%	10%	20%	30%	40%	50%	100%
Max Ap	Ap1 Max	Ap1 Max	Ap1 Max	Ap1 Max	2 x D1	1 x D1	0,5 x D1	0,25 x D1
Feed Multiplier (KFz)	3,60	2,30	1,70	1,25	1,09	1,02	1,00	0,90

To calculate application specific cutting data, please use Kv coefficient table to the right for adaptation of cutting speed and KFz for feed respectively.

Fz new = IPT * KFz

Calculation example:

Application: D1 = 25mm;

N2 material group;

Ae 2,5mm (Ae = 10% of D1)

Cutting data recommendation: 1500m/min;

Fz = 0,213 mm/z

Adjustment coefficients: Ae = 2,5mm equals 10%;

KFz = 1,70

Final cutting data recommendation:

Fz new = 0,213 * 1,70 = 0,362 mm/z

HARVI™ I TE • KOR™ • PCD • Catalog Numbering System

Each character in our catalog number signifies a specific trait of that product. Use the following key columns and corresponding images to easily identify which attributes apply.

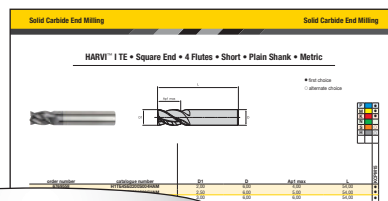

H1TE4SE1200S016HAM





























H1TE	4	SE	1200	S	016	HA			M																																
Series	Number of Flutes	Front End Style	Cutting Diameter D1	Flute Section Style	Length of Cut Ap1 max	Shank Style	Radius	Specific Features	Standard																																
<p>H1TE = HARVI I TE</p> <p>KOR = KOR</p> <p>ALCB = Basic PCD end mill with carbide body</p> <p>ALCC = Complex PCD end mill carbide body</p> <p>ALCR = Roughing PCD end mill with carbide body</p> <p>ALSB = Basic PCD end mill with steel body</p> <p>ALSR = Basic PCD end mill with steel body</p>	<p>1 = 1-Flute</p> <p>2 = 2-Flute</p> <p>3 = 3-Flute</p> <p>4 = 4-Flute</p> <p>5 = 5-Flute</p> <p>6 = 6-Flute</p> <p>7 = 7-Flute</p> <p>8 = 8-Flute</p> <p>9 = 9-Flute</p> <p>M = Multi-flute</p>	<p>SE = Sharp Edge</p> <p>CH = Chamfer</p> <p>RA = Radius</p> <p>BN = Ball Nose</p> <p>TB = Taper Ball Nose</p> <p>TO = Torroid</p>	<p>Metric = D1 in mm</p> <p>Inch = D1 in decimal inch</p>	<p>N = Neck</p> <p>E = Extended Neck</p> <p>S = Short Without Neck</p> <p>R = Regular Without Neck</p> <p>L = Long Without Neck</p> <p>X = Extra Long Without Neck</p>	<p>Metric = Ap1 Max in mm</p> <p>Inch = Ap1 Max in decimal inch</p>	<p>HA = Plain</p> <p>HB = Weldon®</p> <p>SL = Safe-Lock™</p> <p>DL = DUO-LOCK™</p>		<p>C = Chip Splitter</p> <p>I = Internal Coolant</p> <p>O = Coolant Grooves in Shank</p> <p>P = Polished Flutes</p>	<p>M = Metric</p> <p>Blank = Inch</p>																																
						<table border="1"> <thead> <tr> <th>Radius Metric</th> <th>Radius Inch</th> </tr> </thead> <tbody> <tr><td>R020 = 0,2mm</td><td>R010 = .010"</td></tr> <tr><td>R025 = 0,25mm</td><td>R015 = .015"</td></tr> <tr><td>R030 = 0,3mm</td><td>R030 = .030"</td></tr> <tr><td>R040 = 0,4mm</td><td>R060 = .060"</td></tr> <tr><td>R050 = 0,5mm</td><td>R090 = .090"</td></tr> <tr><td>R075 = 0,75mm</td><td>R120 = .120"</td></tr> <tr><td>R100 = 1,0mm</td><td>R160 = .160"</td></tr> <tr><td>R125 = 1,25mm</td><td>R250 = .250"</td></tr> <tr><td>R150 = 1,5mm</td><td>R190 = .190"</td></tr> <tr><td>R200 = 2,0mm</td><td>R375 = .375"</td></tr> <tr><td>R250 = 2,5mm</td><td>R045 = .045"</td></tr> <tr><td>R300 = 3,0mm</td><td></td></tr> <tr><td>R400 = 4,0mm</td><td></td></tr> <tr><td>R500 = 5,0mm</td><td></td></tr> <tr><td>R600 = 6,0mm</td><td></td></tr> </tbody> </table>	Radius Metric	Radius Inch	R020 = 0,2mm	R010 = .010"	R025 = 0,25mm	R015 = .015"	R030 = 0,3mm	R030 = .030"	R040 = 0,4mm	R060 = .060"	R050 = 0,5mm	R090 = .090"	R075 = 0,75mm	R120 = .120"	R100 = 1,0mm	R160 = .160"	R125 = 1,25mm	R250 = .250"	R150 = 1,5mm	R190 = .190"	R200 = 2,0mm	R375 = .375"	R250 = 2,5mm	R045 = .045"	R300 = 3,0mm		R400 = 4,0mm		R500 = 5,0mm		R600 = 6,0mm				
Radius Metric	Radius Inch																																								
R020 = 0,2mm	R010 = .010"																																								
R025 = 0,25mm	R015 = .015"																																								
R030 = 0,3mm	R030 = .030"																																								
R040 = 0,4mm	R060 = .060"																																								
R050 = 0,5mm	R090 = .090"																																								
R075 = 0,75mm	R120 = .120"																																								
R100 = 1,0mm	R160 = .160"																																								
R125 = 1,25mm	R250 = .250"																																								
R150 = 1,5mm	R190 = .190"																																								
R200 = 2,0mm	R375 = .375"																																								
R250 = 2,5mm	R045 = .045"																																								
R300 = 3,0mm																																									
R400 = 4,0mm																																									
R500 = 5,0mm																																									
R600 = 6,0mm																																									

Tool Selector

HIGH-PERFORMANCE ROUGHING & FINISHING					
HARVI™ I TE		HARVI I			
	NEW!	NEW!			
Series	H1TE4CH..R	H1TE4RA..R	UKDV	ULDV	UKBV
Page	112	112	113	113	114
Tool type					
Rougher	●	●	●	●	●
Finisher	○	○	○	○	○
Chamfering					
Main operations					
Workpiece material					
Primary	P M K	P M K S	P M	S	P M
Secondary	S H	H	K S	P M H	K S H
Corner style					
Corner radius [Rε]	—	0,5–3,0mm	—	0,5–4mm	—
Corner chamfer width [BCH]	0,15–0,48mm	—	0,5mm	—	—
Cutting diameter [D1]	10–32mm	10–20mm	10–32mm	10–32mm	10–25mm
Length of cut	1,5 x D	1,5 x D	1,5 x D	1,5 x D	1,5 x D
Maximum cutting depth [Ap1 max]	15–37,5mm	15–30mm	15–48mm	15–48mm	15–37,5mm
Flute helix angle	36°/39°	36°/39°	37°/39°	37°/39°	37°/39°
Number of flutes [ZU]	4	4	4	4	4
Center cutting	✓	✓	✓	✓	✓
Additional operations					























- Primary
- Secondary

Tool Selector

	HIGH-PERFORMANCE ROUGHING & FINISHING		HP ROUGHING & FINISHING		ROUGHER	
	HARVI™ II		HARVI III		KenCut™ RR	
						
Series	UCDV	UDDV	UJDV	UJBV	RQDB	RKDF
Page	114	115	116	116	122	122
Tool type						
Rougher	○	○			●	●
Finisher	●	●	●	●		
Chamfering						
Main operations						
Workpiece material						
Primary	P M	S	S	P M	P M	S
Secondary	K S H	P H	P M H	K S H	K S H	P M K H
Corner style						
Corner radius [Rε]	—	0,5–5mm	0,5–4mm	—	—	0,5–0,75mm
Corner chamfer width [BCH]	0,5mm	—	—	—	0,5mm	—
Cutting diameter [D1]	10–32mm	10–32mm	10–32mm	10–25mm	10–25mm	10–25mm
Length of cut	1,5 x D	1,5 x D	1,5 x D	1,5 x D	1,5 x D	1,5 x D
Maximum cutting depth [Ap1 max]	15–48mm	15–48mm	15–48mm	15–37,5mm	15–37,5mm	15–37,5mm
Flute helix angle	37°/39°	37°/39°	37°/39°	37°/39°	20°	45°
Number of flutes [ZU]	5	5	6	6	4 & 5	4 & 6
Center cutting	—	—	✓	✓	—	✓
Additional operations	 	 			 	 























- Primary
- Secondary

Tool Selector

	FINISHER		ALUMINUM MACHINING		
	KenCut™ FF	RSM II™	MaxiMet™		
					
Series	F MDF	FS DE	AB DF	AB DE	AB BE
Page	124	124	126	126	127
Tool type					
Rougher			●	●	●
Finisher	●	●	○	●	●
Chamfering					
Main operations					
Workpiece material					
Primary	P M	S	N	N	N
Secondary	K S H	P M H			
Corner style					
Corner radius [Rε]	0,5–0,75mm	0,5–4mm	–	0,5–4mm	–
Corner chamfer width [BCH]	–	–	–	–	–
Cutting diameter [D1]	10–25mm	10–25mm	10–20mm	10–25mm	10–25mm
Length of cut	1,5 x D	1,5 x D	1,5 x D	1,5 x D	1,5 x D
Maximum cutting depth [Ap1 max]	15–37,5mm	15–37,5mm	15–30mm	15–37,5mm	15–37,5mm
Flute helix angle	45°	36°	45°	38°	38°
Number of flutes [ZU]	6	9, 11, 15, & 19	2	3	3
Center cutting	✓	–	✓	✓	✓
Additional operations			 	 	 
					

- Primary
- Secondary

Tool Selector

	HIGH-FEED		DRIVEN TOOLING		CHAMFERER	
	KenFeed™		KenCut™ RR	KenCut FF	KenCut CM	
						
Series	KMDA	KSDB	RFDD	FGDF	XADA	XRDA
Page	129	130	132	132	134	134
Tool type						
Rougher	●	●	●	●		
Finisher	●	●		○		
Chamfering					●	●
Main operations						
Workpiece material						
Primary	H	S	P M	P M	P M	P M
Secondary	P	P M	K H	K S H	K N S H	K N S H
Corner style					—	—
Corner radius [R _ε]	0,36–1,25mm	0,36–1,25mm	0,4mm	0,33–0,4mm	—	—
Corner chamfer width [BCH]	—	—	—	—	—	—
Cutting diameter [D1]	10–20mm	10–20mm	10–20mm	10–20mm	10–16mm	10–16mm
Length of cut	—	—	0,75 x D	0,75 x D	2–4mm	1,5–4mm
Maximum cutting depth [A _{p1} max]	0,33–0,67mm	0,33–0,67mm	7,5–15mm	7,5–15mm	2–4mm	1,5–4mm
Flute helix angle	20°	20°	35°	42°/45°/48°	0°	0°
Number of flutes [ZU]	6	6	3	3	4, 5, & 6	4, 5, & 6
Center cutting	—	—	✓	✓	—	—
Additional operations			 	 		

- Primary
- Secondary

DUO-LOCK™

Modular End Milling



NEW!

Portfolio Materials



Portfolio Applications



Plunge Milling



Ramping



Slotting



Side Milling/
Shoulder Milling



3D Milling/Profiling



Chamfer Milling



Side Milling/Shoulder
Milling: Radius

DUO-LOCK®
by HAIMER® and Kennametal

DUO-LOCK is a new revolutionary coupling for solid carbide end milling applications. This replaceable head design combines a high accuracy in runout and length repeatability with maximum stability, making it a precise and virtually unbreakable interface.

The **ONLY** modular system with the performance of a solid carbide end mill.

To adapt DUO-LOCK perfectly to your spindle, a vast array of adapters and extensions is available.

- Standard-length extensions with Safe-Lock™, cylindrical and conical.
- Cut-to-size extensions, cylindrical and conical.
- Integral adapters with HSK, PSC, DV, and BT back ends.

Intermediate diameters are available upon request as custom solutions.

Reconditioning will maximize tool life and your investment.

Double cone eliminates expensive presetting processes by providing an axial $10\mu\text{m}$ repeatability. Length repeatability from insert tip-to-tip within $50\mu\text{m}$.

3rd contact surface delivers high stiffness and highest accuracy below $5\mu\text{m}$ runout.



Vast array of roughing, finishing, profiling, and chamfering tools, and blanks available, covering all end milling applications.

Intelligent thread ensures stress level to remain below critical values, allowing $>25\%$ higher transmittable torque.

With a DUO-LOCK™ wrench, the tool change becomes easy and can be done in a few seconds.

Adapters

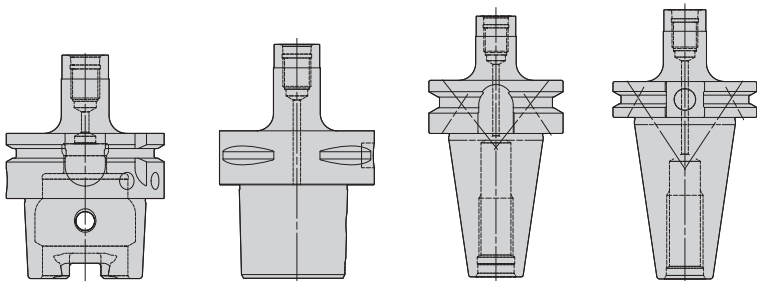

HSK

PSC

BT

CV

Extensions

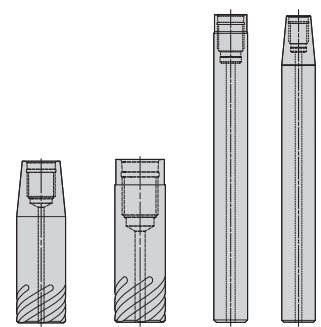

SAFE-LOCK®
by HAIMER®

Cut-to-length

DUO-LOCK™ • HARVI™ I TE • Chamfered • 4 Flutes • Metric

NEW!

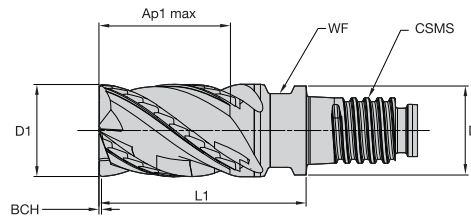

- first choice
- alternate choice

P	●
M	●
K	●
N	○
S	○
H	○

order number	catalogue number	D1	D	Ap1 max	L1	CSMS system size	WF	BCH	KCPM15
6953204	H1TE4CH1000R015DLM	10,00	9,60	15,00	22,50	DL10	8,00	0,50	●
6953205	H1TE4CH1200R018DLM	12,00	11,50	18,00	27,00	DL12	9,50	0,50	●
6953206	H1TE4CH1600R024DLM	16,00	15,50	24,00	36,00	DL16	13,00	0,50	●
6953207	H1TE4CH2000R030DLM	20,00	19,30	30,00	45,00	DL20	16,00	0,50	●
6953208	H1TE4CH2500R038DLM	25,00	24,00	37,50	56,50	DL25	21,00	0,50	●
6953209	H1TE4CH3200R048DLM	32,00	31,00	48,00	72,00	DL32	28,00	0,50	●

DUO-LOCK • HARVI I TE • Radiused • 4 Flutes • Metric

NEW!

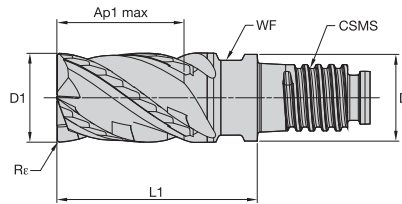

- first choice
- alternate choice

P	●
M	●
K	○
N	○
S	○
H	○

order number	catalogue number	D1	D	Ap1 max	L1	CSMS system size	WF	Rr	KCSM15
6953210	H1TE4RA1000R015DLR050M	10,00	9,60	15,00	22,50	DL10	8,00	0,50	●
6953261	H1TE4RA1200R018DLR050M	12,00	11,50	18,00	27,00	DL12	9,50	0,50	●
6953262	H1TE4RA1200R018DLR100M	12,00	11,50	18,00	27,00	DL12	9,50	1,00	●
6953263	H1TE4RA1600R024DLR100M	16,00	15,50	24,00	36,00	DL16	13,00	1,00	●
6953264	H1TE4RA1600R024DLR300M	16,00	15,50	24,00	36,00	DL16	13,00	3,00	●
6953265	H1TE4RA2000R030DLR300M	20,00	19,30	30,00	45,00	DL20	16,00	3,00	●

148-151	152	145-147	88, 156

DUO-LOCK™ • HARVI™ I • Chamfered • 4 Flutes • Metric

- first choice
- alternate choice

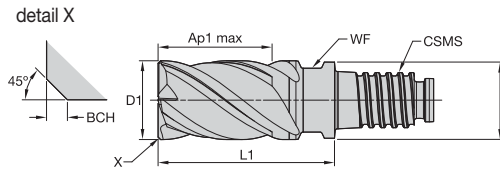

P	●
M	●
K	○
N	○
S	○
H	○

order number	catalogue number	D1	D	Ap1 max	L1	CSMS system size	WF	BCH	KCPM15
6072110	UKDV1000X4CV	10,00	9,60	15,00	22,50	DL10	8,00	0,50	●
6072161	UKDV1200X4CV	12,00	11,50	18,00	27,00	DL12	9,50	0,50	●
6072162	UKDV1600X4CV	16,00	15,50	24,00	36,00	DL16	13,00	0,50	●
6072163	UKDV2000X4CV	20,00	19,30	30,00	45,00	DL20	16,00	0,50	●
6072164	UKDV2500X4CV	25,00	24,00	37,50	56,50	DL25	21,00	0,50	●
6072165	UKDV3200X4CV	32,00	31,00	48,00	71,70	DL32	28,00	0,50	●

DUO-LOCK • HARVI I • Radiused • 4 Flutes • Metric

- first choice
- alternate choice

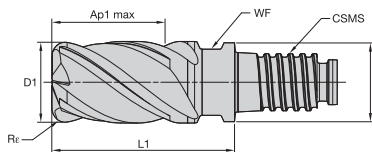

P	●
M	●
K	○
N	○
S	●
H	○

order number	catalogue number	D1	D	Ap1 max	L1	CSMS system size	WF	Re	KCSM15
6072166	ULDV1000X4CQE	10,00	9,60	15,00	22,50	DL10	8,00	0,50	●
6072167	ULDV1000X4CQG	10,00	9,60	15,00	22,50	DL10	8,00	1,00	●
6072168	ULDV1000X4CQJ	10,00	9,60	15,00	22,50	DL10	8,00	1,50	●
6072169	ULDV1200X4CQE	12,00	11,50	18,00	27,00	DL12	9,50	0,50	●
6072170	ULDV1200X4CQG	12,00	11,50	18,00	27,00	DL12	9,50	1,00	●
6072181	ULDV1200X4CQJ	12,00	11,50	18,00	27,00	DL12	9,50	1,50	●
6072182	ULDV1200X4CQL	12,00	11,50	18,00	27,00	DL12	9,50	2,50	●
6072183	ULDV1600X4CQG	16,00	15,50	24,00	36,00	DL16	13,00	1,00	●
6072184	ULDV1600X4CQJ	16,00	15,50	24,00	36,00	DL16	13,00	1,50	●
6072185	ULDV1600X4CQK	16,00	15,50	24,00	36,00	DL16	13,00	2,00	●
6072186	ULDV1600X4CQL	16,00	15,50	24,00	36,00	DL16	13,00	2,50	●
6072187	ULDV1600X4CQM	16,00	15,50	24,00	36,00	DL16	13,00	3,00	●
6408085	ULDV1600X4CQN	16,00	15,50	24,00	36,00	DL16	13,00	4,00	●
6072188	ULDV2000X4CQG	20,00	19,30	30,00	45,00	DL20	16,00	1,00	●
6072189	ULDV2000X4CQK	20,00	19,30	30,00	45,00	DL20	16,00	2,00	●
6072190	ULDV2000X4CQL	20,00	19,30	30,00	45,00	DL20	16,00	2,50	●
6072191	ULDV2000X4CQM	20,00	19,30	30,00	45,00	DL20	16,00	3,00	●
6072192	ULDV2000X4CQN	20,00	19,30	30,00	45,00	DL20	16,00	4,00	●
6408087	ULDV2000X4CQJ	20,00	19,30	30,00	45,00	DL20	16,00	5,00	●
6408088	ULDV2500X4CQG	25,00	24,00	37,50	56,50	DL25	21,00	1,00	●
6072193	ULDV2500X4CQL	25,00	24,00	37,50	56,50	DL25	21,00	2,50	●
6072194	ULDV2500X4CQN	25,00	24,00	37,50	56,50	DL25	21,00	4,00	●
6408089	ULDV2500X4CQJ	25,00	24,00	37,50	56,50	DL25	21,00	5,00	●
6408090	ULDV3200X4CQG	32,00	31,00	48,00	71,70	DL32	28,00	1,00	●
6072195	ULDV3200X4CQL	32,00	31,00	48,00	71,70	DL32	28,00	2,50	●
6072196	ULDV3200X4CQN	32,00	31,00	48,00	71,70	DL32	28,00	4,00	●
6408091	ULDV3200X4CQJ	32,00	31,00	48,00	71,70	DL32	28,00	5,00	●

148-151	152	145-147	88, 156

DUO-LOCK™ • HARVI™ I • Ball Nose • 4 Flutes • Metric

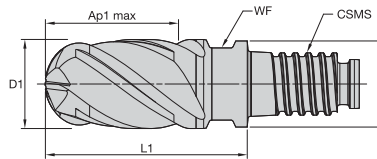

- first choice
- alternate choice

P	●
M	●
K	●
N	○
S	○
H	○

order number	catalogue number	D1	D	Ap1 max	L1	CSMS system size	WF	KCPM15
6072411	UKBV1000X4CN	10,00	9,60	15,00	22,50	DL10	8,00	●
6072412	UKBV1200X4CN	12,00	11,50	18,00	27,00	DL12	9,50	●
6072413	UKBV1600X4CN	16,00	15,50	24,00	36,00	DL16	13,00	●
6072414	UKBV2000X4CN	20,00	19,30	30,00	45,00	DL20	16,00	●
6072415	UKBV2500X4CN	25,00	24,00	37,50	56,50	DL25	21,00	●

DUO-LOCK • HARVI II • Chamfered • 5 Flutes • Metric

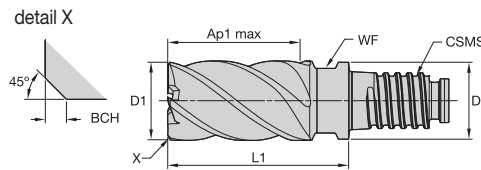

- first choice
- alternate choice

P	●
M	●
K	●
N	○
S	○
H	○

order number	catalogue number	D1	D	Ap1 max	L1	CSMS system size	WF	BCH	KCPM15
6072481	UCDV1000X5CV	10,00	9,60	15,00	22,50	DL10	8,00	0,50	●
6072482	UCDV1200X5CV	12,00	11,50	18,00	27,00	DL12	9,50	0,50	●
6072483	UCDV1600X5CV	16,00	15,50	24,00	36,00	DL16	13,00	0,50	●
6072484	UCDV2000X5CV	20,00	19,30	30,00	45,00	DL20	16,00	0,50	●
6072485	UCDV2500X5CV	25,00	24,00	37,50	56,50	DL25	21,00	0,50	●
6072486	UCDV3200X5CV	32,00	31,00	48,00	71,70	DL32	28,00	0,50	●

148-151	152	145-147	88, 156

DUO-LOCK™ • HARVI™ II • Radiused • 5 Flutes • Metric

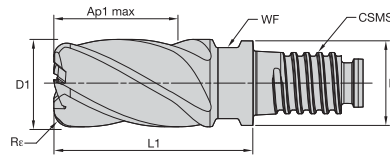

- first choice
- alternate choice

P	■	●
M	■	●
K	■	●
N	■	●
S	■	●
H	■	○
	■	○

order number	catalogue number	D1	D	Ap1 max	L1	CSMS system size	WF	Re	KC643M
6072487	UDDV1000X5CQE	10,00	9,60	15,00	22,50	DL10	8,00	0,50	●
6072488	UDDV1000X5CQJ	10,00	9,60	15,00	22,50	DL10	8,00	1,00	●
6072489	UDDV1000X5CQK	10,00	9,60	15,00	22,50	DL10	8,00	1,50	●
6072491	UDDV1200X5CQE	12,00	11,50	18,00	27,00	DL12	9,50	0,50	●
6072492	UDDV1200X5CQG	12,00	11,50	18,00	27,00	DL12	9,50	1,00	●
6072494	UDDV1200X5CQL	12,00	11,50	18,00	27,00	DL12	9,50	2,50	●
6072495	UDDV1600X5CQG	16,00	15,50	24,00	36,00	DL16	13,00	1,00	●
6072496	UDDV1600X5CQJ	16,00	15,50	24,00	36,00	DL16	13,00	1,50	●
6072497	UDDV1600X5CQK	16,00	15,50	24,00	36,00	DL16	13,00	2,00	●
6072498	UDDV1600X5CQL	16,00	15,50	24,00	36,00	DL16	13,00	2,50	●
6072499	UDDV1600X5CQM	16,00	15,50	24,00	36,00	DL16	13,00	3,00	●
6408050	UDDV1600X5CQN	16,00	15,50	24,00	36,00	DL16	13,00	4,00	●
6408071	UDDV1600X5CQP	16,00	15,50	24,00	36,00	DL16	13,00	6,00	●
6072500	UDDV2000X5CQG	20,00	19,30	30,00	45,00	DL20	16,00	1,00	●
6072501	UDDV2000X5CQK	20,00	19,30	30,00	45,00	DL20	16,00	2,00	●
6072502	UDDV2000X5CQL	20,00	19,30	30,00	45,00	DL20	16,00	2,50	●
6072503	UDDV2000X5CQM	20,00	19,30	30,00	45,00	DL20	16,00	3,00	●
6072504	UDDV2000X5CQN	20,00	19,30	30,00	45,00	DL20	16,00	4,00	●
6408072	UDDV2000X5CQQ	20,00	19,30	30,00	45,00	DL20	16,00	5,00	●
6408073	UDDV2500X5CQG	25,00	24,00	37,50	56,50	DL25	21,00	1,00	●
6072505	UDDV2500X5CQL	25,00	24,00	37,50	56,50	DL25	21,00	2,50	●
6072506	UDDV2500X5CQN	25,00	24,00	37,50	56,50	DL25	21,00	4,00	●
6408074	UDDV2500X5CQQ	25,00	24,00	37,50	56,50	DL25	21,00	5,00	●
6408075	UDDV3200X5CQG	32,00	31,00	48,00	71,70	DL32	28,00	1,00	●
6072507	UDDV3200X5CQL	32,00	31,00	48,00	71,70	DL32	28,00	2,50	●
6072508	UDDV3200X5CQN	32,00	31,00	48,00	71,70	DL32	28,00	4,00	●
6408076	UDDV3200X5CQQ	32,00	31,00	48,00	71,70	DL32	28,00	5,00	●

148-151	152	145-147	88, 156

DUO-LOCK™ • HARVI™ III • Radiused • 6 Flutes • Metric

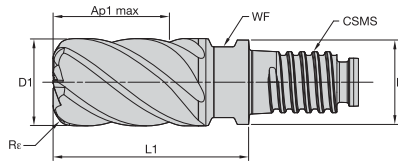

- first choice
- alternate choice

P	<input type="checkbox"/>
M	<input checked="" type="checkbox"/>
K	<input type="checkbox"/>
N	<input type="checkbox"/>
S	<input checked="" type="checkbox"/>
H	<input type="checkbox"/>
	<input type="checkbox"/>

order number	catalogue number	D1	D	Ap1 max	L1	CSMS system size	WF	Re	KCSM15
6072442	UJDV1000X6CQE	10,00	9,60	15,00	22,50	DL10	8,00	0,50	●
6072443	UJDV1000X6CQJ	10,00	9,60	15,00	22,50	DL10	8,00	1,00	●
6072444	UJDV1000X6CQJ	10,00	9,60	15,00	22,50	DL10	8,00	1,50	●
6072445	UJDV1200X6CQE	12,00	11,50	18,00	27,00	DL12	9,50	0,50	●
6072447	UJDV1200X6CQJ	12,00	11,50	18,00	27,00	DL12	9,50	1,50	●
6072448	UJDV1200X6CQL	12,00	11,50	18,00	27,00	DL12	9,50	2,50	●
6072449	UJDV1600X6CQG	16,00	15,50	24,00	36,00	DL16	13,00	1,00	●
6072450	UJDV1600X6CQJ	16,00	15,50	24,00	36,00	DL16	13,00	1,50	●
6072561	UJDV1600X6CQK	16,00	15,50	24,00	36,00	DL16	13,00	2,00	●
6072562	UJDV1600X6CQL	16,00	15,50	24,00	36,00	DL16	13,00	2,50	●
6072563	UJDV1600X6CQM	16,00	15,50	24,00	36,00	DL16	13,00	3,00	●
6408077	UJDV1600X6CQN	16,00	15,50	24,00	36,00	DL16	13,00	4,00	●
6408078	UJDV1600X6CQP	16,00	15,50	24,00	36,00	DL16	13,00	6,00	●
6072564	UJDV2000X6CQG	20,00	19,30	30,00	45,00	DL20	16,00	1,00	●
6072565	UJDV2000X6CQK	20,00	19,30	30,00	45,00	DL20	16,00	2,00	●
6072567	UJDV2000X6CQM	20,00	19,30	30,00	45,00	DL20	16,00	3,00	●
6072568	UJDV2000X6CQN	20,00	19,30	30,00	45,00	DL20	16,00	4,00	●
6408079	UJDV2000X6CQQ	20,00	19,30	30,00	45,00	DL20	16,00	5,00	●
6408080	UJDV2500X6CQG	25,00	24,00	37,50	56,50	DL25	21,00	1,00	●
6072569	UJDV2500X6CQL	25,00	24,00	37,50	56,50	DL25	21,00	2,50	●
6072570	UJDV2500X6CQN	25,00	24,00	37,50	56,50	DL25	21,00	4,00	●
6408081	UJDV2500X6CQQ	25,00	24,00	37,50	56,50	DL25	21,00	5,00	●
6408083	UJDV3200X6CQG	32,00	31,00	48,00	71,70	DL32	28,00	1,00	●
6072572	UJDV3200X6CQN	32,00	31,00	48,00	71,70	DL32	28,00	4,00	●

DUO-LOCK • HARVI III • Ball Nose • 6 Flutes • Metric

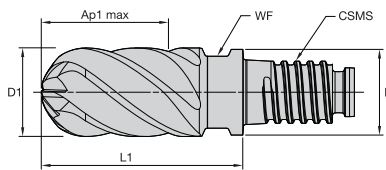

- first choice
- alternate choice

P	<input type="checkbox"/>
M	<input checked="" type="checkbox"/>
K	<input type="checkbox"/>
N	<input type="checkbox"/>
S	<input checked="" type="checkbox"/>
H	<input type="checkbox"/>
	<input type="checkbox"/>

order number	catalogue number	D1	D	Ap1 max	L1	CSMS system size	WF	KCSM15
6072386	UJBV1000X6CN	10,00	9,60	15,00	22,50	DL10	8,00	●
6072387	UJBV1200X6CN	12,00	11,50	18,00	27,00	DL12	9,50	●
6072388	UJBV1600X6CN	16,00	15,50	24,00	36,00	DL16	13,00	●
6072389	UJBV2000X6CN	20,00	19,30	30,00	45,00	DL20	16,00	●
6072390	UJBV2500X6CN	25,00	24,00	37,50	56,50	DL25	21,00	●

148-151	152	145-147	88, 156

DUO-LOCK™ • HARVI™ I TE • Side Milling/Slotting • Application Data • Metric



Material Group					short		medium		long		Recommended feed per tooth (fz = mm/th) for side milling (A). For slotting (B), reduce fz by 20%.										
	A		B		adapter reach						D1 – Diameter										
					KCPM15		KCPM15		KCPM15												
	ap		ae		Cutting Speed – vc m/min		Cutting Speed – vc m/min		Cutting Speed – vc m/min		mm	10,0	12,0	16,0	18,0	20,0	25,0	32,0			
	min	max	min	max	min	max	min	max	min	max											
P	0	1,5 x D	0,5 x D	1 x D	150	–	200	135	–	180	135	–	180	fz	0,072	0,083	0,101	0,108	0,114	0,124	0,125
	1	1,5 x D	0,5 x D	1 x D	150	–	200	135	–	180	135	–	180	fz	0,072	0,083	0,101	0,108	0,114	0,124	0,125
	2	1,5 x D	0,5 x D	1 x D	140	–	190	126	–	171	126	–	171	fz	0,072	0,083	0,101	0,108	0,114	0,124	0,125
	3	1,5 x D	0,5 x D	1 x D	120	–	160	108	–	144	108	–	144	fz	0,061	0,070	0,087	0,095	0,101	0,114	0,123
	4	1,5 x D	0,5 x D	0,75 x D	90	–	150	81	–	135	81	–	135	fz	0,054	0,062	0,077	0,083	0,088	0,098	0,102
	5	1,5 x D	0,5 x D	1 x D	60	–	100	51	–	85	48	–	80	fz	0,048	0,056	0,070	0,076	0,081	0,091	0,099
M	1	1,5 x D	0,5 x D	1 x D	90	–	115	72	–	92	63	–	81	fz	0,061	0,070	0,087	0,095	0,101	0,114	0,123
	2	1,5 x D	0,5 x D	1 x D	60	–	80	48	–	64	42	–	56	fz	0,048	0,056	0,070	0,076	0,081	0,091	0,099
	3	1,5 x D	0,5 x D	1 x D	60	–	70	48	–	56	42	–	49	fz	0,040	0,047	0,057	0,061	0,065	0,071	0,073
K	1	1,5 x D	0,5 x D	1 x D	120	–	150	108	–	135	108	–	135	fz	0,072	0,083	0,101	0,108	0,114	0,124	0,125
	2	1,5 x D	0,5 x D	1 x D	110	–	140	99	–	126	99	–	126	fz	0,061	0,070	0,087	0,095	0,101	0,114	0,123
	3	1,5 x D	0,5 x D	1 x D	110	–	130	99	–	117	99	–	117	fz	0,048	0,056	0,070	0,076	0,081	0,091	0,099
S	1	1,5 x D	0,3 x D	0,3 x D	50	–	90	40	–	72	30	–	54	fz	0,061	0,070	0,087	0,095	0,101	0,114	0,123
	2	1,5 x D	0,3 x D	0,3 x D	50	–	80	40	–	64	30	–	48	fz	0,048	0,056	0,070	0,076	0,081	0,091	0,099
	3	1,5 x D	0,3 x D	0,3 x D	50	–	80	40	–	64	30	–	48	fz	0,032	0,037	0,046	0,050	0,054	0,061	0,067
	4	1,5 x D	0,5 x D	1 x D	50	–	60	40	–	48	30	–	36	fz	0,045	0,052	0,064	0,069	0,074	0,084	0,090
H	1	1,5 x D	0,5 x D	0,75 x D	80	–	140	64	–	112	48	–	84	fz	0,054	0,062	0,077	0,083	0,088	0,098	0,102
	2	1,5 x D	0,5 x D	0,5 x D	70	–	120	56	–	96	42	–	72	fz	0,040	0,047	0,057	0,061	0,065	0,071	0,073

NOTE: Lower value of cutting speed is used for high stock removal applications or for higher hardness (machinability) within group.
Higher value of cutting speed is used for finishing applications or for lower hardness (machinability) within group.
Above parameters are based on ideal conditions. For smaller taper machining centers, please adjust parameters accordingly on diameters greater than 12mm.
For side milling with Ap larger than 1 x D, reduce Fz by 20%.
Cylindrical shanks not recommended for full slotting.

DUO-LOCK • HARVI I TE • Ramping 0°-15° • Application Data • Metric





Material Group	Max Depth					Recommended feed per tooth (fz = mm/z) for Helical Interpolation and Ramping – z _{eff} = 2						
		KCPM15-KCSM15				Diameter – D1 [Ømin–Ømax] for helical interpolation						
		Cutting Speed – vc m/min										
		min	Start	max	mm	10,0	12,0	16,0	20,0	25,0	32,0	
P	0	1 x D	125	150	175	fz	0,055	0,065	0,075	0,087	0,095	0,105
	1	1 x D	125	150	175	fz	0,055	0,065	0,075	0,087	0,095	0,105
	2	1 x D	125	150	175	fz	0,055	0,065	0,075	0,087	0,095	0,105
	3	1 x D	110	130	150	fz	0,047	0,054	0,067	0,078	0,088	0,095
	4	1 x D	75	110	140	fz	0,041	0,048	0,059	0,068	0,075	0,080
	5	0,75 x D	50	70	90	fz	0,037	0,043	0,054	0,062	0,070	0,075
M	1	0,75 x D	40	55	70	fz	0,031	0,036	0,044	0,050	0,055	0,060
	2	0,75 x D	45	55	70	fz	0,037	0,043	0,054	0,062	0,070	0,075
	3	0,5 x D	40	50	65	fz	0,031	0,036	0,044	0,050	0,055	0,060
K	1	1 x D	110	125	140	fz	0,055	0,065	0,075	0,087	0,095	0,105
	2	1 x D	100	115	130	fz	0,047	0,054	0,067	0,078	0,088	0,095
	3	0,75 x D	90	105	120	fz	0,037	0,043	0,054	0,062	0,070	0,075
S	1	0,5 x D	40	60	80	fz	0,047	0,054	0,067	0,078	0,088	0,095
	2	0,5 x D	40	55	70	fz	0,037	0,043	0,054	0,062	0,070	0,075
	3	0,3 x D	20	25	35	fz	0,024	0,029	0,036	0,041	0,047	0,050
	4	0,75 x D	40	45	50	fz	0,034	0,040	0,050	0,057	0,064	0,070
H	1	0,75 x D	70	100	120	fz	0,041	0,048	0,059	0,068	0,075	0,080
	2	0,75 x D	60	90	110	fz	0,029	0,034	0,041	0,048	0,053	0,056

NOTE: Ø min and Ø max to be calculated with formula for helical ramping above.



DUO-LOCK™ • HARVI™ I TE • Plunging/Drilling • Application Data • Metric



Material Group	 			KCPM15-KCSM15			Recommended feed per revolution (fn =mm/rev) for plunging and drilling							
	Max Depth	Applicable	Coolant	Cutting Speed – vc m/min			D1 – Diameter							
				min	Start	max	mm	10,0	12,0	16,0	20,0	25,0	32,0	
P	0	1 x D	●	Preferred	110	130	150	fn	0,056	0,067	0,084	0,112	0,126	0,150
	1	1 x D	●	Required	110	130	150	fn	0,056	0,067	0,084	0,112	0,126	0,150
	2	1 x D	●	Required	110	130	150	fn	0,056	0,067	0,084	0,112	0,126	0,150
	3	1 x D	●	Required	100	105	120	fn	0,042	0,049	0,075	0,088	0,105	0,135
	4	1 x D	●	Required	70	85	100	fn	0,042	0,049	0,075	0,088	0,105	0,135
	5	0,75 x D	○	Required	45	50	65	fn	0,028	0,035	0,046	0,060	0,070	0,076
M	6	0,75 x D	○	Required	40	45	60	fn	0,028	0,035	0,046	0,060	0,070	0,076
	1	0,75 x D	●	Required	60	70	80	fn	0,042	0,049	0,075	0,088	0,105	0,135
	2	0,75 x D	○	Required	40	45	60	fn	0,028	0,035	0,046	0,060	0,070	0,076
K	3	0,5x D	○	Required	35	40	50	fn	0,028	0,035	0,046	0,060	0,070	0,076
	1	1 x D	●	Preferred	100	110	120	fn	0,056	0,067	0,084	0,112	0,126	0,150
	2	1 x D	●	Required	90	100	110	fn	0,042	0,049	0,075	0,088	0,105	0,135
S	3	0,75 x D	○	Required	75	85	100	fn	0,042	0,049	0,075	0,088	0,105	0,135
	1	0,5 x D	○	Required	35	40	55	fn	0,042	0,049	0,075	0,088	0,105	0,135
	2	0,5 x D	○	Required	30	35	45	fn	0,028	0,035	0,046	0,060	0,070	0,076
	3	0,3 x D	○	Required	15	20	28	fn	0,019	0,023	0,031	0,042	0,049	0,058
H	4	0,75 x D	○	Required	30	35	40	fn	0,031	0,035	0,045	0,058	0,070	0,076
	1	0,75 x D	○	Required	60	70	80	fn	0,042	0,049	0,075	0,088	0,105	0,135
	2	0,75 x D	○	Required	50	60	70	fn	0,029	0,034	0,053	0,062	0,074	0,095

NOTE: Other available diameters are not recommended for plunging applications.



DUO-LOCK • HARVI I • Application Data • Metric



UKDV



ULDV

Material Group	 		short	medium	long	Recommended feed per tooth (fz = mm/th) for side milling (A). For slotting (B), reduce fz by 20%.															
	A		B		adapter reach			D1 – Diameter													
	KCPM15		KCPM15		KCPM15																
	UKDV	ULDV	ap	ae	ap	Cutting Speed – vc m/min		Cutting Speed – vc m/min		Cutting Speed – vc m/min		mm	10,0	12,0	16,0	20,0	25,0	32,0			
P	0	0	1,5 x D	0,5 x D	1 x D	150	–	200	135	–	180	135	–	180	fz	0,061	0,070	0,086	0,097	0,105	0,106
	1	1	1,5 x D	0,5 x D	1 x D	150	–	200	135	–	180	135	–	180	fz	0,061	0,070	0,086	0,097	0,105	0,106
	2	2	1,5 x D	0,5 x D	1 x D	140	–	190	126	–	171	126	–	171	fz	0,061	0,070	0,086	0,097	0,105	0,106
	3	3	1,5 x D	0,5 x D	1 x D	120	–	160	108	–	144	108	–	144	fz	0,051	0,060	0,074	0,086	0,097	0,105
	4	4	1,5 x D	0,4 x D	0,75 x D	90	–	150	81	–	135	81	–	135	fz	0,046	0,053	0,065	0,075	0,083	0,087
	5	5	1,5 x D	0,4 x D	1 x D	60	–	100	51	–	85	48	–	80	fz	0,041	0,048	0,059	0,069	0,077	0,084
M	6	6	1,5 x D	0,4 x D	0,75 x D	50	–	75	42,5	–	63,75	40	–	60	fz	0,034	0,040	0,048	0,055	0,060	0,062
	1	1	1,5 x D	0,4 x D	1 x D	90	–	115	72	–	92	63	–	80,5	fz	0,051	0,060	0,074	0,086	0,097	0,105
	2	2	1,5 x D	0,4 x D	1 x D	60	–	80	48	–	64	42	–	56	fz	0,041	0,048	0,059	0,069	0,077	0,084
K	3	3	1,5 x D	0,4 x D	1 x D	60	–	70	48	–	56	42	–	49	fz	0,034	0,040	0,048	0,055	0,060	0,062
	–	1	1,5 x D	0,5 x D	1 x D	120	–	150	108	–	135	108	–	135	fz	0,061	0,070	0,086	0,097	0,105	0,106
	–	2	1,5 x D	0,5 x D	1 x D	110	–	140	99	–	126	99	–	126	fz	0,051	0,060	0,074	0,086	0,097	0,105
S	–	3	1,5 x D	0,5 x D	1 x D	110	–	130	99	–	117	99	–	117	fz	0,041	0,048	0,059	0,069	0,077	0,084
	1	1	1,5 x D	0,3 x D	0,3 x D	50	–	90	40	–	72	30	–	54	fz	0,051	0,060	0,074	0,086	0,097	0,105
	2	2	1,5 x D	0,3 x D	0,3 x D	25	–	40	20	–	32	15	–	24	fz	0,027	0,032	0,039	0,046	0,052	0,057
	3	3	1,5 x D	0,3 x D	0,3 x D	25	–	40	20	–	32	15	–	24	fz	0,027	0,032	0,039	0,046	0,052	0,057
H	4	4	1,5 x D	0,4 x D	1 x D	50	–	60	40	–	48	30	–	36	fz	0,038	0,044	0,055	0,063	0,071	0,077
	–	1	1,5 x D	0,4 x D	0,75 x D	80	–	140	64	–	112	48	–	84	fz	0,046	0,053	0,065	0,075	0,083	0,087
	–	2	1,5 x D	0,2 x D	0,5 x D	70	–	120	56	–	96	42	–	72	fz	0,034	0,040	0,048	0,055	0,060	0,062

NOTE: Lower value of cutting speed is used for high stock removal applications or for higher hardness (machinability) within group.
Higher value of cutting speed is used for finishing applications or for lower hardness (machinability) within group.
Above parameters are based on ideal conditions. Please adjust parameters according to system stability.
For side milling with Ap larger than 1 x D, reduce Fz by 20%.
Cylindrical shanks not recommended for full slotting.



DUO-LOCK™ • HARVI™ III • Application Data • Metric



Roughing

Material Group			short		medium		long		Roughing – Recommended feed per tooth (fz = mm/th) for side milling (A).										
			adapter reach						D1 – Diameter										
	A		KCSM15		KCSM15		KCSM15												
	ap	ae	Cutting Speed – vc m/min		Cutting Speed – vc m/min		Cutting Speed – vc m/min		mm	10,0	12,0	16,0	20,0	25,0	32,0				
P	4	Ap max	0,4 x D	90	–	150	81	–	135	81	–	135	fz	0,046	0,053	0,065	0,075	0,083	0,087
	5	Ap max	0,4 x D	60	–	100	51	–	85	48	–	80	fz	0,041	0,048	0,059	0,069	0,077	0,084
M	1	Ap max	0,4 x D	90	–	115	72	–	92	63	–	80,5	fz	0,051	0,060	0,074	0,086	0,097	0,105
	2	Ap max	0,4 x D	60	–	80	48	–	64	42	–	56	fz	0,041	0,048	0,059	0,069	0,077	0,084
S	3	Ap max	0,4 x D	60	–	70	48	–	56	42	–	49	fz	0,034	0,040	0,048	0,055	0,060	0,062
	1	Ap max	0,4 x D	50	–	90	40	–	72	30	–	54	fz	0,051	0,060	0,074	0,086	0,097	0,105
	2	Ap max	0,4 x D	25	–	40	20	–	32	15	–	24	fz	0,027	0,032	0,039	0,046	0,052	0,057
	3	Ap max	0,4 x D	25	–	40	20	–	32	15	–	24	fz	0,027	0,032	0,039	0,046	0,052	0,057
H	4	Ap max	0,4 x D	50	–	60	40	–	48	30	–	36	fz	0,038	0,044	0,055	0,063	0,071	0,077
	1	Ap max	0,4 x D	80	–	140	64	–	112	48	–	84	fz	0,046	0,053	0,065	0,075	0,083	0,087
	2	Ap max	0,4 x D	70	–	120	56	–	96	42	–	72	fz	0,034	0,040	0,048	0,055	0,060	0,062

Finishing

Material Group			short		medium		long		Finishing – Recommended feed per tooth (fz = mm/th) for side milling (A).										
			adapter reach						D1 – Diameter										
	A		KCSM15		KCSM15		KCSM15												
	ap	ae	Cutting Speed – vc m/min		Cutting Speed – vc m/min		Cutting Speed – vc m/min		mm	10,0	12,0	16,0	20,0	25,0	32,0				
P	4	Ap max	0,06 x D	171	–	285	153,9	–	256,5	153,9	–	256,5	fz	0,046	0,053	0,065	0,075	0,083	0,087
	5	Ap max	0,06 x D	114	–	190	96,9	–	161,5	91,2	–	152	fz	0,041	0,048	0,059	0,069	0,077	0,084
M	1	Ap max	0,06 x D	171	–	218,5	136,8	–	174,8	119,2	–	152,95	fz	0,051	0,060	0,074	0,086	0,097	0,105
	2	Ap max	0,06 x D	114	–	152	91,2	–	121,6	79,8	–	106,4	fz	0,041	0,048	0,059	0,069	0,077	0,084
S	3	Ap max	0,06 x D	114	–	133	91,2	–	106,4	79,8	–	93,1	fz	0,034	0,040	0,048	0,055	0,060	0,062
	1	Ap max	0,06 x D	95	–	171	76	–	136,8	57	–	102,6	fz	0,051	0,060	0,074	0,086	0,097	0,105
	2	Ap max	0,06 x D	47,5	–	76	38	–	60,8	28,5	–	45,6	fz	0,027	0,032	0,039	0,046	0,052	0,057
	3	Ap max	0,06 x D	47,5	–	76	38	–	60,8	28,5	–	45,6	fz	0,027	0,032	0,039	0,046	0,052	0,057
H	4	Ap max	0,06 x D	95	–	114	76	–	91,2	57	–	68,4	fz	0,038	0,044	0,055	0,063	0,071	0,077
	1	Ap max	0,06 x D	152	–	266	121,8	–	212,8	91,2	–	159,6	fz	0,046	0,053	0,065	0,075	0,083	0,087
	2	Ap max	0,06 x D	133	–	228	106,4	–	182,4	79,8	–	136,8	fz	0,034	0,040	0,048	0,055	0,060	0,062

NOTE: Lower value of cutting speed is used for high stock removal applications or for higher hardness (machinability) within group.
 Higher value of cutting speed is used for finishing applications or for lower hardness (machinability) within group.
 Above parameters are based on ideal conditions. Please adjust parameters according to system stability.
 For side milling with Ap larger than 1 x D, reduce Fz by 20%.
 Cylindrical shanks not recommended for full slotting.

DUO-LOCK™ • KenCut™ RR • Chamfered • 4–5 Flutes • Metric

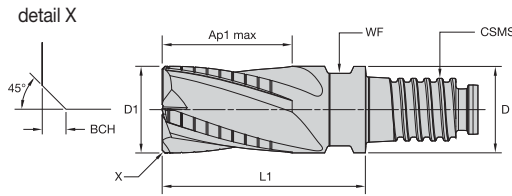

- first choice
- alternate choice

P	●
M	●
K	●
N	○
S	○
H	○

order number	catalogue number	D1	D	Ap1 max	L1	CSMS system size	WF	BCH	Z U	KCPM15
6127286	RQDB1000X4CV	10,00	9,60	15,00	22,50	DL10	8,00	0,50	4	●
6127287	RQDB1200X4CV	12,00	11,50	18,00	27,00	DL12	9,50	0,50	4	●
6127288	RQDB1600X4CV	16,00	15,50	24,00	36,00	DL16	13,00	0,50	4	●
6127289	RQDB2000X4CV	20,00	19,30	30,00	45,00	DL20	16,00	0,50	4	●
6127290	RQDB2500X5CV	25,00	24,00	37,50	56,50	DL25	21,00	0,50	5	●

DUO-LOCK • KenCut RR • Radiused • 4 & 6 Flutes • Metric

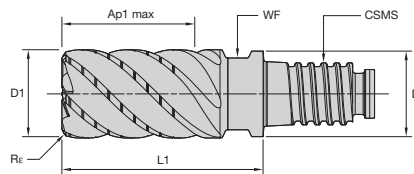

- first choice
- alternate choice

P	○
M	○
K	○
N	○
S	○
H	○

order number	catalogue number	D1	D	Ap1 max	L1	CSMS system size	WF	Re	Z U	KCSM15
6126912	RKDF1000X4CQE	10,00	9,60	15,00	22,50	DL10	8,00	0,50	4	●
6126913	RKDF1200X4CQF	12,00	11,50	18,00	27,00	DL12	9,50	0,75	4	●
6126914	RKDF1600X6CQF	16,00	15,50	24,00	36,00	DL16	13,00	0,75	6	●
6126915	RKDF2000X6CQF	20,00	19,30	30,00	45,00	DL20	16,00	0,75	6	●
6126916	RKDF2500X6CQF	25,00	24,00	37,50	56,50	DL25	21,00	0,75	6	●

148–151	152	145–147	88, 156

DUO-LOCK™ • KenCut™ RR • RQDB • Application Data • Metric



Material Group					short		medium		long		Recommended feed per tooth (fz = mm/th) for side milling (A). For slotting (B), reduce fz by 20%.								
	A		B		adapter reach						D1 – Diameter								
					KCPM15		KCPM15		KCPM15										
	ap		ae		Cutting Speed – vc		Cutting Speed – vc		Cutting Speed – vc										
P	0	1,5 x D	0,5 x D	1 x D	120	–	160	108	–	144	108	–	144	fz	0,061	0,070	0,086	0,097	0,105
	1	1,5 x D	0,5 x D	1 x D	120	–	160	108	–	144	108	–	144	fz	0,061	0,070	0,086	0,097	0,105
	2	1,5 x D	0,5 x D	1 x D	112	–	152	100,8	–	136,8	100,8	–	136,8	fz	0,061	0,070	0,086	0,097	0,105
	3	1,5 x D	0,4 x D	0,75 x D	96	–	128	86,4	–	115,2	86,4	–	115,2	fz	0,051	0,060	0,074	0,086	0,097
	4	1,5 x D	0,3 x D	0,3 x D	72	–	120	64,8	–	108	64,8	–	108	fz	0,046	0,053	0,065	0,075	0,083
M	1	1,5 x D	0,4 x D	0,75 x D	48	–	80	40,8	–	68	38,4	–	64	fz	0,041	0,048	0,059	0,069	0,077
	2	1,5 x D	0,4 x D	0,75 x D	72	–	92	57,6	–	73,6	50,4	–	64,4	fz	0,051	0,060	0,074	0,086	0,097
	3	1,5 x D	0,4 x D	0,75 x D	48	–	64	38,4	–	51,2	33,6	–	44,8	fz	0,041	0,048	0,059	0,069	0,077
K	1	1,5 x D	0,5 x D	1 x D	96	–	120	86,4	–	108	86,4	–	108	fz	0,061	0,070	0,086	0,097	0,105
	2	1,5 x D	0,4 x D	1 x D	88	–	112	79,2	–	100,8	79,2	–	100,8	fz	0,051	0,060	0,074	0,086	0,097
	3	1,5 x D	0,4 x D	1 x D	88	–	104	79,2	–	93,6	79,2	–	93,6	fz	0,041	0,048	0,059	0,069	0,077
S	1	1,5 x D	0,4 x D	0,75 x D	40	–	72	32	–	57,6	24	–	43,2	fz	0,051	0,060	0,074	0,086	0,097
	3	1,5 x D	0,4 x D	0,75 x D	20	–	32	16	–	25,6	12	–	19,2	fz	0,027	0,032	0,039	0,046	0,052
H	1	1,5 x D	0,3 x D	0,3 x D	64	–	112	51,2	–	89,6	38,4	–	67,2	fz	0,046	0,053	0,065	0,075	0,083

NOTE: Lower value of cutting speed is used for high stock removal applications or for higher hardness (machinability) within group.
Higher value of cutting speed is used for finishing applications or for lower hardness (machinability) within group.
Above parameters are based on ideal conditions. Please adjust parameters according to system stability.
For side milling with Ap larger than 1 x D, reduce Fz by 20%.
Cylindrical shanks not recommended for full slotting.

DUO-LOCK • KenCut RR • RKDF • Application Data • Metric



Material Group					short		medium		long		Recommended feed per tooth (fz = mm/th) for side milling (A). For slotting (B), reduce fz by 20%.								
	A		B		adapter reach						D1 – Diameter								
					KCSM15		KCSM15		KCSM15										
	ap		ae		Cutting Speed – vc		Cutting Speed – vc		Cutting Speed – vc										
P	3	1,0 x D	0,5 x D	0,75 x D	120	–	160	108	–	144	108	–	144	fz	0,051	0,060	0,074	0,086	0,097
	4	1,0 x D	0,3 x D	0,75 x D	90	–	150	81	–	135	81	–	135	fz	0,046	0,053	0,065	0,075	0,083
	5	1,0 x D	0,4 x D	0,75 x D	60	–	100	51	–	85	48	–	80	fz	0,041	0,048	0,059	0,069	0,077
	6	1,0 x D	0,3 x D	0,3 x D	50	–	75	42,5	–	63,75	40	–	60	fz	0,034	0,040	0,048	0,055	0,060
M	1	1,0 x D	0,4 x D	0,75 x D	90	–	115	72	–	92	63	–	80,5	fz	0,051	0,060	0,074	0,086	0,097
	2	1,0 x D	0,4 x D	0,75 x D	60	–	80	48	–	64	42	–	56	fz	0,041	0,048	0,059	0,069	0,077
	3	1,0 x D	0,4 x D	0,75 x D	60	–	70	48	–	56	42	–	49	fz	0,034	0,040	0,048	0,055	0,060
K	1	1,0 x D	0,5 x D	1 x D	120	–	150	108	–	135	108	–	135	fz	0,061	0,070	0,086	0,097	0,105
	2	1,0 x D	0,5 x D	1 x D	110	–	140	99	–	126	99	–	126	fz	0,051	0,060	0,074	0,086	0,097
	3	1,0 x D	0,5 x D	1 x D	110	–	130	99	–	117	99	–	117	fz	0,041	0,048	0,059	0,069	0,077
S	1	1,0 x D	0,3 x D	0,75 x D	50	–	90	40	–	72	30	–	54	fz	0,051	0,060	0,074	0,086	0,097
	2	1,0 x D	0,3 x D	0,75 x D	25	–	40	20	–	32	15	–	24	fz	0,027	0,032	0,039	0,046	0,052
	3	1,0 x D	0,3 x D	0,75 x D	25	–	40	20	–	32	15	–	24	fz	0,027	0,032	0,039	0,046	0,052
	4	1,0 x D	0,4 x D	0,75 x D	50	–	60	40	–	48	30	–	36	fz	0,038	0,044	0,055	0,063	0,071
H	1	1,0 x D	0,3 x D	0,3 x D	80	–	140	64	–	112	48	–	84	fz	0,046	0,053	0,065	0,075	0,083
	2	1,0 x D	0,2 x D	0,2 x D	70	–	120	56	–	96	42	–	72	fz	0,034	0,040	0,048	0,055	0,060
	3	1,0 x D	0,2 x D	0,2 x D	60	–	90	48	–	72	36	–	54	fz	0,027	0,032	0,039	0,046	0,052

NOTE: Lower value of cutting speed is used for high stock removal applications or for higher hardness (machinability) within group.
Higher value of cutting speed is used for finishing applications or for lower hardness (machinability) within group.
Above parameters are based on ideal conditions. Please adjust parameters according to system stability.
For side milling with Ap bigger than 1 x D, reduce Fz by 20%.
Cylindrical shanks not recommended for full slotting.



DUO-LOCK™ • KenCut™ FF • Radiused • 6 Flutes • Metric

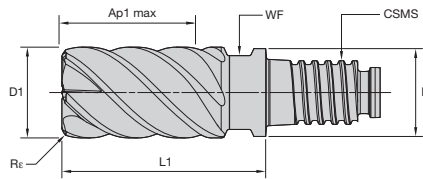

- first choice
- alternate choice

P	●
M	●
K	●
N	●
S	○
H	○

order number	catalogue number	D1	D	Ap1 max	L1	CSMS system size	WF	Re	
6127198	FMDF1000X6CQE	10,00	9,60	15,00	22,50	DL10	8,00	0,50	●
6127199	FMDF1200X6CQF	12,00	11,50	18,00	27,00	DL12	9,50	0,75	●
6127200	FMDF1600X6CQF	16,00	15,50	24,00	36,00	DL16	13,00	0,75	●
6127311	FMDF2000X6CQF	20,00	19,30	30,00	45,00	DL20	16,00	0,75	●
6127312	FMDF2500X6CQF	25,00	24,00	37,50	56,50	DL25	21,00	0,75	●

● KCPM15

DUO-LOCK • RSM II™ • Finisher • Radiused • Multi-Flute • Metric

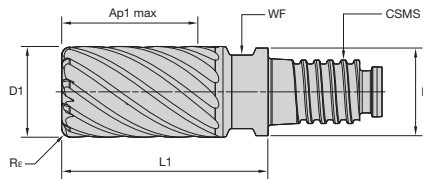

- first choice
- alternate choice

P	○
M	●
K	●
N	●
S	●
H	○

order number	catalogue number	D1	D	Ap1 max	L1	CSMS system size	WF	Re	Z U
6127040	FSDE1000X9CQE	10,00	9,60	15,00	22,50	DL10	8,00	0,50	9
6127072	FSDE1000X9CQJ	10,00	9,60	15,00	22,50	DL10	8,00	1,50	9
6127073	FSDE1200X9CQE	12,00	11,50	18,00	27,00	DL12	9,50	0,50	9
6127074	FSDE1200X9CQG	12,00	11,50	18,00	27,00	DL12	9,50	1,00	9
6127077	FSDE1600XBCQG	16,00	15,50	24,00	36,00	DL16	13,00	1,00	11
6127079	FSDE1600XBCQK	16,00	15,50	24,00	36,00	DL16	13,00	2,00	11
6408046	FSDE1600XBCQN	16,00	15,50	24,00	36,00	DL16	13,00	4,00	11
6127082	FSDE2000XFCQG	20,00	19,30	30,00	45,00	DL20	16,00	1,00	15
6127087	FSDE2500XJCQL	25,00	24,00	37,50	56,50	DL25	21,00	2,50	19
6127088	FSDE2500XJCQN	25,00	24,00	37,50	56,50	DL25	21,00	4,00	19
6408049	FSDE2500XJCQQ	25,00	24,00	37,50	56,50	DL25	21,00	5,00	19

● KC643M

148-151	152	145-147	88, 156

DUO-LOCK™ • KenCut™ FF • FMDf • Application Data • Metric



Material Group			short			medium			long			Recommended feed per tooth (fz = mm/th) for side milling (A).						
			adapter reach									D1 – Diameter						
	A		KCPM15			KCPM15			KCPM15									
	ap	ae	Cutting Speed – vc m/min			Cutting Speed – vc m/min			Cutting Speed – vc m/min			mm	10,0	12,0	16,0	20,0	25,0	
P	0	1,5 x D	0,1 x D	150	–	200	135	–	180	135	–	180	fz	0,072	0,083	0,101	0,114	0,124
	1	1,5 x D	0,1 x D	150	–	200	135	–	180	135	–	180	fz	0,072	0,083	0,101	0,114	0,124
	2	1,5 x D	0,1 x D	140	–	190	126	–	171	126	–	171	fz	0,072	0,083	0,101	0,114	0,124
	3	1,5 x D	0,1 x D	120	–	160	108	–	144	108	–	144	fz	0,061	0,070	0,087	0,101	0,114
	4	1,5 x D	0,1 x D	90	–	150	81	–	135	81	–	135	fz	0,054	0,062	0,077	0,088	0,098
	5	1,5 x D	0,1 x D	60	–	100	51	–	85	48	–	80	fz	0,048	0,056	0,070	0,081	0,091
M	6	1,5 x D	0,1 x D	50	–	75	42,5	–	63,75	40	–	60	fz	0,040	0,047	0,057	0,065	0,071
	1	1,5 x D	0,1 x D	90	–	115	72	–	92	63	–	80,5	fz	0,061	0,070	0,087	0,101	0,114
	2	1,5 x D	0,1 x D	60	–	80	48	–	64	42	–	56	fz	0,048	0,056	0,070	0,081	0,091
K	3	1,5 x D	0,1 x D	60	–	70	48	–	56	42	–	49	fz	0,040	0,047	0,057	0,065	0,071
	1	1,5 x D	0,1 x D	120	–	150	108	–	135	108	–	135	fz	0,072	0,083	0,101	0,114	0,124
S	2	1,5 x D	0,1 x D	110	–	140	99	–	126	99	–	126	fz	0,061	0,070	0,087	0,101	0,114
	3	1,5 x D	0,1 x D	110	–	130	99	–	117	99	–	117	fz	0,048	0,056	0,070	0,081	0,091
	1	1,5 x D	0,1 x D	50	–	90	40	–	72	30	–	54	fz	0,061	0,070	0,087	0,101	0,114
	2	1,5 x D	0,1 x D	25	–	40	20	–	32	15	–	24	fz	0,032	0,037	0,046	0,054	0,061
H	3	1,5 x D	0,1 x D	25	–	40	20	–	32	15	–	24	fz	0,032	0,037	0,046	0,054	0,061
	4	1,5 x D	0,15 x D	50	–	60	40	–	48	30	–	36	fz	0,045	0,052	0,064	0,074	0,084
H	1	1,5 x D	0,1 x D	80	–	140	64	–	112	48	–	84	fz	0,054	0,062	0,077	0,088	0,098
	2	1,5 x D	0,1 x D	70	–	120	56	–	96	42	–	72	fz	0,040	0,047	0,057	0,065	0,071

NOTE: Lower value of cutting speed is used for high stock removal applications or for higher hardness (machinability) within group.
 Higher value of cutting speed is used for finishing applications or for lower hardness (machinability) within group.
 Above parameters are based on ideal conditions. Please adjust parameters according to system stability.
 For side milling with Ap larger than 1 x D, reduce Fz by 20%.
 Cylindrical shanks not recommended for full slotting.

DUO-LOCK • RSM II™ • FSDE • Application Data • Metric



Material Group			short			medium			long			Recommended feed per tooth (fz = mm/th) for side milling (A).						
			adapter reach									D1 – Diameter						
	A		KC643M			KC643M			KC643M									
	ap	ae	Cutting Speed – vc m/min			Cutting Speed – vc m/min			Cutting Speed – vc m/min			mm	10,0	12,0	16,0	20,0	25,0	
P	4	1,5 x D	0,2–0,3mm	135	–	495	122	–	446	122	–	446	fz	0,120	0,129	0,149	0,163	0,166
	5	1,5 x D	0,2–0,3mm	90	–	330	77	–	281	72	–	264	fz	0,108	0,116	0,135	0,150	0,155
M	1	1,5 x D	0,2–0,3mm	135	–	379,5	108	–	304	95	–	266	fz	0,135	0,145	0,169	0,187	0,193
	2	1,5 x D	0,2–0,3mm	90	–	264	72	–	211	63	–	185	fz	0,108	0,116	0,135	0,150	0,155
S	3	1,5 x D	0,2–0,3mm	90	–	231	72	–	185	63	–	162	fz	0,090	0,096	0,110	0,120	0,121
	1	1,5 x D	0,2–0,3mm	75	–	297	60	–	238	45	–	178	fz	0,135	0,145	0,169	0,187	0,193
	2	1,5 x D	0,2–0,3mm	37,5	–	132	30	–	106	23	–	79	fz	0,071	0,077	0,090	0,100	0,104
	3	1,5 x D	0,2–0,3mm	37,5	–	132	30	–	106	23	–	79	fz	0,071	0,077	0,090	0,100	0,104
H	4	1,5 x D	0,2–0,3mm	75	–	198	60	–	158	45	–	119	fz	0,099	0,107	0,124	0,138	0,142
	1	1,5 x D	0,2–0,3mm	120	–	462	96	–	370	72	–	277	fz	0,120	0,129	0,149	0,163	0,166
H	2	1,5 x D	0,2–0,3mm	105	–	396	84	–	317	63	–	238	fz	0,090	0,096	0,110	0,120	0,121

NOTE: For better surface finish, reduce feed per tooth.
 For side milling with Ap larger than 1 x D, reduce Fz by 20%.
 Cylindrical shanks not recommended for full slotting.

DUO-LOCK™ • MaxiMet™ • Square End • 2 Flutes • Metric

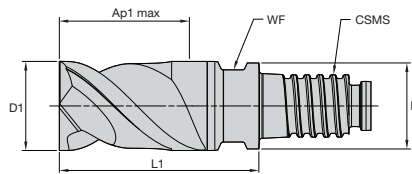

- first choice
- alternate choice

P	■
M	■
K	■
N	●
S	■
H	■

order number	catalogue number	D1	D	Ap1 max	L1	CSMS system size	WF		KG00
6151062	ABDF1000X2CU	10,00	9,60	15,00	22,50	DL10	8,00	●	
6151063	ABDF1200X2CU	12,00	11,50	18,00	27,00	DL12	9,50	●	
6151064	ABDF1600X2CU	16,00	15,50	24,00	36,00	DL16	13,00	●	
6151066	ABDF2000X2CU	20,00	19,30	30,00	45,00	DL20	16,00	●	

DUO-LOCK • MaxiMet • Radiused • 3 Flutes • Metric

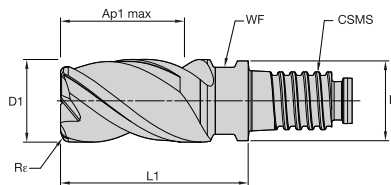

- first choice
- alternate choice

P	■
M	■
K	■
N	●
S	■
H	■

order number	catalogue number	D1	D	Ap1 max	L1	CSMS system size	WF	Re	KG00
6151025	ABDE1000X3CQE	10,00	9,60	15,00	22,50	DL10	8,00	0,50	●
6151026	ABDE1000X3CQG	10,00	9,60	15,00	22,50	DL10	8,00	1,00	●
6151027	ABDE1000X3CQJ	10,00	9,60	15,00	22,50	DL10	8,00	1,50	●
6151028	ABDE1200X3CQE	12,00	11,50	17,50	27,00	DL12	9,50	0,50	●
6151029	ABDE1200X3CQG	12,00	11,50	18,00	27,00	DL12	9,50	1,00	●
6151030	ABDE1200X3CQJ	12,00	11,50	18,00	27,00	DL12	9,50	1,50	●
6151031	ABDE1200X3CQL	12,00	11,50	18,00	27,00	DL12	9,50	2,50	●
6151034	ABDE1600X3CQK	15,97	15,50	24,00	36,00	DL16	13,00	2,00	●
6151035	ABDE1600X3CQL	15,97	15,50	24,00	36,00	DL16	13,00	2,50	●
6151036	ABDE1600X3CQM	15,97	15,50	24,00	36,00	DL16	13,00	3,00	●
6151032	ABDE1600X3CQG	16,00	15,50	24,00	36,00	DL16	13,00	1,00	●
6151033	ABDE1600X3CQJ	16,00	15,50	24,00	36,00	DL16	13,00	1,50	●
6408042	ABDE1600X3CQN	16,00	15,50	24,00	36,00	DL16	13,00	4,00	●
6151037	ABDE2000X3CQG	20,00	19,30	30,00	45,00	DL20	16,00	1,00	●
6151038	ABDE2000X3CQK	20,00	19,30	30,00	45,00	DL20	16,00	2,00	●
6151039	ABDE2000X3CQL	20,00	19,30	30,00	45,00	DL20	16,00	2,50	●
6151040	ABDE2000X3CQM	20,00	19,30	30,00	45,00	DL20	16,00	3,00	●
6408044	ABDE2000X3CQQ	20,00	19,30	30,00	45,00	DL20	16,00	5,00	●
6151043	ABDE2500X3CQL	25,00	24,00	37,50	56,50	DL25	21,00	2,50	●
6151044	ABDE2500X3CQN	25,00	24,00	37,50	56,50	DL25	21,00	4,00	●

148-151	152	145-147	88, 156

DUO-LOCK™ • MaxiMet™ • Ball Nose • 3 Flutes • Metric

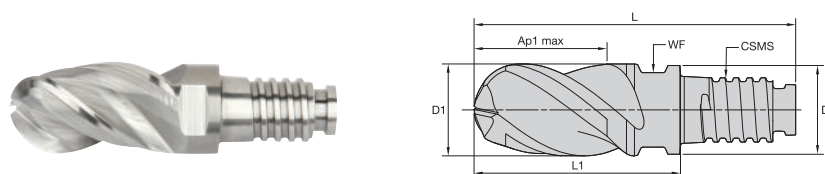

- first choice
- alternate choice

P	■
M	■
K	■
N	●
S	■
H	■

order number	catalogue number	D1	D	Ap1 max	L	L1	CSMS	WF	K600
6626771	ABBE1000X3CN	10,00	9,60	15,00	35,00	22,50	DL10	8,00	●
6626772	ABBE1200X3CN	12,00	11,50	18,00	42,00	27,00	DL12	9,50	●
6626773	ABBE1600X3CN	16,00	15,50	24,00	56,00	36,00	DL16	13,00	●
6626774	ABBE2000X3CN	20,00	19,30	30,00	68,90	45,00	DL20	16,00	●

DUO-LOCK • MaxiMet • ABDF & ABDE • Application Data • Metric



MaxiMet ABDF



MaxiMet ABDE

Material Group	A		B		short		medium		long		Recommended feed per tooth (fz = mm/th) for side milling (A). For slotting (B), reduce fz by 20%.							
	ap		ae		min		max		min		max		D1 – Diameter					
	1,5 x D		0,3 x D		1,0 x D		1,0 x D		1,0 x D		1,0 x D		mm					
	500		1500		400		900		300		900		0,077 0,092 0,122 0,153					
N	1	1,5 x D	0,3 x D	1,0 x D	500	–	2000	400	–	1200	300	–	1200	fz	0,077	0,092	0,122	0,153
	2	1,5 x D	0,3 x D	1,0 x D	500	–	1500	400	–	900	300	–	900	fz	0,069	0,083	0,110	0,138
	3	1,5 x D	0,3 x D	1,0 x D	500	–	1500	400	–	900	300	–	900	fz	0,054	0,064	0,086	0,107
	4	1,5 x D	0,3 x D	1,0 x D	400	–	750	320	–	450	240	–	450	fz	0,054	0,064	0,086	0,107
	5	1,5 x D	0,3 x D	1,0 x D	250	–	1000	200	–	600	150	–	600	fz	0,069	0,083	0,110	0,138

NOTE: Ap for spindle with ceramic bearings multiply by 0,5.
 For better surface finish, reduce feed per tooth.
 Above parameters are based on ideal conditions. Please adjust parameters according to system stability.
 For side milling with Ap bigger than 1 x D, reduce Fz by 20%.
 Cylindrical shanks not recommended for full slotting.

148–151	152	145–147	88, 156

DUO-LOCK™ • MaxiMet™ • ABBE • Application Data • Metric



Material Group					short			medium			long			Recommended feed per tooth (fz = mm/th) for side milling (A). For slotting (B), reduce fz by 20%.				
	A		B		adapter reach									D1 – Diameter				
					K600			K600			K600							
	ap		ae		ap		Cutting Speed – vc m/min			Cutting Speed – vc m/min			Cutting Speed – vc m/min					
	min	max	min	max	min	max	min	max	min	max	min	max	mm	10,0	12,0	16,0	20,0	
N	1	1,0 x D	0,5 x D	1,0 x D	500	–	2000	400	–	1600	300	–	1200	fz	0,075	0,090	0,120	0,150
	2	1,0 x D	0,5 x D	1,0 x D	500	–	1500	400	–	1200	300	–	900	fz	0,068	0,081	0,108	0,135
	3	1,0 x D	0,5 x D	1,0 x D	500	–	1500	400	–	1200	300	–	900	fz	0,053	0,063	0,084	0,105
	4	1,0 x D	0,5 x D	1,0 x D	400	–	750	320	–	600	240	–	450	fz	0,053	0,063	0,084	0,105
	5	1,0 x D	0,5 x D	1,0 x D	250	–	1000	200	–	800	150	–	600	fz	0,068	0,081	0,108	0,135
	6	1,0 x D	0,5 x D	1,0 x D	100	–	750	80	–	600	60	–	450	fz	0,075	0,090	0,120	0,150
	7	1,0 x D	0,5 x D	1,0 x D	100	–	750	80	–	600	60	–	450	fz	0,053	0,063	0,084	0,105

NOTE: These guidelines may require variations to achieve optimum results.
 Lower value of cutting speed is used for high stock removal applications or for higher hardness (machinability) within group.
 Higher value of cutting speed is used for finishing applications or for lower hardness (machinability) within group.
 Above parameters are based on ideal conditions. For smaller taper machining centers, please adjust parameters accordingly on diameters greater than 12mm.
 For better surface finish, reduce feed per tooth.

DUO-LOCK™ • KenFeed™ • KMDA • Radiused • 6 Flutes • Metric

- first choice
- alternate choice

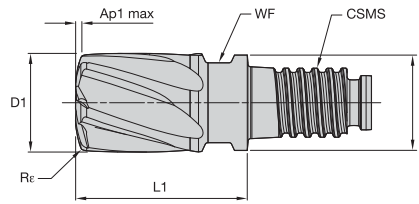

P	●
M	●
K	●
N	●
S	●
H	●

KC639M

order number	catalogue number	D1	D	Ap1 max	L1	CSMS	WF	Rc	
6197625	KMDA1000X6BQX	10,00	9,60	0,53	17,50	DL10	8,00	0,63	●
6197626	KMDA1200X6BQF	12,00	11,50	0,63	21,00	DL12	9,50	0,75	●
6197627	KMDA1600X6BQG	16,00	15,50	0,84	28,00	DL16	13,00	1,00	●
6197628	KMDA2000X6BQH	20,00	19,30	1,05	35,00	DL20	16,00	1,25	●

DUO-LOCK • KenFeed • 6 Flutes • Programming Data

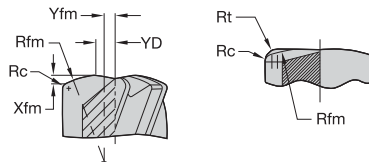

geometrical parameters							ramping guide for circular and linear ramping						
							circular interpolation		linear ramping				
							optimal range of circle diameter for a single pass		calculated length per ramp angle				
catalogue number	D1	Ap1 max	R	Re	YRC	RCN	smallest	largest	1°	2°	3°	4°	5°
KMDA1000X6BQX	10	0,53	10	0,625	1,25	2,20	14,40	20,00	30,20	15,09	10,06	7,54	6,02
KMDA1200X6BQF	12	0,63	12	0,750	1,50	2,64	17,28	24,00	36,24	18,11	12,07	9,05	7,23
KMDA1600X6BQG	16	0,84	16	1,000	2,00	3,52	23,04	32,00	48,31	24,15	16,09	12,06	9,64
KMDA2000X6BQH	20	1,05	20	1,250	2,50	4,40	28,80	40,00	60,39	30,19	20,11	15,08	12,05
recommended degree of programmed feed rate to use while ramping									100%	70%	50%	30%	10%

NOTE: YRC = distance from centerline to the crown of the R radius.
 RCN = distance from centerline to the start of the cutting edge. This dimension can also help determine the minimum circle size when helical ramping.
 R = the head radius size.
 Rc = the shoulder radius or radius at the corner of the cutter.

148-151	152	145-147	88, 156

DUO-LOCK™ • KenFeed™ • KSDB • Radiused • 6 Flutes • Metric

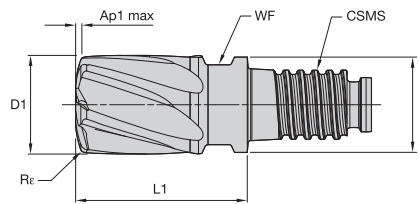

- first choice
- alternate choice

P	●
M	○
K	●
N	○
S	●
H	○

order number	catalogue number	D1	D	Ap1 max	L1	CSMS	WF	Rc	KC643M
6625741	KSDB1000X6BQX	10,00	9,60	0,53	17,50	DL10	8,00	0,63	●
6625742	KSDB1200X6BQX	12,00	11,50	0,63	21,00	DL12	9,50	0,75	●
6625743	KSDB1600X6BQX	16,00	15,50	0,84	28,00	DL16	13,00	1,00	●
6625744	KSDB2000X6BQX	20,00	19,30	1,05	35,00	DL20	16,00	1,25	●

DUO-LOCK • KenFeed • 6 Flutes • Programming Data

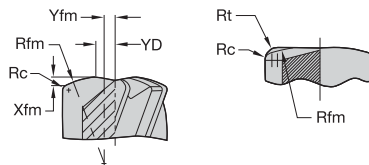

geometrical parameters										ramping guide for circular and linear interpolation						
										circular interpolation		linear interpolation				
										allowed range of hole diameter		calculated length per ramp angle				
catalogue number	D1	Ap1 max	Rfm	Rt	Rc	Xfm	Yfm	YD	Number of flutes	smallest	largest	1°	2°	3°	4°	5°
KSDB1000X6BQX	10,00	0,53	10,00	1,04	0,625	0,53	1,25	2,20	6	14,40	20,00	30,20	15,09	10,06	7,54	6,02
KSDB1200X6BQX	12,00	0,63	12,00	1,24	0,750	0,63	1,50	2,64	6	17,28	24,00	36,24	18,11	12,07	9,05	7,23
KSDB1600X6BQX	16,00	0,84	16,00	1,66	1,000	0,84	2,00	3,52	6	23,04	32,00	48,31	24,15	16,09	12,06	9,64
KSDB2000X6BQX	20,00	1,05	20,00	2,07	1,250	1,05	2,50	4,40	6	28,80	40,00	60,39	30,19	20,11	15,08	12,05
recommended degree of programmed feed rate to use while ramping										100%	70%	50%	30%	10%		

NOTE: YRC = distance from centerline to the crown of the R radius.
 RCN = distance from centerline to the start of the cutting edge. This dimension can also help determine the minimum circle size when helical ramping.
 R = the head radius size.
 Rc = the shoulder radius or radius at the corner of the cutter.

148-151	152	145-147	88, 156

DUO-LOCK™ • KenFeed™ • KMDA • Application Data • Metric



Material Group			straight short			conical medium			conical long			Recommended feed per tooth (fz = mm/th) for side milling (A).					
			KC639M			KC639M			KC639M			D1 – Diameter					
	A		Cutting Speed – vc m/min			Cutting Speed – vc m/min			Cutting Speed – vc m/min			mm	10,0	12,0	16,0	20,0	
	ap	ae	min	–	max	min	–	max	min	–	max	fz					
P	3	0,05 x D	0,55 x D	120	–	160	108	–	144	108	–	144	fz	0,424	0,491	0,610	0,707
	4	0,05 x D	0,55 x D	90	–	150	81	–	135	81	–	135	fz	0,378	0,437	0,538	0,616
H	1	0,05 x D	0,55 x D	80	–	140	64	–	112	48	–	84	fz	0,378	0,437	0,538	0,616
	2	0,05 x D	0,55 x D	70	–	120	56	–	96	42	–	72	fz	0,283	0,326	0,399	0,454

NOTE: These guidelines may require variations to achieve optimum results.
 Lower value of cutting speed is used for high stock removal applications or for higher hardness (machinability) within group.
 Higher value of cutting speed is used for finishing applications or for lower hardness (machinability) within group.
 Above parameters are based on ideal conditions. For smaller taper machining centers, please adjust parameters accordingly on diameters >12mm.
 For better surface finish, reduce feed per tooth.
 For tools with reach > 3 x D, reduce Fz by 20%.
 For tools with reach >5 x D, reduce Fz by 30%.
 For tools with reach >10 x D, reduce Vc and Fz by 30%.

DUO-LOCK • KenFeed • KSDB • Application Data • Metric



Material Group			short			medium			long			Recommended feed per tooth (fz = mm/th) for side milling (A).					
			adapter reach									D1 – Diameter					
	A		KC643M			KC643M			KC643M			mm	10,0	12,0	16,0	20,0	
	ap	ae	min	–	max	min	–	max	min	–	max	fz					
P	5	0,05 x D	0,55 x D	60	–	100	51	–	85	48	–	80	fz	0,290	0,337	0,419	0,485
	6	0,05 x D	0,55 x D	50	–	75	43	–	64	40	–	60	fz	0,242	0,279	0,342	0,389
M	1	0,05 x D	0,55 x D	90	–	115	72	–	92	63	–	81	fz	0,363	0,421	0,523	0,606
	2	0,05 x D	0,55 x D	60	–	80	48	–	64	42	–	56	fz	0,290	0,337	0,419	0,485
S	3	0,05 x D	0,55 x D	60	–	70	48	–	56	42	–	49	fz	0,242	0,279	0,342	0,389
	1	0,05 x D	0,55 x D	50	–	90	40	–	72	30	–	54	fz	0,363	0,421	0,523	0,606
	2	0,05 x D	0,55 x D	25	–	40	20	–	32	15	–	24	fz	0,192	0,223	0,278	0,324
	3	0,05 x D	0,55 x D	25	–	40	20	–	32	15	–	24	fz	0,192	0,223	0,278	0,324
	4	0,05 x D	0,55 x D	50	–	60	40	–	48	30	–	36	fz	0,267	0,310	0,385	0,445

NOTE: These guidelines may require variations to achieve optimum results.
 Lower value of cutting speed is used for high stock removal applications or for higher hardness (machinability) within group.
 Higher value of cutting speed is used for finishing applications or for lower hardness (machinability) within group.
 Above parameters are based on ideal conditions. For smaller taper machining centers, please adjust parameters accordingly on diameters greater than 12mm.
 For cutting aluminum with high silicon TiCN coating is recommended.
 For better surface finish reduce feed per tooth.
 For tools with reach >3 x D, reduce Fz by 20%.
 For tools with reach >5 x D, reduce Fz by 30%.
 For tools with reach >10 x D, reduce Vc and Fz by 30%.

DUO-LOCK™ • KenCut™ RR • Radiused • 3 Flutes • Metric

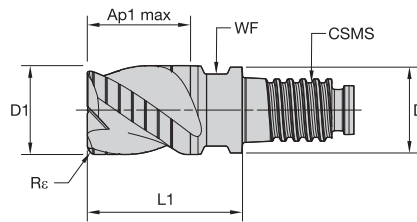

- first choice
- alternate choice

P	●
M	●
K	●
N	●
S	●
H	○

order number	catalogue number	D1	D	Ap1 max	L1	CSMS	WF	Rε	KCPM15
6441047	RFDD1000X3AQD	10,00	9,60	7,50	17,50	DL10	8,00	0,40	●
6441048	RFDD1200X3AQD	12,00	11,50	9,00	21,00	DL12	9,50	0,40	●
6441049	RFDD1600X3AQD	16,00	15,50	12,00	28,00	DL16	13,00	0,40	●
6441050	RFDD2000X3AQD	20,00	19,30	15,00	35,00	DL20	16,00	0,40	●

DUO-LOCK • KenCut FF • Radiused • 3 Flutes • Metric

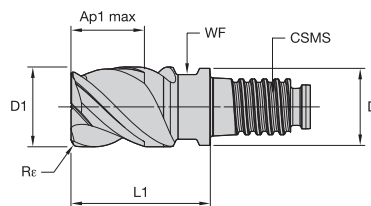

- first choice
- alternate choice

P	●
M	●
K	●
N	●
S	●
H	○

order number	catalogue number	D1	D	Ap1 max	L1	CSMS	WF	Rε	KCPM15
6441043	FGDF0970X3AQX	9,70	9,60	7,50	17,50	DL10	8,00	0,33	●
6441029	FGDF1000X3AQD	10,00	9,60	7,50	17,50	DL10	8,00	0,40	●
6441044	FGDF1170X3AQX	11,70	11,50	9,00	21,00	DL12	9,50	0,33	●
6441030	FGDF1200X3AQD	12,00	11,50	9,00	21,00	DL12	9,50	0,40	●
6441045	FGDF1570X3AQX	15,70	15,50	12,00	28,00	DL16	13,00	0,33	●
6441041	FGDF1600X3AQD	16,00	15,50	12,00	28,00	DL16	13,00	0,40	●
6441046	FGDF1970X3AQD	19,70	19,30	15,00	35,00	DL20	16,00	0,40	●
6441042	FGDF2000X3AQD	20,00	19,30	15,00	35,00	DL20	16,00	0,40	●

148-151	152	145-147	88, 156

DUO-LOCK™ • KenCut™ RR • Application Data • Metric



Material Group					straight short		conical medium			conical long			Recommended feed per tooth (fz = mm/th) for side milling (A). For slotting (B), reduce fz by 20%.					
	A		B		KCPM15		KCPM15			KCPM15			D1 – Diameter					
	ap	ae	ap	ap	Cutting Speed – vc m/min		Cutting Speed – vc m/min			Cutting Speed – vc m/min			mm	10,0	12,0	16,0	20,0	
P	0	0,75 x D	0,5 x D	0,5 x D	150	–	200	135	–	180	135	–	180	fz	0,061	0,070	0,086	0,097
	1	0,75 x D	0,5 x D	0,5 x D	150	–	200	135	–	180	135	–	180	fz	0,061	0,070	0,086	0,097
	2	0,75 x D	0,5 x D	0,5 x D	140	–	190	126	–	171	126	–	171	fz	0,061	0,070	0,086	0,097
	3	0,75 x D	0,5 x D	0,5 x D	120	–	160	108	–	144	108	–	144	fz	0,051	0,060	0,074	0,086
	4	0,75 x D	0,4 x D	0,5 x D	90	–	150	81	–	135	81	–	135	fz	0,046	0,053	0,065	0,075
	5	0,75 x D	0,5 x D	0,5 x D	60	–	100	51	–	85	48	–	80	fz	0,041	0,048	0,059	0,069
M	6	0,75 x D	0,4 x D	0,5 x D	50	–	75	43	–	64	40	–	60	fz	0,034	0,040	0,048	0,055
	1	0,75 x D	0,4 x D	0,5 x D	90	–	115	72	–	92	63	–	81	fz	0,051	0,060	0,074	0,086
	2	0,75 x D	0,4 x D	0,5 x D	60	–	80	48	–	64	42	–	56	fz	0,041	0,048	0,059	0,069
K	3	0,75 x D	0,4 x D	0,5 x D	60	–	70	48	–	56	42	–	49	fz	0,034	0,040	0,048	0,055
	1	0,75 x D	0,5 x D	0,5 x D	120	–	150	108	–	135	108	–	135	fz	0,061	0,070	0,086	0,097
	2	0,75 x D	0,5 x D	0,5 x D	110	–	140	99	–	126	99	–	126	fz	0,051	0,060	0,074	0,086
H	3	0,75 x D	0,4 x D	0,5 x D	110	–	130	99	–	117	99	–	117	fz	0,041	0,048	0,059	0,069
	1	0,75 x D	0,2 x D	0,3 x D	80	–	140	64	–	112	48	–	84	fz	0,046	0,053	0,065	0,075

NOTE: These guidelines may require variations to achieve optimum results.
 Lower value of cutting speed is used for high stock removal applications or for higher hardness (machinability) within group.
 Higher value of cutting speed is used for finishing applications or for lower hardness (machinability) within group.
 Above parameters are based on ideal conditions. For smaller taper machining centers, please adjust parameters accordingly on diameters >12mm.
 For tools with reach > 3 x D, reduce fz by 20%.
 For tools with reach >5 x D, reduce fz by 30%.
 For tools with reach >10 x D, reduce Vc and fz by 30%.

DUO-LOCK™ • KenCut™ FF • Application Data • Metric



Material Group					straight short		conical medium			conical long			Recommended feed per tooth (fz = mm/th) for side milling (A). For slotting (B), reduce fz by 20%.					
	A		B		KCPM15		KCPM15			KCPM15			D1 – Diameter					
	ap	ae	ap	ap	Cutting Speed – vc m/min		Cutting Speed – vc m/min			Cutting Speed – vc m/min			mm	10,0	12,0	16,0	20,0	
P	0	0,75 x D	0,5 x D	0,5 x D	150	–	200	135	–	180	135	–	180	fz	0,061	0,070	0,086	0,097
	1	0,75 x D	0,5 x D	0,5 x D	150	–	200	135	–	180	135	–	180	fz	0,061	0,070	0,086	0,097
	2	0,75 x D	0,5 x D	0,5 x D	140	–	190	126	–	171	126	–	171	fz	0,061	0,070	0,086	0,097
	3	0,75 x D	0,4 x D	0,5 x D	120	–	160	108	–	144	108	–	144	fz	0,051	0,060	0,074	0,086
	4	0,75 x D	0,3 x D	0,5 x D	90	–	150	81	–	135	81	–	135	fz	0,046	0,053	0,065	0,075
	5	0,75 x D	0,4 x D	0,5 x D	60	–	100	51	–	85	48	–	80	fz	0,041	0,048	0,059	0,069
M	6	0,75 x D	0,3 x D	0,5 x D	50	–	75	43	–	64	40	–	60	fz	0,034	0,040	0,048	0,055
	1	0,75 x D	0,4 x D	0,5 x D	90	–	115	72	–	92	63	–	81	fz	0,051	0,060	0,074	0,086
	2	0,75 x D	0,4 x D	0,5 x D	60	–	80	48	–	64	42	–	56	fz	0,041	0,048	0,059	0,069
K	3	0,75 x D	0,4 x D	0,5 x D	60	–	70	48	–	56	42	–	49	fz	0,034	0,040	0,048	0,055
	1	0,75 x D	0,5 x D	0,5 x D	120	–	150	108	–	135	108	–	135	fz	0,061	0,070	0,086	0,097
	2	0,75 x D	0,5 x D	0,5 x D	110	–	140	99	–	126	99	–	126	fz	0,051	0,060	0,074	0,086
S	3	0,75 x D	0,4 x D	0,5 x D	110	–	130	99	–	117	99	–	117	fz	0,041	0,048	0,059	0,069
	1	0,3 x D	0,3 x D	0,5 x D	50	–	90	40	–	72	30	–	54	fz	0,051	0,060	0,074	0,086
	2	0,3 x D	0,3 x D	0,5 x D	25	–	40	20	–	32	15	–	24	fz	0,027	0,032	0,039	0,046
	3	0,75 x D	0,3 x D	0,5 x D	25	–	40	20	–	32	15	–	24	fz	0,027	0,032	0,039	0,046
H	4	0,75 x D	0,3 x D	0,5 x D	50	–	60	40	–	48	30	–	36	fz	0,038	0,044	0,055	0,063
	1	0,75 x D	0,2 x D	0,3 x D	80	–	140	64	–	112	48	–	84	fz	0,046	0,053	0,065	0,075

NOTE: These guidelines may require variations to achieve optimum results.
 Lower value of cutting speed is used for high stock removal applications or for higher hardness (machinability) within group.
 Higher value of cutting speed is used for finishing applications or for lower hardness (machinability) within group.
 Above parameters are based on ideal conditions. For smaller taper machining centers, please adjust parameters accordingly on diameters >12mm.
 For tools with reach > 3 x D, reduce Fz by 20%.
 For tools with reach >5 x D, reduce Fz by 30%.
 For tools with reach >10 x D, reduce Vc and Fz by 30%.

DUO-LOCK™ • KenCut™ CM • Multi-Flute • Metric

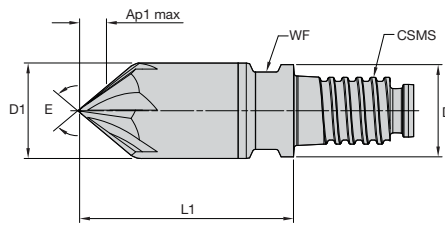

- first choice
- alternate choice

P	●
M	●
K	●
N	●
S	○
H	○

order number	catalogue number	D1	D	Ap1 max	L1	CSMS system size	WF	E	Z U	KCPM15
6127404	XADA1000X4CH45	10,00	9,60	2,00	22,60	DL10	8,00	90	4	●
6408009	XADA1000X4CH60	10,00	9,60	2,00	22,60	DL10	8,00	60	4	●
6127405	XADA1200X5CH45	12,00	11,50	3,00	27,20	DL12	9,50	90	5	●
6408010	XADA1200X5CH60	12,00	11,50	3,00	27,20	DL12	9,50	60	5	●
6127406	XADA1600X6CH45	16,00	15,50	4,00	36,25	DL16	13,00	90	6	●
6408041	XADA1600X6CH60	16,00	15,50	4,00	36,00	DL16	13,00	60	6	●

DUO-LOCK • KenCut CM • Multi-Flute • Metric

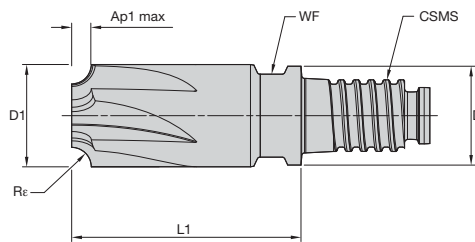

- first choice
- alternate choice

P	●
M	●
K	●
N	●
S	○
H	○

order number	catalogue number	D1	D	Ap1 max	L1	CSMS system size	WF	Re	Z U	KCPM15
6127382	XRDA1000X4CHJ	10,00	9,60	1,50	22,50	DL10	8,00	1,50	4	●
6127383	XRDA1000X4CRM	10,00	9,60	3,00	22,70	DL10	8,00	3,00	4	●
6127384	XRDA1200X5CRG	12,00	11,50	1,00	27,20	DL12	9,50	1,00	5	●
6127385	XRDA1200X5CRK	12,00	11,50	2,00	27,20	DL12	9,50	2,00	5	●
6127386	XRDA1200X5CRM	12,00	11,50	3,00	27,20	DL12	9,50	3,00	5	●
6127387	XRDA1600X6CRK	16,00	15,50	2,00	36,10	DL16	13,00	2,00	6	●
6127388	XRDA1600X6CRM	16,00	15,50	3,00	36,00	DL16	13,00	3,00	6	●
6127389	XRDA1600X6CRN	16,00	15,50	4,00	35,95	DL16	13,00	4,00	6	●

148-151	152	145-147	88, 156

DUO-LOCK™ • Corner Machining • Application Data • Metric



KenCut™ CM – XADA

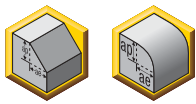

KenCut CM – XRDA

Material Group			short			medium			long			Recommended feed per tooth (fz = mm/th) for side milling (A).				
	A		adapter reach									D1 – Diameter				
			KCPM15 Cutting Speed – vc m/min			KCPM15 Cutting Speed – vc m/min			KCPM15 Cutting Speed – vc m/min							
	ap	ae	min	–	max	min	–	max	min	–	max	mm	10,0	12,0	16,0	
P	0	0,35 x D	0,35 x D	150	–	200	135	–	180	135	–	180	fz	0,058	0,066	0,081
	1	0,35 x D	0,35 x D	150	–	200	135	–	180	135	–	180	fz	0,058	0,066	0,081
	2	0,35 x D	0,35 x D	140	–	190	126	–	171	126	–	171	fz	0,058	0,066	0,081
	3	0,35 x D	0,35 x D	120	–	160	108	–	144	108	–	144	fz	0,048	0,056	0,070
	4	0,35 x D	0,35 x D	90	–	150	81	–	135	81	–	135	fz	0,043	0,050	0,061
	5	0,35 x D	0,35 x D	60	–	100	51	–	85	48	–	80	fz	0,039	0,045	0,056
M	6	0,35 x D	0,35 x D	50	–	75	42,5	–	63,75	40	–	60	fz	0,032	0,037	0,046
	1	0,35 x D	0,35 x D	90	–	115	72	–	92	63	–	80,5	fz	0,048	0,056	0,070
K	2	0,35 x D	0,35 x D	60	–	80	48	–	64	42	–	56	fz	0,039	0,045	0,056
	3	0,35 x D	0,35 x D	60	–	70	48	–	56	42	–	49	fz	0,032	0,037	0,046
	1	0,35 x D	0,35 x D	120	–	150	108	–	135	108	–	135	fz	0,058	0,066	0,081
N	2	0,35 x D	0,35 x D	110	–	140	99	–	126	99	–	126	fz	0,048	0,056	0,070
	3	0,35 x D	0,35 x D	110	–	130	99	–	117	99	–	117	fz	0,039	0,045	0,056
	1	0,35 x D	0,35 x D	500	–	2000	400	–	1600	300	–	1200	fz	0,080	0,096	0,128
	2	0,35 x D	0,35 x D	500	–	1500	400	–	1200	300	–	900	fz	0,072	0,086	0,115
	3	0,35 x D	0,35 x D	500	–	1500	400	–	1200	300	–	900	fz	0,056	0,067	0,090
	4	0,35 x D	0,35 x D	400	–	750	320	–	600	240	–	450	fz	0,056	0,067	0,090
	5	0,35 x D	0,35 x D	250	–	1000	200	–	800	150	–	600	fz	0,072	0,086	0,115
S	6	0,35 x D	0,35 x D	100	–	750	80	–	600	60	–	450	fz	0,080	0,096	0,128
	7	0,35 x D	0,35 x D	100	–	750	80	–	600	60	–	450	fz	0,056	0,067	0,090
	1	0,35 x D	0,35 x D	50	–	90	40	–	72	30	–	54	fz	0,048	0,056	0,070
	2	0,35 x D	0,35 x D	25	–	40	20	–	32	15	–	24	fz	0,026	0,030	0,037
H	3	0,35 x D	0,35 x D	25	–	40	20	–	32	15	–	24	fz	0,026	0,030	0,037
	4	0,35 x D	0,35 x D	50	–	60	40	–	48	30	–	36	fz	0,036	0,041	0,051
	1	0,35 x D	0,35 x D	80	–	140	64	–	112	48	–	84	fz	0,043	0,050	0,061

NOTE: Lower value of cutting speed is used for high stock removal applications or for higher hardness (machinability) within group.
 Higher value of cutting speed is used for finishing applications or for lower hardness (machinability) within group.
 Above parameters are based on ideal conditions. For smaller taper machining centers, please adjust parameters accordingly on diameters >12mm.
 For side milling with Ap larger than 1 x D, reduce Fz by 20%.

DUO-LOCK™ • Intelligent Thread

The DUO-LOCK Intelligent Thread eliminates the force peaks all regular threads have in the first groove.

3 golden rules to success:

1. Clean both sides of the coupling. Thread needs to be free of any lubricant, such as oil, anti seize, grease, etc.
2. Apply recommended torque values.
3. When using DUO-LOCK cylindrical extensions, never clamp on the coupling.

Finite Element Analysis FEA

DUO-LOCK Intelligent Thread

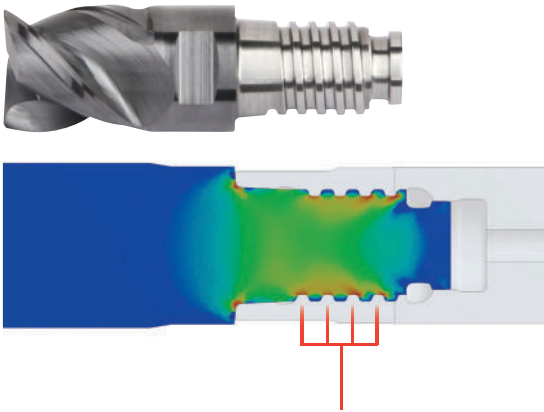

DUO-LOCK Intelligent Thread at maximum load.

The DUO-LOCK Intelligent Thread evenly distributes the forces across the entire length of the thread. This allows a greater than 25% torque transmission than known competitors.

Regular threads

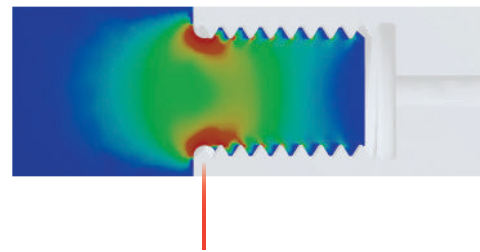

Typical for any regular thread at maximum load.

High force peak in the first groove, limiting the performance of the connection.

DUO-LOCK • Reconditioning

Wear and/or chipping determines to what extent and how often DUO-LOCK tips can be reconditioned. To ensure integrity of the wrench flats, the neck portion cannot be modified.

NOTE: The cutting diameter of reconditioned DUO-LOCK tips might be smaller than the neck diameter, and therefore may not have a clearance anymore. To prevent collisions, precautions need to be taken.

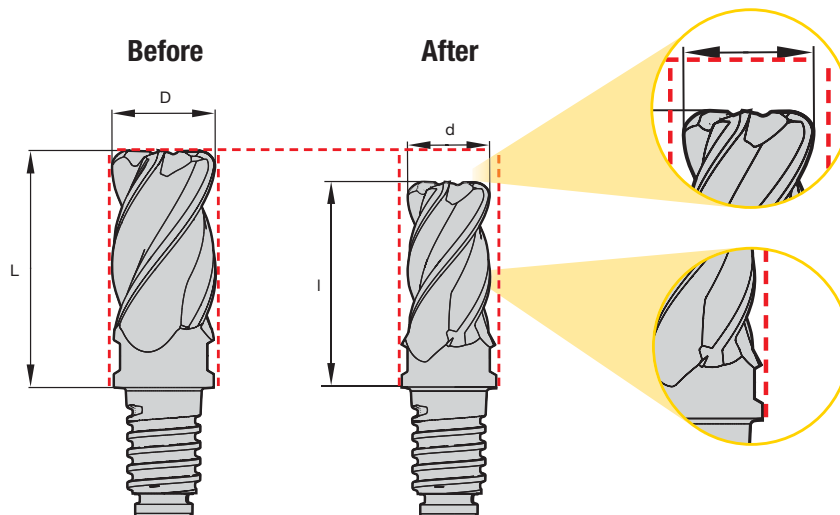

DUO-LOCK™ • Tool Clamping

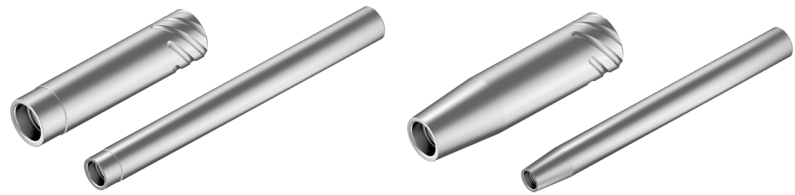

DUO-LOCK Extension Shank Diameter [D2]		10	12	16	20	25	32	12	16	20	25	32	40	50
HydroForce™		–	–	–	●	–	●	–	–	●	–	●	–	●
HydroForce with Sleeve		●	●	●	●	●	–	●	●	●	●	–	●	–
HydroForce with Safe-Lock™ Sleeve *		–	●	●	●	●	–	●	●	●	●	–	–	–
Shrink Fit		●	●	●	●	●	●	●	●	●	●	●	●	●
Safe-Lock™ Shrink Fit *		–	●	●	●	●	●	●	●	●	●	●	●	●
Milling Chuck		–	–	–	●	–	●	–	–	●	–	●	–	–
Milling Chuck with Sleeve		●	●	●	●	●	–	●	●	●	●	–	–	–
ER Collet Chuck		■	■	○	○	○	–	■	■	○	○	–	–	–
TG Collet Chuck		■	■	■	○	○	–	■	■	■	○	–	–	–

* Features Safe-Lock™ pullout protection

● Recommended

○ Not recommended

■ Suitable with limitations

– Not available

NOTE: DUO-LOCK™ steel extensions require high power shrinking units greater than 10KW.
All Safe-Lock™ extensions can be clamped in a cylindrical shank adapter.

DUO-LOCK™ • Steel Extension • Cylindrical • Safe-Lock™ • Metric

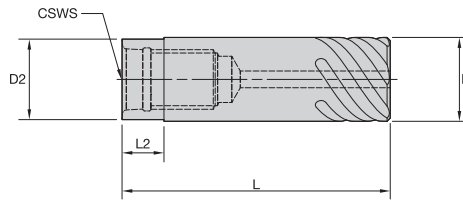

order number	catalogue number	CSWS	D	D2	L	L2	kg
6134889	SS10SLDL10055M	DL10	10	9,58	55	6	0,03
6135043	SS12SLDL12065M	DL12	12	11,50	65	7	0,05
6135049	SS16SLDL16070M	DL16	16	15,50	70	9	0,09
6135057	SS20SLDL20080M	DL20	20	19,30	80	11	0,16
6135063	SS25SLDL25090M	DL25	25	24,00	90	13	0,27
6135067	SS32SLDL32105M	DL32	32	31,00	105	17	0,52

NOTE: Cylindrical shanks not recommended for full slotting.

DUO-LOCK • Steel Extension • Conical • Safe-Lock • Metric

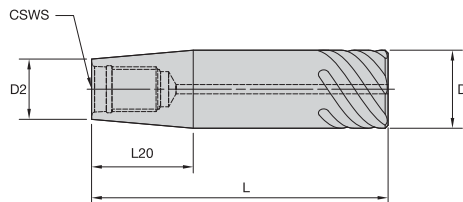

order number	catalogue number	CSWS	D	D2	L	L20	kg
6135041	SS12SLDL10065M	DL10	12	9,58	65	14	0,05
6135045	SS16SLDL10090M	DL10	16	9,58	90	37	0,11
6135051	SS20SLDL10115M	DL10	20	9,58	115	59	0,21
6135047	SS16SLDL12080M	DL12	16	11,50	80	26	0,11
6135053	SS20SLDL12105M	DL12	20	11,50	105	49	0,20
6135055	SS20SLDL16080M	DL16	20	15,50	80	26	0,16
6135059	SS25SLDL16115M	DL16	25	15,50	115	54	0,35
6135061	SS25SLDL20095M	DL20	25	19,30	95	33	0,30
6135065	SS32SLDL25105M	DL25	32	24,00	105	46	0,52
6135069	SS40SLDL32140M	DL32	40	31,00	140	51	1,13
6135081	SS50SLDL32200M	DL32	50	31,00	200	109	2,35

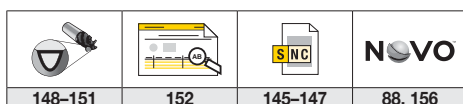

148-151

152

145-147

88, 156

DUO-LOCK™ • Steel Extension • Cylindrical • Straight Shank • Metric

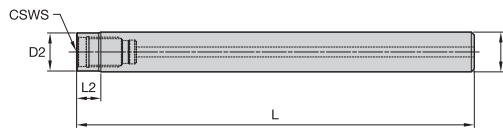

order number	catalogue number	CSWS	D	D2	L	L2	kg
6134890	SS10DL10100M	DL10	10	9,58	100	5	0,05
6135044	SS12DL12120M	DL12	12	11,50	120	6	0,09
6135050	SS16DL16160M	DL16	16	15,50	160	8	0,23
6135058	SS20DL20200M	DL20	20	19,30	200	10	0,45
6135064	SS25DL25250M	DL25	25	24,00	250	13	0,86
6135068	SS32DL32250M	DL32	32	31,00	250	16	1,41

NOTE: Standard catalog cutting data does not apply. Consult tooling application expert before use.

DUO-LOCK • Steel Extension • Conical • Straight Shank • Metric

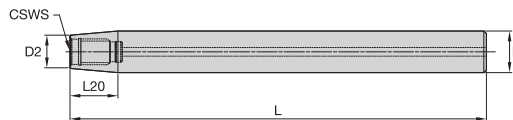

order number	catalogue number	CSWS	D	D2	L	L20	kg
6135042	SS12DL10120M	DL10	12	9,58	120	14	0,10
6135046	SS16DL10160M	DL10	16	9,58	160	37	0,22
6135052	SS20DL10200M	DL10	20	9,58	200	59	0,42
6135048	SS16DL12160M	DL12	16	11,50	160	26	0,23
6135054	SS20DL12200M	DL12	20	11,50	200	48	0,43
6135056	SS20DL16200M	DL16	20	15,50	200	26	0,45
6135060	SS25DL16250M	DL16	25	15,50	250	54	0,86
6135062	SS25DL20250M	DL20	25	19,30	250	32	0,89
6135066	SS32DL25250M	DL25	32	24,00	250	45	1,42
6135070	SS40DL32250M	DL32	40	31,00	250	51	2,20
6135082	SS50DL32250M	DL32	50	31,00	250	108	3,14

NOTE: Standard catalog cutting data does not apply. Consult tooling application expert before use.

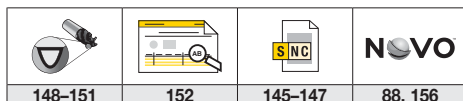

148-151

152

145-147

88, 156

DUO-LOCK™ • Heavy Metal Extension • Cylindrical • Straight Shank • Metric

NEW!

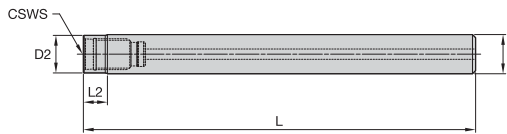

order number	catalogue number	CSWS	D	D2	L	L2	kg
6933541	HS10DL10N020070M	DL10	10	9,58	70	20	0,08
6933545	HS10DL10N040090M	DL10	10	9,58	90	40	0,10
6933542	HS12DL12N023080M	DL12	12	11,50	80	23	0,13
6933546	HS12DL12N047100M	DL12	12	11,50	100	47	0,17
6933543	HS16DL16N030090M	DL16	16	15,50	90	30	0,26
6933547	HS16DL16N062120M	DL16	16	15,50	120	62	0,16
6933544	HS20DL20N037100M	DL20	20	19,30	100	37	0,46
6933548	HS20DL20N077140M	DL20	20	19,30	140	77	0,65

DUO-LOCK • ER Solid Collets

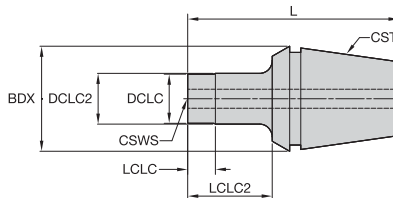



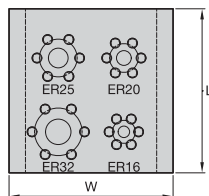
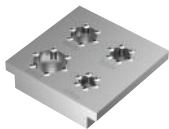

order number	catalogue number	CST	CSWS	BDX	L	DCLC	DCLC2	LCLC	LCLC2	kg	Nm
6612283	16ERDL10	ER16	DL10	17	32,8	9,6	—	5,3	—	0,03	20
6612284	20ERDL10	ER20	DL10	21	37,0	9,6	—	5,5	—	0,06	20
6612285	20ERDL12	ER20	DL12	21	38,0	11,5	—	6,5	—	0,06	30
6612286	25ERDL10	ER25	DL10	26	39,5	9,6	—	5,5	—	0,10	20
6612287	25ERDL12	ER25	DL12	26	40,5	11,5	—	6,5	—	0,10	30
6612288	25ERDL16	ER25	DL16	26	39,5	15,5	—	5,5	—	0,10	60
6612289	32ERDL10	ER32	DL10	33	66,5	9,6	10	5,0	26,5	0,21	20
6612290	32ERDL12	ER32	DL12	33	67,5	11,5	12	6,0	27,5	0,21	30
6612331	32ERDL16	ER32	DL16	33	66,5	15,5	16	8,0	26,5	0,22	60
6612332	32ERDL20	ER32	DL20	33	66,5	19,3	20	10,0	26,5	0,23	80

DUO-LOCK • ER Solid Collet Mounting Plate



order number	catalogue number	L	W	kg
6612333	DLCCDER	100	100	0,57

			
148–151	152	145–147	88, 156

DUO-LOCK™ • Adapter • HSK63 Form A • Metric

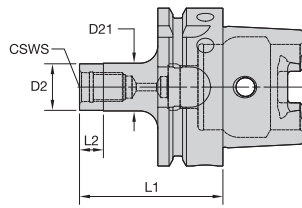
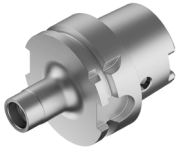

order number	catalogue number	CSWS	D2	D21	L1	L2	kg
6136949	HSK63ADL10048M	DL10	10	10	48	5	0,69
6136950	HSK63ADL12052M	DL12	12	12	52	6	0,69
6136951	HSK63ADL16057M	DL16	16	16	57	8	0,70
6136952	HSK63ADL20057M	DL20	19	20	57	10	0,72
6136953	HSK63ADL25061M	DL25	24	25	61	12	0,74
6136954	HSK63ADL32072M	DL32	31	32	72	16	0,83

DUO-LOCK • Adapter • HSK100 Form A • Metric

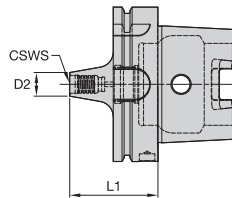
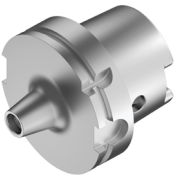



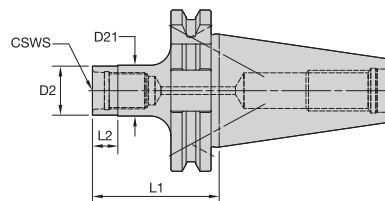
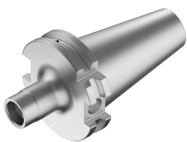

order number	catalogue number	CSWS	D2	L1	kg
6452503	HSK100ADL16060M	DL16	16	60	2,08
6452504	HSK100ADL20060M	DL20	19	60	2,12
6452505	HSK100ADL25065M	DL25	24	65	2,18
6452506	HSK100ADL32075M	DL32	31	75	2,40

DUO-LOCK • Adapter • DV40 • Metric



order number	catalogue number	CSWS	D2	D21	L1	L2	kg
6136993	DV40BDL10041M	DL10	10	10	41	5	0,82
6136994	DV40BDL12041M	DL12	12	12	41	6	0,81
6136995	DV40BDL16050M	DL16	16	16	50	8	0,83
6136996	DV40BDL20050M	DL20	19	20	50	10	0,84

			
148-151	152	145-147	88, 156

DUO-LOCK™ • Adapter • DV50 • Metric

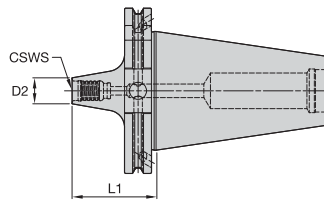

order number	catalogue number	CSWS	D2	L1	kg
6452419	DV50BDL16050M	DL16	16	50	2,68
6452420	DV50BDL20050M	DL20	19	50	2,73
6452501	DV50BDL25056M	DL25	24	56	2,79
6452502	DV50BDL32065M	DL32	31	65	3,01

DUO-LOCK • Adapter • BT40 • Metric

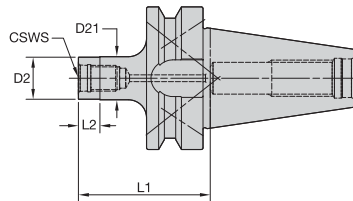
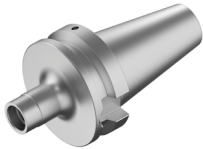

order number	catalogue number	CSWS	D2	D21	L1	L2	kg
6136977	BT40BDL10049M	DL10	10	10	49	5	0,98
6136978	BT40BDL12049M	DL12	12	12	49	6	0,97
6136979	BT40BDL16058M	DL16	16	16	58	8	1,00
6136980	BT40BDL20058M	DL20	19	20	58	10	1,00
6136991	BT40BDL25060M	DL25	24	25	60	12	1,02

DUO-LOCK • Adapter • PSC63 • Metric

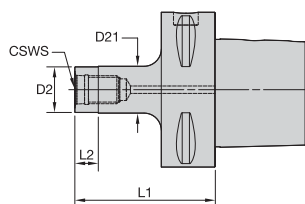

order number	catalogue number	CSWS	D2	D21	L1	L2	kg
6136956	PSC63DL12050M	DL12	12	12	50	6	0,77
6136958	PSC63DL20055M	DL20	19	20	55	10	0,80
6136959	PSC63DL25060M	DL25	24	25	60	12	0,83
6136960	PSC63DL32068M	DL32	31	32	68	16	0,91

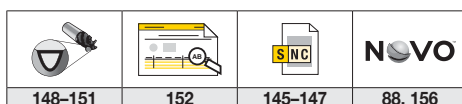

DUO-LOCK™ • Double-Handed Torque Wrench



order number	catalogue number	Description
6135413	TWDLTM	BASIC DUO LOCK WRENCH
6135414	TWTMINsertDL10	TORQUE WRENCH INSERT DL10
6135415	TWTMINsertDL12	TORQUE WRENCH INSERT DL12
6135416	TWTMINsertDL16	TORQUE WRENCH INSERT DL16
6135417	TWTMINsertDL20	TORQUE WRENCH INSERT DL20
6135418	TWTMINsertDL25	TORQUE WRENCH INSERT DL25
6135419	TWTMINsertDL32	TORQUE WRENCH INSERT DL32
6135422	TWTMEXT	TORQUE WRENCH EXTENSION HANDLE
6135423	TWTMBC	TORQUE WRENCH BOLT SET

NOTE: Combine basic DUO-LOCK wrench with selected torque wrench inserts needed.

DUO-LOCK • Torque Wrench • Double-Handed • Kit

1 ERICKSON™ Torque Master Wrench

2 Insert

3 Extension Handle



Order this

Get that

order number	catalogue number	Kit Description	DUO-LOCK Size	torque (Nm)
6342967	TWDL10TM	D-L WRENCH WITH DL10 INSERT AND HANDLES	DL 10	20
6342968	TWDL12TM	D-L WRENCH WITH DL12 INSERT AND HANDLES	DL 12	30
6342969	TWDL16TM	D-L WRENCH WITH DL16 INSERT AND HANDLES	DL 16	60
6342970	TWDL20TM	D-L WRENCH WITH DL20 INSERT AND HANDLES	DL 20	80
6343061	TWDL25TM	D-L WRENCH WITH DL25 INSERT AND HANDLES	DL 25	100
6343062	TWDL32TM	D-L WRENCH WITH DL32 INSERT AND HANDLES	DL 32	130

1+2+3

DUO-LOCK™ • Single-Handed Torque Wrench • Wrench

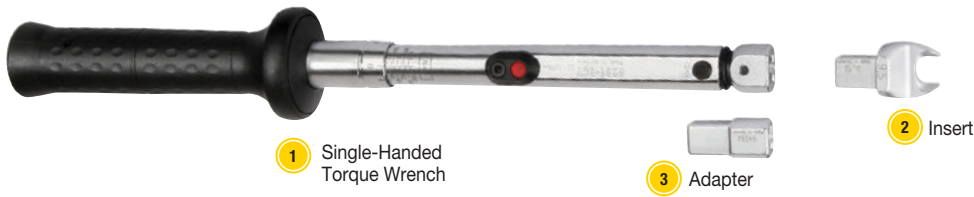

1

order number	catalogue number	description	DUO-LOCK Size	torque (Nm)
6411155	TWDL9X12	D-L SINGLE HAND TORQUE WRENCH	–	–

DUO-LOCK • Single-Handed Torque Wrench • Insert

2

order number	catalogue number	description	DUO-LOCK Size	torque (Nm)
6410950	TWSH9X12INSERTDL10	D-L TORQUE WRENCH SH INSERT	DL10	20
6411151	TWSH9X12INSERTDL12	D-L TORQUE WRENCH SH INSERT	DL12	30
6411152	TWSH9X12INSERTDL16	D-L TORQUE WRENCH SH INSERT	DL16	60
6411153	TWSH9X12INSERTDL20	D-L TORQUE WRENCH SH INSERT	DL20	80

DUO-LOCK • Single-Handed Torque Wrench • Adapter

3

order number	catalogue number	description	DUO-LOCK Size	torque (Nm)
6411154	TWDL9X12CA14X18	D-L ADAPTER 9X12 TO 14X18	–	–

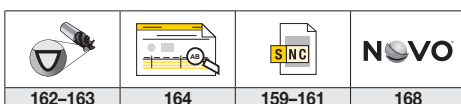

DUO-LOCK™ • Catalog Numbering System

Each character in our catalog number signifies a specific trait of that product. Use the following key columns and corresponding images to easily identify which attributes apply.

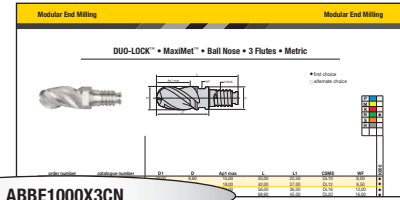

ABBE1000X3CN

AB	B	E	1000	X	3	C	N	
Series	End Mill Shape	Helix Angle	Diameter	Shank Style	Number of Flutes	Length-of-Cut	Shape/Feature	Corner Configuration
AB = MaxiMet™ – Non-ferrous metals FG = Finisher general applications – Steels FM = Finisher multi-flute – Steels FS = RSM II™ multi-flute – High-temperature alloys KM = KenFeed™ – Medium steels RF = Rougher – Chipbreaker design RK = Rougher – Fine-pitch profile design RQ = Rougher – Coarse-pitch profile design UC = HARVI™ II – Stainless steels UD = HARVI II – High-temperature alloys UJ = HARVI III center cut & eccentric cut – High-temperature alloys UK = HARVI I asymmetric fluting – Stainless steels UL = HARVI I asymmetric fluting – High-temperature alloys XA = Chamfering tool XR = Corner rounding tool	B = Ball Nose D = Square End	A = 0–10 B = 11–20 D = 31–35 E = 36–40 F = 41–45 V = 37/39° variable		X = Metric – DUO-LOCK™ Y = Inch – DUO-LOCK	2 3 4 5 6 9 B = 11 F = 15 J = 19	A = 0,75 x D B = 1,0 x D C = 1,5 x D	H = Chamfer N = Necked Q = Necked & Radius R = Radius U = Necked + Sharp V = Necked + Chamfer	Metric D = Metric – 0,4mm E = Metric – 0,5mm F = Metric – 0,75mm H = Metric – 1,25mm J = Metric – 1,5mm N = Metric – 4,0mm S = Sharp X = Custom Inch A = Inch – .015" B = Inch – .030" C = Inch – .060" D = Inch – .090" E = Inch – .120" F = Inch – .250" S = Sharp X = Custom

HARVI™ I TE DUO-LOCK • Catalog Numbering System

H1TE4SE1200S016HAM

H1TE	4	SE	1200	S	016	HA		M
Series	Number of Flutes	Front End Style	Cutting Diameter D1	Flute Section Style	Length of Cut Ap1 max	Shank Style	Radius	Standard
H1TE = HARVI I TE	4 = 4-Flute	SE = Sharp Edge CH = Chamfer RA = Radius	Metric = D1 in mm Inch = D1 in decimal inch	R = Regular Without Neck	Metric = Ap1 Max in mm Inch = Ap1 Max in decimal inch	DL = DUO-LOCK		M = Metric Blank = Inch

DUO-LOCK™ Extensions • Catalog Numbering System

Each character in our catalog number signifies a specific trait of that product. Use the following key columns and corresponding images to easily identify which attributes apply.

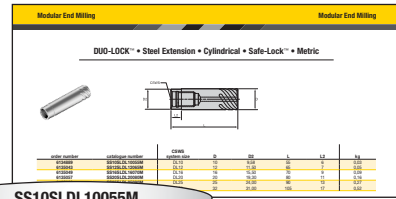

SS10SLDL10055M

SS	10	SL	DL10	055	M
Connection Style Machine Side (CSMS)	Shank Diameter D	Shank Style	Connection Style Workpiece Side (CSWS) System Size	Tool Length	Value
SS = Straight Shank	Metric = D in mm Inch = D in decimal inch	SL = Safe-Lock™ Blank = Plain	DL10 = DUO-LOCK size 10	Metric = L in mm Inch = L in decimal inch	Metric

DUO-LOCK Solid ER Collet • Catalog Numbering System

Each character in our catalog number signifies a specific trait of that product. Use the following key columns and corresponding images to easily identify which attributes apply.

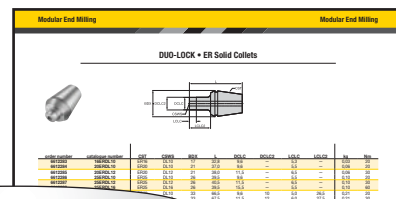

32ERDL16

32	ER	DL16
Collet Size	Collet Type	DUO-LOCK Coupling Size
16 = ER 16 20 = ER 20 25 = ER 25 32 = ER 32	ER	DL10 DL12 DL16 DL20

DUO-LOCK™ Adapters • Catalog Numbering System

Each character in our catalog number signifies a specific trait of that product. Use the following key columns and corresponding images to easily identify which attributes apply.

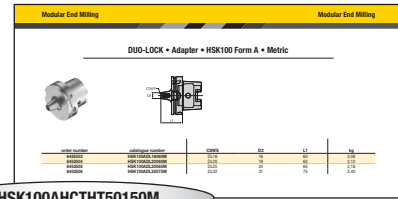

HSK100AHCTHT50150M

HSK	100	A	HCTHT	50	150	M
Connection Style Machine Side (CSMS)	Connection Size	System Flange Form	Hydraulic Chuck Type	Clamping Diameter	Tool Length	Value
KM™ KM4X™ HSK DV CV BT PSC	30 32 40 50 63 80 100 125	A = Form A C = Form C B = Coolant	HCTHT = HydroForce™ HCSL = Slim Line HCSLT = Slim Line T HC = High Performance DL = DUO-LOCK	50 = 50mm 075 = 3/4"	150 = 150mm 413 = 4.13"	M = Metric Blank = Inch

Holemaking

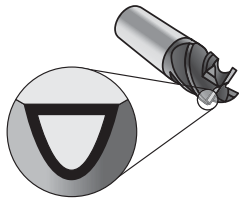

Coatings provide high-speed capability and are engineered for roughing to finishing.

P	Steel
M	Stainless Steel
K	Cast Iron
N	Non-Ferrous
S	High-Temp Alloys
H	Hardened Materials
C	CFRP Materials

wear resistance ← → toughness

Grade	Coating	Grade Description	Material Group																	
				05	10	15	20	25	30	35	40	45								
KC7325		<p>Composition: Multilayered PVD TiN-TiAlN coated fine-grain carbide with a TiN top layer for better wear identification.</p> <p>Application: This multipurpose grade has been combined with a unique general-purpose cutting geometry to offer high versatility and reliability across all material groups at intermediate cutting conditions.</p>	P																	
			M																	
			K																	
			N																	
			S																	
			H																	
KCP15A		<p>Composition: Monolayer PVD AlTiN coated submicron-grain carbide.</p> <p>Application: First choice for steel and second choice for cast iron. This grade consists of an updated AlTiN coating, offering improved high temperature properties on top of the proven fine-grain carbide substrate with required toughness for modular drilling applications.</p>	P																	
			M																	
			K																	
			N																	
			S																	
			H																	
KCMS15		<p>Composition: Monolayer PVD AlTiN coated fine-grain carbide with superior surface finish.</p> <p>Application: First choice for stainless steel and high-temperature-resistant materials. The coating offers high hardness and excellent wear resistance, as well as enhanced high-temperature properties increasing its applicability also to MQL machining of steel.</p>	P																	
			M																	
			K																	
			N																	
			S																	
			H																	
KC7410		<p>Composition: Multilayered PVD AlCrN-based coated fine-grain carbide.</p> <p>Application: First choice for cast iron. Due to the uniquely developed coating, this grade exhibits extraordinary wear resistance in abrasive materials offering the highest material removal rates.</p>	P																	
			M																	
			K																	
			N																	
			S																	
			H																	
KN15		<p>Composition: Uncoated, highly wear-resistant fine-grain carbide.</p> <p>Application: Highly polished chip flute surfaces ensure superior chip evacuation and reduce tendency for built-up edges. First choice for non-ferrous materials.</p>	P																	
			M																	
			K																	
			N																	
			S																	
			C																	
KCC10		<p>Composition: Multilayered CVD diamond-coated, submicron-grain carbide.</p> <p>Application: First choice for machining challenging carbon-fiber reinforced polymers (CFRPs). This grade offers best compromise of abrasive wear resistance and sharpest possible cutting geometries to allow defect-free machining of difficult-to-cut CFRP materials.</p>	P																	
			M																	
			K																	
			N																	
			S																	
			C																	



Holemaking

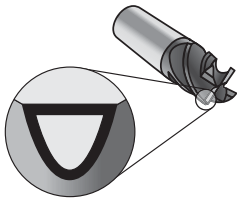

Coatings provide high-speed capability and are engineered for roughing to finishing.

P	Steel
M	Stainless Steel
K	Cast Iron
N	Non-Ferrous
S	High-Temp Alloys
H	Hardened Materials
C	CFRP Materials

wear resistance ← → toughness

Grade	Coating	Grade Description	Material Groups																					
				05	10	15	20	25	30	35	40	45												
KMF		Uncoated carbide grade. KMF is a fine-grain substrate for machining of high-temp alloys and non-ferrous materials and cast irons.																						
			K																					
			N																					
			S																					
KC7315		Composition: Multilayered PVD TiN-TiAlN coated fine-grain carbide Application: Applicable for steel, cast iron, and hardened materials. This grade offers excellent wear resistance and reliability at intermediate to elevated cutting speeds.	P																					
			K																					
			H																					
KCU15		Composition: Multilayered PVD TiN-TiAlN coated submicron-grain carbide. Application: Applicable to all material groups. This grade offers excellent wear resistance and reliability at intermediate and elevated cutting speeds. KCU15 provides excellent coating adhesion even in tough cutting conditions.	P																					
			M																					
			K																					
			N																					
			S																					
			H																					
KCU15A		Composition: Multilayered PVD TiN-TiAlN coated submicron-grain carbide with superior surface finish. Application: Applicable to all material groups. This grade offers excellent wear resistance and reliability at intermediate and elevated cutting speeds. A state-of-the-art surface condition enables superior chip evacuation, high metal removal rates, and highest wear resistance.	P																					
			M																					
			K																					
			N																					
			S																					
			H																					
KCU05A		Composition: Monolayer PVD TiAlSiN coated submicron carbide with enhanced coating surface. Application: Optimized for steel and cast iron, this grade also offers excellent performance in stainless steel and high temperature alloys. High wear resistance and high performance consistency even at elevated cutting conditions makes it the first choice for machining abrasive materials.	P																					
			M																					
			K																					
			S																					

Solid Carbide End Milling & Modular End Milling

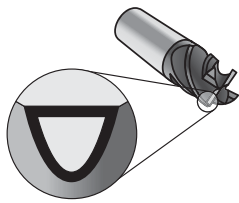

Coatings provide high-speed capability and are engineered for roughing to finishing.

P	Steel
M	Stainless Steel
K	Cast Iron
N	Non-Ferrous
S	High-Temp Alloys
H	Hardened Materials
C	CFRP Materials

wear resistance ← → toughness

Grade	Coating	Grade Description	Material Groups																						
				05	10	15	20	25	30	35	40	45													
K600		<p>Composition: Uncoated, highly wear-resistant submicron-grain carbide.</p> <p>Application: Very high toughness ensures a controlled wear rate. The micrograin structure enables extremely sharp edges. First choice for milling of non-ferrous materials.</p>																							
			N																						
KC633M		<p>Composition: Multilayered PVD TiN/TiAlN-coated submicron-grain carbide.</p> <p>Application: This multi-purpose grade offers highest versatility and best reliability across recommended material groups at intermediate cutting conditions.</p>																							
			P																						
			M																						
			K																						
			S																						
KC643M		<p>Composition: Monolayer PVD AlTiN-coated submicron-grain carbide.</p> <p>Application: This grade offers high hardness and excellent wear resistance for general application in steel, stainless steel, cast iron, and high-temperature alloys.</p>																							
			P																						
			M																						
			K																						
			S																						
KCPM15		<p>Composition: Monolayer PVD AlTiN-coated submicron-grain carbide with smooth coating surface.</p> <p>Application: Proprietary coating with best-in-class tool life as well as performance consistency optimized for applications in steel, stainless steel, cast iron, and hard materials.</p>																							
			P																						
			M																						
			K																						
			H																						
KCSM15		<p>Composition: Monolayer PVD AlTiN-coated submicron-grain carbide with smooth coating surface.</p> <p>Application: Proprietary coating with best-in-class tool life as well as performance consistency optimized for application in stainless steel and high-temperature alloys.</p>																							
			M																						
			S																						



Solid Carbide End Milling & Modular End Milling

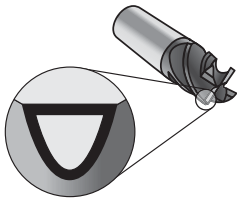

Coatings provide high-speed capability and are engineered for roughing to finishing.

P	Steel
M	Stainless Steel
K	Cast Iron
N	Non-Ferrous
S	High-Temp Alloys
H	Hardened Materials
C	CFRP Materials

wear resistance ← → toughness

Grade	Coating	Grade Description	Performance Metrics																									
				05	10	15	20	25	30	35	40	45																
KC639M		Composition: Monolayer PVD AlTiN-coated, ultra-fine grain carbide. Application: First choice for hardened steels > 55 HRC.																										
KCN05		Composition: CVD diamond-coated, fine-grain carbide. Application: First choice for machining carbon-fiber reinforced polymers (CFRP). The crystalline diamond-coated grade offers the highest degree of abrasive wear resistance.																										
KD1410		Composition: A polycrystalline diamond (PCD) tip brazed onto a carbide substrate. Application: Engineered for good abrasion resistance combined with excellent edge strength for demanding applications. An ideal choice for aluminum with high silicon content as well as CFRP.																										
KYS40		Composition: SiAlON solid ceramic. Application: SiAlON ceramic end mills take dry machining of nickel-based high-temperature alloys to a new level. The increased heat resistance of SiAlON ceramics enables cutting at highest velocities leading to best metal removal rates and productivity.																										



Key to Product Table Column Headings

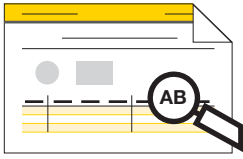

You may notice a slight change in the appearance of our product tables and specification charts. In this catalog, Kennametal introduces a set of short-name codes to improve the readability of tables and drawings. These codes replace full-text descriptions. The full list of codes and their definitions can be found below.

Short-Name Code	Full Text Description
A	Coolant Hole Diameter
Ap max	Maximum Cutting Depth
Ap1 max	Maximum Cutting Depth
B	Shank Width
B1	Front Clearance
B2	Overall Width
B3	Head Back Offset
BCH	Corner Chamfer Width
BR1 - O.D.	Bore Range O.D.
BR1 bore range	Bore Range
BS	Corner Facet Length
BSC	Blade Size Code
CD	Cutting Depth
CE	Cutting Edges
CF	Coolant Supply Size Radial
CFVDI	Coolant Supply Size - VDI
CS	Coolant Supply Size
CSMS	Connection System Size Machine Side
D	Insert: Insert IC Size
D	Shank/Bore Diameter
D max	Maximum Bore Diameter
D min	Minimum Bore Diameter
D1	Insert: Insert Hole Size
D1	Milling: Cutter Diameter
D1	Toolholder: Clamping Diameter
D2	Body Diameter 1 Workpiece Side
D3	Neck Diameter
D5	Body Diameter Machine Side
D6	Hub Diameter
DPM	Pilot Diameter Machine Side
F	F Dimension
FS	Secondary F dimension
G	Connector Thread Size Machine Side
G3	Connection Thread Size Workpiece Side
G3X	Connection Thread Size External
GI	Gage Insert
H	Shank Height
H1	Cutting Height
H1	Centerline Height
H2	Toolholder: Head Height
H2	Overall Height
H3	Head Bottom Offset
hm	Average Chip Thickness
HW	Shank Height
IHS	Insert Holder Size
L	Overall Length
L1	Tool Length
L1	Toolholder: Gage Length
L1 assy	L1 Assembly Length
L1 assy - O.D.	L1 Assembly Length O.D.
L1 assy BB	L1 Assembly Length for back boring
L10	Insert Cutting Edge Length
L2	Milling: Head Length
L2 assy	L2 Assembly Length
L2 assy BB	L2 Assembly Length for back boring
L3	Milling: Maximum Depth
L4	Maximum Boring Depth
lbs	Weight Pounds
LEFF	Tip Length Tangent
LH	Head Length
LI	Insert Length
LPR	Protruding Length
LS	Shank Length
max RPM	Maximum Revolutions Per Minute
RC	Corner Radius Center
R _ε	Corner Radius
RL	Corner Radius Left Hand
RR	Corner Radius Right Hand
S	Insert Thickness
SSC	Seat Size Code
W	Cutting Edge Width or Slot Width
W	Turning: Groove Width
W	Insert Width
W tol ±	Cutting Width (+/-) Tolerance
W1	Blade Width
WF	Milling: Width of Flat
Z	Number of Inserts
ZU	Number of Flutes
αL	Cutting Edge Angle Left Hand
αR	Cutting Edge Angle Right Hand

P	Steel
M	Stainless Steel
K	Cast Iron

N	Non-Ferrous
S	High-Temp Alloys

H	Hardened Materials
C	CFRP Materials

material group	description	content	tensile strength RM (MPa)*	hardness (HB)	hardness (HRC)	material number
P0	Low-Carbon Steels, Long Chipping	C <0,25%	<530	<125	-	-
P1	Low-Carbon Steels, Short Chipping, Free Machining	C <0,25%	<530	<125	-	C15, Ck22, ST37-2, S235JR, 9SMnPb28, GS38
P2	Medium- and High-Carbon Steels	C >0,25%	>530	<220	<25	ST52, S355JR, C35, GS60, Cf53
P3	Alloy Steels and Tool Steels	C >0,25%	600-850	<330	<35	16MnCr5, Ck45, 21CrMoV5-7, 38SMn28
P4	Alloy Steels and Tool Steels	C >0,25%	850-1400	340-450	35-48	100Cr6, 30CrNiMo8, 42CrMo4, C70W2, S6525, X120Mn12
P5	Ferritic, Martensitic, and PH Stainless Steels	-	600-900	<330	<35	100Cr6, 30CrNiMo8, 42CrMo4, C70W2, S6525, X120Mn12
P6	High-Strength Ferritic, Martensitic, and PH Stainless Steels	-	900-1350	350-450	35-48	X102CrMo17, G-X120Cr29
M1	Austenitic Stainless Steel	-	<600	130-200	-	X5CrNi 18 10, X2CrNiMo 17 13 2, G-X25CrNiSi18 9, X15CrNiSi 20 12
M2	High-Strength Austenitic Stainless and Cast Stainless Steels	-	600-800	150-230	<25	X2CrNiMo 13 4, X5NiCr 32 21, X5CrNiNb 18 10, G-X15CrNi 25-20
M3	Duplex Stainless Steel	-	<800	135-275	<30	X8CrNiMo27 5, X2CrNiMoN22 5 3, X20CrNiSi25 4, G-X40CrNiSi27 4
K1	Gray Cast Iron	-	125-500	120-290	<32	GG15, GG25, GG30, GG40, GTW40
K2	Low- and Medium-Strength Ductile Irons (Nodular Irons) and Compacted Graphite Irons (CGI)	-	<600	130-260	<28	GGG40, GTS35
K3	High-Strength Ductile Irons and Austempered Ductile Iron (ADI)	-	>600	180-350	<43	GGG60, GTW55, GTS65
N1	Wrought Aluminum	-	-	-	-	AlMg1, Al99.5, AlCuMg1, AlCuBiPb, AlMgSi1, AlMgSiPb
N2	Low-Silicon Aluminum Alloys and Magnesium Alloys	Si <12,2%	-	-	-	GAISiCu4, GDAISi10Mg
N3	High-Silicon Aluminum Alloys and Magnesium Alloys	Si >12,2%	-	-	-	G-ALSi12, G-ALSi17Cu4, G-ALSi21CuNiMg
N4	Copper-, Brass-, Zinc-Based on Machinability Index Range of 70-100	-	-	-	-	CuZn40, Ms60, G-CuSn5ZnPb, CuZn37, CuSi3Mn
N5	Nylon, Plastics, Rubbers, Phenolics, Resins, Fiberglass	-	-	-	-	LEXAN®, HOSTALEN®, POLYSTYROL®, MAKROLON®
N6	Carbon, Graphite Composites, CFRP	-	-	-	-	CFK, GFK
N7	Metal Matrix Composites (MMC)	-	-	-	-	-
S1	Iron-Based, Heat-Resistant Alloys	-	500-1200	160-260	25-48	X1NiCrMoCu32 28 7, X12NiCrSi36 16, X5NiCrAlTi31 20, X40CoCrNi20 20
S2	Cobalt-Based, Heat-Resistant Alloys	-	1000-1450	250-450	25-48	Haynes® 188, Stellite™ 6,21,31
S3	Nickel-Based, Heat-Resistant Alloys	-	600-1700	160-450	<48	INCONEL® 690, INCONEL 625, Hastelloy®, NIMONIC® 75
S4	Titanium and Titanium Alloys	-	900-1600	300-400	33-48	Ti1, TiAl5Sn2, TiAl6V4, TiAl4Mo4Sn2
H1	Hardened Materials	-	-	-	44-48	GX260NiCr42, GX330NiCr42, GX300CrNiSi952, GX300CrMo153, Hardox® 400
H2	Hardened Materials	-	-	-	48-55	-
H3	Hardened Materials	-	-	-	56-60	-
H4	Hardened Materials	-	-	-	>60	-
C1	CFRP, CFRP/CFRP	-	-	-	-	-
C2	CFRP/Non-Ferrous	-	-	-	-	-
C3	CFRP/High-Temp	-	-	-	-	-
C4	CFRP/Stainless Steel	-	-	-	-	-
C5	CFRP/Non-Ferrous/High-Temp	-	-	-	-	-

NOVO™

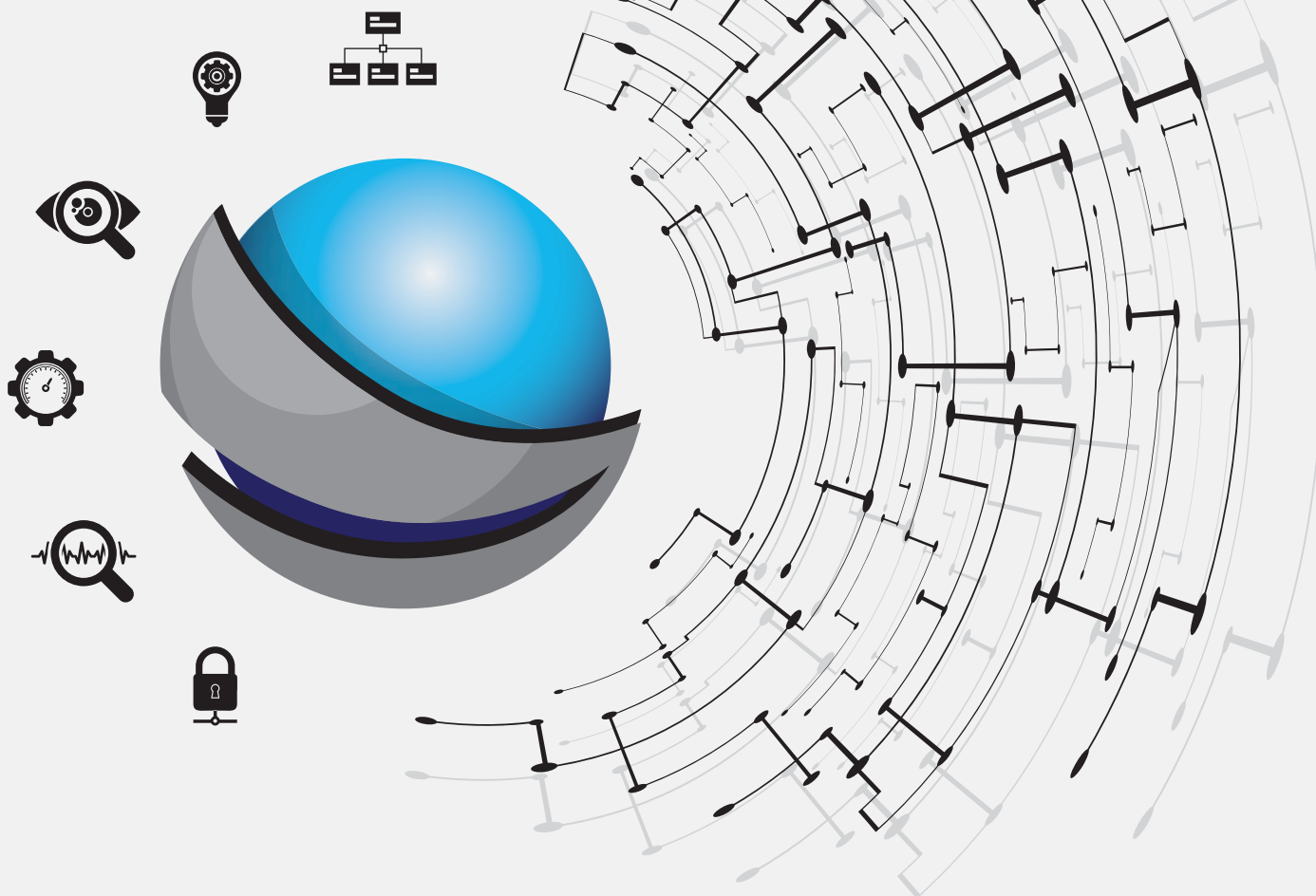

**Digitally access and leverage product data and knowledge
to connect systems and processes throughout
the entire manufacturing lifecycle.**

VISIT KENNAMETAL.COM/NOVO.

METALCUTTING SAFETY

IMPORTANT SAFETY INSTRUCTIONS

Read before using the tools in this catalog!

Projectile and Fragmentation Hazards:

Modern metalcutting operations involve high spindle and cutter speeds and high temperatures and cutting forces. Hot metal chips may fly off the workpiece during metalcutting. Although cutting tools are designed and manufactured to withstand high cutting forces and temperatures, they can sometimes fragment, particularly if they are subjected to over-stress, severe impact, or other abuse.

To avoid injury:

- Always wear appropriate personal protective equipment, including safety goggles, when operating metalcutting machines or working nearby.
- Always make sure all machine guards are in place.

Breathing and Skin Contact Hazards:

Grinding carbide or other advanced cutting tool materials produces dust or mist containing metallic particles. Breathing this dust or mist — especially over an extended period — can cause temporary or permanent lung disease or make existing medical conditions worse. Contact with this dust or mist can irritate eyes, skin, and mucous membranes and may make existing skin conditions worse.

To avoid injury:

- Always wear breathing protection and safety goggles when grinding.
- Provide ventilation control and collect and properly dispose of dust, mist, or sludge from grinding.
- Avoid skin contact with dust or mist.

For more information, read the applicable Material Safety Data Sheet provided by Kennametal and consult General Industry Safety and Health Regulations, Part 1910, Title 29 of the Code of Federal Regulations.

These safety instructions are general guidelines. Many variables affect machining operations. It is impossible to cover every specific situation. The technical information included in this catalog and recommendations on machining practices may not apply to your particular operation. For more information, consult the Kennametal Metalcutting Safety booklet, available free from Kennametal at 724 539 5747 or fax 724 539 5439. For specific product safety and environmental questions, contact our Corporate Environmental Health and Safety Office at 724 539 5066 or fax 724 539 5372.

Kennametal, the stylized K, DUO-LOCK, GDrill, HARVI, HydroForce, KenCut, KenFeed, KenReam, Kenna Universal, KenTIP, KM, KM4X, KOR, KOR5, KOR6, KSEM, KSEM PLUS, MaxiMet, NOVO, RSM II, Stellite, and Y-TECH are trademarks of Kennametal, Inc. and are used as such herein. The absence of a product, service name, or logo from this list does not constitute a waiver of the Kennametal trademark or other intellectual property rights concerning that name or logo.

Android™ is a trademark of Google Inc.

App Store® is a registered trademark of Apple Inc., registered in the U.S. and other countries.

Google Play™ is a trademark of Google Inc.

Hardox® is a registered trademark of SSAB Technology AB Corporation.

Hastelloy® and Haynes® are registered trademarks of Haynes International, Inc. Corporation.

Hostalen™ is a trademark of Hoechst GmbH Corporation.

INCONEL® and NIMONIC are registered trademarks of Special Metals Corporation.

LEXAN® is a registered trademark of Sabic Innovative Plastics IP B.V. Company.

MAKROLON® is a registered trademark of Covestro Deutschland AG.

Polystyrol® is a registered trademark of BASF SE.

SAFE-LOCK® is a registered trademark and Safe-Lock™ is a trademark of Haimer GmbH.

Weldon® is a registered trademark of Weldon Tool Company.

©2022 Kennametal Inc. All rights reserved.



INNOVATIONS

WORLD HEADQUARTERS

Kennametal Inc.

525 William Penn Place | Suite 3300
Pittsburgh, PA 15219 USA
Tel: 1 800 446 7738
ftmill.service@kennametal.com

EUROPEAN HEADQUARTERS

Kennametal Europe GmbH

Rheingoldstrasse 50
CH 8212 Neuhausen am Rheinfall
Switzerland
Tel: +41 52 6750 100
neuhausen.info@kennametal.com

ASIA-PACIFIC HEADQUARTERS

Kennametal Singapore Pte. Ltd.

3A International Business Park
Unit #01-02/03/05, ICON@IBP
Singapore 609935
Tel: +65 6265 9222
k-sg.sales@kennametal.com

INDIA HEADQUARTERS

Kennametal India Limited

CIN: L27109KA1964PLC001546
8/9th Mile, Tumkur Road
Bangalore - 560073
Tel: +91 080 22198444 or +91 080 43281444
bangalore.information@kennametal.com



[kennametal.com](https://www.kennametal.com)