



Makita

2022

SORTIMENT PRÍSLUŠENSTVA

Platnosť od 1. 5. 2022

do 31. 3. 2023



Sortiment aku strojov do záhrady

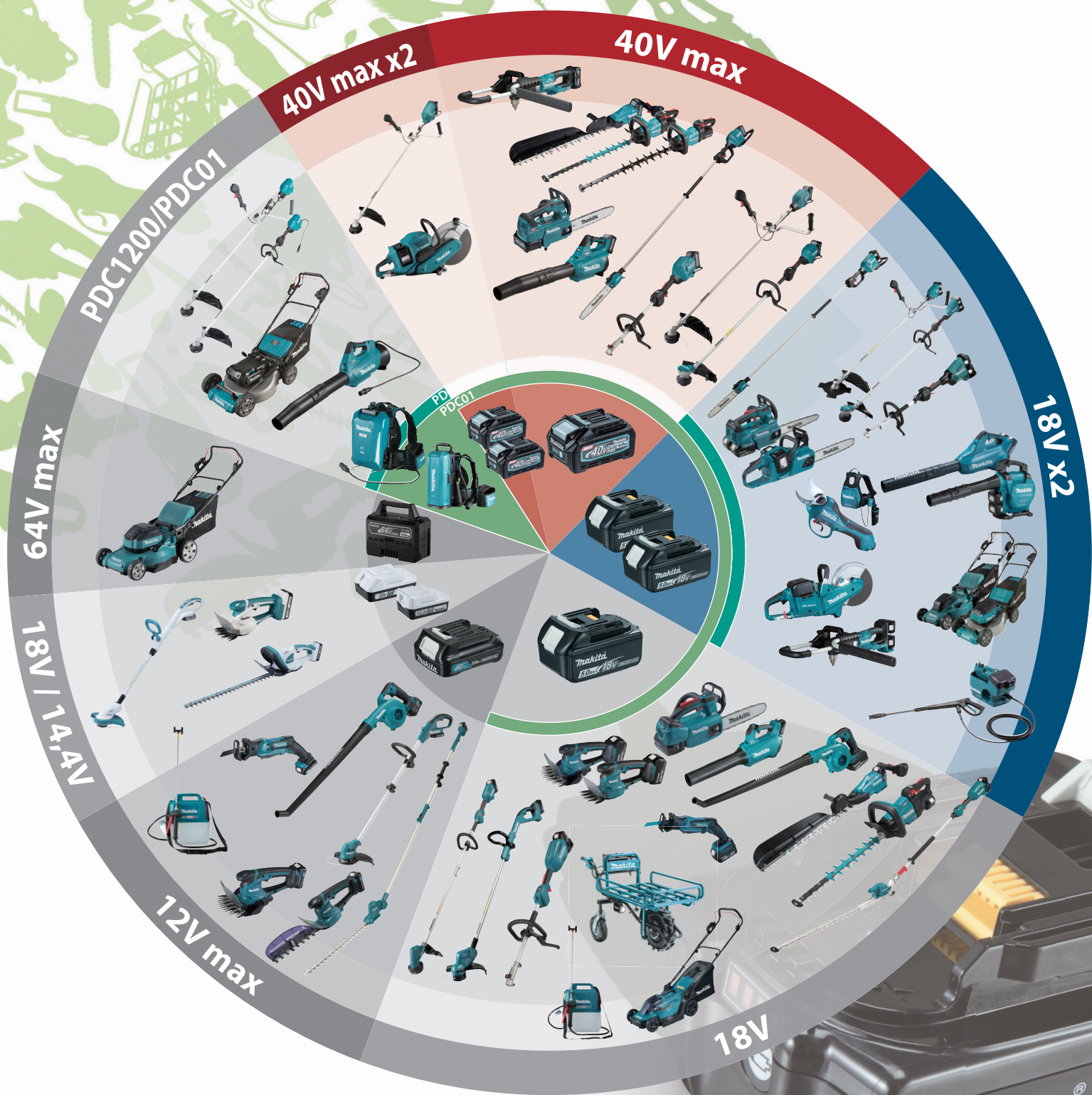

OBSAH

Akumulátory

Nabíjačky, sady akumulátorov, akumulátorové adaptéry, AC adaptéry pre rádia a ventilátory	7 – 11
--	--------

Odkladacie systémy

MAK PAC kufre	13 – 14
Kufre	15
Vnútra systainerov, tašky, opasky	16 – 20

Vrtanie

Kov	21 – 30
Sklo, murivo, kameň	31
Drevo	32 – 37
Vykružovacie korunky	39 – 44
Vrtáky s valcovitou stopkou betón, murivo, kameň	45 – 46
Príklepové vrtáky SDS-PLUS	48 – 52
Príklepové vrtáky SDS-MAX	53 – 54

Sekanie

Sekáče SDS-PLUS	55
Sekáče SDS-MAX	56
Sady sekáčov SDS-PLUS /	57
Sekáče rôzne upínania	58
Príslušenstvo pre vrtacie a sekacie kladivá, rukoväte, skľučovadlá, dorazy	59
Príslušenstvo k vrtáčkam, skľučovadlá, kľúče pre skľučovadlá	60 – 61
Príslušenstvo pre diamantové vrtanie DBM080/130/131/230	62 – 65

Skrutkovanie

Bity Impact PREMIER	68
Bity Impact BLACK	69
Bity, sady bitov	70 – 74

Príslušenstvo pre skrutkovače

Skrutky, bity	75 – 76
Príslušenstvo pre rázové uťahováky	77 – 78

Diamantové rezanie a brúsenie

Diamantové rezanie a brúsenie	80 – 84
Príslušenstvo pre nožnice na plech, závitových tyčí a roxorov	85
Rezné kotúče	86

Brúsne kotúče	87
---------------	----

Lamelové kotúče	90 – 91
-----------------	---------

Fibrové kotúče	92
----------------	----

Príslušenstvo pre Multi Tool	94 – 104
------------------------------	----------

Brúsne kefy	107 – 111
-------------	-----------

Príslušenstvo pre uhlové brúsky, príruby, rukoväte, kľúče, odsávacie adaptéry, kryty kotúčov	112 – 113
---	-----------

Pílové kotúče

EFFICUT drevo	117
EFFICUT železo	118
EFFICUT WPC dosky	118
Makforce	119 – 120
Makblade	121 – 122
Špeciálne pre aku píly	123 – 124
Na hliník	125
Pre ponorné píly	126
Na cementové dosky sendvičové panely	127
Príslušenstvo pre kotúčové a pokosové píly dorazy, odsávacie adaptéry, vodiace lišty, adaptéry pre vodiace lišty	128 – 130
Stoly pod pokosové píly	131

Príslušenstvo pre priamočiare a chvostové píly

Pílové listy	134 – 146
Príslušenstvo pre pásové píly	147
Príslušenstvo pre hoblíky	148

Frézovanie

Frézky	149 – 163
Príslušenstvo pre frézy klieštiny, objímky	164 – 167

Brúsenie

Brúsne papiere	169 – 182
Príslušenstvo pre DSL800/801	182

Príslušenstvo pre leštičky	183
Príslušenstvo pre vibračné brúsky	184
Príslušenstvo pre priame brúsky	185

Príslušenstvo pre dvojkotúčovú brúsku	185
--	-----

Príslušenstvo pre kefovú brúsku 9741	186
---	-----

Spony	187
-------	-----

Klince	188 – 190
--------	-----------

Príslušenstvo pre DCG180, DTR180, DMP180, MP100, DGP180	191
---	-----

Príslušenstvo pre dierovač DPP200	192
--------------------------------------	-----

Príslušenstvo pre nitovačky DVR150, 250	193
--	-----

Benzínová rozbrusovačka	194
-------------------------	-----

Lasery	194
--------	-----

Príslušenstvo vysávače adaptéry	195 – 200
------------------------------------	-----------

Odsávacie adaptéry	201 – 202
--------------------	-----------

Vaky na prach	203
---------------	-----

Odsávacie adaptéry pre vrtacie a sekacie kladivá	204
---	-----

Pripojenie stroja k vysávačom	205 – 211
----------------------------------	-----------

Teplovzdušné pištole	212
----------------------	-----

Príslušenstvo pre lampy, aku kávovar	213
---	-----

Záhrada	214 – 254
---------	-----------

Ručné náradie	255 – 261
---------------	-----------

Ostatné príslušenstvo kufre, spony pre kufre	262 – 269
---	-----------

Uhlíky	270 – 272
--------	-----------





Impact
PREMIER



PIKTOGRAMY



Drevo



Profily



Koža



Odstraňovanie farby



Drevo s klincami



Nehrdzavejúca oceľ



Vystužené vlákna



Čistý rez



Preglejka



Neželezné kovy



Vlnitý plech



Dlhá životnosť



Izolačné materiály



Bi-metal



Guma



Zvárané laserom



Laminátová podlaha



Plexisklo



Podložka



Okružná píla



Lepené drevo / škárovka



Medené rúry



Izolačný materiál



Ponorná píla



Dosky z vlákniťého cementu



PVC



Nie je vhodný pre izolačné materiály



Pokosová píla



DVD dosky



Sklo



Čistý rez



Skracovacia píla



Lepené podlahy drevené



Keramické obklady



Hrubý rez



Stolová píla



DVD dosky



Tehla



Krivý rez



Vibračná brúska



MDF



Tehla / kameň



Rovný rez



Vibračná brúska



Palety



Duté tehly



Pozdĺžny rez



Pásová brúska



Laminátová podlaha



Vápenec



Priečny rez



Benzínová rozbrusovačka



Sendvičové panely



Železobetón



Dierovaný brúsny papier



Excentrická brúska



Kov / oceľ



Betón



Brúsny papier



Uhlová brúska



Hliník



Pórobetón



Suchý zip



Delta brúska



Kov / mäkká oceľ



Polystyrén



Štetec



Uhlová brúska



1/2 BSP Fitting



5/4 UNC



Používať na sucho



Používať s vodou



Nepoužívať režim kladiva



Pre kladivá SDS-PLUS



Pre kladivá SDS-MAX

Akumulátory Lithium-Ion

Obj. č.	Model	MOC s DPH
XGT 40 V max akumulátory		
	191L29-0 BL4020 (40 V 2,0 Ah)	134,99 €
	632R35-7 BL4020 (40 V 2,0 Ah)	119,99 €
	191B36-3 BL4025 (40 V 2,5 Ah)	149,99 €
	191B26-6 BL4040 (40 V 4,0 Ah)	209,99 €
	191L47-8 BL4050 (40 V 5,0 Ah)	259,99 €
LXT 18 V akumulátory		
	196235-0 BL1815N (18 V 1,5 Ah)	64,99 €
	632F01-2 BL1820 (18 V 2,0 Ah)	69,99 €
	632G12-3 BL1830B (18 V 3,0 Ah)	64,99 €
	632F15-1 BL1850B (18 V 5,0 Ah)	89,99 €
	632F69-8 BL1860B (18 V 6,0 Ah)	99,99 €
CXT 12 V max akumulátory		
	197393-5 BL1016 (12 V 1,5 Ah)	32,99 €
	197396-9 BL1021B (12 V 2,0 Ah)	39,99 €
	197406-2 BL1041B (12 V 4,0 Ah)	56,99 €
G – séria		
	198186-3 BL1815G (18 V 1,5 Ah)	49,99 €
	198192-8 BL1415G (14,4 V 1,5 Ah)	44,99 €
10,8 V – séria		
	196066-7 BL1013 (10,8 V 1,3 Ah)	34,99 €
7,2 V – séria		
	198000-3 BL7010 (7,2 V 1,3 Ah)	39,99 €
Atrapy / kryty akumulátorov		
Z74144-2	Atrapa BL1041B CXT	0,00 €
Z86060-0	Atrapa BL1860B LXT	17,49 €
Z74152-0	Atrapa BL4040 XGT	18,69 €
412393-7	Kryt akumulátor XGT	0,19 €
450128-8	Kryt akumulátor LXT	0,29 €
456128-6	Kryt akumulátor CXT	0,40 €

AKUMULÁTORY: AKUMULÁTORY, NABÍJAČKY



Obj. č.	Model	MOC s DPH
---------	-------	-----------



Sady akumulátorov		
191U00-8	Sada XGT 2 × BL4040 + DC40RB	619,99 €
191J97-1	Sada XGT 2 × BL4040 + DC40RA	539,99 €
191J81-6	Sada XGT 2 × BL4025 + DC40RA	419,99 €
197629-2	Sada LXT 2 × BL1850B + DC18RD	339,99 €
197626-8	Sada LXT 4 × BL1850B + DC18RD	539,99 €
198077-8	Sada LXT 2 × BL1860B + DC18RD	369,99 €
198091-4	Sada LXT 4 × BL1860B + DC18RD	599,99 €

Akumulátory Makstar Ni-MH		
193930-3	BH1233C (12 V 3,1 Ah)	129,99 €
193739-3	BH2433 (24 V 3,1 Ah)	199,99 €

Nabíjačky		
191N09-8	DC40RB XGT dvojportová rýchlonabíjačka	219,99 €
191E07-8	DC40RA XGT jednoportová rýchlonabíjačka	129,99 €
196426-3	DC18SF LXT štvorportová nabíjačka	199,99 €
630868-6	DC18RD LXT dvojportová rýchlonabíjačka	119,99 €
196933-6	DC18RD LXT dvojportová rýchlonabíjačka	139,99 €
195584-2	DC18RC LXT jednoportová rýchlonabíjačka	59,99 €
198720-2	DC18RE LXT/CXT dvojportová rýchlonabíjačka	109,99 €
197363-4	DC10SB CXT jednoportová nabíjačka	49,99 €
194588-1	DC10WAc jednoportová nabíjačka	39,99 €
195423-6	DC18WA G-séria jednoportová nabíjačka	29,99 €



LI-ION AKUMULÁTORY A NABÍJAČKY

40Vmax		18V	Fast Charging DC40RA DC40RB*	DC40RC	Fast Charging DC40RA + ADP10 Kompatibilné s LXT	DC40RC + ADP10 Kompatibilné s LXT	Fast Charging DC18RC DC18RD* DC18RE**	DC18SF Except BL1430A	DC18SD DC18SH* DC18SE (Automotive)
XGT 40Vmax Lithium-ion	8,0Ah BL4080F	76min.	170min.	-	-	-	-	-	
	5,0Ah BL4050F	50min.	85min.	-	-	-	-	-	
	4,0Ah BL4040	45min.	67min.	-	-	-	-	-	
	2,5Ah BL4025	28min.	38min.	-	-	-	-	-	
	2,0Ah BL4020	22min.	30min.	-	-	-	-	-	
LXT 18V Lithium-ion	6,0Ah BL1860B	-	-	40min.	85min.	55min.	1 do 2 aku 130 min.	3 do 4 aku 260 min.	130min.
	5,0Ah BL1850B	-	-	35min.	70min.	45min.	110 min.	220 min.	110min.
	4,0Ah BL1840B	-	-	29min.	58min.	36min.	90 min.	180 min.	90min.
	3,0Ah BL1830B	-	-	22min.	42min.	22min.	60 min.	120 min.	60min.
	2,0Ah BL1820B	-	-	24min.	33min.	24min.	45 min.	90 min.	45min.
	1,5Ah BL1815N	-	-	15min.	22min.	15min.	30 min.	60 min.	30min.
CXT 12Vmax Lithium-ion	4,0Ah BL1041B	60min.	130min.	 40Vmax Lithium-ion 18V x2 Lithium-ion	360min.	 40Vmax Lithium-ion 18V x2 Lithium-ion 18V Lithium-ion	Možné použiť so 4 ks 18V LXT aku		
	2,0Ah BL1021B	30min.	70min.						
	1,5Ah BL1016	22min.	50min.						
64Vmax Lithium-ion	4,0Ah BL6440	120min.	10,8V Lithium-ion 7,2V Lithium-ion	1,3Ah BL1013 1,5Ah BL0715	50min. 35min.	18V Lithium-ion 14,4V Lithium-ion	1,5Ah BL1415G BL1815G 2,0Ah BL1420G BL1820G	70 min. 90 min.	80 min. 105 min.

*DC40RB / DC18RD / DC18SH: Dvojnabíjačka

**DC18RE: CXT & LXT Duálna nabíjačka

AKUMULÁTORY: ADAPTÉRY A PRÍSLUŠENSTVO

ADAPTÉRY

ADAPTÉR ADP10 Adaptér ADP10 XGT nabíjačky pre LXT akumulátory	191C10-7 46,99 € (MOC s DPH)		ADAPTÉR 36V BAP36N Predlžovací adaptér 36V BAP36, nie je možné použiť na 36V krovinozez	195311-7 39,99 € (MOC s DPH)	
ADAPTÉR ADP04 adaptér pre 24V	193947-6 34,99 € (MOC s DPH)		ADAPTÉR 18 V ADP05 USB ADAPTÉR 18 V LXT pre nabíjanie mobilných zariadení	DECADP05 24,99 € (MOC s DPH)	
USB ADAPTÉR 12V Max CXT USB ADAPTÉR 12V Max CXT pre nabíjanie telefónov	ATAADP06 26,99 € (MOC s DPH)		ADAPTÉR 2x18V na 36V BCV03 Adaptér 2x18V na 36V, nie je možné použiť pre akumulátory BL1815 a 36V krovinozez	196809-7 84,99 € (MOC s DPH)	
ADAPTÉR 12V MAX Adaptér pre vyhrievané bundy / vesty CXT 12V MAX	YL00000003 29,99 € (MOC s DPH)		Adaptér 1 x 40 V XGT	191N62-4 172,49 € (MOC s DPH)	
ADAPTÉR 18V Adaptér pre vyhrievané bundy / vesty LXT 18V	YL00000004 28,99 € (MOC s DPH)		ADAPTÉR Adaptér pre PDC01, PDC1200 2x18V	191J51-1 cena na vyžiadanie (MOC s DPH)	
ADAPTÉR 12V MAX Adaptér pre chladiace bundy 12V MAX	GM00001605 32,99 € (MOC s DPH)		ADAPTÉR PDC01 Prenosný napájací zdroj pre 4 akumulátory LXT 18V	191A64-2 599,99 € (MOC s DPH)	
ADAPTÉR 14,4 / 18V Adaptér pre chladiace bundy	GM00001607 34,99 € (MOC s DPH)		ADAPTÉR Adaptér pre PDC01 1x18V	191J50-7 159,99 € (MOC s DPH)	
ADAPTÉR BTC05 Adaptér XGT pre tester batérií BTC04	191K30-9 84,99 € (MOC s DPH)		ADAPTÉR Adaptér pre PDC01 1x18V	191J50-7 159,99 € (MOC s DPH)	
PRENOSNÝ NAPÁJACÍ ZDROJ PDC1200A01 Prenosný napájací zdroj so zabudovanou batériou s kapacitou 1200 Wh, 33,5 Ah a napätím 36 V – 40 V max. Dodávané s nabíjačkou DC4001 a s adaptérom 2 x 18 V 191J51-1	PDC1200A01 1 699,99 € (MOC s DPH)		NABÍJAČKA DC4001 nabíjačka pre PDC1200	191L00-4 149,99 € (MOC s DPH)	

Kapacita batérie sa meria v súlade so smernicou o batériách 2006/66 / ES a predpismi EÚ 11. 3. 2010. Li-ion IEC61960.

AC ADAPTÉR LAMPY, RÁDIA, VENTILÁTORY



pre model	Obj. č.	MOC s DPH
DMR 106, DRM 108, DMR112	SE00000101	22,99 €
DMR110, MR003G	SE00000265	18,39 €
DMR114, DMR115, MR002G, MR004G, MR006G, MR007G	SE00000679	36,69 €
DMR200, DMR202	SE00000501	13,49 €
DMR203	SE00000792	14,89 €
MR001G, DMR107, BMR100	SE00000078	23,39 €
CF100	TE00000211	17,69 €
CF001G, DCF203	TE00000173	25,69 €
CF002G	TE00000442	cena na vyžiadanie
DCF300	TE00000174	37,49 €
DMR300, DMR301	TC00000137	cena na vyžiadanie

Makpac systainery

Inteligentný spôsob ukladania strojov a príslušenstva. Systém spojovacích systainerov MakPac sa skladá zo štyroch výškovo odlišných systainerov, troch systainerov na náradie, dvoch chladiacich systainerov a dvoch transportných vozíkov. Púzdra môžu byť ukladané na seba a uzamknuté spolu s uzamykacími západkami. K dispozícii sú tiež vložky pre vaše náradie a príslušenstvo.

Prepojené systainery zaberajú menej úložného priestoru a ľahko sa prepravujú na pracovisko a z neho.



MAKPAC	
<p>Typ 1 821549-5 28,19 € (MOC s DPH)</p> <p>396 × 296 × 105 mm PCV</p>  	<p>Typ 2 821550-0 30,19 € (MOC s DPH)</p> <p>396 × 296 × 157 mm PVC</p>  
<p>Typ 3 821551-8 39,79 € (MOC s DPH)</p> <p>396 × 296 × 210 mm PVC</p>  	<p>Typ 4 821552-6 54,79 € (MOC s DPH)</p> <p>396 × 296 × 315 mm PVC</p>  
<p>Typ 3 chladiaci box 198254-2 90,89 € (MOC s DPH)</p> <p>396 × 296 × 210 mm PVC objem 11L Kompatibilné s Makpac ramenným popruhom</p>   <p>11L   </p>	<p>Typ 4 chladiaci box 198253-4 98,29 € (MOC s DPH)</p> <p>396 × 296 × 210 mm PVC objem 18L Kompatibilné s Makpac ramenným popruhom</p>   <p>18L   </p>
<p>Box na náradie malý P-83836 cena na vyžiadanie (MOC s DPH)</p> <p>396 × 296 × 145 mm PVC</p>  	<p>Box na náradie veľký P-83842 77,99 € (MOC s DPH)</p> <p>396 × 296 × 325 mm PVC</p>  
<p>Box rozkladací P-84137 110,49 € (MOC s DPH)</p> <p>396 × 296 × 234 mm PVC</p>  	<p>Držiak systainera na VC4210 W107418357 32,89 € (MOC s DPH)</p> <p>Pre vysávač VC4210M</p>  
<p>Penová vložka systainera 198978-0 7,01 € (MOC s DPH)</p> 	

MAKPAC

<p>Typ 3 so 4 zásuvkami</p> <p>396 × 296 × 210 mm</p>	<p>P-84311 182,69 € (MOC s DPH)</p> 	<p>Typ 3 s 12 zásuvkami</p> <p>396 × 296 × 210 mm</p>	<p>P-84327 222,49 € (MOC s DPH)</p> 
<p>Typ 3 so 6 zásuvkami</p> <p>396 × 296 × 210 mm</p>	<p>P-84333 208,99 € (MOC s DPH)</p> 	<p>Typ 4 s 5 zásuvkami</p> <p>396 × 296 × 315 mm</p>	<p>P-84349 254,49 € (MOC s DPH)</p> 
<p>Klip na kufor</p> <p>pre všetky typy systainerov</p>	<p>453974-8 0,72 € (MOC s DPH)</p>  	<p>Popruh jednoramenný</p>	<p>196817-8 4,52 € (MOC s DPH)</p>  
<p>Organizér farebný PVC</p> <p>vhodný pre systainer typ 1</p>	<p>P-83652 35,09 € (MOC s DPH)</p>  	<p>Typ 4</p> <p>vhodný pre systainery typ 1, 2, 3, 4</p>	<p>P-83680 15,99 € (MOC s DPH)</p>  
<p>Organizér čierny PVC</p> <p>vhodný pre systainery typ 1, 2, 3, 4</p>	<p>P-83696 16,29 € (MOC s DPH)</p>  	<p>Vozík pre systainer</p> <p>transportný skladací vozík s kolieskami a zaistovacím popruhom</p>	<p>TR0000001 164,69 € (MOC s DPH)</p>  
<p>Vozík pre systainer</p> <p>transportný vozík na štyroch otočných kolieskach, aretácia na dvoch kolieskach, klipy na zaistenie systainera</p>	<p>P-83886 136,99 € (MOC s DPH)</p>  	<p>Taška pre RT0700</p> <p>410 × 350 × 310 mm odolná taška na náradie, vnútorné prepážky pre nástavce, popruh na rameno</p>	<p>831327-5 40,59 € (MOC s DPH)</p> 
<p>Klip zaistovací pre vozík 80591012 6,99 €</p>			

KUFRE PRE STROJE MAKITA

Obj. č.	Model	Materiál	MOC s DPH	Obj. č.	Model	Materiál	MOC s DPH
---------	-------	----------	-----------	---------	-------	----------	-----------





Kufre pre akumulátorové stroje			
824652-1	6270DWPE3	PVC	13,68 €
824698-7	6904, 6905B	PVC	28,66 €
153859-5	6935FD, 6980FD	PVC	40,97 €
154902-3	6936FDWAE	PVC	34,90 €
141485-2	BCS550, BSS500, BSS501,	PVC	24,79 €
141358-9	BDA350, BDA341, BDA351, BPB180	PVC	42,99 €
158597-4	BDF445, BHP452, BDF452, BDF442, BHP442, DHP480, DDF480	PVC	19,39 €
141856-3	BDF456, BHP456	PVC	18,59 €
140392-6	BFS450, BFS440,	PVC	29,11 €
141257-5	DGA452/450	PVC	21,79 €
824975-7	BGD800	PVC	21,06 €
158777-2	BHP453, BDF343, BHP343	PVC	20,29 €
824861-2	BHR202	PVC	23,79 €
141643-0	BHR240, BHR241	PVC	27,39 €
824874-3	BHR261	PVC	64,39 €
141354-7	BJR181, BJR182	PVC	22,39 €
153566-0	BJR240	PVC	cena na vyžiadanie
141486-0	BJV140, BJV180	PVC	28,89 €
824982-0	DKP180, BKP180, DK1893	PVC	59,39 €
141496-7	BPB180	PVC	86,00 €
141074-3	BPT350, BHR162, BST221	PVC	29,04 €
153612-9	BSR730S	PVC	57,35 €
141205-4	BTD140, BTW251, BTP130, BTD132, BTP140, BDF450, BTD130	PVC	27,39 €
141493-3	BTL060, BTL061, BTL062, BTL063	PVC	64,29 €
141487-8	BTW150SA, BTW151SA	PVC	25,68 €
824777-1	BTW450, DTW450	PVC	52,49 €
141494-1	BUC121, BUC122	PVC	76,59 €
821766-7	DVR350	PVC	cena na vyžiadanie
A84384-3	CL Kits	PVC	cena na vyžiadanie
824627-0	DA312, DA392, DA391	PVC	19,56 €
824550-9	DA391D, HR160D	PVC	cena na vyžiadanie
824842-6	DF030D, DF011D, TD090, DF330	PVC	10,59 €
831362-3	DF330DWXP	PVC	14,96 €
824958-7	GA9020/7020	PVC	37,79 €
824708-0	HM0860C	PVC	45,89 €
823308-3	LCT204, LCT303	Hliník	25,42 €
140354-4	LXT202, LXT232, BDF441, BDF451, BHP451, BHP441, BDF450	PVC	34,39 €
831276-6	TD020DSE	látková taška	13,09 €
141353-9	DSS611, DSS610	PVC	24,09 €
141352-1	BFR540, BFR550, BFR750	PVC	47,39 €
824852-3	8271D, 8281D, 8381D	PVC	16,19 €
821737-4	DDA460	PVC	45,24 €
452198-3	DUM165	PVC	1,19 €
821746-3	DHR400	PVC	46,32 €
821725-1	DTR180	PVC	cena na vyžiadanie
832074-1	DLX2248PT1	látková taška	12,62 €
143644-4	TD30D/TM30D	PVC	25,24 €

Kufre pre akumulátorové stroje			
824540-2	3901	PVC	34,79 €
153603-0	8406	PVC	37,48 €
824944-8	1902, 1923B, 1923H	PVC	54,09 €
824002-0	2012NB	PVC	2,69 €
824809-4	4351	PVC	20,59 €
824554-1	5703R	PVC	84,79 €
824651-3	5704RK	PVC	18,23 €
824439-1	6904vh	PVC	26,90 €
824522-4	8406C, 8406	PVC	44,73 €
824985-4	9553NB/9555NB	PVC	18,19 €
824562-2	BTW150SA	PVC	21,19 €
824591-5	BO6040	PVC	24,39 €
824646-6	DA4000LR	PVC	39,26 €
84001020	DBM131	PVC	cena na vyžiadanie
824875-1	GN900SE	PVC	58,00 €
824523-2	HK0500	PVC	38,09 €
150879-0	HM0810	PVC	49,52 €
824905-8	HM0870, HM0871	PVC	38,69 €
150583-1	HM1200K	PVC	45,17 €
824826-4	HM1304/B	Kov	115,89 €
824897-1	HM1317C / CB	PVC	166,89 €
824811-7	HP1631K	PVC	25,09 €
824923-6	HP1640K, HP1641K	PVC	20,59 €
824608-4	HP2040, HP2041	PVC	33,96 €
824650-5	HR1830, HP2050, HP2051, HP2070, HP2071, HR2020, HR2440, HR2450	PVC	13,69 €
824799-1	HR2230, 2460, 2470	PVC	17,49 €
824789-4	HR2811	PVC	17,29 €
824825-6	HR3210CT/SMK	PVC	82,49 €
824539-7	JR3060T, JR3070CT	PVC	10,35 €
821621-3	JR3050T	PVC	18,69 €
824892-1	KP0800	PVC	15,79 €
181789-0	PC1100	Kov	66,09 €
140073-2	PC5000C	Kov	106,19 €
824880-8	RP0900	PVC	17,65 €
824709-8	SG1250	PVC	52,99 €
824703-0	TW0200/ 250	PVC	15,39 €
824702-2	TW0350	PVC	25,89 €
824737-3	TW1000	PVC	56,49 €
824998-5	JV0600K	PVC	15,89 €
98C360	RP801X/RP2301X	PVC	cena na vyžiadanie
824908-2	HM1213	PVC	63,99 €
824559-1	HR3000C	PVC	130,69 €
150582-3	HR5000K/HR38	PVC	74,73 €
824519-3	HR5001C	PVC	73,99 €
824786-0	KP0810	PVC	51,19 €
Iné			
824841-8	AN943	PVC	cena na vyžiadanie
Univerzálne			
P-04101	univerzálny kufor pre skrutkovače a kladivá do 2 kg – 92 × 450 × 250 mm	Kov	66,49 €
824964-2	univerzálny kufor 330 × 460 × 350 mm	PVC	58,99 €
140561-9	HM1111C	PVC	129,99 €

Taška pre stroje **831279-0** **64,39 €** (MOC s DPH)

700 × 360 × 380 mm
odolná taška na náradie a príslušenstvo z nylónového materiálu, priestrané vnútorné vrecká



	kufor Raaco	P-78623	K	88,03 €
	Kufor kombinovaný pre uhlové brúsky s ø 230 mm a ø 125 mm	824984-6	K	49,59 €

KUFRE: VNÚTRA SYSTEMEROV

Obj. č.	Model	Materiál	MOC s DPH
Typ 1 : 821549-5			
837664-5	JR100DWJ, JR102DWJ, JR102DZJ	PVC	5,33 €
837665-3	JV100DWJ, JV100DZJ	PVC	6,99 €
837695-4	DA330DWJ, DA330DZJ, DA331DWJ, DA331DZJ	PVC	6,58 €
837696-2	DK1481J, DK1482J	PVC	4,24 €
837803-7	4327J, 4329J, 4350CTJ, 4350FCTJ, 4350TJ, 4351CTJ, 4351FCTJ, 4351TJ, JV0600J	PVC	3,81 €
837866-3	DF030DWJ, DF030DWJX1, DF030DWLJ, DF030DZJ, DF330DWJ, DF330DWJX2, DF330DWLJ, DF330DWLJ1, DF330DZJ, HP330DWJ, HP330DWLJ, HP330DZJ, TD090DWJ, TD090DWJX1, TD090DZJ, TW100DWJ	PVC	5,62 €
837867-1	DK1488J	PVC	4,30 €
837869-7	6904VJ, 6952J, 6953J, TW0200J	PVC	4,89 €
837871-0	DF010DSJ, DF010DZJ, TD021DSJ	PVC	4,74 €
837872-8	6822J, DP4700J	PVC	4,95 €
837875-2	LCT204J, LCT303JX	PVC	4,24 €
837876-0	6842J, 6842JX, 6843J, 6843JX	PVC	4,86 €
837880-9	DA3010FJ, DA3011FJ	PVC	4,95 €
837881-7	JR1000FTJ	PVC	7,08 €
837882-5	JN1601J, JS1602J	PVC	4,79 €
837895-6	3706J	PVC	cena na vyžiadanie
838027-8	JS1000J, JS1601J	PVC	5,45 €
838030-9	6413J, DP2010J, DP2011J, FS2300J, FS2500J, FS2700J, FS4000J, FS4300J, FS6300J	PVC	4,49 €
838038-3	HP1630J, HP1631J, HP1640J, HP1641FJ, HP1641J	PVC	5,89 €
838039-1	DP3003J, DP4001J, DP4003J, DP4011J, HP2051FHJ, HP2051FJ, HP2051HJ, HP2051J, HP2071FJ, HP2071J	PVC	4,79 €
838062-6	DC0180Y1J, DC0180ZJ	PVC	7,99 €
838312-9	DF031DSAJ, DF031DSMJ, DF031DY1J, DF032DSAJ, DF032DSMJ, DF032DY1J, DF032DZJ, DF331DSAJ, DF331DSMJ, DF331DY1J, DF332DSAJ, DF332DSMJ, DF332DY1J, DF332DZJ, HP331DSAJ, HP331DSMJ, HP331DY1J, HP332DSAJ, HP332DSMJ, HP332DY1J, HP332DZJ, TD110DSAJ, TD110DSMJ, TD110DY1J, TW140DWAE, TW140DZ, TW060DWAE, TW060DZ, TW161DSAJ, TW161DZ, TW160DSAJ, TW160DZ, TW141DWAE, TW141DZ	PVC	3,69 €
838313-7	JR103DSAJ, JR103DSMJ, JR103DY1J, JR105DSMJ	PVC	6,04 €
838439-5	CLX201SAJ, CLX201SMJ, CLX400SAJ1	PVC	4,49 €
838563-4	JV101DSAJ, JV101DSMJ, JV101DY1J	PVC	4,85 €
839742-7	vnútro pre 8 x 18 V LXT akumulátory		3,19 €
838110-1	vnútro pre nabíjačku DC18RC + 4 x 18 V LXT akumulátory	PVC	7,54 €
Typ 3 : 821551-8			
837628-9	DCS550RFJ, DCS550RMJ, DCS550RTJ, DCS550Y1J, DCS550ZJ, DSS500RFJ, DSS500RMJ, DSS500Y1J, DSS500ZJ, DSS501RFJ, DSS501RMJ, DSS501RTJ, DSS501Y1J, DSS501ZJ, DCS552RTJ, DCS552Z	PVC	4,49 €
837631-0	DFR440RFJ, DFR440ZJ, DFR450RMJ, DFR540RFJ, DFR540RMJ, DFR540ZJ, DFR550RFJ, DFR550RFJX, DFR550RMJ, DFR550RMJX, DFR550RTJ, DFR550Y1J, DFR550ZJ	PVC	5,25 €
837634-4	DHR202RFJ, DHR202RMJ, DHR202RTJ, DHR202Y1J, DHR202ZJ	PVC	6,01 €
837641-7	DHR241RFJ, DHR241RMJ, DHR241RTJ, DHR241ZJ	PVC	5,78 €
839387-1	DHR171RMJ	PVC	3,72 €
837642-5	DSS610RFJ, DSS610RMJ, DSS610RTJ, DSS610Y1J, DSS610ZJ	PVC	5,95 €
837645-9	DTW1001RFJ, DTW1001RMJ, DTW1001RTJ, DTW1001ZJ, DTW1002RFJ, DTW1002RMJ, DTW1002RTJ, DTW1002ZJ, DTW450RFJ, DTW450RMJ, DTW450RTJ, DTW450Y1J, DTW450ZJ, DTW800RFJ, DTW800RMJ, DTW800RTJ	PVC	4,32 €
837648-3	DPJ140RFJ, DPJ140RMJ, DPJ140ZJ, DPJ180RFJ, DPJ180RMJ, DPJ180RTJ, DPJ180Y1J, DPJ180ZJ	PVC	6,59 €
837652-2	9403J	PVC	6,82 €
837653-0	9404J	PVC	4,48 €
837654-8	B06030J, B06030JX	PVC	3,83 €
837655-6	B06040J	PVC	4,89 €
837658-0	9910J, 9911J	PVC	4,63 €
837659-8	KP0800J, KP0810CJ, KP0810J	PVC	6,60 €
837660-3	RP0910JFA, RP1110CJFA	PVC	5,31 €
837661-1	PJ7000J	PVC	5,18 €
837671-8	DLX2154TJ1, DTM40RFJ, DTM40ZJ, DTM40RFJ, DTM40RFJX3, DTM40RMJ, DTM40RMJ1J4, DTM40ZJ, DTM40ZJX3, DTM41RFJ, DTM41RMJ, DTM41RMJ1J3, DTM41RMJX3, DTM41Y1J, DTM41ZJ, DTM50RFJ, DTM50RFJX1, DTM50RFJX2, DTM50RFJX3, DTM50RFJX4, DTM50RFJX6, DTM50RMJ, DTM50RMJ1J4, DTM50RMJX2, DTM50ZJ, DTM50ZJX1, DTM50ZJX2, DTM50ZJX4, DTM51RFJ, DTM51RFJX3, DTM51RFJX6, DTM51RMJ, DTM51RMJ1J3, DTM51RMJX1, DTM51RMJX2, DTM51RMJX3, DTM51RTJ, DTM51RTJ1J3, DTM51RTJX2, DTM51Y1J, DTM51ZJ, DTM51ZJX1, DTM51ZJX2, DTM51ZJX3, DTM51ZJX8	PVC	5,17 €
837678-4	DJN160RFJ, DJN160RMJ, DJN160ZJ, DJN161RFJ, DJN161RMJ, DJN161RTJ, DJN161Y1J, DJN161ZJ	PVC	6,58 €
837789-5	DJV141RFJ, DJV141RMJ, DJV141ZJ, DJV141Y1J, DJV141ZJ, DJV181RFJ, DJV181RMJ, DJV181RTJ, DJV181Y1J, DJV181ZJ	PVC	6,66 €
837808-7	DKP180RFJ, DKP180RMJ, DKP180RTJ, DKP180Y1J, DKP180ZJ	PVC	6,58 €
837864-7	DK1817J, DLX2000MJ, DLX2000TJ, DLX2001MJ, DLX2003MJ, DLX2005JX1, DLX2006JX1, DLX2012JX1, DLX2014J, DLX2014JX, DLX2014MJ, DLX2014MJX, DLX2015MJX, DLX2022AJ, DLX2022CJ, DLX2022YJ, DLX2061MJ1, DLX2121AJ, DLX2121J, DLX2127MJ, DLX2127MJ1, DLX2141AJ, DLX2131JX1, DLX2173TJ, DLX2283TJ	PVC	5,20 €
837865-5	DLX2008JX	PVC	4,52 €
837877-8	9902J, 9903J, 9920J	PVC	5,90 €
837878-6	1911BJ, N1923BJ	PVC	4,79 €
837879-4	CC300DWJ, CC300DZJ	PVC	5,75 €
837893-0	DDF343RHLJ, DDF446RFLJ, DDF448RFLJ, DDF453RFLJ, DDF456RFLJ, DDF456RYLJ, DDF458RFLJ	PVC	4,30 €
838023-6	DBN500RFJ, DBN500RMJ, DBN500RTJ, DBN500Y1J, DBN500ZJ	PVC	4,39 €
838026-0	9741J	PVC	4,89 €
838107-0	DLX2004MJ, DLX2040MJ1, DLX2040TJ1, DLX2054MJ1, DLX2118MJ, DLX2119MJ, DLX2132MJ, DLX2176TJ	PVC	4,09 €
838109-6	DHR162RFJ, DHR162RMJ, DHR162Y1J, DHR162ZJ, DHR164RFJ, DHR164RMJ, DHR164Y1J, DHR164ZJ, DHR165RMJ, DHR165RTJ, DHR165Y1J, DHR165ZJ	PVC	5,80 €
838175-3	DGA454RMJ, DGA504RFJ, DGA504RMJ, DGA504RTJ, DGA504RTJ1, DGA504RTJ2, DGA504Y1J, DGA504ZJ, DGA505RFJ, DGA505RMJ, DGA505RTJ, DGA505RTJ1, DGA505Y1J, DGA505ZJ, DGA506RFJ, DGA506RMJ, DGA506RTJ, DGA506Y1J, DGA506ZJ, DGA508RFJ, DGA508RMJ, DGA508RTJ, DGA508Y1J, DGA508ZJ	PVC	4,10 €
838181-8	DS401ZJ	PVC	6,34 €
838182-6	DHS680RFJ, DHS680RMJ, DHS680RTJ, DHS680Y1J, DHS680ZJ	PVC	6,27 €
838246-6	B06050J	PVC	4,39 €
838258-9	DLX2065PMJ, DLX2065PTJ, DLX2101PMJ	PVC	cena na vyžiadanie
838269-4	DCS551RMJ, DCS551RTJ, DCS551Y1J, DCS551ZJ	PVC	5,46 €
838314-5	HS6601J	PVC	5,15 €
839751-6	DCS553ZJ	PVC	3,79 €
839752-4	DHS660RTJ, DHS660Z, DHS661ZJ	PVC	4,99 €
839527-1	DSC102ZJ	PVC	4,57 €
839205-3	vnútro pre nabíjačku DC18RD + 4 x 18 V LXT akumulátory		5,94 €
835K85-1	TW001G, TW007G, TW008G		3,79 €
835F93-2	DF001G, HP001G		cena na vyžiadanie

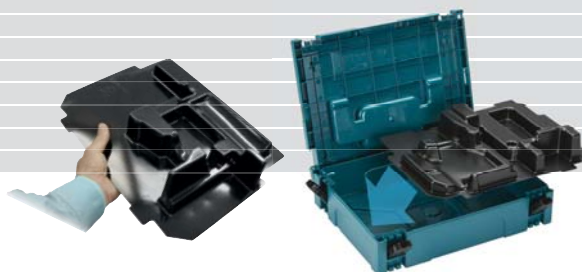

KUFRE: VNÚTRA SYSTAINEROV

Obj. č.	Model	Materiál	MOC s DPH
Typ 2 : 821550-0			
837630-2	JN3201J, JS3201J	PVC	6,34 €
837632-8	DGA452RFJ, DGA452RMJ, DGA452RTJ, DGA452Y1J, DGA452ZJ	PVC	5,24 €
837636-0	DJS101RFJ, DJS101RMJ, DJS101RTJ, DJS101Y1J, DJS101ZJ, DJS160RFJ, DJS160RMJ, DJS160ZJ, DJS161RFJ, DJS161RMJ, DJS161RTJ, DJS161Y1J, DJS161ZJ	PVC	6,89 €
837639-4	DJV140RF1J, DJV140RFJ, DJV140RM1J, DJV140RMJ, DJV140Y1J, DJV140ZJ, DJV142RFJ, DJV142RM1J, DJV142RMJ, DJV142Y1J, DJV142ZJ, DJV180RF1J, DJV180RFJ, DJV180RM1J, DJV180RMJ, DJV180Y1J, DJV180ZJ, DJV182RFJ, DJV182RM1J, DJV182RMJ, DJV182RTJ, DJV182Y1J, DJV182ZJ	PVC	6,98 €
837640-9	DPT350RFJ, DPT350RMJ, DPT350Y1J, DPT350ZJ, DPT351RFJ, DPT351RMJ, DPT351RTJ, DPT351Y1J, DPT351ZJ, DST110RFJ, DST110RMJ, DST110ZJ, DST220RFJ, DST220RMJ, DST220ZJ, DST221RFJ, DST221RMJ, DST221RTJ, DST221Y1J, DST221ZJ	PVC	6,31 €
837644-1	DTL060RF1J, DTL060RFJ, DTL060RM1J, DTL060RMJ, DTL060ZJ, DTL061RF1J, DTL061RFJ, DTL061RM1J, DTL061RMJ	PVC	5,39 €
837646-7	RP0900J, RP0900XJ	PVC	4,86 €
837651-4	HR2300J, HR2600J, HR2601J, HR2610J, HR2611FJ, HR2630J, HR2631FJ	PVC	4,79 €
837660-3	RP0910J, RP1110CJ, RP1111C	PVC	5,31 €
837662-9	HS300DWJ, HS300DZJ	PVC	11,37 €
837670-0	BTP130RFJ, BTP130ZJ, DTD129RFJ, DTD129RHJ, DTD129RMJ, DTD129RMJ1, DTD129RTJ, DTD129Y1J, DTD129ZJ, DTD134RF3J, DTD134RFJ, DTD134RMJ, DTD134Y1J, DTD134ZJ, DTD136RFJ, DTD136RMJ, DTD136Y1J, DTD136ZJ, DTD137RFJ, DTD137RMJ, DTD137Y1J, DTD137ZJ, DTD146RF3J, DTD146RFJ, DTD146RMJ, DTD146RMJ1, DTD146Y1J, DTD146ZJ, DTD147RFJ, DTD147RMJ, DTD147RTJ, DTD147Y1J, DTD147ZJ, DTD148RFJ, DTD148RMJ, DTD148RTJ, DTD148Y1J, DTD148ZJ, DTD152RM3J, DTD152RMJ, DTD152RTJ, DTD152Y1J, DTD152ZJ, DTP131RFJ, DTP131RFJ1, DTP131RMJ, DTP131Y1J, DTP131ZJ, DTP131ZJX1, DTP140RFJ, DTP140RMJ, DTP140Y1J, DTP140ZJ, DTP141RFJ, DTP141RFJ1, DTP141RFJX, DTP141RMJ, DTP141RTJ, DTP141Y1J, DTP141ZJ, DTP141ZJX1, DTS130RFJ, DTS130RMJ, DTS130ZJ, DTS131RFJ, DTS131RMJ, DTS131Y1J, DTS131ZJ, DTS141RFJ, DTS141RMJ, DTS141Y1J, DTS141ZJ, DTW250RFJ, DTW250RMJ, DTW250Y1J, DTW250ZJ, DTW251RFJ, DTW251RMJ, DTW251Y1J, DTW251ZJ, DTW280RFJ, DTW280RMJ, DTW280Y1J, DTW280ZJ, DTW281RFJ, DTW281RMJ, DTW281RTJ, DTW281Y1J, DTW281ZJ, DTW180RMJ, DTW180Z, DTD171Z, DTW181Z	PVC	4,92 €
837671-8	DTM40, DTM50, DTM51	PVC	5,17 €
837672-6	GA5040	PVC	5,95 €
837673-4	TM3000CJ,	PVC	5,55 €
837674-2	3708FCJ, 3710J	PVC	8,71 €
837675-0	BO4900VJ, BO4901J	PVC	5,15 €
837773-0	TM3010CJ,	PVC	7,12 €
837805-3	DFS441RFJ, DFS441RMJ, DFS441ZJ, DFS451RFJ, DFS451RMJ, DFS451Y1J, DFS451ZJ, DFS452RAJ, DFS452RFJ, DFS452RMJ, DFS452RTJ, DFS452Y1J, DFS452ZJ	PVC	6,59 €
837806-1	DGD800	PVC	6,58 €
837809-5	DBO140, DBO180	PVC	6,58 €
837863-9	DDF343, DDF453, DHP343, DHP453,	PVC	5,15 €
837868-9	HR2811	PVC	4,59 €
837870-2	TW0350	PVC	4,80 €
837874-4	BO5041	PVC	6,12 €
837897-2	DJR183, DJR185	PVC	5,44 €
837914-8	HR2610T, HR2611FT	PVC	4,86 €
837916-4	DDF343, DDF441, DDF444, DDF446, DDF448, DDF451, DDF456, DDF458, DDF459, DDF480, DDF481, DDF482, DDF484, DDF485, DDF486, DHP343, DHP441, DHP444, DHP446, DHP448, DHP451, DHP456, DHP458, DHP459, DHP480, DHP481, DHP482, DHP484, DHP485, DHP486	PVC	3,98 €
837920-3	GA5030	PVC	4,99 €
838025-2	9046	PVC	7,99 €
838028-6	BO3711	PVC	5,26 €
838040-6	DDA340, DDA341, DDA350, DDA351	PVC	16,55 €
838550-3	DTW190	PVC	4,09 €
838582-0	DST11, DST112	PVC	5,30 €
838612-7	TM30	PVC	4,79 €
839245-1	HR140, HR166	PVC	7,39 €
Typ 4 : 821552-6			
837247-1	RT0700CJ, RT0700CX2J, RT0700CX3J, RT0700CX5J, RT001G, RT0702	PVC	8,71 €
837635-2	DHS630RFJ, DHS630RMJ, DHS630RTJ, DHS630Y1J, DHS630ZJ	PVC	8,35 €
837647-5	RP1800FX1J, RP1800FXJ, RP1800X1J, RP1800XJ, RP2300FCX3J, RP2300FCX1J	PVC	5,11 €
837649-1	DHR242RFJ, DHR242RMJ, DHR242RTJ, DHR242ZJ, DHR243RFJ, DHR243RMJ, DHR243RTJ, DHR243Y1J, DHR243ZJ	PVC	5,25 €
837650-6	BHR262RDJ, BHR262TDPJ, BHR262TRDJ, BHR262TZJ	PVC	6,39 €
837657-2	5008MGJ, 5008MGJX, 5604RJ	PVC	10,89 €
837787-9	DK1479J, DLX3001J	PVC	4,67 €
837807-9	5704RJ, HS6101J, HS6101J1, HS7101J, HS7101J1, HS7101JX	PVC	6,57 €
837861-3	DHS710PM2J, DHS710PT2J, DHS710RF2J, DHS710RM2J, DHS710RT2J, DHS710ZJ	PVC	16,47 €
837873-6	N5900BJ	PVC	4,68 €
837894-8	4131J	PVC	7,91 €
837988-9	DHR263ZJ, DHR264RM2J, DHR264ZJ	PVC	4,79 €
838096-9	DLX2053ZJ, DLX2125ZJ	PVC	5,80 €
838108-8	HS7601J	PVC	6,95 €
838111-9	SG1251J	PVC	4,19 €
838253-9	DLX2067PMJ, DLX2067PTJ, DLX2106PMJ	PVC	cena na vyžiadanie
838257-1	DHR264PM2J, DHR264PT2J	PVC	8,94 €
838390-9	CA5000XJ	PVC	4,95 €
838538-3	GA5040CJD1	PVC	7,15 €
839523-9	DBN600ZJ	PVC	2,99 €
839559-8	DHR280ZJ, DHR281ZJ	PVC	3,73 €
839290-6	DSP601ZJU, DSP601ZJ	PVC	4,02 €
839891-0	DHR182ZJ	PVC	4,59 €
835R29-3	TW004G, TW005G		cena na vyžiadanie
835U77-0	HP002G, DF002G		cena na vyžiadanie
835E79-0	GA005G, GA013G, GA023G, GA026G, GA029G, GA032G		cena na vyžiadanie
835C84-5	HR001G, HR002G, HR003G, HR004G		2,89 €
835K81-9	HS003G		cena na vyžiadanie
835K82-7	HS004G		cena na vyžiadanie
8352F0-3	RP1803F, RP2303FC		cena na vyžiadanie
8351E4-2	SP001G		cena na vyžiadanie

Držiaky náradia 3. generácie, technické riešenia



Systém remienkov na opasok s rýchlopínacími sponami na koncoch sa dajú ľahko oddeliť od tašiek na náradie a nosiť v páse ako ľahký opasok na náradie. Hodí sa na všetky vrecká a držiaky nástrojov.



3 LAYERS

3L Technológia je jedinečná trojvrstvá kombinácia polyesterov a peny, ktorá poskytuje ďalšie odpruženie. Navrhnuté tak, aby boli tvrdé a odolné voči poveternostným vplyvom. Tieto úžasne ľahké polypropylénové panely sú zložené z troch kompozitných vrstiev, ktoré sú bezpečne spojené do požadovaného tvaru. Inovatívna vlastnosť týchto štruktúrovaných materiálov umožňuje ich tvarovanie do ľubovoľného tvaru.



WATERPROOF BOTTOM

Vodeodolný materiál je vysoko kvalitné riešenie pre tašky na náradie, je pevné, odolné voči opotrebovaniu a vodotesné, takže udržuje náradie suché a chránené. Vystužený plastový podstavec vám pomôže udržiavať vak na náradie čistý.



REAL LEATHER

Pravá koža je zvonku hladká s brúseným semišom vo vnútri. Silná a odolná pre dlhú životnosť, s prídanou odolnosťou proti oderu. Koža bola vybraná pre použitie vo výrobkoch vyžadujúcich silnejšiu vrstvu – 1,8 až 2,0 mm – zabezpečenie produktu najvyššej kvality.



DURABLE RIVETING

Odolné silné nitovanie. Použité silné jednodielne nity s podložkami pre extrémne namáhané spoje. Používajú sa podložky pre väčšiu pevnosť na strategických miestach na jednej alebo na oboch stranách, hore a dole.



ANTI SLIP

Istiace prvky zabráňujú nechcenému vypadávaniu náradia s prepážok tašky a tým predchádzajú poškodeniu samotného náradia. Vysoko kvalitná polypropylénová páska má gumový povrch.



ELASTIC LOOPS

Elastické popruhy, dokonale zaisťujú náradie na svojom mieste proti svojvoľnému vypadnutiu. Elastické popruhy boli použité na širokú škálu našich produktov. Popruhy sa dokážu prispôbiť tak, aby dokonale istili náradie a príslušenstvo.



SIDE-GATE SOLUTION

Klip systém, vám umožní ľahko vložiť nástroj bez toho, aby ste sa museli pozerieť kde máte otvor držiaka náradia. Ďalšia funkcia výkyvu zaisťuje, že váš nástroj je udržiavaný v pohodlnom uhle. Vyrobené z nehrdzavejúcej ocele.









ODKLADACIE SYSTÉMY







Foto	Popis	Rozmery (mm)			STRAP / BELT SYSTEM	3 LAYERS	WATERPROOF BOTTOM	REAL LEATHER	DURABLE RIVETING	ANTI SLIP	ELASTIC LOOPS	SIDE-GATE SOLUTION	Obj. č.	MOC s DPH
		H	L	W										
	taška na skrutkovač	290	170	85	O	O	O	O	O	O	O	E-05094	21,99 €	
	taška na skrutkovač	235	155	75	O	O	O	O	O	O	O	E-05119	14,99 €	
	univerzálna taška na skrutkovač a príslušenstvo	270	260	145	O	O	O	O	O	O	O	E-05125	40,99 €	
	2 kombinácia taška Makita	270	260	145	O	O	O	O	O	O	O	E-05131	28,99 €	
	3 kombinácia taška Makita	270	320	145	O	O	O	O	O	O	O	E-05147	37,99 €	
	univerzálna taška pre pokrivačov	270	290	145	O	O	O	O	O	O	O	E-05153	40,99 €	
	3 kombinácia taška Makita + opasok	270	640	145	O	O	O	O	O	O	O	E-05169	84,99 €	
	opasok na ťažké náradie	310	880	170	O	O	O	O	O	O	O	E-05175	103,99 €	
	taška pre elektrikárov	310	250	125	O	O	O	O	O	O	O	E-05181	29,99 €	
	taška na klince a kladivo	185	180	105	O	O	O	O	O	O	O	E-05197	18,99 €	
	taška na klince	185	175	105	O	O	O	O	O	O	O	E-05206	18,99 €	
	taška pre elektrikárov	205	185	55	O	O	O	O	O	O	O	E-05212	18,99 €	
	taška na ručné náradie a kladivo	205	185	85	O	O	O	O	O	O	O	E-05228	18,99 €	
	držiak na kladivo	165	110	65	O	O	O	O	O	O	O	E-05240	10,99 €	
	taška na meter	165	110	80	O	O	O	O	O	O	O	E-05278	9,99 €	







Opasky

Foto	Popis	Rozmery (mm)			STRAP/BELT SYSTEM	3 LAYERS	WATERPROOF BOTTOM	REAL LEATHER	DURABLE RIVETING	ANTI SLIP	ELASTIC LOOPS	SIDE-GATE SOLUTION	Obj. č.	MOC s DPH
		H	L	W										
	opasok s bedrovým pásom pre ťažké náradie	100	880	30				O	O				E-05321	34,99 €
	opasok s rýchloupínacou sponou	50	1550	-									E-05337	12,99 €
	opasok na ťažké náradie	48	1380	-				O					E-05343	21,99 €
	opasok kožený čierny M	38	1130	-				O					E-05359	21,99 €
	opasok kožený čierny L	38	1330	-				O					E-05365	21,99 €
	opasok kožený hnedý M	38	1130	-				O					E-05371	21,99 €
	opasok kožený hnedý L	38	1330	-				O					E-05387	21,99 €
	popruhy na opasok E-05321, E-05175	410	520	23					O				E-05393	30,99 €
	traky Makita	-	50	-									E-05402	17,99 €

Tašky

Foto	Popis	Rozmery (mm)			STRAP/BELT SYSTEM	3 LAYERS	WATERPROOF BOTTOM	REAL LEATHER	DURABLE RIVETING	ANTI SLIP	ELASTIC LOOPS	SIDE-GATE SOLUTION	Obj. č.	MOC s DPH
		H	L	W										
	taška na náradie	310	510	300	O			O		O			E-05418	87,99 €
	taška na ťažké náradie	265	505	295	O			O		O			E-05424	84,99 €
	taška na náradie otvorená	355	490	310	O			O		O			E-05430	60,99 €
	taška na náradie	250	440	240	O					O			E-05468	48,99 €
	taška na náradie	300	670	330	O			O		O			E-11782	112,49 €
	ruksak na náradie s organizérom	490	390	230				O		O			E-05511	110,99 €
	taška na píly	260	900	270	O			O		O			E-05549	57,99 €

Výbava

Foto	Popis	Rozmery (mm)			STRAP/BELT SYSTEM	3 LAYERS	WATERPROOF BOTTOM	REAL LEATHER	DURABLE RIVETING	ANTI SLIP	ELASTIC LOOPS	SIDE-GATE SOLUTION	Obj. č.	MOC s DPH
		H	L	W										
	puzdro na mobil	165	90	40	O	O				O			E-05583	14,99 €
	termo taška na potraviny	210	330	180		O							E-05614	24,99 €
	ochrana kolena mäkká	240	170	30									E-05642	24,99 €
	ochrana kolena gelová	240	170	95									E-05658	36,99 €
	taška na vodiacu lištu 1,4 – 1,5 m	220	1565	45	O	O							E-05664	39,99 €

VŘTANIE: ŽELEZO



HSS VRTÁKY DO KOVU

HSS-R

HSS-G

Titánové
HSS-TIN

Kobalt
HSS-CO

M-Force

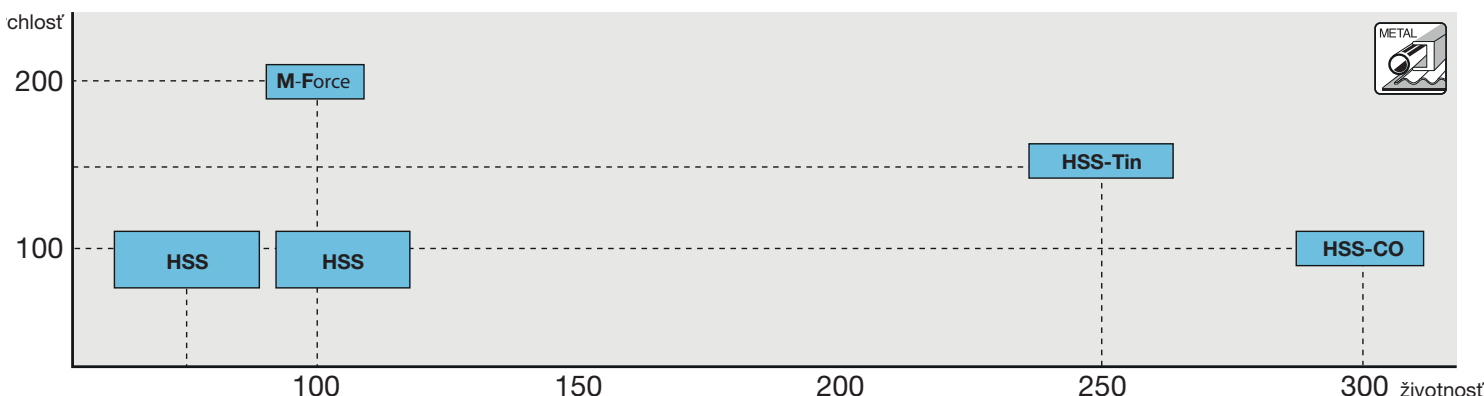

Obj. č.	ø mm	L1 mm	L2 mm	ks/bal	MOC s DPH
---------	------	-------	-------	--------	-----------

Vrták na vrtanie otvorov pre nity



B-56437	3,3	50	20	5	10,06 €
---------	-----	----	----	---	---------

1/4 „stopkový vrták, ktorý je špeciálne navrhnutý na vrtanie otvorov pre nity. Ostrá špička pod uhlom 135 ° čo znamená, že tieto vrtáky vyvrtávajú otvory dvojnásobnou rýchlosťou ako štandardný vrták s ostrejším stredovým bodom.



HSS-R Vrtáky do kovu z rýchloreznej ocele



Tvrdený hrot HSS-R

Vrtáky s výbrusom vhodné pre železné a neželezné kovy, ktoré ponúkajú dobrú rýchlosť vrtania a predĺženú životnosť. Dostupné v priemeroch 1,5 mm – 13 mm



D-09656	1,5	40	18	1	0,62 €
D-09662	2	49	24	1	0,72 €
D-09678	2,5	57	30	1	0,75 €
D-09684	3	61	33	1	0,75 €
D-09690	3,5	70	39	1	1,00 €
D-09709	4	75	43	1	1,18 €
D-09715	4,5	80	47	1	1,37 €
D-09721	5	86	52	1	1,56 €
D-09737	5,5	93	57	1	1,74 €
D-09743	6	93	57	1	1,84 €
D-09759	6,5	101	63	1	2,24 €
D-09765	7	109	69	1	2,62 €
D-09771	7,5	109	69	1	2,96 €
D-09787	8	117	75	1	3,46 €
D-09793	8,5	117	75	1	3,55 €
D-09802	9	125	81	1	4,58 €
D-09818	9,5	125	81	1	5,05 €
D-09824	10	133	87	1	5,89 €
D-09830	10,5	133	87	1	6,42 €
D-09846	11	142	94	1	7,23 €
D-09868	12	151	101	1	8,85 €
D-09874	12,5	151	101	1	9,22 €
D-09880	13	151	101	1	10,25 €

VRTANIE: ŽELEZO

Obj. č.	ø mm	L1 mm	L2 mm	ks/bal	MOC s DPH
---------	------	-------	-------	--------	-----------

Vrtáky do kovov z rýchloreznej ocele (HSS)



Tvrdený hrot HSS-R

Vrtáky s výbrusom vhodné pre železné a neželezné kovy, ktoré ponúkajú dobrú rýchlosť vrtania a predĺženú životnosť.

Dostupné v priemeroch 1,5 mm – 13 mm



D-06236	1,50	40	18	10	2,99 €
D-06258	2,00	49	24	10	3,36 €
D-06264	2,25	53	27	10	4,39 €
D-06270	2,50	57	30	10	4,39 €
D-06286	2,75	61	33	10	5,14 €
D-06292	3,00	61	33	10	5,14 €
D-06301	3,25	65	36	10	6,32 €
D-06317	3,50	70	39	10	6,61 €
D-06323	3,75	70	39	10	8,35 €
D-06339	4,00	75	43	10	8,35 €
D-06345	4,25	75	43	10	9,53 €
D-06351	4,50	80	47	10	9,78 €
D-06367	4,75	80	47	10	11,84 €
D-06373	5,00	86	52	10	11,84 €
D-06389	5,25	86	52	10	14,05 €
D-06395	5,50	93	57	10	14,05 €
D-06404	5,75	93	57	10	16,51 €
D-06410	6,00	93	57	10	16,51 €
D-06426	6,25	101	63	10	20,38 €
D-06432	6,50	101	63	10	20,38 €
D-06454	7,00	109	69	10	24,58 €
D-06460	7,25	109	69	10	26,79 €
D-06476	7,50	109	69	10	26,79 €
D-06482	7,75	117	75	10	32,28 €
D-06498	8,00	117	75	10	32,28 €
D-06507	8,25	117	75	5	18,10 €
D-06513	8,50	117	75	5	18,10 €
D-06529	8,75	125	81	5	22,00 €
D-06535	9,00	125	81	5	22,00 €
D-06563	9,75	133	87	5	28,51 €
D-06579	10,00	133	87	5	28,51 €
D-06591	10,50	133	87	5	30,66 €
D-06600	11,00	142	94	5	34,43 €
D-06622	12,00	151	101	5	43,00 €
D-06638	12,50	151	101	5	34,99 €
D-06644	13,00	151	101	5	50,75 €

Sada vrtákov HSS 13 ks D-54075 6,48 € (MOC s DPH)

1,5/2/2,5/3/3,2/3,5/4/4,5
4,8/5/5,5/6/6,5 mm



Sada vrtákov HSS 19 ks D-54081 14,43 € (MOC s DPH)

1/1,5/2/2,5/3/3,5/4/4,5/5/5,5/
6/6,5/7/7,5/8/8,5/9/9,5/10 mm



170 ks sada vrtákov do železa D-30564 264,05 € (MOC s DPH)

1; 1,5; 2; 2,5; 3; 3,5;
4; 4,5; 5; 5,5 × 10 ks
6; 6,5; 7; 7,5; 8 × 10 ks
8,5; 9; 9,5; 10 × 5 ks



Vrták na vrtanie otvorov pre nity

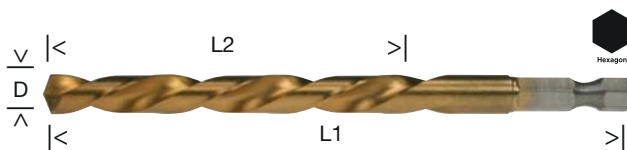

Vrtáky z úpravou Nitrid titánu pre predĺženú životnosť.

S 1/4" upínanie vhodné pre rýchloúpinacie systémy a šesťhranné upínanie. Priemery od 3 – 13mm. Sady sú s valcovitou stopkou.



D-14928	3	80	47	1	1,37 €
D-14934	3,2	85	52	1	1,46 €
D-16081	3,3	85	52	1	1,46 €
D-14940	4	95	57	1	1,56 €
D-14956	4,2	95	57	1	1,74 €
D-14962	5	105	65	1	1,96 €
D-14978	6	110	69	1	2,59 €
D-15827	8	115	75	1	5,55 €
D-15833	10	130	87	1	7,63 €
D-15849	12	150	101	1	12,31 €
D-15855	13	150	101	1	13,96 €

Sada vrtákov HSS – Tin 13 ks D-72229 22,99 € (MOC s DPH)

1,5 × 2; 2 × 2; 2,5 × 2; 3 × 2; 3,2; 3,5
4; 4,5; 5; 5,5; 6; 6,5; 7; 8; 10



Sada vrtákov HSS – Tin 13 ks D-72855 7,39 € (MOC s DPH)

1,5 – 10 mm × 40 – 130 mm



Sada vrtákov do kovu HSS-Tin 6 ks D-72833 5,29 € (MOC s DPH)

Ø mm 2; 3; 4; 5; 6; 8

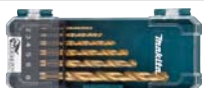

Sada vrtákov HSS – Tin 10 ks D-72849 9,79 € (MOC s DPH)

1; 2; 3; 4; 5; 6; 7;
8; 9; 10



VRTANIE: VRTÁKY DO KOVOV Z RÝCHLOREZNEJ OCELE (HSS)

Vrtáky do kovov HSS-Co 5 %

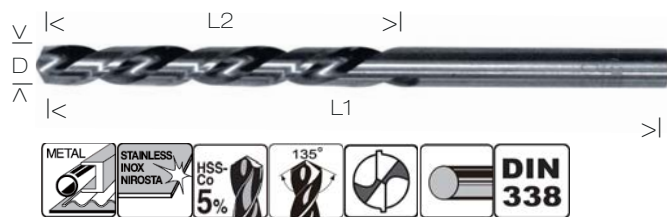

Kobaltové valcovitá stopka

Vrtáky HSS podľa DIN338 s oceľou M35 s obsahom 5% a 8% kobaltu. Toto znamená, že vrták je silnejší a v porovnaní so štandardnými vydrží dlhšie. Uhol špičky 118 ° znižuje riziko pošmyknutia vrtáka určené pre vrtanie do kvalitných ocelí, ťahaných alebo s veľkým obsahom zliatin. Použitie na mäkkú oceľ, nehrdzavejúcu oceľ a ťažko obrábateľné materiály, zvarané švy a práce na karosérii.

Obj. č.	ø mm	L1 mm	L2 mm	ks/bal	MOC s DPH
---------	------	-------	-------	--------	-----------



P-61416-10	1,00	34		10	6,30 €
P-61438-10	1,50	40	16	10	6,76 €
P-76087-10	1,60	43	18	10	7,51 €
P-61450-10	2,00	49	24	10	7,51 €
P-76146-10	2,30	53	27	10	8,81 €
P-76152-10	2,40	57	30	10	8,81 €
P-61472-10	2,50	57	30	10	8,81 €
P-76168-10	2,60	57	30	10	9,96 €
P-76180-10	2,80	61	33	10	9,96 €
P-76196-10	2,90	61	33	10	9,96 €
P-61494-10	3,00	61	33	10	9,96 €
P-76211-10	3,20	65	36	10	11,75 €
P-61503-10	3,25	65	36	10	12,08 €
P-76233-10	3,40	70	39	10	12,08 €
P-61519-10	3,50	70	39	10	12,08 €
P-61525-10	3,75	70	39	10	14,04 €
P-76277-10	3,90	75	43	10	14,04 €
P-61531-10	4,00	75	43	10	14,04 €
P-76283-10	4,10	75	43	10	15,34 €
P-76299-10	4,20	75	43	10	15,34 €
P-61547-10	4,25	75	43	10	15,34 €
P-76308-10	4,30	80	47	10	15,34 €
P-61553-10	4,50	80	47	10	15,34 €
P-76320-10	4,60	80	47	10	18,60 €
P-76342-10	4,80	86	52	10	18,60 €
P-76358-10	4,90	86	52	10	19,42 €
P-61575-10	5,00	86	52	10	19,42 €
P-76364-10	5,10	86	52	10	22,82 €

Obj. č.	ø mm	L1 mm	L2 mm	ks/bal	MOC s DPH
---------	------	-------	-------	--------	-----------

D-17289	1,50	40	16	1	0,90 €
D-17295	2,00	49	24	1	1,00 €
D-17304	2,50	57	30	1	1,09 €
D-17310	3,00	61	33	1	1,50 €
D-17326	3,20	65	36	1	1,50 €
D-17332	3,50	70	39	1	1,50 €
D-17348	4,00	75	43	1	1,74 €
D-17354	4,50	80	47	1	2,03 €
D-17360	5,00	86	52	1	2,21 €
D-17376	5,50	93	57	1	2,52 €
D-17382	6,00	93	57	1	2,87 €
D-17398	6,50	101	63	1	3,21 €
D-17407	7,00	109	69	1	3,86 €
D-17413	7,50	109	69	1	4,95 €
D-17429	8,00	117	75	1	5,83 €
D-17435	8,50	117	75	1	6,67 €
D-17441	9,00	125	81	1	7,04 €
D-17457	9,50	125	81	1	8,54 €
D-17463	10,00	133	87	1	9,53 €
D-17500	12,00	151	101	1	15,14 €



P-76370-10	5,20	86	52	10	22,82 €
P-61581-10	5,25	86	52	10	22,82 €
P-61597-10	5,50	93	57	10	22,82 €
P-76439-10	5,90	93	57	10	26,44 €
P-61612-10	6,00	93	57	10	26,44 €
P-76445-10	6,10	101	63	10	32,15 €
P-76451-10	6,20	101	63	10	32,15 €
P-76467-10	6,30	101	63	10	32,15 €
P-76473-10	6,40	101	63	10	32,15 €
P-76489-10	6,60	101	63	10	38,84 €
P-76495-10	6,70	101	63	10	38,84 €
P-76504-10	6,80	109	69	10	38,84 €
P-61656-10	7,00	109	69	10	38,84 €
P-76548-10	7,30	109	69	10	42,76 €
P-61678-10	7,50	109	69	10	42,76 €
P-61690-10	8,00	117	75	10	52,88 €
P-76607-5	8,10	117	75	5	29,05 €
P-76613-5	8,20	117	75	5	29,05 €
P-61705-5	8,25	117	75	5	29,05 €
P-61715-5	8,50	117	75	5	29,05 €
P-61721-5	9,00	125	81	5	33,78 €
P-61743-5	10,00	133	87	5	42,60 €
P-61759-5	10,50	133	87	5	48,14 €
P-61765-5	11,00	142	94	5	55,49 €
P-61771-5	11,50	142	94	5	60,47 €
P-61787-5	12,00	151	101	5	68,05 €
P-61793-5	12,50	151	101	5	74,09 €
P-61802-5	13,00	151	101	5	79,97 €

VŘTANIE: VRTÁKY DO KOVOV Z RÝCHLOREZNEJ OCELE (HSS)

	Obj. č.	ø mm	L1 mm	L2 mm	ks/bal	MOC s DPH
Vrtáky do kovov HSS-Co 5 % *****						
DIN340, špička pod uhlom 130°	P-62826-10	5,00	132	87	10	46,19 €
	P-62848-10	6,00	139	90	10	58,75 €
	P-62882-5	8,00	165	115	5	56,96 €
	P-62929-5	10,00	184	134	5	96,29 €
	P-62985-5	13,00	205	155	5	172,50 €

	Obj. č.	ø mm	L1 mm	L2 mm	ks/bal	MOC s DPH
Vrtáky do kovov HSS-Co 8 % s valcovitou stopkou *****						
DIN338, špička pod uhlom 130°	P-61880-10	2,00	49	24	10	13,55 €
	P-61905-10	2,50	57	30	10	15,34 €
	P-61927-10	3,00	61	33	10	16,22 €
	P-61949-10	3,50	70	39	10	18,60 €
	P-61961-10	4,00	75	43	10	22,03 €
	P-61977-10	4,25	75	43	10	24,48 €
	P-61983-10	4,50	80	47	10	24,48 €
	P-62000-10	5,00	86	52	10	29,38 €
	P-62044-10	6,00	93	57	10	40,47 €
	P-62066-10	6,50	101	63	10	48,14 €
	P-62094-10	7,50	109	69	10	64,14 €
	P-62103-10	8,00	117	75	10	76,05 €
	P-62147-5	10,00	133	89	10	64,45 €

	Obj. č.	ø mm	L1 mm	L2 mm	ks/bal	MOC s DPH
Vrtáky do kovov HSS-TiN s valcovitou stopkou *****						
DIN338, špička pod uhlom 130°	P-60981-10	1,00	34		10	4,83 €
	P-61008-10	1,50	40	16	10	5,22 €
	P-61020-10	2,00	49	24	10	5,81 €
	P-61042-10	2,50	57	30	10	6,36 €
	P-61064-10	3,00	61	33	10	8,29 €
	P-61070-10	3,25	65	36	10	10,05 €
	P-61086-10	3,50	70	39	10	10,05 €
	P-61101-10	4,00	75	43	10	10,87 €
	P-61117-10	4,25	75	43	10	13,06 €
	P-61123-10	4,50	80	47	10	13,06 €
	P-61145-10	5,00	86	52	10	15,34 €
	P-61167-10	5,50	93	57	10	18,12 €
	P-61173-10	5,75	93	57	10	21,05 €
	P-61189-10	6,00	93	57	10	21,05 €
	P-61204-10	6,50	101	63	10	24,32 €
	P-61226-10	7,00	109	69	10	28,98 €
	P-61248-10	7,50	109	69	10	33,06 €
	P-61260-10	8,00	117	75	10	38,06 €
	P-61282-5	8,50	117	75	5	21,71 €
	P-61298-5	9,00	125	81	5	24,72 €
	P-61313-5	10,00	133	87	5	32,44 €
	P-61329-5	10,50	133	87	5	35,90 €
	P-61341-5	11,50	142	94	5	44,80 €
	P-61357-5	12,00	151	101	5	50,18 €
	P-61367-5	12,50	151	101	5	53,97 €
	P-61379-5	13,00	151	101	5	58,83 €

VŔTANIE: VRTÁKY DO KOVOV Z RÝCHLOREZNEJ OCELE (HSS)

Obj. č.

ø mm

L1 mm

L2 mm

ks/bal

MOC s DPH

Obojstranné vrtáky HSS-G



Vhodné na vytváranie otvorov pre nity a predvrtávanie závitov



B-26652	2,00	38	7,5	10	3,12 €
B-26668	3,00	46	10,6	10	4,70 €
B-26674	3,10	49	11	10	5,70 €
B-26680	3,20	49	11	10	5,89 €
B-26696	3,30	49	11	10	6,01 €
B-26705	3,50	52	13	10	6,57 €
B-26711	3,80	55	14	10	7,51 €
B-26727	4,00	55	14	10	7,51 €
B-26733	4,10	55	14	10	8,07 €
B-26749	4,20	55	14	10	8,35 €
B-26755	4,30	55	14	10	8,38 €
B-26777	4,80	62	17	10	10,19 €
B-26783	4,90	62	17	10	11,12 €
B-26799	5,00	62	17	10	11,12 €
B-26808	5,10	62	17	10	13,12 €
B-26814	5,2	62	17	10	13,12 €



Akumulátory

Odkládacie systémy

Vŕtanie

Skrutkovanie

Brúsky

Pílenie

Frézovanie

Brúsenie

Klince / spony

Špeciálne stroje

Vysávanie

Fény/lampy

Záhrada

Ručné náradie

Ostatné

VŔTANIE: VRTÁKY DO KOVOV Z RÝCHLOREZNEJ OCELE (HSS)

Obj. č.	ø mm	L1 mm	L2 mm	ks/bal	MOC s DPH	Obj. č.	ø mm	L1 mm	L2 mm	ks/bal	MOC s DPH
Vrtáky do kovov HSS-G s valcovitou stopkou 											
P-60115-10	1,00	34	12	10	2,51 €	P-60280-10	5,25	86	52	10	13,97 €
P-75328-10	1,10	36	14	10	2,68 €	P-75661-10	5,30	86	52	10	13,97 €
P-75334-10	1,20	38	16	10	2,68 €	P-60296-10	5,50	93	57	10	13,97 €
P-60121-10	1,25	38	16	10	2,68 €	P-75683-10	5,60	93	57	10	15,21 €
P-75340-10	1,30	38	16	10	2,68 €	P-75708-10	5,80	93	57	10	15,21 €
P-75356-10	1,40	40	18	10	2,68 €	P-75714-10	5,90	93	57	10	15,21 €
P-60137-10	1,50	40	18	10	2,68 €	P-60311-10	6,00	93	57	10	15,21 €
P-75362-10	1,60	43	20	10	3,30 €	P-75720-10	6,10	101	63	10	15,31 €
P-75378-10	1,70	43	20	10	3,30 €	P-75736-10	6,20	101	63	10	15,31 €
P-60143-10	1,75	46	22	10	3,30 €	P-60327-10	6,25	101	63	10	15,31 €
P-75384-10	1,80	46	22	10	3,30 €	P-75742-10	6,30	101	63	10	15,31 €
P-75390-10	1,90	46	22	10	3,30 €	P-75758-10	6,40	101	63	10	15,31 €
P-60159-10	2,00	49	24	10	3,30 €	P-60333-10	6,50	101	63	10	15,31 €
P-75409-10	2,10	49	24	10	4,11 €	P-75764-10	6,60	101	63	10	17,79 €
P-75415-10	2,20	53	27	10	4,11 €	P-75770-10	6,70	101	63	10	17,79 €
P-60165-10	2,25	53	27	10	4,11 €	P-60349-10	6,75	109	69	10	17,79 €
P-75421-10	2,30	53	27	10	4,11 €	P-75786-10	6,80	109	69	10	17,79 €
P-75437-10	2,40	57	30	10	4,11 €	P-60355-10	7,00	109	69	10	17,79 €
P-60171-10	2,50	57	30	10	4,11 €	P-75817-10	7,20	109	69	10	19,91 €
P-75443-10	2,60	57	30	10	5,06 €	P-75823-10	7,30	109	69	10	19,91 €
P-75459-10	2,70	61	33	10	5,06 €	P-60377-10	7,50	109	69	10	19,91 €
P-60187-10	2,75	61	33	10	5,06 €	P-75851-10	7,70	117	75	10	22,10 €
P-75465-10	2,80	61	33	10	5,06 €	P-60383-10	7,75	117	75	10	22,10 €
P-75471-10	2,90	61	33	10	5,39 €	P-75867-10	7,80	117	75	10	22,10 €
P-60193-10	3,00	61	33	10	5,39 €	P-75873-10	7,90	117	75	10	22,10 €
P-75487-10	3,10	65	36	10	6,30 €	P-60399-10	8,00	117	75	10	22,10 €
P-75493-10	3,20	65	36	10	6,30 €	P-75889-5	8,10	117	75	5	12,89 €
P-60202-10	3,25	65	36	10	6,95 €	P-75895-5	8,20	117	75	5	12,89 €
P-75502-10	3,30	65	36	10	6,95 €	P-60408-5	8,25	117	75	5	12,89 €
P-75518-10	3,40	70	39	10	6,95 €	P-75904-5	8,30	117	75	5	12,89 €
P-60218-10	3,50	70	39	10	6,95 €	P-75910-5	8,40	117	75	5	12,89 €
P-75524-10	3,60	70	39	10	8,00 €	P-60414-5	8,50	117	75	5	13,10 €
P-75530-10	3,70	70	39	10	8,00 €	P-75926-5	8,60	125	81	5	15,10 €
P-60224-10	3,75	70	39	10	8,00 €	P-75948-5	8,80	125	81	5	15,10 €
P-75546-10	3,80	75	43	10	8,00 €	P-75954-5	8,90	125	81	5	15,10 €
P-75552-10	3,90	75	43	10	8,00 €	P-60420-5	9,00	125	81	5	15,10 €
P-60230-10	4,00	75	43	10	8,00 €	P-75960-5	9,10	125	81	5	16,65 €
P-75568-10	4,10	75	43	10	8,81 €	P-75982-5	9,30	125	81	5	16,65 €
P-75574-10	4,20	75	43	10	8,81 €	P-60436-5	9,50	125	81	5	16,65 €
P-60246-10	4,25	75	43	10	9,96 €	P-76009-5	9,60	133	87	5	19,75 €
P-75580-10	4,30	80	47	10	9,96 €	P-76015-5	9,70	133	87	5	19,75 €
P-75596-10	4,40	80	47	10	9,96 €	P-76021-5	9,80	133	87	5	19,75 €
P-60252-10	4,50	80	47	10	9,96 €	P-76037-5	9,90	133	87	5	19,75 €
P-75605-10	4,60	80	47	10	11,42 €	P-60442-5	10,00	133	87	5	19,75 €
P-75611-10	4,70	80	47	10	11,42 €	P-60458-5	10,50	133	87	5	21,92 €
P-60268-10	4,75	80	47	10	11,42 €	P-60464-5	11,00	142	94	5	25,49 €
P-75627-10	4,80	86	52	10	11,42 €	P-60470-5	11,50	142	94	5	27,58 €
P-75633-10	4,90	86	52	10	12,24 €	P-60486-5	12,00	151	101	5	30,57 €
P-60274-10	5,00	86	52	10	12,24 €	P-60492-5	12,50	151	101	5	32,64 €
P-75649-10	5,10	86	52	10	13,97 €	P-60501-5	13,00	151	101	5	33,95 €
P-75655-10	5,20	86	52	10	13,97 €						

VŔTANIE: VRTÁKY DO KOVOV Z RÝCHLOREZNEJ OCELE (HSS)

Obj. č.	ø mm	L1 mm	L2 mm	ks/bal	MOC s DPH	Obj. č.	ø mm	L1 mm	L2 mm	ks/bal	MOC s DPH
---------	------	-------	-------	--------	-----------	---------	------	-------	-------	--------	-----------

Vrtáky do kovov HSS-G s valcovitou stopkou



P-63024	2,0	125		1	3,90 €	P-63292	6,50	215		1	13,15 €
P-63052	2,50	140		1	4,39 €	P-63323	7,00	225		1	14,85 €
P-63080	3,00	150		1	4,46 €	P-63351	7,50	225		1	15,60 €
P-63096	3,00	190		1	8,96 €	P-63367	7,50	295		1	24,77 €
P-63111	3,50	165		1	6,82 €	P-63389	8,00	240		1	16,79 €
P-63133	3,50	265		1	14,43 €	P-63395	8,00	305		1	26,05 €
P-63149	4,00	175		1	7,41 €	P-63404	8,00	390		1	40,25 €
P-63155	4,00	220		1	11,93 €	P-63448	9,00	250		1	24,97 €
P-63177	4,50	185		1	7,64 €	P-63507	10,00	265		1	26,24 €
P-63208	5,00	195		1	8,27 €	P-63513	10,00	340		1	36,85 €
P-63214	5,00	245		1	15,46 €	P-63529	10,00	430		1	51,90 €
P-63220	5,00	315		1	23,70 €	P-63563	11,00	280		1	30,53 €
P-63236	5,50	205		1	12,48 €	P-63622	12,00	295		1	35,97 €
P-63264	6,00	205		1	12,48 €	P-63638	12,00	380		1	50,10 €
P-63270	6,00	260		1	18,41 €	P-63688	13,00	295		1	39,49 €
P-63286	6,00	330		1	24,61 €						

Vrtáky do kovov HSS-GM2 s valcovitou stopkou



špička pod uhlom 130°

P-60545-10	1,00	34	12	10	4,73 €	P-60741-10	6,00	93	57	10	21,05 €
P-62496-10	1,00	56	30	10	9,04 €	P-62599-10	6,00	139	91	10	41,62 €
P-60567-10	1,50	40	18	10	5,12 €	P-60763-10	6,50	101	63	10	24,64 €
P-62505-10	1,50	70	39	10	10,51 €	P-62608-10	6,50	148	99	10	49,29 €
P-60589-10	2,00	49	24	10	5,55 €	P-60785-10	7,00	109	69	10	29,21 €
P-62511-10	2,00	85	52	10	11,59 €	P-62614-10	7,00	156	105	10	56,30 €
P-60595-10	2,25	53	26	10	6,04 €	P-60800-10	7,50	109	69	10	32,64 €
P-60604-10	2,50	57	30	10	6,04 €	P-60822-10	8,00	117	75	10	37,70 €
P-62527-10	2,50	95	59	10	12,31 €	P-62636-10	8,00	165	115	10	71,97 €
P-60626-10	3,00	61	33	10	7,67 €	P-60844-5	8,50	117	75	5	21,62 €
P-62533-10	3,00	100	63	10	14,85 €	P-62642-5	8,50	165	115	5	40,96 €
P-60648-10	3,50	70	39	10	9,47 €	P-60850-5	9,00	125	81	5	24,48 €
P-62549-10	3,50	112	71	10	18,77 €	P-60866-5	9,50	125	81	5	27,25 €
P-62555-10	4,00	119	77	10	21,05 €	P-60872-5	10,00	133	87	5	32,07 €
P-60682-10	4,50	80	47	10	13,06 €	P-62670-5	10,00	184	134	5	60,55 €
P-62561-10	4,50	126	81	10	24,15 €	P-60888-5	10,50	133	87	5	35,50 €
P-60698-10	4,75	80	47	10	15,01 €	P-60894-5	11,00	142	94	5	40,64 €
P-60707-10	5,00	86	52	10	15,77 €	P-60903-5	11,50	142	94	5	44,39 €
P-62577-10	5,00	132	87	10	30,52 €	P-60919-5	12,00	151	101	5	50,27 €
P-60729-10	5,50	93	57	10	18,51 €	P-60925-5	12,50	151	101	5	54,18 €
P-62583-10	5,50	139	91	10	35,74 €	P-60931-5	13,00	151	101	5	57,61 €

VŔTANIE: VRTÁKY DO KOVOV Z RÝCHLOREZNEJ OCELE SADY

Sady vrtákov do kovov z rýchloreznej ocele (HSS-G)

Sada vrtákov HSS – G 19 ks

P-73673

37,70 € (MOC s DPH)

1; 1,5; 2; 2,5; 3; 3,5; 4; 4,5; 5; 5,5;
6; 6,5; 7; 7,5; 8,5; 9; 9,5; 10;
PVC obal



Sada vrtákov HSS – G 19 ks

P-60517

29,21 € (MOC s DPH)

1; 1,5; 2; 2,5; 3; 3,5; 4; 4,5; 5; 5,5;
6; 6,5; 7; 7,5; 8,5; 9; 9,5; 10;
Kovový obal



Sada vrtákov HSS – G 25 ks

P-73689

73,41 € (MOC s DPH)

1; 1,5; 2; 2,5; 3; 3,5; 4; 4,5; 5; 5,5;
6; 6,5; 7; 7,5; 8,5; 9; 9,5; 10; 10,5;
11; 11,5; 12; 12,5; 13;
PVC obal



Sada vrtákov HSS – G 25 ks

P-60523

62,54 € (MOC s DPH)

1; 1,5; 2; 2,5; 3; 3,5; 4; 4,5; 5; 5,5;
6; 6,5; 7; 7,5; 8,5; 9; 9,5; 10; 10,5;
11; 11,5; 12; 12,5; 13;
Kovový obal



Sada vrtákov s 1/4" upínaním 5 ks

D-20769

13,58 € (MOC s DPH)

5; 6; do dreva
5; 6; 8; HSS-Tin do kovu



Sada vrtákov s 1/4" upínaním 5 ks

D-23759

10,38 € (MOC s DPH)

5; 6; do dreva
5; 6; ; HSS-Tin do kovu
6; HN CT do tehly a muriva



Sada vrtákov do muriva/ kovu/ muriva

P-23818

22,82 € (MOC s DPH)

HSS 3; 4; 5; 6; 8; 10
murivo 3; 4; 5; 6; 8; 10
drevo 3; 4; 5; 6; 8; 10

18 ks v PVC obal



Sada vrtákov HSS – Tin 19 ks

D-67527

19,57 € (MOC s DPH)

1,5 x 2; 2 x 2; 2,5 x 2; 3 x 2; 3,2; 3,5
4; 4,5; 5; 5,5; 6; 6,5; 7; 8; 10



VŘTANIE: HSS-CO VRTÁKY DO KOVU Z RÝCHLOREZNEJ OCELE S VALCOVITOU STOPKOU

Obj. č.	Dĺžka	Priemer mm	Upínanie	Použitie	Počet brítov	MOC s DPH
---------	-------	------------	----------	----------	--------------	-----------

Záhlbníkový trojbrítový vrták do kovu HSS 90°



DIN 338

Valcovitá stopka. Na hlboké zapustenie sa používa záhlbník s tromi frézami a veľkými drážkami. Je to najbežnejší typ zahĺbenia.



P-73514		4,3	valcovitá stopka	M2	3	4,47 €
P-73520		5,3	valcovitá stopka	M2,5	3	4,47 €
P-73536		6,3	valcovitá stopka	M3	3	5,06 €
P-73542		8,3	valcovitá stopka	M4	3	5,92 €
P-73558		9,4	valcovitá stopka	M4,5	3	7,02 €
P-73564		10,4	valcovitá stopka	M5	3	7,34 €
P-73570		12,4	valcovitá stopka	M6	3	9,14 €
P-73586		16,5	valcovitá stopka	M8	3	13,55 €

Záhlbníkový trojbrítový vrták do kovu HSS-CO 90°



DIN 338

Záhlby so šikmými otvormi majú kužeľovú hlavu so šikmým otvorom. Reznú hranu tvorí šikmý otvor na reznej hlave. Vďaka špeciálnej geometrii reznej hrany môže pilina unikáť kontinuálnym tokom, čo umožňuje stabilnejšie, hladšie a zaoblené zahĺbenie, najmä u tenkých plechov.



P-73601		6,3	valcovitá stopka	M3	3	8,49 €
P-73617		8,3	valcovitá stopka	M4	3	10,80 €
P-73623		10,4	valcovitá stopka	M5	3	12,83 €
P-73639		12,4	valcovitá stopka	M6	3	16,32 €
P-73645		16,5	valcovitá stopka	M8	3	24,55 €

Záhlbníkový vrták do kovu HSS 90°



DIN 338

Záhlbník so šikmými otvormi ma kužeľovú hlavu so šikmým otvorom. Reznú hranu tvorí šikmý otvor na reznej hlave. Vďaka špeciálnej geometrii reznej hrany môže pilina unikáť kontinuálnym tokom, čo umožňuje stabilnejšie, hladšie a zaoblené zahĺbenie, najmä u tenkých plechov.



P-73651		5 – 10	valcovitá stopka	90°	1	9,14 €
P-73667		15 – 20	valcovitá stopka	90°	1	12,40 €

Sada záhlbníkov 6 ks

P-73592 57,71 € (MOC s DPH)

Dĺžka: 45 mm – 63 mm
 Priemer: 6,3 mm, 8,3 mm, 10,4 mm, 12,4 mm, 16,5 mm, 20,5 mm
 Valcovitá stopka 5 – 10 mm
 3 – brít
 Hlboké zahĺbenie pre otvory: M3, M4, M5, M6, M8, M10

DIN 338



VŘTANIE: STUPŇOVITÉ VRTÁKY

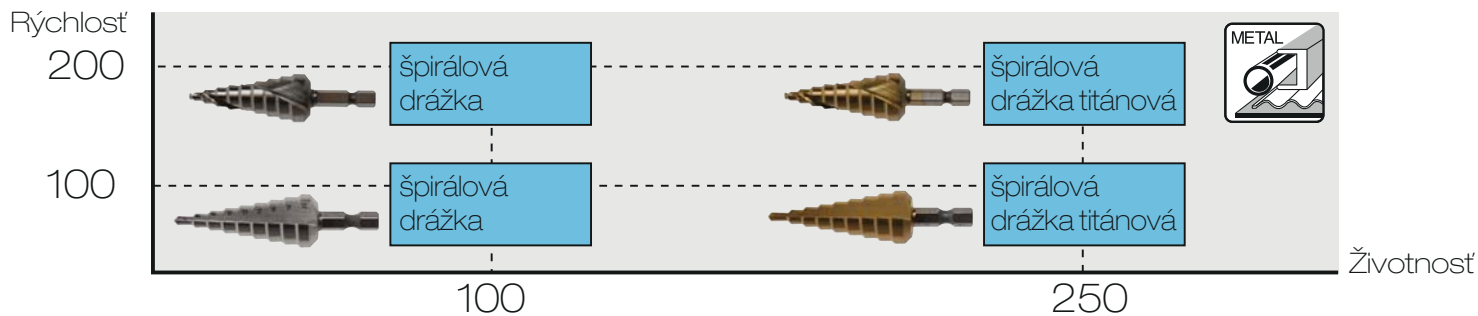

Obj. č.	Drážka	Upínanie	Pre otvory	MOC s DPH
---------	--------	----------	------------	-----------

Stupňovité vrtáky HSS-G so špirálovou drážkou



P-69892	špirálová / 9	valcovitá stopka	4 – 12	22,00 €
P-69901	špirálová / 9	valcovitá stopka	4 – 20	37,21 €
P-69917	špirálová / 14	valcovitá stopka	4 – 30	79,41 €
P-69923	špirálová / 13	valcovitá stopka	6 – 30	77,85 €
P-69939	špirálová / 12	valcovitá stopka	6 – 38	100,01 €
P-69945	špirálová / 12	valcovitá stopka	6 – 37	100,01 €

Stupňovité vrtáky HSS-Co + TiN so špirálovou drážkou



P-69967	špirálová / 9	valcovitá stopka	4 – 12	29,54 €
P-69973	špirálová / 9	valcovitá stopka	4 – 20	50,04 €
P-69995	špirálová / 13	valcovitá stopka	6 – 30	110,55 €
P-70007	špirálová / 12	valcovitá stopka	6 – 38	149,65 €

Sada stupňovitých vrtákov 3 ks HSS-G

P-69951 127,79 € (MOC s DPH)

drážka špirálová / 9 pre otvory 4 – 12
 drážka špirálová / 9 4 – 20
 drážka špirálová / 14 4 – 30



Sada stupňovitých vrtákov 3 ks HSS-Co + TiN

P-70029 192,51 € (MOC s DPH)

drážka špirálová / 9 pre otvory 4 – 12
 drážka špirálová / 9 4 – 20
 drážka špirálová / 14 4 – 30



VŘTANIE: SKLO

Vrtáky do skla s 1/4" šesťhrannou stopkou



Obj. č.	ø mm	L1 mm	L2 mm	ks/bal	MOC s DPH
D-15942	4	65		1	2,90 €
D-15958	5	65		1	2,96 €
D-15964	6	65		1	3,18 €
D-15970	8	70		1	3,40 €
D-15986	10	80		1	4,11 €

Vrtáky do skla s valcovou stopkou



P-60012	3	65		1	3,02 €
P-60028	4	65		1	3,20 €
P-60034	5	65		1	3,38 €
P-60040	6	65		1	3,59 €
P-60056	7	70		1	3,84 €
P-60062	8	70		1	4,10 €
P-60078	9	70		1	4,55 €
P-60084	10	98		1	4,90 €
P-60090	12	98		1	5,87 €
P-60109	13	98		1	6,73 €

VŘTANIE: DO MURIVA A KAMEŇA

Vrtáky do muriva a kameňa s valcovitou stopkou



Obj. č.	ø mm	L1 mm	L2 mm	ks/bal	MOC s DPH
D-05234	4	70	40	1	0,93 €
D-05240	5	85	50	1	0,93 €
D-05256	6	100	60	1	0,93 €
D-05262	6	150	90	1	1,00 €
D-05290	8	110	90	1	1,00 €
D-05309	8	150	90	1	1,00 €
D-05321	10	150	90	1	1,31 €
D-05343	12	150	90	1	1,56 €
D-17728	12	600	550	1	5,70 €
D-05359	13	150	90	1	2,06 €
D-05365	14	150	90	1	2,06 €
D-05371	15	150	90	1	2,43 €
D-17734	16	600	550	1	8,01 €

Sada vrtákov do muriva a kameňa

D-72877

4,89 €

(MOC s DPH)

valcovitá stopka
ø mm 4, 5, 6, 8, 10



VŘTANIE: DREVO

Ploché frézovacie vrtáky do dreva



D priemer mm
L1 celková dĺžka
L2 pracovná dĺžka
Vhodné pre mäkké aj tvrdé drevo so šesťhrannou stopkou



Obj. č.	ø mm	L1 mm	L2 mm	ks/bal	MOC s DPH
D-07696	10	150	120	1	1,40 €
D-07705	12	150	120	1	1,40 €
D-07711	14	150	120	1	1,50 €
D-07727	15	150	120	1	1,50 €
D-07733	16	150	120	1	1,56 €
D-07749	18	150	120	1	1,65 €
D-07755	20	150	120	1	1,84 €
D-07761	22	150	120	1	1,96 €
D-07777	24	150	120	1	2,12 €
D-07783	25	150	120	1	2,12 €
D-07799	26	160	130	1	2,31 €
D-07808	28	160	130	1	2,52 €
D-07814	30	160	130	1	2,77 €
D-07820	32	160	130	1	2,96 €
D-07836	34	160	130	1	3,08 €
D-07842	35	160	130	1	3,21 €
D-07858	36	160	130	1	3,27 €

Ploché frézovacie vrtáky do dreva



D priemer mm
L1 celková dĺžka
L2 pracovná dĺžka
Ideálne pre väčšinu druhov dreva, tvrdé alebo mäkké, šesťhranná stopka



štandardná dĺžka					
Obj. č.	ø mm	L1 mm	L2 mm	ks/bal	MOC s DPH
P-58643	6	150	120	1	1,29 €
P-58659	8	150	120	1	1,48 €
P-58665	10	150	120	1	1,53 €
P-58671	12	150	120	1	1,56 €
P-58687	14	150	120	1	1,58 €
P-58693	15	150	120	1	1,62 €
P-58702	16	150	120	1	1,73 €
P-58713	18	150	120	1	1,83 €
P-58724	20	150	120	1	1,91 €
P-58730	22	150	120	1	2,04 €
P-58746	24	150	120	1	2,14 €
P-58752	25	150	120	1	2,45 €
P-58768	26	160	130	1	2,62 €
P-58774	28	160	130	1	2,81 €
P-58780	30	160	130	1	2,99 €
P-58796	32	160	130	1	3,35 €
P-58805	34	160	130	1	3,64 €
P-58811	35	160	130	1	3,70 €
P-58827	36	160	130	1	3,82 €

Sada vrtákov

E-08698

21,49 € (MOC s DPH)

12, 14, 16, 18, 20, 22, 25, 32 × 150 mm



Obj. č.

ø mm

L1 mm

L2 mm

ks/bal

MOC s DPH

Vrták špirálový do dreva s dvomi ostriami a centrovacím hrotom; valcovitá stopka



D priemer mm
L1 celková dĺžka
L2 pracovná dĺžka



štandardná dĺžka

Obj. č.	ø mm	L1 mm	L2 mm	ks/bal	MOC s DPH
štandardná dĺžka					
D-07026	3	60	30	1	0,56 €
D-07032	4	75	43	1	0,56 €
D-07048	5	85	50	1	0,62 €
D-07054	6	95	58	1	0,75 €
D-07076	8	115	73	1	1,00 €
D-07082	9	125	80	1	1,18 €
D-07098	10	135	85	1	1,28 €
D-07107	12	155	100	1	1,74 €
D-53453	13	151	96	1	2,03 €
D-07113	14	170	120	1	2,24 €
D-53469	15	160	100	1	2,52 €
D-07129	16	180	130	1	2,87 €
D-07135	18	200	140	1	4,42 €
D-07141	20	200	140	1	4,86 €
predĺžené					
D-07157	6	315	150	1	3,05 €
D-07163	8	315	150	1	3,58 €
D-07179	10	315	150	1	3,86 €
D-07185	12	315	150	1	5,23 €
D-07191	14	315	150	1	6,23 €
D-07200	16	315	150	1	7,82 €
D-07216	18	335	150	1	9,97 €
D-07222	20	335	150	1	12,12 €

Skrutkovicové vrtáky do dreva s 1/4" upínaním



1/4 "Šesthranné stopkové upínanie
Vhodné na vrtanie otvorov s malým alebo
stredným priemerom.
Schopný vrtat aj mäkké plasty.



Obj. č.	ø mm	L1 mm	L2 mm	ks/bal	MOC s DPH
P-57679	6	315		1	2,42 €
P-57685	8	315		1	2,95 €
P-57691	10	315		1	3,72 €
P-57700	12	315		1	4,90 €
P-57716	14	315		1	5,84 €
P-57722	16	315		1	7,47 €
P-57744	20	335		1	10,84 €
P-57750	8	450		1	5,03 €
P-57794	16	450		1	11,29 €
P-57803	18	450		1	14,39 €
P-57819	20	450		1	17,95 €

Špirálové vrtáky do dreva podľa DIN338



Obj. č.	ø mm	L1 mm	L2 mm	ks/bal	MOC s DPH
P-57473	3	60		1	0,48 €
P-57489	4	75		1	0,51 €
P-57495	5	85		1	0,59 €
P-57504	6	95		1	0,67 €
P-57510	7	110		1	0,72 €
P-57526	8	115		1	0,88 €
P-57532	9	125		1	1,03 €
P-57548	10	135		1	1,18 €
P-57554	12	155		1	1,75 €
P-57560	14	170		1	2,50 €
P-57576	16	180		1	3,46 €
P-57582	18	200		1	5,57 €
P-57598	20	200		1	6,45 €
P-57607	22	205		1	9,19 €
P-57613	24	215		1	11,26 €
P-57629	26	215		1	13,68 €
P-57635	28	220		1	16,68 €
P-57641	30	220		1	19,32 €

Špirálové vrtáky do dreva s valcovitou stopkou



Obj. č.	ø mm	L1 mm	L2 mm	ks/bal	MOC s DPH
P-57940	8	600		1	10,44 €
P-57956	10	600		1	11,26 €
P-57962	12	600		1	13,81 €
P-57984	16	600		1	18,60 €
P-58051	30	600		1	49,68 €

Obj. č.

ø mm

L1 mm

L2 mm

ks/bal

MOC s DPH

Vrtáky do dreva so šesťhrannou stopkou

P-58067	4	200		1	4,31 €
P-58073	5	200		1	4,37 €
P-58089	6	200		1	5,12 €
P-58095	8	200		1	5,68 €
P-58213	8	300		1	7,96 €
P-58350	8	450		1	10,38 €
P-58497	8	600		1	11,67 €
P-58104	10	200		1	6,66 €
P-58229	10	300		1	8,52 €
P-58366	10	450		1	10,54 €
P-58506	10	600		1	12,31 €
P-58110	12	200		1	7,83 €
P-58235	12	300		1	10,05 €
P-58372	12	450		1	12,63 €
P-58512	12	600		1	14,59 €
P-58388	14	450		1	15,41 €
P-58528	14	600		1	17,72 €
P-58257	15	300		1	14,04 €
P-58132	16	200		1	9,66 €
P-58263	16	300		1	14,49 €
P-58403	16	450		1	17,66 €
P-58534	16	600		1	20,01 €
P-58148	18	200		1	10,97 €
P-58279	18	300		1	16,91 €
P-58419	18	450		1	20,50 €
P-58540	18	600		1	24,61 €
P-58154	20	200		1	12,57 €
P-58285	20	300		1	18,70 €
P-58425	20	450		1	22,52 €
P-58556	20	600		1	27,32 €
P-58160	22	200		1	13,22 €
P-58291	22	300		1	20,47 €
P-58431	22	450		1	26,44 €
P-58562	22	600		1	29,74 €
P-58176	24	200		1	14,95 €
P-58300	24	300		1	22,26 €
P-58447	24	450		1	28,59 €
P-58578	24	600		1	33,23 €
P-58316	25	300		1	24,64 €
P-58453	25	450		1	32,87 €
P-58322	26	300		1	26,47 €
P-58584	26	600		1	40,83 €
P-58338	28	300		1	29,85 €
P-58590	28	600		1	43,90 €
P-58207	30	200		1	21,71 €
P-58344	30	300		1	32,97 €
P-58481	30	450		1	44,42 €
P-58609	30	600		1	51,34 €
P-58615	32	600		1	55,32 €
P-58621	34	600		1	68,81 €
P-58637	36	600		1	75,46 €

Sady vrtákov do dreva

Sada vrtákov do dreva 7 ks 1/4" upínanie, 7 ks, ø mm 2, 3, 3, 4, 5, 6, 8 ***	D-62371 6,39 € (MOC s DPH)		Vrták do dreva 1/4" upínanie ø 6 x 200 mm ***	D-15992 3,65 € (MOC s DPH)	
Sada vrtákov do dreva 5 ks valcovitá stopka ø mm 4, 5, 6, 8, 10 ****	P-57657 3,85 € (MOC s DPH)		Vrták do dreva 1/4" upínanie ø 8 x 200 mm ***	D-16003 4,02 € (MOC s DPH)	
Sada vrtákov do dreva 5 ks valcovitá stopka ø mm 4, 5, 6, 8, 10 ***	D-72861 4,29 € (MOC s DPH)		Sada vrtákov do dreva 7 ks valcovitá stopka ø mm 3, 4, 5, 6, 7, 8, 10 ****	P-57663 5,97 € (MOC s DPH)	

Obj. č.	ø mm	L1 mm	L2 mm	ks/bal	MOC s DPH
---------	------	-------	-------	--------	-----------

Vrtáky na pánty



Forstnerové vrtáky s vystred'ovacou špičkou s 2 ostriami



Obj. č.	ø mm	L1 mm	L2 mm	ks/bal	MOC s DPH
P-58833	8	90		1	3,95 €
P-58849	10	90		1	4,16 €
P-58855	12	90		1	4,55 €
P-58861	14	90		1	5,06 €
P-58877	15	90		1	5,40 €
P-58883	16	90		1	5,68 €
P-58899	18	90		1	6,04 €
P-58908	20	90		1	6,26 €
P-58914	22	90		1	6,44 €
P-58920	24	90		1	6,81 €
P-58936	25	90		1	7,18 €
P-58942	26	90		1	7,87 €
P-58958	28	90		1	8,42 €
P-58964	30	90		1	8,78 €
P-58970	32	90		1	9,34 €
P-58986	34	90		1	9,92 €
P-58992	35	90		1	10,35 €
P-59003	36	90		1	10,61 €
P-59019	38	90		1	11,00 €
P-59025	40	90		1	12,24 €
P-59031	42	90		1	15,34 €
P-59047	45	90		1	15,34 €
P-58053	48	90		1	18,83 €
P-58069	50	90		1	18,83 €

Vrtáky na pánty so šesťhrannou stopkou



D-29963	32	127		1	14,99 €
D-30025	57	127		1	30,94 €
D-30031	65	127		1	34,27 €
D-56518	92	127		1	60,38 €

Obj. č.	ø mm	L1 mm	L2 mm	ks/bal	MOC s DPH
---------	------	-------	-------	--------	-----------

Skrutkové vrtáky do dreva s valcovitou stopkou



D-07238	6	200	130	1	2,77 €
D-07244	8	200	130	1	2,99 €
D-07250	10	200	130	1	3,58 €
D-07266	12	200	130	1	3,83 €
D-07272	14	200	130	1	4,30 €
D-07288	16	200	130	1	4,70 €
D-07294	18	200	130	1	5,17 €
D-07303	20	200	130	1	5,73 €
D-07319	22	200	130	1	6,89 €
D-07325	24	200	130	1	7,51 €
D-07331	6	250	180	1	2,90 €
D-07347	8	250	180	1	3,27 €
D-07353	10	250	180	1	3,83 €
D-07369	12	250	180	1	4,14 €
D-07375	14	250	180	1	4,89 €
D-07381	16	250	180	1	5,27 €
D-07397	18	250	180	1	6,08 €
D-07406	20	250	180	1	6,61 €
D-07412	22	250	180	1	7,73 €
D-07428	24	250	180	1	8,75 €
D-07434	8	400	230	1	6,17 €
D-07440	10	400	230	1	6,42 €
D-07456	12	400	230	1	7,54 €
D-07462	14	400	230	1	8,19 €
D-07478	16	400	230	1	9,13 €
D-07484	18	400	230	1	11,03 €
D-07490	20	400	230	1	12,03 €
D-07509	22	400	230	1	13,27 €
D-07515	24	400	230	1	16,89 €
D-07521	26	400	230	1	18,35 €
D-07537	28	400	230	1	21,90 €
D-07543	30	400	230	1	24,77 €
D-07559	8	450	370	1	7,79 €
D-07565	10	450	370	1	7,98 €
D-07571	12	450	370	1	9,28 €
D-07587	14	450	370	1	9,97 €
D-07593	16	450	370	1	12,24 €
D-07602	18	450	370	1	13,30 €
D-07618	20	450	370	1	14,96 €
D-07624	22	450	370	1	16,79 €
D-07630	24	450	370	1	19,25 €
D-07646	26	450	370	1	21,31 €
D-07652	28	450	370	1	24,93 €
D-07668	30	450	370	1	28,94 €

Obj. č.	ø mm	L1 mm	L2 mm	ks/bal	MOC s DPH
---------	------	-------	-------	--------	-----------

Špirálový vrták do dreva s valcovitou stopkou

























P-57940	8	600		1	10,44 €
P-57956	10	600		1	11,26 €
P-57962	12	600		1	13,81 €
P-57984	16	600		1	18,60 €
P-58051	30	600		1	49,68 €

3D skrutkovité vrtáky do dreva s valcovitou stopkou

E-07755	6	400	325	1	28,89 €
E-07761	8	400	325	1	29,09 €
E-07777	9	400	325	1	28,99 €
E-07783	10	400	325	1	29,09 €
E-07799	10.V	400	325	1	28,89 €
E-07923	10.V	500	425	1	31,69 €
E-07808	11	400	325	1	28,89 €
E-07814	12	400	325	1	29,09 €
E-07939	12	500	425	1	31,69 €
E-07820	13	400	325	1	36,29 €
E-07836	13.V	400	325	1	36,19 €
E-07945	13.V	500	425	1	39,19 €
E-07842	15	400	325	1	36,59 €
E-07951	15	500	425	1	39,29 €
E-07858	16	400	325	1	43,69 €
E-07864	18	400	325	1	43,69 €
E-07967	18	500	425	1	46,99 €
E-07870	21	400	325	1	51,89 €
E-07973	21	500	425	1	55,69 €
E-07886	22	400	325	1	62,59 €
E-07892	24	400	325	1	62,59 €
E-07989	24	500	425	1	65,59 €
E-07901	27	400	325	1	69,59 €
E-07995	27	500	425	1	76,49 €
E-07917	30	400	325	1	78,19 €
E-08006	30	500	425	1	81,19 €

Tabulka použitia

AA : Odporúčené A : Akceptovateľné

Použitie		železo	nerez	Aluminum	neželezné kovy	drevo	MDF	sádrokartón	PVC	sklo-laminát	mäkké obklady	tehla	vápenec	mramor
														
BiM	<i>Ezychange</i> Bi-Metal HSS 8%Co 	AA	A	AA	AA	AA			AA					
	BiM 	AA		A	A	AA			AA					
	BiM pre plechy 	AA	AA	A	A									
Karbíd volfrámu	<i>Ezychange</i> TCT 	AA	AA	AA	AA	AA			AA		A	A	A	
	Viacúčelový TCT 					AA	AA	AA	AA	AA	A		A	
	TCT 	AA	AA	A	A				AA	AA				
	TC zrnitý 											AA	AA	
Diamantové	Vákuovo spájkovaný diamant 										AA	AA	AA	AA
	Diamond wet holesaw 										AA			AA
Uhlíková ocel'	Uhlíková ocel' 					A		A	A					

VŔTANIE: VYKRUŽOVACIE KORUNKY

Obj. č.	ø mm	L1	Adaptér	ks/bal	MOC s DPH
---------	------	----	---------	--------	-----------

BiM vykružovacie korunky

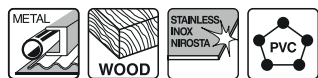

BiM vykružovacie korunky
HSS bimetal
Na vŕtanie do ocele, farebných kovov, plastov,
dreva a sadrokartónu.

D-16994	16	38	D-17170 / D-17603	1	3,55 €
D-17005	19	38	D-17170 / D-17603	1	3,83 €
D-17251	20	38	D-17170 / D-17603	1	4,02 €
D-17011	22	38	D-17170 / D-17603	1	4,33 €
D-17027	24	38	D-17170 / D-17603	1	4,42 €
D-17033	25	38	D-17170 / D-17603	1	4,52 €
D-17267	29	38	D-17170 / D-17603	1	5,23 €
D-17049	32	38	D-17186 / D-17619	1	5,70 €
D-17055	35	38	D-17186 / D-17619	1	5,92 €
D-17061	38	38	D-17186 / D-17619	1	6,32 €
D-17273	40	38	D-17186 / D-17619	1	6,57 €
D-17077	44	38	D-17186 / D-17619	1	7,13 €
D-17083	51	38	D-17186 / D-17619	1	7,98 €
D-24876	54	38	D-17186 / D-17619	1	8,26 €
D-17099	57	38	D-17186 / D-17619	1	8,72 €
D-25688	60	38	D-17186 / D-17619	1	8,85 €
D-24882	65	38	D-17186 / D-17619	1	9,53 €
D-17108	68	38	D-17186 / D-17619	1	10,16 €
D-25694	70	38	D-17186 / D-17619	1	10,47 €
D-17114	76	38	D-17186 / D-17619	1	11,22 €
D-33869	80	38	D-17186	1	11,75 €
D-17120	83	38	D-17186	1	11,93 €
D-17136	92	38	D-17186	1	13,40 €
D-17142	105	38	D-17186	1	15,33 €
D-17158	127	38	D-17186	1	19,13 €
D-17164	152	38	D-17186	1	22,28 €



Obj. č.	ø mm	ø mm	Adaptér/ upínanie	ks/bal	MOC s DPH
D-17170	16 - 29		Hex	1	4,39 €
D-17186	30 - 152		Hex	1	7,91 €
D-17603	14 - 29		SDS-PLUS	1	5,61 €
D-17619	30 - 76		SDS-PLUS	1	10,00 €
D-17192	6	75	centrovací vŕták	1	3,08 €



Akumulátory
Odkladacie systémy
Vŕtanie
Skrutkovanie
Brúsky
Pílenie
Frézovanie
Brúsenie
Špeciálne stroje
Klince / spony
Vysávanie
Fény/lampy
Záhada
Ručné náradie
Ostatné

VŔTANIE: VYKRUŽOVACIE KORUNKY

Vykružovacie korunky sady

Sada vykružovacích korúnok vodárenská D-47117 51,81 € (MOC s DPH)

ø 19, 22, 29, 38, 44, 57mm
2x adaptér



Sada vykružovacích korúnok vodárenská D-63965 49,59 € (MOC s DPH)

ø 19, 22, 29, 38, 44, 57mm
2x adaptér



Sada vykružovacích korúnok elektrikárska D-47139 54,55 € (MOC s DPH)

ø 20, 25, 32, 40, 51, 65mm
2x adaptér



Sada vykružovacích korúnok elektrikárska D-47123 48,01 € (MOC s DPH)

ø 16, 20, 25, 32, 40, 51mm
2x adaptér



Sada Bi – metalových vykružovacích korúnok D-33641-14 291,41 € (MOC s DPH)

ø 22, 25, 29, 32 mm
adaptér
14 ks balenie



Sada Bi – metalových vykružovacích korúnok D-33657 26,69 € (MOC s DPH)

ø 22, 29, 32, 51 mm
adaptér



EzyChange sada vykružovacích korúnok E-12304 147,59 € (MOC s DPH)

vodárenská
ø 19, 22, 29, 38, 44, 57 mm,
adaptér, strediaci vrták



EzyChange sada vykružovacích korúnok E-12310 133,79 € (MOC s DPH)

elektrikárska
ø 16, 20, 25, 32, 40, 51 mm,
adaptér, strediaci vrták



EzyChange sada vykružovacích korúnok E-12326 149,99 € (MOC s DPH)

elektrikárska
ø 20, 25, 32, 40, 65 mm,
adaptér, strediaci vrták



VŔTANIE: VYKRUŽOVACIE KORUNKY

Obj. č.	ø mm	L1	Adaptér	ks/bal	MOC s DPH
---------	------	----	---------	--------	-----------

Bimetalové korunky kov + 5% kobalt

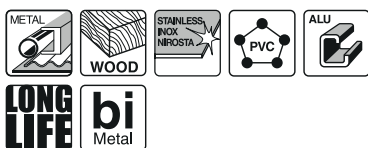

HSS Bi-Metal zub s premenlivým rozstupom 4-btpi s 5% obsahom kobaltu pre dlhšiu životnosť.

Vhodné na drevo, sadrokartón, plasty, neželezné kovy, hliník, oceľ a nehrdzavejúcu oceľ.

Priemery od 14 – 152 mm s šesťhrannými a SDS adaptérmí a navyše adaptéry so šesťhranným a SDS-Plus upínaním dlhý strediaci vrták.



P-35156



P-35162



P-35190



P-35178



For SDS-Plus Hammers

P-52451	14	38	P-35156 / P-35178	1	6,99 €
P-34936	16	38	P-35156 / P-35178	1	7,99 €
P-52467	17	38	P-35156 / P-35178	1	7,99 €
P-34942	19	38	P-35156 / P-35178	1	7,99 €
P-52473	20	38	P-35156 / P-35178	1	7,99 €
P-52489	21	38	P-35156 / P-35178	1	7,99 €
P-34958	22	38	P-35156 / P-35178	1	8,99 €
P-34964	24	38	P-35156 / P-35178	1	8,99 €
P-34970	25	38	P-35156 / P-35178	1	8,99 €
P-52495	27	38	P-35156 / P-35178	1	8,99 €
P-52504	29	38	P-35156 / P-35178	1	8,99 €
P-52510	30	38	P-35162 / P-35184	1	8,99 €
P-34986	32	38	P-35162 / P-35184	1	9,99 €
P-52526	33	38	P-35162 / P-35184	1	9,99 €
P-34992	35	38	P-35162 / P-35184	1	9,99 €
P-52532	37	38	P-35162 / P-35184	1	9,99 €
P-35003	38	38	P-35162 / P-35184	1	10,99 €
P-52548	40	38	P-35162 / P-35184	1	10,99 €
P-52554	41	38	P-35162 / P-35184	1	10,99 €
P-52560	43	38	P-35162 / P-35184	1	10,99 €
P-35019	44	38	P-35162 / P-35184	1	11,99 €
P-52576	46	38	P-35162 / P-35184	1	10,99 €
P-52582	48	38	P-35162 / P-35184	1	10,99 €
P-35025	51	38	P-35162 / P-35184	1	12,99 €
P-52598	52	38	P-35162 / P-35184	1	12,99 €
P-52607	54	38	P-35162 / P-35184	1	12,99 €
P-35031	57	38	P-35162 / P-35184	1	13,99 €
P-52613	59	38	P-35162 / P-35184	1	13,99 €
P-52629	60	38	P-35162 / P-35184	1	13,99 €
P-52635	64	38	P-35162 / P-35184	1	13,99 €
P-52641	65	38	P-35162 / P-35184	1	13,99 €
P-52657	67	38	P-35162 / P-35184	1	14,99 €
P-35047	68	38	P-35162 / P-35184	1	14,99 €
P-52663	70	38	P-35162 / P-35184	1	15,99 €
P-52679	73	38	P-35162 / P-35184	1	15,99 €
P-35053	76	38	P-35162 / P-35184	1	15,99 €
P-52685	79	38	P-35162 / P-35184	1	15,99 €
P-35069	83	38	P-35162 / P-35184	1	17,99 €
P-52691	86	38	P-35162 / P-35184	1	16,99 €
P-52700	89	38	P-35162 / P-35184	1	18,99 €
P-35075	92	38	P-35162 / P-35184	1	18,99 €
P-52716	95	38	P-35162 / P-35184	1	19,99 €
P-52722	98	38	P-35162 / P-35184	1	20,99 €
P-52738	102	38	P-35162 / P-35184	1	21,99 €
P-35081	105	38	P-35162 / P-35184	1	23,99 €
P-52744	108	38	P-35162 / P-35184	1	24,99 €
P-52750	111	38	P-35162 / P-35184	1	23,99 €
P-52766	114	38	P-35162 / P-35184	1	24,99 €
P-52772	121	38	P-35162 / P-35184	1	26,99 €
P-35097	127	38	P-35162 / P-35184	1	30,99 €
P-52788	140	38	P-35162 / P-35184	1	36,99 €
P-52794	146	38	P-35162 / P-35184	1	41,99 €
P-35106	152	38	P-35162 / P-35184	1	49,99 €

Obj. č.	ø mm	ø mm	Adaptér/ upínanie	ks/bal	MOC s DPH
P-35156	14 – 30	9,5	šesťhran	1	10,99 €
P-35162	32 – 210	11	šesťhran	1	20,99 €
P-35190	32 – 210	11	šesťhran	1	18,99 €
P-35178	14 – 30		SDS-Plus	1	18,99 €
P-35184	32 – 210		SDS-Plus	1	24,99 €
P-35209		83	centrovací vrták	1	5,99 €
P-35215		102	centrovací vrták	1	5,99 €

Max rýchlosť vrtania

ø mm	oceľ	meď	hliník	inox	drevo
16	530	730	825	275	3000
19	460	600	690	230	3000
20	440	580	675	220	3000
22	390	520	585	195	3000
24	370	490	555	185	2700
25	350	470	525	175	2700
29	300	400	450	150	2700
30	285	380	425	145	2400
32	275	360	410	140	2400
35	250	330	375	125	2400
38	230	300	345	115	2400
41	210	280	315	105	2100
44	195	260	295	95	2100
48	180	240	270	90	2100

ø mm	oceľ	meď	hliník	inox	drevo
57	170	230	255	85	2000
57	150	200	225	75	2000
60	140	190	220	70	2000
64	135	180	205	65	1850
68	130	170	190	65	1800
70	125	160	185	60	1800
76	115	150	170	55	1800
83	105	140	155	50	1500
92	90	120	140	45	1200
102	85	110	130	40	1000
105	85	110	130	40	1000
127	80	110	120	40	1000
152	65	90	90	30	800

VŔTANIE: VYKRUŽOVACIE KORUNKY

Vykružovacie korunky EZYCHANGE Bi-Metal 8%Co

Ezychange



HSS Bi-Metal Ezychange vykružovacie korunky
Potrebný je iba jeden adaptér pre veľkosti 16 – 152 mm s rýchloupínacím strediacim vrtákom.

Vyrobený z HSS Bi-Metal s 8% kobaltu a progresívnu geometriou zubov zaručuje dlhú životnosť a vysokú rýchlosť rezania. Vhodné pre železné a neželezné kovy, nehrdzavejúcu oceľ, hliník, drevo a plasty.

Korunky Ezychange je možné zakúpiť jednotlivo, alebo ako súpravu navrhnutú v tých správnych veľkostiach, ktoré vyhovujú vášmu remeslu. Kompatibilné s inými významnými výrobcami rýchlo vymeniteľných korúnek.

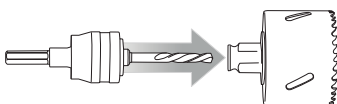

Obj. č.	ø mm	ø mm	Adaptér/ upínanie	ks/bal	MOC s DPH
E-04070			EzyChange adaptér centrovací vrtáka HSS-G	1	27,29 €
E-04086	6,35	85	centrovací vrtáka HSS-G	1	8,29 €
E-04092	6,35	85	centrovací vrtáka HSS-CO	1	11,09 €

Obj. č.	ø mm	L1	Adaptér	ks/bal	MOC s DPH
E-03632	16	44	E-04070	1	9,69 €
E-03648	17	44	E-04070	1	9,69 €
E-03654	19	44	E-04070	1	9,99 €
E-03660	20	44	E-04070	1	9,99 €
E-03676	22	44	E-04070	1	10,59 €
E-03682	24	44	E-04070	1	10,49 €
E-03698	25	44	E-04070	1	10,39 €
E-03707	27	44	E-04070	1	10,79 €
E-03713	29	44	E-04070	1	22,39 €
E-03729	30	44	E-04070	1	11,29 €
E-03735	32	44	E-04070	1	11,79 €
E-03741	35	44	E-04070	1	11,49 €
E-03757	37	44	E-04070	1	12,19 €
E-03763	38	44	E-04070	1	12,19 €
E-03779	40	44	E-04070	1	12,09 €
E-03785	41	44	E-04070	1	12,99 €
E-03791	44	44	E-04070	1	12,79 €
E-03800	46	44	E-04070	1	13,49 €
E-03816	48	44	E-04070	1	13,59 €
E-03822	51	44	E-04070	1	13,59 €
E-03838	52	44	E-04070	1	16,29 €
E-03844	54	44	E-04070	1	16,19 €
E-03850	56	44	E-04070	1	16,19 €
E-03866	57	44	E-04070	1	16,89 €
E-03872	60	44	E-04070	1	17,79 €
E-03888	64	44	E-04070	1	17,89 €
E-03894	65	44	E-04070	1	18,39 €
E-03903	68	44	E-04070	1	18,79 €
E-03919	70	44	E-04070	1	18,79 €
E-03925	73	44	E-04070	1	18,99 €
E-03931	76	44	E-04070	1	19,09 €
E-03947	79	44	E-04070	1	19,79 €
E-03953	83	44	E-04070	1	20,09 €
E-03969	86	44	E-04070	1	20,79 €
E-03975	92	44	E-04070	1	21,89 €
E-03981	95	44	E-04070	1	25,59 €
E-03997	102	44	E-04070	1	30,49 €
E-04008	105	44	E-04070	1	31,39 €
E-04014	111	44	E-04070	1	38,29 €
E-04020	114	44	E-04070	1	40,49 €
E-04036	121	44	E-04070	1	45,19 €
E-04042	127	44	E-04070	1	47,39 €
E-14174	133	44	E-04070	1	cena na vyžiadanie
E-04058	140	44	E-04070	1	49,19 €
E-04064	152	44	E-04070	1	51,89 €



VŔTANIE: VYKRUŽOVACIE KORUNKY

Obj. č.	ø mm	L1 mm	L2 mm	ks/bal	MOC s DPH
---------	------	-------	-------	--------	-----------

Lahké vykružovacie korunky UNICUT

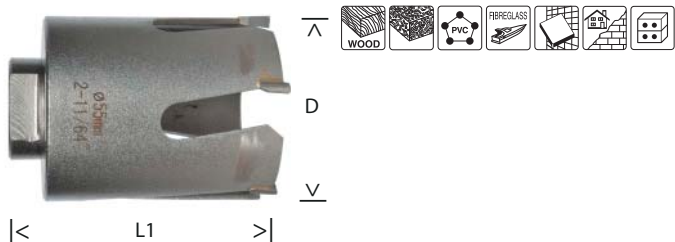

P-64484	35	75		1	34,47 €
P-64490	40	75		1	36,30 €
P-64515	50	75		1	39,36 €
P-64521	55	75		1	42,27 €
P-64543	60	75		1	44,85 €
P-64571	68	75		1	49,19 €
P-64587	70	75		1	56,50 €
P-64593	71	75		1	57,61 €
P-64602	74	75		1	58,30 €
P-64618	76	75		1	60,16 €
P-64630	80	75		1	61,95 €
P-64646	85	75		1	67,43 €
P-64668	105	75		1	89,63 €

Lahká konštrukcia týchto vŕtacích korúnok výrazne rozširuje spektrum využitia vŕtacích kladív SDS-plus. lahkých stavebných hmôt. Hlavnou oblasťou ich využitia sú rôzne remeselnícke práce a práce v dome pri inštaláciách do muriva a moderných lahkých stavebných hmôt.

Príslušenstvo k vykružovacím korunkám UNICU, závit M16			
P-64347	strediaci vŕták 8 ø		4,96 €
P-64319	adaptér SDS-Plus pre vŕtáciu korunku 118 mm		30,09 €
P-64325	adaptér SDS-Plus pre vŕtáciu korunku 220 mm		33,33 €
P-64331	adaptér SDS-Plus pre vŕtáciu korunku 370 mm		37,73 €

Sada korúnok 10 ks **D-51281** **133,44 €** (MOC s DPH)

22, 25, 29, 35, 38, 45, 51mm
strediaci vŕták 10x100mm
TCT strediaci vŕták 8x100mm
13mm Hex adaptér

Sada korúnok 9 ks **D-51297** **141,61 €** (MOC s DPH)

22, 35, 51, 57, 64, 76mm
strediaci vŕták 10x100mm
TCT strediaci vŕták 8x100mm
13mm Hex adaptér

Obj. č.	ø mm	MOC s DPH
---------	------	-----------

Diamantové vŕtáky na kachličky



Na kachličky a dlažbu pre uhlové brúsky pre uhlové brúsky, na sucho, uchytenie M14, max. otáčky 12 000 min⁻¹

D-35025	M14 x 25 mm	25,36 €
D-35019	M14 x 30 mm	29,35 €
D-35003	M14 x 35 mm	32,09 €
D-37007	M14 x 40 mm	37,48 €
D-37013	M14 x 45 mm	42,84 €

Diamantové vŕtáky na kachličky, mramor, granit



Pre uhlové brúsky, na sucho, uchytenie M14, max. otáčky 12 000 min⁻¹



D-61064	5	15,58 €
D-61070	6	16,51 €
D-61086	8	17,07 €
D-61092	10	18,69 €
D-61101	12	20,91 €
D-44432	14	31,97 €
D-44448	16	33,27 €
D-44454	20	25,11 €
D-44460	22	27,54 €
D-44476	25	31,22 €
D-44482	27	33,68 €
D-44498	30	37,36 €
D-44507	32	39,79 €
D-44513	35	43,46 €
D-44529	38	47,11 €
D-44535	40	49,60 €
D-44541	45	55,68 €
D-44557	51	63,15 €
D-44585	60	74,18 €
D-44600	67	82,75 €
D-44616	68	83,97 €
D-44622	70	86,46 €
D-44638	75	92,60 €
D-44644	80	98,70 €
D-44650	83	102,38 €

VŔTANIE: VYKRUŽOVACIE KORUNKY

Vykružovacie korunky

Diamantové korunky do tehly, pórobetónu, kachličiek a mramoru



Obj. č.	ø mm	L1 mm	odporúčane otáčky	ks/bal	MOC s DPH
B-45995	16	40	3 000 – 5 000 min	1	19,72 €
B-46006	19	40	3 000 – 5 000 min	1	23,30 €
B-46012	25	40	3 000 – 5 000 min	1	30,47 €
B-46028	30	40	3 000 – 5 000 min	1	36,42 €
B-46034	32	40	3 000 – 5 000 min	1	38,79 €
B-46040	35	40	3 000 – 5 000 min	1	42,37 €
B-46056	38	40	3 000 – 5 000 min	1	45,96 €
B-46062	45	40	3 000 – 5 000 min	1	54,27 €
B-46078	50	40	3 000 – 5 000 min	1	61,44 €
B-46084	53	40	3 000 – 5 000 min	1	63,90 €
B-46090	57	40	3 000 – 5 000 min	1	68,61 €
B-46109	64	40	3 000 – 5 000 min	1	76,93 €
B-53914	68	40	3 000 – 5 000 min	1	82,60 €

Pre uchytenie s valovitou stopkou

B-46115	Rovná stopka a stredový vrták 182 / 59 mm M12 – M6	1	12,84 €
B-46121	Rovná stopka 182 mm M12 – M6	1	4,58 €
B-46137	Strediaci vrták 59 mm M6	1	9,41 €

Pre uchytenie SDS-Plus

B-52691	Rovná stopka a stredový vrták 182 / 59 mm M12 – M6	1	18,57 €
B-52700	Rovná stopka 182 mm M12 – M6	1	14,67 €

Diamantové vrtáky na kachličky



Obj. č.	ø mm	L1 mm	ks/bal	MOC s DPH
P-66569	5	30	1	9,99 €
P-66575	6	30	1	9,99 €
P-66581	7	30	1	14,99 €
P-66597	8	30	1	11,99 €
P-66612	10	30	1	12,99 €
P-66709	12	30	1	13,99 €
P-66715	15	30	1	15,99 €
P-66721	20	30	1	20,99 €
P-66737	25	30	1	20,99 €

Diamantové vrtáky na kachličky



P-70035	19		1	22,99 €
P-70041	22		1	25,99 €
P-70057	29		1	29,99 €
P-70063	35		1	51,99 €
P-70079	38		1	33,99 €
P-70085	44		1	37,99 €
P-70091	57		1	38,57 €
P-70100	64		1	45,99 €

Upínací adaptér pre diamantový vrták

P-35156	9,6 pre ø 19 – 29	1	10,99 €
P-35162	11 pre ø 35 – 64	1	20,99 €



Sada diamantových vrtákov 3 ks

P-66628

36,99 € (MOC s DPH)

ø 6, 8, 10 mm
vodou chladené



Sada diamantových vrtákov 3 ks

P-66983

60,99 € (MOC s DPH)

ø 15, 20, 25 mm
vodou chladené



VRTANIE: VRTÁKY

Obj. č.	ø mm	L1 mm	ks/bal	MOC s DPH
---------	------	-------	--------	-----------

Príkľepové vrtáky s valcovitou stopkou



Vrtáky s valcovou stopkou sú určené pre vrtanie do betónu, muriva, a prírodného kameňa. Špeciálna špirála v tvare U zaručuje efektívny odvod odvrátených častíc a dlhú životnosť vrtáku.

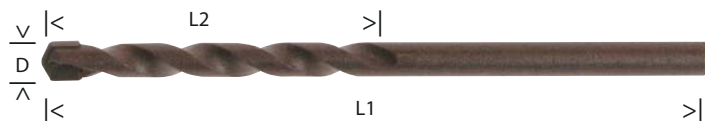

P-59592	3	60	1	0,85 €
P-59601	4	75	1	0,96 €
P-59617	5	85	1	1,06 €
P-59623	6	100	1	1,20 €
P-59754	6	200	1	2,48 €
P-59798	6	400	1	3,75 €
P-59639	7	100	1	1,40 €
P-59645	8	120	1	1,55 €
P-59760	8	200	1	3,00 €
P-59807	8	400	1	4,50 €
P-59900	8	600	1	7,92 €
P-59651	9	120	1	1,73 €
P-59667	10	120	1	2,04 €
P-59776	10	200	1	3,38 €
P-59813	10	400	1	5,17 €
P-59916	10	600	1	8,85 €
P-59689	12	150	1	3,07 €
P-59782	12	200	1	4,37 €
P-59829	12	400	1	6,36 €
P-59922	12	600	1	10,44 €
P-59695	13	150	1	3,80 €
P-59704	14	150	1	4,10 €
P-59835	14	400	1	8,09 €
P-59710	16	150	1	4,90 €
P-59841	16	400	1	9,66 €
P-59726	18	160	1	8,44 €
P-59857	18	400	1	11,55 €

Sada vrtákov do kameňa s valcovitou stopkou

D-72877

4,89 € (MOC s DPH)

4x70mm
5x70mm
6x70mm
8x110mm
10x110mm



Univerzálne vrtáky s valcovitou stopkou



Univerzálne vrtáky s valcovou stopkou určené na vrtanie do betónu, kachličiek, tehly, keramiky, dreva, plastu, hliníku a železa.



D-30287	3	60	1	0,90 €
D-30293	4	70	1	0,90 €
D-30302	5	85	1	0,90 €
D-30318	6	100	1	0,90 €
D-30324	6	150	1	0,93 €
D-31061	6,5	100	1	0,93 €
D-31077	6,5	150	1	1,12 €
D-30346	7	150	1	1,12 €
D-30352	8	110	1	1,00 €
D-30368	8	150	1	1,18 €
D-30380	10	150	1	1,46 €
D-30396	10	400	1	4,24 €
D-30411	12	150	1	1,93 €
D-30427	12	400	1	4,39 €
D-30433	12	600	1	6,01 €
D-30449	13	150	1	2,31 €
D-30455	14	150	1	2,52 €

Univerzálne vrtáky s 1/4" upínaním



Univerzálne vrtáky s 1/4" upínaním určené na vrtanie do kachličiek, tehly, keramiky, dreva, plastu, hliníku a železa.



E-14934	3	90	1	cena na vyžiadanie
E-14940	4	90	1	cena na vyžiadanie
E-14956	5	100	1	cena na vyžiadanie
E-14984	6	100	1	cena na vyžiadanie
E-14990	6	150	1	cena na vyžiadanie
E-15045	8	120	1	cena na vyžiadanie
E-15051	8	150	1	cena na vyžiadanie
E-15067	10	150	1	cena na vyžiadanie
E-15073	12	150	1	cena na vyžiadanie

VŔTANIE: VRTÁKY

Obj. č.	ø mm	L1 mm	L2 mm	ks/bal	MOC s DPH
---------	------	-------	-------	--------	-----------

Vrtáky do tehly s valcovitou stopkou

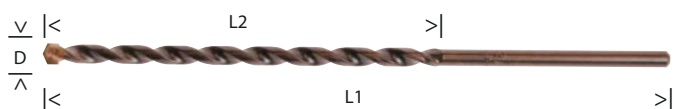

D-40727	3	60	30	1	0,56 €
D-40733	3,5	75	40	1	0,65 €
D-40749	4	75	40	1	0,47 €
D-40755	4,5	85	50	1	0,47 €
D-40761	5	85	50	1	0,53 €
D-40777	5	150	90	1	0,75 €
D-40783	5,5	85	50	1	0,56 €
D-40808	6	100	60	1	0,65 €
D-40814	6	150	90	1	0,84 €
D-40820	6	200	130	1	1,22 €
D-40836	6	400	300	1	1,87 €
D-40842	6,5	100	60	1	0,72 €
D-40886	7	150	90	1	1,00 €
D-40901	8	120	80	1	0,84 €
D-40917	8	150	90	1	1,03 €
D-40923	8	200	130	1	1,40 €
D-40939	8	400	300	1	2,77 €
D-40945	9	120	80	1	1,00 €
D-40951	10	120	80	1	1,18 €
D-40967	10	150	90	1	1,31 €
D-40973	10	200	130	1	1,87 €
D-40989	10	400	300	1	2,96 €
D-41006	12	150	90	1	1,74 €
D-41012	12	200	130	1	2,31 €
D-41028	12	400	300	1	3,68 €

Sada vrtákov HM CT do muriva s valcovitou stopkou E-11536 8,09 € (MOC s DPH)

- 4 x 70 mm
- 5 x 85 mm
- 6 x 100 mm
- 8 x 110 mm
- 10 x 150mm



PRÍSLUŠENSTVO

▣ Vrtanie (búranie)

NEMESIS II



Železo, mäkká oceľ



Hliník



Drevo



Obklad



Betón



Armovaný betón



Tehla



Žula



PVC



Asfalt



Dvoj brit



Štvor brit



Samoostrenie



Menej prachu



Hrot z karbidu volfrámu

Akumulátory
Odkladacie systémy
Vrtanie
Skrutkovanie
Brúsky
Pilenie
Frézovanie
Brúsenie
Klince / spony
Špeciálne stroje
Vysávanie
Fény/lampy
Záhrada
Ručné náradie
Ostatné

VRTANIE: PRÍKLEPOVÉ VRTÁKY SDS-PLUS

NEMESIS II SDS-PLUS 4brit

NEMESIS II



Obj. č.	ø mm	L1 mm	L2 mm	ks/bal	MOC s DPH
B-57897	5	115	50	1	4,99 €
B-57906	5	165	100	1	5,32 €
B-57912	5	215	150	1	7,83 €
B-57928	5	265	200	1	8,00 €
B-57940	5,5	115	50	1	5,03 €
B-57956	5,5	165	100	1	5,35 €
B-57962	6	115	50	1	5,06 €
B-57978	6	165	100	1	5,39 €
B-57984	6	215	150	1	7,02 €
B-57990	6	265	200	1	8,68 €
B-58001	6	315	250	1	12,04 €
B-58023	6,5	165	100	1	7,08 €
B-58039	6,5	215	150	1	9,56 €
B-58045	6,5	265	200	1	12,31 €
B-58051	6,5	315	250	1	14,39 €
B-58067	7	115	50	1	6,76 €
B-58073	7	165	100	1	7,12 €
B-58089	7	215	150	1	8,75 €
B-58095	8	115	50	1	5,84 €
B-58104	8	165	100	1	6,20 €
B-58110	8	215	150	1	7,05 €
B-58126	8	265	200	1	8,68 €
B-58132	8	315	250	1	11,49 €
B-58154	8	465	400	1	18,87 €
B-58176	9	165	100	1	6,66 €
B-58182	9	265	200	1	8,49 €
B-58198	10	115	50	1	6,30 €
B-58207	10	165	100	1	6,85 €
B-58213	10	215	150	1	7,83 €
B-58229	10	265	200	1	9,17 €
B-58235	10	315	250	1	11,29 €
B-58257	10	455	390	1	19,98 €
B-58263	10	600	540	1	26,90 €
B-58279	10	1000	940	1	62,64 €
E-14495	11	160	110	1	7,96 €
E-14504	11	210	160	1	9,63 €
E-14510	11	260	210	1	11,36 €
B-58316	11	310	260	1	15,14 €
E-14532	12	160	110	1	7,64 €
E-14548	12	210	160	1	9,30 €
E-14554	12	260	210	1	10,54 €
E-14560	12	310	260	1	14,49 €
E-14576	12	450	400	1	21,74 €
E-14582	12	600	550	1	27,74 €
B-58388	12	1000	950	1	66,46 €
B-58394	13	160	110	1	10,05 €
B-58403	13	210	160	1	16,78 €
B-58419	13	260	210	1	18,93 €
E-14629	13	310	260	1	20,47 €
E-14635	14	160	110	1	11,03 €
E-14641	14	210	160	1	14,69 €
E-14657	14	260	210	1	16,84 €
E-14663	14	310	260	1	18,15 €
E-14679	14	450	400	1	22,68 €
E-14685	14	600	550	1	30,39 €
B-58497	14	1000	950	1	68,35 €
E-14691	15	160	110	1	16,91 €
E-14700	15	210	160	1	18,96 €
E-14716	15	260	210	1	20,79 €
B-58534	15	450	400	1	27,52 €
E-14738	16	160	110	1	17,63 €
E-14744	16	210	160	1	19,71 €
E-14750	16	260	210	1	21,90 €
E-14766	16	310	260	1	23,34 €
E-14772	16	450	400	1	28,66 €
E-14788	16	600	550	1	37,27 €
B-58609	16	1000	950	1	77,91 €
B-58615	18	250	200	1	29,21 €
B-58621	18	450	400	1	33,13 €
B-58637	20	250	200	1	31,53 €
B-58659	20	450	400	1	37,90 €
B-58665	22	250	200	1	35,64 €
B-58687	22	450	400	1	46,35 €
B-58693	24	250	200	1	44,59 €
B-58702	24	450	400	1	50,72 €
B-58718	25	250	200	1	45,43 €
B-58724	25	450	400	1	58,20 €
B-58746	28	250	200	1	53,53 €
B-58752	28	450	400	1	68,48 €
B-58768	30	250	200	1	60,12 €
B-58774	30	450	400	1	71,64 €
B-58780	32	450	400	1	79,09 €

VŘTANIE: PRÍKLEPOVÉ VRTÁKY SDS-PLUS

NEMESIS II SDS-PLUS 4brit – sady



Sada NEMESIS II **B-58986** **17,40 €** (MOC s DPH)

5 × 110 mm 1 ks
6 × 110 mm 1 ks
8 × 110 mm 1 ks

Sada NEMESIS II **B-59075** **19,98 €** (MOC s DPH)

6 × 160 mm 1 ks
8 × 160 mm 1 ks
10 × 160 mm 1 ks

Sada NEMESIS II **B-58992** **29,67 €** (MOC s DPH)

5 × 110 mm 1 ks
6 × 110 mm 1 ks
6 × 160 mm 1 ks
8 × 160 mm 1 ks
10 × 160 mm 1 ks

Sada NEMESIS II **B-59025** **75,14 €** (MOC s DPH)

5 × 160 mm 1 ks
6 × 160 mm 3 ks
8 × 160 mm 3 ks
10 × 160 mm 3 ks
12 × 160 mm 2 ks

Sada NEMESIS II **B-59031** **50,46 €** (MOC s DPH)

5 × 110 mm 1ks
6 × 110 mm 1 ks
8 × 110 mm 1ks
6 × 160 mm 1ks
8 × 160 mm 1ks
10 × 160 mm 1ks
12 × 160mm 1 ks

Sada NEMESIS II **B-58827** **26,31 €** (MOC s DPH)

6 × 160 mm 5 ks / bal

Sada NEMESIS II **B-58899** **30,26 €** (MOC s DPH)

8 × 160 mm 5 ks / bal

Sada NEMESIS II **B-58914** **33,42 €** (MOC s DPH)

10 × 160 mm 5 ks / bal

Príklepové vrtáky SDS-PLUS 4brit



Obj. č.	ø mm	L1 mm	L2 mm	ks/bal	MOC s DPH
---------	------	-------	-------	--------	-----------

B-62496	6	110	50	1	2,77 €
B-62505	6	160	100	1	2,80 €
B-62511	6	210	150	1	3,08 €
B-62527	6	260	200	1	3,58 €
B-62614	8	160	100	1	3,58 €
B-62620	8	210	150	1	4,21 €
B-62636	8	260	200	1	4,58 €
B-62642	8	310	250	1	4,86 €
B-62658	8	460	400	1	7,73 €
B-62670	10	160	100	1	4,86 €
B-62686	10	210	150	1	5,33 €
B-62692	10	260	200	1	6,17 €
B-62701	10	310	250	1	6,42 €
B-62717	10	350	290	1	6,61 €
B-62723	10	460	400	1	9,72 €
B-62745	12	210	150	1	7,32 €
B-62751	12	260	200	1	7,98 €
B-62789	12	460	400	1	11,68 €

VŔTANIE: PRÍKLEPOVÉ VRTÁKY SDS-PLUS

Ideálne vrtáky na vrtanie s príklepom do betónu, muriva a prírodného kameňa. Moderné tepelné spracovanie a špeciálna technológia kalenia povrchu znižujú opotrebovanie a zaručujú vysokú húževnatosť a odolnosť vrtákov voči namáhaniu ohybom. Vhodné pre vrtacie kladivá triedy 2 – 4 kg.

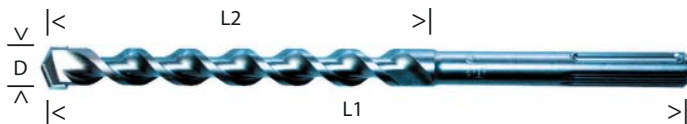

Obj. č.	ø mm	L1 mm	L2 mm	ks/bal	MOC s DPH	Obj. č.	ø mm	L1 mm	L2 mm	ks/bal	MOC s DPH
B-47232	4	110	50	1	3,20 €	B-47765	13	160	110	1	5,84 €
B-47248	4	160	100	1	3,95 €	B-47771	13	210	160	1	6,72 €
B-46492	5	110	50	1	2,55 €	B-46589	14	160	110	1	5,84 €
B-46501	5	160	100	1	3,07 €	B-47802	14	210	160	1	6,85 €
B-47260	5	210	150	1	4,83 €	B-47818	14	260	210	1	8,32 €
B-47282	5	310	250	1	6,30 €	B-47824	14	310	260	1	9,27 €
B-47298	5,5	110	50	1	2,77 €	B-47830	14	450	400	1	12,73 €
B-47307	5,5	160	100	1	3,59 €	B-47846	14	600	550	1	17,92 €
B-47313	5,5	210	150	1	4,70 €	B-47852	14	1000	950	1	43,54 €
B-47329	5,5	260	200	1	5,84 €	B-47868	15	160	110	1	7,67 €
B-46517	6	110	50	1	2,48 €	B-47874	15	210	160	1	8,94 €
B-46523	6	160	100	1	2,68 €	B-47880	15	260	210	1	9,89 €
B-47341	6	210	150	1	4,05 €	B-47896	15	450	400	1	15,37 €
B-47357	6	260	200	1	5,12 €	B-47905	16	160	110	1	7,54 €
B-47363	6	310	250	1	8,71 €	B-47911	16	210	160	1	8,85 €
B-47379	6	460	400	1	12,66 €	B-47927	16	260	210	1	10,38 €
B-47391	6,5	160	100	1	3,59 €	B-47933	16	310	260	1	12,08 €
B-47400	6,5	210	150	1	4,73 €	B-47949	16	450	400	1	16,35 €
B-47416	6,5	260	200	1	6,36 €	B-47955	16	600	550	1	20,40 €
B-47422	6,5	310	250	1	9,17 €	B-47961	16	800	750	1	30,09 €
B-47444	7	160	100	1	3,20 €	B-47977	16	1000	950	1	45,30 €
B-47450	7	210	150	1	4,83 €	B-48000	18	200	150	1	13,64 €
B-47466	7	250	190	1	6,56 €	B-48016	18	300	250	1	16,45 €
B-46539	8	110	50	1	2,87 €	B-48022	18	450	400	1	21,15 €
B-46545	8	160	100	1	3,20 €	B-48038	18	600	550	1	29,31 €
B-47472	8	210	150	1	4,01 €	B-48044	18	1000	950	1	53,66 €
B-47488	8	260	200	1	4,63 €	B-48066	19	450	400	1	26,70 €
B-47494	8	310	250	1	6,33 €	B-48072	20	200	150	1	17,04 €
B-47503	8	400	340	1	9,47 €	B-48088	20	300	250	1	19,26 €
B-47519	8	460	400	1	10,05 €	B-48094	20	450	400	1	25,17 €
B-47525	8	600	540	1	14,98 €	B-48103	20	600	550	1	33,36 €
B-47531	9	160	100	1	4,05 €	B-48119	20	800	750	1	57,74 €
B-47547	9	210	150	1	5,39 €	B-48125	20	1000	950	1	63,13 €
B-47553	9,5	160	100	1	4,41 €	B-48131	22	250	200	1	23,44 €
B-46551	10	110	50	1	3,33 €	B-48147	22	450	400	1	32,41 €
B-46567	10	160	100	1	3,56 €	B-48153	22	600	550	1	41,91 €
B-47569	10	210	150	1	4,63 €	B-48169	22	1000	950	1	67,63 €
B-47575	10	260	200	1	5,16 €	B-48197	24	250	200	1	29,08 €
B-47581	10	310	250	1	6,59 €	B-48206	24	450	400	1	35,45 €
B-47597	10	350	290	1	8,88 €	B-48212	24	600	550	1	42,46 €
B-47606	10	450	390	1	9,92 €	B-48228	25	250	200	1	31,56 €
B-47612	10	600	540	1	14,56 €	B-48234	25	450	400	1	36,69 €
B-47628	10	800	740	1	22,55 €	B-48240	25	600	550	1	54,74 €
B-47634	10	1000	940	1	38,12 €	B-48256	25	1000	950	1	81,80 €
B-47640	11	160	110	1	5,06 €	B-48262	26	250	200	1	31,24 €
B-47656	11	210	160	1	5,94 €	B-48278	26	450	400	1	38,03 €
B-47662	11	260	210	1	6,98 €						
B-47678	11	310	260	1	8,65 €						
B-46573	12	160	110	1	4,24 €						
B-47684	12	210	160	1	5,29 €						
B-47690	12	260	210	1	6,69 €						
B-47709	12	310	260	1	8,58 €						
B-47715	12	360	310	1	10,41 €						
B-47721	12	450	400	1	12,04 €						
B-47737	12	600	550	1	16,25 €						
B-47743	12	800	750	1	26,05 €						
B-47759	12	1000	950	1	42,24 €						



Sada vrtákov SDS plus 2 brit **D-74136** **8,39 €** (MOC s DPH)

5 x 110 mm
6 x 160 mm
8 x 160 mm
10 x 160 mm

VŔTANIE: PRÍKLEPOVÉ VRTÁKY SDS-PLUS

Obj. č.	ø mm	L1 mm	L2 mm	ks/bal	MOC s DPH
---------	------	-------	-------	--------	-----------

Príklepové vrtáky SDS-Plus V Plus



Ideálne vrtáky na vrtanie s príklepom do betónu, muriva a prírodného kameňa. Moderné tepelné spracovanie a špeciálna technológia kalenia povrchu znižujú opotrebovanie a zaručujú vysokú húževnatosť a odolnosť vrtákov voči namáhaniu ohybom. Vhodné pre vrtacie kladivá triedy 2 – 4 kg.



B-46492-5	5	110	50	5	12,66 €
B-47298-5	5,5	110	50	5	13,71 €
B-46517-5	6	110	50	5	12,66 €
B-46523-5	6	160	100	5	13,51 €
B-47341-5	6	210	150	5	20,33 €
B-46539-5	8	110	50	5	14,62 €
B-46545-5	8	160	100	5	16,06 €
B-47472-5	8	210	150	5	20,79 €
B-46567-5	10	160	100	5	18,57 €
B-47569-5	10	210	150	5	24,02 €
B-46573-5	12	160	110	5	22,06 €
B-47684-5	12	210	160	5	27,52 €
B-46517-10	6	110	50	10	24,64 €
B-47341-10	6	210	200	10	40,57 €
B-46545-10	8	160	100	10	31,79 €
B-47472-10	8	210	150	10	40,57 €
B-46567-10	10	160	110	10	35,51 €
B-46573-10	12	160	110	10	42,95 €
B-46523-25	6	160	100	25	64,73 €
B-47472-25	8	210	150	25	99,23 €
B-46567-25	10	160	100	25	87,64 €
B-47569-25	10	210	150	25	115,35 €
B-46517-50	6	110	50	50	119,33 €
B-46523-50	6	160	100	50	127,82 €
B-46545-50	8	160	100	50	154,94 €
B-47472-50	8	210	150	50	196,33 €
B-46567-50	10	160	100	50	173,61 €

Sada vrtákov SDS-Plus V-Plus

B-49052

14,79 € (MOC s DPH)

- 5x110 1 ks
- 6x110 1 ks
- 8x110 1 ks
- 6x160 1 ks
- 8x160 1 ks



Sada vrtákov SDS-Plus V-Plus

B-49074

17,53 € (MOC s DPH)

- 5x110 1 ks
- 6x160 1 ks
- 8x160 1 ks
- 10x160 1 ks
- 12x160 1 ks



Sada vrtákov SDS-Plus V-Plus

B-49080

46,38 € (MOC s DPH)

- 6x110 1 ks
- 6x160 2ks
- 8x160 3 ks
- 10x160 2 ks
- 12x160 2 ks
- 14x160 1 ks
- 16x160 1 ks



Sada vrtákov SDS-Plus V-Plus

B-49096

36,07 € (MOC s DPH)

- 5x110 3 ks
- 6x160 4 ks
- 8x160 2 ks
- 10x160 2 ks
- 12x160 1 ks



Sada vrtákov SDS-Plus V-Plus

B-49105

39,85 € (MOC s DPH)

- 6x160 3 ks
- 8x160 4 ks
- 10x160 3 ks
- 12x160 2 ks



Sada vrtákov SDS-Plus V-Plus

B-49133

14,56 € (MOC s DPH)

- 5x110 1 ks
- 6x110 1 ks
- 6x160 1 ks
- 8x160 1 ks
- 10x160 1 ks



Sada vrtákov SDS-Plus V-Plus

B-49127

34,27 € (MOC s DPH)

- 5x110 1 ks
- 6x110 1 ks
- 6x160 2 ks
- 8x160 2 ks
- 10x160 2 ks
- 10x210 1 ks
- 12x210 1 ks



Sada vrtákov SDS-Plus V-Plus

B-49046

30,42 € (MOC s DPH)

- 5x110 1 ks
- 6x110 1 ks
- 6x160 1 ks
- 8x110 1 ks
- 8x160 1 ks
- 10x160 1 ks
- 12x160 1 ks



Lahké príklepové vrtacie korunky SDS-Plus



Použitie do muriva, moderných ľahkých stavebných hmôt a betónu.



obj. č.	popis	ø mm	MOC s DPH
P-26191	ľahké vrtacie korunky M16	40	55,19 €
P-26200		50	58,92 €
P-26216		65	59,80 €
P-26222		80	66,94 €
P-64347	vystredovaci vrták pre vrtacie korunky		4,96 €
P-67745	upínacia stopka pre vrtacie korunky		21,51 €

VŔTANIE: PRÍKLEPOVÉ VRTÁKY SDS-PLUS

Obj. č.	ø mm	L1 mm	L2 mm	ks/bal	MOC s DPH
---------	------	-------	-------	--------	-----------

Príkľepové vrtáky SDS-Plus V Plus



Vhodné na vrtanie s príklepom do betónu, muriva a prírodného kameňa. Tieto robustné príklepové vrtáky SDS-plus sú cenovo výhodnou alternatívou vrtákov SDS-plus S4. Sú optimálne pre príležitostné vrtanie.

Obj. č.	ø mm	L1 mm	L2 mm	ks/bal	MOC s DPH
D-66612	4	160	100	1	1,46 €
D-66628	5	210	150	1	1,84 €
D-66634	6,5	260	200	1	2,15 €
D-66640	8	310	250	1	2,71 €
D-66656	10	350	290	1	2,99 €
D-66662	11	210	150	1	2,21 €
D-66678	11	260	200	1	2,49 €
D-66684	12	310	250	1	2,90 €
D-66690	13	210	150	1	2,80 €
D-66709	14	310	250	1	3,68 €

Sada vrtákov SDS-Plus V-Plus **D-00795** **7,04 €** (MOC s DPH)

- 5 × 110 mm 1 ks
- 6 × 110 mm 1 ks
- 8 × 110 mm 1 ks
- 6 × 160 mm 1 ks
- 8 × 160 mm 1 ks

Sada vrtákov SDS-Plus V-Plus **D-62723** **17,79 €** (MOC s DPH)

- 6 × 160 mm 3 ks
- 8 × 160 mm 3 ks
- 10 × 160 mm 3 ks
- 12 × 160 mm 3 ks

Sada vrtákov SDS-Plus V-Plus **D-61678** **6,67 €** (MOC s DPH)

- 6 × 110 mm 1 ks
- 6 × 160 mm 1 ks
- 8 × 110 mm 1 ks
- 8 × 160 mm 1 ks
- 10 × 160 mm 1 ks

D-16950	3,5	90	30	1	1,37 €
D-00016	4	110	50	1	1,37 €
D-00022	5	110	50	1	1,37 €
D-00038	5	160	100	1	1,37 €
D-00044	5,5	110	50	1	1,37 €
D-00050	6	110	50	1	1,37 €
D-00066	6	160	100	1	1,40 €
D-00072	6	210	150	1	1,68 €
D-00088	6,5	110	50	1	1,40 €
D-00094	6,5	160	100	1	1,40 €
D-00103	7	110	50	1	1,40 €
D-00119	7	160	100	1	1,40 €
D-00125	8	110	50	1	1,40 €
D-00131	8	160	100	1	1,46 €
D-00147	8	210	150	1	1,78 €
D-00153	8	260	200	1	2,03 €
D-00169	9	210	150	1	1,78 €
D-00175	10	160	100	1	1,56 €
D-00181	10	210	150	1	1,96 €
D-00197	10	260	200	1	2,15 €
D-00206	10	310	250	1	2,62 €
D-17538	10	460	400	1	5,27 €
D-00212	11	160	100	1	1,56 €
D-00228	12	160	100	1	1,78 €
D-00234	12	210	150	1	2,15 €
D-00240	12	260	200	1	2,40 €
D-16271	12	460	400	1	5,45 €
D-00256	13	160	100	1	1,96 €
D-00262	14	160	100	1	2,40 €
D-00278	14	260	200	1	3,12 €
D-17544	14	460	400	1	5,80 €
D-00284	15	160	100	1	2,90 €
D-17550	15	460	400	1	7,35 €
D-00290	16	210	150	1	3,49 €
D-16287	16	460	400	1	6,95 €
D-00309	16	310	250	1	4,24 €
D-00315	17	210	150	1	4,05 €
D-00321	18	210	150	1	4,24 €
D-00337	18	300	240	1	5,45 €
D-17566	18	460	400	1	8,10 €
D-00343	19	210	150	1	5,17 €
D-16293	19	460	400	1	8,94 €
D-00359	20	210	150	1	5,27 €
D-00365	20	310	250	1	6,79 €
D-15235	20	460	400	1	8,94 €
D-00371	22	260	200	1	7,13 €
D-08062	22	310	250	1	7,88 €
D-15241	22	460	400	1	10,00 €
D-16302	24	460	400	1	10,62 €
D-00387	25	260	200	1	8,94 €
D-08517	25	310	250	1	9,63 €
D-15257	25	460	400	1	12,15 €
D-00393	26	260	200	1	10,00 €
D-08078	26	310	250	1	10,90 €
D-15263	26	460	400	1	14,05 €
D-16318	28	460	400	1	16,01 €
D-17572	30	460	400	1	20,75 €

Sada vrtákov a sekáčov SDS-Plus V-Plus **D-58920** **18,16 €** (MOC s DPH)

- 5 × 160 mm 1 ks
- 6 × 160 mm 1 ks
- 8 × 160 mm 1 ks
- sekáč špic 250 mm
- sekáč plochý 20 × 250 mm
- sekáč plochý 40 × 250 mm

VŔTANIE: PRÍKLEPOVÉ VRTÁKY SDS-MAX



Štvorbřité vrtáky ZENTRO MAX sú dokonalou kombináciou nového inovatívneho tvaru hlavy vrtáka so špeciálnym tvarom špirály zaručujúcu nekompromisnú kvalitu v každom detaile. Tieto vrtáky sa vyznačujú veľmi dlhou životnosťou, veľkou presnosťou a ideálnym prenosom energie zo stroja na hrot vrtáku.

Kvalitu týchto vrtákov ocenia hlavne majstri, ktorí potrebujú vrtáť do tvrdých materiálov – betónu, železobetónu alebo prírodného kameňa.



Vrtáky sú cenovo výhodnou variantou a sú určené pre vrtanie do betónu, muriva a prírodného kameňa.

Obj. č.	ø mm	L1 mm	L2 mm	ks/bal	MOC s DPH
---------	------	-------	-------	--------	-----------

Príklepové štvorbřité vrtáky ZENTRO MAX *****

P-17033	12	*340	200	1	31,66 €
P-17049	12	*540	400	1	39,49 €
P-17055	12	*690	550	1	57,02 €
P-17077	14	*340	200	1	36,10 €
P-17083	14	*540	400	1	41,78 €
P-17108	15	*340	200	1	36,72 €
P-17114	15	*540	400	1	41,45 €
P-77730	16	340	200	1	38,87 €
P-77746	16	540	400	1	44,68 €
P-77752	16	920	800	1	66,98 €
P-77768	16	1320	1200	1	170,81 €
P-77774	18	340	200	1	41,03 €
P-77780	18	540	400	1	47,03 €
P-77796	18	920	800	1	70,21 €
P-77805	18	1320	1200	1	172,80 €
P-77811	20	320	200	1	42,46 €
P-77827	20	520	400	1	49,03 €
P-77833	20	920	800	1	75,07 €
P-77849	20	1320	1200	1	177,37 €
P-77861	22	520	400	1	53,82 €
P-77877	22	920	800	1	81,14 €
P-77883	22	1320	1200	1	188,69 €
P-77899	24	320	200	1	53,04 €
P-77908	24	520	400	1	61,40 €
P-77914	25	320	200	1	53,43 €
P-77920	25	520	400	1	59,73 €
P-77936	25	920	800	1	94,13 €
P-77942	25	1320	1200	1	198,48 €
P-77958	26	520	400	1	66,78 €
P-77964	28	370	200	1	59,63 €
P-77970	28	570	450	1	67,63 €
P-77986	28	670	550	1	92,93 €
P-77992	28	920	800	1	109,38 €
P-78003	28	1320	1200	1	207,07 €
P-78019	30	370	250	1	64,37 €
P-78025	30	570	450	1	73,11 €
P-78031	32	370	250	1	68,71 €
P-78047	32	570	450	1	82,58 €
P-78053	32	920	800	1	127,36 €
P-78069	32	1320	1200	1	214,18 €
P-78075	35	370	250	1	82,51 €
P-78081	35	570	450	1	94,17 €
P-78097	35	670	550	1	116,66 €
P-78592	35	1320	1200	1	233,28 €
P-78112	37	570	450	1	113,33 €
P-78128	37	920	800	1	162,32 €
P-78134	38	370	250	1	97,72 €
P-78140	38	570	450	1	118,19 €
P-78156	40	370	250	1	117,21 €
P-78162	40	570	450	1	140,78 €
P-78178	40	920	800	1	190,32 €
P-78184	40	1320	1200	1	258,12 €
B-20323	45	570	450	1	221,89 €
P-78209	45	920	800	1	245,55 €
P-78215	50	570	450	1	227,70 €

Obj. č.	ø mm	L1 mm	L2 mm	ks/bal	MOC s DPH
---------	------	-------	-------	--------	-----------

Príklepové vrtáky SDS-max V-Plus ****

D-33875	12	340	200	1	10,66 €
D-33881	12	540	400	1	15,58 €
D-33897	14	340	200	1	11,96 €
D-33906	14	540	400	1	16,48 €
D-33912	15	340	200	1	13,30 €
D-33928	15	540	400	1	17,63 €
D-33934	16	340	200	1	13,30 €
D-33940	16	540	400	1	17,63 €
D-33956	18	340	200	1	14,52 €
D-33962	18	540	400	1	18,88 €
D-33978	20	340	200	1	16,05 €
D-33984	20	540	400	1	22,06 €
D-33990	22	340	200	1	17,63 €
D-34001	22	540	400	1	23,96 €
D-34017	24	340	200	1	18,79 €
D-34023	24	540	400	1	25,11 €
D-34039	25	340	200	1	18,79 €
D-34045	25	540	400	1	25,11 €
D-34051	28	370	250	1	22,00 €
D-34067	28	570	450	1	33,93 €
D-34073	30	370	250	1	25,86 €
D-34089	30	570	450	1	41,87 €
D-34095	32	370	250	1	36,23 €
D-34104	32	570	450	1	46,33 €
D-34110	35	370	250	1	43,90 €
D-34126	35	570	450	1	51,16 €
D-34132	38	370	250	1	53,81 €
D-34148	38	570	450	1	64,99 €
D-34154	40	370	250	1	60,19 €
D-34160	40	570	450	1	70,57 €

Sada vrtákov SDS-Max V-Plus D-40587 47,64 € (MOC s DPH)

16 × 340 mm 1 ks
18 × 340 mm 1 ks
20 × 340 mm 1 ks



Adaptér SDS-max na SDS-plus P-17027 83,17 € (MOC s DPH)



Rýchlosk/čuchovadlo s upinaním SDS-Max 122829-5 64,19 € (MOC s DPH)



*Priemery 12 – 15 mm sa dodávajú s dvomi ostriami.

VŔTANIE: VŔTANIE SDS-MAX



Obj. č.	ø mm		MOC s DPH
Adptér pre zatíkanie železných tyčí ****			
E-13029	13,3	Adptér pre zatíkanie železných tyčí do zeme pre kladivá s upínaním SDS-max	50,53 €
E-13035	16,5		51,70 €
E-13041	22,2		58,00 €

Vŕtacie korunky SDS-max

Vŕtacie korunky Makita sú ideálne vhodné na vŕtanie do betónu, muriva a prírodného kameňa. Veniec vŕtacej korunky je osadený symetricky usporiadanými, pevnými špeciálnymi zubami z tvrdého kovu. Priamy prenos energie príklepu umožňuje dosahovať rýchly postup vŕtania. Účinná vonkajšia drážka v tvare špirály minimalizuje stratu trením, umožňuje rýchly odsun odvráteného prachu a je zárukou dlhej životnosti.



P-03779	40	100		1	95,44 €	
P-03785	50	100		1	102,98 €	
P-73427	60	100		1	116,43 €	
P-03791	65	100		1	122,47 €	
P-73433	68	100		1	125,83 €	
P-03800	80	100		1	138,00 €	
P-03816	90	100		1	164,18 €	
P-03822	100	100		1	189,34 €	
P-73449	110	100		1	218,66 €	
P-16374	125	100		1	258,87 €	
P-03838	vystredovací vrták pre vŕtacie korunky		11 x 120	1	8,45 €	
P-16994	upínacia stopka pre vŕtacie korunky		180	1	47,00 €	
P-17005			450	1	67,60 €	
P-03763	vyrážací klin pre vŕtacie korunky		140	1	8,03 €	
P-64406	68	80	290	1	202,99 €	
P-64412	80	80	290	1	226,69 €	
P-25993	100	80	550	1	304,99 €	
P-26004	125	80	550	1	364,99 €	

Potrebné dokúpiť strediaci vrták P-03838

Prerážacie vrtáky SDS-max

Výkonové parametre prerážacích vrtákov Makita do betónu:

- Rýchla montáž – nástroj je z jedného kusu
- Vŕtanie celého priemeru – vytláčanie jadra nie je potrebné
- Jednodielna konštrukcia umožňuje prenos energie príklepu na špičku nástroja bez strát v dôsledku útlmu
- Variabilná hĺbka vrtu podľa dĺžky stopky
- Rovná a okrúhla diera s plochým dnom
- Výrazne vyšší vŕtací výkon ako s vŕtacími korunkami



P-03844	40	prerážacie vrtáky so závitovým čapom		1	153,54 €	
P-14439	45			1	176,48 €	
P-03850	50			1	188,89 €	
P-04014	55			1	206,58 €	
P-04020	60			1	214,74 €	
P-03872	80			1	288,34 €	
P-04036	90			1	419,95 €	
P-03925	predĺženie Ratio pre prerážacie vrtáky		280	1	99,85 €	
P-03888	upínacia stopka pre prerážacie vrtáky		185	1	62,70 €	
P-03931	závitový čap		60	1	14,49 €	
B-57629	40		550	1	205,57 €	
B-57635	45		550	1	208,47 €	
B-57641	45		990	1	247,18 €	
B-57657	55		550	1	236,44 €	
B-57663	55		990	1	278,45 €	
B-57679	65		550	1	258,84 €	
B-57685	65		990	1	302,77 €	
B-57691	80		550	1	287,66 €	

Systém MAXCONNET

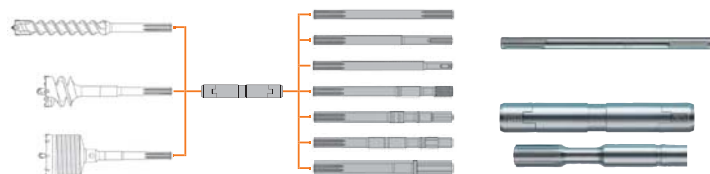

P-53920		320	predĺženie SDS-MAX = SDS-MAX	1	29,31 €	
P-53936		750	predĺženie SDS-MAX = SDS-MAX	1	36,56 €	
P-53942		1100	predĺženie SDS-MAX = SDS-MAX	1	49,19 €	
P-53914	30	190	Adaptér SDS-MAX	1	228,32 €	
P-53958		320	predĺženie BOSCH s klin. hriadetom = SDS-MAX	1	36,23 €	

SEKANIE: SEKÁČE SDS-PLUS

Obj. č.	ø mm	L1 mm	L2 mm	ks/bal	MOC s DPH
---------	------	-------	-------	--------	-----------

Sekáče SDS-plus



Sekáč špic SDS-plus so šesťhrannou stopkou *****					
P-05505		250	190	1	9,39 €
Sekáč špic SDS-plus so šesťhrannou stopkou *****					
D-19015		400	340	1	3,96 €
Sekáč plochý SDS-plus so šesťhrannou stopkou *****					
P-05511	20	250	190	1	9,39 €
P-05527	40	250	190	1	13,89 €
B-14059	40	250	190	1	15,09 €
Sekáč drážkovací SDS-plus so šesťhrannou stopkou *****					
P-05533	22	250	190	1	15,29 €
Sekáč plochý SDS-plus so šesťhrannou stopkou *****					
D-19021	20	400	340	1	4,05 €
Sekáč špic SDS-plus s valcovitou stopkou *****					
P-25068		250	190	1	6,39 €
Sekáč plochý SDS-plus so valcovitou stopkou *****					
P-25074	20	250	190	1	6,39 €
A-30483	40	250	190	1	9,99 €
P-24935	60	250	190	1	16,49 €
Sekáč plochý SDS-plus s valcovitou stopkou *****					
D-61020	80	250	190	1	14,30 €
Sekáč plochý zahnutý SDS-plus s valcovitou stopkou *****					
P-24941	40	250	190	1	11,69 €
P-63987	40	250	190	1	16,39 €
P-24957	60	250	190	1	17,49 €
Sekáč drážkovací SDS-plus s valcovitou stopkou *****					
P-25080	22	250	190	1	12,29 €
Sekáč krídelkový SDS-plus s valcovitou stopkou *****					
P-24963	22	250	190	1	28,29 €
Dláto na dlabanie do dreva SDS-plus *****					
P-25105	20	170	110	1	18,69 €
P-25111	30	170	110	1	26,99 €
Sekací nástavec (HR160D) ***** umožňuje sekание s vŕtacími kladivami bez funkcie sekania (otáčavý pohyb sa zablokuje)					
122547-5				1	14,59 €

Sekáče SDS-max

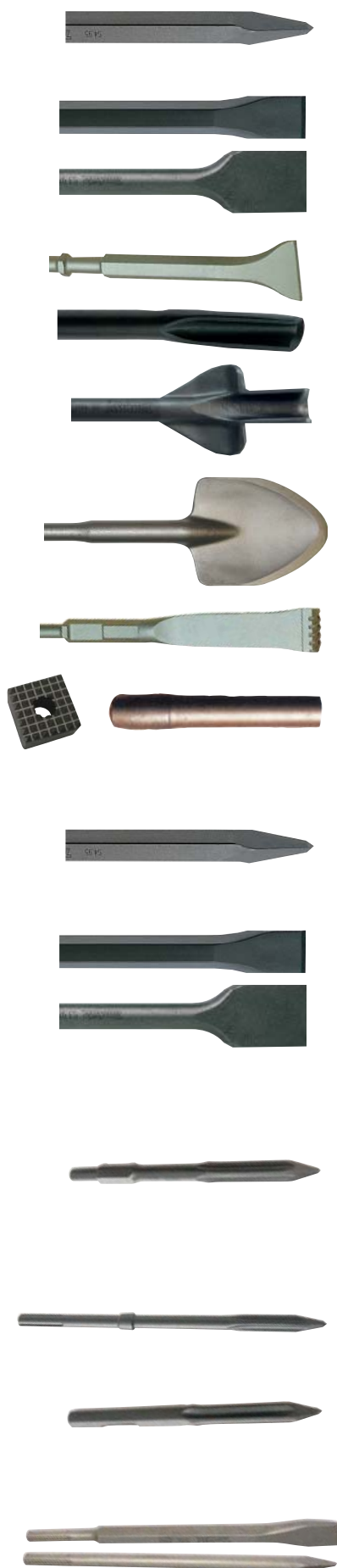

Obj. č.	ø mm	L1 mm	L2 mm	ks/bal	MOC s DPH
---------	------	-------	-------	--------	-----------

Sekáč špic SDS-max

P-16237		280	220	1	8,49 €
P-16243		400	330	1	10,79 €
P-16259		600	520	1	17,09 €

Sekáč plochý SDS-max

P-16265	25	280	220	1	8,49 €
P-16271	25	400	330	1	10,79 €
P-16287	25	600	520	1	17,09 €
P-16302	50	360	300	1	15,39 €
P-16318	80	300	240	1	23,49 €

Sekáč na kachličky SDS-max

P-16324	50	300	240	1	23,59 €
---------	----	-----	-----	---	---------

Sekáč drážkovací SDS-max

P-16293	26	300	120	1	26,29 €
---------	----	-----	-----	---	---------

Sekáč krídelkový SDS-max

P-16330	35	360	190	1	51,59 €
---------	----	-----	-----	---	---------

Sekáč lopatka SDS-max

P-23721	100	400		1	54,19 €
---------	-----	-----	--	---	---------

Sekáč škárový SDS-max

P-16346	38	300		1	75,39 €
---------	----	-----	--	---	---------

Zarovnávací platnička

Upínacia stopka pre zarovnávaciu platničku SDS-max

P-03947	60	60	7 x 7 zubov	1	84,09 €
P-16352		250		1	30,19 €

Sekáč špic SDS-max

D-34176		300	240	1	6,29 €
D-34182		400	330	1	7,32 €
D-34198		600	520	1	10,66 €

Sekáč plochý SDS-max

D-34207	25	300	240	1	6,29 €
D-34213	25	400	330	1	7,32 €
D-34229	25	600	520	1	10,66 €
D-34235	50	400	300	1	8,94 €
D-34241	80	300	240	1	14,52 €

Samoostriace sekáče SDS-max

B-14015	50	350	190	1	22,89 €
B-23064		400	330	1	16,19 €

Samoostriaci sekáč špic šesťhran 28 mm (HM1304B, HM1307 CB, HM1801, HM1810)

B-10372		400		1	30,89 €
---------	--	-----	--	---	---------

Samoostriaci sekáč špic šesťhran 30 mm (HM1304B, HM1307 CB, HM1801, HM1810)

B-10388		400		1	37,79 €
---------	--	-----	--	---	---------

Sada sekáčov SDS-max

D-35324-10	špic	400		5	72,41 €
	25	400		5	

Sady sekáčov a vrtákov SDS-plus

Sada sekáčov a vrtákov SDS-plus 10 ks **D-42385** **53,59 €** (MOC s DPH)

vrták ø 6 × 110, 8 × 160, 10 × 210, 12 × 210 mm
 sekáč špic 250 mm
 sekáč plochý 20 × 250 mm



Sady sekáčov a vrtákov SDS-plus 17 ks **D-42444** **56,27 €** (MOC s DPH)

vrták ø 5, 6, 8, 10 × 110 mm
 6, 8, 10, 12, 14 × 160 mm
 8, 10 × 210 mm
 12 × 260 mm
 sekáč špic 140 mm
 sekáč špic 250 mm
 sekáč plochý 20 × 140 mm
 sekáč plochý 20 × 250 mm
 sekáč široký 40 × 250 mm



Sada sekáčov a vrtákov SDS-plus 10 ks **D-21191** **49,16 €** (MOC s DPH)

vrták ø 5,5, 6 × 110 mm
 7, 8 × 160 mm
 10 × 210 mm
 10, 16, 20 × 460 mm
 sekáč špic 250 mm
 sekáč plochý 20 × 250 mm



Sady sekáčov a vrtákov SDS-plus 17 ks **D-21200** **53,59 €** (MOC s DPH)

vrták ø 5, 5,5, 6, 8, 10 × 110 mm
 6, 7, 8, 10 × 160 mm
 8, 10 × 210 mm
 14 × 260 mm
 sekáč špic 140 mm
 sekáč špic 250 mm
 sekáč plochý 20 × 140 mm
 sekáč plochý 20 × 250 mm
 sekáč široký 40 × 250 mm



Sada sekáčov a vrtákov SDS-plus 13 ks **D-20111** **41,53 €** (MOC s DPH)

vrták ø 5, 6, 7, 8 × 110 mm
 6, 7, 8, 10, 12, 14, 16 × 160 mm
 sekáč špic 250 mm
 sekáč plochý 20 × 250 mm



Sada sekáčov SDS-plus 5 ks **D-16368** **35,92 €** (MOC s DPH)

sekáč špic 2 × 250 mm
 sekáč plochý 2 × 20 × 250 mm
 sekáč široký 40 × 250 mm



Sada samoostriacích sekáčov SDS- plus 5 ks **E-13188** **47,39 €** (MOC s DPH)

sekáč plochý 40 × 250 mm
 sekáč plochý 20 × 250 mm 2 ks
 sekáč špic 250 mm 2 ks



Sady sekáčov a vrtákov SDS-max

Sada sekáčov SDS-max 6 ks **D-40565** **79,29 €** (MOC s DPH)

sekáč špic 2 × 400 mm
 sekáč plochý 2 × 25 × 400 mm
 sekáč plochý 50 × 400 mm
 sekáč plochý 80 × 300



Sada sekáčov SDS-max 5 ks **D-40618** **60,47 €** (MOC s DPH)

sekáč špic 3 × 400 mm
 sekáč plochý 2 × 25 × 400 mm



Sada sekáčov a vrtákov SDS-max 7 ks **D-42494** **141,95 €** (MOC s DPH)

vrták ø 18, 20, 22, 25 × 540 mm
 sekáč špic 400 mm
 sekáč plochý 25 × 400 mm
 sekáč plochý 50 × 400 mm



Sada sekáčov SDS-max 3 ks **D-40543** **47,64 €** (MOC s DPH)

sekáč špic 400 mm
 sekáč plochý 25 × 400 mm
 sekáč plochý 50 × 400 mm



SEKANIE: SEKÁČE

Obj. č.	ø mm	L1 mm	L2 mm	ks/bal	MOC s DPH
---------	------	-------	-------	--------	-----------

Pre kladivá s upnutím Bosch 19 mm



Sekáč špic pre Bosch kladivá 19 mm bez odsústruženého konca

P-05620		400		1	17,29 €
P-05614		600		1	25,39 €

Sekáč plochý pre Bosch kladivá 19 mm bez odsústruženého konca

P-05636	25	400		1	17,29 €
P-05642	25	600		1	25,39 €

Sekáč špic pre Bosch kladivá 19 mm s odsústruženým koncom

P-13138		450		1	20,69 €
---------	--	-----	--	---	---------

Sekáč plochý pre Bosch kladivá 19 mm s odsústruženým koncom

P-13144	26	300		1	17,19 €
P-13150	26	450		1	20,69 €
P-13166	50	300		1	29,29 €

Pre kladivá s upnutím Bosch 28 mm



Sekacie nástroje pre HM1304B, HM1801, HM1810 HM1307CB, HM1317CB, HM1802/HM1812

P-05692		400		1	30,59 €
---------	--	-----	--	---	---------

P-05723	29	400		1	31,19 €
P-05701	80	400		1	56,39 €
P-05717	125	400		1	77,29 €

Sekáč špic uchytenie šesťhran ø 28,6mm



D-65034		350		1	18,94 €
D-17631		410		1	21,87 €

Upínacia stopka Makita



17 mm šesťhranná

P-13035		280		1	15,49 €
---------	--	-----	--	---	---------

P-13057	17	280		1	15,49 €
P-13063	17	450		1	20,09 €

Upínacia stopka Makita



30 mm šesťhranná upínacia stopka pre HM1304, HM1400, HM1307C, HM1317C

P-05549		400		1	32,39 €
P-05561		700		1	48,99 €
P-05577		1000		1	82,79 €

P-13487	32	400		1	32,89 €
P-05583	32	700		1	50,69 €
P-13518	115	400		1	79,59 €
P-05555	125	400		1	83,89 €

A-31485	200	ubíjadlo s upínacou stopkou		1	134,59 €
---------	-----	-----------------------------	--	---	----------

P-05446		ochranná čiapočka proti prachu, sekáče a upínacie stopky		1	3,99 €
423154-0		ochranná čiapočka proti prachu		1	0,49 €

D-54972		prepravný vozík (HM1801/1810/1802/1812)		1	190,99 €
---------	--	---	--	---	----------



SEKANIE: ŠPECIÁLNE PRÍSLUŠENSTVO PRE VRTACIE A SEKACIE KLADIVÁ

Model	Obj. č.	MOC s DPH
-------	---------	-----------



Rukoväte *****

HR3540C, HR3541FC, HR4001C, HR4002, HR4010C, HR4011C, HR4501C, HR4510C, HR4511C	135209-6	20,09 €
DHR400, HR005G, HR4003C, HR4013C	123138-5	21,21 €
HR006G, HR5202C, HR5212C	135629-4	26,19 €
HM001G HM0870C, HM0871C	135332-7	17,90 €
HP1621, HP1630, HP1631, HP2051, HP2071, HR2440, HR2450, HR2470	135302-6	2,79 €
HR3000C, HM0860C	134889-5	20,99 €
HR3200C, HR3210FCT	135197-7	20,59 €
HR4500C	134916-8	24,19 €

Model	Obj. č.	MOC s DPH
-------	---------	-----------



Rukoväte *****

HR4001C, HR4002, HR4010C, HR4011C, HR4501C, HR4510C, HR4511C, HM1101C, HM1111C	134890-0	38,49 €
DHR400, HR005G, HR4013C, HR4003C	196792-8	25,89 €
HR006G, HR5202C, HR5212C, HM1214C	135283-4	41,59 €
HM002G, HM1202C, HM1203C, HM1205C, HM1213C, HM1242C	135269-8	39,79 €
HR5001C	134945-1	28,99 €
HR4500C	134915-0	27,56 €



Mazací tuk pre prevodovky a nástroje *****

mazací tuk pre prevodovky 30 g	181490-7	2,69 €
mazací tuk pre prevodovky 500 g	042040-2A	27,19 €
mazací tuk pre prevodovky 2,5 kg	042025-8A	79,39 €
mazací tuk pre prevodovky 5,0 kg	870181-3	86,69 €
mazací tuk na nástroje 100 ml	198993-4	8,79 €



Doraz hĺbkový *****

DHP441, DHP448 DHP451, DHP454, DHP458, DHP481 DHP486, HP001G	122576-8	1,89 €
HP1630, HP1631, HP1640/F, HP1641/F, HP2050/F, HP2051/F, HP2070/F, HP2071/F	324219-0	0,49 €



Rýchlovýmenné skľučovadlo (vrtanie) *****

HR2320T, HR2470T, HR2470FT, HR2630T, HR2631FT HR2651T HR2653T, HR2810T, HR2811FT, HR2450T, DHR243, DHR264 HR3210FCT	194079-2	50,09 €
DHR281, DHR283, HR002G, HR004G	194568-7	64,29 €
	199139-5	43,69 €



Rýchlovýmenné skľučovadlo (SDS-plus) *****

HR2320T, HR2470T, HR2470FT, HR2630T, HR2631FT HR2651T HR2653T, HR2810T, HR2811FT, HR2450T, DHR243, DHR264 HR3210FCT	194080-7	36,99 €
DHR281, DHR283, HR002G, HR004G	194578-4	74,29 €
	199138-7	21,59 €



Odsávací adaptér *****

DHR242, HR2650, HR2651, HR2652, HR2653, DHR281, DHR283, HR001G, HR003G, HR3012FC, HR2661, HR2663	195173-3	5,29 €
DHR243, HR2651T, HR2653T, HR2300T, HR2320T, HR2631FT, HR2630T, HR002G, HR004G	195179-1	7,39 €

Adaptér *****

adaptér skľučovadla SDS-plus / 1/2" – 20 UNF	122573-4	9,99 €
adaptér + skľučovadlo SDS-plus	122574-2	37,09 €
Bitový adaptér 1/4"	P-21646	9,40 €



Protiprachový kryt pre stopku vrtáka a sekáča *****

protiprachový kryt pre stopku vrtáka a sekáča ø 10 – 18 mm	421664-1	2,29 €
ø 6 – 14 mm	421342-3	1,59 €



Odsávací adaptér *****

HR140D, HR166D, DHR164, DHR165, DHR171, DHR182, DHR202, DHR262, DHR263, DHR264, HR1840, HR2020, HR2022, HR2230, HR2460, HR2460F, HR2470, HR2470F, HR2470FT, HR2470T, HR2475, HR2800, HR2810, HR2810T, HR2811F, HR2811FT,	193472-7	47,99 €
--	----------	---------



Manžeta *****

DX05, DX06, DX07, DX08, DX09, DX12, DX14, HR2652, HR2653, HR2653T, HR2663	424474-5	0,59 €
---	----------	--------



vyfukovací balónik po vrtaní	765009-6	2,29 €
------------------------------	----------	--------

PRÍSLUŠENSTVO K VŔTAČKÁM

Obj. č.	klúč	popis	uchytenie	popis	MOC s DPH	
Skľučovadlá s ozubeným vencom bez kľúča *****						
	192877-8		1,5 – 13	1/2"	8406, 6300-4, 6013B	36,99 €
	192887-5	763418-3*	0,5 – 6,5	3/8"	6013BR, 6305, 6501/X	9,49 €
	193318-7	763432-9*	2,0 – 13		DA4000LR, DA4030	58,19 €
	193822-6	763448-4*	1,5 – 13	1/2"	HP2050, HP2070, DP4010	27,29 €
	763077-3	763418-3*	0,5 – 6,5	3/8"	DP2010	5,79 €
	763174-5	763415-9	0 – 10	3/8"	BDA340, BDA350, DA3010F	38,09 €
	763245-8		0 – 10		DA332	26,49 €
	P-04313		1,5 – 10	3/8"	6412, 6408, 6510LVR	17,89 €
	P-04329		1,5 – 13	1/2"	6013B, 6300-4, DP4700,	21,79 €
	763250-5	763251-3*	2,0 – 13		DDA460, DGA460, DA001G, DG001G	30,69 €

Kľúč ku skľučovadlám *****						
	763414-1		10		DA3000, DA3000R	2,29 €
	763415-9		10		DA3010	2,29 €
	763418-3		10		6412	0,89 €
	763432-9		13		6305, 6013B/BR, 6300-4, DA4000LR, DA6301, UT1305, UT2204	2,29 €
	763448-4		13		DP4010, HP1620, HP1630, HP1640, HP2050, HP2070	1,29 €
	P-04341		10		6305, 6501/X, 6510LVR	0,89 €
	763251-3		13		DDA460, DGA460, DA001G, DG001G	3,19 €
	A-86228		13			4,39 €

Rýchlopínacie skľučovadlá *****						
	136229-3		1,5 – 13		HP001G	123,55 €
	136232-4		1,5 – 13		DF001G	110,04 €
	192016-0		0,8 – 10	3/8"	6408, DA3011F	23,99 €
	192075-4		0,8 – 10	1/4"		26,39 €
	192284-5		1,5 – 13	1/2" – 20 UNF	6311, 8412D	49,69 €
	192685-7		1,5 – 13	1/2"	6013B/BR, 6300-4, DP4001, DP4003, DP4700, HP1621, HP2051, HP2071	33,39 €
	193064-2		1,5 – 13	1/2"		42,89 €
	193226-2		1,0 – 10	1/2"	DP3003	32,99 €
	194254-0		1,5 – 13	1/2"	DP4011, HP2051, HP2071	45,79 €
	196193-0		1,5 – 13	1/2"	6390D, 8390D, HP1621, HP1631, HP1641	18,99 €
	196306-3		1,5 – 13	1/2"	6391D, DDF453, DHP453	12,89 €
	196307-1		1,0 – 10	1/2"	6260D, 6270D, 6280D	11,69 €
	763229-6		0,8 – 10	1/2"	8271D, 8281D, DHP343	6,49 €
	763178-7		1,5 – 13	1/2"	6390D, 8390D, 6317D, 6337D, 6347D	29,09 €
	763182-6		1,5 – 13	1/2"	MT065	15,29 €
	763187-6		1,5 – 10	1/2"	6260D, 6270D, 6280D, 6207D, 8270D, 8280D	15,49 €
	763188-4		1,5 – 13	1/2"	6319D, 6339D, 6349D, 8414D, 8434D, 8444D	33,69 €
	763196-5		1,5 – 13	1/2"	DDF441, DDF451, DHP441, DHP451, DDF444, DDF454, DHP444, DHP454	29,19 €
	763228-8		1,5 – 10	3/8"	BDA341, BDA351, DF330D	14,19 €
	763229-6		0,8 – 10	1/2"	HP330	6,49 €
	763238-5		0,8 – 10	1/2"	HP332, DF332, HP333, DF333	6,99 €
	763241-6		1,5 – 13	1/2"	DDF483, DHP483	16,49 €
	763243-2		0,8 – 10		DDF343, DF347	4,99 €
	763248-2		1,5 – 13	1/2" – 20 UNF	DDF446, DDF456, DDF459, DDF480, DDF482, DDF484, DDF485	21,79 €
	766012-0		0,8 – 10		MT080, DF0300	10,38 €
	766027-7		1,5 – 13	1/2" – 20 UNF	DDF446, DDF456, DDF459, DDF480, DDF482, DDF484, DDF485	13,09 €
	P-04379		0,8 – 10	1/4"		31,49 €
	P-15718		1,5 – 13	1/2"	6013B/BR, 6300-4, DP4001, DP4003, DP4700, HP1621, HP2051, HP2071	27,79 €
	410102-8				držák kľúča ku skľučovadlu	0,19 €

PRÍSLUŠENSTVO K VŔTAČKÁM

Príslušenstvo pre magnetickú vŕtačku HB500



Obj. č.	ø mm	L1 mm	L2 mm	ks/bal	MOC s DPH
12S	12	30		1	21,89 €
13S	13	30		1	21,19 €
14S	14	30		1	19,99 €
15S	15	30		1	21,49 €
16S	16	30		1	23,09 €
17S	17	30		1	23,89 €
18S	18	30		1	24,99 €
19S	19	30		1	24,49 €
20S	20	30		1	26,59 €
22S	22	30		1	30,69 €
24S	24	30		1	30,69 €
26S	26	30		1	36,59 €
28S	28	30		1	41,69 €
30S	30	30		1	42,39 €
32S	32	30		1	45,59 €
34S	34	30		1	48,99 €
36S	36	30		1	55,29 €
38S	38	30		1	60,69 €
40S	40	30		1	70,39 €
42S	42	30		1	67,79 €
44S	44	30		1	73,69 €
46S	46	30		1	79,99 €
48S	48	30		1	94,99 €
50S	50	30		1	85,89 €

PILOTS	strediaci vrták	1	7,89 €
PILOTU1A	strediaci vrták	1	2,99 €
PILOTU1B	strediaci vrták	1	3,99 €
BD062	skľučovadlo pre HB500	1	343,78 €

Vykružovacie korunky do železa a nehrdzavejúcej ocele

obj. č.	ø mm	max. hrúbka materiálu (mm)	ks/bal	MOC s DPH
B-00898	16	4	1	58,39 €
B-00913	20	4	1	58,19 €
B-00935	22	4	1	58,99 €
B-00957	27	4	1	67,49 €
B-00979	30	4	1	74,39 €
B-00985	32	4	1	81,99 €
B-01018	38	4	1	91,79 €
B-01046	50	4	1	120,99 €
B-01177	6	strediaci vrták	1	11,51 €



Híbkový doraz pre aku vŕtacie skrutkovače

obj. č.	ø mm	model	MOC s DPH
122576-8	6	DHP441, DHP448, DHP451, DHP454, DHP458, DHP481, DHP486, HP001G	1,89 €



Háčiky pre aku vŕtacie skrutkovače

obj. č.	model	MOC s DPH
346317-0	BDF444, DDF446, BDF454, DDF456, DDF458, BDF444, DDF446, BDF454, DDF456, DDF458, DDF459, DDF480, DDF481, BHP444, DHP446, BHP454, DHP456, DHP458, DHP459, DHP480, DHP481, DTW250, DTW251, DTW280	1,19 €
281217-6	DFR540RFE, DFR550RFE, DFR750RFE	2,28 €
345736-7	BTW450RFE	1,56 €
197942-8	DTD134, DTD137, DTD138, DTD148, DTD149, DTS130, DTS131, DTS141, DTW152, DTW190, DTW253, DTW284, DTW285, DTW300, DTW301, DTD152, DTD170, DTW250, DTW251,	14,39 €



452947-8	DDF441, DDF444, DDF448, DDF451, DDF454, DDF458, DDF481, DDF486, DF001G, DHP441, DHP444, DHP448, DHP451, DHP454, DHP458, DHP481, DHP486, HP001G	0,26 €
----------	--	--------



Obj. č.	ø mm	popis	L mm	upínanie	ks/bal	MOC s DPH
---------	------	-------	------	----------	--------	-----------

Príslušenstvo pre miešadlá



Kruhové miešadlo vyrovnávacie hmoty, bitumenové vrstvy, farby, základný adhézný náter, náterové tmely, zaliavacie hmoty

Špirálové miešadlo stavebné lepidlá, mazaninu, hotovú maltu, lepidlo na kachličky, škárovaciu hmotu, maltu na lepenie obkladov, omietky, náterové tmely, tepelné izolačné omietky

Zmiešané miešadlo vyrovnávacie hmoty, stavebné lepidlá, betón, mazaninu, hotovú maltu, maltu na lepenie obkladov, nivelačné hmoty, všetky druhy malty



Špirálové miešadlo „negatív“ M14 disperzie, farby, vápenosadrovú maltu, tepelnú izolačnú omietku. Zmiešaný účinok dole



Tanierová metla farba, nivelačné potery



P-02331	80	kruhová metla 10 – 15 kg	400	6 hran	1	13,19 €
P-22012	120	kruhová metla 15 – 30 kg	590	M14	1	23,69 €
P-02347	90	špirálová metla 7 – 10 kg	400	6 hran	1	14,09 €
P-22040	135	špirálová metla 15 – 30 kg	590	M14	1	34,59 €
P-02353	100	zmiešaná metla 5 – 15 kg	590	6 hran	1	33,39 €
P-22056	120	špirálová metla „negatív“ 15 – 25 kg	590	M14	1	36,99 €
D-73514	120	špirálová metla 15 – 25 kg	600	M14	1	16,59 €
D-73520	120	špirálová metla 15 – 25 kg	600	M14	1	15,99 €
P-76766	100	špirálová metla 30 KG	600	M14	1	22,36 €
165757-1	165	tanierová metla		M12	1	7,29 €
A-43686	150	tanierová metla		M12	1	30,09 €
A-43670	130	tanierová metla		M12	1	13,39 €
168349-5		oska miešadla	560	M12	1	19,29 €
323962-8		adaptér miešadla		1/2" – M12	1	6,89 €
P-22062		adaptér miešadla		1/2" – M14	1	9,69 €
P-02325		adaptér miešadla		5/8" – M14	1	9,99 €
458814-5		ochranný kryt		DUT130	1	8,89 €
140G50-6		bočná rukoväť		DUT130	1	13,54 €
152892-4		bočná rukoväť		UT1305 / 2204	1	9,99 €

PRÍSLUŠENSTVO K VŔTAČKÁM

Diamantové vŕtacie korunky na vŕtanie nasucho – upínanie M16



Vhodné pre DBM080 a DBM130.



Obj. č.	ø mm	veľkosť (mm)	MOC s DPH
P-41997	diamantová vŕtacia korunka	68 × 60	168,65 €
P-42008		82 × 60	141,59 €
P-42014		68 × 150	222,89 €
P-42020		76 × 150	280,19 €
P-42036		82 × 150	246,19 €
P-42042		112 × 150	287,23 €
P-42058		132 × 150	283,09 €
P-42064		68 × 400	239,29 €
P-42070		76 × 400	238,49 €
P-42086		82 × 400	238,49 €
P-42092		112 × 400	332,19 €
P-42101		132 × 400	379,39 €
P-41872		odsávací adaptér	M18 × 2,5
P-45082	adaptér	M18–M16	45,89 €
P-41888	vystredovacia tyč	60	32,99 €
P-41894		150	42,49 €
P-41903		420	105,49 €
P-41919	kotúč pre vystredovaciu tyč	68	3,29 €
P-41931		82	4,29 €
P-41969		112	9,19 €
P-41981		132	17,69 €

Do vypredania skladových zásob.

Postup montáže vŕtacích korúnok

Kotúč pre vystredovaciu tyč → Vystredovacia tyč → Diamantová vŕtacia korunka → Odsávací adaptér → DBM130



Diamantové korunky vŕtanie na sucho DB6 DIAMAK



Vhodné na rezanie:
Žula, mramor, vápenec, bridlica,
tvrdé tehly a iné husté
a neabrazívne materiály.



Obj. č.	ø mm	dĺžka mm	ks/bal	MOC s DPH
P-64107	48	150	1	48,99 €
P-64113	52	150	1	48,99 €
P-64129-68	68	150	1	52,99 €
P-64135	78	150	1	55,99 €

Obj. č.	popis	MOC s DPH
P-34562	adaptér 1/2" na HEX	15,99 €
P-30031	adaptér 1/2" na SDS-plus	21,99 €
P-34752	vyrážací klin	4,99 €
P-34746	vodiaca tyč pre korunky	cena na vyžiadanie

Obj. č.	ø mm	H mm	MOC s DPH
---------	------	------	-----------

Diamantové jadrové vrtáky na vrtanie namokro



DWC4CR

Vhodný na rezanie:

betónu, vystuženého betónu, pieskovca, tehál.

Pre použitie s DBM230 nutné dokúpiť adaptér P-41676.



P-40842	12	300	88,45 €
P-40858	14	300	90,74 €
P-40864	16	300	90,44 €
P-40870	18	300	99,99 €
P-40886	20	300	91,39 €
P-40892	22	300	94,01 €
P-40901	24	300	96,29 €
P-40917	25	300	97,92 €
P-40923	28	300	108,39 €
P-40939	30	300	104,45 €
P-40945	32	300	119,20 €
P-40973	36	300	124,99 €
P-40989	38	300	133,82 €
P-40995	40	300	144,09 €
P-41006	52	300	183,99 €

Do vypredania skladových zásob.



Korunky na vrtanie nasucho



Korunky na vrtanie namokro $\phi 12 - \phi 32$
Vrtanie bez armovania
Diamantový jadrový vrták typu DWS3CR

Obj. č.	Priemer	MOC s DPH
P-40733	12	88,45 €
P-40749	14	90,74 €
P-40755	16	91,07 €
P-40761	18	91,39 €
P-40777	20	91,39 €
P-40783	22	94,86 €
P-40799	24	96,29 €
P-40808	25	118,02 €
P-40814	28	104,63 €
P-40820	30	104,45 €
P-40836	32	114,24 €

Korunky na vrtanie namokro $\phi 62 - \phi 132$
Vrtanie s armovaním
Diamantový jadrový vrták typu DWC4

Obj. č.	Priemer	MOC s DPH
P-65816	62	186,85 €
P-41034	65	160,55 €
P-41056	78	189,31 €
P-41078	82	201,38 €
P-41090	92	233,65 €
P-41115	102	245,76 €
P-41137	107	251,33 €
P-41143	112	282,07 €
P-41159	117	270,60 €
P-65822	122	267,65 €
P-41165	127	312,66 €
P-65838	132	347,53 €

M18



Obj. č.	MOC s DPH
P-45082	45,89 €
P-42151	33,62 €
P-41676	60,87 €

Vrtanie bez armovania

Obj. č.	veľkosť	MOC s DPH
P-41997	68x60	168,65 €
P-42008	82x60	141,59 €
P-42014	68x150	222,89 €
P-42020	76x150	280,19 €
P-42036	82x150	246,19 €
P-42042	112x150	287,23 €
P-42058	132x150	283,09 €
P-42064	68x400	239,29 €
P-42070	76x400	238,49 €
P-42086	82x400	238,49 €
P-42092	112x400	332,19 €
P-42101	132x400	379,39 €

Vrtanie s armovaním

Diamantový jadrový vrták typu DWC4CR

Obj. č.	priemer	MOC s DPH
P-40842	12	88,45 €
P-40858	14	90,74 €
P-40864	16	90,44 €
P-40870	18	99,99 €
P-40886	20	91,39 €
P-40892	22	94,01 €
P-40901	24	96,29 €
P-40917	25	97,92 €
P-40923	28	108,39 €
P-40939	30	104,45 €
P-40945	32	119,20 €
P-40973	36	124,99 €
P-40989	38	133,82 €
P-40995	40	144,09 €
P-41006	52	183,99 €

Vrtanie bez armovania

Diamantový jadrový vrták typu DWC7

Obj. č.	Priemer	MOC s DPH
P-65844	62	156,67 €
P-41333	65	159,94 €
P-41355	78	189,31 €
P-41377	82	206,42 €
P-41399	92	212,16 €
P-41414	102	255,53 €
P-41436	107	251,33 €
P-41442	112	274,96 €
P-41458	117	264,38 €
P-65850	122	267,65 €
P-41464	127	297,02 €
P-65866	132	306,82 €



PRÍSLUŠENSTVO K DIAMANTOVÝM VRTAČKÁM

Obj. č.	dĺžka mm	MOC s DPH
---------	-------------	-----------

Šesťhranná predĺžovacia tyč z ocele *****

5/4" UNC na 5/4" UNC		
P-41610	200	47,99 €
P-41626	300	96,61 €
P-41632	400	71,99 €
P-41648	500	129,74 €



Príruby pre vrtáky so „závitom“ *****

P-41654	príruba s 3 otvormi 5/4" UNC	46,35 €
P-41660	príruba so 6 otvormi 5/4" UNC	56,28 €



Príruby pre vrtáky so „závitom“ *****

P-41735	tyč so závitom, 250 mm	15,34 €
P-41729	tyč so závitom, 200 mm	26,11 €
P-41741	kotviaca (zatĺkacia) hmoždinka (M12)	2,77 €



Sada upevňovacích kotiev *****

P-40098	sada kotiev	35,41 €
---------	-------------	---------



Valcovitý predĺžovací nástavec *****

P-41551	Vonkajší 1/2" BSP na vnútorný 1/2" BSP	27,99 €
---------	--	---------



Adaptéry *****

P-41676	P-41682	P-14009	P-41676	vonkajší 5/4" UNC na vonkajší 1/2" BSP	60,87 €
P-41707	P-41698	P-42151	P-41682	vnútorný 1/2" BSP na vnútorný 5/4" UNC	65,99 €
			P-41698	vnútorný 1/2" BSP na vnútorný 1/2" BSP	39,99 €
			P-41707	hl na vonkajší 1/2" BSP	46,99 €
			P-14009	vnútorný 5/4" UNC na M16 vonkajší	49,38 €
			P-42151	vnútorný M18 na vonkajší 5/4" / vnútorný 1/2"	33,62 €



Stojan jadrovej vrtáčky DBM230/131 *****

P-54190	Stojan jadrovej vrtáčky DBM230	1 416,99 €
P-40082	Stojan jadrovej vrtáčky DBM131	802,69 €



Do vypredania skladových zásob.

Akumulátory
Odkladacie systémy
Vrtanie
Skrutkovanie
Brúsky
Pílenie
Frézovanie
Brúsenie
Klince / spony
Špeciálne stroje
Vysávanie
Fény/lampy
Záhrada
Ručné náradie
Ostatné

Príslušenstvo

Skrutkovanie, bity, držiaky, nástrčné kľúče

1. C-form



2. E-form



3. obojstranné



4. držiaky bitov



5. nástrčné kľúče



6. sady bitov



7. adaptéry



8. nástrčné kľúče pre rázové uťahovákы



9. iné produkty

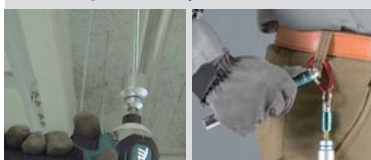

Impact

PREMIER

*Double Torsion
for High Durability.*



*New Steel
is Used.
Supports High Torque.*

*High Precision
Screw Fitting.*

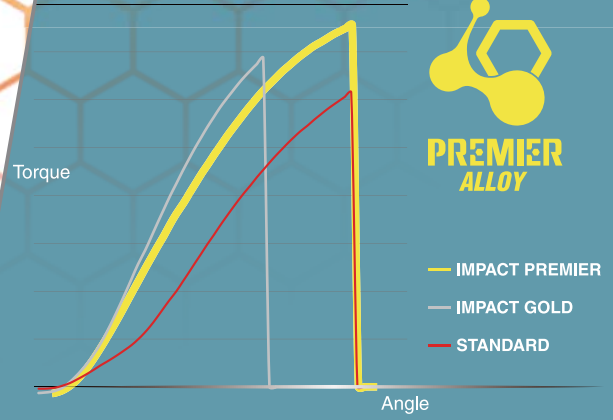
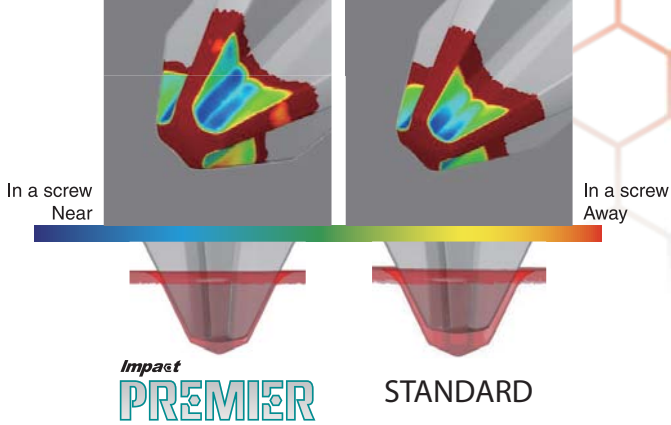

**NEW
INNOVATION**



SKRUTKOVÁČE

Impact
PREMIER

Premier



er



ri



Obj. č.	typ	dĺžka mm	ks/bal	MOC s DPH
E-03121	PH 1	25	2	3,69 €
E-03137	PH 2	25	2	3,69 €
E-03246	PH 2	25	15	18,49 €
E-03143	PH 2R	25	2	3,69 €
E-03159	PH 3	25	2	3,69 €
E-03165	PZ 1	25	2	3,69 €
E-03171	PZ 2	25	2	3,69 €
E-03252	PZ 2	25	15	18,49 €
E-03187	PZ 3	25	2	3,69 €
E-03193	T 10	25	2	3,69 €
E-03202	T 15	25	2	3,69 €
E-03218	T 20	25	2	3,69 €
E-03224	T 25	25	2	3,89 €
E-03230	T 30	25	2	3,69 €
E-03268	PH 1	50	2	4,99 €
E-03274	PH 2	50	2	5,19 €
E-03377	PH 2	50	10	18,59 €
E-03280	PH 3	50	2	4,99 €
E-03296	PZ 1	50	2	4,99 €
E-03305	PZ 2	50	2	5,09 €
E-03383	PZ 2	50	10	18,49 €
E-03311	PZ 3	50	2	4,99 €
E-03327	T 10	50	2	4,99 €
E-03333	T 15	50	2	4,99 €
E-03349	T 20	50	2	4,99 €
E-03355	T 25	50	2	4,99 €
E-03361	T 30	50	2	5,09 €
E-12027	T 40	50	2	4,99 €
E-03399	torzný držiak bitu magnetický	68	1	6,79 €
E-03408	torzný držiak bitu magnetický	150	1	8,99 €
E-03414	torzný držiak bitu ultra magnetický	79	1	8,09 €
E-03458	nástrčný kľúč 6	65	1	4,29 €
E-03464	nástrčný kľúč 8	65	1	4,59 €
E-03470	nástrčný kľúč 10	65	1	4,69 €
E-03486	nástrčný kľúč 13	65	1	7,99 €
E-03492	nástrčný kľúč kĺbový 13	80	1	8,99 €
E-03501	nástrčný kľúč kĺbový 15	80	1	9,39 €
E-03517	nástrčný kľúč kĺbový 17	80	1	9,49 €
E-03523	nástrčný kľúč kĺbový 19	80	1	9,59 €
E-03539	nástrčný kľúč kĺbový 21	80	1	10,09 €
E-03436	adaptér 1/4" – 1/2"	50	1	7,49 €
E-03420	adaptér 1/4" – 3/8"	50	1	6,99 €
E-03567	PH1, PH2, PH3, PZ1, PZ2, PZ3, T15, T20, T25, T30 × 25 mm, Magnetický držiak bitov 50 mm		1	22,39 €
E-03573	PH2, PZ1, PZ2, PZ3, T15, T20, T25, T30, SL4, SL6 × 25 mm, Magnetický držiak bitov 50 mm		1	22,69 €
E-03442	magnetický držiak		1	3,29 €

Obj. č.	typ	dĺžka mm	ks/bal	MOC s DPH
---------	-----	----------	--------	-----------

Impact black



B-63600	PH 1	25	2	1,65 €
B-63616	PH 2	25	2	1,65 €
B-63622	PH 3	25	2	1,65 €
B-63638	PZ 1	25	2	1,65 €
B-63644	PZ 2	25	2	1,65 €
B-63650	PZ 3	25	2	1,65 €
B-63666	T 15	25	2	1,65 €
B-63672	T 20	25	2	1,65 €
B-63688	T 25	25	2	1,65 €
B-63694	T 30	25	2	1,65 €
B-63703	T 40	25	2	1,65 €

B-66793	torzný držiak bitu magnetický	60	1	3,21 €
B-66874	adaptér 1/4" – 1/2"	50	1	2,90 €
B-66868	adaptér 1/4" – 3/8"	50	1	2,24 €

B-63719	PH 1	50	2	2,40 €
B-63725	PH 2	50	2	2,40 €
B-63731	PH 3	50	2	2,40 €
B-63747	PZ 1	50	2	2,40 €
B-63753	PZ 2	50	2	2,40 €
B-63769	PZ 3	50	2	2,40 €
B-63775	T 15	50	2	2,40 €
B-63781	T 20	50	2	2,40 €
B-63797	T 25	50	2	2,40 €
B-63806	T 30	50	2	2,40 €
B-63812	T 40	50	2	2,40 €

IMPACT BLACK SADA BITOV 8 KS **E-11994** cena na vyžiadanie (MOC s DPH)

PH1; 2 X PH2; PH3;
PZ1; PZ2; PZ3,
magnetický držiak bitu 60 mm

IMPACT BLACK SADA BITOV 10 KS **E-12011** cena na vyžiadanie (MOC s DPH)

PH1; PH2; PH3.
PZ1; PZ2; PZ3;
T15; T20; T25; T30;

IMPACT BLACK SADA BITOV 33 ks **B-66896** **39,23 €** (MOC s DPH)

PH1, 3 x PH2, PH3, PZ1,
3 x PZ2, PZ3 x 25 mm
T15, 2 x T20, 2 x T25, T30 x 25 mm
PH2, PZ2, T15, T20, T25, T30 x 50 mm
6/8/10 „orech“
dĺžka 60 mm – držiak bitu 1/4" magnet
dĺžka 80 mm – držiak bitu 1/4" magnet
vrták HSS-G – 2,5 / 3 / 3,5 / 4 / 4,5 / 5 mm

IMPACT BLACK SADA BITOV 35 ks **B-66880** **37,39 €** (MOC s DPH)

PH1, 3 x PH2, PH3, PZ1, 3 x PZ2,
PZ3 x 25 mm
T15, 2 x T20, 2 x T25, T30 x 25 mm
PH1, 2 x PH2, PH3, PZ1, 2 x PZ2,
PZ3 x 50 mm
T15, T20, 2 x T25, T30 x 50 mm
SLO 8 x 5,5 x 50 mm
magnetický držiak bitov 60 mm
6/8/10/13 x 50 mm „orech“

Akumulátory
Odkladacie systémy
Vŕtanie
Skrutkovanie
Brúsky
Pílenie
Frézovanie
Brúsenie
Špeciálne stroje
Klince / spony
Vysávanie
Fény/lampy
Záhradná
Ručné náradie
Ostatné

SKRUTKOVÁČE

Obj. č.	typ	dĺžka mm	ks/bal	MOC s DPH
---------	-----	----------	--------	-----------

Skrutkovacie hroty Krížové „PH“ *****

STANDARD					
	P-47933	PH1	25	5	3,49 €
	P-48402	PH1	50	5	4,49 €
	P-47949	PH2	25	5	3,39 €
	P-47949-50	PH2	25	50	15,49 €
	P-48418	PH2	50	5	4,49 €
	P-47955	PH3	25	5	3,49 €
P-48424	PH3	50	5	4,49 €	



PROFI					
	P-47874	PH1	25	5	3,59 €
	P-48234	PH1	50	5	11,89 €
	P-48240	PH1	89	5	17,29 €
	P-47880	PH2	25	5	3,59 €
	P-47880-50	PH2	25	50	19,79 €
	P-47880-100	PH2	25	100	39,59 €
	P-48256	PH2	50	5	11,89 €
	P-48262	PH2	89	5	16,89 €
	P-48278	PH2	127	5	17,99 €
	P-48315	PH2	141	5	20,69 €
	P-47896	PH3	25	5	3,59 €
	P-48284	PH3	50	5	11,89 €
P-48290	PH3	89	5	17,29 €	

TITAN					
	P-47994	PH1	25	5	6,89 €
	P-48468	PH1	50	5	8,49 €
	P-48000	PH2	25	5	6,89 €
	P-48474	PH2	50	5	8,49 €
P-48480	PH3	50	5	8,49 €	

Skrutkovacie hroty Krížové „PZ“ *****

STANDARD					
	P-47961	PZ1	25	5	3,49 €
	P-48430	PZ1	50	5	4,49 €
	P-47977	PZ2	25	5	3,49 €
	P-47977-50	PZ2	25	50	15,49 €
	P-47977-100	PZ2	25	100	30,89 €
	P-48446	PZ2	50	5	4,49 €
	P-47983	PZ3	25	5	3,49 €
P-48452	PZ3	50	5	4,49 €	



PROFI					
	P-47905	PZ1	25	5	3,59 €
	P-48321	PZ1	50	5	11,89 €
	P-48337	PZ1	89	5	17,29 €
	P-47911	PZ2	25	5	3,59 €
	P-47911-50	PZ2	25	50	19,79 €
	P-47911-100	PZ2	25	100	39,59 €
	P-48343	PZ2	50	5	11,89 €
	P-48359	PZ2	89	5	17,29 €
	P-48365	PZ2	127	5	18,49 €
	P-47927	PZ3	25	5	3,59 €
	P-48371	PZ3	50	5	11,89 €

TITAN					
	P-48022	PZ1	25	5	6,89 €
	P-48038	PZ2	25	5	6,89 €
	P-48505	PZ2	50	5	8,49 €
	P-48044	PZ3	25	5	6,89 €
P-48511	PZ3	50	5	8,49 €	

Obj. č.	typ	dĺžka mm	ks/bal	MOC s DPH
---------	-----	----------	--------	-----------

Skrutkovacie hroty TORX *****

PROFI					
	P-48050	T8	25	5	5,39 €
	P-48527	T8	50	5	5,89 €
	P-48066	T9	25	5	5,39 €
	P-48533	T9	50	5	5,89 €
	P-48072	T10	25	5	5,39 €
	P-48549	T10	50	5	5,79 €
	P-48088	T15	25	5	5,39 €
	P-48555	T15	50	5	5,79 €
	P-48094	T20	25	5	5,39 €
	P-48561	T20	50	5	5,79 €
	P-48103	T25	25	5	5,39 €
	P-48577	T25	50	5	5,79 €
	P-48119	T27	25	5	5,39 €
	P-48583	T27	50	5	5,79 €
	P-48125	T30	25	5	5,39 €
	P-48599	T30	50	5	5,79 €
	P-48131	T40	25	5	5,39 €
	P-48608	T40	50	5	5,79 €



TITAN					
	P-48169	T10	25	5	8,69 €
	P-48636	T10	50	5	9,29 €
	P-48642	T15	50	5	9,29 €
	P-48181	T20	25	5	8,69 €
	P-48658	T20	50	5	9,29 €
	P-48197	T25	25	5	8,69 €
	P-48664	T25	50	5	9,29 €
	P-48670	T27	50	5	9,29 €
	P-48212	T30	25	5	8,69 €
	P-48228	T40	25	5	8,69 €

Nástrčkový bit *****

PROFI					
	P-48723	5,5	50	1	5,69 €
	P-48739	6	50	1	5,69 €
	P-48745	7	50	1	6,49 €
	P-48751	8	50	1	6,49 €
	P-48767	9	50	1	6,49 €
	P-48773	10	50	1	7,19 €
	P-48789	10	65	1	8,29 €
	P-48795	13	50	1	7,89 €
	P-48804	13	65	1	9,09 €
	P-48810	17	50	1	10,59 €
	P-48826	17	65	1	11,09 €



Nástrčkový bit s magnetom *****

PROFI					
	P-48854	7	50	1	10,89 €
	P-48860	8	50	1	10,59 €
	P-48876	10	50	1	11,29 €
	P-48882	10	65	1	12,99 €
	P-48898	13	50	1	11,99 €
	B-39154	6, 8, 10, 12, 13	50	1	6,67 €



SKRUTKOVÁČE

Obj. č.	typ	dĺžka mm	ks/bal	MOC s DPH
Magnetický nadstavec *****				
P-49018	magnetický nadstavec	60	1	6,59 €
B-52445	magnetický nadstavec	60	1	2,96 €
P-49024	magnetický nadstavec	75	1	8,29 €
B-48751	magnetický nadstavec	80	1	3,46 €
B-57750	magnetický nadstavec	150	1	5,23 €
B-57766	magnetický nadstavec	300	1	7,35 €

Obj. č.	typ	dĺžka mm	ks/bal	MOC s DPH
Adaptér *****				
B-54667	adaptér 1/4" – 3/8"	50	1	2,03 €
B-54673	adaptér 1/4" – 1/2"	50	1	2,68 €
B-57738	adaptér 1/4" – 3/8"	150	1	7,07 €
B-57744	adaptér 1/4" – 1/2"	150	1	9,44 €

Nadstavec na sádrokartónske skrutky PH2 *****				
D-61690	upínanie 1/4"	30	1	1,22 €

Nadstavec na zakrúcanie závitových tyčí s upínaním 1/4" *****				
B-42977	M8	66	1	19,19 €

Obojstranné magnetické bity *****				
D-34914	PZ2	65	100	56,70 €
D-31669	PH2	65	100	56,70 €

Obojstranné magnetické bity *****				
B-12326	PH2	85	3	9,99 €
B-12790	PZ2	85	3	10,89 €

Ohybný hriadeľ so skrutkovacou čepel'ou *****				
B-29072		200	1	5,70 €
B-29094		300	1	7,35 €

Sada bitov 11 ks P-53768 **0,00 €** (MOC s DPH)

1 x T7; 1 x T8; 1 x T9; 1 x T10;
1 x T15; 1 x T20; 1 x T25; 1 x T27;
1 x T30; 1 x T40; 1 x magnetický nadstavec



Sada bitov 61 ks P-70144 **44,99 €** (MOC s DPH)

2x5,5 / 2x6,5; 6xPH1; 12xPH2;
4xPH3;
2xPZ0; 6xPZ1; 12xPZ2; 2xPZ3;
2x T10, T15, T20;
2x T25, T30, T40;



Sada bitov 26 ks B-48773 **13,12 €** (MOC s DPH)

5 x PH2 25 mm; 5 x PZ2 25 mm;
5 x T20 25 mm; 5 x T25 25 mm;
5 x T30 25 mm;
x 80 mm magnetický držiak bitov



Sada bitov 11 ks P-49030 **11,39 €** (MOC s DPH)

1ks SL3,5; 1ks SL5,5; 1ks PH1;
2ks PH2; 1ks PH3; 1ks PZ1;
2ks PZ2; 1ks PZ3;
1ks magnetický nadstavec



Sada bitov 31 ks P-73374 **15,99 €** (MOC s DPH)

2ks PH1; 4ks PH2; 2ks PH3; 2ks PZ1;
4ks PZ2; 2ks PZ3; 1ks T8; 2ks T10;
2ks T15; 2ks T20; 3ks T25; 1ks T27;
2ks T30; 1ks T40; 1ks nadstavec



Sada bitov 11 ks P-49046 **18,59 €** (MOC s DPH)

1ks SL3,5; 1ks SL5,5; 1ks PH1;
2ks PH2; 1ks PH3; 1ks PZ1;
2ks PZ2; 1ks PZ3;
1ks magnetický nadstavec



Sada bitov 21 ks B-68323 **19,66 €** (MOC s DPH)





PH1; 2ks PH2; PH3 x 50 mm
PZ1; 2ks PZ2; PZ3; T10; T15;
T20; x 50mm; T10; T15; T20; 2ks T25;
2ks T30; x 50 mm
H3; H4; H5; H6 x 50 mm
SL5,5; SL6,5 x 50 mm



SKRUTKOVÁČE

<p>Sada bitov 31 ks, balenie 12 ks</p> <p>D-30667-12 126,96 € (MOC s DPH)</p> <p>plochý 4 (1 ks); plochý 5,5 (1 ks); plochý 6,5 (1 ks); PH1 (2 ks); PH2 (4 ks); PH3 (1 ks); PZ1 (2 ks); PZ2 (5 ks); PZ3(1 ks); T10 (2 ks); T15 (2 ks); T20 (2 ks); T25 (3 ks); T30 (2 ks); T40 (1 ks)</p> <p>***</p>		<p>Sada bitov 11 ks, balenie 12 ks</p> <p>D-30651-12 116,37 € (MOC s DPH)</p> <p>PH1, PH2, PH3 × 25 mm PZ1, PZ2, PZ3, × 25 mm T15, T20, T25, T30 × 25 mm magnetický nadstavec 50 MM</p> <p>***</p>	
<p>Sada bitov 12 ks, balenie 12 ks</p> <p>D-31083-12 96,15 € (MOC s DPH)</p> <p>plochý 4 (1 ks); plochý 5,5 (1 ks); plochý 6,5 (1 ks); PH1 (2 ks); PH2 (4 ks); PH3 (1 ks); PZ1 (2 ks); PZ2 (5 ks); PZ3(1 ks); T10 (2 ks); T15 (2 ks); T20 (2 ks); T25 (3 ks); T30 (2 ks); T40 (1 ks)</p> <p>***</p>		<p>Sada bitov 31 ks, balenie 12 ks</p> <p>E-00022 149,49 € (MOC s DPH)</p> <p>PH0, PH1, 4 × PH2, PH3 × 25 mm PZ0, PZ1, 4 × PZ2, PZ3 × 25 mm T10, T15, T20, T27, T30, T40 × 25 mm H3, H4, H5, H6 × 25 mm SL4,5, SL5,5, SL6,5 × 25 mm</p> <p>***</p>	
<p>Sada bitov 31 ks, balenie 12 ks</p> <p>E-03090 251,19 € (MOC s DPH)</p> <p>2 × PH1, 5 × PH2, 2 × PH3 × 25 mm 2 × PZ1, 5 × PZ2, 2 × PZ3 × 25 mm 3 × T15, 3 × T20, 3 × T25, 3 × T30 × 25 mm držiak bitov magnetický 60 mm</p> <p>*****</p>		<p>Sada bitov a vrtákov 31 ks</p> <p>B-49389 27,79 € (MOC s DPH)</p> <p>vrtáky do železa ø 2; 2 × 3; 3,3; 4; 4,2; 5; vrtáky do tehly a muriva ø 4; 5; 6; 7; 8; vrtáky do dreva ø 3; 4; 5; 6; 7; 8; nástrčné kľúče ø 6; 8; 10; PH1; PH2; PH3; PZ1; PZ2; PZ3; SL6; SL8; T20; T25; držiak bitov záhlbníkový vrták</p> <p>*****</p>	
<p>Sada bitov a vrtákov 60 ks</p> <p>E-11829 27,59 € (MOC s DPH)</p> <p>bity 25 mm: PZ0 1 ks; PZ1 2 ks; PZ2 6 ks; PZ3 2 ks; PH1 1 ks; PH2 1 ks; PH3 1 ks; T15 1 ks; T20 1 ks; HEX3 1 ks; HEX4 1 ks; HEX5 1 ks; HEX6 1 ks; SL0,5 × 3 1 ks; SL0,8 × 4 3 ks; SL0,8 × 5 1 ks; SL1 × 5,5 2 ks; SL1 × 6 1 ks; SL1,2 × 6,5 3 ks; SL1,2 × 7 1 ks; bit s dorazom 1 ks; magnetický držiak bitov 60 mm 1ks; záhlbník 36 1 ks; Nástrčné kľúče: 5; 6; 7; 8; 9; 10; 11 × 38 mm Vrták do dreva s valcovitou stopkou Ø mm: 3; 4; 5; 6; 7; 8; Vrták do kovu HSS-TiN Ø mm: 2; 3 2 ks; 3,2; 4; 4,5; 5; Vrták do muriva s valcovitou stopkou Ø mm: 5; 5,5; 6; 7; 8;</p>		<p>Sada bitov a vrtákov 102 ks</p> <p>B-68432 48,60 € (MOC s DPH)</p> <p>PH1; PH2; PH3; PZ1; PZ2; PZ3; H3; H4; H5; H6; H7; SL3; SL4; SL6; SL7; SL8; T10; T15; T20; T25; T30; držiak bitov magnetický 60 mm vrtáky do železa, muriva, dreva nástrčné kľúče, záhlbníkový vrták</p> <p>*****</p>	
<p>Sada bitov 32 ks, balenie 12 ks</p> <p>D-74762-12 158,79 € (MOC s DPH)</p> <p>PH1(2 ks); PH2(4 ks);PH3; PZ1(2 ks); PZ2(5 ks) T10(2 ks); T15(2 ks); T20(2 ks); T25(3 ks) T30(2 ks); T40; LS4; SL5,5; SL6,5; Magnetický nadstavec s poistkou 60 mm Adaptér šesťhran na štvorhran</p>		<p>Sada bitov a vrtákov 71 ks</p> <p>D-33691 77,36 € (MOC s DPH)</p> <p>vrták HSS TiN 1,5; 2; 2,5; 3; 3,5; 4; 4,5; 5; 5,5; 6; 6,5; 7 vrták do dreva 4; 5; 6; 8; 10 vrták do kameňa 3; 4; 6; 8 vrták plochý do dreva 8; 15; 20 nástrčný kľúč 8; 10; 12; 13 zalamovací nôž, meter 3 m 2 × PH1, 2 × PH2, 2 × PH3 × 25 mm 2 × PZ1, 2 × PZ2, 2 × PZ3 × 25 mm T20, T25, T30, T40 × 25 mm SL1, SL1,2, SL1,6, H3, H4, H5, H6 × 25 mm 2 × magnetický držiak bitov 50 mm 10 × bit 50 mm</p> <p>*****</p>	

SKRUTKOVAČE

<p>Sada bitov 30 ks</p> <p>Bity 50 mm: PH1; PH2 x 2 ks; PH3; PZ2; SL5,5; T25; T30 Bity 25 mm: PH1; PH2 x 2 ks; PH3; PZ1; PZ2; PZ3; T20 T25; T30; H3; H4; H5; H6; SL5,5; SL6,5; Nástrčný kľúč magnetický 48 mm: 8; 10; 12 Nástrčný kľúč upínanie 3/8": 17; 19; Adaptér 1/4" na 3/8" x 50 mm Magnetický držiak bitov 60 mm</p>	<p>E-07060 29,69 € (MOC s DPH)</p> 	<p>Sada bitov 32 ks</p> <p>Bity 75 mm: PH1; PH2; PZ1; PZ2; SL5,5; T30; SL5,5; SL6,5; Bity 25 mm: PH0; PH1; PH2 x 3 ks; PH3; PZ0; PZ1; PZ2 x 2 ks; PZ3; H3; H4; H5; H6; T10; T15; T20; T25; T30; H3; H4; H5; H6; SL0.5 x 3; SL0.8 x 5.5; SL1.2x6.5 Magnetický držiak bitov 60 mm</p>	<p>E-07076 22,19 € (MOC s DPH)</p> 
<p>Sada bitov a vrtákov 18 ks</p> <p>Bity 50 mm: PH1; PH2 x 2 ks; PZ1; PZ2; PZ3; SL5,5; T30; SL0.8 x 5.5; SL1.2 x 6.5; Nástrčný kľúč magnetický 48 mm: 6; 8; 10; 12 Vrták do betónu SDS-PLUS 160 mm: Ø 5; 6 x 2 ks; 8; 10; Magnetický držiak bitov Quick systém 80 mm</p>	<p>E-07026 26,19 € (MOC s DPH)</p> 	<p>Sada bitov a vrtákov 29 ks</p> <p>Bity 25 mm: PH1; PH2; PZ0; PZ1; PZ2; PZ3; H3; H4; H5; H6; T10; T15; T20; T25; H3; H4; H5; H6; SL0.5 x 3; SL0.8 x 5; SL1 x 6 Magnetický držiak bitov Quick systém 80 mm Vrtáky do kovu HSS-Tin Ø : 3; 4; 5; 6; 8 Vrtáky do betónu Ø: 4; 5; 6; 8; Vrtáky do dreva: Ø: 5; 6; 8;</p>	<p>E-07054 24,19 € (MOC s DPH)</p> 



SKRUTKOVÁČE

Sada bitov a vrtákov 34 ks **D-36980** **34,05 €** (MOC s DPH)

vrták HSS 2; 2,5; 3; 3,5; 4; 4,5; 5;
vrták do dreva 4; 5; 6; 7; 8
vrták do kameňa 4; 5; 6; 7; 8
nástrčný kľúč 7; 8; 10;
záhlbníkový vrták
držiak bitov magnetický 50 mm
PH1, PH2, PH3, PH4, PZ1, PZ2, PZ3,
PZ4
T20, T25, T30, SL1, SL1,2, SL1,6



Sada bitov a vrtákov 102 ks **E-10730** **51,39 €** (MOC s DPH)

25 mm bity PZ1, PZ2, PZ3, PH1, PH2,
PH3,
SL3, SL4, SL4,5, SL6, SL7, SL8
T10, T15, T20, T25, T27, T30
H3, H4, H5, H6, H7
50 mm bity PZ0, PZ1, PZ2, PZ3,
PH1, PH2, PH3
T10, T20, T25, T27,
H3, H4, H5, H6, SL3, SL4, SL 4,5
záhlbníkový vrták
držiak bitov magnetický 60 mm
nástrčný kľúč 5; 5,5; 6; 7; 8; 9; 10; 11;
12; 13
doraz 3; 5; 8; 10; imbus kľúč 2,5 mm
priebojník
vrták do dreva ø 3; 4; 5; 5,5; 6; 6,5;
vrták HSS TiN ø 3; 4; 5; 5,5; 6; 6,5;
vrták do muríva ø 3; 4; 5; 5,5; 6; 6,5;
vrták do dreva plochý ø 12; 16; 19
korunka BiMetal ø 32; 38; 45; 54;
adaptér korunky
rukoväť skrutkovača
vodováha, meter, šablóna s priermi



Sada bitov a vrtákov v systainery 69 ks **B-49638** **103,72 €** (MOC s DPH)

25 mm bity PH0; PH1; PH2; PH3;
PZ0; PZ1; PZ2; PZ3
T10; T15; T20; T25; T30; T40;
T10H; T15H; T20H; T25H; T27H;
T30H; T40H;
SL4; SL4,5; SL5,5; SL6,5; H3; H4; H5;
H6;
50 mm bity PH2; PZ2;
nástrčný kľúč 6; 8; 10; 12; 13;
vrták HSS-G ø 3; 4; 5; 6; 8;
vrták do dreva ø 3; 4; 5; 6; 8;
vrták do muríva ø 5; 6; 8; 10
vrták do dreva plochý ø 16; 20;



Sada bitov a vrtákov v systainery 56 ks **B-53768** **115,71 €** (MOC s DPH)

50 mm bity T10; T15; T20; T25; T30;
T40;
PH1; PH2; PH3; PZ1; PZ2; PZ3
H3; H4; H5; H6;
100 mm bity PZ2; PH2;
nástrčný kľúč 1/4" 6; 8; 10; 12; 13;
vrták HSS-TiN 1/4" ø 3; 3,5; 4; 5; 6; 8;
vrták do dreva 1/4" ø 3; 4; 5; 6; 8;



Sada bitov a vrtákov 212 ks **E-06270** **107,69 €** (MOC s DPH)

25 mm bity PH0; PH1; PH2; PH3;
PH4; PZ0; PZ1; PZ2; PZ3
SL3; SL4; SL5; SL5,5; SL6; SL7; SL8;
H3; H4; H5; H6; H7; H8;
T10; T15; T20; T25; T27; T30; T35;
T40; T45; SQ1; SQ2; SQ3; SQ4;
50 mm bity PH0; PH1; PH2; PH3;
PZ0; PZ1; PZ2; PZ3
SL3; SL4; SL5; SL6; SL7; SL8; H3;
H4; H5; H6; H7; H8;
T10; T15; T20; T25; T27; T30; T35;
T40; T45;
nástrčný kľúč 5; 5,5; 6; 7; 8; 9; 10; 11;
12; 13;
5/35; 3/16; 7/32; 1/4; 9/32; 5/16;
11/32; 3/8; 7/16; 1/2;
záhlbníkový vrták
držiak bitov magnetický 60 mm
doraz 3; 5; 8; 10; imbus kľúč 2,5 mm
korunka BiMetal ø 32; 38; 45; 54;
adaptér korunky
vodováha, meter 3M, šablóna
s priermi; ohybný hriadeľ
rukoväť skrutkovača; rukoväť v tvare
„T“; priebojník; tužka Makita;
vrták HSS ø 1; 1,5; 2; 2,5; 3; 3,2; 3,5;
4; 4,5; 5; 5,5; 6; 6,5; 7; 7,5; 8; 9; 10;
vrták do muríva ø 3; 4; 4,5; 5; 5,5; 6;
6,5; 7; 8; 9; 10
vrták do dreva ø 3; 4; 5; 6; 7; 8; 9; 10;
vrták do dreva plochý ø 12; 16; 18;
20; 22; 25;



Sada bitov a vrtákov 200 ks **D-37194** **180,77 €** (MOC s DPH)

25 mm bity PH0; PH1; PH2; PH3;
PZ0; PZ1; PZ2; PZ3
T10; T15; T20; T25; T30; T35; T40;
SL3; SL4; SL5; SL6; SL8; H3; H4; H5;
H6; H8;
50 mm bity PH0; PH1; PH2; PH3;
PZ0; PZ1; PZ2; PZ3
T10; T15; T20; T25; T30; T35; T40;
nástrčný kľúč 5; 5,5; 6; 7; 8; 9; 10; 11;
12; 13;
orech: 5, 6, 7, 8, 9, 10, 11, 13
korunka BiMetal ø 32; 38; 45; 54; 68;
vrták HSS ø 1; 1,5; 2; 2,5; 3; 3,2; 3,5;
4; 4,5; 5; 5,5; 6; 6,5; 7; 7,5; 8; 10;
vrták do dreva ø 3; 4; 5; 6; 7; 8; 10;
vrták do dreva plochý ø 8; 15; 20;
vrták do muríva ø 3; 4; 5; 6; 7; 8; 10
vodováha, meter 3M, šablóna
s priermi; ohybný hriadeľ
rýchlopínací držiak bitu 50 mm;
nastavovací kľúč
skrutkovač na bity; kliešte,
odstrihávacie kliešte;
baterka LED; orezávací nôž;
záhlbníkový vrták



SKRUTKOVÁČE: PROFESIONÁLNE BITY

Obj. č.	typ	dĺžka mm	ks/bal	MOC s DPH
Profesionálne bity pre skrutkovače *****				
P-06052	PH2	25	10	7,99 €
P-06111	PZ2	25	10	7,99 €
P-06389	T40	25	10	12,19 €
P-53344	PH2	25	3	3,99 €
P-53475	PZ2	25	3	3,99 €

Bit pre skrutkovače so zásobníkom 6842, 6843, DFR540, DFR550 *****				
P-67795	PH2	157	3	13,04 €

Predĺženie rukoväti pre modely 194500-1 85,99 € (MOC s DPH)

6840 / 6841 / 6841R/ 6842 / 6843
6844 / 6845/ DFR440/540/550/750
predĺženie 56 – 66 cm



Automatický podávač skrutiek 199146-8 103,69 € (MOC s DPH)

pre skrutky v pásoch
dĺžky 25 – 55 mm
kompatibilný s modelmi:
DFS452, DFS250, FS6300,
FS4300, FS4000, FS2300.
dodávaný s 2 x 130 mm PH2



Obj. č.	Typ	model	ø (mm)	povrchová úprava	dĺžka mm	ks na páse	bal/ks	Automaticky podávač 25 – 55 mm	MOC s DPH
Skrutky do sadrokartónu upevneného do kovovej konštrukcie *****									
F-30913	PH2	DFR540/DFR550/6842/6843/6845	3,9	fosfátované	25	50	1000	áno	24,69 €
F-30926	PH2	DFR540/DFR550/6842/6843/6845	3,9	fosfátované	30	50	1000	áno	19,99 €
F-31153	PH2	DFR540/DFR550/6842/6843/6845	3,9	fosfátované	35	50	1000	áno	25,19 €
F-30939	PH2	DFR540/DFR750/6842/6843/6845	3,9	fosfátované	45	50	1000	áno	24,99 €
F-30942	PH2	DFR540/DFR55/DFR750/6842/6843/6845	3,9	fosfátované	55	50	1000	áno	29,99 €

Skrutky do sadrokartónu upevneného do dreva *****									
F-31179	PH2	DFR540/DFR550/6842/6843/6845	3,9	fosfátované	35	50	1000	áno	22,99 €
F-31182	PH2	DFR540/DFR550/6842/6843/6845	3,9	fosfátované	41	50	1000	áno	26,19 €
F-31140	PH2	DFR540/6842/6843/6844	3,9	fosfátované	55	50	1000	áno	27,99 €

Skrutky pre dosky typu Fermacell upevnené do kovovej konštrukcie *****									
F-31195	PH2	DFR550	3,5	fosfátované	35	50	1000	áno	23,69 €
F-31748	PH2	DFR540/DFR550/6842/6843/6845	3,9	fosfátované	30	50	1000	áno	26,99 €

Stavebné skrutky do dreva *****									
F-31201	PH2	DFR540/DFR550/6842/6843/6845	4,2	pozinkované	40	50	1000	áno	36,89 €
F-31214	PH2	DFR540/DFR550/DFR750/6842/6843	4,2	pozinkované	55	50	1000	áno	62,79 €

Stavebné rýchloskrutky pre trieskové a OSB dosky *****									
P-31413	PH2	DFR540/DFR550/6842/6843/6845	4,0	biely zinok	35	50	1000	áno	38,01 €
F-31780	PH2	DFR540/DFR550/6842/6843/6845	4,0	biely zinok	40	50	1000	áno	27,99 €
P-13225	PH2	DFR750	4,5	biely zinok	75	50	500	nie	74,70 €

POUŽITIE SKRUTKOVÁČOV

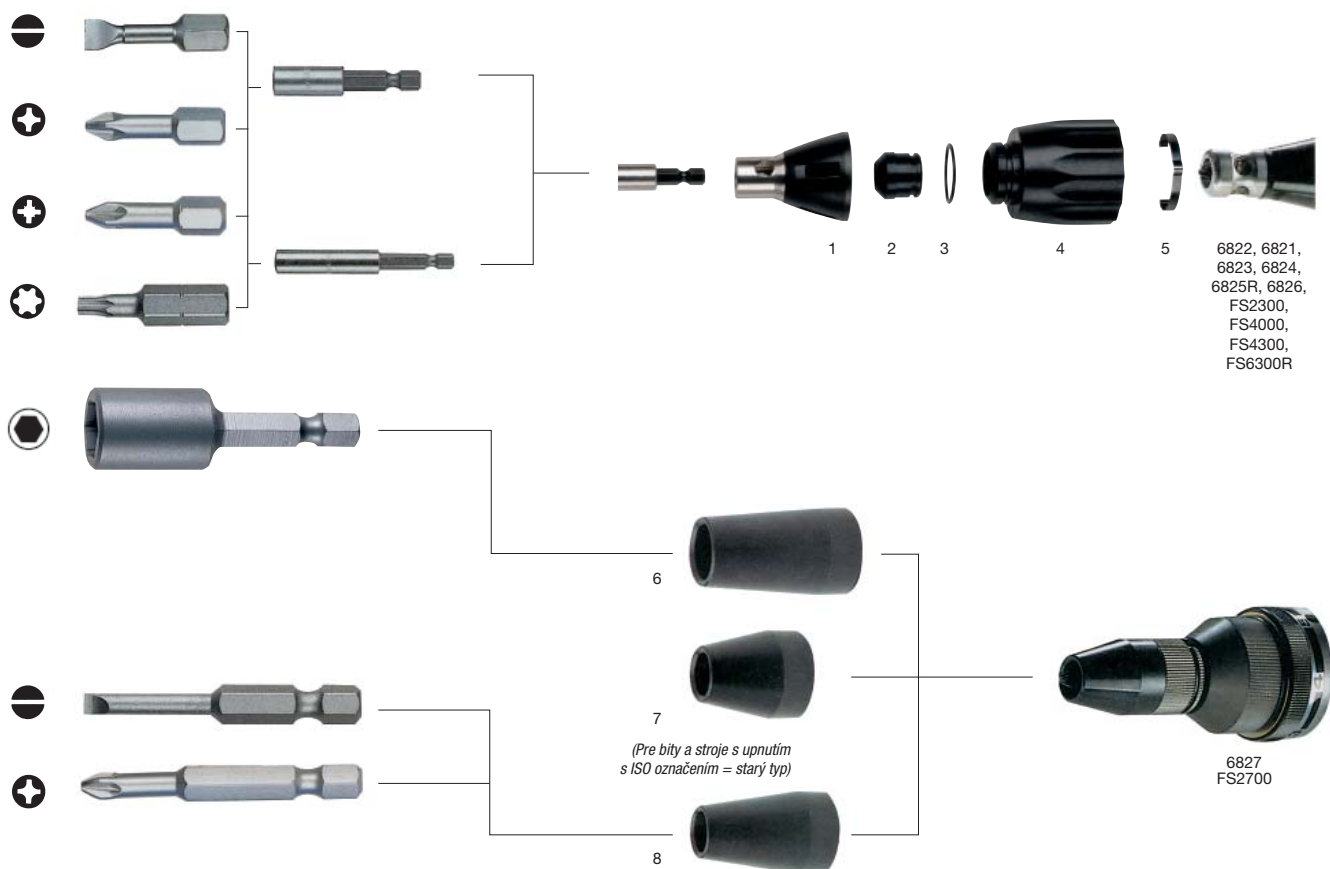

Obj. č.	obr. č.	popis	ø		ks/bal.	model	MOC s DPH
151561-4	1	vodiace puzdro			1	6822	9,89 €
151760-8	1	vodiace puzdro			1	6823, 6824, 6825R	2,39 €
152483-1	1	vodiace puzdro	1/4"		1	6821, 6826	3,19 €
152823-3	1	vodiace puzdro	3/8"		1	6821, 6826	3,89 €
158875-2	1	vodiace puzdro			1	FS2300, FS4000, FS4300, FS6300R	4,19 €
421631-6	2	tesniaci krúžok			1	6822, 6823, 6824, 6825R	0,54 €
424163-2	2	tesniaci krúžok			1	FS2300, FS4000, FS4300, FS6300R	0,17 €
421519-0	2	prachovka			1	6821	0,67 €
421775-2	2	prachovka			1	6826	0,55 €
213953-6	3	o-krúžok 22			1	6821, 6822, 6823, 6824, 6825R, 6826	0,34 €
424235-3	3	o-krúžok			1	FS2300, FS4000, FS4300, FS6300R	0,10 €
416756-9	4	nastavovacie puzdro			1	6822	3,98 €
455428-1	4	nastavovacie puzdro			1	6823, 6824, 6825R, 6827	1,14 €
415570-0	4	nastavovacie puzdro			1	6821	1,33 €
455591-0	4	nastavovacie puzdro			1	FS2300, FS4000, FS4300, FS6300R	2,08 €
232154-7	5	pružina			1	6822, 6823, 6824, 6825R, 6826, 6821	0,91 €
232245-4	5	pružina			1	FS2300, FS4000, FS4300, FS6300R	1,28 €
234266-2	5	pružina			1	FS2300, FS4000, FS4300, FS6300R	0,85 €
455428-1	4	nastavovacie puzdro			1	6823, 6824, 6825R, 6827	1,14 €
322120-3	8	vodiace puzdro	12	50	1	6827, FS2700	1,99 €
134873-0		adaptér			1	6821, 6822, 6823, 6824, 6825R, 6826, 6827	40,19 €

RÁZOVÉ UŤAHOVÁKY: PRÍSLUŠENSTVO

	Obj. č.	upínanie	typ	dĺžka mm	ks/bal	MOC s DPH	
Predĺženie *****							
	B-55728	1/2"		75	1	5,14 €	
	134874-8	1/2"		100	1	25,99 €	
	B-55712	1/2"		150	1	7,13 €	
	B-55706	1/2"		250	1	9,53 €	
	134997-2	3/4"		150	1	52,99 €	
	134870-6	1"		200	1	93,29 €	
Kíbový adaptér *****							
	134877-2	1/2"		100	1	99,49 €	
Adaptér redukcia *****							
	134873-0	1/2" na 1/4"			1	40,19 €	
	B-68448	1/2" na 1/4"			1	14,58 €	
	B-68460	1/2" na 7/16"			1	cena na vyžiadanie	
	P-05941	1/2" na 1/4"			1	47,79 €	
	P-21559	O krúžok pre P-05941				1	2,20 €
	P-21565	čap pre P-05941				1	0,83 €
Adaptér pre DTW800 *****							
	B-59835	7/16" na 3/8"		75	1	4,05 €	
Nástrčné kľúče s upnutím štvorhran 1/2" *****							
	134825-1	1/2"	M8/SW13	38	1	3,69 €	
	134827-7	1/2"	M8/SW13	52	1	5,59 €	
	134829-3	1/2"	M10/SW17	38	1	3,99 €	
	134830-8	1/2"	M10/SW17	52	1	6,09 €	
	134831-6	1/2"	M12/SW19	38	1	4,19 €	
	134832-4	1/2"	M12/SW19	52	1	5,49 €	
	134838-2	1/2"	1/2"/SW21	38	1	5,39 €	
	134833-2	1/2"	1/2"/SW21	52	1	5,69 €	
	134851-0	1/2"	M14/SW22	38	1	5,09 €	
	134834-0	1/2"	M14/SW22	52	1	5,99 €	
	134841-3	1/2"	M16/SW24	45	1	7,19 €	
	134836-6	1/2"	M16/SW24	52	1	6,59 €	
	134844-7	1/2"	M18/SW27	50	1	7,99 €	
	134845-5	1/2"	M18/SW27	78	1	10,19 €	
	134846-3	1/2"	M20/SW30	50	1	7,79 €	
	134847-1	1/2"	M20/SW30	78	1	10,49 €	
	134848-9	1/2"	M22/SW32	50	1	8,59 €	
	134849-7	1/2"	M22/SW32	78	1	12,49 €	
	213405-7	1/2"	O krúžok k nástrčným kľúčom			1	0,23 €
	268057-9	1/2"	čap k nástrčným kľúčom			1	0,88 €

RÁZOVÉ UŤAHOVÁKY: PRÍSLUŠENSTVO

Obj. č.	upínanie	typ	dĺžka mm	ks/bal	MOC s DPH
Nástrčné kľúče s upnutím štvorhran 3/4" *****					
	A-85519	M12/SW19	50	1	8,89 €
	A-85553	M14/SW22	52	1	8,89 €
	A-85575	M16/SW24	52	1	9,29 €
	134855-2	M18/SW27	52	1	9,89 €
	134856-0	M18/SW27	95	1	23,29 €
	134857-8	M20/SW30	52	1	10,19 €
	134858-6	M20/SW30	95	1	19,49 €
	134871-4	M22/SW32	52	1	11,09 €
	134859-4	M22/SW32	95	1	18,09 €
	134862-5	M24/SW36	56	1	13,39 €
	134863-3	M24/SW36	95	1	22,69 €
	213506-1	3/4"	O krúžok k nástrčným kľúčom	1	0,29 €
	256282-4	3/4"	čap k nástrčným kľúčom	1	1,01 €

Nástrčné kľúče s upnutím štvorhran 1" *****						
	134865-9	1"	M24/SW36	80	1	23,39 €
	134872-2	1"	M27/SW41	80	1	36,79 €

Sada nástrčných kľúčov 9ks **B-54645** **26,86 €** (MOC s DPH)

upínanie 1/2"
8, 10, 12, 13, 14, 15, 17, 18 x 30 mm
adaptér 1/4" na 1/2"



Sada nástrčných kľúčov 3 ks **E-12354** **31,69 €** (MOC s DPH)

upínanie 1/2"
kľúč 17, 19, 21 x 86 mm



Sada nástrčných kľúčov 7ks **B-69733** **32,81 €** (MOC s DPH)

upínanie 1/2"
13, 17, 19, 21, 22, 24 x 30 mm
adaptér 1/4" na 1/2"



Sada nástrčných kľúčov 9ks **B-54651** **22,71 €** (MOC s DPH)

upínanie 3/8"
8, 10, 12, 13, 14, 15, 17, 18 x 30 mm
adaptér 1/4" na 3/8"



Predĺženie k rázovým uťahovákam **191G67-2** **133,99 €** (MOC s DPH)

vhodné pre modely
DTW1001, DTW1002, DTW800
DTW700, TW001G,
TW002G, TW003G, TW007G,
TW008G
nastavenie dĺžky: 657 – 807 mm



PRÍSLUŠENSTVO: DIAMANTOVÉ KOTÚČE

Diamantové kotúče typy



Segmentový:

Najčastejšie používané s diamantami v sadených po okrajoch kotúča. Rýchle a pohodlné rezanie.



Segmentový zváraný laserom:

vrstva diamantu a kotúča sú zvárané laserovým lúčom nad 1000 °C. Ideálne použitie s vysoko výkonným strojom.

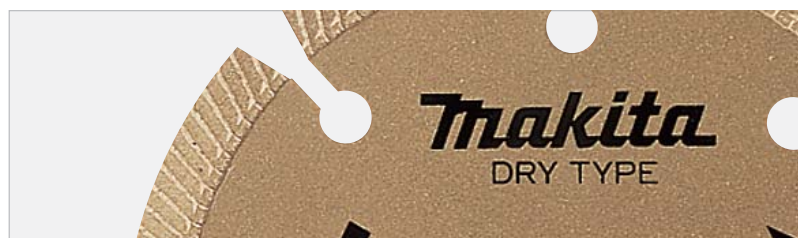

Segmentový so zárezmi:

tieto zárezy zabezpečujú:

- rýchle rezanie s menším odporom
- efektívnejšie odvádzanie rezného prachu
- menšia záťaž na kotúč

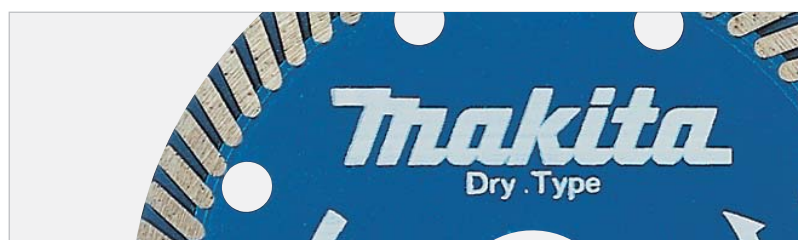

Turbo hrana:

rýchlejšie rezanie ako pri segmentových kotúčoch
čistejší rez bez štrbín na rezanom materiále



Nedelená hrana:

Vrstva diamantov po celom obvode kotúča
čistý a hladký rez aj na tvrdých materiáloch
/keramické obklady, porcelán/

REZANIE: REZNÉ KOTUČE

Obj. č.	upínanie ø otvoru (mm)	ø (mm)	materiál	typ	ks/bal	MOC s DPH
---------	------------------------------	--------	----------	-----	--------	-----------

X-LOCK diamantový rezný kotúč



E-02076	X-LOCK	125	betón	segmentový	1	38,59 €
---------	--------	-----	-------	------------	---	---------

diamantový rezný kotúč určený pre akumulátorové uhlové brúsky X-LOCK – systém uchytania kotúča bez použitia kľúča umožňuje bezpečnú a rýchlu výmenu kotúča možnosť použitia kotúča aj pre štandardné brúsky s upínaním 22,23 mm

Diamantový rezný kotúč pre akumulátorovú rozbrusovačku DCE090



E-02967	22,23	230	betón, žula, mramor	segmentový	1	133,39 €
---------	-------	-----	------------------------	------------	---	----------

Diamantový rezný kotúč pre akumulátorové uhlové brúsky



B-53796	22,23	125	betón, žula, mramor	segmentový	1	42,19 €
B-53693	22,23	125	železo	segmentový	1	46,49 €

Diamantový rezný kotúč pre akumulátorovú rozbrusovačku CE001



E-12996	25,4	355	betón, žula, mramor	segmentový (výška segmentu 8 mm)	1	cena na vyžiadanie
---------	------	-----	------------------------	---	---	-----------------------

Diamantový rezný kotúč na rezanie na mokro



obj. č.	ø otvoru (mm)	ø (mm)	hrúbka segmentu (mm)	výška segmentu (mm)	materiál	typ	bal/ks	MOC s DPH
B-21098	15	85	2	4,5	sklo, obkladačky	hladký	1	33,99 €

vhodný pre modely 4190DW, 4191DWA, CC300, CC301



REZANIE: REZNÉ KOTUČE

Obj. č.	ø (mm)	výška segmentu (mm)	ø otvoru (mm)	ID číslo kotúča	charakteristika	prstenec (mm)	ks/bal	MOC s DPH
---------	--------	---------------------	---------------	-----------------	-----------------	---------------	--------	-----------

Diamantové kotúče Quasar

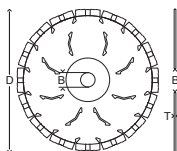

B-12712	230	12	22,23	QDS23022XS	3DDG, Stealth		1	129,09 €
B-13459	300	12	20	QDS30020XS	3DDG, Stealth		1	184,99 €
B-13465	350	12	25,4	QDS35025XS	3DDG, Stealth	20	1	233,89 €
B-13471	400	12	25,4	QDS40025XS	3DDG, Stealth	20	1	291,09 €

Ako čítať nový identifikačný kód diamantových kotúčov Makita



Typ segmentu (Segment Type)
 DS = diamantový segmentovaný
 DT = diamantový turbo
 DC = diamantový nedelený
 DE = diamantový elektrolyticky pokovovaný
 DM = diamantový na maltu (frézovanie škár)
 DA = diamantový asfaltový

Priemer otvoru (v mm) (Bore Diameter)
 15 = 15mm
 16 = 16mm
 20 = 20mm
 22 = 22.23mm
 25 = 25.4mm

QDS30020XS

Označenie (Brand)
 Q = Quasar
 C = Comet
 N = Neutron
 L = Laser (DiaMak+)
 D = DiaMak

Priemer kotúča (v mm) (Blade Diameter)

Špecifické charakteristiky (Special Features)
 e = Enduro
 r = Rapide
 C = chladiace otvory
 V = spevnené jadro
 X = technológia 3D Diamond Grid
 S = technológia Stealth

PRÍKLADY

QDS30020XS: kotúč Quasar, diamantový segmentovaný, priemer 300 mm, priemer otvoru 20 mm, technológia 3D Diamond Grid, technológia Stealth
 CDS40025rCX: kotúč Comet, diamantový segmentovaný, priemer 400 mm, priemer otvoru 25 mm, Rapide, chladiace otvory, technológia 3D Diamond Grid
 NDS11522e: kotúč Neutron – priemer 115 mm, priemer otvoru 22,23 mm, Enduro









REZANIE: REZNÉ KOTUČE

Špeciálny univerzálny kotúč s technológiou 3D Grid pre profesionálny výkon.

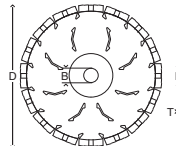
Široké spektrum kvalitných kotúčov s technológiou 3D Grid a voliteľnými prvkami ako technológia Stealth alebo chladiace otvory.

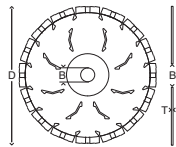
K dispozícii v segmentových špecifikáciách Rapide a Enduro pre maximalizáciu rýchlosti alebo životnosti.

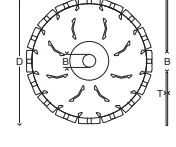
Zvárané laserom. Na mokré a suché použitie.

Obj. č.	ø (mm)	výška segmentu (mm)	ø otvoru (mm)	ID číslo kotúča	charakteristika	prstenec (mm)	ks/bal	MOC s DPH	
Diamantové kotúče Comet *****									
	B-12778	125	10	22,23	CDS12522rC	Rapide, chladiace otvory	20	1	45,99 €
	B-27187	150	10	22,23	CDS15022C	Rapide, chladiace otvory		1	58,99 €
	B-27193	180	10	22,23	CDS18022C	Rapide, chladiace otvory		1	74,99 €
	B-12784	230	10	22,23	CDS23022rCX	3DDG, Rapide, chladiace otvory		1	102,49 €
	B-13546	300	10	20	CDS30020rCX	3DDG, Rapide, chladiace otvory		1	140,79 €
	B-13552	350	10	25,4	CDS35025rCX	3DDG, Rapide, chladiace otvory	20	1	185,39 €
	B-13568	400	10	25,4	CDS40025rCX	3DDG, Rapide, chladiace otvory	20	1	229,79 €
Segmentovaná hrana pre rýchle rezanie Betón, stredne tvrdá/tvrdá tehla, terazzo, keramické dlaždice, bridlica, keramická rúra									
	B-12980	115	7	22,23	CDT11522	štandardné jadro		1	33,99 €
	B-12996	125	7	22,23	CDT12522	štandardné jadro	20	1	37,99 €
	B-13007	150	7	22,23	CDT15022	štandardné jadro	20	1	49,99 €
	B-13013	175	7	22,23	CDT17522	štandardné jadro		1	61,99 €
	B-13029	200	7	30	CDT20030	štandardné jadro	25,4	1	70,99 €
	B-13035	230	8	22,23	CDT23022	štandardné jadro		1	85,99 €
	B-13041	300	8,5	25,4	CDT30025	štandardné jadro		1	160,99 €
	B-13057	350	8,5	25,4	CDT35025	štandardné jadro		1	251,99 €
Turbo hrana na rezanie Tvrdá tehla, žula, vápenec, keramická rúra, bridlica, terazzo, granit									
	B-13063	80	5	15	CDC8015	štandardné jadro		1	59,29 €
	B-13085	115	5	22,23	CDC11522	štandardné jadro		1	23,99 €
	B-13091	125	5	22,23	CDC12522	štandardné jadro	20	1	26,99 €
	B-13100	150	5	22,23	CDC15022	štandardné jadro	20	1	38,99 €
	B-13116	175	5	22,23	CDC17522	štandardné jadro		1	43,99 €
	B-13122	200	5	30	CDC20030	štandardné jadro	25,4	1	39,99 €
	B-13138	230	5	30	CDC23030	štandardné jadro	25,4	1	51,99 €
	B-13144	300	7	25,4	CDC30025	štandardné jadro		1	151,99 €
	B-13150	350	7	30	CDC35030	štandardné jadro	25,4	1	161,99 €
Nedelená hrana na rezanie keramiky, porcelánu, dlaždíc z mramoru a bridlice									
	B-13172	115		22,23	CDE11522	štandardné jadro		1	52,99 €
	B-13188	125		22,23	CDE12522	štandardné jadro	20	1	62,99 €
	B-13194	150		22,23	CDE15022	štandardné jadro	20	1	67,99 €
Elektrolyticky pokovovaný kotúč na rezanie Mramor, sklenené vlákno, drevovláknitá doska /sololit/, sklaminát									
	B-13269	300	10	20	CDA30020	štandardné jadro		1	178,99 €
	B-13275	350	10	25,4	CDA35025	štandardné jadro	20	1	178,89 €
	B-42905	400	10	25,4	CDA40025	štandardné jadro	20	1	263,29 €
Segmentovaná hrana, asfaltový kotúč na rezanie Asfalt, hrubozrnný vápenec, hrubozrnný pieskovec, abrazívny pieskovec, mäkká tvárnica									

REZANIE: REZNÉ KOTÚČE

Špeciálny kotúč laserom zváraný na všeobecné použitie na stavebné materiály. Možno použiť na mokré alebo suché rezanie.

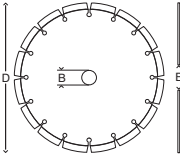
Obj. č.	ø (mm)	výška segmentu (mm)	ø otvoru (mm)	ID číslo kotúča	charakteristika	prstenec (mm)	ks/bal	MOC s DPH
Diamantové kotúče Nebula ***								
	B-53986	115	10	22,23		suchý rez	1	17,89 €
	B-53992	125	10	22,23		suchý rez	1	20,69 €
	B-54003	150	10	22,23		suchý rez	1	24,89 €
	B-54019	180	10	22,23		suchý rez	1	31,89 €
	B-54025	230	10	22,23		suchý rez	1	35,79 €
	B-54031	300	10	20		suchý/mokrý rez	1	67,59 €
	B-54047	300	10	20		suchý/mokrý rez	1	77,99 €
	B-54053	350	10	25,4		suchý/mokrý rez	20	80,59 €
	B-54069	400	10	25,4		suchý/mokrý rez	20	103,99 €
	B-54075	450	10	25,4		suchý/mokrý rez	1	221,99 €

Segmentovaná hrana pre rýchle rezanie
Betón, mäkká tehla, mäkká bridlica, betónové dlaždice

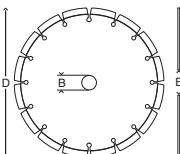
Diamantové kotúče Diamak ***									
Ekonomické kotúče vstupnej úrovne vhodné pre široké spektrum stavebných materiálov. K dispozícii vo viacerých variantoch – segmentované, turbo a nedelené. Na použitie za mokra aj za sucha.									
	D-61123	115	7	22,23	DDS115	Segmentový kotúč	za sucha	1	5,98 €
	D-61139	125	7	22,23	DDS125	Segmentový kotúč	za sucha	1	6,89 €
	D-61145	230	7	22,23	DDS230	Segmentový kotúč	za sucha	1	15,77 €

Segmentovaná hrana – na rezanie
Väčšina murárskych materiálov, dosky, tehly, blokový pieskovec, bridlica a vápenec.

	D-61151	115	7	22,23	DDT115	Turbo hrana	za sucha	1	6,32 €
	D-61167	125	7	22,23	DDT125	Turbo hrana	za sucha	1	7,54 €
	D-61173	230	7	22,23	DDT230	Turbo hrana	za sucha	1	18,88 €

Turbo hrana – na rezanie
Väčšina murárskych materiálov, dosky, tehly, blokový pieskovec, bridlica a vápenec.

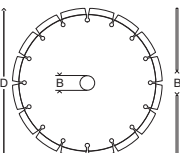
	D-61189	115	7	22,23	DDC115	nedelená hrana	za mokra	1	5,36 €
	P-27224	180	7	22,23	DDC180	nedelená hrana	za mokra	1	40,58 €
	D-61195	200	7	25,4	DDC200	nedelená hrana	za mokra	1	12,90 €
	D-61204	250	7	30 / 25,4	DDC250	nedelená hrana	za mokra	1	17,73 €

Nedelená hrana – na rezanie
Na rezanie dlaždíc, mramoru, vápenca, porcelánu, terazza.

	D-56982	300	7,5	25,4	20	segmentový kotúč	za sucha	1	63,43 €
	D-56998	350	7,5	25,4	20	segmentový kotúč	za sucha	1	81,54 €
	D-57009	400	7,5	25,4	20	segmentový kotúč	za sucha	1	95,12 €

Diamantové kotúče pre benzínové rozbrusovačky na betón

DELENIE: REZNÉ KOTUČE

Obj. č.	ø (mm)	výška segmentu (mm)	ø otvoru (mm)	ID číslo kotúča	charakteristika	prstenec (mm)	ks/bal	MOC s DPH
---------	--------	---------------------	---------------	-----------------	-----------------	---------------	--------	-----------

Diamantové kotúče na betón pre uhlové brúsky



D-41589	115	7	22,23		segmentový kotúč	za sucha	1	8,47 €
D-41595	125	7	22,23		segmentový kotúč	za sucha	1	10,47 €
D-41610	230	7	22,23		segmentový kotúč	za sucha	1	23,30 €



D-41626	115	7	22,23		turbo hrana	za sucha	1	8,47 €
D-41632	125	7	22,23		turbo hrana	za sucha	1	10,47 €
D-41654	230	7	22,23		turbo hrana	za sucha	1	23,30 €

Diamantové brúsne kotúče pre PW5000



obj. č.	ø (mm)	farba kotúča	zrno	bal/ks	Moc s DPH
D-15584	100	modrá	50	1	14,61 €
D-15590	100	žltá	100	1	14,61 €
D-15609	100	oranžová	200	1	14,61 €
D-15615	100	červená	400	1	14,61 €
D-15621	100	tmavozelená	800	1	14,61 €
D-15637	100	svetlozelená	1500	1	14,61 €
D-15643	100	hnedá	3000	1	14,61 €
D-15659	100	zelená	dolešťovanie	1	25,21 €
D-15805	100	sada 8 ks		8	127,43 €
743080-0	100	brúsny kotúč		1	31,99 €

Obj. č.	ø (mm)	ø otvoru (mm)	hrúbka segmentu (mm)	výška segmentu (mm)	druh segmentu	farba kotúča	použitie	max. otáčiky (min ⁻¹)	ks/bal	MOC s DPH
---------	--------	---------------	----------------------	---------------------	---------------	--------------	----------	-----------------------------------	--------	-----------

Diamantový brúsny kotúč pre PC1100

792289-1	110	15	13	5,4	hladký	strieborná		13900	1	273,49 €
----------	-----	----	----	-----	--------	------------	--	-------	---	----------

Diamantový brúsny kotúč pre PC5000/5001

B-12295	125	22,23	8	5	dvoj rad	zlatá	hrubé nečistoty		1	116,09 €
B-12289	125	22,23			hladký	zlatá	jemné čistenie		1	235,19 €

Diamantový brúsny kotúč pre PC5000/5001

B-48561	125	M14	8	5,5	jedno rad	strieborná	hrubé nečistoty		1	75,89 €
B-48577	125	M14	8	5,5	dvoj rad	strieborná	hrubé nečistoty		1	90,09 €
B-48583	125	M14	7	5,5	tvár V	strieborná	hrubé nečistoty		1	94,39 €

D-41458	125	22,23	7	5	dvoj rad	strieborná	hrubé nečistoty		1	50,78 €
D-60682	125	22,23	8	5	jedno rad	strieborná	hrubé nečistoty		1	19,16 €

Diamantové brúsne kotúče z nízkymi vibráciami uchytenie M14

B-48533	125	M14	8	5,5	jedno rad	zlatá	hrubé nečistoty		1	100,59 €
B-48549	125	M14	8	5,5	dvoj rad	zlatá	hrubé nečistoty		1	103,89 €
B-48555	125	M14	7	5,5	tvár V	zlatá	hrubé nečistoty		1	106,29 €
B-49993	125	M14	15	4,5	vejárový	zlatá	hrubé nečistoty		1	124,09 €

Príslušenstvo pre prestrihovače, nožnice na plech, nožnice závitových tyčí a roxorov



model	rozmer	popis	obj. č.	Moc s DPH
DSC102, SC103D	M6	sada 2 ks	199087-8	107,09 €
	M8	sada 2 ks	199085-2	73,79 €
	M10	sada 2 ks	199083-6	74,19 €

DSC162, DSC162R, DSC163 DSC191, DSC191R		sada 2 ks	SC09002470	253,59 €
		sada 2 ks	SC09002030	337,99 €

DSC251	110 x 15 mm 24Z		SC09003260	62,59 €
--------	-----------------	--	------------	---------

DSC250	110 x 15 mm 24Z		SC09003260	62,59 €
	adaptér		SC09030550	71,59 €

model	pozícia	popis	obj. č.	MOC s DPH
-------	---------	-------	---------	-----------

	1	nôž stredný	792744-3	47,99 €
	2	nôž pravý	792742-7	43,89 €
	3	nôž ľavý	792743-5	43,69 €

	1	nôž stredný	725256-1	48,59 €
	2	nôž pravý	725257-9	252,99 €
	3	nôž ľavý	725258-7	252,99 €

	1	nôž stredný	725255-3	81,09 €
	2	nôž pravý	725092-5	47,19 €
	3	nôž ľavý	725093-3	52,59 €

	1	nôž stredný	725129-8	83,49 €
	2	nôž pravý	725130-3	81,89 €
	5	nôž ľavý	725130-3	81,89 €

DJS100, DJS101, JS1000	1	Sada nožov (P + L)	792536-0	59,29 €
	2	nôž stredný	792537-8	98,29 €

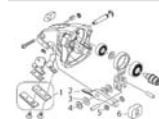

		Sada nožov (P + L)	792533-6	56,69 €
		nôž stredný	792534-4	76,39 €
		mierka (0,5; 1,0; 1,5 mm)	762013-6	3,19 €

JS1602, JS1600	1; 2; 3	Sada nožov (P + L)	191383-0	28,69 €
----------------	---------	--------------------	----------	---------



JS3201, JS3200	1; 2	Sada nožov (P + L)	792287-5	35,59 €
		mierka (1,0; 1,5; 2,0 mm)	762007-1	2,29 €



DJN160, DJN161, JN1601	1	matrica	A-15051	20,09 €
	2	razník	A-83951	29,89 €



JN3201, JN3200	1	matrica	792292-2	26,89 €
	2	razník	792728-1	31,99 €

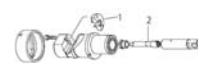

DELENIE: REZNÉ KOTUČE

Obj. č.	ø (mm)	ø otvoru (mm)	popis	hrúbka kotúča	ks/bal	MOC s DPH
---------	--------	---------------	-------	---------------	--------	-----------

Rezné kotúče



Rezné a brúsne kotúče na kovy a nerez určené pre uhlové brúsky s upínaním X- LOCK, možnosť použiť aj pri uhlových brúskach s klasickým upínaním 22,23 mm

E-00393	125	X-LOCK	brúsny kov	6	1	2,19 €
E-00402	125	X-LOCK	brúsny nerez	6	1	3,19 €
E-00418	125	X-LOCK	rezný	1,2	1	2,49 €

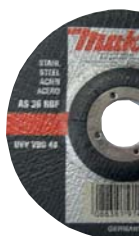

Rezný kotúč na kovy – Rezný kotúč, lisovaný za studena, s pojívom zo syntetickej živice. Univerzálny kotúč, použiteľný vo všetkých oblastiach opracúvania kovov. Vysoký rezný výkon pri dobrej životnosti.

B-14102	115	22,23		1,6	1	1,99 €
A-85307	115	22,23		2,5	1	1,39 €
B-35134	125	22,23		1,6	1	1,99 €
B-64618	230	22,23		1,9	1	3,89 €
A-85313	125	22,23		2,5	1	1,59 €
A-85329	180	22,23		2,5	1	2,29 €
A-85335	230	22,23		2,5	1	3,09 €
B-60464	230	22,23		2	1	3,19 €
B-49448-5*	355	25,4		2,5	5	30,59 €
B-10665-5	355	25,4		3	5	27,49 €
724417-0	400	25,4		3	1	25,69 €

Sada rezných kotúčov na kov

D-65969-12	125	22,23	kovová krabica	1,2	12	11,03 €
E-10877-12	125	22,23	PVC krabica	0,8	12	24,69 €



Rezný kotúč na kameň – Rezný kotúč, lisovaný za studena, s pojívom zo syntetickej živice. Univerzálny kotúč na rezanie prírodného a umelého kameňa, bridlice, mramoru, neželezných kovov. Vysoký rezný výkon pri dlhej životnosti

A-85357	115	22,23		3	1	1,69 €
A-85363	125	22,23		3	1	2,09 €
A-85379	180	22,23		3	1	2,89 €
A-85385	230	22,23		3	1	3,99 €
721710-3	300	20		3,5	1	17,19 €
724408-1	400	25,4		4	1	39,59 €



Rezný kotúč na nerez / železo – Tenký, stredne tvrdý, vysokovýkonný rezný kotúč. Vhodný najmä na tenkostenné materiály ako rúry, profily, plechy a drôty. Nižšie zaťaženie náradia, menšia spotreba materiálu, menšie úsilie pri rezaní. Mimoriadne vysoký rezný výkon pri optimálnej životnosti.

B-45727	115	22,23		0,8	1	1,89 €
B-45755	115	22,23		0,8	1	1,29 €
E-10877	125	22,23		0,8	1	2,09 €
B-46931	125	22,23		1,6	1	1,39 €

Rezný kotúč na ušľachtilú oceľ – Tenký, stredne tvrdý, vysokovýkonný rezný kotúč. Vhodný najmä na tenkostenné materiály ako rúry, profily, plechy a drôty z nehrdzavejúcej ocele. Nižšie zaťaženie náradia, menšia spotreba materiálu, menšie úsilie pri rezaní. Mimoriadne vysoký rezný výkon pri optimálnej životnosti.

B-12201	100	16		1	1	1,59 €
B-12217	115	22,23		1	1	1,69 €
B-12239	125	22,23		1	1	1,89 €
E-13742	150	22,23		1,6	1	2,09 €
E-13758	180	22,23		1,6	1	2,09 €
E-13764	230	22,23		1,9	1	3,69 €

* do vypredania skladových zásob

DELENIE: BRÚSNÉ KOTUČE

Obj. č.	ø (mm)	ø otvoru (mm)	popis	hrúbka kotúča	ks/bal	MOC s DPH
---------	--------	---------------	-------	---------------	--------	-----------

Rezné kotúče



Rezný kotúč na hliník – Rezný kotúč, lisovaný za studena, s pojivom zo syntetickej živice. Vhodný na rezanie hliníkových materiálov. Vysoký rezný výkon pri dlhej životnosti.

B-45331	125	22,23		1	1	1,99 €
B-45347	150	22,23		1,6	1	2,19 €
B-45369	230	22,23		1,9	1	3,89 €

2 v 1 rezný / brúsny kotúč na nerez a železo, vhodný pre akumulátorové brúsky

B-50360	115	22,23		2	1	1,99 €
B-51655	125	22,23		2,2	1	2,19 €

Multi rezný kotúč na kov, nerez, PVC, obkladačky, tehly, betón

E-10724	125	22,23		1,2	1	1,99 €
---------	-----	-------	--	-----	---	--------

Brúsny kotúč na oceľ a nehrdzavejúcu oceľ



Brúsne kotúče Makita sú stredne tvrdé univerzálne kotúče, určené pre všetky oblasti opracúvania kovov. Brúsne kotúče majú hrubú zrnitosť a používajú sa na miestach, kde sa požaduje vysoký úberový výkon. Vzhľad výbrusu je zodpovedajúco hrubý.

Oblasti využitia: začisťovanie zvarov; brúsenie liatinových odliatkov; brúsenie hrán a plôch; brúsenie rohových zvarov; brúsenie bodových zvarov; zahladzovanie a výbrus okovín.

A-80852	100	16		6	1	1,49 €
A-80640	115	22,23		6	1	1,89 €
B-53110	125	22,23		4	1	2,69 €
A-80656	125	22,23		6	1	2,39 €
A-80846	150	22,23		6	1	2,79 €
A-80880	180	22,23		6	1	3,99 €
A-80896	230	22,23		6	1	6,29 €
B-14560	115	22,23		6	1	2,19 €
B-17653	125	22,23		6	1	2,49 €
B-14576	180	22,23		6	1	3,89 €

Brúsny kotúč na kov



Stredne tvrdý, univerzálny brúsny kotúč na celkové opracúvanie normálnej ocele, napr. na odstraňovanie okovín, brúsenie hrán a výbrus plôch.

Mimoriadnou prednosťou tohto kotúča je optimálny pomer ceny a výkonu.

D-18459	115	22,23		6	1	1,28 €
D-18465	125	22,23		6	1	1,59 €
A-80927	115	22,23		6	1	1,49 €
A-80933	125	22,23		6	1	1,69 €
A-84981	150	22,23		6	1	2,39 €
A-80949	180	22,23		6	1	2,59 €
A-80955	230	22,23		6	1	4,59 €

Brúsny kotúč HEAVY DUTY na kov, železo a nerez



Univerzálny, stredne tvrdý brúsny kotúč, lisovaný za studena, s pojivom zo syntetickej živice, na celkové opracúvanie ocele, napr. na odstraňovanie okovín, brúsenie hrán a výbrus plôch.

Mimoriadnou prednosťou tohto kotúča je vysoký úberový výkon pri optimálnej životnosti.

B-21113	115	22,23		6	1	1,31 €
B-21129	125	22,23		6	1	1,65 €
B-21135	180	22,23		6	1	2,68 €
B-21141	230	22,23		6	1	4,21 €

Brúsny kotúč



Štruktúra

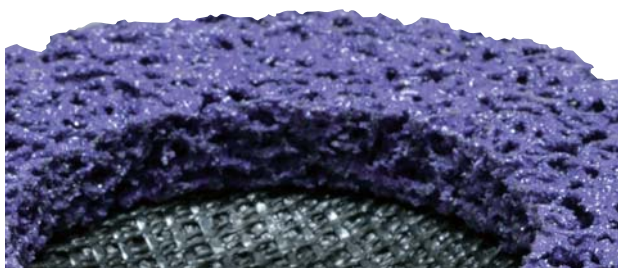

Špeciálny kotúč na odstraňovanie farieb

Grit (SiC)

Štruktúra kotúča SiC (karbid kremíka) a vlákna umožňujú rýchle a zároveň šetrné brúsenie materiálu bez väčšej námahy.

Fiber

Zapuzdrené vlákna pôsobia šetrne na materiál a zabraňujú prílišnému odbrúseniu a poškrabaniu ocele.

Vlastnosti

Rozdiel pri použití na rovnakom materiáli.



špeciálny kotúč

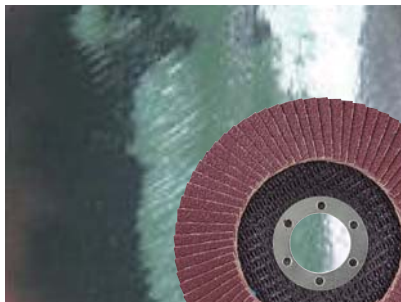

lamelový kotúč



brúsny kotúč

Použitie



*odstraňovanie farby



*odstraňovanie hrdze



*odstraňovanie farebných defektov po zvaroch

Lamelové kotúče



veľkosť

objednávacie číslo

piktogramy

predpísaná norma

max otáčky pri používaní

odporúčané použitie

odporúčané použitie

zrornosť

Typ uchytenia



podložka zo sklenených vlákien
štandardný typ podkladu



nylonová podložka
For heavy duty

Tvar kotúča



plochý
pre rovné povrchy



zaoblený
použitie pri uhloch a rohoch

AA : odporúčané

A : prijateľný

zloženie brusiva	Aluminum oxide	Zirconia alumina	Silicon carbide	Ceramic aluminum oxide
popis a farba štítku	určený na železo 	určený na železo a nerez 	určený na murivo 	určený na železo, nerez a neželezné kovy
drevo	A			
PVC	A			
železo	AA	AA		AA
neželezné kovy	A	A		AA
nerez		AA		AA
murivo			AA	

BRÚSENIE: LAMELOVÉ KOTÚČE

Obj. č.	ø (mm)	ø otvoru (mm)	zrmitosť	max. otáčky	ks/bal	MOC s DPH
Lamelové brúsne kotúče na ocel „Korund“ *****						
	P-65137	115	22,23	40	13 300	1, 2,79 €
	P-65143	115	22,23	60	13 300	1, 2,69 €
	P-65159	115	22,23	80	13 300	1, 2,69 €
	P-65165	115	22,23	120	13 300	1, 2,69 €
	P-65171	125	22,23	40	12 000	1, 3,39 €
	P-65187	125	22,23	60	12 000	1, 3,39 €
	P-65193	125	22,23	80	12 000	1, 3,39 €
	P-65202	125	22,23	120	12 000	1, 3,39 €
	P-65218	150	22,23	40	10 200	1, 4,99 €
	P-65224	150	22,23	60	10 200	1, 4,99 €
	P-65230	150	22,23	80	10 200	1, 4,99 €
	P-65246	150	22,23	120	10 200	1, 4,99 €
	P-65252	180	22,23	40	8 600	1, 6,99 €
	P-65268	180	22,23	60	8 600	1, 6,99 €
	P-65274	180	22,23	80	8 600	1, 7,99 €
	P-65280	180	22,23	120	8 600	1, 6,99 €

Brúsne zrna z korundu je vhodné najmä na brúsenie mäkkej ocele. Lamelové brúsne kotúče sú optimálne ako na hrubý výbrus, tak aj na finálny výbrus a leštenie. Brúsne listy kotúča majú vejárovité usporiadanie, navzájom sa prekrývajú a sú upevnené na vysokokvalitnom kotúči s vláknami zo sklolaminátu. Najdôležitejšie prednosti lamelových brúsnych kotúčov: vysoký a konštantný úberový výkon, studený výbrus; vysoká kvalita výbrusu; dlhá životnosť; nízka hlučnosť. Oblasti využitia: odhrdzovanie; výbrus odliatok; znášanie hrán; výbrus plôch; odstraňovanie farieb/tmelov; finálny výbrus. Vhodný materiál: hliník; mäkké neželezné kovy a ich zliatiny; rôzne stavebné ocele; plasty; drevo; liatina.

Obj. č.	ø (mm)	ø otvoru (mm)	zrmitosť	max. otáčky	ks/bal	MOC s DPH
Lamelový brúsny kotúč na ušľachtilú ocel „Zirkón“ *****						
	P-65458	115	22,23	40	13 300	1, 2,59 €
	P-65464	115	22,23	60	13 300	1, 2,79 €
	P-65470	115	22,23	80	13 300	1, 2,79 €
	P-65486	115	22,23	120	13 300	1, 2,89 €
	P-65492	125	22,23	40	12 000	1, 3,49 €
	P-65501	125	22,23	60	12 000	1, 3,59 €
	P-65517	125	22,23	80	12 000	1, 3,49 €
	P-65523	125	22,23	120	12 000	1, 3,59 €
	P-65539	150	22,23	40	10 200	1, 4,99 €
	P-65545	150	22,23	60	10 200	1, 5,99 €
	P-65551	150	22,23	80	10 200	1, 4,99 €
	P-65567	150	22,23	120	10 200	1, 5,99 €
	P-65573	180	22,23	40	8 600	1, 7,09 €
	P-65589	180	22,23	60	8 600	1, 7,19 €
	P-65595	180	22,23	80	8 600	1, 12,69 €
	P-65604	180	22,23	120	8 600	1, 7,39 €

Brúsne zrna zo zirkónového korundu je vhodné najmä na agresívny výbrus a vysoké namáhanie a je preto optimálne ako na hrubý úber, tak aj na finálny výbrus a leštenie tvrdej ocele. Brúsne listy kotúča majú vejárovité usporiadanie, navzájom sa prekrývajú a sú upevnené na vysokokvalitnom kotúči s vláknami zo sklolaminátu. Najdôležitejšie prednosti lamelových brúsnych kotúčov: mimoriadne vysoký a konštantný úberový výkon; vysoká kvalita povrchu; dlhá životnosť; nízka hlučnosť. Oblasti využitia: odstraňovanie okovín; výbrus odliatok; znášanie hrán; výbrus plôch; odstraňovanie hrdze/tmelov; finálny výbrus. Vhodný materiál: ušľachtilá ocel; neželezné kovy a ich zliatiny; rôzne stavebné ocele; hliník; drevo; liatina.

Obj. č.	ø (mm)	ø otvoru (mm)	zrmitosť	max. otáčky	ks/bal	MOC s DPH
Lamelové brúsne kotúče na kameň *****						
	P-65296	115	22,23	40	13 300	1, 2,69 €
	P-65305	115	22,23	60	13 300	1, 2,59 €
	P-65311	115	22,23	80	13 300	1, 2,59 €
	P-65327	115	22,23	120	13 300	1, 2,59 €
	P-65333	125	22,23	40	12 000	1, 3,39 €
	P-65349	125	22,23	60	12 000	1, 3,39 €
	P-65355	125	22,23	80	12 000	1, 3,39 €
	P-65361	125	22,23	120	12 000	1, 3,39 €
	P-65377	150	22,23	40	10 200	1, 4,99 €
	P-65383	150	22,23	60	10 200	1, 4,99 €
	P-65399	150	22,23	80	10 200	1, 4,99 €
	P-65408	150	22,23	120	10 200	1, 5,99 €
	P-65414	180	22,23	40	8 600	1, 6,99 €
	P-65420	180	22,23	60	8 600	1, 8,14 €
	P-65436	180	22,23	80	8 600	1, 8,14 €
	P-65442	180	22,23	120	8 600	1, 8,14 €

Brúsne zrna z karbidu kremíka má tvrdú štruktúru s ostrými hranami a je vhodné najmä na brúsenie tvrdých a húževnatých materiálov s nízkou pevnosťou v ťahu. Brúsne listy kotúča majú vejárovité usporiadanie, navzájom sa prekrývajú a sú upevnené na vysokokvalitnom kotúči s vláknami zo sklolaminátu. Najdôležitejšie prednosti lamelových brúsnych kotúčov: vysoký a konštantný úberový výkon, studený výbrus; vysoká kvalita povrchu; dlhá životnosť; nízka hlučnosť. Oblasti využitia: znášanie hrán; výbrus plôch; brúsenie hrán; finálny výbrus. Vhodný materiál: kameň; sklo; keramika; plasty.

BRÚSENIE: LAMELOVÉ KOTUČE

Obj. č.	ø (mm)	ø otvoru (mm)	zrmitosť	max. otáčky	ks/bal	MOC s DPH
---------	--------	---------------	----------	-------------	--------	-----------

Lamelové brúsne kotúče na kov



Lamely brúsneho kotúča sú vyrobené z Aluminium oxidu určené na brúsenie kovov, neželezných kovov, PVC a dreva
Podložka zo sklenených vlákien, tvar kotúča zaoblený.

D-63432-10	115	22,23	40	13 300	10	10,99 €
D-63448-10	115	22,23	60	13 300	10	10,99 €
D-63454-10	115	22,23	80	13 300	10	10,99 €
D-63460-10	115	22,23	120	13 300	10	10,99 €
D-63476-10	125	22,23	40	12 000	10	13,79 €
D-63482-10	125	22,23	60	12 000	10	13,99 €
D-63498-10	125	22,23	80	12 000	10	13,79 €
D-63507-10	125	22,23	120	12 000	10	13,79 €



Lamelové brúsne kotúče na kov



Lamely brúsneho kotúča sú vyrobené zo Zirkon aluminium určené na brúsenie kovov, neželezných kovov a nereze
Podložka zo sklenených vlákien, tvar kotúča zaoblený.

D-63747-10	115	22,23	40	13 300	10	15,49 €
D-63753-10	115	22,23	60	13 300	10	15,49 €
D-63769-10	115	22,23	80	13 300	10	14,89 €
D-63775-10	115	22,23	120	13 300	10	14,89 €
D-63781-10	125	22,23	40	12 000	10	19,19 €
D-63797-10	125	22,23	60	12 000	10	18,39 €
D-63806-10	125	22,23	80	12 000	10	18,09 €
D-63812-10	125	22,23	120	12 000	10	17,89 €



Lamelové brúsne kotúče na nerez



Lamely brúsneho kotúča sú vyrobené zo Zirkon aluminium určené na brúsenie kovov, neželezných kovov a nereze
Podložka zo sklenených vlákien, tvar kotúča zaoblený.

B-53920	125	22,23	40	12200	1	7,32 €
B-53936	125	22,23	60	12200	1	7,32 €
B-53942	125	22,23	80	12200	1	7,32 €
D-74186	115	22,23	40	13.300	1	1,79 €
D-74192	115	22,23	60	13.300	1	1,79 €
D-74201	115	22,23	80	13.300	1	1,79 €
D-74217	115	22,23	120	13.300	1	1,79 €
D-74223	125	22,23	40	13.300	1	2,09 €
D-74239	125	22,23	60	13.300	1	2,09 €
D-74245	125	22,23	80	13.300	1	2,09 €
D-74251	125	22,23	120	13.300	1	2,09 €



Brúsný kotúč na odstraňovanie farby



Špeciálne brúsne kotúče určené na odstraňovanie farby a hrdze, vďaka zapleteným vláknam, vyrobených z karbidu hliníka, ktoré umožňujú rýchle brúsenie s menším odporom a slúžia ako poduška, ktorá zabraňuje nadmernému brúseniu a poškrabaniu obrobku. Výborne sa prispôbujú aj nerovnému opracovanému povrchu.
Vhodný materiál: nerez, železo, neželezné kovy.

obj. č.	ø (mm)	ø otvoru (mm)	popis/farba kotúča	max. otáčky	bal/ks	MOC s DPH
B-28977	115	22,23	štandard / čierna	12 000	1	10,44 €
B-28983	125	22,23	štandard / čierna	12 000	1	11,68 €
B-29016	115	22,23	Longlife / fialová	12 000	1	11,68 €
B-29022	125	22,23	Longlife / fialová	12 000	1	13,40 €

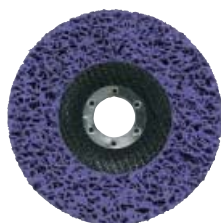

DELENIE: BRÚSNE KOTÚČE

Obj. č.	ø (mm)	ø otvoru (mm)	zrnitosť	ks/bal	MOC s DPH
---------	--------	---------------	----------	--------	-----------

Fíbrový brúsny list „Korund“



Brúsny list so zrnom z korundu, upevneným na fíbrovej podložke pomocou pojiva zo syntetickej živice. Podložka je vyrobená z mimoriadne pevnej tkaniny zo sklenených vlákien. Používa sa s elastickým brúsnym tanierom. Oblasti využitia: odhrdzovanie a čistenie kovových povrchov; výbrus starých lakov a podkladových vrstiev; zarovnávanie zvarov a zahladzovanie, výbrus hrán; odstraňovanie okovín a výbrus nádrží a prístrojov

P-00860	115	13	24	5	4,69 €
P-00876	115	13	36	5	4,59 €
P-00882	115	13	40	5	4,49 €
P-00898	115	13	50	5	4,49 €
P-00907	115	13	60	5	4,39 €
P-00913	115	13	80	5	4,49 €
P-00929	115	13	100	5	4,59 €
P-00957	125	13	24	5	5,09 €
P-00963	125	13	36	5	5,39 €
P-00979	125	13	40	5	5,19 €
P-00985	125	13	60	5	5,79 €
P-00991	125	13	80	5	5,19 €
P-01002	125	13	100	5	5,29 €
P-01018	125	13	120	5	5,29 €
P-01024	180	13	16	5	7,99 €
P-01030	180	13	24	5	6,69 €
P-01046	180	13	36	5	6,69 €
P-01052	180	13	40	5	6,79 €
P-01068	180	13	50	5	6,89 €
P-01074	180	13	60	5	7,29 €
P-01080	180	13	80	5	6,69 €
P-01096	180	13	100	5	6,89 €
P-01105	180	13	120	5	6,69 €

Brúsny papier 180 mm, neperforovaný k brúsnemu kotúču 743053-3

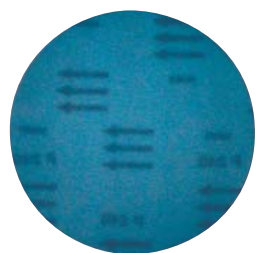

Vhodné pre farebné kovy, plasty, drevo, drevo s klincami, kov, kameň.

obj. č.	ø (mm)	popis	zrnitosť	bal/ks	MOC s DPH
P-33445	180	suchý zip	80	10	8,39 €
P-33451	180	suchý zip	120	10	7,69 €
P-38059	180	suchý zip	240	10	7,59 €
P-38065	180	suchý zip	320	10	6,89 €
P-38087	180	suchý zip	400	10	7,29 €
P-38093	180	suchý zip	500	10	6,89 €

Brúsny papier 180 mm, neperforovaný k brúsnemu kotúču 743053-3



Vhodné pre farebné kovy, plasty, drevo, drevo s klincami, kov, kameň.

obj. č.	ø (mm)	bal/ks	MOC s DPH
P-05882	115	1	4,79 €
P-05898	125	1	5,19 €
P-05907	150	1	8,39 €
P-05913	180	1	9,09 €

PRÍSLUŠENSTVO

Multi Tool



Karbid z volfrámu, #30



Karbid z volfrámu, #30



Diamantové zrno, #40



Zúbkovaná hrana



Ostrá hrana



Ostrá hrana



Delta doska



Brúsna doska

Príslušenstvo

Multi Tool

STARLOCK

Vhodné pre aplikácie
✓ = vhodné



Farebné rozlíšenie pre aplikácie



drevo a kov



drevo



kov



Multi Material



škárovacia hmota

šírka (mm)	počet zubov na palec	materiál	zakrivené zuby
------------	----------------------	----------	----------------

	šírka (mm)	počet zubov na palec	materiál	zakrivené zuby
TMA045	85	18	BiM	
TMA046	100	15	BiM	
TMA047	32	20	BiM	●
TMA048	65	20	BiM	●
TMA057	10	20	BiM	
TMA058	20	20	BiM	
TMA049	85	18	HCS	
TMA050	24	18	HCS	
TMA051	32	18	HCS	●
TMA052	65	20	HCS	●
TMA053	32	14	BiM	●
TMA054	32	14	HCS	●
TMA055	65	14	BiM	●
TMA056	65	14	HCS	●
TMA059	32	20	BiM	
TMA060	20	23	TC	
TMA061	32	23	TC	
TMA079	45	23	TC	
TMA063	100	-	BiM	
TMA064	85	18	BiM	
TMA065	52	-	HCS	
TMA066	52	-	HCS	
TMA067	28	-	HCS	
TMA068	11	-	HCS	
TMA080	32	20	TC	●
TMA081	53	14	BiM	●
TMA082	12	-	Stainless	
TMA069	85	-	TC #30	
TMA070	85	-	Diamond	
TMA071	70	-	TC #50	
TMA072	85	-	TC #40	
TMA073	78	-	TC #20	
TMA074	70	-	TC #40	
TMA075	32	-	TC #50	
TMA076	32	-	TC #40	
TMA077	32	-	TC #100	
TMA083	90	-	TC #20	
TMA084	90	-	TC #40	
TMA085	90	-	TC #60	
TMA086	90	-	TC #100	

drevo a kov									
drevo					kov				
drevo	preglejka	drevotrieska	laminát	sadrokartón	neželezné kovy	plechy	nerez	mäkky klinec	
✓	✓	✓	✓	✓	✓	✓		✓	
✓	✓	✓	✓	✓	✓			✓	
✓	✓	✓	✓	✓	✓	✓		✓	
✓	✓	✓	✓	✓	✓	✓		✓	
✓	✓	✓	✓	✓	✓	✓		✓	
✓	✓	✓	✓						
✓	✓	✓	✓						
✓	✓	✓	✓	✓					
✓	✓	✓	✓	✓					
✓	✓	✓	✓	✓	✓	✓		✓	
✓	✓	✓	✓	✓	✓	✓	✓	✓	
✓	✓	✓	✓	✓	✓	✓	✓	✓	
✓	✓	✓	✓	✓	✓	✓	✓	✓	
✓	✓	✓	✓	✓	✓	✓		✓	
✓	✓	✓	✓	✓	✓	✓	✓	✓	
✓		✓		✓					
				✓					
				✓					
				✓					
✓									
✓	✓			✓					
✓	✓								
✓	✓	✓							
✓	✓	✓							
✓									
✓									
✓									
✓									



Multi Material						škárovacia hmota			
epoxydy	sklolaminát	linoleum	lepidlo na koberce	izolačný materiál	mäkký spojovací materiál	porézny betón, mäkká tehla	mäkké obklady stien	malta, lepidlo na dlaždice	
✓	✓								
✓	✓								
✓	✓								
✓	✓								
✓	✓								
✓	✓								
✓									
✓									
✓	✓								
✓	✓								
✓	✓								
✓	✓								
✓	✓								
✓	✓								
		✓	✓	✓					
✓	✓								
			✓						
			✓						
					✓				
		✓	✓	✓					
✓	✓								
✓	✓				✓				
✓	✓					✓	✓	✓	
✓	✓					✓	✓	✓	
✓	✓					✓	✓	✓	
✓	✓					✓	✓	✓	
✓	✓					✓	✓	✓	
✓	✓					✓	✓	✓	
✓	✓					✓	✓	✓	
✓	✓					✓	✓	✓	
	✓							✓	
	✓							✓	
								✓	
								✓	

zakřivené zuby	materiál	počet zubov na palec	šírka (mm)
----------------	----------	----------------------	------------

	BiM	18	85	TMA045
	BiM	15	100	TMA046
●	BiM	20	32	TMA047
●	BiM	20	65	TMA048
	BiM	20	10	TMA057
	BiM	20	20	TMA058
	HCS	18	85	TMA049
	HCS	18	24	TMA050
●	HCS	18	32	TMA051
●	HCS	20	65	TMA052
●	BiM	14	32	TMA053
●	HCS	14	32	TMA054
●	BiM	14	65	TMA055
●	HCS	14	65	TMA056
	BiM	20	32	TMA059
	TC	23	20	TMA060
	TC	23	32	TMA061
	TC	23	45	TMA079
	BiM	-	100	TMA063
	BiM	18	85	TMA064
	HCS	-	52	TMA065
	HCS	-	52	TMA066
	HCS	-	28	TMA067
	HCS	-	11	TMA068
●	TC	20	32	TMA080
●	BiM	14	53	TMA081
	Stainless	-	12	TMA082
	TC #30	-	85	TMA069
	Diamond	-	85	TMA070
	TC #50	-	70	TMA071
	TC #40	-	85	TMA072
	TC #20	-	78	TMA073
	TC #40	-	70	TMA074
	TC #50	-	32	TMA075
	TC #40	-	32	TMA076
	TC #100	-	32	TMA077
	TC #20	-	90	TMA083
	TC #40	-	90	TMA084
	TC #60	-	90	TMA085
	TC #100	-	90	TMA086

Farebné rozlíšenie pre aplikácie



drevo a kov



drevo



kov



Multi Material



škárovacia hmota

Príslušenstvo

Multi Tool

STARLOCK PLUS STARLOCK MAX



Vhodné pre aplikácie
✓ = vhodné

Farebné rozlíšenie pre aplikácie

šírka (mm)	počet zubov na palec	materiál	zakrivené zuby
------------	----------------------	----------	----------------

drevo a kov									
drevo					kov				
drevo	preglejka	drevotrieska	laminát	sadrokartón	neželezné kovy	plechy	nerez	mäkký klinec	

STARLOCK PLUS



drevo a kov

MAP001	32	20	BiM	●
MAP002	65	20	BiM	●

✓	✓	✓	✓	✓	✓	✓			✓
✓	✓	✓	✓	✓	✓	✓			✓



drevo

MAP003	32	18	HCS	●
--------	----	----	-----	---

✓	✓	✓	✓						
---	---	---	---	--	--	--	--	--	--



kov

MAP004	32	23	TC	
MAP005	45	23	TC	

✓	✓	✓	✓	✓	✓	✓	✓	✓	✓
✓	✓	✓	✓	✓	✓	✓	✓	✓	✓



Multi Material

MAP006	32	20	TC	●
MAP007	52	20	TC	●

✓	✓	✓	✓	✓	✓	✓	✓	✓	✓
✓	✓	✓	✓	✓	✓	✓	✓	✓	✓



škárovacia hmota

MAP008	53	-	TC #40	
--------	----	---	--------	--

✓		✓		✓	✓				✓
---	--	---	--	---	---	--	--	--	---

STARLOCK MAX



drevo a kov

MAM001	32	20	BiM	●
MAM002	52	18	BiM	●
MAM003	100	15	BiM	

✓	✓	✓	✓	✓	✓	✓			✓
✓	✓	✓	✓	✓	✓	✓			✓
✓	✓	✓	✓		✓				✓



drevo

MAM004	32	18	HCS	●
--------	----	----	-----	---

✓	✓	✓	✓						
---	---	---	---	--	--	--	--	--	--



kov

MAM005	32	23	TC	
--------	----	----	----	--

✓	✓	✓	✓	✓	✓	✓	✓	✓	✓
---	---	---	---	---	---	---	---	---	---



Multi Material

MAM006	32	20	TC	●
MAM007	32	-	HCS	
MAM008	32	-	HCS	

✓	✓	✓	✓	✓	✓	✓	✓	✓	✓

MAM009	68	-	TC #50	
MAM010	68	-	TC #30	
MAM011	68	-	Diamond	
MAM012	68	-	Diamond	
MAM013	68	-	TC #40	
MAM014	100	-	TC #40	
MAM015	116	-	TC #20	
MAM016	116	-	TC #40	
MAM017	116	-	TC #60	
MAM018	116	-	TC #100	

				✓					
				✓					
				✓					
				✓					
				✓					
✓	✓			✓	✓				✓
✓	✓	✓							
✓	✓	✓							
✓	✓	✓							



škárovacia hmota

MAM013	68	-	TC #40	
MAM014	100	-	TC #40	
MAM015	116	-	TC #20	
MAM016	116	-	TC #40	
MAM017	116	-	TC #60	
MAM018	116	-	TC #100	

				✓					
				✓					
				✓					
				✓					
✓	✓			✓	✓				✓



Multi Material						škárovacia hmota		
epoxydy	sklolaminát	linoleum	lepidlo na koberce	izolačný materiál	mäkký spojovací materiál	porézny betón, mäkká tehla	mäkké obklady stien	malta, lepidlo na dlaždice

zakřivené zuby	materiál	počet zubov na palec	šírka (mm)	
----------------	----------	----------------------	------------	--

Farebné rozlíšenie pre aplikácie

✓	✓							
✓	✓							

●	BiM	20	32	MAP001
●	BiM	20	65	MAP002



✓								
---	--	--	--	--	--	--	--	--

●	HCS	18	32	MAP003
---	-----	----	----	--------



✓	✓					✓		
✓	✓							

	TC	23	32	MAP004
	TC	23	45	MAP005



✓	✓					✓		
✓	✓					✓		

●	TC	20	32	MAP006
●	TC	20	52	MAP007



✓						✓		
---	--	--	--	--	--	---	--	--

	TC #40	-	53	MAP008
--	--------	---	----	--------



✓	✓							
✓	✓							
✓								

●	BiM	20	32	MAM001
●	BiM	18	52	MAM002
	BiM	15	100	MAM003



--	--	--	--	--	--	--	--	--

●	HCS	18	32	MAM004
---	-----	----	----	--------



✓	✓					✓		
---	---	--	--	--	--	---	--	--

	TC	23	32	MAM005
--	----	----	----	--------



✓	✓					✓		
						✓		
				✓	✓			
				✓	✓			

●	TC	20	32	MAM006
	HCS	-	32	MAM007
	HCS	-	32	MAM008



✓	✓					✓	✓	✓
✓	✓					✓	✓	✓
✓	✓					✓	✓	✓
✓	✓					✓	✓	✓
✓	✓					✓	✓	✓
	✓							✓
	✓							✓
								✓
								✓

	TC #50	-	68	MAM009
	TC #30	-	68	MAM010
	Diamond	-	68	MAM011
	Diamond	-	68	MAM012
	TC #40	-	68	MAM013
	TC #40	-	100	MAM014
	TC #20	-	116	MAM015
	TC #40	-	116	MAM016
	TC #60	-	116	MAM017
	TC #100	-	116	MAM018



DELENIE: PRÍSLUŠENSTVO PRE MULTITOOL



Compatibility with models		Blade Shank		
		STARLOCK	STARLOCK PLUS	STARLOCK MAX
Tool Shank	OIS Compatible Tools	✓	-	-
	STARLOCK MAX	✓	✓	✓

Obj. č.	ø (mm)	materiál	TPI/ zmitosť	použitie	označenie	MOC s DPH
---------	--------	----------	-----------------	----------	-----------	-----------

Pílvy kotúč



B-64836	85	HCS	18	drevo	TMA049	13,39 €
B-64808	100	BiM	15	drevo / kov	TMA046	22,29 €
B-64799	85	BiM	18	drevo / kov	TMA045	17,59 €
B-64973	85	BiM-TiN	18	multi	TMA064	22,19 €

Segmentový pílový kotúč s tvrdokovom



B-65028	85	HM/RIFF	30	rezanie špár	TMA069	25,29 €
B-65034	85	DIA	40	rezanie špár, kachličiek a FRP	TMA070	41,39 €
B-65040	65	HM/TC	50	rezanie tenkých špár (1,6 mm)	TMA071	20,99 €
B-65084	32 × 30	HM/TC	50	fibrové sklo, malta	TMA075	21,09 €

Nástroje na odstraňovanie vrstiev materiálu



B-64989	52 × 26	HCS		odstraňovanie malty, lepidla	TMA065	7,69 €
B-64995	52 × 45	HCS		odstraňovanie lepidiel a silikónu	TMA066	7,69 €
B-65006	28 × 40	HCS		tmel silikón	TMA067	14,49 €
B-69783	12 × 29	HCS		tmel silikón	TMA082	17,09 €

Rezné nástroje



B-65012	11 × 24	HCS		koberce, lino	TMA068	16,99 €
B-64967	100	BiM		polystyrén, guma, izol. materiál	TMA063	22,99 €
B-64939	32 × 50	BiM	20	kov	TMA059	10,99 €
B-64923	20 × 30	BiM	20	kov	TMA058	7,69 €
B-64917	10 × 30	BiM	20	kov	TMA057	7,59 €
B-64864	65 × 40	HCS	20	drevo	TMA052	11,19 €
B-64870	32 × 50	BiM	14	drevo	TMA053	12,39 €
B-64858	32 × 50	HCS	18	drevo	TMA51	9,29 €
B-64842	24 × 50	HCS	18	drevo	TMA050	8,49 €
B-64820	65 × 40	BiM	20	kov, drevo	TMA048	14,79 €
B-64814	32 × 50	BiM	20	kov, drevo	TMA047	11,89 €
B-69755	45	TC/HM	23	kov	TMA079	20,59 €
B-69761	32	TC/HM	20	multi	TMA080	20,59 €
B-69777	53	BiM	14	sadrokartón	TMA081	12,79 €

DELENIE: PRÍSLUŠENSTVO PRE MULTITOOL

Obj. č.	ø (mm)	materiál	TPI/ zrnitosť	použitie	označenie	MOC s DPH
Odsávací adaptér pre multitool *****						
	199618-3			TM3000C		6,89 €
	199627-2			DTM41,DTM51		9,89 €
	191R02-6			DTM52		52,19 €

Brúsny tanier *****							
	B-65062	78	TC/HM	20	malta, lepidlo na obklady	TMA073	19,99 €
	B-69799	90	TC/HM	20	malta, lepidlo na obklady	TMA083	17,59 €
	B-69808	990	TC/HM	40	malta, lepidlo na obklady	TMA84	17,59 €
	B-69814	90	TC/HM	60	malta, lepidlo na obklady	TMA085	17,59 €
	B-69820	90	TC/HM	100	malta, lepidlo na obklady	TMA086	17,59 €

Rezný a brúsny tanier *****							
	B-65078	70	TC/HM	44	malta, lepidlo na obklady	TMA074	35,39 €

Adaptér *****							
	196271-6			adaptér pre príslušenstvo Fein			5,09 €

Sady nástrojov **B-67496** **58,19 €** (MOC s DPH)

B-64923 / B-64989 / B-65028 / B-65115
4 ks/bal



Sady nástrojov **B-67480** **48,49 €** (MOC s DPH)

B-64799 / B-64814 / B-64870 / B-64923
4 ks/bal



Sady nástrojov **B-67505** **46,79 €** (MOC s DPH)

B-64799 / B-64820 / B-64858 / B-64955
4 ks/bal



Sady nástrojov **B-67511** **48,69 €** (MOC s DPH)

B-64799 / B-64814 / B-64870 / B-65115 x 2
5 ks/bal



Sada rezných nástrojov **B-64842-5** **39,79 €** (MOC s DPH)

TMA050 24 x 50 mm, 5 ks/bal.
vhodný na rezanie dreva







Sada rezných nástrojov **B-64870-5** **57,09 €** (MOC s DPH)

TMA053 35 x 50 mm, 5 ks/bal.
vhodný na rezanie dreva

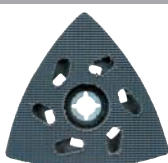

DELENIE: PRÍSLUŠENSTVO PRE MULTITOOL

	Obj. č.	rozmer (mm)	zrmitosť	ks/bal.	MOC s DPH
Drevo / Long Life *****					
 <p>Vhodné na brúsenie dreva, tvrdého dreva, drevotriesky, stavebného dreva alebo kovu</p>	P-33261	93	60	10	2,95 €
	P-33277	93	80	10	2,90 €
	P-33283	93	100	10	2,85 €
	P-33299	93	120	10	2,85 €
	P-33314	93	180	10	2,85 €
	P-33320	93	240	10	2,85 €
	B-21559	93	60, 80, 100, 120, 180 (2 ks z každého)	10	2,96 €
Farba *****					
 <p>Vhodné na brúsenie farieb a lakov</p>	P-42690	93	60	10	2,89 €
	P-42709	93	80	10	2,86 €
	P-42715	93	100	10	2,81 €
	P-42721	93	120	10	2,81 €
	P-42759	93	240	10	2,81 €
	P-42765	93	320	10	2,75 €
	B-21674	93	60,80,100,240,320 (2 ks z každého)	10	2,85 €
Kameň *****					
 <p>Vhodné na hrubé obrúsenie extrémne tvrdých materiálov napríklad kameňa alebo skla</p>	B-21749	93	120	10	2,89 €
	B-21755	93	240	10	2,85 €
	B-21761	93	400	10	2,82 €
	B-21777	93	600	10	2,78 €
	B-21783	93	1200	10	2,78 €
	B-21733	93	120, 240, 400, 600, 1200 (2 ks z každého)	10	2,85 €
	Fleece *****				
 <p>Vhodné na obrusovanie hrdzavých plôch alebo nečistôt z dreva</p>	B-21799	93	100	1	1,63 €
	B-21808	93	280	1	1,63 €
	B-21814	93	bez brusiva	1	1,67 €
Leštenie *****					
 <p>Vhodné na leštenie veľmi nečistých alebo poškrábaných povrchov.</p>	B-21820	93	tvrdý	1	1,74 €
Držiak brúsneho papiera *****					
	B-65115	suchý zip	TMA078	1	10,59 €

Rezanie (ponorné rezanie)



Pílenie



Brúsenie

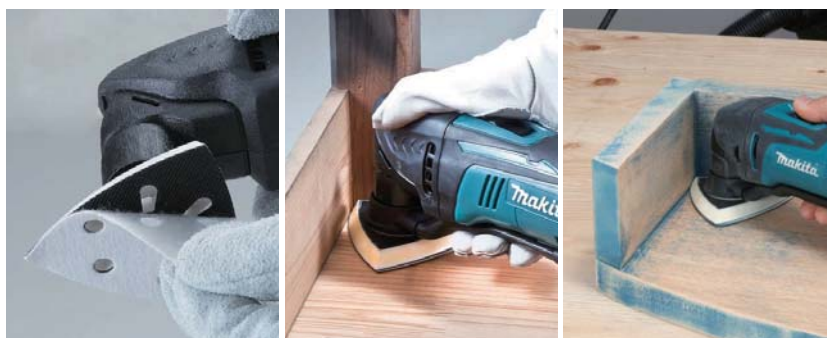

Odstraňovanie škárovacej hmoty a rezanie dlaždíc

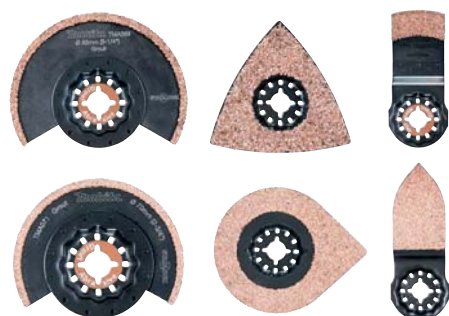

Škrabanie



STARLOCK PLUS

Kompatibilné s modelmi		typ upnutia		
		STARLOCK	STARLOCK PLUS	STARLOCK MAX
typ upnutia	OIS kompatibilné stroje	✓	-	-
		✓	✓	✓

Vhodné najmä na drevo a kov

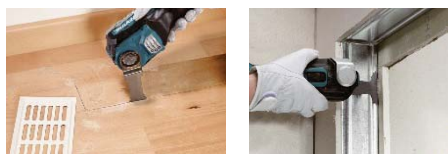

Ponorný pilový list v tvare oblúka 32

MAP001

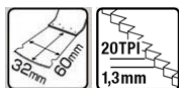

Použitie: Vhodné pre presný ponorný rez, hlboký rez
Vhodné aj pre: epoxid, sklolaminát

rozmer (mm)	typ	ks/bal.	obj. č.	MOC s DPH
32 x 60	BiM, drevo a kov	1	B-66329	12,19 €

Ponorný pilový list v tvare oblúka 65

MAP002

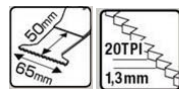

Použitie: Vhodné pre presný ponorný rez, hlboký rez
Ďalší materiál: epoxid, sklolaminát

rozmer (mm)	typ	ks/bal.	obj. č.	MOC s DPH
65 x 50	BiM, drevo a kov	1	B-66335	15,29 €

Vhodné najmä na drevo



Ponorný pilový list v tvare oblúka 32

MAP003

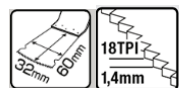

Použitie: Vhodné pre presný ponorný rez, hlboký rez
Vhodné aj pre: epoxid

rozmer (mm)	typ	ks/bal.	obj. č.	MOC s DPH
32 x 60	HCS, drevo	1	B-66341	9,49 €

Vhodné najmä na kovy



TC ponorný pilový list 32

MAP004



Použitie: Vhodné pre ponorný rez, hlboký rez
Vhodné aj pre: drevené materiály, epoxid, sklolaminát

rozmer (mm)	typ	ks/bal.	obj. č.	MOC s DPH
32 x 50	TC/HM, Metal	1	B-66357	21,19 €

TC ponorný pilový list 45

MAP005

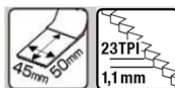

Použitie: Vhodné pre ponorný rez, hlboký rez
Vhodné aj pre: drevené materiály, epoxid, sklolaminát

rozmer (mm)	typ	ks/bal.	obj. č.	MOC s DPH
45 x 50	TC/HM, Metal	1	B-66363	22,59 €

Vhodné najmä pre MultiMaterial



TC ponorný pilový list v tvare oblúka 32

MAP006

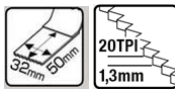

Použitie: Vhodné pre ponorný rez, hlboký rez
Vhodné aj pre: drevené materiály, sádrokartón, nežeľezné kovy, plech, nerez, mäkký klinec

rozmer (mm)	typ	ks/bal.	obj. č.	MOC s DPH
32 x 50	TC/HM, Multi Material	1	B-66379	22,59 €

TC ponorný pilový list v tvare oblúka 52

MAP007



Použitie: Vhodné pre ponorný rez, hlboký rez
Vhodné aj pre: drevené materiály, sádrokartón, nežeľezné kovy, plech, nerez, mäkký klinec

rozmer (mm)	typ	ks/bal.	obj. č.	MOC s DPH
52 x 50	TC/HM, Multi Material	1	B-66385	23,59 €

Vhodné najmä pre škárovacie hmoty



Ponorný pílový list v tvare oblúka 53

MAM008



Použitie: Vhodné pre presný a rýchly ponorný rez
Vhodné aj pre: drevené materiály, sádkokartón, neželezné kovy, mäkký kliniec, epoxid, 1 nôž 2 práce (zápich a rezanie)

rozmer (mm)	typ	ks/bal.	obj. č.	MOC s DPH
53 x 40	TC/HM zrnitc	1	B-66391	16,99 €

STARLOCK MAX

Kompatibilné s modelmi	typ upnutia		
	STARLOCK	STARLOCK PLUS	STARLOCK MAX
typ upnutia			
OIS kompatibilné stroje	✓	-	-
STARLOCK MAX	✓	✓	✓

Vhodné najmä na drevo a kov



Ponorný pílový list v tvare oblúka 32

MAM001

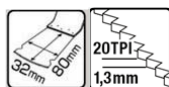

Použitie: Vhodné pre presný ponorný rez, hlboký rez
Vhodné aj pre: epoxid, sklolaminát

rozmer (mm)	typ	ks/bal.	obj. č.	MOC s DPH
32 x 80	BiM, drevo a	1	B-66400	12,79 €

Ponorný pílový list v tvare oblúka 52

MAM002

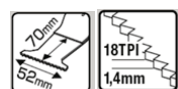

Použitie: Vhodné pre presný ponorný rez, hlboký rez
Vhodné aj pre: epoxid, sklolaminát

rozmer (mm)	typ	ks/bal.	obj. č.	MOC s DPH
52 x 70	BiM, drevo a	1	B-66416	13,79 €

Segmentový pílový kotúč 100

MAM003



Použitie: Vhodné pre rovné dlhé rezy, hlboké a široké rezy
Vhodné aj pre: epoxid, sklolaminát

rozmer (mm)	typ	ks/bal.	obj. č.	MOC s DPH
100	BiM, drevo a	1	B-66422	22,19 €

Vhodné najmä na drevo



Ponorný pílový list v tvare oblúka 32

MAM004



Použitie: Vhodné pre presné zapichovacie rezy, hlboké a rýchle rezy
Vhodné len pre drevo

rozmer (mm)	typ	ks/bal.	obj. č.	MOC s DPH
32 x 80	HCS, dre	1	B-66438	9,89 €

Vhodné najmä na kovy



TC ponorný pílový list 32

MAM005



Použitie: Vhodné pre ponorné, hlboké a rýchle rezy
Vhodné aj pre: epoxid, sklolaminát, drevené materiály, pórobetón

rozmer (mm)	typ	ks/bal.	obj. č.	MOC s DPH
32 x 70	TC/HM, ko	1	B-66444	22,09 €

Vhodné najmä pre MultiMaterial



TC ponorný pílový list v tvare oblúka 32

MAM006

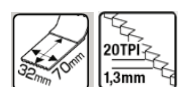

Použitie: Vhodné pre presné ponorné, hlboké a rýchle rezy
Vhodné aj pre: epoxid, sklolaminát, drevené materiály, pórobetón

rozmer (mm)	typ	ks/bal.	obj. č.	MOC s DPH
32 x 70	TC/HM, Multi I	1	B-66450	23,59 €

Ponorný pílový list

MAM007



Použitie: na rezanie mäkkých spojov, tmelov na okná, izolačné materiály, kobercov, gummy, lepenky

rozmer (mm)	typ	ks/bal.	obj. č.	MOC s DPH
32 x 70	HCS, Multi M	1	B-66466	12,89 €

Ponorný pílový list

MAM008



Použitie: na rezanie mäkkých spojov, tmelov na okná, izolačné materiály, kobercov, gummy, lepenky

rozmer (mm)	typ	ks/bal.	obj. č.	MOC s DPH
32 x 55	HCS, Multi M	1	B-66472	6,29 €

Vhodné najmä pre škárovacie hmoty



TC pilový kotúč 68

MAM009



Použitie: Vhodné pre frézovanie škár na obkladačkách
Vhodné aj pre: epoxid, sádkokartón, sklolaminát

priemer (mm)	typ	ks/bal.	obj. č.	MOC s DPH
68	TC/HM grit #50	1	B-66494	26,99 €

TC pilový kotúč 68

MAM010

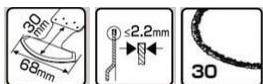

Použitie: Vhodné pre frézovanie škár na obkladačkách
Vhodné aj pre: epoxid, sádkokartón, sklolaminát

priemer (mm)	typ	ks/bal.	obj. č.	MOC s DPH
68	TC/HM grit #30	1	B-66503	26,99 €

Diamantový pilový kotúč 68

MAM011

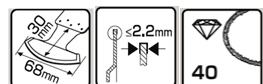

Použitie: Vhodný pre výrezy v mäkkých obkladačkách
Vhodné aj pre: epoxid, sádkokartón, sklolaminát

priemer (mm)	typ	ks/bal.	obj. č.	MOC s DPH
68	Diamond grit #40	1	B-66519	36,59 €

Diamantový pilový kotúč 68

MAM012

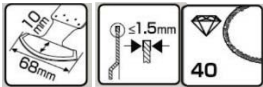

Použitie: Vhodný pre výrezy v mäkkých obkladačkách
Vhodné aj pre: epoxid, sádkokartón, sklolaminát

priemer (mm)	typ	ks/bal.	obj. č.	MOC s DPH
68	Diamond grit #40	1	B-66525	36,59 €

TC segmentový pilový kotúč 68

MAM013

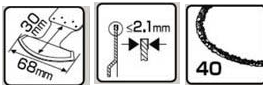

Použitie: Vhodné pre frézovanie škár na obkladačkách
Vhodné aj pre: epoxid, sádkokartón, sklolaminát

priemer (mm)	typ	ks/bal.	obj. č.	MOC s DPH
68	TC/HM grit #40	1	B-66531	21,59 €

TC segmentový pilový kotúč 100

MAM014

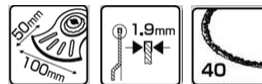

Použitie: Vhodné pre frézovanie škár na obkladačkách
Vhodné aj pre: epoxid, sklolaminát, drevené materiály

priemer (mm)	typ	ks/bal.	obj. č.	MOC s DPH
100	TC/HM grit #40	1	B-66547	25,89 €

TC brúsna doska 116

MAM015

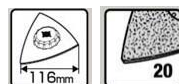

Použitie: Vhodné pre frézovanie škár na obkladačkách
Vhodné aj pre: epoxid, sklolaminát, drevené materiály

priemer (mm)	typ	ks/bal.	obj. č.	MOC s DPH
116	TC/HM grit #20	1	B-66553	19,69 €

TC brúsna doska 116

MAM016

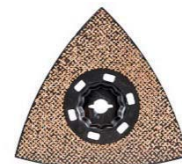
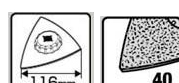

Použitie: Vhodné pre frézovanie škár na obkladačkách
Vhodné aj pre: epoxid, sklolaminát, drevené materiály

priemer (mm)	typ	ks/bal.	obj. č.	MOC s DPH
116	TC/HM grit #40	1	B-66569	19,69 €

TC brúsna doska 116

MAM017

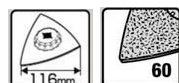

Použitie: Vhodné na brúsenie dreva
Vhodné aj pre: drevené materiály

priemer (mm)	typ	ks/bal.	obj. č.	MOC s DPH
116	TC/HM grit #60	1	B-66575	19,69 €

TC brúsna doska 116

MAM018

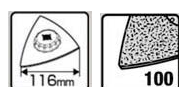

Použitie: Vhodné na brúsenie dreva
Vhodné aj pre: drevené materiály

priemer (mm)	typ	ks/bal.	obj. č.	MOC s DPH
116	TC/HM grit #100	1	B-66581	19,69 €

PRÍSLUŠENSTVO

▣ Brúsne kefy



Brúsne kefy



Typ kefy



Oceľový drôt s priemerom 0,3 mm
Ideálny na odstraňovanie hrdze a náterov.



Nylonová (#80)
Ideálna na odstraňovanie farieb z kovu, dreva a PVC.



Nylonová (#240)
Ideálna na povrchovú úpravu kovov, dreva a PVC.

Typ kefy



Miskovitá
Pre rovné plochy.



Kotúčová
Pre úzke miesta.



Štetcovitá
Pre úzke miesta.



Lopatková
Pre ošetrovanie povrchu dreva.

AA : odporúčané

Typ kefy			
	Oceľový drôt s priemerom 0,3 mm	Nylonová (#80)	Nylonová (#240)
Drevo 		AA	AA
PVC 		AA	AA
Metal 	AA	AA	AA
Opracovanie (kovový povrch)			 dobrúsené po nylonovej kefe (#80)

DELENIE: KEFY Z OCEĽOVÉHO DRÔTU

	Obj. č.	ø kefy (mm)	počet vretien	max. otáčky (min ⁻¹)	upínanie	vhodné pre uhl. brúsky (ø mm)	MOC s DPH
Miskovitá kefa z oceleového drôtu – spletaný drôt *****							
	P-04488	65	18	12500	M14	115 / 125 / 150	12,79 €
	P-04472	100	26	8500	M14	180 / 230	24,19 €
Kuželovitá kefa z oceleového drôtu – spletaný drôt *****							
	P-04494	100	18	12500	M14	180 / 230	16,69 €
Miskovitá kefa z mosadzného drôtu – vlnitý drôt, ø drôtu 0,3 mm ***							
	D-39746	60			M14	125 / 150	3,08 €
	D-39768	75			M14	125 / 150	3,55 €
	D-39780	90			M14	180 / 230	4,58 €
	D-39805	100			M14	180 / 230	6,20 €
Miskovitá kefa z oceleového drôtu – vlnitý drôt, ø drôtu 0,3 mm ***							
	D-39827	100			M14	180 / 230	4,11 €
	D-39849	115			M14	180 / 230	4,70 €
Miskovitá kefa z oceleového drôtu – spletaný drôt, ø drôtu 0,5 mm, ***							
	D-39861	100			M14	180 / 230	4,49 €
	D-39883	115			M14	180 / 230	5,08 €
Miskovitá kefa z oceleového drôtu – vlnitý drôt, ø drôtu 0,3 mm, ***							
	D-24072	60			M14	125 / 150	3,27 €
	D-24094	75			M14	125 / 150	4,05 €
	D-29284	100			M14	180 / 230	5,73 €
Miskovitá kefa z oceleového drôtu – spletaný drôt ø drôtu 0,5 mm, ***							
	D-24119	60			M14	125 / 150	5,27 €
	D-24131	75			M14	125 / 150	5,80 €
Miskovitá kefa z oceleového drôtu – spletaný drôt ø drôtu 0,5 mm, ***							
	D-24153	60			M14	125 / 150	6,11 €
	D-29290	100			M14	180 / 230	9,69 €

Oblasti využitia kief z oceleového drôtu: odstraňovanie lakov, okovín, hrdze, trosky, odstraňovanie zvyškov betónu a tmelov/stierky zahľadzovanie a začisťovanie zvarov, príprava kovových povrchov pred lakovaním. Mimoriadne prednosti: vysoká tuhosť drôtených vretien, vďaka tomu majú kefy vysoký úberový výkon, húževnatosť, veľmi vysoká pevnosť v ťahu umožňuje vysoké otáčky. Kuželovitý tvar kefy uľahčuje kefovanie na ťažko prístupných miestach (vnútorné hrany, ryhy, drážky).

DELENIE: KEFY Z OCEĽOVÉHO DRÔTU

Obj. č.	ø kefy (mm)	počet vretien	max. otáčky (min ⁻¹)	upínanie	vhodné pre uhl. brúsky (ø mm)	MOC s DPH
---------	-------------	---------------	----------------------------------	----------	-------------------------------	-----------

Miskovitá kefa z oceleového drôtu – spletaný drôt, ø drôtu 0,5 mm



D-29555	100			M14	125 – 230	5,23 €
D-29561	115			M14	125 – 230	6,20 €
D-29577	125			M14	125 – 230	7,42 €
D-45761	150			M14	180	9,00 €
D-45777	175			M14	230	11,56 €

Miskovitá kefa z oceleového drôtu, valcovitá stopka



D-40004	12 × 6					1,31 €
D-40010	19 × 6					1,59 €
D-40026	25 × 6					1,87 €
D-40032	30 × 6					2,06 €
D-73704	12		4.500	1/4"		1,49 €
D-73710	19		4.500	1/4"		1,69 €
D-73726	24		4.500	1/4"		1,89 €
D-73732	28		4.500	1/4"		2,19 €

Miskovitá kefa z oceleového drôtu, valcovitá stopka



D-39908	38 × 6					1,50 €
D-39914	50 × 6					1,74 €
D-39920	63 × 6					1,87 €
D-39936	75 × 6					2,15 €
D-39942	80 × 6					2,52 €
D-73601	38		4.500	1/4"		1,49 €
D-73617	50		4.500	1/4"		1,79 €
D-73623	63		4.500	1/4"		1,89 €
D-73639	70		4.500	1/4"		2,19 €
D-73645	80		4.500	1/4"		2,69 €

Oblasti využitia kief z oceleového drôtu: odstraňovanie lakov, okovín, hrdze, trosky, odstraňovanie zvyškov betónu a tmelov/stierky zahladzovanie a začisťovanie zvarov, príprava kovových povrchov pred lakovaním.

Mimoriadne prednosti: vysoká tuhosť drôtených vretien, vďaka tomu majú kefy vysoký úberový výkon húževnaté, veľmi vysoká pevnosť v ťahu umožňujú vysoké otáčky kuželovitý tvar kefy uľahčuje kefovanie na ťažko prístupných miestach (vnútorné hrany, ryhy, drážky)

DELENIE: KEFY Z OCEĽOVÉHO DRÔTU

Obj. č.	ø kefy (mm)	počet vretien	max. otáčky (min ⁻¹)	upínanie	vhodné pre uhl. brusky (ø mm)	MOC s DPH
---------	-------------	---------------	----------------------------------	----------	-------------------------------	-----------

Miskovitá kefa z oceľového drôtu, valcovitá stopka



D-39958	38 x 6					1,46 €
D-39964	50 x 6					1,50 €
D-39970	63 x 6					1,74 €
D-39986	75 x 6					1,87 €
D-39992	100 x 6					2,15 €
D-73651	38		4.500	1/4"		1,49 €
D-73667	50		4.500	1/4"		1,49 €
D-73673	63		4.500	1/4"		1,79 €
D-73689	75		4.500	1/4"		1,89 €
D-73695	100		4.500	1/4"		2,19 €

oceľová drôtená kefa miskovitá – splietaný drôt



D-73798	63		4.500	Ø6		4,79 €
D-73807	75		4.500	Ø6		5,29 €

oceľová drôtená kefa kotúčová – splietaný drôt



D-73813	75		4.500	Ø6		4,79 €
D-73829	100		4.500	Ø6		4,79 €

oceľová drôtená kefa štecovitá – splietaný drôt





D-73835	12		4.500	Ø6		2,39 €
D-73841	19		4.500	Ø6		2,99 €
D-73857	24		4.500	Ø6		3,49 €
D-73863	28		4.500	Ø6		4,69 €

DELENIE: OCEĽOVÉ KEFY X-LOCK

Obj. č.	ø kefy (mm)	počet vretien	max. otáčky (min ⁻¹)	upínanie	vhodné pre uhl. brúsky (ø mm)	MOC s DPH	
oceľová drôtená kefa kotúčová - vlnitý drôt							
	D-73427	115		12500	X-LOCK/22,23	125	9,09 €
	D-73449	115		12500	X-LOCK/22,23	125	6,79 €

oceľová drôtená kefa kotúčová - spleťaný drôt							
	D-73352	115	20	12500	X-LOCK/22,23	125	16,19 €
	D-73368	115	30	12500	X-LOCK/22,23	125	19,09 €
	D-73405	115	20	12500	X-LOCK/22,23	125	8,29 €
	D-73411	115	30	12500	X-LOCK/22,23	125	12,29 €

oceľová drôtená kefa miskovitá - vlnitý drôt							
	D-73346	75		12500	X-LOCK/22,23	125	10,39 €
	D-73396	75		12500	X-LOCK/22,23	125	6,89 €
	D-73433	75		12500	X-LOCK/22,23	125	6,89 €

oceľová drôtená kefa miskovitá - spleťaný drôt							
	D-73330	80	18	12500	X-LOCK/22,23	125	13,99 €
	D-73374	80	18	12500	X-LOCK/22,23	125	7,89 €
	D-73380	80	18	12500	X-LOCK/22,23	125	7,89 €



DELENIE: KEFY NYLÓNOVÉ PRE VŔTAČKY

Miskovitá



Obj. č.	Ø kefy (mm)	zrnitosť	hrúbka drôtu (mm)	MOC s DPH
D-45559	75	jemný (#240)	6	5,73 €
D-45543	63	jemný (#240)	6	5,08 €
D-45537	50	jemný (#240)	6	3,49 €
D-45521	75	hrubý (#80)	6	5,73 €
D-45515	63	hrubý (#80)	6	5,08 €
D-45509	50	hrubý (#80)	6	3,49 €

Kotúčová



D-45618	38	jemný (#240)	6	2,71 €
D-45624	50	jemný (#240)	6	3,36 €
D-45630	63	jemný (#240)	6	3,86 €
D-45646	75	jemný (#240)	6	5,08 €
D-45652	100	jemný (#240)	6	5,73 €
D-45565	38	hrubý (#80)	6	2,71 €
D-45571	50	hrubý (#80)	6	3,36 €
D-45593	75	hrubý (#80)	6	5,08 €
D-45602	100	hrubý (#80)	6	5,73 €

Štetcovitá



D-45705	12	jemný (#240)	6	2,15 €
D-45711	19	jemný (#240)	6	2,80 €
D-45727	25	jemný (#240)	6	3,18 €
D-45733	30	jemný (#240)	6	4,70 €
D-45668	12	hrubý (#80)	6	2,15 €
D-45674	19	hrubý (#80)	6	2,80 €
D-45680	25	hrubý (#80)	6	3,18 €
D-45696	30	hrubý (#80)	6	4,70 €

Lopatková





D-45755	100	jemný	6	6,20 €
D-45749	100	hrubý	6	6,20 €

DELENIE: PRÍSLUŠENSTVO PRE UHLOVÉ BRÚSKY

	Obj. č.	upínanie	popis	vhodné pre uhl. brúsky (ø mm)	MOC s DPH
Príruby, matice *****					
	192227-7	M14	superpríruba	115 – 230	12,59 €
	196297-8	M14	supermatica	115 – 230	20,99 €
	195354-9	M14	špeciálna príruha EZYNUK	180 – 230	59,79 €
	224415-9	M14	upínacia príruha	115 – 230	1,54 €
	224447-6	M14	príruba	115 – 230	3,79 €
	224554-5	M14	prírubová matica	115 – 150	1,29 €
	224543-0	M14	prírubová matica	180 – 230	2,21 €
Rukoväte *****					
	153489-2	M8	štandard		1,29 €
	151776-3	M14	štandard		11,19 €
	152539-0	M14	štandard		2,49 €
	194514-0	M8	antivibračná		15,49 €
	158237-4	M8	štandard	DDA450, DGA504, DGA506, DGA511, DGA513, DGA514, DGA517, DGA518, DGA519, DGA520, DGA521	2,79 €
	162264-5	M14	antivibračná		11,79 €
	194684-5	M14	sada na uchytenie rukoväti	GA7020/S, GA7030/S, GA7040S, GA9020/S, GA9030/S, GA9040S	12,99 €
Kľúče *****					
	782426-5		kľúč kolíkový	PC5000C, PC5001C, PC5010C	4,29 €
	782423-1		kľúč kolíkový	115 – 150	1,69 €
	197610-3		kľúč kolíkový	180 – 230	2,79 €
	782401-1		kľúč kolíkový	PC1100	1,09 €
	194305-9		povoľovacia matica	180 – 230	50,09 €
Ochranný kryt proti prachu *****					
	194289-1		GA6021/C, GA7010C, GA9010C, GA7020, GA7021, GA9020, GA7030/S, GA7040S, GA9030/S, GA7030/S, GA7040S, GA9030/S, GA9040S		1,99 €
Odsávacie adaptéry pre uhlové brúsky *****					
	127147-6	brúsenie	C	115 – 125 mm	39,99 €
	195385-8	brúsenie	C	180 mm	58,49 €
	191F81-2	brúsenie	C	115 – 125 mm X-LOCK	44,19 €
	194044-1	rezanie	A	230 mm	218,49 €
	193794-5	rezanie	A	115 – 125 mm	146,59 €
	196845-3	rezanie	D	115 – 125 mm	86,29 €
	198440-5	rezanie	E	230 mm	143,89 €
	191G05-4	rezanie	D	115 – 125 mm X-LOCK	94,79 €
	191G06-2	rezanie	D	115 – 125 mm	147,89 €
Prídavný kryt pre uhlové brúsky *****					
	199709-0		vhodný pre kryt ø 115 mm, 123144-0		8,39 €
	199710-5		vhodný pre kryt ø 125 mm, 123145-8		9,09 €
Kefky pre brúsne kryty					
	743334-5		1	195385-8	14,99 €
	743335-3		2	195385-8	6,99 €
	743332-9		1	127147-6	13,00 €
	743333-7		2	127147-6	12,81 €
	443144-7		1	PC5000 / 5001	5,10 €
	443145-5		2	PC5000 / 5001	3,19 €
	140J85-5		1	DSL800	49,36 €
	140J86-3		2	DSL800	12,65 €
	743127-0			DSL801	44,29 €

DELENIE: PRÍSLUŠENSTVO PRE UHLOVÉ BRÚSKY

	model	Obj. č.	MOC s DPH	Obj. č.	MOC s DPH	Obj. č.	MOC s DPH
Kryty kotúčov							
							
 1 – otvorený kryt s výmenou na kľúč	9557HN/HNR	123098-1	5,44 €	123144-0	9,55 €	122642-1	3,46 €
	9558HN/HNR						
	9562CR	123099-9	6,36 €	135108-2	4,86 €	122911-0	5,77 €
	9562CVR						
	9564H	123098-1	5,44 €	123144-0	9,55 €	122910-2	5,57 €
	9565CR						
	9565CVR	123099-9	6,36 €	135108-2	4,86 €	122911-0	5,77 €
	9565H						
	9565PCV						
	9566CR	135192-7	6,78 €	123146-6	10,82 €	165744-0	10,36 €
BGA/DGA450	123098-1	5,44 €	123144-0	9,55 €	122910-2	5,57 €	
BGA/DGA452							
DGA504	123099-9	6,36 €	123145-8	7,54 €	122911-0	5,77 €	
DGA506							
DGA519				347618-9	6,89 €	162708-5	9,39 €
GA5080R							
GA4530							
GA4530R							
GA4540							
GA4540C01	123098-1	5,44 €	123144-0	9,55 €	122910-2	5,57 €	
GA4540R							
GA4541C01							
GA4541R							
GA4541X01							
GA5021	123099-9	6,36 €	135108-2	4,86 €	122911-0	5,77 €	
GA5021C							
GA5030	123099-9	6,36 €	123145-8	7,54 €	122911-0	5,77 €	
GA5030R							
GA5040							
GA5040C01	123099-9	6,36 €	123145-8	7,54 €	122911-0	5,77 €	
GA5040R							
GA5041C01							
GA5041R							
GA5041X01							
GA6021	135192-7	6,78 €	123146-6	10,82 €	165744-0	10,36 €	
GA6021C							
GA6040C01							
GA7010C							
GA7020							
GA7020F							
GA7020RF	122889-7	8,27 €	122846-5	9,88 €	122914-4	15,96 €	
GA7030RF01							
GA7040RF01							
GA7060R							
GA7061R							
GA9010C							
GA9020							
GA9020F							
GA9020RF							
GA9020RFK							
GA9030							
GA9030R							
GA9030RF01	122891-0	11,50 €	122847-3	11,40 €	122913-6	4,46 €	
GA9030X01							
GA9040R							
GA9040RF01							
GA9050							
GA9050R							
GA9060R							
GA9061R							
GA9062R							
GA9063R							
GA005G							
GA013G							
GA023G							
GA026G				347480-2	7,43 €		
GA029G							
GA032G							
GA5050R							
GA5051R							

Akumulátory
 Odkladacie systémy
 Vŕtanie
 Skrútkovanie
 Brúsky
 Pilenie
 Frézovanie
 Brúsenie
 Klince / spony
 Špeciálne stroje
 Vysávanie
 Fény/lampy
 Záhrada
 Ručné náradie
 Ostatné

PRÍSLUŠENSTVO

▣ Delenie



Priemer



Počet zubov



Zárez



Hrúbka



Sklon



Ring



Pozdĺžny rez



Priečny rez



Vložený hrot



Silent



M-Force



Rýchly rez



Čistý rez



Extra čistý rez



Coated



Heavy duty



Dlhá životnosť











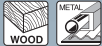









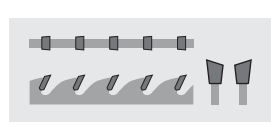
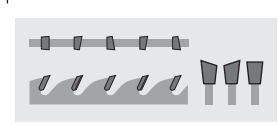
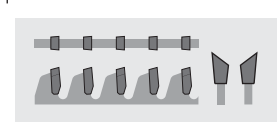
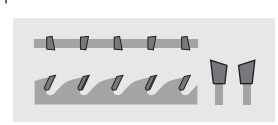
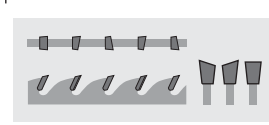

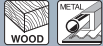
PCD tip



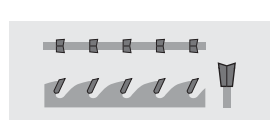
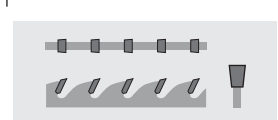
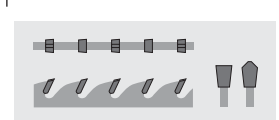
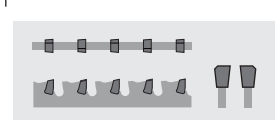
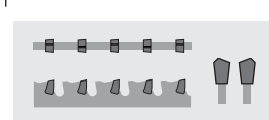

Sharp

Tvary zubov

<p>ATB</p>  	<p>ATBR</p>  	<p>Hi-ATB</p>  	<p>ATAF</p>  	<p>ATAFR</p>  
<p>Striedané vrchné skosenie zubov vhodný pre drevo a hliník.</p>	<p>Pridané ploché zuby do ATB pre ľahké priame rezanie</p>	<p>Striedané vrchné skosenie zubov s väčším horným uhlom skosenia.</p>	<p>Rezanie dreva , preglejky, dyhy, sololitu, drevovláknitých dosiek a drevotrieskových dosiek.</p>	<p>Pridanie plochých zubov do ATAF vhodné pre rovný rez.</p>
				
<p>M-FORCE</p>  	<p>FTG</p>  	<p>TCG</p>  	<p>MTCG</p>  	<p>SMTCG</p>  
<p>Predné a vrchné časti zubov tvarujú symetrickú V drážku so znakmi ATB a FTG.</p>	<p>Ploché zuby, umožňujú ľahké priame rezanie a špičky sú zriedka odštiepené. Na rezanie dreva pozdĺž vlákna a rezanie tenkého kovu.</p>	<p>Trapézové a ploché zuby sa striedajú, Umožňuje ľahké priame rezanie a špičky sú zriedka odštiepené.</p>	<p>Ploché zuby so striedavým skosením. Menej rezného odporu ako ploché zuby.</p>	<p>Kontrast k MTCG, asymetrické dve skosenia na hornej časti zuba, ktoré vytvárajú ostré hrany. Umožňuje ľahké zahryznutie do materiálov.</p>
				

Technical term

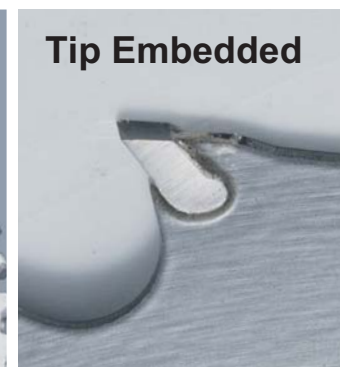
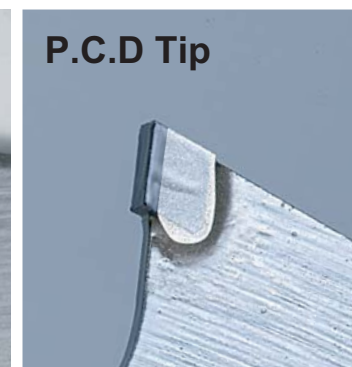
<p>Laser Slit</p> 	<p>Coated</p> 	<p>Tip Embedded</p> 	<p>P.C.D Tip</p> 
<p>Systém tlmenia vibrácií Laserom vyrezané telo vyplnené živcou sloty pre hladšie a tichšie strihy.</p>	<p>PTFE (polytetrafluóretylén) potiahnutý kotúč pre zníženie odporu.</p>	<p>Vložený zub zvyšuje tvrdosť tela zubu od špičky.</p>	<p>PCD (polykrystalický diamant) hrot má extrémnu tvrdosť a odolnosť proti opotrebovaniu. Kotúč s hrotom PCD je najlepšou voľbou pre dlhodobé rezanie vlákno-cementovej dosky.</p>

Pílové kotúče



Sortiment príslušenstva Makita je vyladenou zmesou zloženou z preverených výrobkov a nápaditých inovácií, dôkladne vybraných tak, aby vyhovovali náročným potrebám profesionálnych užívateľov.

I keď je príslušenstvo Makita konštruované obzvlášť pre použitie s kvalitným náradím firmy Makita, väčšina z nich rovnako účinne rozširuje možnosti pri práci s náradím iných značiek.

Sortiment TCT pílových kotúčov

Komplexný sortiment TCT pílových kotúčov, ktorých konštrukcia vyhovuje pílam od firmy Makita i mnoho iných výrobcov. Vysoko kvalitnými pílovými kotúčmi firmy Makita, vyrobenými z tej najlepšej oceli podľa najprísnejších noriem, sa spoľahlivo prevádzajú veľmi presné rezy. Každý zub má perfektne nabrúsené ostrie, ktoré znižuje množstvo malých triesok, čím zaisťuje ostrejšiu a presnejšiu hranu rezu.

Sortiment zahŕňa 5 rôznych typov pílových kotúčov pre ručné a stacionárne náradie.

Makita vyrába vysoko kvalitné príslušenstvo, ktoré v kombinácii s akýmkoľvek profesionálnym náradím vytvorí účinné a spoľahlivé riešenie pre každú prácu.

Mforce sú kotúče s revolučne vyvinutou konštrukciou zubu a dvojitémi zubmi pre rýchlejší a čistejší rez.

Makforce je komplexná rada kvalitne vyrobených ručných pílových kotúčov určených pre široké spektrum aplikácií. Majú vysokokvalitné špičky z karbidu wolframu a predĺženú životnosť.

Makblade Plus sú prvotriedne kotúče pre pokosové a stolné píly so špeciálnou konštrukciou zaručujúcou minimálne vibrácie a tichý chod.

Makblade predstavuje radu kotúčov pre pokosové a akumulátorové píly zahŕňajúce všetky obľúbené značky a modely. Kombinujú v sebe čistý presný rez a dlhú životnosť.

Špeciálne kotúče pre zvláštne aplikácie, stroje alebo materiály. Špeciálne konštruované zuby pre rezanie klinec a „hřč“, hliníku a oceli alebo pre akumulátorové píly.

Ako čítať kódy výrobkov makita

Typ rezu	Priemer listu Ø mm	Víťanie Ø mm
C = Hrubý M = Stredný F = Čistý XF = Extra čistý		A = 10 mm B = 15 mm C = 15,88 mm D = 16 mm E = 20 mm F = 25,4 mm G = 30 mm

Typ pílového kotúča	Špeciálny kotúč	Počet zubov	Zvláštne vlastnosti
MS = Pokosová píla CS = Okružná píla TS = Stolná píla CMS = Akku pokosová píla CC = Akku okružná píla BSS = BSS610 Li-ion CSP = ponorná okružná píla MCS = Píla na kov	X = Mforce E = zub so zapustenou špičkou A = hliník		L = Laserová štrbina a tichý

PRÍKLADY:

MSXF305100GL: pokosová píla – veľmi jemný rez – Ø 305 mm – 100 zubov – víťanie 30 mm – laserová štrbina a tichý chod

CCM15024A: akku kotúčová píla – stredný rez – Ø 150mm – 24 zubov – víťanie 10 mm

TSA20064G: stolná píla – na hliník – Ø 200 mm – 64 zubov – víťanie 30 mm

DELENIE:



Funkcia



Ostrý horný uhol



Vám umožní jemný rez povrhu s malým odporom



Zakrivené telo



Umožňuje vynikajúci odvod triesok



Zošťihlený krčok zuba



Znížením odporu pri rezaní predlžuje výdrž batérii

Viac rezov na jedno nabitie



Rýchly rez



Dlhšia životnosť

Počet rezov na 1 nabitie

Hrúbka kotúča: 1,6 mm



165mm x 48T

Hrúbka kotúča: 1,0 mm



165mm x 50T

EFFICUT

100

× 2,4 viac

240

Výsledky skúšky závisia vo veľkej miere od tvrdosti drevených materiálov atď.

Ø kotúča (mm)	ID kód	hrúbka rezu (mm)	vŕtanie (mm)	počet zubov	hrúbka kotúča (mm)	uhol zuby	tvar zuby	max. otáčky (min ⁻¹)	materiál	Obj. č.	MOC s DPH
165	CCM16525E	1,4	20	25	1	23°	ATAFR	9250	drevo	B-62979	31,89 €
165	CCXF16556EL	1,45	20	56	1	23°	ATAFR	9250	drevo, mdf, laminát	B-57320	59,69 €
165	CMSF16560E	1,85	20	60	1,35	10°	ATAFR	9250	drevo	B-69858	52,59 €
185	CCM18524G	1,45	30	24	1	23°	ATAFR	8250	drevo	E-08676	32,49 €
190	CCM19024G	1,45	30	24	1	23°	ATAFR	8040	drevo	B-64185	32,49 €
190	CCF19045G	1,45	30	45	1	23°	ATAFR	8250	drevo	B-68622	41,59 €
190	CMSC19025E	1,85	20	20	1,35	10°	ATBR	8040	drevo	E-11140	37,39 €
190	CMSM19045E	1,85	20	45	1,35	10°	ATBR	8040	drevo	E-11156	56,39 €
190	CMSF19060E	1,85	20	60	1,35	10°	ATBR	8040	drevo	E-11162	63,49 €
216	CMSM21645G	2	30	45	1,5	10°	ATAFR	7070	drevo	E-06971	57,99 €
216	CMSF21660G	2	30	60	1,5	10°	ATABR	7070	drevo	E-08888	67,29 €
216	CMSXF21680G	2	30	80	1,5	10°	ATABR	7070	drevo	E-08894	79,79 €
235	CCM23524G	2,2	30	24	1,5	20°	ATBR	6500	drevo	E-01909	44,19 €
260	CMSM26045G	2,15	30	45	1,65	10°	ATBR	5870	drevo	B-64624	57,99 €
260	CMSF26060G	2,15	30	60	1,65	10°	ATBR	5870	drevo	B-67234	67,29 €
260	CMSXF26080G	2,15	30	80	1,65	10°	ATBR	5870	drevo	B-67240	79,79 €
260	CCC26024G	2,15	30	24	1,5	23°	ATAFR	5870	drevo	E-07696	58,49 €
305	CMSM30560G	2,15	30	60	1,65	10°	ATBR	5000	drevo	B-67256	80,39 €
305	CMSF30580G	2,15	30	80	1,65	10°	ATBR	5000	drevo	B-67262	95,29 €
305	CMSXF305100G	2,15	30	100	1,65	10°	ATBR	5000	drevo	B-67278	110,49 €

DELENIE: PÍLOVÉ KOTUČE NA KOV

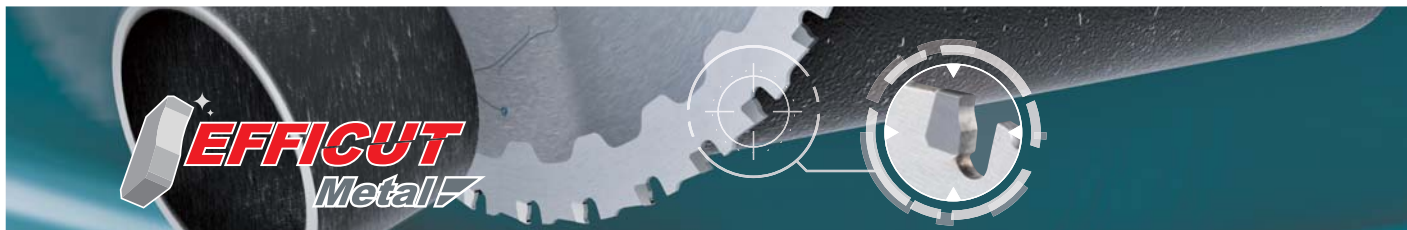

Funkcia

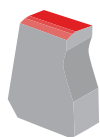

Tvrde, odolné voči ulomeniu



Špeciálny dizajn špičky čepele zvyšuje účinnosť a životnosť.



Ľahký odvod pilín

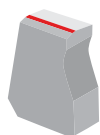

Vynikajúci pri priamom rezaní

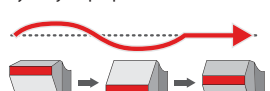

Zataženie špičiek kotúčov je možné efektívne rozložiť, aby sa potlačilo kolísanie pílového kotúča, čo zaisťuje rovnomerné priame rezanie a zvyšuje odolnosť proti zlomeniu hrotu.

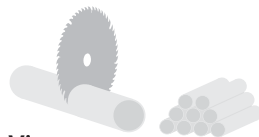

Viac rezov na jedno nabitie



Rýchly rez



Dlhšia životnosť

Počet rezov na 1 nabitie

Hrúbka kotúča: 1,2 mm



150mm x 32T

Hrúbka kotúča: 0,95 mm



150mm x 33T

EFFICUT Metal

100

× 1,6 viac

160

Model: DCS553 (BL1860B)

Materiál: rúrka z uhlíkovej ocele (priemer: 31 mm / hrúbka: 3 mm)

Ø kotúča (mm)	ID kód	hrúbka rezu (mm)	vrtanie (mm)	počet zubov	hrúbka kotúča (mm)	uhol zubu	tvar zubu	max. otáčky (min ⁻¹)	materiál	Obj. č.	MOC s DPH
---------------	--------	------------------	--------------	-------------	--------------------	-----------	-----------	----------------------------------	----------	---------	-----------

EFFICUT na kov



136	MCCS13630E	1,1	20	30	0,95	0°	SMTCG	4,5	železo	B-69266	51,99 €
136	MCCS13645E	1,1	20	45	0,95	0°	SMTCG	4,5	nerez	B-69272	62,99 €
150	MCCS15033E	1,1	20	33	0,95	0°	SMTCG	4,68	železo	B-69288	53,29 €
150	MCCS15048E	1,1	20	48	0,95	0°	SMTCG	4,68	nerez	B-69294	64,39 €

Špeciálne kotúče na kovy pre aku píly DCS550/551/552/553



150		1,5	20	32	1,2	0°	MTCG	4680	kov	B-46296	31,89 €
150	MCCS15052E	1,4	20	52	1,1	-15°	ATB	4680	tenký plech	B-47167	64,29 €
150		1,11	20	60	1,0	0°	SMTCG	4680	nerez/mäkká oceľ	B-47014	50,39 €
150	CCM8520B	1,6	20	52	1,0	0°	ATB	4680	hliník	B-47020	45,29 €

Špeciálne pílové kotúče na kov a nehrdzavejúcu oceľ



136	MCS13656E	1,5	20	56	1,5	-5°		3 600	nerez	B-23086	68,79 €
185	MCSF18564GL	1,6	30	64	1,3	0°		5 800	nerez	B-31669	110,89 €
305	MCS305100F	2,4	25,4	100	1,5	-5°		2 000	nerez	B-23123	310,69 €

Frézovacie kotúče pre CA5000



118		14	20	6	6,0	5°	TCG		frézovací kotúč na hliník pre 90° ohyb materiálu.	B-48832	190,29 €
118		18	20	6	6,0	5°	TCG		frézovací kotúč na hliník pre 135° ohyb materiálu.	B-48860	208,09 €

Pílové kotúče EFFICUT určené pre pílenie WPC dosiek



165	CCF16540EL	1,5	20	40	1	15°	ATAFR	9.250	WPC dosky	E-12158	43,19 €
190	CMSF19050EL	1,85	20	50	1,35	8°	ATAFR	8.040	WPC dosky	E-12186	61,39 €
216	CMSF21660GL	2	30	60	1,5	8°	ATAFR	7070	WPC dosky	E-12192	71,59 €
260	CMSF26075GL	2,15	30	75	1,65	8°	ATAFR	5.870	WPC dosky	E-12201	81,59 €

Sortiment kotúčov na rezanie nehrdzavejúcej ocele od spoločnosti Makita je navrhnutý na čistejšie a rýchlejšie rezanie.

Špeciálne vyrobený karbid v kombinácii s jedinečným dizajnom hrotu odoláva poškodeniu pri náraze a vydrží dlhšie, kotúče Makita vydržia až 30-krát viac ako štandardné kotúče.

- Špeciálne tvarované špičky z tvrdokovu precízne brúsené pre rýchle čisté rezanie.
- Nízke iskrenie a minimálna tvorba prachu.
- Chladné rezy s okrajmi bez otrepuv.

DELENIE: PÍLOVÉ KOTUČE

Obj. č.	Ø kotúča (mm)	ID kód	hrúbka zubu (mm)	vřitanie (mm)	počet zubov	hrúbka kotúča (mm)	uhol zubu	Ø kružku (mm)	rez priechy	rez pozdĺžny	max. otáčky (min ⁻¹)	materiál	MOC s DPH

B-07886	165	CSCX16510E	2	20	10	1,2	15°		• •		9 250	drevo	20,19 €
B-07892	165	CSCX16510G	2	30	10	1,2	15°		• •		9 250	drevo	20,19 €
B-07901	165	CSCX16516E	2	20	16	1,2	15°		• •		9 250	drevo	20,69 €
B-08006	165	CSCX16524E	2	20	24	1,2	15°		• •		9 250	drevo	22,49 €
B-07917	170	CSCX17016G	2	30	16	1,2	15°	15,88	• •		8 980	drevo	22,29 €
B-08012	170	CSMX17024G	2	30	24	1,2	15°	15,88	• •		8 980	drevo	23,89 €
B-07923	180	CSCX18016E	2	20	16	1,2	15°		• •		8 480	drevo	20,69 €
B-07939	180	CSCX18016G	2	30	16	1,2	15°		• •		8 480	drevo	20,69 €
B-08028	180	CSMX18024E	2	20	24	1,2	15°		• •		8 480	drevo	22,49 €
B-08034	180	CSMX18024G	2	30	24	1,2	15°		• •		8 480	drevo	22,49 €
B-07945	185	CSCX18516G	2	30	16	1,2	15°	15,88/20	• •		8 250	drevo	23,59 €
B-08040	185	CSMX18524G	2	30	24	1,2	15°	15,88/20	• •		8 250	drevo	25,29 €
B-07951	190	CSCX19012C	2	15,88	12	1,2	15°		• •		8 040	drevo	20,69 €
B-07967	190	CSCX19012G	2	30	12	1,2	15°	15,88/20	• •		8 040	drevo	23,59 €
B-08056	190	CSMX19024G	2	30	24	1,2	15°	15,88/20	• •		8 040	drevo	26,19 €
B-08062	190	CSMX19024C	2	15,88	24	1,2	15°		• •		8 040	drevo	23,39 €
B-07973	210	CSCX21016G	2,3	30	16	1,4	15°		• •		7 300	drevo	29,79 €
B-08078	210	CSMX21024G	2,3	30	24	1,4	15°		• •		7 300	drevo	32,59 €
B-08109	210	CSFX21040G	2,3	30	40	1,4	15°		• •		7 300	drevo	41,29 €
B-07989	230	CSCX23018G	2,3	30	18	1,6	15°		• •		6 640	drevo	34,19 €
B-08084	230	CSMX23024G	2,3	30	24	1,6	15°		• •		6 640	drevo	38,19 €
B-08115	230	CSFX23040G	2,3	30	40	1,6	15°		• •		6 640	drevo	42,89 €
B-07995	235	CSCX23520G	2,3	30	20	1,6	15°	15,88/25	• •		6 500	drevo	37,09 €
B-08090	235	CSMX23524G	2,3	30	24	1,6	15°		• •		6 500	drevo	38,19 €
B-08121	235	CSFX23540G	2,3	30	40	1,6	15°	15,88/25	• •		6 500	drevo	45,69 €

Pre kotúčové píly

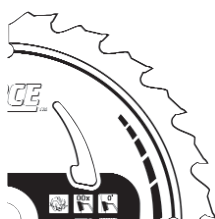

Revolučná zdokonalená konštrukcia zubu, ktorá stanovuje nový medzník v technológii pílových kotúčov. Dvojito zošíkmený bok zubu má ostrejšie rezné hrany a tvar M je rovnocenný dvojnásobnému počtu zubov na kotúči. Väčšia trecia plocha a viac rezných plôch má za následok, že kotúč vydrží až 2x dlhšie ako tradičné kotúče.

Rovnaký výsledok s polovicou zubov
Agresívny rez
Väčšia trecia plocha a dlhšia životnosť

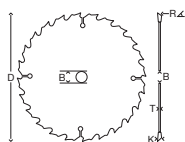

DLHŠIA ŽIVOTNOSŤ

Zošikmená bočná a horná plocha vytvára 6 rezných hrán, čím výrazne predlžuje životnosť v porovnaní s tradičnými kotúčmi.



VÄČŠIA RÝCHLOSŤ REZU

Zošikmený bok zubu má dva uhly 10, ktoré vytvárajú agresívnejší a rýchlejší rez.



ČISTEJŠÍ REZ

Špička tvaru M má viac rezných bodov, čo spôsobuje čistejší rez. Kotúč s 24 zubami má rovnaký výsledok ako 48 zubov u tradičných kotúčoch.



DELENIE: PÍLOVÉ KOTUČE

Obj. č.	Ø kotúča (mm)	ID kód	hrúbka zubu (mm)	vrtanie (mm)	počet zubov	hrúbka kotúča (mm)	uhol zuby	Ø krúžku (mm)	rez priechy	rez pozdĺžny	max. otáčky (min ⁻¹)	materiál	MOC s DPH
Pre kotúčové píly *****													
B-08137	140	CSC14018C	1,5	15,88	18	1	20°		• •	10 910		drevo	29,99 €
B-08280	150	CSM15024E	2,4	20	24	1,5	20°		• •	10 180		drevo	30,59 €
B-08143	160	CSC16016E	2,4	20	16	1,5	20°	15,88	• •	9 540		drevo	26,69 €
B-08296	160	CSM16024E	2,4	20	24	1,5	20°	15,88	• •	9 540		drevo	31,99 €
B-08420	160	CSM16040E	2,4	20	40	1,5	20°	15,88	• •	9 540		drevo	38,29 €
B-08159	165	CSC16510E	2	20	10	1,4	20°		• •	9 250		drevo	27,59 €
B-08165	165	CSC16510G	2	30	10	1,4	20°		• •	9 250		drevo	27,59 €
B-08305	165	CSM16524G	2,4	30	24	1,5	20°		• •	9 250		drevo	31,99 €
B-08436	165	CSM16540G	2,4	30	40	1,5	20°		• •	9 250		drevo	36,89 €
B-08171	170	CSC17016G	2,4	30	16	1,5	20°	15,88	• •	8 980		drevo	26,79 €
B-08311	170	CSM17024G	2,4	30	24	1,5	20°	15,88	• •	8 980		drevo	33,59 €
B-08442	170	CSM17040G	2,4	30	40	1,5	20°	15,88	• •	8 980		drevo	38,29 €
B-08193	180	CSC18016G	2,4	30	16	1,5	20°		• •	8 480		drevo	26,79 €
B-08327	180	CSM18024E	2,4	20	24	1,5	20°		• •	8 480		drevo	33,59 €
B-08333	180	CSM18024G	2,4	30	24	1,5	20°		• •	8 480		drevo	33,59 €
B-08458	180	CSM18040E	2,4	20	40	1,5	20s		• •	8 480		drevo	36,89 €
B-08464	180	CSM18040G	2,4	30	40	1,5	20°		• •	8 480		drevo	36,89 €
B-08202	185	CSC18516C	1,8	15,88	16	1,2	20°		• •	8 250		drevo	28,29 €
B-08349	185	CSM18524C	1,8	15,88	24	1,2	20°		• •	8 250		drevo	32,29 €
B-08470	185	CSM18540C	1,8	15,88	40	1,2	20°		• •	8 250		drevo	36,89 €
B-08218	190	CSC19012C	2,2	15,88	12	1,4	20°		• •	8 040		drevo	28,69 €
B-08224	190	CSC19012G	2	30	12	1,4	20°	15,88/20	• •	8 040		drevo	28,29 €
B-08355	190	CSM19024G	2,2	30	24	1,4	20°	15,88/20	• •	8 040		drevo	32,29 €
B-08361	190	CSM19024C	2,2	15,88	24	1,4	20°		• •	8 040		drevo	33,39 €
B-08486	190	CSM19040G	2,2	30	40	1,4	20°	15,88/20	• •	8 040		drevo	39,69 €
B-08492	190	CSM19040C	2,2	15,88	40	1,4	20°		• •	8 040		drevo	36,89 €
B-08551	190	CSXF19060G	2,2	30	60	1,4	15°	15,88/20	• •	8 040		drevo	41,59 €
B-08230	210	CSC21016G	2,4	30	16	1,6	20°		• •	7 300		drevo	34,09 €
B-08377	210	CSM21024G	2,4	30	24	1,6	20°		• •	7 300		drevo	40,09 €
B-08501	210	CSM21040G	2,4	30	40	1,6	20°		• •	7 300		drevo	42,89 €
B-08383	230	CSM23024G	2,3	30	24	1,6	20°		• •	6 640		drevo	43,79 €
B-08517	230	CSM23040G	2,6	30	40	1,6	20°		• •	6 640		drevo	46,29 €
B-08567	230	CSXF23060G	2,8	30	60	1,8	15°		• •	6 640		drevo	47,59 €
B-08252	235	CSC23518G	2,6	30	18	1,6	20°		• •	6 500		drevo	42,89 €
B-08399	235	CSM23520G	2,3	30	20	1,6	20°		• •	6 500		drevo	32,79 €
B-08408	235	CSM23524G	2,3	30	24	1,6	20°		• •	6 500		drevo	43,79 €
B-08523	235	CSM23540G	2,6	30	40	1,6	20°		• •	6 500		drevo	46,29 €
B-08589	235	CSXF23560G	2,8	30	60	1,8	15°		• •	6 500		drevo	47,59 €
B-08268	270	CSC27024G	2,6	30	24	1,8	20°		• •	5 650		drevo	50,79 €
B-08539	270	CSM27040G	2,6	30	40	1,6	20°		• •	5 650		drevo	66,89 €
B-08573	270	CSXF27060G	2,8	30	60	1,8	15°	20	• •	5 650		drevo	71,99 €
B-08274	355	CSC35524G	3	30	24	2,2	20°		• •	4 300		drevo	78,39 €
B-08414	355	CSM35540G	3	30	40	2,2	20°		• •	4 300		drevo	90,19 €
B-08545	355	CSM35560G	3	30	60	2,2	20°		• •	4 300		drevo	99,99 €
B-08595	355	CSXF35560G	2,8	30	60	1,8	15°		• •	4 300		drevo	99,99 €



Komplexná rada pilových kotúčov pre všetky značky a modely ručných kotúčových píl. Bohatý výber veľkostí od 140 mm – 355 mm a počtu zubov od 10 – 60 pokrýva možnosti použitia pre hrubé pozdĺžne a priečne rezy až po extra jemné priečne rezy.

Tvrdené a vystužené kotúče absorbujú rázy a zostávajú ploché a rovné.

Výrazné predĺženie životnosti kotúčov vďaka použitiu

prvotriedneho karbidu wolframu s pomalým opotrebením.

Úzka rezná špára s menším množstvom odpadu a menším vodiacim tlakom.

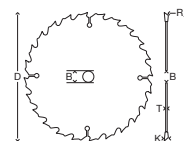

DELENIE: PÍLOVÉ KOTUČE

Obj. č.	Ø kotúča (mm)	ID kód	hrúbka zubu (mm)	vrtanie (mm)	počet zubov	hrúbka kotúča (mm)	uhol zubu	Ø krúžku (mm)	rez priechy	rez pozdĺžny	max. otáčky (min ⁻¹)	materiál	MOC s DPH
Pre pokosové a stolné píly *****													
B-08604	190	MSC19024EL	2,2	20	24	1,6	5°		•		8 040	drevo	51,59 €
B-08757	190	MSF19060EL	2	20	60	1,4	5°		•		8 040	drevo	66,89 €
B-09802	200	TSM20036GL	2,6	30	36	1,6	20°		•	•	7 630	drevo	101,39 €
B-08822	200	TSF20060GL	2,6	30	60	1,6	15°		•	•	7 630	drevo	116,39 €
B-08632	216	MSM21648GL	2,4	30	48	1,6	5°		•		7 070	drevo	86,09 €
B-08676	216	MSM21660GL	2,1	30	60	1,6	5°		•		7 070	drevo	92,99 €
B-08791	216	MSXF21680GL	2,8	30	80	1,8	5°		•		7 070	drevo	103,99 €
B-09818	250	TSM25040GL	2,8	30	40	1,8	20°		•	•	6 110	drevo	121,29 €
B-08838	250	TSF25080GL	2,8	30	80	1,8	15°		•	•	6 110	drevo	143,19 €
B-08626	255	MSC25532GL	2,3	30	32	1,8	5°		•		5 990	drevo	85,49 €
B-08648	255	MSM25540GL	2,4	30	40	1,8	5°		•		5 990	drevo	95,69 €
B-08682	255	MSM25560GL	2,3	30	60	1,8	5°		•		5 990	drevo	108,99 €
B-08763	255	MSF25572GL	2,4	30	72	1,8	5°		•		5 990	drevo	113,49 €
B-08654	260	MSM26040GL	2,3	30	40	1,8	5°		•		5 870	drevo	96,89 €
B-09824	260	TSM26040GL	2,8	30	48	1,8	20°		•	•	5 870	drevo	130,79 €
B-08698	260	MSM26060GL	2,3	30	60	1,8	5°		•		5 870	drevo	109,79 €
B-08707	260	MSM26070GL	2,3	30	70	1,8	5°		•		5 870	drevo	92,49 €
B-08779	260	MSF26080GL	2,3	30	80	1,8	5°		•		5 870	drevo	118,99 €
B-08844	260	TSF26080GL	2,8	30	80	1,8	15°		•	•	5 870	drevo	148,49 €
B-08800	260	MSXF260100GL	2,3	30	100	1,8	5°		•		5 870	drevo	125,39 €
B-09830	300	TSM30048GL	2,8	30	48	1,8	20°		•	•	5 090	drevo	124,69 €
B-08850	300	TSF300100GL	2,8	30	100	1,8	15°		•	•	5 090	drevo	180,79 €
B-08660	305	MSM30540GL	2,3	30	40	1,8	5°		•		5 000	drevo	120,59 €
B-08729	305	MSM30560GLA	2,6	30	60	2	5°		•		5 000	drevo	142,79 €
B-08735	305	MSM30570GL	2,5	30	70	1,9	0°		•		5 000	drevo	110,49 €
B-08785	305	MSF30580GL	2,3	30	80	1,8	5°		•		5 000	drevo	142,79 €
B-08816	305	MSXF305100GL	2,3	30	100	1,8	5°		•		5 000	drevo	149,39 €
B-09846	350	TSM35056GL	3,5	30	56	2,5	20°		•	•	4 360	drevo	142,29 €
B-08741	355	MSM35580GL	3	30	80	2,2	5°		•		4 300	drevo	186,79 €

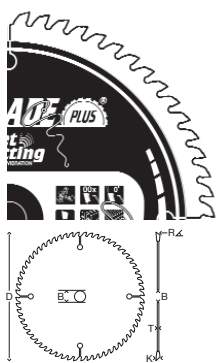

Pílové kotúče Makblade Plus pre pokosové a stolné píly majú jedinečnú patentovanú technológiu. Tieto kotúče sú vyvinuté k pohlienu vibrácií a veľmi tichému chodu. Majú vlastnosti zlepšovať pracovné prostredie, životnosť kotúča a spoľahlivosť celého zariadenia. Kotúč s menšími vibráciami zaisť presnejšie vedenie rezu a tiež znižuje hádzavosť. Výsledným efektom je ideálna rezná plocha. Taktiež má za dôsledok významne dlhšiu životnosť zubov z karbidu wolframu prekračujúcu životnosť konvenčných pílových kotúčov s karbidovými hrotmi. Presne vystužené kotúče s plochejším ostrím a rovnejším rezom. Povrchová vrstva s veľmi malým trením znamená rezanie bez námahy a ochranu pred koróziou.



NÍZKE VIBRÁCIE
Vďaka antivibračnej laserom rezanej drážke.



TICHÉ REZANIE
Povrchová vrstva s veľmi malým trením. Hlučnosť pílového kotúča je jednou z hlavných nepríjemností na pracovisku. MakBlade plus zaisťujú menej hlučné pracovné prostredie.



DELENIE: PÍLOVÉ KOTUČE

Obj. č.	Ø kotúča (mm)	ID kód	hrúbka zubu (mm)	vrtanie (mm)	počet zubov	hrúbka kotúča (mm)	uhol zubu	Ø krúžku (mm)	rez priechy	rez pozdĺžny	max. otáčky (min ⁻¹)	materiál	MOC s DPH
Pre pokosové a stolné píly *****													
B-08894	190	MSC19024E	2,2	20	24	1,6	5°			•	8 040	Drevo	31,19 €
B-08953	190	MSM19048E	2,2	20	48	1,6	5°			•	8 040	Drevo	50,89 €
B-09042	190	MSF19060E	2	20	60	1,4	5°			•	8 040	Drevo	50,69 €
B-08903	216	MSC21624G	2,4	30	24	1,6	5°			•	7 070	Drevo	41,89 €
B-08872	216	CMSM21640G	2,1	30	40	1,6	10°			•	7 070	Drevo	63,69 €
B-08969	216	MSM21648G	2,4	30	48	1,6	5°			•	7 070	Drevo	60,99 €
B-09058	216	MSF21660G	2	30	60	1,4	5°			•	7 070	Drevo	55,89 €
B-09092	216	MSXF21680G	2,8	30	100	1,8	5°			•	7 070	Drevo	58,39 €
B-08919	250	MSC25032G	2,4	30	32	1,6	5°			•	6 110	Drevo	43,79 €
B-08975	250	MSM25048G	2,4	30	48	1,8	5°			•	6 110	Drevo	57,29 €
B-09008	250	MSM25060G	2,3	30	60	1,8	5°			•	6 110	Drevo	58,69 €
B-09064	250	MSF25072G	2,4	30	72	1,8	5°			•	6 110	Drevo	58,19 €
B-09101	250	MSXF250100G	2,3	30	100	1,8	5°			•	6 110	Drevo	63,09 €
B-08925	255	MSC25532G	2,3	30	32	1,8	5°			•	5 990	Drevo	77,69 €
B-08888	255	CMSM25548G	2,1	30	48	1,6	10°			•	5 990	Drevo	67,99 €
B-09014	255	MSM25560G	2,3	30	60	1,8	5°			•	5 990	Drevo	58,69 €
B-08931	260	MSC26032G	2,3	30	32	1,8	5°			•	5 870	Drevo	56,99 €
B-08981	260	MSM26040G	2,3	30	40	1,8	5°			•	5 870	Drevo	43,19 €
B-09020	260	MSM26060G	2,3	30	60	1,8	5°			•	5 870	Drevo	55,89 €
B-09070	260	MSF26080G	2,3	30	80	1,8	5°			•	5 870	Drevo	63,59 €
B-09117	260	MSXF260100G	2,3	30	100	1,8	5°			•	5 870	Drevo	76,29 €
B-08947	305	MSC30532G	2,3	30	32	1,8	5°			•	5 000	Drevo	64,49 €
B-08997	305	MSM30540G	2,3	30	40	1,8	5°			•	5 000	Drevo	62,19 €
B-09036	305	MSM30560G	2,3	30	60	1,8	5°			•	5 000	Drevo	74,89 €
B-09086	305	MSF30580G	2,3	30	80	1,8	5°			•	5 000	Drevo	86,19 €
B-09123	305	MSXF305100G	2,3	30	100	1,8	5°			•	5 000	Drevo	95,09 €
B-46171	315	TSC31528G	2,8	30	28	2,0	20°			•	4850	Drevo	71,09 €
B-46187	315	TSC31548G	2,8	30	48	2,0	10°			•	4850	Drevo	83,69 €
B-46193	315	TSC31560G	2,8	30	60	2,0	10°			•	4850	Drevo	89,69 €
JM27170001	315	TCS31540G	2,8	30	40	2,0	9°			•	4 850	Drevo	33,09 €

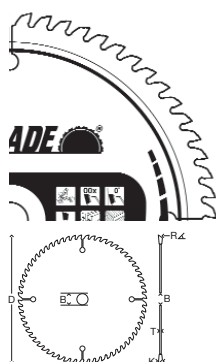

Komplexný výber pílových kotúčov pre všetky značky a modely pokosových píľ a ponorných píľ vrátane akku píľ.

Bohatý výber veľkostí od 190 mm–305 mm a počtu zubov od 24 do 100 pokrýva možnosti použitia od hrubých rezov až po prácu so zvlášť jemnou povrchovou úpravou.

Tvrdené a vystužené kotúče absorbujú rázy a zostávajú ploché a rovné.

Úzka rezná špára s menším množstvom odpadu.

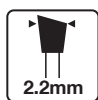

MENŠIA NÁMAHA

Úzka rezná špára znižuje namáhanie počas práce a predlžuje predpokladanú životnosť ako stroja, tak kotúča.



DLHÁ ŽIVOTNOSŤ

Prvotriedne zuby TCT, pomalé opotrebenie.

DELENIE: PÍLOVÉ KOTUČE

Obj. č.	Ø kotúča (mm)	ID kód	hrúbka zubu (mm)	vrtanie (mm)	počet zubov	hrúbka kotúča (mm)	uhol zuby	Ø krúžku (mm)	rez priechy	rez pozdĺžny	max. otáčky (min ⁻¹)	materiál	MOC s DPH
Špeciálne kotúče pre akku píly *****													
B-16885	85	CCF8520B	1	15	20	0,7	10°		• •		2 240	drevo	11,69 €
B-09139	136	CCM13624A	1,5	10	24	1	20°		• •		4 500	drevo	28,19 €
B-09210	136	CCF13636A	1,5	10	36	1	18°		• •		4 500	drevo	28,19 €
B-10643	136	CCC13616E	1,5	20	16	1	20°		• •			drevo	29,99 €
B-10615	136	MCCS13630E	1,5	20	30	1,2	0°		• •			kov	59,59 €
B-09145	150	CCM15024A	1,5	10	24	1	20°		• •		2 500	drevo	29,79 €
B-09226	150	CCF15040A	1,5	10	40	1	18°		• •		2 500	drevo	30,89 €
B-09151	160	CCC16024E	1,5	20	24	1	20°		• •		4 770	drevo	27,39 €
D-51079	165	CCC16524E	1,5	20	16	1	20°		• •		4 770	drevo	9,41 €
B-09173	165	BBS16524E	1,5	20	24	1	20°		• •		4 770	drevo	27,19 €
B-09189	165	CCC16524E	1,5	10	24	1	20°		• •		4 770	drevo	27,79 €
B-09232	165	CCF16540E	1,6	20	40	1	18°		• •		4 770	drevo	30,19 €
B-09248	165	BBS16540E	1,6	20	40	1	18°		• •		4 770	drevo	30,19 €
B-09195	190	CCC19024G	2	30	24	1,4	20°		• •		3 000	drevo	29,19 €
B-09254	190	CCM19040G	2	30	40	1,4	10°		• •		3 000	drevo	36,89 €

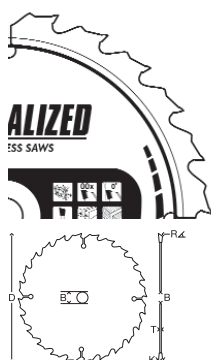

Ušľachtilé pílové kotúče vyrobené špeciálne pre AKKU píly. Ponúkame kotúče na rezanie dreva pomocou všetkých modelov AKKU kotúčových píly v kvalite firmy Makita. Ultratenké, perfektne vystužené oceľové kotúče pre rovné vedenie. Predlžuje výdrž batérií. Presne brúsené z prvotriedneho karbidu pre ľahšie, hladšie rezy a dlhú životnosť. Usporiadanie zubov odpoovedá zvláštnym požiadavkám na rezanie.

Pílové kotúče na laminátové dosky

Obj. č.	Ø kotúča (mm)	ID kód	hrúbka zubu (mm)	vrtanie (mm)	počet zubov	hrúbka kotúča (mm)	uhol zuby	Ø krúžku (mm)	rez priechy	rez pozdĺžny	max. otáčky (min ⁻¹)	materiál	MOC s DPH
Pílové kotúče na laminátové dosky *****													
B-29430	85 mm	CCXF8524B	1	15	24	0,7	7°				2240	laminát	19,19 €
B-33825	136 mm	CCXF13648E	1.4	20	48	1	10°				4500	laminát	40,99 €
B-29452	165 mm	CCXF16552EL	1.45	20	52	1	5°				4770	laminát	64,69 €
B-29468	190 mm	MSXF19060GL	2	20	60	1,4	5°				8040	laminát	75,39 €
B-29474	216 mm	MSXF21672GL	2.5	30	72	1,8	5°				7070	laminát	100,09 €
B-29480	250 mm	MSXF25084GL	2.5	30	84	1,8	5°				6110	laminát	134,19 €
B-29496	260 mm	MSXF26084GL	2.5	30	84	1,8	5°				5870	laminát	134,69 €
B-29505	305 mm	MSXF30596GL	2.5	30	96	1,8	5°				5000	laminát	151,69 €



ŠPECIÁLNA KONŠTRUKCIA
Vynikajúce pre Akku píly – predlžuje výdrž batérie a chráni motor.



NAJLEPŠÍ POVRCH
Presne brúsené zuby s povrchom ako zrkadlo a ostrejšim britom.



ŠIROKÁ MOŽNOSŤ POUŽITIA
Kotúče vhodné pre širokú škálu možného použitia.

DELENIE: PÍLOVÉ KOTUČE

Obj. č.	Ø kotúča (mm)	ID kód	hrúbka zubu (mm)	vrtanie (mm)	počet zubov	hrúbka kotúča (mm)	uhol zuby	Ø krúžku (mm)	rez priechy	rez pozdĺžny	max. otáčky (min ⁻¹)	materiál	MOC s DPH
Špeciálne kotúče pre akku píly – špeciálne zapustené hroti													
B-09329	165	CSCE16516E	2	20	16	1,25	23°		• •	9 250		drevo	40,09 €
B-09391	165	CSME16524E	2	20	24	1,25	23°		• •	9 250		drevo	46,29 €
B-09472	165	CSME16540E	2	20	40	1,25	18°		• •	9 250		drevo	54,89 €
B-09341	185	CSCE18516G	2	30	16	1,25	25°		• •	8 250		drevo	29,69 €
B-09400	185	CSME18524C	2	15,88	24	1,25	23°		• •	8 250		drevo	35,49 €
B-09416	185	CSME18520G	2	30	20	1,25	25°		• •	8 250		drevo	34,49 €
B-09494	185	CSME18540G	2	30	40	1,25	25°		• •	8 250		drevo	46,29 €
B-09357	190	CSCE19016G	2	30	16	1,25	23°		• •	8 040		drevo	30,99 €
B-09422	190	CSME19024G	2	30	24	1,25	23°		• •	8 040		drevo	35,89 €
B-09503	190	CSME19040G	2	30	40	1,25	23°		• •	8 040		drevo	48,09 €
B-09363	210	CSCE21018G	1,9	30	18	1,4	23°		• •	7 300		drevo	38,09 €
B-09438	210	CSME21024G	1,9	30	24	1,4	23°		• •	7 300		drevo	61,49 €
B-09379	235	CSCE23520G	2,3	30	20	1,6	25°		• •	6 500		drevo	44,59 €
B-09444	235	CSME23524G	2,3	30	24	1,6	23°		• •	6 500		drevo	47,59 €
B-09519	235	CSME23548G	2,3	30	48	1,6	18°		• •	6 500		drevo	74,09 €
B-09450	270	CSME27024G	2,6	30	24	1,8	23°		• •	5 650		drevo	95,59 €
B-09385	355	CSCE35524G	3	30	24	2,2	23°		• •	4 300		drevo	124,69 €
B-09466	355	CSME35540G	3	30	40	2,2	23°		• •	4 300		drevo	142,69 €

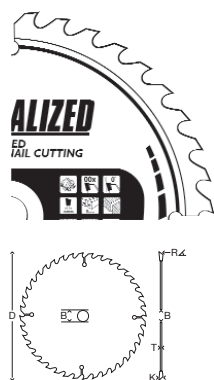

Kotúče so zapustenými hrotmi, alebo „hlbokými zubmi“ sú navrhnuté tak, aby vyhovovali pílam Makita i iných výrobcov. Sú to veľmi pevné kotúče odolné proti opotrebovaniu.

Lahko si poradí s „hrčovitým“ drevom a ani rezanie dreva s klincami alebo skrutkami jeho zuby nepoškodí. Sú obzvlášť vhodné pre použitie na stavebné drevo a demolačné práce. Rezanie klincov a „hřč“.

Extrémne pevný a odolný proti opotrebeniu. Dlhšia životnosť a zvýšená produktivita.



CHRÁNENÉ ZUBY

Kotúče so zapustenými hrotmi alebo hlbokými zubmi majú veľmi silnú väzbu medzi telom listu a hrotom TCT.



VYSOKÉ NÁROKY

Zvlášť vhodné na bednenie a iné náročné práce. Vynikajúce na rezanie dreva s „hrčami“ a klincami.

DELENIE: PÍLOVÉ KOTUČE

Obj. č.	Ø kotúča (mm)	ID kód	hrúbka zubu (mm)	vŕtanie (mm)	počet zubov	hrúbka kotúča (mm)	uhol zubu	Ø krúžku (mm)	rez priechy	rez pozdĺžny	max. otáčky (min ⁻¹)	materiál	MOC s DPH
Špeciálne kotúče na rezanie hliníka pre kotúčové, pokosové a stolné píly *****													
B-09553	160	CSA16060E	2,4	20	58	1,8	0°				9 540	hliník	44,79 €
B-09569	160	CSA16060G	2,4	30	60	1,8	0°	20			9 540	hliník	47,19 €
B-09575	180	CSA18060G	2,4	30	60	1,8	0°	15,88/20			8 480	hliník	56,39 €
B-09597	190	CSA19060G	2,4	30	60	1,8	0°	15,88/20			8 040	hliník	73,19 €
B-09612	190	MSA19060E	2	20	60	1,4	-5°				8 040	hliník	61,59 €
B-09690	200	TSA20064G	2,8	30	64	2,2	0°				7 630	hliník	92,19 €
B-09628	216	MSA21664G	2,2	30	64	1,6	-5°				7 070	hliník	70,19 €
B-09606	235	CSA23580G	2,4	30	80	1,8	0°				6 500	hliník	84,69 €
B-09634	250	MSA25080G	2,4	30	80	1,8	-5°				6 110	hliník	75,09 €
B-09709	250	TSA25080G	2,8	30	80	2,2	0°				6 110	hliník	106,29 €
B-09640	250	MSA250100G	2,4	30	100	1,8	-5°				6 110	hliník	81,49 €
B-09656	260	MSA26080G	2,3	30	80	1,8	-5°				5 870	hliník	76,79 €
B-09715	260	TSA26080G	2,8	30	80	2,2	0°				5 870	hliník	108,19 €
B-09662	260	MSA260100G	2,3	30	100	1,8	-5°				5 870	hliník	83,09 €
B-09721	300	TSA30080G	2,8	30	80	2,2	0°				5 090	hliník	118,99 €
B-09678	305	MSA30580G	2,3	30	80	1,8	-5°				5 000	hliník	101,49 €
B-09684	305	MSA305100G	2,3	30	100	1,8	-5°				5 000	hliník	114,69 €
B-09737	350	TSA350100G	3,2	30	100	2,6	0°				4 360	hliník	155,19 €
B-12522	355	TSA355120G	3	30	120	2,4	-5°				4 360	hliník	181,19 €

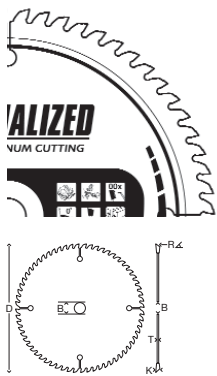

Rada kotúčov pre ručné, pokosové a stolné píly s vynikajúcim rezným výkonom pre hliník, meď, mosadz, bronz a iné farebné kovy. Kotúče sú vhodné aj k práci s plastmi a laminovaným drevom.

Pri rezaní farebných kovov je treba na hroty používať mazivo, aby sa v drážkach kotúča nehromadili triesky. Presne vystužené kotúče pre plochšie brity a rovnejšie rezy. Vynikajúca kvalita rezu farebných kovových materiálov. Špičkový výkon pri laminátových podlahových materiáloch.

Obj. č.	Ø kotúča (mm)	ID kód	hrúbka zubu (mm)	vŕtanie (mm)	počet zubov	hrúbka kotúča (mm)	uhol zubu	tvár zubu	max. otáčky (min ⁻¹)	materiál	MOC s DPH
Pílové kotúče na hliník ***											
D-62103	185		2,2	30	40	1,4	5°	TCG	8300	hliník	10,94 €
D-72970	190		2,2	30	60	1,4	5°	TCG	8040	hliník	18,19 €
D-72992	235		2,4	30	80	1,6	5°	TCG	6550	hliník	26,99 €
D-73003	260		2,8	30	70	1,8	5°	TCG	5870	hliník	29,39 €
D-61874	260		2,6	30	100	1,8	5°	TCG	5870	hliník	30,91 €
D-61880	260		2,6	30	120	1,8	5°	TCG	5870	hliník	33,12 €



PERFEKTNÝ PROFIL
Zuby so špeciálnym profilom pre farebné kovy.



MÁLO TRIESOK
Pri použití na laminátové podlahové materiály vytvára málo triesok a odštiepkov.

DELENIE: PÍLOVÉ KOTUČE

Obj. č.	Ø kotúča (mm)	ID kód	hrúbka zubu (mm)	vrtanie (mm)	počet zubov	hrúbka kotúča (mm)	uhol zuby	Ø krúžku (mm)	rez priechy	rez pozdĺžny	max. otáčky (min ⁻¹)	materiál	MOC s DPH
špeciálne kotúče na rezanie kovov pre kotúčové a skracovacie píly *****													
B-09743	185	MCS18536G	1,9	30	36	1,5	0°				5 800	mäkká oceľ	81,99 €
B-09759	185	MCS18538G	2	30	38	1,6	0°				5 800	mäkká oceľ	72,99 €
B-09787	185	MCS18548G	2	30	48	1,6	0°				5 800	mäkká oceľ	82,49 €
B-09771	185	MCS18570G	1,7	30	70	1,3	-10°				5 800	plech	84,79 €
B-09765	305	MCS30560F	2,1	25,4	60	1,7	0°				2 000	mäkká oceľ	155,29 €
B-09793	305	MCS30578F	2,3	25,4	78	2	-5°				2 000	tenká mäkká oceľ	223,59 €

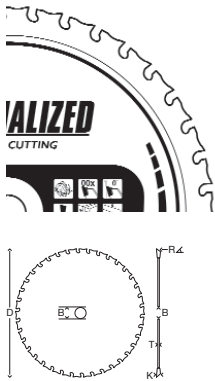

Rada pílových kotúčov Makita na rezanie ocele konštruovaných tak, aby bol rez čistejší a rýchlejší. Predovšetkým vďaka zloženiu karbidu a špeciálnej konštrukcii hrotov sú tieto kotúče odolné proti nárazom a majú dlhú životnosť pri rezaní mäkkej oceli, plechu, potrubia, profilov alebo závitových tyčí.

Kotúče Makita zaisťujú rýchlejší a čistejší rez, pričom vydržia až 30 krát dlhšie ako klasické rezné kotúče. Presne nabrušené hroty so špeciálnym zložením karbidu pre rýchle a čisté rezy. Malá iskrivosť a minimálna tvorba prachu. Menšie náklady na rez.

Špeciálne kotúče pre ponorné píly

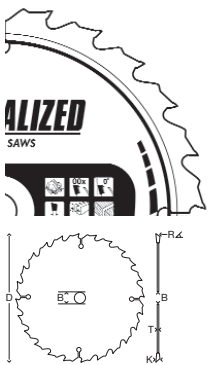

Kotúče konštruované špeciálne pre ponorné píly sú určené na rezanie dreva a hliníku. Majú zvláštnu konštrukciu zaisťujúcu hladký a čistý rez. Kotúče pre ponorné píly majú podobnú špecifikáciu ako Premium MakBlade Plus s patentovanou technológiou eliminujúcou vibrácie. Práca s kotúčmi s nízkymi vibráciami je presnejšia pri menšom hádzaní a ľahko sa ponorí do materiálu pri vynaložení malého úsilia. Špeciálna antivibračná konštrukcia. Presne vystužené kotúče s plochejšími britmi pre perfektne rovné rezy. K dispozícii kotúče na rezanie dreva a hliníku.



Pílové kotúče pre ponorné píly

Pílové kotúče pre ponorné píly *****												
B-09260	160	CSP16028E	2,2	20	28	1,6	23°		• •	9 540	drevo	44,09 €
B-09276	160	CSP16048E	2,2	20	48	1,6	8°		• •	9 540	drevo	54,89 €
B-09282	165	CSP16528E	2,2	20	28	1,6	23°		• •	9 250	drevo	52,79 €
B-09298	165	CSP16548E	2,2	20	48	1,6	8°		• •	9 250	drevo	62,19 €
B-09307	165	CSPX16556E	2,4	20	56	1,7	-3°		• •	9 250	hliník	87,19 €
B-10344	165	CSPX16548E	2,4	20	48	1,7				9 250	corrian	68,39 €

DELENIE: PÍLOVÉ KOTUČE

Ø kotúča (mm)	ID kód	hrúbka rezu (mm)	vrtanie (mm)	počet zubov	hrúbka kotúča (mm)	uhol zubu	tvar zubu	max. otáčky (min ⁻¹)	materiál	Obj. č.	MOC s DPH
Špeciálne pílové kotúče na vlákno cementové a cementové dosky *****											
165	CSC1654EPCD	2,1	20	4	1,4	10°			cementové dosky	B-22997	66,09 €
190	CSC1904GPCD	2,1	30	4	1,4	10°			cementové dosky	B-23008	67,89 €

Ako jeden z rastúcich ekologických materiálov v stavebníctve si vyžaduje vlákno-cementová doska dokonalý pílový kotúč a práve ten vytvorila spoločnosť Makita.

Sortiment pílových kotúčov PCD od spoločnosti Makita bol navrhnutý tak, aby poskytoval vynikajúci výkon pri rezaní vlákno-cementových dosiek vrátane dosiek „Hardy Board“, „Marley Weatherboard“ a lisovaného betónu.

Kotúč pílový na cementové dosky ***											
190		1,8	30	4	1,4	12°	PCD	8040	cementové dosky	D-72073	33,09 €
165		1,8	20	4	1,4	12°	PCD	9250	cementové dosky	D-72067	30,49 €

Špeciálne kotúče na rezanie sendvičových panelov pre kotúčové píly *****											
165	CSF16542EL	1,75	20	45	1,4	0°		9250	sendvič. panel	B-63133	72,39 €
235	CSF23550GL	2,4	30	50	1,8	0°		6 500	sendvič. panel	B-17675	101,99 €
270	CSF27060GL	2,6	30	60	2,0	0°		5 650	sendvič. panel	B-17681	155,59 €
355	CSF35580GL	3,2	30	80	2,6	0°		4 300	sendvič. panel	B-17697	195,39 €

Pílové kotúče vyrobené špeciálne pre rezanie sendvičových panelov. Extrémne pevné a odolné proti opotrebeniu, dlhá životnosť a produktivita.

Špeciálne pílové kotúče konstrukt pre kotúčové píly *****											
190	CSCE19012G	2,6	30	12	1,6	20°			drevo	B-13683	31,09 €
235	CSCE23516G	3,0	30	16	2,6	20°			drevo	B-13699	38,89 €

Špeciálna konštrukcia zubov týchto pílových kotúčov umožňuje rezať stavebné drevo s klincami. Extrémne pevné a odolné proti opotrebeniu, dlhá životnosť a produktivita.

Pílové kotúče pre pokosové a kotúčové píly ***											
190		2,2	30	24	1,4	15°		8040	drevo	D-64951	8,19 €
190		2	30	40	1,3	18°		8040	drevo	D-64973	12,15 €
260		2,6	30	40	1,8	15°		5870	drevo	D-65377	16,70 €
260		2,6	30	60	1,8	15°		5870	drevo	D-65383	19,97 €
260		2,6	30	80	1,8	12°		5870	drevo	D-65399	23,40 €
260		2,6	30	100	1,8	12°		5870	drevo	D-65408	26,51 €

Redukčné krúžky pre pílové kotúče *****



parametre	obj. č.	MOC s DPH
20 mm × 15,88 mm × 1,2 mm	B-20987	2,69 €
20 mm × 15,88 mm × 1,8 mm	B-20993	2,69 €
30 mm × 15,88 mm × 1,2 mm	B-21004	2,69 €
30 mm × 15,88 mm × 1,8 mm	B-21010	2,69 €
30 mm × 20 mm × 1,2 mm	B-21026	2,69 €
30 mm × 20 mm × 1,4 mm	B-21032	2,69 €
30 mm × 20 mm × 1,8 mm	B-21048	2,69 €
30 mm × 25 mm × 1,6 mm	B-21054	2,69 €
30 mm × 25,4 mm × 1,4 mm	B-21060	2,49 €
30 mm × 25,4 mm × 2,2 mm	B-21076	2,69 €

DELENIE: PRÍSLUŠENSTVO PRE KOTUČOVÉ PONORNÉ A POKOSOVÉ PÍLY

	model	Obj. č.	MOC s DPH
Paralelný doraz *****			
	DCS550, DCS551, DCS553, DHS630, DHS660, DHS661, DHS680, DHS710, DHS711, DHS782, DHS783, DSS500, DSS501, DSS610, DSS611, 4191D, 5093D, 5094D, HS300D, 5005BA, 5007F, 5007FA, 5007MG, 5007MGA, 5007N, 5007NB, 5007NF, 5008MG, 5008MGA, 5606B, 5704R, 5740NB, 5800NB, 5806B, HS6100, HS6101, HS6600, HS6601, HS7000, HS7010, HS7100, HS7101, HS7600, HS7601, HS7610, HS7611, HS004G	164095-8	1,49 €
	DSP600, DSP601, SP6000	165447-6	9,49 €
	5017RKB, 5705R	165108-8	7,49 €
	HS0600, N5900B, 5902B,	164367-1	2,19 €
	5103R, 5104, 5104S, 5903R	165084-6	3,79 €
	5143R	152498-8	64,29 €
Adaptér odsávací			
	5603R, 5704R, 5705R/RK	192420-3	2,79 €
	DHS660, DHS661	199230-9	4,49 €
	DHS680	196961-1	1,19 €
	DHS710, DHS780, DHS781, DHS782, DHS783, HS003G, HS004G HS6600, HS6601, HS7000, HS7010, HS7601, HS7610, HS7611	196520-1	1,89 €
	DHS711, HS6600	196843-7	2,89 €
	5103R	415426-7	1,29 €
Kufor PVC			
	5604R, 5603R, 5704R	824555-9	72,49 €
	5705R/RK	824554-1	84,79 €
	5903R	193196-5	85,19 €
	DSS610	824757-7	22,19 €
Vodiace lišty *****			
	1000 mm	199140-0	43,39 €
	1500 mm	199141-8	57,69 €
	3000 mm	194367-7	157,19 €
	spojka vodiacej lišty (sada 2 ks)	198885-7	22,49 €
Náhradné gumy pre vodiace lišty			
	náhradná guma (2) 1400 mm	423359-2	2,80 €
	náhradná guma (2) 1900 mm	423386-9	4,33 €
	náhradná guma (2) 3000 mm	423360-7	7,01 €
	náhradná páska (1) 1400 mm	423361-5	6,86 €
	náhradná páska (1) 1900 mm	451330-6	5,14 €
	náhradná páska (1) 3000 mm	423362-3	13,93 €
	náhradná páska (3) 1400 mm	413101-9	3,89 €
	náhradná páska (3) 1900 mm	423390-8	8,08 €
náhradná páska (3) 3000 mm	413102-7	6,72 €	
Upínacie svorky			
	skrutková svorka (sada 2 ks)	194385-5	31,69 €
	quick systém svorka (sada 2 ks)	199826-6	75,49 €
Uhlový adaptér k vodiacej lište			
		196664-7	37,09 €
Hák na zavesenie			
	DHS660, DHS661	199231-7	6,86 €
	DHS782, DHS783, HS003G, HS004G	199386-8	13,29 €

DELENIE: PÍLOVÉ KOTUČE

Adaptéry pre vodiace lišty Makita

Adapér	A	B	C	D	E	F (N)	G	H	I	J	K	L	M	N (F)		O	P	Q	R
	Kotúčové píly													Prímočiarié píly			Frézy	Píly	
Model	HS7100 HS7101	DHS630 HS6100 HS6101	HS7601 HS7610 HS7611	DHS680	HS6600 HS6601	DHS630 DHS710 DHS711 HS6100 HS6101 HS7100 HS7101	HS0600	5603 5703 5705R	DHS660 DHS661	HS002G	HS006G	5903R	5103R	DJV141, DJV142, DJV180, DJV181, DJV182	DJV141 DJV142 DJV180 DJV181 DJV182		JV102D JV103D	*DRT50 3612BR RP0900 RP0910 RP110C RP1800 RP1800F RP1801 RP1801F RP2300FC RP2301F *RT001G *RT0702C RP1803F RP2303FC	DCC500 DCC501 4100KB, 4100NH2
Obj. č.	195837-9	195838-7	197005-0	196953-0	197462-2	197252-3	198570-2	192505-5	199232-5	199401-8	191L92-3	192506-3	192507-1	197252-3	193517-1	198704-7	194579-2	198673-2	
MOC s DPH	23,15 €	37,30 €	16,49 €	41,39 €	24,09 €	71,19 €	175,19 €	32,89 €	44,59 €	46,20 €	44,99 €	158,59 €	105,29 €	71,19 €	23,29 €	cena na vyžiadanie	42,29 €	19,99 €	

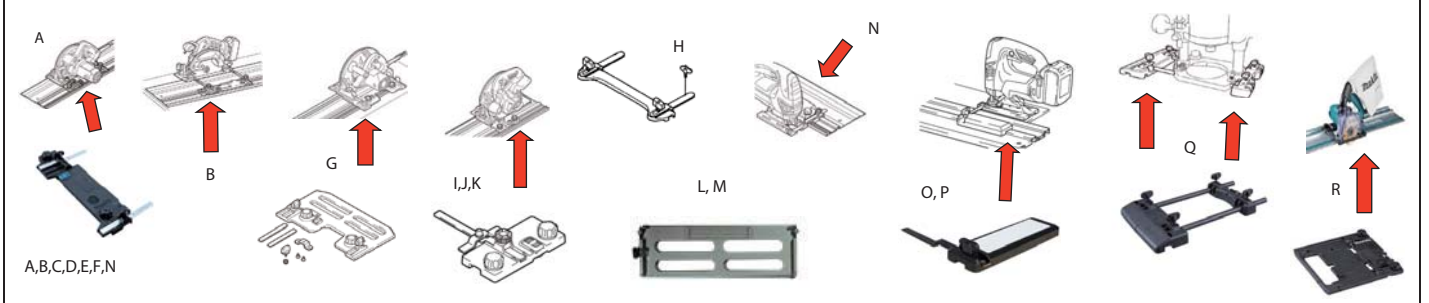

* s použitím základne 195563-0

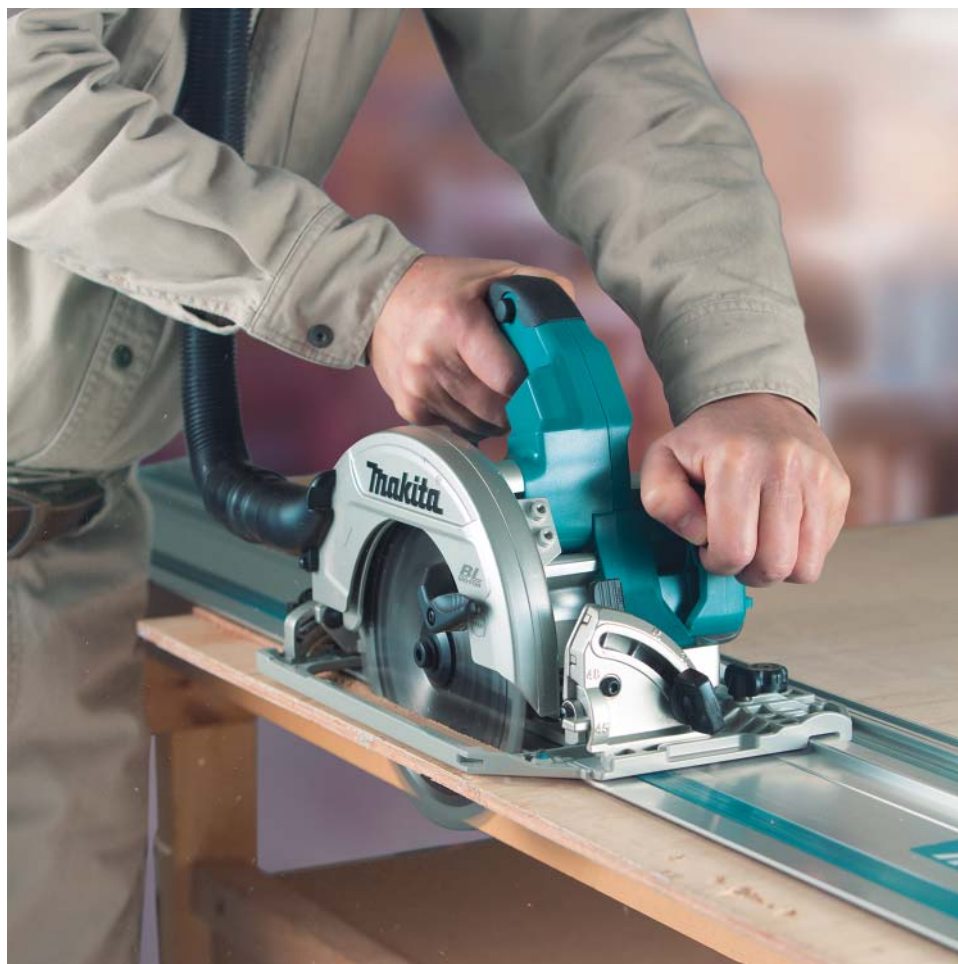

Modely pil priame pripojenie bez použitia adaptéra na vodiacu lištu	Modely pil ktoré sa nedajú použiť s adaptérom na vodiacu lištu
SP6000, DHS900, DHS783, DHS782, DSP601, DSP600, HS004G	5604, 5704, 5143R, N5900B, 5104S, DRS780, DSS610, RS001G, RS002G





DELENIE: PRÍSLUŠENSTVO PRE STOLNÉ A POKOSOVÉ PÍLY

	model	Obj. č.	MOC s DPH
Vak na prach *****			
 	LF1000, LH1040/F, LS0714/F/FL/L, LS1019/L, LS1030N, LS1040/F, LS1045, LS1216/F/FL/L, LS1219/L, LS1221	122852-0	2,99 €
	LH1201FL, LS1017L, LS1018L	JM23100501	3,19 €
	LS0815F/FL	JM23510010	4,69 €
	LS1440	122330-0	17,89 €
	uzáver vaku na prach	410602-8	0,32 €

Svorka zvislá			
	DLS713, DLS714, LS0714, LS0714F, LS0714FL, LS0714L	122571-8	7,99 €
	DLS110, DLS111, DLS112, LS1019/L, LS1219/L	126617-2	19,59 €
	LS0815FL	JM23510009	8,39 €
	LS1017L, LS1018L, LH1201FL	JM23100502	6,29 €
	LS1040, LS1040F, LH1040, LH1040F	122536-0	10,69 €
	LF1000	122728-1	15,89 €
	LS1013	122538-6	9,49 €
	LS1016L, LS1216L	122854-6	18,29 €
	MLS100	JM23000131	9,19 €

Svorka vodorovná			
	LS1017L, LS1018L	122930-6	97,69 €
	LS1030N, LS1040, LS1040F, LS1045, LS1440, LH1040,	122563-7	58,49 €

Predženie stola			
	DLS110, DLS111, DLS112, LS1019/L	326978-2	4,31 €
	LS0815FL	JM23000127	11,69 €
	LS1018L, LH1201FL	JM23100500	7,49 €
	LS1040, LS1040F, LH1040/F	123101-8	11,69 €
	LS1219, LS1219L	327095-1	4,81 €

Uhlový doraz			
	LF1000	122730-4	16,09 €
	2704	122734-6	40,29 €
	2712	JM27110005	29,99 €





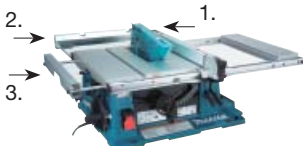

Vodiaci doraz			
	LF1000	122729-9	27,29 €
	LH1040/F	122707-9	10,39 €
	LH1200, LH1201	JM23300008	49,69 €

Hadica odsávania			
	LS1019L	123980-4	46,42 €
	LS1219L	126792-4	53,36 €

Ostatné príslušenstvo			
	tyč pre posun materiálu	JM21080290	1,09 €
	žiarovka pre všetky pokosové píly s označením f	193730-1	4,27 €
	nastavovací trojuholník	762001-3	0,59 €

Príslušenstvo pre 2704			
	popis	obj. č.	Moc s DPH
	kľzné vedenie	194241-9	159,99 €
	1. vodiaci doraz	122740-1	110,39 €
	2. predženie stola vzadu	194087-3	43,79 €
	3. predženie stola vľavo	194086-5	43,29 €

DELENIE: PRÍSLUŠENSTVO PRE STOLNÉ A POKOSOVÉ PÍLY

Stôl	model	Obj. č.	MOC s DPH
	LS0714, LS1040, LH1040, LS1013, LS1016, LS108, LS1214, LS1440	198688-9	124,29 €
	2703, 2704, 2704N, 2705	194093-8	353,49 €
	MLT100, MLT100N,	JM27000300	259,99 €
	pre všetky modely stolných a pokosových píl okrem 2704,LF100	DEAWST05	254,69 €
	pre všetky modely stolných a pokosových píl okrem 2704,LF100 1170/2700 x 500 x 550/800 mm	DEBWST06	227,69 €
	pre všetky modely stolných a pokosových píl okrem 2704,LF100 1765/3830 x 750 x 860 mm	DEAWST07	311,39 €
	lišta upínacia pre stoly WST06, WST07	JM23610050	80,79 €

Akumulátory
 Odkláďacie systémy
 Vŕtanie
 Skrútkovanie
 Brúsky
 Pílenie
 Frézovanie
 Brúsenie
 Klince / spony
 Špeciálne stroje
 Vysávanie
 Fény/lampy
 Záhrada
 Ručné náradie
 Ostatné

PRÍSLUŠENSTVO

▣ Priamočiare a chvostové píly

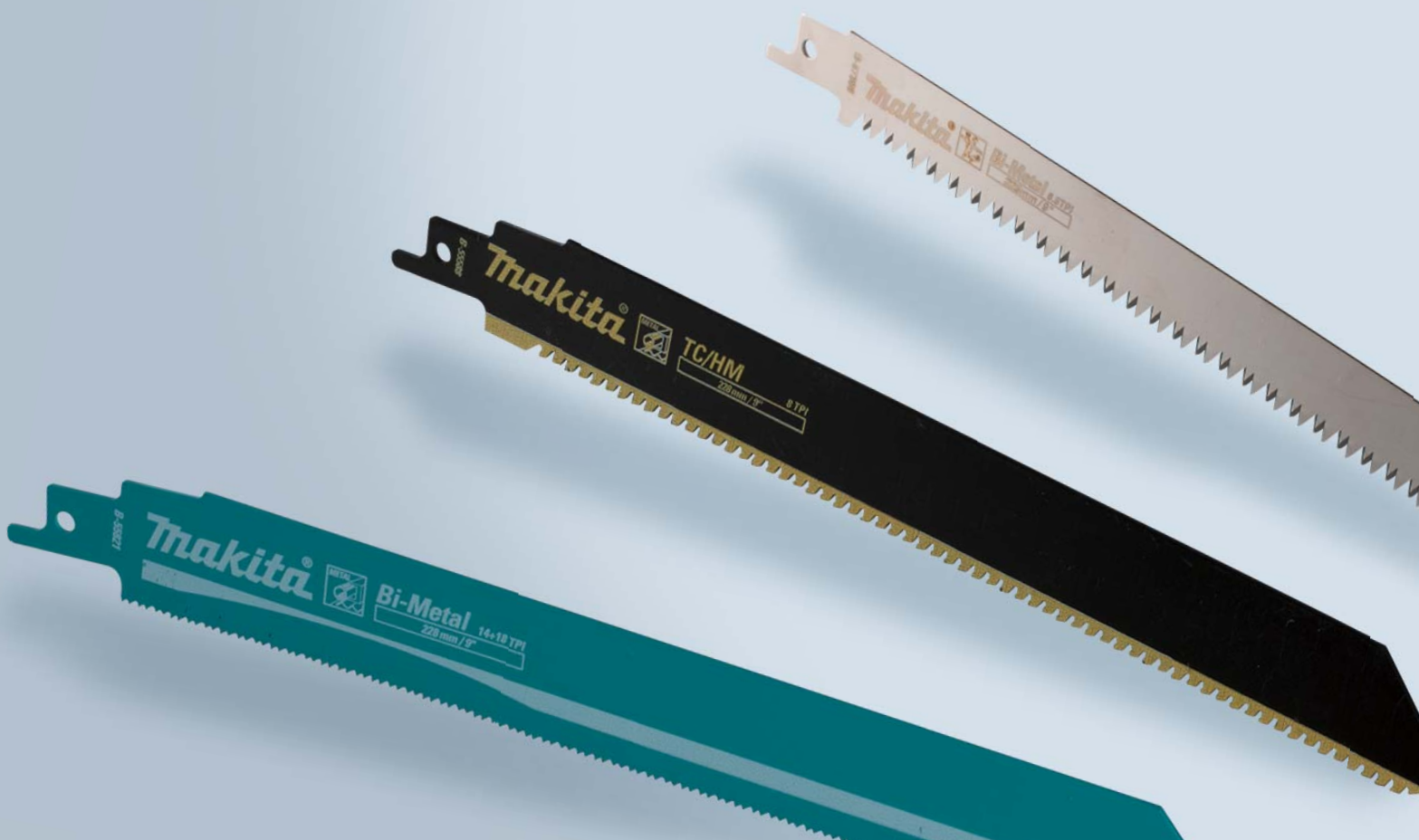

TC plátky



diamantové zrno



zrnitosť



priame rezy



rezanie oblúkov



jemný rez



hrubý rez



tvrdý materiál



tenký materiál



tvrdé zuby



počet zubov na palec



nepoužívať na predrez



použitie chladiacej zmesi

Typ zubu

frézované bočné zuby

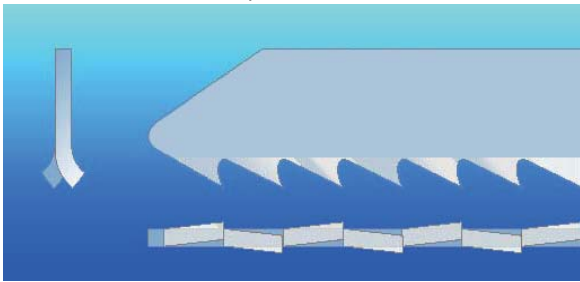

pozdlžne a bočné zuby

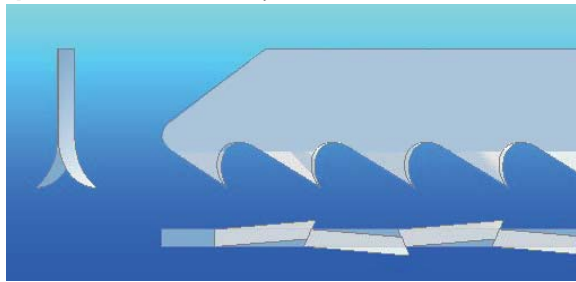

frézované vlnité zuby

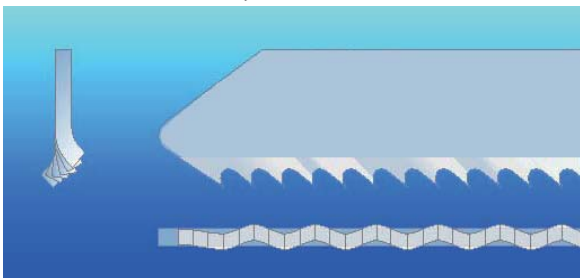

tvrdé kuželovité zuby

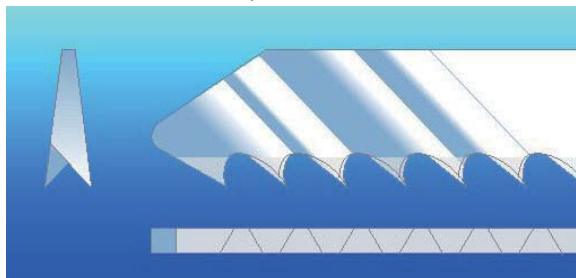

frézované zuby

- pre bežné rezanie
- mäkké až tvrdé materiály
- dlhá životnosť



tvrdé zuby

- veľmi ostré zuby
- presný a čistý rez
- mäkké až stredne tvrdé materiály



Spôsob výroby

- **bočné zuby:** každý jednotlivý zub je striedavo ohnutý doľava a doprava. Príklad: pravá, ľavá, rovná atď.
- **vlnité zuby:** zuby sú tvarované do vlnovky
- **tvrdé zuby:** teleso čepele sa zužuje smerom dozadu (kuželovité)

bočné zuby

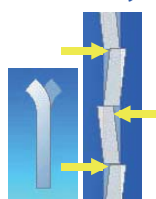

vlnité zuby



tvrdé zuby



Použitie materiály na výrobu pílových listov

- **HCS (ocel s vysokým obsahom uhlíka)** na rezanie mäkkších materiálov, ako je drevo alebo plasty.
- **HSS (rýchlorezná ocel)** na rezanie tvrdších materiálov, ako sú kovy.
- **BiM (dvojkov /HCS a HSS/)** na rezanie mäkkých materiálov a tvrdých materiálov ako drevo, kovy, plasty.
- **TC (karbid volfrámu)** na rezanie plastov vystužených sklenenými vláknami, cementovo viazaných drevovláknitých dosiek alebo sadrokartónu.

DELENIE: PÍLOVÉ LISTY

Hustota píleného materiálu je veľmi odlišná. Najmä pri pílení sa preto vyžaduje dokonalá geometria zubov a pílového listu, aby sa dosiahla optimálna kvalita rezu. Pílové listy sú presne koncipované na požiadavky príslušného materiálu a tak umožňujú dosiahnuť perfektný výsledok pílenia. Pri vyššom namáhaní pri pílení kovov sa musí používať zodpovedajúce chladiace médium na predĺženie životnosti pílového listu.



Materiály používané pri výrobe pílových listov do priamočiarych píl









HSS (High Speed Steel – rýchlorezná ocel) na kovy, hliník, neželezné kovy
 HCS (High Carbon Steel – uhlíková ocel) na drevo, plasty
 CV (legovaná nástrojová ocel) na drevo, plasty
 HM (Hartmetall – tvrdý kov) na ušľachtilú ocel, neželezné kovy, pórobetón
 BiM (Bi-Metal – dvojkov) na hliník, kovy, neželezné kovy

Chladiace médium: • rezací olej Chladiace médium: • terpentín Chladiace médium: ■ voda

Obj. č.	materiál	dĺžka* (mm)	TPP**	popis	na kovy	na drevo	rôzne materiály	ks/bal.	MOC s DPH
 B-07674	uhlíková ocel	80	9	B10 bez vylamovania rezných hrán. Veľmi rýchly a čistý rez.		tvrdé a mäkké drevo, preglejky		100	106,59 €
 B-07680	uhlíková ocel	75	9	B11 veľmi čistý rez		tvrdé a mäkké drevo, preglejky a drevotlákňité dosky do 30 mm	Plasty ■	100	104,69 €
 B-07696	uhlíková ocel	80	6	B12 veľmi čistý rez		tvrdé a mäkké drevo, preglejky a drevotlákňité dosky do 60 mm	Plasty ■	100	104,09 €
 B-07705	uhlíková ocel	80	8	B13 hrubý rez		tvrdé a mäkké drevo do 60 mm	Plasty ■	100	69,69 €
 B-07733	rýchlorezná ocel	50	14	B23	mäkká ocel ♦ 3 – 6 mm, farebné kovy, zliatiny hliníka 3 – 10 mm ♦♦			100	82,49 €
 B-07749	rýchlorezná ocel	50	24	B22	mäkká ocel ♦ farebné kovy • ♦ hliník a jeho zliatiny • ♦ plechy z nehrdzavejúcej oceli 1,5 – 4 mm			100	87,69 €

** počet zubov na palec (teeth per inch)

DELENIE: PÍLOVÉ LISTY

Obj. č.	materiál	dĺžka* (mm)	TPI**	popis	na kovy	na drevo	rôzne materiály	ks./bal.	MOC s DPH
 B-07711	uhlíková oceľ	75	6	B16 rýchly rez		tvrdé a mäkké drevo, preglejky a drevovláknité dosky do 30 mm	plasty	100	87,59 €
 B-07777	uhlíková oceľ	65	9	BR13 veľmi čistý rez		tvrdé a mäkké drevo, preglejky a drevovláknité dosky, dosky s vrstvami z plastov do 60 mm		100	75,09 €
 B-07755	rýchlorezná oceľ	75	9	B25	mäkká oceľ ♦ 3 – 6 mm, farebné kovy, zliatiny hliníka • ♦ 3 – 15 mm olovo a zinok ♦ do 20 mm		plasty do 30 mm, vystužené plasty do 20 mm	100	98,39 €
 B-07727	uhlíková oceľ	45	14	B18 pílový list na pílenie v krivkách, veľmi úzky		na pílenie do dreva do 20 mm v úzkych krivkách alebo pravých uhloch	na pílenie do plastov do 20 mm v úzkych krivkách alebo pravých uhloch	100	64,99 €
 A-86290	uhlíková oceľ	105	7	L1 veľmi tenký pílový list na rovné rezy, so šikmým ostrením a kónickým výbrusom, delenie zubov 4 mm		tvrdé a mäkké drevo, preglejky, drevovláknité dosky do 80 mm	plasty do 80 mm	5	9,39 €
 A-86309	uhlíková oceľ	105	7	L2 rýchly rez, s rozvedenými a ostrenými zubami (šíkmé), delenie zubov 4 mm		tvrdé a mäkké drevo do 80 mm		5	7,69 €
 A-86315	uhlíková oceľ	155	7	L10 s rozvedenými a ostrenými zubami, delenie zubov 4 mm		tvrdé a mäkké drevo do 110 mm		5	9,09 €
 P-05929	tvrdý kov	50	24	pílový list z tvrdého kovu	ušľachtilá oceľ ♦ 5 mm neželezné kovy • ♦ 10 mm			1	11,29 €

** počet zubov na palec (teeth per inch)

DELENIE: PÍLOVÉ LISTY

Obj. č.	materiál	dĺžka* (mm)	TPI**	popis	na kovy	na drevo	rôzne materiály	ks/bal.	MOC s DPH
---------	----------	-------------	-------	-------	---------	----------	-----------------	---------	-----------

Do priamočiarych píl s univerzálnou stopkou



A-85737	rýchlorezná oceľ	50	24	B22	mäkká oceľ ♦ farebné kovy ♦ ♦ hliník a jeho zliatiny ♦ ♦ plechy z nehrdzavejúcej ocele 1,5 – 4 mm			5	4,79 €
A-85709	rýchlorezná oceľ	42	16	B29 pílový list na pílenie v krivkách, veľmi úzky		tvrdé drevo, mäkké drevo, drevotriekové dosky 2 – 25 mm	plasty- lamináty 2 – 25 mm	5	3,79 €
A-85743	rýchlorezná oceľ	50	14	B23	mäkká oceľ ♦ 3 – 6 mm, farebné kovy, zliatiny hliníka 3 – 10 mm ♦ ♦			5	4,69 €
A-85759	rýchlorezná oceľ	50	32	B24 pri pílení plechov pod 1 mm píliť spolu s drevenou podložkou.	mäkká oceľ ♦ farebné kovy ♦ ♦ zliatiny hliníka do 2 mm			5	4,79 €
B-04961	rýchlorezná oceľ	50	24	B30	mäkká oceľ ♦, farebné kovy ♦ ♦, hliník a zliatiny hliníka ♦ ♦ 1 – 3 mm			5	10,69 €
A-80416		75		B-K			penový polystyrén do 50 mm, lepenka do 30 mm, guma do 10 mm, koža do 5 mm	5	18,29 €
A-85765	rýchlorezná oceľ	75	9	B25	mäkká oceľ ♦ 3 – 6 mm, farebné kovy, zliatiny hliníka ♦ ♦ 3 – 15 mm olovo a zinok ♦ do 20 mm		plasty do 30 mm, vystužené plasty do 20 mm	5	5,79 €
A-85771	rýchlorezná oceľ	75	9	B26 vhodný najmä na pílenie v krivkách	mäkká oceľ ♦ 3 – 6 mm farebné kovy, zliatiny hliníka ♦ ♦ 3 – 15 mm olovo a zinok ♦ do 20 mm		plasty do 30 mm, vystužené plasty do 20 mm	5	6,99 €

DELENIE: PÍLOVÉ LISTY

Obj. č.	materiál	dĺžka* (mm)	TPI**	popis	na kovy	na drevo	rôzne materiály	ks/bal.	MOC s DPH
 A-85721	rýchlorezná oceľ	75	12	B21 veľmi čistý rez	farebné kovy • ♦ hliník • ♦ do 10 mm			5	8,69 €
 A-85787	rýchlorezná oceľ	75	24	B27 vhodný najmä na pílenie v krivkách	mäkká oceľ 4 3 mm, farebné kovy • ♦ zliatiny hliníka • ♦ do 6 mm	tvrdé a mäkké drevo do 8 mm	lisované materiály, tvrdá tkanina, izolačné materiály do 8 mm	5	5,29 €
 A-85662	uhlíková oceľ	50	18	B14		preglejky a drevovláknité dosky do 15 mm	lisované materiály, tvrdá tkanina, izolačné materiály do 8 mm, plexisklo a linoleum ■ do 8 mm	5	3,69 €
 A-85678	uhlíková oceľ	50	12	B15		preglejky a drevovláknité dosky do 30 mm	lisované materiály, tvrdá tkanina, izolačné materiály do 20 mm, plexisklo ■ do 20 mm	5	3,69 €
 A-85709	uhlíková oceľ	45	14	B18 pílový list na pílenie v krivkách, veľmi úzky		na pílenie do dreva do 20 mm v úzkych krivkách alebo pravých uhloch	na pílenie do plastov do 20 mm v úzkych krivkách alebo pravých uhloch	5	3,79 €
 A-85634	uhlíková oceľ	75	9	B11 veľmi čistý rez		tvrdé a mäkké drevo, preglejky a drevovláknité dosky do 30 mm	plasty ■	5	5,69 €
 A-85640	uhlíková oceľ	80	6	B12 veľmi čistý rez		tvrdé a mäkké drevo, preglejky a drevovláknité dosky do 60 mm	plasty ■	5	5,69 €
 A-85656	uhlíková oceľ	80	8	B13 hrubý rez		tvrdé a mäkké drevo do 60 mm	plasty ■	5	3,89 €



Akumulátory
 Odkladacie systémy
 Vŕtanie
 Skrútkovanie
 Brúsky
 Pílenie
 Frézovanie
 Brúsenie
 Klince / spony
 Špeciálne stroje
 Vysávanie
 Fény/lampy
 Záhrada
 Ručné náradie
 Ostatné

DELENIE: PÍLOVÉ LISTY









Obj. č.	materiál	dĺžka* (mm)	TPI**	popis	na kovy	na drevo	rôzne materiály	ks/bal.	MOC s DPH
---------	----------	----------------	-------	-------	---------	----------	--------------------	---------	-----------

Do priamočiarych píl s univerzálnou stopkou



	A-85793	uhlíková oceľ	65	9	BR13 veľmi čistý rez		tvrdé a mäkké drevo, preglejky a drevotrásné dosky, dosky s vrstvami z plastov do 60 mm	5	4,19 €
	A-85232	uhlíková oceľ	75	8	B8		2° efekt výkyvu, pre modely bez výkyvu pílového listu; na mäkké a tvrdé drevo 4 – 60 mm	5	5,49 €
	A-85690	uhlíková oceľ	70	6	B17 vhodný najmä na rezy v krivkách		tvrdé a mäkké drevo do 60 mm	5	5,09 €
	A-85715	uhlíková oceľ	70	9	B19 bez vylamovania rezných hrán		tvrdé a mäkké drevo, preglejky	5	5,49 €
	A-85628	uhlíková oceľ	80	9	B10 bez vylamovania rezných hrán; veľmi rýchly a čistý rez.		tvrdé a mäkké drevo, preglejky	5	5,69 €
	B-06890	tvrdý kov	75	17	B60		lisované drevotrásné dosky 5 – 50 mm	3	22,89 €
	B-06909	tvrdý kov	105	24	B61		lisované drevotrásné dosky 5 – 50 mm	3	32,99 €
	B-10970		59	13	veľmi čistý rez		laminát, laminátové podlahy	5	12,29 €
	B-10986		59	13	veľmi čistý rez		laminát, laminátové podlahy	5	14,29 €



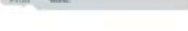



DELENIE: PÍLOVÉ LISTY





Obj. č.	materiál	dĺžka* (mm)	TPJ**	popis	na kovy	na drevo	rôzne materiály	ks/bal.	MOC s DPH
 P-31566		60	13	veľmi čistý rez			laminát, laminátové podlahy	5	9,99 €
 P-31572		75	6,35	rýchly rez			všetky typy dreva	5	6,99 €
 P-38788		54		hrubý rez			sklo, keramika, fibrové sklo	3	13,09 €
 P-05929		75		rýchly rez	železo 1 – 5 mm hliník, zinok 1,5 – 3 mm nerez 1 – 2,5 mm			1	11,29 €
 B-31887	Bi-metal	100	15	rovný rez			na drevené a laminátové podlahy	5	12,39 €
 P-49622		100		rýchly rez	na železo		drevo s klincami	5	9,99 €
 P-49644		180		rýchly rez	železo, hliník.		sendvičo- vé panely	5	12,29 €
 P-71308-25		116		rýchly rez			všetky typy dreva	25	29,99 €
 P-47204		130	25	rýchly rez			sendvičové panely	5	8,99 €





Akumulátory
 Odkladacie
 systémy
 Vŕtanie
 Skrútkovanie
 Brúsky
 Pílenie
 Frézovanie
 Brúsenie
 Klince / spony
 Špeciálne stroje
 Vysávanie
 Fény/lampy
 Záhrada
 Ručné náradie
 Ostatné

DELENIE: PÍLOVÉ LISTY

Obj. č.	dĺžka* (mm)	TPI**	popis	materiál	ks/bal.	MOC s DPH
Do priamočiarych píl Super Express s univerzálnou stopkou 						
	B-06460	77	8,5 – 10,6	B50 pílový list z uhlíkovej ocele	preglejky 5 – 50 mm, plasty 5 – 50 mm	5 6,59 €
	B-06476	77	9,8 – 18,1	B51 pílový list z rýchloreznej ocele	mäkká oceľ 1 – 8 mm, nehrdzavejúca oceľ 1 – 3 mm	5 7,29 €
	B-06482	77	5,5 – 9,8	B52 pílový list z rýchloreznej ocele	drevo 5 – 50 mm, plasty 5 – 50 mm, hliník 3 – 35 mm, nehrdzavejúca oceľ 3 – 5 mm, mäkká oceľ 3 – 8 mm	5 7,89 €
  	B-06292			sada, obsahujúca 1 x B-06460 1 x B-06476 1 x B-06482	pozri materiály pílových listov B-06460 B-06476 B-06482	3 4,79 €

Obj. č.	dĺžka* (mm)	TPI**	popis	materiál	ks/bal.	MOC s DPH
Pílové listy do chvostových píl „Super Express“ 						
	B-05038				5	15,49 €
	B-05038-2	152	7,5	Pílový list z dvojkovu	plechy 1 – 8 mm, profily 5 – 100 mm	2 6,89 €
	B-05038-25				25	69,39 €
	B-05044				5	15,19 €
	B-05044-2	152	5,5	Pílový list z dvojkovu	drevo s klincami, hliníkové profily 3 – 18 mm, plasty, sklolaminátové dosky	2 6,89 €
	B-05044-25				25	68,29 €
	B-05153				5	16,19 €
	B-05153-2	203	10,6	Pílový list z uhlíkovej ocele	plasty 6 – 150 mm, drevo, panely do 175 mm, stavebné rezivo 6 – 150 mm, drevotrieskové dosky, preglejky	2 7,19 €
	B-05153-25				25	72,59 €

Obj. č.	dĺžka* (mm)	TPI**	hrúbka (mm)	výška plátky (mm)	materiál	ks/bal.	MOC s DPH	
Pílový list na tehly a pórobetón 								
	B-10394	300	12,7/2	1,5	tehla, pórobetón	1	36,09 €	
	B-10403	450	12,7/2	1,5	tehla, pórobetón	1	50,29 €	
	B-12809	240	12,7/2	1,5	tehla, pórobetón	1	26,49 €	
	B-63585	305	8,5/3	1,5	2,2	Ytong, pórobetón, sadru, pálené tehly	2	38,89 €
	B-63591	400	12,7/2	1,5	2,2	Ytong, pórobetón, sadru, pálené tehly	2	51,39 €

* uvedená dĺžka je ozubená dĺžka

DELENIE: PÍLOVÉ LISTY

Obj. č.	dĺžka* (mm)	TPI**	popis	materiál	ks/bal.	MOC s DPH
---------	-------------	-------	-------	----------	---------	-----------

Pílové listy do chvostových píl s univerzálnou stopkou

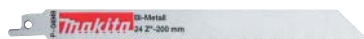

P-04874	100	18	pílový list z dvojkovu	plechy a profily 1,5 – 3 mm	5	11,09 €
P-04880	150	18	pílový list z dvojkovu	plechy a profily 1,5 – 3 mm	5	12,69 €
P-04896	100	24	pílový list z dvojkovu	plechy a profily 1,2 – 2 mm	5	12,09 €
P-04905	150	24	pílový list z dvojkovu	plechy a profily 1,2 – 2 mm	5	12,69 €
P-04911	150	14	pílový list z dvojkovu	ocel' a farebné kovy 3 – 8 mm	5	12,99 €
P-04927	200	14	pílový list z dvojkovu	ocel' a farebné kovy 3 – 8 mm	5	17,49 €
P-04933	200	18	pílový list z dvojkovu	ocel' a farebné kovy 1,5 – 3 mm	5	17,49 €
P-04949	200	24	pílový list z dvojkovu	ocel' a farebné kovy 1,2 – 2 mm	5	17,49 €
P-04955	150	32	pílový list z dvojkovu	ocel', farebné kovy a profily do 1 mm	5	13,89 €
P-04983	290	10	pílový list z dvojkovu	liatinové a oceľové rúry 3 – 10 mm, farebné kovy, izolačný materiál a drevo s klincami	5	21,59 €
P-05088	150	6	pílový list z dvojkovu	liatinové a oceľové rúry 3 – 12 mm, farebné kovy, izolačný materiál a drevo s klincami	5	18,79 €
P-04999	150	4	pílový list z rýchloreznej ocele	všetky druhy dreva (najmä na mokré drevo), sádra, hrubý rez, od 3 mm	5	8,99 €
P-05000	150	10	pílový list z rýchloreznej ocele	všetky druhy dreva, drevené palety a sádra, jemný rez, do 3 mm	5	9,19 €
B-55566	100	8	pílový list z rýchloreznej ocele	železo, nerez, liatinové rúry	1	11,19 €
B-55572	152	8	pílový list z rýchloreznej ocele	železo, nerez, liatinové rúry	1	14,69 €
B-55588	288	8	pílový list z rýchloreznej ocele	železo, nerez, liatinové rúry	1	19,99 €
B-55594	305	8	pílový list z rýchloreznej ocele	železo, nerez, liatinové rúry	1	24,89 €

* uvedená dĺžka je ozubená dĺžka; ** počet zubov na palec (teeth per inch)

Sada pilových listov do chvostových píl s univerzálnou stopkou









P-83945	200 150 150 150 300	14 14 18 4 6	sada obsahujúca: P-04927 P-04911 P-04880 P-04999 P-05016	ocel', 3-8 mm ocel', 3-8 mm plechy 1,5 – 3 mm drevo s klincami čisté drevo		13,99 €
---------	---------------------------------	--------------------------	---	--	--	---------





Akumulátory
Odkladacie systémy
Vŕtanie
Skrutkovanie
Brúsky
Pílenie
Frézovanie
Brúsenie
Klince / spony
Špeciálne stroje
Vysávanie
Fény/lampy
Záhradná
Ručné náradie
Ostatné

DELENIE: PÍLOVÉ LISTY

Obj. č.	popis	celková dĺžka (mm)	prac. dĺžka (mm)	TPI	poznámka	ks/bal	MOC s DPH	
Pílové listy do chvostových píl s univerzálnou stopkou								
	B-20454	Bi-metal pílový plátok na železo a drevo	100	75	14 – 18	5	11,99 €	
	B-20395	Bi-metal pílový plátok na železo (0,7 – 3 mm)	100	75	24	5	10,59 €	
	B-20426	Bi-metal pílový plátok na železo (3 – 12 mm) a drevo s klincami (10 – 50 mm)	100	75	10	5	10,59 €	
	B-20410	Bi-metal pílový plátok na železo (3 – 8 mm)	100	75	14	5	10,59 €	
	B-16835	Bi-metal pílový plátok na železo (5 – 100 mm)	150	127	24	5	10,99 €	
	B-16835-2					2	5,19 €	
	B-16813	HCS pílový plátok na drevo	150	127	3	rýchly rez	5	8,19 €
	B-16841	Bi-metal pílový plátok na železo (10 – 100 mm)	150	127	14	5	10,99 €	
	B-16841-2					2	5,19 €	
	B-31843	Bi-metal pílový plátok na palety, drevo/železo	150	127	10	5	10,99 €	
	B-31859	Bi-metal pílový plátok na palety, drevo/železo	225	175	10	5	16,69 €	
	B-43175	Bi-metal pílový plátok na železo (3 – 8 mm) (ø max 175 mm)	225	175	14+18	5	19,29 €	
	B-43169-2	Bi-metal pílový plátok na kovové platne 0,7 – 3 mm rúrky ø max 175 mm	225	175	24	2	7,39 €	
	B-43197-2	Bi-metal pílový plátok na hrubé plechy 2 – 10 mm rúrky ø max 175 mm	225	175	10 – 14	rýchly rez	2	8,49 €
	B-16857	Bi-metal pílový plátok na kovové rúrky, 5 – 200 mm PVC a hliník 5 – 20 mm	305	250	10 – 14	rýchly rez	5	20,29 €
	B-16857-2						2	8,89 €
	B-43212-2	Bi-metal pílový plátok na hrubé plechy 2 – 10 mm rúrky ø max 250 mm	305	250	8 – 10	2	9,79 €	

DELENIE: PÍLOVÉ LISTY

Obj. č.	popis	celková dĺžka (mm)	prac. dĺžka (mm)	TPI**	poznámka	ks/bal.	MOC s DPH	
Pílové listy do chvostových píl s univerzálnou stopkou 								
	B-16782	Bi-metal pílový plátok na železo (5 – 175 mm)	225	205	18		5	16,59 €
	B-16782-2						2	7,39 €
	B-31871	Diamantový pílový plátok na liatinové-železné rúry (ø 150 mm)	223	205			2	42,19 €
	B-16807	HCS pílový plátok na drevo, /OSB dosky/ preglejka	150	127	10		5	8,19 €
	B-16798		150	127	6	rýchly rez	5	8,19 €
	B-16863	HSS pílový plátok na mokré drevo a opíľovanie stromov	280	250	6,4		5	18,99 €

Obj. č.	popis	ks/bal.	materiál	MOC s DPH	
Pílové listy do chvostových píl s univerzálnou stopkou pre rezanie izolačných materiálov (sklená vlna, nobasil, polystyrén) 					
	P-80438	225x19x1,17	3	uhlíková oceľ	25,99 €
	P-80444	300x19x1,27	3	uhlíková oceľ	33,99 €
	B-52130	400x45x1,5	1	uhlíková oceľ	29,49 €

Obj. č.	popis	ks/bal.	MOC s DPH	
Príslušenstvo pre DSD180/SD100 				
	B-49703	pílový plátok na sadrokartón	2	20,39 €
	B-49719	pílový plátok na drevo	2	27,69 €

DELENIE: PÍLOVÉ LISTY

Obj. č.	dĺžka* (mm)	TPI**	popis	materiál	ks/bal.	MOC s DPH
---------	-------------	-------	-------	----------	---------	-----------

Pílové listy do chvostových píl s univerzálnou stopkou



P-45705	150		špeciálne zuby v tvare m	nerez, železo, hliník	5	16,99 €
P-45711	200		špeciálne zuby v tvare m	nerez, železo, hliník	5	20,99 €
P-46975	225	10	Bi-metal demolačný pílový list	železo, drevo s klincami	3	14,99 €
P-47042	225	6	Bi-metal demolačný pílový list	železo, drevo s klincami	3	15,99 €
B-43256-2	225	5 – 8	Bi-metal pílový plátok	železo, drevo s klincami drevotrieskové dosky	2	11,09 €
B-31859	225	10	Bi-metal pílový plátok	drevo s klincami, palety	5	16,69 €
B-43278-2	305	5 – 8	Bi-metal pílový plátok	železo, drevo s klincami drevotrieskové dosky	2	12,79 €

Obj. č.	šírka (mm)	TPI**	rozměr (mm)	názov	použitie	ks/bal.	MOC s DPH
---------	------------	-------	-------------	-------	----------	---------	-----------

Pílové listy pre LB1200F



JM21080294	6	6	2240 × 0,5	pílový pás	drevo, rez do oblúka	1	29,19 €
JM21080295	13	4	2240 × 0,5	pílový pás	drevo, univerzálny rez	1	29,69 €
JM21080296	16	4	2240 × 0,5	pílový pás	drevo, priečny rez	1	32,60 €
JM21080297	16	14	2240 × 0,5	pílový pás	neželezné kovy,	1	27,19 €
B-16689	6	6	2240 × 0,5	pílový pás	drevo, rez do oblúka	3	51,59 €
B-16673	13	4	2240 × 0,5	pílový pás	drevo, univerzálny rez	3	51,49 €
B-16667	16	4	2240 × 0,5	pílový pás	drevo, priečny rez	3	63,39 €
B-16695	16	14	2240 × 0,5	pílový pás	neželezné kovy,	3	68,39 €
JM21080290				tyč pre posun materiálu		1	1,09 €
JM21080260				mierka		1	10,59 €
JM21080230				paralelný doraz		1	20,99 €
JM23300008				paralelný doraz		1	49,69 €

DELENIE: PÍLOVÉ LISTY

Obj. č.	dĺžka* (mm)	TPI**	popis	materiál	ks/bal.	MOC s DPH
---------	-------------	-------	-------	----------	---------	-----------

Pílové listy do chvostových píl s univerzálnou stopkou





P-05022	150	6	pílový list z rýchloreznej ocele, hrubý a rýchly rez	všetky druhy dreva bez klincov, plasty, hrubý a rýchly rez, ako aj rezy v krivkách, od 3mm	5	10,29 €
P-05016	300	6	pílový list z rýchloreznej ocele, hrubý a rýchly rez	všetky druhy dreva bez klincov, plasty, hrubý a rýchly rez, ako aj rezy v krivkách, od 3mm	5	14,59 €
B-16829	300	6	pílový list z uhlíkovej ocele	s rozvedenými a šikmo brúsenými zubami, na všetky druhy dreva od 3mm	5	13,59 €
B-16829-2					2	6,19 €
P-05038	90	6	pílový list so zubami z tvrdého kovu	drevotrieskové dosky, GFK, eternit, liatina, oceľoliatina, karbón, polyuretánová pena, abrazívne materiály od 3mm	1	21,29 €
P-05044	150	6	pílový list so zubami z tvrdého kovu	drevotrieskové dosky, GFK, eternit, liatina, oceľoliatina, karbón, polyuretánová pena, abrazívne materiály od 3mm	1	23,99 €
P-05050	300	6	pílový list so zubami z tvrdého kovu	GFK, eternitové rúry, abrazívne materiály, atď. od 3mm	1	58,19 €
P-05066	400	3		pórobeton, plynobeton		48,79 €
B-16863	300	4 – 5	pílový list z rýchloreznej ocele	s ozubením na rez čerstvého dreva, odvetvovanie a rez stromov, hrubý rez	5	18,99 €
B-05169	152	18	pílový list z dvojkovu	tenké kovové dosky 1,5 – 4 mm, rúry, profily 5 – 100 mm	5	10,99 €
B-05169-2					2	5,19 €
B-05175	152	6	pílový list z dvojkovu	drevo s klincami 10 – 100 mm, plastové profily 5 – 100 mm, GFK, drevo, kovy, rámy okien do 100 mm	5	12,99 €
B-05175-2					2	5,99 €
B-10637	305	8	pílový list z dvojkovu	drevo s klincami, plastové profily, GFK, drevo, kovy, rámy okien	3	14,69 €
B-07250	152	18	pílový list so zubami z tvrdého kovu na kovy	nehrdzavejúca tvarovaná oceľ 5 – 100 mm, dosky z nehrdzavejúcej ocele 2 – 4 mm	2	30,99 €
B-20454	100	14 – 18	Bi-Metal	hrubý kov 3 – 8 mm drevo 10 – 50 mm	5	11,99 €







Akumulátory
 Odkladacie systémy
 Vŕtanie
 Skrutkovanie
 Brúsky
 Pílenie
 Frézovanie
 Brúsenie
 Klince / spony
 Špeciálne stroje
 Vysávanie
 Fény/lampy
 Záhrada
 Ručné náradie
 Ostatné

DELENIE: PÍLOVÉ LISTY

	TPI	celková dĺžka (mm)	hrúbka (mm)	použitie	materiál	Obj. č.	ks/bal.	MOC s DPH
Pre mrazené potraviny, ľad a kosti *****								
	3	305	1,25	pre mrazené potraviny a kosti, 10 – 250 mm	nerez	B-10609	1	8,49 €
	6	305	1,2	pre mrazené potraviny a kosti, 10 – 250 mm	nerez	B-23248	1	23,29 €
	10	305	1,2	pre mrazené potraviny a kosti, 10 – 250 mm	nerez	B-23254	1	22,99 €

Pílový list na sadrokartónové dosky								
	6	100	0,9	pre sadrokartónové dosky 5,0 – 50,0 mm	Bi-Metal	B-20448	5	11,99 €







	Obj. č.	popis	ks/bal.	MOC s DPH
Špeciálne príslušenstvo do chvostovej píly JR1000FTK *****				
	B-04977	brúsny list/velkronové upínanie, zrnitosť 60 na drevo, rozmery 95 x 22 mm	10	4,22 €
	A-40951	plochý pilník na kovy; celková dĺžka 153 mm; pracovná dĺžka 60 mm	3	29,09 €

	Obj. č.	materiál	pracovná dĺžka (mm)	zub/palec	materiál	ks/bal.	MOC s DPH
Pílové plátky s upínaním Makita *****							
	A-85868	3 / HCS	60	9	drevo, plast	5	3,89 €
	A-85818	10 / HCS	60	9	drevo, preglejka, rýchly rez	5	5,59 €
	A-85846	17 / HSS	63	14	drevo, preglejka, obľý rez	5	5,29 €
	A-02288	BR-3 / HCS	60	9	drevo, čistý rez	5	3,49 €
	A-85802	1 / HCS	60	24	tenké železo	5	5,69 €
	B-00022	HCS	120	6	všetky typy dreva	5	9,09 €
	792543-3	HCS	120	9	všetky typy dreva	5	8,09 €

DELENIE: DLABAČKA

	Obj. č.	popis	šírka (mm)	MOC s DPH
Dlabačka 7104L *****				
	A-16592	dlabacia refaz	21	521,79 €
	133571-3	vodiaca lišta	15 – 24	175,20 €

DELENIE: PRÍSLUŠENSTVO PRE PRIAMOČIARE PÍLY

		model	Obj. č.	MOC s DPH					
Odsávací adaptér 									
		DJV180, 4350T/CT/FCT, 4351T/CT/FCT	417853-4	0,89 €					
		DJV181, DJV182	126331-0	6,59 €					
		4331D, 4334D	192547-9	2,49 €					
Plastová klzná doska 									
		DJV180, DJV181, DJV182, JV100D, JV183D 4350CT/FCT, 4351CT/FCT	417852-6	1,00 €					
Chránič proti vytrhávaniu materiálu 									
		DJV180, DJV181, DJV182, JV100D, JV101D, JV102D, JV103D, 4326, 4327, 4329, 4350T/CT/FT/FCT, 4351T/CT/FCT, JV0600	415524-7	0,19 €					
Adaptér k vodiacim lištám Makita 									
		JV100D, JV101D, JV102D, JV103D, JV143D, JV183D 4326, 4327/M, 4328, 4329, JV0600 DJV180, DJV181, DJV182, 4350T/CT,/FCT, 4351T/CT/FCT	193517-1	23,29 €					
Doraz na vyrezávanie kruhov 									
		JV100D, JV101D, JV102D, JV103D, JV143D, JV183D 4326, 4327/M, 4328, 4329, JV0600 DJV180, DJV181, DJV182, 4350T/CT,/FCT, 4351T/CT/FCT	192732-4	5,69 €					
model	materiál	max. rezný výkon	TPI	tvar zubov	použitie	rozmer (mm)	ks/bal.	Obj. č.	MOC s DPH
Pílové pásy 									
	Bi-Metal	viac ako 5 mm	14		plast, neželezné kovy, mäkká oceľ, liata oceľ	835 x 13 x 0,5	5	B-40543	51,89 €
DPB181	Bi-Metal	4 – 5 mm	18		plast, neželezné kovy, mäkká oceľ, liata oceľ	835 x 13 x 0,5	5	B-40559	51,69 €
DPB182	Bi-Metal	max 4 mm	24		plast, neželezné kovy, mäkká oceľ, liata oceľ	835 x 13 x 0,5	5	B-40565	51,59 €
	zliatina uhlíka a ocele		6		drevo	1140 x 13 x 0,5	3	792567-9	36,49 €
	zliatina uhlíka a ocele	viac ako 5 mm	14		plast, neželezné kovy, mäkká oceľ, liata oceľ	1140 x 13 x 0,5	3	792560-3	36,59 €
DPB180,	zliatina uhlíka a ocele	4 – 5 mm	18		plast, neželezné kovy, plast, neželezné kovy	1140 x 13 x 0,5	3	792559-8	35,19 €
2107F,	zliatina uhlíka a ocele	max 4 mm	24		plast, neželezné kovy, mäkká oceľ, liata oceľ	1140 x 13 x 0,5	3	792559-8	35,19 €
2107FW	Bi-Metal	viac ako 5 mm	14		plast, neželezné kovy, mäkká oceľ, liata oceľ	1140 x 13 x 0,5	3	792557-2	21,99 €
	Bi-Metal	4 – 5 mm	18		plast, neželezné kovy, mäkká oceľ, liata oceľ	1140 x 13 x 0,5	3	792556-4	21,69 €
	Bi-Metal	max 4 mm	24		plast, neželezné kovy, mäkká oceľ, liata oceľ	1140 x 13 x 0,5	3	194692-6	22,09 €
2107/PB002G	BiM	viac ako 6 mm	10		oceľ, nerez	1,140x13x0.5	1	B-30128	cena na vyžiadanie
model	popis	Obj. č.	MOC s DPH						
Príslušenstvo pre pásové píly 									
DPB181, DPB182,	kryt pílového pásu	197975-3	25,05 €						
všetky modely	rezací vosk	191897-9	14,69 €						
DPB183	rukoväť	158237-4	2,79 €						
Prepravné kufre									
DJV180, DJV181, DJV182, JV100D,	PVC	141486-0	28,89 €						
4350FC/FCT, 4351FC/FCT	PVC	824809-4	20,59 €						
univerzálny 92 x 450 x 250 mm	kov	P-04101	66,49 €						

Akumulátory
Odkladacie systémy
Vŕtanie
Skrutkovanie
Brúsky
Pílenie
Frézovanie
Brúsenie
Klince / spony
Špeciálne stroje
Vysávanie
Fény/lampy
Záhradá
Ručné náradie
Ostatné

DELENIE: PRÍSLUŠENSTVO PRE HOBLÍKY

model	Obj. č.	MOC s DPH
Mierka na nastavenie nožov ****		
DKP180, DKP181, KP0800, KP0810/C, N1900B, N1923B, 1002BA, 1100, 1902, 1911B, 1912B	123062-2	3,19 €
2012NB	762016-0	4,99 €
Nástrčný kľúč 9		
DKP180, DKP181, KP312, KP0800, KP0810/C, N1900B, N1923B, 1002BA, 1100, 1804N, 1805N, 1806B, 1902, 1911B, 1912B	782209-3	1,79 €
2012NB	782203-5	2,29 €
Prítlačná doštička		
DKP180, DKP181, KP0800, KP0810/C, N1900B, N1923B, 1100, 1902	A-86175	3,78 €
KP312/S	345328-2	26,60 €
Držiak noža na brúsenie		
DKP180, DKP181, KP0800, KP0810/C, N1900B, N1923B, 1100, 1902	123004-6	3,39 €
1804N, 1805N, 1806B	123006-2	6,29 €
1002BA, 1911B 1912B	123055-9	3,09 €
Paralelný doraz		
KP0800, DKP180, N1923B, MT191, M1901, M1902	165581-2	4,69 €
DKP181, KP810/C	122785-2	cena na vyžiadanie
1806B	123053-3	12,39 €
1911B, 1923H, N1923B	165259-7	12,39 €
Paralelný doraz pre bočné vedenie		
DKP181	191C22-0	81,49 €
KP0810, KP0810C	122791-4	30,39 €
Skrutka zaistovania paralelného dorazu		
DKP180, DKP181, KP0800, KP810/C	265785-7	0,50 €
Odsávacie adaptéry		
1902, N1923B	152122-3	3,79 €
1806	122397-8	62,29 €
1911B	414468-8	2,69 €
DKP180, DKP181, KP0800, KP810/C	416368-8	2,19 €
1923H	192065-7	5,19 €
Adaptér na odsávaciu hadicu ø 45 mm		
1806, KP312S	181575-9	6,09 €
DKP180, KP0800, KP0810/C	451329-1	1,69 €
N1923B, 1902, 1911B, 1923H	JPA122275	5,29 €
Vak na prach		
1902	STEX122269	40,99 €
DKP180, KP0800, KP0810/C	122793-0	23,39 €
DKP181	191C21-2	33,19 €
Plastový kufrík		
KP0800	824892-1	15,79 €
KP0810/C	824786-0	51,19 €
Príslušenstvo ku 2012NB		
držiak s magnetom	762014-4	4,29 €
nastaviteľná doska pre nôž	343692-5	7,50 €
skrutka noža M4 x 6	922103-9	0,26 €
odsávací nástavec	193036-7	20,79 €
(bez možnosti pripojenia k vysávačom Makita)		

model	dĺžka (mm)	materiál	ks/bal	Obj. č.	MOC s DPH
Nože ****					
N1923B/H, KP0810/C	82	HSS	set 2 ks	D-16346	6,85 €
KP0800, DKP180/181	82	TC	set 2 ks	D-07967	16,51 €
1911B	110	TC	set 2 ks	D-08822	26,70 €
1806	170	HSS	set 2 ks	D-63666	24,89 €
2012NB	306	HSS	set 2 ks	199911-5	109,99 €
Nože obojstranné ****					
N1923B/H, KP0810/C	82	TC	set 2 ks	D-07945	10,75 €
KP0800, DKP180/181	82	TC	set 5ks	D-35302	52,00 €
	82	TC	set 2 ks D-07945, 1 ks D-07967 + platnička	D-07951	13,18 €
KP312/S	312	HSS	set 2 ks	B-02870	45,39 €
2012NB	306	HSS	set 2 ks	793346-8	46,19 €

Brúsny kameň

veľkosť (mm)	zmitosť	obj. č.	MOC s DPH
150	WA1200	794061-7	11,69 €
180	WA1200	794060-9	13,89 €



TCT drážkovacia fréza



Prírodné a ručne opracované drevo a plasty.
Táto séria líčovacích fréz sa môže používať na profilovanie, lícovanie, drážkovanie, vyrezávanie otvorov, rýh a zahlbovanie do širokej palety rôznych materiálov.
Táto paleta líčovacích fréz kombinuje kvalitu, spoľahlivosť a výkonnosť. Sú vyrobené z karbidu volfrámu, ktorý zabezpečuje dlhšiu životnosť fréz.

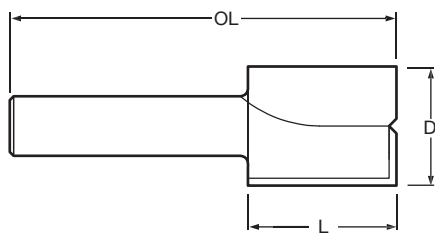
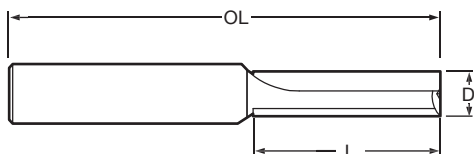

Obj. č.	D (mm)	L (mm)	OL (mm)	stopka (mm)	MOC s DPH
P-78689	3	10	42	8	28,99 €
P-78695	4	10	42	8	26,99 €
P-78704	5	16	51	8	25,99 €
P-78710	6	16	51	8	29,99 €
P-78726	6	23	58	8	32,99 €
P-78732	8	20	52	8	31,99 €
P-78760	10	20	52	8	34,99 €
P-78776	12	20	52	8	35,99 €
P-78748	12	25	67	12	42,99 €
P-78754	12	50	92	12	57,99 €

P-78782	14	20	52	8	36,99 €
P-78798	15	20	52	8	40,99 €
P-78807	16	20	52	8	36,99 €
P-78813	18	20	52	8	38,99 €
P-78829	20	20	52	8	39,99 €
P-78835	24	20	52	8	41,99 €
P-78841	25	20	52	8	40,99 €

FRÉZOVANIE

TCT žliabkovacia fréza s ložiskom

Prírodne a ručne opracované drevo a plasty. Dva tvary produkované jednou frérou pomocou výmeny ložiska. Ložisko B16 odstraňuje drážky. Väčšie ložiská sú menej náchylné na vznik tepla a majú dlhšiu životnosť ako malé ložiská.

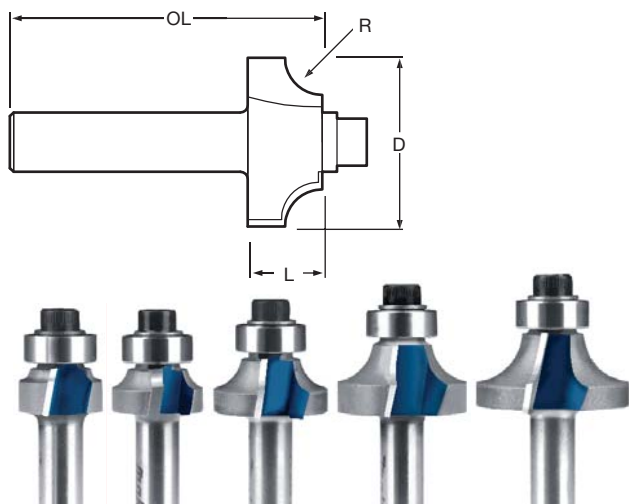

Obj. č.	D (mm)	R (mm)	L (mm)	OL (mm)	stopka (mm)	MOC s DPH
---------	--------	--------	--------	---------	-------------	-----------

P-78857	16,7	2	8	40	8	33,99 €
P-78863	18,7	3	8	40	8	39,99 €
P-78879	22	5	10	42	8	37,99 €
P-78885	25	6,3	12,7	45	8	39,99 €
P-78891	28,35	8	13	45	8	39,99 €
P-78900	31,7	9,5	15,8	48	8	42,99 €

Tvary dosiahnuté pomocou zaobľovacích fréz.

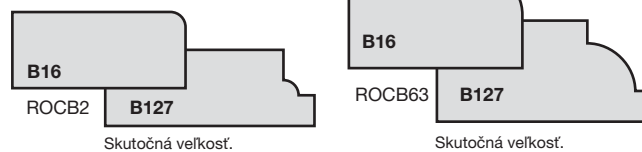

Obj. č.	D (mm)	d (mm)	R (mm)	L (mm)	OL (mm)	stopka (mm)	MOC s DPH
---------	--------	--------	--------	--------	---------	-------------	-----------

TCT zaobľovacia fréza s ložiskom

Prírodne a ručne opracované drevo a plasty. Táto séria obrysových fréz sa môže používať na profilovanie a vyhladzovanie profilov. Vďaka karbidovým hrotom je možné tieto frézy používať na širokú paletu rôznych materiálov. Táto séria je vyrábaná s menšími priermi.

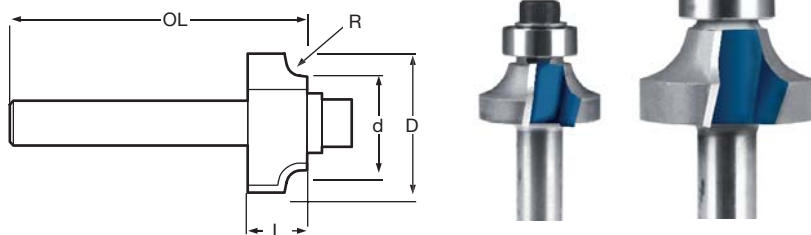

P-78916	18,7	12,7	2	8	40	6	40,99 €
P-78922	20	12,7	3	9	41	6	40,99 €

TCT škárovacia fréza (Biskvit)

Prírodne a ručne opracované drevo a plasty. Umožňuje frézovanie biskvitových spojovacích štrbín do drevotriesky, MDF a tvrdých dreiev pomocou ručnej frézy.

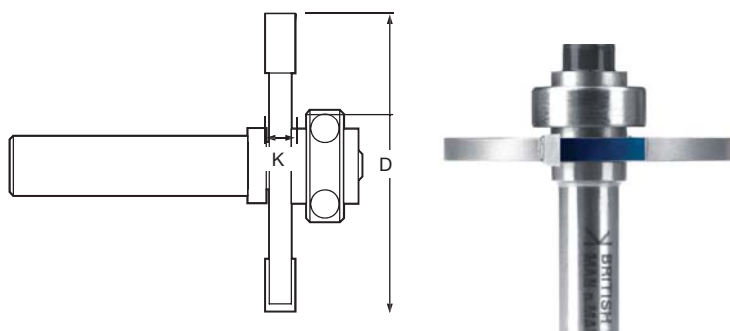

Obj. č.	D (mm)	K (mm)	stopka (mm)	MOC s DPH
---------	--------	--------	-------------	-----------

P-79120	40	4	8	47,99 €
---------	----	---	---	---------

TCT žliabkovacia fréza

Prírodne a ručne opracované drevo a plasty.
Kompletná séria fréz s možnosťou zahĺbenia s horným rezom. Väčšina fréz je kompatibilná so sériou používanou pri linkových spojoch.

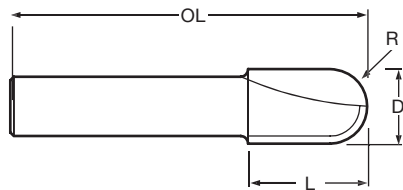

Obj. č.	D (mm)	R (mm)	L (mm)	OL (mm)	stopka (mm)	MOC s DPH
P-78950	10	5	16	48	8	28,99 €
P-78966	12,7	6,3	17	49	8	30,99 €
P-78972	16	8	18	50	8	23,99 €
P-78944	20	10	18	50	8	38,99 €

TCT profilová fréza (vnútorný úkos)

Prírodne a ručne opracované drevo a plasty.
Umožňuje vytváranie pravouhlých rámov. Po zostavení a pri čapovaní sa nevyžaduje lícovanie.

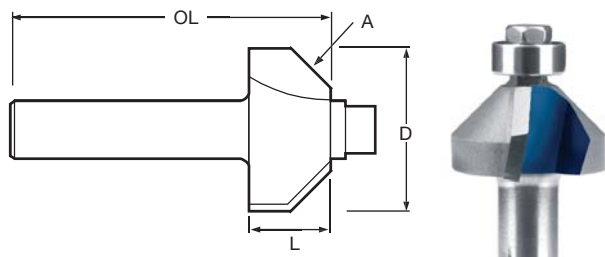

Obj. č.	D (mm)	A°	L (mm)	OL (mm)	stopka (mm)	MOC s DPH
P-79083	22	45	11	43	8	31,99 €

TCT falcovacia fréza (Fréza na poldrážku)

Prírodne a ručne opracované drevo a plasty.

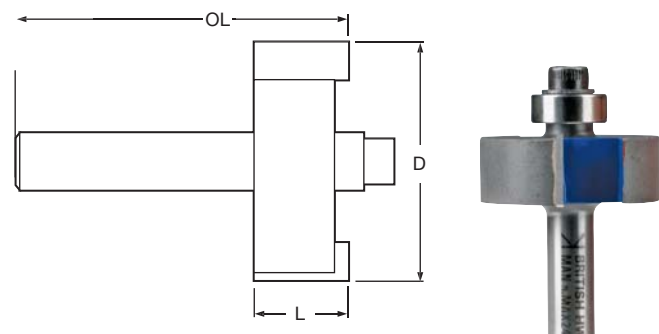

Obj. č.	D (mm)	L (mm)	OL (mm)	stopka (mm)	MOC s DPH
P-79136	32	12,7	44	8	37,99 €

TCT fazetová fréza s ložiskom (fréza na vyduté panely)

Prírodné a ručne opracované drevo a plasty.
Panelové frézy na profilovanie alebo drážkovanie
dekoratívnych šablón a panelov.
Vynikajúce pre čelá zásuviek.

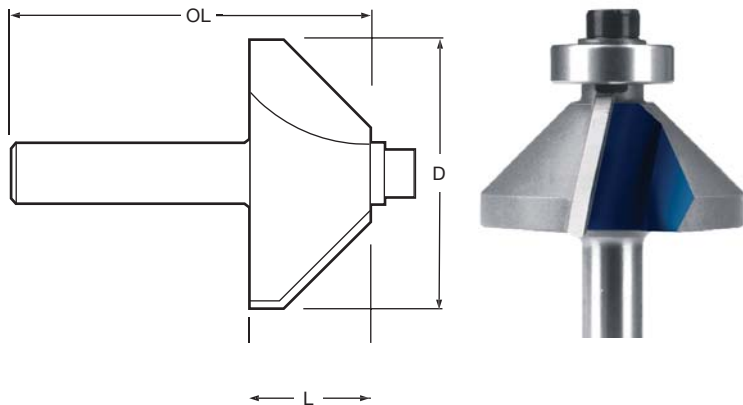

Obj. č.	D (mm)	L (mm)	OL (mm)	stopka (mm)	MOC s DPH
P-79099	36	16	49	8	33,99 €

TCT zarovnávací fréza (fréza na vodiace hrany)

Prírodné a ručne opracované drevo a plasty.
Fréza s dlhšou životnosťou. Mimoriadne populárne
frézy na frézovanie umakartu a laminátu.

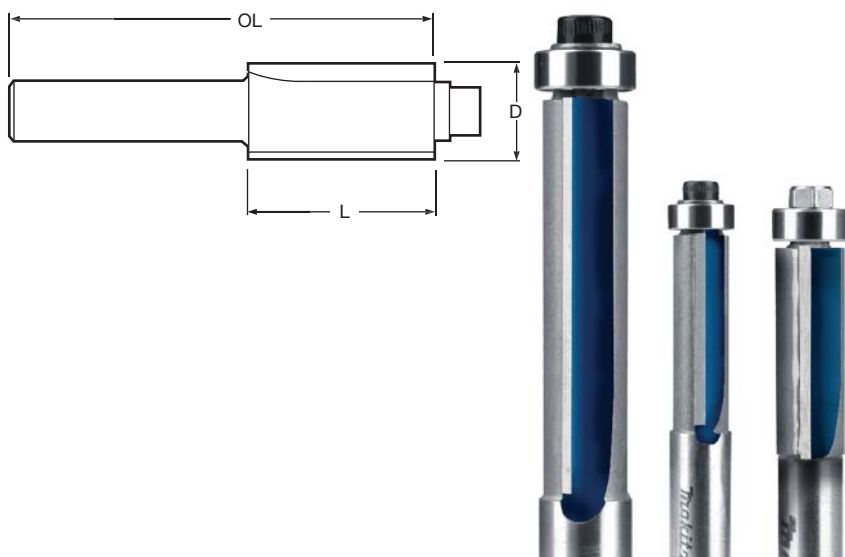

Obj. č.	D (mm)	L (mm)	OL (mm)	stopka (mm)	MOC s DPH
P-78994	12,71	38,1	86	12	37,99 €
P-79005	12,7	25,4	57	8	31,99 €
P-79011	9,5	25	57	8	32,99 €

TCT zarovnávací fréza (Fréza na vodiace hrany, malé priemery)

Prírodné a ručne opracované drevo a plasty.
Vhodné na vyrezávanie otvorov a dier v karavanoch
a v priemysle mobilných domov.

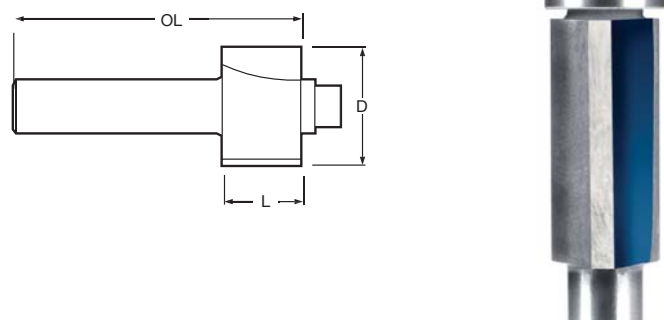

Obj. č.	D (mm)	L (mm)	OL (mm)	stopka (mm)	MOC s DPH
P-79027	18	50	98	12	57,99 €
P-78988	18	12	50	8	27,99 €

TCT žliabkovacia fréza s ložiskom

TCT žliabkovacia fréza

Prírodne a ručne opracované drevo a plasty. Táto séria obrysových fréz sa môže používať na profilovanie a úpravu hladkých povrchov na profile. Tieto frézy sa môžu vďaka karbidovým špičkám používať na rôzne druhy materiálov. Táto séria sa vyrába s menším priemerom.

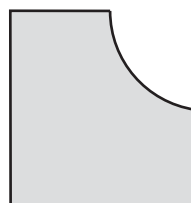
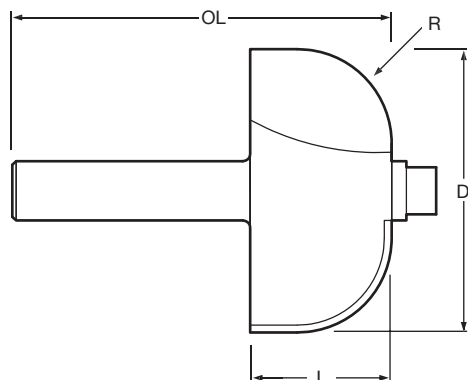

CMC127 – Aktuálna veľkosť

Dodávané s ložiskami B 127 a B 16.

Tvar dosiahnutý pomocou frézy.

Obj. č.	D (mm)	R (mm)	L (mm)	OL (mm)	stopka (mm)	MOC s DPH
P-78938	36	12,7	19	51	8	25,99 €

Ložiská pre frézy

objednávacie číslo frézy	typ ložiska	objednávacie číslo frézy	typ ložiska	objednávacie číslo frézy	typ ložiska	objednávacie číslo frézy	typ ložiska
P-78857	B127/B95	P-78916	B127	P-79011	B95/3.175	P-79083	B95/3.175
P-78863	B127/B95	P-78922	B127	P-79027	B18	P-79099	B127
P-78879	B127/B95	P-78938	B127	P-79033	B16/8	P-79120	B15
P-78885	B127/B95	P-78988	B18	P-79049	B16/8	P-79136	B127
P-78891	B127/B95	P-78994	B127	P-79055	B19/127		
P-78900	B127/B95	P-79005	B127	P-79077	B16		

Ložiská pre frézy

objednávacie číslo	typ ložiska	popis	cena s DPH
P-79245	B127	D=12,7 d=6,35 H=4,8	5,99 €
P-79267	B16	D=16 d=6,35 H=5	8,99 €

D – vonkajší priemer
d – vnútorný priemer
H – výška

objednávacie číslo	popis	cena s DPH
P-79310	Inbusová skrutka M4 × 6	1,99 €

FRÉZOVANIE

TCT profilová vodiaca fréza s ložiskom

Prírodne a ručne opracované drevo a plasty.
Séria PGC fréz je vyrábaná s centrálnymi hrotmi a je ideálna na slepé profilovanie a zahlbovanie napríklad pri dvojvrstvovej lepenke. Tieto frézy majú vodiace ložiská určené na elimináciu hornej montážnej šablóny.

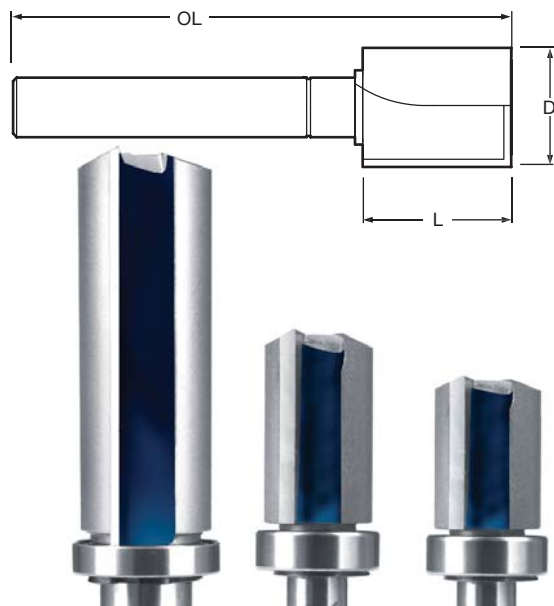

V porovnaní so sekačkou má séria s vodiacim profilom tú výhodu, že je schopná prechádzať cez vrstvu, ktorá má byť osekaná.

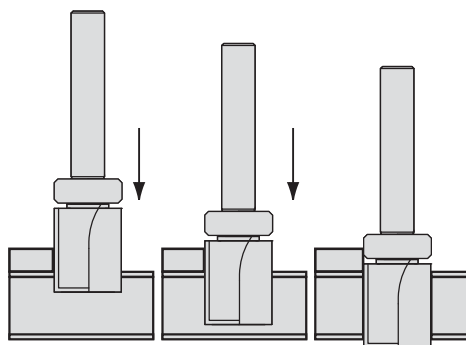

Obj. č.	D (mm)	L (mm)	OL (mm)	stopka (mm)	MOC s DPH
---------	--------	--------	---------	-------------	-----------

P-79055	19	50	96	12	67,99 €
P-79049	16	25	72	8	47,99 €
P-79033	16	20	67	8	48,99 €

TCT rybinová fréza

Prírodne a ručne opracované drevo a plasty.
Štandardná veľkosť pre všetky aplikácie, napríklad frézovanie na rybinu, skrytú rybinu atď. K dispozícii s rysovacími ihlami (na vyžiadanie), čo umožňuje ich používanie spoločne s prenosnými vodiacimi prípravkami.

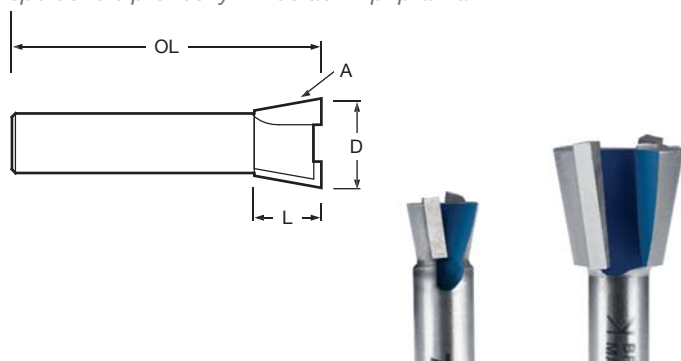

Obj. č.	D (mm)	A°	L (mm)	OL (mm)	stopka (mm)	MOC s DPH
---------	--------	----	--------	---------	-------------	-----------

P-79108	12	10	10	42	8	27,99 €
P-79114	20	10	16	48	8	39,99 €

TCT profilová fréza (drážkovanie – veľký prierez)

Prírodne a ručne opracované drevo a plasty.
Panelové frézy na profilovanie alebo drážkovanie
dekoratívnych tvarov a panelov. Dokonalé na čelá
zásuviek.

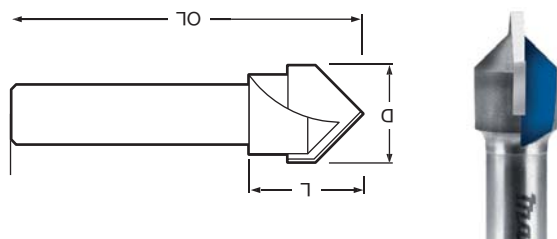

Obj. č.	D (mm)	L (mm)	OL (mm)	stopka (mm)	MOC s DPH
P-79061	12,7	10	47	8	39,99 €



TCT fazetová fréza s ložiskom (na hrany)

Prírodne a ručne opracované drevo a plasty.
Táto fréza je najefektívnejšia na tvorbu sklonu a orezávanie
plastov a laminátu.

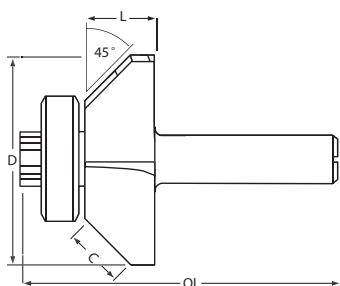



P-79077	24	9	41	8	33,99 €
---------	----	---	----	---	---------





FRÉZOVANIE

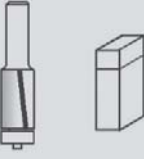



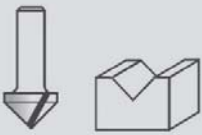

Obj. č.		priemer (mm)	dĺžka (mm)	celková dĺžka (mm)	rádus (mm)	hlbka rezu (mm)	uhol (dg)	stopka (mm)	veľkosť ložiska (mm)	max. otáčky (rpm)	MOC s DPH
TCT profilová vodiaca fréza											
D-47379		3	13	51	-	-	-	8	-	28000	6,67 €
D-47385		4	13	51	-	-	-	8	-	28000	7,07 €
D-47391		5	13	48	-	-	-	8	-	28000	6,39 €
D-47400		6	19	50,8	-	-	-	8	-	28000	6,61 €
D-47416		6	19	50,8	-	-	-	6	-	28000	6,61 €
D-47422		6	16	48	-	-	-	6	-	28000	6,79 €
D-47438		6	25	57	-	-	-	6	-	24000	7,07 €
D-47444		8	19	51	-	-	-	6	-	28000	7,63 €
D-47450		8	25,4	57,4	-	-	-	6	-	24000	7,26 €
D-47466		10	25,4	57,4	-	-	-	6	-	24000	7,42 €
D-47472		12	32	64	-	-	-	6	-	24000	9,28 €
D-47488		14	19	51	-	-	-	6	-	24000	8,66 €
D-47494		20	19	51	-	-	-	6	-	24000	11,22 €
D-47503		6	16	48	-	-	-	8	-	28000	6,79 €
D-47519		6	19	51	-	-	-	8	-	28000	7,04 €
D-47525		8	19	51	-	-	-	8	-	28000	7,63 €
D-47531		10	19	51	-	-	-	8	-	28000	7,82 €
D-47547		12	19	51	-	-	-	8	-	28000	7,54 €
D-47553		14	19	51	-	-	-	8	-	24000	8,85 €

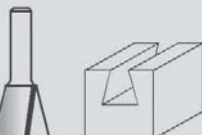

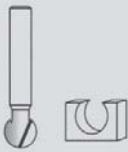
Obj. č.		priemer (mm)	dĺžka (mm)	celková dĺžka (mm)	rádius (mm)	hlĺbka rezu (mm)	uhol (dg)	stopka (mm)	veľkosť ložiska (mm)	max. otáčky (rpm)	MOC s DPH
TCT profilová vodiaca fréza											
D-47569		16	19	51	-	-	-	8	-	24000	9,72 €
D-47575		18	19	51	-	-	-	8	-	24000	11,00 €
D-47581		20	19	51	-	-	-	8	-	24000	11,28 €
D-47597		22	25,4	57,2	-	-	-	8	-	24000	12,43 €
D-47606		24	25,4	57	-	-	-	8	-	24000	15,52 €
D-47612		8	25	70	-	-	-	12	-	24000	8,44 €
D-47628		10	25,4	70	-	-	-	12	-	24000	8,63 €
D-47634		12	32	73	-	-	-	12	-	24000	9,91 €
D-47640		14	32	73	-	-	-	12	-	24000	10,81 €
D-47656		16	32	73	-	-	-	12	-	24000	11,78 €
D-47662		19	32	73	-	-	-	12	-	24000	14,02 €
D-47678		22	32	73	-	-	-	12	-	24000	15,58 €
D-47684		25	32	73	-	-	-	12	-	18000	16,48 €
D-47690			9,5	26	66,9	-	-	-	6	9,5	24000
D-47709	12,7		13	56	-	-	-	6	12,7	28000	8,07 €
D-47715	12,7		26	68,5	-	-	-	6	12,7	24000	8,82 €
D-47721	9,5		26	67	-	-	-	8	9,5	24000	8,38 €
D-47737	12,7		13	55,7	-	-	-	8	12,7	28000	8,66 €
D-47743	12,7		26	68,5	-	-	-	8	12,7	24000	8,94 €
D-47759	12,7		26	68,5	-	-	-	8	12,7	24000	12,81 €
D-47765	12,7	38	91,4	-	-	-	12	12,7	24000	15,36 €	
D-47771		6,35	19	65	-	-	-	6	-	28000	6,95 €
D-47787		6,35	19	65	-	-	-	8	-	28000	6,95 €
D-47793		9,5	26	75	-	-	-	12	-	24000	9,22 €
D-47802		6,35	12,7	44,5	3,2	-	-	6	-	28000	6,67 €
D-47818		9,5	12,7	44,5	4,8	-	-	6	-	28000	7,51 €
D-47824		12,7	19	51	6,35	-	-	6	-	28000	11,03 €
D-47830		6,35	12,7	44,5	3,2	-	-	8	-	28000	6,67 €
D-47846		9,5	12,7	44,5	4,8	-	-	8	-	28000	7,51 €
D-47852		12,7	19	51	6,35	-	-	8	-	28000	11,03 €

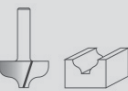

FRÉZOVANIE

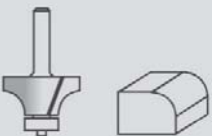
Obj. č.		priemer (mm)	dĺžka (mm)	celková dĺžka (mm)	rádus (mm)	hlbka rezu (mm)	uhol (dg)	stopka (mm)	veľkosť ložiska (mm)	max. otáčky (rpm)	MOC s DPH
TCT profilová vodiaca fréza											
D-47868		12,7	12,7	44,7	-	-	90dg	6	-	28000	7,98 €
D-47874		12,7	16	48	-	-	60dg	6	-	28000	8,29 €
D-47880		19	16	47,6	-	-	90dg	6	-	24000	9,78 €
D-47896		12,7	12,7	44,7	-	-	90dg	8	-	28000	7,98 €
D-47905		15,9	12,7	44	-	-	90dg	8	-	24000	8,54 €
D-47911		12,7	12,7	54	-	-	90dg	12	-	28000	8,16 €
D-47927		15,9	12,7	50,8	-	-	90dg	12	-	24000	8,85 €
D-47933		19	16	47,6	-	-	90dg	8	-	24000	9,78 €
D-47949		19	16	57,3	-	-	90dg	12	-	24000	14,30 €
D-47955		28,6	22,2	60,3	-	-	90dg	12	-	18000	20,06 €
D-47961		12,7	16	48	-	-	60dg	8	-	28000	8,29 €
D-47977			6,35	6,35	38,3	3,2	-	-	8	-	28000
D-47983	7,9		8	40	4	-	-	8	-	28000	7,07 €
D-47999	9,5		9,5	41,3	4,8	-	-	8	-	28000	7,23 €
D-48000	12,7		10	41,5	6,35	-	-	8	-	28000	7,54 €
D-48016	15,8		12,7	44,5	7,9	-	-	8	-	24000	9,78 €
D-48022	15,8		12,7	54	7,9	-	-	12	-	24000	10,16 €
D-48038	19		12,7	50,8	9,5	-	-	12	-	24000	11,37 €
D-48044	25,4		16	57	12,7	-	-	12	-	18000	17,51 €
D-48050		6,35	8	63,5	-	-	7.5 dg	8	-	28000	7,13 €
D-48066		9,5	9,5	40	-	-	9 dg	8	-	28000	7,32 €
D-48072		12,7	13	45	-	-	14 dg	8	-	28000	7,63 €
D-48088		15	14,3	52	-	-	15 dg	8	-	24000	8,75 €
D-48094		19	22,2	63,4	-	-	7 dg	12	-	24000	11,19 €
D-48103		25,4	22,2	64	-	-	14 dg	12	-	18000	13,49 €
D-61852		38	13	53	-	-	-	12	-		62,99 €

Obj. č.		priemer (mm)	dĺžka (mm)	celková dĺžka (mm)	rádius (mm)	hlbka rezu (mm)	uhol (dg)	stopka (mm)	veľkosť ložiska (mm)	max. otáčky (rpm)	MOC s DPH
TCT profilová vodiaca fréza s ložiskom											
D-48119		9,5	8,3	41,3	4,8	-	-	8	-	28000	7,88 €
D-48125		12,7	11,4	44,5	6,4	-	-	8	-	28000	8,82 €
D-48131		15,9	14,8	47,6	7,9	-	-	8	-	24000	10,47 €
D-48147		19	18,2	50,8	9,5	-	-	8	-	24000	11,50 €
D-48153		19	12,7	44,7	6,35	-	-	8	-	24000	11,59 €
D-48169		25,4	16	47,6	9,5	-	-	8	-	18000	13,86 €
D-48175		38,1	28,6	60,3	12,7	-	-	8	-	16000	22,71 €
D-48181		19	11	42,4	3,2	-	-	8	-	24000	11,84 €
D-48197		31,3	16	47,9	6,35	-	-	8	-	18000	17,17 €
D-48206		12,7	10	42	2,4	-	-	8	-	28000	8,35 €
D-48212		19	12,7	44,7	4	-	-	8	-	24000	11,87 €
D-48228		25,4	16	54	5,6	-	-	12	-	18000	15,42 €
D-48234		31,8	19	57	8,7	-	-	12	-	18000	24,21 €
D-48240		12,7	9,5	41,5	2	-	-	8	-	28000	9,13 €
D-48256		19	11	43,1	3,2	-	-	8	-	24000	11,75 €
D-48262		22	13	54	3,2	-	-	8	22,2	24000	19,50 €
D-48278		19	9,5	42,5	3,2	-	-	6	-	24000	8,38 €
D-48284		25,4	13,5	45,5	6,35	-	-	6	-	18000	12,31 €
D-48290		19	9,5	53,4	3,2	-	-	6	12,7	24000	10,28 €
D-48309		20,6	10	58,6	4	-	-	6	12,7	24000	12,34 €
D-48315		25,4	13,5	56,5	6,35	-	-	6	12,7	18000	14,14 €
D-48321		28,6	14,5	57,3	7,9	-	-	6	12,7	18000	15,17 €
D-48337		31,8	16,7	59,7	9,5	-	-	6	12,7	18000	17,98 €



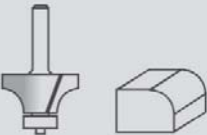
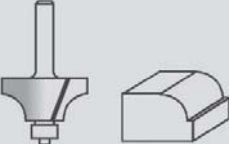





Akumulátory
 Odkladacie systémy
 Vŕtanie
 Skrutkovanie
 Brúsky
 Pilenie
 Frézovanie
 Brúsenie
 Klince / spony
 Špeciálne stroje
 Vysávanie
 Fény/lampy
 Záhrada
 Ručné náradie
 Ostatné

FRÉZOVANIE

Obj. č.		priemer (mm)	dĺžka (mm)	celková dĺžka (mm)	rádus (mm)	hlbka rezu (mm)	uhol (dg)	stopka (mm)	veľkosť ložiska (mm)	max. otáčky (rpm)	MOC s DPH
TCT profilová vodiaca fréza s ložiskom											
D-48343		17,3	8	51	2,3	-	-	8	12,7	24000	10,28 €
D-48359		19	9,5	53,4	3,2	-	-	8	12,7	24000	10,28 €
D-48365		20,7	10	52,3	4	-	-	8	12,7	24000	12,34 €
D-48371		22,2	12,7	55	4,8	-	-	8	12,7	24000	12,81 €
D-48387		25,4	13,5	56,5	6,35	-	-	8	12,7	18000	14,14 €
D-48393		28,6	14,5	57,3	7,9	-	-	8	12,7	18000	15,17 €
D-48402		31,8	16,7	59,7	9,5	-	-	8	12,7	18000	17,98 €
D-48418		38,1	19	62	12,7	-	-	8	12,7	16000	21,31 €
D-48424		50,8	25,4	76,2	19	-	-	12	12,7	14000	35,08 €
D-48430		17	8	49,1	2,3	-	-	6	9,5	24000	10,28 €
D-48446		19	9,5	51,6	3,2	-	-	6	9,5	24000	10,28 €
D-48452		20,3	10	50,5	4	-	-	6	9,5	24000	12,34 €
D-48468		22,2	12,7	53,2	4,8	-	-	6	9,5	24000	12,81 €
D-48474		28,6	14,5	55,5	7,9	-	-	6	9,5	18000	15,17 €
D-48480		17,3	8	49,1	2,3	-	-	8	9,5	24000	10,28 €
D-48496		19	9,5	51,6	3,2	-	-	8	9,5	24000	10,28 €
D-48505		20,7	10	50,5	4	-	-	8	9,5	24000	12,34 €
D-48511		22,2	13	53,2	4,8	-	-	8	9,5	24000	12,81 €
D-48527		25,4	13,5	54,7	6,35	-	-	8	9,5	18000	14,14 €
D-48533	28,6	14,5	55,5	7,9	-	-	8	9,5	18000	15,17 €	
D-48549	31,8	17	57,9	9,5	-	-	8	9,5	18000	17,98 €	
D-48555	38,1	19	60,2	12,7	-	-	8	9,5	16000	21,31 €	
D-48561	50,8	25,4	74,5	19	-	-	12	9,5	14000	36,70 €	
D-48577		28,6	12,7	50,8	4	-	-	8	12,7	18000	14,49 €

Obj. č.		priemer (mm)	dĺžka (mm)	celková dĺžka (mm)	rádius (mm)	hlĺbka rezu (mm)	uhol (dg)	stopka (mm)	veľkosť ložiska (mm)	max. otáčky (rpm)	MOC s DPH	
TCT profilová vodiaca fréza s ložiskom												
D-48583		15,9	6,35	49,2	1,6	-	-	8	12,7	24000	12,84 €	
D-48599		17,5	6,35	49	2,4	-	-	8	12,7	24000	12,84 €	
D-48608		19	9,7	45,6	3,2	-	-	8	12,7	24000	11,37 €	
D-48614		22,2	12,7	55,6	4,8	-	-	8	12,7	24000	12,06 €	
D-48620		28,6	12,7	55,5	7,9	-	-	8	12,7	18000	15,33 €	
D-48636		31,8	14	56	9,5	-	-	8	12,7	18000	18,44 €	
D-48642		38,1	15,4	58,3	12,7	-	-	8	12,7	16000	22,56 €	
D-48658		25,4	11	51	-	-	45dg	6	12,7	18000	13,68 €	
D-48664		22,2	12,7	56,1	-	-	25dg	6	12,7	24000	11,68 €	
D-48670		30,2	12,7	54,5	-	-	45dg	8	12,7	18000	16,48 €	
D-48686		31,8	13,5	55,1	-	-	45dg	8	12,7	18000	17,54 €	
D-48692		34,9	16	58,8	-	-	45dg	8	12,7	16000	19,91 €	
D-48701		41,3	20	58,9	-	-	45dg	8	12,7	16000	25,77 €	
D-48717		44,5	22,6	68,6	-	-	45dg	12	12,7	16000	25,64 €	
D-48723		50,8	27	70,9	-	-	45dg	12	12,7	14000	33,03 €	
D-48739			31,8	12,2	54,6	-	9,5	-	8	12,7	18000	17,04 €
D-48745			31,8	12,2	60,8	-	9,5	-	12	12,7	18000	17,26 €
D-48804		25,4	9,5	52,5	3,2	-	-	6	12,7	18000	15,83 €	
D-48810		28,6	13	55,3	4	-	-	6	12,7	18000	13,18 €	
D-48751		28,6	13	55,3	4	-	-	8	12,7	18000	14,02 €	
D-48767		38,1	17,5	60	6,35	-	-	8	12,7	16000	22,46 €	
D-48773		31,8	12,7	55,6	4,8	-	-	8	12,7	18000	19,35 €	
D-48789		38,1	16	58,9	6,35	-	-	8	12,7	16000	23,77 €	
D-48795		25,4	12,7	53,7	4,8	-	-	6	12,7	18000	14,61 €	

FRÉZOVANIE

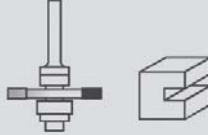
Obj. č.		priemer (mm)	dĺžka (mm)	celková dĺžka (mm)	rádius (mm)	hlbka rezu (mm)	uhol (dg)	stopka (mm)	veľkosť ložiska (mm)	max. otáčky (rpm)	MOC s DPH
D-48826		25,4	13	61,2	4,8	-	-	8	16	18000	20,10 €
D-48832		19	26	67,1	-	4,7	-	8	9,5	24000	24,80 €
D-48848		28,6	41	90,2	-	7,9	-	12	12,7	18000	34,24 €
D-48854		44,5	28,6	79,2	-	15,9	-	12	12,7	16000	39,79 €
D-48860		34,9	26	69,4	-	11,1	-	8	12,7	18000	35,86 €
D-48876		57,2	47,5	102,6	-	22,2	-	12	12,7	14000	58,29 €
D-48882		41	23,4	78,5	-	-	-	12	22	16000	47,26 €
D-48898		41	23,4	78,5	-	-	-	12	22	16000	47,26 €
D-48907		9,5	10,5	48	-	-	-	8	-	28000	6,67 €
D-48913		30,1	25,4	57,2	-	6,35	-	8	-	18000	26,95 €
D-48929		41,3	25,4	76,2	-	7,9	-	12	-	16000	33,03 €
D-48935		41	19	71	-	8,5	-	12	24	16000	37,48 €
D-48941		47,6	2	59	-	12,7	-	8	22,2	16000	18,57 €
D-48957		47,6	2,5	59	-	12,7	-	8	22,2	16000	18,57 €
D-48963		47,6	3	59	-	12,7	-	8	22,2	16000	18,57 €
D-48979		47,6	4	59	-	12,7	-	8	22,2	16000	17,63 €
D-48985		47,6	5	59	-	12,7	-	8	22,2	16000	17,63 €
D-48991		47,6	5,5	59	-	12,7	-	8	22,2	16000	18,76 €



Frézy s britmi osadenými tvrdokovom

Obj. č.	Popis	D	A1	A2	A3	A4	L1	L2	L3	L4	R	R1	R2	H	3612, 3612C RP1800FX RP2300FCX	3620, RP0900 RP0910, RP1110C	3707, 3708, 3709, 3710	MOC s DPH
D-09357	fréza na zaoblené hrany	6	20	8			45	10	4	4					•	•	•	18,99 €
D-09363		6	25	9			48	13	5	8					•	•	•	21,39 €
D-09260	drážkovacia fréza	6	8				50	18							•	•	•	10,19 €
733239-7		6	6				50	18							•	•	•	8,59 €
D-09329	drážkovacia fréza – tvar U	6					50	18	3						•	•	•	13,99 €
D-16988	frézy na hliník	6	10				50	20							•	•	•	12,49 €
D-10584	licovacia fréza	8					60	20	35						•	•		13,99 €
D-12027	pérová fréza	12	38				61	4	20						•			51,09 €
D-09422	fréza na oblé hrany	6	15	8			37	7	3,5	3					•	•	•	21,69 €
D-09547		6	26	12	8		42	12	4,5	8					•	•	•	23,79 €
D-09488	fréza na skosené hrany	6	26	8			42	12					45°		•	•	•	25,79 €

Akumulátory
Odkladacie systémy
Vŕtanie
Skrutkovanie
Brúsky
Pílenie
Frézovanie
Brúsenie
Klince / spony
Špeciálne stroje
Vysávanie
Fény/lampy
Záhrada
Ručné náradie
Ostatné

PRÍSLUŠENSTVO FRÉZY

Klieštiny



model	klúč	upínanie	Obj. č.	MOC s DPH
3706, 3708	17 mm	1/8"	324149-5	9,59 €
		6 mm	763607-0	2,69 €
		1/4"	763608-8	2,59 €
		matica	763240-8	2,99 €
DCO180, DCO181	17 mm	6 mm	763678-7	7,89 €
		1/8"	763677-9	10,79 €
		1/4"	763676-1	14,49 €
3709, 3710, 3711, 3712, M3700, M3702, MT372	10 mm 17 mm	matica	763258-9	5,49 €
		6 mm	763662-2	3,49 €
		1/4"	763663-0	3,49 €
DRT50, RT0700C, RT0702C, M3601, MT361, RT001G	13 mm 22 mm	matica	763661-4	0,89 €
		6 mm	763636-3	8,59 €
		8 mm	763618-5	1,29 €
		1/4"	763637-1	8,49 €
3612, 3612C, 3612BR	13 mm 24 mm	matica	763615-1	1,09 €
		12 mm	763628-2	14,79 €
		1/2"	763622-4	12,89 €
RP0900	13 mm 22 mm	matica	763629-0	3,49 €
		6 mm	763636-3	8,59 €
		8 mm	763618-5	1,29 €
		1/4"	763637-1	8,49 €
RP0910, RP1110C	17 mm	matica	763615-1	1,09 €
		6 mm	*193180-0	25,19 €
		8 mm	*193178-7	23,49 €
RP1800, RP2300, RP1803, RP2303, 3612, 3612C, M3600, M3602, MT362	24 mm	matica	763652-5	3,08 €
		12 mm	763628-2	14,79 €
		1/2"	763622-4	12,89 €
RP1800, RP1803, RP2300, RP2303, 3612, 3612C	12 mm	matica	763674-5	5,79 €
		6 mm	763801-4	3,59 €
		8 mm	763804-8	3,29 €
		10 mm	763807-2	3,99 €
		1/4"	763808-0	4,09 €

* sada

Vodiace objímky

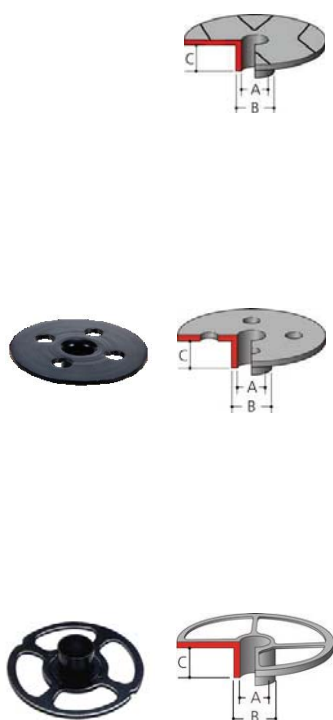

model	A (mm)	B (mm)	C (mm)	Obj. č.	MOC s DPH
DRT50, 3707/F/FC, 3708/F/FC, 3709, 3710, 3711, 3712, N3701, RT0700C, RT0702C	8	10	9,5	343577-5	0,49 €
DRT50**, 3612BR, RP0900, RP1800/F, RP1801/F, RP1803C, RP2300FC, RP2301FC, RP2303C, RT0700C**, RT0702C**	7,7	09.V	11.V	164379-4	13,09 €
	9	11	13	164775-6	13,19 €
	10	12	9	164388-3	14,29 €
	11	12.VII	13	164776-4	17,39 €
	14.V	16	13	344364-5	1,79 €
	18	20	13	164393-0	26,09 €
	24	27	13	164470-8	12,39 €
	25	29	15	163080-8	10,89 €
	27	30	13	164471-6	12,39 €
	37	40	13	165046-4	21,99 €
RP0910, RP1110C	9	11	11.V	193331-5	9,19 €
	14,5	16	11,5	193334-9	13,59 €
	22	24	13	193340-4	17,09 €
	27	30	13	193338-1	15,89 €
	37	40	13	193339-9	18,19 €

**Použite s montážou ponornej základne

PRÍSLUŠENSTVO FRÉZY

Obj. č.	popis	MOC s DPH
Príslušenstvo pre frézy RT0700, DRT50, RT0702C, RT001G 		
	196613-4 vodiaca základňa	24,09 €
	454842-8 platňa základne	2,54 €
	199089-4 vodiaca základňa priehľadná	19,19 €
	195563-0 základňa na ponor	74,59 €
	198987-9 základňa uhlová -30° až 45°	43,19 €
	195562-2 predsadená základňa	93,59 €
	831327-5 taška pre RT0700, RT0702C, DRT50, 3706, RT001G rozmery (ŠxVxD) 304 x 406 x 304 mm	40,59 €



Akumulátory
 Odkladacie systémy
 Vŕtanie
 Skrutkovanie
 Brúsky
 Pílenie
 Frézovanie
 Brúsenie
 Klince / spony
 Špeciálne stroje
 Vysávanie
 Fény/lampy
 Záhrada
 Ručné náradie
 Ostatné

FRÉZOVANIE

model	popis	typ	Obj. č.	MOC s DPH
-------	-------	-----	---------	-----------

Príslušenstvo pre frézy



3707/F/FC, 3708/F/FC	vodiaca základňa		193904-4	41,89 €
3709, 3710, 3711, 3712	vodiaca základňa		194267-1	cena na vyžiadanie
3709, 3710, 3711, 3712	sklopná základňa		194269-7	cena na vyžiadanie
3709, 3710, 3708, 3711, 3712, RT001G, RT0700, RT0702C	vedenie frézy		122703-7	3,99 €
3612BR, RP1800, RP2300, RP1803C, RP2303C	vedenie frézy		123022-4	14,79 €

Paralelne dorazy



DRT50, RT0700		A	122965-7	3,59 €
3709, 3710		A	122704-5	3,49 €
3612BR, RP1800, RP2300		A	342428-9	4,19 €
3620, RP0900/0910, RP1110C M3601, MT361		A	164834-6	3,89 €
DRT50*, RP0900, RP0910, RP1110C, RP1800, RP1803C, RP2300, RP2303C, RT0700C*, RT0702C, RT001G, 3711, 3712		B	195136-9	48,69 €
RT001G**, DRT50**, RT0702C**, 3612BR, RP0900, RP0910, RP1110C, RP1111C, RP1800C, RP1803C, RP2300C, RP2303C	adaptér k vodiacej lište		194579-2	42,29 €

* s použitím ponornej základne 195563-0; ** s použitím základne 195563-0

Držiak paralelného dorazu



3612			122256-6	24,79 €
DRT50, RT001G, RT0700, RT0702C	použitie s ponornou základňou 195563-0		195564-8	4,89 €

Odsávacie adaptéry

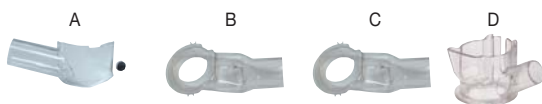

RT0700, RT0702C, DRT50, RT001G		A	195559-1	2,39 €
RP0900, RT0700***, RT001G, RT0702C, DRT50***		B	194733-8	2,99 €
3612, M3600, MT362		C	415412-8	4,69 €
RP1800, RP2300, RP1803C, RP2303C		C	194934-8	9,49 €
3706, DCO180, DCO181		D	193449-2	6,29 €

*** použitie s ponornou základňou 195563-0

Príslušenstvo pre štrbinové frézy DPJ180, PJ7000, 3901

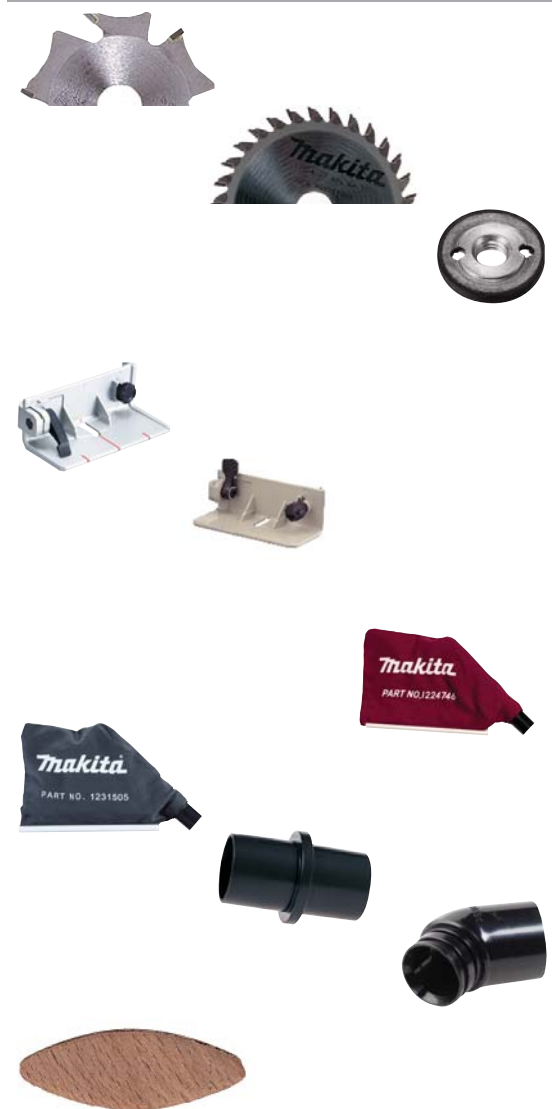

ø mm	vŕtanie	popis	počet zubov	hrúbka kotúča (mm)	Obj. č.	MOC s DPH
100	22	štrbinová fréza	6	4	B-20644	23,29 €
110	20	pílový kotúč	30	4	P-13605	46,09 €
40		príruba vnútorná			224280-6	3,40 €
40		matica príruby			224505-8	2,89 €
		doraz PJ700, DPJ180			123149-0	16,89 €
		doraz 3901			122473-8	45,19 €
		kľúč kolíkový			782401-1	1,09 €
		vak na prach 3901			122474-6	4,59 €
		vak na prach PJ700, DPJ180			123150-5	5,19 €
		adaptér 25 – 27 mm			192349-3	6,69 €
		adaptér odsávania (koleno)			415252-4	1,12 €
		lodička spojovacia N°20 56 x 23,5 mm			P-08850	38,29 €



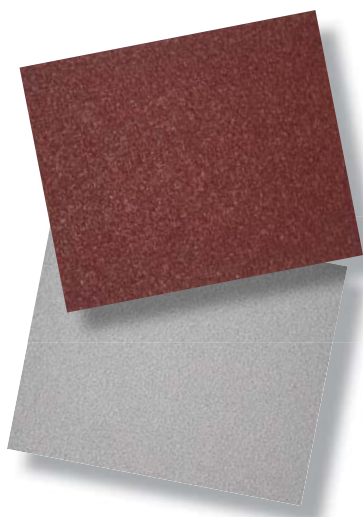

PRÍSLUŠENSTVO NA BRÚSENIE

Brúsne papiere

V našej ponuke nájdete dva typy brúsnych papierov:

Červené – brúsne papiere s dlhou životnosťou vhodné na brúsenie dreva, farebných kovov, plastov, kovu alebo kameňa. Tieto papiere sú štandardne dodávané perforované alebo neperforované v širokej škále zrnitosti, veľkostí a balení.

Biele – brúsne papiere s dlhou životnosťou vhodné na brúsenie dreva, farebných kovov, plastov, kovu alebo kameňa. Tieto brúsne papiere sú ideálne na konečnú úpravu materiálov – brúsenie farieb a lakov. Brúsne papiere sú štandardne dodávané perforované alebo neperforované v širokej škále zrnitosti, veľkostí a balení.

Použitie brúsnych papierov

farba	drevo	drevené materiály	kov	kameň	plasty	konečná povrchová úprava (farba/lak)
červená	••	••	••	••	••	•
biela	•	•	•	•	•	••

•• Ideálne použitie / • Možné použitie

Každý obal brúsnych papierov Makita obsahuje nasledujúce informácie

Makita®

P-37683
150mm

MAKITA
BOSCH
B&D/DEWALT
METABO

100

WOOD

10x



Informácie z obrázku:



- Rozloženie dier na odsávanie prachu
- Uchytenie (v tomto prípade na suchý zips)
- Typ stroja (v tomto prípade excentrická brúska)
- Odporúčaný materiál (v tomto prípade drevo, kov a dokončovacie práce)
- Zrnitosť
- Počet kusov v balení
- Objednávacie číslo
- Rozmer brúsneho papiera
- Značky, pri ktorých je možné tiež použiť papier



Ikony nástrojov a aplikácií:

- Vibračné brúsky
- Excentrické brúsky
- Pásovité brúsky
- Vibračné brúsky
- Multi Tool
- Elektrické pilníky
- Kov
- Farby, lak
- Odstraňovanie hrdzí
- Suchý zips
- Dokončovacie práce

VIBRAČNÉ BRÚSKY – MALÉ VIBRAČNÉ BRÚSKY

Obj. č.	popis	zrornosť	ks/bal	BO4555	BO4556	BO4557	BO4565	BO4563	MOC s DPH
Brúsny papier 114 × 140 mm, neperforovaný 									
<i>Vhodné pre farebné kovy, plasty, drevo, drevo s klincami, kov, kameň</i>									
		brúsny papier	P-36398	40	10	•	•	•	2,97 €
P-32904			60	10	•	•	•	2,62 €	
P-36407			80	10	•	•	•	2,54 €	
P-32910			100	10	•	•	•	2,35 €	
P-32926			120	10	•	•	•	2,35 €	
P-32932			150	10	•	•	•	2,35 €	
P-36413			180	10	•	•	•	2,35 €	
P-36429			240	10	•	•	•	2,35 €	
P-36485			150	50	•	•	•	8,84 €	

Obj. č.	popis	zrornosť	ks/bal	BO4555	BO4556	BO4557	BO4565	BO4563	MOC s DPH
Brúsny papier 114 × 140 mm, neperforovaný 									
<i>Vhodné pre laky a farby, farebné kovy, plasty, drevo, drevo s klincami, kov, kameň.</i>									
		brúsny papier	P-36522	60	10	•	•	•	3,38 €
P-36538			80	10	•	•	•	3,29 €	
P-36544			100	10	•	•	•	3,21 €	
P-36550			120	10	•	•	•	3,21 €	
P-36572			180	10	•	•	•	3,21 €	
P-36619			80	50	•	•	•	12,88 €	
P-36625			100	50	•	•	•	12,43 €	

Obj. č.	popis	zrornosť	ks/bal	BO4555	BO4556	BO4557	BO4565	BO4563	MOC s DPH
Brúsny papier na suchý zips 114 × 102 mm, perforovaný, 6 otvorov 									
<i>Vhodné pre farebné kovy, plasty, drevo, drevo s klincami, kov, kameň.</i>									
		brúsny papier	P-33087	40	10	•	•	•	3,79 €
P-33093			60	10	•	•	•	3,65 €	
P-33102			80	10	•	•	•	3,57 €	
P-33118			100	10	•	•	•	3,53 €	
P-33124			120	10	•	•	•	3,53 €	
P-33130			150	10	•	•	•	3,53 €	
P-33146			180	10	•	•	•	3,53 €	
P-33152			240	10	•	•	•	3,53 €	
P-33168			320	10	•	•	•	3,53 €	
P-42416			40	50	•	•	•	16,03 €	
P-42422			60	50	•	•	•	15,35 €	
P-42438			80	50	•	•	•	14,96 €	
P-42450			120	50	•	•	•	14,72 €	

VIBRAČNÉ BRÚSKY – MALÉ VIBRAČNÉ BRÚSKY

Obj. č.	popis	zrornosť	ks/bal	BO4555	BO4556	BO4557	BO4565	BO4563	MOC s DPH
Brúsny papier na suchý zips 114 × 102mm, perforovaný 6 otvorov *****									
Vhodné pre laky a farby, farebné kovy, plasty, drevo, drevo s klincami, kov, kameň.	brúsny papier	P-35807	40	10	•		•	•	4,39 €
		P-35813	60	10	•		•	•	4,16 €
		P-35829	80	10	•		•	•	4,05 €
		P-35835	100	10	•		•	•	3,97 €
		P-35841	120	10	•		•	•	3,97 €
		P-35857	150	10	•		•	•	3,97 €
		P-35885	320	10	•		•	•	3,97 €
		P-42503	40	50	•		•	•	19,06 €
		P-42519	60	50	•		•	•	17,87 €
		P-42553	150	50	•		•	•	16,95 €
P-42581	320	50	•		•	•	16,95 €		



Obj. č.	popis	zrornosť	ks/bal	BO4555	BO4556	BO4557	BO4565	BO4563	MOC s DPH	
Brúsny papier na suchý zips 95 × 95 × 95mm, perforovaný 6 otvorov *****										
Vhodné pre farebné kovy, plasty, drevo, drevo s klincami, kov, kameň.	brúsny papier	P-33255	40	10				•	•	3,03 €
		P-33261	60	10				•	•	2,95 €
		P-33277	80	10				•	•	2,90 €
		P-33283	100	10				•	•	2,85 €
		P-33299	120	10				•	•	2,85 €
		P-33308	150	10				•	•	2,85 €
		P-33314	180	10				•	•	2,85 €
		P-33320	240	10				•	•	2,85 €
		P-33336	320	10				•	•	2,85 €
		P-42597	40	50				•	•	12,20 €
		P-42606	60	50				•	•	11,81 €
		P-42612	80	50				•	•	11,57 €
		P-42628	100	50				•	•	11,32 €
		P-42634	120	50				•	•	11,32 €
		P-42640	150	50				•	•	11,32 €
		P-42656	180	50				•	•	11,32 €
		P-42662	240	50				•	•	11,32 €



Obj. č.	popis	zrornosť	ks/bal	BO4555	BO4556	BO4557	BO4565	BO4563	MOC s DPH	
Brúsny papier na suchý zips 95 × 95 × 95mm, perforovaný 6 otvorov *****										
Vhodné pre laky a farby, farebné kovy, plasty, drevo, drevo s klincami, kov, kameň.	brúsny papier	P-42684	40	10				•	•	3,02 €
		P-42690	60	10				•	•	2,89 €
		P-42709	80	10				•	•	2,86 €
		P-42715	100	10				•	•	2,81 €
		P-42721	120	10				•	•	2,81 €
		P-42737	150	10				•	•	2,81 €
		P-42743	180	10				•	•	2,81 €
		P-42759	240	10				•	•	2,81 €
		P-42765	320	10				•	•	2,75 €
		P-42771	40	50				•	•	12,16 €
		P-42787	60	50				•	•	11,52 €
		P-42793	80	50				•	•	11,39 €
		P-42802	100	50				•	•	11,14 €
		P-42818	120	50				•	•	11,14 €
		P-42852	320	50				•	•	10,84 €



VIBRAČNÉ BRÚSKY – MALÉ VIBRAČNÉ BRÚSKY

Brúsny papier na suchý zips 100 × 240mm, perforovaný, 10 otvorov



Vhodné pre farebné kovy, plasty, drevo, drevo s klincami, kov, kameň.

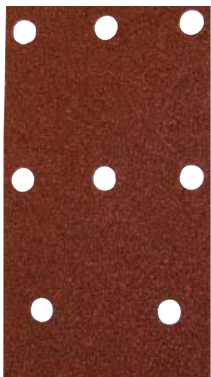

Obj. č.	popis	zrornosť	ks/bal	BO4555	BO4556	BO4557	BO4565	BO4563	MOC s DPH
P-42868	brúsny papier	40	10	•		•	•		5,37 €
P-42874		60	10	•		•	•		5,17 €
P-42896		100	10	•		•	•		4,98 €
P-42905		120	10	•		•	•		4,98 €
P-42911		150	10	•		•	•		4,98 €
P-42977		100	50	•		•	•		21,96 €
P-42983		120	50	•		•	•		21,96 €

Ďalšie príslušenstvo



Obj. č.	popis	ks/bal	BO4555	BO4556	BO4557	BO4565	BO4563	MOC s DPH
450066-4	dierovacia doska	1	•	•	•			0,79 €
135246-0	papierové vrečko vrátane držiaku	1	•	•	•	•	•	4,79 €
193293-7	papierové vrečko / balenie	5	•	•	•	•	•	6,69 €
192349-3	odsávací adaptér k vysávačom 25 – 50 mm	1	•	•	•	•	•	6,69 €
02300B0N	sacia hadica ø 30 mm – 440	1	•	•	•	•	•	66,79 €
P-70487	sacia hadica ø 27 mm – 446L/447L	1	•	•	•	•	•	89,69 €
824806-0	transportný kufrík	1	•	•	•	•	•	13,49 €

VIBRAČNÉ BRÚSKY – MALÉ VIBRAČNÉ BRÚSKY

Obj. č.	popis	zrornosť	ks/bal	9036	BO3700, BO3710, BO3711	BO4900V	9046	MOC s DPH
---------	-------	----------	--------	------	------------------------------	---------	------	-----------

Brúsny papier 93 × 228 mm, perforovaný



Vhodné pre farebné kovy, plasty, drevo, drevo s klincami, kov, kameň.



P-31837	brúsny papier	40	10		•			2,88 €
P-31843		60	10		•			2,67 €
P-31859		80	10		•			2,62 €
P-31865		100	10		•			2,56 €
P-36011		120	10		•			2,56 €
P-36027		150	10		•			2,56 €
P-36033		180	10		•			2,56 €
P-36049		240	10		•			2,56 €
P-36055		40	50		•			11,46 €
P-36061		60	50		•			10,40 €
P-36077		80	50		•			10,15 €
P-36083		100	50		•			9,89 €
P-36099		120	50		•			9,89 €
P-36108		150	50		•			9,89 €
P-36114		180	50		•			9,89 €
P-36120		240	50		•			9,89 €

Brúsny papier na suchý zips 93 × 185 mm, perforovaný, suchý zips



Vhodné pre farebné kovy, plasty, drevo, drevo s klincami, kov, kameň.



P-31871	brúsny papier	40	10		•			4,50 €
P-31887		60	10		•			4,03 €
P-31893		80	10		•			3,93 €
P-31902		100	10		•			3,82 €
P-35891		120	10		•			3,82 €
P-35900		150	10		•			3,82 €
P-35916		180	10		•			3,82 €
P-35922		240	10		•			3,82 €
P-35938		40	50		•			19,58 €
P-35944		60	50		•			17,23 €
P-35950		80	50		•			16,70 €
P-35966		100	50		•			16,17 €
P-35972		120	50		•			16,17 €
P-35988		150	50		•			16,17 €
P-35994		180	50		•			16,17 €

Brúsny papier 93 × 228 mm, neperforovaný









Vhodné pre farebné kovy, plasty, drevo, drevo s klincami, kov, kameň.



P-36136	brúsny papier	40	10	•	•			2,49 €
P-32948		60	10	•	•			2,28 €
P-36142		80	10	•	•			2,23 €
P-32954		100	10	•	•			2,17 €
P-36158		120	10	•	•			2,17 €
P-32960		150	10	•	•			2,17 €
P-36164		180	10	•	•			2,17 €
P-36170		240	10	•	•			2,17 €

VIBRAČNÉ BRÚSKY – MALÉ VIBRAČNÉ BRÚSKY

Obj. č.	popis	zrntosť	ks/bal	9036	BO3700, BO3710, BO3711	BO4900V	9046	MOC s DPH		
Brúsny papier 115 × 280mm, neperforovaný 										
<i>Vhodné pre farebné kovy, plasty, drevo, drevo s klincami, kov, kameň.</i>		P-36267	40	10			•	•	4,20 €	
		P-32976	60	10			•	•	3,51 €	
		P-36273	80	10			•	•	3,36 €	
		P-32982	100	10			•	•	3,22 €	
		P-36289	120	10			•	•	3,22 €	
		P-32998	150	10			•	•	3,22 €	
		P-36295	180	10			•	•	3,22 €	
		P-36304	240	10			•	•	3,22 €	
		P-36310	40	50			•	•	17,57 €	
		P-36326	60	50			•	•	14,64 €	
		P-36332	80	50			•	•	13,76 €	
		P-36348	100	50			•	•	13,18 €	
		P-36360	150	50			•	•	13,18 €	
		P-36382	240	50			•	•	13,18 €	
		Brúsny papier 115 × 280mm, perforovaný, 14 otvorov 								
<i>Vhodné pre farebné kovy, plasty, drevo, drevo s klincami, kov, kameň.</i>		P-33009	40	10			•	•	3,69 €	
		P-33015	60	10			•	•	3,38 €	
		P-33021	80	10			•	•	3,28 €	
		P-33037	100	10			•	•	3,22 €	
		P-33043	120	10			•	•	3,22 €	
		P-33059	150	10			•	•	3,22 €	
		P-33065	180	10			•	•	3,22 €	
		P-33071	240	10			•	•	3,22 €	
		P-35667	80	50			•	•	13,47 €	
		P-35695	150	50			•	•	13,18 €	
		P-35710	240	50			•	•	13,18 €	
		Brúsny papier so suchým zipsom 115 × 229mm, perforovaný 10 otvorov 								
		<i>Vhodné pre farebné kovy, plasty, drevo, drevo s klincami, kov, kameň.</i>		P-33174	40	10			•	•
P-33180	60			10			•	•	5,56 €	
P-33196	80			10			•	•	5,27 €	
P-33205	100			10			•	•	5,17 €	
P-33211	120			10			•	•	5,17 €	
P-33227	150			10			•	•	5,17 €	
P-33233	180			10			•	•	5,17 €	
P-33249	240			10			•	•	5,17 €	
P-35748	80			50			•	•	23,42 €	
P-35760	120			50			•	•	22,94 €	
P-35798	240			50			•	•	22,94 €	

VIBRAČNÉ BRÚSKY – MALÉ VIBRAČNÉ BRÚSKY

Obj. č.	popis	zrmitosť	ks/bal	9036	BO3700, BO3710, BO3711	BO4900V	9046	MOC s DPH
Brúsny papier so suchým zipsom 115 × 229 mm, perforovaný 14 otvorov *****								
<i>Vhodné pre farebné kovy, plasty, drevo, drevo s klincami, kov, kameň.</i>								
P-43022	brúsny papier	40	10			•	•	5,86 €
P-43038		60	10			•	•	5,56 €
P-43044		80	10			•	•	5,27 €
P-43050		100	10			•	•	5,17 €
P-43066		120	10			•	•	5,17 €
P-43088		180	10			•	•	5,17 €
P-43094		240	10			•	•	5,17 €
P-43125		80	50			•	•	23,42 €
P-43131		100	50			•	•	22,94 €
P-43147		120	50			•	•	22,94 €
P-43175		240	50			•	•	22,94 €

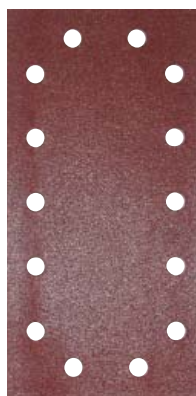

Obj. č.	popis	ks/bal	BO3700	BO3710, BO3711	BO4900V	9036	9046	MOC s DPH
Ďalšie príslušenstvo *****								
192989-7	dierovacia doska	1	•	•				6,09 €
192523-3		1			•		•	26,19 €
194930-6	základná doska – suchý zips	1	•	•				15,19 €
193521-0		1			•		•	26,59 €
122442-9	základná doska	1				•		37,93 €
140441-9		1		•				2,59 €
162172-0		1					•	24,07 €
193294-5	papierové vrečko vrátane držiaku	1	•	•	•		•	11,19 €
135246-0		1	•					4,79 €
135246-0		1		•				4,79 €
• 194746-9	papierové vrečko / balenie pre držiak 135237-0 a 135246-0	5	•					4,69 €
•• 193293-7	papierové vrečko / balenie pre držiak 193294-5	5	•	•	•		•	6,69 €
••• 168557-8	papierové vrečko / balenie pre držiak 135237-0 a 135246-0	1		•				1,99 €

*len k nádobe 135246-0 **len k držiaku 193294-5 ***len k nádobe 135237-0

EXCENTRICKÉ BRÚSKY

Brúsny papier na suchý zips 125 mm, 8 otvorov



Vhodné pre farebné kovy, plasty, drevo, drevo s klincami, kov, kameň.

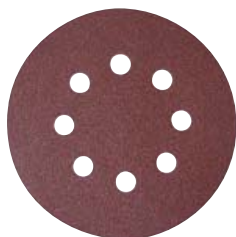

Obj. č.	popis	zrornosť	ks/bal	BO5010, BO5012, BO5030, BO5031	BO5020, BO5021, BO5041	BO6030	BO6040	MOC s DPH
P-43533	brúsny papier	40	10	•	•			4,39 €
P-43549		60	10	•	•			4,19 €
P-43555		80	10	•	•			3,89 €
P-43561		100	10	•	•			3,89 €
P-43577		120	10	•	•			3,89 €
P-43583		180	10	•	•			3,89 €
P-43599		240	10	•	•			3,89 €
P-43608		320	10	•	•			3,89 €
P-43614		400	10	•	•			3,79 €
P-43620		40	50	•	•			18,59 €
P-43636		60	50	•	•			17,99 €
P-43642		80	50	•	•			16,69 €
P-43658		100	50	•	•			16,39 €
P-43664		120	50	•	•			16,39 €
P-43670		180	50	•	•			16,49 €
P-43686		240	50	•	•			16,49 €
P-43692		320	50	•	•			16,39 €
P-43701		400	50	•	•			16,29 €

Brúsny papier na suchý zips 125 mm, 8 otvorov



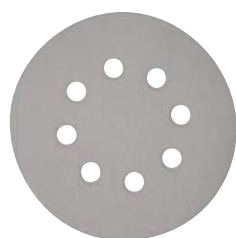

Vhodné pre farebné kovy, plasty, drevo, drevo s klincami, kov, kameň.



Obj. č.	popis	zrornosť	ks/bal	BO5010, BO5012, BO5030, BO5031	BO5020, BO5021, BO5041	BO6030	BO6040	MOC s DPH
P-33342	brúsny papier	40	10	•	•			3,79 €
P-33358		60	10	•	•			3,69 €
P-33364		80	10	•	•			3,49 €
P-33370		100	10	•	•			3,39 €
P-33386		120	10	•	•			3,39 €
P-33392		180	10	•	•			3,39 €
P-33401		240	10	•	•			3,39 €
P-33417		320	10	•	•			3,39 €
P-33423		400	10	•	•			3,39 €
P-37384		40	50	•	•			16,39 €
P-37390		60	50	•	•			15,59 €
P-37409		80	50	•	•			14,79 €
P-37415		100	50	•	•			14,09 €
P-37421		120	50	•	•			14,29 €
P-37437		180	50	•	•			14,09 €
P-37443		240	50	•	•			13,99 €
P-37459		320	50	•	•			14,09 €
P-37465		400	50	•	•			14,29 €

EXCENTRICKÉ BRÚSKY

Obj. č.	popis	zrnitost	ks/bal	BO5010, BO5012, BO5030, BO5031	BO5020, BO5021, BO5041	BO6030	BO6040	MOC s DPH	
Brúsny papier na suchý zips 150mm, 6 otvorov *****									
<p>Vhodné pre laky a farby, farebné kovy, plasty, drevo, drevo s klincami, kov, kameň.</p> 	P-37471	brúsny papier	40	10			•	•	6,09 €
	P-37487		60	10			•	•	5,79 €
	P-37493		80	10			•	•	5,69 €
	P-37502		100	10			•	•	5,29 €
	P-37518		120	10			•	•	5,29 €
	P-37524		180	10			•	•	5,29 €
	P-37530		240	10			•	•	5,29 €
	P-37546		320	10			•	•	4,89 €
	P-37552		400	10			•	•	5,29 €
	P-37568		40	50			•	•	27,89 €
	P-37574		60	50			•	•	27,19 €

Obj. č.	popis	zrnitost	ks/bal	BO5010, BO5012, BO5030, BO5031	BO5020, BO5021, BO5041	BO6030	BO6040	MOC s DPH	
Brúsny papier na suchý zips 150mm, 6 otvorov *****									
<p>Vhodné pre laky a farby, farebné kovy, plasty, drevo, drevo s klincami, kov, kameň.</p> 	P-37580	brúsny papier	80	50			•	•	25,29 €
	P-37596		100	50			•	•	24,19 €
	P-37605		120	50			•	•	23,79 €
	P-37611		180	50			•	•	23,99 €
	P-37627		240	50			•	•	24,39 €
	P-37633		320	50			•	•	25,49 €
	P-37649		400	50			•	•	24,29 €

Obj. č.	popis	zrnitost	ks/bal	BO5010, BO5012, BO5030, BO5031	BO5020, BO5021, BO5041	BO6030	BO6040	MOC s DPH	
Brúsny papier na suchý zips 150mm, 6 otvorov *****									
<p>Vhodné pre laky a farby, farebné kovy, plasty, drevo, drevo s klincami, kov, kameň.</p> 	P-37655	brúsny papier	40	10			•	•	5,69 €
	P-37661		60	10			•	•	5,29 €
	P-37677		80	10			•	•	5,19 €
	P-37683		100	10			•	•	4,99 €
	P-37699		150	10			•	•	4,89 €
	P-37708		180	10			•	•	4,99 €
	P-37714		240	10			•	•	4,99 €
	P-37720		320	10			•	•	4,79 €
	P-37736		400	10			•	•	4,99 €
	P-37742		40	50			•	•	24,29 €
	P-37758		60	50			•	•	22,09 €
	P-37764		80	50			•	•	21,59 €
	P-37770		100	50			•	•	20,99 €
	P-37786		120	50			•	•	20,99 €
	P-37792		180	50			•	•	20,39 €
	P-37801		240	50			•	•	21,19 €
	P-37817		320	50			•	•	21,29 €
	P-37823		400	50			•	•	20,29 €

EXCENTRICKÉ BRÚSKY

Obj. č.	popis	zrmitosť	ks/bal	BO5010, BO5012, BO5030, BO5031	BO5020, BO5021, BO5041	BO6030	BO6040	MOC s DPH
---------	-------	----------	--------	---	------------------------------	--------	--------	-----------

Brúsny papier na suchý zips 150 mm, 8 + 1 otvor



Vhodné pre farebné kovy, plasty, drevo, drevo s klincami, kov, kameň.



P-31918	brúsny papier	40	10			•	•	6,09 €
P-31924		60	10			•	•	5,79 €
P-31930		80	10			•	•	5,59 €
P-31946		100	10			•	•	5,39 €
P-31952		120	10			•	•	5,29 €
P-31968		150	10			•	•	5,19 €
P-31974		180	10			•	•	5,29 €
P-31980		220	10			•	•	5,29 €
P-31996		240	10			•	•	5,19 €
P-32007		320	10			•	•	5,29 €
P-32580		60	50			•	•	26,89 €
P-32596		80	50			•	•	26,19 €
P-32605		100	50			•	•	23,99 €
P-32611		120	50			•	•	23,69 €
P-32661		320	50			•	•	23,89 €
P-32677		400	50			•	•	23,29 €

Brúsny papier na suchý zips 150 mm, 8 + 1 otvor



Vhodné pre laky a farby, farebné kovy, plasty, drevo, drevo s klincami, kov, kameň.



P-37839	brúsny papier	40	10			•	•	5,79 €
P-37845		60	10			•	•	5,39 €
P-37851		80	10			•	•	5,19 €
P-37867		100	10			•	•	4,89 €
P-37873		120	10			•	•	4,89 €
P-37889		150	10			•	•	4,99 €
P-37895		180	10			•	•	4,89 €
P-37904		220	10			•	•	4,59 €
P-37910		240	10			•	•	4,89 €
P-37932		400	10			•	•	4,89 €
P-37960		80	50			•	•	20,99 €
P-37976		100	50			•	•	19,79 €
P-37982		120	50			•	•	20,29 €
P-37998		180	50			•	•	19,79 €
P-38009		240	50			•	•	19,89 €
P-38015		320	50			•	•	19,59 €
P-38021		400	50			•	•	20,59 €

EXCENTRICKÉ BRÚSKY

Brúsny papier / rolka



Obj. č.	popis	rozmer / m	zrnitosť	MOC s Dph

P-38102	brúsny papier	120 / 5	40	6,99 €
P-38118		120 / 5	60	5,19 €
P-38205		120 / 50	60	45,99 €
P-38124		120 / 5	80	4,49 €
P-38211		120 / 50	80	41,99 €
P-38130		120 / 5	100	4,09 €
P-38227		120 / 50	100	36,99 €
P-38146		120 / 5	120	4,09 €
P-38233		120 / 50	120	38,99 €
P-38152		120 / 5	180	3,99 €
P-38249		120 / 50	180	36,99 €
P-38168		120 / 5	240	4,19 €
P-38174		120 / 5	320	3,99 €
P-38261		120 / 50	320	36,99 €
P-38180		120 / 5	400	3,99 €



ELEKTRICKÉ PILNÍKY

Obj. č.	popis	zrnitosť	ks/bal	9032	9031	9910	9911	MOC s DPH
---------	-------	----------	--------	------	------	------	------	-----------

Textilný brúsny pás 6 × 533 mm



Vhodné pre farebné kovy, plasty, drevo, drevo s klincami, kov, kameň.



P-43181	Brúsny papier	40	5	•				4,61 €
P-43197		60	5	•				4,51 €
P-43206		80	5	•				4,41 €
P-43212		100	5	•				4,38 €
P-43228		120	5	•				4,38 €

Textilný brúsny pás 9 × 533 mm



Vhodné pre farebné kovy, plasty, drevo, drevo s klincami, kov, kameň.



P-43256	Brúsny papier	40	5	•				5,19 €
P-43262		60	5	•				5,09 €
P-43278		80	5	•				4,99 €
P-43284		100	5	•				4,89 €
P-43290		120	5	•				4,99 €
P-43309		150	5	•				4,59 €
P-43315		240	5	•				4,89 €
P-43256		40	5	•				5,19 €
P-43262		60	5	•				5,09 €
P-43278		80	5	•				4,99 €
P-43284		100	5	•				4,89 €
P-43290		120	5	•				4,99 €

Textilný brúsny pás 13 × 533 mm



Vhodné pre farebné kovy, plasty, drevo, drevo s klincami, kov, kameň.



P-43321	Brúsny papier	40	5	•				6,39 €
P-43337		60	5	•				6,09 €
P-43343		80	5	•				6,19 €
P-43359		100	5	•				5,89 €
P-43365		120	5	•				6,49 €
P-43371		150	5	•				5,99 €
P-43387		240	5	•				5,99 €

Textilný brúsny pás 30 × 533 mm



Vhodné pre farebné kovy, plasty, drevo, drevo s klincami, kov, kameň.



P-36675	Brúsny papier	40	5	•				4,19 €
P-36681		60	5	•				4,09 €
P-36697		80	5	•				3,89 €
P-36706		100	5	•				3,79 €
P-36712		120	5	•				3,69 €
P-36728		150	5	•				3,79 €
P-36734		240	5	•				3,79 €

ELEKTRICKÉ PILNÍKY

Obj. č.	popis	zrntosť	ks/bal	9032	9037	9910	9911	MOC s DPH
---------	-------	---------	--------	------	------	------	------	-----------

Textilný brúsny pás 30 × 533 mm



Vhodné na sklo –
suché brúsenie.



P-01404	Brúsny papier	60	5		•			9,19 €
P-01199		80	5		•			9,09 €
P-01208		100	5		•			8,69 €
P-01214		120	5		•			7,89 €
P-01220		150	5		•			7,99 €
P-01236		240	5		•			9,99 €

PÁSOVÉ BRÚSKY

Textilný brúsny pás 76 × 457 mm



Vhodné na sklo –
suché brúsenie



P-37091	Brúsny papier	40	5			•	•	8,59 €
P-37100		60	5			•	•	8,49 €
P-37116		80	5			•	•	8,39 €
P-37122		100	5			•	•	8,19 €
P-37138		120	5			•	•	8,09 €
P-37144		150	5			•	•	8,19 €
P-37150		240	5			•	•	8,09 €
P-37166		40, 80, 120	3			•	•	4,99 €

Obj. č.	popis	zrntosť	ks/bal	9903	9920	9924DB	9402	9403	9404	MOC s DPH
---------	-------	---------	--------	------	------	--------	------	------	------	-----------

Textilný brúsny pás 76 × 533 mm



Vhodné pre farebné
kovy, plasty, drevo,
drevo s klincami,
kov, kameň.



P-37172	Brúsny papier	40	5	•						9,29 €
P-37188		60	5	•						8,79 €
P-37194		80	5	•						8,29 €
P-37203		100	5	•						8,09 €
P-37219		120	5	•						8,19 €
P-37225		150	5	•						8,09 €
P-37231		240	5	•						8,09 €
P-37247		40	25	•						40,29 €
P-37253		60	25	•						37,19 €
P-37269		80	25	•						35,59 €
P-37275		100	25	•						34,59 €
P-37281		120	25	•						33,79 €
P-37297		150	25	•						34,39 €
P-43393		40	50	•						73,99 €
P-43402		60	50	•						71,89 €
P-43418		80	50	•						66,49 €
P-43424		100	50	•						67,49 €
P-43430		120	50	•						65,29 €
P-43446		150	50	•						68,99 €
P-43452		240	50	•						62,99 €

PÁSOVÉ BRÚSKY

Obj. č.	popis	zrmitosť	ks/bal	9903	9920	9924DB	9402	9403	9404	MOC s DPH
---------	-------	----------	--------	------	------	--------	------	------	------	-----------

Textilný brúsny pás 76 × 610mm



Vhodné pre farebné kovy, plasty, drevo, drevo s klincami, kov, kameň.



P-37312	Brúsny papier	40	40	5		•	•			9,99 €
P-37328		60	60	5		•	•			9,59 €
P-37334		80	80	5		•	•			8,89 €
P-37340		100	100	5		•	•			8,69 €
P-37356		120	120	5		•	•			8,59 €
P-37362		150	150	5		•	•			8,59 €
P-37378		240	240	5		•	•			8,59 €
P-51144		40	40	25		•	•			44,29 €
P-51150		60	60	25		•	•			41,49 €
P-51164		80	80	25		•	•			41,19 €
P-51172		100	100	25		•	•			37,79 €
P-51188		120	120	25		•	•			38,39 €

Textilný brúsny pás 100 × 610mm





Vhodné pre farebné kovy, plasty, drevo, drevo s klincami, kov, kameň.



P-36887	Brúsny papier	40	5			•	•	•	•	11,49 €
P-36893		60	5			•	•	•	•	10,99 €
P-36902		80	5			•	•	•	•	11,19 €
P-36918		100	5			•	•	•	•	10,59 €
P-36924		120	5			•	•	•	•	10,59 €
P-36930		150	5			•	•	•	•	10,59 €
P-36946		240	5			•	•	•	•	10,49 €
P-36952		40	25			•	•	•	•	48,49 €
P-36968		60	25			•	•	•	•	45,79 €
P-36974		80	25			•	•	•	•	45,79 €
P-36980		100	25			•	•	•	•	44,69 €
P-36996		120	25			•	•	•	•	44,89 €
P-37007		150	25			•	•	•	•	44,49 €
P-37013		240	25			•	•	•	•	44,09 €
P-43468		40	50			•	•	•	•	94,99 €
P-43474		60	50			•	•	•	•	91,59 €
P-43480		80	50			•	•	•	•	91,39 €
P-43496		100	50			•	•	•	•	84,49 €
P-43505		120	50			•	•	•	•	88,29 €
P-43511		150	50			•	•	•	•	87,29 €
P-43527	240	50			•	•	•	•	86,69 €	

PÁSOVÉ BRÚSKY

Obj. č.	popis	zrnitosť	ks/bal	9903	9920	9924DB	9402	9403	9404	MOC s DPH
Textilný brúsny pás 100 × 620 mm *****										
<i>Vhodné pre farebné kovy, plasty, drevo, drevo s klincami, kov, kameň.</i>										
		Brúsny papier	P-37029	40	5					11,79 €
			P-37035	60	5					11,29 €
			P-37041	80	5					11,09 €
			P-37063	120	5					10,79 €
			P-37079	150	5					10,69 €
			P-37085	240	5					10,59 €

Obj. č.	popis	zrnitosť	ks/bal	9903	9920	9924DB	9402	9403	9404	MOC s DPH		
Textilný brúsny pás 100 × 560 mm *****												
<i>Vhodné pre farebné kovy, plasty, drevo, drevo s klincami, kov, kameň.</i>												
		Brúsny papier	P-36740	40	5	•	•	•	•	•	10,79 €	
			P-36756	60	5	•	•	•	•	•	•	10,49 €
			P-36762	80	5	•	•	•	•	•	•	10,29 €
			P-36778	100	5	•	•	•	•	•	•	9,69 €
			P-36784	120	5	•	•	•	•	•	•	9,09 €
			P-36790	150	5	•	•	•	•	•	•	10,09 €
			P-36815	40	25	•	•	•	•	•	•	46,79 €
			P-36821	60	25	•	•	•	•	•	•	41,99 €
			P-36837	80	25	•	•	•	•	•	•	38,69 €
			P-36859	120	25	•	•	•	•	•	•	37,99 €

popis	ø (mm)	typ	Obj. č.	MOC s DPH
Príslušenstvo pre DSL800, DSL801 *****				
brúsny tanier	220	HARD	199938-5	63,89 €
suchý zip	210	SOFT	199939-3	55,39 €
	210	MEDIUM	199940-8	62,99 €
náhradné kefkы		1	140J85-5	49,36 €
		2	140J86-3	12,65 €
predĺženie sada			199937-7	164,39 €

ø (mm)	zrnitosť	popis	ks/bal	Obj. č.	MOC s DPH
Príslušenstvo pre DSL800, DSL801 *****					
		brúsny papier			
225	40		25	B-68389	30,69 €
225	80		25	B-68395	29,09 €
225	120		25	B-68404	25,19 €
225	180		25	B-68410	25,19 €
225	320	25	B-68426	25,19 €	



PRÍSLUŠENSTVO BRÚSKY

model	popis	ø (mm)	typ	Obj. č.	MOC s DPH
Brúsne taniere *****					
BO6050	suchý zip	150	SOFT	197314-7	45,59 €
	suchý zip	130	HARD	197317-1	50,69 €
DPO500, DPO600	suchý zip	125		197922-4	64,59 €
	suchý zip	150		197928-2	59,89 €
DBO180, BO5030/31, BO5040/41	suchý zip	123		197468-0	11,89 €
BO6030, BO6040	suchý zip	150	SOFT	196684-1	29,39 €
	suchý zip	150	MEDIUM	196685-9	24,79 €
	suchý zip	150	HARD	196686-7	30,39 €
9237C/CB, PV7000, SA7000	gumený	170		P-05913	9,09 €
	suchý zip	165		743053-3	19,09 €
9237C/CB, PV7000, SA7000	suchý zip	120		P-21777	11,79 €
9237C/CB, PV7000, SA7000	kotúč na uchytenie kotúču z jahňaciny	170		P-21761	38,09 €

Leštiace kotúče *****						
	BO6030, BO6050, DPO500, DPO600	plstený kotúč na odstraňovanie vosku	150	suchý zip	193288-0	22,99 €
	BO5031, BO5041, DPO0500, DPO0600, DBO180	taniere na nanášanie vosku, žltý	125	suchý zip	794558-6	18,19 €
	9237C/CB, PV7000, SA7000	hustá hubka na dvojvrstvové farebné nátery,	150	biela	P-21727	14,39 €
	9237C/CB, PV7000, SA7000	mäkká hubka na celulózu, akryláty	150	modrá	P-21733	12,09 €
	9237C/CB, PV7000, SA7000	pevná hubka na leštenie	150	oranžová	P-21749	9,19 €

Kotúče z jahňaciny na leštenie do vysokého lesku *****						
			140	suchý zip	794560-9	17,29 €
			150	suchý zip	199424-6	25,69 €
			180	suchý zip	192629-7	17,89 €
			180		*794176-0	24,99 €
			230		D-70873	18,10 €
		adaptér pre kotúč D-70873, M14				D-56960

*použitie s brúsnym taniereom P-05913

Príslušenstvo pre brúsky DPV300 / PV301 *****					
	leštenie do vysokého lesku	80	plstený/ suchý zip	191N92-5	12,59 €
	penová špongia na nanášanie vosku	80	biela/ suchý zip	191N91-7	13,09 €
	penová špongia na leštenie	80	žltá/ suchý zip	191N90-9	10,49 €
	pad	50		743124-6	13,09 €
	pad	75	suchý zip	743125-4	37,29 €
	adaptér pre pad 743124-6				743126-2

model	popis	ks/bal	Obj. č.	MOC s DPH
-------	-------	--------	---------	-----------

Papierové sáčky a držiaky



DBO140, DBO180, BO3710, BO3711, BO4555, BO4556, BO4557, BO4558, BO4565,	papierové vrečko s držiakom	1	135246-0	4,79 €
BO4566, BO5030, BO5031, BO5040, BO5041, DBO180	papierové vrečko	5	194746-9	4,69 €
9046, BO4900, BO4900V,	papierové vrečko s držiakom	1	193294-5	11,19 €
BO6030	papierové vrečko	5	193293-7	6,69 €

Elektrické pílníky



9032, DBS180	oporné rameno 9 x 533 mm		125158-5	38,19 €
	oporné rameno 13 x 533 mm		125159-3	76,59 €

Pásové brúsky



9903, 9920, 9403	stojan na brúsku		193055-3	92,09 €
9920	brúsny rám		193071-5	84,39 €
9404	brúsny rám		193072-3	105,39 €
9903	brúsny rám		193070-7	83,09 €
9401, 9402	držiak brúsky		342332-2	2,59 €
9910, 9911	upínacie svorky		192694-6	60,59 €
9404, 9902, 9903, 9920	zberné vrečko na prach		122591-2	15,79 €
9910, 9911	zberné vrečko na prach		122548-3	7,09 €
9924DB	zberné vrečko na prach		122296-4	16,29 €
9401, 9402	zberné vrečko na prach		122297-2	15,19 €
9403	zberné vrečko na prach		122562-9	16,49 €

model	Popis	Obj. č.	MOC s DPH	Popis	Obj. č.	MOC s DPH	Popis	Obj. č.	MOC s DPH
-------	-------	---------	-----------	-------	---------	-----------	-------	---------	-----------

Pásové brúsky



9401, 9402	oceľová doska	342328-3	2,89 €	korková doska	424058-9	0,99 €	grafitová doska	A-86262	3,59 €
9403	oceľová doska s korkom	150980-1	5,89 €	korková doska	424058-9	0,99 €	grafitová doska	424057-1	1,02 €
9404	oceľová doska s korkom	151751-9	5,63 €	korková doska	423314-4	3,29 €	grafitová doska	423317-8	4,79 €
9924DB	oceľová doska s korkom	341705-6	2,19 €	korková doska	423035-8	2,79 €	grafitová doska	423036-6	2,69 €
9902, 9903	oceľová doska s korkom	151749-6	4,49 €	korková doska	423312-8	1,89 €	grafitová doska	423315-2	2,99 €
9910, 9911	oceľová doska	345503-0	4,39 €						
9920	oceľová doska s korkom	151750-1	5,10 €	korková doska	423313-6	2,59 €	grafitová doska	423316-0	3,79 €

PRIAME BRÚSKY

Klieštiny		model	ključ	upínanie	Obj. č.	MOC s DPH
	DGD800, DGD801	13 mm 19 mm	3 mm	763669-8	16,99 €	
			6 mm	763670-3	9,59 €	
			8 mm	763671-1	18,39 €	
			matica	763668-0	1,29 €	
	906	10 mm 17 mm	3 mm	763627-4	10,89 €	
			6 mm	763620-8	7,99 €	
			matica	763240-8	2,99 €	
	GD0600, GD0601	13 mm x2	3 mm	763627-4	10,89 €	
			6 mm	763620-8	7,99 €	
			matica	763664-8	1,29 €	
	GD0603	10 mm x2	3 mm	763627-4	10,89 €	
			6 mm	763620-8	7,99 €	
matica			763236-9	1,99 €		
GD0602	13 mm x2	3 mm	763669-8	16,99 €		
		6 mm	763670-3	9,59 €		
		8 mm	763671-1	18,39 €		
		matica	763668-0	1,29 €		
GD0800/C GD0810C, GD0801C, GD0811C	13 mm 19 mm	3 mm	*193011-3	26,89 €		
		6 mm	*193012-1	20,89 €		
		8 mm	*192988-9	27,99 €		
		matica	763645-2	2,39 €		











*sada klieština + matica

model	použitie	typ	rozměr	ks/bal	Obj. č.	MOC s DPH	
	GD0600, GD0601C,	kov, nerez	A	10x20x6 mm	1	B-52716	14,39 €
	GD0602, GD0801C	hliník, neželezné kovy	A	10x20x6 mm	1	B-52738	13,59 €
	GD0800, GD0800C,	kov, nerez	B	10x20x6 mm	1	B-52772	13,29 €
		hliník, neželezné kovy	B	10x25x6 mm	1	B-52825	13,79 €

DVOJKOTÚČOVÉ BRÚSKY

model	typ/ zrnitosť	použitie	rozměr (mm)	Obj. č.	MOC s DPH	
	A36M	železo	150 x 16 x 12,7	B-51904	13,21 €	
	A60M	železo	150 x 16 x 12,7	B-51910	13,21 €	
	GB602	GC120H	tenké plechy Cu,Ni,Ms,Zn	150 x 16 x 12,7	B-51932	16,70 €
	GB602W	A60M	železo	150 x 6,4 x 12,7	B-51895	11,47 €
	GB801	WA60K	Železo/nerez	150 x 16 x 12,7	B-51926	15,17 €
		A36P	železo	205 x 19 x 15,88	B-51948	22,81 €
		A60P	železo	205 x 19 x 15,88	B-51954	22,81 €
		GC120H	tenké plechy Cu,Ni,Ms,Zn	205 x 19 x 15,88	B-51976	29,04 €
		WA60K	železo/nerez	205 x 19 x 15,88	B-51960	24,43 €

KEFOVÉ BRÚSKY

Obj. č.	Popis	Zrnitosť	MOC s DPH
Kotúče pre kefovú brúsku 9741			
	P-01127	lamelová brúsna kefa na brúsenie povrchov, odstraňovanie farieb a pod.	40 71,39 €
	P-65648	kefa z oceleového drôtu, potiahnutá mosadzou, 0,3 mm pre vysoký uber vhodná na štruktúrovanie dreva, na odrezávanie a čistenie	119,99 €
	794382-7	drôtená kefa na leštenie železných plôch	120 145,29 €
	P-04400	kefa z oceleového drôtu 0,3 mm na odstraňovanie rezu a farieb, na čistenie betónového debnenia	126,99 €
	P-04416	fibrová kefa na zapracovanie moridiel a lakov + na následné vyhladenie	101,49 €
	794381-9	bavlnená leštiaca kefa na leštenie povrchových plôch aj s pridaním zodpovedajúcich leštiacich pást	210,29 €
	P-04422	brúsna nylonová kefa na štruktúrovanie mäkkého dreva a na dopracovávanie štruktúrovaní starého dreva pre zvýraznenie štruktúry dreva a na odstraňovanie existujúcich drevených vlákien pre optimálnu prípravu plôch na lakovanie a morenie pre zhotovenie brúsneho obrazu na ušľachtilej oceli a hliníku	60 119,99 €
	P-04438		80 119,99 €
	P-04444		120 119,89 €
	P-04450		180 119,99 €
	794384-3		80 192,39 €
	P-18035	valcová kefa vlies na jemné štruktúrovanie ušľachtilej ocele a jemné brúsenie povrchových plôch dreva	80 65,39 €
	P-18041		120 66,29 €
	P-18029		180 65,89 €
	P-18057	valcová kombinovaná kefa leinen/vlies na jemné štruktúrovanie ušľachtilej ocele a jemné brúsenie povrchových plôch dreva	80 73,79 €
	P-19233		120 73,49 €
	P-19249		180 74,89 €
	410899-9	nástavec na odsávanie	1,19 €

Kotúče pre kefovú brúsku 9741			
	D-73564	oceľová kefa pre rýchly uber materiálu	32,69 €
	D-73570	oceľová kefa mosadzná úprava, pre brúsenie dreva a kovových materiálov	32,69 €
	D-73586	nylónová kefa na štruktúrovanie mäkkého a starého dreva, pre zvýraznenie štruktúr dreva pri príprave plôch pred lakovaním a morením a pre zhotovenie brúsneho obrazu ušľachtilej oceli a hliníku	60 41,39 €
	D-73592	nylónová kefa na štruktúrovanie mäkkého a starého dreva, pre zvýraznenie štruktúr dreva pri príprave plôch pred lakovaním a morením a pre zhotovenie brúsneho obrazu ušľachtilej oceli a hliníku	80 41,39 €

Spony pre AT638

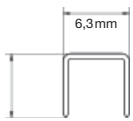

Obj. č.	typ	šírka (mm)	dĺžka (mm)	ks/bal	vhodné pre stroj	MOC s DPH
F-33607	spony	6,3	25	5000	AT638	17,79 €
F-33623	spony	6,3	30	5000	AT638	21,09 €
F-33636	spony	6,3	32	5000	AT638	25,29 €
F-33649	spony	6,3	38	5000	AT638	26,89 €

Spony pre AT1150A

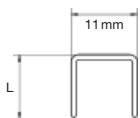

F-32078	spony	11	25	10000	AT1150A	84,29 €
F-32081	spony	11	28	10000	AT1150A	60,89 €
F-32094	spony	11	32	10000	AT1150A	100,69 €
F-32100	spony	11	35	10000	AT1150A	69,79 €
F-32113	spony	11	40	10000	AT1150A	90,49 €
F-32126	spony	11	45	10000	AT1150A	91,99 €
F-32139	spony	11	51	10000	AT1150A	147,79 €

Spony pre AT2550A

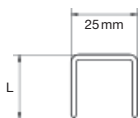

F-32023	spony	25	25	10000	AT2550A	91,69 €
F-32036	spony	25	32	10000	AT2550A	88,79 €
F-32049	spony	25	38	10000	AT2550A	136,39 €
F-32052	spony	25	45	10000	AT2550A	122,39 €
F-32065	spony	25	51	10000	AT2550A	110,79 €

Spony pre T221/DST220BST/DST221

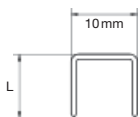

F-32917	spona	10	8	5000		9,19 €
F-32647	spona	10	10	5000		13,19 €
F-32650	spona	10	13	5000		12,29 €
F-32663	spona	10	16	5000		15,59 €
F-32676	spona	10	19	5000		18,49 €
F-32689	spona	10	22	5000		20,49 €

Spony pre ST113/DST112

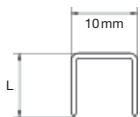

F-81518	spona	10	7	2500		20,91 €
F-81521	spona	10	10	2500		15,73 €



KLINCOVAČKY

Obj. č.	typ	typ drôtku	šířka (mm)	délka (mm)	ks/bal	Vhodné pro stroj	MOC s DPH
---------	-----	------------	------------	------------	--------	------------------	-----------

Klince do betónu pre AN250HC



F-33575	klince do betónu		2,5	22	1000	AN250HC	57,99 €
F-33588	klince do betónu		2,5	25	1000	AN250HC	63,79 €

Klince pre AN450, AN454 (klince páskované pod 16° uhlom)

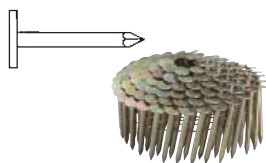

F-30762	klince spájané drôtom	hladký	3,1	22	7200	AN450, AN454	64,18 €
F-30775	klince spájané drôtom	hladký	3,1	25	7200	AN450, AN454	70,29 €
F-30788	klince spájané drôtom	hladký	3,1	32	7200	AN450, AN454	84,84 €
F-30807	klince spájané drôtom	hladký	3,1	45	7200	AN450, AN454	116,37 €

Klince pre AN560, AN611, AN621, AN635H, AN760, AN901, AN902, AN935H, AN953H

(klince páskované pod 16° uhlom)

F-30810	klince spájané drôtom	hladký	2,5	45	10800		110,73 €
F-31243	klince spájané drôtom	hladký	2,5	50	10800		122,60 €

Klince pre AN611, AN621, AN635H, AN760, AN901, AN902, AN935H, AN953H, AN960, AN961

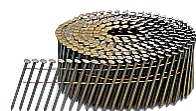

F-30878	klince spájané drôtom	skrutkovitý	2,5	57	8100		108,52 €
F-31256	klince spájané drôtom	hladký	2,5	57	8100		103,47 €
F-30900	klince spájané drôtom	skrutkovitý	2,5	65	8100		119,14 €
F-31269	klince spájané drôtom	hladký	2,5	65	8100		125,44 €

Klince pre AN560, AN611, AN621, AN635H, AN760, AN901, AN902, AN935H, AN953H

F-30823	klince spájané drôtom	hladký	2,8	50	9000		135,44 €
F-30971	klince spájané drôtom	skrutkovitý	2,9	50	9000		141,04 €

Klince pre AN611, AN621, AN635H, AN760, AN901, AN902, AN935H, AN953H, AN960, AN961

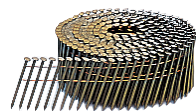

F-31272	klince spájané drôtom	skrutkovitý	2,9	57	6750		120,70 €
F-30881	klince spájané drôtom	skrutkovitý	2,9	57	6750		135,62 €
F-30836	klince spájané drôtom	hladký	3,1	65	6750		131,42 €
F-30852	klince spájané drôtom	hladký	3,3	65	6750		98,80 €

Klince pre AN760, AN901, AN902, AN935H, AN953H, AN960, AN961

(klince páskované pod 16° uhlom)

F-31320	klince spájané drôtom	skrutkovitý	3,2	75	4050		108,46 €
---------	-----------------------	-------------	-----	----	------	--	----------

Klince pre AN901, AN902, AN935H, AN953H, AN960, AN961

(klince páskované pod 16° uhlom)

F-31359	klince spájané drôtom	hladký	3,4	75	3600		107,80 €
F-31304	klince spájané drôtom	hladký	3,1	85	4050		113,72 €
F-31317	klince spájané drôtom	hladký	3,1	90	4050		121,26 €
F-31346	klince spájané drôtom	skrutkovitý	3,2	90	4050		128,77 €
F-31362	klince spájané drôtom	hladký	3,8	90	2700		119,11 €

Obj. č.	typ	typ drieru	šírka (mm)	dĺžka (mm)	ks/bal	Vhodné pre stroj	MOC s DPH
---------	-----	------------	------------	------------	--------	------------------	-----------

Klince pre AN560, AN611, AN635H

(klince páskované pod 16° uhlom)

F-32766	klince spájané drôtom	hladký	2,1	32	21600		135,56 €
---------	-----------------------	--------	-----	----	-------	--	----------

Klince pre AN560, AN611, AN621, AN635H, AN760, AN901, AN935H

(klince D s hladkým drierom, páskované papierom pod 34° uhlom)

F-32782	klince spájané drôtom	hladký	2,1	45	18000		171,05 €
F-32814	klince spájané drôtom	skrutkovitý	2,1	45	18000		179,52 €

Klince pre AN943



F-30566	páskované papierom	hladký	2,9	60	3000		54,62 €
F-30582	páskované papierom	hladký	3,1	75	3000		111,45 €
F-30614	páskované papierom	hladký	3,3	75	3000		85,24 €
F-30627	páskované papierom	hladký	3,3	75	3000		126,87 €
F-30601	páskované papierom	hladký	3,1	83	3000		80,88 €
F-30630	páskované papierom	hladký	3,3	83	3000		93,34 €
F-30643	páskované papierom	hladký	3,3	83	3000		139,71 €
F-30656	páskované papierom	hladký	3,3	90	3000		90,04 €
F-31645	páskované papierom	hladký	3,3	90	3000		111,63 €

Klince pre AF505, AF506, DBN500

DFN350 klince len do dĺžky 35 mm (kolárske klince)



P-45923	kolárske klince	hladký	1	20	5000		10,99 €
P-45939	kolárske klince	hladký	1	25	5000		12,99 €
P-45945	kolárske klince	hladký	1	30	5000		13,99 €
P-45951	kolárske klince	hladký	1	40	5000		16,99 €
P-45967	kolárske klince	hladký	1	50	5000		18,99 €
F-31867	kolárske klince	hladký	1	15	5000		10,49 €
F-31870	kolárske klince	hladký	1	20	5000		12,49 €
F-31883	kolárske klince	hladký	1	25	5000		14,99 €
F-31896	kolárske klince	hladký	1	30	5000		17,09 €
F-31915	kolárske klince	hladký	1	35	5000		20,59 €
F-31928	kolárske klince	hladký	1	38	5000		19,19 €
F-31931	kolárske klince	hladký	1	40	5000		22,19 €
F-31944	kolárske klince	hladký	1	45	5000		24,89 €
F-31957	kolárske klince	hladký	1	50	5000		28,89 €

SPONKOVAČKY

Obj. č.	typ	typ drieku	šírka (mm)	dĺžka (mm)	ks/bal	Vhodné pre stroj	MOC s DPH
---------	-----	------------	------------	------------	--------	------------------	-----------

Klince pre AF353, AF201Z, BPT/DPT350, BPT/DPT351, DPT353, PT354

(klince bez hlavičky – pinky)



F-31825	klince – pinky	hladký	0,6	18	10000		13,69 €
F-32142	klince pozink	hladký	0,6	18	10000		26,99 €
F-31838	klince – pinky	hladký	0,6	25	10000		17,29 €
F-32155	klince pozink	hladký	0,6	25	10000		37,99 €
F-31841	klince – pinky	hladký	0,6	30	10000		18,29 €
F-32168	klince pozink	hladký	0,6	30	10000		41,99 €
F-31854	klince – pinky	hladký	0,6	35	10000		21,19 €
F-32171	klince pozink	hladký	0,6	35	10000		48,99 €

Klince pre AN621



P-51487	klince spájané drôtom	krúžok	2,5	45	9000		87,99 €
P-51502	klince spájané drôtom	krúžok	2,5	64	9000		103,99 €
P-51493	klince spájané drôtom	krúžok	2,5	50	9000		90,99 €

Klince pre AN901



P-51524	klince spájané drôtom	krúžok	2,8	65	5000		66,99 €
P-51530	klince spájané drôtom	krúžok	2,8	75	5000		101,99 €
P-51552	klince spájané drôtom	krúžok	3,1	90	4500		99,99 €

model	popis	rozmer	Obj. č.	MOC s DPH
-------	-------	--------	---------	-----------

Ďalšie príslušenstvo ku sponkovačkám/klincovačkám

AN621, AN911, AN510H, AN610, AN620H, AN711H, AN911H	vsuvka H22PN		243105-5	11,08 €
AN902, AN901, AN621, AT1150, AT2250, AT638, AF201Z, AF505, AF506	vsuvka	1/2"	HY00000080	1,18 €
AN621, AN911, AN510H, AN610, AN620H, AN711H, AN911H, AT638, AT1150, AT2250	kompresorová vsuvka	1/4"	P-45989	9,99 €
AN943	kompresorová vsuvka	3/8"	243104-7	4,80 €
AT1150, AT2250, AF201, AN621, AN911, AN943	kompresorová hadica	ø 8 mm 15 m	P-45973	70,99 €
AN450, AN610, AN620, AN711, AN911	vysokotlaková hadica	7,5 m	B-80036	177,09 €
AN450, AN610, AN620, AN711, AN911	vysokotlaková hadica	15 m	B-80014	211,59 €
AN450, AN610, AN620, AN711, AN911	navijak na vysokotlakové hadice		B-80008	518,89 €
pre všetky klincovačky a sponkovačky	olej	30 ml	181434-7	1,79 €

PRÍSLUŠENSTVO PRE ŠPECIÁLNE STROJE MAKITA

typ	popis	Obj. č.	MOC s DPH
-----	-------	---------	-----------

Príslušenstvo pre BCG/DCG180, CG100

A: 300 ml



C: 800 ml



B: 600 ml



D: 400 ml



A	300 ml set	196351-8	37,19 €
B	600 ml set	196352-6	96,49 €
C	800 ml set	197195-9	68,29 €
D	400 ml set	191P89-6	92,49 €
A	držiak 300 ml	454275-7	10,18 €
A	matica	454223-6	3,79 €
A	ozubené tiahlo	142041-1	35,12 €
B	matica	318958-2	4,49 €
B	tryska	454226-0	2,29 €
A, B	piestik	142071-2	3,19 €
A, B	piestik	142072-0	3,91 €
C	piestik	123221-8	20,93 €

ø (mm)	ks/bal	popis	Obj. č.	MOC s DPH
--------	--------	-------	---------	-----------

Príslušenstvo pre Aku viazač armatúr DTR180

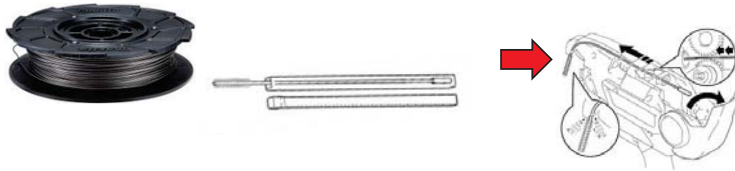

0,8	50	žiňaný viazací drôt	199137-9	202,59 €
0,8	50	žiňaný viazací drôt pozink	191A57-9	313,29 €
	1	kefka čistiacia	162755-6	32,29 €

popis	Obj. č.	MOC s DPH
-------	---------	-----------

Príslušenstvo pre AKU kompresory DMP180, DMP181, MP001, MP100D



adaptér pre francúzske ventily	TE00000334	0,73 €
adaptér na lopty, nafukovačky	TE00000333	0,56 €
adaptér na lopty	TE00000335	0,65 €
adaptér pre anglické ventily	TE00000346	0,90 €
hadica	TE00000345	13,21 €

Príslušenstvo pre Aku maznicu DGP180

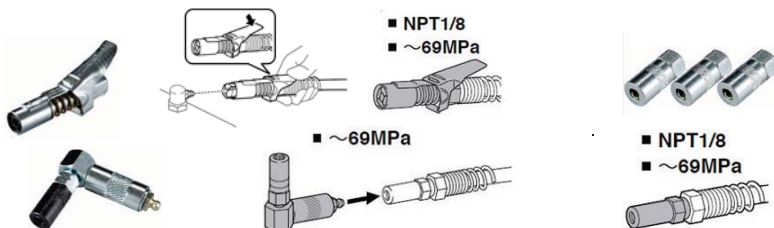

maznica s poistkou	191A76-5	139,79 €
maznica uhlová	191A77-3	80,09 €
sada mazníc 3 ks	191A78-1	47,39 €
hadica 0,6 m	191A80-4	82,79 €
hadica 1,2 m	191A79-9	84,09 €

Príslušenstvo pre Aku maznicu DGP180



tuba pre kartuše a ručné plnenie 400 g	191B12-7	89,49 €
tuba pre kartuše a ručné plnenie 450 g	191A81-2	cena na vyžiadanie
tuba pre kartuše a ručné plnenie 500 g	191F23-6	116,09 €
tuba pre 400 g kartuše	191F24-4	73,19 €
tuba pre 450 g kartuše	191F25-2	cena na vyžiadanie
tuba pre 500 g kartuše	191F27-8	73,99 €

PRISLÚŠENSTVO PRE DIEROVAČ DPP200

Ø (mm)	obj.č	MOC s DPH	Ø (mm)	obj.č	MOC s DPH	mäkká ocel	Nehrdzavajúca ocel
--------	-------	-----------	--------	-------	-----------	------------	--------------------

razník

matrica

hrúbka materiálu

Okrúhle dierovanie



6	SC05340040	110,29 €	SB6	SC00000203	111,09 €	t2-t4	t3-t4
8	SC05340060	110,29 €	SB8	SC00000207	111,09 €	t2-t6	t3-t4
10	SC05340080	109,29 €	SB10	SC00000211	110,19 €	t2-t6	t3-t4
12	SC05340100	111,89 €	SB12	SC00000215	156,89 €	t2-t8	t3-t6
14	SC05340120	110,19 €	SB14	SC00000219	110,99 €	t2-t8	t3-t6
15	SC05340130	110,19 €	SB15	SC00000221	110,99 €	t2-t8	t3-t6
16	SC05340140	110,19 €	SB16	SC05332710	110,99 €	t2-t8	t3-t6
18	SC05340150	110,59 €	SB18	SC00000223	111,39 €	t2-t8	t3-t6
19	SC05340170	cena na vyžiadanie	SB19	SC05332740	cena na vyžiadanie	t2-t8	t3-t6
20	SC05340160	110,19 €	SB20	SC05352510	110,99 €	t2-t8	t3-t6

razník

matrica

hrúbka materiálu

Oválne dierovanie



6.5 × 10	SC05340200	150,59 €	6.5 × 10B	SC00000244	110,99 €	t2-t6	t3-t4
6.5 × 13	SC05340210	150,69 €	6.5 × 13B	SC00000246	111,09 €	t2-t6	t3-t4
8.5 × 13	SC05340220	150,69 €	8.5 × 13B	SC00000248	111,09 €	t2-t6	t3-t4
8.5 × 17	SC05340230	149,89 €	8.5 × 17B	SC00000250	110,49 €	t2-t6	t3-t4
9 × 13.5	SC05340240	150,59 €	9 × 13.5B	SC00000252	110,99 €	t2-t6	t3-t4
9 × 18	SC05340250	150,59 €	9 × 18B	SC00000254	110,99 €	t2-t6	t3-t4
10 × 15	SC05340260	150,69 €	10 × 15B	SC00000256	111,09 €	t2-t8	t3-t6
10 × 20	SC05340270	150,79 €	10 × 20B	SC00000258	111,19 €	t2-t8	t3-t6
11 × 16.5	SC05340280	150,59 €	11 × 16.5B	SC00000260	110,99 €	t2-t8	t3-t6
12 × 18	SC05340290	150,69 €	12 × 18B	SC00000262	111,09 €	t2-t8	t3-t6
13 × 19.5	SC05340300	151,19 €	13 × 19.5B	SC00000264	111,49 €	t2-t8	t3-t6
14 × 21	SC05340310	150,59 €	14 × 21B	SC00000266	110,99 €	t2-t8	t3-t6

Príslušenstvo pre Aku nitovačky DRV150 / DRV250

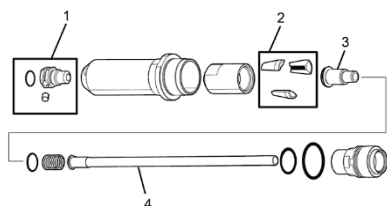

ø (mm)	typ	popis	Obj. č.	MOC s DPH
2,4	1	hlavička	127230-9	16,52 €
	3	posúvač čeluste	127478-3	5,95 €
	4	rúrka prepadu	162747-5	23,84 €
3,2	2	čeluste set 3 ks	199731-7	16,89 €
	1	hlavička	127229-4	15,97 €
	3	posúvač čeluste	127477-5	6,22 €
4,0	4	rúrka prepadu	162746-7	23,67 €
	2	čeluste set 3 ks	199731-7	16,89 €
	1	hlavička	127228-6	15,90 €
4,8	3	posúvač čeluste	127476-7	5,99 €
	2	čeluste set 3 ks	199731-7	16,89 €
	1	hlavička	127225-2	22,15 €
4,8	3	posúvač čeluste	127475-9	8,75 €
	2	čeluste set 3 ks	199731-7	16,89 €
2,4	1, 3, 4	sada	199729-4	35,59 €
3,2	1, 3, 4	sada	199728-6	33,89 €
4,0	1, 3, 4	sada	191C04-2	17,19 €
4,8	1, 3, 4	sada	191C03-4	16,99 €

Príslušenstvo pre Aku nitovačky DRV250

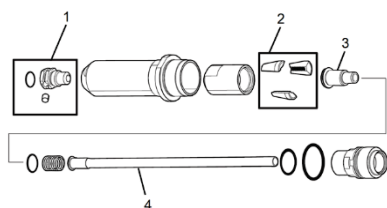

2,4	1	hlavička	127230-9	16,52 €
	3	posúvač čeluste	127478-3	5,95 €
	4	rúrka prepadu	162747-5	23,84 €
3,2	2	čeluste set 3 ks	199731-7	16,89 €
	1	hlavička	127229-4	15,97 €
	3	posúvač čeluste	127477-5	6,22 €
4,0	4	rúrka prepadu	162746-7	23,67 €
	2	čeluste set 3 ks	199731-7	16,89 €
	1	hlavička	127228-6	15,90 €
4,8	3	posúvač čeluste	127476-7	5,99 €
	2	čeluste set 3 ks	199731-7	16,89 €
	1	hlavička	127225-2	22,15 €
4,8	3	posúvač čeluste	127475-9	8,75 €
	4	rúrka prepadu	162744-1	14,95 €
	2	čeluste set 3 ks	199731-7 199730-9	16,89 € 19,59 €
6,0	1	hlavička	127224-4	16,20 €
	3	posúvač čeluste	127474-1	6,09 €
	4	rúrka prepadu	162744-1	14,95 €
6,4	2	čeluste set 3 ks	199730-9	19,59 €
	1	hlavička	127223-6	20,98 €
	3	posúvač čeluste	127473-3	8,89 €
6,4	4	rúrka prepadu	162743-3	20,00 €
	2	čeluste set 3 ks	199730-9	19,59 €
2,4	1, 3, 4	sada	199729-4	35,59 €
3,2	1, 3, 4	sada	199728-6	33,89 €
4,0	1, 3, 4	sada	191F80-4	59,39 €
4,8	1, 3, 4	sada	191C03-4	16,99 €
			191F79-9	30,19 €
6,0	1, 3, 4	sada	199725-2	28,69 €
6,4	1, 3, 4	sada	191C02-6	cena na vyžiadanie



	DVR150	ochrana gumená	191G65-6	120,49 €
	DVR250	ochrana gumená	191G66-4	99,79 €

BENZÍNOVÉ ROZBRUSOVAČKY

popis	Obj. č.	MOC s DPH
-------	---------	-----------

Benzínové rozbrusovačky



rezací kotúč oceľ / 300 × 20 mm	724415-4	11,39 €
rezací kotúč oceľ / 350 × 20 mm	721713-7	28,99 €
rezací kotúč kameň / 300 × 20 mm	721710-3	17,19 €
rezací kotúč kameň / 400 × 4 × 25,4 mm	724408-1	39,59 €
diamantový kotúč za sucha betón / 355 × 25,4 mm	D-56998	81,54 €
diamantový kotúč za sucha asfalt / 355 × 25,4 mm	B-13275	178,89 €
tlaková nádrž na vodu/10 l (3 – 5 bar)	957802600	389,29 €
vodná armatúra na tlakovú a spádovú nádrž	197201-0	44,69 €
uhlový uzáver nádrže, dopĺňanie paliva	010114081	9,48 €
súprava náradia kompletná	197200-2	cena na vyžiadanie
kombinovaný kľúč 13 / 19 mm	782028-7	2,19 €
uhlový skrutkovač (torx)	782025-3	0,39 €
redukčný krúžok z 24,5 mm na 20 mm	394228121	1,27 €
olej do dvojtaktných motorov 100 ml, 1 : 50	195957-9	1,39 €
olej do dvojtaktných motorov 1 liter, 1 : 51	980008607	5,99 €
zapaľovacia sviečka dvojtakt	168517-0	2,69 €
zapaľovacia sviečka štvortakt	168652-4	9,80 €
filter	424700-2	2,44 €
filter vzduchový EK7651	442165-6	13,18 €
filter prachový EK7651	166106-5	3,09 €
filter vzduchový EK8100	424701-0	5,09 €
vozik pre štvortaktné rozbrusovačky	DT4000	1 149,12 €
vozik pre dvojtaktné rozbrusovačky	DT2010	729,99 €

LASERY

Príslušenstvo pre Lasery



statív 1000 – 2700 mm (5,8" upínanie)	P-81315	325,39 €
statív 400-1100 mm so závitom 5/8"	TKOLM2000F	49,29 €
meracia tyč hliníková (4 m)	P-81309	82,19 €

SK102 / SK103 / SK104 / SK105 / SK106

nástenný držiak vrátane 1/4" skrutky	LE00785637	136,99 €
--------------------------------------	------------	----------

SK102Z, SK103PZ, SK104Z



magnetický držiak s 5/8" a 1/4" adaptérom	LE00785633	19,59 €
kĺbový adaptér 1/4" na 1/4"	LE00785519	25,89 €
detektor	LE00837085	197,99 €

SK102Z, SK103PZ, SK104Z, SK700, SK700D



taška (SK102Z)	LE00785636	25,84 €
taška SK103PZ/SK104Z	LE00822220	31,75 €
USB Power Supply Cable – SK105/SK106	199178-5	11,69 €
prijímač LDX1	LE00855702	256,79 €
magnetický terč	LE00785638	25,59 €

SKR200





prijímač	LE00796587	375,09 €
magnetický držiak	LE00784968	76,19 €
diaľkové ovládanie	LE00796588	69,69 €
držiak na stenu s 5/8" skrutkou	LE00791661	95,79 €

SK312GD

taška	TKAK400MUN	204,79 €
laserový prijímač LDG3	TKOLDG301G	350,40 €
napájací kábel USB	199010-3	12,09 €
nástenný držiak	TK000ET03F	275,99 €

PRÍSLUŠENSTVO ELEKTRICKÉ VYSÁVAČE

Obj. č.	MOC, s DPH	ks/bal	typ	VC210LM	VC351LM	VC2000/VC210 VC2511/VC2012 VC3512/VC3011	VC321ML VC3210L VC3211H	VC3012LM	446	447LM	440, 448
Vrecká do elektrických vysávačov											
	W107418353	38,39 €	5	vrecko na prach z netkanej textilie	•						
	W107418354	198,49 €	1	vrecko na prach z netkanej textilie na opakované použitie	•						
	P-78293	28,79 €	5	vrecko na prach papierové		•					
	P-72899	20,59 €	5	vrecko na prach z netkanej textilie			•				•
	P-84078	29,49 €	5	vrecko na prach z netkanej textilie				•			
	P-70194	26,09 €	5	vrecko na prach papierové					•		•
	195558-3	23,29 €	5	vrecko na prach z netkanej textilie			•				
	P-70203	77,29 €	5	vrecko na prach papierové						•	
	P-81804	18,99 €	2	vrecko na prach papierové						•	
	195440-6	9,79 €	10	vrecko PVC			•				
	P-70297	37,89 €	5	vrecko PVC		•		•			•
	P-70306	53,49 €	5	vrecko PVC						•	
	W107418355	32,39 €	5	vrecko PVC	•						
Filtry do elektrických vysávačov											
	P-70219	36,79 €	1	filter kartuš		•	•			•	
	P-70225	78,29 €	1	filter kartuš							•
	W107418352	34,79 €	1	filter motora	•						
	*195441-4	55,89 €	1	prachový, suché vysávanie							•
	196251-2	23,39 €	1	prachový, suché vysávanie							•
	**196253-8	13,29 €	1	prefilter			•				
	W107418351	71,79 €	1	hepa filter	•						
	*len pre model VC3210; ** okrem modelu VC3210										
Hubice pre elektrické vysávače											
	P-81789	22,79 €	1	hubica na koberce 35 x 300 mm	•					•	
	W107402706	14,39 €	1	hubica na koberce 35 x 260 mm			•				
	W14295	3,19 €	1	hubica na vankúše			•				
	W107417892	81,29 €	1	hubica univerzálna		•	•			•	•
	P-70471	12,39 €	1	hubica s kefou		•	•			•	•
	195551-7	28,69 €	1	hubica univerzálna mokré/suché vysávanie						•	
	191657-9	12,29 €	1	hubica s kefou tvar „O“		•	•			•	•
	60277B0N	10,99 €	1	hubica široká – základňa						•	•
	60279B0N	8,89 €	1	kefa kobercová pre základňu 60277B0N						•	•
	410306-2	1,69 €	1	hubica štrbinová 330 mm						•	
	W6084	4,65 €	1	hubica štrbinová 35 x 300 mm			•			•	•
	P-72964	76,59 €	1	hubica na mokré vysávanie			•				•
Rúry pre elektrické vysávače											
	W107418350	34,09 €	3	rúra vysávača 36 x 350 mm, chrómová	•	•	•			•	•
	192562-3	6,49 €	1	rúra vysávača rovná, hliník							•
	192563-1	6,79 €	1	rúra vysávača ohnutá, hliník							•
	P-72942	32,89 €	2	rúra vysávača 36 x 520 mm, kov		•	•			•	•
	P-70437	51,09 €	2	rúra vysávača 36 x 515 mm, chrómová	•	•	•			•	•
Rukoväte pre elektrické vysávače											
	P-70346	34,99 €	1	rukoväť ohnutá 36 mm, chróm	•					•	•
	P-72908	26,39 €	1	rukoväť s reguláciou			•				
	50096B0N	17,39 €	1	rukoväť bez regulácie							•
	50095B0N	7,79 €	1	regulácia k rukoväti 50096B0N							•
	W107413340	18,79 €		rukoväť s reguláciou pre hadicu P-81739		•	•	•			
Hadice pre elektrické vysávače											
	02300B0N	66,79 €	1	hadica ø 25 mm x 3 m							•
	01319B0N	72,99 €	1	hadica ø 45 mm x 4 m							•
	195433-3	59,69 €	1	hadica ø 28 mm x 3,5 m						•	
	195434-1	66,59 €	1	hadica ø 38 mm x 2,5 m						•	
	P-70487	89,69 €	1	hadica ø 27 mm x 3,5 m						•	•
	W15365	64,71 €	1	hadica s adaptérom P-70421, ø 36 mm x 4 m						•	•
	192108-5	25,99 €	1	hadica ø 19 mm x 2,5 m							•
	P-84084	77,79 €	1	hadica ø 32 mm x 4 m	•					•	
	P-70487	89,69 €	1	hadica antistatická ø 27 mm x 3,5 m			•			•	•
	P-70362	131,39 €	1	hadica antistatická ø 36 mm x 3 m			•			•	•
	P-72914	70,49 €	1	hadica s integrovanou rukoväťou quick systém ø 32 mm x 3 m			•			•	•
	P-72920	39,39 €	1	hadica s integrovanou rukoväťou quick systém ø 36 mm x 3 m			•			•	•
	P-81739	39,99 €	1	hadica s integrovanou rukoväťou quick systém ø 32 mm x 3,5 m		•	•	•			
	01316B0N	30,89 €	1	hadica s integrovanou rukoväťou ø 45 mm x 2 m							•

PRÍSLUŠENSTVO PRE AKU TYČOVÉ VYSÁVAČE

	model	popis	Obj. č.	MOC s DPH
	CL001G, DCL282F	teleskopická ø 28 x 590 – 942 mm hliník	140G19-0	19,49 €
	DCL280F, CL141FD	teleskopická ø 28 x 590 – 942 mm PVC	127605-2	33,29 €
	DCL281F	rúra vysávania flexi	191E30-3	14,19 €
		rúra vysávania ø 28 x 479 mm	459356-2	1,69 €
	DCL180, CL106D, CL070D	teleskopická ø 28 x 500 – 850 mm PVC	198559-0	20,72 €
	DCL181F, CL107FD	rúra vysávania flexi	191496-7	4,69 €
	DCL182, CL108FD	rúra vysávania ø 28 x 465 mm	451424-7	1,79 €
	CL183D, CL100D			

Hubice

	vhodné pre všetky tyčové modely	podlahová, farba maslová	122520-5	6,99 €
		podlahová, farba maslová	198149-9	13,19 €
		podlahová, farba modra	198527-3	15,89 €
		podlahová, farba modrá	123488-8	9,49 €
		podlahová, farba biela	123486-2	9,59 €
		hubica tvar O, farba maslová	198552-4	5,59 €
		hubica tvar O, farba, modrá	198553-2	5,69 €
		hubica tvar O, farba šedá	191D67-4	5,79 €
		hubica tvar O, farba modrá 360 mm	191D67-4	5,79 €
		kefa úzka, farba maslová	198537-0	5,49 €
		kefa úzka, farba maslová	191724-0	6,39 €
		hubica štrbinová farba modrá	451243-1	0,59 €
		hubica štrbinová farba modrá 330 mm	198990-0	2,36 €
		hubica na čalúnenie, farba biela, 180 mm	199038-1	8,89 €
		hubica na čalúnenie, farba modrá, 180 mm	199041-2	7,67 €
		hubica na čalúnenie, farba modrá, 120 mm	140H95-0	6,19 €
		hubica na koberce, farba modrá 120 mm	459056-4	2,39 €
kefa na hrubé nečistoty	193M30-1	cena na vyžiadanie		

Filtre, sáčky

	CL001G, CL002G, DCL282F	cyklónový filter	191D73-9	38,19 €
	DCL280F, CL141FD			
	DCL281F			
	DCL180, CL106D, CL070D	cyklónový filter	191D75-5	37,99 €
	DCL181F, CL107FD			
	DCL182, CL108FD			
	CL183D, CL100D			
	DCL180, DCL181F, CL183D			
	CL108FD, CL106FD,	filter prachový nylónový	199966-0	9,61 €
	CL070D, CL001G,	predfilter	451208-3	1,39 €
	DCL281F, DCL280F	HEPA filter	*199989-8	6,69 €
	DCL282F, DCL182/F,	papierový sáčok 5 ks	194566-1	3,89 €
	CL114FD, CL121D,	papierový sáčok 5 ks	198745-3	4,39 €
CL107FD, DCL184	vrecko na opakované použitie 1 ks	166084-9	0,79 €	

*okrem modelu CL183D

vhodné pre všetky tyčové modely	nástenný držiak vysávača	458571-5	3,99 €
	prenosná taška	199901-8	22,09 €

PRÍSLUŠENSTVO PRE AKU VYSÁVAČE

Príslušenstvo pre DVC750



Popis	Obj. č.	MOC s DPH
hubica	458891-7	3,09 €
hubica štrbinová	458919-1	1,29 €
hubica štrbinová dlhá	410306-2	1,69 €
hubica v tvare O	191657-9	12,29 €
hadica ø 28 mm x 2 m	140G04-3	8,29 €
popruh ramenný	199486-4	5,79 €
adaptér ø 38 mm	418500-0	3,02 €
HEPA filter	162518-0	24,76 €
nylónový predfilter	162635-6	11,22 €
filter	422449-8	2,89 €
filter na mokré vysávanie	191M39-3	14,09 €

Príslušenstvo pre DCL184/CL121



1 x textilné vrecko na prach	166084-9	0,79 €
5 x papierové vrecko na prach	194566-1	3,89 €
Flexi hadica vysávací	140H92-6	14,46 €
Nástavec s kefou 360°	140H94-2	4,19 €
Hubica na čalúnenie	140H95-0	6,19 €
Jednoramenný popruh	162544-9	4,79 €
Štrbinový nástavec	422437-5	6,89 €
Hubica na auto koberce	459056-4	2,39 €
Nástavec fukára	140J64-3	7,88 €

Aku vysávač Model: DVC560

28 mm príslušenstvo

Dlhá štrbinová hubica 300

- 191D65-8
- 198919-6
- 198990-0
- 198992-6



Okrúhla kefa

- 191D67-4
- 198552-4
- 198878-4
- 198553-2
- 198555-8



Kefa

- 198537-0
- 198873-4
- 198538-8
- 198540-1

Hubica 28

na auto

- 199038-1
- 199041-2
- 199039-9



Hubica 120

na auto

140H95-0



Hubica 120

na auto

459056-4



Štrbinová hubica

- 416041-0
- 451240-7
- 456586-6



Štrbinová hubica 415

199439-3



Jemná kefa 360

140H94-2



Zberné vrecká

10 ks / bal

191D63-2



Hepa filter

191E39-5



Kefa

191D69-0



PRÍSLUŠENSTVO PRE DVC150L/155L/157L/860/862/864

Popis	Obj. č.	MOC s DPH
-------	---------	-----------

Príslušenstvo pre Aku chrbtový vysávač DVC261 / 265 / 660 / 665



hadica ø 28 mm x 1,5 m	152992-0	33,79 €
hadica na pripojenie so strojmi ø 28 mm x 1,5 m s adaptérom	A-34235	34,69 €
teleskopická ø 28 x 590 – 942 mm PVC	123584-2	16,49 €
teleskopická ø 28 x 590 – 942 mm hliník	140G19-0	19,49 €
rukoväť s reguláciou	127093-3	10,29 €
hubica štrbinová dlhá	192236-6	5,69 €
hubica gumená	197901-2	7,29 €
hubica podlahová	123486-2	9,59 €
hubica podlahová	199454-7	31,09 €
hubica podlahová	127082-8	29,49 €
hubica prachová	A-59950	62,79 €
držiak hadice	166116-2	1,09 €
Nástavec s kefou 360°	140H94-2	4,19 €
Hubica na čalúnenie	140H95-0	6,19 €
Hubica na auto koberce	459056-4	2,39 €
adaptér ø 22 mm	195547-8	2,29 €
adaptér ø 24 mm	195546-0	2,59 €
adaptér ø 38 mm	195545-2	5,39 €
adaptér ø 22 – 38 mm	195548-6	11,69 €
vrecko na opakované použitie DVC660/665	191C30-1	15,79 €
vrecko na opakované použitie DVC261/265	197899-3	25,99 €
vrecko na prach 10 ks DVC660/665	191C26-2	20,79 €
vrecko na prach 10 ks DVC261/265	197903-8	15,99 €
HEPA filter DVC660/665	191D12-9	11,17 €
HEPA filter DVC261/265	127725-2	7,09 €

Príslušenstvo pre DVC150L/155L/157L/860/862/864



rukoväť ohnutá hliníková	140G26-3	9,19 €
hubica – univerzálny nástavec suché/mokrú	195551-7	28,69 €
hubica na suché vysávanie	195549-4	23,29 €
hubica na mokré vysávanie	195550-9	18,69 €
rúra odsávania hliník rovná (1 ks)	192563-1	6,79 €
rúra odsávania hliník zahnutá (1 ks)	192562-3	6,49 €
Štrbinový nástavec	410306-2	1,69 €
teleskopická ø 28 x 590 – 942 mm hliník	140G19-0	19,49 €
teleskopická ø 28 x 590 – 942 mm PVC	127605-2	33,29 €
hadica ø 32 mm x 1,7 m	199493-7	18,89 €
hadica antistatická ø 28 mm x 3,5 m s adaptéromi ø 22, 24, 38	195433-3	59,69 €
hadica antistatická ø 38 mm x 2,5 m	195434-1	66,59 €
hadica ø 28 mm x 5 m s adaptéromi ø 22, 24, 38	195436-7	81,79 €
hadica ø 28 mm x 2,5 m s adaptéromi ø 22, 24, 38	195437-5	53,19 €
hadica ø 28 mm x 1 m s adaptéromi ø 22, 38	A-34235	34,69 €
hadica ø 38 mm x 5 m	195435-9	113,39 €
adaptér 28 / 24 mm	195546-0	2,59 €
adaptér 28 / 22 mm	195547-8	2,29 €
adaptér 28 / 38 mm	195545-2	5,39 €
adaptér/spojka 22 / 38 mm	195548-6	11,69 €
vrecká na prach igelitové 10 ks/bal	195440-6	9,79 €
vrecká na prach igelitové 10 ks/bal	195432-5	10,59 €
vrecká na prach textilný 5 ks/bal	661914-4	9,29 €
MODUL AWS pre vysávače s AWS systémom	198900-7	64,79 €
sieťový adaptér pre DVC150	661914-4	9,29 €
HEPA filter	197166-6	55,29 €
predfilter suché vysávanie	195553-3	18,79 €
predfilter suché/mokrú vysávanie	142248-3	cena na vyžiadanie

Obj. č.	obsah sady	MOC s DPH
Príslušenstvo pre vysávanie pre vysávače 446L, 447L a VC2010L / VC2511 / VC3511 L		
	P-70312	102,99 €
	P-70328	132,29 €
	W302002734	89,99 €

Obj. č.	popis	MOC s DPH
Sada príslušenstva pre vysávače DVC860LZ, 862LZ, 864LZ		
	195439-1	108,49 €

Obj. č.	popis	MOC s DPH
Príslušenstvo pre DRC200Z		
SH00000231(EU)	páska na vytýčenie hranice (15 m rolka)	54,59 €
SH00000065	bočné kefy	47,63 €
SH00000063	výkonná kefa	91,49 €
SH00000064	kryt rotačnej kefy	38,44 €
SH00000213	filter	82,48 €

ø mm	model	Obj. č.	MOC s DPH
Adaptéry			
28 – 38	Proteam	191M79-1	9,09 €
28 – 35	KARCHER/Nifisk	191M78-3	9,09 €
28 – 32	PACVAC SHOPVAC Proteam	P-19299	5,29 €

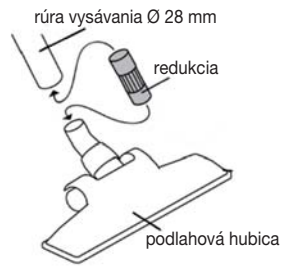

Akumulátory
 Odkladacie systémy
 Vŕtanie
 Skrútkovanie
 Brúsky
 Pilenie
 Frézovanie
 Brúsenie
 Klince / spony
 Špeciálne stroje
 Vysávanie
 Fény/lampy
 Záhrada
 Ručné náradie
 Ostatné

ROZMERY ADAPTÉROV NA ODSÁVANIE



Obj. č.	popis	poznámka	Ø adaptéru (mm)	pre vysávač	MOC s DPH
---------	-------	----------	-----------------	-------------	-----------

Adaptéry na hadice vysávačov



50075B0N	adaptér hadice (k vysávaču)	pre hadicu 01318B09, Ø 45 mm	60	440/445X/448	3,09 €
P-70409	adaptér hadice (k vysávaču)	pre hadicu P-70487, Ø 36 mm	58	446L, 447L, VC2010L, VC2511, VC3511L	14,79 €
P-70390	adaptér hadice (k vysávaču)	pre hadicu P-70362 a P-72920, Ø 36 mm	58	446L, 447L, VC2010L, VC2511, VC3511L	14,99 €
P-70378	adaptér ku stroju antistatický (použiteľný s krúžkom 213419-6)	pre hadicu s rýchlopínaním	25/38	446L, 447L, VC2010L, VC2511, VC3511L	27,79 €
W107418688	adaptér ku stroju antistatický (použiteľný s krúžkom 213419-6)	pre hadicu s rýchlopínaním	38	446L, 447L, VC2010L, VC2511, VC3511L, VC4210L/M	31,59 €
P-70415	adaptér ku stroju antistatický (použiteľný s krúžkom 213419-6)	pre hadicu P-70487, Ø 27 mm	37/45	446L, 447L, VC2010L, VC2511, VC3511L	10,59 €
213419-6	O krúžok	pre adaptéry ku strojom			2,39 €
P-70421	antistatický adaptér	pre hadicu P-70487, Ø 27 mm	25/38	446L, 447L, VC2010L, VC2511, VC3511L	23,09 €
P-72936	adaptér	pre hadicu P-72914, Ø 32 mm	25/38	446L, 447L, VC2010L, VC2511, VC3511L	11,99 €
195547-8	adaptér 22	pre hadicu 195433-3, Ø 28 mm	22	VC3210LX1, BCV340, BCV350	2,29 €
195546-0	adaptér ku stroju 24	pre hadicu 195433-3, Ø 28 mm	24	VC3210LX1, BCV340, BCV350	2,59 €
195545-2	adaptér 38	pre hadicu 195433-3, Ø 28 mm	38	VC3210LX1, BCV340, BCV350	5,39 €
195547-8	adaptér 22	pre hadicu 195433-3 priemer 28 mm	22	VC3210, VC3211, BCV340, BCV350, DVC860L, VC2211M	2,29 €
195546-0	adaptér 22	pre hadicu 195433-3 priemer 28 mm	24	VC3210, VC3211, BCV340, BCV350, DVC860L, VC2211M	2,59 €
P-81745	adaptér s reguláciou	pre hadicu P-81739 priemer 32 mm	25/38	VC2012L, VC2512L, VC3011L	20,89 €
W107418661	adaptér ku stroju	pre hadicu Ø 32 mm	32/22	VC2012L, VC2512L, 3011L, VC2000L	15,19 €
W107418680	adaptér ku stroju	pre hadicu Ø 32 mm	32/38	VC2012L, VC2512L, 3011L, VC2000L	18,29 €

ADAPTÉRY NA ODSÁVANIE

Obj. č.	popis	Vhodné pre stroj	priemer (mm)	MOC s DPH
Príslušenstvo na odsávanie				
	193472-7	sada na odsávanie pre kladivá	DHR262, HR2450, HR2020, HR2440, HR2460, HR2470, HR2810, HR2811, DHR261, DHR241, DHR202	25 47,99 €
	JPA122275	odsávací adaptér pre hoblíky	1902, 1911B, 1923H, N1923B	5,29 €
	181575-9		1806B, KP312S	6,09 €
	192065-7	nástavec pre odsávanie	1923B, 1923H	5,19 €
	193733-5		K312S	32,99 €
	414468-8		1911B	2,69 €
	152122-3		N1923B	3,79 €
	451329-1		KP0800	1,69 €
	416368-8		LF1000, KP0800, KP0810/C, DKP180	2,19 €
	JPA122194	odsávací adaptér	N/1923B	9,99 €
	199142-6	odsávacia sada	HR4003C, HR4013C	73,99 €
	196858-4		HR5202C, HR5212C	85,49 €
	199144-2	odsávanie na sekacie kladivá	SDS-MAX	42,99 €
	195179-1	odsávací adaptér pre kladivá	SDS-plus	7,39 €
	P-81795	adaptér 50 mm	LF1000	41,99 €

Akumulátory
Odkláďacie systémy
Vŕtanie
Skrutkovanie
Brúsky
Pílenie
Frézovanie
Brúsenie
Klince / spony
Špeciálne stroje
Vysávanie
Fény/lampy
Záhrada
Ručné náradie
Ostatné

ADAPTÉRY NA ODSÁVANIE

Obj. č.	popis	Vhodné pre stroj	priemer (mm)	MOC s DPH
Príslušenstvo na odsávanie				
	410899-9	odsávací adaptér pre kefovú pílu	9741	1,19 €
	192613-2	odsávací adaptér	4105KB, 9401, PC1100	17,89 €
	192504-7	odsávací adaptér	BO4550, BO4553, BO4554, BO4561, BO4563	2,59 €
	192518-6	odsávací adaptér	9924DB	20,99 €
	192420-3		5603R, 5604R, 5703R, 5704R, 5705R	2,79 €
	453289-3		HS6101, HS7101	2,99 €
	415816-4	odsávací adaptér k okružným pílam	5143R	5,09 €
	450316-7		5104S	3,09 €
	196520-1		HS6601, HS7611, DHS7601, DHS782, DHS783, HS004G, DHS710	1,89 €
	416706-4		5621RDWA, BSR730WA	3,46 €
	419283-5	odsávací adaptér	BSS610, DSS610, DSS611	1,69 €
	194314-8		DHS630	6,59 €
	192547-9		4304 – 4305T, 4331D, 4334D	2,49 €
	196022-7	odsávací adaptér	TM3000C	4,09 €
	417853-4		4340CT-51FCT, DJV140/180RFE	0,89 €
	192035-6		3612BR, 3620	16,09 €
	415412-8		3612, 3612C	4,69 €
	194934-8	uhlový adaptér	RP1800FX/2300FCX	9,49 €
	194733-8		RP0900, RT0700C	2,99 €
	122609-9	odsávací adaptér	RP0910, RP1110C	5,89 €

VAKY NA PRACH

	model	Obj. č.	MOC s DPH
--	-------	---------	-----------

Pre elektrické modely



UB1100, UB1101	122321-1	2,69 €
UB1102, UB1103	123241-2	6,99 €
1901, 1902	STEX122269	40,99 €
1923H	196298-6	38,21 €
3901	122474-6	4,59 €
4100KB	126738-0	6,29 €
9924DB	122296-4	16,29 €
9401, 9402	122297-2	15,19 €
9404, 9902, 9903, 9920	122591-2	15,79 €
9921, 9403	122562-9	16,49 €
9910, 9911	122548-3	7,09 €
SP6000	122562-9	16,49 €
LF1000, LH1040/F, LS0714/F/FL/L, LS1019/L, LS1030N, LS1040/F, LS1045, LS1216/F/FL/L, LS1219L	122852-0	2,99 €
LS1221, LH1201FL, LS1017L, LS1018L	JM23100501	3,19 €
LS0810	122351-2	5,99 €
LS0815F/FL	JM23510010	4,69 €
LS1440	122330-0	17,89 €
KP0810/C, KP0800	122793-0	23,39 €
PC5000C, PC5001C	122853-8	4,69 €
PJ7000	123150-5	5,19 €
BO4900, BO4900V, BO6030	151517-7	24,99 €
BO4555, BO4556, BO4557, BO4558, BO4565, BO4566, BO5030, BO5031, BO5040, BO5041	135222-4	4,49 €

Pre akumulátorové modely



DUB182	122814-8	3,79 €
UB100D, UB101D, DUB185, DUB186	123241-2	6,99 €
DLS110, DLS111, DLS112, DLS211, DLS212, DLS713, DLS714	122852-0	2,99 €
LS002G	127512-9	8,60 €
DSP600, DSP601	126599-8	12,99 €
DKP180	122793-0	23,39 €
DKP181	191C21-2	33,19 €
DPJ180	123150-5	5,19 €
DBO140, DBO180	135222-4	4,49 €

Akumulátory

Odkladacie systémy

Vŕtanie

Skrutkovanie

Brúsky

Pílenie

Frézovanie

Brúsenie

Brúsenie

Klince / spony

Špeciálne stroje

Vysávanie

Fény/lampy

Záhrada

Ručné náradie

Ostatné

VŔTANIE / SEKANIE

Odsávanie

Len pre sekacie Ø hadice 28 mm na priame pripojenie



model	Obj. č.	MOC s DPH	
DHR400, HM001G, HM002G, HR005G, HR006G, HM0830, HM0870C, HM0871C, HM1101C, HM1111C, HM1201, HM1203C, HM1205C, HM1213C, HM1214C, HR3530, HR3540C, HR3541FC, HR4001C, HR4002, HR4003C, HR4010C, HR4011C, HR4013C, HR4030C, HR4041C, HR4501C, HR4510C, HR4511C, HR5212C, HR5202C	odsávací set s hadicou	199144-2	42,99 €
	odsávací set bez hadice	199143-4	13,69 €
HM1304/B, HM1306, HM1307C/CB, HM1317C/CB, HM1400, HM1500/B, HM1801, HM1802, HM1810, HM1812	odsávací set s hadicou	197148-8	77,01 €
	odsávací set bez hadice	197168-2	44,99 €
HM1501, HM1502, HM1511, HM1512	odsávací set s hadicou	191M20-4	62,49 €
	odsávací set bez hadice	191M21-2	22,39 €

odsávanie príslušenstvo pre SDS-max 40 – 45 mm vŕtanie / sekacie

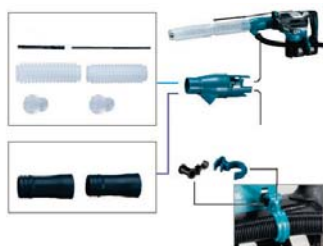

DHR400, HR005G, HR4003C, HR4013C, HM001G, HM002G, HM0830, HM0870C, HM0871C, HM1101C, HM1111C, HM1201, HM1203C, HM1205C, HM1213C, HM1214C	199142-6	73,99 €
HR006G	191N81-0	cena na vyziadanie
HR4001C, HR4002, HR4010C, HR4011C, HR4501C, HR4510C, HR4511C	196074-8	95,79 €
HR5212C, HR5202C	196858-4	85,49 €

Odsávacie adaptéry pre vŕtacie kladivá

Odsávacie adaptéry pre vŕtacie kladivá
Tento systém je navrhnutý tak, aby efektívne zachytával prach pri zapnutí / vypnutí nástrojov



DHR182	DX05	199664-4	cena na vyziadanie
DHR243	DX07	199572-1	115,69 €
DHR280, DHR282	DX08	199581-0	134,39 €
HR3011F	DX10	191F49-8	46,99 €
HR3012F	DX11	191F49-9	cena na vyziadanie
HR001G, HR003G	DX12	191E54-9	139,69 €
HR002G, HR004G	DX14	191E60-4	146,39 €
HR2652, HR2653, HR2653T, HR2663		127185-8	99,69 €
DHR242, HR2650, HR2651, HR2652, HR2653, HR2661, HR2663, DHR281, DHR283, HR002G, HR004G HR3012FC, DHR243		195173-3	5,29 €
DHR242, HR2650, HR2651, HR2652, HR2653, HR2661, HR2663, DHR281, DHR283, HR002G, HR004G HR3012FC, DHR243		195179-1	7,39 €
HR140D, HR166D, DHR164, DHR165, DHR171, DHR182, DHR263, DHR264 DHR202, DHR262, HR1840, HR2020, HR2460, HR2460F, HR2470FT, HR2470T, HR2470, HR2470F, HR2475, HR2800, HR2810, HR2810T, HR2811F, HR2811FT,		193472-7	47,99 €

HEPA filtre pre odsávacie adaptéry



DX06, DX07, DX08, DX09, DX10, DX11, DX12, DX14, HR2652, HR2653, HR2653T, HR2663	199557-7	9,69 €
DX05	199596-7	7,19 €
filter s oklepom pre DX05	199595-9	60,73 €

Manžety



DX05, DX06, DX07, DX08, DX09, DX12, DX14, HR2652, HR2653, HR2653T, HR2663	424474-5	0,59 €
protiprachový kryt pre stopku vŕtáka sekáča Ø 6 – 14 mm	421342-3	1,59 €
protiprachový kryt pre stopku vŕtáka sekáča Ø 10 – 18 mm	421664-1	2,29 €

Pripojenie stroja k vysávačom *Ien pre modely DVC261, DVC265, DVC660, DVC66

Model VC002GL VC004GL DVC157L DVC867L		Model VC3211H VC3211M VC2211M VC3210L VC2510L VC1310L		Model VC009G DVC265 DVC665 DVC350		Model DVC750L		Model VC3012L/M VC4210L/M		Model VC2012L VC2512L VC3011L	
--	---	--	---	--	---	-------------------------	--	--	---	---	---

Hadica 28 mm

1.0m *143787-2 bez koncovky hadice
 1.5m A-34235 s koncovkou hadice 22, 38
 2.5m 195437-5 s koncovkou hadice 22, 24, 39
 3.5m 195433-3 s koncovkou hadice 22, 24, 39
 5.0m 195436-7 s koncovkou hadice 22, 24, 40
 5.0m A-34229 s koncovkou hadice 22, 38



Hadica 38 mm
s adaptérom 38

1.5 198757-6
 2.5 195434-1
 5.0 195435-9



32-B Hadica 32 mm
4m P-84084



32-B Hadica 32 mm
3.5m P-81739



Koncovka hadice

Koncovka hadice 38
195545-2

Koncovka hadice 22
195547-8



Koncovka hadice 24
195546-0



Redukcia 22 - 38
195548-6



Koncovka hadice 24
195546-0



Adaptér
Quicksystem ø24 (set)
P-70378
Quicksystem ø38 (set)
W107418688



Adaptér



Odsávacie adaptéry



AWS
Auto-start Wireless System

Modul AWS Bluetooth



WUT02
Adaptér na prepojenie elektrických vysávačov s akumulátorovými strojmi



Adaptéry, redukcie a pripojenie hadíc

Hadica 28 mm

Dodávaná s dvomi adaptérmí 22 a 38



Koncovka hadice

Koncovka hadice 38
vnútorný priemer 38 mm
vonkajší priemer 44,2 mm

Koncovka hadice 22
vnútorný priemer 22,4 mm
vonkajší priemer 25 mm

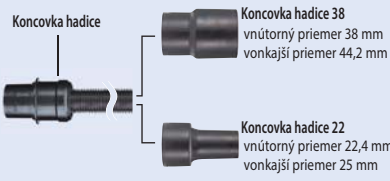

Hadica 38 mm



Koncovka hadice

Koncovka hadice 38
vnútorný priemer 38 mm
vonkajší priemer 44,2 mm



Koncovka 22, 24, 38

Hadica 28 s koncovkou 22

Hadica 28 s koncovkou 38

Hadica 38 s koncovkou 38

Koncovkou 24

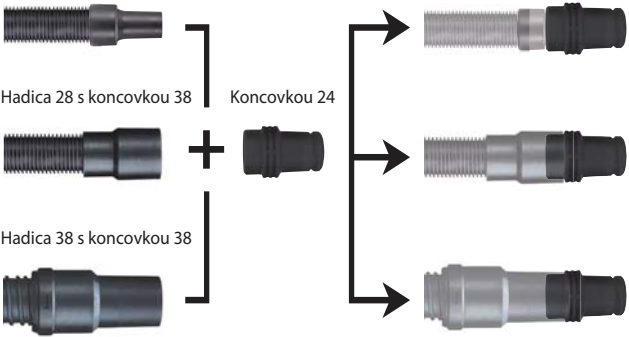

Prepojenie hadice s hadicou

Hadica 28 s koncovkou 38

Hadica 38 s koncovkou 38

Hadica 28 Koncovka hadice

Hadica 38 Koncovka hadice

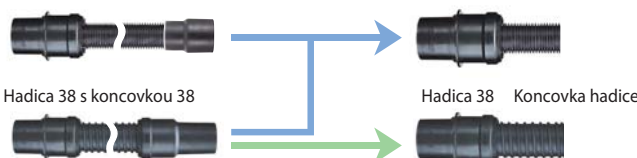













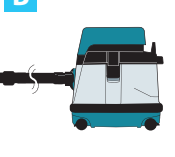

Adaptér 22 - 38

Hadica s koncovkou 38

Adaptér 22 - 38

Rozmery
vnútorný priemer 22,4 mm
vonkajší priemer 25 mm



<p>A</p>  <p>W/ Ø28mm Hadica</p> <p>Model VC3211H VC3211M VC2211M VC3210L</p> <p>S koncovkou hadice</p>  <p>38 24 22</p>	<p>B</p>  <p>W/ Ø28mm Hadica</p> <p>Model VC002GL VC1310L VC004GL DVC157L DVC867L VC2510L</p> <p>S koncovkou hadice</p>  <p>38 24 22</p>	<p>C</p>  <p>W/ Ø28mm Hadica</p> <p>Model DVC350</p> <p>S koncovkou hadice</p>  <p>38 24 22</p>	<p>D</p>  <p>W/ Ø38mm Hadica</p> <p>Model VC001GL DVC860L VC003GL DVC861L VC005GL DVC865L DVC155L DVC866L DVC156L DVC750L</p> <p>W/ Joint 22-38</p> 	<p>E</p>  <p>W/ Ø28mm Hadica</p> <p>Model VC008G DVC261 VC009G DVC265 DVC660 DVC665</p> <p>S koncovkou hadice</p>  <p>38 24 22</p>	<p>F</p>  <p>W/ Ø32mm Hadica</p> <p>Model VC2012L VC2512L VC3011L</p> <p>W/ Tool adapter 24</p>  <p>P-81745 P-70421</p>	<p>G</p>  <p>W/ Ø32mm Hadica</p> <p>Model VC3012L VC4010L VC3012M VC4010M</p> <p>Adaptér</p>  <p>24 38 P-70378 W107418688</p>
---	---	--	---	---	--	--

Vŕtacie a búracie kladivá

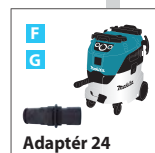

Model	Prevádzkový režim	Odsávací adaptér		Koncovka / hadice veľkosť
		Typ	Obj. č.	

Model	Prevádzkový režim	Odsávací adaptér		Koncovka / hadice veľkosť
		Typ	Obj. č.	
Búracie kladivá HM1501, HM1502, HM1511, HM1512	---	bez hadice	191M21-2 191M23-8**	Hadica 28 bez koncovky
	---	s hadicou	191M20-4 191M22-0**	Koncovka 24 alebo 38
Búracie kladivá HM1304/B, HM1306, HM1303C/CB, HM1307C/CB, HM1317C/CB, HM1400, HM1500/B, HM1801, HM1802, HM1810, HM1812	---	bez hadice	197168-2 197170-5**	Hadica 28 bez koncovky
	---	s hadicou	197148-8 197172-1**	Koncovka 24 alebo 38
Sekacie kladivá HM001G, HM002G, HM0830, HM0870C, HM0871C, HM1101C, HM1111C, HM1201, HM1203C, HM1205C, HM1213C, HM1214C	---	bez hadice	199143-4 199017-9**	Hadica 28 bez koncovky
	---	s hadicou	199142-6 199014-5**	Koncovka 24 alebo 38
Kombinované kladivá DHR400, HR005G, HR4013C, HR4003C, HR5212C, HR5202C, HR006G, HR4001C, HR4002, HR4010C, HR4501C, HR4510C, HR4511C, HR5212C, HR5202C, HR4001C, HR4002, HR4010C, HR4501C, HR4510C, HR4511C, HR4041C, HR4030C, HR4013C, HR4003C, HR3541C, DHR400, HR005G, HR006G	Sekanie / vŕtanie	-	197148-8 197172-1**	Koncovka 22
	Sekanie / vŕtanie	-	196858-4	Koncovka 22
	Sekanie / vŕtanie	s hadicou	191N81-0 191N82-8**	Koncovka 22
	Sekanie	-	196074-8	Koncovka 22
Kombinované kladivá DHR242, DHR280, DHR282, HR001G, HR003G, HR2300, HR2600, HR2601, HR2601F, HR2630, HR2631F, HR2641, HR2651, HR2652, HR2653, HR2663, HR3001C, HR3011F, HR007G, DHR243, DHR281, DHR283, HR002G, HR004G, HR2320T, HR2630T, HR2631FT, HR2653T, HR3012F	Sekanie / vŕtanie	-	199144-2 199019-5**	Koncovka 24 alebo 38
	Sekanie / vŕtanie	-	199143-4 199017-9**	Hadica 28 bez koncovky
	Sekanie / vŕtanie	-	199143-4 199017-9**	Hadica 28 bez koncovky

Kotúčové píly a ponorné píly

*potrebná aj vnútorná príruka



*nie je potrebná koncovka hadice 24



Model	Adaptér		Koncovka
	Popis	Obj. č.	
DHS630	Odsávací adaptér	194314-8	22
DHS631	Odsávací adaptér	196995-4	22
DHS660, DHS661	Odsávací adaptér	199230-9	24
DHS680	Odsávací adaptér	196961-1	24
DHS710	Odsávací adaptér	196520-1	24
DHS711	Odsávací adaptér	196843-7	24
DHS780, DHS781, DHS782, DHS783	Odsávací adaptér	196520-1	24
HS009G, HS010G, HS011G	---	---	24
DHS900, DHS901, DSP600, DSP601	---	---	24
DSS501	Odsávací adaptér	194415-2	22
DSS611	Odsávací adaptér	199460-2	22
RS001G	---	---	24
RS002G, 5017RKB	---	---	38
5007F, 5007FA, 5007NB	Odsávací adaptér	199711-3	24
5007MGA, 5007MG	Odsávací adaptér	199716-3	24
5007N, 5007NF	Odsávací adaptér	199712-1	24
5008MG, 5008MGA	Odsávací adaptér	194489-3	38
5103R	Adaptér s 2 x skrútkou	415426-7/192419-8	38
5104, 5104S	Adaptér	199427-0	38
5143R	Adaptér	192490-2	38
N5900B, 5902B	Adaptér	193068-4/193823-4	38
5903R	Adaptér	192419-8	38
HS003G, HS004G	Odsávací adaptér	196520-1	24
HS301D	Odsávací adaptér	195334-5	22
HS0600	Odsávací adaptér	198263-1 / 198265-7	24
HS6100, HS6101	Odsávací adaptér	195801-0	24
HS6600	Odsávací adaptér	196843-7 / 196520-1	24
HS6601	Odsávací adaptér	196520-1	24
HS7000	Odsávací adaptér	197221-4 / 196520-1	24
HS7010	Odsávací adaptér	196520-1	24
HS7100, HS7101	Odsávací adaptér	195801-0	24
HS7600	Odsávací adaptér	197221-4 / 196520-1	24
HS7010, HS7610, HS7611	Odsávací adaptér	198933-2	24
HS7601, HS7610, HS7611	Odsávací adaptér	196520-1	24
SP6000, SP001G	---	---	24

Uhlové brúsky

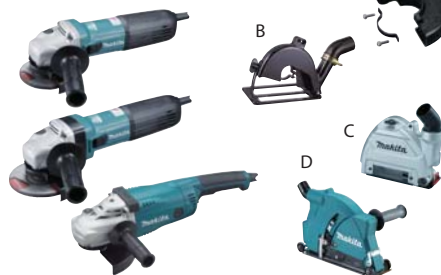















Model	Kryt kotúča na zachytávanie prachu		Koncovka
	Typ krytu kotúča	Obj. č.	
pre uhl. brúsky 115/125 mm	C	196845-3	38
125 mm modely X-Lock	C	191G05-4	38
pre uhl. brúsky 115/125 mm, bez nástrojová výmena	C	191G06-2	38
pre uhl. brúsky 180/230 mm	D	198379-2(M14 spindle) 198440-5(EU) 198509-5 (5/8" spindle) 198510-0 (M16 spindle)	38
pre uhl. brúsky 180/230 mm	B	194044-1	38











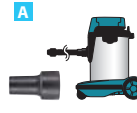

Uhlové brúsky / diamantové brúsenie

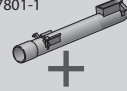

Model	Kryt kotúča pre diamantové brúsenie		Koncovka
	Priemer kotúča	Obj. č.	
125 mm modely X-Lock	125mm	191F81-2	38
pre uhl.brúsky 115/125 mm	125mm	127147-6	38
pre uhl.brúsky 180/230 mm použitie len 180 mm brúsný kotúč	180mm	195385-8	38

Model	Systém prepojenie s vysávačom
Pásová brúska DBS180, 9032 	Adaptér 122652-8 
Pásová brúska 9031 	
Vibračné brúsky DBO380, DBO381, DBO480, DBO481, DBO482 9046, BO3700, BO3710, BO3711, BO4900/V, BO4901 BO4555, BO4556, BO4565, BO4566, BO4557, BO4558  	
Excentrické brúsky BO5012, BO5030, BO5031, BO5040, BO5041, BO6030, BO6040, DBO180 	
Multi Tool DTM52 DTM51 DTM50 TM3000C TM3010C  	Odsávacie adaptéry 191R02-6 199627-2 199621-4 199618-3 199624-8 
Pásová brúska 9404, 9902, 9903, 9910, 9911, 9920, 	
Excentrická brúska BO6050 	Koncovka hadice 24 195546-0 
Brúska na sádkartón DSL800, DSL801 	Koncovka hadice 24 195546-0 









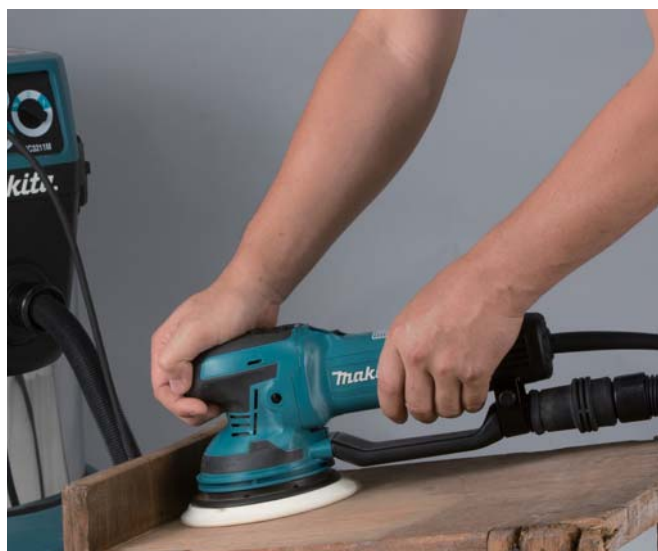





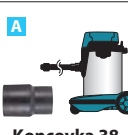

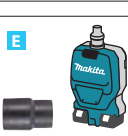

*Nie je potrebný pri koncovke hadice 24

Model	Systém prepojenie s vysávačom
Priamočiare píly JV100D, JV143D JV183D, 4326, 4327, 4328, 4329 JV0600  	Koncovka 22 
Priamočiare píly DJV180, 4350T/CT/FCT, 4351T/CT/FCT  	Odsávací adaptér 417853-4 
Akumulátorové priamočiare píly DJV181, DJV182 **JV102D, JV103D  	Odsávací adaptér 126331-0 457801-1  
Pila na kov DC5553 	Kryt komplet 



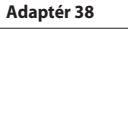



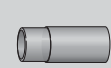



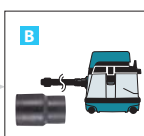



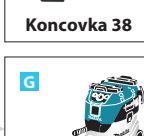





**Použitie s krytom 458191-5









*Nie je potrebný pri koncovke hadice 24



Model	Systém prepojenie s vysávačom
Uhlová rezačka 4112H, 4112HS, 4114, 4114S 	Zahnutý adaptér 32 192613-2 
Diamantová rezačka 4100KB Akumulátorová diamantová rezačka DCC500 Píla so zberným zásobníkom 4157KB  	 A Koncovka 38  B Koncovka 38  C Koncovka 38  D
Drážkovacie frézy SG1251, SG1250 	 E Koncovka 38  E
Leštička PC5000C, PC5001C, PC5010C 	 G Adaptér 38
Pásová brúska 9924DB Adaptér 32 192518-6  	 E Koncovka 38
Pásová brúska 9403, 9921 	Adaptér 32 192349-3 
Keľová brúska 9741 	Adaptér 410899-9 



Model	Systém prepojenie s vysávačom
Akumulátorové pokosové píly DLS713, DLS714 	A Koncovka 38  B Koncovka 38  C Koncovka 38  D  E  E Koncovka 38  G Adaptér 38 
Pokosové píly LS0714/F/FL/L, LS0815F/FL, LS1016L, LS1017L, LS1018/L, LS1216/L 	 E Koncovka 38
Pokosové píly LS1030N, LS1440 	 E Koncovka 38
Pokosové píly LS1040/F, LS1045, LS1221 	 E Koncovka 38
Akumulátorové pokosové píly DLS600 	 E Koncovka 38
Stolové pokosové píly LH1040/F, LH1201FL 	 G Adaptér 38
Pokosové píly LS1019/L, LS1219/L Koncovka hadice 195546-0  	 G Adaptér 38
Akumulátorové pokosové píly LS002G, LS003G, LS004G, DLS110, DLS111, DLS112, DLS211, DLS212 	 G Adaptér 38



Model	System preporenie s vysavačom
Stolová píla 2704N, 2705 	Adaptér 419093-0 
Stolová píla 2703 	Adaptér 55 192799-2 
Stolová píla MLT100N 	Adaptér JM27000090 
Stolová píla 2712 	
Pásová píla LB1200F 	Adaptér 419093-0 



Hoblovačka 2012NB 	Odsávací adaptér 193036-7 Vonkajší priemer 76 mm 
--	--

Pre odsávacie hadice s vnútorným priemerom 76 mm



Model	System preporenie s vysavačom
Hoblíky KP001G, DKP181, KP0810/C 	A Koncovka 38 
Hoblíky DKP180, KP0800 	Adaptér 451329-1 
Hoblíky 1805N 	Adaptér JPA122277 
Hoblíky 1100 	Adaptér 415452-6 
Hoblíky 1911B 	Adaptér 192082-7 
Hoblíky N1900B, N1923B, KP0800, 1804N, 1805N, 1806B, KP312/S 	Adaptér 38 

*C: DVC350 nie je možné použiť s hoblíkmi

Odsávací adaptér



Adaptér *Zahnutý



Model	Obj. č.	Model	Obj. č.
N1900B	191569-6	N1900B, N1923B	192799-2 JPA122275
N1923B	152464-5	DKP180, DKP181, KP0810/ C, KP0800	*191C20-4
KP0800, DKP180, DKP140	451329-1	1804N, 1805N, 1806B, KP312/S	181575-9
1804N	JPA122278 (122278-6)		
1805N	JPA122277 (122277-8)		
1806B	414499-7		
KP312/S	193733-5		

Model	Systém prepojenie s vysávačom
Lamelovacia fréza PJ7000, DPJ180	 Koncovka 22
Jednoručná fréza 3706	 Koncovka 22
Akumulátorová ručná fréza DCO181, DCO180	Odsávací adaptér 193449-2
Akumulátorová píla na sádkartón DSD180, SD100D	 Koncovka 22
Horné frézy RP1111C, RP1110C, RP0910	 Adaptér 22-38 195548-6
	 Koncovka 22
	 Adaptér 24 + Adaptér 25-50 192349-3
	 Adaptér 38 + Adaptér 22-38 195548-6

*C: DVC350 nie je možné použiť s frézami

Model	Systém prepojenie s vysávačom
Horné frézy RP1802/ F, RP1803/ F, RP1801/ F, RP1800/ F, RP2302FC, RP2303FC RP2301FC, RP2300FC	Odsávací adaptér 194934-8
3612BR	 Koncovka 38
Horné frézy RD1101, RF1101, RP1101	Odsávací adaptér 193379-7
Horné frézy RP0900, ***RT0700C, ***RT0702C	 Koncovka 38
Akumulátorové horné frézy ***RT001G, ***DRT50	Odsávací adaptér 194733-8
*** Use with Plunge base assembly	 Koncovka 38
Horná fréza RT0700C	Odsávací adaptér 195559-1
Akumulátorové horné frézy RT001G, DRT50	 Koncovka 38
	 Koncovka 38
	 Adaptér 38

Spoločnosť Makita odporúča použiť hadicu s priemerom 38 mm pri frézach





Príslušenstvo pre modely HG6031, HG6030, HG5030, HG6530, HG6531

popis	Obj. č.	MOC s DPH	
	dýza chrániaca sklo pred poškodením	PR00000028	5,59 €
	dýzy plochá	PR00000029	5,29 €
	dýzy odrazová	PR00000030	6,79 €
	dýza redukčná	PR00000031	5,69 €
	dýzy pre zváranie preplátovaním	PR00000032	12,39 €
	dýza pájkovacia odrazová	PR00000033	15,19 €
	dýza zvracia	PR00000034	11,49 €
	valček prítlačný	PR00000035	8,99 €
	tavné tyčinky ABS použitie v automobilovom priemysle	PR00000036	9,39 €
	tavné tyčinky HDPE polyetylén s vysokou hustotou	PR00000037	8,49 €
	tavné tyčinky PP pre materiály z polypropylénu tavná teplota 250-310°	PR00000038	8,39 €
	dýza pre rýchle zváranie, použitie len s dýzou	PR00000039	10,19 €
	škrabka plochá	PR00000040	9,29 €
	škrabka sada 4 ks	PR00000041	7,59 €
	škrabka	PR00000042	30,79 €

model	výška	popis	upevňovacia skrutka	Obj. č.	MOC s DPH	
	DML805	992 – 1 750 mm	možnosť pripevniť dve lampy	M8	GM00002283	72,99 €
	DML809, DML811, ML003	1 300 – 2 000 mm	možnosť pripevniť dve lampy	M10	GM00002073	207,39 €
	DML805		upínacia svorka	M8	GM00001396	20,89 €
	DML805		anti reflexná fólia		A-58154	3,89 €
	ML105, ML104		magnet		GM00001683	19,49 €

popis	Obj. č.	MOC s DPH
-------	---------	-----------

Príslušenstvo k Akku kávovaru DCM501

	hrnček	KF00000020	10,79 €
	viečko hrnčeka	KF00000021	1,55 €
	dávkovač kávy	KF00000033	1,10 €

PRÍSLUŠENSTVO

▣ Príslušenstvo pre záhradu



Matice nožov, podložky, misky

*with chisel blade (Arbor size 20mm)















*** podložka s ochranou proti namotaniu trávy

Model	Veľkosť vretena / tvar		1 Podložka			2 Upínacia podložka noža		3 Miska noža		4 Matica noža
			Vŕtanie noža (mm)	Priemer (mm)	Obj. č.	Priemer (mm)	Obj. č.	Priemer (mm)	Obj. č.	Obj. č.
DUR190L, DUR190U, DUR191L, DUR191U	M10x1.25LH	Zaoblený obdĺžnik	25.4	---	***140T23-7	50	347668-4	68	168526-9	264025-0
DUR365U, DUR366L, UR006G, UR007G	M10x1.25LH	Ozubené 10T	25.4	42	**326518-6	50	346084-7	68	168526-9	264025-0
				---	***140L84-9					
DUR368A, DUR368L, UR002G, UR003G	M10x1.25LH	Ozubené 10T	25.4	---	***140L84-9	50	346084-7	68	168526-9	264025-0
DUR369A, DUR369L, UR101C, UR201C	M10x1.25LH	Ozubené 10T	25.4	64.5	144312-2	43	347104-0	68	457274-8	252236-9
UR012G	M10x1.25LH	Ozubené 10T	25.4	70.5	140J59-6	54.5	162567-7	Integrované s podložkou na upínanie noža		252236-9
Elektrické krovinorezy										
UR2300	M10x1.25LH	-	25.4	-	YA00000540	50	346084-7	68	168526-9	264025-0
UR3502	M10x1.25LH	-	-	-	YA00000540	-	-	-	-	-
Delený krovinorez										
EM402MP	M10x1.25LH	Ozubené 10T	25.4	60	326821-5	50	346084-7	68	168526-9	264025-0
EM401MP	M10x1.25LH	Ozubené 10T	25.4	60	331861-0 326821-5	50	346084-7	68	168526-9	264025-0
EM403MP, EM404MP	M10x1.25LH	Ozubené 10T	25.4	64.5	144312-2	43	347105-8	68	457290-0	252236-9
EM405MP, EM406MP	M10x1.25LH	Ozubené 10T	-	64.5	144312-2	-	-	-	-	252236-9
EM408MP	M10x1.25LH	Ozubené 10T	25.4	64.5	140N88-3	43	347766-4	68	413201-5	252236-9
EM409MP	M10x1.25LH	Ozubené 10T	-	64.5	140N88-3	-	-	-	-	252236-9

Akumulátorový vyžíňač

Model	Veľkosť vretena	Podložka		Podložka s ochranou proti namotaniu trávy	Model	Veľkosť vretena	Podložka		Podložka s ochranou proti namotaniu trávy
		Priemer (mm)	Obj. č.				Priemer (mm)	Obj. č.	
DUR364L	M8x1.25RH	44	319245-2	346857-8	DUR184L	M8x1.25RH	36.5	326683-1 144512-4	346857-8
DUR366L	M10x1.25LH	42	326518-6	346622-5	DUR187L, DUR187U, DUR188L, DUR188U	M8x1.25LH	36.5	144512-4	346857-8
DUR369N, UR202C	M10x1.25LH	65	140N88-3		DUR189	M8x1.25RH	36.5	144512-4	346857-8
					DUR192L	M10x1.25LH	71	140W47-1	



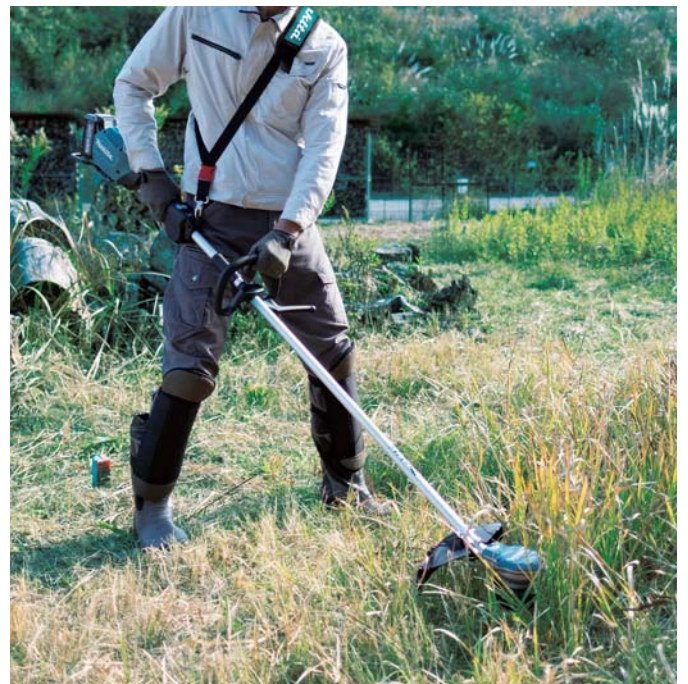

Odporúčané použitie

Typ				
		Malá a riedka tráva	Vysoká a hustá tráva	Zarastené porasty s drevenými kříkmi
Nylónová hlava		← →		
Plastový nôž		← →		
Kovový nôž		← →		
		← →		
		← →		
Žací nôž		← →		
Mulčovací nôž			← →	
Píllový kotúč				← →
Žací nôž				← →
T.C.T pílový kotúč		← →		



Nože pre krovinořezy

Vrtanie nožov: 25,4 mm



	Priemer / počet zubov	Hrúbka noža	Vhodné pre modely	Obj. č.	MOC s DPH
2-zubý nôž 	230mm / 2	2.0mm	DUR369A, DUR369L, UR006G, UR007G, UR101C, UR201C, EM400MP, EM401MP, EM402MP, EM403MP, EM404MP	*197808-2	8,89 €
	255mm / 2	2.0mm	DUR369A DUR369L, UR006G, UR007G, UR101C, UR201C	**D-66064	5,29 €
	305mm / 2	2.0mm	UR012G	195624-6	cena na vyžiadanie
4-zubý nôž 	230mm / 4	1.8mm	DUR368A, DUR368L, DUR369A, DUR369L, UR002G, UR003G, UR006G, UR007G, UR101C, UR201C, EM400MP, EM401MP, EM402MP, EM403MP, EM404MP	**D-66008	5,79 €
	255mm / 4	2.0mm	DUR369A, DUR369L, EM3400U/L, UR006G, UR007G, UR101C, UR201C	729023-6	5,99 €
	255mm / 4	2.0mm	DUR369A, DUR369, UR006G, UR007G, UR101C, UR201C	**D-66014	cena na vyžiadanie
8-zubý nôž 	200mm / 8	1.4mm	DUR194	191Y44-2	cena na vyžiadanie
3-zubý nôž 	255mm / 3	3.0mm	UR006G, UR007G, UR101C, UR201C	385224340	15,59 €
	305mm / 3	3.0mm	UR012G	385224150	18,19 €

Špeciálne nože ochranné kryty



Na hustú trávu, tenké drevené výhonky. Nie je k dispozícii v niektorých krajinách kvôli miestnym predpisom

Vhodné pre model	Nôž						Ochranný kryt				
	Priemer		Vrtanie noža	Hrúbka noža	Obj. č.	MOC s DPH		Popis	Priemer rúry	Obj. č.	MOC s DPH
UR012G	225mm		25.4mm	1.8mm	199872-9	18,29 €		Bez ochrannej svorky	28mm	199873-7	17,69 €

Mulčovací nôž

Vhodné pre model	Nôž						Ochranný kryt				
	Priemer		Vrtanie noža	Hrúbka noža	Obj. č.	MOC s DPH		Popis	Priemer rúry	Obj. č.	MOC s DPH
UR012G	270mm		25.4mm	3.9mm	199874-5	27,39 €		Bez ochrannej svorky	28mm	199875-3	15,19 €

Rotačné nožnice

Vhodné pre model	Nôž				Ochranný kryt					
	Priemer		Obj. č.	MOC s DPH		Popis	Priemer rúry	Obj. č.	MOC s DPH	
EM407MP	230mm		A : SY00146013 B : SY00146014	31,40 € 28,56 €		Bez ochrannej svorky	24mm	412999-1	9,39 €	

Nylónové žacie hlavy

Žacie hlavy s rýchlím navíjaním lanka

(UN-74L, UN-72L, 96-M8L/R, 96-M10L, 121-M10L)

Žacie lanko sa navíja bez rozobratia žacej hlavy



0 85(sec.)



0 35(sec.)



Až o **58 %**
kratší čas
doplnenia!

Nylónové žacie hlavy



* s adaptérom

Očko 2ks/sada pre Push & Go 4L/4R/Z5L, Ultra Auto 4R/4L/6L obj. č. A-15992











Popis	Typ hlavy	Veľkosť	Závit vretena	Vhodné pre modely	Veľkosť lanka	Typ lanka	Obj. č.	MOC s DPH
Žacia hlava s rýchlím navíjaním lanka Push & Go 	96-M8R	4"	M8x1.25RH	DUR189	2.0mm x 4m	štvorlistok	191D92-5	14,99 €
	96-M8L	4"	M8x1.25LH	DUR187L	2.0mm x 4m	štvorlistok	191D91-7	12,39 €
	96-M10L	4"	M10x1.25LH	DUR190L, DUR190U, DUR191L, DUR191U, DUR192L, DUR368A, DUR368L, DUR369A, DUR369L, DUR369N, UR002G, UR003G, UR006G, UR007G, UR101C, UR201C, UR202C, EM400MP, EM401MP, EM403MP, EM404MP, EM405MP, EM406MP, EM408MP, EM409MP	2.0mm x 4m	štvorlistok	191D89-4	12,29 €
					2.4mm x 3m	štvorlistok	191D90-9	12,29 €
121-M10L	5"	M10x1.25LH	UR012G	2.4mm x 4m	štvorlistok	191D93-3	19,69 €	
Push & Go 	76-M8R	3"	M8x1.25RH	UR100D	1.65mm x 8m	štvorlistok	198854-8	13,09 €
	95-M8R	4"	M8x1.25RH	DUR189	2.0mm x 3m	štvorlistok	198971-4	14,39 €
	95-M8L	4"	M8x1.25LH	DUR187U/L, DUR188U/L, EM2500U/L, EM2600U/L	2.0mm x 3m	štvorlistok	198385-7	12,99 €
	95-M10L	4"	M10x1.25LH	DUR190L, DUR190U, DUR191L, DUR191U, DUR192L, DUR365U, DUR366L, DUR368A, DUR368L, DUR369A, DUR369L, DUR369N, UR002G, UR003G, UR006G, UR007G, UR101C, UR201C, UR202C, EM400MP, EM401MP, EM403MP, EM404MP, EM405MP, EM406MP, EM408MP, EM409MP	2.0mm x 3m	štvorlistok	198893-8	11,89 €
2.4mm x 3m					štvorlistok	123556-7	10,69 €	
Push & Go 	Bump & Feed ECO 4L	4" Low profile	M10x1.25LH	DUR192L, DUR368A, DUR368L, DUR369A, DUR369L, DUR369N, UR002G, UR003G, UR006G, UR007G, UR101C, UR201C, UR202C, EM408MP, EM409MP	2.0mm x 3m	štvorlistok	197296-3	15,89 €
	Bump & Feed Z5L/105-M10L	5"	M10x1.25LH	UR012G	2.7mm x 3m	štvorlistok	199884-2	cena na vyžiadanie
Automatické podávanie a Push & Go 	Ultra Auto 4L	4"	M8&10x1.25LH	DUR187U/L, DU188U/L, EM400MP, EM401MP, EM403MP, EM404MP, EM405MP, EM406MP	2.4mm x 3m	okruhlé	*B-02945	22,59 €

Lanko vysúva približne o 3 cm na obidve strany
– rotácia hlavy dosiahne otáčky 8 500 min⁻¹
– klepnúť hlavu o zem keď je v otáčkach, lanko sa automaticky vysunie



Rada nylónov

Tvar	Ostrosť hrany	Úspora	Hľučnosť
		A	A
	AA		
	A	AA	AA

Farebné rozlíšenie

Priemer	Farba / tvar	Ľahká práca		Ťažká práca	
		Riedka tráva	Hustá tráva	Riedka tráva	Hustá tráva
1.3mm		↔			
1.6mm - 1.65mm	 	↔↔			
2.0mm	 		↔↔↔		
2.4mm	  		↔↔↔↔		
2.7mm				↔↔↔↔↔	
3.0mm	 				↔↔↔↔↔↔





Štandardné nylónové lanko

Farba / tvar		Priemer (mm)	Dĺžka (m)	Obj. č.	MOC s DPH	MOC za 1 m s DPH
	Single	1.3	15	E-02727	1,79 €	0,12 €
	Single	1.6	15	E-02733	1,99 €	0,13 €
	Single	2.0	15	E-02705	1,99 €	0,13 €
	Single	2.0	126	E-02711	9,19 €	0,70 €
	Single	2.4	15	E-02749	2,69 €	0,18 €
	Single	2.4	87	E-02761	9,89 €	0,11 €
	Single	2.4	262	E-02783	24,99 €	0,10 €
	Single	3.0	15	369224809	4,99 €	0,33 €
	Single	3.0	56	369224811	13,99 €	0,25 €
	Single	3.0	168	369224815	35,99 €	0,21 €
	Single	3.3	15	369224810	4,99 €	0,33 €
	Single	3.3	46	369224812	13,99 €	0,30 €
	Single	2.4	15	E-02808	2,79 €	0,19 €
	Single	2.4	69	E-02814	9,19 €	0,13 €
	Single	2.4	206	E-02820	24,99 €	0,12 €
	Single	3.0	15	369224819	5,99 €	0,40 €
	Single	3.0	44	369224821	13,99 €	0,32 €
	Single	3.0	132	369224825	34,99 €	0,27 €
Single	4.0	25	369224824	12,99 €	0,52 €	

Nylónové lanko štvorhran točeny

Farba / tvar		Priemer (mm)	Dĺžka (m)	Obj. č.	MOC s DPH	MOC za 1 m s DPH
	Single	2.0	15	369224060	3,89 €	0,26 €
	Single	2.0	120	369224062	18,89 €	0,16 €
	Single	2.4	120	369224072	21,79 €	0,18 €
	Single	2.7	90	369224063	21,79 €	0,24 €
	Single	2.7	15	369224673	4,99 €	0,33 €
	Single	3.0	15	369224674	5,99 €	0,40 €



Nylónové lanko v tvare štvorlístka

Farba / tvar		Priemer (mm)	Dĺžka (m)	Obj. č.	MOC s DPH	MOC za 1 m s DPH
	Single	1.65	15	E-01731	2,29 €	0,15 €
	Single	1.65	30	E-01747	4,19 €	0,14 €
	Single	1.65	445	E-01753	30,39 €	0,07 €
	Single	2.0	15	E-01769	2,59 €	0,17 €
	Single	2.0	30	E-01775	4,69 €	0,17 €
	Single	2.0	310	E-01781	30,39 €	0,10 €
	Single	2.4	15	E-01797	3,09 €	0,21 €
	Single	2.4	30	E-01806	5,69 €	0,19 €
	Single	2.4	225	E-01812	30,39 €	0,14 €
	Single	2.7	15	E-01828	3,19 €	0,21 €
	Single	2.7	30	E-01834	6,29 €	0,21 €
	Single	2.7	180	E-01840	30,39 €	0,17 €

Dvojité nylónové lanko

Increased durability up to 130%* thanks to Flexible core coated with Impact & abrasion resistant skin
*compared to standard nylon cord



Farba / tvar		Priemer (mm)	Dĺžka (m)	Obj. č.	MOC s DPH	MOC za 1 m s DPH
	Single	3.0	15	E-02836	3,99 €	0,27 €
	Single	3.0	56	E-02842	11,39 €	0,20 €
	Single	3.0	168	E-02858	28,49 €	0,17 €
	Single	3.0	279	E-02864	45,49 €	0,16 €
	Single	3.0	15	E-02870	4,19 €	0,28 €
	Single	3.0	44	E-02886	10,69 €	0,24 €
	Single	3.0	132	E-02892	28,49 €	0,22 €
	Single	3.0	219	E-02901	45,49 €	0,21 €

model

vhodný
pre
model

Obj. č.

MOC s DPH

Popruhy

Popruh pre PDC01 a PDC1200

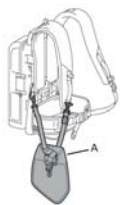

Model	Obj. č.	MOC bez DPH
A	191E43-4	20,48 €



Jednoramenný	DUA250, DUA251, DUA300, DUA301, DUN500W, DUN501W, DUR181, DUR184L, DUR187L, DUR188L, DUR189, DUR190L, DUR191L, DUR192L, DUR194, DUR368A, DUR368L, DUR369A, DUR369L, UA001G, UA002G, UA003G, UA004G; UR100D, DUX60	125516-5	4,19 €
Jednoramenný	DUR190L, DUR190U, DUR191U, DUR369A, DUR369L, UR006G, UR007G	125520-4	3,59 €
Dvojamenný	DUR369A, UR002G, UR006G, UR007G	122906-3	15,59 €
Dvojamenný	DUR369A, UR006G, UR007G	*199378-7	cena na vyžiadanie
	DUR368U, DUR369U, UR006G, UR012D	122A37-4	cena na vyžiadanie

Žacie hlavy pre vyžinače



Vhodné pre model	Priemer/dĺžka	Tvar lanka	Obj. č.	MOC bez DPH
DUR180, DUR181	1.65mmx8m	okruhlé	195858-1	4,39 €
DUR193D	1.65mmx8m	štvorlístok	191Y39-5	cena na vyžiadanie

Žací nôž plastový



Vhodné pre model	Žací nôž plastový				Náhradné čepele		
	Závit vretena	Šírka záberu	Obj. č.	MOC bez DPH	ks/bal.	Obj. č.	MOC bez DPH
UR100D	M8x1.25RH	230mm	198848-3	17,09 €	5	198851-4	3,59 €
DUR187L, DUR187U, DUR188L, DUR190L, DUR190U, DUR191L, DUR191U, DUR188U, DUR189, DUR364L, DUR366L, DUR368A, DUR368L, DUR369A, DUR369L, DUR369N, UR001G, UR002G, UR003G, UR006G, UR007G, UR008G, UR101C, UR201C, UR202C, EM403MP, EM404MP, EM405MP, EM406MP, DUR369A, DUR369L, DUR369N, UR101C, UR201C, UR202C, UR012G	M8x1.25RH M8x1.25LH M10x1.25LH	255mm	198383-1	16,99 €	12	198426-9	6,59 €
	M10x1.25LH	305mm	199868-0	23,59 €	12	199870-3	7,19 €

model	popis	vhodný pre model	Obj. č.	MOC s DPH
	Krovinorez Šírka záberu: 300 mm (žacia hlava) 230 mm (žací nož kov, vrtanie 25,4 mm) závit vretena: M10 x 1.25 LH	DUX60, UX01G	195650-5	83,99 €
	Krovinorez Šírka záberu: 300 mm (žacia hlava) 230 mm (žací nož kov, vrtanie 25,4 mm) závit vretena: M10 x 1.25 LH	DUX60, UX01G	126603-3	64,99 €
	Rotačné nožnice Šírka záberu: 230 mm	DUX18, DUX60, UX01G	191M56-3	485,99 €
	Krovinorez Šírka záberu: 300 mm (žacia hlava) 230 mm (žací nož kov, vrtanie 25,4 mm) závit vretena: M10 x 1.25 LH	DUX18, DUX60, UX01G	191N31-5	71,99 €
	Fukár	DUX18, DUX60, UX01G	191F65-0	135,99 €
	Fukár	DUX18, DUX60, UX01G	191P72-3	134,99 €
	Vyvetvovacia píla dĺžka lišty: 25 cm	DUX18, DUX60, UX01G	199927-0	215,99 €
	Vyvetvovacia píla dĺžka lišty: 30 cm	DUX18, DUX60, UX01G	191T38-7	135,99 €
	Nožnica na živé ploty s nastavením uhla	DUX18, DUX60, UX01G	196257-0	224,99 €
	Nožnica na živé ploty rovná	DUX18, DUX60, UX01G	197732-9	122,09 €
	Nožnica na trávnu s nastavením uhla	DUX18, DUX60, UX01G	198054-0	221,99 €
	Kultivátor Šírka: 160 mm	DUX18, DUX60, UX01G	195709-8	110,99 €
	Nylónová kefa	DUX18, DUX60, UX01G	199317-7	321,99 €
	Gumená kefa	DUX18, DUX60, UX01G	199338-9	331,99 €
	Predĺženie 1 m	DUX18, DUX60, UX01G	191E24-8	69,99 €

Pílové reťaze a lišty



A Dĺžka lišty

Dĺžka lišty udáva priemer rezu, je olišniá od celkovej dĺžky



B Vodiaci článok

Dĺžka pílovej reťaze sa určuje počtom vodiacich článkov

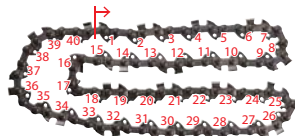

C Delenie reťaze

Delenie reťaze je definované vzdialenosťou medzi akýmkoľvek tromi po sebe idúcimi nitmi delené dvoma. Delenie je dôležité, pretože hnacie ozubené koleso musí mať rovnaké delenie ako reťaz.



D Šírka drážky lišty

Šírku drážky určuje šírka vodiaceho článku, je potrebné používať lištu aj reťaz s rovnakou šírkou.

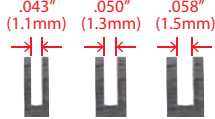

E Vymedzovací zub

Vymedzovací zub určuje záber pílového zubu do dreva.



Charakteristika pílových reťazí

D Šírka drážky lišty	C Delenie reťaze	Rýchlosť rezu			
		Rýchle	Pomalé		
0.043" (1.1mm)					
0.050" (1.3mm)					
0.058" (1.5mm)					
0.063" (1.6mm)					
	1/4"	25AP 25F			
	.325"LP	80			
	3/8"LP	90PX	91PX 91F 91VXL		
	.325"		20BPX 95VPX	21BPX 21LPX	22BPX 22LPX
	3/8"		72LPX 72V	73DPX 73LGX 73LPX	75LPX 75LPX
	.404"				27X 59AC

Typy lišt

Lišta s ozubeným kolesom

Ozubené koleso na špičke lišty zabezpečuje pohyb reťaze s menším trením.



Lišty bez ozubeného kolesa

Špička lišty spevnená stelitom (zliatina kobaltu a chrómu), určená pre obzvlášť náročnú prácu s drevom v v lesoch po požiaroch a vo veľmi prašnom prostredí



Carvingová lišta

Lišty vyrobené z vysoko kvalitnej ocele a stelitom, sú vysoko odolné voči opotrebovaniu. Špička lišty má malý priemer pre presné rezanie. Určené pre vyrezávanie a orezávanie presných tvarov.



Starostlivosť o lištu

Napnutie reťaze

Pred použitím skontrolujte napnutie reťaze.



Okraj lišty

Udržujte v 90° uhle pomocou plochého pilníka.



Čistenie lišty

Čistite lištu pravidelne pri ostrení alebo výmene reťaze.



Ozubené koleso lišty

Pravidelne premažte ozubené koleso lišty, pre bez problémový chod reťaze.

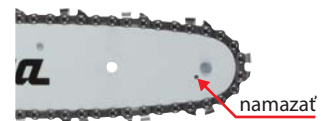

Ostrenie pílovej reťaze

Okružný pilník s držiakom



Lepšie ostrenie reťaze vďaka pevnému uchyteniu pilníka v držiaku.

Držiak má vyznačené presné uhly ostrenia reťaze (30°) a zabraňuje pod brúseniu reťaze.

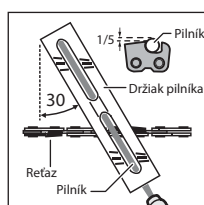

Mierka reťaze

Pomocou mierky reťaze kontrolujete výšku vymedzovacieho zubu a plochým pilníkom ho zbrúsite na požadovanú veľkosť.

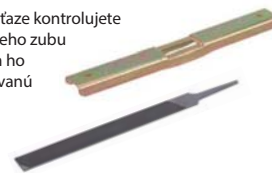

Plochý pilník

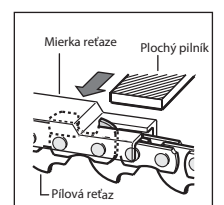

Reťazové píly

Lišty / pílové reťaze / kryty lišt / záberové koleso

Typ zubov: CC: dlátovitý, SC: polodlátovitý, MC: Mikro zub



Vhodné pre model	Lišta					Pílové reťaze						Kryt lišty		Záberové koleso		
	Dĺžka lišty	Typ lišty	Počet zubov	Obj. č.	MOC s DPH	Počet vodiacich článkov	Šírka drážky lišty	Delenie reťaze	Typ reťaze	Typ zubov	Obj. č.	MOC s DPH	Obj. č.	MOC s DPH	Typ/delenie	Obj. č.

Vyvetvovacie píly

*EY401MP	25cm/10"	S ozubeným kolesom	7	165695-7	13,19 €	39	1.3mm/.050"	3/8" LP	91VXL	SC	196142-7	17,09 €	458501-6	3,09 €	Sprocket 3/8"LP	XTM0000014	12,73 €
*EY402MP	25cm/10"	S ozubeným kolesom	7	161846-0	9,69 €	40	1.1mm/.043"	3/8" LP	90PX	CC	199075-5	8,19 €	458501-6	3,09 €	Sprocket 3/8"LP	226992-7	3,34 €
*EY403MP	30cm/12"		7	165245-8	9,89 €	46					196740-7	11,79 €	419288-5	1,89 €			
DUA250	30cm/12"		7	168406-9	9,49 €	40	196205-9	10,29 €	458501-6	3,09 €							
DUA251 DUA300 DUA301 UA001 GUA002 GUA003 GUA004G	30cm/12"		7	165200-0	8,99 €	46	1.3mm/.050"	3/8" LP	91PX	CC	958492046	10,99 €	419288-5	1,89 €			

Akumulátorové reťazové píly

DUC121, DUC122	16cm/ 6-1/4"	Bez ozubeného kolesa	-	158476-6	19,59 €	42	1.3mm/.050"	1/4"	25AP	MC	791284-8	12,69 €	416311-7	2,49 €	Sprocket 1/4"	221527-9	2,54 €			
DUC204 DUC254 DUC254C	25cm/10"	Carvingová lišta	-	168395-8	57,69 €	60	1.3mm/.050"	1/4"	25AP	MC	194098-8	20,69 €	458501-6	3,09 €	Sprocket 1/4"	198259-2	3,09 €			
	25cm/10"	S ozubeným kolesom	7	161846-0	9,69 €	40	1.1mm/.043"	3/8" LP	90PX	CC	199075-5	8,19 €	458501-6	3,09 €	Sprocket 3/8"LP	199063-2	2,06 €			
	30cm/12"		7	165245-8	9,89 €	46					196740-7	11,79 €	419288-5	1,89 €						
	25cm/10"	S ozubeným kolesom	7	168406-9	9,49 €	40	1.3mm/.050"	3/8" LP	91PX	CC	511492740	8,99 €	458501-6	3,09 €						
UC002G UC003G UC004G UC006G UC007G	25cm/10"	Carvingová lišta	-	168395-8	57,69 €	60	1.3mm/.050"	1/4"	25AP	MC	194098-8	20,69 €	458501-6	3,09 €				Sprocket 1/4"	191V92-3	9,29 €
	30cm/12"	S ozubeným kolesom	8	191T86-6	cena na vyžiadanie	51	1.1mm/.043"	.325" LP	80TXL	MC	191T90-5	cena na vyžiadanie	419288-5	1,89 €	Sprocket .325"LP	191V91-5	cena na vyžiadanie			
	35cm/14"		8	191T87-4	cena na vyžiadanie	59					191T91-3	cena na vyžiadanie	419288-5	1,89 €						
	40cm/16"		8	191T88-2	cena na vyžiadanie	64					191T92-1	cena na vyžiadanie	419242-9	1,99 €						
	25cm/10"	S ozubeným kolesom	7	161846-0	9,69 €	40	1.1mm/.043"	3/8" LP	90PX	CC	199075-5	8,19 €	458501-6	3,09 €				Sprocket .325"LP	191V90-7	8,27 €
	30cm/12"		7	165245-8	9,89 €	46					196740-7	11,79 €	419288-5	1,89 €						
	35cm/14"		7	165246-6	10,19 €	52					196741-5	9,79 €	419288-5	1,89 €						
	40cm/16"		7	165247-4	11,39 €	56					196742-3	12,79 €	419242-9	1,99 €						
	25cm/10"		7	168406-9	9,49 €	40					196205-9	10,29 €	458501-6	3,09 €						
	30cm/12"		7	165200-0	8,99 €	46					958492046	10,99 €	419228-5	cena na vyžiadanie						
35cm/14"	7		165201-8	11,19 €	52	958492052					12,29 €	419288-5	1,89 €							
40cm/16"	7	165202-6	9,39 €	56	958492056	13,09 €	419242-9	1,99 €												
DUC252 DUC302 DUC352 DUC252C	25cm/10"	Carvingová lišta	-	168395-8	57,69 €	60	1.3mm/.050"	1/4"	25AP	MC	194098-8	20,69 €	458501-6	3,09 €	Sprocket 1/4"	221528-7	6,32 €			
	25cm/10"	S ozubeným kolesom	7	161846-0	9,69 €	40	1.1mm/.043"	3/8" LP	90PX	CC	199075-5	8,19 €	458501-6	3,09 €	Sprocket 3/8"LP	221526-1	1,43 €			
	30cm/12"		7	165245-8	9,89 €	46					1.1mm/.043"	196740-7	11,79 €	419288-5				1,89 €		
	35cm/14"		7	165246-6	10,19 €	52					1.1mm/.043"	196741-5	9,79 €	419288-5				1,89 €		
	25cm/10"	S ozubeným kolesom	7	168406-9	9,49 €	40	1.3mm/.050"	3/8" LP	91PX	CC	196205-9	10,29 €	458501-6	3,09 €						
	30cm/12"		7	165200-0	8,99 €	46	1.3mm/.050"				958492046	10,99 €	419288-5	1,89 €						
	35cm/14"		7	165201-8	11,19 €	52	1.3mm/.050"				958492052	12,29 €	419288-5	1,89 €						
35cm/14"	7		165201-8	11,19 €	52	1.3mm/.050"	958492052				12,29 €	419288-5	1,89 €							
DUC256 DUC306 DUC356 DUC406 DUC256C	25cm/10"	Carvingová lišta	-	168395-8	57,69 €	60	1.3mm/.050"	1/4"	25AP	MC	194098-8	20,69 €	458501-6	3,09 €	Sprocket 1/4"	198259-2	3,09 €			
	25cm/10"	S ozubeným kolesom	7	161846-0	9,69 €	40	1.1mm/.043"	3/8" LP	90PX	CC	199075-5	8,19 €	458501-6	3,09 €	Sprocket 3/8"LP	199063-2	2,06 €			
	30cm/12"		7	165245-8	9,89 €	46					1.1mm/.043"	196740-7	11,79 €	419288-5				1,89 €		
	35cm/14"		7	165246-6	10,19 €	52					1.1mm/.043"	196741-5	9,79 €	419288-5				1,89 €		
	40cm/16"	7	165247-4	11,39 €	56	165247-4	11,39 €	56	196742-3	12,79 €	419242-9	1,99 €								
	25cm/10"	S ozubeným kolesom	7	168406-9	9,49 €	40	1.3mm/.050"	3/8" LP	91PX	CC	196205-9	10,29 €	458501-6	3,09 €						
	30cm/12"		7	165200-0	8,99 €	46					958492046	10,99 €	419228-5	cena na vyžiadanie						
	35cm/14"		7	165201-8	11,19 €	52					958492052	12,29 €	419288-5	1,89 €						
35cm/14"	7		165201-8	11,19 €	52	958492052					12,29 €	419288-5	1,89 €							
40cm/16"	7		165202-6	9,39 €	56	958492056					13,09 €	419242-9	1,99 €							

Vhodné pre model	Lišta					Pilové reťaze							Kryt lišty		Záberové koleso		
	Dĺžka lišty	Typ lišty	Počet zubov	Obj. č.	MOC s DPH	Počet vodiacich článkov	Šírka drážky lišty	Delenie reťaze	Typ reťaze	Typ zubov	Obj. č.	MOC s DPH	Obj. č.	MOC s DPH	Typ/delenie	Obj. č.	MOC s DPH
DUC303 DUC353 DUC400 DUC305 DUC355 DUC405	25cm/10"	Carvingová lišta	7	168395-8	57,69 €	60	1.3mm/ .050"	1/4"	25AP	MC	194098-8	20,69 €	458501-6	3,09 €	Sprocket 1/4"	198259-2	3,09 €
	30cm/12"	S ozubeným kolesom	7	165245-8	9,89 €	46	1.1mm/ .043"	3/8" LP	90PX	CC	196740-7	11,79 €	419288-5	1,89 €	Sprocket 3/8"LP	199063-2	2,06 €
	35cm/14"		7	165246-6	10,19 €	52					196741-5	9,79 €	419288-5	1,89 €			
	40cm/16"		7	165247-4	11,39 €	56					196742-3	12,79 €	419242-9	1,99 €			
	30cm/12"	S ozubeným kolesom	7	165200-0	8,99 €	46	1.3mm/ .050"	3/8" LP	91PX	CC	958492046	10,99 €	419228-5	cena na vyžiadanie	Sprocket 3/8"LP	191V90-7	8,27 €
	35cm/14"		7	165201-8	11,19 €	52					958492052	12,29 €	419288-5	1,89 €			
	40cm/16"		7	165202-6	9,39 €	56					958492056	13,09 €	419242-9	1,99 €			
UC010G UC011G UC012G UC013G UC014G UC015G UC016G UC017G UC020G	30cm/12"	S ozubeným kolesom	8	191T86-6	cena na vyžiadanie	51	1.1mm/ .043"	.325" LP	80TXL	MC	191T90-5	cena na vyžiadanie	419288-5	1,89 €	Sprocket .325"LP	191V91-5	cena na vyžiadanie
	35cm/14"		8	191T87-4	cena na vyžiadanie	59					191T91-3	cena na vyžiadanie	419288-5	1,89 €			
	40cm/16"		8	191T88-2	cena na vyžiadanie	64					191T92-1	cena na vyžiadanie	419242-9	1,99 €			
	45cm/18"		8	191X03-0	cena na vyžiadanie	70					191X04-8	cena na vyžiadanie	419242-9	1,99 €			
	30cm/12"	S ozubeným kolesom	7	165245-8	9,89 €	46	1.1mm/ .043"	3/8" LP	90PX	CC	196740-7	11,79 €	419288-5	1,89 €	Sprocket 3/8"LP	191V90-7	8,27 €
	35cm/14"		7	165246-6	10,19 €	52					196741-5	9,79 €	419288-5	1,89 €			
	40cm/16"		7	165247-4	11,39 €	56					196742-3	12,79 €	419242-9	1,99 €			
	30cm/12"	S ozubeným kolesom	7	165200-0	8,99 €	46	1.3mm/ .050"	3/8" LP	91PX	CC	958492046	10,99 €	419228-5	cena na vyžiadanie	Sprocket 3/8"LP	191V90-7	8,27 €
	35cm/14"		7	165201-8	11,19 €	52					958492052	12,29 €	419288-5	1,89 €			
	40cm/16"		7	165202-6	9,39 €	56					958492056	13,09 €	419242-9	1,99 €			
	45cm/18"			7	165390-9	10,19 €	62				511492762	13,89 €	419242-9	1,99 €			

Elektrické reťazové pily

UC3041A, UC3541A, UC4041A	30cm/12"	S ozubeným kolesom	7	165245-8	0,00 €	46	1.1mm/ .043"	3/8"	90PX	CC	196740-7	0,00 €	419288-5	1,89 €	Sprocket 3/8"LP	221526-1	1,43 €
	35cm/14"		7	165246-6	0,00 €	52					196741-5	0,00 €	419288-5	1,89 €			
	40cm/16"		7	165247-4	11,39 €	56					196742-3	12,79 €	419242-9	1,99 €			
	30cm/12"	S ozubeným kolesom	7	165200-0	8,99 €	46	1.3mm/ .050"	3/8"	91PX	CC	958492046	10,99 €	419288-5	cena na vyžiadanie	Sprocket 3/8"LP	221521-1	cena na vyžiadanie
	35cm/14"		7	165201-8	11,19 €	52					958492052	12,29 €	419288-5	1,89 €			
	40cm/16"		7	165202-6	9,39 €	56					958492056	13,09 €	419242-9	1,99 €			
UC3050A, UC3550A, UC4050A, UC4550A, UC3051A, UC3551A, UC4051A, UC4551A	30cm/12"	S ozubeným kolesom	7	165200-0	8,99 €	46	1.3mm/ .050"	3/8"	91PX	CC	958492046	10,99 €	419288-5	1,89 €	Sprocket 3/8"LP	221521-1	cena na vyžiadanie
	35cm/14"		7	165201-8	11,19 €	52					958492052	12,29 €	419288-5	1,89 €			
	40cm/16"		7	165202-6	9,39 €	56					958492056	13,09 €	419242-9	1,99 €			
	45cm/18"		7	165390-9	10,19 €	62					511492762	13,89 €	419242-9	1,99 €			

Karvingová lišta

250mm: Obj. č. 168395-8



Pilová reťaz 25AP-60 vodiacich článkov
Obj. č. 194098-8



Ozubené koleso 1/4"

DUC204, DUC254, DUC254C, DUC303, DUC353, DUC400, DUC305, DUC355, DUC405, DUC256, DUC306, DUC356, DUC406, DUC256C: Part No. 198259-2

DUC252, DUC302, DUC352, DUC252C: 221528-7

UC002G, UC003G, UC004G, UC006G, UC007G: 191V92-3



Vhodné pre model	Lišta					Pílové reťaze						
	Dĺžka lišty	Typ lišty	Počet zubov	Obj. č.	MOC s DPH	Počet vodiacich článkov	Šírka drážky lišty	Delenie reťaze	Typ reťaze	Typ zubov	Obj. č.	MOC s DPH

Pílové lišty a reťaze pre benzínové píly

PS-220 TH PS-221 TH	25 cm/10"	S ozubeným kolesom	7	168406-9	9,49 €	40	1,3 mm/.050"	3/8"	91PX	CC	511492740	8,99 €
PS32C/TLC PS-35 C/TLC PS-310 TH PS-3410TH PS-350 SC PS-352 / TLC	30 cm/12"	S ozubeným kolesom	7	958500003	11,59 €	46	1,3 mm/.050"	3/8"	91PX	CC	958492046	10,99 €
	35 cm/14"		7	958500002	12,09 €	52	1,3 mm/.050"	3/8"	91PX	CC	958492052	12,29 €
	40 cm/16"		7	958500051	12,99 €	56	1,3 mm/.050"	3/8"	91PX	CC	958492056	13,09 €
PS-410, PS-411, PS-420 C PS-460 PS-500/C PS-550 PS-6100 PS-5105/C PS-4605	30 cm/13"	S ozubeným kolesom	7	414033141	12,29 €	56	1,3 mm/.050"	0.325"	95VPX	CC	512484756	12,29 €
	38 cm/15"		7	161419-9	15,89 €	64	1,3 mm/.050"	0.325"	95VPX	CC	512484764	13,89 €
	45 cm/18"		7	414045141	18,59 €	72	1,3 mm/.050"	0.325"	95VPX	CC	512484772	14,79 €
	38 cm/15"		7	958500001	23,29 €	56	1,5 mm/.058"	3/8"	73DPX	SC	523093756	14,19 €
	45 cm/18"		7	958500044	25,69 €	64	1,5 mm/.058"	3/8"	73DPX	SC	523093764	16,09 €
	38 cm/15"		7	162829-3	24,79 €	64	1,5 mm/.058"	0.325"	21BPX	CC	958086064	15,59 €
	45 cm/18"		7	415045631	24,29 €	72	1,5 mm/.058"	0.325"	21BPX	CC	958086072	16,29 €
	38 cm/15"		7	958500001	23,29 €	56	1,5 mm/.058"	3/8"	73LPX	CC	958099056	15,19 €
	45 cm/18"		7	958500044	25,69 €	64	1,5 mm/.058"	3/8"	73LPX	CC	958099064	17,49 €
	38 cm/15"		7	162829-3	24,79 €	64	1,5 mm/.058"	0.325"	21LPX	CC	514686764	14,89 €
45 cm/18"	7	415045631	24,29 €	72	1,5 mm/.058"	0.325"	21LPX	CC	514686772	16,99 €		
PS-6400/HS PS-6400 H PS-7310 PS-7910	38 cm/15"	S ozubeným kolesom	7	415038655	23,69 €	60	1,5 mm/.058"	3/8"	73LPX	CC	528099760	16,19 €
	43 cm/17"		64	1,5 mm/.058"	3/8"	73LPX	CC	958099064	17,49 €			
	45 cm/18"		7	415045655	24,29 €	68	1,5 mm/.058"	3/8"	73LPX	CC	528099768	18,29 €
	50 cm/20"		7	415050655	26,39 €	72	1,5 mm/.058"	3/8"	73LPX	CC	528099772	18,79 €

Rolky reťazí

	Delenie reťaze	Šírka drážky		Počet článkov na kotúči*	Profil zuby**	Obj. č.	MOC (s DPH)
	3/8"	1,1 mm	0,043"	1637	HM	957 291 801	346,79 €
	3/8"	1,3 mm	0,050"	1637	HM	957 492 801	350,59 €
	3/8"	1,5 mm	0,058"	1637	HM	957 093 801	395,19 €
	3/8"	1,5 mm	0,058"	1637	VM	957 099 801	419,79 €
	0,325"	1,3 mm	0,050"	1848	HM	957 484 801***	390,69 €
	0,325"	1,5 mm	0,058"	1848	HM	957 086 801***	419,79 €
	0,325"	1,5 mm	0,058"	1848	VM	957 686 801	419,79 €

* +/- 5 článkov na 1 kotúč

** VM – hranatý profil zuby; HM – guľatý profil zuby

*** do vypredania zásob

Okrúhle pilníky

pre pilové reťaze
*s rukoväťou



Typ pilovej reťaze	Okrúhly pilník			Pilník s vodičkom		
	Priemer	Obj. č.	ks/bal	MOC s DPH	Obj. č.	MOC s DPH
25F, 25AP, 91P, 91PX, 91PXL, 91VXL, M91VXL	4.0mm	*744003-1	1	2,19 €	-	
		953003090	1	2,09 €	958500166 953030010	8,59 € 13,99 €
		958500162	3	3,89 €	D-70948	6,09 €
90PX, 90SG	4.5mm	953003100	1	2,09 €	195923-6 953030020	13,99 € 13,99 €
		958500163	3	3,89 €	D-70954	6,29 €
95VPX, 95TXL, 20BPX, 21BPX, 22BPX, 20LPX, 21LPX, 22LPX, 082, 086, 686, 484	4.8mm	953003070	1	2,09 €	953030030	6,29 €
		958500164	3	3,89 €	D-70960	6,09 €
90PX, 90SG	5.2mm	953003110	1	2,09 €		
72V, 73V, 75V, 72APX, 72DPX, 73DPX, 75DPX, 72EXL, 73EXL, 75EXL, 72EXJ, 73EXJ, 75EXJ, 72LGX, 73LGX, 75LGX, 72JGX, 73JGX, 75JGX, 72JPX, 73JPX, 75JPX, 72LPX, 73LPX, 75LPX, 72RD, 73RD, 75RD, 496, 093, 099	5.5mm	953003040	1	2,09 €	958500169	8,59 €

* dodávané s rukoväťou

Plochy pilník, mierka reťaze



Plochy pilník			Mierka reťaze		Pilník plochy s držiakom	
Obj. č.	ks/bal	MOC s DPH	Obj. č.	MOC s DPH	Obj. č.	MOC s DPH
953003060	1	6,19 €	953100090	6,09 €	D-70998	4,89 €

Rukoväť pilníka



ks/bal	Obj. č.	MOC s DPH
1	273646-7	2,39 €
1	D-67496	3,49 €

Držiak káblov



Typ	Popis	Obj. č.	MOC s DPH
A	Držiak kábla na ruku	194679-8	3,69 €
B	Držiak kábla na opasok	194677-2	1,29 €
C	Úchytka kábla spojovacia	158024-1	1,36 €

Olej na pilové reťaze

Popis		Obj. č.	MOC s DPH	MOC s DPH / 1l
Olej na pilové reťaze	Olej na mazanie pilovej reťaze s prímiesou adhezíva, ochrana voči opotrebovaniu a korózii, dobrá priľnavosť, viskozita za studena, univerzálne využite v lete i v zime.	1L 195093-1	4,69 €	4,69 €
		5L 988002658	19,99 €	3,99 €
BIOTOP Olej na pilové reťaze	Rastlinný olej na mazanie pilových reťazí, biologicky rýchlo degradovateľný, neznečisťuje pôdu, spodné vody, ochrana voči opotrebovaniu a korózii, dobrá priľnavosť, viskozita za studena, univerzálne využite v lete i v zime. Splňa prísne požiadavky RAL UZ48 (environmentálna značka pre životné prostredie)	1L 980008610	5,49 €	5,49 €

Olej pre dvojtaktné motory 50:1

Popis		Obj. č.	MOC s DPH	MOC s DPH / 1l
	100 ml	195957-9	1,39 €	13,90 €
	1 l	980008607	5,99 €	5,99 €
	1 l s odmerkou	980008612	8,99 €	8,99 €
	5l	980008618	29,99 €	5,99 €
	200 l	980008151	1 099,99 €	5,49 €

Olej pre štvortaktné motorové kosačky a krovinořezy HD-30

Popis		Obj. č.	MOC s DPH	MOC s DPH / 1l
	100 ml	197010-7	4,99 €	49,90 €
	600 ml	980808620	3,49 €	5,82 €

Čistiace a ochranné prostriedky

Popis		Obj. č.	MOC s DPH	MOC s DPH / 1l
Multifukčný olej	300 ml	980008301*	6,49 €	21,63 €
Prostriedok na čistenie pilových reťazí	500 ml	980008125	7,79 €	15,58 €

*do vypredania zásob

Vysávačky, dávkovače oleja, kanistre

Popis	Obj. č.	MOC s DPH
Vysávačka / striekačka oleja	664718000	47,49 €
Dávkovač oleja - pumpa	242072-1	2,99 €
Kanister priehľadný 5 l	949000033	17,79 €
Kanister zelený 20 l	949000039	42,99 €

Predĺženie

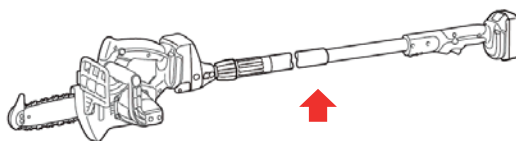

Vhodné pre model	Použitie len s akumulátorom	Obj. č.	MOC s DPH
DUC122	BL1830B	195595-7	184,19 €

Nožnice, kryty nožíc pre nožnice na trávnu



Vhodné pre model	Šírka strihu	1	2	3
		Nožnica	Kryt nožnice	Zberač trávy
DUM168, DUM604, UM600D, UM603D	160mm	195267-4	452055-5	457426-1
MOC s DPH		34,69 €	2,19 €	1,99 €
DUM111 UM110D	110mm	191N23-4	459011-6	454880-0
MOC s DPH		21,59 €	cena na vyžiadanie	2,39 €

Zmena nožíc na trávnu na nožnice na kríky

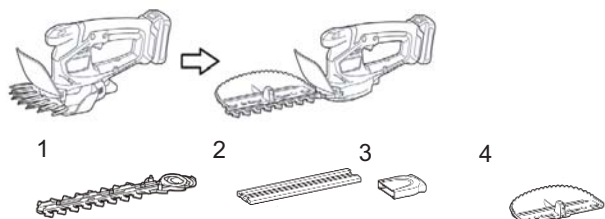

*With clank cover

Vhodné pre model	1		Povrchová úprava
	Nožnica	MOC s DPH	
DUM111 DUM110	191N24-2	15,09 €	BLACK OXIDE
DUM604, UM600D, UM603D	198408-1	17,19 €	NICKEL PLATING

Vhodné pre model	2		4	MOC s DPH
	Kryt nožnice	MOC s DPH	Zberač odrezkov	
DUM111 DUM110	458342-0	12,19 €	198401-5	16,79 €
	*195274-7	cena na vyžiadanie		
DUM604, UM600D, UM603D	458342-0	12,19 €	198401-5	16,79 €



Nožnice pre plotostrihy

Typ nožnice

A:

Optimálne pre hladké rezanie



Konáre sa ľahko zachytia a držia

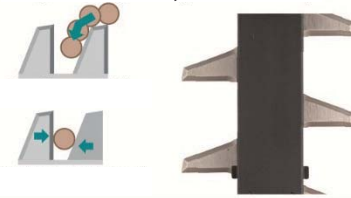

B: Nože s pevným úchopom

Horné / dolné zuby nožnice s nabrúsenými 3 hranami pre čistý a rýchly rez

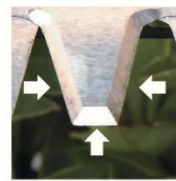

C: Nože s poniklovanou povrchovou úpravou

Rovnomerne a silne prilievajúca povrchová úprava, ktorá sa vyznačuje vysokou odolnosťou proti oderu.

Živica na nožoch (po 10 hodinovej práci)



nože pred použitím nože po použití

Vhodné pre model	Veľkosť noža	Typ noža	Nôž		Kryt noža	
			Obj. č.	MOC s DPH	Obj. č.	MOC s DPH

Akumulátorové nožnice na živý plot

UH201D DUH202	200mm	C	198408-1	17,19 €	458342-0	12,19 €
DUH551	550mm	C	196687-5	87,39 €	450489-6	4,79 €
DUH651	650mm	C	194674-8	67,25 €	450490-1	2,39 €
DUH523	520mm		195769-0	36,99 €	452685-2	2,99 €
DUH601	600mm	A	191R53-9	cena na vyžiadanie	412911-1	5,09 €
DUH751	750mm	A	191R54-7	cena na vyžiadanie	412912-9	5,19 €
DUH604S	600mm	A	191Y03-6	cena na vyžiadanie	459121-9	4,39 €
DUH754S	750mm	A	191Y05-2	cena na vyžiadanie	459122-7	4,59 €
DUH502	500mm	B	191T47-6	51,69 €	412768-0	cena na vyžiadanie
DUH602	600mm	B	191R57-1	53,69 €	412769-8	2,09 €
UH004G	600mm	A	191R53-9	cena na vyžiadanie	412911-1	5,09 €
UH005G	750mm	A	191R54-7	cena na vyžiadanie	412912-9	5,19 €
UH006G	600mm	B	191R55-5	110,49 €	412911-1	5,09 €
UH007G	750mm	B	191R56-3	121,29 €	412912-9	5,19 €
UH008G	600mm	B	191R57-1	53,69 €	459121-9	4,39 €
UH013G	600mm	A	191Y03-6	cena na vyžiadanie	413B98-4	cena na vyžiadanie
UH014G	750mm	A	191Y05-2	cena na vyžiadanie	413B99-2	cena na vyžiadanie

Vhodné pre model	Veľkosť noža	Typ noža	Nôž		Kryt noža	
			Obj. č.	MOC s DPH	Obj. č.	MOC s DPH

Akumulátorové nožnice na živý plot

*s chráničom noža
**bez chrániča noža

DUN461W, DUN460W	460mm		191P00-8	37,99 €	413720-1	2,59 €
DUN500W	500mm		191C14-9	90,79 €	458413-3	13,99 €

Elektrické nožnice na živé ploty

UH4261	420mm	C	140826-9	29,19 €	452683-6	cena na vyžiadanie
UH4861	480mm	C	140830-8	cena na vyžiadanie	452684-4	3,09 €
UH5261	520mm	C	140827-7	68,76 €	452685-2	2,99 €
UH4570	450mm	C	194661-7	58,57 €	450489-6	4,79 €
UH5570	550mm	C	194664-1	38,19 €	450489-6	4,79 €
UH6570	650mm	C	194667-5	cena na vyžiadanie	450490-1	2,39 €
UH5580	550mm	C	196687-5	87,39 €	450489-6	4,79 €
UH6580	650mm	C	194674-8	67,25 €	450490-1	2,39 €
UH7580	750mm	C	194676-4	93,20 €	450490-1	2,39 €

Zberače odrezkov

• Pripievateľné na obe strany noža



Vhodné pre model	Popis	Obj. č.	MOC s DPH
DUH202, *DUM111, *DUM604, UH201D, *UM110D, *UM600D, *UM603D	jednoduchá montáž / demontáž jedným zatlačením	198401-5	16,79 €
DUH551, DUH651, UH4570, UH5570, UH5580, UH6570, UH6580, UH7580	jednoduchá montáž / demontáž jedným zatlačením	194681-1	19,99 €
DUH483, DUH523, UH4261, UH4861, UH5261	5 ks skrutky M5 x 12 v balení	195050-9	cena na vyžiadanie
DUH501, DUH502, DUH601, DUH602, DUH751, DUH752	jednoduchá montáž / demontáž jedným zatlačením	199151-5	15,79 €
DUH502, DUH602, DUH752	jednoduchá montáž / demontáž jedným zatlačením	199152-3**	17,19 €
DUH504S, DUH604S, UH013G	Bez skrutiek v balení (obj.č. skrutiek 915211-3)	191D33-1	19,09 €
DUH754S, UH014G	Bez skrutiek v balení (obj.č. skrutiek 915211-3)	191D34-9	25,79 €
UH004G, UH006G, UH008G	jednoduchá montáž / demontáž jedným zatlačením	191R51-3	31,39 €
UH005G, UH007G, UH009G	jednoduchá montáž / demontáž jedným zatlačením	191R52-1	50,79 €
DUN500W, DUN501W, DUN600L	jednoduchá montáž / demontáž jedným zatlačením	191M40-8	cena na vyžiadanie
DUN461W, UN460WD	jednoduchá montáž / demontáž jedným zatlačením	191T43-4	10,79 €

Predženie pre nožnice na trávu



Vhodné pre model	Obj. č.	MOC s DPH
DUM604, *DUH202, UM110D, DUM111, UM600D, UM603D, *UH201D	198516-8	40,89 €

Nožnice na vinič a konáre (sada)

Vhodné pre model	Obj. č.	MOC s DPH
*DUP361, *DUP362	199311-9	170,69 €



Strihacie nožnice

Nôž horný

Nôž spodný

Nepoužívajte opätovne
zaistovaciu podložku E-4



Zaistovacia podložka E-4

So zaistovacou podložkou E-4 (obj.č. 961011-9)

Potrebné objednať skrutky M3x6
obj. č. 266183-8 a M8 251573-8

Vhodné pre model	Typ	Nôž horný		Nôž spodný	
		Obj. č.	MOC s DPH	Obj. č.	MOC s DPH
DUP361 DUP362	Štandard	197366-8	47,69 €	197367-6	43,99 €
	Pre tvrdé konáre	199216-3	68,09 €	199217-1	117,89 €

Diamantový pilník pre brúsenie nožníc

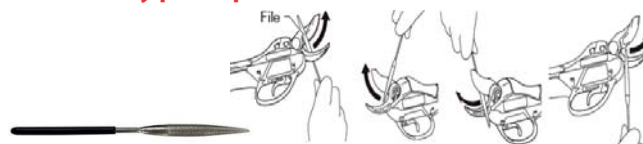

Vhodné pre model	Obj. č.	MOC s DPH
DUP361, DUP362	794530-8	11,59 €

Ostatné príslušenstvo pre nožnice na vinič a konáre

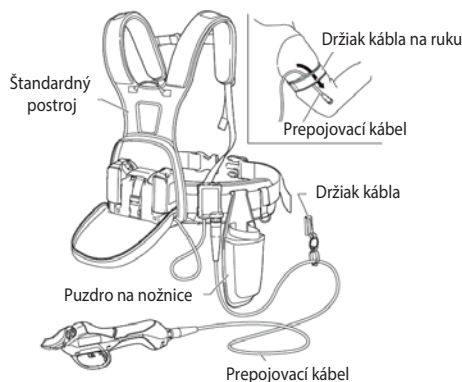

Vhodné pre model	Popis	Obj. č.	MOC s DPH
DUP361 DUP362	Štandardný postroj	161377-9	19,39 €
	Puzdro na nožnice	161379-5	5,49 €
	Držiak kábla na ruku	166062-9	9,79 €
	Držiak kábla	154511-8	0,59 €
	Prepojovací kábel	661445-3	69,69 €

Nadstavce na fúrik

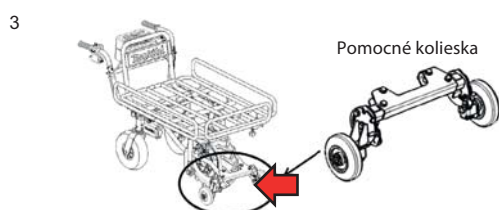

Vhodné pre model	Popis	Obj. č.	MOC s DPH
DCU180	1	Rám	199009-8 141,29 €
	2	Vaňa	199008-0 99,79 €
	3	Pomocné kolieska	191A01-6 91,69 €

Nože pre kosačky



Vhodné pre model	Velkosť	Obj. č.	MOC s DPH
Akumulátorové kosačky			
DLM380	380 mm	196863-1	13,19 €
DLM432	430 mm	191D43-8	10,89 €
DML460, DLM461, DLM463, DLM464	460 mm	199367-2	8,19 €
DLM462, DLM465	460 mm	191D51-9	16,79 €
LM001J	480 mm	191V97-3	cena na vyžiadanie
DLM530, DLM531, DLM532, DLM533, DLM534, DLM535, DLM536, DLM537, LM001C	530 mm	191D52-7	28,29 €
DLM530, DLM532, DLM533, DLM536, LM001C	530 mm	*191W87-2	cena na vyžiadanie

Elektrické kosačky

ELM3320	330 mm	YA00000745	7,89 €
ELM3720	370 mm	YA00000746	8,89 €
ELM4120	410 mm	YA00000747	9,89 €
ELM4121	410 mm	YA00000738	9,89 €
ELM4620	460 mm	YA00000741	12,09 €
ELM4621	460 mm	YA00000741	12,09 €

Nože pre kosačky s výsuvnými nožmi



Vhodné pre model	Bubon s výsuvnými nožmi			Náhradné nože		
	Velkosť	Obj. č.	MOC s DPH	ks/bal.	Obj. č.	MOC s DPH
DLM462, DLM465	460 mm	191D49-6	36,09 €	4	191D47-0	30,79 €
DLM530, DLM531, DLM532, DLM533, DLM535, DLM536, DLM537, LM001C	530 mm	191D50-1	42,29 €	4	191D48-8	35,19 €

Náhradné valce pre elektrické vertikutátory

Vhodné pre model		Obj. č.	MOC s DPH
UV3200		Prevdzušnovací nôž	652024718 23,29 €
		Pružinový valec	652024719 27,99 €
UV3600		Prevdzušnovací nôž	652024746 20,59 €
		Kombinovaný valec	652024750 18,49 €
		Pružinový valec	652024749 84,39 €

Mulčovacie klíny pre akumulátorové kosačky

Vhodné pre model	Obj. č.	MOC s DPH
DLM382 DLM432	191D46-2	8,09 €

Nože pre motorové kosačky

Vhodné pre model	Obj. č.	MOC (s DPH)
PM42, PM43	664531043	9,69 €
PM48, PM48S, PM480, PM480S4	664531048	12,29 €
PM530, PM530S, PM5175S1, 5165S3, PM5360S3, PM5360S3E	664004381	12,49 €
PM4660S1, PM4655S4, PM4860/S/S4	664004366	13,99 €
PM5120/S/R	DA00000944	10,29 €
PM410, PM411C	671001433	25,79 €
PM46N/S/C, PM460, PM461R, PLM4628N	671014610	16,09 €
PLM5113N2, PM5100S3, PM5101S3/S3C, PM5102S3/S3C	DA00000973	15,89 €
PM5600S3/S3C/R, PLM5600N2	671002532	16,79 €
PM4810, PM4820S	671003181	15,59 €

Príslušenstvo pre akumulátorové zemné vrtáky DDG460 a DG001G



Vhodné na vrtanie do piesočnatej a hlinitej pôdy.

Zemné vrtáky

Priemer	Celková dĺžka	Pracovná dĺžka	Obj. č.
NEW ø50 mm	800 mm	550 mm	E-13611
NEW ø60 mm			E-13627
NEW ø80 mm			E-13633
ø100 mm			E-07294
ø150 mm			E-07303
ø200 mm			E-07319

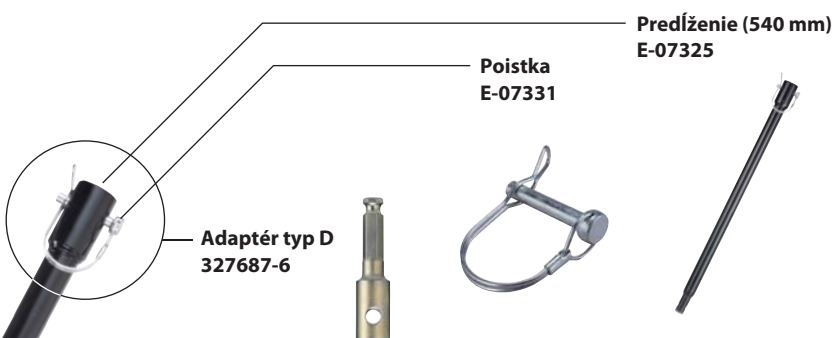

V porovnaní s naším predchádzajúcim vrtákom, ktorý má iba jednu špirálovú drážku, tento nový vrták má dve špirálové drážky, vďaka ktorým je vrtanie stabilnejšie. To tiež vedie k 10% zvýšeniu rýchlosti vrtania v porovnaní s predchádzajúcim vrtákom.

Dva rôzne typy rezných nožov (plochý a zubový).

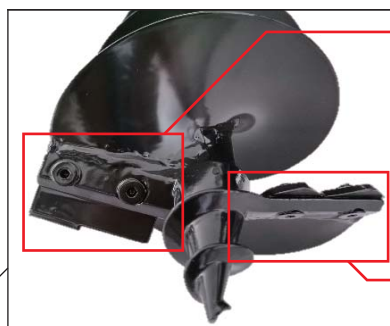

Plochý nôž

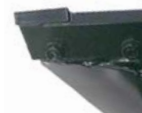

Plochý nôž, vhodný pre trávnaté plochy.

Zubový nôž



Zubový nôž, vhodný pre kamienkové pôdy.

Nože pre zemné vrtáky

(sady nožov komplet)

Priemer	Obj. č.	Priemer	Obj. č.
NEW vrták 50 mm	E-13649	vrták 100 mm	E-07630
NEW vrták 60 mm	E-13655	vrták 150 mm	E-07646
NEW vrták 80 mm	E-13661	vrták 200 mm	E-07652

*Priemer 200 mm používať iba pre piesočnatú pôdu.

Príslušenstvo pre akumulátorové zemné vrtáky DDG460 a DG001G

Príslušenstvo pre akumulátorový zemný vrták

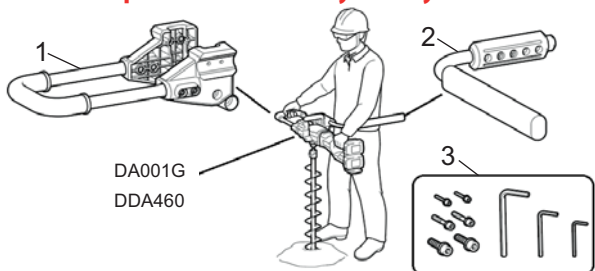

Vhodné pre model	Popis	Obj. č.	MOC s DPH
DA001G, DA002G, DDA460	1-3set	191P11-3	100,09 €

Adaptéry pre zemné vrtáky

Model		Obj. č.	MOC s DPH
DDG460, DG001G	20mm pre vrtáky STIHL	327684-2	26,59 €
DA001G + 191P11-3	25.5mm pre vrtáky Dolmar	327685-0	37,79 €
DDA460 + 191P11-3	20mm pre vrtáky Makita	327687-6	23,09 €

Zemné vrtáky



Priemer (mm)	Celková dĺžka (mm)	Pracovná dĺžka (mm)	Obj. č.	MOC (s DPH)
50	800	550	E-13611	cena na vyžiadanie
60	800	550	E-13627	cena na vyžiadanie
80	800	550	E-13633	cena na vyžiadanie
100	800	550	E-07294	63,19 €
150	800	550	E-07303	74,29 €
200	800	550	E-07319	87,09 €

Sety náhradných nožov nožov

Vrták priemer (mm)	Obj. č.	MOC (s DPH)
50	E-13649	cena na vyžiadanie
60	E-13655	cena na vyžiadanie
80	E-13661	cena na vyžiadanie
100	E-07630	7,19 €
150	E-07646	7,89 €
200	E-07652	9,09 €

Predĺženie

Dĺžka (mm)	Obj. č.	MOC (s DPH)
540	E-07325	19,89 €













Zaistovacia poistka



Obj. č.	MOC (s DPH)
E-07331	2,09 €

Príslušenstvo pre fukáre

*použitie len s adaptérom rúry 71
 *použitie len s adaptérom rúry 80-72
 *použitie len s adaptérom rúry 85-72
 *použitie len s adaptérom rúry MG

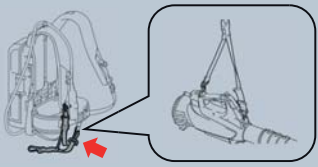
Vhodné pre model	Popis	Obj. č.	MOC s DPH
DUB184	Predaná rúra 	183P96-3	5,89 €
DUB362	Predĺžená rúra 	183R02-0	3,29 €
DUB363	Koncová rúra 72 	183R01-2	3,39 €
DUB363	Predĺžovacia rúra 90-72 	183R06-2	5,89 €
UB001C UB001G	Koncová rúra 80 	191P97-7	18,89 €
DUB184** DUB362 DUB363 UB001C*** UB001G*** UB400MP**** UB401MP****	Dýza okrúhla 	197888-8	5,19 €
UB001C UB001G UB400MP**** UB401MP****	Dýzy ploché 	197889-6	3,49 €
DUB184** DUB362* DUB363 UB001C*** UB001G*** UB400MP**** UB401MP****	Sada na čistenie okapov (celková dĺžka 2,9 m)  sada obsahuje: 3 x rúra 0,9 m 1 x dýza (otočné kolo) 3 x sťahovacia objímka	191B03-8	59,09 €
DUB362 DUB363	Rúra adaptér 71 	191J13-3	6,29 €
DUB184	Rúra adaptér 80-72 	191L13-5	3,49 €
UB001C UB001G	Rúra adaptér 85-72 	191L96-5	7,29 €
UB400MP UB401MP	Rúra adaptér MG 	191C15-7	5,79 €
UB001G DUB184 DUB362	Popruh jednoramenný 	166094-6	2,19 €
UB001C + PDC1200 UB001C + PDC01	Popruh 	191J48-4	21,29 €

Hubice pre fukáre

A: štandardne dodávané



Vhodné pre model	Dĺžka (mm)	Typ	Obj. č.	MOC s DPH
UB100D, UB101D, DUB185, DUB186	220	A	123245-4	2,09 €
	430	-	123246-2	6,99 €

Štrbinová dýza



Použitie len s hubicou 132025-7

Vhodné pre model	Farba	Obj. č.	MOC s DPH
UB100D, UB101D, DUB185, DUB186	Gray	192236-6	7,99 €

Predĺžená hubica



Vhodné pre model	Obj. č.	MOC s DPH
UB100D, UB101D, DUB183, DUB185, DUB186	191G09-6	3,99 €

Zberný vak



Vhodné pre model	Obj. č.	MOC s DPH
UB100D, UB101D, DUB185, DUB186	123241-2	6,99 €

Flexibilná hadica

(Max. dĺžka 95 cm)



Vhodné pre model	Obj. č.	MOC s DPH
DUB185, DUB186, UB100D, UB101D	196643-5	6,99 €

Príslušenstvo pre vysávanie

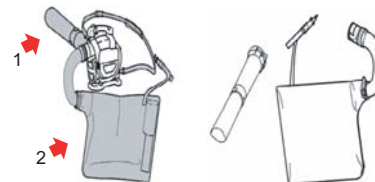

Vhodné pre model	Číslo	Popis	Obj. č.	MOC s DPH
DUB363	1+2	Sada na odsávanie	191E19-1	42,59 €
	2	Zberný vak	162697-4	19,79 €

Príslušenstvo pre vysokotlaké čističe DHW080, HW1200, HW1300

Typ	Vhodné pre model	Obj. č.	MOC s DPH
Striekacia pištoľ	DHW080 HW1200 HW1300	197842-2	16,79 €
Aretovateľná dýza	DHW080 HW1200 HW1300	197822-8	8,99 €
Vario tryska set	DHW080 HW1200 HW1300	191U88-8	22,69 €
Vario tryska set	DHW080 HW1200 HW1300	191U86-2	15,49 €
Predĺženie	DHW080 HW1200 HW1300	191U84-4	cena na vyžiadanie
Vario tryska	DHW080 HW1200 HW1300	197876-5	18,19 €
Turbo tryska	DHW080 HW1200 HW1300	197824-4	8,99 €
Kefa na podlahy	DHW080 HW1200 HW1300	197864-2	13,39 €
Zahnutá tryska	DHW080 HW1200* HW1300* (*for 110-127V)	197859-5	23,09 €
	HW1200** HW1300** (**for 220V-240V)	198909-9	10,29 €
Predĺžovacia sada (0,9m / 1,3m / 1,7m)	DHW080 HW1200 HW1300	197870-7	38,09 €
Rotačná kefa	DHW080 HW1200 HW1300	197831-7	11,69 €
Kefa	DHW080 HW1200 HW1300	197828-6	6,09 €
Nádržka na saponát	DHW080 HW1200 HW1300	197886-2	13,79 €
Hadica na čistenie potrubia	DHW080	10m 197837-5	21,59 €
	HW1200 HW1300	15m 197840-6	26,39 €
Vysokotlaková predĺžovacia hadica	DHW080	5m 197845-6	21,79 €
	HW1200	8m 197847-2	30,09 €
	HW1300	10m 197850-3	34,79 €

Typ	Vhodné pre model	Obj. č.	MOC s DPH
Spojka klbová	DHW080 HW1200 HW1300	197867-6	12,59 €
Nasávací hadica	DHW080 HW1200 HW1300	197873-1	24,09 €
Spojka trysky	DHW080 HW1200 HW1300	197853-7	4,59 €
Nadstavec na ventil	DHW080 HW1200 HW1300	197881-2	3,29 €
Spojka na prívodnú hadicu	DHW080 HW1200 HW1300	197883-8	3,19 €
Čistiaca ihla	DHW080 HW1200 HW1300	197879-9	1,59 €
Jednoramenný popruh	DHW080	199486-4	4,09 €
Hadica 10 m	HW1300	TG00000009	44,99 €
Hadica 10 m	HW1200	123784-4	13,89 €



VYSOKOTLAKOVÉ ČISTIČE

(Makita)
HW1 02
(Dolmar)
HP-20

(Makita)
HW1 11
(Dolmar)
HP-300

(Makita)
HW1 12
(Dolmar)
HP-350

(Makita)
HW1 32
(Dolmar)
HP-450

(Makita)
HW1 51
(Dolmar)
HP-7000









Obj. č.

MOC s DPH



Striekacia pištoľ	☺	☺	☺			3320152	5,89 €
Striekacia pištoľ				☺		3640920	18,89 €
Striekacia pištoľ					☺	41154	21,29 €
Aretovateľná dýza	☺					3640640	3,99 €
Aretovateľná dýza		☺	☺			3640650	2,89 €
Aretovateľná dýza				☺		3641150	6,79 €
Aretovateľná dýza					☺	40246	20,49 €
Vysokotlaková hadica 5 m	☺					3640630	7,49 €
Vysokotlaková hadica 8 m		☺	☺	☺	☺	3640960	51,49 €
Predlžovacia hadica 8 m		☺	☺	☺		609041199	61,29 €
Tryska napeňovacia		☺	☺	☺		3640670	2,23 €
Hadica na čistenie potrubia 8 m	☺	☺	☺	☺	☺	40863	36,69 €
Hadica na čistenie potrubia 16 m	☺	☺	☺	☺	☺	40864	65,89 €
Kefa na podlahy	☺	☺	☺	☺		41150	31,29 €
Filter na vodu	☺	☺	☺	☺	☺	40855	13,69 €
Filter na vodu	☺	☺	☺	☺	☺	3082130	1,09 €
Kefa na podlahy s nádržkou na čistiaci prostriedok					☺	41849	49,69 €
Univerzálny čistič 1 L	☺	☺	☺	☺	☺	40724	12,99 €

VYSOKOTLAKOVÉ ČISTIČE

	(Makita) HW101 (Dolmar) HP-10	(Makita) HW110 (Dolmar) HP-115	(Makita) HW130 (Dolmar) HP-135	(Makita) HW131 (Dolmar) HP-1500	Obj. č.	MOC s Dph
	☺				40797	12,79 €
Aretovateľná dýza	☺				40798	6,89 €
			☺		40879	12,29 €
Aretovateľná dýza				☺	609 040 886	25,99 €
Turbo tryska			☺		40721	11,99 €
				☺	40867	40,99 €
Vysokotlaková hadica 3 m	☺				3082290	18,25 €
Vysokotlaková hadica 5,5 m		☺			609 040 856	19,79 €
			☺		609 040 857	26,49 €
Hadica na čistenie potrubia 8 m		☺	☺		40863	36,69 €
		☺	☺		40864	65,89 €
				☺	609 040 866	69,09 €
Kefa	☺	☺	☺		40869	21,68 €
		☺	☺		609 040 896	26,29 €
				☺	609 040 897	20,99 €
		☺	☺	☺	40855	13,69 €
				☺	41849	49,69 €

Akumulátory
Odkladacie systémy
Vŕtanie
Skrutkovanie
Brúsky
Pílenie
Frézovanie
Brúsenie
Klince / spony
Špeciálne stroje
Vysávanie
Fény/lampy
Záhradná
Ručné náradie
Ostatné

zapaľovacie sviečky

	Zapaľovacia sviečka pre modely	Typ	Obj. č.	MOC (s DPH)
	PS-33, PS-330, PS-340/344, PS-400/401, PS-410/411	BPMR6F / NGK	965 603 018	3,99 €
	PS-2, PS-3, PS-4, PS-34, PS-36, PS-41, PS-43, PS-45, PS-3400 TH, PS-3410, PS-3410 TH, PS-350 C, PS-420 C, PS-460, PS-500, PS-500 C, PS-4600 S, PS-4605, PS-5000, PS-5105, PS-5105 C, PS-52, PS-630, PS-6100, PS-6400, PS-7300, PS-7310, PS-7900, PS-7910, PS-6000i, PS-6800i, PS-9000, PS-9010, 109, 110, 111, 115, 115i, LT-30, MS-20, MS-26, MS-2600, MS-24 U, MS-30 U, MS-30 C, MS-340, MS-3310, MS-400, MS-4010, MS-4200, MS-4211, MS-4510, PC-6112, PC-6114, PC-6212, PC-6412, PC-6414, PC-7414, PC-8116, PC-8216, 309, 343, PB-500 R, PD-520 R	BPMR7A / NGK	168517-0	2,69 €
	LT-250, MS-220, MS-250, MS-252, MS-2300, MS-3200, MS-3202, PB-250, HT-2256 D, HT-2276 E	BMR7A / NGK	381 014 981	3,19 €
	MS-250.4, MS-252.4 U, MS-352.4 U, MS-245.4U/UE, MS-335.4U, PS-222 TH, PS-32 C, PS-35 C, PB-7600.4	CMR6A / NGK	168401-9	6,69 €
	PS-350 SC, PS-420 SC	CMR7A-5 / NGK	965 603 040	6,69 €

zapaľovacie sviečky – servisné balenie

		ks/bal	Obj. č.	MOC (s DPH)
	WSR6F / Bosch	100	965 603 014*	5,09 €
	BPMR6F / NGK	100	965 603 018*	3,99 €
	BPMR7A / NGK	100	168517-0*	2,69 €



* cena za 1 ks







kombinované kľúče

		Obj. č.	MOC (s DPH)
	Kombinovaný kľúč 13/16 pre hobby píly.	941 716 132	2,09 €
	Kombinovaný kľúč 13/16 pre farmárske píly.	941 713 161	2,09 €
	Kombinovaný kľúč 19/13 pre profi píly.	941 719 133	1,89 €
	Kombinovaný kľúč 17/19 pre profi píly.	941 717 192	1,49 €
	Kombinovaný kľúč 13/19 pre hobby píly.	782028-7	2,19 €
	Kombinovaný kľúč 19/13 s 8 mm stopkou pre používanie zvieracieho prípravku na kombi kanistri.	941 719 133	1,89 €
	Kombinovaný kľúč 13 pre elektrické píly.	941 713 001	1,69 €
	Sviečkový kľúč 21 mm.	671 001 078	1,19 €

kryty lišt a pílových reťazí

		Obj. č.	MOC (s DPH)
	Kryt reťaze pre dĺžku lišty do 35 cm. 33 × 10 cm.	952 010 130	1,89 €
	Kryt reťaze pre dĺžku lišty do 45 cm. 43 × 10 cm.	952 010 140	2,09 €
	Kryt reťaze pre dĺžku lišty do 40 cm. 41 × 11 cm.	952 020 140	2,39 €
	Kryt reťaze pre dĺžku lišty do 50 cm. 51 × 11 cm.	952 020 150	5,29 €

ŽACIE HLAVY





		Priemer lanka (mm)	ET-40, UR3000	ET-70, 100C, LT-27, 30	ET-71, 101C, UR3500, 3501	ET-110C, UR3502	LT250	LT245, 4	MS-20U	MS-24, 34U	MS-26, 27U	CS-246, 4	MS-260U	MS-330U	MS-430U	MS-3202UE
	Tap&Go	1,6	☺													
	Tap&Go	1,6			☺											
	Tap&Go	2,0				☺										
	Tap&Go	2,4														
	Tap&Go	2,4							☺		☺					
	Tap&Go	2,4								☺						
	Tap&Go	3,0														
	Tap&Go	3,0														
	Tap&Go	3,0														
	Tap&Go	2,7								☺*		☺				
	Automatic	3,0											☺	☺	☺	
	Automatic	2,4					☺	☺								
	Automatic	2,4							☺	☺	☺	☺				☺

* len pre model MS-34

MS-4200E	MS-4520U	MS-245,4,246,4U,JE,CE	MS-335,4U/K	MS-5700U	MS-252,4U	MS-352,4U/R	MS-252U	MS-340,341U	MS-400U	MS-3310U	MS-4010,4011U	MS-4510,4511U	MS-430,4,4300,40/R	Objednávacie číslo	MOC EUR s DPH
														DA00000001	6,49 €
														YA00000649	6,79 €
														YA00000681	12,99 €
												☺		122931-4	17,49 €
														DA00000500	11,99 €
														161341-0	15,69 €
												☺		196053-6	43,59 €
☺					☺	☺								366 224 010	20,19 €
	☺			☺										722540/NE	7,69 €
		☺	☺											B-06507	17,49 €
								☺	☺	☺	☺	☺		384 224 503	52,99 €
														B-70518	19,59 €
		☺	☺				☺							B-02945	22,59 €

ŽACIE NOŽE

pre krovinorezy

		MS-20U	MS-24,34U	MS-26,27U	CS-246,4	MS-260U	MS-330U	MS-430U	MS-3202UE
	8 zubý vyžíňací nôž 230x25,4	☺		☺					
	4 zubý žací nôž 230x25,4	☺	☺	☺	☺	☺	☺	☺	
	4 zubý žací nôž 255x25,4								☺
	4 zubý žací nôž 255x20								
	3 zub nôž na burinu 255x25,4			☺					
	3 zub nôž na burinu 300x20								
	3 zub nôž na burinu 300x25,4								
	2 zub žací nôž 230x25,4	☺	☺	☺	☺	☺	☺	☺	
	2 zub žací 255x25,4								
	Pilový kotúč na krovie 200x20								
	Pilový kotúč na krovie 225x20								
	Pilový kotúč na krovie 255x20								

MS-4200UE	MS-4520U	MS-245,4,246,4U,UE,CE	MS-335,4U/K	MS-5700U	MS-252,4U	MS-352,4U/R	MS-252U	MS-340,341U	MS-400U	MS-3310U	MS-4010,4011U	MS-4510,4511U	MS-430,4,4300,4U/R	Obj. č.	MOC (s DPH)
☺		☺	☺				☺						☺	362 224 180	12,19 €
☺		☺	☺		☺		☺						☺	D-66008	5,79 €
☺			☺			☺							☺	729023-6	5,99 €
								☺	☺	☺	☺	☺		385 224 140	12,59 €
		☺	☺			☺	☺						☺	385 224 340	15,59 €
										☺	☺	☺		385 224 130	8,89 €
			☺			☺							☺	385 224 150	18,19 €
☺		☺	☺		☺		☺						☺	197808-2	8,89 €
			☺										☺	D-66064	5,29 €
											☺	☺		385 224 171	19,59 €
										☺	☺	☺		385 224 161	22,69 €
								☺		☺	☺	☺		385 224 300	55,99 €

KRYTY ŽACÍCH HLÁV A NOŽŮV



















		ET-40, UR3000	ET-71/101, UR3500, 3501	ET-110, UR3502	MS-20U	MS22C	MS-24	MS-26U	MS-34U	CS-246,4
	kryt komplet								☺	
	kryt žacej hlavy		☺							
	kryt žacej hlavy			☺						
	kryt komplet	☺								
	kryt komplet				☺					
	kryt žacej hlavy						☺			
	kryt noža						☺			
	kryt komplet					☺				
	kryt komplet							☺		
	kryt noža							☺		
	kryt žacej hlavy							☺		
	kryt komplet									
	kryt noža									
	násuvný kryt žacej hlavy									
	kryt noža									
	kryt noža									☺
	násuvný kryt žacej hlavy									☺
	kryt noža									
	kryt komplet									
	kryt komplet									
	kryt noža									
	kryt komplet									
	kryt komplet									
	kryt pilového kotúča ø200mm									
	kryt pilového kotúča ø255mm									

MS-3202UE	MS-4200UE	MS-4520U	MS-245,4U/UE	MS-245,4/247,4CE	MS-246,4U/UE	MS-335,4U	MS-5700U	MS-352,4U/R	MS-252U	MS-340/400/341U	MS-3310/4010/4011/4510/4511	MS-430,4/4300,4U	Obj. č.	MOC (s DPH)
													140424-9	6,95 €
													YA00000653	24,32 €
													YA00000636	4,27 €
													DA00000047	3,41 €
													6198014001	24,00 €
													DA00000526	4,43 €
													DA00000525	6,70 €
													6198014001	24,00 €
													6258064001	16,85 €
													6258065001	10,72 €
☺	☺												140424-9	6,95 €
	☺												6358008004	14,92 €
		☺					☺						542410/NE	7,62 €
		☺					☺						729200	3,80 €
			☺	☺									452260-4	5,20 €
					☺								452260-4	5,20 €
			☺	☺	☺	☺						☺	135 753-3	3,67 €
						☺						☺	452 259-9	5,08 €
								☺					XNR0000343	7,22 €
									☺				6258060002	17,51 €
									☺				6258061002	17,51 €
										☺			010 341 202	46,49 €
											☺		010 341 612	43,69 €
											☺		010 341 030	65,69 €
											☺		010 341 100	66,29 €

ŽACIE HLAVY

		Vhodné pre modely	Obj. č.	MOC (s DPH)
	žacia hlava	MS-260 U, MS-330 U, MS-430 U	B-06507 /351 502 030/	17,49 €
	kryt hlavy spodný	MS-260 U, MS-330 U, MS-430 U	351 502 032	15,29 €
	bubon silónu	MS-260 U, MS-330 U, MS-430 U	351 502 033	12,52 €
	kryt hlavy – domec	MS-260 U, MS-330 U, MS-430 U	351 502 031	17,88 €
	adaptér	MS-260 U, MS-330 U, MS-430 U	351 502 034	10,43 €
	veko hlavy	MS-20U, MS-26U, MS-245.4U,UE, MS-335.4U, MS-252U, MS-3202, MS-246.4 U/UE, MS-24U, CS-246.4 C/CBC, MS-247.4 CE	B-70390	4,62 €
	vnútorné telo hlavy	MS-20U, MS-26U, MS-245.4U,UE, MS-335.4U, MS-252U, MS-3202, MS-246.4 U/UE, MS-24U, CS-246.4 C/CBC, MS-247.4 CE	A-15986	1,88 €
	bubon silónu	MS-20U, MS-26U, MS-245.4U,UE, MS-335.4U, MS-252U, MS-3202, MS-246.4 U/UE, MS-24U, CS-246.4 C/CBC, MS-247.4 CE	A-15970	2,99 €
	adaptér M8 (LH)	MS-20U, MS-26U, MS-245.4U,UE, MS-335.4U, MS-252U, MS-3202, MS-246.4 U/UE, MS-24U, CS-246.4 C/CBC, MS-247.4 CE	A-16025	2,79 €
	očko nylonovej hlavy	MS-20U, MS-26U, MS-245.4U,UE, MS-335.4U, MS-252U, MS-3202, MS-246.4 U/UE, MS-24U, CS-246.4 C/CBC, MS-247.4 CE	A-15992	2,36 €
	kryt hlavy – domec	MS-20U, MS-26U, MS-245.4U,UE, MS-335.4U, MS-252U, MS-3202, MS-246.4 U/UE, MS-24U, CS-246.4 C/CBC, MS-247.4 CE	A-16003	12,29 €
	pružina	MS-20U, MS-26U, MS-245.4U,UE, MS-335.4U, MS-252U, MS-3202, MS-246.4 U/UE, MS-24U, CS-246.4 C/CBC, MS-247.4 CE	A-16097	2,79 €
	adaptér M10 (LH)	MS-20U, MS-26U, MS-245.4U,UE, MS-335.4U, MS-252U, MS-3202, MS-246.4 U/UE, MS-24U, CS-246.4 C/CBC, MS-247.4 CE	A-16031	2,99 €
	montážny kľúč	MS-20U, MS-26U, MS-245.4U,UE, MS-335.4U, MS-252U, MS-3202, MS-246.4 U/UE, MS-24U, CS-246.4 C/CBC, MS-247.4 CE	A-16069	2,69 €

ŽACIE HLAVY

		Vhodné pre modely	Obj. č.	MOC (s DPH)
	žacia hlava	MS-30C,U, MS-340 U, MS-400 U, MS-3310 U, MS-4010 U, MS-4011 U, MS-4510 U, MS-4511 U	384 224 503	52,99 €
	kryt hlavy spodný	MS-30C,U, MS-340 U, MS-400 U, MS-3310 U, MS-4010 U, MS-4011 U, MS-4510 U, MS-4511 U	384 224 520	10,09 €
	krytka nyl. hlavy spodná	MS-30C,U, MS-340 U, MS-400 U, MS-3310 U, MS-4010 U, MS-4011 U, MS-4510 U, MS-4511 U	384 224 530	9,09 €
	bubon silónu	MS-30C,U, MS-340 U, MS-400 U, MS-3310 U, MS-4010 U, MS-4011 U, MS-4510 U, MS-4511 U	385 224 571	8,99 €
	pružina	MS-30C,U, MS-340 U, MS-400 U, MS-3310 U, MS-4010 U, MS-4011 U, MS-4510 U, MS-4511 U	384 224 510	2,09 €
	adaptér (M10 × 1,25 L)	MS-30C,U, MS-340 U, MS-400 U, MS-3310 U, MS-4010 U, MS-4011 U, MS-4510 U, MS-4511 U	387 224 590	4,59 €
	adaptér (M12 × 1,5 L)	MS-30C,U, MS-340 U, MS-400 U, MS-3310 U, MS-4010 U, MS-4011 U, MS-4510 U, MS-4511 U	385 224 550	4,59 €
	skrutka hlavy horná	MS-30C,U, MS-340 U, MS-400 U, MS-3310 U, MS-4010 U, MS-4011 U, MS-4510 U, MS-4511 U	384 224 540	6,29 €
	očko nylónovej hlavy	MS-30C,U, MS-340 U, MS-400 U, MS-3310 U, MS-4010 U, MS-4011 U, MS-4510 U, MS-4511 U	385 224 560	2,69 €
	žacia hlava	MS-430.4 U, MS-4300.4 U	196053-6	43,59 €
	kryt hlavy vrchný	MS-430.4 U, MS-4300.4 U	453957-8	5,78 €
	kryt hlavy spodný	MS-430.4 U, MS-4300.4 U	453960-9	6,54 €
	Tap & Go tlačítko	MS-430.4 U, MS-4300.4 U	453961-7	2,80 €
	bubon silónu	MS-430.4 U, MS-4300.4 U	453958-6	3,97 €
	prevodová doska	MS-430.4 U, MS-4300.4 U	453956-0	4,79 €
	pružina	MS-430.4 U, MS-4300.4 U	234260-4	2,47 €
	pružina	MS-430.4 U, MS-4300.4 U	234259-9	4,85 €
	skrutka hlavy M10	MS-430.4 U, MS-4300.4 U	318918-4	3,65 €
	očko nylónovej hlavy	MS-430.4 U, MS-4300.4 U	318917-6	1,49 €
	platnička	MS-430.4 U, MS-4300.4 U	453955-2	3,56 €

Akumulátory

Odkladacie systémy

Vŕtanie

Skrutkovanie

Brúsky

Pílenie

Frézovanie

Brúsenie

Klince / spony

Špeciálne stroje

Vysávanie







Fény/lampy

Záhrada

Ručné náradie

Ostatné

ŽACIE HLAVY

		Vhodné pre modely	Obj. č.	MOC (s DPH)
	žacia hlava	MS-20 U, MS-26 U, MS-252 U, MS-27 U	DA00000500	11,99 €
	kryt hlavy spodný	MS-20 U, MS-26 U, MS-252 U, MS-27 U	DA00000168	2,36 €
	bubon silónu	MS-20 U, MS-26 U, MS-252 U, MS-27 U	DA00000166	2,78 €
	kryt hlavy – domec	MS-20 U, MS-26 U, MS-252 U, MS-27 U	DA00000440	4,15 €
	pružina	MS-20 U, MS-26 U, MS-252 U, MS-27 U	DA00000165	0,71 €
	podložka spodná	MS-20 U, MS-26 U, MS-252 U, MS-27 U	DA00000164	0,34 €
	podložka vrchná	MS-20 U, MS-26 U, MS-252 U, MS-27 U	DA00000164	0,34 €

KLINY, MERACIE PÁSMA, KRIEDY



		Obj. č.	MOC (s DPH)
	Klin plastový 14 cm.	945 900 001	9,69 €
	Klin plastový 20 cm.	988 070 819	7,29 €
	Klin plastový 25 cm.	988 070 824	7,79 €
	Klin hliníkový – duralový 26 cm.	988 070 101	34,39 €
	Klin z tvrdého dreva pre nasadzovanie násad na sekery, kladivá 43 mm.	988 090 090	0,69 €
	Klin z tvrdého dreva pre nasadzovanie násad na sekery, kladivá 50 mm.	988 090 080	0,69 €

príslušenstvo



		Obj. č.	MOC (s DPH)
	Meracie pásmo 15 m	988 050 615	55,39 €
	Meracie pásmo 20 m	988 050 620	60,49 €
	Označovacia krieda žltá 12 ks/bal	988 050 690	10,99 €
	Označovacia krieda modrá 12 ks/bal	988 050 730	10,99 €

ŽACIE NOŽE

unášače pre elektrické kosačky

	EM3310/3511	EM33	EM3713/3913	EM37	EM330	EM370	EM380/ ELM3800	EM331/ ELM3320	EM371/ ELM3720
	☺		☺				☺		
		☺		☺	☺	☺			
	☺		☺						
		☺		☺	☺	☺	☺		
								☺	
									☺

unášače pre benzínové kosačky

	PM410/460/462C/4602S /5102S3/S3C/4600S/S3/ 5101S3/S3C/5600S3/S3C PLM5113N2	PM42/43/48/480/530 /4860	PM46/N/S/SBC PLM4628N	PM4601S/SC/S3C/ 461/4602SC/S3C/5100S3	PM4602SR/5600S3R PLM5600N2	PM4660S1/5175S1/ 4860S/S4/5360S3/ S3E/5365S3pro	PM4655S4	PM4810/4820/S
	☺			☺	☺			
		☺				☺		
				☺				
								☺
	☺		☺	☺	☺			☺
		☺				☺	☺	

EM41	EM4316	EM460/460S	EM461/S	EM4818/S	EM410/ ELM4120	EM411/ ELM4121	EM462/463S ELM4620/4621	Obj. č.	MOC (s DPH)
								DA00000917	9,14 €
								664 465 602	9,69 €
				☺				664 998 186	11,59 €
								671 492 001	9,89 €
☺								671 325 001	6,39 €
			☺					671 005 057	8,04 €
		☺						671 478 001	9,69 €
							☺	YA00001066	2,03 €
								664 004 352	4,59 €
				☺				664 793 101	0,99 €
			☺					671 100 802	0,47 €
								671 006 017	50,00 €
☺		☺						671 100 802	0,47 €
					☺	☺		YA00000827	0,35 €
							☺	YA00001067	1,61 €

PM5120	PM5120S	PM5165S3	Obj. č.	MOC (s DPH)
			671 002 977	6,06 €
			664 463 012	13,69 €
			664 465 607	23,09 €
☺			671 002 051	5,59 €
	☺		671 002 049	9,34 €
			671 002 448	5,20 €
		☺	664 465 608	23,59 €
		☺	664 735 698	2,69 €
☺			DA00000528	0,91 €

MULČOVACIE KLINY

pre elektrické kosačky

	EM460/S	EM461/S	EM4818/S
			
			☺
	☺		
		☺	

pre benzínové kosačky

	PM410/411	PM46SBC/ PLM4628N	PM460/4600S/S3	PM462/C/ 4602SSC/S3C/R 5102S3/S3C	PM461/46N/ S/4601S/SC/ S3/S3C
					
		☺			
	☺		☺*		
			☺*		☺
				☺	

*model 2009 – 2011

**model 2012

***model2017

EM411/ELM4121	EM462/463S, ELM4620/4621	Obj. č.	MOC (s DPH)
	☺	YA00001047	2,76 €
☺		YA00000978	9,69 €
		664 140 223	12,92 €
		671 469 001	11,32 €
		DA00000844	8,44 €

PM48/S/480/S4	PM530/S	PM4860S/S4/S4E /4660S1/4655S4/ 5165S3/5175S1/ 5360S3/S3E/S3pro	PM5100S3/ 5101S3/S3C/ PLM5113N2	PM5600S3/S3C/R/ PLM5600N2	Obj. č.	MOC (s DPH)
☺					664 140 223	12,99 €
	☺				664 140 222	25,99 €
					671 326 001	11,99 €
			☺*		671 450 001	14,92 €
					671 660 001	10,69 €
					DA00000844	8,89 €
		☺*			664 140 224	23,79 €
				☺	671 315 001	21,13 €

prevodník strojov Makita/Dolmar

Dolmar	Makita
AH-1848	UH482DW
AH-1852	UH522DZ
AH-1852 H	DUH523Z
AK-3622	UK360
AL-3630	BUR360Z
AM-3643	LM430DZ
AS-1212	DUC122DZ
AS-1813	DUC122
AS-3625	DUC250
AS-3626	DUC252
AT-1826	UR180DZ
AT-1826 H	DUR181Z
AX-1820	UM167DZ
AX-1820 H	DUM168Z
SP-1815	BVF154RF
PB-250	RBL250, EUB251
PB-250.4	BHX2500
PB-250.4 V	BHX2510
PB-252.4	BHX2501
PB-252.4 V	BHX2511
PB-7600.4	BBX7600
PB-7600.4	BBX7600
CS-246.4 C	EX2650L
ET-100 C	UM4030
ET-40	UR3000
ET-70 C	UM3830
ET-101C	UR3501
ET-110C	UR3502
LT-245.4	ER2550LH
LT-250	RST250
LT-30	DST300
MS-20 C	RBC201
MS-20 U	RBC200, MEM201
MS-22 C	RBC2110
MS-23 C	EM2301L
MS-23 U	EM2301U
MS-230 C	BCM2310
MS-24 U	EM2500U
MS-245.4 C	EBH252L
MS-245.4 CE	EBH253L
MS-245.4 U	EBH252U
MS-245.4 UE	EBH253U
MS-246.4 C	EM2650L
MS-246.4 CE	EM2651L
MS-246.4 UE	EM2651U
MS-25 C	DBC251
MS-25 CS	DBC251S
MS-25 U	DBC250
MS-25 US	DBC250S
MS-251.4	EM4251, MEM425
MS-252	RBC2500
MS-252.4 C	BCX2510

Dolmar	Makita
MS-252.4 U	BCX2500
MS-253	RBC2510
MS-26 C	DBC260L
MS-26 U	DBC260U
MS-260 C	BCM2610
MS-260 U	BCM2600
MS-290 C	DBC291
MS-290 U	DBC290
MS-30 C	DBC301
MS-30 U	DBC300
MS-3202	RBC3101
MS-330 C	BCM3310
MS-330 U	BCM3300
MS-3310	DBC3310
MS-335.4 U	EBH341U
MS-340	DBC340
MS-352.4 C	BCX3410
MS-352.4 R	EBH341R
MS-352.4 U	BCX3400
MS-400	DBC400
MS-4010	DBC4010
MS-4200 E	RBC420E
MS-4205	RBC412U
MS-4211	RBC421L
MS-430 U	BCM4300
MS-430.4 C	EM4350LH
MS-430.4 U	EM4350UH
MS-4300.4 U	EM4351UH
MS-4510	DBC4510
PE-251	ETR2500
ES-152 A	UC3001A
ES-162 A	UC3501A
ES-172 A	UC4001A
ES-2035 A	UC3503A
ES-2040 A	UC4003A
ES-2135 AP	UC3530AP
ES-2140 AP	UC4030AP
ES-33 A	UC3020A
ES-38 A	UC3520A
ES-42 A	UC4020A
109	DCS430
111	DCS520
115	DCS5200
109 Happy Start	DCS431, DE4345
PS-221 TH	DCS231T
PS-222 TH	DCS232TH
PS-32 C	MEA3200S
PS-32 C TLC	EA3201S
PS-34	DCS34
PS-340	DCS340
PS-341	DCS341
PS-3410	DCS3410

Dolmar	Makita
PS-3410 TH	DCS3410TH
PS-35	EA3502S
PS-35 C	EA3500S
PS-35 C TLC	EA3501S
PS-35 TLC	EA3503S
PS-350	DCS3500, MDE350
PS-350	DCS3500, MDE350
PS-350 C	DCS3501, MDE354
PS-350 S	EA3501F
PS-350 SC	EA3500F
PS-400	DCS400, MDE400
PS-401	DCS401, DE4040
PS-410	DCS410
PS-411	DCS411
PS-420	DCS4300, MDE430
PS-420 C	DCS4301, MDE435
PS-420 C	DCS4301, MDE435
PS-420 S	EA4301F
PS-420 SC	EA4300F
PS-45	DCS4610
PS-460	DCS460
PS-4600 S	DCS4600S
PS-4600 SH	DCS4600SH
PS-4605	DCS4630
PS-500	DCS500
PS-500 C	DCS5121
PS-5000	DCS5000
PS-5000 D	DCS5001, DE5045
PS-5000 H	DCS5000H
PS-5000 HD	DCS5001H
PS-5105	DCS5030
PS-5105 C	EA5000P
PS-5105 D	DCS5031
PS-6100	EA6100P
PS-6400	DCS6400
PS-7300	DCS7300
PS-7310	EA7300P
PS-7900	DCS7900
PS-7900	DCS7901
PS-7910	EA7900P
PS-9010	DCS9010
PD-491	PD491
PD-520	BBA520
HT-140	UH4050
HT-148	UH4850
HT-155	UH5550
HT-163	UH6350
HT-345	UH4570
HT-355	UH5570
HT-365	UH6570
HT-42	UH4260
HT-43	UH4261

Dolmar	Makita	Dolmar	Makita	Dolmar	Makita
HT-4500	UH4540	PM-4600 S	PLM4611	MH-2556	PTR2500
HT-48	UH4860	PM-4600 S3	PLM4612	EE-150	UW2500
HT-49	UH4861	PM-4601 S	PLM4621	MP-245.4	MEW1050H
HT-52	UH5260	PM-4601 S3	PLM4622	MP-245.4 Z	EW1050HX
HT-53	UH5261	PM-4602 S	PLM4631	MP-335.4	MEW1060H
HT-5500	UH5540	PM-4602 S3	PLM4632	MP-335.4 Z	EW1060HX
HT-5510	UH5580	PM-461	PLM4620	MP-352.4	EPH1000
HT-6500	UH6540	PM-462	PLM4630	MP-352.4 Z	EPH1000
HT-6510	UH6580	PM-4655 S4	PLM4816	HP-10	HW101
HT-7510	UH7580	PM-4660 S1	PLM4815	HP-115	HW110
HT-2249 D	HTR4901	PM-48	PLM4600	HP-135	HW130
HT-2350 D	EH5000W	PM-48 S	PLM4601	HP-1500	HW131
HT-2360 D	EH6000W	PM-480	PLM4602	HP-20	HW102
HT-2375 D	EH7500W	PM-480 S4	PLM4603	HP-300	HW111
HT-245	HTS4500	PM-4855 SA pro	PLM4814	HP-350	HW112
HT-2460	EH6000S	PM-4860	PLM4810	HP-400	HW121
HT-2475	EH7500S	PM-4860	PLM4810	HP-450	HW132
HT-255	HTS5500	PM-4860 S	PLM4811	HP-6000	HW140
HT-2556 D	HTR5600	PM-4860 S4	PLM4812	HP-7000	HW151
HT-2576 E	HTR7610	PM-4860 S4E	PLM4813	HP351	HW1200
HT-2950	HTS5000	PM-5100 S3	PLM5102	HP401	HW1300
HT-2960	HTS6000	PM-5101 S3	PLM5113	EV-3213	UV3200
HT-2975	HTS7500	PM-5101S3R	PLM5113N2	EV-3618	UV3600
EM-33	ELM3310	PM-5102 S3	PLM5130	EV-3918	UV380
EM-330	ELM3311	PM-5120	PLM5120	PV-3936	EUV400
EM331	ELM3320	PM-5120 S	PLM5121	FH-2500	UD2500
EM-3511	ELM3300	PM-5165 S3	PLM5115	SP-7600.4	PM7650H
EM-37	ELM3710	PM-5175 S1	PLM5114	EP-132	PF0800
EM371	ELM3720	PM-530	PLM5100	EP-144 D	PF1010
EM-370	ELM3711	PM-530 S	PLM5101	EP-1500 DS	PF1110
EM-3913	ELM3700	PM-5360 S3	PLM5110	EP-1680 S	PF1100
EM-41	ELM4110	PM-5360 S3E	PLM5112	EP-720 S	PF0403
EM410	ELM4120	PM-5365 S3 pro	PLM5111	EP-84	PF0300
EM411	ELM4121	PM-5600 S3	PLM5600	EP-84 D	PF0410
EM-4316	ELM4100	PM-5600S3R	PLM5600N2	EP-960 DS	PF0610
EM-460	ELM4610	RM-63.7	PRM0600		
EM-460 S	ELM4611	RM-72.13 H	PRM0700		
EM-461	ELM4612	TM-102.16	PTM1000		
EM-461 S	ELM4613	TM-102.16 H2	PTM1003		
EM462	ELM4620	TM-102.18 H	PTM1001		
EM463S	ELM4621	TM-102.20 H2	PTM1002		
EM-4818	ELM4600	TM-122.22 H2	PTM1200		
EM-4818 S	ELM4601	TM-92.14	PTM0900		
PM-410	PLM4110	TM-92.14 H	PTM0901		
PM-411	PLM4120	TM-92.14 H2	PTM0903		
PM-42	PLM4100	TM-98.14 H2D	PTM0902		
PM-43	PLM4101	TM-98.14 H2D	PTM0902		
PM-46	PLM4616	RM-72.13 H	PRM0700		
PM-46 N	PLM4617	LS-6002	MLS6000		
PM-46 S	PLM4618	MH-246.4 D	EN4950H		
PM46SBC	PLM4628	MH-246.4 DS	EN5950SH		
PM-460	PLM4610	MH-246.4 ES	EN7350SH		

Makita[®]

RUČNÉ NÁRADIE



Inštalátorske kliešte

B-65486
250 mm, max nastavenie 50,8 mm

23⁸³ €

B-65492
300 mm, max nastavenie 76,2 mm

29⁵¹ €



Ergonomická rukoväť, potiahnutá protišmykovým materiálom.

Inštalátorske kliešte

B-65741
Dĺžka 180 mm

47³⁹ €

B-65757
Dĺžka 240 mm

42⁰⁹ €

B-65763
Dĺžka 300 mm

56⁶⁹ €



Kľúč nastaviteľný vidlicový uzamykací

B-65470
Dĺžka 250 mm
Rozsah upínania 0 – 35 mm



35⁸³ €

Konštrukcia so šesťhrannou čelustou redukuje sklz a pevne uchopí skrutku, poskytuje dvojnásobný uchopovací výkon na zaoblených hranách.

Kľúč nastaviteľný vidlicový s račňou + 10 ks nástrčných kľúčov

B-65458
Dĺžka 250 mm
10 ks nástrčných kľúčov:
10 mm, 11 mm, 12 mm, 13 mm, 14 mm,
15 mm, 16 mm, 17 mm, 18 mm, 19 mm



46⁴⁹ €

Konštrukcia so šesťhrannou čelustou redukuje sklz a pevne uchopí skrutku, širšia rukoväť poskytuje viac pohodlia a menej namáhania ruky.

Kľúč nastaviteľný vidlicový

B-65414
150 mm, max nastavenie 28 mm

12⁴³ €

B-65420
200 mm, max nastavenie 32 mm

16⁰¹ €

B-65436
250 mm, max nastavenie 36 mm

20⁶³ €

B-65442
300 mm, max nastavenie 41 mm

cena na vyžiadanie



RUČNÉ NÁRADIE



Skrutkovače krížové PH okrúhly profil

B-65903 PH1 dĺžka 100 mm

4 61 €

B-65919 PH2 dĺžka 100 mm

5 61 €

B-65931 PH3 dĺžka 150 mm

7 79 €

Ergonomická rukoväť, potiahnutá
protišmykovým materiálom,
magnetický hrot



Skrutkovače ploché okrúhly profil

B-66020 4 mm dĺžka 100 mm

3 55 €

B-66036 5,5 mm dĺžka 100 mm

4 61 €

B-66042 6,5 mm dĺžka 125 mm

5 61 €

B-66058 8 mm dĺžka 150 mm

7 79 €

Ergonomická rukoväť, potiahnutá
protišmykovým materiálom,
magnetický hrot



Skrutkovače krížové PZ hranatý profil

B-66092 PZ1 dĺžka 75 mm

5 55 €

B-66101 PZ2 dĺžka 100 mm

6 57 €

B-66117 PZ3 dĺžka 150 mm

9 10 €

Ergonomická rukoväť, potiahnutá pro-
tíšmykovým materiálom,
magnetický hrot



Skrutkovače krížové PZ okrúhly profil

B-65947 PZ1 dĺžka 80 mm

4 42 €

B-65953 PZ2 dĺžka 100 mm

5 61 €

B-65969 PZ3 dĺžka 150 mm

7 79 €

Ergonomická rukoväť, potiahnutá
protišmykovým materiálom,
magnetický hrot



Skrutkovače TORX okrúhly profil

B-65975 T10 dĺžka 100 mm

4 80 €

B-65981 T15 dĺžka 100 mm

4 80 €

B-65997 T20 dĺžka 100 mm

4 80 €

B-66008 T25 dĺžka 100 mm

5 64 €

B-66014 T30 dĺžka 100 mm

5 64 €



Skrutkovač magnetický

B-42438 PH2 × 125 mm B-42466 PZ3 × 150 mm

18 79 €

21 99 €

B-42444 PH3 × 150 mm B-42450 PZ2 × 125 mm

21 99 €

18 59 €





72 zubov na vnútornom krúžku vyrobenom zo špeciálnej ocele umožňuje ťahovanie aj pri pohybe kľúča v rozsahu len 5°.

Sada kombinovaných rovných kľúčov s račňovým mechanizmom na očkovej časti

B-65523

8 ks / bal.

8, 10, 12, 13, 14, 15, 17, 19 mm

72³⁸ €

Sada obojstranných očkových kľúčov

B-65551

5 ks / bal.

8x9, 10x11, 12x13, 14x15, 18x19 mm

31⁹⁷ €



75° vyhnuté hlavy, 12 kontaktných bodov pre spoľahlivú príľnavosť a pevnosť, kľúče z ušľachtilej ocele, povrch leštený nikel chrómovaný pre dlhú životnosť kľúčov a jednoduché čistenie.



Kľúče z ušľachtilej ocele, povrch leštený nikel chrómovaný pre dlhú životnosť kľúčov a jednoduché čistenie.

Sada vidlicových kľúčov na prevlečné matice

B-65545

5 ks / bal.

9x11, 10x12, 13x14, 15x17, 16x18 mm

23⁷⁴ €

Sada kombinovaných kľúčov očko / vidlica

B-65539

9 ks / bal.

8, 10, 12, 13, 14, 15, 16, 17, 18 mm

38⁶⁷ €



12 kontaktných bodov pre spoľahlivú príľnavosť a pevnosť na očku kľúča.

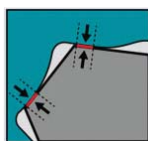

Silnejší úchyt



**Račňový kľúč
priechodný s kĺbom**
B-65626

50% tenšia hlava ako pri bežných račňových kľúčoch,
11 uzamykacích polôh, 5 polôh uhla hlavy

34⁷⁹ €

Račňový kľúč priechodný

B-65610



25% tenšia hlava račne umožňuje prácu
v úzkych priestoroch, 72 zubov na vnútornom
krúžku umožňuje uťahovanie aj pri pohybe
kľúča v rozsahu len 5°

19¹³ €

Predĺženie pre račne

B-65632

dĺžka 75 mm



4⁹⁵ €

**Nástrčný kľúč
pre račne**

B-65648 10 mm **2¹⁵ €**

B-65654 11 mm **2¹⁵ €**

B-65660 12 mm **2¹⁵ €**

B-65676 13 mm **2¹⁵ €**

B-65682 14 mm **2¹⁵ €**

B-65698 15 mm **2⁵² €**

B-65707 16 mm **2⁵² €**

B-65713 17 mm **2⁵² €**

B-65729 18 mm **2⁸⁰ €**

B-65735 19 mm **2⁸⁰ €**



25% tenšie telo
ako pri štandardných typoch



Adaptér pre závitové oká

B-65888

Použitie na šesťhranné
a okrúhle oká

16³⁹ €

Adaptér

B-65872

funkcia automatického uzamknutia,
kryt s pružinou umožňuje rýchle
uvoľnenie adaptéra z račne

35⁷⁹ €



**Račňa na závitové oká
a závitníky**

B-65866

Použitie na šesťhranné
a okrúhle oká

24⁴⁹ €



Adaptér

B-65844 1/4"

5⁰⁹ €



Adaptér

B-65850 3/8"

5⁰⁹ €



RUČNÉ NÁRADIE

40 ks sada na rezanie závitov

B-65838

Malá/stredná račňa, adaptér krátky / stredný,
Hex adaptér stredný, skrutkovač, závtová šablóna,
NC Hex Die 3 mm × 0,50 • 3 mm × 0,60
4 mm × 0,70 • 4 mm × 0,75 • 5 mm × 0,80
5 mm × 0,90 • 6 mm × 1,00 • 7 mm × 1,00
8 mm × 1,25 • 9 mm × 1,25 • 10 mm × 1,50
11 mm × 1,50 • 12 mm × 1,75
NC Plug Tap 8 mm × 1,25 • 9 mm × 1,25
10 mm × 1,50 • 11 mm × 1,50 • 12 mm × 1,75
NC Taper Tap 3 mm × 0,50 • 3 mm × 0,60
4 mm × 0,70 • 4 mm × 0,75 • 5 mm × 0,80
5 mm × 0,90 • 6 mm × 1,00 • 7 mm × 1,00
NF Hex Die 9 mm × 1,00 • 10 mm × 1,25
12 mm × 1,50 • NF Plug Tap 9 mm × 1,00
10 mm × 1,25 • 12 mm × 1,50
BSP Hex Die 1/8-28, BSP Tap 1/8-28



150³⁹ €

Gola sada s račňou 1/2"

B-65589

23 ks / set



102⁴⁷ € račňa 1/2", adaptér na 3/8", 1/2" univerzálny kľb, nástrčný kľúč: 10, 11, 12, 13, 14, 15, 16, 17, 18, 19, 20, 21, 22, 23, 24, 27, 30, 32, predĺžovací adaptér 5", 10"



Gola sada s račňou 1/4"

B-65567

34 ks / set

50³² €



Gola sada s račňou 3/8"

B-65573

23 ks / set

59⁵⁷ €

račňa 1/4", bitový adaptér 1/4", nástrčný kľúč: 4, 4, 5, 5, 5, 6, 7, 8, 9, 10, 11, 12, 13, predĺžený nástrčný kľúč: 5, 6, 7, 8, 9, 10, 11, 12, 13, predĺžovací adaptér 3", 6", torx bity : T8, T10, T15, T20, T25, T27, T30, T40 × 25 mm

račňa 3/8", adaptér na 1/2", nástrčný kľúč: 8, 9, 10, 11, 12, 13, 14, 15, 16, 17, 18, 19, 20, predĺžený nástrčný kľúč: 10, 13, 16 17, 19, predĺžovací adaptér 3", 6"

Gola sada

14 ks

B-65595

47¹⁷ €



Nástrčný kľúč 10 mm, 11 mm, 12 mm, 13 mm, 14 mm, 15 mm, 16 mm, 17 mm, 18 mm, 19 mm, Adaptér 1/4", 3/8", Predĺženie 75 mm, Račňa

Gola sada

21 ks

B-65604

56⁸⁰ €



Nástrčný kľúč 10 mm, 11 mm, 12 mm, 13 mm, 14 mm, 15 mm, 16 mm, 17 mm, 18 mm, 19 mm, Nástrčný kľúč 3/8", 7/16", 1/2" 9/16", 5/8", 11/16", 3/4", Adaptér 1/4", 3/8" Predĺženie 75 mm, Račňa

RUČNÉ NÁRADIE

Orezávací nôž zalamovací

B-65501

Ergonomická rukoväť, potiahnutá protišmykovým materiálom, dodávané s jednou čepeľkou



13⁶⁸ €

Orezávací nôž

B-65785



17⁵⁹ €



Náhradné čepeľky 10 ks

B-65517

2¹² €



Tesárske kladivo

B-65779

47¹⁹ €

Kovaná jednodielna oceľová konštrukcia, dráp na vyťahovanie klinec, antivibračná rukoväť.

Ručné nožnice na plech

20⁷⁹ €

B-65791
Rovný strih

21³⁹ €

B-65816
Pravý a rovný strih

21¹⁹ €

B-65800
Lavý a rovný strih

21⁸⁹ €

B-65822
Univerzálne kliešte



Kované čeľuste CrMoV s vrúbkovaným ostrím pre presné strihanie, rukoväť potiahnutá protišmykovým materiálom

Imbusové kľúče

9 ks / set

B-65894

1,5 2, 3, 4, 5, 6, 8, 10



11⁶⁸ €

Guľový bod pre stiesnené miesta a upevnenie v max. uhle 25°, s klipom na opask pre jednoduché použitie

RUČNÉ NÁRADIE

Gola-sada 212 ks

E-10883

194⁹⁹ €

račňa 1/2"; 1/4"
 krížový kľúč 1/4"
 predĺženie 1/4" 50; 100 mm
 predĺženie 1/2" 50; 100 mm
 adaptér 1/2" na 3/8"
 kľbový adaptér 1/4" na 1/4"
 kľbový adaptér 1/2" na 1/2"
 kľúč na sviečky 1/2" 16; 21 × 65 mm
 orech šesťhran 1/4": 4; 4,5; 5; 5,5; 6; 7; 8; 9; 10; 11; 12; 13; 14 × 25 mm
 orech šesťhran 1/2": 15; 16; 17; 19; 20; 21; 22; 24 × 38 mm; 27 × 40 mm; 30; 32 × 44 mm
 orech hviezda 1/2": E10; E12; E14; E16; E18; E20; E24 × 38 mm
 kľúč nástrčný 1/4": 5; 5,5; 6; 7; 8 × 2; 9; 10 × 2; 11; 12; 13 × 38 mm
 kľúč očko/vidlica: 8; 10; 11; 12; 13; 14; 15; 16; 17; 18; 19
 sada imbusov do ruky: 1,5; 2; 2,5; 3; 4; 5; 6; 8
 rukoväť skrutkovača 1/4" samec
 rukoväť skrutkovača 1/4" samica
 bity 1/4" × 37 mm SL4; SL5; SL6; PH1; PH2; PH3; PZ1; PZ2; PZ3; T10; T15; T20; T25; T27;
 T30; T40; HEX3; HEX4; HEX5; HEX6
 adaptér bitu 1/4" na 1/4" × 25 mm
 adaptér bitu 1/2" na 5/16" × 38 mm
 predĺžovací adaptér 1/4" 80 mm
 magnetický adaptér 1/4" 60 mm
 bity 25 mm PH0 5ks; PH1 5ks; PH2 20ks, PH3 5ks, PH4; T8 2ks; T9 2ks; T10 2ks; T15 2ks;
 T20 2ks; T25; T27; T30; T40; T9H; T10H; T15H; T20H; T25H; T27H; T30H 2ks;
 T40H; PZ0 2 ks; PZ1 2ks; PZ2 3ks; PZ3 2 ks; PZ4; SL3 2 ks; SL4 2 ks; SL5 2 KS;
 SL5,5 2ks; SL6,5 2 KS; H3; H4; H5; H6; H7; H8; H3H; H4H; H5H; H6H
 bity 30 mm PH3; PH4; PZ3; PZ4; T25; T27; T30; T35; T40; T45; T50; H4; H5; H6; H7; H8; SL6;
 SL7; SL8; T25H; T27H; T30H; T35H; T40H; T45H; T50H; M5; M6; M8; M10

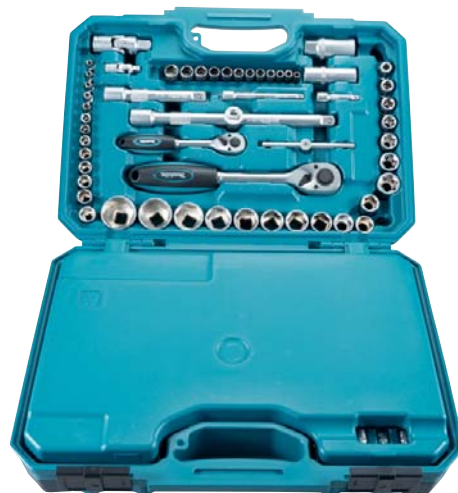

Makita meter

E-03078

Dĺžka 2 m

6⁰⁹ €



Makita meter

B-57130

Dĺžka 3,5 m

9⁷⁹ €



Makita meter

B-57152

Dĺžka 7,5 m

25²⁹ €



Makita meter

B-57168

Dĺžka 10 m

31⁴⁹ €

PREPRAVNÉ KUFRE

model	Obj. č.	materiál	MOC s Dph	model	Obj. č.	materiál	MOC s Dph
1806B	821137-8	H	124,39 €	6333D	824476-5	K	22,59 €
2107FK	824728-4	K	67,39 €	6336D	824525-8	K	34,96 €
4112HS	824697-9	K	87,29 €	6337D	183763-4	K	31,49 €
4304	824809-4	K	20,59 €	6339D	824626-2	K	37,99 €
4304T	824809-4	K	20,59 €	6343D	824525-8	K	34,96 €
4305	824809-4	K	20,59 €	6347D	183763-4	K	31,49 €
4305T	824809-4	K	20,59 €	6349D	824626-2	K	37,99 €
4326	824572-9	M	16,99 €	6381D	824852-3	K	16,19 €
4327	824572-9	M	16,99 €	6390	824744-6	K	10,49 €
4329	824572-9	M	16,99 €	6391D	824852-3	K	16,19 €
4331DWD	824553-3	K	27,15 €	6503D	824635-1	K	7,49 €
4334DWD	824553-3	K	27,15 €	6704D	824380-8	K	58,19 €
4350CT/FCT	824809-4	K	20,59 €	6824	824449-8	K	9,09 €
4351CT/FCT	824809-4	K	20,59 €	6825R	824449-8	K	9,09 €
4604DW	824556-7	K	46,62 €	6826	824449-8	K	9,09 €
5017RKB	193196-5	K	85,19 €	6827	824449-8	K	9,09 €
5603R	824555-9	K	72,49 €	6830	824421-0	K	49,61 €
5604R	824555-9	K	72,49 €	6831D	824551-7	K	26,89 €
5621RDWA	824533-9	K	57,25 €	6832	824421-0	K	49,61 €
5703RK	824554-1	K	84,79 €	6833	824421-0	K	49,61 €
5704R	824555-9	K	72,49 €	6834	824421-0	K	49,61 €
5705RK	824554-1	K	84,79 €	6835D	824551-7	K	26,89 €
5903R	193196-5	K	85,19 €	6842	824808-6	K	34,39 €
6016DW	824723-4	K	16,93 €	6844	824808-6	K	34,39 €
6017D	824723-4	K	16,93 €	6904VH	824439-1	K	26,90 €
6018D	824723-4	K	16,93 €	6906	182604-1	M	100,92 €
6019D	824723-4	K	16,93 €	6908D	824635-1	K	7,49 €
6095D	824723-4	K	16,93 €	6914D	824635-1	K	7,49 €
6096D	824723-4	K	16,93 €	6915D	824549-4	K	21,56 €
6203D	824476-5	K	22,59 €	6916D	824635-1	K	7,49 €
6204D	824635-1	K	7,49 €	6918D	824635-1	K	7,49 €
6207D	183763-4	K	31,49 €	6934FD	824635-1	K	7,49 €
6213D	824476-5	K	22,59 €	6940D	824686-4	K	46,90 €
6214D	824635-1	K	7,49 €	6951	824439-1	K	26,90 €
6216D	824525-8	K	34,96 €	6960D	824635-1	K	7,49 €
6226D	824635-1	K	7,49 €	8271D	824635-1	K	7,49 €
6227D	824635-1	K	7,49 €	8281D	824635-1	K	7,49 €
6228D	824635-1	K	7,49 €	8391D	824581-8	K	9,09 €
6261D	824635-1	K	7,49 €	8413D	824626-2	K	37,99 €
6271D	824852-3	K	16,19 €	8414D	824626-2	K	37,99 €
6281D	824635-1	K	7,49 €	8433D	824626-2	K	37,99 €
6313D	824476-5	K	22,59 €	8434D	824626-2	K	37,99 €
6314D	824635-1	K	7,49 €	8443D	824626-2	K	37,99 €
6315D	824525-8	K	34,96 €	8444D	824626-2	K	37,99 €
6316D	824525-8	K	34,96 €	9554NB	824736-5	K	11,89 €
6317D	183763-4	K	31,49 €	9555NB	824736-5	K	11,89 €
6319D	824626-2	K	37,99 €	9557H/R	188627-7	M	25,69 €
6327D	824635-1	K	7,49 €	9558H/R	188627-7	M	25,69 €
6328D	824635-1	K	7,49 €	AF505	HY00000090	K	25,89 €

K – plast; M – železo; H – drevo; T – taška

PREPRAVNÉ KUFRE

model	Obj. č.	materiál	MOC s DPH	model	Obj. č.	materiál	MOC s DPH
AN450H	824792-5	K	39,76 €	BHR162	141074-3	K	29,04 €
AN510H	824793-3	K	39,63 €	BHR200	824690-3	K	41,99 €
AN610H	824490-1	K	27,36 €	BHR202	141642-2	K	23,99 €
AN620H	824490-1	K	27,36 €	BHR240	141643-0	K	27,39 €
AN621	824582-6	K	17,79 €	BHR241	141643-0	K	27,39 €
AN711H	824792-5	K	39,76 €	BHR243	141401-4	K	33,39 €
AN901	824545-2	K	49,29 €	BHR261	142551-8	K	67,29 €
AN911H	824792-5	K	39,76 €	BHR262	142551-8	K	67,29 €
AT638	A0905-0361	K	8,90 €	BHS630	824995-1	K	55,69 €
BBO180	821533-0	K	42,96 €	BJR181	141354-7	K	22,39 €
BCS550	141485-2	K	24,79 €	BJS101	141478-9	K	41,43 €
BDA340	141358-9	K	42,99 €	BJS130	140392-6	K	29,11 €
BDA341	141358-9	K	42,99 €	BJV140	141486-0	K	28,89 €
BDF343	158777-2	K	20,29 €	BJV180	141486-0	K	28,89 €
BDF440	141205-4	K	27,39 €	BKP180	824982-0	K	59,39 €
BDF441	140354-4	K	34,39 €	BO4555	824806-0	K	13,49 €
BDF442	158597-4	K	19,39 €	BO4557	824806-0	K	13,49 €
BDF444	140354-4	K	34,39 €	BO4565	824806-0	K	13,49 €
BDF446	141856-3	K	18,59 €	BO6040	824591-5	K	24,39 €
BDF450	141205-4	K	27,39 €	BPB180	141496-7	K	86,00 €
BDF451	140354-4	K	34,39 €	BPJ180	141533-7	K	57,59 €
BDF452	158597-4	K	19,39 €	BPT350	141074-3	K	29,04 €
BDF453	158777-2	K	20,29 €	BPT351	141932-3	K	84,83 €
BDF454	140354-4	K	34,39 €	BSR730	153612-9	K	57,35 €
BDF456	141856-3	K	18,59 €	BSS500	141485-2	K	24,79 €
BDF459	158597-4	K	19,39 €	BSS610	824757-7	K	22,19 €
BDF460	824567-2	K	39,98 €	BTD130	141205-4	K	27,39 €
BFR440	140392-6	K	29,11 €	BTD132	141205-4	K	27,39 €
BFR540	824807-8	K	36,62 €	BTD133	141205-4	K	27,39 €
BFR550	824807-8	K	36,62 €	BTD134	824979-9	K	30,09 €
BFR750	824807-8	K	36,62 €	BTD136	824979-9	K	30,09 €
BFS451	824978-1	K	37,67 €	BTD140	141205-4	K	27,39 €
BGA450	141257-5	K	21,79 €	BTD146	824979-9	K	30,09 €
BGA452	141257-5	K	21,79 €	BTD147	824979-9	K	30,09 €
BGD800	824975-7	K	21,06 €	BTD200	824593-1	K	44,46 €
BHP343	158777-2	K	20,29 €	BTL060	141493-3	K	64,29 €
BHP440	141205-4	K	27,39 €	BTL061	141493-3	K	64,29 €
BHP441	140354-4	K	34,39 €	BTM50	141562-0	K	26,49 €
BHP442	158597-4	K	19,39 €	BTP130	141205-4	K	27,39 €
BHP444	140354-4	K	34,39 €	BTP140	141205-4	K	27,39 €
BHP446	141856-3	K	18,59 €	BTP141	824979-9	K	30,09 €
BHP450	141205-4	K	27,39 €	BTS130	141205-4	K	27,39 €
BHP451	140354-4	K	34,39 €	BTW251	141205-4	K	27,39 €
BHP452	158597-4	K	19,39 €	BTW450	141644-8	K	56,11 €
BHP453	158777-2	K	20,29 €	BUC122	141494-1	K	76,59 €
BHP454	140354-4	K	34,39 €	BVR450	141481-0	K	40,99 €
BHP456	141856-3	K	18,59 €	DA312D	824627-0	K	19,56 €
BHP459	158597-4	K	19,39 €	DA330D	821556-8	K	18,33 €
BHP460	824567-2	K	39,98 €	DA391D	824627-0	K	19,56 €

K – plast; M – železo; H – drevo; T – taška

PREPRAVNÉ KUFRE

model	Obj. č.	materiál	MOC s Dph	model	Obj. č.	materiál	MOC s Dph
DA392D	824627-0	K	19,56 €	HM1101C	140562-7	K	97,59 €
DA4000LR	824646-6	K	39,26 €	HM1111C	140562-7	K	97,59 €
DBM080	P-45135	M	118,45 €	HM1130C	150676-4	K	69,75 €
DBM130	P-45141	M	134,09 €	HM1140C	150676-4	K	69,75 €
DDF482	141856-3	K	18,59 €	HM1200	150583-1	K	45,17 €
DF010DSE	824781-0	K	2,69 €	HM1200B	150586-5	K	52,21 €
DF030D	824842-6	K	10,59 €	HM1202C	824564-8	K	70,69 €
DF031D	821661-1	K	12,69 €	HM1203C	824876-9	K	61,99 €
DF330D	824842-6	K	10,59 €	HM1205C	824876-9	K	61,99 €
DF331D	821661-1	K	12,69 €	HM1213C	824908-2	K	63,99 €
DF347D	824981-2	K	17,19 €	HM1214C	824882-4	K	194,09 €
DF457D	824981-2	K	17,19 €	HM1303	182852-2	M	162,11 €
DGA900/901	821717-0	K	47,29 €	HM1303B	182852-2	M	162,11 €
DHP482	141856-3	K	18,59 €	HM1304	183567-4	M	117,89 €
DHR263	142551-8	K	67,29 €	HM1304B	824826-4	M	115,89 €
DHR264	142551-8	K	67,29 €	HM1307C	824898-9	K	167,39 €
DHR400	821746-3	K	46,32 €	HM1307CB	824898-9	K	167,39 €
DJR181	141354-7	K	22,39 €	HM1317C	824898-9	K	167,39 €
DJR186	821620-5	K	23,99 €	HP1620K	824923-6	K	20,59 €
DJR187	821620-5	K	23,99 €	HP1621K	824923-6	K	20,59 €
DJR360	821670-0	K	39,79 €	HP1630K	824811-7	K	25,09 €
DP3003	824595-7	K	27,99 €	HP1631K	824811-7	K	25,09 €
DP4001	824595-7	K	27,99 €	HP1640K	824923-6	K	20,59 €
DP4003	824595-7	K	27,99 €	HP1641K	824923-6	K	20,59 €
DPB181RFE	831303-9	T	21,38 €	HP2040	824449-8	K	9,09 €
DSC191RF	SC09009190	K	233,83 €	HP2041	824449-8	K	9,09 €
DTD152	141856-3	K	18,59 €	HP2050	824650-5	K	13,69 €
DTS141RFE	824979-9	K	30,09 €	HP2051	824650-5	K	13,69 €
DUC122	141494-1	K	76,59 €	HP2070	824650-5	K	13,69 €
DVR450	141481-0	K	40,99 €	HP2071	824650-5	K	13,69 €
FS2700	824890-5	K	16,09 €	HP330D	821525-9	K	12,59 €
GA9020	824958-7	K	37,79 €	HP331	821661-1	K	12,69 €
GN420CSE	821512-8	K	62,59 €	HP457DWE	824981-2	K	17,19 €
HB500	CASE14	K	239,91 €	HR1830	824650-5	K	13,69 €
HG5002K	HG130442	K	16,59 €	HR2010	824464-2	K	25,89 €
HG5012K	HG130442	K	16,59 €	HR2020	824650-5	K	13,69 €
HG550VK	HG130442	K	16,59 €	HR2230	824799-1	K	17,49 €
HG551VK	HG130442	K	16,59 €	HR2300	824914-7	K	22,19 €
HG650CK	HG130442	K	16,59 €	HR2400	824445-6	K	27,29 €
HG651CK	HG130442	K	16,59 €	HR2410	824445-6	K	27,29 €
HK0500	824523-2	K	38,09 €	HR2432	824729-2	K	24,39 €
HK1810	150640-5	K	33,72 €	HR2440	824650-5	K	13,69 €
HK1820	824789-4	K	17,29 €	HR2450	824650-5	K	13,69 €
HM0810B	150878-2	K	87,09 €	HR2450T	824695-3	K	15,49 €
HM0860C	824708-0	K	45,89 €	HR2460	824799-1	K	17,49 €
HM0870C	824905-8	K	38,69 €	HR2470	824799-1	K	17,49 €
HM0871C	824905-8	K	38,69 €	HR2470T	824799-1	K	17,49 €
HM1100	150676-4	K	69,75 €	HR2600	824914-7	K	22,19 €
HM1100C	150676-4	K	69,75 €	HR2610	140402-9	K	18,99 €

K – plast; M – železo; H – drevo; T – taška

PREPRAVNÉ KUFRE

model	Obj. č.	materiál	MOC s DPH	model	Obj. č.	materiál	MOC s DPH
HR2610T	140404-5	K	33,29 €	JR100DWE	824993-5	K	18,09 €
HR2611F	140401-1	K	21,24 €	JR103D	821662-9	K	20,49 €
HR2611FT	140403-7	K	28,49 €	JR180DWD	824565-6	K	45,69 €
HR2630	824914-7	K	22,19 €	JR3000V	824539-7	K	10,35 €
HR2630T	824914-7	K	22,19 €	JR3000VT	824539-7	K	10,35 €
HR2631F	824914-7	K	22,19 €	JR3020	824539-7	K	10,35 €
HR2631FT	824914-7	K	22,19 €	JR3030	824539-7	K	10,35 €
HR2641	824695-3	K	15,49 €	JR3030T	824539-7	K	10,35 €
HR2800	824789-4	K	17,29 €	JR3050T	821621-3	K	18,69 €
HR2810	824789-4	K	17,29 €	JR3060T	821621-3	K	18,69 €
HR2810T	824789-4	K	17,29 €	JR3070CT	821621-3	K	18,69 €
HR2811F	824789-4	K	17,29 €	JV0600K	824998-5	K	15,89 €
HR2811FT	824789-4	K	17,29 €	JV100DWE	821508-9	K	20,89 €
HR3000C	824559-1	K	130,69 €	JV183DWE	821646-7	K	18,09 €
HR3200C	824825-6	K	82,49 €	KP0800	824892-1	K	15,79 €
HR3210C	824825-6	K	82,49 €	KP0810	824786-0	K	51,19 €
HR3210FCT	824825-6	K	82,49 €	KP0810C	824786-0	K	51,19 €
HR3520	150597-0	K	51,84 €	N1923B	P-72366	K	68,48 €
HR3540C	824825-6	K	82,49 €	NHP1300S	824700-6	K	24,40 €
HR3550C	824559-1	K	130,69 €	PC1100	181789-0	M	66,09 €
HR4000C	824479-9	K	72,49 €	PC5000C	140073-2	M	106,19 €
HR4001C	196183-3	K	104,11 €	PC5001C	140073-2	M	106,19 €
HR4002	824798-3	K	37,29 €	PJ7000	821509-7	K	30,19 €
HR4003C	196531-6	K	112,39 €	RT0700C/CX2	831327-5	T	40,59 €
HR4010C	196183-3	K	104,11 €	SC130DRA	SC08100910	K	173,23 €
HR4011C	196183-3	K	104,11 €	SG1250	824709-8	K	52,99 €
HR4013C	196531-6	K	112,39 €	SG1251	821552-6	K	54,79 €
HR4500C	824607-6	K	72,99 €	SG150	B50856	M	93,19 €
HR4501C	158275-6	K	84,39 €	SG180	B06337	M	116,95 €
HR4510C	158275-6	K	84,39 €	SP6000K	821552-6	K	54,79 €
HR4511C	158273-0	K	97,09 €	TD020DSE	831276-6	T	13,09 €
HR5001C	824519-3	K	73,99 €	TD021DSE	831276-6	T	13,09 €
HR5201C	158275-6	K	84,39 €	TD090D	824842-6	K	10,59 €
HR5202C	196552-8	K	154,99 €	TD091D	141740-2	K	13,24 €
HR5210C	158275-6	K	84,39 €	TD110D	821661-1	K	12,69 €
HR5211C	158273-0	K	97,09 €	TM3000C	821596-6	K	18,99 €
HR5212C	196552-8	K	154,99 €	TW0200	824703-0	K	15,39 €
HS300D	824961-8	K	17,39 €	TW0350	824702-2	K	25,89 €
HS301D	821663-7	K	20,89 €	TW1000	824737-3	K	56,49 €
HS7101	141736-3	K	72,69 €	VR250D	824486-2	K	20,14 €
JR1000FTK	824722-6	K	21,18 €				

K – plast; M – železo; H – drevo; T – taška

SPONY PRE PREPRAVNÉ KUFRE

model	kufor	spona	MOC s DPH	model	kufor	spona	MOC s DPH
1050DWA	824544-4	417059-4	0,20 €	6222DWE	824715-3	186347-7	1,39 €
1806B	821137-8			6223DWE	824510-1	186347-7	1,39 €
1902	182113-0			6226DWE	824635-1	186347-7	1,39 €
1923H	182113-0			6227DWE	824635-1	186347-7	1,39 €
2012NB	824002-0			6228DWE	824635-1	186347-7	1,39 €
2107FK	824728-4	163455-1	0,92 €	6261DWE	824853-1	163455-1	0,92 €
3612/C	P-38314			6261DWLE	824853-1	163455-1	0,92 €
3620	P-38314			6271DWAE	824853-1	163455-1	0,92 €
3901	824540-2	417059-4	0,20 €	6271DWALE	824581-8		
4112HS	824697-9	163467-4	1,32 €	6271DWPE	824853-1	163455-1	0,92 €
4304	824809-4			6281DWAE	824853-1	163455-1	0,92 €
4304T	824809-4			6281DWALE	824581-8		
4305	824809-4			6313DWAE	824476-5	416661-0	1,29 €
4305T	824809-4			6313DWBE	824476-5	416661-0	1,29 €
4326	824572-9	186347-7	1,39 €	6314DWAE	824635-1	186347-7	1,39 €
4327	824572-9	186347-7	1,39 €	6316DWAE	824525-8	417075-6	6,49 €
4329	824572-9	186347-7	1,39 €	6316DWBE	824525-8	417075-6	6,49 €
4331DWD	824553-3	416661-0	1,29 €	6317DWDRE	183763-4	417724-5	0,35 €
4334DWD	824553-3	416661-0	1,29 €	6319DWFE	824626-2	450909-0	0,26 €
4350CT/FCT	824809-4			6327DWE	824635-1	186347-7	1,39 €
4351CT/FCT	824809-4			6328DWE	824635-1	186347-7	1,39 €
4604DW	824556-7	416401-6	2,23 €	6333DWAE	824476-5	416661-0	1,29 €
5017RKB	193196-5	183336-3	1,41 €	6333DWBE	824476-5	416661-0	1,29 €
5103R	P-15942			6336DWAE	824525-8	417075-6	6,49 €
5603R	824606-8	183336-3	1,41 €	6336DWBE	824525-8	417075-6	6,49 €
5604R	824555-9			6337DWDESP	183763-4	417724-5	0,35 €
5621RDWA	824533-9	417075-6	6,49 €	6339DWFE	824626-2	450909-0	0,26 €
5703RK	824606-8	183336-3	1,41 €	6343DWAE	824525-8	417075-6	6,49 €
5704R	824555-9			6343DWBE	824525-8	417075-6	6,49 €
5705RK	824606-8	183336-3	1,41 €	6347DWDESP	183763-4	417724-5	0,35 €
5903R	193196-5	183336-3	1,41 €	6349DWFE	824626-2	450909-0	0,26 €
6016DW	824723-4			6380	824744-6		
6017DWE	824723-4			6381DWAE	824852-3	163455-1	0,92 €
6018DWE	824723-4			6390	824744-6		
6019DWE	824723-4			6391DWAE	824853-1	163455-1	0,92 €
6019DWE	824723-4			6391DWALE	824853-1	163455-1	0,92 €
6095DWE	824723-4			6503DWDE	824635-1	186347-7	1,39 €
6095DWE	824723-4			6704DW	824380-8		
6096DWE	824723-4			6800DBV	824700-6		
6096DWE	824723-4			6802DBV	824700-6		
6203DWAE	824476-5	416661-0	1,29 €	6805DBV	824700-6		
6203DWBE	824476-5	416661-0	1,29 €	6822	824700-6		
6204DWAE	824653-1	186347-7	1,39 €	6824	824449-8		
6207DWDE	183763-4	417724-5	0,35 €	6825R	824449-8		
6213DWAE	824476-5	416661-0	1,29 €	6826	824449-8		
6213DWBE	824476-5	416661-0	1,29 €	6827	824449-8		
6214DWAE	824635-1	186347-7	1,39 €	6830	824421-0		
6216DWAE	824525-8	417075-6	6,49 €	6831DWH	824551-7	417075-6	6,49 €
6216DWBE	824525-8	417075-6	6,49 €	6832	824421-0		
6221DWE	824715-3	186347-7	1,39 €	6833	824421-0		

SPONY PRE PREPRAVNÉ KUFRE

model	kufor	spona	MOC s DPH	model	kufor	spona	MOC s DPH
6834	824421-0			AN621	824582-6		
6835DWH	824551-7	417075-6	6,49 €	AN711H	824792-5		
6842	824808-6	163455-1	0,92 €	AN901	824545-2	417075-6	6,49 €
6844	824808-6	163455-1	0,92 €	AN911H	824792-5		
6904VH	824439-1			AN943K	824841-8		
6905B	824698-7			BCS550RFE	824802-8	163455-1	0,92 €
6905H	824698-7			BDA340RFE	824851-5	163455-1	0,92 €
6906	182604-1			BDA341RFE	824851-5	163455-1	0,92 €
6908DWA	824635-1	186347-7	1,39 €	BDA350Z	824816-7	163455-1	0,92 €
6914DWA	824635-1	186347-7	1,39 €	BDA351Z	824816-7	163455-1	0,92 €
6915DWA	824549-4	186347-7	1,39 €	BDF343SHE	824862-0	163455-1	0,92 €
6916DWA	824635-1	186347-7	1,39 €	BDF430F	824710-3	417724-5	0,35 €
6918DWA	824635-1	186347-7	1,39 €	BDF440RFE	824753-5	417724-5	0,35 €
6918FDWDE	824635-1	186347-7	1,39 €	BDF441RFE	824754-3	417724-5	0,35 €
6934FDWDE	824635-1	186347-7	1,39 €	BDF442RFE	824774-7	417724-5	0,35 €
6935FDWDE	824635-1	186347-7	1,39 €	BDF450RFE	824753-5	417724-5	0,35 €
6936FDWDE	154902-3			BDF451RFE	824754-3	417724-5	0,35 €
6940DW	824686-4			BDF452RFE	824774-7	417724-5	0,35 €
6951	824439-1			BDF453SHE	824862-0	163455-1	0,92 €
6953	824630-1	186347-7	1,39 €	BDF460SH	153514-9	417075-6	6,49 €
6960DWA	824635-1	186347-7	1,39 €	BFR440RFE	824756-9	417059-4	0,20 €
6980FDWDE	824710-3	417724-5	0,35 €	BFR540RFE	824807-8	163455-1	0,92 €
8271DWAE	824853-1	163455-1	0,92 €	BFR550RFE	824807-8	163455-1	0,92 €
8281DWAE	824853-1	163455-1	0,92 €	BFR750RFE	824807-8	163455-1	0,92 €
8281DWAET2	149504-3			BFS230F	824710-3	417724-5	0,35 €
8281DWALE	824853-1	163455-1	0,92 €	BFS440Z	824756-9	417724-5	0,35 €
8381DWAE	824852-3	163455-1	0,92 €	BFS450Z	824756-9	417724-5	0,35 €
8391DWAE	824853-1	163455-1	0,92 €	BGA450RFE	824767-4	163455-1	0,92 €
8391DWALE	824853-1	163455-1	0,92 €	BGA452RFE	824767-4	163455-1	0,92 €
8413DWDE	824626-2	450909-0	0,26 €	BHP343SHE	824862-0	163455-1	0,92 €
8414DWFE	824626-2	450909-0	0,26 €	BHP440RFE	824753-5	417724-5	0,35 €
8433DWDE	824626-2	450909-0	0,26 €	BHP441RFE	824754-3	417724-5	0,35 €
8434DWFE	824626-2	450909-0	0,26 €	BHP442RFE	824774-7	417724-5	0,35 €
8443DWDE	824626-2	450909-0	0,26 €	BHP450RFE	824753-5	417724-5	0,35 €
8444DWFE	824626-2	419655-4	0,23 €	BHP451RFE	824754-3	417724-5	0,35 €
9554NB	824736-5			BHP452RFE	824774-7	417724-5	0,35 €
9555NB	824736-5			BHP453SHE	824862-0	163455-1	0,92 €
9557HN	188627-7			BDF / BHP456	141856-3	162302-3	0,79 €
9558HNC	188627-7			BHP460SH	153514-9	417075-6	6,49 €
9562CH/CVH	188627-7			BHR162RFE	824815-9	417724-5	0,35 €
9564H	188627-7			BHR200SF	824690-3	417152-4	1,07 €
9565CR/CVR	188627-7			BHR200SJE	824690-3	417152-4	1,07 €
9565CLR	188627-7			BHR202RFE	824861-2	163455-1	0,92 €
9565H	188627-7			BHR240	824771-3	163455-1	0,92 €
9566CR/CVR	188627-7			BHR241RFE	824771-3	163455-1	0,92 €
AF505	HY00000090			BHR261RDE/TRDE	824874-3	162271-8	1,39 €
AN450H	824792-5			BJR181RFE	824760-8	163455-1	0,92 €
AN510H	824793-3			BJS101RFE	824899-7	163455-1	0,92 €
AN610H	824490-1			BJS130RFE	824756-9	417059-4	0,20 €
AN620H	824490-1			BJV140RFE	824775-5	450909-0	0,26 €

Akumulátory
 Odkladacie systémy
 Vŕtanie
 Skrutkovanie
 Brúsky
 Pilenie
 Frézovanie
 Brúsenie
 Klince / spony
 Špeciálne stroje
 Vysávanie
 Fény/lampy
 Záhrada
 Ručné náradie
 Ostatné

SPONY PRE PREPRAVNÉ KUFRE

model	kufor	spona	MOC s DPH	model	kufor	spona	MOC s DPH
BJV180RFE	824775-5	450909-0	0,26 €	GA4530	188627-7		
BO4555/4556	824806-0			GA5030	188627-7		
BO4557	824806-0			GA7010C	824878-5	163455-1	0,92 €
BO4565/4566	824806-0			GA7020	824878-5	163455-1	0,92 €
BO5030	824562-2			GA7030	824878-5	163455-1	0,92 €
BO5031	824562-2			GA7040	824878-5	163455-1	0,92 €
BO6040	824591-5	417059-4	0,20 €	GA9010C	824878-5	163455-1	0,92 €
BPB180RFE	824766-6	163467-4	1,32 €	GA9020	824878-5	163455-1	0,92 €
BPT350RFE	824863-8			GA9020SFK	824878-5	163455-1	0,92 €
BSR730SH	153612-9	417075-6	6,49 €	GA9030	824878-5	163455-1	0,92 €
BSS500RFE	824802-8			GA9040	824878-5	163455-1	0,92 €
BSS610RFE	824757-7	163455-1	0,92 €	HG5002K	HG118897		
BTD123F	824710-3	417724-5	0,35 €	HG5012K	HG118897		
BTD130FRFE	824753-5	417724-5	0,35 €	HG550VK	HG118897		
BTD132RFE	140058-8	417724-5	0,35 €	HG551VK	HG118897		
BTD133RFE	140058-8	417724-5	0,35 €	HG650CK	HG118897		
BTD140RFE	824753-5	417724-5	0,35 €	HG651CK	HG118897		
BTD200SH	824593-1	417075-6	6,49 €	HK0500	824523-2	163455-1	0,92 €
BTL060RFE	824816-7	163455-1	0,92 €	HK1810	150640-5	417059-4	0,20 €
BTL061RFE	824816-7	163455-1	0,92 €	HK1820	824789-4	417724-5	0,35 €
BTP130RFE	824753-5	417724-5	0,35 €	HM0810	150879-0	417383-5	0,28 €
BTP140RFE	824753-5	417724-5	0,35 €	HM0810B	150878-2	162202-7	1,02 €
BTW200SH	824593-1	417075-6	6,49 €	HM0810T	150879-0	417383-5	0,28 €
BTW250RFE	824753-5	417724-5	0,35 €	HM0860C	824708-0	162202-7	1,02 €
BTW251RFE	824753-5	417724-5	0,35 €	HM0870C	824905-8		
BTW450RFE	824777-1	163467-4	1,32 €	HM0871C	824904-0		
BUC122RFE	824820-6	163455-1	0,92 €	HM1100	150676-4	416401-6	2,23 €
BVR450RFE	824768-2	417383-5	0,28 €	HM1100C	150676-4	416401-6	2,23 €
DA302D	824627-0	186347-7	1,39 €	HM1101C	140561-9		
DA312D	824627-0	186347-7	1,39 €	HM1111C	140561-9		
DA312DWAE	824627-0	186347-7	1,39 €	HM1130C	150676-4	163467-4	1,32 €
DA391DW	824627-0	186347-7	1,39 €	HM1140C	150676-4	163467-4	1,32 €
DA392D	824627-0	186347-7	1,39 €	HM1200	150583-1	163467-4	1,32 €
DA400LR	824646-6	163467-4	1,32 €	HM1200B	150586-5	163467-4	1,32 €
DA6300	181791-3			HM1200K	150583-1	163467-4	1,32 €
DA6301	181791-3			HM1202C	824564-8	163467-4	1,32 €
DBM080	P-45135			HM1203C	824876-9	162271-8	1,39 €
DBM130	P-45141			HM1213C	824908-2	162271-8	1,39 €
DF010DSE	824781-0	417724-5	0,35 €	HM1214C	824882-4	162271-8	1,39 €
DF030DWE	824842-6	417724-5	0,35 €	HM1303	182714-4		
DF330DWE	824842-6	417724-5	0,35 €	HM1303B	182851-4		
DK1150	E02248-2			HM1304	183567-4		
DK1867	824774-7	417724-5	0,35 €	HM1304B	183598-3		
DP3003	824595-7	417059-4	0,20 €	HM1307C	824898-9		
DP4001	824595-7	417059-4	0,20 €	HM1307CB	824898-9		
DP4003	824595-7	417059-4	0,20 €	HM1317C	824897-1		
DP4010	P-04101			HP1620K	824724-2		
DP4011	P-04101			HP1621K	824724-2		
DP4700	P-04101			HP1630K	824811-7	417724-5	0,35 €
FS2700	824890-5			HP1631K	824811-7	417724-5	0,35 €

SPONY PRE PREPRAVNÉ KUFRE

model	kufor	spona	MOC s DPH	model	kufor	spona	MOC s DPH
HP1640K	824724-2			HR4501C	158274-8	163467-4	1,32 €
HP1641K	824724-2			HR4510C	158275-6	163467-4	1,32 €
HP1830	824650-5	417724-5	0,35 €	HR4511C	158273-0	163467-4	1,32 €
HP2030	824485-4			HR5001C	824519-3	163467-4	1,32 €
HP2031	824485-4			HR5201C	158274-8	163467-4	1,32 €
HP2050	824650-5	417724-5	0,35 €	HR5210C	158275-6	163467-4	1,32 €
HP2051	824650-5	417724-5	0,35 €	HR5211C	158273-0	163467-4	1,32 €
HP2051F	824650-5	417724-5	0,35 €	824961-8	HS300D		
HP2070	824650-5	417724-5	0,35 €	JN3200	181797-1		
HP2071	824650-5	417724-5	0,35 €	JR1000FTK	824722-6	417059-4	0,20 €
HP2071F	824650-5	417724-5	0,35 €	JR180DWD	824565-6	417152-4	1,07 €
HR160DWA	824550-9	417059-4	0,20 €	JR3000V	824539-7	417059-4	0,20 €
HR1830	824650-5	417724-5	0,35 €	JR3000VT	824539-7	417059-4	0,20 €
HR2010	824464-2	186347-7	1,39 €	JR3020	824539-7	417059-4	0,20 €
HR2020	824650-5	417724-5	0,35 €	JR3030	824539-7	417059-4	0,20 €
HR2230	824799-1	417724-5	0,35 €	JR3030T	824539-7	417059-4	0,20 €
HR2400	824445-6			JR3050T	824734-9	417724-5	0,35 €
HR2410	824445-6			JR3060T	824734-9	417724-5	0,35 €
HR2430	824575-3	417059-4	0,20 €	JR3070CT	824734-9	417724-5	0,35 €
HR2431	824575-3	417059-4	0,20 €	JS3200	181797-1		
HR2432	824729-2	163455-1	0,92 €	KP0810	824786-0		
HR2440	824650-5	417724-5	0,35 €	KP0810C	824786-0		
HR2450	824650-5	417724-5	0,35 €	LCT304	824842-6		
HR2450T	824695-3			MEU041	824888-2		
HR2460	824799-1	417724-5	0,35 €	NHP1300S	824700-6		
HR2470	824799-1	417724-5	0,35 €	PC1100	181789-0		
HR2470T	824799-1	417724-5	0,35 €	PC5000C	140073-2		
HR2600	141856-3	162302-3	0,79 €	SC130DRA	SC08100910		
HR2650/2651	141856-3	162302-3	0,79 €	SG1250	824709-8	163455-1	0,92 €
HR2800	824789-4	417724-5	0,35 €	SG150	B50856		
HR2810	824789-4	417724-5	0,35 €	SKR60	LM.400.02		
HR2810T	824789-4	417724-5	0,35 €	SKR301	ZA.023.0M		
HR2811F	824789-4	417724-5	0,35 €	SP6000K	824783-6		
HR2811FT	824789-4	417724-5	0,35 €	T221DW	183771-5		
HR3000C	824559-1	163467-4	1,32 €	TD020DSE	831272-4		
HR3200C	824819-1	163467-4	1,32 €	TD090DWE	824842-6	417724-5	0,35 €
HR3210C	824825-6	163467-4	1,32 €	TW0200	824703-0	186347-7	1,39 €
HR3210FCT	824825-6	163467-4	1,32 €	TW0350	824702-2	186347-7	1,39 €
HR3520	150597-0	163467-4	1,32 €	TW1000	824737-3	416401-6	2,23 €
HR3540C	824819-1	163467-4	1,32 €	UC120DWAE	824491-9	417059-4	0,20 €
HR3541FC	824819-1	163467-4	1,32 €	VR250DWAE	824486-2		
HR3550C	824559-1	163467-4	1,32 €	VR250DWDE	824486-2		
HR3850	150582-3	163467-4	1,32 €				
HR3850K	150582-3	163467-4	1,32 €				
HR4000C	824479-9	416401-6	2,23 €				
HR4001C	158693-8	163467-4	1,32 €				
HR4002	824798-3	163467-4	1,32 €				
HR4010C	158691-2	163467-4	1,32 €				
HR4011C	158692-0	163467-4	1,32 €				
HR4500C	824607-6	163467-4	1,32 €				

Akumulátory
 Odkladacie systémy
 Vŕtanie
 Skrutkovanie
 Brúsky
 Pílenie
 Frézovanie
 Brúsenie
 Klince / spony
 Špeciálne stroje
 Vysávanie
 Fény/lampy
 Záhrada
 Ručné náradie
 Ostatné

model	obj. číslo	model	obj. číslo	model	obj. číslo	model	obj. číslo	model	obj. číslo
440	80051B5X*	6501	CB-70	9920	CB-303	BFT123FZ	CB-434	BTD140	CB-448
445X	80050B0X*	6510LVR	CB-64	9924DB	CB-100	BFT124FZ	CB-434	BTD146	CB-448
446L	W49625*	6821	CB-419	BCS550	CB-430	BFT124RZ	CB-434	BTP130	CB-448
447L	W49625*	6822	CB-419	BDA340	CB-448	BFT125FZ	CB-434	BTP140	CB-448
448	80051B5X*	6823	CB-419	BDA341	CB-448	BFT126FZ	CB-434	BTP141	CB-448
906	CB-64	6824	CB-419	BDA350	CB-448	BGA450	CB-430	BTS130	CB-448
1806B	CB-153	6825R	CB-419	BDA351	CB-448	BGA452	CB-430	BTW200	CB-441
1902	CB-51	6826	CB-419	BDF440	CB-448	BGD800	CB-430	BTW250	CB-448
1911B	CB-106	6827	CB-419	BDF441	CB-448	BHP440	CB-448	BTW251	CB-448
1923H	CB-132	6842	CB-411	BDF442	CB-448	BHP441	CB-448	BTW450	CB-441
2012NB	CB-153	6844	CB-411	BDF444	CB-448	BHP442	CB-448	BUB360	CB-430
2107FK	CB-303	6904VH	CB-415	BDF446	CB-448	BHP444	CB-448	BUC122	CB-430
2414EN	CB-203	6905B	CB-65	BDF448	CB-448	BHP446	CB-448	BUC250	CB-442
2414NB	CB-203	6905H	CB-415	BDF450	CB-448	BHP448	CB-448	BUH550	CB-442
2704	CB-153	6906	CB-100	BDF451	CB-448	BHP450	CB-448	CA5000	CB-303
3612C	CB-203	6916FD	CB-431	BDF452	CB-448	BHP451	CB-448	DA3010F	CB-419
3612	CB-203	6918FD	CB-434	BDF454	CB-448	BHP452	CB-448	DA3011F	CB-419
3620	CB-106	6934FD	CB-434	BDF456	CB-448	BHP454	CB-448	DA4000LR	CB-303
3706	CB-64	6935FD	CB-434	BDF458	CB-448	BHP456	CB-448	DA6301	CB-100
3707	CB-411	6936FD	CB-434	BFL060FZ	CB-434	BHP458	CB-448	DBM080	EE7332022S**
3708	CB-411	6951	CB-411	BFL061FZ	CB-434	BHR162	CB-430	DBM130	EE7332022S**
3709	CB-411	6953	CB-411	BFL080FZ	CB-434	BHR200	CB-430	DBM230	EE7332022S**
3710	CB-411	6980FD	CB-434	BFL081FZ	CB-434	BHR202	CB-441	DBN500	CB-448
3901	CB-411	7104L	CB-153	BFL082FZ	CB-434	BHR240	CB-430	DCO180	CB-430
4101RH	CB-303	8414D	CB-430	BFL120FZ	CB-434	BHR241	CB-441	DCS550	CB-430
4105KB	CB-100	8434D	CB-430	BFL122FZ	CB-434	BHR261	CB-442	DDA340	CB-448
4112HS	CB-204	8444D	CB-430	BFL200FZ	CB-434	BHR262	CB-442	DDA341	CB-448
4131	CB-303	9031	CB-411	BFL201FZ	CB-434	BHS630	CB-441	DDA350	CB-448
4157KB	CB-153	9032	CB-411	BFL201RZ	CB-434	BJN161	CB-430	DDA351	CB-448
4326	CB-64	9046	CB-419	BFL202FZ	CB-434	BJR181	CB-411	DDF446	CB-448
4327	CB-64	9079SF	CB-204	BFL300FZ	CB-434	BJS101	CB-430	DDF448	CB-448
4329	CB-64	9207SPB	CB-100	BFL301FZ	CB-434	BJS130	CB-448	DDF456	CB-448
4350	CB-419	9227CB	CB-303	BFL301RZ	CB-434	BJV140	CB-430	DDF458	CB-448
4351	CB-419	9237CB	CB-303	BFL400FZ	CB-434	BJV180	CB-430	DDF482	CB-448
5014/5016	CB-403	9403	CB-303	BFL402FZ	CB-434	BKP180	CB-441	DFR440	CB-448
5017RKB	CB-303	9404	CB-303	BFL402RZ	CB-434	BLS713	CB-441	DFR540	CB-448
5103R	CB-203	9541/9542	CB-302	BFR440	CB-448	BO3700	CB-64	DFR550	CB-448
5104S	CB-203	9554/55NB	CB-325	BFR540	CB-448	BO3710	CB-64	DFR750	CB-448
5143R	CB-203	9557/58	CB-325	BFR550	CB-448	BO3711	CB-64	DFS440	CB-448
5603R	CB-303	9562CH/CVH	CB-318	BFR750	CB-448	BO4555	CB-419	DFS450	CB-448
5604R	CB-303	9562CR	CB-318	BFS440	CB-448	BO4556	CB-419	DFS451	CB-448
5704R	CB-303	9562CVH	CB-318	BFS441	CB-448	BO4557	CB-419	DGA450	CB-430
5705R	CB-303	9562CVR	CB-318	BFS450	CB-448	BO4565	CB-419	DGA452	CB-430
5903R	CB-203	9564H	CB-325	BFS451	CB-448	BO4900V	CB-419	DGD800	CB-430
6013B	CB-51	9565C/CV	CB-318	BFT020FZ	CB-434	BO5021	CB-64	DHP446	CB-448
6207D	CB-430	9565CLR	CB-318	BFT022FZ	CB-434	BO5030	CB-419	DHP448	CB-448
6300-4	CB-51	9565CR	CB-318	BFT040FZ	CB-434	BO5031	CB-419	DHP456	CB-448
6305	CB-303	9565CVL	CB-318	BFT041FZ	CB-434	BO5041	CB-64	DHP458	CB-448
6317D	CB-430	9565CVR	CB-318	BFT041RZ	CB-434	BO6030	CB-419	DHP482	CB-448
6319D	CB-430	9565H	CB-325	BFT042FZ	CB-434	BO6040	CB-318	DHR162	CB-430
6337D	CB-430	9565HZ1	CB-325	BFT043FZ	CB-434	BO6050	CB-325	DHR164	CB-430
6339D	CB-430	9565PCV	CB-318	BFT044FZ	CB-434	BPB180	CB-430	DHR165	CB-430
6347D	CB-430	9566C/CV	CB-318	BFT080FZ	CB-434	BPJ180	CB-430	DHR202	CB-441
6349D	CB-430	9566CR	CB-318	BFT082FZ	CB-434	BSS500	CB-430	DHR241	CB-441
6408	CB-419	9566CVR	CB-318	BFT082RZ	CB-434	BSS501	CB-430	DHR263	CB-442
6412	CB-64	9741	CB-100	BFT083FZ	CB-434	BSS610	CB-411	DHR264	CB-442
6413	CB-64	9903	CB-303	BFT084FZ	CB-434	BTD130	CB-448	DHS630	CB-441
6501X	CB-70	9910/11	CB-411	BFT122FZ	CB-434	BTD134	CB-448	DHS710	CB-442

model	obj. číslo	model	obj. číslo	model	obj. číslo	model	obj. číslo	model	obj. číslo
DJN161	CB-430	GA6040C01	CB-325	HP2051	CB-419	JS1660	CB-65	TM3000C	CB-459
DJR181	CB-411	GA7010C	CB-204	HP2070	CB-419	JS1670	CB-65	TM3010C	CB-459
DJS101	CB-430	GA7020	CB-204	HP2071	CB-419	JS3200	CB-100	TW0200	CB-411
DJS130	CB-448	GA7030	CB-204	HR1830	CB-419	JS3201	CB-303	TW0350	CB-411
DJV140	CB-430	GA7040	CB-204	HR2010	CB-105	JV0600	CB-64	TW1000	CB-153
DJV180	CB-430	GA7060R	CB-204	HR2230	CB-325	KC100	CB-203	UB1101	CB-303
DKP180	CB-441	GA7061R	CB-204	HR2300	CB-325	KP0800	CB-411	UB1103	CB-303
DLS713	CB-441	GA7070/7071	191T31-1	HR2432	CB-419	KP0810	CB-132	UB360D	CB430
DP2010	CB-419	GA9010	CB-204	HR2450	CB-419	KP0810C	CB-132	UC250D	CB442
DP2011	CB-419	GA9020	CB-204	HR2460	CB-325	KP312S	CB-203	UC3020A	CB-132
DP3003	CB-419	GA9030	CB-204	HR2470	CB-325	LC1230	CB-203	UC3030A	181044-0*
DP4001	CB-419	GA9040	CB-204	HR2600	CB-325	LF1000	CB-153	UC3041A	CB-132
DP4003	CB-419	GA9050	CB-204	HR2610	CB-325	LH1040	CB-153	UC3051A	CB-153
DP4010	CB-419	GA9060R	CB-204	HR2611	CB-325	LH1200FL	JM23300083*	UC3520A	CB-132
DP4011	CB-419	GA9061R	CB-204	HR2630	CB-325	LH1201FL	JM23000123*	UC3530A	181044-0*
DP4700	CB-64	GA9070/9071	191T31-2	HR2630T	CB-325	LS0714	CB-303	UC3541A	CB-132
DPB180	CB-430	GD0600	CB-325	HR2631F	CB-325	LS0714FL	CB-303	UC3551A	CB-153
DPJ180	CB-430	GD0601	CB-325	HR2631FT	CB-325	LS0815FL	JM23500117	UC4020A	CB-132
DS4010	CB-411	GD0602	CB-325	HR2641	CB-325	LS1013	CB-153	UC4030A	181044-0*
DS4011	CB-411	GD0603	CB-64	HR2800	CB-325	LS1013L	CB-153	UC4041A	CB-132
DSC191	CB-448	GD0800C	CB-318	HR2810	CB-325	LS1016	CB-153	UC4051A	CB-153
DSS500	CB-430	GD0801C	CB-318	HR2811F	CB-325	LS1016L	CB-153	UC4530A	181044-0*
DSS610	CB-411	GD0810C	CB-318	HR2811FT	CB-325	LS1018L	JM23000123*	UC4551A	CB-153
DTD134	CB-448	GD0811C	CB-318	HR3200C	CB-350	LS1040	CB-153	UH4260	CB-419
DTD146	CB-448	HB500	EIB106C*	HR3210C	CB-350	LS1214	CB-153	UH4261	CB-419
DTD152	CB-448	HK0500	CB-113	HR3210FCT	CB-350	LS1214L	CB-153	UH4570	CB-419
DTP141	CB-448	HK1820	CB-350	HR3540C	CB-350	LS1216	CB-153	UH4860	CB-419
DTS130	CB-448	HK1820L	CB-350	HR3541FC	CB-350	LS1216L	CB-153	UH4861	CB-419
DTW250	CB-448	HM0810T	CB-105	HR4001C	CB-350	LS1440	CB-154	UH5260	CB-419
DTW251	CB-448	HM0860C	CB-327	HR4002	CB-350	LW1400	CB-203	UH5261	CB-419
DTW450	CB-441	HM0870C	CB-350	HR4003C	CB-175	LW1401	CB-203	UH550D	CB442
DUB361	CB-430	HM0871C	CB-350	HR4011C	CB-350	M6001/6002	CB-85	UH5540	223804410*
DUC122	CB-430	HM1101C	CB-175	HR4013C	CB-175	M8100/8001	CB-85	UH5550	957800410*
DVC860L	CB-353	HM1111C	CB-175	HR4501C	CB-175	M8103/8104	CB-85	UH5570	CB-419
FS2300	CB-419	HM1200	CB-155	HR4510C	CB-175	MLS100	JM23000123*	UH5580	CB-419
FS2700	CB-419	HM1200B	CB-155	HR4511C	CB-175	MLT100X	JM23000123*	UH6350	957800410*
FS4000	CB-419	HM1202C	CB-155	HR5201C	CB-175	N1923B	CB-51	UH6540	223804410*
FS4300	CB-419	HM1203C	CB-175	HR5202C	CB-175	N5900B	CB-153	UH6570	CB-419
FS6300R	CB-419	HM1205C	CB-175	HR5210C	CB-175	PC1100	CB-100	UH6580	CB-419
GA4530	CB-459	HM1213C	CB-175	HR5211C	CB-175	PC5000C	CB-253	UH7580	CB-419
GA4530R	CB-459	HM1214C	CB-175	HR5212C	CB-175	PC5001C	CB-253	UR3500	YA00000504*
GA4540	CB-325	HM1304	CB-204	HS6100/6101	CB-174	PJ7000	CB-459	UR3501	YA00000504*
GA4540C01	CB-325	HM1304B	CB-204	HS7100/7101	CB-174	PV7000C	CB-303	UT120	EE80700013**
GA4540R	CB-325	HM1307C	CB-175	HS6101	CB-147	PW5000CH	CB-318	UT1200	EE80700032
GA4541C01	CB-325	HM1307CB	CB-175	HS7101	CB-147	RP0900	CB-107	UT1305	CB-303
GA4541R	CB-325	HM1317C	CB-175	HS7601	CB-303	RP0910	CB-303	UT1400	EE80700013**
GA4541X01	CB-325	HM1400	CB-155	JN1601	CB-411	RP1110C	CB-303	UT1401	EE80700013**
GA5021	CB-303	HM1801	CB-204	JN3200	CB-100	RP1800FX	CB-203	UT1600	EE7332022S**
GA5030	CB-459	HM1802	CB-218	JN3201	CB-303	RP2300FCX	CB-203	UT2204	CB-303
GA5030R	CB-459	HM1810	CB-204	JR1000FTK	CB-419	RT0700C	CB-411	VC2211	CB-173
GA5040	CB-325	HM1812	CB-218	JR180DWDE	CB-432	SA5040C	CB-318	VC3210	CB-173
GA5040C01	CB-325	HP1620	CB-419	JR3050T	CB-303	SA7000C	CB-204	VC3211	CB-173
GA5040R	CB-325	HP1621	CB-419	JR3060T	CB-303	SG1250	CB-318		
GA5041C01	CB-325	HP1630	CB-85	JR3070CT	CB-303	SG1251J	CB-318		
GA5041R	CB-325	HP1631	CB-85	JS1000	CB-459	SG150	B45872**		
GA5041X01	CB-325	HP1640	CB-419	JS1600	CB-65	SP6000	CB-303		
GA5050/5051R	CB-260	HP1641	CB-419	JS1601	CB-459	SP6000K	CB-303		
GA6021	CB-303	HP2050	CB-419	JS1602	CB-459	TD0101F	CB-411		

* zároveň obj. číslo; ** zároveň obj. číslo, iba 1 ks v balení

Akumulátory
 Odkladacie systémy
 Vŕtanie
 Skrutkovanie
 Brúsky
 Pílenie
 Frézovanie
 Brúsenie
 Klince / spony
 Špeciálne stroje
 Vysávanie
 Fény/lampy
 Záhrada
 Ručné náradie
 Ostatné

typ	obj. č.	délka	šířka A	šířka B	MOC s DPH
CB-51	181021-2	11,8	8	5	1,59 €
CB-55	181026-2	11,7	8	5	3,99 €
CB-64	191627-8	10,8	8	5	1,69 €
CB-65	191628-6	11,7	8	5	2,59 €
CB-70	191914-5	10,8	8	5	2,49 €
CB-85	191998-3	k.A.	k.A.	k.A.	3,69 €
CB-100	181030-1	14,8	10	6	1,69 €
CB-105	181038-5	15,3	9,9	5,9	4,99 €
CB-106	181410-1	14,8	10	6	3,29 €
CB-113	191904-8	14,8	9,9	6	6,19 €
CB-132	191972-1	14,7	10	6	3,39 €
CB-153	181044-0	17,8	13,4	6,5	1,99 €
CB-154	181047-4	17,8	13,4	6,5	3,19 €
CB-155	181048-2	17,8	13,4	6,5	5,29 €
CB-173	195483-8	k.A.	k.A.	k.A.	6,99 €
CB-174	196018-8	k.A.	k.A.	k.A.	8,99 €
CB-175	195844-2	26,6	8,4	6,5	3,49 €
CB-203	191953-5	15,8	17,9	6,9	2,59 €
CB-204	191957-7	16,2	17,9	7	2,99 €
CB-218	197129-2	23,7	17,9	6,9	4,49 €
CB-251	194547-5	16,8	10,9	6,9	2,99 €
CB-253	194547-5	16,8	10,9	6,9	2,99 €
CB-260	191D85-2	k.A.	k.A.	k.A.	6,39 €
CB-302	191959-3	k.A.	k.A.	k.A.	8,99 €
CB-303	191963-2	17,8	10,9	5	1,99 €
CB-318	191978-9	15,7	10,9	5	6,19 €
CB-325	194074-2	15,8	11	4,9	1,49 €
CB-327	194285-9	16,8	11	4,9	4,69 €
CB-350	194160-9	25,3	10,9	6,5	4,19 €
CB-353	197208-6	k.A.	k.A.	k.A.	19,99 €
CB-403	191928-4	k.A.	k.A.	k.A.	8,99 €
CB-411	191940-4	11,7	8,9	6	2,49 €
CB-414	191949-6	11,6	5,7	3,7	2,99 €
CB-415	191950-1	8,7	8,9	6	3,89 €
CB-417	191955-1	9,4	8,9	6	5,99 €
CB-419	191962-4	11,3	9	6	1,79 €
CB-424	191966-6	8,7	5,3	4,8	2,19 €
CB-430	191971-3	9,7	7,2	6,9	2,39 €
CB-434	193466-2	11,8	5,8	4,9	2,79 €
CB-441	194435-6	10,8	10,8	6,9	3,39 €
CB-442	194928-3	10,8	10,7	6,9	2,69 €
CB-448	196854-2	13,3	9,9	3	2,49 €
CB-459	194722-3	12,8	8,9	6	1,89 €
	191T31-1	k.A.	k.A.	k.A.	4,29 €
	80051B5X	28	11,2	6,2	0,00 €
	80050B0X	k.A.	k.A.	k.A.	0,00 €
	B45872 (iba 1 ks)	20	9,9	6,2	10,50 €
	EE7132A22S (iba 2 ks)	17,9	9,9	6,2	17,59 €
	EE7332022S (iba 2 ks)	20	15,9	6,2	23,69 €
	EIB106C	k.A.	k.A.	k.A.	26,99 €
	JM23000123	17,3	13,4	6,5	2,99 €
	W49625	32	10,9	6,3	39,99 €
	JM23500117	k.A.	k.A.	k.A.	2,49 €
	EE7701822S	k.A.	k.A.	k.A.	15,19 €
	YA00000504	k.A.	k.A.	k.A.	0,80 €

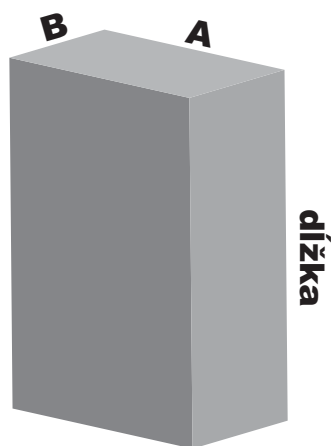

VYSVETLIVKY

18 V / 12 V MAX program

- Z – dodávané bez akumulátora a nabíjačky
- J – dodávané v systainery
- K – dodávané v kufri
- X – extra príbal príslušenstva
- PT2 – Dvojnabíjačka /rýchlonabíjačka/, 2 ks 5,0 Ah akumulátor
- PT4 – Dvojnabíjačka /rýchlonabíjačka/, 4 ks 5,0 Ah akumulátor
- PF2 – Rýchlonabíjačka, 2 ks 3,0 Ah akumulátor
- RF – Rýchlonabíjačka, 1 ks 3,0 Ah akumulátor
- SYE – Nabíjačka, 2 ks 1,5 Ah akumulátor
- RFJ – Rýchlonabíjačka, 2 ks 3,0 Ah akumulátor, systainer
- RFE – Rýchlonabíjačka, 2 ks 3,0 Ah akumulátor
- RTE – Rýchlonabíjačka, 2 ks 5,0 Ah akumulátor
- RTJ – Rýchlonabíjačka, 2 ks 5,0 Ah akumulátor, systainer
- RF3J – Rýchlonabíjačka, 3 ks 3,0 Ah akumulátor, systainer
- RFEb – Rýchlonabíjačka, 2 ks 3,0 Ah akumulátor, čierne prevedenie stroja
- RTJV – Rýchlonabíjačka, 2 ks 5,0 Ah akumulátor, systainer, odsávacie zariadenie
- DZ – dodávané bez akumulátora a nabíjačky
- DSAE – Rýchlonabíjačka, 2 ks 2,0 Ah akumulátor
- DSME – Rýchlonabíjačka, 2 ks 4,0 Ah akumulátor

40 V program

- GD101 – Rýchlonabíjačka, 1 ks 2,5 Ah akumulátor
- GM101 – Rýchlonabíjačka, 1 ks 4,0 Ah akumulátor
- GT101 – Rýchlonabíjačka, 1 ks 5,0 Ah akumulátor
- GZ – dodávané bez akumulátora a nabíjačky
- GD201 – Rýchlonabíjačka, 2 ks 2,5 Ah akumulátor
- GM201 – Rýchlonabíjačka, 2 ks 4,0 Ah akumulátor
- GT201 – Rýchlonabíjačka, 2 ks 5,0 Ah akumulátor

Označenie akumulátorov 12 / 14,4 / 18 V

- Y – 1,5 Ah
- A – 2,0 Ah
- F – 3,0 Ah
- M – 4,0 Ah
- T – 5,0 Ah
- G – 6,0 Ah



- A – 2,0 Ah
- D – 2,5 Ah
- M – 4,0 Ah
- T – 5,0 Ah

ADT – Automatická regulácia otáčok

AFT – Automatické zastavenie stroja

DXT – presný rez

Deep and Exact Cutting Technology

XPT – ochrana proti zvýšenej prašnosti a vlhkosti

EXTREME PROTECTION TECHNOLOGY

SJST – antivibračný systém

SUPER JOINT SYSTEM

AWS – prepojenie aku strojov s aku vysávačom

AVT – antivibračný systém

ANTI VIBRATION TECHNOLOGY

BL – bezuhlíkový motor

MOTOR

(BRAKE) – brzda

Sortiment príslušenstva



Spoločnosť Makita si vyhradzuje právo kedykoľvek vykonávať zmeny ponuky bez predchádzajúceho upozornenia. Ponuky sú k dispozícii do vypredania skladových zásob. Obrázky sú ilustračné a oproti skutočnosti sa môžu líšiť.



Makita s. r. o.
Priemyselná 26
974 01 Banská Bystrica
Web: www.makita.sk

Uvedené ceny sú odporúčané maloobchodné ceny vrátane DPH. Technické údaje sú nezáväznú. Výrobca nie je zodpovedný za tlačové chyby.