



DESIGN BUILD CATALOG



'2023

Introduction

Electrical Wholesalers and HZ Electric Supply have simplified the process for you to price a commercial or industrial project. In this catalog, you will see a comprehensive list of items we currently stock. Please check with your Sales Rep for the most up-to-date pricing and inventory levels.

In this book, you will find the following categories:



Switchgear

Light commercial gear, including panel boards, breakers, dry-type transformers, safety switches, fuses, load centers, enclosed breakers, and basic motor controls

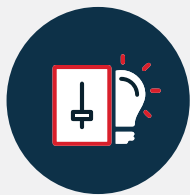

Dimming & Controls

Standard dimming and control sensors, switches, system controls, and smart home automation



Interior, Exterior, & Emergency Lighting

Interior and exterior LED lighting for replacing existing fluorescent lamps and HID fixtures, as well as exit signs and emergency lighting



Solutions & Services

EW & HZ delivery and pickup options, inventory and project management, prefab, wire, job site, energy, truck storage, and digital solutions



YOUR NEXT JOB... SIMPLIFIED

“It is our goal to meet and exceed the needs of our customers. Every day, we strive to improve our systems and solutions so we can provide you with the highest level of customer service possible.”

VIEW DIGITALLY

View the Design Build Catalog online for quick reference. Access all online categorized products for up to date pricing and product additions.



**SCAN
TO VIEW
ONLINE**



VISIT OUR WEBSITE TO:



**VIEW UP TO DATE
PRICING & PRODUCTS**



**ACCESS YOUR ACCOUNT
& SHOP ONLINE**



**ASK YOUR SALES REP
OR LOCAL BRANCH TO
LEARN MORE**

THANK YOU FOR YOUR BUSINESS & SUPPORT!

Pricing Disclaimer



PRICING IS NOT LISTED IN THIS EDITION OF THE CATALOG.
Please check with your Sales Rep or sign into your account on our website for the most up-to-date pricing and product inventory levels.

A LETTER FROM THE PRESIDENT

I am pleased to present the latest edition of our Electrical Wholesalers and HZ Electric Supply Design Build Catalog for 2023. Our Marketing Team, in conjunction with our Product Specialists, compiled an excellent resource for you to utilize while making your product selection.

In this edition, we will showcase many advancements in product design and technology. This includes ABB and Eaton distribution equipment, lighting fixtures, and lighting controls by our premier vendors.

Over the past couple of years, supply chain constraints and price increases have drastically affected the Electrical Distribution industry and other construction trades. With the demand for material outpacing the supply, maintaining consistent pricing and inventory has been a challenge, to say the least.

In this edition, we have omitted pricing. Going forward, we will utilize “QR” codes on each page that will direct you to shopping lists on our e-commerce site. When the page loads, the product(s) you are interested in will appear. Once you log in, your specific pricing will populate. To some, this may require some assistance in getting set up. Please refer to page 5 (next page) for login assistance or contact your local representative for help.

With this method, pricing and availability will be current. Our staff is always eager to assist with your product and pricing needs. I wish all our customers good health and a prosperous 2023 during these uncertain times. I welcome your feedback, m.osak@ew-inc.com. Thank you for your continued support.

Sincerely,
Mark Osak
Region President
Electrical Wholesalers – HZ Electric Supply

Need Additional Help or More Information?

Our sales reps can assist you! Scan the QR codes below to visit our Sales Support pages to request more information or get started on a quote.

**REQUEST MORE
INFORMATION
ONLINE SECURELY**



**FAST 24HR
TURN-AROUND**



**ACCURATE
PRICING
INFORMATION**



**PLEASE REACH OUT TO REQUEST SUPPORT
OR FOR ORDERING ASSISTANCE**



**SCAN NOW TO
CONTACT AN
EW SALES REP!**



**SCAN NOW TO
CONTACT AN
HZ SALES REP!**

STAY CONNECTED

Get connected with us! Sign up for our email list to get updates on upcoming events, sales, news, and more!

CONNECT WITH EW



CONNECT WITH HZ



 www.ew-ct.com

 www.hzelectric.com

Table of Contents

LOCATIONS

08-11 EW & HZ Branch Locations | Events & Promotions

ABB SWITCHGEAR

- 12-13** Intro to ABB Switchgear & Supporting Branches
- 14-17** Pro-Stock | Panelboards | Breakers | Kits | NEMA 3R Enclosures | Formula A Ordering Code
- 18-19** Branch Circuit Breakers & Enclosures
- 20-21** (General Duty) Safety Switches
- 22-23** (Heavy Duty) Safety Switches
- 24-25** Enclosure Accessories | Fuses | Neutral Kits
- 26-27** Dry Type Transformers | Weather Shields | Rated Line Voltage Chart
- 28-29** Single-Phase & Three-Phase Load Centers | Circuit Breakers
- 30-31** Group Metering | Circuit Breakers | Meter Stacks | Barrier Kits
- 32-33** Motor Controls | Enclosed Starters & Accessories

EATON SWITCHGEAR

- 34-35** Intro to Eaton Switchgear & Supporting Branches
- 36-39** Pow-R-Xpress | Panelboards | Breakers | Main Breaker/Subfeed/Lug Kits | NEMA 3R Enclosures
- 40-41** Pow-R-Xpress Branch Circuit Breakers | Series C Breaker Connector Kits & Plates
- 42-43** Series C Breaker Loose Breakers - PRLC Panelboards & Switch Boards
- 44-47** Residential Enclosed Circuit Breakers | Legacy Breaker Selector Sheet | Power Defense Breakers
- 48-51** (General Duty) & (Heavy Duty) Safety Switches & Neutral Kits
- 52-53** Enclosure Accessories & Fuses
- 54-55** Dry Type Transformers | Lug Kits | Weather Shields | Rated Line Voltage Charts
- 56-57** Residential Surge Protectors | Single-Phase Load Centers
- 58-59** Plug-On Neutral Accessories | Three-Phase Load Centers & Accessories
- 60-63** (Type BR) Circuit Breakers for Load Centers | Retrofit Loadcenter Interior Form
- 64-67** Residential & Commercial Main Devices | Meter Stacks | Tenant Feeder Breakers
- 68-69** Eaton's WBM (Wall Mounted Main Breaker & CT Cabinet)
- 70-71** Motor Controls | Enclosed Starters | Horsepower Rating Chart
- 72-73** Lighting Contactors | Starter Accessories | Pushbutton Packs & Accessories
- 74-75** Residential EV Chargers | EV Smart Breaker Chargers Kits & Pedestals
- 76-77** Ampacity Rating & Voltage Drop Charts

DIMMING & CONTROLS

- 78-81** Intro to Dimming | Standard Dimming & Controls
- 82-83** Lighting Controls & Sensors
- 84-85** Lutron System Controls
- 86-91** Smart Home Automation

INTERIOR LIGHTING

- 92-97** Intro to Lighting | Energy Solutions | EV Charging | Eversource Energy Excellence Award
- 98-99** Ductless Mini-Splits | Haier Single Zone Systems
- 100-101** IES Footcandle Recommendations
- 102-107** Retrofit & Recessed Downlights | Housing & Trim | Wafer & Gimbal Downlights
- 108-109** LED Strips | Wrap-Arounds | Flush Mounts | Stairwells
- 110-111** LED Linear High Bays
- 112-113** LED Recessed Troffers & Baskets
- 114-115** LED Flat Panels | Surface Mount Kits | Fixture Hanging Accessories

EXTERIOR LIGHTING

- 116-117** Intro to Exterior Lighting
- 118-119** LED Area Lights | Poles Kits & Hardware | Canopy Lights
- 120-123** Exterior Wall Packs
- 124-127** Exterior Floodlights

EMERGENCY LIGHTING

- 128-129** Intro to Emergency Lighting
- 130-131** Emergency Lighting | Remote Heads | Exit Signs

REPLACEMENT LAMPS

- 132-133** Intro to Replacement Lighting
- 134-135** Corn Cob - HID Retrofits
- 136-137** TLED & Drivers
- 138-139** Programmable Drivers
- 140-141** LED Replacement Lamps

SERVICES & SOLUTIONS

- 142-143** Intro to Services & Solutions | Solutions Trailer
- 144-145** Wire Solutions | Job Site Solutions
- 146-147** Prefabrication Solutions & Precision Prefab Offerings
- 148-149** Inventory Management | Will Call & Delivery Express Services
- 150-153** E-Commerce | USESI Billtrust Services | Request Support
View Design Build Digitally

Branch Locations

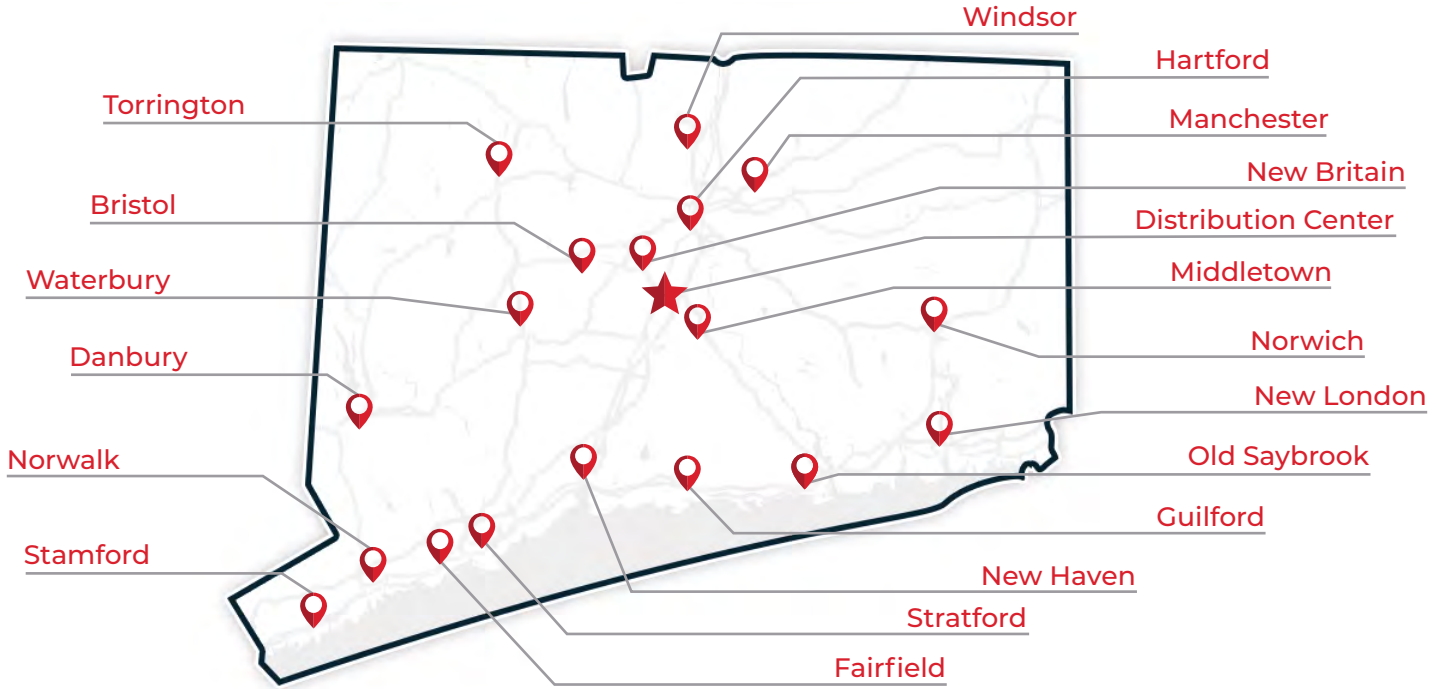

Electrical Wholesalers Inc.

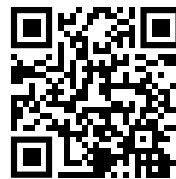

VIEW EW BRANCHES

- BRISTOL**
400 Middle St
Bristol, CT 06010
860-585-8375
- DANBURY**
60 Shelter Rock Rd
Danbury, CT 06810
203-743-5578
- FAIRFIELD**
107 Ardmore St
Fairfield, CT 06824
203-256-2333
- GUILFORD**
200A Village Walk Plz
Guilford, CT 06437
203-453-9537
- HARTFORD**
500 Ledyard St
Hartford, CT 06114
860-548-3567
- MANCHESTER**
18 Sheldon Rd
Manchester, CT 06042
860-643-6400
- MIDDLETOWN**
304 South Main St
Middletown, CT 06457
860-346-7677
- NEW BRITAIN**
255 Columbus Blvd
New Britain, CT 06051
860-229-1630
- NEW HAVEN**
75 Hamilton St
New Haven, CT 06511
203-777-9644
- NEW LONDON**
163 State Pier Rd
New London, CT 06320
860-443-4381
- NORWALK**
330 Westport Ave
Norwalk, CT 06851
203-846-8100
- NORWICH**
192 West Town St
Norwich, CT 06360
860-887-5882
- OLD SAYBROOK**
1383 Boston Post Rd
Old Saybrook, CT 06475
860-388-3001
- STAMFORD**
45 Harborview Ave
Stamford, CT 06902
203-356-1822
- STRATFORD**
1935 Stratford Ave
Stratford, CT 06615
203-377-1935
- TORRINGTON**
100 Commercial Blvd
Torrington, CT 06790
860-489-9223
- WATERBURY**
237 East Aurora St
Waterbury, CT 06708
203-754-7471
- WINDSOR**
130 Addison Rd
Windsor, CT 06095
860-925-6720



CENTRAL DISTRIBUTION CENTER



701 Middle Street, Middletown, CT 06457

EW - 860-522-3232 | HZ - 413-734-6407

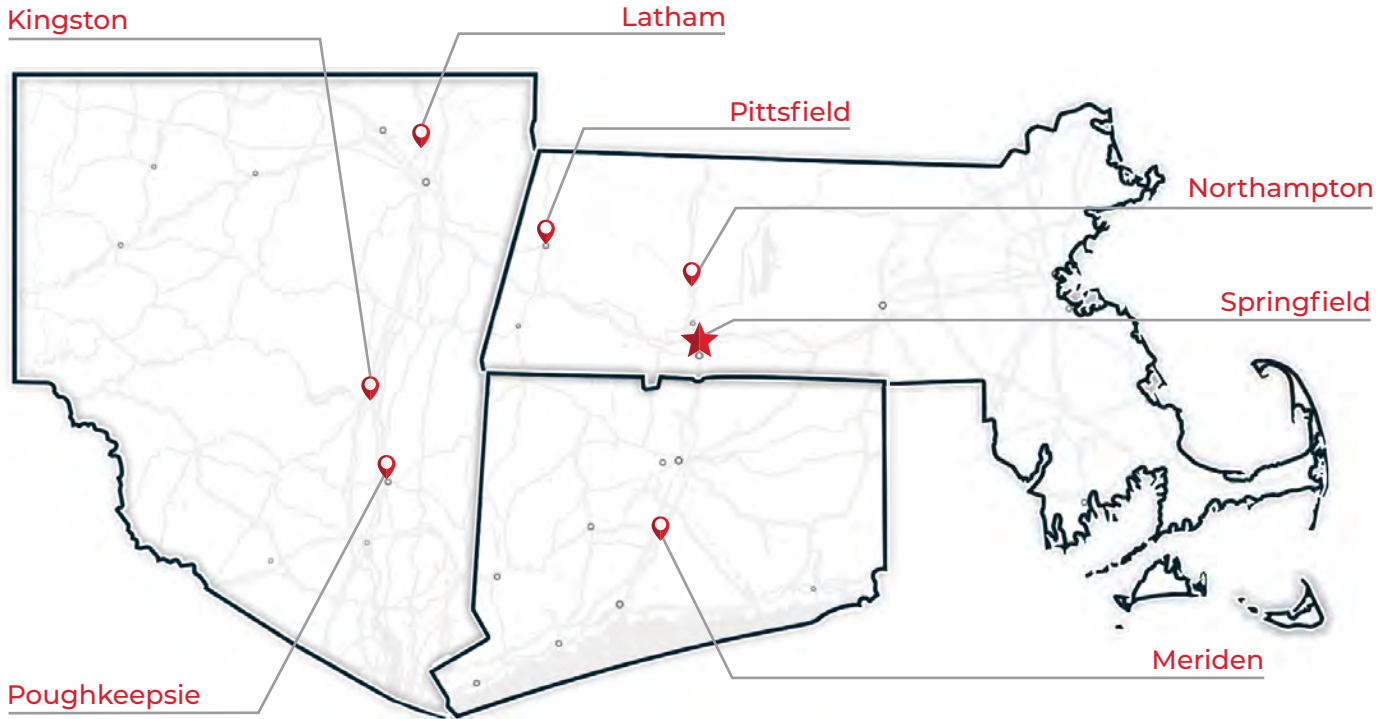

LOCATIONS

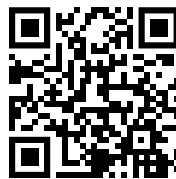

VIEW HZ BRANCHES

NEW YORK

POUGHKEEPSIE
135 North Hamilton St
Poughkeepsie, NY 12601
845-214-1100

LATHAM
22 Wade Rd
Latham, NY 12110
518-785-6677

KINGSTON
1034 Morton Blvd
Kingston, NY 12401
845-382-2852

MASSACHUSETTS

SPRINGFIELD
274 Taylor St
Springfield, MA 01105
413-734-6407

PITTSFIELD
485 Fenn St
Pittsfield, MA 01201
413-499-4020

NORTHAMPTON
440 Pleasant St
Northampton, MA 01060
413-584-5160

CONNECTICUT

MERIDEN
154 Research Pkwy
Meriden, CT 06450
203-237-8944

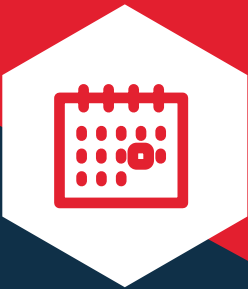

**VIEW UPCOMING
COUNTER DAYS &
BRANCH EVENTS**



**ACCESS EXCLUSIVE
CONTRACTOR TRAININGS**



**SAVE THE DATE FOR
OUR TRADE SHOWS**

VIEW EVENTS

Check out our calendar of upcoming events and don't miss out on our exciting trade shows, counter days, & trainings!



SCAN TO VIEW EW OR HZ EVENTS



**VIEW EW
EVENTS**



**VIEW HZ
EVENTS**

Sales & Specials

Visit our promotional pages to stay up to date on current sales, specials, product discounts, and prize offers! Redeem prizes for eligible online orders through our secure form entry.

VIEW
CURRENT SALES
& SPECIALS



SUBMIT
ORDERS TO
REDEEM PRIZES



VIEW UPCOMING
EVENTS
& TRAININGS



PLEASE REACH OUT TO MARKETING WITH ANY
QUESTIONS ON PROMOTIONS OR EVENTS



SCAN NOW TO
VIEW EW SALES
& SPECIALS!



SCAN NOW TO
VIEW HZ SALES
& SPECIALS!

www.ew-ct.com/promotions

www.hzelectric.com/promotions



ABB Switchgear

The following Electrical Wholesalers branches carry GE/ABB Switchgear. Fully stocked inventory is also available at our Central Distribution Center located at 701 Middle Street, Middletown, CT 06457.

BRISTOL

400 Middle St
Bristol, CT 06010
860-585-8375

HARTFORD

500 Ledyard St
Hartford, CT 06114
860-548-3567

MANCHESTER

18 Sheldon Rd
Manchester, CT 06042
860-643-6400



MIDDLETOWN

304 South Main St
Middletown, CT 06457
860-346-7677

NEW BRITAIN

255 Columbus Blvd
New Britain, CT 06051
860-229-1630

NORWALK

330 Westport Ave
Norwalk, CT 06851
203-846-8100



NORWICH

192 West Town St
Norwich, CT 06360
860-887-5882

OLD SAYBROOK

1383 Boston Post Rd
Old Saybrook, CT 06475
860-388-3001

STRATFORD

1935 Stratford Ave
Stratford, CT 06615
203-377-1935



TORRINGTON

100 Commercial Blvd
Torrington, CT 06790
860-489-9223

WATERBURY

237 East Aurora St
Waterbury, CT 06708
203-754-7471

- 12-13** Intro to ABB Switchgear & Supporting Branches
- 14-17** Pro-Stock | Panelboards | Breakers | Kits | NEMA 3R Enclosures | Formula A Ordering Code
- 18-19** Branch Circuit Breakers & Enclosures
- 20-21** (General Duty) Safety Switches
- 22-23** (Heavy Duty) Safety Switches
- 24-25** Enclosure Accessories | Fuses | Neutral Kits
- 26-27** Dry Type Transformers | Weather Shields | Rated Line Voltage Chart
- 28-29** Single-Phase & Three-Phase Load Centers | Circuit Breakers
- 30-31** Group Metering | Circuit Breakers | Meter Stacks | Barrier Kits
- 32-33** Motor Controls | Enclosed Starters & Accessories



PRICING IS NOT LISTED IN THIS EDITION OF THE CATALOG.
Please check with your Sales Rep or sign into your account on our website for the most up-to-date pricing and product inventory levels.

The Best of Both: ABB & GE Industrial Solutions

Delivering a Best in Class Source-to-Socket Portfolio of Industry Leading Technologies.

We've built a new, combined portfolio to provide you with the most comprehensive one-line construction package available today, to meet your current and future project needs.



Get the "Best of Both" app to explore the future of ABB through this augmented reality experience.

GET THE APP

ABB SWITCHGEAR

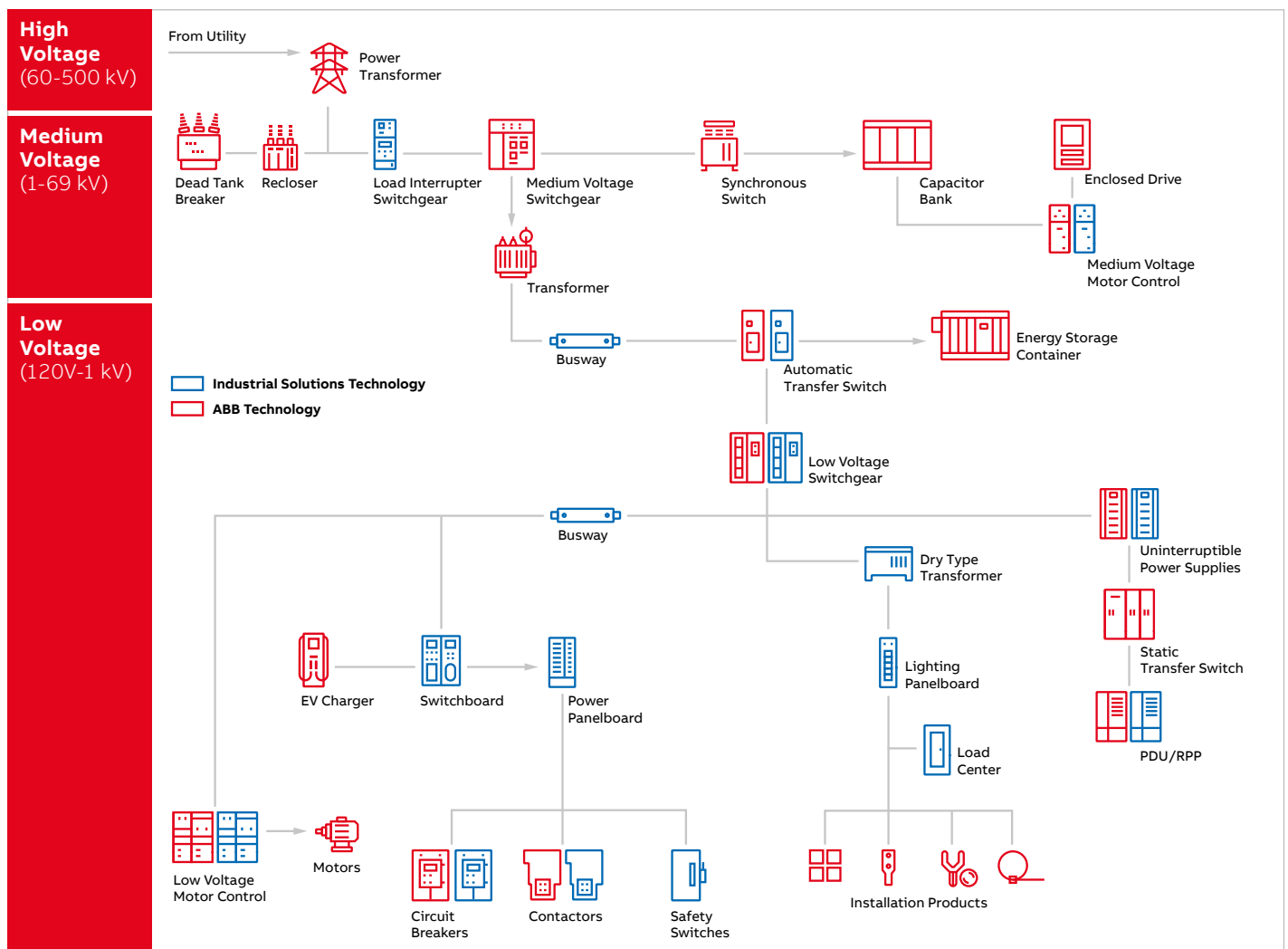

Pro-Stock

Main Lug Panelboards

Includes All Components. (Please reference branch breakers on pg 18.)

Main Lug Panelboards

Amp	Accepts Branch Breakers	Number of Circuits	CU Bus	Interior	NEMA 1 Box	Cover (Surface Mount)	Main Lug Kit
240Vac. One-Phase							
100-225	THQB	18		GED AQU1182RCXAXT1	AB37B	AF37S	MLA1
100-225	THQB	30		GED AQU1302RCXAXT1	AB43B	AF43S	MLA1
100-225	THQB	42		GED AQU1422RCXAXT1	AB49B	AF49S	MLA1
208/120Vac. Three-Phase							
100-225	THQB	18		GED AQU3182RCXAXT1	AB37B	AF37S	MLA1
100-225	THQB	30		GED AQU3302RCXAXT1	AB43B	AF43S	MLA1
100-225	THQB	42		GED AQU3422RCXAXT1	AB49B	AF49S	MLA1
400	THQB	42	•	GED AQU3424RCXAXT1B4	AB76B	AF76S	MLA41
480/277Vac. Three-Phase							
100-225	TEY	18		GED AEU3182RCXAXT1	AB37B	AF37S	MLA1
100-225	TEY	30		GED AEU3302RCXAXT1	AB43B	AF43S	MLA1
100-225	TEY	42		GED AEU3422RCXAXT1	AB49B	AF49S	MLA1
400	TEY	42	•	GED AEU3424RCXAXT1B4	AB76B	AF76S	MLA41

Main Lug Kits

Amp	Part Number
225	GED MLA1
400	GED MLA41



VIEW EW PRICING

Shop ABB Pro-Stock
View pricing and product updates.

Main Breaker Panelboards

Includes All Components. (Please reference branch breakers on pg 18.)

Main Breaker Panelboards

Amp	Accepts Branch Breakers	Number of Circuits	CU Bus	With Breaker	Interior	NEMA 1 Box	Cover (Surface Mount)	Main Breaker Kit	Breaker
240V AC One-Phase									
100	THQB	18			GED AQU1182RCXAXT1	AB37B	AF37S	MB612	THQB21100
225	A2A	30			GED AQU1302RCXAXT1	AB43B	AF43S	MBA12	A2A225TL-2
225	A2A	42			GED AQU1422RCXAXT1	AB49B	AF49S	MBA12	A2A225TL-2
208/120V AC Three-Phase									
100	THQB	18			GED AQU3182RCXAXT1	AB37B	AF37S	MB613	THQB32100
225	A2A	30			GED AQU3302RCXAXT1	AB43B	AF43S	MBA13	A2A225TT
225	A2A	42	•		GED AQU3422RCXAXT1B4	AB49B	AF49S	MBA13	A2A225TT
400	XT4N	42	•	•	GED AQU3424RCXAXT1B4	AB76B	AF76S	MBB16WB	--
480/277V AC Three-Phase									
100	TEY	18			GED AEU3182RCXAXT1	AB37B	AF37S	MB423	TEY3100
225	XT4H	30		•	GED AEU3302RCXAXT1	AB43B	AF43S	MBB33WB	--
225	XT4H	42		•	GED AEU3422RCXAXT1	AB49B	AF49S	MBB33WB	--
400	XT5H	42	•	•	GED AEU3424RCXAXT1B4	AB76B	AF76S	MBM334WB	--

Main Breaker Kits

Amp	Voltage	Two-Pole	Three-Pole	Six-Pole	With Breaker	Part Number
Main Breaker Kits						
100	240	•				GED MB612
225	240	•				GED MBA12
100	208/120		•			GED MB613
225	208/120		•			GED MBA13
400	208/120			•	•	GED MBB16WB
100	480/277		•			GED MB423
225	480/277		•		•	GED MBB33WB
400	480/277			•	•	GED MBB36WB
400	480/277		•		•	GED MBM334WB

NEMA 3R Enclosure

Height	Part Number
37"	GED AB373
43"	GED AB433
49"	GED AB493
76"	GED AB763

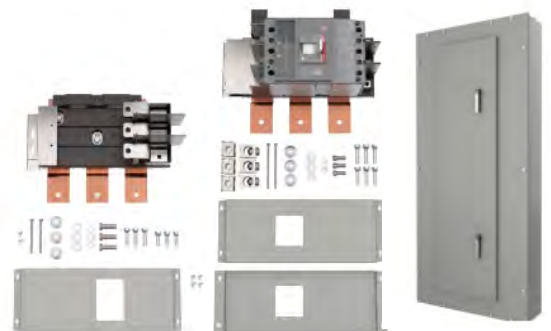

ReliaGear™ Pro-Stock™



Industrial
Solutions

A lighting panelboard for projects with short turnaround

ABB SWITCHGEAR



ReliaGear™ Pro-Stock™ lighting panelboards

A smart investment when operational downtime can't be afforded.

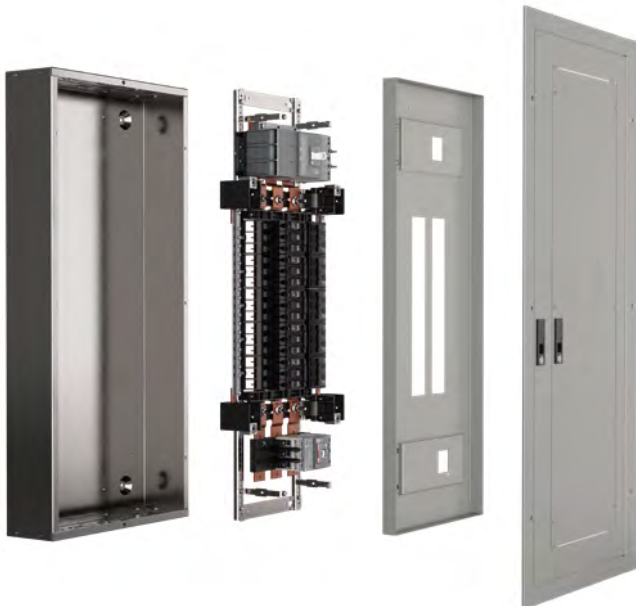

Projects with short turn around

Emergency situations property damage, strip malls, subways, small business or buildings



XTRa value at every level

A smart investment when operational downtime can't be afforded



Unassembled

Assemble and install on site in about 30 minutes



+1K configurations

XTreme flexibility to meet your application requirements



No lead time

Available immediately on the distributors' shelves



Standard parts

7 steps to complete your selection

by ABB

MOLDED CASE CIRCUIT BREAKERS

Formula A

Ordering code construction

A										W	
Frame size						Number of poles					
1 = 100 A, UL						-1 = 1-pole (UL) ¹					
2 = 250 A, UL						-2 = 2-pole (UL and IEC)					
A = 125 A, IEC						None 3-pole (UL and IEC)					
B = 250 A, IEC						-4 = 4-pole (IEC)					
C = 400 A, IEC						¹ A1 1-pole UL only;					
D = 630 A, IEC						A2 1-pole is not available.					
Interrupting rating class						Type connectors					
A = Adequate (UL and IEC)						W = None					
B = Basic (IEC)											
C = Common (IEC)											
N = Normal (UL and IEC)											
S = Standard (IEC)											
Current rating						Trip unit function					
015 = 15 A (UL and IEC)			100 = 100 A (UL and IEC)			T = Thermal-magnetic (UL and IEC)					
016 = 16 A (IEC)			125 = 125 A (UL and IEC)			A = ELT — LI (IEC)					
020 = 20 A (UL and IEC)			150 = 150 A (UL and IEC)								
025 = 25 A (UL and IEC)			160 = 160 A (UL and IEC)								
030 = 30 A (UL and IEC)			175 = 175 A (UL and IEC)								
032 = 32 A (IEC)			200 = 200 A (UL and IEC)								
040 = 40 A (UL and IEC)			225 = 225 A (UL and IEC)								
050 = 50 A (UL and IEC)			250 = 250 A (UL and IEC)								
060 = 60 A (UL and IEC)			320 = 320 A (IEC)								
063 = 63 A (IEC)			400 = 400 A (IEC)								
070 = 70 A (UL and IEC)			500 = 500 A (IEC)								
080 = 80 A (UL and IEC)			630 = 630 A (IEC)								
090 = 90 A (UL and IEC)											



Branch Circuit Breakers

10 KAIC & 14 KAIC*

(*For a higher AIC rating please contact your Sales Rep.)

RQ Series Branch Circuit Breakers

10 KAIC

Amp	Voltage	Part Number
One Pole		
15	120/240V	GED THQB1115
20	120/240V	GED THQB1120
25	120/240V	GED THQB1125
30	120/240V	GED THQB1130
40	120/240V	GED THQB1140
50	120/240V	GED THQB1150
60	120/240V	GED THQB1160
70	120/240V	GED THQB1170
Two Pole		
15	120/240V	GED THQB2115
20	120/240V	GED THQB2120
25	120/240V	GED THQB2125
30	120/240V	GED THQB2130
40	120/240V	GED THQB2140
50	120/240V	GED THQB2150
60	120/240V	GED THQB2160
70	120/240V	GED THQB2170
80	120/240V	GED THQB2180
90	120/240V	GED THQB2190
100	120/240V	GED THQB21100
Three Pole		
15	240V	GED THQB32015
20	240V	GED THQB32020
25	240V	GED THQB32025
30	240V	GED THQB32030
40	240V	GED THQB32040
50	240V	GED THQB32050
60	240V	GED THQB32060
70	240V	GED THQB32070
80	240V	GED THQB32080
90	240V	GED THQB32090
100	240V	GED THQB32100

RE Series Branch Circuit Breakers

14 KAIC

Amp	Voltage	Part Number
One Pole		
15	277V	GED TEY115
20	277V	GED TEY120
30	277V	GED TEY130
40	277V	GED TEY140
50	277V	GED TEY150
60	277V	GED TEY160
70	277V	GED TEY170
80	277V	GED TEY180
90	277V	GED TEY190
100	277V	GED TEY1100
Two Pole		
15	277/480V	GED TEY215
20	277/480V	GED TEY220
30	277/480V	GED TEY230
40	277/480V	GED TEY240
50	277/480V	GED TEY250
60	277/480V	GED TEY260
70	277/480V	GED TEY270
80	277/480V	GED TEY280
90	277/480V	GED TEY290
100	277/480V	GED TEY2100
Three Pole		
15	277/480V	GED TEY315
20	277/480V	GED TEY320
30	277/480V	GED TEY330
40	277/480V	GED TEY340
50	277/480V	GED TEY350
60	277/480V	GED TEY360
70	277/480V	GED TEY370
80	277/480V	GED TEY380
90	277/480V	GED TEY390
100	277/480V	GED TEY3100

Circuit Breakers & Enclosures

NEMA 1 & NEMA 3R

Includes Breaker, Enclosure, Mounting Hardware, and Lugs. (*For other available sizes please contact your Sales Rep.)

*Circuit Breakers & Enclosures				
NEMA 1				
Amp	Voltage	Frame Type	NEMA 1	Required Lugs
60	240V	GED THQL32060	GED TQL70S	--
100	240V	GED THQL32100	GED TQL100S	--
225	240V	★ GED A2A225TW	GED A2ENCL250S	GED KA2225-3
250	240V	★ GED A2A250TW	GED A2ENCL250S	GED KA2225-3
NEMA 3R				
Amp	Voltage	Frame Type	NEMA 3R	Required Lugs
70	240V	GED THQL32060	GED TQL70R	--
100	240V	GED THQL32100	GED TQL100R	--
225	240V	★ GED A2A225TW	GED A2ENCL250R	GED KA2225-3
250	240V	★ GED A2A250TW	GED A2ENCL250R	GED KA2225-3



ABB SWITCHGEAR

★ (2) Sets of lugs for line and load required.



 **VIEW EW PRICING**

Shop ABB Circuit Breakers & Enclosures
View pricing and product updates.



(General Duty) Safety Switches

NEMA 1 (Indoor)

Nema 1 (Indoor) Fusible & Non-Fusible | 30-600 Amp | 240 VAC

General Duty Safety Switches - Fusible

NEMA 1 (Indoor) Fusible

Amp	Fusible	Part Number
Two-Pole Three-Wire		
30	•	GED TG3221
60	•	GED TG3222
100	•	GED TG3223
200	•	GED TG3224
400	•	GED TG3225
600	•	GED TG3226
Three-Pole Three-Wire		
400	•	GED TG3325
600	•	GED TG3326
Three-Pole Four-Wire		
30	•	GED TG4321
60	•	GED TG4322
100	•	GED TG4323
200	•	GED TG4324
400	•	GED TG4325
600	•	GED TG4326

General Duty Safety Switches - Non Fusible

NEMA 1 (Indoor) Non-Fusible

Amp	Fusible	Part Number
Three-Pole Three-Wire		
30		GED TGN3321
60		GED TGN3322
100		GED TGN3323
200		GED TGN3324
400		GED TGN3325
600		GED TGN3326



VIEW EW PRICING

Shop ABB (General Duty) Safety Switches
View pricing and product updates.

NEMA 3R (Outdoor)

Nema 3R (Outdoor) Fusible & Non-Fusible | 30-600 Amp | 240 VAC

General Duty Safety Switches - Fusible

NEMA 3R (Outdoor) Fusible		
Amp	Fusible	Part Number
Two-Pole Three-Wire		
30	•	GED TG3221R
60	•	GED TG3222R
100	•	GED TG3223R
200	•	GED TG3224R
400	•	GED TG3225R
600	•	GED TG3226R
Three-Pole Three-Wire		
400	•	GED TG3325R
600	•	GED TG3326R
Three-Pole Four-Wire		
30	•	GED TG4321R
60	•	GED TG4322R
100	•	GED TG4323R
200	•	GED TG4324R



ABB SWITCHGEAR

General Duty Safety Switches - Non Fusible

NEMA 3R (Outdoor) Non-Fusible		
Amp	Fusible	Part Number
Three-Pole Three-Wire		
30		GED TGN3321R
60		GED TGN3322R
100		GED TGN3323R
200		GED TGN3324R

(Heavy Duty) Safety Switches

NEMA 1 (Indoor)

Nema 1 (Indoor) Fusible & Non-Fusible | 30-600 Amp | 240 & 600 VAC

Heavy Duty Safety Switches - Fusible

NEMA 1 (Indoor) Fusible

Amp	Fusible	Part Number
Two-Pole Three-Wire		
30	•	GED TH3221
60	•	GED TH3222
100	•	GED TH3223
200	•	GED TH3224
400	•	GED TH3225
600	•	GED TH3226
Three-Pole Three-Wire		
30	•	GED TH3361
60	•	GED TH3362
100	•	GED TH3363
200	•	GED TH3364
400	•	GED TH3365
Three-Pole Four-Wire		
30	•	GED TH4321
60	•	GED TH4322
100	•	GED TH4323
200	•	GED TH4324
400	•	GED TH4325
600	•	GED TH4326

Heavy Duty Safety Switches - Non Fusible

NEMA 1 (Indoor) Non-Fusible

Amp	Fusible	Part Number
Three-Pole Three-Wire		
30		GED THN3361
60		GED THN3362
100		GED THN3363
200		GED THN3364
400		GED THN3365



 **VIEW EW PRICING**

Shop ABB (Heavy Duty) Safety Switches
View pricing and product updates.

NEMA 3R (Outdoor)

Nema 3R (Outdoor) Fusible & Non-Fusible | 30-600 Amp | 240 & 600 VAC



Heavy Duty Safety Switches - Fusible

NEMA 3R (Outdoor) Fusible		
Amp	Fusible	Part Number
Two-Pole Three-Wire		
30	•	GED TH3221R
60	•	GED TH3222R
100	•	GED TH3223R
200	•	GED TH3224R
400	•	GED TH3225R
600	•	GED TH3226R
Three-Pole Three-Wire		
30	•	GED TH3361R
60	•	GED TH3362R
100	•	GED TH3363R
200	•	GED TH3364R
400	•	GED TH3365R

Heavy Duty Safety Switches - Non Fusible

NEMA 3R (Outdoor) Non-Fusible		
Amp	Fusible	Part Number
Three-Pole Three-Wire		
30		GED THN3361R
60		GED THN3362R
100		GED THN3363R
200		GED THN3364R
400		GED THN3365R

Heavy Duty Safety Switch Accessories

Amp	Fusible	Part Number
DPDT - Double Pole Double Throw		
30A		GED THAUX21D
60-200A		GED THAUX64D

ABB SWITCHGEAR

Enclosure Accessories

Aluminum Hubs

Aluminum Hubs

3R Safety Switches (Raintight)

Nominal Conduit Diameter	Part Number
1"	GED TC100
1 1/4"	GED TC125
1 1/2"	GED TC150
2"	GED TC200
2 1/2"	GED TC250

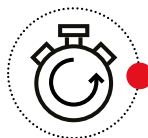

Small Projects - Same Day

The solution to your small project needs. Because sometimes you just can't wait.



Need it fast?

Get products for small projects from your local distributor's stock **right now**.



Tight deadlines?

Same day availability means you can meet project demands faster and be in a better position to **win more small project contracts**.



Can't wait?

Pick up **Pro-Stock™ panelboards** and other Small Project - Same Day products **from your local distributor's inventory**.



Standard Order Cycle

- Products drop shipped from factory
- Normal lead times

2 Weeks



Small Projects - Same Day

- Flexible Pro-Stock Panels can meet almost any small project need
- Competitively priced directly from your local distributor's inventory

1 Day



Key Benefits

- ▶ **Convenient** Immediate availability
- ▶ **Minimize** Shipping issues
- ▶ **Reliable** Delivery
- ▶ **Competitive** Pricing
- ▶ **Simple** Ordering and pickup

Small Project - Same Day Products



Panelboards

- A-Series™ II Pro-Stock



Transformers

- Single Phase
- Three Phase
- General Purpose
- Buck-Boost
- Control Power Single Phase



Safety Switches

- General Duty
- Heavy Duty



NEMA Starters

- GE300 Line by ABB



Lighting Contactors

- CR460 Series Build Your Own Assembly

Fuses

Fuses & Neutral Kits

Fuses			
Amp	250V Fuse	600V Fuse	Part Number
30	250V		BUSS FRN-R-30
30		600V	BUSS FRS-R-30
60	250V		BUSS FRN-R-60
60		600V	BUSS FRS-R-60
100	250V		BUSS FRN-R-100
100		600V	BUSS FRS-R-100
200	250V		BUSS FRN-R-200
200		600V	BUSS FRS-R-200
400	250V		BUSS FRN-R-400
400		600V	BUSS FRS-R-400

Neutral Kits						
For Type TG & TH						
Amp	Use With	Enclosures	Fusible	Non-Fusible	Voltage	Part Number
30	TG & TH	NEMA 1 & 3R	•	•	240	GED TNI62
60	TG & TH	NEMA 1 & 3R	•	•	240	GED TNIA62
100	TG & TH	NEMA 1 & 3R	•	•	240-600V	GED TNIA63
100	TG & TH	NEMA 1 & 3R		•	240-600V	GED TNI63
200	TH	NEMA 1 & 3R	•	•	240-600V	GED TNIA64



 **VIEW EW PRICING**



Shop ABB Enclosure Accessories & Fuses
View pricing and product updates.

Dry Type Transformers

— Three-Phase - 480V - 208/120V

Aluminum Windings | 150° Temp Rise | DOE 16 Compliant

Three-Phase Transformers

kVA Rating	Part Number
15	GED 9T10A1001
30	GED 9T10A1002
45	GED 9T10A1003
75	GED 9T10A1004
112.5	GED 9T10A1005

Weather Shields

kVA Rating	Part Number
15	GED 9T18Y1071G06
30	GED 9T18Y1072G06
45	GED 9T18Y1072G06
75	GED 9T18Y1074G06
112.5	GED 9T18Y1074G06



Rated Line Voltage Chart

— Full Load Amps

Dry-Type Distribution Transformers

Rated Line Voltage (Full Load Amps)							
kVA Rating	208V	240V	480V	600V	2400V	4160V	4800V
3	8.34	7.23	3.61	2.89	0.72	0.42	0.36
6	16.66	14.43	7.22	5.77	1.44	0.83	0.72
9	25	21.6	10.8	8.67	2.17	1.25	1.08
15	41.63	36.08	18.04	14.43	3.61	2.08	1.8
30	83.27	72.17	36.08	28.87	7.22	4.16	3.61
45	125	108.4	54.2	43.3	10.85	6.26	5.41
75	208.17	180.42	90.21	72.16	18.04	10.41	9.02
112.5	312.5	271.6	135.3	108.2	27.1	15.6	13.53
150	416.34	360.84	180.42	144.33	36.08	20.82	18.04
225	625	541.9	270.7	216.5	54.2	31.3	27.06
300	832.68	721.67	360.83	266.83	72.17	41.63	36.08

ABB SWITCHGEAR

$$\text{THREE-PHASE LINE CURRENT} = \frac{\text{Amps x Voltage x 1.732}}{1000}$$

 **VIEW EW PRICING**

Shop ABB Transformers
View pricing and product updates.



Single-Phase Load Centers

— Load Centers & Circuit Breakers

Single-Phase Load Centers



Amp	Number of Circuits	Part Number
Main Lug Only		
125	12	GED TLM1212CCU
125	24	GED TLM2412CCU
200	32	GED TLM3220CCU
200	40	GED TLM4020CCU
Main Circuit Breaker		
100	20	GED TM2010CCU
100	32	GED TM3210CCU
200	32	GED TM3220CCU
200	40	GED TM4020CCU

ABB SWITCHGEAR

Single-Phase Circuit Breakers



Amp	One-Pole	Two-Pole	Part Number
15	•		GED THQL1115AF2
20	•		GED THQL1120AF2
15	•		GED THQL1115GFT
20	•		GED THQL1120GFT
15	•		GED THQL1115DF
20	•		GED THQL1120DF
15		•	GED THQL2115GFT
20		•	GED THQL2120GFT
30		•	GED THQL2130GFT
40		•	GED THQL2140GFT
50		•	GED THQL2150GFT



 **VIEW EW PRICING**

Shop ABB Load Centers & Circuit Breakers
View pricing and product updates.

Three-Phase Load Centers

NEMA 1 & NEMA 3R

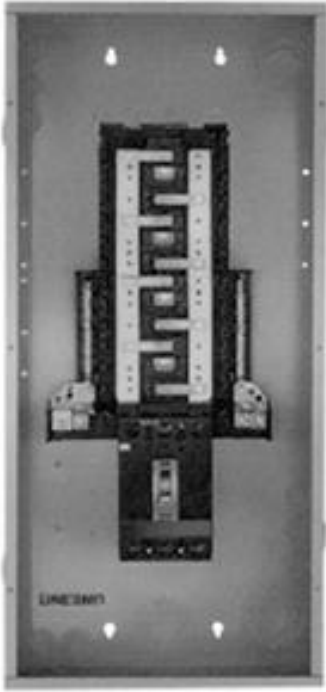

Three-Phase Load Centers

NEMA 1 (Indoor)

Amp	Number of Circuits	Main	Part Number
100	18	Breaker	GED TM18410C
150	18	Lug	GED TL18415C
200	30	Breaker	GED TM30420C
200	30	Lug	GED TL30420C
200	42	Breaker	GED TM42420C
200	42	Lug	GED TL42420C

NEMA 3R (Outdoor)

Amp	Number of Circuits	Main	Part Number
100	18	Breaker	GED TM18410R
150	18	Lug	GED TL18415R
200	30	Breaker	GED TM30420R
200	30	Lug	GED TL30420R
200	42	Breaker	GED TM42420R
200	42	Lug	GED TL42420R

ABB SWITCHGEAR

Q-Line Plug-In Breakers (120/240V)

10 KAIC

Amp	One-Pole	Part Number	Two-Pole	Part Number	Three-Pole	Part Number
15	●	GED THQL1115	●	GED THQL2115	●	GED THQL32015
20	●	GED THQL1120	●	GED THQL2120	●	GED THQL32020
30	●	GED THQL1130	●	GED THQL2130	●	GED THQL32030
40	●	GED THQL1140	●	GED THQL2140	●	GED THQL32040
50	●	GED THQL1150	●	GED THQL2150	●	GED THQL32050
60			●	GED THQL2160	●	GED THQL32060
70			●	GED THQL2170	●	GED THQL32070
80			●	GED THQL2180	●	GED THQL32080
90			●	GED THQL2190	●	GED THQL32090
100			●	GED THQL21100	●	GED THQL32100

Group Metering

— Main Breaker, Main Lug & Kits

Main Breaker Kits

Three-Phase

Amp	Part Number
400	GED TMP3SB4R
600	GED TMP3SB6R

Main Lug Kits

Three-Phase

Amp	Part Number
400	GED TMP3L4R
600	GED TMP3L6R

Barrier Kits

Part Number	Description
GED TMBR	Individual Meter Socket Barrier Kit
GED TMBR3	Individual Meter Socket Barrier Kit/3pcs

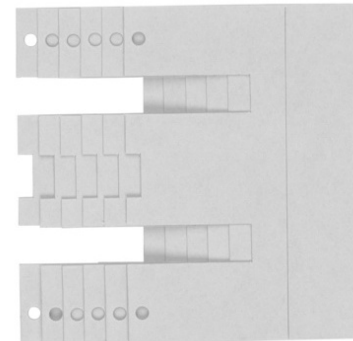

 **VIEW EW PRICING**

Shop ABB Group Metering
View pricing and product updates.

Meter Stacks & Breakers

(*Includes Breaker & Bypass. **Breaker Includes Load Side Lugs.)

Meter Stacks				
Single-Phase (Includes Bypass)				
Amp	Gange Type	Dimensions	Voltage	Part Number
225	1-Gang	18" W x 8.75" D x 25.4" H	120/240V	GED TMPR12122R
225	2-Gang	18" W x 8.75" D x 52.6" H	120/240V	GED TMPR12222R
225	3-Gang	18" W x 8.75" D x 52.6" H	120/240V	GED TMPR12322R
225	4-Gang	18" W x 8.75" D x 66.6" H	120/240V	GED TMPR12422R
Three-Phase (Includes Bypass)				
225	1-Gang	18" W x 8.75" D x 25.4" H	120/240V 208Y/120	GED TMPR312122R
225	2-Gang	18" W x 8.75" D x 52.6" H	120/240V 208Y/120	GED TMPR312222R
225	3-Gang	18" W x 8.75" D x 52.6" H	120/240V 208Y/120	GED TMPR312322R
225	4-Gang	18" W x 8.75" D x 52.6" H	120/240V 208Y/120	GED TMPR312422R
Three-Phase (Includes Breaker & Bypass)				
400	1-Gang	18" W x 8.75" D x 52.6" H	120/240V 208Y/120	GED TMPR312140RB*

Group Metering Circuit Breakers

Amp	KAIC	Part Number
Two-Pole		
100	10	GED TQD22100**
125	10	GED TQD22125**
150	42	TMQC22150MM**
200	10	GED TQD22200**
Three-Pole		
150	22	THQD32100**
125	10	GED TQD32125**
150	10	GED TQD32150**
200	10	GED TQD32200**



Motor Controls

Definite Purpose Contactors

Motor Controls

Definite Purpose Contactor (Open Style) with 120V Coil

Amp Rating	Two-Pole	Three-Pole	Part Number
25	•		★ GED DP25C2P-1
25		•	★ GED DP25C3P-1
30	•		★ GED DP30C2P-1
30		•	★ GED DP30C3P-1
40	•		★ GED DP40C2P-1
40		•	★ GED DP40C3P-1
50	•	•	★ GED DP50C3P-1

★ Contact your Sales Rep for most accurate part numbers when ordering. Additional coil voltage options available.



Enclosed Starters & Accessories

NEMA 1 Enclosed Starters & Starter Accessory Kits

Starter Accessories

Size	Part Number
HOA Push Button	
00	GED CR305X130N
0	GED CR305X130N
1	GED CR305X130N
2	GED CR305X230N
Stop/Start Push Button	
00	GED CR305X120N
0	GED CR305X120N
1	GED CR305X120N
2	GED CR305X220N
1NO/1NC Auxiliary Contact Side Mount	
0	GED CR305X100C
1	GED CR305X100C
2	GED CR305X200C
Red Indicating Light	
00	GED CR305X150N
0	GED CR305X150N
1	GED CR305X150N
2	GED CR305X250N

Enclosed Starters NEMA 1

Size	Voltage	Part Number
Non-Combination Non-Reversing Starter		
00	115V	GED CR306A102
0	115V	GED CR306B102
1	115V	GED CR306C102
2	120V	GED CR306D102



ABB SWITCHGEAR

 **VIEW EW PRICING**

Shop ABB Motor Controls, Starters & Accessories
View pricing and product updates.



Eaton Switchgear

The following Electrical Wholesalers and HZ Electric Supply branches carry Eaton Switchgear. Fully stocked inventory is also available at our Central Distribution Center located at 701 Middle Street, Middletown, CT 06457.



Electrical Wholesalers Inc.

DANBURY

60 Shelter Rock Rd
Danbury, CT 06810
203-743-5578

FAIRFIELD

107 Ardmore St
Fairfield, CT 06824
203-256-2333

GUILFORD

200A Village Walk Plz
Guilford, CT 06437
203-453-9537

NEW HAVEN

75 Hamilton St
New Haven, CT 06511
203-777-9644

NEW LONDON

163 State Pier Rd
New London, CT 06320
860-443-4381

STAMFORD

45 Harborview Ave
Stamford, CT 06902
203-356-1822

WINDSOR

130 Addison Rd
Windsor, CT 06095
860-925-6720



KINGSTON

1034 Morton Blvd
Kingston, NY 12401
845-382-2852

LATHAM

22 Wade Rd
Latham, NY 12110
518-785-6677

MERIDEN

154 Research Pkwy
Meriden, CT 06450
203-237-8944

PITTSFIELD

485 Fenn St
Pittsfield, MA 01201
413-499-4020

POUGHKEEPSIE

135 North Hamilton St
Poughkeepsie, NY
12601 845-214-1100

SPRINGFIELD

274 Taylor St
Springfield, MA 01105
413-734-6407

NORTHAMPTON

440 Pleasant St (Rte 5)
Northampton, MA 01060
413-584-5160



PRICING IS NOT LISTED IN THIS EDITION OF THE CATALOG.
Please check with your Sales Rep or sign into your account on our website for the most up-to-date pricing and product inventory levels.

Introduction

EATON SWITCHGEAR

- 34-35** Intro to Eaton Switchgear & Supporting Branches
- 36-39** Pow-R-Xpress | Panelboards | Breakers | Main Breaker/Subfeed/Lug Kits | NEMA 3R Enclosures
- 40-41** Pow-R-Xpress Branch Circuit Breakers | Series C Breaker Connector Kits & Plates
- 42-43** Series C Breaker Loose Breakers - PRLC Panelboards & Switch Boards
- 44-47** Residential Enclosed Circuit Breakers | Legacy Breaker Selector Sheet | Power Defense Breakers
- 48-51** (General Duty) & (Heavy Duty) Safety Switches & Neutral Kits
- 52-53** Enclosure Accessories & Fuses
- 54-55** Dry Type Transformers | Lug Kits | Weather Shields | Rated Line Voltage Charts
- 56-57** Residential Surge Protectors | Single-Phase Load Centers
- 58-59** Plug-On Neutral Accessories | Three-Phase Load Centers & Accessories
- 60-63** (Type BR) Circuit Breakers for Load Centers | Retrofit Loadcenter Interior Form
- 64-67** Residential & Commercial Main Devices | Meter Stacks | Tenant Feeder Breakers
- 68-69** Eaton's WBM (Wall Mounted Main Breaker & CT Cabinet)
- 70-71** Motor Controls | Enclosed Starters | Horsepower Rating Chart
- 72-73** Lighting Contactors | Starter Accessories | Pushbutton Packs & Accessories
- 74-75** Residential EV Chargers | EV Smart Breaker Chargers Kits & Pedestals
- 76-77** Ampacity Rating & Voltage Drop Charts



Pow-R-Xpress

Main Lug Panelboards & Kits

Main Lug Panelboards | NEMA 1 Box | Trim | NEMA 3R Enclosure | Main Lug Kits

Main Lug Panelboards

Amp	Number of Circuits	Aluminum Bus	Copper Bus	Part Number	NEMA 1 Box	Trim (Surf or Flush)	NEMA 3R Enclosure	Main Lug Kit
120/240V Single-Phase (Three-Wire)								
100	18	•		PRL1X1100X18A	EZB2036RBS	EZT2036	GWPBQ2036PR	LUGKIT100
225	30	•		PRL1X1225X30A	EZB2048RBS	EZT2048	GWPBQ2048PR	LUGKIT225
225	42	•		PRL1X1225X42AS*	EZB2048RBS	EZT2048	GWPBQ2048PR	LUGKIT225
208Y/120V Three-Phase (Four-Wire)								
100	18	•		PRL1X3100X18A	EZB2036RBS	EZT2036	GWPBQ2036PR	LUGKIT100
225	30	•		PRL1X3225X30A	EZB2048RBS	EZT2048	GWPBQ2048PR	LUGKIT225
225	42	•		PRL1X3225X42AS*	EZB2048RBS	EZT2048	GWPBQ2048PR	LUGKIT225
225	42		•	PRL1X3225X42C	EZB2060RBS	EZT2060	GWPBQ2060PR	LUGKIT225
400	42	•		PRL1X3400X42AS*	EZB20760RBS	EZT2060	GWPBQ2060PR	LUGKIT400
600	42		•	PRL1X3600X42CL	EZB2090R	EZT2090	GWPBQ2090PR	LUGKIT600
480Y/277V Three-Phase (Four-Wire)								
100	18	•		PRL2X3100X18A	EZB2036RBS	EZT2036	GWPBQ2036PR	LUGKIT100
225	30	•		PRL2X3225X30A	EZB2048RBS	EZT2048	GWPBQ2048PR	LUGKIT225
225	42	•		PRL2X3225X42AS*	EZB2048RBS	EZT2048	GWPBQ2048PR	LUGKIT225
400	42	•		PRL2X3400X42AS*	EZB2060RBS	EZT2060	GWPBQ2060PR	LUGKIT400
400	42		•	PRL2X3400X42CS*	EZB2060RBS	EZT2060	GWPBQ2060PR	LUGKIT400
600	42		•	PRL2X3600X42CL	EZB2090R	EZT2090	GWPBQ2090PR	LUGKIT600

*Short interior. Sub-feed lug and sub-feed breakers not available.



VIEW EW PRICING

Shop Eaton Pow-R-Xpress
View pricing and product updates.



VIEW HZ PRICING

Shop Eaton Pow-R-Xpress
View pricing and product updates.

Main Breaker Panelboards & Kits

Main Breaker Panelboards | NEMA 1 Box | Trim | NEMA 3R Enclosure | Main Breaker & Subfeed Kits

(Please reference branch breakers on page 40.)

Main Breaker Panelboards

Amp	Max Poles	Aluminum Bus	Copper Bus	Part Number	NEMA 1 Box	Trim (Surface or Flush)	NEMA 3R Enclosure	Main Breaker & Subfeed Kit
120/240V Single-Phase (Three-Wire)								
100	18	•		PRL1X1100X18A	EZB2036RBS	EZT2036	GWPBQ2036PR	BKD2G100
225	30	•		PRL1X1225X30A	EZB2048RBS	EZT2048	GWPBQ2048PR	BKD2G225
225	40	•		PRL1X1225X42AS*	EZB2048RBS	EZT2048	GWPBQ2048PR	BKD2G225
208Y/120V Three-Phase (Four-Wire)								
100	18	•		PRL1X3100X18A	EZB2036RBS	EZT2036	GWPBQ2036PR	BKD2G100
225	30	•		PRL1X3225X30A	EZB2048RBS	EZT2048	GWPBQ2048PR	BKD2G225
225	42	•		PRL1X3225X42AS*	EZB2048RBS	EZT2048	GWPBQ2048PR	BKD2G225
225	42		•	PRL1X3225X42C	EZB2060RBS	EZT2060	GWPBQ2060PR	BKD2G225
400	42	•		PRL1X3400X42AS*	EZB2060RBS	EZT2060	GWPBQ2060PR	BKG3G400
600	42		•	PRL1X3600X42CL	EZB2090R	EZT2090	GWPBQ2090PR	BKG3G600
480Y/277V Three-Phase (Four-Wire)								
100	18	•		PRL2X3100X18A	EZB2036RBS	EZT2036	GWPBQ2036PR	BKD2G100
225	30	•		PRL2X3225X30A	EZB2048RBS	EZT2048	GWPBQ2048PR	BKD2G225
225	42	•		PRL2X3400X42AS*	EZB2048RBS	EZT2048	GWPBQ2048PR	BKD2G225
400	42	•		PRL2X3400X42AS*	EZB2060RBS	EZT2060	GWPBQ2060PR	BKG3G400
400	42		•	PRL2X3400X42CS*	EZB2060RBS	EZT2060	GWPBQ2060PR	BKG3G400
600	42		•	PRL2X3600X42CL	EZB2090R	EZT2090	GWPBQ2090PR	BKG3G600



*Short interior. Sub-feed lug and sub-feed breakers not available.



DOWNLOAD THE PANELBOARD QUOTE SHEET

Download the EATON panel quote sheet. Fill in and send to your Sales Rep for easy ordering.

Pow-R-Xpress

Subfeed Breaker & Lug Kits

EATON SWITCHGEAR

Subfeed Breaker Kits

Amp	Voltage	Part Number	Single-Phase	Three-Phase
Pow-R-Xpress (Top & Bottom Mounting)				
100	240	BKD2G100	•	•
125	240	BKD2G125	•	•
150	240	BKD2G150	•	•
200	240	BKD2G200	•	•
225	240	BKD2G225	•	•
100	480	BKG2G100	•	•
200	480	BKG2G200	•	•
225	480	BKG2G225	•	•
400	480	BKG3G400	•	•
Pow-R-Xpress (Top & Bottom Mounting)				
100	240	BKD2F100	•	•
125	240	BKD2F125	•	•
150	240	BKD2F150	•	•
175	240	BKD2F175	•	•
200	240	BKD2F200	•	•
255	240	BKD2F225	•	•
Pow-R-Xpress (Bottom Mounting Only)				
100	240	BKD2F100B	•	•
125	240	BKD2F125B	•	•
150	240	BKD2F150B	•	•
175	240	BKD2F175B	•	•
200	240	BKD2F200B	•	•
225	240	BKD2F225B	•	•

Lug/Subfeed Kit

Amp	Part Number
100	LUGKIT100
225	LUGKIT225
400	LUGKIT400
600	LUGKIT600

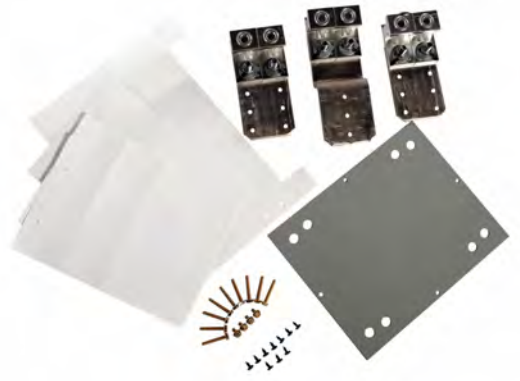

VIEW EW PRICING

Shop Eaton Pow-R-Xpress
View pricing and product updates.



VIEW HZ PRICING

Shop Eaton Pow-R-Xpress
View pricing and product updates.

Subfeed Breaker Mounting & Service Entrance Accessories

Subfeed Breaker Mounting Accessories

Amp	Subfeed Cover Top & Bottom
225	SFBCVR225BTOP
225	SFBCVR225BBOT
400	SFBCVR400ATOP
400	SFBCVR400ABOT
225	SFBCVR225ATOP
225	SFBCVR225ABOT

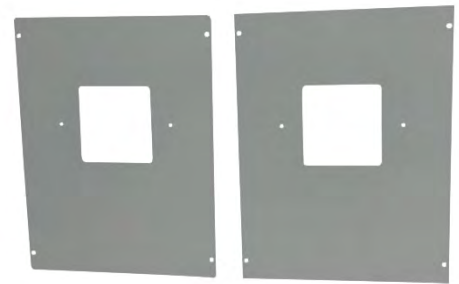

SFBCVR225BTOP & SFBCVR225BBOT needed for 225A frame sub-feed breaker mounted in a 400A Pow-R-Xpress Panelboard.

SFBCVR225ATOP & SFBCVR225ABOT needed for 225A frame sub-feed breaker mounted in a 600A Pow-R-Xpress Panelboard.

SFBCVR400ATOP & SFBCVR400ABOT needed for 400A frame sub-feed breaker mounted in a 600A Pow-R-Xpress Panelboard.



Service Entrance Accessory Kits

Amp	Part Number	Description
Service Entrance & Barrier Kits		
100/225	SEK1/2 2	SERVICE ENTRANCE KIT 100A/225A
--	SEPD2	SERVICE ENTRANCE BARRIER KIT PD2 FRAME BREAKER WITH SEK1/2
--	SEKB 2	SERVICE ENTRANCE BARRIER KIT FOR BAB BREAKER WITH SEK 1/2
--	SEKG 2	SERVICE BARRIER KIT FOR G FRAME WITH SEK 1/2
400/600	SEK4/6 2	SERVICE ENTRANCE KIT 400A/600A
--	SEPD3	SERVICE ENTRANCE BARRIER KIT PD3 FRAME BREAKER WITH SEK4/6



Branch Circuit Breakers

Pow-R-Xpress Branch Breakers

Pow-R-Xpress Branch Breakers

Breaker	No. of Poles	Amp	Voltage	KAIC Rating	Part Number	Panelboard Type
BAB 1 2	1	15-70	120	10	BAB1020	PRL1X
	2	15-100	120/240	10	BAB2020	PRL1X
	2	15-100	240	10	BAB2040H	PRL1X
	3	15-100	240	10	BAB3030H	PRL1X
QBAF	1	15-20	120	10	QBAF1020	PRL1X
QB-AFGF	1	15-20	120	10	QB1015AFGF	PRL1X
QB-CAF	1	15-20	120	22	QB1020CAF	PRL1X
QBH-CAF	1	15-20	120	10	QBH1020CAF	PRL1X
QB-GF	1	15-20	120	22	QB1020GF	PRL1X
QBGFT	1	15-40	120	10	QBGFT1020	PRL1X
	2	15-50	120/240	10	QBGFT2040	PRL1X
QBHGFT	1	15-30	120	22	QBHGFT1020	PRL1X
	2	15-30	120/240	22	QBHGFT2020	PRL1X
QBGFEP	2	15-50	120/240	10	QBGFEP2020	PRL1X
QBH-EP	1	15-30	120	22	QBH1020EP	PRL1X
QBHGFEF	2	15-30	120/240	22	QBHGFEF2020	PRL1X
QBHW 1	1	15-70	120	22	QBHW1020	PRL1X
	2	15-100	120/240	22	QBHW2020	PRL1X
	2	15-100	240	22	QBHW2040H	PRL1X
	3	15-100	240	22	QBHW3030H	PRL1X
GHQ 1	1	15-20	277	14	GHQ1020	PRL2X
GHB 1 2	1	15-100	277	14	GHB1020	PRL2X
	2	15-100	480Y/277	14	GHB2040	PRL2X
	3	15-100	480Y/277	14	GHB3060	PRL2X

- 1** BAB, QBHW, GHQ and GHB breakers installed in PRL1X and PRL2X are available with shunt trip, i.e., BAB1020S.
- 2** BAB-H, QBHW-H and GHB 50-100 A available as chassis-mounted main device.



VIEW EW PRICING

Shop Eaton Branch Circuit Breakers
View pricing and product updates.



VIEW HZ PRICING

Shop Eaton Branch Circuit Breakers
View pricing and product updates.

Breaker Connector Kits & Plates

Series C Breaker Connector Kits & Blank Filler Covers for PRLC Panelboards & Switch Boards

Series C - Breaker Connector Kits & Plates

Connector Kits

Connector Kit Part Number	Existing Equipment Type	Existing Breaker Frame	Single or Twin Mount	Amperage Max
KPRL3AED3	Panelboard - PRL3A	ED Frame	Single	225A
KPRL3AFD3	Panelboard - PRL3A	FD Frame	Single	225A
KPRL4FD	PRLC Switchboard or PRL4A Panelboard	F-Frame	Twin	225A
KPRL4JDS	PRLC Switchboard or PRL4A Panelboard	J-Frame	Single	250A
KPRL4JDT	PRLC Switchboard or PRL4A Panelboard	J-Frame	Twin	250A
KPRL4KDS	PRLC Switchboard or PRL4A Panelboard	K-Frame	Single	400A
KPRL4KDT	PRLC Switchboard or PRL4A Panelboard	K-Frame	Twin	400A
KPRL4LG	PRLC Switchboard or PRL4A Panelboard	LG-Frame	Single	600A

Blank Filler Covers

Filler Part Numbers	Existing Equipment Type	Number of X Space (1X = 1.375inches)	Filler Plate Dimensions	Existing Enclosure Dimensions
P41X17	PRLC Switchboard or PRL4 Panelboard	1X	1.375" H, 17" W	Fits 24" & 26" Enclosures
P42X17	PRLC Switchboard or PRL4 Panelboard	2X	2.75" H, 17" W	Fits 24" & 26" Enclosures
P43X17	PRLC Switchboard or PRL4 Panelboard	3X	4.125" H, 17" W	Fits 24" & 26" Enclosures
P44X17	PRLC Switchboard or PRL4 Panelboard	4X	5.5" H, 17" W	Fits 24" & 26" Enclosures
P41X25	PRLC Switchboard or PRL4 Panelboard	1X	1.375" H, 25" W	Fits 36", 44" & 45" Enclosures
P42X25	PRLC Switchboard or PRL4 Panelboard	2X	2.75" H, 25" W	Fits 36", 44" & 45" Enclosures
P43X25	PRLC Switchboard or PRL4 Panelboard	3X	4.125" H, 25" W	Fits 36", 44" & 45" Enclosures
P44X25	PRLC Switchboard or PRL4 Panelboard	4X	5.5" H, 25" W	Fits 36", 44" & 45" Enclosures

EATON SWITCHGEAR

Please reference page 42 for Series C loose breakers for PRLC & switch panelboards.

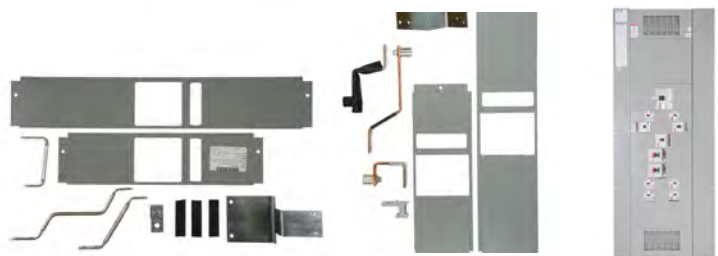

VIEW EW PRICING

Shop Eaton Series C Breaker Connector Kits & Covers
View pricing and product updates.



VIEW HZ PRICING

Shop Eaton Series C Breaker Connector Kits & Covers
View pricing and product updates.

Series C Loose Breakers

Breakers for PRLC Panelboards & Switch Boards

Series C - Loose Breakers

Breaker Part Number	Number of Poles	Amp	Voltage	KAIC By Voltage			
EHD2100	2P	100A	240	240V	18KAIC	480V	14KAIC
EHD3020	3P	20A	240	240V	18KAIC	480V	14KAIC
EHD3030	3P	30A	240	240V	18KAIC	480V	14KAIC
EHD3060	3P	60A	240	240V	18KAIC	480V	14KAIC
EHD3100	3P	100A	240	240V	18KAIC	480V	14KAIC
FD2015	2P	15A	240	240V	65KAIC	480V	35KAIC
FD2020	2P	20A	240	240V	65KAIC	480V	35KAIC
FD2060	2P	60A	240	240V	65KAIC	480V	35KAIC
FD2100	2P	100A	240	240V	65KAIC	480V	35KAIC
FD3015	3P	15A	240	240V	65KAIC	480V	35KAIC
FD3020	3P	20A	240	240V	65KAIC	480V	35KAIC
FD3030	3P	30A	240	240V	65KAIC	480V	35KAIC
FD3060	3P	60A	240	240V	65KAIC	480V	35KAIC
FD3080	3P	80A	240	240V	65KAIC	480V	35KAIC
FD3100	3P	100A	240	240V	65KAIC	480V	35KAIC
HFD2100	2P	100A	240	240V	100KAIC	480V	65KAIC
HFD3015	3P	15A	240	240V	100KAIC	480V	65KAIC
HFD3020	3P	20A	240	240V	100KAIC	480V	65KAIC
HFD3030	3P	30A	240	240V	100KAIC	480V	65KAIC
HFD3040	3P	40A	240	240V	100KAIC	480V	65KAIC
HFD3045	3P	45A	240	240V	100KAIC	480V	65KAIC
HFD3050	3P	50A	240	240V	100KAIC	480V	65KAIC
HFD3060	3P	60A	240	240V	100KAIC	480V	65KAIC
HFD3070	3P	70A	240	240V	100KAIC	480V	65KAIC
HFD3080	3P	80A	240	240V	100KAIC	480V	65KAIC
HFD3100	3P	100A	240	240V	100KAIC	480V	65KAIC
ED3100	3P	100A	240	240V	65KAIC	C	SERIES
FD3125	3P	125A	240	240V	65KAIC	480V	35KAIC
FD3200	3P	200A	240	240V	65KAIC	480V	35KAIC
HFD3125	3P	125A	240	240V	100KAIC	480V	65KAIC
HFD3150	3P	150A	240	240V	100KAIC	480V	65KAIC
HFD3175	3P	175A	240	240V	100KAIC	480V	65KAIC
HFD3200	3P	200A	240	240V	100KAIC	480V	65KAIC
HFD3225	3P	225A	240	240V	100KAIC	480V	65KAIC
ED3150	3P	150A	240	240V	65KAIC	C	SERIES
ED3175	3P	175A	240	240V	65KAIC	C	SERIES
ED3200	3P	200A	240	240V	65KAIC	C	SERIES
ED3225	3P	225A	240	240V	65KAIC	C	SERIES
HJD3250	3P	250A	240	240V	100KAIC	480V	65KAIC
JD3250	3P	250A	240	240V	65KAIC	480V	35KAIC
KD3225	3P	225A	240	240V	65KAIC	480V	35KAIC
KD3300	3P	300A	240	240V	65KAIC	480V	35KAIC
KD3400	3P	400A	240	240V	65KAIC	480V	35KAIC
HKD3400	3P	400A	240	240V	100KAIC	480V	65KAIC



EHD2100



FD2225



FD3015



HFD2200



HFD3065



ED3225



HFD3125



HFD3050



ED3225



JD3250



HJD3250



HKD3400



VIEW EW PRICING

Shop Eaton Series C Loose Breakers
View pricing and product updates.



VIEW HZ PRICING

Shop Eaton Series C Loose Breakers
View pricing and product updates.

Residential Enclosed Circuit Breakers

— NEMA 1, NEMA 3R, & AC Disconnects

(*Enclosure Only NEMA 3R, Single-Phase or Three-Phase Surface Mount.)

Residential Enclosed Breakers (250V)

Enclosure Part Number	NEMA Rating	Amp	Breaker Part Number		Wire Size
			Two-Pole 10 KAIC	Three-Pole 10 KAIC	
ECC225S	NEMA 1, Surface Mounted	100	CCV2100	CC3100	#2-300 kcmil
		200	CCV2200	CC3200	#2-300 kcmil
		225	CCV225	CC3225	#2-300 kcmil
ECC225R	NEMA 3R	100	CCV2100	CC3100	#2-300 kcmil
		200	CCV2200	CC3200	#2-300 kcmil
		225	CCV225	CC3225	#2-300 kcmil

AC Disconnects

AC Non-fused Disconnect

Amp	Two-Pole	Voltage	Part Number	Steel	Poly-carbonate	NEMA 3R
NEMA 3R						
60	•	240	DPU222R	•		•
60	•	240	ACD60R		•	•



Lug Chart

Part Number	Wire Size
3T100FB	#14-1/10 AWG Cu/Al
3T20FB	#14-10 AWG Cu/Al
3TA225FD	#4-4/0 AWG Cu/Al
TA250KB	#4 AWG-350 kcmil Cu
TA300K	#3 AWG-350 kcmil Cu/Al
3TA401K	(2) #2/0 AWG-250 kcmil
	(1) 2/0-500 kcmil Cu/Al



VIEW EW PRICING

Shop Eaton Breakers, AC Disconnects, & Lugs
View pricing and product updates.

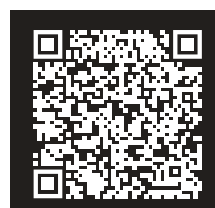

VIEW HZ PRICING

Shop Eaton Breakers, AC Disconnects, & Lugs
View pricing and product updates.

Enclosed Molded Case Breaker Selector Sheet

Legacy Breakers

Enclosed Molded Case Breakers								
Enclosure Part Number	Neutral Kit Part Number	Breaker Frame	Breaker Part Number	Breaker Description	*Lug Part Number	*Qty of lugs required		
SFDN100 (NEMA 1) OR RFDN100 (NEMA 3R)	DH100NK	EHD	EHD2100	EHD2100 2P 100A 14kaic at 277V	3T100FB	1		
			EHD3020	EHD3020 3P 20A 240V 18KAIC 480V 14KAIC C SERIES	3T100FB	1		
			EHD3020	EHD3020 3P 20A 240V 18KAIC 480V 14KAIC C SERIES	3T20FB	1		
			EHD3030	EHD3030 3P 30A 240V 18KAIC 480V 14KAIC C SERIES	3T100FB	1		
			EHD3060	EHD3060 3P 60A 240V 18KAIC 480V 14KAIC C SERIES	3T100FB	1		
			EHD3100	EHD3100 3P 100A 240V 18KAIC 480V 14KAIC C SERIES	3T100FB	1		
		FD	FD2015	FD2015 2P 15A 240V 65KAIC 480V 35KAIC C SERIES	3T100FB	1		
			FD2020	FD2020 2P 20A 240V 65KAIC 480V 35KAIC C SERIES	3T100FB	1		
			FD2060	FD2060 2P 60A 240V 65KAIC 480V 35KAIC C SERIES	3T100FB	1		
			FD2100	FD2100 2P 100A 240V 65KAIC 480V 35KAIC C SERIES	3T100FB	1		
			FD3015	FD3015 3P 15A 240V 65KAIC 480V 35KAIC C SERIES	3T100FB	1		
			FD3020	FD3020 3P 20A 240V 65KAIC 480V 35KAIC C SERIES	3T100FB	1		
			FD3030	FD3030 3P 30A 240V 65KAIC 480V 35KAIC C SERIES	3T100FB	1		
			FD3060	FD3060 3P 60A 240V 65KAIC 480V 35KAIC C SERIES	3T100FB	1		
			FD3080	FD3080 3P 80A 240V 65KAIC 480V 35KAIC C SERIES	3T100FB	1		
			FD3100	FD3100 3P 100A 240V 65KAIC 480V 35KAIC C SERIES	3T100FB	1		
			HFD	HFD2100	HFD2100 2P 100A 240V 100KAIC 480V 65KAIC C SERIES	3T100FB	1	
				HFD3015	HFD3015 3P 15A 240V 100KAIC 480V 65KAIC C SERIES	3T100FB	1	
		HFD3020		HFD3020 3P 20A 240V 100KAIC 480V 65KAIC C SERIES	3T100FB	1		
		HFD3030		HFD3030 3P 30A 240V 100KAIC 480V 65KAIC C SERIES	3T100FB	1		
		HFD3040		HFD3040 3P 40A 240V 100KAIC 480V 65KAIC C SERIES	3T100FB	1		
		HFD3045		HFD3045 3P 45A 240V 100KAIC 480V 65KAIC C SERIES	3T100FB	1		
		HFD3050		HFD3050 3P 50A 240V 100KAIC 480V 65KAIC C SERIES	3T100FB	1		
		HFD3060		HFD3060 3P 60A 240V 100KAIC 480V 65KAIC C SERIES	3T100FB	1		
		HFD3070		HFD3070 3P 70A 240V 100KAIC 480V 65KAIC C SERIES	3T100FB	1		
		HFD3080		HFD3080 3P 80A 240V 100KAIC 480V 65KAIC C SERIES	3T100FB	1		
		HFD3100	HFD3100 3P 100A 240V 100KAIC 480V 65KAIC C SERIES	3T100FB	1			
		ED	ED3100	ED3100 3P 100A 240V 65KAIC C SERIES	3T100FB	1		
		SFDN225 (NEMA 1) OR RFDN225 (NEMA 3R)	INK250	FD	FD3125	FD3125 3P 125A 240V 65KAIC 480V 35KAIC C SERIES	3TA225FD	1
					FD3200	FD3200 3P 200A 240V 65KAIC 480V 35KAIC C SERIES	3TA225FD	1
				HFD	HFD3125	HFD3125 3P 125A 240V 100KAIC 480V 65KAIC C SERIES	3TA225FD	1
					HFD3150	HFD3150 3P 150A 240V 100KAIC 480V 65KAIC C SERIES	3TA225FD	1
					HFD3175	HFD3175 3P 175A 240V 100KAIC 480V 65KAIC C SERIES	3TA225FD	1
HFD3200	HFD3200 3P 200A 240V 100KAIC 480V 65KAIC C SERIES				3TA225FD	1		
HFD3225	HFD3225 3P 225A 240V 100KAIC 480V 65KAIC C SERIES				3TA225FD	1		
ED	ED3150				ED3150 3P 150A 240V 65KAIC C SERIES	3TA225FD	1	
ED3175	ED3175 3P 175A 240V 65KAIC C SERIES			3TA225FD	1			
ED3200	ED3200 3P 200A 240V 65KAIC C SERIES			3TA225FD	1			
ED3225	ED3225 3P 225A 240V 65KAIC C SERIES	3TA225FD	1					
SJDN250 (NEMA 1) OR RJDN250 (NEMA 3R)	INK250	HJD	HJD3250	HJD3250 3P 250A 240V 100KAIC 480V 65KAIC C SERIES	TA250KB	3		
		JD	JD3250	JD3250 3P 250A 240V 65KAIC 480V 35KAIC C SERIES	TA250KB	3		
SKDN400 (NEMA 1) OR RKDN400 (NEMA 3R)	INK400	KD	KD3225	KD3225 3P 225A 240V 65KAIC 480V 35KAIC C SERIES	TA300K	3		
			KD3300	KD3300 3P 300A 240V 65KAIC 480V 35KAIC C SERIES	TA300K	3		
			KD3400	KD3400 3P 400A 240V 65KAIC 480V 35KAIC C SERIES	3TA401K	1		
		HKD	HKD3400	HKD3400 3P 400A 240V 100KAIC 480V 65KAIC C SERIES	3TA401K	1		

EATON SWITCHGEAR

*Refer to lug chart on page 44 for wire sizes.

Power Defense Molded Case Enclosed Circuit Breakers

Power Defense Molded Case Breaker Selector Guide

Enclosure PN	Neutral Kit PN	Breaker Frame	Breaker Max Amperage	Number of Poles	KAIC Rating	Breaker Part Number	Description of Breaker from Vista	
SPD2K0225 (NEMA 1) OR FPD2K0225 (NEMA 1 FLUSH) OR RPD2K0225 (NEMA 3R)	ECB225NK	PD2	225A	3P	High	PDD23G0100TFFL	PDD2,3P,100A,65KA/240V,FXFXTMTU	
						PDD23G0125TFFL	PDD2,3P,125A,65KA/240V,FXFXTMTU	
						PDD23G0175TFFL	PDD2,3P,175A,65KA/240V,FXFXTMTU	
					PDD23G0225TFFL	PDD2,3P,225A,65KA/240V,FXFXTMTU		
					PDD23F0100TFFL	PDD2,3P,100A,35KA/240V,FXFXTMTU		
					PDD23F0150TFFL	PDD2,3P,150A,35KA/240V,FXFXTMTU		
				Standard	PDD23F0200TFFL	PDD2,3P,200A,35KA/240V,FXFXTMTU		
					PDD23F0225TFFL	PDD2,3P,225A,35KA/240V,FXFXTMTU		
					PDG21G0020TFFL	PDG2,1P,20A,35KA/480V,FXFXTMTU		
					PDG21G0030TFFL	PDG2,1P,30A,35KA/480V,FXFXTMTU		
					PDG21M0020TFFL	PDG2,1P,20A,65KA/480V,FXFXTMTU		
					PDG21M0030TFFL	PDG2,1P,30A,65KA/480V,FXFXTMTU		
		1P	Standard	PDG22G0015TFFL	PDG2,2P,15A,35KA/480V,FXFXTMTU			
				PDG22G0060TFFL	PDG2,2P,60A,35KA/480V,FXFXTMTU			
				PDG22M0100TFFL	PDG2,2P,100A,65KA/480V,FXFXTMTU			
		2P	High	PDG23M0020TFFL	PDG2,3P,20A,65KA/480V,FXFXTMTU			
				PDG23M0030TFFL	PDG2,3P,30A,65KA/480V,FXFXTMTU			
				PDG23F0060TFFL	PDG2,3P,60A,25KA/480V,FXFXTMTU			
		PDG2	100A	Standard	3P	Low	PDG23F0100TFFL	PDG2,3P,100A,25KA/480V,FXFXTMTU
							PDG23G0015TFFL	PDG2,3P,15A,35KA/480V,FXFXTMTU
							PDG23G0020TFFL	PDG2,3P,20A,35KA/480V,FXFXTMTU
						PDG23G0050TFFL	PDG2,3P,50A,35KA/480V,FXFXTMTU	
						PDG23G0060TFFL	PDG2,3P,60A,35KA/480V,FXFXTMTU	
						PDG23G0100TFFL	PDG2,3P,100A,35KA/480V,FXFXTMTU	
				High	PDG23M0040TFFL	PDG2,3P,40A,65KA/480V,FXFXTMTU		
					PDG23M0050TFFL	PDG2,3P,50A,65KA/480V,FXFXTMTU		
					PDG23M0060TFFL	PDG2,3P,60A,65KA/480V,FXFXTMTU		
					PDG23M0070TFFL	PDG2,3P,70A,65KA/480V,FXFXTMTU		
					PDG23M0080TFFL	PDG2,3P,80A,65KA/480V,FXFXTMTU		
					PDG23M0090TFFL	PDG2,3P,90A,65KA/480V,FXFXTMTU		
Standard	PDG23M0100TFFL			PDG2,3P,100A,65KA/480V,FXFXTMTU				
	PDG23M0125TFFL			PDG2,3P,125A,65KA/480V,FXFXTMTU				
	PDG23M0150TFFL			PDG2,3P,150A,65KA/480V,FXFXTMTU				
	PDG23M0200TFFL			PDG2,3P,200A,65KA/480V,FXFXTMTU				
	PDG23M0225TFFL			PDG2,3P,225A,65KA/480V,FXFXTMTU				
	PDG23M0250TFFL			PDG2,3P,250A,65KA/480V,FXFXTMTU				
SPD3K0400 (NEMA 1) OR FPD3K0400 (NEMA 1 FLUSH) OR RPD3K0400 (NEMA 3R)	ECB400NK	PD3 (400A)	400A	2P/3P	High	PDD33G0400TFAJ	PDD3,3P,400A,65KA/240V,FXADJ TMTU	
						PDG33M0250TFAJ	PDG3,3P,250A,65KA/480V,FXADJ TMTU	
						PDG33M0300TFAJ	PDG3,3P,300A,65KA/480V,FXADJ TMTU	
						PDG33M0400TFAJ	PDG3,3P,400A,65KA/480V,FXADJ TMTU	
						PDG33M0500TFAJ	PDG3,3P,500A,65KA/480V,FXADJ TMTU	
						PDG33M0600TFAJ	PDG3,3P,600A,65KA/480V,FXADJ TMTU	
		PDG3	630A	3P	High	PDG33G0250TFAJ	PDG3,3P,250A,35KA/480V,FXADJ TMTU	
						PDG33G0300TFAJ	PDG3,3P,300A,35KA/480V,FXADJ TMTU	
						PDG33G0400TFAJ	PDG3,3P,400A,35KA/480V,FXADJ TMTU	
						PDG33G0500TFAJ	PDG3,3P,500A,35KA/480V,FXADJ TMTU	
						PDG33G0600TFAJ	PDG3,3P,600A,35KA/480V,FXADJ TMTU	
						PDG33G0600TFAJ	PDG3,3P,600A,35KA/480V,FXADJ TMTU	
SPD4K0800 (NEMA 1) OR RPD4K0800 (NEMA 3R)	DS800NK	PDG4	800A	3P	Standard	PDG43K0800TFAJ	PDG4,3P,800A,50KA/480V,FXADJ TMTU	

EATON SWITCHGEAR



**VIEW EW
PRICING**

Shop Eaton Power Defense Breakers, Enclosures, & Kits
View pricing and product updates.



**VIEW HZ
PRICING**

Shop Eaton Power Defense Breakers, Enclosures, & Kits
View pricing and product updates.

Service Entrance Barrier Kits	Lug Kit Information	Lugs*	
		Part Number	Qty
PRLSEBPD2	PDG2X3T100**	T100FB	1
	PDG2X3TA225**	TA225FD	1
	PDG2X3TA225**	TA225FD	1
	PDG2X3TA225**	TA225FD	1
	PDG2X3T100**	T100FB	1
	PDG2X3TA225**	TA225FD	1
	PDG2X3TA225**	TA225FD	1
	PDG2X3TA225**	TA225FD	1
	PDG2X1T100**	T100FB	1
	PDG2X1T100**	T100FB	1
	PDG2X1T100**	T100FB	1
	PDG2X1T100**	T100FB	1
	PDG2X2T100**	T100FB	1
	PDG2X2T100**	T100FB	1
	PDG2X2T100**	T100FB	1
	PDG2X3T100**	T100FB	1
	PDG2X3T100**	T100FB	1
	PDG2X3T100**	T100FB	1
	PDG2X3T100**	T100FB	1
	PDG2X3T100**	T100FB	1
	PDG2X3T100**	T100FB	1
	PDG2X3T100**	T100FB	1
	PDG2X3T100**	T100FB	1
	PDG2X3T100**	T100FB	1
	PDG2X3T100**	T100FB	1
	PDG2X3T100**	T100FB	1
	PDG2X3T100**	T100FB	1
	PDG2X3T100**	T100FB	1
	PDG2X3T100**	T100FB	1
	PDG2X3T100**	T100FB	1
	PDG2X3T100**	T100FB	1
PDG2X3T100**	T100FB	1	
PDG2X3TA225**	TA225FD	1	
PDG2X3TA225**	TA225FD	1	
PDG2X3TA225**	TA225FD	1	
PDG2X3TA225**	TA225FD	1	
PRLSEBPD3	PDG3X3TA400***	TA400K	1
	PDG3X3TA350***	TA350K	1
	PDG3X3TA350***	TA350K	1
	PDG3X3TA350***	TA350K	1
	PDG3X3TA400***	TA400K	1
	PDG3X3TA630***	TA632LK	1
	PDG3X3TA630***	TA632LK	1
	PDG3X3TA350***	TA350K	1
	PDG3X3TA350***	TA350K	1
	PDG3X3TA400***	TA400K	1
	PDG3X3TA630***	TA632LK	1
	PDG3X3TA630***	TA632LK	1
PDG4X3TA800***	TA800MA2	1	

*Refer to lug chart above for wire sizes. **Load lugs only. ***Line and load lugs included.

Lug Chart

Lug Kit Part Number	Number of Lugs in Each Kit	Part Number of Lugs in Kit	Wire Size
PDG2X3T100	3	T100FB	(1) 14-1/0
PDG2X3TA225	3	TA225FD	(1) 4-4/0 Al
PDG3X3TA400	3	TA400K	(2) 3/0-250MCM Al
PDG3X3TA350	3	TA350K	(1) 250MCM-500MCM
PDG3X3TA630	3	TA632LK	(2) 2-500MCM
PDG4X3TA800	3	TA800MA2	(3) 3/0-400MCM



EATON SWITCHGEAR

(General Duty) Safety Switches

— NEMA 1 (Indoor)

Nema 1 (Indoor) Fusible & Non-Fusible | With or Without Neutral | 30-400 Amp | 240 VAC (*Neutral Kit Not Included.)

General Duty Safety Switches - Fusible with Neutral

NEMA 1 (Indoor) Fusible

Amp	Fusible	With Neutral	Part Number
Two-Pole			
30	•	•	DG221NGB
60	•	•	DG222NGB
100	•	•	DG223NGB
Three-Pole			
30	•	•	DG321NGB
60	•	•	DG322NGB
100	•	•	DG323NGB
200	•	•	DG324NGK
400	•	•	DG325NGK

General Duty Safety Switches - Non Fusible without Neutral

NEMA 1 (Indoor) Non-Fusible

Amp	Fusible	With Neutral	Part Number
Two-Pole			
30			DG221UGB*
60			DG222UGB*
100			DG223UGB*
Three-Pole			
30			DG321UGB*
60			DG322UGB*
100			DG323UGB*
200			DG324UGK*
400			DG325UGK*



VIEW EW PRICING

Shop Eaton (General Duty) Switches
View pricing and product updates.



VIEW HZ PRICING

Shop Eaton (General Duty) Switches
View pricing and product updates.

NEMA 3R (Outdoor)

Nema 3R (Outdoor) Fusible & Non-Fusible | With or Without Neutral | 30-400 Amp | 240 VAC (*Neutral Kit Not Included.)

General Duty Safety Switches - Fusible with Neutral

NEMA 3R (Outdoor) Fusible

Amp	Fusible	With Neutral	Part Number
Two-Pole			
30	•	•	DG221NGB
60	•	•	DG222NGB
100	•	•	DG223NGB
Three-Pole			
30	•	•	DG321NGB
60	•	•	DG322NGB
100	•	•	DG323NGB
200	•	•	DG324NGK
400	•	•	DG325NGK

Safety Switch Neutral Kits

Amp	Part Number	Description
General Duty		
30	DG030NB	30A DG
60-100	DG100NB	60-100A DG
Heavy Duty		
30-60	DH030NK	30-60A DH
100	DH100NK	100A DH
General & Heavy Duty		
200	DG200NK	200A DG, DH (NEMA 1, 3R ENCLOSURES)
400	DS400NK	400A DG, DH
600	DS600NK	600A DG, DH

General Duty Safety Switches - Non Fusible without Neutral

NEMA 3R (Outdoor) Non-Fusible

Amp	Fusible	With Neutral	Part Number
Two-Pole			
30			DG221URB*
60			DG222URB*
100			DG223URB*
Three-Pole			
30			DG321URB*
60			DG322URB*
100			DG323URB*
200			DG324URK*
400			DG325URK*
Double Throw General Duty (Two-Pole)			
100		•	DT223URH-N w/ Neutral



(Heavy Duty) Safety Switches

NEMA 1 (Indoor)

Nema 1 (Indoor) Fusible & Non-Fusible | 30-400 Amp | With or Without Neutral | 240 & 600VAC (*Neutral Kit Not Included.)

Heavy Duty Safety Switches - Fusible with Neutral

NEMA 1 (Indoor) Fusible

Amp	Voltage	Fusible	With Neutral	Part Number
Two-Pole				
30	240	•	•	DH221NGK
30	600	•	•	DH261NGK
60	240	•	•	DH222NGK
60	600	•	•	DH262NGK
100	240	•	•	DG223NGB
100	600	•	•	DH263NGK
Three-Pole				
30	240	•	•	DH321NGK
30	600	•	•	DH361NGK
60	240	•	•	DH322NGK
60	600	•	•	DH362NGK
100	240	•	•	DH323NGK
100	600	•	•	DH363NGK
200	240	•	•	DH324NGK
200	600	•	•	DH364NGK
400	240	•	•	DH325NGK
400	600	•	•	DH365NGK

Heavy Duty Safety Switches - Non Fusible without Neutral

NEMA 1 (Indoor) Non-Fusible

Amp	Voltage	Fusible	With Neutral	Part Number
Two-Pole				
30	600			DH261UGK*
60	600			DH262UGK*
100	600			DH263UGK*
Three-Pole				
30	600			DH361UGK*
60	600			DH362UGK*
100	600			DH363UGK*
200	600			DH364UGK*
400	600			DH365UGK*

Heavy Duty Switch Accessories

Auxiliary Contact Kits for HD Switches

Type	Part Number
1 -NO 1- NC	DS200EK1
2 -NO 2- NC	DS200EK2



VIEW EW PRICING

Shop Eaton (Heavy Duty) Switches
View pricing and product updates.



VIEW HZ PRICING

Shop Eaton (Heavy Duty) Switches
View pricing and product updates.

NEMA 3R (Outdoor)

Nema 3R (Outdoor) Fusible & Non-Fusible | 30-400 Amp | With or Without Neutral | 240 & 600 VAC (*Neutral Kit Not Included.)

Heavy Duty Safety Switches - Fusible with Neutral

NEMA 3R (Outdoor) Fusible

Amp	Voltage	Fusible	With Neutral	Part Number
Two-Pole				
30	600	•	•	DH261NRK
60	600	•	•	DH262NRK
100	600	•	•	DH263NRK
Three-Pole				
30	600	•	•	DH361NRK
60	600	•	•	DH362NRK
100	600	•	•	DH363NRK
200	600	•	•	DH364NRK
400	600	•	•	DH365NRK

Safety Switch Neutral Kits

Amp	Part Number	Description
General Duty		
30	DG030NB	30A DG
60-100	DG100NB	60-100A DG
Heavy Duty		
30-60	DH030NK	30-60A DH
100	DH100NK	100A DH
General & Heavy Duty		
200	DG200NK	200A DG, DH (NEMA 1, 3R ENCLOSURES)
400	DS400NK	400A DG, DH
600	DS600NK	600A DG, DH

Heavy Duty Safety Switches - Non Fusible without Neutral

NEMA 3R (Outdoor) Non-Fusible

Amp	Voltage	Fusible	With Neutral	Part Number
Two-Pole				
30	600			DH261URK*
60	600			DH262URK*
100	600			DH263URK*
Three-Pole				
30	600			DH361URK*
60	600			DH362URK*
100	600			DH363URK*
200	600			DH364URK*
400	600			DH365URK*

Double Throw Heavy Duty (Two-Pole)

200	240	DT224URK*
-----	-----	-----------



Enclosure Accessories

— Aluminum Hubs

Aluminum Hubs

For 3R Safety Switches Enclosures (Raintight)

Nominal Conduit Diameter	Part Number
1 1/4"	DS125H1
1 1/2"	DS150H1
2"	DS200H1



 **VIEW EW PRICING**

Shop Eaton Enclosure Accessories & Fuses
View pricing and product updates.

Fuses

250V & 600V

Fuses			
Amp	250V Fuse	600V Fuse	Part Number
30	250V		BUSS FRN-R-30
30		600V	BUSS FRS-R-30
60	250V		BUSS FRN-R-60
60		600V	BUSS FRS-R-60
100	250V		BUSS FRN-R-100
100		600V	BUSS FRS-R-100
200	250V		BUSS FRN-R-200
200		600V	BUSS FRS-R-200
400	250V		BUSS FRN-R-400
400		600V	BUSS FRS-R-400

EATON SWITCHGEAR



VIEW HZ PRICING

Shop Eaton Enclosure Accessories & Fuses
View pricing and product updates.

Dry Type Transformers

Transformers, Lug Kits & Weather Shields

Aluminum or Copper Windings | 150° Temp Rise | DOE 16 Compliant

EATON SWITCHGEAR

Three-Phase Transformers

kVA Rating	Transformer Part Number	Three-Phase	Material	Voltage Rating	Temp Rise	Lug Kit
15	V48M28T1516	•	Alum Windings	480-208Y/120	150 °C	LKS1
30	V48M28T3016	•	Alum Windings	480-208Y/120	150 °C	LKS1
45	V48M28T4516	•	Alum Windings	480-208Y/120	150 °C	LKS1
75	V48M22T7516	•	Alum Windings	480-240V/120	150 °C	LKS2
75	V48M28T7516	•	Alum Windings	480-208Y/120	150 °C	LKS2
75	V48M28T7516CU	•	Copper Windings	480-208Y/120	150 °C	LKS2
112.5	V48M28T1216	•	Alum Windings	480-208Y/120	150 °C	LKS2
150	V48M28T4916	•	Alum Windings	480-208Y/120	150 °C	LKS3

Weather Shield Accessories

kVA Rating	Part Number
15	WS57
30	WS58
45	WS58
75	WS59
112.5	WS60
150	WS60



VIEW EW PRICING

Shop Eaton Transformers
View pricing and product updates.



VIEW HZ PRICING

Shop Eaton Transformers
View pricing and product updates.

Rated Line Voltage Charts

Single-Phase

Rated Line Amperes for kVA and Voltages of Single-Phase Dry-Type Distribution Transformers

kVA Rating	Rated Line Voltage								
	120	208	240	277	480	600	2400	4160	4800
1.0	8.3	4.8	4.2	3.6	2.1	1.7	.4	.2	.2
1.5	12.5	7.2	6.3	5.4	3.1	2.5	.6	.4	.3
2.0	16.7	9.6	8.3	7.2	4.2	3.3	.8	.5	.4
3.0	25.0	14.4	12.5	10.8	6.3	5.0	1.3	.7	.6
5.0	41.7	24.0	20.8	18.0	10.4	8.3	2.1	1.2	1.0
7.5	62.5	36.6	31.3	27.1	15.6	12.5	3.1	1.8	1.6
10.0	83.3	48.1	41.7	36.1	20.8	16.7	4.2	2.4	2.1
15.0	125.0	72.1	62.5	54.2	31.3	25.0	6.3	3.6	3.1
25.0	208.3	120.2	104.2	90.3	52.1	41.7	10.4	6.0	5.2
37.5	312.5	180.3	156.3	135.4	78.1	62.5	15.6	9.0	7.8
50.0	416.7	240.4	208.3	180.5	104.2	83.3	20.8	12.0	10.4
75.0	625.0	360.6	312.5	270.8	156.3	125.0	31.3	18.0	15.6
100.0	833.3	480.8	416.7	361.0	208.3	166.7	41.7	24.0	20.8
167.0	1391.7	802.9	695.8	602.9	347.9	278.3	69.6	40.1	34.8
250.0	2083.3	1201.9	1041.7	902.5	520.8	416.7	104.2	60.1	52.1
333.0	2775.0	1601.0	1387.5	1202.2	693.8	555.0	138.8	80.0	69.4
500.0	4166.7	2403.8	2083.3	1805.1	1041.7	833.3	208.3	120.2	104.2

$$\text{Line Current} = \frac{\text{kVA} \times 1000}{\text{Line Voltage}}$$

Three-Phase

Rated Line Amperes for kVA and Voltages of Three-Phase Dry-Type Distribution Transformers

kVA Rating	Rated Line Voltage						
	208	240	480	600	2400	4160	4800
3.0	8.3	7.2	3.6	2.9	.7	.4	.4
6.0	16.7	14.4	7.2	5.8	1.4	.8	.7
9.0	25.0	21.6	10.8	8.7	2.2	1.3	1.1
15.0	41.6	36.1	18.0	14.4	3.6	2.1	1.8
30.0	83.3	72.2	36.1	28.9	7.2	4.2	3.6
45.0	125.0	108.4	54.2	43.3	10.9	6.3	5.4
75.0	208.2	180.4	90.2	72.2	18.0	10.4	9.0
112.5	312.5	271.6	135.3	108.2	27.1	15.6	13.5
150.0	416.3	360.8	180.4	144.3	36.1	20.8	18.0
225.0	625.0	541.9	270.7	216.5	54.2	31.3	27.1
300.0	832.7	721.7	360.8	288.7	72.2	41.6	36.1
500.0	1387.8	1202.8	601.4	481.1	120.3	69.4	60.1
750.0	2081.9	1804.3	902.1	721.7	180.4	104.1	90.2
1000.0	2775.8	2405.7	1202.9	962.3	240.6	138.8	120.3

$$\text{Three-Phase Line Current} = \frac{\text{kVA} \times 1000}{\text{Line Voltage} \times 1.732}$$

Residential Surge Protectors

Home Surge Protection

EATON SWITCHGEAR

Residential Surge Protectors

Part Number	Description
BRPSURGE	Plug on surge arrestor for Eaton BRP loadcenters
CHSPT2ULTRA	Whole house surge protection
CLNSURGE	Plug in surge arrestor. Classified series. UL rated for Siemens, Murray, Thomas & Betts, Square D, Crouse-Hinds, and General Electric

A complete masterpiece
Eaton's plug-on neutral portfolio

QUICK **EASY** **CLEAN**

EATON
Powering Business Worldwide

SEE FOR YOURSELF ▶



VIEW EW PRICING

Shop Surge Protectors
View pricing and product updates.



VIEW HZ PRICING

Shop Surge Protectors
View pricing and product updates.

Single-Phase Load Centers

Plug-On Neutral Load Centers

Single-Phase Load Centers

Amp	Number of Circuits	Part Number	White Cover
Main Lug Only			
125	12	BRP12L125	
125	12	BRP12L125G	
125	16	BRP16L125	
125	20	BRP20L125	
150	20	BRP20L150	
200	20	BRP20L200	
125	24	BRP24L125	
125	24	BRP24L125G	
125	30	BRP30L125	BRPX5A30L1FW
200	30	BRP30L200	BRPX5A30L2FW
200	30	BRP30L200G	BRPX5A30L2FW
200	40	BRP40L200	
200	40	BRP40L200G	
Main Circuit Breaker			
100	12	BRP12B100	
100	16	BRP16B100	
100	20	BRP20B100	
100	20	BRP20B100V25	
200	20	BRP20B200	
100	30	BRP30B100	
150	30	BRP30B150	
200	30	BRP30B200	BRPX6A30B2FW
200	40	BRP40B200	BRPX8A40B2FW
200	60	BRP60B200	



EATON SWITCHGEAR

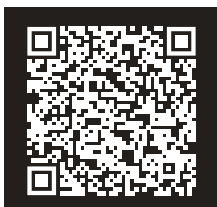

**VIEW EW
PRICING**

Shop Loadcenters & Accessories
View pricing and product updates.



**VIEW HZ
PRICING**

Shop Loadcenters & Accessories
View pricing and product updates.

Plug-On Neutral Accessories

Ground Bar Kits | Generator Interlocks & Hardware

Ground Bar Kits for Plug-On Neutral Load Centers

Circuits	Terminals	Part Number
Used with Type BR & CH Series Load Centers		
5	5	GBKP5
10	10	GBKP10
14	14	GBKP14
21	21	GBKP21
21	21	GBKP2120 + (1) 2/0 LUG



Generator Interlocks Kits & Hardware

Amps	Part Number
For Type BR Series Load Centers	
Up to 125A	BRPMIKBR
Hold Down Screw Kit for Generator Interlock BRPMIKBR	
--	BRPHDGENBR
For Type BR Series Load Centers with Type CSR Main Breaker	
150-200A	BRPMIKCSR
Hold Down Screw Kit for Generator Interlock BRPMIKCSR	
--	BRPHDGENCSR



Three-Phase Load Centers

— NEMA 1 | NEMA 3R & Accessories

Three-Phase Load Centers & Accessories			
Amp	Number of Circuits	Main Lug or Breaker	Part Number
NEMA 1 (Indoor)			
225	42	Lug	3BR4242L225
200	42	Breaker	3BR4242B200
2400	42	Breaker	3BR4242B400S
NEMA 3R (Outdoor)			
225	42	Lug	3BR4242L225R
200	42	Breaker	3BR4242B200R
200	30/42	Breaker or Lug	3BR3042L200R

Ground Bar Kits for Three-Phase Load Centers

Circuits	Terminals	Part Number
21	21	GBK2120 + (1) 2/0 LUG



EATON SWITCHGEAR



VIEW EW PRICING

Shop Eaton Loadcenters, Accessories & Breakers
View pricing and product updates.



VIEW HZ PRICING

Shop Eaton Loadcenters, Accessories & Breakers
View pricing and product updates.

(Type BR) Circuit Breakers

— Type BR | Arc Fault | GFI | Combo Breakers

*Circuit Breakers for Load Centers (Type BR)

10 KAIC

Amp	One-Pole	Voltage	Part Number	Two-Pole	Voltage	Part Number	Three-Pole	Voltage	Part Number
15	•	120/240	BR115	•	120/240	BR215	•	240	BR315
20	•	120/240	BR120	•	120/240	BR220	•	240	BR320
30	•	120/240	BR130	•	120/240	BR230	•	240	BR330
40				•	120/240	BR240	•	240	BR340
50				•	120/240	BR250	•	240	BR350
60				•	120/240	BR260	•	240	BR360
70				•	120/240	BR270	•	240	BR370
80				•	120/240	BR280	•	240	BR380
90				•	120/240	BR290	•	240	BR390
100				•	120/240	BR2100	•	240	BR3100
125				•	120/240	BR2125			

*Additional Breakers Available. Ask Your Sales Rep to Learn More.

*Arc Fault & Dual Function Circuit Breakers (Type BR)

Arc Fault

Amp	One-Pole	Two-Pole	Plug-On	Voltage	Part Number
15	•		•	120	BRN115AF
15	•		•	120	BRP115AF
20	•		•	120	BRN120AF
Two-Pole Combination Arc Fault					
15		•		120/240	BRL215CAF
20		•		120/240	BRL220CAF
Dual Function - Arc Fault & Ground Fault					
15	•		•	120/240	BRN115DF
15	•		•	120/240	BRN120DF
20	•		•	120/240	BRP115DF
20	•		•	120/240	BRP120DF

*Ground Fault Circuit Breakers (Type BR)

Plug-in Ground Fault

Amp	One-Pole	Two-Pole	Plug-On	Voltage	Part Number
15	•		•	120/240	BRN115GF
15	•		•	120/240	BRP115GF
20	•		•	120/240	BRN120GF
20	•		•	120/240	BRP120GF
Ground Fault Circuit Interruptor					
15		•		120/240	GFTCB215
20		•		120/240	GFTCB220
30		•		120/240	GFTCB230
40		•		120/240	GFTCB240
50		•		120/240	GFTCB250

Retrofit Interior Kits

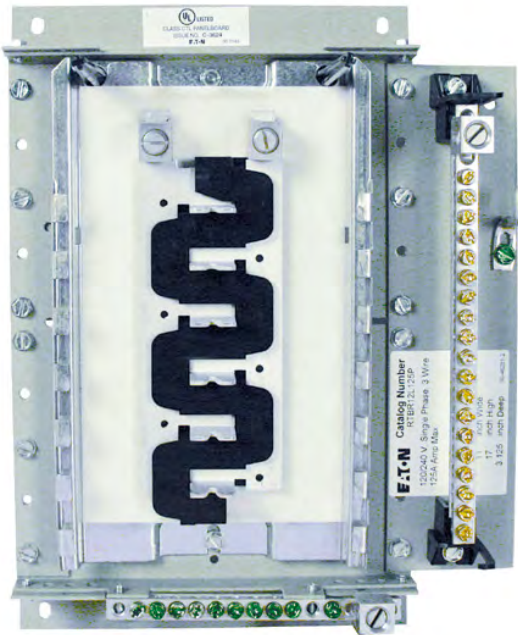

Uses existing panel box and wires

Eaton's unique Retrofit Interior allows the customer to cost-effectively and safely upgrade an electrical service without removing the existing enclosure from the wall.

The Retrofit Interior is designed and tested specifically for renovating an outdated electrical panel in an apartment, condominium, or a single family home. These outdated panels are being recognized by local inspectors and other authorities as a possible hazard.

Features:

- Saves 2-3 hours compared to a complete panel change out; get off the job faster.
- Eliminates expensive and time consuming drywall repair.
- Replaces vintage brands that have hard to find, expensive replacement breakers.
- Safely upgrade to arc fault and ground fault breakers to meet current electrical code requirements.
- Eco-friendly in asbestos-filled environments.
- Meets 2008 NEC wire bending requirements.

Opportunities to Retrofit:

- Single or three phase.
- Main lug only or main breaker.
- Up to 42 circuits.
- Up to 400 Ampere.
- Available with CH Breakers (3/4") with copper bus or BR Breakers (1") with aluminum bus.
- The minimum warranty for residential loadcenters and breakers shall be as follows:
 - Limited lifetime warranty on all CH branch breakers and loadcenters.
 - 10-year warranty on all BR branch breakers and loadcenters.
- Refer to Eaton for complete warranty details.

Complete Assembly*

Adjustable Interior

- Factory Installed ground and neutral bars positioned to accept existing wires.
- Field adjustable depth matches existing panel box.
- Adjustable height enables optional placement of the interior.
- Field bondable for service entrance options.

Standard Trim and Collar

- Standard trim matches new interior.
- New circuit directory for updated labeling.
- Oversized collar eliminates



Adjustable Interior



Collar & Assembly with Trim



**DOWNLOAD
THE RETROFIT
LOADCENTER
INTERIOR FORM**

Download the EATON retrofit loadcenter interior form! Fill in and send to your Sales Rep for easy ordering.



Retrofit Loadcenter Interior Form



Powering Business Worldwide

Existing Loadcenter Dimensions

_____ " Height x _____ " Width x _____ " Depth

Panel Type

- | | | |
|--|---|-----------------------------|
| <input type="checkbox"/> Main Lugs Only | <input type="checkbox"/> Main Breaker | Amperage _____ |
| <input type="checkbox"/> Single Phase
120/240 VAC | <input type="checkbox"/> Three Phase
120/208 VAC | Number of
Circuits _____ |
| <input type="checkbox"/> Top Feed | <input type="checkbox"/> Bottom Feed | |

Incoming Wire Size _____

Cover Requirements

- Flush Mount
- Surface Mount
- Door Lock Required

Additional Features

- Dual Feed Lugs
- Feed Through Lugs

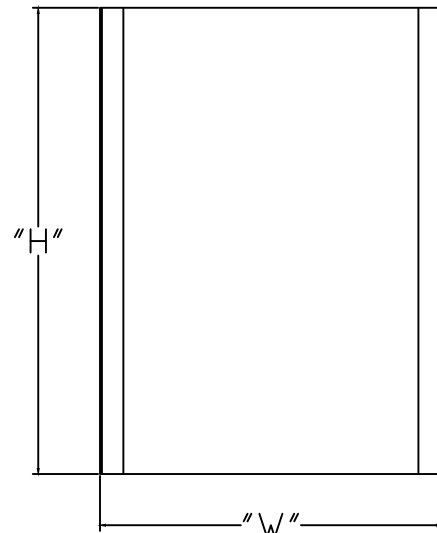

EATON SWITCHGEAR

PROVIDE THE FILLED IN FORM TO YOUR SALES REP FOR A QUOTE ON A RETROFIT LOADCENTER TODAY!

4

3

2

1

Loadcenter Dimensions



Powering Business Worldwide

_____ " Height x _____ " Width x _____ " Depth

Panel Type

<input type="checkbox"/> Main Lugs Only	<input type="checkbox"/> Main Breaker	Amperage _____
<input type="checkbox"/> Single Phase 120/240 VAC	<input type="checkbox"/> Three Phase 120/208 VAC	Number of Circuits _____
<input type="checkbox"/> Top Feed	<input type="checkbox"/> Bottom Feed	

Incoming Wire Size _____

RC "Gutter" Width _____

Cover Requirements

- Flush Mount
- Surface Mount
- Gutter on Left
- Gutter on Right
- Door Lock Required

Additional Features

- Dual Feed Lugs
- Feed Through Lugs

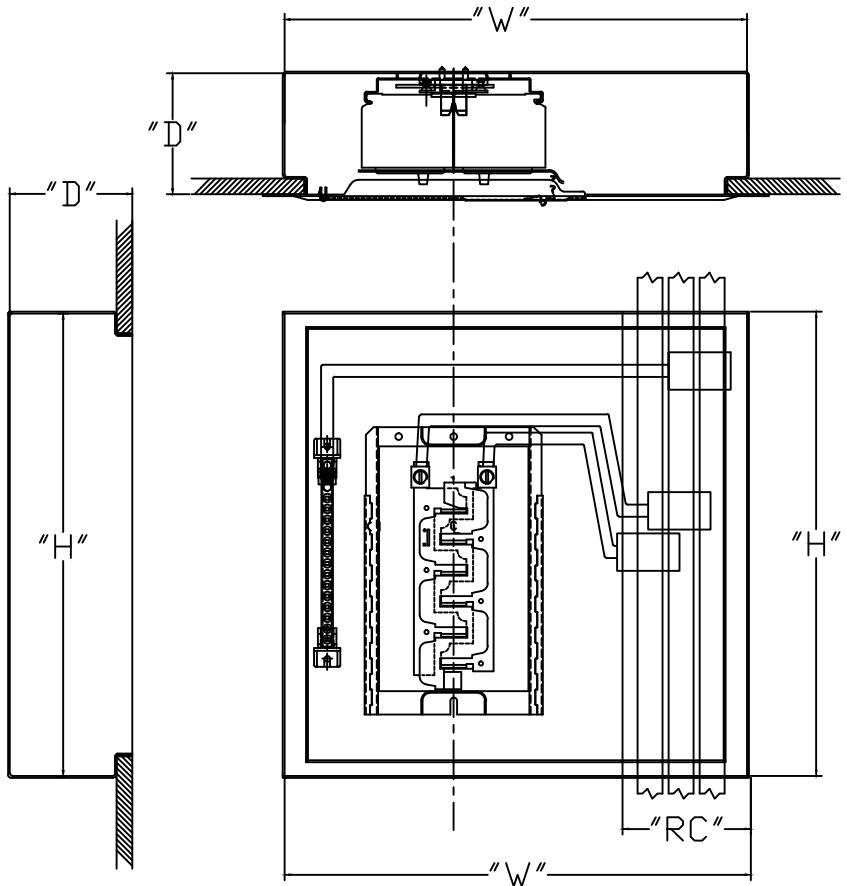

D

C

B

EATON SWITCHGEAR



VIEW THE RETROFIT LOADCENTER INTERIOR FORM

Download the EATON retrofit loadcenter interior form! Fill in and send to your Sales Rep for easy ordering.

Residential Meter Stacks

Main Devices & Residential Meter Stacks

STEP 1

Select Your Main Device

Main Fusible Switch, Main Breaker, or Main Tap Box

If tenant feeder breakers are single phase out, 125A or less, 65kaic or less go to Step 2A. Otherwise, go to Step 2B on page 66.



STEP 2A

Select Your Residential Meter Stack

Single-Phase & Barrier Kit



Main Breaker & Main Tap Boxes (For Commercial & Residential Meter Stacks)

Amp	Main Breaker	Main Terminal	KAIC	Voltage	Part Number
Single-Phase (Three-Wire)					
400	•		65	120/240V	1PMB400R
Three-Phase (Four-Wire)					
400	•		65	120/208V	3PMB400R
800	•		65	120/208V	3PMB800R
1200	•		65	120/280V	3PMB1200R* (*with Arms)
400		•		120/208V	3MTB400R
600		•		120/208V	3MTB600R
800		•		120/208V	3MTB800R

Residential Meter Stacks (125A Sockets)

For Residential Meter Stacks Only

Single-Phase (Includes Bypass)

Amp	Gange Type	Dimensions	Voltage	Part Number
225	2-Gang	15" W x 44" D x 9" H	120/208V	3MM212RRLV
225	3-Gang	15" W x 44" D x 9" H	120/208V	3MM312RRLV
225	4-Gang	15" W x 54" D x 9" H	120/208V	3MM412RRLV
Barrier Kit for Residential Stacks				
-	-	-	-	3MMBK

Tenant Feeder Circuit Breakers

(*For other KAIC rated tenant feeder breakers, please contact your Sales Rep.)

STEP 3A

Select your Tenant Feeder Circuit Breakers for Residential Meter Stacks

*Circuit Breakers for Residential Meter Stacks

Amp	KAIC	Voltage	Part Number
Two-Pole - Used with 3MM Stacks			
60	10	120/240V	BR260
100	10	120/240V	BR2100
110	10	120/240V	BR2110
125	10	120/240V	BR2125
60	22	120/240V	BRH260
100	22	120/240V	BRH2100
110	22	120/240V	BRH2110
125	22	120/240V	BRH2125

EATON SWITCHGEAR



VIEW EW PRICING

Shop Eaton Meter Stacks
View pricing and product updates.



VIEW HZ PRICING

Shop Eaton Meter Stacks
View pricing and product updates.

Commercial Meter Stacks

Main Devices & Commercial Meter Stacks

STEP 2B

Select Your Commercial Meter Stack

Single-Phase, Three-Phase,
& Barrier Kit

If tenant feeder breakers are single phase out, 400A or less, and 100 kaic or less select a Commercial Meter Stack (35MM)

If tenant feeder breakers are three phase out, 400A or less, and 100 kaic or less select a Commercial Meter Stack (37MM)

Commercial Meter Stacks (225A Sockets)

For Commercial & Residential Meter Stacks

Single-Phase (Includes Bypass)

Amp	Gange Type	Dimensions	Voltage	Part Number
225	1-Gang	8.75" W x 18.25" D x 10.5" H	120/240V	35MM120R12
225	2-Gang	8.75" W x 18.25" D x 11" H	120/240V	35MM220R12
225	3-Gang	8.75" W x 18.25" D x 52.63" H	120/240V	35MM320R12
225	4-Gang	8.75" W x 68.25" D x 10.5" H	120/240V	35MM420R12
400	1-Gang	18.3" W x 10.93" D x 52.62" H	120/240V	35MM140R1240**

Three-Phase (Includes Bypass)

225	1-Gang	18.25" W x 8.75" D x 25.38" H	208Y/120V	37MM120R12
225	2-Gang	18.25" W x 8.75" D x 52.63" H	208Y/120V	37MM220R12
225	3-Gang	18.25" W x 8.75" D x 52.63" H	208Y/120V	37MM320R12
225	4-Gang	18.25" W x 8.75" D x 66.63" H	208Y/120V	37MM420R12
400	1-Gang	18.25" W x 8.75" D x 52.63" H	208Y/120V	37MM140R1240**
400	1-Gang	18.25" W x 8.75" D x 25.38" H	208Y/120V	37MM140R12***

Barrier Kit for Commercial Stacks

37MMBK

400A breaker included. *400A rated socket, 1 gang socket that can hold up to (2) 225A breakers.



Tenant Feeder Circuit Breakers

(*For other KAIC rated tenant feeder breakers, please contact your Sales Rep.)

STEP 3B

Select your Tenant Feeder Breakers for Commercial Meter Stacks

Commercial Circuit Breakers



*Circuit Breakers for Commercial Meter Stacks

Amp	KAIC	Voltage	Part Number
Two-Pole - Used with 35MM Stacks			
100	10	120/240V	CCV2100X
125	10	120/240V	CCV2125X
150	10	120/240V	CCV2150X
100	10	120/240V	CCV2200X
100	25	120/240V	CCVH2100X
125	25	120/240V	CCVH2125X
150	25	120/240V	CCVH2150X
200	25	120/240V	CCVH2200X
Three-Pole - Used with 37MM Stacks			
100	10	120/208Y	CC3100X
125	10	240V	CC3125X
150	10	240V	CC3150X
200	10	240V	CC3200X
100	42	240V	CVS3100X
125	42	240V	CVS3125X
150	42	240V	CVS3150X
200	42	240V	CVS3200X



VIEW EW PRICING

Shop Eaton Meter Stacks
View pricing and product updates.



VIEW HZ PRICING

Shop Eaton Meter Stacks
View pricing and product updates.

NOW IN STOCK!

CHECK OUT EATON'S WBM



**WALL MOUNTED
COMBINATION CT
MAIN BREAKER/
FUSIBLE SWITCH**

with optional distribution
branch breakers

- Eversource Approved
- 600A-1200A
- Single Phase or Three Phase
- Main Breaker or Main Fusible Switch
- Wall Mounted

**NOW
IN
STOCK!**

EATON

Powering Business Worldwide

**CONTACT YOUR SALES
REP TO PLACE AN ORDER!**

Eaton WBM's

Wall Mounted Main Breaker + CT Cabinet

WBM (Main Breaker C/T Cabinet) 120/208V

NEMA 1 (Indoor)

Part Number	Amp	Voltage	Feed	Incoming Lug Size	Outgoing Lug Size	Box Height
WBM-600A-N1-120/208	600A	208Y/120V 3Ph 4W	BOTTOM	(2) #2-500 kcmil (Cu/Al)	(2) #4-500 kcmil (Cu/Al)	73.5 x 36
WBM-800A-N1-120/208	800A	208Y/120V 3Ph 4W	BOTTOM	(2) 500-750 kcmil (Cu/Al)	(3) #2-500 kcmil (Cu/Al)	73.5 x 36
WBM-1200A-N1-120/208	1200A	208Y/120V 3Ph 4W	BOTTOM	(3) 500-750 kcmil (Cu/Al)	(4) #2-500 kcmil (Cu/Al)	90 x 44

NEMA 3R (Outdoor)

WBM-600A-N3R-120/208	600A	208Y/120V 3Ph 4W	BOTTOM	(2) #2-500 kcmil (Cu/Al)	(2) #4-500 kcmil (Cu/Al)	73.5 x 36
WBM-800AN3R-120/208	800A	208Y/120V 3Ph 4W	BOTTOM	(2) 500-750 kcmil (Cu/Al)	(3) #2-500 kcmil (Cu/Al)	73.5 x 36
WBM-1200A-N3R-120/208	1200A	208Y/120V 3Ph 4W	BOTTOM	(4) 4/0-500 kcmil (Cu/Al)	(4) #2-500 kcmil (Cu/Al)	73.5 x 36

WBM (Main Breaker C/T P/T Cabinet) 480/277V

NEMA 1 (Indoor)

Part Number	Amp	Voltage	Feed	Incoming Lug Size	Outgoing Lug Size	Box Height
WBM-600A-N1-480/277	600A	480Y/277V 3Ph 4W	BOTTOM	(2) #2-500 kcmil (Cu/Al)	(2) #4-500 kcmil (Cu/Al)	73.5 x 36
WBM-800A-N1-480/277	800A	480Y/277V 3Ph 4W	BOTTOM	(2) 500-750 kcmil (Cu/Al)	(3) #2-500 kcmil (Cu/Al)	73.5 x 36
WBM-1200A-N1-480/277	1200A	480Y/277V 3Ph 4W	BOTTOM	(3) 500-750 kcmil (Cu/Al)	(4) #2-500 kcmil (Cu/Al)	90 x 44

NEMA 3R (Outdoor)

WBM-600A-N3R-480/277	600A	480Y/277V 3Ph 4W	BOTTOM	(2) #2-500 kcmil (Cu/Al)	(2) #4-500 kcmil (Cu/Al)	73.5 x 36
WBM-800A-N3R480/277	800A	480Y/277V 3Ph 4W	BOTTOM	(2) 500-750 kcmil (Cu/Al)	(3) #2-500 kcmil (Cu/Al)	73.5 x 36
WBM-1200A-N3R-480/277	1200A	480Y/277V 3Ph 4W	BOTTOM	(4) 4/0-500 kcmil (Cu/Al)	(4) #2-500 kcmil (Cu/Al)	73.5 x 36



**VIEW EW
PRICING**

Shop Eaton WBM's
View pricing and product updates.

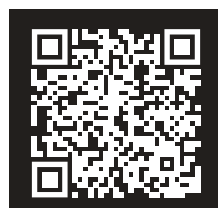

**VIEW HZ
PRICING**

Shop Eaton WBM's
View pricing and product updates.

Motor Controls

Definite Purpose Contactors and Lighting Contactors

Motor Controls			
Definite Purpose Contactor (Open Style) with 120V Coil			
Amp Rating	Two-Pole	Three-Pole	Part Number
25		•	C25DND325A
30	•		C25DND230A
30		•	C25DND330A
40	•		C25DNF240A
40		•	C25DNF340A
50		•	C25DNJ350A
Enclosures for Definite Purpose Contactors			
15-50	•	•	C799B18
60	•	•	C899B2001

Lighting Contactors	
Electrically Held, 30A, 120V Coil, Nema 1	
Part Number	Number of Poles
ECC03C1A2A	2
ECC03C1A4A	4
ECC03C1A6A	6



VIEW EW PRICING

Shop Eaton Motor Controls
View pricing and product updates.



VIEW HZ PRICING

Shop Eaton Motor Controls
View pricing and product updates.

Enclosed Starters

Enclosed Starters with Solid State Overloads

Replacement coils, cover controls, and auxiliary contacts can be found on the next page. (*Solid State Overloads. Heaters are not needed.)

Enclosed Starters with Solid State Overloads					
Non-Combination Non-Reversing Starter					
NEMA Size	Motor Voltage	Max HP*	Magnet Coil Voltage	Full Load Current	Part Number
0	460	*See HP Rating Chart Below	120	1-5	ECN0501AAA-R63/B
0	200		208	1-5	ECN0501EAA-R63/B
0	230		240	1-5	ECN0501BAA-R63/B
0	460		480	1-5	ECN0501CAA-R63/B
0	460		120	4-20	ECN0501AAA-R63/C
0	200		208	4-20	ECN0501EAA-R63/C
0	230		240	4-20	ECN0501BAA-R63/C
0	460		480	4-20	ECN0501CAA-R63/C
1	460		120	4-20	ECN0511AAA-R63/C
1	200		208	4-20	ECN0511EAA-R63/C
1	230		240	4-20	ECN0511BAA-R63/C
1	460		480	4-20	ECN0511CAA-R63/C
1	460		120	9-45	ECN0511AAA-R63/D
1	200		208	9-45	ECN0511EAA-R63/D
1	230		240	9-45	ECN0511BAA-R63/D
1	460		480	9-45	ECN0511CAA-R63/D
1	460		120	9-45	ECN0521AAA-R63/D
1	200		208	9-45	ECN0521EAA-R63/D
1	230		240	9-45	ECN0521BAA-R63/D
1	460		480	9-45	ECN0521CAA-R63/D

*Horsepower Rating by Motor Voltage						
MOTOR VOLTAGE:	Single phase			Three phase		
	115V	230V	200V	230V	460V	575V
NEMA Size Starter	Max Horsepower rating by Motor Voltage					
00	0.33	1	1.5	1.5	2	2
0	1	2	3	3	5	5
1	2	3	7.5	7.5	10	10
2	3	7.5	10	15	25	25

Contactors & Starter Accessories

Motor Control Coils | Auxiliary Contacts Start/Stop & HOA Kits

Replacement coils, cover controls, and auxiliary contacts.

Motor Control Coils

Coil Voltage	Size	Part Number
Motor Control Renewal Parts		
240V 60 HZ or 220V 50 HZ	0	9-2876-2
480V 60 HZ or 440V 50 Hz	0	9-2876-3
208V 60 Hz	0	9-2876-5
24V 60 Hz - 24V 50 Hz	0	9-2876-36
Motor Control Renewal Parts Coil & Contactor Kits		
240V 60 HZ or 220V 50 HZ	1 and 2	9-3285-2
480V 60 HZ or 440V 50 Hz	1 and 2	9-2703-3
208V 60 Hz	1 and 2	9-3285-9
24V	1 and 2	9-3285-6

Auxiliary Contacts (Side Mounted)

Freedom NEMA Auxiliary Contact	
Contacts	Part Number
1NO	C320KGS1
1NC	C320KGS2
1NO-1NC	C320KGS3
2NO	C320KGS4
2NC	C320KGS5

Start/Stop & HOA Kits

Voltage	Part Number	Description
Start/Start Kits		
-	C600M1	START/STOP OVAL
85-264VAC	C600M101A	START/STOP OVAL-RED RUN
HOA Kits		
-	C600M12	HOA SS ONLY
85-264VAC	C600M121A	HOA SS-RED RUN
85-264VAC	C600M9A	RED RUN LIGHT ONLY



VIEW EW PRICING

Shop Eaton Starters & Pushbutton Packs
View pricing and product updates.



VIEW HZ PRICING

Shop Eaton Starters & Pushbutton Packs
View pricing and product updates.

Pushbutton Packs & Accessories

Pushbutton Clam Shell Packs | Accessories | Enclosures

Pushbutton Clam Shell Packs & Accessories

Part Number	Operating Mode / Positions	Description	NEMA Rating	Actuator
Black Heavy-Duty Selector Switch				
10250T20KB-POP	2 POSITION	"OFF/ON", "HAND/AUTO", "RUN/ JOG", 1NO/1NC	NEMA 3, NEMA 3R, NEMA 4, NEMA 4X, NEMA 12, NEMA 13	BLACK KNOB
10250T22KB-POP	3 POSITION	"HAND/OFF/AUTO", 1NO	NEMA 3, NEMA 3R, NEMA 4, NEMA 4X, NEMA 12, NEMA 13	BLACK PLASTIC
10250T30B-POP	MOMENTARY	FLUSH, "START", "JOG"	NEMA 4, NEMA 4X, NEMA 3, NEMA 13, NEMA 3R, NEMA 12	BLACK PLASTIC
Red Heavy-Duty Pushbuttons				
10250T31R-POP	MOMENTARY	EXTENDED, "STOP", 1NO/1NC	NEMA 12, NEMA 4X, NEMA 4, NEMA 13, NEMA 3, NEMA 3R	RED PLASTIC
10250T32R-POP	MOMENTARY	MUSHROOM, "EMERGENCY STOP", "STOP", 1NO/1NC	NEMA 12, NEMA 3R, NEMA 13, NEMA 4X, NEMA 4, NEMA 3	RED PLASTIC
10250T33-POP	MOMENTARY	JUMBO MUSHROOM, "EMERGENCY STOP" ENGRAVED	NEMA 12, NEMA 3R, NEMA 13, NEMA 4X, NEMA 4, NEMA 3	RED PLASTIC
10250T34R-POP	LIGHT UNIT	"RUN", "JOG", 120VAC	NEMA 3, NEMA 3R, NEMA 3S, NEMA 4, NEMA 4X, NEMA 12, NEMA 13	RED PLASTIC
10250T411C21-1-POP	LIGHT UNIT	"POWER ON", 120VAC, 1NO/1NC	NEMA 3, NEMA 13, NEMA 3R, NEMA 4X, NEMA 4, NEMA 12	RED PLASTIC
10250T5B62-1-POP	2 POSITION	MAINTAINED, 1NO/1NC	NEMA 3, NEMA 3R, NEMA 4, NEMA 4X, NEMA 12, NEMA 13	RED PLASTIC

EATON SWITCHGEAR

Pushbutton Enclosures (Case & Cover)

Die Cast Enclosures		
Number of Elements	One Contact Part Number	Two Contact Part Number
1	10250TN1	10250TN11
2	10250TN2	10250TN12
3	10250TN3	10250TN13
Polyester Enclosures		
1	--	E34N51
2	--	E34N52
3	--	E34N53
4	--	E34N54



Residential EV Chargers

Green Motion EV Smart Breaker Charger Kits & Pedestal

EATON SWITCHGEAR

Residential EV Chargers						
Green Motion EV Smart Breaker Charger Kits & Pedestal						
Part Number	Voltage	Amp	Number of Poles	Breaker Type	Breaker Amp Rating	Description
GMEV32BR-DC	208/240	32A	2P	BR plug-on	40A	EV DIRECT CONNECT KIT
GMEV32BR-JB	208/240	32A	2P	BR plug-on	40A	EV JUNCTION BOX KIT
GMEV32BR-WC	208/240	32A	2P	BR	40A	EV WALL CHARGER KIT – hard wired and wall mount. Use with a pedestal.
GMEV32BR-WCPL	208/240	32A	2P	BR	40A	EV WALL CHARGER KIT – Plug in, comes with Nema 14-50.
GMEV-DPED	EV DUAL PORT PEDESTAL – Pedestal that they can put two on.					



Smart charging starts
with smart breakers.

EATON SWITCHGEAR



 **VIEW EW
PRICING**

Shop Eaton EV Chargers
View pricing and product updates.



 **VIEW HZ
PRICING**

Shop Eaton EV Chargers
View pricing and product updates.

Ampacity Rating

AMPERAGE						
COPPER				ALUMINUM		
SIZE (AWG OR kcmil)	TW, UF-B, NM-B (60°C)	RHH, THW, THWN, XHHW, SE (75°C)	RHH, THHN, THWN-2, XHHW-2, RHW-2, USE-2 (90°C)	(60°C)	THW, RHH, THWN, XHHW, SE (75°C)	THHN, THWN-2, XHHW-2, RHW-2, USE-2 (90°C)
14	15	15	15	–	–	–
12	20	20	20	–	–	–
10	30	30	30	–	–	–
8	40	50	55	35	40	45
6	55	65	75	40	50	55
4	70	85	95	55	65	75
3	85	100	110	65	75	85
2	95	115	130	75	90	100
1	110	130	145	85	100	115
1/0	125	150	170	100	120	135
2/0	145	175	195	115	135	150
3/0	165	200	225	130	155	175
4/0	195	230	260	150	180	205
250	215	255	290	170	205	230
300	240	285	320	195	230	260
350	260	310	350	210	250	280
400	280	335	380	225	270	305
500	320	380	430	260	310	350
600	350	420	475	285	340	385
–	385	460	520	315	375	425
750	400	475	535	320	385	435
–	410	490	555	330	395	445
–	435	520	585	355	425	480
1000	455	545	615	375	445	500

Note: Ampacities for insulated wires or cables rated 0-2000 volts and not more than three current carrying conductors in raceway or cable or earth. Based on 30°C (86°F) ambient. Ampacity is based upon the National Electrical Code.

Voltage Drop

RECOMMENDED CIRCUIT LENGTHS FOR VOLTAGE DROP*

	WIRE SIZE (AWG)	RATING OF CIRCUIT BREAKER OR FUSE IN AMPERES									
		15	20	30	40	50	60	70	80	90	100
	14	40									
C	12	65	50								
O	10	105	80	55							
P	8	160	120	80	60	50*					
P	6	260	195	130	100	80	60*				
E	4	420	305	205	155	120	100	85	70*		
R	2	665	500	330	250	200	165	140	125	110	95*
A	6	155	115	80	60	50					
L	4	245	185	125	95	75	60				
U	2	295	295	200	150	120	100	85	75	65	

*For single conductors (THHN/THWN(-2), XHHW-2, etc.) only. This amperage not allowed for types NM-B and UF-B cable.

Recommended maximum circuit lengths in feet for voltage system of 120 volts. For 240-volt systems, circuit lengths may be doubled. Note: Extremely long circuits can produce voltage losses whereby some electrical equipment may not operate properly. Following these recommended values should provide reasonable efficiency of operation.

AMPERAGE ALLOWANCE FOR 3-WIRE SINGLE PHASE DWELLING SERVICES

SERVICE RATING (AMPS)	COPPER SIZE (AWG) OR KCMIL	ALUMINUM SIZE (AWG) OR KCMIL
100	4	2
125	2	1/0
150	1	2/0
200	2/0	4/0
225	3/0	250
250	4/0	300
300	250	350
350	350	500
400	400	600



Powering Business Worldwide

Dimming & Controls

All Electrical Wholesalers and HZ Electric Supply branches fully stock the following dimming, controls, sensors, and home automation products.



Dimming | Controls | Home Automation

- | | |
|--------------|--|
| 78-79 | Intro to Dimming & Controls |
| 80-81 | Standard Dimming Controls - Preset Multi-location Fan Controls |
| 82-83 | Lighting Controls & Sensors - Occupancy Sensors & Power Packs |
| 84-85 | Lutron System Controls - Dimming & Switch Controls Sensors Remotes Wireless Hub |
| 86-91 | Smart Home Automation - Dimming Switches Wireless Controls Media Bridge & Adaptors |



PRICING IS NOT LISTED IN THIS EDITION OF THE CATALOG.

Please check with your Sales Rep or sign into your account on our website for the most up-to-date pricing and product inventory levels.

Introducing RadioRA3

Lutron raises the bar once again. 10 years in the making, RadioRA 3 is a new, game-changing system that promises to transform the way your residential clients look at connected lighting control.



WHAT'S NEW **Simply Beautiful**

RadioRA 3 brings the contemporary **light bar design** to a full range of connected residential products — dimmers with capacitive touch technology, switches and keypads. The enhanced functionality and new aesthetic of RA3 make it easier for your clients to say “yes” to adding lighting control to their home projects.



Standard Dimming Controls

Dimmers | Switches | Fan Controls

Standard Dimming & Controls

Mfr	Part Number	Series	Product Description	Voltage Rating	UL Listed
Toggle & Switch Preset Dimmers					
LUTRON	AYCL-153P-WH	ARIADNI	1-POLE 3-WAY PRESET DIMMER TOGGLE	120	•
LUTRON	AYLV-600P-WH	ARIADNI	1-POLE MAGNETIC LOW VOLTAGE PRESET DIMMER TOGGLE	120	•
LUTRON	DVCL-153P-WH	DIVA	1-POLE 3-WAY DIMMER SWITCH	120	•
LUTRON	MACL-153M-WH	MAESTRO	1-POLE MULTI-LOCATION DIMMER SWITCH	120	•
LUTRON	MA-R-WH	MAESTRO	1-POLE 3-WAY MULTI-LOCATION COMPANION DIMMER	120	•
LUTRON	STCL-153M-WH	SUNNATA	1-POLE 3-WAY TOUCH DIMMER W/ LED+ ADVANCED TECHNOLOGY	120	•
LUTRON	ST-AS-WH	SUNNATA	3-WAY MULTI-LOCATION LED+ SUNNATA COMPANION ACCESSORY SWITCH	120	•
LUTRON	ST-PRO-N-WH	SUNNATA	1-POLE MULTI-LOCATION LED+ DIMMER SWITCH	120	•
LUTRON	ST-RD-SW	SUNNATA	COMPANION DIMMER SWITCH FOR SUNNATA PRO	120	•
LUTRON	ST-6ANS-WH	SUNNATA	1-POLE MULTI-LOCATION SWITCH W/ INDICATION LIGHT	120	•
LUTRON	ST-RS-WH	SUNNATA	SUNNATA COMPANION ROCKER SWITCH W/ INDICATOR LIGHT FROR ST-6ANS	120	•
Toggle & Switch Preset Dimmers - Low Voltage					
LUTRON	DVLV-600P-WH	DIVA	1-POLE MAGNETIC LOW VOLTAGE PRESET DIMMER	120	•
LUTRON	DVELV-300P-WH	DIVA	1-POLE ELECTRONIC LOW VOLTAGE PRESET DIMMER	120	•
LUTRON	MA-PRO-WH	MAESTRO	1-POLE 3-WAY MAGNETIC & ELECTRONIC LOW VOLTAGE UNIVERSAL DIMMER	120	•
Switch & Silde Dimmers					
LUTRON	SCL-153P-WH	SKYLARK	1-POLE 3-WAY PRESET DIMMER	120	•
LEVITON	DSL06-1LZ	DECORA	1-POLE or 3-WAY DECORA SLIDE DIMMER 600W	120	•
LEVITON	DDMX1-BLZ	DECORA	1-POLE or 3-WAY DECORA DIGITAL BLUETOOTH 24HR TIMER DIMMER 450-1000W	120	•
Switch & Silde Dimmers - Low Voltage					
LUTRON	SLV-600P-WH	SKYLARK	1-POLE MAGNETIC LOW VOLTAGE PRESET DIMMER	120	•
0-10 Volt Control Dimmers					
LUTRON	DVSTV-WH	DIVA	1-POLE 3-WAY LED+ 0-10V PADDLE SWITCH DIMMER	120/277	•
LEVITON	DS710-10Z	DECORA	1-POLE or 3-WAY ELECTRO-MECHANICAL 0-10V DECORA SLIDE DIMMER	120/277	•
LEVITON	IP710-LFZ	DECORA	1-POLE 3-WAY ELECTRO-MECHANICAL SLIDE DIMMER	120/277	•
Preset Fan-Speed Controls					
LUTRON	DVFSQ-F-WH	DIVA	1-POLE 3-WAY 3-SPEED FAN CONTROL SWITCH	120	•
LUTRON	MACL-LFQ-WH	MAESTRO	1-POLE 3-SPEED FAN/LIGHT CONTROL DIMMER SWITCH	120	•



Work Smarter,
Not Harder

Installs
- up to -
**70%
Faster**
Than Wired
Systems



With Vive, you can do more with less.

Contact Yusen For More Information * lutron@yusen.com * 781.935.8500



YUSEN sales and marketing for
the electrical industry



DIMMING & CONTROLS



LUTRON ARIADNI



LUTRON SUNNATA



LUTRON DIVA



LUTRON MAESTRO



LUTRON SKYLARK



LEVITON DECORA SMART



LEVITON DECORA ILLUMATECH



VIEW EW PRICING

Shop Dimming & Controls
View pricing and product updates.



VIEW HZ PRICING

Shop Dimming & Controls
View pricing and product updates.

Lighting Controls & Sensors

Leviton Sensors & Power Packs

Leviton Occupancy Sensors & Power Packs

Mfr	Part Number	Series	Product Description	Voltage	Coverage Sq.Ft.
Wall Mount					
LEVITON	ODS10-IDW	DECORA	AUTO ON/ AUTO OFF OCC SENSOR	120/277	2100
LEVITON	ODS15-IDW	DECORA	SMART PIR WALLBOX SWITCH SENSOR	120/277	2100
LEVITON	OSSMT-GDW	DECORA	MULTI-TECH WALL BOX OCC SENSOR	120/277	2400
LEVITON	ODD10-IDW	DECORA	SMART PIR 0-10V DIMMING WALLBOX SENSOR	120/277	1100
Ceiling Mount					
LEVITON	ODC05-I1W	ODC05	8'-10' CEILING MT OCC SENSOR	120-220-277	530
LEVITON	OSC10-M0W	OSC10	SWITCHABLE CEILING MT OCC SENSOR	24VDC	1000
LEVITON	OSC20-M0W	OSC20	MULTI-TECH CEILING MT OCC SENSOR	24VDC	2000
LEVITON	OSC04-I0W	OSC03	SELF-ADJ CEILING MT OCC SENSOR	24VDC	450
Fixture Mount					
LEVITON	OSFHU-ITW	OSFHU	ADJ HIGH BAY FIXTURE MT OCC SENSOR	120-347	8'-40'
Power Packs					
LEVITON	OPP20-D1	OPP20	20A POWER PACK FOR OCC SENSORS	120-220-277	--
LEVITON	OPP20-D2	OPP20	20A POWER PACK FOR OCC SENSORS	120-220-277	--



LEVITON
DECORA
SERIES



LEVITON ODC
& OSC SERIES



LEVITON OSFHU
& OPP SERIES



LITHONIA RLSXR, RSBOR &
RPP SERIES



LITHONIA CM &
CMR SERIES



LITHONIA WSXA &
SPODMRA SERIES



**VIEW EW
PRICING**

Shop Controls & Sensors
View pricing and product updates.



**VIEW HZ
PRICING**

Shop Controls & Sensors
View pricing and product updates.

Acuity Sensor Switch

Occupancy Sensors & Power Packs

Mfr	Part Number	Series	Product Description	Voltage	Programmable	Battery Powered	DLC Listed
Ceiling Mount Occupancy Sensors							
ACUITY	LITH CM9	CM	LOW VOLTAGE CEILING MT OCC SENSOR / PIR	120/277	•		
ACUITY	LITH CM-PDT-9	CM	LINE VOLTAGE CEILING MT OCC SENSOR PIR / MICROPHONICS	120/277	•		
ACUITY	LITH CMR-9	CMR	LINE VOLTAGE CEILING MT OCC SENSOR / PIR	120/277	•		
ACUITY	LITH CMR-PDT-9	CMR	LINE VOLTAGE CEILING MT OCC SENSOR PIR / MICROPHONICS	120/277	•		
ACUITY	LITH RCMSB-7-G2	RCMSB	NLIGHT AIR WIRELESS BATTERY OPERATED OCC / PHOTO SENSOR	--	•	•	•
Wall Switch Occupancy Sensors							
ACUITY	LITH WSX-WH	WSX	WALL SWITCH OCC SENSOR / PIR	120/277	•		
ACUITY	LITH WSX-PDT-WH	WSX	WALL SWITCH OCC SENSOR PIR / MICROPHONICS	120/277	•		
ACUITY	LITH RPODB-DX-WH-G2	RPODB	NLIGHT AIR WIRELESS WALL SWITCH DIMMABLE	--	•	•	•
Outdoor Pole / Fixture Mount Occupancy Sensors							
ACUITY	LITH RSBOR-10-WH-G2	RSBOR	NLIGHT AIR NLIGHT BOX MOUNT OUTDOOR / LARGE MOTION / EXTENDED RANGE 360° LENS	120/277	•		
ACUITY	LITH RLSXR-10-WH-G2	RLSXR	NLIGHT AIR FIXTURE MOUNT SENSOR / LARGE MOTION / EXTENDED RANGE 360° LENS / WH	120/277	•		•
Power Packs							
ACUITY	LITH PP-20	PP	POWER PACK WITH 20A RELAY WITH SWITCH	120/277	--		
ACUITY	LITH RPP20-D-G2	RPP20	NLIGHT AIR WIRELESS POWER RELAY PACK / DIMMABLE	120/277	•		•
ACUITY	LITH WSXA WH	WSXA	WALL SENSOR SWITCH	120/277	•		
ACUITY	LITH WSXA PDT WH	WSXA	WALL SENSOR SWITCH WITH PASSIVE DUAL	120/277	•		
SensorSwitch JOT Enabled Wall Switch							
ACUITY	LITH SPODMRA JOT DX WH	SPODMRA	Aesthetic Dimming Switch-Pod,Just One Touch,Raise/Lower Dimming,White	120/277	•		•

Lutron System Controls

Controls | Sensors | Remotes | Hubs

DIMMING & CONTROLS

Lutron System Controls						
Mfr	Part Number	Series	Product Description	Voltage	Dimmable	Battery Powered
Wall Dimming & Switch Controls						
LUTRON	MRF2S-6CL-WH	MAESTRO	CFL/LED WIRELESS DIMMER	120	•	
LUTRON	MRF2S-8ANS120-WH	MAESTRO	MULTI-LOCATION WIRELESS RF SWITCH	120	•	
PowPak Modules						
LUTRON	RMJS-16R-DV-B	VIVE	POWPAK RF RELAY MODULE	120/277		
LUTRON	RMJS-8T-DV-B	VIVE	POWPAK RF DIMMING MODULE 0-10V	120/277	•	
LUTRON	RMJS-PNE-DV	VIVE	POWPAK PHASE SELECT DIMMING MODULE	120-277	•	
Occupancy Sensors						
LUTRON	LRF2-OCR2B-P-WH	RADIO POWR SAVR	WIRELESS CEILING MOUNT 360° OCC/ VACANCY SENSOR	--	--	•
Remotes, Wallplates & Adaptors						
LUTRON	PJ2-2B-GWH-L01	PICO	2-BUTTON WIRELESS ON/OFF SWITCH REMOTE	3	•	•
LUTRON	PJ2-2BRL-GWH-L01	PICO	2-BUTTON WIRELESS RAISE/LOWER REMOTE	3	•	•
LUTRON	PJ2-3BRL-GWH-L01	PICO	3-BUTTON WIRELESS RAISE/LOWER REMOTE	3	•	•
LUTRON	CW-1-WH	CLARO	SCREWLESS WALLPLATE 1-GANG	--	--	--
LUTRON	PICO-WBX-ADAPT	PICO	WALLPLATE MOUNTING BRACKET	--	--	--
Wireless Hub						
LUTRON	HJS-0-FM	VIVE	WIRELESS HUB FOR POWPACK, DIMMING, SWITCHING MODULES	120/277	--	--



VIEW EW PRICING

Shop Lutron System Controls
View pricing and product updates.



VIEW HZ PRICING

Shop Lutron System Controls
View pricing and product updates.

Create a Vive System

Step 1

Choose dimming and/or switching controls.



Vive Integral Fixture Control with Daylight/Occ Sensing.

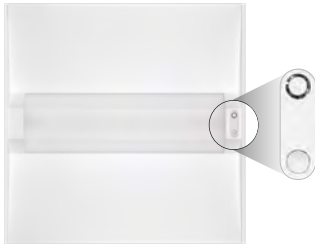

Load Type	Wall Controls		Ceiling Controls	
	120V	277V		
Switching Bulb (Any load type)	120V	MRF2S-8S-DV-XX	RMJS-16R-DV-B	
	277V			
Dimmable Bulb (LED, MLV, INC, HAL)	120V	MRF2S-6CL-XX	MRF2S-6CL-GR	
	277V	(Contact Lutron)	(Contact Lutron)	
ELV	120V	MRF2S-6ELV-XX	MRF2S-6ELV-GR	
	277V	(Contact Lutron)	(Contact Lutron)	
Switching LED Fixture	120V	MRF2S-8SS-XX	RMJS-16R-DV-B	
	277V	MRF2S-8S-DV-XX		
Dimmable 0-10V LED Fixture	120V	MRF2S-8DS010-XX	RMJS-8T-DV-B	
	277V			
Vive Enabled Fixture				

*UL 924 rated emergency wireless controls available, contact your local rep for details

DIMMING & CONTROLS

Step 2

Choose a Radio Powr Savr occupancy/vacancy sensor.

Wireless ceiling mount, 360°
Coverage varies by ceiling height

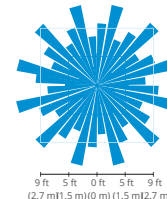

Ceiling mount (LRF2-OCR2B-P-WH)

Step 3

Choose Pico wireless remotes for personal control.



On/Off (PJ2-2B-GXX-L01)



Dimming (PJ2-3BRL-GXX-L01)



Wallplate (CW-1-XX)



Wallplate adapter (PICO-WBX-ADPT)

Step 4

Add intelligence (optional).



Vive Wireless Hub (HJS-0-FM)

Smart Home Automation

Lutron Smart Home Automation

Lutron Smart Home Automation

Mfr	Part Number	Series	Product Description	Wattage Rating	Bridge/Hub Required
Dimmers					
LUTRON	PD-6WCL-WH	CASÉTA	1-POLE WIRELESS CFL/LED DIMMER	150W	•
LUTRON	PD-10NXD-WH	CASÉTA	1-POLE 3-WAY WIRELESS CFL/LED DIMMER	1000W	•
LUTRON	P-PKG1W-WH	CASÉTA	WIRELESS DIMMER 3-WAY SWITCH & REMOTE KIT	150W	•
LUTRON	P-DIM-3WAY-WH	CASÉTA	3 WAY DIMMING KIT W/PICO & ADAPTOR	150W	•
Dimmer Switches					
LUTRON	DVRF-6L-WH	CASÉTA	DIVA SMART DIMMER SWITCH, WHITE	150W	•
LUTRON	DVRF-5NS-WH	CASÉTA	CLARO SMART SWITCH, WHITE	5A LED 3A FAN	•
LUTRON	DVRF-BDG-1D	CASÉTA	DIVA SMART DIMMER SWITCH START KIT	150W	•
Switches & Plugs					
LUTRON	PD-5WS-DV-WH	CASÉTA	1-POLE 3-WAY WIRELESS MULTI-LOCATION SWITCH	600W	•
LUTRON	PD-6ANS-WH	CASÉTA	WIRELESS WALL SWITCH W/ NEUTRAL WIRES	600W	•
LUTRON	P-PKG1WS-WH	CASÉTA	WIRELESS 3-WAY SWITCH & REMOTE KIT	600W	•
LUTRON	PD-15OUT-BL	CASÉTA	WIRELESS OUTDOOR SMART PLUG	15A	
Wireless Remote Controls					
LUTRON	PJ2-2B-GWH-L01	PICO	TWO BUTTON WIRELESS REMOTE CONTROL	--	
LUTRON	PJ2-3BRL-WH-L01R	PICO	THREE BUTTON WIRELESS REMOTE CONTROL WITH RAISE/LOWER FUNCTION	--	•
Fan Speed Control					
LUTRON	PD-FSQN-WH	CASÉTA	FAN SPEED CONTROL	--	•
Occupancy Sensors					
LUTRON	PD-OSENS-WH	CASÉTA	MOTION SENSOR - OCCUPANCY/VACANCY	--	•
Media Bridge & Adaptors					
LUTRON	PICO-WBX-ADAPT	PICO	WIRELESS WALLPLATE BRACKET ADAPTOR	--	--
LUTRON	L-BDGPRO2-WH	CASÉTA	SMART BRIDGE PRO	--	--
LUTRON	P-BDG-PKG1W	CASÉTA	WIRELESS DIMMER KIT WITH SMART BRIDGE	150-600W	•
LUTRON	LUT-MLC	CASÉTA	LOAD ADAPTOR FOR CASÉTA - WIRELESS IN-WALL SWITCH	--	--



VIEW EW PRICING

Shop Lutron Smart Home
View pricing and product updates.



VIEW HZ PRICING

Shop Lutron Smart Home
View pricing and product updates.



LUTRON CASÉTA
REMOTE KIT



LUTRON CASÉTA
SWITCH & REMOTE KIT



LUTRON CASÉTA
DIMMER SWITCH &
REMOTE KIT



LUTRON CASÉTA
REMOTE KIT & PICO
3-BUTTON REMOTE



LUTRON CASÉTA
MOTION SENSOR



LUTRON CASÉTA
DIMMER KIT WITH
SMART BRIDGE

DIMMING & CONTROLS

Caséta by LUTRON

Now Offering Choice in Aesthetic



DIVA
#1 Style in Dimmers
Win with the PRO

+

ORIGINAL SMART



CASÉTA
Leader in Smart Lighting
Proven wireless technology

=

DIVASMART CLARO SMART



New Aesthetic

Contact Yusen Today For All Of Your Smart Home Needs * lutron@yusen.com * 781.935.8500

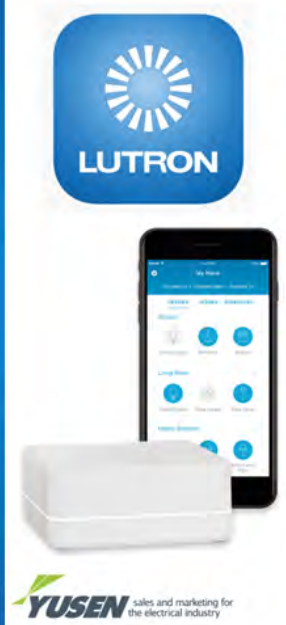

Smart Home Automation

Leviton Smart Home Automation

Leviton Smart Home Automation					
Mfr	Part Number	Series	Product Description	Wattage Rating	Decora Smart/ Digital Device Required
Dimmers					
LEVITON	D26HD-1BW	DECORA SMART	WIFI GEN 2 UNIVERSAL DIMMER LED/INCANDESCENT	600W	
LEVITON	DWVAA-1BW	DECORA SMART	VOICE WIFI DIMMER WITH AMAZON ALEXA BUILT-IN	300W	
LEVITON	D2MSD-1BW	DECORA SMART	WI-FI GEN 2 MOTION SENSING DIMMER	300/450W	
Switches & Plug-ins					
LEVITON	D215S-1BW	DECORA SMART	WI-FI GEN 2 15A SWITCH LED/INCANDESCENT	--	
LEVITON	D23LP-1BW	DECORA SMART	WIFI GEN 2 MINI PLUG-IN DIMMER LED/INCANDESCENT	100/300W	
LEVITON	D215P-1BW	DECORA SMART	WIFI GEN 2 MINI PLUG-IN SWITCH	--	
LEVITON	D2SCS-1BW	DECORA SMART	WIFI GEN 2 FOUR BUTTON CONTROLLER	--	
Wireless Remote Controls					
LEVITON	DD00R-DLZ	DECORA SMART	WIFI DIMMER COMPANION 120/277V	--	•
LEVITON	DD0SR-DLZ	DECORA SMART	WIFI SWITCH COMPANION 120/277V	--	•
LEVITON	DAWDC-1BW	DECORA SMART	ANYWHERE DIMMER COMPANION - PAIRS WITH WIFI GEN 2 - BATTERY OPERATED	--	•
LEVITON	DAWSC-1BW	DECORA SMART	ANYWHERE SWITCH COMPANION - PAIRS WITH WIFI GEN 2 - BATTERY OPERATED	--	•
Fan Speed Control					
LEVITON	D24SF-1BW	DECORA SMART	WIFI GEN 2 FAN SPEED CONTROLLER	--	
Receptacles					
LEVITON	D215R-1BW	DECORA SMART	WIFI GEN 2 15A TAMPER RESISTANT RECEPTACLE	--	

DIMMING & CONTROLS



**VIEW EW
PRICING**

Shop Leviton Smart Home
View pricing and product updates.



**VIEW HZ
PRICING**

Shop Leviton Smart Home
View pricing and product updates.

Make Every Home a Smart Home



DIMMING & CONTROLS



works with
my leviton

Offer your customers a full portfolio of Wi-Fi® connected lighting and load control devices with Decora Smart®. Our award-winning collection features dimmers, switches, smart plugs, fan controllers, outlets, and motion sensing, including new options for homes that may not have neutral wiring.

So go ahead, make any home – new or old – a **Smart home!**



Scan QR code to see the full line
of **Decora Smart Products.**

THE FUTURE IS ON®

LEVITON®

Smart Home Automation

Leviton Color Change Kits

DIMMING & CONTROLS

Leviton Smart Home Automation			
Mfr	Part Number	Color	Product Description
Switch Kits			
LEVITON	DDKIT-SW	WHITE	SWITCH COLOR CHANGE KIT
LEVITON	DDKIT-SI	IVORY	SWITCH COLOR CHANGE KIT
LEVITON	DDKIT-ST	LIGHT ALMOND	SWITCH COLOR CHANGE KIT
LEVITON	DDKIT-SE	BLACK	SWITCH COLOR CHANGE KIT
LEVITON	DDKIT-SG	GRAY	SWITCH COLOR CHANGE KIT
LEVITON	DDKIT-SB	BROWN	SWITCH COLOR CHANGE KIT
Dimmer/Fan Kits			
LEVITON	DDKIT-W	WHITE	DIMMER/FAN COLOR CHANGE KIT
LEVITON	DDKIT-I	IVORY	DIMMER/FAN COLOR CHANGE KIT
LEVITON	DDKIT-T	LIGHT ALMOND	DIMMER/FAN COLOR CHANGE KIT
LEVITON	DDKIT-E	BLACK	DIMMER/FAN COLOR CHANGE KIT
LEVITON	DDKIT-G	GRAY	DIMMER/FAN COLOR CHANGE KIT
LEVITON	DDKIT-B	BROWN	DIMMER/FAN COLOR CHANGE KIT
Receptacle Kits			
LEVITON	DSRKT-1PW	WHITE	RECEPTACLE COLOR CHANGE KIT
LEVITON	DSRKT-1PI	IVORY	RECEPTACLE COLOR CHANGE KIT
LEVITON	DSRKT-1PT	LIGHT ALMOND	RECEPTACLE COLOR CHANGE KIT
LEVITON	DSRKT-1PE	BLACK	RECEPTACLE COLOR CHANGE KIT
LEVITON	DSRKT-1PG	GRAY	RECEPTACLE COLOR CHANGE KIT
LEVITON	DSRKT-1PB	BROWN	RECEPTACLE COLOR CHANGE KIT
Button Kits			
LEVITON	DS4KT-1PW	WHITE	FOUR BUTTON COLOR CHANGE KIT
LEVITON	DS4KT-1PI	IVORY	FOUR BUTTON COLOR CHANGE KIT
LEVITON	DS4KT-1PT	LIGHT ALMOND	FOUR BUTTON COLOR CHANGE KIT
LEVITON	DS4KT-1PE	BLACK	FOUR BUTTON COLOR CHANGE KIT
LEVITON	DS4KT-1PG	GRAY	FOUR BUTTON COLOR CHANGE KIT
LEVITON	DS4KT-1PB	BROWN	FOUR BUTTON COLOR CHANGE KIT



**VIEW EW
PRICING**

Shop Leviton Smart Home
View pricing and product updates.



**VIEW HZ
PRICING**

Shop Leviton Smart Home
View pricing and product updates.



*LEVITON DECORA
SMART DIMMER*



*LEVITON DECORA
SMART DIMMER SWITCH*



*LEVITON DECORA
SMART PLUG-IN SWITCH*



*LEVITON DECORA
SMART WIFI DIMMER
COMPANION*



*LEVITON DECORA
SMART WIFI DIMMER
SWITCH*



*LEVITON DECORA
SMART ANYWHERE
DIMMER & SWITCH
COMPANION*



*LEVITON DECORA
SMART WIFI FAN
CONTROLLER*



*LEVITON DECORA
SMART WIFI
RECEPTACLE*



*LEVITON SMART
HOME COLOR
CHANGE KITS*

DIMMING & CONTROLS

Energy Solutions & Interior Lighting

All Electrical Wholesalers and HZ Electric Supply branches fully stock the following LED interior lighting fixtures.



LED Interior Lighting Fixtures

- 92-97** Intro to Lighting | Energy Solutions | EV Charging | Eversource Energy Excellence Award
- 98-99** Ductless Mini-Splits | Haier Single Zone Systems
- 100-101** IES Footcandle Recommendations
- 102-107** Retrofit & Recessed Downlights | Housing & Trim | Wafer & Gimbal Downlights
- 108-109** LED Strips | Wrap-Arounds | Flush Mounts | Stairwells
- 110-111** LED Linear High Bays
- 112-113** LED Recessed Troffers & Baskets
- 114-115** LED Flat Panels | Surface Mount Kits | Fixture Hanging Accessories



PRICING IS NOT LISTED IN THIS EDITION OF THE CATALOG.

Please check with your Sales Rep or sign into your account on our website for the most up-to-date pricing and product inventory levels.



INTERIOR LIGHTING



Contractor Select™

The right products, readily available, from the brands you can trust.



CS

CONTRACTOR
SELECT™

Everyday Lighting Done Right™

To view the full program portfolio of products and more information, please visit ContractorSelect.com

Energy Solutions

Our Energy Solutions team can help you drastically improve your facility while reducing your energy consumption and saving you money. They offer a variety of services to improve your existing lighting and controls; thus offering savings solutions for you or your customers' full facilities.

WHAT WE OFFER



COMPLETE ENERGY AUDIT

A complete energy audit of your facility.



LIGHTING CONTROL DESIGN & TRAINING

Lighting control design and customized training classes at our facility or yours.



PAYBACK ANALYSIS

Monthly savings and information on tax benefits and available incentives.



PRODUCT VETTING

To ensure the most efficient and cost-effective solutions.

We understand the rising energy costs and how they impact your business in today's market. These energy costs can be the difference between success and failure in a highly competitive business environment. We also understand that technology is always changing. Our team has the expertise and experience to offer the best custom solutions while maximizing performance, improving environments, and meeting or exceeding customer expectations. Our team can work with any size client.

Our Energy Solutions team can assist you with the complete energy upgrade process including:

- A full energy audit of your facility
- Lighting control design & upgrades
- Product vetting to ensure the most efficient and cost-effective solutions are employed
- Customized training classes at our facility or yours.
- Payback analyses
- Identifying tax benefits and incentives that are available to you or your customer
- Referrals to experts in the field



GET IN TOUCH WITH ENERGY SOLUTIONS

Contact the Energy Solutions team at EnergySolutions@USESI.com

ENERGY INCENTIVES AVAILABLE!

EV CHARGING

ASK ABOUT OUR RESIDENTIAL & COMMERCIAL OPTIONS



ENERGY SOLUTIONS

Get Started with EV charging

We provide green solutions for residential, commercial, and industrial vehicles both on-site and on the road. Get started with charging equipment today!



Future-proof your business



Achieve sustainability goals



Put your business on the map



Generate a new revenue stream

Ask about qualifying energy incentives!

Reach out to the Energy Solutions team to learn about available energy incentives for qualifying EV charging applications.



ENERGY SOLUTIONS

GET IN TOUCH WITH ENERGY SOLUTIONS TODAY!

Contact the Energy Solutions team at EnergySolutions@USESI.com

2021

**Energy
Excellence
Award**

Winning Category
**SUPPLY CHAIN
PARTNER**

**U.S. Electrical
Services Inc.**
and Eversource Partner to Upgrade
Lighting for a Distribution Center
in Hartford, Connecticut

FEATURED EVERSOURCE PARTNER:

USES I is comprised of more than 150 locations, which make up their 12 regionally-managed electrical distribution and service-related companies. One of these companies, Electrical Wholesalers Inc. (EW), is one of the nation's leading electrical distributors, providing products for all electrical trade sectors, including residential and commercial contractors, as well as industrial, OEM, utility and construction companies.

This energy efficiency initiative demonstrates the importance of suppliers in driving efficiency outcomes and is a winner of the Eversource Energy Excellence Awards 2021 in the category of Supply Chain Partner for U.S. Electrical Services Inc. (USES I)

BACKGROUND

USES I and its subsidiary, EW, facilitated a complete lighting replacement at a distribution center for a postage metering company in Hartford, Connecticut. In order to maximize savings and comfort for building occupants, the EW team used a full tier 3 networked lighting control system to maximize savings and comfort for the building occupants.

RESULTS

Besides the energy savings inherent in upgrading lighting to high efficiency LEDs, additional results for this distribution center included:

- No lighting maintenance for the foreseeable future
- Carbon reduction
- Improved lighting quality
- Ability to control individual lighting fixtures for employee comfort and safety

Additionally, and important to USESI to support, the customer was located in an Environmental Justice Community (EJC), meaning the surrounding area is historically disadvantaged. Projects like this one, by USESI and EW, represent the benefits energy efficiency can bring to business owners, employees and/or residents in EJs and the importance of enabling efficiency opportunities – and the savings that result – in these areas.

To Learn More, Visit;

eversource.com

usesi.com



PROJECTED SAVINGS

314,500 kWh
annual savings

\$47,200 annual
savings

959 mT CO₂
reduction

USESI has been named an awardee of the Eversource Energy Excellence Awards. Eversource does not claim a proprietary relationship with this organization and jointly promotes this case study as a winning project of the 2021 Excellence Awards and example of a leading energy efficiency initiative.

The information in this case study is an accurate representation of this customer's experience at the time of publication. Results, including cost savings, from energy efficiency measures can vary based on each individual customer's situation.

7-0104

**Eversource, #1 Energy Efficiency
Provider in the Nation**

Eversource is a Proud Sponsor of





PLEASE CHECK LICENSE & CODE REQUIREMENTS FOR INSTALLATION IN YOUR TERRITORY.



NOW AVAILABLE! DUCTLESS MINI-SPLITS

Haier

THE ENERGY EFFICIENT WAY TO GET CUSTOMIZED COMFORT

SINGLE ZONE DUCTLESS MINI-SPLITS

ADVANCED PLUS SERIES

The ultimate combination of performance and comfort.



- More budget-friendly option for cold climates with ability to heat and cool larger spaces
- Energy Star rated for efficiency
- Keeps your space toasty warm down to -15°F
- Quiet operation down to a whispering 23 dBA



**VIEW EW
PRICING**

Shop Ductless Mini-Splits
View pricing and product updates.

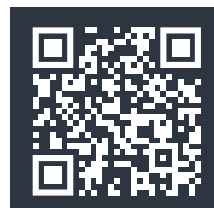

**VIEW HZ
PRICING**

Shop Ductless Mini-Splits
View pricing and product updates.

Advanced Plus SERIES



The ultimate combination of performance and comfort, Advanced Plus delivers efficiencies up to 23 SEER and whisper-quiet operation; as low as 23 dB(A). Available Capacities: 9,000 BTU, 12,000 BTU, 15,000 BTU, 18,000 BTU, and 24,000 BTU.

Key Features

- | | |
|--|---|
| <p>DC INVERTER</p> <p>A-PAM DC INVERTER
Latest high efficiency DC inverter technology</p> | <p>-15°F HEATING</p> <p>Low ambient heating down to -15F (-26C)</p> |
| <p>3-D AIR FLOW</p> <p>Delivers air vertically and horizontally for even distribution throughout the room</p> | <p>EASY INSTALLATION CLIP</p> <p>Built-in bracket allows more room to install and service</p> |
| <p>BLUE FIN</p> <p>A hydrophilic aluminum fin, ensures condensing water flows smoothly</p> | <p>QUIET MODE</p> <p>Minimizes indoor noise while maintaining comfort levels</p> |
| <p>WARM START</p> <p>Ensures the fan will not blow cold air during heating mode startup</p> | <p>2-WAY PIPING DRAIN</p> <p>Right or left side drain configuration simplifies installation</p> |
| <p>TURBO MODE</p> <p>Cools or heats the room quickly</p> | <p>AUTO LOUVER</p> <p>Adjusts airflow upward when cooling, or downward when heating</p> |
| <p>60+ FT LONG DISTANCE AIR SUPPLY</p> <p>Optimized fan motor and blower design enables up to 60 feet of air flow</p> | <p>BASE PAN HEATER</p> <p>Prevents condensate water from accumulating in the outdoor unit in extremely cold temperatures</p> |

ENERGY SOLUTIONS

IES Footcandle Recommendations

A footcandle (fc), the most common unit of measure used for quantifying light levels, is a measure of illuminance with one footcandle being equal to one lumen per square foot. The Illuminating Engineering Society (IES) has established recommended average maintained footcandle levels for a broad range of applications to ensure adequate illumination and safety for occupants. Maximize energy savings by identifying overlit spaces and use IES recommendations to establish new light levels.

Application & Task	Maintained Horizontal		Maintained Vertical		Additional Information
	Average (fc) ¹	Range (fc) ²	Average (fc) ¹	Range (fc) ²	
COMMON AREAS					
ATM or Service Kiosk	20	10 - 40	10	5 - 20	Vertical at face of ATM
Circulation/Corridor	5	2.5 - 10	3	1.5 - 6	Independent passageway
Conference Room	30	15 - 60	-	-	-
Filing (Intermittent)	15	7.5 - 30	10	5 - 20	-
Restroom (General)	5	2.5 - 10	3	1.5 - 6	-
Restroom (Vanities)	15	7.5 - 30	20	10 - 40	
Lunch & Break Room	10	5 - 20	3	1.5 - 6	
Stairs	5	2.5 - 10	3	1.5 - 6	Not high activity or surveillance
COMMERCIAL OFFICE					
Open Office (Desk)	40	30 - 50	-	-	Measured at desk height
Private Office (Desk)	40	30 - 50	-	-	Measured at desk height
Conference Room (Table)	30	15 - 60	-	-	
Whiteboard (Reading)	-	-	15	7.5 - 30	
Whiteboard (Presenting)	-	-	30	15 - 60	
Presentation Screen (Projector)	-	-	1.5	1.5 - 6	
Lunch & Break Room	15	5 - 20	-	-	
EDUCATIONAL (SCHOOLS)					
Classroom (Challenging Applications) ³	25	25 - 100	3.75	3.75 - 15	Arts, blueprints, lab bench; measured at desk height
Classroom (Typical Applications) ³	15	15 - 60	2.5	2.5 - 10	Reading, writing; measured at desk height
Auditorium/Lecture Hall (AV, Notes)	5	2.5 - 10	5	2.5 - 10	
Auditorium/Lecture Hall (AV)	1	0.5 - 2	5	2.5 - 10	
Auditorium/Lecture Hall (No AV)	10	5 - 20	5	2.5 - 10	
Gymnasium - Class I (Pro or Div. 1 College)	100	-	30	-	See NCAA; > 5000 spectators
Gymnasium - Class II (Div. 2 or 3 College)	75	-	20	-	Competition; ≤ 5000 spectators
Gymnasium - Class III (High School)	50	-	150	-	Competition; Some spectators
Gymnasium - Class IV (Elementary)	30	-	100	-	Competition or Rec; No spectators

Application & Task	Maintained Horizontal		Maintained Vertical		Additional Information
	Average (fc) ¹	Range (fc) ²	Average (fc) ¹	Range (fc) ²	
EXTERIOR					
Parking (Covered)	5	-	-	-	1 min; 10:1 max-min uniformity
Parking (Uncovered) Zone 3 (Urban)	1.5	0.75 - 3	0.8	0.4 - 1.6	
Parking (Uncovered) Zone 2 (Suburban)	1	0.5 - 2	0.6	0.3 - 1.2	
Gas Station Canopy	12.5	15-Oct	-	-	
Safety (Building exterior)	1 0.5 - 2	2.5 - 10	-	-	Security issues - raise avg to 3
INDUSTRIAL/MANUFACTURING					
Assembly & Inspection (Simple) Component Manufacture (Large part)	30	15 - 60	30	15 - 60	
Component Manufacture (Med. part)	50	25 - 100	50	25 - 100	
Assembly & Inspection (Difficult) Component Manufacture (Fine part)	100	50 - 200	100	50 - 200	
Assembly & Inspection (Exacting)	300	150 - 600	-	-	
RETAIL					
Discount/Warehouse/Drug/ Convenience (Ambient)	50	25 - 100	20	10 - 40	
Discount/Warehouse/Drug/ Convenience (Perimeter)	-	-	50	25 - 100	
Department Store (Ambient)	40	20 - 80	15	7.5 - 30	
Department Store (Perimeter)	-	-	75	25 - 150	
Accent Lighting (Displays)	-	-	-	-	3-10 times more than ambient
RETAIL (AUTOMOTIVE SALES)					
Showroom	50	25 - 100	10	5 - 20	
Service Area	50	25 - 100	30	15 - 60	
Sales Lot (Exterior) Zone 3 (Urban)	20	10 - 40	20	10 - 40	
Sales Lot (Exterior) Zone 2 (Suburban)	15	7.5 - 30	15	7.5 - 30	
RETAIL (GROCERY)					
Circulation	20	10 - 40	7.5	3.5 - 15	
General Retail	50	25 - 100	20	Oct-40	
Perimeter	-	-	50	25 - 100	
WAREHOUSE & STORAGE					
Bulky Items - Large Labels	10	5 - 20	5	2.5 - 10	
Small Items - Small Labels	30	15 - 60	15	7.5 - 30	
Receiving/Shipping Dock	10	5 - 20	3	1.5 - 6	
Receiving/Staging	30	15 - 60	10	5 - 20	

Source: Compiled by CleaResult Consulting from the 'The Lighting Handbook' 10th Edition from the Illuminating Engineering Society (IES); Adapted from Foot Candle Light Guide produced by Energy Trust of Oregon and Lighting Design.

Horizontal - Average maintained foot-candles are measured at horizontal plane. **Vertical** - Average maintained foot-candles are measured at vertical plane. **1** - At least half of users (occupants) are in the 25 - 65 age range. **2** - Ranges are based on situations where at least half of users are < 25 years of age (Low value) and > 65 years of age (High value). **3** - Recommendation for Classrooms assume at least half of users are < 25 years of age (Low range value); When designing the space for students, allowances should be made for the instructor (e.g. task lighting or downlight over desk).

LED Retrofit Downlights

4", 5", 6", 8" Retrofit & Recessed Downlights

INTERIOR LIGHTING

LED Downlights								
Retrofit & Recessed								
Mfr	Part Number	Can Size	Product Description	Wattage	In-door	Out-door	Selectable CCT	Energy Star Listed
PHILIPS	LOL CP4RB07830W	4"	RETROFIT 700LM 80CRI 30K	11W	•			•
PHILIPS	LOL CP5RB08830W	5"	RETROFIT 950LM 90CRI 30K	13W	•			
PHILIPS	LOL CP6RB10830W	6"	RETROFIT 1200LM 90CRI 30K	14W	•			•
COOPER	HALO LT4069FS231EWHR	4"	RETROFIT 600LM 90CRI 27/30/35K	6.97W	•	•	•	•
COOPER	HALO LT4069FS351EWHR	4"	RETROFIT BAFFLE 600LM 90CRI 27/30/35/30/40/50K	6.97W	•	•	•	•
COOPER	HALO LT560WH6930R	5/6"	RETROFIT 600LM 90CRI 30K	10.2W	•			•
COOPER	HALO RL4069S1EWHDMR	4"	RECESSED 652LM 90CRI 30K	8.7W	•	•		•
COOPER	HALO HLB6099FS1EMWR	6"	RECESSED 1061LM 90CRI	14.2W	•	•	•	•
COOPER	HALO HLB4069FS1EMWR	4"	RECESSED 723LM 90CRI	10.7W	•	•	•	•
COOPER	HALO HLA406VWFL9FS1EMWR	4"	RECESSED 660LM 90CRI	10.15W	•	•	•	•
COOPER	HALO RL56099S1EWHR	5/6"	RETROFIT 600/900/1200LM 90CRI	12.1W	•		•	•
COOPER	HALO RA4069S1EWHR	4"	RETROFIT ADJUSTABLE GIMBAL 600LM 90CRI	7W	•	•	•	•
COOPER	HALO RLS4099FS1EWHDMR	4"	SLOPE CEILING DIRECT MOUNT DOWNLIGHT 90CRI	11.1w	•	•	•	•
COOPER	HALO RLS6159FS1EWHDMR	6"	SLOPE CEILING DIRECT MOUNT DOWNLIGHT 90CRI	19w	•	•	•	•



LIGHTOLIER CP4/5/6 SERIES



HALO RL SLOPE & LT4/56 SERIES

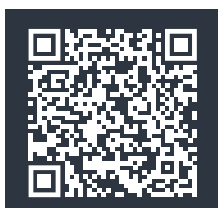

VIEW EW PRICING

Shop Downlights & Trim
View pricing and product updates.

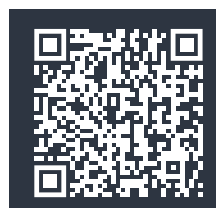

VIEW HZ PRICING

Shop Downlights & Trim
View pricing and product updates.

Recessed Housing & Trim

Recessed Housing | Kits | Trim

Recessed Housing & Trim				
Mfr	Part Number	Can Size	Product Description	IC Rated
Recessed Housing				
COOPER	HALO H245ICAT	4"	ULTRA-SHALLOW HOUSING	•
COOPER	HALO H245RICAT	4"	AIRTIGHT ULTRA-SHALLOW HOUSING	•
COOPER	HALO E7ICAT	6"	RECESSED HOUSING	•
COOPER	HALO E5ICAT	5"	AIRTIGHT HOUSING	•
COOPER	HALO E4ICATSB	4"	AIRTIGHT NEW CONSTRUCTION HOUSING	•
COOPER	HALO E7RICAT	6"	REMODEL RECESSED HOUSING	•
COOPER	HALO E5RICAT	5"	AIRTIGHT REMODEL HOUSING	•
Recessed Cans & Kits				
PHILIPS	LOL 1104IC	6"	3/4" FRAME-IN KIT RECESSED CAN	•
PHILIPS	LOL 1004IC	5"	3/8" FRAME-IN KIT RECESSED CAN	•
PHILIPS	LOL L4RAE1VA	4"	LYTECASTER DIMMABLE AIRTIGHT FRAME-IN KIT	•
PHILIPS	LOL L4R06830VA	4"	LYTECASTER RECESSED DOWNLIGHT MODULE	•
PHILIPS	LOL 1003R	5"	3/8" LYTECASTER REMODEL FRAME-IN KIT	
PHILIPS	LOL 2000IC	3"	3/4" LYTECASTER INSULATED FRAME-IN KIT	•
Trim				
COOPER	HALO 410W	6"	WHITE COILEX BAFFLE TRIM	
COOPER	HALO 310W	6"	WHITE COILEX BAFFLE TRIM	
COOPER	HALO 5001P	5"	WHITE METAL BAFFLE TRIM	
COOPER	HALO 993W	4"	WHITE COILEX BAFFLE TRIM	
PHILIPS	LOL L4RBW	4"	WHITE BAFFLE TRIM	
PHILIPS	LOL 2005WH	3"	3/4" STEP WHITE BAFFLE TRIM	
PHILIPS	LOL 1076WH	5"	WHITE BAFFLE TRIM	
PHILIPS	LOL 1176WH	6"	3/4" WHITE BAFFLE TRIM	

INTERIOR LIGHTING



HALO RECESSED HOUSING & TRIM



LIGHTOLIER RECESSED CANS & TRIM

LED Wafer & Gimbal Downlights

4", 6", 8" Wafer & Gimbal Trim Downlights

LED Wafer Thin & Gimbal Ultra-Thin Downlights

Mfr	Part Number	Can Size	Product Description	Watts	Select CCT	Select Lumens	Dim- mable	Energy Star Listed
COOPER	HALO HLBPH4069FS1EMWR	4"	LED DOWNLIGHT WITH REMOTE DRIVER / JUNCTION	10W	•		•	•
COOPER	HALO HLBPH6099FS1EMWR	6"	LED DOWNLIGHT WITH REMOTE DRIVER / JUNCTION	14W	•		•	•
COOPER	HALO HLA406VWFL9FS1EMWR	4"	GIMBAL 90CRI 27-50K	10.5W	•	•	•	•
COOPER	HALO HLB4069FS1EMWR	4"	WAFER 90CRI 27-50K	12W	•	•	•	•
COOPER	HALO HLB6099FS1EMWR	6"	WAFER 90CRI 27-50K	16W	•	•	•	•
PHILIPS	LOL FD4R7ESCT1W	4"	FLAT DOWNLIGHT 90CRI 27-50K	11W	•		•	•
PHILIPS	LOL CR6RLMCCT	6"	COMMERCIAL RETROFIT DOWNLIGHT	7-10-17W	•	•	•	•
PHILIPS	LOL CR8RLMCCT	8"	COMMERCIAL RETROFIT DOWNLIGHT	10-15-21W	•	•	•	•



LIGHTOLIER FD4/6, MD3, & MG3 SERIES



HALO HLB SERIES



HALO HLA SERIES



VIEW EW PRICING

Shop Wafer/Gimbal Downlights
View pricing and product updates.



VIEW HZ PRICING

Shop Wafer/Gimbal Downlights
View pricing and product updates.

HALO[®]

CANLESS DIRECT MOUNT RECESSED DOWNLIGHTS

MORE FLEXIBILITY!
SAVE TIME AND MONEY!



NO HOUSING NEEDED!

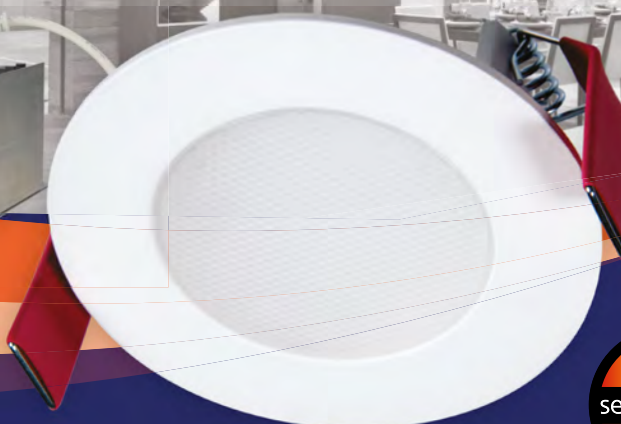

INTERIOR LIGHTING

Go where standard “can” lighting can’t

Go Slim.



HLB low-profile direct mounts are available in 3”, 4”, 6”, 8”, and 12” for residential and light commercial applications.

Go Classic.



RL and LT Direct Mounts mimic the look of a traditional recessed trim.

Go Adjustable.



HLA, RA, and RL-Slope are available for standard and sloped ceilings.

GO CANLESS!



Learn more at cooperlighting.com



© 2022 Cooper Lighting Solutions
Publication ID: SA525812

LED Wafer & Gimbal Downlights

3", 4", & 6" Wafer & Gimbal Trim Downlights

LED Wafer Thin & Gimbal Ultra-Thin Downlights

Mfr	Part Number	Can Size	Product Description	Watts	Select CCT	Select Lumens	Dim-mable	Energy Star Listed
ACUITY	LITH WF4-REG-SWW5-90CRI-MW	4"	REGRESSED BAFFLE 90CRI 27-50K	9W	•		•	•
ACUITY	LITH WF6-REG-SWW5-90CRI-MW	6"	REGRESSED BAFFLE 90CRI 27-50K	13W	•		•	•
ACUITY	LITH WF3-LED-30K-MW-M6	3"	WAFER 90CRI 30K	8W			•	•
RAB	WFRL4R99FA120WS	4"	DIRECT MOUNT WAFER SELECTABLE	9W	•	•	•	•
RAB	WFRL4R99FA120WB	4"	DIRECT MOUNT WAFER SELECTABLE	9W	•	•	•	•
RAB	WFRLA4R89FA120WS	4"	5CCT FIELD ADJUSTABLE RETROFIT GIMBAL	8W	•		•	•
RAB	WFRL6R139FA120WS	6"	DIRECT MOUNT WAFER SELECTABLE	13W	•	•	•	•
RAB	WFRL6R139FA120WB	6"	DIRECT MOUNT WAFER SELECTABLE	13W	•	•	•	•
RAB	WFRLA6R129FA120WS	6"	5CCT FIELD ADJUSTABLE GIMBAL WAFER	12W	•	•	•	•
New Construction - Mountain Frames & Pans								
COOPER	HALO HL4RSMF	4"	4" ROUND OR SQUARE MOUNTING FRAME	--	--	--	--	--
COOPER	HALO HL6RSMF	6"	6" ROUND OR SQUARE MOUNTING FRAME	--	--	--	--	--
ACUITY	LITH WF8643-PAN-U	--	UNIVERSAL NEW CONSTRUCTION PAN	--	--	--	--	--
ACUITY	LITH WF8643-PAN-R6	--	UNIVERSAL NEW CONSTRUCTION PAN	--	--	--	--	--

INTERIOR LIGHTING



VIEW EW PRICING

Shop Wafer/Gimbal Downlights
View pricing and product updates.



VIEW HZ PRICING

Shop Wafer/Gimbal Downlights
View pricing and product updates.



*LITHONIA WF4/WF6
REG SWW5 SERIES*



*LITHONIA WF NEW
CONSTRUCTION PAN*



*RAB WFRL4R/6R
FA SERIES*



*RAB WFRLA4R/6R
FA SERIES*

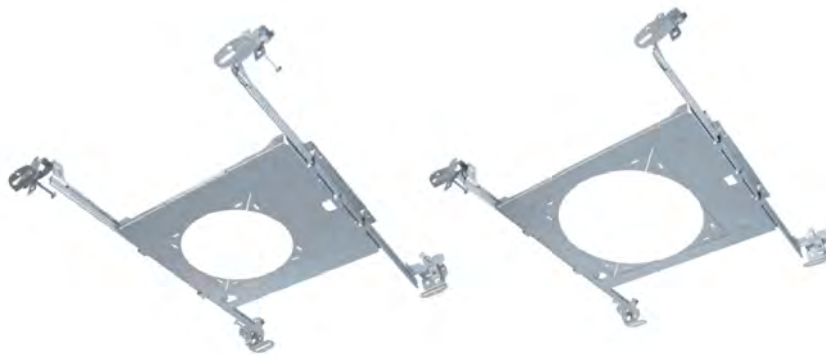

*HALO HL4RSMF/HL6RSMF
MOUNTING FRAME*

LED Strips & Wraps

2', 4', & 8' LED Strips

LED Strips

Mfr	Part Number	Length	Watts	Selectable CCT	Dimmable	Adj Lumens	DLC/Energy Star	Integral Controls
Strips								
COOPER	MTX 2ST2L20SC3	2'	19.2	•	•		•	
COOPER	MTX 4ST2L40SC3	4'	40W	•	•		•	
COOPER	MTX 8ST2L80SC3	8'	80W	•	•		•	
COOPER	MTX 8SLSTPSLC-UNV	8'	33-89W	•	•	•	•	
ACUITY	LITH CSS-L48-ALO3-MVOLT-SWW3	4'	24-39W	•	•	•	•	•
ACUITY	LITH CSS-L96-ALO4-MVOLT-SWW3	8'	48-78W	•	•	•	•	•
ACUITY	LITH CSS L48 ALO3 MVOLT SWW3 80CRI SFR7CSS	4'	24-39W	•	•	•	•	•
ACUITY	LITH CSS L96 ALO4 MVOLT SWW3 80CRI SFR7CSS	8'	48-78W	•	•	•	•	•



METALUX 2ST/4ST/8ST & 8SLS SERIES



LITHONIA CSS SERIES



LITHONIA CSS SERIES W/ SENSOR



VIEW EW PRICING

Shop Strips, Wraps, & Stairwells
View pricing and product updates.

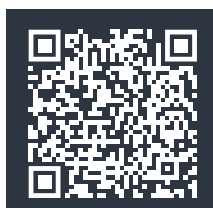

VIEW HZ PRICING

Shop Strips, Wraps, & Stairwells
View pricing and product updates.

Wrap-Arounds | Flush Mounts | Stairwells

Wrap-Arounds & Stairwells

Mfr	Part Number	Length	Watts	Selectable CCT	Dimmable	Adj Lumens	DLC/Energy Star	Integral Controls
Wrap-Arounds & Flush Mounts								
ACUITY	LITH LBL4-LP840 WRAP AROUND 40K	4'	33W		•		•	
ACUITY	LITH FMLWL-48-840 WRAP FLUSH MT 40K	4'	40W		•		•	
ACUITY	LITH FMLWL-LNK-48-ALO4-8SWW2	4'	25-55W	•		•	•	
COOPER	MTX 4WNLED-LD4-40SL-F-UNV-L835 WRAP AROUND	4'	36W	•	•		•	
COOPER	MTX 4WNLED-LD4 SURFACE WRAP 35K	4'	36W		•		•	
COOPER		4'	39.2W	•	•	•	•	
COOPER	MTX FM11WRCCR FLUSH MT	11"	14W	•	•		•	
COOPER	MTX FM15WRCCR FLUSH MT	15"	21W	•	•		•	
RAB	GUSJR4-27-840WU	4'	27W		•		•	•
RAB	GUS4-36NW/D10	4'	36W		•		•	•
RAB	GUS4-50NW/D10	4'	50W		•		•	•
Stairwell Wrap-Around								
PHILIPS	DAY NWL440L8CST-UNV-DIM-OCC	4'	34W	•	•		•	•



LITHONIA LBL/FML SERIES



METALUX 4WNLED, 4NWS3, & FM11/15 SERIES



RAB GUS4/JR SERIES



DAYBRITE NWL SERIES

LED Linear Highbays

Commercial & Industrial Highbays

LED Linear High Bays & Vaportights

Mfr	Part Number	Lumens	Watts	Selectable CCT	Dim-mable	Integral Controls	DLC Listed
120 - 277V High Bays							
COOPER	MTX VHB-1215-W-UNV-L840-CD-U 40K	12249-15980	80.6-109.9W		•	•	•
COOPER	MTX VHB-1824-N-UNV-L840-CD-U 40K	18772-22776	125.5-158.3W		•	•	•
COOPER	MTX UHBS-1218-MV-L84050-U 40/50K	13134-18402	81W/99W/120W	•	•		•
COOPER	MTX UHBS-2436-MV-L84050-U 40/50K	24825-37167	150/200/240W	•	•		•
PHILIPS	DAY FCY22L8CST-UNV-DIM 40/50K	22,000	164W	•	•	•	•
PHILIPS	DAY FCY29L8CST-UNV-DIM 40/50K	30,000	213W	•	•	•	•
ACUITY	LITH CPHB-12LM-MVOLT-40K	12,000	89W		•		•
ACUITY	LITH CPHB-15LM-MVOLT-40K	15,000	104W		•		•
ACUITY	LITH CPHB-18LM-MVOLT-40K	18,000	133W		•		•
ACUITY	LITH CPHB-24LM-MVOLT-40K	24,000	170W		•		•
ACUITY	LITH CPRB-18LM-MVOLT-40K-80CRI-DWH	18,000	132W		•	•	•
ACUITY	LITH CPRB-24LM-MVOLT-40K-80CRI-DWH	24,000	175W		•	•	•
RAB	H17 FA HIGH BAY	21,483	148.6W	•	•	•	•
RAB	RBAY17S FA HIGH BAY	18,200	130W	•	•	•	•
RAB	RBAY17M FA HIGH BAY	36,400	260W	•	•	•	•
Vaportights							
ACUITY	LITH CSVT-L48-ALO3-MVOLT-SWW3-80CRI	3,190-5,274	35.3W	•	•		
ACUITY	LITH CSVT-L96-ALO4-MVOLT-SWW3-80CRI	6,495-10,300	55.3 - 87.9W	•	•		
RAB	SEAL4 LINEAR WASHDOWN FA	6,500	50W	•	•	•	
RAB	SEAL8 LINEAR WASHDOWN FA	13,100	100W	•	•	•	
RAB	SHARK4-50NW/D10 40K	6,881	50W		•	•	
RAB	SHARK8-100NW/D10 40K	13,240	100		•	•	

INTERIOR LIGHTING



VIEW EW PRICING

Shop Linear Highbays
View pricing and product updates.



VIEW HZ PRICING

Shop Linear Highbays
View pricing and product updates.



METALUX VHB & UHBS SERIES



DAYBRITE FCY SERIES



LITHONIA CPHB & CPRB SERIES



RAB H17 & RBAY17 FA SERIES



LITHONIA CSV SERIES



RAB SEAL, FA & SHARK SERIES

METALUX INDUSTRIAL LED LIGHTING SOLUTIONS

Delivering the most innovative and sustainable lighting and controls products, Metalux has a trusted reputation by providing a complete offering of versatile LED luminaires designed with advanced optical performance, engineered for energy savings and constructed to offer long-lasting durability.



LHB Series
High Bay



VHB Series
High Bay



UHBS Series
High Bay



Learn more at cooperlighting.com

© 2022 Cooper Lighting Solutions

LED Recessed Troffers & Baskets

Standard & Control Enabled Troffers

LED Recessed Troffers & Baskets

Mfr	Part Number	Size	Color	Lumens	Watts	Voltage	Dimmable	Integral Controls	DLC Listed
Standard LED Troffers/Baskets									
ACUITY	LITH STAKS-1X4-ALO6-SWW7	1x4	35/40/50K	40L/50L/60L	31W - 49W	120-277	•		•
ACUITY	LITH STAKS-2X2-ALO3-SWW7	2x2	35/40/50K	30L/40L/50L	26W - 45W	120-277	•		•
ACUITY	LITH STAKS-2X4-ALO6-SWW7	2x4	35/40/50K	40L/50L/60L	35W - 55W	120-277	•		•
ACUITY	LITH 2BLT2-33L-ADP-LP835	2x2	35K	3300	26W	120-277	•		•
ACUITY	LITH 2BLT2-33L-ADP-LP840	2x2	40K	3300	26W	120-277	•		•
ACUITY	LITH 2BLT4-40L-ADP-LP835	2x4	35K	4000	26W	120-277	•		•
ACUITY	LITH 2BLT4-40L-ADP-LP840	2x4	40K	4000	26W	120-277	•		•
LED Troffers/Baskets with Integral Controls									
COOPER	MTX 22CZ2-24HE-UNV-L835-CD1-U	2x2	35K	2400	19W	277	•	•	•
COOPER	MTX 22CZ2-24HE-UNV-L840-CD1-U	2x2	40K	2400	19W	277	•	•	•
COOPER	MTX 24CZ2-40HE-UNV-L835-CD1-U	2x4	35K	4000	31W	120-277	•	•	•
COOPER	MTX 24CZ2-40HE-UNV-L840-CD1-U	2x4	40K	4000	31W	120-277	•	•	•
ACUITY	LITH 2BLT2-33L-ADSMT-EZ1-LP830	2x2	30K	3300	26W	120-277	•	•	•
PHILIPS	DAY 2FGXG30L835-2-FS-UNV-DIM-SWZCS	2x2	35K	3000	21W	120-277	•	•	•
PHILIPS	DAY 2FGXG30L840-2-FS-UNV-DIM-SWZCS	2x2	40K	3000	21W	120-277	•	•	•
PHILIPS	DAY 2FGXG38L835-4-FS-UNV-DIM-SWZCS	2x4	35K	3800	26W	120-277	•	•	•
PHILIPS	DAY 2FGXG38L840-4-FS-UNV-DIM-SWZCS	2x4	40K	3800	26W	120-277	•	•	•



SAVE BIG WITH CONTROLS!

Get increased energy incentives when purchasing qualifying fixtures for commercial applications.

ASK YOUR SALES REP TO LEARN MORE



VIEW EW PRICING

Shop Troffers & Baskets
View pricing and product updates.



VIEW HZ PRICING

Shop Troffers & Baskets
View pricing and product updates.



STACK Switch™

LED Center-Element Lay-in

Switchable Technology. Next-Generation Capabilities.
Meet the newest family of LED lay-ins from Lithonia Lighting®.

- Three Switchable Color Temperatures (SWW)
- Three Adjustable Lumen Outputs (ALO)
- Available in 1'x4', 2'x2' and 2'x4'
- 27 possible configurations in three fixtures
- Easy installation into grid ceilings
- Less than 2" in overall depth
- Part of Contractor Select™
- Extremely flexible and versatile

2'x2'	3000 LUMENS	4000 LUMENS	5000 LUMENS
1'x4' 2'x4'	4000 LUMENS	5000 LUMENS	6000 LUMENS

Switchable Lumens



STAKS 1X4 ALO6 SWW7
STAKS 2X2 ALO3 SWW7
STAKS 2X4 ALO6 SWW7



STACK™ Pack

The jobsite friendly LED lay-in from the STACK family.



One Box
4 Housings 4 Drivers 4 Lenses

Packing
STACK PACK fits 128% more fixtures per pallet

Capacity
2x more fixtures fit per truck

Fuel Usage
Significantly reduced transportation fuel consumption per year

44%
Carbon Footprint REDUCTION

Comparisons calculated based on annual sales of similar sized fixtures (2'x2' lay-ins).

- STAKPAK 2X2 ALO3 35K CP4
- STAKPAK 2X2 ALO3 40K CP4
- STAKPAK 2X4 ALO6 35K CP2
- STAKPAK 2X4 ALO6 40K CP2

LED Flat Panels

Standard & Control Enabled Flat Panels

INTERIOR LIGHTING

LED Flat Panels									
Mfr	Part Number	Size	Color	Lumens	Watts	Voltage	Dimmable	Integral Controls	DLC Listed
Standard LED Flat Panels									
COOPER	MTX 22CGTS-L3C3	2x2	35/40/50K	Switchable	27-52.8W	120-277	•		•
COOPER	MTX 24CGTS-L3C3	2x4	35/40/50K	Switchable	27-52.8W	120-277	•		•
ACUITY	LITH CPX-1X4-ALO7-SSW7-M4	1x4	35/40/50K	Switchable	19-35W	120-277	•		•
ACUITY	LITH CPX-2X2-ALO7-SWW7-M4	2x2	35/40/50K	Switchable	19-37W	120-277	•		•
ACUITY	LITH CPX-2X4-ALO8-SWW7-M2	2x4	35/40/50K	Switchable	28-50W	120-277	•		•
LED Flat Panels with Integral Controls									
ACUITY	LITH CPX-2X2-32L-35K-JOTVVTX15	2x2	35K	3200	33W	120-277	•	•	•
ACUITY	LITH CPX-2X2-32L-40K-JOTVVTX15	2x2	40K	3200	33W	120-277	•	•	•
ACUITY	LITH CPX-2X4-40L-35K-JOTVVTX15	2x4	35K	4000	41W	120-277	•	•	•
ACUITY	LITH CPX-2X4-40L-40K-JOTVVTX15	2x4	40K	4000	41W	120-277	•	•	•
RAB	T34FA-1X4	1x4	35/40/50K	2137-4089	30W	120-277	•	•	•
RAB	T34FA-2X2	2x2	35/40/50K	2279-4328	30W	120-277	•	•	•
RAB	T34FA-2X4	2x4	35/40/50K	3833-6027	40W	120-277	•	•	•



METALUX CGTS SERIES

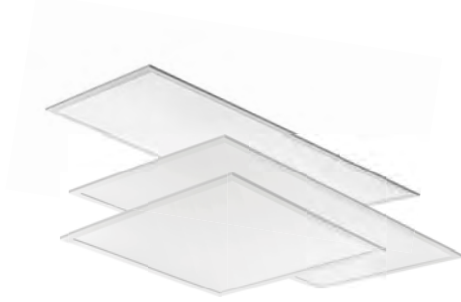

LITHONIA CPX STANDARD & JOT ENABLED SERIES



RAB T34FA SERIES



VIEW EW PRICING

Shop Flat Panels, Kits, & Accessories
View pricing and product updates.



VIEW HZ PRICING

Shop Flat Panels, Kits, & Accessories
View pricing and product updates.

Surface Mount Kits & Accessories

Mounting Kits & Speed Link Cables

INTERIOR LIGHTING

Surface Mount Kits

Mfr	Part Number	Size	Description	Compatible Fixtures	Depth
Surface Mount Kits					
ACUITY	LITH 1X4SMKSH	1x4	Multi-Use Surface Mount Kit 1x4, Shallow Depth	EPANL, CPX, CPANL	3.6"
ACUITY	LITH 2X2SMKSH	2x2	Multi-Use Surface Mount Kit 2x2, Shallow Depth	EPANL, CPX, CPANL	3.6"
ACUITY	LITH 2X4SMKSH	2x4	Multi-Use Surface Mount Kit 2x4, Shallow Depth	EPANL, CPX, CPANL	3.6"
COOPER	MTX FPSURF22	2x2	FP Surface Mount Kit 2x2	FP	2.125"
COOPER	MTX FPSURF24	2x4	FP Surface Mount Kit 2x4	FP	2.125"



LITHONIA EPANL SURFACE MOUNT TROFFER KIT



METALUX FP SURFACE MOUNT KITS



NVENT CADDY HANGING ACCESSORIES

Fixture Hanging Accessories

Mfr	Part Number	Static Load	Description	Wire Rope Diameter	Wire Rope Length	Height(H) Width(W) Thickness (T)
ElectroGalvanized Speed Link Cables						
NVENT CADDY	ERICO SLK2YH500L2	100lb	Speed Link SLK with Y-Hook	2mm	6.6' x (YL) 19.6'	2.15" (H) 3/4" (W) 1/2" (T)



Exterior Lighting

All Electrical Wholesalers and HZ Electric Supply branches fully stock the following LED area lights, area poles and hardware, canopy fixtures, wall packs, and floodlights.



Exterior Lighting

116-117 Intro to Exterior Lighting

118-119 LED Area Lights | Poles Kits & Hardware | Canopy Lights

120-123 Exterior Wall Packs

124-127 Exterior Floodlights



PRICING IS NOT LISTED IN THIS EDITION OF THE CATALOG.

Please check with your Sales Rep or sign into your account on our website for the most up-to-date pricing and product inventory levels.

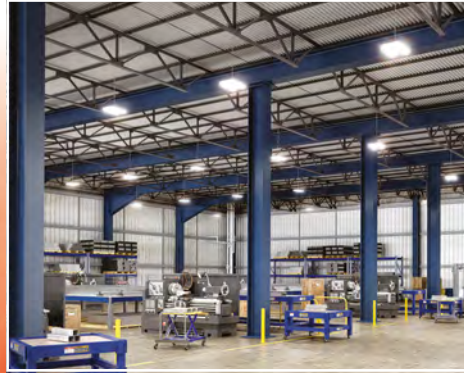

WAVELINX LITE

Commercial | Industrial | Outdoor

Simple. Secure. Scalable.

Integrated sensors provide immediate out-of-the-box performance and can be configured as a system from a secure mobile application.



LIGHTING

Advanced LED fixtures

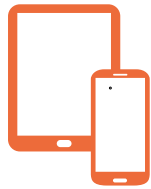

MOBILE APP

Intuitive project provisioning and configuration tool



SECURE PORTAL

Initiate new projects, transfer completed projects to building owners, and store backup data safely

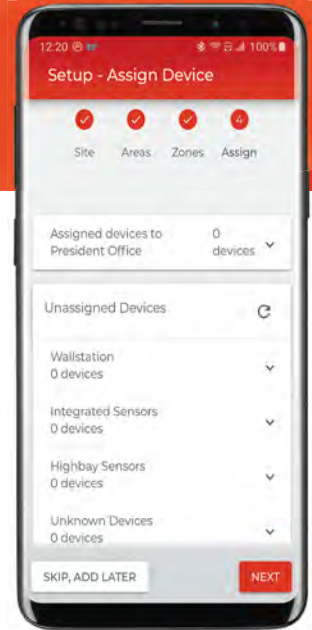

EXTERIOR LIGHTING

Wavelinx Lite is a scalable lighting control solution that eliminates all hassles associated with complex lighting controls systems and makes the commissioning process intuitive and flexible, giving more power to the installing contractor.

- Out of the box functionality for standalone and controlled applications
- Automatic code compliance
- Integrated fixtures, wall control, and tile-mount sensors available



Scan for more information and to download our WaveLinX Mobile App.



Scan to watch Wavelinx Lite instruction videos.

LED Area Lights

Outdoor Pole & Arm-Mounted Fixtures

EXTERIOR LIGHTING

LED Area Lights								
Outdoor Pole/Arm-Mounted Area and Roadway Light								
Mfr	Part Number	Color Temp	Lumens	Watts	MH Equivalent	Dimmable	Integral Controls	DLC Listed
RAB Lighting "Good"								
RAB	A17XFU150	30/40/50K	11,168	70/100/150W	--	•	•	•
RAB Lighting "Better"								
RAB	IVAT3-75LPA750ZU	50K	7,565	67W	150W	•	•	•
RAB	IVAT3-100LPA750ZU	50K	11,359	94W	250W	•	•	•
RAB	IVAT4-130LPA750ZU	50K	14,322	117W	450W	•	•	•
RAB Lighting "Best"								
RAB	ALED3T78	50K	9,263	78W	250W	•	•	•
RAB	ALED3T125	50K	14,891	125W	350W	•	•	•
RAB	ALED3T150	50K	16,839	150W	400W	•	•	•
RAB	ALED5T78	50K	9,530	78W	250W	•	•	•
RAB	ALED5TWM/7PR	50K	10,917	80W	250W	•	•	•
RAB	ALED3TWM/7PR	50K	19,192	150W	400W	•	•	•
RAB	ALEDL4T/WS4	50K	25,350-37,708	260W	1000W	•	•	•
RAB	ALEDXL4T	50K	41,024-50,899	385W	1500W	•	•	•
RAB	ALEDXL3TN	40K	40,170-49,283	385W	1500W	•	•	•
Other Manufacturer Area Lights								
COOPER	PRVS-C15-UNV-T3	40K	7,000	52W	1500W	•	•	•
COOPER	PRVS-C25-UNV-T3	40K	13,000	96W	1500W	•	•	•
COOPER	PRVS-C40-UNV-T3	40K	48,600	350W	1500W	•	•	•
COOPER	LAS100S-T5	40K	34,000	250W	1000W	•	•	•
COOPER	LAS45S-T5	40K	34,000	250W	1000W	•	•	•
ACUITY	LITH ESX1-LED-P2-40K-R3-MVOLT-UPA-BLS-DDBXD-M2	40K	8K-14K	50-98W	150-250W			•
ACUITY	LITH ESX1-LED-P4-40K-R3-MVOLT-UPA-BLS-DDBXD-M2	40K	21K-25K	146-190K	400W			•



RAB IVELOT SERIES



RAB A17XFU150, ALED FA, TYPE V & TYPE III SERIES



LUMARK LAS & PREVAIL SERIES

Area Light Poles & Canopy Lights

Pole Kits & Hardware | Canopy Fixtures

EXTERIOR LIGHTING

Area Light Poles & Hardware Kits

Mfr	Part Number	Product Description	Color	Length
COOPER	LUM SSS4-A-15-SFM4BZ	SQUARE STRAIGHT STEEL POLE INCLUDES BASE AND HARDWARE KIT	BRONZE	15'
COOPER	LUM SSS4-A-20-SFM4-BZ	SQUARE STRAIGHT STEEL POLE DRILLED ON 4 TOP SIDES INCLUDES BASE AND HARDWARE KIT	BRONZE	20'
COOPER	LUM SSS4A25SFM4 SSS POLE	SQUARE STRAIGHT STEEL POLE INCLUDES BASE AND HARDWARE KIT	BRONZE	25'
COOPER	LUM AB1 3/4" X25"	X3" ANCHOR BOLTS	--	--
Brackets				
COOPER	FA63	FLAT MOUNT BRACKET PARAPET BRACKET	BRONZE	--
COOPER	SAB-BZ	STEEL ANGLE BRACKET	GALVANIZED	--
COOPER	TR40-2	TENON REDUCER	BRONZE	4" OD TO 2-3/8"
COOPER	101-A23	STEEL POLE TOP BRACKETS	BRONZE	2X36"

LED Canopy Luminaires

Mfr	Part Number	Lumens	Watts	MH Equiv	Color	Integral Controls	DLC Listed
Low & Mid Output Canopy Lighting							
ACUITY	LITH CNYLEDP140KMVOLTDDBM4	4476	35W	150W	40K	•	•
ACUITY	LITH CNYLEDP240KMVOLTDDBM2	6600	51W	250W	40K	•	•
COOPER	LUM CLCS17S Small LED	5,500 - 17,600	56W	150-400W	50K		•
COOPER	LUM CLCS40S Large LED	13,600-17,600	123W	150-400W	50K		•
COOPER	LUM RPGC25S PARKING GARAGE	3,690-7811	31/49/ 63W	150-250W	40K		•



LITHONIA ESX SERIES

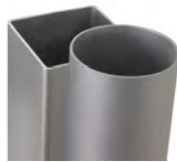

LUMARK POLES & HARDWARE



LUMARK CLCS & RPGC SERIES



LITHONIA CNY SERIES



VIEW EW PRICING

Shop Area Lights & Poles
View pricing and product updates.



VIEW HZ PRICING

Shop Area Lights & Poles
View pricing and product updates.

Exterior Wall Packs

Outdoor Non-Cutoff/Semi-Cutoff Wall Packs & Tall Packs

EXTERIOR LIGHTING

LED Wall Packs							
Mfr	Part Number	Lumens / Selectable	Color / Selectable	Watts	MH Equiv	Dimmable	DLC Listed
RAB Lighting "Good"							
RAB	WP1FA29	4010-4204	30/40/50K	29W	125W	•	•
RAB	WP2FA29	4176-4350	30/40/50K	29W	125W	•	•
RAB	WP2FA40	5238-5714	30/40/50K	40W	175W	•	•
RAB	WP2FA60	7780-8583	30/40/50K	60W	250W	•	•
RAB	WP2FA80	12032-12770	30/40/50K	80W	400W	•	•
RAB	WP3FA150	21514-23223	30/40/50K	150W	750W	•	•
RAB	WP2XFU100	9228-15745	30/40/50K	60W	250W	•	•
RAB	BRISK17FA20	2600-2921	30/40/50K	20W	100W	•	•
RAB	SLIM17FA15ADJ	1761-1904	30/40/50K	15W	70W	•	•
RAB	SLIM17FA30ADJ	3540-3813	30/40/50K	30W	175W	•	•
RAB	SLIM17FAFC40	4595-5421	30/40/50K	40W	200W	•	•
RAB	SLIM17FAFC60	7035-8190	30/40/50K	60W	350W	•	•
RAB Lighting "Best"							
RAB	WPLED26	3484	50K	26W	150W	•	•
RAB	WPLED52	7392	50K	52W	250W		•
RAB	BRISKS11L/PCU	1142	50K	8W	50W	•	•
RAB	BRISKS17L/PCU	1765	50K	12W	70W	•	•



VIEW EW PRICING

Shop Exterior Wall Packs
View pricing and product updates.



VIEW HZ PRICING

Shop Exterior Wall Packs
View pricing and product updates.

Field adjustability that puts you in control.



T34FA



NEWLY REDESIGNED

ALED



H17 & H17XL



CCT FA Wafers



NEWLY REDESIGNED

FFLED

RAB[®]

EXTERIOR LIGHTING



RAB SLIM & SLIMFA SERIES



RAB WP1/2/3 FA SERIES



RAB BRISK & BRISK17FA SERIES

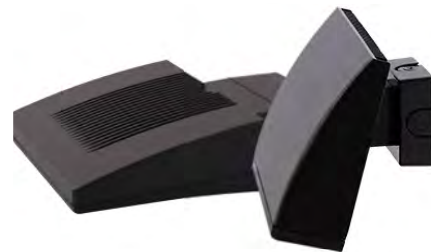

RAB WPLED SERIES

Exterior Wall Packs

Outdoor Non-Cutoff/Semi-Cutoff Wall Packs

LED Wall Packs

Mfr	Part Number	Lumens	Color/ Selectable	Watts	MH Equiv	Dim- mable	DLC Listed
ACUITY	LITH TWH-LED-ALO-40K - ADJ LUMENS	2076-9214	40K	16-78W	70-400W	•	•
ACUITY	LITH TWH-LED-ALO-50K - ADJ LUMENS	2076-9214	50K	16-78W	70-400W	•	•
ACUITY	LITH WPX0-LED-ALO-SWW2-MVOLT- PE-DDBXD-M2	1550 - 9200	30/40/50K	6.4 - 13W	70-400W	•	•
ACUITY	LITH WPX1-LED-P1-40K-MVOLT-E4WH- DDBXD	1550	40K	11W	150W	•	•
ACUITY	LITH WPX1-LED-P2-40K-MVOLT- DDBXD	2900	40K	22W	150W	•	•
ACUITY	LITH WPX2-LED-40K-MVOLT-DDBXD	6000	40K	47W	250W	•	•
ACUITY	LITH WPX3-LED-40K-MVOLT-DDBXD	9200	40K	69W	400W	•	•
ACUITY	LITH TWX1-LED-ALO-40K-MVOLT-PE	600-2950	40K	22W	100W	•	•
ACUITY	LITH TWX2-LED-ALO-40K-MVOLT-PE	1450-6850	40K	54W	250W	•	•
ACUITY	LITH TWX3-LED-ALO-40K-MVOLT-PE	2900-13850	40K	108W	400W	•	•
ACUITY	LITH TWR1-LED-ALO-40K-MVOLT	1100-6200	40K	9-51W	70-250W	•	•
COOPER	LUM WPMLED15S	4000-7800	30/40/50K	30-60W	70-250W	•	•
COOPER	LUM WPMLED25S	9800-13400	30/40/50K	70-100W	70-250W	•	•
KEYSTONE	KT-WPLED20-S1-8CSB-VDIM	2500-2700	30/40/50K	20W	50-70W	•	•
KEYSTONE	KT-WPLED35-M1-8CSB-VDIM	4690-5040	30/40/50K	35W	150W	•	•
KEYSTONE	KT-WPLED55-M1-8CSB-VDIM	7370-7920	30/40/50K	55W	175-250W	•	•
KEYSTONE	KT-WPLED80-M1-8CSB-VDIM	10800-11200	30/40/50K	80W	250-320W	•	•
KEYSTONE	KT-WPLED120-L1-8CSB-VDIM	15600-16800	30/40/50K	120W	400W	•	•

LUMARK OUTDOOR LIGHTING SOLUTIONS

Cooper Lighting Solutions delivers a range of innovative and reliable outdoor lighting solutions, designed to maximize performance, energy efficiency and cost savings.

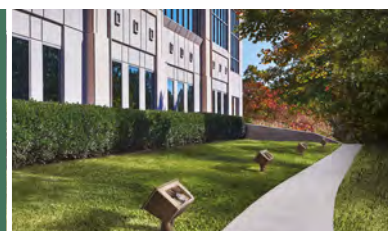

WPM Luminaire
Wall Pack



Night Falcon Luminaire
Floodlight



LAS Luminaire
Area/Site



Learn more at cooperlighting.com

© 2022 Cooper Lighting Solutions



VIEW EW
PRICING

Shop Exterior Wall Packs
View pricing and product updates.



VIEW HZ
PRICING

Shop Exterior Wall Packs
View pricing and product updates.



LITHONIA TWH SERIES



LITHONIA WPX0/1/2/3 SERIES



LITHONIA TWX1/2/3 LED ALO SERIES



LITHONIA TWR1 SERIES



LUMARK WPMLD SERIES



KEYSTONE KT-WPLED20-S1 & KT-WPLED35/55/80-M1

FLOODLIGHTS & WALL PACKS

HID REPLACEMENT LAMPS



Outdoor Fixtures



Direct Drive HID LED

Built-in Photocell meets DLC integrated control for increased rebates.

Power and Color Select optimizes output/color temperature, provides flexibility.



DUSK-TO-DAWN PHOTOCELL

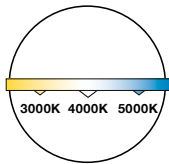

COLOR SELECTABLE



DLC LISTED

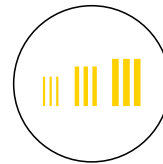

POWER SELECTABLE

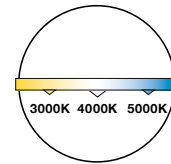

COLOR SELECTABLE

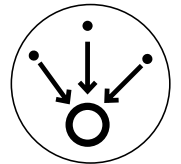

VERSATILITY & FLEXIBILITY



Keystone Technologies Philadelphia, PA 800.464.2680 keystonetech.com
LAMPS | FIXTURES | POWER SUPPLIES | CONTROLS

Exterior Floodlights

Outdoor Flood & Spot Lights

LED Floodlights

Mfr	Part Number	Lumens / Selectable	Color / Selectable	Watts	MH / INC Equiv	Dim- mable	DLC Listed	Energy Star Listed
ACUITY	LITH HGX-LED-2RH-ALO-SWW2-120-PE-DDB-M2	1800-2750	•	15-25W (2) 200W				•
ACUITY	LITH HGX-LED-2RH-ALO-SWW2-120-PE-WH-M2	1800-2750	•	15-25W (2) 200W				•
ACUITY	LITH HGX-LED-2SH-ALO-SWW2-120-PE-WH-M2	1700-2700	•	15-25W (2) 200W				•
ACUITY	LITH HGX-LED-3RH-ALO-SWW2-120-PE-DDB-M2	1750-4100	•	15-36W (2) 200W				•
ACUITY	LITH HGX-LED-3RH-ALO-SWW2-120-PE-WH-M2	1750-4100	•	15-36W (2) 200W				•
ACUITY	LITH HGX-LED-2RH-ALO-SWW2-120-PIR-DDB-M2	2150-2600	•	21-26W (2) 200W				•
ACUITY	LITH HGX-LED-2RH-ALO-SWW2-120-PIR-WH-M2	2150-2600	•	21-26W (2) 200W				•
ACUITY	LITH ESXF1-P0-SWW2-THK-DDB-M2	2500	•	17W	75W	•	•	
ACUITY	LITH ESXF1-ALO-SWW2-KY-DDB-M2	1500 -5000	•	9-34W	150W	•	•	
ACUITY	LITH ESXF2-ALO-SWW2-KY-DDB-M2	3500 - 7500	•	56-77W	175W	•	•	
ACUITY	LITH ESXF3-ALO-SWW2-UVOLT-YS-DDB-M2	8500 - 14000	•	53-100W	250W	•	•	
ACUITY	LITH ESXF3-ALO-SWW2-YS-DDB-M2	8500 - 14000	•	53-100W	250W	•	•	
ACUITY	LITH ESXF4-ALO-SWW2-UVOLT-YS-DDB-M2	16000 - 20000	•	111-150W	400W	•	•	
ACUITY	LITH ESXF4-ALO-SWW2-YS-DDB-M2	16000 - 20000	•	111-150W	400W	•	•	
COOPER	LUM NFFLD-C40-T	16923	40K	128W	400W		•	•
COOPER	LUM NFFLD-C40-S	16923	40K	129W	400W		•	•
COOPER	LUM NFFLD-C25-T	10673	40K	85W	400W	•	•	•
COOPER	LUM NFFLD-S-C15-KNC-UNV	5976	40K	52W	400W	•	•	•
KEYSTONE	KT-FLED15-R1A-UNV-8CSB-VDIM	1920-2175	30/40/50K	15W	70W	•	•	•
KEYSTONE	KT-FLED15-R1A-UNV-8CSB-VDIM-W	1920-2175	30/40/50K	15W	70W	•	•	•
KEYSTONE	KT-FLED35-R1A-UNV-8CSB-VDIM	4480-5075	30/40/50K	35W	150-175W	•	•	•
KEYSTONE	KT-FLED35-R1A-UNV-8CSB-VDIM-W	4480-5075	30/40/50K	35W	150-175W	•	•	•
KEYSTONE	KT-FLED60-R1A-UNV-8CSB-VDIM	7320-8580	30/40/50K	60W	250W	•	•	•
KEYSTONE	KT-FLED75-R1A-UNV-8CSB-VDIM	9150-10725	30/40/50K	75W	250-320W	•	•	•
KEYSTONE	KT-FLED100-R1A-UNV-8CSB-VDIM	12200-14300	30/40/50K	100W	400W	•	•	•

EXTERIOR LIGHTING



ESXF LED Floodlights

36 Floods in One

- Four sizes suitable for replacing up to 400W HID
- Adjustable lumen output (ALO) with three lumen settings
- Switchable color temperature (3000K/4000K/5000K)
- Dusk-to-dawn photocell
- 2 mounting options in each box



©2022 Acuity Brands Lighting, Inc. All rights reserved.



EXTERIOR LIGHTING



LITHONIA HGX SERIES



LITHONIA ESXF SERIES



LUMARK NFFLD SERIES



KEYSTONE FLED SERIES



VIEW EW PRICING

Shop Exterior Floodlights
View pricing and product updates.



VIEW HZ PRICING

Shop Exterior Floodlights
View pricing and product updates.

Exterior Floodlights

Outdoor Flood & Spot Lights

LED Floodlights								
Mfr	Part Number	Description	Lumens / Selectable	Color / Selectable	Watts	MH Equiv	Dimmable	DLC Listed
RAB Lighting "Good"								
RAB	X17FA15	Field Adj Knuckle Mt	2097-2259	30/40/50K	15W	70W	•	•
RAB	X17FA35	Field Adj Knuckle Mt	4642-5034	30/40/50K	35W	150W	•	•
RAB	X17FA35W	Field Adj Knuckle Mt	4642-5034	30/40/50K	35W	150W	•	•
RAB	X17FA60	Field Adj Knuckle Mt	7782-8372	30/40/50K	60W	250W	•	•
RAB	X17FA80	Field Adj Knuckle Mt	10712-11509	30/40/50K	80W	400W	•	•
RAB	X17FA80T	Field Adj Trunnion Mt	10712-11509	30/40/50K	80W	400W	•	•
RAB	X17FA105T	Field Adj Trunnion Mt	13243-14129	30/40/50K	105W	400W	•	•
RAB	X17FA105SF	Field Adj Slipfitter Mt	13243-14129	30/40/50K	105W	400W	•	•
RAB	X17FA140T	Field Adj Trunnion Mt	17894-19158	30/40/50K	140W	750W	•	•
RAB	X17FA140SF	Field Adj Slipfitter Mt	17894-19158	30/40/50K	140W	750W	•	•
RAB	X17FA140S	Field Adj Slipfitter Mt	17894-19158	30/40/50K	140W	750W	•	•
RAB Lighting "Better"								
RAB	HBLED13A	Landscape Bullet	1799	50K	13W	250W BR40	•	•
RAB	FFLEDS	Field Adj Knuckle Mt	2615-6243	40/50K	26W	200W	•	•
RAB	FFLEDM	Field Adj Knuckle Mt	8138-10813	40/50K	52W	350W	•	•
RAB	FFLEDLT	Field Adj Trunnion Mt	18739-38662	40/50K	120W	1000W	•	•
RAB Lighting "Best"								
RAB	FXLEDST	Field Adj Trunnion Mt	10206-22010	40/50K	168W	750W	•	•
RAB	FXLEDMT	Field Adj Trunnion Mt	30156-45135	40/50K	346W	1000W	•	•
RAB	FXLEDLT	Field Adj Trunnion Mt	61887-72677	40/50K	534W	1500W	•	•



RAB X17FA SERIES



RAB HBLED SERIES



RAB FFLEDS/M/LT SERIES



RAB FXLEDST/MT SERIES



 **VIEW EW
PRICING**

Shop Exterior Floodlights
View pricing and product updates.



 **VIEW HZ
PRICING**

Shop Exterior Floodlights
View pricing and product updates.

Emergency Lighting

All Electrical Wholesalers and HZ Electric Supply branches fully stock the following LED emergency fixtures, remote head fixtures, exit signs, and combo fixtures.



Emergency & Exit Sign Lighting

- 128-129 Intro to Emergency Lighting
- 130-131 Emergency Lighting | Remote Heads | Exit Signs



PRICING IS NOT LISTED IN THIS EDITION OF THE CATALOG.

Please check with your Sales Rep or sign into your account on our website for the most up-to-date pricing and product inventory levels.

COMMERCIAL LED LIGHTING

Cooper Lighting Solutions delivers innovation, quality and reliability with affordable and energy efficient interior solutions.



Metalux SLSTPS
Striplight



Metalux CGTS
Flat Panel



Sure-Lite APELMINI
Emergency Lighting



Learn more at [cooperlighting.com](https://www.cooperlighting.com)

© 2022 Cooper Lighting Solutions

OUTDOOR LIGHTING BUYING GUIDE

COMMERCIAL & RESIDENTIAL LIGHTING

SELECT PRODUCTS MAY QUALIFY FOR ENERGY INCENTIVES



SHOP NOW 



**SHOP EW
OUTDOOR
LIGHTING**



**SHOP HZ
OUTDOOR
LIGHTING**

EMERGENCY LIGHTING

Emergency Lighting

Emergency Lighting & Remote Heads

LED Emergency Lighting

Mfr	Part Number & Description	Voltage	Battery Backup	Coverage	Run-Time	UL Listed
Emergency Lighting						
COOPER	SURE-LITES ALLPRO AP2SQLED	120/277	•	10'	90MIN	•
COOPER	SURE-LITES ALLPRO APEL	120/277	•	17'	90MIN	•
COOPER	SURE-LITES SEL17	120/277	•	17'	90MIN	•
ACUITY	LITH ELM2L-M12-WHITE Aimable Optics	120/277	•	33'	90MIN	•
ACUITY	LITH EU2L-M12-WHITE	120/277	•	12'	90MIN	•
Wet Location Rated - Remote Heads						
COOPER	SURE-LITES APWR1 REMOTE SINGLE HEAD	3.6		17'	--	•
COOPER	SURE-LITES APWR2 REMOTE DUAL HEAD	3.6		17'	--	•
Wet Location Rated - Remote Heads						
EMERGI-LITE	EMIU-250 MINI INVERTER 250W WALL MOUNT	120/277	--	--	--	•



ALLPRO AP2SQLED



ALLPRO APEL



SURE LITES SEL17



SURE LITES
APWR1 &
APWR2 SERIES



LITHONIA ELM2L
& EU2L SERIES



**VIEW EW
PRICING**

Shop Emergency & Exit Signs
View pricing and product updates.



**VIEW HZ
PRICING**

Shop Emergency & Exit Signs
View pricing and product updates.

Exit Signs

Red & Green Exit Signs | Emergency & Exit Sign Combos

LED Exit Signs						
Mfr	Part Number & Description	Voltage	Battery Backup	Coverage	Run-Time	UL Listed
Exit Signs						
COOPER	SURE-LITES APX7R LED RED EXIT SIGN	120/277	•	--	90MIN	•
COOPER	SURE-LITES APX7G LED GREEN EXIT SIGN	120/277	•	--	90MIN	•
COOPER	SURE-LITES EUS70R RED EXIT SIGN	120/277	•	--	90MIN	•
ACUITY	LITH EXRGELM6 RED/GREEN SWITCHABLE EXIT SIGN	120/277	•	--	90MIN	•
ASTRALITE	EANY-HC-U-R-W-EM-CT EXIT SIGN WITH CT SYMBOL OF ACCESS	120/277	•	--	90MIN	•
Emergency & Exit Sign Combos						
COOPER	SURE-LITES APC7G LED GREEN ALL-PRO COMBO	120/277	•	17'	90MIN	•
COOPER	SURE-LITES APC7R LED RED COMBO	120/277	•	17'	90MIN	•
COOPER	SURE-LITES APCH7R COMBO DUAL REMOTE HEAD COMBO	120/277	•	17'	90MIN	•
ACUITY	LITH ECRGRDM6 RED/GREEN SWITCHABLE W/ DUAL REMOTE HEAD COMBO	120/277	•	--	90MIN	•
ASTRALITE	LG-8ST-200-LED-HC-U-R-W-CT COMBO UNIT WITH CT SYMBOL OF ACCESS	120/277	•	--	90MIN	•

EMERGENCY LIGHTING



SURE LITES APX7R & APX7G SERIES



ASTRALITE EANY-HC-CT & LG-8ST-200-HC MODELS



LITHONIA EXR & ECRG SERIES



SURE LITES EUS70R



SURE LITES APC7G, APC7R, & APCH7R SERIES

Interior & Exterior Replacement Lamps

All Electrical Wholesalers and HZ Electric Supply branches fully stock the following LED corn cob HID retrofit lamps, TLEDs, drivers, programmable drivers, and LED replacement lamps.



Interior & Exterior Replacement Lamps

132-133 Intro to Replacment Lighting

134-135 Corn Cob - HID Retrofits

136-137 TLED & Drivers

138-139 Programmable Drivers

140-141 LED Replacement Lamps



PRICING IS NOT LISTED IN THIS EDITION OF THE CATALOG.

Please check with your Sales Rep or sign into your account on our website for the most up-to-date pricing and product inventory levels.

PHILIPS

LED lamps

Field Selectable
Products



REPLACEMENT LIGHTING

Flip the Switch to Selectable LED Lamps!

We're excited to announce a new addition to the selectable lamp family - MainsFit TLED (Type B) 5CCT. This TLED has a switch to select between 5 different CCTs from 3000K to 6500K. This product line is a nice addition to the full family already available in a PLED and LED HID Replacement Corn Cob styles helping to further streamline inventory.

Corn Cob - HID Retrofits

Medium & Mogul Based HID Replacement LED Lamps

LED Corn Cob - HID Retrofits

Mfr	Part Number	Mfr Part Number	Product Description	Lumens	Color / Selectable	Watts	MH Equiv	Dim- mable	DLC Listed
Medium Screw Base									
PHILIPS	559641	929002395304	18CC/LED/840/ND E26 G2 BB 6/1	2400	40K	18W	70W		
PHILIPS	559658	929002395404	18CC/LED/850/ND E26 G2 BB 6/1	2500	50K	18W	70W		
PHILIPS	559674	929002395604	27CC/LED/840/ND E26 G2 BB 6/1	3700	40K	27W	100W		
PHILIPS	559682	929002395704	27CC/LED/850/ND E26 G2 BB 6/1	3800	50K	27W	100W		
PHILIPS	559708	929002395904	36CC/LED/840/ND E26 G2 BB 6/1	5200	40K	36W	150W		
PHILIPS	578856	929003507804	19GC/LED/840/ND E26 BB 6/1	3000	50K	19W	100W		
KEYSTONE	KT-LED36PSHID-E26-8CSB-D		Available in 3K,4K, or 5K E26 DirectDrive	1740	•	18/27/36W	150W		
KEYSTONE	KT-LED45PSHID-E26-8CSB-D		Available in 3K,4K, or 5K E26 DirectDrive	2610	•	27/36/45W	175W		
Mogul Screw Base									
PHILIPS	564153	929002999004	36CC/LED/840/LS EX39 G3 BB 3/1	5200	40K	36W	150W	•	•
PHILIPS	564187	929002999304	45CC/LED/840/LS EX39 G3 BB 3/1	6500	40K	45W	175W	•	•
PHILIPS	564195	929002999404	45CC/LED/850/LS EX39 G3 BB 3/1	6700	50K	45W	175W	•	•
PHILIPS	564245	929002999904	63CC/LED/840/LS EX39 G3 BB 3/1	9000	40K	63W	250W	•	•
PHILIPS	564062	929002996204	80CC/LED/850/LS EX39 G2 BB 3/1	12000	50k	80W	250W	•	•
PHILIPS	564252	929003000004	63CC/LED/850/LS EX39 G3 BB 3/1	9200	50K	63W	250W	•	•
PHILIPS	564070	929002996404	115CC/LED/840/LS EX39 G2 BB 3/1	18000	40K	115W	320W	•	•
PHILIPS	564088	929002996504	115CC/LED/850/LS EX39 G2 BB 3/1	18000	50K	115W	320W	•	•
PHILIPS	577601	929003150704	36GC/LED/850/ND E39 BB 6/1	5900	50K	36W	150W		
Mogul Screw Base - Color & Luman Selectable									
KEYSTONE	KT-LED36PSHID-EX39-8CSB-D		Available in 3K,4K, or 5K EX39 Base, DirectDrive	2430-5220	•	18/27/36W	70/100/150W	•	•
KEYSTONE	KT-LED45PSHID-EX39-8CSB-D		Available in 3K,4K, or 5K EX39 Base, DirectDrive	3645-6525	•	27/36/45W	100/150/175W	•	•
KEYSTONE	KT-LED54PSHID-EX39-8CSB-D		Available in 3K,4K, or 5K EX39 Base, DirectDrive	6525-9035	•	36/45/54W	150/175/250W	•	•
KEYSTONE	KT-LED63PSHID-EX39-8CSB-D		Available in 3K,4K, or 5K EX39 Base, DirectDrive	2430-5220	•	45/54/63W	175/250/320W	•	•
KEYSTONE	KT-LED80PSHID-EX39-8CSB-D		Available in 3K,4K, or 5K EX39 Base, DirectDrive	3645-6525	•	54/63/80W	175/250/320W	•	•
KEYSTONE	KT-LED100PSHID-EX39-8CSB-D		Available in 3K,4K, or 5K EX39 Base, DirectDrive	6525-9035	•	63/80/100W	250/320/400W	•	•

PHILIPS

HID Replacement LED lamps

Get the perfect light with the right fit

A wide assortment of LED HID replacement lamps for all types of applications, from 50W to 1000W perfect-fit solutions. Get the benefit of lumen select-ability on all of our mogul based corn cob lamps and even the choice of color selectable lamps to optimize your space.



REPLACEMENT LIGHTING



innovation  you

Learn more about our HID Replacement LED lamps at: philips.com/HIDreplacementLEDlamps



 **VIEW EW PRICING**

Shop Corn Cob Retrofits
View pricing and product updates.



 **VIEW HZ PRICING**

Shop Corn Cob Retrofits
View pricing and product updates.

TLED Tubes

T8 LED 4' Tubes & TLED Drivers

REPLACEMENT LIGHTING

LED Fluorescent Replacements						
Manufacturer	Part Number	Manufacturer Part Number	Product Description	Wattage	Dimmable	DLC Listed
T8 LED 4' Tubes						
PHILIPS	565598	9290030254	8.9T8/MAS/48-835/IF15/P/DIM 10/1	8.9W	•	•
PHILIPS	565606	9290030255	8.9T8/MAS/48-840/IF16/P/DIM 10/1	8.9W	•	•
PHILIPS	565614	9290030256	8.9T8/MAS/48-850/IF16/P/DIM 10/1	8.9W	•	•
PHILIPS	473934	9290013977	13T8/MAS/48-835/IF20/P/DIM 10/1	13W	•	•
PHILIPS	473942	9290013978	13T8/MAS/48-840/IF21/P/DIM 10/1	13W	•	•
PHILIPS	553230	929001991734	10T8/COR/48-840/IF16/G DIM 10/1	10W	•	•
PHILIPS	553248	929001991834	10T8/COR/48-850/IF16/G DIM 10/1	10W	•	•
PHILIPS	470112	9290013432	14T8/COR/48-840/IF21/G/DIM 10/1	14W	•	•
PHILIPS	470120	9290013433	14T8/COR/48-850/IF21/G/DIM 10/1	14W	•	•
TLED Drivers						
PHILIPS	ADV ICN2P16TLEDN35M		2 LAMP DRIVER 120-277V	16W	•	
PHILIPS	ADV ICN3P16TLEDN35M		3 LAMP DRIVER 120-277V	16W	•	
PHILIPS	ADV ICN4P16TLEDN35M		4 LAMP DRIVER 120-277V	16W	•	



 **VIEW EW PRICING**

Shop TLEDs and Drivers
View pricing and product updates.



TLED offerings and features

Type A InstantFit



Fastest ROI plug-and-play

- Professionals choose Philips Type A
- B-brands are exiting due to the compatibility challenge

Type A UniversalFit



Works regardless of the ballast type

- Severe safety issue & potential UL challenge
- Energy-saving story eliminated for many competitors

Hybrid A/B FlexFit



If not compatible, rewire on the spot

- Redundant for majority of professionals due to expertise, and costly circuitry
- Type B typically SE, which requires lamp + socket
- Limited Type A compatibility

Type B MainsFit



Long term simplicity

- Professionals can readily rewire
- Significant entrants in the Type B space, with varied quality

Type C InstantFit



Most efficient solution

- Increasingly required for rebates and to ensure no "snap-back"
- Philips Type A lamps double our Type C

MasterClass



- Plastic lamp - shatter prevention
- Built-in surge & shock protection
- 70k hour life & 7-year limited warranty
- No visible flicker



CorePro



- Glass lamp
- Built-in surge & shock protection
- Up to 50k life & 5-year limited warranty
- >320° illumination angle
- Available no visible flicker



 **VIEW HZ PRICING**

Shop TLEDs and Drivers
View pricing and product updates.



LED Programmable Drivers

Philips Advance LED Drivers

REPLACEMENT LIGHTING

LED Programmable Drivers

Mfr	Part Number	Manufacturer Part Number	Product Description	Input	Output	Watt	Dimmable
Dimmable LED Drivers							
PHILIPS	XI036C100V054DSM1M	929000748413	LED Driver	120-277VAC	27-54VDC	36W	•
PHILIPS	XI020C056V054BST2M	929000754913	LED Driver	120-277VAC	22.5-54VDC	20W	•
PHILIPS	XI054C150V054BST1M	929000752513	LED Driver	120-277VAC	27-54VDC	54W	•
PHILIPS	XI075C200V054BST1M	929000755113	LED Driver	120-277VAC	27-54VDC	75W	•
PHILIPS	XI055C180V054BSJ1M	929000795213	LED Driver	120-277VAC	18-54VDC	55W	•
PHILIPS	XI095C275V054BSF1M	929000780513	LED Driver	120-277VAC	20-54VDC	95W	•



VIEW EW PRICING

Shop TLEDs and Drivers
View pricing and product updates.



VIEW HZ PRICING

Shop TLEDs and Drivers
View pricing and product updates.

ADVANCE

by  Signify

Advance Express

Programmable Drivers

Quickly replace a LED driver in the field

Programmable replacement LED drivers

Recommended Driver List

Troffer / Linear	Part Number / 12NC
	XI020C056V054BST2 929000754913
	XI054C150V054BST1 929000752513
	XI075C200V054BST1 929000755113
	XI036C100V054DSM1 929000748413
	XI055C180V054BSJ1 929000795213
	XI095C275V054BSF1 929000780513
	XI180C125V200BSF1 929000749513

REPLACEMENT LIGHTING



Team up with



LIGHTOLIER



^ Most up-to-date ^
Ready-to-go stock guide

LED Replacement Lamps

— A-line | R20 | BR30 | BR40 | PAR38

LED Replacement Lamps

Mfr	Part Number	Manufacturer Part Number	Product Description	Wattage	Energy Star Listed	Dimmable
A-Line LED Lamps						
PHILIPS	550418	9290020358	5A19/PER/930/P/E26/DIM	5W	•	•
PHILIPS	547042	9290020359	5A19/PER/940/P/E26/DIM	5W	•	•
PHILIPS	550434	9290020361	8.8A19/PER/927/P/E26/DIM	8.8W	•	•
PHILIPS	550442	9290020362	8.8A19/PER/930/P/E26/DIM	8.8W	•	•
PHILIPS	550459	9290020363	8.8A19/PER/950/P/E26/DIM	8.8W	•	•
PHILIPS	561043	9290023853	12.2A19/PER/930/P/E26/DIM	12.2W	•	•
PHILIPS	561076	9290023856	16A19/PER/930/P/E26/DIM	16W	•	•
PHILIPS	556928	9290022850	14A21/LED/927/P/E26/3WAY/ND	14W	•	•
PHILIPS	550400	9290020357	5A19/PER/927/P/E26/DIM	5W	•	
PHILIPS	550418	9290020358	5A19/PER/930/P/E26/DIM	5W	•	
PHILIPS	550434	9290020361	8.8A19/PER/927/P/E26/DIM	8.8W	•	
PHILIPS	550442	9290020362	8.8A19/PER/930/P/E26/DIM	8.8W	•	
PHILIPS	561043	9290023853	12.2A19/PER/930/P/E26/DIM	12.2W	•	
PHILIPS	561076	9290023856	16A19/PER/930/P/E26/DIM	16W	•	
PHILIPS	556928	9290022850	14A21/LED/927/P/E26/3WAY/ND	14W	•	
Reflectors						
PHILIPS	547406	9290020353	5R20/PER/930/P/E26/DIM	5W	•	•
PHILIPS	547414	9290020354	5R20/PER/940/P/E26/DIM	5W	•	•
PHILIPS	456979	9290020089	5R20/PER/927-22/P/E26/WG	5W	•	•
PHILIPS	553891	9290020923	7.2BR30/PER/927/P/E26/DIM	7.2W	•	•
PHILIPS	545905	9290020321	7.2BR30/PER/930/P/E26/DIM	7.2W	•	•
PHILIPS	545913	9290020322	7.2BR30/PER/940/P/E26/DIM	7.2W	•	•
PHILIPS	547422	9290020355	8.8BR40/PER/930/P/E26/DIM	8.8W	•	•
Par38						
PHILIPS	567917	929003029304	10PAR38/LED/940/F40/DIM/GULW	10W	•	•
PHILIPS	567818	9290030303	13PAR38/LED/940/F40/DIM/GULW	13W	•	•

LED A-Shape Plastic - A19

Features

- Dimmable to at least 10%
- Enclosable
- Damp Location
- 15,000 Life Hours Enclosed / 25,000 Life Hours Non-Enclosed
- 40W/60W (E26 Base) – A19
- 75W/100W (E26 Base) – A21 Transitioned to A19 NOW
- Title 20 Compliant in California

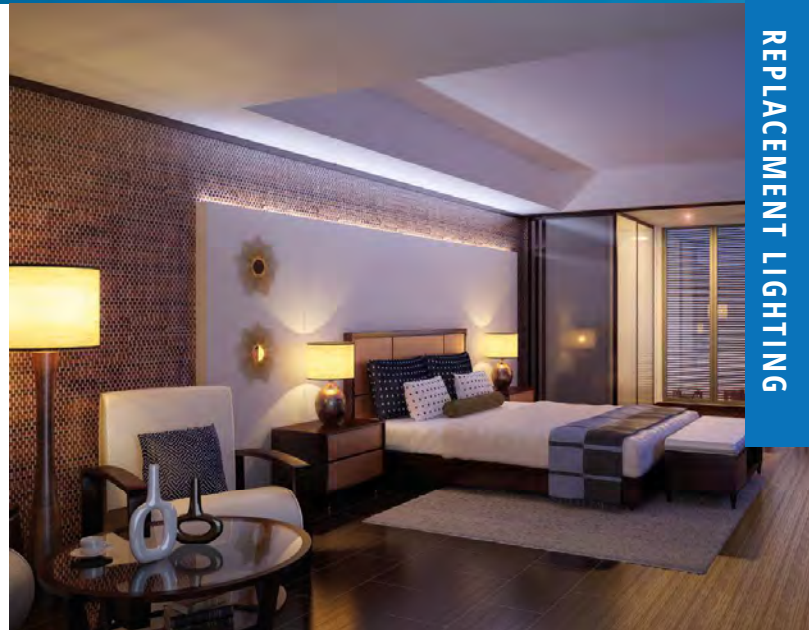

REPLACEMENT LIGHTING



A-LINE LAMPS



R20 LAMPS



BR30 LAMPS



BR40 LAMPS



VIEW EW PRICING

Shop LED Lamps
View pricing and product updates.



VIEW HZ PRICING

Shop LED Lamps
View pricing and product updates.

Services & Solutions

Capabilities & Solution Services

- 142-143 Intro to Services & Solutions | Solutions Trailer
- 144-145 Wire Solutions | Job Site Solutions
- 146-147 Prefabrication Solutions & Precision Prefab Offerings
- 148-149 Inventory Management | Will Call & Delivery Express Services
- 150-153 E-Commerce | USESI Billtrust Services | Request Support

SOLUTION SERVICES



SOLUTIONS

Capabilities & Solution Services



WIRE SOLUTIONS

Each of our wire management solutions is designed to save you money, decrease your installation time, and improve safety on the job site. Featuring Southwire SIMpull™ Solutions.



JOB SITE SOLUTIONS

Save time and money with our job site solutions. We provide job site cages, fixture carts, and prefab services.



PREFAB SOLUTIONS

Increase profits while reducing operating expenses with our prefabrication solution and precision prefab offerings.



INVENTORY MANAGEMENT

Get real-time visibility of inventory and automatic replenishment of your job site trailer, remote stockroom, service truck, or warehouse.



WILL CALL & DELIVERY SERVICES

Place your orders online until 7PM for our express will call service or next-day delivery!



E-COMMERCE & BILLTRUST SERVICES

Take advantage of our online services! Check pricing & inventory and place orders on our website. Use our Billtrust service to pay your bill, view past invoices, and track jobs.

GET IN TOUCH WITH OUR SOLUTIONS TEAM

Contact the Solutions Team at SolutionsR22A@USESI.com

Wire Solutions

Each wire management solution is designed to save you money, decrease your installation time, and improve safety on the job site.

FULLY CUSTOMIZE YOUR WIRE SOLUTIONS

Prepared wire and cables offer you the exact product you need without your crew having to cut, configure, or strip the wire before usage: This includes; twisted or paired wires and cut and stripped wires in all gauge sizes. We offer larger sizes that are available upon request.

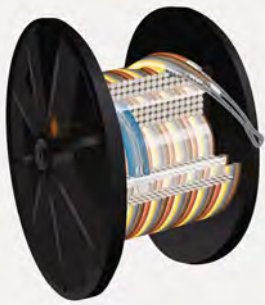

SOUTHWIRE SIMpull™ REEL

The SIMpull™ Reel revolutionizes the job site by allowing one person to safely move a reel that weighs up to 6,000lbs., without the need of pallet jacks, jacks stands, or other equipment.



BENEFITS

- Stack parallels on top of one another to reduce the number of total reels needed
- Pre-installed pulling heads
- Significantly easier and safer to move reels
- Reels fit through standard 36" doorways
- Allows reel to be placed right next to feed point conduit

FEATURES

- Independently rotating outer flanges
- Separately rotating inner reel
- Integral magnetic reel chocks
- Integral payoff tension adjustment
- 6000-lbs maximum load capacity
- Reel Size - 61"H x 32"W

ADDITIONAL SOUTHWIRE SIMpull™ SOLUTIONS

SIMpull™ FLANGE

Turn a wooden reel up to 34" and 2,000 lbs.

SIMpull™ HEAD

Allows wire to be ready to pull as soon as it's delivered.

SIMpull™ TRUCK

Eliminate the excess cost, time, and labor while improving overall productivity.



SCAN TO VISIT

EW-CT.COM/WIRE-SOLUTIONS



SCAN TO VISIT

HZELECTRIC.COM/WIRE-SOLUTIONS

Job Site Solutions

Save time and money with our job site solutions. We provide job site cages, fixture carts, and prefab services.

JOB SITE CAGES



- Lockable cage to store material
- Easily move material around the job site
- Lowers risk of material being stolen
- Keep material consolidated and organized
- Keep on-site for the duration of the job and refill as needed

FIXTURE CARTS

- We ship unpackaged fixtures to your job site to increase installation efficiency and reduce labor costs
- Save ~ 10 minutes per fixture (unpackaging fixtures and waste disposal)
- We unpackage the fixtures FOR YOU
- Fits 24 2x2, 12 2x4, strip fixtures
- Spot fixture damage BEFORE they arrive on the job site



PUT FOCUS BACK ON YOUR JOBS & CUSTOMERS

**SIMPLIFY
YOUR LIFE**



**SAVE
MONEY**



**GROW
YOUR
BUSINESS**



Prefabrication Solutions

We offer comprehensive electrical prefab services in Massachusetts, New York, and Connecticut. We can design and prepare materials to your exact specifications while helping cut down on waste. As a result, you can complete each job with more continuity while working more efficiently and minimizing completion times.

INCREASE PROFITS WHILE REDUCING OPERATING EXPENSES!



Our prefabrication facility is fully equipped with advanced tools and technology to handle high-end bending and cutting conduit, strut, and threading jobs. Our systems can also customize MC whips for both boxes and fixtures.



**PIPE
BENDING**



**PIPE THREADING
& CUTTING**



**STRUT CUTTING
& ASSEMBLY**



WHIPS

LEARN MORE BY VISITING OUR WEBSITE BELOW



SCAN TO VISIT

EW-CT.COM/PREFAB



SCAN TO VISIT

HZELECTRIC.COM/PREFAB

GET STARTED WITH OUR

PRECISION PREFAB OFFERINGS

*We have standardized
our most popular
prefabrication solutions
to be highly competitive
within the market.*

AVAILABLE NOW



**VIEW OUR PRECISION PREFAB
OFFERINGS BOOKLET**

*TELL US ABOUT YOUR SPECIFIC PREFAB
NEEDS TODAY!*

Inventory Management

To help your business succeed, we've made inventory simple and painless with our **FREE** Inventory Management System. Now ordering and maintaining your inventory is faster and easier!

SAVE



Time & Money

REDUCE



Errors, Stock-Outs, & Overages

SIMPLIFY



Ordering & Billing

INCREASE

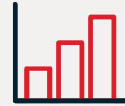

Focus on Your Business

HOW IT WORKS

To accommodate your specific challenges, we'll meet to review your current inventory processes and future goals. We'll develop recommendations, and then review those recommendations with you. Together, we'll map out a custom system that fits your unique situation.

INSTALLATION & IMPLEMENTATION

- Designed to your needs, flexible, and easy to use - your new system may include bins, bar-codes, job cages, software, and even trailers
- Adjustable - as your business grows, your system grows with it
- Initial inventory is taken and an order is created based on current on-hand quantities
- Training provided



REPLACING & REPLENISHING INVENTORY



- **Auto-replenishment** - automatically re-order material based upon minimum and maximum inventory thresholds
- **Scan-to-order** - scan barcodes to re-order materials as needed - barcodes can be listed in barcode booklets and/or on labels
- **Monitoring** - enjoy full visibility of your inventory with accurate analytical tools.



 **SCAN TO VISIT**

EW-CT.COM/INVENTORY-MANAGEMENT



 **SCAN TO VISIT**

HZELECTRIC.COM/INVENTORY-MANAGEMENT

Will Call & Delivery **EXPRESS** Services

Electrical Wholesalers and HZ Electric Supply carry thousands of items eligible for free in-store pickup when ordered online. Now, with Electrical Wholesalers' **FASTLANE Express** Will Call program and HZ Electric's **Grab 'N Go Express** Will Call program, convenience is key. Just place your order online, grab it, and go!

ORDER IN THREE EASY STEPS

STEP 1

Select a branch to deliver your order.



STEP 2

Add products to your cart and choose - Pick Up.



STEP 3

Pick up your order from the branch.



Once your order is placed, you will receive an order confirmation. Bring your invoice number with you for quick retrieval from the Will Call shelf.



BRANCH ORDER PICK UP

When you arrive at the branch look for the **EW FASTLANE** or **HZ GRAB 'N GO Express Will Call** signage and stickers. To make changes to your order before pick up, email customersupport@ew-inc.com or customersupport@hzelectric.com.

PLACE YOUR ORDERS ONLINE UNTIL 7PM
FOR OUR EXPRESS WILL CALL SERVICE OR NEXT DAY DELIVERY!



Delivery Notifications - Request to be notified when your orders are delivered via text message or email.

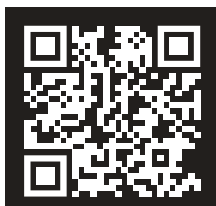

 **SCAN TO VISIT**
EW-CT.COM/FASTLANE



 **SCAN TO VISIT**
HZELECTRIC.COM/GRAB-N-GO

E-Commerce

Speak to your Solutions Manager or Branch Manager today about registering for our website. Learn the benefits of our e-commerce system, mobile app, and our barcode booklet.

BENEFITS

- Access to your "specific" account pricing
- Enhanced search engine to view products by keyword, trade name, or category
- Release quotes your salesperson entered at your convenience
- Set permissions to control who from your company can place orders and view pricing

MOBILE APPS

Access your account through our mobile app available in the App Store and Google Play.

Benefits include:

- Barcode scanner for easy ordering and inventory management
- Checking live inventory from local branches in the area



CUSTOM BARCODE CATALOG

Request a custom barcode list of material or we can provide a booklet of your most frequently ordered items. Email SolutionsR22A@usesi.com.



USESI Billtrust & System Solutions

View and pay your bill online with USESI Billtrust Services. We offer system solutions to integrate and automate material, pricing, or other financial information.

USESI BILLTRUST

- Pay your bill online
- Integrate with popular industry accounting systems
- Enrollment token and instructions listed on the bottom of each customer invoice

**PAY INVOICES
ONLINE SECURELY**



**MANAGE & ACCESS
INVOICES 24/7**



**UPLOAD INTO
ACCOUNTING
SOFTWARE**



SYSTEM SOLUTIONS

- Integrations cover the automation of material, pricing, and financial documents including:
 - Estimates
 - Project Management
 - Purchasing
 - Accounting



 **SCAN TO LOGIN TO YOUR ACCOUNT**

USESI.BILLTRUST.COM

Need Additional Help or More Information?

REQUEST MORE
INFORMATION
ONLINE SECURELY



FAST 24HR
TURN-AROUND



ACCURATE
PRICING
INFORMATION



PLEASE REACH OUT TO REQUEST SUPPORT
OR FOR ORDERING ASSISTANCE

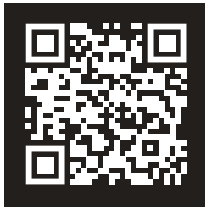

 **SCAN NOW TO CONTACT
AN EW SALES REP!**

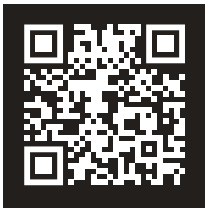

 **SCAN NOW TO CONTACT
AN HZ SALES REP!**



**ASK YOUR SALES
REP OR LOCAL BRANCH
TO LEARN MORE**



**ACCESS YOUR ACCOUNT
& SHOP ONLINE**



**VIEW UP TO DATE
PRICING & PRODUCTS**

VIEW DIGITALLY

View the Design Build Catalog online for quick reference. Access all online categorized products for up to date pricing and product additions.



**SCAN TO
VIEW ONLINE**



Electrical Wholesalers Corporate Office

-  701 Middle Street, Middletown, CT 06457
-  860-522-3232
-  customersupport@ew-ct.com
-  www.ew-ct.com



HZ Electric Supply Corporate Office

-  274 Taylor Street, Springfield, MA 01105
-  413-734-6407
-  customersupport@hzelectric.com
-  www.hzelectric.com

*Emergency After Hours

-  860-662-6042 | *Emergency services subject to charge fee.