

CHARACTERISTICS

Ambient temperature	-10 ÷ +45 °C	
Fluid	50 µm filtered air, with or without lubrication	
Commutation system	spool	
Max pressure	10 bar	
Connections	G1/8	G1/4
Nominal bore (mm)	6,5	8,5
Nominal flow rate (NI/min)	890	1480
Valve body	die-cast zamak (G1/8), aluminium (G1/4)	
Seals	NBR	
Spool	aluminium	
Electropilot/Coil	AA series/U1-U3	
Power consumption	3,5 W (DC) - 5 VA (AC)	
Connector	AM-5110	
Voltage	12 V DC - 24 V DC - 24 V AC - 110 V AC - 230 V AC	
Manual override	impulse screw - 2 positions	



NOTE: some versions with high temperature seals are available upon request (for further information please contact our Sales Office)

UNIVERSAL Modular System

MECHANICAL

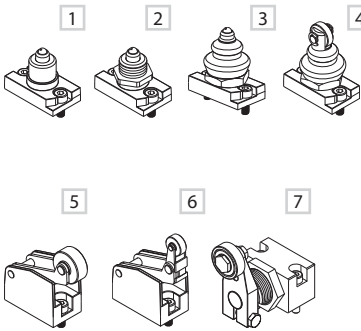

MANUAL

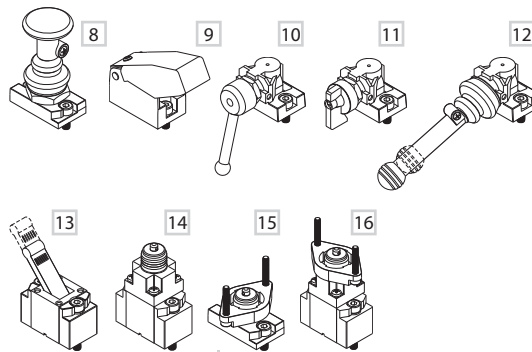

ELECTRICAL

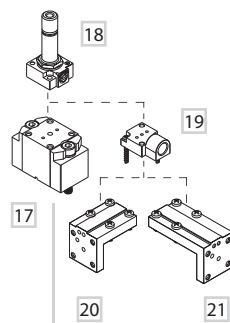

PNEUMATIC

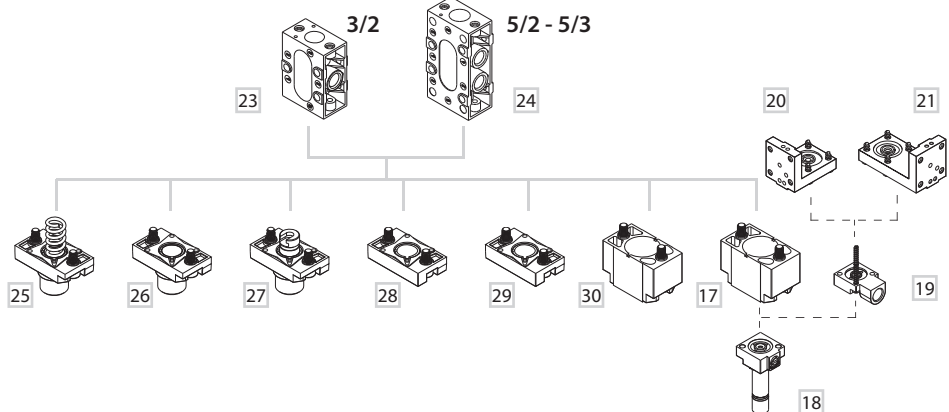
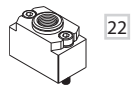

MECHANICAL CONTROL

- 1 Ball push
- 2 Ball push for screw panel mounting
- 3 Ball push with dust protection
- 4 Roller with dust protection
- 5 Roller lever
- 6 One-way roller lever
- 7 Two-way side roller lever

MANUAL CONTROL

- 8 Push-pull
- 9 Push button
- 10 Rotating lever
- 11 Selector

12 90° short/long lever

- 13 Short/long lever
- 14 Threaded indirect operation
- 15 Panel direct operation
- 16 Panel indirect operation

ELECTRICAL CONTROL

- 17 Electrical amplified
- 18 U1 electropilot
- 19 Plate for external pilot supply
- 20 Angle plate for "H" solenoid option
- 21 Angle plate for "P" solenoid option

PNEUMATIC CONTROL

- 22 Pneumatic amplified

BODY

- 23 3/2 body
- 24 5/2 body

RETURN

- 25 Mechanical spring
- 26 Pneumatic not amplified
- 27 Bottom plate - 2/3 positions
- 28 Bottom plate
- 29 Pneumatic spring
- 30 Pneumatic amplified

See ATEX Catalogue for types and versions

Valves G1/8 with direct mechanical operation

■ Roller lever

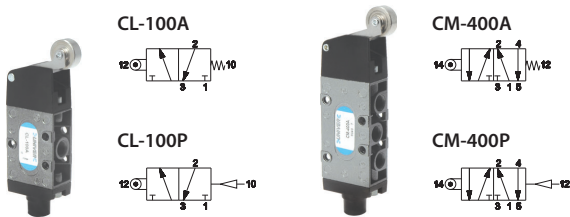

■ One-way roller lever

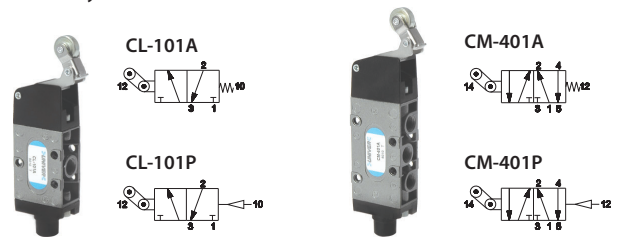

■ Two-way side roller lever

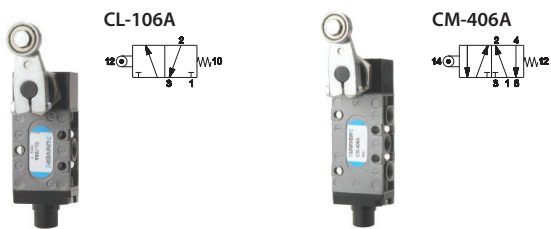

■ Adjustable two-way side roller lever

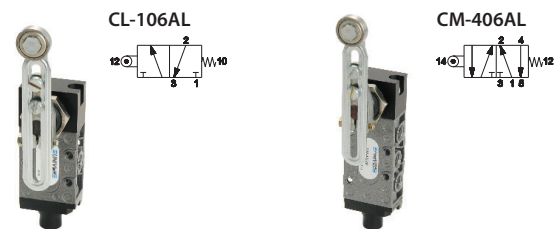

■ Ball-push

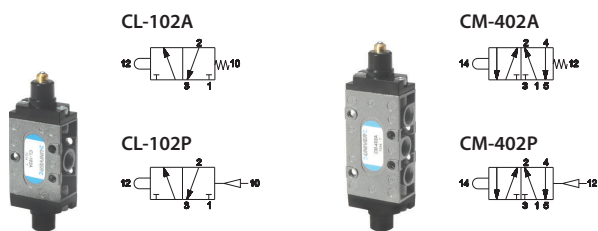

■ Roller with dust protection

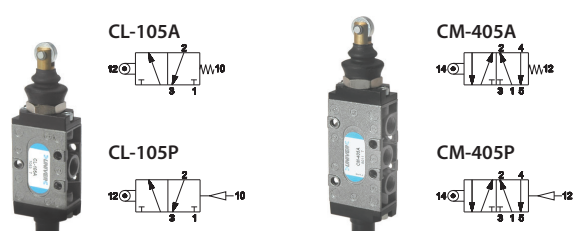

■ Ball push with dust protection

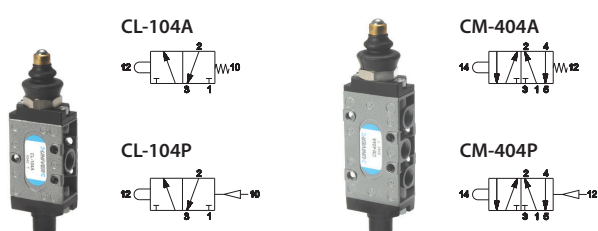

■ Ball push for screw panel mounting

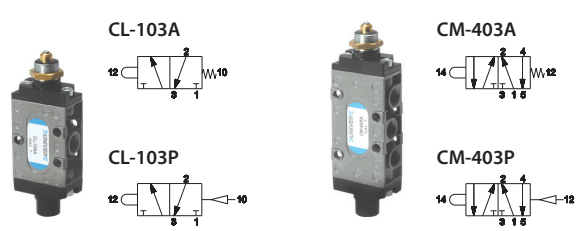

Valves G1/4 with direct mechanical operation

■ Ball push

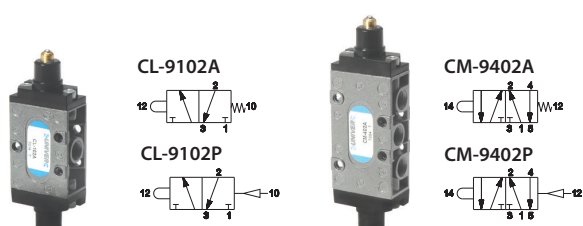

■ Ball push for screw panel mounting

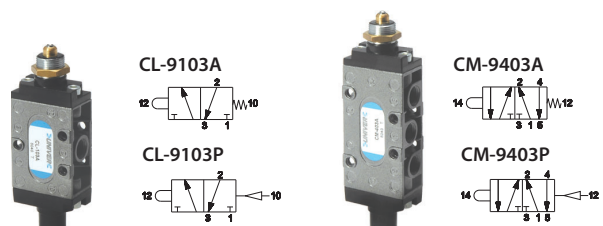

Valves G1/8 - G1/4 with indirect mechanical operation for pneumatic and mechanical operators

■ Ball push								■ Sensible ball push							
	CL-110A G 1/8		CL-9110A G 1/4		CM-410A G 1/8		CM-9410A G 1/4		CL-111A G 1/8		CL-9111A G 1/4		CM-411A G 1/8		CM-9411A G 1/4
	CL-110P G 1/8		CL-9110P G 1/4		CM-410P G 1/8		CM-9410P G 1/4		CL-111P G 1/8		CL-9111P G 1/4		CM-411P G 1/8		CM-9411P G 1/4
	AI-3550		AI-3551		AI-3560		AI-3562		AI-3563		AI-3570		AI-3571		AI-3572
								AI-3511 ■	AI-3514 ■	AI-3515 ■	AI-3520 ■	AI-3522 ■	AI-3524 ■	AI-3525 ■	AI-3526 ■
								AI-3512 ■	AI-3516 ■	AI-3517 ■	AI-3521 ■	AI-3522 (2 pos.)			
								AI-3513 ■	AI-3514D ■	AI-3519 ■		AI-3523 ■			
								AI-3516D ■							

Valves G1/8 - G1/4 with direct and indirect operation for panel operators

■ Ball push (direct operation)								■ Ball push (indirect operation)							
	CL-112A		CM-412A		CL-113A G 1/8		CM-413A G 1/8		CL-9113A G 1/4		CM-9413A G 1/4		CL-112P		CM-412P
	CL-112P		CM-412P		CL-113P G 1/8		CM-413P G 1/8		CL-9113P G 1/4		CM-9413P G 1/4		CL-113P		CM-413P
	AI-3511Q ■		AI-3514Q ■		AI-3515Q ■		AI-3524Q ■		AI-3511Q ■		AI-3514Q ■		AI-3515Q ■		AI-3520Q ■
	AI-3512Q ■		AI-3516Q ■		AI-3517Q ■		AI-3521Q ■		AI-3512Q ■		AI-3516Q ■		AI-3517Q ■		AI-3521Q ■
	AI-3513Q ■		AI-3514QD ■		AI-3519Q ■		AI-3523Q ■		AI-3513Q ■		AI-3514QD ■		AI-3519Q ■		
			AI-3516QD ■												

Valves G1/8 with manual operation

■ Push-pull

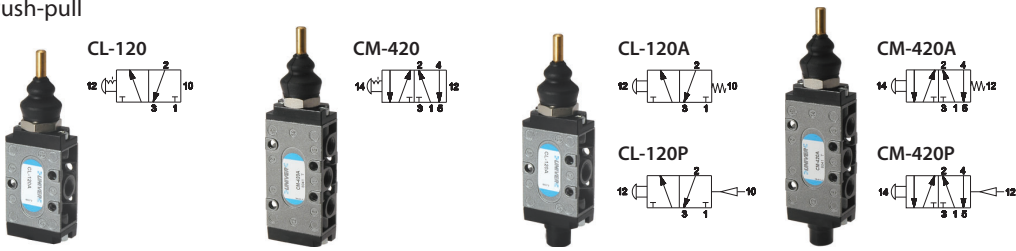

Valves are supplied without operator



- YELLOW
CP-911G
- RED
CP-911R
- BLACK
CP-911N
- GREEN
CP-911V

■ Long lever

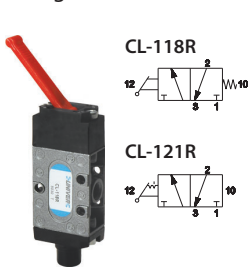

■ Short lever

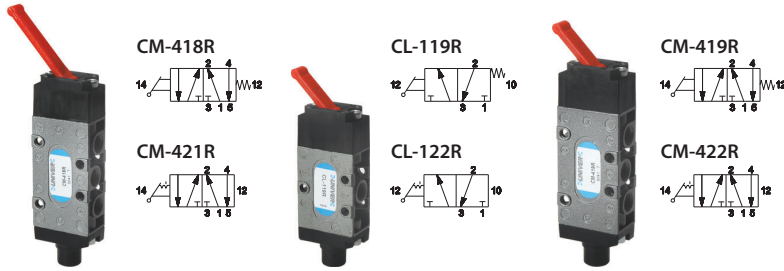

LONG LEVER

STANDARD

- RED

UPON REQUEST

- YELLOW
- BLACK

SHORT LEVER

STANDARD

- RED

UPON REQUEST

- YELLOW
- BLACK
- GREEN

■ Button

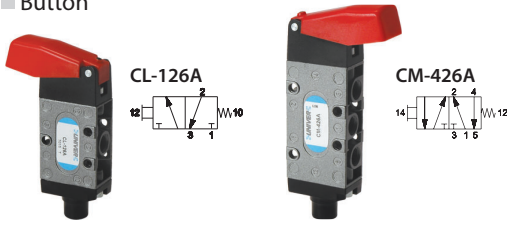

STANDARD

- RED

■ Rotating lever



Valves are supplied without operator



- RED
CP-915R



- RED
CP-916R

■ 90° Lever

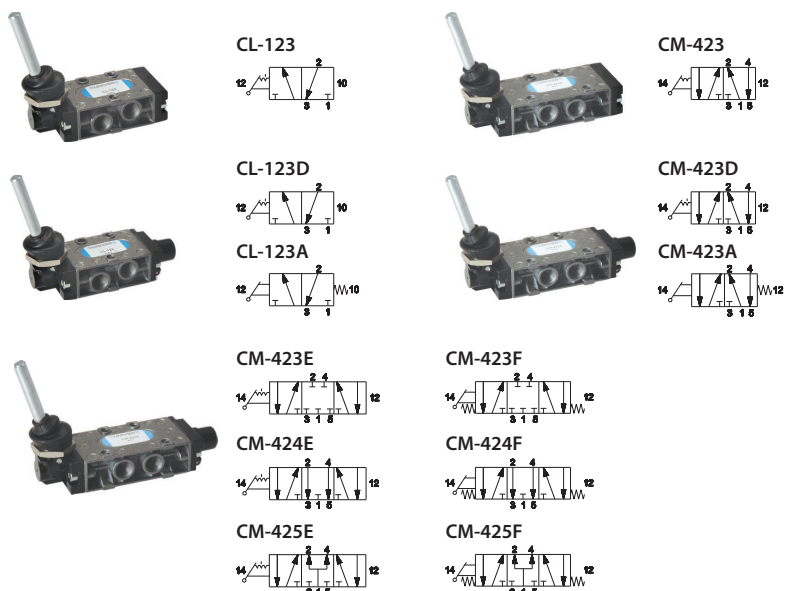

LONG LEVER



- RED
CP-913R

SHORT LEVER



- YELLOW
CP-912G
- RED
CP-912R
- BLACK
CP-912N

Valves are supplied without operator

Valves G1/4 with manual operation

■ Push-pull

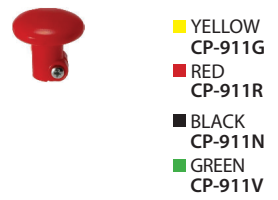
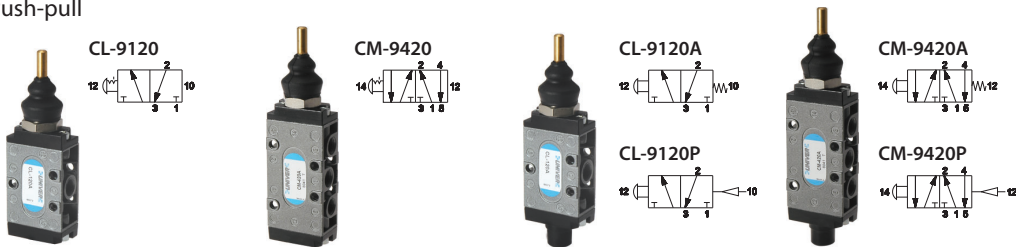

Valves are supplied without operator

■ Long lever

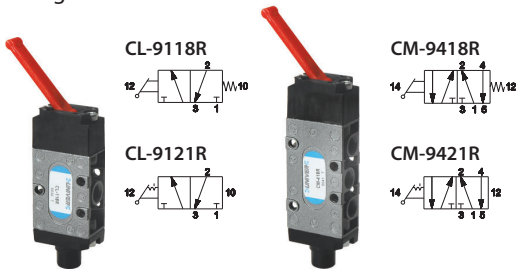

■ Rotating lever

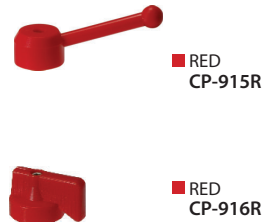

Valves are supplied without operator

■ 90° Lever

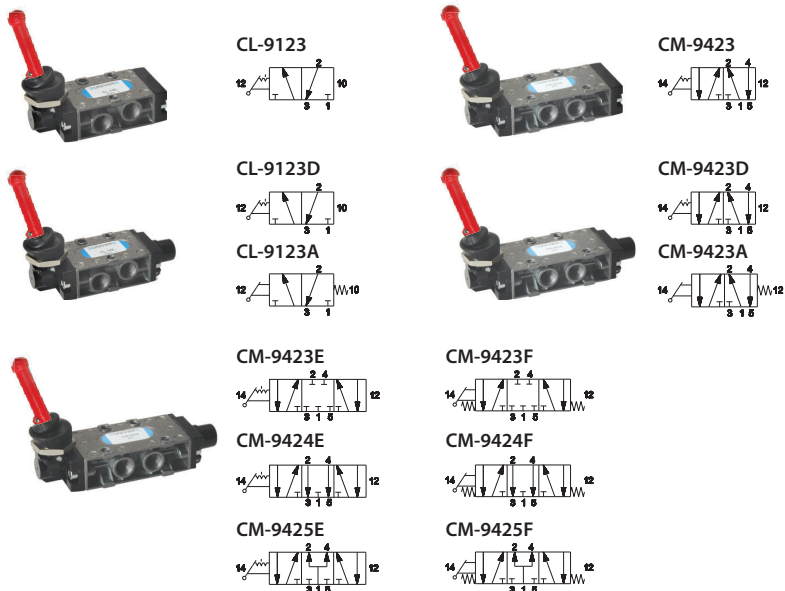

Valves are supplied with long lever operator

Valves G1/8 - G1/4 with pneumatic operation

Single impulse



CL-200 G1/8
CL-9200 G1/4

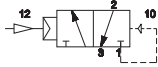

CL-203 G1/8 (NO)
CL-9203 G1/4 (NO)

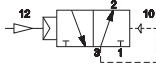

CL-200A G1/8
CL-9200A G1/4

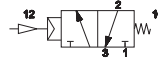

CM-500 G1/8
CM-9500 G1/4

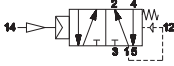

CM-500A G1/8
CM-9500A G1/4

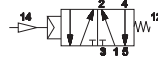

Double impulse



CL-220 G1/8
CL-9220 G1/4



CL-221 G1/8
CL-9221 G1/4



CL-224 G1/8
CL-9224 G1/4



CM-521 G1/8
CM-9521 G1/4

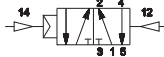

CM-524 G1/8
CM-9524 G1/4

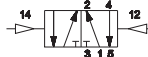

CM-520 G1/8
CM-9520 G1/4

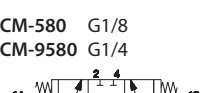
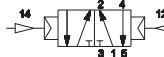

CM-580 G1/8
CM-9580 G1/4

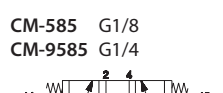
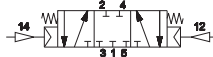

CM-585 G1/8
CM-9585 G1/4

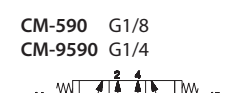
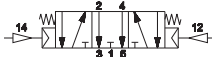

CM-590 G1/8
CM-9590 G1/4

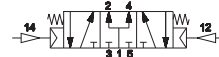

Valves G1/8 - G1/4 with electrical operation

Single impulse



CL-300 G1/8
CL-9300 G1/4

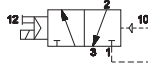

CL-302A G1/8
CL-9302A G1/4

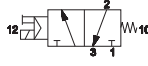

CL-301 G1/8
CL-9301 G1/4

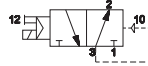

CL-303A G1/8 (NO)
CL-9303A G1/4 (NO)

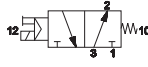

CM-600 G1/8
CM-9600 G1/4

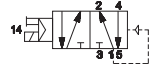

CM-602A G1/8
CM-9602A G1/4

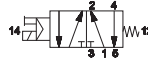

Double impulse



CL-320 G1/8
CL-9320 G1/4

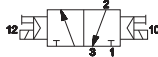

CL-321 G1/8
CL-9321 G1/4

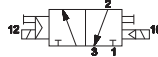

CL-322 G1/8
CL-9322 G1/4

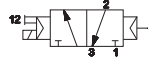

CM-620 G1/8
CM-9620 G1/4

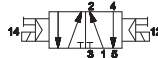

CM-621 G1/8
CM-9621 G1/4

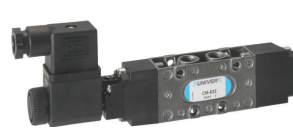
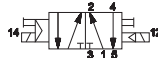

CM-622 G1/8
CM-9622 G1/4

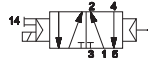

CM-680 G1/8
CM-9680 G1/4

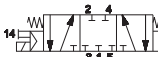

CM-685 G1/8
CM-9685 G1/4

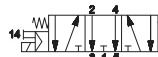

CM-690 G1/8
CM-9690 G1/4

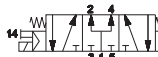

Solenoid valves are supplied without coil, connector and locking nut

AM-5148

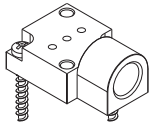
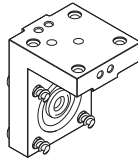

Plate for external pilot supply

AM-5151



Angle plate for "H" solenoid option

AM-5152

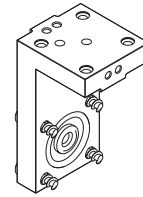

Angle plate for "P" solenoid option

CLIPS Modular sub-base G1/8 - G1/4 for 3/2 - 5/2 - 5/3 valves

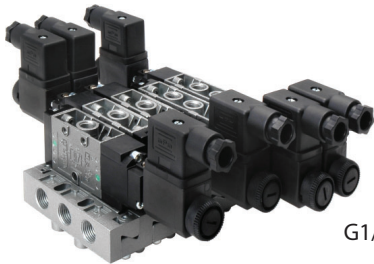

G1/8

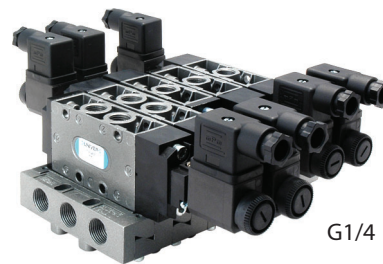

G1/4

CP-100/CP-9100

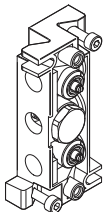

modular sub-base with adjustable and conveyed exhausts
CP-100 for G1/8, **CP-9100** for G1/4
material: zamak

standard supplied: screws, seals, exhaust regulator and coupling for valve fixing

CP-101/CP-9101

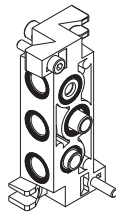

modular sub-base without adjustable exhausts
CP-101 for G1/8, **CP-9101** for G1/4
material: zamak

standard supplied: screws, seals and coupling for valve fixing

CP-105/CP-9105

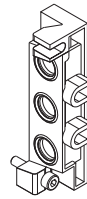

side connection inlet plate
CP-105 G1/4, **CP-9105** G3/8
material: zamak

standard supplied: screws and seals

CP-106



closing plate for unused place bases G1/8
material: aluminium

CP-110/CP-9110



coupling
connections: **CP-110** G1/8, **CP-9110** G1/4
material: brass

CP-111/CP-9111



pressure separator
CP-111 for G1/8, **CP-9111** for G1/4
material: aluminium

CP-112/CP-9112



plug for 3/2 valve mounting
CP-112 for G1/8, **CP-9112** for G1/4
material: aluminium

CP-113/CP-9113

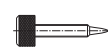

adjustment needle
CP-113 for G1/8, **CP-9113** for G1/4
material: brass

For each additional pressure, one coupling and two separators are required

Plug for mounting 3/2 NC-NO valves on "CLIPS" sub-base to close unused way. Sub-base with adjustment screw (screwdriver slot) standard supplied. Upon request: adjustment needle with milled handle

■ Assembly Example
Manifold supplied by three different pressures

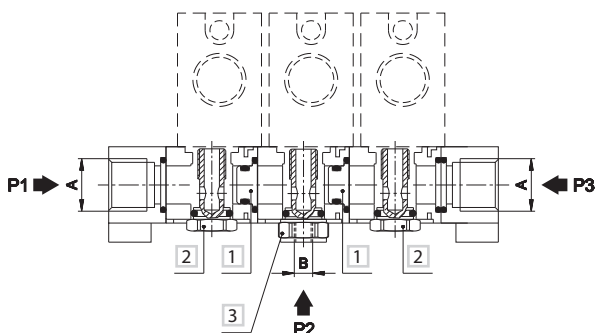

	A	B
G1/8	G1/4	G1/8
G1/4	G3/8	G1/4

- 1 Pressure separator CP-111/CP-9111
- 2 Fixing coupling for valve embodied in the sub-base
- 3 Coupling CP-110/CP-9110