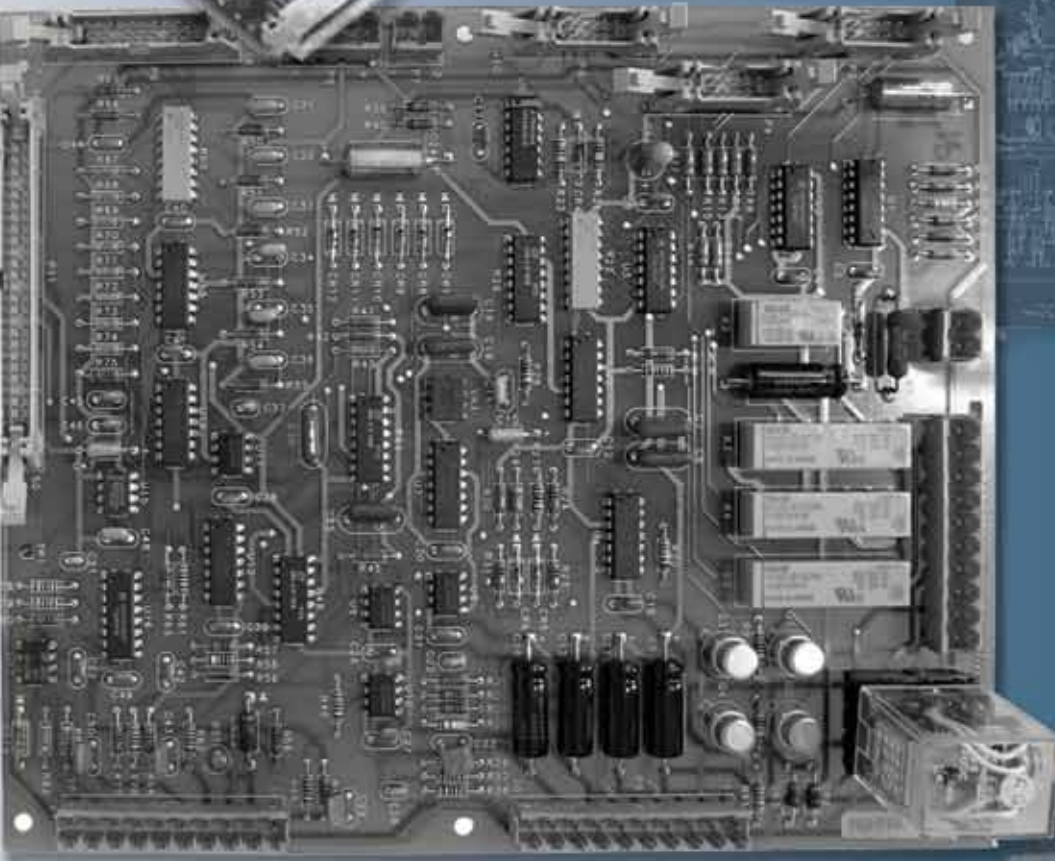
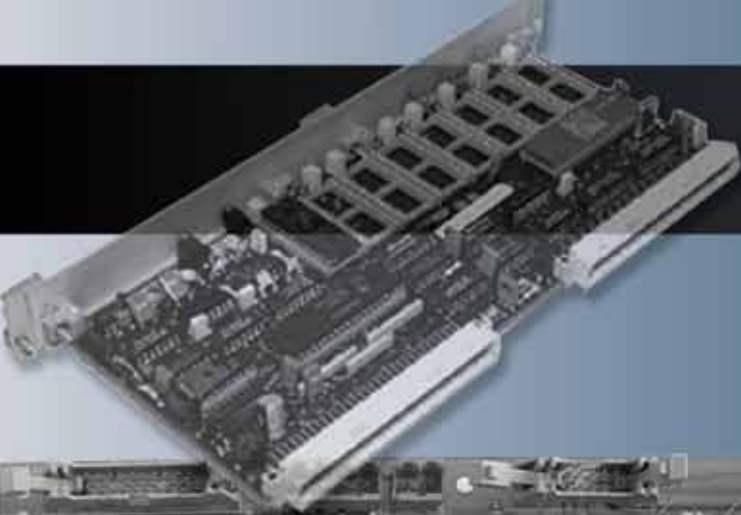


PC BOARDS



UNITEC

EXCELLENCE FROM THE GROUND UP

EXCELLENCE FROM THE GROUND UP

800 / 328-7840

PC Board

PC BOARDS

©2013, UNITEC Parts Company



Phone: 800/ 328 - 7840 • Fax 860/ 286 - 1625



About This Catalog

This catalog lists many of the printed circuit boards that can be purchased, repaired, or exchanged by the UNITEC Parts Company in Bloomfield, Connecticut.

It also contains some of the related electronics we repair, such as contactors, heat sinks, and drives.

There is a chapter for each elevator manufacturer for which boards are available, and they are presented alphabetically. Within the longer chapters, there are subsections for each elevator/escalator system, which are also in alphabetical order. For each part number that is provided, a brief description is given along with any related part numbers (alternate, substituted, or superseded numbers). In most cases, the system on which the board is used is given, and many of the listings are accompanied by a photo of the board.

Subsequent revisions of this catalog will feature additional photos and enhanced descriptions.

Note that a great many PC boards have their part number stamped on the board itself, or applied via a label. For those used on non-Otis systems, our part numbers are the manufacturer's part number preceded by a company prefix (such as WEST for Westinghouse). Refer to the note below for further information.

Terminology & Symbols

Part Number: The part number you will use to order the part from UNITEC.

Description: PCB description.

Alt/Sub/Sup P/N: Any alternate, substituted, or superseded part numbers for this board.

* An asterisk designates boards that can currently be repaired only, and are not available for purchase or exchange.

NOTE: UNITEC inventories non-Otis boards using the original manufacturer's part number with an OEM prefix (e.g., DOVR9715710).

Choice...

Exchange

Reducing downtime is the most critical component of quality elevator service. Exchanging your PC board is the most efficient method to get an elevator back in service quickly. UNITEC offers overnight delivery.

Repair

Repair is your most cost-effective option. UNITEC's PC board repair process includes troubleshooting, replacement of defective components, and testing. Our state-of-the-art in-circuit, functional, and simulator testing capabilities guarantee that your board is fixed right the first time. All boards are warranted for 45 days against defects.

Purchase

Available PC boards are also available for purchase. Call your UNITEC representative at 800.328.7840 for more information.

Table of Contents

About This Catalog	2
Terminology & Symbols	2
Choice.....	2
Exchange.....	2
Repair	2
Purchase	2
Armor	7
Dynaglide	7
CEC.....	8
Modmaster / Swift 5000.....	8
Modmaster / Swift 5000 w/DSD 412 Drive.....	10
Swift 5000 CPU.....	10
Swift Futura	11
Swift Futura w/SCR Drive.....	11
Delta	13
Dover.....	14
Composite.....	14
DMC-I	15
Fixture	17
MSC-I.....	18
Oildraulic.....	18
Solid State	19
Selector and Position Devices.....	21
T-I, T-II	21
T-II 22	
TII Selector & Position Devices	22
TIII 23	
TIII & TIV	25
TIV 26	
Miscellaneous	28
Haughton	29
Accufflite	29
Electronic Stepping Switch.....	29



Table of Contents

Goldflight	30
Hydro	31
Miconic	31
Static Drives Reliance Cards.....	32
Miscellaneous	33
KONE.....	34
KCM 831.....	34
TMS 900	34
MCE.....	35
Montgomery.....	38
Door.....	38
Escalator.....	38
Hydro	39
MAC Door Operator	40
MIPROM 21.....	42
MIPROM Hydro and Traction.....	45
SSC-6010	50
Otis	52
506 Escalators.....	52
Black Belt Door Operator.....	52
CB Base	52
Elevonic 211	57
Elevonic 101 & 401	58
Elevonic 311 & 411	68
Elevonic 335M	77
GAMMA D.....	78
GEM, MVS	80
IDS 81	
LR, LRV, LHM, LRV	82
MPGC	85
MRQ, EMO, TEMO	86
MRS, MRV, MRVF, LR.....	87
VIP260	93
Miscellaneous	95

PC BOARDS

©2013, UNITEC Parts Company

Schindler	99
321A Hydro, 321A/330A.....	99
Escalator.....	99
Goldflight	99
Miconic 300A	100
Miconic A.....	101
QKS Operator	102
Miscellaneous	103
Swift.....	104
Swift 5000 Modmaster with 3412 Drive.....	104
Thyssen-Krupp	105
TAC 20	105
TAC 50, TAC 50-04	113
US Elevator	118
Ascension 1000.....	118
MP-1200, MP-1210, MP-1220.....	118
Westinghouse	121
DMR.....	121
Door Operator	121
Epoch.....	122
ER8, ER9, ERL.....	127
Fixtures.....	127
Motor Drive (MD-1A).....	128
Motrol	128
Mark IV, Mark V	129
MPH.....	131
QKS Operator	134
Relay.....	135
Miscellaneous	135
World Elevator	136



PC BOARDS

Armor

Dynaglide

Image	Part Number	Description	Alt/Sub/Sup P/N
<i>Photo Not Available</i>	*ARMRD0588371-01	Car Control	
<i>Photo Not Available</i>	*ARMR058-8502-01	Current Brake / Field Board	*MTGM515629
<i>Photo Not Available</i>	ARMRC058-826105	PC Timer 0.5-5 Sec.	AFET1MGTIMERKIT
<i>Photo Not Available</i>	ARMRC058-8261-05	Timer 0.5-5 Sec.	AFET1MGTIMERKIT
<i>Photo Not Available</i>	ARMRC058826104	Timer, 0.5-5 Sec., 110 VDC	AFET250KTIMERKIT
<i>Photo Not Available</i>	ARMRC058826101	Timer, 1-5 Sec., 250 VDC	*KONE500233-003
<i>Photo Not Available</i>	*ARMRC058826203	Timer, 5-40 Sec.	




CEC

Modmaster / Swift 5000


Image	Part Number	Description	Alt/Sub/Sup P/N
<i>Photo Not Available</i>	*CEC01594	256K X 8 Memory w/ RTC & Battery Backup	
	*CEC01048	BW–Alpha Board, Lobby, Car or Machine Room	
<i>Photo Not Available</i>	CEC01825	Car 8825	CEC01225
	CEC01225	Car 8825 w/SBC 341	
	CEC01466	Car 8825 w/SBC 341, SBX 351	
	CEC01498	DAR-3 Board for Modmaster / Swift 5000	

PC BOARDS

©2013, UNITEC Parts Company

Image	Part Number	Description	Alt/Sub/Sup P/N
<i>Photo Not Available</i>	*CEC01173	Diode Board	
	*CEC01226	Group 8825	
<i>Photo Not Available</i>	*CEC01418	Group 8825 w/SBC 341	
<i>Photo Not Available</i>	CEC01465	Group 8825 W/Sbc341, SBX 351	
<i>Photo Not Available</i>	CEC01107	GVI-3 Board for Modmaster / Swift 5000	
	CEC01150	PMI, 16 I/O, Unpopulated (Dover/CEC)	
	CEC01510	REG-3 Board for Modmaster / Swift 5000	
<i>Photo Not Available</i>	*CEC01292	RGB-Alpha	


CEC Modmaster / Swift 5000 (continued)

Image	Part Number	Description	Alt/Sub/Sup P/N
	CEC01492	RTG-3 Board for Modmaster / Swift 5000	
<i>Photo Not Available</i>	CEC01290	SBC 341 Modified U6. Used for EEPROM.	
<i>Photo Not Available</i>	CEC01826	Serial Comm Mod RS-422, for CPU	
<i>Photo Not Available</i>	*CEC01172	TOC Interface Board for Modmaster / Swift 5000	

Modmaster / Swift 5000 w/DSD 412 Drive


Image	Part Number	Description
<i>Photo Not Available</i>	*CEC02090	DAR-3 Board, for Modmaster / Swift 5000 w/DSD 412

Swift 5000 CPU

Image	Part Number	Description
	CEC01827	SBC-18603a-03, Car / Group CPU, Swift 5000

PC BOARDS

Swift Futura

Image	Part Number	Description
	*CEC02318	REG-3F2 Board. Used on Futura systems.
<i>Photo Not Available</i>	*CEC02215	SEM

Swift Futura w/SCR Drive

Image	Part Number	Description	Alt/Sub/Sup P/N
<i>Photo Not Available</i>	*CEC02185	BKMF Power Board	



P/N CEC02142 Shown

CEC02142M CPT Board for Futura w/SCR Drive



CEC02147 EPU COP Board


Swift Futura w/SCR Drive (continued)

Image	Part Number	Description	Alt/Sub/Sup P/N
<i>Photo Not Available</i>	*CEC02167	EPU Link Board	
<i>Photo Not Available</i>	CEC02042	Futura SPU CPU Board	
<i>Photo Not Available</i>	*CEC02148	HPU, Old Style	
<i>Photo Not Available</i>	*CEC02186	Motor Field Control Board	
<i>Photo Not Available</i>	CEC02184	SMIC	
<i>Photo Not Available</i>	CEC02043	SPU Link Board	



CEC02183	Universal I/O Board	CEC02183-R
----------	---------------------	------------

Delta

Image	Part Number	Description	Alt/Sub/Sup P/N
	DELT01-1274	Driver Board	
<i>Photo Not Available</i>	DELT50-1274	Driver Board	DELT01-1274
<i>Photo Not Available</i>	*DELT5049-00-0600	Traffic Analyzer Component (Part OFMT-128001)	
<i>Photo Not Available</i>	*MT-128001	Traffic Analyzer—Delta 5049 Type	



Dover

Composite

Image	Part Number	Description	Alt/Sub/Sup P/N
<i>Photo Not Available</i>	DOVR145557	Optical Leveling	DOVR9845550
<i>Photo Not Available</i>	DOVR9845550	Optical Leveling	DOVR9840266
<i>Photo Not Available</i>	DOVR9840266	Optical Leveling Conversion Kit	

PC BOARDS

DMC-I

Image	Part Number	Description	Alt/Sub/Sup P/N
<i>Photo Not Available</i>	DOVR141335	Auxiliary Sensor	DOVR9741331
<i>Photo Not Available</i>	DOVR9741331	Auxiliary Sensor	
<i>Photo Not Available</i>	DOVR6300CE2	Auxiliary Sensor	DOVR9741331
<i>Photo Not Available</i>	DOVR6300BP1	CLC Board	DOVR9841337
<i>Photo Not Available</i>	DOVR6300BP2	CLC Board	DOVR9841337
<i>Photo Not Available</i>	DOVR6300BP3	CLC Board	DOVR9841337
<i>Photo Not Available</i>	DOVR6300BP4	CLC Board	DOVR9715710
<i>Photo Not Available</i>	DOVR141336	CLC Board	DOVR9841337
<i>Photo Not Available</i>	DOVR141310	CLC Main Processor Board	DOVR9841337



DOVR9715710 CLC Processor Board, New



DOVR9841337 CLC Processor Board, Old




<i>Photo Not Available</i>	*DOVR6300FX2	Door Board, DMC-I	
<i>Photo Not Available</i>	*DOVR6300FX4	Door Board, TAC 20	
<i>Photo Not Available</i>	*DOVR6300FX5	Door Operator Board, DMC-I HD85	
<i>Photo Not Available</i>	DOVR6300PY2	Door Operator Board, DMC-I HD85	DOVR9832439
<i>Photo Not Available</i>	*DOVR6300EH1	Door Operator Board, DMC-I HD85	
<i>Photo Not Available</i>	DOVR9881323	Door Operator Board, DMC-I HD85	DOVR9804134
<i>Photo Not Available</i>	*DOVR6300FX1	Door Operator Board, DMC-I HD85	
<i>Photo Not Available</i>	*DOVR6300FX3	Door Operator Board, DMC-I HD85	
<i>Photo Not Available</i>	*DOVR6300FX6	Door Operator Board, TAC 20	




*DOVR9804134 Door Operator Processor Board, DMC-I HD85 DOVR6300FX3

<i>Photo Not Available</i>	DOVR6300DC5	I/O 2 CLC Expansion Board	DOVR9841453
<i>Photo Not Available</i>	DOVR141457	I/O Expansion Board	DOVR9841453



Dover DMC-I (continued)

Image	Part Number	Description	Alt/Sub/Sup P/N
	DOVR9841453	I/O Expansion Board	
<i>Photo Not Available</i>	DOVR9841490	I/O Expansion Board	
<i>Photo Not Available</i>	DOVR9841465	I/O Expansion Board (Options)	
<i>Photo Not Available</i>	DOVR6300DC4	I/O Expansion Board (Options)	DOVR9841465
<i>Photo Not Available</i>	DOVR6300CD2	Main Sensor	DOVR9841325
	DOVR9841325	Main Sensor	
<i>Photo Not Available</i>	DOVR141329	Micro Door Operator	DOVR9804134
<i>Photo Not Available</i>	DOVR6300BJ13	Power Board, DMC-IA	DOVR9836494
	DOVR9841301	Power Relay Board	
<i>Photo Not Available</i>	DOVR6300BJ11	Power Relay Board	DOVR9841301
<i>Photo Not Available</i>	DOVR6300BJ7	Power Relay Board	DOVR9841301
<i>Photo Not Available</i>	DOVR9851379	Power Relay Board	DOVR9841301
<i>Photo Not Available</i>	DOVR6300BJ8	Power Relay Board	DOVR9851379
<i>Photo Not Available</i>	DOVR9841507	Power Supply, 5/12 VDC	
<i>Photo Not Available</i>	DOVR141305	Power Unit Relay Board	*DOVR9851379
<i>Photo Not Available</i>	DOVR6300CV1	Selector	DOVR9841313
<i>Photo Not Available</i>	DOVR6300CV2	Selector	DOVR9841313
<i>Photo Not Available</i>	DOVR141317	Selector Board	DOVR9841313



PC BOARDS

Image	Part Number	Description	Alt/Sub/Sup P/N
	*DOVR9841313	Selector Processor Board	
<i>Photo Not Available</i>	DOVR141323	Sensor Board	*DOVR9841325


Fixture

Image	Part Number	Description	Alt/Sub/Sup P/N
<i>Photo Not Available</i>	DOVR9713335	Digital PI Card, 7-Segment	
	DOVR118412	Emergency Light Board	DOVR9818420
	DOVR9818420	Emergency Light Board	
<i>Photo Not Available</i>	*DOVR9830443	Logic, Board, 1.00 Dot Matrix PI	
<i>Photo Not Available</i>	DOVR9811382	PI Driver Power Board	DOVR9811370
<i>Photo Not Available</i>	*DOVR9811370	PI Driver Power Board	
<i>Photo Not Available</i>	*DOVR9814050	PI Interface	
<i>Photo Not Available</i>	DOVR113336	PI Readout Board	DOVR9713335
<i>Photo Not Available</i>	*DOVR9713244	Power Logic Board 48 V	

MSC-I

Image	Part Number	Description	Alt/Sub/Sup P/N
	*DOVR9813378	Decoder Board	
<i>Photo Not Available</i>	DOVR140483	Power	*DOVR9880665
<i>Photo Not Available</i>	DOVR6300DP1	Power Board	DOVR9840485
	*DOVR9840485	Power w/Plug-In Terminals	
<i>Photo Not Available</i>	DOVR9880665	Power w/Screw Terminals	
<i>Photo Not Available</i>	DOVR9840497	Regulator	
<i>Photo Not Available</i>	DOVR140490	Regulator, for Power Monitor	*DOVR9840497
<i>Photo Not Available</i>	DOVR9781870	Relay, Reverse-Phase, for SPF Controllers	

Oilraulic

Image	Part Number	Description	Alt/Sub/Sup P/N
<i>Photo Not Available</i>	DOVR9805254	Option Board, 4 Slot	DOVR9753217
<i>Photo Not Available</i>	*DOVR9753217	Option Board, 6 Slot	
	*DOVR9855245	Power Board, 4 Slot	

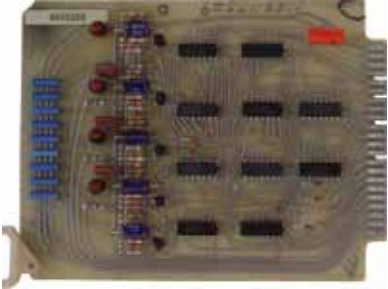
PC BOARDS

Solid State

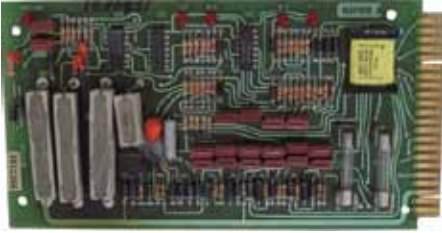

Image	Part Number	Description	Alt/Sub/Sup P/N
	DOVR9855221	Car Board	
<i>Photo Not Available</i>	DOVR68179	Car Board, 3-Slot	*DOVR9855221
<i>Photo Not Available</i>	DOVR123948	Car Board, 4-Slot	*DOVR9855221
<i>Photo Not Available</i>	DOVR9881797	Car Hydro Board	*DOVR9855221
	DOVR9855257	Card, Top and Bottom, 4-Slot	
<i>Photo Not Available</i>	DOVR124519	Door Board, 4-Slot	DOVR9855233
	*DOVR9855233	Door Board	
<i>Photo Not Available</i>	DOVR9884336	Duplex Hydro Board, 3-Slot	
<i>Photo Not Available</i>	*DOVR68432	Intermediate Board, 3-Slot	
<i>Photo Not Available</i>	*DOVR105252	Intermediate Board, 4 Slot	

©2013, UNITEC Parts Company

Dover Solid State (continued)


Image	Part Number	Description	Alt/Sub/Sup P/N
	*DOVR9855269	Intermediate, Hydro	
<i>Photo Not Available</i>	DOVR9781808	Logic Board, 3-Slot	
<i>Photo Not Available</i>	DOVR68525	Option Board, 3-Slot	DOVR9753217
<i>Photo Not Available</i>	DOVR105254	Option Board, 4-Slot	DOVR9753217
<i>Photo Not Available</i>	DOVR68177	Power Board	DOVR9855245
<i>Photo Not Available</i>	DOVR105248	Power Board, 4-Slot	DOVR9855245
<i>Photo Not Available</i>	*DOVR63131	Top/Bottom Board, 3-Slot	
<i>Photo Not Available</i>	*DOVR9825257	Top/Bottom Board, 4-Key	DOVR105251
<i>Photo Not Available</i>	*DOVR105251	Top/Bottom Board, 4-Slot	
<i>Photo Not Available</i>	*DOVR66691	Top/Bottom Board, Hydro	

Selector and Position Devices

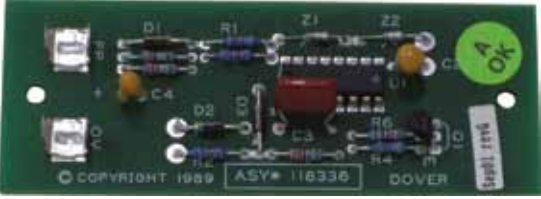
Image	Part Number	Description	Alt/Sub/Sup P/N
	DOVR9811266	Leveling Control Board	DOVR9834140 DOVR9840266 DOVR9845550
<i>Photo Not Available</i>	DOVR9813779	LS1 Card	
<i>Photo Not Available</i>	DOVR9813720	LS5-HS Card	
<i>Photo Not Available</i>	*DOVR9707918	LS6-HS T2	
<i>Photo Not Available</i>	DOVR112261	Optical Leveling Board	DOVR9811266
<i>Photo Not Available</i>	DOVR126125	Optical Leveling Board	DOVR9811266
	DOVR9834140	Optical Leveling Card	
<i>Photo Not Available</i>	DOVR6300FF1	Selector Leveling Board	DOVR9834140
<i>Photo Not Available</i>	DOVR6300FF2	Selector Leveling Board	DOVR9834140
<i>Photo Not Available</i>	DOVR9885213	Selector Leveling Board	DOVR9834140

©2013, UNITEC Parts Company

T-I, T-II

Image	Part Number	Description
	DOVR9813937	ISS Card
<i>Photo Not Available</i>	DOVR9813949	ISP Card

T-II

Image	Part Number	Description	Alt/Sub/Sup P/N
<i>Photo Not Available</i>	DOVR9832026	Call Card	
<i>Photo Not Available</i>	*DOVR9832373	Constant Current Source Card	
<i>Photo Not Available</i>	*DOVR9732020	Control Mother Board	
<i>Photo Not Available</i>	*DOVR9832786	CPU Card	
<i>Photo Not Available</i>	DOVR9832063	Field Half Bridge Card	
<i>Photo Not Available</i>	DOVR9832051	Generator Field Reg. Mother-board	
<i>Photo Not Available</i>	*DOVR9833006	I/O Control Card	
<i>Photo Not Available</i>	*DOVR9832075	I/O Decode Card	
<i>Photo Not Available</i>	DOVR9761627	I/O Input Card	
<i>Photo Not Available</i>	*DOVR9728600	I/O Mother Board	
	DOVR9813937	LSS Card	
<i>Photo Not Available</i>	DOVR9813925	LSZ Card	
<i>Photo Not Available</i>	*DOVR9762772	Parallel Card	
<i>Photo Not Available</i>	*DOVR9832099	Relay Board	
<i>Photo Not Available</i>	*DOVR9845148	Relay Card	
<i>Photo Not Available</i>	DOVR9762012	Relay Output Card	
<i>Photo Not Available</i>	*DOVR9764070	Serial Datricon Card	
<i>Photo Not Available</i>	*DOVR9762218	Solid State Output Card	
<i>Photo Not Available</i>	*DOVR9762073	Wathcard Card	

TII Selector & Position Devices

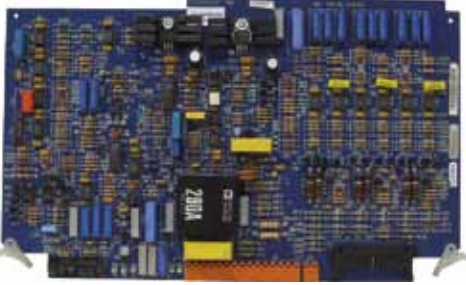
Image	Part Number	Description	Alt/Sub/Sup P/N
<i>Photo Not Available</i>	*DOVR9813779	LS1 Card	
<i>Photo Not Available</i>	*DOVR9812568	LS10 Card	
<i>Photo Not Available</i>	DOVR132566	LS8 Auxilliary Board, For TII & TIII	DOVR9812398
<i>Photo Not Available</i>	*DOVR9812398	LS8 Card	
<i>Photo Not Available</i>	*DOVR9813950	LSC Card	
<i>Photo Not Available</i>	*DOVR9763004	Motor Field Regulator Card. For TII & TIII	

PC BOARDS

TIII


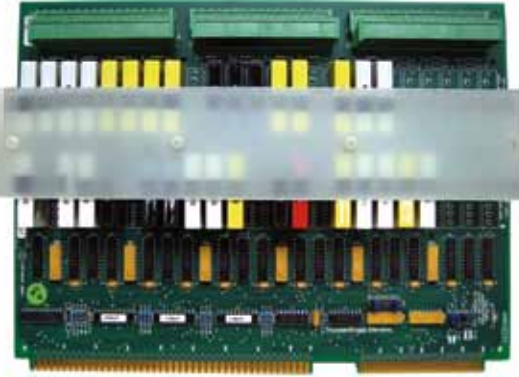
Image	Part Number	Description	Alt/Sub/Sup P/N
	DOVR9860289	CPU Car	
<i>Photo Not Available</i>	DOVR6300CT4	CPU Board	DOVR9860289
<i>Photo Not Available</i>	DOVR6300CT7	CPU Board	*DOVR9860289
<i>Photo Not Available</i>	DOVR9860277	CPU Duplex	*DOVR9840114
	*DOVR9860253	CPU Duplex Board, Intel SBC-86/05A	
	*DOVR9853820	CPU Simplex Board, Intel SBC-86/05A	
<i>Photo Not Available</i>	*DOVR9760027	DAR Board	
<i>Photo Not Available</i>	DOVR6300BL3	DDI Board	*DOVR9841908
<i>Photo Not Available</i>	*DOVR9841908	DDI Board	
	*DOVR9853686	Main Sensor	
<i>Photo Not Available</i>	DOVR6300AA3	Main Sensor	*DOVR9853686
<i>Photo Not Available</i>	*DOVR9853704	PMI 16 I/O Board	
<i>Photo Not Available</i>	DOVR6300CN1	PMI 48	*DOVR9863000
<i>Photo Not Available</i>	*DOVR9881232	PMI 48 I/O, w/o Modules	

Dover TIII (continued)



Image	Part Number	Description	Alt/Sub/Sup P/N
<i>Photo Not Available</i>	DOVR6300CN2	PMI-48	*DOVR9881232
<i>Photo Not Available</i>	*DOVR6300CN3	PMI-48 Board	
<i>Photo Not Available</i>	DOVR9881359	PMI I/O 48 POS Board	*DOVR9863000
	DOVR9760052	REG Board	
<i>Photo Not Available</i>	DOVR6300AD2	REG Board	*DOVR9760052
<i>Photo Not Available</i>	*DOVR9714881	RTG Board	
<i>Photo Not Available</i>	DOVR6300AD4	RTG Board	*DOVR9760052
<i>Photo Not Available</i>	DOVR6300AE2	SEL I/O	*DOVR9853728
<i>Photo Not Available</i>	*DOVR9853728	SEL I/O Assembly	

PC BOARDS



TIII & TIV

Image	Part Number	Description	Alt/Sub/Sup P/N
<i>Photo Not Available</i>	DOVR6300ER5	CPU Board	*DOVR9840114
	DOVR9840114	CPU Car	
<i>Photo Not Available</i>	DOVR6300ER4	CPU Car	DOVR9840114
<i>Photo Not Available</i>	DOVR6300CN4	PMI Board, 48 I/O	DOVR9863000
<i>Photo Not Available</i>	DOVR6300CN5	PMI Board, 48 I/O	*DOVR9863000
	DOVR9863000	PMI Board, 48 I/O	
<i>Photo Not Available</i>	DOVR9853765	Video Board, Machine Room	
<i>Photo Not Available</i>	*DOVR9853777	Video Lobby Board	

TIV





Image	Part Number	Description	Alt/Sub/Sup P/N
<i>Photo Not Available</i>	DOVR9816100	Backplane	
<i>Photo Not Available</i>	DOVR6300CT9	CPU Board, Duplex	DOVR9840114
 <p><i>(DOVR9840114 Pictured)</i></p>	DOVR9860290	CPU Board, Duplex	DOVR9840114
<i>Photo Not Available</i>	*DOVR9716853	Current Regulator Board, Digital	
	DOVR9731817	DSP Board. For TIV & TAC 50	THSN6300DE42
<i>Photo Not Available</i>	DOVR9841349	DSP-SCR ETSD Board	THSN6300DE40
<i>Photo Not Available</i>	DOVR9719490	DSP-VVVF ETSD Board	THSN6300DE41
<i>Photo Not Available</i>	*DOVR9716841	Gate Driver Board	

PC BOARDS

Image	Part Number	Description	Alt/Sub/Sup P/N
	*DOVR9716830	HDW/Vector Control Board	
<i>Photo Not Available</i>	*DOVR9843978	Inverter Snubber Board	
<i>Photo Not Available</i>	*DOVR9841600	Loadweigher CN.Board	
	*DOVR9816392	QSR Board	

©2013, UNITEC Parts Company

Miscellaneous

Image	Part Number	Description	Alt/Sub/Sup P/N
	*DOVR6300JC2	CPU Card, 16 MHz	
	*DOVR9832439	Door Operator Board, HD85	
<i>Photo Not Available</i>	DOVR113065	Double / Single Phase Rectifier	DOVR9892989
<i>Photo Not Available</i>	DOVR149355	Emergency Light	*DOVR9839720
	*DOVR9839720	Emergency Light Board, 120 VAC	
<i>Photo Not Available</i>	*DOVR9836494	Power Relay Board, DMC-I	
<i>Photo Not Available</i>	DOVR9830390	Power Supply	
<i>Photo Not Available</i>	DOVR9730394	Power Supply, Dot Matrix PI, 48 Volt	
<i>Photo Not Available</i>	DOVR9892989	Rectifier Board	
	DOVR9833080	Timer, BRT	

Haughton



Accuflite

Image	Part Number	Description	Alt/Sub/Sup P/N
<i>Photo Not Available</i>	*HGTN3-40006-55	Input Buffer	

Electronic Stepping Switch



Image	Part Number	Description	Alt/Sub/Sup P/N
<i>Photo Not Available</i>	HGTN3-40233-63	Stepper Relay Board	HGTN3-40324-87
<i>Photo Not Available</i>	HGTN3-40324-87	Stepper Switch, Electronic	
<i>Photo Not Available</i>	HGTN3-40233-59B	Stepping Switch Mother Board, 120 Volt	HGTN3-40233-59
<i>Photo Not Available</i>	HGTN3-40233-59	Stepping Switch Mother Board. 120 Volt	

Goldflight

Image	Part Number	Description	Alt/Sub/Sup P/N	Application
<i>Photo Not Available</i>	*HGTN3-40005-04	Counter C		Goldflight
<i>Photo Not Available</i>	*HGTN3-40277-78B	GMG Amp Board	HGTN3-40281-07	Goldflight
<i>Photo Not Available</i>	*HGTN3-40281-06	GMG Amp Board, for Geared and Gearless	HGTN3-40281-07	Goldflight MG
	HGTN3-40281-07	GMG Amp Board, for Geared and Gearless		Goldflight MG
<i>Photo Not Available</i>	*HGTN3-40280-33	Heat Sink Assembly (LV), Dynatron CAC	HGTN3-40280-34	Goldflight GAC
<i>Photo Not Available</i>	*HGTN3-40005-01	Memory D		Goldflight
<i>Photo Not Available</i>	HGTN3-40256-98	Pattern Board		Goldflight
<i>Photo Not Available</i>	*HGTN3-40267-48F	Pattern Generator Board	HGTN3-40267-48	Goldflight
<i>Photo Not Available</i>	HGTN3-40280-81	Pattern Generator Board		Goldflight
	HGTN3-40280-85	Predictor Board		Goldflight
<i>Photo Not Available</i>	HGTN3-40284-28	Reverse Phase		Goldflight GAC

PC BOARDS

©2013, UNITEC Parts Company

Image	Part Number	Description	Alt/Sub/Sup P/N	Application
	HGTN3-40267-48	S6R Pattern Gen Board		Goldflight
<i>Photo Not Available</i>	*HGTN3-40280-18F	Timer Board	HGTN3-40280-18	Goldflight MG
	*HGTN3-40280-18	Timer Board		Goldflight

Hydro

Image	Part Number	Description
<i>Photo Not Available</i>	HGTN3-40267-66	Hydro A Board

Miconic




Image	Part Number	Description	Alt/Sub/Sup P/N	Application
<i>Photo Not Available</i>	*HGTN3-40254-93	Current Loop Driver	HGTN0-51865-1	Miconic V
<i>Photo Not Available</i>	*HGTN3-40315-37	Loadweigh		Miconic VM
<i>Photo Not Available</i>	*HGTN3-40333-48	PAL-216MA Board		Miconic V

Static Drives Reliance Cards

Image	Part Number	Description	Alt/Sub/Sup P/N
<i>Photo Not Available</i>	*HGTN3-40255-26	CV-TD Board	
	HGTN0-51831-3	CVTD Module	
<i>Photo Not Available</i>	*HGTN3-40318-72	Heat Sink Assembly	
	*HGTN3-40255-50	S6R High Voltage Heat Sink 86466-18S	HGTN3-40318-72

PC BOARDS

Miscellaneous

Image	Part Number	Description	Alt/Sub/Sup P/N	Application
<i>Photo Not Available</i>	*HGTN3-40246-69	Amplifier		Model V
<i>Photo Not Available</i>	*HGTN3-40229-95	Amplifier Board	*HGTN3-40246-69	Model V
<i>Photo Not Available</i>	*HGTN3-40340-01	CLRC-1 Board		S9RFM
<i>Photo Not Available</i>	*HGTN3-40162-07	Excess Error Board		Model I, III, IV
<i>Photo Not Available</i>	*HGTN3-40221-95	Fail Det Board		Model V
	*HGTN3-40229-98	Failure Detector		Model V
<i>Photo Not Available</i>	*HGTN3-40155-92	High Voltage Board		Model II, III, IV
	*HGTN3-40142-97	Pattern Gen Board		Model I, III
	*HGTN3-40143-02	SCR Trigger Monitor Board		Model III, IV, V
<i>Photo Not Available</i>	*HGTN3-40221-64	V EVC Amplifier Board	*HGTN3-40246-69	Model III, IV, V

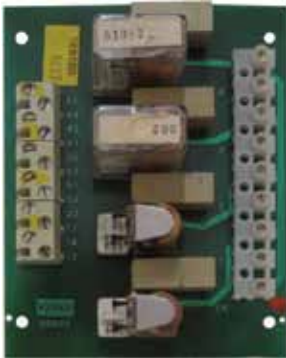
KONE

KCM 831

Image	Part Number	Description	Alt/Sub/Sup P/N
<i>Photo Not Available</i>	KONEKM762710G01	Hall FLR Board	
<i>Photo Not Available</i>	KONEKM935697G01	LCE ADON Kit Board	KONEKM838770G01

TMS 900






Image	Part Number	Description	Alt/Sub/Sup P/N
<i>Photo Not Available</i>	KONEB0580704-01	Current Brake/Field Board	*MTGM515629
<i>Photo Not Available</i>	KONEB0588502-01	Current Brake/Field Board	*MTGM515629
<i>Photo Not Available</i>	KONE140216G02	Firing Card	
<i>Photo Not Available</i>	*KONE157103G02	Power Supply Board	
<i>Photo Not Available</i>	KONE165812G01	Power Supply Board	



	*KONE515572	Relay In Board	
<i>Photo Not Available</i>	KONE515620	Relay Output Board	
<i>Photo Not Available</i>	KONE166628G01	Speed Reference Board A6A6 4TMS900	MTGM515568
<i>Photo Not Available</i>	*KONE140202G01	Transformer Pulse Board	

PC BOARDS


MCE

Image	Part Number	Description	Alt/Sub/Sup P/N	Application
<i>Photo Not Available</i>	*MCECHC-CI/0 REV3	Call Board	MCECHC-CI/0 REV4	
<i>Photo Not Available</i>	*MCECHC-CI/0 REV4	Call Board		
<i>Photo Not Available</i>	*MCECHC-CI/0	Call I/O		
<i>Photo Not Available</i>	*MCECHC-RPSDB	Door Power Supply Board		
	*MCECHC-CI/0N	HC-C I/O N Board		
	*MCECHC-I/OX	HC-I/OX Expander Board		VVMC-1000
	*MCECHC-PCI0	HC-PC-I/O Power and Call Board Combined		
<i>Photo Not Available</i>	*MCECHC-I40	I/O Expander Board, 16 in and 4 out		
	*MCECHC-PI/0	Input/ Output HC-PI/O Board		VVMC-1000
	*MCECHC-CI/0-1B	Input/Output	MCECHC-CI/0	VVMC-1000
<i>Photo Not Available</i>	*MCECHC-PI/0-1C	Input/Output HC-PI/O	MCECHC-PI/0	

MCE (continued)



Image	Part Number	Description	Alt/Sub/Sup P/N	Application
	*MCECHC-IPLS	Landing System Board		
<i>Photo Not Available</i>	*MCECMC-MP-1ES	Main Microprocessor Board		
<i>Photo Not Available</i>	*MCECHC-CI/0-E	MCE Board		
<i>Photo Not Available</i>	*MCECHC-CI/0-L	MCE Board		
	*MCECHC-DFLS	MCE DF Landing Systems Board		
<i>Photo Not Available</i>	*MCECHC-DFLS-TR	MCE DF Landing Systems Board		
	*MCECHC-DB-M0D	Mod Door Operator Board		
	*MCECMC-PCA-0A	Motion Controls PCA Board		
	*MCECHC-PCI0-L	Power-Call I/O Board, Low Voltage		

PC BOARDS

Image	Part Number	Description	Alt/Sub/Sup P/N	Application
	*MCECSCR-PRI-ENH	Relay Interface Board	MCECSCR-PRI-EE	
<i>Photo Not Available</i>	*MCECSCR-PRI-EE	SCR Power Relay Inter- face Board		

Montgomery

Door

Image	Part Number	Description
	*MTGMP-31872-003	105 Door Board, Closed Loop
	*MTGMP-31729-005	Marathon Door Operator Board WG Closed Loop



© 2013, UNITEC Parts Company

Escalator



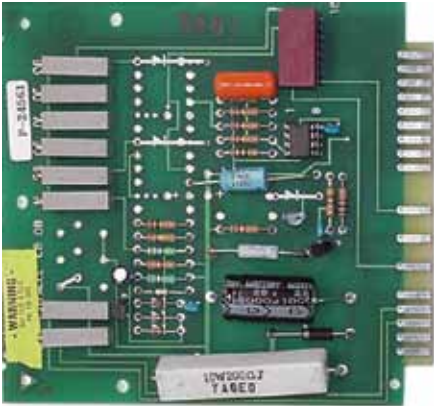
Image	Part Number	Description	Alt/Sub/Sup P/N
<i>Photo Not Available</i>	*MTGMP-31787-001	Escalator PCB	
<i>Photo Not Available</i>	*MTGMP-31787-004	Escalator PCB	
<i>Photo Not Available</i>	*MTGMP-32302-002	E-5000 CPU Board	
<i>Photo Not Available</i>	*MTGMP-32302-003S	E-5000 CPU Board	MTGMP-32302-004S

PC BOARDS


Hydro

Image	Part Number	Description	Alt/Sub/Sup P/N
	MTGMP-16783	I/O Interface Board	
<i>Photo Not Available</i>	*MTGMP-15603	Performance Comparator Board	
	*MTGMP-15885	Prom II 64K Board	

MAC Door Operator

Image	Part Number	Description	Alt/Sub/Sup P/N
<i>Photo Not Available</i>	*MAC0P-24783	104 Door Control Board	MAC0P-24783-004
	MAC0P-24783-004	104 Door Control Board	
	*MTGMP-24783-004	Door Board	MAC0P-24783-004
<i>Photo Not Available</i>	*MTGMP-24173	Door Control Power, HP	
<i>Photo Not Available</i>	*MAC0P-24173	HP Power Board	*MTGMP-24173
<i>Photo Not Available</i>	*MTGMP-24562	MAC High Performance Door Speed Board	MTGMP-24561
	MTGMP-24561	MAC Motor Speed Board	EC1A103109-4-LCD

PC BOARDS

Image	Part Number	Description	Alt/Sub/Sup P/N
<i>Photo Not Available</i>	*MAC0P-24172	Power Board	MTGMP-24172
	MTGMP-24172	Power Board	
<i>Photo Not Available</i>	*MAC0P-24561	Speed Board	MTGMP-24561
<i>Photo Not Available</i>	*MAC0P-15764	Speed Control	
<i>Photo Not Available</i>	*MAC0P-24170	Speed Control Board	

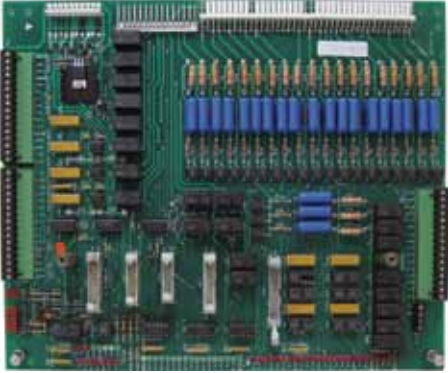


MIPROM 21

Image	Part Number	Description	Alt/Sub/Sup P/N
<i>Photo Not Available</i>	*MTGM90154-002	1395 Digital DC Drive, 80 Amp, 460 VAC, Series A Drive	
	*MTGMP-30323	Card Rack Assembly	
<i>Photo Not Available</i>	MTGMP-24377	CPU Board	*MTGMP-31807-002
<i>Photo Not Available</i>	MTGMP-31807-002	CPU Board	
<i>Photo Not Available</i>	MTGMP-24873	CPU Board 256K	MTGMP-31807-002
<i>Photo Not Available</i>	*MTGMP-24872	CPU Board, 64K	*MTGMP-24873
	*MTGMP-24571	ETS Board	
<i>Photo Not Available</i>	*MTGMP-31675	M2 Relay Pilot Board	
<i>Photo Not Available</i>	*MTGMP-24842	M2, CPU2, SIO2, EPROM	
	*MTGMP-24301	M2, Parallel I/O, F Board	



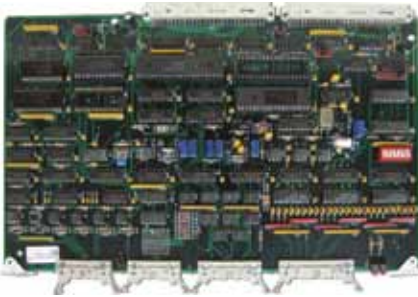

42 * An asterisk designates boards that can currently be repaired only, and are not available for purchase or exchange.
NOTE: Illustrations are not to scale!

PC BOARDS

©2013, UNITEC Parts Company


Image	Part Number	Description	Alt/Sub/Sup P/N
	*MTGMP-24323	M2, Relay Pilot Board	
	*MTGM95740-002	Main Control Board	
<i>Photo Not Available</i>	*MTGMP-24568-001	Mega, NTS, 1 Switch	
<i>Photo Not Available</i>	*MTGMP-24568-002	Mega, NTS, 2 Switch	
<i>Photo Not Available</i>	*MTGMP-24568-003	Mega, NTS, 3 Switch	
<i>Photo Not Available</i>	*MTGMP-24568-005	Mega, NTS, 5 Switch	
<i>Photo Not Available</i>	*MTGMP-24615	MIPROM	*MTGMP-24377
	*MTGMP-24150	MLS Door Operator Board	MTGMP-22267-002, WRLD7603.9008
<i>Photo Not Available</i>	*MTGMP-24288	Mother Board	
<i>Photo Not Available</i>	*MTGMP-16802	Mother Board, I/O Card Rack	*MTGMP-15771
<i>Photo Not Available</i>	*MTGMP-24700-003	MST2, 110 DC, Relay	

Montgomery MIPROM 21 (continued)

Image	Part Number	Description	Alt/Sub/Sup P/N
	MTGMP-24321	MSU Board	*MTGMP-30387
	MTGMP-24972	MSU Board	*MTGMP-30387
<i>Photo Not Available</i>	MTGMP-30387	MSU Board	
	MTGMP-30390	MSU Board	*MTGMP-30387
<i>Photo Not Available</i>	*MTGMP-24302	P I/O Buffer Board	
<i>Photo Not Available</i>	*MTGMP-24264	PC Monitor Board	
<i>Photo Not Available</i>	*MTGMP-24869-003	PI, Dig, #3, w/EPROM, Service	
	*MTGMP-24325	Power Relay Board	
<i>Photo Not Available</i>	*MTGMB-49711	Power Relay, Bare Board	MTGMP-24172
<i>Photo Not Available</i>	*MTGMP-29077	Power Supply	
<i>Photo Not Available</i>	*MTGMP-29089	Power Supply	MTGMP-31895-002

PC BOARDS

©2013, UNITEC Parts Company

Image	Part Number	Description	Alt/Sub/Sup P/N
<i>Photo Not Available</i>	*MTGMP-16364	Relay Power Door Board	MTGMP-24172
	MTGMP-31652-002	SIO,2neur, RS485molx	
<i>Photo Not Available</i>	*MTGMP-16776	Univ AC Output, w/Terminal Connector	*MTGMP-15775
<i>Photo Not Available</i>	*MTGMB-47109	Univ Input II, Bare Board	*MTGMP-29629-002

MIPROM Hydro and Traction

Image	Part Number	Description	Alt/Sub/Sup P/N
<i>Photo Not Available</i>	*MTGMP-16777	AC Output, w/Molex Connector	*MTGMP-15774
<i>Photo Not Available</i>	MTGM49860-036	Cable Relay Output Assy.	
<i>Photo Not Available</i>	*MTGMP-15838	Card Rack	*MTGMP-15839




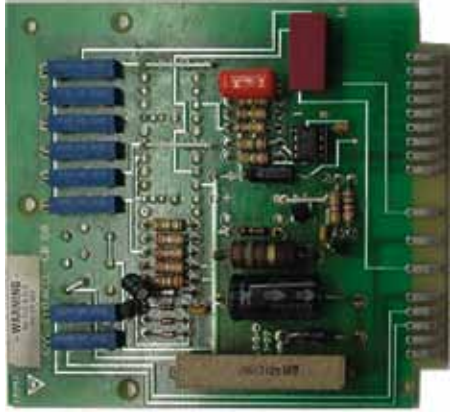



<i>Photo Not Available</i>	*MTGMP-15778	DC Output, w/Terminal Connector	MTGM49860-036 MTGMP-24100
----------------------------	--------------	---------------------------------	------------------------------



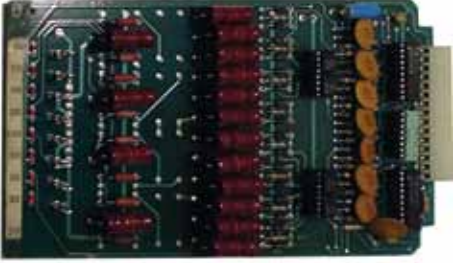
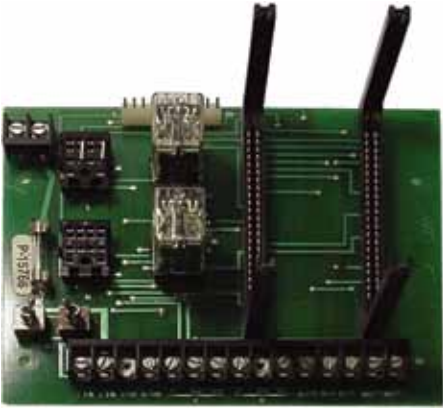



	*MTGMP-15903	Power Supply	
--	--------------	--------------	--

MIPROM Hydro

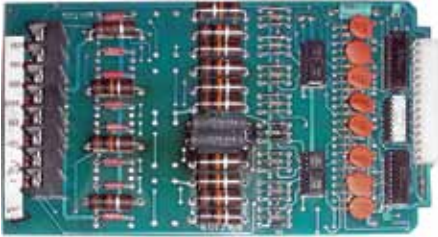


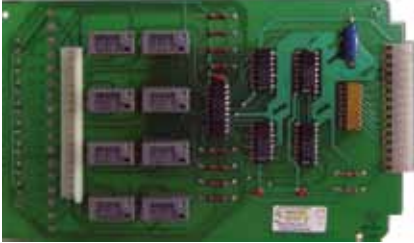

Image	Part Number	Description	Alt/Sub/Sup P/N
	*MTGMP-15771	Card Rack Assembly, MIPROM I/O w/LM317T	
	*MTGMP-15839	CPU I/O Card Rack Assembly	
	*MTGMP-15783	CPU MIPROM SC/MP II Board	
<i>Photo Not Available</i>	*MTGMP-16778	DC Output Board w/Terminal Block Connector	*MTGMP-24100
	*MTGMP-15764	Door Operator Speed Control Board	MAC0P-24783-004
	*MTGMP-15828	Hydro PM Relay, Finl	

PC BOARDS

©2013, UNITEC Parts Company

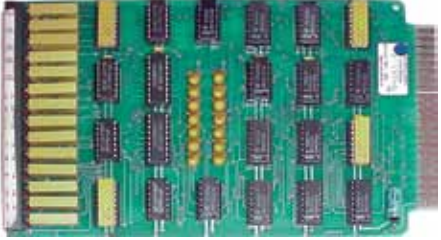
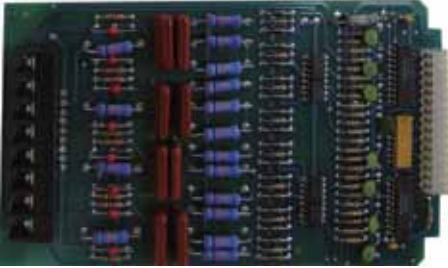

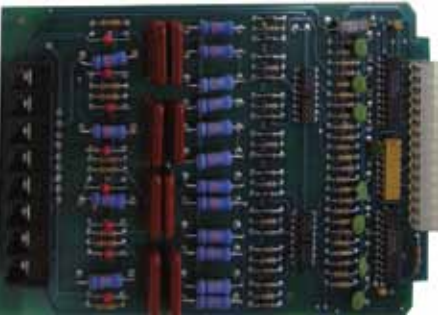
Image	Part Number	Description	Alt/Sub/Sup P/N
<i>Photo Not Available</i>	MTGMP-15730	Input Board, w/Terminal Block	*MTGMP-29629-001
	MTGMP-15761	Input w/Terminal Block Connector	MTGMP-29629-001
	MTGMP-15766	MAC Speed Control Board	MAC0P-24783-004
	*MTGMP-15774	Output 8X AC, w/Dual Triax, Molex Connector	
	*MTGMP-15775	Output 8X, w/Terminal Connector	
	*MTGMP-24147	Output Board	

Montgomery MIPROM Hydro (continued)

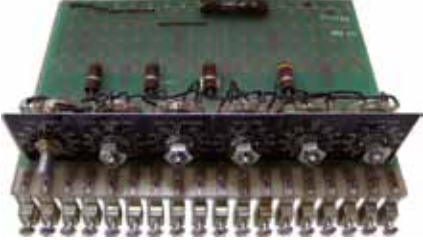




Image	Part Number	Description	Alt/Sub/Sup P/N
	*MTGMP-24151	Output Board w/Montgomery Block	
<i>Photo Not Available</i>	*MTGMP-16775	Output Board, 4 AC and 4 DC Outputs	*MTGMP-24100
	*MTGMP-16835	Power Board, MIPROM	
	*MTGMP-15765	Power Door	MTGMP-24172
	*MTGMP-24100	Relay Output Board	
	MTGMP-16553	Timer	

PC BOARDS

©2013, UNITEC Parts Company

Image	Part Number	Description	Alt/Sub/Sup P/N
<i>Photo Not Available</i>	*MTGMP-16780	Timer Board 9X, Adjustable	*MTGMP-15760
	MTGMP-15760	Timer Board X14	
<i>Photo Not Available</i>	MTGMP-15759	Timer Board X8	
	*MTGMP-29630-001	Universal Input II w/Molex Board	
	MTGMP-15762	Universal Input II w/Molex Connectors	*MTGMP-29630-001
	MTGMP-29629-001	Universal Input II w/Terminal Block	*MTGMP-29629-002
<i>Photo Not Available</i>	MTGMP-29629-002	Universal Input II w/Terminal Block	

SSC-6010

Image	Part Number	Description	Alt/Sub/Sup P/N
	*MTGM46255-001	2CA SSC6010 Board	*MTGMP-24115
	MTGMP-24115	2CA SSC-6010 Board	
<i>Photo Not Available</i>	*MTGMP-24109	6 Pulse Firing Board	
<i>Photo Not Available</i>	*MTGMP-24110	Distribution Board	
<i>Photo Not Available</i>	*MTGMP-24107	Dual Bridge Field Control, 240 V	
	*MTGMP-24112	LIN 6010 Accl/Decl	
	*MTGMP-24105	SS Field Regulation Board	
	*MTGMP-24103	SS Multiple Operator	

50 * An asterisk designates boards that can currently be repaired only, and are not available for purchase or exchange.
NOTE: Illustrations are not to scale!

PC BOARDS

TMS 900

Image	Part Number	Description	Alt/Sub/Sup P/N
<i>Photo Not Available</i>	*MTGM515629	Current Reg Straight CO Board	
<i>Photo Not Available</i>	*MTGMP-24548-003	ESC Speed Board	
<i>Photo Not Available</i>	MTGM515611	I/O Module Board	
<i>Photo Not Available</i>	MTGM515568	Speed Reference Board A6A6 4TMS900	

Otis

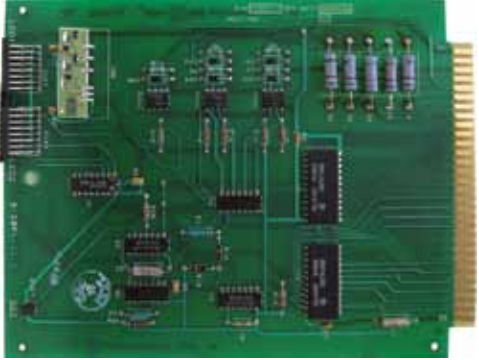

506 Escalators

Image	Part Number	Description	Alt/Sub/Sup P/N	Application
<i>Photo Not Available</i>	A9707C3	Motherboard		506SL
<i>Photo Not Available</i>	YXG0630D2	Relay Assembly		506
<i>Photo Not Available</i>	*YXG0630D3	Relay Assembly, 110/220 V		506

Black Belt Door Operator

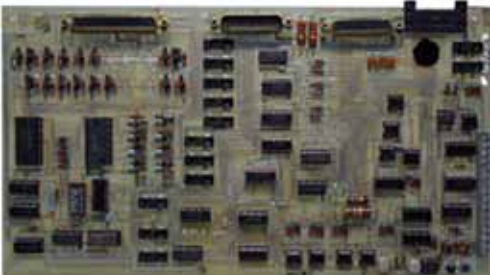
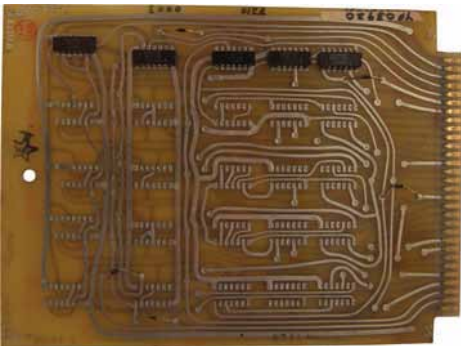
Image	Part Number	Description
	AAA26800AHJ1	Board Assembly

CB Base

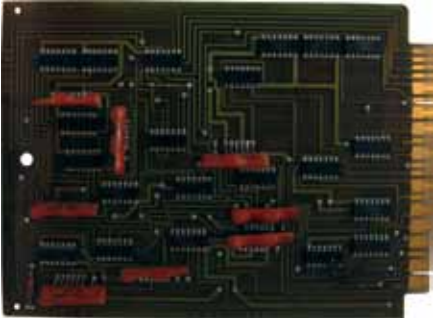
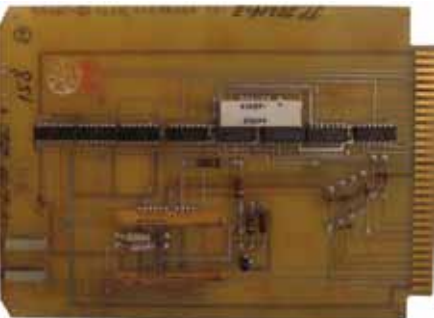
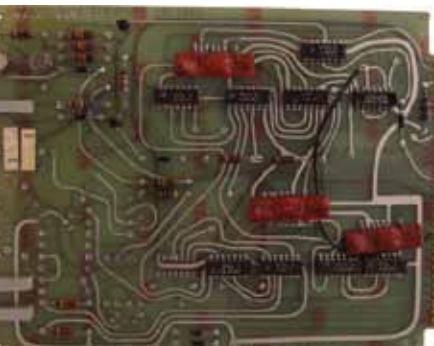
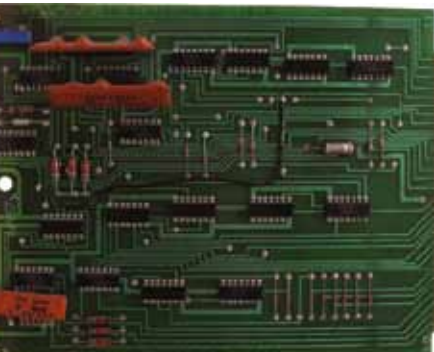
Image	Part Number	Description	Alt/Sub/Sup P/N
	*8120P1	Binary Decoder Interface Board	
<i>Photo Not Available</i>	*8120F1	Binary Position Encoder (BPE) Board	
	*8120F2	Binary Position Encoder (BPE) Board	

PC BOARDS

©2013, UNITEC Parts Company

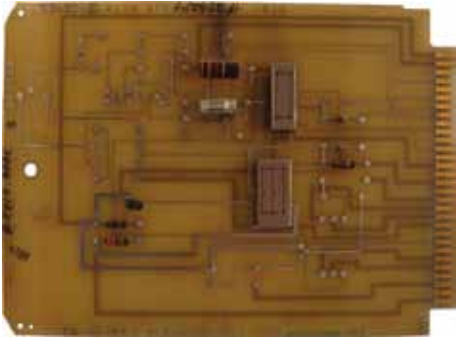

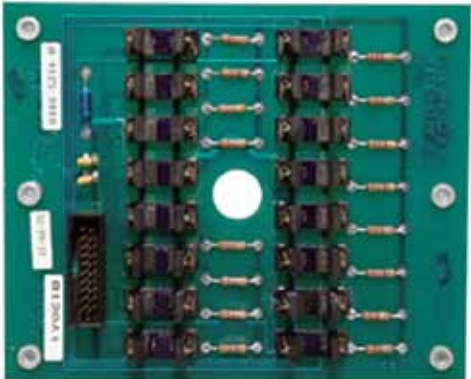
Image	Part Number	Description	Alt/Sub/Sup P/N
<i>Photo Not Available</i>	*8120B2	Binary Reading Board (for 8126H1)	
<i>Photo Not Available</i>	*8120C2	Binary Reading Board (for 8126H2)	
<i>Photo Not Available</i>	*8120C1	Binary Reading Board (for 8126H3)	
	*8120B1	Binary Reading Board (for 8126H4)	
<i>Photo Not Available</i>	*114-A8124AL3	Board	*A8114AA3
<i>Photo Not Available</i>	*A8111C2	Board	*B8111C2
<i>Photo Not Available</i>	1-7088B1	Board	
<i>Photo Not Available</i>	1-A8119AK1	Board	
	*A8110A1	Board	
<i>Photo Not Available</i>	*A8110A2	Board	
<i>Photo Not Available</i>	*A8110A5	Board	
<i>Photo Not Available</i>	*A8110B1	Board	
<i>Photo Not Available</i>	*A8111A1	Board	
<i>Photo Not Available</i>	*A8111A3	Board	
<i>Photo Not Available</i>	*A8112B3	Board	
<i>Photo Not Available</i>	*A8112C1	Board	
<i>Photo Not Available</i>	*A8112C10	Board	
<i>Photo Not Available</i>	*A8112D2	Board	
<i>Photo Not Available</i>	*A8112H3	Board	
<i>Photo Not Available</i>	*A8113G2	Board	
<i>Photo Not Available</i>	*A8115B1	Board	
<i>Photo Not Available</i>	*B8110C1	Board	

Otis CB Base (continued)

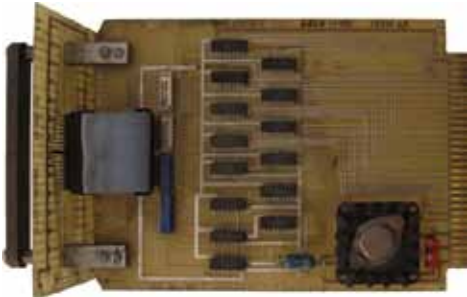
Image	Part Number	Description	Alt/Sub/Sup P/N
	B8110C2	Board	
	*B8112A3	Board	
	*B8112B3	Board	
<p data-bbox="289 1434 500 1461"><i>Photo Not Available</i></p>	*B8112C1	Board	
	*B8112H2	Board	

PC BOARDS

©2013, UNITEC Parts Company

Image	Part Number	Description	Alt/Sub/Sup P/N
<i>Photo Not Available</i>	*B8114G1	Board	
	*B8115B2	Board	
<i>Photo Not Available</i>	*C8112B10	Car Variable 3 (CV3) Board	
<i>Photo Not Available</i>	*C8112B3	Car Variable 3 (CV3) Board	
<i>Photo Not Available</i>	*C8112B4	Car Variable 3 (CV3) Board	
<i>Photo Not Available</i>	*C8112B8	Car Variable 3 (CV3) Board	
	*A8112A3	Delayed Car and Door Protection Board	
<i>Photo Not Available</i>	*A8116A11	Electronic Hall Call Register Board	
<i>Photo Not Available</i>	*A8116A12	Electronic Hall Call Register Board	
<i>Photo Not Available</i>	*B8111C2	Group Zone Board	
<i>Photo Not Available</i>	*C8114G1	Lantern Driver Board	
	*8120A1	Optical Sensor Board	

Otis CB Base (continued)




Image	Part Number	Description	Alt/Sub/Sup P/N
<i>Photo Not Available</i>	*34-A8124AL2	Pre-Amplifier Card	
<i>Photo Not Available</i>	*AAA26800RE1	Regulator Power Supply Card	
<i>Photo Not Available</i>	*8120G1	Slowdown Control Printed Board	
<i>Photo Not Available</i>	*110-A8124AL1	Special Emergency Service Board	
<i>Photo Not Available</i>	*114-A8124AL1	Supplemental Interface Board	*A8114AA1
<i>Photo Not Available</i>	*114-A8124AL10	Supplemental Interface Function Board	*A8114AA10
	*B8117B1	Test Signal Board	
<i>Photo Not Available</i>	*A8124UN402	Universal Board	
<i>Photo Not Available</i>	*B8111A3	Zoning Board	

PC BOARDS

Elevonic 211

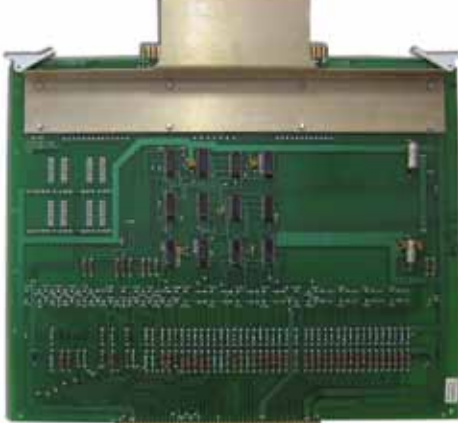
Image	Part Number	Description	Alt/Sub/Sup P/N	Application
<i>Photo Not Available</i>	*ABA26800TS1	I/O Board		211M
<i>Photo Not Available</i>	*AAA26800TD1	Processor Board		211M
<i>Photo Not Available</i>	GDA25005B10	RS 14 Board	AAA26800MT1	211 (LR95)/ E411MC/Hydrau- lic Controller, Microprocessor Phase II (Unified Mod or NEB) 211LVM
<i>Photo Not Available</i>	AAB22439E5	Tape Reader Assembly	ACA22439E5	211M

Elevonic 101 & 401





Image	Part Number	Description	Alt/Sub/Sup P/N
	*LA46S2439-0010	12SCR Cont Board	
<p><i>Photo Not Available</i></p>	*LA46S1607-1050	12SCR Main/Aux Board	
	*LA46S1607-1060	12SCR Main/Aux Board	
<p><i>Photo Not Available</i></p>	*8403A1	Adfix Cab Fixture Interface Board	
	*ABA26800ZZ1	ADPCM Speech Board, E401, E411, MRS	
<p><i>Photo Not Available</i></p>	HT201727-1	Cab Controller Motherboard	
<p><i>Photo Not Available</i></p>	*HT201732-1	Group Controller Communication I/O Board	

PC BOARDS

©2013, UNITEC Parts Company





Image	Part Number	Description	Alt/Sub/Sup P/N
	*HT201734-3	Relay I/O Board	
	*8200EB1	Board, E401, MRS, MRVF, E411	*A8200EB1
<p><i>Photo Not Available</i></p>	HT201735-1	Buffer Board Assembly	
	HT201736-1	*Bus Terminator Board	
<p><i>Photo Not Available</i></p>	*HT204327-1	Bus Terminator Board	

Otis 101 & 401 (continued)




Image	Part Number	Description	Alt/Sub/Sup P/N
	*HT201731-4	Cab I/O Board Assembly	
	*HT203103-1	CF I/O Board	
	HT201732-4	Comm I/O Board	*HT201732-1
	*HT201732-8	Comm I/O Board	

PC BOARDS

©2013, UNITEC Parts Company

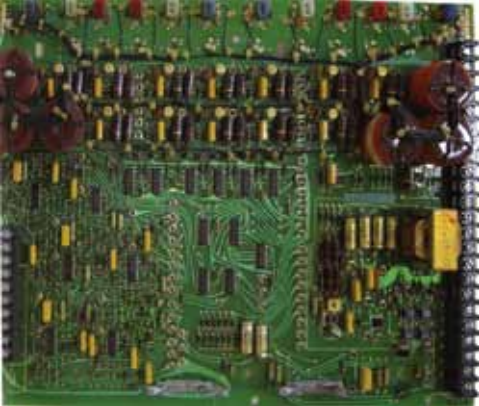

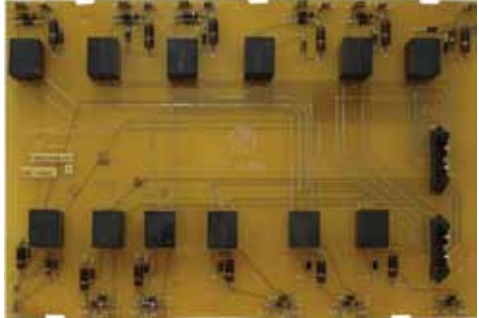
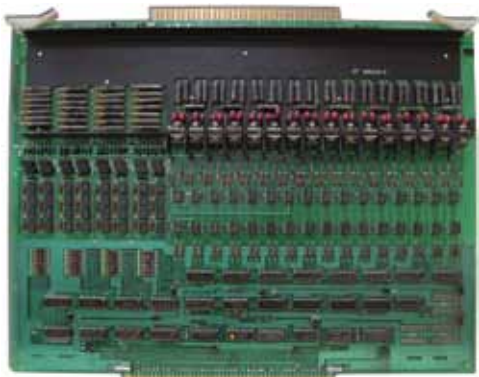
Image	Part Number	Description	Alt/Sub/Sup P/N
	*HT201732-6	Comm. I/O Board Assembly	
<i>Photo Not Available</i>	*8200EA2	Communication-HTS Buffer Board, E401	*A8200EB4
	*RB560-275-2	Control Board	
	*ABA25000C1	COP II CPU/Pocket/Handle Sub-Assembly, E401	
<i>Photo Not Available</i>	HT204349-4	CPU Board Assembly, E401	HT204349-5
	*HT204349-5	CPU Board Assembly, E401	
<i>Photo Not Available</i>	*SA14-193-770-572	DC Contactor, 250 V Coil, w/3TY7 Aux. Contact, LA, 401	

Otis 101 & 401 (continued)

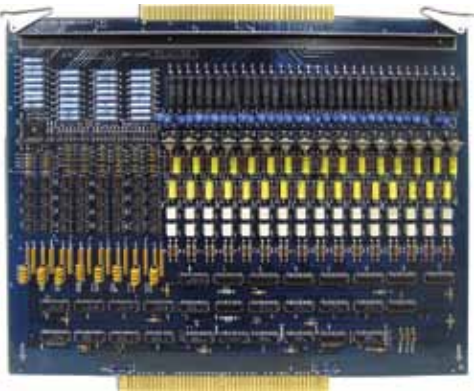

Image	Part Number	Description	Alt/Sub/Sup P/N
	*SA14-193-770-570	DC Rev Contactor w/3TY7 Aux. Contact, E401	
<i>Photo Not Available</i>	SA14-193-770-571	DC Rev. Contactor, 250 V, w/3TY7 Aux. Contact, Robicon, 401	
	*LA46S2206-0013	Elev Control Board	
	*LA46S2440-0010	Elev Control Board	

PC BOARDS

©2013, UNITEC Parts Company



Image	Part Number	Description	Alt/Sub/Sup P/N
	*RB560-276-02	Gate Board	
	*LA46S1677-0070	Gate Firing Board	
	*LA46S2441-0010	Gate Firing Board	
	*HT203102-1	GF I/O Board	
<p><i>Photo Not Available</i></p>	*HT201723-1	GP I/O Full Board	HT201723-2

Otis 101 & 401 (continued)



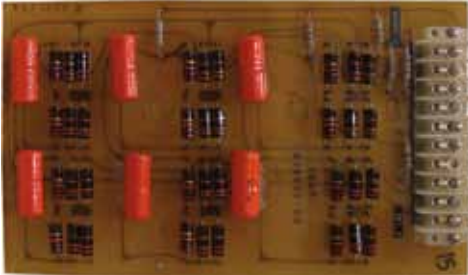
Image	Part Number	Description	Alt/Sub/Sup P/N
	HT201723-2	GP I/O Full Board	
<i>Photo Not Available</i>	*LA46S2438-0050	Heat Sink	
<i>Photo Not Available</i>	*LA46S2438-0010	Heat Sink Assembly	
<i>Photo Not Available</i>	*LA46S2438-0020	Heat Sink Assembly	
<i>Photo Not Available</i>	*LA46S2438-0030	Heat Sink Assembly	
<i>Photo Not Available</i>	*LA46S2438-0040	Heat Sink Assembly	
<i>Photo Not Available</i>	*RB326-052-4	Heat Sink Assembly	
<i>Photo Not Available</i>	*RB326-052-5	Heat Sink Assembly	
<i>Photo Not Available</i>	*RB326-052-1	Heat Sink Assembly R	
<i>Photo Not Available</i>	*RB326-052-2	Heat Sink Assembly R	
<i>Photo Not Available</i>	*RB326-052-3	Heat Sink Assembly R	
<i>Photo Not Available</i>	*LA46S2284-0010	Heat Sink Assembly, E101	
<i>Photo Not Available</i>	AAA21000C3	KEC Group Power Supply on Adapter Plate Assembly, E401	
<i>Photo Not Available</i>	*B8200BT1	Pet Board	
<i>Photo Not Available</i>	*B8200BT2	Pet Board	
	B8200BT3	Pet Board	*B8200BT2
<i>Photo Not Available</i>	*HT204411-2	Power Amp	
<i>Photo Not Available</i>	*HT206412-1	Power Amp	
<i>Photo Not Available</i>	*HT205925-1	Power Amp I/O	

PC BOARDS


©2013, UNITEC Parts Company

Image	Part Number	Description	Alt/Sub/Sup P/N
<i>Photo Not Available</i>	*HT201725-1	Power Amp I/O Board	*HT205925-1
<i>Photo Not Available</i>	*HT201725-2	Power Amp I/O Board	*HT205925-1
<i>Photo Not Available</i>	*HT206020-2	Power Amp LA/RB	
	*AAA8126K1	Power Supply Assembly, E101	*ABA8126K1
<i>Photo Not Available</i>	*ABA8126K1	Power Supply Assembly, E101	
<i>Photo Not Available</i>	*205410-3	Power Supply Assembly, E401	*205410-4
<i>Photo Not Available</i>	205410-4	Power Supply Assembly, E401	
<i>Photo Not Available</i>	*HT201781-1	Power Supply (HTS)	
<i>Photo Not Available</i>	*HT201450-1	Door Motor Power Amplifier	
<i>Photo Not Available</i>	2700CBL1	PPT, & Cable Assy.	
<i>Photo Not Available</i>	*HT206481-3	Processor Board Assembly	*HT206481-4
<i>Photo Not Available</i>	HT206481-4	Processor Board Assembly	*HT204349-5
<i>Photo Not Available</i>	*HT202088-2	Relay I/O Board	*HT203101-2
<i>Photo Not Available</i>	*HT203101-1	Relay I/O Board	HT203101-2
	HT203101-2	Relay I/O Board	
<i>Photo Not Available</i>	*LA46S2284-0050	SCR Bridge Assembly	*LA46S2284-0060
<i>Photo Not Available</i>	*LA46S2284-0020	SCR Bridge Assembly	

Otis 101 & 401 (continued)

Image	Part Number	Description	Alt/Sub/Sup P/N
	*A8200EB4	Speech Board, ADPCM, E401, MRS	*ABA26800ZZ4
<i>Photo Not Available</i>	*A8200EB3	Speech Board, ADPCM, w/o Chips, E401, MRS	*ABA26800ZZ1
	A8200EB1	Speech Board, E401, MRS	ABA26800ZZ1
<i>Photo Not Available</i>	*8200EB5	Speech Board, OKI, E401, MRS, MRVF, E412	ABA26800ZZ1
<i>Photo Not Available</i>	ABA26800ZZ4	Speech, Male Voice, E401, E411, MRS	*A8200EB4
<i>Photo Not Available</i>	*RB326-010-55	Suppressor	
<i>Photo Not Available</i>	*RB326-010-53	Suppressor Board	*RB326-010-73
<i>Photo Not Available</i>	*RB326-010-70	Suppressor Board	
<i>Photo Not Available</i>	RB326-010-72	Suppressor Board	
<i>Photo Not Available</i>	*RB326-010-73	Suppressor Board	
<i>Photo Not Available</i>	*RB326-010-50	Suppressor Board R	
<i>Photo Not Available</i>	*RB326-010-51	Suppressor Board R	*RB326-010-71
	*RB326-010-52	Suppressor Board R	*RB326-010-72
<i>Photo Not Available</i>	*HT201733-1	Transducer I/O Board Assembly	
<i>Photo Not Available</i>	*HT200750-1	Transducer, Primary, E101	*AAA21430L1
<i>Photo Not Available</i>	AAA21430L1	Transducer, Primary, Upgraded HT200750-1	

PC BOARDS




Image	Part Number	Description	Alt/Sub/Sup P/N
<i>Photo Not Available</i>	*HT201734-5	WL Relay I/O P	HT203101-2
	*LA46S1692-0060	Zero Current Detector	

Elevonic 311 & 411




Image	Part Number	Description	Alt/Sub/Sup P/N	Application
<i>Photo Not Available</i>	*LA46S2690-0023	12SCR Controller Board		E311 / 411 M & MV Direct Drive Controller Panel
<i>Photo Not Available</i>	*LA46S2686-2020	12SCR Gate Firing/Voltage Divider Board		E311 / 411 M & MV Direct Drive Controller Panel
<i>Photo Not Available</i>	*AAA26800KK2	ADISS Board	*ABA26800KK4	E311/411M
	*ABA26800KK3	ADISS Board	*ABA26800KK4	E311M, E411M, E311MV, E411MV
<i>Photo Not Available</i>	ABA26800KK4	ADISS Board		E311M, E411M, E311MV, E411MV
	*B9693MG1	ADISS Board		E411, E312
<i>Photo Not Available</i>	*AAA26800KK3	ADISS Board, Modified AAA26800NR1 PC	*ABA26800KK4	E311/411M
<i>Photo Not Available</i>	*B9693MG2	ADISS Board. Supersedes A9693MG2		E411, E313

PC BOARDS

©2013, UNITEC Parts Company

Image	Part Number	Description	Alt/Sub/Sup P/N	Application
<i>Photo Not Available</i>	GDA21270A4	RCBII Board		E311VF (MVS)
	*GHA21270A3	RCBII Board		E311VF (MVS), GEM/411MMS
	AAB26810A1	Remote Station PC Board Assembly		E311M
<i>Photo Not Available</i>	ABA26800ABL001	Chime Board		E311VF (MVS), GEM
<i>Photo Not Available</i>	*AEA26800AAP002	Control Board	*AFA26800AAP002	E411, GAMMA D
<i>Photo Not Available</i>	AFA26800AAP001	Control Board		E411, GAMMA D
<i>Photo Not Available</i>	AFA26800AAP002	Control Board		E411, GAMMA D
	*AAA26800QM1	CPU		411MMS, MVE, E411
<i>Photo Not Available</i>	*LA46S2691-0041	DBSS Board		E311M/ E411M, E311MV/ E411MV High Speed Ward Leonard
<i>Photo Not Available</i>	SA14-193-770-567	DC Contactor, 125 V, 3TY7 Aux. Contact, LA E411		E411

Otis 311 & 411 (continued)

Image	Part Number	Description	Alt/Sub/Sup P/N	Application
	SA14-193-770-568	DC Rev Contactor, 125 V, 3TY7 Aux. Contact, LA E411		E411
<i>Photo Not Available</i>	*B9693MB1	DISS Board	*C9693MB2	E411, E311
<i>Photo Not Available</i>	*ABA26800KJ4	DISS Board		E311MV, E411MV
	*C9693MB2	DISS Board		E311, E411, E411M
	*C9693MB1	DISS Board. Replaces AAA26800NP1.	*ACA21290BJ2	E311, E411, E411M
<i>Photo Not Available</i>	ACA21290BM1- UNITEC (Exchange Only)	Drive Board, OVF, 210 Amp, 480 Volt		E411MVF, MVS, GEM, GEN2
<i>Photo Not Available</i>	ADA21290AK2- UNITEC (Exchange Only)	Drive Board, OVF, 70 Amp, 480 Volt		E411MVF, MVS, GEM, GEN2
<i>Photo Not Available</i>	ACA21290BJ2- UNITEC (Exchange Only)	Drive Board, OVF, 90 Amp, 480 Volt		E411MVF, MVS, GEM, GEN2

PC BOARDS

©2013, UNITEC Parts Company

Image	Part Number	Description	Alt/Sub/Sup P/N	Application
<i>Photo Not Available</i>	ACA21290BA4-UNITEC (Exchange Only)	Drive Board, OVF, for ETO, 120 Amp, 480 Volt		E411MVF, MVS, GEM, GEN2
<i>Photo Not Available</i>	ACA21290BA2-UNITEC (Exchange Only)	Drive Board, OVF, for NAO, 120 Amp, 480 Volt		E411MVF, MVS, GEM, GEN2
<i>Photo Not Available</i>	*LA46S2965-0011	Field Brake Assembly		E311/E411 Magnetek Direct Drive
<i>Photo Not Available</i>	*LA46S2965-0021	Field Brake Assembly		E311/E411 Magnetek Direct Drive
<i>Photo Not Available</i>	*LA46S2689-0061	Field Brake Control		E311 / 411 M & MV Direct Drive Controller Panel, Magnetek Direct Drive
<i>Photo Not Available</i>	AAA26800KP1	Filter Assembly		E311VF (MVS), GEM
<i>Photo Not Available</i>	AAA21380D1	Filter Module Assembly		E311VF (MVS), GEM



ABA26800XU1

Geared VF Drive Low Voltage Interface Board

ACA26800XU1

E311VF (MVS), GEM




ABA26800XU2

Geared VF Drive Low Voltage Interface Board

ACA26800XU2

E311VF (MVS), GEM

Otis 311 & 411 (continued)

Image	Part Number	Description	Alt/Sub/Sup P/N	Application
<i>Photo Not Available</i>	*LA46S2868-0030	Hall/Relay Interface Board		E311M/ E411M, E311MV/ E411MV High Speed Ward Leonard
<i>Photo Not Available</i>	LA46S2869-0011	H-Bridge Snubber Board		E311M/ E411M, E311MV/ E411MV High Speed Ward Leonard
	*LA46S2685-0040	Heat Sink Assembly		E311M/ E411M
<i>Photo Not Available</i>	*ADA26800RB1	High Voltage Interface Board		E411MVF, MVS, GEM, GEN2
<i>Photo Not Available</i>	*ADA26800VF1	High Voltage Interface Board		E411MVF, MVS, GEM, GEN2
<i>Photo Not Available</i>	*AFA26800UD1	High Voltage Interface Board	AGA26800UD1	E411MVS, MVS, GEM
<i>Photo Not Available</i>	AFA26800UD3	High Voltage Interface Board	*AGA26800UD3	E411MVS, MVS, GEM
<i>Photo Not Available</i>	*AGA26800UD1	High Voltage Interface Board		E411MVS, MVS, GEM
<i>Photo Not Available</i>	*AGA26800UD2	High Voltage Interface Board		E411MVS, MVS, GEM
<i>Photo Not Available</i>	*AGA26800UD3	High Voltage Interface Board		E411MVS, MVS, GEM
<i>Photo Not Available</i>	*ABA26800ABV2	Interface Board, 32 Channel		E311M
<i>Photo Not Available</i>	AAA26800GM1	Load Weighing Interface Board Assembly		E311MV, E411MV

PC BOARDS

©2013, UNITEC Parts Company

Image	Part Number	Description	Alt/Sub/Sup P/N	Application
<i>Photo Not Available</i>	AAA26800LM1	LVDT		E311MV, E411MV
<i>Photo Not Available</i>	ABA26800LB1	LWSS Processor Board		MMS, MVF
<i>Photo Not Available</i>	*ACA26800ABB001	MCSS I/O Board		E311MV/ E411MV
<i>Photo Not Available</i>	*ACA26800ABB002	MCSS I/O Board		E311MV/ E411MV
	*ABA26800ABA002	MCSS Microprocessor		E311MV, E411MV
	AAA26800MT1	Mod Remote Station Extender Board		E411MMS
<i>Photo Not Available</i>	*JGA26801AAF002	Motion Control Board		E311MV, E411MV
<i>Photo Not Available</i>	*ABA26800XH1	Motion Logic III Board	*ACA26800XH1	E411MMS
	ACA26800XH1	Motion Logic III Board		E411MMS
<i>Photo Not Available</i>	*ACA26800XH2	Motion Logic III Board		E411MMS

Otis 311 & 411 (continued)

Image	Part Number	Description	Alt/Sub/Sup P/N	Application
	*ABA26800AJV1	Motion Logic III Board		E411MMS
	*ABA26800AJV2	Motion Logic III Board		E411MMS
	*ABA26800AJV3	Motion Logic III Board		E411MMS
<i>Photo Not Available</i>	*AAA26800AJV1	Motion Logic III Board, E411MMS	*ABA26800AJV1	MMS, MVF, GEN2
<i>Photo Not Available</i>	AAA26800AJV2	Motion Logic III Board, E411MMS	*ABA26800AJV2	MMS, MVF, GEN2
<i>Photo Not Available</i>	*LA46S2870-0012	Motor/Brake Snubber Board		E311M/ E411M, E311MV/ E411MV High Speed Ward Leonard
<i>Photo Not Available</i>	*LA46S2692-0031	Power Supply Board		E311/E411 Magnetek Direct Drive
<i>Photo Not Available</i>	ADA26800VA1-UNITEC (Exchange Only)	Processor Board		E411MVF, MVS, GEM, GEN2

PC BOARDS

©2013, UNITEC Parts Company

Image	Part Number	Description	Alt/Sub/Sup P/N	Application
<i>Photo Not Available</i>	*LA46S2728-0041	Relay Interface Board		E311 / 411 M & MV Direct Drive Controller Panel, Magnetek Direct Drive
<i>Photo Not Available</i>	*LA46S2728-0052	Relay Interface Board		E311/E411 Magnetek Direct Drive
<i>Photo Not Available</i>	AAA26800NL1	Resistor Network Board		E311MV, E411MV
<i>Photo Not Available</i>	*A9693D1	Ring Car Board		E411, MRQ
<i>Photo Not Available</i>	*GEA21270A1	Ring Car Board II	*GEA21270A3	E311, E411, E411M, GEM, MVS
<i>Photo Not Available</i>	GEA21270A3	Ring Car Board II	*GFA21270A3 *GHA21270A3	
<i>Photo Not Available</i>	GFA21270A3	Ring Car Board II	*GEA21270A3 *GGA21270A3	
<i>Photo Not Available</i>	GGA21270A3	Ring Car Board II	*GGA21270A6 *GHA21270A3	
<i>Photo Not Available</i>	GGA21270A6	Ring Car Board II	*GGA21270A3	E311, E411, E411M, GEM, MVS
<i>Photo Not Available</i>	GCA21270A1	Ring Car/LCSS Board		E311, E411, E411M, GEM, MVS
<i>Photo Not Available</i>	GCA23550B1	RS4 Gong Board		E311, E411, E411M, GEM, MVS
<i>Photo Not Available</i>	ABA26800KT1	Seismic Assembly		E311VF (MVS), GEM
<i>Photo Not Available</i>	ABB21380E1	Seismic Module		E311VF (MVS), GEM
<i>Photo Not Available</i>	LA46S2877-0022	Snubber Card		E311 / 411 M & MV Direct Drive Controller Panel, Magnetek Direct Drive
<i>Photo Not Available</i>	ABA26800KS1	Standby Power Service Board		E311VF (MVS), GEM
<i>Photo Not Available</i>	ABB21380F1	Standby Power Service Module		E311VF (MVS), GEM




Otis 311 & 411 (continued)




Image	Part Number	Description	Alt/Sub/Sup P/N	Application
<i>Photo Not Available</i>	A9693F1	Switch Module Assembly		E311VF (MVS), GEM, MVS, E411
<i>Photo Not Available</i>	*AEA26800AAP004	Tape Reader Board	AFA26800AAP004	E411, GAMMA D
<i>Photo Not Available</i>	AFA26800AAP004	Tape Reader Board		E411, GAM- MA D
<i>Photo Not Available</i>	*AAA26800NR1	ADISS PCB	*B9693MG1	E311MV, E411MV
<i>Photo Not Available</i>	*AAA26800NP1	DISS PCB		E311MV, E411MV
<i>Photo Not Available</i>	*LA46S2686-2030	Voltage Divider Board		E311 / 411 M & MV Direct Drive Control- ler Panel

PC BOARDS

Eleonic 335M



Image	Part Number	Description	Alt/Sub/Sup P/N
<i>Photo Not Available</i>	AAA21255J120	Armature Interface (W) 100 A Drive Board	*AAA21255J132
<i>Photo Not Available</i>	AAA21255J110	Armature Interface (W) 190 A Drive Board	AAA21255J132
<i>Photo Not Available</i>	AAA21255J132	Armature Interface Board	AAA21255J148
<i>Photo Not Available</i>	AAA21255J148	Armature Upgrade Kit, 100/190 Amp	
<i>Photo Not Available</i>	*AAA21255J109	Drive Control Board	
<i>Photo Not Available</i>	*AAA21255J14	Drive Panel Assembly, Motor Amps 100 2.0-40	
<i>Photo Not Available</i>	*AAA21255J15	Drive Panel Assembly, Motor Amps 190 2.0-40	
<i>Photo Not Available</i>	*AAA21255J16	Drive Panel Assembly, Motor Amps 300 2.0-40	
<i>Photo Not Available</i>	*AAA21255J20	DSD 401 Drive	
<i>Photo Not Available</i>	*AAA21255J21	DSD 401 Drive	
<i>Photo Not Available</i>	9693J1	Line Terminator Board	
<i>Photo Not Available</i>	9693J2	Line Terminator Board	
<i>Photo Not Available</i>	*ACA26800MK1	Motion Logic Board, E335M-MLB	
	AAA21255J113	Motor Field Interface, 6.3-16.7 A Board	
<i>Photo Not Available</i>	*AAA21255J114	Snubber Capacitor Board	
<i>Photo Not Available</i>	AAB22439E4	Tape Reader Assembly, 335MW	ACA22439E4
<i>Photo Not Available</i>	AAB22439E2	Tape Reader Subassembly	ACA22439E2

GAMMA D

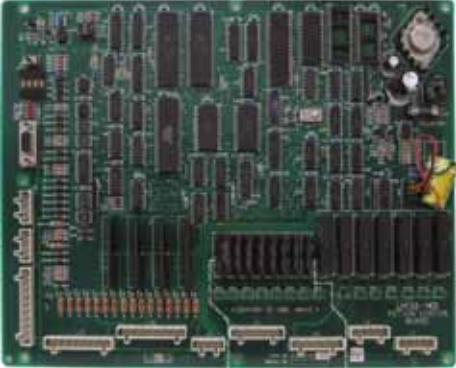

Image	Part Number	Description	Alt/Sub/Sup P/N
<i>Photo Not Available</i>	*D9708AE1	GAMMA 160 Board	*F9708AE3
	*B9708BN1	Gamma I/O Board	
<i>Photo Not Available</i>	*B9708BN2	I/O Board	
<i>Photo Not Available</i>	*A9693A3	Limited Car Board, GAMMA D, MRQ, EMO, TEMO	*B9693A3
<i>Photo Not Available</i>	B9693A3	Limited Car Board	*C9693A3
<i>Photo Not Available</i>	C9693A3	Limited Car Board	
	*C9693A60	Limited Car Board	
<i>Photo Not Available</i>	*A9708BJ1	Power Pack	*A9708BJ3
<i>Photo Not Available</i>	*B9708BM2	Processor Board	*C9708BM2
	*C9708BM2	Processor Board	
<i>Photo Not Available</i>	B9693AE1	Remote Station Extender Board, GAMMA D, COP	C9693AE1

PC BOARDS

©2013, UNITEC Parts Company

Image	Part Number	Description	Alt/Sub/Sup P/N
	*A9708BJ3	Thyristor Panel	
	*A9708BJ4	Thyristor Panel	

GEM, MVS

Image	Part Number	Description	Alt/Sub/Sup P/N	Application
<i>Photo Not Available</i>	AAA21380M1	ANSI Speed Check Module Assembly	AAA21380M3	GEM, E311VF, MVS, HVS, GMP
<i>Photo Not Available</i>	AAA21380D1	Filter Module Assembly		GEM, E311VF, MVS, HVS, GMP
	JFA26801AAF105	MCB Board	*JGA26801AAF105	GEM / MVS
	JGA26801AAF105	MCB Board		GEM / MVS
<i>Photo Not Available</i>	ABA26800TV1	Remote Station Board Assembly		GEM / MVS / COP
<i>Photo Not Available</i>	ABA26800TH1	Remote Station Extender (Card Reader)		GEM / MVS / COP

PC BOARDS

IDS


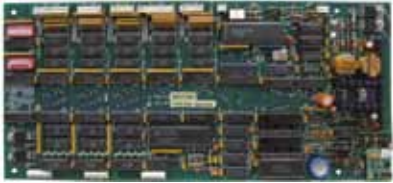

Image	Part Number	Description	Alt/Sub/Sup P/N
<i>Photo Not Available</i>	*8200AR1	Data Distribution Board	
<i>Photo Not Available</i>	8200AR2	IDS Distribution Board	

LR, LRV, LHM, LRV



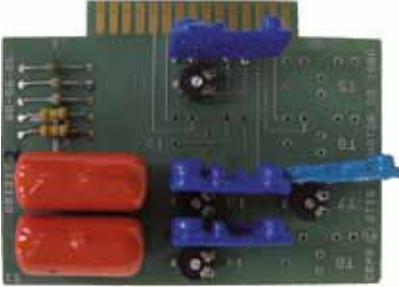
Image	Part Number	Description	Alt/Sub/Sup P/N	Application
<i>Photo Not Available</i>	A8121D4	BM Board		LR
<i>Photo Not Available</i>	A8121D1	BP Board		LR
	8200AJ1	BP Door Operator Panel		LR, MRS
	*E8121BE1	Button Interface Module		LRV4, LRS3
<i>Photo Not Available</i>	A8121D5	C-3074 Board		LR
<i>Photo Not Available</i>	*A8128EF1	Cab Interface Board		LRV
<i>Photo Not Available</i>	A8121B2	Car or Hall Call Interface Board	A8121B2-TEMP	LR
	*A8121P1	COM1 Printed Board		LR
<i>Photo Not Available</i>	*8128EE1	Controller Interface Board		LRV5, LRV5L
<i>Photo Not Available</i>	*AAA26800KX1	Controller Interface Board		LRV5, LHM
	*AAA26800NZ1	Controller Interface Board		LHM/LRV5L

PC BOARDS

©2013, UNITEC Parts Company




Image	Part Number	Description	Alt/Sub/Sup P/N	Application
<i>Photo Not Available</i>	A8121E4	Double Gong Board		LR
<i>Photo Not Available</i>	*B8121AX1	EMI Board	*C8121AX1	LRV3, LRV4, LRS3
<i>Photo Not Available</i>	*A8121AW1-UNITEC	GMI Board, R/F		
<i>Photo Not Available</i>	*8200BE1	Gong Board	A8200BE1	LRV4, LRS
<i>Photo Not Available</i>	A8200BE1	Gong Board		LRV4, LRS
<i>Photo Not Available</i>	*A8121AY1-UNITEC	Hall Button Interface (HBI)		LRV3
<i>Photo Not Available</i>	ABA07900AAA001	Hydro Retrofit Kit		LRV3
<i>Photo Not Available</i>	A8121D3	Interface Board		LR
<i>Photo Not Available</i>	*B8121BC1	Microcomputer Board	*D8121BC1	LRS3
	*D8121BC1	Microcomputer Board		LRS3
	*E8121DB1	Microcontroller PC		LRS3
	*F8121BC1	Microcontroller PC		LRS3
	*C8121DB1	Microprocessor		LRV4
<i>Photo Not Available</i>	*C8211B1	MRVF Board		LRV4
<i>Photo Not Available</i>	*A8121Y3	MRVF-Board		LR
<i>Photo Not Available</i>	*AAA26800MZ1	Relay Board, LRVM	ABA26800MZ1	LRVM
<i>Photo Not Available</i>	ABA26800MZ1	Relay Board, LRVM		LRVM

Otis LR, LRV, LHM, LRV (continued)



Image	Part Number	Description	Alt/Sub/Sup P/N	Application
	*C8121AX1	Relay Board, LRVM		LRVH, LRVM, LRV3, LRV4, LRS3
<i>Photo Not Available</i>	A8121D2	Relay Driver Board, Latching Interface		LR
	ABB22439E6	Tape Reader Assembly	ACA22439E6	LVM
<i>Photo Not Available</i>	*A8121Y1	Timer Board		LR
	*A8121Y2	Timer Board		LR
<i>Photo Not Available</i>	B8121BJ1	Touch Tone Interface Board		LRS3

PC BOARDS

MPGC




Image	Part Number	Description	Alt/Sub/Sup P/N
<i>Photo Not Available</i>	*D8121BX1	9-Channel Board	
<i>Photo Not Available</i>	*A8121BM1	MPGC Board	*B8121BM1
<i>Photo Not Available</i>	*A8121BS1	MPGC Board	
	*A8121BT1	MPGC Board	
<i>Photo Not Available</i>	*A8121CB1	MPGC Board	
<i>Photo Not Available</i>	*A8121CB3	MPGC Board	
	*B8121BK1	MPGC Board	
	*B8121BM1	MPGC Board	

MRQ, EMO, TEMO


Image	Part Number	Description	Alt/Sub/Sup P/N	Application
<i>Photo Not Available</i>	*A8128DP1	Counter Board		MRQ
<i>Photo Not Available</i>	*B9693A3	Limited Car Board	C9693A3	MRQ, EMO, TEMO, GAMMA D
<i>Photo Not Available</i>	*C9693A3	Limited Car Board		MRQ, EMO, TEMO, GAMMA D
	*C9693A60	Limited Car Board		MRQ, EMO, TEMO, GAMMA D
<i>Photo Not Available</i>	10260P10*	Spec 60 Drive		MRQ
	*B8128DR1	Speed Check I/O Board		MRQ
<i>Photo Not Available</i>	*B8128DR2	Speed Check I/O Board		MRQ

PC BOARDS

MRS, MRV, MRVF, LR


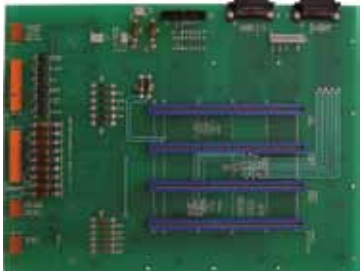



Image	Part Number	Description	Alt/Sub/Sup P/N	Application
<i>Photo Not Available</i>	*8128CN1	Amplifier Assembly Board		MRVF
<i>Photo Not Available</i>	8200A1	Back Panel Board	*AAA268000A1	MRVF
<i>Photo Not Available</i>	*A8211F1	Base Drive Phase A Board	*C8211F1	MRVF
<i>Photo Not Available</i>	*A8211F2	Base Drive Phase A Board	*C8211F2	MRVF
<i>Photo Not Available</i>	*7416E3	Base Drive Subassembly	AAA27076AS1	MRVF
<i>Photo Not Available</i>	*A628G1	Battery Charger		MRVF
<i>Photo Not Available</i>	C628B1	Battery Charger		MRVF
	*8211A1	Board		MRVF
<i>Photo Not Available</i>	*A8121AH6	BP-MRVF Board	AAA8121W1	MRS, LR
<i>Photo Not Available</i>	A8211F3	Buffer Board	*C8211F3	MRVF
	*A8121AT1	Buffer Board		MRVF
<i>Photo Not Available</i>	*A621G1	Carrier Power Supply		
<i>Photo Not Available</i>	B621G1	Carrier Power Supply	*C621G1	MRVF
	C621G1	Carrier Power Supply		MRVF
<i>Photo Not Available</i>	*8128CM1	Comparator Assembly Board	1F-7416BB1	MRVF
<i>Photo Not Available</i>	*8211B1	DLU Board		MRVF
<i>Photo Not Available</i>	*A8211D1	DLU Board	*B8211D1	MRVF

Otis MRS, MRV, MRVF, LR (continued)




Image	Part Number	Description	Alt/Sub/Sup P/N	Application
<i>Photo Not Available</i>	*B8211E1	EMI Board	1F-7416BB1	MRVF
	*C8211F1	EN50150 Board		MRVF
<i>Photo Not Available</i>	*C8211F2	EN50150 Board		MRVF
<i>Photo Not Available</i>	*C8211F3	EN50150 Board		MRVF
<i>Photo Not Available</i>	*A8211D2	Freq & Amp Board	*B8211D1	MRVF
	*B9708BF1	Impulse Transformer Board		MRV
<i>Photo Not Available</i>	*B9708BF3	Impulse Transformer Board		MRV
	*9708AG1	Input Interface Board		MRV
	*9708BH1	Interface Board		MRV
<i>Photo Not Available</i>	*A8211B1	Inverter Control Board		MRVF
<i>Photo Not Available</i>	*9708AB1	Logic Board	*CYX9708AB1	MRV
<i>Photo Not Available</i>	*B9708AD2	Logic Board	*C9708AD2	MRV
<i>Photo Not Available</i>	*C9708AD1	Logic Board		MRV

PC BOARDS


©2013, UNITEC Parts Company

Image	Part Number	Description	Alt/Sub/Sup P/N	Application
	C9708AD2	Logic Board		MRV
	*8211A1	Mother Board		MRVF
<i>Photo Not Available</i>	*A8121AA11	MRVF Board		MRVF
<i>Photo Not Available</i>	*A9708AH1	Output Interface Board		MRV
<i>Photo Not Available</i>	9708BJ1	Power Pack w/Fan	A9708BJ3	MRV
<i>Photo Not Available</i>	*621J1	Power Supply	*A621J1	MRVF
	*B9708AF1	Power Supply Board		MRV
	*A621J1	Power Supply, Multi-Output, DC		MRVF
<i>Photo Not Available</i>	*621W1	Primary Power Supply (PPS)		MRVF
<i>Photo Not Available</i>	*C8121CH1	PWM Board		MRVF
	*A8121AR1	Reader Card		MRVF

Otis MRS, MRV, MRVF, LR (continued)



Image	Part Number	Description	Alt/Sub/Sup P/N	Application
<i>Photo Not Available</i>	*B8121AM1	Receiver Board	C8121AM1	MRS, MRVF
<i>Photo Not Available</i>	*C8121AM1	Receiver Board		MRVF
<i>Photo Not Available</i>	*C9708AE1	Speed Control Board	*F9708AE3	MRV
<i>Photo Not Available</i>	*F9708AE1	Speed Control Board	F9708AE2	MRV
	*F9708AE3	Speed Control Board		
<i>Photo Not Available</i>	F9708AE2	Speed Control Board	*F9708AE3	MRV, MRVF
<i>Photo Not Available</i>	*A8211C1	Speed Control Board	1F-7416BB1	MRVF
<i>Photo Not Available</i>	*E9708AE1	Speed Control Board		MRVF
<i>Photo Not Available</i>	*A8211E1	Speed Dictation Board	1F-7416BB1	MRVF
	*8128GE3	Stepper Board Assembly, Electronic		MRVF, MRS
<i>Photo Not Available</i>	*8128GE2	Stepper Board, 8 Relays		MRVF, MRS
<i>Photo Not Available</i>	*CYX9708AB1	Thyristor Control		MRVF
<i>Photo Not Available</i>	9708BJ2	Thyristor Panel	A9708BJ4	MRV
	*A9708BJ3	Thyristor Panel		MRV
<i>Photo Not Available</i>	A8121AA3	Timer Board	*A8121AA9	MRS, LR
<i>Photo Not Available</i>	A8121AA7	Timer Board	*A8121AA10	MRS, LR
<i>Photo Not Available</i>	A8121AA8	Timer Board	*A8121AA9 *A8121AA10	
<i>Photo Not Available</i>	A8121AB1	Timer Board		MRS, LR
<i>Photo Not Available</i>	*A8121AL1	Timer Board		MRVF, MRS, LR

PC BOARDS

Image	Part Number	Description	Alt/Sub/Sup P/N	Application
<i>Photo Not Available</i>	*A8121AL23	Timer Board		MRVF, MRS, LR
<i>Photo Not Available</i>	*A8121AL24	Timer Board		MRVF, MRS, LR
<i>Photo Not Available</i>	*A8121AL4	Timer Board		MRVF, MRS, LR
<i>Photo Not Available</i>	*A8121AL7	Timer Board		MRVF, MRS, LR
	*A8121AA9	Timer Board, BM	A8121AA10	MRS, LR
<i>Photo Not Available</i>	*A8121AA2	Timer Board	*A8121AA10	MRS, LR
<i>Photo Not Available</i>	*A8121AA4	Timer Board	*A8121AA10	MRS, LR
<i>Photo Not Available</i>	*A8121AA6	Timer Board	*A8121AA10	MRS, LR
<i>Photo Not Available</i>	*A8121AA1	Timer Board	*A8121AA9 *A8121AA10 A8121AA8	MRS, LR
<i>Photo Not Available</i>	A8121AA4	Timer Board	A8121AA10	MRS, LR
<i>Photo Not Available</i>	A8121AL5	Timer Board		MRVF, MRS, LR
<i>Photo Not Available</i>	*A8121AL10	Timer Board	*A8121AL24	MRVF, MRS, LR
<i>Photo Not Available</i>	A8121AA10	Timer Board, MPO		MRS, LR
<i>Photo Not Available</i>	*A8121AA5	Timer Board	*A8121AA10	MRS, LR
<i>Photo Not Available</i>	B8121AH1	Vacuum Fluorescent & Speech (VFSB) Board		MRS, MRVF
<i>Photo Not Available</i>	*B8121AH2	Vacuum Fluorescent & Speech (VFSB) Board w/Program Chip	AAA8121W1	MRS, MRVF
<i>Photo Not Available</i>	*A8121AH2	Vacuum Fluorescent and Speech Board	B8121AH2	MRS, LR

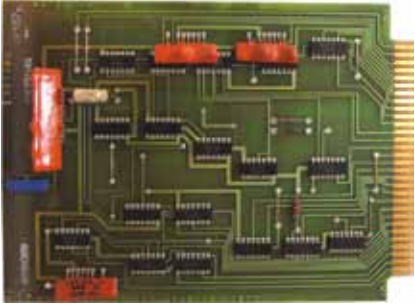
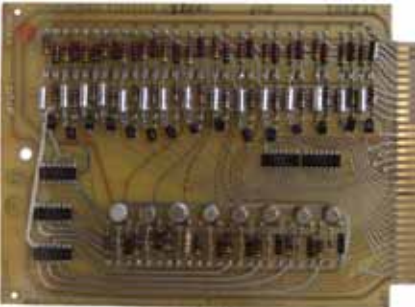
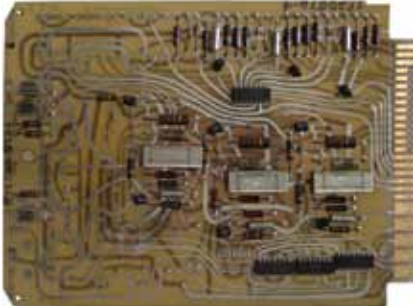
©2013, UNITEC Parts Company

Otis MRS, MRV, MRVF, LR (continued)


Image	Part Number	Description	Alt/Sub/Sup P/N	Application
<i>Photo Not Available</i>	*D8211C1	VF Speed Control Board	*E8211C1	MRVF
	E8211C1	VF Speed Control Board		MRVF
<i>Photo Not Available</i>	*D8211E1	VF Speed Dictation Board	*E8211E1	MRVF
	E8211E1	VF Speed Dictation Board		MRVF
<i>Photo Not Available</i>	*7416E1	W57795 Drive Board	AAA27076AS1	MRVF

PC BOARDS

VIP260






Image	Part Number	Description	Alt/Sub/Sup P/N
<i>Photo Not Available</i>	*A8111B3	Board	
<i>Photo Not Available</i>	*A8111D2	Board	
<i>Photo Not Available</i>	A8112D1	Board	
	*A8112G1	Board	
<i>Photo Not Available</i>	*A8112H1	Board	
	*A8114A1	Board	
<i>Photo Not Available</i>	*A8114AA1	Board	
<i>Photo Not Available</i>	*A8114AA10	Board	
<i>Photo Not Available</i>	*A8114AA3	Board	
<i>Photo Not Available</i>	*A8114AB1	Board	
<i>Photo Not Available</i>	*A8114AD4	Board	
<i>Photo Not Available</i>	*A8114B5	Board	
<i>Photo Not Available</i>	*A8114C5	Board	
<i>Photo Not Available</i>	*A8114E1	Board	
<i>Photo Not Available</i>	*A8114E2	Board	
	*A8114E3	Board	
<i>Photo Not Available</i>	*A8114E4	Board	

Otis VP260 (continued)





Image	Part Number	Description	Alt/Sub/Sup P/N
	*A8114E5	Board	
<i>Photo Not Available</i>	*A8114F1	Board	
<i>Photo Not Available</i>	*A8114G1	Board	
<i>Photo Not Available</i>	*A8116B1	Board	
<i>Photo Not Available</i>	*A8116B2	Board	
<i>Photo Not Available</i>	*A8116B3	Board	
<i>Photo Not Available</i>	*A8119AM1	Component Board	
<i>Photo Not Available</i>	*A8119AN2	Component Board	
<i>Photo Not Available</i>	*A8114D2	Interface Board	
<i>Photo Not Available</i>	A8114D3	Interface Board	
<i>Photo Not Available</i>	*A8114D5	Interface Board	
<i>Photo Not Available</i>	*A8116B4	Mechanical Hall Call Register Board	
<i>Photo Not Available</i>	*A8111B2	PC Panel	
<i>Photo Not Available</i>	*8200A1	Readout Assembly	*AAA26800UA1
<i>Photo Not Available</i>	AAA26800UA1	Readout, Alpha Numeric	
<i>Photo Not Available</i>	*A8118A1	Regulator Board	*AAA26800RE1
<i>Photo Not Available</i>	*A8119AL2	Relay Board	
<i>Photo Not Available</i>	*A8114AA7	Supplementary Interface Function Board	
<i>Photo Not Available</i>	*A8119AT4	Timer Board	

PC BOARDS

Miscellaneous

Image	Part Number	Description	Alt/Sub/Sup P/N	Application
	*ADA26800RD1	Aut-O-Safe Board		AUT-O-SAFE
	*B8128EF1	Cab Interface Board		
	*AAA26800XF1	CLQL Door Operator Control Board		Door
	*AAA24350AE1	Drive Subassembly		
	*ABA26800HT1	ELD Buffer Board Assembly		ELD

Otis Miscellaneous Boards (continued)

Image	Part Number	Description	Alt/Sub/Sup P/N	Application
<i>Photo Not Available</i>	AFA26800AAS001	ELD Interface Board Assembly	*AAA26800SG1	ELD
	*AAA26800VT1	Electronic Door Restrictor Board		Door
<i>Photo Not Available</i>	*AAA26800SG1	Elevator Display Controller		EDC
	GAA26800AR2	Escalator Control Board		Escalator
	*CAA26800B1	ESMCDO Board-Arrg#1		
	*CAA26800B2	ESMCDO Board-Arrg#2		

PC BOARDS

©2013, UNITEC Parts Company

Image	Part Number	Description	Alt/Sub/Sup P/N	Application
	AAA26800RV1	Hall Lantern Board Assembly		COP
<i>Photo Not Available</i>	AAA26800RV2	Hall Lantern Board Assembly		COP
	*AFA26800KE3	HPDS Control Board Assembly		Door Operator
	*AFA26800KE4	HPDS Control Board Assembly		Door Operator
<i>Photo Not Available</i>	AAA639CH1	Internal PC Hard Disk Drive, EIDE Interface		EMS
	AEA26800QA7	LAMBDA 2 Board Assembly		Door Detector
<i>Photo Not Available</i>	*6840CH1	Panel		UMV
<i>Photo Not Available</i>	*6840AY1	Panel Assembly	*6840CH1	UMV
<i>Photo Not Available</i>	J06840NS1	Relay Unit Board		

Otis Miscellaneous Boards (continued)

Image	Part Number	Description	Alt/Sub/Sup P/N	Application
	*D8211B1	VF-Inverter Control Assembly		7416A MRVF Motion Controller & 7415A MRVF Battery Box


Schindler

321A Hydro, 321A/330A

Image	Part Number	Description	Alt/Sub/Sup P/N	Application
<i>Photo Not Available</i>	SCHD225825	CIO		
<i>Photo Not Available</i>	SCHD222834	CPB/AUXF	SCHD224476	321A Hydro
<i>Photo Not Available</i>	SCHD222831	CRIP	*SCHD223956	321A Hydro
<i>Photo Not Available</i>	SCHD223956	CRIPHNA 1	(SCHD225313	321A Hydro
<i>Photo Not Available</i>	SCHD225445	CRIPHNA 4 w/Access		321A/330A
<i>Photo Not Available</i>	*SCHD225313	CRIPHNA 4 w/o Access		321A/330A
<i>Photo Not Available</i>	SCHD222971	GCIO 360	SCHD590862	
<i>Photo Not Available</i>	SCHD225445	321A/330A		
<i>Photo Not Available</i>	SCHD590862	GCIO 360		321A/330A
<i>Photo Not Available</i>	SCHD222837	HPBHNA		321A/330A
<i>Photo Not Available</i>	SCHD225212	MCIO	SCHD225825	321A/330A
<i>Photo Not Available</i>	SCHD222836	P/I Board 24 Volt Push-button	SCHD222837	321A/330A

©2013, UNITEC Parts Company




Escalator

Image	Part Number	Description	Alt/Sub/Sup P/N	Application
<i>Photo Not Available</i>	SCHDSME438517	Comblight Assembly, 24 Volt, 60 Hertz LED		SWE Escalator
	SCHDSSA897200	Lftng Solenoid, 110 Volt		SWE / 9300 Escalator
<i>Photo Not Available</i>	SCHD090596S059	Processor / Motherboard	*SCHDSY387600	SWE Escalator
<i>Photo Not Available</i>	*SCHDSY387600	Processor / Motherboard		SWE Escalator

Goldflight


Image	Part Number	Description	Alt/Sub/Sup P/N	Application
<i>Photo Not Available</i>	SCHD3-40281-07	GMG Amp Board	*HGTN3-40281-07	Goldflight MG
<i>Photo Not Available</i>	SCHD3-40267-48	Pattern Board	*HGTN3-40267-48	Goldflight

Miconic 300A

Image	Part Number	Description	Alt/Sub/Sup P/N
<i>Photo Not Available</i>	*WEST998C247H11	CIO	*WEST998C247H14
	WEST998C247H14	CIO	*SCHD225088
<i>Photo Not Available</i>	*WEST998C246H11	MIO	*WEST998C246H12
	WEST998C246H12	MIO	
<i>Photo Not Available</i>	WEST998C245H11	PIB	*WEST998C245H12
<i>Photo Not Available</i>	WEST998C272H12	REL	*WEST998C272H13
	WEST998C272H13	REL	
<i>Photo Not Available</i>	*SCHD225088	SCIO	

PC BOARDS


©2013, UNITEC Parts Company

Image	Part Number	Description	Alt/Sub/Sup P/N
	WEST998C238H11	V2V Board, Miconic AM VFAC	*WEST998C238H12
<i>Photo Not Available</i>	*WEST998C238H12	V2V Board, Miconic AM VFAC	
<i>Photo Not Available</i>	*WEST998C225H12	VEC	

Miconic A



Image	Part Number	Description	Alt/Sub/Sup P/N	Application
<i>Photo Not Available</i>	SCHD224310	SETS	SCHD225881	Miconic A
<i>Photo Not Available</i>	SCHD225881	SETS		Miconic A
<i>Photo Not Available</i>	*SCHD224213	SHVM		Miconic A, MPH II
<i>Photo Not Available</i>	SCHD225723	SMTV	*WEST998C197H13	Epoch II VA, Miconic A
<i>Photo Not Available</i>	SCHD2897C96G01	SPB	*SCHD998C149H13	Miconic A
<i>Photo Not Available</i>	SCHD998C149H12	SPB		Miconic A

QKS Operator

Image	Part Number	Description	Alt/Sub/Sup P/N	Application
<i>Photo Not Available</i>	*SCHD223824	STDC	*SCHD223825	QKS Operator
	SCHD223825	STDC		QKS Operator
<i>Photo Not Available</i>	SCHD225621	TDC	SCHD223825	QKS Operator

PC BOARDS

Miscellaneous

Image	Part Number	Description	Alt/Sub/Sup P/N	Application
<i>Photo Not Available</i>	SCHD3-40267-66	Hydro-A Board	*HGTN3-40267-66	Hydro
<i>Photo Not Available</i>	SCHD7283C79G01	MTA	WEST998C280H11	MTA Button Fixture
<i>Photo Not Available</i>	SCHD455469	PE-8MB Board		
<i>Photo Not Available</i>	SCHD7283C82H01	RAW Board	WEST998C280H11	
	*SCHD225094	SFCB		MPH I, II Hydro
<i>Photo Not Available</i>	*SCHD225515	SMHC		MPH II Hydro
	*SCHD224371	SSCM		
<i>Photo Not Available</i>	*SCHD225053	SSCM		
<i>Photo Not Available</i>	SCHD8544C48H01	Westinghouse Phase Protec- tor (PRD)		



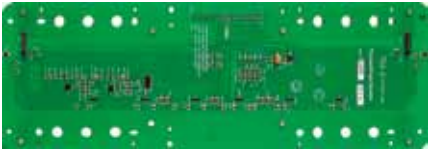



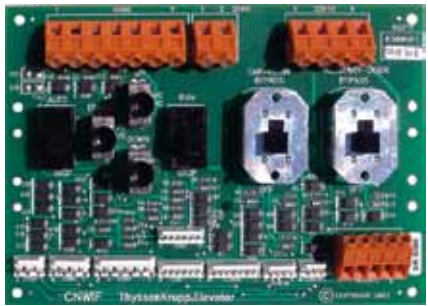
Swift

Swift 5000 Modmaster with 3412 Drive

Image	Part Number	Description	Alt/Sub/Sup P/N	Application
<i>Photo Not Available</i>	*LA46S2592-0010	12 Channel Firing Board, SCR Drive		With 3412 Drive
<i>Photo Not Available</i>	*LA46S2439-0130	12 SCR Board (165/509 V), SCR Drive		With 3412 Drive
<i>Photo Not Available</i>	LA46S2975-0302	Dover DSD 412 Drive Control Board	AAA21255J151	With 3412 Drive
<i>Photo Not Available</i>	*LA46S2740-0020	Elevator Interface Board, SCR Drive		With 3412 Drive
<i>Photo Not Available</i>	LA46S3046-0030	Field Interface Board	*AAA21255J150	With 3412 Drive
<i>Photo Not Available</i>	*LA46S2485-0021	Field Regulator Signal Board		

Thyssen-Krupp

TAC 20






Image	Part Number	Description	Alt/Sub/Sup P/N
<i>Photo Not Available</i>	THSN6300KY9	188E CPU Simplex, w/o Serial Channels	DOVR9782576
<i>Photo Not Available</i>	*THSN6300LR3	AC/DC Current Regulator Board	
<i>Photo Not Available</i>	*THSN6300KC2	Auxiliary Power Supply, Group, 24 VDC	THSN9782709
	THSN6300MK1	Auxiliary Sensor Card, Tape Selector, Hi	
	THSN6300MK2	Auxiliary Sensor Card, Tape Selector, LON	
<i>Photo Not Available</i>	DOVR6300LG1	Buss Voltage Indicator	
	*THSN6300MB1	Car Wiring Interface Distributed, LON	
<i>Photo Not Available</i>	THSN6300MA1	Car Wiring Interface, Central Non-LON	THSN6300MA2
	THSN6300MA2	Car Wiring Interface, Central Non-LON	
	THSN6300NP1	Controller Inspection Run Assembly	

Thyssen-Krupp TAC 20 (continued)

Image	Part Number	Description	Alt/Sub/Sup P/N
	*THSN6300JL2	Controller Wiring Interface	
<i>Photo Not Available</i>	THSN6300KY8	CPU (188E), Single Car w/ 2 LON Ch.	DOVR9782564
	DOVR9782564	CPU (188E)	
	*DOVR6300JC2	CPU Card, 16 MHz	
	THSN6300MG1	Cross-Connect Interface, Distributed	

PC BOARDS

©2013, UNITEC Parts Company




Image	Part Number	Description	Alt/Sub/Sup P/N
	THSN6300LE1	Door Bypass Board	
	THSN2783465	Drive Board	
<i>Photo Not Available</i>	DOVR6300FX4	Door Board	*DOVR9832875
<i>Photo Not Available</i>	DOVR6300PY1	Door Operator Board	DOVR9832875
	DOVR9832875	Door Operator Board	
	*THSN9782874	HCID (Hoistway Cable Interface Disp.) Board	
<i>Photo Not Available</i>	THSN6300MF1	Hoistway Cable Interface Distributed	
<i>Photo Not Available</i>	THSN6300MC1	Hoistway Cable, Interface C., Non-LON	THSN9782886
	THSN9782886	Hoistway Cable, Interface C., Non-LON	

Thyssen-Krupp TAC 20 (continued)

Image	Part Number	Description	Alt/Sub/Sup P/N
	THSN6300RE3	IOA Board	
<i>Photo Not Available</i>	THSN6300LM1	I/O Controller Board, LON Node, 24 V	*AAA26800AMW1
	THSN6300LL1	I/O Expansion Card, LON 24 V	AAA26800AMW1
	THSN6300JH2	I/O Expansion Card, Non-LON, 115 VAC	

PC BOARDS

©2013, UNITEC Parts Company






Image	Part Number	Description	Alt/Sub/Sup P/N
 <p>A green printed circuit board (PCB) expansion card. It features a large multi-pin connector on the left side, several integrated circuits (chips) in the center, and two vertical multi-pin connectors on the right side. The board is populated with various electronic components.</p>	THSN6300JH3	I/O Expansion Card, Non-LON, 230 VAC	
 <p>A green PCB expansion card with a multi-pin connector on the left and several multi-pin connectors on the top. It contains several integrated circuits and other electronic components. The board is labeled 'I/O EXPANSION'.</p>	THSN6300JG1	I/O Expansion Card, Non-LON, 24 VDC	
 <p>A green PCB expansion card with a multi-pin connector on the left and several multi-pin connectors on the right. It features several integrated circuits and other components. The board is labeled 'I/O EXPANSION'.</p>	THSN6300JH1	I/O Expansion Card, Non-LON, 24/48 V	

Thyssen-Krupp TAC 20 (continued)

Image	Part Number	Description	Alt/Sub/Sup P/N
	DOVR6300PN1	Interface Board	
	AAA26800AMW1	LON I/O Controller	
	AAA26800AMV1	LON I/O Extender	
	THSN6300KX1	LON Position Indicator Display, 5 x 7	
	THSN6300KW1	LON Position Indicator, 16 Segment, # 4	

PC BOARDS

©2013, UNITEC Parts Company




Image	Part Number	Description	Alt/Sub/Sup P/N
	DOVR9782552	Main Processor Board	
	DOVR9782576	Main Processor Board	
	THSN9782904	Position Indicator, 5x7 LED	
	AAA621AT4	Power Supply, 24 VDC, 50 Watts, APS1	
	THSN6300RD3	Processor Board	

Thyssen-Krupp TAC 20 (continued)

Image	Part Number	Description	Alt/Sub/Sup P/N
	THSN6300NC1	Relay Rectifier	
<i>Photo Not Available</i>	THSN6300MJ3	Tape Reader, High Resolution	
	THSN9782849	Tape Reader, Low Resolution	
	THSN9782898	TC1D, Board	
<i>Photo Not Available</i>	THSN6300MD1	Traveling Cable Interface Distributed	THSN9782898
<i>Photo Not Available</i>	THSN6300ME1	Traveling Cable, Interface C., Non-LON	THSN9782862
	THSN9782862	Traveling Cable, Interface C., Non-LON	

PC BOARDS

TAC 50, TAC 50-04






Image	Part Number	Description	Alt/Sub/Sup P/N
<i>Photo Not Available</i>	DOVR9816410	AC/DC Current Regulator Board	
<i>Photo Not Available</i>	*DOVR9846410	AC/DC Current Regulator Board, TAC 50-04	
<i>Photo Not Available</i>	THSN6300GC3	AC/DC Regenerative Control Board, TAC 50-04	THSN9755597
	THSN9782709	Auxiliary Power Supply Board	
<i>Photo Not Available</i>	DOVR9816100	Backplane	
	THSN6300NJ1	Battery Charger Board, TAC 50-04	
<i>Photo Not Available</i>	DOVR6300LV2	Brake Current Regulator Board	
	THSN6300NE2	Brake Regulator 2407BC Board, TAC 50-04.	
<i>Photo Not Available</i>	THSN6300VV1	CAN Node Board, TAC 50-04	

Thyssen-Krupp TAC 50, TAC 50-04 (continued)





Image	Part Number	Description	Alt/Sub/Sup P/N
	THSN6300NP1	Controller Inspection Run Assembly	
	*DOVR9843991	CPU Card 16 MHz, TAC 50	
<p><i>Photo Not Available</i></p>	DOVR6300JC3	CPU Card, 16 MHz	DOVR9843991
	DOVR9782564	CPU, 188E Board	
	DOVR9816975	Current Regulator Board, TAC 50-04	

PC BOARDS

©2013, UNITEC Parts Company




Image	Part Number	Description	Alt/Sub/Sup P/N
	THSN6300HL1	Display/Interface Board, TAC 50-04 & UDB	AAA26800ATF1
	*DOVR9832875	Door Operator Board, TAC 50-04	
<p><i>Photo Not Available</i></p>	DOVR6300GE2	Door Operator Board, Dover	*DOVR9871822
<p><i>Photo Not Available</i></p>	DOVR6300GE4	Door Operator Board, Dover	DOVR9871822
	DOVR9871822	Door Operator Board, Dover	
	DOVR9731817	DSP Board	THSN6300DE42
	*DOVR9839720	Emergency Light Board, Dover, 120 VAC, TAC 50-04	
<p><i>Photo Not Available</i></p>	THSN6300VR1	Hall Node	

Thyssen-Krupp TAC 50, TAC 50-04 (continued)

Image	Part Number	Description	Alt/Sub/Sup P/N
	DOVR9781146	Hall Node	THSN6300VR1
	THSN6300TX2	I/O Board	DOVR9740375
<i>Photo Not Available</i>	DOVR6300HC2	Inverter Board, 80/120 HP, TAC 50-04	DOVR9816446
<i>Photo Not Available</i>	THSN9816446	Interface 80/120/160 Hp Board, TAC 50-04	DOVR9816446
<i>Photo Not Available</i>	DOVR9816458	Invert Snubber, 80/120 Hp Board	
<i>Photo Not Available</i>	DOVR9816689	Inverter Interface, 3/00 Rev (6 Pack), TAC 50-04	
<i>Photo Not Available</i>	*DOVR9816380	Inverter Interface	
	DOVR9816446	Inverter, 80/120 Hp, Board	
	THSN6300VH1	IOC Board, TAC 50-04	DOVR970193

PC BOARDS

©2013, UNITEC Parts Company





Image	Part Number	Description	Alt/Sub/Sup P/N
	*DOVR9863000	PMI 48 I/O Board	
<p><i>Photo Not Available</i></p>	DOVR9719234	POS Encoder Reg	
	THSN9782801	Position Indicator Controller, LON	
<p><i>Photo Not Available</i></p>	DOVR9816124	PS2 Power Supply Board	
	*DOVR9816392	QSR Board	
<p><i>Photo Not Available</i></p>	DOVR9755470	Snubber Board	

US Elevator

Ascension 1000

Image	Part Number	Description
<i>Photo Not Available</i>	*USEL146-05610-300	Personality Board
<i>Photo Not Available</i>	*USEL146-05650-300	Motion Board


MP-1200, MP-1210, MP-1220

Image	Part Number	Description	Alt/Sub/Sup P/N	Application
<i>Photo Not Available</i>	USEL146-05020-300	A1 Drive Intf.	*USEL146-05021-300	MP-1230
	USEL146-05021-300	A1 Drive Intf.		MP-1230
	*USEL146-05212-300	A1 Sup. Rel.		MP-1200/ MP-1210TM
<i>Photo Not Available</i>	USEL145-05010-300	A2 Computer	*USEL146-05010-300	MP-1230
<i>Photo Not Available</i>	*USEL146-05220-300	A2 Computer Board	*USEL146-05221-300	MP-1220
	USEL146-05010-300	A2 Computer Board	USEL146-05011-300	MP-1230
	USEL146-05011-300	A2 Computer Board		MP-1230

PC BOARDS

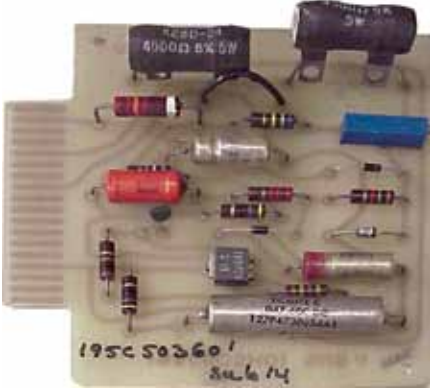
Image	Part Number	Description	Alt/Sub/Sup P/N	Application
	*USEL146-05221-300	A2 Computer Board		MP-1220
<i>Photo Not Available</i>	USEL148-05003-300C	A3 Gen Field Control	USEL148-05003-300	MP-1200/ MP-1210TM
<i>Photo Not Available</i>	*USEL146-05030-300	A3 Option Board		MP-1230
	*USEL146-05230-300	A3, A4, A5 Board		MP-1220
<i>Photo Not Available</i>	*USEL146-05230-200	A3, A4, A5 Input/Output	USEL146-05230-300	MP-1220
<i>Photo Not Available</i>	*USEL145-05134-300	Call Storage		MP-1200/ MP-1210TM, MP-1220, MP-1230
	*USEL146-05286-300	I/O Board, Input Buffer		MP-1220
	*USEL146-05287-300	I/O Board, Output Latch		MP-1220
	*USEL146-05300-300	Mother Board		MP-1230

US Elevator MP-1200, MP-1210, MP-1220 (continued)

Image	Part Number	Description	Alt/Sub/Sup P/N	Application
	*USEL146-05285-300	Multiplex Transceiver Board		MP-1220
<i>Photo Not Available</i>	*USEL146-05080-300	Personality Board		MP-1230, MP-1220
<i>Photo Not Available</i>	*USEL146-05071-300	Power Relay Board		MP-1230
<i>Photo Not Available</i>	*USEL146-05263-300	Power Relay Board		MP-1200/ MP-1210TM
<i>Photo Not Available</i>	*USEL146-05260-300	Power Relay Mother-board		MP-1220
	*USEL146-05060-300	Power Supply		MP-1220, MP-1230
<i>Photo Not Available</i>	*USEL146-05090-300	Power Supply		MP-1220, MP-1230
<i>Photo Not Available</i>	*USEL145-05179-300	SSD-1 Drive Interface		MP-1200/ MP-1210TM
<i>Photo Not Available</i>	USEL149-00001-001	Varitron SS-D1 Board	*WRLD.7000.9012	MP-1200, MP-1210, RELAY SOL- ID STATE


Westinghouse

DMR

Image	Part Number	Description	Alt/Sub/Sup P/N	Application
<i>Photo Not Available</i>	WEST998C275H11	MT3 Dual Timers		
	WEST195C503G01	MT3 Dual Timers	WEST998C275H11	DMR MD1A
<i>Photo Not Available</i>	WEST195C503H01	Timer	WEST998C275H11	DMR MD1A

©2013, UNITEC Parts Company

Door Operator

Image	Part Number	Description	Alt/Sub/Sup P/N
<i>Photo Not Available</i>	*WEST998C147H12	DCB	*WEST998C147H15
	WEST998C147H15	DCB	

Epoch

Image	Part Number	Description	Alt/Sub/Sup P/N	Application
<i>Photo Not Available</i>	WEST2633C12G03	Car Top Sensor		Epoch I
	*WEST998C199H12	DCI	WEST998C199H13	Epoch II VA / Miconic A
<i>Photo Not Available</i>	*WEST998C076H11	DDD	*WEST998C076H14	Epoch I
<i>Photo Not Available</i>	*WEST998C076H13	DDD	*WEST998C076H14	Epoch I
	*WEST998C076H14	DDD		Epoch I
<i>Photo Not Available</i>	WEST998C224H11	ENC		Epoch II VA / Miconic A ACVF
<i>Photo Not Available</i>	WEST998C214H25	High Voltage PCB	*SCHD224213	
<i>Photo Not Available</i>	WEST998C123H11	HPI		Epoch
	WEST998C214H11	HVM	*WEST998C214H12	Epoch II, MPH II
<i>Photo Not Available</i>	WEST998C214H12	HVM	*SCHD224213	Epoch II, MPH II
<i>Photo Not Available</i>	WEST998C227H12	INT		Epoch II VA / Miconic A ACVF
<i>Photo Not Available</i>	*WEST998C090H11	IO2	*WEST998C090H12	Epoch I
<i>Photo Not Available</i>	WEST998C090H12	IO2		Epoch I

PC BOARDS

©2013, UNITEC Parts Company





Image	Part Number	Description	Alt/Sub/Sup P/N	Application
	WEST998C091H11	IO6	WEST998C091H12	Epoch I
<i>Photo Not Available</i>	WEST998C091H12	IO6		Epoch I
	WEST998C092H11	IO8	*WEST998C092H12	Epoch I
	WEST998C092H12	IO8		Epoch I
<i>Photo Not Available</i>	*WEST998C102H14	IOT	*WEST998C102H12	Epoch I
	WEST998C102H11	IOT	WEST998C102H12	Epoch I
<i>Photo Not Available</i>	WEST998C102H12	IOT		Epoch I
	*WEST998C030H27	MFR		Epoch I MD 4, MD6 Drives

Westinghouse Epoch (continued)


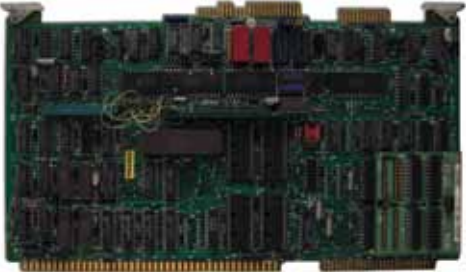
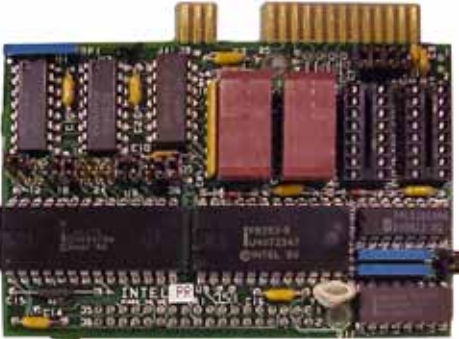

Image	Part Number	Description	Alt/Sub/Sup P/N	Application
	*WEST998C080H14	MGA	WEST998C080H15	Epoch I
	WEST998C080H15	MGA		Epoch I
	*WEST998C255H14	MGC		Epoch II
<i>Photo Not Available</i>	*WEST998C002H12	MGI	*WEST998C002H14	Epoch I
<i>Photo Not Available</i>	*WEST998C002H14	MGI		Epoch I
	*WEST998C254H12	MGS		Epoch II, Miconic VA
<i>Photo Not Available</i>	WEST998C153H13	MPT	*WEST998C153H14 *WEST998C153H15	Epoch II
<i>Photo Not Available</i>	WEST998C153H14	MPT	WEST998C153H15	Epoch II
<i>Photo Not Available</i>	WEST998C153H15	MPT		Epoch II

PC BOARDS

©2013, UNITEC Parts Company

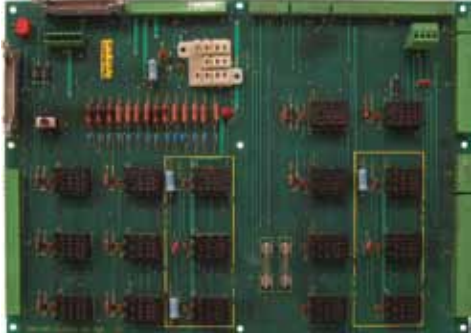
Image	Part Number	Description	Alt/Sub/Sup P/N	Application
<i>Photo Not Available</i>	WEST998C197H12	MTV	*WEST998C197H13	Epoch II, Miconic VA
<i>Photo Not Available</i>	WEST998C197H13	MTV	*SCHD225723	Epoch II VA Miconic A
	*WEST998C026H26	MVR		Epoch I, MD 4, MD 6 Drives
	*WEST6919C50G01	RAM Module, REM Board 8k Add-On for SBCc		Epoch I
<i>Photo Not Available</i>	*WEST6916C24G01	SBC		Epoch I
	*WEST6916C23G03	SBC-U As- sembly, for Dispatcher Car 1-4 Slot U		Epoch I
	*WEST6916C23G05	SBC-W		Epoch I

Westinghouse Epoch (continued)

Image	Part Number	Description	Alt/Sub/Sup P/N	Application
	*WEST6916C23G01	SBC-W Board Assembly, for Car Slot W		Epoch I
	*WEST6916C23G02	SBC-W Board Assembly, for Car Slot W, Last Car		Epoch I
<i>Photo Not Available</i>	WEST6916C25G01	SBX-351	*SCHD224371	Epoch I
	WEST6916C25G02	SBX-351 Board, for Last Car	*SCHD225053	Epoch I
<i>Photo Not Available</i>	*WEST998C113H11	TB3		Epoch I
	*WEST998C276H22	TCP		Epoch II Car Station
<i>Photo Not Available</i>	*WEST999C003H25	TRM	*WEST999C003H26	Epoch II

PC BOARDS

©2013, UNITEC Parts Company

Image	Part Number	Description	Alt/Sub/Sup P/N	Application
	WEST999C003H11	TRM	*WEST999C003H26	Epoch II
<i>Photo Not Available</i>	WEST999C003H12	TRM	*WEST999C003H26	Epoch II
<i>Photo Not Available</i>	WEST999C003H24	TRM	*WEST999C003H26	Epoch II
<i>Photo Not Available</i>	*WEST999C003H26	TRM		Epoch II

ER8, ER9, ERL

Image	Part Number	Description	Alt/Sub/Sup P/N	Application
<i>Photo Not Available</i>	*WEST196C628H01	ER Amplifier Board	*WEST998C110H12	ERL
<i>Photo Not Available</i>	WEST477C977H03	ER8/ER9 Amplifier	*WEST998C108H12	ERL
<i>Photo Not Available</i>	WEST477C843H03	ERL Amplifier Board	*WEST477C977H03	ERL
<i>Photo Not Available</i>	WEST998C110H11	ERB Amplifier	*WEST998C110H12	ERL
<i>Photo Not Available</i>	WEST998C110H12	ERB Amplifier		ERL

Fixtures

Image	Part Number	Description
<i>Photo Not Available</i>	*WEST998C280H11	MTA, for MTA Button Fixture

Motor Drive (MD-1A)

Image	Part Number	Description	Alt/Sub/Sup P/N
	*WEST998C033H22	MCI	

Motrol



Image	Part Number	Description	Alt/Sub/Sup P/N
	*WEST998C204H12	DTS	
<i>Photo Not Available</i>	WEST998C205H11	MS1	
<i>Photo Not Available</i>	*WEST999C225H25	MSR	

PC BOARDS

Mark IV, Mark V

Image	Part Number	Description	Alt/Sub/Sup P/N	Application
<i>Photo Not Available</i>	WEST998C013H35	D02 Car Controller Board		Mark V
<i>Photo Not Available</i>	*WEST1185C12H01	DN2 Corridor Cage Board		Mark V
<i>Photo Not Available</i>	*WEST998C015H11	DN3		Mark V
<i>Photo Not Available</i>	*WEST998C015H21	DN3		Mark V
<i>Photo Not Available</i>	*WEST998C015H22	DN3		Mark V
<i>Photo Not Available</i>	*WEST998C015H23	DN3		Mark V
<i>Photo Not Available</i>	WEST998C015H33	DN3		Mark V
<i>Photo Not Available</i>	WEST1185C23H01	DN3 Car Controller Board		Mark V
<i>Photo Not Available</i>	*WEST1185C13H01	DN3 Corridor Cage Board		Mark V
<i>Photo Not Available</i>	*WEST998C016H33	DS1		Mark V
<i>Photo Not Available</i>	*WEST998C027H12	FS1	WEST998C027H22	Mark V
<i>Photo Not Available</i>	*WEST998C027H22	FS1	*WEST998C027H23	Mark V
	*WEST998C027H34	FS1		Mark V
<i>Photo Not Available</i>	WEST998C028H14	FS2	*WEST998C072H13	Mark V
<i>Photo Not Available</i>	*WEST998C072H13	FS2		Mark V
<i>Photo Not Available</i>	WEST998C036H23	PD2		Mark V
<i>Photo Not Available</i>	WEST998C279H12	PD2		Mark V
<i>Photo Not Available</i>	WEST998C279H13	PD2		Mark V
<i>Photo Not Available</i>	WEST998C037H11	PD3		Mark V
	WEST998C042H11	PE1		Mark V
<i>Photo Not Available</i>	*WEST1185C43H01	PE2	WEST1185C43H02	Mark V
<i>Photo Not Available</i>	*WEST1185C43H02	PE2	*WEST1185C43H03	Mark V

Westinghouse Mark IV, Mark V (continued)

Image	Part Number	Description	Alt/Sub/Sup P/N	Application
	WEST1185C43H03	PE2	WEST2633C12G03	Mark V
	*WEST1185C43H04	PE2		Mark V
<i>Photo Not Available</i>	*WEST1185C45H01	PR1		Mark V/Epoch I
<i>Photo Not Available</i>	*WEST998C045H11	PR1		Mark V
<i>Photo Not Available</i>	*WEST998C045H12	PR1		Mark V
<i>Photo Not Available</i>	*WEST196C597H01	SMF2 Design PC		Mark IV Selectomatic
<i>Photo Not Available</i>	*WEST1185C63H01	TM2		Mark V
<i>Photo Not Available</i>	*WEST998C063H11	TM2		Mark V
<i>Photo Not Available</i>	*WEST998C063H12	TM2	WEST998C063H13	Mark V
<i>Photo Not Available</i>	*WEST998C063H13	TM2		Mark V
<i>Photo Not Available</i>	WEST998C003H12	TRM		Mark V

PC BOARDS

MPH





Image	Part Number	Description	Alt/Sub/Sup P/N	Application
<i>Photo Not Available</i>	*WEST998C198H13	DPI		MPH II
	WEST998C198H12	DPI		MPH II
<i>Photo Not Available</i>	*WEST998C148H11	FCB	*SCHD225094	MPH I and II
<i>Photo Not Available</i>	*WEST998C148H12	FCB	*SCHD225094	MPH I and II
<i>Photo Not Available</i>	*WEST998C148H13	FCB	*SCHD225094	MPH I and II
<i>Photo Not Available</i>	WEST998C148H14	FCB	*SCHD225094	MPH I and II
	WEST998C148H15	FCB	*SCHD225094	MPH I and II
	WEST998C148H25	FCB	*SCHD225094 *WEST998C148H26	MPH I and II
	WEST998C148H26	FCB	*SCHD225094	MPH I and II
	*WEST998C177H11	HR2		MPH
<i>Photo Not Available</i>	*WEST998C146H11	HRM	*WEST998C146H22	MPH I
<i>Photo Not Available</i>	*WEST998C146H21	HRM	*WEST998C146H22	MPH I

Westinghouse MPH (continued)

Image	Part Number	Description	Alt/Sub/Sup P/N	Application
	*WEST998C146H22	HRM		MPH I
<i>Photo Not Available</i>	*WEST998C214H25	HVM	*SCHD224213	MPH II, Miconic A
	WEST998C188H11	IOX	*SCHD224213	MPH II, Miconic A
<i>Photo Not Available</i>	*WEST998C187H11	MHC		MPH II
<i>Photo Not Available</i>	*WEST998C187H14	MHC		MPH II
	WEST998C187H12	MHC	WEST998C187H13	MPH II
	WEST998C187H13	MHC		MPH II

PC BOARDS

©2013, UNITEC Parts Company

Image	Part Number	Description	Alt/Sub/Sup P/N	Application
	WEST998C187H24	MHC		MPH II
<i>Photo Not Available</i>	WEST998C187H25	MHC	*WEST998C187H26	MPH II
	WEST998C187H26	MHC	*SCHD225515	MPH II
<i>Photo Not Available</i>	*WEST998C145H11	MPH		MPH I
<i>Photo Not Available</i>	*WEST998C145H22	MPH		MPH I
<i>Photo Not Available</i>	*WEST998C145H23	MPH	*WEST998C145H24	MPH I
<i>Photo Not Available</i>	*WEST998C145H25	MPH	*WEST998C145H24	MPH I
	*WEST998C145H24	MPH		MPH I
<i>Photo Not Available</i>	WEST998C173H21	NSP	WEST998C173H22	MPH
	WEST998C173H22	NSP		MPH
<i>Photo Not Available</i>	*WEST998C189H12	RMH		MPH II
<i>Photo Not Available</i>	*WEST998C189H13	RMH	WEST998C189H14	MPH II
<i>Photo Not Available</i>	*WEST998C189H14	RMH	*WEST998C216H28	MPH II

Westinghouse MPH (continued)

Image	Part Number	Description	Alt/Sub/Sup P/N	Application
<i>Photo Not Available</i>	*WEST998C216H13	RMH	*WEST998C216H26 *WEST998C216H28	MPH II
<i>Photo Not Available</i>	*WEST998C216H14	RMH	*WEST998C216H26 *WEST998C216H28	MPH II
<i>Photo Not Available</i>	WEST998C216H12	RMH	*WEST998C216H26 *WEST998C216H28	MPH II
<i>Photo Not Available</i>	WEST998C216H15	RMH	*WEST998C216H26 *WEST998C216H28	MPH II
<i>Photo Not Available</i>	WEST998C216H26	RMH	*WEST998C216H28	MPH II
<i>Photo Not Available</i>	WEST998C216H27	RMH	*WEST998C216H26 *WEST998C216H28	MPH II
<i>Photo Not Available</i>	WEST998C216H28	RMH		MPH II

QKS Operator

Image	Part Number	Description	Alt/Sub/Sup P/N
<i>Photo Not Available</i>	*WEST7267C08G01	TDC	*WEST999C001H25
<i>Photo Not Available</i>	*WEST998C308H11	TDC	*WEST999C001H36
<i>Photo Not Available</i>	*WEST999C001H11	TDC	*WEST999C001H25 *WEST999C001H36
<i>Photo Not Available</i>	*WEST999C001H23	TDC	*WEST999C001H25
<i>Photo Not Available</i>	*WEST999C001H31	TDC	*SCHD223825 *WEST999C001H36
<i>Photo Not Available</i>	WEST999C001H12	TDC	*WEST999C001H25 *WEST999C001H36
<i>Photo Not Available</i>	WEST999C001H24	TDC	*WEST999C001H25 *WEST999C001H36
<i>Photo Not Available</i>	*WEST999C001H25	TDC	*WEST999C001H36



*WEST999C001H36 TDC *SCHD223825

Relay

Image	Part Number	Description	Alt/Sub/Sup P/N
<i>Photo Not Available</i>	*WEST477C977H02	Amplifier Board	*WEST998C110H12
<i>Photo Not Available</i>	WEST998C118H11	ASM	
<i>Photo Not Available</i>	*WEST5196D35H	ER10 Amplifier	
<i>Photo Not Available</i>	WEST103D976G01	ER9 Model Electronic Regulator	*WEST1718C08G01
<i>Photo Not Available</i>	WEST1718C08G01	ER11 ERL Regulator Assy.	
<i>Photo Not Available</i>	*WEST998C108H11	ERA Amp	*WEST998C108H12
<i>Photo Not Available</i>	*WEST998C108H12	ERA Amp	
<i>Photo Not Available</i>	*WEST478C315	Timer	WEST478C315G01
<i>Photo Not Available</i>	WEST478C315G01	Timer Y-Delta 5 Min	

Miscellaneous

Image	Part Number	Description	Alt/Sub/Sup P/N
<i>Photo Not Available</i>	WEST195C502G01	MG Timer	
<i>Photo Not Available</i>	WEST195C252H01	PRD	SCHD8544C48H01
<i>Photo Not Available</i>	SCHD8544C48H01	PRD, Phase Protector	



World Elevator

Image	Part Number	Description	Alt/Sub/Sup P/N
<i>Photo Not Available</i>	*WRLD7101.9031	1 Phase Rectifier Assembly	DOVR9879810
<i>Photo Not Available</i>	*WRLD7101.9032	3 Phase Rectifier Assembly	DOVR9879675
<i>Photo Not Available</i>	*WRLD7601.9009	AC Output w/TB	MTGMP-15775
<i>Photo Not Available</i>	*WRLD7601.9010	AC Output, w/Molex	MTGMP-15774
<i>Photo Not Available</i>	*WRLD7103.9009	Auxiliary Sensor, for DMC-I	*DOVR9741331
<i>Photo Not Available</i>	*WRLD7101.9006	Car Board, 4-Slot, Dover	*DOVR9855221
<i>Photo Not Available</i>	*WRLD7103.9016	CLC Processor, New Style	*DOVR9715710
<i>Photo Not Available</i>	*WRLD7000.9019	Counter Board	
<i>Photo Not Available</i>	*WRLD7602.9005	CPU Board, for Miprom 21	*MTGMP-24377
<i>Photo Not Available</i>	WRLD7000.9007	Digital Display, 7-Segment	
<i>Photo Not Available</i>	*WRLD7101.9033	Digital PI Card, 7-Segment, Dover	DOVR9713335
<i>Photo Not Available</i>	WRLD7000.9003	Diode Array, World Replacement for Amtech	
<i>Photo Not Available</i>	*WRLD7101.0004	Door 4 Slot	DOVR124519
<i>Photo Not Available</i>	*WRLD7101.9004	Door 4 Slot	*DOVR9855233
<i>Photo Not Available</i>	WRLD7000.9002	Door Operator Control, Amtech	
<i>Photo Not Available</i>	*WRLD7101.9044	Double / Single Phase Rectifier	DOVR9892989
<i>Photo Not Available</i>	*WRLD7000.9034	Dual Timer Board, Omega 1000	
<i>Photo Not Available</i>	*WRLD7101.9013	Duplex 3-Slot Board, Dover	*DOVR9884336
<i>Photo Not Available</i>	*WRLD7202.9002	ER10 Amp	*WEST998C110H12
<i>Photo Not Available</i>	*WRLD7202.9001	ER9 Amp	*WEST998C108H12
<i>Photo Not Available</i>	*WRLD7401.9004	EVC Leveling Switch	
<i>Photo Not Available</i>	*WRLD7103.9002	HD-85 Door Operator	*DOVR9804134
<i>Photo Not Available</i>	*WRLD7103.9017	HD-85 Door Operator Board, for DMC-I	*DOVR6300FX3
<i>Photo Not Available</i>	*WRLD7103.9012	I/O Expansion Board, for DMC-I	*DOVR9841453
<i>Photo Not Available</i>	*WRLD7206.9012	I/O X Board, Westinghouse	*WEST998C188H11
<i>Photo Not Available</i>	*WRLD7601.9007	Input Board w/Tb	
<i>Photo Not Available</i>	*WRLD7601.9015	Input Board w/Tb	*MTGMP-24151
<i>Photo Not Available</i>	*WRLD7601.9008	Input w/Molex	

© 2013, UNITEC Parts Company

PC BOARDS

©2013, UNITEC Parts Company


Image	Part Number	Description	Alt/Sub/Sup P/N
<i>Photo Not Available</i>	WRLD7000.9030	Interface Board	
<i>Photo Not Available</i>	*WRLD7103.9011	Interface Box, for Freedom Tool	WRLD7502.9027
<i>Photo Not Available</i>	*WRLD7101.9010	Intermediate 4 Slot Board, Dover	*DOVR9855269
<i>Photo Not Available</i>	WRLD7000.9004	Level Sensor Decoder	
<i>Photo Not Available</i>	*WRLD7401.0004	Leveling Switch Decoder	*HGTM76693
<i>Photo Not Available</i>	*WRLD7101.9015	Logic 3 Slot Board, Dover	*DOVR681808
<i>Photo Not Available</i>	*WRLD7101.9048	LSP Printed Board	*DOVR9813949
<i>Photo Not Available</i>	*WRLD7103.9008	Main Sensor, for DMC-I	*DOVR9841325
<i>Photo Not Available</i>	*WRLD7105.9009	Main Sensor, for Dover T-III	*DOVR9853686
<i>Photo Not Available</i>	*WRLD7206.9009	MHC Processor	
<i>Photo Not Available</i>	*WRLD7601.9018	Mini-Monitor Diagnostic Tool, Montgomery	
<i>Photo Not Available</i>	*WRLD7412.9005	MIO Processor Board	*WEST998C246H12
<i>Photo Not Available</i>	WRLD7603.9008	MLS Door Operator Board	
<i>Photo Not Available</i>	*WRLD7603.1008	MLS Door Operator Board, for Miprom 21	
<i>Photo Not Available</i>	*WRLD7603.9004	Motherboard	*MTGMP-15766
<i>Photo Not Available</i>	WRLD7403.9009	Motherboard, 120 V	
<i>Photo Not Available</i>	*WRLD7602.9002	Motherboard, for Miprom 21	*MTGMP-24288
<i>Photo Not Available</i>	*WRLD7603.9003	Motor Power Board, MAC	MTGMP-24172
<i>Photo Not Available</i>	*WRLD7206.9002	MPH Processor	*WEST998C145H24
<i>Photo Not Available</i>	*WRLD7104.9007	MSC-I Power Board	*DOVR9880665



*WRLD7104.9008	MSC-I Regulator	*DOVR9840497
----------------	-----------------	--------------

<i>Photo Not Available</i>	*WRLD7602.9004	MSU Board, for Miprom 21	*MTGMP-24972
----------------------------	----------------	--------------------------	--------------

World Elevator (continued)

Image	Part Number	Description	Alt/Sub/Sup P/N
	*WRLD7101.9023	Optical Leveling Card	*DOVR9811266
<i>Photo Not Available</i>	*WRLD7101.9012	Option 4 Slot Board, Dover	*DOVR9753217
<i>Photo Not Available</i>	*WRLD7601.9014	Output Board w/Tb	*MTGMP-24147
<i>Photo Not Available</i>	*WRLD7602.9006	P I/O Board, for Miprom 21	*MTGMP-24301
<i>Photo Not Available</i>	*WRLD7000.9010	PI Display, 7-Segment, Double Digit Display	
<i>Photo Not Available</i>	*WRLD7101.9024	PI Driver Power Board	*DOVR9811370
<i>Photo Not Available</i>	*WRLD7601.1013	PI, Dig, #3, w/EPROM, Service	MTGMP-24869-003
<i>Photo Not Available</i>	*WRLD7101.9002	Power 4 Slot Board, Dover	*DOVR9855245
<i>Photo Not Available</i>	*WRLD7103.9007	Power Supply, 5/12 VDC. For DMC-I.	*DOVR9841507
<i>Photo Not Available</i>	*WRLD7103.9001	Power Unit Relay Board	*DOVR9841301
<i>Photo Not Available</i>	*WRLD7101.9039	Rectifier Board	DOVR9715289
<i>Photo Not Available</i>	*WRLD7101.9035	Rectifier, 3-Phase, Universal	
<i>Photo Not Available</i>	*WRLD7601.9011	Relay Output Board	*MTGMP-24100
<i>Photo Not Available</i>	WRLD7000.9011	Reverse-Phase Module	
<i>Photo Not Available</i>	*WRLD7101.9025	Reverse-Phase Relay Board, for Dover	DOVR9781870
<i>Photo Not Available</i>	*WRLD7206.9003	RHM Relay Board	
<i>Photo Not Available</i>	*WRLD7412.9006	RHM Relay Board	
<i>Photo Not Available</i>	*WRLD7105.9008	Sel. I/O Assembly, for Dover T-III	*DOVR9853728
<i>Photo Not Available</i>	*WRLD7101.9043	Selector Leveling Board	
<i>Photo Not Available</i>	*WRLD7103.9004	Selector Processor Board, for DMC-I	*DOVR9841313
<i>Photo Not Available</i>	*WRLD7603.9002	Speed Control Board, MAC	MTGMP-24561
<i>Photo Not Available</i>	WRLD7000.9001	Stepper Board, Amtech	
<i>Photo Not Available</i>	*WRLD7104.9003	System Monitor Board, for MSC-I	

PC BOARDS

Image	Part Number	Description	Alt/Sub/Sup P/N
<i>Photo Not Available</i>	*WRLD-7501-0042	Top Board on GFC-IIA Assembly	WRLD.7000.9012
<i>Photo Not Available</i>	*WRLD-7501-0043	Top Board on GFC-IIA Assembly	WRLD.7000.9012
<i>Photo Not Available</i>	*WRLD7101.9008	Top/Bottom Board, 4KY	*DOVR9855257
<i>Photo Not Available</i>	*WRLD7109.9507	Universal Timer, 0.1-260 Sec.	
<i>Photo Not Available</i>	WRLD.7000.9012	Varitron / SSD1	



UNITEC

EXCELLENCE FROM THE GROUND UP

800 / 328-7840