

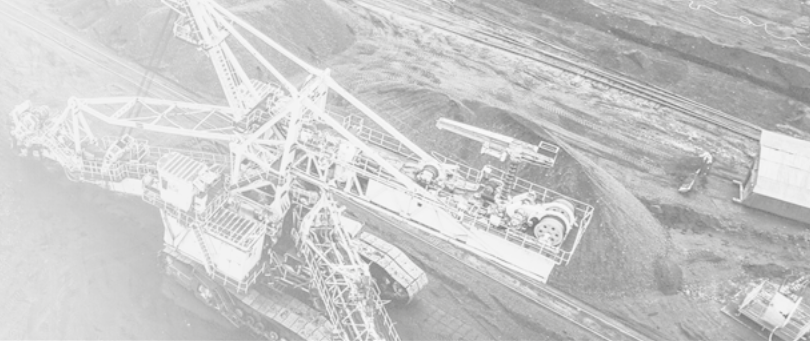

# FPB

## PRESSURE FILTERS



### DESCRIPTION

High pressure inline filter

### MATERIALS

Head: Cast iron  
Bowl: Steel  
Bypass valve: Steel  
Seals: NBR Nitrile (FKM Fluoroelastomer on request)  
Indicator housing: Brass

### PRESSURE

Max. working: 42 MPa (420 bar)  
Collapse, differential for the filter element series standard 2 MPa (20 bar)  
series H+ 21 MPa (210 bar)

### BYPASS VALVE

Setting: 600 kPa (6 bar)  $\pm$  10%

### FLOW RATE

Qmax 450 l/min

### WORKING TEMPERATURE

From -25° to +110° C

### COMPATIBILITY (ISO 2943)

Full with fluids: HH-HL-HM-HV-HTG  
(according to ISO 6743/4)  
For fluids different than the above mentioned,  
please contact our Customer Service

### HYDRAULIC DIAGRAM

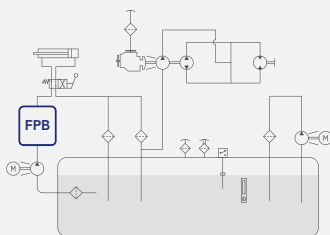

Is this datasheet the latest release? Please check on our website

# FPB

## PRESSURE FILTERS



### ORDERING AND OPTION CHART

F	P	B	COMPLETE FILTER FAMILY												FILTER ELEMENT FAMILY		
			SIZE & LENGTH	11	12	13	21	22	31	32	33	34	35	SIZE & LENGTH	E	P	B
			PORT TYPE														
			B = BSP thread	B	B	B	B	B	B	B	B	B	B	B	B	B	B
			N = NPT thread	N	N	N	N	N	N	N	N	N	N	N	N	N	
			S = SAE thread	S	S	S	S	S	S	S	S	S	S	S	S	S	
			F = SAE flange 3000 psi	-	-	-	F	F	F	F	F	F	F	F	F	F	
			G = SAE flange 6000 psi	-	-	-	G	G	G	G	G	G	G	G	G	G	
			PORT SIZE														
			04 = 1/2" (S04 not available)	04	04	04	-	-	-	-	-	-	-	-	-	-	
			06 = 3/4" (F06 not available)	06	06	06	06	06	-	-	-	-	-	-	-	-	
			08 = 1" (G08 not available; F08 for FPB2 only)	-	-	-	08	08	08	08	08	08	08	08	08		
			10 = 1" 1/4 (N10 not available)	-	-	-	-	-	10	10	10	10	10	10	10		
			12 = 1" 1/2 (G12 option not available)	-	-	-	-	-	12	12	12	12	12	12	12		
			BYPASS VALVE														
			W = without	W	W	W	W	W	W	W	W	W	W	W	W	W	
			C = 600 kPa (6 bar)	C	C	C	C	C	C	C	C	C	C	C	C	C	
			R = reverse flow valve*	-	-	-	R	R	R	R	R	R	R	R	R	R	
			P = reverse flow + bypass valve*	-	-	-	P	P	P	P	P	P	P	P	P	P	
			SEALS														
			N = NBR Nitrile	N	N	N	N	N	N	N	N	N	N	N	N	N	
			F = FKM Fluoroelastomer	F	F	F	F	F	F	F	F	F	F	F	F	F	
			G = Treatment for water-glycol	G	G	G	G	G	G	G	G	G	G	G	G	G	
			FormulaUFI MEDIA														
			FA = FormulaUFI.MICRON 5 $\mu\text{m}_{(c)}$ $\beta > 1.000$	FA	FA	FA	FA	FA	FA	FA	FA	FA	FA	FA	FA	FA	
			FB = FormulaUFI.MICRON 7 $\mu\text{m}_{(c)}$ $\beta > 1.000$	FB	FB	FB	FB	FB	FB	FB	FB	FB	FB	FB	FB	FB	
			FC = FormulaUFI.MICRON 12 $\mu\text{m}_{(c)}$ $\beta > 1.000$	FC	FC	FC	FC	FC	FC	FC	FC	FC	FC	FC	FC	FC	
			FS = FormulaUFI.MICRON 16 $\mu\text{m}_{(c)}$ $\beta > 1.000$	FS	FS	FS	FS	FS	FS	FS	FS	FS	FS	FS	FS	FS	
			FD = FormulaUFI.MICRON 21 $\mu\text{m}_{(c)}$ $\beta > 1.000$	FD	FD	FD	FD	FD	FD	FD	FD	FD	FD	FD	FD	FD	
			FE = FormulaUFI.MICRON 30 $\mu\text{m}_{(c)}$ $\beta > 1.000$	FE	FE	FE	FE	FE	FE	FE	FE	FE	FE	FE	FE	FE	
			HA = FormulaUFI.MICRON 5 $\mu\text{m}_{(c)}$ $\beta > 1.000$	HA	HA	HA	HA	HA	HA	HA	HA	HA	HA	HA	HA	HA	
			HB = FormulaUFI.MICRON 7 $\mu\text{m}_{(c)}$ $\beta > 1.000$	HB	HB	HB	HB	HB	HB	HB	HB	HB	HB	HB	HB	HB	
			HC = FormulaUFI.MICRON 12 $\mu\text{m}_{(c)}$ $\beta > 1.000$	HC	HC	HC	HC	HC	HC	HC	HC	HC	HC	HC	HC	HC	
			HD = FormulaUFI.MICRON 21 $\mu\text{m}_{(c)}$ $\beta > 1.000$	HD	HD	HD	HD	HD	HD	HD	HD	HD	HD	HD	HD	HD	
			CLOGGING INDICATOR **														
			03 = port, plugged	03	03	03	03	03	03	03	03	03	03	03	03	03	
			5E = visual differential 500 kPa (5 bar)	5E	5E	5E	5E	5E	5E	5E	5E	5E	5E	5E	5E	5E	
			5F = visual differential 800 kPa (8 bar)	5F	5F	5F	5F	5F	5F	5F	5F	5F	5F	5F	5F	5F	
			6E = electrical differential 500 kPa (5 bar)	6E	6E	6E	6E	6E	6E	6E	6E	6E	6E	6E	6E	6E	
			6F = electrical differential 800 kPa (8 bar)	6F	6F	6F	6F	6F	6F	6F	6F	6F	6F	6F	6F	6F	
			7E = indicator 6E with LED	7E	7E	7E	7E	7E	7E	7E	7E	7E	7E	7E	7E	7E	
			7F = indicator 6F with LED	7F	7F	7F	7F	7F	7F	7F	7F	7F	7F	7F	7F	7F	
			T2 = elect. diff. 500 kPa (5 bar) with thermostat 30°C	T2	T2	T2	T2	T2	T2	T2	T2	T2	T2	T2	T2	T2	
			T3 = elect. diff. 800 kPa (8 bar) with thermostat 30°C	T3	T3	T3	T3	T3	T3	T3	T3	T3	T3	T3	T3	T3	
X	X		ACCESSORI / ACCESSORIES														
			XX = no accessory available	XX	XX	XX	XX	XX	XX	XX	XX	XX	XX	XX	XX	XX	

\* On request only

\*\* When the filter is ordered with FKM seals, the first digit of the indicator code is a letter (please see the Clogging Indicator Chapter for further details)

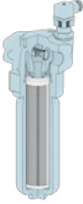
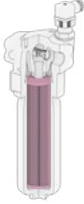
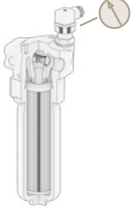

## SPARE PARTS

FILTER HOUSING	FILTER ELEMENT	CLOGGING INDICATOR																						
																								
<table border="1"> <tr> <td>B</td><td>P</td><td>B</td><td></td><td></td><td></td><td></td><td></td><td></td><td></td><td></td><td>X</td><td>X</td> </tr> </table>	B	P	B									X	X	<table border="1"> <tr> <td>E</td><td>P</td><td>B</td><td></td><td></td><td></td><td></td> </tr> </table>	E	P	B					<table border="1"> <tr> <td></td><td></td> </tr> </table>		
B	P	B									X	X												
E	P	B																						

## SPARE SEAL KIT

	NBR	FKM
FPB11 - 12 - 13	521.0002.2	521.0086.2
FPB21 - 22	521.0003.2	521.0030.2
FPB31 - 32 - 33 - 34 - 35	521.0004.2	521.0087.2

# FPB

## PRESSURE FILTERS

### INSTALLATION DRAWING

FPB1

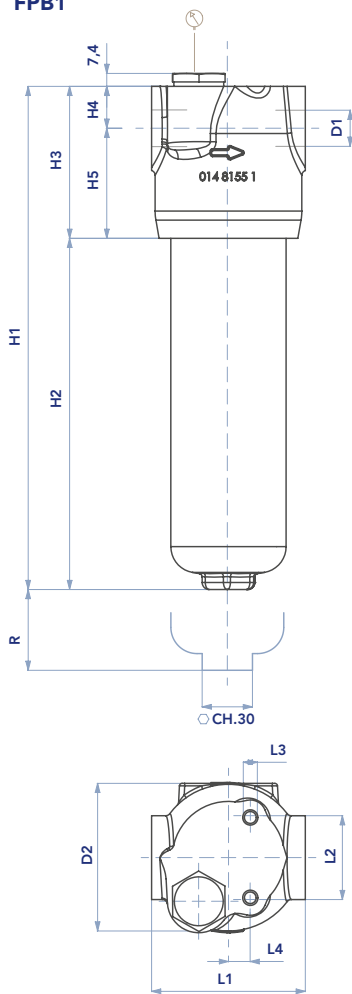

FPB2

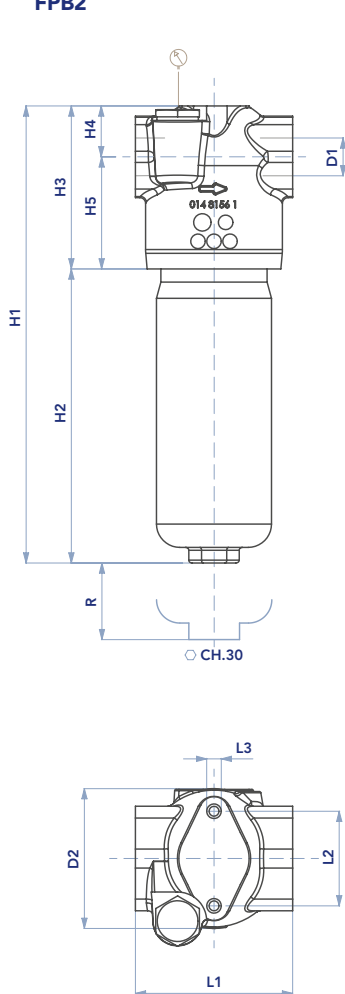

FPB 31-32-33

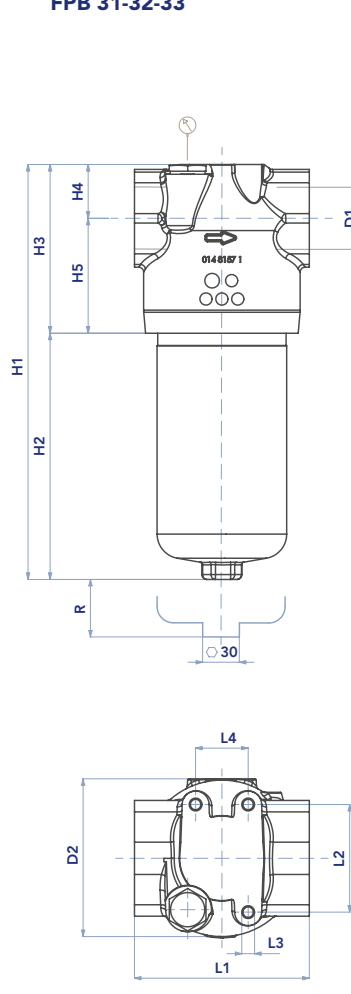

FPB 34-35

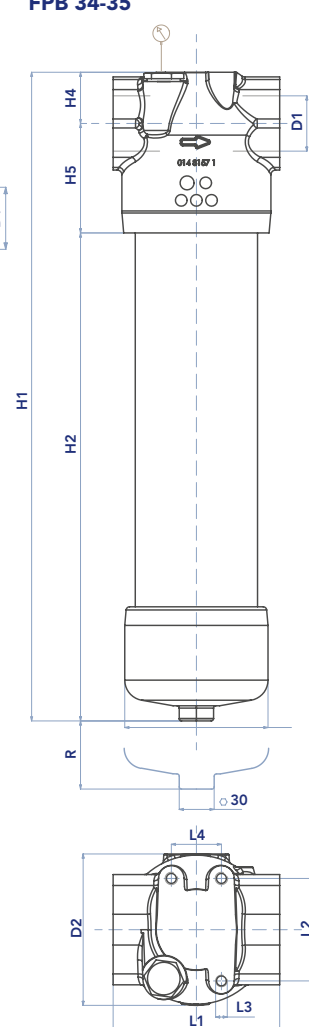

### FILTER HOUSING

	D1	D2	H1	H2	H3	H4	H5	L1	L2	L3	L4	R	kg
FPB11	1/2"-3/4"	86	162	75	87	24	63	88	46	M8	12,5	100	4,4
FPB12	1/2"-3/4"	86	194	107	87	24	63	88	46	M8	12,5	100	4,6
FPB13	1/2"-3/4"	86	288	201	87	24	63	88	46	M8	12,5	100	5,2
FPB21	3/4" - 1"	96	219	107	112	35	77	108	65	M8	-	100	6,6
FPB22	3/4" - 1"	96	314	202	112	35	77	108	65	M8	-	100	8,2
FPB31	1" - 1"1/4 - 1"1/2	130	243	105	138	44	94	143	88	M10	43	100	11,0
FPB32	1" - 1"1/4 - 1"1/2	130	337	199	138	44	94	143	88	M10	43	100	13,9
FPB33	1" - 1"1/4 - 1"1/2	130	460	322	138	44	94	143	88	M10	43	100	17,2
FPB34	1" - 1"1/4 - 1"1/2	130	558	420	138	44	94	143	88	M10	43	100	22,0
FPB35	1" - 1"1/4 - 1"1/2	130	658	520	138	44	94	143	88	M10	43	100	25,0



## FILTER ELEMENT

	Kg			AREA (cm <sup>2</sup> )				
	A	B	C	Media F & C	Media H	Media F+	Media H+	Media C+
<b>EPB11</b>	45	25	85	0,15	0,25	355	340	310
<b>EPB12</b>	45	25	116	0,20	0,55	500	475	435
<b>EPB13</b>	45	25	211	0,30	0,45	935	915	815
<b>EPB21</b>	52	23,5	115	0,25	0,40	975	975	780
<b>EPB22</b>	52	23,5	210	0,35	0,55	1.830	1.785	1.465
<b>EPB31</b>	78	42,5	118	0,40	0,70	2.000	1.470	1.720
<b>EPB32</b>	78	42,5	210	0,80	1,30	3.695	2.695	3.170
<b>EPB33</b>	78	42,5	330	1,00	1,60	5.025	4.325	4.025
<b>EPB34</b>	78	42,5	430	1,20	1,80	6.585	5.685	6.585
<b>EPB35</b>	78	42,5	530	1,40	2,00	8.145	7.045	8.645

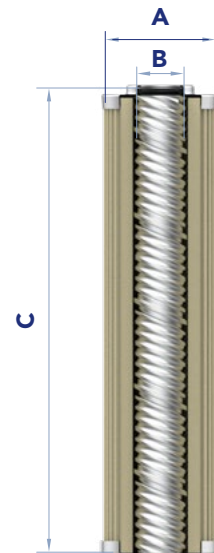

## MAINTENANCE

- 1) Stop the system and verify there is no pressure in the filter.
- 2) Collect the oil inside the filter with a suitable container.
- 3) Unscrew the bowl (1) and clean it.
- 4) Remove the dirty filter element (2).  
N.B. The exhausted filter elements and the oil dirty filter parts are classified "Dangerous waste material" and must be disposed of according to the local laws, by authorized Companies.
- 5) Check the filter element part number on the filter label or in the ordering and option chart.  
Use only original spare parts.
- 6) Lubricate the element o-ring gasket (3) with oil.
- 7) Insert the clean element into its seat with care.
- 8) Check the bowl o-ring condition (4) and lubricate with oil  
If damaged, check the seal kit part number in the spare seal kit table.  
N.B. The anti-extrusion o-ring (5) must be positioned downwards (under the gasket).
- 9) Screw the bowl (1) until it stops, with a tightening torque of 70 Nm + 5/0.

Accessories:

Clogging indicator (6).

If damaged, unscrew and replace it (check the part number in the ordering and option chart).

Lubricate the o-ring gasket with oil and tighten until it stops, with a tightening torque of 40 Nm +5/0.

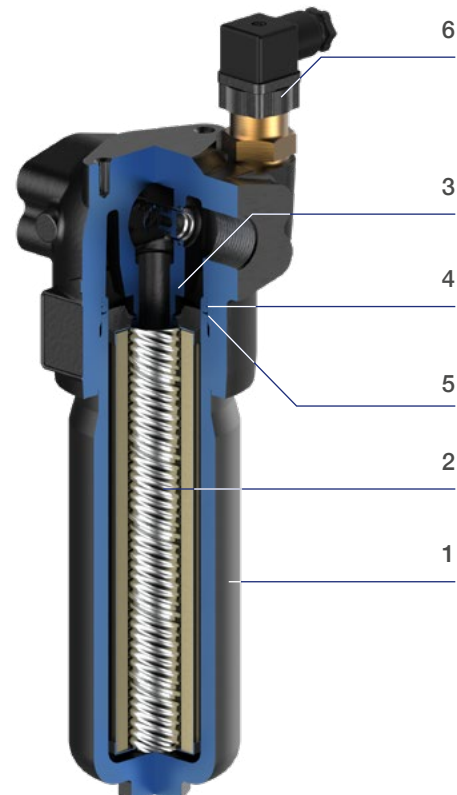

# FPB

## PRESSURE FILTERS

### PRESSURE DROP CURVES ( $\Delta p$ )

The “Assembly Pressure Drop ( $\Delta p$ )” is obtained by adding the pressure drop values of the Filter Housing and of the Clean Filter Element corresponding to the considered Flow Rate and it must be

lower than 120 kPa (1,2 bar). In any case this value should never exceed 1/3 of the bypass valve setting.

FILTER HOUSING PRESSURE DROP  
(mainly depending on the port size)

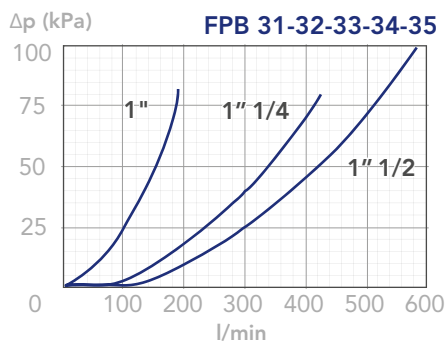
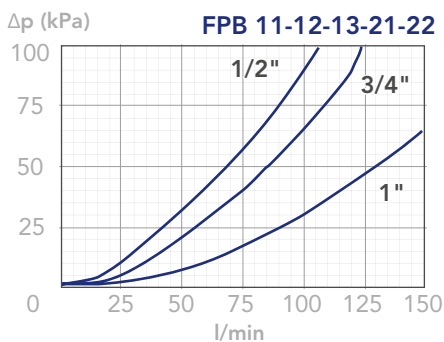

CLEAN FILTER ELEMENT PRESSURE DROP WITH F+ MEDIA  
(depending both on the internal diameter of the element and on the filter media)

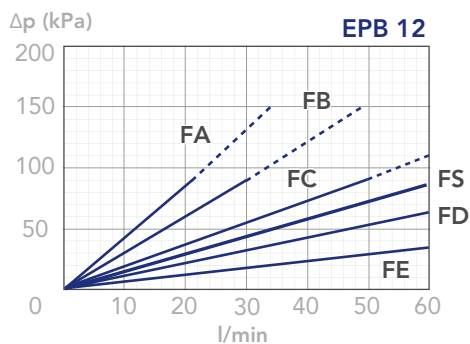
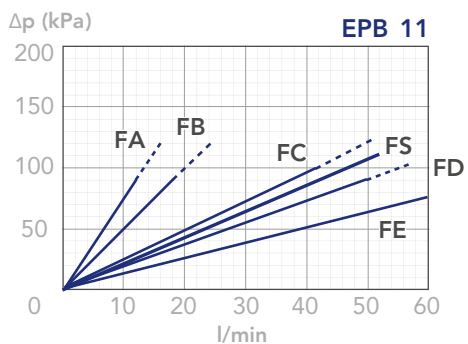



CLEAN FILTER ELEMENT PRESSURE DROP WITH F+ MEDIA  
 (depending both on the internal diameter of the element and on the filter media)

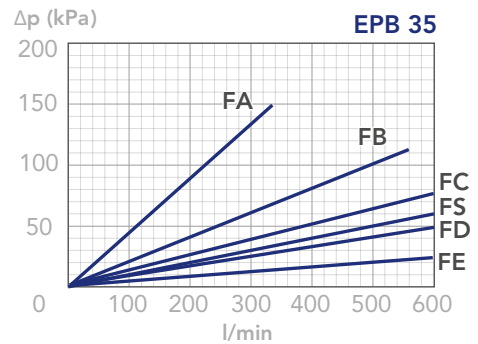
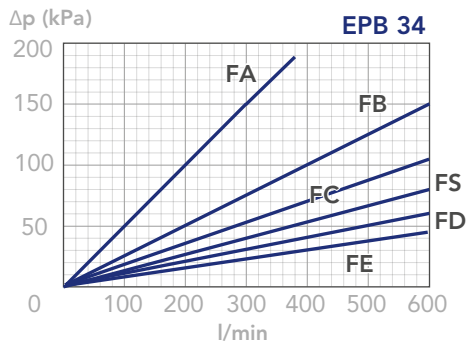
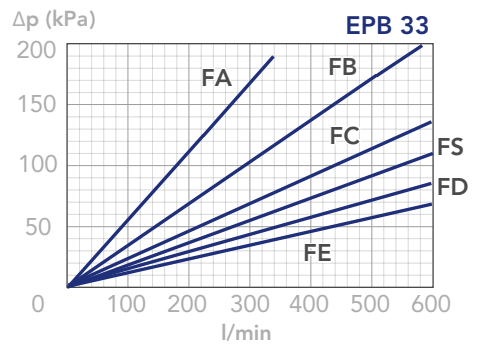
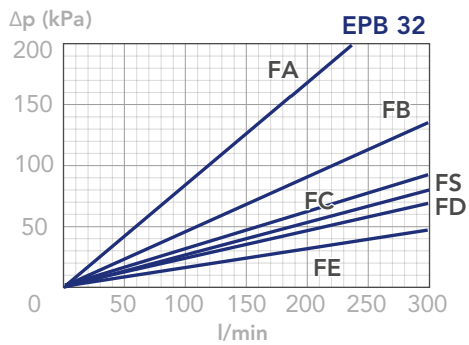
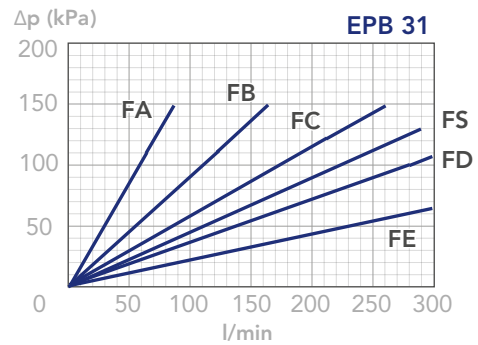
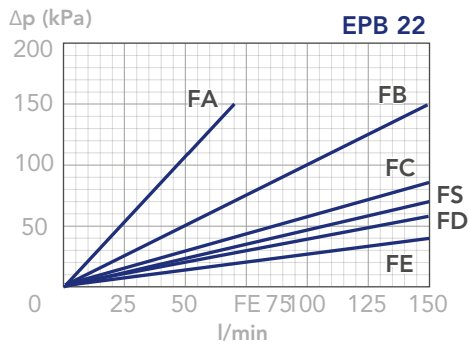
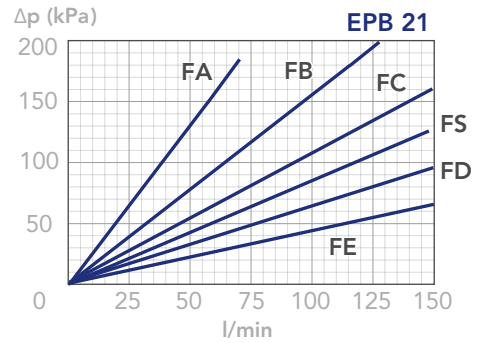
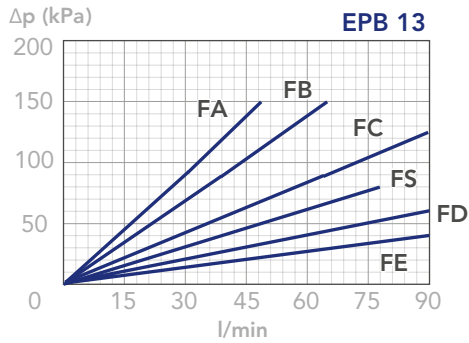

# FPB

## PRESSURE FILTERS



### PRESSURE DROP CURVES ( $\Delta p$ )

The "Assembly Pressure Drop ( $\Delta p$ )" is obtained by adding the pressure drop values of the Filter Housing and of the Clean Filter Element corresponding to the considered Flow Rate and it must be

lower than 120 kPa (1,2 bar). In any case this value should never exceed 1/3 of the bypass valve setting.

CLEAN FILTER ELEMENT PRESSURE DROP WITH H+ MEDIA  
(depending both on the internal diameter of the element and on the filter media) - Recommended with no bypass option

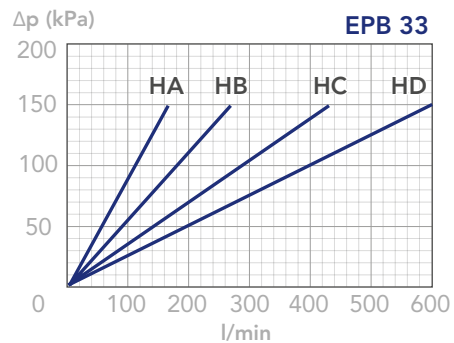
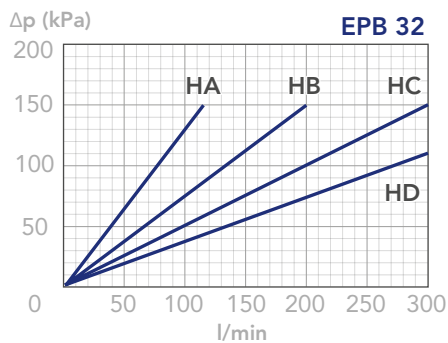
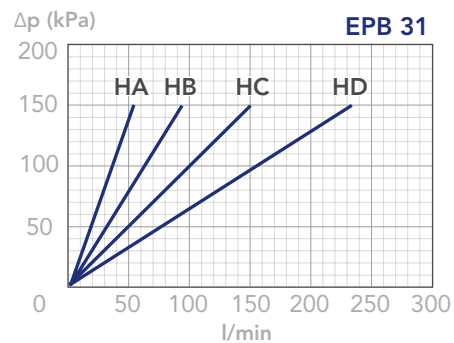
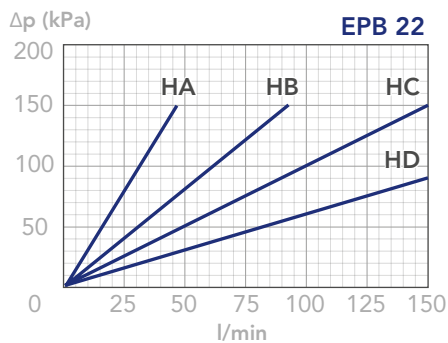
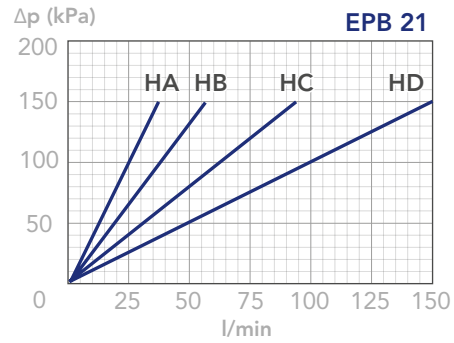
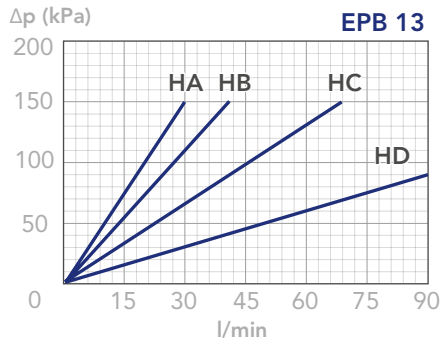
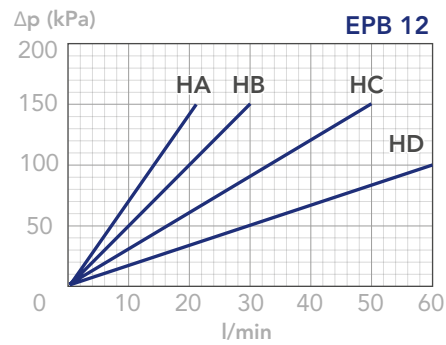
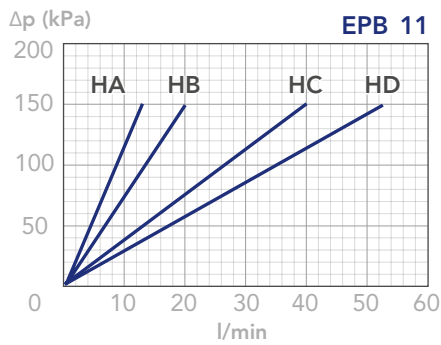



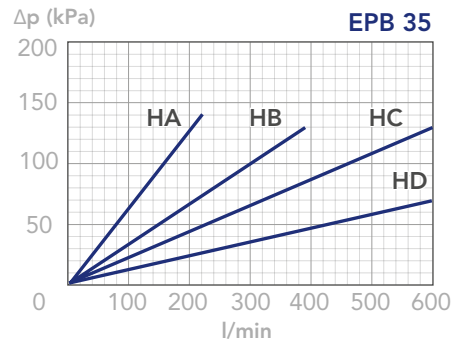
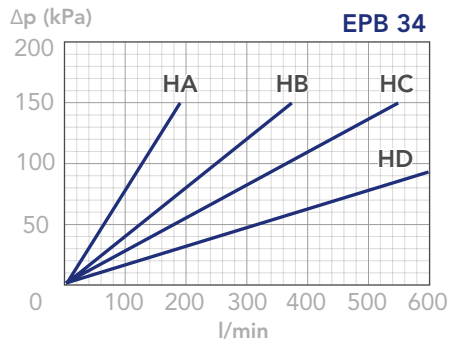

#### BYPASS VALVE PRESSURE DROP

When selecting the filter size, these curves must be taken into account if it is foreseen that any flow peak is to be absorbed by the bypass valve, it also must be of proper configuration to avoid pressure peaks. The valve pressure drop is directly proportional to fluid specific gravity.

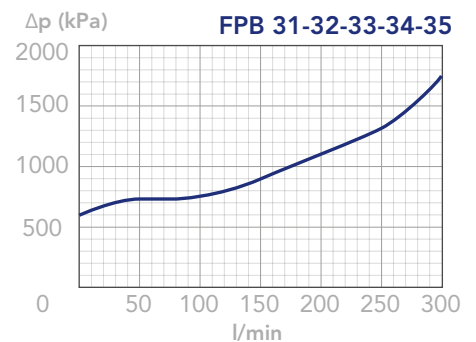
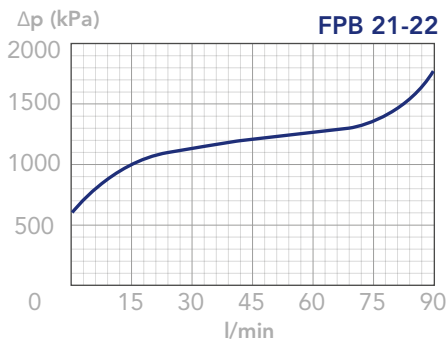
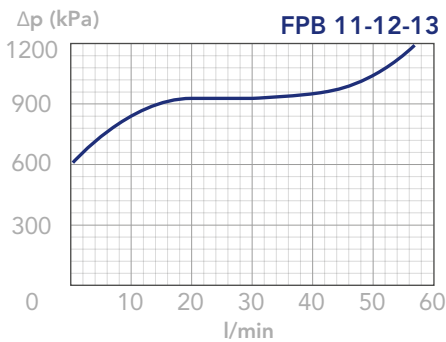

#### REVERSE FLOW VALVE

For hydraulic systems where reverse flow can occur, the pressure filters series FPB2+ and FPB3+ are available with a free reverse flow valve allowing the fluid to pass through the filter element in the normal direction and to bypass the filter element in the reverse direction (option "R"). The reverse flow valve is available also with incorporated bypass valve for the normal flow direction, set at 6 bar (option "P").

In normal flow conditions the whole flow pass through the filter element. In the option "P", if the differential pressure across the element exceeds 6 bar the bypass is activated.

In reverse flow conditions the flow bypasses the filter element.

Pressure drop through the valve in the reverse direction:

- 0,4 bar at 100 L/min
- 0,6 bar at 200 L/min
- 0,8 bar at 300 L/min

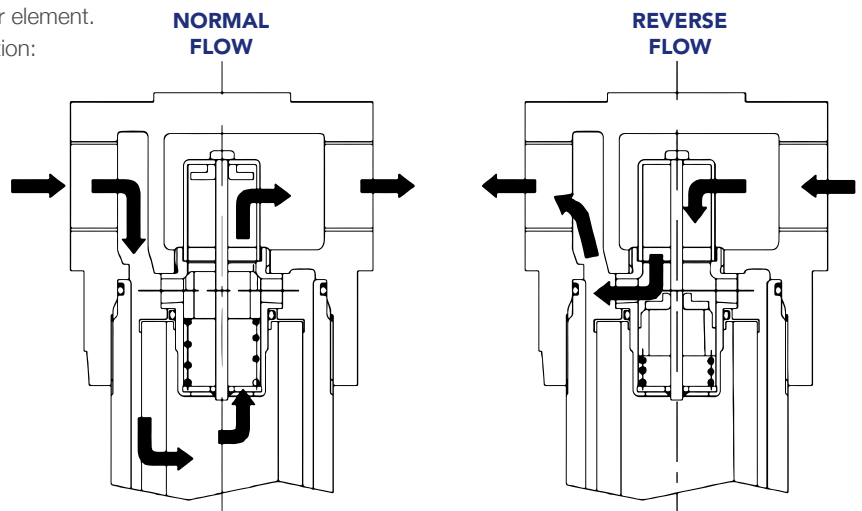

#### N.B.

All the curves have been obtained with mineral oil having a kinematic viscosity 30 cSt and specific gravity 0,86 kg/dm<sup>3</sup>; for fluids with different features, please consider the factors described in the first part of this catalogue. All the curves

are obtained from test done at the UFI FILTERS HYDRAULICS Laboratory, according to the specification ISO 3968:2005. In case of discrepancy, please check the contamination level, viscosity and features of the fluid in use.