

# Valve Hardware

TPMS Tools & Accessories | Tire Gauges  
Air Chucks | Inflator Gauges



Group **31**  
INCORPORATED

www.31inc.com

# Xtra seal

LEADING THE INDUSTRY



PROFESSIONAL TIRE REPAIR & SUPPLIES

TPMS SENSORS, SERVICE KITS & TOOLS



**TPMS**  
network

www.31inc.com

# Solutions For Better Vehicle Service

## TPMS SCAN TOOLS

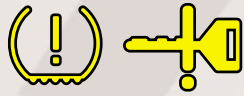

## QUICK SERVICE TOOLS



## TREAD DEPTH TOOLS

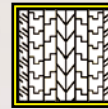

## SPECIALTY PRODUCTS



As Bartec continues to expand our product line beyond TPMS Diagnostic and Service Tools, we remain committed to providing the very best in quality, service and support in ALL THAT WE DO!

Our mission is to provide the users of our products, the very best experience possible. We recognize that our customers rely on our products in their businesses and this is something we take very seriously!

- ✓ Better Tools!
- ✓ Better Service!
- ✓ Better Support!
- ✓ Bartec!

# Dill®

Air  
Controls  
Products

## REDI-Sensor™



- Ready out of the box! Programming not needed!
- Patented Design: Install, Relearn, Done.
- OE Manufactured, Tested, & Validated.
- Adjustable valve angle.

**Made in the USA**  
**Chucks & Gauges**



**More Reliable**  
**More Durable** than any current part on the market.

### TPMS Products

Replacement Stems  
Service Kits

OEM Sensors

Torque Tools

Retro-fit TPMS  
2 - 10 positions



**Tire Valves**  
**Car, Truck, Motorcycle, OTR & More**



If it has wheels, we have the stems for it.

[www.DILLVALVES.COM](http://www.DILLVALVES.COM)  
VIDEOS, TSBs, VEHICLE LOOK-UP



# TPMS BEST PRACTICES

## Always test BEFORE you touch

- ✓ Check for the TPMS Indicator
  - **Flashing Light = System Fault**
  - **Solid Light = Low Pressure**
- ✓ Always adjust pressure to placard
- ✓ Always begin testing at LEFT FRONT
- ✓ Always work CLOCKWISE around the vehicle



## Refer to the VIN for the proper MODEL YEAR

The 10<sup>th</sup> character of the VIN indicates the proper model year. This is important as TPMS sensors and protocols change from year to year. [The following is from a 2003 model year]

3VWPE69MX**3**M169854

YEAR	05	06	07	08	09	10	11	12	13	14	15	16
CODE	5	6	7	8	9	A	B	C	D	E	F	G

## Standard TPMS Placard

TIRE AND LOADING INFORMATION			
SEATING CAPACITY	TOTAL	88	FRONT 8   REAR 88
The combined weight of occupants and cargo should never exceed XXX kg or XXX lbs.			
TIRE	ORIGINAL SIZE	COLD TIRE PRESSURE	SEE OWNER'S MANUAL FOR ADDITIONAL INFORMATION
FRONT	P235/60R17XL	200 kPa, 29 PSI	
REAR	P235/60R17XL	200 kPa, 29 PSI	
SPARE	P235/60R17XL	200 kPa, 29 PSI	

1G6TY34AX45601310

## Testing MAGNET ACTIVATED Sensors

Early Corvette and Cadillac models used a magnet (included in kit) to activate the sensors. You can use the Tech 400SD to check these sensors.

1. Set up tool
2. Position tool on wheel
3. Press Test
4. Place magnet over stem

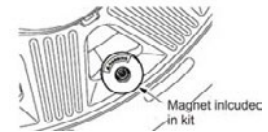

## Sample TPMS Thresholds

Placard Pressure	25	30	35	40	45	50	55
TPMS Light on @	18.8	22.5	26.3	30.0	33.8	37.5	41.3

## Testing "NON-LF ACTIVATED" Sensors

Some vehicle manufacturers use sensors that have no LF wakeup. These sensors are activated by a change in pressure or ΔP. You can use the Tech 400SD to check these sensors.

1. Set up tool
2. Position tool on wheel (see below)
3. Press Test (follow on screen instruction)

## Proper TPMS Tool Positioning

- Position the tool against side wall at sensor
- Aim the tool at the sensor
- Press to start activation
- Wait for beeping before moving the tool
- If no response, reposition tool and try again.
- Follow instructions on the tool display



Clamp or Snap – Aim tool right at the sensor.

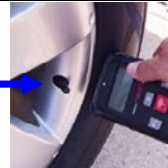

Banded Sensor – Aim tool 180° opposite the valve stem.



## TPMS FAQ's

### Technicians

#### Am I REQUIRED to service TPMS vehicles?

If during the repair you cause a TPMS malfunction, or the light comes on after you've serviced a vehicle's tires, **YES you have to repair the vehicle.**

**If the TPMS light is on BEFORE I service a vehicle, am I responsible?** No! This is why **TEST BEFORE YOU TOUCH** is so important. If the TPMS is faulty when it arrives at your shop, you are not required to fix it. However, it is good business to inform your customer and recommend that it be repaired.

**If I sell a new set of seasonal or custom wheels, do I have to fit sensors to those new wheels?** Yes, you either sell new sensors for the additional wheel set and program them to the car, or take the OE sensors from their wheels and fit them to the new set.

**What if I just send the work to the dealer?** You risk losing a customer. The dealer can service the vehicle, and in many cases sell them tires as well.

**How do I make money with TPMS?** Invest in a tool, proper replacement inventory and get training. Understand that when the sensor battery fails, there will be a huge opportunity to service vehicles. Practice – practice – practice!

### Consumers

#### Why does my car have TPMS anyways?

It is a federally mandated safety system. It's included when you buy the car, it protects your investment, and most importantly it keeps you safe!

#### How does TPMS work?

Sensors are in each wheel. These sensors send information to you using a radio signal. When one or more of your tires go below an acceptable limit, you will get a light on your dashboard.

#### Why do I now have to PAY for tire rotations?

Your service provider has invested in the proper tools and training in order to properly and safely maintain your car. When rotating tires, or replacing TPMS Sensors, the car needs programming.

#### What happens if a sensor stops working?

You will get a flashing light on your dashboard indicating a faulty system. Go to your service provider to get this repaired.

#### Do TPMS Sensors need servicing?

Generally the sensors only need servicing when replacing the tires. With every tire change, the mounting and sealing components should be changed to prevent leaks. Also with every tire service, the valve core and cap should be replaced to limit corrosion. Your service provider should have a TPMS Tool that checks the sensors condition.



# Want the Best TPMS Relearn Chart on the Market? This is it!



WORKING FOR THE INDUSTRY...WORKING FOR YOU.



Forget the competitor's TPMS relearn information. The **TIA TIRE PRESSURE MONITORING SYSTEM (TPMS) RELEARN CHART** serves as a valuable, comprehensive and quick reference guide that technicians can easily navigate through to service any vehicle, foreign and domestic, that is quipped with TPMS.

**Your organization won't want to be without one! It will save you time and money the first time you use it!**

## TIA TPMS RELEARN CHART

**FEATURES:** Information on vehicles equipped with TPMS; Laminated Flip Chart designed to provide accurate information on all aspects of TPMS applications, including relearn procedures; Chart is divided into Domestic & Import vehicle sections

### CHART PROVIDES THE FOLLOWING INFORMATION:

- **The type of TPMS, whether direct or indirect**
- **Three columns of data that indicate when a system relearn is necessary**, i.e. after a change in air pressure, tire rotation, or tire/sensor replacement
- **A relearn summary:** this includes a reference number that corresponds to the vehicle's procedure for initiating sensor relearn mode. The vehicle relearns are located in the back of the corresponding section, either domestic or import
- **The sensor manufacturer**
- **Replacement part numbers:** OEM sensor part number, Schrader replacement sensor part and service pack numbers, Dill replacement sensor part and kit and band numbers, Continental replacement sensor part and kit and band numbers, and NAPA replacement sensor part and service pack numbers
- **The torque specifications** for the sensor nut, torx bolt, worm gear and lug nuts are listed

DOMESTIC VEHICLES															
Make	Model	Year	Direct/Indirect TPMS	Relearn Required After:	Relearn Summary	Service Manual	TPMS Sensor Part #	Schrader Sensor Part #	OEM Sensor Part #	TPMS Sensor Part #	Schrader Sensor Part #	Service Pack Part #	Band Part #	Worm Gear Part #	Lug Nut Part #
Acura	2006	1	✓	✓	GM-2	Schrader	20158	20064	1670K	821011	820125		4375		1801460
Acura	2007	0	✓	✓	GM-4	Siemens	13821013	20030	1587	1570K	820110	823387	824389	8075	1801460
Acura	2008	0	✓	✓	GM-11	Schrader	20158	20064	1670K	821011	820125		4375		1801460
Acura	2009	0	✓	✓	GM-11	Siemens	13821013	20030	1587	1570K	820110	823387	824389	8075	1801460
Cadillac	2008-09	1	✓	✓	GM-2	Schrader	2380815	20143	20068	8113	821021	820145	8075	11.0	1801460

**IMPORT RELEARN**

Summary of steps are referred to the procedure listed on the flip chart. Other vehicle or specific make TPMS relearn procedures are listed in the corresponding section. Sensor ID's will be indicated accordingly.

**GM-1**

1. Inflate all tires to pressure listed on the placard.
2. Hold each tire's pressure for 30 seconds.
3. Press RELEARN button.
4. Press RELEARN button.
5. Press RELEARN button.
6. Press RELEARN button.
7. Press RELEARN button.
8. Press RELEARN button.

**GM-2**

1. Inflate all tires to pressure indicated on the placard.
2. Turn ignition to the position (engine off).
3. Press RELEARN button.
4. Press RELEARN button.
5. Press RELEARN button.
6. Press RELEARN button.
7. Press RELEARN button.
8. Press RELEARN button.

**GM-3**

1. Inflate all tires to pressure indicated on the placard.
2. Turn ignition to the position (engine off).
3. Press RELEARN button.
4. Press RELEARN button.
5. Press RELEARN button.
6. Press RELEARN button.
7. Press RELEARN button.
8. Press RELEARN button.

**GM-4**

1. Inflate all tires to pressure indicated on the placard.
2. Turn ignition to the position (engine off).
3. Press RELEARN button.
4. Press RELEARN button.
5. Press RELEARN button.
6. Press RELEARN button.
7. Press RELEARN button.
8. Press RELEARN button.

Snapshots of what is included in the TIA TPMS Relearn Chart





➔ TPMS Tools, Sensors, Replacement Valves & Valve Stems

# TPMS Sensor Activation Tools

## AUTEL TPMS TOOL

▪ The **MaxiTPMS® TS508** is a new generation TPMS diagnostic & service tool specially designed to activate all known TPMS sensors, read TPMS sensor status, check TPMS system health condition, program MX-sensors and conduct TPMS relearn

▪ With Quick Mode and Advanced Mode options, you can save time and energy by choosing the most suitable way to complete TPMS work

FREE SOFTWARE UPDATES

ACTIVATE ALL KNOWN TPMS SENSORS



469-00508

TUFFY NO.	MFG. NO.	DESCRIPTION
469-00508	TS508	Autel TPMS Tool

## AUTEL MAXI TPMS DIAGNOSTIC TOOL

▪ **Activate all known TPMS sensors and read sensor status**

▪ Diagnose ECU for complete TPMS health check with DTC description

▪ Read DTCs from ECU and erase DTCs

▪ Program MX-Sensors by copying original sensor IDs or creating new IDs randomly

▪ On-tool relearn procedure and wide OBD relearn coverage

▪ Equipped with a 7-inch touch screen with 1024 \* 600P resolution and a VCI mini for wireless communication with the test vehicle



469-00608

TUFFY NO.	MFG. NO.	DESCRIPTION
469-00608	TS608	Autel Maxi TPMS Diagnostic Tool

## AUTEL MX-SENSOR PROGRAMMABLE UNIVERSAL TPMS SINGLE SENSOR

▪ **Combines 315MHz & 433MHz frequencies into a single sensor**

▪ 98% vehicle coverage

▪ The exclusive MX-Sensor patented PRESS release valve allows rubber and metal valve stems to freely interchange by hand without requiring a tool

▪ Built to match or exceed OEM sensors in frequency strength and durability

▪ 100% ID clone-able with no relearn required

▪ Quickly update during installation with an Autel wireless programming tool



461-20326

TUFFY NO.	MFG. NO.	DESCRIPTION
461-20326	1-Sensor	Autel MX-Sensor Programmable Universal TPMS Single Sensor

## AUTEL MX-SENSOR REPLACEMENT RUBBER VALVE STEM

▪ **Patented PRESS release valve design**

▪ No valve tools required

▪ Simply click in and press out

▪ *Cap and core included*



469-20280

TUFFY NO.	MFG. NO.	DESCRIPTION
469-20280	RV1000	Autel MX-Sensor Replacement Rubber Valve Stem

## AUTEL MX-SENSOR REPLACEMENT METAL VALVES

▪ **Patented PRESS release valve design**

▪ No valve tools required

▪ Simply click in and press out

▪ *Cap and core included*



469-20279

TUFFY NO.	MFG. NO.	DESCRIPTION
469-20279	MV1000	Autel MX-Sensor Replacement Metal Valve
469-20281	CV-001	Autel Black MX-Sensor Replacement Metal Valve
469-20282	CV-002	Autel Titanium Grey MX-Sensor Replacement Metal Valve

VALVE HARDWARE // TPMS TOOLS & ACCESSORIES



➔ Bartec Tech400Pro TPMS Tool



## TPMS Sensor Activation Tools (cont.)

### BARTEC TECH400PRO TPMS TOOL

The industry leading all-in-one TPMS Scan tool, the Tech400Pro is the only tool that combines powerful OBDII functionality with wireless updating.



Bartec Tech400Pro TPMS Tool

INDUSTRY-LEADING TPMS SCAN TOOL

WI-FI AND BLUETOOTH

- ADVANCED TPMS TECHNOLOGY:** With TIA Tech Tips inside and Bartec's advance TPMS Engine, you can work with more sensors and repair more cars
- COMPREHENSIVE OBD RELEARN COVERAGE:** Because the Tech400Pro works on more vehicles through OBD, it's easier to use and offers greater diagnostics
- COVERS IMPORT AND DOMESTIC VEHICLES:** Market leading TPMS vehicle coverage means you can fix more cars
- TPMS PLACARD PRESSURE ADJUSTING:** Keep the TPMS Operative when up-fitting and plus-sizing by re-programming the in inflation pressure
- AFTERMARKET REPLACEMENT SENSORS:** Program and configure more replacement sensors, keep your sensor inventory flexible
- WI-FI AND BLUETOOTH CAPABLE:** Always keep your tool up to date with Wi-Fi updating and easily send vehicle data to a POS using Bluetooth
- PASSIVE KEY TESTING:** Only the Tech400Pro can test today's passive and keyless entry systems



469-4111



469-4112



469-4113



Software Updates

#### SNAPSHOTS OF THE BARTEC TECH400PRO TPMS TOOL:



Programming a replacement sensor

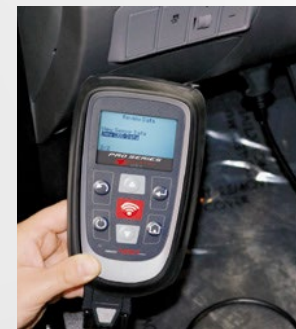

Performing a TPMS OBD Relearn



Testing a transmitter of a passive entry system



Verifying the placard settings and VIN

TUFFY NO.	MFG. NO.	DESCRIPTION
469-4111	WRT400PRO	Tech400Pro Tool, Charging Pad, OBDII Cable, USB Cable, Magnet, Power Supply and Bluetooth Dongle
469-4112	WRT400TK	Tech400Pro Kit Plus a Mechanical Tool Kit and TPMS Training DVD Kit
469-4113	WRT400PROMK	Total Kit Plus a Wall Mounted Charging Cradle and TPMS Consumer Kit
469-4401	WRT400PROSUL1	One Year Activation Certificate for the Tech400Pro
469-4402	WRT400PROSUL2	Two Year Activation Certificate for the Tech400Pro
469-4403	WRT400PROSUL3	Three Year Activation Certificate for the Tech400Pro

VALVE HARDWARE // TPMS TOOLS & ACCESSORIES







➔ Bartec Tech300Pro TPMS Tool, Software Updates

### BARTEC TECH300PRO TPMS TOOL

The industry's first scalable TPMS Tool. Start with a powerful activation and sensor programming tool, and upgrade to a scan tool when it makes sense for your business.

- **SCALABLE TPMS TECHNOLOGY:** The Tech300Pro begins an activation only tool, and can be upgraded to a TPMS scan tool buy purchasing the upgrade module. Grow TPMS service at your own pace
- **COMPREHENSIVE OBD RELEARN COVERAGE:** Because the Tech300Pro works on more vehicles through OBD, it's easier to use and offers greater diagnostics
- **COVERS IMPORT AND DOMESTIC VEHICLES:** Market leading TPMS vehicle coverage means you can fix more cars
- **AFTERMARKET REPLACEMENT SENSORS:** Program and configure more replacement sensors, keep your sensor inventory flexible
- **TIA INSIDE TECHNOLOGY:** Tech tips and relearn procedures right at you finger tips makes the repair process faster and more accurate
- **BLUETOOTH CAPABLE:** Easily and wirelessly send vehicle data to a POS or our TPMS Desktop using Bluetooth



Bartec Tech300Pro TPMS Tool

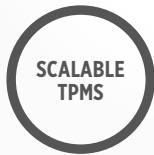

469-30013



Software Updates



469-31113

### BARTEC TECH500 SOFTWARE UPDATES

- **1, 2 or 3-year updates available**
- Tool updates annually adding features, function and coverage
- Software updates will continue to be supported for this tool even though the tool has been discontinued

TUFFY NO.	MFG. NO.	DESCRIPTION
469-50011	WRT500SUL1	One year activation certificate for the Tech500
469-50022	WRT500SUL2	Two year activation certificate for the Tech500
469-50033	WRT500SUL3	Three year activation certificate for the Tech500

### BARTEC TECH400SD SOFTWARE UPDATES

- **1, 2 or 3-year updates available**
- Tool updates annually adding features, function and coverage
- Software updates will continue to be supported for this tool even though the tool has been discontinued



TUFFY NO.	MFG. NO.	DESCRIPTION
469-44001	WRT400SUL1	One Year Activation Certificate for the Tech400SD
469-44002	WRT400SUL2	Two Year Activation Certificate for the Tech400SD
469-44011	WRT400PROSUL1	One Year Activation Certificate for the Tech400Pro

TUFFY NO.	MFG. NO.	DESCRIPTION
469-30013	WRT300PRO	Base Tech300Pro Tool, USB Cable, Magnet, Power Supply and Bluetooth Dongle
469-30113	WRT300PROUPG	OBDSII Upgrade Module, OBDSII Cable and Quick Start Guide
469-31113	WRT300PROC	Tech300Pro with the OBDSII Module Factory Installed, OBDSII Cable, Power Supply, USB Cable, Magnet
469-33111	WRT300PROSUL0	One Year Activation Certificate for the Base Tech300Pro
469-33011	WRT300PROSUL1	One Year Activation Certificate for the Tech300ProC
469-33022	WRT300PROSUL2	Two Year Activation Certificate for the Tech300ProC
469-33033	WRT300PROSUL3	Three Year Activation Certificate for the Tech300ProC

VALVE HARDWARE // TPMS TOOLS & ACCESSORIES



➔ Bartec Tech200Pro & Tech200 TPMS Tools



TPMS Sensor Activation Tools (cont.)

BARTEC TECH200PRO TPMS TOOL

The industry's first ALL-IN-ONE tire inspection tool, combining the testing and measurement of Tread Depth, TPMS and Tire Pressure in a single, easy to operate tool. The Tech200Pro has all of the rock solid TPMS testing capability you've come to expect from a Bartec tool, combined with state of the art depth measurement, and the ability to take "stick pressure" as well. All of this data is displayed on a high resolution color display and can be transmitted via wireless Bluetooth.

- **INTEGRATED FUNCTIONALITY:** Allows the technician to complete a complete "Test before you Touch" assessment of the consumer's tires and TPMS, quickly and accurately check pressure, tread and TPMS
- **ADVANCED TREAD DEPTH MEASUREMENT:** This highly accurate tool prompts the user to measure in three places to accurately display remaining tread and tire wear profile
- **WIRELESS DATA MANAGEMENT:** Successful tire sales relies on conveying the right message and details, send the inspection results via Bluetooth to a handheld device or your point of sale workstation
- **BUILT FOR THE TIRE SHOP:** The Tech200Pro is a rugged inspection tool built to last in the automotive repair bay or in the tire shop
- **STANDALONE OPERATION:** A rechargeable battery and quick connect pressure gauge means the Tech200Pro is a standalone service tool, that doesn't require connection to any other devices. The wall mounted charging cradle offers a safe place to store the tool and keep the battery fully charged



Bartec Tech200Pro TPMS Tool

RUGGED AND BUILT TO LAST

Customer: Rich Nahn      Registration: P105773  
 Date: 10/05/2017      Mileage: Chevrolet058  
 Reference: CUSTW00057      Year: The Standard

<b>Left Front</b> Tread: Replace Today 3/32" 3/32" 2/32" Pressure: Not Read Manufacturer: Unknown		<b>Right Front</b> Tread: OK 5/32" 5/32" 5/32" Pressure: Not Read Manufacturer: Unknown
<b>Left Rear</b> Tread: Replace Today 3/32" 5/32" 8/32" Pressure: Not Read Manufacturer: Unknown	<b>Right Rear</b> Tread: Replace Today 8/32" 8/32" 8/32" Pressure: Not Read Manufacturer: Unknown	

OK	7/32" and Up	Tire is OK for use.
Replace Soon	3/32" to 6/32"	Tire is worn. Consider purchasing new tires.
Replace Today	2/32" and Below	Tire is no longer safe. Tire must be replaced.

Vehicle audit

BARTEC TECH200 TPMS TOOL

The entry level TPMS activation tool that packs a wireless punch! Send TPMS Sensor data to the TPMS desktop via wireless Bluetooth.

- **Test sensors before service begins** ▪ Activates sensors for stationary relearns ▪ Wirelessly transmits data to the TPMS Desktop ▪ Programs aftermarket replacement sensors ▪ Properly handles multi-protocol sensors
- Only entry level tool with Bluetooth ▪ Ships as a complete kit ▪ Easy update through the TPMS Desktop

Bartec Tech200 TPMS Tool

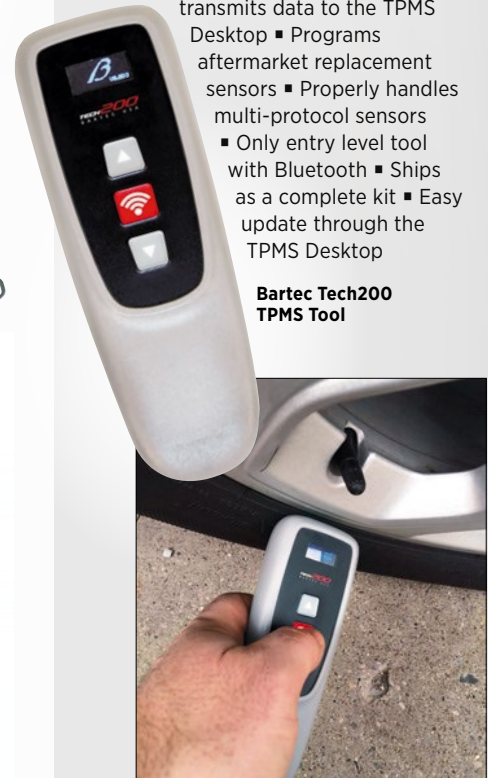

Testing the Tech200 TPMS Tool

SNAPSHOTS OF THE BARTEC TECH200PRO TPMS TOOL:

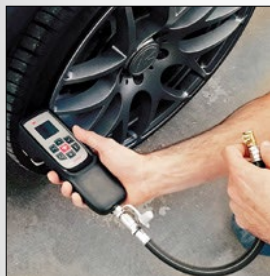

Testing the Bartec Tech200Pro TPMS Tool



Measuring the tread



Checking air pressure



469-21222

TUFFY NO.	MFG. NO.	DESCRIPTION
469-20222	WRT200PRO	Tech200Pro, USB Cable, Charging Cradle, and USB Cable

TUFFY NO.	MFG. NO.	DESCRIPTION
469-21222	WRT200G	Tech200, and USB Cable



## ➔ Wireless Bluetooth Printer, Charging Cradle, Programming Fixture, Reset Tools

### WIRELESS BLUETOOTH PRINTER

- Quickly retrieve basic vehicle TPMS information for fast reference and vehicle identification
- Wirelessly transmit tool data to this printer and generate a summary ticket
- Includes a wireless charging docking station
- Bluetooth communications
- Pre-formatted report
- Rechargeable battery



469-48001

TUFFY NO.	MFG. NO.	DESCRIPTION
469-48001	WRTPROWMP	Wireless Bluetooth Printer

### WALL MOUNTED CHARGING CRADLE

- The Wall Mounted Charging Cradle provides a safe storage place for your Pro Series tool while keeping it fully charged
- The cradle has inductive charging, and when the Tech300Pro or Tech400Pro is inserted into the cradle, provides a charge to the tool
- Includes wall mounting hardware
- Power supply also included



469-48002

TUFFY NO.	MFG. NO.	DESCRIPTION
469-48002	WRTPROWMC	Wall Mounted Charging Cradle

### SUPPLEMENTAL PLACARD LABEL ROLLS

- If you have a Tech400Pro, you can adjust the recommended inflation pressure of certain vehicles. That means a new supplemental placard label!
- Roll of 25 or 100 TPMS Placard Labels.

SUPPLEMENTAL TIRE COLD INFLATION PRESSURE		
Tire Size	Load Index	Cold Inflation Pressure (PSI)
Front:		
Rear:		

AT THE VEHICLE CAPACITY WEIGHT ON TIRE SAFETY PLACARD

TUFFY NO.	MFG. NO.	DESCRIPTION
469-48025	WRPLACARD25	Supplemental Placard Labels Roll of 25
469-48100	WRPLACARD100	Supplemental Placard Labels Roll of 100

### BARTEC CONTACT PROGRAMMING FIXTURE

- The contact programmer plugs into the Pro Series sensors
- Must order the proper programmer based on the brand of sensors being programmed



469-56022

TUFFY NO.	MFG. NO.	DESCRIPTION
469-56022	WRT500CPF002	Contact Programming Fixture

### TOYOTA LOOP RESET TOOL

- Resets TPMS warning light when stuck in loop
- Plugs into OBD II connection and hold button
- No pin jumping required with the WRTRST50
- Accurate and fast



469-00450

TUFFY NO.	MFG. NO.	DESCRIPTION
469-00450	WRTRST50	Toyota Loop Reset Tool

### NISSAN RESET TOOL

- Designed to extinguish the Tire Pressure Warning Light on 2003 & newer Nissan vehicles with TPM Reset Connector



469-71985

TUFFY NO.	MFG. NO.	DESCRIPTION
469-71985	71985	Nissan Reset Tool

## TPMS Sensor Activation Tools (cont.)

### TPMS TRANSMITTER CHECK BOX

- Identify a difference between gauge and your vehicle dash reading
- Helps eliminate possible transmitter defects or failures before mounting and inflating transmitter on wheel
- An ideal device to ensure quality service
- Designed for use with all styles of direct TPMS transmitters
- Portable and easy to use
- Equipped with a regulator and gauge to ensure proper functionality

PORTABLE AND EASY TO USE



469-03200

TUFFY NO.	MFG. NO.	DESCRIPTION
469-03200	OCB	TPMS Transmitter Check Box

### STANDALONE TPMS RESET TOOL FOR MITSUBISHI LANCER, OUTLANDER AND MIRAGE

- The MitsuReset enables TPMS relearn mode on most Mitsubishi vehicles. When connected to the vehicle's OBD2 port, it allows TPMS sensor ID's to be written to the ECU during sensor activation
- With the Mitsureset, tire shops now have a low-cost, simple solution for performing TPMS relearns on compatible Mitsubishi vehicles without the need for a scan tool
- The Mitsureset can be used together with the ATEQ VT56 TPMS diagnostic tool, VT55 TPMS diagnostic tool, VT36 sensor activation and programming tool, VT30 TPMS reset tool, the VT15 TPMS activation tool or any other trigger tool

ENABLES TPMS RELEARN MODE

LOW-COST, SIMPLE SOLUTION



469-05000

TUFFY NO.	MFG. NO.	DESCRIPTION
469-05000	OBDS-M000	Standalone TPMS Reset tool for Mitsubishi Lancer, Outlander and Mirage

### VT55 OBDII TPMS TOOL KIT

- RF range adjustable from 300 to 900 Mhz by software to accommodate future sensors
- Duplicate sensor warning to prevent displaying or writing incorrect information to vehicle ECU
- Visual, audible and physical feedback when VT55 receives sensor information
- Rewrite sensor information directly to TPMS ECU
- USB port to print decoded sensor information and update VT55 with PC
- Large, fluid resistant tool reference guide
- Useful remote keyless entry option to test battery/signal strength
- Test and diagnose all TPM sensors
- KIT INCLUDES: VT55, protective pouch, USB cable, CD manual and software, power supply, magnet, OBDII connector, reference guide



469-05500

REMOTE KEYLESS ENTRY OPTION

TUFFY NO.	MFG. NO.	DESCRIPTION
469-05500	VT550BD	VT55 OBDII TPMS Tool Kit

### VT36 TPMS SENSOR ACTIVATION TOOL

- The VT36 TPMS programming tool offers functionality and flexibility at an affordable price
- Its rugged casing and durable rechargeable battery is designed for tough service station environments
- Thanks to frequent updates, the newest TPMS sensors and vehicles are introduced each year
- Low cost, robust and easy to use
- Test all TPMS sensor data before working on customer's vehicle
- Program all leading aftermarket sensors



469-36100

LOW-COST, ROBUST & EASY TO USE

RUGGED, DURABLE CASING

TUFFY NO.	MFG. NO.	DESCRIPTION
469-36100	VT36-1000	TPMS Sensor Activation Tool

VALVE HARDWARE // TPMS TOOLS & ACCESSORIES





➔ Tool Master Kit, Tire Tread Depth Gauge, Software Licenses

### VT56 TPMS PROGRAMMING TOOL MASTER KIT

The VT56 is the all-in-one comprehensive TPMS tool with coverage for American, European and Asian vehicles. Its advanced features and functions provides complete TPMS management. Thanks to frequent updates, it includes all new TPMS sensors and vehicles, immediately when introduced each year.

- **FAST AND INTELLIGENT:** The fastest TPMS tool; designed to continuously adapt to a technician's needs
- **SAVES TIME AND MONEY:** The only TPMS tool with a VIN barcode scanner for fast vehicle selection (North America only)
- **INTEGRATED HELP:** Tool training, TPMS reset procedures, sensor part numbers, OBD2 locations - all at your fingertips

FAST & INTELLIGENT

SAVES TIME & MONEY



469-56100

TUFFY NO.	MFG. NO.	DESCRIPTION
469-56100	TS56-1000	VT56 TPMS Diagnostic & Reset Master Kit
469-56102	TS56-1002	VT56 TPMS Tool OBDII

### VT56 TIRE TREAD DEPTH GAUGE

▪ **The Tire Tread Depth Gauge is an add-on accessory for the VT56 OBD2 Diagnostic TPMS Tool** ▪ The accessory allows a technician to measure tire tread depth with high accuracy when checking TPMS sensors during routine service and maintenance checks ▪ In one simple gesture, it can detect worn tires, tire damage and indicate poor alignment ▪ A quick vehicle safety check ▪ An additional service and tire sales opportunity ▪ **IDEAL FOR TIRE MANAGEMENT:** Records tire condition before and after storage



469-10000

SIMPLE, QUICK & EASY TO USE

TUFFY NO.	MFG. NO.	DESCRIPTION
469-10000	TTD01-0000	VT56 Tire Tread Depth Gauge

### ATEQ SOFTWARE LICENSES

▪ **Receive monthly updates on your Ateq TPMS tools with the annual software subscription including the latest and greatest features and coverage** ▪ The latest software update subscription also includes new tool functionalities, procedures, corrections, vehicle coverage, sensor coverage and more



RECEIVE MONTHLY UPDATES

SUBSCRIBE ANNUALLY

TUFFY NO.	MFG. NO.	DESCRIPTION
469-56001	SW56-0001	VT56 Annual Software License
469-55001	SW55-0001	VT55 Annual Software License

VALVE HARDWARE // TPMS TOOLS & ACCESSORIES





TPMS Reset Tool & Master Kit, TPR Tool

TPMS Sensor Activation Tools (cont.)

TIRE PRESSURE MONITORING SYSTEM RESET TOOL MASTER KIT

- **OTC's TPR is a fast and simple to use stand alone TPMS activation tool**
- Works on all known TPMS sensors through 2009
- Automatically adjusts activation output power to eliminate cross activation of near sensors
- Easily Updated with a wireless connection to the Genisys scan tool when new software is installed on the Genisys
- **COMBINE TPR ACTIVATION WITH THE POWER OF GENISYS SCAN:** Compatible with the entire Genisys family of scan tools
- Register new sensor ID's on Asian vehicles
- Use the TPR to activate and decode sensor ID's and transmit them to the Genisys wirelessly
- *Bluetooth wireless communication adapter included*
- Quick reference reset procedures can be quickly accessed on the Genisys



469-03835

TUFFY NO.	MFG. NO.	DESCRIPTION
469-03835	OTC-3835	Tire Pressure Monitoring System Reset Tool Master Kit

TIRE PRESSURE MONITORING SYSTEM RESET TOOL

- **The OTC's TPR is a fast and simple to use stand alone TPMS activation tool** ▪ Works on all known TPMS sensors through 2009 ▪ Bright graphic display and simple navigation buttons enable vehicle selection for fast activation ▪ Automatically adjusts activation output power to eliminate cross activation of near sensors ▪ **Compatible with the entire Genisys family of scan tools** ▪ Register new sensor ID's on Asian vehicles ▪ Use the TPR to activate and decode sensor ID's and transmit them to the Genisys wirelessly ▪ *Bluetooth wireless communication adapter included* ▪ Quick reference reset procedures can be quickly accessed on the Genisys ▪ **INCLUDES:** TPR handheld, DB25 wireless adapter, carry case registration card, user manual for TPR and Genisys' interface



469-03834

TUFFY NO.	MFG. NO.	DESCRIPTION
469-03834	OTC-3834	Tire Pressure Monitoring System Reset Tool

TPR TOOL WITH EZ-SENSOR™ PROGRAMMING

- **Fast simple programming using OTC TPR Tool** ▪ Eliminates the need to perform relearn procedures when replacing sensors
- No scan tool required for programming ▪ Replaces over 90% of current TPMS sensors! ▪ Save money & fit the right part ▪ Fast simple assembly to the wheel rim ▪ **INCLUDES:** EZ-sensor™ programming cradle, EZ-sensor™ User guide, Quick Start Guide, USB cable, EZ-sensor™ Application chart, EZ-sensor™ Training Video, Software Activation Certificate, Six months of updates at [www.tpmsupdates.com](http://www.tpmsupdates.com)



469-13834

TUFFY NO.	MFG. NO.	DESCRIPTION
469-13834	OTC-3834EZ	TPR Tool with EZ-Sensor™ Programming

VALVE HARDWARE // TPMS TOOLS & ACCESSORIES



➔ Tire Pressure Reset Tool, Intellisense App, Programming Pad



**GENISYS EVO® USA 2012 KIT WITH TIRE PRESSURE RESET TOOL**

- **INCLUDES:** Genisys EVO featuring the NEW System 5.0 with Code-Assist™ experienced-based Confirmed Fixes™ from Identifix®, NEW USA 2011 Domestic / Asian with ABS and European 2010 software including Pathfinder, Repair-Trac®, Fast fixes™ information, InfoTech Component Information software, Automated System Test™, OBD II Smart Cable, USA Domestic and ABS/Airbag OEM vehicle cables (for GM, Ford, Chrysler, Jeep, Saturn), manuals, and carrying case
- **TIRE PRESSURE RESET TOOL KIT INCLUDES:** TPR handheld, DB25 wireless adapter, registration card, user manual for TPR and Genisys interface
- **NOTE:** OEM cables may be required for certain vehicle system functions. Additional OEM cables are available individually or in convenient kits - Asian OEM Cable Kit 3421-94 and European OEM Cable Kit 3421-75.

SYSTEM 5.0 WITH CODE-ASSIST

OEM CABLES MAY BE NEEDED



351-03874

TUFFY NO.	MFG. NO.	DESCRIPTION
351-03874	OTC-3874TPR	Genisys EVO® USA 2012 Kit with Tire Pressure Reset Tool

**HUF INTELLISENSE APP**



- **Uses iOS or Android to service TPMS (HC1000 required)** ▪ Scan VIN or enter vehicle selection manually (YMM) ▪ Look up Huf replacement parts and service kits ▪ Program Huf IntelliSens universal sensors ▪ Displays relearn procedures and vehicle specific TPMS information ▪ No need to manually update, the app updates itself on every startup (internet required)
- Technical support at the touch of a button by phone or email ▪ Identifies relearn requirements for servicing vehicles during rotation and balance ▪ Video training on the app



469-01111

TUFFY NO.	MFG. NO.	DESCRIPTION
469-01111	HC1000	Huf IntelliSense App

**SCHRADER EZ SENSOR PROGRAMMING PAD**



- **Quick and simple programming tool for EZ-sensor** ▪ LIVE vehicle coverage updates are available immediately after release. No tool update required ▪ Both mobile and desktop friendly compatible with iOS, Android and Windows
- **LONG BATTERY LIFE:** 8 hours or up to 120 sensors ▪ Works with the free Schrader TPMS app, while connected to the internet



469-27028

SIMPLE, QUICK & EASY TO USE

TUFFY NO.	MFG. NO.	DESCRIPTION
469-27028	27028	Schrader EZ Sensor Programming Pad

VALVE HARDWARE // TPMS TOOLS & ACCESSORIES





# TPMS Accessories & Kits

## SCHRADER TPMS ACCESSORY KITS

- The OEM requires that the four sealing components be replaced when re-installing a TPMS sensor
- The replacement components are supplied in TPMS accessory kits, which are sensor specific
- **EACH TPMS ACCESSORY KIT CONTAINS:** 1 Nut, 1 Valve Core, 1 Cap, 1 Grommet



469-20097

TUFFY NO.	MFG. NO.	DESCRIPTION
469-20002	20002	Accessory Kit for ford Transmitters - Replaces 469-29601 & 469-23501
469-20003	20003	Accessory Kit for Chrysler Transmitters - Replaces 469-21701 & 469-22801
469-20004	20004	Accessory Kit for GM Transmitters - Replaces 469-20701 & 469-21601
469-20005	20005	Accessory Kit for Steel Wheel Nissan Transmitters
469-20006	20006	Accessory Kit for Hummer Transmitters
469-20007	20007	Accessory Kit for Alloy Wheel Nissan Transmitters
469-20009	20009	Accessory Kit for Suzuki Replacement Transmitter
469-20010	20010	Accessory Kit for Prowler Replacement Transmitter
469-20011	20011	Accessory Kit for Subaru Replacement Transmitter
469-20012	20012	Accessory Kit for Corvette Replacement Transmitter
469-20013	20013	Accessory Kit for Dodge Nitro Transmitters
469-20014	20014	Accessory Kit for Nissan Transmitters
469-20015	20015	Accessory Kit for GM/TRW Transmitters
469-20016	20016	Accessory Kit for Mercedes Transmitters
469-20017	20017	Accessory Kit for Volkswagen/Siemens Transmitters
469-20018	20018	Replacement Snap-In Valve ford 20315 Transmitter, Box of 50
469-20019	20019	Accessory Kit for Honda/Acura Transmitters
469-20020	20020	TPMS Service Pack - Stem Only - Chrysler, Dodge, Jeep
469-20022	20022	Accessory Kit for Hyundai/Kia Transmitters
469-20023	20023	Accessory Kit for Beru Stems - No Valve
469-20030	20030	Accessory Kit for Chrysler/Siemens Transmitters
469-20031	20031	Accessory Kit for Pacific Transmitters
469-20032	20032	Accessory Kit for Toyota/Pacific Transmitters
469-20035	20035	Accessory Kit for TRW Long Valve Transmitters
469-20036	20036	Accessory Kit for TRW Short Valve Transmitters
469-22008	22008	Assembled Chrome Replacement Snap-In Valve for Schrader 20153 Transmitter
469-20037	20037	Accessory Kit - Silver Insert - for Audi, BMW, Hyundai, Kia, Mercedes, Porsche, VW
469-20038	20038	Accessory Kit - Green Insert - for Audi, BMW, Hyundai, Kia, Mercedes, Porsche, VW
469-20039	20039	Accessory Kit - Black Insert - for Audi, BMW, Hyundai, Kia, Mercedes, Porsche, VW
469-20040	20040	Accessory Kit - Orange Insert - for Audi, BMW, Hyundai, Kia, Mercedes, Porsche, VW
469-20041	20041	Accessory Kit - Schrader Aluminum Grommet Seat for Adjustable angle stem, 25 Pack
469-20043	20043	Accessory Kit - Continental Rubber Snap-in Valve OE# 68193587AB, 50 Pack
469-20046	20046	Accessory Kit for Schrader High-Speed Snap-In, 50 Pack
469-20047	20047	Accessory Kit for Schrader Gen Gamma Adjustable Angle Aluminum Clamp-in Stem, 50 Pack
469-20049	20049	Accessory Kit for Schrader Gen Gamma Adjustable Angle Aluminum Clamp-in Stem (Mercedes), 50 Pack
469-20635	20635	Accessory Kit for TRW1 Rubber Snap-in Valve, 50 Pack
469-20895	20895	Replacement T-10 Screws, 100 Pack
469-22005	22005	TPMS Snap-In Dress Up Kit

## SCHRADER TPMS ACCESSORY KIT ASSORTMENTS

- Contains all the parts you will need when servicing tires and wheels that are equipped with Schrader Original Equipment pressure monitoring transmitter valves
- All components are individually packaged for easy identification by vehicle application and are stored in a handy plastic box



469-20598

TUFFY NO.	MFG. NO.	DESCRIPTION
469-20097	20097	<b>Small Assortment Kit. INCLUDES:</b> 30 Bags (5 ea) Accessory Kits for Each Transmitter Size, 25 Plastic Valve Caps and Core Tool
469-20698	20698	<b>Accessory Assortment Kit w/ EZ-sensor. 1 PLASTIC TRAY CONTAINING:</b> 10 Each of Schrader's 12 Most Popular Accessory Kits (20002, 20003, 20004, 20007, 20008, 20013, 20014, 20020, 20023, 20030, 20032, 20036), four 315MHz EZ-sensors 33000 & (2) 433MHz
469-20598	20598	<b>TPMS Service Pack Assortment. INCLUDES:</b> 8 each of service packs 20002, 20003, 20004, 20008, 20013, 20014, 20020, 20021, 20023, 20030, 20032 and 20036

VALVE HARDWARE // TPMS TOOLS & ACCESSORIES







➔ TPMS Accessory Kits, Replacement Stem & Kit for Chrysler/Dodge

DILL TPMS ACCESSORY KITS

TUFFY NO.	MFG. NO.	DESCRIPTION
469-00035	VS-35	Clamp-In Replacement Valve for Dodge 1500, 2500, & 3500 Trucks
469-00065	VS-65	Snap-In Replacement Valve for Dodge 1500, 2500, & 3500 Trucks
469-00919	VS-919	For use in light truck applications fitted with rims with a 0.625 diameter rim hole using the Ford, GM, and Chrysler snap in TPMS sensor design
469-00925	VS-925A	Aluminum Metal Replacement Valve for GM Snap-in & Ford
469-00950	VS-950	Rubber Snap-In Replacement Valve for GM & Ford Transmitters
469-00951	950SC/4PK	TPMS Snap-IN Chrome Sleeve and Cap 4/Pack for VS-950
469-01010	VS-1010	Rubber Snap-In Stem for Hyundai Sante Fe
469-01030	1030K	Siemens Kit for VW (Fits 1053 Sensor)
469-01031	1031K	VW Kit for Special Wheel Package
469-01040	1040K	Siemens Mercedes Assembled Valve
469-01050	1050K	Siemens Kit for Chrysler w/special metal washer
469-01060	1060K	Kit for Ford, Lincoln, Mercury
469-01070	1070K	Kit for Buick, Cadillac, Chevrolet, GMC, Isuzu, Pontiac, Saab
469-01077	1077K	Accessory Kit for 8006 Sensor, 97-00 Corvette
469-01080	1080K	Kit for Cadillac, Chevrolet, Chrysler, Dodge, Infiniti, Isuzu, Jeep, Mitsubishi, Nissan, Plymouth, Subaru
469-01090	1090K	Compatible with Beru Sensors
469-01096	1096	TPMS Stem For Hyundai, Kia, Honda
469-01097	1097	TPMS Stem For Hyundai, Kia, Honda
469-01098	1098K	Dodge Sprinter Replacement Valve
469-01100	1100K	Compatible with Pacific Sensors for Toyota/Lexus
469-01110	1110K	Compatible with Pacific Sensors for Toyota
469-01130	1130K	Kit for Mazda, Mitsubishi, Nissan
469-02040	2040K	Kit fo Hyundai, KIA
469-02045	2045K	Kit for Honda/Acura
469-07000	7000K	Kit for Acura, Chrysler, Dodge, Jeep, Nissan
469-07020	7020K	Kit for BMW, Cadillac, Honda, Hyujndai, Infiniti, Jaguar, KIA, + more & REDi-Sensor
469-09251	VS-925C	Chrome Replacement Valve for GM & Ford Snap-in
469-09252	VS-925B	Black Nut/Black Cap Metal Replacement Valve for GM & Ford
469-20025	2000K	Kit for Acura, Honda, Hyundai, KIA
469-20130	2030K	Kit for Chrysler, Dodge, M-Benz, Nissan
469-21010	2010K	Kit for Saturn, Volvo
469-21020	2020K	Early 2007 GM Kit for Entire Sensors
469-90662	9066K-LS	TPMS Valve Stem Kit with ball joint



469-00035



469-00065



469-00919



469-00925



469-00950



469-01010

VALVE HARDWARE // TPMS TOOLS & ACCESSORIES

COMPLETE REPLACEMENT KIT FOR CHRYSLER/DODGE TPMS APPLICATIONS

▪ COMPLETE REPLACEMENT KIT INCLUDES THE FOLLOWING: Aluminum TPMS Valve Stem w/ Grommet, Valve Nut, Valve Core



469-90660

TUFFY NO.	MFG. NO.	DESCRIPTION
469-90660	9066-K	Dill Chrysler TPMS Complete Stem Replacement Kit

REPLACEMENT STEM FOR CHRYSLER/DODGE TPMS APPLICATIONS



469-90661

TUFFY NO.	MFG. NO.	DESCRIPTION
469-90661	9066-1	Dill Chrysler TPMS Replacement Stem Only



TPMS Accessory Kits



TPMS Accessories & Kits (cont.)

UNIVERSAL MASTER TPMS TRANSMITTER HARDWARE & TOOL SERVICE SET

▪ Versatile 152 piece assortment (15 unique kits) covers over 55 different OEM sensor models and 90% of US vehicles ▪ **TOOLS INCLUDED:** A Sensor Service Tool, Ratcheting Torque Wrench, 2 Deep Sockets, 2 Torque Drivers and bits

VERSATILE:  
152 PIECES

15 UNIQUE  
KITS



469-30000

TUFFY NO.	MFG. NO.	DESCRIPTION
469-30000	30000	Universal Master TPMS Set

DILL TPMS MASTER ACCESSORY ASSORTMENT

▪ **INCLUDES 4 OF EACH KITS:** 1130K, 1030K, 2045K, 1070K, VS-20, VS-90, 1050K, 1080K, 1100K, 2030K, 1110K, 1060K, 2010K, VS-65, 2040K, 2000K, 7020K, 1090K, 7000K and **6 EACH:** VS-950 Stems ▪ 97% coverage



469-07100

TUFFY NO.	MFG. NO.	DESCRIPTION
469-07100	7100	Dill TPMS Master Accessory Assortment

DILL TPMS REPLACEMENT STEM ASSORTMENT

▪ **INCLUDES 4 OF EACH:** VS-65, VS-40, VS-925C, 9066K, 1040K, VS-1010, VS-950, VS-90, VS-925B, VS-20, VS-70 and **2 OF EACH OF THE FOLLOWING:** 1092, 1093, 1094, 1097K, 1096K, VS-965 ▪ 99% coverage



469-07300

TUFFY NO.	MFG. NO.	DESCRIPTION
469-07300	7300	Dill TPMS Replaceable Stem Assortment

VALVE HARDWARE // TPMS TOOLS & ACCESSORIES





➔ Valve Stems, Replacement Valves & Stems, Chrome Sleeves & Caps

REDI-SENSOR VALVE STEMS



TUFFY NO.	MFG. NO.	DESCRIPTION
469-00045	VS-45	Clamp-In Stem for REDI-Sensor w/ Clip Design, Chrome Plated Brass. Fits 7001HP-R & Certain OE Sensors
469-00770	VS-70	REDI-Sensor Replacement Valve Stem w/ All Components
469-00771	VS-70B	REDI-Sensor Valve with Black Anodized Nut and Black Cap
469-00772	VS-70S	REDI-Sensor Valve Stem with Cap and Core Assembled

DILL ALUMINUM REPLACEMENT TPMS STEM

▪ Metal Replacement Clamp-In Valve for GM, Ford, Dodge Ram, Subaru & Suzuki ▪ Made from anodized aluminum ▪ T-10 screw included ▪ QUANTITY: Packaged 20 per box



TUFFY NO.	MFG. NO.	DESCRIPTION
469-00925	VS-925A	Dill Aluminum Replacement TPMS Stem
469-01925	VS-925B	Dill Aluminum Replacement TPMS Stem - Black
469-02925	VS-925C	Dill Aluminum Replacement TPMS Stem - Chrome

RUBBER TPMS SNAP-IN REPLACEMENT VALVES

▪ Rubber stem and attaching screw for snap-in transmitters ▪ Cap & core included ▪ Requires T-10 Torx Tool for assembly/disassembly ▪ VS-1010 requires 5415-2 7mm socket adapter



TUFFY NO.	MFG. NO.	DESCRIPTION	QTY./BOX
469-00030	VS-30	Rubber Snap-In TPMS Stem w/ Clip	4
469-00065	VS-65	Snap-In Replacement Valve for Dodge 1500, 2500 & 3500 Trucks	25
469-00090	VS-90	Rubber Valve Stem Kit for New Dodge and GM Transmitters	25
469-00200	VS-20	Rubber Snap-In for GM & Ford Transmitters	25
469-00438	VS-438	Mercedes-Benz 8.8mm Snap-In Replacement Valve for Spare Tire	10
469-00950	VS-950	Rubber Snap-In Replacement Valve for GM & Ford Transmitters	25
469-01010	VS-1010	Rubber Snap-In Stem for Hyundai Santa Fe	25
469-20018	20018	Replacement Snap-In Valve for Schrader Ford 20315 Transmitter	50

TPMS SNAP-IN CHROME SLEEVES AND CAPS



TUFFY NO.	MFG. NO.	DESCRIPTION
469-00951	950SC/4PK	TPMS Snap-In Chrome Sleeve and Cap 4/Pack for VS-950

VALVE HARDWARE // TPMS TOOLS & ACCESSORIES



➔ Replacement Valve Stems, TPMS Kits



## TPMS Accessories & Kits (cont.)

### REDI-SENSOR TPMS COMBO KIT

**INCLUDES:** 4 of Each REDI-Sensor (7001HPR, 7002A, 7003A, 7004), (5112A) Service Kit Cabinet (180 pcs) ■ Receive a FREE 8200 TPMS Tool Kit and 9700 Counter Aid



469-07415

TUFFY NO.	MFG. NO.	DESCRIPTION
469-07415	7415A	REDI-Sensor TPMS Combo Kit

### REDI-SENSOR TPMS COMBO KIT

**INCLUDES:** 4 of each REDI-Sensor (7001HPR, 7002A, 7003A, 7004), (7100 Kit) Service Kit Assortment (86 pcs) ■ Receive a FREE 4065 Toolkit and 9700 Counter Aid



469-17415

TUFFY NO.	MFG. NO.	DESCRIPTION
469-17415	7415	REDI-Sensor TPMS Combo Kit

### DILL CLAMP-IN REPLACEMENT TPMS VALVE STEMS



469-00917

469-00240

469-00241

469-00913

469-00919

469-00920

469-01240

CORROSION FREE

TUFFY NO.	MFG. NO.	DESCRIPTION
469-00240	VS-240MC	Silver Chrome Clamp-In 0.453 TPMS Stem. Compatible anywhere a VS-65 or VS-20 is used OEM.
469-00241	VS-241	Clamp-In TPMS Valve for 2017 Ford Truck & Ram 3500. Includes USA Double Seal Cap. 6 Per Pack.
469-00913	VS-913	0.625" Clamp-In TPMS Stem for 2017+ Ford Super Duty. 20 Per Pack.
469-00917	VS-917	Silver Chrome Clamp-In 0.625 TPMS Stem. Used on 7001HPR REDI-Sensor with Push Button.
469-00919	VS-919	Silver Clamp-In 0.625 TPMS Stem. Compatible anywhere a VS-950 is used OEM.
469-00920	VS-920	Silver Clamp-In 0.625 TPMS Stem. Compatible anywhere a VS-65 is used OEM.
469-01240	VS-240BC	Black Chrome Clamp-In 0.453 TPMS Stem. Compatible anywhere a VS-65 or VS-20 is used OEM.

### TPMS KIT FOR REDI-SENSOR



469-07000

469-07020

TUFFY NO.	MFG. NO.	DESCRIPTION
469-07000	7000K	TPMS Kit for OE Sensors
469-07020	7020K	TPMS Replacement Component Kit for REDI-Sensor and OE Sensors

VALVE HARDWARE // TPMS TOOLS & ACCESSORIES



➔ Valve Caps, Cores, Stems & Inserts

SCHRADER TPMS VALVE CAPS



468-20595 468-00050



468-20495 468-20795 468-20995



468-59019

TUFFY NO.	MFG. NO.	DESCRIPTION	QTY./BOX
468-00050	20395	Plastic Valve Caps	100
468-20495	20495	Aluminum Valve Caps	100
468-20595	20595	Black TPMS Plastic Sealing Valve Caps for Snap-In Transmitters	100
468-20695	20695	Green TPMS Plastic Sealing Valve Caps for Snap-In Transmitters	100
468-20795	20795	Green TPMS Plastic Sealing Valve Caps	100
468-20995	20995	Black TPMS Plastic Sealing Valve Caps	100
468-59019	59-0019	Green Nitrogen Indicating Aluminum Valve Cap	100
468-59021	59-0021	Chrome-Plated Brass Valve Caps	100
468-59023	59-0023	Universal Nitrogen Caps	100

REPLACEMENT ALUMINUM VALVE STEM



469-34000

TUFFY NO.	MFG. NO.	DESCRIPTION
469-34000	34000	Replacement Aluminum Valve Stem

SCHRADER TPMS VALVE CORE

▪ Electroless Nickel-Plated valve core ▪ QUANTITY: Packaged 100 per box



468-20055

TUFFY NO.	MFG. NO.	DESCRIPTION
468-20055	20055	Schrader TPMS Valve Core

BERU TPMS VALVE INSERTS

▪ Original equipment valve insert for the HUF Tire Safety System  
 ▪ Each Insert comes complete with cap, core, grommet & grommet nut  
 ▪ Colored bottom to differentiate inserts ▪ APPLICATIONS: Audi, Bentley, BMW, Ferrari, Land Rover, Maserati, Maybach, Mercedes-Benz, Porsche, Volkswagen ▪ Requires TX-20EZ torx tool for assembly/disassembly



T-20 INFO ON PAGE 224



461-59307

461-59337

461-59357

461-59387

TUFFY NO.	MFG. NO.	DESCRIPTION
461-59307	59.0342	Green Insert
461-59337	59.0340	Silver Insert
461-59357	59.0346	Orange Insert
461-59387	59.0344	Black Insert
469-02020	TX-20EZ	Torx Screwdriver

ORIGINAL EQUIPMENT VALVE INSERT

COLORED BOTTOMS

VALVE HARDWARE // TPMS TOOLS & ACCESSORIES



➔ Replacement Valves, Valve Caps & Cores

TPMS Accessories & Kits (cont.)

DILL TPMS VALVE CAPS & CORES

▪ **QUANTITY:**  
Packaged  
100 per box



TUFFY NO.	MFG. NO.	DESCRIPTION
468-00635	635	Plastic Cap for VS-950 TPMS Snap-In Valve
468-00650	650	Small Plastic TPMS Valve Cap - Gray
468-00680	680	N2 Aluminum Cap for TPMS
468-00690	690	N2 Plastic Cap for TPMS
468-01001	100-TP	Electroless Nickel Plated Valve Core
468-06300	630N	Plastic TPMS Valve Cap - Gray
469-00650	650B	Short Black Plastic TPMS Valve Cap

ALLIGATOR TPMS SNAP-IN REPLACEMENT VALVE

▪ **Alligator's innovative anti-rotation feature with a rubber lip at the base to prevent the sensor and valve from spinning in the wheel** ▪ Maximum published speed rating of 130 MPH - Industry highest ▪ Self-tapping T10 screw provides better torque and locks the valve to the sensor for a tighter, longer lasting fit ▪ Made in Germany



469-59132

TUFFY NO.	MFG. NO.	DESCRIPTION
469-59132	591320	Alligator TPMS Snap-In Replacement Valve

TPMS REPLACEMENT VALVES



TUFFY NO.	MFG. NO.	DESCRIPTION
469-17245	17-20045	High-Speed TPMS Snap-In Valve Stem
469-17246	17-20046	TPMS Snap-In Valve Stem (Right Angle Key)
469-17395	17-50395	Snap-In Sensor Rubber Valve Stem (Square Key)
469-17397	17-50397	Snap-In Sensor Rubber Valve Stem
469-17539	17-50399	Hyundai TPMS Snap-In Valve

Please contact us for more information regarding **TPMS Replacement Valves, Stems & Caps**



VALVE HARDWARE // TPMS TOOLS & ACCESSORIES



➔ Torque Wrenches & Sockets, Socket Driver, Torque Tools

# TPMS Tools

## TPMS TORQUE WRENCHES AND SOCKETS

- Perfect for tightening grommet nut to manufacturer specifications
- Periodic calibration recommended



TUFFY NO.	MFG. NO.	DESCRIPTION
162-27211	27211	3/8" Drive x 11mm Socket
162-27212	27212	3/8" Drive x 12mm Socket
167-12110	1211D	1/4" Drive x 11mm x 12 mm Chrome Flip Socket
168-72100	72100	3/8" Drive, 20 - 200 In.-lbs.
168-72120	72120	3/8" Drive, 25 - 250 In.-lbs.
169-01002	1002E	1/4" Drive x 2" Chrome Extension

## ELECTRONIC TPMS TORQUE WRENCH

- **RANGE:** 12-120 in.-lbs. ▪ **ACCURACY:** ± 2% ▪ Green light for power on/red light and buzzer for reaching target signal ▪ Red flash for overload signal ▪ Torque set quickly with unique slide bar on the scale ▪ Indexing head allows for use straight (screwdriver position) to spin nut down quickly. Rotate to 90° position to torque and leverage ▪ Torque limit LED flashes with audible beep ▪ Power switch with LED indicator ▪ Uses coin style batteries ▪ Approximately 8.5" long



TUFFY NO.	MFG. NO.	DESCRIPTION
168-38325	3833-25	Electronic TPMS Torque Wrench

## 1/4" SOCKET DRIVER

- Durable screwdriver handle and a chrome vanadium shank ▪ Ideal for use with the TPMS 11mm x 12mm flip socket
- 6" Overall Length, 2-1/2" Shank Length ▪ **MADE IN THE USA**



TUFFY NO.	MFG. NO.	DESCRIPTION
319-72521	7252100	1/4" Socket Driver

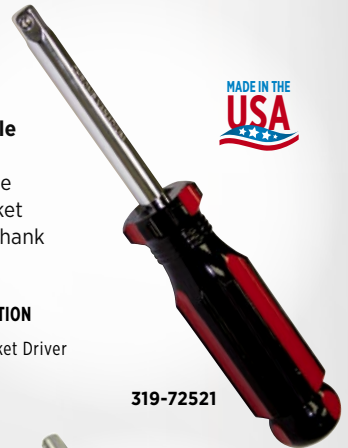

## VALVE CORE TORQUE TOOL

- Preset torque guarantees correct setting every time on all cores ▪ Calibrated to 4 in.-lbs. of torque ▪ Meets the Tire & Rim Association (TRA) specifications for installing valve cores on TPMS applications ▪ Can be used to install and remove cores in standard valves

TUFFY NO.	MFG. NO.	DESCRIPTION
469-00044	TPMS-4VC	1/4" Socket Driver



## SPEED TORQUE TOOLS FOR TPMS

- Never adjust a TPMS torque wrench again
- Durable and long-lasting
- **NO MORE TORQUE ERRORS:** It is either "Hi" or "Low"
- Ergonomically designed hand grip
- Open cross chamber on the 5565 allows for extra leverage bar



TUFFY NO.	MFG. NO.	DESCRIPTION
469-05540	5540	TPMS Speed Torque Wrench: Preset at 40 In./Lbs.
469-05565	5565	TPMS Speed Torque Wrench: Preset at 65 In./Lbs.



VALVE HARDWARE // TPMS TOOLS & ACCESSORIES



➔ Replacement Valves, Valve Caps & Cores

TPMS Tools (cont.)

GROMMET INSTALLATION/REMOVAL TOOL



469-20144

TUFFY NO.	MFG. NO.	DESCRIPTION
469-20144	20144	Grommet Installation/Removal Tool

METAL GROMMET REMOVAL TOOL



▪ Makes grommet and metal washer installation/removal easy and safe ▪ MADE IN THE USA



469-04700

TUFFY NO.	MFG. NO.	DESCRIPTION
469-04700	4700	Meta; Grommet Removal Tool

CORE CAP REMOVAL TOOL



469-20250

TUFFY NO.	MFG. NO.	DESCRIPTION
469-20250	20250	Core/Cap Removal Tool

VALVE CORE TOOLS: SCREWDRIVER TYPE & STANDARD BORE LONG VALVE

▪ Has a plastic screwdriver handle for better grip and leverage



469-00612

469-00607

TUFFY NO.	MFG. NO.	DESCRIPTION
469-00607	607	Screwdriver Type Valve Core Tool
469-00612	612	Standard Bore Long Valve Core Tool

T-10 TORQUE TOOL WITH REPLACEABLE TIP

▪ Installs replacement snap-in valves to Schrader snap-in transmitters  
▪ Preset to 12 in./lbs.

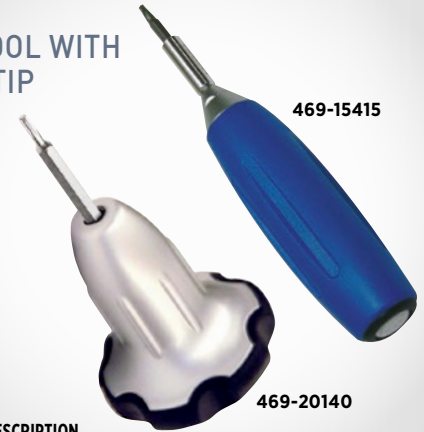

469-15415

469-20140

TUFFY NO.	MFG. NO.	DESCRIPTION
469-15415	15415	T-10 Torque Tool w/ Replaceable Tip
469-20140	20140	T-10 Torque Tool
469-25415	15415-1	Replacement T-10 Tip
469-35415	5415-2	Replacement 7mm Socket for VS-1010 TPMS Snap-In Stem

T-20 TORQUE TOOL WITH REPLACEABLE TIP

▪ Installs replacement Beru clamp-in valves ▪ Preset to 35 in./lbs.



469-15535

TUFFY NO.	MFG. NO.	DESCRIPTION
469-15535	15535	T-20 Torque Tool w/ Replaceable Tip
469-25535	15535-1	Replacement T-20 Tip

VALVE HARDWARE // TPMS TOOLS & ACCESSORIES





➔ Inflator Gauge, Valve Stem Fishing Tool, Tire Deflator, Tire Deflator Set

**DIGITAL TIRE INFLATOR GAUGE**

- **RANGE:** 0-175 PSI ▪ **ACCURATE TO:** +/- 1.2 psi up to 59 psi; +/- 2.3 psi 59-145 psi; 3.6 psi more than 145 psi
- **3-IN-1 FUNCTION:** inflate, deflate and measure tire pressure ▪ Long-life battery with low battery warning signal, Extra battery included ▪ Clip-on chuck with swivel hose to prevent kinking
- Covered with rubber sleeve for extra comfort and durability
- One-button operation



477-00130

TUFFY NO.	MFG. NO.	DESCRIPTION
477-00130	H-30	Digital Tire Inflator Gauge: 21" Hose
477-00136	H-30-6	Digital Tire Inflator Gauge: 6' Hose 1-Year Warranty, <b>Equivalent to Rema H300532P</b>

**TPMS VALVE STEM FISHING TOOL**

- **Secures TPMS sensor to wheel during demount**
- One handle end can be used as a deflator; the other as a core remover ▪ 3" Overall length



469-08910

TUFFY NO.	MFG. NO.	DESCRIPTION
469-08910	8910	TPMS Valve Stem Fishing Tool

**TIRE DEFLATOR/VALVE CORE REMOVER**

- **Screws on TPMS valve stems to deflate the tire without removing the valve core**



469-00021

TUFFY NO.	MFG. NO.	DESCRIPTION
469-00021	TL-615	Tire Deflator/Valve Core Remover

**TIRE DEFLATOR SET FOR TPMS VALVE STEMS**



- **Simply replace a standard sized valve cap with this handy tool and the special design will depress the pin in the valve core** ▪ Large openings on the sides of the tool allow air to escape quickly from the tire ▪ Tools are marked so tires can be returned to their original position on the vehicle so TPMS will not need to be reset ▪ Also saves time since the valve core has not been removed from the sensor ▪ Packaged in a set of 4

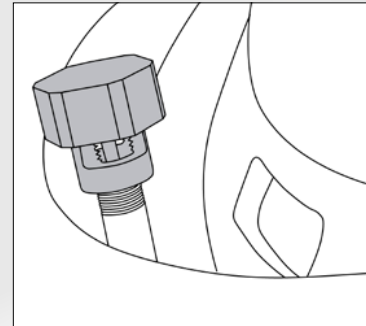

The Tire Deflator Set in use.



469-19860

TUFFY NO.	MFG. NO.	DESCRIPTION
469-19860	19860	Tire Deflator Set for TPMS Valve Stems

VALVE HARDWARE // TPMS TOOLS & ACCESSORIES



TPMS Master Tool Kit, TPMS Mechanical Tool Kits

TPMS Tools (cont.)

TPMS MASTER TOOL KIT



▪ Accurately and quickly install and remove any TPMS component ▪ NO MORE TORQUE ERRORS: Simplest TPMS set available



469-08200

DILL NO. TYPE DESCRIPTION

DILL TPMS MASTER TOOL KIT CONTENTS

DILL NO.	TYPE	DESCRIPTION
4700	TPMS Grommet tool	Easily remove and install TPMS valve stem grommets
5540	Speed Torque 40 IN-LB	Fast and accurate TPMS installer for 45 in./lbs. and below Service Kits
5565	Speed Torque 65 IN-LB	Fast and accurate TPMS installer for 65 in./lbs. and above Service Kits
(w/ 5540 & 5565)	Drive Sockets	11mm and 12mm deep well sockets
5414	Valve Core Torque Tool	Installs valve cores to recommended torque (3.5 in./lbs.)
5415	Torque Screwdriver	Torque T-10 screw installation, 12.5 in./lbs. (i.e. VS-950 rubber stem).
5417	Beru Valve Holding Tool	Holds Beru valve in place for easy installation
5535	Torque Screwdriver	Torque T-20 screw installation, 35 in./lbs. (i.e. VS-80 rubber stem)
8910	3-way Fishing Tool	Retains sensor in a secure position, deflates, removes the core
NA	T-bar	May be used for extra leverage with the speed torque tools
N/A	Case	Hard plastic case to keep all of your items secure

TUFFY NO.	MFG. NO.	DESCRIPTION
469-08200	8200	Dill TPMS Master Tool Kit

TPMS MECHANICAL TOOL KIT



469-04065

DILL TPMS MECHANICAL TOOL KIT CONTENTS

11mm socket	40 in./lbs. Preset Torque Driver
12mm socket	65 in./lbs. Torque Driver

TUFFY NO.	MFG. NO.	DESCRIPTION
469-04065	4065	Dill TPMS Mechanical Tool Kit

TPMS MECHANICAL TOOL KIT

▪ Similar to Bartec WRTMT103



469-10015

TPMS MECHANICAL TOOL KIT CONTENTS

3/8" drive torque wrench	Grommet tool
11mm socket	Multi-purpose grommet tool
12mm socket	T-10 torque tool
Valve core torque tool	T-20 torque tool
TPMS fishing tool	Blow molded case

TUFFY NO.	MFG. NO.	DESCRIPTION
469-10015	TPMKT015	TPMS Mechanical Tool Kit



➔ Banded Transmitter Packages and Accessories

# Banded TPMS Systems

## TPMS BAND TRANSMITTER ACCESSORIES

- **TPMS Band is adjustable to accommodate 14"- 26" wheels**
- **Plastic clip included with TPMS Cradle** ▪ **APPLICATIONS:** For use on vehicles equipped with banded transmitters

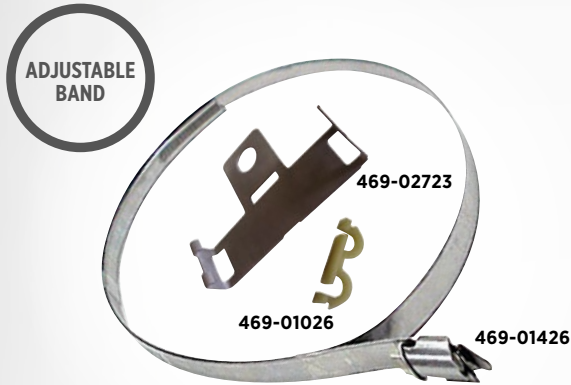

TUFFY NO.	MFG. NO.	DESCRIPTION
469-01026	1026	Plastic Replacement Clip for TPMS Replacement Cradle
469-01426	TPSTRAP	14" - 26" Adjustable Band for Banded TPMS Sensors
469-02723	TPCRADLE	Cradle with Clip for Banded TPMS Sensors

## FORD COMPLETE BANDED TRANSMITTER PACKAGE

- **Replacement transmitter for Ford OE #6F2Z1A189A**
- **INCLUDES:** 461-01048 transmitter, 469-02723 cradle/clip & 469-01426 band



TUFFY NO.	MFG. NO.	DESCRIPTION
469-05105	5105	Complete Banded Transmitter Package

## FORD COMPLETE BANDED HIGH PRESSURE SENSOR PACKAGE

- **Replacement transmitter for Ford OE # 8C2Z-1A189A**
- **INCLUDES:** 461-11048 transmitter w/ cradle and clip & 469-01426 band ▪ *Equivalent to Dill part no. 5105HP*
- **APPLICATIONS:** Pre-June Ford F250/350/450 Super Duty Trucks ▪ Shipped together in a plastic bag

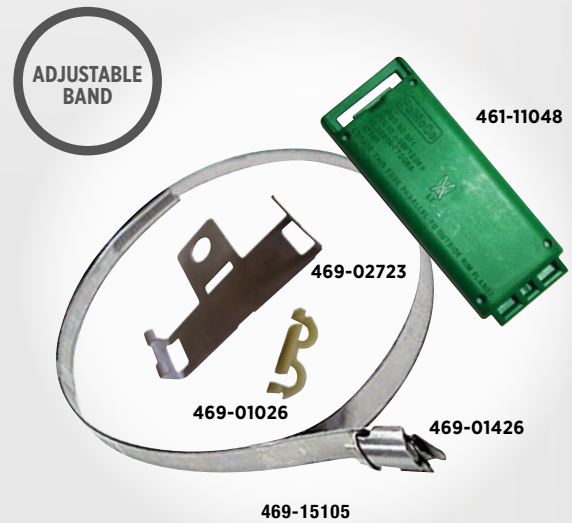

TUFFY NO.	MFG. NO.	DESCRIPTION
469-15105	5105HP	Ford Complete Banded High Pressure Sensor Package

## BAND TRANSMITTER FOR FORD

TUFFY NO.	MFG. NO.	OE PART NO.	DESCRIPTION
461-01048	1048	6F2Z1A189A	Lear Ford Banded Transmitter



## HIGH PRESSURE FORD BANDED TRANSMITTER

TUFFY NO.	MFG. NO.	OE PART NO.	DESCRIPTION
461-11048	1048-HP	8C2Z1A189A	High Pressure Ford Banded Transmitter



VALVE HARDWARE // TPMS TOOLS & ACCESSORIES





# Schrader TPMS Transmitters

## SCHRADER TIRE PRESSURE MONITORING SYSTEM (TPMS) TRANSMITTERS

▪ **INCLUDES:** Transmitter, grommet, nut, cap & core



461-20064



461-20099



461-20335

TUFFY NO.	MFG. NO.	O.E. NO.	DESCRIPTION
461-20028	20028	5208-8990AC	Chrysler Repl. Transmitter
461-20034	20034	MN103081	Mitsubishi Repl. Transmitter
461-20064	20064	40700-CD001	Nissan Repl. Transmitter
461-20069	20069	40700-CK002	Nissan Repl. Transmitter For Vehicles With Steel Wheels
461-20076	20076	25758220	GM 2006 Cadillac & Corvette Repl. Transmitter
461-20077	20077	4D0907275C	Audi, Bentley, Ferrari, MB, Porsche & VW Repl. Transmitter
461-20078	20078	4F0907275B	Audi, Bentley, Porsche & VW Repl. Transmitter
461-20079	20079	4D0907275A	Audi, BMW, MB Porsche & VW Repl. Transmitter
461-20080	20080	36118378682	BMW Repl. Transmitter
461-20081	20081	28103-AG00A	Subaru Repl. Transmitter
461-20082	20082	96484045	Daewoo Repl. Transmitter
461-20083	20083	36236781847	BMW, Mini, Porsche & Rolls Royce Repl. Transmitter
461-20084	20084	224551	Ferrari, Prosche & VW Repl. Transmitter
461-20085	20085	52933-4D200	Hyundai/Kia Repl. Transmitter
461-20086	20086	52933-2G200	Hyundai/Kia Repl. Transmitter
461-20087	20087	4313054J20	Suzuki Repl. Transmitter
461-20088	20088	1K0907253D & E	Audi & VW Repl. Transmitter
461-20089	20089	68038945AA	Dodge Sprinter Van 2007-2009 Repl. Transmitter
461-20090	20090	XR855950, C2C25519	Jaguar & Land Rover Repl. Transmitter
461-20091	20091	LR018860	Jaguar & Land Rover Repl. Transmitter
461-20092	20092	529332M000	Kia Repl. Transmitter
461-20093	20093	GN3A-37-140B	Mazda Repl. Transmitter
461-20094	20094	25407917	Mercedes Repl. Transmitter
461-20095	20095	25408017	Mercedes Repl. Transmitter
461-20096	20096	4L2T-1A150-BA	Ford Small Truck Repl. Transmitter
461-20097	20097	31280297	Volvo Repl. Transmitter
461-20098	20098	42753-STK-A04	Acura, Honda Repl. Transmitter
461-20099	20099	42752SWA306	Honda Repl. Transmitter
461-20100	20100	42753-TP6-A82	Honda 2010 Crosstour Repl. Transmitter
461-20103	20103	4FO-907-275D	Beru Repl. Transmitter Only
461-20107	20107	15114379	GM Large Truck Repl. Transmitter
461-20115	20115	15136883	GM 2004 Large SUV Repl. Transmitter
461-20116	20116	25774005	GM Small Truck Repl. Transmitter
461-20117	20117	25773946	GM Cadillac & Corvette Repl. Transmitter
461-20131	20131	15122618	Hummer Repl. Transmitter
461-20135	20135	5L1Z-1A150-AA	Ford Large Truck Repl. Transmitter
461-20153	20153	70503153	GM Snap-In Type Repl. Transmitter - Complete Unit
461-20156	20156	8651700	Volvo Repl. Transmitter
461-20158	20158	15268606, 10394110	GM 2006 Repl. Transmitter
461-20159	20159	13227143	Saab Repl. Transmitter
461-20161	20161	40700-CK-001	Nissan Repl. Transmitter For Vehicles With Alloy Wheels
461-20213	20213	A0009050030	Mercedes Repl. Transmitter
461-20218	20218	52933-B2100	Kia Repl. Transmitter
461-20223	20223	13581560	GM Repl. Transmitter
461-20228	20228	13581559	GM Repl. Transmitter
461-20280	20280	F2GT-1A180-AB	Ford Repl. Transmitter
461-20281	20281	52933-C1100	Hyundai Repl. Transmitter
461-20284	20284	670002790	Maserati Repl. Transmitter

Schrader TPMS Transmitters continue on the next page ➔

VALVE HARDWARE // TPMS TOOLS & ACCESSORIES





➔ Schrader TPMS Transmitters

TUFFY NO.	MFG. NO.	O.E. NO.	DESCRIPTION
461-20315	20315	9L3Z1189A	Ford 09/10 Snap-In Style Repl. Transmitter Complete Unit
461-20335	20335	04727392AD, 5127-335AB, 5127-335AD, SE57243	Chrysler Siemens Repl. Transmitter
461-20398	20398	56029398AB	Chrysler/Jeep Repl. Transmitter
461-20720	20720	42756TK4 A01	Acura Repl. Transmitter
461-28004	28004	04815132AB	Chrysler Prowler Repl. Transmitter
461-28006	28006	10438853	97-00 Corvette Repl. Transmitter
461-28078	28078	24437708	Saab Repl. Transmitter
461-28081	28081	36106790054	BMW Repl. Transmitter
461-28082	28082	36146752128	BMW, Land Rover Repl. Transmitter
461-28087	28087	99760602120	Porsche Repl. Transmitter
461-28096	28096	4250A225	Mitsubishi Repl. Transmitter
461-28126	28126	36 106 798 872	BMW 3 Series MY2014 Repl. Transmitter
461-28128	28128	42753 TX4 A51	Acura Repl. Transmitter
461-28129	28129	4250A030	Mitsubishi Repl. Transmitter
461-28167	28167	40700JA01A	Nissan Repl. Transmitter O.E. 40700-JA01A
461-28203	28203	28103AG01A	Subaru Snap-In Repl. Transmitter OE 28103AG01A
461-28204	28204	40700JA01B	Nissan Repl. Transmitter O.E. 40700-JA01B
461-28206	28206	20922900	GM/Chevy Repl. Transmitter
461-28210	28210	40700JK00B	Nissan/Infiniti Repl. Transmitter
461-28211	28211	13598787	GM Repl. Transmitter
461-28214	28214	45421518	Mercedes Gen Alpha WALA Repl. Transmitter
461-28239	28239	A4479050500	Mercedes Benz Repl. Transmitter
461-28291	28291	56029400AB	Chrysler Repl. Transmitter
461-28300	28300	426070C010	Toyota Repl. Transmitter
461-28304	28304	31362304	Volvo Repl. Transmitter Snap-in
461-28305	28305	426070C020	Toyota Repl. Transmitter
461-28308	28308	56053036AA	Chrysler Snap-In Repl. Transmitter
461-28310	28310	4260724010	Lexus Repl. Transmitter
461-28315	28315	4260724020	Lexus Repl. Transmitter
461-28320	28320	4260724030	Lexus Repl. Transmitter
461-28325	28325	426724040	Lexus Repl. Transmitter
461-28335	28335	426724040	Lexus & Toyota Repl. Transmitter
461-28342	28342	40700 1PA0A	Nissan Repl. Transmitter
461-28345	28345	4260735010	Lexus & Toyota Repl. Transmitter
461-28355	28355	42607AD020	Toyota Repl. Transmitter
461-28360	28360	4260706011	Toyota Repl. Transmitter
461-28362	28362	31200923	Vovlo Repl. Transmitter
461-28365	28365	4260733011	Lexus, Scion, Toyota Repl. Transmitter
461-28370	28370	4260733021	Lexus & Toyota Repl. Transmitter
461-28380	28380	42607AD010	Toyota Repl. Transmitter
461-28385	28385	6F2Z1A189A	Ford Banded Repl. Transmitter
461-28390	28390	7L1Z1A189A	High-Pressure Ford Banded Repl. Transmitter
461-28395	28395	8C2Z1A189A	Ford Banded Repl. Transmitter
461-28423	28423	20964159	Camaro ZL1 Repl. Transmitter
461-28434	28434	56029319AC	Chrysler Snap-In Repl. Transmitter
461-28461	28461	56029319AC, 68137699AA	Chrysler Snap-In Repl. Transmitter
461-28505	28505	52933-2V000	Hyundai Snap-In Repl. Transmitter
461-28586	28586	68193586AA	Dodge Snap-In Repl. Transmitter
461-28670	28670	426070C050	Toyota Repl. Transmitter
461-28720	28720	42753SNA83	Honda Acura Repl. Transmitter
461-28849	28849	529332F000	Hyundai Kia Repl. Transmitter
461-28981	28981	56029398AB	Acura, Honda Repl. Transmitter
461-28982	28982	06421-S9V-A01	Honda Repl. Transmitter
461-28983	28983	958104D100	Hyundai Repl. Transmitter
461-28984	28984	68239720AA	Chrysler Repl. Transmitter
461-29014	29014	G1ET-1A180-AA	Ford Repl. Transmitter



461-20398



461-28081



461-28308

VALVE HARDWARE // TPMS TOOLS & ACCESSORIES





# Dill TPMS Transmitters

## DILL TIRE PRESSURE MONITORING SYSTEM (TPMS) TRANSMITTERS

▪ **INCLUDES:** Transmitter, grommet, nut, cap & core



461-01048

461-11048



461-01051



461-01057



461-01204



461-06815



461-09011

TUFFY NO.	MFG. NO.	O.E. NO.	DESCRIPTION
461-01027	1027	36236779490	Huf BMW Repl. Transmitter
461-01028	1028	529334D200	Lear Hyundai/Kia Repl. Transmitter
461-01029	1029	529332F000	Entire Kia Spectra/Rio Repl. Transmitter
461-01041	1041	Check VIN	Volkswagen Repl. Transmitter w/ O-Ring Nut
461-01042	1042	68006771AA	Dodge Sprinter Repl. Transmitter
461-01043	1043	68001698AA	Siemens 2008 Chrysler Repl. Transmitter
461-01044	1044	30666931, 6G92-1A159-BB	2007-2008 Volvo Repl. Transmitter
461-01045	1045	LRO32833	2008-2011 Land Rover Replacement Transmitter - 315 MHz
461-01046	1046	Check VIN	Siemens Land Rover/Jaguar Repl. Transmitter - 433 MHz
461-01048	1048	6F2Z1Z189A	Lear Ford Banded Repl. Transmitter
461-01049	1049	Check VIN	Siemens Mercedes Repl. Transmitter - 433 MHz
461-01051	1051	4250A225	Siemens Chrysler Repl. Transmitter
461-01052	1052	Check VIN	Siemens 2004 Chrysler Repl. Transmitter
461-01053	1053	Check VIN	Siemens Volkswagen Repl. Transmitter
461-01054	1054	Check VIN	Siemens Mercedes Repl. Transmitter
461-01055	1055	Check VIN	Siemens Land Rover/Jaguar Repl. Transmitter
461-01056	1056	GN3A-37-140B	Siemens Mazda Repl. Transmitter
461-01057	1057	06421-S3V-A02	Entire Acura/Honda Repl. Transmitter
461-01058	1058	0642SCVA00	Entire Hyundai/Kia Repl. Transmitter
461-01059	1059	0642IS9VA01	Entire Honda Repl. Transmitter
461-01068	1068	59233-2G200	Hyundai/Kia Repl. Transmitter
461-01203	1203	42607-0C010/AD010	Toyota Repl. Transmitter - 40 Degree Angle
461-01204	1204A	42607-33021	Aftermarket Pacific/Toyota Repl. Transmitter
461-01207	1207	42607-0C040/OC060	Toyota Replacement Transmitter
461-01208	1208	42753-SWA-316	Honda Accord/CRV/Fit Repl. Transmitter
461-01209	1209	42753-STK-A04	Honda Pilot/Some Acura Repl. Transmitter
461-01212	1212	42753-SNA-A83	Honda Civic Repl. Transmitter
461-01214	1214	42753-TK4-A01	Honda/Acura Repl. Transmitter
461-01216	1216	40700-1LA0A, 40700-1LA0B, 40700-1LA0C	Nissan Repl. Transmitter
461-01217	1217-WH	42607-24010	Lexus SC 430 White Replacement Transmitter
461-01218	1218	42607-06020	2012 Toyota Camry, Yari Replacement Transmitter
461-01219	1219	42753-SZA-A12	2009-2012 Honda Pilot w/ Steel Wheels Replacement Transmitter
461-01222	1222	52933-3X200	Hyundai Repl. Transmitter - Only Use w/ Bartec Rev.
461-01225	1225	42607-0R010	2014 Highlände/RAV4 RKE Repl. Transmitter
461-01230	1230	42607-06030	2015 Toyota Camry Repl. Transmitter
461-01233	1233	52933-3V000	2012-14 Hyundai Azera Repl. Transmitter
461-01382	1382	40700-EZ00A	Nissan Titan XD Repl. Transmitter
461-02112	2112	6004985	Tesla Replacement Transmitter
461-02168	2168	1034602	2015-16 Tesla Repl. Transmitter
461-02510	2510	52933-A7000	2014-2015 Kia Tucson/Sportage/Forte Repl. Transmitter
461-03205	3205	52933-3X205	Hyundai Elantra 2014-2016 Repl. Transmitter
461-03751	3751	42753-TG7-A51	2016 Honda Pilot Repl. Transmitter
461-05134	5134	31341893	2015 Volvo Repl. Transmitter

Dill TPMS Transmitters continue on the next page ➔

VALVE HARDWARE // TPMS TOOLS & ACCESSORIES





➔ Dill TPMS Transmitters, HUF TPMS Transmitters

TUFFY NO.	MFG. NO.	O.E. NO.	DESCRIPTION
461-05256	5256	36106856209	2014 BMW Repl. Transmitter
461-05328	5328	LR066378	2015 Land Rover Repl. Transmitter
461-05507	5507	52933-2M000, 52933-2L500, 52933-2L700	Hyundai/Kia Repl. Transmitter
461-05508	5508	52933-A5000	2013-2015 Hyundai/Kia Repl. Transmitter
461-05510	5510	52933-3N100	2015 Hyundai Genesis/Santa Fe Repl. Transmitter
461-05511	5511	42753-TP6-A82, 42753-TP6-A82-M1	Honda/Acura Repl. Transmitter
461-05512	5512	42753-TX4-A51	2013 Acura RDX Replacement Transmitter
461-05513	5513	42753-TX6-A81	2013 Acura ILX Replacement Transmitter
461-05514	5514	42753-TZ3-A51	Acura ILX/MDX//RDX/TLX Repl. Transmitter
461-05523	5523	52933-D4100	2017 Hyundai Elantra/Kia Sportage Repl. Transmitter
461-05555	5555	4070-3ANOA	Nissan Replacement Transmitter
461-05556	5556	40700-3JA0A	2013 Nissan Altima/Pathfinder Replacement Transmitter
461-05557	5557	40700-3AN1A	Nissan Replacement Transmitter
461-05558	5558	40700-4GA0A	2014 Infiniti Q50 Repl. Transmitter
461-05559	5559	40700-3VU0A	2014 Nissan Rogue Repl. Transmitter
461-05775	5775	68193586AA	2013 Dodge Dart Replacement Transmitter
461-06815	6815	68157568AB	2014 Dodge Ram/Jeep Cherokee Replacement Transmitter
461-06825	6825	68239725AA	Snap-In Rubber Stem and Sensor for Inner Dual on Dodge Ram
461-06829	6829	68239729AA	Clamp-In Stem and Sensor for Outer Alloy on Dodge Ram
461-09001	9001	A0008223306	HUF RDE 001 Repl. Transmitter for Audi/Mercedes - 433MHz
461-09002	9002	36118378682	HUF RDE 002 Repl. Transmitter for BMW 3/5/7 Series - 433 MHz
461-09003	9003	36146752128	HUF RDE 003 Repl. Transmitter for BMW X5/Land Rover - 433MHz
461-09004	9004	A0008223406	HUF RDE 004 Repl. Transmitter for Mercedes
461-09005	9005	7L0907275	HUF RDE 005 Cayenne/Touareg Replacement Transmitter - 433 MHz
461-09010	9010	N/A	Prevost/Volvo/Nova Bus & ITEC Truck Replacement Transmitter
461-09011	9011	4F0907275D	2010 Audi Repl. Transmitter
461-09012	9012	3610679 054	2010 BMW, Mini Cooper Repl. Transmitter
461-09013	9013	3AA 907 275-B	2013 Volkswagen CC Replacement Transmitter
461-09017	9017	36 10 6 798 872	2013 BMW 3-Series Replacement Transmitter
461-09018	9018	5Q0907275	2014 Panamera Repl. Transmitter
461-09159	9159	1322-7143	2008+ Saab 9-3 Repl. Transmitter
461-09204	9204	40700-1AA0D	Nissan Replacement Transmitter
461-09280	9280	F2GZ-1A189-A	2015 Ford Mustang/F-150 Series Repl. Transmitter
461-09315	9315-625	9L3Z-1A-189A	Ford Replacement Transmitter w/ VS-919 Stem
461-09342	9342	40700-1PA0A	Nissan NV Repl. Transmitter
461-09398	9398	56029398AB	Chrysler Snap-In Replacement Transmitter
461-09481	9481	56029481AB	2012 Jeep Liberty, Wrangler Replacement Transmitter
461-09505	9505	52933-2V000	Hyundai Velostar, Azera Replacement Transmitter
461-11048	1048-HP	8C2Z1A189A	Lear High Pressure Ford Banded Repl. Transmitter
461-11204	1204	42607-33021	Toyota/Lexus Replacement Transmitter
461-11206	1206A	42607-0C050	Aftermarket Pacific/Toyota Repl. Transmitter
461-11217	1217-BL	42607-24020	Lexus SC 430 Blue Replacement Transmitter
461-21217	1217-RD	42607-24030	Lexus SC 430 Red Replacement Transmitter
461-31217	1217-YL	42607-24040	Lexus SC 430 Yellow Replacement Transmitter



HUF TIRE PRESSURE MONITORING SYSTEM (TPMS) TRANSMITTERS

▪ **Two-piece design to adapt to rim configurations**  
 ▪ *Valve insert & transmitter sold separately* ▪ For use with most European vehicles equipped with TPMS. Call for application information.



TUFFY NO.	MFG. NO.	APPLICATION
461-00121	RDE001V21	Alfa Romeo, Audi, Bentley, Ferrari, Maybach, Maserati, Mercedes-Benz, Porsche, Volkswagen
461-00221	RDE002V21	BMW
461-00321	RDE003V21	BMW, Land Rover
461-00421	RDE004V21	Audi, BMW, Maybach, Mercedes-Benz, Porsche, Volkswagen
461-00521	RDE005V21	Ferrari, Porsche, Volkswagen
461-00821	RDE008V21	BMW, Mini
461-01121	RDE011V21	Audi, Bentley, Ferrari, Lamborghini, Maserati, Porsche, Volkswagen
461-01221	RDE012V21	BMW, Mini, Rolls-Royce
461-01321	RDE013V21	Volkswagen
461-01421	RDE014V21	Ford, Lincoln, Mazda, Mercury
461-01521	RDE015V21	Ford, Lincoln
461-01621	RDE016V21	Ford, Lincoln, Mazda, Mercury, VPG
461-01721	RDE017V21	BMW, Mini
461-01821	RDE018V21	Porsche, Volkswagen
461-01921	RDE019V21	Hyundai, KIA
461-02021	RDE020V21	Hyundai, KIA
461-02221	RDE022V21	Audi, Porsche, Volkswagen
461-02341	RDE023V41	Ford, Lincoln, Mazda, Mercury, VPG
461-02721	RDE027V21	BMW, Mini

VALVE HARDWARE // TPMS TOOLS & ACCESSORIES



➔ Dual Band EZ-Sensor, Redi-Sensor Universal Transmitters

# EZ-Sensor & REDI-Sensor TPMS Transmitters



## DUAL BAND EZ-SENSOR

▪ **Designed to eliminate multiple sensors required for TPMS work**  
 ▪ **APPLICATIONS:** Covers most GM, Chrysler, Honda, Nissan, Toyota, Lexus, Scion, Ford, Lincoln, & Mercury vehicles and some Mitsubishi, Subaru & Suzuki vehicles  
 ▪ Fully programmable  
 ▪ *Compatible with Bartec, Schrader and SPX/OTC programming tools*  
 ▪ Replacement aluminum valve stem available separately (469-34000)  
 ▪ 33200 EZ Sensor features Wireless Auto Locate or WAL that allows the vehicle's TPMS system to locate and identify each TPMS sensor's specific location



Covers over 92% of TPMS equipped vehicles

461-33500

TUFFY NO.	MFG. NO.	DESCRIPTION
461-33500	33500	Dual Band EZ-Sensor
461-33501	33500M	Schrader Dual Band EZ- Sensor - Bulk 210 Pack
461-33502	33500-24	Schrader Dual Band EZ- Sensor - Bulk 24 Pack
461-33700	33700	Schrader High-Speed EZ-Sensor



## REDI-SENSOR MULTI-APPLICATION SENSOR

▪ **Installs right out of the box** ▪ No programming required, saving you 8-10 minutes per vehicle  
 ▪ Reduces replacement sensor inventory  
 ▪ Adjustable valve stem design ▪ **Fits over 90% of the market** ▪ No additional training required ▪ *All REDI-Sensors are available in a rubber stem format*

### WORKS WITH EXISTING MAJOR TPMS SCAN TOOLS:

If a shop has the tools to handle OE sensors, it's ready for REDI-Sensor. Unlike other sensors that require the purchase of specialized tools and software upgrades, no additional purchases, training or investments are needed with REDI-Sensor.

It works with all major TPMS scan tools, including ATEQ, Bartec, OTC and T.I.P.S. With REDI-Sensor, technicians can use the OE scan tool procedures for TPMS service – no new service routines are required.

REDI-Sensor saves valuable time during the vehicle relearn process, when using trigger tools that incorporate a hunt mode.

REDI-Sensor uses an "intelligent design" to wake faster and deliver positive results sooner. This prevents the relearn process from timing out, which eliminates the need to redo the procedure.

### BUILT TO DELIVER LONG-LIFE RELIABILITY!



461-07001



461-07002



461-07003



A small sampling of existing major TPMS scan tools that are compatible with the REDI-Sensor Universal Transmitter.

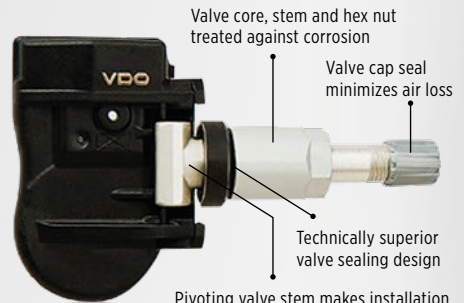

TUFFY NO.	MFG. NO.	DESCRIPTION
461-07001	7001HP	315MHz REDI-Sensor Multi-Application Sensor (Clamp-In Style)
461-07002	7002A	REDI-Sensor for Honda, Hyundai, Kia, Lexus, Toyota & Scion
461-07003	7003A	315MHz REDI-Sensor Multi-Application Sensor (Clamp-In Style)
461-07004	7004	433MHz REDI-Sensor Multi-Application Sensor (Clamp-In Style)
461-07011	7001HP-R	315MHz REDI-Sensor Multi-Application Sensor (Snap-In Style)

VALVE HARDWARE // TPMS TOOLS & ACCESSORIES





➔ HUF Aftermarket TPMS Accessory Kits, HUF Intellisens Universal Sensors

# HUF Intellisens Universal Sensors & Aftermarket TPMS Accessory Kits

## AFTERMARKET TPMS ACCESSORY KITS

TUFFY NO.	MFG. NO.	DESCRIPTION
468-17490	17-490T	TPMS High Temp (Red) Valve Core Nickel Plated
468-17491	17-490TY	TPMS High Temp Valve Core, Nickel Plated, YELLOW Band
468-17492	17-492L-1	Long Skirted Black Plastic Cap with Seal for 17-20008
468-17493	17-493NP	Chrome Plated Plastic Cap, Green Top
468-17592	17-492T-1	Gray Plastic TPMS Valve Cap with Red Silicone Seal
468-17593	17-493P	Chrome Plated Plastic Cap
468-17692	17-492LG-1	Long Skirted GREEN Plastic Cap with Seal for 17-20008
469-17107	17-20107AK	TPMS Parts Kit for GM Applications
469-17198	17-20198AK	TPMS Parts Kit for Dodge Sprinter Applications
469-17205	17-20005AK	TPMS Parts Kit for Nissan Applications
469-17206	17-20006AK	TPMS Parts Kit for GMC, Hummer, Isuzu Applications
469-17207	17-20007AK	TPMS Parts Kit for Nissan, Infiniti Applications
469-17208	17-20008	GM TPMS Rubber Snap-In Valve
469-17209	17-20009AK	TPMS Parts Kit for Saab, Suzuki Applications
469-17210	17-20010AK	TPMS Parts Kit for Volvo Applications
469-17211	17-20011AK	TPMS Parts Kit for Subaru Applications
469-17212	17-20012AK	TPMS Parts Kit for Prowler, Corvette Applications
469-17213	17-20013AK	TPMS Parts Kit for Dodge, Jeep, Chrysler Applications
469-17214	17-20014AK	TPMS Parts Kit for Nissan, Infiniti Applications
469-17215	17-20015AK	TPMS Parts Kit for GM with TRW Clamp-In Sensor
469-17216	17-20016AK	TPMS Parts Kit for Mercedes, Smart Applications
469-17218	17-20018	TPMS Ford Rubber Snap-In Valve
469-17221	17-20201AK	TPMS Parts Kit for Chrysler, GM Applications
469-17222	17-20202AK	TPMS Parts Kit for Audi, Mercedes, Volkswagen Applications
469-17223	17-20203AK	TPMS Parts Kit for Audi, Mercedes Application
469-17224	17-20204AK	TPMS Parts Kit for Acura, Honda, Kia Applications
469-17226	17-20206AK	TPMS Parts Kit for Hyundai, Honda, Kia Applications
469-17227	17-20207AK	TPMS Parts Kit for Volkswagen Applications
469-17228	17-20028AK	TPMS Parts Kit for Chrysler, Dodge, Mitsubishi Applications
469-17235	17-20035AK	TPMS Parts Kit for Honda Applications
469-17236	17-20036AK	TPMS Parts Kit for Acura, Honda, Kia Applications
469-17272	17-20720AK	TPMS Parts Kit for Conti OE Sensors & Redi-Sensor
469-17275	17-20725AK	TPMS Service Kit with Valve
469-17296	17-20096AK	TPMS Parts Kit for Ford Applications
469-17311	17-20211AK	TPMS Parts Kit for Misc. Import Applications
469-17316	17-20216AK	TPMS Parts Kit for Lexus/Toyota Applications
469-17317	17-20217AK	TPMS Parts Kit for Lexus/Toyota Applications
469-17320	17-20020	TPMS Stem Only for Chrysler, Dodge, Mercedes
469-17321	17-20221AK	TPMS Parts Kit for Lexus SC430 Applications
469-17420	17-20020AK	TPMS Parts Kit + Stem for Chrysler, Dodge, Mercedes Applications
469-17539	17-50399	TPMS Snap-In Valve, Hyundai



469-17208



469-17210



469-17211



469-17275

## HUF INTELLISENS UNIVERSAL SENSORS

▪ **Huf IntelliSens Universal Sensors are Configurable (Programmable), Reprogrammable and Copy Clone Capable** ▪ Protocol is already set on the sensor, 3 seconds to configure to specific application ▪ OE equivalent sensor ▪ **ADVANCED SOFTWARE FEATURES INCLUDE:** Temperature readings, rapid pressure loss, and WAL technology for locating tire position ▪ Supported by Bartec and ATEQ TPMS Diagnostic tools ▪ Replacement Valves ▪ Available in Silver, Black and Titanium colors ▪ Available in lengths 43, 48, 49, 51 and 56mm



461-02000

OE EQUIVALENT SENSOR

461-03031

TUFFY NO.	MFG. NO.	APPLICATIONS
461-02000	UVS2000	Audi, Bentley, BMW, Ferrari, Lamborghini, Maserati, Porsche, Rolls-Royce, Volkswagen
461-03030	UVS3030 Metal valve	Acura, Audi, Buick, Cadillac, Chevrolet, Chrysler, Dodge, Ford, Freightliner, GMC, Honda, Hummer, Hyundai, Infiniti, Isuzu, Jaguar, Jeep, Kia, Land Rover, Lexus, Lincoln, Mazda, Mercedes-Benz, Mercury, Mitsubishi, Nissan, Pontiac, Saab, Saturn, Scion, Subaru
461-03031	UVS3031 Rubber valve	Acura, Audi, Buick, Cadillac, Chevrolet, Chrysler, Dodge, Fiat, Freightliner, Hyundai, Infiniti, Isuzu, Jeep, Kia, Lotus, Mercedes-Benz, Mini, Mitsubishi, Nissan, Porsche, Ram, Rolls-Royce, Saab, Saturn, Smart, SRT, Volkswagen, Volvo
461-04030	UVS4030 Metal valve	
461-04031	UVS4031 Rubber valve	

VALVE HARDWARE // TPMS TOOLS & ACCESSORIES



Smart Sensor Pro+ Programming/Scanning Tool, Replacement Sensors & Stems



# Smart Sensor Pro+

## SMART SENSOR PRO+ PROGRAMMING/SCANNING TOOL

- Quickly & easily program Smart Sensor “blank” sensors to emulate the protocol
- Program a Smart Sensor in seconds
- Copies the original sensor ID to Smart Sensor
- Recognized by specific vehicles
- Scans OE sensors
- Upgradeable!
- Replacement Sensors and stems available

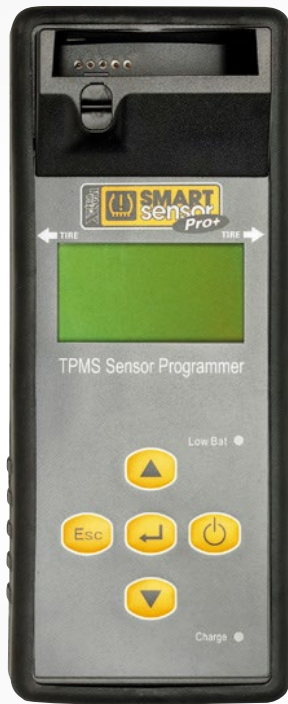

469-17144



The Smart Sensor Pro+ Programming/Scanning Tool with Replacement Sensors\* (available separately).

TUFFY NO.	MFG. NO.	DESCRIPTION
469-17144	17-144	Smart Sensor Pro+ Programming/Scanning Tool

## REPLACEMENT SENSORS AND REPLACEMENT STEMS FOR THE SMART SENSOR PRO+ PROGRAMMING/SCANNING TOOL

- 315 MHz (green) and 433 MHz (brown) are available
- 90% market coverage with 2 sensors
- Easy to use

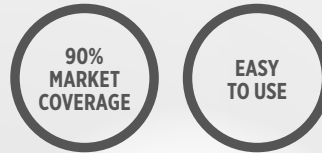

TUFFY NO.	MFG. NO.	DESCRIPTION
461-17431	17-43011	315 MHz Smart Sensor Snap-In (Green)
461-17432	17-43012	433 MHz Smart Sensor (Brown)
461-17433	17-43013	315 MHz Replacement Sensor (Green)
461-17434	17-43014	433 MHz Replacement Sensor (Brown)
469-17436	17-43016	Replacement Smart Sensor Rubber Stem Snap-In Valve
469-17437	17-43017	Gloss Black Replacement Stem
469-17438	17-43018	Black Replacement Stem
469-17439	17-43019	Aluminum Replacement Stem
469-17440	17-43020	Polished Chrome Replacement Stem

VALVE HARDWARE // TPMS TOOLS & ACCESSORIES





➔ Smart Sensor OBDII Module, Auto-Locate Smart Sensor

SMART SENSOR OBDII MODULE

▪ Turns your Smart Sensor Pro+ Tool into a complete TPMS service tool capable of performing both stationary and OBDII relearns ▪ Perform OBDII relearns on Asian and Domestic vehicles where OBDII is required, when installing a new sensor or rotating tires ▪ Download TPMS sensor ID's from the ECU or advanced diagnostics



469-17145

Turns your Smart Sensor Pro+ Tool into a complete TPMS service tool capable of performing both stationary and OBDII relearns.



If you have a 17-144 Smart Sensor Pro+ Scan Tool and you DO NOT have a side port then the 4-piece Smart Sensor OBDII Module Expansion Kit is used in its entirety.

Later tools produced include the side port so it is only necessary to use the cable and the OBDII connector.

TUFFY NO.	MFG. NO.	DESCRIPTION
469-17145	17-144-2	Smart Sensor OBDII Module - 2-Piece Kit

AUTO-LOCATE SMART SENSOR

▪ WAL technology allows the vehicle's TPMS to automatically locate and identify each sensor's specific location on the vehicle ▪ Standard on many Chrysler, Dodge, Jeep, Fiat, Mercedes-Benz and Smart vehicles ▪ These sensors do not require a relearn after tire rotation, sensor replacement or new summer/winter tire changeovers ▪ The Pro+ Tool (updated to software v3.3) will automatically detect when a 17-43024 is loaded in the Cradle and skip the RIGHT WHEEL/LEFT WHEEL step



461-17435

TUFFY NO.	MFG. NO.	DESCRIPTION
461-17435	17-43024	Black 433 MHz Auto-Locate Smart Sensor



Please contact us for more information regarding TPMS Sensors

VALVE HARDWARE // TPMS TOOLS & ACCESSORIES



# TPMS Retrofit Kits, TPMS Systems

## SCHRADER TPMS RETROFIT KITS



▪ For installation on vehicles not equipped with OE TPMS Systems ▪ Stand-alone kit includes dash mounted display ▪ Four wheel mounted transmitters and installation instructions

## DILL TRAILER TPMS SYSTEMS



▪ Dill's aftermarket Trailer TPMS is available in 2-wheel and up to 10-wheel combinations ▪ 4 optional valve stems that attach to the sensors are available for different wheel styles ▪ Protect the goods you tow, Increase fuel economy and extend tire life



469-20256



469-20257



The display on the Dill Trailer TPMS System.



469-02453

469-04416

TUFFY NO.	MFG. NO.	DESCRIPTION
469-20154	20154	Replacement Sensor for Retrofit Kits
469-20256	20256	Battery Operated
469-20257	20257	Hard-Wired

TUFFY NO.	MFG. NO.	DESCRIPTION
469-02453	1502-453	Trailer TPMS Kit, Two (2) Wheels, 0.453" Rim Hole Diam.
469-04416	1504-416	Trailer TPMS Kit, Four (4) Wheels, 0.453" Rim Hole Diam.
469-04572	1504-572	Trailer TPMS Kit, Four (4) Wheels, 0.625" Rim Hole Diam.
469-06453	1506-453	Trailer TPMS Kit, Six (6) Wheels, 0.453" Rim Hole Diam.
469-06572	1506-572	Trailer TPMS Kit, Six (6) Wheels, 0.625" Rim Hole Diam.
469-08453	1508-453	Trailer TPMS Kit, Eight (8) Wheels, 0.453" Rim Hole Diam.
469-08572	1508-572	Trailer TPMS Kit, Eight (8) Wheels, 0.625" Rim Hole Diam.
469-10453	1510-453	Trailer TPMS Kit, Ten (10) Wheels, 0.453" Rim Hole Diam.
469-10572	1510-572	Trailer TPMS Kit, Ten (10) Wheels, 0.625" Rim Hole Diam.

VALVE HARDWARE // TPMS TOOLS & ACCESSORIES



# Training & Promotional Materials

## TIA TPMS RELEARN CHART

▪ **Features information on vehicles equipped with TPMS** ▪ Laminated Flip Chart designed to provide accurate information on all aspects of TPMS applications, including relearn procedures ▪ Chart is divided into Domestic & Import vehicle sections ▪ **CHART PROVIDES THE FOLLOWING INFORMATION:** The **type of TPMS**, whether direct or indirect; three columns of data that indicate when a system relearn is necessary; a **relearn summary** (this includes a reference number that corresponds to the vehicle's procedure for initiating sensor relearn mode); the **sensor manufacturer**; **replacement part numbers**; the **torque specifications** for the sensor nut, torx bolt, worm gear and lug nuts are listed

DOMESTIC & IMPORT SECTIONS

LAMINATED FLIP CHART



TIA TPMS Relearn Chart



Snapshots of what is included in the TIA TPMS Relearn Chart.



## TPMS DESKTOP

▪ **The TPMS Desktop is a free utility available to Bartec tool users** ▪ This application “ties it all together” for easy and efficient TPMS service ▪ Use the Desktop to update your tool, download TPMS audit reports, look up vehicle data, operate the TPMS Pad, and look up TSB’s and Videos



TUFFY NO.	MFG. NO.	DESCRIPTION	469-60110
469-60110	WRTPMSDT	Free Download Tool and TPMS Support Application	

## TRAINING DVD KIT

▪ **This 90 minute, 2 DVD set is chocked full of TPMS basics! Get familiar with terminology, concepts, and how systems work, with this comprehensive training kit** ▪ The workbook guides you through the concepts and serves as a reference guide ▪ *A TIA chart is included as an added source of reference*

### TRAINING DVD KIT CONTENTS

- 90-Minute DVD Set
- Workbook
- TIA Relearn Chart

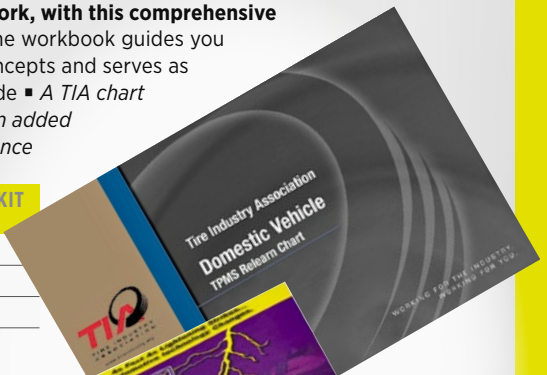

469-60116

CHOCK FULL OF TPMS BASICS

TIA CHART INCLUDED

TUFFY NO.	MFG. NO.	DESCRIPTION
469-60116	WRTRKIT6	2 DVD Kit with workbook and TIA Chart

VALVE HARDWARE // TPMS TOOLS & ACCESSORIES



TPMS Consumer Kit, Training DVD, Countertop Display

Training & Promotional Materials (cont.)



TPMS CONSUMER KIT

▪ It's not enough to have the right tools, the right training and the right support - you **MUST** be able to "TALK TPMS" with your customers ▪ Being able to explain why TPMS exists, how it works, its benefits and impact on SAFETY, and how your company provides TPMS service, will help you sell more TPMS service!

TPMS CONSUMER KIT CONTENTS

8' Shop Banner	Counter-top Tri-fold Display
Counter Mat	Two Different Informative Tri-folds
Mouse Pad	Talking TPMS Handbook



469-60111

TUFFY NO.	MFG. NO.	DESCRIPTION
469-60111	WRTCNK001	Consumer based information products



Call for details on a complete line of TPMS point-of-purchase displays and training materials.



SCHRADER TPMS TRAINING DVD

▪ Available in both English and Spanish versions  
▪ Call for more details



491-21355

TUFFY NO.	MFG. NO.	DESCRIPTION
491-21355	21355	Training DVD (English Version)
491-21357	21357	Training DVD (Spanish Version)



DILL 9700 TPMS DISPLAY

▪ TPMS Educational Counter Display with reasons why to replace service kits on back ▪ 6" X 6.5" ▪ Dummy sensor included as a visual reference ▪ Display explains in common terms the individual components that are involved in the installation of sensors and why these components should be replaced each time the tire is disassembled ▪ Provides a photograph of the universal "horseshoe" symbol that indicates the existence of TPMS ▪ Some assembly required



469-09700

TUFFY NO.	MFG. NO.	DESCRIPTION
469-09700	9700	TPMS Educational Counter Display



TPMS Consumer Brochures, TPMS Cabinets

TPMS TRI-FOLD  
CONSUMER BROCHURE,  
BROCHURE HOLDER



469-22006



717-00400

TUFFY NO.	MFG. NO.	DESCRIPTION
469-22006	469-22006	Schrader TPMS Consumer Brochure
717-00400	W40A	Clear Plastic Brochure Holder



DILL TPMS CONSUMER BROCHURE

Consumer Brochure to educate today's driver on TPMS and why it must be maintained during tire service



469-05708

TUFFY NO.	MFG. NO.	DESCRIPTION
469-05708	5708	Dill TPMS Consumer Brochure

Cabinets

DILL TPMS CABINETS



Fully stocked 15-drawer TPMS kit cabinets.

Fully stocked 15-drawer TPMS kit cabinets with 180 pieces. Assortment includes the top moving service kits for maximized coverage. Metal cabinet is 17" X 11" X 11" and is mountable.



469-05112

Fully stocked dual 15-drawer TPMS kit cabinet with 475 pieces for the most coverage, with 34 different kits and stems. Each metal cabinet is mountable or stackable.



469-15112

TUFFY NO.	MFG. NO.	DESCRIPTION	DIMENSIONS
469-05112	5112A	Dill TPMS Service Kit Assortment - 180 Pcs.	17" X 11" X 11"
469-15112	5112M	Dill TPMS Service Kit Assortment - 475 Pcs.	17" X 22" X 11"

VALVE HARDWARE // TPMS TOOLS & ACCESSORIES





# Tubeless Tire Valves (Passenger)

## SNAP-IN TUBELESS TIRE VALVES

▪ Dill, Schrader or equivalent available



Dill Signature Cap



TR412 TR415 TR413

TUFFY NO.	TR NO.	EFFECTIVE LENGTH
FOR .453" VALVE HOLES		
461-00412	412	7/8"
461-00413	413	1-1/4"
461-00414	414	1-1/2"
461-00418	418	2"
461-00423	423	2-1/2"

TUFFY NO.	TR NO.	EFFECTIVE LENGTH
FOR .625" VALVE HOLES		
461-00415	415	1-1/2"
461-00425	425	2"



TR414 TR418 TR423

## CHROME-SLEEVE SNAP-IN TYPE TUBELESS TIRE VALVES

▪ Standard snap-in type tubeless tire valves are fitted with an attractively designed hexagon valve cap and chrome sleeve to cover the valve stem area ▪ Available in two lengths to fit .453" valve holes

TUFFY NO.	TR NO.	EFFECTIVE LENGTH
461-41211	412SC	7/8"
461-41311	413SC	1-1/4"
461-41811	418SC	2"



461-41311

## HIGH PRESSURE SNAP-IN VALVES

▪ Tubeless snap-in type valves for high pressure applications ▪ Maximum cold inflation pressure is 80 PSI ▪ For .453" or .625" rim holes ▪ Do not use on tire rims that exceed .205" in thickness at the valve hole

TUFFY NO.	TR NO.	EFFECTIVE LENGTH	VALVE HOLE DIAMETER
461-00600	600HP	1.27"	.453"
461-00602	602HP	2"	.453"
461-00801	801HP	1.25"	.625"
461-00802	802HP	2"	.625"



461-00600

461-00602

## CLAMP-IN TUBELESS TIRE VALVES

▪ Nickel plated metal valves can be installed in all passenger cars, light trucks and industrial rims with .453" or .625" valve holes ▪ Rubber grommet forms a seal when valve is clamped to rim by tightening hex nut ▪ Maximum inflation pressure is 200 PSI ▪ Includes 2 rubber grommets

TUFFY NO.	TR NO.	EFFECTIVE LENGTH
462-00416	416	1-1/4"
461-01416	416L	2"



462-00416

## REPLACEMENT GROMMETS

▪ Replacement grommets for .453" and .625" valve holes

TUFFY NO.	TR NO.	EFFECTIVE LENGTH
468-59765	RG-54	Grommet for .453" Hole
468-99393	RG-39	Grommet for .625" Hole



468-59765

## HIGH PERFORMANCE VALVE

▪ Chrome plated clamp-in valves are easily installed in all types of passenger car wheels ▪ For .453" or .625" valve holes

TUFFY NO.	MFG NO.	DESCRIPTION
462-00800	VS-944	High Performance Valve



462-00800

## ENKEI VALVES



▪ A high performance "No Show" type chrome plated valve that installs from the outside ▪ A rubber washer and nut are on the inside ▪ Fits .453" diameter hole

TUFFY NO.	MFG NO.	DILL NO.	DESCRIPTION	462-06020
462-06010	TV-6010	VS-934E	3/4" Length, Standard	
462-06020	TV-6020	VS-933E	Bent at 45° Angle	
462-06030	TV-6030	VS-936E	1-1/4" Length, Standard	
462-06040	TV-6040	VS-935E	1-3/4" Length, Standard	



462-06040

## HIGH PRESSURE CHROME SLEEVE TIRE VALVE

▪ Used to 80 PSI cold inflation pressure ▪ Fits 453" diameter valve hole, maximum rim thickness .205" at valve hole ▪ Chrome sleeve

TUFFY NO.	TR NO.	DESCRIPTION
461-01600	600HPC	High Pressure Chrome Sleeve Tire Valve



461-01600



**IMPORTANT:** Snap-in passenger valve stems are safe for tire pressures up to a maximum of 65 PSI (cold tire pressure) and for a maximum rim thickness of .156" (3.9mm). If greater pressure or rim thickness is required, metal clamp-in valve stems are recommended.

VALVE HARDWARE // VALVES & VALVE TOOLS





➔ Tubeless Tire Valves, Nitrogen O-Ring & Sleeves, Replacement Valve Components

# Tubeless Tire Valves (Truck)

## TRUCK & BUS TUBELESS TIRE VALVES: 570 SERIES

- Used on both demountable and non-demountable rims with standard 5/8" (.625") side hole valve mountings
- Heavy duty rubber grommet forms airtight seal when valve is clamped in rim by tightening the hex nut
- Eight valves cover all truck rim requirements
- Available in custom bends
- Dill or Haltec equivalent available

TUFFY NO.	TR NO.	EFFECTIVE LENGTH
463-00575	575	1-1/8"
463-00501	501	1-1/2"
463-00500	500	2"
463-00570	570	3-1/8"
463-00571	571	3-3/8"
463-00572	572	3-3/4"
463-00573	573	4-3/8"
463-00574	574	5"



## ALUMINUM WHEEL TRUCK TUBELESS TIRE VALVES: 540 & 550 SERIES

- Designed for use with 9.7mm (.382") rim hole
- Rubber O-ring forms a seal when valve is clamped to rim by tightening hex nut
- Designed specifically for use in aluminum wheels
- Dill or equivalent available
- 550 Series equipped with rubber grommet

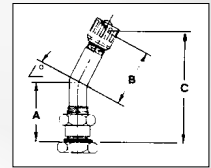

TUFFY NO.	TR NO.	A	B	C
<b>540 SERIES</b>				
463-00542	542	1.25"	—	—
463-00543	543	2.31"	—	—
463-00544	544	2.86"	—	—
463-00545	545	3.50"	—	—
463-00546	546	4.25"	—	—
463-01544	544C	0.86"	1.94"	45°
463-05433	543C	0.93"	1.43"	45°
463-05434	543D	0.98"	1.38"	60°
463-05435	543E	0.98"	1.38"	75°
463-05444	544D	0.98"	1.94"	60°
463-05454	545D	0.98"	2.60"	60°
463-05464	546D	0.98"	3.35"	60°
463-05465	546E	0.98"	3.35"	75°
463-05474	547D	0.98"	3.78"	60°
463-15454	545E	0.98"	2.60"	75°
463-54636	546-36	0.98"	3.35"	36°
468-10060	RG-60	Repl. O-Ring TR-540 Series		

TUFFY NO.	TR NO.	A	B	C
<b>550 SERIES</b>				
463-00552	552	1.25"	—	—
463-00553	553	2.31"	—	—
463-01553	553C	0.93"	1.43"	45°
463-02553	553D	0.98"	1.38"	60°
463-03553	553E	0.98"	1.38"	75°
463-02554	554D	0.98"	1.94"	60°
463-01555	555D	0.98"	2.60"	60°
463-02555	555E	0.98"	2.60"	75°
468-10070	RG-70	Grommet for 550 Series		

## REPLACEMENT VALVE COMPONENTS

- Packaged 100 per Box

TUFFY NO.	DILL NO.	DESCRIPTION
468-00103	100-TB	Dill Replacement Core
468-00462	462G	Dill Green High Temp Grommet
468-00765	765	Dill Replacement Dome Cap
468-01462	462-F	Dill Red High Temp Grommet (-50F to 400F)
468-02462	462	Dill Black Rubber Grommet
468-05952	595-2	Replacement Washer
468-05953	595-3	Replacement Grommet
468-05954	595-4	Replacement Hex Nut

## TUBELESS VALVES FOR ALUMINUM DISC WHEELS

- For drop-center aluminum disc wheels with 5/8" bottom valve hole

TUFFY NO.	TR NO.	EFFECTIVE LENGTH
463-00509	509	4-3/4"
463-00510	510	5-1/2"
463-00511	511	4-1/4"
468-05093	509-3	Replacement Rubber Grommet



## METRIC RIM HOLE VALVES (9.7MM VALVE HOLE)

- Some imported trucks will have steel wheels that incorporate the 9.7mm valve hole (.382")
- Most popular valves for this application
- Other sizes available upon request

TUFFY NO.	MFG NO.	ETRTO	BEND	A	B
462-04100	41 MS-00	V3-20-1	STR	1-3/16"	—
462-06027	60 MS-27	—	27°	1-3/16"	1-3/16"
462-07025	70 MS-27	V3-20-5	27°	1-3/16"	1-9/16"
462-08027	80 MS-27	V3-20-7	27°	1-3/16"	2"
462-09027	90 MS-27	V3-20-4	27°	1-3/16"	2-3/8"
462-11527	115 MS-27	V3-20-6	27°	1-3/16"	3-3/8"
468-00707	70 MS-7	—	7°	—	—



## NITROGEN O-RING & SLEEVES

- Fits 540 and 570 Truck Valves
- Nitrogen use in truck tires

TUFFY NO.	TR NO.	DESCRIPTION
468-00307	TS-OR	O-Ring
468-00607	NITSLV	Indicator Sleeves

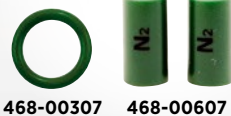

➔ Tire Valves, Repair Valves, Valve Breaker

# Truck & Specialty Valves

## RADIAL COMMANDER VALVE FOR 15" DISC WHEELS

▪ **23° bend clamp-down valve for .625" valve hole** ▪ Bend allows clearance of brake drum for tire service ▪ *Cap and core not included*

TUFFY NO.	MFG NO.	DESCRIPTION
462-01147	VS-1223R	Radial Commander Valve. Made in the USA.
462-01224	VS-1224	Longer Radial Commander Valve for Equal Applications



462-01224

## VALVE FOR 16 X 6KS WITH OVAL HOLE

▪ **Oval rim slot valve for 16 x 6KS and 16 x 6-1/2LS rim contours** ▪ Allows a positive seal in this special valve hole ▪ *Check the valve hole for metal burrs prior to installation*

TUFFY NO.	MFG NO.	DESCRIPTION
462-05010	H5010V	Oval Rim Slot Valve



462-05010

## TRUCK/BUS SCREW-ON REPAIR VALVES

▪ **Replace damaged cured-in or cured-on valves without cutting out old valve base** ▪ 1-1/16" horizontal diameter

TUFFY NO.	MFG NO.	EFFECTIVE LENGTH
463-01177	1177A	3-3/4"
463-01175	1175A	4-1/2"
463-01078	1078A	5"



463-01078

## TRACTOR FRONT WHEEL VALVES

▪ **Low profile valve offers minimum protrusion above the rim** ▪ 9/16" effective length with chrome finish ▪ Fits .453" or .625" valve holes

TUFFY NO.	MFG NO.	DESCRIPTION
462-06008	TV-6008C	Tractor Front Wheel Valve With Chrome Finish
462-16008	TV-6008	Tractor Front Wheel Valve With Brass Finish



462-06008

## TUBELESS MOTORCYCLE VALVE

▪ **Has O-ring seal** ▪ Fits .327" valve holes  
▪ **EFFECTIVE LENGTH: 1-13/16"**

TUFFY NO.	MFG NO.	DESCRIPTION
462-00430	TR-430	Tubeless Motorcycle Valve



462-00430

## ALLOY VALVE

▪ **Light alloy valve used on racing and light alloy wheels** ▪ Fits .453" valve hole ▪ Has O-ring seal

TUFFY NO.	MFG NO.	DESCRIPTION
462-00523	H-523MS	Alloy Valve



462-00523

## SPECIAL CLAMP-IN TIRE VALVE

▪ **Designed for front wheel drive Toronado ('66-'78) and Eldorado ('67-'78) cars**

TUFFY NO.	MFG NO.	DESCRIPTION
462-00417	417	Special Clamp-In Tire Valve



462-00417

## VALVE BREAKER

▪ **Removes valves quickly** ▪ Slide hammer with an internal spring absorbs the shock of impact  
▪ **Easy to use** ▪ Designed to shear the bottom flange off the valve with one or two blows



469-32012

TUFFY NO.	MFG NO.	DESCRIPTION
469-35934	35934	27" Valve Breaker
469-32011	35936	45" Valve Breaker
469-32012	35935	Valve Breaker Parts Kit

469-32011

VALVE HARDWARE // VALVES & VALVE TOOLS



➔ Ford "F" Series Truck Valves & "Cut-Away" Valves, Truck Valve Stem Removal Tool



**FORD "F" SERIES TRUCK VALVE**

- Ford F-Series Trucks with inner dual wheels
- Sealing metal cap
- 0.453" valve hole
- Torque 25-45 inch/lbs.

TUFFY NO.	MFG NO.	DESCRIPTION
462-00962	VS-962C	Ford "F" Series Truck Valve



462-00962

**FORD "F" SERIES TRUCK VALVE**

- Ford "F" series with dual wheels
- Accuride steel 16" x 16"
- Front and rear wheels
- Nickel finish
- Includes dual seal cap

TUFFY NO.	MFG NO.	DESCRIPTION
462-02416	TV-416MC	Ford "F" Series Valve



462-02416

**FORD "F" SERIES TRUCK VALVE**

- Ford "F" series with dual wheels
- Alcoa aluminum 16"
- Front and rear wheels
- Chrome finish
- Includes dual seal cap

TUFFY NO.	MFG NO.	DESCRIPTION
462-01600	N-1600	Ford "F" Series Truck Valve



462-01600

**FORD "F" SERIES VALVE**

- Ford "F" series with dual wheels
- Accuride steel 19.5"
- Front and rear wheels
- Nickel finish
- Includes dual seal cap

TUFFY NO.	MFG NO.	DESCRIPTION
462-03416	TV-416/DS-1	Ford "F" Series Valve



462-03416

**NUT SPLITTER**

- Removes brass tire valves from truck rims
- Available in manual and pneumatic

TUFFY NO.	MFG. NO.	DESCRIPTION
469-00580	NS58B	Manual Nut Splitter
469-00590	NS59B	Pneumatic Nut Splitter. Attaches To Pneumatic Hammer

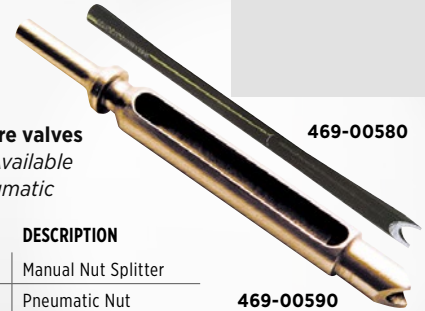

469-00580

469-00590

**FORD "CUT-AWAY" SERIES VALVE**

- Ford "cut-away" series with dual wheels
- Accuride steel 16" x 16"
- wheels
- Front and rear wheels
- Nickel finish
- Includes dual seal cap

TUFFY NO.	MFG NO.	DESCRIPTION
462-01416	TV-416LF	Ford "F" Series Valve



462-01416

**FORD "CUT-AWAY" AND CARGO VAN SERIES VALVE**

- Ford "cut-away" and Cargo van series with single rear wheels
- Accuride steel 16" x 7"
- wheels
- Front and rear wheels
- Chrome Finish

TUFFY NO.	MFG NO.	DESCRIPTION
462-01575	TV-575HP/DS-1	Ford "Cut-Away" & Cargo Van Series



462-01575

**VALVE BLASTER TRUCK VALVE STEM REMOVAL TOOL**

- Removes valves quickly
- Slide hammer with an internal spring absorbs the shock of impact
- Easy to use
- Designed to shear the bottom flange off the valve with one or two blows
- OAL - 63"

TUFFY NO.	MFG. NO.	DESCRIPTION
469-22011	VB	Valve Blaster Truck Valve Stem Removal Tool
469-22012	RE	Replaceable End for Valve Blaster Truck Stem Removal Tool



469-22011

VALVE HARDWARE // VALVES & VALVE TOOLS



➔ Valve Nut Torque Wrenches

Truck & Specialty Valves (cont.)



VALVE NUT TORQUE WRENCH

▪ These wrenches give the user two sensory identifiers indicating to the user that the application of torque has been achieved for tightening the fastener ▪ Both a tactile impulse and a visual indicator alert the user that complete and proper torque has been applied

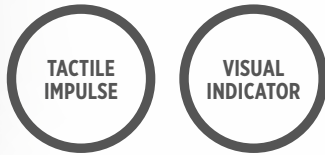

168-01942



The Valve Nut Torque Wrench in use.

TUFFY NO.	MFG. NO.	DESCRIPTION
168-01942	CTP-150-1-9-42	Valve Nut Torque Wrench - 9/16" - Visual indicating torque wrench for TR570 series tire valves. Preset at 42 in./lbs.
168-10100	CTP-150-1-10-100	Valve Nut Torque Wrench - 5/8" - Visual indicating torque wrench for TR540 & TR550 series tire valves. Preset at 100 in./lbs.

SLIMLINE VALVE NUT TORQUE WRENCH

▪ **OPERATING RANGE:** 40-180 in./lbs. (4-20 Nm)  
 ▪ **ACCURACY:** +/- 4% ▪ Perfect for TPMS applications  
 ▪ Traceable calibration certificate supplied to satisfy ISO 9000 quality systems ▪ High quality 72-tooth ratchet allows use in confined spaces ▪ Production 'P' Type versions designed to discourage unauthorized alteration ▪ Wide variety of end fittings available, to suit most applications  
 ▪ Unmistakable signal when set torque is reached ▪ Ends sold separately and not included with 11126 Torque Wrench



168-11126

TUFFY NO.	MFG. NO.	DESCRIPTION
168-11126	11126	Slimline Valve Nut Torque Wrench
<b>AVAILABLE ENDS FOR SLIMLINE VALVE NUT TORQUE WRENCH</b>		
168-29706	29706	9/16" Open End
168-29731	29731	9/16" Ring End
168-29756	29756	9/16" Flare End
168-29707	29707	5/8" Open End
168-29732	29732	5/8" Ring End
168-29757	29757	5/8" Flare End

VALVE HARDWARE // VALVES & VALVE TOOLS



➔ Truck Valves, Truck Valve Tool Kit



**O-RING SEAL SILICONE TRUCK VALVES**

- **Handles any type of high temp application**
- Operating temperature from -67° F to 500° F
- Seals between the rim and valve more effectively
- **REPLACEMENT O-RINGS**



**AVAILABLE:** RG-150 (468-30015)

TUFFY NO.	MFG. NO.	DESCRIPTION
463-01571	VS-571-EQ	O-Ring Silicone Truck Valve for TR571
463-01572	VS-572-EQ	O-Ring Silicone Truck Valve for TR572
463-01573	VS-573-EQ	O-Ring Silicone Truck Valve for TR573
469-02570	VS-570EQ	O-Ring Silicone Truck Valve for TR570
469-02572	VS-572EQ-13	O-Ring Silicone Truck Valve for TR572 - 13° Bend
469-02573	VS-573EQ-13	O-Ring Silicone Truck Valve for TR573 - 13° Bend



*Air Tight Solutions*

**HIGH TEMPERATURE BRASS VALVES W/ VITON O-RINGS**

- **Perfect for all applications**
- Does not need to be changed between tire changes (Green product for the environment)
- Can be bent after installation without O-ring damage
- Operating temperature from -130° F to 4000° F
- **REPLACEMENT BRASS GROMMETS WITH O-RINGS AVAILABLE:** AS100-1 (fits all TR valves)
- **REPLACEMENT O-RINGS AVAILABLE:** AS100-OR
- Eliminates the labor of removing wheels in order to re-tighten a valve stem nut
- Eliminates flat repair charges due to leaking valve stem grommets
- Less time spent maintaining air pressure

TUFFY NO.	MFG. NO.	DESCRIPTION
463-10001	AS-100-1	Brass Grommet w/Viton O-Rings (Fits all TR Valves)
463-10572	AS-100-572	TR572 w/Brass Grommet & Viton O-Ring
463-10573	AS-100-573	TR573 w/Brass Grommet & Viton O-Ring
468-10002	AS-100-OR	Replacement Viton O-Rings for AS100



463-10001



**DILL TRUCK VALVE TOOL KIT**

- **Tool Kit for alloy and steel truck wheels**
- Allows you to accurately inspect, gauge and install truck valves with pre-set torque tools
- Follows industry guidelines and valve hole measurements
- Included industry-recognized truck valve stem installation procedures poster is 34" x 22" in size and is printed on heavy poster paper with gloss

**DILL TRUCK VALVE TOOL KIT CONTENTS**

540G & 570G Go/No-Go Gauges	572G-6 T-Handle Hex Tool to hold base of stems
T-540 & T-570 Preset Torque Wrenches	Industry-Recognized Truck Valve Stem Installation Procedures Poster



469-05720

TUFFY NO.	MFG. NO.	DESCRIPTION
469-05720	5720	Dill Truck Valve Tool Kit
469-15720	5720-Poster	Dill Truck Valve Installation Poster

VALVE HARDWARE // VALVES & VALVE TOOLS



➔ Valve Cores, Valve Caps

# Valve Caps, Cores & Extensions

## STANDARD VALVE CORES

▪ Valve cores all have .206"-36" threads and are compatible with existing U.S.A. and E.T.R.O. housing standards as well as proposed I.S.O. standards -meets specification ZZ-V-25 and TR C-1 ▪ 5405V recommended for all truck, bus and commercial applications; general purpose heat-resistant applications ▪ 8500TV for general purpose valve use ▪ **STANDARD PACK QUANTITY: 100**



TUFFY NO.	MFG. NO.	OPERATING PRESSURE RANGE	OPERATING TEMP RANGE (F)	OPENING PRESSURE	PLUG SEALING MATERIAL	PLUNGER SEALING MATERIAL
468-00103	100-TP	Up to 300 PSI Max	-65° To +250°F	80 PSIG	Teflon	Silicone
468-08500	8500TV	0-200 PSI - Peaks Of 300	-40° To +225°F	60 PSIG	Green Teflon	Black Nitrile



## PASSENGER VALVE CAPS



468-06300 468-00635 468-00650

TUFFY NO.	MFG. NO.	DESCRIPTION	QTY./BOX
468-06300	630N	Gray Plastic TPMS Cap (Tall)	100
468-00635	635	Black Plastic TPMS Cap for VS950 Applications	100
468-00650	650	Gray Plastic TPMS Cap (Short)	100

## PASSENGER VALVE CAPS

▪ Fits .305"-32" threads on standard type valves



TUFFY NO.	MFG. NO.	DESCRIPTION	TR NO.	PACK SIZE	FINISH
468-00107	Cap-P	Plastic Valve Cap	-	100	Plastic
468-00207	CAP-PG	Green Plastic Nitrogen Cap	-	100	Plastic
468-00660	VC8	Standard Black Plastic Valve Cap	VC8	-	Plastic
468-00680	680	N2 Aluminum Cap for TPMS With Adhesive Green Ring	-	100	Aluminum
468-00690	690	N2 Plastic Painted Metallic Silver Cap for TPMS With Adhesive N2	-	100	Plastic
468-05005	2413CS	Combination Cap/Sleeve for TR413	TR413	-	Chrome
468-59019	59-0019	Green Nitrogen Indicating Aluminum Valve Cap	-	100	Aluminum
468-59021	59-0021	Chrome Plated Nitrogen Indicating Brass Valve Cap	-	100	Aluminum

## DOUBLE SEALING VALVE CAPS

▪ Light weight design uses both high temperature and low temperature resistant airtight seals at extension tip and valve mouth ▪ External grooves accommodate all industry standard air chucks and gauges ▪ Knurled surface for easy hand installation ▪ Nickel plated for better appearance and improved corrosion protection ▪ Brass or plated, grooved or knurled ▪ Increases productivity ▪ **MADE & TESTED IN THE USA**



468-26541



468-16541



TUFFY NO.	MFG. NO.	DESCRIPTION	QTY./BOX
468-06541	6541N	Double Seal Valve Cap	50
468-16541	6541N	Double Seal Valve Cap	250
468-26541	6541N2	Double Seal Cap for Nitrogen	250

## TRUCK VALVE CAPS



TUFFY NO.	MFG. NO.	DESCRIPTION	TR NO.	SEALING WASHER MATERIAL	OPERATING PRESSURE	OPERATING TEMP RANGE (F)	PACK SIZE	FINISH
468-00765	765	Dill Dome Cap	VC3	Nitrile	0-200 PSI	-40° To +165°F	100	Nickel Plated
468-00632	632	Dill High Temp Dome Cap	VC3	Plastic	100 PSI	-40° To +250°F	100	Nickel Plated
468-00102	6300V	All Purpose Cap With Screwdriver Top For Removing/ Inserting Valve Cores	VC2	Nitrile	0-200 PSI	-40° To +165°F	100	Nickel Plated

VALVE HARDWARE // VALVES & VALVE TOOLS



➔ Double Seal Caps, Dual Seal Caps, Valve Extensions



**DOUBLE SEAL CAP**

- **A time, money and labor saving alternative to common valve caps**
- Reduce pressure check time by 65%
- Designed for high pressure truck tire service
- Inflate, deflate or gauge directly thru the DS-1 saving time during inflation and pressure checks
- Automatic inflation systems lock right onto the DS-1
- Seals like a high pressure cap, yet offers the convenience of an inflate thru extension
- Performs like a check valve, the seal becomes tighter in the event of a core failure
- Heat resistant grommets provide additional protection for extended high temperature running
- Features tough all metal housing, precision fit brass components and durable self-sealing O-Ring



468-04191

TUFFY NO.	MFG. NO.	DESCRIPTION
468-04191	DS-1	Double Seal Cap



**ALLIGATOR V2B DUAL SEAL CAP**

- **Made in Germany by Alligator**
- Increased tire life
- Lower fuel consumption
- Safety for driver and vehicle
- **QUANTITY: 50 caps per box**



468-02222

TUFFY NO.	MFG. NO.	DESCRIPTION	QTY./BOX
468-02222	V2B	Alligator V2B Dual Seal Cap	50



**DUAL WHEEL EXTENSIONS**

- **For convenient air service access to inner rear dual wheels**
- Fit standard valve cap threads and include a clip to secure the extension to the wheel cutout
- Can be used on campers, recreational vehicles and light trucks

TUFFY NO.	MFG. NO.	EFF. LENGTH
468-10017	9059-7	7"
468-10019	9059-9	9"
468-10011	9059-11	11"

**PASSENGER CAR EXTENSIONS**



- **Provides a seal against contaminants while extending the valve mouth for convenient access**

TUFFY NO.	MFG. NO.	FINISH	EFF. LENGTH
468-00685	685-P	Nylon	.50"
468-00686	686-P	Nylon	.75"
468-00687	687-P	Nylon	1.00"
468-00688	688-P	Nylon	1.25"
468-00689	689-P	Nylon	1.50"
468-62410	6241-B	Ni-Plated Brass	.50"
468-62411	6241-M	Ni-Plated Brass	.75"
468-62412	6241-J	Ni-Plated Brass	1.25"
468-62413	6241-G	Ni-Plated Brass	1.50"



468-00685



468-62411

**DILL TRUCK VALVE EXTENSIONS**

- **Extensions screw onto the standard .305" valve cap threads of the valve stem and make valve mouth accessible for air service**
- Available in various lengths

TUFFY NO.	MFG. NO.	EFFECTIVE LENGTH
<b>STRAIGHT METAL EXTENSIONS</b>		
468-00330	330	4-1/8"
468-00331	331	3-1/8"
468-00341	341	4-7/16"
468-00346	346	1"
468-00347	347	3-1/16"
468-00348	348	5-1/16"
468-00349	349	6-1/16"
468-00350	350	2-7/32"
468-00356	356	1-13/32"

TUFFY NO.	MFG. NO.	BEND ANGLE	EFFECTIVE LENGTH
<b>BENT METAL EXTENSIONS</b>			
468-08028	8028	45°	1-3/8"



468-00347

**DILL LIGHTWEIGHT TRUCK VALVE EXTENSIONS**

- **Made from nickel plated brass**
- Provide the additional length necessary to inflate, deflate or gauge tires with valves hidden by decorative wheel covers
- Lightweight

TUFFY NO.	MFG. NO.	COLLAR TYPE	EFF. LENGTH
468-01032	1032	Short 3/8"	2"
468-01033	1033	Short 3/8"	2.93"
468-01034	1034	Short 3/8"	3.93"
468-01035	1035	Short 3/8"	5.12"
468-01037	1037	Long 1"	2.93"
468-01038	1038	Long 1"	5.12"
468-01039	1039	Long 1"	6"



468-01038

468-01039

VALVE HARDWARE // VALVES & VALVE TOOLS





## Valve Caps, Cores & Extensions (cont.)

### VALVE ACCESSORIES

TUFFY NO. TR. NO. FITS THREAD FOR USES ON

**HEX NUTS**

468-10013	HN-13	.406"-28	TR570 Series
468-10004	HN-4	.406"-28	TR416
468-10117	HN-17	.406"-28	TR509, 510
468-00808	RW-8	.406"-28	TV500 & TV570 Series



468-10015

**GROMMETS**

468-10015	RG-15	.625"	TR570 Series
468-11700	G-170S	.625"	Heat Resistant for TV570
468-10046	RG-46	.625"	TR509, 510
468-10039	RG-39	.625"	TR416
468-10054	RG-54	.453"	TR416



468-10046

**O-RING**

468-10060	RG-60	.328"	TR540 Series
-----------	-------	-------	--------------



468-10060

### DUAL WHEEL FLEXIBLE VALVE EXTENSIONS

Provide easy access to the inner dual tire found on campers, recreational vehicles and light trucks. Fit standard valve cap threads. Come with clamp to secure extension to wheel cutout. 2 extensions per pack and available in steel braided hose.



468-30007

468-40007

TUFFY NO.	MFG. NO.	DESCRIPTION	EFF. LENGTH
468-30007	FE-300-7	Flexible Extension	7"
468-30010	FE-300-9	Flexible Extension	9"
468-40007	SFE-400-7	Steel Braided Extension	7"
468-40010	SFE-400-10	Steel Braided Extension	10"
468-90597	9059-7	Reinforced Rubber Hose	7"
468-90599	9059-9	Reinforced Rubber Hose	9"
468-95911	9059-11	Reinforced Rubber Hose	11"

### HALTEC ALUMINUM EXTENSIONS

Extremely lightweight. Made from aluminum.



TUFFY NO.	MFG. NO.	COLLAR TYPE	EFF. LENGTH
468-01390	HE-390A	Long	2"
468-01391	HE-391A	Long	2-15/16"
468-01392	HE-392A	Long	5-1/8"
468-01393	HE-393A	Long	6"



468-01390

### HALTEC TRUCK VALVE EXTENSIONS

**HE-370 SERIES:** Lightweight Extensions have the short collar for use on tube-type valves or tubeless lightweight valves. Has a double seal feature to assure positive seal. **HE-390 SERIES:** Lightweight Extensions are the same as the HE-370 series except with a long collar. **HE-380 SERIES:** Standard Style Extensions screw on the standard valve stem (.305"-32" cap thread) and make valve mouth accessible. Extensions & stabilizers available for Alcoa wheels.

TUFFY NO. MFG. NO. COLLAR TYPE EFF. LENGTH

468-00370	HE-370	Short 3/8"	2"
468-00371	HE-371	Short 3/8"	2-15/16"
468-00372	HE-372	Short 3/8"	3-15/16"
468-00373	HE-373	Short 3/8"	5-1/8"
468-00389	HE-389	Long 1"	1-1/16"
468-00390	HE-390	Long 1"	2"
468-00391	HE-391	Long 1"	2-15/16"
468-00392	HE-392	Long 1"	5-1/8"
468-00393	HE-393	Long 1"	6"
468-00394	HE-394	Long 1"	8"
468-00395	HE-395	Long 1"	10"
468-00396	HE-396	Long 1"	12"
468-00397	HE-397	Long 1"	14"

**STANDARD STYLE**

468-00381	HE-381	Long 1"	3-1/16"
468-00382	HE-382	Long 1"	5-1/16"
468-00383	HE-383	Long 1"	6-1/16"

468-00370



468-00390



468-00382

### BLACK POLYMER VALVE EXTENSIONS

Light-weight truck extensions are made of a durable, tough plastic able to withstand the conditions tire valve extensions are exposed to. They are designed for use where vibration and weight is a concern for valve stem breakage.

TUFFY NO. MFG. NO. CAP EFF. LENGTH

468-13500	HE-350	VC-3	2.04"
468-13501	HE-350D	DS-1	2.63"
468-13510	HE-351	VC-3	3.82"
468-13511	HE-351D	DS-1	4.41"
468-13520	HE-352	VC-3	5.21"
468-13521	HE-352D	DS-1	5.80"
468-13530	HE-353	VC-3	5.94"
468-13531	HE-353D	DS-1	6.53"



468-13530

VALVE HARDWARE // VALVES & VALVE TOOLS





➔ Inflating Connections, Strut Valves, Tank Valves, Tire Pressure Equalization System

# Special Application Products



## HIGH-PRESSURE INFLATING CONNECTIONS

▪ Connections attach securely by hand or wrench to the valve cap threads of high-pressure valves



468-00556 486-06116

TUFFY NO.	MFG. NO.	DESCRIPTION
468-00556	H-556	Fits .305"-32" Thread Size With 1/8" NPT Male Connection. Has Core Depressor Pin, Copper Sealing Washer. <b>MAX. WORKING PRESSURE: 3000 PSI</b>
468-06116	H-6116B	Fits .305"-32" Thread Size With 1/8" NPT Female Connection With 70° Bend. Equipped With Hard Fiber Sealing Washer. <b>MAX. WORKING PRESSURE: 3000 PSI</b>

## HIGH-PRESSURE SHOCK/STRUT VALVES

▪ Constructed of stainless steel bodies for use in high pressure shock absorber units, hydraulic pressure accumulator, surge cylinders and high pressure pneumatic systems ▪ 1/2"-20 U.N.F. - 3A threads for connection to container



468-07607 468-04361 468-00798

TUFFY NO.	MFG. NO.	OPERATING PRESSURE	CONFORMS TO
468-07607	H-7607	2000 PSI	AN-812-1
468-04361	H-4361	3000 PSI	AN-6287-1
468-00798	H-798	5000 PSI	MS-28889-2

## TANK VALVES

▪ Use on pressure containers where gauging or service may be required  
 ▪ Used with various gases, fluids and operating pressures



468-00399 468-00400 468-00401 468-00402

TUFFY NO.	MFG. NO.	OAL	BASE THREAD	CAP THREAD	HEX SIZE
468-00399	TV-399	1-5/16"	1/8" NPT	.305"-32	7/16"
468-00400	TV-400	1-5/16"	1/4" NPT	.305"-32	9/16"
468-00401	TV-401	27/32"	1/8" NPT	.305"-32	7/16"
468-00402	TV-402	1-5/16"	1/8" NPT	.305"-32	7/16"

## CROSSFIRE DUAL™ TIRE PRESSURE EQUALIZATION SYSTEM

**HOW CROSSFIRE WORKS:** Crossfire is a pressure equalizing and monitoring valve that is mounted between dual tires. It bolts easily to the lug, hub cap, or drive axle end. Properly mounted, air freely flows from one tire to the other, maintaining equal tire pressure and load distribution.

- **Maximizes tire life** ▪ Decreases rolling resistance for increased fuel mileage ▪ Cuts maintenance time due to single-point inflation and the visual pressure gauge ▪ Improves stability, braking and overall safety ▪ Installs in minutes and requires little maintenance ▪ Pays for itself in less than a year
- **American-made and guaranteed for two years**



Under-inflation 20% under-inflation can cause a minimum 30% loss of tire life expectancy



Over-inflation 20% over-inflation can cause a minimum 10% loss of tire life expectancy

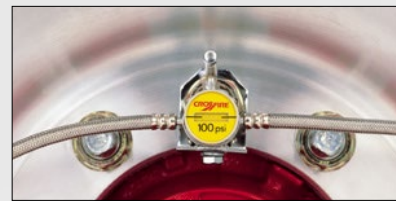

Proper-inflation Mounted correctly, Crossfire's yellow indicator verifies that air is flowing freely from one tire to the other, equalizing the load

MFG. NO.	DESCRIPTION
CF-PSI-RH	Crossfire Rubber Hoses
CF-PSI-HD	Crossfire Heavy Duty Hoses
CF-PSI-ST	Crossfire Stainless Steel Hoses
SS-PSI-RH	Super Single Rubber Hoses
SS-PSI-ST	Super Single Steel Hoses

Crossfire valves are available for desired air pressures of 50 to 150 PSI in 5 PSI increments.

Example: CF-100-ST = Crossfire valve, 100 PSI air pressure, stainless steel hose with AT & BH brackets.

VALVE HARDWARE // VALVES & VALVE TOOLS



➔ Air/Liquid/Agricultural Valves & Extensions, Rim Nuts & Bushings, Rim Hole Plugs, Core Housings



# Air/Liquid/Agricultural Valves

AIR/LIQUID VALVES FOR TRACTOR AND GRADER SERVICE



464-00618

TUFFY NO.	MFG NO.	A	B	BEND ANGLE	VALVE HOLE
464-00618*	TV-618A*	1-7/8"	—	—	.625"
464-01618	TV-618B	1-1/2"	—	—	.625"
464-00718	TV-618RB	1-7/8"	—	—	.625" Rubber
464-00621	TV-621A	1-1/2"	3"	65°	.625"
464-00622	TV-622A	1-3/4"	4-1/2"	90°	.625"
464-00623	TV-623A	1-1/2"	2-1/4"	65°	.625"
464-00619	TV-619A	1-7/8"	—	—	.812"
464-02618	TV-618A-SS	1-7/8"	—	—	.625"

\*TR618A Made in USA available from Dill

RIM NUTS AND BUSHINGS



468-00010



468-00009



468-00006

TUFFY NO.	MFG. NO.	DESCRIPTION
468-00202	RN-02	Rim Hole Reducer
468-00010	LN-10	Plastic Rim Nut. For Tractor Tube Valves TR-218A, TR-220A
468-00009	B-9A	Bushing Assembly. Fits Over TR-218A, TR-220A Valves For Use In 13/16" Valve Hole. Includes B9 Bushing and LN-13 Nut
468-00006	B-6	Bushing. Fits Over TR-13 Tube Valve When Used in 5/8" Valve Hole

TRACTOR AND GRADER TUBE VALVE

- Valve assemblies with removable core housing for liquid fill
- Vulc-on back to allow field repair



VULC-ON BACK



467-00218

TUFFY NO.	TR NO.	BASE DIAM.	CORE HOUSING	VERTICAL HEIGHT	VALVE HOLE
467-00218	TR-218A	2-1/2"	TV-CH-3	1-7/8"	.625"
467-00220	TR-220A	2-1/2"	TV-CH-3	2-15/16"	.625"
467-00916	TR--916A	3-1/4"	R-372	1-7/8"	.812"

RIM HOLE PLUGS



464-00015



464-01025



464-00030

TUFFY NO.	MFG. NO.	DESCRIPTION
464-00015	P-15	For Tube-Type Wheels. Used to Plug 5/8" Rim Hole and Avoid Tube Pouching
464-01025	N-1012S	Used to Seal 5/8" Rim Hole When Relocating Valve
464-00030	T-30	Used to Seal 13/16" Rim Hole When Relocating Valve

AIR/LIQUID EXTENSION

- Use with tractor or grader valve stems
- 90° angle for more accessible valve



467-05905



90 DEGREE ANGLE

TUFFY NO.	MFG. NO.	DESCRIPTION
464-05905	TV-5905	Air/Liquid Extension

CORE HOUSINGS



468-00201



468-00203



468-00216

TUFFY NO.	MFG. NO.	DESCRIPTION
468-00201	TV-CH-1	Fits Old Style TR-218, TR220 Valves
468-00203	TV-CH-3	Fits All Fast Flow Air-Liquid Valves Except Super Large Bore
468-00216	TR-CH-16	Fits SP816 Tube Spud and T-81, C-100



VALVE HARDWARE // VALVES & VALVE TOOLS



➔ Valve Adapter Gun, Liquid Fill Tools, Aqua Quick Fill

VALVE ADAPTER GUN

▪ **1/2" female pipe thread and attaches to any calcium tire filling pump** ▪ Extracts valve core from standard bore valve or core housing from tractor valve ▪ Securely holds valve core or core housing up in the gun body during tire filling or evacuation of liquid from a tire

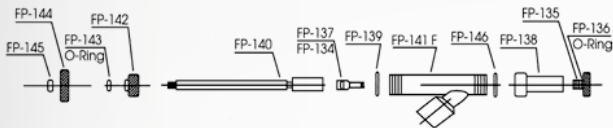

**SECURE HOLD**

**EXTRACTS VALVE CORE**



464-00310

TUFFY NO.	MFG. NO.	DESCRIPTION
464-00310	310	Valve Adapter Gun
464-00134	FP-134	Large Bore Core Remover
464-00135	FP-135	Adapter For Standard Valve
464-00136	FP-136	O-Ring For FP-135 Adapter
464-00137	FP-137	Standard Valve Core Remover
464-00138	FP-138	Ejector Union
464-00139	FP-139	Gasket
464-00140	FP-140	Stem
464-00141	FP-141F	Adapter Body
464-00142	FP-142	Stem Sealing Nut
464-00143	FP-143	O-Ring For FP-142
464-00144	FP-144	Hand Wheel
464-00145	FP-145	Lock Nut
464-00146	FP-146	Teflon Gasket

LIQUID FILL TOOLS



464-01091



464-01451



464-10912



464-01452



464-10913

TUFFY NO.	MFG. NO.	DESCRIPTION
464-01091	N-1091	Water Adapter For Liquid Fill Tires
464-10912	N-1091-2	For Water Adapter
464-10913	N-1091-3	For Water Adapter
464-01451	N-1451	1/2" FNPT Coupler for Fluid Use
464-01452	N-1452	1/2" MNPT Nipple for Fluid Use

AQUA QUICK FILL

▪ **To fill a tractor tire or off-the-road tire with liquid without supervision** ▪ Automatically vents excess pressure through side port while tire is filled ▪ Indicates tire is filled by water escaping through vent hole

**VENTS EXCESS PRESSURE**



464-10001

TUFFY NO.	MFG. NO.	DESCRIPTION
464-10001	AQF-1	Aqua Quick Fill

VALVE HARDWARE // VALVES & VALVE TOOLS



➔ Single, Double and Triple Bend Swivel Valves



# Large Bore Valves

## SINGLE BEND SWIVEL VALVES



465-00431



465-00702



465-00710

TUFFY NO.	MFG. NO.	DESCRIPTION
465-00431	K-431	<b>Clamp-In Type Spud.</b> Grommet increases The Sealing Area. Can Be Removed and Replaced Without Dismounting The Tire. Do Not Use In Continuous Service. Temporary Use Only
465-00702	H-41	<b>TR-SP-2 Tubeless Spud.</b> Fits 13/16" Rim Hole Used With All Large Bore Swivel Valves
465-00710	C-10	<b>TR-C-10 Large Bore Screw-In Spud.</b> Screws Into 1/2" NPT Tapped Hole In The Rim. Can Be Replaced Without Dismounting Tire

## DOUBLE AND TRIPLE BEND SWIVEL VALVES

- These valve stems can be used with any of the spuds above
- Any other lengths can be ordered
- All valves equipped with core and hex cap
- On lengths over 6", 2 lock nuts are furnished



Double Bend Swivel Valve



Triple Bend Swivel Valve

TUFFY NO.	MFG. NO.	TR NO.	BEND ANGLE	LENGTH	HEIGHT
<b>DOUBLE BEND SWIVEL VALVES</b>					
465-00661	WH-70-J661	J-661	82°-8°	4-1/2"	1-5/64"
465-70255	WH-70-J661-10-1/2	-	82°-8°	10-1/2"	1-5/64"
465-70285	WH-70-J661-25-1/2	-	82°-8°	25-1/2"	1-5/64"
465-70280	WH-70-J661-28	-	82°-8°	28"	1-5/64"
465-00664	WH-70-J664	J-664	90°-13°	8-3/4"	1-5/64"
465-70125	WH-70-J664-12-1/2	-	90°-13°	12-1/2"	1-5/64"
465-00667	WH-70-J667	J-667	90°-11°	7-1/2"	1-5/64"
465-71090	WH-71-J-9	-	55°-35°	9"	1-33/64"
465-72212	WH-72-J-21-1/4	-	70°-20°	21-1/4"	1-5/64"
465-72280	WH-72-J-28	-	70°-20°	28"	1-5/64"
465-73212	WH-73-J-21-1/4	-	60°-30°	21-1/4"	1-3/8"
<b>TRIPLE BEND SWIVEL VALVES</b>					
465-00662	WH-75-J662	J-662	90°-20°-20°-	14"	1-5/64"
465-75610	WH-75-J662-10-1/2	-	90°-20°-20°	10-1/2"	1-5/64"
465-00663	WH-75-J663	J-663	90°-8°-8°	25"	1-5/64"
465-00665	WH-75-J665	J-665	90°-13°-13°	32"	1-5/64"
465-00666	WH-75-J666	J-666	84°-6°-31°-31°	20-1/8"	1-5/64"

## SINGLE BEND SWIVEL VALVES

- Any other lengths may be ordered
- All valves equipped with core and hex cap
- On lengths over 6", 2 lock nuts are furnished
- Large bore swivel valves can be used with any of the spuds on this page

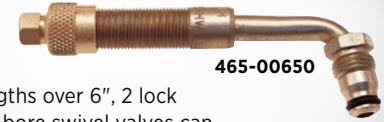

465-00650

TUFFY NO.	MFG. NO.	TR NO.	BEND ANGLE	LENGTH	HEIGHT
465-01418	N-1418	-	74°	1-3/4"	1-5/64"
465-00650	WH-300-J-650	J-650	80°	3-1/8"	1-5/64"
465-00653	WH-300-J-653	J-653	80°	2-1/2"	1-5/64"
465-00657	WH-300-J-657	J-657	80°	4"	1-5/64"
465-30045	WH-300-4-1/2	-	80°	4-1/2"	1-5/64"
465-00658	WH-300-J-658	J-658	80°	5-1/2"	1-5/64"
465-03009	WH-300-9	-	80°	9"	1-5/64"
465-00446	WH-44-6	-	Strt.	6"	1-5/64"
465-40001	WH-45-2-1/2	J-4000-2-1/2	90°	2-1/2"	1-5/64"
465-00454	WH-45-4	-	90°	4"	1-5/64"
465-40002	WH-45-4-1/2	J-4000-4-1/2	90°	4-1/2"	1-5/64"
465-00455	WH-45-5	-	90°	5"	1-5/64"
465-40003	WH-45-6	J-4000-6	90°	6"	1-5/64"
465-40004	WH-45-7-1/2	J-4000-7-1/2	90°	7-1/2"	1-5/64"
465-00458	WH-45-8	-	90°	8"	1-5/64"
465-40005	WH-45-9	J-4000-9	90°	9"	1-5/64"
465-04510	WH-45-10	-	90°	10"	1-5/64"
465-45105	WH-45-101/2	-	90°	10-1/2"	1-5/64"
465-04512	WH-45-12	-	90°	12"	1-5/64"
465-04513	WH-45-13	-	90°	13"	1-5/64"
465-04524	WH-45-24	-	90°	24"	1-5/64"
465-40006	WH-45-28	J-4000-28	90°	28"	1-5/64"
465-40007	WH-45-29-1/2	J-4000-29-1/2	90°	29-1/2"	1-5/64"
465-04530	WH-45-30	-	90°	30"	1-5/64"
465-04532	WH-45-32	-	90°	32"	1-5/64"
465-04536	WH-45-36	-	90°	36"	1-5/64"
465-00651	WH-46-J-651	J-651	90°	4-11/16"	1-17/64"
465-04645	WH-46-4-1/2	-	90°	4-1/2"	1-17/64"
465-00652	WH-47-J-652	J-652	86°	5-1/2"	1-5/64"
465-04745	WH-47-4-1/2	-	86°	4-1/2"	1-5/64"
465-00479	WH-47-9	-	86°	9"	1-5/64"
465-00655	WH-48-J-655	J-655	74°	3-1/8"	1-5/64"
465-00654	WH-49-J-654	J-654	60°	3-1/8"	1-5/64"
465-00659	WH-50-J-659	J-659	90°	3-1/2"	1-57/64"
465-00660	WH-50-J-660	J-660	90°	8-3/4"	1-57/64"
465-00506	WH-50-6	-	90°	6"	1-57/64"
465-00507	WH-50-7-1/2	-	90°	7-1/2"	1-57/64"
465-00668	WH-51-J-668	J-668	90°	4-11/16"	5-1/8"
465-00522	WH-52-2	-	25°	2"	1-5/64"
465-00535	WH-53-5-1/2	-	80°	5-1/2"	1-21/64"
465-00546	WH-54-6	-	90°	6"	2-25/64"
465-00552	WH-55-2-1/2	-	90°	2-1/2"	2-25/64"
465-00558	WH-55-8-1/2	-	90°	8-1/2"	2-25/64"
465-00563	WH-56-3	-	65°	3"	1-5/64"
465-00573	WH-57-3	-	80°	3"	1-5/64"
465-00582	WH-58-2-1/2	-	60°	2-1/2"	2-1/8"
465-00656	WH-59-J-656	J-656	90°	3-11/16"	2-5/8"

VALVE HARDWARE // VALVES & VALVE TOOLS





➔ Hydroflating Valves, Air/Liquid Valves, Turret Valves, High-Bend Valves, Double Spud Valves, Valve Adapters

**SPECIAL HYDROFLATING VALVES**

▪ **For faster filling of tires with liquid** ▪ Does not contain valve core ▪ Straight-through 5/16" opening sealed with special O-ring cap, No. A-151 ▪ Used on loader tire in conjunction with similar large bore air valve

**AIR WATER VALVES**

▪ Used in conjunction with WH-330-J-694 large bore valve



TUFFY NO.	MFG. NO.	TR NO.	ANGLE BEND	HORIZONTAL LENGTH	CAP
465-00994	WH-JF-994	JF-994	28°	3.5" (88.9mm)	A-151

**TURRET VALVE FOR PLANETARY GEAR WHEELS**



TUFFY NO.	MFG. NO.	TR NO.	ANGLE BEND	OFFSET INCHES	LENGTH
465-00690	WH-330-J-690	J-690	2 Bends	9/16"	4-11/16"
465-00691	WH-330-J-691	J-691	18°	-	3-5/16"
465-00691B	WH-330-J-691B	J-691	18°	-	8-1/2"
465-00692	WH-330-J-692	J-692	28°	9/16"	4-11/16"
465-00693	WH-330-J-693	J-693	60°	1"	5"
465-00694	WH-330-J-694	J-694	28°	-	3-1/2"
465-00695	WH-330-J-695	J-695	50°	1"	4-1/8"
465-00696	WH-330-J-696	J-696	42°	29/32"	4-1/4"

**LARGE RADIUS, HIGH-BEND AIR-VALVE USED WITH 977S**

▪ All valves fit 13/16" valve hole  
▪ INCLUDES: A-145 valve core and A-149 cap

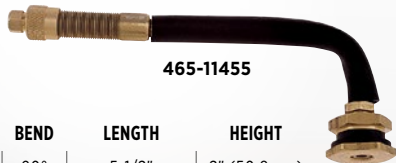

TUFFY NO.	MFG. NO.	BEND	LENGTH	HEIGHT
465-11455	1145-5-1/2	90°	5-1/2" (139.7mm)	2" (50.8mm)
465-11411	1145-11	90°	11" (279.4mm)	2" (50.8mm)

**LARGE RADIUS, HIGH-BEND AIR/LIQUID VALVE**

▪ Uses super large bore T-81 spud (TR-SP-8) ▪ Uses A-151 cap



TUFFY NO.	MFG. NO.	BEND	LENGTH	HEIGHT
465-97755	977S-5-1/2	90°	5-1/2" (139.7mm)	2" (50.8mm)
465-97711	977S-11	90°	11" (279.4mm)	2" (50.8mm)

**DOUBLE SPUD VALVES**



TUFFY NO.	MFG. NO.	DESCRIPTION
465-00385	DS-385	<b>Rigid Extension For Double Spud.</b> For Rims With Valve Hole Counterbore On O.D. Of Rim
465-00390	DS-390	<b>Rigid Extension For Double Spud.</b> For Rims With 1/2" Tapered Pipe Thread Rim Hole
465-00400	DS-400	<b>Large Bore Double Spud Valve.</b> Eliminates Most of The Plugging of Large Bore Valves Which Occurs At The Bend of The Swivel Type Large Bore Valve

**VALVE ADAPTERS**



TUFFY NO.	MFG. NO.	DESCRIPTION
468-00100	AD-1	Adapts Large Bore Valve Down To Standard Valve Bore. Fits. 305-32" Valve Core Threads
468-08007	8807N-4	Adapts Large Bore Valve Down To Standard Valve Bore. Fits .485-26" Valve Cap Threads

VALVE HARDWARE // VALVES & VALVE TOOLS



➔ Single, Double and Triple Bend Swivel Valves



## Large Bore Valves (cont.)

### MISCELLANEOUS VALVES



TUFFY NO.	MFG. NO.	TR NUMBER	DESCRIPTION
465-00670	T-670	—	<b>Loader Tire Valve.</b> Complete With Core, Hex Cap & O-Ring Seal. Thread Size: 1-1/16-12. Height: 1-25/32"
465-00671	H-47	TR-J-671	<b>Tank Valve.</b> Screw-In Type With 1/4" Male Pipe Thread. Complete With Core and Cap. 1-19/32" Length
465-00702	H-41	SP-2	<b>Tubeless Spud.</b> Used With All Large Bore Swivel Valves. Fits 13/16" Rim Hole
465-06702	H-42	TR-J-670-2	<b>Straight Valve.</b> Equipped With Core and Hex Cap. Height Is 1-1/2"
465-06703	H-45	TR-J-670-3	<b>Spud and Valve Complete.</b> Consists Of H-41 & H-42. Height Is 1-5/8"

### STANDARD O-RINGS FOR TUBELESS RIMS

▪ Made of high quality polysoprene rubber ▪ Packaged 2 per poly bag, 24 O-rings per case ▪ Manufactured to major OEM specifications ▪ Arctic style O-ring available



TUFFY NO.	MFG. NO.	ROD DIAM.	SIZE
471-80001	OR-20-JM	0.26"	Hwy (JM Rim) 20"
471-80002	OR-22-JM	0.26"	Hwy (JM Rim) 22"
471-80003	OR-24-JM	0.26"	Hwy (JM Rim) 24"
471-80004	OR-21-T	0.26"	Hwy 21"
471-80009	OR-321-T	0.385"	EM 21"
471-80008	OR-25-T	0.26"	EM 25"
471-80010	OR-325-T	0.385"	EM 25"
471-80011	OR-329-T	0.385"	EM 29"
471-80024	OR-232-T	0.26"	EM 32"
471-80012	OR-333-T	0.385"	EM 33"
471-80014	OR-335-T	0.385"	EM 35"
471-80015	OR-339-T	0.385"	EM 39"
471-80025	OR-239-T	0.385"	EM 39"
471-80016	OR-343-T	0.385"	EM 43"
471-80017	OR-345-T	0.385"	EM 45"
471-80018	OR-349-T	0.385"	EM 49"
471-80019	OR-351-T	0.385"	EM 51"
471-80021	OR-451-T	0.50"	EM 51"
471-80020	OR-357-T	0.39"	EM 57"
471-80022	OR-457-T	0.50"	EM 57"
471-80023	OR-463T	0.50"	EM 63"
471-80005	OR-217-L	0.28"	Grader 17"
471-80006	OR-220-TG	0.26"	Grader 20"
471-80007	OR-224-TG	0.26"	Grader 24"
471-80215	OR-215-H	0.28"	Grader 15"
471-80225	OR-225-T	0.26"	Grader 25"
471-80449	OR-449-T	0.50"	EM 49"
471-80451	OR-451-OVM	0.50"	EM 51"
471-80457	OR-457-OVM	0.50"	Titan OVM 57"
471-80463	OR-463-OVM	0.50"	MEM 63"
471-80469	OR-469T	0.50"	RM 69"

VALVE HARDWARE // VALVES & VALVE TOOLS

### LARGE BORE CAPS AND CORES



TUFFY NO.	MFG. NO.	DESCRIPTION
465-00145	A-145	<b>Large Bore Core (Short).</b> Fits 305-32" Threads
465-00144	A-144	<b>Large Bore Core (Long).</b> Fits .305-32" Threads
465-00148	A-148	<b>Screwdriver Valve Cap.</b> Fits .482-26" Threads
465-00149	A-149	<b>Hex Valve Cap.</b> Fits .482-26" Threads
468-00151	A-151	<b>Air-Water Valve Cap (TR-FC-1).</b> O-Ring Sealing Cap. Used With 465-00994, 465-97755, 465-97711





➔ L-Rings, Large Bore Screw-On Repair Valves & Adapters, Rim Spuds

**L-RINGS FOR EARTHMOVERS**

▪ **Creates an air seal where the tire bead and rim seat are not completely compatible** ▪ *Not a cure for damaged beads nor damaged wheels and rims!* ▪ **CAUTION:** Should be used during fitments, do not install where a broken bead is suspected

TUFFY NO.	MFG. NO.	SIZE
471-80125	LR-25	25"
471-80129	LR-29	29"
471-80133	LR-33	33"
471-80135	LR-35	35"
471-80139	LR-39	39"
471-80145	LR-45	45"
471-80149	LR-49	49"
471-80151	LR-51	51"
471-80157	LR-57	57"
471-80163	LR-63	63"
471-80169	LR-69	69"



**LARGE BORE SCREW-ON REPAIR VALVES FOR INNER TUBES**

▪ **Supplied in straight or bent form ready for installation on tubes** ▪ *Equipped with A-146 valve coer and A-149 hex cap* ▪ Used with SP-1000 tube spud

**SUPPLIED IN STRAIGHT OR BENT FORM**



465-10781

TUFFY NO.	MFG. NO.	TR NUMBER	A-ANGLE BEND	B-VERTICAL HEIGHT	C-HORIZONTAL LENGTH
465-01014	LB-216	J-1014	Straight	1-29/32"	-
465-10760	LB-217	J-1076A	Straight	4-5/32"	-
465-10761	LB-218	J-1076B	86°	1-1/8"	3-1/4"
465-10762	LB-219	J-1076C	90°	1-1/2"	2-7/8"
465-10763	LB-220	J-1076D	90°	2-1/16"	2-5/16"
465-10764	LB-221	J-1076E	88°	1-3/8"	3"
465-11750	LB-223	J-1175A	Straight	5-9/32"	-
465-11751	LB-224	J-1175B	82°	1-1/4"	4-1/4"
465-11752	LB-225	J-1175C	88°	1-3/8"	4-1/8"
465-10780	LB-226	J-1078A	Straight	5-25/32"	-
465-10781	LB-227	J-1078B	82°	1-3/8"	4-5/8"
465-10782	LB-228	J-1078C	90°	1-1/8"	4-7/8"
465-11790	LB-229	J-1179A	Straight	6-13/32"	-
465-11791	LB-230	J-1179B	88°	1-3/8"	5-1/4"
465-11792	LB-231	J-1179C	86°	1-1/8"	5-1/2"

**LARGE BORE SCREW-ON REPAIR VALVE ADAPTERS FOR INNER TUBES**



TUFFY NO.	MFG. NO.	DESCRIPTION	465-40000
465-40000	H-4000	Adapter Converts Tubes having SP-1000 Type Spud To Accept Large Bore Swivel Valves. Equipped With BW-18 Washer and Used With Rim Slots	
465-40011	H-4000-1	Same As H-4000 Except Without Bridge Washer and Hex Nut	

**CLAMP-IN RIM SPUD**

▪ **Fits 13/16" diameter valve hole**  
 ▪ Can attach to any super large bore valve to the rim through a standard valve hole (13/16" diameter)



464-00208

TUFFY NO.	MFG. NO.	TR NUMBER	DESCRIPTION
464-00208	T-81	TR-SP8	Clamp-In Rim Spud

**SCREW-IN RIM SPUDS**

▪ **Used to attach any of the super large bore valves to the rim and is designed to screw into a 1/2" NPT tapped rim hole** ▪ Can be changed without dismounting the tire



464-00209

TUFFY NO.	MFG. NO.	DESCRIPTION
464-00209	C-100	Effective Length 1/4" Longer

**SCREW-IN RIM SPUDS**

▪ 85° bend angle



TUFFY NO.	MFG. NO.	DESCRIPTION	466-00850	466-00851
466-00850	S-85	Fits 1/2" NPT Tapped Rim Hole		
466-00851	S-85-D	Furnished With A Locking Nut With A Teflon Seal So Direction Can Be Reversed		

**CORE HOUSING**

▪ **Complete with core and cap** ▪ Designated at Tire and Rim as the CH-8 ▪ Integral part of the system as the CH-8 is removed from the valve assembly with the IN-80A adapter to utilize the larger opening and the fullest flow of the 6185 check valve



TUFFY NO.	MFG. NO.	TR NO.	DESCRIPTION	466-00918
466-00918	R-520	TR-CH-8	Core Housing	



➔ Check Valve, Inflation Chuck, Inflator Adapter



## Large Bore Valves (cont.)

### CHECK VALVE

▪ **Complete with cap** ▪ Permits rapid inflation and deflation ▪ Eliminates need for core housing and inflation adapter ▪ *Used with 6190 air chuck*

TUFFY NO.	MFG. NO.	TR NO.	DESCRIPTION
466-00860	6185	TR-L-860	Check Valve



466-00860

### QUICK CONNECTION INFLATION CHUCK

▪ **Designed specifically for use with 6185 check valve** ▪ Sliding sleeve locks air chuck onto check valve and permits unrestricted air flow ▪ Gauging can be done through valve on chuck ▪ *Positive air line shut off-valve must be installed in back of air chuck*

TUFFY NO.	MFG. NO.	DESCRIPTION
466-06190	6190	Quick Connection Inflation Chuck



466-06190

### SWIVEL ANGLE CONNECTORS

▪ **Component two of the super large bore system is generally a swivel connector that screws onto the spud** ▪ *Connectors of various angles and lengths are available* ▪ Other end of the connector accommodates a MT-3000 flexible extension which attaches to the R-520 core housing of the 6185 check valve



TUFFY NO.	MFG. NO.	BEND ANGLE
466-00525	R-525	90°
466-00685	R-685	85°
466-00625	R-625	80°
466-00675	R-675	75°
466-00660	R-660	60°
466-00529	R-529-5-1/4	90°



466-00525



466-00675



LARGE BORE GAUGES & CHUCKS ON PAGE 274

### SUPER LARGE BORE INFLATOR ADAPTER

▪ **1/2" pipe thread for easy air hose connection** ▪ During inflation, air pressure in the tire can be checked through the stem knob with a tire pressure gauge ▪ **Reduces inflation time 60%, deflation time 80%** ▪ Core housing held in a stainless steel extractor by a snap ring ▪ Extractor is rugged enough so that the core housing can be loosened or tightened without being damaged ▪ **FAST INFLATION OR DEFLATION OF A TIRE:** After removing the valve cap, inflator is screwed onto the valve stem. Inflator stem is pushed in to engage the flats on the core housing. By rotating the stem counter/clockwise, the core housing can be removed without any danger to the person removing it. The core housing is pulled up into the inflator body and held there during inflation or deflation.



466-05310

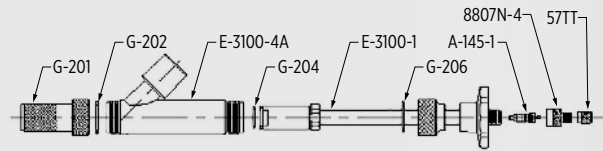

**PARTS LIST:**

<b>G-201</b>	Ejector Union	<b>G-202</b>	Gasket for G-201
<b>E-3100-4A</b>	Adapter Body	<b>G-204</b>	Snap Ring for Collet
<b>G-206</b>	Gasket for E-3100-1	<b>A-145-1</b>	Large Bore Valve Core
<b>8807N-4</b>	Cap Adapter	<b>57TT</b>	Standard Bore Cap
<b>E-3100-1</b>	Complete Stem and Collet		

**IN-80A PARTS LIST**

G-201 Ejector Union	G-202 Gasket for G-201
E-3100-4A Adapter Body	G-204 Snap Ring for Collet
G-206 Gasket for E-3100-1	A-145 Large Bore Valve Core
8807N-4 Cap Adapter	57TT Standard Bore Cap
E-3100-1 1-Piece Stem and Collet	



TUFFY NO.	MFG. NO.	DESCRIPTION
466-05310	IN-80A	Super Large Bore Inflator Adapter







➔ Flexible Extensions, super Large Bore Valves, Swivel Valves

**FLEXIBLE EXTENSION SERIES**

▪ Flexible extensions are made up in any length to allow the extension to fit the wheel configuration ▪ Specially designed fittings and thermoplastic hose will not fatigue or crush during service ▪ Corrosion problems are eliminated ▪ Able to customize your extension in the field ▪ The R-969-K and R-969K-1 kits are available to field assemble your own flexible extensions with the T-620 assembly tool (not shown)

MADE UP  
IN ANY  
LENGTH

CORROSION  
PROBLEMS  
ELIMINATED



466-03000

TUFFY NO.	MFG. NO.	DESCRIPTION
466-03000	MT-3000	Flexible Extension

**ASSEMBLY KIT FOR SUPER LARGE BORE VALVES-FIELD SERVICE**



466-96901

TUFFY NO.	MFG. NO.	DESCRIPTION
466-96901	R-969K-1	Consists Of R-762S Swivel Connector, R-763 Straight Tubing Connector, R-764R (2) Tubing Connector Sleeves and B-222 Nuts (2)
466-96900	R-969-K	Consists Of The Above Plus The R-520 Core Housing Complete With Core and Cap
466-76000	R-760	Extension Tubing Available In 50' and 100' Lengths

**RIGID METAL SWIVEL VALVES**



466-00200



466-00800



466-00890



466-01850



Custom Valve

TUFFY NO.	MFG. NO.	DESCRIPTION
466-00200	M-2000	Swivel Valve Assembly. 90° Swivel Valve - 3-1/8" Horizontal Length
466-00800	MR-800	Swivel Valve: MR-800-Length. Rigid Metal Swivel Valve With R-520 Core Housing And 2B-222 Lock Nuts
466-00890	MR-890	Turret Valve: MR-890. Rigid Metal Turret Type Valve With R-520 Core Housing & (3)B-222 Lock Nuts
466-01850	MR-850	Swivel Valve: MR-850. Same As MR-800 Except With A T-81 Rim Spud

Call for more details regarding **Large Bore Valves and Super Large Bore Valves.**



VALVE HARDWARE // VALVES & VALVE TOOLS



➔ Single, Double and Triple Bend Swivel Valves



Large Bore Valves (cont.)

RIGID METAL SWIVEL VALVES



466-00296



466-04000



466-07910

TUFFY NO.	MFG. NO.	DESCRIPTION
466-00296	DS-296	<b>Super Large Bore Double Spud Valve Assembly (with Flexible Extension).</b> Designed For Use Where Above Rim Is 7/8". Consists Of DS-210 Double Spud, DS-215 Plug And MT-4000 Flexible Extension
466-04000	MT-4000	<b>Flexible Extension.</b> Used With DS-296 And PB-210. Consists Of: DS-226 Connector, R-763 Connector, (2) R-764R Sleeves, R-760 Tubing
466-07910	S-7910	<b>Valve Support</b> For Super Large Bore
466-08860	S-8860	<b>Valve Support</b> For Large Bore

SUPER LARGE BORE VALVES



466-01066



466-01870

TUFFY NO.	MFG. NO.	DESCRIPTION
466-01066	N-1066	<b>Super Large Bore Loader Valve.</b> Accepts R-520 Core Housing Or Other Super Large Bore Swivel Fittings. Thread Size is 1-1/16"-12. Super Large Bore Version Of T-670
466-05000	M-5000	<b>Straight Valve Assembly.</b> Screw-In Type Spud With O-Ring Seal. R-521 Core Housings Not Interchangeable In Other SLB Spuds. Thread Size Is 3/4-16"
466-01870	M-1870	<b>Straight Valve Assembly.</b> Super Large Bore Straight Valve Assembly Consists of R-520 Core Housing And T-81 Spud
466-01050	N-1050	Same as M-1870 but with T-82 Spud

SUPER LARGE BORE AIR/LIQUID VALVES FOR TRACTOR AND GRADER

SUPER LARGE BORE TURRET VALVES

▪ Long super large bore turret valve with 15° bend ▪ Used on Caterpillar applications



466-01538



466-01543

TUFFY NO.	MFG. NO.	DESCRIPTION
466-01538	N-1538B	7-7/8" Long Super Large Bore Turret
466-01543	N-1543A	6-1/8" Long Super Large Bore Turret



464-00208



464-00216



466-50910

TUFFY NO.	MFG. NO.	DESCRIPTION
464-00208	T-81	Fits 13/16" Dia. Rim Holes
464-00216	R-372	Fits T-81, C-100, TRSP 816 Tube Spuds
466-50910	H-50	Components T-81 Spud And R-372 Core Housing



VALVE HARDWARE // VALVES & VALVE TOOLS



# Large Bore Extensions

## HAND BENDABLE LARGE BORE EXTENSIONS

- Equipped with 2 lock nuts and 3/4" hex sealing nut
- Teflon gasket seals on end of valve; the lead seal in the sealing nut is forced into the threads for a second seal, locking extension to valve
- Cap and core not included
- Should be removed from valve and transferred to extension

TUFFY NO.	MFG. NO.	EFFECTIVE LENGTH
465-75035	753S-3-1/2	3-1/2"
465-75040	753S-4	4"
465-75045	753S-4-1/2	4-1/2"
465-75080	753S-8	8"
465-75090	753S-9	9"
465-75010	753S-10	10"
465-75115	753S-11-1/2	11-1/2"
465-75120	753S-12	12"
465-75135	753S-13-1/2	13-1/2"
465-75160	753S-16	16"
465-75170	753S-17	17"
465-75175	753S-17-1/2	17-1/2"
465-75180	753S-18	18"
465-75185	753S-18-1/2	18-1/2"
465-75190	753S-19	19"
465-75205	753S-20-1/2	20-1/2"
465-75210	753S-21	21"
465-75215	753S-21-1/2	21-1/2"
465-75225	753S-22-1/2	22-1/2"
465-75235	753S-23-1/2	23-1/2"
465-75245	753S-24-1/2	24-1/2"
465-75250	753S-25	25"
465-75295	753S-29-1/2	29-1/2"
465-75320	753S-32	32"



465-75035



465-81090

## FLEXIBLE LARGE BORE EXTENSIONS

- Made with tough rubber hose and reusable hydraulic type fittings
- Equipped with 2 lock nuts and 3/4" hex sealing nut
- A Teflon gasket seals on end of valve
- The lead seal in the sealing nut is forced into the threads for a second seal, positively locking extension to valve

TUFFY NO.	MFG. NO.	EFFECTIVE LENGTH
465-81080	810F-8	8"
465-81090	810F-9	9"
465-81100	810F-10	10"
465-81200	810F-20-1/2"	20-1/2"
465-81250	810F-25	25"
465-81320	810F-32	32"
465-81400	810F-40	40"

## RIGID BRASS LARGE BORE EXTENSIONS

- All-brass extensions used when mounted in straight line with valve
- Full length deflector pin opens core in valve when servicing
- Equipped with hex cap, 2 lock nuts on extensions over 5" in length

TUFFY NO.	MFG. NO.	EFFECTIVE LENGTH
465-86032	867- 1-1/4	1-1/4"
465-86015	867- 1-1/2	1-1/2"
465-86020	867- 2	2"
465-86025	867- 2-1/2	2-1/2"
465-86030	867- 3	3"
465-86033	867- 3-3/8	3-3/8"
465-86040	867- 4	4"
465-86045	867- 4-1/2	4-1/2"
465-86050	867- 5	5"
465-86059	867- 5-9/16	5-9/16"
465-86060	867- 6	6"
465-86067	867- 6-7/8	6-7/8"
465-86072	867- 7-1/4	7-1/4"
465-86077	867- 7-3/4	7-3/4"
465-86080	867- 8	8"
465-86085	867- 8-1/2	8-1/2"
465-86090	867- 9	9"
465-86100	867-10	10"
465-86107	867- 10-3/4	10-3/4"
465-86120	867-12	12"
465-86125	867- 12-1/2	12-1/2"
465-86160	867- 16	16"
465-86187	867- 18-7/8	18-7/8"
465-86225	867- 22-1/2	22-1/2"
465-86245	867- 24-1/2	24-1/2"



465-86060

## CUSTOM BENT SWIVEL VALVES AND EXTENSIONS

TUFFY NO.	MFG. NO.	OVERALL LENGTH	NO. OF BENDS	TYPE
465-00570	WHG-0570VC	19-31/32"	5	Valve
465-00585	WHD-0585EC	17-15/16"	4	Extension
465-01450	WHG-1450VC	32-7/8"	5	Valve
465-04985	WHG-4985VC	19-3/4"	4	Valve
465-05008	WHD-5008EC	17-13/16"	4	Extension
465-05112	WHG-5112VC	28-3/8"	4	Valve
465-05200	WHG-5200VC	27"	5	Valve
465-05410	WHG-5410VC	31-9/16"	5	Valve
465-05420	WHG-5420VC	33"	5	Valve
465-05922	WHD-5922EC	15-1/4"	5	Extension
465-07103	WHD-7103EC	16-1/4"	4	Extension
465-07601	WHD-7601EC	16-3/4"	4	Extension
465-07602	WHD-7602EC	14-1/4"	4	Extension
465-07940	WHD-7940EC	19"	5	Extension
465-07948	WHD-7948EC	20-5/8"	4	Extension
465-07949	WHD-7949EC	28-7/8"	4	Extension
465-08018	WHG-8018VC	26-3/4"	4	Valve
465-08019	WHG-8019VC	8"	1	Valve
465-08852	WHG-8852VC	18-9/16"	4	Valve
465-09440	WHG-9440VC	27"	5	Valve
465-09470	WHG-9470VC	31-1/2"	5	Valve
465-09903	WHD-9903EC	16-7/8"	4	Extension



VALVE HARDWARE // VALVES & VALVE TOOLS





# Z-Bore Valve System

**There are three spud types available:** the standard clamp-in spud, a screw-in spud and an angle screw-in spud. There is no temporary outside-in clamp-in spud for Z-Bore. The Z-Bore Valve System is very similar to the Super Large Bore System. By using an O-Ring to seal the clamp-in spud to the rim, a greater flow diameter is created without sacrificing strength or performance. Flows 370 CFM compared to 240 CFM on the Z-Bore Valve System.

## Z-1 SCREW-IN SPUD

- The screw-in spud is used to attach any Z-Bore valves to the rim
- Designed to screw into a 1/2" NPT-tapped rim hole
- Can be changed without demounting the tire

TUFFY NO.	MFG. NO.	DESCRIPTION
466-70001	Z-1	Screw-In Spud



466-70001

## Z-2 CLAMP-IN SPUD

- Can attach any Z-Bore valve to the rim through a standard valve hole (13/16")
- Fits a 13/16" diameter valve hole
- Tire must be dismounted to change spud

TUFFY NO.	MFG. NO.	DESCRIPTION
466-70002	Z-2	Clamp-In Spud



466-70002

## Z-13 SCREW-IN SPUD

- The Z-13 screw-in spud screws into the 3/4" NPT-tapped rim hole and converts Mega Bore to Z-Bore

TUFFY NO.	MFG. NO.	DESCRIPTION
466-70013	Z-13	Screw-In Spud



466-70013

## Z-4 ANGLE SCREW-IN SPUD

- Fits 1/2" NPT-tapped rim hole
- 85° bend angle

TUFFY NO.	MFG. NO.	DESCRIPTION
466-70004	Z-4	Angle Screw-In Spud



466-70004

## ANGLE CONNECTOR

- Connectors of various angles and lengths are available
- The connector accommodates a flexible extension which attaches to the Z-10 core housing

TUFFY NO.	MFG. NO.	DESCRIPTION
469-70360	Z3-60	60° Angle
466-70375	Z3-75	75° Angle
466-70380	Z3-80	80° Angle
466-70390	Z3-90	90° Angle



466-70390

## Z-BORE FLEXIBLE EXTENSIONS

- Made up in any length to allow extension to fit the wheel configuration
- Specially designed fittings and thermoplastic hose will not fatigue or crush during service
- Corrosion problems are eliminated
- Able to customize extension in the field
- ZFAK field assembly kit available to assemble your own

TUFFY NO.	MFG. NO.	DESCRIPTION
466-70700	ZBFE-Length	Flexible Extension
466-70701	ZFAK	<b>Assembly Kit For Z-Bore Valves. INCLUDES:</b> Contains Z-8 Swivel Connector, Z-7 Straight Tubing Connector, 2x Z2-2 Nuts, 2x Z-9 Tubing Connector Sleeves, Z-10 Core Housing. Z-100 Tubing Is Ordered Separately

## Z-10 CORE HOUSING

- Complete with core and cap
- Integral part of the system as the Z-10 is removed from the valve assembly with the Haltec Z-12B inflator to utilize the larger opening and the fullest flow

TUFFY NO.	MFG. NO.	DESCRIPTION
466-70010	Z-10	Core Housing w/Core & Cap



466-70010

## Z-12B INFLATOR

- To maximize air flow, a Z-12B inflator is used to remove core housing during inflation and deflation
- Operates like the IN-80A Super Large Bore inflator

TUFFY NO.	MFG. NO.	DESCRIPTION
466-70012	Z-12B	Inflator



466-70012





➔ Large Bore Extensions, Custom Bent Swivel Valves

# PT Valve System

The best way to insure maximum tire life is through proper tire inflation. Using a PT valve and gauge assembly, tire pressure monitoring has never been easier. Use the proper PT gauge for daily checks and a separate master gauge for weekly checks which will prevent air loss before it can cause permanent tire damage. The PT valve and gauge can be used on most Large Bore and Super Large Bore applications.

## PT VALVES

- Designed with trouble-free, urethane O-rings on the valve barrel
- Other valves and sizes available
- Assemble the valve to the tire and wheel assembly before installing the PT gauge to the PT valve

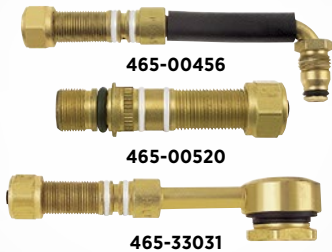

TUFFY NO.	MFG. NO.	DESCRIPTION
465-00042	PT-H-42	H-42 With PT Grooves & O-Rings
465-00456	PT-45-6	WJ-45-6 With PT Grooves & O-Rings
465-00520	PT-R-520	R-520 With PT Grooves & O-Rings For Super Large Bore
465-00524	PT-EX	Large Bore Extension w/1-5/8" Effective length to allow PT Gauge installation on existing valves
465-07536	PT-753S-6	753S-6 With PT Grooves & O-Rings
465-30060	PT-300-J-650	WH-300-J-650 With PT Grooves & O-Rings
465-33031	PT-330-3-1/2	Turret Style Valve With 3-1/2" Effective Length
465-33069	PT-330-J-690	WH-330-J-690 With PT Grooves & O-Rings

## PT GAUGES

- Easy-to-read dial gauge attaches to the valve
- Includes gauge and nut
- Calibrated 0-160 PSI
- Has an all-anodized aluminum body and is totally sealed to prevent moisture from fogging the glow-in-the-dark dial



TUFFY NO.	MFG. NO.	DESCRIPTION
468-00101	PT Gauge	Digital Passenger Gauge

## PTC BLOCK-OFF COLLAR

- For PT valves when gauge is not attached
- Can be installed to prevent air leakage



TUFFY NO.	MFG. NO.	DESCRIPTION
468-00580	PTC	5/8" Hex

## VALVE CAP

- Valve cap used on PT-style valves
- 5/8" hex



TUFFY NO.	MFG. NO.	DESCRIPTION
468-00150	A-150	Valve Cap

## PT VALVE TOOL

- Tightens nut to hold PT gauge on valve assembly
- Also tightens A-150 cap and PTC collar

TUFFY NO.	MFG. NO.	DESCRIPTION
468-00634	TL-634	PT Valve Tool



## LARGE BORE VALVE TOOLS

TUFFY NO.	MFG. NO.	DESCRIPTION
469-00010	ASP-10	Tube Deflation Aspirator. For Large Bore
469-00631	TL-631	Super Large Bore Retreading Tool. Used To Retread 11/16-24" Thread On Any Super Large Bore Valve
469-00680	TL-680	Three-Way Large Bore Tool. For Removing Large Bore Cores, Hex Caps And Screwdriver Caps
469-01610	N-1610	Large Bore Core Tool
469-01710	N-1710	Large Bore Core Tool. Valve Core Screwdriver Tool. Sliding Sleeve Allows Positive Grip On Valve Core For Hard To Reach Valves
469-01810	N-1810	Large Bore Hex Cap Remover. Plastic Handle For Positive Grip. 10" OAL
469-01910	N-1910	Large Bore Core Remover. Plastic Handle For Positive Grip. 5 - 6" OAL
469-06900	TL-690	Four-Way Large Bore Core Tool. Thread Repair For Core And Cap Threads And Core Remover For Large Bore And Super Large Bore
469-06950	TL-695	Four-Way Tool. Repairs Internal And External Threads On Air/Liquid Spuds. Also Large Bore Valve Core Insertion Tool
469-08909	8909-C	Large Bore Valve Fishing Tool
469-08910	8910	TPMS Valve Fishing Tool. Secures TPMS sensor to wheel during demount. One handle end can be used as a deflator, the other as a core remover. 3" OAL



VALVE HARDWARE // VALVES & VALVE TOOLS



➔ Valve Insertion & Removal Tools, Standard Bore Valve Tools, Sur-Lock Valve Tools

# Valve Hardware Tools

## VALVE INSERTION AND REMOVAL TOOLS



TUFFY NO.	MFG. NO.	DESCRIPTION
469-00033	VT-33	<b>No-Mar Valve Stem Remover &amp; Installer.</b> Installs And Removes Tubeless Valves Without Marring Or Scratching Chrome And Alloy Wheels
469-00040	00040R	<b>Valve Stem Puller with Rubber Boot</b>
469-00992	992	<b>Tubeless Tire And Tire Valve Inserting And Removing Tool.</b> For All Sizes Of Snap-In Passenger Car Tire Valves
469-01124	VT-1124	<b>Tubeless Tire Valve Service Tool.</b> Pull-A-Stem Tool Pulls Old Valves Or Inserts New Valves. Tool Fits All Sizes Or Lengths
469-03333	VT-03P	<b>Plastic Valve Puller with Metal Rod Insert</b>
469-43002	43002	<b>Plastic Valve Puller</b>

## VALVE CORE INSERTION AND REMOVAL TOOLS



TUFFY NO.	MFG. NO.	DESCRIPTION
469-00001	CT-1	<b>Pocket-Size Valve Core Remover</b>
469-00003	CT-3	<b>Heavy Duty Standard Valve Core Remover</b>
469-00005	CT-5	<b>For Both Standard and Large Bore Valves</b>
469-00607	607	Has Plastic Screwdriver Handle For Better Grip And Leverage
469-01638	1638A	<b>Heavy Duty Professional Plastic Valve Puller.</b> Steel Tube Reinforced Handle Provides Extreme Rigidity. Safety Orange Color For Easy Visibility. Protects Wheels From Damage During Installation/Removal Of Snap-In Valve Stems
469-15407	15407	<b>Angled Tubeless Tire Valve Inserting And Removing Tool</b>

## STANDARD BORE VALVE TOOLS



TUFFY NO.	MFG. NO.	DESCRIPTION
469-00612	TL-612	<b>Standard Bore Core Tool.</b> With An Overall Length Of 8" And Oversized Handle
469-00625	TL-625	<b>Standard Bore Core Tool.</b> With Recessed Probe. Fits In Pocket
469-00630	TL-630	<b>Hex Nut Driver.</b> For 500 Series Truck. For Tubeless Clamp-In Metal Valves. For All Lengths of Tubeless Truck Valves
469-00632	TL-632	<b>Truck Extension Service Tool.</b> Tightens Both Metric European And Domestic Type Extensions. Broached To Engage The Metric Hex At The Extension Top and Will Reach The Hex On A 7" U.S.A. Type Extension
469-00633	TL-633	<b>Valve Cap Tool.</b> Easy To Remove And Install Valve Caps On Inside Dual Wheels. For Aluminum Wheels
469-01440	1440	<b>Valve Cap Tool.</b> Length 9". Accommodates 440/1046 Valve Caps With Knurled Sockets

## SUR-LOCK VALVE TOOLS

- Special design allows the valve core to stay attached to the tool after it is removed from the valve
- Great tool to keep the valve core from getting dropped or lost

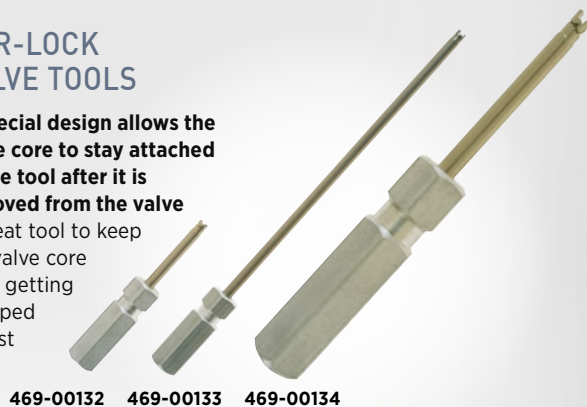

TUFFY NO.	MFG. NO.	DESCRIPTION
469-00131	TL-131	For Bicycles
469-00132	TL-132	For Cars. 1-3/4" Length
469-00133	TL-133	For Trucks. 8-1/4" Length
469-00134	TL-134	For Large Bore Cores. 10-1/2" Length

VALVE HARDWARE // VALVES & VALVE TOOLS



VALVE AND CORE TOOLS

TUFFY NO.	MFG. NO.	DESCRIPTION
469-00002	CT-2	<b>Black Heat Treated Heavy Duty Tire Valve Repair Tool.</b> 4-in-1 Standard Valve Tool Repairs Cap Threads, Repairs Core Threads. Easy-Out Feature For Removing Damaged Cores & Removing Standard Caps
469-00004	CT-4	<b>Economy Standard Bore 4-Way Tool</b>
469-00011	VT-11	<b>Cable Valve Fishing Tool.</b> Valve Core Wrench And Deflating Pin With Flexible Cable For Fishing Valve Through Rim Hole. 24" effective length
469-00018	VSW18	<b>Valve Stem Ratchet.</b> For TR570 Series Valves
469-00020	VSW20	<b>Valve Stem Ratchet.</b> For TR540 Series Valves
469-00021	VT-21	<b>Double-Use Tool.</b> Removes Valve Cores. Screws On Valve Mouth To Open Core.
469-00081	TVT-81	<b>Heavy Duty 4-Way Valve Core Tool</b>
469-00567	567A	<b>Core Removing Tool.</b> Screwdriver Grip. Easy Out For Removing Broken Cores
469-00609	TL-609	<b>Chain Valve Fishing Tool.</b> Guides Valve Smoothly Through Rim Hole While Mounting Tire & Tube
469-01115	VT-1115	<b>Valve Core Tool.</b> For Inserting And Removing. Valve Cores. Long Hex Body For Easy Access.
469-05262	5262	<b>Tube Deflating Aspirator.</b> Screwing Aspirator Onto Valve Mouth And Applying Air Chuck To Threaded Inlet Creates Vacuum That Siphons Air From Tube
469-11115	VT-1115I	<b>Recessed Valve Core Tool.</b> Core Tool Is Recessed Into The Handle. Design Eliminates The Possibility Of The Tool Poking Through A Shirt Pocket. Easily Fits Into A Shirt Pocket. Includes Clip
469-21610	BJ-BP01	<b>Valve Puller w/ Pivoting Head</b>
469-23430	VG8	<b>Tube Deflator.</b> Removes Air Completely, Quickly After The Valve Core Is Moved. Fits On Every Type Of Standard Bore Valve
469-32850	3285D	<b>Lock-On Screwdriver Core Tool.</b> 5" Effective Length. Allows The Valve Core To Stay Attached To The Tool After It Is Removed From The Valve. Protects The Valve Core From Loss. Aluminum Handles Provide A Sturdy Grip For Inserting And Removing Valve Cores
469-32851	3285E	<b>Lock-On Screwdriver Core Tool.</b> 6.5" Effective Length. Allows The Valve Core To Stay Attached To The Tool After It Is Removed From The Valve. Protects The Valve Core From Loss. Aluminum Handles Provide A Sturdy Grip For Inserting And Removing Valve Cores
469-52000	S-2	<b>Valve Copper Inner Dual Valve Core/Cap Tool</b>
469-00673	673-D	<b>Screwdriver/Core Tool.</b> Lock-On Feature For The Valve Core. Metal Pocket Clip. Flat-Head Screwdriver Tip



VALVE HARDWARE // VALVES & VALVE TOOLS



# Why do you need Quality Air Gauges?

**Keeping an eye on tire pressure is a critical part of regular inspection and maintenance.** Tire pressure is a critical function in many different ways. Underinflated (or grossly overinflated) tires don't handle safely, and if you find yourself in a "steer out of trouble" situation, improperly inflated tires can get you into a lot of trouble. Low tires heat up and can blow out, not only destroying the tire but also putting you in an accident-likely situation.

Keeping tires properly inflated also makes sense from a dollars and sense perspective: Underinflated tires wear out more quickly. Overinflated tires can make the ride rough, and actually wear out suspension parts. And yes, fuel economy is really affected by tire inflation. The solution to these safety and money issues is as simple as regularly checking tire inflation, and for this you need an accurate tire pressure gauge.

**PLEASE USE THIS GAUGE ACCURACY GUIDE AS A HELPFUL TOOL!**

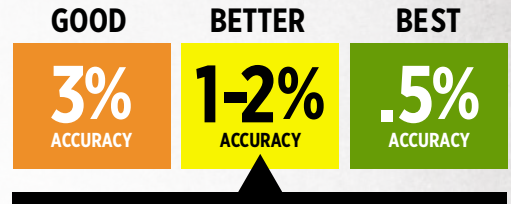

**A QUICK GUIDELINE FOR OUR GAUGES IS SHOWN WITH THE PRODUCTS IN THE SECTIONS BELOW**

**0.5% ACCURACY** ⬇

**DIGITAL & PENCIL GAUGES**

RECOMMENDED FOR ALL TYPES OF VEHICLES



476-03501  
➔ 10-100 PSI

477-10001  
➔ 0-174 PSI

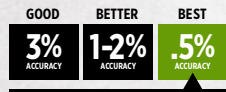

**1-2% ACCURACY** ⬇

**DIGITAL GAUGES**

RECOMMENDED FOR ALL TYPES OF VEHICLES



477-00130  
➔ 0-175 PSI



**1-2% ACCURACY** ⬇

**ANALOG GAUGES**

RECOMMENDED FOR ALL TYPES OF VEHICLES



477-10004  
➔ 0-138 PSI



**1-2% ACCURACY** ⬇

**BAYONET & SIGHT GLASS GAUGES**

RECOMMENDED FOR ALL TYPES OF VEHICLES



477-00001  
➔ 0-150 PSI

476-32921  
➔ 10-160 PSI

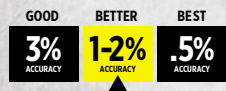

**3% ACCURACY** ⬇

**TRUCK SERVICE GAUGES**

RECOMMENDED FOR ALL TYPES OF VEHICLES



476-10155  
➔ 10-150 PSI

476-10480  
➔ 10-150 PSI

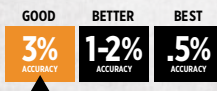

**3% ACCURACY** ⬇

**PENCIL GAUGES**

RECOMMENDED FOR ALL TYPES OF VEHICLE



476-10160  
➔ 20-120 PSI

476-10105  
➔ 10-50 PSI

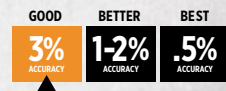

VALVE HARDWARE // TIRE GAUGES & CHUCKS







# Tire Gauges & Chucks

## BARTEC TPG200 TREAD DEPTH/PRESSURE GAUGE

The TPG200 is our mid-range Tread Depth and Tire Pressure checker. This rugged tool measures the tire in three places, easily showing the profile as well as tread depth. The TPG200 also measure tire pressure with the detachable air chuck and hose, included with the tool. The easy to read display, even sunlight, show all the important information. Once the tires are tested, send the data wirelessly to the computer using the Bluetooth radio.

- **INTEGRATED FUNCTIONALITY:** Allows the technician to quickly and accurately check pressure, and remaining tread.
- **ADVANCED TREAD DEPTH MEASUREMENT:** This highly accurate tool prompts the user to measure in three places to accurately display remaining tread and tire wear profile.
- **WIRELESS DATA MANAGEMENT:** Successful tire sales relies on conveying the right message and details, send the inspection results via Bluetooth to a handheld device or your point of sale workstation.
- **BUILT FOR THE TIRE SHOP:** The TPG200 is a rugged inspection tool built to last in the automotive repair bay or in the tire shop.
- **BUILT WITH THE TECHNICIAN IN MIND:** From the integrated flash lite that illuminates the work space to the intuitive menu flow, the TPG200 is easy and accurate to use.
- **STANDALONE OPERATION:** A rechargeable battery and quick connect pressure gauge means the TPG200 is a standalone service tool, that doesn't require connection to any other devices. The wall mounted charging cradle offers a safe place to store the tool and keep the battery fully charged.



476-10002

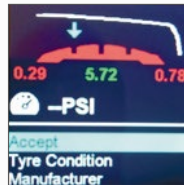

The easy to read display shows all the important information.



TUFFY NO.	MFG. NO.	DESCRIPTION
476-10002	TPG200	Tread Depth/Pressure Gauge

## BARTEC TPG100 TREAD DEPTH/PRESSURE GAUGE

The TPG100 is an easy to use, entry level Tread Depth and Tire Pressure Gauge. Despite its ease of use it offers high tech capability. The TPG100 Measures Tire Pressure and Tread Depth. Easily measure tire tread depth and measure tire pressure, then send the data to your smart phone via Bluetooth! The phone app is available for iPhone and Android and is free to download. Use the app and your phone to scan the VIN, look up vehicle information and then collect the data from the tool.

- **HIGH POWERED ENTRY LEVEL TOOL:** The TPG100 is small in size, but includes high end features like Bluetooth, LED light and a free data management application.
- **WIRELESS DATA MANAGEMENT:** Successful tire sales relies on conveying the right message and details, send the inspection results via Bluetooth to a handheld device or smart phone.
- **STANDALONE OPERATION:** TPG100 is a standalone service tool, that doesn't require connection to any other devices.



476-10001



The Bartec TPG100 Tread Depth/Pressure Gauge in use.

TUFFY NO.	MFG. NO.	DESCRIPTION
476-10001	TPG100	Tread Depth/Pressure Gauge

VALVE HARDWARE // TIRE GAUGES & CHUCKS



➔ Tire Tread Depth Gauges, Black Plated Master Tire Gauge, Automotive Tire Gauges

## Tire Gauges & Chucks (cont.)

### TIRE TREAD DEPTH GAUGES



454-00190

454-00599

454-00712

454-01420

454-01599

454-05127

TUFFY NO.	MFG. NO.	DESCRIPTION
454-00190	HT-190L	<b>3-Color All-Metal Tread Depth Gauge</b>
454-00599	595	<b>Tire Tread Depth Gauge.</b> Used To Measure Tire Tread Depth In 1/32" Increments: 0-1"
454-00712	NS712	<b>All Metal Tread Depth Gauge</b>
454-01420	HT-1420	<b>Truck Tire Depth Gauge.</b> Calibrated In mm and 1/32nd of Inch. Measures Shoulder Wear and Tread Depth. Durable Metal Construction
454-01599	599-C	<b>3-Color Tread Depth Gauge</b>
454-05127	5127	<b>Red-Yellow-Green Metal indicator bar with black numbers 0-32In 32NDS</b>

### TPMS BLACK PLATED MASTER TIRE GAUGE

- **RANGE:** 10-100 PSI in 2-PSI increments
- **ACCURACY:** ± .5 PSI accuracy
- Black electro-plated coating
- 2-sided plastic bar
- Angled chuck head
- Perfect for TPMS applications



BLACK ELECTRO-PLATED COATING

476-03501

TUFFY NO.	MFG. NO.	DESCRIPTION
476-03501	3501	Black Plated Master Tire Gauge w/ Angled Chuck - ± .5% Accuracy

### AUTOMOTIVE TIRE GAUGES\*

- Pencil, chrome tire gauges with nylon indicator bars

NYLON INDICATOR BARS

TUFFY NO.	MFG. NO.	RANGE	TYPE
476-10105	GA-150	10-50 PSI	<b>Passenger Gauge</b>
476-10115	GA-115	20-120 PSI	<b>High Pressure Gauge</b>
476-10100	GA-100	1-20 PSI	<b>Low Pressure Gauge</b>
476-10110	GA-110M	10-50 PSI	<b>Passenger Gauge</b> 75-340 kPa Calibrated in PSI & kPa
476-10120	GA-120M	20-120 PSI	<b>High Pressure Gauge</b> 150-280 kPa Calibrated in PSI & kPa
476-10125	GA-125	5-45 PSI	<b>Air/Liquid Gauge</b>
476-10145	GA-145	10-75 PSI	<b>Mid-Range Gauge</b> 70-500 kPa Calibrated in PSI & kPa



476-10125

476-10140

\* Imprinted gauges available with your name

### MASTER TEST GAUGES

- Used to check accuracy of gauges
- Calibrated 10 -160 PSI

TUFFY NO.	MFG. NO.	DESCRIPTION
476-10140	GA-140	Master Test Gauge

VALVE HARDWARE // TIRE GAUGES & CHUCKS



➔ Truck Gauges, Digital Tire & Tread Depth Gauges,

**POCKET TRUCK GAUGES**

TUFFY NO.	MFG. NO.	DESCRIPTION
476-10150	GA-150	<b>Straight-On/Angled Gauge.</b> 20 -120 psi. Chrome Plated
476-10160	GA-160	<b>Straight-On/Angled Gauge.</b> 20 -120 PSI. Black Baked Epoxy Protective Finish
476-10130	GA-130	<b>Dual Foot Angled Pencil Gauge.</b> 20 -120 psi



476-10160

**TRUCK SERVICE GAUGES**

▪ **Wide variety of service gauges to accommodate the numerous tire and wheel configurations encountered by tire service personnel**

▪ Available in chrome plated or protective black epoxy finish as indicated

▪ Calibrated from 10-150 PSI in 2-pound increments ▪ Nylon or metal indicator bars



476-10135

476-10155

476-10165

476-10185

TUFFY NO.	MFG. NO.	DESCRIPTION
476-10480	1048T	<b>Dual Chuck Service Gauge.</b> Straight-On/Angled With Metal Bar, Black Epoxy Finish
476-10135	GA-135	<b>Angle Chuck</b> With Nylon Bar
476-11135	GA-135S	Same As Above, <b>Angle Chuck</b> With Metal Bar
476-10155	GA-155	<b>Straight-On</b> With 30° Reverse Chuck
476-10165	GA-165	Same As Above, <b>Straight-On</b> With 30° Reverse Chuck, Black Epoxy Finish
476-11148	1048S	<b>Dual Straight Service Gauge,</b> Short Length
476-11155	GA-155S	Same As Above, <b>Straight-On</b> With 30° Reverse Chuck, Metal Bar
476-11048	1048-ADJ	<b>Internal Adjustable Field Service Gauge</b>
476-10185	GA-185	<b>Dual Foot Service Gauge</b> With Nylon Bar, 180° Chuck, Chrome Plated
476-11185	GA-185S	Same As Above, <b>Dual Foot Service Gauge</b> With Metal Bar

**DIGITAL TIRE GAUGES**

▪ **Large, easy-to-read LCD numbers for precise readings**

▪ Features pinpoint accuracy, convenient air bleed, protective casing ▪ Features dual foot chuck ▪ Reads 3 to 160 PSI



476-10500

476-15038



TUFFY NO.	MFG. NO.	DESCRIPTION
476-10500	DT-105	Digital Passenger Gauge
476-15038	DT150-38CV	Digital Truck Gauge PSI

**DIGITAL TREAD DEPTH GAUGE**

▪ **Made from strong carbon fiber composite** ▪ Zero setting in any position ▪ Metric, decimal inch and fraction inch toggle ▪ Large LCD display



454-00209



The Digital Tread Depth Gauge in use.

TUFFY NO.	MFG. NO.	DESCRIPTION
454-00209	NS209S	Digital Tread Depth Gauge

VALVE HARDWARE // TIRE GAUGES & CHUCKS



➔ Digital Pocket & Truck Tire Gauges, Dial Gauges, Air/Liquid Master Gauge

Tire Gauges & Chucks (cont.)



DIGITAL TIRE PRESSURE GAUGE

▪ **OPERATING RANGE:** 4-100 psi ▪ Automatically shuts off after 30 seconds of non-use to save battery life ▪ Easy-grip handle features innovative material to ensure gauge is held properly for the most accurate reading



476-05900

TUFFY NO.	MFG. NO.	DESCRIPTION
476-05900	5900	Digital Tire Pressure Gauge
476-05988	5988	Digital Tire Pressure Gauge w/ Backlight

DIGITAL TRUCK TIRE GAUGE

▪ **OPERATING RANGE:** 0-180 PSI ▪ **RESOLUTION:** 0.5 PSI ▪ **ACCURACY:** +/- 1% + 0.5 PSI at 100 PSI  
 ▪ Calibration in BAR, KG/CM<sup>2</sup>, KPA and PSI  
 ▪ Auto power off, simple operation ▪ Built-in backlight with clear, large LCD display  
 ▪ Replaceable LED battery ▪ **POWER SOURCE:** Lithium & LR 44 Alkaline



478-03238

TUFFY NO.	MFG. NO.	DESCRIPTION
476-03238	N/A	Digital Truck Tire Gauge

DIGITAL POCKET GAUGE

▪ **RANGE:** 0-150 PSI in .5 PSI increments  
 ▪ **ACCURACY:** ±1% PSI accuracy  
 ▪ Large LCD display ▪ Red backlight ▪ Angled chuck head



476-32380

TUFFY NO.	MFG. NO.	DESCRIPTION
476-32380	3238P	Digital Pocket Gauge w/ Angle Chuck - 1-150 PSI

DIAL GAUGE

▪ **Calibrated 0 to 160 PSI in 5 PSI units and 150 to 1100 in kPa metric scale**  
 ▪ 14" flexible hose ▪ Holds pressure readout until released



476-00274

TUFFY NO.	MFG. NO.	DESCRIPTION
476-00274	GA-274	Dial Gauge. 0 -160 PSI

DIAL GAUGE W/ EXTENSION HANDLE & BLEEDER VALVE

▪ 18" Standard & Large Bore Gauge w/Extension Handle & bleeder valve  
 ▪ Calibrated 0-160 PSI in 5 PSI increments



476-00276

TUFFY NO.	MFG. NO.	DESCRIPTION
476-00276	GA-276	Dial Gauge w/ Extension Handle & Bleeder Valve - 0-160 PSI

STANDARD AND LARGE BORE AIR/LIQUID MASTER GAUGE

▪ **Straight-on air chuck fits both standard and large bore valves**  
 ▪ Calibrated to 0 to 160 PSI in 1 PSI increments and 0-1100 in kPa metric scale ▪ Has recalibration feature and replaceable filters



476-00290

TUFFY NO.	MFG. NO.	DESCRIPTION
476-00290	GA-290	Standard and Large Bore Air/Liquid Master Gauge

DIAL GAUGE WITH RIGID EXTENSION

▪ **Calibrated 0 -160 PSI in 1 PSI increments. 0 to 1100 in kPa metric scale**

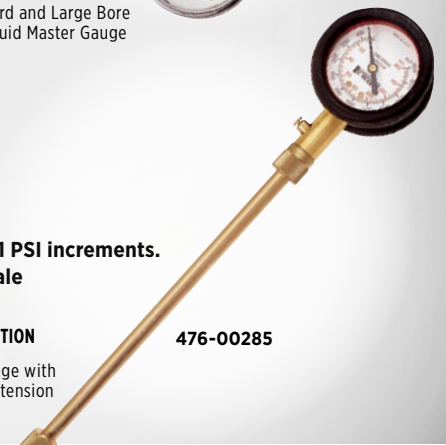

476-00285

TUFFY NO.	MFG. NO.	DESCRIPTION
476-00285	GA-285	Dial Gauge with Rigid Extension

VALVE HARDWARE // TIRE GAUGES & CHUCKS





➔ Adjustable Tire & Field Service Gauges, Master Test Gauge, Air Gauge Checking Stations, Economy Passenger Gauges

**DILL ADJUSTABLE TRUCK TIRE GAUGES**

TUFFY NO.	MFG. NO.	DESCRIPTION
476-07125	7125H	Straight and 30 Degree Reverse, Chrome, White Nylon Bar
476-07233	7233	360 Deg. Swivel for Standard and Large Bore
476-07262	7262	Straight and 30 Degree Reverse, Black, Black Metal Bar
476-07275	7275RB	Adjustable Truck Service Gauge with 25 Degree Offset Angle Chuck (Internally Adjustable)
476-07285	7285R	Dual Foot Service Gauge With Reverse Angle Chuck (Internally Adjustable)
476-17275		Adjustable Truck Service Gauge with 25 Degree Offset Angle Chuck (Externally Adjustable)
476-17285	7285E	External Adjustable Truck Service Gauge
476-27275	7275	Dual Angle, Chrome, Black Metal Bar
476-37285	7285	Straight and 30 Degree Reverse, Chrome, Black Metal Bar



**MASTER TEST GAUGE**

▪ For checking accuracy of service and pencil gauges ▪ Has dual foot chuck and a retaining valve to hold pressure reading after gauge is removed from valve to within +/- 2% of total dial reading ▪ Includes protective case ▪ **MADE IN THE USA**



TUFFY NO.	MFG. NO.	DESCRIPTION	RANGE
476-08860	8860C	Master Test Gauge	0 - 160 PSI

476-08860



**DILL AIR GAUGE CHECKING STATIONS**

▪ Use for checking air gauges for accuracy ▪ **MADE, TESTED & CERTIFIED IN THE USA**



476-08500

476-08501



TUFFY NO.	MFG. NO.	DESCRIPTION
476-03502	3502	Replacement Digital Air Gauge
476-08500	8500	Dill Air Gauge Checking Station
476-08501	8500D	Dill Digital Air Gauge Checking Station
476-08900	8900	Replacement Dial Air Gauge (Fully Calibrated)

**ADJUSTABLE FIELD SERVICE GAUGES**

▪ **Field adjustable truck service gauges** ▪ External Adjustment Screw makes calibration quick & easy  
 ▪ Adjustable Calibration  
 ▪ Plated finish provides corrosion protection and great looks ▪ 4-sided metal indicator bar is durable and easy to read  
 ▪ Hang-up ring provides a convenient method of storage  
 ▪ Flat-head screwdriver required for calibration



476-01046

476-11048

TUFFY NO.	MFG. NO.	DESCRIPTION
476-00135	135S-RCL	Adjustable Dual Foot Service Gauge
476-00165	165S-RCL	Adjustable Dual Foot Service Gauge
476-00185	185S-RCL	Adjustable Dual Foot Service Gauge -180 Degree Reverse Chuck
476-00250	250S-RCL	Adjustable Large Bore Pencil Gauge
476-00255	255S-RCL	Adjustable Large Bore Swivel Gauge
476-01046	1046-ADJ	Screwdriver Adjustable Calibration Gauge
476-11048	1048-ADJ	Internal Adjustable Metal Bar Gauge

**ECONOMY PASSENGER GAUGES**

▪ **10 - 75 PSI** ▪ Available with your company logo

TUFFY NO.	MFG. NO.	DESCRIPTION
476-05600	5600ST	Aluminum Barrel
476-05601	5600	Chrome Barrel



476-05600

VALVE HARDWARE // TIRE GAUGES & CHUCKS





# Dill USA Gauges

Proudly made in the USA

CUSTOM SCREEN PRINTING AVAILABLE FOR DILL USA GAUGES



476-07277

**A** DILL USA PENCIL GAUGES



**B** DILL USA DUAL FOOT TRUCK GAUGES



**C** DILL USA TRUCK SERVICE GAUGES



## A. DILL USA PENCIL GAUGES†

TUFFY NO.	MFG. NO.	RANGE	DESCRIPTION	FINISH	QTY./PACK
476-05602	5600-CH-USA*	10-75 PSI	Chrome Finish Gauge	Chrome	10
476-05603	5600-ST-USA*	10-75 PSI	Standard Silver Gauge	Aluminum	200
476-05604	5600-CF*	10-75 PSI	Classic Camouflage Gauge	Camouflage	10
476-07212	7212-USA*	20-120 PSI	High Pressure Gauge	Chrome	10
476-07213	7213-USA*	10-50 PSI	Passenger Car Gauge	Chrome	10
476-07215	7215-USA	20-120 PSI	High Pressure Gauge	Gold	10
476-07226	7226H*	20-120 PSI	Small Diameter Straight Chuck - Fits Standard and Large Bore	Chrome	10
476-07229	7229-USA*	1-20 PSI	Low Pressure 1/2 PSI Units	Chrome	10
476-07230	7230-USA*	5-45 PSI	Air Liquid Gauge	Chrome	10
476-07277	7277-USA*	10-75 PSI	Assorted 10 Colored Pencil Display Pack	Chrome	10
476-07290	7290-USA*	20-90 PSI	Standard Blue Pencil Gauge	Blue	200
476-01941	941-USA*	20-120 PSI	High Pressure Gauge	Silver	10

† Red, blue, green, gold, purple and grey colors available.

## B. DILL USA DUAL FOOT TRUCK GAUGES

TUFFY NO.	MFG. NO.	RANGE	DESCRIPTION	FINISH	QTY./PACK
476-07248	7248-USA*	20-120 PSI	Dual Angle Foot Chuck	Chrome	10
476-07263	7263-USA*	20-120 PSI	Straight-On 30° Reverse Chuck	Black Powder	10
476-07278	7278-USA*	20-120 PSI	Straight-On 30° Reverse Chuck	Chrome	10

## C. DILL USA TRUCK SERVICE GAUGES

TUFFY NO.	MFG. NO.	RANGE	DESCRIPTION	FINISH	QTY./PACK
476-00001	SG1	10-150 PSI	Dual Foot Head; Chrome Body with Black Markings on a White Bar	Chrome	1
476-00002	SG2	10-150 PSI	Dual Foot Head; Chrome Body with White Markings on a Black Bar	Chrome	1
476-00003	SG3	10-150 PSI	Dual Foot Head; Chrome Body with White Markings on a Black Bar - Adjustable	Chrome	1

\* Denotes gauges meet the proposed California Regulation for Under Inflated Vehicle Tires No. 95550.

VALVE HARDWARE // TIRE GAUGES & CHUCKS





Dill USA Chucks



# Dill USA Chucks

Proudly made in the USA



**A** DILL USA AIR CHUCKS



478-62931

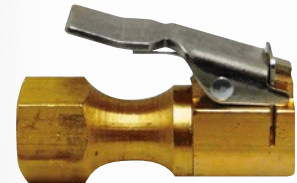

478-62932



478-62933

**B** DILL USA CLIP-ON AIR CHUCKS

## A. DILL USA AIR CHUCKS

TUFFY NO.	MFG. NO.	LENGTH	DESCRIPTION	FINISH	QTY./PACK
478-06172	6172-USA	6"	Angle Chuck for Inner Dual Wheels with Tilted Valves	Chrome	10
478-06173	6173-USA	6"	Lock Feature Straight-On 180° Degree Reverse Angle Chuck	Chrome	10
478-06174	6174-USA	14"	Extra Long Length Lock Feature Straight and 30° Reverse Angle Chuck	Chrome	10
478-16174	6174-BLK-USA	14"	Extra Long Length Lock Feature Straight and 30° Reverse Angle Chuck	Black Poly	10
478-06175	6175-USA	6"	Lock Feature Straight-On 30° Reverse Angle Chuck	Black Poly	10
478-06176	6176-USA	6"	For Standard Air Line Service	Chrome	10
478-06999	6999-USA	6"	Straight with 30° Reverse Angle Chuck	Chrome	10
478-16999	6999L-USA	6"	Same as 6999-USA Except for Lock-On	Chrome	10

## B. DILL USA CLIP-ON AIR CHUCKS

TUFFY NO.	MFG. NO.	CONNECTION	DESCRIPTION	FINISH	QTY./PACK
478-62930	6293C-USA	5/16" Barbed Fitting	Straight Clip Chuck for European Type Tire Changer, Normally Open	Silver Clip	10
478-62931	6293D-USA	1/4" NPT Female	Straight Clip Chuck for European Type Tire Changer, Normally Open	Silver Clip	10
478-62932	6293E-USA	1/4" NPT Female	Straight Clip Chuck for European Type Tire Changer, Flow Through	Black Clip	10
478-62933	6293	1/4" NPT Female	Ball Foot Chuck, Normally Closed	Silver Clip	10
478-62934	6293A	1/4" NPT Female	Clip Only for 6293 & 6293B Clip-On Chuck	Silver Clip	10
478-62935	6293B	1/4" NPT Female	Ball Foot Chuck, Normally Open	Black Clip	10

VALVE HARDWARE // TIRE GAUGES & CHUCKS



➔ Dual Foot, Angle Head & Lock-On Air Chucks, Ball Foot Chucks, European-Style Clip-on Chucks

# Air Chucks

## DUAL FOOT AIR CHUCKS



TUFFY NO.	MFG. NO.	DESCRIPTION
478-00335	CH-335	Angled Chuck. Plated Finish (Normally Closed)
478-01330	6568-FT	Dual Foot Chuck. 1/4" FPT, 6" Long, Lock-On Threads (Normally Open)
478-01335	CH-335-OP	Angled Chuck. Plated Finish (Normally Open)
478-01350	CH-350-LO	Straight-On/Angled Chuck. Protective Black Epoxy Finish (Normally Closed)
478-01351	6568T-FT	Straight-On/Angled Chuck. Black Epoxy Finish (Normally Open)
478-03300	CH-330-LO	Straight-On/Angled Chuck. With Lock-On Threads (Normally Closed)
478-03301	CH-330	Straight-On/Angled Chuck (Normally Closed)
478-03330	CH-333-LO	Straight-On/Angled Chuck. 14" Long (Normally Closed)
478-03370	CH-370-LO	Straight-On/180° Chuck. 1/4" NPT (Normally Closed)
478-06585	6585LB	Large and Standard Bore Chuck. 1/4" NPT (Normally Closed)

## ANGLE HEAD AIR CHUCKS

TUFFY NO.	MFG. NO.	DESCRIPTION
478-03238	3238P-C	Angle Head Air Chuck - Chrome Finish



## BALL FOOT CHUCKS



TUFFY NO.	MFG. NO.	DESCRIPTION
478-00305	CH-305	Ball Foot Chuck. 1/4" Female Thread (Normally Closed)
478-00315	CH-315	Ball Foot Chuck With Lock-on Clip. 1/4" Female Thread (Normally Closed)
478-00325	CH-325	Ball Foot Chuck With Lock-on Clip. 1/4" Female Thread (Normally Open)
478-05451	-	Ball Foot Chuck With Lock-on Clip. 1/4" Female Thread (Normally Closed - Alligator)
478-00707	-	Replacement Washer. For 478-05451 Ball Foot Chuck
478-04500	-	Air Chuck Clip. For All Ball Foot Chucks
478-04501	-	Economy Clip for Clip-On Ball Foot Air Chuck

## EUROPEAN-STYLE CLIP-ON CHUCKS



TUFFY NO.	MFG. NO.	DESCRIPTION
478-06293	6293-S	European-Style Clip-On Chuck. 1/4" Barbed Fitting. Straight Clip Chuck. Small Head Design. Silver Clip (Normally Open)
478-00001	N-1200	European-Style Clip-On Chuck. Serrated Shank for 1/4" I.D. Hose. Silver (Normally Open)
478-02985	CH-360	European-Style Clip-On Chuck. 1/4" Female Fitting. Silver Clip (Normally Closed)
478-02995	CH-360-OP	European-Style Clip-On Chuck. 1/4" Female Fitting. Black Clip (Normally Open)

## LOCK-ON AIR CHUCKS

TUFFY NO.	MFG. NO.	DESCRIPTION
478-00340	CH-340	Lock-On Air Chuck. 1/4" NPT Female Thread. Securely Locks Onto Valve When Sleeve Is Pushed Forward
478-01340	CH-340-OP	Lock-On Air Chuck. Available For Use With Tire Changers
478-05265	H-5265	Lock-On Air Chuck. Specially Designed To Lock Onto The Cap Of A Standard Bore Valve Stem When The Sliding Sleeve Is Pushed To Forward Position



478-00340



478-05265





➔ Lock-On Chucks, Clip-On Chucks, Truck Lock-On Extension Chuck, Master Air Gauge Checking Stations



**REVERSE ANGLE LOCK-ON AIR CHUCK**

▪ Reverse angle lock-on chuck allows easy access to outer dual valve



478-00345

TUFFY NO.	MFG. NO.	DESCRIPTION
478-00345	CH-345	Reverse Angle Lock-On Air Chuck (Normally Closed)
478-01345	CH-345-OP	Reverse Angle Lock-On Air Chuck (Normally Open)



**TRUCK LOCK-ON EXTENSION CHUCK**

▪ Extended reach for dual wheels ▪ Easy on/off application ▪ Steel pins for increased service life ▪ Automatic locking design ▪ Improves seal on flow through caps ▪ 22" overall length



TUFFY NO.	MFG. NO.	DESCRIPTION
478-32072	32071-L2	Truck Lock-On Extension Chuck

478-32072

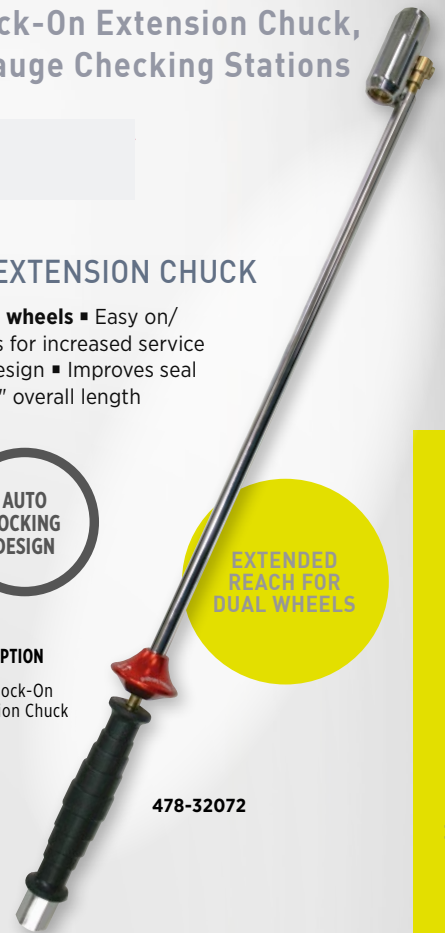

**LONG REACH STRAIGHT LOCK-ON CHUCK**

TUFFY NO.	MFG. NO.	DESCRIPTION
478-00346	CH-346	Long Reach Straight Lock-On Chuck (Normally Closed)
478-01346	CH-346-OP	Long Reach Straight Lock-On Chuck (Normally Open)

478-00346



**MASTER AIR GAUGE CHECKING STATIONS**

▪ INFLATION RANGE: 0-200 PSI ▪ ACCURATE TO: ±1 PSI  
 ▪ Designed to allow users to quickly and accurately check their air gauges and inflator gauges ▪ **THREE CHECKING POINTS:** standard valve port, large bore valve port & female coupler port ▪ Most accurate checking station on the market ▪ Equipped with a regulator and filter for proper air and water filtration ▪ CARB Certified ▪ Back-lit readout for ease of use  
 ▪ Can be mounted to a bench or a wall



476-35020

476-35021

TUFFY NO.	MFG. NO.	DESCRIPTION
476-35020	TS3502A	Digital Gauge Checking Station
476-35021	TS3502AL	Air/Liquid Gauge Checking Station

**EUROPEAN-STYLE CLIP-ON CHUCK**



478-02975

TUFFY NO.	MFG. NO.	DESCRIPTION
478-02975	CH-360S	European-Style Clip-On Chuck, 1/4" Female Fitting - With Spring Loaded Deflector Pin



➔ Large Bore Gauges, Large Bore Air Chucks

Air Chucks (cont.)

LARGE BORE AIR CHUCKS

LARGE BORE GAUGES

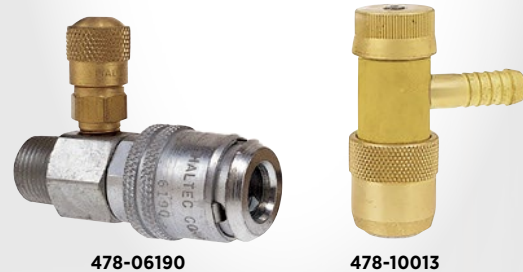

454-05131    476-10240    476-10250    476-10255

478-00322

478-00326

478-00377

478-00328

478-04660

478-06190

478-10013

TUFFY NO.	MFG. NO.	DESCRIPTION
454-01410	N-1410	Off-Highway Tire Tread Depth Gauge. Calibrated With 32nds And MM. Magnified Sight Glass For Easy Readability
454-05131	5131	Large Bore Tread Depth Gauge
454-05300	5300	Tire Tread Depth Gauge w/ Magnifying Lens - Calibrated with 32nds & MM
476-07233	7233	Dill Swivel Gauge
476-10240	GA-240	Straight-On Gauge. 20 - 120 PSI
476-10250	GA-250S	Swivel Gauge. Nickel Plated Brass. Plastic Bar. Calibrated 10 - 150 Psi In 2 Lb. Units. Swivels 360° For Those Hard-To-Reach Valves
476-10255	GA--255S	Swivel Gauge. Nickel Plated Brass. Metal Slide Bar. Calibrated 10 - 150 Psi In 2 Lb. Units. Swivels 360° For Those Hard-To-Reach Valves

TUFFY NO.	MFG. NO.	DESCRIPTION
478-00322	322	Large Bore Dual Foot Air Chuck. 45° Chuck For Easy Access To Valve. 1/4" NPT Female Thread
478-00326	326	Screw-On Air Chuck. .458"-26 Internal Thread. 1/2" NPT External Thread. Full Flow For Seating Of Tire Beads
478-00328	AC-B10	Short Lock-On Air Chuck. Locks On Valve When Cocked On Threads. Greater Air Flow And Seat Cannot Be Blown Out If Seal Fails. 1/4" NPT Thread
478-00377	AC-B11	Long Lock-On Air Chuck
478-04660	AC-B12	Clip-On Air Chuck. Locks Onto Valve When Sleeve Is Pushed Forward, Releases When Sleeve Is Pulled Back. 1/4" NPT Female Thread
478-06190	6190	Quick Connection Inflation Gauge. For Use With 6185 Check Valve. Sliding Sleeve Locks Chuck Onto Check Valve. Permits Unrestricted Air Flow
478-10013	10013	Large Bore Screw-On Chuck. Fits 3/8" ID Air Hose

VALVE HARDWARE // TIRE GAUGES & CHUCKS



# Inflator Gauges

## DIGITAL HAND-HELD TIRE INFLATOR\*

- **INFLATION RANGE:** 0 - 174 PSI
- **ACCURACY:** +/- .2 PSI ▪ 6' Hose
- Lightweight shock-resistant design
- High specification ceramic sensor
- Long life, easily replaceable battery
- Available in custom hose lengths and chuck styles
- Valve has provisions for checking air pressure during inflation
- Threaded for 1/4" male NPT hose fittings

LIGHTWEIGHT & SHOCK RESISTANT



477-10001

TUFFY NO.	MFG. NO.	DESCRIPTION
477-10001	Accura 1	Digital Hand-Held Tire Inflator

\* This gauge provides more accurate air pressure readings which is essential with TPMS.

## MK4 HEAVY DUTY HAND-HELD INFLATOR

- **NEW VIEWING WINDOW:** Larger window gives 20% greater field of viewing
- **LIGHTER WEIGHT:** Gauge body weighs 2.035lbs, less work strain and easier for repetitive use
- **BIOMORPHIC SHAPE:** Ergonomic, easier to use and less prone to damage when dropped
- **NEW VALVE MECHANISM:** Simplified 2-stage mechanism design prevents user having to "push" against full line pressure on deflate preventing fatigue
- **NEW PISTON & SEAL DESIGN:** New design, less drag, reduced friction & less movement inertia means no internal corrosion, no sticking and no skewing of accuracy
- **NEW CLEAR LITHOGRAPHIC DESIGN:** Fast and accurate reading of results
- **MAXIMUM INFLATION PRESSURE:** 160 PSI

NEW, LARGER VIEWING WINDOW

NEW VALVE MECHANISM

NEW PISTON & SEAL DESIGN



477-10004

TUFFY NO.	MFG. NO.	DESCRIPTION
477-10004	MK4	MK4 Heavy Duty Hand-Held Inflator

## EASYFLATE AUTOMATIC HAND-HELD INFLATOR

- **Auto-off after 90 seconds**
- Ideal for cars, trucks, bikes, etc.
- Large easy to read LCD display with audible warning
- Rechargeable Lithium-Ion battery
- Individually calibrated and tested
- Calibration certificate
- BSP to NPT adaptor
- Includes AC Power adaptor/charger
- Includes rubber sleeve for inflator

AUTO-OFF AFTER 90 SECONDS

LARGE, EASY-TO-READ DISPLAY



477-24868

TUFFY NO.	MFG. NO.	DESCRIPTION
477-24868	24868	EasyFlate Automatic Hand-Held Inflator



**WARNING:** Never inflate a tire on a multi-piece rim (a rim made up of 2 or more separate pieces) unless the tire and rim are mounted in OSHA regulation 29-CFR Part 1910.177 or D.O.T. approved tire inflation cage. OSHA Regulations require that an inflator gauge must be equipped with a lock-on chuck and have a hose extension sufficiently long for the operator to stand clear of the possible trajectory of a multi-piece rim.



➔ Heavy Duty Hose Inflator, Digital Tire & Large Bore Inflator Gauges

## Inflator Gauges (cont.)

### HEAVY DUTY HOSE INFLATOR



- Has two separate clip-on chucks with five-foot hoses
- One chuck, CH-360, fits standard bore valves and the other, H-4660A, large bore valves
- Has springloaded, hand-operated valve and has provisions for checking air pressure during inflation
- Threaded for 1/4" male NPT hose fittings

AUTO-OFF AFTER 90 SECONDS

LARGE, EASY-TO-READ DISPLAY



477-00404

TUFFY NO.	MFG. NO.	DESCRIPTION
477-00404	I-404	Heavy Duty Hose Inflator

### DILL DIGITAL TIRE INFLATOR GAUGE



- Digital backlight readout
- 0-170 PSI range
- 2 or 6ft. hose
- Clip-on or dual-foot chuck
- ASSEMBLED AND TESTED IN THE USA

DIGITAL BACKLIGHT READOUT

CLIP-ON OR DUAL FOOT CHUCK



477-76063

TUFFY NO.	MFG. NO.	DESCRIPTION
477-76023	7260-2-6293E	Digital Inflator - 2 Ft. Hose - Clip-On Chuck
477-76029	7260-2-6999FT	Digital Inflator - 2 Ft. Hose - Straight Chuck
477-76063	7260-6-6293E	Digital Inflator - 6 Ft. Hose - Clip-On Chuck
477-76069	7260-6-6999FT	Digital Inflator - 6 Ft. Hose - Straight Chuck

### LARGE BORE AIR LINE INFLATOR GAUGES

- Large Bore inflation unit with in-line gauge
- Equipped with AC-B12 large bore chuck
- Gauge is calibrated 10-140 PSI in 2 lb. increments
- Available in hose lengths of 6', 9' & 12'
- 477-01006
- Similar to Haltec I-409



IN-LINE GAUGE

TUFFY NO.	DESCRIPTION
477-01006	6' Hose with AC-B12 Large Bore Chuck
477-01009	9' Hose with AC-B12 Large Bore Chuck
477-01012	12' Hose with AC-B12 Large Bore Chuck

477-01006,  
477-01009,  
477-01012

Please contact us for more information about Inflator Gauges



VALVE HARDWARE // INFLATOR GAUGES



## AIR LINE INFLATORS

- Ideal for gauging and inflating dual tires on trucks and buses as well as passenger cars and light trucks
- Solid brass indicator bar
- Allows operator to stand away while inflating and deflating tires
- Bleeder valve allows user to adjust tire pressure without touching either the tire or valve stem



Hand-held



Digital



Safety Inflator Gauge with Ball Foot (Clip-On) Chuck



Safety Inflator Gauge with Straight Lock-On Chuck

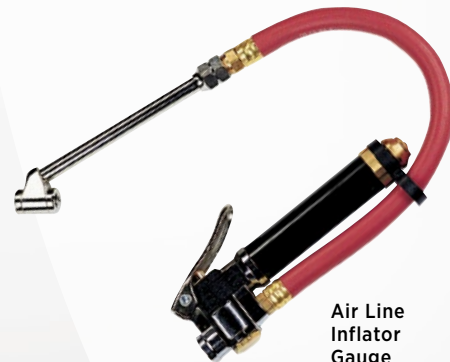

Air Line Inflator Gauge

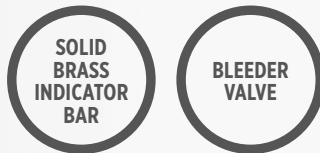

STANDARD #	HAND HELD #	DIGITAL BODY #	DESCRIPTION
<b>AIR LINE INFLATOR GAUGE</b>			
477-00001	477-20001	477-30001	12" Hose w/ Dual Foot Chuck
477-00011	N/A	477-30011	12" Hose w/ Tapered Chuck
477-00111	477-20111	477-30111	12" Hose w/ Lock-On Chuck
477-01111	477-21111	477-31111	12" Hose w/ No Chuck
477-11111	N/A	N/A	12" Hose w/ Lock-On Chuck & Bleeder Valve
<b>SAFETY INFLATOR GAUGE</b>			
477-00002	477-20002	477-30002	3' Hose w/ Ball Foot (Clip-On) Chuck
477-00003	477-20003	477-30003	3' Hose w/ Straight Lock-On Chuck
477-00004	477-20004	477-30004	6' Hose w/ Ball Foot (Clip-On) Chuck
477-00005	477-20005	477-30005	6' Hose w/ Straight Lock-On Chuck
477-00008	477-20008	477-30008	9' Hose w/ Ball Foot (Clip-On) Chuck
477-00009	477-20009	477-30009	9' Hose w/ Straight Lock-On Chuck
477-00010	477-20010	477-30010	12' Hose w/ Ball Foot (Clip-On) Chuck
477-00012	477-20012	477-30012	12' Hose w/ Straight Lock-On Chuck
477-00014	477-20014	477-30014	6' Hose w/ No Chuck
477-00015	477-20015	477-30015	15' Hose w/ Straight Lock-On Chuck
477-00020	477-20020	477-30020	20' Hose w/ Straight Lock-On Chuck
477-00033	477-20033	477-30033	3' Hose w/ Euro-Style Chuck
477-00066	477-20066	477-30066	6' Hose w/ Euro-Style Chuck
477-00099	477-20099	477-30099	9' Hose w/ Euro-Style Chuck
477-00112	477-20112	477-30112	3' Hose w/ No Chuck
477-00113	477-20113	477-30113	3' Hose w/ Sleeve Chuck
477-00115	477-20115	477-30115	6' Hose w/ Black Epoxy Lock-On Chuck
477-00118	477-20118	477-30118	9' Hose w/ No Chuck
477-00144	477-20144	477-30144	12' Hose w/ Euro-Style Chuck
477-01112	477-21112	477-31112	12' Hose w/ No Chuck

VALVE HARDWARE // INFLATOR GAUGES



➔ Dual Tire & Large Bore Inflation Gauges, Inflator Systems



## Inflator Gauges (cont.)

### DUAL TIRE INFLATOR GAUGE

- Features 5' hose to a tee connection, 2' of hose on each side with 12" sliding sleeve
- Lock-on chuck for easy access to inner dual and dual foot lock-on chuck for outer dual tire
- Allows user to engage and disengage chuck quickly

LOCK-ON  
CHUCK

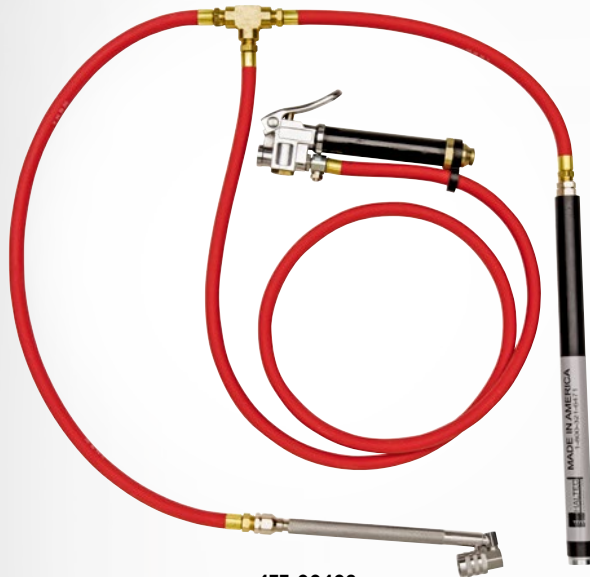

477-00408

TUFFY NO.	MFG. NO.	DESCRIPTION
477-00408	I-408	Dual Tire Inflator Gauge

### LARGE BORE INFLATION GAUGE

- Large bore inflation unit with in-line gauge
- Equipped with H-4660A chuck and 6' hose
- Gauge calibrated 10-120 PSI (70-800 kPa) in 2 PSI increments

IN-LINE  
GAUGE

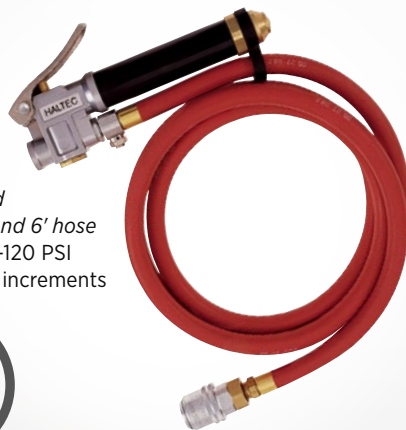

477-00409

TUFFY NO.	MFG. NO.	DESCRIPTION
477-00409	I-409	Large Bore Inflation Gauge

### INFLATOR SYSTEM

- 1/2" ball valve with dial gauge for checking pressure
- Equipped with safety coupler for releasing pressure in case of emergency
- 1/2" NPT connection
- 3/8" ID for maximum air flow



477-35020

TUFFY NO.	MFG. NO.	DESCRIPTION
477-35020	I-350-20	Inflator System

### INFLATOR SYSTEM

- 1/2" ball valve with dial gauge for checking pressure
- Equipped with safety coupler for releasing pressure in case of emergency
- 1/2" NPT connection
- 3/8" ID for maximum air flow



477-34020

TUFFY NO.	MFG. NO.	DESCRIPTION
477-34020	I-340-20	Inflator System

### INFLATOR SYSTEM

- Safely removes operator away from blast zone by using the 15' hose
- Shut-off valve (ball valve) enables operator to stop inflation for proper tire inspection
- Includes IN-95 and three additional unions to adapt different sizes, such as SLB, MB & ZB



477-49515

TUFFY NO.	MFG. NO.	DESCRIPTION
477-49515	I-495-15	Inflator w/ 15' Hose



# TPMS

Tire Pressure Maintenance Solutions



## TPMS Tools

1. Check to make sure tire sensors are working
2. Check each tire's pressure and temperature
3. Help vehicle's computer 'relearn' new sensors
4. Program blank sensors



## ATEQ Products

**VT56:** Comprehensive TPMS service tool with continuously updated global vehicle and TPMS sensor coverage, colored screen, VIN scan and integrated help

**VT36:** Low cost sensor activation and programming tool

**TTD:** Tire Tread Depth gauge is a VT56 accessory that quickly takes 3 precise tire tread measurements

**Printer:** Wireless VT56 accessory for printing TPMS sensor and tire tread depth data

**Docking Station:** Used for housing and charging the VT56 and printer

### VT36 Kit



### VT56 Kit



### VT56 Accessories

Docking Station



Printer



TTD



# TPMS WITHOUT LIMITS

Long gone are the days when quality must be sacrificed for fewer SKUs. As the global OE market leader in TPMS, Schrader has consistently led the industry in sensor innovation, quality and design. Schrader's aftermarket program is no exception. The same sensors made on the OE production lines, are put into a different box and sold to the aftermarket: the same OE quality, the same OE technology. Quality is key to having a successful TPMS program.

## However...

An ideal TPMS program would also allow you to stock as few parts as possible. Schrader changed TPMS forever when we introduced our single SKU EZ-sensor®. An OE quality, programmable sensor that covers over 90% of TPMS equipped vehicles.

A single SKU inventory provides:

- ▶ Increased inventory levels and turns
- ▶ Faster service
- ▶ Decreased lost sales
- ▶ Reduced overall cost of service

With Schrader's EZ-sensor, you can have an OE quality part as well as the efficient and profit-building features of a single SKU inventory. That is TPMS without limits.

**EZ-sensor®**



Part #33500

- ▶ Combines 314.9, 315 & 433 MHz applications into ONE sensor
- ▶ Future proofed to support new and pending OE system technologies
- ▶ Achieves OE quality requirements
- ▶ Replicates OE functionality, including auto-locate technology

**SCHRADER®**  
PERFORMANCE SENSORS

