



ttieurope.com

Relay & Power Application Guide

TTI, Inc., – A Berkshire Hathaway Company



ttieurope.com



The Specialist in Electronic Component Distribution



One of the largest Autostore systems in Europe

Why Choose TTI?

Founded in 1971, TTI has steadily grown to become a world leading specialist distributor of electronic components. The company was founded on the premise that passive component purchasing could be made more efficient by offering product specialization, customer-driven service and proprietary supply chain solutions.

Global Distribution Centres

Our European headquarters is located just outside of Munich, Germany in Maisach-Gernlinden. In total, we have 35,000m² of dedicated warehouse space and local sales and technical support in over 40 locations across Europe. TTI has more than 120,000m² of automated warehousing in North America, Europe and Asia. All are linked into a global warehouse management system that provides superior customer service and overall business efficiencies. Wherever you are in the world, TTI can support you.

Year after year, customers rate our inventory availability, on-time delivery and accuracy among the very best in the industry – contact us today to find out what a true specialist has to offer.

Quality and Reliability

TTI is the first distributor to have all global warehouse locations ISO registered and certified to ISO 9001 and ISO 14001 Standards. TTI Europe is also certified to EN9120/EN9100, IECQ-CECC and ISO/IEC 27001 Standards. Additionally, all of our European sales branches are ISO 9001 certified. TTI has one global documentation system that ensures that every TTI branch and warehouse in the world follows the same processes.



Local Sales and Technical Support in over 40 locations across EMEA

Global Distribution Centres
120,000m²

of automated warehousing in North America, Europe and Asia

European HQ, Munich
35,000m²

of dedicated warehouse space



Finding the Right Product Solution for your Design

TTI has a wealth of Relay design expertise and offers a wide range of relays from safety critical relays, automotive specified relays, solid state relays, MOSFET relays, signal relays and power relays. We have a wide range of high voltage contactors for battery management systems for electric cars, trucks, buses and DC charging stations and energy storage systems.

Finding the right power solution for your design requirements from front-end, low, mid, high power AC/DC converters to DC/DC standardised bricks, converters, POLs, plug-in external power supplies, adaptors, Industrial DIN-rail and intelligent configurable power supplies; TTI has a world-class range of power supplies to offer.

TTI's specialised power engineers welcome the opportunity to work with you to help develop power solutions and resolve your issues like EMI, heat dissipation, medical/rail regulations and certifications.

Industrial

Factory Automation/Process Control	06
HVACR – Heating, Ventilation, Air-Conditioning and Refrigeration	12
Lighting	14
Oil & Gas/Hazardous Environment	20
Renewable Energy	21
SMART Buildings	24
Smart Metering	27

Transportation

Automotive Systems (12-24VDC)	28
Battery Management Systems	30
Charging Stations/Wallboxes	32
Electrical Vehicles	33
Rail – Rolling Stock	35

Defence and Aerospace

Avionics	38
Ground Vehicles	39
Military Communications	41

Medical

Home Healthcare & Portable Medical Devices	44
Medical Equipment, Imaging & Diagnostics	45

Networking & Communications

Datacommunications Infrastructure (Data Centres)	52
RF/Microwave/Broadcast	53
Telecom Infrastructure	55

Consumer

Appliances	57
Wearables	62



Relay & Power Line Card

Relays & Circuit Breakers

	IDEC	KEMET	Littelfuse - Ixys	Omron	Panasonic	Phoenix Contact	Radiall	Standex Meder	Sensata - Crydom, Cynergy 3	TDK Electronics	TE Connectivity - KLOVAC, CII, Kissing	Toshiba	Vishay	Weidmüller
Relays														
Automotive														
Communication														
Contactors/Electrification														
Control														
Counters														
Crystal Can (Military)														
Definite Purpose Contactors														
DIN Rail Mounted														
Force Guided Contact														
General Purpose														
High Frequency Relays														
High Voltage														
Industrial DC & AC														
Input/Output Modules														
Magnetic Latching														
Microwave														
Military/Space														
Miniature PCB														
MOSFET/PhotoMOS*														
Panel/Plug-In														
Power														
Reed														
Safety														
Signal														
Sockets														
Solid State Relays														
Time Relays														
Circuit Breakers														
Magnetic Circuit Breakers														
Thermal Circuit Breakers														

Power Supplies

	Advanced Energy (Artesyn & Excelsys)	Flex Power Modules	ABB, Embedded Power	MEAN WELL	Murata Power Solutions
Internal/Embedded - AC/DC					
Low to Mid Power (1W - 500W)					
High Power (500 - 1.5KW)					
Single Output					
Multi-Output (Dual, Triple, Quad)					
PCB Mount					
Open Frame					
U-Channel/Enclosed					
Modular/Configurable					
ATX					
Front End, Bulk Power					
Medical Rated					
Conduction Cooled					
Industrial Temperature					
Extended Temperature					
I2C PMBus* Control/Interface					
Power Over Ethernet (PoE)					
External - AC/DC					
Wall Mount Adapters					
Desktop					
Medical Rated					
DIN Rail					
High Power (1KW - 24KW)					
LED Drivers					
KNX products					
Specific Purpose					
UPS					
Battery Charging					
Inverter (DC/AC)					
Security					
DC/DC					
Isolated DC/DC Converters					
Fractional Brick					
Digital Control					
Industrial Pin-Out					
Intermediate Bus Converter					
Low Power Unregulated					
Wide Input Range 4:1					
Surface Mount					
DC/DC Railway					
Non Isolated POL Converters					
Digital Control					
Through Hole					
Single In Line					
Surface Mount					
Ancillary Power Products					
ATCA PIM Modules					
RF/Power Amplifier					
PFC Modules					
300Vin Modules					
Embedded DC/DC					
Open Frame/Enclosed					
Front End Bulk Power					

Power Supply Accessories

	3M	EBM PAPST*	Ohmite
Thermal Management			
DC Fans			
AC Fans			
Heatsinks			
Thermal Foils			
Thermal Adhesive/Compounds			

ABB

ABB

Rectifier CP3500AC65TEZ

Modern factory processes benefit from this high efficient/high density power solution. Its wide programmable output voltage makes it versatile. RS485 and I2C communication buses effortlessly connect to a wide range of standard applications.

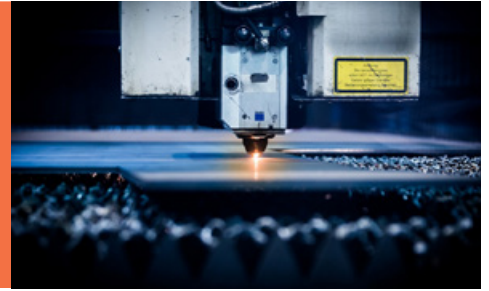

Applications

- Lasers
- RF power amplifiers
- Industrial battery chargers

CP3500AC65TEZ

Features & Benefits

- Compact 1RU form factor with 40 W/in³
- Efficiency exceeding 96% (meets 80+ Titanium)
- Programmable output 23–65VDC
- Redundant +5V at 2A Aux power
- Redundant, parallel operation with active load sharing
- Incorporates RS485 and I2C communications busses



Non-isolated point of load converters

Demanding process control circuits benefit from these POL converters. Industrial input ranges, rugged specifications and DOSA make them ideal for ease of design. Design cycles are shortened by selecting these standard off-the-shelf parts with proven track records.



Applications

- Electronic control circuits
- FPGA designs
- Communication circuits



DLynx

Features & Benefits

- Advanced thermal management gives high efficiency (96%)
- Wide input (3–14.4Vdc) and wide output range (0.45–5.5Vdc)
- Both digital and analog versions

ProLynx

Features & Benefits

- Three products available, 3A, 5A and 12A
- Ultra wide input voltage range of 9–36Vdc
- Extended output voltage range 3–18Vdc
- High efficiency operation up to 97%
- Possible to create negative output from a positive input
- Extended shock and vibration

LITTELFUSE/IXYS

Semiconductor relays for industrial applications

The combination of low on-resistance and high load current handling capabilities makes the IXYS MOSFET relays suitable for a variety of high-performance switching Industrial applications. Switching of these relays is controlled via a highly efficient GaAlAs LED on the input side which provides the light that is converted into electrical energy by a photovoltaic generator/driver on the isolated output side.



Applications

- Industrial controls
- Motor control
- HVAC control
- Robotics
- Multiplexers
- Electronic switching
- Starter ignition circuits
- Rail applications

CPC1706 (60V_{DC}, 4A_{DC})

Features & Benefits

- 1-pole: 1 NO output
- Load currents up to 4ADC at 60VDC
- Power SIP package
- Fulfills low drive power requirements
- 2500VRMS isolation, input to output

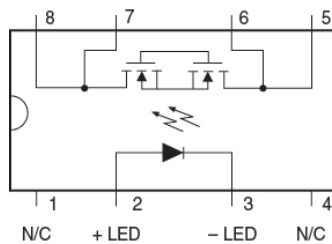
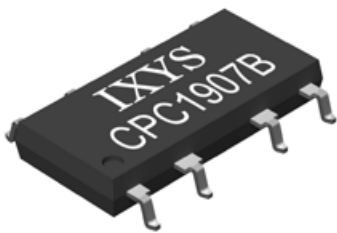
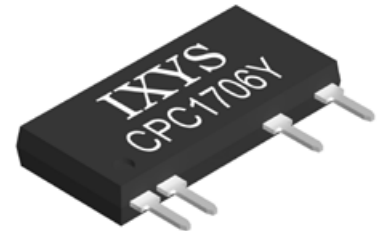
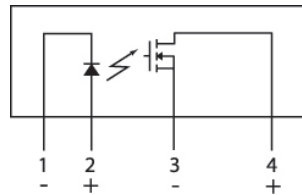

CPC1907B

(60V AC peak or DC, 6A)

Features & Benefits

- 1-pole: 1 NO output
- Load currents up to ± 6 ADC or 6ARMS at 60VP
- 5000VRMS input/output isolation
- Arc-free with no snubbing circuits
- No EMI/RFI generation

CPC1909 (60V AC peak or DC, 15A)

Features & Benefits

- 1-pole: 1 NO output
- Load currents up to 6.5ADC or 6.5ARMS (Free Air)
- Load currents up to 15ADC or 15ARMS (5K/W heatsink)
- Low 0.1 Ω on-Resistance
- 2500VRMS input/output isolation
- Flammability rating UL 94V-0

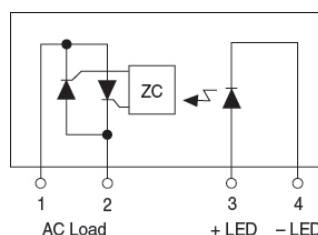
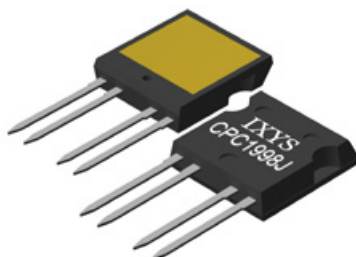
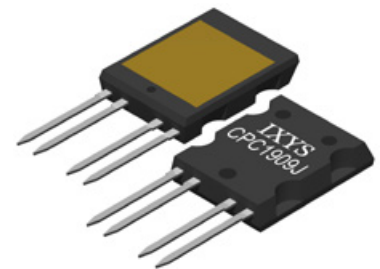
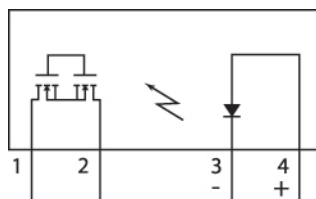

CPC1998

(20–240VAC, 20ARMS)

Features & Benefits

- 1-pole: 1 NO output
- Load currents up to 5ARMS (free air)
- Load currents up to 20ARMS (5K/W heatsink)
- 800VP blocking voltage
- 5mA control current
- 2500VRMS isolation, input to output

MEAN WELL



Industrial Power Rack

Modern factory processes benefit from this high efficient/high density power solution. Its wide programmable output voltage makes it versatile. PMBus® (I2C) or CANBus® communication buses effortlessly connect to a wide range of standard applications. Active current sharing supports layout for fail safe operation of equipment in critical processes.

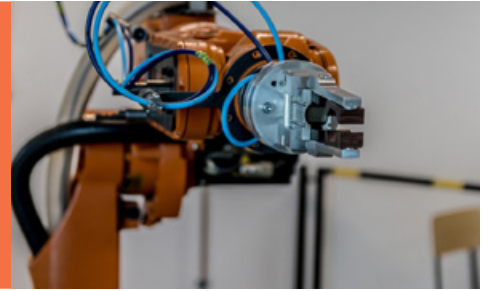

Applications

- Charging applications in harsh environment
- Laser cutting
- Electrolysis system
- Telecommunication
- Robotic

DPU/DBU/DRP/DBR-3200

Features & Benefits

- Full range AC input 90-264Vac
- Output: 24V/48V
- Fully digital control
- High efficiency up to 94.5%
- Built-in OR-ing MOSFET and hot-swap capability (DRP/DRB Rack Systems)
- PV and PC functions
- Active current sharing, parallel up to 5 units for 16kW system (25600W for 2 x DRP racks)
- Built-in charging curve options for different batteries (DBU/DRB-3200)
- Built-in I2C/PMBus® communication protocol (CANBus® optional)
- Protections: Short/OLP/OVP/OTP
- 5 year warranty



Panasonic

Panasonic
INDUSTRY

Safety relays: miniaturization of designs

Panasonic Industry offers safety relays for a variety of applications such as factory & industrial automation, machine tool, robots, safety PLCs and more. Especially with SFM, SF-Y and SFS series, Panasonic Industry serves the demand for safety relays suiting modern slim and miniaturized application designs.



Applications

- Safety Relay modules
- Safety controller/PLCs
- Safe motion control
- Access control
- Elevator control
- Escalator control
- AGV (automated guided vehicle)
- Emergency stop

SFM

The 6A SFM – the world's flattest 2-pole relay with forced guided contacts – comes with an unrivaled height of 7.8mm and can directly control loads without using a separate relay in a wide range of applications. Unique is the reflow soldering capability of SFM series, that makes production as easy as it has never been before.

Features & Benefits

- 1 NO/1 NC relay with forcibly guided contacts according to EN 61810-3
- Extremely low height of 7.8mm
- Rating 6A (NO), 4A (NC) at 250VAC and 30VDC
- 100mW coil holding power
- High shock resistance >20g
- THT and THR type available
- Reinforced insulation $\geq 5.5\text{mm}$ (V=230V overvoltage category III, 6KV) on NO side



SFY

The 4- and 6-pole SFY relays deliver low power consumption and high switching capacity, requiring only up to 40% less space compared to alternative relays. The strong silver alloy contacts can handle 6A at the same time on every switching path – without derating even for the 5a1b type.

Features & Benefits

- Forcibly guided contacts according to EN 61810-3, Type A
- 4-pole version: 2 NO/2 NC or 3 NO and 1 NC contacts
- 6-pole version: 4 NO/2 NC or 5 NO and 1 NC contacts
- Low profile design, 14.5mm high
- Very low coil power dissipation
- High shock and vibration resistance
- Degree of protection RTIII
- Suitable for applications requiring IEC/EN 60335-1
- Reinforced insulation

SFS

Designed in a slim PCB space-saving way, the 4- and 6-pole SFS relays stand out with very low dissipation power and high switching current – and delivers the option of an integrated status LED for industrial purposes.

Features & Benefits

- Forcibly guided contacts according to EN 61810-3, Type A
- 4-pole version: 2 NO/2 NC or 3 NO and 1 NC contacts
- 6-pole version: 4 NO/2 NC, 5 NO and 1 NC or 3 NC and 3 NO contacts
- Optional LED & integrated freewheeling diode
- Sockets for PC boards or DIN-rail mounting available
- VDE approval according to DIN EN 60947-5-1 available

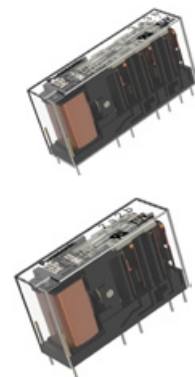



TE Connectivity's SCHRACK Relays

Industrial safety power relays (6/8A)

TE's SCHRACK range of forcibly guided relays safeguard devices by providing stopping and starting safety executions, with minimal effort. Safety relays constantly examine and verify the safety of machinery and provide high performance, reliability and are certified according to EN50205 regulations.



Applications

- Emergency shut-off/stop
- Press control
- Machine control
- Process technology
- Elevator control
- Escalator control
- Safety modules & doors
- Rail applications

SR2M

Features & Benefits

- 2-pole: 1 NO + 1 NC and 2 CO contacts
- 6A at 250VAC
- Reinforced insulation between poles 1.500VA
- According to EN50205

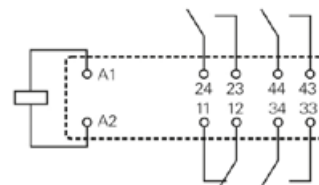
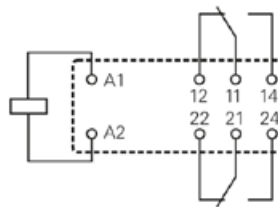

SR4D/M

Features & Benefits

- 4-pole: 2 NO + 2 NC and 3 NO + 1 NC contacts
- 8A at 250VAC
- Compact design, space efficient
- Reinforced insulation between all contacts 2.000VA
- According to EN50205

SR6 A/B/C/V

Features & Benefits

- 4-pole: 3 NO + 1 NC and 2 NO + 2 NC contacts
- 6-pole: 3 NO + 3 NC/4 NO + 2 NC/5 NO + 1NC
- 8A at 250VAC
- Reinforced insulation between all contacts depending on version 2.000VA
- According to EN50205

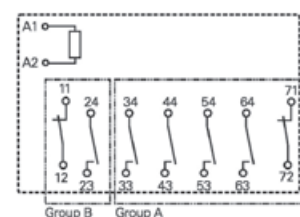
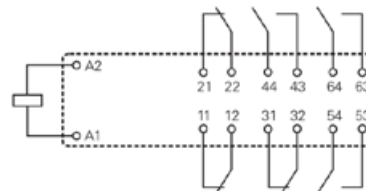

SRL7

Features & Benefits

- 7-pole: 2 NC + 5 NO contacts
- 6A at 250VAC
- 1.500VA
- Coil power: 700mW
- According to EN50205

TE Connectivity's SCHRACK Relays



Industrial power & panel plug-in relays (1-32A)

Virtually every control panel installed in an industrial application will require industrial relays. Complying with standardized PCB footprints, TE offers a wide range of inrush current capabilities, coil and termination options that address the complete spectrum of requirements for factory automation & control panels.



Applications

- Production lines
- Robotics
- Elevators
- Control panels
- CNC machines
- Interface technology

PT (2/3/4 Pole)

Features & Benefits

- 1/2/5/6/10/12A and 2/3/4 form C (CO) contact
- Sensitive coil 750-900mW
- Manual test tab, optionally lockable
- Mechanical indicator
- Optional LED, protection diode

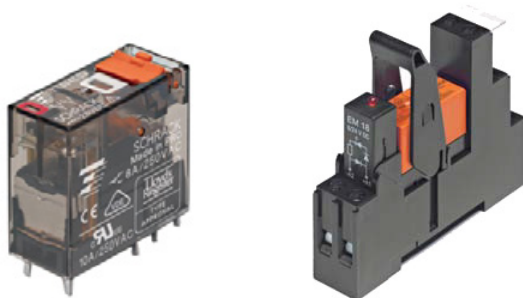

XT (1/2 Pole)

Features & Benefits

- 8/16A and 1/2 form C (CO) contact
- 4kV/8mm dielectric strength between coil and contact
- Reinforced insulation
- Mechanical and electrical indicator

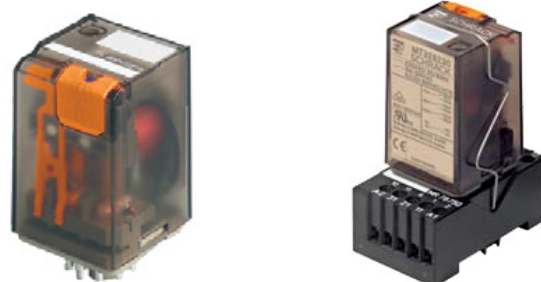

MT (2/3 Pole)

Features & Benefits

- 4/10A and 2/3 form C (CO) contact
- DC and AC coils
- Mechanical indicator, indicator lamp and push-to-test options
- Industry standard octal/undecal type termination



RM2/3/7/8/C/D (1/2/3 Pole)

Features & Benefits

- 10/16/25/30/32A and 1/2/3 form C (CO) + 1Z (NO+NC) + 1X (NO) contact
- Power relay with push-on and solder terminals
- Various mounting options
- Indicator lamps and mechanical indicator
- Optional push to test button

Advanced Energy



Conduction Cooled enclosed PSU

Industrial thermal management shows a growing demand for fanless power supplies that provide high usable power at elevated temperatures with some environmental protection. The absence of unwanted airflow minimizes the circulation of controlled particles, contaminants and microbes



Applications

- Industrial heaters
- HVAC systems
- Large industrial coolers
- Thermal management in the food industry
- Compressors and motor drives for thermal management

LCC Series

Features & Benefits

- 250W and 600W available higher power models in development will be launched in 2021
- No temperature derating over wide temperature range -40°C to 85°C baseplate
- Adjustable output
- IP65 version
- I2C/PMBus®
- Remote On/Off; AC_OK; DC_OK
- Active current share
- ITE and medical safety



OMRON

OMRON

PCB power relays G2RL/G5RL

Heating, ventilation and air conditioning is the technology of indoor and vehicular environmental comfort. Its goal is to provide thermal comfort and acceptable indoor air quality.



Applications

- HVACR
- Building automation (shutter, lighting)
- Boilers/heaters
- Home appliance: white goods

Both the G2RL and G5RL relay family are low profile PCB power relays with 15.7mm height which makes them ideal for use in HVAC applications.

Features and Benefits

G2RL-RELAY

- Conforms to VDE (EN61810-1), UL508 and CSA22.2
- IEC/EN 60335-1 conformed (HA model)
- Ambient operating temperature of 85°C and 105°C (CV model)
- Coil insulation system: Class F (UL1446)

G5RL-RELAY

- 10kV Impulse withstand voltage
- Models with AC or latching coil available
- High-inrush model available (Inrush peak 100A)
- Low Noise and TV8 models available



Miniature Power Relay G5NB/G5Q (EL/EL2/EL3)

Now with OMRON G5NB and G5Q slim power relays, small PCB designs for HVAC can be easier to create than ever. These relays have 40–60% smaller footprints compared to standard cube relays.

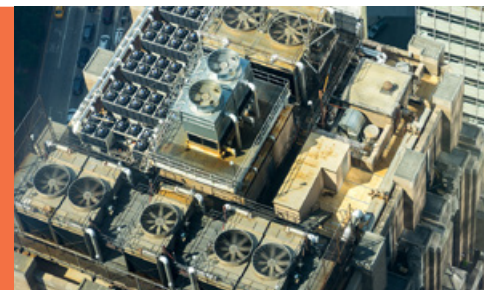

Applications

- FA I/O modules
- Output of control systems
- Small electric appliances
- Air conditioners

Features and Benefits

G5NB-RELAY

- Coil power consumption of only 200mW
- 10-kV impulse withstand voltage
- IEC/EN 60335-1 conformed (-HA model)
- IEC/EN 60079-15 conformed versions available

G5Q-RELAY

- IEC/EN 60335-1 conformed
- Switching IEC/EN 60079-15
- EL: 100,000 operations durability at 10A (250 VAC)
- EL2: 40A inrush current & UL508 TV3 conform
- EL3: 30A inrush current for motor switching



Advanced Energy



Lowering the cost of powering your horticultural lighting systems

Using a large centralized current source outside the environmentally controlled growth areas directly powering all the luminaires eliminates the need for individual drivers and the associated costs. High degree of control enables easier design of flexible light programs.



Applications

- Horticultural lighting
- Large industrial lighting systems
- Centralised powered lighting for large buildings/sites

iHP Series

Features & Benefits

- Outputs versatile CC or CV
- Output voltages up to 1kV
- Output currents up to 1600A
- 12kW or 24kW rack
- 4/8 slots
- 100% digital control
- Fully programmable lighting control allowing independent management of multiple areas with different schedules and light intensities



MEAN WELL



Enclosed and rainproof PSU for LED sign panel

Wide voltage ranges, form factor and mechanical construction of MEAN WELL's UHP and ERP series make it ideal for signage, industrial, and residential applications to be mounted under just a protecting roof. These power supplies provide reliable, affordable conversion for outdoor applications where only limited protection against the environment is available. Cooling by free air convection and wide temperature range support life long operation.



Applications

- LED strip lighting
- LED channel letters
- LED moving sign
- LED display
- Industrial automation machinery
- Household appliances
- Industrial control system
- Charging related equipment
- Test and measurement instrument
- Laser related machine

UHP Series

Features & Benefits

- Series: UHP-200/350/500(R)/750/1000/1500/2500
- Output voltage: 3.3,4.2,5,12,15,24,36,48
- Universal AC input: 90~264VAC
- Low profile: 26 to 41mm (H)
- Active PFC function
- 150% peak load capability (100ms)
- Fanless design (semi-potted)
- Optional "R" model: DC OK and redundancy functions
- Operating altitude up to 5000m
- Working temperature: -30~+70°C
- UL62368-1, TÜV EN62368, EN 60335-1
- 3 year warranty
- CANBus®/PMBus® optional for 1000W

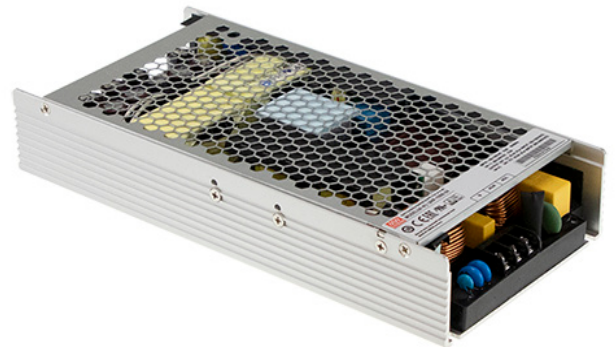

ERP Series

Features & Benefits

- Design against rain splash
- Cooling by free air convection
- Withstand 300VAC surge for 5 seconds
- For outdoor use under roof
- 400W model for EU, 200W and 400W for ROW
- Wide AC input
- Low cost high reliability

MEAN WELL



XBG Series

Its circular shape makes this driver ideal for high bay lighting in warehouses and large halls but also for outdoor applications. The design features constant power mode operation minimizing stock keeping units



Applications

- LED bay lighting
- LED stage lighting
- LED spot lighting
- Explosion-proof lighting
- Type HL LED driver for class I division 2

XBG Series

Features & Benefits

- Full power output at 70–100% constant current range operation
- Wide input range 90–305VAC with active PFC function
- Metal housing design with IP67
- Multiple dimming functions: 3 in 1 (0–10V/PWM/Resistor)
- Dimming circuit with Isolated for latest safety regulation
- Surge protection with 6KV/4KV
- Typical lifetime > 50000 hours and 5 year warranty
- AC input cable with connector for flexible installation



MEAN WELL



XLG Series

Features such as IP67-grade and good surge protection make this driver perfect for demanding outdoor environments. This series builds on MEAN WELL's proven track records as market leader adding constant power mode to the range. This constant power mode helps minimizing stock keeping units supporting users in efficiently and timely go to market



Applications

- Street lighting
- Signage
- Stage lighting
- Fishing lighting
- Horticulture lighting

XLG Series

Features & Benefits

- XLG:25/50/75/100/150/200/240
- Constant power and constant voltage versions
- Constant Power: L type(700~1050 mA) M type(1400~2100 mA) H type(250~6600 mA)
- Constant voltage: 12V,24V
- Wide input voltage range(100~305VAC), suitable for various lighting worldwide
- Low profile
- Surge protection: 6kV/4kV
- Optional: 10KV/6KV
- Metal enclosure IP67, suitable for outdoor & harsh environment
- 3-in-1 dimming (dim to off and isolation design)
- XLG-25/50 meets SELV
- High efficiency up to 93%
- 5 year warranty



Sensata/Crydom

Solid State Relays for Lighting Control Applications

The SSR utilizes a back-to-back SCR output which provides added reliability in commercial and heavy industrial applications. The SSR has a high surge current rating and is available with a zero voltage (resistive loads) or instantaneous turn-on (inductive or phase controlled loads) output. Therefore CX & 53TP Series are the ideal solution.



Applications

- Lighting
- Control of incandescent lamps
- Heating systems
- Control of electromagnets
- Motor controls
- Control of discharge lamps

CX Series (PCB Mount)

The CX Series SIP Solid State relay is ideally suited for high density PCB applications where a maximum of 5A of current is required. CX Series is available with a wide range of AC and DC outputs to suit most applications. All relays in this range are UL, CSA and TÜV rated.

Features & Benefits

- Standard SIP package
- Ratings of 5 A at 280 VAC
- Back-to-back SCR output for heavy industrial loads
- AC or DC control
- Zero voltage turn-on (resistive loads) output
- UL, CSA and TÜV certified, CE compliant to EN60950-1



53TP (Panel Mount)

Crydom panel mount solid state relays are designed to easily mount on flat panels or heat sinks with screws through the SSR's baseplate. Available in various industry standard sizes, the panel mount relay is currently the most used mounting type in the solid state relay market.

Features & Benefits

- Three-phase solid-state relay; ratings 25 A, 50 A per phase at 48–530 VAC
- 2 package styles IP00 or IP20 (See IP20 spec sheet)
- SCR output for heavy industrial loads
- Transient protection built in
- AC or DC control
- Zero-crossing (resistive loads) or random-fire (inductive loads) output
- LED input status indicator
- UL recognized, CE compliant to EN60950-1

Panasonic

Panasonic
INDUSTRY

Variety of polarized relays for efficient lighting control

For switching requirements in the field of IoT, home automation and lighting, Panasonic Industry offers a number of polarized relay innovations such as the DE or DJ-H series.



Applications

- Smart plugs/smart switch
- Smart lighting/lighting
- Security equipment
- KNX-Bus application
- Office automation
- Shutter/sunblind control
- Street lighting

DE

Being one of the smallest 16A polarized power relay in the market, DE series enable miniaturization in any application – and render the perfect choice for contemporary slim luminaire products. The polarized coil system and especially the latching versions helps to increase the power efficiency of your application: the DE relay consumes no power during on or off states, just during the short switching period.

To cover applications that cannot allow latching relays, the DE relay is available as a monostable version with very low power consumption to keep losses low.

Features & Benefits

- Small size 25x12.5x12.5mm
- 16A 250VAC, 10A 30VDC
- Nominal operating power 200mW
- Single side stable, latching 1 and 2 coils
- Constant & short set/reset/bounce time over whole lifetime
- Coil voltage from 1.5V up to 48V
- Separated contact chambers for 1a1b/2a versions
- UL/CSA , VDE approved



DJ-H

The DJ-H is a 50A polarized power relay with high inrush current, serving the purposes of many building automation features such as switching actuators for lighting and motor loads. DJ-H relays can switch 50A at 277VAC (resistive load) and are certified for fluorescent lamp loads according to IEC 60669-1 at 200µF/20A and 250VAC

Features & Benefits

- High inrush capability
- Tungsten load (TV-20 class)
- Electronic ballast load (NEMA410)
- Capacitive load (IEC 60669-1)
- Ambient temperature: -40 to +85°C
- Manual switch type available
- Sensitive coil: 1- coil latching: 1W; 2-coil latching: 2W
- Surge breakdown voltage between contact and coil: 12kV

Panasonic

Panasonic
INDUSTRY

Switching under harsh conditions

Panasonic Industry meets next generation requirements of securing safety levels within sophisticated industrial units by offering the 5mm slim PA-N type. The purpose of those power relays is, in essence, to reliably switch an ever increasing number of actuators – and a wide variety of load-behavior they may encounter.



Applications

- Output relays for programmable controllers
- Output relay for temperature controllers
- Industrial equipment
- Interface relay

ATEX-certified PA-N relay

ATEX-certified PA-N relay is conceived for harsh, hazardous or potentially explosive environments with currents up to 5A and can be operated in a temperature range up to 110°C.

Features & Benefits

- Small size 20 x 12,5 x 5mm
- 5A 250 VAC, 5A 30 VDC
- High reliable bifurcated contacts
- Minimal switching load 1mA 5VDC
- Nominal operating power of 110mW
- Coil voltage 3VDC up to 24VDC
- Ambient temperature up to 110°C
- Sealed construction RTIII
- ATEX conformity
- Reinforced insulation according to IEC61010-2



MEAN WELL



Ultra wide 150-1500VDC Input DC/DC

In oil & Gas and renewable energy environments very often wide input solutions are required and have to be engineered. With this MEAN WELL DIN rail part a standard product is now available. Placed in an appropriate cabinet this product is the most suitable solution providing wide adjustable DC output.



Applications

- Photovoltaic power generation
- Wind turbine power generation
- High voltage frequency conversion applications

DDRH-60

Features & Benefits

- 150–1500Vdc 10:1 ultra wide input range
- 57mm slim width
- 4KVac I/O high isolation(Reinforced isolation)
- Output module: 5V/12V/24V/48V. Wide Vo adj. range 3–55Vdc
- Fully potted
- Cooling by free air convection
- Over Voltage Category II (OVC II)
- Operating altitude up to 5000 meters
- Operating temperature -30~+80°C
- Can be installed on DIN rail TS-35/7.5 or 15
- IEC62109-1 (LVD)
- 3 year warranty



OMRON

OMRON

Relays for renewable energy applications

Relays for renewable energy applications have two target functions within the solar converter. The DC relays, to switch the DC voltage generated by the solar panel, and the AC relays with big contact gap, to switch the generated electricity to the power grid to provide the necessary safety “circuit-break-function”.



Applications

- Power conditioner inverter
- Industrial inverter
- Energy storage systems
- Photovoltaic power systems
- Uninterruptible power supply (UPS)
- Grid protection

G7L-X REL

The G7L-X is a high voltage DC bi-directional switching relay with capability to switch up to 1000VDC. Key applications include residential and light commercial energy storage systems, battery management and DC link disconnect.

Features & Benefits

- 25A DC high capacity switching for both normal and reverse polarity
- Two poles wired in series to break or switch 600 to 1000 VDC
- Contribute to low power consumption
- UL and EN conformed
- Designed for safety with 6.0mm contact gap (two-pole series wiring)

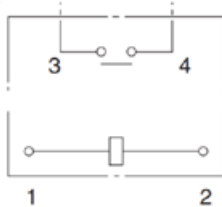
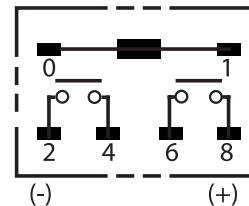

G7EB RELAY

The new G7EB offers high performance with energy savings and contributes to reduced initial and maintenance costs by reduced heat rise for durable extended life. Industry standard footprint with two terminal options including castellated. Key applications: Grid Protection/AC Disconnect for Solar PV Inverter and UPS.

Features & Benefits

- 480 VAC/100 A high current switching capable
- Ambient temperature 85°C
- High impulse withstand voltage, 10kV
- Contact gap ≥ 3.6 mm (Applied to VDE0126)
- Low initial contact resistance ≤ 5 m Ω

G2RG-X RELAY

Omron Electronics G2RG-X PCB power relays are designed for inrush prevention in energy storage systems and are in a compact case with a 13.5mm x 29mm footprint. The G2RG-X relays achieve 500V 10A switching capacity used with 2-pole series wiring.

Features & Benefits

- Achieves 500VDC 10A switching capacity
- 3.0mm contact gap (2 pole series wiring) Insulation distance above 8mm
- Withstand voltage of 10kV between coil and contacts
- UL and TÜV certified



Panasonic

Panasonic
INDUSTRY

HE-Series: Switching Large Amounts Of Power

More than ever before, domestic solar-power systems use relays to efficiently control the flow of current for local consumption via an inverter, to battery storage, or back into the power grid. Thanks to latest relay technology, Panasonic Industry enables the customer to use PCB technology for high current applications.



Applications

- Photovoltaic inverter
- Wind energy inverter
- Industrial motor control
- Uninterruptable power supply
- Energy self-sufficient housing

Panasonic Industry HE series for reliably and efficiently switching large amounts of power

Offering its HE-relays, Panasonic Industry Europe meets the growing demands for safe, robust and energy-efficient ways to switch relatively large amounts of power. This enables engineers now to use PCB technology for high current applications and at the same time realizing downsizing and energy saving at a new level.

Features & Benefits

- Switching current up to 120A AC (HE-N)
- Switching voltage up to 1,000VDC (HE-V)
- Galvanic separation, large contact gap
- Extreme low contact resistance
- Low coil power dissipation
- Temperature range: -40° to 85°C
- Conform to UL and VDE, further approvals on request



Series	HE-V	HE-S	HE-Y5	HE-Y6	HE-N(Y7)
Switching current	20A DC	35A AC	48A AC	90A AC	120A AC
Dimensions	41x50x39.4mm	30x36x40mm	38x33x36.3mm	38x33x38.8mm	50x40x43mm
Holding power*	210mW	170mW	310mW	310mW	400mW
Contact gap	3.8mm	3.2mm	2.5mm	3.0mm	3.6mm

*with reduced coil holding voltage

Sensata/Crydom

Solid state relays for smart buildings

Solid state relays can be used in a wide range of AC and DC applications. Ideal for smart building applications, SSR's are suitable for motion, power and lighting applications – especially for demanding applications that require higher levels of reliability.



Applications

- HVAC&R
- Lighting
- Access control
- Water and waste water treatments
- Alarm systems

CW Series Panel Mount AC output Solid State Relays

Features & Benefits

- Ratings from 10 A to 125 A at 24–280 VAC or 48–660 VAC
- LED status indicator
- UL/CSA/TÜV Approved, CE Compliant to EN60950-1
- AC or DC control and universal AC/DC control
- EMC compliant to Level 3
- Removable IP20 touch-safe cover



DR67 DIN Rail Mount Solid State Relay

Features & Benefits

- 3-Phase AC output DIN rail mount SSRs
- Output ratings up to 75 Amps at 600 VAC
- Over temperature protection w/alarm (optional)
- Built-in overvoltage protection
- AC or DC control
- cULus listed and VDE approved

DR22 Series AC Output DIN Rail Mount Solid State Relays

Features & Benefits

- Output ratings up to 35 Amps at 600 VAC
- Built-in overvoltage protection
- DBC substrate for superior thermal performance
- IP20 touch-safe housing
- AC or DC control
- Relay or contactor configuration
- C-UL-US and TÜV approved



DRH Series DIN Rail Mount Solid State Contactors

Features & Benefits

- Ratings up to 20 Amps at 600 VAC
- Fits standard 35mm DIN Rail
- Integrated over-temperature protection
- Alarm output in case of over-temperature
- Multicolor LED with input status and alarm indicator
- AC or DC control
- C-UL-US Listed, IEC Rated, CE & RoHS compliant, horsepower rated
- Built-in overvoltage protection

TE Connectivity's SCHRACK Relays



Power relays for energy management

Power relays can be used to ensure that energy is only consumed when it is needed. The last person to leave the building can easily turn off all relevant groups of appliances, such as lighting and electricity for desks. Electrical bus systems in combination with relays can also be set to turn on lights automatically at 8am, or whenever employees arrive in the morning.



Applications

- PLC (programmable logic controllers)
- Measurement and control
- Home automation
- Machine control
- Energy control
- Input/output cards
- Timers
- Intelligent sockets

RE/REL & PE – 5/6A

Features & Benefits

- PE: 5A & 1 CO, RE/REL: 6A & 1 NO contact
- Sensitive coil 200/360mW
- Low height 10.6mm (REL: 12mm)
- PE: mono or bistable (latching) coil versions available
- PE: WG type available (IEC 60335-1)
- Miniature PCB relays with PCB area 200mm²
- Wash tight

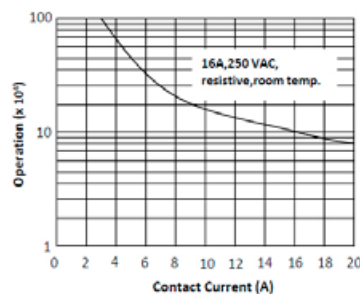

OMIH – 10/16A

Features & Benefits

- 1pole 10/16A, 1 form A (NO) or 1 form C (CO) contact
- Meet 5000V dielectric voltage between coil and contacts
- Meet 10000V surge voltage between coil and contacts
- Can provide anti-explosion type => meet IEC-60079-15/GB3836.1-2010/GB3836.8-2014

V23092 – 6A

Features & Benefits

- 1pole 6A, 1 form C (CO) or A (NO) contact
- Sensitive coil 170mW
- Clearance/creepage between contact and coil $\geq 6/8$ mm
- Very slim: system width only 5.0mm/6.2mm (with socket)
- Reinforced insulation (protection class II)
- Flat pack version available

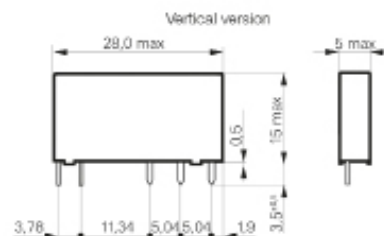

RT – 8/12/16A

Features & Benefits

- 8/12/16A and 1/2 form NO or CO contact
- DC and AC coils available
- Mono or bistable (latching) coil versions possible
- WG type available (IEC 60335-1)
- High ambient temperature version (105°C)
- THR (reflow) version available
- Sensitive version available

TE Connectivity's SCHRACK Relays



High inrush current power relays (12-16A)

High inrush current relays offer a compact and powerful design solution for applications that require high inrush current resistance. They can withstand up to a 800A peak inrush current and are conform to industry safety standards and making them an ideal design solution for KNX-Bus and lighting applications.



Applications

- Door control
- KNX Bus (Intelligent Sockets)
- Interface modules
- Air conditioning systems
- Heating systems
- LED lighting
- Filament & incandescent lamp loads
- Movement detectors & Motors

RZ/RZH (12A or 16A)

Features & Benefits

- 1-pole 12/16 A, 1 form C (CO) or 1 form A (NO) contact
- DC coil 400 mW
- Ambient temperature 85°C/RZH: 105°C
- 5kV/10mm coil-contact, reinforced insulation
- Product in accordance to IEC 60335-1
- RZ: Reflow version for THR mounting process

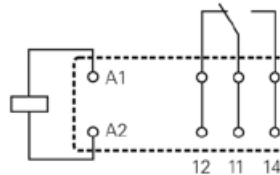

RZ-INRUSH (12A or 16A & 117A Inrush Current)

Features & Benefits

- 1-pole 12/16 A, 1 form C (CO) or 1 form A (NO) contact
- 5kV/10mm coil-contact, reinforced insulation
- Ambient temperature 85°C
- Product in accordance to IEC 60335-1
- UL TV-8 Rating: 117A inrush current

RTX (16A & 370A Inrush Current)

Features & Benefits

- 16A and 1 form NO
- Inrush peak currents up to 370A
- W pre-make contact + AgSnO2
- Bistable coil & reinforced insulation
- 140µF load, 16A/250V, 30000 operations
- 16A rated fluorescent load acc. EN60669-1
- 1 1/2 HP motor load acc. UL508

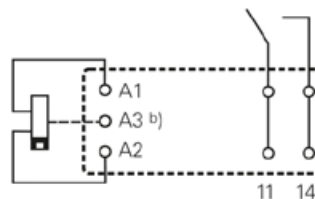

RT-iPOWER (16A & 165A/800A Inrush Current)

Features & Benefits

- 1-pole 16A, 1 form A (NO) contact
- AgSnO2 or W pre-make contact + AgSnO2
- Mono or bistable coil
- 5kV/10mm coil-contact
- Inrush peak currents up to 165A (20ms), 800A (200µs)
- WG version: product in accordance to IEC60335-1
- RTS3T: Electronic ballast UL508/NEMA 410 rated
- RTSET: 8A Electronic ballast rated

TE Connectivity's SCHRACK Relays



Bistable/latching power relays (8-120A)

Power bistable relays can be used to switch applications in energy-saving manner. These relays retain their switched position if supply voltage fails, preventing loss of information on the current switching status. Just a short switching impulse of a few milliseconds is enough to switch the relay into a defined switch position.

Applications

- Battery powered equipment
- Memory function (mains failure)
- Lighting control
- Bus actuator
- Circuit protection
- Inverters
- Electricity meters
- Prepaid power meters

RT1/RT2-Bistable

Features & Benefits

- 8/12/16A and 1/2 form NO/CO contact
- Rated Voltage: 250VAC
- 1 or 2-Coil versions
- 29x12.7x15.7mm (LxWxH)
- WG type available (IEC 60335-1)
- 5kV/10mm coil-contact



EW60/EW80

Features & Benefits

- 1-pole 60A/80A 1 form A (NO) contact
- Rated Voltage: 250VAC
- Polarized bistable (latching) with 1 or 2 coils
- 552A inrush, 2.1ms
- EW60: NEMA 410-2015, 16A, 347VAC
- EW80: Shunt implementation optional

TOU80

Features & Benefits

- 1-pole 80A, 1 form A (NO) contact
- Coil Voltage: 6/9/12/24VDC
- Rated Voltage: 250VAC
- Polarized bistable (latching) with 1 or 2 coils
- In accordance to IEC 62055-31 UC2
- Shunt implementation optional
- Meet IEC62055-31 UC3

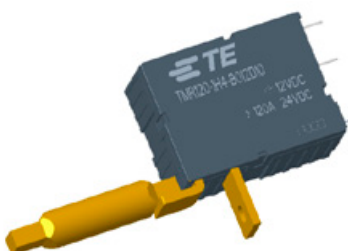
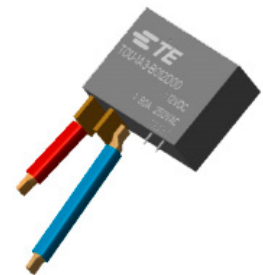

TMR120

Features & Benefits

- 1-pole 120A, 1 form A (NO) contact
- Rated Voltage: 24VDC
- Polarized bistable (latching) with 1 or 2 coils
- Auxiliary switch optional
- Shunt implementation optional
- Various terminal configurations
- Meet IEC62055-31 UC3

Automotive 12-24VDC Relays

OMRON



Low voltage (12V) PCB automotive relays

The Omron automotive PCB relays have been designed to correspond with various automotive applications. These relays are suitable for motor control of automotive parts such as door lock motors, power window motors, washer and sunroof motors, typically for applications with short term operation.



Applications

- Door lock motor
- Power window motor
- Wiper motor
- Washer motor
- Electrical seat adjustment
- Sunroof motor

G8NB (25A/5A, 1-Pole or 2-Pole SPDT)

Features & Benefits

- GM certified
- Maximum switching current 30A
- Standard, low or super low operating voltage
- Applicable to pin in paste reflow (through hole reflow)
- Terminal arrangement is same as G8N (replaceable)

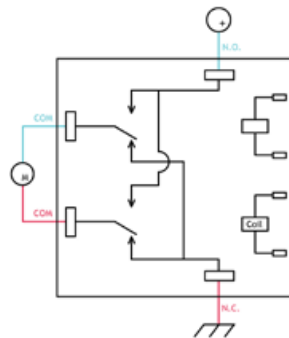
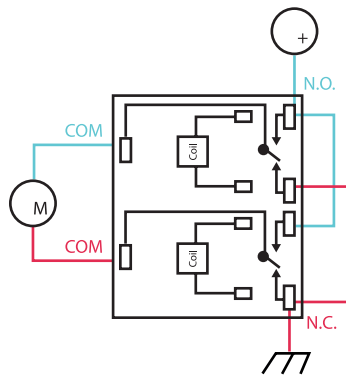

G8NDL (25A/5A, 2-Pole H-Bridge)

Features & Benefits

- Reduced height (typ. 11.5mm)
- H-Bridge relay with small space to simplify board design
- Maximum switching current 30A
- Mechanical durability: min. 1 million cycles
- Applicable to pin in paste reflow (through hole reflow)

G8PM-1AW (45A, 1-Pole SPST)

Features & Benefits

- Ratings from 45 A at 14VDC
- Operating temperature range: -40°C +125°C
- Low contact resistance of typ. 2.6mΩ
- 1A (SPST) double contact
- Max applying current: 68A/1h



TE Automotive



Low Voltage DC automotive relays (40–175A)

TE automotive relays are engineered for DC voltages in passenger comfort and infotainment systems and power levels in harsh environments. Automotive relays are especially designed to provide switching functions that support modern electrical conveniences and advanced safety features in today's vehicles.



Applications

- Commercial vehicles
- Construction vehicles
- Buses
- Seat adjustment
- Automobiles
- Electric powertrain
- Off-road vehicles
- Prepaid power meters

F4/VF4A Shrouded (40A)

Features & Benefits

- 1 NO + 1 NC/2 NO/1 CO contacts
- 40A at 12V or 24V (85°C)
- Plug-in (F4&VF4A) or PCB terminals (F4)
- Pin assignment similar to ISO 7588 part 1
- Mini ISO Relay
- Integrated components (e.g. resistor, diode)
- Ambient temperature -40 to +125°C

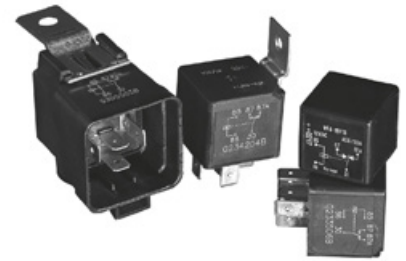

F7 (70A)

Features & Benefits

- 1 NO contact
- 70A at 12V or 24V
- Plug-in (F4&VF4A) or PCB terminals (F4)
- Maxi ISO Relay
- Integrated components (e.g. resistor, diode)
- Ambient temperature -40 to +125°C

HCR150 (130A)

Features & Benefits

- 1 NO/1 NC/1 CO/1NO DM contacts
- 130A at 12V or 24V (85°C)
- Current switching ability up to 300A (23°C)
- Heat, moisture and vibration resistant
- Minimal contact resistance
- Dustproof and sealed versions

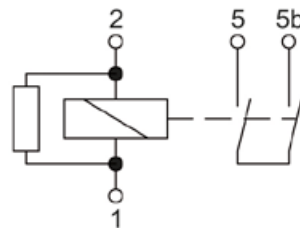

HCR200 (175A)

Features & Benefits

- 1 NC contact
- 175A at 12V (85°C)
- Current switching ability up to 245A (23°C)
- Integrated components resistor or diode
- Degree of protection: IP64 (IEC 60529)
- Ambient temperature -40 to +110°C





STANDEX MEDER



High voltage reed relay: KT Series

KT relay series from Standex Electronics is ideal for the economic applications that require high isolation properties together with reliable and precise switching. It is ideal for use in green applications, such as battery measurement systems, in photovoltaic technology or electro and hybrid vehicles.

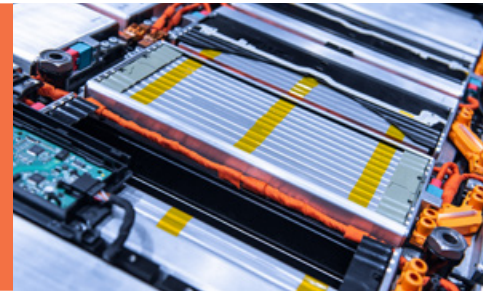

Applications

- Photovoltaic/solar systems
- Inverters
- Hybrid vehicles
- E-Mobility (battery management systems)
- Test and measurement
- Medical

KT Series of High Isolation Reed Relays for SMD & THT in a compact housing

It is particularly helpful in measuring isolation resistance and leakage currents across several electric circuits while providing great galvanic isolation. This is being used to prevent an injury, further current leakages and power loss. Can find its place also in medical or test & measurement equipment.

Features & Benefits

- Small size 30mm x 8.6mm x 10.6mm
- High isolation resistance of minimum $10^{13}\Omega$

- Breakdown voltage across open switch up to 5kVDC
- Dielectric strength coil/contact of over 7kVDC
- Low leakage current
- Switching voltages of 1.000V
- 1A switching current, 2.5A carry current
- Coil voltages 3V, 5V, 12V and 24V
- Available in THT and SMD
- Tested in accordance with AEC-Q200, UL-Listed
- Dynamically tested contacts can perform millions of reliable operations
- 5V coil and THT pinout recommended for automotive applications

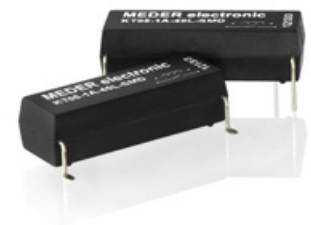

Sensata/Cynergy3



High voltage reed relay: D-HR Series

Very high isolation voltages, up to 15kV, are achieved through the use of high vacuum reed switches. Rhodium or tungsten contacts make these relays suitable for high reliability applications, such as battery management systems, cardiac defibrillators, test equipment and high voltage power supplies.



Applications

- Battery management systems
- Cardiac defibrillators
- Test equipments
- High voltage power supplies

Features & Benefits

- 5kV, 7.5kV, 10kV or 15kV isolation
- Low contact resistance
- $1 \times 10^{14} \Omega$ s minimum insulation resistance
- PCB or flying leads connections
- Switching voltages: 1kV, 3.5kV, 5kV, 7kV and 10kV

- Switching currents: 2A or 3A (depending on contact material)
- Carry current: 2A, 3A or 4A (depending on contact material)
- UL Approved



Panasonic

Panasonic
INDUSTRY

PhotoMOS® relays for xEVs

In the field of battery isolation monitoring, Panasonic Industry PhotoMOS® relays constructively surpass conventional electromechanical products in some crucial functionality aspects.



Applications

- Isolation monitoring
- Battery monitoring

Coming in PCB-efficient, miniaturized designs – 6 PIN DIP SMD AQV2*HAX for isolation monitoring and 8 PIN DIP SMD AQW2*HAX for other automotive switching purposes – they considerably stand out with their MOSFET-based semiconductor principle of non-aging contact resistance and hence unlimited switching cycles. Low CxR values, high optical isolation between input and output as well as DC and AC/DC load ratings constructively ensure contact reliability and operational safety of the switching requirements. Due to not being conceived on a mechanical but an optical principle, Panasonic Industry PhotoMOS® relays are unaffected by vibration, shock and other conditional effects – a fact that can be considered as utterly crucial within the steadily harsh automotive conditions of operation.

Features & Benefits

- Tested according to AEC-Q101
- Available for high voltage
- 1500V for AQV258HAX
- Minimal leakage current (typ. <1nA)
- Turn-on time: Max. 0.5ms – 1.0ms
- Turn-off time: Max. 0.5ms
- Input/output isolation up to 5kVrms
- Linear output characteristics
- No threshold voltage
- Stable on-resistance over the entire lifetime
- Compact housing
- Highly shock and vibration resistant



Series	U	I
AQV2*HAX	1.500V	20mA
AQW2*HAX	600V	40mA

Charging Stations/Wallboxes

HE-S relay for 35A with feedback contact

Thanks to the safety contact mechanism conform to EN 61851-1, the Panasonic Industry HE-S 35A relay offers an ideal switching solution for charging stations & wallboxes up to 22kW.



Applications

- Charging cable
- AC/DC wallbox
- AC/DC charging station
- Inverters
- Industrial equipment
- Uninterruptable power supply (UPS)
- Energy management

Able to handle a high resistive load of 35A to 277V AC for 50,000 cycles, this series constitutes the industry's smallest, high capacity multi-contact power relays. It also provides a mirror contact structure (EN60947-4-1 compliant) that uses 2FormA coupled with 1FormB contact assembly.

Features & Benefits

- Contact gap 3.2mm
- Ambient temperature -40 to +85°C
- 2FormA or 2FormA1FormB contact arrangement
- Max. switching voltage 480VAC
- Switching current 35A
- Dimensions 30x36x40mm
- Holding power 170 mW with reduced coil holding voltage





Charging & disconnection of HV batteries

TDK high voltage contactors are designed with excellent extinguishing characteristics and can be used bipolar for charging and discharging. It is further available as a dual-coil non-bipolar version for increased load-cycle performance.



Applications

- Battery management system/ Battery junction boxes for EV, buses and commercial vehicles
- Photovoltaic and energy storage systems – for DC tensions > 400 V
- DC charging stations for e-mobility applications
- Uninterruptable power supplies using HV batteries

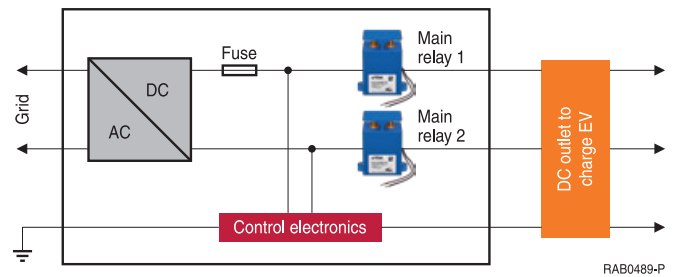
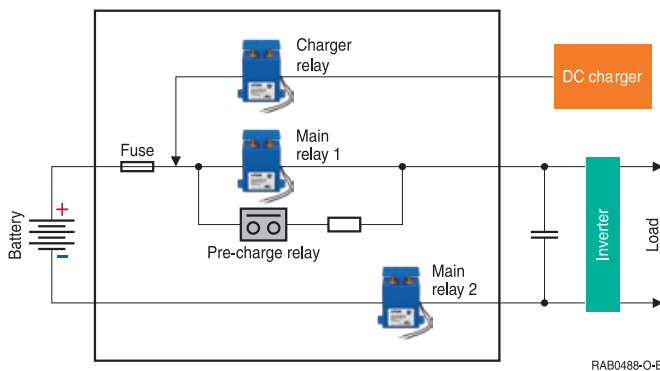

HVC43 (250A)

Features & Benefits

- 1-pole: 1 NO contact
- No polarity of contact terminals
- Rated operational voltage: 450VDC

- Maximum operating voltage: 750VDC
- Continuous carry current: 250A
- 12VDC or 24VDC single coil



HVC200 (200A)

Features & Benefits

- 1-pole: 1 NO contact
- Rated operational voltage: 750VDC
- Maximum operating voltage: 1.000VDC

- Continuous carry current: 200A
- 12VDC or 24VDC single coil or double coil
- Auxiliary contacts available
- Higher operating voltage, different coil voltage, auxiliary contact, voltage sensor and temperature sensor upon request.

HVC300 (300A)

Features & Benefits

- 1-pole: 1 NO contact
- Rated operational voltage: 750VDC
- Maximum operating voltage: 1.000VDC

- Continuous carry current: 300A
- 12VDC or 24VDC single coil or energy saving double coil
- Auxiliary contacts available



HVC500 (500A)

Features & Benefits

- 1-pole: 1 NO contact
- Rated operational voltage: 750VDC
- Maximum operating voltage: 1.000VDC

- Continuous carry current: 500A
- 12V/24VDC single coil or double coil
- Auxiliary contacts available

Sensata/Crydom

Solid State Relays for DC Applications

Crydom DC output solid state relays are available with ratings of 3 to 100 Amps at 1 to 1000 VDC and solid state contactors with resistive current ratings of up to 160 Amps at 150 VDC and motor ratings of up to 25 FLA/3 HP at 150 VDC, on single channel and motor reversing configurations.



Applications

- DC motor control
- DC heating systems
- Inverters
- UPS systems
- Regulators
- Converters

1DC High Voltage Solid State Contactors

These high voltage solid state contactors have a long life and a broad range of benefits: no moving parts, minimal electrical noise, low power consumption, shock & vibration resistance, fast switching, low weight, galvanic isolation by Opto coupling, insensitivity to position, and more.

Features & Benefits

- Ratings from 7A to 40A at 200VDC and from 7A to 10A at 500VDC
- MOSFET Output
- UL Approved, CE compliant to EN60950-1
- Improved SEMS screw and washer
- Redesigned housing with anti-rotation barriers



PowerPlus Series Panel Mount DC Output

Crydom's new "PowerPlus DC Series" of DC output panel mounted solid state relays expands Crydom's Series 1 line of DC output SSRs with new features including an optional clear IP20 "touch safe" cover, LED input status indicator and higher speed switching circuit minimizing switching losses and permitting higher frequency PWM operation.

Features & Benefits

- Ratings from 10A to 40A at 200VDC and 10A & 20A at 400 VDC
- Relays are easily paralleled for higher-current applications
- UL Approved, CE compliant to EN60950-1
- Improved SEMS screw and washer
- Redesigned housing with anti-rotation barriers

SSC Series Panel Mount 1.000VDC Output

Series SSC solid state DC contactors feature IGBT technology for high voltage DC switching applications. All models come in Crydom's standard panel-mount package.

Features & Benefits

- Ratings up to 25A at 1000 VDC
- IGBT output
- CE Compliant to EN60950-1
- Improved SEMS screw and washer
- Redesigned housing with anti-rotation barriers



TE Connectivity's KILOVAC Contactors



High Voltage and high current contactors 20A–1.000A

Designed for harsh environments and loads, the KILOVAC contactors from TE offer exceptional performance for a device this small and light. Therefore these contactors provide reliable and long-lasting performance in electrical vehicles, military ground, military and commercial aerospace and marine applications.

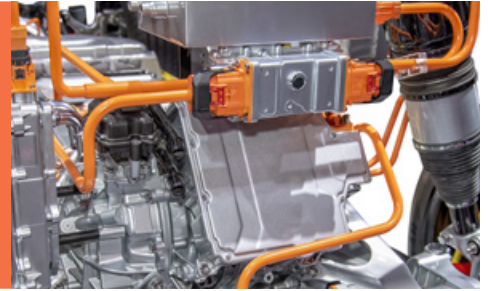

Applications

- Electric Vehicles
- (Solar) Inverters
- HV Test Equipment's
- Capacitor banks
- Battery management systems
- Energy storage systems
- Marine applications
- Military ground vehicles

Mini K-HV (Pre-charge Relay)

Features & Benefits

- 1-pole: 1 NO DM contact
- 20A at 400VDC
- Available with PCB and plug-in terminals
- Suitable for voltage levels up to 450VDC
- IEC 60664 compliant



LEV100H/EV200(B)

Features & Benefits

- LEV100H&EV200: 1 NO, EV200B: 1 NC contact
- LEV100H: 150A at 1.000VDC/ EV200(B): 500A at 900VDC
- Optional auxiliary contacts
- Not position sensitive
- EV200: UL Recognized (File E208033)

EV600

Features & Benefits

- 1-pole: 1 NO contact
- 100A at 600VDC
- Bidirectional switching
- Withstands higher current pulse
- Increased current interrupting capability
- Form A auxiliary contact



K1K

Features & Benefits

- 1-pole: 1 NO contact
- 1.000A at 1.000VDC
- Bidirectional switching
- No contact oxidation over periods of non-use
- Bottom or buss bar mount
- Economizer with internal suppression





Flex Power Modules

DC/DC power solutions for rail – rolling stock

Flex Power Modules provides a series of power modules for railway systems designed to meet the most stringent electrical and environmental specifications.



Applications

- Monitoring and entertainment systems
- Lighting and information systems
- Broadcasting and communication systems
- Door and signal systems
- GPS and driving systems
- Sensors





These products can work under dust, moisture, severe vibration and other harsh conditions. DC/DC converters for rolling stock are also subject to greater demands for operational safety, durability and thermal shock.

Flex Power Modules offers ultra-wide 12:1 input range solutions rated from 50 to 200 W which are now required by many of our world-wide railway customers.

For industrial applications, working from 12 or 24 V inputs, our forthcoming PNA series of Industrial Point of Loads housed in a small form factor and low-profile package offers customers increased design flexibility.

Features & Benefits

- Compliant to EN50155, an internationally recognized standard for rolling stock equipment
- Fully encapsulated converters
- Ultra-wide input ranges from 12-160 V
- Up to 4000 V isolation

Product	Series	V _{in}	V _{out}	P _{out}	I _{out}	Efficiency	Foot print
	PMU8000	4.5–17V	0.6–5V	–	4/6/8 A	Up to 95%	LGA
	PNA*	9–32V	0.9–5.5V	–	6A	89.7%	LGA
	PKM7100W	14–160V	3.3/5/12/ 13.8/15/24/ 48/54V	100W	–	87–90%	Quarter brick
	PKE7300A	43–160V	5/12/15/ 24/48/54V	30W	–	Up to 91%	2" x 1"
	PKJ7000	60–160V	12/13.8/15/ 24/48/54V	200–300W	–	89–91%	Half brick
	PKJ7200W*	14–160V	12/13.8/15/ 24/48/54V	200W	–	88.5%	Half brick

*Soon to be released



Littelfuse



Time delay relays for railway applications

Electromechanical relay-output time relays are available with a number of different functions and assure isolation between input and output. SSR time relays have no moving parts to arc, a lifespan of up to 100x that of a relay-output timer. In addition, all solid state time delay relays are fully encapsulated to protect against shock, vibration and humidity, therefore ideal for Railway applications.



Applications

- Flashing light control
- Furnace safety purge control
- Motor soft-start delay control
- Conveyor belt sequence delay
- Power supply sequencing
- Oven ignitor controls

KRPS Series

Features & Benefits

- 1-pole: 1 CO contact
- Isolated 10A AC/DC output
- Microcontroller based
- Encapsulated to protect against shock, vibration and humidity



HRV Series

Features & Benefits

- 1-pole: 1 CO contact
- Isolated 30A AC output
- Switch selectable coin start
- Coin switch can be connected to a counter
- Encapsulated

TDB/TDBH/TDBL Series

Features & Benefits

- 1-pole: 1 CO or 2-pole 2 CO contacts
- 3 time ranges available (0.1s to 2.8h)
- Microcontroller based
- LED indication
- DIP switch adjustment
- Isolated output contacts



ASQU/ASTU Series

Features & Benefits

- 24 to 240VAC or 9 to 110VDC models
- Compact 17.5mm size
- Multifunction: 5 timing functions
- Knob adjustable time delay
- 0.7A steady, 10A inrush solid-state output
- Watchdog circuitry



Murata Power Solutions

Rail compliant DC/DC converters

For rolling stock compliance to EN50155 is a key feature. Murata's new range of products offer standard of the shelf solutions to meet the stringent requirements of this standard.



Applications

- Trains, buses and metros
- HVAC
- Door control
- Passenger information systems
- Window wiper
- Cabin heater
- Toilet cleaning system
- Warning circuits conductor

10:1 Input Brick Sized Solutions 50–250W

Features & Benefits

- Designed to meet EN50155
- 10:1 input
- Half brick 250W
- Quarter brick 150W
- Eight brick 120W
- Sixteenth brick 50W
- High efficiency
- DOSA compatible



IRV300 series 300W Input Range 10:1

Features & Benefits

- 16V–160VDC input
- Models 12V, 24V, 54V
- +15% adjustable
- EN50155 compliant
- 10ms holdup
- Oring





TE Connectivity's HARTMAN Contactors

AC/DC contactors (28VDC/115VAC)

TE's HARTMAN AC&DC contactors are lightweight and environmentally sealed, with hermetically-sealed enclosures available for most severe environmental conditions or altitudes above 50,000 feet. Multiple main contact configurations and auxiliary contact configurations are available and meet the applicable requirements of MIL-PRF-6106 and/or specific customer specifications.



Applications

- Airliners
- Deep space probes
- Space shuttles
- Transformer rectifier units
- Starter/generators
- Military aircraft

D7, DH7, DHR7, DR7 (50A)

Features & Benefits

- 3-pole: 3 NO or 3 CO contacts
- 50A at 115/200 VAC, 400Hz
- Gasket sealed or Hermetically sealed
- D7, DR7: 50,000 ft/DH7, DHR7: 80,000ft
- Auxiliary contacts available
- Meets many requirements of MIL-PRF-6106

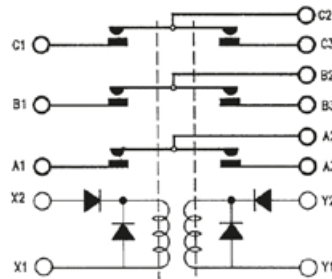

K400 (400A)

Features & Benefits

- 1-pole: 1 NO contact, double break
- 400A at 28VDC
- Buss bar or chassis mount design
- Gasket sealed
- Auxiliary contacts available
- Meets many requirements of MIL-PRF-6106

B-484 (500A)

Features & Benefits

- 3-pole: 3 NO contacts
- 500A at 115/200 VAC, 400 Hz
- Magnetic Latching
- Gasket sealed
- Auxiliary contacts available
- Meets many requirements of MIL-PRF-6106

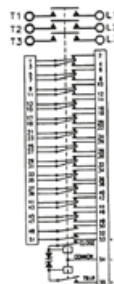

A-791M (1.000A)

Features & Benefits

- 1-pole: 1 NO contact
- 1.000A at 28V DC
- Reverse current protection for DC starter/generators
- Main contactor coil: economized
- High Reliability
- Meets many requirements of MIL-R-610

TE Connectivity's CII Relays



Hermetically sealed military relays

CII high performance signal level and mid-range Relays are designed to perform in a wide range of extreme environments in aerospace, military electronics for fighting armored vehicles and commercial applications. Both mil-spec and commercial versions of these hermetically-sealed Relays are offered.



Applications

- Ground vehicles
- Weapons systems
- Ground support equipment
- Fuel pumps
- Avionics main power feed
- Power distribution & motion control

1MS (1A)/HFW (2A) Relay

Features & Benefits

- 1MS: 1-pole: 1 NO/HFW: 2-pole CO contacts
- 1MS: 1A/HFW: 2A at 28VDC
- 1MS: MIL-R-39016/10HFW: MIL-R-39016/6
- High shock & vibration ratings
- Excellent RF switching
- Safe for application in harsh and explosive environments

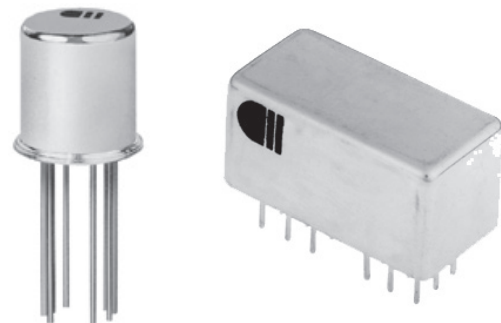

FC-325 Relay (25A)

Features & Benefits

- Excellent for switching harsh inductive, motor, and lamp loads
- Switching voltages of 1.000V
- -70°C to +125°C temperature range
- 25km/80.000 feet altitude rating
- Qualified to MS27418 specifications
- Higher current ratings than standard M83536 mid-range relays

FCA-150 Relay (50A)

Features & Benefits

- 1 Form X (SPST-NO-DM) contact
- 50 A switching capability
- 50,000 cycles under resistive load
- Rated for altitude to 300,000ft.
- -70° to +125°C temperature range
- Available with 1 Form C (SPDT) 2A auxiliary contact



FCC-360 Contactor (60A)

Features & Benefits

- 60A contact rating with 10 x rupture current
- Gasket sealed/2A Aux contact rating
- Double make contact design for less wear and tear on contact
- Utilizes economized coil
- 15 milliseconds operating time
- Designed to performance requirements in MIL- PRF-610628



TE Connectivity's KILOVAC Contactors

TE contactors for harsh environments

Designed for harsh environments and loads, the KILOVAC contactors from TE Connectivity (TE) offer exceptional performance for a device this small and light. Therefore these contactors provide reliable and long-lasting performance in military ground, military and commercial aerospace, and marine applications.



Applications

- Military ground applications
- Military aerospace
- High-voltage DC converter systems
- Marine applications
- Power distribution & motion control
- Battery management systems

CAP120/CAP202

Features & Benefits

- CAP120: 1 NO/CAP202: 2 NO contacts
- CAP 120: 150A at 600VDC/CAP202: 350A at 900VDC
- Bidirectional switching
- Integrated dual-coil electronic economizer
- 2 or 4 auxiliary contacts available at CAP202
- Coil suppression for EMC compliance

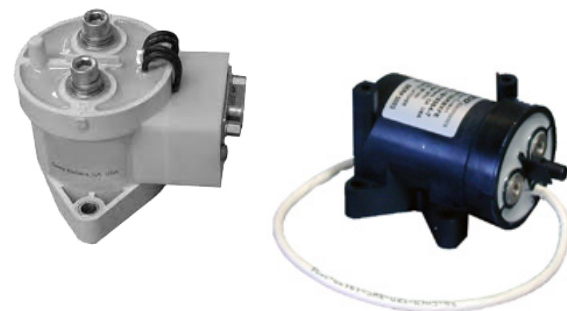

MAP100/MAP200

Features & Benefits

- 1-pole: 1 NO contact
- MAP100: 100A/MAP200: 500A at 900VDC
- Hermetically sealed – intrinsically safe
- Not position sensitive, can be mounted in any orientation
- Auxiliary contacts available
- No contact oxidation during long periods of non-operation

KCS01/KCS03 (With Current Sensing Sensor)

Features & Benefits

- 1-pole: 1 NO contact
- KCS01: 100A/KCS03: 600A at 600VDC
- Bidirectional switching
- Saves space by eliminating the need for external sensor
- Extremely small size & weight (KCS01:145g/KCS03:500g)
- EMC compliant: no radiated coil emissions



KHR500

Features & Benefits

- 1-pole: 1 NO contact
- 600A at 1.000VDC
- 3.300 A break at 400 Vdc
- Capable of handling inrush currents as high 4.000 A
- UL 508 recognized for US and Canada
- Safe for application in harsh and explosive environments

MEAN WELL



HEP Series

Military Communications are life critical and need to be 100% reliable – always. In every situation including rough handling of the gear, very harsh environments, temperature and mechanical shocks the equipment needs to function immediately. MEAN WELL HEP series offers COTS for these demanding applications



Applications

- Military application
- Outdoor telecommunication equipment
- Robotic/AGV
- Electronic transportation vehicle
- Outdoor electronic signage and billboard
- Harsh environment battery charger

HEP Series

Features & Benefits

- Series: HEP-100/150/185/240/320/480/600/1000
- Output voltage: 12,15,24,36,48,54
- Universal AC input: 90~264VAC
- Low profile: 26 to 41mm (H)
- Active PFC function
- Fanless design
- Battery charging function: (HEP-600C and HEP-1000)
- Vibration test: 10G
- Operating altitude up to 5000m
- Wide working temperature: -55~+70)°C
- Communication protocol PMBus® and CANBus® optional (for HEP-1000).
- High efficiency up to 96%
- IP-65 (optional IP-68)



TE Connectivity's KILOVAC Relays



High voltage relays (3.5kV – 15kV)

TE's KILOVAC HV relays are resistant to shock, vibration and extreme temperature levels. Many of these relays are hermetically sealed and can be operated in high humidity or in potentially explosive atmospheres. The very short operating time makes HV-relays suitable for RF-applications like in transmitters and antenna tuners.



Applications

- Broadcast
- Military Communication
- Automated test systems (ATE)
- High-voltage measurement
- Charging and discharging of capacitors
- Medical technology (X-ray, MR)

H-14/H-16 (12kV)

Features & Benefits

- 2-pole: 2 CO contacts
- 30A at 12kV (DC or 50/60Hz AC), H-14: 8A at 32Mhz, H-16: 4A at 32Mhz
- Contact Resistance: H-14: 0.015Ω, H-16: 0.03Ω,
- Widely used as a transmit/receive switch
- Meets requirements of MIL-R-83725



HC-1/HC-3/HC-5 (3.5kV)

Features & Benefits

- 1-pole: 1 CO contact
- Carry Current: HC-1: 25A, HC-3: 18A, HC-5: 8A
- Widely used for RF applications
- Contact Resistance: HC-1: 0.01Ω, HC-3: 0.02Ω, HC-5: 0.50Ω
- HC-1 & HC-3: Meets requirements of MIL-R-83725

HC-2/HC-4/HC-6 (8kV)

Features & Benefits

- 1-pole: 1 CO contact
- Carry Current: HC-2: 25A, HC-4: 15A, HC-6: 8A
- Stable, low contact resistance
- Contact Resistance: HC-2: 0.01Ω, HC-4: 0.02Ω, HC-6: 0.05Ω
- HC-2 & HC-4: Meets requirements of MIL-R-83725



KC-2/KC-11 (15kV), KC-14/KC-18 (15kV) and KC-15/KC-16 (15kV)

KC-2/KC-11 (15kV) (KC11=threaded base version of KC2)

- 1-pole: 1 CO contact
- Carries 50A at 15kV DC or 50/60Hz AC or 10A at 7kV 32Mhz AC

KC-14/KC-18 (15kV) (K18= threaded base version of KC14)

- 1-pole: 1 CO contact/Meets requirements of MIL-R-83725
- 30A at 15kV (DC or 50/60Hz AC)

KC-15/KC-16 (15kV) (KC16= threaded base version of KC15)

- 1-pole: 1 CO contact/Meets requirements of MIL-R-83725
- 12A at 15kV (DC or 50/60Hz AC)



TE Connectivity's KILOVAC Relays



High voltage relays (5–70kV)

TE's KILOVAC high voltage relays have safely and reliably helped manage a variety of high voltage applications. These small, lightweight relays are used extensively in aerospace, space, subsea and military applications like broadcast & communications as well as a variety of ground-based applications.



Applications

- Broadcast
- Military communications
- Automated test systems (ATE)
- Charging and discharging of capacitors
- High-voltage measurement
- Medical technology (X-ray, MR)
- Aerospace & avionics
- HF communication equipment

K41C (5kV)

Features & Benefits

- 1-pole: 1 CO contact
- 30A at 5kV DC or 50/60Hz AC or 12A at 2.8kV 32MHz AC
- Contact resistance max. 0.02 Ω
- RF ratings to 32 MHz
- Meets requirements of MIL-R-83725
- QPL version available, M83725/23

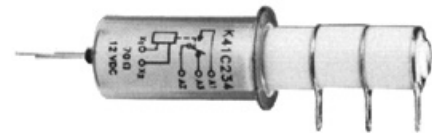

K81C (10kV)

Features & Benefits

- 1-pole: 1 CO contact
- 10A at 10kV (DC or 50/60Hz AC)
- Contact resistance max. 0.05 Ω
- Vacuum dielectric for power switching low current loads
- PCB solder connection or flying leads)

K60C (35kV)

Features & Benefits

- 1-pole: 1 CO contact
- 10A at 35kV (DC or 50/60Hz AC)
- Operating temperature range: -55°C to +85°C
- Smallest 35kV rated relay available
- Mechanical life – 1 million cycles



K70C (70kV)

Features & Benefits

- 1-pole: 1 CO contact
- 10A at 70kV DC or 30kV 50/60Hz AC
- Contact resistance max. 2 Ω
- SF-6 gas-filled for high voltage isolation applications
- Suitable for charging and discharging of HV capacitors
- Mechanical life – 500k cycles





MEAN WELL

Medical Adapters

Short time to competitive markets doesn't go well together with certification. Using high quality standard Adapters tackles this problem. The adapter has been designed, tested and certified. The application can be made for SELV environment.

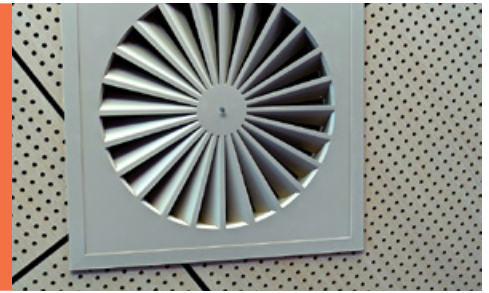

Applications

- Home healthcare appliances
- Ventilators
- Breathing machine
- Portable hemodialysis machine

GEM Series

Features & Benefits

- Various DC plug quick adapter accessory available
- Series: GEM-06/12/18/30/40/60
- Output voltage: 5,7.5,9,12,15,18,24,48
- Universal AC input: 90~264VAC
- Interchangeable AC plugs
- 2 X MOPP medical safety
- Extremely low leakage current
- No load power consumption should be <math><0.075\sim 0.3W</math> based on different power
- Energy efficiency level V
- Class II
- 3 year warranty



GSM Series

Features & Benefits

- Series: GSM-06/12/18/25/36/40/60/90/120/160/220
- Output voltage: 5,7.5,9,12,15,18,24,48 *
- Universal AC input: 90~264VAC
- Global certifications
- 2 X MOPP medical safety
- Extremely low leakage current
- No load consumption should be: <math><0.1W\sim 0.15W</math>
- Wide range working temperature: -30 ~+70°C
- Energy efficiency Level VI
- Class II and class I
- 3 year warranty





Advanced Energy

Configurable power

Medical devices require a wide variety of voltages and benefit from flexible, high efficiency power products enabling a short design cycle. Medical certified products simplify safety compliance. Smart fan technology or conducted cooling minimize the troubles caused by thermal challenges.



Applications

- X-Ray equipment
- MRI Scanner
- Cosmetic/aesthetic equipment
- Surgical robotics
- Surgical lasers
- Electroporation

Cost efficient – uMP Series

Features & Benefits

- Up to 1800W
- Up to 12 outputs
- High density
- Cost efficient



High Precision – iHP Series

Features & Benefits

- 12kW and 24kW racks
- 4 or 8 individual outputs per rack
- Fully digital controlled
- Combine outputs up to 1000V/1600A



Compact – CoolX platform

Features & Benefits

- 600W, 1000W fanless
- 1800W ultra compact with fans
- 3000W with fans up to 24 isolated outputs
- 4/6 slots
- Suitable for BF applications
- 5 or 12V AUX always on



Flexible – Ultimod platform

Features & Benefits

- Off-the-shelf front end in standard chassis
- Off-the-shelf modules slide in providing DC output
- 4 slot chassis 750W/6 slot chassis 1340W
- Choice of 25 modules
- Floating outputs
- Configuration following engineering can be ordered pre assembled with unique part number





Advanced Energy

Fanless operation

Medical devices require a wide variety of voltages and benefit from flexible, high efficiency power products enabling a short design cycle. Medical certified products simplify safety compliance. Smart fan technology or conducted cooling minimize the troubles caused by thermal challenges.



Applications

- X-Ray equipment
- MRI Scanner
- Cosmetic/aesthetic equipment
- Surgical robotics
- Surgical lasers
- Electroporation

Convection cooled – CS1000

Features & Benefits

- Compact, fanless 1000W solution
- 24 or 48 V adjustable
- 5 or 12V AUX always on
- Suitable for BF applications



Conduction cooled LCC Series

Features & Benefits

- 250W and 600W available, 1200W under development
- No need for cooling fans
- IP65 versions available
- Digital control

CNS650

Features & Benefits

- Medical and ITE safety approvals 2x MOPP
- PMBus® interface
- Total power: 650 watts
- Input voltage: 90 – 264V





Littelfuse/IXYS

Semiconductor relays for medical applications

Medical applications like isolation current monitor circuits for higher voltage systems require high blocking voltage, low off-state leakage current relays with high input-to-output isolation rating to prevent potential lethal current conduction to the system chassis.



Applications

- Patient/equipment isolation
- Instrumentation
- Multiplexers
- Data acquisition
- Medical equipment
- Electronic switching
- Security systems
- Reed relay replacement

CPC1008N (100V AC peak or DC, 150mA)

Features & Benefits

- 1-pole: 1 NO output in 4-pin SOP
- Load currents up to 150mA at 100V AC/DC
- 1500VRMS input/output isolation
- Fulfills low drive power requirements
- Flammability rating UL 94 V-0

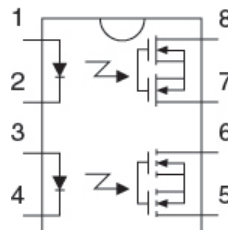
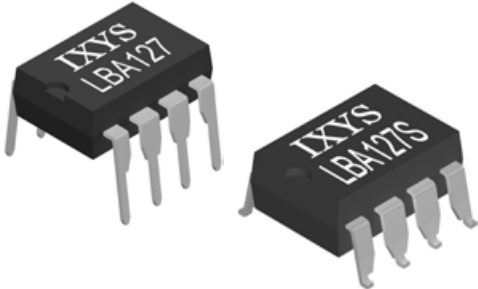
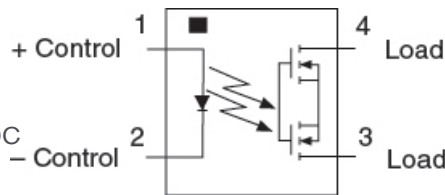

LBA127 (200V AC peak or DC, 200mA)

Features & Benefits

- Dual-pole relay: 1 NO + 1NC output
- Load currents up to 200mARMS or DC
- 3750VRMS input/output isolation
- Small 8-pin package
- VDE & FCC compatible

CPC1976Y (240VAC, 2ARMS)

Features & Benefits

- 1-pole: 1 NO output
- Load currents up to 2ARMS at 20–240VAC
- 600VP blocking voltage
- 5mA LED input sensitivity
- Zero-crossing turn-on
- TTL and CMOS compatible

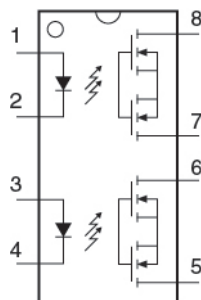
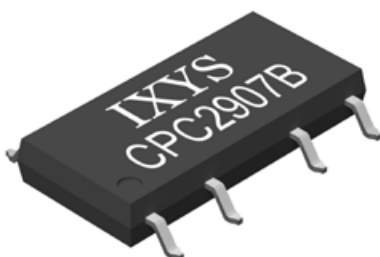
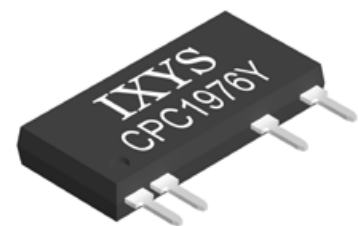
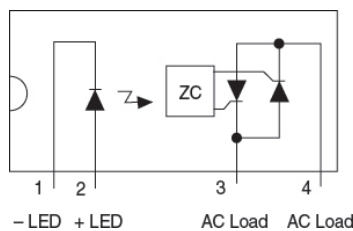

CPC2907B (60V AC peak or DC, 2A)

Features & Benefits

- Dual-pole relay: 1 NO + 1NO output
- Load currents up to 2ARMS or DC at 60V AC peak or DC
- Low on-resistance: 150mΩ Max.
- 4000VRMS input/output isolation
- 8-pin SOIC surface mount package

MEAN WELL



Modular power 650/1200W

Modern medical devices requiring multiple voltage rails with a high degree of flexibility are developed more easily by selecting modular power supplies. Virtually any combination of voltages and currents is possible within the power range provided by the chosen chassis size.



Applications

- Medical screen
- Diagnostic equipment
- Test & measurement equipment
- Medical communication equipment

NMP Series

Features & Benefits

- 650W and 1200W
- Case 1U height, efficiency up to 91%
- Medical grade 2xMOPP
- Output module: 5V/12V/24V/48V. Wide V_o adj. range 3–55Vdc
- PV & PC functions via external DC signal
- Built-in active current sharing function
- Auxiliary output: 5V at 2A (NMP-1K2)/5V at 1.5A (NMP-650)
- Cooling by thermostatically controlled fan
- Operating temperature -30~+70°C
- Safety approval: ANSI/AAMI ES60601-1, TÜV EN60601-1, IEC60601-1(ed. 3.1), DUL62368-1, TÜV EN62368-1
- 5 year warranty



Murata Power Solutions



U Frame medical power supply

Cooling fans often are most unwanted in Medical devices. Murata's superior thermal design allows 450W without any fans. Power boost gives 800W peak power for 30 seconds during start-up – enabling, for example, motors to start-up reliably.



Applications

- Hospital communication system
- Hospital bed
- Mobile x-ray equipment
- Ultrasound devices
- Mobile computing unit

PQU650 Series

Features & Benefits

- Wide AC input global coverage
- Models 12, 24, 28, 48, 54 VDC output
- 6" x 4" x 40mm U channel
- 450W convection
- 650W fan cooled
- Medical approved
- Also 250W available
- 48V and 54V suitable for POE
- 800W power boost for 30s



Panasonic



PhotoMOS® relays for medical and health care devices

Modern, light-weight and mobile health care devices, such as endoscopes, blood pressure gauges or ultrasonic diagnostic equipment require components coming in miniaturized designs for saving PCB space – but nonetheless securing flawless lifetime reliability.



Applications

- Blood pressure gauge
- Ultrasonic diagnostic equipment
- Endoscope systems

PhotoMOS® are solid state relays with MOSFET output featuring low off-state leakage current and stable on-resistance over component lifetime.

Longtime life-cycles through unlimited contact operations and a reliable non-aging contact resistance render the compact AQY210S and AQY280 suitable components for signal control and sensor input transmission of next-generation blood pressure gauges – respectively for I/O signal switching in diagnostic endoscope systems. For signal control and the scanner circuit inside ultrasonic devices, the AQY22*R* PhotoMOS® would be the relay of choice as it ensures a continuously high operational speed and high frequency signal switching while coming in a compact housing.

But also x-ray or CT equipment profit from Low CxR values, high optical isolation between input and output, and DC and AC/DC load ratings and a corresponding operational safety of the switching requirements.

Features & Benefits

- Extremely long lifetime
- Smallest packages enables PCB size reduction
- High reliability without aging of contacts
- Low CxR types
- Suitable for high frequency switching



Series	U	I
AQY210S	60–400V	100–500mA
AQY280	350V	80–500mA
AQY22*R*	60–80V	150–500mA

Sensata/Crydom

Solid state relays for medical applications

Components used in the medical industry must be reliable and must sustain high frequency switching. Crydom manufactures a wide range of solid state relays offering precision, reliability and quiet operation making them an ideal choice for temperature, motion and power control in medical applications.



Applications

- Medical small pumps
- Incubators
- Electric hospital beds
- Dialysis machines
- Warmers for blood transfusion equipments
- Sterilizers and ovens

DRA3 Solid State Contactors

All the DRA3P series models are C-UL-US recognized. The DRA3P three phase solid state contactor is available in 2 configurations, with 2 or 3 controlled legs for added flexibility. In the case of the version with 2 controlled legs, the third leg is linked internally.

Features & Benefits

- 2.4 & 4.2 Amp rated solid state contactor
- Load voltage range of 48–510 VAC, 3-Phase
- LED input status indicator
- AC or DC control
- cUL recognized, CE, RoHS compliant, IEC & HP rated
- Built in overvoltage protection



SOLICON DRC3 Solid State Contactors

All the models of Solicon DRC3 Series combine the benefits and advantages of a solid state contactor with the functionality and simplicity of use of an electromechanical contactor thanks to the proprietary thermal management technology (patented) and complete electrical insulation (no grounding required).

Features & Benefits

- 7.6 amp AC semiconductor motor controller
- Load voltage range up to 600 VAC
- LED input status indicator
- AC or DC control
- C-UL-US listed, IEC rated, CE & RoHS compliant
- Built-in overvoltage protection

DRA1 SPF AC Output Solid State Relays

These relays ensure precision, reliability and quiet operation making them an ideal choice for temperature, lighting and motion control in a variety of medical equipment such as small pumps and warmers for blood transfusion equipment, incubators, electric hospital beds, dialysis machines, warming blankets, sterilizers and ovens.

Features & Benefits

- 10mm single channel DIN rail mount SSR assembly
- AC ratings up to 380 VAC and 10 Amps
- 3–15 VDC, 15–32VDC, 18–36 VAC and 90–140 VAC control
- Cage style screw terminals for easy connection
- Includes LED status indicator (DC control only)





Flex Power Modules

DC/DC power solutions for data communication Infrastructure

Flex Power Modules has a long and successful track record in DC/DC power solutions. In digital power, we are one of the leading players driven by innovation, technical know-how and open standard software.



Applications

- Cloud applications
- Network security
- IoT
- Data center application
- AI
- Big data

One of our main business areas is datacom applications, which typically run on a 40–60 Vin supply voltage.

Flex Power Modules offers multiple solutions to populate on customers' boards from 48/54 V input down to the voltages needed by the processors, ASICs, FPGAs, memories and other chipsets through various power architectures including IBC + digital POLs, IBC + VRMs, direct conversion, switched capacitor + digital POLs, switched capacitor + VRMs.

Key selling factors include extremely high levels of power integration, increased system level efficiencies, improved board level space savings, low profile solutions, and supported software design capabilities thanks to the Flex Power Designer tool.

Features & Benefits

- Digital DC/DC IBC converters (48V to IBC voltage)
- Direct conversion devices (48V to load voltage)
- Digital point of loads (PoL)
- Switched capacitor IBC (intermediate bus converter)
- Multi-phase voltage regulation modules (VRMs) – high density up to 8-phase for high current loads

Product	Series	V _{in}	V _{out}	P _{out}	I _{out}	Efficiency	Foot print
	BMR480	45–60V	12V	1300W	108.3A	97%	Quarter brick
	BMR491* (HRR)	40–60V	12V	1540W (2450W peak)	205A	97.5%	Quarter brick
	BMR469	7.5–14V	0.6–5V	–	2 x 25A/ 2 x 40A	Up to 94%	SMD
	BMR461	4.5–14V	0.6–5V	–	6/12/ 15/18A	96%	LGA
	BMR481	40–60V	1V	70W	70A	91.6%	27.7 x 12.7 x 16.8mm
	BMR310*	40–60V	10–15V	875W	–	>98 %	58.4 x 25 x 10.3mm
	BMR510*	4.5–16V	0.5–1.5V	–	480A peak	>88%	10.35 x 37.5 x 10.9mm

*Soon to be released



Flex Power Modules

DC/DC power solutions for 5G/RFPA and microwave

Flex Power Modules has a large product portfolio for Radio Frequency Power Amplifier (RFPA), microwave and small cell applications.



Applications

- LTE/5G RRH/RRU/RU
- Small cell
- Massive MIMO
- PTP/PTMP microwave
- In-building wireless

Our products come in industry standard form factors from 1/16 brick up to 1/2 brick size, delivering from 60W up to 1300W per module.

They are particularly designed for the 5G rollout which is accelerating the world over. Flex Power Modules offers a complete set of solutions to address radio frequency power amplifiers using LDMOS or GAN technology.

The latest products integrate a digital interface to monitor, control and configure the modules using PMBus®.

Our recently launched PKU-A family offers excellent performance in a cost optimized package to support high volume small cell solutions.

Features & Benefits

- High efficiencies of more than 95%
- High reliability with MTBF (mean time between failures) of up to 17.5 Mhrs
- Power levels of up to 1300W
- Typical input voltage range 36–75V

Product	Series	V _{in}	V _{out}	P _{out}	Efficiency	Foot print
	PKU4717YA	36–60V	4.5V	72W	94%	Sixteenth brick
	PKU4116C	36–75V	30V	100W	92.9%	Sixteenth brick
	PKB4216C	36–75V	24/28/30V	Up to 250W	95%	Eighth brick
	PKB4216HD	36–60V	48/50V			
	PKM-D	36–75V	28/30/48/50V	504W	96.2%	Quarter brick
	PKJ4000	36–75V	28/30/48/50V	700W	96.2%	Half brick
	BMR683	36–60V	28V	500W	95.2%	Quarter brick
	BMR685*	36–75V	50V	1300W	96.5%	Half brick

*Soon to be released



TE Connectivity's Axicom Relays

High frequency relays for up to 6 Ghz Applications

TE's Axicom high frequency relays provide a reliable solution for switching radio frequency applications up to DC 6 GHz by achieving very low insertion loss, very low return loss and very high isolation. HF relays are available as shielded or non shielded versions with 1 form C switching configuration at 50 or 75 Ωs.



Applications

- Antenna switching devices
- Power amplifiers
- Hi-speed test systems
- Satellite/audio/video tuners
- Wireless base stations
- Cable modems
- Automated test equipment
- Oscilloscope input selection
- High speed routers

Features & Benefits

- Frequency range DC up to 6 GHz.
- Ideal for 5G relay switching applications
- Shielded options for higher performance
- No load carry & hot switching capability
- RF power capability of 50 W (150W on request)
- High isolation and a low insertion loss.
- Low coil power consumption (70mW and 140mW)
- Sealed according to IEC 61810, RT III (wash tight)
- Mono-stable and Bistable coils available
- 50 and 75 Ω impedance versions available
- Surge breakdown voltage between contact and coil: 12kV

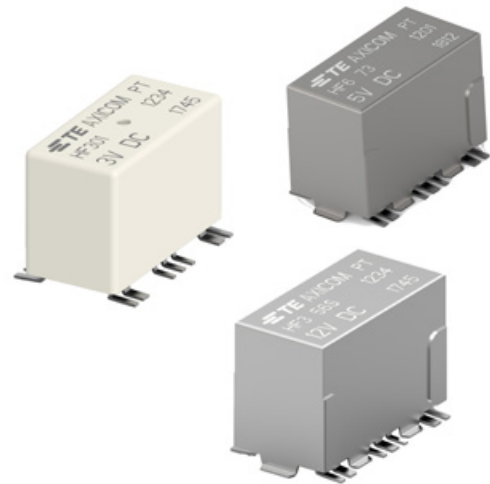

OMRON



Telecommunication and security relays G5V-1/G5V-2



Applications

G5V-1 Relay

- Telecommunication equipment
- Audio-visual products

- Security equipment
- Building automation equipment

G5V-2 Relay

- Telecommunication equipment
- Security equipment

The G5V-2 relay series are serving general purpose, where cost efficiency is just as important as characteristics such as high dielectric strength or UL and CSA standard. The wide range of switching power from 10µA to 2A makes it ideal for security and telecommunication equipment.

- Conforms to FCC Part 68 requirements for coil to contacts. (1,500V, 10×160µs)
- Models for ambient temperatures up to 90°C added to series.

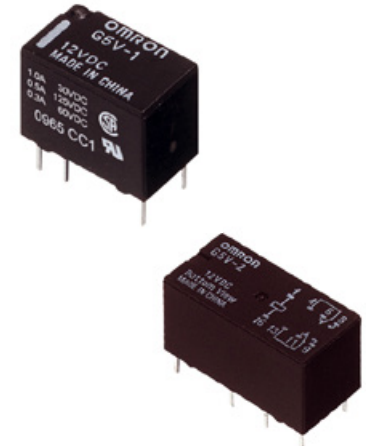

Features & Benefits

G5V-1 RELAY

- Ultra-miniature at 12.5×7.5×10mm (L×W×H)
- Wide switching power of 1mA to 1 A
- High sensitivity: 150mW nominal coil power consumption
- Fully-sealed construction offering environment resistance

G5V2-RELAY

- General-purpose DIL terminal layout.
- Wide switching power of 10µA to 2A.
- Fully-sealed type Relays standardized with bifurcated crossbar contacts.
- Conforms to FCC Part 68 requirements for coil to contacts. (1,500 V, 10×160µs)
- High dielectric strength at 1,000 VAC between coil and contacts,
- UL and CSA standard approved.

Panasonic



PhotoMOS® relays for telecommunication equipment

It is a wide variety of signals that are imposed upon telecommunication networks: levels range from millivolts (at microamperes) to tens of volts (at several hundred milliamperes), AC or DC and even high bit-rate signals.



Applications

- Modems

- Network modules

- DCS

- UPS

The switches in communication circuits – which normally carry DC signals – also carry AC signals on top of the DC level when an intermittent signal is being sent. Especially the PhotoMOS® RF series with an optimized and low CxR allows high frequency switching – with a very low output capacitance at open state and a very low on resistance when switched on.

Features & Benefits

- Low CxR
- Linear output characteristics
- No threshold voltage
- Minimum leakage current (pA)
- Extremely long lifetime
- Stable ON-resistance over the entire lifetime
- Extremely compact design (VSSOP, SON, SSOP, SOP, DIP)
- No contact bounce
- Highly resistant to shock and vibration
- Flexible mounting orientation



Series	U	I
AQY221N5T	20V	180mA
AQY221*V	25–40V	120–1.000mA



TE Connectivity's Axicom Relays

Reliable signal relays for telecom applications

TE's signal relays are one of the smallest electromechanical relays fitting in many continuously shrinking customer applications and are designed for high volume applied technologies. Depending on series, they are available as 1 form A, 2 form A, 1 form C and 2 form C contact versions.



Applications

- Automotive infotainment systems (CAN)
- 5G Network systems & infrastructure
- Modems
- Test equipment
- Antenna switching
- Smart thermostats
- Medical solutions
- Keyless entry

IM Relay

Features & Benefits

- Switching current: 2/5A, voltage: 220VDC/250VAC, power: 60W/62.5VA
- Slim line 10x6mm, low profile 5.65mm and min. board-space 60mm²
- Low coil power consumption: 50mW, 100mW and 140mW version available
- High contact reliability up to 10,000,000 operations
- Very low and stable contact resistance
- THT, SMT design for reflow soldering by providing a smaller footprint option
- High mechanical shock resistance up to 50g functional

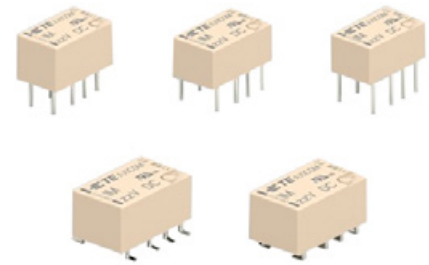

P2 (V23079) Relay

Features & Benefits

- 2 form C bifurcated contacts (2 changeover contacts, 2 CO)
- Switching current: 2/5A, voltage: 220VDC/250VAC, power: 60W/62.5VA
- Standard telecom relay (ringing and test access)
- Slim line 15x7.5mm (.590x.295")
- Immersion cleanable
- Very low coil power dissipation
- High sensitivity for low power consumption 140mW/70mW
- SMD & THT versions available
- 1 coil version meets Telcordia requirement GR-1089 & FCC Part 68

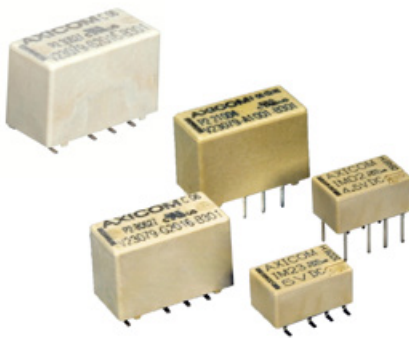

D2N (V23105) Relay

Features & Benefits

- 2 form C contacts (2 CO, 2 changeover contacts)
- Switching current: 3A, voltage: 220VDC/250VAC
- Standard DIL relay, can be mounted onto a DIL socket
- Four different coil sensitivities, 150mW, 200mW, 400mW, >500mW
- Surge voltage resistance meets FCC Part 68 requirement
- Immersion cleanable

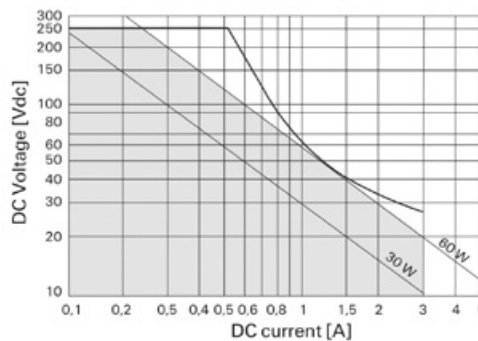

MEAN WELL



PCB mounted PSU

Perfect fit for appliances – miniature size/high density. Directly mounted onto the PCB these power supplies enable easy connection. Standard industrial and medical ranges available for use in all consumer appliances. Also available are versions compliant to household standard, mandatory for more and more consumer appliances



Applications

- IOT
- EV charging
- Home appliances
- Small electronic devices

IRM Series

Features & Benefits

- 1W–90W Standard Models
- No load power consumption < 0.075W
- Comply with EN55022 class B without any additional components
- Withstand 5G vibration test
- UL62368-1, TÜV EN62368,
- TÜV EN60335-1 household appliance (IRM-03/30/45/60/90 only)
- OVC III:(IRM-30/45/60/90 only)
- Pass LPS



MPM Series (medical)

Features & Benefits

- 5W–90W standard models
- 3.3V–48VDC output
- Wide AC input
- 2 x MOPP medical safety
- Suitable for BF application with appropriate system consideration
- No load power consumption < 0.1W
- Extremely low leakage current

Applications

- Portable medical device
- Mobile clinical workstation
- Medical computer monitor
- Medical examination instrument





MEAN WELL

Enclosed power supplies

Modern consumer appliances need to be compliant with the household norm IEC60335. MEAN WELL's LRS range also complies with industrial standard and can be used as a true standard power supply, build it in and focus on functional design.



Applications

- IOT
- Home appliances
- Electronic instruments, equipment or apparatus
- Industrial automation machinery
- EV charging

LRS Series

Features & Benefits

- LRS-35/50/75/100/150
- No load power consumption < 0.2W
- Low profile
- High operating temperature up to 70°C
- UL62368-1, TÜV EN62368
- Compliance to IEC/EN 60335-1(PD3) and IEC/EN61558-1, 2-16 for household appliances
- Operating altitude up to 5000 meters
- Over voltage category III (OVC III)
- Withstand 5G vibration test.
- Cooling by free air convection
- 3 year warranty



MEAN WELL



Indoor LED drivers

MEAN WELL LED drivers for indoor applications span a complete range with suitable models for every lighting application. A special flavor is the KNX compatible LCM series for easy control and access to customer defined light programs.



Applications

- LED indoor lighting
- LED office lighting
- LED architectural lighting
- LED panel lighting

LCM Series

Features & Benefits

- LCM-25/40/60 ENOCEN/KNX/Casambi/TUYA/Silvair
- AC input range: 180~295V(U type for 110Vac in)
- Class II input, no FG
- Output current level selectable by DIP switch
- Protections: short circuit/OVP/OTP
- Built-in 0~10VDC and PWM dimming function
- Built-in DALI interface and push dimming function (DA-type)
- Built-in 12V/50mA auxiliary output for IOT control.
- Power supplies synchronization function up to 10 units
- Safety certificate:UL8750, ENEC EN61347-2-13, EN62384, CE approved
- Comply with DALI standards: IEC62386-101, 102, 207 (DA-Type)
- 3 year warranty





Murata Power Solutions

PCB mounted PSU

Directly mounted onto the PCB these power supplies enable easy connection. Compliant with both medical and industrial regulations this is an ideal solution for any appliance. SIP model saves board space where DIP model offers increased stability.



Applications

- Air-conditioning
- Tools
- Washing machines
- Blood pressure monitor

BAC Series

- 1W, 3W, 5W & 10W available
- Medical and also industrial safety
- Wide input range
- Operating -40°C – 85°C
- Convection cooled
- Isolation > 4kV hi pot test
- Low standby power

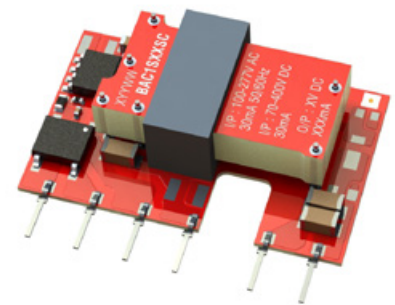

POL converters 5, 12, 24, 36Vin

Where space is critical these non-isolated point of load converters with wide variety of input ranges are versatile offering reliable and standard of the shelf conversion.



Applications

- Electronic control circuits
- FPGA designs
- Communication circuits

MYM, MYS/MYL Series

Features & Benefits

- 4–30A output current variants
- Open Frame or encapsulated
- Small footprint
- Digital communication
- Compatible with FPGA

MYRGM-WB	MYRGP	MYMGK	MYSGK	MYLSM



TE Connectivity's SCHRACK Power Relays

Appliance power relays

General purpose power relays are among the many components TE provides appliance manufacturers. From a broad range of small countertop appliances to major home appliances and other in-home equipment, TE relays switch heating elements, motors, compressors, lamps and other loads.



Applications

- White goods
- Small appliances like coffee makers
- Power supplies
- Floor care
- Motors
- Heating temperature controllers
- Air conditioning

PCJ-WG (3/5A) Relay

Features & Benefits

- 1pole 3A/5A, 1 form A (NO) contact
- Sensitive coil 200mW
- Ambient temperature 85°C
- WG version: product in accordance to IEC60335-1

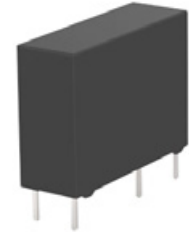

PB/PBH (10A) Relay

Features & Benefits

- 1pole 10A, 1 form C (CO) or 1 form A (NO)
- Class F coil system standard
- Compact and simple design gives high process security
- WG version: product in accordance to IEC60335-1

OJ-LMH2-WG (8A) Relay

Features & Benefits

- 1-pole 8A, 1NO contact
- Sensitive coil, 200mW
- 3kV or 4kV dielectric strength between coil and contacts
- WG Version in accordance to IEC60335-1

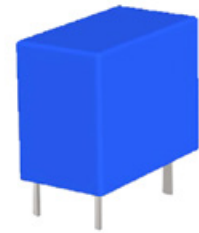

T9G (30A) Relay

Features & Benefits

- 30A switching in NO and 20A in CO
- Meets UL 508 and IEC 61810-1
- 6.3mm load connections via quick connect terminals possible
- 4kV dielectric withstand and 8kV surge voltage
- UL approved for 480 VAC switching

RF (16A) Relay

Features & Benefits

- 1-pole 16A, 1 NO or 1 NC contact
- Coil power 400mW
- Ambient temperature up to 105°C
- Quick connect terminals for load side
- WG version: in accordance to IEC 60335-1



Murata Power Solutions



Picoblock POL converters

Electronic accessories like smartwatches, alarm units for the elderly, VR applications need small light and reliable DC/DC converters to convert the battery voltage to minimize size and weight.



Applications

- Smartwatch
- Therapeutic VR application
- Alarm unit for care needing individuals
- Smart key

MYR series

Features & Benefits

- Small size (< 3x3mm)
- Easy development
- Low EMI noise
- Excellent thermal behaviour
- 2.5–18Vin
- 0.8–15Vout
- Output adjustable



2.5mm x 2.0mm x 1.0mm



3.2mm x 2.5mm x 1.0mm

PKG Type	Small Size	High PD	Low EMI	Characteristic
Pocket Coil Type MYRGP series	○	○	○	Low EMI
Multiples Type MYRGP series	○	○	○	High PD Low profile
Cool Post Type MYRGP series	○	○	○	High PD Low EMI



ttieurope.com

Local Sales and Technical Support in over 40 Locations Across EMEA

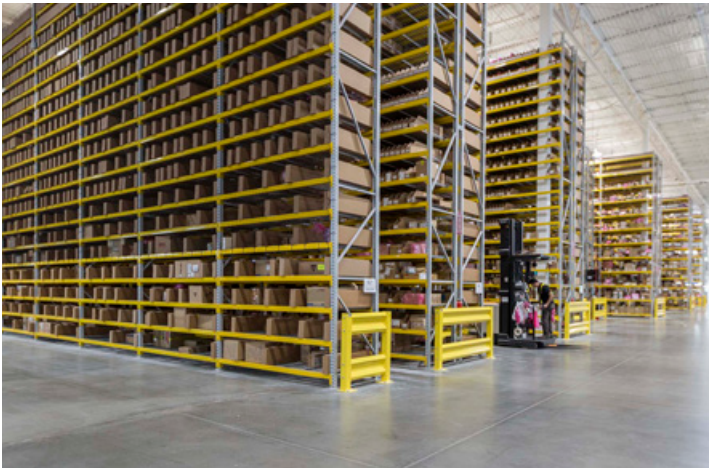

**European HQ,
Munich 35,000m²
of dedicated
warehouse space**





ttieurope.com



Contact TTI today to see what a true specialist can offer.

Corporate Headquarters

TTI, Inc.
2441 Northeast Parkway, Fort Worth, Texas 76106 U.S.A.
T: +1 817 740 9000 | F: +1 817 740 9898
E: information@ttiinc.com

European Sales Offices

Austria

Vienna
T: +43 (0) 18 79 85 90
E: sales.vienna@at.ttiinc.com

Benelux

Eindhoven
T: +31 (0) 40 290 1616
E: sales.benelux@nl.ttiinc.com

Bulgaria

Varna
T: +359 52 51 10 59
E: sales.varna@bg.ttiinc.com

Czech/Slovak Republic

Brno
T: +420 541 126 714
E: sales.brno@cz.ttiinc.com

Denmark

Brøndby
T: +45 (0) 43 29 35 35
E: sales.copenhagen@dk.ttiinc.com
Risskov
T: +45 (0) 38 41 31 00
E: sales.copenhagen@dk.ttiinc.com

Estonia

Tallinn
T: +372 664 81 00
E: sales.estonia@ee.ttiinc.com

Finland & Baltic Region

Espoo
T: +358 98 94 65 200
E: sales.finland@fi.ttiinc.com

France

Brive
T: +33 (0) 5 55 92 92 93
E: sales.france@fr.ttiinc.com

Bron

T: +33 (0) 472 81 2030
E: sales.lyon@fr.ttiinc.com

Bruz

T: +33 (0) 2 99 77 60 84
E: sales.rennes@fr.ttiinc.com

La Ciotat

T: +33 (0) 442 84 4142
E: sales.marseille@fr.ttiinc.com

Montigny Le Bretonneux

T: +33 (0) 130 13 7380
E: sales.paris@fr.ttiinc.com

Germany

Berlin
T: +49 (0) 30 8877 40 200
E: sales.berlin@de.ttiinc.com
Dortmund
T: +49 (0) 2301 91 304 0
E: sales.dortmund@de.ttiinc.com
Frankfurt
T: +49 (0) 6102 5999 100
E: sales.frankfurt@de.ttiinc.com

Hanover

T: +49 (0) 5 11 7 80 59 0
E: sales.hannover@de.ttiinc.com

Munich

T: +49 (0) 81 42 66 80 110
E: sales.munich@de.ttiinc.com

Nuremberg

T: +49 (0) 911 9520 0
E: sales.BDG@de.ttiinc.com

Pforzheim

T: +49 (0) 7231 14788 0
E: sales.stuttgart@de.ttiinc.com

Hungary

Budapest
T: +36 1 40 22 111
E: sales.budapest@hu.ttiinc.com

Ireland

T: +44 (0)1494 460000
E: sales.ireland@ie.ttiinc.com

Israel/Ray-Q Ltd.

Airport City
T: +972 3 975 3333
E: sales@ray-q.com

Italy

Civitanova Marche
T: +39 0733 81 8655
E: sales.milan@it.ttiinc.com

Florence

T: +39 (0) 55 094 63 76
E: sales.milan@it.ttiinc.com

Milan

T: +39 02 822 521
E: sales.milan@it.ttiinc.com

Naples

T: +39 081 4245719
E: sales.milan@it.ttiinc.com

European Headquarters

TTI, Inc.
Ganghoferstr. 34, 82216 Maisach-Gernlinden Germany
T: +49 (0) 81 42 66 80 0 | F: +49 (0) 81 42 66 80 490
E: sales@de.ttiinc.com
Technical support: eur.power@de.ttiinc.com
or TTI.Relays@de.ttiinc.com

Padova

T: +39 049 7802311
E: sales.milan@it.ttiinc.com

Rome

T: +39 0774 57 1302
E: sales.rome@it.ttiinc.com

Norway

Drammen
T: +47 (0) 92 66 87 66
E: sales.norway@no.ttiinc.com

Poland

Kwidzyn
T: +48 (0) 55 279 67 57
E: sales.poland@pl.ttiinc.com

Portugal

Vila Nova de Famalicao
T: +351 252 493084
E: sales.barcelona@es.ttiinc.com

Romania

Cluj Napoca
T: +40 (0) 733 339 002
E: sales.romania@ro.ttiinc.com

Russia

Saint Petersburg
T: +7 (0) 812 4962053
E: sales.russia@ru.ttiinc.com

South Africa

Pretoria
T: +27 86 111 2844
E: sales.southafrica@za.ttiinc.com

Spain

Barcelona
T: +34 (0) 93 645 25 75
E: sales.barcelona@es.ttiinc.com

Madrid

T: +34 (0) 91 416 11 90
E: sales.madrid@es.ttiinc.com

Vizcaya

T: +34 (0) 94 623 25 80
E: sales.bilbao@es.ttiinc.com

Sweden

Gothenburg
T: +46 (0) 31 741 12 90
E: sales.gothenburg@se.ttiinc.com

Stockholm

T: +46 (0) 8 594 11 800
E: sales.stockholm@se.ttiinc.com

Switzerland

Baar
T: +41 (0) 41 76741 90
E: sales.swiss@ch.ttiinc.com

Egypt, Morocco & Tunisia

T: +212 695592855
E: sales.tunis@fr.ttiinc.com

Turkey

Istanbul
T: +90 (0) 216 688 91 75 76
E: sales.turkey@tr.ttiinc.com

United Kingdom

Basildon
T: +44 (0)1268 498460
E: sales.essex@uk.ttiinc.com

High Wycombe

T: +44 (0)1494 460000
E: sales.london@uk.ttiinc.com

Manchester

T: +44 (0)161 872 2019
E: sales.london@uk.ttiinc.com

Resellers or Distributors

TTI Connect - Europe
T: +49 8142 6680 168
E: service@tticonnect.com

TE Connectivity, TE connectivity (logo), TE, KILOVAC, Axicom, HARTMAN and SCHRACK are trademarks.

TTI, Inc. Headquarters Europe



www.tuev-sued.de/ms-zert



IECQ P.ES1 14.0013
IECQ P.ES1 14.0013.02
www.iecq.org