



REGULAR TOWN COUNCIL MEETING

Monday, November 2, 2020 at 7:30 pm

1. CALL TO ORDER, PRAYER AND PLEDGE
2. ROLL CALL
3. APPROVAL OF AGENDA - ADDITIONS/DELETIONS/CHANGES

- a. **Resolution 19-2020 Appoint to Planning and Zoning Board**

A RESOLUTION OF THE TOWN OF MALABAR, BREVARD COUNTY, FLORIDA, PROVIDING FOR THE APPOINTMENT OF ELIZABETH "LIZ" RITTER TO THE MALABAR PLANNING AND ZONING BOARD AS A REGULAR MEMBER; PROVIDING FOR REPEAL OF RESOLUTIONS OR PARTS OF RESOLUTIONS IN CONFLICT HERewith; PROVIDING FOR AN EFFECTIVE DATE.

Agenda Item to be added after Agenda Item 11c and before Agenda Item 11d as Agenda Item 11c(1)

Exhibit: Agenda Report Number 11c(1)

Attachments:

- Agenda Report Number 11c(1) (Agenda_Report_Number_11c_1_.pdf)

4. CONSENT AGENDA

- a. **Approve Minutes of Regular Town Council Meeting of 10/19/2020**

Exhibit: Agenda Report Number 4a

Attachments:

- Agenda Report Number 4a (Agenda_Report_Number_4a.pdf)

5. ATTORNEY REPORT

6. BOARD / COMMITTEE REPORTS

- a. T&G Committee
 - b. Park & Recreation Board
 - c. Planning & Zoning Board

7. STAFF REPORTS

- a. Manager

Attachments:

- Agenda Report Number 7a (Agenda_Report_Number_7a.pdf)

- b. Public Works Director - Written Report
 - c. Fire Chief

d. Clerk

8. PUBLIC COMMENTS

Comments at this point may address items NOT on the Agenda. Comments related to subsequent Agenda Items may be made as those items come up. Public comments do not require a Council response. (Speaker Card is Required)

Five (5) Minute Limit per Speaker

9. PUBLIC HEARINGS / SPECIAL ORDERS : 0

10. UNFINISHED BUSINESS/GENERAL ORDERS MAY INCLUDE ITEMS DIRECTLY RELATED TO RESIDENTS PRESENT AT MEETING : 0

(RECOMMENDATIONS FROM BOARDS, HOA REQUESTS, RESIDENT GRIEVANCES)

11. ACTION ITEMS

ORDINANCES FOR FIRST READING: 2

RESOLUTIONS: 1

MISCELLANEOUS: 7

a. Ordinance 2020-12 Budget Amendment for FY 2019/2020

AN ORDINANCE OF THE TOWN OF MALABAR, BREVARD COUNTY, FLORIDA, PERTAINING TO A BUDGET AMENDMENT IN THE FISCAL YEAR 2019/2020 TO PROVIDE FOR ADDITIONAL REVENUES RECEIVED; PROVIDING FOR THE UNSPENT BUDGETED FUNDS DUE TO REDUCED EXPENDITURES; PROVIDING DIRECTION TO DELEGATE SUCH EXCESS FUNDS TO DESIGNATED RESTRICTED RESERVES FOR BUILDING DEPARTMENT USE, STORMWATER USE, FIRE DEPARTMENT AND STREETS AND ROADS FOR VEHICLE REPLACEMENT; PROVIDING FOR THE SHIFTING OF UNSPENT MONIES BETWEEN DEPARTMENTS TO BALANCE THE EXPENDITURES; PROVIDING FOR CONFLICT; AND PROVIDING FOR AN EFFECTIVE DATE.

Exhibit: Agenda Report Number 11a

Attachments:

- [Agenda Report Number 11a \(Agenda_Report_Number_11a_Revised.pdf\)](#)

b. Ordinance 2020-13 Amendment to Chapter 9

AN ORDINANCE OF THE TOWN OF MALABAR, BREVARD COUNTY, FLORIDA, AMENDING CHAPTER 9 OF THE CODE OF ORDINANCE OF THE TOWN; ADOPTING THE REVISED FLOOD INSURANCE STUDY AND FLOOD INSURANCE RATE MAPS; TO INCORPORATE REQUIREMENTS FOR COASTAL HIGH HAZARD AREAS; PROVIDING FOR APPLICABILITY, INCLUSION IN THE CODE OF ORDINANCE, SEVERABILITY AND AN EFFECTIVE DATE.

Exhibit: Agenda Report Number 11b

Attachments:

- [Agenda report Number 11b \(Agenda_Report_Number_11b.pdf\)](#)

c. Resolution 17-2020 - Extend or Sunset Face Covering Policy

A RESOLUTION OF THE TOWN OF MALABAR, BREVARD COUNTY, FLORIDA, PURSUANT TO THE GENERAL POWERS RESERVED TO THE TOWN COUNCIL IN THE TOWN CHARTER; MAKING LEGISLATIVE FINDINGS; PROVIDING FOR DEFINITIONS; REQUIRING ALL PERSONS TO WEAR FACE COVERING AT DESIGNATED TOWN FACILITIES; PROVIDING FOR EXCEPTIONS; PROVIDING FOR SUNSET; PROVIDING FOR SEVERABILITY, CONFLICTS AND EFFECTIVE DATE.

Exhibit: Agenda Report Number 11c

Attachments:

- Agenda Report Number 11c (Agenda_Report_Number_11c.pdf)

d. Piggyback National Association of State Procurement Officials (NASPO) ValuePoint Program Contract for AT&T FirstNet Solutions and AT&T Mobility Services.

Exhibit: Agenda Report Number 11d

Attachments:

- Agenda Report Number 11d (Agenda_Report_Number_11d.pdf)

e. Piggyback Brevard County B-6-19-23/Road Construction Materials

Exhibit: Agenda Report Number 11e

Attachments:

- Agenda Report Number 11e (Agenda_Report_Number_11e.pdf)

f. Piggyback Brevard County B-6-19-12/ Aggregate (57 Stone & Pea Gravel)

Exhibit: Agenda Report Number 11f

Attachments:

- Agenda Report Number 11f (Agenda_Report_Number_11f.pdf)

g. Piggyback Brevard County B-6-20-57/Asphaltic Concrete

Exhibit: Agenda Report Number 11g

Attachments:

- Agenda Report Number 11g (Agenda_Report_Number_11g.pdf)

h. Piggyback Omni Partners National Cooperative Purchase Contract

Exhibit: Agenda Report Number 11h

Attachments:

- Agenda Report Number 11h (Agenda_Report_Number_11h.pdf)

i. Approve Replacement Vehicle Purchase utilizing the Florida Sheriff Association (FSA) Cooperative Purchasing Program utilizing Duval Fleet, 5203 Waterside Drive, Jacksonville, FL 32210, an awarded contract holder

Exhibit: Agenda Report Number 11i

Attachments:

- Agenda Report Number 11i (Agenda_Report_Number_11i.pdf)

j. Consideration of Amending of Land Development Code / Article XIX Sinage

Exhibit: Agenda Report Number 11j

Attachments:

- Agenda Report Number 11j (Agenda_Report_Number_11j.pdf)

k. Consideration of Amending of Land Development Code / Article III District Provisions

Exhibit: Agenda Report Number 11k

Attachments:

- Agenda Report Number 11k (Agenda_Report_Number_11k.pdf)

COUNCIL CHAIR MAY EXCUSE ATTORNEY AT THIS TIME

12. DISCUSSION/POSSIBLE ACTION

13. PUBLIC COMMENTS

General Items (Speaker Card Required)

14. REPORTS - MAYOR AND COUNCIL MEMBERS

15. ANNOUNCEMENTS

(1) Vacancy on the Parks and Recreation Board; (2) Vacancies on the Trails and Greenways Committee

16. ADJOURNMENT

If an individual decides to appeal any decision made by this board with respect to any matter considered at this meeting, a verbatim transcript may be required, and the individual may need to ensure that a verbatim transcript of the proceedings is made (Florida Statute 286.0105).

The Town does not provide this service. In compliance with F.S. 86.26 and the Americans with Disabilities Act (ADA), anyone who needs a special accommodation for this meeting should contact the Town's ADA Coordinator at 321-727-7764 at least 48 hours in advance of this meeting.

TOWN OF MALABAR

TOWN COUNCIL

AGENDA ITEM NO: Added after 11.c. and before 11.d.

Meeting Date: November 2, 2020

Prepared By: Debby K. Franklin, C.M.C. Town Clerk/Treasurer

SUBJECT: Appointment to Board with expiring terms – Resolution 19-2020

BACKGROUND/HISTORY:

Board and Committee terms are for three years. As the term expires at the end of October, this is normally done at the 2nd meeting of October. It was the intent of Council to have the seated Council make the appointments, not the incoming Council. We have sent out requests to continue to those Board Members with expiring terms.

Council also changed the method to appoint stating in the Code that existing members that wish to continue need to complete and submit a new application for consideration. In addition, the Council adopted the Board Code of Conduct. All this information was sent to the members with expiring terms.

ATTACHMENTS:

Reso 19-2020 Liz Ritter

ACTION OPTIONS:

Staff requests Action on this Resolution.

Council Member Cheryl White
Council Member Brian Bell
Council Member Steve Bell
Council Member Edna Bell
Council Member Cheryl White

The Resolution was presented to the Council on November 2, 2020.

TOWN OF MALABAR
by _____
Mayor/President/Board Chair

ATTEST

Debby K. Franklin, C.M.C.
Town Clerk/Treasurer

(Seal)
Approved as to form and content

Ken W. Howell, Jr. Town Attorney

RESOLUTION 19--2020

A RESOLUTION OF THE TOWN OF MALABAR, BREVARD COUNTY, FLORIDA, PROVIDING FOR THE APPOINTMENT OF ELIZABETH "LIZ" RITTER TO THE MALABAR PLANNING AND ZONING BOARD AS A REGULAR MEMBER; PROVIDING FOR REPEAL OF RESOLUTIONS OR PARTS OF RESOLUTIONS IN CONFLICT HEREWITH; PROVIDING FOR AN EFFECTIVE DATE.

WHEREAS, Malabar Town Council has been notified of completed terms on the Planning and Zoning Board; and

WHEREAS, Malabar Town Council desires to fill this opening by appointment.

NOW, THEREFORE, BE IT RESOLVED BY THE TOWN COUNCIL OF THE TOWN OF MALABAR, BREVARD COUNTY, FLORIDA, that:

Section 1. The Town Council of Malabar, Brevard County, Florida, hereby approves the appointment of Elizabeth "Liz" Ritter as a regular member of the Planning and Zoning Board for a three-year term.

Section 2. The Town Council of Malabar, Brevard County, Florida, hereby authorizes and directs the Town Clerk to notify the member, the Board Chair and the Board Secretary of this appointment.

Section 3. All resolutions or parts of resolutions in conflict herewith are hereby repealed.

Section 4. This resolution shall take effect immediately upon adoption.

This Resolution was moved for adoption by Council Member _____. This motion was seconded by Council Member _____ and, upon being put to vote, the vote was as follows:

Council Member Grant Ball	_____
Council Member Brian Vail	_____
Council Member Steve Rivet	_____
Council Member David Scardino	_____
Council Member Danny White	_____

This Resolution was then declared to be duly passed and adopted this 2nd day of November 2020.

TOWN OF MALABAR
By: _____
Mayor Patrick T. Reilly, Council Chair

ATTEST:

Debby K. Franklin, C.M.C.
Town Clerk/Treasurer

(seal)

Approved as to form and content:

Karl W. Bohne, Jr., Town Attorney

Town of Malabar

Volunteer Committee/Board Application

Planning & Zoning Advisory Board Application

The Planning and Zoning Board is hereby established and shall consist of five (5) seats and two (2) alternate-seats. The Planning and Zoning Board is advisory in nature. Members of the Board shall hold no other Town office. The affirmative vote of a majority of the regular and alternate board members present and voting (maximum of five votes) shall be necessary for the adoption of any motion. The Planning and Zoning Board deals with land use issues such as site plans, conditional uses, special exceptions, residential subdivision developments, plats, re-plats and zoning change requests. They also review and compile updates for the Comprehensive Plan and present to Council. They shall also draft land development code to conform to changes adopted by Council to the Comprehensive Plan. They shall annually prepare a Capital Improvement Projects list to submit to Council. Some of the issues that the Board considers will be quasi-judicial and staff will alert them to those situations.

- 1. Name: Liz Ritter Cell Phone: 321-544-2036
 - 2. Home Address: 2860 Orange Ave, Malabar, FL 32950-0827
 - 3. Email Address: FL Liz Ritter@aol.com
 - 4. Are you a resident of the Town: Yes No
 - 5. How long have you been a resident of the Town of Malabar: 32 years
 - 6. Are you currently involved with any other organization of the Town: Yes No
- If yes, which organization: _____

Town of Malabar 2725 Malabar Road Malabar, Florida 32950
Phone: 321-727-7763 ~ Fax 321-722-2234 ~ Email: townclerk@townofmalabar.org
Website: www.townofmalabar.org

TOWN OF MALABAR

OCT 15 2020 8:42

APPLICATION FOR APPOINTMENT TO BOARD/COMMITTEE

NOTE: Florida's Public Records Law, Chapter 119, Florida Statutes states, "It is the policy of this state that all state, county, and municipal records shall at all times be open for a personal inspection by any person." Your application when filed will become a public record and subject to the above statute. In addition, any appointed member of a board of any political subdivision (except members of solely advisory bodies) and all members of bodies exercising planning, zoning or natural resources responsibilities are required to file a financial disclosure form within 30 days after appointment and annually thereafter for the duration of the appointment as required by F.S. Chap. 112.

NAME: Liz Ritter Telephone: 321-544-2036
ADDRESS: 2860 Orange Ave Malabar FL 32950-0827
EMAIL: FLiz.Ritter@aol.com

RESIDENT OF TOWN FOR 12 MONTHS OR LONGER: YES NO

OCCUPATION: (If retired, please indicate former occupation or profession.)
Camelot RD Park Admin

PROFESSIONAL AND/OR COMMUNITY ACTIVITIES:
MCA, CM&GS, VAA

ADDITIONAL INFORMATION/REFERENCES:

Please select the Board that you would like to serve on by indicating first choice & second choice:

- Board of Adjustment
Parks & Recreation
Planning & Zoning
Trails & Greenways

Per Town Code, Council shall require removal of members after 3 successive absences.

Signature of Applicant: Elizabeth Buni Ritter Date: 10-14-20

Please return this form to: Town Clerk, Town of Malabar, 2725 Malabar Road, Malabar, FL 32950-4427, Email: townclerk@townofmalabar.org

Note: If you need more information concerning the duties of these Boards, please contact the Town Clerk. Please attach a copy of your resume to this application. You will be notified of the date of the Town Council Meeting that your application will be considered for appointment. You will need to plan to attend the Council Meeting.

Applicant Certification

By completing this application with the Town of Malabar and placing my signature below, I do hereby acknowledge the following:

- This application, when completed and filed with the Office of the Town Clerk, is a PUBLIC RECORD UNDER Chapter 119, Florida Statute, and is open to public inspection.
- I am responsible for keeping the information on this form current and that any changes or updates will be provided to the Office of the Town Clerk.
- I acknowledge that I am a resident of the Town of Malabar.
- I consent to filing the Statement of Financial Interest as required by Chapter 112, Florida Statutes.
- If appointed to a Committee or Board, I acknowledge that it is my obligation and duty to comply with the following:
 - o Malabar Code of Conduct
 - o Code of Ethics for Public Officials (F.S., Chapter 112, Part III)
 - o Florida Sunshine Law (F.S., Chapter 286)

I understand the responsibilities associated with being a Committee or Board member and I will have adequate time to serve on this Committee or Board.

The information provided on this form is true and correct and consent is hereby given to the Town Council or its designated representative to verify any and/or all the information provided.

Elizabeth Bera-Ritter
Signature

10-14-20
Date

Town of Malabar 2725 Malabar Road Malabar, Florida 32950
Phone: 321-727-7763 ~ Fax 321-722-2234 ~ Email: townclerk@townofmalabar.org
Website: www.townofmalabar.org



TOWN OF MALABAR

2725 MALABAR ROAD • MALABAR, FLORIDA 32950

(321) 727-7764 OFFICE • (321) 722-2234 FAX

www.townofmalabar.com

Town of Malabar Board Member Code of Conduct

(Malabar Code Chap 2. – Code of Conduct) In addition to adhering to the requirements of State Law, any person appointed to serve as a Member of a Town Board or Committee shall commit to the following Code of Conduct by written affirmation, which shall remain on file with the Town Clerk, as follows:

I affirm that the proper Statutory and Town Charter role of Members of appointed Town Boards and Committees, as with any Member of an appointed government body, is to act collectively, not individually, to apply the Town's governing policies, and that the Town Administrator and Staff administer such policies.

I understand that an appointed Board or Committee Member does not manage the affairs of the Town. I will not intrude into daily operations or spheres of responsibility designated by Florida Statutes, Town Code, and Town Charter to the Town Administrator as the Chief Executive Officer; or undermine the Town Administrator's lawful authority. Further, I understand that the Town Administrator is responsible for administering the policy direction established by a majority vote of the Town Council and not the individual wishes of Board or Committee Members.

I will represent the interests of the entire Town when making decisions and will rely upon available facts and my independent judgment. In my capacity as an appointed Board or Committee Member, I will avoid conflicts of interest and avoid using my official position for personal, professional, or partisan gain.

I will demonstrate dignity, respect, and courtesy toward those whom I am in contact with in my capacity as an appointed Board or Committee Member. I will refrain from intimidation and ridicule of fellow Board or Committee Members, Town Council Members, Town Administrator, Town Attorney, Staff, citizens of the Town, and those conducting business with the Town.

In my capacity as an appointed Board or Committee Member, I will refrain from inappropriate language including statements that are malicious, threatening, slanderous, disparaging, mean-spirited, vulgar or abusive. All disagreements, concerns or criticisms shall be framed in language that is in keeping with the dignity and professionalism of an appointed official and the honor of my respective Town Board or Committee.

I will focus on solving problems. I will maintain appropriate decorum and professional demeanor in the conduct of Town business and work cooperatively and conscientiously with others as I request or receive information, examine data or weigh alternatives in the decision-making process.

I will demonstrate patience and refrain from demanding, interruptive access to Staff or immediate responses or services when requesting information that requires significant Staff time in research, preparation or analysis or that will result in Staff neglect of urgent duties. Such requests will be made through the Town Administrator for scheduling and prioritizing through consensus of my respective Town Board or Committee.

I will devote adequate time for preparation prior to my respective Town Board or Committee meetings and as much as possible, I will be in attendance at such meetings and all other scheduled events where my participation is required.

I will respect diversity and encourage the open expression of divergent ideas and opinions from fellow Board or Committee Members, Town Council Members, Town Administrator, Town Attorney, Staff, citizens of Malabar. I will listen actively and objectively to others' concerns or constructive criticisms.

OCT 29 2020 PM 3:41

I will refrain from any individual action that could compromise lawfully authorized decisions of the Town or the integrity of the Town and my fellow Board or Committee Members. I will delineate clearly for any audience whether I am acting or speaking as an individual citizen or in my capacity as a Town Board or Committee Member.

I will maintain the confidentiality of privileged information and will abide by all laws of the State applicable to my conduct as a Board or Committee Member, including but not limited to the Government in the Sunshine Law, the Florida Code of Ethics for Public Officers, and Town Rules of Procedure and Codes of Conduct.

I will promote constructive relations in a positive climate with all Members of the Town Council, Town employees, Town Attorney, and Town contractors and consultants consistent with my role as a Board or Committee Member, as a means to enhance the productivity and morale of the Town. I will support the Town Administrator's decision to employ the most qualified persons for Staff positions. I will recognize the bona fide achievements of the Town Council, Town Administrator, Staff, Town Attorney, Town contractors and consultants, business partners, and others sharing in, and striving to achieve, the Town's mission.

I will enhance my knowledge and ability to contribute value to the Town as a Board or Committee Member by keeping abreast of issues and trends that could affect the Town through reading, continuing education and training. I will study policies and issues affecting the Town, and will attend training programs if required by the Town. My continuing goal will be to improve my performance as a Board or Committee Member.

I will value and assist my fellow Board or Committee Members by exchanging ideas, concerns, and knowledge through lawful means of communication. I will help build positive community support for the Town's mission and the policies established by the Town Council.

I will support and advocate for my beliefs, but will remain open to understanding the views of others. I recognize that I share in the responsibility for all Town decisions that my respective Board makes and will accept the will of the majority.

As a Board or Committee Member, I will always hold the best interests of the citizens of the Town and the public health, safety and welfare of the community in the highest regard. I will seek to provide appropriate leadership that nurtures and motivates Town citizens to be stakeholders in the affairs and achievements of the Town.

I will be accountable to the Town Council for violations of this Code of Conduct.

Elizabeth Bona Ritter
Signature

10-14-20
Date

Elizabeth Bona Ritter
Print Name

Debra Frankel
Witness

TOWN OF MALABAR

COUNCIL MEETING

AGENDA ITEM NO: 4.
Meeting Date: November 02, 2020

Prepared By: Debby Franklin, C.M.C., Town Clerk/Treasurer

SUBJECT: 4. Consent Agenda

BACKGROUND/HISTORY:

- a. Town Council Regular Meeting Minutes – 10/19/2020

ATTACHMENTS:

- a. Draft Minutes of 10/19/2020

ACTION OPTIONS:

Council Action on Consent Agenda

**MALABAR TOWN COUNCIL REGULAR MEETING MINUTES
OCTOBER 19, 2020 7:30 PM**

This meeting of the Malabar Town Council was held at Town Hall at 2725 Malabar Road.

1. CALL TO ORDER:

Council Chair, Mayor Patrick T. Reilly called the meeting to order at 7:30 pm. CM Rivet led P&P.

2. ROLL CALL:

CHAIR:	MAYOR PATRICK T. REILLY
VICE CHAIR:	STEVE RIVET
COUNCIL MEMBERS:	GRANT BALL
	BRIAN VAIL
	DAVID SCARDINO
	DANNY WHITE
	LISA MORRELL
	KARL BOHNE
	DEBBY FRANKLIN

TOWN MANAGER: (ITM)

TOWN ATTORNEY:

TOWN CLERK/TREASURER:

3. APPROVAL OF AGENDA - ADDITIONS/DELETIONS/CHANGES: none

4. CONSENT AGENDA:

4.a. Regular Town Council Mtg Minutes of 10/02/2020

MOTION: CM White / CM Vail to approve consent agenda. VOTE: All Ayes.

5. ATTORNEY REPORT: nothing

6. STAFF REPORTS:

6.a. Manager: Went over handout from WM on quarterly stats and will get more info on types of service requests. WM has a new route manager and they have done a complete sweep of Town on the uncollected yard waste. She also provided an updated yard waste list they are working on. She has addressed the temporary signs in ROW and those that exceed the maximum four-square feet for temp signs. She contacted all political parties and reminded them of Malabar code requirements. She called and emailed, and some were moved, others were not so PW picked them up. She said she was prepared to recognize the donation of the re-roof job on the large pavilion at Malabar Community Park. She would still like to publicly recognize Florida Native Roofing but has learned the owner Jason recently passed away and asked for one moment of silence. She then asked Council to consider possibly naming the pavilion after him or perhaps a plaque. RR did not close on Saturday. Has been updated and Malabar is not on a future closing. She will advise.

6.b. Clerk: Nothing

7. PRESENTATION: Sue Hann for the School Board – Asst Super of Facilities. Went through the services they provide and the PowerPoint presentation on how the surtax has been spent to date and how they plan to designate future funds if approved by voters on November 3.

8. PUBLIC COMMENTS: Comments at this point may address items NOT on the Agenda. Comments related to subsequent Agenda Items may be made as those items come up. (Speaker Card is Required) Five (5) Minute Limit

9. PUBLIC HEARINGS: 0

10. UNFINISHED BUSINESS/GENERAL ORDERS MAY INCLUDE ITEMS DIRECTLY RELATED TO RESIDENTS PRESENT AT MEETING (RECOMMENDATIONS FROM BOARDS, HOA REQUESTS, RESIDENT GRIEVANCES) 0

**11. ACTION ITEMS: ORDINANCES for FIRST READING: 0
RESOLUTIONS: 2**

11.a. Resolution 17—2020 – Face Coverings

A RESOLUTION OF THE TOWN OF MALABAR, BREVARD COUNTY, FLORIDA, PURSUANT TO THE GENERAL POWERS RESERVED TO THE TOWN COUNCIL IN THE TOWN CHARTER; MAKING LEGISLATIVE FINDINGS; PROVIDING FOR DEFINITIONS; REQUIRING ALL PERSONS TO WEAR FACE COVERING AT DESIGNATED TOWN FACILITIES; PROVIDING FOR EXCEPTIONS; PROVIDING FOR SUNSET; PROVIDING FOR SEVERABILITY, CONFLICTS AND EFFECTIVE DATE.

Exhibit: Agenda Report No. 11.a.

Reso read by title only. Attorney said they need to put a date in the Resolution. Council Chair said they can cancel or extend at the next meeting on November 2, 2020. Use 11/3/2020.

MOTION: CM White / CM Rivet to adopt Reso 17-2020. Discussion: none

ROLLCALL VOTE: CM Ball, Aye; CM Vail, Aye; CM Rivet, Aye; CM Scardino, Aye; CM White, Aye. Motion carried 5 to 0.

11.b. Resolution 18-2020 – Appoint to T&G Committee

A RESOLUTION OF THE TOWN OF MALABAR, BREVARD COUNTY, FLORIDA, PROVIDING FOR THE APPOINTMENT OF MURRAY HANN TO THE MALABAR TRAILS AND GREENWAYS COMMITTEE AS A REGULAR MEMBER; PROVIDING FOR REPEAL OF RESOLUTIONS OR PARTS OF RESOLUTIONS IN CONFLICT HEREWITH; PROVIDING FOR AN EFFECTIVE DATE.

Exhibit: Agenda Report No. 11.b.

Reso read by title only.

MOTION: CM Vail / CM Ball to adopt Reso 18-2020. Discussion: none

ROLLCALL VOTE: CM Ball, Aye; CM Vail, Aye; CM Rivet, Aye; CM Scardino, Aye; CM White, Aye. Motion carried 5 to 0.

MISCELLANEOUS: 3**11.c. Consideration of Piggy Back Contract Equipment Rentals**

ITM explained the benefit to the Town being able to use these vendors, contractors and suppliers at reduced costs that have already been through the bid and negotiation process. Currently must get three quotes. Allows for the competitive process already done and will enable us to use these companies at better rates than we could negotiate. CM Scardino asked if we have done an analysis of the use of certain equipment. Perhaps we should buy it if there is a threshold of value. ITM will check with PW Director. CM White said we would be able to utilize the lower costs that bigger agencies have already negotiated. Better pricing than we could negotiate.

MOTION: CM Rivet / CM Ball to approve the piggy back contract equipment rentals.

VOTE: All Ayes.

11.d. Consideration of Piggy Back Contract: Florida Sherriff's Association (FSA) – Cooperative Purchasing Program

Exhibit: Agenda Report No. 11.d.

ITM explained to Council similar to previous item. Gave example of cost of a new loader discussed during budget workshops. We got a cost from vendor and it was still much more than if we could use FSA Cooperative Purchasing Program. You have limited resources and this availability to use this contract. It is a great research tool.

MOTION: CM Vail / CM White to approve the piggy back contract Florida Sherriff's Assc.

VOTE: All Ayes.

11.e. Consideration of Transportation Impact Fee Trust Fund Disbursement Agreement between Brevard County and the Town of Malabar for eligible project: hard surface paving improvements of Hunter Lane

Exhibit: Agenda Report No. 11.e.

ITM explained to Council this is a disbursement. We don't have our own impact fees. This is the Town share for the paving of Hunter Lane. They are still waiting on engineering specs to proceed. The Engineer wants to include stormwater improvements. CM White said he has talked to the Engineer about the purpose of the paving project; the residents want their road paved. We have not got the drainage assessment. Engineer told him that almost every driveway culvert would have to be replaced. That would increase this project by 100K and would not be paid with TIFT funds. That is a non-starter. WM White said when he spoke with the Engineer, Morris asked him to please put it in an email. That is why he copied Council on the email. He has contacted him a couple of times. We need to get this project moving. He has appealed to ITM Lisa. Maybe Morris has too much on his plate.

MOTION: CM White / CM Vail to approve the TIFT disbursement. Discussion: none

VOTE: All Ayes.

Chair excused Attorney at this time.

DISCUSSION/POSSIBLE ACTION: 0

12. PUBLIC COMMENTS: General Items (Speaker Card Required) None:

13. REPORTS – MAYOR AND COUNCIL MEMBERS

Mayor asked CM White about SCAT bus stop. CM White said he did a ride along and it seemed simple to him, but they said they would have to change the whole schedule at great cost. CM White did not pursue. Mayor got behind one.

CM Ball: He was asking about the possible business operating in town without a local BTR. He had Deputy Clerk run a search and it was first result. If you are running a business, you should pay for a BTR. He has a business since 1967 and he has paid every year. Asked Franklin. Franklin stated he did come in today and said he would drop off application. If it is appropriate in that zoning, then we should be getting paid for the BTR.

CM White said about a business on Billie that has heavy truck traffic. It can be done right. Operating a real business and not a family business then he needs to be on a commercial.

CM Vail: Jason Hungerbuhler recently passed and the idea of dedicating the pavilion or a plaque is a great idea. He was always helping the community and was a tremendous part of this community. Send this item to Park Board for recommendation.

CM Rivet: thanked ITM Lisa for attacking the sign issue. The update will help him share with his constituents.

CM Scardino: nothing

Mayor: Talked about a memorial wall at the Malabar Community Park. Construction is up and building contractors are busy. We should pursue. Put it back before Park Board.

Mayor: Referenced the recent Mayor's Breakfast meeting sponsored by Palm Bay Chamber and hosted by Sherriff Wayne Ivey. It was a zoom meeting. Thanked Rich. Will have seven new Mayors after the election.

14. ANNOUNCEMENTS: Openings on T&G and Park and Rec Bds.

15. ADJOURNMENT: There being no further business to discuss and without objection, the meeting was adjourned at 8:10 P.M.

BY: _____
Mayor Patrick T. Reilly, Council Chair

ATTEST:

Debby Franklin, C.M.C.
Town Clerk/Treasurer

Date Approved: 11/02/2020

TOWN OF MALABAR

COUNCIL MEETING

Staff Report

Meeting Date: November 2, 2020

Prepared By: Lisa Morrell, Interim Town Manager on October 28, 2020

SUBJECT: Town Manager Report for November 2, 2020 Council Meeting

Waste Management

Inquired to Customer Outreach to improve the consumer knowledge of new recycling criteria, stickers on the recycle container lids provided by waste management versus bill inserts or mailers.

Collected illegal dumping on US 1 in the ROW, ie. couch and commode.

Mayor's Fitness Challenge

Keith Heinly from United Way of Brevard has contacted the town participate in this year's annual Mayor's Fitness Challenge set to kick off on February 6, 2021 in person with masks and socially distant or virtually via Zoom. The goal for this program is to continue to encourage increased physical activity and wellness throughout Brevard County.

Last year's challenge, with COVID-19, Brevard County participants completed over 4.5 million minutes of exercise with over 2,500 participants from a total of 11 municipalities. Health First has approved the grant request as our primary sponsor for 2021, with the understanding that we will operate under COVID-19 CDC/DOH recommendations. In the coming days and weeks, we will be contacting your municipality to agree to participate in the 2021 challenge.

Save the Dates:

- Virtual Kick-Off Event will be held on February 6, 2021
 - Invite Team Leaders and Mayors will be invited participate in person with social distancing and masks/We will provide ZOOM for participants.
- The 2021 HFMFC will be Feb. 6 - Mar. 27 There will not be any organized team activities. Individual participants will submit their weekly minutes of exercise.
- The Great Weight Off will be Feb. 6 - Mar. 27 We are working on the logistics
- Registration Dates: Dec. 7 -Mar. 26 with goal of 2500 participants
- Sponsors
 - Sponsors In-kind: Oct. 20 - Nov. 16 Billboard/Florida Today/Social Media
 - Sponsors Financial: Oct. 20 - Nov. 16
- Shirt registration: Dec. 7 - Jan. 11
- Virtual Awards Ceremony 10-Apr Open or Virtual (we'll see)
- Mayors Photo: Early December
- Pre-Kick off Virtual Meeting for the Mayors 16-Nov

Singhoffen & Associates – Stormwater Master Plan Update as of 10/9

The project is comprised of 8 Major Tasks:

1. Data Collection and Review - 58% complete.
2. Asset Management GeoDatabase Development – 76% complete.
3. Stormwater Model Development – 67% complete.
4. Model Setup, Execution, Debug and Stabilization – 4% Complete
5. SWMP Model Validation – Target Milestone Date 11/13/2020
6. Final Model Execution and Floodplain Development - Target Milestone Date 11/13/2020
7. Design Solution Development Target Milestone Date 2/12/2021
8. Report documentation - Target Milestone Date 3/12/2021

Town of Malabar online ESRI ArcGIS Map link (in development)

<https://TownOfMalabar.maps.arcgis.com>

Hunter Lane Design Update

Smith Engineering reports the survey point have been completed and converted to three dimensional for a surface model of the project site. Multiple cross sections and profiles have been created to determine the most appropriate proposed profile grade line. As of Tuesday, October 27th, tasks in progress to complete are new overlay geometric layout, typical cross section and proposed grades. The plans will be completed this Friday October 30th.

Rental Equipment Analysis

As of follow up to the Piggyback Contract for Rental Equipment, Public Works reports that the most frequent piece of equipment is a loader, rented about 12 times per year. Additionally, a roller and mini excavator are periodically rented and items we do not own are reviewed on a projects as-needed basis.

Florida League of Cities

Mandatory Ethics Training & Updates - 4 hours – Recording Available on the FLC Online Learning Library:

<https://www.gotostage.com/channel/270e67f662b2489e858d9ea3c69164cf/recording/5c067ecf90804c9b814d9416a4f7c9e4/watch>

TOWN OF MALABAR

COUNCIL MEETING

AGENDA ITEM NO: 11.a.
Meeting Date: November 02, 2020

Prepared By: Debby Franklin, C.M.C., Town Clerk/Treasurer

SUBJECT: FY 19/20 Budget Amendment (Ordinance 2020-12) – 1st Reading

BACKGROUND/HISTORY:

It is within normal governmental accounting practices to perform necessary year-end budgetary amendments up to 60 days after the close of the FY.

Historically, we have used a Budget Amendment Ordinance to reflect the shift of budgeted funds from one department to another. We have an internal process to track when we reallocate funds within each department.

As of September 30, 2020, we have received additional Building Permit fees that were not recognized in the adopted budget. This amendment will recognize those additional monies and allocate them to restricted reserves for the Building Department. We had budgeted to use 20,299 of BD reserves on deposit to pay for the Bldg Dept upgrades. There were additional cost overruns in the Bldg Dept due to outside professional consultants on land use related issues and those will be offset by the permitting fees collected in the amount of \$11,978.00.

We budgeted to place monies into the reserves set aside for vehicle replacement and future road paving projects and those payments will be made into the reserves as stated. Additional revenues received and not restricted will go into reserves.

Stormwater funds budgeted for projects that were not completed in this fiscal year will be directed back into the restricted reserves account for stormwater projects.

The approved budget had reduced expenditures due to unfilled positions in the Streets and Roads department for a good portion of the year. Due to equipment and staffing issues the amount anticipated for road work expenditures was also not realized.

No money will be needed from unrestricted General Fund reserves on deposit in order to balance the 19/20 budget.

This ordinance will be legally advertised for a Public Hearing to be held at the next meeting for the second reading on 11/16/2020.

FINANCIAL IMPACT:

\$11,978.00 funds from Restricted Building Department reserves on deposit

Amend the final budget from \$2,204,996 to \$2,216,974 as stated in the ordinance

Shifted departmental funds to balance each department

Direct funds as stated in the ordinance to specific restricted and unrestricted funds on deposit

ATTACHMENTS: Ordinance 2020-12

ACTION OPTIONS: Action on 1st reading of Ordinance 2020-12

ORDINANCE 2020-12

AN ORDINANCE OF THE TOWN OF MALABAR, BREVARD COUNTY, FLORIDA, PERTAINING TO A BUDGET AMENDMENT IN THE FISCAL YEAR 2019/2020 TO PROVIDE FOR ACTUAL REVENUES RECEIVED; PROVIDING FOR THE UNSPENT BUDGETED FUNDS DUE TO REDUCED EXPENDITURES; PROVIDING DIRECTION TO DELEGATE SUCH EXCESS FUNDS TO DESIGNATED RESTRICTED RESERVES FOR BUILDING DEPARTMENT USE, STORMWATER USE; PROVIDE FOR THE DEPOSIT INTO RESERVES FOR VEHICLE REPLACEMENTS AS BUDGETED IN THE FIRE AND STREETS AND ROADS DEPARTMENTS AND PAVING RESERVES; PROVIDING THE SHIFTING OF UNSPENT MONIES BETWEEN DEPARTMENTS TO BALANCE THE EXPENDITURES; PROVIDING REMAINING EXCESS FUNDS TO RESERVES ON DEPOSIT; PROVIDING FOR CONFLICT; AND PROVIDING FOR AN EFFECTIVE DATE.

WHEREAS, the Town Council has directed that staff prepare a budget amendment to recognize additional revenues received over budgeted amounts and the reduced expenditures from the budgeted expenditures.

NOW, THEREFORE BE IT ORDAINED BY THE TOWN COUNCIL OF THE TOWN OF MALABAR, BREVARD COUNTY, FLORIDA that;

SECTION 1. Total Revenues.

Total revenues in the 2019/2020 Fund 001 General Fund be amended from \$2,204,996.00 to \$2,216,974.00 to reflect the reduced receipts from the State in Revenue Sharing and the half cent Sales Tax due to COVID-19 and increased receipts from Building Permits and an additional allocation of \$11,978.00 from Restricted Building Department Funds to balance the Building Department expenditures as listed.

SECTION 2. Total Disbursements.

Total disbursements in the 2019/2020 Fund 001 General Fund be amended from \$2,204,996.00 to \$2,216,974 which will provide disbursements into reserves and designated in the approved budget and remaining surplus into the indicated reserve accounts on deposit:

- \$ 8,204.00 to Fire Dept Vehicle Replacement Reserves (diff between Bud & Actual)
- \$ 79,249.00 to Restricted Building Department Reserves (overage in 322.1000)
- \$ 66,903.00 to Restricted Storm Water Reserves (difference between Rev & Exp)
- \$ 53,000.00 to Streets and Roads Vehicle Replacement Reserves
- \$100,000.00 to Streets and Roads Paving C.I.P. Reserves
- \$ 45,160.00 to Park & Rec Dept for future C.I.P. Reserves (S/D Rec fee & DEP payment
- \$ 38,297.00 to Unrestricted Reserves on Deposit

SECTION 3. Funding Source.

The funds for this Budget Amendment to the FY 2019/2020 budget are from the approved budget allocations, reduced expenditures in Stormwater and Streets and Roads; utilizing \$11,978.00 from the restricted Building Department reserves; revenues from the State for infrastructure improvements to Fern Creek prior to sale; subdivision recreational fees, and receipts from FDEP for Stormwater Master Plan invoicing.

SECTION 4. Conflict.

All ordinances or parts of ordinances in conflict herewith are hereby repealed.

SECTION 5.

This ordinance shall become effective immediately upon its adoption after the second reading and public hearing.

This ordinance was moved for adoption by Council Member _____ and was seconded by Council Member _____ and, upon being put to a vote, the vote was as follows:

Council Member Grant Ball	_____
Council Member Brian Vail	_____
Council Member Steve Rivet	_____
Council Member David Scardino	_____
Council Member Danny White	_____

This ordinance was then declared to be duly passed and adopted this 16th day of November 2020.

TOWN OF MALABAR

By

Mayor Patrick T. Reilly, Council Chair

First Reading: 11/02/2020 Approved ___ to ___
Second Reading: 11/16/2019

ATTEST:

Debby K. Franklin, CMC,
Town Clerk/Treasurer

(Seal)

Approved as to Form and Content:

Karl W. Bohne, Jr.,
Town Attorney

TOWN OF MALABAR

COUNCIL MEETING

AGENDA ITEM NO: 11.b.
Meeting Date: November 02, 2020

Prepared By: Lisa Morrell, Interim Town Manager

SUBJECT: Ordinance 2020-13 First Reading Amending Chapter 9

BACKGROUND/HISTORY:

The Town Council adopted Ordinance 2014-02 to comply with the revised Flood Insurance Rate Maps (FIRM) that went into effect on March 17, 2014. Since that time, FEMA has made some changes to the language as required with the new Coastal High Hazard language adopted by the State Legislature and incorporated into our last update of the Comprehensive Plan. FEMA has directed that each municipality amend their Code to comply with these new regulations that will become effective on January 29, 2021.

A highlighted change document is attached for review. The major change to this ordinance is the inclusion and update pertaining to the new designation and information of Coastal High Hazard (Zone V and A), which pertains to the additional duties of the Floodplain Administrator to advise inform applicants in the Coastal High Hazard for new structure and buildings in developed and undeveloped locations.

New protections of sand dunes and mangrove stands must seek approvals from the Florida Department of Environmental Protection and an engineering analysis of any increased impact of flood damage to proposed alterations for new construction per Section 105.3(4) of this ordinance. Construction or restoration of dunes under or around elevated buildings and structures for site improvements shall comply with Section 307.8(3) of this ordinance. Two new definitions have been added to the ordinance to include Coastal high hazard area and sand dunes.

Additional requirements for manufactured homes, underground an above ground tank storage, parking pads, enclosure floors, landings, decks, walkways, patios and similar nonstructural uses (bulkheads, seawalls, retaining walls, fences, and onsite sewage treatment and disposal systems, fill, and landscaping). have been added to those areas identified located in coastal high hazard zones.

To avoid conflicts, the references to The State of Florida Building Codes and Editions have been struck whereas the Town's Code of Ordinances pertaining to the Building Codes will be updated and amended within that section in January 2021.

FINANCIAL IMPACT:

N/A

ATTACHMENTS:

Ordinance 2020-013

ACTION OPTIONS:

Staff requests action on Ordinance 2020-13

ORDINANCE 2020-13

AN ORDINANCE OF THE TOWN OF MALABAR, BREVARD COUNTY, FLORIDA AMENDING CHAPTER 9 OF THE CODE OF ORDINANCES OF THE TOWN; ADOPTING THE REVISED FLOOD INSURANCE STUDY AND FLOOD INSURANCE RATE MAPS; TO INCORPORATE REQUIREMENTS FOR COASTAL HIGH HAZARD AREAS; PROVIDING FOR APPLICABILITY, INCLUSION IN THE CODE OF ORDINANCES, SEVERABILITY AND AN EFFECTIVE DATE.

WHEREAS, the Legislature of the State of Florida has, in Chapter 166 of the Florida Statutes, conferred upon local governments the authority to adopt regulations designed to promote the public health, safety, and general welfare of its citizenry; and

WHEREAS, the Federal Emergency Management Agency has identified special flood hazard areas within the boundaries of the Town of Malabar and such areas may be subject to periodic inundation which may result in loss of life and property, health and safety hazards, disruption of commerce and governmental services, extraordinary public expenditures for flood protection and relief, and impairment of the tax base, all of which adversely affect the public health, safety and general welfare, and

WHEREAS, the Town of Malabar was accepted for participation in the National Flood Insurance Program on September 28, 1979 and the Town Council desires to continue to meet the requirements of Title 44 Code of Federal Regulations, Sections 59 and 60, necessary for such participation; and

WHEREAS, the Federal Emergency Management Agency (FEMA) revised the Flood Insurance Study for Brevard County, Florida and Incorporated Areas with an effective date of January 29, 2021; and

WHEREAS, the revised Flood Insurance Rate Maps identify some flood hazard areas as Coastal High Hazard Areas for which the National Flood Insurance Program has specific requirements for development in such areas and the Florida Building Code has specific requirements for buildings in such areas; and

WHEREAS, the Town of Malabar must adopt additional requirements for development in Coastal High Hazard Areas to maintain consistency with the National Flood Insurance Program.

NOW, THEREFORE, BE IT ORDAINED by the Town Council of the Town of Malabar that the following floodplain management regulations are hereby adopted.

SECTION 1. Part 2, Chapter 9 of the Code of Ordinances of the Town of Malabar is amended as follows:

"ARTICLE I ADMINISTRATION

SUBPART 1. GENERAL

Town of Malabar, hereinafter referred to as "this ordinance."

9-2 Scope. The provisions of this ordinance shall apply to all development that is wholly within or partially within any flood hazard area, including but not limited to the subdivision of land; filling, grading, and other site improvements and utility installations; construction, alteration, remodeling, enlargement, improvement, replacement, repair, relocation or demolition of buildings, structures, and facilities that are exempt from the *Florida Building Code*; placement, installation, or replacement of manufactured homes and manufactured buildings; installation or replacement of tanks; placement of recreational vehicles; installation of swimming pools; and any other development.

9-3 Intent. The purposes of this ordinance and the flood load and flood resistant construction requirements of the *Florida Building Code* are to establish minimum requirements to safeguard the public health, safety, and general welfare and to minimize public and private losses due to flooding through regulation of development in flood hazard areas to:

1. Minimize unnecessary disruption of commerce, access and public service during times of flooding;
2. Require the use of appropriate construction practices in order to prevent or minimize future flood damage;
3. Manage filling, grading, dredging, mining, paving, excavation, drilling operations, storage of equipment or materials, and other development which may increase flood damage or erosion potential;
4. Manage the alteration of flood hazard areas, watercourses, and shorelines to minimize the impact of development on the natural and beneficial functions of the floodplain;
5. Minimize damage to public and private facilities and utilities;
6. Help maintain a stable tax base by providing for the sound use and development of flood hazard areas;
7. Minimize the need for future expenditure of public funds for flood control projects and response to and recovery from flood events; and
8. Meet the requirements of the National Flood Insurance Program for community participation as set forth in the Title 44 Code of Federal Regulations, Section 59.22.

9-4 Coordination with the *Florida Building Code*. This ordinance is intended to be administered and enforced in conjunction with the *Florida Building Code*. Where cited, ASCE 24 refers to the edition of the standard that is referenced by the *Florida Building Code*.

9-5 Warning. The degree of flood protection required by this ordinance and the *Florida Building Code*, as amended by this community, is considered the minimum reasonable for regulatory purposes and is based on scientific and engineering considerations. Larger floods can and will occur. Flood heights may be increased by man-made or natural causes. This ordinance does not imply that land outside of mapped special flood hazard areas, or that uses permitted within such flood hazard areas, will be free from flooding or flood damage. The flood hazard areas and base flood elevations contained in the Flood Insurance Study and shown on Flood Insurance Rate Maps and the requirements of Title 44 Code of Federal Regulations, Sections 59 and 60 may be revised by the Federal Emergency Management Agency, requiring this community to revise these regulations to remain eligible for participation in the National Flood Insurance Program. No guaranty of vested use, existing use, or future use is implied or expressed by compliance with

this ordinance.

9-6 Disclaimer of Liability. This ordinance shall not create liability on the part of the Town of Malabar or by any officer or employee thereof for any flood damage that results from reliance on this ordinance or any administrative decision lawfully made thereunder.

SUBPART 2. APPLICABILITY

9-20 General. Where there is a conflict between a general requirement and a specific requirement, the specific requirement shall be applicable.

9-21 Areas to which this ordinance applies. This ordinance shall apply to all flood hazard areas within the Town of Malabar, as established in Section 9-22 of this ordinance.

9-22 Basis for establishing flood hazard areas. The Flood Insurance Study for Brevard County, Florida and Incorporated Areas dated ~~March 17, 2014~~ **January 29, 2021** and all subsequent amendments and revisions, and the accompanying Flood Insurance Rate Maps (FIRM), and all subsequent amendments and revisions to such maps, are adopted by reference as a part of this ordinance and shall serve as the minimum basis for establishing flood hazard areas. Studies and maps that establish flood hazard areas are on file at the Office of the Town Clerk.

9-23 Submission of additional data to establish flood hazard areas. To establish flood hazard areas and base flood elevations, pursuant to Subpart V of Article I of ~~this ordinance~~ the Floodplain Administrator may require submission of additional data. Where field surveyed topography prepared by a Florida licensed professional surveyor or digital topography accepted by the community indicates that ground elevations:

1. Are below the closest applicable base flood elevation, even in areas not delineated as a special flood hazard area on a FIRM, the area shall be considered as flood hazard area and subject to the requirements of this ordinance and, as applicable, the requirements of the *Florida Building Code*.
2. Are above the closest applicable base flood elevation, the area shall be regulated as special flood hazard area unless the applicant obtains a Letter of Map Change that removes the area from the special flood hazard area.

9-24 Other laws. The provisions of this ordinance shall not be deemed to nullify any provisions of local, state or federal law.

9-25 Abrogation and greater restrictions. This ordinance supersedes any ordinance in effect for management of development in flood hazard areas. However, it is not intended to repeal or abrogate any existing ordinances including but not limited to land development regulations, zoning ordinances, stormwater management regulations, or the *Florida Building Code*. In the event of a conflict between this ordinance and any other ordinance, the more restrictive shall govern. This ordinance shall not impair any deed restriction, covenant or easement, but any land that is subject to such interests shall also be governed by this ordinance.

9-26 Interpretation. In the interpretation and application of this ordinance, all provisions shall be:

1. Considered as minimum requirements;

2. Liberally construed in favor of the governing body; and
3. Deemed neither to limit nor repeal any other powers granted under state statutes.

SUBPART 3. DUTIES AND POWERS OF THE FLOODPLAIN ADMINISTRATOR

9-30 Designation. The Town Building Official is currently designated as the Floodplain Administrator. This designation may be changed by resolution of the Town Council.

9-31 General. The Floodplain Administrator is authorized and directed to administer and enforce the provisions of this ordinance. The Floodplain Administrator shall have the authority to render interpretations of this ordinance consistent with the intent and purpose of this ordinance and may establish policies and procedures in order to clarify the application of its provisions. Such interpretations, policies, and procedures shall not have the effect of waiving requirements specifically provided in this ordinance without the granting of a variance pursuant to Subpart 7 Article I of this ordinance.

9-32 Applications and permits. The Floodplain Administrator, in coordination with other pertinent offices of the community, shall:

1. Review applications and plans to determine whether proposed new development will be located in flood hazard areas;
2. Review applications for modification of any existing development in flood hazard areas for compliance with the requirements of this ordinance;
3. Interpret flood hazard area boundaries where such interpretation is necessary to determine the exact location of boundaries; a person contesting the determination shall have the opportunity to appeal the interpretation;
4. Provide available flood elevation and flood hazard information;
5. Determine whether additional flood hazard data shall be obtained from other sources or shall be developed by an applicant;
6. Review applications to determine whether proposed development will be reasonably safe from flooding;
7. Issue floodplain development permits or approvals for development other than buildings and structures that are subject to the *Florida Building Code*, including buildings, structures and facilities exempt from the *Florida Building Code*, when compliance with this ordinance is demonstrated, or disapprove the same in the event of noncompliance; and
8. Coordinate with and provide comments to assure that applications, plan reviews, and inspections for buildings and structures in flood hazard areas comply with the applicable provisions of this ordinance.

9-33 Substantial Improvement and substantial damage determinations. For applications for building permits to improve buildings and structures, including alterations, movement, enlargement, replacement, repair, change of occupancy, additions, rehabilitations, renovations, substantial improvements, repairs of substantial damage, and any other improvement of or work on such buildings and structures, the Floodplain Administrator, shall:

1. Estimate the market value, or require the applicant to obtain an appraisal of the market value prepared by a qualified independent appraiser, of the building or structure before

the start of construction of the proposed work; in the case of repair, the market value of the building or structure shall be the market value before the damage occurred and before any repairs are made;

2. Compare the cost to perform the improvement, the cost to repair a damaged building to its pre-damaged condition, or the combined costs of improvements and repairs, if applicable, to the market value of the building or structure;
3. Determine and document whether the proposed work constitutes substantial improvement or repair of substantial damage; and
4. Notify the applicant if it is determined that the work constitutes substantial improvement or repair of substantial damage and that compliance with the flood resistant construction requirements of the *Florida Building Code* and this ordinance is required.

9-34 Modifications of the strict application of the requirements of the *Florida Building Code*. The Floodplain Administrator shall review requests that seek approval to modify the strict application of the flood load and flood resistant construction requirements of the *Florida Building Code* to determine whether such requests require the granting of a variance pursuant to Subpart 7 of Article I of this ordinance.

9-35 Notices and orders. The Floodplain Administrator shall coordinate with appropriate local agencies for the issuance of all necessary notices or orders to ensure compliance with this ordinance.

9-36 Inspections. The Floodplain Administrator shall make the required inspections as specified in Subpart 6 of Article I of this ordinance for development that is not subject to the *Florida Building Code*, including buildings, structures and facilities exempt from the *Florida Building Code*. The Floodplain Administrator shall inspect flood hazard areas to determine if development is undertaken without issuance of a permit.

9-37 Other duties of the Floodplain Administrator. The Floodplain Administrator shall have other duties, including but not limited to:

1. Establish procedures for administering and documenting determinations of substantial improvement and substantial damage made pursuant to Section 9-33 of this ordinance;
2. Require that applicants proposing alteration of a watercourse notify adjacent communities and the Florida Division of Emergency Management, State Floodplain Management Office, and submit copies of such notifications to the Federal Emergency Management Agency (FEMA);
3. Require applicants who submit hydrologic and hydraulic engineering analyses to support permit applications to submit to FEMA the data and information necessary to maintain the Flood Insurance Rate Maps if the analyses propose to change base flood elevations, flood hazard area boundaries, or floodway designations; such submissions shall be made within 6 months of such data becoming available;
4. Review required design certifications and documentation of elevations specified by this ordinance and the *Florida Building Code* and this ordinance to determine that such certifications and documentations are complete. and
5. Notify the Federal Emergency Management Agency when the corporate boundaries of the Town of Malabar are modified; and

6. Advise applicants for new buildings and structures, including substantial improvements, that are located in any unit of the Coastal Barrier Resources System established by the Coastal Barrier Resources Act (Pub. L. 97-348) and the Coastal Barrier Improvement Act of 1990 (Pub. L. 101-591) that federal flood insurance is not available on such construction; areas subject to this limitation are identified on Flood Insurance Rate Maps as "Coastal Barrier Resource System Areas" and "Otherwise Protected Areas."

9-38 Floodplain management records. Regardless of any limitation on the period required for retention of public records, the Floodplain Administrator shall maintain and permanently keep and make available for public inspection all records that are necessary for the administration of this ordinance and the flood resistant construction requirements of the *Florida Building Code*, including Flood Insurance Rate Maps; Letters of Map Change; records of issuance of permits and denial of permits; determinations of whether proposed work constitutes substantial improvement or repair of substantial damage; required design certifications and documentation of elevations specified by the *Florida Building Code* and this ordinance; notifications to adjacent communities, FEMA, and the state related to alterations of watercourses; assurances that the flood carrying capacity of altered watercourses will be maintained; documentation related to appeals and variances, including justification for issuance or denial; and records of enforcement actions taken pursuant to this ordinance and the flood resistant construction requirements of the *Florida Building Code*. These records shall be available for public inspection at the office of the Town Clerk.

SUBPART 4. PERMITS

9-40 Permits required. Any owner or owner's authorized agent (hereinafter "applicant") who intends to undertake any development activity within the scope of this ordinance, including buildings, structures and facilities exempt from the *Florida Building Code*, which is wholly within or partially within any flood hazard area shall first make application to the Floodplain Administrator, and the Building Official if applicable, and shall obtain the required permit(s) and approval(s). No such permit or approval shall be issued until compliance with the requirements of this ordinance and all other applicable codes and regulations has been satisfied.

9-41 Floodplain development permits or approvals. Floodplain development permits or approvals shall be issued pursuant to this ordinance for any development activities not subject to the requirements of the *Florida Building Code*, including buildings, structures and facilities exempt from the *Florida Building Code*. Depending on the nature and extent of proposed development that includes a building or structure, the Floodplain Administrator may determine that a floodplain development permit or approval is required in addition to a building permit.

9-42 Buildings, structures and facilities exempt from the *Florida Building Code*. Pursuant to the requirements of federal regulation for participation in the National Flood Insurance Program (44 C.F.R. Sections 59 and 60), floodplain development permits or approvals shall be required for the following buildings, structures and facilities that are exempt from the *Florida Building Code* and any further exemptions provided by law, which are subject to the requirements of this ordinance:

1. Railroads and ancillary facilities associated with the railroad.
2. Nonresidential farm buildings on farms, as provided in section 604.50, F.S.
3. Temporary buildings or sheds used exclusively for construction purposes.
4. Mobile or modular structures used as temporary offices.

5. Those structures or facilities of electric utilities, as defined in section 366.02, F.S., which are directly involved in the generation, transmission, or distribution of electricity.
6. Chickees constructed by the Miccosukee Tribe of Indians of Florida or the Seminole Tribe of Florida. As used in this paragraph, the term "chickee" means an open-sided wooden hut that has a thatched roof of palm or palmetto or other traditional materials, and that does not incorporate any electrical, plumbing or other non-wood features.
7. Family mausoleums not exceeding 250 square feet in area which are prefabricated and assembled on site or preassembled and delivered on site and have walls, roofs, and a floor constructed of granite, marble, or reinforced concrete.
8. Temporary housing provided by the Department of Corrections to any prisoner in the state correctional system.
9. Structures identified in section 553.73(10)(k), F.S., are not exempt from the *Florida Building Code* if such structures are located in flood hazard areas established on Flood Insurance Rate Maps

9-43 Application for a permit or approval. To obtain a floodplain development permit or approval the applicant shall first file an application in writing on a form furnished by the community. The information provided shall:

1. Identify and describe the development to be covered by the permit or approval.
2. Describe the land on which the proposed development is to be conducted by legal description, street address or similar description that will readily identify and definitively locate the site.
3. Indicate the use and occupancy for which the proposed development is intended.
4. Be accompanied by a site plan or construction documents as specified in Subpart 5 of Article I of this ordinance.
5. State the valuation of the proposed work.
6. Be signed by the applicant or the applicant's authorized agent.
7. Give such other data and information as required by the Floodplain Administrator.

9-44 Validity of permit or approval. The issuance of a floodplain development permit or approval pursuant to this ordinance shall not be construed to be a permit for, or approval of, any violation of this ordinance, the *Florida Building Codes*, or any other ordinance of this community. The issuance of permits based on submitted applications, construction documents, and information shall not prevent the Floodplain Administrator from requiring the correction of errors and omissions.

9-45 Expiration. A floodplain development permit or approval shall become invalid unless the work authorized by such permit is commenced within 180 days after its issuance, or if the work authorized is suspended or abandoned for a period of 180 days after the work commences. Extensions for periods of not more than 180 days each shall be requested in writing and justifiable cause shall be demonstrated.

9-46 Suspension or revocation. The Floodplain Administrator is authorized to suspend or revoke a floodplain development permit or approval if the permit was issued in error, on the basis of incorrect, inaccurate or incomplete information, or in violation of this ordinance or any

other ordinance, regulation or requirement of this community.

9-47 Other permits required. Floodplain development permits and building permits shall include a condition that all other applicable state or federal permits be obtained before commencement of the permitted development, including but not limited to the following:

1. The Saint Johns River Water Management District; section 373.036, F.S.
2. Florida Department of Health for onsite sewage treatment and disposal systems; section 381.0065, F.S. and Chapter 64E-6, F.A.C.
3. Florida Department of Environmental Protection for activities subject to the Joint Coastal Permit; section 161.055, F.S.
4. Florida Department of Environmental Protection for construction, reconstruction, changes or physical activities for shore protection or other activities seaward of the coastal construction control line; section 161.041, F.S.
5. Florida Department of Environmental Protection for activities that affect wetlands and alter surface water flows, in conjunction with the U.S. Army Corps of Engineers; Section 404 of the Clean Water Act.
6. Federal permits and approvals.

SUBPART 5. SITE PLANS AND CONSTRUCTION DOCUMENTS

9-50 Information for development in flood hazard areas. The site plan or construction documents for any development subject to the requirements of this ordinance shall be drawn to scale and shall include, as applicable to the proposed development:

1. Delineation of flood hazard areas, floodway boundaries and flood zone(s), base flood elevation(s), and ground elevations if necessary, for review of the proposed development.
2. Where base flood elevations, or floodway data are not included on the FIRM or in the Flood Insurance Study, they shall be established in accordance with Section 9-51 (2) or (3) of this ordinance.
3. Where the parcel on which the proposed development will take place will have more than 50 lots or is larger than 5 acres and the base flood elevations are not included on the FIRM or in the Flood Insurance Study, such elevations shall be established in accordance with Section 9-51(1) of this ordinance.
4. Location of the proposed activity and proposed structures, and locations of existing buildings and structures; in coastal high hazard areas, new buildings shall be located landward of the reach of mean high tide.
5. Location, extent, amount, and proposed final grades of any filling, grading, or excavation.
6. Where the placement of fill is proposed, the amount, type, and source of fill material; compaction specifications; a description of the intended purpose of the fill areas; and evidence that the proposed fill areas are the minimum necessary to achieve the intended purpose.
7. Extent of any proposed alteration of sand dunes or mangrove stands, provided such alteration is approved by the Florida Department of Environmental Protection.
- (8) (7) Existing and proposed alignment of any proposed alteration of a watercourse.

The Floodplain Administrator is authorized to waive the submission of site plans, construction documents, and other data that are required by this ordinance but that are not required to be prepared by a registered design professional if it is found that the nature of the proposed development is such that the review of such submissions is not necessary to ascertain compliance with this ordinance.

9-51 Information in flood hazard areas without base flood elevations. Where flood hazard areas are delineated on the FIRM and base flood elevation data have not been provided, the Floodplain Administrator shall:

1. Require the applicant to include base flood elevation data prepared in accordance with currently accepted engineering practices.
2. Obtain, review, and provide to applicants base flood elevation and floodway data available from a federal or state agency or other source or require the applicant to obtain and use base flood elevation and floodway data available from a federal or state agency or other source.
3. Where base flood elevation and floodway data are not available from another source, where the available the data are deemed by the Floodplain Administrator to not reasonably reflect flooding conditions, or where the available data are known to be scientifically or technically incorrect or otherwise inadequate:
 - a. Require the applicant to include base flood elevation data prepared in accordance with currently accepted engineering practices; or
 - b. Specify that the base flood elevation is two (2) feet above the highest adjacent grade at the location of the development, provided there is no evidence indicating flood depths have been or may be greater than two (2) feet.
4. Where the base flood elevation data are to be used to support a Letter of Map Change from FEMA, advise the applicant that the analyses shall be prepared by a Florida licensed engineer in a format required by FEMA, and that it shall be the responsibility of the applicant to satisfy the submittal requirements and pay the processing fees.

9-52 Additional analyses and certifications. As applicable to the location and nature of the proposed development activity, and in addition to the requirements of this section, the applicant shall have the following analyses signed and sealed by a Florida licensed engineer for submission with the site plan and construction documents:

1. For development activities proposed to be located in a regulatory floodway, a floodway encroachment analysis that demonstrates that the encroachment of the proposed development will not cause any increase in base flood elevations; where the applicant proposes to undertake development activities that do increase base flood elevations, the applicant shall submit such analysis to FEMA as specified in Section 9-53 of this ordinance and shall submit the Conditional Letter of Map Revision, if issued by FEMA, with the site plan and construction documents.
2. For development activities proposed to be located in a riverine flood hazard area for which base flood elevations are included in the Flood Insurance Study or on the FIRM and floodways have not been designated, hydrologic and hydraulic analysis that demonstrates the cumulative effect of the proposed development, when combined with all other existing and anticipated flood hazard area encroachments, will not increase the

base flood elevation more than one (1) foot at any point within the community. This requirement does not apply in isolated flood hazard areas not connected to a riverine flood hazard area or in flood hazard areas identified as Zone AO or Zone AH.

3. For alteration of a watercourse, an engineering analysis prepared in accordance with standard engineering practices which demonstrates that the flood-carrying capacity of the altered or relocated portion of the watercourse will not be decreased, and certification that the altered watercourse shall be maintained in a manner which preserves the channel's flood-carrying capacity; the applicant shall submit the analysis to FEMA as specified in Section 9-53 of this ordinance.
4. For activities that propose to alter sand dunes or mangrove stands in coastal high hazard areas (Zone V), an engineering analysis that demonstrates that the proposed alteration will not increase the potential for flood damage.

9-53 Submission of additional data. When additional hydrologic, hydraulic or other engineering data, studies, and additional analyses are submitted to support an application, the applicant has the right to seek a Letter of Map Change from FEMA to change the base flood elevations, change floodway boundaries, or change boundaries of flood hazard areas shown on FIRMs, and to submit such data to FEMA for such purposes. The analyses shall be prepared by a Florida licensed engineer in a format required by FEMA. Submittal requirements and processing fees shall be the responsibility of the applicant.

SUBPART 6. INSPECTIONS

9-60 General. Development for which a floodplain development permit or approval is required shall be subject to inspection.

9-61 Development other than buildings and structures. The Floodplain Administrator shall inspect all development to determine compliance with the requirements of this ordinance and the conditions of issued floodplain development permits or approvals.

9-62 Buildings, structures and facilities exempt from the *Florida Building Code*. The Floodplain Administrator shall inspect buildings, structures and facilities exempt from the *Florida Building Code* to determine compliance with the requirements of this ordinance and the conditions of issued floodplain development permits or approvals.

9-63 Buildings, structures and facilities exempt from the *Florida Building Code*, lowest floor inspection. Upon placement of the lowest floor, including basement, and prior to further vertical construction, the owner of a building, structure or facility exempt from the *Florida Building Code*, or the owner's authorized agent, shall submit to the Floodplain Administrator:

1. If a design flood elevation was used to determine the required elevation of the lowest floor, the certification of elevation of the lowest floor prepared and sealed by a Florida licensed professional surveyor; or
2. If the elevation used to determine the required elevation of the lowest floor was determined in accordance with Section 9-51(3) (b) of this ordinance, the documentation of height of the lowest floor above highest adjacent grade, prepared by the owner or the owner's authorized agent.

9-64 Buildings, structures and facilities exempt from the *Florida Building Code*, final inspection. As part of the final inspection, the owner or owner's authorized agent shall submit

to the Floodplain Administrator a final certification of elevation of the lowest floor or final documentation of the height of the lowest floor above the highest adjacent grade; such certifications and documentations shall be prepared as specified in Section 9-63 of this ordinance.

9-65 Manufactured homes. The Building Official shall inspect manufactured homes that are installed or replaced in flood hazard areas to determine compliance with the requirements of this ordinance and the conditions of the issued permit. Upon placement of a manufactured home, certification of the elevation of the lowest floor shall be submitted to the Building Official.

SUBPART 7. VARIANCES AND APPEALS

9-70 General. The Board of Adjustment shall hear and decide on requests for appeals and requests for variances from the strict application of this ordinance. Pursuant to section 553.73(5), F.S., the Board of Adjustment shall hear and decide on requests for appeals and requests for variances from the strict application of the flood resistant construction requirements of the *Florida Building Code*.

9-71 Appeals. The Board of Adjustment shall hear and decide appeals when it is alleged there is an error in any requirement, decision, or determination made by the Floodplain Administrator in the administration and enforcement of this ordinance. Any person aggrieved by the decision of the Board of Adjustment may appeal such decision to the Circuit Court, as provided by Florida Statutes.

9-72 Limitations on authority to grant variances. The Board of Adjustment shall base its decisions on variances on technical justifications submitted by applicants, the considerations for issuance in Section 9-76 of this ordinance, the conditions of issuance set forth in Section 9-77 of this ordinance, and the comments and recommendations of the Floodplain Administrator and the Building Official. The Board of Adjustment has the right to attach such conditions as it deems necessary to further the purposes and objectives of this ordinance.

9-73 Restrictions in floodways. A variance shall not be issued for any proposed development in a floodway if any increase in base flood elevations would result, as evidenced by the applicable analyses and certifications required in Section 9-52 of this ordinance.

9-74 Historic buildings. A variance is authorized to be issued for the repair, improvement, or rehabilitation of a historic building that is determined eligible for the exception to the flood resistant construction requirements of the *Florida Building Code, Existing Building, Chapter 11 Historic Buildings*, upon a determination that the proposed repair, improvement, or rehabilitation will not preclude the building's continued designation as a historic building and the variance is the minimum necessary to preserve the historic character and design of the building. If the proposed work precludes the building's continued designation as a historic building, a variance shall not be granted and the building and any repair, improvement, and rehabilitation shall be subject to the requirements of the *Florida Building Code*.

9-75 Functionally dependent uses. A variance is authorized to be issued for the construction or substantial improvement necessary for the conduct of a functionally dependent use, as defined in this ordinance, provided the variance meets the requirements of Section 9-73, is the minimum necessary considering the flood hazard, and all due consideration has been given to use of methods and materials that minimize flood damage during occurrence of the base flood.

9-76 Considerations for issuance of variances. In reviewing requests for variances, the Board of Adjustment shall consider all technical evaluations, all relevant factors, all other applicable provisions of the *Florida Building Code*, this ordinance, and the following:

1. The danger that materials and debris may be swept onto other lands resulting in further injury or damage;
2. The danger to life and property due to flooding or erosion damage;
3. The susceptibility of the proposed development, including contents, to flood damage and the effect of such damage on current and future owners;
4. The importance of the services provided by the proposed development to the community;
5. The availability of alternate locations for the proposed development that are subject to lower risk of flooding or erosion;
6. The compatibility of the proposed development with existing and anticipated development;
7. The relationship of the proposed development to the comprehensive plan and floodplain management program for the area;
8. The safety of access to the property in times of flooding for ordinary and emergency vehicles;
9. The expected heights, velocity, duration, rate of rise and debris and sediment transport of the floodwaters and the effects of wave action, if applicable, expected at the site; and
10. The costs of providing governmental services during and after flood conditions including maintenance and repair of public utilities and facilities such as sewer, gas, electrical and water systems, streets and bridges.

9-77 Conditions for issuance of variances. Variances shall be issued only upon:

1. Submission by the applicant, of a showing of good and sufficient cause that the unique characteristics of the size, configuration, or topography of the site limit compliance with any provision of this ordinance or the required elevation standards;
2. Determination by the Board of Adjustment that:
 - a. Failure to grant the variance would result in exceptional hardship due to the physical characteristics of the land that render the lot undevelopable; increased costs to satisfy the requirements or inconvenience do not constitute hardship;
 - b. The granting of a variance will not result in increased flood heights, additional threats to public safety, extraordinary public expense, nor create nuisances, cause fraud on or victimization of the public or conflict with existing local laws and ordinances; and
 - c. The variance is the minimum necessary, considering the flood hazard, to afford relief;
3. Receipt of a signed statement by the applicant that the variance, if granted, shall be recorded in the Office of the Clerk of the Court in such a manner that it appears in the chain of title of the affected parcel of land; and
4. If the request is for a variance to allow construction of the lowest floor of a new building, or substantial improvement of a building, below the required elevation, a copy in the

record of a written notice from the Floodplain Administrator to the applicant for the variance, specifying the difference between the base flood elevation and the proposed elevation of the lowest floor, stating that the cost of federal flood insurance will be commensurate with the increased risk resulting from the reduced floor elevation (up to amounts as high as \$25 for \$100 of insurance coverage), and stating that construction below the base flood elevation increases risks to life and property.

SUBPART 8. VIOLATIONS

9-80 Violations. Any development that is not within the scope of the *Florida Building Code* but that is regulated by this ordinance that is performed without an issued permit, that is in conflict with an issued permit, or that does not fully comply with this ordinance, shall be deemed a violation of this ordinance. A building or structure without the documentation of elevation of the lowest floor, other required design certifications, or other evidence of compliance required by this ordinance or the *Florida Building Code* is presumed to be a violation until such time as that documentation is provided.

9-81 Authority. For development that is not within the scope of the *Florida Building Code* but that is regulated by this ordinance and that is determined to be a violation, the Floodplain Administrator is authorized to serve notices of violation or stop work orders to owners of the property involved, to the owner's agent, or to the person or persons performing the work.

9-83 Unlawful continuance. Any person who shall continue any work after having been served with a notice of violation or a stop work order, except such work as that person is directed to perform to remove or remedy a violation or unsafe condition, shall be subject to penalties as prescribed by Section 1-13 of the Code of Ordinances of the Town.

ARTICLE II DEFINITIONS

SUBPART 1. GENERAL

9-2010 Scope. Unless otherwise expressly stated, the following words and terms shall, for the purposes of this ordinance, have the meanings shown in this section.

9-2011 Terms defined in the *Florida Building Code*. Where terms are not defined in this ordinance and are defined in the *Florida Building Code*, such terms shall have the meanings ascribed to them in that code.

Terms not defined. Where terms are not defined in this ordinance or the *Florida Building Code*, such terms shall have ordinarily accepted meanings such as the context implies.

SUBPART 2. DEFINITIONS

Alteration of a watercourse. A dam, impoundment, channel relocation, change in channel alignment, channelization, or change in cross-sectional area of the channel or the channel capacity, or any other form of modification which may alter, impede, retard or change the direction and/or velocity of the riverine flow of water during conditions of the base flood.

Appeal. A request for a review of the Floodplain Administrator's interpretation of any provision of this ordinance ~~or a request for a variance.~~

ASCE 24. A standard titled *Flood Resistant Design and Construction* that is referenced by the *Florida Building Code*. ASCE 24 is developed and published by the American Society of Civil Engineers, Reston, VA.

Base flood. A flood having a 1-percent chance of being equaled or exceeded in any given year. [Also defined in FBC, B, Section 1612.2.] The base flood is commonly referred to as the "100-year flood" or the "1-percent-annual chance flood."

Base flood elevation. The elevation of the base flood, including wave height, relative to the National Geodetic Vertical Datum (NGVD), North American Vertical Datum (NAVD) or other datum specified on the Flood Insurance Rate Map (FIRM). [Also defined in FBC, B, Section 1612.2.]

Basement. The portion of a building having its floor subgrade (below ground level) on all sides. [Also defined in FBC, B, Section 1612.2.]

Coastal high hazard area. A special flood hazard area extending from offshore to the inland limit of a primary frontal dune along an open coast and any other area subject to high velocity wave action from storms or seismic sources. Coastal high hazard areas are also referred to as "high hazard areas subject to high velocity wave action" or "V Zones" and are designated on Flood Insurance Rate Maps (FIRM) as Zone V1-V30, VE, or V.

Design flood. The flood associated with the greater of the following two areas: [Also defined in FBC, B, Section 1612.2.]

1. Area with a floodplain subject to a 1-percent or greater chance of flooding in any year; or
2. Area designated as a flood hazard area on the community's flood hazard map, or otherwise legally designated.

Design flood elevation. The elevation of the "design flood," including wave height, relative to the datum specified on the community's legally designated flood hazard map. In areas designated as Zone AO, the design flood elevation shall be the elevation of the highest existing grade of the building's perimeter plus the depth number (in feet) specified on the flood hazard map. In areas designated as Zone AO where the depth number is not specified on the map, the depth number shall be taken as being equal to 2 feet. [Also defined in FBC, B, Section 1612.2.]

Development. Any man-made change to improved or unimproved real estate, including but not limited to, buildings or other structures, tanks, temporary structures, temporary or permanent storage of equipment or materials, mining, dredging, filling, grading, paving, excavations, drilling operations or any other land disturbing activities.

Encroachment. The placement of fill, excavation, buildings, permanent structures or other development into a flood hazard area which may impede or alter the flow capacity of riverine flood hazard areas.

Existing building and existing structure. Any buildings and structures for which the "start of construction" commenced before September 28, 1979 [Also defined in FBC, B, Section 1612.2.]

Existing manufactured home park or subdivision. A manufactured home park or subdivision for which the construction of facilities for servicing the lots on which the manufactured homes

are to be affixed (including, at a minimum, the installation of utilities, the construction of streets, and either final site grading or the pouring of concrete pads) is completed before September 28, 1979.

Expansion to an existing manufactured home park or subdivision. The preparation of additional sites by the construction of facilities for servicing the lots on which the manufactured homes are to be affixed (including the installation of utilities, the construction of streets, and either final site grading or the pouring of concrete pads).

Federal Emergency Management Agency (FEMA). The federal agency that, in addition to carrying out other functions, administers the National Flood Insurance Program.

Flood or flooding. A general and temporary condition of partial or complete inundation of normally dry land from: [Also defined in FBC, B, Section 1612.2.]

1. The overflow of inland or tidal waters.
2. The unusual and rapid accumulation or runoff of surface waters from any source.

Flood damage-resistant materials. Any construction material capable of withstanding direct and prolonged contact with floodwaters without sustaining any damage that requires more than cosmetic repair. [Also defined in FBC, B, Section 1612.2.]

Flood hazard area. The greater of the following two areas: [Also defined in FBC, B, Section 1612.2.]

1. The area within a floodplain subject to a 1-percent or greater chance of flooding in any year.
2. The area designated as a flood hazard area on the community's flood hazard map, or otherwise legally designated.

Flood Insurance Rate Map (FIRM). The official map of the community on which the Federal Emergency Management Agency has delineated both special flood hazard areas and the risk premium zones applicable to the community. [Also defined in FBC, B, Section 1612.2.]

Flood Insurance Study (FIS). The official report provided by the Federal Emergency Management Agency that contains the Flood Insurance Rate Map, the Flood Boundary and Floodway Map (if applicable), the water surface elevations of the base flood, and supporting technical data. [Also defined in FBC, B, Section 1612.2.]

Floodplain Administrator. The office or position designated and charged with the administration and enforcement of this ordinance (may be referred to as the Floodplain Manager).

Floodplain development permit or approval. An official document or certificate issued by the community, or other evidence of approval or concurrence, which authorizes performance of specific development activities that are located in flood hazard areas and that are determined to be compliant with this ordinance.

Floodway. The channel of a river or other riverine watercourse and the adjacent land areas that must be reserved in order to discharge the base flood without cumulatively increasing the water surface elevation more than one (1) foot. [Also defined in FBC, B, Section 1612.2.]

Floodway encroachment analysis. An engineering analysis of the impact that a proposed encroachment into a floodway is expected to have on the floodway boundaries and base flood elevations; the evaluation shall be prepared by a qualified Florida licensed engineer using standard engineering methods and models.

Florida Building Code. The family of codes adopted by the Florida Building Commission, including *Florida Building Code, Building*; *Florida Building Code, Residential*; *Florida Building Code, Existing Building*; *Florida Building Code, Mechanical*; *Florida Building Code, Plumbing*; *Florida Building Code, Fuel Gas*.

Functionally dependent use. A use which cannot perform its intended purpose unless it is located or carried out in close proximity to water, including only docking facilities, port facilities that are necessary for the loading and unloading of cargo or passengers, and ship building and ship repair facilities; the term does not include long-term storage or related manufacturing facilities.

Highest adjacent grade. The highest natural elevation of the ground surface prior to construction next to the proposed walls or foundation of a structure.

Historic structure. Any structure that is determined eligible for the exception to the flood hazard area requirements of the *Florida Building Code, Existing Building*, Chapter 11 Historic Buildings.

Letter of Map Change (LOMC). An official determination issued by FEMA that amends or revises an effective Flood Insurance Rate Map or Flood Insurance Study. Letters of Map Change include:

Letter of Map Amendment (LOMA): An amendment based on technical data showing that a property was incorrectly included in a designated special flood hazard area. A LOMA amends the current effective Flood Insurance Rate Map and establishes that a specific property, portion of a property, or structure is not located in a special flood hazard area.

Letter of Map Revision (LOMR): A revision based on technical data that may show changes to flood zones, flood elevations, special flood hazard area boundaries and floodway delineations, and other planimetric features.

Letter of Map Revision Based on Fill (LOMR-F): A determination that a structure or parcel of land has been elevated by fill above the base flood elevation and is, therefore, no longer located within the special flood hazard area. In order to qualify for this determination, the fill must have been permitted and placed in accordance with the community's floodplain management regulations.

Conditional Letter of Map Revision (CLOMR): A formal review and comment as to whether a proposed flood protection project or other project complies with the minimum NFIP requirements for such projects with respect to delineation of special flood hazard areas. A CLOMR does not revise the effective Flood Insurance Rate Map or Flood Insurance Study; upon submission and approval of certified as-built documentation, a Letter of Map Revision may be issued by FEMA to revise the effective FIRM.

Light-duty truck. As defined in 40 C.F.R. 86.082-2, any motor vehicle rated at 8,500 pounds Gross Vehicular Weight Rating or less which has a vehicular curb weight of 6,000 pounds or less and which has a basic vehicle frontal area of 45 square feet or less, which is:

1. Designed primarily for purposes of transportation of property or is a derivation of such a

- vehicle, or
2. Designed primarily for transportation of persons and has a capacity of more than 12 persons; or
 3. Available with special features enabling off-street or off-highway operation and use.

Lowest floor. The lowest floor of the lowest enclosed area of a building or structure, including basement, but excluding any unfinished or flood-resistant enclosure, usable solely for vehicle parking, building access or limited storage provided that such enclosure is not built so as to render the structure in violation of the non-elevation requirements of the *Florida Building Code* or ASCE 24. [Also defined in FBC, B, Section 1612.2.]

Manufactured home. A structure, transportable in one or more sections, which is eight (8) feet or more in width and greater than four hundred (400) square feet, and which is built on a permanent, integral chassis and is designed for use with or without a permanent foundation when attached to the required utilities. The term "manufactured home" does not include a "recreational vehicle" or "park trailer." [Also defined in 15C-1.0101, F.A.C.]

Manufactured home park or subdivision. A parcel (or contiguous parcels) of land divided into two or more manufactured home lots for rent or sale.

Market value. The price at which a property will change hands between a willing buyer and a willing seller, neither party being under compulsion to buy or sell and both having reasonable knowledge of relevant facts. As used in this ordinance, the term refers to the market value of buildings and structures, excluding the land and other improvements on the parcel. Market value may be established by a qualified independent appraiser, Actual Cash Value (replacement cost depreciated for age and quality of construction), or tax assessment value adjusted to approximate market value by a factor provided by the Property Appraiser.

New construction. For the purposes of administration of this ordinance and the flood resistant construction requirements of the *Florida Building Code*, structures for which the "start of construction" commenced on or after September 28, 1979 and includes any subsequent improvements to such structures.

New manufactured home park or subdivision. A manufactured home park or subdivision for which the construction of facilities for servicing the lots on which the manufactured homes are to be affixed (including at a minimum, the installation of utilities, the construction of streets, and either final site grading or the pouring of concrete pads) is completed on or after September 28, 1979.

Park trailer. A transportable unit which has a body width not exceeding fourteen (14) feet and which is built on a single chassis and is designed to provide seasonal or temporary living quarters when connected to utilities necessary for operation of installed fixtures and appliances. [Defined in Section 320.01 F.S.]

Recreational vehicle. A vehicle, including a park trailer, which is: [See Section 320.01F.S.)

1. Built on a single chassis;
2. Four hundred (400) square feet or less when measured at the largest horizontal projection;
3. Designed to be self-propelled or permanently towable by a light-duty truck; and

4. Designed primarily not for use as a permanent dwelling but as temporary living quarters for recreational, camping, travel, or seasonal use.

Sand dunes. Naturally occurring accumulations of sand in ridges or mounds landward of the beach.

Special flood hazard area. An area in the floodplain subject to a 1 percent or greater chance of flooding in any given year. Special flood hazard areas are shown on FIRMs as Zone A, AO, A1-A30, AE, A99, AH, V1-V30, VE or V. [Also defined in FBC, B Section 1612.2.]

Start of construction. The date of issuance of permits for new construction and substantial improvements to existing structures, provided the actual start of construction, repair, reconstruction, rehabilitation, addition, placement, or other improvement is within 180 days of the date of the issuance. The actual start of construction means either the first placement of permanent construction of a building (including a manufactured home) on a site, such as the pouring of slab or footings, the installation of piles, or the construction of columns.

Permanent construction does not include land preparation (such as clearing, grading, or filling), the installation of streets or walkways, excavation for a basement, footings, piers, or foundations, the erection of temporary forms or the installation of accessory buildings such as garages or sheds not occupied as dwelling units or not part of the main buildings. For a substantial improvement, the actual "start of construction" means the first alteration of any wall, ceiling, floor or other structural part of a building, whether that alteration affects the external dimensions of the building. [Also defined in FBC, B Section 1612.2.]

Substantial damage. Damage of any origin sustained by a building or structure whereby the cost of restoring the building or structure to its before-damaged condition would equal or exceed 50 percent of the market value of the building or structure before the damage occurred. [Also defined in FBC, B Section 1612.2.]

Substantial improvement. Any repair, reconstruction, rehabilitation, alteration, addition, or other improvement of a building or structure, the cost of which equals or exceeds 50 percent of the market value of the building or structure before the improvement or repair is started. If the structure has incurred "substantial damage," any repairs are considered substantial improvement regardless of the actual repair work performed. The term does not, however, include either: [Also defined in FBC, B, Section 1612.2.]

1. Any project for improvement of a building required to correct existing health, sanitary, or safety code violations identified by the building official and that are the minimum necessary to assure safe living conditions.
2. Any alteration of a historic structure provided the alteration will not preclude the structure's continued designation as a historic structure.

Variance. A grant of relief from the requirements of this ordinance, or the flood resistant construction requirements of the *Florida Building Code*, which permits construction in a manner that would not otherwise be permitted by this ordinance or the *Florida Building Code*.

Watercourse. A river, creek, stream, channel or other topographic feature in, on, through, or over which water flows at least periodically.

ARTICLE III FLOOD RESISTANT DEVELOPMENT

SUBPART 1. BUILDINGS AND STRUCTURES

9-310 Design and construction of buildings, structures and facilities exempt from the *Florida Building Code*. Pursuant to Section 9-42 of this ordinance, buildings, structures, and facilities that are exempt from the *Florida Building Code*, including substantial improvement or repair of substantial damage of such buildings, structures and facilities, shall be designed and constructed in accordance with the flood load and flood resistant construction requirements of ASCE 24. Structures exempt from the *Florida Building Code* that are not walled and roofed buildings shall comply with the requirements of Subpart 7 of Article III of this ordinance.

SUBPART 2. SUBDIVISIONS

9-320 Minimum requirements. Subdivision proposals, including proposals for manufactured home parks and subdivisions, shall be reviewed to determine that:

1. Such proposals are consistent with the need to minimize flood damage and will be reasonably safe from flooding;
2. All public utilities and facilities such as sewer, gas, electric, communications, and water systems are located and constructed to minimize or eliminate flood damage; and
3. Adequate drainage is provided to reduce exposure to flood hazards; in Zones AH and AO, adequate drainage paths shall be provided to guide floodwaters around and away from proposed structures.

9-321 Subdivision plats. Where any portion of proposed subdivisions, including manufactured home parks and subdivisions, lies within a flood hazard area, the following shall be required:

1. Delineation of flood hazard areas, floodway boundaries and flood zones, and design flood elevations, as appropriate, shall be shown on preliminary plats.
2. Where the subdivision has more than 50 lots or is larger than 5 acres and base flood elevations are not included on the FIRM, the base flood elevations determined in accordance with Section 9-51(1) of this ordinance; and
3. Compliance with the site improvement and utilities requirements of Subpart 3 of Article III of this ordinance.

SUBPART 3. SITE IMPROVEMENTS, UTILITIES AND LIMITATIONS

9-330 Minimum requirements. All proposed new development shall be reviewed to determine that:

1. Such proposals are consistent with the need to minimize flood damage and will be reasonably safe from flooding;
2. All public utilities and facilities such as sewer, gas, electric, communications, and water systems are located and constructed to minimize or eliminate flood damage; and
3. Adequate drainage is provided to reduce exposure to flood hazards; in Zones AH and AO, adequate drainage paths shall be provided to guide floodwaters around and away from proposed structures.

9-331 Sanitary sewage facilities. All new and replacement sanitary sewage facilities, private sewage treatment plants (including all pumping stations and collector systems), and on-site waste disposal systems shall be designed in accordance with the standards for onsite sewage treatment and disposal systems in Chapter 64E-6, F.A.C. and ASCE 24 Chapter 7 to minimize or eliminate infiltration of floodwaters into the facilities and discharge from the facilities into flood waters, and impairment of the facilities and systems.

9-332 Water supply facilities. All new and replacement water supply facilities shall be designed in accordance with the water well construction standards in Chapter 62-532.500, F.A.C. and ASCE 24 Chapter 7 to minimize or eliminate infiltration of floodwaters into the systems.

9-333 Limitations on sites in regulatory floodways. No development, including but not limited to site improvements, and land disturbing activity involving fill or regrading, shall be authorized in the regulatory floodway unless the floodway encroachment analysis required in Section 9-52(1) of this ordinance demonstrates that the proposed development or land disturbing activity will not result in any increase in the base flood elevation.

9-334 Limitations on placement of fill. Subject to the limitations of this ordinance, fill shall be designed to be stable under conditions of flooding including rapid rise and rapid drawdown of floodwaters, prolonged inundation, and protection against flood-related erosion and scour. In addition to these requirements, if intended to support buildings and structures (Zone A only), fill shall comply with the requirements of the *Florida Building Code*.

Sec. 9-335. - Limitations on sites in coastal high hazard areas (Zone V). In coastal high hazard areas, alteration of sand dunes and mangrove stands shall be permitted only if such alteration is approved by the Florida Department of Environmental Protection and only if the engineering analysis required by Section 105.3(4) of this ordinance demonstrates that the proposed alteration will not increase the potential for flood damage. Construction or restoration of dunes under or around elevated buildings and structures shall comply with Section 307.8(3) of this ordinance.

Secs. 9-335 9-336—9.339. - Reserved

SUBPART 4. MANUFACTURED HOMES

9-340 General. All manufactured homes installed in flood hazard areas shall be installed by an installer that is licensed pursuant to section 320.8249, F.S., and shall comply with the requirements of Chapter 15C-1, F.A.C. and the requirements of this ordinance.

9-341 Foundations. All new manufactured homes and replacement manufactured homes installed in flood hazard areas shall be installed on permanent, reinforced foundations that:

(1) In flood hazard areas (Zone A) other than coastal high hazard areas, are designed in accordance with the foundation requirements of the *Florida Building Code Residential* Section R322.2 and this ordinance. Foundations for manufactured homes subject to Section 304.6 9-345 of this ordinance are permitted to be reinforced piers or other foundation elements of at least equivalent strength.

(2) In coastal high hazard areas (Zone V), are designed in accordance with the foundation requirements of the *Florida Building Code, Residential* Section R322.3 and this ordinance.

9-342 Anchoring. All new manufactured homes and replacement manufactured homes shall be installed using methods and practices which minimize flood damage and shall be securely anchored to an adequately anchored foundation system to resist flotation, collapse or lateral movement. Methods of anchoring include, but are not limited to, use of over-the-top or frame ties to ground anchors. This anchoring requirement is in addition to applicable state and local anchoring requirements for wind resistance.

9-343 Elevation. Manufactured homes that are placed, replaced, or substantially improved shall comply with Section 9-344 or 9-345 of this ordinance, as applicable.

9-344 General elevation requirement. Unless subject to the requirements of Section 9-345 of this ordinance, all manufactured homes that are placed, replaced, or substantially improved on sites located: (a) outside of a manufactured home park or subdivision; (b) in a new manufactured home park or subdivision; (c) in an expansion to an existing manufactured home park or subdivision; or (d) in an existing manufactured home park or subdivision upon which a manufactured home has incurred "substantial damage" as the result of a flood, shall be elevated such that the bottom of the frame is at or above the elevation required, as applicable to the flood hazard area, in the *Florida Building Code, Residential* Section R322.2 (Zone A-) or Section R322.3 (Zone V).

9-345 Elevation requirement for certain existing manufactured home parks and subdivisions. Manufactured homes that are not subject to Section 9-344 of this ordinance, including manufactured homes that are placed, replaced, or substantially improved on sites located in an existing manufactured home park or subdivision, unless on a site where substantial damage as result of flooding has occurred, shall be elevated such that either the:

1. Bottom of the frame of the manufactured home is at or above the elevation required, as applicable to the flood hazard area, in the *Florida Building Code, Residential* Section R322.2 (Zone A) or Section R322.3 (Zone V); or
2. Bottom of the frame is supported by reinforced piers or other foundation elements of at least equivalent strength that are not less than 36 inches in height above grade.

9-346 Enclosures. Enclosed areas below elevated manufactured homes shall comply with the requirements of the *Florida Building Code, Residential* Section R322 or R322.3 for such enclosed areas, as applicable to the flood hazard area.

9-347 Utility equipment. Utility equipment that serves manufactured homes, including electric, heating, ventilation, plumbing, and air conditioning equipment and other service facilities, shall comply with the requirements of the *Florida Building Code, Residential* Section R322, as applicable to the flood hazard area.

SUBPART 5. RECREATIONAL VEHICLES AND PARK TRAILERS

9-350 Temporary placement. Recreational vehicles and park trailers placed temporarily in flood hazard areas shall:

1. Be on the site for fewer than 180 consecutive days; or
2. Be fully licensed and ready for highway use, which means the recreational vehicle or park model is on wheels or jacking system, is attached to the site only by quick-disconnect type utilities and security devices, and has no permanent attachments such as additions, rooms, stairs, decks and porches.

9-351 Permanent placement. Recreational vehicles and park trailers that do not meet the limitations in Section 9-350 of this ordinance for temporary placement shall meet the requirements of Subpart 4 of Article III of this ordinance for manufactured homes.

SUBPART 6. TANKS

9-360 Underground tanks. Underground tanks in flood hazard areas shall be anchored to prevent flotation, collapse or lateral movement resulting from hydrodynamic and hydrostatic loads during conditions of the design flood, including the effects of buoyancy assuming the tank is empty.

9-361 Above-ground tanks not elevated. Above-ground tanks that do not meet the elevation requirements of Section 9-362 of this ordinance shall be:

(1) Be permitted in flood hazard areas (Zone A) other than coastal high hazard areas, provided the tanks are anchored or otherwise designed and constructed to prevent flotation, collapse or lateral movement resulting from hydrodynamic and hydrostatic loads during conditions of the design flood, including the effects of buoyancy assuming the tank is empty and the effects of flood-borne debris.

(2) Not be permitted in coastal high hazard areas (Zone V).

9-362 Above-ground tanks, elevated. Above-ground tanks in flood hazard areas shall be ~~attached to and~~ elevated to or above the design flood elevation ~~on and attached to~~ a supporting structure that is designed to prevent flotation, collapse or lateral movement during conditions of the design flood. Tank-supporting structures shall meet the foundation requirements of the applicable flood hazard area.

9-363 Tank inlets and vents. Tank inlets, fill openings, outlets and vents shall be:

1. At or above the design flood elevation or fitted with covers designed to prevent the inflow of floodwater or outflow of the contents of the tanks during conditions of the design flood; and
2. Anchored to prevent lateral movement resulting from hydrodynamic and hydrostatic loads, including the effects of buoyancy, during conditions of the design flood.

SUBPART 7. OTHER DEVELOPMENT

9-370 General requirements for other development. All development, including man-made changes to improved or unimproved real estate for which specific provisions are not specified in this ordinance or the *Florida Building Code*, shall:

1. Be located and constructed to minimize flood damage;
2. Meet the limitations of Section 9-333 of this ordinance if located in a regulated floodway;
3. Be anchored to prevent flotation, collapse or lateral movement resulting from hydrostatic loads, including the effects of buoyancy, during conditions of the design flood;
4. Be constructed of flood damage-resistant materials; and
5. Have mechanical, plumbing, and electrical systems above the design flood elevation ~~or~~ ~~meet the requirements of ASCE 24~~, except that minimum electric service required to address life safety and electric code requirements is permitted below the design flood

elevation provided it conforms to the provisions of the electrical part of building code for wet locations.

9-371 Fences in regulated floodways. Fences in regulated floodways that have the potential to block the passage of floodwaters, such as stockade fences and wire mesh fences, shall meet the limitations of Section 9-333 of this ordinance.

9-372 Retaining walls, sidewalks and driveways in regulated floodways. Retaining walls and sidewalks and driveways that involve the placement of fill in regulated floodways shall meet the limitations of Section 9-333 of this ordinance.

9-373 Roads and watercourse crossings in regulated floodways. Roads and watercourse crossings, including roads, bridges, culverts, low-water crossings and similar means for vehicles or pedestrians to travel from one side of a watercourse to the other side, that encroach into regulated floodways shall meet the limitations of Section 9-333 of this ordinance. Alteration of a watercourse that is part of a road or watercourse crossing shall meet the requirements of Section 9-52 (3) of this ordinance."

Sec. 9-374. - Concrete slabs used as parking pads, enclosure floors, landings, decks, walkways, patios and similar nonstructural uses in coastal high hazard areas (Zone V). In coastal high hazard areas, concrete slabs used as parking pads, enclosure floors, landings, decks, walkways, patios and similar nonstructural uses are permitted beneath or adjacent to buildings and structures provided the concrete slabs are designed and constructed to be:

- (1) Structurally independent of the foundation system of the building or structure;
- (2) Frangible and not reinforced, so as to minimize debris during flooding that is capable of causing significant damage to any structure; and
- (3) Have a maximum slab thickness of not more than four (4) inches.

Sec. 9-375. - Decks and patios in coastal high hazard areas (Zone V). In addition to the requirements of the *Florida Building Code*, in coastal high hazard areas decks and patios shall be located, designed, and constructed in compliance with the following:

- (1) A deck that is structurally attached to a building or structure shall have the bottom of the lowest horizontal structural member at or above the design flood elevation and any supporting members that extend below the design flood elevation shall comply with the foundation requirements that apply to the building or structure, which shall be designed to accommodate any increased loads resulting from the attached deck.
- (2) A deck or patio that is located below the design flood elevation shall be structurally independent from buildings or structures and their foundation systems, and shall be designed and constructed either to remain intact and in place during design flood conditions or to break apart into small pieces to minimize debris during flooding that is capable of causing structural damage to the building or structure or to adjacent buildings and structures.
- (3) A deck or patio that has a vertical thickness of more than twelve (12) inches or that is constructed with more than the minimum amount of fill necessary for site drainage shall not be approved unless an analysis prepared by a qualified registered design professional demonstrates no harmful diversion of floodwaters or wave runup and wave reflection that would increase damage to the building or structure or to adjacent buildings and structures.

- (4) A deck or patio that has a vertical thickness of twelve (12) inches or less and that is at natural grade or on nonstructural fill material that is similar to and compatible with local soils and is the minimum amount necessary for site drainage may be approved without requiring analysis of the impact on diversion of floodwaters or wave runup and wave reflection.

Sec. 9-376. - Other development in coastal high hazard areas (Zone V). In coastal high hazard areas, development activities other than buildings and structures shall be permitted only if also authorized by the appropriate federal, state or local authority; if located outside the footprint of, and not structurally attached to, buildings and structures; and if analyses prepared by qualified registered design professionals demonstrate no harmful diversion of floodwaters or wave runup and wave reflection that would increase damage to adjacent buildings and structures. Such other development activities include but are not limited to:

- (1) Bulkheads, seawalls, retaining walls, revetments, and similar erosion control structures;
- (2) Solid fences and privacy walls, and fences prone to trapping debris, unless designed and constructed to fail under flood conditions less than the design flood or otherwise function to avoid obstruction of floodwaters; and
- (3) On-site sewage treatment and disposal systems defined in 64E-6.002, F.A.C., as filled systems or mound systems.

Sec. 9-377. - Nonstructural fill in coastal high hazard areas (Zone V). In coastal high hazard areas:

- (1) Minor grading and the placement of minor quantities of nonstructural fill shall be permitted for landscaping and for drainage purposes under and around buildings.
- (2) Nonstructural fill with finished slopes that are steeper than one unit vertical to five units horizontal shall be permitted only if an analysis prepared by a qualified registered design professional demonstrates no harmful diversion of floodwaters or wave runup and wave reflection that would increase damage to adjacent buildings and structures.
- (3) Where authorized by the Florida Department of Environmental Protection or applicable local approval, sand dune construction and restoration of sand dunes under or around elevated buildings are permitted without additional engineering analysis or certification of the diversion of floodwater or wave runup and wave reflection if the scale and location of the dune work is consistent with local beach-dune morphology and the vertical clearance is maintained between the top of the sand dune and the lowest horizontal structural

SECTION 2. APPLICABILITY.

For the purposes of jurisdictional applicability, this ordinance shall apply in Town of Malabar. This ordinance shall apply to all applications for development, including building permit applications and subdivision proposals, submitted on or after the effective date of this ordinance.

SECTION 3. INCLUSION INTO THE CODE OF ORDINANCES.

It is the intent of the Town Council that the provisions of this ordinance shall become and be made a part of the Town of Malabar's Code of Ordinances, and that the sections of this ordinance may be renumbered or re-lettered and the word "ordinance" may be changed to "section," "article," "regulation," or such other appropriate word or phrase in order to accomplish such intentions.

SECTION 4. SEVERABILITY.

If any section, subsection, sentence, clause or phrase of this ordinance is, for any reason, declared by the courts to be unconstitutional or invalid, such decision shall not affect the validity of the ordinance as a whole, or any part thereof, other than the part so declared.

SECTION 5. EFFECTIVE DATE.

This ordinance shall take effect immediately upon adoption.

The foregoing Ordinance was moved for adoption by Councilmember _____. The motion was seconded by Councilmember _____ and, upon being put to a vote, the vote was as follows:

Council Member Grant Ball	_____
Council Member Brian Vail	_____
Council Member Steve Rivet	_____
Council Member David Scardino	_____
Council Member Danny White	_____

This ordinance was then declared to be duly passed and adopted this 16th day of November 2020.

TOWN OF MALABAR

By

(Seal)

Mayor Patrick T. Reilly, Council Chair

First Reading: 11/02/2020 Approved ___ to ___
Second Reading: 11/16/2019

ATTEST:

Debby K. Franklin, CMC,
Town Clerk/Treasurer

Approved as to Form and Content:

Karl W. Bohne, Jr.,
Town Attorney

TOWN OF MALABAR

COUNCIL MEETING

AGENDA ITEM NO: 11.c.
Meeting Date: November 02, 2020

Prepared By: Debby Franklin, C.M.C., Town Clerk/Treasurer

SUBJECT: 11.c. Continue or Sunset Policy Requiring Face Coverings and Social Distancing - Reso 17-2020

BACKGROUND/HISTORY:

Town Council approved this policy on October 5, 2020 and formalized it into Reso 17-2020 on October 19, 2020 to require face coverings and social distancing in all Town owned buildings effective October 5, 2020. The end date was left open for Council consideration at a meeting in November. It is set to sunset at 12:01 a.m. on November 3, 2020, if not extended by Council at this meeting.

Staff has updated the information and signage at Town Hall and shared the policy with the Boards and employees.

ATTACHMENTS:

- a. Reso 17-2020 – see page 3

ACTION OPTIONS:

Council Action on Reso 17-2020

RESOLUTION 17-2020

A RESOLUTION OF THE TOWN OF MALABAR, BREVARD COUNTY, FLORIDA, PURSUANT TO THE GENERAL POWERS RESERVED TO THE TOWN COUNCIL IN THE TOWN CHARTER; MAKING LEGISLATIVE FINDINGS; PROVIDING FOR DEFINITIONS; REQUIRING ALL PERSONS TO WEAR FACE COVERING AT DESIGNATED TOWN FACILITIES; PROVIDING FOR EXCEPTIONS; PROVIDING FOR SUNSET; PROVIDING FOR SEVERABILITY, CONFLICTS AND EFFECTIVE DATE.

WHEREAS, Novel Coronavirus Disease (COVID-19) is a severe acute respiratory illness that can spread among humans through respiratory transmission and causes symptoms similar to those of influenza, and in some cases death; and

WHEREAS, guidance released by the CDC on June 15, 2020 states that (i) the COVID-19 virus is mostly spread by respiratory droplets released when people cough, sneeze and talk and (ii) that a person can get COVID-19 by touching a surface or object that has the virus on it and then by touching their mouth, nose or possibly their eyes. This guidance goes on to state that "personal prevention practices (such as staying home when sick, social distancing, wearing a cloth face covering, and handwashing) and environmental prevention practices (such as cleaning and disinfection) are important are important ways to prevent the spread of COVID-19; and

WHEREAS, the CDC has expressly found that "COVID-19 spreads mainly from person to person through respiratory droplets produced when a person coughs, sneezes or talks. These droplets can land on the mouths or noses of people nearby and possibly inhaled into the lungs. Studies and evidence on infection control report that these droplets usually travel around 6 feet (about "2 arms' length"); and

WHEREAS, the CDC therefore specifically recommends that as communities reopen, and people resume their daily activities, people should wear face coverings to slow the spread of COVID-19 particularly in "public settings where other social distancing measures are difficult to maintain"; and

WHEREAS, based on the advice of medical professionals, the number of COVID-19 cases may continue to rise unless measures are instituted to slow the spread and stop the introduction of the COVID-19 virus; and

WHEREAS, the State of Florida has the highest percentage of population in the United States 65 years of age and older, as well as the second largest population of that demographic; and

WHEREAS, according to the CDC, the vast majority of persons that test positive for the COVID-19 virus that are hospitalized are persons over the age of 65 years and/or have underlying health conditions; and

WHEREAS, according the CDC the highest percentage of severe outcomes among persons are aged 85 years of age and older; and

WHEREAS, the Town Council finds that it is in the best interest of the residents of the Town of Malabar and the general public, and it is in furtherance of the public health, safety, and welfare, to formally adopt this Resolution to require face coverings at and in designated Town Facilities.

NOW, THEREFORE, BE IT RESOLVED BY THE TOWN COUNCIL OF THE TOWN OF MALABAR, FLORIDA, as follows:

Section 1. The above recitals are adopted by the Town Council as legislative findings.

Section 2. Definitions.

“Face Covering” shall mean a uniform piece of material, made of paper or cloth and including plastic shield coverings, that securely covers a persons’ nose and mouth and remains affixed in place without the use of one’s hands, whether store-bought or homemade, concurrent with CDC guidelines.

“Social Distancing” shall mean keeping space between yourself and other people by staying at least 6 feet.

Section 3.

Face Coverings Required in Designated Town Owned and Operated Facilities.

(a) Every Person living, working, or visiting the Town of Malabar shall wear a face covering in the following Town owned and operated facilities:

1. Town Hall 2725 Malabar Road
2. Malabar Fire Dept, 1840 Malabar Road
3. Malabar Public Works Building 1435 Centre Street

(b) Exceptions:

1. Persons under the age of 6 years old; and
2. Persons observing social distancing under the CDC guidelines; and
3. Persons for whom a face covering would cause impairment due to an existing health condition; and

- 4. When a person who is hearing impaired needs to see the mouth of someone wearing a face covering in order to communicate.

Section 4. Severability. In the event a court of competent jurisdiction shall hold or determine that any part of this Resolution is invalid or unconstitutional, the remainder of the Resolution shall not be affected and it will be presumed that the Town did not intend to enact such invalid or unconstitutional provision. It shall further be assumed that the Town Council would have enacted the remainder of this Resolution without said invalid and unconstitutional provision thereby causing said remainder to remain in full force and effect.

Section 5. Conflicts. All ordinances or parts of ordinances in conflict herewith are hereby repealed.

Section 6. Effective Date and Sunset. This Resolution shall become effective *nun* pro tunc on October 5, 2020, and shall sunset at 12:01 a.m. on November 3, 2020, unless extended by the Town Council.



The foregoing Resolution was moved for adoption by Council Member White and, upon being put to a vote, the vote was as follows:
Rivet The motion was seconded by Council Member

Council Member Grant Ball	Aye
Council Member Brian Vail	Aye
Council Member Steve Rivet	Aye
Council Member David Scardino	Aye
Council Member Danny White	Aye

PASSED AND ADOPTED by the Town Council, Town of Malabar, Brevard County, Florida this 19th day of October 2020.

BY: TOWN OF MALABAR

Patrick T. Reilly
 Mayor Patrick T. Reilly, Council Chair

ATTEST:

Debby K. Franklin
 Debby K. Franklin, C.M.C.
 Town Clerk/Treasurer

TOWN OF MALABAR

COUNCIL MEETING

AGENDA ITEM NO: 11.d
Meeting Date: November 2, 2020

Prepared By: Lisa Morrell, Interim Town Manager

SUBJECT: Piggyback National Association of State Procurement Officials (NASPO) ValuePoint Program Contract for AT&T FirstNet Solution And AT&T Mobility Services

BACKGROUND/HISTORY:

FirstNet is a government subsidized wireless network specifically designed for the needs of public safety users; access to FirstNet services will be limited to defined categories of users related to public safety. FirstNet was created under the Middle-Class Tax Relief and Job Creation Act of 2012.

FirstNet is the only nationwide, high-speed broadband communications platform dedicated to and purpose-built for America's first responders and the extended public safety community. Built with AT&T in a public-private partnership with the First Responder Network Authority (FirstNet Authority) – an independent agency within the federal government.

Public Safety Entities and their Authorized Users can choose from a broad portfolio of commercially available devices and accessories to meet the demands of administrative personnel and front line first responders. The portfolio includes choices from premium smartphones, rugged smartphones and feature phones, tablets, laptops, wearables, trunk mounted modems/routers, and accessories (remote speaker mics, cases, covers, headsets, etc.). Customers will be able to choose devices that are on the Android, iOS, or Windows operating systems. FirstNet equipment is certified by AT&T. Available FirstNet equipment includes FirstNet Capable and FirstNet Ready devices.

Florida's first responders are getting a major boost in their wireless communications with the addition of new, purpose-built FirstNet cell sites and more than 2,000 other network enhancements. New FirstNet cell sites – located in Brevard, Citrus, Flagler, Glades, Gulf, Hendry, Lake, Lee, Marion, Nassau, Orange, Osceola, Putnam, Saint Johns, Sumter, Suwannee and Union counties – have launched.

This is a publicly solicited contract established through an RFP process conducted by a Lead Public Agency, State of Utah, which satisfies the formal competitive bid with a contract term of December 6, 2019 through August 11, 2024 for Contract #MA149.

In accordance with The Town of Malabar Code of Ordinances, ARTICLE V. entitled PURCHASING, Section 2-101 - Competitive bids:

“The town administrator is authorized to piggy back contracts for any purpose where the stipulated consideration thereunder to be paid by the town exceeds two thousand dollars (\$2,000.00) awarded by any other governmental entity so long as the bidding process utilized by the other governmental entity in awarding such contract is consistent with the competitive bid procedures outlined in this section. “

The Town of Malabar will utilize this contract for mobile communication services and devices; specifically, (2) FirstNet Smartphones with monthly mobile communication services and (1) FirstNet certified Rugged Laptop with monthly mobile communication services for the Fire

Department for a mobile data terminal (MDT) in conjunction with Brevard County Computer Aided Dispatch (CAD). The estimated annual spend for these (3) devices totals \$1,440.

The NASPO contract is also utilized for AT&T Mobility services associated with six (6) mobile devices for The Town. The average monthly mobile communication services spend is \$125, pending usage per the plan assigned as well as replacement devices as necessary, totaling an estimated annual spend of \$1,500.

FINANCIAL IMPACT:

FY21 Approved Budget General Government 519.4100 Telephone/Communications Service totals \$2,940 annually for monthly recurring mobile communication services. A one-time expense of \$3,440 for a certified FirstNet Rugged Laptop device expended from 522.5210 Operating Expenses. Total annual spend for the contract is \$6,380.

ATTACHMENTS:

- NASPO Master Agreement: 1583253609_MA149 ATT MA.PDF
- NASPO Contract Amendment 1: 1583253599_MA149 ATT Amendment 1.PDF
- NASPO ATT FirstNet Solution: FirstNet_Attachment_GOV_2017-11-15.PDF
- NASPO AT&T Mobility Products: ATT_NASPO_Mobility_Products_2018-7-27.PDF
- Public Private Partnership Presentation: FirstNet Solution State of Florida.PDF

ACTION OPTIONS:

Motion to utilize the National Association of State Procurement Officials (NASPO) Value Point Program Contract for AT&T FirstNet Solution for Public Safety Wireless Services and Devices.



STATE OF UTAH
CONTRACT AMENDMENT

AMENDMENT # 1 To CONTRACT # MA149-1

TO BE ATTACHED TO AND MADE A PART OF the above numbered contract by and between the State of Utah,
Division of Purchasing referred to as State Entity and, AT&T Corp., referred to as Contractor.

THE PARTIES AGREE TO AMEND THE CONTRACT AS FOLLOWS:

1. Contract period:

12/6/2019 (original starting date)
8/11/2024 (current ending date)
8/11/2024 new ending date

2. Agreed to changes:

The Parties Agree as follows:
Rename the Master Agreement from "MA149-1" to "MA149"

4. Effective Date of Amendment: 2/14/2019

All other conditions and terms in the original contract and previous amendments remain the same.

IN WITNESS WHEREOF, the parties sign and cause the amendment to be executed.

CONTRACTOR

STATE

Linda J Cottingham 02/18/20
Contractor's signature Date

[Signature] Feb 20, 2020
Director, Division of Purchasing Date

Linda J Cottingham - Sr. Contract Manager
Type or Print Name and Title

Christopher Jennings Agency Contact Person
801-957-7151 Telephone Number
N/A Fax Number
ctjennings@utah.gov Email



STATE OF UTAH COOPERATIVE CONTRACT

1. CONTRACTING PARTIES: This contract is between the Division of Purchasing and the following Contractor:

<u>AT&T Corp.</u>	Name	
<u>One AT&T Way</u>	Address	
<u>Bedminster</u>	<u>New Jersey</u>	<u>07921-0752</u>
<u>City</u>	<u>State</u>	<u>Zip</u>

LEGAL STATUS OF CONTRACTOR

- Sole Proprietor
- Non-Profit Corporation
- For-Profit Corporation
- Partnership
- Government Agency

Contact Person Donnie Powell Phone #(214) 208-2353 Email dp1416@att.com
 Vendor #VC0000115383 Commodity Code #72551, 91579

2. GENERAL PURPOSE OF CONTRACT: The general purpose of this contract is to provide: Contractor is permitted to provide wireless solutions identified in the Master Agreement to Participating Entities once a Participating Addendum has been signed.

3. PROCUREMENT: This contract is entered into as a result of the procurement process on Bid#CJ18012.

4. CONTRACT PERIOD: Effective Date: 12/6/2019 Termination Date: 8/11/2024 unless terminated early or extended in accordance with the terms and conditions of this contract. Renewal options (if any): May be extended an additional 5 years.

5. Subject to Master Agreement §1(a), the Master Agreement includes the following:

- ATTACHMENT A: Master Terms and Conditions
- ATTACHMENT AA: Contractor's Special Terms and Conditions
- ATTACHMENT B: Scope of Work
- ATTACHMENT C: Cost Sheet
- ATTACHMENT G: Plan Description
- ATTACHMENT H: Award Category 1 Reporting Template
- ATTACHMENT I: Award Category 2 Reporting Template

- ATTACHMENT J: Award Category 3 Reporting Template
- ATTACHMENT L: Network Technology Questionnaire
- ATTACHMENT M: New Product Request Form
- ATTACHMENT N: New Product Log
- ATTACHMENT S: Security Disclosure
- ATTACHMENT V: Award Category Sheet
- ATTACHMENT W: Award Category Sheet

Any conflicts between Attachment A and the other Attachments will be resolved in favor of Attachment A.

6. DOCUMENTS INCORPORATED INTO THIS CONTRACT BY REFERENCE BUT NOT ATTACHED:

- a. All other governmental laws, regulations, or actions applicable to the goods and/or services authorized by this contract.
- b. Utah State Procurement Code, Procurement Rules, and Contractor's response to Bid #CJ18012.

7. Each signatory below represents that he or she has the requisite authority to enter into this contract.

IN WITNESS WHEREOF, the parties sign and cause this contract to be executed.

CONTRACTOR

STATE

Linda J Cottingham 12/03/19
 Contractor's signature Date

[Signature] Dec 4, 2019
 Director, Division of Purchasing Date

Linda J Cottingham - Sr. Contract Manager
 Type or Print Name and Title

<u>Christopher Jennings</u>	<u>801-538-3157</u>	<u>N/A</u>	<u>ctjennings@utah.gov</u>
Division of Purchasing Contact Person	Telephone Number	Fax Number	Email

**Attachment A:
NASPO ValuePoint Master Agreement Terms and Conditions**



**Attachment A:
NASPO ValuePoint Master Agreement Terms and Conditions**

1. MASTER AGREEMENT ORDER OF PRECEDENCE

a. The Master Agreement consists of the documents set forth in §1(a)(2) through §1(a)(7) below (the "Master Agreement"). A valid Participating Addendum combined with the Master Agreement constitutes the full agreement between Contractor and the corresponding Participating Entity and its Purchasing Entities (the "Agreement"). In the event of any conflicts between the documents comprising the Agreement, the following constitutes the order of precedence:

- (1) The Purchasing Entity's applicable Participating Addendum;
- (2) State of Utah Cooperative Contract Cover Page;
- (3) NASPO ValuePoint Master Agreement Terms & Conditions;
- (4) A Purchase Order issued against the Master Agreement;
- (5) The Specifications or Statement of Work;
- (6) Contractor's response to the Solicitation, as revised (if permitted) and accepted by the Lead State, including Exhibit AA to the Master Agreement (Contractor's Special Terms and Conditions);
- (7) The Solicitation or, if separately executed after award, the Lead State's bilateral agreement that integrates applicable provisions;

b. These documents shall be read to be consistent and complementary. Any conflict among these documents shall be resolved by giving priority to these documents in the order listed above. Contractor terms and conditions that apply to this Master Agreement are only those that are expressly accepted by the Lead State and must be in writing and attached to this Master Agreement as an Exhibit or Attachment.

2. DEFINITIONS

“Acceptable Use Policy” means Contractor’s Acceptable Use Policy which applies to (a) Services provided over or accessing the internet; and (b) wireless (i.e., cellular) data and messaging Services. The AUP can be found at www.att.com/aup or other locations Contractor may designate.

“Acceptance” is defined by the applicable commercial code, except Acceptance shall not occur before the completion of delivery in accordance with the Order, installation if required, and a reasonable time for inspection of the Product.

“Confidential Information” means, except as may be required by applicable law or regulation: (a) information the parties or their Affiliates share with each other in connection with the Agreement or in anticipation of providing Services under this Agreement (including pricing or other proposals), but only to the extent identified as Confidential Information in writing; and (b) the Agreement.

“Contractor” means the person or entity providing solutions under the terms and conditions set forth in this Master Agreement. Contractor also includes its employees, subcontractors, agents and affiliates who are providing the services agreed to under the Master Agreement.

“Embedded Software” means one or more software applications which permanently reside on a computing device.

“Intellectual Property” means any and all patents, copyrights, service marks, trademarks, trade secrets, trade names, patentable inventions, or other similar proprietary rights, in tangible or intangible form, and all rights, title, and interest therein.

“Lead State” means the state centrally administering any resulting Master Agreement(s).

“Master Agreement” has the definition set forth in §1(a) herein.

“NASPO ValuePoint” is the cooperative contracting arm of the National Association of State Procurement Officials (NASPO), a non-profit organization formed in 1947 to promote public procurement throughout the country. NASPO ValuePoint facilitates administration of the NASPO cooperative group contracting consortium of state chief procurement officials for the benefit of state departments, institutions, agencies, and political subdivisions and other eligible entities (i.e., colleges, school districts, counties, cities, some nonprofit organizations, etc.) for all states, the District of Columbia, and territories of the United States. NASPO ValuePoint is identified in the Master Agreement as the recipient of reports and the NASPO ValuePoint administrative fee; and may perform contract administration functions relating to collecting and receiving reports and fees, as well as other contract administration functions as

assigned by the Lead State.

“Order” or “Purchase Order” means any purchase order, sales order, contract or other document used by a Purchasing Entity to order Services and/or Products under the Agreement.

“Participating Addendum” means a bilateral agreement executed by a Contractor and a Participating Entity incorporating this Master Agreement and (A) provisions required under the laws of the corresponding State; and/or (B) provisions mutually agreed upon between such Participating Entity and Contractor.

“Participating Entity” means a state, or other authorized entity that has properly executed a Participating Addendum.

“Participating State” means a state, the District of Columbia, or one of the territories of the United States that is listed in the Request for Proposal as intending to participate. Upon execution of the Participating Addendum, a Participating State becomes a Participating Entity; however, a Participating State listed in the Request for Proposal is not required to participate through execution of a Participating Addendum.

“Product” means any Service, equipment, software (including embedded software), documentation, service or other deliverables supplied or created by Contractor pursuant to this Master Agreement. The terms Product, supplies and services, and products and services are used interchangeably in these terms and conditions.

“Purchasing Entity” means a state (as well as the District of Columbia and U.S territories), city, county, district, other political subdivision of a State, and a nonprofit organization under the laws of some states authorized to place an Order against a Participating Addendum and the Master Agreement.

“Service” means commercial mobile radio services (including, without limitation, Voice Service, Wireless Data Service), and Additional Products provided by Contractor pursuant to the Contract.

“Total Wireless Spend” means, with respect to the Administration Fee, the total amount of the charges set forth on the invoices sent by Contractor to Participating Entities under the Master Agreement, less taxes, fees and surcharges. Regulatory Fees and Surcharges include, but are not limited to, the FUSF/UCC (Federal Universal Service Fee / Universal Connectivity Charge), the AEF (Administrative Expense Fee), the FRF (Federal Regulatory Fee), the PTA (Property Tax Allotment), the FARF (Federal Access Recovery Fee), the CLC (Carrier Line

Charge), and the SLC/EUCL (Subscriber Line Charge / End User Carrier Line charge).

NASPO ValuePoint Program Provisions

3. TERM OF THE MASTER AGREEMENT

a. The initial term of this Master Agreement is for five (5) years. This Master Agreement may be extended beyond the original contract period for up to five (5) additional years by mutual agreement and upon review of requirements of Participating Entities, current market conditions, and Contractor performance.

b. The Master Agreement may be extended for a reasonable period of time in adherence to the Lead State's Procurement Code, if in the judgment of the Lead State a follow-on, competitive procurement will be unavoidably delayed (despite good faith efforts) beyond the planned date of execution of the follow-on master agreement. This subsection shall not be deemed to limit the authority of a Lead State under its state law otherwise to negotiate contract extensions.

4. AMENDMENTS

The terms of this Master Agreement shall not be waived, altered, modified, supplemented or amended in any manner whatsoever without prior written agreement of the Lead State and Contractor.

5. PARTICIPANTS AND SCOPE

a. Contractor may not deliver Products or perform Services under this Master Agreement until a Participating Addendum acceptable to the Participating Entity and Contractor is executed. The NASPO ValuePoint Master Agreement Terms and Conditions are applicable to any Order by a Purchasing Entity, except to the extent altered, modified, supplemented or amended by a Participating Addendum or included in a Purchase Order as expressly required by a Purchasing Entity's laws or regulations. By way of illustration and not limitation, this authority may apply to unique delivery and invoicing requirements, confidentiality requirements, defaults on Orders, governing law and venue relating to Orders by a Participating Entity, indemnification, and insurance requirements. Statutory or constitutional requirements relating to availability of funds may require specific language in some Participating Addenda in order to comply with applicable law. The expectation is that these alterations, modifications, supplements, or amendments will be addressed in the Participating Addendum or, with the consent of the Purchasing Entity and Contractor, may be included in the ordering document (e.g. purchase order or contract) used by the Purchasing Entity to place the Order.

b. Use of specific NASPO ValuePoint cooperative Master Agreements by state agencies, political subdivisions and other Participating Entities (including cooperatives) authorized by individual state's statutes to use state contracts is subject to the approval of the respective State Chief Procurement Official. Issues of interpretation and eligibility for participation are solely within the authority of the respective State Chief Procurement Official.

c. Obligations under this Master Agreement are limited to those Participating Entities who have signed a PA and Purchasing Entities within the scope of those Participating Addenda. States or other entities permitted to participate may use an informal competitive process to determine which Master Agreements to participate in through execution of a Participating Addendum. Financial obligations of Participating Entities who are states are limited to the Orders placed by the departments or other state agencies and institutions having available funds. Participating Entities who are states incur no financial obligations on behalf of other Purchasing Entities. Contractor shall email a fully executed PDF copy of each Participating Addendum to PA@naspovaluepoint.org to support documentation of participation and posting in appropriate data bases.

d. NASPO ValuePoint, a division of the National Association of State Procurement Officials (NASPO), is not a party to the Master Agreement. It is a nonprofit cooperative purchasing organization assisting states in administering the NASPO cooperative purchasing program for state government departments, institutions, agencies and political subdivisions (e.g., colleges, school districts, counties, cities, etc.) for all 50 states, the District of Columbia and the territories of the United States.

e. Participating Addenda shall not be construed to amend the following provisions in this Master Agreement between the Lead State and Contractor that prescribe NASPO ValuePoint Program requirements: Term of the Master Agreement; Amendments; Participants and Scope; Administrative Fee; NASPO ValuePoint Summary and Detailed Usage Reports; NASPO ValuePoint Cooperative Program Marketing and Performance Review; Right to Publish; Price and Rate Guarantee Period; and Individual Customers. Any such language shall be void and of no effect.

f. Participating Entities who are not states may under some circumstances sign their own Participating Addendum, subject to the consent to participation by the Chief Procurement Official of the state where the Participating Entity is located. The Participating Entity must coordinate requests for such participation through NASPO ValuePoint. Any permission to participate through execution of a Participating Addendum is not a determination that procurement authority exists in the Participating Entity; the Participating Entity must ensure that they have the requisite procurement authority to execute a Participating Addendum.

g. Subject to any explicit permission in a PA, Purchasing Entities may not resell Products. Absent any such explicit permission, this limitation does not prohibit: (i) payments by employees of a Purchasing Entity as explicitly permitted under the Agreement; (ii) transfer of tangible Products (not including Service) between public agencies; (iii) sales of tangible Products (not including Service) as surplus property; and (iv) fees associated with inventory transactions with other governmental or nonprofit entities and consistent with a Purchasing Entity's laws and regulations. Any sale or transfer permitted by this subsection must be consistent with license rights granted for use of intellectual property.

6. ADMINISTRATIVE FEES

a. The Contractor shall pay to NASPO ValuePoint, or its assignee, a NASPO ValuePoint Administrative Fee of (i) 0.25% of all CRUs' Total Wireless Spend; and (ii) 0.10% of all IRUs' Total Wireless Spend. The Administrative Fees will be calculated after each calendar quarter and AT&T will pay the quarterly amount due no later than seventy-five (75) days following the end of each calendar quarter. The NASPO ValuePoint Administrative Fee shall be submitted quarterly and is based on Total Wireless Spend. The NASPO ValuePoint Administrative Fee is not negotiable. This fee is to be included as part of the pricing submitted with proposal.

b. Additionally, some states may request an additional fee be paid directly to the state only on purchases made by Purchasing Entities within that state. If AT&T agrees to such a request, then the fee level, payment method and schedule for such reports and payments will be incorporated into the corresponding PA. The Contractor may adjust the Master Agreement pricing accordingly for purchases made by Purchasing Entities within the jurisdiction of the state. All such state-level administrative fees shall not affect the NASPO ValuePoint Administrative Fee percentage or the prices paid by the Purchasing Entities outside the jurisdiction of the state requesting the additional fee.

7. NASPO VALUEPOINT SUMMARY AND DETAILED USAGE REPORTS

In addition to other reports that may be required by this solicitation, the Contractor shall provide the following NASPO ValuePoint reports.

a. **Summary Sales Data.** The Contractor shall submit quarterly sales reports directly to NASPO ValuePoint using the NASPO ValuePoint Quarterly Sales/Administrative Fee Reporting Tool found at <http://calculator.naspovaluepoint.org>, or as otherwise agreed to by the Parties in writing. Any/all sales made under this Master Agreement shall be reported as cumulative totals by state for Government Responsible accounts. A separate report shall be submitted and reported as cumulative totals by state for Individual Responsible (IRU)

accounts. Even if Contractor experiences zero sales during a calendar quarter, a report is still required. Reports shall be due no later than forty-five (45) days following the end of the calendar quarter (as specified in the reporting tool).

b. Detailed Sales Data. Contractor shall also report detailed sales data using the format provided in Attachments H, I, J and K. Reports are due on a quarterly basis and must be received by the Lead State and NASPO ValuePoint no later than forty-five days after the end of the reporting period. Reports shall be delivered to the Lead State and to NASPO ValuePoint electronically through a designated portal, email, CD-ROM, flash drive or other method as determined by the Lead State and NASPO ValuePoint. Detailed sales data reports shall include sales information for all sales under this Master Agreement.

c. Reportable Sales. Reportable sales for the summary sales data report and detailed sales data report includes sales to employees for personal use where authorized by the solicitation and the Participating Addendum. Report data for employees should be limited to ONLY the state and entity they are participating under the authority of (state and agency, city, county, school district, etc.) and the amount of sales. No personal identification numbers, e.g. names, addresses, social security numbers or any other numerical identifier, may be submitted with any report.

d. Executive Summary. Contractor shall provide NASPO ValuePoint with an executive summary each quarter that includes, at a minimum, a list of states with an active Participating Addendum, states that Contractor is in negotiations with and any Participating Addendum roll out or implementation activities and issues. NASPO ValuePoint and Contractor will determine the format and content of the executive summary. The executive summary is due forty-five days after the conclusion of each calendar quarter.

e. Ownership. Timely submission of these reports is a material requirement of the Master Agreement. The recipient of the reports shall have exclusive ownership of the media containing the reports. The Lead State and NASPO ValuePoint shall have a perpetual, irrevocable, non-exclusive, royalty free, transferable right to display, modify, copy, and otherwise use reports, data and information provided under this section.

8. NASPO VALUEPOINT COOPERATIVE PROGRAM MARKETING, TRAINING, AND PERFORMANCE REVIEW

a. Contractor agrees to work cooperatively with NASPO ValuePoint personnel. Contractor agrees to present plans to NASPO ValuePoint for the education of Contractor's contract administrator(s) and sales/marketing workforce regarding the Master Agreement including the competitive nature of NASPO ValuePoint procurements, the Master Agreement, PA process, and the manner in which qualified entities can participate in the Master

Agreement.

b. Contractor agrees, as PAs become executed, if requested by ValuePoint personnel to provide proposals to launch the program within the Participating State. Such proposals will include time frames to launch the Agreement and confirmation that the Contractor's website has been updated to properly reflect the offer as available in the Participating State.

c. Contractor agrees, absent anything to the contrary outlined in a Participating Addendum, to consider the Participating Entity's proposed terms and conditions, as deemed important to the Participating Entity, for possible inclusion into the Participating Addendum. Contractor will ensure that their sales force is aware of this contracting option.

d. Contractor agrees to participate in an annual contract performance review at a location selected by the Lead State and NASPO ValuePoint, which may include a discussion of marketing action plans, target strategies, marketing materials, as well as Contractor reporting and timeliness of payment of Administrative Fees.

e. Contractor acknowledges that the NASPO ValuePoint logos may not be used by Contractor in sales and marketing until a logo use agreement is executed with NASPO ValuePoint.

f. The Lead State expects to evaluate the utilization of the Master Agreement at the annual performance review. Lead State may, in its discretion, cancel the Master Agreement pursuant to section 28, or not exercise an option to renew, when Contractor utilization does not warrant further administration of the Master Agreement. The Lead State may exercise its right to not renew the Master Agreement if vendor fails to record or report revenue for three consecutive quarters, upon 60-calendar day written notice to the Contractor. Cancellation based on nonuse or under-utilization will not occur sooner than one year after award (or execution if later) of the Master Agreement. This subsection does not limit the discretionary right of either the Lead State or Contractor to cancel the Master Agreement pursuant to section 28 or to terminate for default pursuant to section 30.

g. Contractor agrees to notify the Lead State and NASPO ValuePoint of any contractual most-favored-customer provisions in third-party contracts or agreements that may affect the promotion of this Master Agreements or whose terms provide for adjustments to future rates or pricing based on rates, pricing in, or Orders from this master agreement. Upon request of the Lead State or NASPO ValuePoint, Contractor shall provide a copy of any such provisions.

9. [RESERVED]

10. RIGHT TO PUBLISH

Throughout the duration of this Master Agreement, Contractor must secure from the Lead State prior approval for the release of information that pertains to the potential work or activities covered by the Master Agreement. This limitation does not preclude publication about the award of the Master Agreement or marketing activities consistent with any proposed and accepted marketing plan. The Contractor shall not make any representations of NASPO ValuePoint's opinion or position as to the quality or effectiveness of the services that are the subject of this Master Agreement without prior written consent. Failure to adhere to this requirement may result in termination of the Master Agreement for cause.

11. PRICE AND RATE GUARANTEE PERIOD

All prices and rates must be guaranteed for the initial term of the Master Agreement. Following the initial Master Agreement period, any request for price or rate increase must be for an equal guarantee period and must be made at least (90 Days) days prior to the requested effective date. Requests for price or rate increases must include sufficient documentation supporting the request. Any such adjustment or amendment to the Master Agreement shall not be effective unless approved by the Lead State. No retroactive adjustments to prices or rates will be allowed.

12. INDIVIDUAL CUSTOMERS

Except to the extent modified by a Participating Addendum, each Purchasing Entity shall follow the terms and conditions of the Master Agreement and applicable Participating Addendum and will have the same rights and responsibilities for their purchases as the Lead State has in the Master Agreement, including but not limited to, any indemnity or right to recover any costs as such right is defined in the Master Agreement and applicable Participating Addendum for their purchases. Each Purchasing Entity is responsible for its own charges, fees, and liabilities. The Contractor will apply the charges and invoice each Purchasing Entity individually.

Administration of Orders

13. ORDERING

- a. Contractor shall provide, by phone or online system, a means and method for providing Order reference numbers and tracking orders.
- b. Purchasing Entities may define entity or project-specific requirements and

informally compete the requirement among companies having a Master Agreement on an “as needed” basis. This procedure may also be used when requirements are aggregated, or other firm commitments may be made to achieve reductions in pricing. This procedure may be modified in Participating Addenda and adapted to the Purchasing Entity’s rules and policies. The Purchasing Entity may in its sole discretion determine which NASPO Contractors should be solicited for a quote. The Purchasing Entity may select the quote that it considers most advantageous, cost and other factors considered.

c. Each Purchasing Entity will identify and utilize its own appropriate purchasing procedure and documentation. Contractor is expected to become familiar with each Purchasing Entity’s rules, policies, and procedures regarding the ordering of supplies and/or services contemplated by this Master Agreement.

d. Contractor shall not begin work without a valid Purchase Order or other appropriate commitment document under the law of the Purchasing Entity.

e. Purchase Orders may be placed consistent with the terms of this Master Agreement during the term of the Master Agreement.

f. All Purchase Orders placed pursuant to an Agreement, at a minimum, shall include:

- (1) The Products being ordered;
- (2) The date of the Purchase Order;
- (3) The place and requested time of delivery;
- (4) A billing address;
- (5) The name, phone number, and address of the Purchasing Entity representative;
- (6) The price per hour or other pricing elements consistent with this Master Agreement and the contractor’s proposal;
- (7) A ceiling amount of the Purchasing Order for Products being ordered; and
- (8) The Master Agreement identifier.

g. All communications concerning administration of Purchasing Orders placed shall be furnished solely to the authorized purchasing agent within the Purchasing Entity’s purchasing office, or to such other individual identified in writing in the Purchase Order.

h. Purchase Orders must be placed pursuant to this Master Agreement prior to the termination date thereof but may have a delivery date or performance period up to 120 days

past the then-current termination date of this Master Agreement. Contractor is reminded that financial obligations of Purchasing Entities payable after the current applicable fiscal year are contingent upon agency funds for that purpose being appropriated, budgeted, and otherwise made available.

i. Notwithstanding the expiration, cancellation or termination of this Master Agreement, Contractor agrees to perform in accordance with the terms of any Purchasing Orders then outstanding at the time of such expiration or termination. Contractor shall not honor any Purchase Orders placed after the expiration, cancellation or termination of this Master Agreement, or otherwise inconsistent with its terms. Purchase Orders from any separate indefinite quantity, task orders, or other form of indefinite delivery order arrangement priced against this Master Agreement may not be placed after the expiration or termination of this Master Agreement, notwithstanding the term of any such indefinite delivery order agreement.

14. SHIPPING AND DELIVERY

a. The prices are the delivered price to any Purchasing Entity. All deliveries shall be F.O.B. destination, freight pre-paid, with all transportation and handling charges paid by the Contractor. The minimum shipment amount, if any, will be found Exhibit AA. Any order for less than the specified amount is to be shipped with the freight prepaid and added as a separate item on the invoice. Any portion of an Order to be shipped without transportation charges that is back ordered shall be shipped without charge.

b. In the event a Participating Entity intends to negotiate for Inside Deliveries, AT&T agrees to negotiate in good faith with such Participating Entity to include corresponding language in its PA.

c. All products must be delivered in the manufacturer's standard package. Costs shall include all packing and/or crating charges. Cases shall be of durable construction, good condition, properly labeled and suitable in every respect for storage and handling of contents. Each shipping carton shall be marked with the commodity, brand, quantity, item code number and the Purchasing Entity's Purchase Order number.

15. LAWS AND REGULATIONS

Any and all Products offered and furnished shall comply fully with all applicable Federal and State laws and regulations.

16. INSPECTION AND ACCEPTANCE

a. Where the Master Agreement or an Order does not otherwise specify a process

for inspection and Acceptance, this section governs. This section is not intended to limit rights and remedies under the applicable commercial code.

b. All Products are subject to inspection at reasonable times and places before Acceptance. Contractor shall provide right of access to the Lead State, or to any other authorized agent or official of the Lead State or other Participating or Purchasing Entity, at reasonable times, in order to monitor and evaluate performance, compliance, and/or quality assurance requirements under this Master Agreement. Products that do not meet specifications may be rejected. Failure to reject upon receipt, however, does not relieve the Contractor of liability for material (nonconformity that substantial impairs value) latent or hidden defects subsequently revealed when goods are put to use. Acceptance of such goods may be revoked in accordance with the provisions of the applicable commercial code, and the Contractor is liable for any resulting expense incurred by the Purchasing Entity related to the preparation and shipping of Product rejected and returned, or for which Acceptance is revoked.

c. If any Products or Services performed do not conform to Master Agreement requirements, the Purchasing Entity may require the Contractor to provide the Products and/or perform the Services again in conformity with Master Agreement requirements, at no increase in Order amount. When defects cannot be corrected by re-performance, the Purchasing Entity may require the Contractor to take necessary action to ensure that future performance conforms to Master Agreement requirements; and reduce the Master Agreement price to reflect the reduced value of the Products provided and/or the Services performed.

d. The warranty period shall begin upon delivery except as otherwise set forth in a statement of work.

e. Acceptance Testing may be explicitly set out in a Scope of Work ("SOW") to ensure conformance to an explicit standard of performance. Acceptance Testing means the process set forth in the Master Agreement or SOW for ascertaining that the Product meets the standard of performance prior to Acceptance by the Purchasing Entity. Unless otherwise set forth in a SOW, this subsection applies to applicable Products purchased under this Master Agreement, including any additional, replacement, or substitute Product(s) and any Product(s) which are modified by or with the written approval of Contractor after Acceptance by the Purchasing Entity. The Acceptance Testing period shall be thirty (30) calendar days or other time period identified in this Master Agreement or the Participating Addendum, starting from the day after the Product is delivered or, if installed, the day after the Product is installed and Contractor certifies that the Product is ready for Acceptance Testing. If the Product does not meet the standard of performance during the initial period of Acceptance Testing, Purchasing

Entity may, at its discretion, continue Acceptance Testing on a day-to-day basis until the standard of performance is met. Upon rejection, the Contractor will have fifteen (15) calendar days to cure the standard of performance issue(s). If after the cure period, the Product still has not met the standard of performance, the Purchasing Entity may, at its option: (a) declare Contractor to be in breach and terminate the Order; (b) demand replacement Product from Contractor at no additional cost to Purchasing Entity; or, (c) continue the cure period for an additional time period agreed upon by the Purchasing Entity and the Contractor. Contractor shall pay all costs related to the preparation and shipping of Product returned pursuant to the section. No Product shall be deemed Accepted and no charges shall be paid until the standard of performance is met. The warranty period shall begin upon Acceptance.

17. PAYMENT

a. Payment. Each Purchasing Entity must pay all charges, including, without limitation, airtime, roaming, recurring monthly service, optional feature charges, license fees, toll, collect call and directory assistance charges, Service charges, Equipment charges, Additional Products charges, and any other charges or calls billed to its CRUs' phone number. Purchasing Entities may be billed for multiple types of usage simultaneously. Purchasing Entities must also pay administrative and late payment fees, restoral and reactivation charges, and any Other Monthly Charges (as defined in Attachment AA, Contractor's Special Terms and Conditions, §9). For any termination of a CRU account (including when a Number is switched to another carrier), Purchasing Entity will be responsible for payment of all fees and charges through the end of the billing cycle in which termination occurs. Payment is due within forty-five (45) days after the date of the invoice.

b. Taxes. Subject to this §17(b), Purchasing Entities must pay applicable taxes and governmental fees regardless of whether they are imposed on a Purchasing Entity, a CRU, Contractor, or Carrier. Notwithstanding the foregoing, Contractor acknowledges that in certain instances, a Purchasing Entity may be tax-exempt. Contractor will accord the proper tax-exempt status to each Purchasing Entity that properly establishes such status. Notwithstanding this tax-exempt status, each Purchasing Entity must pay any and all taxes, fees, surcharges and other charges incurred under the Agreement not covered by its tax-exempt status.

c. Overdue Account Charges. Payment after Acceptance is normally made within forty-five (45) days following the date of the invoice is received, whichever is later. After forty-five (45) days the Contractor may assess overdue account charges up to a maximum rate of one percent per month on the outstanding balance, unless a different late payment amount is specified in a Participating Addendum, Order, or otherwise prescribed by applicable law.

d. Purchasing Card. Payments will be remitted by mail or by electronic fund

transfer (EFT). Payments may be made via a State or political subdivision "Purchasing Card" with no additional charge.

18. WARRANTY

18.1 General. Contractor warrants that all services, deliverables, and/or work product under this Contract shall be completed in a workmanlike manner consistent with standards in the trade, profession, or industry. Except as specifically set forth above or expressly set forth in a scope of work for services, Contractor makes no representations or warranties, express or implied, and specifically disclaims any representation or warranty of merchantability, fitness for a particular purpose, title, non-infringement or any warranty arising by usage of trade or course of dealing. Further, Contractor makes no representation or warranty that wireless calls or other transmissions will be routed or completed without error or interruption (including calls to 911 or any similar emergency response number), or guarantee regarding network security, the encryption employed by any service, the integrity of any data that is sent, backed up, stored or subject to load balancing, or that contractor's security procedures will prevent the loss or alteration of, or improper access to, a Participating Entity's data and information. Contractor does not authorize anyone to make a warranty of any kind on its behalf, and Participating Entities should not rely on anyone making such statements. Contractor is not the manufacturer of equipment purchased by or provided to participating entities in connection with use of the service. Notwithstanding the foregoing, Contractor will pass through any and all manufacturer's warranty to the fullest extent allowed under law.

18.2 No Optimization Warranty. Notwithstanding any other provision in the Agreement including, without limitation, Contractor's response to RFP Attachment B, §6.1.3 Contractor, the Lead State, NASPO, and any and all Participating Entities and Purchasing Entities under the Agreement hereby acknowledge and agree (a) that nothing in the Agreement, including the RFP, the Solicitation, and/or Contractor's response to the Solicitation, requires Contractor to provide an Optimization, Optimization Reports, suggestions, or guidance about ways to use or change Services or Products to Optimize, reduce or otherwise lessen a Purchasing Entity's charges incurred under the Agreement; and (b) that for any analysis or reporting that AT&T provides, there is no contractual guarantee or any other legally enforceable right that the reporting will Optimize, reduce or otherwise lessen a Purchasing Entity's charges incurred under the Agreement.

18.3 Optimization. The Parties acknowledge and agree that, notwithstanding any industry or other definition, the contents of an optimization report hereunder shall be defined as follows: "Optimize" or "Optimization Report" means an individual Purchasing Entity working with Contractor to find a plan best suited to the most effective use of Contractor's Service without any guarantee of cost savings or other advantage by Contractor.

19. TITLE OF PRODUCT

Upon Acceptance by the Purchasing Entity, Contractor shall convey to Purchasing Entity title to the Product free and clear of all liens, encumbrances, or other security interests. Contractor grants to the Purchasing Entity a non-exclusive, royalty free, perpetual license to use the Embedded Software to achieve the purposes of the Master Agreement. If Purchasing Entity subsequently transfers title of the Product to another entity, Purchasing Entity shall have the right to transfer the license to use the Embedded Software with the transfer of Product title. A subsequent transfer of this software license shall be at no additional cost or charge to either Purchasing Entity or Purchasing Entity's transferee.

20. LICENSE OF PRE-EXISTING INTELLECTUAL PROPERTY

Software, Purchased Equipment and Third-Party Services may be provided subject to the terms of a separate license or other agreement between the Purchasing Entity and either the licensor, the third-party service provider or the manufacturer to which the Contractor is not a Party. Upon request by the Purchasing Entity, Contractor shall provide to the Purchasing Entity a copy of all applicable license agreements relating to the placement of an Order for Software, Purchased Equipment or Third-Party Services. The Purchasing Entity's use of Software, Purchased Equipment or Third-Party Services is that Purchasing Entity's agreement to comply with such separate license, unless prohibited by law.

General Provisions

21. INSURANCE

a. Unless otherwise agreed in a Participating Addendum, Contractor shall, during the term of this Master Agreement, maintain in full force and effect, the insurance described in this section. Contractor shall acquire such insurance from an insurance carrier or carriers eligible to conduct business in each Participating Entity's state and having a rating of A-, Class VII or better, in the most recently published edition of A.M. Best's Insurance Reports. Failure to buy and maintain the required insurance may result in this Master Agreement's termination or, at a Participating Entity's option, result in termination of its Participating Addendum.

b. Required Coverage shall be written on an occurrence basis. The acceptable limits shall be as indicated below:

- (1) Commercial General Liability per ISO CG form 00 01 or equivalent covering premises operations, independent contractors, products and completed operations, blanket contractual liability, personal injury (including death), advertising liability, and property damage, with a limit of \$1 million per

occurrence/\$2 million general aggregate;

(2) Contractor must comply with any applicable State Workers Compensation or Employers Liability Insurance requirements.

c. Contractor shall pay premiums on all insurance policies. Contractor shall provide written notice to a Participating Entity, with thirty days' notice of cancellation or nonrenewal of any required coverage that is not replaced or fails to meet the requirements set forth herein.

d. Prior to commencement of performance, Contractor shall provide to the Lead State a written endorsement to the Contractor's general liability insurance policy or other documentary evidence acceptable to the Lead State that (1) includes the Participating States identified in the Request for Proposal as additional insureds, and provides that the Contractor's required commercial general liability insurance policy shall be primary, with any liability insurance of any Participating State as secondary and noncontributory. Unless otherwise agreed in any Participating Addendum, other state Participating Entities' rights and Contractor's obligations are the same as those specified in the first sentence of this subsection except the endorsement is provided to the applicable state. Contractor may self-insure any required coverage and will notify Lead State with written notice thirty (30) calendar days in advance. In the event that Contractor opts to self-insure, Contractor shall comply with reasonable requests for information from Lead State's risk managers.

e. Contractor shall furnish to the Lead State copies of certificates of all required insurance in a form sufficient to show required coverage within thirty (30) calendar days of the execution of this Master Agreement and prior to performing any work. Copies of renewal certificates of all required insurance shall be furnished within thirty (30) days after any renewal date to the applicable state Participating Entity. Failure to provide evidence of coverage may, at the sole option of the Lead State, or any Participating Entity, result in this Master Agreement's termination or the termination of any Participating Addendum.

f. Coverage and limits shall not limit Contractor's liability and obligations under this Master Agreement, any Participating Addendum, or any Purchase Order.

22. RECORDS ADMINISTRATION AND AUDIT

a. The Contractor shall maintain books, records, documents, and other evidence pertaining to this Master Agreement and Orders placed by Purchasing Entities under it to the extent and in such detail as shall adequately reflect the accuracy of AT&Ts invoices to the Participating Entities and corresponding Administrative Fees. Contractor may redact from the

billing records provided to Participating Entity any information that reveals the identity or non-public information of other Contractor customers or other Contract Confidential Information that is not relevant to the purposes of the review, performance and administration of payments and fees. Once every twelve (12) months during the term of the Agreement, the State may review AT&T's relevant billing records for a period not to exceed the preceding twelve (12) months; except the State may conduct, at its own expense, additional audits required by a separate auditing body within the State as part of its routine audits or as a result of an investigation. Contractor shall permit the Lead State, a Participating Entity, a Purchasing Entity, the federal government (including its grant awarding entities and the U.S. Comptroller General), and any other duly authorized agent of a governmental agency, to audit, inspect, examine, copy and/or transcribe Contractor's books, billing, documents, papers and records directly pertinent to this Master Agreement or orders placed by a Purchasing Entity under it for the purpose of making audits, examinations, excerpts, and transcriptions. The State may employ such assistance, as it deems desirable to conduct such reviews, but may not employ the assistance of any entity that derives a substantial portion of its revenues from the provision of services that are substantially similar to the Services provided hereunder or any person who has previously made prohibited use of AT&T's Confidential Information. This right shall survive for a period of five (5) years following termination of this Agreement or final payment for any order placed by a Purchasing Entity against this Agreement, whichever is later, or such longer period as is required by the Purchasing Entity's state statutes, to assure compliance with the terms hereof or to evaluate performance hereunder.

b. Without limiting any other remedy available to any governmental entity, the Contractor shall correct any billing error that is revealed in a billing review, including refunding any overpayment by reimburse the applicable Lead State, Participating Entity, or Purchasing Entity for any overpayments inconsistent with the terms of the Master Agreement or Orders or underpayment of fees found as a result of the examination of the Contractor's records in the form of a credit within two (2) full billing cycles, and/or (ii.) invoice the State any underpayments as soon as reasonably practicable under the circumstances.

c. The rights and obligations herein exist in addition to any quality assurance obligation in the Master Agreement requiring the Contractor to self-audit Master Agreement obligations and that permits the Lead State to review compliance with those obligations.

23. CONFIDENTIALITY, NON-DISCLOSURE, AND INJUNCTIVE RELIEF

a. **Confidentiality.** The Parties acknowledge that they and their employees or agents may, in the course of performing under this Master Agreement, be exposed to or acquire information that is confidential or proprietary to the other party. Any and all information of any form that is marked as confidential or proprietary or would by its nature be deemed confidential or proprietary, including, but not limited to, (1) business records, (2)

personnel records, and (3) personally identifying information, shall be considered confidential or proprietary information. Any reports or other documents or items (including software) that result from the use of the confidential or proprietary information by a party shall be treated in the same manner as the confidential or proprietary information. Confidential or proprietary information does not include information that (A) is or becomes publicly known; (B) is rightfully in a party's possession without the obligation of nondisclosure prior to the time of its disclosure under this Master Agreement; or (C) is disclosed with the written consent of the other party. Pursuant to relevant public records law, information or documents the Lead State or Purchasing Entity receives from Contractor may be open to public inspection and copying. The Lead State or Purchasing Entity may have the duty to disclose unless a particular record falls within an exemption. Contractor may label specific documents or verbally indicate in presentations or meetings, including specific portions thereof, as a "confidential" or "proprietary" in accordance with relevant public records law.

b. Non-Disclosure. Except as may be required by law, the Parties shall hold Confidential Information in confidence, using at least the industry standard of confidentiality, and shall not copy, reproduce, sell, assign, license, market, transfer or otherwise dispose of, give, or disclose Confidential Information to third-parties or use Confidential Information for any purposes whatsoever other than what is necessary to the performance of Orders placed under this Master Agreement. The Parties and Purchasing Entities shall advise each of its employees and agents of their obligations to keep Confidential Information confidential. Contractor shall use commercially reasonable efforts to assist Purchasing Entity in identifying and preventing any unauthorized use or disclosure of any Confidential Information. Without limiting the generality of the foregoing, each Party and each Purchasing Entity shall advise the other Party and/or Purchasing Entity, the applicable Participating Entity, and the Lead State immediately if such Party learns or has reason to believe that any person who has had access to Confidential Information has violated or intends to violate the terms of this Master Agreement, and such Party shall at its expense cooperate with the others in seeking injunctive or other equitable relief in the name of the Purchasing Entity, Participating Entity or Party against any such person. Except as directed by a Party the other Party, any Purchasing Entity and the applicable Participating Entity will not at any time during or after the term of this Master Agreement disclose, directly or indirectly, any Confidential Information to any person, except in accordance with this Master Agreement, and that upon termination of this Master Agreement or at Purchasing Entity's request, such Party shall turn over to the other Party, the Purchasing Entity and/or the applicable Participating Entity all documents, papers, and other matter in such Party's, Purchasing Entity's, or Participating Entity's possession that embody Confidential Information. Notwithstanding the foregoing, a Party, a Purchasing Entity and a Participating Entity may keep one copy of such Confidential Information necessary for quality assurance, audits and evidence of the performance of this Master Agreement.

c. Injunctive Relief. The Parties acknowledges that breach of this section, including disclosure of any Confidential Information, will cause irreparable injury to a Party and/or a Purchasing Entity that is inadequately compensable in damages. Accordingly, a Party, Purchasing Entity, and/or Participating Entity may seek and obtain injunctive relief against the breach or threatened breach of the foregoing undertakings, in addition to any other legal remedies that may be available. The Parties, all Purchasing Entities, and all Participating Entities acknowledges and agrees that the covenants contained herein are necessary for the protection of the legitimate business interests of such entities and are reasonable in scope and content.

d. Public Disclosure Laws. These provisions shall be applicable only to the extent they are not in conflict with the applicable public records law of the Lead State or Purchasing Entity.

e. Extension of Rights. The rights granted under this section 23 shall also extend to NASPO ValuePoint's Confidential Information, defined to include Participating Addenda, as well as Orders or transaction data relating to Orders under this Master Agreement that identify the Participating Entity, Purchasing Entity, Order dates, line item descriptions and volumes, and prices/rates. This provision does not apply to disclosure to the Lead State, a Participating State, or any governmental entity exercising an audit, inspection, or examination pursuant to §22. To the extent permitted by law, a Party, Purchasing Entity, Participating Entity, and/or NASPO ValuePoint shall notify the affected entity of the identify of any entity seeking access to the Confidential Information described in this subsection.

f. Consents. Participating Entities are deemed to have consented to the sharing of customer proprietary network information (CPNI) and account information with the Lead State and NASPO ValuePoint as a condition of utilizing this Master Agreement with its associated pricing. Said information will only be used for purposes of calculating the administrative fees to which NASPO ValuePoint may be entitled for administering this contract. Where such information is required by any Participating State, which may impose its own administrative fee, such information may also only be used by it for purposes of calculating the administrative fee to which it may be entitled.

24. PUBLIC INFORMATION

This Master Agreement and all related documents are subject to disclosure pursuant to the Purchasing Entity's public information and public records laws.

25. ASSIGNMENT/SUBCONTRACTS

a. Assignment. Contractor shall not assign, sell, transfer, subcontract or sublet

rights, or delegate responsibilities under this Master Agreement, in whole or in part, without the prior written approval of the Lead State. Such approval shall not be unreasonably withheld. Notwithstanding the foregoing, prior written approval of the Lead State is not necessary for changes in control of Contractor, including mergers or acquisitions, or for subcontracts necessary to support Contractor's regular operations. Upon request from the Lead State or a Participating Entity, changes in control, including mergers or acquisitions may require the execution of a mutually agreeable assignment agreement between the Parties. If the Lead State or a Participating Entity is unable to execute an assignment agreement subject to a legal restriction or lack of legally required approval, the Participating Entity may terminate its Participating Addendum upon thirty (30) days' written notice to Contractor.

b. Reservation of Rights. The Lead State reserves the right to assign any rights or duties, including written assignment of contract administration duties to NASPO ValuePoint and other third parties.

26. CHANGES IN CONTRACTOR REPRESENTATION

The Contractor must notify the Lead State of changes in the Contractor's key administrative personnel managing the Master Agreement in writing within ten (10) calendar days of the change. The Contractor agrees to propose replacement key personnel having substantially equal or better education, training, and experience as was possessed by the key person proposed and evaluated in the Contractor's proposal.

27. INDEPENDENT CONTRACTOR

The Contractor shall be an independent contractor. Contractor shall have no authorization, express or implied, to bind the Lead State, Participating States, other Participating Entities, or Purchasing Entities to any agreements, settlements, liability or understanding whatsoever, and agrees not to hold itself out as agent except as expressly set forth herein or as expressly agreed in any Participating Addendum.

28. CANCELLATION

a. General. Unless otherwise stated, this Master Agreement may be canceled by either Party upon sixty (60) days' written notice prior to the effective date of the cancellation. Further, any Participating Entity may cancel its participation upon thirty (30) days' written notice, unless otherwise limited or stated in the Participating Addendum. Cancellation may be in whole or in part. Any cancellation under this provision shall not affect the rights and obligations attending Orders outstanding at the time of cancellation, including any right of a Purchasing Entity to indemnification by the Contractor, rights of payment for Products or Services delivered and accepted, rights attending any warranty or default in

performance in association with any Order, and requirements for records administration and audit.

b. Termination/Suspension.

(i) This Agreement may be terminated immediately upon notice by either party if the other party becomes insolvent, ceases operations, is the subject of a bankruptcy petition, enters receivership or any state insolvency proceeding or makes an assignment for the benefit of its creditors.

(ii) The following additional termination and/or suspension provisions apply:

(A) **Material Breach.** If either party commits and Event of Default (see §31(a)(i)) fails to perform or observe any material warranty, representation, term or condition of the Master Agreement, including non-payment of charges, and such failure continues un-remedied for thirty (30) days after receipt of notice, the aggrieved party may terminate (and Contractor may suspend and later terminate) the affected Service components and, if the breach materially and adversely affects the entire Master Agreement, terminate (and Contractor may suspend and later terminate) the entire Master Agreement.

(B) **Materially Adverse Impact.** If Contractor revises a Service Guide, the revision has a materially adverse impact on Participating Entity and Contractor does not affect revisions that remedy such materially adverse impact within thirty (30) days after receipt of notice from Participating Entity, then Participating Entity may, as Participating Entity's sole remedy, elect to terminate the affected Service components on thirty (30) days' notice to Contractor, given not later than ninety (90) days after Participating Entity first learns of the revision to the Service Guide. "Materially adverse impacts" do not include changes to non-stabilized pricing, changes required by governmental authority, or assessment of or changes to additional charges such as surcharges or taxes.

(C) **Internet Services.** If Participating Entity fails to rectify a violation of the AUP within fifteen (15) days after receiving notice from Contractor, Contractor may suspend the affected Service components. Contractor reserves the right, however, to suspend or terminate immediately when: (1) Contractor's suspension or termination is in response to multiple or repeated AUP violations or complaints; (2) Contractor is acting in response to a court order or governmental notice that certain conduct must be stopped; or (3) Contractor reasonably determines that (x) it may be exposed to sanctions, liability, prosecution or other adverse consequences under applicable law if Contractor were to allow the violation to continue; (y) such violation may harm or interfere with the integrity, normal operations or security of Contractor's network or networks with which Contractor is interconnected or may interfere with another customer's use of Contractor services or the Internet; or (z) such violation otherwise presents an imminent risk of harm to Contractor,

Contractor's customers or its or their respective employees.

(D) **Fraud or Abuse.** Contractor may terminate or suspend an affected Service or Service component if a corresponding Purchasing Entity, in the course of breaching the Agreement: (1) commits a fraud upon Contractor; (2) uses the Service to commit a fraud upon another party; (3) unlawfully uses the Service; (4) abuses or misuses Contractor's network or Service; or (5) interferes with another customer's use of Contractor's network or services.

(E) **Infringing Services.** If the options described in §34 are not reasonably available, Contractor may at its option terminate the affected Services or Service components without liability other than as stated in §34.

(F) **Hazardous Materials.** If Contractor encounters any hazardous materials at the site, Contractor may terminate the affected Services or Service components or may suspend performance until Purchasing Entity removes and remediates the hazardous materials at Purchasing Entity's expense in accordance with applicable law.

(G) **Non-Appropriations of Funding.** If Purchasing Entity is a government entity dependent on government funding, by participating in this Master Agreement, Purchasing Entity agrees that Purchasing Entity has funds appropriated and available to pay all amounts due hereunder through the end of Purchasing Entity's current fiscal period. In the event Purchasing Entity is unable to obtain the necessary appropriations or funding for the Products provided under this Master Agreement, Purchasing Entity may terminate the Products without liability for the Termination Charges set forth in this §28 upon the following conditions: (1) Purchasing Entity has taken appropriate actions necessary to obtain adequate appropriations or funding; and (2) despite Purchasing Entity's best efforts funds have not been appropriated and are otherwise unavailable to pay for the Services. Purchasing Entity must provide Contractor thirty (30) days' written notice of its intent to terminate the Services under this section. Termination of the Products for failure to obtain necessary appropriations or funding shall be effective as of the last day for which funds were appropriated or otherwise made available. If Purchasing Entity terminates the Products under this Master Agreement under this section, Purchasing Entity agrees as follows: (x) it will pay all amounts due for Services incurred through date of termination, and reimburse all unrecovered non-recurring charges; and (y) it will not contract with any other provider for the same or substantially similar services or equipment for the immediately subsequent, non-funded, fiscal year.

(H) This Master Agreement may be terminated by either the Lead State or Contractor upon sixty (60) days' written notice prior to the effective date of the termination. Termination may be in whole or in part. Further, Contracting and a Participating Entity may, but are not required to, negotiate mutually acceptable termination for convenience language in their corresponding Participating Addendum.

(l) Any termination under this §28 shall not affect the rights and obligations attending orders outstanding at the time of termination, including any right of any Purchasing Entity to indemnification by the Contractor, rights of payment for Products provided and accepted, data ownership, Contractor obligations regarding Purchasing Entity's data, and any responsibilities arising out of a Security Incident or Data Breach. Termination of the Master Agreement due to Contractor default may be immediate.

c. Effect of Termination.

(i) Termination or suspension by either party of a Service or Service component does not waive any other rights or remedies a party may have under this Agreement and will not affect the rights and obligations of the parties regarding any other Service or Service component.

(ii) If a Service or Service component is terminated, Purchasing Entity will pay all amounts incurred prior to the effective date of termination.

d. Termination Charges.

(i) If Lead State terminates this Master Agreement or an affected Service or Service component for cause, or for non-appropriation (under §29(b)(ii)(G)) in accordance with the Agreement then Lead State will not be liable for termination charges.

(ii) If a Participating Entity terminates its PA or an affected Service or Service component for cause or for non-appropriation (under §29(b)(ii)(G)) in accordance with the Master Agreement, then that Participating Entity and its corresponding Purchasing Entities will not be liable for termination charges.

(iii) If a Purchasing Entity terminates an affected Service or Service component for cause or for non-appropriation (under §29(b)(ii)(G)) in accordance with the Agreement, then Purchasing Entity will not be liable for termination charges.

(iv) If Contractor terminates an affected Service or Service component for cause, then the corresponding Participating Entity or Purchasing Entity (as applicable depending on which entity is financially responsible for the affected Service or Service component), is liable for termination charges.

29. LIMITATIONS OF LIABILITY AND DISCLAIMERS

a. Limitation of Liability. For purposes of this §29 only, the term "Party," means the Lead State, the Participating Entity, and/or the Purchasing Entity on the one hand and means AT&T on the other.

(1) EITHER PARTY'S ENTIRE LIABILITY AND THE OTHER PARTY'S EXCLUSIVE REMEDY FOR DAMAGES ON ACCOUNT OF ANY CLAIM ARISING OUT OF AND NOT DISCLAIMED

UNDER THIS AGREEMENT SHALL BE:

(A) FOR BODILY INJURY, DEATH OR DAMAGE TO REAL PROPERTY OR TO TANGIBLE PERSONAL PROPERTY PROXIMATELY CAUSED BY A PARTY'S NEGLIGENCE, PROVEN DIRECT DAMAGES;

(B) FOR BREACH OF §23 (Confidential Information), PROVEN DIRECT DAMAGES;

(C) FOR ANY THIRD-PARTY CLAIMS, THE REMEDIES AVAILABLE UNDER §34 (Third Party Claims);

(D) FOR CLAIMS ARISING FROM THE OTHER PARTY'S GROSS NEGLIGENCE OR WILLFUL MISCONDUCT, PROVEN DAMAGES; OR

(E) FOR CLAIMS OTHER THAN THOSE SET FORTH IN §29 (a)(i) (A)-(D), PROVEN DIRECT DAMAGES NOT TO EXCEED, ON AN AGGREGATE BASIS DURING ANY TWELVE (12) MONTH PERIOD, AN AMOUNT EQUAL TO TWO TIMES THE TOTAL NET CHARGES INCURRED BY A PURCHASING ENTITY DURING THAT TWELVE (12) MONTH TIME-PERIOD UNDER A CORRESPONDING PARTICIPATING ADDENDUM OR \$3,000,000.00, WHICHEVER IS GREATER.

(2) EXCEPT AS SET FORTH IN §34 (Third-Party Claims) OR IN THE CASE OF A PARTY'S GROSS NEGLIGENCE OR WILLFUL MISCONDUCT, NEITHER PARTY WILL BE LIABLE TO THE OTHER PARTY FOR ANY INDIRECT, INCIDENTAL, CONSEQUENTIAL, PUNITIVE, RELIANCE OR SPECIAL DAMAGES, INCLUDING WITHOUT LIMITATION DAMAGES FOR LOST PROFITS, ADVANTAGE, SAVINGS OR REVENUES OR FOR INCREASED COST OF OPERATIONS.

(3) THE LIMITATIONS IN THIS §29 SHALL NOT LIMIT PURCHASING ENTITY'S RESPONSIBILITY FOR THE PAYMENT OF ALL PROPERLY DUE CHARGES UNDER THIS AGREEMENT.

b. Disclaimer of Liability. CONTRACTOR WILL NOT BE LIABLE FOR ANY DAMAGES ARISING OUT OF OR RELATING TO: INTEROPERABILITY, ACCESS OR INTERCONNECTION OF THE SERVICES WITH APPLICATIONS, DATA, EQUIPMENT, SERVICES, CONTENT OR NETWORKS PROVIDED BY PURCHASING ENTITY OR THIRD PARTIES; SERVICE DEFECTS, SERVICE LEVELS, DELAYS OR ANY SERVICE ERROR OR INTERRUPTION, INCLUDING INTERRUPTIONS OR ERRORS IN ROUTING OR COMPLETING ANY 911 OR OTHER EMERGENCY RESPONSE CALLS OR ANY OTHER CALLS OR TRANSMISSIONS (EXCEPT FOR CREDITS EXPLICITLY SET FORTH IN THIS AGREEMENT); LOST OR ALTERED MESSAGES OR TRANSMISSIONS; OR UNAUTHORIZED ACCESS TO OR THEFT, ALTERATION, LOSS OR DESTRUCTION OF PURCHASING ENTITY'S (OR ITS AFFILIATES', USERS' OR THIRD PARTIES') APPLICATIONS, CONTENT, DATA, PROGRAMS, INFORMATION, NETWORKS OR SYSTEMS.

30. FORCE MAJEURE

Neither party to this Master Agreement shall be held responsible for delay or default caused by fire, riot, explosion, cable cuts, power blackout, earthquake, flood, strike, embargo, labor disputes, acts of civil or military authority, terrorism, acts of public enemy, omissions of carriers or suppliers, acts of regulatory government, unusually severe weather, other acts of God, or war which are beyond that party's reasonable control. The Lead State may terminate this Master Agreement after determining such delay or default will reasonably prevent successful performance of the Master Agreement.

31. DEFAULTS AND REMEDIES

a. The occurrence of any of the following events shall be an "Event of Default" under this Master Agreement:

- (1) Nonperformance of contractual requirements; or
- (2) A material breach of any term or condition of this Master Agreement; or
- (3) Any certification, representation or warranty by Contractor in response to the solicitation or in this Master Agreement that proves to be untrue or materially misleading; or
- (4) Institution of proceedings under any bankruptcy, insolvency, reorganization or similar law, by or against Contractor, or the appointment of a receiver or similar officer for Contractor or any of its property, which is not vacated or fully stayed within thirty (30) calendar days after the institution or occurrence thereof; or
- (5) Any default specified in another section of this Master Agreement.

b. Upon the occurrence of an Event of Default under Agreement, the non-defaulting Party shall issue a written notice of default, identifying the nature of the default, and providing a period of thirty (30) calendar days in which the defaulting Party shall have an opportunity to cure the default. The non-defaulting Party shall not be required to provide advance written notice or a cure period and may immediately terminate the Master Agreement or Participating Addendum in whole or in part if the non-defaulting Party, in its sole discretion, determines that it is reasonably necessary to preserve public safety or prevent immediate public crisis. Time allowed for cure shall not diminish or eliminate the defaulting Party's liability for damages.

c. If the defaulting Party is afforded an opportunity to cure and fails to cure the default within the period specified in the written notice of default, then the defaulting Party shall be in breach of its obligations under the Master Agreement and the non-defaulting Party shall have the right to exercise any or all of the following remedies:

- (1) Exercise any remedy provided by law;

(2) Terminate this Master Agreement and any applicable Participating Addenda or portions thereof;

(3) If the Lead State is the non-defaulting Party then it may suspend Contractor's performance; and

(4) Withhold payment until the default is remedied.

d. Unless otherwise specified in the Participating Addendum, in the event of a default under a Participating Addendum, the non-defaulting party shall provide a written notice of default as described in this section and shall have all of the rights and remedies under this paragraph regarding its participation in the Master Agreement, in addition to those set forth in its Participating Addendum. A Purchasing Entity shall provide written notice of default as described in this section and have all of the rights and remedies under this paragraph and any applicable Participating Addendum with respect to an Order placed by the Purchasing Entity. Nothing in these Master Agreement Terms and Conditions shall be construed to limit the rights and remedies available to a Purchasing Entity under the applicable commercial code.

32. WAIVER OF BREACH

Failure of the Lead State, Participating Entity, or Purchasing Entity to declare a default or enforce any rights and remedies shall not operate as a waiver under this Master Agreement or Participating Addendum. Any waiver by the Lead State, Participating Entity, or Purchasing Entity must be in writing. Waiver by the Lead State or Participating Entity of any default, right or remedy under this Master Agreement or Participating Addendum, or by Purchasing Entity with respect to any Purchase Order, or breach of any terms or requirements of this Master Agreement, a Participating Addendum, or Purchase Order shall not be construed or operate as a waiver of any subsequent default or breach of such term or requirement, or of any other term or requirement under this Master Agreement, Participating Addendum, or Purchase Order.

33. DEBARMENT

The Contractor certifies that neither it nor its principals are presently debarred, suspended, proposed for debarment, declared ineligible, or voluntarily excluded from participation in this transaction (contract) by any governmental department or agency. This certification represents a recurring certification made at the time any Order is placed under this Master Agreement. If the Contractor cannot certify this statement, attach a written explanation for review by the Lead State.

34. THIRD-PARTY CLAIMS

a. **Contractor's Obligations.** Contractor shall at its expense indemnify, defend, and either settle any third-party claim against Lead State, Participating Entities, Purchasing

Entities, or their Affiliates and their respective employees and directors or to pay all damages that a court finally awards against such parties for a claim alleging that a Product provided to a Purchasing Entity under this Master Agreement infringes any patent, trademark, copyright or trade secret, but not where the claimed infringement arises out of or results from: (i) Lead State's, Participating Entity's, Purchasing Entities, or their Affiliate's or a User's content; (ii) modifications to a Product by a Purchasing Entity, its Affiliate or a third party, or combinations of the Product with any non-Contractor services or products by Purchasing Entity or others; (iii) Contractor's adherence to Lead State's, Participating Entity's, Purchasing Entity's, or their Affiliate's written requirements; or (iv) use of a Service in violation of this Agreement.

b. Infringing Services. Whenever Contractor is liable under §34, Contractor may at its option either procure the right for Purchasing Entity to continue using, or may replace or modify, the Service so that it is non-infringing.

c. Notice and Cooperation. The Party seeking defense or settlement of a third-party claim under this §34 will provide notice to the other party promptly upon learning of any claim for which defense or settlement may be sought, but failure to do so will have no effect except to the extent the other party is prejudiced by the delay. To the extent permitted by law, the party seeking defense or settlement will allow the other party to control the defense and settlement of the claim and will reasonably cooperate with the defense. The defending party will use counsel reasonably experienced in the subject matter at issue and will not settle a claim without the written consent of the party being defended, which consent will not be unreasonably withheld or delayed, except that no consent will be required to settle a claim where relief against the party being defended is limited to monetary damages that are paid by the defending party under this §34.

35. NO WAIVER OF SOVEREIGN IMMUNITY

In no event shall this Master Agreement, any Participating Addendum or any contract or any Purchase Order issued thereunder, or any act of the Lead State, a Participating Entity, or a Purchasing Entity be a waiver of any form of defense or immunity, whether sovereign immunity, governmental immunity, immunity based on the Eleventh Amendment to the Constitution of the United States or otherwise, from any claim or from the jurisdiction of any court.

This section applies to a claim brought against the Participating Entities who are states only to the extent Congress has appropriately abrogated the state's sovereign immunity and is not consent by the state to be sued in federal court. This section is also not a waiver by the state of any form of immunity, including but not limited to sovereign immunity and immunity based on the Eleventh Amendment to the Constitution of the United States.

36. GOVERNING LAW AND VENUE

a. **Governing Law for Master Agreement.** The procurement, evaluation, and award of the Master Agreement shall be governed by and construed in accordance with the laws of the Lead State sponsoring and administering the procurement. The construction and effect of the Master Agreement after award shall be governed by the law of the state serving as Lead State (in most cases also the Lead State).

b. **Governing Law of Participating Addenda.** The construction and effect of any Participating Addendum or Order against the Master Agreement shall be governed by and construed in accordance with the laws of the Participating Entity's or Purchasing Entity's State.

c. **Venue for Disputes under Master Agreement.** Unless otherwise specified in the RFP, the venue for any protest, claim, dispute or action relating to the procurement, evaluation, and award is in the Lead State. Venue for any claim, dispute or action concerning the terms of the Master Agreement shall be in the state serving as Lead State. Venue for any claim, dispute, or action concerning any Order placed against the Master Agreement or the effect of a Participating Addendum shall be in the Purchasing Entity's State.

d. **Federal Venue.** If a claim is brought in a federal forum, then it must be brought and adjudicated solely and exclusively within the United States District Court for (in decreasing order of priority): the Lead State for claims relating to the procurement, evaluation, award, or contract performance or administration if the Lead State is a party; the Participating State if a named party; the Participating Entity state if a named party; or the Purchasing Entity state if a named party.

e. **No Waiver.** This section is also not a waiver by the Participating State of any form of immunity, including but not limited to sovereign immunity and immunity based on the Eleventh Amendment to the Constitution of the United States.

37. ASSIGNMENT OF ANTITRUST RIGHTS

Contractor irrevocably assigns to a Participating Entity who is a state any claim for relief or cause of action which the Contractor now has or which may accrue to the Contractor in the future by reason of any violation of state or federal antitrust laws (15 U.S.C. § 1-15 or a Participating Entity's state antitrust provisions), as now in effect and as may be amended from time to time, in connection with any goods or services provided in that state for the purpose of carrying out the Contractor's obligations under this Master Agreement or Participating Addendum, including, at the Participating Entity's option, the right to control any such litigation on such claim for relief or cause of action.

38. PROVISIONS FOR ORDERS UTILIZING FEDERAL FUNDS

Pursuant to Appendix II to 2 Code of Federal Regulations (CFR) Part 200, Contract

Provisions for Non-Federal Entity Contracts Under Federal Awards, Orders funded with federal funds may have additional contractual requirements or certifications that must be satisfied at the time the Order is placed or upon delivery. These federal requirements may be proposed by Participating Entities in Participating Addenda and Purchasing Entities for incorporation in Orders placed under this Master Agreement.

39. LEASING OR ALTERNATIVE FINANCING METHODS

The procurement and other applicable laws of some Purchasing Entities may permit the use of leasing or alternative financing methods for the acquisition of Products under this Master Agreement. Where the terms and conditions are not otherwise prescribed in an applicable Participating Addendum, the terms and conditions for leasing or alternative financing methods are subject to negotiation between the Contractor and Purchasing Entity.

MA149-1
ATTACHMENT AA
Contractor's Special Terms and Conditions

1. **Service Generally.** Contractor, through Carriers, will provide Service to Participating Entities, Purchasing Entities, and their respective CRUs and IRUs pursuant to the terms and conditions of the Master Agreement including, without limitation, the Service Guide, corresponding Sales Information and Attachments. Except as otherwise set forth in the Master Agreement, Service, including without limitation, eligibility requirements, Plans, pricing, Features, promotions, offers, and/or Service Areas is subject to change without notice; provided, however, that the Service Discount and Equipment Discount may only be changed by written amendment executed by both Parties. End User must qualify for the chosen Service, If an End User loses his or her eligibility for a Service, Contractor may change the Service to one for which they qualify. Service is available for purchase only in Contractor Markets, as may be modified by Contractor from time to time. Nothing set forth in the Service Guide, corresponding Sales Information, and Attachments referenced in Exhibit AA will be deemed to modify, diminish, or otherwise derogate the terms and conditions set forth in the Master Agreement.

2. **Plans.** A Participating Entity or Purchasing Entity may choose from (a) Voice Service and Wireless Data Service Plans found at the "Plans" page of the Program Website, as may be modified by Contractor from time to time and (b) custom Plans set forth in the Agreement and/or the applicable PA. Subject to the Master Agreement, the pricing, terms and conditions of the Service depend upon the Plan, feature, promotion or other offer selected when Service is activated or changed. Nothing contained in this Attachment AA or its reference attachments, webpages, Plans, or Service; Guides will be deemed to modify, diminish, or otherwise derogate the terms and conditions set forth in the Master Agreement, except to the extent allowed by law.

3. **Equipment.** Contractor will provide Equipment and accessories to Participating Entities and their respective CRUs and IRUs pursuant to the terms and conditions of the Master Agreement including, without limitation, Exhibit AA which includes the Service Guide, corresponding Sales Information, and Attachments. With respect to Numbers provisioned from Contractor Markets, Participating Entities may purchase available Equipment found at the "Equipment" page of the Program Website, the list of which may be modified by Contractor from time to time in accordance with the Master Agreement.

4. **Additional Products.** Subject to the Master Agreement, Contractor may make certain products, services, Equipment and/or programs available to Participating Entities and Purchasing Entities through Attachments posted under the "Additional Products, Services, Equipment and Programs" section of the Program Website (collectively, "Additional Products"). To the extent a Purchasing Entity orders, pays for, or otherwise receives the benefit of any Additional Product, such Purchasing Entity will be bound by the rates, terms and conditions set forth in the corresponding Attachment, as well as in any Sales Information referenced therein. Contractor represents that it has the authority (a) to sell, resell, sub-license such Additional Products; and/or (b) distribute the corresponding software license agreements, warranty and/or maintenance service terms, as applicable. Title to any software referred to herein remains with Contractor or the corresponding third-party.

5. **Sales Information: Attachments.** Service, Equipment and Additional Products are provided to Participating Entities subject to the terms and conditions set forth in the Master Agreement, including Exhibit AA and its corresponding Attachments and/or Sales Information, as applicable.. Participating Entities can contact their Contractor account representative for copies of, or references to any such Sales Information. Any provisions in Sales Information or an Attachment governing Service, Equipment or an Additional Product which, by their terms, are to exist for a specified period of time, will survive any termination or expiration of the Agreement.

5.1 Attachment Modification. If Contractor materially modifies an Attachment to Exhibit AA, a Participating Entity may opt out of the corresponding Additional Product by providing Contractor with written notice to that effect. If such Participating Entity provides such opt-out notice, then Contractor has the option of terminating the corresponding Additional Product immediately, or allowing the Participating Entity to continue to use the Additional Product under the immediately prior version of the Attachment for a period of time to be determined solely

by Contractor, during which Contractor and the Participating Entity will cooperate on developing a path towards terminating Participating Entity's use of the Additional Product.

6. Custom Offers. Notwithstanding anything to the contrary elsewhere in the Master Agreement, the Lead State and NASPO ValuePoint expressly authorizes Contractor to make certain customized offers to individual Purchasing Entities based on competitive necessity. Any such custom offers do not need to be provided to all Purchasing Entities and/or Participating Entities; provided, however, that Contractor will consider providing such customized offer(s) to similarly situated Participating Entities under the Master Agreement.

7. Discounts.

7.1 Service Discount. Contractor will provide Participating Entities' CRUs with a Service Discount of TWENTY-FIVE PERCENT (25%). Contractor will provide Participating Entities' IRUs with a Service Discount of SEVENTEEN PERCENT (17%). Contractor will only apply the Service Discount to the Monthly Service Charge of eligible Plans. Contractor will not apply the Service Discount to other monthly service charges such as monthly recurring charges for features, and/or any other charges under the Master Agreement. Contractor may restrict certain Plans or certain other discount programs from qualifying for the Service Discount. Contractor will advise NASPO when such restrictions apply. It may take several billing cycles for the Service Discount to be applied.

7.2 Equipment Discount; Accessories. Subject to the restrictions set forth in this §7.2, Contractor will provide Participating Entities with an Equipment Discount of FIFTY PERCENT (50%) off MSRP or Vendor Subsidized Price, whichever discount is greater, applies to eligible subsidized devices only with active service on qualified plans. Device eligibility is subject to vendor discretion. Unsubsidized devices may be purchased at full MSRP or purchased through a monthly Equipment Installment Plan where eligible. Devices purchased with a qualified Equipment Installment Plan, purchased at full price, or bring your own device are eligible for an additional MRC discount on qualified rate plans. Equipment found at the "Equipment" page of the Program Website or the Participating Entity's Premier Website, as may be modified by Contractor from time to time. Contractor will apply the Equipment Discount only to the prices set forth on the corresponding Program Website page. The Equipment Discount does not apply to accessories to Equipment. Instead, Contractor will provide a discount of THIRTY PERCENT (30%) off the price of such accessories found at each Participating Entity's corresponding Premier website. Contractor will only provide Equipment with Service activated. The Equipment Discount will not apply to upgrade purchases, made prior to the eighteen (18) month upgrade window, and may not be combined with any other equipment offer.

8. Employee Benefit Program. Contractor will provide Participating Entities the ability to have their Employees participate in the Employee Benefit Program described herein. Such Employees will be IRUs under the Agreement and must be correspondingly validated as an eligible IRU. Any Employees not so validated will not be IRUs under the Agreement and will not receive the corresponding benefits. IRUs may not be eligible for certain Plans, Equipment and/or Additional Products under the Agreement.

8.1 Employee Benefit Program Activation Processes and Procedures. Each IRU participating in the Employee Benefit Program: (a) must enter into, and be individually responsible for complying with an IRU Service Agreement including, without limitation, the corresponding obligations to comply with all of the terms and conditions of the chosen Plan and to pay all charges incurred under the IRU Service Agreement; and (b) must follow the activation, validation, migration, upgrade and related policies, procedures and processes established by Contractor from time to time, including without limitation paying any applicable enrollment fees.

8.2 Employee Benefit Program Features. Under the Employee Benefit Program: (a) IRUs may choose from select Plans available to Participating Entities under the Agreement (provided they qualify for the chosen Plan); (b) IRUs will receive the Service Discount in accordance with §7.1 of these Special Terms and Conditions; and (c) IRUs will receive the Equipment Discount in accordance with §7.2 of these Special Terms and Conditions.

9. Other Monthly Charges. In addition to the monthly cost of the Plan and any selected features, AT&T imposes the following charges: (a) a Regulatory Cost Recovery Charge of up to \$1.25 per line per month, which varies by state, to

help defray its cost incurred in complying with obligations and charges imposed by state and federal telecom regulations, (b) a gross receipts surcharge, (c) state and federal universal service charges, and (d) other governmental assessments on AT&T, including, without limitation, a Property Tax Allotment surcharge applied with respect to each CRU's assigned Number. These are not taxes or government-required charges. Purchasing Entities understand and agree that state and federal universal service fees and other governmentally imposed fees, whether or not assessed directly upon Purchasing Entities and/or their End Users may be increased based upon the government's or AT&T's calculations. Purchasing Entities and their CRUs should visit att.com/additionalcharges to view estimates of such discretionary charges for a CRU's area.

9.1 Disputed Charges. Except as otherwise provided by law with respect to unauthorized charges, disputed charges must be disputed to Contractor in writing within six (6) months after the date of the affected invoice, or the right to dispute is waived. In the event of a disputed invoice, to the extent permitted by law Participating Entity will pay the entire undisputed amount of the invoice. Contractor, Participating Entity and Carriers will use good faith efforts to reconcile the dispute within sixty (60) days of submission of the dispute to Contractor.

10. Processes and Procedures. Except as otherwise set forth in the Master Agreement, Participating Entities will follow the policies and processes established by Contractor to purchase, activate, migrate, terminate, or otherwise modify a Service, as may be modified from time to time. Each Participating Entity authorizes Contractor to provide information about and to make changes to Participating Entity's account, including adding new Service, upon the direction of any individual representative of Participating Entity able to provide information Contractor deems sufficient to identify Participating Entity. Any order for Service that Participating Entity's representative submits to Contractor will be binding upon Participating Entity pursuant to the terms and conditions of the Agreement. Contractor may reasonably rely on the authority of any person who executes an order on Participating Entity's behalf. Participating Entity consents to the use by Contractor or its authorized agents of regular mail, predictive or autodialing equipment, email, text messaging, facsimile or other reasonable means to contact Participating Entity and/or its CRUs to advise Participating Entity and/or its CRUs about Contractor's Services or other matters Contractor believes may be of interest to Participating Entity and its CRUs. In any event, Contractor reserves the right to contact Participating Entity and/or its CRUs by any means regarding customer service-related notifications, or other such information.

11. Participating Addendum Template. Contractor may use the template Participating Addendum attached hereto and incorporated herein as Exhibit 1, with Participating Entities under the Agreement. The parties expressly acknowledge and agree that immediately upon execution of the Master Agreement, Contractor may begin signing new Participating Entities onto Participating Addenda under the Master Agreement and may begin migrating existing Participating Entities onto new Participation Addenda.

12. Acceptable Use; Restrictions Regarding Service. All use of Contractor's wireless network and Service is governed by the Acceptable Use Policy, as determined solely by Contractor. Contractor can revise its Acceptable Use Policy at any time without notice. Use of Service is also subject to any restrictions and/or prohibited uses described in the applicable Sales Information. Nothing set forth in the Acceptable Use Policy will be deemed to modify, diminish, or otherwise derogate the terms and conditions set forth in the Master Agreement.

13. Definitions.

"Additional Products" means products, services, features, offers, promotions, software applications, hardware, Equipment, accessories, and/or programs offered by Contractor and/or third-parties, other than Voice Service, Wireless Data Service, and certain Equipment and accessories.

"Administrative Fee" means the NASPO ValuePoint administrative fee as more fully described in Master Agreement §7.

"Affiliate" of a party means any entity that controls, is controlled by or is under common control with such party.

"Agreement" has the definition set forth in Master Agreement §1(a).

“Attachment” means Contractor’s terms and conditions posted on the Program Website, applicable to corresponding Service, Equipment, and/or Additional Products available under the Agreement, as such terms and conditions may be modified by Contractor from time to time, all of which are incorporated herein by reference.

“Carrier or Carriers” means a licensed Affiliate of AT&T that operates commercial mobile radio telecommunications systems in the geographic areas covered by the Agreement and, with respect to Master Agreement §29, includes the Carriers’ respective employees, officers, agents and subcontractors.

“Contractor Markets” means a geographic area served by Affiliates under Contractor’s common control.

“CRU and Corporate Responsibility User” mean an Employee receiving Service under a Participating Entity’s account.

“Employees” means Participating Entity’s or its Affiliates current, validated personnel receiving Federal W-2 or K-1 tax treatment.

“End Users” means CRUs and IRUs, collectively.

“Equipment” means the wireless receiving and transmitting equipment or SIM (Subscriber Identity Module) Card that AT&T has authorized to be programmed with a Number or Identifier, and any accessories.

“Equipment Discount” means a discount on select Equipment found at the Program Website, as described in the Agreement.

“IRU and Individual Responsibility User” mean an Employee receiving Service under an individual account in accordance with the Employee Benefit Program.

“IRU Service Agreement” means a separate two-year agreement between an IRU and Contractor for Service, Equipment, and related products.

“Master Agreement Effective Date” means the date of the last signature on the Master Agreement.

“Monthly Service Charge” means a Plan’s monthly wireless access charges (i.e., the set fee charged monthly for use of a particular Plan).

“Number or Identifier” means any number, IP address, e-mail address or other identifier provisioned by Carriers, their agents or the Equipment manufacturer to be used with Service.

“Plan” means a Contractor Voice Service, Wireless Data Service or other rate plan as set forth in the Agreement.

“Program Website” means that certain website found at www.att.com/wscaterms, together with all applicable content found thereon, all of which is incorporated into the Master Agreement by this reference. Nothing set forth on the Program Website will be deemed to modify, diminish, or otherwise derogate the terms and conditions set forth in the Master Agreement.

“Sales Information” means Contractor’s printed and/or on-line marketing-related materials applicable to Service, Plans, Equipment, Additional Products provided under the Contract, as such materials may be modified by Contractor from time to time, all of which are incorporated herein by this reference. Sales Information includes, but is not limited to: (a) the Enterprise Customers: Additional Service and Equipment Related Terms found at att.com/abs-addtl-terms, and (b) product-specific pricing and/or terms and conditions set forth in separate product briefs, rate brochures, service guides, ordering documents or acknowledgements, or other marketing materials provided by AT&T at Customer’s request and/or found at att.com/abs-addtl-terms, at wireless.att.com/businesscenter or at such other site that AT&T may designate.

“Service Discount” means a monthly discount on eligible Service, applied to an End User's Monthly Service Charges as described in the Exhibit AA.

“Service Guide” means (a) the AT&T dynamic, online document that includes the descriptions, pricing and other terms and conditions for Products provided under the Master Agreement which can be found at: , or other locations Contractor may designate; and (b) the AUP.

“Voice Services” means wireless voice telecommunications services.

“Wireless Data Services” means wireless data telecommunications services.



NASPO

ValuePoint

MA149-1

Wireless Data, Voice, and Accessories

Attachment B

Scope of Work

Section 1: General

1.1 Background

The purpose of this Master Agreement is to provide Wireless Data, Voice, and Accessories for all Participating States. The Master Agreement may be used by state governments (including departments, agencies, institutions), institutions of higher education, political subdivisions (i.e., colleges, school districts, counties, cities, etc.), the District of Columbia, territories of the United States, and other eligible entities subject to approval of the individual chief procurement official and compliance with local statutory and regulatory provisions. The initial term of the master agreement shall be 5 (Five) years with renewal provisions for an additional 5 (Five) as outlined in Section 3 of the NASPO ValuePoint Master Terms and Conditions (Attachment A).

1.2 Order of precedence

Per the NASPO ValuePoint Master Terms and Conditions, Participating Addenda (called "PA") will have precedence over the Master Agreement within the participating jurisdiction.

1.3 Green Awards

End users of the Master Agreement may have requirements to purchase products and services that adhere best practices of sustainability and environmental consciousness. Contractor should anticipate addressing these needs as they arise in the Participating Addendum process.

1.4 E-Rate

To the extent the services offered are subject to the E-rate discount program, all award Contract Vendors must commit to participation in the Federal Communication Commission's E-rate discount program established under authority of the Federal Telecommunications Commission Act of 1996. Participation in, and implementation of, this program must be provided without the addition of any service or administration fee by the Contract Vendor.

1.5 Net Neutrality

Recent changes by the Federal Communications Commission in their rules related to the issue of Net Neutrality have increased state's interest in promulgating their own law, rule and policies on this topic. This solicitation will have no requirements related to Net Neutrality for the Master Agreements. It is anticipated, that this issue will be pertinent in the Participating Addendum process. Potential participating entities will be made aware of this consideration by the Lead State in a reasonable fashion.

Section 2: Categories of Award

2.0 Overview of Award Categories

The products and services for this contract are awarded in 3 (three) categories. These categories are:

Category 1- Cellular Wireless Services: This category will cover the basic cellular wireless transport services for voice, data and messaging, as well as any new basic transport services that may be introduced for applications like those defined for Internet of Things (IoT) applications. "Cellular wireless transport" is defined to mean carrier provided wireless services that employ a radio access network based on technologies defined by the Third Generation Partnership Program (3GPP). We are requesting pricing for both traditional cellular plans that include a subsidized mobile device as well as bring your own device (BYOD) plans where the user will supply their own mobile device and require only network service from the carrier.

Category 2- Equipment and Accessories: This category includes any equipment or accessories operating over cellular carrier provided network services or intended for use with cellular connected devices.

Category 3- Turnkey Wireless and IoT Solutions that are offered as a product: This category includes any of the wireless or IoT solutions or applications being offered as a complete product by the cellular wireless carriers or any other Contractor(s).

2.1 Category 1- Cellular Wireless Services

This category will cover the basic cellular wireless transport services for voice, data and messaging, as well as any new basic transport services that may be introduced for applications like those defined for Internet of Things (IoT) applications. “Cellular wireless transport” is defined to mean carrier provided wireless services that employ a radio access network based on technologies defined by the Third Generation Partnership Program (3GPP). We are requesting pricing for both traditional cellular plans that include a subsidized mobile device as well as bring your own device (BYOD) plans where the user will supply their own mobile device and require only network service from the carrier.

This Award Category is for National Award only.

2.1.1 Definitions

3rd Generation Partnership Project (3GPP) The international standards body that covers cellular telecommunications network technologies (<http://www.3gpp.org>).

3G Third generation of wireless mobile telecommunication technology as defined by the 3rd Generation Partnership Project (3GPP).

4G Fourth generation of wireless mobile telecommunication technology as defined by the 3rd Generation Partnership Project (3GPP).

5G Fifth generation of wireless mobile telecommunication technology as defined by the 3rd Generation Partnership Project (3GPP).

Bandwidth Throttling The mechanism a service provider uses to reduce the data network capacity available to a user of its wireless services.

Bandwidth Throttling Threshold In “unlimited” cellular data plans, the data volume at which the carrier begins instituting bandwidth throttling for the balance of the billing period.

Bring Your Own Device (BYOD) Plans where the user will supply their own mobile device and require only network service from the carrier.

Cellular Wireless Carrier: A wireless carrier that owns the majority of its infrastructure and operates a mobile wireless network primarily utilizing standards developed by the 3GPP.

Cellular Voice A wireless voice telephone service offered by the cellular carriers.

Cellular Wireless Carrier-provided wireless services that employs a radio access network based on technologies defined by the 3rd Generation Partnership Program (3GPP).

Coverage Area The geographic area in which a carrier provides service. When located within this area, a subscriber with a compatible device should be able to access usable wireless services on that carrier’s network or its partner networks.

FirstNet FirstNet is a government subsidized wireless network specifically designed for the needs of public safety users; access to FirstNet services will be limited to defined categories of users related to public safety. FirstNet was created under the Middle Class Tax Relief and Job Creation Act of 2012.

Individual Responsible (IR) Plan Discount Individual Responsible Accounts (“IRU”) are accounts for products and services between Contractors awarded a contract under this solicitation and individuals who are employees of eligible users of the Master Agreement. IRU accounts are for the personal use of individual employees of eligible end users of the Master Agreement.

Corporate/Government Responsible (CRU) Plan CRU plans are plans that are purchased by end users of the Master Agreement that is awarded from this solicitation.

Land Mobile Radio (LMR) Terrestrial-based, wireless communications systems, generally operating in the frequency range below 1 GHz, and commonly used by emergency responders to support voice and low-speed data communications.

Mission Critical Push-to-Talk (MCPTT) A new standard for public safety PTT systems (starting with 3GPP Rel. 13) that also operates over the cellular carriers’ wireless networks and supports, among other capabilities, the ability for wireless stations to discover and communicate directly with other system users without relaying those transmissions through a cellular base station.

LTE (Long-Term Evolution) A 3GPP standard for high-speed cellular wireless communications.

Mobile Messaging The ability to compose and exchange electronic messages that may include text, audio, video and other symbols between two or more users of mobile phones, tablets or other devices.

Public Safety The functions of government, which ensure the protection of citizens, persons in their territory, organizations, and institutions against threats to their well-being.

Push-to-Talk (PTT) A method of wireless voice communications using a momentary button to switch the wireless device from voice reception mode to transmit mode; in a cellular PTT system, all transmissions are relayed over the carrier’s radio channels and through a server installed in the carrier’s network infrastructure. Transmissions are received by all stations within range of that particular radio channel and are part of that broadcast group.

Quality of Service (QoS) Mechanisms employed in packet switching networks that allows them to prioritize certain classes of traffic over others thereby providing better performance for those preferred classes with regard to transit delay, jitter (variation in transit delay), and packet loss.

Short Message Service (SMS)/Multimedia Messaging Service (MMS) Wireless services offered by the cellular carriers allowing users to exchange short text (SMS) or audio/video files (MMS). These services are differentiated from other messaging services like Apple Messages and WhatsApp by the fact that they are offered by the cellular carriers and are typically charged as a separate item on the service plan along with voice and data.

Subsidized Plan Cellular plans where the carrier will provide a phone, or tablet at a subsidized price.

Wireless The transmitting of signals using radio waves instead of wires.

Wireless Carrier A provider of wireless communications services that owns or controls all the elements necessary to sell and deliver services to an end user including radio spectrum allocation, wireless network infrastructure, back haul infrastructure, billing, customer care, provisioning computer systems and marketing and repair organizations.

Wireless Data A communication service offered by mobile carriers that allows users to access the internet and other data services via its wireless networks using a smartphone, tablet or other cellular-connected mobile device.

Wireless Plan A bundled subscription offering from a cellular carrier providing some combination of services.

Wireless Priority Service (WPS) A government-directed emergency phone service managed by the Department of Homeland Security's Office of Emergency Communications (OEC). Like FirstNet for data services, WPS provides priority network access to wireless voice service (2G or VoLTE) exclusively to defined categories of qualified subscribers.

2.1.2 Subsequent Network Characteristics and Technology

This solicitation covers the addition of new technology and methods that are substantively similar to existing 3G, 4G, and 5G Network characteristics.

2.1.3 Plans

Contractors will define the rate plans to be available under the Master Agreement that results from this solicitation and must provide all details of every plan offered in Attachment G. At a minimum plan details should include the items listed in Attachment G if applicable.

Subsidized Plans

Subsidized plans are those that include a device to connect to the wireless network as a part of the monthly plan cost.

Bring Your Own Device Plans

Bring your own device plans are those that require the user to provide a device for connection to the cellular network or to pay for a device separately from the monthly service plan.

2.1.4 Legacy Plans

Plans covered by the predecessor Master Agreements administered by the State of Nevada (Contract No. 1907)(“Legacy Plans”) for purchasing entities who are currently enrolled will be included within the scope of the Master Agreements awarded by this solicitation. All Legacy Plans must be described on Attachment G: Plan Coverage Attachment.

Discontinuance of Plans

Contractor will maintain plans if they are being used. Contractor may discontinue any plan or feature that has not had any active subscribers for at least the previous 90 days. Contractor to provide a minimum of 90 days notice to Lead State if a Plan is to be discontinued to end users.

2.1.5 Service Requirements

Designated Sales Point of Contact

Each Master Agreement awarded by this solicitation shall have a designated point of contact for sales purposes.

Designated Customer Service Point of Contact

Each Master Agreement awarded by this solicitation shall have a designated point of contact for Customer Service escalation purposes.

Designated Contract Manager

Each Master Agreement awarded by this solicitation shall have a designated point of contact who manages the contract and may be contacted by administrators of the Master Agreement or PAs.

2.1.6 Pricing Requirements

Subsidized Device Plans

Plans covered by the predecessor Master Agreements administered by the State of Nevada (Contract No. 1907) that offered phones at no cost are to be included by the Master Agreements awarded by this solicitation if the Contractor is awarded under this solicitation. For any new plans offered under this contract, Proposers have the flexibility to include a subsidized phone in the plan cost or to require the user to provide a device or pay for it separately.

Financing

Financing is allowed under the Master Agreement, but may be subject to each PA as some jurisdictions may not allow Financing.

Individual Responsible (IRU) Plan Discount

Pricing Discounts for Individual Responsible plans by public employees are to be stated on the Cost sheet. See Section 5.

Waiver of Service Activation Fees

Service Activations Fees will not be allowed under the Master Agreements that derive from this solicitation.

Number Porting

Carrier must provide wired or wireless number porting to/from the mobile device with no charges or penalty.

Upgrade

Users must be able to upgrade or downgrade their service plan at any time with no limits and no restarting of service line contract terms.

Cancellation Fees

Carrier must provide for any participating entity the ability to cancel at least 25% of the active lines of service under contract (subsidized device) in any given year with no early termination fees or other cancellation fees.

Carrier must not assess any cancellation fee or early termination fee for any lines of service that are provided under a Bring Your Own Device option where subsidized equipment is not included in the monthly rate plan cost.

Activation and Billing

Carrier must not commence billing for a device until completion of an order and activation request is executed by the participating entity representative, the user or another individual designated by the participating entity representative. Specific billing and activation procedures may be refined within Participating Addenda.

Cost Sheet

Contractor must populate the cost sheet Attachment C. The plans identified in Attachment C are to be offered to end users and will be included in Attachment G. Contractor must also indicate a discount for plans available under the master agreement that results from this solicitation., that are not entered into Attachment C.

Plan Description

Contractor must include detailed descriptions of all new rate plans approved by the lead state by fully populating Attachment G with complete details related to each plan and feature offered under this contract.

Presentation

Contractors should propose plans that can be easily understood without complex restrictions and terms. Scoring will reflect the degree of concise and impactful plans – from flexibility and cost perspectives.

2.1.7 Internet of Things (IoT) Services

Data plans related to Internet of Things services are covered by this award category. Please describe your Internet of Things offering as it relates to Attachment L, Network Technology Questionnaire in your proposal.

2.1.8 Public Safety/Wireless Priority Service

2.1.8 PUBLIC SAFETY CATEGORY

The Wireless Services Provider (Contractor) will describe how their proposal if and how they intend to provide an exclusive, dedicated broadband network for public safety communications to public safety entities and first responders.

Contractor will describe if and how they would provide for a dedicated network exclusive for use by emergency response providers such as Federal, State, and local emergency public safety, law enforcement, emergency response, emergency medical (including hospital emergency facilities), and related personnel, agencies, and authorities; including Native American Tribes (Sovereign Nations) or authorized tribal organization and rural communities, unincorporated town or village, or other public entity.

Carriers will describe how their proposed services will have the ability to provide the most comprehensive, reliable coverage and highest priority for emergency communications, such as:

- Broadband LTE network allowing first responders and other public safety personnel to send and receive voice, data, video, images, push-to-talk and text without concerns about network congestion.
- Mobile Devices
- Mobile Device Management, to include Maintenance and Replacement
- Public Safety Applications and Solutions
- Assured Priority and Preemption when needed
- Network Security

Interoperability:

Interoperability is critical to all public safety agencies, therefore; The Wireless Service Provider (the Contractor), will describe how they enable comprehensive public safety broadband interoperability at all levels including the sharing of priority and preemption protocols, applications, and mission critical Push-to-Talk (MCPTT) communications and off-air device to device communications during an emergency situation.

Deployable Access:

The Wireless Service Provider (the Contractor) will describe how they will provide cellular connection in areas where service does not exist or where service fails during emergency circumstances. The Wireless Service Provider will describe how they provide dedicated access to Satellite Cell on Wheels and Portable Emergency Communications.

The Wireless Service Provider (Contractor) will describe additional deployable equipment for dedicated access in areas where service does not exist or where service fails during emergency situations.

Optional Services:

Additional Public Safety Services sold under the NASPO ValuePoint Master Agreement other than the requirements listed, must be properly reviewed and approved by the lead state.

Option to Terminate:

The NASPO ValuePoint Master Agreement is an additional procuring mechanism. The Wireless Service Provider (the Contractor) must agree; if a Public Service Entity chooses to utilize the

NASPO ValuePoint Master Agreement, the procuring agency has the option to terminate their agreement at any time without added fees or penalties for cancellation.

The Lead State may cancel the Public Safety/Wireless Priority Service portion of the Category 1 Scope at any time. If the Lead State chooses to cancel the Public Safety/Wireless Priority Service portion of Category 1 Scope, it will provide contractors with 180 days notice.

No other Terms and Conditions, End User Agreements, or any other terms will be offered with the new product or service unless it is included in the Master Agreement.

2.2 Category 2- Equipment and Accessories

This category includes any equipment or accessories operating over cellular carrier provided network services or intended for use with cellular connected devices.

This Award Category is for National Award only.

2.2.1 Definitions

Accessories Any equipment, component or add-on accessory intended for use with cellular connected devices.

Equipment Any device operating over cellular carrier provided network. Does not include servers, desktops or laptop computing devices.

Cellular Devices Any phones or other equipment used to connect over wireless services offered by cellular carriers (Category 1).

2.2.2 Eligible Equipment and Accessories

Those products eligible as equipment and accessories under this solicitation, currently includes and may be expanded as technology advances:

- Basic Cellular Devices
- Smartphones - iOS, Android, Other
- Stand Alone, Integrated or USB Dongle Cellular Modems
- Wi-Fi/Cellular Routers
- Tablets that are cellular-network connected
- Other equipment with a primary purpose for communicating over the cellular carrier network, currently including:
 - Sensors

- Cellular-enabled Video cameras
- Accessories:
 - Replacement Batteries
 - Cases & related accessories
 - Screen Protectors
 - Chargers
 - Cords / cables
 - Signal Boosters / antennae
 - Headsets and speakers for use with wireless devices

2.2.3 Service Requirements

Condition of Equipment and Accessories

All equipment and accessories provided under this contact must be new, unused and properly functioning when received by participating entity if priced as a new product.

Superseded, used, returned, or reconditioned items will be accepted if labelled as such in the sales order.

Trial Period

Contractor may allow for a designated trial period for testing/evaluating equipment and accessories without additional charges or fees if applicable. Contractor will describe the timeframe for the 'trial period' and procedures for implementing this policy in the sales invoice or purchase order.

Return of Equipment and Accessories

Any equipment or accessories that are not properly functioning when received by the participating entity must be replaced by the contractor with new and properly functioning equipment or accessories within 5 business days of the defective equipment or accessories being reported to the contractor.

Participating entities shall not be responsible for any costs related to the return and/ or replacement of any equipment or accessories that are returned due to quality problems, duplicate shipments or other shipping errors, outdated products or other issues related to non-compliance with terms of this agreement. Contractors must confirm in writing to the end user when returns are received.

Participating entities shall not be assessed restocking fees or any other fees for items trialed and then returned as unacceptable for any reason.

Contractor will allow for equipment and accessory purchases at all retail stores open to the public. Sales personnel at retail stores will be aware of pricing from the Master Agreement that results from this solicitation.

2.2.4 Pricing

Cost Sheet

See Attachment C for details for Award Category 2.

Financing

Financing is allowed under the Master Agreement, but may be subject to each PA as some jurisdictions may not allow Financing.

Individual Responsible (IRU) Plan Discount

Pricing Discounts for equipment and accessories offered to public employees with Individual Responsible plans are to be stated on the Cost sheet (Attachment C). See section 5 for additional details.

Shipping

Contractor if a Carrier must activate service on new equipment within 72 hours of request or shipping.

2.3 Category 3 – Internet of Things and other Turnkey Wireless Applications

This category includes any of the wireless or IoT solutions or applications being offered as a complete product by the cellular wireless carriers or any other Contractor(s).

This Award Category may be for National Award, or Regional Award at the indication of the Contractor in their proposal. Contractors will indicate this preference in Attachment W.

Awards will be made in each individual sub-category of Category 3, not for Category 3 as a whole. An award in one sub-category does not entitle a vendor to offer products or services in any other subcategories for which they were not specifically awarded.

2.3.1 Definitions

Turnkey Wireless Solution For the purposes of this solicitation a Turnkey Wireless Solution is an integrated, on premise or hybrid system that includes three broad elements:

- End Points physical objects (things like sensors, cameras, end point devices, etc.) that contain embedded technology to sense or interact with their internal state or external environment and the ability to communicate with a remote application
- Network Services a wireless communication network providing M2M communication services or some other method of data transport connecting the dedicated physical objects with;
- Back Office Systems applications and central or back end systems (servers, software, operating systems, storage, etc.).

2.3.2 Turnkey Wireless Solutions

A Proposal shall fully disclose what is included in the Turnkey Wireless Solutions, including all operational components, training, services, equipment, licenses, third party agreements, any and all fees and performance guarantees.

Products and services offered by carriers/Contractors under Legacy Plans that are now part of Category 3 awards under this solicitation will be part of the contracts that result from this solicitation if the carrier/Contractors has also been awarded under that Category and Sub-category.

For example: MDM products under legacy plans may only be offered under the new Master Agreement if the Contractor is awarded under the MDM subcategory of Category 3 awards.

If an Contractor is not awarded a product under an Award Category 3 subcategory, but has provided a product or service under Legacy Plans, the Contractor may continue to offer the product to end users already under contract. The product may not be offered to new end users unless the Contractor has won award of the subcategory.

Turnkey Wireless Solutions Single Contract The provider offering a Turnkey Wireless Solutions may utilize subcontractors and partners to provide various elements of the system, but the system including all licensing rights will be covered by a single contract between the end user that purchases the system and the provider who is awarded a master agreement for this category of award.

Limited Related Service The provider shall provide support services as needed to install, maintain and enhance the system over the life of the system. These Limited Related Services shall be included in the system pricing. Installation services may be capped in proportion to the project at hand. The Proposal shall describe all related services that are included in the Turnkey Wireless System. The purchasing entity shall have the option to purchase additional services at pricing offered by the proposer and provide an hourly rate related to the project for the Additional Consulting or Integration Services.

Additional Consulting or Integration Services

- a. The purchasing entity shall have the ability to purchase consulting or integration services from the provider.
- b. Consulting Services – In Category 3, “Consulting Service” means planning, assessment and other professional consulting services provided by the Contractor related to the public entities planning, design, assessing, operating or maintaining an IoT solution.
- c. Additional Services – In Category 3, “Integration Service” means the process of making new IoT devices, data, platforms and applications, as well as existing IT assets (for example, business applications, data, mobile, SaaS and legacy systems) work well together in the context of implementing end-to-end IoT business solutions. Integration services are not part of turnkey system or limited related service, but may be acquired from the provider or from a separate integration service provider at the sole discretion of the purchasing entity.

Limited Related Service and Additional Consulting or Integration Services will be billed at an Hourly rate will be included on the Cost Sheet (Attachment C) and will be included in the Master Agreement. The Hourly rate will be a blended rate and will encompass all related cost for these additional services.

2.3.3 Category 3 Subcategories of Award

See Attachment V for Category 3 Subcategory Definitions.

Right to Refresh

This category of master agreements (Turnkey Wireless Solutions) may be reopened and refreshed at the sole discretion of the Lead State at any time. The refresh may allow additional Turnkey Wireless Solutions offering in the broad scope or by specifically identified sub categories. The

Lead State reserves the right to change the methodology for award for all or any subcategories at the time of the refresh/reopen of the solicitation. Awards for Award Category 3 in any refresh solicitation will be given the same contract term as the initial award.

Data Protection

The provider shall:

- a. Specify the best available standards-based encryption technologies and options to protect sensitive data, depending on the particular service model that you intend to provide under this Master Agreement, while in transit or at rest.
- b. Describe whether or not it is willing to sign relevant and applicable agreements that may be necessary to protect data with a Purchasing Entity.
- c. Describe how it will only use data for purposes defined in the Master Agreement, participating addendum, or related service level agreement.
- d. Specify its data disposal procedures, policies and destruction confirmation process

Subcontractors

Providers must explain for each Turnkey Wireless Solutions offered if they intend to provide it directly or through the use of Subcontractors. Any Subcontractor that a Provider chooses to use in fulfilling the requirements of the solicitation must also meet all Administrative, Business and Technical Requirements of the RFP, as applicable to the solutions provided in this category.

- a. Contractor must describe the extent to which it intends to use subcontractors to perform contract requirements. Include each position providing service and provide a detailed description of how the subcontractors are anticipated to be involved under the Master Agreement.
- b. If the subcontractor is known, provide the qualifications of the subcontractor to provide the services; if not, describe how you will guarantee selection of a subcontractor that meets the experience requirements of the RFP.
- c. Include a description of how the Contractor will ensure that all subcontractors and their employees will meet all Statement of Work requirements.

2.3.4 Security For each Turnkey Wireless Solutions proposed include both a security disclosure statement.

Contractors for Award Category 3 must submit answers to Attachment S.

2.3.5 Client Infrastructure Impact and Support

Contractors will be willing to provide a description of the Impact and Support on End User infrastructure upon request Assessment what impacts the Turnkey Wireless application will have on the infrastructure used by purchasing entity, including the client's network, data storage and client owned and operated endpoints before installation. Contractor will at the time of purchase identify any support required by the purchasing entity to support the proposed Turnkey Wireless Solutions.

2.3.6 Client Infrastructure and Support

Unless the purchasing entity waives the requirement, the Contractor shall provide a description of the Impact and Support on the End User infrastructure. This shall include an assessment of impacts the Turnkey Wireless application will have on the infrastructure used by purchasing entity, including the client's network, data storage and client owned and operated endpoints before installation. The description shall also identify any resources required by the purchasing entity to support the proposed Turnkey Wireless Solutions.

2.3.7 Pricing Requirements

Cost Sheet

See Attachment C for details for Award Category 3.

No other Terms and Conditions, End User Agreements, or any other terms will be offered with the new product or service unless it is included in the Master Agreement at formation or by Amendment.

Section 3: Adding New Products and Services

The Lead State anticipates establishing a process for regular communication with contractors and addition of new products and services. Addition of new products will be treated differently based on which category of award covers the product or service.

3.1 General Requirements

The Lead State, along with the sourcing committee of this Solicitation will review and add new products and services to the Master Agreements outlined below. The Lead State reserves the right to modify this process to ensure open, transparent and reasonable review of proposed new products and services.

3.2 New Products added under Award Category 1

For new service plans under Award Category 1, Carriers may add new plans as they become available to end users, so long as the plans are added to Attachment G, Contract Coverage Attachment, at the next quarterly update and therefore incorporated into the Master Agreement. If the new plans are not added to Attachment G at the next quarterly update, they will not be included within the scope of the Master Agreements that result from this solicitation. Once plans are incorporated into the Master Agreement in this manner, they are subject to the termination restrictions in section 2.1.4.

3.3 New Products added under Award Category 2

Contractors may add new products under Award Category 2 at any time as long as they fall within the scope of that award category. The Lead State reserves the right to make the determination of whether a product falls within award category 2.

3.4 New Products added under Award Category 3

For new products under Award Category 3, Contractors must submit a request to the Lead State and sourcing team for consideration using Attachment N. All new products under Award Category 3 will be allowed only through amendment of the Master Agreements that result from this solicitation.

After consultation with the sourcing team, the Lead State may choose to include the new product under the Master Agreements by amendment. The Contractor will provide an updated Attachment G at the next quarterly update for public distribution.

3.4.1 New Product Request Form

The New Product Request form will be submitted to the Lead State to request any new products or services under Award Category 3(See Attachment M).

Proposed additional terms and conditions, end user agreements or related materials to be used with the new product must be included with the New Product Request form to be considered for addition to the Master Agreement. Terms and Conditions for additional products/services may be negotiated by the Lead State before addition.

3.4.2 New Product Request Log

All new added products and services under Award Category 3 will be included on Attachment N, Request Log sheet that will include Lead State recommendations and observations. This log will be included in the contract file and will be available for public view.

3.4.3 Quarterly Amendments

The Lead State expects to conduct quarterly amendments of the Master Agreement to add new products and services under Award Category 3. The Lead State reserves the right to amend, or not amend the Master Agreement at any time.

Terms and Conditions not included in the addition of new products for Award Category 3 will not be part of any agreement with end users. Contractors will present end users only with the Terms and Conditions agreed to by the parties in the Master Agreement Amendment.

3.4.4 Terms and Conditions Compliance with Master Agreement

All Products offered under Award Category 3 shall comply fully with all applicable Federal and State laws and regulations. The Order of Precedence clause in the NASPO ValuePoint Master Agreement Terms and Conditions and/or Participating Addendum will control in the event of any conflict between the NASPO ValuePoint Master Agreement and/or Participating Addendum and the Product Terms and Conditions. Any third-party product provider must agree to the Master Agreement Terms and Conditions.

3.5 Quarterly Call/Meeting

The Lead State expects to have a call with contractors every quarter to discuss the status of the contracts, discuss proposed new products and services, and any other issues that may arise regarding the contract. These calls/meetings will be scheduled at mutually agreed upon times.

3.6 Terms and Conditions Compliance with Master Agreement

Any and all Products offered and furnished under any award category shall comply fully with all applicable Federal and State laws and regulations. The Order of Precedence clause in the NASPO ValuePoint Master Agreement Terms and Conditions and/or Participating Addendum will control in the event of any conflict between the NASPO ValuePoint Master Agreement and/or Participating Addendum and the Product Terms and Conditions. Any third-party product provider must agree to the Master Agreement Terms and Conditions.

Section 4: Individual Responsible Account Discounts

4.1 Individual Responsible Account Definition

Individual Responsible Accounts (“IRU”) are accounts for products and services between Contractors awarded a contract under this solicitation and individuals who are employees of eligible users of the Master Agreement. IRU accounts are for the personal use of individual employees of eligible end users of the Master Agreement. IRU discount offerings are not required by Contractors but are scored as a Technical Scorable Criteria for Award Category 1.

All other plans used under this contract by eligible end users are Government/Corporate Responsible Plans (CRU).45.2 Corporate Responsible Account Definition

Corporate Responsible Accounts (“CRU”) are accounts for end users of the Master Agreement.

4.3 Discount for Individual Responsible Account offerings

Contractors will indicate what, if any discount they allow for IRU accounts under this Master Agreement. This discount is entered in their Costsheets (Attachment C) and be included in the Master Agreement.

Section 5: Reporting

5.1 General Requirements

5.1.1 Reporting shall be provided in the format required by NASPO ValuePoint:

6.1.1.1 Attachment H (Award Category 1)

6.1.1.2 Attachment I (Award Category 2)

6.1.1.3 Attachment J (Award Category 3)

5.1.2 Attachment G: Contract Coverage Attachment

Contractors under the Master Agreement that results from this contract will submit quarterly Attachment G to the Lead State. This attachment is intended to encapsulate the

plans, services and offerings of the contractor. This would include any legacy and current offerings, including the plans entered on Attachment C. (anything that would be covered by the Master Agreement).

For Award Category 1, all legacy plans that have a discount under the Current Nevada Master Agreement must continue the discount to be covered by the Master Agreement that results from this solicitation. All legacy plans that do not have a discount under the Current Nevada Master Agreement may continue to have no discount under the Master Agreement that results from this solicitation

Attachment G must be submitted by Contractors awarded under Award Category 1, Award Category 3 and Award Category 4.

5.1.3 Individual participating entities may request specific equipment sales summaries, which shall be provided at no cost.

Upon request, provide reporting elements and/or management reports related to usage for services that are available and would optimize the participating entity's ability to assess utilization and cost.

Be able to provide custom reports as may be requested by individual participating entities. Describe in general, the level of sophistication and complexity, custom usage report data that you can provide to the participating entities. Vendors should provide a sample report with their proposal.

Upon request, provide subscribers with usage reports which include full itemization of call details (such as the information on the Contractor's standard bill for consumer accounts) to enable verification of usage including: (1) call date, call number call length, call time, and (2) plan cost, per minute charges, overage cost, additional features charges and other fees, etc.

5.2 Quarterly Call/Meeting

Contractors must be available for a quarterly meeting by phone, video conference, or in person to discuss contract concerns, developments and any upcoming additional products or services related to reporting.

5.4 Usage Reports (Other States)

Other States and participating entities may have alternate reporting requirements and will be addressed by their Participating Addendum.

Section 6: Pricing Landing Page

6.1 General

NASPO ValuePoint will develop a pricing landing page (webpage) to display contractor pricing in several key areas on an ongoing basis. It is anticipated that the end users will be able to use this Pricing Landing page as a tool to aid in pricing and negotiating plans and device accessory purchases from all awarded contractors. Contractors are expected to provide certain required fields for the Pricing Landing Page. This Section applies only to Category 1 awards.

6.2 Pricing Landing Page Requirements

6.2.1 General Requirements

The Pricing Landing Page will consist of a webpage to allow for quick reference of plans, equipment, accessories and services offered by contractors. Contractors may update the required fields at their discretion whenever they wish. The fields must be populated by contractors.

6.2.2 for Carriers/Contractors (Awarded under Category 1)

At the onset of the contract, Carriers/Contractors will be required to enter in pricing plans for the following scenarios that are found in Attachment C (Costsheet):

- Plans that include a subsidized device in the monthly rate plan cost
 - Basic phone with unlimited voice and messaging
 - Smartphone - 4 Gig of data, unlimited voice & messaging
 - Smartphone - 300 minutes of voice, unlimited data & messaging
 - Smartphone - unlimited data, voice & messaging
 - data only - low - 150 kb
 - data only - moderate - 4 Gig
 - data only - unlimited data
- Plans that require user to supply the device or pay for it separately
 - Smartphone - 4 Gig of data, unlimited voice & messaging
 - Smartphone - unlimited data, voice & messaging
 - Tablet - 1 Gig of data
 - Tablet - shares data with other devices
 - data only - low - 150 kb
 - data only - moderate - 4 Gig
 - data only - unlimited data

These categories have been identified as representing the rate plans and services that are most commonly purchased by NASPO Participating Entities. The categories may be changed as desired by the contractor by submitting updates to NASPO ValuePoint.

6.3 Pricing Landing Page Features

Pricing information

The Lead state will develop a required reporting based on the 14 scenarios listed in Attachment C for the landing page. The lead state reserves the right to determine requirements.

Disclaimers

Clear disclaimers to end users that all pricing reflects contractors best estimates for hypothetical use cases and does not represent local fees, taxes and potential discounts available at specific locations

Point of Contact Information

Sales, Customer Service and Contract Administration point of contact information for ease of reference

Current Offers

Current Discounts, Offers, and Specials available to end users. This would be done on a national basis. Disclaimers for reasonable variance will be allowed at the discretion of the lead state.

Section 7: Administration of Contracts

7.1 Quarterly Amendment

The Lead State anticipates it will provide for regular quarterly amendments to the Master Agreement if there is a need to add new products or services. (Section 4). The Lead State at its discretion may elect to amend the Master Agreement at any time.

7.2 Quarterly Call

The Lead State and sourcing team intend to hold quarterly calls to facilitate new products/services, discuss the administration of the Master Agreements, and all other applicable aspects of the master agreement.

7.3 Annual Meeting

Contractors must be available for an annual meeting in person to discuss continuing administration of the contract. The Lead State anticipates meeting once a year in person to facilitate more in depth communication. The location of in-person meetings will be in The Salt Lake City area, or elsewhere at the discretion of the Lead State.

7.4 Published Documents

The Lead State intends to publish all new product/service request forms, new product logs, and any sourcing committee recommendations and notes related for reference. End users may use these documents to aid in their purchasing decisions.

MA149-1 Wireless Voice, Data and Accessories Attachment C: Costsheet

Award Category 1 Price Sheet

Vendor Name:		AT&T Corp									
		Subsidized Device Scenarios				Bring Your Own Device Scenarios					
Scenario	Description (enter provider a device along with the core plan. Pricing is for 1 device/line as applicable per scenario)	rate \$ per month	Usage Weight	Weighted Cost	OFFEROR NOTES Describe plan attributes and characteristics per the instructions*	Scenario	Description (assume customer provides own device per scenario. Pricing is for 1 device/line as applicable per scenario)	rate	Usage Weight	Weighted Cost	OFFEROR NOTES Describe plan attributes and characteristics per the instructions*
1	basic phone - unlimited voice & messaging	\$22.99	0.115	\$3.64	\$35.00 less modifier \$4.35 25% discount \$7.66 = net Monthly Service Charge of \$22.99 AT&T Mobile Select Pooled Plan 100MB for Feature Phones unlimited talk and text with pooled data: • For basic and quick messaging phones only. • Unlimited texting from the U.S. to over 120 countries. • Unlimited talk from the U.S. to Mexico and Canada. • Plans for smartphones and plans for feature phones also include no roaming charges for plan voice, text, and data use while in Mexico.	8	Smartphone - 4 GIG of data, unlimited voice & messaging	\$41.25	0.01	\$0.41	\$55.00 less 25% discount \$13.75 = net Monthly Service Charge of \$41.25 AT&T Mobile Select - Pooled Plans for Smartphones Pooled data and unlimited talk & text SGB • Flexible pooled data - Light users can help balance out heavy users within a single Billing Account. • Purchase at full price, purchase with a qualified installment agreement, bring your own, or on month-to-month term Plans for smartphones, plans for feature phones and plans for Connected Wearables include: • Unlimited texting from the U.S. to over 120 countries • Unlimited talk from the U.S. to Mexico & Canada Plans for smartphones and plans for feature phones also include: • No roaming charges for plan voice, text, and data use while in Mexico • Data Coverage: Pay-per-use rate of \$0.00009936/KB applies.
2	Smartphone - 4 GIG of data, unlimited voice & messaging	\$41.25	0.053	\$2.27	\$55.00 less 25% discount \$13.75 = net Monthly Service Charge of \$41.25 AT&T Mobile Select Pooled Plan 5GB for Smartphones, unlimited talk and text with pooled data: • Flexible pooled data - Light users can help balance out heavy users within a single Billing Account. • Unlimited texting from the U.S. to more than 120 countries. • Unlimited talk from the U.S. to Mexico and Canada. • On plans for smartphones and plans for feature phones, there are no roaming charges for plan voice, text, and data use while in Mexico. • On plans for eligible data-only devices that have a Monthly Service Charge of \$20.00 or more, there are no roaming charges for plan data use while in Mexico. • Data Coverage: Pay-per-use rate of \$0.00009936/KB applies.	9	Smartphone - unlimited data, voice & messaging	\$31.24	0.01	\$0.31	\$110.00 less \$25 unsubsidized less modifier \$43.35 credit 25% discount \$30.41 net Monthly Service Charge of \$31.24 Unlimited Voice, Data, Text GOV Bundle: • 2GB of data usage; AT&T may slow speeds. • Unlimited number of domestic calls and texts. • Data Coverage: Pay-per-use rate of \$0.00009936/KB applies.
3	Smartphone - 300 minutes of voice, unlimited data & messaging	\$48.75	0.397	\$17.40	\$104 less \$39 Modifier and 25% off = \$48.75 US Coverage, International Roaming outside of the US is additional	10	Tablet - 1 GIG of data	\$20.00	0.01	\$0.20	Monthly Service Charge of \$20.00 AT&T Mobile Select Pooled Plan 1GB data-only devices pooled data: • Flexible pooled data - Light users can help balance out heavy users within a single Billing Account. • Eligible data-only devices: tablets, connected devices, laptops, LaptopConnect/aircards, netbooks, cases, mobile hotspot devices, and select other data-only devices. Connected devices include cameras, game consoles, and select other data-only connected devices. Connected devices have no plan usage in Mexico. Pay-per-use roaming rates apply. • On plans for eligible data-only devices that have a Monthly Service Charge of \$20.00 or more, there are no roaming charges for plan data use while in Mexico. • Data Coverage: Pay-per-use rate of \$0.00009936/KB applies.
4	Smartphone - unlimited data, voice & messaging	\$49.99	0.048	\$2.40	\$110.00 less 25% modifier \$43.35 less discount \$16.66 net Monthly Service Charge of \$49.99 AT&T Business Connect Plan 5MB: Unlimited Voice, Data, Text GOV Bundle: • 2GB of data usage; AT&T may slow speeds. • Unlimited number of domestic calls and texts. • Plans for smartphones include unlimited texting from the U.S. to more than 120 countries. • Unlimited talk from the U.S. to Mexico and Canada. • No roaming charges for plan, voice, text, and data use while in Mexico.	11	Unlimited Data Plans (No Throttling that are used by First Responders)	\$30.00	0.01	\$0.30	\$40.00 less 25% discount \$30.00 = net Monthly Service Charge of \$30.00 AT&T Mobile Select Pooled Plan 3GB data-only devices pooled data: • Flexible pooled data - Light users can help balance out heavy users within a single Billing Account. • Eligible data-only devices: tablets, connected devices, laptops, LaptopConnect/aircards, netbooks, cases, mobile hotspot devices, and select other data-only devices. Connected devices include cameras, game consoles, and select other data-only connected devices. Connected devices have no plan usage in Mexico. Pay-per-use roaming rates apply. • On plans for eligible data-only devices that have a Monthly Service Charge of \$20.00 or more, there are no roaming charges for plan data use while in Mexico. • Data Coverage: Pay-per-use rate of \$0.00009936/KB applies.
5	data only - low - 150 kb	\$3.75	0.014	\$0.05	\$5.00 less 25% discount \$1.25 = net Monthly Service Charge of \$3.75 AT&T Business Connect Plan 5MB: • Wirelessly enable your qualified data-only devices, such as routers, scanners, and monitoring devices. • Telemetry - these pooling plans are best suited for qualified devices using machine-to-machine business applications that have low data usage. • Pooling plans offer data pooling for qualified lines within a single Billing Account Number. • Data Coverage: Pay-per-use rate of \$0.000976/KB applies.	12	data only - low - 150 kb	\$3.75	0.01	\$0.04	\$5.00 less 25% discount \$1.25 = net Monthly Service Charge of \$3.75 AT&T Business Connect Plan 5MB: • Wirelessly enable your qualified data-only devices, such as routers, scanners, and monitoring devices. • Telemetry - these pooling plans are best suited for qualified devices using machine-to-machine business applications that have low data usage. • Pooling plans offer data pooling for qualified lines within a single Billing Account Number. • Data Coverage: Pay-per-use rate of \$0.000976/KB applies.
6	data only - moderate - 4 GIG	\$37.50	0.04	\$1.50	\$50.00 less 25% discount \$11.50 = net Monthly Service Charge of \$37.50 AT&T Mobile Select Pooled Plan 5GB data-only devices pooled data: • Flexible pooled data - Light users can help balance out heavy users within a single Billing Account. • Eligible data-only devices: tablets, connected devices, laptops, LaptopConnect/aircards, netbooks, cases, mobile hotspot devices, and select other data-only devices. Connected devices include cameras, game consoles, and select other data-only connected devices. Connected devices have no plan usage in Mexico. Pay-per-use roaming rates apply. • On plans for eligible data-only devices that have a Monthly Service Charge of \$20.00 or more, there are no roaming charges for plan data use while in Mexico. • Data Coverage: Pay-per-use rate of \$0.00009936/KB applies.	13	data only - moderate - 4 GIG	\$37.50	0.01	\$0.38	\$50.00 less 25% discount \$12.50 = net Monthly Service Charge of \$37.50 AT&T Mobile Select Pooled Plan 5GB data-only devices pooled data: • Flexible pooled data - Light users can help balance out heavy users within a single Billing Account. • Eligible data-only devices: tablets, connected devices, laptops, LaptopConnect/aircards, netbooks, cases, mobile hotspot devices, and select other data-only devices. Connected devices include cameras, game consoles, and select other data-only connected devices. Connected devices have no plan usage in Mexico. Pay-per-use roaming rates apply. • On plans for eligible data-only devices that have a Monthly Service Charge of \$20.00 or more, there are no roaming charges for plan data use while in Mexico. • Data Coverage: Pay-per-use rate of \$0.00009936/KB applies.
7	data only - unlimited data	\$29.99	0.287	\$11.48	\$69.99 less Modifier of \$16.67 25% off = \$39.99 US Coverage, International Roaming outside of the US is additional	14	data only - unlimited data	\$29.99	0.01	\$0.40	\$69.99 less Modifier of \$16.67 25% off = \$39.99 US Coverage, International Roaming outside of the US is additional
Total				\$37.71		Total				\$2.04	
Grand Total (K14 + K14)				\$39.78							

		Subsidized Device Scenario Requirements				Bring Your Own Device Scenarios	
Scenario	Description	requirements	Scenario	Description	requirements		
1	basic phone - unlimited voice & messaging	Monthly rate covers 1 user / plan for device, network access, unlimited voice talk time and unlimited messaging. Device must be most current in stock device. *Data used on device will be pulled from account pool. *Plan includes unlimited messaging from the US to other countries	8	Smartphone - 4 GIG of data, unlimited voice & messaging	Monthly rate covers 1 user / plan for network access, unlimited voice talk time, unlimited messaging, unlimited mobile hot spot and at least 4 GIG of 4G data *Data must contribute to overall account pool *Unsubsidized data from the previous month may roll over into the next month's allowance		
3	Smartphone - 4 GIG of data, unlimited voice & messaging	Monthly rate covers 1 user / plan for device, network access, unlimited voice talk time, unlimited messaging, unlimited mobile hot spot and at least 4 GIG of 4G data Device must be no older than one generation removed from most current model. *Data must contribute to overall account pool. *Unsubsidized data from the previous month may roll over into the next month's allowance	9	Smartphone - unlimited data, voice & messaging	Monthly rate covers 1 user / plan for network access, unlimited voice talk time, unlimited messaging, unlimited mobile hot spot and unlimited 4G data *Data must contribute to overall account pool *Unsubsidized data from the previous month may roll over into the next month's allowance		
3	Smartphone - 300 minutes of voice, unlimited data & messaging	Monthly rate covers 1 user / plan for device, network access, 300 minutes of voice talk time, unlimited messaging, unlimited mobile hot spot and unlimited 4G data Device must be no older than one generation removed from most current model. *Data must contribute to overall account pool. *Unsubsidized data from the previous month may roll over into the next month's allowance	10	Tablet - 1 GIG of data	Monthly rate covers 1 user / plan for network access, unlimited mobile hot spot and at least 1 GIG of 4G data *Data must contribute to overall account pool *Unsubsidized data from the previous month may roll over into the next month's allowance		
4	Smartphone - unlimited data, voice & messaging	Monthly rate covers 1 user / plan for device, network access, unlimited voice talk time, unlimited messaging, unlimited mobile hot spot and unlimited 4G data Device must be no older than one generation removed from most current model. *Data must contribute to overall account pool. *Plan includes unlimited messaging from the US to other countries	11	Unlimited Data Plans (No Throttling that are used by First Responders)	Monthly rate covers 1 user / plan for network access, unlimited voice talk time, unlimited messaging, unlimited mobile hot spot and unlimited 4G data *Data must contribute to overall account pool *Unsubsidized data from the previous month may roll over into the next month's allowance		
5	data only - low - 150 kb	Monthly rate covers 1 user / plan for device, network access, and at least 150 kb of 4G data Device must be no older than one generation removed from most current model. *Data must contribute to overall account pool. *Unsubsidized data from the previous month may roll over into the next month's allowance	12	data only - low - 150 kb	Monthly rate covers 1 user / plan for network access, at least 150 kb of 4G data *Data must contribute to overall account pool *Unsubsidized data from the previous month may roll over into the next month's allowance		
6	data only - moderate - 4 GIG	Monthly rate covers 1 user / plan for device, network access, at least 4 GIG of 4G data and unlimited mobile hotspot Device must be no older than one generation removed from most current model. *Data must contribute to overall account pool. *Unsubsidized data from the previous month may roll over into the next month's allowance	13	data only - moderate - 4 GIG	Monthly rate covers 1 user / plan for network access, at least 4 GIG of 4G data and unlimited mobile hotspot *Data must contribute to overall account pool *Unsubsidized data from the previous month may roll over into the next month's allowance		
7	data only - unlimited data	Monthly rate covers 1 user / plan for device, network access, unlimited 4G data and unlimited mobile hotspot Device must be no older than one generation removed from most current model. *Data must contribute to overall account pool. *Unsubsidized data from the previous month may roll over into the next month's allowance	14	data only - unlimited data	Monthly rate covers 1 user / plan for network access, unlimited 4G data and unlimited mobile hotspot *Data must contribute to overall account pool *Unsubsidized data from the previous month may roll over into the next month's allowance		

Catalog Discount Offering		
Description	Percentage Off (%)	What aspects of plans does this discount apply to? Please be specific.
Percentage off discount rate offered plans as defined by the Scope of Work (Must be an entry to be responsive)	25%	Contractor will only apply the Service Discount to the Monthly Service Charge of eligible Plans. Contractor will not apply the Service Discount to other monthly service charges such as monthly recurring charges for features, and/or any other charges under the Contract. Contractor may restrict certain Plans or certain other discount programs from qualifying for the Service Discount. Contractor will advise WSA when such restrictions apply. It may take several billing cycles for the Service Discount to be applied.

ILU Discount Offering		
Description	Percentage Off (%)	What aspects of plans does this discount apply to? Please be specific.
Percentage off discount rate offered to ILU accounts as defined by the Scope of Work	17%	Contractor will only apply the Service Discount to the Monthly Service Charge of eligible Plans. Contractor will not apply the Service Discount to other monthly service charges such as monthly recurring charges for features, and/or any other charges under the Contract. Contractor may restrict certain Plans or certain other discount programs from qualifying for the Service Discount. Contractor will advise WSA when such restrictions apply. It may take several billing cycles for the Service Discount to be applied.

MA149-1 Wireless Voice, Data and Accessories Attachment C: Worksheet

Category 34: Fleet Management Capabilities

Instructions: Offeror, Please fill out all fields in this offer below. The value in Cell (T10) will be used to determine cost points in the evaluation of your Fleet Management offering. Although only basic Fleet Management costs will be used to evaluate cost, offeror shall make available their full suite of Fleet Management services should they be awarded under this contract.

VENDOR		AT&T - Product Name: Fleet Complete (Sub-Category 4)		Monthly Recurring Cost
Description	minimum quantity of vehicles	monthly fee	total annual cost (for x Fee x 12)	OFFEROR NOTES: Describe plan attributes and characteristics per the instructions*
Basic Fleet Management	10	\$7.50	\$900.00	<p>There are multiple options for "Basic Fleet Management" and price points are not dependent on the number of vehicles, but the features selected. The example to the left is based on the 23MB data plan</p> <p>Monthly Costs: Data Plan 23MB, average \$1.00/MB - \$3.75/month Data Plan 5MB, average \$1.00/MB - \$5.25/month Data Plan 25MB, average \$1.00/MB - \$7.25/month Hours of Service (POS/ELI) - \$6.65/month Monthly Hardware Costs (6 month term) - \$6.65/month Fleet Tracker - \$17.50/month Asset Tracker One Software - \$6.41/month Resource Tracker - Fleet Worker - \$8.50/month First Responder Tracking Service - \$13.30/month Dispatch - \$31.75/month Enhanced Fleet Tracking - \$35.15/month Video Telematics - \$19.00/month Asset Tracker One Software - \$6.41/month Asset Tracker One Hardware Bundle - \$130/month</p>
	100	\$7.50	\$9,000.00	<p>There are multiple options for "Basic Fleet Management" and price points are not dependent on the number of vehicles, but the features selected. The example to the left is based on the 23MB data plan</p> <p>Monthly Costs: Data Plan 23MB, average \$1.00/MB - \$3.75/month Data Plan 5MB, average \$1.00/MB - \$5.25/month Data Plan 25MB, average \$1.00/MB - \$7.25/month Hours of Service (POS/ELI) - \$6.65/month Monthly Hardware Costs (6 month term) - \$6.65/month Fleet Tracker - \$17.50/month Asset Tracker - \$13.00/month Resource Tracker - Fleet Worker - \$9.50/month First Responder Tracking Service - \$13.30/month Dispatch - \$31.75/month Enhanced Fleet Tracking - \$33.15/month Video Telematics - \$19.00/month Asset Tracker One Software - \$6.41/month Asset Tracker One Hardware Bundle - \$130/month</p>
	500	\$7.50	\$45,000.00	<p>There are multiple options for "Basic Fleet Management" and price points are not dependent on the number of vehicles, but the features selected. The example to the left is based on the 23MB data plan</p> <p>Monthly Costs: Data Plan 23MB, average \$1.00/MB - \$3.75/month Data Plan 5MB, average \$1.00/MB - \$5.25/month Data Plan 25MB, average \$1.00/MB - \$7.25/month Hours of Service (POS/ELI) - \$6.65/month Monthly Hardware Costs (6 month term) - \$6.65/month Fleet Tracker - \$17.50/month Asset Tracker - \$8.00/month Resource Tracker - Fleet Worker - \$9.50/month First Responder Tracking Service - \$13.30/month Dispatch - \$31.75/month Enhanced Fleet Tracking - \$33.15/month Video Telematics - \$19.00/month Asset Tracker One Software - \$6.41/month Asset Tracker One Hardware Bundle - \$130/month</p>
	1000	\$7.50	\$90,000.00	<p>There are multiple options for "Basic Fleet Management" and price points are not dependent on the number of vehicles, but the features selected. The example to the left is based on the 23MB data plan</p> <p>Monthly Costs: Data Plan 23MB, average \$1.00/MB - \$3.75/month Data Plan 5MB, average \$1.00/MB - \$5.25/month Data Plan 25MB, average \$1.00/MB - \$7.25/month Hours of Service (POS/ELI) - \$6.65/month Monthly Hardware Costs (6 month term) - \$6.65/month Fleet Tracker - \$17.50/month Asset Tracker - \$6.50/month Resource Tracker - Fleet Worker - \$9.50/month First Responder Tracking Service - \$13.30/month Dispatch - \$31.75/month Enhanced Fleet Tracking - \$33.15/month Video Telematics - \$19.00/month Asset Tracker One Software - \$6.41/month Asset Tracker One Hardware Bundle - \$130/month</p>
	5000	\$7.50	\$450,000.00	<p>There are multiple options for "Basic Fleet Management" and price points are not dependent on the number of vehicles, but the features selected. The example to the left is based on the 23MB data plan</p> <p>Monthly Costs: Data Plan 23MB, average \$1.00/MB - \$3.75/month Data Plan 5MB, average \$1.00/MB - \$5.25/month Data Plan 25MB, average \$1.00/MB - \$7.25/month Hours of Service (POS/ELI) - \$6.65/month Monthly Hardware Costs (6 month term) - \$6.65/month Fleet Tracker - \$17.50/month Asset Tracker - \$9.50/month Resource Tracker - Fleet Worker - \$9.50/month First Responder Tracking Service - \$13.30/month Dispatch - \$31.75/month Enhanced Fleet Tracking - \$33.15/month Video Telematics - \$19.00/month Asset Tracker One Software - \$6.41/month Asset Tracker One Hardware Bundle - \$130/month</p>
Total Annual Recurring Cost			\$994,800.00	

Description	Requirements	Service Requirements
Basic Fleet Management	<ul style="list-style-type: none"> Hardware to track, monitor & manage vehicles while collecting information on vehicle location & operation Based base option to connect to vehicles on board (dependent on vehicle type) Ability to monitor vehicle location Provide location based vehicle alerts support Provide information on driver performance Real time and historical reporting on events, operational performance Ability to set up alerts based on customer defined parameters 	

Description		minimum quantity of vehicles	cost per vehicle	Total Set Up Cost	OFFEROR NOTES: Details of installation and set up of customer's instance
Total One Time Cost for installation, Set Up and Basic System Administration/Training	10	\$147.25	\$1,472.50	\$1,472.50	<p>Installation and set-up costs significantly vary based on customer needs. The item to the left is for the up-front hardware costs. Other options include: Hardware - Up front charge - \$147.25 PT100 Hardware - Personal Tracker Tracking Unit - \$243.55 MS5000 Hardware - LTE Fleet Tracking Unit - \$147.25 AT1000 Hardware - LTE Asset Tracking Unit w/Wireless or Extreme Temperature long-life battery - \$189.05 MS5000 Hardware - LTE Fleet Tracking Unit with External Antenna - \$147.25 Vision External Camera - Bluetooth Video Telematics External Dash Camera - \$80.75 Asset Tracker One Hardware - \$47.50 Asset Tracker One Solar Hardware - \$66.50</p>
	100	\$147.25	\$14,725.00	\$14,725.00	<p>Installation and set-up costs significantly vary based on customer needs. The item to the left is for the up-front hardware costs. Other options include: Hardware - Up front charge - \$147.25 PT100 Hardware - Personal Tracker Tracking Unit - \$243.55 MS1000 Hardware - LTE Asset Tracking Unit - \$147.25 AT1000 Hardware - LTE Asset Tracking Unit w/Wireless or Extreme Temperature long-life battery - \$189.05 MS5000 Hardware - LTE Fleet Tracking Unit with External Antenna - \$147.25 Vision External Camera - Bluetooth Video Telematics External Dash Camera - \$80.75 Asset Tracker One Hardware - \$47.50 Asset Tracker One Solar Hardware - \$66.50</p>
	500	\$147.25	\$73,625.00	\$73,625.00	<p>Installation and set-up costs significantly vary based on customer needs. The item to the left is for the up-front hardware costs. Other options include: Hardware - Up front charge - \$147.25 PT100 Hardware - Personal Tracker Tracking Unit - \$243.55 MS5000 Hardware - LTE Fleet Tracking Unit - \$147.25 AT1000 Hardware - LTE Asset Tracking Unit w/Wireless or Extreme Temperature long-life battery - \$189.05 MS5000 Hardware - LTE Fleet Tracking Unit with External Antenna - \$147.25 Vision External Camera - Bluetooth Video Telematics External Dash Camera - \$80.75 Asset Tracker One Hardware - \$47.50 Asset Tracker One Solar Hardware - \$66.50</p>
	1000	\$147.25	\$147,250.00	\$147,250.00	<p>Installation and set-up costs significantly vary based on customer needs. The item to the left is for the up-front hardware costs. Other options include: Hardware - Up front charge - \$147.25 PT100 Hardware - Personal Tracker Tracking Unit - \$243.55 MS5000 Hardware - LTE Fleet Tracking Unit - \$147.25 MS5000 Hardware - LTE Fleet Tracking Unit with External Antenna - \$147.25 AT1000 Hardware - LTE Asset Tracking Unit w/Wireless or Extreme Temperature long-life battery - \$189.05 Vision External Camera - Bluetooth Video Telematics External Dash Camera - \$80.75 Asset Tracker One Hardware - \$47.50 Asset Tracker One Solar Hardware - \$66.50</p>
	5000	\$147.25	\$736,250.00	\$736,250.00	<p>Installation and set-up costs significantly vary based on customer needs. The item to the left is for the up-front hardware costs. Other options include: Hardware - Up front charge - \$147.25 PT100 Hardware - Personal Tracker Tracking Unit - \$243.55 MS5000 Hardware - LTE Fleet Tracking Unit - \$147.25 MS5000 Hardware - LTE Fleet Tracking Unit with External Antenna - \$147.25 AT1000 Hardware - LTE Asset Tracking Unit w/Wireless or Extreme Temperature long-life battery - \$189.05 Vision External Camera - Bluetooth Video Telematics External Dash Camera - \$80.75 Asset Tracker One Hardware - \$47.50 Asset Tracker One Solar Hardware - \$66.50</p>
Total Installation and Set Up Cost			\$970,325.00		

Description	Requirements	Installation & Set Up Requirements
Installation, Set up and Basic System Administration/Training	<ul style="list-style-type: none"> Hardware and integration of customer's instance is provided to meet customer needs. Install each vehicle and connect to OBD-II 	

Security Cost		\$970,325.00
----------------------	--	---------------------

MA169-1 Wireless Voice, Data and Accessories Attachment C: Costsheet

Category 3A: Fleet Management Costsheet

Instructions: Offeror, Please fill out all fields in this color below. The value in Cell D30 will be used to determine cost points in the evaluation of your Fleet Management offering. Although only basic Fleet Management costs will be used to evaluate cost, offeror shall make available their full suite of Fleet Management services should they be awarded under this contract.

VENDOR		AT&T - Product Name: AT&T Fleet Management for Government (Sub-Category A)		Monthly Recurring Cost
Description	minimum quantity of vehicle	cost per vehicle	total annual cost (per vehicle)	OFFEROR NOTES: Describe plan attributes and characteristics per the instructions*
Basic Fleet Management	10	\$21.20	\$3,024.00	There are four options for "Basic Fleet Management" and price points are not dependent on the number of vehicles, but the features selected. The item to the left is for the Pro-Active Tracking. Does not include hardware fees (e.g., OBDII device). Monthly Plan Options: - Standard Plan (No commit, includes connectivity) - \$8.00/month - Base Tracking (No commit, includes connectivity) - \$11.70/month - Pro Tracking (No commit, includes connectivity) - \$13.60/month - Pro-Active Tracking (No commit, includes connectivity) - \$23.20/month
	100	\$15.20	\$30,240.00	There are four options for "Basic Fleet Management" and price points are not dependent on the number of vehicles, but the features selected. The item to the left is for the Pro-Active Tracking. Does not include hardware fees (e.g., OBDII device). Monthly Plan Options: - Standard Plan (No commit, includes connectivity) - \$8.00/month - Base Tracking (No commit, includes connectivity) - \$11.70/month - Pro Tracking (No commit, includes connectivity) - \$13.60/month - Pro-Active Tracking (No commit, includes connectivity) - \$23.20/month
	500	\$15.20	\$18,720.00	There are four options for "Basic Fleet Management" and price points are not dependent on the number of vehicles, but the features selected. The item to the left is for the Pro-Active Tracking. Does not include hardware fees (e.g., OBDII device). Monthly Plan Options: - Standard Plan (No commit, includes connectivity) - \$8.00/month - Base Tracking (No commit, includes connectivity) - \$11.70/month - Pro Tracking (No commit, includes connectivity) - \$13.60/month - Pro-Active Tracking (No commit, includes connectivity) - \$23.20/month
	1000	\$15.20	\$30,240.00	There are four options for "Basic Fleet Management" and price points are not dependent on the number of vehicles, but the features selected. The item to the left is for the Pro-Active Tracking. Does not include hardware fees (e.g., OBDII device). Monthly Plan Options: - Standard Plan (No commit, includes connectivity) - \$8.00/month - Base Tracking (No commit, includes connectivity) - \$11.70/month - Pro Tracking (No commit, includes connectivity) - \$13.60/month - Pro-Active Tracking (No commit, includes connectivity) - \$23.20/month
	5000	\$15.20	\$1,872,000.00	There are four options for "Basic Fleet Management" and price points are not dependent on the number of vehicles, but the features selected. The item to the left is for the Pro-Active Tracking. Does not include hardware fees (e.g., OBDII device). Monthly Plan Options: - Standard Plan (No commit, includes connectivity) - \$8.00/month - Base Tracking (No commit, includes connectivity) - \$11.70/month - Pro Tracking (No commit, includes connectivity) - \$13.60/month - Pro-Active Tracking (No commit, includes connectivity) - \$23.20/month
Total Annual Recurring Cost			\$1,998,816.00	

Description	requirements
Basic Fleet Management	Follow to track, monitor & manage vehicle while collecting information on vehicle location & operation Must have option to connect to vehicle's On Board Diagnostics (OBD-II) port Ability to monitor vehicle location Provide location-based routing support Provide information on driver performance Real time and historical reporting via various, customized portal Ability to set alerts based on user-defined parameters

Installation & Set Up Costs

Description	minimum quantity of vehicle	cost per vehicle	Total Set Up Cost	OFFEROR NOTES: Details of Installation and Set Up of customer's instance
Total One Time Cost for Installation, Set Up and Basic System Administrator Training	10	\$3,091.25	\$39,812.50	Installation and set-up costs significantly vary based on customer needs. The item to the left is a total of all options, but may not apply to every customer. Possible one-time charges can include: - Single vehicle install using a straight harness. Does not include the harness cost. (ISO OBDII device) (Labor only) - \$99.75 - Extended install - Extended installation using a T-Cable. (ISO OBDII device) (Labor only) - \$120.00 - Fee for installations conducted on the customer premises. Cost is for 1 installer, 1 day, for 10 vehicles - \$242.25 - 3 wire standard installation - (ISO OBDII device) (vehicles without ports) (Labor only) - \$135.00 - Installation of Driver ID NFC Reader (ISO-AUX) add-on - \$23.75 - Standard in-dash installation that uses the ISO-AUX port on the OBD. Per Unit Fee - \$23.75 - Non-Standard in-dash installation that uses the ISO-AUX port on the OBD. Per Unit Fee - \$60.75 - Remove old OBDII/Re-install new OBDII. Rates (per unit) without cable - \$123.50 - Remove/Re-install Rates (per unit) OBDII with straight cable \$142.50 - Professional services for any installation/demolition items not covered in the pricing schedule (per vehicle) (hourly) - \$145.00 - No-Show Fees (per vehicle) - \$47.50 - Gate access wait fee (per hour) when waiting to/from vehicles to perform installations - \$95.00 - Technician fee when the requires special Homeland Security Clearance (THIC) cards, minimum 2 techs per location - \$400.00 - Training (per day) - combine with Training travel fees. Per event - \$1,425.00 - Training travel fees if applicable per location - \$607.50 - Per location shipping fee - \$40.00
	100	\$3,091.25	\$308,125.00	Installation and set-up costs significantly vary based on customer needs. The item to the left is a total of all options, but may not apply to every customer. Possible one-time charges can include: - Single vehicle install using a straight harness. Does not include the harness cost. (ISO OBDII device) (Labor only) - \$99.75 - Extended install - Extended installation using a T-Cable. (ISO OBDII device) (Labor only) - \$120.00 - Fee for installations conducted on the customer premises. Cost is for 1 installer, 1 day, for 10 vehicles - \$242.25 - 3 wire standard installation - (ISO OBDII device) (vehicles without ports) (Labor only) - \$135.00 - Installation of Driver ID NFC Reader (ISO-AUX) add-on - \$23.75 - Standard in-dash installation that uses the ISO-AUX port on the OBD. Per Unit Fee - \$23.75 - Non-Standard in-dash installation that uses the ISO-AUX port on the OBD. Per Unit Fee - \$60.75 - Remove old OBDII/Re-install new OBDII. Rates (per unit) without cable - \$123.50 - Remove/Re-install Rates (per unit) OBDII with straight cable \$142.50 - Professional services for any installation/demolition items not covered in the pricing schedule (per vehicle) (hourly) - \$145.00 - No-Show Fees (per vehicle) - \$47.50 - Gate access wait fee (per hour) when waiting to/from vehicles to perform installations - \$95.00 - Technician fee when the requires special Homeland Security Clearance (THIC) cards, minimum 2 techs per location - \$400.00 - Training (per day) - combine with Training travel fees. Per event - \$1,425.00 - Training travel fees if applicable per location - \$607.50 - Per location shipping fee - \$40.00
	500	\$3,091.25	\$1,545,625.00	Installation and set-up costs significantly vary based on customer needs. The item to the left is a total of all options, but may not apply to every customer. Possible one-time charges can include: - Single vehicle install using a straight harness. Does not include the harness cost. (ISO OBDII device) (Labor only) - \$99.75 - Extended install - Extended installation using a T-Cable. (ISO OBDII device) (Labor only) - \$120.00 - Fee for installations conducted on the customer premises. Cost is for 1 installer, 1 day, for 10 vehicles - \$242.25 - 3 wire standard installation - (ISO OBDII device) (vehicles without ports) (Labor only) - \$135.00 - Installation of Driver ID NFC Reader (ISO-AUX) add-on - \$23.75 - Standard in-dash installation that uses the ISO-AUX port on the OBD. Per Unit Fee - \$23.75 - Non-Standard in-dash installation that uses the ISO-AUX port on the OBD. Per Unit Fee - \$60.75 - Remove old OBDII/Re-install new OBDII. Rates (per unit) without cable - \$123.50 - Remove/Re-install Rates (per unit) OBDII with straight cable \$142.50 - Professional services for any installation/demolition items not covered in the pricing schedule (per vehicle) (hourly) - \$145.00 - No-Show Fees (per vehicle) - \$47.50 - Gate access wait fee (per hour) when waiting to/from vehicles to perform installations - \$95.00 - Technician fee when the requires special Homeland Security Clearance (THIC) cards, minimum 2 techs per location - \$400.00 - Training (per day) - combine with Training travel fees. Per event - \$1,425.00 - Training travel fees if applicable per location - \$607.50 - Per location shipping fee - \$40.00
	1000	\$3,091.25	\$3,091,250.00	Installation and set-up costs significantly vary based on customer needs. The item to the left is a total of all options, but may not apply to every customer. Possible one-time charges can include: - Single vehicle install using a straight harness. Does not include the harness cost. (ISO OBDII device) (Labor only) - \$99.75 - Extended install - Extended installation using a T-Cable. (ISO OBDII device) (Labor only) - \$120.00 - Fee for installations conducted on the customer premises. Cost is for 1 installer, 1 day, for 10 vehicles - \$242.25 - 3 wire standard installation - (ISO OBDII device) (vehicles without ports) (Labor only) - \$135.00 - Installation of Driver ID NFC Reader (ISO-AUX) add-on - \$23.75 - Standard in-dash installation that uses the ISO-AUX port on the OBD. Per Unit Fee - \$23.75 - Non-Standard in-dash installation that uses the ISO-AUX port on the OBD. Per Unit Fee - \$60.75 - Remove old OBDII/Re-install new OBDII. Rates (per unit) without cable - \$123.50 - Remove/Re-install Rates (per unit) OBDII with straight cable \$142.50 - Professional services for any installation/demolition items not covered in the pricing schedule (per vehicle) (hourly) - \$145.00 - No-Show Fees (per vehicle) - \$47.50 - Gate access wait fee (per hour) when waiting to/from vehicles to perform installations - \$95.00 - Technician fee when the requires special Homeland Security Clearance (THIC) cards, minimum 2 techs per location - \$400.00 - Training (per day) - combine with Training travel fees. Per event - \$1,425.00 - Training travel fees if applicable per location - \$607.50 - Per location shipping fee - \$40.00
	5000	\$3,091.25	\$15,456,250.00	Installation and set-up costs significantly vary based on customer needs. The item to the left is a total of all options, but may not apply to every customer. Possible one-time charges can include: - Single vehicle install using a straight harness. Does not include the harness cost. (ISO OBDII device) (Labor only) - \$99.75 - Extended install - Extended installation using a T-Cable. (ISO OBDII device) (Labor only) - \$120.00 - Fee for installations conducted on the customer premises. Cost is for 1 installer, 1 day, for 10 vehicles - \$242.25 - 3 wire standard installation - (ISO OBDII device) (vehicles without ports) (Labor only) - \$135.00 - Installation of Driver ID NFC Reader (ISO-AUX) add-on - \$23.75 - Standard in-dash installation that uses the ISO-AUX port on the OBD. Per Unit Fee - \$23.75 - Non-Standard in-dash installation that uses the ISO-AUX port on the OBD. Per Unit Fee - \$60.75 - Remove old OBDII/Re-install new OBDII. Rates (per unit) without cable - \$123.50 - Remove/Re-install Rates (per unit) OBDII with straight cable \$142.50 - Professional services for any installation/demolition items not covered in the pricing schedule (per vehicle) (hourly) - \$145.00 - No-Show Fees (per vehicle) - \$47.50 - Gate access wait fee (per hour) when waiting to/from vehicles to perform installations - \$95.00 - Technician fee when the requires special Homeland Security Clearance (THIC) cards, minimum 2 techs per location - \$400.00 - Training (per day) - combine with Training travel fees. Per event - \$1,425.00 - Training travel fees if applicable per location - \$607.50 - Per location shipping fee - \$40.00
Total Installation and Set Up Cost			\$6,481,762.50	

Description	requirements
Installation, Set Up and Basic System Administrator Training	Not to exceed 10% of customer's instance or provider's hourly rate/contract.

Baseable Cost: \$2,460,125.00

CJ18020 Wireless Voice, Data and Accessories Attachment C: Costsheet

Category 3B: Mobile Device Management Costsheet

Instructions: Offeror, Please fill out all fields in this color below. The value in Cell D30 will be used to determine cost points in the evaluation of your Mobile Device Management offering. Although only basic Mobile Device Management costs will be used to evaluate cost, offeror shall make available their full suite of Mobile Device Management services should they be awarded under this contract.

MobileIron Core		AT&T Mobile Iron Core		
Monthly Recurring Cost				
Description	minimum quantity of licenses	monthly fee	total annual cost (qty x fee x 12)	OFFEROR NOTES Describe plan attributes and characteristics per the instructions*.
MA149-1 Wireless Voice, Data and Accessories Attachment C: Costsheet	10	\$6.00	\$720.00	Support Mac OS, Windows 10, iOS, and Android management. Configure, deploy, and update apps and policies — no user intervention required. Support both SDK and wrapping methods for app containerization. Remote Wipe. AD/LDAP, Kiosk Mode/Apple DEP, Separate enterprise and personal apps and data on the device. Derived credentials and Bridge.
	100	\$6.00	\$7,200.00	
	500	\$6.00	\$36,000.00	
	1000	\$6.00	\$72,000.00	
Total Annual Recurring Cost			\$115,920.00	

Service Requirements	
Description	requirements
Basic Mobile Device Management	<ul style="list-style-type: none"> *central control to enroll, configure, secure, monitor and manage all enrolled devices (iOS, Android, Blackberry, Windows) *Ability to configure and update devices over-the-air *Ability to push and update custom apps to devices over-the-air *Enforce security and compliance policies *Secure Mobile Access to corporate resources *Provide Secure Container for corporate apps and data on each device *Ability to remote wipe entire device and / or only apps and data in secure container

Installation & Set Up Costs				
Description	minimum quantity of licenses		Total Set Up Cost	OFFEROR NOTES Details of Installation and Set Up of customer's instance
Total One Time Cost for Installation, Set Up and Basic System Administrator Training	10		\$9,000.00	Kick-Off Call, Readiness Call of Customer Environment/Server Install Core, Install Connector integrate to Active Directory, Install (up to) 2 Sentries and integrate to Exchange, Add 10 Applications, Add 10 Policies and configurations, Add 10 Users/Devices, Access control, Policy configuration alerts, Add 10 Users/Devices, Admin training, Policy configuration alerts, Configure and test Docs@Work, Configure and test Web@Work, Configure and test Dataview, Configure and test Tunnel, Additional details covered in Statement of Work
	100		\$9,000.00	
	500		\$9,000.00	
	1000		\$9,000.00	
Total Installation and Set Up Cost			\$36,000.00	

Installation & Set Up Requirements	
Description	requirements
Installation, Set Up and Basic System Administrator Training	<ul style="list-style-type: none"> *Set up and configuration of customer's instance in provider's hosted environment. *At least one remote meeting with customer's designated system administrator to complete set up and provide knowledge transfer.

Scorable Cost	\$151,920.00
----------------------	---------------------

Consultative Hourly Rate (this rate will be included in the contract)	\$250.00
---	----------

MA149-1 Wireless Voice, Data and Accessories Attachment C: Costsheet

Category 3B: Mobile Device Management Costsheet

Instructions: Offeror, Please fill out all fields in this color below. The value in Cell D30 will be used to determine cost points in the evaluation of your Mobile Device Management offering. Although only basic Mobile Device Management costs will be used to evaluate cost, offeror shall make available their full suite of Mobile Device Management services should they be awarded under this contract.

MobileIron Cloud		AT&T Mobile Iron Cloud		
Monthly Recurring Cost				
Description	minimum quantity of licenses	monthly fee	total annual cost (qty x fee x 12)	OFFEROR NOTES Describe plan attributes and characteristics per the instructions*.
Basic Mobile Device Management cost per device	10	\$6.00	\$720.00	Support Mac OS, Windows 10, iOS, and Android management. Configure, deploy, and update apps and policies — no user intervention required. Support both SDK and wrapping methods for app containerization. Remote Wipe. AD/LDAP, Kiosk Mode/Apple DEP, Separate enterprise and personal apps and data on the device. Derived credentials and Bridge
	100	\$6.00	\$7,200.00	
	500	\$6.00	\$36,000.00	
	1000	\$6.00	\$72,000.00	
Total Annual Recurring Cost			\$115,920.00	
Service Requirements				
Description	requirements			
Basic Mobile Device Management	*central control to enroll, configure, secure, monitor and manage all enrolled devices (iOS, Android, Blackberry, Windows) *Ability to configure and update devices over-the-air *Ability to push and update custom apps to devices over-the-air *Enforce security and compliance policies *Secure Mobile Access to corporate resources *Provide Secure Container for corporate apps and data on each device *Ability to remote wipe entire device and / or only apps and data in secure container			
Installation & Set Up Costs				
Description	minimum quantity of licenses		Total Set Up Cost	OFFEROR NOTES Details of Installation and Set Up of customer's instance
Total One Time Cost for Installation, Set Up and Basic System Administrator Training	10		\$5,500.00	Kick-Off Call, Readiness Call of Customer Environment/Server, Install Connector and integrate with Active Directory, Install (up to) 2 Sentries and integrate with Exchange and other features, Add 10 Applications, Add 10 Policies and configurations, Add 10 Users/Devices, Set up Kiosk Mode, Policy configuration alerts Configure and test Docs@Work, Configure and test Web@Work Configure and test Dataview, Configure and test Tunnel, Additional details covered in Statement of Work
	100		\$5,500.00	
	500		\$5,500.00	
	1000		\$5,500.00	
Total Installation and Set Up Cost			\$22,000.00	
Installation & Set Up Requirements				
Description	requirements			
Installation, Set Up and Basic System Administrator Training	*Set up and configuration of customer's instance in provider's hosted environment. *At least one remote meeting with customer's designated system administrator to complete set up and provide knowledge transfer.			

Scorable Cost	\$137,920.00
----------------------	---------------------

MA149-1 Wireless Voice, Data and Accessories Attachment C: Costsheets

Category 3B: Mobile Device Management Costsheets

Instructions: Offeror, Please fill out all fields in this color below. The value in Cell D30 will be used to determine cost points in the evaluation of your Mobile Device Management offering. Although only basic Mobile Device Management costs will be used to evaluate cost, offeror shall make available their full suite of Mobile Device Management services should they be awarded under this contract.

VENDOR		AT&T VMware		
Description	minimum quantity of licenses	Fee	Monthly Recurring Cost	
			total annual cost	OFFEROR NOTES Describe plan attributes and characteristics per the instructions*.
AirWatch by VMware Government Services, Green Management Suite, Dedicated Cloud, Per Device, ASD Support	20	\$7.50	\$1,800.00	AirWatch by VMware provides secure access and device management. VMware's platform is the intelligence-driven digital workspace platform that simply and securely delivers and manages any app on any device by integrating access control, application management and multi-platform endpoint management. It begins with consumer simple, single sign-on access to cloud, mobile, web and Windows apps in one unified catalog and includes powerfully integrated email, calendar, file and social collaboration tools that engage employees.
AirWatch by VMware Government Services, Green Management Suite, Dedicated Cloud, Per Device, VMware Production Support	20	\$7.50	\$1,800.00	AirWatch by VMware provides secure access and device management. VMware's platform is the intelligence-driven digital workspace platform that simply and securely delivers and manages any app on any device by integrating access control, application management and multi-platform endpoint management. It begins with consumer simple, single sign-on access to cloud, mobile, web and Windows apps in one unified catalog and includes powerfully integrated email, calendar, file and social collaboration tools that engage employees.
AirWatch by VMware Government Services, Orange Management Suite, Dedicated Cloud, Per Device, ASD Support	20	\$8.25	\$1,980.00	AirWatch by VMware provides secure access and device management. VMware's platform is the intelligence-driven digital workspace platform that simply and securely delivers and manages any app on any device by integrating access control, application management and multi-platform endpoint management. It begins with consumer simple, single sign-on access to cloud, mobile, web and Windows apps in one unified catalog and includes powerfully integrated email, calendar, file and social collaboration tools that engage employees.
AirWatch by VMware Government Services, Orange Management Suite, Dedicated Cloud, Per Device, VMware Production Support	20	\$8.25	\$1,980.00	AirWatch by VMware provides secure access and device management. VMware's platform is the intelligence-driven digital workspace platform that simply and securely delivers and manages any app on any device by integrating access control, application management and multi-platform endpoint management. It begins with consumer simple, single sign-on access to cloud, mobile, web and Windows apps in one unified catalog and includes powerfully integrated email, calendar, file and social collaboration tools that engage employees.
AirWatch by VMware Government Services, Blue Management Suite, Dedicated Cloud, Per Device, ASD Support	20	\$9.50	\$2,280.00	AirWatch by VMware provides secure access and device management. VMware's platform is the intelligence-driven digital workspace platform that simply and securely delivers and manages any app on any device by integrating access control, application management and multi-platform endpoint management. It begins with consumer simple, single sign-on access to cloud, mobile, web and Windows apps in one unified catalog and includes powerfully integrated email, calendar, file and social collaboration tools that engage employees.
AirWatch by VMware Government Services, Blue Management Suite, Dedicated Cloud, Per Device, VMware Production Support	20	\$9.50	\$2,280.00	AirWatch by VMware provides secure access and device management. VMware's platform is the intelligence-driven digital workspace platform that simply and securely delivers and manages any app on any device by integrating access control, application management and multi-platform endpoint management. It begins with consumer simple, single sign-on access to cloud, mobile, web and Windows apps in one unified catalog and includes powerfully integrated email, calendar, file and social collaboration tools that engage employees.
AirWatch by VMware Government Services, Yellow Management Suite, Dedicated Cloud, Per Device, ASD Support	20	\$12.24	\$2,937.60	AirWatch by VMware provides secure access and device management. VMware's platform is the intelligence-driven digital workspace platform that simply and securely delivers and manages any app on any device by integrating access control, application management and multi-platform endpoint management. It begins with consumer simple, single sign-on access to cloud, mobile, web and Windows apps in one unified catalog and includes powerfully integrated email, calendar, file and social collaboration tools that engage employees.
AirWatch by VMware Government Services, Yellow Management Suite, Dedicated Cloud, Per Device, VMware Production Support	20	\$12.42	\$2,980.80	AirWatch by VMware provides secure access and device management. VMware's platform is the intelligence-driven digital workspace platform that simply and securely delivers and manages any app on any device by integrating access control, application management and multi-platform endpoint management. It begins with consumer simple, single sign-on access to cloud, mobile, web and Windows apps in one unified catalog and includes powerfully integrated email, calendar, file and social collaboration tools that engage employees.
Total Annual Recurring Cost			\$18,038.40	

Service Requirements	
Description	requirements
Basic Mobile Device Management	<ul style="list-style-type: none"> *Central control to enroll, configure, secure, monitor and manage all enrolled devices (ios, Android, BlackBerry, Windows) *Ability to configure and update devices over-the-air *Ability to push and update custom apps to devices over-the-air *Enforce security and compliance policies *Secure Mobile Access to corporate resources *Provide Secure Container for corporate apps and data on each device *Ability to remotely wipe entire device and / or only apps and data in secure container

Installation & Set Up Costs			
Description	minimum quantity of licenses	Total Set Up Cost	OFFEROR NOTES Details of Installation and Set Up of customer's instance
Basic Installation - Hosted	20	\$ 1,000.00	AT&T will provide implementation services. The deployment will be conducted in an AirWatch hosted environment with optional integration supported by an AirWatch Connector in the Customer's data centers and initial deployment of an initial pilot set of devices.
Basic PLUS Installation - Hosted	20	\$ 1,500.00	Basic Plus offer includes all of the features of Basic Installation and Training plus the configuration of the AirWatch Launcher feature for the setup of shared Android devices.
Premium Installation - Hosted	20	\$ 2,000.00	AT&T will provide implementation services. The services include installation of the AirWatch Console, an optional Connector and either a Secure Email Gateway or PowerShell Integration for email management and an initial pilot set of devices.
Premium PLUS Installation - Hosted	20	\$ 4,500.00	Premium Plus Installation and Training Services include all the features of Premium Installation and Training, as well as installation of a Mobile Access Gateway for content management or highly secure browsing, and installation, configuration, and training for VMware Identity Manager.
VMware Identity Manager Professional Services - Hosted	20	\$ 1,200.00	Identity Manager™ is identity management for the mobile cloud that delivers one-touch access to nearly any app, from any subscribed device, optimized with AirWatch Conditional Access. Empower employees to get productive quickly with a self-service app store, while giving IT a central place to manage user provisioning and access policy with enterprise-class directory integration, identity federation and user analytics.
ADD-ON AOC (AirWatch Cloud Connector)	20	\$ 500.00	AT&T will remotely configure and integrate one AirWatch Connector. Setup will include integration to one Active Directory server. Customer is responsible for provisioning a server in accordance with the configuration checklist provided.
Total Installation and Set Up Cost			\$1,700.00

Installation & Set Up Requirements	
Description	Requirements
Installation, Set Up and Basic System Administrator Training	<ul style="list-style-type: none"> *Set up and configuration of customer's instance in provider's hosted environment. *At least one remote meeting with customer's designated system administrator to complete set up and provide knowledge transfer.

Scorable Cost **\$19,738.40**

MA149-1 Wireless Voice, Data and Accessories Attachment C: Costsheet
Category 3B: Mobile Device Management Costsheet

Instructions: Offeror, Please fill out all fields in this color below. The value in Cell D30 will be used to determine cost points in the evaluation of your Mobile Device Management offering. Although only basic Mobile Device Management costs will be used to evaluate cost, offeror shall make available their full suite of Mobile Device Management services should they be awarded under this contract.

VENDOR		AT&T MaaS360		
Monthly Recurring Cost				
Description	minimum quantity of licenses	monthly fee	total annual cost (qty x fee x 12)	OFFEROR NOTES Describe plan attributes and characteristics per the instructions*.
Basic Mobile Device Management cost per device	20	\$6.25	\$1,500.00	
	100	\$6.25	\$7,500.00	
	500	\$6.25	\$37,500.00	
	1000	\$6.25	\$75,000.00	
Total Annual Recurring Cost			\$121,500.00	
Service Requirements				
Description	requirements			
Basic Mobile Device Management	<ul style="list-style-type: none"> *central control to enroll, configure, secure, monitor and manage all enrolled devices (iOS, Android, Blackberry, Windows) *Ability to configure and update devices over-the-air *Ability to push and update custom apps to devices over-the-air *Enforce security and compliance policies *Secure Mobile Access to corporate resources *Provide Secure Container for corporate apps and data on each device *Ability to remote wipe entire device and / or only apps and data in secure container 			
Installation & Set Up Costs				
Description	minimum quantity of licenses		Total Set Up Cost	OFFEROR NOTES Details of Installation and Set Up of customer's instance
Total One Time Cost for Installation, Set Up and Basic System Administrator Training	20		\$2,000.00	
	100		\$2,000.00	
	500		\$2,000.00	
	1000		\$2,000.00	
Total Installation and Set Up Cost			\$8,000.00	
Installation & Set Up Requirements				
Description	requirements			
Installation, Set Up and Basic System Administrator Training	<ul style="list-style-type: none"> *Set up and configuration of customer's instance in provider's hosted environment. *At least one remote meeting with customer's designated system administrator to complete set up and provide knowledge transfer. 			

Scorable Cost	\$129,500.00
----------------------	---------------------

MA149-1 Wireless Voice, Data and Accessories Attachment C: Costsheet
Category 3B: Mobile Device Management Costsheet

Instructions: Offeror, Please fill out all fields in this color below. The value in Cell D30 will be used to determine cost points in the evaluation of your Mobile Device Management offering. Although only basic Mobile Device Management costs will be used to evaluate cost, offeror shall make available their full suite of Mobile Device Management services should they be awarded under this contract.

VENDOR		AT&T Lookout
---------------	--	--------------

Monthly Recurring Cost

Description	minimum quantity of licenses	monthly fee	total annual cost (qty x fee x 12)	OFFEROR NOTES Describe plan attributes and characteristics per the instructions*.
Basic Mobile Device Management cost per device	10	\$5.50	\$660.00	Per license per month fee - one license covers one device
	100	\$5.25	\$6,300.00	Per license per month fee - one license covers one device
	500	\$5.00	\$30,000.00	Per license per month fee - one license covers one device
	1000	\$4.50	\$54,000.00	Per license per month fee - one license covers one device
Total Annual Recurring Cost			\$90,960.00	

Service Requirements

Description		requirements
Basic Mobile Device Management		<ul style="list-style-type: none"> *central control to enroll, configure, secure, monitor and manage all enrolled devices (iOS, Android, Blackberry, Windows) *Ability to configure and update devices over-the-air *Ability to push and update custom apps to devices over-the-air *Enforce security and compliance policies *Secure Mobile Access to corporate resources *Provide Secure Container for corporate apps and data on each device *Ability to remote wipe entire device and / or only apps and data in secure container

Installation & Set Up Costs

Description	minimum quantity of licenses		Total Set Up Cost	OFFEROR NOTES Details of Installation and Set Up of customer's instance
Total One Time Cost for Installation, Set Up and Basic System Administrator Training	10		\$750.00	
	100		\$750.00	
	500		\$750.00	
	1000		\$750.00	
Total Installation and Set Up Cost			\$3,000.00	

Installation & Set Up Requirements

Description		requirements
Installation, Set Up and Basic System Administrator Training		<ul style="list-style-type: none"> *Set up and configuration of customer's instance in provider's hosted environment. *At least one remote meeting with customer's designated system administrator to complete set up and provide knowledge transfer.

Scorable Cost	\$93,960.00
----------------------	--------------------

MA149-1 Wireless Voice, Data and Accessories Attachment C: Costsheets

Category 3B: Mobile Device Management Costsheets

Instructions: Offeror, Please fill out all fields in this color below. The value in Cell D30 will be used to determine cost points in the evaluation of your Mobile Device Management offering. Although only basic Mobile Device Management costs will be used to evaluate cost, offeror shall make available their full suite of Mobile Device Management services should they be awarded under this contract.

VENDOR		AT&T SEP		
Monthly Recurring Cost				
Description	minimum quantity of licenses	monthly fee	total annual cost (qty x fee x 12)	OFFEROR NOTES Describe plan attributes and characteristics per the instructions*.
Basic Mobile Device Management cost per device	10	\$6.00	\$720.00	Per license per month fee - one license covers one device
	100	\$5.50	\$6,600.00	Per license per month fee - one license covers one device
	500	\$5.00	\$30,000.00	Per license per month fee - one license covers one device
	1000	\$4.50	\$54,000.00	Per license per month fee - one license covers one device
Total Annual Recurring Cost			\$91,320.00	

Service Requirements		
Description		requirements
Basic Mobile Device Management		*central control to enroll, configure, secure, monitor and manage all enrolled devices (iOS, Android, Blackberry, Windows) *Ability to configure and update devices over-the-air *Ability to push and update custom apps to devices over-the-air *Enforce security and compliance policies *Secure Mobile Access to corporate resources *Provide Secure Container for corporate apps and data on each device *Ability to remote wipe entire device and / or only apps and data in secure container

Installation & Set Up Costs				
Description	minimum quantity of licenses		Total Set Up Cost	OFFEROR NOTES Details of Installation and Set Up of customer's instance
Total One Time Cost for Installation, Set Up and Basic System Administrator Training	10		\$750.00	
	100		\$750.00	
	500		\$750.00	
	1000		\$750.00	
Total Installation and Set Up Cost			\$3,000.00	

Installation & Set Up Requirements		
Description		requirements
Installation, Set Up and Basic System Administrator Training		*Set up and configuration of customer's instance in provider's hosted environment. *At least one remote meeting with customer's designated system administrator to complete set up and provide knowledge transfer.

Scorable Cost	\$94,320.00
----------------------	--------------------

**MA149-1 Wireless Voice, Data and Accessories Attachment C: Costsheet
Category 3C: Mobile Integration Costsheet**

Instructions: Offeror, Please fill out all fields in this color below. The value in Cell D30 will be used to determine cost points in the evaluation of your Mobile Integration offering. Although only basic Mobile Integration Features will be used to evaluate cost, offeror shall make available their full suite of Mobile Integration services should they be awarded under this contract.

VENDOR	AT&T Collaborate - Enhanced Mobile
---------------	------------------------------------

Monthly Recurring Cost				
Description	minimum quantity of licenses	monthly fee	total annual cost (qty x fee x 12)	OFFEROR NOTES Describe plan attributes and characteristics per the instructions*.
Basic Mobile Integration cost per device	10	\$14.95	\$1,794.00	
	100	\$14.95	\$17,940.00	
	500	\$14.95	\$89,700.00	
	1000	\$14.95	\$179,400.00	
Total Annual Recurring Cost			\$288,834.00	

Service Requirements		
Description		requirements
Basic Mobile Integration		As a minimum, solutions meeting this criteria will provide: <ul style="list-style-type: none"> •Single Number Reach or the ability for a user to be reached at a single business telephone number. •Calls to that single telephone number would ring at both the user's desk phone or mobile device either through simultaneous and/or sequential ringing. • Single Voicemail Box for calls to that single business number.

Installation & Set Up Costs				
Description	minimum quantity of licenses		Total Set Up Cost	OFFEROR NOTES Details of Installation and Set Up of customer's instance
Total One Time Cost for Installation, Set Up and Basic System Administrator Training	10			
	100			
	500			
	1000			
Total Installation and Set Up Cost			\$0.00	

Installation & Set Up Requirements		
Description		requirements
Installation, Set Up and Basic System Administrator Training		*Set up and configuration of customer's mobile service with integration to wired service. *At least one remote meeting with customer's designated system administrator to complete set up and provide knowledge transfer.

Scorable Cost	\$288,834.00
----------------------	---------------------

Consultative Hourly Rate (this rate will be included in the	\$0.00
---	--------

G: Plan Coverage

Type: V- Voice, D- Data, T- Text, F- Feature, I- International, O- Other, W- Wireless

ID	Messaging			Equipment		Details of Add-On Features					Plan or Feature Rules & Restrictions	Available to new Users	Type	Additional Notes			
	Qty SMS Included	Qty MMS Included	Pooled	Cost per SMS over	Cost per MMS over	Subsidized Device	Equipment Requirements	Discount/Item of cost	Qty of units included	Units of coverage					Cost per unit of coverage	Data network/AT	Starts after how many months usage
55	Unlimited	Unlimited	No	\$0.00	\$0.00									Modifier Monthly Credit \$39	Yes	VDT	Existing Plan on 1907
56	Unlimited	Unlimited	No	\$0.00	\$0.00									Modifier Monthly Credit \$42.85	Yes	VDT	Existing Plan on 1907
57	Unlimited	Unlimited	No	\$0.00	\$0.00									Modifier Monthly Credit \$16.67 Coverage US Only	Yes	D	Existing Plan on 1907
58	1000		No	\$3.00 per Message										For use with Business Nation Flat Rate Plan	Yes	T	Existing Plan on 1907
59	Unlimited		No	\$0.00										For use with Business Nation Flat Rate Plan	Yes	T	Existing Plan on 1907
60														Modifier Monthly Credit 4.68	Yes	F	Existing Plan on 1907
61														Modifier Monthly Credit \$2.00	Yes	F	Existing Plan on 1907
62														Modifier Monthly Credit \$9.99	Yes	F	Existing Plan on 1907
63	Unlimited	Unlimited	No	\$0.00	\$0.00									Unlimited number of domestic calls and texts Unlimited texting from the U.S. to over 120 countries Unlimited talk from the U.S. to Mexico & Canada No roaming charges for plan voice, text and data use while in Mexico	Yes	VDT	
64	Unlimited	Unlimited	No	\$0.00	\$0.00									Unlimited number of domestic calls and texts Unlimited texting from the U.S. to over 120 countries Unlimited talk from the U.S. to Mexico & Canada No roaming charges for plan voice, text and data use while in Mexico	Yes	VDT	
65	Unlimited	Unlimited	No	\$0.00	\$0.00									Unlimited number of domestic calls and texts Unlimited texting from the U.S. to over 120 countries Unlimited talk from the U.S. to Mexico & Canada No roaming charges for plan voice, text and data use while in Mexico	Yes	VDT	
66	Unlimited	Unlimited	No	\$0.00	\$0.00									Unlimited number of domestic calls and texts Unlimited texting from the U.S. to over 120 countries Unlimited talk from the U.S. to Mexico & Canada No roaming charges for plan voice, text and data use while in Mexico	Yes	VDT	
67	Unlimited	Unlimited	No	\$0.00	\$0.00									\$25 Monthly Credit for BOVO, Unsubsidized Devices, or 25th month of ownership after Subsidy Unlimited number of domestic calls and texts Unlimited texting from the U.S. to over 120 countries Unlimited talk from the U.S. to Mexico & Canada No roaming charges for plan voice, text and data use while in Mexico	Yes	VDT	
68	Unlimited	Unlimited	No	\$0.00	\$0.00									\$25 Monthly Credit for BOVO, Unsubsidized Devices, or 25th month of ownership after Subsidy Unlimited number of domestic calls and texts Unlimited texting from the U.S. to over 120 countries Unlimited talk from the U.S. to Mexico & Canada No roaming charges for plan voice, text and data use while in Mexico	Yes	VDT	
69	Unlimited	Unlimited	No	\$0.00	\$0.00									\$28 Monthly Credit for BOVO, Unsubsidized Devices, or 25th month of ownership after Subsidy Unlimited number of domestic calls and texts Unlimited texting from the U.S. to over 120 countries Unlimited talk from the U.S. to Mexico & Canada No roaming charges for plan voice, text and data use while in Mexico	Yes	VDT	
70	Unlimited	Unlimited	No	\$0.00	\$0.00									\$25 Monthly Credit for BOVO, Unsubsidized Devices, or 25th month of ownership after Subsidy Unlimited number of domestic calls and texts Unlimited texting from the U.S. to over 120 countries Unlimited talk from the U.S. to Mexico & Canada No roaming charges for plan voice, text and data use while in Mexico	Yes	VDT	
71	Unlimited	Unlimited	No	\$0.00	\$0.00									\$26 Monthly Credit for BOVO, Unsubsidized Devices, or 25th month of ownership after Subsidy Unlimited number of domestic calls and texts Unlimited texting from the U.S. to over 120 countries Unlimited talk from the U.S. to Mexico & Canada No roaming charges for plan voice, text and data use while in Mexico	Yes	VDT	
72	Unlimited	Unlimited	No	\$0.00	\$0.00									Modifier \$4.35 Unlimited number of domestic calls and texts Unlimited texting from the U.S. to over 120 countries Unlimited talk from the U.S. to Mexico & Canada No roaming charges for plan voice, text and data use while in Mexico	Yes	VDT	
73	Unlimited	Unlimited	No	\$0.00	\$0.00									Unlimited number of domestic calls and texts Unlimited texting from the U.S. to over 120 countries Unlimited talk from the U.S. to Mexico & Canada	Yes	D	
74	Unlimited	Unlimited	No	\$0.00	\$0.00									Unlimited number of domestic calls and texts Unlimited texting from the U.S. to over 120 countries Unlimited talk from the U.S. to Mexico & Canada	Yes	W	
75	Unlimited	Unlimited	No	\$0.00	\$0.00									Modifier \$43.35 Unlimited Talk, Text, and Data 10GB Mobile Hotspot - after 10GB, hotspot speed limited to max of 128 Kbps Unlimited texting from the U.S. to over 120 countries Unlimited talk from the U.S. to Mexico & Canada No roaming charges for plan voice, text and data use while in Mexico	Yes	VDT	
76	Unlimited	Unlimited	No	\$0.00	\$0.00									Modifier \$43.35 Unsubsidized Credit \$25 Unlimited Talk, Text, and Data 10GB Mobile Hotspot - after 10GB, hotspot speed limited to max of 128 Kbps Unlimited texting from the U.S. to over 120 countries Unlimited talk from the U.S. to Mexico & Canada No roaming charges for plan voice, text and data use while in Mexico	Yes	VDT	
77														Plans for eligible data-only devices that have a monthly service charge of \$20 or more include: No roaming charges for plan data use while in Mexico	Yes	D	
78														Plans for eligible data-only devices that have a monthly service charge of \$20 or more include: No roaming charges for plan data use while in Mexico	Yes	D	
79														Plans for eligible data-only devices that have a monthly service charge of \$20 or more include: No roaming charges for plan data use while in Mexico	Yes	D	
80														Plans for eligible data-only devices that have a monthly service charge of \$20 or more include: No roaming charges for plan data use while in Mexico	Yes	D	
81														Includes no roaming charges for plan data use while in Mexico	Yes	D	
82														Includes no roaming charges for plan data use while in Mexico	Yes	D	
83															Yes	O	
84															Yes	O	
85															Yes	O	
86	O	O	No	\$0.15 less 5% Discount \$0.14	\$0.14									Domestic SMS messaging	Yes	T	
87	O	O	No	\$0.50 less 5% Discount \$0.48	\$0.48									International SMS messaging	Yes	T	
88	O	O	No	\$0.15 less 5% Discount \$0.14	\$0.14									International SMS messaging	Yes	T	
89								MB	O	MB	\$10.00 less 5% Discount \$9.50			International billed \$9.50 per MB used while roaming internationally	Yes	I	

Rate	Messaging			Equipment		Details of Add-On Features					Available to New Customers	Type	Additional Notes				
	Qty SMS Included	Qty MMS Included	Paid	cost per SMS over	cost per MMS over	Subsidized Device	Equipment Requirements	Description of Unit	Qty of Units Included	units of average				cost per unit of average	data network?	Expires after how much monthly usage	
								MB	1MB	MB	\$4.00 1MB	Yes		Feature available for use with Control Center M2M Plans No available with Control Center for FirstNet	Yes	F	
								MB	12MB	MB	\$9.00 12 MB	Yes		Feature available for use with Control Center M2M Plans No available with Control Center for FirstNet	Yes	F	
								MB	60MB	MB	\$20.00 60 MB	Yes		Feature available for use with Control Center M2M Plans No available with Control Center for FirstNet	Yes	F	
														These pooling plans are best suited for qualified devices using machine-to-machine business applications that have low data usage.	Yes	D	
														These pooling plans are best suited for qualified devices using machine-to-machine business applications that have low data usage.	Yes	D	
														These pooling plans are best suited for qualified devices using machine-to-machine business applications that have low data usage.	Yes	D	
														These pooling plans are best suited for qualified devices using machine-to-machine business applications that have low data usage.	Yes	D	
														These pooling plans are best suited for qualified devices using machine-to-machine business applications that have variable usage. The plan provides a low cost solution in low-usage months and data usage protection in the occasional high-usage month. The plan is ideal for use as a temporary solution while your Wide Area Network (WAN) is being installed or as a backup solution for your WAN.	Yes	D	
														These pooling plans are designed as a backup mobile data connection to help keep your business systems running smoothly during peak usage or network congestion.	Yes	D	
														These pooling plans are designed as a backup mobile data connection to help keep your business systems running smoothly during peak usage or network congestion.	Yes	D	
														These pooling plans are designed as a backup mobile data connection to help keep your business systems running smoothly during peak usage or network congestion.	Yes	D	
														These pooling plans are designed as a backup mobile data connection to help keep your business systems running smoothly during peak usage or network congestion.	Yes	D	
														These pooling plans are designed as a backup mobile data connection to help keep your business systems running smoothly during peak usage or network congestion.	Yes	D	
	Unlimited	Unlimited	No	\$0.00	\$0.00									Up to 10 Eligible Devices	Yes	VDT	
	Unlimited	Unlimited	No	\$0.00	\$0.00									Includes AT&T Collaborate - Enhanced Mobile Up to 10 Eligible Devices	Yes	VDT	
	Unlimited	Unlimited	No	\$0.00	\$0.00									Includes AT&T Collaborate - Enhanced Mobile Up to 10 Eligible Devices	Yes	VDT	
	Unlimited	Unlimited	No	\$0.00	\$0.00									Includes AT&T Collaborate - Enhanced Mobile Up to 10 Eligible Devices	Yes	VDT	
	Unlimited	Unlimited	No	\$0.00	\$0.00									Includes AT&T Collaborate - Enhanced Mobile Up to 10 Eligible Devices	Yes	VDT	
	Unlimited	Unlimited	No	\$0.00	\$0.00									Includes AT&T Collaborate - Enhanced Mobile Up to 10 Eligible Devices	Yes	VDT	
	Unlimited	Unlimited	No	\$0.00	\$0.00									Includes AT&T Collaborate - Enhanced Mobile Up to 10 Eligible Devices	Yes	VDT	
	Unlimited	Unlimited	No	\$0.00	\$0.00									Includes AT&T Collaborate - Enhanced Mobile Up to 10 Eligible Devices	Yes	VDT	
	Unlimited	Unlimited	No	\$0.00	\$0.00									Includes AT&T Collaborate - Enhanced Mobile Up to 10 Eligible Devices	Yes	VDT	
	Unlimited	Unlimited	No	\$0.00	\$0.00									Includes AT&T Collaborate - Enhanced Mobile Up to 10 Eligible Devices	Yes	VDT	
	Unlimited	Unlimited	No	\$0.00	\$0.00									Includes AT&T Collaborate - Enhanced Mobile Up to 10 Eligible Devices	Yes	VDT	
	Unlimited	Unlimited	No	\$0.00	\$0.00									Includes AT&T Collaborate - Enhanced Mobile Up to 10 Eligible Devices	Yes	VDT	
	Unlimited	Unlimited	No	\$0.00	\$0.00									Includes AT&T Collaborate - Enhanced Mobile Up to 10 Eligible Devices	Yes	VDT	
	Unlimited	Unlimited	No	\$0.00	\$0.00									Includes AT&T Collaborate - Enhanced Mobile Up to 10 Eligible Devices	Yes	VDT	
	Unlimited	Unlimited	No	\$0.00	\$0.00									Includes AT&T Collaborate - Enhanced Mobile Up to 10 Eligible Devices	Yes	VDT	
	Unlimited	Unlimited	No	\$0.00	\$0.00									Includes AT&T Collaborate - Enhanced Mobile Up to 10 Eligible Devices	Yes	VDT	
	Unlimited	Unlimited	No	\$0.00	\$0.00									Includes AT&T Collaborate - Enhanced Mobile Up to 10 Eligible Devices	Yes	VDT	
	Unlimited	Unlimited	No	\$0.00	\$0.00									Includes AT&T Collaborate - Enhanced Mobile Up to 10 Eligible Devices	Yes	VDT	
	Unlimited	Unlimited	No	\$0.00	\$0.00									Includes AT&T Collaborate - Enhanced Mobile Up to 10 Eligible Devices	Yes	VDT	
	Unlimited	Unlimited	No	\$0.00	\$0.00									Includes AT&T Collaborate - Enhanced Mobile Up to 10 Eligible Devices	Yes	VDT	
	Unlimited	Unlimited	No	\$0.00	\$0.00									Includes AT&T Collaborate - Enhanced Mobile Up to 10 Eligible Devices	Yes	VDT	
	Unlimited	Unlimited	No	\$0.00	\$0.00									Includes AT&T Collaborate - Enhanced Mobile Up to 10 Eligible Devices	Yes	VDT	
	Unlimited	Unlimited	No	\$0.00	\$0.00									Includes AT&T Collaborate - Enhanced Mobile Up to 10 Eligible Devices	Yes	VDT	
	Unlimited	Unlimited	No	\$0.00	\$0.00									Includes AT&T Collaborate - Enhanced Mobile Up to 10 Eligible Devices	Yes	VDT	
	Unlimited	Unlimited	No	\$0.00	\$0.00									Includes AT&T Collaborate - Enhanced Mobile Up to 10 Eligible Devices	Yes	VDT	
	Unlimited	Unlimited	No	\$0.00	\$0.00									Includes AT&T Collaborate - Enhanced Mobile Up to 10 Eligible Devices	Yes	VDT	
	Unlimited	Unlimited	No	\$0.00	\$0.00									Includes AT&T Collaborate - Enhanced Mobile Up to 10 Eligible Devices	Yes	VDT	
	Unlimited	Unlimited	No	\$0.00	\$0.00									Includes AT&T Collaborate - Enhanced Mobile Up to 10 Eligible Devices	Yes	VDT	
	Unlimited	Unlimited	No	\$0.00	\$0.00									Includes AT&T Collaborate - Enhanced Mobile Up to 10 Eligible Devices	Yes	VDT	
	Unlimited	Unlimited	No	\$0.00	\$0.00									Includes AT&T Collaborate - Enhanced Mobile Up to 10 Eligible Devices	Yes	VDT	
	Unlimited	Unlimited	No	\$0.00	\$0.00									Includes AT&T Collaborate - Enhanced Mobile Up to 10 Eligible Devices	Yes	VDT	
	Unlimited	Unlimited	No	\$0.00	\$0.00									Includes AT&T Collaborate - Enhanced Mobile Up to 10 Eligible Devices	Yes	VDT	
	Unlimited	Unlimited	No	\$0.00	\$0.00									Includes AT&T Collaborate - Enhanced Mobile Up to 10 Eligible Devices	Yes	VDT	
	Unlimited	Unlimited	No	\$0.00	\$0.00									Includes AT&T Collaborate - Enhanced Mobile Up to 10 Eligible Devices	Yes	VDT	

MA149-1 Attachment H

NASPO ValuePoint Cooperative Contract Detailed Sales Report

No Quarterly Sales

Contractor:

Quarter:

Vendor Name	Vendor Contract Number	State	Customer Type	Bill to Agency	Bill to City	Bill to State	Bill to Zipcode	Acct # or Customer #	Invoice Date	Invoice #	Product Description	CRU Lines	CRU Minutes	CRU Text	CRU Data	monthly service cost	Equipment Lease/Rental Cost	Total cost (monthly service + lease/rental)	Admin Fee
-------------	------------------------	-------	---------------	----------------	--------------	---------------	-----------------	----------------------	--------------	-----------	---------------------	-----------	-------------	----------	----------	----------------------	-----------------------------	---	-----------

MA149-1 Attachment I

Field Name	Field Description
Contractor Name	The awarded Contractor's name
CT NUMBER	Lead State assigned contract number (using Lead State's numbering protocol)
State	State postal abbreviation code (Alaska = AK, Missouri = MO, etc.)
(SEGMENT)	State Gov't, Education-K12, Education-HED, Local Gov't, Medical, Other - are acceptable segments. [determined by industrial practice for each contract - uniform for each contract]
Customer Name	Customer (agency) Bill to name
Customer Address	Customer (agency) Bill to address
Customer City	Customer (agency) Bill to city
Customer Zip	Zip code in standard 5-4 format [standard 5 digits is acceptable, formatted as a zip code]
Ship to Name	Customer (agency) Ship to name
Ship to Address	Customer (agency) Ship to address
Ship to City	Customer (agency) Ship to city
Ship to Zip	Zip code in standard 5-4 format [standard 5 digits is acceptable, formatted as a zip code]
Vendor Order Number	Vendor assigned order number
Order Date	(mm/dd/ccyy)
Invoice Date	(mm/dd/ccyy)
Vendor Invoice Number	Vendor assigned Invoice Number
Product Description	Product description of purchased product
Commodity Code	Commodity-level code based on UNSPSC code rules (8 Digits)
List Price	List Price - US Currency (\$99999.999) [determined by industrial practice for each contract - uniform for each contract]
Unit Price	NASPO ValuePoint Price- US Currency (\$99999.999)
Quantity	Quantity Invoiced (99999.999)
Extended Price	Extended Price (unit price multiplied by the quantity invoiced) - US Currency (\$999999999.999)
Administrative Fee	Administrative Fee based on Total Price - US Currency (\$999999.999)
Distributor	If a VAR/Reseller/Distributor, name of VAR/Reseller/Distributor and state where located
Energy Star Compliant	Yes = 1 No = 2 Energy Star Does not Apply = 0
Remarks	More information

I Award Category 2 Reporting Template

Quarter:

 No Quarterly Sales

Bill to City	Bill to Zipcode	Ship to Agency	Ship to Address	Ship to City	Ship to Zipcode	Order Number	PO Date	Invoice Date	Invoice Number	Product Description	Quantity	UNSPSC Commodity	IRU or CRU	List Price/MSRP	NASPO ValuePoint Price	Total Price	Admin Fee	EPEAT	Energy Star Compliant
Need to match up with Green Language In RFP																			

Provider lists each Make / Model of equipment sold and the quantity sold of each.

Quantity Sold	Equipment/ Accessory Type	Part Number	Manufacturer	Model	Discount Eligible	List Price	Notes
---------------	---------------------------------	----------------	--------------	-------	----------------------	------------	-------

yes / no

to be taken
from category
2 cost sheet
examples:
smart phone
tablet
case
etc ...

NASPO ValuePoint Cooperative Contract Detailed Sales Report

Contractor:

Quarter:

Vendor Name	Vendor Contract Number	State	Customer Type	Invoice Date	IRU Lines	Total Cost	Admin Fee
-------------	------------------------	-------	---------------	--------------	-----------	------------	-----------

Carrier lists every plan in use under the NASPO contract, provides the quantity of the lines of service using each plan and provides basic details of the plan

Line Count	Plan #	Plan Description	Discount Eligible	Access Cost Before Discount	Included in Plan						Notes
					Voice		Data		Text	subsidized	
					Minutes	Pooled	GB	Pooled	Qty	Device	

qty devices o if yes / no
 this plan carrier
 has one

Field Name	Field Description
VENDOR	The awarded Contractor's name
VENDOR CONTRACT NUMBER	Lead State assigned contract number (using Lead State's numbering protocol)
STATE	State postal abbreviation code (Alaska = AK, Missouri = MO, etc.)
CUSTOMER TYPE (SEGMENT)	State Gov't, Education-K12, Education-HED, Local Gov't, Medical, Other - are acceptable segments. [determined by industrial practice for each contract - uniform for each contract]
BILL TO AGENCY	Customer (agency) Bill to name
BILL TO CITY	Customer (agency) Bill to city
INVOICE DATE	(mm/dd/ccyy)
PRODUCT DESCRIPTION	Product description of purchased product
CRU Lines	Commodity-level code based on UNSPSC code rules (8 Digits)
CRU Minutes	Number of voice minutes used
CRU Text	Number of texts sent and received
CRU Data	Amount of data used
CRU Gross Sales	Gross Sales
Equipment Lease	Amount of monthly charges for leased equipment
LIST PRICE/MSRP/CATALOG PRICE	uniform for each contract]
NASPO ValuePoint PRICE	NASPO ValuePoint Price- US Currency (\$99999.999)
QUANTITY	Quantity Invoiced (99999.999)
TOTAL PRICE	Extended Price (unit price multiplied by the quantity invoiced) - US Currency (\$99999999.999)
NASPO ValuePoint ADMIN FEE	Administrative Fee based on Total Price - US Currency (\$999999.999)

AT&T Mobility Products



Under the NASPO ValuePoint (formerly WSCA) Agreement with AT&T

AccessMyLAN from AT&T

Actsoft® from AT&T

The Archiving Platform™ from Smarsh®

Associate PLEDGE from AT&T

AT&T Business Messaging

AT&T Campus Guide Plus

AT&T Control Center and AT&T Control Center for FirstNet

AT&T Dynamic Traffic Management

AT&T Encrypted Mobile Voice

AT&T Fleet Manager

AT&T Global Smart Messaging Suite

AT&T Landline Texting

AT&T Landline Texting - API

AT&T Location Information Services

AT&T Message Archiving

AT&T Messaging Toolkit™

AT&T MetroCell

AT&T Mobile Barcode Services

AT&T Mobile Device Management™

AT&T Mobile Forms

AT&T Mobile Platform Solution powered by Taqtile Mobility™

AT&T Office@Hand

AT&T OfficeDirect™

AT&T Remote Mobility Zone

AT&T Workforce Manager®

AT&T Work Platform

Bigtincan Hub from AT&T

Box from AT&T

FirstNet

FirstNet Satellite

Fleet Complete® Asset Tracker from AT&T

Fleet Complete® Fleet Tracker from AT&T

Fleet Complete® Track & Dispatch from AT&T

Geotab Fleet Management for Government

Good for Enterprise™ from AT&T

IBM MaaS360 from AT&T

McAfee® SaaS EMM™ Software from AT&T

Mobile Device Deployment Services from AT&T

Mobile Enterprise Applications Platform (Powered by Kony®)

Mobile Enterprise Applications Platform (Powered by ANTENNA®)

Mobile Enterprise Applications Platform (Powered by Modo Labs, Inc.®)

Mobile Enterprise Applications Platform (Powered by Verivo®) Mobile

Remote Access Services from AT&T

MobileIron Core

Mobile Iron Hosted

NetMotion® Wireless from AT&T

pdvConnect from AT&T

Professional Services from AT&T Mobility Solutions Services

Professional Services for NetMotion® Wireless from AT&T

Rave Campus Messenger from AT&T

Rave Guardian from AT&T

Smart 911

Skycure

VMware Workspace ONE™-Hosted

VMware Workspace ONE™-On Premise

XORA® StreetSmart Workforce™ Locator from AT&T

XORA® StreetSmart Workforce™ from AT&T

Telenav Asset Tracker™ from AT&T

Telenav Vehicle Tracker™ from AT&T

Quadrant® from AT&T®

An aerial night view of a city skyline, likely New York City, with numerous skyscrapers illuminated. Overlaid on the city is a network of glowing white lines and nodes, representing a digital or communication network. The sky is a mix of dark blue and orange, suggesting a sunset or sunrise.

FirstNet Solution

Tim Fellows
FirstNet Principal Consultant – State of Florida



©2016 AT&T Intellectual Property. FirstNet, First Responder Network Authority, and FirstNet logo are registered trademarks and service marks of FirstNet, an independent authority within the U.S. Department of Commerce. All other marks are the property of their respective owners.

FirstNet & AT&T: An Innovative Public – Private Partnership



Partnership Launch

MARCH 30, 2017



Innovative Public-Private Partnership



Creating an infrastructure dedicated to public safety

© 2017 AT&T Intellectual property. All rights reserved. AT&T and Globe Logo are registered trademarks and service marks of AT&T Intellectual property. FirstNet, First Responder Network Authority and FirstNet logo are registered trademarks and service marks of FirstNet, an independent authority within the U.S. Department of Commerce. All other marks are the property of their respective owners.



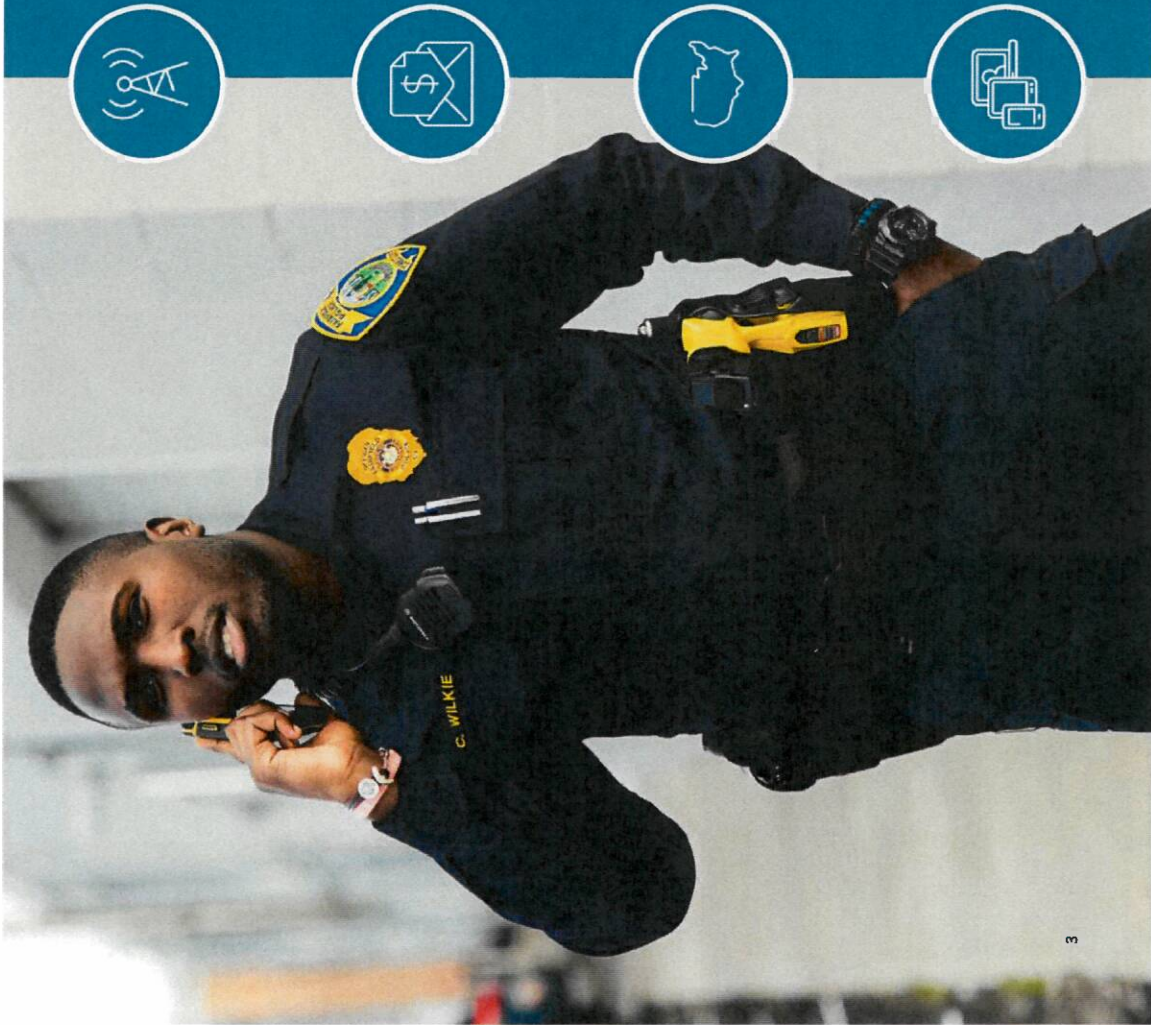

Public Safety Priorities

Delivering on what public safety asked for



- Public safety always gets priority
- Highly secure network to meet public safety's data requirements
- Controlled access by public safety agencies for their users
- Exclusive, well-vetted content
- Coverage where public safety operates
- Enhanced user experience
- Same or lower cost

FIRSTNET SOLUTION OVERVIEW



COVERAGE

- Reaches over 99% of US population
- 40,000 Wi-Fi hotspots
- Satellite and deployable coverage 99%+

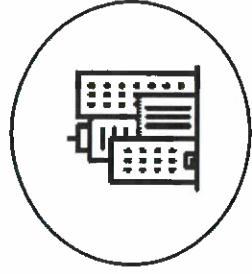

IN-BUILDING SOLUTIONS

- Access to more than 6,000 existing AT&T in-building assets including stadiums and transportation facilities

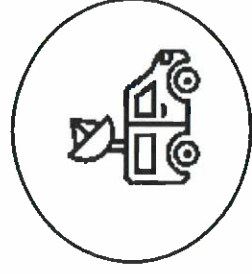

DEPLOYABLES

- Hundreds of AT&T units for daily network maintenance
- 72 deployables for FirstNet customer requests



SERVICE PLANS & PROCUREMENT

- Competitive and compelling rate plans
- Purchase through a variety of contract vehicles

FIRSTNET SOLUTION OVERVIEW



DEVICES & BYOD

- Any AT&T LTE device can be a FirstNet device
- Wide choices, aggressive pricing

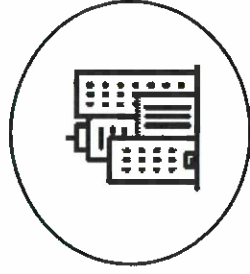

BASIC & FUTURE SERVICES

- Includes voice, data and messaging features of commercial networks
- Future roadmap for Mission Critical services



PRIORITY & PREEMPTION

- Priority and Preemption on Band 14 + existing AT&T LTE bands
- Multiple priority levels within agencies

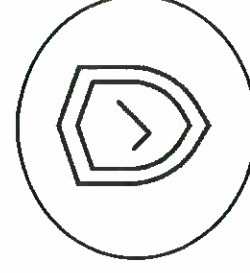

CYBERSECURITY

- Security Operations Center for FirstNet
- Uses AT&T's global cybersecurity assets

FIRSTNET SOLUTION OVERVIEW

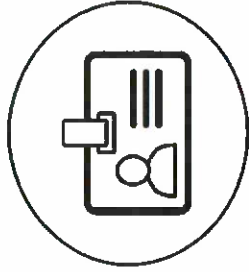

ICAM

- Single Sign-On capability across all FirstNet applications plus agency applications



FIRSTNET APP STORE

- Shows only security audited apps from trusted vendors
- Can integrate with agency MDM/MAM

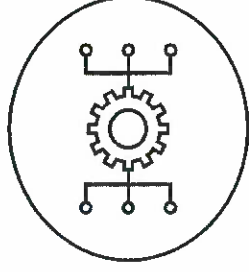

LOCAL CONTROL

- One stop web tool for managing user rate plans, priority levels, PTT groups, ICAM authorizations and more

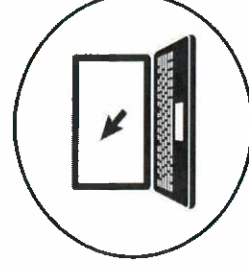

PUBLIC SAFETY HOME PAGE

- Unprecedented visibility into network status and more

FIRSTNET SOLUTION OVERVIEW

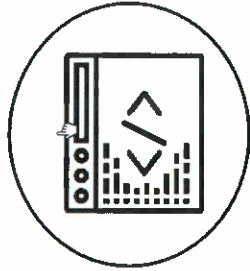

APP DEVELOPER PROGRAM

- Foster innovation and interoperability in public safety mobile apps
- APIs for FirstNet specific features



SOLUTIONS

- First-party options for key services like PTT, mobile VPN, messaging, LBS and more
- Or bring your own apps



TRAINING

- Public safety solution specialists to educate agencies on how to maximize their use of FirstNet services

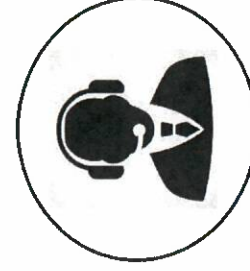

SUPPORT

- Dedicated 24 x 7 x 365 FirstNet mobility customer care

USER TYPES – DEFINING PRIORITY LEVELS

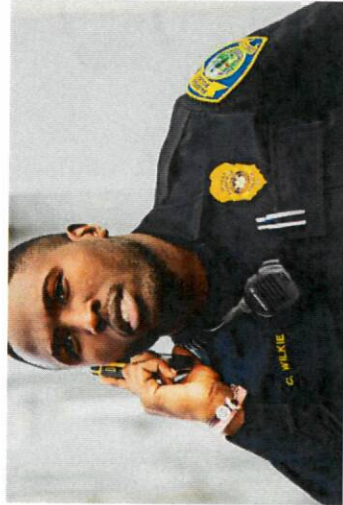

Primary Users

- Fire
- Law Enforcement
- Rescue / EMS
- Emergency Management



Extended Primary Users

- Hospitals
- Utilities
- Transportation
- Public Works



Volunteer Users

Volunteers for a primary agency, but maintains service responsibility

- Volunteer Fire Fighter
- Auxiliary Police

WHAT IS QPP, AND WHY DOES PUBLIC SAFETY NEED IT?

QPP : QoS -- Priority - Preemption

- Quality of Service (QoS): establishes min/max service quality parameters
- Priority: Gives users preferred access to network resources
- Preemption: Terminates or relocates lower priority users to provide primary users with access



NORMAL OPERATIONS

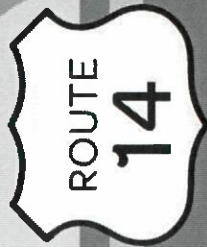

PRIMARY

EXTENDED
PRIMARY

COMMERCIAL

QPP PARKWAY

PRIORITY LANE

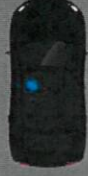

PRIORITY LEVEL

CRISIS OCCURS

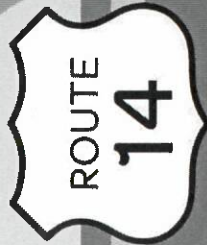

QPP PARKWAY

PRIORITY LEVEL



PRIORITY LANE

PRIMARY

EXTENDED
PRIMARY

COMMERCIAL TRAFFIC

COMMERCIAL

CRISIS WORSENS

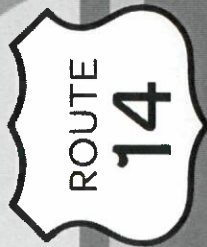

QPP PARKWAY

PRIMARY

PRIMARY

EXTENDED
PRIMARY

PRIORITY LEVEL

PRIORITY LANE

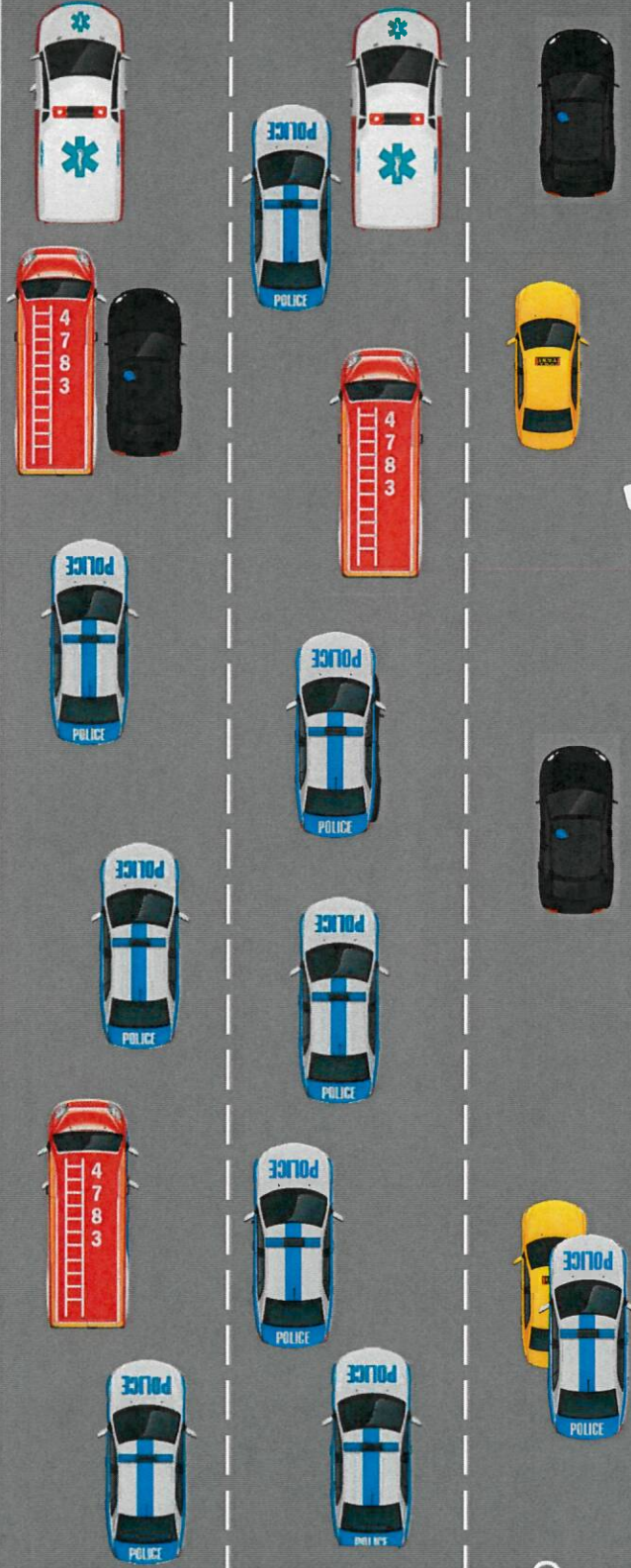

AT&T Property (Restrict) Only for use by authorized individuals or any above-designated team(s) within the AT&T companies and not for general distribution. © 2016 AT&T Intellectual Property. All rights reserved. AT&T, the AT&T logo and all other AT&T marks contained herein are trademarks of AT&T Intellectual Property and/or AT&T affiliated companies. The information contained herein is not an offer, nor a commitment, and may be used without AT&T. Except under written agreement.

CRISIS WORSENS



ROUTE
14

QPP PARKWAY

PRIMARY

PRIMARY

PRIMARY

PRIORITY LEVEL



PRIORITY LANE

PRIORITY LEVEL

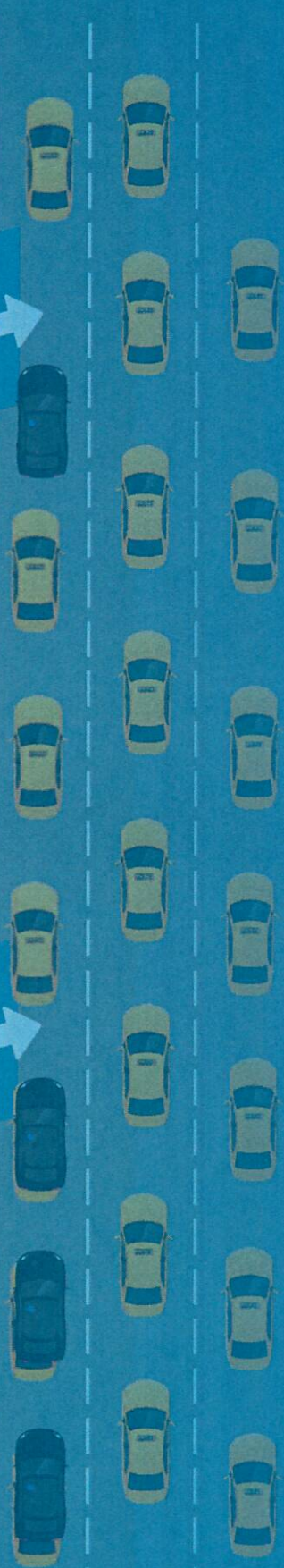

ROUTE 17

ROUTE 12

ROUTE 4

COMMERCIAL ROAD

AT&T Proprietary (rearranged) Only for use by authorized individuals or any above-designated teams within the AT&T companies and not for general distribution. All rights reserved. AT&T, the AT&T logo and all other AT&T marks contained herein are trademarks of AT&T Intellectual Property and/or AT&T affiliated companies. The information contained herein is not an offer, your commitment, and may be void outside the U.S. Except where written otherwise.

Coverage and Expansion Plans

129 NSB's planned and funded for general network expansion

38 Connect America First Sites

70 FirstNet Sites

237 Total NSB's throughout Florida before 2021

This represents a 43% increase in the number of cell sites initially proposed.

FIRSTNET WORLD-CLASS DEVICE ECOSYSTEM

SMARTPHONES



Apple iPhone (iOS)
Samsung (Android)
LG (Android)
Kyocera Duraforce
(Android rugged)

FEATURE PHONE



Sonim XP5 (rugged)
Kyocera Dura
(rugged)
LG X Venture
(rugged)

TABLETS



Apple iPad
Samsung Galaxy
LG G Pad
Microsoft Surface

DATA ONLY



Netgear Unite Hotspot (rugged)
ZTE USB Aircards
ZTE Hotspot
AT&T Home Base (router)

WEARABLES



Apple Watch
LG Watch
Samsung Gear

SPECIALTY DEVICES CERTIFIED TO MEET UNIQUE NEEDS OF PUBLIC SAFETY

TRUNK MOUNTED
MODEM



Cradlepoint IBR1100 (Band 14 Class)

Enables connectivity
to a wide variety of
connected devices

IoT
CONNECTIVITY

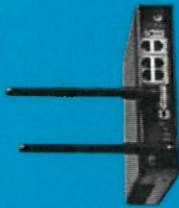

Cisco 819 4G LTE M2M Router

Connects and enables
smart devices

RUGGEDIZED
TABLETS & LAPTOPS



Panasonic Toughbook CF-53

Highly Secure in-vehicle
access to critical
applications and services

PTT DEVICES &
ACCESSORIES



Soniim XP7

Efficient wireless
connectivity to existing
LMR Radio systems

LMR INTEROPERABILITY



Extended Coverage

EPTT available nationwide on AT&T 3G/4G/LTE and Wi-Fi networks

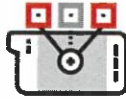
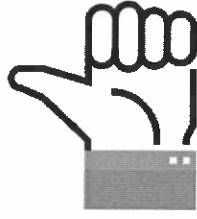

Data Apps

Access AT&T data apps and LMR EPTT on the same device that a user already uses



Expanded Capacity

Give EPTT to new users that don't have to carry radios while maintaining full communication



Lower Cost

Extend, expand and enhance LMR network without cost to add frequencies, sites, radios



Shared Responsibility

AT&T has end-to-end responsibility for EPTT users/service

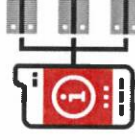

Admin Tools

Automated tools for user administration and software updates

PUBLIC FIRSTNET SITES



FirstNet.gov



FirstNet.com



Developer Portal

SECURE FIRSTNET SITES

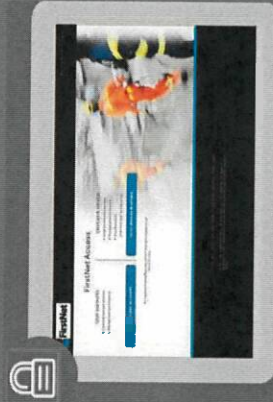

Public Safety Home Page



State Plan Portal



App Developer Portal



Application Store

LOCAL CONTROL / DEVICE MANAGEMENT

- Ability to monitor the Network in real time, including site locations and service level conditions
- Provides real time Situational Awareness
- Ability to create trouble tickets directly from the “Local Control” portal
- Ability to enable and disable agency owned devices locally
- Secure site with required login credentials



AT&T NETWORK DISASTER RECOVERY PROGRAM

- ✓ No Cost to Public Safety for approved incident response
 - ✓ Staffed and Available 24/7 – full time dedicated personnel
 - ✓ Existing expertise with documented processes
- ✓ \$600M Investment
- ✓ 300+ Vehicles



Full - SatCOLT



Mid - SatCOLT



Mini - SatCOLT

DEPLOYABLE ASSETS AVAILABLE TO PUBLIC SAFETY

Existing Assets

120+

LTE Deployables

Dedicated Public Safety Assets

72

FirstNet dedicated SatCOLTs

Florida Assets

3

FirstNet SatCOLTs

*** Potential to Use Your Own Entity Assets**

THE FIRSTNET DIFFERENCE



COMMITMENT

- Unique, purpose-made solutions, solely for public safety community
- 25-year contract
- \$40B investment into FirstNet network by AT&T
- A single nationwide, interoperable, broadband network with priority and preemption 24/7
- Expected to create 10K U.S. jobs over the next 2 years



ACCOUNTABILITY

- AT&T is bound by contract to deliver unique services for public safety's dedicated use
- Stiff penalties if AT&T fails to meet its commitment
- Unprecedented transparency into the network performance at the local level



SECURITY

- Dedicated core with end-to-end LTE network encryption
- U.S. based FirstNet security operations center and dedicated 24x7x365 support
- A dedicated team of experts who monitor the network and keep your vital apps, devices and connections secure



INNOVATION

- Open, inclusive ecosystem to serve as the backbone of public safety communications
- Contractually mandated roadmap includes:
 - Mission critical push-to-talk
 - Voice, data, text, and video
 - Broadcast technology and z-Axis location based services



AGILITY

- 72 FirstNet dedicated deployables
- Only company to receive the Private Sector Preparedness Program Certification from DHS



FIRSTNET[™]

Built with AT&T

AT&T FIRSTNET SOLUTION ATTACHMENT Last Revised 04/30/2020

1. General. Pursuant to the terms and conditions of the Agreement and this Attachment, AT&T will provide the AT&T FirstNet Solution, as described more fully below.

2. AT&T FirstNet Solution. The AT&T FirstNet Solution includes additional Services that are available and intended for use with the AT&T FirstNet Nationwide Public Safety Broadband Network (collectively, the "AT&T FirstNet Solution").

3. Eligibility. In order to take advantage of the AT&T FirstNet Solution, Customer must (a) be a qualified "Public Service Entity" as recognized by the First Responder Network Authority, and (b) restrict access to the AT&T FirstNet Solution solely to Authorized Users (as defined in the AT&T FirstNet Solution Service Guide described below) who must be located in a state or territory which has opted in to use the AT&T FirstNet Nationwide Public Safety Broadband Network, unless otherwise authorized by AT&T prior to submission of an order for service.

4. U.S. Pacific Territories. Only FirstNet Services are available to Customers in the U.S. Pacific Territories of American Samoa, Guam and the Commonwealth of the Northern Mariana Islands (the "Pacific Territories"). Customers in the Pacific Territories may purchase only those FirstNet Plans and FirstNet Services that are designated as available in the Pacific Territories in the applicable FirstNet Service Guide. FirstNet Services and features not available in the Pacific Territories to Customers in the Territories may be available to those Customers when traveling in the domestic U.S., Canada and Mexico.

5. AT&T FirstNet Solution Pricing and Terms. In the event Customer takes advantage of the AT&T FirstNet Solution, Customer will be bound by the rates, terms and conditions set forth in the AT&T FirstNet Solution Service Guide found at: http://serviceguidenew.att.com/sg_flashPlayerPage/FIRSTNET_NASPO as such rates, terms and conditions may be modified by AT&T from time to time, all of which are incorporated herein by reference.

TOWN OF MALABAR

COUNCIL MEETING

AGENDA ITEM NO: 11.e.
Meeting Date: November 2, 2020

Prepared By: Lisa Morrell, Interim Town Manager

SUBJECT: Piggyback Brevard County B-6-19-23/Road Construction Materials

BACKGROUND/HISTORY:

An analysis of road materials purchased by the Town in FY20 reveals an annual spend of \$30,890 for road base stabilization materials. An additional \$11,800 was expended on other road base materials of asphalt, various stone size, crushed concrete. Included in the analysis of the expenditures, it is important to note delivery and trucking fees were in addition to the material ordered.

Brevard County has awarded contract number B-6-19-23 entitled Road Construction Materials to multiple vendors with a primary, Florida Sand, Shell, & Aggregates, and secondary vendor, Green Dream, for fulfillment of orders based on availability and need for the following road base materials: Masonry Sand per DOT Section 902, Fill Dirt per DOT Section 120, and stabilized Shell Material for a contract period of January 1, 2019 through December 31, 2021. The contract pricing includes the delivery to various locations in Brevard County.

"The town administrator is authorized to piggy back contracts for any purpose where the stipulated consideration thereunder to be paid by the town exceeds two thousand dollars (\$2,000.00) awarded by any other governmental entity so long as the bidding process utilized by the other governmental entity in awarding such contract is consistent with the competitive bid procedures outlined in this section. "

The Town of Malabar will utilize this contract as needed for Public Works Streets and Roads.

FINANCIAL IMPACT:

FY21 Approved Budget General Government 519.4610 Repair and Maintenance of Roads, not to exceed \$25,000 annually.

ATTACHMENTS:

- Brevard County B-6-19-23 Road Construction Materials Award.PDF

ACTION OPTIONS:

Motion to use the Brevard County B-6-19-23/Road Construction Materials awarded contract as needed for road base materials within the estimated annual spend.



Purchasing Services
 2725 Judge Fran Jamieson Way
 Building C, Room 303
 Viera, Florida 32940

REVISED NOTICE OF AWARD
JANUARY 29, 2019
B-6-19-23/Road Construction Materials

PROCUREMENT ANALYST: Karen DiNatale

<u>VENDOR</u>	<u>VENDOR CITY AND STATE</u>	<u>MEETS MINIMUM REQUIREMENTS</u>	<u>ITEMS AWARDED</u>	<u>AWARD AMOUNT</u>
Florida Sand, Shell & Aggregates	Edgewater, FL	Yes	Primary: Masonry Sand Fill Dirt Stabilized Shell Material	\$86,000.00
Green Dream	Alexandria, VA	Yes	Secondary: Fill Dirt	

BOARD AWARD--AGENDA ATTACHED

APPROVED AWARD (NON-BOARD AGENDA):
 (Per Sections III.E. & III.I. & J., BCC-25, PROCUREMENT)

Steven A. Darling Jr., Purchasing Manager

Award to overall lowest, most responsive bidder, minimum three responses received.

Award to other than low, with low bid being non-responsive.

REASON FOR NON-RESPONSIVENESS:

Award to low bid, less than three responses received.

REASON FOR LESS THAN THREE RESPONSES: 85 suppliers solicited through VendorLink, resulting in 11 planholders.

AWARDED BY A COMMITTEE CONSISTING OF: Bruce Black, Public Works; Karen DiNatale, Procurement Analyst

FOR PURCHASING USE ONLY:

ONE-TIME PURCHASE

ANNUAL BID:

EFFECTIVE DATE: 01/10/2019 ENDING DATE: 01/09/2022

RENEWAL OPTION One year Other (fill in) Two (2) One (1) Year

Renewal

Prompt Payment Discount Offered Yes 2% Net 30 (Terms) NO

Performance and payment bonds received with construction contract documents.

Release Cashier's or Certified Check Received for Bid Deposit on Bids

SPECIAL INSTRUCTIONS TO AWARDED VENDOR:

Please provide certificate of insurance.

Please provide performance and payment bonds as required.

OTHER:

NOTICE OF AWARD
JANUARY 10, 2019
B-6-19-23/Road Construction Materials

PROCUREMENT ANALYST: Karen DiNatale

<u>VENDOR</u>	<u>VENDOR CITY AND STATE</u>	<u>MEETS MINIMUM REQUIREMENTS</u>	<u>ITEMS AWARDED</u>	<u>AWARD AMOUNT</u>
Florida Sand, Shell & Aggregates	Edgewater, FL	Yes	Primary: Masonry Sand Fill Dirt Stabilized Shell Material	\$136,000.00
Green Dream	Alexandria, VA	Yes	Secondary: Fill Dirt	

BOARD AWARD--AGENDA ATTACHED

APPROVED AWARD (NON-BOARD AGENDA):
(Per Sections III.E. & III.I. & J., BCC-25, PROCUREMENT)



Steven A. Darling Jr., Purchasing Manager

Award to overall lowest, most responsive bidder, minimum three responses received.

Award to other than low, with low bid being non-responsive.

REASON FOR NON-RESPONSIVENESS:

Award to low bid, less than three responses received.

REASON FOR LESS THAN THREE RESPONSES: 85 suppliers solicited through VendorLink, resulting in 11 planholders.

AWARDED BY A COMMITTEE CONSISTING OF: Bruce Black, Public Works; Karen DiNatale, Procurement Analyst

FOR PURCHASING USE ONLY:

ONE-TIME PURCHASE

ANNUAL BID:

EFFECTIVE DATE: 01/10/2019 ENDING DATE: 01/09/2022

RENEWAL OPTION One year Other (fill in) Two (2) One (1) Year

Renewal

Prompt Payment Discount Offered Yes 2% Net 30 (Terms) NO

Performance and payment bonds received with construction contract documents.

Release Cashier's or Certified Check Received for Bid Deposit on Bids

SPECIAL INSTRUCTIONS TO AWARDED VENDOR:

Please provide certificate of insurance.

Please provide performance and payment bonds as required.

OTHER:

B-6-19-23 Bid Tabulation

Bid Title: Road Construction Materials

Bid No: B-6-19-23

Opening Date & Time: December 13, 2018 @ 3:00 p.m.

Posting Date & Time: December 17, 2018 @ 9:00 a.m. through December 27, 2018 @ 5:00 p.m.

	Quantity	Florida Sand, Shell & Aggregates		Green Dream International	
		Unit Price	Extended Price	Unit Price	Extended Price
Unit - Cubic Yard					
MARL	20,000		No Bid		No Bid
Masonry Sand	1,000	\$ 6.00	\$ 6,000.00		No Bid
Fill Dirt	20,000	\$ 4.00	\$ 80,000.00	\$ 4.99	\$ 99,800.00
Stabilized Shell Material	10,000	\$ 5.00	\$ 50,000.00	\$ 10.13	\$ 101,300.00
Cemented Coquina	10,000		No Bid		No Bid
TOTAL			\$ 136,000.00		\$ 201,100.00

Bid tabulations with award recommendations are posted to VendorLink at www.myvendorlink.com or DemandStar at www.demandstar.com. Brevard County encourages prompt and fair handling of all complaints and disputes with the business community. Filing of any disputes and appeals shall be in accordance with procedures specified in bid documents.

Approval Initials



SUBMIT SEALED BID TO: BREVARD COUNTY PURCHASING SERVICES 2725 JUDGE FRANK JAMIESON WAY BLDG C, 3rd FLOOR SUITE C-303 VIERA, FL 32940			INVITATION TO BID Bid Acknowledgment
PROCUREMENT ANALYST: Karen DeNatale Karen.Denatale@brevard.org	(321)617-7300 Ext. 5-4664	AN EQUAL OPPORTUNITY EMPLOYER	FLORIDA TAX EXEMPT #65 801.3621749C-1 FEDERAL TAX EXEMPT #59-6000523
BID SPECIFICATIONS MAY BE OBTAINED AT Purchasing Services, 2725 Judge Frank Jamieson Way, Bldg. C, Suite 303, Viera, FL 32940, or at the County's Online Bid website and VendorLink.			
MAHING DATE: November 15, 2018	BID TITLE: Road Construction Materials	BID NUMBER: B-6-18-23	BID OPENING DATE AND TIME: November 15, 2018 @ 3:00 p.m.
PRE-BID DATE, TIME, AND LOCATION: None Scheduled		<input type="checkbox"/> Mandatory <input type="checkbox"/> Non-Mandatory	BIDS RECEIVED AFTER ABOVE DATE AND TIME WILL NOT BE ACCEPTED

▼ VENDOR MUST COMPLETE THIS AREA AND RETURN FORM ▼

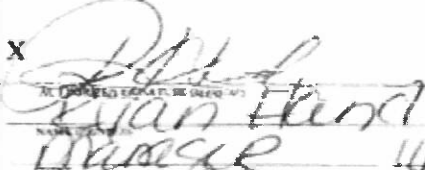
LEGAL NAME OF BIDDER AND BUSINESS ADDRESS: FLORIDA FISHERS & AQUACULTURE LLC D/B/A FLORIDA SAND, SHELL & AQUACULTURE	FEDERAL ID NO. (FEIN) OR SOCIAL SECURITY NO. (SSN): 47-4264483
PHONE NUMBER/CELL/FREE NUMBER: 1	If returning as a "no bid," state reason:
I certify that this bid is made without error, understanding, agreement, or connections with any corporation, firm or person submitting a bid for the same materials, supplies or equipment, and it is all respect for and without collusion or fraud. I agree to abide by all conditions of this bid and certify that I am authorized to sign this bid for the bidder. In submitting a bid to the County of Brevard, the bidder offers and agrees that if the bid is accepted, the bidder will comply with, assist, or assist in the County of Brevard all rights, title, and interest in and to all cases of action in any now or hereafter acquire under the various laws of the United States and the State of Florida. The price being related to the particular commodities or services provided or required by the County of Brevard. At the County's discretion, such payment shall be made and become effective at the time the County renders final payment to the bidder.	The bidder acknowledges that information provided in this IFB is true and correct. X  ATTEST: Ryan Hand NAME: Ryan Hand TITLE: Manager DATE: 11/30/18

THIS FORM MUST BE NOTARIZED AND RETURNED WITH YOUR BID

Sworn to and subscribed before me this 30th day of November 2018

Personally known: Ryan Hand
Or produced identification: Type of ID: _____
STATE: _____
NAME OF NOTARY PUBLIC (PRINTED): Kim Shoup

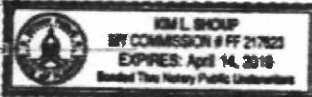
My commission expires: 

BOND DATA

VENDOR MUST PROVIDE:	AMOUNT:
Yes <input type="checkbox"/> No <input checked="" type="checkbox"/> BID BOND	<u>n/a</u>
Yes <input type="checkbox"/> No <input checked="" type="checkbox"/> PERFORMANCE BOND	<u>n/a</u>
Yes <input type="checkbox"/> No <input checked="" type="checkbox"/> LABOR, MATERIAL, PERFORMANCE BOND	<u>n/a</u>

In cases where the amount of a surety bond exceeds \$500,000, the surety company must have an A.M. Best's rating as specified in this document, and depending on the amount of the bond, shall have a minimum A.M. Best's financial size category (FSC) ranking as follows:

BOND AMOUNT UP TO:	FINANCIAL CLASS	BOND AMOUNT UP TO:	FINANCIAL CLASS
\$ 1,000,000	I	\$ 25,000,000	V
\$ 2,000,000	II	\$ 50,000,000	VI
\$ 5,000,000	III	\$ 100,000,000	VII
\$ 10,000,000	IV		

Bonds must be issued by a surety company who complies with the requirement of § 257.0935, Fla. Stat.

PAYMENT OF GOODS OR SERVICES PROVIDED AS A RESULT OF THIS SOLICITATION WILL BE MADE PER FLORIDA STATUTE.

ALL FIRST TIME VENDORS MUST SUBMIT A W-9 FORM.

GENERAL CONDITIONS, TERMS, AND PROVISIONS

1. **DEFINITIONS:**
 - a. **COUNTY** - The term "COUNTY" herein refers to the County of Brevard, Florida, and its duly authorized representatives.
 - b. **BIDDER** - The term "BIDDER" used herein refers to the dealer/manufacturer/business organization submitting a bid to the County in response to this invitation.
 - c. **VENDOR** - The term "VENDOR" used herein refers to any dealer/manufacturer/business organization that will be awarded a contract pursuant to the terms, conditions and quotations of the bid.
 - d. **USING AGENCY** - The term "USING AGENCY" used herein refers to any department, division, agency, commission, board, committee, authority or other unit in the County Government using supplies or procuring contractual services as provided for in the Purchasing Ordinance of the County of Brevard.
 - e. **HEAVY DUTY** - The item(s) to which the term "HEAVY DUTY" is applied shall exceed the usual quality and/or capacity supplied with standard production equipment and shall be able to withstand unusual strain, exposure, temperature, wear and use.
 - f. **QUALIFIED BIDDER** - The best bidder who has the capability in all respects to fully perform the bid requirements, and has the financial stability, honesty, integrity, skill, business judgment, experience, facilities, and reliability necessary to assure good faith performance of the contract, as determined by reference to the Contractor's Qualification Statement, evaluations by County staff of the bidder or its subcontractors' past performance for the Board, or any other information required by Board policies.
 - g. **RESPONSIVE BIDDER** - A bidder who has submitted a bid, which conforms in all respects to the requirements of the bid package, including, but not limited to, submission of the bid on required forms with all required information, signatures, and notarizations at the place and time specified.
 - h. **DUE CAUSE** - An applicable reason affecting and concerning the ability and fitness of the contractor(s) to perform to the specifications and requirements of the contract.
2. **SUBMISSION OF BIDS:** All bids shall be submitted in a sealed envelope. The bid number, title, and opening date shall be clearly displayed on the outside of the sealed envelope. The delivery of said bid to Purchasing Services prior to the specified opening date and time is solely and strictly the responsibility of the bidder. Any bids received in Purchasing after the specified date and time will not be accepted.
3. **EXECUTION OF BID:** Bid must contain a manual signature of authorized representative in the space(s) provided. Bids must be typed or printed in ink. Use of erasable ink is not permitted. All corrections made by bidder to any bid entry must be initialed. The company name and Federal Employer Identification Number (FEID) number shall appear in the space(s) provided.
4. **BID OPENING:** Bid opening shall be public on the date and time specified. Sealed bids received by an agency pursuant to invitations to bid are exempt from the provisions of subsection (1) and s. 24(a), Art. I of the State Constitution until such time as the agency provides notice of a decision or intended decision pursuant to s. 120.57(3)(a) or within 30 days after bid or proposal opening, whichever is earlier. In accordance with Florida Statute 119.071(1)(b)2, the names of the firms submitting a competitive solicitation will be read aloud at this time of the opening. No details of the competitive solicitation will be released. Bid must be submitted on forms provided by the County. No other forms will be accepted. Fax, telephone, emailed, or verbal Bids are not acceptable and will not be considered. No bid may be modified after opening. No bid may be withdrawn after opening for a period of ninety (90) days unless otherwise specified.
5. **BID TABULATIONS:** Bid tabulations are posted to the DemandStar website at: www.demandstar.com and VendorLink
6. **CLARIFICATION/CORRECTION OF BID ENTRY:** The County reserves the right to allow for the clarification of questionable entries and for the correction of OBVIOUS MISTAKES.
7. **INTERPRETATION:** No interpretation of the meaning of the specifications, or other contract documents will be made orally to any bidder. Every request for such interpretation must be in writing, addressed to Purchasing Services at 2725 Judge Fran Jamieson Way, Bldg. C, 3rd Floor, Suite 303 Viera, FL 32940, or emailed to the attention of the applicable Procurement Analyst. To be given consideration, such requests must be received at least five (5) business days prior to the date fixed for the opening of the bid. Any and all such interpretation and supplemental instructions will be in the form of a written addendum. Failure of any bidder to receive any such addendum or interpretation shall not relieve said bidder from any obligation under his bid as submitted. All addenda so issued shall become part of the contract documents, whether or not the successful bidder received a copy of such addendum, it being understood that all bidders are responsible to verify that they have received any such addenda prior to submitting their bid.
8. **EEO STATEMENT:** Vendors must ensure that employees and applicants for employment are not discriminated against for reasons of race, color, age, religion, sex, national origin, or handicapped status. Minority and female-owned businesses are encouraged to participate. Brevard County is an equal opportunity employer.
9. **PRICING:** Firm prices shall be proposed and include FOB DESTINATION, all packing, handling, shipping charges, fuel surcharges and delivery, unless otherwise indicated, to any point within the County to a secure area or inside delivery. All prices, costs, and conditions shall remain firm and valid for 90 days from the date of opening. The obligations of Brevard County under this award are subject to the availability of funds lawfully appropriated for its purpose by the State of Florida and/or the Brevard County Board of County Commissioners.
10. **ADDITIONAL TERMS & CONDITIONS:** The County of Brevard reserves the right to reject bids containing any additional terms or conditions not specifically requested in the original conditions and specifications.
11. **TAXES:** The County of Brevard is exempt from Federal excise taxes and all sales taxes.
12. **DISCOUNTS:** All discounts, EXCEPT THOSE FOR PROMPT PAYMENT, shall be considered in determining the lowest net cost for bid evaluation purposes.
13. **MEETS SPECIFICATIONS:** All equipment and accessories furnished under these specifications shall be new, the latest model in current production, and shall be of good quality, workmanship, and material. The bidder represents that all equipment offered under these specifications shall meet or exceed the minimum requirements specified. Delivery specifications shall be strictly adhered to. The bidder shall be responsible for performing the work necessary to meet County standards in a safe, neat, good, and workmanlike manner.
14. **BRAND NAME OR EQUAL:** If items called for by this invitation have been identified in the specifications by a "Brand Name or Equal" description, such identification is intended to be descriptive, but not restrictive, and is to indicate the quality and characteristics of products that will be acceptable. Bids offering "equal" products will be considered for award if such products are clearly identified in the bid and are determined by the County to meet fully the salient characteristics requirements listed in the specifications. Unless the bidder clearly indicates in his bid that he is offering an "equal" product, the bid shall be considered as offering the same brand name product referenced in the specifications. If the bidder proposes to furnish an "equal" product, the brand name if any, or the product to be furnished shall be inserted in the space provided or such product shall be otherwise clearly identified. The evaluation of bids and the determination as to equality of the product offered shall be the responsibility of the County and will be based on information furnished by the bidder. Purchasing Services is not responsible for locating or securing any information, which is not identified in the bid and reasonably available to Purchasing Services. To ensure that sufficient information is available the bidder shall furnish as a part of the bid, or prior to bid opening, as indicated, all descriptive material necessary for Purchasing Services to determine whether the product offered meets the salient characteristics required by the specifications and establish exactly what the bidder proposes to furnish and what the County would be binding itself to purchase by making an award.

15. **SILENCE OF SPECIFICATIONS:** The apparent silence of the specifications and any supplemental specifications as to any details or the omission from same of any detailed description concerning any point, shall be regarded as meaning that only the best commercial practices are to prevail and only materials of first quality be provided. All interpretations of this specification shall be made upon the basis of this statement.
16. **ASSIGNMENT:** Any purchase order (PO) issued pursuant to this bid and the moneys, which may become due hereunder is not assignable except with the prior written approval of the Purchasing Manager.
17. **INDEMNIFICATION:** The successful bidder agrees to indemnify and hold harmless the County and their employees from all claims, losses and expenses, including attorneys' fees, arising out of or resulting from the performance, failure in the performance of, or defect in, the products or services to be contracted, provided such claim, damage, loss or expense (1) is attributable to bodily injury, sickness, disease, death, or personal injury, or to property damage, including loss of use resulting therefrom, and (2) is caused in whole or in part by any negligent act or omission of the vendor, any subcontractor or any of their employees, or arises from a job-related injury. The successful bidder acknowledges adequate consideration for this indemnification provision.
18. **PATENTS AND ROYALTIES:** The bidder, without exception shall indemnify and save harmless the County of Brevard and its employees from liability of any nature of kind including cost and expenses for or on account of any copyrighted, patented, or unpatented invention, process, or article manufactured or used in the performance of the contract, including its use by the County of Brevard. If the bidder uses any design, device, or materials covered by letters, patent or copyright, it is mutually agreed and understood without exception that the bid prices shall include all royalties or cost arising from the use of such design, device, or materials in any involved in the work.
19. **TRAINING:** If specified, supplier(s) may be required at the convenience of the County, to provide employees training in the operation and maintenance of any items(s) purchased from this bid.
20. **ACCEPTANCE:** Items may be tested for compliance with specification. Items delivered not conforming to specifications may be rejected and returned at vendor's expense. Those items not delivered as per delivery date in bid and/or purchase order may be purchased on the open market. Any increase in cost may be charged against the vendor. Any violations of these stipulations may also result in the vendor name being removed from the bid list and the vendor disqualified from doing business with the County.
21. **SAFETY WARRANTY:** The selling dealer, distributor, supplier, and manufacturer shall be responsible for having complied with all Federal, State and local standards, regulations, and laws concerning the equipment specified and the use thereof, applicable and effective on the date of manufacture including safety and environmental standards as apply to both private industry and governmental agencies.
22. **WARRANTY:** The bidder agrees that, unless otherwise specified, the supplies and/or services furnished under this bid shall be covered by the most favorable commercial warranty the bidder gives to any customer for comparable quantities of such supplies and/or services and that the rights and remedies provided herein are in addition to and do not limit any rights afforded to the County by any other provision of this bid.
23. **AWARDS:** As the best interest of the County may require, the right is reserved to make award(s) by individual items, group of items, all or none, or a combination thereof; on a geographical basis and/or on a countywide basis with one or more suppliers; to reject any and all bids or waive any minor irregularity or technicality in bids received. Bidders are cautioned to make no assumptions unless their bid has been evaluated as being responsive and qualified. All awards made as a result of this bid shall conform to applicable ordinances of the County. The Board may return, for full credit, any unused items received which fail to meet the Board's performance standards. Brevard County reserves the right to cancel an awarded bid upon due cause—i.e., vendor misrepresentation, vendor negligence, non-performance, etc. via written notice.
24. **Unless otherwise noted in the bid document, vendors shall submit one bid only.**
25. **CONFLICT OF INTEREST:** The award hereunder is subject to provisions of State of Florida Statutes and Brevard County Ordinances. All Bidders must disclose with their bid the name of any officer, director, or agent who is also an employee of Brevard County. Further, all bidders must disclose the name of any County employee who owns, directly or indirectly, any interest in the proposer's firm or any of its branches.
26. **PURCHASING AGREEMENTS WITH OTHER GOVERNMENTAL ENTITIES:** Brevard County permits the awarded vendor(s) to extend the pricing, terms and conditions of this solicitation to other governmental entities at the vendor's discretion. Each governmental entity that utilizes this solicitation or resulting contract will be responsible for execution of its own requirements with the awarded vendor(s).
27. **DRUG-FREE WORKPLACE:** Whenever two or more bids, which are equal with respect to price, quality, and service, are received by Brevard County for the procurement of commodities or contractual services, a bid received from a business that has implemented a drug-free workplace program per 287.087, Fla. Stat. shall be given preference in the award process.
28. **LOBBYING STATEMENT:** All firms are hereby placed on notice the County Commission and staff shall not be contacted about this Bid. Firms and their agents are hereby placed on notice that they are not to contact members of the County Commission or staff (with the exception of designated liaison). Public meetings and public deliberations of the Selection Committee are the only acceptable forum for the discussion of merits of products/services requested by the invitation to Bid; and written correspondence concerning Bids may be submitted to the County Manager. Each Bid will have one non-voting staff member designated who will serve as the liaison. Failure to adhere to these requirements could result in Board action to disqualify your firm from consideration of award.
29. **PUBLIC ENTITY CRIMES:** All bidders are hereby placed on notice that a person or affiliate who has been placed on the convicted vendor list following a conviction for a public entity crime may not submit a bid on a contract to provide any goods or services to a public entity, may not submit a bid on a contract with a public entity for the construction repair of a public building or public work, may not submit bids on leases of real property to a public entity, may not be awarded or perform work as a contractor, supplier, subcontractor, or consultant under a contract with a public entity, and may not transact business with any public entity in excess of the threshold amount provided in 287.017 Fla. Stat. for CATEGORY TWO (currently \$35,000) for a period of thirty-six (36) months from the date of being placed on the convicted vendor list.
30. **DISCRIMINATORY VENDOR LIST:** An entity or affiliate placed on the Discriminatory Vendor List shall not submit a Bid for a contract to provide goods or services to a public entity, shall not submit a Bid on a contract with a public entity for the construction or repair of a public building or perform any public work, shall not submit Bids for leases of real property to a public entity, shall not award or perform work as a contractor, supplier, subcontractor, or consultant under any contract with any public entity, and shall not transact business with any public entity per 287.134(3)(d), Fla. Stat.
31. **SCRUTINIZED COMPANIES:** Awarded Contractor shall certify that it and its subcontractors are not on the Scrutinized Companies that Boycott Israel List. Pursuant to Section 287.135, F.S., the County may immediately terminate any Agreement at its sole option if the Contractor or its subcontractors are found to have submitted a false certification; or if the Contractor, or its subcontractors are placed on the Scrutinized Companies that Boycott Israel List or is engaged in the boycott of Israel during the term of the Agreement. If the Agreement is for more than one million dollars, the Contractor further certifies that it and its subcontractors are also not on the Scrutinized Companies with Activities in Sudan, Scrutinized Companies with Activities in the Iran Petroleum Energy Sector List, or engaged with business operations in Cuba or Syria as identified in Section 287.135, F.S. Pursuant to Section 287.135, F.S., the County may immediately terminate this Agreement at its sole option if the Contractor, its affiliates, or its subcontractors are found to have submitted a false certification; or if the Contractor, its affiliates, or its subcontractors are placed on the Scrutinized Companies that Boycott the Scrutinized

Companies with Activities in Sudan List, or Scrutinized Companies with Activities in the Iran Petroleum Energy Sector List, or engaged with business operations in Cuba or Syria during the term of the Agreement. The Contractor agrees to observe the above requirements for applicable subcontracts entered into for the performance of work under this Agreement.

As provided in Subsection 287.135(B), F.S., if federal law ceases to authorize these contracting prohibitions, this section shall become inoperative and unenforceable.

32. **LICENSES, CERTIFICATIONS, AND PERMITS:** The successful vendor will be required to secure, at its expense and show proof of the proper business tax receipt and/or any other license/certification required of the applicable service/work being performed. Prior to award, the apparent low bidder will be required to provide proof of license and/or certification within two (2) business days of the posted awarded recommendation and submit copies of license/certifications to the Purchasing Office. The Brevard County Contractor Licensing Regulation & Enforcement (LR&E) office is responsible for the county licensing of trades: General Building, drywall, plumbing, electric, HVAC, roofing, etc. If you have questions concerning the licensing requirements for a Brevard County contractor's license, please contact the Brevard County LR&E office at (321) 633-2058, option 0, for any questions. The awarded contractor shall fully comply with all federal and state laws, county and municipal ordinances and regulations in any manner affecting the performance of the work. The successful vendor is responsible for obtaining all permits necessary to construct the project. Brevard County does not exempt itself from permitting requirements. The Owner shall pay all Brevard County permit, inspection and impact fees required for the project or services required under this contract; all other fees for permits required by agencies/municipalities other than Brevard County shall be the responsibility of the awarded Contractor. A copy of issued permit shall be provided to the User Department of the County for their records.
33. **ERRORS:** In the event of extension error(s), the unit price will prevail. In the event of addition error(s), the extended totals will prevail. In either case, the bidder's total offer will be adjusted accordingly.
34. **CANCELLATION AND REINSURANCE:** If any insurance should be canceled or changed by the insurance expiring during the period of this bid award, the vendor shall be responsible for securing other acceptable insurance to provide the coverage specified in the bid to maintain continuous coverage during the life of the award.
35. **INCURRED COST:** Brevard County is not liable for any cost incurred by any vendor prior to an award. Costs for developing a response to this request for bid are entirely the obligation of the bidder and shall not be chargeable in any manner to Brevard County.
36. **MATERIALS/SUPPLIES:** No materials or supplies for the work shall be purchased by the vendor or by any subcontractor subject to any chattel mortgage or under a conditional sale or other agreement by which an interest is retained by the seller.
37. **SUBCONTRACTORS:** The vendor shall be fully responsible for all acts and omissions of his subcontractors and of persons and organizations directly or indirectly employed by them and of persons and organizations for whose acts and omissions of persons directly employed by him.
38. **VERBAL INSTRUCTIONS:** No negotiations, decisions, or actions shall be initiated or executed by the vendor as a result of any discussions with any County employee. Only those communications, which are in writing from an authorized County representative, may be considered. Only written communications from vendors, which are assigned by a person designated as authorized to bind the company, will be recognized by the County as duly authorized expressions on behalf of the company.
39. **LITIGATION VENUE:** All litigation shall take place either in the State Courts of Florida, wherein venue shall lie in Brevard County, Florida, or in the Federal Courts wherein venue shall lie in the Middle District in and for the State of Florida. The vendor expressly waives venue in any other location.
40. **ADDITION, DELETION, OR MODIFICATION OF SERVICES:** The County reserves the right at its sole discretion to increase, decrease, or delete any portion of this agreement/contract at any time without cause, and if

such right is exercised by the County, the total fee shall be reduced by a prorate basis. If work has already been accomplished on the portion of the contract to be increased, decreased, or deleted, the contractor shall be paid for the correct portion on the basis of the estimated percentage agreed upon by the County, the contractor, and the contract manager upon completion of such portion.

41. **OPERATION DURING DISPUTE:** In the event the County has not canceled the contract in accordance with the terms of the contract, and there remains a dispute between the bidder and the County, the bidder agrees to continue to operate and perform under the terms of the contract while such dispute is pending. Further, the bidder agrees that, in the event a suit is filed for injunction or other relief, it will continue to operate the system until the final adjudication of such suit by the court.
42. **CONTRACT TERMINATION:** The contract resulting from this bid shall commence upon issuance and acceptance of the fully executed contract. The County user agency shall issue orders against the contract on an as needed basis. The contract may be canceled by the vendor, for good cause, upon ninety (90) days prior written notice. The County retains the right to terminate the contract, in part or in its entirety, with or without good cause, upon thirty (30) days prior written notice or as stated herein. In the event of termination by either party as provided herein, the awarded vendor shall be paid for services performed through the date of termination.
43. **SPECIAL ACCOMMODATIONS:** In accordance with the Americans with Disabilities Act (ADA) and Section 286.26, Fla. Stat., persons with disabilities needing special accommodations to participate should contact the ADA Coordinator at (321) 633-2017 or by email at Brian.Breslin@BrevardFL.gov, and must be made no later than 48 hours prior the public meeting/hearing in order to provide the requested service.
44. **BIDDER RESPONSIBILITIES:** Bidders, by submitting a bid, certify that it understands all planning, coordinating, and implementation of the described services shall be done through personal contact between the bidder and the contract manager, and that telephone contact and mail correspondence may, in some cases, not be appropriate. County approved representatives of the bidder shall be available to meet with the contract manager, as may be required, to accomplish the County's objectives as effectively and efficiently as possible, during all phases of this agreement/contract/bid.
45. **SUPERVISION OF CONTRACT PERFORMANCE:** The bidder's performance of the contract will be notified by the contract manager. The bidder shall be notified of lack of performance in writing by the contract manager. If at any time during the term of the contract, performance satisfactory to the contract manager shall not have been made, the bidder, upon written notification by the contract manager, shall within three (3) days increase the force, tools and equipment as needed to properly perform the contract. The failure of the contract manager to file such notification shall not relieve the bidder of the obligation to perform the work at the time and in the manner specified by the contract. If the bidder does not increase the force or neglects to do the work properly, the contract manager can withhold a percentage of payment or withhold the entire dollar amount due as per the contract.
46. **MISUNDERSTANDING:** To prevent misunderstanding and any litigation, the contract manager shall decide any and all questions, which may arise concerning the quality and acceptability of the work, and services performed the sufficiency of performance, the interpretation of the provisions of the contract, and the acceptable fulfillment of the contract on the part of the bidder. The Contract Manager will determine whether or not the amount, quantity, character and quality of the work performed are satisfactory, which determination shall be final, conclusive and binding upon both the bidder and the County. The contract manager shall make such explanation as may be necessary to complete, explain, or make definite the provisions of the contract, and his findings and conclusions shall be final and binding upon both parties.
47. **GREEN PROCUREMENT POLICY:** The Board of County Commissioners approved a "green procurement" policy in March 2004 to establish procurement requirements that promote the purchase and use of Environmentally Preferred Products as defined by the United States Environmental Protection Agency. Environmentally Preferred Products

- (EPP) are those products and services that have a reduced effect on the human health and the environment when compared to other products and services that serve the same purpose. EPP products encourage (1) waste reduction; (2) reduced exposure to hazardous materials; (3) natural resource conservation; and (4) energy efficiency.
48. **MONITORING OF WORK:** The bidder shall provide the contract manager with every reasonable opportunity to ascertain whether or not the work, as performed, is in accordance with the requirements of the contract. The bidder shall designate, in writing, a person to serve as liaison between the bidder and the County.
49. **PROMPT PAYMENT:** For payment promptness, Brevard County shall remit payment in accordance with the Florida Prompt Payment Act, Section 218.70, Fla. Stat., et seq. Brevard County does not expect to be billed in excess of the ordered quantity and will not pay for any quantity above the ordered quantity. Any order placed as a result of this bid will be subject to Billing Instructions and Conditions on the back of the Brevard County Purchase Order form. Bidders may offer cash discounts for prompt payment but they will not be considered in determination of award. If a bidder offers a discount, it is understood that the discount time will be from the date of satisfactory delivery, at the place of acceptance, and receipt of correct invoice, at the office specified, whichever occurs last. Requests for final payment for any work or services for which a permit is required shall include a copy of all required permits and copies of all required inspection reports. Failure to provide proof of acquisition of all required permits and successful completion of all required inspections shall represent an incomplete invoice and will delay payment.
50. **RIGHT TO AUDIT RECORDS:** In performance of this Agreement, the Contractor shall keep books, records, and accounts of all activities related to the Agreement, in compliance with generally accepted accounting procedures. All documents, papers, books, records, and accounts made or received by the contractor in conjunction with the Agreement and the performance of this Agreement shall be open to inspection during regular business hours by an authorized representative of the office, and shall be retained by the contractor for a period of five (5) years after termination of this Agreement—unless such records are exempt from section 24(a) of Article I of the State Constitution and section 119.07(1), Fla. Stat.
51. **UNAUTHORIZED ALIEN WORKERS:** Brevard County will not accept bids from vendors who knowingly employ unauthorized alien workers, constituting a violation of the employment provisions contained in 8 U.S. Code § 1324a(e) (Section 274A(e) of the Immigration and Nationality Act "INA"). The County shall consider a vendor's intentional employment of unauthorized aliens as grounds for immediate termination of any awarded proposal. The CONSULTANT shall utilize the U.S. Department of Homeland Security's E-Verify system to verify the employment eligibility of all new employees hired by the CONSULTANT during the term of the Contract and shall expressly require any subcontractors performing work or providing services pursuant to the Contract to likewise utilize the U.S. Department of Homeland Security's E-Verify system to verify the employment eligibility of all new employees hired by the subcontractor during the Contract term.
52. **FLORIDA PUBLIC RECORDS LAW:** Both parties understand that the County is subject to the Florida Public Records Law, Chapter 119, Fla. Stat. and all other applicable Florida Statutes. If the materials provided by the Contractor do not fall under a specific exemption, under Florida or federal law, materials provided by the Contractor to the County would have to be provided to anyone making a public records request. It will be the bidder's duty to identify the information, which it deems is exempt under Florida/federal law, and identify the statute by number, which exempts that information.
- Should any person or entity make a public request of the County—which requires or would require the County to allow inspection or provide copies of records which the Contractor maintains are exempt from Public Records Law or are confidential—it shall be the Contractor's obligation to provide the County within 24 hours (not including weekends and legal holidays), of notification by the County to the Contractor of the request, of the specific exemption or confidentiality provision so the County will be able to comply with the requirements of Chapter 119, Fla. Stat.
- Should the County face any kind of legal action to require or enforce inspection or production of any records provided by the Contractor to the County which the Contractor maintains are exempt or confidential from such inspection/production as a public record, then the Contractor shall hire and compensate attorney(s) who shall represent the interest of the County as well as the Contractor in defending such action. The Contractor shall also pay any costs to defend such action and shall pay any costs and attorney fees, which may be awarded pursuant to 119.12, Fla. Stat.
- All material submitted becomes the property of the County and may be returned only at the County's option. The County has the right to use any or all ideas presented in any reply to this ITB. Selection or rejection of any bid does not affect this right.
53. **PREFERENCE GIVEN TO COMMODITIES MANUFACTURED, GROWN, OR PRODUCED IN FLORIDA:** In accordance with 287.082, Fla. Stat., whenever two or more competitive sealed bids are received, one or more of which relates to commodities manufactured, grown, or produced within this State, and whenever all things stated in such received bids are equal with respect to price, quality, and service, the commodities manufactured, grown, or produced within this State shall be given preference.
54. **COUNTY SEAL:** Use of the County Seal without the express approval of the Board of County Commissioners is a violation of 165.043, Fla. Stat. punishable as a misdemeanor.
55. **TIE BIDS:** Award of all tie quotes/bids shall be made by the Purchasing Manager in accordance with State Statutes, which allows a firm certified as a Drug-Free Workplace to have precedence. When evaluation of vendor responses to solicitations results in identical offers, with regards to bids or quotations, or identical ranking with regards to proposals, from two or more vendors, the County shall determine the order of award using the following criteria in order of preference listed below (from highest priority to lowest priority):
- For tie bids, quotations or proposals, priority shall be given to the vendor certifying that he/she is a Drug-Free Workplace as defined within 287.087, Fla. Stat.;
 - In the event that a tie still exists after progressing through a-c, the decision shall be made by lot or coin toss. The drawing of lots or coin toss shall be conducted in the presence of the effected bidders if they elect to be present.
56. **VENDOR COMPLAINTS AND DISPUTES:** Brevard County encourages prompt and fair handling of all complaints and disputes with the business community. In order to resolve disputed matters in an equitable manner, the following procedures are adopted:
- POSTING OF AWARD NOTICES**
FORMAL SEALED BIDS/QUOTES: No later than three (3) business days after a bid opening the Purchasing Manager, or his/her designee, shall post a tabulation of competitive sealed bids/quotes to the www.demandstar.com and Vendorlink. The apparent, responsive low bid/quote will be the intended award recommendation. If after posting the tabulation, the apparent low bid/quote is found to be non-responsive to the specifications, the formal award evaluation will be posted. The time for filing a protest will begin the date of the later posting.
FORMAL SEALED PROPOSALS: No later than three (3) business days after the selection committee recommendations are finalized, the Purchasing Manager or his/her designee shall post the selection committee's rankings and recommended award for bids.
 - PROTESTS**
Any bidder, quoter, or proposer who is allegedly aggrieved in connection with the solicitation or pending award of a contract must file a formal written protest with the Purchasing Manager within five (5) business days of the posted award recommendation.
The formal written protest shall reference the bid/quote/proposal number, and shall state with particularity

the facts and laws upon which the protest is based, including full details of adverse effects and the relief sought.

Within seven (7) calendar days of receipt of the formal written protest, the Purchasing Manager will arrange a meeting of the Protest Committee and the affected parties. The Protest Committee shall consist of two (2) Department Directors or designees, both of whom must be from an organizational group which the user department or group is not assigned; one (1) Assistant County Manager, who must be from an organizational group which the user department or group is not assigned under. The Purchasing Manager shall act as a non-voting Hearing Coordinator and the County Attorney or designee may be requested to attend as a non-voting member. The Purchasing Manager or designee record the meeting and provide any information as the committee may request. The purpose of the meeting of the Protest Committee is to provide an opportunity to: (1) review the basis of the protest, (2) evaluate the facts and merits of the bid protest, and (3) if possible, to reach a resolution of the protest that is acceptable to the affected parties. For the purpose of the Protest Committee hearing, resolution shall mean that the Protestor finds the decision of the Protest Committee acceptable.

In the event the matter is not resolved with the Protestor's acceptance of the Protest Committee's decision, the

Purchasing Manager will schedule the recommended award including the details of the protest and the Protest Committee's recommendation before the Board of County Commissioners via Board Agenda. The County Manager, prior to approval and placement on the Board agenda, may elect to resolve the matter before presentation to the Board. In the event that the County Manager cannot bring the matter to resolution, a copy of the Agenda Report shall be furnished immediately to all affected parties. The affected parties may appear before the Board of County Commissioners as a final means of administrative remedy.

c. **STAY OF PROCUREMENTS DURING PROTESTS**

Failure to observe any or all of the above procedures shall constitute a waiver the right to protest a contract award. In the event of a timely protest under the procedure, the County shall not proceed further with solicitation or with the award until a recommendation is made by the Committee, or a written determination is made by the County Manager that the award must be made immediately in order to protect the public interest. Invoice disputes between an awarded vendor and user agency will follow the guidelines set forth in AO-33, *Prompt Payment of Invoices*.

ROAD CONSTRUCTION MATERIALS
B-6-19-23
BIDDER'S CHECKLIST

The items indicated are required for submission with your bid. Failure to submit any items indicated as required may result in rejection of the bid. Offers to provide required items after the date and time designated for the receipt of bid will not be considered.

- Signed/Notarized Bid Invitation
- Completed and Signed Price Sheet, to include Insurance Indemnification Acknowledgement (Page 12-13)
- Confirmation of Drug Free Workplace Form
- Reference Form
- E-Verify Affidavit
- W-9 Form – Latest Edition

In order for this bid to be valid, the above forms and information shall be completed in their entirety, signed by an authorized representative of the responding vendor, and returned as part of the bid response.

ROAD CONSTRUCTION MATERIALS
B-6-19-23
SPECIAL CONDITIONS

1. PURPOSE

Brevard County Purchasing Services, on behalf of the Public Works Road and Bridge Department, is soliciting annual bids for the purchase of miscellaneous materials for road construction countywide.

CONTRACT PERIOD: The terms of this agreement shall be effective January 1, 2019 through December 31, 2021. The agreement may be extended by mutual agreement, for an additional two one-year periods with the option to negotiate pricing, terms and conditions. Brevard County will notify the Vendor in writing ninety (90) days prior to the expiration of the agreement as to its intent to renew the agreement.

Bid prices shall remain firm for the first twelve (12) months of this contract. The awarded vendor may have an opportunity to request an annual price adjustment for the second and subsequent years of this contract. The request for price adjustment must be submitted in writing no later than ninety (90) calendar days prior to the annual anniversary of the contract start date. The request for price adjustment must include written justification (raw material price increase, labor, etc.) for the increase and a copy must be sent to the Purchasing Manager. Any approved request for price adjustment will not take effect until the anniversary of the contract start date and any such granted price adjustment will be in effect for the twelve (12) month period following the said anniversary start date. Written request for price adjustments shall not exceed the rate of inflation determined by the Consumer Price Index (CPI). Any price adjustment shall be approved by the Purchasing Manager or designee prior to the new price becoming effective.

DELIVERY

All bids must be FOB Destination, packing, shipping, handling and fuel surcharges, and delivery included to various locations in Brevard County, with inside delivery. Delivery addresses and quantities of orders may vary from order to order throughout Brevard County.

2. INFORMATION OR CLARIFICATION

For information concerning procedures for responding to this bid, contact Karen DiNatale, Purchasing Services at 321-617-7390 or by email at karen.dinatale@brevardfl.gov. Such contact shall be for clarification purposes only. Material changes, if any, to the specifications will be transmitted by written addendum through Purchasing Services and posted to the DemandStar website at [Onvia DemandStar® website](#) and [VendorLink](#). The County will not notify bidders of addenda. It is the sole responsibility of the bidder to check the website prior to submitting a bid to verify receipt of all documents to include written addendum.

Bidders shall promptly notify Purchasing Services, prior to submission of their bid, of any ambiguity, inconsistency or error, which they may discover upon examination of the bid documents. No interpretation of the meaning of specifications or other documents will be made to any bidder orally, nor may bidder rely on any such pre-bid statements in completing the bid. Every request for such interpretation must be in writing addressed to Purchasing Services at 2725 Judge Fran Jamieson Way, Bldg. C, Suite 303, Viera, FL 32940, or emailed to the attention of Karen DiNatale at karen.dinatale@brevardfl.gov. To be given consideration, such requests must be received in writing no later than five (5) business days prior to the date for opening of the bids.

3. RECEIVING OF BIDS

Bids must be received by Brevard County Purchasing Services, 2725 Judge Fran Jamieson Way, Bldg. C, Suite C303, Viera, FL 32940 no later than December 13, 2018 @ 3:00 p.m. Bids must be submitted on County format to be considered. The official time clock will be the date and time stamp clock located in the Purchasing Office.

Bids shall be submitted in one (1) original and one (1) copy with the "Original" clearly marked. Paper documents must be provided, but should be accompanied by an equivalent electronic PDF file on CD or USB flash drive.

Note* Please ensure that if you use a third party carrier (DHL Express, FedEx, UPS, USPS, etc.) that they are properly instructed to deliver your bid only to Purchasing Services on the third (3rd) floor at the above address. Vendors are advised that U.S. Postal Service 1st Class and Express mail is delivered to a P.O. Box and is not delivered to the Purchasing Services Office. Delivery via the USPS is at the Vendor's risk. To be considered, a bid must be accepted in Purchasing Services no later than the ITB closing date and time. If the bid is delivered anywhere else, it may not reach Purchasing Services in time.

4. PRE-BID/WALK THROUGH

None Scheduled

ROAD CONSTRUCTION MATERIALS
B-6-19-23
SCOPE OF SERVICES

1. Brevard County Purchasing Services, on behalf of the Public Works Road and Bridge Department, is soliciting annual bids for the purchase of miscellaneous materials for road construction countywide to include Marl, Masonry Sand, Fill Dirt, and Stabilized Shell Material.
2. Materials to be loaded by the Contractor at the pit and hauled by the County or by contracted trucking firm. Prices to be FOB Mine site.

The masonry sand shall be bid as FOB Brevard County to the following Road and Bridge department location:

Department locations:

2675 N. Flake Rd., Titusville
555 Cone Rd, Merritt Island
4690 N. Wickham Rd, Melbourne
51 Wenner Way, Cocoa

3. Road and Bridge personnel will inspect all materials prior to award, for quality of materials. All pits required to be in full compliance of all necessary permits for legal operation of borrow pit.
4. With the exception of Masonry Sand, Brevard County intends to award to multiple contractors. The county will determine on a project by project basis, which contractor is the most cost effective for the job, based on the contractors unit price, combined with the trucking fees which shall be based on the current trucking bid rates and the distance from the vendors pit to the project location. Below is an example of the methodology to be used:

Contractor A – Unit Price \$3.50/ton (Pit Location Palm Bay)
Contractor B – Unit Price \$4.00/ton (Pit Location Cocoa)
Contractor C – Unit Price \$2.75/ton (Pit Location Titusville)

Job Location is in Melbourne and requires 30 Tons

Contractor A – Unit Price \$3.50 x 30 tons = \$105.00
Distance from pit to job-site 11 miles = Trucking rate \$.181 x 11 (miles) x 30 (tons) = \$59.73
Total = \$164.73

Contractor B – Unit Price \$4.00 x 30 tons = \$120.00
Distance from pit to job-site 19 miles = Trucking rate \$.181 x 19 (miles) x 30 (tons) = \$103.17
Total = \$223.17

Contractor C – Unit Price \$2.75 x 30 tons = \$82.50
Distance from pit to job-site 40 miles = Trucking rate \$.181 x 40 (miles) x 30 (tons) = \$217.20
Total = \$299.70

Contractor A would receive this project at \$3.50/ton based on combined material and trucking costs.

The mileage used to determine the trucking charges will be determined by Brevard County using a DMI (Digital Measuring Instrument), and will be calculated using the shortest legal route.

5. Materials must be stockpiled at mine site 24 hours prior to pick-up. Repeated failure to meet County order timeframes may necessitate cancellation of the award and the award being made to another contractor. The County will give the awarded contractor(s) a minimum of 24 hour's notice before pick-up.
6. Material for road construction must conform to DOT Section 902 specifications.
7. Brevard County reserves the right to solicit competitive bids on large volume orders, defined as orders exceeding \$10,000.00. In this event, an awarded contractor will be given the opportunity to bid as well.

ROAD CONSTRUCTION MATERIALS
B-6-19-23
PRICE SHEET

Item Description	Quantity	Unit	Unit Price	Extended Price
MARL – DOT Section 912. Must be of commercial quality without excessive sand or rock; suitable for Type B stabilization	20,000	Cu Yd	\$ /CY	\$
*MARL Dot Ton Cost			\$ /Ton	\$
MASONRY SAND – DOT Section 902. Suitable for mixing concrete, laying block, bricks, etc.	1,000	Cu Yd	\$ 4.00 /CY	\$ 4,000.00
*Masonry Sand – Ton Cost			\$ /Ton	\$
FILL DIRT – DOT Section 120. Clean fill dirt absent of rocks, organic material, roots, rubbish, etc. Fill must be capable of obtaining proper densities.	20,000	Cu Yd	\$ 4.00 /CY	\$ 80,000
* Fill Dirt Ton Cost			\$ /Ton	
Stabilized Shell Material for use on Road & Bridge Construction Projects.	10,000	Cu Yd	\$ 5.00 /CY	\$ 50,000
			\$ /Ton	
Cemented Coquina per DOT Section 915	10,000	Cu Yd	\$ /CY	\$
			\$ /Ton	
Estimated Annual Cost (Based on CY)				\$ 136,000

ACH PAYMENTS

Does your company accept ACH Payment Method? Yes / No

PROMPT PAYMENT DISCOUNT

Brevard County shall remit payment in accordance with the Florida Prompt Payment Act, Florida Statutes section 218.70. Bidders may offer cash discounts for prompt payment but they will not be considered in determination of award. If a bidder offers a discount, it is understood that the discount time will be from the date of satisfactory delivery, at the place of acceptance, and receipt of correct invoice, at the office specified, whichever occurs last.

* If Prompt Payment Discount is offered, please state discount and terms:

2% prompt net 30

ADDENDUM ACKNOWLEDGMENT

Bidder acknowledges receipt of amendments by indicating amendment number and its date of issue.

Add. No. _____ Dated _____ // Add. No. _____ Dated _____

Add. No. _____ Dated _____ // Add. No. _____ Dated _____

I hereby acknowledge that I have read, understand, and agree to all terms, conditions, insurance, scope of work, specifications and pricing for Bid #B-6-19-23/Road Construction Materials.

COMPANY NAME Florida Sand, Gravel & Aggregate

ADDRESS 4988 Old Blue Ridge Rd. Edgewater FL 32141

AUTHORIZED SIGNATURE 

PRINTED SIGNATURE Ryan Hart DATE 1/25/18

TELEPHONE # 386 345-0080 FAX # 386 345-0020

EMAIL luma@floridafishcgs.com

BREVARD COUNTY BOARD OF COUNTY COMMISSIONERS
INDEMNIFICATION AND INSURANCE REQUIREMENTS
ROAD CONSTRUCTION MATERIALS
B-6-19-23

INDEMNIFICATION

The County shall be held harmless against any and all claims for bodily injury, sickness, disease, death, personal injury, damage to property or loss of use of any property or assets resulting therefrom, arising out of or resulting from the performance of the products or from the services for which the County is contracting hereunder, provided such is caused in whole or in part by any negligent act or omission of the vendor, or any subcontractor or any of their agents or employees, or arises from a job-related injury.

The vendor agrees to indemnify the County and pay the cost of the County's legal defenses, including fees of attorneys as may be selected by the County, for all claims described in the hold harmless clause herein. Such payment on behalf of the County shall be in addition to any and all other legal remedies available to the County and shall not be considered to be the County's exclusive remedy.

It is agreed by the parties hereto that the Vendor has received specific consideration under this agreement for this hold harmless/indemnification provision.

INSURANCE REQUIREMENTS

The vendor providing services under this agreement will be required to procure and maintain, at their own expense and without cost to the County, until final acceptance by the County of all products or services covered by the purchase order or contract, the following types of insurance. The policy limits required are to be considered minimum amounts:

General Liability Insurance Workers Compensation insurance providing statutory benefits as required in the State of Florida. The Contractor shall require any subcontractor to provide evidence of this coverage. Additionally, if the contract requires working on or around a navigable waterway, the Contractor and all subcontractors shall provide evidence of United States Longshoremen's and Harbor Workers (USL&H) coverage and contingent coverage of Jones Act (Marine Employers Liability) in compliance with Federal statutes or proof of exemption. The Contractor shall be responsible for compliance with these requirements by each subcontractor, vendor or supplier when applicable.

Auto Liability Insurance, which includes coverage for all owned, non-owned and rented vehicles with a \$1,000,000 combined single limit for each occurrence.

Workers' Compensation and Employers Liability Insurance covering all employees of the vendor and subcontractors, as required by law.

In the event that the contract involves professional or consulting services, in addition to the aforementioned insurance requirements, the vendor shall also be protected by a Professional Liability Insurance Policy in the amount of \$1,000,000 per claim.

In the event the contract involves services related to construction projects, the vendor shall also procure and maintain a Builders Risk Insurance Policy or Installation Floater with loss limits equal to the value of the construction project.

In addition to the above, Specialty Insurance policies covering specific risks of loss (including but not limited to, for example; Longshore coverage, Crane and Rigging, Inland Marine, etc.) may be required by Brevard County Insurance and Risk Management. Any additional specialty insurance coverage requirement will be dictated by the specific goods, products or services provided under the subject contract and insurance underwriting standards, practices, procedures or products available in the commercial insurance market at the time of the contract inception. The Vendor is required to procure and maintain all such specialty coverage in accordance with prudent business practices within the Vendors industry.

The awarded vendor shall have five (5) days to provide certificates of insurance to the County demonstrating that the aforementioned insurance requirements have been met prior to the commencement of work under this contract. **The certificate(s) of insurance (COI) shall indicate that the policies have been endorsed to cover the County as an additional insured (a waiver of subrogation in lieu of additional insured status on the workers' compensation policy is acceptable)** and that these policies may not be canceled or modified without thirty (30) days prior written notice to the County.

The insurance coverage enumerated above constitutes the minimum requirements and shall in no way lessen or limit the liability of the vendor under the terms of the contract. Sub-Contractor's insurance shall be the responsibility of the vendor.

**ROAD CONSTRUCTION MATERIALS
B-6-19-23
CONFIRMATION OF DRUG-FREE WORKPLACE FORM**

In accordance with Section 287.087, Florida Statutes, "[w]henver two or more bids are equal with respect to price, quality, and service which are received by any political subdivision for the procurement of commodities or contractual services, a bid received from a business that certifies that it has implemented a drug-free workplace program shall be given preference in the award process. In order to have a drug-free workplace program, a business shall:

- (1) Publish a statement notifying employees that the unlawful manufacture, distribution, dispensing, possession, or use of a controlled substance is prohibited in the workplace and specifying the actions that will be taken against employees for violations of such prohibition,
- (2) Inform employees about the dangers of drug abuse in the workplace, the business's policy of maintaining a drug-free workplace, any available drug counseling, rehabilitation, and employee assistance programs, and the penalties that may be imposed upon employees for drug abuse violations.
- (3) Give each employee engaged in providing the commodities or contractual services that are under bid a copy of the statement specified in subsection (1).
- (4) In the statement specified in subsection (1), notify the employees that, as a condition of working on the commodities or contractual services that are under bid, the employee will abide by the terms of the statement and will notify the employer of any conviction of, or plea of guilty or nolo contendere to, any violation of chapter 893 or of any controlled substance law of the United States or any state, for a violation occurring in the workplace no later than 5 days after such conviction.
- (5) Impose a sanction on, or require the satisfactory participation in a drug abuse assistance or rehabilitation program if such is available in the employee's community by, any employee who is so convicted.
- (6) Make a good faith effort to continue to maintain a drug-free workplace through implementation of this section."

As the person authorized to sign the statement, I certify that this firm complies with the above requirements and the Florida Statutes Section 287.087. This form is in conjunction with Brevard County's General Conditions, Item 27, Drug-Free Workplace.

DB/A Florida Fisheries & Aquaponics
 Florida Sand, Shell & Gravel B-6-19-23
 Business Name Bid Number and Name
 Authorized Representative's Signature Date
 Ryan Hand Manager
 Name Position

**ROAD CONSTRUCTION MATERIALS
B-6-19-23
REFERENCE FORM**

List a minimum of three (3) / maximum five (5) customers for the services specified in the solicitation in the spaces provided.

Note: A contact person shall be someone who has personal knowledge of the bidder's performance for the specific requirement listed. Contact person must have been informed that they are being used as a reference and that the County may be calling them. Do not list persons who will be unable to answer specific questions regarding the requirements.

Ref #1. Customer/Client: P&S
 Date of Services: 10/20/17
 Description of Services: Provide-Fill, Shell Material
 Street Address: 3701 Oakwood Dr
 City, State, ZIP Code: Durham, NC 27614
 Telephone #: 352-255-7911 Fax #: _____
 Contact Person: Brian Dawson Email: _____

Ref #2. Customer/Client: Orphan Western
 Date of Services: 08/01/17
 Description of Services: Shell - Select Fill
 Street Address: 135 Tequesta Blvd. Davenport, FL 32114
 City, State, ZIP Code: Davenport, FL 32114
 Telephone #: 386-333-9575 Fax #: _____
 Contact Person: Wesley Rodriguez Email: _____

Ref #3. Customer/Client: DeMoya
 Date of Services: Jan 2014 thru letter
 Description of Services: Fill - Select Shell
 Street Address: 14000 SW 136th St
 City, State, ZIP Code: Miami, FL
 Telephone #: 305-333-5597 Fax #: _____
 Contact Person: Wade Email: _____

Ref #4. Customer/Client: Double K
 Date of Services: ongoing
 Description of Services: Fill - Select Shell
 Street Address: 305 Lake Dr
 City, State, ZIP Code: Edgewater, FL 32141
 Telephone #: 386-319-5330 Fax #: _____
 Contact Person: Sarah McLeod Email: _____

Ref #5. Customer/Client: Florida State Parker Brothers
 Date of Services: fill shell etc ongoing
 Description of Services: _____
 Street Address: 713 E. Ave. M.S. Ave
 City, State, ZIP Code: Edgewater, FL 32141
 Telephone #: 407-271-3147 Fax #: _____
 Contact Person: Patrice Email: _____

BIDDER NAME: Florida Sand Shell & Aggregate
 ADDRESS: 4488 Old Blue Ridge Rd. Edgewater, FL 32141
 PRINTED SIGNATURE: [Signature]
 AUTHORIZED SIGNATURE: [Signature]
 TELEPHONE # 386-319-2080 FAX # 386-450-0020 DATE 11/25/18
 EMAIL: Kim@FloridaSandShell.com



December 13, 2018

BREVARD COUNTY PURCHASING SERVICES
2725 JUDGE FRAN JAMIESON WAY
BLDG. C, 3rd FLOOR, SUITE C-303
VIERA, FL 32940

SUBJECT: #B-6-19-23 - Road Construction Materials

Dear Ms. DiNatale,

We are pleased to give you our offer for this bid.
Attached you will also find the files below:

1. Bid Acknowledgment
2. Bidder's Checklist
3. Price Sheet
4. Confirmation Of Drug-Free Workplace Form
5. Reference Form
6. Confirmation Of E-Verify
7. W-9
8. Green Dream Registration in Florida
9. Letter of Attorney
10. Certificate of Insurance and worker comp
11. List of Contract-Green Dream International

Please also note that Green Dream is registered in SAM.

Should you have further questions, please contact Mark Alexander at telephone number 804-220-0634 or e-mail m.alexander@greendreamgr.com.

Best Regards,

Mark Alexander
Account Manager
Green Dream International
Phone: 804-220-0634
Fax: 202-204-8444

SUBMIT SEALED BID TO: BREVARD COUNTY PURCHASING SERVICES 2725 JUDGE FRAN JAMIESON WAY BLDG. C, 3rd FLOOR, SUITE C-303 VIERA, FL 32940			INVITATION TO BID Bid Acknowledgment
PROCUREMENT ANALYST: Karen DiNatale karen.dinatale@brevardfl.gov	(321) 617-7391 Ext. 5-6068	AN EQUAL OPPORTUNITY EMPLOYER	FLORIDA TAX EXEMPT #85-8012621749C-1 FEDERAL TAX EXEMPT #59-6000523
BID SPECIFICATIONS MAY BE OBTAINED AT: Purchasing Services, 2725 Judge Fran Jamieson Way, Bldg. C, Suite 303, Viera, FL 32940, or at the Onvia DemandStar® website and VendorLink.			
MAILING DATE: November 15, 2018	BID TITLE: Road Construction Materials	BID NUMBER: B-4-19-23	BID OPENING DATE AND TIME: December 13, 2018 at 3:00 p.m.
PRE-BID DATE, TIME, AND LOCATION: None Scheduled		<input type="checkbox"/> Mandatory <input type="checkbox"/> Non-Mandatory	BIDS RECEIVED AFTER ABOVE DATE AND TIME WILL NOT BE ACCEPTED

▼ VENDOR MUST COMPLETE THIS AREA AND RETURN FORM ▼

LEGAL NAME OF BIDDER AND BUSINESS ADDRESS: Green Dream International LLC 2331 Mill Rd, Suite 100 Alexandria, VA 22314 TELEPHONE NUMBER/TOLL-FREE NUMBER: (202) 470-4600	FEDERAL ID NO. (FEIN) OR SOCIAL SECURITY NO. (SSN): 46-0522758
If returning as a "no bid," state reason:	
I certify that this bid is made without prior understanding, agreement, or connections with any corporation, firm or person submitting a bid for the same materials, supplies or equipment, and is in all respects fair and without collusion or fraud. I agree to abide by all conditions of this bid and certify that I am authorized to sign this bid for the bidder. In submitting a bid to the County of Brevard, the bidder offers and agrees that if the bid is accepted, the bidder will convey, sell, assign, or transfer to the County of Brevard all rights, title, and interest in and to all causes of action it may now or hereafter acquire under the antitrust laws of the United States and the State of Florida for price fixing relating to the particular commodities or services purchased or acquired by the County of Brevard. At the County's discretion, such assignment shall be made and become effective at the time the County tenders final payment to the bidder.	The bidder acknowledges that information provided in this ITB is true and correct. X <i>Bushra</i> AUTHORIZED SIGNATURE (PRINT) Bushra Mubarak NAME (PRINTED) Treasurer DATE December 13, 2018

THIS FORM MUST BE NOTARIZED AND RETURNED WITH YOUR BID

Sworn to and subscribed before me this _____ day of _____ 20____

Personally known:

Or produced identification: Type of ID: *Driver license*

SIGNATURE OF NOTARY PUBLIC:
Emad Windi

NAME OF NOTARY PUBLIC (PRINTED):
Emad Windi

My commission expires: *11/15/2022*

(APPLY SEAL OR STAMP)

COMMONWEALTH OF PENNSYLVANIA • NOTARY SEAL
Emad Windi, Notary Public
Erie County
My Commission Expires 11/15/2022
Commission Number 1343349

BOND DATA

VENDOR MUST PROVIDE:	AMOUNT:		
Yes <input type="checkbox"/> No <input checked="" type="checkbox"/> BID BOND	_____		
Yes <input type="checkbox"/> No <input checked="" type="checkbox"/> PERFORMANCE BOND	_____		
Yes <input type="checkbox"/> No <input checked="" type="checkbox"/> LABOR, MATERIAL, PERFORMANCE BOND	_____		
In cases where the amount of a surety bond exceeds \$500,000, the surety company must have an A.M. Best's rating as specified in this document, and depending on the amount of the bond, shall have a minimum A.M. Best's financial size category (FSC) ranking as follows:			
BOND AMOUNT UP TO:	FINANCIAL CLASS	BOND AMOUNT UP TO:	FINANCIAL CLASS
\$ 1,000,000	I	\$ 25,000,000	V
\$ 2,000,000	II	\$ 50,000,000	VI
\$ 5,000,000	III	\$ 100,000,000	VII
\$ 10,000,000	IV		
Bonds must be issued by a surety company who complies with the requirements of § 287.0935, Fla. Stat.			
PAYMENT OF GOODS OR SERVICES PROVIDED AS A RESULT OF THIS SOLICITATION WILL BE MADE PER FLORIDA STATUTE.			
ALL FIRST TIME VENDORS MUST SUBMIT A W-9 FORM.			

ROAD CONSTRUCTION MATERIALS
B-6-19-23
BIDDER'S CHECKLIST

The items indicated are required for submission with your bid. Failure to submit any items indicated as required may result in rejection of the bid. Offers to provide required items after the date and time designated for the receipt of bid will not be considered.

- Signed/Notarized Bid Invitation
- Completed and Signed Price Sheet, to include Insurance Indemnification Acknowledgement (Page 12-13)
- Confirmation of Drug Free Workplace Form
- Reference Form
- E-Verify Affidavit
- W-9 Form – Latest Edition

Comment [DS1]: Need to add box and requirement for electronic copy of pdf proposal on USB/CD.

In order for this bid to be valid, the above forms and information shall be completed in their entirety, signed by an authorized representative of the responding vendor, and returned as part of the bid response.

**ROAD CONSTRUCTION MATERIALS
B-6-19-23
PRICE SHEET**

Item Description	Quantity	Unit	Unit Price	Extended Price
MARL – DOT Section 912. Must be of commercial quality without excessive sand or rock; suitable for Type B stabilization	20,000	Cu Yd	\$ /CY No Bid	\$ No Bid
*MARL Dot Ton Cost			\$ /Ton	\$
MASONRY SAND – DOT Section 902. Suitable for mixing concrete, laying block, bricks, etc.	1,000	Cu Yd	\$ /CY No Bid	\$ No Bid
*Masonry Sand – Ton Cost			\$ /Ton	\$
FILL DIRT – DOT Section 120. Clean fill dirt absent of rocks, organic material, roots, rubbish, etc. Fill must be capable of obtaining proper densities.	20,000	Cu Yd	\$ 4.99 /CY	\$ 99,800.00
* Fill Dirt Ton Cost			\$ /Ton	
Stabilized Shell Material for use on Road & Bridge Construction Projects.	10,000	Cu Yd	\$ 10.13 /CY	\$ 101,300.00
			\$ /Ton	
Cemented Coquina per DOT Section 915	10,000	Cu Yd	\$ /CY No Bid	\$ No Bid
			\$ /Ton	
Estimated Annual Cost (Based on CY)				\$ 201,100.00

ACH PAYMENTS

Does your company accept ACH Payment Method? Yes / No

PROMPT PAYMENT DISCOUNT

Brevard County shall remit payment in accordance with the Florida Prompt Payment Act, Florida Statutes section 218.70. Bidders may offer cash discounts for prompt payment but they will not be considered in determination of award. If a bidder offers a discount, it is understood that the discount time will be from the date of satisfactory delivery, at the place of acceptance, and receipt of correct invoice, at the office specified, whichever occurs last.

* If Prompt Payment Discount is offered, please state discount and terms:

Net 30

The mine address is 28001 SR 520 Christmas Florida directly across the street from the Coco water treatment plant

ADDENDUM ACKNOWLEDGMENT

Bidder acknowledges receipt of amendments by indicating amendment number and its date of issue.

Add. No. _____ Dated _____ // Add. No. _____ Dated _____

Add. No. _____ Dated _____ // Add. No. _____ Dated _____

I hereby acknowledge that I have read, understand, and agree to all terms, conditions, insurance, scope of work, specifications and pricing for Bid #B-6-19-23/Road Construction Materials.

COMPANY NAME Green Dream International LLC

ADDRESS 2331 Mill Rd, Suite 100 Alexandria, VA 22314

AUTHORIZED SIGNATURE Varand Vartanian

PRINTED SIGNATURE _____ DATE December 13, 2018

TELEPHONE # 202-470-4600 FAX # 202 204 8444

EMAIL info@greendreamgr.com

Comment [JLM11]: Insert Bid # and title.

ROAD CONSTRUCTION MATERIALS
B-6-19-23
CONFIRMATION OF DRUG-FREE WORKPLACE FORM

In accordance with Section 287.087, Florida Statutes, "[w]henver two or more bids are equal with respect to price, quality, and service which are received by any political subdivision for the procurement of commodities or contractual services, a bid received from a business that certifies that it has implemented a drug-free workplace program shall be given preference in the award process. In order to have a drug-free workplace program, a business shall:

- (1) Publish a statement notifying employees that the unlawful manufacture, distribution, dispensing, possession, or use of a controlled substance is prohibited in the workplace and specifying the actions that will be taken against employees for violations of such prohibition.
- (2) Inform employees about the dangers of drug abuse in the workplace, the business's policy of maintaining a drug-free workplace, any available drug counseling, rehabilitation, and employee assistance programs, and the penalties that may be imposed upon employees for drug abuse violations.
- (3) Give each employee engaged in providing the commodities or contractual services that are under bid a copy of the statement specified in subsection (1).
- (4) In the statement specified in subsection (1), notify the employees that, as a condition of working on the commodities or contractual services that are under bid, the employee will abide by the terms of the statement and will notify the employer of any conviction of, or plea of guilty or nolo contendere to, any violation of chapter 893 or of any controlled substance law of the United States or any state, for a violation occurring in the workplace no later than 5 days after such conviction.
- (5) Impose a sanction on, or require the satisfactory participation in a drug abuse assistance or rehabilitation program if such is available in the employee's community by, any employee who is so convicted.
- (6) Make a good faith effort to continue to maintain a drug-free workplace through implementation of this section."

As the person authorized to sign the statement, I certify that this firm complies with the above requirements and the Florida Statutes Section 287.087. This form is in conjunction with Brevard County's General Conditions, Item 27, Drug-Free Workplace.

Green Dream International LLC

Business Name

Authorized Representative's Signature

Varand Vartanian

Name

B-6-19-23 -Road Construction Materials

Bid Number and Name

December 13, 2018

Date

President

Position

AGGREGATE (57 STONE & PEA GRAVEL)

B-6-19-13

REFERENCE FORM

List a minimum of three (3) / maximum five (5) customers for the services specified in the solicitation in the spaces provided.

Note: A contact person shall be someone who has personal knowledge of the bidder's performance for the specific requirement listed. Contact person must have been informed that they are being used as a reference and that the County may be calling them. Do not list persons who will be unable to answer specific questions regarding the requirements.

Ref #1. Customer/Client: Florida Department of Agriculture and Consumer Services
Date of Services: May 3, 2018
Description of Services: Aggregate for Withlacoochee State Forest
Street Address: Withlacoochee Forestry Center 15019 Broad St
City, State, ZIP Code: Brooksville, FL 34601
Telephone #: (352) 797-4124 Fax #: (352) 797-4103
Contact Person: Melvin Reese Jr. Email: Melvin.ReeseJr@freshfromflorida.com

Ref #2. Customer/Client: FWS, DIVISION OF CONTRACTING AND GR
Date of Services: September 2017
Description of Services: Procure Ditch Lining and Limerock to repair refuge levees
Street Address: ATLANTA GA 30345-3310 SUITE 310
City, State, ZIP Code: 1875 CENTURY BOULEVARD
Telephone #: 404- 679-4055 Fax #: _____
Contact Person: Tracy Gamble Email: tracy_gamble@fws.gov

Ref #3. Customer/Client: USDA FOREST SERVICE
Date of Services: 01/17/2017
Description of Services: Aggregate and chip rock delivery 2016 Road Materials
Street Address: USDA Forest Service Sidney R. Yates Federal Building 201
City, State, ZIP Code: 14th Street, SW Washington, DC
Telephone #: 530 478 6162 Fax #: _____
Contact Person: Raymond Garleb Email: rgarleb@fs.fed.us

Ref #4. Customer/Client: NATIONAL PARK SERVICE, OLYMPIC NATIONAL PARK
Date of Services: 07/18/2017
Description of Services: Paving in Elwha & Mora, Olympic National Park
Street Address: Project locations within Elwha Subdistrict within Clallam County, Olympic National Park,
City, State, ZIP Code: _____
Telephone #: 360-565-3175 Fax #: _____
Contact Person: Cody Manzer Email: cody_manzer@nps.gov

Ref #5. Customer/Client: USDA FOREST SERVICE
Date of Services: 06/09/2017
Description of Services: provide and delivery of crushed lime aggregate
Street Address: USDA Forest Service Sidney R. Yates Federal Building 201
City, State, ZIP Code: 14th Street, SW Washington, DC
Telephone #: 3045362144 Fax #: _____
Contact Person: CARRIE EDWARDS Email: cledwards@fs.fed.us

BIDDER NAME Green Dream International LLC
ADDRESS 2331 Mill Rd, Suite 100 Alexandria, VA 22514
PRINTED SIGNATURE _____
AUTHORIZED SIGNATURE Varand Vartanian
TELEPHONE # 202-470-4600 FAX# 202 204 8444 DATE December 13, 2018
EMAIL: info@greendreamgr.com

BREVARD COUNTY BOARD OF COUNTY COMMISSIONERS

CONFIRMATION OF E-VERIFY PARTICIPATION FORM

In accordance with BCC Policy 25 all vendors that conduct business with Brevard County are required to be registered with and utilize the U.S. Department of Homeland Security's E-Verify System in accordance with the terms governing use of the system.

1. The County shall not enter into, or renew, a contract for goods or services with a Vendor/contractor that is not enrolled into E-Verify. Any Vendor/contractor providing goods or services to the County shall be contractually required to utilize E-Verify to confirm the employment eligibility of any employee hired during the term of the contract.
2. Vendors/contractors shall provide acceptable evidence of their enrollment at the time of the submission of the vendor's/contractor's bid/quote/proposal. Acceptable evidence shall include, but not be limited to, a copy of the fully executed E-Verify Memorandum of Understanding for the business and/or a signed copy of this affidavit.
3. All vendors/contractors must meet this requirement unless:
 - a. The contract is solely for goods-based procurement where no services are provided;
or
 - b. Where the requirement is waived by the Board of County Commissioners.
4. A vendor/contractor who registers with and participates in the E-Verify program may not be barred or penalized under BCC Policy 25(3)(V) if, as a result of receiving inaccurate verification information from the E-Verify program, the contractor hires or employs a person who is not eligible for employment.
5. Vendors/contractors shall expressly require any contractor or subcontractor performing work or providing services pursuant to the County contract to likewise utilize the U.S. Department of Homeland Security's E-Verify system to verify the employment eligibility of all new employees hired by the subcontractor during the contract term.
6. Nothing in BCC Policy 25(3)(V) may be construed to allow intentional discrimination of any class protected by law.

As the person authorized to sign the statement, I certify that this firm complies with the above requirements and the BCC-25. This form is in conjunction with Brevard County's General Conditions, Unauthorized Alien Workers.

Green Dream International LLC

Business Name

B-6-19-23

Bid Number and Name

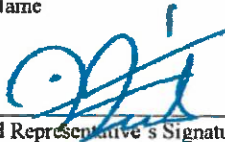

Authorized Representative's Signature

December 13, 2018

Date

Varand Vartanian

Name

President

Position

Request for Taxpayer Identification Number and Certification

**Give Form to the
 requester. Do not
 send to the IRS.**

▶ Go to www.irs.gov/FormW9 for instructions and the latest information.

Print or type.
 See Specific Instructions on page 3.

1 Name (as shown on your income tax return). Name is required on this line; do not leave this line blank. <div style="text-align: center; font-size: 1.2em;">Green Dream International LLC</div>	
2 Business name/disregarded entity name, if different from above <div style="text-align: center;">same as above</div>	
3 Check appropriate box for federal tax classification of the person whose name is entered on line 1. Check only one of the following seven boxes. <input type="checkbox"/> Individual/sole proprietor or single-member LLC <input type="checkbox"/> C Corporation <input type="checkbox"/> S Corporation <input type="checkbox"/> Partnership <input type="checkbox"/> Trust/estate <input checked="" type="checkbox"/> Limited liability company. Enter the tax classification (C=C corporation, S=S corporation, P=Partnership) ▶ <u>C</u> <small>Note: Check the appropriate box in the line above for the tax classification of the single-member owner. Do not check LLC if the LLC is classified as a single-member LLC that is disregarded from the owner unless the owner of the LLC is another LLC that is not disregarded from the owner for U.S. federal tax purposes. Otherwise, a single-member LLC that is disregarded from the owner should check the appropriate box for the tax classification of its owner.</small> <input type="checkbox"/> Other (see instructions) ▶	4 Exemptions (codes apply only to certain entities, not individuals; see instructions on page 3): Exempt payee code (if any) _____ Exemption from FATCA reporting code (if any) _____ <small>(Applies to accounts maintained outside the U.S.)</small>
5 Address (number, street, and apt. or suite no.) See instructions. 2331 Mill Rd suite 100	Requester's name and address (optional)
6 City, state, and ZIP code Alexandria, VA 22314	
7 List account number(s) here (optional)	

Part I Taxpayer Identification Number (TIN)

Enter your TIN in the appropriate box. The TIN provided must match the name given on line 1 to avoid backup withholding. For individuals, this is generally your social security number (SSN). However, for a resident alien, sole proprietor, or disregarded entity, see the instructions for Part I, later. For other entities, it is your employer identification number (EIN). If you do not have a number, see *How to get a TIN*, later.

Note: If the account is in more than one name, see the instructions for line 1. Also see *What Name and Number To Give the Requester* for guidelines on whose number to enter.

Social security number									
or									
Employer identification number									
4	6	-	0	5	2	2	7	5	8

Part II Certification

Under penalties of perjury, I certify that:

1. The number shown on this form is my correct taxpayer identification number (or I am waiting for a number to be issued to me); and
2. I am not subject to backup withholding because: (a) I am exempt from backup withholding, or (b) I have not been notified by the Internal Revenue Service (IRS) that I am subject to backup withholding as a result of a failure to report all interest or dividends, or (c) the IRS has notified me that I am no longer subject to backup withholding; and
3. I am a U.S. citizen or other U.S. person (defined below); and
4. The FATCA code(s) entered on this form (if any) indicating that I am exempt from FATCA reporting is correct.

Certification instructions. You must cross out item 2 above if you have been notified by the IRS that you are currently subject to backup withholding because you have failed to report all interest and dividends on your tax return. For real estate transactions, item 2 does not apply. For mortgage interest paid, acquisition or abandonment of secured property, cancellation of debt, contributions to an individual retirement arrangement (IRA), and generally, payments other than interest and dividends, you are not required to sign the certification, but you must provide your correct TIN. See the instructions for Part II, later.

Sign Here	Signature of U.S. person ▶		Date ▶	November 06, 2018
------------------	----------------------------	--	--------	-------------------

General Instructions

Section references are to the Internal Revenue Code unless otherwise noted.

Future developments. For the latest information about developments related to Form W-9 and its instructions, such as legislation enacted after they were published, go to www.irs.gov/FormW9.

Purpose of Form

An individual or entity (Form W-9 requester) who is required to file an information return with the IRS must obtain your correct taxpayer identification number (TIN) which may be your social security number (SSN), individual taxpayer identification number (ITIN), adoption taxpayer identification number (ATIN), or employer identification number (EIN), to report on an information return the amount paid to you, or other amount reportable on an information return. Examples of information returns include, but are not limited to, the following.

- Form 1099-INT (interest earned or paid)

- Form 1099-DIV (dividends, including those from stocks or mutual funds)
- Form 1099-MISC (various types of income, prizes, awards, or gross proceeds)
- Form 1099-B (stock or mutual fund sales and certain other transactions by brokers)
- Form 1099-S (proceeds from real estate transactions)
- Form 1099-K (merchant card and third party network transactions)
- Form 1098 (home mortgage interest), 1098-E (student loan interest), 1098-T (tuition)
- Form 1099-C (canceled debt)
- Form 1099-A (acquisition or abandonment of secured property)

Use Form W-9 only if you are a U.S. person (including a resident alien), to provide your correct TIN.

If you do not return Form W-9 to the requester with a TIN, you might be subject to backup withholding. See What is backup withholding, later.



FLORIDA DEPARTMENT OF STATE
Division of Corporations

May 9, 2018

CSC

Qualification documents for GREEN DREAM INTERNATIONAL LLC were filed on May 8, 2018, and assigned document number M18000004443. Please refer to this number whenever corresponding with this office.

Your limited liability company is authorized to transact business in Florida as of the file date.

To maintain "active" status with the Division of Corporations, an annual report must be filed yearly between January 1st and May 1st beginning in the year following the file date or effective date indicated above. If the annual report is not filed by May 1st, a \$400 late fee will be added.

A Federal Employer Identification Number (FEI/EIN) will be required when this report is filed. Apply today with the IRS online at:

<https://sa.www4.irs.gov/modiein/individual/index.jsp>.

Please notify this office if the limited liability company address changes.

Should you have any questions regarding this matter, please contact this office at the address given below.

Octavia L Simmons
Regulatory Specialist III
Registration Section
Division of Corporations

Letter Number: 218A00009554

Account number: I20000000195

Amount charged: 125.00

www.sunbiz.org

Division of Corporations - P.O. BOX 6327 -Tallahassee, Florida 32314

APPLICATION BY FOREIGN LIMITED LIABILITY COMPANY FOR AUTHORIZATION TO TRANSACT BUSINESS IN FLORIDA

IN COMPLIANCE WITH SECTION 605.0902, FLORIDA STATUTES, THE FOLLOWING IS SUBMITTED TO REGISTER A FOREIGN LIMITED LIABILITY COMPANY TO TRANSACT BUSINESS IN THE STATE OF FLORIDA:

1. Green Dream International LLC
(Name of Foreign Limited Liability Company; must include "Limited Liability Company," "L.L.C.," or "LLC.")

(If name unavailable, enter alternate name adopted for the purpose of transacting business in Florida. The alternate name must include "Limited Liability Company," "L.L.C." or "LLC.")

2. Arkansas
(Jurisdiction under the law of which foreign limited liability company is organized)

3. _____
(FEI number, if applicable)

4. _____
(Date first transacted business in Florida, if prior to registration.)
 (See sections 605.0904 & 605.0905, F.S. to determine penalty liability)

5. 2331 Mill Rd, STE 100
(Street Address of Principal Office)
Alexandria, VA, 22314

6. 2331 Mill Rd, Ste 100
(Mailing Address)
Alexandria, VA, US, 22314

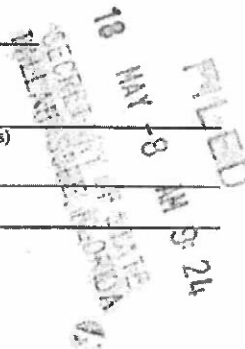

7. Name and street address of Florida registered agent: (P.O. Box NOT acceptable)

Name: Corporation Service Company

Office Address: 1201 Hays Street

Tallahassee, Florida 32301
(City) (Zip code)

Registered agent's acceptance:

Having been named as registered agent and to accept service of process for the above stated limited liability company at the place designated in this application, I hereby accept the appointment as registered agent and agree to act in this capacity. I further agree to comply with the provisions of all statutes relative to the proper and complete performance of my duties, and I am familiar with and accept the obligations of my position as registered agent.

Emily Croft
(Registered agent's signature)

Emily Croft
Asst. Vice President

8. The name, title or capacity and address of the person(s) who has/have authority to manage is/are:

<u>Title or Capacity:</u>	<u>Name and Address:</u>	<u>Title or Capacity:</u>	<u>Name and Address:</u>
<u>President</u>	<u>Varand Vartanian</u> <small>2331 Mill Rd, Ste 100 Alexandria, VA 22314</small>	_____	_____
_____	_____	_____	_____
_____	_____	_____	_____

(Use attachments if necessary)

9. Attached is a certificate of existence, no more than 90 days old, duly authenticated by the official having custody of records in the jurisdiction under the law of which it is organized. (If the certificate is in a foreign language, a translation of the certificate under oath of the translator must be submitted)

[Signature]
Signature of an authorized person

10. This document is executed in accordance with section 605.0203 (1) (b), Florida Statutes. I am aware that any false information submitted in a document to the Department of State constitutes a third degree felony as provided for in s.817.155, F.S.

Varand Vartanian
Typed or printed name of signee



**Arkansas Secretary of State
Mark Martin**

State Capitol Building ♦ Little Rock, Arkansas 72201-1094 ♦ 501-682-3409

Certificate of Good Standing

I, Mark Martin, Secretary of State of the State of Arkansas, and as such, keeper of the records of domestic and foreign corporations, do hereby certify that the records of this office show

GREEN DREAM INTERNATIONAL LLC

authorized to transact business in the State of Arkansas as a Limited Liability Company, filed Articles of Organization in this office June 26, 2009.

Our records reflect that said entity, having complied with all statutory requirements in the State of Arkansas, is qualified to transact business in this State.



In Testimony Whereof, I have hereunto set my hand and affixed my official Seal. Done at my office in the City of Little Rock, this 4th day of May 2018.

Mark Martin

Mark Martin
Secretary of State

Online Certificate Authorization Code: 948a29a0ea3254c

To verify the Authorization Code, visit sos.arkansas.gov

MITCHELL || WILLIAMS

H. MAURICE MITCHELL
(1925-2011)
WILLIAM H.L. WOODYARD, III
(1945-2014)

MICHEL S ALLGOOD
JOHN K. BAKER
MELISSA BANDY
SHERRY P. BARTLEY
TRAV BAXTER
R. T. BEARD, III
BENJAMIN D. BRENNER¹
JASON T. BROWNING
MICHELLE L. BROWNING
JOHN S. BRYANT
C. DOUGLAS BUFORD, JR.
BURNIE BURNER²
FREDERICK K. CAMPBELL³
CHARLES B. CLETT, JR.⁴
CRAIG R. COCKRELL
ADRIA W. CONKLIN⁵
KEN COOK
COURTNEY C. CROUCH, III
ELISABETH S. DELARGY⁶
DOAK FOSTER⁷
BYRON FRERLAND

KAREN P. FREEMAN⁸
ALLAN GATES⁹
KATHLYN GRAVES
JILL R. GRIMSLEY
HAROLD W. HAMLIN
MEGAN D. HARGRAVES
L. KYLE HEFFLEY⁸
BEN D. JACKSON
ANTON L. JANIK, JR.⁹
WENDY L. JOHNSON
MARGARET A. JOHNSTON
M. SAMUEL JONES III
D. NICOLE LOVELL
AMANDA L. MACLENNAN⁹
WALTER E. MAY
BRUCE MCCANDLESS III¹⁰
CHRISTOPHER A. MCNULTY
LANCE R. MILLER
STUART P. MILLER
T. ARK MONROE, III⁹
JENNIFER R. PIERCE
BRIAN A. PIPKIN
CHRISTOPHER D. PLUMLEE
JULIE M. POMERANTZ¹¹
SCOTT PROVENCHER

425 WEST CAPITOL AVENUE, SUITE 1800
LITTLE ROCK, ARKANSAS 72201-3525
TELEPHONE 501-688-8800
FAX 501-688-8807

LYN P. FRUIT
CHRISTOPHER T. ROGERS
J. SCOTT SCHALLHORN
¹²BARRY G. SKOLNICK
¹³DERRICK W. SMITH
STAN D. SMITH
MANDY L. STANTON
ZACHARY T. STEADMAN
CLAYBORNE S. STONE
¹⁴JEFFREY THOMAS
MARY CATHBRINE WAY
WALTER G. WRIGHT, JR.

JOHN E. ALEXANDER
DEVIN R. BATES
KATIE BRANSCUM
MATT BRUNSON
¹⁵ERYCE C. CRAWFORD
¹⁶LAUREN N. DILIZIA
¹⁷NATALIE M. DODD
ASHLEY L. GILL
DAVID F. KOEHLER
¹⁸BETHANY N. MARSHALL
JACOB MCELROY
BRITTANY H. PETTINGILL

KENDRA PRUITT
¹⁹SAINABOU M. SONKO
GRAHAM C. TALLEY
COUNSEL
²⁰DAVID N. BLACKORBY
²¹TRACY H. BOWDEN
²²LANA L. FREEMAN
MORRIS H. HARRIMAN, JR.
²³MARTHA MCKENZIE HILL
²⁴GINGER HYNEMAN
KELLY MARCHAND
²⁵RACHAEL K. PADGETT
²⁶NATHAN A. READ
²⁷STANTON K. STRICKLAND
ALBERT J. THOMAS III
LARRY O. WATKINS
²⁸JORDAN P. WIMPY

OF COUNSEL
W. CHRISTOPHER BARRIER
JOSEPH W. GELZINE
DONALD H. HENRY
²⁹HERMANN NESTER
ANNE S. PARKER
JOHN S. SELIG
RICHARD A. WILLIAMS

¹ ADMITTED IN CALIFORNIA AND ARKANSAS
² ONLY ADMITTED IN TEXAS
³ ADMITTED IN DISTRICT OF COLUMBIA AND ARKANSAS
⁴ ADMITTED IN ARIZONA, TEXAS AND ARKANSAS
⁵ ADMITTED IN TEXAS AND ARKANSAS
⁶ ADMITTED IN TENNESSEE AND TEXAS
⁷ ADMITTED IN OKLAHOMA, MISSOURI AND ARKANSAS
⁸ ADMITTED IN MISSOURI AND ARKANSAS
⁹ ADMITTED IN COLORADO AND ARKANSAS
¹⁰ ADMITTED IN DISTRICT OF COLUMBIA, NEW YORK, AND TEXAS
¹¹ ADMITTED IN GEORGIA AND TEXAS

WRITER'S DIRECT DIAL
501-688-8854

March 9, 2018

¹² ADMITTED IN NEW YORK AND PENNSYLVANIA
¹³ ADMITTED IN ALABAMA AND TEXAS
¹⁴ ADMITTED IN OKLAHOMA AND ARKANSAS
¹⁵ ADMITTED IN ARKANSAS, GEORGIA, NEW JERSEY, AND NEW YORK
¹⁶ ADMITTED IN ARKANSAS, ARIZONA, OREGON, AND TEXAS
¹⁷ ADMITTED IN TENNESSEE AND ARKANSAS
¹⁸ ADMITTED IN ARKANSAS AND NEW JERSEY
¹⁹ ADMITTED IN WYOMING AND ARKANSAS
²⁰ ADMITTED IN THE U.S. PATENT AND TRADEMARK OFFICE AND ARKANSAS
ALL OTHERS ADMITTED ONLY IN ARKANSAS

Green Dream International LLC
Attn: Saman Souran
2331 Mill Road, Suite 100
Alexandria, VA 22314

Re: Preferences in Arkansas Procurement Law

Dear Saman:

You have inquired about the preferences granted by the law of the State of Arkansas in the letting of any or all public contracts. Based upon our review of the Arkansas Procurement Law, codified at Ark. Code Ann. § 19-11-201 *et seq.*, we believe the statutes summarized below are responsive to your request.¹ The following summary is qualified in its entirety by reference to the complete text of the statutes cited below, which are enclosed herein for your convenience and incorporated by reference in this letter.

1. **Ark. Code Ann. § 19-11-259—Preference of Arkansas Firms.** Pursuant to this section, except as prohibited by applicable federal law, in the purchase of commodities² by competitive bidding, all public agencies shall accept the lowest qualified bid from a firm resident in Arkansas,³ but only if (i) the bid does not exceed the lowest qualified bid from a nonresident firm by

¹ Please note that there are special rules related to commodities and services, including small purchases, which may be required to be procured from nonprofit work centers for individuals with disabilities in certain circumstances. This is outside the scope of our review, and such rules are not addressed herein.

² "Commodities" means materials and equipment used in the construction of public works projects. Ark. Code Ann. § 19-11-259(a)(2)(A).

³ "Firm resident in Arkansas" means any individual, partnership, association, or corporation, whether domestic or foreign, that: (i) Maintains at least one (1) staffed office in this state; (ii) For not fewer than two (2) successive years

March 8, 2018

Page 2

more than five percent (5%) and (ii) one (1) or more firms resident in Arkansas made written claim for a preference at the time the bids were submitted. Please note that this section applies only to projects designed to provide utility needs of a county or municipality. See Ark. Code Ann. § 19-11-259(c)(1)(A).⁴

2. **Ark. Code Ann. § 19-11-260—Recycled Paper Purchases—Goals.** Pursuant to this section, with respect to the procurement of paper products, a preference for recycled paper products shall be exercised if the use of the products is technically feasible and the price does not exceed the lowest qualified bid of a vendor offering paper products manufactured or produced from virgin material by ten percent (10%). Please note an additional one percent (1%) preference shall be allowed from products containing the largest amount of postconsumer materials recovered within the State of Arkansas. Notwithstanding the foregoing, however, a bidder receiving a preference under this section shall not be entitled to an additional preference under § 19-11-259 discussed above.

3. **Ark. Code Ann. § 19-11-305—Multiple Private Industry Bids.** Subject to any applicable bonding requirements, in all bidding procedures involving a bid by one (1) or more out-of-state penal institutions⁵ and a bid by one (1) or more private industries located within the State of Arkansas, the contract shall be awarded to the sole Arkansas bidder or lowest Arkansas bidder if the Arkansas bidder is not underbid by more than five percent (5%), as provided in § 19-11-259, by another representative of private industry located outside the State of Arkansas or by more than fifteen percent (15%) by an out-of-state correctional institution.

Sincerely,

MITCHELL, WILLIAMS, SELIG,
GATES & WOODYARD, P.L.L.C.

By



J. Scott Schallhorn

JSS: alg
Enclosures

immediately prior to submitting a bid, has paid taxes under the Department of Workforce Services Law, § 11-10-101 *et seq.*, unless exempt, and either the Arkansas Gross Receipts Act of 1941, § 26-52-101 *et seq.*, or the Arkansas Compensating Tax Act of 1949, § 26-53-101 *et seq.*, on any property used or intended to be used for or in connection with the firm's business; and (iii) Within the two-year period, has paid any taxes to one (1) or more counties, school districts, or municipalities of the State of Arkansas on either real or personal property used or intended to be used or in connection with the firm's business.

⁴ To the extent federal purchasing laws or bidding preferences conflict, the Arkansas Procurement Law does not apply to projects related to supplying water or wastewater utility services, operations, or maintenance to a federal military installation by a municipality of the state.

⁵ "Penal institution" means a penitentiary, jail, prison, reformatory, or other such establishment owned, operated, or funded by a state or local government wherein incarcerated criminals are kept. Ark. Code Ann. § 19-11-302(2).



GREEN05

OP ID: AG

CERTIFICATE OF LIABILITY INSURANCE

DATE (MM/DD/YYYY)

01/03/2018

THIS CERTIFICATE IS ISSUED AS A MATTER OF INFORMATION ONLY AND CONFERS NO RIGHTS UPON THE CERTIFICATE HOLDER. THIS CERTIFICATE DOES NOT AFFIRMATIVELY OR NEGATIVELY AMEND, EXTEND OR ALTER THE COVERAGE AFFORDED BY THE POLICIES BELOW. THIS CERTIFICATE OF INSURANCE DOES NOT CONSTITUTE A CONTRACT BETWEEN THE ISSUING INSURER(S), AUTHORIZED REPRESENTATIVE OR PRODUCER, AND THE CERTIFICATE HOLDER.

IMPORTANT: If the certificate holder is an ADDITIONAL INSURED, the policy(ies) must have ADDITIONAL INSURED provisions or be endorsed. If SUBROGATION IS WAIVED, subject to the terms and conditions of the policy, certain policies may require an endorsement. A statement on this certificate does not confer rights to the certificate holder in lieu of such endorsement(s).

PRODUCER Kerxton Insurance Agency, Inc. 7679 Limestone Drive, Ste 155 Gainesville, VA 20155 Phil Borner	703-352-0030	CONTACT NAME: Phil Borner PHONE (A/C, No, Ext): 703-352-0030 E-MAIL ADDRESS: pborner@kerxton.com	FAX (A/C, No): 703-591-3948
	INSURER(S) AFFORDING COVERAGE		
INSURED Green Dream International, LLC 2331 Mill Rd. Ste. 100 Alexandria, VA 22314	INSURER A: Selective Insurance Company		NAIC #
	INSURER B: NCCI		
	INSURER C:		
	INSURER D:		
	INSURER E:		
	INSURER F:		

COVERAGES CERTIFICATE NUMBER: REVISION NUMBER:

THIS IS TO CERTIFY THAT THE POLICIES OF INSURANCE LISTED BELOW HAVE BEEN ISSUED TO THE INSURED NAMED ABOVE FOR THE POLICY PERIOD INDICATED. NOTWITHSTANDING ANY REQUIREMENT, TERM OR CONDITION OF ANY CONTRACT OR OTHER DOCUMENT WITH RESPECT TO WHICH THIS CERTIFICATE MAY BE ISSUED OR MAY PERTAIN, THE INSURANCE AFFORDED BY THE POLICIES DESCRIBED HEREIN IS SUBJECT TO ALL THE TERMS, EXCLUSIONS AND CONDITIONS OF SUCH POLICIES. LIMITS SHOWN MAY HAVE BEEN REDUCED BY PAID CLAIMS.

INSR LTR	TYPE OF INSURANCE	ADDL INSD	SUBR WVD	POLICY NUMBER	POLICY EFF (MM/DD/YYYY)	POLICY EXP (MM/DD/YYYY)	LIMITS
A	<input checked="" type="checkbox"/> COMMERCIAL GENERAL LIABILITY <input type="checkbox"/> CLAIMS-MADE <input checked="" type="checkbox"/> OCCUR GEN'L AGGREGATE LIMIT APPLIES PER: <input checked="" type="checkbox"/> POLICY <input type="checkbox"/> PROJECT <input type="checkbox"/> LOC OTHER:			S 2191158	09/28/2017	09/28/2018	EACH OCCURRENCE \$ 1,000,000 DAMAGE TO RENTED PREMISES (Ea.occurrence) \$ 500,000 MED EXP (Any one person) \$ 15,000 PERSONAL & ADV INJURY \$ 1,000,000 GENERAL AGGREGATE \$ 2,000,000 PRODUCTS - COMP/OP AGG \$ 2,000,000
A	AUTOMOBILE LIABILITY <input type="checkbox"/> ANY AUTO OWNED AUTOS ONLY <input type="checkbox"/> SCHEDULED AUTOS <input checked="" type="checkbox"/> HIRED AUTOS ONLY <input checked="" type="checkbox"/> NON-OWNED AUTOS ONLY			S 2191158	09/28/2017	09/28/2018	COMBINED SINGLE LIMIT (Ea. accident) \$ 1,000,000 BODILY INJURY (Per person) \$ BODILY INJURY (Per accident) \$ PROPERTY DAMAGE (Per accident) \$
	UMBRELLA LIAB OCCUR EXCESS LIAB CLAIMS-MADE DED RETENTION \$						EACH OCCURRENCE \$ AGGREGATE \$
B	WORKERS COMPENSATION AND EMPLOYERS' LIABILITY ANY PROPRIETOR/PARTNER/EXECUTIVE OFFICER/MEMBER EXCLUDED? (Mandatory in NH) <input type="checkbox"/> Y/N If yes, describe under DESCRIPTION OF OPERATIONS below		N/A	TBD	12/25/2017	12/25/2018	<input checked="" type="checkbox"/> PER STATUTE <input type="checkbox"/> OTHER E.L. EACH ACCIDENT \$ 500,000 E.L. DISEASE - EA EMPLOYEE \$ 500,000 E.L. DISEASE - POLICY LIMIT \$ 500,000

DESCRIPTION OF OPERATIONS / LOCATIONS / VEHICLES (ACORD 101, Additional Remarks Schedule, may be attached if more space is required)

VERIFICATION OF INSURANCE ONLY

CERTIFICATE HOLDER GREENDR Green Dream International LLC 2331 MILL RD STE 100 ALEXANDRIA, VA 22314	CANCELLATION SHOULD ANY OF THE ABOVE DESCRIBED POLICIES BE CANCELLED BEFORE THE EXPIRATION DATE THEREOF, NOTICE WILL BE DELIVERED IN ACCORDANCE WITH THE POLICY PROVISIONS.
	AUTHORIZED REPRESENTATIVE 

Selected list of Green Dream International Contracts

Award Date	State	Contract No.	Contract Subject	Client	Contract Value
9/9/2018	Washington	140P8318P0074	Delivery of 2500 ton of different size of RipRap	NPS, Ashford WA	\$103,975.40
11/1/2018	North Carolina	4800029214	The order is 5000 Tone but they needed 2000 Tons now and the rest later.	NC Department of Transportation	\$135,000.00-
10/1/2018	Florida	PO #S-4200-G1480	Supply of Fish Grade Limestone	Florida Department of Agriculture and Consumer Services	\$47,385.00
9/1/2018	Florida	PO # 4500099155	Supply of Lime Rock Material for Solid Waste Landfilel	Brevard County Government Center	\$80,953.63
9/1/2018	Kansas	W91QF4-16-A-0006	Supply of Four materials for Department of Army MICC FORT LEAVENWORTH	MICC FORT LEAVENWORTH	\$146,095.60
7/3/2018	California	OP-MT-18-001	Provision of 2800 ton of Ballast # 3 to SMART	Sonoma-Marin Area Rail Transit (SMART)in CA	\$99,486.56
5/22/2018	North Dakota	W901UZ-18-P-5008	Delivery of 10000 ton CLASS 5 AGGREGATE	W901UZ USPFO FOR NORTH DAKOTA	\$127,700.00
5/1/2018	Montana	PO # 140P1418P0094	Delivery of 4000 tons 3/4 Inch Minus Crushed Weed Free Gravel	NPS, Glacier NP MT	\$45,880
4/17/2018	Texas	1/18/2446	Supply and delivery of Surface Treatment Aggregate (Type D, Grade 4)	Denton County	\$169,000.00
4/13/2018	North Carolina	OQT-4800028756	Sand 1-S	Department of Transportation	\$59,850.00
4/13/2018	North Carolina	4800028755	Aggregate ABC	Department of Transportation	\$157,500.00
4/13/2018	Tennessee	140F0418P0163	Supply and delivery of Rip Rap and Limestone	FWS, DIVISION OF CONTRACTING AND GR	\$23,596.88
4/10/2018	Wyoming	140L6218P0037	Aggregate (Grading "W") Road base	Department of the Interior	\$17,994.00
4/5/2018	Tennessee	140F0418P0156	Limestone	Department of the Interior	\$70,789.63
3/23/2018	Michigan	12569R18D0006	Road Repair IDIQ	Department of Agriculture	\$10,000,000.00
3/19/2018	West Virginia	12343418D0002	Supply and Delivery of Aggregate	Department of Agriculture	\$39,999.65
3/16/2018	Mississippi	140F0418P0137	Supply and delivery of Rip Rap and Limestone	Department of the Interior	\$49,398.00
2/22/2018	Pennsylvania	4300576052	DSA Little Medix Road FD 9	DCNR-PA	\$207,049.50
2/21/2018	Iowa	W912EK-16-A-0004	Aggregate	Department of Army	\$14,005.00
2/21/2018	Virginia	46367	Stone	Department of Transportation	\$143,500.00
2/15/2018	Missouri	605SE18001588	Limestone	Department of Transportation	\$58,185.00
2/15/2018	Oklahoma	W52P1J-17-D-3000	Base Course	Department of Army	\$163,100.00
2/14/2018	North Carolina	4800028602	Supplying Sand	Department of Transportation	\$117,000.00
2/2/2018	Missouri	IFB605SE18001513	Pug Mill Aggregate	Department of Transportation	\$110,790.00
2/1/2018	Missouri	1516	Pug Mill Aggregate	Department of Transportation	\$448,200.00
1/31/2018	South Carolina	17-17/18	MBC STONE FOR DISTRICT 6 ROADS	South Carolina Florence County	\$283,106.25
1/31/2018	South Carolina	16-17/18	Macadam Base Course-phase 2	South Carolina Florence County	\$408,996.00
1/23/2018	North Dakota	18P0020P00001	Eggerts Playground	Department of the Army	\$58,724.00
1/1/2018	California	140P8418P0013.	Delivery of Aggregate	Department of the Interior	\$23,902.84
12/29/2017	Mississippi	140F0418Q0011	Crushed Limeston	US Fish & Wildlife Service	\$24,188.45
12/28/2017	South Carolina	103732	Macadam Base Course-phase 1	Florence County	\$534,996.00
12/14/2017	North Carolina	4800028458	Aggregate	State of North Carolina	\$123,750.00
12/14/2017	Oklahoma	56584	Class A sand	State of Oklahoma	\$19,950.00
12/14/2017	Oklahoma	56581	Class A sand	State of Oklahoma	\$19,950.00
12/4/2017	North Carolina	NC8672	Aggregate	State of North Carolina	\$11,025.00
12/4/2017	North Carolina	NC8694	Aggregate	State of North Carolina	\$11,815.00
12/4/2017	North Carolina	NC6041	ABC Aggregate	State of North Carolina	\$24,500.00
11/17/2017	South Carolina	4400017562	Rip Rap, CRUSHER RUN, AND SAND	SC-Transportation	\$163,231.00
10/20/2017	South Carolina	4400017421	Ballast/Granite Stone	SC-Natural Resources	\$39,750.00
10/18/2017	Oklahoma	W52P1J-17-D-3000	McAlester Aggregate	Department of the Army	\$2,937,250.00
9/29/2017	California	W911S2-17-P-1077	Base Rock and Sand	Department of the Army	\$93,146.00
9/27/2017	Kansas	W912DQ17A1015	Gravel	Department of the Army	\$37,502.62
9/27/2017	Nebraska	W912DQ17A1015x	Rip Rap	Department of the Army	\$59,316.40
9/22/2017	Florida	F17PX02523	Supplying Ditch Lining & Limerock	Department of the Interior	\$109,951.00
9/21/2017	Indiana	F17PX02612	Gravel Big Oaks	US Fish & Wildlife Service	\$25,000.00

Selected list of Green Dream International Contracts

Award Date	State	Contract No.	Contract Subject	Client	Contract Value
9/20/2017	California	AG-9AC7-P-17-0224	Gravel	US Fish & Wildlife Service	\$37,536.00
9/15/2017	Tennessee	F17PX02386	Supplying Limestone and Gabion	Department of the Interior	\$20,943.00
9/1/2017	North Carolina	F17PX02027	PEE DEE NWR GRANITE GRAVEL, STONE, AND RIP RAP	Department of the Interior	\$428,075.00
8/31/2017	Washington	W9123F-17-A-0007	Gravel, Sand and Rock	Department of the Army	\$14,950.00
8/28/2017	South Carolina	4400016975	Granite Stone	SC-Transportation	\$12,780.00
8/23/2017	Arizona	HHSI245201701299P	Chainlink Fence	Department of Health	\$22,505.99
8/23/2017	Missouri	F17PX01877	Gravel (Deliver & Tailgate spread)	US Fish & Wildlife Service	\$25,000.00
8/23/2017	South Carolina	4400016967	CR14 Crusher Run	SC-General Services	\$47,275.00
8/18/2017	South Carolina	4400016940	MLBC	SC-Transportation	\$194,700.00
8/14/2017	Washington	L16PA00088	Crushed Aggregate	Department of the Interior	\$19,995.00
8/8/2017	South Carolina	4600584183	CR14 Crusher Run	SC-Correction	\$22,692.00
6/23/2017	Washington	P16PC00727	Paving in Elwha & Mora	Department of the Interior	\$29,740.00
6/16/2017	Oregon	AG-04N7-C-17-0020	Fish Gravel	Department of Agriculture	\$44,667.00
6/15/2017	Louisiana	F17PX01191	REPLACE ROCK PILE	Department of the Interior	\$45,270.65
6/15/2017	Mississippi	F17PX00140	Red Clay Dirt	Department of the Interior	\$22,667.00
6/14/2017	Wisconsin	W911SA-17-D-1002	supply of Crushed Rock Gravel for five Years IDIQ, from July 2017 to July 6, 2022	Department of the Army	\$6,960,308.20
6/2/2017	Montana	FA462617P0026	Supplying Base Course and Concrete	Department of Air Force	\$29,801.00
6/1/2017	Maryland	W912K6-17-Q0025	Supply of gravel and Geotextile	National Guard Bureau of Dept of the Army	\$36,095.34
5/30/2017	Pennsylvania	W912KC-17-P-0077	Dark Limestone	Department of the Army	\$14,316.50
5/12/2017	Pennsylvania	4300544693	Callen Run DSA	State of Pennsylvania	\$99,970.00
4/12/2017	Louisiana	F17PX00351	Red Clay Dirt	Department of the Interior	\$77,200.00
4/7/2017	California	N00244-17-P-0254	Crushed Gravel	Department of the Navy	\$29,886.90
4/4/2017	Tennessee	W912P5-17-P-0047	supply of BEACH SAND	US ARMY CORPS OF ENGINEERS- CELRN-RC-N	\$26,124.00
3/31/2017	Pennsylvania	4300543889	Top Soil	State of Pennsylvania	\$20,216.25
2/9/2017	West Virginia	AG-3434-C-16-0003	Gravel	US Fish & Wildlife Service	\$1,000,000.00
9/19/2016	Washington	P16PC00727	Paving in Elwha & Mora	Department of the Interior	\$141,263.00
9/2/2016	Colorado	R16PX00867	Aggregate Stockpile	Bureau of Reclamation	\$136,000.00
9/1/2016	Kansas	W91QF4-16-A-0006	Rock&Ice Control	Department of the Army	\$665,000.00
8/16/2016	Washington	L16PB00766	Crushed Aggregate	Department of the Interior	\$18,987.50
7/29/2016	Florida	FA4819-16-P-3037	Crushed Concrete	Department of the Air Force	\$47,470.00
7/27/2016	Oklahoma	W44W9M-16-P-0393	Rock	Department of the Army	\$116,600.00
7/27/2016	Washington	R16PX00673	Wildcat Riprap supply	Department of the Interior	\$11,960.00
7/25/2016	South Carolina	W912QG-16-C-0004	Gravel	Department of the Army	\$699,815.00
7/15/2016	Arizona	P16PX02223	Road Base	Department of the Interior	\$21,585.00
7/6/2016	Ohio	W91384-16-P-0119	Gravel Aggregates	Department of the Army	\$11,728.60
5/11/2016	Pennsylvania	4300505388	Top Soil	Penn DOT	\$30,640.50
4/29/2016	Washington	310PO1612109	Pit Run	State of Washington	\$22,500.00
4/20/2016	Florida	P16PX01212	Rip Rap	Department of the Interior	\$11,389.40
4/11/2016	Washington	4600011575	Crushed Aggregate	City of Tacoma	\$196,940.00
4/7/2016	South Carolina	W9124C-16-P-0033	Ballast Rocks	Department of the Army	\$27,000.00
4/1/2016	Arkansas	W911RP-16-D-0001	Roadway Materials	Department of the Army	\$270,752.00
3/30/2016	Washington	R16PX00263	Gravel, Sand, Rip-Rap	Department of the Interior	\$11,120.00
3/9/2016	Washington	R16PX00263	Gravel, Sand, Rip-Rap	Department of the Interior	\$14,208.00
2/29/2016	Washington	F16PX00463	Rock Delivery	Department of the Interior	\$21,203.00
2/9/2016	Ohio	P16PX00580	Materials For Sylvan Dam Project	Department of the Interior	\$21,185.00
2/5/2016	California	F16PX00429	Roofing Replacement	Department of the Interior	\$29,688.00
2/3/2016	Wisconsin	W912ES-16-D-0004	Rock	Department of the Army	\$321,989.96
12/21/2015	South Carolina	4400012170	FLBC limestone	State of South Carolina	\$74,520.00
10/18/2015	Oklahoma	W52P1J-15-D-3036	Aggregate	Department of the Army	\$3,000,000.00
10/15/2015	Arizona	11135-C	Aggregate Materials	Maricopa County-Arizona	\$1,063,500.00
9/22/2015	Colorado	P15PX04247	Crusher Fines	Department of the Interior	\$39,071.00
9/10/2015	Guam	FA5240-15-P-0162	Crushed Stone	Department of the Air Force	\$45,340.00
8/25/2015	Texas	F15PS00955	Limestone Roadbase	Department of the Interior	\$76,844.55
7/7/2015	Illinois	W52P1J-16-D-3036	approved aggregate stone products 2015-2016	US Army Contracting Command Rock Island	\$3,33,200.00

TOWN OF MALABAR

COUNCIL MEETING

AGENDA ITEM NO: **11.f**
Meeting Date: November 2, 2020

Prepared By: Lisa Morrell, Interim Town Manager

SUBJECT: Piggyback Brevard County B-6-19-12/Aggregate (57 Stone & Pea Gravel)

BACKGROUND/HISTORY:

Brevard County has awarded contract number B-6-19-12 entitled Aggregate (57 Stone & Pea Gravel) to Green Dream International, the purchase of FDOT Certified Aggregate (57 Stone and Pea Gravel) for countywide projects for Brevard County Public Works, Road and Bridge Department. The contract options to include County pick-up and trucking with vendor loading as well as vendor loaded and delivery pricing to areas in Brevard County; specifically, North, Central, and South. The contract period is December 14, 2018 through December 13, 2021

"The town administrator is authorized to piggy back contracts for any purpose where the stipulated consideration thereunder to be paid by the town exceeds two thousand dollars (\$2,000.00) awarded by any other governmental entity so long as the bidding process utilized by the other governmental entity in awarding such contract is consistent with the competitive bid procedures outlined in this section. "

The Town of Malabar may utilize this contract as needed for Public Works Streets and Roads.

FINANCIAL IMPACT:

FY21 Approved Budget General Government 519.4610 Repair and Maintenance of Roads, not to exceed \$25,000 annually.

ATTACHMENTS:

- Brevard County B-6-19-12 Aggregate (57 Stone & Pea Gravel) Award.PDF

ACTION OPTIONS:

Motion to use the B-6-19-12 Aggregate (57 Stone & Pea Gravel) awarded contract as needed for road base materials within the estimated annual spend.

NOTICE OF AWARD
NOVEMBER 30, 2018
BID #B-6-19-12/AGGREGATE (57 STONE & PEA GRAVEL)

PROCUREMENT ANALYST:

<u>VENDOR</u>	<u>VENDOR CITY AND STATE</u>	<u>MEETS MINIMUM REQUIREMENTS</u>	<u>ITEMS AWARDED</u>	<u>AWARD AMOUNT</u>
Green Dream International	Alexandria, VA	Yes	All	\$587,193.75

BOARD AWARD--AGENDA ATTACHED

APPROVED AWARD (NON-BOARD AGENDA):
(Per Sections III.E. & III.I. & J., BCC-25, PROCUREMENT)

Steven A. Darling Jr., Purchasing Manager

- Award to overall lowest, most responsive bidder, minimum three responses received.
 Award to other than low, with low bid being non-responsive.

REASON FOR NON-RESPONSIVENESS:

Award to low bid, less than three responses received.

REASON FOR LESS THAN THREE RESPONSES: 132 suppliers solicited through VendorLink, resulting in 18 Planholders.

AWARDED BY A COMMITTEE CONSISTING OF: Bruce Black, Public Works; Steven Darling, Purchasing Manager; and Karen DiNatale, Procurement Analyst

FOR PURCHASING USE ONLY:

ONE-TIME PURCHASE

ANNUAL BID:

EFFECTIVE DATE: 12/14/2018 ENDING DATE: 12/13/2021

RENEWAL OPTION One year Other (fill in) Two (2), one (1) year

- Prompt Payment Discount Offered Yes _____ (Terms) NO
 Performance and payment bonds received with construction contract documents.
 Release Cashier's or Certified Check Received for Bid Deposit on Bids

SPECIAL INSTRUCTIONS TO AWARDED VENDOR:

- Please provide certificate of insurance.
 Please provide performance and payment bonds as required.
 OTHER:

 SD

SUBMIT SEALED BID TO: BREVARD COUNTY PURCHASING SERVICES 2725 JUDGE FRAN JAMIESON WAY BLDG. C, 3rd FLOOR, SUITE C-303 VIERA, FL 32940				<h1 style="text-align: center;">INVITATION TO BID</h1> <h2 style="text-align: center;">Bid Acknowledgment</h2>	
PROCUREMENT ANALYST: Karen DiNatale karen.dinatale@brevardfl.gov		(321) 617-7390 Ext. 5-6068		AN EQUAL OPPORTUNITY EMPLOYER	
BID SPECIFICATIONS MAY BE OBTAINED AT: Purchasing Services, 2725 Judge Fran Jamieson Way, Bldg. C, Suite 303, Viera, FL 32940, or at the Quvia DemandStar website and VendorLink					
MAILING DATE: October 25, 2018		BID TITLE: Aggregate (57 Stone & Pea Gravel)		BID NUMBER: B-6-19-12	
PRE-BID DATE, TIME, AND LOCATION: N/A				<input type="checkbox"/> Mandatory <input type="checkbox"/> Non-Mandatory	
BID OPENING DATE AND TIME: November 15, 2018 @ 2:00 p.m.					
BIDS RECEIVED AFTER ABOVE DATE AND TIME WILL NOT BE ACCEPTED					

▼ VENDOR MUST COMPLETE THIS AREA AND RETURN FORM ▼

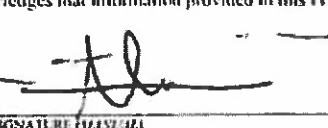
LEGAL NAME OF BIDDER AND BUSINESS ADDRESS: Green Dream International LLC 2331 Mill Rd, Suite 100 Alexandria, VA 22314		FEDERAL ID NO. (FEIN) OR SOCIAL SECURITY NO. (SSN): 46-0522758	
TELEPHONE NUMBER/TOLL-FREE NUMBER: (202) 470-4600 free number: 888-779-2861		If returning as a "no bid," state reason:	
I certify that this bid is made without prior understanding, agreement, or connections with any corporation, firm or person submitting a bid for the same materials, supplies or equipment, and is in all respects fair and without collusion or fraud. I agree to abide by all conditions of this bid and certify that I am authorized to sign this bid for the bidder. In submitting a bid to the County of Brevard, the bidder offers and agrees that if the bid is accepted, the bidder will convey, sell, assign, or transfer to the County of Brevard all rights, title, and interest in and to all causes of action it may now or hereafter acquire under the antitrust laws of the United States and the State of Florida for price fixing relating to the particular commodities or services purchased or acquired by the County of Brevard. At the County's discretion, such assignment shall be made and become effective at the time the County renders final payment to the bidder.		The bidder acknowledges that information provided in this form is true and correct.	
X			
AUTHORIZED SIGNATURE (PRINTED) Emad Windi		DATE November 15, 2018	
NAME (PRINTED) CEO		TITLE	

THIS FORM MUST BE NOTARIZED AND RETURNED WITH YOUR BID

Sworn to and subscribed before me this 13 day of November 2018.

Personally known:

Or produced identification: Type of ID: PADL 32014451

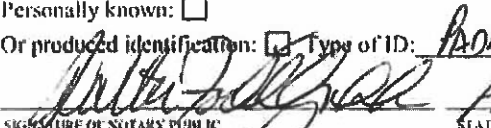
 SIGNATURE OF NOTARY PUBLIC STATE

WALTER TODD GRIESBACH
 NAME OF NOTARY PUBLIC (PRINTED)

My commission expires: June 26, 19

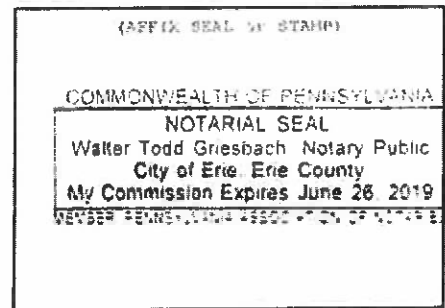

BOND DATA

VENDOR MUST PROVIDE:		AMOUNT:	
Yes <input type="checkbox"/>	No <input checked="" type="checkbox"/>	BID BOND	_____
Yes <input type="checkbox"/>	No <input checked="" type="checkbox"/>	PERFORMANCE BOND	_____
Yes <input type="checkbox"/>	No <input checked="" type="checkbox"/>	LABOR, MATERIAL, PERFORMANCE BOND	_____

In cases where the amount of a surety bond exceeds \$500,000, the surety company must have an A.M. Best's rating as specified in this document, and depending on the amount of the bond, shall have a minimum A.M. Best's financial size category (FSC) ranking as follows:

BOND AMOUNT UP TO:	FINANCIAL CLASS	BOND AMOUNT UP TO:	FINANCIAL CLASS
\$ 1,000,000	I	\$ 25,000,000	V
\$ 2,000,000	II	\$ 50,000,000	VI
\$ 5,000,000	III	\$ 100,000,000	VII
\$ 10,000,000	IV		

Bonds must be issued by a surety company who complies with the requirements of § 287.0935, Fla. Stat.

PAYMENT OF GOODS OR SERVICES PROVIDED AS A RESULT OF THIS SOLICITATION WILL BE MADE PER FLORIDA STATUTE. ALL FIRST TIME VENDORS MUST SUBMIT A W-9 FORM.

GENERAL CONDITIONS, TERMS, AND PROVISIONS

1. DEFINITIONS:

- a. COUNTY - The term "COUNTY" herein refers to the County of Brevard, Florida, and its duly authorized representatives.
 - b. BIDDER - The term "BIDDER" used herein refers to the dealer/manufacturer/business organization submitting a bid to the County in response to this invitation.
 - c. VENDOR - The term "VENDOR" used herein refers to any dealer/manufacturer/business organization that will be awarded a contract pursuant to the terms, conditions and quotations of the bid.
 - d. USING AGENCY - The term "USING AGENCY" used herein refers to any department, division, agency, commission, board, committee, authority or other unit in the County Government using supplies or procuring contractual services as provided for in the Purchasing Ordinance of the County of Brevard.
 - e. HEAVY DUTY - The item(s) to which the term "HEAVY DUTY" is applied shall exceed the usual quality and/or capacity supplied with standard production equipment and shall be able to withstand unusual strain, exposure, temperature, wear and use.
 - f. QUALIFIED BIDDER - The best bidder who has the capability in all respects to fully perform the bid requirements, and has the financial stability, honesty, integrity, skill, business judgment, experience, facilities, and reliability necessary to assure good faith performance of the contract, as determined by reference to the Contractor's Qualification Statement, evaluations by County staff of the bidder or its subcontractors' past performance for the Board, and any other information required by Board policies.
 - g. RESPONSIVE BIDDER - A bidder who has submitted a bid, which conforms in all respects to the requirements of the bid package, including, but not limited to, submission of the bid on required forms with all required information, signatures, and notarizations at the place and time specified.
 - h. DUE CAUSE - An applicable reason affecting and concerning the ability and fitness of the contractor(s) to perform to the specifications and requirements of the contract.
2. **SUBMISSION OF BIDS:** All bids shall be submitted in a sealed envelope. The bid number, title, and opening date shall be clearly displayed on the outside of the sealed envelope. The delivery of said bid to Purchasing Services prior to the specified opening date and time is solely and strictly the responsibility of the bidder. Any bids received in Purchasing after the specified date and time will not be accepted.
3. **EXECUTION OF BID:** Bid must contain a manual signature of authorized representative in the space(s) provided. Bids must be typed or printed in ink. Use of erasable ink is not permitted. All corrections made by bidder to any bid entry must be initialed. The company name and Federal Employer Identification Number (FEID) number shall appear in the space(s) provided.
4. **BID OPENING:** Bid opening shall be public on the date and time specified. Sealed bids received by an agency pursuant to invitations to bid are exempt from the provisions of subsection (1) and s. 24(a), Art. I of the State Constitution until such time as the agency provides notice of a decision or intended decision pursuant to s. 120.57(3)(a) or within 30 days after bid or proposal opening, whichever is earlier. In accordance with Florida Statute 119.071(1)(b)2, the names of the firms submitting a competitive solicitation will be read aloud at this time of the opening. No details of the competitive solicitation will be released. Bid must be submitted on forms provided by the County. No other forms will be accepted. Fax, telephone, emailed, or verbal Bids are not acceptable and will not be considered. No bid may be modified after opening. No bid

may be withdrawn after opening for a period of ninety (90) days unless otherwise specified.

5. **BID TABULATIONS:** Bid tabulations are posted to the DemandStar website at: www.demandstar.com and [VendorLink](#)
6. **CLARIFICATION/CORRECTION OF BID ENTRY:** The County reserves the right to allow for the clarification of questionable entries and for the correction of OBVIOUS MISTAKES.
7. **INTERPRETATION:** No interpretation of the meaning of the specifications, or other contract documents will be made orally to any bidder. Every request for such interpretation must be in writing, addressed to Purchasing Services at 2725 Judge Fran Jamieson Way, Bldg. C, 3rd Floor, Suite 303 Viera, FL 32940, or emailed to the attention of the applicable Procurement Analyst. To be given consideration, such requests must be received at least five (5) business days prior to the date fixed for the opening of the bid. Any and all such interpretation and supplemental instructions will be in the form of a written addendum. Failure of any bidder to receive any such addendum or interpretation shall not relieve said bidder from any obligation under his bid as submitted. All addenda so issued shall become part of the contract documents, whether or not the successful bidder received a copy of such addendum, it being understood that all bidders are responsible to verify that they have received any such addenda prior to submitting their bid.
8. **EEO STATEMENT:** Vendors must ensure that employees and applicants for employment are not discriminated against for reasons of race, color, age, religion, sex, national origin, or handicapped status. Minority and female-owned businesses are encouraged to participate. Brevard County is an equal opportunity employer.
9. **PRICING:** Firm prices shall be proposed and include FOB DESTINATION, all packing, handling, shipping charges, fuel surcharges and delivery, unless otherwise indicated, to any point within the County to a secure area or inside delivery. All prices, costs, and conditions shall remain firm and valid for 90 days from the date of opening. The obligations of Brevard County under this award are subject to the availability of funds lawfully appropriated for its purpose by the State of Florida and/or the Brevard County Board of County Commissioners.
10. **ADDITIONAL TERMS & CONDITIONS:** The County of Brevard reserves the right to reject bids containing any additional terms or conditions not specifically requested in the original conditions and specifications.
11. **TAXES:** The County of Brevard is exempt from Federal excise taxes and all sales taxes.
12. **DISCOUNTS:** All discounts, EXCEPT THOSE FOR PROMPT PAYMENT, shall be considered in determining the lowest net cost for bid evaluation purposes.
13. **MEETS SPECIFICATIONS:** All equipment and accessories furnished under these specifications shall be new, the latest model in current production, and shall be of good quality, workmanship, and material. The bidder represents that all equipment offered under these specifications shall meet or exceed the minimum requirements specified. Delivery specifications shall be strictly adhered to. The bidder shall be responsible for performing the work necessary to meet County standards in a safe, neat, good, and workmanlike manner.
14. **BRAND NAME OR EQUAL:** If items called for by this invitation have been identified in the specifications by a "Brand Name or Equal" description, such identification is intended to be descriptive, but not restrictive, and is to indicate the quality and characteristics of products that will be acceptable. Bids offering "equal" products will be considered for award if such products are clearly identified in the bid and are determined by the County to meet fully the salient characteristics requirements listed

- in the specifications. Unless the bidder clearly indicates in his bid that he is offering an "equal" product, the bid shall be considered as offering the same brand name product referenced in the specifications. If the bidder proposes to furnish an "equal" product, the brand name if any, or the product to be furnished shall be inserted in the space provided or such product shall be otherwise clearly identified. The evaluation of bids and the determination as to equality of the product offered shall be the responsibility of the County and will be based on information furnished by the bidder. Purchasing Services is not responsible for locating or securing any information, which is not identified in the bid and reasonably available to Purchasing Services. To ensure that sufficient information is available the bidder shall furnish as a part of the bid, or prior to bid opening, as indicated, all descriptive material necessary for Purchasing Services to determine whether the product offered meets the salient characteristics required by the specifications and establish exactly what the bidder proposes to furnish and what the County would be binding itself to purchase by making an award.
15. **SILENCE OF SPECIFICATIONS:** The apparent silence of the specifications and any supplemental specifications as to any details or the omission from same of any detailed description concerning any point, shall be regarded as meaning that only the best commercial practices are to prevail and only materials of first quality be provided. All interpretations of this specification shall be made upon the basis of this statement.
 16. **ASSIGNMENT:** Any purchase order (PO) issued pursuant to this bid and the moneys, which may become due hereunder is not assignable except with the prior written approval of the Purchasing Manager.
 17. **INDEMNIFICATION:** The successful bidder agrees to indemnify and hold harmless the County and their employees from all claims, losses and expenses, including attorneys' fees, arising out of or resulting from the performance, failure in the performance of, or defect in, the products or services to be contracted, provided such claim, damage, loss or expense (1) is attributable to bodily injury, sickness, disease, death, or personal injury, or to property damage, including loss of use resulting therefrom, and (2) is caused in whole or in part by any negligent act or omission of the vendor, any subcontractor or any of their employees, or arises from a job-related injury. The successful bidder acknowledges adequate consideration for this indemnification provision.
 18. **PATENTS AND ROYALTIES:** The bidder, without exception shall indemnify and save harmless the County of Brevard and its employees from liability of any nature of kind including cost and expenses for or on account of any copyrighted, patented, or unpatented invention, process, or article manufactured or used in the performance of the contract, including its use by the County of Brevard. If the bidder uses any design, device, or materials covered by letters, patent or copyright, it is mutually agreed and understood without exception that the bid prices shall include all royalties or cost arising from the use of such design, device, or materials in any involved in the work.
 19. **TRAINING:** If specified, supplier(s) may be required at the convenience of the County, to provide employees training in the operation and maintenance of any items(s) purchased from this bid.
 20. **ACCEPTANCE:** Items may be tested for compliance with specification. Items delivered not conforming to specifications may be rejected and returned at vendor's expense. Those items not delivered as per delivery date in bid and/or purchase order may be purchased on the open market. Any increase in cost may be charged against the vendor. Any violations of these stipulations may also result in the vendor name being removed from the bid list and the vendor disqualified from doing business with the County.
 21. **SAFETY WARRANTY:** The selling dealer, distributor, supplier, and manufacturer shall be responsible for having complied with all Federal, State and local standards, regulations, and laws concerning the equipment specified and the use thereof, applicable and effective on the date of manufacture including safety and environmental standards as apply to both private industry and governmental agencies.
 22. **WARRANTY:** The bidder agrees that, unless otherwise specified, the supplies and/or services furnished under this bid shall be covered by the most favorable commercial warranty the bidder gives to any customer for comparable quantities of such supplies and/or services and that the rights and remedies provided herein are in addition to and do not limit any rights afforded to the County by any other provision of this bid.
 23. **AWARDS:** As the best interest of the County may require, the right is reserved to make award(s) by individual items, group of items, all or none, or a combination thereof; on a geographical basis and/or on a countywide basis with one or more suppliers; to reject any and all bids or waive any minor irregularly or technicality in bids received. Bidders are cautioned to make no assumptions unless their bid has been evaluated as being responsive and qualified. All awards made as a result of this bid shall conform to applicable ordinances of the County. The Board may return, for full credit, any unused items received which fail to meet the Board's performance standards. Brevard County reserves the right to cancel an awarded bid upon due cause—i.e., vendor misrepresentation, vendor negligence, non-performance, etc. via written notice.
 24. **Unless otherwise noted in the bid document, vendors shall submit one bid only.**
 25. **CONFLICT OF INTEREST:** The award hereunder is subject to provisions of State of Florida Statutes and Brevard County Ordinances. All Bidders must disclose with their bid the name of any officer, director, or agent who is also an employee of Brevard County. Further, all bidders must disclose the name of any County employee who owns, directly or indirectly, any interest in the proposer's firm or any of its branches.
 26. **PURCHASING AGREEMENTS WITH OTHER GOVERNMENTAL ENTITIES:** Brevard County permits the awarded vendor(s) to extend the pricing, terms and conditions of this solicitation to other governmental entities at the vendor's discretion. Each governmental entity that utilizes this solicitation or resulting contract will be responsible for execution of its own requirements with the awarded vendor(s).
 27. **DRUG-FREE WORKPLACE:** Whenever two or more bids, which are equal with respect to price, quality, and service, are received by Brevard County for the procurement of commodities or contractual services, a bid received from a business that has implemented a drug-free workplace program per 287.087, Fla. Stat. shall be given preference in the award process.
 28. **LOBBYING STATEMENT:** All firms are hereby placed on notice the County Commission and staff shall not be contacted about this Bid. Firms and their agents are hereby placed on notice that they are not to contact members of the County Commission or staff (with the exception of designated liaison). Public meetings and public deliberations of the Selection Committee are the only acceptable forum for the discussion of merits of products/services requested by the Invitation to Bid; and written correspondence concerning Bids may be submitted to the County Manager. Each Bid will have one non-voting staff member designated who will serve as the liaison. Failure to adhere to these requirements could result in Board action to disqualify your firm from consideration of award.
 29. **PUBLIC ENTITY CRIMES:** All bidders are hereby placed on notice that a person or affiliate who has been placed on the convicted vendor list following a conviction for a public entity crime may not submit a bid on a contract to provide any goods or services to a public entity, may not submit a bid on a contract with a public entity for the construction repair of a public building or public work, may not submit bids on leases of real property to a public entity, may not be awarded or perform work as a contractor, supplier, subcontractor, or consultant under a contract with a public entity, and may not transact business with any public entity in excess of the threshold amount provided in 287.017 Fla. Stat. for CATEGORY TWO (currently \$35,000) for a period of thirty-six (36) months from the date of being placed on the convicted vendor list.

30. **DISCRIMINATORY VENDOR LIST:** An entity or affiliate placed on the Discriminatory Vendor List shall not submit a Bid for a contract to provide goods or services to a public entity, shall not submit a Bid on a contract with a public entity for the construction or repair of a public building or perform any public work, shall not submit Bids for leases of real property to a public entity, shall not award or perform work as a contractor, supplier, subcontractor, or consultant under any contract with any public entity, and shall not transact business with any public entity per 287.134(3)(d), Fla. Stat.

31. **SCRUTINIZED COMPANIES:** Awarded Contractor shall certify that it and its subcontractors are not on the Scrutinized Companies that Boycott Israel List. Pursuant to Section 287.135, F.S., the County may immediately terminate any Agreement at its sole option if the Contractor or its subcontractors are found to have submitted a false certification; or if the Contractor, or its subcontractors are placed on the Scrutinized Companies that Boycott Israel List or is engaged in the boycott of Israel during the term of the Agreement.

If the Agreement is for more than one million dollars, the Contractor further certifies that it and its subcontractors are also not on the Scrutinized Companies with Activities in Sudan, Scrutinized Companies with Activities in the Iran Petroleum Energy Sector List, or engaged with business operations in Cuba or Syria as identified in Section 287.135, F.S.

Pursuant to Section 287.135, F.S., the County may immediately terminate this Agreement at its sole option if the Contractor, its affiliates, or its subcontractors are found to have submitted a false certification; or if the Contractor, its affiliates, or its subcontractors are placed on the Scrutinized Companies that Boycott the Scrutinized Companies with Activities in Sudan List, or Scrutinized Companies with Activities in the Iran Petroleum Energy Sector List, or engaged with business operations in Cuba or Syria during the term of the Agreement.

The Contractor agrees to observe the above requirements for applicable subcontracts entered into for the performance of work under this Agreement.

As provided in Subsection 287.135(8), F.S., if federal law ceases to authorize these contracting prohibitions, this section shall become inoperative and unenforceable.

32. **LICENSES, CERTIFICATIONS, AND PERMITS:** The successful vendor will be required to secure, at its expense and show proof of the proper business tax receipt and/or any other license/certification required of the applicable service/work being performed. Prior to award, the apparent low bidder will be required to provide proof of license and/or certification within two (2) business days of the posted awarded recommendation and submit copies of license/certifications to the Purchasing Office. The Brevard County Contractor Licensing Regulation & Enforcement (LR&E) office is responsible for the county licensing of trades: General Building, drywall, plumbing, electric, HVAC, roofing, etc. If you have questions concerning the licensing requirements for a Brevard County contractor's license, please Contact the Brevard County LR&E office at (321) 633-2058, option 0, for any questions.

The awarded contractor shall fully comply with all federal and state laws, county and municipal ordinances and regulations in any manner affecting the performance of the work. The successful vendor is responsible for obtaining all permits necessary to construct the project. Brevard County does not exempt itself from permitting requirements. The Owner shall pay all Brevard County permit, inspection and impact fees required for the project or services required under this contract; all other fees for permits required by agencies/municipalities other than Brevard County shall be the responsibility of the awarded Contractor. A copy of issued permit shall be provided to the User Department of the County for their records.

33. **ERRORS:** In the event of extension error(s), the unit price will prevail. In the event of addition error(s), the extended totals will prevail. In either case, the bidder's total offer will be adjusted accordingly.

34. **CANCELLATION AND REINSURANCE:** If any insurance should be canceled or changed by the insurance expiring during the period of this bid award, the vendor shall be responsible for securing other acceptable insurance to provide the coverage specified in the bid to maintain continuous coverage during the life of the award.

35. **INCURRED COST:** Brevard County is not liable for any cost incurred by any vendor prior to an award. Costs for developing a response to this request for bid are entirely the obligation of the bidder and shall not be chargeable in any manner to Brevard County.

36. **MATERIALS/SUPPLIES:** No materials or supplies for the work shall be purchased by the vendor or by any subcontractor subject to any chattel mortgage or under a conditional sale or other agreement by which an interest is retained by the seller.

37. **SUBCONTRACTORS:** The vendor shall be fully responsible for all acts and omissions of his subcontractors and of persons and organizations directly or indirectly employed by them and of persons and organizations for whose acts and omissions of persons directly employed by him.

38. **VERBAL INSTRUCTIONS:** No negotiations, decisions, or actions shall be initiated or executed by the vendor as a result of any discussions with any County employee. Only those communications, which are in writing from an authorized County representative, may be considered. Only written communications from vendors, which are assigned by a person designated as authorized to bind the company, will be recognized by the County as duly authorized expressions on behalf of the company.

39. **LITIGATION VENUE:** All litigation shall take place either in the State Courts of Florida, wherein venue shall lie in Brevard County, Florida, or in the Federal Courts wherein venue shall lie in the Middle District in and for the State of Florida. The vendor expressly waives venue in any other location.

40. **ADDITION, DELETION, OR MODIFICATION OF SERVICES:** The County reserves the right at its sole discretion to increase, decrease, or delete any portion of this agreement/contract at any time without cause, and if such right is exercised by the County, the total fee shall be reduced by a prorata basis. If work has already been accomplished on the portion of the contract to be increased, decreased, or deleted, the contractor shall be paid for the correct portion on the basis of the estimated percentage agreed upon by the County, the contractor, and the contract manager upon completion of such portion.

41. **OPERATION DURING DISPUTE:** In the event the County has not canceled the contract in accordance with the terms of the contract, and there remains a dispute between the bidder and the County, the bidder agrees to continue to operate and perform under the terms of the contract while such dispute is pending. Further, the bidder agrees that, in the event a suit is filed for injunction or other relief, it will continue to operate the system until the final adjudication of such suit by the court.

42. **CONTRACT TERMINATION:** The contract resulting from this bid shall commence upon issuance and acceptance of the fully executed contract. The County user agency shall issue orders against the contract on an as needed basis. The contract may be canceled by the vendor, for good cause, upon ninety (90) days prior written notice. The County retains the right to terminate the contract, in part or in its entirety, with or without good cause, upon thirty (30) days prior written notice or as stated herein. In the event of termination by either party as provided herein, the awarded vendor shall be paid for services performed through the date of termination.

43. **SPECIAL ACCOMMODATIONS:** In accordance with the Americans with Disabilities Act (ADA) and Section 286.26, Fla. Stat., persons with disabilities needing special accommodations to participate should contact the ADA Coordinator at (321) 633-2017 or by email at Brian.Breslin@BrevardFL.gov, and must be made no later than 48 hours

prior the public meeting/hearing in order to provide the requested service.

44. **BIDDER RESPONSIBILITIES:** Bidders, by submitting a bid, certify that it understands all planning, coordinating, and implementation of the described services shall be done through personal contact between the bidder and the contract manager, and that telephone contact and mail correspondence may, in some cases, not be appropriate. County approved representatives of the bidder shall be available to meet with the contract manager, as may be required, to accomplish the County's objectives as effectively and efficiently as possible, during all phases of this agreement/contract/bid.
45. **SUPERVISION OF CONTRACT PERFORMANCE:** The bidder's performance of the contract will be notified by the contract manager. The bidder shall be notified of lack of performance in writing by the contract manager. If at any time during the term of the contract, performance satisfactory to the contract manager shall not have been made, the bidder, upon written notification by the contract manager, shall within three (3) days increase the force, tools and equipment as needed to properly perform the contract. The failure of the contract manager to file such notification shall not relieve the bidder of the obligation to perform the work at the time and in the manner specified by the contract. If the bidder does not increase the force or neglects to do the work properly, the contract manager can withhold a percentage of payment or withhold the entire dollar amount due as per the contract.
46. **MISUNDERSTANDING:** To prevent misunderstanding and any litigation, the contract manager shall decide any and all questions, which may arise concerning the quality and acceptability of the work, and services performed, the sufficiency of performance, the interpretation of the provisions of the contract, and the acceptable fulfillment of the contract on the part of the bidder. The Contract Manager will determine whether or not the amount, quantity, character and quality of the work performed are satisfactory, which determination shall be final, conclusive and binding upon both the bidder and the County. The contract manager shall make such explanation as may be necessary to complete, explain, or make definite the provisions of the contract, and his findings and conclusions shall be final and binding upon both parties.
47. **GREEN PROCUREMENT POLICY:** The Board of County Commissioners approved a "green procurement" policy in March 2004 to establish procurement requirements that promote the purchase and use of Environmentally Preferred Products as defined by the United States Environmental Protection Agency. Environmentally Preferred Products (EPP) are those products and services that have a reduced effect on the human health and the environment when compared to other products and services that serve the same purpose. EPP produces encourage (1) waste reduction; (2) reduced exposure to hazardous materials; (3) natural resource conservation; and (4) energy efficiency.
48. **MONITORING OF WORK:** The bidder shall provide the contract manager with every reasonable opportunity to ascertain whether or not the work, as performed, is in accordance with the requirements of the contract. The bidder shall designate, in writing, a person to serve as liaison between the bidder and the County.
49. **PROMPT PAYMENT:** For payment promptness, Brevard County shall remit payment in accordance with the Florida Prompt Payment Act, Section 218.70, Fla. Stat., et seq. Brevard County does not expect to be billed in excess of the ordered quantity and will not pay for any quantity above the ordered quantity. Any order placed as a result of this bid will be subject to Billing Instructions and Conditions on the back of the Brevard County Purchase Order form. Bidders may offer cash discounts for prompt payment but they will not be considered in determination of award. If a bidder offers a discount, it is understood that the discount time will be from the date of satisfactory delivery, at the place of acceptance, and receipt of correct invoice, at the office specified, whichever occurs last. Requests for final payment for any work or services for which a permit is required shall include a copy of all required

permits and copies of all required inspection reports. Failure to provide proof of acquisition of all required permits and successful completion of all required inspections shall represent an incomplete invoice and will delay payment.

50. **RIGHT TO AUDIT RECORDS:** In performance of this Agreement, the Contractor shall keep books, records, and accounts of all activities related to the Agreement, in compliance with generally accepted accounting procedures. All documents, papers, books, records, and accounts made or received by the contractor in conjunction with the Agreement and the performance of this Agreement shall be open to inspection during regular business hours by an authorized representative of the office, and shall be retained by the contractor for a period of five (5) years after termination of this Agreement—unless such records are exempt from section 24(a) of Article I of the State Constitution and section 119.07(1), Fla. Stat.
51. **UNAUTHORIZED ALIEN WORKERS:** Brevard County will not accept bids from vendors who knowingly employ unauthorized alien workers, constituting a violation of the employment provisions contained in 8 U.S. Code § 1324a(e) (Section 274A(e) of the Immigration and Nationality Act "INA"). The County shall consider a vendor's intentional employment of unauthorized aliens as grounds for immediate termination of any awarded proposal. The CONSULTANT shall utilize the U.S. Department of Homeland Security's E-Verify system to verify the employment eligibility of all new employees hired by the CONSULTANT during the term of the Contract and shall expressly require any subcontractors performing work or providing services pursuant to the Contract to likewise utilize the U.S. Department of Homeland Security's E-Verify system to verify the employment eligibility of all new employees hired by the subcontractor during the Contract term.
52. **FLORIDA PUBLIC RECORDS LAW:** Both parties understand that the County is subject to the Florida Public Records Law, Chapter 119, Fla. Stat. and all other applicable Florida Statutes. If the materials provided by the Contractor do not fall under a specific exemption, under Florida or federal law, materials provided by the Contractor to the County would have to be provided to anyone making a public records request. It will be the bidder's duty to identify the information, which it deems is exempt under Florida/federal law, and identify the statute by number, which exempts that information.

Should any person or entity make a public request of the County—which requires or would require the County to allow inspection or provide copies of records which the Contractor maintains are exempt from Public Records Law or are confidential—it shall be the Contractor's obligation to provide the County within 24 hours (not including weekends and legal holidays), of notification by the County to the Contractor of the request, of the specific exemption or confidentiality provision so the County will be able to comply with the requirements of Chapter 119, Fla. Stat.

Should the County face any kind of legal action to require or enforce inspection or production of any records provided by the Contractor to the County which the Contractor maintains are exempt or confidential from such inspection/production as a public record, then the Contractor shall hire and compensate attorney(s) who shall represent the interest of the County as well as the Contractor in defending such action. The Contractor shall also pay any costs to defend such action and shall pay any costs and attorney fees, which may be awarded pursuant to 119.12, Fla. Stat.
53. **COUNTY SEAL:** Use of the County Seal without the express approval of the Board of County Commissioners is a violation of 165.043, Fla. Stat. punishable as a misdemeanor.

54. **TIE BIDS:** Award of all tie quotes/bids shall be made by the Purchasing Manager in accordance with State Statutes, which allows a firm certified as a Drug-Free Workplace to have precedence. When evaluation of vendor responses to solicitations results in identical offers, with regards to bids or quotations, or identical ranking with regards to proposals, from two or more vendors, the County shall determine the order of award using the following criteria in order of preference listed below (from highest priority to lowest priority):

- a. For tie bids, quotations or proposals, priority shall be given to the vendor certifying that he/she is a Drug-Free Workplace as defined within 287.087, Fla. Stat.;
- b. Should a tie still exist, in the case of proposals only, priority shall be given until the tie is broken, to the vendor with the highest total of raw scores for each evaluation criteria, progressing from the highest weighted criteria to the lowest rated criteria. If multiple evaluation criteria have identical weights, the combined total weights of the identically weighted criteria shall be used;
- c. In the event that a tie still exists after progressing through a-c, the decision shall be made by lot or coin toss. The drawing of lots or coin toss shall be conducted in the presence of the effected bidders if they elect to be present.

55. **VENDOR COMPLAINTS AND DISPUTES:** Brevard County encourages prompt and fair handling of all complaints and disputes with the business community. In order to resolve disputed matters in an equitable manner, the following procedures are adopted:

a. **POSTING OF AWARD NOTICES**

FORMAL SEALED BIDS/QUOTES: No later than three (3) business days after a bid opening the Purchasing Manager, or his/her designee, shall post a tabulation of competitive sealed bids/quotes to the www.demandstar.com and [VendorLink](#). The apparent, responsive low bid/quote will be the intended award recommendation. If after posting the tabulation, the apparent low bid/quote is found to be non-responsive to the specifications, the formal award evaluation will be posted. The time for filing a protest will begin the date of the later posting.

FORMAL SEALED PROPOSALS: No later than three (3) business days after the selection committee recommendations are finalized, the Purchasing Manager or his/her designee shall post the selection committee's rankings and recommended award for bids.

b. **PROCEEDINGS**

Any bidder, quoter, or proposer who is allegedly aggrieved in connection with the solicitation or pending award of a contract must file a formal written protest with the Purchasing Manager within five (5) business days of the posted award recommendation.

The formal written protest shall reference the bid/quote/proposal number, and shall state with particularity the facts and laws upon which the protest is based, including full details of adverse effects and the relief sought.

Within seven (7) calendar days of receipt of the formal written protest, the Purchasing Manager will arrange a meeting of the Protest Committee and the affected parties. The Protest Committee shall consist of two (2) Department Directors or designees, both of whom must be from an organizational group which the user department or group is not assigned; one (1) Assistant County Manager, who must be from an organizational group which the user department or group is not assigned under. The Purchasing Manager shall act as a non-voting Hearing Coordinator and the County Attorney or designee may be requested to attend as a non-voting member. The Purchasing Manager or designee record the meeting and provide any information as the committee may request. The purpose of the meeting of the Protest Committee is to provide an opportunity to: (1) review the basis of the protest, (2) evaluate the facts and merits of the bid protest, and (3) if possible, to reach a resolution of the protest that is acceptable to the affected parties. For the purpose of the Protest Committee hearing, resolution shall mean that the Protestor finds the decision of the Protest Committee acceptable.

In the event the matter is not resolved with the Protestor's acceptance of the Protest Committee's decision, the Purchasing Manager will schedule the recommended award including the details of the protest and the Protest Committee's recommendation before the Board of County Commissioners via Board Agenda. The County Manager, prior to approval and placement on the Board agenda, may elect to resolve the matter before presentation to the Board. In the event that the County Manager cannot bring the matter to resolution, a copy of the Agenda Report shall be furnished immediately to all affected parties. The affected parties may appear before the Board of County Commissioners as a final means of administrative remedy.

c. **STAY OF PROCUREMENTS DURING PROTESTS**

Failure to observe any or all of the above procedures shall constitute a waiver the right to protest a contract award. In the event of a timely protest under the procedure, the County shall not proceed further with solicitation or with the award until a recommendation is made by the Committee, or a written determination is made by the County Manager that the award must be made immediately in order to protect the public interest. Invoice disputes between an awarded vendor and user agency will follow the guidelines set forth in AO-33, *Prompt Payment of Invoices*.

AGGREGATE (57 STONE & PEA GRAVEL)
B-6-19-12
BIDDER'S CHECKLIST

The items indicated are required for submission with your bid. Failure to submit any items indicated as required may result in rejection of the bid. Offers to provide required items after the date and time designated for the receipt of bid will not be considered.

- Signed/Notarized Bid Invitation
- Completed and Signed Price Sheet, to include Insurance Indemnification Acknowledgement (Page 15)
- Drug Free Workplace Form
- E-Verify Participation Affidavit
- W-9 Form – Latest Edition
- Reference Sheet

In order for this bid to be valid, the above forms and information shall be completed in their entirety, signed by an authorized representative of the responding vendor, and returned as part of the bid response.

AGGREGATE (57 STONE & PEA GRAVEL)

B-6-19-12

SPECIAL CONDITIONS

1. PURPOSE

Brevard County Purchasing Services, on behalf of the Public Works Department, is soliciting annual bids for the purchase of FDOT Certified Aggregate (57 Stone and Pea Gravel) for countywide projects for Brevard County Public Works, Road and Bridge Department.

CONTRACT PERIOD: The terms of this agreement shall be effective for (three) years from the date of award. The agreement may be extended by mutual agreement, for an additional two (1) year period with the option to negotiate pricing, terms and conditions. Brevard County will notify the Vendor in writing ninety (90) days prior to the expiration of the agreement as to its intent to renew the agreement.

DELIVERY

If vendor delivered, delivery is required within five (5) days after receipt of order.

Delivery areas are divided as follows:

North: Based on an East/West line from Canaveral Groves at US1 north to County Line.

Central: Based on an East/West line from Wickham Rd. at I-95 North to Canaveral Groves Blvd.

South: Based on an East/West line from Wickham

2. INFORMATION OR CLARIFICATION

For information concerning procedures for responding to this bid, contact Karen DiNatale, Purchasing Services at 321-617-7390 or by email at karen.dinatale@brevardfl.gov. Such contact shall be for clarification purposes only. Material changes, if any, to the specifications will be transmitted by written addendum through Purchasing Services and posted to the DemandStar website at Onvia DemandStar® website and VendorLink. The County will not notify bidders of addenda. It is the sole responsibility of the bidder to check the website prior to submitting a bid to verify receipt of all documents to include written addendum.

Bidders shall promptly notify Purchasing Services, prior to submission of their bid, of any ambiguity, inconsistency or error, which they may discover upon examination of the bid documents. No interpretation of the meaning of specifications or other documents will be made to any bidder orally, nor may bidder rely on any such pre-bid statements in completing the bid. Every request for such interpretation must be in writing addressed to Purchasing Services at 2725 Judge Fran Jamieson Way, Bldg. C, Suite 303, Viera, FL 32940, or emailed to the attention of Karen DiNatale at karen.dinatale@brevardfl.gov. To be given consideration, such requests must be received in writing no later than five (5) business days prior to the date for opening of the bids.

3. RECEIVING OF BIDS

Bids must be received by Brevard County Purchasing Services, 2725 Judge Fran Jamieson Way, Bldg. C, Suite C303, Viera, FL 32940 **no later than November 15, 2018 @ 2:00 p.m.** Bids must be submitted on County format to be considered. **The official time clock will be the date and time stamp clock located in the Purchasing Office.**

Bids shall be submitted in one (1) original with the "Original" clearly marked. Paper documents must be provided, but should be accompanied by an equivalent electronic PDF file. Provide one original and one (1) compact disc (CD) or USB flash drive.

Electronic Price Sheet may be completed electronically on Excel spreadsheet. Electronically completed spreadsheet should be saved on compact disc (CD) or USB flash drive and included with bid submittal. Bidders must also print out a hardcopy of the completed Price Sheet, sign where indicated, and submit with the bid. **DO NOT MODIFY OR REISSUE THE PRICE SHEET; USE THE PRICE SHEET FORM PROVIDED.**

Note* Please ensure that if you use a third party carrier (DHL Express, FedEx, UPS, USPS, etc.) that they are properly instructed to deliver your bid only to Purchasing Services on the third (3rd) floor at the above address. **Vendors are advised that U.S. Postal Service 1st Class and Express mail is delivered to a P.O. Box and is not delivered to the Purchasing Services Office. Delivery via the USPS is at the Vendor's risk. To be considered, a bid must be accepted in Purchasing Services no later than the ITB closing date and time.** If the bid is delivered anywhere else, it may not reach Purchasing Services in time.

4. PRE-BID/WALK THROUGH

N/A

5. MATERIALS

Aggregate must be in accordance with FDOT Standard Specifications for Road and Bridge Construction. Section 901, Table 1. and must be FDOT certified.

6. ESTIMATED QUANTITIES

Please note that the quantities listed on the attached Price Sheet are estimates only, and in no way constitute a minimum or maximum volume to be purchased during the term of this agreement. The actual amount purchased annually under this agreement may be less than, or more than the quantities provided.

7. Aggregate items are to be priced as follows: Price as County Pick-up with vendor loading into County (or County trucking services) vehicle; and price as vendor loaded and vendor delivered based on area.

8. Pea Stone price must be based on a #89 or ½ inch or less smooth type river rock or equivalent. No calcium or lime based rock will be accepted. It must be a non-calcareous rock.

9. Granite rock price must be based on ¾ inch size.

Note* This bid may be awarded to multiple vendors if determined to be in the County's best interest.

BREVARD COUNTY BOARD OF COUNTY COMMISSIONERS
INDEMNIFICATION AND INSURANCE REQUIREMENTS
AGGREGATE (57 STONE & PEA GRAVEL)
B-6-19-12

INDEMNIFICATION

The County shall be held harmless against any and all claims for bodily injury, sickness, disease, death, personal injury, damage to property or loss of use of any property or assets resulting therefrom, arising out of or resulting from the performance of the products or from the services for which the County is contracting hereunder, provided such is caused in whole or in part by any negligent act or omission of the vendor, or any subcontractor or any of their agents or employees, or arises from a job-related injury.

The vendor agrees to indemnify the County and pay the cost of the County's legal defenses, including fees of attorneys as may be selected by the County, for all claims described in the hold harmless clause herein. Such payment on behalf of the County shall be in addition to any and all other legal remedies available to the County and shall not be considered to be the County's exclusive remedy.

It is agreed by the parties hereto that the Vendor has received specific consideration under this agreement for this hold harmless/indemnification provision.

INSURANCE REQUIREMENTS

The vendor providing services under this agreement will be required to procure and maintain, at their own expense and without cost to the County, until final acceptance by the County of all products or services covered by the purchase order or contract, the following types of insurance. The policy limits required are to be considered minimum amounts:

General Liability Insurance policy with a \$1,000,000 combined single limit for each occurrence to include the following coverage: Operations, Products and Completed Operations, Personal Injury, Contractual Liability covering this contract, "X-C-U" hazards, and Errors & Omissions.

Auto Liability Insurance, which includes coverage for all owned, non-owned and rented vehicles with a \$1,000,000 combined single limit for each occurrence.

Workers' Compensation and Employers Liability Insurance covering all employees of the vendor and subcontractors, as required by law.

In the event that the contract involves professional or consulting services, in addition to the aforementioned insurance requirements, the vendor shall also be protected by a Professional Liability Insurance Policy in the amount of \$1,000,000 per claim.

In the event the contract involves services related to construction projects, the vendor shall also procure and maintain a Builders Risk Insurance Policy or Installation Floater with loss limits equal to the value of the construction project.

In addition to the above, Specialty Insurance policies covering specific risks of loss (including but not limited to, for example; Longshore coverage, Crane and Rigging, Inland Marine, etc.) may be required by Brevard County Insurance and Risk Management. Any additional specialty insurance coverage requirement will be dictated by the specific goods, products or services provided under the subject contract and insurance underwriting standards, practices, procedures or products available in the commercial insurance market at the time of the contract inception. The Vendor is required to procure and maintain all such specialty coverage in accordance with prudent business practices within the Vendors industry.

The awarded vendor shall have five (5) days to provide certificates of insurance to the County demonstrating that the aforementioned insurance requirements have been met prior to the commencement of work under this contract. **The certificate(s) of insurance (COI) shall indicate that the policies have been endorsed to cover the County as an additional insured (a waiver of subrogation in lieu of additional insured status on the workers' compensation policy is acceptable)** and that these policies may not be canceled or modified without thirty (30) days prior written notice to the County.

The insurance coverage enumerated above constitutes the minimum requirements and shall in no way lessen or limit the liability of the vendor under the terms of the contract. Sub-Contractor's insurance shall be the responsibility of the vendor.

AGGREGATE (57 STONE & PEA GRAVEL)
B-6-19-12
CONFIRMATION OF DRUG-FREE WORKPLACE FORM

In accordance with Section 287.087, Florida Statutes, "[w]henver two or more bids are equal with respect to price, quality, and service which are received by any political subdivision for the procurement of commodities or contractual services, a bid received from a business that certifies that it has implemented a drug-free workplace program shall be given preference in the award process. In order to have a drug-free workplace program, a business shall:

- (1) Publish a statement notifying employees that the unlawful manufacture, distribution, dispensing, possession, or use of a controlled substance is prohibited in the workplace and specifying the actions that will be taken against employees for violations of such prohibition.
- (2) Inform employees about the dangers of drug abuse in the workplace, the business's policy of maintaining a drug-free workplace, any available drug counseling, rehabilitation, and employee assistance programs, and the penalties that may be imposed upon employees for drug abuse violations.
- (3) Give each employee engaged in providing the commodities or contractual services that are under bid a copy of the statement specified in subsection (1).
- (4) In the statement specified in subsection (1), notify the employees that, as a condition of working on the commodities or contractual services that are under bid, the employee will abide by the terms of the statement and will notify the employer of any conviction of, or plea of guilty or nolo contendere to, any violation of chapter 893 or of any controlled substance law of the United States or any state, for a violation occurring in the workplace no later than 5 days after such conviction.
- (5) Impose a sanction on, or require the satisfactory participation in a drug abuse assistance or rehabilitation program if such is available in the employee's community by, any employee who is so convicted.
- (6) Make a good faith effort to continue to maintain a drug-free workplace through implementation of this section."

As the person authorized to sign the statement, I certify that this firm complies with the above requirements and the Florida Statutes Section 287.087. This form is in conjunction with Brevard County's General Conditions, Item 27, Drug-Free Workplace.

Business Name

Bid Number and Name

Authorized Representative's Signature

Date

Name

Position

AGGREGATE (57 STONE & PEA GRAVEL)

B-6-19-12

REFERENCE FORM

List a minimum of three (3) / maximum five (5) customers for the services specified in the solicitation in the spaces provided.

Note: A contact person shall be someone who has personal knowledge of the bidder's performance for the specific requirement listed. Contact person must have been informed that they are being used as a reference and that the County may be calling them. Do not list persons who will be unable to answer specific questions regarding the requirements.

Ref #1. Customer/Client: _____
Date of Services: _____
Description of Services: _____
Street Address: _____
City, State, ZIP Code: _____
Telephone #: _____ Fax #: _____
Contact Person: _____ Email: _____

Ref #2. Customer/Client: _____
Date of Services: _____
Description of Services: _____
Street Address: _____
City, State, ZIP Code: _____
Telephone #: _____ Fax #: _____
Contact Person: _____ Email: _____

Ref #3. Customer/Client: _____
Date of Services: _____
Description of Services: _____
Street Address: _____
City, State, ZIP Code: _____
Telephone #: _____ Fax #: _____
Contact Person: _____ Email: _____

Ref #4. Customer/Client: _____
Date of Services: _____
Description of Services: _____
Street Address: _____
City, State, ZIP Code: _____
Telephone #: _____ Fax #: _____
Contact Person: _____ Email: _____

Ref #5. Customer/Client: _____
Date of Services: _____
Description of Services: _____
Street Address: _____
City, State, ZIP Code: _____
Telephone #: _____ Fax #: _____
Contact Person: _____ Email: _____

BIDDER NAME _____

ADDRESS _____

PRINTED SIGNATURE _____

AUTHORIZED SIGNATURE _____

TELEPHONE # _____ FAX# _____ DATE _____

EMAIL: _____

BREVARD COUNTY BOARD OF COUNTY COMMISSIONERS

CONFIRMATION OF E-VERIFY PARTICIPATION FORM

In accordance with BCC Policy 25 all vendors that conduct business with Brevard County are required to be registered with and utilize the U.S. Department of Homeland Security’s E-Verify System in accordance with the terms governing use of the system.

1. The County shall not enter into, or renew, a contract for goods or services with a Vendor/contractor that is not enrolled into E-Verify. Any Vendor/contractor providing goods or services to the County shall be contractually required to utilize E-Verify to confirm the employment eligibility of any employee hired during the term of the contract.
2. Vendors/contractors shall provide acceptable evidence of their enrollment at the time of the submission of the vendor’s/contractor’s bid/quote/proposal. Acceptable evidence shall include, but not be limited to, a copy of the fully executed E-Verify Memorandum of Understanding for the business and/or a signed copy of this affidavit.
3. All vendors/contractors must meet this requirement unless:
 - a. The contract is solely for goods-based procurement where no services are provided;
or
 - b. Where the requirement is waived by the Board of County Commissioners.
4. A vendor/contractor who registers with and participates in the E-Verify program may not be barred or penalized under BCC Policy 25(3)(V) if, as a result of receiving inaccurate verification information from the E-Verify program, the contractor hires or employs a person who is not eligible for employment.
5. Vendors/contractors shall expressly require any contractor or subcontractor performing work or providing services pursuant to the County contract to likewise utilize the U.S. Department of Homeland Security’s E-Verify system to verify the employment eligibility of all new employees hired by the subcontractor during the contract term.
6. Nothing in BCC Policy 25(3)(V) may be construed to allow intentional discrimination of any class protected by law.

As the person authorized to sign the statement, I certify that this firm complies with the above requirements and the BCC-25. This form is in conjunction with Brevard County’s General Conditions, Unauthorized Alien Workers.

Business Name

Bid Number and Name

Authorized Representative’s Signature

Date

Name

Position

AGGREGATE (57 STONE & PEA GRAVEL)

B-6-19-12

STATEMENT OF NO BID

NOTE: If you do not intend to bid on this requirement, please return this form to:

Brevard County Purchasing Services
2725 Judge Fran Jamieson Way, Bldg C, Suite 303
Viera, FL 32940

We the undersigned have declined to bid on your Bid No. B-6-19-12 for the following reason(s):

- Specifications too "restrictive," i.e., geared toward one brand or manufacturer only (*please specify below*)
- Insufficient time to respond to the Invitation to Bid
- We do not offer this commodity/service or equivalent
- Our product schedule would not permit us to perform
- Specifications unclear (*please specify below*)
- Unable to meet bond or insurance requirements
- Remove our company from vendor database for this commodity/service
- Other (*please specify below*)

Remarks: _____

PLEASE PRINT

COMPANY NAME _____

COMPANY ADDRESS _____

TELEPHONE NUMBER _____

PRINTED SIGNATURE _____

AUTHORIZED SIGNATURE _____

NOTE: Failure to submit either a Bid or a Statement of No Bid may be cause for removal from the Brevard County Purchasing Services vendor database.



GREEN DREAM

Building your green dreams

November 15, 2018

BREVARD COUNTY PURCHASING SERVICES
2725 JUDGE FRAN JAMIESON WAY
BLDG. C, 3rd FLOOR, SUITE C-303
VIERA, FL 32940

SUBJECT: Bid Number: B-6-19-12-Aggregate (57 Stone & Pea Gravel)

Dear Karen DiNatale,

We are pleased to give you our offer for this bid.

Attached you will also find the files below:

1. INVITATION TO BID FORM
2. BIDDER'S CHECKLIST
3. CONFIRMATION OF DRUG-FREE WORKPLACE FORM
4. REFERENCE FORM
5. BREVARD COUNTY BOARD OF COUNTY COMMISSIONERS
6. Bid Price
7. Specification sheets
8. E-Verify Participation Affidavit
9. W-9
10. certificate of Insurance and worker comp
11. Green Dream Registration in Florida
12. Attorney Opinion on Preference
13. List of Contracts-Green Dream International

Should you have further questions, please contact Mark Alexander at telephone number 804-220-0634 or e-mail m.alexander@greendreamgr.com.

Best Regards,

Mark Alexander
Account Manager
Green Dream International
Phone: 202-455-8918
Fax: 202-204-8444

**AGGREGATE (57 STONE & PEA GRAVEL)
B-6-19-12
BIDDER'S CHECKLIST**

The items indicated are required for submission with your bid. Failure to submit any items indicated as required may result in rejection of the bid. Offers to provide required items after the date and time designated for the receipt of bid will not be considered.

- Signed/Notarized Bid Invitation
- Completed and Signed Price Sheet, to include Insurance Indemnification Acknowledgement (Page 15)
- Drug Free Workplace Form
- E-Verify Participation Affidavit
- W-9 Form – Latest Edition
- Reference Sheet

In order for this bid to be valid, the above forms and information shall be completed in their entirety, signed by an authorized representative of the responding vendor, and returned as part of the bid response.

AGGREGATE (57 STONE & PEA GRAVEL)
B-6-19-12
CONFIRMATION OF DRUG-FREE WORKPLACE FORM

In accordance with Section 287.087, Florida Statutes, "[w]henver two or more bids are equal with respect to price, quality, and service which are received by any political subdivision for the procurement of commodities or contractual services, a bid received from a business that certifies that it has implemented a drug-free workplace program shall be given preference in the award process. In order to have a drug-free workplace program, a business shall:

- (1) Publish a statement notifying employees that the unlawful manufacture, distribution, dispensing, possession, or use of a controlled substance is prohibited in the workplace and specifying the actions that will be taken against employees for violations of such prohibition.
- (2) Inform employees about the dangers of drug abuse in the workplace, the business's policy of maintaining a drug-free workplace, any available drug counseling, rehabilitation, and employee assistance programs, and the penalties that may be imposed upon employees for drug abuse violations.
- (3) Give each employee engaged in providing the commodities or contractual services that are under bid a copy of the statement specified in subsection (1).
- (4) In the statement specified in subsection (1), notify the employees that, as a condition of working on the commodities or contractual services that are under bid, the employee will abide by the terms of the statement and will notify the employer of any conviction of, or plea of guilty or nolo contendere to, any violation of chapter 893 or of any controlled substance law of the United States or any state, for a violation occurring in the workplace no later than 5 days after such conviction.
- (5) Impose a sanction on, or require the satisfactory participation in a drug abuse assistance or rehabilitation program if such is available in the employee's community by, any employee who is so convicted.
- (6) Make a good faith effort to continue to maintain a drug-free workplace through implementation of this section."

As the person authorized to sign the statement, I certify that this firm complies with the above requirements and the Florida Statutes Section 287.087. This form is in conjunction with Brevard County's General Conditions, Item 27, Drug-Free Workplace.

Green Dream International LLC

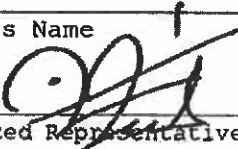
Business Name

Authorized Representative's Signature
Varand Vartanian

Name

ITB/FFS-18/19-31-BASE GRADE LIMEROCK
WITHIN SEMINOLE STATE

Bid Number and Name
November 15, 2018

Date
President

Position

AGGREGATE (57 STONE & PEA GRAVEL)

B-6-19-12

REFERENCE FORM

List a minimum of three (3) / maximum five (5) customers for the services specified in the solicitation in the spaces provided.

Note: A contact person shall be someone who has personal knowledge of the bidder's performance for the specific requirement listed. Contact person must have been informed that they are being used as a reference and that the County may be calling them. Do not list persons who will be unable to answer specific questions regarding the requirements.

Ref #1. Customer/Client: Florida Department of Agriculture and Consumer Services
Date of Services: May 3, 2018
Description of Services: Aggregate for Withlacoochee State Forest
Street Address: Withlacoochee Forestry Center 15019 Broad St
City, State, ZIP Code: Brooksville, FL 34601
Telephone #: (352) 797-4124 Fax #: (352) 797-4103
Contact Person: Melvin Reese Jr. Email: Melvin.Reesejr@freshfromflorida.com

Ref #2. Customer/Client: FWS, DIVISION OF CONTRACTING AND GR
Date of Services: September 2017
Description of Services: Procure Ditch Lining and Limerock to repair refuge levees
Street Address: ATLANTA GA 30345-3310 SUITE 310
City, State, ZIP Code: 1875 CENTURY BOULEVARD
Telephone #: 404- 679-4055 Fax #: _____
Contact Person: Tracy Gamble Email: tracy_gamble@fws.gov

Ref #3. Customer/Client: USDA FOREST SERVICE
Date of Services: 01/17/2017
Description of Services: Aggregate and chip rock delivery 2016 Road Materials
Street Address: USDA Forest Service Sidney R. Yates Federal Building 201
City, State, ZIP Code: 14th Street, SW Washington, DC
Telephone #: 530 478 6162 Fax #: _____
Contact Person: Raymond Garleb Email: rgarleb@fs.fed.us

Ref #4. Customer/Client: NATIONAL PARK SERVICE, OLYMPIC NATIONAL PARK
Date of Services: 07/18/2017
Description of Services: Paving in Elwha & Mora, Olympic National Park
Street Address: Project locations within Elwha Subdistrict within Clallam County, Olympic National Park,
City, State, ZIP Code: _____
Telephone #: 360-565-3175 Fax #: _____
Contact Person: Cody Manzer Email: cody_manzer@nps.gov

Ref #5. Customer/Client: USDA FOREST SERVICE
Date of Services: 06/09/2017
Description of Services: provide and delivery of crushed lime aggregate
Street Address: USDA Forest Service Sidney R. Yates Federal Building 201
City, State, ZIP Code: 14th Street, SW Washington, DC
Telephone #: 3045362144 Fax #: _____
Contact Person: CARRIE EDWARDS Email: cledwards@fs.fed.us

BIDDER NAME Green Dream International LLC
ADDRESS 2331 Mill Rd, Suite 100 Alexandria, VA 22314
PRINTED SIGNATURE _____
AUTHORIZED SIGNATURE Varand Vartanian
TELEPHONE # 202-470-4600 FAX# 202 204 8444 DATE November 15, 2018
EMAIL: info@greendreamgr.com

BREVARD COUNTY BOARD OF COUNTY COMMISSIONERS

CONFIRMATION OF E-VERIFY PARTICIPATION FORM

In accordance with BCC Policy 25 all vendors that conduct business with Brevard County are required to be registered with and utilize the U.S. Department of Homeland Security's E-Verify System in accordance with the terms governing use of the system.

1. The County shall not enter into, or renew, a contract for goods or services with a Vendor/contractor that is not enrolled into E-Verify. Any Vendor/contractor providing goods or services to the County shall be contractually required to utilize E-Verify to confirm the employment eligibility of any employee hired during the term of the contract.
2. Vendors/contractors shall provide acceptable evidence of their enrollment at the time of the submission of the vendor's/contractor's bid/quote/proposal. Acceptable evidence shall include, but not be limited to, a copy of the fully executed E-Verify Memorandum of Understanding for the business and/or a signed copy of this affidavit.
3. All vendors/contractors must meet this requirement unless:
 - a. The contract is solely for goods-based procurement where no services are provided; or
 - b. Where the requirement is waived by the Board of County Commissioners.
4. A vendor/contractor who registers with and participates in the E-Verify program may not be barred or penalized under BCC Policy 25(3)(V) if, as a result of receiving inaccurate verification information from the E-Verify program, the contractor hires or employs a person who is not eligible for employment.
5. Vendors/contractors shall expressly require any contractor or subcontractor performing work or providing services pursuant to the County contract to likewise utilize the U.S. Department of Homeland Security's E-Verify system to verify the employment eligibility of all new employees hired by the subcontractor during the contract term.
6. Nothing in BCC Policy 25(3)(V) may be construed to allow intentional discrimination of any class protected by law.

As the person authorized to sign the statement, I certify that this firm complies with the above requirements and the BCC-25. This form is in conjunction with Brevard County's General Conditions, Unauthorized Alien Workers.

Green Dream International LLC
Business Name

Authorized Representative's Signature

Varand Vartanian
Name

ITB/FFS-18/19-31-BASE GRADE LIMEROCK
WITHIN SEMINOLE STATE
Bid Number and Name

November 15, 2018
Date

President
Position

ITEM	DESCRIPTION (County Pickup)	EST. QTY.	Material Cost per Ton	EXTENDED PRICE
1	Size #4 or 57 Calcareous Course Aggregate From Martin Marietta Canaveral Marine	4000	\$ 26.00	\$104,000.00
2	Size #89 (pea gravel) Non-Calcareous From Martin Marietta Canaveral Marine	1000	\$ 35.00	\$ 35,000.00
3	Size # 3/4" Granite Rock Non-Calcareous #57 Granite which covers both 1/2" & 3/4" from Cemex City Point Quarry	1000	\$ 39.75	\$ 39,750.00
4	Size # 1/2" Granite Rock Non-Calcareous Martin Marietta #7(1/2" minus) from Canaveral Marine	1000	\$ 35.00	\$ 35,000.00
5	Lime Rock Material - Lime Rock bearing ratio not less than 100; at least 97% (by weight) of the material must pass a 3-1/2 sieve	5000	\$ 18.00	\$ 90,000.00
		TOTALS		\$303,750.00

Delivered to North Area

ITEM	Description	EST. QTY.	COST PER TON	EXTENDED PRICE	base fuel surcharge as a % of \$/Ton	Total with fuel surcharge
6	Size #4 or 57 Calcareous Course Aggregate	1000	\$ 35.00	\$ 35,000.00	0%	\$35,000.00
8	Size 1/2 or #89 (pea gravel) River Rock #89 Stone - Granite FDOT Spec. from City Point Quarry	333	\$ 45.75	\$ 15,234.75	0%	\$15,234.75

9	Size # 3/4" Granite Rock Non-Calcareous #57 Granite which covers both 1/2" & 3/4" from City Point Quarry	333	\$ 45.00	\$ 14,985.00	0%	\$14,985.00
7	Size # 1/2" Granite Rock Non-Calcareous #57 Granite which covers both 1/2" & 3/4" from City Point Quarry	333	\$ 45.00	\$ 14,985.00	0%	\$14,985.00

Delivered to Central Area

ITEM	Description	EST. QTY.	COST PER TON	EXTENDED PRICE	base fuel surcharge	Total with fuel surcharge
6	Size #4 or 57 Calcareous Course Aggregate	2000	\$ 35.00	\$ 70,000.00	0%	\$70,000.00
7	Size 1/2 or #89 (pea gravel) River Rock #89 Stone - Granite FDOT Spec.from City Point Quarry	333	\$ 55.00	\$ 18,315.00	0%	\$18,315.00
8	Size # 3/4" Granite Rock Non-Calcareous #57 Granite which covers both 1/2" & 3/4" from City Point Quarry	333	\$ 45.00	\$ 14,985.00	0%	\$14,985.00
9	Size # 1/2" Granite Rock Non-Calcareous #57 Granite which covers both 1/2" & 3/4" from City Point Quarry	333	\$ 45.00	\$ 14,985.00	0%	\$14,985.00

Delivered to South Area

ITEM	Description	EST. QTY.	COST PER TON	EXTENDED PRICE	base fuel surcharge	Total with fuel surcharge
6	Size #4 or 57 Calcareous Course Aggregate	1000	\$ 39.00	\$ 39,000.00	0%	\$39,000.00
7	Size 1/2 or #89 (pea gravel) River Rock #89 Stone - Granite FDOT Spec.from City Point Quarry	333	\$ 55.00	\$ 18,315.00	0%	\$18,315.00
8	Size # 3/4" Granite Rock Non-Calcareous #57 Granite which covers both 1/2" & 3/4" from City Point Quarry	333	\$ 49.00	\$ 16,317.00	0%	\$16,317.00

9	Size # 1/2" Granite Rock Non-Calcareous #57 Granite which covers both 1/2" & 3/4" from City Point Quarry	333	\$ 49.00	\$ 16,317.00	0%	\$16,317.00
---	--	-----	----------	--------------	----	-------------

ACH PAYMENTS

Does your company accept ACH Payment Method? Yes / No

PROMPT PAYMENT DISCOUNT

Brevard County shall remit payment in accordance with the Florida Prompt Payment Act, Florida Statutes section 218.70. Bidders may offer cash discounts for prompt payment but they will not be considered in determination of award. If a bidder offers a discount, it is understood that the discount time will be from the date of satisfactory delivery, at the place of acceptance, and receipt of correct invoice, at the office specified, whichever occurs last.

* If Prompt Payment Discount is offered, please state discount and terms:

ADDENDUM ACKNOWLEDGMENT

Bidder acknowledges receipt of amendments by indicating amendment number and its date of issue.

Add. No. _____ Dated _____ // Add. No. _____ Dated _____

Add. No. _____ Dated _____ // Add. No. _____ Dated _____

I hereby acknowledge that I have read, understand, and agree to all terms, conditions, insurance, scope of work, specifications and pricing for Bid #B-6-19-12/Aggregate (57 Stone Pea Gravel).

COMPANY NAME: Green Dream International LLC

ADDRESS: 2331 Mill Rd, Suite 100, Alexandria, VA 22314

AUTHORIZED SIGNATURE _____ 

PRINTED SIGNATURE: Varand Vartanian /President DATE: November 15, 2018

TELEPHONE # 804-220-0634

FAX # 202-204-8444

EMAIL: m.alexander@greendreamgr.com

Specification for Item #4 Pickup



Basic Quality Statistical Summary Report

Plant 20405-Port Canaveral II
Product 0700-#7 FDOT Superpave
Specification #7 FDOT Superpave Code 44
Period 05/02/2018 - 08/02/2018

Sieve/Test	Tests	Average	Target	Specification
1" (25mm)	5	100.0	100	95-100
3/4" (19mm)	5	100.0	100	95-100
1/2" (12.5mm)	5	93.6	94	84-100
3/8" (9.5mm)	5	67.4	71	56-86
#4 (4.75mm)	5	13.7	17	7-27
#8 (2.36mm)	5	4.2	2	0-7
Pan	5	0.00		

Query Query Selections
Date Created 08/02/2018
Date Range 05/02/2018 - 08/02/2018
Plant Port Canaveral II



Specifications for Items 3 and 4 Delivered

Basic Quality Statistical Summary Report

Plant 1341-Macon (Postell) Quarry
Product 570-# 57 Cert for FDOT code 10
Specification #57 Code 10
Period 07/24/2018 - 10/24/2018

Sieve/Test	Tests	Average	St Dev	Target	Specification
Absorption	3	0.46	0.029		
SPGR (Dry,Gsb)	3	2.701	0.0108		
SPGR (SSD)	3	2.713	0.0117		
SPGR (Apparent,Gsa)	3	2.735	0.0131		
LA Abrasion (B,500)	2	18.7	0.99		



Specification for Item 2 Delivered

Basic Quality Statistical Summary Report

Plant 1341-Macon (Postell) Quarry
Product 890-# 89 S-1-B Code 52
Specification CAM #89 S-1-B Code 52
Period 07/24/2018 - 10/24/2018

Sieve/Test	Tests	Average	St Dev	Target	Specification
FM	80	5.69	0.029		
Total Moisture	80	3.53	0.202		
Absorption	14	0.61	0.059		
SPGR (Dry, Gsb)	14	2.693	0.0117		2.655-2.755
SPGR (SSD)	14	2.710	0.0123		
SPGR (Apparent, Gsa)	14	2.738	0.0139		
LA Abrasion (C,500)	3	21.2	0.64		



Enter Old and New Passwords

i Passwords must have the following characteristics:

- At least one uppercase or lowercase letter;
- At least one number;
- At least one special character; Special characters include: ! @ \$ % * { } < > ? : ; { } + - ~
- Contain no more than two identical consecutive characters in any position from the previous password;
- Contain a non-numeric in the first and last positions;
- Not be identical to the User ID.

Additionally as a policy, it is recommended that passwords should not:

- Contain any dictionary word;
- Contain any proper noun or the name of any person, pet, child, or fictional character, nor any employee serial number, Social Security Number, birth date, phone number, or any information that could be readily guessed about the creator of the password;
- Contain any simple pattern of letters or numbers, such as "qwerly" or "xyz123";
- Be any word, noun, or name spelled backwards.

* Old Password

* New Password

* Re-type New Password

Enter Password Challenge Questions and Answers

Password Challenge Question #1

What is the name of your first pet? ▼

* Answer

Boogy

Password Challenge Question #2

What is your mother's maiden name? ▼

* Answer

Esm

Password Challenge Question #3

What is your favorite movie? ▼

* Answer

Fiddler on the roof

Submit



**Request for Taxpayer
 Identification Number and Certification**

Give Form to the
 requester. Do not
 send to the IRS.

Print or type See Specific Instructions on page 2.	Name (as shown on your income tax return) Green Dream International LLC	
	Business name/disregarded entity name, if different from above	
	Check appropriate box for federal tax classification: <input type="checkbox"/> Individual/sole proprietor <input type="checkbox"/> C Corporation <input type="checkbox"/> S Corporation <input type="checkbox"/> Partnership <input type="checkbox"/> Trust/estate <input checked="" type="checkbox"/> Limited liability company. Enter the tax classification (C=C corporation, S=S corporation, P=partnership) ▶ C <input type="checkbox"/> Exempt payee <input type="checkbox"/> Other (see instructions) ▶	
	Address (number, street, and apt. or suite no.) 2331 Mill Rd, Suite 100	Requester's name and address (optional)
City, state, and ZIP code Alexandria, VA 22314		
List account number(s) here (optional)		

Part I Taxpayer Identification Number (TIN)

Enter your TIN in the appropriate box. The TIN provided must match the name given on the "Name" line to avoid backup withholding. For individuals, this is your social security number (SSN). However, for a resident alien, sole proprietor, or disregarded entity, see the Part I instructions on page 3. For other entities, it is your employer identification number (EIN). If you do not have a number, see *How to get a TIN* on page 3.

Note. If the account is in more than one name, see the chart on page 4 for guidelines on whose number to enter.

Social security number									
				-					
Employer identification number									
4	6	-	0	5	2	2	7	5	8

Part II Certification

Under penalties of perjury, I certify that:

- The number shown on this form is my correct taxpayer identification number (or I am waiting for a number to be issued to me), and
- I am not subject to backup withholding because: (a) I am exempt from backup withholding, or (b) I have not been notified by the Internal Revenue Service (IRS) that I am subject to backup withholding as a result of a failure to report all interest or dividends, or (c) the IRS has notified me that I am no longer subject to backup withholding, and
- I am a U.S. citizen or other U.S. person (defined below).

Certification Instructions. You must cross out item 2 above if you have been notified by the IRS that you are currently subject to backup withholding because you have failed to report all interest and dividends on your tax return. For real estate transactions, item 2 does not apply. For mortgage interest paid, acquisition or abandonment of secured property, cancellation of debt, contributions to an individual retirement arrangement (IRA), and generally, payments other than interest and dividends, you are not required to sign the certification, but you must provide your correct TIN. See the instructions on page 4.

Sign Here	Signature of U.S. person ▶	Date ▶ June 22, 2018
------------------	----------------------------	-----------------------------

General Instructions

Section references are to the Internal Revenue Code unless otherwise noted.

Purpose of Form

A person who is required to file an information return with the IRS must obtain your correct taxpayer identification number (TIN) to report, for example, income paid to you, real estate transactions, mortgage interest you paid, acquisition or abandonment of secured property, cancellation of debt, or contributions you made to an IRA.

Use Form W-9 only if you are a U.S. person (including a resident alien), to provide your correct TIN to the person requesting it (the requester) and, when applicable, to:

- Certify that the TIN you are giving is correct (or you are waiting for a number to be issued),
- Certify that you are not subject to backup withholding, or
- Claim exemption from backup withholding if you are a U.S. exempt payee. If applicable, you are also certifying that as a U.S. person, your allocable share of any partnership income from a U.S. trade or business is not subject to the withholding tax on foreign partners' share of effectively connected income.

Note. If a requester gives you a form other than Form W-9 to request your TIN, you must use the requester's form if it is substantially similar to this Form W-9.

Definition of a U.S. person. For federal tax purposes, you are considered a U.S. person if you are:

- An individual who is a U.S. citizen or U.S. resident alien,
- A partnership, corporation, company, or association created or organized in the United States or under the laws of the United States,
- An estate (other than a foreign estate), or
- A domestic trust (as defined in Regulations section 301.7701-7).

Special rules for partnerships. Partnerships that conduct a trade or business in the United States are generally required to pay a withholding tax on any foreign partners' share of income from such business. Further, in certain cases where a Form W-9 has not been received, a partnership is required to presume that a partner is a foreign person, and pay the withholding tax. Therefore, if you are a U.S. person that is a partner in a partnership conducting a trade or business in the United States, provide Form W-9 to the partnership to establish your U.S. status and avoid withholding on your share of partnership income.



CERTIFICATE OF LIABILITY INSURANCE

DATE (MM/DD/YYYY)
01/03/2018

THIS CERTIFICATE IS ISSUED AS A MATTER OF INFORMATION ONLY AND CONFERS NO RIGHTS UPON THE CERTIFICATE HOLDER. THIS CERTIFICATE DOES NOT AFFIRMATIVELY OR NEGATIVELY AMEND, EXTEND OR ALTER THE COVERAGE AFFORDED BY THE POLICIES BELOW. THIS CERTIFICATE OF INSURANCE DOES NOT CONSTITUTE A CONTRACT BETWEEN THE ISSUING INSURER(S), AUTHORIZED REPRESENTATIVE OR PRODUCER, AND THE CERTIFICATE HOLDER.

IMPORTANT: If the certificate holder is an ADDITIONAL INSURED, the policy(ies) must have ADDITIONAL INSURED provisions or be endorsed. If SUBROGATION IS WAIVED, subject to the terms and conditions of the policy, certain policies may require an endorsement. A statement on this certificate does not confer rights to the certificate holder in lieu of such endorsement(s).

PRODUCER Kerxton Insurance Agency, Inc. 7879 Limestone Drive, Ste 155 Gainesville, VA 20155 Phil Borner	703-352-0030	CONTACT NAME: Phil Borner PHONE (A/C, No, Ext): 703-352-0030 E-MAIL ADDRESS: pborner@kerxton.com	FAX (A/C, No): 703-591-3948
INSURED Green Dream International, LLC 2331 Mill Rd. Ste. 100 Alexandria, VA 22314	INSURER(S) AFFORDING COVERAGE		NAIC #
INSURER A: Selective Insurance Company			
INSURER B: NCCI			
INSURER C:			
INSURER D:			
INSURER E:			
INSURER F:			

COVERAGES CERTIFICATE NUMBER: REVISION NUMBER:

THIS IS TO CERTIFY THAT THE POLICIES OF INSURANCE LISTED BELOW HAVE BEEN ISSUED TO THE INSURED NAMED ABOVE FOR THE POLICY PERIOD INDICATED. NOTWITHSTANDING ANY REQUIREMENT, TERM OR CONDITION OF ANY CONTRACT OR OTHER DOCUMENT WITH RESPECT TO WHICH THIS CERTIFICATE MAY BE ISSUED OR MAY PERTAIN, THE INSURANCE AFFORDED BY THE POLICIES DESCRIBED HEREIN IS SUBJECT TO ALL THE TERMS, EXCLUSIONS AND CONDITIONS OF SUCH POLICIES. LIMITS SHOWN MAY HAVE BEEN REDUCED BY PAID CLAIMS.

INSR LTR	TYPE OF INSURANCE	ADDL SUBR INSD WVD	POLICY NUMBER	POLICY EFF (MM/DD/YYYY)	POLICY EXP (MM/DD/YYYY)	LIMITS
A	COMMERCIAL GENERAL LIABILITY CLAIMS-MADE <input checked="" type="checkbox"/> OCCUR GEML AGGREGATE LIMIT APPLIES PER: <input checked="" type="checkbox"/> POLICY <input type="checkbox"/> PRO-JECT <input type="checkbox"/> LOC OTHER		S 2191158	09/28/2017	09/28/2018	EACH OCCURRENCE \$ 1,000,000 DAMAGE TO RENTED PREMISES (Ea occurrence) \$ 500,000 MED EXP (Any one person) \$ 15,000 PERSONAL & ADV INJURY \$ 1,000,000 GENERAL AGGREGATE \$ 2,000,000 PRODUCTS - COMP/OP AGG \$ 2,000,000
A	AUTOMOBILE LIABILITY ANY AUTO OWNED AUTOS ONLY <input checked="" type="checkbox"/> HIRED AUTOS ONLY SCHEDULED AUTOS <input checked="" type="checkbox"/> NON-OWNED AUTOS ONLY		S 2191158	09/28/2017	09/28/2018	COMBINED SINGLE LIMIT (Ea accident) \$ 1,000,000 BODILY INJURY (Per person) \$ BODILY INJURY (Per accident) \$ PROPERTY DAMAGE (Per accident) \$
	UMBRELLA LIAB <input type="checkbox"/> OCCUR EXCESS LIAB <input type="checkbox"/> CLAIMS-MADE DED RETENTION \$					EACH OCCURRENCE \$ AGGREGATE \$
B	WORKERS COMPENSATION AND EMPLOYERS' LIABILITY ANY PROPRIETOR/PARTNER/EXECUTIVE OFFICER/MEMBER EXCLUDED? (Mandatory in NH) If yes, describe under DESCRIPTION OF OPERATIONS below	Y/N <input type="checkbox"/>	N/A TBD	12/25/2017	12/25/2018	<input checked="" type="checkbox"/> PER STATUTE <input type="checkbox"/> OTHER E L EACH ACCIDENT \$ 500,000 E L DISEASE - EA EMPLOYEE \$ 500,000 E L DISEASE - POLICY LIMIT \$ 500,000

DESCRIPTION OF OPERATIONS / LOCATIONS / VEHICLES (ACORD 101, Additional Remarks Schedule, may be attached if more space is required)

VERIFICATION OF INSURANCE ONLY

CERTIFICATE HOLDER

GREENDR

Green Dream International LLC
2331 MILL RD STE 100
ALEXANDRIA, VA 22314

CANCELLATION

SHOULD ANY OF THE ABOVE DESCRIBED POLICIES BE CANCELLED BEFORE THE EXPIRATION DATE THEREOF, NOTICE WILL BE DELIVERED IN ACCORDANCE WITH THE POLICY PROVISIONS.

AUTHORIZED REPRESENTATIVE



**FLORIDA DEPARTMENT OF STATE
Division of Corporations**

May 9, 2018

CSC

Qualification documents for GREEN DREAM INTERNATIONAL LLC were filed on May 8, 2018, and assigned document number M18000004443. Please refer to this number whenever corresponding with this office.

Your limited liability company is authorized to transact business in Florida as of the file date.

To maintain "active" status with the Division of Corporations, an annual report must be filed yearly between January 1st and May 1st beginning in the year following the file date or effective date indicated above. If the annual report is not filed by May 1st, a \$400 late fee will be added.

A Federal Employer Identification Number (FEI/EIN) will be required when this report is filed. Apply today with the IRS online at:

<https://sa.www4.irs.gov/modiein/individual/index.jsp>.

Please notify this office if the limited liability company address changes.

Should you have any questions regarding this matter, please contact this office at the address given below.

Octavia L Simmons
Regulatory Specialist III
Registration Section
Division of Corporations

Letter Number: 218A00009554

Account number: I20000000195

Amount charged: 125.00

www.sunbiz.org

Division of Corporations - P.O. BOX 6327 -Tallahassee, Florida 32314

APPLICATION BY FOREIGN LIMITED LIABILITY COMPANY FOR AUTHORIZATION TO TRANSACT BUSINESS IN FLORIDA

IN COMPLIANCE WITH SECTION 605.0902, FLORIDA STATUTES, THE FOLLOWING IS SUBMITTED TO REGISTER A FOREIGN LIMITED LIABILITY COMPANY TO TRANSACT BUSINESS IN THE STATE OF FLORIDA:

1. Green Dream International LLC
(Name of Foreign Limited Liability Company; must include "Limited Liability Company," "L.L.C.," or "LLC.")

(If name unavailable, enter alternate name adopted for the purpose of transacting business in Florida. The alternate name must include "Limited Liability Company," "L.L.C.," or "LLC.")

2. Arkansas
(Jurisdiction under the law of which foreign limited liability company is organized)

3. _____
(FBI number, if applicable)

4. _____
(Date first transacted business in Florida, if prior to registration.)
 (See sections 605.0904 & 605.0905, F.S. to determine penalty liability)

5. 2331 Mill Rd, STE 100
(Street Address of Principal Office)
Alexandria, VA, 22314

6. 2331 Mill Rd, Ste 100
(Mailing Address)
Alexandria, VA, US, 22314



7. Name and street address of Florida registered agent: (P.O. Box NOT acceptable)

Name: Corporation Service Company

Office Address: 1201 Hays Street

Tallahassee, Florida 32301
(City) (Zip code)

Registered agent's acceptance:

Having been named as registered agent and to accept service of process for the above stated limited liability company at the place designated in this application, I hereby accept the appointment as registered agent and agree to act in this capacity. I further agree to comply with the provisions of all statutes relative to the proper and complete performance of my duties, and I am familiar with and accept the obligations of my position as registered agent.

Emily Croft
(Registered agent's signature) **Emily Croft**
Asst. Vice President

8. The name, title or capacity and address of the person(s) who has/have authority to manage is/are:

<u>Title or Capacity:</u>	<u>Name and Address:</u>	<u>Title or Capacity:</u>	<u>Name and Address:</u>
<u>President</u>	<u>Varand Vartanian</u> <small>2331 Mill Rd, Ste 100 Alexandria, VA 22314</small>	_____	_____
_____	_____	_____	_____
_____	_____	_____	_____

(Use attachments if necessary)

9. Attached is a certificate of existence, no more than 90 days old, duly authenticated by the official having custody of records in the jurisdiction under the law of which it is organized. (If the certificate is in a foreign language, a translation of the certificate under oath of the translator must be submitted)

[Signature]
Signature of an authorized person

10. This document is executed in accordance with section 605.0203 (1) (b), Florida Statutes. I am aware that any false information submitted in a document to the Department of State constitutes a third degree felony as provided for in s.817.155, F.S.

Varand Vartanian
Typed or printed name of signer



**Arkansas Secretary of State
Mark Martin**

State Capitol Building ♦ Little Rock, Arkansas 72201-1094 ♦ 501-682-3409

Certificate of Good Standing

I, Mark Martin, Secretary of State of the State of Arkansas, and as such, keeper of the records of domestic and foreign corporations, do hereby certify that the records of this office show

GREEN DREAM INTERNATIONAL LLC

authorized to transact business in the State of Arkansas as a Limited Liability Company, filed Articles of Organization in this office June 26, 2009.

Our records reflect that said entity, having complied with all statutory requirements in the State of Arkansas, is qualified to transact business in this State.



In Testimony Whereof, I have hereunto set my hand and affixed my official Seal. Done at my office in the City of Little Rock, this 4th day of May 2018.

Mark Martin

Mark Martin
Secretary of State

Online Certificate Authorization Code: 948a29a0ea3254c

To verify the Authorization Code, visit sos.arkansas.gov

MITCHELL | WILLIAMS

H. MAURICE MITCHELL
(1925-2011)
WILLIAM H.L. WOODYARD, III
(1945-2014)

MICHELE ALLGOOD
JOHN K. BAKER
MELISSA BANDY
SHERRY P. BARTLEY
TRAY BAXTER
R. T. BEARD, III
BENJAMIN D. BRENNER¹
JASON T. BROWNING
MICHELLE L. BROWNING
JOHN S. BRYANT
C. DOUGLAS BUFORD, JR.
BURNIE BURNER²
FREDERICK K. CAMPBELL³
CHARLES B. CUETT, JR.⁴
CRAIG R. COCKRELL
ADRIA W. CONKLIN⁵
KEN COOK
COURTNEY C. CROUCH, III
ELISABETH S. DELARGY⁶
DOAK FOSTER⁷
BYRON FRIELAND

KAREN P. FREEMAN⁸
ALLAN GATES⁹
KATHLYN GRAVES
JILL R. GRIMBLEY¹⁰
HAROLD W. HAMLIN
MEGAN D. HARGRAVES
L. KYLE HEFFLEY¹¹
BEN D. JACKSON
ANTON L. JANIK, JR.⁹
WENDY L. JOHNSON
MARGARET A. JOHNSTON
M. SAMUEL JONES III
D. NICOLE LOVELL
AMANDA L. MACLENNAN²
WALTER E. MAY
BRUCE MCCANDLESS III¹⁰
CHRISTOPHER A. MCNULTY
LANCE R. MILLER
STUART P. MILLER
T. ARK MONROE, III³
JENNIFER R. PIERCE
BRIAN A. PIPKIN
CHRISTOPHER D. PLUMLEE
JULIE M. POMERANTZ¹¹
SCOTT PROVENCHER

425 WEST CAPITOL AVENUE, SUITE 1800
LITTLE ROCK, ARKANSAS 72201-3525
TELEPHONE 501-688-8800
FAX 501-688-8807

LYN P. PRUITT
CHRISTOPHER T. ROGERS
J. SCOTT SCHALLHORN
BARRY G. SKOLNICK¹²
DERRICK W. SMITH
STAN D. SMITH
MANDY L. STANTON
ZACHARY T. STEADMAN
CLAYBORNE S. STONE
JEFFREY THOMAS
MARY CATHERINE WAY
WALTER G. WRIGHT, JR.

JOHN E. ALEXANDER
DEVIN R. BATES
KATIE BRANSCUM
MATT BRUNSON
BRYCE G. CRAWFORD
LAUREN N. DILJEIA
NATALIE M. DODD
ASHLEY L. OILL
DAVID F. KOEHLER
BETHANY N. MARSHALL
JACOB MCELROY
BRITTANY H. PETTINGILL

KENDRA FRUITT
SAINABOU M. SONKO
GRAHAM C. TALLEY

COUNSEL
DAVID N. BLACKBORBY
TRACY H. BOWDEN
LANA L. FREEMAN
MORRIS H. HARRIMAN, JR.
MARTHA MCKENZIE HILL
GINGER HYNEMAN
KELLY MARCHAND
RACHAEL K. PADGETT
NATHAN A. READ
STANTON K. STRICKLAND
ALBERT J. THOMAS III
LARRY O. WATSON
JORDAN P. WIMPY

OF COUNSEL
W. CHRISTOPHER BARRIER
JOSEPH W. GELZINE
DONALD H. HENRY
HERMANN IVESTER
ANNE S. PARKER
JOHN S. SELIG
RICHARD A. WILLIAMS

1 ADMITTED IN CALIFORNIA AND ARKANSAS
2 ONLY ADMITTED IN TEXAS
3 ADMITTED IN DISTRICT OF COLUMBIA AND ARKANSAS
4 ADMITTED IN ARIZONA, TEXAS AND ARKANSAS
5 ADMITTED IN TEXAS AND ARKANSAS
6 ADMITTED IN TENNESSEE AND TEXAS
7 ADMITTED IN OKLAHOMA, MISSOURI AND ARKANSAS
8 ADMITTED IN MISSOURI AND ARKANSAS
9 ADMITTED IN COLORADO AND ARKANSAS
10 ADMITTED IN DISTRICT OF COLUMBIA, NEW YORK, AND TEXAS
11 ADMITTED IN GEORGIA AND TEXAS

WRITER'S DIRECT DIAL
501-688-8854

March 9, 2018

12 ADMITTED IN NEW YORK AND PENNSYLVANIA
13 ADMITTED IN ALABAMA AND TEXAS
14 ADMITTED IN OKLAHOMA AND ARKANSAS
15 ADMITTED IN ARKANSAS, GEORGIA, NEW JERSEY, AND NEW YORK
16 ADMITTED IN ARKANSAS, ARIZONA, OREGON, AND TEXAS
17 ADMITTED IN TENNESSEE AND ARKANSAS
18 ADMITTED IN ARKANSAS AND NEW JERSEY
19 ADMITTED IN WYOMING AND ARKANSAS
20 ADMITTED IN THE U.S. PATENT AND TRADEMARK OFFICE AND ARKANSAS
ALL OTHERS ADMITTED ONLY IN ARKANSAS

Green Dream International LLC

Attn: Saman Souran
2331 Mill Road, Suite 100
Alexandria, VA 22314

Re: Preferences in Arkansas Procurement Law

Dear Saman:

You have inquired about the preferences granted by the law of the State of Arkansas in the letting of any or all public contracts. Based upon our review of the Arkansas Procurement Law, codified at Ark. Code Ann. § 19-11-201 *et seq.*, we believe the statutes summarized below are responsive to your request.¹ The following summary is qualified in its entirety by reference to the complete text of the statutes cited below, which are enclosed herein for your convenience and incorporated by reference in this letter.

1. Ark. Code Ann. § 19-11-259—Preference of Arkansas Firms. Pursuant to this section, except as prohibited by applicable federal law, in the purchase of commodities² by competitive bidding, all public agencies shall accept the lowest qualified bid from a firm resident in Arkansas,³ but only if (i) the bid does not exceed the lowest qualified bid from a nonresident firm by

¹ Please note that there are special rules related to commodities and services, including small purchases, which may be required to be procured from nonprofit work centers for individuals with disabilities in certain circumstances. This is outside the scope of our review, and such rules are not addressed herein.

² "Commodities" means materials and equipment used in the construction of public works projects. Ark. Code Ann. § 19-11-259(a)(2)(A).

³ "Firm resident in Arkansas" means any individual, partnership, association, or corporation, whether domestic or foreign, that: (i) Maintains at least one (1) staffed office in this state; (ii) For not fewer than two (2) successive years

March 8, 2018

Page 2

more than five percent (5%) and (ii) one (1) or more firms resident in Arkansas made written claim for a preference at the time the bids were submitted. Please note that this section applies only to projects designed to provide utility needs of a county or municipality. See Ark. Code Ann. § 19-11-259(c)(1)(A).⁴

2. **Ark. Code Ann. § 19-11-260—Recycled Paper Purchases—Goals.** Pursuant to this section, with respect to the procurement of paper products, a preference for recycled paper products shall be exercised if the use of the products is technically feasible and the price does not exceed the lowest qualified bid of a vendor offering paper products manufactured or produced from virgin material by ten percent (10%). Please note an additional one percent (1%) preference shall be allowed from products containing the largest amount of postconsumer materials recovered within the State of Arkansas. Notwithstanding the foregoing, however, a bidder receiving a preference under this section shall not be entitled to an additional preference under § 19-11-259 discussed above.

3. **Ark. Code Ann. § 19-11-305—Multiple Private Industry Bids.** Subject to any applicable bonding requirements, in all bidding procedures involving a bid by one (1) or more out-of-state penal institutions⁵ and a bid by one (1) or more private industries located within the State of Arkansas, the contract shall be awarded to the sole Arkansas bidder or lowest Arkansas bidder if the Arkansas bidder is not underbid by more than five percent (5%), as provided in § 19-11-259, by another representative of private industry located outside the State of Arkansas or by more than fifteen percent (15%) by an out-of-state correctional institution.

Sincerely,

MITCHELL, WILLIAMS, SELIG,
GATES & WOODYARD, P.L.L.C.

By

J. Scott Schallhorn

JSS: alg
Enclosures

immediately prior to submitting a bid, has paid taxes under the Department of Workforce Services Law, § 11-10-101 *et seq.*, unless exempt, and either the Arkansas Gross Receipts Act of 1941, § 26-52-101 *et seq.*, or the Arkansas Compensating Tax Act of 1949, § 26-53-101 *et seq.*, on any property used or intended to be used for or in connection with the firm's business; and (iii) Within the two-year period, has paid any taxes to one (1) or more counties, school districts, or municipalities of the State of Arkansas on either real or personal property used or intended to be used or in connection with the firm's business.

⁴ To the extent federal purchasing laws or bidding preferences conflict, the Arkansas Procurement Law does not apply to projects related to supplying water or wastewater utility services, operations, or maintenance to a federal military installation by a municipality of the state.

⁵ "Penal institution" means a penitentiary, jail, prison, reformatory, or other such establishment owned, operated, or funded by a state or local government wherein incarcerated criminals are kept. Ark. Code Ann. § 19-11-302(2).

Contract No.	State	Contract Subject	Client	Award Date	Contract Value
01-18-2446	Texas	Supply and delivery of Surface Treatment Aggregate (Type D, Grade 4)	Denton County	04/17/18	\$169,000.00
140F0418P0163	Tennessee	Supply and delivery of Rip Rap and Limestone	FWS, DIVISION OF CONTRACTING AND GR	04/13/18	\$23,596.88
4800028755	North Carolina	Aggregate ABC	Department of Transportation	04/13/18	\$157,500.00
OQT-4800028756	North Carolina	Sand 1-S	Department of Transportation	04/13/18	\$59,850.00
140L6218P0037	Wyoming	Aggregate (Grading "W") Roadbase	Department of the Interior	04/10/18	\$17,994.00
140F0418P0156	Tennessee	Limestone	Department of the Interior	04/05/18	\$70,789.63
12569R18D0006	Michigan	Road Repair IDIQ	Department of Agriculture	03/23/18	\$10,000,000.00
12343418D0002	West Virginia	Supply and Delivery of Aggregate	Department of Agriculture	03/19/18	\$39,999.65
140F0418P0137	Mississippi	Supply and delivery of Rip Rap and Limestone	Department of the Interior	03/16/18	\$49,398.00
4300576052	Pennsylvania	DSA Little Medix Road FD 9	DCNR-PA	02/22/18	\$207,049.50
46367	Virginia	Stone	Department of Transportation	02/21/18	\$143,500.00
W912EK-16-A-0004	Iowa	Aggregate	Department of Army	02/21/18	\$14,005.00
605SE18001568	Missouri	Limestone	Department of Transportation	02/15/18	\$58,185.00
W52P1J-17-D-3000	Oklahoma	Base Course	Department of Army	02/15/18	\$163,100.00
4800028602	North Carolina	Supplying Sand	Department of Transportation	02/14/18	\$117,000.00
IFB605SE18001513	Missouri	Pug Mill Aggregate	Department of Transportation	02/02/18	\$110,780.00
1516	Missouri	Pug Mill Aggregate	Department of Transportation	02/01/18	\$448,200.00
17-17/18	South Carolina	MBC STONE FOR DISTRICT 6 ROADS	South Carolina Florence County	01/31/18	\$283,106.25
18-17/18	South Carolina	Macadam Base Course-phase 2	South Carolina Florence County	01/31/18	\$408,996.00
18P0020P00001	North Dakota	Eggerts Playground	Department of the Army	01/23/18	\$58,724.00
140P8418P0013	California	Delivery of Aggregate	Department of the Interior	01/01/18	\$23,902.84
140F0418Q0011	Mississippi	Crushed Limestone	US Fish & Wildlife Service	12/29/17	\$24,188.45
103732	South Carolina	Macadam Base Course-phase 1	Florence County	12/28/17	\$534,996.00
56584	Oklahoma	Class A sand	State of Oklahoma	12/14/17	\$19,950.00
56581	Oklahoma	Class A sand	State of Oklahoma	12/14/17	\$19,950.00
4800028458	North Carolina	Aggregate	State of North Carolina	12/14/17	\$123,750.00
NC8694	North Carolina	Aggregate	State of North Carolina	12/04/17	\$11,815.00
NC8672	North Carolina	Aggregate	State of North Carolina	12/04/17	\$11,025.00
NC6041	North Carolina	ABC Aggregate	State of North Carolina	12/04/17	\$24,500.00
4400017562	South Carolina	Rip Rap, CRUSHER RUN, AND SAND	SC-Transportation	11/17/17	\$163,231.00
4400017421	South Carolina	Ballast/Granite Stone	SC-Natural Resources	10/20/17	\$39,750.00
W52P1J-17-D-3000	Oklahoma	McAlester Aggregate	Department of the Army	10/18/17	\$2,937,250.00
W911S2-17-P-1077	California	Base Rock and Sand	Department of the Army	09/29/17	\$93,146.00
W912DQ17A1015x	Nebraska	Rip Rap	Department of the Army	09/27/17	\$59,316.40
W912DQ17A1015	Kansas	Gravel	Department of the Army	09/27/17	\$37,502.62
F17PX02523	Florida	Supplying Ditch Lining & Limerock	Department of the Interior	09/22/17	\$109,851.00
F17PX02612	Indiana	Gravel Big Oaks	US Fish & Wildlife Service	09/21/17	\$25,000.00
AG-8AC7-P-17-0224	California	Gravel	US Fish & Wildlife Service	09/20/17	\$37,536.00
F17PX02386	Tennessee	Supplying Limestone and Gabion	Department of the Interior	09/15/17	\$20,943.00
F17PX02027	North Carolina	PEE DEE NWR GRANITE GRAVEL, STONE, AND RIP RAP	Department of the Interior	09/01/17	\$428,075.00
W9123F-17-A-0007	Washington	Gravel, Sand and Rock	Department of the Army	08/31/17	\$14,950.00
4400016975	South Carolina	Granite Stone	SC-Transportation	08/28/17	\$12,780.00
HHS1245201701299P	Arizona	Chainlink Fence	Department of Health	08/23/17	\$22,505.99
F17PX01877	Missouri	Gravel (Deliver & Tailgate spread)	US Fish & Wildlife Service	08/23/17	\$25,000.00
4400016967	South Carolina	CR14 Crusher Run	SC-General Services	08/23/17	\$47,275.00
4400016940	South Carolina	MLBC	SC-Transportation	08/18/17	\$194,700.00
L16PA00088	Washington	Crushed Aggregate	Department of the Interior	08/14/17	\$19,995.00
4600584183	South Carolina	CR14 Crusher Run	SC-Correction	08/08/17	\$22,692.00
P16PC00727	Washington	Paving in Elwha & Mora	Department of the Interior	06/23/17	\$29,740.00
AG-04N7-C-17-0020	Oregon	Fish Gravel	Department of Agriculture	06/16/17	\$44,667.00
F17PX01191	Louisiana	REPLACE ROCK PILE	Department of the Interior	06/15/17	\$45,270.65
F17PX00140	Mississippi	Red Clay Dirt	Department of the Interior	06/15/17	\$22,667.00
W911SA-17-D-1002	Wisconsin	supply of Crushed Rock Gravel for five Years IDIQ from July 2017 to July 6, 2022	Mission and Installation Contracting Command (Department of the Army)	06/14/17	\$6,960,308.20
FA462617P0026	Montana	Supplying Base Course and Concrete	Department of Air Force	06/02/17	\$29,801.00
W912K6-17-Q0025	Maryland	Supply of gravel and Geotextile	National Guard Bureau of Dept of the Army	06/01/17	\$36,095.34
W912KC-17-P-0077	Pennsylvania	Dark Limestone	Department of the Army	05/30/17	\$14,316.50
4300544693	Pennsylvania	Callen Run DSA	State of Pennsylvania	05/12/17	\$99,970.00
F17PX00351	Louisiana	Red Clay Dirt	Department of the Interior	04/12/17	\$77,200.00
N00244-17-P-0254	California	Crushed Gravel	Department of the Navy	04/07/17	\$29,886.90
W912P5-17-P-0047	Tennessee	supply of BEACH SAND	US ARMY CORPS OF ENGINEERS-CELRN-RC-N	04/04/17	\$26,124.00
4300543689	Pennsylvania	Top Soil	State of Pennsylvania	03/31/17	\$20,216.25
AG-3434-C-16-0003	West Virginia	Gravel	US Fish & Wildlife Service	02/09/17	\$1,000,000.00
P16PC00727	Washington	Paving in Elwha & Mora	Department of the Interior	09/19/16	\$141,263.00
R16PX00867	Colorado	Aggregate Stockpile	Bureau of Reclamation	09/02/16	\$136,000.00
W91QF4-16-A-0006	Kansas	Rock&Ice Control	Department of the Army	09/01/16	\$665,000.00

L16PB00766	Washington	Crushed Aggregate	Department of the Interior	08/16/16	\$18,987.50
FA4819-16-P-3037	Florida	Crushed Concrete	Department of the Air Force	07/29/16	\$47,470.00
W44W9M-16-P-0393	Oklahoma	Rock	Department of the Army	07/27/16	\$116,600.00
R16PX00673	Washington	Wildcat Riprap supply	Department of the Interior	07/27/16	\$11,960.00
W912QG-16-C-0004	South Carolina	Gravel	Department of the Army	07/25/16	\$699,815.00
P16PX02223	Arizona	Road Base	Department of the Interior	07/15/16	\$21,585.00
W91364-16-P-0119	Ohio	Gravel Aggregates	Department of the Army	07/06/16	\$11,728.60
4300505388	Pennsylvania	Top Soil	Penn DOT	05/11/16	\$30,640.50
310PO1612109	Washington	Pit Run	State of Washington	04/29/16	\$22,500.00
P16PX01212	Florida	Rip Rap	Department of the Interior	04/20/16	\$11,389.40
4600011575	Washington	Crushed Aggregate	City of Tacoma	04/11/16	\$196,940.00
W9124C-16-P-0033	South Carolina	Ballast Rocks	Department of the Army	04/07/16	\$27,000.00
W911RP-16-D-0001	Arkansas	Roadway Materials	Department of the Army	04/01/16	\$270,752.00
R16PX00263	Washington	Gravel, Sand, Rip-Rap	Department of the Interior	03/30/16	\$11,120.00
R16PX00263	Washington	Gravel, Sand, Rip-Rap	Department of the Interior	03/09/16	\$14,208.00
F16PX00463	Washington	Rock Delivery	Department of the Interior	02/29/16	\$21,203.00
P16PX00580	Ohio	Materials For Sylvan Dam Project	Department of the Interior	02/09/16	\$21,185.00
F16PX00429	California	Roofing Replacement	Department of the Interior	02/05/16	\$29,888.00
W912ES-16-D-0004	Wisconsin	Rock	Department of the Army	02/03/16	\$321,989.98
4400012170	South Carolina	FLBC limestone	State of South Carolina	12/21/15	\$74,520.00
W52P1J-15-D-3036	Oklahoma	Aggregate	Department of the Army	10/18/15	\$3,000,000.00
11135-C	Arizona	Aggregate Materials	Maricopa County-Arizona	10/15/15	\$1,063,500.00
P15PX04247	Colorado	Crusher Fines	Department of the Interior	09/22/15	\$39,071.00
FA524D-15-P-0162	Guam	Crushed Stone	Department of the Air Force	09/10/15	\$45,340.00
F15PS00955	Texas	Limestone Roadbase	Department of the Interior	08/25/15	\$76,844.55

AGGREGATE (57 STONE PEA GRAVEL)

B-6-19-12
PRICE SHEET

ITEM	DESCRIPTION (County Pickup)	EST. QTY.	Material Cost per Ton	EXTENDED PRICE
1	Size #4 or 57 Calcareous Course Aggregate	4000	\$ 26.00	\$ 104,000.00
2	Size #89 (pea gravel) Non-Calcareous	1000	\$ 35.00	\$ 35,000.00
3	Size # 3/4" Granite Rock Non-Calcareous	1000	\$ 39.75	\$ 39,750.00
4	Size # 1/2" Granite Rock Non-Calcareous	1000	\$ 35.00	\$ 35,000.00
5	Lime Rock Material - Lime Rock bearing ratio not less than 100; at least 97% (by weight) of the material must pass a 3-1/2 sieve	5000	\$ 18.00	\$ 90,000.00
		TOTALS		\$ 303,750.00

Delivered to North Area

ITEM	Description	EST. QTY.	COST PER TON	EXTENDED PRICE	base fuel surcharge as a % of \$/Ton	Total with fuel surcharge
6	Size #4 or 57 Calcareous Course Aggregate	1000	\$ 35.00	\$ 35,000.00	0%	\$35,000.00
8	Size 1/2 or #89 (pea gravel) River Rock	333	\$ 45.75	\$ 15,234.75	0%	\$15,234.75
9	Size # 3/4" Granite Rock Non-Calcareous	333	\$ 45.00	\$ 14,985.00	0%	\$14,985.00
7	Size # 1/2" Granite Rock Non-Calcareous	333	\$ 45.00	\$ 14,985.00	0%	\$14,985.00

Delivered to Central Area

ITEM	Description	EST. QTY.	COST PER TON	EXTENDED PRICE	base fuel surcharge as a % of \$/Ton	Total with fuel surcharge
6	Size #4 or 57 Calcareous Course Aggregate	2000	\$ 35.00	\$ 70,000.00	0%	\$70,000.00
7	Size 1/2 or #89 (pea gravel) River Rock	333	\$ 55.00	\$ 18,315.00	0%	\$18,315.00
8	Size # 3/4" Granite Rock Non-Calcareous	333	\$ 45.00	\$ 14,985.00	0%	\$14,985.00
9	Size # 1/2" Granite Rock Non-Calcareous	333	\$ 45.00	\$ 14,985.00	0%	\$14,985.00

Delivered to South Area

ITEM	Description	EST. QTY.	COST PER TON	EXTENDED PRICE	base fuel surcharge as a % of \$/Ton	Total with fuel surcharge
6	Size #4 or 57 Calcareous Course Aggregate	1000	\$ 39.00	\$ 39,000.00	0%	\$39,000.00
7	Size 1/2 or #89 (pea gravel) River Rock	333	\$ 55.00	\$ 18,315.00	0%	\$18,315.00
8	Size # 3/4" Granite Rock Non-Calcareous	333	\$ 49.00	\$ 16,317.00	0%	\$16,317.00
9	Size # 1/2" Granite Rock Non-Calcareous	333	\$ 49.00	\$ 16,317.00	0%	\$16,317.00

AGGREGATE (57 STONE PEA GRAVEL)

B-6-19-12

PRICE SHEET

ACH PAYMENTS

Does your company accept ACH Payment Method? ____ Yes / ____ No

PROMPT PAYMENT DISCOUNT

Brevard County shall remit payment in accordance with the Florida Prompt Payment Act, Florida Statutes section 218.70. Bidders may offer cash discounts for prompt payment but they will not be considered in determination of award. If a bidder offers a discount, it is understood that the discount time will be from the date of satisfactory delivery, at the place of acceptance, and receipt of correct invoice, at the office specified, whichever occurs last.

* If Prompt Payment Discount is offered, please state discount and terms:

ADDENDUM ACKNOWLEDGMENT

Bidder acknowledges receipt of amendments by indicating amendment number and its date of issue.

Add. No. _____ Dated _____ // Add. No. _____ Dated _____

Add. No. _____ Dated _____ // Add. No. _____ Dated _____

I hereby acknowledge that I have read, understand, and agree to all terms, conditions, insurance, scope of work, specifications and pricing for Bid #B-6-19-12/Aggregate (57 Stone Pea Gravel).

COMPANY NAME _____

ADDRESS _____

AUTHORIZED SIGNATURE _____

PRINTED SIGNATURE _____ DATE _____

TELEPHONE # _____ FAX # _____

EMAIL _____

Bid Title: Aggregate (57 Stone Pea Gravel)

Bid Tabulation

Bid Number: B-6-19-12

Opening Date/Time: November 15, 2018 @ 2:00 p.m.

Posted 11/21/18 through 11/28/18 @ 5pm; Posted by KDINatale

ITEM	DESCRIPTION (County Pickup)	EST. QTY.	Green Dream International		
			Material Cost per Ton	EXTENDED PRICE	PICKUP POINTS
1	Size #4 or 57 Calcareous Course Aggregate	4000	\$ 26.00	\$ 104,000.00	Martin Marietta Canaveral Marine
2	Size #89 (pea gravel) Non-Calcareous	1000	\$ 35.00	\$ 35,000.00	Martin Marietta Canaveral Marine
3	Size # 3/4" Granite Rock Non-Calcareous	1000	\$ 39.75	\$ 39,750.00	Cemex Cocoa
4	Size # 1/2" Granite Rock Non-Calcareous	1000	\$ 35.00	\$ 35,000.00	Martin Marietta Canaveral Marine
5	Lime Rock Material - Lime Rock bearing ratio not less than 100; at least 97% (by weight) of the material must pass a 3-1/2 sieve	5000	\$ 18.00	\$ 90,000.00	Cemex Cocoa
TOTAL				\$ 303,750.00	

Delivered to North Area

ITEM	Description	EST. QTY.	COST PER TON	EXTENDED PRICE	base fuel surcharge as a % of \$/Ton	Total with fuel surcharge
6	Size #4 or 57 Calcareous Course Aggregate	1000	\$ 35.00	\$ 35,000.00	0%	\$35,000.00
7	Size 1/2 or #89 (pea gravel) River Rock	333	\$ 44.75	\$ 14,901.75	0%	\$14,901.75
8	Size # 3/4" Granite Rock Non-Calcareous	333	\$ 45.00	\$ 14,985.00	0%	\$14,985.00
9	Size # 1/2" Granite Rock Non-Calcareous	333	\$ 45.00	\$ 14,985.00	0%	\$14,985.00
TOTAL						\$79,871.75

Delivered to Central Area

ITEM	Description	EST. QTY.	COST PER TON	EXTENDED PRICE	base fuel surcharge as a % of \$/Ton	Total with fuel surcharge
6	Size #4 or 57 Calcareous Course Aggregate	2000	\$ 35.00	\$ 70,000.00	0%	\$70,000.00
7	Size 1/2 or #89 (pea gravel) River Rock	333	\$ 46.00	\$ 15,318.00	0%	\$15,318.00
8	Size # 3/4" Granite Rock Non-Calcareous	333	\$ 45.00	\$ 14,985.00	0%	\$14,985.00
9	Size # 1/2" Granite Rock Non-Calcareous	333	\$ 45.00	\$ 14,985.00	0%	\$14,985.00
TOTAL						\$115,288.00

Delivered to South Area

ITEM	Description	EST. QTY.	COST PER TON	EXTENDED PRICE	base fuel surcharge as a % of \$/Ton	Total with fuel surcharge
6	Size #4 or 57 Calcareous Course Aggregate	1000	\$ 39.00	\$ 39,000.00	0%	\$39,000.00
7	Size 1/2 or #89 (pea gravel) River Rock	333	\$ 50.00	\$ 16,650.00	0%	\$16,650.00
8	Size # 3/4" Granite Rock Non-Calcareous	333	\$ 49.00	\$ 16,317.00	0%	\$16,317.00
9	Size # 1/2" Granite Rock Non-Calcareous	333	\$ 49.00	\$ 16,317.00	0%	\$16,317.00
TOTAL						\$88,284.00

Approval Initials: 

Brevard County encourages prompt and fair handling of all complaints and disputes with the business community.
Filing of any disputes and appeals shall be in accordance with procedures specified in bid documents.

Apparent Low Bidder is Green Dream International

AGGREGATE (57 STONE PEA GRAVEL)

B-6-19-12

PRICE SHEET

ITEM	DESCRIPTION (County Pickup)	EST. QTY.	Material Cost per Ton	EXTENDED PRICE
1	Size #4 or 57 Calcareous Course Aggregate	4000		\$ -
2	Size #89 (pea gravel) Non-Calcareous	1000		\$ -
3	Size # 3/4" Granite Rock Non-Calcareous	1000		\$ -
4	Size # 1/2" Granite Rock Non-Calcareous	1000		\$ -
5	Lime Rock Material - Lime Rock bearing ratio not less than 100; at least 97% (by weight) of the material must pass a 3-1/2 sieve	5000		\$ -
		TOTALS		\$ -

Delivered to North Area

ITEM	Description	EST. QTY.	COST PER TON	EXTENDED PRICE	base fuel surcharge as a % of \$/Ton	Total with fuel surcharge
6	Size #4 or 57 Calcareous Course Aggregate	1000		\$ -		\$0.00
8	Size 1/2 or #89 (pea gravel) River Rock	333		\$ -		\$0.00
9	Size # 3/4" Granite Rock Non-Calcareous	333		\$ -		\$0.00
7	Size # 1/2" Granite Rock Non-Calcareous	333		\$ -		\$0.00

Delivered to Central Area

ITEM	Description	EST. QTY.	COST PER TON	EXTENDED PRICE	base fuel surcharge as a % of \$/Ton	Total with fuel surcharge
6	Size #4 or 57 Calcareous Course Aggregate	2000		\$ -		\$0.00
7	Size 1/2 or #89 (pea gravel) River Rock	333		\$ -		\$0.00
8	Size # 3/4" Granite Rock Non-Calcareous	333		\$ -		\$0.00
9	Size # 1/2" Granite Rock Non-Calcareous	333		\$ -		\$0.00

Delivered to South Area

ITEM	Description	EST. QTY.	COST PER TON	EXTENDED PRICE	base fuel surcharge as a % of \$/Ton	Total with fuel surcharge
6	Size #4 or 57 Calcareous Course Aggregate	1000		\$ -		\$0.00

AGGREGATE (57 STONE PEA GRAVEL)

B-6-19-12

PRICE SHEET

ACH PAYMENTS

Does your company accept ACH Payment Method? ____ Yes / ____ No

PROMPT PAYMENT DISCOUNT

Brevard County shall remit payment in accordance with the Florida Prompt Payment Act, Florida Statutes section 218.70. Bidder shall not be offered cash discounts for prompt payment but they will not be considered in determination of award. If a bidder offers a discount, it is understood that the discount time will be from the date of satisfactory delivery, at the place of acceptance, and receipt of correct invoice, as specified, whichever occurs last.

* If Prompt Payment Discount is offered, please state discount and terms:

ADDENDUM ACKNOWLEDGMENT

Bidder acknowledges receipt of amendments by indicating amendment number and its date of issue.

Add. No. _____ Dated _____ // Add. No. _____ Dated _____

Add. No. _____ Dated _____ // Add. No. _____ Dated _____

I hereby acknowledge that I have read, understand, and agree to all terms, conditions, insurance, scope of work, specifications for Bid #B-6-19-12/Aggregate (57 Stone Pea Gravel).

COMPANY NAME _____

ADDRESS _____

AUTHORIZED SIGNATURE _____

PRINTED SIGNATURE _____ DATE _____

TELEPHONE # _____ FAX # _____

EMAIL _____

AGGREGATE (57 STONE PEA GRAVEL)

B-6-19-12

PRICE SHEET

ITEM	DESCRIPTION (County Pickup)	EST. QTY.	Material Cost per Ton	EXTENDED PRICE
1	Size #4 or 57 Calcareous Course Aggregate	4000	\$ 26.00	\$ 104,000.00
2	Size #89 (pea gravel) Non-Calcareous	1000	\$ 35.00	\$ 35,000.00
3	Size # 3/4" Granite Rock Non-Calcareous	1000	\$ 39.75	\$ 39,750.00
4	Size # 1/2" Granite Rock Non-Calcareous	1000	\$ 35.00	\$ 35,000.00
5	Lime Rock Material - Lime Rock bearing ratio not less than 100; at least 97% (by weight) of the material must pass a 3-1/2 sieve	5000	\$ 18.00	\$ 90,000.00
		TOTALS		\$ 303,750.00

Delivered to North Area

ITEM	Description	EST. QTY.	COST PER TON	EXTENDED PRICE	base fuel surcharge as a % of \$/Ton	Total with fuel surcharge
6	Size #4 or 57 Calcareous Course Aggregate	1000	\$ 35.00	\$ 35,000.00	0%	\$35,000.00
8	Size 1/2 or #89 (pea gravel) River Rock	333	\$ 45.75	\$ 15,234.75	0%	\$15,234.75
9	Size # 3/4" Granite Rock Non-Calcareous	333	\$ 45.00	\$ 14,985.00	0%	\$14,985.00
7	Size # 1/2" Granite Rock Non-Calcareous	333	\$ 45.00	\$ 14,985.00	0%	\$14,985.00

Delivered to Central Area

ITEM	Description	EST. QTY.	COST PER TON	EXTENDED PRICE	base fuel surcharge as a % of \$/Ton	Total with fuel surcharge
6	Size #4 or 57 Calcareous Course Aggregate	2000	\$ 35.00	\$ 70,000.00	0%	\$70,000.00
7	Size 1/2 or #89 (pea gravel) River Rock	333	\$ 55.00	\$ 18,315.00	0%	\$18,315.00
8	Size # 3/4" Granite Rock Non-Calcareous	333	\$ 45.00	\$ 14,985.00	0%	\$14,985.00
9	Size # 1/2" Granite Rock Non-Calcareous	333	\$ 45.00	\$ 14,985.00	0%	\$14,985.00

Delivered to South Area

ITEM	Description	EST. QTY.	COST PER TON	EXTENDED PRICE	base fuel surcharge as a % of \$/Ton	Total with fuel surcharge
6	Size #4 or 57 Calcareous Course Aggregate	1000	\$ 39.00	\$ 39,000.00	0%	\$39,000.00

AGGREGATE (57 STONE PEA GRAVEL)

B-6-19-12

PRICE SHEET

ACH PAYMENTS

Does your company accept ACH Payment Method? ____ Yes / ____ No

PROMPT PAYMENT DISCOUNT

Brevard County shall remit payment in accordance with the Florida Prompt Payment Act, Florida Statutes section 218.70. Bidder shall not receive cash discounts for prompt payment but they will not be considered in determination of award. If a bidder offers a discount, it is understood that the discount time will be from the date of satisfactory delivery, at the place of acceptance, and receipt of correct invoice, if any, as specified, whichever occurs last.

* If Prompt Payment Discount is offered, please state discount and terms:

ADDENDUM ACKNOWLEDGMENT

Bidder acknowledges receipt of amendments by indicating amendment number and its date of issue.

Add. No. _____ Dated _____ // Add. No. _____ Dated _____

Add. No. _____ Dated _____ // Add. No. _____ Dated _____

I hereby acknowledge that I have read, understand, and agree to all terms, conditions, insurance, scope of work, specifications for Bid #B-6-19-12/Aggregate (57 Stone Pea Gravel).

COMPANY NAME _____

ADDRESS _____

AUTHORIZED SIGNATURE _____

PRINTED SIGNATURE _____ DATE _____

TELEPHONE # _____ FAX # _____

EMAIL _____

AGGREGATE (57 STONE PEA GRAVEL)

B-6-19-12

PRICE SHEET

ITEM	DESCRIPTION (County Pickup)	EST. QTY.	Material Cost per Ton	EXTENDED PRICE
1	Size #4 or 57 Calcareous Course Aggregate	4000	\$ 26.00	\$ 104,000.00
2	Size #89 (pea gravel) Non-Calcareous	1000	\$ 35.00	\$ 35,000.00
3	Size # 3/4" Granite Rock Non-Calcareous	1000	\$ 39.75	\$ 39,750.00
4	Size # 1/2" Granite Rock Non-Calcareous	1000	\$ 35.00	\$ 35,000.00
5	Lime Rock Material - Lime Rock bearing ratio not less than 100; at least 97% (by weight) of the material must pass a 3-1/2 sieve	5000	\$ 18.00	\$ 90,000.00
		TOTALS		\$ 303,750.00

PROPO
Material per To
\$ 3
\$ 1

Delivered to North Area

ITEM	Description	EST. QTY.	COST PER TON	EXTENDED PRICE	base fuel surcharge as a % of \$/Ton	Total with fuel surcharge	EXTENC PRICE
6	Size #4 or 57 Calcareous Course Aggregate	1000	\$ 35.00	\$ 35,000.00	0%	\$35,000.00	\$ 3
8	Size 1/2 or #89 (pea gravel) River Rock	333	\$ 45.75	\$ 15,234.75	0%	\$15,234.75	\$ 4
9	Size # 3/4" Granite Rock Non-Calcareous	333	\$ 45.00	\$ 14,985.00	0%	\$14,985.00	\$ 4
7	Size # 1/2" Granite Rock Non-Calcareous	333	\$ 45.00	\$ 14,985.00	0%	\$14,985.00	\$ 4

Delivered to Central Area

ITEM	Description	EST. QTY.	COST PER TON	EXTENDED PRICE	base fuel surcharge as a % of \$/Ton	Total with fuel surcharge	
6	Size #4 or 57 Calcareous Course Aggregate	2000	\$ 35.00	\$ 70,000.00	0%	\$70,000.00	\$ 3
7	Size 1/2 or #89 (pea gravel) River Rock	333	\$ 55.00	\$ 18,315.00	0%	\$18,315.00	
8	Size # 3/4" Granite Rock Non-Calcareous	333	\$ 45.00	\$ 14,985.00	0%	\$14,985.00	\$ 4
9	Size # 1/2" Granite Rock Non-Calcareous	333	\$ 45.00	\$ 14,985.00	0%	\$14,985.00	\$ 4

Delivered to South Area

ITEM	Description	EST. QTY.	COST PER TON	EXTENDED PRICE	base fuel surcharge as a % of \$/Ton	Total with fuel surcharge	
	Size #4 or 57 Calcareous Course						

AGGREGATE (57 STONE PEA GRAVEL)

B-6-19-12

PRICE SHEET

ACH PAYMENTS

Does your company accept ACH Payment Method? _____ Yes / _____ No

PROMPT PAYMENT DISCOUNT

Brevard County shall remit payment in accordance with the Florida Prompt Payment Act, Florida Statutes section 218.70. Bidder shall not receive cash discounts for prompt payment but they will not be considered in determination of award. If a bidder offers a discount, it is understood that the discount time will be from the date of satisfactory delivery, at the place of acceptance, and receipt of correct invoice, as specified, whichever occurs last.

* If Prompt Payment Discount is offered, please state discount and terms:

ADDENDUM ACKNOWLEDGMENT

Bidder acknowledges receipt of amendments by indicating amendment number and its date of issue.

Add. No. _____ Dated _____ // Add. No. _____ Dated _____

Add. No. _____ Dated _____ // Add. No. _____ Dated _____

I hereby acknowledge that I have read, understand, and agree to all terms, conditions, insurance, scope of work, specifications for Bid #B-6-19-12/Aggregate (57 Stone Pea Gravel).

COMPANY NAME _____

ADDRESS _____

AUTHORIZED SIGNATURE _____

PRINTED SIGNATURE _____ DATE _____

TELEPHONE # _____ FAX # _____

EMAIL _____

TOWN OF MALABAR

COUNCIL MEETING

AGENDA ITEM NO: 11.g

Meeting Date: November 2, 2020

Prepared By: Lisa Morrell, Interim Town Manager

SUBJECT: Piggyback Brevard County B-6-20-57/Asphaltic Concrete

BACKGROUND/HISTORY:

Brevard County has awarded contract number B-6-20-57 entitled asphaltic Concrete for the purpose asphaltic concrete on a continuing basis to be purchased on an as needed basis to multiple vendors: V.A. Paving, Inc; Preferred Materials Inc., C.W. Roberts Contracting, Inc, Goodson Paving, Inc. and Community Asphalt Corp. The contract period is effective for one (1) year from the date of award and may be extended, mutually, for two (2) additional one (1) one-year periods; the contract was awarded August 17, 2020. The bid tabulation includes all turnkey vendor delivered and placed services for road paving, parking lots, and bike paths with various paving methodologies as desired and needed for surfaces.

"The town administrator is authorized to piggy back contracts for any purpose where the stipulated consideration thereunder to be paid by the town exceeds two thousand dollars (\$2,000.00) awarded by any other governmental entity so long as the bidding process utilized by the other governmental entity in awarding such contract is consistent with the competitive bid procedures outlined in this section. "

The Town of Malabar may utilize this contract as needed for Public Works Streets and Roads.

FINANCIAL IMPACT:

FY21 Budget Streets and Roads, Capital Outlay 541 includes TIFT projects, identified and approved as Hunter Lane, with Future CIP Road paving funds; expenditures shall be within the annual budget and projects as identified and approved by Town Council.

ATTACHMENTS:

- Brevard County B-6-20-57 Asphaltic Concrete Award.PDF

ACTION OPTIONS:

Motion to use the Brevard County B-6-20-57 Asphaltic Concrete contract for Town Council approved road improvement projects.



Purchasing Services
 2725 Judge Fran Jamieson Way
 Building C, Room 303
 Viera, Florida 32940

NOTICE OF AWARD
 August 17, 2020
 B-6-20-57 Asphaltic Concrete

PROCUREMENT ANALYST: Debbie Feingold

<u>VENDOR</u>	<u>VENDOR CITY AND STATE</u>	<u>MEETS MINIMUM REQUIREMENTS</u>	<u>ITEMS AWARDED</u>	<u>AWARD AMOUNT</u>
V.A Paving, INC	Cocoa, FL	Yes	Per Attached Tabulation	\$4,300,000 annually (Estimate only).
Preferred Materials, INC	Orlando, FL	Yes	Per Attached Tabulation	
C.W. Roberts Contracting, INC.	Palm City, FL	Yes	Per Attached Tabulation	
Goodson Paving, INC.	Cocoa, FL	Yes	Per Attached Tabulation	
Community Asphalt Corp	Vero Beach, FL	Yes	Per Attached Tabulation	

BOARD AWARD--AGENDA ATTACHED

APPROVED AWARD (NON-BOARD AGENDA):
 (Per Sections III.E. & III.I. & J., BCC-25, PROCUREMENT)

Steven A. Daring Jr., Central Services Director

- Award to overall lowest, most responsive bidder, minimum three responses received.
- Award to other than low, with low bid being non-responsive.
 REASON FOR NON-RESPONSIVENESS:
- Award to low bid, less than three responses received.
 REASON FOR LESS THAN THREE RESPONSES:

AWARDED BY A COMMITTEE CONSISTING OF: Bruce Black, Public Works; Daniel Blackburn, Public Works; Debbie Feingold, Purchasing Services

FOR PURCHASING USE ONLY:

ONE-TIME PURCHASE

ANNUAL BID:
 EFFECTIVE DATE: August 22, 2020 ENDING DATE: August 21, 2021
 RENEWAL OPTION One year Other (fill in) Two (2), One (1) Year

- Prompt Payment Discount Offered Yes _____ (Terms) NO
- Performance and payment bonds received with construction contract documents.
- Release Cashier's or Certified Check Received for Bid Deposit on Bids

SPECIAL INSTRUCTIONS TO AWARDED VENDOR:

- Please provide certificate of insurance.
- Please provide performance and payment bonds as required.
- OTHER:

SW



BID TABULATION SHEET

Bid Title: Asphaltic Concrete
Bid No: B-6-20-57

OPENING DATE & TIME: August 6, 2020 @ 2:00pm
POSTING TIME/DATE: August 10, 2020 THROUGH: August 14, 2020 @ 5pm

	V.A PAVING, INC		PREFERRED MATERIALS, INC.		C.W. ROBERTS CONTRACTING, INC.		GOODSON PAVING, INC		COMMUNITY ASPHALT CORP	
ASPHALTIC CONCRETE										
Superpave SP-9.5 Vendor Delivered, Vendor Placed										
ROAD PAVING	\$81.00	TON	\$89.09	TON	\$107.75	TON	\$96.40	TON	\$146.00	TON
PARKING LOTS	\$115.00	TON	\$150.00	TON	\$117.75	TON	\$126.20	TON	\$172.00	TON
BIKE PATHS	\$170.00	TON	\$225.00	TON	\$157.75	TON	\$162.00	TON	\$172.00	TON
Superpave SP-12.5 Vendor Delivered, Vendor Placed										
ROAD PAVING	\$78.00	TON	\$85.09	TON	\$102.50	TON	\$95.40	TON	\$139.00	TON
PARKING LOTS	\$115.00	TON	\$150.00	TON	\$112.50	TON	\$124.90	TON	\$159.00	TON
BIKE PATHS	\$170.00	TON	\$225.00	TON	\$152.50	TON	\$155.60	TON	\$166.00	TON

FRICTION COURSE										
Friction Course FC-5 Vendor Delivered, Vendor Placed										
ROAD PAVING	\$180.00	TON	\$175.00	TON	\$188.00	TON	\$199.25	TON	\$202.00	TON
Friction Course FC-9.5 Vendor Delivered, Vendor Placed										
ROAD PAVING	\$110.00	TON	\$125.00	TON	\$137.50	TON	\$126.05	TON	\$199.00	TON
Friction Course FC-12.5 Vendor Delivered, Vendor Placed										
ROAD PAVING	\$109.00	TON	\$108.00	TON	\$119.50	TON	\$128.25	TON	\$166.00	TON
SPEED HUMPS SP-9.5 Vendor Delivered, Vendor Placed										
ROAD PAVING	\$575.00	TON	\$750.00	TON	\$2,000.00	TON	\$426.00	TON	\$365.00	TON
LESS THAN 25 TN PATCHING SP-9.5 Vendor Delivered, Vendor Placed										
ROAD PAVING	\$500.00	TON	\$750.00	TON	\$415.00	TON	\$342.00	TON	\$352.00	TON
25-50 TN PATCHING SP 9.5 Vendor Delivered, Vendor Placed										
ROAD PAVING	\$300.00	TON	\$500.00	TON	\$255.00	TON	\$295.60	TON	\$268.00	TON
TACK FOB Gallon Vendor Delivered, Vendor Placed										
ROAD PAVING	\$12.00	GAL	NO BID	GAL	\$5.50	GAL	NO BID	GAL	\$21.00	GAL
PRIME Vendor Delivered, Vendor Placed										
ROAD PAVING	\$1.00	SY	\$1.00	SY	\$0.75	SY	\$0.80	SY	\$1.00	SY
PRIM AND SAND Vendor Delivered, Vendor Placed										
ROAD PAVING	\$2.00	SY	\$1.20	SY	\$1.10	SY	\$1.55	SY	\$1.00	SY
SAND 3% HOT MIX Vendor Delivered, Vendor Placed										
ROAD PAVING	\$1,000.00	TON	\$500.00	TON	NO BID	TON	\$375.00	TON	NO BID	TON
PARKING LOTS	\$14.00	SY	\$7.00	SY	NO BID	SY	\$3.64	SY	NO BID	SY
HOT ASPHALT FOR PICK UP FOB AT PLANT SP-9.5 FOR PICK UP										
ROAD PAVING	\$65.00	TON	\$70.00	TON	\$70.00	TON	NO BID	TON	\$93.00	TON
TEMPORARY STRIPING Vendor Schedules and Provides										
ROAD PAVING	\$5.00	L.F.	\$2.00	L.F.	\$4.50	L.F.	\$6.00	L.F.	\$4.00	L.F.
NIGHT WORK Cost Per Ton										
ROAD PAVING	\$10.00	TON	\$10.00	TON	\$10.00	TON	\$16.50	TON	\$10.00	TON
COST FOR MILLING & CLEANUP SY 0-2,500 and Under										
ROAD PAVING	\$5.00	SY	\$5.00	SY	\$4.75	SY	\$6.37	SY	\$7.00	SY
COST FOR MILLING & CLEANUP SY 2,501 - 5,000										
ROAD PAVING	\$3.00	SY	\$3.00	SY	\$2.75	SY	\$3.62	SY	\$5.00	SY
COST FOR MILLING & CLEANUP SY 5,001 - 15,000										
ROAD PAVING	\$2.75	SY	\$2.10	SY	\$2.75	SY	\$3.38	SY	\$4.00	SY
COST FOR MILLING & CLEANUP SY 15,001 and over										
ROAD PAVING	\$2.50	SY	\$2.10	SY	\$2.75	SY	\$3.10	SY	\$4.00	SY

ASPHALT MILLINGS FOR PICKUP FOB AT PLANT										
ROAD PAVING										
COST PER TON TO ADD ARAMID FIBER TO THE ASPHALT MIX										
FOR SPECIFIC PROJECTS ONLY										
ROAD PAVING	\$10.00	TON	\$15.00	TON	\$10.00	TON	\$15.00	TON	NO BID	TON

INTENT TO AWARD: All items will be awarded to V.A. Paving, Inc., Preferred Materials, Inc., C.W. Roberts Contracting, Inc., Goodson Paving, Inc., and Community Asphalt Corp to be utilized per job based on price and availability of each contractor with the above tabulation.

Bid tabulations with award recommendations are posted to VendorLink at www.myvendorlink.com or DemandStar at www.demandstar.com. Brevard County encourages prompt and fair handling of all complaints and disputes with the business community. Filing of any disputes and appeals shall be in accordance with procedures specified in bid documents.

Approval Initials: *[Signature]*



Tammy Rowe, Clerk to the Board, 400 South Street • P.O. Box 999, Titusville, Florida 32781-0999

Telephone: (321) 637-2001
Fax: (321) 264-6972
Tammy.Rowe@brevardclerk.us

August 7, 2019

MEMORANDUM

TO: Leslie Rothering, Interim Central Services Director

RE: Item F.8., Permission to Issue Annual Supply Bids, Proposals, and Requests for Qualifications (FY 2019/2020) and/or Negotiate Competitive Agreements

The Board of County Commissioners, in regular session on August 6, 2019, granted approval to perform the following actions regarding the attached list of commodities and services for fiscal year 2019/2020: 1.) Solicit competitive bids, quotes, and/or negotiate competitive agreements and award to lowest, responsive, responsible and most qualified supplier; 2.) solicit competitive proposals and requests for qualifications, establish selection and negotiation committees approved by the County Manager (or designee); and award contracts and/or open purchase orders with the highest ranked proposer; 3.) exercise renewal options upon evaluation of supplier performance, and recommendation from user departments/offices; this establishes that continuance of the contract is favorable prior to renewal of the agreement; and 4.) authorize the Chair to execute contracts and renewals over \$100,000 in total aggregate value, subject to prior approval by the County Attorney's Office and Risk Management.

Your continued cooperation is greatly appreciated.

Sincerely yours,

BOARD OF COUNTY COMMISSIONERS
SCOTT ELLIS, CLERK

Tammy Rowe

Tammy Rowe, Deputy Clerk

/cmw

cc: Budget
Finance

ANNUAL BID/QUOTE/PROPOSAL LIST

FY 2018/2019

- Over \$100,000 Annually -

COMMODITY/SERVICE	CONTRACT YEAR & RENEWAL OPTION	ESTIMATED ANNUAL EXPENDITURES (>\$100K)
Aggregate (57 Stone & Pea Gravel)	Up to 5 years	\$200,000.00
Agricultural & Aquatic Chemicals	Up to 5 years	\$270,000.00
Asphaltic Concrete	Up to 5 years	\$4,300,000.00
Automotive Parts	Up to 5 years	\$100,000.00
Brevard County Government 2019/2020 Health Plan	5 years	Dependent on plan participants
Bunker Gear for Brevard County Fire Rescue	5 yr. & 5 (1 yr.) renewals	\$300,000.00
Cab & Chassis Trucks and Other Fleet Equipment	Up to 5 years	\$1,000,000.00
Cold in Place Recycling	Up to 5 years	\$100,000.00
Computer Equipment, Peripherals & Services	Up to 5 years	\$100,000.00
Concrete Pipe	Up to 5 years	\$300,000.00
Concrete Sidewalk, Curb, and Gutter Construction	Up to 5 years	\$340,000.00
Consultant Professional Engineering Services, A&E, Roofing Services - All departments	Up to 5 years	Varies per CIP Project and Tasking
Continuing Roofing Contracting Services	Up to 5 years	Varies per CIP Project and Tasking
Contracted Seasonal Recreation Worker Services for P&R	Up to 5 years	\$640,000.00
Copy Machine Rental	5 yr. & 1 (1 yr.) renewal	\$500,000.00
County Dental Insurance	3 yr. & 1 (1 yr.) renewal	
County Group Vision Plan	3 yr. & 2 (1 yr.) renewals	
Debt Collection Services	3 Years	
Deceased Removal and Transport	Up to 5 years	\$140,000.00
Disaster Debris Removal and Recovery Management Services	5 yr. & no renewals	
Disaster Debris Removal Services	5 yr. & no renewals	
Electrical Contractor Services - Hourly	Up to 5 years	\$265,000.00
Electronics Waste Recycling Services	Up to 5 years	\$175,000.00
Emergency Generator Repair & Maintenance	Up to 5 years	\$100,000.00
EMS Billing Services	Up to 5 years	\$630,000.00
Fencing (Brevard County Cooperative Bid)	Up to 5 years	\$210,000.00
Fertilizers	5 yr. & 5 (1 yr.) renewals	\$100,000.00
Fire Rescue Equipment	Up to 5 years	\$150,000.00
Floor Cleaning - Countywide	Up to 5 years	\$167,000.00
Full Depth Reclamation	Up to 5 years	\$100,000.00
Gasoline, Diesel, Fuel Oils (Brevard County Cooperative Bid)	Up to 5 years	\$3,500,000.00
Grassing Services (Brevard County Cooperative Bid)	Up to 5 years	\$380,000.00
HVAC & Ice Machine Services	Up to 5 years	\$200,000.00
HVAC for Maintenance	Up to 5 years	\$1,200,000.00
Inlets, Manholes, & Grates	Up to 5 years	\$485,000.00
Janitorial Services - County Wide	Up to 5 years	\$465,000.00
Janitorial Supplies	Up to 5 years	\$185,000.00
Laboratory Testing & Related Professional Services	Up to 5 years	\$200,000.00
Landfill Stormwater Collection & Gas System Repairs & Installation	Up to 5 years	\$100,000.00
Landscape Design & Detailing Maintenance Svs (Complete) - Facilities	Up to 5 years	\$150,000.00
Lawn Maintenance - Parks & Rec	Up to 5 years	\$249,000.00
Lawn Maintenance (Full Detail) - Merritt Island, District 2	Up to 5 years	\$185,000.00
Lawn Services - Full (Public Works): Mow, Irrigation, Pesticide	Up to 5 years	\$150,000.00
Lime Rock for Solid Waste and Public Works	Up to 5 years	\$100,000.00
Marketing Services for SCAT	Up to 5 years	\$400,000.00
Medical Supplies (EMS) - (Brevard County Cooperative Bid)	Up to 5 years	\$1,900,000.00
Mix-in-Place Soil Cement	Up to 5 years	\$250,000.00
Mulching & Disposal Services for Yard Trash & Vegetative Waste (On Site)	Up to 5 years	\$1,250,000.00
Mulching & Yard Trash/Vegetative Disposal Services (Off Site)	Up to 5 years	\$1,500,000.00
Office Supplies	Up to 5 years	\$200,000.00
Personal Protection Equipment (PPE)	Up to 5 years	\$100,000.00
Petroleum Products - Lube Oil	Up to 5 years	\$100,000.00
Physical Examinations - Fire Rescue	Up to 5 years	\$225,000.00
Pipe, Cured-In-Place Pipe (CIPP)	Up to 5 years	\$3,000,000.00
Plans Examiner Services	Up to 5 years	\$300,000.00
Plumbing Services	Up to 5 years	\$100,000.00
Plumbing Supplies Catalog Discount	Up to 5 years	\$100,000.00
Polymer, Sludge Dewatering	Up to 5 years	\$150,000.00
Postal & Courier Services - Libraries	Up to 5 years	\$200,000.00
Pumpout Services for Cleaning Baffle Box & Sediment Collection Devices Countywide	Up to 5 years	\$180,000.00
Radio System (800 MHZ) Maintenance Contract	Up to 5 years	\$500,000.00
Removal & Disposal of Dewatered Biosolids	Up to 5 years	\$230,000.00
Removal & Final Disposal of Mulch & Wood Waste	Up to 5 years	\$350,000.00
Retention Pond Mowing (Countywide): Natural Resources & Public Works	Up to 5 years	\$140,000.00
Road Construction Materials	Up to 5 years	\$4,000,000.00

ANNUAL BID/QUOTE/PROPOSAL LIST
FY 2018/2019
- Over \$100,000 Annually -

COMMODITY/SERVICE	CONTRACT YEAR & RENEWAL OPTION	ESTIMATED ANNUAL EXPENDITURES (>\$100K)
Road Striping - Paint & Reflective Pavement Marking	Up to 5 years	\$150,000.00
Road Striping - Thermoplastic & Reflective Pavement Marking	Up to 5 years	\$1,400,000.00
SAP Support Services	Up to 5 years	\$150,000.00
SCAT Vehicle Fleet Maintenance & Repair Management Services	Up to 5 years	\$4,350,000.00
Security Services - Brevard Government Complexes	Up to 5 years	\$250,000.00
Security Services Unarmed - Multidepartmental	Up to 5 years	\$500,000.00
Select Common Fill - Sarno Road Landfill	Up to 5 years	\$100,000.00
Select Common Fill - for Landfills (CDF Only)	Up to 5 years	\$983,000.00
Septic Tank, Grease Trap, Lift Station & Sewage Hauling Services	Up to 5 years	\$140,000.00
Sodium Hypochlorite Supply Services	Up to 5 years	\$250,000.00
Soil Cement Pub Mill Mix	Up to 5 years	\$180,000.00
Soil Cement with Oil Injection	Up to 5 years	\$100,000.00
Street Sweeping and Inlet Basket Cleaning	Up to 5 years	\$100,000.00
Structured Cabling System - Small Projects/Limited Drop	Up to 5 years	\$100,000.00
Submersible Pump and Motor Repair Services	Up to 5 years	\$160,000.00
TDC - Website Development & Maintenance Services	Up to 5 years	\$200,000.00
Temporary Employment Services	Up to 5 years	\$250,000.00
Temporary Traffic Control Devices	Up to 5 years	\$100,000.00
Tire Shredding & Disposal Services	Up to 5 years	\$335,000.00
Traffic Sign Materials	Up to 5 years	\$100,000.00
Traffic Signal Construction, Rehab, Maintenance & Emergency Repairs	Up to 5 years	\$250,000.00
Transportation of Dead Bodies	Up to 6 years	\$167,000.00
Travel Media Relations (For TDO)	Up to 5 years	\$200,000.00
Tree Trimming and Removal Services	Up to 5 years	\$150,000.00
Trucking Services	Up to 5 years	\$110,000.00
Uniform Apparel: Fire Rescue	Up to 5 years	\$100,000.00
Water & Wastewater Treatment Chemicals - Sodium Hypochlorite (Brevard County Cooperative Bid)	Up to 5 years	\$100,000.00
Welding/Medical Gases & Supplies	Up to 5 years	\$100,000.00

SUBMIT SEALED BID TO:
 BREVARD COUNTY PURCHASING SERVICES
 2725 JUDGE FRAN JAMIESON WAY
 BLDG. C, 3rd FLOOR, SUITE C-303
 VIERA, FL 32940



INVITATION TO BID

Bid Acknowledgment

PROCUREMENT ANALYST: (321) 617-7390
 Debbie Feingold Ext. 5-9332
 debbie.feingold@brevardfl.gov

AN EQUAL
 OPPORTUNITY
 EMPLOYER

FLORIDA TAX EXEMPT #85-8012621749C-1
 FEDERAL TAX EXEMPT #59-6000523

BID SPECIFICATIONS MAY BE OBTAINED AT: Purchasing Services, 2725 Judge Fran Jamieson Way, Bldg. C, Suite 303, Viera, FL 32940, or at the Onvia DemandStar® website and VendorLink

RELEASE DATE: July 16, 2020	BID TITLE: Asphaltic Concrete	BID NUMBER: B-6-20-57	BID OPENING DATE AND TIME: August 6, 2020 @ 2pm
---------------------------------------	---	---------------------------------	---

PRE-BID DATE, TIME, AND LOCATION:
 A non-mandatory pre-bid meeting will be held on July 23, 2020 at 10:30 a.m. in the Florida Room located at 2725 Judge Fran Jamieson Way, Bldg. C, 3rd Floor, Viera, FL 32940

Mandatory
 Non-Mandatory

BIDS RECEIVED AFTER ABOVE DATE AND TIME WILL NOT BE ACCEPTED

▼ CONTRACTOR MUST COMPLETE THIS AREA AND RETURN FORM ▼

LEGAL NAME OF CONTRACTOR AND BUSINESS ADDRESS: V.A. Paving, Inc. 2955 Lake Dr Cocoa, FL 32926	FEDERAL ID NO. (FEIN) OR SOCIAL SECURITY NO. (SSN): 59-2147362
---	--

If returning as a "no bid," state reason:

TELEPHONE NUMBER/TOLL-FREE NUMBER:
 (321) 636-2565

I certify that this bid is made without prior understanding, agreement, or connections with any corporation, firm or person submitting a bid for the same materials, supplies or equipment, and is in all respects fair and without collusion or fraud. I agree to abide by all conditions of this bid and certify that I am authorized to sign this bid for the Contractor. In submitting a bid to the County of Brevard, the Contractor offers and agrees that if the bid is accepted, the Contractor will convey, sell, assign, or transfer to the County of Brevard all rights, title, and interest in and to all causes of action it may now or hereafter acquire under the antitrust laws of the United States and the State of Florida for price fixing relating to the particular commodities or services purchased or acquired by the County of Brevard. At the County's discretion, such assignment shall be made and become effective at the time the County tenders final payment to the Contractor.

The Contractor acknowledges that information provided in this ITB is true and correct.

X

AUTHORIZED SIGNATURE (PRINTED)
 Debra Mallard
 NAME (PRINTED)
 President
 TITLE

8/6/2020
 DATE

THIS FORM MUST BE NOTARIZED AND RETURNED WITH YOUR BID

Sworn to and subscribed before me this 6 day of August 2020.

Personally known:
 Or produced identification: Type of ID: _____

SIGNATURE OF NOTARY PUBLIC FL STATE

Joni E H Bohne
 NAME OF NOTARY PUBLIC (PRINTED)

My commission expires: 7/24/21

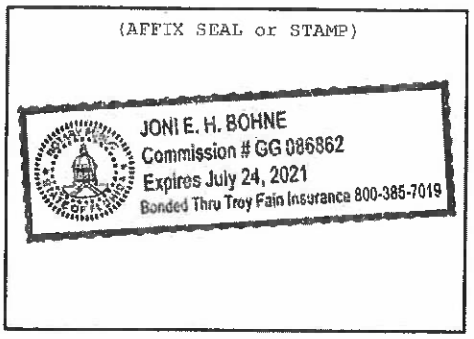

BOND DATA

CONTRACTOR MUST PROVIDE:	AMOUNT:
Yes <input type="checkbox"/> No <input checked="" type="checkbox"/> BID BOND	
Yes <input checked="" type="checkbox"/> No <input type="checkbox"/> PERFORMANCE BOND	<u>100% on projects over \$100,000</u>
Yes <input type="checkbox"/> No <input checked="" type="checkbox"/> LABOR, MATERIAL, PERFORMANCE BOND	

In cases where the amount of a surety bond exceeds \$500,000, the surety company must have an A.M. Best's rating as specified in this document, and depending on the amount of the bond, shall have a minimum A.M. Best's financial size category (FSC) ranking as follows:

BOND AMOUNT UP TO:	FINANCIAL CLASS	BOND AMOUNT UP TO:	FINANCIAL CLASS
\$ 1,000,000	I	\$ 25,000,000	V
\$ 2,000,000	II	\$ 50,000,000	VI
\$ 5,000,000	III	\$ 100,000,000	VII
\$ 10,000,000	IV		

Bonds must be issued by a surety company who complies with the requirements of § 287.0935, Fla. Stat.

PAYMENT OF GOODS OR SERVICES PROVIDED AS A RESULT OF THIS SOLICITATION WILL BE MADE PER FLORIDA STATUTE. ALL FIRST TIME CONTRACTORS MUST SUBMIT A W-9 FORM.

GENERAL CONDITIONS, TERMS, AND PROVISIONS

1. DEFINITIONS:

- a. **COUNTY** - The term "COUNTY" herein refers to the County of Brevard, Florida, and its duly authorized representatives.
- b. **CONTRACTOR** - The term "CONTRACTOR" used herein refers to any dealer/manufacturer/business organization that will be awarded a contract pursuant to the terms, conditions and quotations of the bid.
- c. **USING AGENCY** - The term "USING AGENCY" used herein refers to any department, division, agency, commission, board, committee, authority or other unit in the County Government using supplies or procuring contractual services as provided for in the Purchasing Ordinance of the County of Brevard.
- d. **HEAVY DUTY** - The item(s) to which the term "HEAVY DUTY" is applied shall exceed the usual quality and/or capacity supplied with standard production equipment and shall be able to withstand unusual strain, exposure, temperature, wear and use.
- e. **QUALIFIED CONTRACTOR** - The best Contractor who has the capability in all respects to fully perform the bid requirements, and has the financial stability, honesty, integrity, skill, business judgment, experience, facilities, and reliability necessary to assure good faith performance of the contract, as determined by reference to the Contractor's Qualification Statement, evaluations by County staff of the Contractor or its subcontractors' past performance for the Board, and any other information required by Board policies.
- f. **RESPONSIVE CONTRACTOR** - A Contractor who has submitted a bid, which conforms in all respects to the requirements of the bid package, including, but not limited to, submission of the bid on required forms with all required information, signatures, and notarizations at the place and time specified.
- g. **DUE CAUSE** - An applicable reason affecting and concerning the ability and fitness of the contractor(s) to perform to the specifications and requirements of the contract.

2. **SUBMISSION OF BIDS:** All bids shall be submitted in a sealed envelope. The bid number, title, and opening date shall be clearly displayed on the outside of the sealed envelope. The delivery of said bid to Purchasing Services prior to the specified opening date and time is solely and strictly the responsibility of the Contractor. Any bids received in Purchasing after the specified date and time will not be accepted.

3. **EXECUTION OF BID:** Bid must contain a manual signature of authorized representative in the space(s) provided. Bids must be typed or printed in ink. Use of erasable ink is not permitted. All corrections made by Contractor to any bid entry must be initialed. The company name and Federal Employer Identification Number (FEID) number shall appear in the space(s) provided.

4. **BID OPENING:** Bid opening shall be public on the date and time specified. Sealed bids received by an agency pursuant to invitations to bid are exempt from the provisions of subsection (1) and s. 24(a), Art. I of the State Constitution until such time as the agency provides notice of a decision or intended decision pursuant to s. 120.57(3)(a) or within 30 days after bid or proposal opening, whichever is earlier. In accordance with Florida Statute 119.071(1) (b) 2, the names of the firms submitting a competitive solicitation will be read aloud at this time of the opening. No details of the competitive solicitation will be released. Bid must be submitted on forms provided by the County. No other forms will be accepted. Fax, telephone, emailed, or verbal Bids are not acceptable and will not be considered. No bid may be modified after opening. No bid may be withdrawn after opening for a period of ninety (90) days unless otherwise specified.

5. **BID TABULATIONS:** Bid tabulations are posted to the [demandstar](#) and [VendorLink](#) websites.

6. **CLARIFICATION/CORRECTION OF BID ENTRY:** The County reserves the right to allow for the clarification of questionable entries and for the correction of OBVIOUS MISTAKES.

7. **INTERPRETATION:** No interpretation of the meaning of the specifications, or other contract documents will be made orally to any Contractor. Every request for such interpretation must be in writing, addressed to Purchasing Services at 2725 Judge Fran Jamieson Way, Bldg. C, 3rd Floor, Suite 303 Viera, FL 32940, or emailed to the attention of the applicable Procurement Analyst. To be given consideration, such requests must be received at least five (5) business days prior to the date fixed for the opening of the bid. Any and all such interpretation and supplemental instructions will be in the form of a written addendum. Failure of any Contractor to receive any such addendum or interpretation shall not relieve said Contractor from any obligation under his bid as submitted. All addenda so issued shall become part of the contract documents, whether or not the successful Contractor received a copy of such addendum, it being understood that all Contractors are responsible to verify that they have received any such addenda prior to submitting their bid.

8. **EEO STATEMENT:** Contractors must ensure that employees and applicants for employment are not discriminated against for reasons of race, color, age, religion, sex, national origin, or handicapped status. Minority and female-owned businesses are encouraged to participate. Brevard County is an equal opportunity employer.

9. **PRICING:** Firm prices shall be proposed and include FOB DESTINATION, all packing, handling, shipping charges, fuel surcharges and delivery, unless otherwise indicated, to any point within the County to a secure area or inside delivery. All prices, costs, and conditions shall remain firm and valid for 90 days from the date of opening. The obligations of Brevard County under this award are subject to the availability of funds lawfully appropriated for its purpose by the State of Florida and/or the Brevard County Board of County Commissioners.

10. **ADDITIONAL TERMS & CONDITIONS:** The County of Brevard reserves the right to reject bids containing any additional terms or conditions not specifically requested in the original conditions and specifications.

11. **TAXES:** The County of Brevard is exempt from Federal excise taxes and all sales taxes.

12. **DISCOUNTS:** All discounts, EXCEPT THOSE FOR PROMPT PAYMENT, shall be considered in determining the lowest net cost for bid evaluation purposes.

13. **MEETS SPECIFICATIONS:** All equipment and accessories furnished under these specifications shall be new, the latest model in current production, and shall be of good quality, workmanship, and material. The Contractor represents that all equipment offered under these specifications shall meet or exceed the minimum requirements specified. Delivery specifications shall be strictly adhered to. The Contractor shall be responsible for performing the work necessary to meet County standards in a safe, neat, good, and workmanlike manner.

14. **BRAND NAME OR EQUAL:** If items called for by this invitation have been identified in the specifications by a "Brand Name or Equal" description, such identification is intended to be descriptive, but not restrictive, and is to indicate the quality and characteristics of products that will be acceptable. Bids offering "equal" products will be considered for award if such products are clearly identified in the bid and are determined by the County to meet fully the salient characteristics requirements listed in the specifications. Unless the Contractor clearly indicates in his bid that he is offering an "equal" product, the bid shall be considered as offering the same brand name product referenced in the specifications. If the Contractor proposes to furnish an "equal" product, the brand name if any, or the product to be furnished shall be inserted in the space provided or such product shall be otherwise clearly identified. The evaluation of bids and the determination as to equality of the product offered shall be the

- responsibility of the County and will be based on information furnished by the Contractor. Purchasing Services is not responsible for locating or securing any information, which is not identified in the bid and reasonably available to Purchasing Services. To ensure that sufficient information is available the Contractor shall furnish as a part of the bid, or prior to bid opening, as indicated, all descriptive material necessary for Purchasing Services to determine whether the product offered meets the salient characteristics required by the specifications and establish exactly what the Contractor proposes to furnish and what the County would be binding itself to purchase by making an award.
15. **SILENCE OF SPECIFICATIONS:** The apparent silence of the specifications and any supplemental specifications as to any details or the omission from same of any detailed description concerning any point, shall be regarded as meaning that only the best commercial practices are to prevail and only materials of first quality be provided. All interpretations of this specification shall be made upon the basis of this statement.
 16. **ASSIGNMENT:** Any purchase order (PO) issued pursuant to this bid and the moneys, which may become due hereunder is not assignable except with the prior written approval of the Purchasing Manager.
 17. **INDEMNIFICATION:** The successful Contractor agrees to indemnify and hold harmless the County and their employees from all claims, losses and expenses, including attorneys' fees, arising out of or resulting from the performance, failure in the performance of, or defect in, the products or services to be contracted, provided such claim, damage, loss or expense (1) is attributable to bodily injury, sickness, disease, death, or personal injury, or to property damage, including loss of use resulting therefrom, and (2) is caused in whole or in part by any negligent act or omission of the Contractor, any subcontractor or any of their employees, or arises from a job-related injury. The successful Contractor acknowledges adequate consideration for this indemnification provision.
 18. **PATENTS AND ROYALTIES:** The Contractor, without exception shall indemnify and save harmless the County of Brevard and its employees from liability of any nature of kind including cost and expenses for or on account of any copyrighted, patented, or unpatented invention, process, or article manufactured or used in the performance of the contract, including its use by the County of Brevard. If the Contractor uses any design, device, or materials covered by letters, patent or copyright, it is mutually agreed and understood without exception that the bid prices shall include all royalties or cost arising from the use of such design, device, or materials in any involved in the work.
 19. **TRAINING:** If specified, supplier(s) may be required at the convenience of the County, to provide employees training in the operation and maintenance of any items(s) purchased from this bid.
 20. **ACCEPTANCE:** Items may be tested for compliance with specification. Items delivered not conforming to specifications may be rejected and returned at Contractor's expense. Those items not delivered as per delivery date in bid and/or purchase order may be purchased on the open market. Any increase in cost may be charged against the Contractor. Any violations of these stipulations may also result in the Contractor name being removed from the bid list and the Contractor disqualified from doing business with the County.
 21. **SAFETY WARRANTY:** The selling dealer, distributor, supplier, and manufacturer shall be responsible for having complied with all Federal, State and local standards, regulations, and laws concerning the equipment specified and the use thereof, applicable and effective on the date of manufacture including safety and environmental standards as apply to both private industry and governmental agencies.
 22. **WARRANTY:** The Contractor agrees that, unless otherwise specified, the supplies and/or services furnished under this bid shall be covered by the most favorable commercial warranty the Contractor gives to any customer for comparable quantities of such supplies and/or services and that the rights and remedies provided herein are in addition to and do not limit any rights afforded to the County by any other provision of this bid.
 23. **AWARDS:** As the best interest of the County may require, the right is reserved to make award(s) by individual items, group of items, all or none, or a combination thereof; to reject any and all bids or waive any minor irregularity or technicality in bids received. Contractors are cautioned to make no assumptions unless their bid has been evaluated as being responsive and qualified. All awards made as a result of this bid shall conform to applicable ordinances of the County. The Board may return, for full credit, any unused items received which fail to meet the Board's performance standards. Brevard County reserves the right to cancel an awarded bid upon due cause—i.e., Contractor misrepresentation, Contractor negligence, non-performance, etc. via written notice.
 24. **Unless otherwise noted in the bid document, Contractors shall submit one bid only.**
 25. **CONFLICT OF INTEREST:** The award hereunder is subject to provisions of State of Florida Statutes and Brevard County Ordinances. All Contractors must disclose with their bid the name of any officer, director, or agent who is also an employee of Brevard County. Further, all Contractors must disclose the name of any County employee who owns, directly or indirectly, any interest in the Contractor's firm or any of its branches.
 26. **PURCHASING AGREEMENTS WITH OTHER GOVERNMENTAL ENTITIES:** Brevard County permits the awarded Contractor(s) to extend the pricing, terms and conditions of this solicitation to other governmental entities at the Contractor's discretion. Each governmental entity that utilizes this solicitation or resulting contract will be responsible for execution of its own requirements with the awarded Contractor (s).
 27. **DRUG-FREE WORKPLACE:** Whenever two or more bids, which are equal with respect to price, quality, and service, are received by Brevard County for the procurement of commodities or contractual services, a bid received from a business that has implemented a drug-free workplace program per 287.087, Fla. Stat. shall be given preference in the award process.
 28. **LOBBYING STATEMENT:** All firms are hereby placed on notice the County Commission and staff shall not be contacted about this Bid. Firms and their agents are hereby placed on notice that they are not to contact members of the County Commission or staff (with the exception of designated liaison). Public meetings and public deliberations of the Selection Committee are the only acceptable forum for the discussion of merits of products/services requested by the Invitation to Bid; and written correspondence concerning Bids may be submitted to the County Manager. Each Bid will have one non-voting staff member designated who will serve as the liaison. Failure to adhere to these requirements could result in Board action to disqualify your firm from consideration of award.
 29. **PUBLIC ENTITY CRIMES:** All Contractor are hereby placed on notice that a person or affiliate who has been placed on the convicted vendor list following a conviction for a public entity crime may not submit a bid on a contract to provide any goods or services to a public entity, may not submit a bid on a contract with a public entity for the construction repair of a public building or public work, may not submit bids on leases of real property to a public entity, may not be awarded or perform work as a contractor, supplier, subcontractor, or consultant under a contract with a public entity, and may not transact business with any public entity in excess of the threshold amount provided in 287.017 Fla. Stat. for CATEGORY TWO (currently \$35,000) for a period of thirty-six (36) months from the date of being placed on the convicted vendor list.
 30. **DISCRIMINATORY VENDOR LIST:** An entity or affiliate placed on the Discriminatory Vendor List shall not submit a Bid for a contract to provide goods or services to a public entity, shall not submit a Bid on a contract with a public entity for the construction or repair of a public building or perform any public work, shall not submit Bids for leases of real property to a public entity, shall not award or perform work as a contractor, supplier, subcontractor, or consultant under any contract with any public entity, and shall not transact business with any public entity per 287.134(3)(d), Fla. Stat.

31. **SCRUTINIZED COMPANIES:** Awarded Contractor shall certify that it and its subcontractors are not on the Scrutinized Companies that Boycott Israel List. Pursuant to Section 287.135, F.S. if the Agreement is for more than \$1,000,000 the Contractor further certifies that it and its subcontractors are also not on the Scrutinized Companies with Activities in Sudan, Scrutinized Companies with Activities in the Iran Petroleum Energy Sector List, or engaged with business operations in Cuba or Syria as identified in Section 287.135, F.S.

For Contracts of any amount, if the County determines the Contractor submitted a false certification under Section 287.135(5) of the Florida Statutes, or if the Contractor has been placed on the Scrutinized Companies that Boycott Israel List, or is engaged in a boycott of Israel, the County shall either terminate the Contract after it has given the Contractor notice and an opportunity to demonstrate the County's determination of false certification was in error pursuant to Section 287.135(5)(a) of the Florida Statutes, or on a case-by-case basis the County may choose to maintain the Contract if the conditions of Section 287.135(4) of the Florida Statutes are met. For Contracts \$1,000,000 and greater, if the County determines the Contractor submitted a false certification under Section 287.135(5) of the Florida Statutes, or if the Contractor has been placed on the Scrutinized Companies with Activities in the Sudan List, or the Scrutinized Companies with Activities in the Iran Petroleum Energy Sector List, the County shall either terminate the Contract after it has given the Contractor notice and an opportunity to demonstrate the County's determination of false certification was in error pursuant to Section 287.135(5)(a) of the Florida Statutes, or on a case-by-case basis the County may choose to maintain the Contract if the conditions of Section 287.135(4) of the Florida Statutes are met.

The Contractor agrees to observe the above requirements for applicable subcontracts entered into for the performance of work under this Agreement.

As provided in Subsection 287.135(8), F.S., if federal law ceases to authorize these contracting prohibitions, this section shall become inoperative and unenforceable.

32. **LICENSES, CERTIFICATIONS, AND PERMITS:** The successful Contractor will be required to secure, at its expense and show proof of the proper business tax receipt and/or any other license/certification required of the applicable service/work being performed. Prior to award, the apparent low Contractor will be required to provide proof of license and/or certification within two (2) business days of the posted awarded recommendation and submit copies of license/certifications to the Purchasing Office. The Brevard County Contractor Licensing Regulation & Enforcement (LR&E) office is responsible for the county licensing of trades: General Building, drywall, plumbing, electric, HVAC, roofing, etc. If you have questions concerning the licensing requirements for a Brevard County contractor's license, please contact the Brevard County LR&E office at (321) 633-2058, option 0, for any questions.

The awarded contractor shall fully comply with all federal and state laws, county and municipal ordinances and regulations in any manner affecting the performance of the work. The successful Contractor is responsible for obtaining all permits necessary to construct the project. Brevard County does not exempt itself from permitting requirements. The Owner shall pay all Brevard County permit, inspection and impact fees required for the project or services required under this contract; all other fees for permits required by agencies/municipalities other than Brevard County shall be the responsibility of the awarded Contractor. A copy of issued permit shall be provided to the User Department of the County for their records.

33. **ERRORS:** In the event of extension error(s), the unit price will prevail. In the event of addition error(s), the extended totals will prevail. In either case, the Contractor's total offer will be adjusted accordingly.
34. **CANCELLATION AND REINSURANCE:** If any insurance should be canceled or changed by the insurance expiring during the period of this bid award, the Contractor shall be responsible for securing other acceptable

insurance to provide the coverage specified in the bid to maintain continuous coverage during the life of the award.

35. **INCURRED COST:** Brevard County is not liable for any cost incurred by any Contractor prior to an award. Costs for developing a response to this request for bid are entirely the obligation of the Contractor and shall not be chargeable in any manner to Brevard County.
36. **MATERIALS/SUPPLIES:** No materials or supplies for the work shall be purchased by the Contractor or by any subcontractor subject to any chattel mortgage or under a conditional sale or other agreement by which an interest is retained by the seller.
37. **SUBCONTRACTORS:** The Contractor shall be fully responsible for all acts and omissions of his subcontractors and of persons and organizations directly or indirectly employed by them and of persons and organizations for whose acts and omissions of persons directly employed by him.
38. **VERBAL INSTRUCTIONS:** No negotiations, decisions, or actions shall be initiated or executed by the Contractor as a result of any discussions with any County employee. Only those communications, which are in writing from an authorized County representative, may be considered. Only written communications from Contractors, which are assigned by a person designated as authorized to bind the company, will be recognized by the County as duly authorized expressions on behalf of the company.
39. **LITIGATION VENUE:** All litigation shall take place either in the State Courts of Florida, wherein venue shall lie in Brevard County, Florida, or in the Federal Courts wherein venue shall lie in the Middle District in and for the State of Florida. The Contractor expressly waives venue in any other location.
40. **ADDITION, DELETION, OR MODIFICATION OF SERVICES:** The County reserves the right at its sole discretion to increase, decrease, or delete any portion of this agreement/contract at any time without cause, and if such right is exercised by the County, the total fee shall be reduced by a prorate basis. If work has already been accomplished on the portion of the contract to be increased, decreased, or deleted, the contractor shall be paid for the correct portion on the basis of the estimated percentage agreed upon by the County, the contractor, and the contract manager upon completion of such portion.
41. **OPERATION DURING DISPUTE:** In the event the County has not canceled the contract in accordance with the terms of the contract, and there remains a dispute between the Contractor and the County, the Contractor agrees to continue to operate and perform under the terms of the contract while such dispute is pending. Further, the Contractor agrees that, in the event a suit is filed for injunction or other relief, it will continue to operate the system until the final adjudication of such suit by the court.
42. **CONTRACT TERMINATION:** The contract resulting from this bid shall commence upon issuance and acceptance of the fully executed contract. The County user agency shall issue orders against the contract on an as needed basis. The contract may be canceled by the Contractor, for good cause, upon ninety (90) days prior written notice. The County retains the right to terminate the contract, in part or in its entirety, with or without good cause, upon thirty (30) days prior written notice or as stated herein. In the event of termination by either party as provided herein, the awarded Contractor shall be paid for services performed through the date of termination.
43. **SPECIAL ACCOMMODATIONS:** In accordance with the Americans with Disabilities Act (ADA) and Section 286.26, Fla. Stat., persons with disabilities needing special accommodations to participate should contact the ADA Coordinator at (321) 633-2017 or by email at Brian.Breslin@BrevardFL.gov, and must be made no later than 48 hours prior the public meeting/hearing in order to provide the requested service.
44. **CONTRACTOR RESPONSIBILITIES:** Contractors, by submitting a bid, certify that it understands all planning, coordinating, and implementation

of the described services shall be done through personal contact between the Contractor and the contract manager, and that telephone contact and mail correspondence may, in some cases, not be appropriate. County approved representatives of the Contractor shall be available to meet with the contract manager, as may be required, to accomplish the County's objectives as effectively and efficiently as possible, during all phases of this agreement/contract/bid.

45. **SUPERVISION OF CONTRACT PERFORMANCE:** The Contractor's performance of the contract will be notified by the contract manager. The Contractor shall be notified of lack of performance in writing by the contract manager. If at any time during the term of the contract, performance satisfactory to the contract manager shall not have been made, the Contractor, upon written notification by the contract manager, shall within three (3) days increase the force, tools and equipment as needed to properly perform the contract. The failure of the contract manager to file such notification shall not relieve the Contractor of the obligation to perform the work at the time and in the manner specified by the contract. If the Contractor does not increase the force or neglects to do the work properly, the contract manager can withhold a percentage of payment or withhold the entire dollar amount due as per the contract.
46. **MISUNDERSTANDING:** To prevent misunderstanding and any litigation, the contract manager shall decide any and all questions, which may arise concerning the quality and acceptability of the work, and services performed the sufficiency of performance, the interpretation of the provisions of the contract, and the acceptable fulfillment of the contract on the part of the Contractor. The Contract Manager will determine whether or not the amount, quantity, character and quality of the work performed are satisfactory, which determination shall be final, conclusive and binding upon both the Contractor and the County. The contract manager shall make such explanation as may be necessary to complete, explain, or make definite the provisions of the contract, and his findings and conclusions shall be final and binding upon both parties.
47. **GREEN PROCUREMENT POLICY:** The Board of County Commissioners approved a "green procurement" policy in March 2004 to establish procurement requirements that promote the purchase and use of Environmentally Preferred Products as defined by the United States Environmental Protection Agency. Environmentally Preferred Products (EPP) are those products and services that have a reduced effect on the human health and the environment when compared to other products and services that serve the same purpose. EPP produces encourage (1) waste reduction; (2) reduced exposure to hazardous materials; (3) natural resource conservation; and (4) energy efficiency.
48. **MONITORING OF WORK:** The Contractor shall provide the contract manager with every reasonable opportunity to ascertain whether or not the work, as performed, is in accordance with the requirements of the contract. The Contractor shall designate, in writing, a person to serve as liaison between the Contractor and the County.
49. **PROMPT PAYMENT:** For payment promptness, Brevard County shall remit payment in accordance with the Florida Prompt Payment Act, Section 218.70, Fla. Stat., et seq. Brevard County does not expect to be billed in excess of the ordered quantity and will not pay for any quantity above the ordered quantity. Any order placed as a result of this bid will be subject to Billing Instructions and Conditions on the back of the Brevard County Purchase Order form. Contractors may offer cash discounts for prompt payment but they will not be considered in determination of award. If a Contractor offers a discount, it is understood that the discount time will be from the date of satisfactory delivery, at the place of acceptance, and receipt of correct invoice, at the office specified, whichever occurs last. Requests for final payment for any work or services for which a permit is required shall include a copy of all required permits and copies of all required inspection reports. Failure to provide proof of acquisition of all required permits and successful completion of all required inspections shall represent an incomplete invoice and will delay payment.

50. **RIGHT TO AUDIT RECORDS:** In performance of this Agreement, the Contractor shall keep books, records, and accounts of all activities related to the Agreement, in compliance with generally accepted accounting procedures. All documents, papers, books, records, and accounts made or received by the contractor in conjunction with the Agreement and the performance of this Agreement shall be open to inspection during regular business hours by an authorized representative of the office, and shall be retained by the contractor for a period of five (5) years after termination of this Agreement—unless such records are exempt from section 24(a) of Article I of the State Constitution and section 119.07(1), Fla. Stat.

51. **UNAUTHORIZED ALIEN WORKERS:** Brevard County will not accept bids from Contractors who knowingly employ unauthorized alien workers, constituting a violation of the employment provisions contained in 8 U.S. Code § 1324a(e) (Section 274A(e) of the Immigration and Nationality Act "INA"). The County shall consider a Contractor's intentional employment of unauthorized aliens as grounds for immediate termination of any awarded proposal. The CONTRACTOR shall utilize the U.S. Department of Homeland Security's E-Verify system to verify the employment eligibility of all new employees hired by the CONSULTANT during the term of the Contract and shall expressly require any subcontractors performing work or providing services pursuant to the Contract to likewise utilize the U.S. Department of Homeland Security's E-Verify system to verify the employment eligibility of all new employees hired by the subcontractor during the Contract term. If the County is unable to electronically verify the lowest responsive responsible Contractor participates in the E-Verify Program: the lowest responsive responsible CONTRACTOR SHALL be required to submit a copy of the fully executed E-Verify Memorandum of Understanding before the County will enter into contract or issue notice to proceed with Contractor.

52. **FLORIDA PUBLIC RECORDS LAW:** Both parties understand that the County is subject to the Florida Public Records Law, Chapter 119, Fla. Stat. and all other applicable Florida Statutes. If the materials provided by the Contractor do not fall under a specific exemption, under Florida or federal law, materials provided by the Contractor to the County would have to be provided to anyone making a public records request. It will be the Contractor's duty to identify the information, which it deems is exempt under Florida/federal law, and identify the statute by number, which exempts that information.

Should any person or entity make a public request of the County—which requires or would require the County to allow inspection or provide copies of records which the Contractor maintains are exempt from Public Records Law or are confidential—it shall be the Contractor's obligation to provide the County within 24 hours (not including weekends and legal holidays), of notification by the County to the Contractor of the request, of the specific exemption or confidentiality provision so the County will be able to comply with the requirements of Chapter 119, Fla. Stat.

Should the County face any kind of legal action to require or enforce inspection or production of any records provided by the Contractor to the County which the Contractor maintains are exempt or confidential from such inspection/production as a public record, then the Contractor shall hire and compensate attorney(s) who shall represent the interest of the County as well as the Contractor in defending such action. The Contractor shall also pay any costs to defend such action and shall pay any costs and attorney fees, which may be awarded pursuant to 119.12, Fla. Stat.

All material submitted becomes the property of the County and may be returned only at the County's option. The County has the right to use any or all ideas presented in any reply to this ITB. Selection or rejection of any bid does not affect this right.

53. **PREFERENCE GIVEN TO COMMODITIES MANUFACTURED, GROWN, OR PRODUCED IN FLORIDA:** In accordance with 287.082, Fla. Stat., whenever two or more competitive sealed bids are received, one or more of which relates to commodities manufactured, grown, or produced within this State, and whenever all things stated in such received bids are equal with

respect to price, quality, and service, the commodities manufactured, grown, or produced within this State shall be given preference.

54. **COUNTY SEAL:** Use of the County Seal without the express approval of the Board of County Commissioners is a violation of 165.043, Fla. Stat. punishable as a misdemeanor.

55. **TIE BIDS:** Award of all tie quotes/bids shall be made by the Purchasing Manager in accordance with State Statutes, which allows a firm certified as a Drug-Free Workplace to have precedence. When evaluation of Contractor responses to solicitations results in identical offers, with regards to bids or quotations, or identical ranking with regards to proposals, from two or more Contractors, the County shall determine the order of award using the following criteria in order of preference listed below (from highest priority to lowest priority):

- a. For tie bids, quotations or proposals, priority shall be given to the Contractor certifying that he/she is a Drug-Free Workplace as defined within 287.087, Fla. Stat.;
- b. In the event that a tie still exists after progressing through a, the decision shall be made by lot or coin toss. The drawing of lots or coin toss shall be conducted in the presence of the effected Contractors if they elect to be present.

56. **CONTRACTOR COMPLAINTS AND DISPUTES:** Brevard County encourages prompt and fair handling of all complaints and disputes with the business community. In order to resolve disputed matters in an equitable manner, the following procedures are adopted:

a. **POSTING OF AWARD NOTICES**

FORMAL SEALED BIDS: No later than three business days after a bid opening the Purchasing Manager or his/her designee shall post a tabulation of competitive sealed bids to the DemandStar and VendorLink websites. The apparent responsive low contractor will be the intended award recommendation. If after posting the tabulation, the apparent low contractor is found to be non-responsive to the specifications, a revised tabulation will be posted indicating that the low contractor is non-responsive, and that the next lowest contractor is the intended awardee. The time for filing a protest will begin the date of the later posting.

b. **PROCEEDINGS**

Any contractor who is allegedly aggrieved in connection with the solicitation or pending award of a contract must file a formal written protest with the Purchasing Manager within five (5) business days of the posted award recommendation.

The formal written protest shall reference the bid/quote/proposal number, and shall state with particularity the facts and laws upon which the protest is based, including full details of adverse effects and the relief sought.

Within seven (7) calendar days of receipt of the formal written protest, the Purchasing Manager will arrange a meeting of the Protest Committee and the affected parties. The Protest Committee shall consist of two (2) Department Directors or designees, both of whom must be from an organizational group which the user department or group is not assigned; one (1) Assistant County Manager, who must be from an organizational group which the user department or group is not assigned under. The Purchasing Manager shall act as a non-voting Hearing Coordinator and the County Attorney or designee may be requested to attend as a non-voting member. The Purchasing Manager or designee record the meeting and provide any information as the committee may request. The purpose of the meeting of the Protest Committee is to provide an opportunity to: (1) review the basis of the protest, (2) evaluate the facts and merits of the bid protest, and (3) if possible, to reach a resolution of the protest that is acceptable to the affected parties. For the purpose of the Protest Committee hearing, resolution shall mean that the Protestor finds the decision of the Protest Committee acceptable.

In the event the matter is not resolved with the Protestor's acceptance of the Protest Committee's decision, the Purchasing Manager will schedule the recommended award including the details of the protest and the Protest Committee's recommendation before the Board of County Commissioners via Board Agenda. The County Manager, prior to approval and placement on the Board agenda, may elect to resolve the matter before presentation to the Board. In the event that the County Manager cannot bring the matter to resolution, a copy of the Agenda Report shall be furnished immediately to all affected parties. The affected parties may appear before the Board of County Commissioners as a final means of administrative remedy.

c. **STAY OF PROCUREMENTS DURING PROTESTS**

Failure to observe any or all of the above procedures shall constitute a waiver the right to protest a contract award. In the event of a timely protest under the procedure, the County shall not proceed further with solicitation or with the award until a recommendation is made by the Committee, or a written determination is made by the County Manager that the award must be made immediately in order to protect the public interest. Invoice disputes between an awarded Contractor and user agency will follow the guidelines set forth in AO-33, *Prompt Payment of Invoices*.

57. **Federal Emergency Management Agency (FEMA) Contract Requirements:** During a hurricane, civil disturbance, or other County declared emergency, the Contractor will be required to begin response within one hour after notification and be on site no later than two hours after notification unless due to circumstances beyond control of the Contractor (roadway damage, etc.). Cost of the service will be at the non-standard working hours. If State of Florida declares a State of Emergency, Contractor agrees to the terms outlined in the Federal Emergency Management Agency (FEMA) Contract Requirements (Attachment A).

**Asphaltic Concrete
B-6-20-57
CONTRACTOR'S CHECKLIST**

The items indicated are required for submission with your bid. Failure to submit any items indicated as required may result in rejection of the bid. Offers to provide required items after the date and time designated for the receipt of bid will not be considered.

- Signed/Notarized Bid Invitation, including Electronic Copy on CD or USB drive
- Completed and Signed Price Sheet, to include Insurance Indemnification Acknowledgement
- Price Sheet completed in Excel and submitted on CD or USB flash drive
- Confirmation of Drug Free Workplace Form
- Reference Form
- Contractor Affidavit Regarding Scrutinized Company List

In order for this bid to be valid, the above forms and information shall be completed in their entirety, signed by an authorized representative of the responding Contractor, and returned as part of the bid response.

Attachment A: Federal Emergency Management Agency (FEMA) Contract Requirements
Attachment B: Ace Fiber Specs
Attachment C: Forta Fi Fiber Specs
Attachment D: Excel Price Sheet

**Asphaltic Concrete
B-6-20-57
SPECIAL CONDITIONS**

1. PURPOSE

Brevard County Purchasing Services, on behalf of the Brevard County Public Works Department, is soliciting annual bids for the purchase of asphaltic concrete on a continuing basis to be purchased on an as needed basis.

Estimated annual quantities are provided for Brevard County. The quantities provided are estimates only, and do not constitute a minimum or maximum volume of work to be accomplished under this agreement.

CONTRACT PERIOD

The terms of this agreement shall be effective for one (1) year from the date of award. The agreement may be extended by mutual agreement, for two (2) additional one (1) year periods. Brevard County will notify the Contractor in writing ninety (90) days prior to the expiration of the agreement as to its intent to renew the agreement.

DELIVERY

All bids must be F.O.B. Destination, packing, shipping, handling and fuel surcharges, and delivery included to various locations in Brevard County, with inside delivery. Delivery addresses and quantities of orders may vary from order to order throughout Brevard County.

2. INFORMATION OR CLARIFICATION

For information concerning procedures for responding to this bid, contact Debbie Feingold, Purchasing Services at 321-617-7390 or by email at Debbie.feingold@brevardfl.gov. Such contact shall be for clarification purposes only. Material changes, if any, to the specifications will be transmitted by written addendum through Purchasing Services and posted online at [Onvia DemandStar® website](#) and [VendorLink](#). The County will not notify Contractors of addenda. It is the sole responsibility of the Contractor to check the website prior to submitting a bid to verify receipt of all documents to include written addendum.

Contractors shall promptly notify Purchasing Services, prior to submission of their bid, of any ambiguity, inconsistency or error, which they may discover upon examination of the bid documents. No interpretation of the meaning of specifications or other documents will be made to any Contractor orally, nor may Contractor rely on any such pre-bid statements in completing the bid. Every request for such interpretation must be in writing addressed to Purchasing Services at 2725 Judge Fran Jamieson Way, Bldg. C, Suite 303, Viera, FL 32940, or emailed to the attention of Debbie Feingold at Debbie.feingold@brevardfl.gov. To be given consideration, such requests must be received in writing no later than July 30, 2020 @ 5pm.

3. RECEIVING OF BIDS

Bids must be received by Brevard County Purchasing Services, 2725 Judge Fran Jamieson Way, Bldg. C, Suite C303, Viera, FL 32940 **no later than August 6, 2020 @ 2pm**. Bids must be submitted on County format to be considered. **The official time clock will be the date and time stamp clock located in the Purchasing Office.**

**Electronic bid filing is now available on VendorLink at www.myvendorlink.com .
Electronic bidding is preferred; however hard copy bids will still be received.**

If submitting hard copies, bids shall be submitted in one original and should be accompanied by an equivalent electronic PDF file on compact disc or USB flash drive. Electronic Price Sheet may be completed electronically on Excel spreadsheet. Electronically completed spreadsheet should

be saved on compact disc (CD) or USB flash drive and included with bid submittal. Contractors must also print out a hardcopy of the completed Price Sheet, sign where indicated, and submit with the bid. **DO NOT MODIFY OR REISSUE THE PRICE SHEET; USE THE PRICE SHEET FORM PROVIDED.**

Note* Please ensure that if you use a third party carrier (DHL Express, FedEx, UPS, USPS, etc.) that they are properly instructed to deliver your bid only to Purchasing Services on the third (3rd) floor at the above address. **Contractors are advised that U.S. Postal Service 1st Class and Express mail is delivered to a P.O. Box and is not delivered to the Purchasing Services Office. Delivery via the USPS is at the Contractor's risk. To be considered, a bid must be accepted in Purchasing Services no later than the ITB closing date and time. If the bid is delivered anywhere else, it may not reach Purchasing Services in time.**

4. PRE-BID/WALK THROUGH

A pre-bid meeting/walk through shall be held on July 23, 2020 @ 10:30am located in the Florida Room, 2725 Judge Fran Jamieson Way, Bldg. C, 3rd Floor, Viera, FL 32940. Interested Contractors are highly encouraged to attend this meeting. All contractors attending this pre-bid walk thru should meet in the Florida Room – 3rd Floor.

Mandatory **Non-Mandatory**

**Asphaltic Concrete
B-6-20-57
SCOPE OF SERVICES**

1. The material and services to be provided and performed by the awarded vendor are anticipated to be, but not limited to, those services set forth in the specifications. If the contractor fails to properly perform the conditions of the contract, in the sole opinion of the County, the County will communicate to the contractor, in writing, the problem(s) that exist. If the problem(s) persist or reoccur, the County reserves the right to cancel the contract by advising the contractor in writing as per General Conditions #42.
2. All material supplied under this contract must meet the requirements of sections 300, 320, 327, 330, 334, and 337 of the Florida D.O.T. Standard Specifications for Road and Bridge Construction, 2020 edition.
3. All materials supplied under this contract for road paving, resurfacing, patching, and cold patch (one-ton minimum) must be available with 72 hours of notification by the agency, and within five business days' notice by the agency for any nighttime work. In the event the contractor cannot meet the 72-hour availability notification the County reserves the right to move to the next available contractor.
4. The asphalt contractor shall furnish all materials, equipment, labor and incidentals for mixing aramid fibers into the existing mix design of the particular type of asphalt specified. The asphalt contractor shall introduce the fibers into the asphalt mix conforming to the specifications and requirements of the manufacturer. The asphalt contractor shall use the automated dosing machine recommended by the manufacturer to blend the specified rate of fibers per ton of asphalt per the Superpave Asphalt Concrete-Reinforcing Fiber in Asphalt Per Article 334-2.
5. The contractor must provide a minimum of 48-hour notice prior to leaving job site if scheduled work is not complete.
6. Bidders shall include in their bids the cost for all equipment, materials, and labor to power sweep and apply a tack coat prior to resurfacing and/or patching roads where applicable. No asphalt or patch shall be installed in standing water, or during raining conditions. Asphalt that is installed in such conditions will be removed by the contractor at the contractor's expense.
7. Contractor will be responsible for cleaning of driveways (tack, dirt and debris from brooming).
8. Contractor shall be responsible for rideability (must bring any problems of existing conditions to County's attention prior to paving.) Corrections on "New Pavement" (reconstructed or new rock base or soil cement) shall be in accordance with FDOT Standards 2020. Roadways subject to straight edge requirements.
9. Contractor to place all asphalt mixtures by the string line method, per FDOT 330-6.1.1. Contractor is to provide a uniform centerline and edge line +/- 1.5 inches. Any corrections for variations will be absorbed at the expense of the contractor.
10. The contractor shall provide temporary striping in accordance with section 102-1 and 102-2 of the Florida D.O.T. Standard Specification for Road and Bridge construction, 2020 edition. When the County's Striping Contractor is not available, the Asphalt Contractor must provide temporary striping.
11. When required, the contractor shall provide all equipment, labor and materials for Maintenance of Traffic in accordance with Florida D.O.T. Design Standards for Design. Construction, Maintenance

and Utility Operations on the State Highway System, Standard Specifications for Road and Bridge Construction, as well as the Manual on Uniform Traffic Control Devices (MUTCD) latest editions.

12. The contractor shall conform to the requirements of Section 330, "Hot Mix Asphalt - General Construction Requirements" of Florida D.O.T. Standard Specifications for Road and Bridge Construction 2020 Edition.
12. The contractor shall conform to the requirements of section 327 "Milling of Existing Asphalt Pavement" The Milled surface must be of uniform grade, and be consistent with the profile which existed prior to milling, and be clean and free of loose materials prior to the placement of hot mix.
13. The County will make award in accordance with General Conditions # 23 on the following:
 - Vendor Delivered and Vendor Placed price for SP9.5, SP12.5, FC9.5, FC12.5, and pick-up price for FOB 9.5 asphalt.
 - The Vendor Delivered and Vendor Placed price per ton must include all associated costs. Additional hauling costs will not be allowed.
14. Plant locations must be identified with bid.
15. Projects still in progress under the County's current agreement will be completed by the contractor under the current agreement. The contractor awarded this bid will be responsible for completion of any projects already in progress when the term of this bid expires.
16. An electronic weight ticket with Brevard County contract number, product mix design number, and plant location clearly marked must accompany all deliveries. Payment may be withheld where no delivery ticket is received with shipment, or if the ticket has incomplete information.
17. Subsequent to award and prior to commencement of contract, successful bidder(s) will be required to furnish proof of minimal insurance coverage per the attached requirements.
18. All references to specifications refer to the Florida Department of Transportation Standard Specifications for Road & Bridge Construction, 2020 edition.
19. Any "pushing" or "slipping" of the asphalt within a 12-month period after placement will be repaired at the contractor's expense.
20. At the start of all paving operations, the edge of the previous pavement shall be saw cut to provide a uniform edge to begin the construction of the paving process. When paving starts in a section where there is no edge, a section of the existing paving shall be milled to a depth of at least 1" and 12' along surface, the width of the section to be paved.
21. Testing by the County may be required using the following guidelines. Extraction and Gradation samples will be taken from the plant and random field samples for each daily production run per FDOT or County requirements (samples from the field shall be taken directly in front of the power-screw feed). All deficiencies will be corrected per FDOT Standards & Specifications for Road & Bridge (2020 version). Cores may also be required to verify thickness.
22. LIQUIDATED DAMAGES

If the Contractor does not arrive on site as scheduled, the County will provide the Contractor with 24-hours' notice that work will be acquired elsewhere. In the event that the County acquires work elsewhere due to contractor non-performance, liquidated damages will be assessed at the actual cost difference the County incurs from the alternate supplier.

Liquidated damages may be collected by the County by deducting damages from any outstanding invoices.

23. DEFECTIVE MATERIALS

If the contractor provides the County with any defective materials, it shall be the contractor's responsibility to remove the defective materials and replace them with correct materials at their own expense. The County will not remit payment for the original materials ordered until this correction is complete.

24. ESTIMATED QUANTITIES/USAGES

Below is a listing of estimated quantities/usages as referenced in Item 1 of the Special Conditions. Please be aware that these are estimates only, and are provided to assist you in preparing your bids. The quantities below in no way guarantee any minimum or maximum amount of product or work to be purchased.

Brevard County Board of County Commissioners:

- Superpave 9.5 – 85,000 TONS
- Superpave 12.5 – 15,000 TONS
- FC 12.5 – 25,000 TONS

The Contractor shall be responsible for preventing all asphalt paving debris from entering the storm drainage system of Brevard County. The Contractor shall use best management practices to establish inlet protection and the prevention of all unsuitable materials from entering into the storm system.

ASPHALTIC CONCRETE		REVISED PRICE SHEET		
BID # B-6-20-57		ROAD PAVING	PARKING LOTS	BIKE PATHS
ASPHALTIC CONCRETE	DESCRIPTION	ROAD PAVING	PARKING LOTS	BIKE PATHS
Superpave SP-9.5	Vendor Delivered, Vendor Placed	\$ 81.00 Ton	\$115.00 Ton	\$170.00 Ton
Superpave SP-12.5	Vendor Delivered, Vendor Placed	\$78.00 Ton	\$115.00 Ton	\$170.00 Ton
FRICTION COURSE		ROAD PAVING		
Friction Course FC-5	Vendor Delivered, Vendor Placed	\$ 180.00 Ton		
Friction Course FC-9.5	Vendor Delivered, Vendor Placed	\$110.00 Ton		
Friction Course FC-12.5	Vendor Delivered, Vendor Placed	\$109.00 Ton		
SPEED HUMPS SP-9.5	Vendor Delivered, Vendor Placed	\$575.00 Ton		
LESS THAN 25 TN PATCHING SP-9.5	Vendor Delivered, Vendor Placed	\$500.00 Ton		
25-50 TN PATCHING SP 9.5	Vendor Delivered, Vendor Placed	\$300.00 Ton		
TACK FOB Gallon	FOB GALLON	\$12.00 Gal		
PRIME	Vendor Delivered, Vendor Placed	\$1.00 SY		
PRIM AND SAND	Vendor Delivered, Vendor Placed	\$2.00 SY		
SAND 3% HOT MIX	Vendor Delivered, Vendor Placed	\$1,000.00 Ton	\$14.00 SY	
HOT ASPHALT FOR PICK UP FOB AT PLANT SP-9.5	FOR PICK UP	\$65.00 Ton		
TEMPORARY STRIPING	Vendor Schedules and Provides	\$5.00 L.F.		
Night Work	Cost per ton	\$10.00 Ton		
Cost for Milling & Clean Up	SY 0-2,500 and under	\$5.00 SY		
	SY \$2,501 - 5,000	\$3.00 SY		
	SY 5,001 to 15,000	\$2.75 SY		
	SY 15,001 and over	\$2.50 SY		
Asphalt Millings for Pickup FOB at Plant		\$75.00 Ton		
Cost per ton to add Aramid Fiber to the asphalt mix (Per attached Fiber Specs)	*			
SPECIFIC PROJECTS ONLY *		\$10.00 Ton		

Plant Locations: _____ 800 Cidco Rd Cocoa, FL 32926

**ASPHALTIC CONCRETE
BID # B-6-20-57**

**REVISED PRICE SHEET
(Continued)**

Addendum Acknowledgment:

Add. No. 1 Dated 7/28/2020 / Add. No. Dated

Add. No. Dated / Add. No. Dated

PROMPT PAYMENT DISCOUNT:

Brevard County shall remit payment in accordance with the Florida Prompt Payment Act, Florida Statutes section 218.70. Bidders may offer cash discounts for prompt payment, but they will not be considered in determination of award. If a bidder offers a discount, it is understood that the discount time will be from the date of satisfactory

If Prompt Payment Discount is offered, please state discount terms below:

Does your company accept payment via ACH? YES / NO

I hereby certify that I have read and agree to all terms and conditions, specifications, and insurance requirements outlined herein:

VENDOR V.A. Paving, Inc.

ADDRESS 2955 Lake Dr Cocoa, FL 32926

AUTHORIZED SIGNATURE  _____

DATE 8/6/2020

PRINTED SIGNATURE Debra Mallard, President

TELEPHONE # 321-636-2565 FAX # 321-631-4541

BREVARD COUNTY BOARD OF COUNTY COMMISSIONERS
INDEMNIFICATION AND INSURANCE REQUIREMENTS
Asphaltic Concrete
B-6-20-57

INDEMNIFICATION

The County shall be held harmless against any and all claims for bodily injury, sickness, disease, death, personal injury, damage to property or loss of use of any property or assets resulting therefrom, arising out of or resulting from the performance of the products or from the services for which the County is contracting hereunder, provided such is caused in whole or in part by any negligent act or omission of the Contractor, or any subcontractor or any of their agents or employees, or arises from a job-related injury.

The Contractor agrees to indemnify the County and pay the cost of the County's legal defenses, including fees of attorneys as may be selected by the County, for all claims described in the hold harmless clause herein. Such payment on behalf of the County shall be in addition to any and all other legal remedies available to the County and shall not be considered to be the County's exclusive remedy.

It is agreed by the parties hereto that the Contractor has received specific consideration under this agreement for this hold harmless/indemnification provision.

INSURANCE REQUIREMENTS

The Contractor providing services under this agreement will be required to procure and maintain, at their own expense and without cost to the County, until final acceptance by the County of all products or services covered by the purchase order or contract, the following types of insurance. The policy limits required are to be considered minimum amounts:

General Liability Insurance policy with a \$1,000,000 combined single limit for each occurrence to include the following coverage: Operations, Products and Completed Operations, Personal Injury, Contractual Liability covering this contract, "X-C-U" hazards, and Errors & Omissions.

Auto Liability Insurance, which includes coverage for all owned, non-owned and rented vehicles with a \$1,000,000 combined single limit for each occurrence.

Workers' Compensation and Employers Liability Insurance Workers Compensation insurance providing statutory benefits as required in the State of Florida. The Contractor shall require any subcontractor to provide evidence of this coverage. Additionally, if the contract requires working on or around a navigable waterway, the Contractor and all subcontractors shall provide evidence of United States Longshoremen's and Harbor Workers (USL&H) coverage and contingent coverage of Jones Act (Marine Employers Liability) in compliance with Federal statutes or proof of exemption. The Contractor shall be responsible for compliance with these requirements by each subcontractor, Contractor or supplier when applicable.

In the event that the contract involves professional or consulting services, in addition to the aforementioned insurance requirements, the Contractor shall also be protected by a Professional Liability Insurance Policy in the amount of \$1,000,000 per claim.

In the event the contract involves services related to construction projects, the Contractor shall also procure and maintain a Builders Risk Insurance Policy or Installation Floater with loss limits equal to the value of the construction project.

In addition to the above, Specialty Insurance policies covering specific risks of loss (including but not limited to, for example; Longshore coverage, Crane and Rigging, Inland Marine, etc.) may be required by Brevard County Insurance and Risk Management. Any additional specialty insurance coverage requirement will be dictated by the specific goods, products or services provided under the subject contract and insurance underwriting standards, practices, procedures or products available in the commercial insurance market at the time of the contract inception. The Contractor is required to procure and maintain all such specialty coverage in accordance with prudent business practices within the Contractors industry.

The awarded Contractor shall have five (5) days to provide certificates of insurance to the County demonstrating that the aforementioned insurance requirements have been met prior to the commencement of work under this contract. **The certificate(s) of insurance (COI) shall indicate that the policies have been endorsed to cover the County as an additional insured (a waiver of subrogation in lieu of additional insured status on the workers' compensation policy is acceptable)** and that these policies may not be canceled or modified without thirty (30) days prior written notice to the County.

The insurance coverage enumerated above constitutes the minimum requirements and shall in no way lessen or limit the liability of the Contractor under the terms of the contract. Sub-Contractor's insurance shall be the responsibility of the Contractor.

**Asphaltic Concrete
B-6-20-57
CONFIRMATION OF DRUG-FREE WORKPLACE FORM**

In accordance with Section 287.087, Florida Statutes, "whenever two or more bids are equal with respect to price, quality, and service which are received by any political subdivision for the procurement of commodities or contractual services, a bid received from a business that certifies that it has implemented a drug-free workplace program shall be given preference in the award process. In order to have a drug-free workplace program, a business shall:

- (1) Publish a statement notifying employees that the unlawful manufacture, distribution, dispensing, possession, or use of a controlled substance is prohibited in the workplace and specifying the actions that will be taken against employees for violations of such prohibition.
- (2) Inform employees about the dangers of drug abuse in the workplace, the business's policy of maintaining a drug-free workplace, any available drug counseling, rehabilitation, and employee assistance programs, and the penalties that may be imposed upon employees for drug abuse violations.
- (3) Give each employee engaged in providing the commodities or contractual services that are under bid a copy of the statement specified in subsection (1).
- (4) In the statement specified in subsection (1), notify the employees that, as a condition of working on the commodities or contractual services that are under bid, the employee will abide by the terms of the statement and will notify the employer of any conviction of, or plea of guilty or nolo contendere to, any violation of chapter 893 or of any controlled substance law of the United States or any state, for a violation occurring in the workplace no later than 5 days after such conviction.
- (5) Impose a sanction on, or require the satisfactory participation in a drug abuse assistance or rehabilitation program if such is available in the employee's community by, any employee who is so convicted.
- (6) Make a good faith effort to continue to maintain a drug-free workplace through implementation of this section."

As the person authorized to sign the statement, I certify that this firm complies with the above requirements and the Florida Statutes Section 287.087. This form is in conjunction with Brevard County's General Conditions, Item 27, Drug-Free Workplace.

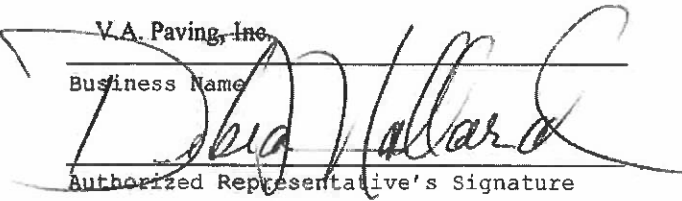
<p>V.A. Paving, Inc. Business Name</p> <p> Authorized Representative's Signature</p> <p>Debra Mallard Name</p>	<p>B-6-20-57 Asphaltic Concrete Bid Number and Name</p> <p>8/6/2020 Date</p> <p>President Position</p>
---	--

PUBLIC CONSTRUCTION BOND

(Payment and Performance)

BY THIS BOND, We _____, having its principal place of business at _____, (____)____-____
herein called Principal, and _____, having its principal place of business
at _____, (____)____-____, a corporation as
Surety, are bound to Board of County Commissioners of Brevard County, Florida, 2725 Judge Fran
Jamieson Way, Viera, Florida, 32940, (321) 633-2000, herein called Owner, in the sum of
_____. (\$_____.00) for payment of which we bind ourselves,
our heirs, personal representatives, successors, and assigns, jointly and severally.

THE CONDITIONS OF THIS BOND are that if Principal:

1. Performs the contract number _____ dated _____ between Principal and
Owner for construction of (project description) _____
_____, the contract being made a part of this bond by
reference, at the times and in the manner prescribed in the contract; and
2. Promptly makes payments to all claimants, as defined in Section 255.05(1), Florida
Statutes, supplying Principal with labor, materials, or supplies, used directly or indirectly
by Principal in the prosecution of the work provided for in the contract; and
3. Pays Owner all losses, damages, expenses, costs, and attorney's fees, including appellate
proceedings, that Owner sustains because of a default by Principal under the contract;
and
4. Performs the guarantee of all work and materials furnished under the contract for the
time specified in the contract, then this bond is void; otherwise it remains in full force.
Any action instituted by a claimant under this bond for payment must be in accordance

with the notice and time limitation provisions in Section 255.05(2) and (10), Florida Statutes. Any changes in or under the contract documents and compliance or noncompliance with any formalities connected with the contract or the changes does not affect Surety's obligation under this bond.

Signed and sealed this ____ day of _____, 20__.

Witness:

(Principal) (Seal)

Its: _____
(Title)

Witness:

(Surety) (Seal)

Its _____
(Title)

**Asphaltic Concrete
B-6-20-57
REFERENCE FORM**

List a minimum of three (3) / maximum five (5) customers for the services specified in the solicitation in the spaces provided.

Note: A contact person shall be someone who has personal knowledge of the Contractor's performance for the specific requirement listed. Contact person must have been informed that they are being used as a reference and that the County may be calling them. Do not list persons who will be unable to answer specific questions regarding the requirements.

Ref #1. Customer/Client: Brevard County
Date of Services: 12/2019 to present
Description of Services: Road Resurfacing
Street Address: 2725 Judge Fran Jamieson Way, Bldg. A-219
City, State, ZIP Code: Viera, FL 32940
Telephone #: (321) 617-7202 Fax #: 633-2170
Contact Person: Craig Kupec Email: Craig.Kupec@brevardfl.gov

Ref #2. Customer/Client: City of Melbourne
Date of Services: 9/2019 to present
Description of Services: Road Resurfacing
Street Address: 900 E Strawbridge Ave
City, State, ZIP Code: Melbourne, FL 32901
Telephone #: (321) 953-6313 Fax #: 321-608-5135
Contact Person: Dani Straub Email: dani.straub@mlbfl.org

Ref #3. Customer/Client: City of Palm Bay
Date of Services: 8/2019 to January 2020
Description of Services: Road Resurfacing
Street Address: 1050 Malabar Rd
City, State, ZIP Code: Palm Bay, FL 32907
Telephone #: (321) 917-3430 Fax #: 321-952-3424
Contact Person: Frank Watanabe Email: Frank.Watanabe@palmbayflorida.org

Ref #4. Customer/Client: City of Titusville
Date of Services: 06/2020 to present
Description of Services: Road Resurfacing
Street Address: 2910 Garden St
City, State, ZIP Code: Titusville, FL 32796
Telephone #: (321) 383-5815 Fax #: (321) 383-5628
Contact Person: Vanessa Maldonado Email: Vanessa.Maldonado@Titusville.com

Ref #5. Customer/Client: Space Florida
Date of Services: 05/2020 to present
Description of Services: Road Resurfacing
Street Address: 505 Odyssey Way, Suite 300
City, State, ZIP Code: Exploration Park, FL 32953
Telephone #: (321) 730-5301 Fax #: (321) 730-5307
Contact Person: Bunti Patel Email: Bunti.Patel@aecom.com

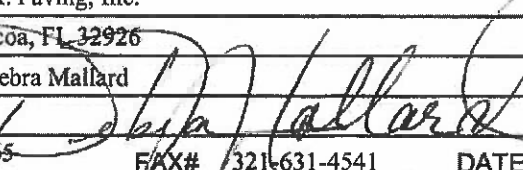
CONTRACTOR NAME V.A. Paving, Inc.
ADDRESS 2955 Lake Dr Cocoa, FL 32926
PRINTED SIGNATURE Debra Mallard
AUTHORIZED SIGNATURE 
TELEPHONE # 321-636-2565 FAX# 321-631-4541 DATE 8/6/2020
EMAIL: debra.mallard@vapaving.com

CONTRACTOR AFFIDAVIT REGARDING SCRUTINIZED COMPANY LIST

Awarded Contractor shall certify that it and its subcontractors are not on the Scrutinized Companies that Boycott Israel List. Pursuant to Section 287.135, F.S. If the Contract is for more than \$1,000,000 the Contractor further certifies that it and its subcontractors are also not on the Scrutinized Companies with Activities in Sudan, Scrutinized Companies with Activities in the Iran Petroleum Energy Sector List, or engaged with business operations in Cuba or Syria as identified in Section 287.135, F.S.

For Contracts of any amount, if the County determines the Contractor submitted a false certification under Section 287.135(5) of the Florida Statutes, or if the Contractor has been placed on the Scrutinized Companies that Boycott Israel List, or is engaged in a boycott of Israel, the County shall either terminate the Contract after it has given the Contractor notice and an opportunity to demonstrate the County's determination of false certification was in error pursuant to Section 287.135(5)(a) of the Florida Statutes, or on a case-by-case basis the County may choose to maintain the Contract if the conditions of Section 287.135(4) of the Florida Statutes are met. For Contracts \$1,000,000 and greater, if the County determines the Contractor submitted a false certification under Section 287.135(5) of the Florida Statutes, or if the Contractor has been placed on the Scrutinized Companies with Activities in the Sudan List, or the Scrutinized Companies with Activities in the Iran Petroleum Energy Sector List, the County shall either terminate the Contract after it has given the Contractor notice and an opportunity to demonstrate the County's determination of false certification was in error pursuant to Section 287.135(5)(a) of the Florida Statutes, or on a case-by-case basis the County may choose to maintain the Contract if the conditions of Section 287.135(4) of the Florida Statutes are met.

STATE OF FLORIDA

COUNTY OF Brevard

BEFORE ME, the undersigned authority, personally appeared

Debra Mallard, who, being by me first duly sworn, made the following statement:

1. The Business address of V.A. Paving, Inc. (name of Contractor) is 2955 Lake Dr Cocoa, FL 32926.
2. My relationship to V.A. Paving, Inc. (name of Contractor) is President (relationship such as sole proprietor, partner, president, vice president).
3. I understand that "Boycott of Israel" has the same meaning as defined in §215.4725, Florida Statutes, and means refusing to deal, terminating business activities, or taking other actions to limit commercial relations with Israel, or persons or entities doing business in Israel or in Israeli-controlled territories, in a discriminatory manner. A statement by a company that it is participating in a boycott of Israel, or that it has initiated a boycott in response to a request for a boycott of Israel or in compliance with, or in furtherance of, calls for a boycott of Israel, may be considered by the State Board of Administration to be evidence

that a company is participating in a boycott of Israel. The term does not include restrictive trade practices or boycotts fostered or imposed by foreign countries against Israel.

4. I understand that "business operations" means, for purposes specifically related to Cuba or Syria, engaging in commerce in any form in Cuba or Syria, including, but not limited to, acquiring, developing, maintaining, owning, selling, possessing, leasing, or operating equipment, facilities, personnel, products, services, personal property, real property, military equipment, or any other apparatus of business or commerce.
5. V.A. Paving, Inc. (name of Contractor) is not on the Scrutinized Companies that Boycott Israel List, created pursuant to s. 215.4725, Florida Statutes, or is engaged in a boycott of Israel.
6. V.A. Paving, Inc. (name of Contractor) is not on the Scrutinized Companies with Activities in Sudan List or the Scrutinized Companies with Activities in the Iran Petroleum Energy Sector List, created pursuant to s. 215.473, Florida Statutes.
7. V.A. Paving, Inc. (name of Contractor) is not engaged in business operations in Cuba or Syria.

Signature
Debra Mallard, President

Sworn to and subscribed before me in the state and county first mentioned above on the 6 day of August, 2020.

Notary Public

My commission expires:
7/24/21

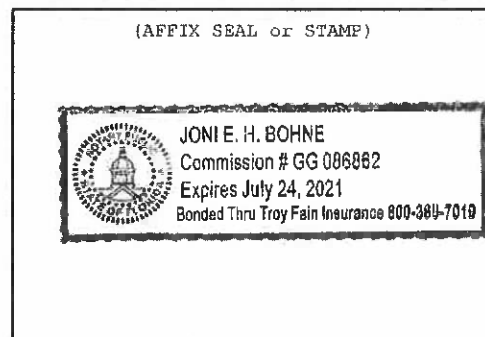

FEDERAL EMERGENCY MANAGEMENT AGENCY (FEMA) CONTRACT REQUIREMENTS
Attachment A

During the performance of this contract, the Consultant agrees as follows:

1. The consultant will not discriminate against any employee or applicant for employment because of race, color, religion, sex, or national origin. The consultant will take affirmative action to ensure that applicants are employed, and that employees are treated during employment without regard to their race, color, religion, sex or national origin. Such action shall include, but not be limited to the following: Employment, upgrading, demotion, or transfer; recruitment or recruitment advertising; layoff or termination; rates of pay or other forms of compensation; and selection for training, including apprenticeship. The consultant agrees to post in conspicuous places, available to all employees and applicants for employment, notices to be provided setting forth the provisions of this non-discrimination clause.
2. The consultant will, in all solicitations or advertisements for employees placed by or on behalf of the consultant, state that all qualified applicants will receive considerations for employment without regard to race, color, religion, sex or national origin.
3. The consultant will send to each labor union or representative of workers with which he has a collective bargaining agreement or other contract or understanding, a notice to be provided advising the said labor union or worker's representatives of the consultant's commitments under this section, and shall post copies of the notice in conspicuous places available to employees and applicants for employment.
4. The consultant will comply with all provisions of Executive Order 11246 of September 24, 1965, and the rules, regulations and relevant orders of the Secretary of Labor.
5. The consultant will furnish all information and reports required by Executive Order 11246 of September 24, 1965, and by rules, regulations, and orders of the Secretary of Labor, or pursuant thereto, and will permit access to its books, records, and accounts by the administering agency and the Secretary of Labor for purposes of investigation to ascertain compliance with such rules, regulations and orders.
6. In the event of the consultant's non-compliance with the non-discrimination clauses of this contract or with any of the said rules, regulations, or orders, this contract may be canceled, terminated, or suspended in whole or in part and the contractor may be declared ineligible for further Government contracts or federally assisted construction contracts in accordance with procedures authorized in Executive Order 11246 of September 24, 1965, and such other sanctions as may be imposed and remedies invoked as provided in Executive Order of September 24, 1965, or by rule, regulation, or order of the Secretary of Labor, or as otherwise provided by law.
7. The consultant will include the portion of the sentence immediately preceding paragraph (1) and the provisions of paragraphs (1) through (7) in every subcontract or purchase order unless exempted by rules, regulations, or orders of the Secretary

of Labor issued pursuant to section 204 of Executive Order 11246 of September 24, 1965, so that such provisions will be binding upon each subcontractor or vendor. The consultant will take such action with respect to any subcontract or purchase order as the administering agency may direct as a means of enforcing such provisions, including sanctions for noncompliance: Provided, however, that in the event a consultant becomes involved in, or is threatened with, litigation with a subcontractor or vendor as a result of such direction by the administering agency the consultant may request the United States to enter into such litigation to protect the interests of the United States."

8. **Clean Air Act and the Federal Water Pollution Control Act:** (For all contracts in excess of \$150,000)

Clean Air Act -

- i. The consultant agrees to comply with all applicable standards, orders or regulations issued pursuant to the Clean Air Act, as amended, 42 U.S.C. § 7401 et seq.
- ii. The consultant agrees to report each violation to the Brevard County Facilities Department and understands that the Brevard County Facilities Department will, in turn, report each violation as required to assure notification to the Federal Emergency Management Agency, and the appropriate Environmental Protection Agency Regional office.
- iii. The consultant agrees to include these requirements in each subcontract exceeding \$150,000 financed in whole or in part with Federal assistance provided by FEMA.

Federal Water Pollution Control Act -

- i. The consultant agrees to comply with all applicable standards, orders or regulations issued pursuant to the Federal Water Pollution Control Act, as amended, 33 U.S.C. 1251 et seq.
- ii. The consultant agrees to report each violation to the Brevard County Facilities Department and understands and agrees that the Brevard County Facilities Department will, in turn, report each violation to assure notification to the Federal Emergency Management Agency, and the appropriate Environmental Protection Agency Regional Office.

9. **Suspension and Debarment:**

- i. This contract is a covered transaction for purposes of 2 C.F.R. pt. 180 and 2 C.F.R. pt. 3000. As such the consultant is required to verify that none of the consultant, its principals (defined at 2 C.F.R. § 180.995), or its affiliates (defined at 2 C.F.R. § 180.905) are excluded (defined at 2 C.F.R. § 180.940) or disqualified (defined at 2 C.F.R. § 180.935).
- ii. The consultant must comply with 2 C.F.R. pt. 180, subpart C and 2 C.F.R. pt. 3000, subpart C and must include a requirement to comply with these regulations in any lower tier covered transaction it enters into.
- iii. This certification is a material representation of fact relied upon by Brevard County Facilities Department. If it is later determined that the consultant did not comply with 2 C.F.R. pt. 180, subpart C and 2 C.F.R. pt. 3000, subpart C, in addition to remedies available to Federal Emergency Management Agency and Brevard County Facilities Department, the Federal Government may

pursue available remedies, including but not limited to suspension and/or debarment.

10. **Byrd Anti-Lobbying Amendment, 31 U.S.C. § 1352 (as amended):**
Consultants who apply or bid for an award of \$100,000 or more shall file the required certification. Each tier certifies to the tier above that it will not and has not used Federal appropriated funds to pay any person or organization for influencing or attempting to influence an officer or employee of any agency, a member of Congress, officer or employee of Congress, or an employee or a member of Congress in connection with obtaining any Federal contract, grant, or any other award covered by 31 U.S.C. § 1352. Each tier shall also disclose any lobbying with non-Federal funds that takes place in connection with obtaining any Federal award. Such disclosures are forwarded from tier-to-tier up to the recipient.
11. **Certification for Contracts, Grants, Loans, and Cooperative Agreements**
(To be submitted with each bid or offer exceeding \$100,000)
The Consultant certifies, to the best of his or her knowledge, that:
- i. No Federal appropriated funds have been paid or will be paid, by or on behalf of the undersigned, to any person for influencing or attempting to influence an officer or employee of an agency, a Member of Congress, an officer or employee of Congress, or an employee of a Member of Congress in connection with the awarding of any Federal contract, the making of any Federal grant, the making of any Federal loan, the entering into of any cooperative agreement, and the extension, continuation, renewal, amendment, or modification of any Federal contract, grant, loan, or cooperative agreement.
 - ii. If any funds other than Federal appropriated funds have been paid or will be paid to any person for influencing or attempting to influence an officer or employee of any agency, a Member of Congress, an officer or employee of Congress, or an employee of a Member of Congress in connection with this Federal contract, grant, loan, or cooperative agreement, the undersigned shall complete and submit Standard Form-LLL, "Disclosure Form to Report Lobbying," in accordance with its instructions.
 - iii. The undersigned shall require that the language of this certification be included in the award documents for all sub-awards at all tiers (including subcontracts, sub-grants, and contracts under grants, loans, and cooperative agreements) and that all sub-recipients shall certify and disclose accordingly.

This certification is a material representation of fact upon which reliance was placed when this transaction was made or entered into. Submission of this certification is a prerequisite for making or entering into this transaction imposed by 31, U.S.C. § 1352 (as amended by the Lobbying Disclosure Act of 1995). Any person who fails to file the required certification shall be subject to a civil penalty of not less than \$10,000 and not more than \$100,000 for each such failure. The Contractor certifies or affirms the truthfulness and accuracy of each statement of its certification and disclosure, if any. In addition, the Contractor understands and agrees that the provisions of 31 U.S.C. § 3801 et seq., apply to this certification and disclosure, if any.

12. **Procurement of Recovered Materials:**

In the performance of this contract, the consultant shall make maximum use of products containing recovered materials that are EPA-designated items unless the product cannot be acquired:

- i. Competitively within a timeframe providing for compliance with the contract performance schedule;
 - ii. Meeting contract performance requirements; or
 - iii. At a reasonable price.
- Information about this requirement, along with the list of EPA-designate items, is available at EPA's Comprehensive Procurement Guidelines website at <https://www.epa.gov/smm/comprehensive-procurement-guideline-cpg-program>.

13. **Additional FEMA Requirements:**

A. **Access to Records:**

- i. The consultant agrees to provide Brevard County Facilities Department, the FEMA Administrator, the Comptroller General of the United States, or any of their authorized representative access to any books, documents, papers and records of the consultant which are directly pertinent to this contract for the purposes of making audits, examinations, excerpts and transcriptions.
- ii. The consultant agrees to permit any of the foregoing parties to reproduce by any means whatsoever or to copy excerpts and transcriptions as reasonably needed.
- iii. The consultant agrees to provide the FEMA Administrator or his authorized representative access to construction or other work sites pertaining to the work being completed under the contract.

B. **DHS (Department of Homeland Security) Seal, Logo and Flags:**

The consultant shall not use DHS seal(s), logos, crests, or reproductions of flags or likenesses of DHS agency officials without specific FEMA pre-approval.

C. **Compliance with Federal Law, Regulations and Executive Orders:**

The consultant acknowledges that FEMA financial assistance will be used to fund the contract only. The consultant will comply with all applicable federal law, regulations, executive orders, FEMA policies, procedures and directives.

D. **No Obligation by Federal Government:**

The Federal Government is not a party to this contract and is not subject to any obligations or liabilities to the non-Federal entity, contractor, or any other party pertaining to any matter resulting from the contract.

E. **Fraud and False or Fraudulent or Related Acts:**

The consultant acknowledges that 31 U.S.C. Chap. 38 (Administrative Remedies for False Claims and Statements) applies to the consultant's actions pertaining to this contract.

**SUPERPAVE ASPHALT CONCRETE – REINFORCING FIBER IN ASPHALT.
(1-24-19)**

ARTICLE 334-2 is expanded by the following new Subarticle:

334-2.5 Reinforcing Fibers: When specified in the Contract Documents, provide reinforcing fibers conforming to the requirements below. Design the asphalt mixture without the fiber. Do not alter the final mix design for the addition of fiber at the asphalt plant.

334-2.5.1 Description: Furnish all materials, equipment, labor, and incidentals for mixing aramid fiber into the asphalt mix. Aramid fibers must be treated to prevent them from becoming airborne during the mixing process and the treatment must become soluble in the asphalt binder. Continuously feed and mix treated aramid fiber into the asphalt mix per the dosage and mixing requirements of this specification. Provide a certification report signed and sealed by a registered professional engineer upon project completion, which provides the actual dosage rate used for the project and states all specification requirements were adhered to.

334-2.5.2 Materials: Meet the following Aramid and Treatment material properties.

Aramid Properties	Measure
Material	Para-Aramid Fiber (50-52% by weight)
Form	Filament Yarn
Tensile Strength	> 2.758 (GPa)
Elongation at Break	< 4.4 (%)
Modulus	> 95 (GPa)
Specific Gravity	1.44-1.45 (g/cm ³)
Decomposition Temperature	> 800 (°F)
Treatment Properties	Measure
Treatment Type	Sasobit® Wax (48-50% by weight)
Treatment Melting Temperature	> 175 (°F)
Short Cut Aramid Fiber Bundles	Measure
Length	1.50 +/-0.05 (inch)
Appearance/Handling	Free Flowing Coated Fiber Bundles (visual)
Storage	Store dry with no contact with moisture

334-2.5.3 Dosage & Mixing Requirements: Use an aramid dosage rate of 2.1 ounces (+/- 5.0%) per ton of mix. This does not include the treatment weight. Meter and continuously feed treated aramid fibers in a constant stream-like manner for uniform disbursement. Mix the fibers with the heated aggregates before injection of the liquid asphalt during the asphalt mixing process. Use an automated dosing machine to feed the treated aramid fibers into the mixing drum through the RAP collar. Calibrate the metering based on the asphalt production rate (tons/hr), and the dosage rate (oz/ton). Feed the fibers in a constant stream-like manner through the RAP collar.

**SUPERPAVE ASPHALT CONCRETE – REINFORCING FIBERS IN ASPHALT.
(02-14-19)**

ARTICLE 334-2 is expanded by the following new Subarticle:

334-2.5 Reinforcing Fibers: When specified in the Contract Documents, provide reinforcing fibers conforming to the requirements below. Design the asphalt mixture without the fibers. Do not alter the final mix design for the addition of fibers at the asphalt plant.

Add the fibers at a rate of 1 pound per ton of total mix. Introduce the fibers into the asphalt drum with a fiber delivery system meeting the requirements of the fiber manufacturer. Furnish with the mix design submittal certified test data for the fibers to be used on the project.

The physical properties of the reinforcing fibers shall be as follows:

1. Materials in a blend of polyolefin and para-aramid or aramid.
2. Length: 3/4 inch
3. Form:
 - a. Polyolefin: Serrated
 - b. Aramid: Monofilament
4. Specific Gravity:
 - a. Polyolefin: 0.91
 - b. Aramid: 1.44
5. Tensile Strength:
 - a. Aramid: $\geq 400,000$ psi
6. Melt Temperature:
 - a. Polyolefin: $\geq 270^{\circ}\text{F}$
 - b. Aramid: $\geq 800^{\circ}\text{F}$
7. Acid/Alkali Resistance: Inert



[Department of State](#) / [Division of Corporations](#) / [Search Records](#) / [Search by Entity Name](#) /

Detail by Entity Name

Florida Profit Corporation

V. A. PAVING, INC.

Filing Information

Document Number F59465
FEI/EIN Number 59-2147362
Date Filed 12/23/1981
State FL
Status ACTIVE
Last Event AMENDMENT
Event Date Filed 12/27/2001
Event Effective Date NONE

Principal Address

% DEBRA D MALLARD
 2955 LAKE DRIVE
 COCOA, FL 32926-4334

Changed: 02/23/2011

Mailing Address

% DEBRA D MALLARD
 2955 LAKE DRIVE
 COCOA, FL 32926-4334

Changed: 02/23/2011

Registered Agent Name & Address

MALLARD, DEBRA D
 2955 LAKE DR
 COCOA, FL 32926

Name Changed: 02/23/2011

Address Changed: 01/04/2006

Officer/Director Detail

Name & Address

Title VSD

HART, TERRI M

4108 FISHERMANS PLACE
COCOA, FL 32926

Title VTD

MALLARD, ARNOLD A JR
2125 DALE LANE
COCOA, FL 32926

Title PD

MALLARD, DEBRA D
755 Adamson Road
COCOA, FL 32926

Annual Reports

Report Year	Filed Date
2018	01/11/2018
2019	02/21/2019
2020	02/03/2020

Document Images

02/03/2020 -- ANNUAL REPORT	View image in PDF format
02/21/2019 -- ANNUAL REPORT	View image in PDF format
01/11/2018 -- ANNUAL REPORT	View image in PDF format
01/11/2017 -- ANNUAL REPORT	View image in PDF format
02/12/2016 -- ANNUAL REPORT	View image in PDF format
07/24/2015 -- ANNUAL REPORT	View image in PDF format
02/25/2014 -- ANNUAL REPORT	View image in PDF format
03/21/2013 -- ANNUAL REPORT	View image in PDF format
02/28/2012 -- ANNUAL REPORT	View image in PDF format
02/23/2011 -- ANNUAL REPORT	View image in PDF format
01/21/2010 -- ANNUAL REPORT	View image in PDF format
03/19/2009 -- ANNUAL REPORT	View image in PDF format
01/07/2008 -- ANNUAL REPORT	View image in PDF format
05/10/2007 -- ANNUAL REPORT	View image in PDF format
01/05/2007 -- ANNUAL REPORT	View image in PDF format
01/04/2006 -- ANNUAL REPORT	View image in PDF format
01/12/2005 -- ANNUAL REPORT	View image in PDF format
06/30/2004 -- ANNUAL REPORT	View image in PDF format
04/25/2003 -- ANNUAL REPORT	View image in PDF format
03/15/2002 -- ANNUAL REPORT	View image in PDF format
12/27/2001 -- Amendment	View image in PDF format
01/26/2001 -- ANNUAL REPORT	View image in PDF format
03/24/2000 -- ANNUAL REPORT	View image in PDF format
01/25/1999 -- ANNUAL REPORT	View image in PDF format
02/05/1998 -- ANNUAL REPORT	View image in PDF format
01/21/1997 -- ANNUAL REPORT	View image in PDF format
03/07/1996 -- ANNUAL REPORT	View image in PDF format

[01/17/1995 -- ANNUAL REPORT](#)

[View image in PDF format](#)

Florida Department of State, Division of Corporations





[Skip to Main Content](#)

Department of Management Services

[Florida Department of Management Services](#) > [Business Operations](#) > [State Purchasing](#) > [State Agency Resources](#) > [Vendor Registration and Vendor Lists](#) > [Suspended Vendor List](#)

Suspended Vendor List

The Department of Management Services maintains a list of vendors that have been removed from the Vendor List "for failing to fulfill any of its duties specified in a contract with the State," in accordance with [Rule 60A-1.006\(2\)](#), [Florida Administrative Code](#).

Vendor Name/Address	Agency of Origin	Effective Date	Notice of Default
Building Maintenance of America, LLC d/b/a Florida Building Maintenance 333 North Falkenburg Road #A117 Tampa, FL 33619	DMS	07/02/14	Notice of Default - Building Maintenance of America, LLC d/b/a Florida Building Maintenance ( 575.81 KB)
Club Tex, Inc. 2025 Broadway, Suite #15G New York, NY 10023	DOC	01/24/19	Notice of Default - Club Tex, Inc. ( 111.75 KB)
Correctional Consultants, LLC P.O. Box 515 Chattahoochee, FL 32324	DOC	12/10/19	Notice of Default - Correctional Consultants, LLC ( 85.95 KB)
iColor Printing and Mailing, Inc. 22873 Lockness Avenue Torrance, CA 90501	DEP	02/20/12	Notice of Default - iColor Printing and Mailing, Inc. ( 320.17 KB)
Visual Image Design Firm, LLC 6845 Narcoossee Road, Suite 59 Orlando, FL 32822	DOH	06/25/15	Notice of Default - Visual Image Design Firm, LLC ( 1.78 MB)

Updated 12/10/19

Document reader download link

-  [Adobe PDF Reader](#)

[Terms and Conditions](#) | [Privacy Statement](#) | [Accessibility Statement](#) | Copyright ©2020 Department of Management Services - State of Florida

Vendor Search

Vendor Search

How do I use this tool? [Search Help Documents](#)

Maximum Results: 25

Vendor Name: V.A. Paving Email Address:

Last Name: User Name:

No search results were found. Please try a different search.

Vendor Name	First Name	Last Name	Phone	Email
-------------	------------	-----------	-------	-------



A NEW WAY TO SIGN IN - If you already have a SAM account, use your SAM email for login.gov.

Log In

Login.gov FAQs

ALERT: SAM.gov will be down for scheduled maintenance Saturday, 08/15/2020 from 8:00 AM to 10:00 PM

Entity Dashboard

V. A. Paving, Inc.
DUNS: 063896807 CAGE Code: OCYK4
Status: Active
Expiration Date: 10/03/2020
Purpose of Registration: All Awards

2955 Lake Dr
Cocoa, FL, 32926-4334
UNITED STATES

- › [Entity Overview](#)
- › [Entity Registration](#)
 - › [Core Data](#)
 - › [Assertions](#)
 - › [Reps & Certs](#)
 - › [POCs](#)
- › [Exclusions](#)
 - › [Active Exclusions](#)
 - › [Inactive Exclusions](#)
 - › [Excluded Family Members](#)

RETURN TO SEARCH

Entity Overview

Entity Registration Summary

Name: V. A. Paving, Inc.
Business Type: Business or Organization
Last Updated By: Debra Mallard
Registration Status: Active
Activation Date: 10/04/2019
Expiration Date: 10/03/2020

Exclusion Summary

Active Exclusion Records? No



IBM-P-20200717-1140
WWW2

- [Search Records](#)
- [Disclaimers](#)
- [FAPIS.gov](#)
- [Data Access](#)
- [Accessibility](#)
- [GSA.gov/IAE](#)
- [Check Status](#)
- [Privacy Policy](#)
- [GSA.gov](#)
- [About](#)
- [USA.gov](#)
- [Help](#)

This is a U.S. General Services Administration Federal Government computer system that is "FOR OFFICIAL USE ONLY." This system is subject to monitoring. Individuals found performing unauthorized activities are subject to disciplinary action including criminal prosecution.

[Skip to Main Content](#)

Department of Management Services

[Florida Department of Management Services](#) > [Business Operations](#) > [State Purchasing](#) > [State Agency Resources](#) > [Vendor Registration and Vendor Lists](#) > Discriminatory Vendor List

Discriminatory Vendor List

The Department of Management Services maintains "a list of the names and addresses of any entity which has been disqualified from the public contracting and purchasing process" under [section 287.134, Florida Statutes](#).

There are currently no vendors on this list.

[Terms and Conditions](#) | [Privacy Statement](#) | [Accessibility Statement](#) | Copyright ©2020 Department of Management Services - State of Florida



[Skip to Main Content](#)

Department of Management Services

[Florida Department of Management Services](#) > [Business Operations](#) > [State Purchasing](#) > [State Agency Resources](#) > [Vendor Registration and Vendor Lists](#) > Convicted Vendor List

Convicted Vendor List

The Department of Management Services maintains "a list of the names and addresses of those who have been disqualified from the public contracting and purchasing process" under [section 287.133, Florida Statutes](#).

Vendor Name	Agency of Origin	Effective Date	Expiration Date	Final Order
Calixte, Jacques A. (Haitian American Association Against Cancer, Inc.)	DOH	10/25/18	10/25/21	Final Order - Calixte, Jacques A. (Haitian American Association Against Cancer, Inc.) ( 1.71 MB)
Hoffman, Tracy J. (Gator Signage and Striping, LLC)	DOT	01/22/18	01/22/21	Final Order - Hoffman, Tracy J. (Gator Signage and Striping, LLC) ( 753.24 KB)

Updated 12/10/19

Document reader download link

-  [Adobe PDF Reader](#)

[Terms and Conditions](#) | [Privacy Statement](#) | [Accessibility Statement](#) | Copyright ©2020 Department of Management Services - State of Florida

FEDERAL EMERGENCY MANAGEMENT AGENCY (FEMA) CONTRACT REQUIREMENTS
Attachment A

During the performance of this contract, the Consultant agrees as follows:

1. The consultant will not discriminate against any employee or applicant for employment because of race, color, religion, sex, or national origin. The consultant will take affirmative action to ensure that applicants are employed, and that employees are treated during employment without regard to their race, color, religion, sex or national origin. Such action shall include, but not be limited to the following: Employment, upgrading, demotion, or transfer; recruitment or recruitment advertising; layoff or termination; rates of pay or other forms of compensation; and selection for training, including apprenticeship. The consultant agrees to post in conspicuous places, available to all employees and applicants for employment, notices to be provided setting forth the provisions of this non-discrimination clause.
2. The consultant will, in all solicitations or advertisements for employees placed by or on behalf of the consultant, state that all qualified applicants will receive considerations for employment without regard to race, color, religion, sex or national origin.
3. The consultant will send to each labor union or representative of workers with which he has a collective bargaining agreement or other contract or understanding, a notice to be provided advising the said labor union or worker's representatives of the consultant's commitments under this section, and shall post copies of the notice in conspicuous places available to employees and applicants for employment.
4. The consultant will comply with all provisions of Executive Order 11246 of September 24, 1965, and the rules, regulations and relevant orders of the Secretary of Labor.
5. The consultant will furnish all information and reports required by Executive Order 11246 of September 24, 1965, and by rules, regulations, and orders of the Secretary of Labor, or pursuant thereto, and will permit access to its books, records, and accounts by the administering agency and the Secretary of Labor for purposes of investigation to ascertain compliance with such rules, regulations and orders.
6. In the event of the consultant's non-compliance with the non-discrimination clauses of this contract or with any of the said rules, regulations, or orders, this contract may be canceled, terminated, or suspended in whole or in part and the contractor may be declared ineligible for further Government contracts or federally assisted construction contracts in accordance with procedures authorized in Executive Order 11246 of September 24, 1965, and such other sanctions as may be imposed and remedies invoked as provided in Executive Order of September 24, 1965, or by rule, regulation, or order of the Secretary of Labor, or as otherwise provided by law.
7. The consultant will include the portion of the sentence immediately preceding paragraph (1) and the provisions of paragraphs (1) through (7) in every subcontract or purchase order unless exempted by rules, regulations, or orders of the Secretary

of Labor issued pursuant to section 204 of Executive Order 11246 of September 24, 1965, so that such provisions will be binding upon each subcontractor or vendor. The consultant will take such action with respect to any subcontract or purchase order as the administering agency may direct as a means of enforcing such provisions, including sanctions for noncompliance: Provided, however, that in the event a consultant becomes involved in, or is threatened with, litigation with a subcontractor or vendor as a result of such direction by the administering agency the consultant may request the United States to enter into such litigation to protect the interests of the United States."

8. **Clean Air Act and the Federal Water Pollution Control Act:** (For all contracts in excess of \$150,000)

Clean Air Act -

- i. The consultant agrees to comply with all applicable standards, orders or regulations issued pursuant to the Clean Air Act, as amended, 42 U.S.C. § 7401 et seq.
- ii. The consultant agrees to report each violation to the Brevard County Facilities Department and understands that the Brevard County Facilities Department will, in turn, report each violation as required to assure notification to the Federal Emergency Management Agency, and the appropriate Environmental Protection Agency Regional office.
- iii. The consultant agrees to include these requirements in each subcontract exceeding \$150,000 financed in whole or in part with Federal assistance provided by FEMA.

Federal Water Pollution Control Act -

- i. The consultant agrees to comply withal applicable standards, orders or regulations issued pursuant to the Federal Water Pollution Control Act, as amended, 33 U.S.C. 1251 et seq.
- ii. The consultant agrees to report each violation to the Brevard County Facilities Department and understands and agrees that the Brevard County Facilities Department will, in turn, report each violation to assure notification to the Federal Emergency Management Agency, and the appropriate Environmental Protection Agency Regional Office.

9. **Suspension and Debarment:**

- i. This contract is a covered transaction for purposes of 2 C.F.R. pt. 180 and 2 C.F.R. pt. 3000. As such the consultant is required to verify that none of the consultant, its principals (defined at 2 C.F.R. § 180.995), or its affiliates (defined at 2 C.F.R. § 180.905) are excluded (defined at 2 C.F.R. § 180.940) or disqualified (defined at 2 C.F.R. § 180.935).
- ii. The consultant must comply with 2 C.F.R. pt. 180, subpart C and 2 C.F.R. pt. 3000, subpart C and must include a requirement to comply with these regulations in any lower tier covered transaction it enters into.
- iii. This certification is a material representation of fact relied upon by Brevard County Facilities Department. If it is later determined that the consultant did not comply with 2 C.F.R. pt. 180, subpart C and 2 C.F.R. pt. 3000, subpart C, in addition to remedies available to Federal Emergency Management Agency and Brevard County Facilities Department, the Federal Government may

pursue available remedies, including but not limited to suspension and/or debarment.

10. **Byrd Anti-Lobbying Amendment, 31 U.S.C. § 1352 (as amended):**

Consultants who apply or bid for an award of \$100,000 or more shall file the required certification. Each tier certifies to the tier above that it will not and has not used Federal appropriated funds to pay any person or organization for influencing or attempting to influence an officer or employee of any agency, a member of Congress, officer or employee of Congress, or an employee or a member of Congress in connection with obtaining any Federal contract, grant, or any other award covered by 31 U.S.C. § 1352. Each tier shall also disclose any lobbying with non-Federal funds that takes place in connection with obtaining any Federal award. Such disclosures are forwarded from tier-to-tier up to the recipient.

11. **Certification for Contracts, Grants, Loans, and Cooperative Agreements**

(To be submitted with each bid or offer exceeding \$100,000)

The Consultant certifies, to the best of his or her knowledge, that:

- i. No Federal appropriated funds have been paid or will be paid, by or on behalf of the undersigned, to any person for influencing or attempting to influence an officer or employee of an agency, a Member of Congress, an officer or employee of Congress, or an employee of a Member of Congress in connection with the awarding of any Federal contract, the making of any Federal grant, the making of any Federal loan, the entering into of any cooperative agreement, and the extension, continuation, renewal, amendment, or modification of any Federal contract, grant, loan, or cooperative agreement.
- ii. If any funds other than Federal appropriated funds have been paid or will be paid to any person for influencing or attempting to influence an officer or employee of any agency, a Member of Congress, an officer or employee of Congress, or an employee of a Member of Congress in connection with this Federal contract, grant, loan, or cooperative agreement, the undersigned shall complete and submit Standard Form-LLL, "Disclosure Form to Report Lobbying," in accordance with its instructions.
- iii. The undersigned shall require that the language of this certification be included in the award documents for all sub-awards at all tiers (including subcontracts, sub-grants, and contracts under grants, loans, and cooperative agreements) and that all sub-recipients shall certify and disclose accordingly.

This certification is a material representation of fact upon which reliance was placed when this transaction was made or entered into. Submission of this certification is a prerequisite for making or entering into this transaction imposed by 31, U.S.C. § 1352 (as amended by the Lobbying Disclosure Act of 1995). Any person who fails to file the required certification shall be subject to a civil penalty of not less than \$10,000 and not more than \$100,000 for each such failure. The Contractor certifies or affirms the truthfulness and accuracy of each statement of its certification and disclosure, if any. In addition, the Contractor understands and agrees that the provisions of 31 U.S.C. § 3801 et seq., apply to this certification and disclosure, if any.

12. **Procurement of Recovered Materials:**

In the performance of this contract, the consultant shall make maximum use of products containing recovered materials that are EPA-designated items unless the product cannot be acquired:

- i. Competitively within a timeframe providing for compliance with the contract performance schedule;
- ii. Meeting contract performance requirements; or
- iii. At a reasonable price.

Information about this requirement, along with the list of EPA-designate items, is available at EPA's Comprehensive Procurement Guidelines website at <https://www.epa.gov/smm/comprehensive-procurement-guideline-cpg-program>.

13. **Additional FEMA Requirements:**

A. **Access to Records:**

- i. The consultant agrees to provide Brevard County Facilities Department, the FEMA Administrator, the Comptroller General of the United States, or any of their authorized representative access to any books, documents, papers and records of the consultant which are directly pertinent to this contract for the purposes of making audits, examinations, excerpts and transcriptions.
- ii. The consultant agrees to permit any of the foregoing parties to reproduce by any means whatsoever or to copy excerpts and transcriptions as reasonably needed.
- iii. The consultant agrees to provide the FEMA Administrator or his authorized representative access to construction or other work sites pertaining to the work being completed under the contract.

B. **DHS (Department of Homeland Security) Seal, Logo and Flags:**

The consultant shall not use DHS seal(s), logos, crests, or reproductions of flags or likenesses of DHS agency officials without specific FEMA pre-approval.

C. **Compliance with Federal Law, Regulations and Executive Orders:**

The consultant acknowledges that FEMA financial assistance will be used to fund the contract only. The consultant will comply with all applicable federal law, regulations, executive orders, FEMA policies, procedures and directives.

D. **No Obligation by Federal Government:**

The Federal Government is not a party to this contract and is not subject to any obligations or liabilities to the non-Federal entity, contractor, or any other party pertaining to any matter resulting from the contract.

E. **Fraud and False or Fraudulent or Related Acts:**

The consultant acknowledges that 31 U.S.C. Chap. 38 (Administrative Remedies for False Claims and Statements) applies to the consultant's actions pertaining to this contract.

SUPERPAVE ASPHALT CONCRETE – REINFORCING FIBER IN ASPHALT.

(1-24-19)

ARTICLE 334-2 is expanded by the following new Subarticle:

334-2.5 Reinforcing Fibers: When specified in the Contract Documents, provide reinforcing fibers conforming to the requirements below. Design the asphalt mixture without the fiber. Do not alter the final mix design for the addition of fiber at the asphalt plant.

334-2.5.1 Description: Furnish all materials, equipment, labor, and incidentals for mixing aramid fiber into the asphalt mix. Aramid fibers must be treated to prevent them from becoming airborne during the mixing process and the treatment must become soluble in the asphalt binder. Continuously feed and mix treated aramid fiber into the asphalt mix per the dosage and mixing requirements of this specification. Provide a certification report signed and sealed by a registered professional engineer upon project completion, which provides the actual dosage rate used for the project and states all specification requirements were adhered to.

334-2.5.2 Materials: Meet the following Aramid and Treatment material properties.

Aramid Properties	Measure
Material	Para-Aramid Fiber (50-52% by weight)
Form	Filament Yarn
Tensile Strength	> 2.758 (GPa)
Elongation at Break	< 4.4 (%)
Modulus	> 95 (GPa)
Specific Gravity	1.44-1.45 (g/cm ³)
Decomposition Temperature	> 800 (°F)
Treatment Properties	Measure
Treatment Type	Sasobit® Wax (48-50% by weight)
Treatment Melting Temperature	> 175 (°F)
Short Cut Aramid Fiber Bundles	Measure
Length	1.50 +/-0.05 (inch)
Appearance/Handling	Free Flowing Coated Fiber Bundles (visual)
Storage	Store dry with no contact with moisture

334-2.5.3 Dosage & Mixing Requirements: Use an aramid dosage rate of 2.1 ounces (+/- 5.0%) per ton of mix. This does not include the treatment weight. Meter and continuously feed treated aramid fibers in a constant stream-like manner for uniform disbursement. Mix the fibers with the heated aggregates before injection of the liquid asphalt during the asphalt mixing process. Use an automated dosing machine to feed the treated aramid fibers into the mixing drum through the RAP collar. Calibrate the metering based on the asphalt production rate (tons/hr), and the dosage rate (oz/ton). Feed the fibers in a constant stream-like manner through the RAP collar.

SUPERPAVE ASPHALT CONCRETE – REINFORCING FIBERS IN ASPHALT.
(02-14-19)

ARTICLE 334-2 is expanded by the following new Subarticle:

334-2.5 Reinforcing Fibers: When specified in the Contract Documents, provide reinforcing fibers conforming to the requirements below. Design the asphalt mixture without the fibers. Do not alter the final mix design for the addition of fibers at the asphalt plant.

Add the fibers at a rate of 1 pound per ton of total mix. Introduce the fibers into the asphalt drum with a fiber delivery system meeting the requirements of the fiber manufacturer. Furnish with the mix design submittal certified test data for the fibers to be used on the project.

The physical properties of the reinforcing fibers shall be as follows:

1. Materials in a blend of polyolefin and para-aramid or aramid.
2. Length: 3/4 inch
3. Form:
 - a. Polyolefin: Serrated
 - b. Aramid: Monofilament
4. Specific Gravity:
 - a. Polyolefin: 0.91
 - b. Aramid: 1.44
5. Tensile Strength:
 - a. Aramid: $\geq 400,000$ psi
6. Melt Temperature:
 - a. Polyolefin: $\geq 270^{\circ}\text{F}$
 - b. Aramid: $\geq 800^{\circ}\text{F}$
7. Acid/Alkali Resistance: Inert

**ASPHALTIC CONCRETE
 BID # B-6-20-57**

PRICE SHEET

ASPHALTIC CONCRETE	DESCRIPTION	ROAD PAVING	PARKING LOTS	BIKE PATHS
Superpave SP-9.5	Vendor Delivered, Vendor Placed	\$ _____ Ton	\$ _____ Ton	\$ _____ Ton
Superpave SP-12.5	Vendor Delivered, Vendor Placed	\$ _____ Ton	\$ _____ Ton	\$ _____ Ton
FRICITION COURSE		ROAD PAVING		
Friction Course FC-5	Vendor Delivered, Vendor Placed	\$ _____ Ton		
Friction Course FC-9.5	Vendor Delivered, Vendor Placed	\$ _____ Ton		
Friction Course FC-12.5	Vendor Delivered, Vendor Placed	\$ _____ Ton		
SPEED HUMPS SP-9.5	Vendor Delivered, Vendor Placed	\$ _____ Ton		
LESS THAN 25 TN PATCHING SP-9.5	Vendor Delivered, Vendor Placed	\$ _____ Ton		
25-50 TN PATCHING SP 9.5	Vendor Delivered, Vendor Placed	\$ _____ Ton		
TACK FOB Gallon	FOB GALLON	\$ _____ Gal		
PRIME	Vendor Delivered, Vendor Placed	\$ _____ SY		
PRIM AND SAND	Vendor Delivered, Vendor Placed	\$ _____ SY		
SAND 3% HOT MIX	Vendor Delivered, Vendor Placed	\$ _____ Ton	\$ _____ SY	
HOT ASPHALT FOR PICK UP FOB AT PLANT SP-9.5	FOR PICK UP	\$ _____ Ton		
TEMPORARY STRIPING	Vendor Schedules and Provides	\$ _____ L.F.		
Night Work	Cost per ton	\$ _____ Ton		
Cost for Milling & Clean Up	SY 0-2,500 and under	\$ _____ SY		
	SY \$2,501 - 5,000	\$ _____ SY		
	SY 5,001 to 15,000	\$ _____ SY		
	SY 15,001 and over	\$ _____ SY		
Asphalt Millings for Pickup FOB at Plant		\$ _____ Ton		
Cost per ton to add Aramid Fiber to the asphalt mix (Per attached Fiber Specs)		\$ _____ Ton		

Plant Locations: _____

**ASPHALTIC CONCRETE
BID # B-6-20-57**

PRICE SHEET (Continued)

Addendum Acknowledgment:

Add. No. _____ Dated _____ / Add. No. _____ Dated _____

Add. No. _____ Dated _____ / Add. No. _____ Dated _____

PROMPT PAYMENT DISCOUNT:

Brevard County shall remit payment in accordance with the Florida Prompt Payment Act, Florida Statutes section 218.70. Bidders may offer cash discounts for prompt payment, but they will not be considered in determination of award. If a bidder offers a discount, it is understood that the discount time will be from the date of satisfactory

If Prompt Payment Discount is offered, please state discount terms below:

Does your company accept payment via ACH? _____ YES / _____ NO

I hereby certify that I have read and agree to all terms and conditions, specifications, and insurance requirements outlined herein:

VENDOR _____

ADDRESS _____

AUTHORIZED SIGNATURE _____

DATE _____

PRINTED SIGNATURE _____

TELEPHONE # _____ FAX # _____

SUBMIT SEALED BID TO: BREVARD COUNTY PURCHASING SERVICES 2725 JUDGE FRAN JAMIESON WAY BLDG. C, 3rd FLOOR, SUITE C-303 VIERA, FL 32940			INVITATION TO BID Bid Acknowledgment	
PROCUREMENT ANALYST: Debbie Feingold debbie.feingold@brevardfl.gov	(321) 617-7390 Ext. 5-9332		AN EQUAL OPPORTUNITY EMPLOYER	FLORIDA TAX EXEMPT #85-8012621749C-1 FEDERAL TAX EXEMPT #59-6000523
BID SPECIFICATIONS MAY BE OBTAINED AT: Purchasing Services, 2725 Judge Fran Jamieson Way, Bldg. C, Suite 303, Viera, FL 32940, or at the Onvia DemandStar® website and VendorLink				
RELEASE DATE: July 16, 2020	BID TITLE: Asphaltic Concrete	BID NUMBER: B-6-20-57	BID OPENING DATE AND TIME: August 6, 2020 @ 2pm	
PRE-BID DATE, TIME, AND LOCATION: A non-mandatory pre-bid meeting will be held on July 23, 2020 at 10:30 a.m. in the Florida Room located at 2725 Judge Fran Jamieson Way, Bldg. C, 3rd Floor, Viera, FL 32940		<input type="checkbox"/> Mandatory <input checked="" type="checkbox"/> Non-Mandatory	BIDS RECEIVED AFTER ABOVE DATE AND TIME WILL NOT BE ACCEPTED	

▼ **CONTRACTOR MUST COMPLETE THIS AREA AND RETURN FORM** ▼

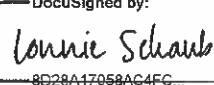
LEGAL NAME OF CONTRACTOR AND BUSINESS ADDRESS: Preferred Materials, Inc. 1806 33rd Street, Suite 150 Orlando, FL 32839	FEDERAL ID NO. (FEIN) OR SOCIAL SECURITY NO. (SSN): 58-1401468
TELEPHONE NUMBER/TOLL-FREE NUMBER: (407) 343-7445	If returning as a "no bid," state reason:
I certify that this bid is made without prior understanding, agreement, or connections with any corporation, firm or person submitting a bid for the same materials, supplies or equipment, and is in all respects fair and without collusion or fraud. I agree to abide by all conditions of this bid and certify that I am authorized to sign this bid for the Contractor. In submitting a bid to the County of Brevard, the Contractor offers and agrees that if the bid is accepted, the Contractor will convey, sell, assign, or transfer to the County of Brevard all rights, title, and interest in and to all causes of action it may now or hereafter acquire under the antitrust laws of the United States and the State of Florida for price fixing relating to the particular commodities or services purchased or acquired by the County of Brevard. At the County's discretion, such assignment shall be made and become effective at the time the County tenders final payment to the Contractor.	The Contractor acknowledges that information provided in this ITB is true and correct. DocuSigned by: X  8028A17058AC4FC AUTHORIZED SIGNATURE (MANUAL) Lonnie Schaub NAME (PRINTED) Vice President TITLE 08/06/2020 DATE

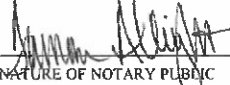
THIS FORM MUST BE NOTARIZED AND RETURNED WITH YOUR BIDSworn to and subscribed before me this 6th day of August 2020.Personally known: Or produced identification: Type of ID: _____

SIGNATURE OF NOTARY PUBLIC
 FL
STATE

Tamara Albright

NAME OF NOTARY PUBLIC (PRINTED)

My commission expires: 11/03/2021

(AFFIX SEAL or STAMP)

TAMARA ALBRIGHT
Notary Public-State of Florida
Commission # GG141165
Commission Expires 11/3/2021

BOND DATA**CONTRACTOR MUST PROVIDE:**Yes No

BID BOND

Yes No

PERFORMANCE BOND

Yes No

LABOR, MATERIAL, PERFORMANCE BOND

AMOUNT:100% on projects over \$100,000

In cases where the amount of a surety bond exceeds \$500,000, the surety company must have an A.M. Best's rating as specified in this document, and depending on the amount of the bond, shall have a minimum A.M. Best's financial size category (FSC) ranking as follows:

BOND AMOUNT UP TO:	FINANCIAL CLASS	BOND AMOUNT UP TO:	FINANCIAL CLASS
\$ 1,000,000	I	\$ 25,000,000	V
\$ 2,000,000	II	\$ 50,000,000	VI
\$ 5,000,000	III	\$ 100,000,000	VII
\$ 10,000,000	IV		

Bonds must be issued by a surety company who complies with the requirements of § 287.0935, Fla. Stat.

PAYMENT OF GOODS OR SERVICES PROVIDED AS A RESULT OF THIS SOLICITATION WILL BE MADE PER FLORIDA STATUTE.
ALL FIRST TIME CONTRACTORS MUST SUBMIT A W-9 FORM.

Asphaltic Concrete
B-6-20-57
CONTRACTOR'S CHECKLIST

The items indicated are required for submission with your bid. Failure to submit any items indicated as required may result in rejection of the bid. Offers to provide required items after the date and time designated for the receipt of bid will not be considered.

- Signed/Notarized Bid Invitation, including Electronic Copy on CD or USB drive
- Completed and Signed Price Sheet, to include Insurance Indemnification Acknowledgement
- Price Sheet completed in Excel and submitted on CD or USB flash drive
- Confirmation of Drug Free Workplace Form
- Reference Form
- Contractor Affidavit Regarding Scrutinized Company List

In order for this bid to be valid, the above forms and information shall be completed in their entirety, signed by an authorized representative of the responding Contractor, and returned as part of the bid response.

Attachment A: Federal Emergency Management Agency (FEMA) Contract Requirements

Attachment B: Ace Fiber Specs

Attachment C: Forta Fi Fiber Specs

Attachment D: Excel Price Sheet

**Asphaltic Concrete
B-6-20-57
CONFIRMATION OF DRUG-FREE WORKPLACE FORM**

In accordance with Section 287.087, Florida Statutes, "whenever two or more bids are equal with respect to price, quality, and service which are received by any political subdivision for the procurement of commodities or contractual services, a bid received from a business that certifies that it has implemented a drug-free workplace program shall be given preference in the award process. In order to have a drug-free workplace program, a business shall:

- (1) Publish a statement notifying employees that the unlawful manufacture, distribution, dispensing, possession, or use of a controlled substance is prohibited in the workplace and specifying the actions that will be taken against employees for violations of such prohibition.
- (2) Inform employees about the dangers of drug abuse in the workplace, the business's policy of maintaining a drug-free workplace, any available drug counseling, rehabilitation, and employee assistance programs, and the penalties that may be imposed upon employees for drug abuse violations.
- (3) Give each employee engaged in providing the commodities or contractual services that are under bid a copy of the statement specified in subsection (1).
- (4) In the statement specified in subsection (1), notify the employees that, as a condition of working on the commodities or contractual services that are under bid, the employee will abide by the terms of the statement and will notify the employer of any conviction of, or plea of guilty or nolo contendere to, any violation of chapter 893 or of any controlled substance law of the United States or any state, for a violation occurring in the workplace no later than 5 days after such conviction.
- (5) Impose a sanction on, or require the satisfactory participation in a drug abuse assistance or rehabilitation program if such is available in the employee's community by, any employee who is so convicted.
- (6) Make a good faith effort to continue to maintain a drug-free workplace through implementation of this section."

As the person authorized to sign the statement, I certify that this firm complies with the above requirements and the Florida Statutes Section 287.087. This form is in conjunction with Brevard County's General Conditions, Item 27, Drug-Free Workplace.

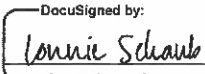
Preferred Materials, Inc.
 Business Name
 DocuSigned by:

 Representative's Signature
Lonnie Schaub
 Name

B-6-20-57 - Asphaltic Concrete
 Bid Number and Name
08/06/2020
 Date
Vice President
 Position

**Asphaltic Concrete
B-6-20-57
REFERENCE FORM**

List a minimum of three (3) / maximum five (5) customers for the services specified in the solicitation in the spaces provided.

Note: A contact person shall be someone who has personal knowledge of the Contractor's performance for the specific requirement listed. Contact person must have been informed that they are being used as a reference and that the County may be calling them. Do not list persons who will be unable to answer specific questions regarding the requirements.

Ref #1. Customer/Client: Osceola County Board of County Commissioners
Date of Services: 2016 - present
Description of Services: Asphalt Milling & Resurfacing
Street Address: 1 Courthouse Square
City, State, ZIP Code: Kissimmee, FL
Telephone #: (407) 742-2000 Fax #: _____
Contact Person: Heidi Lockwood Email: heidi.lockwood@osceola.org

Ref #2. Customer/Client: Central Florida Expressway Authority
Date of Services: 04/2019 to present
Description of Services: Asphalt Milling & Resurfacing
Street Address: 4974 ORL Tower Road
City, State, ZIP Code: Orlando, FL 32807
Telephone #: (407) 690-5000 Fax #: _____
Contact Person: Ben Dreiling Email: ben.dreiling@cfxway.com

Ref #3. Customer/Client: Florida Department of Transportation
Date of Services: 2018 - 2020
Description of Services: Asphalt Milling & Resurfacing
Street Address: P.O. Box 613069
City, State, ZIP Code: Ocoee, FL 34761
Telephone #: (407) 532-3999 Fax #: _____
Contact Person: Brian Qualls Email: bqualls@elipsisec.com

Ref #4. Customer/Client: _____
Date of Services: _____
Description of Services: _____
Street Address: _____
City, State, ZIP Code: _____
Telephone #: _____ Fax #: _____
Contact Person: _____ Email: _____

Ref #5. Customer/Client: _____
Date of Services: _____
Description of Services: _____
Street Address: _____
City, State, ZIP Code: _____
Telephone #: _____ Fax #: _____
Contact Person: _____ Email: _____

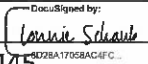
CONTRACTOR NAME Preferred Materials, Inc.
ADDRESS 1806 33rd Street, Suite 150, Orlando, FL 32839
PRINTED SIGNATURE Lonnie Schaub
AUTHORIZED SIGNATURE  _____
TELEPHONE # 407-343-7445 FAX# 407-839-1458 DATE 08/06/2020
EMAIL: lonnie.schaub@preferredmaterials.com

CONTRACTOR AFFIDAVIT REGARDING SCRUTINIZED COMPANY LIST

Awarded Contractor shall certify that it and its subcontractors are not on the Scrutinized Companies that Boycott Israel List. Pursuant to Section 287.135, F.S. If the Contract is for more than \$1,000,000 the Contractor further certifies that it and its subcontractors are also not on the Scrutinized Companies with Activities in Sudan, Scrutinized Companies with Activities in the Iran Petroleum Energy Sector List, or engaged with business operations in Cuba or Syria as identified in Section 287.135, F.S.

For Contracts of any amount, if the County determines the Contractor submitted a false certification under Section 287.135(5) of the Florida Statutes, or if the Contractor has been placed on the Scrutinized Companies that Boycott Israel List, or is engaged in a boycott of Israel, the County shall either terminate the Contract after it has given the Contractor notice and an opportunity to demonstrate the County's determination of false certification was in error pursuant to Section 287.135(5)(a) of the Florida Statutes, or on a case-by-case basis the County may choose to maintain the Contract if the conditions of Section 287.135(4) of the Florida Statutes are met. For Contracts \$1,000,000 and greater, if the County determines the Contractor submitted a false certification under Section 287.135(5) of the Florida Statutes, or if the Contractor has been placed on the Scrutinized Companies with Activities in the Sudan List, or the Scrutinized Companies with Activities in the Iran Petroleum Energy Sector List, the County shall either terminate the Contract after it has given the Contractor notice and an opportunity to demonstrate the County's determination of false certification was in error pursuant to Section 287.135(5)(a) of the Florida Statutes, or on a case-by-case basis the County may choose to maintain the Contract if the conditions of Section 287.135(4) of the Florida Statutes are met.

STATE OF FLORIDA

COUNTY OF Orange

BEFORE ME, the undersigned authority, personally appeared Lonnie Schaub, who, being by me first duly sworn, made the following statement:

1. The Business address of Preferred Materials, Inc. (name of Contractor) is 1806 33rd Street, Suite 150, Orlando, FL 32839
2. My relationship to Preferred Materials, Inc. (name of Contractor) is (relationship such as sole proprietor, partner, president, vice president).
3. I understand that "Boycott of Israel" has the same meaning as defined in §215.4725, Florida Statutes, and means refusing to deal, terminating business activities, or taking other actions to limit commercial relations with Israel, or persons or entities doing business in Israel or in Israeli-controlled territories, in a discriminatory manner. A statement by a company that it is participating in a boycott of Israel, or that it has initiated a boycott in response to a request for a boycott of Israel or in compliance with, or in furtherance of, calls for a boycott of Israel, may be considered by the State Board of Administration to be evidence

that a company is participating in a boycott of Israel. The term does not include restrictive trade practices or boycotts fostered or imposed by foreign countries against Israel.

4. I understand that "business operations" means, for purposes specifically related to Cuba or Syria, engaging in commerce in any form in Cuba or Syria, including, but not limited to, acquiring, developing, maintaining, owning, selling, possessing, leasing, or operating equipment, facilities, personnel, products, services, personal property, real property, military equipment, or any other apparatus of business or commerce.
5. Preferred Materials, Inc. (name of Contractor) is not on the Scrutinized Companies that Boycott Israel List, created pursuant to s. 215.4725, Florida Statutes, or is engaged in a boycott of Israel.
6. Preferred Materials, Inc. (name of Contractor) is not on the Scrutinized Companies with Activities in Sudan List or the Scrutinized Companies with Activities in the Iran Petroleum Energy Sector List, created pursuant to s. 215.473, Florida Statutes.
7. Preferred Materials, Inc. (name of Contractor) is not engaged in business operations in Cuba or Syria.

DocuSigned by:

 8D28A17068AC4FC

 Signature

Sworn to and subscribed before me in the state and county first mentioned above on the 6th day of August, 2020.



 Notary Public

My commission expires: 11/03/2021

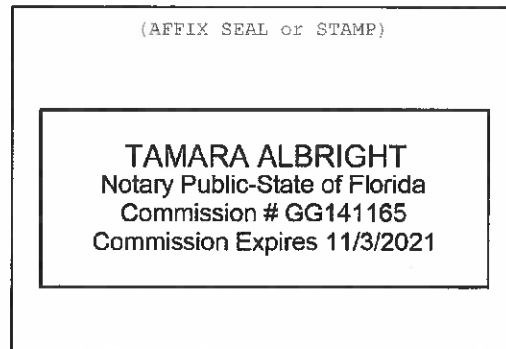

ASPHALTIC CONCRETE BID # B-6-20-57		REVISED PRICE SHEET		
ASPHALTIC CONCRETE	DESCRIPTION	ROAD PAVING	PARKING LOTS	BIKE PATHS
Superpave SP-9.5	Vendor Delivered, Vendor Placed	\$ 89.09 Ton	\$ 150.00 Ton	\$ 225.00 Ton
Superpave SP-12.5	Vendor Delivered, Vendor Placed	\$ 85.09 Ton	\$ 150.00 Ton	\$ 225.00 Ton
FRICITION COURSE		ROAD PAVING		
Friction Course FC-5	Vendor Delivered, Vendor Placed	\$ 175.00 Ton		
Friction Course FC-9.5	Vendor Delivered, Vendor Placed	\$ 125.00 Ton		
Friction Course FC-12.5	Vendor Delivered, Vendor Placed	\$ 108.00 Ton		
SPEED HUMPS SP-9.5	Vendor Delivered, Vendor Placed	\$ 750.00 Ton		
LESS THAN 25 TN PATCHING SP-9.5	Vendor Delivered, Vendor Placed	\$ 750.00 Ton		
25-50 TN PATCHING SP 9.5	Vendor Delivered, Vendor Placed	\$ 500.00 Ton		
TACK FOB Gallon	FOB GALLON	\$ N/A Gal		
PRIME	Vendor Delivered, Vendor Placed	\$ 1.00 SY		
PRIM AND SAND	Vendor Delivered, Vendor Placed	\$ 1.20 SY		
SAND 3% HOT MIX	Vendor Delivered, Vendor Placed	\$ 500.00 Ton	\$ 7.00 SY	
HOT ASPHALT FOR PICK UP FOB AT PLANT SP-9.5	FOR PICK UP	\$ 70.00 Ton		
TEMPORARY STRIPING	Vendor Schedules and Provides	\$ 2.00 L.F.		
Night Work	Cost per ton	\$ 10.00 Ton		
Cost for Milling & Clean Up	SY 0-2,500 and under	\$ 5.00 SY		
	SY \$2,501 - 5,000	\$ 3.00 SY		
	SY 5,001 to 15,000	\$ 2.10 SY		
	SY 15,001 and over	\$ 2.10 SY		
Asphalt Millings for Pickup FOB at Plant		\$ 35.00 Ton		
Cost per ton to add Aramid Fiber to the asphalt mix (Per attached Fiber Specs)	*			
SPECIFIC PROJECTS ONLY *		\$ 15.00 Ton		

Plant Locations: Melbourne, Kissimmee and Winter Springs, FL

**ASPHALTIC CONCRETE
BID # B-6-20-57**

**REVISED PRICE SHEET
(Continued)**

Addendum Acknowledgment:

Add. No. 1 Dated 07/28/20 / Add. No. _____ Dated _____

Add. No. _____ Dated _____ / Add. No. _____ Dated _____

PROMPT PAYMENT DISCOUNT:

Brevard County shall remit payment in accordance with the Florida Prompt Payment Act, Florida Statutes section 218.70. Bidders may offer cash discounts for prompt payment, but they will not be considered in determination of award. If a bidder offers a discount, it is understood that the discount time will be from the date of satisfactory

If Prompt Payment Discount is offered, please state discount terms below:

Does your company accept payment via ACH? YES / NO

I hereby certify that I have read and agree to all terms and conditions, specifications, and insurance requirements outlined herein:

VENDOR Preferred Materials, Inc.

ADDRESS 1806 33rd Street, Suite 150. Orlando, FL 32839

AUTHORIZED SIGNATURE  _____

PRINTED SIGNATURE Lonnie Schaub, Vice President DATE 08/06/20

TELEPHONE # (407) 343-7445

FAX # (407) 839-1458



[Skip to Main Content](#)

Department of Management Services

[Florida Department of Management Services](#) > [Business Operations](#) > [State Purchasing](#) > [State Agency Resources](#) > [Vendor Registration and Vendor Lists](#) > Convicted Vendor List

Convicted Vendor List

The Department of Management Services maintains "a list of the names and addresses of those who have been disqualified from the public contracting and purchasing process" under [section 287.133, Florida Statutes](#).

Vendor Name	Agency of Origin	Effective Date	Expiration Date	Final Order
Calixte, Jacques A. (Haitian American Association Against Cancer, Inc.)	DOH	10/25/18	10/25/21	Final Order - Calixte, Jacques A. (Haitian American Association Against Cancer, Inc.) ( 1.71 MB)
Hoffman, Tracy J. (Gator Signage and Striping, LLC)	DOT	01/22/18	01/22/21	Final Order - Hoffman, Tracy J. (Gator Signage and Striping, LLC) ( 753.24 KB)

Updated 12/10/19

Document reader download link

-  [Adobe PDF Reader](#)

[Terms and Conditions](#) | [Privacy Statement](#) | [Accessibility Statement](#) | Copyright ©2020 Department of Management Services - State of Florida

[Skip to Main Content](#)

Department of Management Services

[Florida Department of Management Services](#) > [Business Operations](#) > [State Purchasing](#) > [State Agency Resources](#) > [Vendor Registration and Vendor Lists](#) > Discriminatory Vendor List

Discriminatory Vendor List

The Department of Management Services maintains "a list of the names and addresses of any entity which has been disqualified from the public contracting and purchasing process" under [section 287.134, Florida Statutes](#).

There are currently no vendors on this list.

[Terms and Conditions](#) | [Privacy Statement](#) | [Accessibility Statement](#) | Copyright ©2020 Department of Management Services - State of Florida



A NEW WAY TO SIGN IN - If you already have a SAM account, use your SAM email for login.gov.

Log In

Login.gov FAQs

ALERT: SAM.gov will be down for scheduled maintenance Saturday, 08/15/2020 from 8:00 AM to 10:00 PM

Entity Dashboard

Preferred Materials, Inc. 4636 Scarborough Dr
 DUNS: 809022671 CAGE Code: 7EK24 Lutz, FL, 33559-8506 ,
 Status: Active UNITED STATES
 Expiration Date: 11/13/2020
 Purpose of Registration: All Awards

- ▶ [Entity Overview](#)
- ▶ [Entity Registration](#)
 - ▶ [Core Data](#)
 - ▶ [Assertions](#)
 - ▶ [Reps & Certs](#)
 - ▶ [POCs](#)
- ▶ [Exclusions](#)
 - ▶ [Active Exclusions](#)
 - ▶ [Inactive Exclusions](#)
 - ▶ [Excluded Family Members](#)

RETURN TO SEARCH

Entity Overview

Entity Registration Summary
Name: Preferred Materials, Inc.
Business Type: Business or Organization
Last Updated By: Ashley Turner
Registration Status: Active
Activation Date: 11/14/2019
Expiration Date: 11/13/2020

Exclusion Summary
Active Exclusion Records? No



IBM-P-20200717-1140
WWW2

- [Search Records](#)
- [Disclaimers](#)
- [FAPIS.gov](#)
- [Data Access](#)
- [Accessibility](#)
- [GSA.gov/LAE](#)
- [Check Status](#)
- [Privacy Policy](#)
- [GSA.gov](#)
- [About](#)
- [USA.gov](#)
- [Help](#)

This is a U.S. General Services Administration Federal Government computer system that is "FOR OFFICIAL USE ONLY." This system is subject to monitoring. Individuals found performing unauthorized activities are subject to disciplinary action including criminal prosecution.

View Vendor Detail

General Vendor Information	
Vendor Status / Effective Date:	AC /
Vendor Name:	Preferred Materials
Short Name (Does Business As):	
Dun and Bradstreet Number (DUNS):	112758800
Website:	
W9 Status:	Valid W-9 on File
DFS W9 Last Update Date:	Sep 21, 2015
Business Designation	Corporation
	Primary Place of Business: FL
Collections Indicator:	Y

Certified Business Enterprise (CBE) Category
Other Non-Profit / Non-Woman-Owned / Non-FVBE

Solicitations
Registered for Sourcing: No
Registered for VBS: No

Special Exceptions
Fee has been waived: <input type="checkbox"/>
Terms of Use have not been agreed to: <input type="checkbox"/>

Reluctant Vendor
Reluctant Vendor:

Florida Terms of Use
Accepted: Yes, 04/28/2015
Accepted By: Ashley Turner

Contacts
View Contact List

Locations
024 Preferred Materials, Inc. Status: AC Details

[-] Commodity Codes
No Commodity Codes Selected

[Return to List](#)

[Copyright © 2009 State of Florida](#) | [Privacy Statement](#) :: [Required Information](#) :: [Terms of Use](#) :: [Frequently Asked Questions](#) :: [Glossary](#)

MyFloridaMarketPlace Vendor Registration Customer Service: 866-FLA-EPRO (866-352-3776)



[Department of State](#) / [Division of Corporations](#) / [Search Records](#) / [Search by Entity Name](#) /

Detail by Entity Name

Foreign Profit Corporation

PREFERRED MATERIALS, INC.

Filing Information

Document Number	F07000005569
FEI/EIN Number	26-1171248
Date Filed	11/09/2007
State	DE
Status	INACTIVE
Last Event	WITHDRAWAL
Event Date Filed	06/10/2011
Event Effective Date	NONE

Principal Address

375 NORTHRIDGE ROAD
SUITE 350
ATLANTA, GA 30350

Changed: 06/10/2011

Mailing Address

375 NORTHRIDGE ROAD
SUITE 350
ATLANTA, GA 30350

Changed: 06/10/2011

Registered Agent Name & Address

NONE

Officer/Director Detail

Name & Address

Title PD

DUKE, ROBERT F
375 NORTHRIDGE ROAD, SUITE 350
ATLANTA, GA 30350

Title VPAS

MILLER, WILLIAM B

375 NORTHRIDGE ROAD, SUITE 350
ATLANTA, GA 30350

Title ST

BROWN, CHARLIE
375 NORTHRIDGE ROAD, SUITE 350
ATLANTA, GA 30350

Title VPAS

LAING, KENNETH C
375 NORTHRIDGE ROAD, SUITE 350
ATLANTA, GA 30350

Title DIR

MERGENS, RICHARD
375 NORTHRIDGE ROAD, SUITE 350
ATLANTA, GA 30350

Title AS

HICKMAN, GARY P
375 NORTHRIDGE ROAD, SUITE 350
ATLANTA, GA 30350

Annual Reports

Report Year	Filed Date
2009	06/24/2009
2010	04/20/2010
2011	04/11/2011

Document Images

06/10/2011 -- Withdrawal	View image in PDF format
04/11/2011 -- ANNUAL REPORT	View image in PDF format
08/30/2010 -- Merger	View image in PDF format
04/20/2010 -- ANNUAL REPORT	View image in PDF format
06/24/2009 -- ANNUAL REPORT	View image in PDF format
06/22/2009 -- ANNUAL REPORT	View image in PDF format
05/13/2009 -- ANNUAL REPORT	View image in PDF format
03/24/2009 -- ANNUAL REPORT	View image in PDF format
04/18/2008 -- ANNUAL REPORT	View image in PDF format
11/09/2007 -- Foreign Profit	View image in PDF format





[Skip to Main Content](#)

Department of Management Services

[Florida Department of Management Services](#) > [Business Operations](#) > [State Purchasing](#) > [State Agency Resources](#) > [Vendor Registration and Vendor Lists](#) > Suspended Vendor List

Suspended Vendor List

The Department of Management Services maintains a list of vendors that have been removed from the Vendor List "for failing to fulfill any of its duties specified in a contract with the State," in accordance with [Rule 60A-1.006\(2\)](#), [Florida Administrative Code](#).

Vendor Name/Address	Agency of Origin	Effective Date	Notice of Default
Building Maintenance of America, LLC d/b/a Florida Building Maintenance 333 North Falkenburg Road #A117 Tampa, FL 33619	DMS	07/02/14	Notice of Default - Building Maintenance of America, LLC d/b/a Florida Building Maintenance ( 575.81 KB)
Club Tex, Inc. 2025 Broadway, Suite #15G New York, NY 10023	DOC	01/24/19	Notice of Default - Club Tex, Inc. ( 111.75 KB)
Correctional Consultants, LLC P.O. Box 515 Chattahoochee, FL 32324	DOC	12/10/19	Notice of Default - Correctional Consultants, LLC ( 85.95 KB)
iColor Printing and Mailing, Inc. 22873 Lockness Avenue Torrance, CA 90501	DEP	02/20/12	Notice of Default - iColor Printing and Mailing, Inc. ( 320.17 KB)
Visual Image Design Firm, LLC 6845 Narcoossee Road, Suite 59 Orlando, FL 32822	DOH	06/25/15	Notice of Default - Visual Image Design Firm, LLC ( 1.78 MB)

Updated 12/10/19

Document reader download link

-  [Adobe PDF Reader](#)

[Terms and Conditions](#) | [Privacy Statement](#) | [Accessibility Statement](#) | Copyright ©2020 Department of Management Services - State of Florida

SUBMIT SEALED BID TO:
 BREVARD COUNTY PURCHASING SERVICES
 2725 JUDGE FRAN JAMIESON WAY
 BLDG. C, 3rd FLOOR, SUITE C-303
 VIERA, FL 32940



INVITATION TO BID

Bid Acknowledgment

PROCUREMENT ANALYST: (321) 617-7390
 Debbie Feingold Ext. 5-9332
 debbie.feingold@brevardfl.gov

AN EQUAL
 OPPORTUNITY
 EMPLOYER

FLORIDA TAX EXEMPT #85-8012621749C-1
 FEDERAL TAX EXEMPT #59-6000523

BID SPECIFICATIONS MAY BE OBTAINED AT: Purchasing Services, 2725 Judge Fran Jamieson Way, Bldg. C, Suite 303, Viera, FL 32940, or at the Onvia DemandStar® website and VendorLink

RELEASE DATE: July 16, 2020	BID TITLE: Asphaltic Concrete	BID NUMBER: B-6-20-57	BID OPENING DATE AND TIME: August 6, 2020 @ 2pm
PRE-BID DATE, TIME, AND LOCATION: A non-mandatory pre-bid meeting will be held on July 23, 2020 at 10:30 a.m. in the Florida Room located at 2725 Judge Fran Jamieson Way, Bldg. C, 3rd Floor, Viera, FL 32940		<input type="checkbox"/> Mandatory <input checked="" type="checkbox"/> Non-Mandatory	BIDS RECEIVED AFTER ABOVE DATE AND TIME WILL NOT BE ACCEPTED

▼ CONTRACTOR MUST COMPLETE THIS AREA AND RETURN FORM ▼

LEGAL NAME OF CONTRACTOR AND BUSINESS ADDRESS:
 Goodson Paving, Inc
 430 Cleo Road
 Cocoa, FL 32924

TELEPHONE NUMBER/TOLL-FREE NUMBER:
 (321) 681-5523

FEDERAL ID NO. (FEIN) OR SOCIAL SECURITY NO. (SSN):
 59-2872065

If returning as a "no bid," state reason:

I certify that this bid is made without prior understanding, agreement, or connections with any corporation, firm or person submitting a bid for the same materials, supplies or equipment, and is in all respects fair and without collusion or fraud. I agree to abide by all conditions of this bid and certify that I am authorized to sign this bid for the Contractor. In submitting a bid to the County of Brevard, the Contractor offers and agrees that if the bid is accepted, the Contractor will convey, sell, assign, or transfer to the County of Brevard all rights, title, and interest in and to all causes of action it may now or hereafter acquire under the antitrust laws of the United States and the State of Florida for price fixing relating to the particular commodities or services purchased or acquired by the County of Brevard. At the County's discretion, such assignment shall be made and become effective at the time the County tenders final payment to the Contractor.

The Contractor acknowledges that information provided in this ITB is true and correct.

X

AUTHORIZED SIGNATURE (MANUAL)
 Travis Goodson
NAME (PRINTED)

Vice President
TITLE

8/6/2020
DATE

THIS FORM MUST BE NOTARIZED AND RETURNED WITH YOUR BID

Sworn to and subscribed before me this 6 day of Aug 2020.

Personally known:
 Or produced identification: Type of ID: _____

(AFFIX SEAL OR STAMP)

SIGNATURE OF NOTARY PUBLIC

Faith Hemric
 NAME OF NOTARY PUBLIC (PRINTED)



FAITH HEMRIC
 Commission # GG 118866
 Expires August 13, 2021
 Bonded Thru Budget Notary Services

My commission expires: _____

BOND DATA

CONTRACTOR MUST PROVIDE:		AMOUNT:
Yes <input type="checkbox"/>	No <input checked="" type="checkbox"/>	BID BOND
Yes <input checked="" type="checkbox"/>	No <input type="checkbox"/>	PERFORMANCE BOND
Yes <input type="checkbox"/>	No <input checked="" type="checkbox"/>	LABOR, MATERIAL, PERFORMANCE BOND

100% on projects over \$100,000

In cases where the amount of a surety bond exceeds \$500,000, the surety company must have an A.M. Best's rating as specified in this document, and depending on the amount of the bond, shall have a minimum A.M. Best's financial size category (FSC) ranking as follows:

BOND AMOUNT UP TO:	FINANCIAL CLASS	BOND AMOUNT UP TO:	FINANCIAL CLASS
\$ 1,000,000	I	\$ 25,000,000	V
\$ 2,000,000	II	\$ 50,000,000	VI
\$ 5,000,000	III	\$ 100,000,000	VII
\$ 10,000,000	IV		

Bonds must be issued by a surety company who complies with the requirements of § 287.0935, Fla. Stat.

PAYMENT OF GOODS OR SERVICES PROVIDED AS A RESULT OF THIS SOLICITATION WILL BE MADE PER FLORIDA STATUTE. ALL FIRST TIME CONTRACTORS MUST SUBMIT A W-9 FORM.

**Asphaltic Concrete
B-6-20-57
CONTRACTOR'S CHECKLIST**

Items indicated are required for submission with your bid. Failure to submit any items indicated as required may result in rejection of the bid. Offers to provide required items after the date and time designated for the receipt of bid will not be considered.

- Signed/Notarized Bid Invitation, including Electronic Copy on CD or USB drive
- Completed and Signed Price Sheet, to include Insurance Indemnification Acknowledgement
- Price Sheet completed in Excel and submitted on CD or USB flash drive
- Confirmation of Drug Free Workplace Form
- Reference Form
- Contractor Affidavit Regarding Scrutinized Company List

In order for this bid to be valid, the above forms and information shall be completed in their entirety, signed by an authorized representative of the responding Contractor, and returned as part of the bid response.

- Attachment A: Federal Emergency Management Agency (FEMA) Contract Requirements
- Attachment B: Ace Fiber Specs
- Attachment C: Forta FI Fiber Specs
- Attachment D: Excel Price Sheet

ASPHALTIC CONCRETE BID # B-6-20-57		REVISED PRICE SHEET		
ASPHALTIC CONCRETE	DESCRIPTION	ROAD PAVING	PARKING LOTS	BIKE PATHS
Superpave SP-9.5	Vendor Delivered, Vendor Placed	96.4	126.2	162
Superpave SP-12.5	Vendor Delivered, Vendor Placed	95.4	124.9	155.6
FRICTION COURSE		ROAD PAVING		
Friction Course FC-5	Vendor Delivered, Vendor Placed	199.15		
Friction Course FC-9.5	Vendor Delivered, Vendor Placed	126.05		
Friction Course FC-12.5	Vendor Delivered, Vendor Placed	128.25		
SPEED HUMPS SP-9.5	Vendor Delivered, Vendor Placed	426		
LESS THAN 25 TN PATCHING SP-9.5	Vendor Delivered, Vendor Placed	342		
25-50 TN PATCHING SP 9.5	Vendor Delivered, Vendor Placed	295.6		
TACK FOB Gallon	FOB GALLON	NO BID		
PRIME	Vendor Delivered, Vendor Placed	0.8		
PRIM AND SAND	Vendor Delivered, Vendor Placed	1.55		
SAND 3% HOT MIX	Vendor Delivered, Vendor Placed	375	3.64	
HOT ASPHALT FOR PICK UP FOB AT PLANT SP-9.5	FOR PICK UP	NO BID		
TEMPORARY STRIPING	Vendor Schedules and Provides	6		
Night Work	Cost per ton	16.5		
Cost for Milling & Clean Up	SY 0-2,500 and under	6.37		
	SY \$2,501 - 5,000	3.62		
	SY 5,001 to 15,000	3.38		
	SY 15,001 and over	3.1		
Asphalt Millings for Pickup FOB at Plant		NO BID		
Cost per ton to add Aramid Fiber to the asphalt mix (Per attached Fiber Specs)	*			
SPECIFIC PROJECTS ONLY *		15		

Plant Locations: VA PAVING, 800 Cidco Road, Cocoa - PREFERRED ASPHALT, 6210 N. US1, Melbourne

**ASPHALTIC CONCRETE
BID # B-6-20-57**

**REVISED PRICE SHEET
(Continued)**

Addendum Acknowledgment:

Add. No. 1 Dated 07.28.2020 Add. No. _____ Dated _____

Add. No. _____ Dated _____ / Add. No. _____ Dated _____

PROMPT PAYMENT DISCOUNT:

218.70. Bidders may offer cash discounts for prompt payment, but they will not be considered in determination of award. If a bidder offers a discount, it is understood that the discount time will be from the date of satisfactory delivery, at the place of acceptance, and receipt of correct invoice, at the office specified, whichever occurs last.

If Prompt Payment Discount is offered, please state discount terms below:

N/A

Does your company accept payment via ACH? _____ YES / X NO

I hereby certify that I have read and agree to all terms and conditions, specifications, and insurance requirements outlined herein:

VENDOR__ Goodson Paving, Inc

ADDRESS__ 630 Cidco Road, Cocoa, FL 32926

AUTHORIZED SIGNATURE _____

PRINTED SIGNATURE__ Travis Goodson

DATE__ August 6,
2020

TELEPHONE #_ 321.631.5523

FAX #_ 321.639.0497

**Asphaltic Concrete
B-6-20-57
CONFIRMATION OF DRUG-FREE WORKPLACE FORM**

In accordance with Section 287.087, Florida Statutes, "whenever two or more bids are equal with respect to price, quality, and service which are received by any political subdivision for the procurement of commodities or contractual services, a bid received from a business that certifies that it has implemented a drug-free workplace program shall be given preference in the award process. In order to have a drug-free workplace program, a business shall:

- (1) Publish a statement notifying employees that the unlawful manufacture, distribution, dispensing, possession, or use of a controlled substance is prohibited in the workplace and specifying the actions that will be taken against employees for violations of such prohibition.
- (2) Inform employees about the dangers of drug abuse in the workplace, the business's policy of maintaining a drug-free workplace, any available drug counseling, rehabilitation, and employee assistance programs, and the penalties that may be imposed upon employees for drug abuse violations.
- (3) Give each employee engaged in providing the commodities or contractual services that are under bid a copy of the statement specified in subsection (1).
- (4) In the statement specified in subsection (1), notify the employees that, as a condition of working on the commodities or contractual services that are under bid, the employee will abide by the terms of the statement and will notify the employer of any conviction of, or plea of guilty or nolo contendere to, any violation of chapter 893 or of any controlled substance law of the United States or any state, for a violation occurring in the workplace no later than 5 days after such conviction.
- (5) Impose a sanction on, or require the satisfactory participation in a drug abuse assistance or rehabilitation program if such is available in the employee's community by, any employee who is so convicted.
- (6) Make a good faith effort to continue to maintain a drug-free workplace through implementation of this section."

As the person authorized to sign the statement, I certify that this firm complies with the above requirements and the Florida Statutes Section 287.087. This form is in conjunction with Brevard County's General Conditions, Item 27, Drug-Free Workplace.

Goodson Paving, Inc.
Business Name

[Signature]
Authorized Representative's Signature

Travis Goodson
Name

B-6-20-57 Asphaltic Concrete
Bid Number and Name

8/6/2020
Date

Vice President
Position

Asphaltic Concrete

B-6-20-57

REFERENCE FORM

List a minimum of three (3) / maximum five (5) customers for the services specified in the solicitation in the spaces provided.

Note: A contact person shall be someone who has personal knowledge of the Contractor's performance for the specific requirement listed. Contact person must have been informed that they are being used as a reference and that the County may be calling them. Do not list persons who will be unable to answer specific questions regarding the requirements.

Ref #1. Customer/Client: W.E.J. Construction
Date of Services: 1988 - Present
Description of Services: General Contractor
Street Address: 1005 Viva Blvd Suite 202
City, State, ZIP Code: Rockledge FL 32955
Telephone #: 321-632-1660 Fax #: 321-632-5927
Contact Person: Erik Costine Email: erik@wjconstruction.com

Ref #2. Customer/Client: M.H. Williams Construction
Date of Services: 1988 - Present
Description of Services: General Contractor
Street Address: 1287 N. Eau Gallie Blvd
City, State, ZIP Code: Maitland, FL 32935
Telephone #: 321-751-5750 Fax #: 321-751-3660
Contact Person: Mike Williams Jr. Email: mikelj@mhwilliams.com

Ref #3. Customer/Client: Doug Wilson Enterprises
Date of Services: 1988 - Present
Description of Services: General Contractor
Street Address: 1121 N. Atlantic Ave #102
City, State, ZIP Code: Coral Gables, FL 33134
Telephone #: 321-783-0903 Fax #: 321-783-7941
Contact Person: Bruce Simmonds Email: rsimmonds@dwillent.com

Ref #4. Customer/Client: Brevard County Road & Bridge
Date of Services: 1988 - Present
Description of Services: County Contractor
Street Address: 1725 Judge Frank Simmons Way
City, State, ZIP Code: Viera FL 32940
Telephone #: 321-690-6815 Fax #: 321-690-6841
Contact Person: Bruce Black Email: Bruce.Black@brevardcounty.us

Ref #5. Customer/Client:
Date of Services:
Description of Services:
Street Address:
City, State, ZIP Code:
Telephone #: Fax #:
Contact Person: Email:

CONTRACTOR NAME: Goodson Paving, Inc
ADDRESS: 630 Lido Road, Cocoa, FL 32924
PRINTED SIGNATURE: Travis Goodson
AUTHORIZED SIGNATURE: [Signature]
TELEPHONE #: 321-631-5623 FAX #: 321-639-0497 DATE: 8/11/2020
EMAIL: goodsonpaving@gmail.com

CONTRACTOR AFFIDAVIT REGARDING SCRUTINIZED COMPANY LIST

Awarded Contractor shall certify that it and its subcontractors are not on the Scrutinized Companies that Boycott Israel List. Pursuant to Section 287.135, F.S. If the Contract is for more than \$1,000,000 the Contractor further certifies that it and its subcontractors are also not on the Scrutinized Companies with Activities in Sudan, Scrutinized Companies with Activities in the Iran Petroleum Energy Sector List, or engaged with business operations in Cuba or Syria as identified in Section 287.135, F.S.

For Contracts of any amount, if the County determines the Contractor submitted a false certification under Section 287.135(5) of the Florida Statutes, or if the Contractor has been placed on the Scrutinized Companies that Boycott Israel List, or is engaged in a boycott of Israel, the County shall either terminate the Contract after it has given the Contractor notice and an opportunity to demonstrate the County's determination of false certification was in error pursuant to Section 287.135(5)(a) of the Florida Statutes, or on a case-by-case basis the County may choose to maintain the Contract if the conditions of Section 287.135(4) of the Florida Statutes are met. For Contracts \$1,000,000 and greater, if the County determines the Contractor submitted a false certification under Section 287.135(5) of the Florida Statutes, or if the Contractor has been placed on the Scrutinized Companies with Activities in the Sudan List, or the Scrutinized Companies with Activities in the Iran Petroleum Energy Sector List, the County shall either terminate the Contract after it has given the Contractor notice and an opportunity to demonstrate the County's determination of false certification was in error pursuant to Section 287.135(5)(a) of the Florida Statutes, or on a case-by-case basis the County may choose to maintain the Contract if the conditions of Section 287.135(4) of the Florida Statutes are met.

STATE OF FLORIDA

COUNTY OF Myward

BEFORE ME, the undersigned authority, personally appeared

Travis Goodson, who, being by me first duly sworn, made the following statement:

1. The Business address of Goodson Paving, Inc (name of Contractor) is 630 Cedar Road
Cocoa, FL 32924
2. My relationship to Goodson Paving, Inc (name of Contractor) is (relationship such as sole proprietor, partner, president, vice president).
3. I understand that "Boycott of Israel" has the same meaning as defined in §215.4725, Florida Statutes, and means refusing to deal, terminating business activities, or taking other actions to limit commercial relations with Israel, or persons or entities doing business in Israel or in Israeli-controlled territories, in a discriminatory manner. A statement by a company that it is participating in a boycott of Israel, or that it has initiated a boycott in response to a request for a boycott of Israel or in compliance with, or in furtherance of, calls for a boycott of Israel, may be considered by the State Board of Administration to be evidence

that a company is participating in a boycott of Israel. The term does not include restrictive trade practices or boycotts fostered or imposed by foreign countries against Israel.

4. I understand that "business operations" means, for purposes specifically related to Cuba or Syria, engaging in commerce in any form in Cuba or Syria, including, but not limited to, acquiring, developing, maintaining, owning, selling, possessing, leasing, or operating equipment, facilities, personnel, products, services, personal property, real property, military equipment, or any other apparatus of business or commerce.
5. Goodson Paving, Inc (name of Contractor) is not on the Scrutinized Companies that Boycott Israel List, created pursuant to s. 215.4725, Florida Statutes, or is engaged in a boycott of Israel.
6. Goodson Paving, Inc (name of Contractor) is not on the Scrutinized Companies with Activities in Sudan List or the Scrutinized Companies with Activities in the Iran Petroleum Energy Sector List, created pursuant to s. 215.473, Florida Statutes.
7. Goodson Paving, Inc (name of Contractor) is not engaged in business operations in Cuba or Syria.



Signature

Sworn to and subscribed before me in the state and county first mentioned above on the 6 day of AUGUST, 2020.

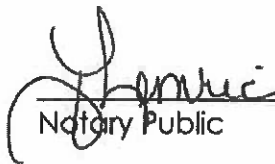

Notary Public

My commission expires:

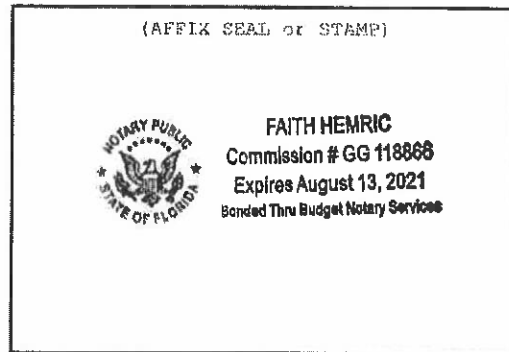

SEE WARNING SIGN PLACEMENT TABLE

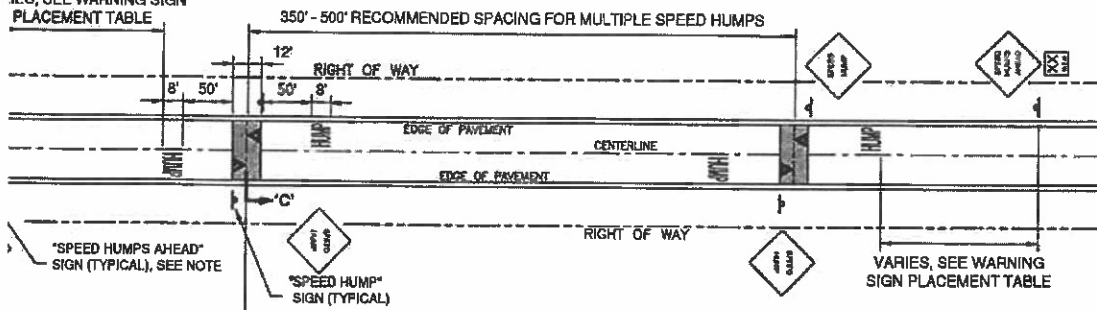

PLAN VIEW (N.T.S.)

Note: "Speed Humps Ahead" sign may be omitted if only one (1) speed hump is installed or if multiple speed humps are not in close proximity. In this case, the Advisory Speed plaque shall be installed at the "Speed Hump" sign.

WARNING SIGN PLACEMENT	
POSTED SPEED	MIN. DISTANCE FROM SIGN TO SIGN
20 MPH	75'
25 MPH	100'
30 MPH	125'

WARNING SIGN PLACEMENT TABLE

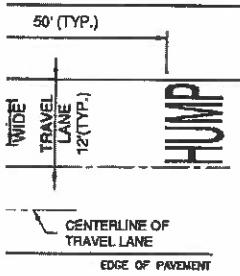

TAPER, TYPICAL, BOTH ENDS SEE DETAIL, SECTION 'C'

PLAN VIEW (N.T.S.)

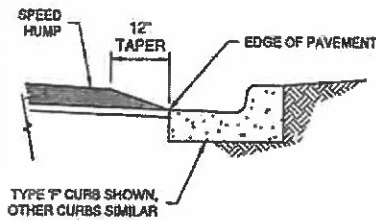

SECTION 'C' (N.T.S.)

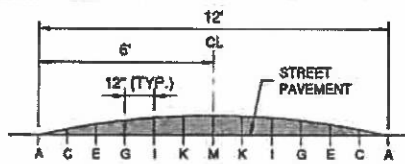

SPEED HUMP THICKNESS TABLE							
DESIGN SPEED	A	C	E	G	I	K	M
20 MPH	0.0	0.9	1.7	2.3	2.7	2.9	3.0

SPEED HUMP SECTION (N.T.S.)

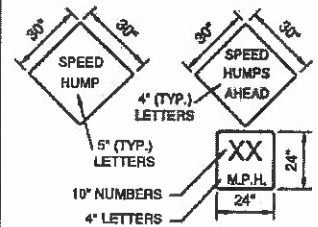

MUTCD REF. W17-1 (MODIFIED) AND W13-1

SPEED HUMP SIGN DETAILS

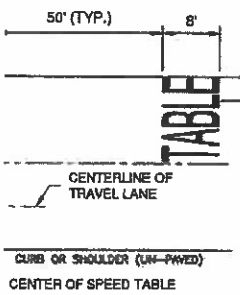

PLAN VIEW (N.T.S.)

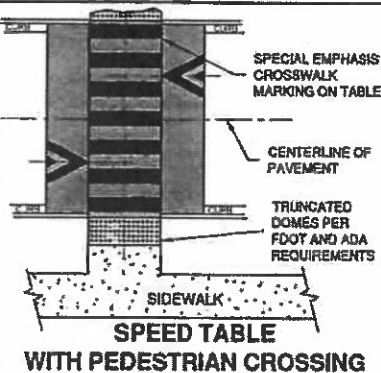

SPEED TABLE WITH PEDESTRIAN CROSSING

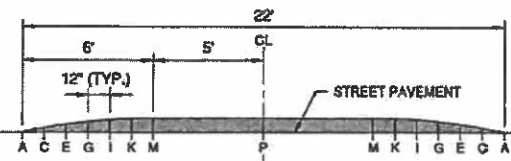

SPEED TABLE THICKNESS TABLE										
DESIGN SPEED	CENTER HEIGHT	A	C	E	G	I	K	M	P	
25 MPH	3.5" TALL TABLE	0.0	1.1	2.0	2.7	3.2	3.4	3.5	3.5	
30 MPH	5" TALL TABLE	0.0	0.6	1.7	2.3	2.7	2.9	3.0	3.0	

SPEED TABLE SECTION (N.T.S.)

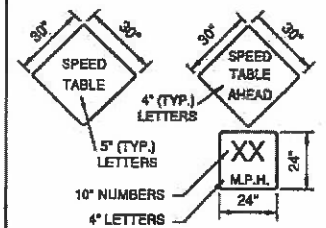

MUTCD REF. W17-1 (MODIFIED) AND W13-1

SPEED TABLE SIGN DETAILS

PREPARED BY: PUBLIC WORKS DEPARTMENT
ENGINEERING DIVISION
BREVARD COUNTY BOARD OF COUNTY COMMISSIONERS
2705 JUNGLE FRM FACEDOR WAY, RD. 01, BOCA A. VERDE, FL 32940
Ph. (321) 622-6077, Fax (321) 627-5475

PREPARED FOR: PUBLIC WORKS DEPT.
BREVARD COUNTY
BOARD OF COUNTY COMMISSIONERS

DATE: AUG 2016

APPROVED BY: *[Signature]*
DATE: 8-4-2016

SPEED HUMP DETAILS

SHEET: 01 OF 01



[Skip to Main Content](#)

Department of Management Services

[Florida Department of Management Services](#) > [Business Operations](#) > [State Purchasing](#) > [State Agency Resources](#) > [Vendor Registration and Vendor Lists](#) > Convicted Vendor List

Convicted Vendor List

The Department of Management Services maintains "a list of the names and addresses of those who have been disqualified from the public contracting and purchasing process" under [section 287.133, Florida Statutes](#).

Vendor Name	Agency of Origin	Effective Date	Expiration Date	Final Order
Calixte, Jacques A. (Haitian American Association Against Cancer, Inc.)	DOH	10/25/18	10/25/21	Final Order - Calixte, Jacques A. (Haitian American Association Against Cancer, Inc.) ( 1.71 MB)
Hoffman, Tracy J. (Gator Signage and Striping, LLC)	DOT	01/22/18	01/22/21	Final Order - Hoffman, Tracy J. (Gator Signage and Striping, LLC) ( 753.24 KB)

Updated 12/10/19

Document reader download link

-  [Adobe PDF Reader](#)

[Terms and Conditions](#) | [Privacy Statement](#) | [Accessibility Statement](#) | Copyright ©2020 Department of Management Services - State of Florida

[Skip to Main Content](#)

Department of Management Services

[Florida Department of Management Services](#) > [Business Operations](#) > [State Purchasing](#) > [State Agency Resources](#) > [Vendor Registration and Vendor Lists](#) > Discriminatory Vendor List

Discriminatory Vendor List

The Department of Management Services maintains "a list of the names and addresses of any entity which has been disqualified from the public contracting and purchasing process" under [section 287.134, Florida Statutes](#).

There are currently no vendors on this list.

[Terms and Conditions](#) | [Privacy Statement](#) | [Accessibility Statement](#) | Copyright ©2020 Department of Management Services - State of Florida

View Vendor Detail

General Vendor Information	
Vendor Status / Effective Date:	IN / 02/24/2012
Inactive Reason:	DMS Request - No reason provided
Vendor Name:	GOODSON PAVING
Short Name (Does Business As):	
Dun and Bradstreet Number (DUNS):	061992343
Website:	
W9 Status:	Valid W-9 on File
DFS W9 Last Update Date:	Apr 17, 2015
Business Designation	Corporation
	Primary Place of Business: FL
Collections Indicator:	Y

Certified Business Enterprise (CBE) Category
Non-Minority / Non-Woman-Owned / Non-FVBE

Solicitations
Registered for Sourcing: No
Registered for VBS: No

Special Exceptions
Fee has been waived: <input type="checkbox"/>
Terms of Use have not been agreed to: <input type="checkbox"/>

Reluctant Vendor
Reluctant Vendor:

Florida Terms of Use
Accepted: Yes, 03/17/2008
Accepted By: Tom Goodson

Contacts
View Contact List

Locations
002 GOODSON PAVING Status: IN Details

[-] Commodity Codes
No Commodity Codes Selected

[Return to List](#)

[Copyright © 2009 State of Florida](#) | [Privacy Statement](#) :: [Required Information](#) :: [Terms of Use](#) :: [Frequently Asked Questions](#) :: [Glossary](#)

MyFloridaMarketPlace Vendor Registration Customer Service: 866-FLA-EPRO (866-352-3776)



[Department of State](#) / [Division of Corporations](#) / [Search Records](#) / [Search by Entity Name](#) /

Detail by Entity Name

Florida Profit Corporation
GOODSON PAVING, INC.

Filing Information

Document Number	M70222
FEI/EIN Number	59-2872065
Date Filed	02/26/1988
State	FL
Status	ACTIVE

Principal Address

630 CIDCO RD
COCOA, FL 32926

Changed: 04/07/2000

Mailing Address

630 CIDCO RD
COCOA, FL 32926

Changed: 04/07/2000

Registered Agent Name & Address

GOODSON, TOMMY
620 CIDCO RD
COCOA, FL 32927

Address Changed: 04/07/2000

Officer/Director Detail

Name & Address

Title PD

GOODSON, TOMMY
1175 TUCKAWAY DRIVE
ROCKLEDGE, FL 32955

Title S

GOODSON, EVELYN L.
1175 TUCKAWAY DRIVE
ROCKLEDGE, FL 32955

Title VP

GOODSON, TRAVIS L
1145 TUCKAWAY DR.
ROCKLEDGE, FL 32955

Annual Reports

Report Year	Filed Date
2018	01/15/2018
2019	01/08/2019
2020	01/14/2020

Document Images

01/14/2020 -- ANNUAL REPORT	View image in PDF format
01/08/2019 -- ANNUAL REPORT	View image in PDF format
01/15/2018 -- ANNUAL REPORT	View image in PDF format
01/10/2017 -- ANNUAL REPORT	View image in PDF format
01/25/2016 -- ANNUAL REPORT	View image in PDF format
01/12/2015 -- ANNUAL REPORT	View image in PDF format
01/09/2014 -- ANNUAL REPORT	View image in PDF format
01/16/2013 -- ANNUAL REPORT	View image in PDF format
01/06/2012 -- ANNUAL REPORT	View image in PDF format
04/19/2011 -- ANNUAL REPORT	View image in PDF format
02/24/2010 -- ANNUAL REPORT	View image in PDF format
04/06/2009 -- ANNUAL REPORT	View image in PDF format
10/01/2008 -- ANNUAL REPORT	View image in PDF format
01/08/2008 -- ANNUAL REPORT	View image in PDF format
03/16/2007 -- ANNUAL REPORT	View image in PDF format
05/02/2006 -- ANNUAL REPORT	View image in PDF format
03/24/2005 -- ANNUAL REPORT	View image in PDF format
03/12/2004 -- ANNUAL REPORT	View image in PDF format
02/25/2003 -- ANNUAL REPORT	View image in PDF format
04/17/2002 -- ANNUAL REPORT	View image in PDF format
04/11/2001 -- ANNUAL REPORT	View image in PDF format
04/07/2000 -- ANNUAL REPORT	View image in PDF format
04/23/1999 -- ANNUAL REPORT	View image in PDF format
03/09/1998 -- ANNUAL REPORT	View image in PDF format
04/22/1997 -- ANNUAL REPORT	View image in PDF format
04/15/1996 -- ANNUAL REPORT	View image in PDF format
03/21/1995 -- ANNUAL REPORT	View image in PDF format



A NEW WAY TO SIGN IN - If you already have a SAM account, use your **SAM email** for login.gov.

[Log In](#)

[Login.gov FAQs](#)

⚠ ALERT: SAM.gov will be down for scheduled maintenance Saturday, 08/15/2020 from 8:00 AM to 10:00 PM

Search Results

Current Search Terms: GOODSON PAVING, INC.*

Total records: 0

[Save PDF](#)

[Export Results](#)

[Print](#)

Result Page:

Sort by **Relevance** ▼

Order by **Descending** ▼

Your search for GOODSON PAVING, INC.* returned the following results...

No records found.

Result Page:

[Save PDF](#)

[Export Results](#)

[Print](#)



IBM-P-20200717-1140
WWW2

[Search Records](#) [Disclaimers](#) [FAPIS.gov](#)
[Data Access](#) [Accessibility](#) [GSA.gov/IAE](#)
[Check Status](#) [Privacy Policy](#) [GSA.gov](#)
[About](#) [USA.gov](#)
[Help](#)





[Skip to Main Content](#)

Department of Management Services

[Florida Department of Management Services](#) > [Business Operations](#) > [State Purchasing](#) > [State Agency Resources](#) > [Vendor Registration and Vendor Lists](#) > [Suspended Vendor List](#)

Suspended Vendor List

The Department of Management Services maintains a list of vendors that have been removed from the Vendor List "for failing to fulfill any of its duties specified in a contract with the State," in accordance with [Rule 60A-1.006\(2\)](#), Florida Administrative Code.

Vendor Name/Address	Agency of Origin	Effective Date	Notice of Default
Building Maintenance of America, LLC d/b/a Florida Building Maintenance 333 North Falkenburg Road #A117 Tampa, FL 33619	DMS	07/02/14	Notice of Default - Building Maintenance of America, LLC d/b/a Florida Building Maintenance ( 575.81 KB)
Club Tex, Inc. 2025 Broadway, Suite #15G New York, NY 10023	DOC	01/24/19	Notice of Default - Club Tex, Inc. ( 111.75 KB)
Correctional Consultants, LLC P.O. Box 515 Chattahoochee, FL 32324	DOC	12/10/19	Notice of Default - Correctional Consultants, LLC ( 85.95 KB)
iColor Printing and Mailing, Inc. 22873 Lockness Avenue Torrance, CA 90501	DEP	02/20/12	Notice of Default - iColor Printing and Mailing, Inc. ( 320.17 KB)
Visual Image Design Firm, LLC 6845 Narcoossee Road, Suite 59 Orlando, FL 32822	DOH	06/25/15	Notice of Default - Visual Image Design Firm, LLC ( 1.78 MB)

Updated 12/10/19

Document reader download link

-  [Adobe PDF Reader](#)

[Terms and Conditions](#) | [Privacy Statement](#) | [Accessibility Statement](#) | Copyright ©2020 Department of Management Services - State of Florida

SUBMIT SEALED BID TO: BREVARD COUNTY PURCHASING SERVICES 2725 JUDGE FRAN JAMIESON WAY BLDG. C, 3rd FLOOR, SUITE C-303 VIERA, FL 32940			INVITATION TO BID Bid Acknowledgment
PROCUREMENT ANALYST: Debbie Feingold debbie.feingold@brevardfl.gov	(321) 617-7390 Ext. 5-9332	AN EQUAL OPPORTUNITY EMPLOYER	FLORIDA TAX EXEMPT #85-8012621749C-1 FEDERAL TAX EXEMPT #59-6000523
BID SPECIFICATIONS MAY BE OBTAINED AT: Purchasing Services, 2725 Judge Fran Jamieson Way, Bldg. C, Suite 303, Viera, FL 32940, or at the Onvia DemandStar® website and VendorLink			
RELEASE DATE: July 16, 2020	BID TITLE: Asphaltic Concrete	BID NUMBER: B-6-20-57	BID OPENING DATE AND TIME: August 6, 2020 @ 2pm
PRE-BID DATE, TIME, AND LOCATION: A non-mandatory pre-bid meeting will be held on July 23, 2020 at 10:30 a.m. in the Florida Room located at 2725 Judge Fran Jamieson Way, Bldg. C, 3rd Floor, Viera, FL 32940		<input type="checkbox"/> Mandatory <input checked="" type="checkbox"/> Non-Mandatory	BIDS RECEIVED AFTER ABOVE DATE AND TIME WILL NOT BE ACCEPTED

▼ CONTRACTOR MUST COMPLETE THIS AREA AND RETURN FORM ▼

LEGAL NAME OF CONTRACTOR AND BUSINESS ADDRESS: Community Asphalt Corp. 2975 Industrial Boulevard Vero Beach, FL 32967	FEDERAL ID NO. (FEIN) OR SOCIAL SECURITY NO. (SSN): 59-2023298
TELEPHONE NUMBER/TOLL-FREE NUMBER: (786) 418-3576	If returning as a "no bid," state reason:

I certify that this bid is made without prior understanding, agreement, or connections with any corporation, firm or person submitting a bid for the same materials, supplies or equipment, and is in all respects fair and without collusion or fraud. I agree to abide by all conditions of this bid and certify that I am authorized to sign this bid for the Contractor. In submitting a bid to the County of Brevard, the Contractor offers and agrees that if the bid is accepted, the Contractor will convey, sell, assign, or transfer to the County of Brevard all rights, title, and interest in and to all causes of action it may now or hereafter acquire under the antitrust laws of the United States and the State of Florida for price fixing relating to the particular commodities or services purchased or acquired by the County of Brevard. At the County's discretion, such assignment shall be made and become effective at the time the County tenders final payment to the Contractor.	The Contractor acknowledges that information provided in this ITB is true and correct. X AUTHORIZED SIGNATURE (A/U.C.)  08/06/2020 NAME (PRINTED) Corporate Vice President TITLE 08/06/20 DATE
--	---

THIS FORM MUST BE NOTARIZED AND RETURNED WITH YOUR BID

Sworn to and subscribed before me this 6th day of August 2020.

Personally known:

Or produced identification: Type of ID: _____

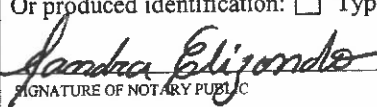
SIGNATURE OF NOTARY PUBLIC

Florida
STATE

Sandra Elizondo
NAME OF NOTARY PUBLIC (PRINTED)

My commission expires: August 24, 2020

BOND DATA

CONTRACTOR MUST PROVIDE:	AMOUNT:		
Yes <input type="checkbox"/> No <input checked="" type="checkbox"/> BID BOND			
Yes <input checked="" type="checkbox"/> No <input type="checkbox"/> PERFORMANCE BOND	<u>100% on projects over \$100,000</u>		
Yes <input type="checkbox"/> No <input checked="" type="checkbox"/> LABOR, MATERIAL, PERFORMANCE BOND			
In cases where the amount of a surety bond exceeds \$500,000, the surety company must have an A.M. Best's rating as specified in this document, and depending on the amount of the bond, shall have a minimum A.M. Best's financial size category (FSC) ranking as follows:			
BOND AMOUNT UP TO:	FINANCIAL CLASS	BOND AMOUNT UP TO:	FINANCIAL CLASS
\$ 1,000,000	I	\$ 25,000,000	V
\$ 2,000,000	II	\$ 50,000,000	VI
\$ 5,000,000	III	\$ 100,000,000	VII
\$ 10,000,000	IV		

Bonds must be issued by a surety company who complies with the requirements of § 287.0935, Fla. Stat.

PAYMENT OF GOODS OR SERVICES PROVIDED AS A RESULT OF THIS SOLICITATION WILL BE MADE PER FLORIDA STATUTE. ALL FIRST TIME CONTRACTORS MUST SUBMIT A W-9 FORM.

Asphaltic Concrete
B-6-20-57
CONTRACTOR'S CHECKLIST

The items indicated are required for submission with your bid. Failure to submit any items indicated as required may result in rejection of the bid. Offers to provide required items after the date and time designated for the receipt of bid will not be considered.

- Signed/Notarized Bid Invitation, including Electronic Copy on CD or USB drive
- Completed and Signed Price Sheet, to include Insurance Indemnification Acknowledgement
- Price Sheet completed in Excel and submitted on CD or USB flash drive
- Confirmation of Drug Free Workplace Form
- Reference Form
- Contractor Affidavit Regarding Scrutinized Company List

In order for this bid to be valid, the above forms and information shall be completed in their entirety, signed by an authorized representative of the responding Contractor, and returned as part of the bid response.

Attachment A: Federal Emergency Management Agency (FEMA) Contract Requirements

Attachment B: Ace Fiber Specs

Attachment C: Forta Fi Fiber Specs

Attachment D: Excel Price Sheet

ASPHALTIC CONCRETE		REVISED PRICE SHEET		
ASPHALTIC CONCRETE		ROAD PAVING	PARKING LOTS	BIKE PATHS
Superpave SP-9.5	Vendor Delivered, Vendor Placed	\$ 146.00 Ton	\$ 172.00 Ton	\$ 172.00 Ton
Superpave SP-12.5	Vendor Delivered, Vendor Placed	\$ 139.00 Ton	\$ 159.00 Ton	\$ 166.00 Ton
FRICITION COURSE		ROAD PAVING		
Friction Course FC-5	Vendor Delivered, Vendor Placed	\$ 202.00 Ton		
Friction Course FC-9.5	Vendor Delivered, Vendor Placed	\$ 199.00 Ton		
Friction Course FC-12.5	Vendor Delivered, Vendor Placed	\$ 166.00 Ton		
SPEED HUMPS SP-9.5	Vendor Delivered, Vendor Placed	\$ 365.00 Ton		
LESS THAN 25 TN PATCHING SP-9.5	Vendor Delivered, Vendor Placed	\$ 352.00 Ton		
25-50 TN PATCHING SP 9.5	Vendor Delivered, Vendor Placed	\$ 268.00 Ton		
TACK FOB Gallon	FOB GALLON	\$ 21.00 Gal		
PRIME	Vendor Delivered, Vendor Placed	\$ 1.00 SY		
PRIM AND SAND	Vendor Delivered, Vendor Placed	\$ 1.00 SY		
SAND 3% HOT MIX	Vendor Delivered, Vendor Placed	\$ N/A Ton	\$ N/A SY	
HOT ASPHALT FOR PICK UP FOB AT PLANT SP-9.5	FOR PICK UP	\$ 93.00 Ton		
TEMPORARY STRIPING	Vendor Schedules and Provides	\$ 4.00 L.F.		
Night Work	Cost per ton	\$ 10.00 Ton		
Cost for Milling & Clean Up	SY 0-2,500 and under	\$ 7.00 SY		
	SY \$2,501 - 5,000	\$ 5.00 SY		
	SY 5,001 to 15,000	\$ 4.00 SY		
	SY 15,001 and over	\$ 4.00 SY		
Asphalt Millings for Pickup FOB at Plant		\$ 13.00 Ton		
Cost per ton to add Aramid Fiber to the asphalt mix (Per attached Fiber Specs)	*	\$ N/A Ton		
SPECIFIC PROJECTS ONLY *		\$ N/A Ton		

Plant Locations: Vero Beach Plant: 2975 Industrial Boulevard, Vero Beach, FL 32967

ASPHALTIC CONCRETE
BID # B-6-20-57

REVISED PRICE SHEET
(Continued)

Addendum Acknowledgment:

Add. No. 1 Dated July 28, 2020 / Add. No. _____ Dated _____

Add. No. _____ Dated _____ / Add. No. _____ Dated _____

PROMPT PAYMENT DISCOUNT:

218.70. Bidders may offer cash discounts for prompt payment, but they will not be considered in determination of award. If a bidder offers a discount, it is understood that the discount time will be from the date of satisfactory delivery, at the place of acceptance, and receipt of correct invoice, at the office specified, whichever occurs last.

If Prompt Payment Discount is offered, please state discount terms below:

Not Applicable

Does your company accept payment via ACH? YES / NO

I hereby certify that I have read and agree to all terms and conditions, specifications, and insurance requirements outlined herein:

VENDOR Community Asphalt Corp.

ADDRESS 2975 Industrial Blvd, Vero Beach, FL 32967

AUTHORIZED SIGNATURE  _____ DATE 08/06/20

PRINTED SIGNATURE Manuel Aguiar

TELEPHONE # 786-418-3476 FAX # 305-829-8772

**Asphaltic Concrete
B-6-20-57
CONFIRMATION OF DRUG-FREE WORKPLACE FORM**

In accordance with Section 287.087, Florida Statutes, "whenever two or more bids are equal with respect to price, quality, and service which are received by any political subdivision for the procurement of commodities or contractual services, a bid received from a business that certifies that it has implemented a drug-free workplace program shall be given preference in the award process. In order to have a drug-free workplace program, a business shall:

- (1) Publish a statement notifying employees that the unlawful manufacture, distribution, dispensing, possession, or use of a controlled substance is prohibited in the workplace and specifying the actions that will be taken against employees for violations of such prohibition.
- (2) Inform employees about the dangers of drug abuse in the workplace, the business's policy of maintaining a drug-free workplace, any available drug counseling, rehabilitation, and employee assistance programs, and the penalties that may be imposed upon employees for drug abuse violations.
- (3) Give each employee engaged in providing the commodities or contractual services that are under bid a copy of the statement specified in subsection (1).
- (4) In the statement specified in subsection (1), notify the employees that, as a condition of working on the commodities or contractual services that are under bid, the employee will abide by the terms of the statement and will notify the employer of any conviction of, or plea of guilty or nolo contendere to, any violation of chapter 893 or of any controlled substance law of the United States or any state, for a violation occurring in the workplace no later than 5 days after such conviction.
- (5) Impose a sanction on, or require the satisfactory participation in a drug abuse assistance or rehabilitation program if such is available in the employee's community by, any employee who is so convicted.
- (6) Make a good faith effort to continue to maintain a drug-free workplace through implementation of this section."

As the person authorized to sign the statement, I certify that this firm complies with the above requirements and the Florida Statutes Section 287.087. This form is in conjunction with Brevard County's General Conditions, Item 27, Drug-Free Workplace.

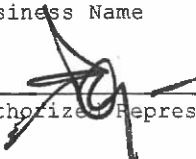
Community Asphalt Corp.
Business Name

Authorized Representative's Signature
Manuel Aguiar
Name

ITB-B-6-20-57-0-2020/DF: Asphaltic Concrete
Bid Number and Name
08/06/20
Date
Corporate Vice President
Position

**Asphaltic Concrete
B-6-20-57
REFERENCE FORM**

List a minimum of three (3) / maximum five (5) customers for the services specified in the solicitation in the spaces provided.

Note: A contact person shall be someone who has personal knowledge of the Contractor's performance for the specific requirement listed. Contact person must have been informed that they are being used as a reference and that the County may be calling them. Do not list persons who will be unable to answer specific questions regarding the requirements.

Ref #1. Customer/Client: Indian River County
Date of Services: 2020
Description of Services: Asphalt Paving & Resurfacing
Street Address: 1800 27th Avenue
City, State, ZIP Code: Vero Beach, FL 32960
Telephone #: 772-226-1416 Fax #: 772-770-5140
Contact Person: Jeff Hoffman Email: jhoffman@ircgov.com

Ref #2. Customer/Client: City of Cape Coral
Date of Services: 2018-2019
Description of Services: Asphalt Paving & Resurfacing
Street Address: 1015 Cultural Park Blvd.
City, State, ZIP Code: Cape Coral, FL 33990
Telephone #: 239-574-0839 Fax #: _____
Contact Person: Trina Chamners Email: tchamnes@capecoral.net

Ref #3. Customer/Client: Lee County Board of County Commissioners
Date of Services: 2019-2020
Description of Services: Asphalt Paving & Resurfacing
Street Address: 2115 Second, Street, 1st Floor
City, State, ZIP Code: Fort Myers, FL 33901
Telephone #: 239-533-8881 Fax #: _____
Contact Person: Jake Bond Email: jbond@leegov.com

Ref #4. Customer/Client: City of Sanibel
Date of Services: 2019
Description of Services: Asphalt Paving Resurfacing
Street Address: 800 Dunlop Road
City, State, ZIP Code: Sanibel, FL 33957-4096
Telephone #: 239-472-6397 Fax #: _____
Contact Person: John Mort Email: John.Mort@sanibel.com

Ref #5. Customer/Client: Florida Department of Transportation
Date of Services: 2019
Description of Services: Asphalt Paving & Resurfacing
Street Address: 2981 NE Pine Road
City, State, ZIP Code: Cape Coral, FL 33909
Telephone #: 239-985-7851 Fax #: _____
Contact Person: Tom Pegues Email: Thomas.Pegues@dot.state.fl.us

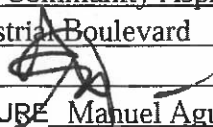
CONTRACTOR NAME Community Asphalt Corp.
ADDRESS 2975 Industrial Boulevard
PRINTED SIGNATURE 
AUTHORIZED SIGNATURE Manuel Aguiar
TELEPHONE # 786-418-3476 FAX# 305-829-8772 DATE 08/06/20
EMAIL: Manuel.Aguiar@ohlina.com

CONTRACTOR AFFIDAVIT REGARDING SCRUTINIZED COMPANY LIST

Awarded Contractor shall certify that it and its subcontractors are not on the Scrutinized Companies that Boycott Israel List. Pursuant to Section 287.135, F.S. If the Contract is for more than \$1,000,000 the Contractor further certifies that it and its subcontractors are also not on the Scrutinized Companies with Activities in Sudan, Scrutinized Companies with Activities in the Iran Petroleum Energy Sector List, or engaged with business operations in Cuba or Syria as identified in Section 287.135, F.S.

For Contracts of any amount, if the County determines the Contractor submitted a false certification under Section 287.135(5) of the Florida Statutes, or if the Contractor has been placed on the Scrutinized Companies that Boycott Israel List, or is engaged in a boycott of Israel, the County shall either terminate the Contract after it has given the Contractor notice and an opportunity to demonstrate the County's determination of false certification was in error pursuant to Section 287.135(5)(a) of the Florida Statutes, or on a case-by-case basis the County may choose to maintain the Contract if the conditions of Section 287.135(4) of the Florida Statutes are met. For Contracts \$1,000,000 and greater, if the County determines the Contractor submitted a false certification under Section 287.135(5) of the Florida Statutes, or if the Contractor has been placed on the Scrutinized Companies with Activities in the Sudan List, or the Scrutinized Companies with Activities in the Iran Petroleum Energy Sector List, the County shall either terminate the Contract after it has given the Contractor notice and an opportunity to demonstrate the County's determination of false certification was in error pursuant to Section 287.135(5)(a) of the Florida Statutes, or on a case-by-case basis the County may choose to maintain the Contract if the conditions of Section 287.135(4) of the Florida Statutes are met.

STATE OF FLORIDA

COUNTY OF Miami-Dade

BEFORE ME, the undersigned authority, personally appeared

 Manuel Aguiar , who, being by me first duly sworn, made the following statement:

1. The Business address of Community Asphalt Corp. (name of Contractor) is .
2. My relationship to Manuel Aguiar (name of Contractor) is (relationship such as sole proprietor, partner, president, vice president).
3. I understand that "Boycott of Israel" has the same meaning as defined in §215.4725, Florida Statutes, and means refusing to deal, terminating business activities, or taking other actions to limit commercial relations with Israel, or persons or entities doing business in Israel or in Israeli-controlled territories, in a discriminatory manner. A statement by a company that it is participating in a boycott of Israel, or that it has initiated a boycott in response to a request for a boycott of Israel or in compliance with, or in furtherance of, calls for a boycott of Israel, may be considered by the State Board of Administration to be evidence

that a company is participating in a boycott of Israel. The term does not include restrictive trade practices or boycotts fostered or imposed by foreign countries against Israel.

4. I understand that "business operations" means, for purposes specifically related to Cuba or Syria, engaging in commerce in any form in Cuba or Syria, including, but not limited to, acquiring, developing, maintaining, owning, selling, possessing, leasing, or operating equipment, facilities, personnel, products, services, personal property, real property, military equipment, or any other apparatus of business or commerce.
5. Manuel Aguiar (name of Contractor) is not on the Scrutinized Companies that Boycott Israel List, created pursuant to s. 215.4725, Florida Statutes, or is engaged in a boycott of Israel.
6. Manuel Aguiar (name of Contractor) is not on the Scrutinized Companies with Activities in Sudan List or the Scrutinized Companies with Activities in the Iran Petroleum Energy Sector List, created pursuant to s. 215.473, Florida Statutes.
7. Manuel Aguiar (name of Contractor) is not engaged in business operations in Cuba or Syria.



Signature

Sworn to and subscribed before me in the state and county first mentioned above on the
8th day of August, 2020.

Notary Public
Sandra Elizondo
My commission expires:
August 24, 2020

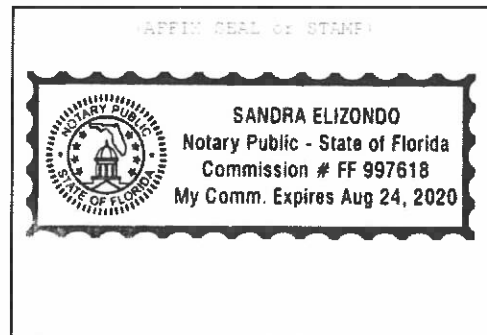

**Asphaltic Concrete
B-6-20-57
STATEMENT OF NO BID**

NOT APPLICABLE

NOTE: If you do not intend to bid on this requirement, please return this form to:

Brevard County Purchasing Services
2725 Judge Fran Jamieson Way, Bldg. C, Suite 303
Viera, FL 32940

We the undersigned have declined to bid on your Bid No. B-6-20-57 for the following reason(s):

- Specifications too "restrictive," i.e., geared toward one brand or manufacturer only *(please specify below)*
- Insufficient time to respond to the Invitation to Bid
- We do not offer this commodity/service or equivalent
- Our product schedule would not permit us to perform
- Specifications unclear *(please specify below)*
- Unable to meet bond or insurance requirements
- Remove our company from Contractor database for this commodity/service
- Other *(please specify below)*

Remarks: _____

PLEASE PRINT

COMPANY NAME _____

COMPANY ADDRESS _____

TELEPHONE NUMBER _____

PRINTED SIGNATURE _____

AUTHORIZED SIGNATURE _____

NOTE: Failure to submit either a Bid or a Statement of No Bid may be cause for removal from the Brevard County Purchasing Services Contractor database.



Ron DeSantis, Governor

Halsey Beshears, Secretary



STATE OF FLORIDA
DEPARTMENT OF BUSINESS AND PROFESSIONAL REGULATION

CONSTRUCTION INDUSTRY LICENSING BOARD

THE GENERAL CONTRACTOR HEREIN IS CERTIFIED UNDER THE
PROVISIONS OF CHAPTER 489, FLORIDA STATUTES

AGUIAR, MANUEL ANTONIO

COMMUNITY ASPHALT CORP.
9675 NORTHWEST 117TH AVENUE STE 108
MIAMI FL 33178

LICENSE NUMBER: CGC1521192

EXPIRATION DATE: AUGUST 31, 2022

Always verify licenses online at MyFloridaLicense.com



Do not alter this document in any form.

This is your license. It is unlawful for anyone other than the licensee to use this document.



July 23, 2020

Brevard County Purchasing Services
2725 Judge ran Jamieson Way
Bldg. C, 3rd floor, suite C-303
Viera, FL 32940

REF: Asphaltic Concrete ITB-B-6-20-57-0-2020/DF

To whom it may concern,

As the authorized broker for Community Asphalt Corp. Aon Risk Services Northeast, Inc. we can confirm that Community Asphalt Corp. maintains the below insurances.

Policy	Limits	Carrier
Workers Compensation	\$1M Per Occurrence	The Charter Oak Fire Ins. Co.
Auto Liability	\$2M Combined Single Limit	Travelers Property & Casualty Co of America
General Liability	\$2M Per Occurrence /\$4M Aggregate	Travelers Indemnity Co.

If you have any questions regarding or require additional information, please feel free to contract us.

Sincerely,

AON RISK SOLUTIONS

Karen Carratura

Karen Carratura
Account Specialist II
516-396-4332
Construction Services Group



[Department of State](#) / [Division of Corporations](#) / [Search Records](#) / [Search by Entity Name](#) /

Detail by Entity Name

Florida Profit Corporation

COMMUNITY ASPHALT CORP.

Filing Information

Document Number 688538
FEI/EIN Number 59-2023298
Date Filed 09/22/1980
State FL
Status ACTIVE
Last Event AMENDED AND RESTATED
 ARTICLES
Event Date Filed 07/25/2006
Event Effective Date NONE

Principal Address

9675 NW 117 AVENUE
 STE 108
 MIAMI, FL 33178

Changed: 04/22/2016

Mailing Address

9675 NW 117 AVENUE
 STE 108
 MIAMI, FL 33178

Changed: 04/22/2016

Registered Agent Name & Address

COGENCY GLOBAL INC.
 115 NORTH CALHOUN ST., STE 4
 TALLAHASSEE, FL 32301

Name Changed: 04/22/2016

Address Changed: 04/22/2016

Officer/Director Detail

Name & Address

Title Corporate Vice President

AGUIAR, MANUEL
9675 NW 117 AVENUE
STE 108
MIAMI, FL 33178

Title Executive Vice President

HICKEY, DONALD
9675 NW 117 AVENUE
STE 108
MIAMI, FL 33178

Title Asst. Secretary

Mahoney, Megan
9675 NW 117 AVENUE
STE 108
MIAMI, FL 33178

Title Director, CEO

Patel, Ashok R.
9675 NW 117 AVENUE
108
MIAMI, FL 33178

Title Secretary

Pereira, Cesar F.
26-15 Ulmer Street
College Point, NY 11354

Title Director

Fernandez Gallar, Jose Antonio
Paseo de la Castellana 250 D
Torre Espacio
Madrid 28046 ES

Title CFO

Saitzyk, Martin W.
26-15 Ulmer St.
College Point, NY 11354

Title COO

Ruiz Andujar, Daniel
9675 NW 117 AVENUE
STE 108
MIAMI, FL 33178

Annual Reports

Report Year	Filed Date
2019	02/15/2019
2019	04/12/2019
2020	06/05/2020

Document Images

06/05/2020 -- ANNUAL REPORT	View image in PDF format
10/02/2019 -- AMENDED ANNUAL REPORT	View image in PDF format
08/05/2019 -- AMENDED ANNUAL REPORT	View image in PDF format
06/28/2019 -- AMENDED ANNUAL REPORT	View image in PDF format
04/12/2019 -- AMENDED ANNUAL REPORT	View image in PDF format
02/15/2019 -- ANNUAL REPORT	View image in PDF format
06/18/2018 -- AMENDED ANNUAL REPORT	View image in PDF format
02/28/2018 -- ANNUAL REPORT	View image in PDF format
08/23/2017 -- AMENDED ANNUAL REPORT	View image in PDF format
06/21/2017 -- AMENDED ANNUAL REPORT	View image in PDF format
05/30/2017 -- AMENDED ANNUAL REPORT	View image in PDF format
03/01/2017 -- ANNUAL REPORT	View image in PDF format
04/28/2016 -- ANNUAL REPORT	View image in PDF format
04/22/2016 -- Reg. Agent Change	View image in PDF format
04/06/2015 -- AMENDED ANNUAL REPORT	View image in PDF format
03/27/2015 -- ANNUAL REPORT	View image in PDF format
07/28/2014 -- AMENDED ANNUAL REPORT	View image in PDF format
05/01/2014 -- AMENDED ANNUAL REPORT	View image in PDF format
04/29/2014 -- ANNUAL REPORT	View image in PDF format
04/16/2013 -- ANNUAL REPORT	View image in PDF format
12/18/2012 -- ANNUAL REPORT	View image in PDF format
10/25/2012 -- ANNUAL REPORT	View image in PDF format
02/29/2012 -- ANNUAL REPORT	View image in PDF format
04/18/2011 -- ANNUAL REPORT	View image in PDF format
03/29/2010 -- ANNUAL REPORT	View image in PDF format
02/11/2009 -- ANNUAL REPORT	View image in PDF format
03/07/2008 -- ANNUAL REPORT	View image in PDF format
04/25/2007 -- ANNUAL REPORT	View image in PDF format
12/14/2006 -- Reg. Agent Change	View image in PDF format
10/05/2006 -- Reg. Agent Change	View image in PDF format
07/25/2006 -- Amended and Restated Articles	View image in PDF format
04/26/2006 -- ANNUAL REPORT	View image in PDF format
12/02/2005 -- Amendment	View image in PDF format
01/19/2005 -- Amendment	View image in PDF format
01/12/2005 -- ANNUAL REPORT	View image in PDF format
04/12/2004 -- ANNUAL REPORT	View image in PDF format
01/27/2003 -- ANNUAL REPORT	View image in PDF format
05/06/2002 -- ANNUAL REPORT	View image in PDF format
05/15/2001 -- ANNUAL REPORT	View image in PDF format
01/18/2000 -- ANNUAL REPORT	View image in PDF format
02/22/1999 -- ANNUAL REPORT	View image in PDF format

04/02/1998 -- ANNUAL REPORT	View image in PDF format
01/17/1997 -- ANNUAL REPORT	View image in PDF format
01/25/1996 -- ANNUAL REPORT	View image in PDF format
06/13/1995 -- ANNUAL REPORT	View image in PDF format

Florida Department of State, Division of Corporations



[Skip to Main Content](#)

Department of Management Services

[Florida Department of Management Services](#) > [Business Operations](#) > [State Purchasing](#) > [State Agency Resources](#) > [Vendor Registration and Vendor Lists](#) > Convicted Vendor List

Convicted Vendor List

The Department of Management Services maintains "a list of the names and addresses of those who have been disqualified from the public contracting and purchasing process" under [section 287.133, Florida Statutes](#).

Vendor Name	Agency of Origin	Effective Date	Expiration Date	Final Order
Calixte, Jacques A. (Haitian American Association Against Cancer, Inc.)	DOH	10/25/18	10/25/21	Final Order - Calixte, Jacques A. (Haitian American Association Against Cancer, Inc.) ( 1.71 MB)
Hoffman, Tracy J. (Gator Signage and Striping, LLC)	DOT	01/22/18	01/22/21	Final Order - Hoffman, Tracy J. (Gator Signage and Striping, LLC) ( 753.24 KB)

Updated 12/10/19

Document reader download link

-  [Adobe PDF Reader](#)

[Terms and Conditions](#) | [Privacy Statement](#) | [Accessibility Statement](#) | Copyright ©2020 Department of Management Services - State of Florida

[Skip to Main Content](#)

Department of Management Services

[Florida Department of Management Services](#) > [Business Operations](#) > [State Purchasing](#) > [State Agency Resources](#) > [Vendor Registration and Vendor Lists](#) > Discriminatory Vendor List

Discriminatory Vendor List

The Department of Management Services maintains "a list of the names and addresses of any entity which has been disqualified from the public contracting and purchasing process" under [section 287.134, Florida Statutes](#).

There are currently no vendors on this list.

[Terms and Conditions](#) | [Privacy Statement](#) | [Accessibility Statement](#) | Copyright ©2020 Department of Management Services - State of Florida

Visit our [Temporary Policies \(/node/5093\)](/node/5093) Related to COVID-19 page for E-Verify and Form I-9 changes due to COVID-19.

HOW TO FIND PARTICIPATING EMPLOYERS

Use the E-Verify search tool to find employers who are currently enrolled in E-Verify. Your search will display the following information:

- **Employer name** – The name the employer used when they enrolled in E-Verify. This can be the business' legal name, a trade name, or an abbreviation.
- **Doing Business As (DBA) name** – The name an employer uses publicly. The public may see the DBA, but the employer may have used another name when they enrolled in E-Verify.
- **Account Status** – Indicates whether the account is currently enrolled or terminated.
- **Enrollment date** – The date the E-Verify Memorandum of Understanding is signed.
- **Termination Date** – The E-Verify Memorandum of Understanding termination date.
- **Workforce size** – Appears as long as the employer reported they have at least five employees.
- **Number of hiring sites** – The locations where employers hire employees and where they complete Form I-9.
- **Hiring site locations (by state)** – The geographic location(s) of hiring sites, by state, reported by the employer.

Parameters:

- USCIS updates the search tool data every quarter.
- Employers report their own data at the time they enroll in E-Verify. The accuracy and completeness of the data depend on what was submitted by employers at the time of enrollment and as reported throughout the employer's relationship with E-Verify.
- Review Employer Data Parameters (</employer-data-parameters>)

Search

[Employer \(?business-name=Community%20Asphalt&field_account_status_value=All&items_per_page=10&order=name&](#)

Community Asphalt Corp

[Employer \(?business-name=Community%20Asphalt&field_account_status_value=All&items_per_page=10&order=name&:](#)

Community Asphalt Corp

Community Asphalt Corp

COMMUNITY ASPHALT CORP.

Showing 1 to 4 of 4 entries.

ENROLLING IN E-Verify IS EASY! WANT TO LEARN MORE?

[E-Verify ENROLLMENT \(/employers/enrolling-in-e-verify\)](#)

Last Updated Date: 03/31/2020

View Vendor Detail

General Vendor Information

Vendor Status / Effective Date:	AC / 02/24/2012
Vendor Name:	Community Asphalt Corp
Short Name (Does Business As):	
Dun and Bradstreet Number (DUNS):	
Website:	
W9 Status:	Valid W-9 on File
DFS W9 Last Update Date:	Jul 11, 2016
Business Designation	Corporation
	Primary Place of Business: FL

Certified Business Enterprise (CBE) Category

Non-Minority / Non-Woman-Owned / Non-FVBE

Solicitations

Registered for Sourcing: Yes, Date participated: 12/10/09 1:15 PM
 Registered for VBS: Yes, Date participated: 12/10/09 1:15 PM
 Solicitation/Sales Contact EMail: esandra@cacorp.net

Special Exceptions

Fee has been waived:
 Terms of Use have not been agreed to:

Reluctant Vendor

Reluctant Vendor:

Florida Terms of Use

Accepted: Yes, 01/12/2010
 Accepted By: Sandra Elizondo

Contacts

[View Contact List](#)

Locations

011 Community Asphalt Corp. Status: [AC Details](#)

[-] Commodity Codes

81101700 Electrical and electronic engineering
 81101800 Chemical engineering
 81101900 Oil and gas engineering
 81102000 Mining engineering

81102000 Mining engineering
81102100 Ocean engineering
81102200 Transportation engineering
81102300 Aeronautical engineering
81102400 Electrical power transmission engineering
81102500 Permitting services
81102600 Sampling services
81102700 Instrumented control systems design and engineering services

[Return to List](#)





[Skip to Main Content](#)

Department of Management Services

[Florida Department of Management Services](#) > [Business Operations](#) > [State Purchasing](#) > [State Agency Resources](#) > [Vendor Registration and Vendor Lists](#) > [Suspended Vendor List](#)

Suspended Vendor List

The Department of Management Services maintains a list of vendors that have been removed from the Vendor List "for failing to fulfill any of its duties specified in a contract with the State," in accordance with [Rule 60A-1.006\(2\)](#), Florida Administrative Code.

Vendor Name/Address	Agency of Origin	Effective Date	Notice of Default
Building Maintenance of America, LLC d/b/a Florida Building Maintenance 333 North Falkenburg Road #A117 Tampa, FL 33619	DMS	07/02/14	Notice of Default - Building Maintenance of America, LLC d/b/a Florida Building Maintenance ( 575.81 KB)
Club Tex, Inc. 2025 Broadway, Suite #15G New York, NY 10023	DOC	01/24/19	Notice of Default - Club Tex, Inc. ( 111.75 KB)
Correctional Consultants, LLC P.O. Box 515 Chattahoochee, FL 32324	DOC	12/10/19	Notice of Default - Correctional Consultants, LLC ( 85.95 KB)
iColor Printing and Mailing, Inc. 22873 Lockness Avenue Torrance, CA 90501	DEP	02/20/12	Notice of Default - iColor Printing and Mailing, Inc. ( 320.17 KB)
Visual Image Design Firm, LLC 6845 Narcoossee Road, Suite 59 Orlando, FL 32822	DOH	06/25/15	Notice of Default - Visual Image Design Firm, LLC ( 1.78 MB)

Updated 12/10/19

Document reader download link

-  [Adobe PDF Reader](#)

[Terms and Conditions](#) | [Privacy Statement](#) | [Accessibility Statement](#) | Copyright ©2020 Department of Management Services - State of Florida



A NEW WAY TO SIGN IN - If you already have a SAM account, use your SAM email for login.gov.

Log In

Login.gov FAQs

ALERT: SAM.gov will be down for scheduled maintenance Saturday, 08/15/2020 from 8:00 AM to 10:00 PM

Entity Dashboard

Community Asphalt Corp.
DUNS: 055217699 CAGE Code: 1H6A4
Status: Active
Expiration Date: 06/15/2021
Purpose of Registration: All Awards

9675 Nw 117th Ave Ste 108
Miami, FL, 33178-1244 ,
UNITED STATES

- › [Entity Overview](#)
- › [Entity Registration](#)
 - › [Core Data](#)
 - › [Assertions](#)
 - › [Reps & Certs](#)
 - › [POCs](#)
- › [Exclusions](#)
 - › [Active Exclusions](#)
 - › [Inactive Exclusions](#)
 - › [Excluded Family Members](#)

RETURN TO SEARCH

Entity Overview

Entity Registration Summary

Name: Community Asphalt Corp.
Business Type: Business or Organization
Last Updated By: Sandra Elizondo
Registration Status: Active
Activation Date: 06/15/2020
Expiration Date: 06/15/2021

Exclusion Summary

Active Exclusion Records? No



IBM-P-20200717-1140
WWW2

- Search Records
- Disclaimers
- FAPIS.gov
- Data Access
- Accessibility
- GSA.gov/IAE
- Check Status
- Privacy Policy
- GSA.gov
- About
- USA.gov
- Help

This is a U.S. General Services Administration Federal Government computer system that is "FOR OFFICIAL USE ONLY." This system is subject to monitoring. Individuals found performing unauthorized activities are subject to disciplinary action including criminal prosecution.

SUBMIT SEALED BID TO: BREVARD COUNTY PURCHASING SERVICES 2725 JUDGE FRAN JAMIESON WAY BLDG. C, 3rd FLOOR, SUITE C-303 VIERA, FL 32940			INVITATION TO BID Bid Acknowledgment
PROCUREMENT ANALYST: Debbie Feingold debbie.feingold@brevardfl.gov		(321) 617-7390 Ext. 5-9332	AN EQUAL OPPORTUNITY EMPLOYER FLORIDA TAX EXEMPT #85-8012621749C-1 FEDERAL TAX EXEMPT #59-6000523
BID SPECIFICATIONS MAY BE OBTAINED AT: Purchasing Services, 2725 Judge Fran Jamieson Way, Bldg. C, Suite 303, Viera, FL 32940, or at the Onvia DemandStar® website and VendorLink			
RELEASE DATE: July 16, 2020	BID TITLE: Asphaltic Concrete	BID NUMBER: B-6-20-57	BID OPENING DATE AND TIME: August 6, 2020 @ 2pm
PRE-BID DATE, TIME, AND LOCATION: A non-mandatory pre-bid meeting will be held on July 23, 2020 at 10:30 a.m. in the Florida Room located at 2725 Judge Fran Jamieson Way, Bldg. C, 3rd Floor, Viera, FL 32940		<input type="checkbox"/> Mandatory <input checked="" type="checkbox"/> Non-Mandatory	BIDS RECEIVED AFTER ABOVE DATE AND TIME WILL NOT BE ACCEPTED

▼ CONTRACTOR MUST COMPLETE THIS AREA AND RETURN FORM ▼

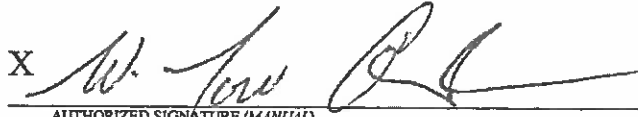
LEGAL NAME OF CONTRACTOR AND BUSINESS ADDRESS: C.W. Roberts Contracting, Inc. 8530 SW Jayme Way Palm City, FL 34990	FEDERAL ID NO. (FEIN) OR SOCIAL SECURITY NO. (SSN): 59-1683951
TELEPHONE NUMBER/TOLL-FREE NUMBER: (772) 288-0951	If returning as a "no bid," state reason:
I certify that this bid is made without prior understanding, agreement, or connections with any corporation, firm or person submitting a bid for the same materials, supplies or equipment, and is in all respects fair and without collusion or fraud. I agree to abide by all conditions of this bid and certify that I am authorized to sign this bid for the Contractor. In submitting a bid to the County of Brevard, the Contractor offers and agrees that if the bid is accepted, the Contractor will convey, sell, assign, or transfer to the County of Brevard all rights, title, and interest in and to all causes of action it may now or hereafter acquire under the antitrust laws of the United States and the State of Florida for price fixing relating to the particular commodities or services purchased or acquired by the County of Brevard. At the County's discretion, such assignment shall be made and become effective at the time the County tenders final payment to the Contractor.	The Contractor acknowledges that information provided in this ITB is true and correct. X  AUTHORIZED SIGNATURE (MANUAL) W. Todd Castleberry NAME (PRINTED) Vice President TITLE 08/06/2020 DATE

THIS FORM MUST BE NOTARIZED AND RETURNED WITH YOUR BID

Sworn to and subscribed before me this 6th day of August 2020.

Personally known:

Or produced identification: Type of ID: _____

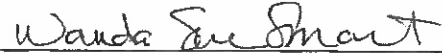

SIGNATURE OF NOTARY PUBLIC

STATE

Wanda Sue Smart
NAME OF NOTARY PUBLIC (PRINTED)

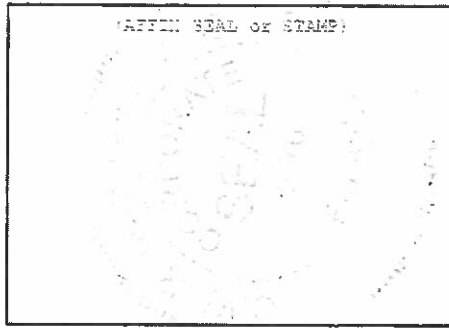

WANDA SUE SMART
Commission # GG 200367
Expires April 25, 2022
Bonded Thru Budget Notary Services



My commission expires: 04/25/2022

BOND DATA

CONTRACTOR MUST PROVIDE:	AMOUNT:
Yes <input type="checkbox"/> No <input checked="" type="checkbox"/> BID BOND	
Yes <input checked="" type="checkbox"/> No <input type="checkbox"/> PERFORMANCE BOND	100% on projects over \$100,000
Yes <input type="checkbox"/> No <input checked="" type="checkbox"/> LABOR, MATERIAL, PERFORMANCE BOND	

In cases where the amount of a surety bond exceeds \$500,000, the surety company must have an A.M. Best's rating as specified in this document, and depending on the amount of the bond, shall have a minimum A.M. Best's financial size category (FSC) ranking as follows:

BOND AMOUNT UP TO:	FINANCIAL CLASS	BOND AMOUNT UP TO:	FINANCIAL CLASS
\$ 1,000,000	I	\$ 25,000,000	V
\$ 2,000,000	II	\$ 50,000,000	VI
\$ 5,000,000	III	\$ 100,000,000	VII
\$ 10,000,000	IV		

Bonds must be issued by a surety company who complies with the requirements of § 287.0935, Fla. Stat.

PAYMENT OF GOODS OR SERVICES PROVIDED AS A RESULT OF THIS SOLICITATION WILL BE MADE PER FLORIDA STATUTE.
ALL FIRST TIME CONTRACTORS MUST SUBMIT A W-9 FORM.

ASPHALTIC CONCRETE		REVISED PRICE SHEET		
BID # B-6-20-57				
ASPHALTIC CONCRETE	DESCRIPTION	ROAD PAVING	PARKING LOTS	BIKE PATHS
Superpave SP-9.5	Vendor Delivered, Vendor Placed	\$107.75 Ton	\$117.75 Ton	\$157.75 Ton
Superpave SP-12.5	Vendor Delivered, Vendor Placed	\$102.50 Ton	\$112.50 Ton	\$152.50 Ton
FRICTION COURSE		ROAD PAVING		
Friction Course FC-5	Vendor Delivered, Vendor Placed	\$188.00 Ton		
Friction Course FC-9.5	Vendor Delivered, Vendor Placed	\$137.50 Ton		
Friction Course FC-12.5	Vendor Delivered, Vendor Placed	\$119.50 Ton		
SPEED HUMPS SP-9.5	Vendor Delivered, Vendor Placed	\$2,000.00 Ton		
LESS THAN 25 TN PATCHING SP-9.5	Vendor Delivered, Vendor Placed	\$415.00 Ton		
25-50 TN PATCHING SP 9.5	Vendor Delivered, Vendor Placed	\$255.00 Ton		
TACK FOB Gallon	FOB GALLON	\$5.50 Gal		
PRIME	Vendor Delivered, Vendor Placed	\$0.75 SY		
PRIM AND SAND	Vendor Delivered, Vendor Placed	\$1.10 SY		
SAND 3% HOT MIX	Vendor Delivered, Vendor Placed	\$N/A Ton	\$N/A SY	
HOT ASPHALT FOR PICK UP FOB AT PLANT SP-9.5	FOR PICK UP	\$70.00 Ton		
TEMPORARY STRIPING	Vendor Schedules and Provides	\$4.50 L.F.		
Night Work	Cost per ton	\$10.00 Ton		
Cost for Milling & Clean Up	SY 0-2,500 and under	\$4.75 SY		
	SY \$2,501 - 5,000	\$2.75 SY		
	SY 5,001 to 15,000	\$2.75 SY		
	SY 15,001 and over	\$2.75 SY		
Asphalt Millings for Pickup FOB at Plant		\$17.50 Ton		
Cost per ton to add Aramid Fiber to the asphalt mix (Per attached Fiber Specs) *				
SPECIFIC PROJECTS ONLY *		\$10.00 Ton		

Plant Locations: 8530 SW Jayme Way, Palm City, FL 34990; 806 NW 9th Street, Okeechobee, FL 34972

ASPHALTIC CONCRETE
BID # B-6-20-57

REVISED PRICE SHEET
(Continued)

Addendum Acknowledgment:

Add. No. 1 Dated 07/28/2020 / Add. No. _____ Dated _____

Add. No. _____ Dated _____ / Add. No. _____ Dated _____

PROMPT PAYMENT DISCOUNT:

Brevard County shall remit payment in accordance with the Florida Prompt Payment Act, Florida Statutes section 218.70. Bidders may offer cash discounts for prompt payment, but they will not be considered in determination of award. If a bidder offers a discount, it is understood that the discount time will be from the date of satisfactory

If Prompt Payment Discount is offered, please state discount terms below:

No prompt payment discount will apply.

Does your company accept payment via ACH? YES / NO

I hereby certify that I have read and agree to all terms and conditions, specifications, and insurance requirements outlined herein:

VENDOR: C.W. Roberts Contracting, Inc.

ADDRESS: 8530 SW Jayme Way _____

AUTHORIZED SIGNATURE 

PRINTED SIGNATURE W. Todd Castleberry

DATE 08/06/2020

TELEPHONE # (772) 288-0951

FAX # (772) 288-0983



**Asphaltic Concrete
B-6-20-57
CONFIRMATION OF DRUG-FREE WORKPLACE FORM**

In accordance with Section 287.087, Florida Statutes, "whenever two or more bids are equal with respect to price, quality, and service which are received by any political subdivision for the procurement of commodities or contractual services, a bid received from a business that certifies that it has implemented a drug-free workplace program shall be given preference in the award process. In order to have a drug-free workplace program, a business shall:

- (1) Publish a statement notifying employees that the unlawful manufacture, distribution, dispensing, possession, or use of a controlled substance is prohibited in the workplace and specifying the actions that will be taken against employees for violations of such prohibition.
- (2) Inform employees about the dangers of drug abuse in the workplace, the business's policy of maintaining a drug-free workplace, any available drug counseling, rehabilitation, and employee assistance programs, and the penalties that may be imposed upon employees for drug abuse violations.
- (3) Give each employee engaged in providing the commodities or contractual services that are under bid a copy of the statement specified in subsection (1).
- (4) In the statement specified in subsection (1), notify the employees that, as a condition of working on the commodities or contractual services that are under bid, the employee will abide by the terms of the statement and will notify the employer of any conviction of, or plea of guilty or nolo contendere to, any violation of chapter 893 or of any controlled substance law of the United States or any state, for a violation occurring in the workplace no later than 5 days after such conviction.
- (5) Impose a sanction on, or require the satisfactory participation in a drug abuse assistance or rehabilitation program if such is available in the employee's community by, any employee who is so convicted.
- (6) Make a good faith effort to continue to maintain a drug-free workplace through implementation of this section."

As the person authorized to sign the statement, I certify that this firm complies with the above requirements and the Florida Statutes Section 287.087. This form is in conjunction with Brevard County's General Conditions, Item 27, Drug-Free Workplace.

C. W. Roberts Contracting, Inc.

Business Name

Authorized Representative's Signature

W. Todd Castleberry

Name

B-6-20-57; Asphaltic Concrete

Bid Number and Name

08/06/2020

Date

Vice President

Position

**Asphaltic Concrete
B-6-20-57
REFERENCE FORM**

List a minimum of three (3) / maximum five (5) customers for the services specified in the solicitation in the spaces provided.

Note: A contact person shall be someone who has personal knowledge of the Contractor's performance for the specific requirement listed. Contact person must have been informed that they are being used as a reference and that the County may be calling them. Do not list persons who will be unable to answer specific questions regarding the requirements.

Ref #1. Customer/Client: Martin County Board of County Commissioners
 Date of Services: 04/01/2017 - 03/31/2020
 Description of Services: Annual Paving & Drainage in Martin County
 Street Address: 2401 SE Monterey Road
 City, State, ZIP Code: Stuart, FL 34996
 Telephone #: (772) 288-5430 Fax #: (772) 288-5789
 Contact Person: Ken Vreeland Email: kvreelan@martin.fl.us

Ref #2. Customer/Client: Florida Department of Transportation
 Date of Services: 03/12/2014 - 03/11/2018
 Description of Services: Annual Miscellaneous Paving in Martin, St. Lucie, and Indian River Counties
 Street Address: 3400 W. Commercial Blvd
 City, State, ZIP Code: Ft. Lauderdale, FL 33309-3421
 Telephone #: (772) 429-4817 Office; (561) 756-1854 Cell Fax #: _____
 Contact Person: Barry Rawdon Email: barry.rawdon@dot.state.fl.us

Ref #3. Customer/Client: City of Vero Beach
 Date of Services: 08/09/2017 - 06/08/2019
 Description of Services: Street Resurfacing Project (Miscellaneous Asphalt Repairs in the City of Vero Beach)
 Street Address: PO Box 1389
 City, State, ZIP Code: Vero Beach, FL 32960
 Telephone #: (772) 978-4872 Fax #: (772) 770-5836
 Contact Person: Don Dexter Email: ddexter@covb.org

Ref #4. Customer/Client: Floridian National Golf Club
 Date of Services: 06/06/2014 - 11/16/2017
 Description of Services: Complete sitework including preparation & installation of Asphaltic Concrete
 Street Address: 3700 SE Floridian Drive
 City, State, ZIP Code: Palm City, FL 34990
 Telephone #: (772) 781-5010 Fax #: (772) 781-1631
 Contact Person: Christy Zsiros Email: Cziros@thefloridian.com

Ref #5. Customer/Client: City of Port St. Lucie
 Date of Services: 06/05/2017 - 02/19/2018
 Description of Services: Full Depth Reclamation, Asphaltic Paving, Sidewalk Reconstruction (Rosser Blvd), Drainage
 Street Address: 121 SW Port St. Lucie Blvd
 City, State, ZIP Code: Port St. Lucie, FL 34984
 Telephone #: (772) 892-4344 Fax #: _____
 Contact Person: Gary Jones (Captec Engineering) Email: gjones@gocaptec.com

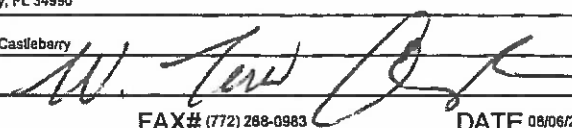
CONTRACTOR NAME C.W. Roberts Contracting, Inc.
 ADDRESS 8530 SW Jayme Way, Palm City, FL 34990
 PRINTED SIGNATURE W. Todd Castleberry
 AUTHORIZED SIGNATURE 
 TELEPHONE # (772) 288-0951 FAX# (772) 288-0983 DATE 08/06/2020
 EMAIL: RSIone@cwrccontracting.com

CONTRACTOR AFFIDAVIT REGARDING SCRUTINIZED COMPANY LIST

Awarded Contractor shall certify that it and its subcontractors are not on the Scrutinized Companies that Boycott Israel List. Pursuant to Section 287.135, F.S. If the Contract is for more than \$1,000,000 the Contractor further certifies that it and its subcontractors are also not on the Scrutinized Companies with Activities in Sudan, Scrutinized Companies with Activities in the Iran Petroleum Energy Sector List, or engaged with business operations in Cuba or Syria as identified in Section 287.135, F.S.

For Contracts of any amount, if the County determines the Contractor submitted a false certification under Section 287.135(5) of the Florida Statutes, or if the Contractor has been placed on the Scrutinized Companies that Boycott Israel List, or is engaged in a boycott of Israel, the County shall either terminate the Contract after it has given the Contractor notice and an opportunity to demonstrate the County's determination of false certification was in error pursuant to Section 287.135(5)(a) of the Florida Statutes, or on a case-by-case basis the County may choose to maintain the Contract if the conditions of Section 287.135(4) of the Florida Statutes are met. For Contracts \$1,000,000 and greater, if the County determines the Contractor submitted a false certification under Section 287.135(5) of the Florida Statutes, or if the Contractor has been placed on the Scrutinized Companies with Activities in the Sudan List, or the Scrutinized Companies with Activities in the Iran Petroleum Energy Sector List, the County shall either terminate the Contract after it has given the Contractor notice and an opportunity to demonstrate the County's determination of false certification was in error pursuant to Section 287.135(5)(a) of the Florida Statutes, or on a case-by-case basis the County may choose to maintain the Contract if the conditions of Section 287.135(4) of the Florida Statutes are met.

STATE OF FLORIDA

COUNTY OF Florida

BEFORE ME, the undersigned authority, personally appeared
W. Todd Castleberry, who, being by me first duly sworn, made the following statement:

1. The Business address of C.W. Roberts Contracting, Inc. (name of Contractor) is 8530 SW Jayme Way, Palm City, FL 34990
2. My relationship to C.W. Roberts Contracting, Inc. (name of Contractor) is (relationship such as sole proprietor, partner, president, vice president).
3. I understand that "Boycott of Israel" has the same meaning as defined in §215.4725, Florida Statutes, and means refusing to deal, terminating business activities, or taking other actions to limit commercial relations with Israel, or persons or entities doing business in Israel or in Israeli-controlled territories, in a discriminatory manner. A statement by a company that it is participating in a boycott of Israel, or that it has initiated a boycott in response to a request for a boycott of Israel or in compliance with, or in furtherance of, calls for a boycott of Israel, may be considered by the State Board of Administration to be evidence

that a company is participating in a boycott of Israel. The term does not include restrictive trade practices or boycotts fostered or imposed by foreign countries against Israel.

4. I understand that "business operations" means, for purposes specifically related to Cuba or Syria, engaging in commerce in any form in Cuba or Syria, including, but not limited to, acquiring, developing, maintaining, owning, selling, possessing, leasing, or operating equipment, facilities, personnel, products, services, personal property, real property, military equipment, or any other apparatus of business or commerce.
5. C.W. Roberts Contracting, Inc. (name of Contractor) is not on the Scrutinized Companies that Boycott Israel List, created pursuant to s. 215.4725, Florida Statutes, or is engaged in a boycott of Israel.
6. C.W. Roberts Contracting, Inc. (name of Contractor) is not on the Scrutinized Companies with Activities in Sudan List or the Scrutinized Companies with Activities in the Iran Petroleum Energy Sector List, created pursuant to s. 215.473, Florida Statutes.
7. C.W. Roberts Contracting, Inc. (name of Contractor) is not engaged in business operations in Cuba or Syria.

Signature

Sworn to and subscribed before me in the state and county first mentioned above on the 6th day of August, 2020.

Wanda Sue Smart
Notary Public

My commission expires: 04/25/2022

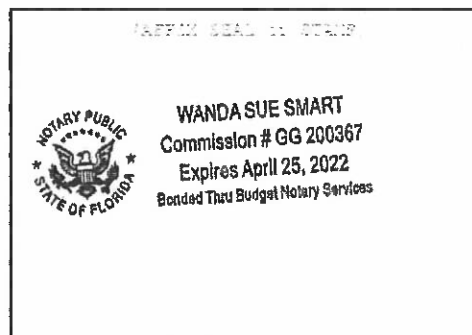

Asphaltic Concrete
B-6-20-57
STATEMENT OF NO BID

NOTE: If you do not intend to bid on this requirement, please return this form to:

Brevard County Purchasing Services
2725 Judge Fran Jamieson Way, Bldg. C, Suite 303
Viera, FL 32940

We the undersigned have declined to bid on your Bid No. B-6-20-57 for the following reason(s):

- Specifications too "restrictive," i.e., geared toward one brand or manufacturer only (*please specify below*)
- Insufficient time to respond to the Invitation to Bid
- We do not offer this commodity/service or equivalent
- Our product schedule would not permit us to perform
- Specifications unclear (*please specify below*)
- Unable to meet bond or insurance requirements
- Remove our company from Contractor database for this commodity/service
- Other (*please specify below*)

Remarks: We are bidding this project

PLEASE PRINT

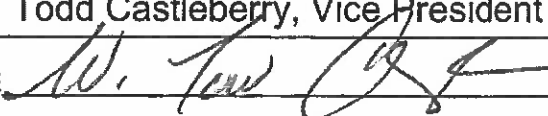
COMPANY NAME C.W. Roberts Contracting, Inc.
COMPANY ADDRESS 8530 SW Jayme Way, Palm City, FL 34990
TELEPHONE NUMBER (772) 288-0951
PRINTED SIGNATURE W. Todd Castleberry, Vice President
AUTHORIZED SIGNATURE 

NOTE: Failure to submit either a Bid or a Statement of No Bid may be cause for removal from the Brevard County Purchasing Services Contractor database.



Ron DeSantis, Governor

Halsey Beshears, Secretary

**STATE OF FLORIDA
DEPARTMENT OF BUSINESS AND PROFESSIONAL REGULATION**

CONSTRUCTION INDUSTRY LICENSING BOARD

THE GENERAL CONTRACTOR HEREIN IS CERTIFIED UNDER THE
PROVISIONS OF CHAPTER 489, FLORIDA STATUTES

FLOWERS, ROBERT P

C. W. ROBERTS CONTRACTING, INCORPORATED
3372 CAPITAL CIRCLE NE
TALLAHASSEE FL 32308

LICENSE NUMBER: CGC1505785

EXPIRATION DATE: AUGUST 31, 2022

Always verify licenses online at MyFloridaLicense.com



Do not alter this document in any form.

This is your license. It is unlawful for anyone other than the licensee to use this document.

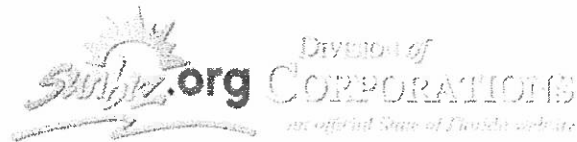

[Department of State](#) / [Division of Corporations](#) / [Search Records](#) / [Search by Entity Name](#) /

Detail by Entity Name

Florida Profit Corporation

C. W. ROBERTS CONTRACTING, INCORPORATED

Filing Information

Document Number	493846
FE/EIN Number	59-1683951
Date Filed	01/19/1976
State	FL
Status	ACTIVE
Last Event	AMENDMENT
Event Date Filed	05/08/2020
Event Effective Date	NONE

Principal Address

1603 BAY AVENUE
PANAMA CITY, FL 32405

Changed: 02/23/2017

Mailing Address

P.O. BOX 16279
TALLAHASSEE, FL 32317

Changed: 04/09/2007

Registered Agent Name & Address

FLOWERS, ROBERT P
3372 CAPITAL CIRCLE NE
TALLAHASSEE, FL 32308

Name Changed: 09/13/2013

Address Changed: 09/13/2013

Officer/Director Detail

Name & Address

Title President

FLOWERS, ROBERT P
3372 CAPITAL CIRCLE NE
TALLAHASSEE, FL 32308

Title Secretary, CFO

DELISLE, ROBERT
3372 CAPITAL CIRCLE NE
TALLAHASSEE, FL 32308

Title VP

Palmer, Alan
P.O. BOX 16279
TALLAHASSEE, FL 32317

Title VP

Fleming III, Ned N
P.O. BOX 16279
TALLAHASSEE, FL 32317

Title CEO

Owens, Charles E
P.O. BOX 16279
TALLAHASSEE, FL 32317

Title VP, Asst. Secretary, Treasurer

Matteson, Mark R
P.O. BOX 16279
TALLAHASSEE, FL 32317

Title VP

Savoy, Stuart
P.O. BOX 16279
TALLAHASSEE, FL 32317

Title VP

Riley, Chris
P.O. BOX 16279
TALLAHASSEE, FL 32317

Title VP

STRAIN, JAMES(JIMMY) A
P.O. BOX 16279
TALLAHASSEE, FL 32317

Title V.P.

CASTLEBERRY, WILLIAM T.

P.O. BOX 16279
TALLAHASSEE, FL 32317

Title V.P.

ARMSTRONG, M. BRETT
P.O. BOX 16279
TALLAHASSEE, FL 32317

Annual Reports

Report Year	Filed Date
2018	01/24/2018
2019	01/10/2019
2020	01/07/2020

Document Images

05/08/2020 -- Amendment	View image in PDF format
01/07/2020 -- ANNUAL REPORT	View image in PDF format
07/15/2019 -- Amendment	View image in PDF format
04/02/2019 -- Amendment	View image in PDF format
01/10/2019 -- ANNUAL REPORT	View image in PDF format
08/14/2018 -- Amendment	View image in PDF format
01/24/2018 -- ANNUAL REPORT	View image in PDF format
03/28/2017 -- AMENDED ANNUAL REPORT	View image in PDF format
01/24/2017 -- ANNUAL REPORT	View image in PDF format
03/01/2016 -- ANNUAL REPORT	View image in PDF format
01/23/2015 -- ANNUAL REPORT	View image in PDF format
01/08/2014 -- ANNUAL REPORT	View image in PDF format
09/13/2013 -- Amendment	View image in PDF format
01/16/2013 -- ANNUAL REPORT	View image in PDF format
03/16/2012 -- ANNUAL REPORT	View image in PDF format
04/06/2011 -- ANNUAL REPORT	View image in PDF format
03/02/2010 -- ANNUAL REPORT	View image in PDF format
04/10/2009 -- ANNUAL REPORT	View image in PDF format
03/11/2008 -- ANNUAL REPORT	View image in PDF format
04/09/2007 -- ANNUAL REPORT	View image in PDF format
02/23/2006 -- ANNUAL REPORT	View image in PDF format
04/13/2005 -- ANNUAL REPORT	View image in PDF format
02/18/2004 -- ANNUAL REPORT	View image in PDF format
01/22/2003 -- ANNUAL REPORT	View image in PDF format
03/14/2002 -- ANNUAL REPORT	View image in PDF format
01/30/2002 -- Mercer	View image in PDF format
04/06/2001 -- ANNUAL REPORT	View image in PDF format
03/24/2000 -- ANNUAL REPORT	View image in PDF format
02/17/1999 -- ANNUAL REPORT	View image in PDF format
02/03/1998 -- ANNUAL REPORT	View image in PDF format
02/03/1997 -- ANNUAL REPORT	View image in PDF format
02/22/1996 -- ANNUAL REPORT	View image in PDF format

04/07/1995 -- ANNUAL REPORT

View image in PDF format



[Department of State](#) / [Division of Corporations](#) / [Search Records](#) / [Search by Entity Name](#) /

Detail by Entity Name

Florida Profit Corporation

C. W. ROBERTS CONTRACTING, INCORPORATED

Filing Information

Document Number	493846
FEI/EIN Number	59-1683951
Date Filed	01/19/1976
State	FL
Status	ACTIVE
Last Event	AMENDMENT
Event Date Filed	05/08/2020
Event Effective Date	NONE

Principal Address

1603 BAY AVENUE
PANAMA CITY, FL 32405

Changed: 02/23/2017

Mailing Address

P.O. BOX 16279
TALLAHASSEE, FL 32317

Changed: 04/09/2007

Registered Agent Name & Address

FLOWERS, ROBERT P
3372 CAPITAL CIRCLE NE
TALLAHASSEE, FL 32308

Name Changed: 09/13/2013

Address Changed: 09/13/2013

Officer/Director Detail

Name & Address

Title President

FLOWERS, ROBERT P
3372 CAPITAL CIRCLE NE
TALLAHASSEE, FL 32308

Title Secretary, CFO

DELISLE, ROBERT
3372 CAPITAL CIRCLE NE
TALLAHASSEE, FL 32308

Title VP

Palmer, Alan
P.O. BOX 16279
TALLAHASSEE, FL 32317

Title VP

Fleming III, Ned N
P.O. BOX 16279
TALLAHASSEE, FL 32317

Title CEO

Owens, Charles E
P.O. BOX 16279
TALLAHASSEE, FL 32317

Title VP, Asst. Secretary, Treasurer

Matteson, Mark R
P.O. BOX 16279
TALLAHASSEE, FL 32317

Title VP

Savoy, Stuart
P.O. BOX 16279
TALLAHASSEE, FL 32317

Title VP

Riley, Chris
P.O. BOX 16279
TALLAHASSEE, FL 32317

Title VP

STRAIN, JAMES(JIMMY) A
P.O. BOX 16279
TALLAHASSEE, FL 32317

Title V.P.

CASTLEBERRY, WILLIAM T.
P.O. BOX 16279
TALLAHASSEE, FL 32317

TALLAHASSEE, FL 32317

Title V.P.

ARMSTRONG, M. BRETT
 P.O. BOX 16279
 TALLAHASSEE, FL 32317

Annual Reports

Report Year	Filed Date
2018	01/24/2018
2019	01/10/2019
2020	01/07/2020

Document Images

05/08/2020 -- Amendment	View image in PDF format
01/07/2020 -- ANNUAL REPORT	View image in PDF format
07/15/2019 -- Amendment	View image in PDF format
04/02/2019 -- Amendment	View image in PDF format
01/10/2019 -- ANNUAL REPORT	View image in PDF format
08/14/2018 -- Amendment	View image in PDF format
01/24/2018 -- ANNUAL REPORT	View image in PDF format
03/28/2017 -- AMENDED ANNUAL REPORT	View image in PDF format
01/24/2017 -- ANNUAL REPORT	View image in PDF format
03/01/2016 -- ANNUAL REPORT	View image in PDF format
01/23/2015 -- ANNUAL REPORT	View image in PDF format
01/08/2014 -- ANNUAL REPORT	View image in PDF format
09/13/2013 -- Amendment	View image in PDF format
01/16/2013 -- ANNUAL REPORT	View image in PDF format
03/16/2012 -- ANNUAL REPORT	View image in PDF format
04/06/2011 -- ANNUAL REPORT	View image in PDF format
03/02/2010 -- ANNUAL REPORT	View image in PDF format
04/10/2009 -- ANNUAL REPORT	View image in PDF format
03/11/2008 -- ANNUAL REPORT	View image in PDF format
04/09/2007 -- ANNUAL REPORT	View image in PDF format
02/23/2006 -- ANNUAL REPORT	View image in PDF format
04/13/2005 -- ANNUAL REPORT	View image in PDF format
02/18/2004 -- ANNUAL REPORT	View image in PDF format
01/22/2003 -- ANNUAL REPORT	View image in PDF format
03/14/2002 -- ANNUAL REPORT	View image in PDF format
01/30/2002 -- Merger	View image in PDF format
04/06/2001 -- ANNUAL REPORT	View image in PDF format
03/24/2000 -- ANNUAL REPORT	View image in PDF format
02/17/1999 -- ANNUAL REPORT	View image in PDF format
02/03/1998 -- ANNUAL REPORT	View image in PDF format
02/03/1997 -- ANNUAL REPORT	View image in PDF format
02/22/1996 -- ANNUAL REPORT	View image in PDF format
04/07/1995 -- ANNUAL REPORT	View image in PDF format

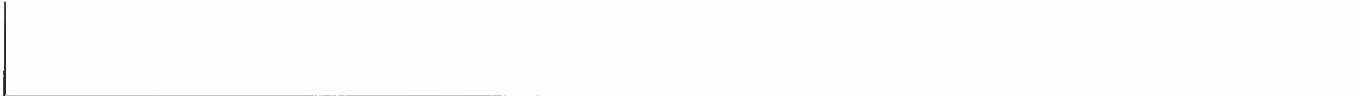

Florida Department of State, Division of Corporations



[Skip to Main Content](#)

Department of Management Services

[Florida Department of Management Services](#) > [Business Operations](#) > [State Purchasing](#) > [State Agency Resources](#) > [Vendor Registration and Vendor Lists](#) > Convicted Vendor List

Convicted Vendor List

The Department of Management Services maintains "a list of the names and addresses of those who have been disqualified from the public contracting and purchasing process" under [section 287.133, Florida Statutes](#).

Vendor Name	Agency of Origin	Effective Date	Expiration Date	Final Order
Calixte, Jacques A. (Haitian American Association Against Cancer, Inc.)	DOH	10/25/18	10/25/21	Final Order - Calixte, Jacques A. (Haitian American Association Against Cancer, Inc.) ( 1.71 MB)
Hoffman, Tracy J. (Gator Signage and Striping, LLC)	DOT	01/22/18	01/22/21	Final Order - Hoffman, Tracy J. (Gator Signage and Striping, LLC) ( 753.24 KB)

Updated 12/10/19

Document reader download link

-  [Adobe PDF Reader](#)

[Terms and Conditions](#) | [Privacy Statement](#) | [Accessibility Statement](#) | Copyright ©2020 Department of Management Services - State of Florida

[Skip to Main Content](#)

Department of Management Services

[Florida Department of Management Services](#) > [Business Operations](#) > [State Purchasing](#) > [State Agency Resources](#) > [Vendor Registration and Vendor Lists](#) > Discriminatory Vendor List

Discriminatory Vendor List

The Department of Management Services maintains "a list of the names and addresses of any entity which has been disqualified from the public contracting and purchasing process" under [section 287.134, Florida Statutes](#).

There are currently no vendors on this list.

[Terms and Conditions](#) | [Privacy Statement](#) | [Accessibility Statement](#) | Copyright ©2020 Department of Management Services - State of Florida



A NEW WAY TO SIGN IN - If you already have a SAM account, use your SAM email for login.gov.

Log In

Login.gov FAQs

ALERT: SAM.gov will be down for scheduled maintenance Saturday, 08/15/2020 from 8:00 AM to 10:00 PM

Entity Dashboard

C. W. Roberts Contracting, Incorporated
DUNS: 094593589 CAGE Code: OCHA7
Status: Active
Expiration Date: 12/03/2020
Purpose of Registration: All Awards

3372 Capital Cir NE
Tallahassee, FL, 32308-3710,
UNITED STATES

- [Entity Overview](#)
- [Entity Registration](#)
 - [Core Data](#)
 - [Assertions](#)
 - [Reps & Certs](#)
 - [POCs](#)
- [Exclusions](#)
 - [Active Exclusions](#)
 - [Inactive Exclusions](#)
 - [Excluded Family Members](#)

RETURN TO SEARCH

Entity Overview

Entity Registration Summary

Name: C. W. Roberts Contracting, Incorporated
Business Type: Business or Organization
Last Updated By: Christopher Riley
Registration Status: Active
Activation Date: 12/04/2019
Expiration Date: 12/03/2020

Exclusion Summary

Active Exclusion Records? No



IBM-P-20200717-1140
WWW2

- [Search Records](#)
- [Disclaimers](#)
- [FAPIS.gov](#)
- [Data Access](#)
- [Accessibility](#)
- [GSA.gov/IAE](#)
- [Check Status](#)
- [Privacy Policy](#)
- [GSA.gov](#)
- [About](#)
- [USA.gov](#)
- [Help](#)

This is a U.S. General Services Administration Federal Government computer system that is "FOR OFFICIAL USE ONLY." This system is subject to monitoring. Individuals found performing unauthorized activities are subject to disciplinary action including criminal prosecution.

Visit our [Temporary Policies \(/node/5093\)](/node/5093) Related to COVID-19 page for E-Verify and Form I-9 changes due to COVID-19.

HOW TO FIND PARTICIPATING EMPLOYERS

Use the E-Verify search tool to find employers who are currently enrolled in E-Verify. Your search will display the following information:

- **Employer name** – The name the employer used when they enrolled in E-Verify. This can be the business' legal name, a trade name, or an abbreviation.
- **Doing Business As (DBA) name** – The name an employer uses publicly. The public may see the DBA, but the employer may have used another name when they enrolled in E-Verify.
- **Account Status** – Indicates whether the account is currently enrolled or terminated.
- **Enrollment date** – The date the E-Verify Memorandum of Understanding is signed.
- **Termination Date** – The E-Verify Memorandum of Understanding termination date.
- **Workforce size** – Appears as long as the employer reported they have at least five employees.
- **Number of hiring sites** – The locations where employers hire employees and where they complete Form I-9.
- **Hiring site locations (by state)** – The geographic location(s) of hiring sites, by state, reported by the employer.

Parameters:

- USCIS updates the search tool data every quarter.
- Employers report their own data at the time they enroll in E-Verify. The accuracy and completeness of the data depend on what was submitted by employers at the time of enrollment and as reported throughout the employer's relationship with E-Verify.
- Review Employer Data Parameters (</employer-data-parameters>)

Search

[Employer \(?business-name=C.W.%20Roberts%20Contracting&field_account_status_value=All&items_per_page=10&order](#)

C.W. Roberts Contracting, Inc.

[Employer \(?business-name=C.W.%20Roberts%20Contracting&field_account_status_value=All&items_per_page=10&order](#)

C.W. Roberts Contracting, Inc.

Showing 1 to 2 of 2 entries.

ENROLLING IN E-Verify IS EASY! WANT TO LEARN MORE?

[E-Verify ENROLLMENT \(/employers/enrolling-in-e-verify\)](#)

Last Updated Date: 03/31/2020

View Vendor Detail

General Vendor Information

Vendor Status / Effective Date:	AC /
Vendor Name:	C.W. Roberts Contracting, Inc.
Short Name (Does Business As):	
Dun and Bradstreet Number (DUNS):	
Website:	http://www.cwrcontracting.com/
W9 Status:	Valid W-9 on File
DFS W9 Last Update Date:	Sep 11, 2019
Business Designation	Corporation
	Primary Place of Business: FL
Collections Indicator:	Y

Certified Business Enterprise (CBE) Category

Non-Minority / Non-Woman-Owned / Non-FVBE

Solicitations

Registered for Sourcing: Yes, Date participated: 5/15/18 9:49 AM
 Registered for VBS: Yes, Date participated: 5/15/18 9:49 AM
 Solicitation/Sales Contact EMail: bflowers@cwrcontracting.com

Special Exceptions

Fee has been waived:
 Terms of Use have not been agreed to:

Reluctant Vendor

Reluctant Vendor:

Florida Terms of Use

Accepted: Yes, 05/15/2018
 Accepted By: Bob Flowers

Contacts

[View Contact List](#)

Locations

005 Corporate Office Status: [AC Details](#)

[-] Commodity Codes

30121600 Asphalts
 72141000 Highway and road construction services



[Return to List](#)

[Copyright © 2009 State of Florida](#) | [Privacy Statement](#) :: [Required Information](#) :: [Terms of Use](#) :: [Frequently Asked Questions](#) :: [Glossary](#)

MyFloridaMarketPlace Vendor Registration Customer Service: 866-FLA-EPRO (866-352-3776)





[Skip to Main Content](#)

Department of Management Services

[Florida Department of Management Services](#) > [Business Operations](#) > [State Purchasing](#) > [State Agency Resources](#) > [Vendor Registration and Vendor Lists](#) > [Suspended Vendor List](#)

Suspended Vendor List

The Department of Management Services maintains a list of vendors that have been removed from the Vendor List "for failing to fulfill any of its duties specified in a contract with the State," in accordance with [Rule 60A-1.006\(2\)](#), [Florida Administrative Code](#).

Vendor Name/Address	Agency of Origin	Effective Date	Notice of Default
Building Maintenance of America, LLC d/b/a Florida Building Maintenance 333 North Falkenburg Road #A117 Tampa, FL 33619	DMS	07/02/14	Notice of Default - Building Maintenance of America, LLC d/b/a Florida Building Maintenance ( 575.81 KB)
Club Tex, Inc. 2025 Broadway, Suite #15G New York, NY 10023	DOC	01/24/19	Notice of Default - Club Tex, Inc. ( 111.75 KB)
Correctional Consultants, LLC P.O. Box 515 Chattahoochee, FL 32324	DOC	12/10/19	Notice of Default - Correctional Consultants, LLC ( 85.95 KB)
iColor Printing and Mailing, Inc. 22873 Lockness Avenue Torrance, CA 90501	DEP	02/20/12	Notice of Default - iColor Printing and Mailing, Inc. ( 320.17 KB)
Visual Image Design Firm, LLC 6845 Narcoossee Road, Suite 59 Orlando, FL 32822	DOH	06/25/15	Notice of Default - Visual Image Design Firm, LLC ( 1.78 MB)

Updated 12/10/19

Document reader download link

-  [Adobe PDF Reader](#)

[Terms and Conditions](#) | [Privacy Statement](#) | [Accessibility Statement](#) | Copyright ©2020 Department of Management Services - State of Florida

**Asphaltic Concrete
B-6-20-57
July 28, 2020
Addendum 1**

TO ALL PROSPECTIVE BIDDERS

This is an Addendum to and shall be considered as part of the original bid package for the above-mentioned bid. Please acknowledge receipt of Addendum 1 in space provided on Price Sheet. Bidders are requested to acknowledge receipt of this addendum with their bid.

CLARIFICATION TO QUESTIONS ASKED RECEIVED:

1. **QUESTION:** Please provide additional information regarding performance bonds required over \$100,000.00. How many projects will there be over \$100,000.00 each year? What is the average dollar amount of each of these projects? Which bid items will the performance bonds pertain to?
1. **RESPONSE:** Performance Bonds will be required for streets that exceed \$100,000 of cost under items collectively performed by one contractor. It is estimated that there are approximately 20 streets county-wide with an aggregate of \$6.7 million in costs which meet this criteria.
2. **QUESTION:** On Page 8 Note No. 1 Contract Period of the Asphaltic Concrete Bid # B-6-20-57 Special Conditions it states "The terms of this agreement shall be effective for one (1) year from the date of award. The agreement may be extended by mutual agreement, for two (2) additional one (1) year periods". Is the Price Sheet for the Asphaltic Concrete Bid # B-6-20-57 for the first year of this agreement?

RESPONSE: The price sheet included in the bid package is for the entire contract. The price sheet is based off of the API.

3. **QUESTION:** Will there be an opportunity to address cost increases for extended years?

RESPONSE: The cost increases and/or decreases are based on the API. Increases and/or decreases are evaluated when a change of 5% occurs in either direction. The contractor(s) will send in a request to raise the cost. Additionally, if price adjustments are required, the criteria on the price adjustment sheet and FDOT Specs, Section 9-2.1.1 will be followed.

4. **QUESTION:** Is the FDOT Fuel & Bituminous Average Price Index in effect for this bid?

RESPONSE: Yes, the FOT Fuel and Bituminous Average Price Index is used for this contract.

5. **QUESTION:** On Page 10 Note No. 8, of the Asphaltic Concrete Bid # B-6-20-57 Scope of Services it states "Corrections on. "New Pavement" (reconstructed or new rock base or soil cement) shall be in accordance with FDOT Standards 2020". How does a Contractor get paid for these additional costs incurred for these unforeseen correction conditions?

2. **RESPONSE:** This is referring to the corrections in the pavement and not the base, there is no cost to the County.

6. **QUESTION:** On Page 11 Note No. 13 of the Asphaltic Concrete Bid # B-6-20-57 Scope of Services it states "The County will make award in accordance with General Conditions #23 on the following:..... What is General Conditions #23?

RESPONSE: This statement is referring to the General Conditions, Terms, and Provisions located on Page 3, item # 23 – AWARDS.

7. **QUESTION:** On Page 12 Note No. 24 Estimated Quantities/Usages of the Asphaltic Concrete Bid # B-6-20-57 Scope of Services it states "Below is a listing of estimated quantities/usages as referenced in Item 1 of the Special Conditions. Please be aware that these are estimates only, and are provided to assist you in preparing your bids. The quantities below in no way guarantee any minimum or maximum amount of product or work to be purchased. Brevard County Board of County Commissioners: Superpave 9.5 – 85,000 TONS; Superpave 12.5 – 15,000 TONS; FC12.5 – 25,000 TONS". How much of the Superpave 9.5 – 85,000 TONS are FOB at Plant?

RESPONSE: None, this was based off of last year's performance, 85,000 Tons, this was asphalt placed on the roads.

8. **QUESTION:** On the Price Sheet the last bid item states "Cost per ton to add Aramid Fiber to the asphalt mix (Per attached Fiber Specs)" at a per ton price. Please provide the following information: How often will asphalt requiring fiber occur, the minimum tons that shall be required for each occurrence, and the allowable time-frame for procuring the fiber portion of the asphalt prior to placement?

RESPONSE: Based on last year's production we installed 11,000 Tons of Asphalt. This was 4 projects. One Month time frame on the fiber procurement.

9. **QUESTION:** Are FDOT Composite Pay Factors in effect for this bid?

RESPONSE: No, FDOT Composite Pay Factors are not in effect for this bid.

10. **QUESTION:** Please provide a breakdown of the overall annual quantities for each bid item that was performed during each of the last three (3) years. This will help us provide you with our most competitive bid.

RESPONSE: Please see table below:

Asphalt Type	Year	Tons	SY
SP 9.5	18-19	58,000	
SP 12.5	18-19	14,000	
FC 12.5	18-19	30,000	
FOB 9.5	18-19		
FC-5	18-19	0	
SP 9.5	19-20	85,000	
SP 12.5	19-20	15,000	
FC 12.5	19-20	25,000	
FOB 9.5	19-20	800	
Milling	19-20		491,295
FC 5	19-20	0	
Speed			
Humps	19-20	210	

11. **QUESTION:** Does the Contractor retain all the asphalt millings?

RESPONSE: Yes, the contractor retains all of the asphalt millings.

12. **QUESTION:** Will the County accept any milling material (which would contain base material, subgrade material, etc.) if any of the existing roads, parking lots, or bike paths proposed for milling & resurfacing does not have enough asphalt thickness?

RESPONSE: Yes, the County will accept any milling material if any of the existing roads, parking lots, or bike paths proposed for milling & resurfacing does not have enough asphalt thickness.

13. **QUESTION:** Will one contractor perform the asphalt milling for a particular roadway, parking lot, or bike path and another contractor perform the asphalt paving for this same roadway, parking lot, or bike path if one contractor is low on the asphalt milling item and another contractor is low on the asphalt paving item?

3. **RESPONSE:** One contractor would mill and pave. Typically, the contractor that is low after adding the two items together will be awarded the project.

14. **QUESTION:** Will one contractor perform both the asphalt milling and asphalt paving for particular roadways, parking lots, or bike paths that are proposed?

RESPONSE: Yes, one contractor will perform both the asphalt milling and asphalt paving for particular roadways, parking lots, or bike paths that are proposed.

15. **QUESTION:** Since there's not a bid line item for the fibers and only a limited amount has fibers, how should this be included in the tonnage price?

RESPONSE: Please see Addendum 1 – Attachment B – Revised Price Sheet. The cost per ton to add fiber to the existing mix is location on the last line of the Revised Price Sheet. This line should reflect the cost to add the fiber to the existing mix. There are two companies that produce the fibers. The contractors should coordinate with the company of their choice to introduce the fiber into the mix. The cost per ton is the charge the contractor is charging for this process. The contractor is responsible for purchasing the fiber and installing it into the mix per manufacturer's recommendations.

16. **QUESTION:** What is the expected tonnage for the FC-5 and FC-9.5?

RESPONSE: Currently, there are no projects scheduled requiring FC-5. For FC-9.5, we expect 1,000 tons.

17. **QUESTION:** The speed humps are calculated by the ton, what are the average length, width and height? Could they be bid by the linear foot?

RESPONSE: Speed humps are typically 3 tons each. Contractors usually install the speed humps with a template. Please see Addendum 1 – Attachment A – Speed Hump Design

18. **QUESTION:** On the first page of the specifications, under Delivery, it states, "...to various locations in Brevard County, with inside delivery." Can you please provide further clarification on what is meant by "inside delivery"?

RESPONSE: This statement is a general statement to reflect that the bid price should be "All inclusive to put the asphalt on the road per ton".

19. **QUESTION:** In the solicitation there is no reference to pricing being subject to adjustment in accordance with Florida Department of Transportation (FDOT) Bituminous Index. Does the county intend to include FDOT bituminous index adjustments in this contract?

RESPONSE: Yes, the FDOT bituminous index adjustments will be used for this contract.

20. **QUESTION:** The Solicitation references delivery with FOB. Can you please clarify what is included in the FOB line item price?

RESPONSE: FOB is only for the asphalt SP 9.5 picked up at the plant.

21. **QUESTION:** FDOT has locked the FDOT bituminous index at 1.9079 (unmodified binders) and 2.4637 (modified binder) for several months now due to complications from the COVID -19 virus pandemic. Should this contract incorporate a bituminous index adjustment, will future adjusts be based on the FDOT bituminous index at the time of bid?

RESPONSE: Bids should be submitted with the FDOT bituminous index at the current rate. Adjustments will be made when the FDOT bituminous index increases or decreases by a minimum of 5%.

22. **QUESTION:** On page 5 bullet 45 of the solicitation describes if the contractor is not meeting production, the contract manager will notify the contractor to increase force. What is the minimum and maximum monthly production the bid should be based on?

RESPONSE: We do not have a set schedule for the next year. What we have included is the estimated tons for the year. If we just take the projected 70 miles next year and divide it by 10, we are doing 7 miles per month. There will be times when the work load will increase because of additional projects such as the reclamation roads being completed at the same time we are doing resurfacing.

Please note that the bid opening date and time remains August 6, 2020 @ 2:00pm.

All other terms and conditions remain unchanged.

Sincerely,



Steven A. Darling, Jr.
Central Services Director

cc: file
Public Works

END OF ADDENDUM 1

SW

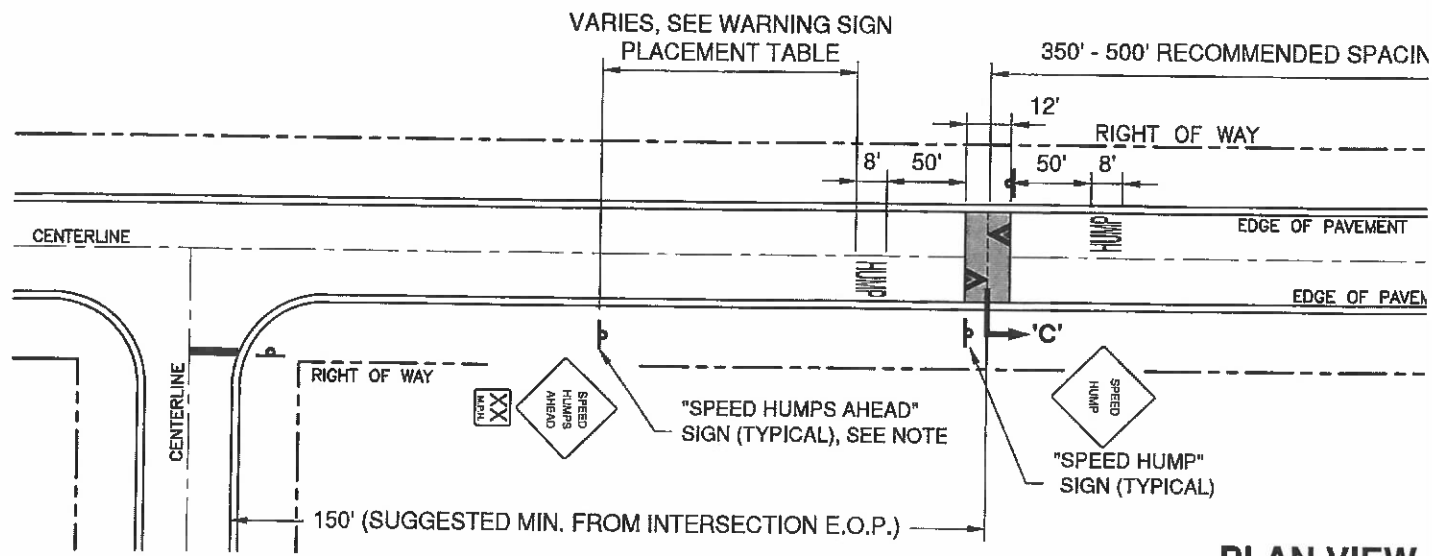

PLAN VIEW

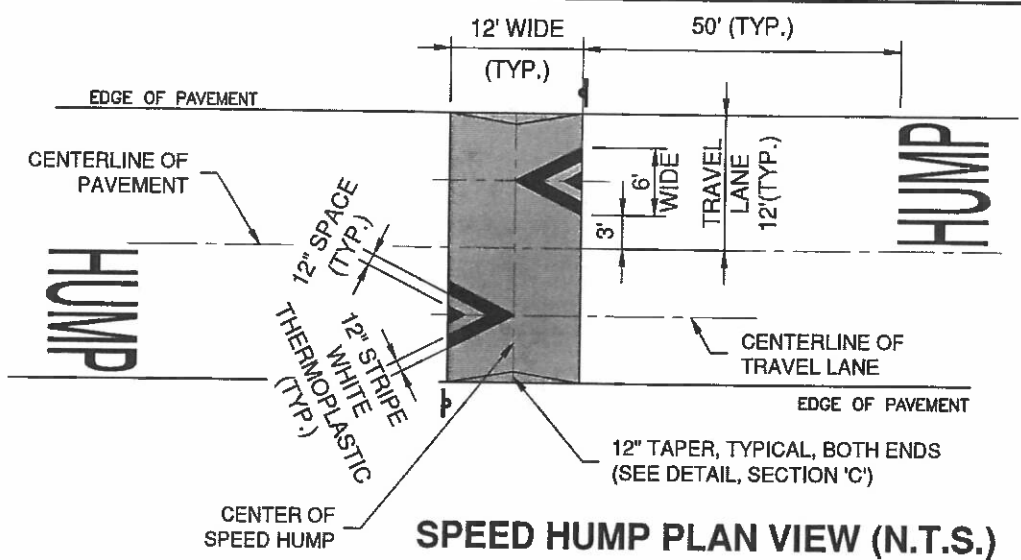

SPEED HUMP PLAN VIEW (N.T.S.)

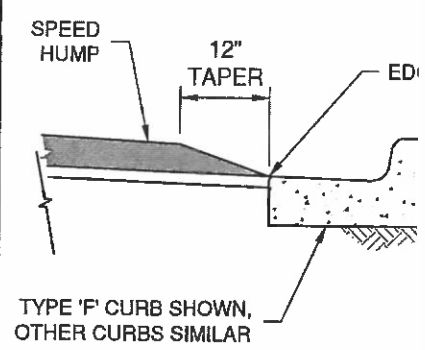

SECTION 'C' (N.T.S.)

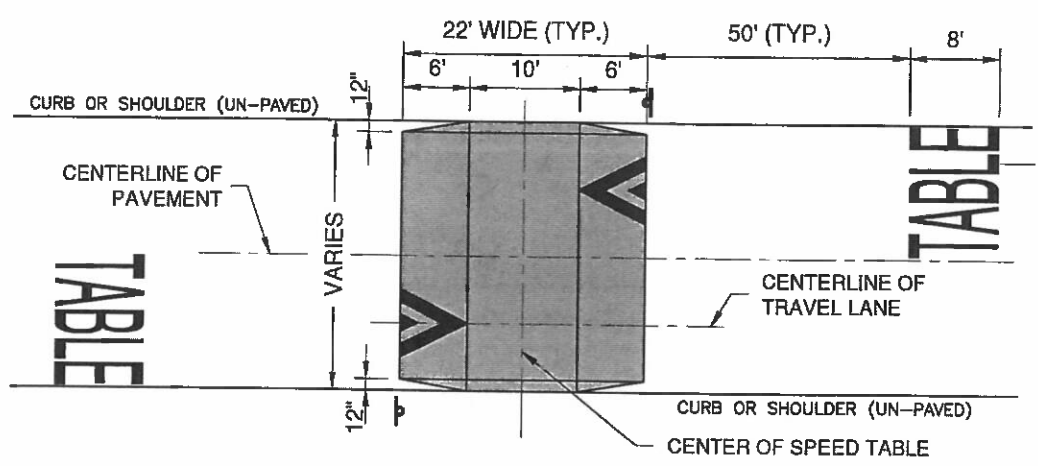

SPEED TABLE PLAN VIEW (N.T.S.)

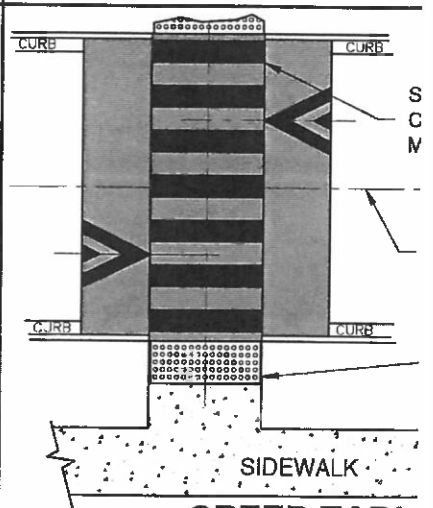

SPEED TABLE WITH PEDESTRIAN CROSSWALK (N.T.S.)

DRAWN BY: S.D. CHECKED BY: C. GUMM	DATE:	REVISION:	BY:	PREPARED BY:	PUBLIC WORKS DEPARTMENT ENGINEERING DIVISION BREVARD COUNTY BOARD OF COUNTY COMMISSIONERS 2725 JUDGE FRANK JAMIESON WAY, RM. 211, BLDG A, VIERA, FL 32940 Ph. (321) 633-2077, Fax. (321) 637-5471
	1.				
	2.				
	3.				
	4.				

**ASPHALTIC CONCRETE
 BID # B-6-20-57**

REVISED PRICE SHEET

ASPHALTIC CONCRETE	DESCRIPTION	ROAD PAVING	PARKING LOTS	BIKE PATHS
Superpave SP-9.5	Vendor Delivered, Vendor Placed	\$ _____ Ton	\$ _____ Ton	\$ _____ Ton
Superpave SP-12.5	Vendor Delivered, Vendor Placed	\$ _____ Ton	\$ _____ Ton	\$ _____ Ton
FRICITION COURSE		ROAD PAVING		
Friction Course FC-5	Vendor Delivered, Vendor Placed	\$ _____ Ton		
Friction Course FC-9.5	Vendor Delivered, Vendor Placed	\$ _____ Ton		
Friction Course FC-12.5	Vendor Delivered, Vendor Placed	\$ _____ Ton		
SPEED HUMPS SP-9.5	Vendor Delivered, Vendor Placed	\$ _____ Ton		
LESS THAN 25 TN PATCHING SP-9.5	Vendor Delivered, Vendor Placed	\$ _____ Ton		
25-50 TN PATCHING SP 9.5	Vendor Delivered, Vendor Placed	\$ _____ Ton		
TACK FOB Gallon	FOB GALLON	\$ _____ Gal		
PRIME	Vendor Delivered, Vendor Placed	\$ _____ SY		
PRIM AND SAND	Vendor Delivered, Vendor Placed	\$ _____ SY		
SAND 3% HOT MIX	Vendor Delivered, Vendor Placed	\$ _____ Ton	\$ _____ SY	
HOT ASPHALT FOR PICK UP FOB AT PLANT SP-9.5	FOR PICK UP	\$ _____ Ton		
TEMPORARY STRIPING	Vendor Schedules and Provides	\$ _____ L.F.		
Night Work	Cost per ton	\$ _____ Ton		
Cost for Milling & Clean Up	SY 0-2,500 and under	\$ _____ SY		
	SY \$2,501 - 5,000	\$ _____ SY		
	SY 5,001 to 15,000	\$ _____ SY		
	SY 15,001 and over	\$ _____ SY		
Asphalt Millings for Pickup FOB at Plant		\$ _____ Ton		
Cost per ton to add Aramid Fiber to the asphalt mix (Per attached Fiber Specs) *		\$ _____ Ton		
SPECIFIC PROJECTS ONLY *		\$ _____ Ton		

Plant Locations: _____

**ASPHALTIC CONCRETE
BID # B-6-20-57**

**REVISED PRICE SHEET
(Continued)**

Addendum Acknowledgment:

Add. No. _____ Dated _____ / Add. No. _____ Dated _____

Add. No. _____ Dated _____ / Add. No. _____ Dated _____

PROMPT PAYMENT DISCOUNT:

Brevard County shall remit payment in accordance with the Florida Prompt Payment Act, Florida Statutes section 218.70. Bidders may offer cash discounts for prompt payment, but they will not be considered in determination of award. If a bidder offers a discount, it is understood that the discount time will be from the date of satisfactory

If Prompt Payment Discount is offered, please state discount terms below:

Does your company accept payment via ACH? YES / NO

I hereby certify that I have read and agree to all terms and conditions, specifications, and insurance requirements outlined herein:

VENDOR _____

ADDRESS _____

AUTHORIZED SIGNATURE _____

DATE _____

PRINTED SIGNATURE _____

TELEPHONE # _____ FAX # _____

TOWN OF MALABAR

COUNCIL MEETING

AGENDA ITEM NO: 11.h.
Meeting Date: November 2, 2020

Prepared By: Lisa Morrell, Interim Town Manager

SUBJECT: Piggyback Omni Partners National Cooperative Purchase Contract

BACKGROUND/HISTORY:

Omnia Partners has extensive portfolio of cooperative contracts and partnerships for organizations nationwide. All contracts available through OMNIA Partners are competitively solicited and publicly awarded by a lead agency (government entity/educational institution), using a competitive solicitation process consistent with applicable procurement laws and regulations.

"The town administrator is authorized to piggy back contracts for any purpose where the stipulated consideration thereunder to be paid by the town exceeds two thousand dollars (\$2,000.00) awarded by any other governmental entity so long as the bidding process utilized by the other governmental entity in awarding such contract is consistent with the competitive bid procedures outlined in this section. "

The Town of Malabar may utilize this contract as needed for awarded vendors of the contract. The following vendors awarded within the contract have been identified by staff and records of utilization for town services to include but limited to: Facility Maintenance and Supplies, General Building Hardware and Materials, Shipping and Freight Services, office and Supply Products, Vehicle Maintenance, Information Technology, and Surplus Services of Publicly Owned Property. Vendors identified within the awarded national contract are: CDW-G, Office Depot, SHI, Grainger, Fedex, HD Supply, Amazon Business, Insight Public Sector, Lowe's, AutoZone, B&H Photo, HP, Anixter, and GovDeals. Complete contract documents and awards are available online at <https://public.omniapartners.com/contracts>.

FINANCIAL IMPACT:

Within the FY21 Approved Budget not to exceed \$25,000 utilizing the Omni Partners National Cooperative Purchase Contract

ATTACHMENTS:

- Omnia Master Contracts Listing and Terms as of 2020-10-28.PDF

ACTION OPTIONS:

Motion to use the Omni Partners National Cooperative Purchase Contract for purchase of goods and services from awarded vendors of the contract to maintain town services, supplies, and projects as needed.

Supplier Name	Contract Title	Start Date	Renewed Until	Potential Final Expiration Date	Lead Agency	Contract Number
Thatcher Chemicals	Water Treatment Chemicals (Polymers and Misc.)	10/01/2020	09/30/2021	09/30/2025	City of Tucson, AZ	212528
Office Depot	Office Supplies, Related Products and Services	07/01/2019	06/30/2024	06/30/2029	Region 4 ESC - TX	R190303
Office Depot	Online Marketplace	05/16/2020	05/05/2025	05/05/2025	State of Utah	MA3459
US Foods	Food Products and Distribution with Related Equipment, Supplies, and Services	01/22/2018	01/22/2023	01/21/2023	Minnesota Public Agency (Sourcewell)	112917-USF
The Home Depot Pro	Maintenance, Repair, Operating Supplies, Industrial Supplies and Related Products and Services	02/01/2017	12/31/2026	12/31/2026	Maricopa County, AZ	16154
CDW-G	Online Marketplace - Technology Category	05/06/2020	05/05/2025	05/05/2025	State of Utah	MA3458
CDW-G	Information Technology Solutions & Services	03/01/2018	02/28/2023	02/28/2025	City of Mesa, AZ	2018011-01
Ricoh Americas Corporation	Multifunction Devices and Related Services	02/11/2013	06/30/2022	06/30/2022	Fairfax County, VA	4400003732
Xerox Corporation	Copiers and Printers	06/01/2020	05/31/2023	05/31/2025	Region 4 ESC - TX	R191104
Graybar Electric Company, Inc.	Electrical, Lighting, Data Communications and Security Products and Related Products, Services and Solutions	02/01/2018	01/31/2023	01/31/2029	City of Kansas City, MO	EV2370
SHI	Information Technology Solutions & Services	03/01/2018	02/28/2023	02/28/2025	City of Mesa, AZ	2018011-02
Grainger	Maintenance, Repair and Operations (MRO) Supplies, Parts, Equipment, Materials, and Related Services	07/01/2019	12/31/2022	12/31/2024	City of Tucson, AZ	192163
Grainger	Online Marketplace	05/06/2020	05/05/2025	05/05/2025	State of Utah	MA3461
Grainger	Maintenance, Repair, Operations (MRO) Supplies and Related Services	07/01/2018	06/30/2023	06/30/2025	University of California, CA	2018.000207
Garland/DBS, Inc.	Roofing Supplies and Services, Waterproofing, and Related Products and Services	10/15/2019	10/14/2024	10/14/2029	Racine County, WI	PW1925
Herman Miller	Furniture, Installation and Related Products & Services	01/01/2020	12/31/2024	12/31/2026	City of Charlotte, NC	2020000622
Herman Miller	Office Furniture and Related Services and Solutions	01/01/2013	12/31/2020	12/31/2020	Fairfax County, VA	4400003403
Herman Miller	Office Furniture	05/28/2020	04/30/2024	04/30/2029	University of California, CA	2019.001890
Trane	Energy Savings Performance Contracting (ESCO) Technical Energy Audit Services	12/01/2017	12/03/2023	12/03/2028	Port of Portland, OR	1153
Trane	HVAC Products, Installation, Services and Related Products and Services	10/01/2015	09/30/2022	09/30/2022	Harford County Public Schools, MD	15-JLP-023
FedEx	Expedited Mail, Small Ground Freight, Related Products and Services	04/27/2020	04/27/2025	04/27/2029	University of California, CA	2020.002169
Grainger	Maintenance, Repair and Operations (MRO) Supplies & Related Services	04/01/2020	03/31/2023	03/31/2025	Region 4 ESC - TX	R192002
Network Services Company	Janitorial and Sanitation Supplies, Equipment, and Related Services	06/01/2020	05/31/2023	05/31/2025	City of Tucson, AZ	202329-01
Network Services Company	Network/Waxie Janitorial Supplies & Equipment	04/27/2020	04/26/2027	04/26/2030	University of California, CA	2020002301
Network Services Company	Janitorial Supplies, Equipment, Maintenance and Repair	03/01/2017	02/28/2022	02/28/2022	Region 4 ESC - TX	R162101
HD Supply	Maintenance, Repair, Operating Supplies, Industrial Supplies and Related Products and Services	02/01/2017	12/31/2026	12/31/2026	Maricopa County, AZ	16154
The Home Depot Pro Institutional former US Communities	Cleaning Supplies, Equipment and Custodial Related Services and Solutions	11/01/2017	10/31/2022	10/31/2022	Fresno Unified School District, CA	17-21

The Home Depot Pro Institutional (form:Omnia Partners	Janitorial Supplies & Equipment	06/01/2020	05/31/2027	05/31/2030	University of California, CA	2020002299
Steelcase	Office Furniture	05/21/2020	04/30/2024	04/30/2029	University of California, CA	2019.001899
Office Depot	Furniture, Installation and Related Services	05/01/2020	04/30/2023	04/30/2025	Region 4 ESC - TX	R191812
The Home Depot Pro Institutional (form:US Communities	Maintenance, Repair, Operating Supplies, Industrial Supplies, and Related Products and Services	02/01/2017	12/31/2026	12/31/2026	Maricopa County, AZ	16154
Amazon Business	Online Marketplace	09/09/2020	05/05/2025	05/05/2025	State of Utah	MA3457
Amazon Business	Online Marketplace for the Purchase of Products and Services	01/19/2017	01/18/2022	01/18/2028	Prince William County Public Schools, VA	R-TC-17006
Virco	Classroom Furniture	11/01/2017	12/31/2022	12/31/2026	Prince William County Public Schools, VA	R-TC-18004
Insight Public Sector, Inc.	Technology Products, Services, Solutions and Related Products and Services	05/01/2016	04/30/2021	04/30/2023	Fairfax County, VA	4400006644
Cintas Corporation	Facilities Management Products and Solutions	12/13/2018	10/31/2023	10/31/2027	Prince William County Public Schools, VA	R-88-19002
Tremco/Weatherproofing Technologies, National IPA	Roofing Products, Services, and Job-Order-Contracting(JOC) Services	03/01/2019	02/28/2022	02/28/2024	Region 4 ESC - TX	R180903
Acro Service Corporation	Staffing Services and Related Solutions	01/01/2017	12/31/2021	03/31/2026	Maricopa County, AZ	16111
Knoll	Furniture, Installation and Related Products & Services	01/01/2020	12/31/2024	12/31/2026	City of Charlotte, NC	2020000608
Knoll	Office Furniture and Related Services and Solutions	01/01/2013	12/31/2020	12/31/2020	Fairfax County, VA	4400003404
KONE Inc	Elevator, Chairlift and Platform Lift Maintenance & Repair and Related Services	10/01/2019	09/30/2024	09/30/2029	University of California, CA	2019001564
GameTime	Playground and Outdoor Fitness Equipment, Site Accessories, Surfacing, and Related Products and Services	01/01/2017	06/30/2022	06/30/2026	City of Charlotte, NC	2017001134
Haworth	Furniture, Installation and Related Products & Services	01/01/2020	12/31/2024	12/31/2026	City of Charlotte, NC	2020000606
Haworth	Office Furniture and Related Services and Solutions	01/01/2013	12/31/2020	12/31/2020	Fairfax County, VA	4400009402
Mythics, Inc.	Oracle Products and Services	01/01/2020	12/31/2021	12/31/2024	Region 4 ESC - TX	R190801
Mythics, Inc.	Oracle Products and Services	12/12/2018	11/30/2023	11/30/2028	Maricopa County, AZ	180233.002
Canon Solutions America	Multi-Function Copier Devices and Service Solutions	10/01/2018	09/30/2023	09/30/2023	County of DuPage, IL	18-020-LG
Advance Auto Parts	Automotive Parts & Supplies	01/01/2017	12/31/2021	12/31/2023	City of Charlotte, NC	2017000280
School Specialty	Athletic and Physical Education Supplies and Uniforms	10/01/2015	12/31/2020	12/31/2020	Region 4 ESC - TX	R151103
School Specialty	Educational School Supplies	07/01/2019	06/30/2022	06/30/2024	Region 4 ESC - TX	R190503
School Specialty	Furniture, Installation and Related Services	05/01/2020	04/30/2023	04/30/2025	Region 4 ESC - TX	R191815
National Office Furniture	System Furniture and Related Services	04/01/2016	03/31/2021	03/31/2021	County of DuPage, IL	P15-150-DT
National Office Furniture	Furniture, Installation and Related Services	05/01/2020	04/30/2023	04/30/2025	Region 4 ESC - TX	R191811
UNICOM Government, Inc.	Technology Products, Services, Solutions and Related Products and Services	05/01/2016	04/30/2021	04/30/2023	Fairfax County, VA	4400006645
MeTEOR Education	Furniture and Installation	05/01/2015	10/31/2020	10/31/2020	Region 4 ESC - TX	R142203

Michaels Stores, Inc.	Omnia Partners	Arts, Crafts, Framing, and Related Services	04/01/2020	03/31/2023	03/31/2025	Harford County Public Schools, MD	20-SEH-20
HON Company	Omnia Partners	Furniture, Installation and Related Services	05/01/2020	04/30/2023	04/30/2025	Region 4 ESC - TX	R191804
HON Company	National IPA	Furniture and Installation	05/01/2015	10/31/2020	10/31/2020	Region 4 ESC - TX	R142208
Toro	National IPA	Grounds Maintenance Equipment, Parts, Accessories, Supplies, Related Services, and Equipment	04/01/2017	03/31/2022	03/31/2024	City of Mesa, AZ	2017025
Safeware	US Communities	Public Safety and Emergency Preparedness and Related Service	10/01/2018	09/30/2023	09/30/2028	Fairfax County, VA	4400008468
Mallory	US Communities	Public Safety and Emergency Preparedness and Related Service	10/01/2018	09/30/2023	09/30/2028	Fairfax County, VA	4400008495
EPIC Business Essentials	Omnia Partners	Office Supplies	06/01/2019	05/31/2024	05/31/2029	Region 4 ESC - TX	R190301
Herc Rentals Inc.	US Communities	Equipment Rentals and Related Products and Services	11/01/2018	10/31/2023	10/31/2027	City of Charlotte, NC	2019000318
Michelin North America, Inc.	Omnia Partners	Vehicle Tires, Accessories and Related Services	12/01/2019	11/30/2024	11/30/2029	City of Mesa, AZ	2019209
Daikin Applied	Omnia Partners	HVAC Equipment, Installation, Service, & Related Products	10/01/2020	09/30/2023	09/30/2025	Region 4 ESC - TX	R200401
Daikin Applied	National IPA	HVAC Equipment, Installation, Service, & Related Products	10/01/2015	12/31/2020	12/31/2020	Region 4 ESC - TX	R150505
Connection	National IPA	Information Technology & Interactive Whiteboards	08/01/2016	07/31/2021	07/31/2021	Region 4 ESC - TX	R160202
ALC Schools	Omnia Partners	Alternative Student/Customer Transportation	01/01/2020	12/31/2022	12/31/2024	Region 4 ESC - TX	R190401
Toter	National IPA	Refuse and Recycling Container Solutions and Related Products, Equipment and Services	02/01/2018	01/31/2021	01/31/2023	City of Tucson, AZ	171717
Fastenal	National IPA	Maintenance, Repair, Operations (MRO) Supplies and Related Services	07/01/2018	06/30/2023	06/30/2025	University of California, CA	2018.000208
Fastenal	Omnia Partners	Maintenance, Repair & Operations (MRO) Supplies	04/01/2020	03/31/2023	03/31/2025	Region 4 ESC - TX	R192001
Lowe's Home Centers, Inc.	Omnia Partners	Maintenance, Repair and Operations (MRO) Supplies & Related Services	04/01/2020	03/31/2023	03/31/2025	Region 4 ESC - TX	R192006
DLT Solutions (Oracle)	US Communities	Oracle Products and Services	12/12/2018	11/30/2023	11/30/2028	Maricopa County, AZ	180233-001
AstroTurf Corporation	National IPA	Sports Surfaces, Installation, and Related Material	06/01/2017	05/31/2022	05/31/2022	Region 4 ESC - TX	R162201
Caterpillar	National IPA	Heavy Equipment Rental & Sales	05/01/2017	04/30/2021	04/30/2022	City of Tucson, AZ	161534
MeTEOR Education	Omnia Partners	Furniture, Installation and Related Services	05/01/2020	04/30/2023	04/30/2025	Region 4 ESC - TX	R191810
Kompan, Inc.	US Communities	Playground and Outdoor Fitness Equipment, Site Accessories, Surfacing, and Related Products and Services	01/01/2017	06/30/2022	06/30/2026	City of Charlotte, NC	2017001135
Kimball	Omnia Partners	Office Furniture	05/29/2020	04/30/2024	04/30/2029	University of California, CA	2019.001896
Kimball	National IPA	System Furniture and Related Services	04/01/2016	03/31/2021	03/31/2021	County of DuPage, IL	P15-150-DT
ThyssenKrupp Elevator Corporation	Omnia Partners	Elevator Industry Equipment, Repair, Related Products and Services	10/01/2020	09/30/2023	09/30/2025	Region 4 ESC - TX	R200502
ThyssenKrupp Elevator Corporation	National IPA	Elevator Equipment, Service, Repair and Related Services	09/01/2015	12/31/2020	12/31/2020	Region 4 ESC - TX	R150801
AutoZone	National IPA	Automotive Parts and Supplies	05/01/2017	04/30/2022	04/30/2022	Region 4 ESC - TX	R170201
Vaughn Construction	Omnia Partners	Job Order Contracting Services	05/01/2020	04/30/2022	04/30/2025	Region 4 ESC - TX	R200107

Vaughn Construction	National IPA	Job Order Contracting (TX)	11/01/2016	10/31/2021	Region 4 ESC - TX	R160405
Club Car, LLC	Omnia Partners	Utility, Transportation and Golf Vehicles Plus Related Accessories, Equipment, Parts and Services	01/01/2020	12/31/2030	City of Kansas City, MO	EV2671-01
VS America, Inc.	National IPA	Furniture and Installation	05/01/2015	10/31/2020	Region 4 ESC - TX	R142216
B&H Photo & Electronics Corp.	National IPA	Audio Visual Equipment, Accessories and Services	10/01/2016	09/30/2021	Region 4 ESC - TX	R160901
HP Inc.	National IPA	Technology and Interactive Whiteboard Solutions Products and Services	08/01/2016	07/31/2021	Region 4 ESC - TX	R160203
Kronos Incorporated	US Communities	Workforce Management Systems and Related Products, Services and Solutions	03/18/2019	03/17/2022	Cobb County, GA	18220 and 18221
Konica Minolta	Omnia Partners	Copiers and Printers	06/01/2020	05/31/2023	Region 4 ESC - TX	R191101
BSN SPORTS	Omnia Partners	Athletic, Physical Education Supplies, and Team Uniforms	10/01/2020	09/30/2023	Region 4 ESC - TX	R201101
BSN SPORTS	National IPA	Athletic & P.E. Supplies and Team Uniforms	10/01/2016	09/30/2021	Region 4 ESC - TX	R160701
Sunbelt Rentals, Inc.	Omnia Partners	Equipment and Tool Rental Services	11/01/2020	10/31/2023	Region 4 ESC - TX	R200601
Sunbelt Rentals, Inc.	National IPA	Equipment & Tool Rental Services	11/01/2015	10/31/2020	Region 4 ESC - TX	R151501
Allsteel	National IPA	System Furniture and Related Services	04/01/2016	03/31/2021	County of DuPage, IL	P15-150-DT
TDIndustries	Omnia Partners	HVAC Equipment, Installation, Services & Related Products	10/01/2020	09/30/2023	Region 4 ESC - TX	R200403
TDIndustries	National IPA	HVAC Equipment, Installation, Service & Related Products	10/01/2015	12/31/2020	Region 4 ESC - TX	R150501
TCG Consulting, LP / First Financial	National IPA	Employee Benefits and Retirement Enrollment	07/01/2018	06/30/2022	Region 4 ESC - TX	R180801
Applied Industrial Technologies Inc.	US Communities	Administrative Services Industrial Supplies	02/01/2017	12/31/2021	Maricopa County, AZ	16154
RingCentral	Omnia Partners	Unified Communications as a Service (UCaaS)	10/01/2020	09/30/2023	Region 4 ESC - TX	R200902
Teknion	National IPA	Furniture and Installation	05/01/2015	10/31/2020	Region 4 ESC - TX	R142214
Teknion	Omnia Partners	Furniture, Installation and Related Services	05/01/2020	04/30/2023	Region 4 ESC - TX	R191816
Teknion	Omnia Partners	Furniture, Installation and Related Products & Services	01/01/2020	12/31/2024	City of Charlotte, NC	2020000610
ThunderCat Technology	Omnia Partners	Cyber Security Solutions and Associated Products & Services	10/01/2020	09/30/2023	Region 4 ESC - TX	R200804
Schindler Elevator Corporation	Omnia Partners	Elevator Industry Equipment, Repair, Related Products and Services	10/01/2020	09/30/2023	Region 4 ESC - TX	R200501
vCloud Tech	Omnia Partners	Cyber Security Solutions and Associated Products & Services	10/01/2020	09/30/2023	Region 4 ESC - TX	R200805
SYNNEX Corporation	Omnia Partners	Cyber Security Solutions and Associated Products & Services	10/01/2020	09/30/2023	Region 4 ESC - TX	R200803
Iron Bow Technologies	Omnia Partners	Cyber Security Solutions and Associated Products & Services	10/01/2020	09/30/2023	Region 4 ESC - TX	R200802
Alvarez & Marsal	US Communities	Public Sector Consulting	04/29/2015	04/28/2021	Fairfax County, VA	4400005869
Daktronics	National IPA	Scoreboards and Electronic Signs	05/01/2017	04/30/2022	Region 4 ESC - TX	R170101
OF5 Brands Holdings, Inc.	Omnia Partners	Furniture, Installation and Related Services	05/01/2020	04/30/2023	Region 4 ESC - TX	R191813

Fisher Science Education	US Communities	Science/Labware Supplies and Equipment for K-12, Community Colleges, Higher Education and Other Public	07/01/2015	06/30/2022	06/30/2022	Harford County Public Schools, MD	C15-JL-12
BCI Burke Company, LLC	National IPA	Playground Systems, Installation, Service and Related Items	05/01/2017	04/30/2022	04/30/2022	Region 4 ESC - TX	R170301
Tradition Energy	US Communities	Comprehensive Energy Consulting and Management Services	08/01/2013	05/16/2021	05/16/2026	City of Mesquite, TX	2018-017
Pocket Nurse	Omnia Partners	Chemistry, Biology, Physics and Anatomy Instructional Supplies & Services	07/01/2019	06/30/2022	06/30/2024	Region 4 ESC - TX	R190201
Rehrig Pacific Company	US Communities	Waste Carts, Recycling Carts, Cart Parts, Bins and Related Products and Services	10/05/2016	09/30/2021	09/30/2026	Miami-Dade County, FL	254
OTIS Elevator Company	Omnia Partners	Elevator, Escalator, Chairlift and Platform Lift Maintenance & Repair and Related Services	10/01/2019	09/30/2024	09/30/2029	University of California, CA	2019001563
RoofConnect	National IPA	Roofing Products, Services, and Job-Order-Contracting(JOC) Services	03/01/2019	02/28/2022	02/28/2024	Region 4 ESC - TX	R180902
Carahsoft Technology Corp.	Omnia Partners	Educational Software Solutions and Services	05/01/2020	04/30/2023	04/30/2025	Region 4 ESC - TX	R191902
Ridwell	Omnia Partners	Athletic, Physical Education Supplies, and Team Uniforms	10/01/2020	09/30/2023	09/30/2025	Region 4 ESC - TX	R201102
Skanska USA Building Inc.	National IPA	Job Order Contracting (TX)	11/01/2016	10/31/2021	10/31/2021	Region 4 ESC - TX	R160406
FieldTurf USA, Inc.	National IPA	Sports Surfaces, Installation and Related Materials (National)	06/01/2017	05/31/2022	05/31/2022	Region 4 ESC - TX	R162203
Lawson Products, Inc.	Omnia Partners	Maintenance, Repair & Operations (MRO) Supplies	04/01/2020	03/31/2023	03/31/2025	Region 4 ESC - TX	R192005
Anixter, Inc.	National IPA	Cabling and Networking Products & Solutions	04/01/2017	03/31/2022	03/31/2022	Region 4 ESC - TX	R161701
Granite Telecommunications	Omnia Partners	Unified Communications as a Service (UCaaS)	10/01/2020	09/30/2023	09/30/2025	Region 4 ESC - TX	R200901
Schneider Electric	National IPA	Energy Performance Contracting Services	03/01/2018	02/28/2021	02/28/2021	Region 4 ESC - TX	R171202
Tarkett (formerly Tandiv Centiva US LLC	Omnia Partners	Systemwide Flooring	04/15/2020	04/14/2025	04/14/2030	University of California, CA	2020002143
Shaw Industries	Omnia Partners	Systemwide Flooring	04/15/2020	04/14/2025	04/14/2030	University of California, CA	2020002144
Milliken	Omnia Partners	Systemwide Flooring	04/15/2020	04/14/2025	04/14/2030	University of California, CA	2020002150
Belfor USA Group, Inc.	National IPA	Disaster Restoration of Operation Services	04/01/2015	12/31/2020	12/31/2020	Region 4 ESC - TX	R142501
Belfor USA Group, Inc.	Omnia Partners	Disaster and Non-Disaster Restoration of Operational Services	05/01/2020	04/30/2022	04/30/2025	Region 4 ESC - TX	R191601
Belfor USA Group, Inc.	Omnia Partners	Job Order Contracting Services	05/01/2020	04/30/2022	04/30/2025	Region 4 ESC - TX	R200101
CORE Construction	Omnia Partners	Disaster and Non-Disaster Restoration of Operational Services	05/01/2020	04/30/2022	04/30/2025	Region 4 ESC - TX	R191604
DKI Restoration	Omnia Partners	Disaster and Non-Disaster Restoration of Operational Services	05/01/2020	04/30/2022	04/30/2025	Region 4 ESC - TX	R191606
Panasonic	National IPA	Mobile Computing Solutions Including Ruggedized Laptops, Tablets, Accessories and Related Technology Products and Furniture, Installation and Related Products & Services	10/11/2017	10/09/2021	10/10/2022	City of Tucson, AZ	171725-01
Exemplis LLC (SitOnIt Seating, IDEON, Sy	Omnia Partners	Furniture, Installation and Related Products & Services	01/01/2020	12/31/2024	12/31/2026	City of Charlotte, NC	2020000604
Xerox Corporation	National IPA	Managed Print Solutions	03/01/2018	02/28/2022	02/28/2023	Region 4 ESC - TX	R171406
Johnson Controls	Omnia Partners	HVAC Equipment, Installation, Services & Related Products	10/01/2020	09/30/2023	09/30/2025	Region 4 ESC - TX	R200402
Office Depot	Omnia Partners	Janitorial Supplies & Equipment	04/27/2020	04/26/2027	04/26/2030	University of California, CA	2020002300

Office Depot	National IPA	Furniture and Installation	05/01/2015	10/31/2020	10/31/2020	Region 4 ESC - TX	R142212
Office Depot	National IPA	Janitorial Supplies, Equipment, Maintenance and Repair	03/01/2017	02/28/2022	02/28/2022	Region 4 ESC - TX	R162102
Office Depot	National IPA	Technology & Interactive Whiteboard Solutions Products & Services	08/01/2016	07/31/2021	07/31/2021	Region 4 ESC - TX	R160204
Office Depot	National IPA	Managed Print Solutions	03/01/2018	02/28/2022	02/28/2023	Region 4 ESC - TX	R171404
Office Depot	Omnia Partners	Educational School Supplies	07/01/2019	06/30/2022	06/30/2024	Region 4 ESC - TX	R190502
Office Depot	National IPA	Office and Educational Supplies	01/01/2016	12/31/2023	12/31/2023	Oregon State University, OR	JP156810
Office Depot	Omnia Partners	Office Supplies, Products and Related Services	10/14/2019	10/13/2023	10/13/2027	City of Tamarac, FL	19-12R
The Home Depot Pro	US Communities	Paint and Paint Supplies	03/09/2017	02/28/2025	02/28/2027	MariCopa County, AZ	170009
CDW-G	National IPA	Technology and Interactive White Boards	08/01/2016	07/31/2021	07/31/2021	Region 4 ESC - TX	R160201
CDW-G	National IPA	Total Cloud Solutions	10/01/2017	09/30/2021	09/30/2022	Region 4 ESC - TX	R171001
Trendway Corporation	Omnia Partners	Furniture, Installation and Related Services	05/01/2020	04/30/2023	04/30/2025	Region 4 ESC - TX	R191817
Lakeshore Learning Materials	Omnia Partners	Educational School Supplies	07/01/2019	06/30/2022	06/30/2024	Region 4 ESC - TX	R190501
Sterling	Omnia Partners	Pre-Employment Background Screening, Related Products and Services	01/01/2020	12/31/2022	12/31/2024	Region 4 ESC - TX	R191303
ServiceWear Apparel, Inc.	National IPA	Apparel, Uniforms, Accessories, Product and Services	11/01/2016	10/31/2021	10/31/2021	Region 4 ESC - TX	R160801
VS America, Inc.	Omnia Partners	Furniture, Installation and Related Services	05/01/2020	04/30/2023	04/30/2025	Region 4 ESC - TX	R191818
22nd Century Technologies, Inc.	Omnia Partners	Non IT Temporary Labor Services	01/01/2020	12/31/2024	12/31/2026	University of California, CA	2019-001919
Accruent, LLC	National IPA	Facilities Management Software & Solutions	04/01/2017	03/31/2022	03/31/2022	Region 4 ESC - TX	R161801
Accurate Background, LLC	Omnia Partners	Pre-Employment Background Screening, Related Products and Services	01/01/2020	12/31/2022	12/31/2024	Region 4 ESC - TX	R191301
Adjusters International	Omnia Partners	Risk Preparedness and Claims Recovery Services	05/01/2020	04/30/2022	04/30/2025	Region 4 ESC - TX	R191501
Adjusters International	National IPA	Risk Preparedness and Consulting Services	04/01/2015	12/31/2020	12/31/2020	Region 4 ESC - TX	R142401
ADP	National IPA	Managed Business/Operational Services and Solutions	05/01/2016	04/30/2021	04/30/2021	Region 4 ESC - TX	R151901
ADP	Omnia Partners	Pre-Employment Background Screening, Related Products and Services	01/01/2020	12/31/2022	12/31/2024	Region 4 ESC - TX	R191302
AGCO Corporation	US Communities	Tractors, Implements and Related Parts and Services	05/15/2017	05/14/2021	05/14/2022	Cobb County, GA	17-6221
Agile Mind	Omnia Partners	Educational Software Solutions and Services	05/01/2020	04/30/2023	04/30/2025	Region 4 ESC - TX	R191901
Affordable Interior Systems, Inc. (AIS)	Omnia Partners	Furniture, Installation and Related Services	05/01/2020	04/30/2023	04/30/2025	Region 4 ESC - TX	R191801
Allsteel	Omnia Partners	Furniture, Installation and Related Services	05/01/2020	04/30/2023	04/30/2025	Region 4 ESC - TX	R191802
Allsteel	National IPA	Furniture and Installation	05/01/2015	10/31/2020	10/31/2020	Region 4 ESC - TX	R142201
Alpha Building Corporation	National IPA	Job Order Contracting (TX)	11/01/2016	10/31/2020	10/31/2021	Region 4 ESC - TX	R160401

AMPLEXOR, Inc.	National IPA	Language Service Providers and Related Services	07/01/2018	06/30/2022	06/30/2023	Region 4 ESC - TX	R180701
Anixter, Inc.	National IPA	Security System Services	07/01/2017	06/30/2022	06/30/2022	Region 4 ESC - TX	R170501
Ardham Technologies	Omnia Partners	Software Solutions and Services	02/01/2015	12/31/2022	12/31/2024	Region 4 ESC - TX	R190901
Articobell Corporation	National IPA	Furniture and Installation	05/01/2015	10/31/2020	10/31/2020	Region 4 ESC - TX	R142202
AVI-SPL	Omnia Partners	Audio Visual Goods and Services	11/10/2019	11/08/2024	11/08/2027	University of California, CA	2019.001535
Axon	National IPA	Body Worn Cameras and Storage System	07/28/2016	01/31/2021	01/31/2021	City of Tucson, AZ	151089
Beil Equipment Company	National IPA	Street Sweepers, Parts, Accessories, Supplies, Related Services and Equipment	04/11/2017	04/10/2021	04/10/2022	City of Rochester Hills, MI	RH-16-045
Bentley Mills	Omnia Partners	Systemwide Flooring	04/15/2020	04/14/2025	04/14/2030	University of California, CA	2020002146
BI Incorporated	US Communities	Offender Monitoring Services	02/01/2014	01/31/2022	01/31/2024	City and County of Denver, CO	201844994
Big Truck Rental LLC	US Communities	Equipment Rentals and Related Products and Services	11/01/2018	10/31/2023	10/31/2027	City of Charlotte, NC	2019000319
BMK Ventures, Inc.	Omnia Partners	Bleeding Control Kits and Related Hemorrhage Control Products and Services	01/01/2020	12/31/2022	12/31/2024	Region 4 ESC - TX	R200201
Bob Barker Co	National IPA	Inmate and Detention Supplies, Solutions and Services	10/05/2016	10/04/2021	10/04/2021	County of Sacramento, CA	WA00034777
Brown & Root	Omnia Partners	Job Order Contracting Services	05/01/2020	04/30/2022	04/30/2025	Region 4 ESC - TX	R200102
Brown & Root	Omnia Partners	Disaster and Non-Disaster Restoration of Operational Services	05/01/2020	04/30/2022	04/30/2025	Region 4 ESC - TX	R191603
Brown & Root	National IPA	Job Order Contracting (TX)	11/01/2016	10/31/2021	10/31/2021	Region 4 ESC - TX	R160402
Canon Solutions America	National IPA	Managed Print Solutions	03/01/2018	02/28/2022	02/28/2023	Region 4 ESC - TX	R171401
Carahsoft Technology Corp.	US Communities	Google Products, Services and Solutions	05/01/2016	04/30/2021	04/30/2023	Fairfax County, VA	4400006642
CKEUSA	National IPA	Foodservice Equipment, Smallwares, Parts, Design and/or Installation	03/01/2018	02/28/2021	02/28/2023	Region 4 ESC - TX	R180201
Cleerwing Systems Integration, LLC	National IPA	Audio Visual Equipment, Accessories and Services	10/01/2016	09/30/2021	09/30/2021	Region 4 ESC - TX	R160902
Columbia	Omnia Partners	Utility, Transportation and Golf Vehicles plus Related Accessories, Equipment, Parts and Services	01/01/2020	12/31/2026	12/31/2030	City of Kansas City, MO	EV2671
CORE Construction	Omnia Partners	Job Order Contracting Services	05/01/2020	04/30/2022	04/30/2025	Region 4 ESC - TX	R200103
Comfort Systems USA	National IPA	HVAC Equipment, Installation, Service, & Related Products	10/01/2015	12/31/2020	12/31/2020	Region 4 ESC - TX	R150504
Companion Data Services	National IPA	Enterprise Content Management Solutions	10/01/2018	09/30/2021	09/30/2023	Region 4 ESC - TX	R180501
Comprehensive Risk Services, LLC	National IPA	Disaster Restoration of Operation Services	04/01/2015	12/31/2020	12/31/2020	Region 4 ESC - TX	R142503
Con10gency Consulting, LLC.	Omnia Partners	Bleeding Control Kits and Related Hemorrhage Control Products and Services	01/01/2020	12/31/2022	12/31/2024	Region 4 ESC - TX	R200202
Continental Flooring Company	National IPA	Commercial Floor Coverings	07/01/2018	06/30/2022	06/30/2023	Region 4 ESC - TX	R171701
Convergint Technologies LLC	National IPA	Facility Technology Integration	07/01/2017	06/30/2022	06/30/2022	Region 4 ESC - TX	R170601
Convergint Technologies LLC	National IPA	Security System Services	07/01/2017	06/30/2022	06/30/2022	Region 4 ESC - TX	R170502

Toshiba	Omnia Partners	Copiers and Printers	06/01/2020	05/31/2023	05/31/2025	Region 4 ESC - TX	R191103
Corby Energy Services, Inc.	National IPA	Trenchless Technology Rehabilitation and Related Products and Services	05/01/2017	04/30/2022	04/30/2022	Region 4 ESC - TX	R170801
Colton Commercial USA, Inc.	National IPA	Disaster Restoration of Operation Services	04/01/2015	12/31/2020	12/31/2020	Region 4 ESC - TX	R142504
Colton Commercial USA, Inc.	Omnia Partners	Disaster and Non-Disaster Restoration of Operational Services	05/01/2020	04/30/2022	04/30/2025	Region 4 ESC - TX	R191605
Crabtree Interpreting Services	National IPA	Language Service Providers and Related Services	07/01/2018	06/30/2021	06/30/2023	Region 4 ESC - TX	R180702
DIRTT Environmental Solutions	National IPA	Movable Wall Systems	04/01/2018	03/31/2022	03/31/2023	Region 4 ESC - TX	R180101
DLT Solutions (Amazon Web Services)	US Communities	Technology Products, Services, Solutions and Related Products and Services (Amazon Web Services)	05/01/2016	04/30/2021	04/30/2023	Fairfax County, VA	4400006643
DLT Solutions (Software Solutions)	Omnia Partners	Software Solutions and Services	01/01/2020	12/31/2022	12/31/2024	Region 4 ESC - TX	R190902
Dude Solutions	National IPA	Facilities Management Software and Solutions	04/01/2017	03/31/2022	03/31/2022	Region 4 ESC - TX	R161802
E-Z-GO and Cushman	National IPA	Golf, Utility and Hospitality Carts, Parts, Accessories, Supplies and Related Services	01/01/2017	12/31/2021	12/31/2021	Region 4 ESC - TX	R161101
edmentum (formerly PLATO)	Omnia Partners	Educational Software Solutions and Services	05/01/2020	04/30/2023	04/30/2025	Region 4 ESC - TX	R191903
Elevate K-12	National IPA	General Tutoring Services	03/01/2016	02/28/2021	02/28/2021	Region 4 ESC - TX	R152001
Elite Sports Builders	National IPA	Sports Surfaces, Installation and Related Material (AZ, CA, CO, NM, NV, and TX)	10/01/2017	09/30/2021	09/30/2022	Region 4 ESC - TX	R171102
Enwork	Omnia Partners	Furniture, Installation and Related Services	09/01/2020	04/30/2023	04/30/2025	Region 4 ESC - TX	R191819
Enwork	National IPA	Furniture and Installation	05/01/2015	10/31/2020	10/31/2020	Region 4 ESC - TX	R142204
ESI, a division of Fellowes, Inc	National IPA	Ergonomic Solutions	04/01/2018	03/31/2022	03/31/2023	Region 4 ESC - TX	R180401
Exemplis LLC (SitOnit Seating, IDEON, Sy	Omnia Partners	Furniture, Installation and Related Services	05/01/2020	04/30/2023	04/30/2025	Region 4 ESC - TX	R191803
Exemplis LLC (SitOnit Seating, IDEON, Sy	National IPA	Furniture and Installation	05/01/2015	10/31/2020	10/31/2020	Region 4 ESC - TX	R142205
EZ Access	National IPA	Modular Aluminum Walkway Systems	03/01/2018	02/28/2022	02/28/2023	Region 4 ESC - TX	R171602
Facilities Sources (formerly Dura Pier)	Omnia Partners	Job Order Contracting Services	05/01/2020	04/30/2022	04/30/2025	Region 4 ESC - TX	R200104
Facilities Sources (formerly Dura Pier)	National IPA	Job Order Contracting (TX)	11/01/2016	10/31/2020	10/31/2020	Region 4 ESC - TX	R160403
Fairfax Imaging	National IPA	Online Registration and Automated Payment Solutions	01/01/2019	12/31/2021	12/31/2024	Region 4 ESC - TX	R190102
Farber Specialty Vehicles	US Communities	Emergency and Specialty Vehicles, Equipment and Accessories and Any Related Equipment, Supplies and Sports Surfaces, Installation and Related Material (AZ)	06/01/2016	05/31/2021	05/31/2021	Port of Portland, OR	128867
FieldTurf USA, Inc.	National IPA	Sports Surfaces, Installation and Related Material (AZ)	10/01/2017	09/30/2021	09/30/2021	Region 4 ESC - TX	R171103
FleetCor Technologies dba Fuelman	National IPA	Fuel Card Services and Related Products	04/01/2017	03/31/2022	03/31/2022	Region 4 ESC - TX	R161501
Frey Scientific	Omnia Partners	Chemistry, Biology, Physics and Anatomy Instructional Supplies & Services	07/01/2019	06/30/2022	06/30/2024	Region 4 ESC - TX	R190202
Gonzalez Office Products	Omnia Partners	Office Supplies	06/01/2019	05/31/2024	05/31/2029	Region 4 ESC - TX	R190302
Gopher Sport	US Communities	Athletic & P. E. Supplies, Equipment and Related Products	10/01/2016	09/30/2021	09/30/2023	Harford County Public Schools, MD	C16-SRD-010

GovDeals, Inc.	Omnia Partners	Auctioneer Services and Related Products	01/01/2020	01/31/2023	01/31/2025	Region 4 ESC - TX	R190601
Gunlocke	National IPA	Furniture and Installation	05/01/2015	10/31/2020	10/31/2020	Region 4 ESC - TX	R142206
HACI Service	National IPA	HVAC Equipment, Installation, Service, & Related Products	10/01/2015	12/31/2020	12/31/2020	Region 4 ESC - TX	R150506
HARBRO, Inc.	Omnia Partners	Disaster and Non-Disaster Restoration of Operational Services	05/01/2020	04/30/2022	04/30/2025	Region 4 ESC - TX	R191607
Harrell's	National IPA	Groundskeeping Materials - Fertilizer, Pesticide, Herbicide, Grass Seed and Related Items	12/01/2018	11/30/2021	11/30/2023	City of Rochester Hills, MI	RFP-RH-18-014
Hertz Furniture	National IPA	Furniture and Installation	05/01/2015	10/31/2020	10/31/2020	Region 4 ESC - TX	R142207
Hi-Line Electric	Omnia Partners	Maintenance, Repair and Operations (MRO) Supplies & Related Services	04/01/2020	03/31/2023	03/31/2025	Region 4 ESC - TX	R192003
HITT Contracting Inc.	Omnia Partners	Job Order Contracting Services	05/01/2020	04/30/2022	04/30/2025	Region 4 ESC - TX	R200105
HOIN Company	National IPA	Ergonomic Solutions	04/01/2018	03/31/2022	03/31/2023	Region 4 ESC - TX	R180403
Honeywell	National IPA	Energy Performance Contracting Services	03/01/2018	02/28/2022	02/28/2023	Region 4 ESC - TX	R171201
HP Inc.	National IPA	Managed Print Solutions	03/01/2018	02/28/2022	02/28/2023	Region 4 ESC - TX	R171402
HumanWare	National IPA	Assistive Technology Products & Services	11/01/2018	10/31/2021	10/31/2023	Region 4 ESC - TX	R180601
Hyland Software, Inc.	Omnia Partners	Software Solutions and Services	01/01/2020	12/31/2022	12/31/2024	Region 4 ESC - TX	R190904
imixGroup (formerly EC America)	Omnia Partners	Software Solutions and Services	01/01/2020	12/31/2022	12/31/2024	Region 4 ESC - TX	R190903
Interface Americas, Inc.	Omnia Partners	Systemwide Flooring	04/15/2020	04/14/2025	04/14/2030	University of California, CA	2020002145
Irwin Seating Company	Omnia Partners	Furniture, Installation and Related Services	05/01/2020	04/30/2023	04/30/2025	Region 4 ESC - TX	R191805
JSI	Omnia Partners	Furniture, Installation and Related Services	05/01/2020	04/30/2023	04/30/2025	Region 4 ESC - TX	R191806
JSI	National IPA	Furniture and Installation	05/01/2015	10/31/2020	10/31/2020	Region 4 ESC - TX	R142217
K12 Insight	National IPA	Feedback and Customer Service Solutions for Schools	04/01/2017	03/31/2022	03/31/2022	Region 4 ESC - TX	R170401
Kaplan Early Learning Company	Omnia Partners	Furniture, Installation and Related Services	05/01/2020	04/30/2023	04/30/2025	Region 4 ESC - TX	R191807
KEV Group	National IPA	Online Registration and Automated Payment Solutions	01/01/2019	12/31/2021	12/31/2024	Region 4 ESC - TX	R190103
Key Code Media	Omnia Partners	Audio Visual Goods and Services	09/01/2019	08/31/2024	08/31/2027	University of California, CA	2019.001407
Kimball Midwest	Omnia Partners	Maintenance, Repair & Operations (MRO) Supplies	04/01/2020	03/31/2023	03/31/2025	Region 4 ESC - TX	R192004
KONE Inc	US Communities	Elevator, Escalator and Walkway Maintenance and Modernization Services and Related Solutions	12/01/2018	11/30/2024	11/30/2029	City of Kansas City, MO	EV2516
Kratos Public Safety & Security Solutions	National IPA	Security Services (Supplemental)	03/01/2018	02/28/2021	02/28/2021	Region 4 ESC - TX	R171301
Krueger International (KI)	Omnia Partners	Furniture, Installation and Related Services	05/01/2020	04/30/2023	04/30/2025	Region 4 ESC - TX	R191808
Krueger International (KI)	National IPA	Ergonomic Solutions	04/01/2018	03/31/2022	03/31/2023	Region 4 ESC - TX	R180402
Krueger International (KI)	National IPA	Furniture and Installation	05/01/2015	10/31/2020	10/31/2020	Region 4 ESC - TX	R142210

Kyocera Document Solutions America, Ir Omnia Partners	Copiers and Printers	06/01/2020	05/31/2023	05/31/2025	Region 4 ESC - TX	R191102
Landscape Structures Inc.	Playground Systems, Installation, Service and Related Items	05/01/2017	04/30/2022	04/30/2022	Region 4 ESC - TX	R170302
Language Line Services, Inc	Language Service Providers and Related Services	07/01/2018	06/30/2022	06/30/2023	Region 4 ESC - TX	R180703
Lemons Auctioneer, LLC & Online Pros	Auctioneer Services and Related Products	02/01/2020	01/31/2023	01/31/2025	Region 4 ESC - TX	R190602
Lerch Bates Inc.	Elevator Services, Repair, Maintenance, Inspection/Testing, Parts, and Modernization	10/01/2019	09/30/2024	09/30/2029	University of California, CA	2019001568
Leslie's Poolmart	Swimming Pool Supplies, Including Chemicals, Equipment, and Related Services & Materials	07/25/2019	07/24/2021	07/24/2024	City of Tucson, AZ	192051-02
Lexmark International, Inc.	Managed Print Solutions	03/01/2018	02/28/2022	02/28/2023	Region 4 ESC - TX	R171403
Lightspeed Technologies, Inc.	Assistive Technology Products & Services	11/01/2018	10/31/2021	10/31/2023	Region 4 ESC - TX	R180602
Lionbridge Global Solutions II, Inc.	Language Service Providers and Related Services	07/01/2018	06/30/2022	06/30/2023	Region 4 ESC - TX	R180704
Lone Star Auctioneers, Inc.	Auctioneer Services and Related Products	02/01/2020	01/31/2023	01/31/2025	Region 4 ESC - TX	R190603
Mackin Educational Resource	Books (Conventional/eBooks) and Related Services	08/01/2017	07/31/2021	07/31/2022	Region 4 ESC - TX	R170704
Mahindra USA Inc.	Tractors, Implements and Related Parts and Services	05/15/2017	05/14/2021	05/14/2022	Cobb County, GA	17-6221
Mannington	Systemwide Flooring	04/15/2020	04/14/2025	04/14/2030	University of California, CA	2020002148
Mansfield Oil Co. of Gainesville, Inc.	Motor and Aviation Fuels and Related Services	01/01/2020	12/31/2020	12/31/2024	City of Fort Worth, TX	53315
Martin Eagle Oil Company, Inc.	Motor and Aviation Fuels and Related Services	01/01/2020	12/31/2020	12/31/2024	City of Fort Worth, TX	53315
MasterWord Services, Inc.	Language Service Providers and Related Services	07/01/2018	06/30/2022	06/30/2023	Region 4 ESC - TX	R180705
Maxon	Furniture, Installation and Related Services	05/01/2020	04/30/2023	04/30/2025	Region 4 ESC - TX	R191809
McGriff	Risk Preparedness and Claims Recovery Services	05/01/2020	04/30/2022	04/30/2025	Region 4 ESC - TX	R191502
McKinstry	Energy Savings Performance Contracting, Technical Energy Audit Services	12/01/2017	12/03/2028	12/03/2028	Port of Portland, OR	1158
Micro Integration	Security Services (Supplemental)	03/01/2018	02/28/2021	02/28/2021	Region 4 ESC - TX	R171302
Mohawk Carpet Distribution, Inc.	Systemwide Flooring	04/15/2020	04/14/2025	04/14/2030	University of California, CA	2020002149
Mohawk Carpet Distribution, Inc.	Commercial Floor Coverings	07/01/2018	06/30/2022	06/30/2023	Region 4 ESC - TX	R171702
Music & Arts	Performing Arts Apparel, Instruments, Furnishings, Storage and Related Services	11/01/2019	10/31/2022	10/31/2024	Region 4 ESC - TX	R191201
Mythics Emergent Group	Total Cloud Solutions	10/01/2017	09/30/2021	09/30/2022	Region 4 ESC - TX	R171002
National Restaurant Supply Co., Inc.	Foodservice Equipment, Smallwares, Parts, Design and/or Installation	03/01/2018	02/28/2021	02/28/2023	Region 4 ESC - TX	R180202
National Roofing Partners	Roofing Products, Services, and Job-Order-Contracting(JOC) Services	03/01/2019	02/28/2022	02/28/2024	Region 4 ESC - TX	R180961
Need These	Cabling and Networking Products & Solutions	04/01/2017	03/31/2022	03/31/2022	Region 4 ESC - TX	R161702
North American Lubricants	Auto Lubricants and Related Products	05/01/2017	04/30/2022	04/30/2024	City of Mesa, AZ	2017017

North American Rescue, LLC.	Omnia Partners	Bleeding Control Kits and Related Hemorrhage Control Products and Services	01/01/2020	12/31/2022	12/31/2024	Region 4 ESC - TX	R200203
Northern Safety Co., Inc.	Omnia Partners	Maintenance, Repair and Operations (MRO) Supplies & Related Services	04/01/2020	03/31/2023	03/31/2025	Region 4 ESC - TX	R192007
OTIS Elevator Company	National IPA	Elevator, Escalator, Lifts Maintenance, Repair and Related Services	08/05/2016	07/31/2021	07/31/2021	Metropolitan Government of Nashville, TN	384899
Petroleum Traders Corporation	Omnia Partners	Motor and Aviation Fuels and Related Services	01/01/2020	12/31/2020	12/31/2024	City of Fort Worth, TX	53315
Pinnacle Petroleum, Inc.	Omnia Partners	Motor and Aviation Fuels and Related Services	01/01/2020	12/31/2020	12/31/2024	City of Fort Worth, TX	53315
Play & Park Structures	National IPA	Playground Systems, Installation, Service and Related Items	05/01/2017	04/30/2022	04/30/2022	Region 4 ESC - TX	R170503
Playcraft Systems, a Playcore Company	National IPA	Playground Systems, Installation, Service and Related Items	05/01/2017	04/30/2022	04/30/2022	Region 4 ESC - TX	R170504
Premier - US Foods	US Communities	K-12 Food Products and Distribution	03/01/2019	05/31/2021	05/31/2027	Frederick County Public Schools, MD	19F51
Premier - US Foods	US Communities	Food Distribution Services and Products	02/01/2018	06/30/2023	06/30/2027	North Carolina State University, NC	42356
Premier Healthcare Alliance, L.P.	US Communities	Pharmaceutical, Medical Equipment, Supplies and Distribution	11/21/2014	12/31/2020	12/31/2020	Dane County, WI	12151
Prudential Overall Supply	National IPA	Rental of Uniforms: Floor Mats, Mops, and Towels and Related Services	10/06/2017	10/05/2021	10/05/2022	City of Tucson, AZ	171695
P5X Inc	National IPA	Security Services (Supplemental)	03/01/2018	02/28/2021	02/28/2021	Region 4 ESC - TX	R171303
Quill Corporation	Omnia Partners	Office Supplies	06/01/2019	05/31/2024	05/31/2029	Region 4 ESC - TX	R190304
RAE Security	National IPA	Security Services (Supplemental)	03/01/2018	02/28/2022	02/28/2023	Region 4 ESC - TX	R171304
REDD Team by Sapa	National IPA	Modular Aluminum Walkway Systems	03/01/2018	02/28/2022	02/28/2023	Region 4 ESC - TX	R171601
Renin	Omnia Partners	Non IT Temporary Labor Services	01/01/2020	12/31/2024	12/31/2026	University of California, CA	2019.001917
RPS Holdings, Inc.	National IPA	Video Conferencing Products and Services	05/01/2018	04/30/2022	04/30/2023	Region 4 ESC - TX	R180301
RS Commercial Construction	Omnia Partners	Job Order Contracting Services	05/01/2020	04/30/2022	04/30/2025	Region 4 ESC - TX	R200106
Safco Products Co.	Omnia Partners	Furniture, Installation and Related Services	05/01/2020	04/30/2023	04/30/2025	Region 4 ESC - TX	R191814
Safco Products Co.	National IPA	Furniture and Installation	05/01/2015	10/31/2020	10/31/2020	Region 4 ESC - TX	R142211
SAFEbuilt	Omnia Partners	On Call Plan Review Services	10/21/2015	10/20/2021	10/20/2021	City of Tucson, AZ	151310
SAK Construction	National IPA	Trenchless Technology Rehabilitation and Related Products and Services	05/01/2017	04/30/2022	04/30/2022	Region 4 ESC - TX	R170802
Samson Equipment, Inc.	Omnia Partners	Athletic, Physical Education Supplies, and Team Uniforms	10/01/2020	09/30/2023	09/30/2025	Region 4 ESC - TX	R201103
Samson Equipment, Inc.	National IPA	Athletic and Physical Education Supplies and Uniforms	10/01/2016	09/30/2021	09/30/2021	Region 4 ESC - TX	R160702
School Health Corporation	Omnia Partners	Athletic, Physical Education Supplies, and Team Uniforms	10/01/2020	09/30/2023	09/30/2025	Region 4 ESC - TX	R201104
Schneider Electric	National IPA	Facility Technology Integration	07/01/2017	06/30/2022	06/30/2022	Region 4 ESC - TX	R170602
Schneider Electric	National IPA	Security System Services	07/01/2017	06/30/2022	06/30/2022	Region 4 ESC - TX	R170504
Separation Systems Consultants, Inc.	National IPA	Landscaping and Grounds Maintenance Services	12/01/2017	11/30/2020	11/30/2020	Region 4 ESC - TX	R171501

Shred-It USA LLC.	US Communities	Document and Media Destruction Services	05/15/2018	05/14/2021	05/14/2024	Cobb County, GA	18-6320
Social Sentinel, Inc.	National IPA	Social Media Monitoring Products & Services	11/01/2018	10/31/2021	10/31/2023	Region 4 ESC - TX	R181002
Soft HQ, Inc.	Omnia Partners	Non IT Temporary Labor Services	01/01/2020	12/31/2024	12/31/2026	University of California, CA	2019.001934
Solenis	National IPA	Water Treatment Chemicals-Polymers	05/14/2015	11/30/2020	11/30/2020	City of Las Vegas, NV	150001-SK
SouthEast Texas Regional Advisory Coun	Omnia Partners	Bleeding Control Kits and Related Hemorrhage Control Products and Services	01/01/2020	12/31/2022	12/31/2024	Region 4 ESC - TX	R200204
Southeastern Equipment Co., Inc.	National IPA	Combination Sewer Trucks, Parts, Accessories, Supplies, Related Services and Related Equipment	05/18/2016	04/30/2021	04/30/2021	City of Rochester Hills, MI	RH-15-034
SpaceSaver	National IPA	System Furniture and Related Services	04/01/2016	03/31/2021	03/31/2021	County of DuPage, IL	P15-150-DT
Sport Surface Specialties LLC	National IPA	Sports Surfaces, Installation and Related Materials	06/01/2017	05/31/2022	05/31/2022	Region 4 ESC - TX	R162204
St. Paul Linoleum & Carpet	National IPA	Flooring and Outdoor Surface Solutions	06/01/2015	05/31/2021	05/31/2021	Region 4 ESC - TX	R150103
Stanbury Uniforms	Omnia Partners	Performing Arts Apparel, Instruments, Furnishings, Storage and Related Services	11/01/2019	10/31/2022	10/31/2024	Region 4 ESC - TX	R191202
Stantec	Omnia Partners	On Call Plan Review Services	10/21/2015	10/20/2021	10/20/2021	City of Tucson, AZ	151310
Sun Mechanical	National IPA	HVAC Equipment, Installation, Service, & Related Products	10/01/2015	12/31/2020	12/31/2020	Region 4 ESC - TX	R150509
Sunstate Mechanical Services, LLC	National IPA	HVAC Equipment, Installation, Service, & Related Products	10/01/2015	12/31/2020	12/31/2020	Region 4 ESC - TX	R150503
Tarkett (formerly Tandus Centiva US LLC	National IPA	Commercial Floor Coverings	07/01/2018	06/30/2022	06/30/2023	Region 4 ESC - TX	R171703
Thatcher Chemicals	National IPA	Water Treatment Chemicals	07/28/2015	01/31/2021	01/31/2021	City of Las Vegas, NV	150063-SK-A
The Chariot Group, Inc.	Omnia Partners	Online Marketplace - Technology Category	05/11/2020	05/10/2025	05/10/2025	State of Utah	MA3460
The Grasshopper Company	US Communities	Mowing Equipment and Related Parts and Services	05/05/2017	05/14/2021	05/14/2022	Cobb County, GA	17-6221
The Public Group	National IPA	Online Auction Services	08/08/2016	08/08/2021	08/07/2026	City of Tucson, AZ	161468
Tidal Basin Government Consulting, LLC	National IPA	Claims Recovery and Related Professional Services	04/01/2015	12/31/2020	12/31/2020	Region 4 ESC - TX	R142603
Toshiba	National IPA	Managed Print Solutions	03/01/2018	02/28/2022	02/28/2023	Region 4 ESC - TX	R171405
Traffic & Parking Control Co., Inc. (TAPCC	Omnia Partners	Traffic Control Products and Related Products and Solutions	02/28/2025	02/28/2025	02/28/2030	Barron County, WI	2020-200
Tremco/Weatherproofing Technologies, Omnia Partners	Omnia Partners	Job Order Contracting Services	05/01/2020	04/30/2022	04/30/2025	Region 4 ESC - TX	R200108
Tremco/Weatherproofing Technologies, National IPA	National IPA	Job Order Contracting (TX)	11/01/2016	10/31/2021	10/31/2021	Region 4 ESC - TX	R160407
Trendway Corporation	National IPA	Movable Wall Systems	04/01/2018	03/31/2022	03/31/2023	Region 4 ESC - TX	R180102
Troxell Communications	National IPA	Audio Visual Equipment, Accessories and Services	10/01/2016	09/30/2021	09/30/2021	Region 4 ESC - TX	R160903
Truman Arnold Companies	Omnia Partners	Motor and Aviation Fuels and Related Services	01/01/2020	12/31/2020	12/31/2024	City of Fort Worth, TX	53317
Uniglobe Travel Designers	National IPA	Travel Management Services	04/01/2017	03/31/2022	03/31/2022	Region 4 ESC - TX	R161201
United Language Group	US Communities	Foreign Language Interpretation and Translation Services	03/15/2016	03/14/2021	03/14/2022	City of Chicago, IL	33851

Van Deusen & Associates	Omnia Partners	Elevator, Escalator, Chairlift and Platform Lift Maintenance & Repair and Related Services	10/01/2019	09/30/2024	09/30/2029	University of California, CA	2019001567
VARI Sales Corporation (VARIDESK)	National IPA	Ergonomic Solutions	04/01/2018	03/31/2022	03/31/2023	Region 4 ESC - TX	R180404
Washington Music Center, Inc.	Omnia Partners	Performing Arts Apparel, Instruments, Furnishings, Storage and Related Services	11/01/2019	10/31/2022	10/31/2024	Region 4 ESC - TX	R191203
Webbco Enterprises LLC dba Visual Comi National IPA	National IPA	Language Service Providers and Related Services	07/01/2018	06/30/2022	06/30/2023	Region 4 ESC - TX	R180706
Wenger Corporation	Omnia Partners	Performing Arts Apparel, Instruments, Furnishings, Storage and Related Services	11/01/2019	10/31/2022	10/31/2024	Region 4 ESC - TX	R191204
WESCO Distribution, Inc.	Omnia Partners	Maintenance, Repair & Operations (MRO) supplies	04/01/2020	03/31/2023	03/31/2025	Region 4 ESC - TX	R192008
WillScot	National IPA	Modular Buildings, Portable Storage & Relocatable Walk	07/01/2016	06/30/2021	06/30/2021	Region 4 ESC - TX	R160101
XG Communities	National IPA	Wireless Marketing Plan	09/19/2016	06/27/2021	06/27/2041	City of Sacramento, CA	2016-0801

TOWN OF MALABAR

COUNCIL MEETING

AGENDA ITEM NO: 11i
Meeting Date: November 02, 2020

Prepared By: Lisa Morrell, Interim Town Manager

SUBJECT: Replacement Vehicle Purchase utilizing the Florida Sherriff Association (FSA) Cooperative Purchasing Program utilizing Duval Fleet, 5203 Waterside Drive, Jacksonville, FL 32210, an awarded contract holder.

BACKGROUND/HISTORY:

Currently the Public Works Department utilizes a 1997 Chevrolet 3500 Utility Truck, asset tag #UT-1, which has 90,369 and a lengthy fleet service record of repairs. The truck no longer provides reliable transportation for the public works crews for public infrastructure and services.

The FY21 approved budget includes funding for a replacement vehicle in Streets and Roads, capital outlay line item entitled Equipment Replacement to include a replacement utility truck. Staff has performed due diligence to ensure competitive quotes of two contract holders for the FSA contract by obtaining quotes from Palmetto Ford and Duval Fleet.

In accordance with The Town of Malabar Code of Ordinances, ARTICLE V. entitled PURCHASING, Section 2-101 - Competitive bids:

“The town administrator is authorized to piggy back contracts for any purpose where the stipulated consideration thereunder to be paid by the town exceeds two thousand dollars (\$2,000.00) awarded by any other governmental entity so long as the bidding process utilized by the other governmental entity in awarding such contract is consistent with the competitive bid procedures outlined in this section. “

Staff will surplus the 1997 Chevrolet 3500 Utility Truck, asset tag #UT-1, through a public property sale process in accordance with Florida State Statute 274 entitled Tangible Personal Property Owned by Local Government.

Staff is requesting the Town Council to consider allocating the surplus sale revenues of the 1997 Chevrolet 3500 Utility Truck, asset tag #UT-1 to the Streets and Roads FY21 Budget for future equipment acquisition funding, as opposed to the general fund balance.

FINANCIAL IMPACT:

FY21 Approved Budget Streets and Roads 541.6410, \$57,619.00.

ATTACHMENTS:

- 20201014 Duval Fleet Quote for Town of Malabar.PDF
- 20201027 Palmetto Fleet Quote for Town of Malabar.PDF

ACTION OPTIONS:

Motion to approve the purchase of a replacement vehicle, #UT-1, utilizing the FSA contract # FSA20-VEH18.0 Heavy Trucks from contract holder, Duval Fleet.

Motion approve the surplus activity for Tangible Personal Property Owned by Local Government, 1997 Chevrolet 3500 Utility Truck, asset tag #UT-1

Motion to approve the budget allocation of surplus funds received from the 1997 Chevrolet Truck, asset tag #UT-1 sale to the FY21 Approved Budget, Streets and Roads, 541.6400 for future Public Works Equipment acquisition.

TOWN OF MALABAR

Prepared for:		Contract Holder	DATE:
TOWN OF MALABAR RICHARD KOHLER 321-727-7764 rkohler@townofmalabar.org		DUVAL FLEET Bambi Darr (Work) 904-381-6596 (Cell) 910-622-6544 (Fax) 904-387-6816 bambi.darr@duvalfleet.com 5203 Waterside Dr. Jax, FL 32210 CENTRAL	10/14/20
PLEASE CONFIRM RECEIPT OF QUOTE VIA EMAIL.			
We appreciate your interest and the opportunity to quote. Pricing per FLORIDA SHERIFFS ASSOCIATION LIGHT VEHICLE CONTRACT FSA20-VEL28.0 Heavy Equipment and Trucks FSA20-VEH 18.0. If you have any questions regarding this quote please call! Note, Vehicle will be ordered white exterior unless specified on purchase order. Shipping and Invoicing instructions are required on agency purchase order.			
Labor	Code	Equipment	Price
0	SPEC 27	2021 FORD F-450 SUPER DUTY SUPER CREW DUAL REAR WHEELS 4X4 XL- W4H	\$ 41,012.00
0	99T	6.7 V8 DIESEL ENGINE	NC
0	650A	EQUIPMENT GROUP: XL	NC
0	179	179" WHEELBASE 60"CA FOR 9FT SERVICE BODY	NC
0	X4N	4.10 LIMITED SLIP AXLE	NC
0	90L	POWER WINDOWS & DOOR LOCKS	\$ 1,074.00
0	872	BACKUP CAMERA	\$ 414.00
0	52B	TRAILER BRAKE CONTROLLER	\$ 269.00
0	534	TRAILER TOW PACKAGE- Includes trailer wiring to end of frame and bed center with appropriate body option, 6 or 7 way plug, Receiver Hitch class IV/V with solid ball mount, 2 5/16" ball with pin and clip	\$ 1,645.00
0	KSB 3	9' KNAPHEIDE STEEL BODY- 6108D54 DRW 60" CA	\$ 10,297.00
0	CAMLOC	RELOCATE CAMERA ONCE SERVICE BODY IS COMPLETE	\$ 285.00
0	SPRAY A & C	SPRAY IN BEDLINER TO INCLUDE TOPS AND BUMPER	\$ 1,150.00
0	31V	SHIP THROUGH TO KNAPHEIDE TO INCLUDE WEIGHT SLIP, MSO, CERTIFICATION & DEALER PDI	\$ 625.00
0	LED PKG 1	4 CORNER LED LIGHTS (2- SURFACE MOUNTED IN GRILLE & 2- IN TAIL LAMPS) AMBER/WHITE	\$ 675.00
0	TAG	NEW TAG	\$ 173.00
0			
0	Z1	EXTERIOR: OXFORD WHITE	NC
0	AS	INTERIOR: DARK SLATE VINYL SEATS 40/20/40	NC
0		VINYL FLOOR	NC
	VENDOR COMMENTS	PLEASE CLEARLY NOTATE ON YOUR PURCHASE ORDER WHERE DUVAL FORD IS TO SHIP YOUR VEHICLE, HOW THE VEHICLE IS TO BE TITLED, AND WHERE THE INVOICE IS TO BE MAILED.	
UNIT COST			\$ 57,619.00
TOTAL QUANTITY		1	TOTAL PURCHASE \$ 57,619.00

Palmetto Ford Truck Sales, Inc.

7245 NW 36 Street Miami, Florida 33166
305-470-1334 / 305-470-1344 fax / 305-972-7133 cell
croders@palmettotruck.com

FLORIDA SHERIFFS ASSOCIATION PRICE SHEET

Bid / Contract #: FSA20-VEH18.0

Purchaser: TOWN OF MALABAR
Address: 2725 MALABAR ROAD
City: MALABAR, FL. 32950

Date: 10/27/2020
Phone: 321-727-7764

RICHARD KOHLER
rkohler@malabar.org

Base Model:	SPEC 27 - 2021 FORD F450 CREW CAB 4X4 XL - W4H	\$40,525.00
Inc.	AM/FM/MP3 RADIO, AIR CONDITIONING	
Exterior / Interior Color:	OXFORD WHITE / GRAY VINYL	

Delivery Info: ESTIMATED AT 145 DAYS FROM RECEIPT OF PURCHASE ORDER

Option #	99T - 6.7L V8 DIESEL ENGINE	Price:	\$0.00
Option #	44G - FORD 10-SPEED AUTOMATIC TRANSMISSION	Price:	\$0.00
Option #	153 - FRONT LICENSE PLATE BRACKET	Price:	\$0.00
Option #	52B - TOW COMMAND FACTORY BRAKE CONTROLLER	Price:	\$265.00
Option #	872I - FACTORY ELECTRIC BRAKE CONTROLLER	Price:	\$605.00
Option #	FCS - FOUR CORNER LED STROBES (PLEASE SPECIFY WHITE OR AMBER)	Price:	\$690.00
Option #	SLINER - SPRAY LINER IN CARGO AREA, COMPARTMENT TOPS AND TOP	Price:	\$1,430.00
Option #	OF REAR BUMPER	Price:	\$0.00
Option #	TOWPKG - TOWING PACKAGE, INC. 7 WAY PLUG, HITCH RECEIVER AND 2"	Price:	\$745.00
Option #	BALL	Price:	\$0.00
Option #	UTILITY-9 - 9' READING OR KNAPHEIDE UTILITY BODY WITH STANDARD	Price:	\$14,702.00
Option #	SHELVES	Price:	\$0.00
Option #		Price:	\$0.00
Option #		Price:	\$0.00
Option #		Price:	\$0.00
Option #		Price:	\$0.00
Option #		Price:	\$0.00
NOTE:		Price:	\$0.00
NOTE:		Price:	\$0.00

Total Price of Base Unit and all Selected Options: \$58,962.00

Total Price for Multiple Units - Quantity: 1 \$58,962.00

TOWN OF MALABAR

COUNCIL MEETING

AGENDA ITEM NO: 11.j.
Meeting Date: November 2, 2020

Prepared By: Lisa Morrell, Interim Town Manager

SUBJECT: Consideration of Amending of Land Development Code / Article XIX Signage

BACKGROUND/HISTORY:

In reviewing the Town's Code of Ordinances, particularly the Land Development Code, Article XIX Signage, Section 1.19.18 District Sign Regulations, Table 1-19.8, as it may be a counter intuitive to the intent and adoption of maximum area of a permitted sign within Residential Zoning Districts and Non-Residential Zoning Districts for sign type identified as General Outdoor Advertising.

Specifically, in Table 1-19.18, under item (1) Sign Regulations Within Residential Zoning Districts, table heading General Outdoor Advertising and construction class of wall or detached has a maximum area defined as 32 square feet, or the equivalent to a 4'x8' sheet of plywood in a residential area.

Conversely in Table 1-19.18, under item (1) Sign Regulations Within Non-Residential Zoning Districts, table heading General Outdoor Advertising, the maximum area of a wall sign is 10 square feet, or the equivalent of 5.5'x5'5 and a detached sign is 3 square feet, or 1.5'x1.5'; in a commercial area.

ATTACHMENTS:

Town of Malabar Code of Ordinances Section 1-19.18 District Sign Regulations.PDF

ACTION OPTIONS:

Request for Town Council to review the current attached code and provide staff direction, if any, to amend or clarify the Town's Code of Ordinances, Land Development Code Chapter, Article XIX Signage, Section 1.19.18 District Sign Regulations, and Table 1-19.8 pertaining to the maximum area allowed for sign type, General Outdoor Advertising, in each zoning district, Residential and Non-Residential.

Section 1-19.18. - District sign regulations.

The provisions of Table 1-19.8 "Zoning District Sign Regulations" shall apply to each lot or parcel of land, and/or each business establishment as may be applicable in each case. In the following zoning classifications, the specified sign types and construction classes shall be permitted subject to the restrictions and limitations contained herein.

Also, any and all allowed &/or required Federal, State, County, &/or Local Signage or Flags as covered per their regulations and as such shall abide by their rules and regulations relating to each. These may be regarding Public Display for; information, location, display protocol, public safety, traffic safety, etc.

TABLE 1-19.18. ZONING DISTRICT SIGN REGULATIONS

(1) Sign Regulations Within Residential Zoning Districts.

Sign Type	Accessory	Construction	Directory	Directional
Construction Class	Wall or Detached	Wall or Detached	Wall or Detached	Wall or Detached
Maximum Number	1	1	1	1
Maximum Area	4 sq. ft.	32 sq. ft.	10 sq. ft.	3 sq. ft.
Maximum Height	10 ft.	Detached: 10 ft. Wall: Roof line of building	10 ft.	Detached: 3 ft. Wall: 12 ft.
Placement	Must observe all yard regulations	Front setback: 10 ft. Side and Rear: 25 ft.	Must observe all yard regulations	Non-Restricted
Illumination	None	None	Indirect	None
Special Regulations	Permitted only in conjunction with a permitted home occupation. See Footnote 1.	Must be removed immediately upon completion of construction or occupancy	None	None

Sign Type	Future Improvement	General Outdoor Advertising
Construction Class	Detached	Wall or Detached

Maximum Number	1	1
Maximum Area	10 sq. ft.	32 sq. ft.
Maximum Height	10 ft.	10 ft.
Placement	Front setback: 10 ft. Side and Rear: 25 ft.	No signs to impede vision at any intersection
Illumination	None	None
Special Regulations	None	See Footnotes 1 and 2

(2) Sign Regulations Within Non-Residential Zoning Districts.

Sign Type	Accessory	Accessory	Temporary
Construction Class	Wall	Detached, Marquee, and Projecting	Snipe/Signs
Maximum Number	3	2 total from this group	4
Maximum Area	10% of the wall area, and no more than 60 sq. ft. of cumulative area	60 sq. ft. total cumulative area	4 sq. ft. each
Maximum Height	Roof line of building	Detached: 25 ft. Others: Roof line of building	Roof line of building
Placement	Non-Restricted	Must observe yard regulations and Front setback: 10 ft.	Must observe yard regulations
Illumination	Direct, Indirect	Direct, Indirect	None
Special Regulations	See Footnotes 1, 3, and 4	See Footnotes 4 and 5	See Footnote 7

Sign Type	Construction	Directory	Directional	General Outdoor Advertising
Construction Class	Wall or Detached	Wall or Detached	Wall or Detached	Wall or Detached
Maximum Number	1	2	2	1
Maximum Area	32 sq. ft.	Sum of 30 sq. ft.	3 sq. ft. each	Detached: 3 sq. ft. Wall: 10 sq. ft.
Maximum Height	Detached: 10 ft. Wall: Roof line of building	10 ft.	Detached: 3 ft. Wall: 10 ft.	10 ft.
Placement	Front Setback: 10 ft. Rear and Side: 25 ft.	Must observe all yard regulations	Non-Restricted	Front setback: 10 ft. Rear and Side: 25 ft.
Illumination	Indirect	Indirect	Indirect	Indirect
Special Regulations	Must be immediately removed upon completion of construction or occupancy	None	None	See Footnotes 1 and 2

(3) *Sign Regulations Within Non-Residential Zoning Districts.*

Sign Type	Future Improvement
Construction Class	Detached
Maximum Number	1
Maximum Area	32 sq. ft.
Maximum Height	10 ft.
Placement	Front setback: 10 ft.

	Side and Rear: 25 ft.
Illumination	Indirect
Special Regulations	None

Footnotes to charts:

- (1) All inside signs within five (5) feet of a window shall be counted as wall signs and in addition shall not exceed twenty (20) inches of the glassed area of the window in which the sign is located.
- (2) Only permitted are those signs which may be off the premises for which they relate and are within two hundred (200) feet of the property for which they relate to. However, if the sign is three (3) square feet or less in area, the property to which the sign relates may be within one (1) mile of the sign.
- (3) Apartment complexes and dwellings of up to ten (10) units are permitted thirty-two (32) square feet. For excess of ten (10) units, one (1) square foot may be added for each unit, up to a maximum of forty-eight (48) square feet in cumulative area.
- (4) If illumination/animation is permitted a minimum refresh rate is six (6) seconds
- (5) One (1) additional sign of this construction class up to thirty (30) square feet in area shall be permitted for each two hundred (200) feet of street frontage.
- (6) For a group of more than four (4) sites and in lieu of the nine (9) square foot individual lot sign, one thirty-two (32) square feet shall be permitted.
- (7) Minimum distance between Temporary Signs shall be twenty (20) feet.

(Ord. No. 19-06, § 1, 7-15-19)

TOWN OF MALABAR

COUNCIL MEETING

AGENDA ITEM NO: 11.k.
Meeting Date: November 2, 2020

Prepared By: Lisa Morrell, Interim Town Manager

SUBJECT: Consideration of Amending of Land Development Code / Article III District Provisions

BACKGROUND/HISTORY:

Town staff as conferred with potential individuals and or representatives of developers of vacant and unimproved land for construction or improvements to zoning district of "Residential Mobile Homes (R-MH) in recent months. During those discussions, with no applications requested, it has been noted that the Town's Code of Ordinances, Land Development Code, Article III, section 1-3.1. - Purpose and intent of districts, item F titled R-MH allows for six (6) units per acre to be developed in the R-MH zone conflicts with the number of units per acre of developed and existing R-MH zones.

Section 1-3.1. - Purpose and intent of districts.

This section presents the basic purpose and intent of each zoning district.

"F. R-MH "Residential Mobile Homes." The R-MH district is established to implement comprehensive plan policies for managing high density mobile home residential development. The district is designed for managing mobile home development at a density not to exceed six units per acre. The district is intended to provide sites for mobile home development within existing established mobile home parks."

Staff reviewed two existing R-MH zones for research and validation:

Enchanted Lakes located at 750 Malabar Road with a gross acreage of 19.1 acres is occupied with 77 Mobile Home units and 71 Recreation Vehicle units. The Town's code is moot to density calculation for net acreage*, therefore using the gross acreage of 19 with the multiplier of 6, per the Town's code the number of units that should exist would be 54 units.

Camelot RV Park located at 1600 South US1 has a gross acreage of 15.94 acres and is occupied with 145 Sites. Per the code, the site should have a maximum number of 96 units.

*Net acreage consists of the total acreage within the site excluding: water bodies, wetlands, public rights of ways, acreage dedicated to public use (parks, common facilities, utility services), or acreage dedicated to other uses (ex. commercial, office, industrial, institutional).

ACTION OPTIONS:

Request for Town Council's direction to have the staff provide a report to the Planning and Zoning Board for discussion and public hearing notice and requirements for Town Council's advisement and consideration.