

CATALOG & TECHNICAL GUIDE 2020.2



SOLID END MILLS

>30,000

STANDARD PRODUCTS



>75

COUNTRIES



>4,100

DEDICATED EMPLOYEES



Headquartered in Fagersta, Sweden and present in more than 75 countries, Seco Tools is a leading global provider of metal cutting solutions for milling, stationary tools, holmaking and tooling systems.

For more than 80 years, the company has provided the technologies, processes and support that manufacturers depend on for maximum productivity and profitability. For more information on how Seco's innovative products and expert services bring success to manufacturers across all industry segments, please visit www.secotools.com.

WELCOME TO SECO SOLID MILLING



JABRO was founded in 1976 in Lottum, Netherlands.

JABRO is Seco's competence centre for solid milling solutions, and has the global responsibility for Research & Development, Manufacturing and Application Engineering.

Seco JABRO's products provide the world market with a wide range of standard tools and custom tool solutions, including reconditioning, mainly for General Engineering, Aerospace, Energy, Medical and Mould & Die customers.

Advanced manufacturing technology and an environmental focus, ensures Seco's sustainable development and production of products that successfully respond to market demands in milling operations for both ferrous and non-ferrous materials.

- General Engineering
- Mould & Die
- Aerospace
- Medical
- Power energy
- 3C segment (Computer Customer Electronics and Communications)

Universal	General	
	Index.....	3
	Product introduction and technical information	5
	Universal	
Steel and cast iron	Product information and cutting data	25
	Steel and cast iron	
	Product information and cutting data	181
	Stainless steel and S-materials (HRSA and Titanium alloys)	
Stainless steel and S-materials	Product information and cutting data	207
	Non-ferrous	
	Product information and cutting data	296
Non ferrous	Hardened steels	
	Product information and cutting data	339
	Plastic and CFRPs	
	Product information and cutting data	376
Hardened steels	Graphite	
	Product information and cutting data	429
	Technical information	
Graphite	Recalculation.....	444
	Cutting calculations and definitions.....	453
	Minimaster® Plus	
	Product information and cutting data	455
	Minimaster	
Technical information	Product information and cutting data	522
	SMG	
Minimaster Plus	Workpiece Materials - SMG (Seco material group).....	616
Minimaster		
SMG		

Solid²

JS412	300-301
JS413	303-304
JS452	306-314
JS453	311-314
JS506	121-122
JS509	125-126
JS512	32-34
JS513	39-42
JS514	47-49
JS520	102-103
JS522	106
JS532	109-110
JS533	113-114
JS534	117-118
JS553	54-61
JS554	70-81
JS554-3C	90-91
JS564	94-95
JS565	98-99
JS720	239-247
JS730	249-251
JS754	211-225
JS755	228-237

TORNADO

JH112	199-200, 357-358
JH120	348
JH130	350
JH142	194-195, 354-355
JH150	203, 361
JH160	205, 363
JH40	320-321
JH410	327
JH421	323-325
JH440	329
JH450	331
JH460	333
JH710	278
JH720	288
JH721	290
JH722	292
JH730	282
JH740	276
JH770	274
JH780	286
JH790	280
JH910	129-130
JH930	133, 352
JH970	135, 197

HPM

JHP170	342-343
JHP490	316-318
JHP750	253-254
JHP760	256-258
JHP770	260-265
JHP780	267-270
JHP951	190-191
JHP993	184-185
JHP994	284

HFM

JHF181	345
JHF980	137-138

MINI

JM403	335
JM404	335
JM406	335
JM413	337
JM416	337
JMB112	372-375
JMB542	169
JMB562	175-176
JMB563	179-180
JMB642	442
JMB662	442
JME142	365-369
JME144	370-371
JME542	162, 164
JME562	165-166
JME564	172-173
JME642	440-441

DIAMOND

JD620	432
JD630	434
JD640	436
JD660	438

COMPOSITE

JC845	380
JC850	382
JC860	384
JC870	386-389
JC871	392-395
JC875	398-399
JC876	402-403
JC877	406-407
JC880	410
JC885	412
JC898	414
JC899	416-417
JPD850	419
JPD880	421
JPD890	423

VHM

HK/HKM	147-158
V31	159
J28	427
J29	141
J36	144
J93	425

CERAMIC

JCG790	272
--------	-----

HSS-E

JCO710	294
--------	-----

MINIMASTER

MM06	528-529
MM08	544-545
MM10	561-562
MM12	580-581
MM16	600-601

MINIMASTER PLUS

MP10	460-461
MP12	481-482
MP16	502-503

MINIMASTER

MM06.....	530-534
MM08.....	546-549
MM10.....	562-568
MM12.....	582-588
MM16.....	602-606

MINIMASTER PLUS

MP10.....	463-467
MP12.....	484-488
MP16.....	505-508

Product family overview

SOLID²



Jabro-Solid² is a range of solid carbide end mills for applications in general machining, offering flexibility, speed and cost efficiency. Jabro-Solid² is available in a diameter range of $\varnothing 1$ - $\varnothing 32$ mm and in *inch* $\varnothing 1/32$ - 1 1/4. Jabro-Solid² also includes a group of dedicated advanced roughing tools (JS564 and JS565). The 564 and 565 offer excellent performance when applied in well defined tool paths with constant arc of contact with high cutting speed and high cutting depth applications (advanced roughing). For the complete range of JS500 series tools all chamfer ($c^{\circ}45^{\circ}$) have the following tolerances: $c = DC \pm 0,01$, $3 < DC \leq 6 \pm 0,02$, $6 < DC \leq 10 \pm 0,03$, $10 < DC \leq 14 \pm 0,04$, $14 < DC \leq 18 \pm 0,05$, $18 < DC \leq 24 \pm 0,06$. All Jabro-Solid² product codes begin with JS. Please see page 9 for a grouped overview of JS² products.

HSM/TORNADO



These tools are characterized by high precision tolerances, short cutting lengths, reduced necks and significant core diameters, maximizing rigidity. These tools have been developed to excel in peripheral milling and copy milling machining methods. Please see page 9 for a grouped overview of HSM/TORNADO (high speed machining) products.

HPM



Optimized endmills are dedicated for original equipment manufacturers and first-tier suppliers where large batches of a single component have to be machined and where processes need to be fully optimized to reduce cycle times, reducing costs per part. Please see page 10 for a grouped overview of HPM (high performance machining) products.

HFM



High feed machining is the first choice for applications with deep and shallow workpiece features, 3D profiling for mold & die applications and machining in unstable conditions. High feed tools excel in plunge milling machine methods. Please see page 10 for a grouped overview of HFM (high feed machining) products.

Product family overview

MINI



Seco's range of micro solid carbide end mills consists of square end mills and ballnose cutters with small cutting diameters. Universal tools are applicable for common workpiece materials and specific tools are dedicated for graphite and hardened-steel applications. All tools have a thin layered coating for optimal performance in small-sized applications. Please see page 10 for a grouped overview of MINI (micro machining) products.

DIAMOND



Available in a variety of geometries and an extensive diameter range, these tools feature the best possible substrate to ensure the perfect adhesion of the diamond coating across a range of cutting parameters. Overall, these end mills significantly increase productivity and lower tooling costs by requiring fewer tool changes and being able to produce precision parts at high feed rates. Please see page 10 for a grouped overview of DIAMOND (diamond coated) products.

COMPOSITE



It consists of diamond-coated and uncoated solid carbide and PCD end mills incorporating different geometries as well as with PCD-brazed cutting edges. This is a product range offering optimized tools for difficult cutting conditions on challenging workpiece materials. Please see page 10 for a grouped overview of COMPOSITE (JC) products.

VHM



Includes universal coated and uncoated endmills, a range of products dedicated for machining plastics and aluminum, chamfer end mills and conical tools. These products consist of high-quality grades and coatings for predictable and premium tool life. Please see page 11 for a grouped overview of VHM (general engineering) products.

Product family overview

CERAMIC



To cut the world's toughest heat-resistant superalloys (HRSA) quickly, you need a tool just as strong and advanced as the materials themselves. Streamline your processes and cut your HRSA parts considerably faster with these high-performance ceramic solid end mills. Please see page 11 for a grouped overview of CERAMIC products.

HSS-CO





High speed steel cobalt is a premium grade that offers higher performance compared to traditional high speed steels. Due to increased hardness, these end mills last longer in today's abrasive, heat resistant and exotic materials. The high-quality, low-cost production advantages of these end mills are a direct result of engineered flute designs, wear resistant coatings and optimized features like internal coolant channels for these challenging materials. Please see page 11 for a grouped overview of HSS-CO products.

Product family overview

Product family	Technology	Product	1xx	4xx	5xx	6xx	7xx	8xx	9xx
Jabro-Solid²	General machining	JS		■	■		■		
Jabro - HPM	High performance machining	JHP	■	■			■		■
Jabro - HFM	High feed machining	JHF	■						■
Jabro - Mini	Micro machining	JM	■	■	■	■			■
Jabro - HSM/Tornado	High speed machining	JH	■	■			■		■
Jabro - Ceramic	High performance machining	JCG					■		
Jabro - Diamond	Graphite machining	JD				■			
Jabro - Composites	Composite machining	JC, JPD						■	
Jabro - VHM	General machining	J		■					■
Jabro-HSS-E	General machining	JCO					■		
SMG									
P1-8					■				■
P11-12					■				■
M1-3					■		■		
M4-5					■		■		
K1-7					■				■
S1-3					■		■		
S11-13					■		■		
H			■		■				
N1				■	■				
N2-3				■	■				
N11				■	■				
TS				■				■	
TP				■				■	
GR						■			
For further explanation on SMG (Seco material group) please see page 616									

Summary

	Page	Family name	Name	P1-8	P11-12	M1-3	M4-5	K1-7	N1	N2-3	N11	S1-3	S11-13	H3-31	TS1	TS2-3	TS4	TP1	TP2-3	TP4	Honeycomb	GR		
	32	JS ²	JS512	●	○	●	○	●	○	○	○	○	●	○	○			○				○		
	39		JS513	●	○	●	○	●	○	○	○	○	○	●	○	○			○				○	
	47		JS514	●	○	○	○	●	○	○	○	○	○	○	●	○	○			○				○
	54		JS553	●	●	●	●	●	●	●	●	●	●	●	●	●	●			●				○
	70		JS554	●	●	●	●	●	●	●	●	●	●	●	●	●	●			●				○
	300		JS412							●	●	●	●	●	●	●	●			●				○
	303		JS413							●	●	●	●	●	●	●	●			●				○
	306		JS452							●	●	●	●	●	●	●	●			●				○
	311		JS453							●	●	●	●	●	●	●	●			●				○
	102		JS520			○	○	○	○	●	●	●	●	○	●	○	●	●			●			○
	106		JS522			○	○	○	○	●	●	●	●	○	●	○	●	●			●			○
	109		JS532			○	○	○	○	●	●	●	●	○	●	○	●	●			●			○
	113		JS533			○	○	○	○	●	●	●	●	○	●	○	●	●			●			○
	117		JS534			○	○	○	○	●	●	●	●	○	●	○	●	●			●			○
	121		JS506			○	○	○	○	●	●	●	●	○	●	○	●	●			●			○
	125		JS509			○	○	○	○	●	●	●	●	○	●	○	●	●			●			○
	94		JS564			○	○	○	○	●	●	●	●	○	●	○	●	●			●			○
	98		JS565			○	○	○	○	●	●	●	●	○	●	○	●	●			●			○
	239		JS720					●	●	●	●	●	●	○	●	○	●	●						○
	249		JS730					●	●	●	●	●	●	○	●	○	●	●						○
	211		JS754			○	○	○	○	●	●	●	●	○	●	○	●	●			●			○
	228		JS755			○	○	○	○	●	●	●	●	○	●	○	●	●			●			○
	320	HSM/TORNADO	JH40						●	●	●	●	●	●	●									
	199, 358		JH112					●	●	●	●	●	○	●	○	●	●							
	348		JH120							●	●	●	●	○	●	○	●	●						
	350		JH130							●	●	●	●	○	●	○	●	●						
	194, 355		JH142	●	●			●	●	●	●	●	○	●	○	●	●							
	361		JH150					●	●	●	●	●	○	●	○	●	●							
	363		JH160	●	○											●	●							
	327		JH410							●	●	●	●	○	●	○	●	●						
	323		JH421							●	●	●	●	○	●	○	●	●						
	329		JH440							●	●	●	●	○	●	○	●	●						
	331		JH450							●	●	●	●	○	●	○	●	●						
	333		JH460							●	●	●	●	○	●	○	●	●						
	278		JH710							●	●	●	●	○	●	○	●	●						
	288		JH720			●	●			●	●	●	●	○	●	○	●	●						
	290		JH721							●	●	●	●	○	●	○	●	●						
	292		JH722							●	●	●	●	○	●	○	●	●						
	282		JH730							●	●	●	●	○	●	○	●	●						
	276		JH740							●	●	●	●	○	●	○	●	●						
	274		JH770							●	●	●	●	○	●	○	●	●						
	286		JH780							●	●	●	●	○	●	○	●	●						
	280		JH790							●	●	●	●	○	●	○	●	●						
	129		JH910			●	○	●	●	●	●	●	●	○	●	○	●	●			●			●
	133, 352		JH930			●	○	●	●	●	●	●	●	○	●	○	●	●						○
	135, 197		JH970			○	○	●	●	●	●	●	●	○	●	○	●	●						○



● Preferred choice, ○ Alternative choice

Summary

	Page	Family name	Name	P1-8	P11-12	M1-3	M4-5	K1-7	N1	N2-3	N11	S1-3	S11-13	H3-31	TS1	TS2-3	TP1	TP2-3	TS2/TP2+N1	TS2/TP2+S12	Honeycomb	GR	
	342	HPM	JHP170											•									
	253		JHP750										•	•									
	256		JHP760			•	•																
	260		JHP770											•									
	267		JHP780											•									
	316		JHP490							•	•												
	190		JHP951		•	○			•														
	184		JHP993		•	○			•														
	284		JHP994											•	•								
	345		JHF181		○	○			•					•	•	•							
	137	HFM	JHF980	•	○	•	•	•				•	•	○									
	372	MINI	JMB112											•									
	365		JME142												•								
	370		JME144												•								
	335		JM403/404/406							•	•												
	337		JM413/416							•	•	•				•		•					
	169		JMB542		•	•	•	•		○	○	○		•	○								○
	175		JMB562		•	•	•	•		○	○	○		•	○								○
	179		JMB563		•	•	•	•		○	○	○		•	○								○
	162		JME542		•	•	•	•		○	○	○		•	○								○
	165		JME562		•	•	•	•		○	○	○		•	○								○
	172		JME564		•	•	•	•		○	○	○		•	○								○
	442		JMB642																				•
	442		JMB662																				•
	440		JME642																				•
	432	DIAMOND	JD620																			•	
	434		JD630																				•
	436		JD640																				•
	438		JD660																				•
	380	COMPOSITE	JC845												•		•						
	382		JC850													•		•					
	384		JC860													•		•					•
	386		JC870													•		•					•
	392		JC871													•		•					•
	398		JC875													•		•					
	402		JC876													•		•					
	406		JC877													•		•					
	410		JC880													•		•					
	412		JC885													•		•					
	414		JC898													•		•		•	•		
	416		JC899													•		•		•	•		
	419		JPD850													•		•					
	421		JPD880													•		•					
	423		JPD890													•		•					

• Preferred choice, ○ Alternative choice

Summary

	Page	Family name	Name	P1-8	P11-12	M1-3	M4-5	K1-7	N1	N2-3	N11	S1-3	S11-13	H3-31	TS1	TS2-3	TS4	TP1	TP2-3	TP4	Honeycomb	GR	
	427	VHM	J28												•								
	144		J36	○	•	○	○	○	○	○	•	•	○	○		○			○				
	147		HK/HKM	•	○	•	•	•	•	•	○	•	•	•		•			•				
	159		V31	•	○	•	○	•	•	•	•	•	•	•		•			•				•
	141		J29	•	•	•	•	•	•	•	•	•	•	•		•			•				•
	425		J93F														•		•				
	272	Ceramic	JCG790									•											
	294	HSS-Co	JCO710			•	•						•										

• Preferred choice, ○ Alternative choice

Code key

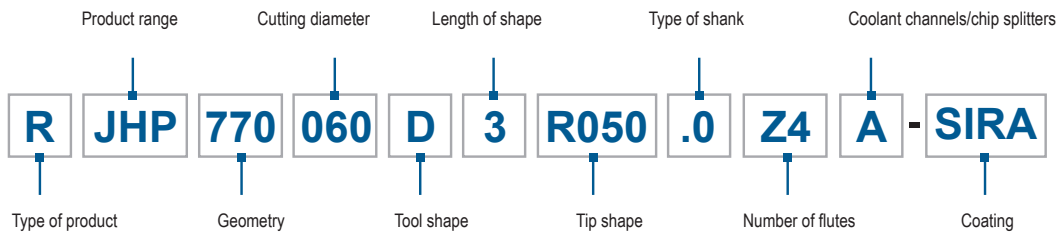

Product range	Type of product
<p>J = JABRO® VHM JC = JABRO® Composites JD = JABRO® Diamond JH = JABRO® HSM/Tornado JHF = JABRO® HFM JHP = JABRO® HPM JM = JABRO® Mini JS = JABRO® SOLID² JPD = JABRO® PCD JCO = JABRO® HSS-Co JCG = JABRO® Ceramic</p>	<p>BLANK = Standard (catalogue) product R = Reconditioned product (complete) RK = Reconditioned product (frontal)</p>

Length of shape	Number of flutes
<p>A single digit that gives an indication of the length of the cutter compared to other products with the same cutting geometry. This replaces the previous L, XL, SL, K, and other versions. For most products 1=K, 2=N, 3=L, 4=XL</p>	<p>This figure indicates the number of flutes in the cutter. For example; PCEDC2= 2 flutes, PCEDC6 = 6 flutes</p>

Cutting diameter	Coolant channels/chip splitters
<p>Metric = 3 digit code (in case of 4 digit code – xx,xx mm) Imperial = a dot followed by a 3 digit code For example: (050 = metric, 5 mm) / (.500 = imperial, ½ inch)</p>	<p>BLANK = No coolant channels A = Internal coolant channel(s) C = Chip splitters</p>

Geometry	Type of shank
<p>Geometry A three-digit combination specifying the cutting geometry. For example; 111, 950, 553, 514, etc.</p>	<p>Indicates the shank types that are available. .0 = Cylindrical .3 = Weldon .5 = Whistle Notch .9 = Safe-Lock</p>

Description

Tip shape						Coating
Sharp	Ball-nose	Corner radius	Concave radius	Chamfer	High feed	4 character code specifying the coating on the cutter. MEGA = MEGA MT = MEGA-T M64 = MEGA-64 M64T = MEGA-64-T TRI = TRIBON SIRA = SIRON-A HEMI = HEMI DIA = DIAMOND DURA = DURA NXT = NXT HXT = HXT STAX = STAX
S	B	R...	K...	C	H	
Size of radius for convex and concave radius tipped products						
<p>000 = For metric products the tip shape is shown by a three-digit figure. By dividing this figure by 100 you will get the actual corner radius size in millimetres.</p> <p>.000 = For imperial products the tip shape is shown by a dot, followed by a three-digit figure. This figure actually shows the size of the corner radius in <i>inch</i> (e.g. R.100 would indicate a radius of 0.100 <i>inch</i>).</p>						

Tool shape						
(DC = DMM)		(DC < DMM)				(DC > DMM)
D	E	F	G	J	N	P

How our solutions can benefit you

The individual solution - Custom and modified tools

If the requirements are very special, we have the right solution with our individual and customized tools - solutions that have been tailored specifically to your individual requirements. This will enable you to take your machining productivity to a whole new level.

In addition to the standard solutions, our offer includes:



Custom tools

They are modified geometries or form shaped tools for customer specific demands as we can fully cooperate with the customer and design a specific tool which answers the needs. Examples can be:

- Modified tools within a standard geometry
- MEP (Mechanised edge Profiling)
- Firtree,
- Dovetail
- Tapered ballnose
- Condyle cutter
- Form shaped tools

Modified tools

Seco offers a quick delivery solution for standard tools requiring modification to meet specific dimensional requirements as this can be:

- (full) Radius/Facet/Chamfer/Concave
- OD reduction (neck reduction), including increased length
- Coating (application for uncoated tools)
- Reduced cutting diameter
- Chip breakers
- Adding Weldon / Safelock
- External coolant channels

Reconditioning cuts cost and tools inventory

Seco's modern carbide tools offer remarkable performance by utilizing the best combinations of carbide substrates with highly wear resistant coatings, optimized cutting geometry and controlled edge preparation.

However good a tool is, as part of its function, it will eventually show signs of wear on the cutting edge. Controlling this wear and the timely replacement of the tool will allow the used tool to be reconditioned, thus reducing tool investment costs. And we use the same advanced technology to recondition your solid carbide tools as we use to manufacture new products.

Reconditioning cuts cost and tools inventory

Your benefits from reconditioning

- Manufactured to Seco's high standards with the original Seco geometry, edge preparation and coating processes.
- Savings on tooling costs by repeated use of the same solid carbide tool.
- Our easy to use and free 'reconditioning box' includes a pre-prepared delivery note.
- Free, reliable collection on the following day when you call your Seco contact for pick up.
- An easy process due to the package service, reconditioning box and prepared delivery note.
- Delivery via the normal Seco channels.
- Safe transportation and storage of the reconditioned tools by packaging them in similar packaging as new tools.
- A new packaging label is included.
- Work towards greener and cleaner environment. -Seco's processes are globally certified with ISO14001.
- Guaranteed quality, as all processes are ISO9001 certified.

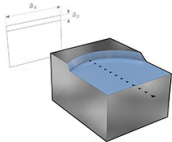
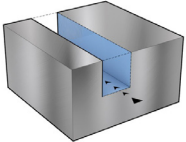
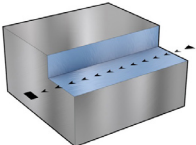
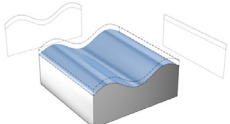

Basic operations:

Face milling:	Slot milling:
<p>Operation where the tool is in engagement with less than 180° arc of contact. Tool engagement: Small a_p and large a_e.</p> 	<p>Operation where the full diameter is in engagement, a_e is equal to DC and a_p up to 2 times DC depending on the machining strategy in use.</p> 
Side milling:	Copy milling:
<p>Operation where the side of the tool is in engagement, a_p is large and a_e is small.</p> 	<p>Operation where the radius is in engagement. a_p and a_e are both small.</p> 

Advanced machining methods:

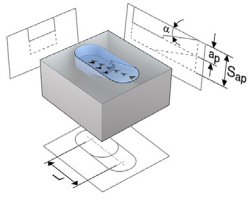
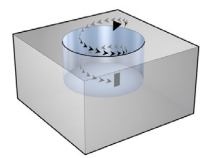
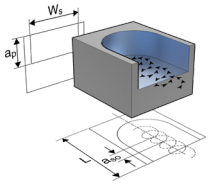
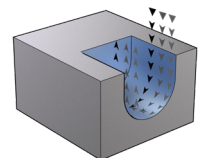
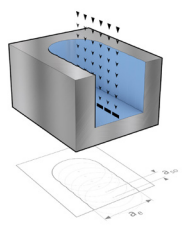
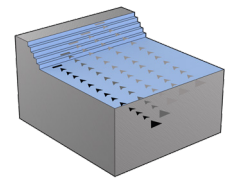
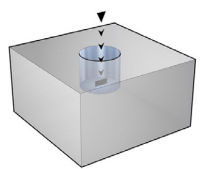
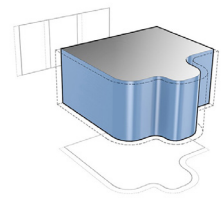
<p>Ramping:</p> <p>Opening up a pocket by making a Z axis at an angle.</p> 	<p>Helical interpolation ramping:</p> <p>Opening a pocket by making a circular movement with the tool while ramping in Z axis.</p> 
<p>Trochoidal:</p> <p>Opening a slot by using side milling, making a partial circular movement in X- or Y-axis. (changing slot milling into side milling).</p> 	<p>Push-pull:</p> <p>Machining a 3D form by making a down and up copying movement following the profile of the form.</p> 
<p>Plunge milling:</p> <p>Opening up a deep slot by using drilling (Z) axis.</p> 	<p>Z-leveling:</p> <p>Machining a surface by making a small drilling or ramping in Z axis then opening the pocket with X and Y movements.</p> 
<p>Drilling:</p> <p>Making a hole with movement in Z axis.</p> 	<p>Advanced roughing/ Optirough</p> <p>Well defined tool paths with constant arc of contact for reliable roughing of simple & complex shapes. The large axial depths (a_p) & small radial depths (a_e) of cut combined with high feeds per tooth (f_z) and cutting speeds (V_c) results in high productivity.</p> 

Definitions, machining strategies:

General machining:

A machining strategy for general use. $a_e - a_p$ ratio can vary depending on the operation. Tool characteristics: Tools have relatively long cutting lengths and thin core diameters. There are no high requirements on the tolerances. Machine requirements: There are no special machine requirements needed. With basic CNC technology, difficult advanced machining methods are not possible. Average results will be reached on metal removal rate Q (cm³/min). The application area usually includes small batch sizes and a wide range of materials.

High Performance Machining:

Is a machining strategy where very high metal removal rates can be achieved. Typical for this strategy is that a_e is 1 times DC and a_p is 1 to 1½ times DC depending the workpiece material.

With HPM (High Performance Machining) you achieve an extremely high metal removal rate by using a much higher chip load than in general machining.

Tool characteristics: Specially developed chip formers in the flute of the tool, tip protection with a small 45° face or corner radius, special smooth formed chip space and coating, with or without Weldon shank.

Machine requirements: High stability, high power requirements, CNC control, rigid clamping system.

The application areas are: Operations in a mass production environment where production time/lead time is of great importance or on single products where a high metal removal rate Q (cm³/min.) is required.

High Feed Machining:

Is a machining strategy where high feed rates can be reached with large radial engagements (a_e) in combination with a small a_p .

With HFM (High Feed Machining) you achieve high metal removal rates and/or surface finish by using a much higher table feed compared to general machining.

Tool characteristics: Specially developed front teeth, very short cutting length and coating.

Machine requirements: Good stability, CNC, possibility for high table feed (v_f).

The big advantage of this technology is that it is very user friendly, easy, safe and quick to program in CAM. By using the so called Z-leveling strategy it is relatively easy to program complex forms without the necessity of having extensive experience in programming.

The application area is: From soft to hardened steel, titanium and stainless steel and it is very good as a pre operation before HSM is used.

It can also be applied in deep pocket machining.

Micro machining:

Is a machining strategy where extremely small tool diameters are used.

Tool characteristics: Diameter range \varnothing 0,1 to 2,0 mm, small cutting lengths, a wide range of OD reductions, high accuracy, coating.

Machine requirements: High spindle accuracy, high RPM, CNC, thermal stability against spindle growth.

Application area is: Production of cavities like slots, pockets, holes or engravings in many types of material.

High speed machining:

Is a machining strategy where a combination of a small radial depth of cut and high cutting speed and table feeds are used.

Depending on the method a high metal removal and a low R_a value can be reached. Typical for this strategy are the low cutting forces, less heat build up in tool and workpiece, less burr formation and high dimensional accuracy on the workpiece.

With HSM (High Speed Machining) you achieve high metal removal rate and/or surface finish by using a much higher cutting speed compared to general machining.

Tool characteristics: Stable, (thick core diameter and a short cutting length) clear and well formed chip space for good chip evacuation, coating.

Machine requirements: Quick CNC control, high RPM, quick transmission to the axis. The applications area is: Mould & Die industry on pre-finishing and finishing operations in hardened steel (48-62 HRC) in a short lead time.

This technique can also be applied in most other materials when using the right tool and advanced machining method.

Advanced roughing / Optirough:

Well defined tool paths with constant arc of contact for reliable roughing of simple & complex shapes. The large axial depths (a_p) & small radial depths (a_e) of cut combined with high feeds per tooth (f_z) and cutting speeds (V_c) results in high productivity.

These CAM-based rough-machining, or dynamic milling, strategies are ones that centre on a cutting tool's arc of contact and its average chip load.

When reducing the arc of contact, the amount of heat generated during roughing operations is reduced. As the radial depth of cut decreases, so does a cutter's arc of contact. A smaller amount of contact results in less friction and, therefore, less heat between the tool's cutting edges and the workpiece it is machining. These lower machining temperatures, in turn, allow for increased cutting speeds shorter cycle times.

How our products can benefit you

Achieve Revolutionary speeds in superalloys with JABRO® Ceramic end mills

SiAlON ceramics, high-strength geometries and reinforced frontal teeth are some of the main features of these highly optimized tools and allow full utilization of high speed, high-performance machine tools. The tools can operate at cutting speeds of up to 1200M/min and can offer a significant productivity increase when compared to standard solid carbide solutions.

Since high temperatures are needed, also a significant amount of RPM is needed in order to achieve the high vc. The high temperatures are required in order to reach a level where the HRSA softens (850c +). With these tools, multiple strategies can be applied as long as a constant cut and constant contact with the workpiece is maximized.

The tool is designed for side milling, slot milling, high-feed milling and advanced roughing! All these are possible. To maintain the high cutting temperature in the cutting zone, coolant is compressed air. Because the tool operates at high speeds, also run out is of high importance.

You can find JABRO® Ceramic tools on page 272.



Simplify aerospace hybrid materials holemaking with two-in-one-geometry

The JC899 has a patented two-in-one double geometry solution, designed for machining hybrid stacked material combinations such as CFRP-Ti and CFRP-Alu. Due to its left-hand helix, right-hand cut design, this tool is preventing delamination, fiber pull-out and chip marks from damaging the workpiece surface (this as chips will be pushed downwards out of the hole). As a result, the JC899 left-hand helix, right-hand cut STAX finisher gives a perfect surface finish and prevents chip pollution between the 2 stack layers.

This means post-machining, unstacking, cleaning and deburring, and re-stacking is not needed anymore which can boost process efficiency by as much as 200 to 300 percent and provide tool life three to six times longer than that of conventional reamers.

At the same time the drilling process is replaced by applying the JC898 high feed rougher. This tool helical interpolates and allows the JC899 to operate in continuous stock conditions, maximizing quality output while minimizing corellation in hole size and tolerance.

You can find JABRO® JC898/JC899 on pages 414 - 416.



Take the risk out of micro milling operations

Achieve accuracy, precision and high surface finish quality from the very start when machining small, micro-sized surfaces with our range of solid-carbide JABRO® end mills. SECO's new Mini ranges deliver longer tool life, stability and peace of mind for machining operations where it is typically impossible to actually see the workpiece and cutting tool as it works.

Precisely produced geometries, virtually zero runout, advanced coatings and true line-form radius tolerances give these mini ranges its incredibly long tool life and reliability. Key is to apply these tools in suitable conditions, in which the benefits can be maximized. Minimize run-out of the tool plus the tool holder is essential. Also the CAM program can be optimized with the SECO JABRO® feed optimizer which calculates the ideal RPM and feed speed (vf) for every application. As a result, the tool and set-up help to eliminate any unforeseen problems during rough, pre-finish and final finish micro milling operations.

You can find an overview of JABRO®Mini tools on page 10, 10.



JS522 long flute finisher

The JS522 long-flute finishing tool is capable of meeting the aerospace industry's stringent criteria for perpendicularity, fine surface finish, high metal removal rates and more effective machining.

With a cutting length of $5 \cdot D_c$, an increased core diameter and a slightly negative taper to compensate deflection, the JS522 is specially designed to machine high shoulders in single-pass finishing operations. This single pass saves time (up to 80%) but most important, also delivers instant quality. This tool is often used in mass production areas.

Once in place and optimized, this has proven to be the number one cost saver in multiple applications!

You can find JABRO® JS522 on page 106.

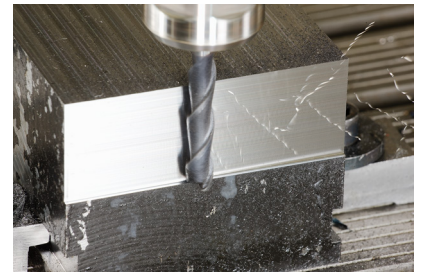

Explanation of Advanced Roughing

Advanced Roughing, what does it mean?

Today's CAM packages offer toolpath strategies specifically for inside/outside radii shapes where changing arcs of contact are common when using conventional toolpaths. These software packages automatically apply different feeds to control arc of contact and keep chip loads consistent.

These CAM-based rough-machining, or advanced roughing, focus on a cutting tool's arc of contact and its average chip load. When reducing the arc of contact, the amount of heat generated during roughing operations is reduced. As the radial depth of cut decreases, so does a cutter's arc of contact. A smaller amount of contact results in less friction and, therefore, less heat between the tool's cutting edges and the workpiece it is machining. These lower machining temperatures, in turn, allow for increased cutting speeds shorter cycle times. Also, the resulting cutting force is lower, allowing high APMXS, or cutting depth to be programmed.

In advanced roughing, to maintain arc of contact, CAM packages need to employ trochoidal machining-like techniques when entering a radius.

When using an optimized roughing toolpath and maintaining consistent arc of contact, the cutter's radius can match that of the inside radius being cut without risk of cutter overload. This capability allows our Advanced Roughing tools (JS554-3C, JS564, JS565, JS574, JS575 and JS720) to remove more stock in the roughing pass, thus reducing the amount of stock the finish pass has to cut – all of which translates to faster machining cycle times and longer tool life. Also, while the remaining stock is constant the finishing tool can generate a better final surface quality and at the same time will have longer tool life.

Impact of arc of contact on cutting speed and feed per tooth

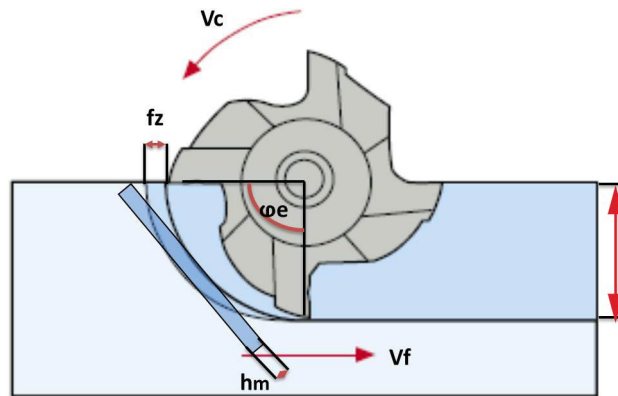





Key symbols

 Center cut PCEDC 1	 Center cut PCEDC 2	 No center cut PCEDC 2	 Center cut PCEDC 3	 No center cut PCEDC 3	 Center cut PCEDC 4
 No center cut PCEDC 4	 No center cut PCEDC 5	 Center cut PCEDC 6	 No center cut PCEDC 6	 No center cut PCEDC 7	 No center cut PCEDC 8
 No center cut PCEDC 9					
 Cylindrical shank	 Weldon shank	 Safelock shank			
 Sharp	 Chamfer	 Corner radius	 Ball nose	 Tapered sharp	 Tapered ball nose
 250° Cutter	 T-shape				



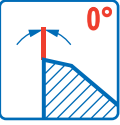
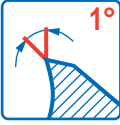
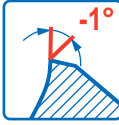
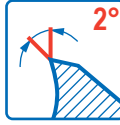
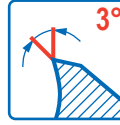
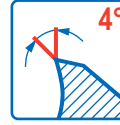
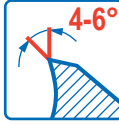
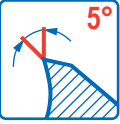
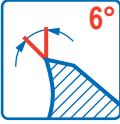
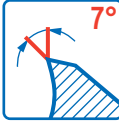
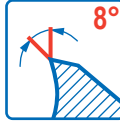
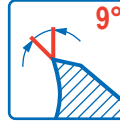
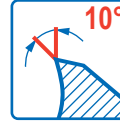
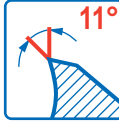

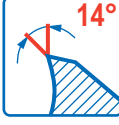
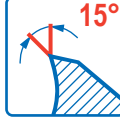
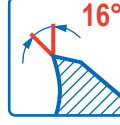
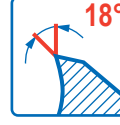
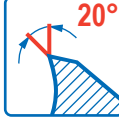
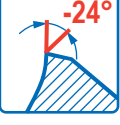
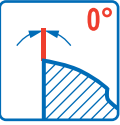
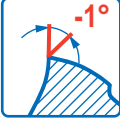
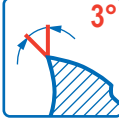
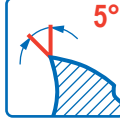
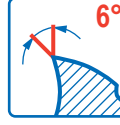
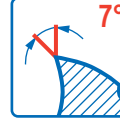
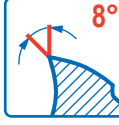
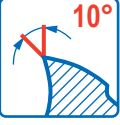
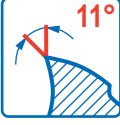
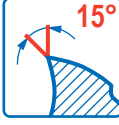
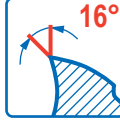
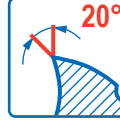
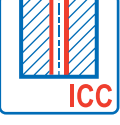

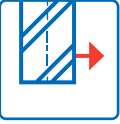
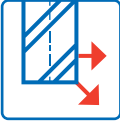
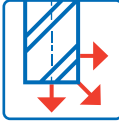









Key symbols

Helix angle 0°	Helix angle 3°	Helix angle 4°	Helix angle 10°	Helix angle 15°	Helix angle 17°	Helix angle 20°
Helix angle 25°	Helix angle 28°	Helix angle 30°	Helix angle 35°	Helix angle 37,5°	Helix angle 38°	Helix angle 40°
Helix angle 41°	Helix angle 42°	Helix angle 44°	Helix angle 45°	Helix angle 46°	Helix angle 48°	Helix angle 50°
Helix angle Left 3°	Helix angle Left 10°	Helix angle Left 15°				
Double helix 20° - 20°	Double helix 27° - 25°	Double helix 35° - 25°	Double helix 34° - 36°	Left hand helix 40° - 10°	Double helix 40° - 42°	
Double core	Tapered Core					
Chip splitters	Roughing profile	Router profile				

Key symbols

 Cutting rake 0° Angular relief	 Cutting rake 1° Angular relief	 Cutting rake -1° Angular relief	 Cutting rake 2° Angular relief	 Cutting rake 3° Angular relief	 Cutting rake 4° Angular relief	 Cutting rake 4-6° Angular relief
 Cutting rake 5° Angular relief	 Cutting rake 6° Angular relief	 Cutting rake 7° Angular relief	 Cutting rake 8° Angular relief	 Cutting rake 9° Angular relief	 Cutting rake 10° Angular relief	 Cutting rake 11° Angular relief
 Cutting rake 12° Angular relief	 Cutting rake -12° Angular relief	 Cutting rake 14° Angular relief	 Cutting rake 15° Angular relief	 Cutting rake 16° Angular relief	 Cutting rake 18° Angular relief	 Cutting rake 20° Angular relief
 Cutting rake -24° Angular relief						
 Cutting rake 0° Radial relief	 Cutting rake -1° Radial relief	 Cutting rake 3° Radial relief	 Cutting rake 5° Radial relief	 Cutting rake 6° Radial relief	 Cutting rake 7° Radial relief	 Cutting rake 8° Radial relief
 Cutting rake 10° Radial relief	 Cutting rake 11° Radial relief	 Cutting rake 15° Radial relief	 Cutting rake 16° Radial relief	 Cutting rake 20° Radial relief		
 ICC straight	 ICC and Y					
 Radial	 Radial/Ramping	 Radial/Ramping/Plunging				

Key symbols

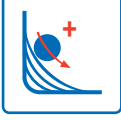
 Diamond	 Dura	 Hemi	 HSS-Co	 HXT
 Mega	 Mega-T	 Mega-64	 Mega-64-T	 NXT
 Stax	 Siron-A	 Tribon	 Ceramic	 PCD
 <i>Regrind possible</i>	 <i>Advanced roughing</i>			



UNIVERSAL

Seco offers a complete range of high performance solid carbide square shoulder end mills, ballnose cutters and finish end mills for high productivity and extended tool life. This range covers universal products and optimized end mills for specific workpiece materials.

Universal products offer full machining flexibility at an excellent price/performance ratio.

- JS512, JS513, JS514, JS553, JS554, JS564, JS565 and JS520 with 45° chamfer type.
- JS522, JS553, JS554, JH910, JH930, JHF980, J36, JME542, JME562 and JME564 for radius type.
- JS506, JS509, J29 and V31 with V-type.
- JS532, JS533, JS534, JH970, JMB542, JMB562 and JMB563 for ball-nose type.





Universal		Tool selection Universal				
Steel and cast iron						
Name		JS512	JS513	JS514	JS553	JS554
Page(s)		32	39	47	54	70
Family name		JS ²	JS ²	JS ²	JS ²	JS ²
Type of mill						
Non ferrous	Shank					
	Cylindrical	<input checked="" type="checkbox"/>	<input checked="" type="checkbox"/>	<input checked="" type="checkbox"/>	<input checked="" type="checkbox"/>	<input checked="" type="checkbox"/>
	Weldon	<input type="checkbox"/>	<input type="checkbox"/>	<input type="checkbox"/>	<input checked="" type="checkbox"/>	<input checked="" type="checkbox"/>
Number of Flutes		2	3	4	3	4
ICC						
Stainless steel and S-materials	Diameter range					
	Metric	1-25	1-25	1-25	2-25	3-25
	Inch				1/8 - 1/2	1/4-1
Hard	Length availability					
		2,3,4	2,3,4	2,3,4	2,3	2,3
Plastic and cfrp	Operation					
Minimaster Plus	Graphite					
	SMG					
	P1-8	<input checked="" type="checkbox"/>	<input checked="" type="checkbox"/>	<input checked="" type="checkbox"/>	<input checked="" type="checkbox"/>	<input checked="" type="checkbox"/>
	P11-12	<input type="checkbox"/>	<input type="checkbox"/>	<input type="checkbox"/>	<input checked="" type="checkbox"/>	<input checked="" type="checkbox"/>
	M1-3	<input checked="" type="checkbox"/>	<input checked="" type="checkbox"/>	<input type="checkbox"/>	<input checked="" type="checkbox"/>	<input checked="" type="checkbox"/>
	M4-5	<input type="checkbox"/>	<input type="checkbox"/>	<input type="checkbox"/>	<input checked="" type="checkbox"/>	<input checked="" type="checkbox"/>
	K1-7	<input checked="" type="checkbox"/>	<input checked="" type="checkbox"/>	<input checked="" type="checkbox"/>	<input checked="" type="checkbox"/>	<input checked="" type="checkbox"/>
	S1-3	<input type="checkbox"/>	<input type="checkbox"/>	<input type="checkbox"/>	<input checked="" type="checkbox"/>	<input checked="" type="checkbox"/>
	S11-13	<input checked="" type="checkbox"/>	<input checked="" type="checkbox"/>	<input checked="" type="checkbox"/>	<input checked="" type="checkbox"/>	<input checked="" type="checkbox"/>
	H5 H8 H11 H12 H21 H31	<input type="checkbox"/>	<input type="checkbox"/>	<input type="checkbox"/>	<input checked="" type="checkbox"/>	<input checked="" type="checkbox"/>
Minimaster	N1	<input type="checkbox"/>	<input type="checkbox"/>	<input type="checkbox"/>	<input checked="" type="checkbox"/>	<input checked="" type="checkbox"/>
	N2-3	<input type="checkbox"/>	<input type="checkbox"/>	<input type="checkbox"/>	<input checked="" type="checkbox"/>	<input checked="" type="checkbox"/>
	N11	<input type="checkbox"/>	<input type="checkbox"/>	<input type="checkbox"/>	<input checked="" type="checkbox"/>	<input checked="" type="checkbox"/>
	TS1	<input type="checkbox"/>	<input type="checkbox"/>	<input type="checkbox"/>	<input checked="" type="checkbox"/>	<input checked="" type="checkbox"/>
	TP1	<input type="checkbox"/>	<input type="checkbox"/>	<input type="checkbox"/>	<input checked="" type="checkbox"/>	<input checked="" type="checkbox"/>
	GR	<input type="checkbox"/>	<input type="checkbox"/>	<input type="checkbox"/>	<input type="checkbox"/>	<input type="checkbox"/>

■ Stock standard □ Weldon available, delivery time is 3 days.

● Preferred choice ○ Alternative choice

*JS554 3C also available. Can be applied in advanced roughing.

Tool selection Universal

						
Name		JS564	JS565	JS520	JS522	JS532
Page(s)		94	98	102	106	109
Family name		JS ²	JS ²	JS ²	JS ²	JS ²
Type of mill						
Shank	Cylindrical	■	■	■	■	■
	Weldon	■	■	□		□
Number of Flutes		4	5	5,6,8	2	2
ICC						
Diameter range	Metric	3-20	4-20	4-25	6-32	1-20
	Inch					
Length availability						
		2,3	2,3	2,3	4	1,2,3
Operation						
						
SMG						
P1-8		●	●	●	●	●
P11-12		○	○	○	●	○
M1-3		●	●	○	●	●
M4-5		●	●	○	●	●
K1-7		●	●	●	●	●
S1-3		●	●	○	○	○
S11-13		●	●	●	●	●
H5 H8 H11 H12 H21 H31		●	●	○		
N1		●	●	●	●	●
N2-3		●	●	●	●	●
N11		●	●	●	●	●
TS1				●	●	●
TP1				●	●	●
GR				○	○	○

■ Stock standard □ Weldon available, delivery time is 3 days.
● Preferred choice ○ Alternative choice

Universal

Steel and cast iron

Stainless steel and S-materials

Non ferrous

Hard

Plastic and cfrp

Graphite



















Minimaster Plus

Minimaster

Universal		Tool selection Universal			
Steel and cast iron					
	Name	JS533	JS534	JS506	JS509
	Page(s)	113	117	121	125
	Family name	JS ²	JS ²	JS ²	JS ²
Stainless steel and S-materials	Type of mill				
Non ferrous	Shank	Cylindrical	<input checked="" type="checkbox"/>	<input checked="" type="checkbox"/>	<input checked="" type="checkbox"/>
		Weldon	<input type="checkbox"/>	<input type="checkbox"/>	<input checked="" type="checkbox"/>
	Number of Flutes	3	4	3-4	3-4
	ICC				
	Diameter range	Metric	1-20	2-20	3-12
		Inch			
Hard	Length availability				
		1,2	1,2,3	2	2
Plastic and cfrp	Operation				
Graphite	SMG				
	P1-8	●	●	●	●
	P11-12	○	○	○	○
	M1-3	●	●	●	●
	M4-5	●	●	●	●
	K1-7	●	●	●	●
	S1-3	○	○	○	○
Minimaster Plus	S11-13	●	●	●	●
	H5 H8 H11 H12 H21			●	●
	N1	●	●	●	●
	N2-3	●	●	●	●
	N11	●	●	●	●
Minimaster	TS1	●	●	●	●
	TP1	●	●	●	●
	GR	○	○	○	○

■ Stock standard □ Weldon available, delivery time is 3 days.
● Preferred choice ○ Alternative choice

Tool selection Universal

					
Name		JH910	JH930	JH970	JHF980
Page(s)		129	133, 352	135, 197	137
Family name		HSM/TORNADO	HSM/TORNADO	HSM/TORNADO	HFM
Type of mill					
Shank	Cylindrical	■	■	■	■
	Weldon				
Number of Flutes		3	5,6,8	2	2,3,4,5
ICC					
Diameter range	Metric	2-17	6-20	2-16	1-12
	Inch				
Length availability					
		2,3,4	2	1,2,3	1,2,3,4
Operation					
					
					
SMG					
P1-8		●	●	●	●
P11-12		○	○	○	○
M1-3		●		●	●
M4-5		●		●	●
K1-7		●	●	●	●
S1-3		●	●	●	●
S11-13		●	●	●	●
H3 H5 H7 H8 H11 H12 H21 H31			●		○
N1					
N2-3					
N11					
TS1					
TP1		●			
GR		●			

■ Stock standard □ Weldon available, delivery time is 3 days.
● Preferred choice ○ Alternative choice

Universal

Steel and cast iron

Stainless steel and S-materials

Non ferrous

Hard

Plastic and cfrp

Graphite

Minimaster Plus

Minimaster

Universal		Tool selection Universal				
Steel and cast iron						
Name		J29	J36	HK/HKM	V31	
Page(s)		141	144	147	159	
Family name		VHM	VHM	VHM	VHM	
Type of mill						
Shank	Cylindrical	■	■	■	■	
	Weldon					
Number of Flutes		1	3	2,3,4	4	
ICC						
Diameter range	Metric	0,2-6	2-20	1-10	6-28	
	Inch					
Hard	Length availability					
		2	2	2	2	
Plastic and cfrp	Operation					
Graphite	SMG					
	P1-8	●	○	●	●	
	P11-12	●	●		○	
	M1-3	●	○	●	●	
	M4-5	●	○	●	○	
	Minimaster Plus	K1-7	●	○	●	●
		S1-3	●	○	●	●
		S11-13	●	○	●	●
H5 H8 H11 H12 H21		○		●	●	
N1		●	○	●	●	
N2-3		●	●	○	●	
N11		●	●			
Minimaster		TS1	●	○	●	●
	TP1	●	○	●	●	
	GR	●			●	

■ Stock standard □ Weldon available, delivery time is 3 days.

● Preferred choice ○ Alternative choice

Tool selection Universal						
Name	JME542	JME562	JME564	JMB542	JMB562	JMB563
Page(s)	162	165	172	169	175	179
Family name	MINI	MINI	MINI	MINI	MINI	MINI
Type of mill						
Shank	Cylindrical	■	■	■	■	■
	Weldon					
Number of Flutes	2	2	4	2	2	3
ICC						
Diameter range	Metric	0,2-3,0	0,5-3,0	0,5-3,0	0,2-3,0	1,0-3,0
	Inch					
Length availability						
		1,3,4,5,6	2,4,5,6,7	2,4	1,3,4,5,6	2,4,5,6,7
Operation						
SMG						
P1-8	●	●	●	●	●	●
P11-12	●	●	●	●	●	●
M1-3	●	●	●	●	●	●
M4-5	●	●	●	●	●	●
K1-7						
S1-3						
S11-13	●	●	●	●	●	●
H3 H5 H7 H8 H11 H12 H21 H31	○	○	○	○	○	○
N1	○	○	○	○	○	○
N2-3	○	○	○	○	○	○
N11	○	○	○	○	○	○
TS1						
TP1						
GR	○	○	○	○	○	○

■ Stock standard □ Weldon available, delivery time is 3 days.

● Preferred choice ○ Alternative choice

Universal

Steel and cast iron

Stainless steel and S-materials

Non ferrous

Hard

Plastic and cfrp

Graphite

Minimaster Plus

Minimaster

JS512

General purpose – Universal – Square – 2 Flutes – Cylindrical – Chamfer

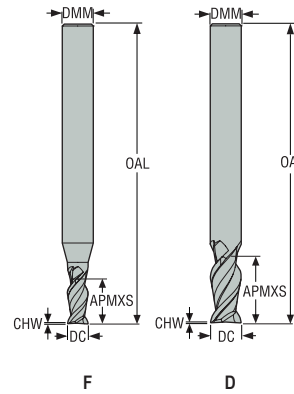

- Tolerances:
- DMM= h5
- DC= e8
- Regrind possible if DC is ≥ 06

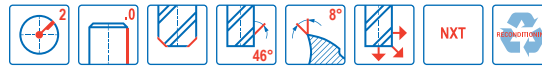

	Designation	Item number	Length index	Tool shape	DC	DMM	APMXS	OAL	CHW	PCEDC	Cylindrical
	JS512010F2C.0Z2-NXT	02927161	2	F	1,0	3	2,0	38	0,01	2	■
	JS512015F2C.0Z2-NXT	02927163	2	F	1,5	3	3,0	38	0,015	2	■
	JS512021F2C.0Z2-NXT	02927165	2	F	2,0	3	4,0	38	0,02	2	■
	JS512020F2C.0Z2-NXT	02927164	2	F	2,0	6	4,0	57	0,02	2	■
	JS512030D2C.0Z2-NXT	02927167	2	D	3,0	3	6,0	38	0,03	2	■
	JS512030F2C.0Z2-NXT	02927166	2	F	3,0	6	6,0	57	0,03	2	■
	JS512040D2C.0Z2-NXT	02927169	2	D	4,0	4	8,0	50	0,04	2	■
	JS512040F2C.0Z2-NXT	02927168	2	F	4,0	6	8,0	57	0,04	2	■
	JS512050D2C.0Z2-NXT	02927171	2	D	5,0	5	10,0	50	0,05	2	■
	JS512050F2C.0Z2-NXT	02927170	2	F	5,0	6	10,0	57	0,05	2	■
	JS512060D2C.0Z2-NXT	02927172	2	D	6,0	6	12,0	57	0,06	2	■
	JS512080D2C.0Z2-NXT	02927173	2	D	8,0	8	16,0	63	0,08	2	■
	JS512100D2C.0Z2-NXT	02927174	2	D	10,0	10	20,0	72	0,1	2	■
	JS512120D2C.0Z2-NXT	02927175	2	D	12,0	12	24,0	83	0,12	2	■
	JS512160D2C.0Z2-NXT	02927176	2	D	16,0	16	30,0	92	0,16	2	■
	JS512200D2C.0Z2-NXT	02927191	2	D	20,0	20	35,0	104	0,2	2	■
	JS512250D2C.0Z2-NXT	02927192	2	D	25,0	25	40,0	125	0,25	2	■
	JS512010F3C.0Z2-NXT	02927193	3	F	1,0	3	3,0	38	0,01	2	■
	JS512015F3C.0Z2-NXT	02927194	3	F	1,5	3	6,0	38	0,015	2	■
	JS512020F3C.0Z2-NXT	02927177	3	F	2,0	6	7,0	57	0,02	2	■
	JS512030F3C.0Z2-NXT	02927178	3	F	3,0	6	10,0	57	0,03	2	■
	JS512040F3C.0Z2-NXT	02927179	3	F	4,0	6	14,0	57	0,04	2	■
	JS512050F3C.0Z2-NXT	02927195	3	F	5,0	6	18,0	57	0,05	2	■
	JS512060D3C.0Z2-NXT	02927180	3	D	6,0	6	20,0	63	0,06	2	■
	JS512080D3C.0Z2-NXT	02927181	3	D	8,0	8	28,0	80	0,08	2	■
	JS512100D3C.0Z2-NXT	02927182	3	D	10,0	10	35,0	89	0,1	2	■
	JS512120D3C.0Z2-NXT	02927183	3	D	12,0	12	42,0	100	0,12	2	■
	JS512160D3C.0Z2-NXT	02927196	3	D	16,0	16	50,0	115	0,16	2	■
	JS512200D3C.0Z2-NXT	02927197	3	D	20,0	20	60,0	125	0,2	2	■

■ Stocked standard.

JS512

General purpose – Universal – Square – 2 Flutes – Cylindrical – Chamfer

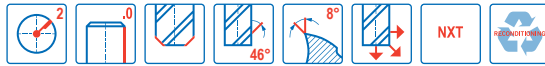
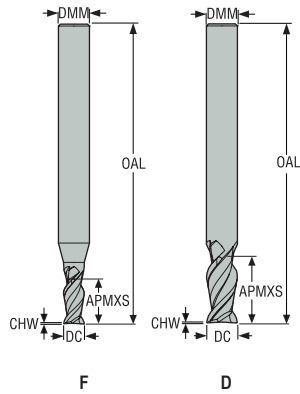

- Tolerances:
- DMM=h5
- DC=e8
- Regrind possible if DC is ≥Ø6

Designation	Item number	Length index	Tool shape	DC	DMM	APMXS	OAL	CHW	PCEDC	Cylindrical
				mm	mm	mm	mm	mm		
JS512020F4C.0Z2-NXT	02927184	4	F	2,0	6,0	10,0	57,0	0,02	2	■
JS512030F4C.0Z2-NXT	02927185	4	F	3,0	6,0	15,0	57,0	0,03	2	■
JS512040F4C.0Z2-NXT	02927186	4	F	4,0	6,0	20,0	63,0	0,04	2	■
JS512050F4C.0Z2-NXT	02927199	4	F	5,0	6,0	25,0	63,0	0,05	2	■
JS512060D4C.0Z2-NXT	02927188	4	D	6,0	6,0	30,0	75,0	0,06	2	■
JS512080D4C.0Z2-NXT	02927189	4	D	8,0	8,0	40,0	100,0	0,08	2	■
JS512100D4C.0Z2-NXT	02927190	4	D	10,0	10,0	50,0	100,0	0,1	2	■
JS512120D4C.0Z2-NXT	02927200	4	D	12,0	12,0	60,0	125,0	0,12	2	■
JS512160D4C.0Z2-NXT	02927201	4	D	16,0	16,0	70,0	130,0	0,16	2	■
JS512200D4C.0Z2-NXT	02927202	4	D	20,0	20,0	80,0	150,0	0,2	2	■
JS512250D4C.0Z2-NXT	02927203	4	D	25,0	25,0	90,0	165,0	0,25	2	■

■ Stocked standard.

Universal

Steel and cast iron

Stainless steel and S-materials

Non ferrous

Hard

Plastic and cfrp

Graphite

Minimaster Plus

Minimaster

JS512

General purpose – Universal – Square – 2 Flutes – Weldon – Chamfer

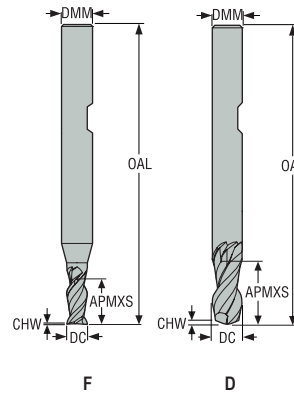

- Tolerances:
- DMM=h5
- DC=e8
- Regrind possible if DC is $\geq \varnothing 6$

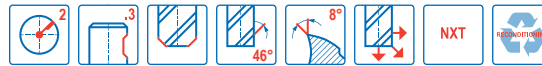

Designation	Item number	Length index	Tool shape	DC	DMM	APMXS	OAL	CHW	PCEDC	Weldon
				mm	mm	mm	mm	mm		
JS512020F2C.3Z2-NXT	02927267	2	F	2,0	6,0	4,0	57,0	0,02	2	<input type="checkbox"/>
JS512030F2C.3Z2-NXT	02927268	2	F	3,0	6,0	6,0	57,0	0,03	2	<input type="checkbox"/>
JS512040F2C.3Z2-NXT	02927269	2	F	4,0	6,0	8,0	57,0	0,04	2	<input type="checkbox"/>
JS512050F2C.3Z2-NXT	02927270	2	F	5,0	6,0	10,0	57,0	0,05	2	<input type="checkbox"/>
JS512060D2C.3Z2-NXT	02927271	2	D	6,0	6,0	12,0	57,0	0,06	2	<input type="checkbox"/>
JS512080D2C.3Z2-NXT	02927272	2	D	8,0	8,0	16,0	63,0	0,08	2	<input type="checkbox"/>
JS512100D2C.3Z2-NXT	02927273	2	D	10,0	10,0	20,0	72,0	0,1	2	<input type="checkbox"/>
JS512120D2C.3Z2-NXT	02927274	2	D	12,0	12,0	24,0	83,0	0,12	2	<input type="checkbox"/>
JS512160D2C.3Z2-NXT	02927275	2	D	16,0	16,0	30,0	92,0	0,16	2	<input type="checkbox"/>
JS512200D2C.3Z2-NXT	02927276	2	D	20,0	20,0	35,0	104,0	0,2	2	<input type="checkbox"/>
JS512250D2C.3Z2-NXT	02927277	2	D	25,0	25,0	40,0	125,0	0,25	2	<input type="checkbox"/>
JS512020F3C.3Z2-NXT	02927278	3	F	2,0	6,0	7,0	57,0	0,02	2	<input type="checkbox"/>
JS512030F3C.3Z2-NXT	02927279	3	F	3,0	6,0	10,0	57,0	0,03	2	<input type="checkbox"/>
JS512040F3C.3Z2-NXT	02927280	3	F	4,0	6,0	14,0	57,0	0,04	2	<input type="checkbox"/>
JS512050F3C.3Z2-NXT	02927281	3	F	5,0	6,0	18,0	57,0	0,05	2	<input type="checkbox"/>
JS512060D3C.3Z2-NXT	02927282	3	D	6,0	6,0	20,0	63,0	0,06	2	<input type="checkbox"/>
JS512080D3C.3Z2-NXT	02927283	3	D	8,0	8,0	28,0	80,0	0,08	2	<input type="checkbox"/>
JS512100D3C.3Z2-NXT	02927284	3	D	10,0	10,0	35,0	89,0	0,1	2	<input type="checkbox"/>
JS512120D3C.3Z2-NXT	02927285	3	D	12,0	12,0	42,0	100,0	0,12	2	<input type="checkbox"/>
JS512160D3C.3Z2-NXT	02927286	3	D	16,0	16,0	50,0	115,0	0,16	2	<input type="checkbox"/>
JS512200D3C.3Z2-NXT	02927287	3	D	20,0	20,0	60,0	125,0	0,2	2	<input type="checkbox"/>
JS512250D3C.3Z2-NXT	02927288	3	D	25,0	25,0	70,0	150,0	0,25	2	<input type="checkbox"/>
JS512020F4C.3Z2-NXT	02927289	4	F	2,0	6,0	10,0	57,0	0,02	2	<input type="checkbox"/>
JS512030F4C.3Z2-NXT	02927290	4	F	3,0	6,0	15,0	57,0	0,03	2	<input type="checkbox"/>
JS512040F4C.3Z2-NXT	02927291	4	F	4,0	6,0	20,0	63,0	0,04	2	<input type="checkbox"/>
JS512050F4C.3Z2-NXT	02927292	4	F	5,0	6,0	25,0	63,0	0,05	2	<input type="checkbox"/>
JS512060D4C.3Z2-NXT	02927293	4	D	6,0	6,0	30,0	75,0	0,06	2	<input type="checkbox"/>
JS512080D4C.3Z2-NXT	02927294	4	D	8,0	8,0	40,0	100,0	0,08	2	<input type="checkbox"/>
JS512100D4C.3Z2-NXT	02927295	4	D	10,0	10,0	50,0	100,0	0,1	2	<input type="checkbox"/>
JS512120D4C.3Z2-NXT	02927296	4	D	12,0	12,0	60,0	125,0	0,12	2	<input type="checkbox"/>
JS512160D4C.3Z2-NXT	02927297	4	D	16,0	16,0	70,0	130,0	0,16	2	<input type="checkbox"/>
JS512200D4C.3Z2-NXT	02927298	4	D	20,0	20,0	80,0	150,0	0,2	2	<input type="checkbox"/>
JS512250D4C.3Z2-NXT	02927299	4	D	25,0	25,0	90,0	165,0	0,25	2	<input type="checkbox"/>

Weldon available. Delivery time is 3 days.

Cutting data – JS512 Side milling $a_p/DC = 0,2$

SMG	Coolant	a_e/DC	a_p/DC	f_z												v_c
				1	2	3	4	5	6	8	10	12	16	20	25	
P1	M/A/D/E	0.400	1.2	0.0085	0.017	0.026	0.034	0.044	0.050	0.070	0.085	0.10	0.13	0.15	0.17	190 (160 – 220)
		0,400	1,2	0,00034	0,00065	0,0010	0,0013	0,0017	0,0020	0,0028	0,0034	0,0040	0,0050	0,0060	0,0065	620 (530 – 720)
P2	M/A/D/E	0.400	1.2	0.0090	0.018	0.026	0.036	0.044	0.055	0.070	0.090	0.10	0.13	0.15	0.17	180 (160 – 210)
		0,400	1,2	0,00036	0,00070	0,0010	0,0014	0,0017	0,0022	0,0028	0,0036	0,0040	0,0050	0,0060	0,0065	590 (530 – 680)
P3	M/A/D/E	0.400	1.2	0.0085	0.017	0.025	0.034	0.042	0.050	0.065	0.085	0.10	0.12	0.14	0.16	160 (140 – 180)
		0,400	1,2	0,00034	0,00065	0,0010	0,0013	0,0017	0,0020	0,0026	0,0034	0,0040	0,0048	0,0055	0,0065	520 (460 – 590)
P4	M/A/D/E	0.400	1.2	0.0080	0.016	0.025	0.032	0.042	0.050	0.065	0.080	0.095	0.12	0.14	0.16	140 (120 – 160)
		0,400	1,2	0,00032	0,00065	0,0010	0,0013	0,0017	0,0020	0,0026	0,0032	0,0038	0,0048	0,0055	0,0065	460 (400 – 520)
P5	M/A/D/E	0.400	1.2	0.0080	0.016	0.024	0.032	0.040	0.048	0.065	0.080	0.095	0.12	0.14	0.15	135 (120 – 150)
		0,400	1,2	0,00032	0,00065	0,00095	0,0013	0,0016	0,0019	0,0026	0,0032	0,0038	0,0048	0,0055	0,0060	445 (400 – 490)
P6	M/A/D/E	0.400	1.2	0.0080	0.016	0.024	0.032	0.040	0.048	0.065	0.080	0.095	0.12	0.14	0.15	150 (130 – 170)
		0,400	1,2	0,00032	0,00065	0,00095	0,0013	0,0016	0,0019	0,0026	0,0032	0,0038	0,0048	0,0055	0,0060	490 (430 – 550)
P7	M/A/D/E	0.400	1.2	0.0080	0.016	0.024	0.032	0.040	0.048	0.065	0.080	0.095	0.12	0.14	0.15	145 (120 – 160)
		0,400	1,2	0,00032	0,00065	0,00095	0,0013	0,0016	0,0019	0,0026	0,0032	0,0038	0,0048	0,0055	0,0060	475 (400 – 520)
P8	M/A/D/E	0.400	1.2	0.0085	0.017	0.025	0.034	0.042	0.050	0.065	0.085	0.10	0.12	0.14	0.16	135 (120 – 150)
		0,400	1,2	0,00034	0,00065	0,0010	0,0013	0,0017	0,0020	0,0026	0,0034	0,0040	0,0048	0,0055	0,0065	445 (400 – 490)
P11	M/A/D/E	0.400	1.0	0.012	0.024	0.036	0.046	0.060	0.070	0.095	0.12	0.14	0.17	0.20	0.22	140 (130 – 150)
		0,400	1,0	0,00048	0,00095	0,0014	0,0018	0,0024	0,0028	0,0038	0,0048	0,0055	0,0065	0,0080	0,0085	460 (430 – 490)
P12	M/A/D/E	0.400	1.0	0.0080	0.016	0.024	0.032	0.040	0.048	0.065	0.080	0.095	0.12	0.14	0.15	90 (79 – 100)
		0,400	1,0	0,00032	0,00065	0,00095	0,0013	0,0016	0,0019	0,0026	0,0032	0,0038	0,0048	0,0055	0,0060	295 (260 – 320)
M1	E/M/A	0.400	1.0	0.0090	0.018	0.026	0.036	0.044	0.055	0.070	0.090	0.10	0.13	0.15	0.17	110 (95 – 120)
		0,400	1,0	0,00036	0,00070	0,0010	0,0014	0,0017	0,0022	0,0028	0,0036	0,0040	0,0050	0,0060	0,0065	360 (320 – 390)
M2	E/M/A	0.400	1.0	0.0080	0.016	0.024	0.032	0.040	0.048	0.065	0.080	0.095	0.12	0.14	0.15	90 (79 – 100)
		0,400	1,0	0,00032	0,00065	0,00095	0,0013	0,0016	0,0019	0,0026	0,0032	0,0038	0,0048	0,0055	0,0060	295 (260 – 320)
M3	E/M/A	0.400	1.0	0.0080	0.016	0.024	0.032	0.040	0.048	0.065	0.080	0.095	0.12	0.14	0.15	55 (46 – 67)
		0,400	1,0	0,00032	0,00065	0,00095	0,0013	0,0016	0,0019	0,0026	0,0032	0,0038	0,0048	0,0055	0,0060	180 (160 – 210)
M4	E/M/A	0.400	1.0	0.0070	0.014	0.022	0.028	0.036	0.042	0.055	0.070	0.085	0.10	0.12	0.14	44 (35 – 52)
		0,400	1,0	0,00028	0,00055	0,00085	0,0011	0,0014	0,0017	0,0022	0,0028	0,0034	0,0040	0,0048	0,0055	145 (120 – 170)
M5	E/M/A	0.400	1.0	0.0070	0.014	0.022	0.028	0.036	0.042	0.055	0.070	0.085	0.10	0.12	0.14	36 (30 – 43)
		0,400	1,0	0,00028	0,00055	0,00085	0,0011	0,0014	0,0017	0,0022	0,0028	0,0034	0,0040	0,0048	0,0055	120 (99 – 140)
K1	A/D/M/E	0.400	1.2	0.0080	0.016	0.024	0.032	0.040	0.048	0.065	0.080	0.095	0.12	0.14	0.15	170 (150 – 190)
		0,400	1,2	0,00032	0,00065	0,00095	0,0013	0,0016	0,0019	0,0026	0,0032	0,0038	0,0048	0,0055	0,0060	560 (500 – 620)
K2	A/D/M/E	0.400	1.2	0.0075	0.015	0.022	0.030	0.036	0.044	0.060	0.075	0.085	0.11	0.12	0.14	150 (130 – 160)
		0,400	1,2	0,00030	0,00060	0,00085	0,0012	0,0014	0,0017	0,0024	0,0030	0,0034	0,0044	0,0048	0,0055	490 (430 – 520)
K3	A/D/M/E	0.400	1.2	0.0075	0.015	0.022	0.030	0.036	0.044	0.060	0.075	0.085	0.11	0.12	0.14	125 (110 – 140)
		0,400	1,2	0,00030	0,00060	0,00085	0,0012	0,0014	0,0017	0,0024	0,0030	0,0034	0,0044	0,0048	0,0055	410 (370 – 450)
K4	A/D/M/E	0.400	1.2	0.0075	0.015	0.022	0.030	0.036	0.044	0.060	0.075	0.085	0.11	0.12	0.14	120 (110 – 130)
		0,400	1,2	0,00030	0,00060	0,00085	0,0012	0,0014	0,0017	0,0024	0,0030	0,0034	0,0044	0,0048	0,0055	395 (370 – 420)
K5	A/D/M/E	0.400	1.2	0.0080	0.016	0.024	0.032	0.040	0.048	0.065	0.080	0.095	0.12	0.13	0.15	145 (130 – 160)
		0,400	1,2	0,00032	0,00065	0,00095	0,0013	0,0016	0,0019	0,0026	0,0032	0,0038	0,0048	0,0050	0,0060	475 (430 – 520)
K6	A/D/M/E	0.400	1.2	0.0090	0.018	0.026	0.036	0.044	0.055	0.070	0.090	0.10	0.13	0.15	0.17	210 (180 – 240)
		0,400	1,2	0,00036	0,00070	0,0010	0,0014	0,0017	0,0022	0,0028	0,0036	0,0040	0,0050	0,0060	0,0065	690 (600 – 780)
K7	A/D/M/E	0.400	1.2	0.0080	0.016	0.024	0.032	0.040	0.048	0.065	0.080	0.095	0.12	0.13	0.15	185 (160 – 210)
		0,400	1,2	0,00032	0,00065	0,00095	0,0013	0,0016	0,0019	0,0026	0,0032	0,0038	0,0048	0,0050	0,0060	610 (530 – 680)

For cutting data recalculations, see pages 445 - 452

SMG = Seco material group
Coolant = A=air D=dry E=emulsion M=mist spray
 v_c = m/min (sf/min)
 f_z = mm/tooth (in/tooth)
 a_p = mm/DC (in/DC) = factor
 a_e = mm/DC (in/DC) = factor
All cutting data are target values

Universal
Steel and cast iron
Stainless steel and S-materials
Non ferrous
Hard
Plastic and chip
Graphite
Mimimaster Plus
Mimimaster

Cutting data – JS512 Side milling $a_p/DC = 0,2$

Universal	SMG	Coolant	a_p/DC	a_r/DC	f_z											v_c	
					1	2	3	4	5	6	8	10	12	16	20		25
Steel and cast iron	N1	E/M/A	0.300	1.0	0.011	0.022	0.032	0.044	0.055	0.065	0.085	0.11	0.13	0.16	0.18	0.20	465 (350—570)
			0.300	1.0	0,00044	0,00085	0,0013	0,0017	0,0022	0,0026	0,0034	0,0044	0,0050	0,0065	0,0070	0,0080	1525 (1200—1800)
	N2	E/M/A	0.300	1.0	0.011	0.022	0.032	0.044	0.055	0.065	0.085	0.11	0.13	0.16	0.18	0.20	300 (230—370)
Stainless steel and S-materials	S1	E	0.300	1.0	0.011	0.022	0.032	0.044	0.055	0.065	0.085	0.11	0.13	0.16	0.18	0.20	200 (150—240)
			0.300	1.0	0,00044	0,00085	0,0013	0,0017	0,0022	0,0026	0,0034	0,0044	0,0050	0,0065	0,0070	0,0080	660 (500—780)
	S2	E	0.200	1.0	0.0044	0.0085	0.013	0.017	0.022	0.026	0.034	0.044	0.050	0.065	0.075	0.085	45 (28—63)
Non ferrous	S3	E	0.200	1.0	0.0044	0.0085	0.013	0.017	0.022	0.026	0.034	0.044	0.050	0.065	0.075	0.085	36 (22—51)
			0.200	1.0	0,00017	0,00034	0,00050	0,00065	0,00085	0,0010	0,0013	0,0017	0,0020	0,0026	0,0030	0,0034	150 (92—200)
	S11	E	0.200	1.0	0.0044	0.0085	0.013	0.017	0.022	0.026	0.034	0.044	0.050	0.065	0.075	0.085	32 (20—44)
Hard	S12	E	0.200	1.0	0.0040	0.0080	0.012	0.016	0.020	0.024	0.032	0.040	0.048	0.060	0.070	0.075	120 (73—160)
			0.200	1.0	0,00016	0,00032	0,00048	0,00065	0,00080	0,00095	0,0013	0,0016	0,0019	0,0024	0,0028	0,0030	105 (66—140)
	S13	E	0.300	1.0	0.0070	0.014	0.022	0.028	0.036	0.044	0.060	0.070	0.085	0.11	0.12	0.14	110 (78—130)
Plastic and cfrp	H5	M/A/D	0.300	1.0	0.0028	0.0055	0.0085	0.011	0.014	0.017	0.024	0.034	0.044	0.055	0.065	0.075	360 (260—420)
			0.300	1.0	0,00028	0,00055	0,00085	0,0011	0,0014	0,0017	0,0024	0,0034	0,0044	0,0055	0,0065	0,0075	0,0085
	H8	E	0.300	1.0	0.0070	0.014	0.022	0.028	0.036	0.044	0.060	0.070	0.085	0.11	0.12	0.14	85 (60—100)
Graphite	H21	M/A/D	0.300	1.0	0.0065	0.013	0.019	0.025	0.032	0.038	0.050	0.065	0.075	0.095	0.11	0.12	65 (47—84)
			0.300	1.0	0,00026	0,00050	0,00075	0,0010	0,0013	0,0015	0,0020	0,0026	0,0030	0,0038	0,0044	0,0048	215 (160—270)
	H31	E	0.0300	0.50	0.012	0.024	0.036	0.048	0.060	0.070	0.095	0.12	0.14	0.19	0.24	0.30	80 (65—96)
Minimaster Plus	TS1	A/D	0.0300	0.50	0.012	0.024	0.036	0.048	0.060	0.070	0.095	0.12	0.14	0.19	0.24	0.30	80 (65—96)
			0.0300	0.50	0,00048	0,00095	0,0014	0,0019	0,0024	0,0028	0,0038	0,0048	0,0055	0,0075	0,0095	0,012	260 (220—310)
	TP1	A/D	0.0300	0.50	0.012	0.024	0.036	0.048	0.060	0.070	0.095	0.12	0.14	0.19	0.24	0.30	80 (65—96)
Minimaster	GR1	A/D	0.0300	0.50	0.012	0.024	0.036	0.048	0.060	0.070	0.095	0.12	0.14	0.19	0.24	0.30	60 (49—72)
			0.0300	0.50	0,00048	0,00095	0,0014	0,0019	0,0024	0,0028	0,0038	0,0048	0,0055	0,0075	0,0095	0,012	260 (220—310)
	TS1	A/D	0.400	1.4	0.013	0.026	0.038	0.050	0.065	0.080	0.10	0.13	0.15	0.19	0.22	0.25	550 (450—660)
Minimaster	TP1	A/D	0.400	1.4	0.013	0.026	0.038	0.050	0.065	0.080	0.10	0.13	0.15	0.19	0.22	0.25	550 (450—660)
			0.400	1.4	0,00050	0,0010	0,0015	0,0020	0,0026	0,0032	0,0040	0,0050	0,0060	0,0075	0,0085	0,010	1800 (1500—2100)
	GR1	A/D	0.400	1.4	0.013	0.026	0.038	0.050	0.065	0.080	0.10	0.13	0.15	0.19	0.22	0.25	550 (450—660)
			0.400	1.4	0,00050	0,0010	0,0015	0,0020	0,0026	0,0032	0,0040	0,0050	0,0060	0,0075	0,0085	0,010	1800 (1500—2100)

For cutting data recalculations, see pages 445 - 452

SMG = Seco material group
Coolant = A=air D=dry E=emulsion M=mist spray
 $v_c = m/min (sf/min)$
 $f_z = mm/tooth (in/tooth)$
 $a_p = mm/DC (in/DC) = factor$
 $a_e = mm/DC (in/DC) = factor$
All cutting data are target values

Cutting data – JS512 Slot milling

SMG		a _p /DC	f _z												v _c
			1	2	3	4	5	6	8	10	12	16	20	25	
P1	E	1.0	0.0050	0.010	0.015	0.020	0.025	0.030	0.040	0.050	0.060	0.080	0.10	0.13	170 (150–190)
		1.0	0.0020	0.0040	0.0060	0.0080	0.010	0.012	0.016	0.020	0.024	0.032	0.040	0.050	560 (500 – 620)
P2	E	1.0	0.0050	0.010	0.015	0.020	0.025	0.030	0.040	0.050	0.060	0.080	0.10	0.13	165 (140–190)
		1.0	0.0020	0.0040	0.0060	0.0080	0.010	0.012	0.016	0.020	0.024	0.032	0.040	0.050	540 (460 – 620)
P3	E	1.0	0.0050	0.010	0.015	0.020	0.025	0.030	0.040	0.050	0.060	0.080	0.10	0.13	145 (120–160)
		1.0	0.0020	0.0040	0.0060	0.0080	0.010	0.012	0.016	0.020	0.024	0.032	0.040	0.050	475 (400 – 520)
P4	E	1.0	0.0050	0.010	0.015	0.020	0.025	0.030	0.040	0.050	0.060	0.080	0.10	0.13	125 (110–140)
		1.0	0.0020	0.0040	0.0060	0.0080	0.010	0.012	0.016	0.020	0.024	0.032	0.040	0.050	410 (370 – 450)
P5	E	1.0	0.0050	0.010	0.015	0.020	0.025	0.030	0.040	0.050	0.060	0.080	0.10	0.13	120 (110–140)
		1.0	0.0020	0.0040	0.0060	0.0080	0.010	0.012	0.016	0.020	0.024	0.032	0.040	0.050	395 (370 – 450)
P6	E	1.0	0.0050	0.010	0.015	0.020	0.025	0.030	0.040	0.050	0.060	0.080	0.10	0.13	135 (120–150)
		1.0	0.0020	0.0040	0.0060	0.0080	0.010	0.012	0.016	0.020	0.024	0.032	0.040	0.050	445 (400 – 490)
P7	E	1.0	0.0050	0.010	0.015	0.020	0.025	0.030	0.040	0.050	0.060	0.080	0.10	0.13	125 (110–140)
		1.0	0.0020	0.0040	0.0060	0.0080	0.010	0.012	0.016	0.020	0.024	0.032	0.040	0.050	410 (370 – 450)
P8	E	1.0	0.0050	0.010	0.015	0.020	0.025	0.030	0.040	0.050	0.060	0.080	0.10	0.13	120 (110–140)
		1.0	0.0020	0.0040	0.0060	0.0080	0.010	0.012	0.016	0.020	0.024	0.032	0.040	0.050	395 (370 – 450)
P11	E	0.80	0.0050	0.010	0.015	0.020	0.025	0.030	0.040	0.050	0.060	0.080	0.10	0.13	135 (120–150)
		0.80	0.0020	0.0040	0.0060	0.0080	0.010	0.012	0.016	0.020	0.024	0.032	0.040	0.050	445 (400 – 490)
P12	E	0.80	0.0050	0.010	0.015	0.020	0.025	0.030	0.040	0.050	0.060	0.080	0.10	0.13	80 (70 – 89)
		0.80	0.0020	0.0040	0.0060	0.0080	0.010	0.012	0.016	0.020	0.024	0.032	0.040	0.050	260 (230 – 290)
M1	E	0.80	0.0050	0.010	0.015	0.020	0.025	0.030	0.040	0.050	0.060	0.080	0.10	0.13	100 (87–110)
		0.80	0.0020	0.0040	0.0060	0.0080	0.010	0.012	0.016	0.020	0.024	0.032	0.040	0.050	330 (290 – 360)
M2	E	0.80	0.0050	0.010	0.015	0.020	0.025	0.030	0.040	0.050	0.060	0.080	0.10	0.13	80 (71 – 89)
		0.80	0.0020	0.0040	0.0060	0.0080	0.010	0.012	0.016	0.020	0.024	0.032	0.040	0.050	260 (240 – 290)
M3	E	0.60	0.0050	0.010	0.015	0.020	0.025	0.030	0.040	0.050	0.060	0.080	0.10	0.13	50 (40 – 60)
		0.60	0.0020	0.0040	0.0060	0.0080	0.010	0.012	0.016	0.020	0.024	0.032	0.040	0.050	165 (140–190)
M4	E	0.60	0.0050	0.010	0.015	0.020	0.025	0.030	0.040	0.050	0.060	0.080	0.10	0.13	38 (30 – 45)
		0.60	0.0020	0.0040	0.0060	0.0080	0.010	0.012	0.016	0.020	0.024	0.032	0.040	0.050	125 (99–140)
M5	E	0.60	0.0050	0.010	0.015	0.020	0.025	0.030	0.040	0.050	0.060	0.080	0.10	0.13	31 (25 – 37)
		0.60	0.0020	0.0040	0.0060	0.0080	0.010	0.012	0.016	0.020	0.024	0.032	0.040	0.050	100 (83–120)
K1	E	1.0	0.0050	0.010	0.015	0.020	0.025	0.030	0.040	0.050	0.060	0.080	0.10	0.13	150 (130–170)
		1.0	0.0020	0.0040	0.0060	0.0080	0.010	0.012	0.016	0.020	0.024	0.032	0.040	0.050	490 (430 – 550)
K2	E	1.0	0.0050	0.010	0.015	0.020	0.025	0.030	0.040	0.050	0.060	0.080	0.10	0.13	130 (120–140)
		1.0	0.0020	0.0040	0.0060	0.0080	0.010	0.012	0.016	0.020	0.024	0.032	0.040	0.050	425 (400 – 450)
K3	E	1.0	0.0050	0.010	0.015	0.020	0.025	0.030	0.040	0.050	0.060	0.080	0.10	0.13	110 (96–120)
		1.0	0.0020	0.0040	0.0060	0.0080	0.010	0.012	0.016	0.020	0.024	0.032	0.040	0.050	360 (320 – 390)
K4	E	1.0	0.0050	0.010	0.015	0.020	0.025	0.030	0.040	0.050	0.060	0.080	0.10	0.13	105 (91–110)
		1.0	0.0020	0.0040	0.0060	0.0080	0.010	0.012	0.016	0.020	0.024	0.032	0.040	0.050	345 (300 – 360)
K5	E	0.80	0.0050	0.010	0.015	0.020	0.025	0.030	0.040	0.050	0.060	0.080	0.10	0.13	130 (110–150)
		0.80	0.0020	0.0040	0.0060	0.0080	0.010	0.012	0.016	0.020	0.024	0.032	0.040	0.050	425 (370 – 490)
K6	E	0.80	0.0050	0.010	0.015	0.020	0.025	0.030	0.040	0.050	0.060	0.080	0.10	0.13	190 (170 – 220)
		0.80	0.0020	0.0040	0.0060	0.0080	0.010	0.012	0.016	0.020	0.024	0.032	0.040	0.050	620 (560–720)
K7	E	0.80	0.0050	0.010	0.015	0.020	0.025	0.030	0.040	0.050	0.060	0.080	0.10	0.13	165 (150–190)
		0.80	0.0020	0.0040	0.0060	0.0080	0.010	0.012	0.016	0.020	0.024	0.032	0.040	0.050	540 (500 – 620)

For cutting data recalculations, see pages 445 - 452

SMG = Seco material group
 Coolant = A=air D=dry E=emulsion M=mist spray
 v_c = m/min (sf/min)
 f_z = mm/tooth (in/tooth)
 a_p = mm/DC (in/DC) = factor
 a_e = mm/DC (in/DC) = factor
 All cutting data are target values

Universal
 Steel and cast iron
 Stainless steel and S-materials
 Non ferrous
 Hard
 Plastic and chip
 Graphite
 Mimimaster Plus
 Mimimaster

Cutting data – JS512 Slot milling

Universal	SMG	Coolant	a _p /DC	f _z												v _c
				1	2	3	4	5	6	8	10	12	16	20	25	
Steel and cast iron	N1	E	0.40	0.0060	0.012	0.018	0.024	0.030	0.036	0.048	0.060	0.070	0.095	0.12	0.15	400 (300 – 500)
			0.40	0,00024	0,00048	0,00070	0,00095	0,0012	0,0014	0,0019	0,0024	0,0028	0,0038	0,0048	0,0060	1300 (990 – 1600)
Steel and cast iron	N2	E	0.40	0.0060	0.012	0.018	0.024	0.030	0.036	0.048	0.060	0.070	0.095	0.12	0.15	255 (200 – 320)
			0.40	0,00024	0,00048	0,00070	0,00095	0,0012	0,0014	0,0019	0,0024	0,0028	0,0038	0,0048	0,0060	840 (660 – 1000)
Steel and cast iron	N3	E	0.40	0.0060	0.012	0.018	0.024	0.030	0.036	0.048	0.060	0.070	0.095	0.12	0.15	170 (130 – 210)
			0.40	0,00024	0,00048	0,00070	0,00095	0,0012	0,0014	0,0019	0,0024	0,0028	0,0038	0,0048	0,0060	560 (430 – 680)
Steel and cast iron	N11	E	1.0	0.0060	0.012	0.018	0.024	0.030	0.036	0.048	0.060	0.070	0.095	0.12	0.15	300 (210 – 400)
			1.0	0,00024	0,00048	0,00070	0,00095	0,0012	0,0014	0,0019	0,0024	0,0028	0,0038	0,0048	0,0060	980 (690 – 1300)
Steel and cast iron	S1	E	0.20	0.0020	0.0040	0.0060	0.0080	0.010	0.012	0.016	0.020	0.024	0.032	0.040	0.050	36 (22 – 50)
			0.20	0,00080	0,0016	0,0024	0,0032	0,0040	0,0048	0,0065	0,0080	0,0095	0,013	0,016	0,020	120 (73 – 160)
Stainless steel and S-materials	S2	E	0.20	0.0020	0.0040	0.0060	0.0080	0.010	0.012	0.016	0.020	0.024	0.032	0.040	0.050	29 (18 – 40)
			0.20	0,00080	0,0016	0,0024	0,0032	0,0040	0,0048	0,0065	0,0080	0,0095	0,013	0,016	0,020	95 (60 – 130)
Stainless steel and S-materials	S3	E	0.20	0.0020	0.0040	0.0060	0.0080	0.010	0.012	0.016	0.020	0.024	0.032	0.040	0.050	25 (15 – 35)
			0.20	0,00080	0,0016	0,0024	0,0032	0,0040	0,0048	0,0065	0,0080	0,0095	0,013	0,016	0,020	80 (50 – 110)
Stainless steel and S-materials	S11	E	0.60	0.0040	0.0080	0.012	0.016	0.020	0.024	0.032	0.040	0.048	0.065	0.080	0.10	90 (65 – 110)
			0.60	0,0016	0,0032	0,0048	0,0065	0,0080	0,0095	0,013	0,016	0,019	0,026	0,032	0,040	295 (220 – 360)
Stainless steel and S-materials	S12	E	0.60	0.0040	0.0080	0.012	0.016	0.020	0.024	0.032	0.040	0.048	0.065	0.080	0.10	70 (50 – 90)
			0.60	0,0016	0,0032	0,0048	0,0065	0,0080	0,0095	0,013	0,016	0,019	0,026	0,032	0,040	230 (170 – 290)
Stainless steel and S-materials	S13	E	0.60	0.0040	0.0080	0.012	0.016	0.020	0.024	0.032	0.040	0.048	0.065	0.080	0.10	55 (39 – 69)
			0.60	0,0016	0,0032	0,0048	0,0065	0,0080	0,0095	0,013	0,016	0,019	0,026	0,032	0,040	180 (130 – 220)
Non ferrous	H5	M/A/D	0.20	0.0020	0.0040	0.0060	0.0080	0.010	0.012	0.016	0.020	0.024	0.032	0.040	0.050	50 (41 – 60)
			0.20	0,00080	0,0016	0,0024	0,0032	0,0040	0,0048	0,0065	0,0080	0,0095	0,013	0,016	0,020	165 (140 – 190)
Non ferrous	H8	M/A/D	0.20	0.0020	0.0040	0.0060	0.0080	0.010	0.012	0.016	0.020	0.024	0.032	0.040	0.050	50 (41 – 60)
			0.20	0,00080	0,0016	0,0024	0,0032	0,0040	0,0048	0,0065	0,0080	0,0095	0,013	0,016	0,020	165 (140 – 190)
Non ferrous	H11	M/A/D	0.20	0.0020	0.0040	0.0060	0.0080	0.010	0.012	0.016	0.020	0.024	0.032	0.040	0.050	65 (52 – 77)
			0.20	0,00080	0,0016	0,0024	0,0032	0,0040	0,0048	0,0065	0,0080	0,0095	0,013	0,016	0,020	215 (180 – 250)
Non ferrous	H12	M/A/D	0.20	0.0020	0.0040	0.0060	0.0080	0.010	0.012	0.016	0.020	0.024	0.032	0.040	0.050	60 (47 – 70)
			0.20	0,00080	0,0016	0,0024	0,0032	0,0040	0,0048	0,0065	0,0080	0,0095	0,013	0,016	0,020	195 (160 – 220)
Hard	H21	M/A/D	0.20	0.0020	0.0040	0.0060	0.0080	0.010	0.012	0.016	0.020	0.024	0.032	0.040	0.050	50 (41 – 60)
			0.20	0,00080	0,0016	0,0024	0,0032	0,0040	0,0048	0,0065	0,0080	0,0095	0,013	0,016	0,020	165 (140 – 190)
Hard	TS1	A	1.0	0.0080	0.016	0.024	0.032	0.040	0.048	0.065	0.080	0.095	0.13	0.16	0.20	500 (400 – 600)
			1.0	0,0032	0,0065	0,0095	0,013	0,016	0,019	0,026	0,032	0,038	0,050	0,065	0,080	1650 (1400 – 1900)
Hard	TP1	A	1.0	0.0080	0.016	0.024	0.032	0.040	0.048	0.065	0.080	0.095	0.13	0.16	0.20	500 (410 – 600)
			1.0	0,0032	0,0065	0,0095	0,013	0,016	0,019	0,026	0,032	0,038	0,050	0,065	0,080	1650 (1400 – 1900)
Hard	GR1	D/A	1.0	0.0080	0.016	0.024	0.032	0.040	0.048	0.065	0.080	0.095	0.13	0.16	0.20	500 (400 – 600)
			1.0	0,0032	0,0065	0,0095	0,013	0,016	0,019	0,026	0,032	0,038	0,050	0,065	0,080	1650 (1400 – 1900)

For cutting data recalculations, see pages 445 - 452

SMG = Seco material group
Coolant = A=air D=dry E=emulsion M=mist spray
v_c = m/min (sf/min)
f_z = mm/tooth (in/tooth)
a_p = mm/DC (in/DC) = factor
a_e = mm/DC (in/DC) = factor
All cutting data are target values

JS513

General purpose – Universal – Square – 3 Flutes – Cylindrical – Chamfer

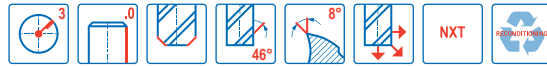
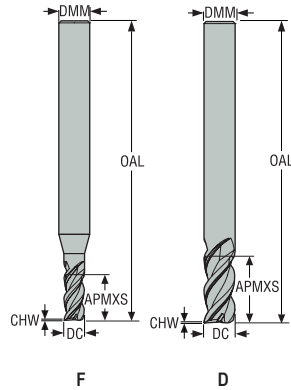

- Tolerances:
- DMM=h5
- DC=e8
- Regrind possible if DC is ≥Ø6

Designation	Item number	Length index	Tool shape	DC	DMM	APMXS	OAL	CHW	PCEDC	Cylindrical
				mm	mm	mm	mm	mm	mm	
JS513010F2C.0Z3-NXT	02927301	2	F	1,0	3,0	2,0	38,0	0,01	3	■
JS513015F2C.0Z3-NXT	02928157	2	F	1,5	3,0	3,0	38,0	0,015	3	■
JS513021F2C.0Z3-NXT	02927304	2	F	2,0	3,0	4,0	38,0	0,02	3	■
JS513020F2C.0Z3-NXT	02927303	2	F	2,0	6,0	4,0	57,0	0,02	3	■
JS513025F2C.0Z3-NXT	02927305	2	F	2,5	6,0	5,0	57,0	0,025	3	■
JS513030F2C.0Z3-NXT	02927306	2	F	3,0	6,0	6,0	57,0	0,03	3	■
JS513030D2C.0Z3-NXT	02927307	2	D	3,0	3,0	6,0	38,0	0,03	3	■
JS513040F2C.0Z3-NXT	02927308	2	F	4,0	6,0	8,0	57,0	0,04	3	■
JS513040D2C.0Z3-NXT	02927310	2	D	4,0	4,0	8,0	50,0	0,04	3	■
JS513050F2C.0Z3-NXT	02927311	2	F	5,0	6,0	10,0	57,0	0,05	3	■
JS513050D2C.0Z3-NXT	02927312	2	D	5,0	5,0	10,0	50,0	0,05	3	■
JS513060D2C.0Z3-NXT	02927313	2	D	6,0	6,0	12,0	57,0	0,06	3	■
JS513080D2C.0Z3-NXT	02927314	2	D	8,0	8,0	16,0	63,0	0,08	3	■
JS513100D2C.0Z3-NXT	02927315	2	D	10,0	10,0	20,0	72,0	0,1	3	■
JS513120D2C.0Z3-NXT	02927316	2	D	12,0	12,0	24,0	83,0	0,12	3	■
JS513140D2C.0Z3-NXT	02927317	2	D	14,0	14,0	28,0	83,0	0,14	3	■
JS513160D2C.0Z3-NXT	02927318	2	D	16,0	16,0	30,0	92,0	0,16	3	■
JS513180D2C.0Z3-NXT	02927319	2	D	18,0	18,0	35,0	100,0	0,18	3	■
JS513200D2C.0Z3-NXT	02927341	2	D	20,0	20,0	35,0	104,0	0,2	3	■
JS513250D2C.0Z3-NXT	02927342	2	D	25,0	25,0	40,0	125,0	0,25	3	■
JS513010F3C.0Z3-NXT	02927302	3	F	1,0	3,0	3,0	38,0	0,01	3	■
JS513015F3C.0Z3-NXT	02927320	3	F	1,5	3,0	6,0	38,0	0,015	3	■
JS513020F3C.0Z3-NXT	02927321	3	F	2,0	6,0	7,0	57,0	0,02	3	■
JS513025F3C.0Z3-NXT	02927343	3	F	2,5	6,0	9,0	57,0	0,025	3	■
JS513030F3C.0Z3-NXT	02927322	3	F	3,0	6,0	10,0	57,0	0,03	3	■
JS513040F3C.0Z3-NXT	02927323	3	F	4,0	6,0	14,0	57,0	0,04	3	■
JS513050F3C.0Z3-NXT	02927324	3	F	5,0	6,0	18,0	57,0	0,05	3	■
JS513060D3C.0Z3-NXT	02927325	3	D	6,0	6,0	20,0	63,0	0,06	3	■
JS513080D3C.0Z3-NXT	02927326	3	D	8,0	8,0	28,0	80,0	0,08	3	■
JS513100D3C.0Z3-NXT	02927327	3	D	10,0	10,0	35,0	89,0	0,1	3	■
JS513120D3C.0Z3-NXT	02927328	3	D	12,0	12,0	42,0	100,0	0,12	3	■
JS513140D3C.0Z3-NXT	02927329	3	D	14,0	14,0	50,0	120,0	0,14	3	■
JS513160D3C.0Z3-NXT	02927330	3	D	16,0	16,0	50,0	115,0	0,16	3	■
JS513200D3C.0Z3-NXT	02927331	3	D	20,0	20,0	60,0	125,0	0,2	3	■
JS513250D3C.0Z3-NXT	02927344	3	D	25,0	25,0	70,0	150,0	0,25	3	■

■ Stocked standard.

Universal
Steel and cast iron
Stainless steel and S-materials
Non ferrous
Hard
Plastic and chip
Graphite
Minimaster Plus
Minimaster

JS513

General purpose – Universal – Square – 3 Flutes – Cylindrical – Chamfer

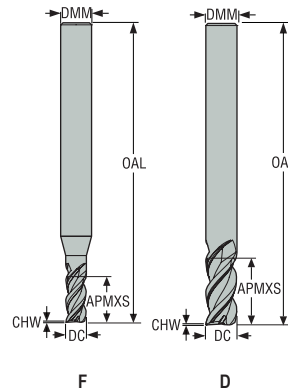

- Tolerances:
- DMM=h5
- DC=e8
- Regrind possible if DC is $\geq \phi 6$

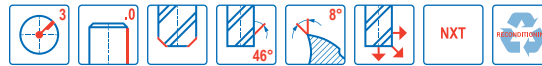

Designation	Item number	Length index	Tool shape	DC	DMM	APMXS	OAL	CHW	PCEDC	Cylindrical
				mm	mm	mm	mm	mm		
JS513020F4C.0Z3-NXT	02927332	4	F	2,0	6,0	10,0	57,0	0,02	3	■
JS513025F4C.0Z3-NXT	02927345	4	F	2,5	6,0	13,0	57,0	0,025	3	■
JS513030F4C.0Z3-NXT	02927333	4	F	3,0	6,0	15,0	57,0	0,03	3	■
JS513040F4C.0Z3-NXT	02927334	4	F	4,0	6,0	20,0	57,0	0,04	3	■
JS513050F4C.0Z3-NXT	02927335	4	F	5,0	6,0	25,0	63,0	0,05	3	■
JS513060D4C.0Z3-NXT	02927336	4	D	6,0	6,0	30,0	80,0	0,06	3	■
JS513080D4C.0Z3-NXT	02927337	4	D	8,0	8,0	40,0	100,0	0,08	3	■
JS513100D4C.0Z3-NXT	02927338	4	D	10,0	10,0	50,0	100,0	0,1	3	■
JS513120D4C.0Z3-NXT	02927339	4	D	12,0	12,0	60,0	125,0	0,12	3	■
JS513140D4C.0Z3-NXT	02927346	4	D	14,0	14,0	65,0	140,0	0,14	3	■
JS513160D4C.0Z3-NXT	02927340	4	D	16,0	16,0	70,0	130,0	0,16	3	■
JS513200D4C.0Z3-NXT	02927348	4	D	20,0	20,0	80,0	150,0	0,2	3	■
JS513250D4C.0Z3-NXT	02927349	4	D	25,0	25,0	90,0	165,0	0,25	3	■

■ Stocked standard.

Universal

Steel and cast iron

Stainless steel and S-materials

Non ferrous

Hard

Plastic and cfrp

Graphite

Minimaster Plus

Minimaster

JS513

General purpose – Universal – Square – 3 Flutes – Weldon – Chamfer

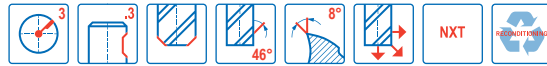
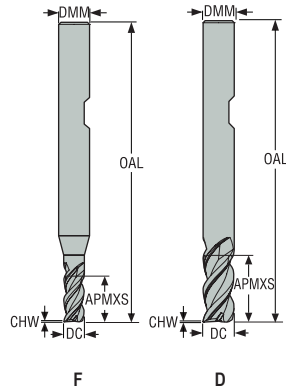

- Tolerances:
- DMM=h5
- DC=e8
- Regrind possible if DC is ≥Ø6

Designation	Item number	Length index	Tool shape	DC	DMM	APMXS	OAL	CHW	PCEDC	Weldon
				mm	mm	mm	mm	mm		
JS513020F2C.3Z3-NXT	02927355	2	F	2,0	6,0	4,0	57,0	0,02	3	<input type="checkbox"/>
JS513025F2C.3Z3-NXT	02927356	2	F	2,5	6,0	5,0	57,0	0,025	3	<input type="checkbox"/>
JS513030F2C.3Z3-NXT	02927357	2	F	3,0	6,0	6,0	57,0	0,03	3	<input type="checkbox"/>
JS513040F2C.3Z3-NXT	02927358	2	F	4,0	6,0	8,0	57,0	0,04	3	<input type="checkbox"/>
JS513050F2C.3Z3-NXT	02927359	2	F	5,0	6,0	10,0	57,0	0,05	3	<input type="checkbox"/>
JS513060D2C.3Z3-NXT	02927360	2	D	6,0	6,0	12,0	57,0	0,06	3	<input checked="" type="checkbox"/>
JS513080D2C.3Z3-NXT	02927361	2	D	8,0	8,0	16,0	63,0	0,08	3	<input checked="" type="checkbox"/>
JS513100D2C.3Z3-NXT	02927362	2	D	10,0	10,0	20,0	72,0	0,1	3	<input checked="" type="checkbox"/>
JS513120D2C.3Z3-NXT	02927363	2	D	12,0	12,0	24,0	83,0	0,12	3	<input checked="" type="checkbox"/>
JS513140D2C.3Z3-NXT	02927364	2	D	14,0	14,0	28,0	83,0	0,14	3	<input type="checkbox"/>
JS513160D2C.3Z3-NXT	02927365	2	D	16,0	16,0	30,0	92,0	0,16	3	<input type="checkbox"/>
JS513180D2C.3Z3-NXT	02927366	2	D	18,0	18,0	35,0	100,0	0,18	3	<input type="checkbox"/>
JS513200D2C.3Z3-NXT	02927367	2	D	20,0	20,0	35,0	104,0	0,2	3	<input type="checkbox"/>
JS513250D2C.3Z3-NXT	02927368	2	D	25,0	25,0	40,0	125,0	0,25	3	<input type="checkbox"/>
JS513020F3C.3Z3-NXT	02927369	3	F	2,0	6,0	7,0	57,0	0,02	3	<input type="checkbox"/>
JS513025F3C.3Z3-NXT	02927370	3	F	2,5	6,0	9,0	57,0	0,025	3	<input type="checkbox"/>
JS513030F3C.3Z3-NXT	02927371	3	F	3,0	6,0	10,0	57,0	0,03	3	<input type="checkbox"/>
JS513040F3C.3Z3-NXT	02927372	3	F	4,0	6,0	14,0	57,0	0,04	3	<input checked="" type="checkbox"/>
JS513050F3C.3Z3-NXT	02927373	3	F	5,0	6,0	18,0	57,0	0,05	3	<input type="checkbox"/>
JS513060D3C.3Z3-NXT	02927374	3	D	6,0	6,0	20,0	63,0	0,06	3	<input checked="" type="checkbox"/>
JS513080D3C.3Z3-NXT	02927375	3	D	8,0	8,0	28,0	80,0	0,08	3	<input type="checkbox"/>
JS513100D3C.3Z3-NXT	02927376	3	D	10,0	10,0	35,0	89,0	0,1	3	<input type="checkbox"/>
JS513120D3C.3Z3-NXT	02927377	3	D	12,0	12,0	42,0	100,0	0,12	3	<input type="checkbox"/>
JS513140D3C.3Z3-NXT	02927378	3	D	14,0	14,0	50,0	120,0	0,14	3	<input type="checkbox"/>
JS513160D3C.3Z3-NXT	02927379	3	D	16,0	16,0	50,0	115,0	0,16	3	<input type="checkbox"/>
JS513200D3C.3Z3-NXT	02927380	3	D	20,0	20,0	60,0	125,0	0,2	3	<input type="checkbox"/>
JS513250D3C.3Z3-NXT	02927381	3	D	25,0	25,0	70,0	150,0	0,25	3	<input type="checkbox"/>

■ Stocked standard. □ Weldon available. Delivery time is 3 days.

Universal
Steel and cast iron
Stainless steel and S-materials
Non ferrous
Hard
Plastic and chip
Graphite
Minimaster Plus
Minimaster

JS513

General purpose – Universal – Square – 3 Flutes – Weldon – Chamfer

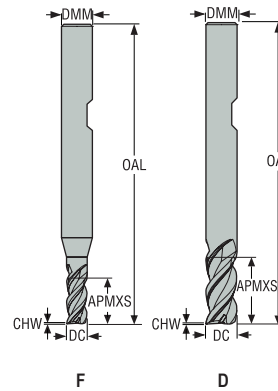

- Tolerances:
- DMM=h5
- DC=e8
- Regrind possible if DC is $\geq \phi 6$

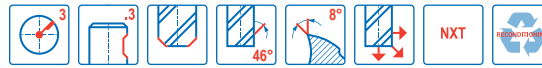

Designation	Item number	Length index	Tool shape	DC	DMM	APMXS	OAL	CHW	PCEDC	Weldon
				mm	mm	mm	mm	mm		
JS513020F4C.3Z3-NXT	02927382	4	F	2,0	6,0	10,0	57,0	0,02	3	<input type="checkbox"/>
JS513025F4C.3Z3-NXT	02927383	4	F	2,5	6,0	13,0	57,0	0,025	3	<input type="checkbox"/>
JS513030F4C.3Z3-NXT	02927384	4	F	3,0	6,0	15,0	57,0	0,03	3	<input type="checkbox"/>
JS513040F4C.3Z3-NXT	02927385	4	F	4,0	6,0	20,0	57,0	0,04	3	<input type="checkbox"/>
JS513050F4C.3Z3-NXT	02927386	4	F	5,0	6,0	25,0	63,0	0,05	3	<input type="checkbox"/>
JS513060D4C.3Z3-NXT	02927387	4	D	6,0	6,0	30,0	80,0	0,06	3	<input type="checkbox"/>
JS513080D4C.3Z3-NXT	02927388	4	D	8,0	8,0	40,0	100,0	0,08	3	<input type="checkbox"/>
JS513100D4C.3Z3-NXT	02927389	4	D	10,0	10,0	50,0	100,0	0,1	3	<input type="checkbox"/>
JS513120D4C.3Z3-NXT	02927390	4	D	12,0	12,0	60,0	125,0	0,12	3	<input type="checkbox"/>
JS513140D4C.3Z3-NXT	02927391	4	D	14,0	14,0	65,0	140,0	0,14	3	<input type="checkbox"/>
JS513160D4C.3Z3-NXT	02927392	4	D	16,0	16,0	70,0	130,0	0,16	3	<input type="checkbox"/>
JS513200D4C.3Z3-NXT	02927393	4	D	20,0	20,0	80,0	150,0	0,2	3	<input type="checkbox"/>
JS513250D4C.3Z3-NXT	02927394	4	D	25,0	25,0	90,0	165,0	0,25	3	<input type="checkbox"/>

Weldon available. Delivery time is 3 days.

Universal

Steel and cast iron

Stainless steel and S-materials

Non ferrous

Hard

Plastic and cfrp

Graphite

Minimaster Plus

Minimaster

Cutting data – JS513 Side milling

Universal	SMG	Coolant	a _e /DC	a _p /DC	f _z															v _c
					1	2	3	4	5	6	8	10	12	14	16	18	20	25		
Steel and cast iron	N1	E/M/A	0.300	1.0	0.0050	0.010	0.015	0.020	0.025	0.030	0.040	0.050	0.060	0.065	0.075	0.080	0.085	0.095	400 (300 – 490)	
			0,300	1,0	0,00020	0,00040	0,00060	0,00080	0,0010	0,0012	0,0016	0,0020	0,0024	0,0026	0,0030	0,0032	0,0034	0,0038	1300 (990 – 1600)	
	N2	E/M/A	0.300	1.0	0.0050	0.010	0.015	0.020	0.025	0.030	0.040	0.050	0.060	0.065	0.075	0.080	0.085	0.095	255 (200 – 320)	
			0,300	1,0	0,00020	0,00040	0,00060	0,00080	0,0010	0,0012	0,0016	0,0020	0,0024	0,0026	0,0030	0,0032	0,0034	0,0038	840 (660 – 1000)	
Stainless steel and S-materials	N3	E/M/A	0.300	1.0	0.0050	0.010	0.015	0.020	0.025	0.030	0.040	0.050	0.060	0.065	0.075	0.080	0.085	0.095	170 (130 – 210)	
			0,300	1,0	0,00020	0,00040	0,00060	0,00080	0,0010	0,0012	0,0016	0,0020	0,0024	0,0026	0,0030	0,0032	0,0034	0,0038	560 (430 – 680)	
	N11	E/M/A	0.400	1.0	0.0090	0.018	0.028	0.036	0.046	0.055	0.075	0.090	0.11	0.12	0.14	0.15	0.16	0.18	350 (240 – 460)	
			0,400	1,0	0,00036	0,00070	0,0011	0,0014	0,0018	0,0022	0,0030	0,0036	0,0044	0,0048	0,0055	0,0060	0,0065	0,0070	1150 (790 – 1500)	
Non ferrous	S1	E	0.200	1.0	0.0075	0.015	0.022	0.030	0.038	0.046	0.060	0.075	0.090	0.10	0.11	0.12	0.13	0.14	44 (27 – 61)	
			0,200	1,0	0,00030	0,00060	0,00085	0,0012	0,0015	0,0018	0,0024	0,0030	0,0036	0,0040	0,0044	0,0048	0,0050	0,0055	145 (89 – 200)	
	S2	E	0.200	1.0	0.0075	0.015	0.022	0.030	0.038	0.046	0.060	0.075	0.090	0.10	0.11	0.12	0.13	0.14	35 (22 – 49)	
			0,200	1,0	0,00030	0,00060	0,00085	0,0012	0,0015	0,0018	0,0024	0,0030	0,0036	0,0040	0,0044	0,0048	0,0050	0,0055	115 (73 – 160)	
Hard	S3	E	0.200	1.0	0.0070	0.014	0.022	0.028	0.036	0.042	0.055	0.070	0.085	0.095	0.10	0.11	0.12	0.13	31 (19 – 43)	
			0,200	1,0	0,00028	0,00055	0,00085	0,0011	0,0014	0,0017	0,0022	0,0028	0,0034	0,0038	0,0040	0,0044	0,0048	0,0050	100 (63 – 140)	
	S11	E	0.400	1.0	0.0060	0.012	0.018	0.024	0.030	0.036	0.048	0.060	0.070	0.080	0.090	0.095	0.10	0.12	100 (72 – 120)	
			0,400	1,0	0,00024	0,00048	0,00070	0,00095	0,0012	0,0014	0,0019	0,0024	0,0028	0,0032	0,0036	0,0038	0,0040	0,0048	330 (240 – 390)	
Plastic and CFRP	S12	E	0.400	1.0	0.0060	0.012	0.018	0.024	0.030	0.036	0.048	0.060	0.070	0.080	0.090	0.095	0.10	0.12	75 (56 – 99)	
			0,400	1,0	0,00024	0,00048	0,00070	0,00095	0,0012	0,0014	0,0019	0,0024	0,0028	0,0032	0,0036	0,0038	0,0040	0,0048	245 (190 – 320)	
	S13	E	0.400	1.0	0.0055	0.011	0.016	0.022	0.026	0.032	0.042	0.055	0.065	0.070	0.080	0.085	0.090	0.10	60 (44 – 78)	
			0,400	1,0	0,00022	0,00044	0,00065	0,00085	0,0010	0,0013	0,0017	0,0022	0,0026	0,0028	0,0032	0,0034	0,0036	0,0040	195 (150 – 250)	
Minimaster Plus	H5	M/A/D	0.0300	0.060	0.010	0.020	0.030	0.040	0.050	0.060	0.080	0.10	0.12	0.14	0.16	0.18	0.20	0.25	85 (67 – 100)	
			0,0300	0,060	0,00040	0,00080	0,0012	0,0016	0,0020	0,0024	0,0032	0,0040	0,0048	0,0055	0,0065	0,0070	0,0080	0,010	280 (220 – 320)	
	H8	M/A/D	0.0300	0.060	0.010	0.020	0.030	0.040	0.050	0.060	0.080	0.10	0.12	0.14	0.16	0.18	0.20	0.25	85 (67 – 100)	
			0,0300	0,060	0,00040	0,00080	0,0012	0,0016	0,0020	0,0024	0,0032	0,0040	0,0048	0,0055	0,0065	0,0070	0,0080	0,010	280 (220 – 320)	
Minimaster	H21	M/A/D	0.0300	0.060	0.010	0.020	0.030	0.040	0.050	0.060	0.080	0.10	0.12	0.14	0.16	0.18	0.20	0.25	85 (67 – 100)	
			0,0300	0,060	0,00040	0,00080	0,0012	0,0016	0,0020	0,0024	0,0032	0,0040	0,0048	0,0055	0,0065	0,0070	0,0080	0,010	280 (220 – 320)	
	H31	M/A/D	0.0300	0.060	0.010	0.020	0.030	0.040	0.050	0.060	0.080	0.10	0.12	0.14	0.16	0.18	0.20	0.25	65 (51 – 75)	
			0,0300	0,060	0,00040	0,00080	0,0012	0,0016	0,0020	0,0024	0,0032	0,0040	0,0048	0,0055	0,0065	0,0070	0,0080	0,010	215 (170 – 240)	
Graphite	TS1	A/D	0.400	1.4	0.013	0.026	0.038	0.050	0.065	0.080	0.10	0.13	0.15	0.17	0.19	0.20	0.22	0.25	550 (450 – 660)	
			0,400	1,4	0,00050	0,0010	0,0015	0,0020	0,0026	0,0032	0,0040	0,0050	0,0060	0,0065	0,0075	0,0080	0,0085	0,010	1800 (1500 – 2100)	
	TP1	A/D	0.400	1.4	0.013	0.026	0.038	0.050	0.065	0.080	0.10	0.13	0.15	0.17	0.19	0.20	0.22	0.25	550 (450 – 660)	
0,400			1,4	0,00050	0,0010	0,0015	0,0020	0,0026	0,0032	0,0040	0,0050	0,0060	0,0065	0,0075	0,0080	0,0085	0,010	1800 (1500 – 2100)		
Minimaster	GR1	A/D	0.400	1.4	0.013	0.026	0.038	0.050	0.065	0.080	0.10	0.13	0.15	0.17	0.19	0.20	0.22	0.25	550 (450 – 660)	
			0,400	1,4	0,00050	0,0010	0,0015	0,0020	0,0026	0,0032	0,0040	0,0050	0,0060	0,0065	0,0075	0,0080	0,0085	0,010	1800 (1500 – 2100)	

For cutting data recalculations, see pages 445 - 452

SMG = Seco material group
Coolant = A=air D=dry E=emulsion M=mist spray
v_c = m/min (sf/min)
f_z = mm (in/tooth)
a_p = mm/DC (in/DC) = factor
a_e = mm/DC (in/DC) = factor
All cutting data are target values

Cutting data – JS513 Slot milling

Universal	SMG	Coolant	a _p /DC	f _z													v _c	
				1	2	3	4	5	6	8	10	12	14	16	18	20		25
Steel and cast iron	S1	E	0.20	0.0032	0.0065	0.0095	0.013	0.016	0.019	0.025	0.032	0.038	0.044	0.050	0.055	0.065	0.080	36 (22 – 50)
			0.20	0.00013	0.00026	0.00038	0.00050	0.00065	0.00075	0.0010	0.0013	0.0015	0.0017	0.0020	0.0022	0.0026	0.0032	120 (73–160)
	S2	E	0.20	0.0032	0.0065	0.0095	0.013	0.016	0.019	0.025	0.032	0.038	0.044	0.050	0.055	0.065	0.080	29 (18 – 40)
			0.20	0.00013	0.00026	0.00038	0.00050	0.00065	0.00075	0.0010	0.0013	0.0015	0.0017	0.0020	0.0022	0.0026	0.0032	95 (60–130)
	S3	E	0.20	0.0032	0.0065	0.0095	0.013	0.016	0.019	0.025	0.032	0.038	0.044	0.050	0.055	0.065	0.080	25 (16 – 35)
			0.20	0.00013	0.00026	0.00038	0.00050	0.00065	0.00075	0.0010	0.0013	0.0015	0.0017	0.0020	0.0022	0.0026	0.0032	80 (53–110)
S11	E	0.40	0.0032	0.0065	0.0095	0.013	0.016	0.019	0.025	0.032	0.038	0.044	0.050	0.055	0.065	0.080	90 (66–110)	
		0.40	0.00013	0.00026	0.00038	0.00050	0.00065	0.00075	0.0010	0.0013	0.0015	0.0017	0.0020	0.0022	0.0026	0.0032	295 (220 – 360)	
S12	E	0.40	0.0032	0.0065	0.0095	0.013	0.016	0.019	0.025	0.032	0.038	0.044	0.050	0.055	0.065	0.080	70 (51 – 90)	
		0.40	0.00013	0.00026	0.00038	0.00050	0.00065	0.00075	0.0010	0.0013	0.0015	0.0017	0.0020	0.0022	0.0026	0.0032	230 (170 – 290)	
S13	E	0.40	0.0032	0.0065	0.0095	0.013	0.016	0.019	0.025	0.032	0.038	0.044	0.050	0.055	0.065	0.080	55 (39 – 69)	
		0.40	0.00013	0.00026	0.00038	0.00050	0.00065	0.00075	0.0010	0.0013	0.0015	0.0017	0.0020	0.0022	0.0026	0.0032	180 (130 – 220)	
Stainless steel and S-materials	H5	M/A/D	0.060	0.0020	0.0040	0.0060	0.0080	0.010	0.012	0.016	0.020	0.025	0.028	0.032	0.036	0.040	0.050	50 (41 – 60)
			0.060	0.000080	0.00016	0.00024	0.00032	0.00040	0.00048	0.00065	0.00080	0.0010	0.0011	0.0013	0.0014	0.0016	0.0020	165 (140–190)
	H8	M/A/D	0.060	0.0020	0.0040	0.0060	0.0080	0.010	0.012	0.016	0.020	0.025	0.028	0.032	0.036	0.040	0.050	50 (41 – 60)
			0.060	0.000080	0.00016	0.00024	0.00032	0.00040	0.00048	0.00065	0.00080	0.0010	0.0011	0.0013	0.0014	0.0016	0.0020	165 (140–190)
	H21	M/A/D	0.060	0.0020	0.0040	0.0060	0.0080	0.010	0.012	0.016	0.020	0.025	0.028	0.032	0.036	0.040	0.050	50 (41 – 60)
			0.060	0.000080	0.00016	0.00024	0.00032	0.00040	0.00048	0.00065	0.00080	0.0010	0.0011	0.0013	0.0014	0.0016	0.0020	165 (140–190)
H31	M/A/D	0.060	0.0020	0.0040	0.0060	0.0080	0.010	0.012	0.016	0.020	0.025	0.028	0.032	0.036	0.040	0.050	38 (31 – 45)	
		0.060	0.000080	0.00016	0.00024	0.00032	0.00040	0.00048	0.00065	0.00080	0.0010	0.0011	0.0013	0.0014	0.0016	0.0020	125 (110–140)	
Non ferrous	TS1	A/D	0.90	0.0080	0.016	0.024	0.032	0.040	0.048	0.065	0.080	0.095	0.11	0.13	0.14	0.16	0.20	500 (410 – 600)
			0.90	0.00032	0.00065	0.00095	0.0013	0.0016	0.0019	0.0026	0.0032	0.0038	0.0044	0.0050	0.0055	0.0065	0.0080	1650 (1400–1900)
	TP1	A/D	0.90	0.0080	0.016	0.024	0.032	0.040	0.048	0.065	0.080	0.095	0.11	0.13	0.14	0.16	0.20	500 (410 – 600)
0.90			0.00032	0.00065	0.00095	0.0013	0.0016	0.0019	0.0026	0.0032	0.0038	0.0044	0.0050	0.0055	0.0065	0.0080	1650 (1400–1900)	
GR1	A/D	0.80	0.0080	0.016	0.024	0.032	0.040	0.048	0.065	0.080	0.095	0.11	0.13	0.14	0.16	0.20	500 (400 – 590)	
		0.80	0.00032	0.00065	0.00095	0.0013	0.0016	0.0019	0.0026	0.0032	0.0038	0.0044	0.0050	0.0055	0.0065	0.0080	1650 (1400–1900)	

For cutting data recalculations, see pages 445 - 452

SMG = Seco material group
Coolant = A=air D=dry E=emulsion M=mist spray
v_c = m/min (sf/min)
f_z = mm (in/tooth)
a_p = mm/DC (in/DC) = factor
a_e = mm/DC (in/DC) = factor
All cutting data are target values

JS514

General purpose – Universal – Square – 4 Flutes – Cylindrical – Chamfer

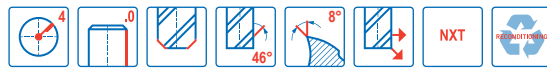
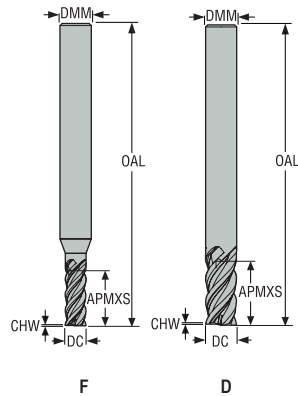

- Tolerances:
- DMM=h5
- DC=e8
- Regrind possible if DC is ≥Ø6

Designation	Item number	Length index	Tool shape	DC	DMM	APMXS	OAL	CHW	PCEDC	Cylindrical
				mm	mm	mm	mm	mm		
JS514010F2C.0Z4-NXT	02927398	2	F	1,0	3,0	2,0	38,0	0,01	4	■
JS514015F2C.0Z4-NXT	02927399	2	F	1,5	3,0	3,0	38,0	0,015	4	■
JS514020F2C.0Z4-NXT	02927400	2	F	2,0	6,0	5,0	57,0	0,02	4	■
JS514021F2C.0Z4-NXT	02927401	2	F	2,0	3,0	5,0	38,0	0,02	4	■
JS514030F2C.0Z4-NXT	02927402	2	F	3,0	6,0	7,0	57,0	0,03	4	■
JS514030D2C.0Z4-NXT	02927403	2	D	3,0	3,0	7,0	38,0	0,03	4	■
JS514040F2C.0Z4-NXT	02927404	2	F	4,0	6,0	10,0	57,0	0,04	4	■
JS514040D2C.0Z4-NXT	02927405	2	D	4,0	4,0	10,0	50,0	0,04	4	■
JS514050F2C.0Z4-NXT	02927406	2	F	5,0	6,0	12,0	57,0	0,05	4	■
JS514050D2C.0Z4-NXT	02927407	2	D	5,0	5,0	12,0	50,0	0,05	4	■
JS514060D2C.0Z4-NXT	02927408	2	D	6,0	6,0	13,0	57,0	0,06	4	■
JS514080D2C.0Z4-NXT	02927409	2	D	8,0	8,0	18,0	63,0	0,08	4	■
JS514100D2C.0Z4-NXT	02927410	2	D	10,0	10,0	22,0	72,0	0,1	4	■
JS514120D2C.0Z4-NXT	02927411	2	D	12,0	12,0	26,0	83,0	0,12	4	■
JS514160D2C.0Z4-NXT	02927412	2	D	16,0	16,0	32,0	92,0	0,16	4	■
JS514200D2C.0Z4-NXT	02927413	2	D	20,0	20,0	40,0	104,0	0,2	4	■
JS514250D2C.0Z4-NXT	02927414	2	D	25,0	25,0	50,0	125,0	0,25	4	■
JS514010F3C.0Z4-NXT	02927415	3	F	1,0	3,0	3,0	38,0	0,01	4	■
JS514015F3C.0Z4-NXT	02927416	3	F	1,5	3,0	6,0	38,0	0,015	4	■
JS514020F3C.0Z4-NXT	02927417	3	F	2,0	6,0	8,0	57,0	0,02	4	■
JS514030F3C.0Z4-NXT	02927418	3	F	3,0	6,0	12,0	57,0	0,03	4	■
JS514040F3C.0Z4-NXT	02927419	3	F	4,0	6,0	16,0	57,0	0,04	4	■
JS514050F3C.0Z4-NXT	02927420	3	F	5,0	6,0	21,0	63,0	0,05	4	■
JS514060D3C.0Z4-NXT	02927421	3	D	6,0	6,0	23,0	63,0	0,06	4	■
JS514080D3C.0Z4-NXT	02927422	3	D	8,0	8,0	32,0	80,0	0,08	4	■
JS514100D3C.0Z4-NXT	02927423	3	D	10,0	10,0	40,0	89,0	0,1	4	■
JS514120D3C.0Z4-NXT	02927424	3	D	12,0	12,0	45,0	100,0	0,12	4	■
JS514160D3C.0Z4-NXT	02927425	3	D	16,0	16,0	55,0	115,0	0,16	4	■
JS514200D3C.0Z4-NXT	02927426	3	D	20,0	20,0	65,0	125,0	0,2	4	■
JS514250D3C.0Z4-NXT	02927427	3	D	25,0	25,0	80,0	150,0	0,25	4	■

■ Stocked standard.

Universal
Steel and cast iron
Stainless steel and S-materials
Non ferrous
Hard
Plastic and cfrp
Graphite
Minimaster Plus
Minimaster

JS514

General purpose – Universal – Square – 4 Flutes – Cylindrical – Chamfer

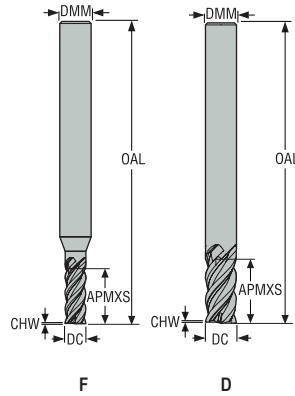

- Tolerances:
- DMM=h5
- DC=e8
- Regrind possible if DC is $\geq \phi 6$

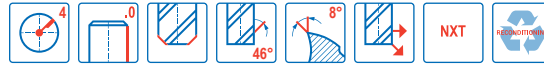

Designation	Item number	Length index	Tool shape	DC	DMM	APMXS	OAL	CHW	PCEDC	Cylindrical
				mm	mm	mm	mm	mm		
JS514020F4C.0Z4-NXT	02927428	4	F	2,0	6,0	10,0	57,0	0,02	4	■
JS514030F4C.0Z4-NXT	02927429	4	F	3,0	6,0	17,0	57,0	0,03	4	■
JS514040F4C.0Z4-NXT	02927430	4	F	4,0	6,0	25,0	63,0	0,04	4	■
JS514050F4C.0Z4-NXT	02927431	4	F	5,0	6,0	28,0	75,0	0,05	4	■
JS514060D4C.0Z4-NXT	02927432	4	D	6,0	6,0	35,0	75,0	0,06	4	■
JS514080D4C.0Z4-NXT	02927433	4	D	8,0	8,0	45,0	100,0	0,08	4	■
JS514100D4C.0Z4-NXT	02927434	4	D	10,0	10,0	55,0	100,0	0,1	4	■
JS514120D4C.0Z4-NXT	02927435	4	D	12,0	12,0	65,0	125,0	0,12	4	■
JS514160D4C.0Z4-NXT	02927436	4	D	16,0	16,0	80,0	150,0	0,16	4	■
JS514200D4C.0Z4-NXT	02927437	4	D	20,0	20,0	90,0	150,0	0,2	4	■
JS514250D4C.0Z4-NXT	02927438	4	D	25,0	25,0	110,0	196,0	0,25	4	■

■ Stocked standard.

Universal

Steel and cast iron

Stainless steel and S-materials

Non ferrous

Hard

Plastic and cfrp

Graphite

Minimaster Plus

Minimaster

JS514

General purpose – Universal – Square – 4 Flutes – Weldon – Chamfer

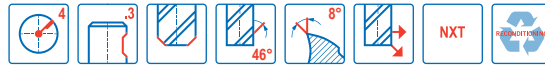
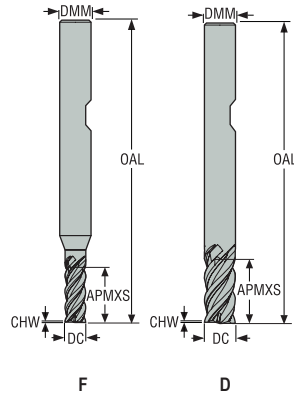

- Tolerances:
- DMM=h5
- DC=e8
- Regrind possible if DC is ≥Ø6

Designation	Item number	Length index	Tool shape	DC	DMM	APMXS	OAL	CHW	PCEDC	Weldon
				mm	mm	mm	mm	mm		
JS514020F2C.3Z4-NXT	02927441	2	F	2,0	6,0	5,0	57,0	0,02	4	<input type="checkbox"/>
JS514030F2C.3Z4-NXT	02927442	2	F	3,0	6,0	7,0	57,0	0,03	4	<input type="checkbox"/>
JS514040F2C.3Z4-NXT	02927443	2	F	4,0	6,0	10,0	57,0	0,04	4	<input type="checkbox"/>
JS514050F2C.3Z4-NXT	02927444	2	F	5,0	6,0	12,0	57,0	0,05	4	<input type="checkbox"/>
JS514060D2C.3Z4-NXT	02927445	2	D	6,0	6,0	13,0	57,0	0,06	4	<input type="checkbox"/>
JS514080D2C.3Z4-NXT	02927446	2	D	8,0	8,0	18,0	63,0	0,08	4	<input type="checkbox"/>
JS514100D2C.3Z4-NXT	02927447	2	D	10,0	10,0	22,0	72,0	0,1	4	<input checked="" type="checkbox"/>
JS514120D2C.3Z4-NXT	02927448	2	D	12,0	12,0	26,0	83,0	0,12	4	<input checked="" type="checkbox"/>
JS514160D2C.3Z4-NXT	02927449	2	D	16,0	16,0	32,0	92,0	0,16	4	<input checked="" type="checkbox"/>
JS514200D2C.3Z4-NXT	02927450	2	D	20,0	20,0	40,0	104,0	0,2	4	<input checked="" type="checkbox"/>
JS514250D2C.3Z4-NXT	02927451	2	D	25,0	25,0	50,0	125,0	0,25	4	<input type="checkbox"/>
JS514020F3C.3Z4-NXT	02927452	3	F	2,0	6,0	8,0	57,0	0,02	4	<input type="checkbox"/>
JS514030F3C.3Z4-NXT	02927453	3	F	3,0	6,0	12,0	57,0	0,03	4	<input type="checkbox"/>
JS514040F3C.3Z4-NXT	02927454	3	F	4,0	6,0	16,0	57,0	0,04	4	<input type="checkbox"/>
JS514050F3C.3Z4-NXT	02927455	3	F	5,0	6,0	21,0	63,0	0,05	4	<input type="checkbox"/>
JS514060D3C.3Z4-NXT	02927456	3	D	6,0	6,0	23,0	63,0	0,06	4	<input type="checkbox"/>
JS514080D3C.3Z4-NXT	02927457	3	D	8,0	8,0	32,0	80,0	0,08	4	<input type="checkbox"/>
JS514100D3C.3Z4-NXT	02927458	3	D	10,0	10,0	40,0	89,0	0,1	4	<input checked="" type="checkbox"/>
JS514120D3C.3Z4-NXT	02927459	3	D	12,0	12,0	45,0	100,0	0,12	4	<input type="checkbox"/>
JS514160D3C.3Z4-NXT	02927460	3	D	16,0	16,0	55,0	115,0	0,16	4	<input type="checkbox"/>
JS514200D3C.3Z4-NXT	02927461	3	D	20,0	20,0	65,0	125,0	0,2	4	<input type="checkbox"/>
JS514250D3C.3Z4-NXT	02927462	3	D	25,0	25,0	80,0	150,0	0,25	4	<input type="checkbox"/>
JS514020F4C.3Z4-NXT	02927463	4	F	2,0	6,0	10,0	57,0	0,02	4	<input type="checkbox"/>
JS514030F4C.3Z4-NXT	02927464	4	F	3,0	6,0	17,0	57,0	0,03	4	<input type="checkbox"/>
JS514040F4C.3Z4-NXT	02927465	4	F	4,0	6,0	25,0	63,0	0,04	4	<input type="checkbox"/>
JS514050F4C.3Z4-NXT	02927466	4	F	5,0	6,0	28,0	75,0	0,05	4	<input type="checkbox"/>
JS514060D4C.3Z4-NXT	02927467	4	D	6,0	6,0	35,0	75,0	0,06	4	<input type="checkbox"/>
JS514080D4C.3Z4-NXT	02927468	4	D	8,0	8,0	45,0	100,0	0,08	4	<input checked="" type="checkbox"/>
JS514100D4C.3Z4-NXT	02927469	4	D	10,0	10,0	55,0	100,0	0,1	4	<input checked="" type="checkbox"/>
JS514120D4C.3Z4-NXT	02927470	4	D	12,0	12,0	65,0	125,0	0,12	4	<input type="checkbox"/>
JS514160D4C.3Z4-NXT	02927471	4	D	16,0	16,0	80,0	150,0	0,16	4	<input type="checkbox"/>
JS514200D4C.3Z4-NXT	02927472	4	D	20,0	20,0	90,0	150,0	0,2	4	<input type="checkbox"/>
JS514250D4C.3Z4-NXT	02927473	4	D	25,0	25,0	110,0	196,0	0,25	4	<input checked="" type="checkbox"/>

■ Stocked standard. □ Weldon available. Delivery time is 3 days.

Universal
Steel and cast iron
Stainless steel and S-materials
Non ferrous
Hard
Plastic and cfrp
Graphite
Minimaster Plus
Minimaster

Cutting data – JS514 Side milling

SMG		a _e /DC	a _p /DC	f _z												v _c
				1	2	3	4	5	6	8	10	12	16	20	25	
P1	M/A/D/E	0.300	1.0	0.0095	0.019	0.030	0.038	0.048	0.060	0.075	0.095	0.11	0.14	0.16	0.19	195 (190 – 220)
		0.300	1.0	0.00038	0.00075	0.0012	0.0015	0.0019	0.0024	0.0030	0.0038	0.0044	0.0055	0.0065	0.0075	640 (630 – 720)
P2	M/A/D/E	0.300	1.0	0.010	0.020	0.030	0.040	0.050	0.060	0.080	0.10	0.12	0.14	0.17	0.19	190 (180 – 220)
		0.300	1.0	0.00040	0.00080	0.0012	0.0016	0.0020	0.0024	0.0032	0.0040	0.0048	0.0055	0.0065	0.0075	620 (600 – 720)
P3	M/A/D/E	0.300	1.0	0.0095	0.019	0.028	0.038	0.046	0.055	0.075	0.095	0.11	0.14	0.16	0.18	165 (160 – 190)
		0.300	1.0	0.00038	0.00075	0.0011	0.0015	0.0018	0.0022	0.0030	0.0038	0.0044	0.0055	0.0065	0.0070	540 (530 – 620)
P4	M/A/D/E	0.300	1.0	0.0090	0.018	0.028	0.036	0.046	0.055	0.075	0.090	0.11	0.13	0.15	0.18	145 (140 – 170)
		0.300	1.0	0.00036	0.00070	0.0011	0.0014	0.0018	0.0022	0.0030	0.0036	0.0044	0.0050	0.0060	0.0070	475 (460 – 550)
P5	M/A/D/E	0.300	1.0	0.0090	0.018	0.026	0.036	0.044	0.055	0.070	0.090	0.11	0.13	0.15	0.17	140 (130 – 160)
		0.300	1.0	0.00036	0.00070	0.0010	0.0014	0.0017	0.0022	0.0028	0.0036	0.0044	0.0050	0.0060	0.0065	460 (430 – 520)
P6	M/A/D/E	0.300	1.0	0.0090	0.018	0.026	0.036	0.044	0.055	0.070	0.090	0.10	0.13	0.15	0.17	160 (150 – 180)
		0.300	1.0	0.00036	0.00070	0.0010	0.0014	0.0017	0.0022	0.0028	0.0036	0.0040	0.0050	0.0060	0.0065	520 (500 – 590)
P7	M/A/D/E	0.300	1.0	0.0090	0.018	0.026	0.036	0.044	0.055	0.070	0.090	0.10	0.13	0.15	0.17	150 (140 – 170)
		0.300	1.0	0.00036	0.00070	0.0010	0.0014	0.0017	0.0022	0.0028	0.0036	0.0040	0.0050	0.0060	0.0065	520 (500 – 590)
P8	M/A/D/E	0.300	1.0	0.0095	0.019	0.028	0.038	0.046	0.055	0.075	0.095	0.11	0.14	0.16	0.18	140 (130 – 160)
		0.300	1.0	0.00038	0.00075	0.0011	0.0015	0.0018	0.0022	0.0030	0.0038	0.0044	0.0055	0.0065	0.0070	460 (430 – 520)
P11	M/A/D/E	0.300	1.0	0.0060	0.012	0.018	0.024	0.030	0.036	0.048	0.060	0.070	0.085	0.10	0.11	150 (140 – 160)
		0.300	1.0	0.00024	0.00048	0.00070	0.00095	0.0012	0.0014	0.0019	0.0024	0.0028	0.0034	0.0040	0.0044	490 (460 – 520)
P12	M/A/D/E	0.300	1.0	0.0040	0.0080	0.012	0.016	0.020	0.024	0.032	0.040	0.048	0.060	0.070	0.075	95 (84 – 100)
		0.300	1.0	0.00016	0.00032	0.00048	0.00065	0.00080	0.00095	0.0013	0.0016	0.0019	0.0024	0.0028	0.0030	310 (280 – 320)
M1	E/M/A	0.300	1.0	0.0044	0.0090	0.013	0.018	0.022	0.026	0.036	0.044	0.055	0.065	0.075	0.085	115 (110 – 130)
		0.300	1.0	0.00017	0.00036	0.00050	0.00070	0.00085	0.0010	0.0014	0.0017	0.0022	0.0026	0.0030	0.0034	490 (460 – 520)
M2	E/M/A	0.300	1.0	0.0040	0.0080	0.012	0.016	0.020	0.024	0.032	0.040	0.048	0.060	0.070	0.075	95 (84 – 100)
		0.300	1.0	0.00016	0.00032	0.00048	0.00065	0.00080	0.00095	0.0013	0.0016	0.0019	0.0024	0.0028	0.0030	310 (280 – 320)
M3	E/M/A	0.300	1.0	0.0040	0.0080	0.012	0.016	0.020	0.024	0.032	0.040	0.048	0.060	0.070	0.075	60 (48 – 71)
		0.300	1.0	0.00016	0.00032	0.00048	0.00065	0.00080	0.00095	0.0013	0.0016	0.0019	0.0024	0.0028	0.0030	195 (160 – 230)
M4	E/M/A	0.300	1.0	0.0036	0.0070	0.011	0.014	0.018	0.022	0.028	0.036	0.042	0.050	0.060	0.070	45 (37 – 54)
		0.300	1.0	0.00014	0.00028	0.00044	0.00055	0.00070	0.00085	0.0011	0.0014	0.0017	0.0020	0.0024	0.0028	150 (130 – 170)
M5	E/M/A	0.300	1.0	0.0036	0.0070	0.011	0.014	0.018	0.022	0.028	0.036	0.042	0.050	0.060	0.070	38 (31 – 45)
		0.300	1.0	0.00014	0.00028	0.00044	0.00055	0.00070	0.00085	0.0011	0.0014	0.0017	0.0020	0.0024	0.0028	125 (110 – 140)
K1	A/D/M/E	0.300	1.0	0.0090	0.018	0.026	0.036	0.044	0.055	0.070	0.090	0.11	0.13	0.15	0.17	160 (140 – 170)
		0.300	1.0	0.00036	0.00070	0.0010	0.0014	0.0017	0.0022	0.0028	0.0036	0.0044	0.0050	0.0060	0.0065	520 (460 – 550)
K2	A/D/M/E	0.300	1.0	0.0080	0.016	0.024	0.032	0.040	0.048	0.065	0.080	0.095	0.12	0.14	0.16	145 (130 – 150)
		0.300	1.0	0.00032	0.00065	0.00095	0.0013	0.0016	0.0019	0.0026	0.0032	0.0038	0.0048	0.0055	0.0065	475 (430 – 490)
K3	A/D/M/E	0.300	1.0	0.0080	0.016	0.024	0.032	0.040	0.048	0.065	0.080	0.095	0.12	0.14	0.16	120 (110 – 120)
		0.300	1.0	0.00032	0.00065	0.00095	0.0013	0.0016	0.0019	0.0026	0.0032	0.0038	0.0048	0.0055	0.0065	395 (370 – 390)
K4	A/D/M/E	0.300	1.0	0.0080	0.016	0.024	0.032	0.040	0.048	0.065	0.080	0.095	0.12	0.14	0.16	115 (100 – 120)
		0.300	1.0	0.00032	0.00065	0.00095	0.0013	0.0016	0.0019	0.0026	0.0032	0.0038	0.0048	0.0055	0.0065	375 (330 – 390)
K5	A/D/M/E	0.300	1.0	0.0070	0.014	0.020	0.028	0.034	0.042	0.055	0.070	0.085	0.10	0.12	0.13	145 (130 – 150)
		0.300	1.0	0.00028	0.00055	0.00080	0.0011	0.0013	0.0017	0.0022	0.0028	0.0034	0.0040	0.0048	0.0050	475 (430 – 490)
K6	A/D/M/E	0.300	1.0	0.0080	0.016	0.024	0.032	0.038	0.046	0.060	0.080	0.090	0.11	0.13	0.15	210 (180 – 220)
		0.300	1.0	0.00032	0.00065	0.00095	0.0013	0.0015	0.0018	0.0024	0.0032	0.0036	0.0044	0.0050	0.0060	690 (600 – 720)
K7	A/D/M/E	0.300	1.0	0.0070	0.014	0.020	0.028	0.034	0.042	0.055	0.070	0.085	0.10	0.12	0.13	190 (160 – 200)
		0.300	1.0	0.00028	0.00055	0.00080	0.0011	0.0013	0.0017	0.0022	0.0028	0.0034	0.0040	0.0048	0.0050	620 (530 – 650)

For cutting data recalculations, see pages 445 - 452

SMG = Seco material group
Coolant = A=air D=dry E=emulsion M=mist spray
v_c = m/min (sf/min)
f_z = mm (in/tooth)
a_p = mm/DC (in/DC) = factor
a_e = mm/DC (in/DC) = factor
All cutting data are target values

Cutting data – JS514 Side milling

SMG	Coolant	a _e /DC	a _p /DC	f _z												v _c
				1	2	3	4	5	6	8	10	12	16	20	25	
N1	E/M/A	0.300	1.0	0.0090	0.018	0.026	0.036	0.044	0.055	0.070	0.090	0.11	0.13	0.15	0.17	500 (400 – 590)
		0,300	1,0	0,00036	0,00070	0,0010	0,0014	0,0017	0,0022	0,0028	0,0036	0,0044	0,0050	0,0060	0,0065	1650 (1400 – 1900)
N2	E/M/A	0.300	1.0	0.0090	0.018	0.026	0.036	0.044	0.055	0.070	0.090	0.11	0.13	0.15	0.17	320 (260 – 380)
		0,300	1,0	0,00036	0,00070	0,0010	0,0014	0,0017	0,0022	0,0028	0,0036	0,0044	0,0050	0,0060	0,0065	1050 (860 – 1200)
N3	E/M/A	0.300	1.0	0.0090	0.018	0.026	0.036	0.044	0.055	0.070	0.090	0.11	0.13	0.15	0.17	215 (180 – 250)
		0,300	1,0	0,00036	0,00070	0,0010	0,0014	0,0017	0,0022	0,0028	0,0036	0,0044	0,0050	0,0060	0,0065	710 (600 – 820)
N11	E/M/A	0.300	1.0	0.0090	0.018	0.026	0.036	0.044	0.055	0.070	0.090	0.11	0.13	0.15	0.17	350 (240 – 460)
		0,300	1,0	0,00036	0,00070	0,0010	0,0014	0,0017	0,0022	0,0028	0,0036	0,0044	0,0050	0,0060	0,0065	1150 (790 – 1500)
S1	E	0.200	0.60	0.0044	0.0085	0.013	0.017	0.022	0.026	0.034	0.044	0.050	0.065	0.075	0.085	45 (28 – 72)
		0,200	0,60	0,00017	0,00034	0,00050	0,00065	0,00085	0,0010	0,0013	0,0017	0,0020	0,0026	0,0030	0,0034	150 (92 – 230)
S2	E	0.200	0.60	0.0044	0.0085	0.013	0.017	0.022	0.026	0.034	0.044	0.050	0.065	0.075	0.085	37 (22 – 58)
		0,200	0,60	0,00017	0,00034	0,00050	0,00065	0,00085	0,0010	0,0013	0,0017	0,0020	0,0026	0,0030	0,0034	120 (73 – 190)
S3	E	0.200	0.60	0.0040	0.0080	0.012	0.016	0.020	0.024	0.032	0.040	0.048	0.060	0.070	0.075	32 (20 – 51)
		0,200	0,60	0,00016	0,00032	0,00048	0,00065	0,00080	0,00095	0,0013	0,0016	0,0019	0,0024	0,0028	0,0030	105 (66 – 160)
S11	E	0.300	1.0	0.0090	0.018	0.026	0.036	0.044	0.055	0.070	0.090	0.11	0.13	0.15	0.17	105 (76 – 130)
		0,300	1,0	0,00036	0,00070	0,0010	0,0014	0,0017	0,0022	0,0028	0,0036	0,0044	0,0050	0,0060	0,0065	345 (250 – 420)
S12	E	0.300	1.0	0.0090	0.018	0.026	0.036	0.044	0.055	0.070	0.090	0.11	0.13	0.15	0.17	80 (59 – 100)
		0,300	1,0	0,00036	0,00070	0,0010	0,0014	0,0017	0,0022	0,0028	0,0036	0,0044	0,0050	0,0060	0,0065	260 (200 – 320)
S13	E	0.300	1.0	0.0080	0.016	0.024	0.032	0.040	0.048	0.065	0.080	0.095	0.12	0.13	0.15	65 (47 – 83)
		0,300	1,0	0,00032	0,00065	0,00095	0,0013	0,0016	0,0019	0,0026	0,0032	0,0038	0,0048	0,0050	0,0060	215 (160 – 270)
H5	M/A/D	0.0300	0.60	0.015	0.030	0.044	0.060	0.075	0.090	0.12	0.15	0.18	0.24	0.26	0.30	85 (70 – 100)
		0,0300	0,60	0,00060	0,0012	0,0017	0,0024	0,0030	0,0036	0,0048	0,0060	0,0070	0,0095	0,010	0,012	280 (230 – 320)
H8	M/A/D	0.0300	0.60	0.012	0.024	0.036	0.048	0.060	0.075	0.095	0.12	0.14	0.18	0.20	0.22	90 (73 – 100)
		0,0300	0,60	0,00048	0,00095	0,0014	0,0019	0,0024	0,0030	0,0038	0,0048	0,0055	0,0070	0,0080	0,0085	295 (240 – 320)
H21	M/A/D	0.0300	0.60	0.012	0.024	0.036	0.048	0.060	0.075	0.095	0.12	0.14	0.18	0.20	0.22	90 (73 – 100)
		0,0300	0,60	0,00048	0,00095	0,0014	0,0019	0,0024	0,0030	0,0038	0,0048	0,0055	0,0070	0,0080	0,0085	295 (240 – 320)
H31	M/A/D	0.0300	0.60	0.010	0.020	0.032	0.042	0.050	0.065	0.085	0.10	0.12	0.15	0.18	0.20	70 (57 – 81)
		0,0300	0,60	0,00040	0,00080	0,0013	0,0017	0,0020	0,0026	0,0034	0,0040	0,0048	0,0060	0,0070	0,0080	230 (190 – 260)
TS1	A/D	0.300	1.5	0.0095	0.019	0.028	0.038	0.048	0.060	0.075	0.095	0.11	0.14	0.16	0.18	640 (550 – 740)
		0,300	1,5	0,00038	0,00075	0,0011	0,0015	0,0019	0,0024	0,0030	0,0038	0,0044	0,0055	0,0065	0,0070	2100 (1900 – 2400)
TP1	A/D	0.300	1.5	0.0095	0.019	0.028	0.038	0.048	0.060	0.075	0.095	0.11	0.14	0.16	0.18	640 (550 – 740)
		0,300	1,5	0,00038	0,00075	0,0011	0,0015	0,0019	0,0024	0,0030	0,0038	0,0044	0,0055	0,0065	0,0070	2100 (1900 – 2400)
GR1	A/D	0.400	1.0	0.013	0.026	0.038	0.050	0.065	0.080	0.10	0.13	0.15	0.19	0.22	0.25	630 (510 – 750)
		0,400	1,0	0,00050	0,0010	0,0015	0,0020	0,0026	0,0032	0,0040	0,0050	0,0060	0,0075	0,0085	0,010	2075 (1700 – 2400)

For cutting data recalculations, see pages 445 - 452

SMG = Seco material group
 Coolant = A=air D=dry E=emulsion M=mist spray
 v_c = m/min (sf/min)
 f_z = mm (in/tooth)
 a_p = mm/DC (in/DC) = factor
 a_e = mm/DC (in/DC) = factor
 All cutting data are target values

Universal
 Steel and cast iron
 Stainless steel and S-materials
 Non ferrous
 Hard
 Plastic and chip
 Graphite
 Mimimaster Plus
 Mimimaster

Cutting data – JS514 Slot milling

SMG		a _p /DC	f _z												v _c
			1	2	3	4	5	6	8	10	12	16	20	25	
P1	M/A/D/E	0.50	0.0050	0.010	0.015	0.020	0.025	0.030	0.040	0.050	0.060	0.080	0.10	0.13	170 (160–190)
		0.50	0,00020	0,00040	0,00060	0,00080	0,0010	0,0012	0,0016	0,0020	0,0024	0,0032	0,0040	0,0050	560 (530 – 620)
P2	M/A/D/E	0.50	0.0050	0.010	0.015	0.020	0.025	0.030	0.040	0.050	0.060	0.080	0.10	0.13	165 (160–190)
		0.50	0,00020	0,00040	0,00060	0,00080	0,0010	0,0012	0,0016	0,0020	0,0024	0,0032	0,0040	0,0050	540 (530 – 620)
P3	M/A/D/E	0.50	0.0050	0.010	0.015	0.020	0.025	0.030	0.040	0.050	0.060	0.080	0.10	0.13	145 (140–160)
		0.50	0,00020	0,00040	0,00060	0,00080	0,0010	0,0012	0,0016	0,0020	0,0024	0,0032	0,0040	0,0050	475 (460 – 520)
P4	M/A/D/E	0.50	0.0050	0.010	0.015	0.020	0.025	0.030	0.040	0.050	0.060	0.080	0.10	0.13	125 (120–140)
		0.50	0,00020	0,00040	0,00060	0,00080	0,0010	0,0012	0,0016	0,0020	0,0024	0,0032	0,0040	0,0050	410 (400 – 450)
P5	M/A/D/E	0.50	0.0050	0.010	0.015	0.020	0.025	0.030	0.040	0.050	0.060	0.080	0.10	0.13	120 (120–140)
		0.50	0,00020	0,00040	0,00060	0,00080	0,0010	0,0012	0,0016	0,0020	0,0024	0,0032	0,0040	0,0050	395 (400 – 450)
P6	M/A/D/E	0.50	0.0050	0.010	0.015	0.020	0.025	0.030	0.040	0.050	0.060	0.080	0.10	0.13	135 (130–150)
		0.50	0,00020	0,00040	0,00060	0,00080	0,0010	0,0012	0,0016	0,0020	0,0024	0,0032	0,0040	0,0050	445 (430 – 490)
P7	M/A/D/E	0.50	0.0050	0.010	0.015	0.020	0.025	0.030	0.040	0.050	0.060	0.080	0.10	0.13	125 (120–140)
		0.50	0,00020	0,00040	0,00060	0,00080	0,0010	0,0012	0,0016	0,0020	0,0024	0,0032	0,0040	0,0050	445 (400 – 450)
P8	M/A/D/E	0.50	0.0050	0.010	0.015	0.020	0.025	0.030	0.040	0.050	0.060	0.080	0.10	0.13	120 (120–140)
		0.50	0,00020	0,00040	0,00060	0,00080	0,0010	0,0012	0,0016	0,0020	0,0024	0,0032	0,0040	0,0050	395 (400 – 450)
P11	M/A/D/E	0.50	0.0020	0.0040	0.0060	0.0080	0.010	0.012	0.016	0.020	0.025	0.032	0.040	0.050	135 (120–150)
		0.50	0,00080	0,00016	0,00024	0,00032	0,00040	0,00048	0,00065	0,00080	0,0010	0,0013	0,0016	0,0020	445 (400 – 490)
P12	M/A/D/E	0.50	0.0020	0.0040	0.0060	0.0080	0.010	0.012	0.016	0.020	0.025	0.032	0.040	0.050	80 (70 – 89)
		0.50	0,00080	0,00016	0,00024	0,00032	0,00040	0,00048	0,00065	0,00080	0,0010	0,0013	0,0016	0,0020	260 (230 – 290)
M1	E	0.50	0.0020	0.0040	0.0060	0.0080	0.010	0.012	0.016	0.020	0.025	0.032	0.040	0.050	100 (87–110)
		0.50	0,00080	0,00016	0,00024	0,00032	0,00040	0,00048	0,00065	0,00080	0,0010	0,0013	0,0016	0,0020	330 (290 – 360)
M2	E	0.50	0.0020	0.0040	0.0060	0.0080	0.010	0.012	0.016	0.020	0.025	0.032	0.040	0.050	80 (71 – 90)
		0.50	0,00080	0,00016	0,00024	0,00032	0,00040	0,00048	0,00065	0,00080	0,0010	0,0013	0,0016	0,0020	260 (240 – 290)
M3	E	0.40	0.0020	0.0040	0.0060	0.0080	0.010	0.012	0.016	0.020	0.025	0.032	0.040	0.050	50 (41 – 59)
		0.40	0,00080	0,00016	0,00024	0,00032	0,00040	0,00048	0,00065	0,00080	0,0010	0,0013	0,0016	0,0020	165 (140 – 190)
M4	E	0.40	0.0020	0.0040	0.0060	0.0080	0.010	0.012	0.016	0.020	0.025	0.032	0.040	0.050	37 (30 – 44)
		0.40	0,00080	0,00016	0,00024	0,00032	0,00040	0,00048	0,00065	0,00080	0,0010	0,0013	0,0016	0,0020	120 (99 – 140)
M5	E	0.40	0.0020	0.0040	0.0060	0.0080	0.010	0.012	0.016	0.020	0.025	0.032	0.040	0.050	31 (25 – 37)
		0.40	0,00080	0,00016	0,00024	0,00032	0,00040	0,00048	0,00065	0,00080	0,0010	0,0013	0,0016	0,0020	100 (83 – 120)
K1	E	0.60	0.0030	0.0060	0.0090	0.012	0.015	0.018	0.024	0.030	0.036	0.048	0.060	0.075	150 (130–150)
		0.60	0,00012	0,00024	0,00036	0,00048	0,00060	0,00070	0,00095	0,0012	0,0014	0,0019	0,0024	0,0030	490 (430 – 490)
K2	E	0.60	0.0030	0.0060	0.0090	0.012	0.015	0.018	0.024	0.030	0.036	0.048	0.060	0.075	130 (120–130)
		0.60	0,00012	0,00024	0,00036	0,00048	0,00060	0,00070	0,00095	0,0012	0,0014	0,0019	0,0024	0,0030	425 (400 – 420)
K3	E	0.60	0.0030	0.0060	0.0090	0.012	0.015	0.018	0.024	0.030	0.036	0.048	0.060	0.075	110 (96–110)
		0.60	0,00012	0,00024	0,00036	0,00048	0,00060	0,00070	0,00095	0,0012	0,0014	0,0019	0,0024	0,0030	360 (320 – 360)
K4	E	0.60	0.0030	0.0060	0.0090	0.012	0.015	0.018	0.024	0.030	0.036	0.048	0.060	0.075	105 (91–110)
		0.60	0,00012	0,00024	0,00036	0,00048	0,00060	0,00070	0,00095	0,0012	0,0014	0,0019	0,0024	0,0030	345 (300 – 360)
K5	E	0.50	0.0030	0.0060	0.0090	0.012	0.015	0.018	0.024	0.030	0.036	0.048	0.060	0.075	130 (110–140)
		0.50	0,00012	0,00024	0,00036	0,00048	0,00060	0,00070	0,00095	0,0012	0,0014	0,0019	0,0024	0,0030	425 (370 – 450)
K6	E	0.50	0.0030	0.0060	0.0090	0.012	0.015	0.018	0.024	0.030	0.036	0.048	0.060	0.075	190 (170 – 200)
		0.50	0,00012	0,00024	0,00036	0,00048	0,00060	0,00070	0,00095	0,0012	0,0014	0,0019	0,0024	0,0030	620 (560 – 650)
K7	E	0.50	0.0030	0.0060	0.0090	0.012	0.015	0.018	0.024	0.030	0.036	0.048	0.060	0.075	165 (150–170)
		0.50	0,00012	0,00024	0,00036	0,00048	0,00060	0,00070	0,00095	0,0012	0,0014	0,0019	0,0024	0,0030	540 (500 – 550)

For cutting data recalculations, see pages 445 - 452

SMG = Seco material group
Coolant = A=air D=dry E=emulsion M=mist spray
v_c = m/min (sf/min)
f_z = mm/tooth (in/tooth)
a_p = mm/DC (in/DC) = factor
a_e = mm/DC (in/DC) = factor
All cutting data are target values

Cutting data – JS514 Slot milling

SMG		a _p /DC	f _z												v _c
			1	2	3	4	5	6	8	10	12	16	20	25	
N11	E	0.50	0.0050	0.010	0.015	0.020	0.025	0.030	0.040	0.050	0.060	0.080	0.10	0.13	300 (200 – 400)
		0.50	0,00020	0,00040	0,00060	0,00080	0,0010	0,0012	0,0016	0,0020	0,0024	0,0032	0,0040	0,0050	980 (660–1300)
S1	E	0.20	0.0020	0.0040	0.0060	0.0080	0.010	0.012	0.016	0.020	0.025	0.032	0.040	0.050	36 (22 – 57)
		0.20	0,000080	0,00016	0,00024	0,00032	0,00040	0,00048	0,00065	0,00080	0,0010	0,0013	0,0016	0,0020	120 (73–180)
S2	E	0.20	0.0020	0.0040	0.0060	0.0080	0.010	0.012	0.016	0.020	0.025	0.032	0.040	0.050	29 (18 – 46)
		0.20	0,000080	0,00016	0,00024	0,00032	0,00040	0,00048	0,00065	0,00080	0,0010	0,0013	0,0016	0,0020	95 (60–150)
S3	E	0.20	0.0020	0.0040	0.0060	0.0080	0.010	0.012	0.016	0.020	0.025	0.032	0.040	0.050	25 (15 – 40)
		0.20	0,000080	0,00016	0,00024	0,00032	0,00040	0,00048	0,00065	0,00080	0,0010	0,0013	0,0016	0,0020	80 (50–130)
S11	E	0.30	0.0050	0.010	0.015	0.020	0.025	0.030	0.040	0.050	0.060	0.080	0.10	0.13	90 (66–110)
		0.30	0,00020	0,00040	0,00060	0,00080	0,0010	0,0012	0,0016	0,0020	0,0024	0,0032	0,0040	0,0050	295 (220 – 360)
S12	E	0.30	0.0050	0.010	0.015	0.020	0.025	0.030	0.040	0.050	0.060	0.080	0.10	0.13	70 (51 – 90)
		0.30	0,00020	0,00040	0,00060	0,00080	0,0010	0,0012	0,0016	0,0020	0,0024	0,0032	0,0040	0,0050	230 (170 – 290)
S13	E	0.30	0.0050	0.010	0.015	0.020	0.025	0.030	0.040	0.050	0.060	0.080	0.10	0.13	55 (39 – 69)
		0.30	0,00020	0,00040	0,00060	0,00080	0,0010	0,0012	0,0016	0,0020	0,0024	0,0032	0,0040	0,0050	180 (130 – 220)
H5	M/A/D	0.20	0.0020	0.0040	0.0060	0.0080	0.010	0.012	0.016	0.020	0.025	0.032	0.040	0.050	55 (46 – 65)
		0.20	0,000080	0,00016	0,00024	0,00032	0,00040	0,00048	0,00065	0,00080	0,0010	0,0013	0,0016	0,0020	180 (160 – 210)
H8	M/A/D	0.20	0.0020	0.0040	0.0060	0.0080	0.010	0.012	0.016	0.020	0.025	0.032	0.040	0.050	55 (46 – 65)
		0.20	0,000080	0,00016	0,00024	0,00032	0,00040	0,00048	0,00065	0,00080	0,0010	0,0013	0,0016	0,0020	180 (160 – 210)
H11	M/A/D	0.20	0.0020	0.0040	0.0060	0.0080	0.010	0.012	0.016	0.020	0.025	0.032	0.040	0.050	70 (58 – 83)
		0.20	0,000080	0,00016	0,00024	0,00032	0,00040	0,00048	0,00065	0,00080	0,0010	0,0013	0,0016	0,0020	230 (200 – 270)
H12	M/A/D	0.50	0.0042	0.0085	0.013	0.017	0.022	0.026	0.034	0.042	0.050	0.065	0.070	0.080	55 (47 – 66)
		0.50	0,00017	0,00034	0,00050	0,00065	0,00085	0,0010	0,0013	0,0017	0,0020	0,0026	0,0028	0,0032	180 (160 – 210)
H21	M/A/D	0.20	0.0020	0.0040	0.0060	0.0080	0.010	0.012	0.016	0.020	0.025	0.032	0.040	0.050	55 (46 – 65)
		0.20	0,000080	0,00016	0,00024	0,00032	0,00040	0,00048	0,00065	0,00080	0,0010	0,0013	0,0016	0,0020	180 (160 – 210)
H31	M/A/D	0.20	0.0020	0.0040	0.0060	0.0080	0.010	0.012	0.016	0.020	0.025	0.032	0.040	0.050	42 (35 – 49)
		0.20	0,000080	0,00016	0,00024	0,00032	0,00040	0,00048	0,00065	0,00080	0,0010	0,0013	0,0016	0,0020	140 (120–160)
GR1	A	0.50	0.013	0.025	0.038	0.050	0.065	0.075	0.10	0.13	0.15	0.19	0.22	0.24	500 (410 – 590)
		0.50	0,00050	0,0010	0,0015	0,0020	0,0026	0,0030	0,0040	0,0050	0,0060	0,0075	0,0085	0,0095	1650 (1400–1900)

For cutting data recalculations, see pages 445 - 452

SMG = Seco material group
 Coolant = A=air D=dry E=emulsion M=mist spray
 v_c = m/min (sf/min)
 f_z = mm/tooth (in/tooth)
 a_p = mm/DC (in/DC) = factor
 a_e = mm/DC (in/DC) = factor
 All cutting data are target values

Universal
Steel and cast iron
Stainless steel and S-materials
Non ferrous
Hard
Plastic and chip
Graphite
Mimimaster Plus
Mimimaster

JS553

High performance – Universal – Square – 3 Flutes – Cylindrical – Sharp

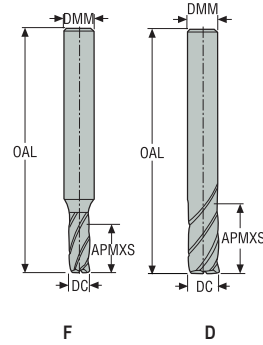

- Tolerances:
- DMM=h5
- DC=e7
- Regrind possible if DC is $\geq \varnothing 6$

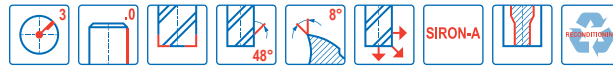

Designation	Item number	Length index	Tool shape	DC	DMM	APMXS	OAL	PCEDC	Cylindrical
				mm	mm	mm	mm		
553020SZ3.0-SIRON-A	02733903	2	F	2,0	6,0	5,0	50,0	3	■
553030SZ3.0-SIRON-A	02733906	2	F	3,0	6,0	7,0	50,0	3	■
553040SZ3.0-SIRON-A	02733910	2	F	4,0	6,0	10,0	55,0	3	■
553050SZ3.0-SIRON-A	02733912	2	F	5,0	6,0	12,0	55,0	3	■
553060SZ3.0-SIRON-A	02733914	2	D	6,0	6,0	14,0	55,0	3	■
553080SZ3.0-SIRON-A	02733918	2	D	8,0	8,0	18,0	60,0	3	■
553100SZ3.0-SIRON-A	02733922	2	D	10,0	10,0	22,0	70,0	3	■

■ Stocked standard.

Universal

Steel and cast iron

Stainless steel and S-materials

Non ferrous

Hard

Plastic and cfrp

Graphite

Minimaster Plus

Minimaster

JS553

High performance – Universal – Square – 3 Flutes – Cylindrical – Chamfer

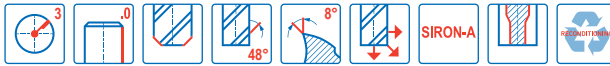
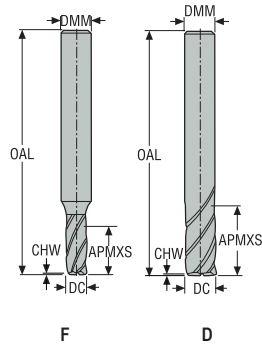

- Tolerances:
- DMM= h5
- DC= e7
- Regrind possible if DC is ≥Ø6

Designation	Item number	Length index	Tool shape	DC	DMM	APMXS	OAL	CHW	PCEDC	Cylindrical
				mm	mm	mm	mm	mm		
553020Z3.0-SIRON-A	02679241	2	F	2,0	6,0	5,0	50,0	0,025	3	■
553025Z3.0-SIRON-A	02679352	2	F	2,5	6,0	7,0	50,0	0,025	3	■
553030Z3.0-SIRON-A	02679353	2	F	3,0	6,0	7,0	50,0	0,035	3	■
553035Z3.0-SIRON-A	02679359	2	F	3,5	6,0	9,0	55,0	0,035	3	■
553040Z3.0-SIRON-A	02679360	2	F	4,0	6,0	10,0	55,0	0,045	3	■
553045Z3.0-SIRON-A	02679361	2	F	4,5	6,0	12,0	55,0	0,045	3	■
553050Z3.0-SIRON-A	02679364	2	F	5,0	6,0	12,0	55,0	0,055	3	■
553055Z3.0-SIRON-A	02679365	2	F	5,5	6,0	14,0	55,0	0,055	3	■
553060Z3.0-SIRON-A	02679368	2	D	6,0	6,0	14,0	55,0	0,075	3	■
553075Z3.0-SIRON-A	02733916	2	F	7,5	8,0	18,0	60,0	0,1	3	■
553080Z3.0-SIRON-A	02679371	2	D	8,0	8,0	18,0	60,0	0,1	3	■
553095Z3.0-SIRON-A	02733920	2	F	9,5	10,0	22,0	70,0	0,125	3	■
553100Z3.0-SIRON-A	02679374	2	D	10,0	10,0	22,0	70,0	0,125	3	■
553115Z3.0-SIRON-A	02733925	2	F	11,5	12,0	26,0	80,0	0,15	3	■
553120Z3.0-SIRON-A	02679380	2	D	12,0	12,0	26,0	80,0	0,15	3	■
553140Z3.0-SIRON-A	02733932	2	D	14,0	14,0	30,0	85,0	0,175	3	■
553160Z3.0-SIRON-A	02679384	2	D	16,0	16,0	34,0	90,0	0,2	3	■
553200Z3.0-SIRON-A	02679389	2	D	20,0	20,0	42,0	110,0	0,25	3	■
553250Z3.0-SIRON-A	02679393	2	D	25,0	25,0	52,0	125,0	0,3	3	■
553L020Z3.0-SIRON-A	02733962	3	F	2,0	6,0	7,0	50,0	0,025	3	■
553L030Z3.0-SIRON-A	02733971	3	F	3,0	6,0	10,0	55,0	0,035	3	■
553L040Z3.0-SIRON-A	02733972	3	F	4,0	6,0	14,0	60,0	0,045	3	■
553L050Z3.0-SIRON-A	02733974	3	F	5,0	6,0	18,0	60,0	0,055	3	■
553L060Z3.0-SIRON-A	02733982	3	D	6,0	6,0	20,0	65,0	0,075	3	■
553L080Z3.0-SIRON-A	02733986	3	D	8,0	8,0	28,0	70,0	0,1	3	■
553L100Z3.0-SIRON-A	02733992	3	D	10,0	10,0	35,0	85,0	0,125	3	■
553L120Z3.0-SIRON-A	02733994	3	D	12,0	12,0	40,0	95,0	0,15	3	■
553L160Z3.0-SIRON-A	02733996	3	D	16,0	16,0	50,0	110,0	0,2	3	■
553L200Z3.0-SIRON-A	02733998	3	D	20,0	20,0	60,0	125,0	0,25	3	■
553L250Z3.0-SIRON-A	02734000	3	D	25,0	25,0	75,0	150,0	0,3	3	■

■ Stocked standard.

Universal

Steel and cast iron

Stainless steel and S-materials

Non ferrous

Hard

Plastic and cfrp

Graphite

Minimaster Plus

Minimaster

JS553

High performance – Universal – Square – 3 Flutes – Cylindrical – Corner radius

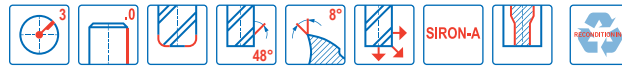
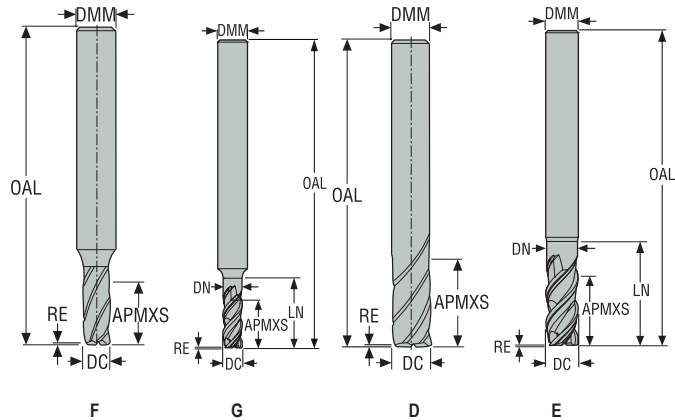

- Tolerances:
- DMM=h5
- DC=e7
- RE= ±0,02 mm
- Regrind possible if DC is ≥Ø6

Designation	Item number	Length index	Tool shape	DC	DMM	APMXS	OAL	LN	DN	RE	PCEDC	Cylindrical
				mm	mm	mm	mm	mm	mm	mm		
JS553020G2R050.0Z3-SIRA	02881683	2	G	2,0	6,0	5,0	57,0	8,0	1,9	0,5	3	■
553030R015Z3.0-SIRON-A	02733908	2	F	3,0	6,0	7,0	50,0	8,5	3,0	0,15	3	■
JS553030G2R050.0Z3-SIRA	02881684	2	G	3,0	6,0	7,0	57,0	11,0	2,85	0,5	3	■
553040R020Z3.0-SIRON-A	02733911	2	F	4,0	6,0	10,0	55,0	11,7	4,0	0,2	3	■
JS553040G2R050.0Z3-SIRA	02881685	2	G	4,0	6,0	10,0	57,0	13,0	3,8	0,5	3	■
553050R020Z3.0-SIRON-A	02687282	2	F	5,0	6,0	12,0	55,0	14,7	5,0	0,2	3	■
JS553050G2R050.0Z3-SIRA	02881686	2	G	5,0	6,0	10,0	57,0	15,0	4,75	0,5	3	■
553060R020Z3.0-SIRON-A	02679369	2	D	6,0	6,0	14,0	55,0	-	-	0,2	3	■
JS553060E2R050.0Z3-SIRA	02881687	2	E	6,0	6,0	14,0	57,0	19,0	5,7	0,5	3	■
JS553060E2R100.0Z3-SIRA	02881688	2	E	6,0	6,0	14,0	57,0	19,0	5,7	1,0	3	■
553080R050Z3.0-SIRON-A	02679372	2	D	8,0	8,0	18,0	60,0	-	-	0,5	3	■
553100R050Z3.0-SIRON-A	02679375	2	D	10,0	10,0	22,0	70,0	-	-	0,5	3	■
553100R100Z3.0-SIRON-A	02679376	2	D	10,0	10,0	22,0	70,0	-	-	1,0	3	■
553100R250Z3.0-SIRON-A	02810365	2	D	10,0	10,0	22,0	70,0	-	-	2,5	3	■
553100R310Z3.0-SIRON-A	02810366	2	D	10,0	10,0	22,0	70,0	-	-	3,1	3	■
553100R200Z3.0-SIRON-A	02810364	2	D	10,0	10,0	22,0	70,0	-	-	2,0	3	■
553120R050Z3.0-SIRON-A	02679381	2	D	12,0	12,0	26,0	80,0	-	-	0,5	3	■
553120R100Z3.0-SIRON-A	02679382	2	D	12,0	12,0	26,0	80,0	-	-	1,0	3	■
553120R200Z3.0-SIRON-A	02810367	2	D	12,0	12,0	26,0	80,0	-	-	2,0	3	■
553120R250Z3.0-SIRON-A	02810368	2	D	12,0	12,0	26,0	80,0	-	-	2,5	3	■
553120R310Z3.0-SIRON-A	02810369	2	D	12,0	12,0	26,0	80,0	-	-	3,1	3	■
553160R050Z3.0-SIRON-A	02679385	2	D	16,0	16,0	34,0	90,0	-	-	0,5	3	■
553160R100Z3.0-SIRON-A	02679386	2	D	16,0	16,0	34,0	90,0	-	-	1,0	3	■
553160R200Z3.0-SIRON-A	02810370	2	D	16,0	16,0	34,0	90,0	-	-	2,0	3	■
553160R310Z3.0-SIRON-A	02810372	2	D	16,0	16,0	34,0	90,0	-	-	3,1	3	■
553160R400Z3.0-SIRON-A	02810373	2	D	16,0	16,0	34,0	90,0	-	-	4,0	3	■
553160R250Z3.0-SIRON-A	02810371	2	D	16,0	16,0	34,0	90,0	-	-	2,5	3	■
553200R050Z3.0-SIRON-A	02679390	2	D	20,0	20,0	42,0	110,0	-	-	0,5	3	■
553200R100Z3.0-SIRON-A	02679391	2	D	20,0	20,0	42,0	110,0	-	-	1,0	3	■
JS553200E2R200.0Z3-SIRA	02881689	2	E	20,0	20,0	42,0	110,0	54,0	19,0	2,0	3	■
553250R050Z3.0-SIRON-A	02679395	2	D	25,0	25,0	52,0	125,0	-	-	0,5	3	■
553250R100Z3.0-SIRON-A	02679396	2	D	25,0	25,0	52,0	125,0	-	-	1,0	3	■

■ Stocked standard.

JS553

High performance – Universal – Square – 3 Flutes – Weldon – Sharp

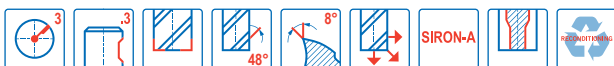
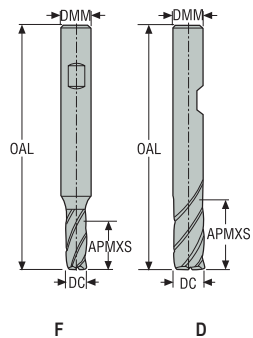

- Tolerances:
- DMM=h5
- DC=e7
- Regrind possible if DC is $\geq \varnothing 6$

Designation	Item number	Length index	Tool shape	DC	DMM	APMXS	OAL	PCEDC	Weldon
				mm	mm	mm	mm		
553020SZ3.0-SIRON-AW	02733936	2	F	2,0	6,0	5,0	50,0	3	■
553030SZ3.0-SIRON-AW	02733939	2	F	3,0	6,0	7,0	50,0	3	■
553040SZ3.0-SIRON-AW	02733943	2	F	4,0	6,0	10,0	55,0	3	■
553050SZ3.0-SIRON-AW	02733945	2	F	5,0	6,0	12,0	55,0	3	■
553060SZ3.0-SIRON-AW	02733946	2	D	6,0	6,0	14,0	55,0	3	■
553080SZ3.0-SIRON-AW	02733950	2	D	8,0	8,0	18,0	60,0	3	■
553100SZ3.0-SIRON-AW	02733952	2	D	10,0	10,0	22,0	70,0	3	■

■ Stocked standard.

Universal

Steel and cast iron

Stainless steel and S-materials

Non ferrous

Hard

Plastic and CFRP

Graphite

Minimaster Plus

Minimaster

JS553

High performance – Universal – Square – 3 Flutes – Weldon – Chamfer

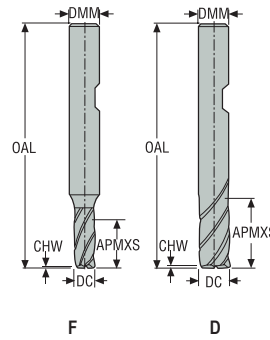

- Tolerances:
- DMM= h5
- DC= e7
- Regrind possible if DC is ≥ 06

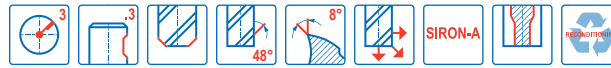

	Designation	Item number	Length index	Tool shape	DC	DMM	APMXS	OAL	CHW	PCEDC	Weldon
					mm	mm	mm	mm	mm		
	553020Z3.0-SIRON-AW	02697423	2	F	2,0	6,0	5,0	50,0	0,025	3	□
	553025Z3.0-SIRON-AW	02700354	2	F	2,5	6,0	7,0	50,0	0,025	3	■
	553030Z3.0-SIRON-AW	02700355	2	F	3,0	6,0	7,0	50,0	0,035	3	■
	553035Z3.0-SIRON-AW	02700357	2	F	3,5	6,0	9,0	55,0	0,035	3	■
	553040Z3.0-SIRON-AW	02700358	2	F	4,0	6,0	10,0	55,0	0,045	3	■
	553045Z3.0-SIRON-AW	02700359	2	F	4,5	6,0	12,0	55,0	0,045	3	□
	553050Z3.0-SIRON-AW	02700360	2	F	5,0	6,0	12,0	55,0	0,055	3	■
	553055Z3.0-SIRON-AW	02700361	2	F	5,5	6,0	14,0	55,0	0,055	3	□
	553060Z3.3-SIRON-A	02679367	2	D	6,0	6,0	14,0	55,0	0,075	3	■
	553075Z3.3-SIRON-A	02733915	2	F	7,5	8,0	18,0	60,0	0,1	3	■
	553080Z3.3-SIRON-A	02679370	2	D	8,0	8,0	18,0	60,0	0,1	3	■
	553095Z3.3-SIRON-A	02733919	2	F	9,5	10,0	22,0	70,0	0,125	3	■
	553100Z3.3-SIRON-A	02679373	2	D	10,0	10,0	22,0	70,0	0,125	3	■
	553115Z3.3-SIRON-A	02733923	2	F	11,5	12,0	26,0	80,0	0,15	3	■
	553120Z3.3-SIRON-A	02679379	2	D	12,0	12,0	26,0	80,0	0,15	3	■
	553140Z3.3-SIRON-A	02733929	2	D	14,0	14,0	30,0	85,0	0,175	3	■
	553160Z3.3-SIRON-A	02679383	2	D	16,0	16,0	34,0	90,0	0,2	3	■
	553200Z3.3-SIRON-A	02679388	2	D	20,0	20,0	42,0	110,0	0,25	3	■
	553250Z3.3-SIRON-A	02679392	2	D	25,0	25,0	52,0	125,0	0,3	3	■
	553L020Z3.0-SIRON-AW	02734001	3	F	2,0	6,0	7,0	50,0	0,025	3	□
	553L030Z3.0-SIRON-AW	02734006	3	F	3,0	6,0	10,0	55,0	0,035	3	■
	553L040Z3.0-SIRON-AW	02734007	3	F	4,0	6,0	14,0	60,0	0,045	3	■
	553L050Z3.0-SIRON-AW	02734008	3	F	5,0	6,0	18,0	60,0	0,055	3	□
	553L060Z3.3-SIRON-A	02733980	3	D	6,0	6,0	20,0	65,0	0,075	3	■
	553L080Z3.3-SIRON-A	02733984	3	D	8,0	8,0	28,0	70,0	0,1	3	■
	553L100Z3.3-SIRON-A	02733988	3	D	10,0	10,0	35,0	85,0	0,125	3	■
	553L120Z3.3-SIRON-A	02733993	3	D	12,0	12,0	40,0	95,0	0,15	3	■
	553L160Z3.3-SIRON-A	02733995	3	D	16,0	16,0	50,0	110,0	0,2	3	■
	553L200Z3.3-SIRON-A	02733997	3	D	20,0	20,0	60,0	125,0	0,25	3	■
	553L250Z3.3-SIRON-A	02733999	3	D	25,0	25,0	75,0	150,0	0,3	3	■

■ Stocked standard. □ Weldon available. Delivery time is 3 days.

JS553

High performance – Universal – Square – 3 Flutes – Weldon – Corner radius

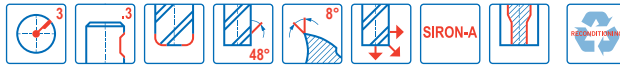
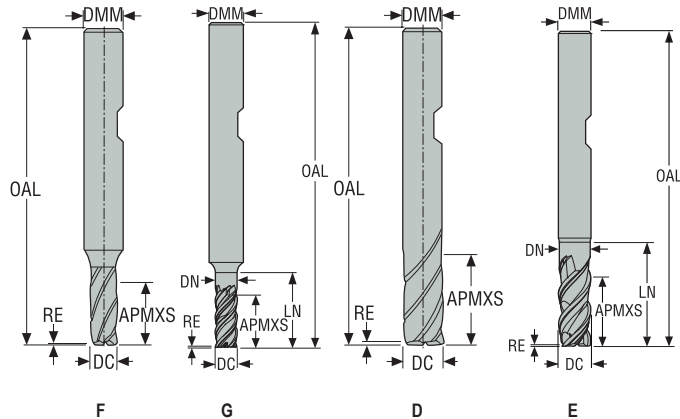

- Tolerances:
- DMM=h5
- DC=e7
- RE= ±0,02 mm
- Regrind possible if DC is ≥Ø6



Designation	Item number	Length index	Tool shape	DC	DMM	APMXS	OAL	LN	DN	RE	PCEDC	Weldon
				mm	mm	mm	mm	mm	mm	mm		
JS553020G2R050.3Z3-SIRA	02881690	2	G	2,0	6,0	5,0	57,0	8,0	1,9	0,5	3	□
553030R015Z3.0-SIRON-AW	02733941	2	F	3,0	6,0	7,0	50,0	8,5	3,0	0,15	3	□
JS553030G2R050.3Z3-SIRA	02881691	2	G	3,0	6,0	7,0	57,0	11,0	2,85	0,5	3	□
553040R020Z3.0-SIRON-AW	02733944	2	F	4,0	6,0	10,0	55,0	11,7	4,0	0,2	3	□
JS553040G2R050.3Z3-SIRA	02881692	2	G	4,0	6,0	10,0	57,0	13,0	3,8	0,5	3	□
553050R020Z3.0-SIRON-AW	02703763	2	F	5,0	6,0	12,0	55,0	14,7	5,0	0,2	3	□
JS553050G2R050.3Z3-SIRA	02881693	2	G	5,0	6,0	10,0	57,0	15,0	4,75	0,5	3	□
553060R020Z3.0-SIRON-AW	02700364	2	D	6,0	6,0	14,0	55,0	-	-	0,2	3	□
JS553060E2R050.3Z3-SIRA	02881694	2	E	6,0	6,0	14,0	57,0	19,0	5,7	0,5	3	□
JS553060E2R100.3Z3-SIRA	02881695	2	E	6,0	6,0	14,0	57,0	19,0	5,7	1,0	3	■
553080R050Z3.0-SIRON-AW	02700366	2	D	8,0	8,0	18,0	60,0	-	-	0,5	3	■
553100R050Z3.0-SIRON-AW	02700369	2	D	10,0	10,0	22,0	70,0	-	-	0,5	3	□
553100R100Z3.0-SIRON-AW	02700371	2	D	10,0	10,0	22,0	70,0	-	-	1,0	3	□
553100R200Z3.3-SIRON-A	02810422	2	D	10,0	10,0	22,0	70,0	-	-	2,0	3	□
553100R250Z3.3-SIRON-A	02810423	2	D	10,0	10,0	22,0	70,0	-	-	2,5	3	□
553100R310Z3.3-SIRON-A	02810424	2	D	10,0	10,0	22,0	70,0	-	-	3,1	3	□
553120R050Z3.0-SIRON-AW	02700373	2	D	12,0	12,0	26,0	80,0	-	-	0,5	3	□
553120R100Z3.0-SIRON-AW	02700374	2	D	12,0	12,0	26,0	80,0	-	-	1,0	3	□
553120R200Z3.3-SIRON-A	02810425	2	D	12,0	12,0	26,0	80,0	-	-	2,0	3	□
553120R250Z3.3-SIRON-A	02810426	2	D	12,0	12,0	26,0	80,0	-	-	2,5	3	□
553120R310Z3.3-SIRON-A	02810427	2	D	12,0	12,0	26,0	80,0	-	-	3,1	3	□
553160R050Z3.0-SIRON-AW	02700378	2	D	16,0	16,0	34,0	90,0	-	-	0,5	3	□
553160R100Z3.0-SIRON-AW	02700381	2	D	16,0	16,0	34,0	90,0	-	-	1,0	3	□
553160R200Z3.3-SIRON-A	02810428	2	D	16,0	16,0	34,0	90,0	-	-	2,0	3	□
553160R250Z3.3-SIRON-A	02810429	2	D	16,0	16,0	34,0	90,0	-	-	2,5	3	□
553160R310Z3.3-SIRON-A	02810430	2	D	16,0	16,0	34,0	90,0	-	-	3,1	3	□
553160R400Z3.3-SIRON-A	02810431	2	D	16,0	16,0	34,0	90,0	-	-	4,0	3	□
553200R050Z3.0-SIRON-AW	02700383	2	D	20,0	20,0	42,0	110,0	-	-	0,5	3	■
553200R100Z3.0-SIRON-AW	02700384	2	D	20,0	20,0	42,0	110,0	-	-	1,0	3	□
JS553200E2R200.3Z3-SIRA	02881696	2	E	20,0	20,0	42,0	110,0	54,0	19,0	2,0	3	□
553250R100Z3.0-SIRON-AW	02700385	2	D	25,0	25,0	52,0	125,0	-	-	1,0	3	□
553250R050Z3.0-SIRON-AW	02700386	2	D	25,0	25,0	52,0	125,0	-	-	0,5	3	□

■ Stocked standard. □ Weldon available. Delivery time is 3 days.

Universal
Steel and cast iron
Stainless steel and S-materials
Non ferrous
Hard
Plastic and chip
Graphite
Minimaster Plus
Minimaster

JS553

High performance – Universal – Square – 3 Flutes – Cylindrical – Corner radius or chamfer – Inch

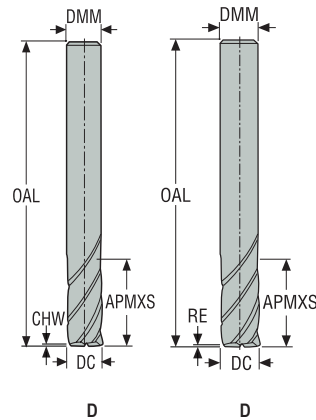

- Tolerances:
- DMM=h5
- DC=e7
- Regrind possible if DC is $\geq \varnothing 0.375$

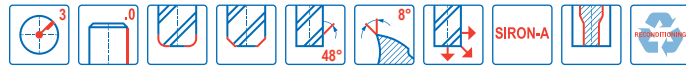

Designation	Item number	Length index	Tool shape	DC	DMM	APMXS	OAL	CHW	RE	PCEDC	Cylindrical
				Inch	Inch	Inch	Inch	Inch	Inch		
5530125Z3.0-SIRON-A	02712684	2	D	0.125	0.125	0.250	2.000	0.001	–	3	■
5530187Z3.0-SIRON-A	02712687	2	D	0.188	0.188	0.375	2.000	0.001	–	3	■
5530250Z3.0-SIRON-A	02712688	2	D	0.250	0.250	0.500	2.500	0.003	–	3	■
5530250R015Z3.0-SIRON-A	02712689	2	D	0.250	0.250	0.500	2.500	–	0.015	3	■
5530312Z3.0-SIRON-A	02712690	2	D	0.313	0.313	0.625	2.500	0.004	–	3	■
5530312R015Z3.0-SIRON-A	02712693	2	D	0.313	0.313	0.625	2.500	–	0.015	3	■
5530375Z3.0-SIRON-A	02712694	2	D	0.375	0.375	0.750	3.000	0.005	–	3	■
5530375R015Z3.0-SIRON-A	02712695	2	D	0.375	0.375	0.750	3.000	–	0.015	3	■
5530375R030Z3.0-SIRON-A	02712696	2	D	0.375	0.375	0.750	3.000	–	0.030	3	■
5530500Z3.0-SIRON-A	02712699	2	D	0.500	0.500	1.000	3.500	0.006	–	3	■
5530500R015Z3.0-SIRON-A	02712701	2	D	0.500	0.500	1.000	3.500	–	0.015	3	■
5530500R030Z3.0-SIRON-A	02712703	2	D	0.500	0.500	1.000	3.500	–	0.030	3	■

■ Stocked standard.

Universal

Steel and cast iron

Stainless steel and S-materials

Non ferrous

Hard

Plastic and cfrp

Graphite

Minimaster Plus

Minimaster

JS553

High performance – Universal – Square – 3 Flutes – Weldon – Corner radius or chamfer – Inch

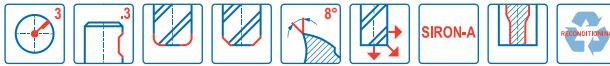
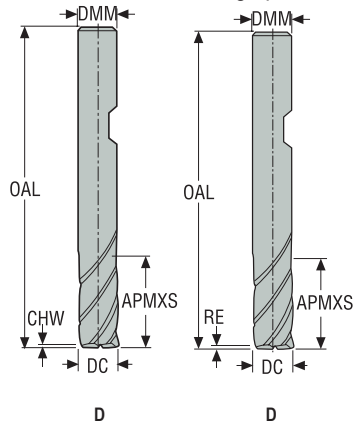

- Tolerances:
- DMM=h5
- DC=e7

Designation	Item number	Length index	Tool shape	DC	DMM	APMXS	OAL	CHW	RE	PCEDC	Weldon
				Inch	Inch	Inch	Inch	Inch	Inch	Inch	
5530500Z3.3-SIRON-A	02712697	2	D	0.500	0.500	1.000	3.500	0.006	-	3	■
5530500R015Z3.3-SIRON-A	02712700	2	D	0.500	0.500	1.000	3.500	-	0.015	3	■
5530500R030Z3.3-SIRON-A	02712702	2	D	0.500	0.500	1.000	3.500	-	0.030	3	■

■ Stocked standard.

Universal

Steel and cast iron

Stainless steel and S-materials

Non ferrous

Hard

Plastic and cfrp

Graphite

Minimaster Plus

Minimaster

Cutting data – JS553 Side milling

Universal	SMG	Coolant	a _e /DC	a _p /DC	f _z											v _c
					2	3	4	5	6	8	10	12	14	16	20	
P1	M/A/D/E	0.400 0.400	1.0 1.0	0.020 0.00080	0.030 0.0012	0.040 0.0016	0.050 0.0020	0.060 0.0024	0.080 0.0032	0.10 0.0040	0.12 0.0048	0.13 0.0050	0.15 0.0060	0.17 0.0065	0.19 0.0075	225 (200 – 250)
																740 (660 – 820)
P2	M/A/D/E	0.400 0.400	1.0 1.0	0.020 0.00080	0.030 0.0012	0.040 0.0016	0.050 0.0020	0.060 0.0024	0.080 0.0032	0.10 0.0040	0.12 0.0048	0.13 0.0050	0.15 0.0060	0.17 0.0065	0.19 0.0075	220 (190 – 240)
																720 (630 – 780)
P3	M/A/D/E	0.400 0.400	1.0 1.0	0.019 0.00075	0.028 0.0011	0.038 0.0015	0.048 0.0019	0.055 0.0022	0.075 0.0030	0.095 0.0038	0.11 0.0044	0.13 0.0050	0.14 0.0055	0.16 0.0065	0.18 0.0070	190 (170 – 210)
																620 (560 – 680)
P4	M/A/D/E	0.400 0.400	1.0 1.0	0.019 0.00075	0.028 0.0011	0.038 0.0015	0.046 0.0018	0.055 0.0022	0.075 0.0030	0.095 0.0038	0.11 0.0044	0.13 0.0050	0.14 0.0055	0.16 0.0065	0.18 0.0070	165 (150 – 190)
																540 (500 – 620)
P5	M/A/D/E	0.400 0.400	1.0 1.0	0.018 0.00070	0.028 0.0011	0.036 0.0014	0.046 0.0018	0.055 0.0022	0.075 0.0030	0.090 0.0036	0.11 0.0044	0.12 0.0048	0.13 0.0050	0.16 0.0065	0.18 0.0070	160 (140 – 180)
																520 (460 – 590)
P6	M/A/D/E	0.400 0.400	1.0 1.0	0.018 0.00070	0.028 0.0011	0.036 0.0014	0.046 0.0018	0.055 0.0022	0.075 0.0030	0.090 0.0036	0.11 0.0044	0.12 0.0048	0.13 0.0050	0.15 0.0060	0.17 0.0065	180 (160 – 200)
																590 (530 – 650)
P7	M/A/D/E	0.400 0.400	1.0 1.0	0.018 0.00070	0.028 0.0011	0.036 0.0014	0.046 0.0018	0.055 0.0022	0.075 0.0030	0.090 0.0036	0.11 0.0044	0.12 0.0048	0.13 0.0050	0.15 0.0060	0.17 0.0065	170 (150 – 190)
																560 (500 – 620)
P8	M/A/D/E	0.400 0.400	1.0 1.0	0.019 0.00075	0.028 0.0011	0.038 0.0015	0.048 0.0019	0.055 0.0022	0.075 0.0030	0.095 0.0038	0.11 0.0044	0.13 0.0050	0.14 0.0055	0.16 0.0065	0.18 0.0070	160 (140 – 180)
																520 (460 – 590)
P11	M/A/D/E	0.400 0.400	1.0 1.0	0.018 0.00070	0.026 0.0010	0.036 0.0014	0.044 0.0017	0.055 0.0022	0.070 0.0028	0.090 0.0036	0.11 0.0044	0.12 0.0048	0.13 0.0050	0.15 0.0060	0.17 0.0065	145 (130 – 160)
																475 (430 – 520)
P12	M/A/D/E	0.400 0.400	1.0 1.0	0.012 0.00048	0.018 0.00070	0.024 0.00095	0.030 0.0012	0.036 0.0014	0.048 0.0019	0.060 0.0024	0.070 0.0028	0.080 0.0032	0.090 0.0036	0.10 0.0040	0.12 0.0048	95 (82 – 100)
																310 (270 – 320)
M1	E	0.400 0.400	1.0 1.0	0.013 0.00050	0.020 0.00080	0.026 0.0010	0.034 0.0013	0.040 0.0016	0.055 0.0022	0.065 0.0026	0.080 0.0032	0.090 0.0036	0.10 0.0040	0.11 0.0044	0.13 0.0050	115 (100 – 120)
																375 (330 – 390)
M2	E	0.400 0.400	1.0 1.0	0.012 0.00048	0.018 0.00070	0.024 0.00095	0.030 0.0012	0.036 0.0014	0.048 0.0019	0.060 0.0024	0.070 0.0028	0.080 0.0032	0.090 0.0036	0.10 0.0040	0.12 0.0048	95 (82 – 100)
																310 (270 – 320)
M3	E	0.400 0.400	1.0 1.0	0.010 0.00040	0.015 0.00060	0.020 0.00080	0.025 0.0010	0.030 0.0012	0.040 0.0016	0.050 0.0020	0.060 0.0024	0.070 0.0028	0.075 0.0030	0.085 0.0034	0.10 0.0040	60 (47 – 69)
																195 (160 – 220)
M4	E	0.400 0.400	1.0 1.0	0.0090 0.00036	0.013 0.00050	0.018 0.00070	0.022 0.00085	0.026 0.0010	0.036 0.0014	0.044 0.0017	0.055 0.0022	0.060 0.0024	0.065 0.0026	0.075 0.0030	0.085 0.0034	45 (36 – 53)
																150 (120 – 170)
M5	E	0.400 0.400	1.0 1.0	0.0090 0.00036	0.013 0.00050	0.018 0.00070	0.022 0.00085	0.026 0.0010	0.036 0.0014	0.044 0.0017	0.055 0.0022	0.060 0.0024	0.065 0.0026	0.075 0.0030	0.085 0.0034	37 (30 – 44)
																120 (99 – 140)
K1	E	0.400 0.400	1.2 1.2	0.016 0.00065	0.024 0.00095	0.032 0.0013	0.040 0.0016	0.048 0.0019	0.065 0.0026	0.080 0.0032	0.095 0.0038	0.11 0.0044	0.12 0.0048	0.14 0.0055	0.16 0.0065	165 (160 – 190)
																540 (530 – 620)
K2	E	0.400 0.400	1.2 1.2	0.015 0.00060	0.022 0.00085	0.030 0.0012	0.038 0.0015	0.044 0.0017	0.060 0.0024	0.075 0.0030	0.090 0.0036	0.10 0.0040	0.11 0.0044	0.13 0.0050	0.14 0.0055	145 (140 – 170)
																475 (460 – 550)
K3	E	0.400 0.400	1.2 1.2	0.015 0.00060	0.022 0.00085	0.030 0.0012	0.038 0.0015	0.044 0.0017	0.060 0.0024	0.075 0.0030	0.090 0.0036	0.10 0.0040	0.11 0.0044	0.13 0.0050	0.14 0.0055	125 (120 – 140)
																410 (400 – 450)
K4	E	0.400 0.400	1.2 1.2	0.015 0.00060	0.022 0.00085	0.030 0.0012	0.038 0.0015	0.044 0.0017	0.060 0.0024	0.075 0.0030	0.090 0.0036	0.10 0.0040	0.11 0.0044	0.13 0.0050	0.14 0.0055	120 (110 – 140)
																395 (370 – 450)
K5	E	0.400 0.400	1.1 1.1	0.016 0.00065	0.024 0.00095	0.032 0.0013	0.040 0.0016	0.048 0.0019	0.065 0.0026	0.080 0.0032	0.095 0.0038	0.11 0.0044	0.12 0.0048	0.14 0.0055	0.16 0.0065	155 (140 – 170)
																510 (460 – 550)
K6	E	0.400 0.400	1.1 1.1	0.018 0.00070	0.028 0.0011	0.036 0.0014	0.046 0.0018	0.055 0.0022	0.070 0.0028	0.090 0.0036	0.11 0.0044	0.12 0.0048	0.13 0.0050	0.15 0.0060	0.17 0.0065	220 (190 – 250)
																720 (630 – 820)
K7	E	0.400 0.400	1.1 1.1	0.016 0.00065	0.024 0.00095	0.032 0.0013	0.040 0.0016	0.048 0.0019	0.065 0.0026	0.080 0.0032	0.095 0.0038	0.11 0.0044	0.12 0.0048	0.14 0.0055	0.16 0.0065	195 (170 – 220)
																640 (560 – 720)

For cutting data recalculations, see pages 445 - 452

SMG = Seco material group
Coolant = A=air D=dry E=emulsion M=mist spray
v_c = m/min (sf/min)
f_z = mm (in/tooth)
a_p = mm/DC (in/DC) = factor
a_e = mm/DC (in/DC) = factor
All cutting data are target values

Cutting data – JS553 Side milling

SMG		a _e /DC	a _p /DC	f _z												v _c
				2	3	4	5	6	8	10	12	14	16	20	25	
N1	E	0.500	1.0	0.016	0.024	0.032	0.040	0.048	0.065	0.080	0.095	0.11	0.12	0.14	0.15	620 (520–720)
		0,500	1,0	0,00065	0,00095	0,0013	0,0016	0,0019	0,0026	0,0032	0,0038	0,0044	0,0048	0,0055	0,0060	2025 (1800 – 2300)
N2	E	0.500	1.0	0.016	0.024	0.032	0.040	0.048	0.065	0.080	0.095	0.11	0.12	0.14	0.15	400 (340 – 460)
		0,500	1,0	0,00065	0,00095	0,0013	0,0016	0,0019	0,0026	0,0032	0,0038	0,0044	0,0048	0,0055	0,0060	1300 (1200–1500)
N3	E	0.500	1.0	0.016	0.024	0.032	0.040	0.048	0.065	0.080	0.095	0.11	0.12	0.14	0.15	265 (230 – 300)
		0,500	1,0	0,00065	0,00095	0,0013	0,0016	0,0019	0,0026	0,0032	0,0038	0,0044	0,0048	0,0055	0,0060	870 (760 – 980)
N11	E	0.500	1.1	0.016	0.024	0.032	0.040	0.048	0.065	0.080	0.095	0.11	0.12	0.13	0.15	310 (260 – 350)
		0,500	1,1	0,00065	0,00095	0,0013	0,0016	0,0019	0,0026	0,0032	0,0038	0,0044	0,0048	0,0050	0,0060	1025 (860–1100)
S1	E	0.150	0.50	0.017	0.026	0.034	0.044	0.050	0.070	0.085	0.10	0.12	0.13	0.15	0.17	43 (26 – 60)
		0,150	0,50	0,00065	0,0010	0,0013	0,0017	0,0020	0,0028	0,0034	0,0040	0,0048	0,0050	0,0060	0,0065	140 (86–190)
S2	E	0.150	0.50	0.017	0.026	0.034	0.044	0.050	0.070	0.085	0.10	0.12	0.13	0.15	0.17	35 (21 – 48)
		0,150	0,50	0,00065	0,0010	0,0013	0,0017	0,0020	0,0028	0,0034	0,0040	0,0048	0,0050	0,0060	0,0065	115 (69–150)
S3	E	0.150	0.50	0.016	0.024	0.032	0.040	0.048	0.065	0.080	0.095	0.11	0.12	0.14	0.15	30 (19 – 42)
		0,150	0,50	0,00065	0,00095	0,0013	0,0016	0,0019	0,0026	0,0032	0,0038	0,0044	0,0048	0,0055	0,0060	100 (63–130)
S11	E	0.400	1.0	0.012	0.018	0.024	0.030	0.036	0.048	0.060	0.070	0.080	0.090	0.10	0.12	110 (78–130)
		0,400	1,0	0,00048	0,00070	0,00095	0,0012	0,0014	0,0019	0,0024	0,0028	0,0032	0,0036	0,0040	0,0048	360 (260 – 420)
S12	E	0.400	1.0	0.012	0.018	0.024	0.030	0.036	0.048	0.060	0.070	0.080	0.090	0.10	0.12	85 (60–100)
		0,400	1,0	0,00048	0,00070	0,00095	0,0012	0,0014	0,0019	0,0024	0,0028	0,0032	0,0036	0,0040	0,0048	280 (200 – 320)
S13	E	0.400	1.0	0.011	0.016	0.022	0.026	0.032	0.042	0.055	0.065	0.070	0.080	0.090	0.10	65 (48 – 84)
		0,400	1,0	0,00044	0,00065	0,00085	0,0010	0,0013	0,0017	0,0022	0,0026	0,0028	0,0032	0,0036	0,0040	215 (160 – 270)
H5	M/A/D	0.200	0.90	0.013	0.020	0.026	0.032	0.040	0.050	0.065	0.075	0.085	0.095	0.11	0.12	75 (62 – 91)
		0,200	0,90	0,00050	0,00080	0,0010	0,0013	0,0016	0,0020	0,0026	0,0030	0,0034	0,0038	0,0044	0,0048	245 (210 – 290)
H8	M/A/D	0.200	0.90	0.010	0.015	0.020	0.025	0.030	0.040	0.050	0.060	0.065	0.075	0.085	0.095	80 (65 – 96)
		0,200	0,90	0,00040	0,00060	0,00080	0,0010	0,0012	0,0016	0,0020	0,0024	0,0026	0,0030	0,0034	0,0038	260 (220 – 310)
H21	M/A/D	0.200	0.90	0.010	0.015	0.020	0.025	0.030	0.040	0.050	0.060	0.065	0.075	0.085	0.095	80 (65 – 96)
		0,200	0,90	0,00040	0,00060	0,00080	0,0010	0,0012	0,0016	0,0020	0,0024	0,0026	0,0030	0,0034	0,0038	260 (220 – 310)
H31	M/A/D	0.200	0.90	0.010	0.015	0.020	0.025	0.030	0.040	0.050	0.060	0.065	0.075	0.085	0.095	60 (49–72)
		0,200	0,90	0,00040	0,00060	0,00080	0,0010	0,0012	0,0016	0,0020	0,0024	0,0026	0,0030	0,0034	0,0038	195 (170 – 230)
TS1	A	0.500	1.2	0.020	0.030	0.040	0.050	0.060	0.080	0.10	0.12	0.13	0.15	0.17	0.19	290 (180 – 400)
		0,500	1,2	0,00080	0,0012	0,0016	0,0020	0,0024	0,0032	0,0040	0,0048	0,0050	0,0060	0,0065	0,0075	950 (600–1300)
TP1	A	0.500	1.2	0.020	0.030	0.040	0.050	0.060	0.080	0.10	0.12	0.13	0.15	0.17	0.19	300 (180 – 410)
		0,500	1,2	0,00080	0,0012	0,0016	0,0020	0,0024	0,0032	0,0040	0,0048	0,0050	0,0060	0,0065	0,0075	980 (600–1300)
GR1	A	0.500	1.2	0.020	0.030	0.040	0.050	0.060	0.080	0.10	0.12	0.13	0.15	0.17	0.19	580 (470 – 690)
		0,500	1,2	0,00080	0,0012	0,0016	0,0020	0,0024	0,0032	0,0040	0,0048	0,0050	0,0060	0,0065	0,0075	1900 (1600 – 2200)

For cutting data recalculations, see pages 445 - 452

SMG = Seco material group
 Coolant = A=air D=dry E=emulsion M=mist spray
 v_c= m/min (sf/min)
 f_z = mm (in/tooth)
 a_p = mm/DC (in/DC) = factor
 a_e = mm/DC (in/DC) = factor
 All cutting data are target values

Universal
Steel and cast iron
Stainless steel and S-materials
Non ferrous
Hard
Plastic and chip
Graphite
Minimaster Plus
Minimaster

Cutting data – JS553 Slot milling

SMG		a _p /DC	f _z												v _c
			2	3	4	5	6	8	10	12	14	16	20	25	
N1	E	0.70	0.010	0.015	0.020	0.025	0.030	0.040	0.050	0.060	0.070	0.080	0.10	0.13	580 (490 – 670)
		0,70	0,00040	0,00060	0,00080	0,0010	0,0012	0,0016	0,0020	0,0024	0,0028	0,0032	0,0040	0,0050	1900 (1700 – 2100)
N2	E	0.70	0.010	0.015	0.020	0.025	0.030	0.040	0.050	0.060	0.070	0.080	0.10	0.13	375 (320 – 430)
		0,70	0,00040	0,00060	0,00080	0,0010	0,0012	0,0016	0,0020	0,0024	0,0028	0,0032	0,0040	0,0050	1225 (1100–1400)
N3	E	0.70	0.010	0.015	0.020	0.025	0.030	0.040	0.050	0.060	0.070	0.080	0.10	0.13	250 (210 – 290)
		0,70	0,00040	0,00060	0,00080	0,0010	0,0012	0,0016	0,0020	0,0024	0,0028	0,0032	0,0040	0,0050	820 (690 – 950)
N11	E	0.60	0.010	0.015	0.020	0.025	0.030	0.040	0.050	0.060	0.070	0.080	0.10	0.13	290 (250 – 330)
		0,60	0,00040	0,00060	0,00080	0,0010	0,0012	0,0016	0,0020	0,0024	0,0028	0,0032	0,0040	0,0050	950 (830–1000)
S1	E	0.30	0.0065	0.0095	0.013	0.016	0.019	0.025	0.032	0.038	0.044	0.050	0.065	0.080	34 (21 – 47)
		0,30	0,00026	0,00038	0,00050	0,00065	0,00075	0,0010	0,0013	0,0015	0,0017	0,0020	0,0026	0,0032	110 (69–150)
S2	E	0.30	0.0065	0.0095	0.013	0.016	0.019	0.025	0.032	0.038	0.044	0.050	0.065	0.080	27 (17 – 38)
		0,30	0,00026	0,00038	0,00050	0,00065	0,00075	0,0010	0,0013	0,0015	0,0017	0,0020	0,0026	0,0032	90 (56–120)
S3	E	0.30	0.0065	0.0095	0.013	0.016	0.019	0.025	0.032	0.038	0.044	0.050	0.065	0.080	23 (15 – 32)
		0,30	0,00026	0,00038	0,00050	0,00065	0,00075	0,0010	0,0013	0,0015	0,0017	0,0020	0,0026	0,0032	75 (50–100)
S11	E	0.50	0.012	0.018	0.024	0.030	0.036	0.048	0.060	0.070	0.080	0.090	0.10	0.11	85 (63–110)
		0,50	0,00048	0,00070	0,00095	0,0012	0,0014	0,0019	0,0024	0,0028	0,0032	0,0036	0,0040	0,0044	280 (210 – 360)
S12	E	0.50	0.012	0.018	0.024	0.030	0.036	0.048	0.060	0.070	0.080	0.090	0.10	0.11	65 (48 – 86)
		0,50	0,00048	0,00070	0,00095	0,0012	0,0014	0,0019	0,0024	0,0028	0,0032	0,0036	0,0040	0,0044	215 (160 – 280)
S13	E	0.50	0.010	0.016	0.020	0.026	0.032	0.042	0.050	0.060	0.070	0.075	0.090	0.10	55 (39 – 69)
		0,50	0,00040	0,00065	0,00080	0,0010	0,0013	0,0017	0,0020	0,0024	0,0028	0,0030	0,0036	0,0040	180 (130 – 220)
H5	M/A/D	0.50	0.0040	0.0060	0.0080	0.010	0.012	0.016	0.020	0.025	0.028	0.032	0.040	0.050	65 (52–77)
		0,50	0,00016	0,00024	0,00032	0,00040	0,00048	0,00065	0,00080	0,0010	0,0011	0,0013	0,0016	0,0020	215 (180 – 250)
H8	M/A/D	0.50	0.0040	0.0060	0.0080	0.010	0.012	0.016	0.020	0.025	0.028	0.032	0.040	0.050	65 (52–77)
		0,50	0,00016	0,00024	0,00032	0,00040	0,00048	0,00065	0,00080	0,0010	0,0011	0,0013	0,0016	0,0020	215 (180 – 250)
H11	M/A/D	0.50	0.0040	0.0060	0.0080	0.010	0.012	0.016	0.020	0.025	0.028	0.032	0.040	0.050	80 (66 – 98)
		0,50	0,00016	0,00024	0,00032	0,00040	0,00048	0,00065	0,00080	0,0010	0,0011	0,0013	0,0016	0,0020	260 (220 – 320)
H12	M/A/D	1.0	0.0095	0.014	0.019	0.024	0.028	0.038	0.046	0.055	0.060	0.070	0.080	0.090	65 (52–77)
		1,0	0,00038	0,00055	0,00075	0,00095	0,0011	0,0015	0,0018	0,0022	0,0024	0,0028	0,0032	0,0036	215 (180 – 250)
H21	M/A/D	0.50	0.0040	0.0060	0.0080	0.010	0.012	0.016	0.020	0.025	0.028	0.032	0.040	0.050	65 (52–77)
		0,50	0,00016	0,00024	0,00032	0,00040	0,00048	0,00065	0,00080	0,0010	0,0011	0,0013	0,0016	0,0020	215 (180 – 250)
TS1	A	1.0	0.020	0.030	0.040	0.050	0.060	0.080	0.10	0.12	0.13	0.15	0.17	0.19	245 (150 – 340)
		1,0	0,00080	0,0012	0,0016	0,0020	0,0024	0,0032	0,0040	0,0048	0,0050	0,0060	0,0065	0,0075	800 (500–1100)
TP1	A	1.0	0.020	0.030	0.040	0.050	0.060	0.080	0.10	0.12	0.13	0.15	0.17	0.19	250 (160 – 350)
		1,0	0,00080	0,0012	0,0016	0,0020	0,0024	0,0032	0,0040	0,0048	0,0050	0,0060	0,0065	0,0075	820 (530–1100)
GR1	A	1.0	0.020	0.030	0.040	0.050	0.060	0.080	0.10	0.12	0.13	0.15	0.17	0.19	490 (400 – 580)
		1,0	0,00080	0,0012	0,0016	0,0020	0,0024	0,0032	0,0040	0,0048	0,0050	0,0060	0,0065	0,0075	1600 (1400–1900)

For cutting data recalculations, see pages 445 - 452

SMG = Seco material group
 Coolant = A=air D=dry E=emulsion M=mist spray
 v_c = m/min (sf/min)
 f_z = mm/tooth (in/tooth)
 a_p = mm/DC (in/DC) = factor
 a_e = mm/DC (in/DC) = factor
 All cutting data are target values

Universal
Steel and cast iron
Stainless steel and S-materials
Non ferrous
Hard
Plastic and chip
Graphite
Mimimaster Plus
Mimimaster

Cutting data – JS553 Side milling – Inch

SMG		a _e /DC	a _p /DC	f _z						v _c
				1/8	3/16	1/4	5/16	3/8	1/2	
P1	M/A/D/E	0.400	1.0	0.032	0.048	0.065	0.080	0.095	0.12	225 (200 – 250)
		0.400	1.0	0.0013	0.0019	0.0026	0.0032	0.0038	0.0048	740 (660 – 820)
P2	M/A/D/E	0.400	1.0	0.032	0.048	0.065	0.080	0.095	0.13	220 (190 – 240)
		0.400	1.0	0.0013	0.0019	0.0026	0.0032	0.0038	0.0050	720 (630–780)
P3	M/A/D/E	0.400	1.0	0.030	0.046	0.060	0.075	0.090	0.12	190 (170 – 210)
		0.400	1.0	0.0012	0.0018	0.0024	0.0030	0.0036	0.0048	620 (560 – 680)
P4	M/A/D/E	0.400	1.0	0.030	0.044	0.060	0.075	0.090	0.12	165 (150–190)
		0.400	1.0	0.0012	0.0017	0.0024	0.0030	0.0036	0.0048	540 (500 – 620)
P5	M/A/D/E	0.400	1.0	0.030	0.044	0.060	0.075	0.085	0.11	160 (140–180)
		0.400	1.0	0.0012	0.0017	0.0024	0.0030	0.0034	0.0044	520 (460 – 590)
P6	M/A/D/E	0.400	1.0	0.028	0.044	0.060	0.070	0.085	0.11	180 (160 – 200)
		0.400	1.0	0.0011	0.0017	0.0024	0.0028	0.0034	0.0044	590 (530 – 650)
P7	M/A/D/E	0.400	1.0	0.028	0.044	0.060	0.070	0.085	0.11	170 (150–190)
		0.400	1.0	0.0011	0.0017	0.0024	0.0028	0.0034	0.0044	560 (500 – 620)
P8	M/A/D/E	0.400	1.0	0.030	0.046	0.060	0.075	0.090	0.12	160 (140–180)
		0.400	1.0	0.0012	0.0018	0.0024	0.0030	0.0036	0.0048	520 (460 – 590)
P11	M/A/D/E	0.400	1.0	0.028	0.042	0.055	0.070	0.085	0.11	145 (130–160)
		0.400	1.0	0.0011	0.0017	0.0022	0.0028	0.0034	0.0044	475 (430 – 520)
P12	M/A/D/E	0.400	1.0	0.019	0.030	0.038	0.048	0.060	0.075	95 (82–100)
		0.400	1.0	0.00075	0.0012	0.0015	0.0019	0.0024	0.0030	310 (270 – 320)
M1	E	0.400	1.0	0.022	0.032	0.042	0.055	0.065	0.085	115 (100–120)
		0.400	1.0	0.00085	0.0013	0.0017	0.0022	0.0026	0.0034	375 (330 – 390)
M2	E	0.400	1.0	0.019	0.030	0.038	0.048	0.060	0.075	95 (82–100)
		0.400	1.0	0.00075	0.0012	0.0015	0.0019	0.0024	0.0030	310 (270 – 320)
M3	E	0.400	1.0	0.016	0.024	0.032	0.040	0.048	0.065	60 (47 – 69)
		0.400	1.0	0.00065	0.00095	0.0013	0.0016	0.0019	0.0026	195 (160 – 220)
M4	E	0.400	1.0	0.014	0.022	0.028	0.036	0.042	0.055	45 (36 – 53)
		0.400	1.0	0.00055	0.00085	0.0011	0.0014	0.0017	0.0022	150 (120–170)
M5	E	0.400	1.0	0.014	0.022	0.028	0.036	0.042	0.055	37 (30 – 44)
		0.400	1.0	0.00055	0.00085	0.0011	0.0014	0.0017	0.0022	120 (99–140)
K1	E	0.400	1.2	0.026	0.038	0.050	0.065	0.080	0.10	165 (160–190)
		0.400	1.2	0.0010	0.0015	0.0020	0.0026	0.0032	0.0040	540 (530 – 620)
K2	E	0.400	1.2	0.024	0.036	0.048	0.060	0.070	0.090	145 (140–170)
		0.400	1.2	0.00095	0.0014	0.0019	0.0024	0.0028	0.0036	475 (460 – 550)
K3	E	0.400	1.2	0.024	0.036	0.048	0.060	0.070	0.090	125 (120–140)
		0.400	1.2	0.00095	0.0014	0.0019	0.0024	0.0028	0.0036	410 (400 – 450)
K4	E	0.400	1.2	0.024	0.036	0.048	0.060	0.070	0.090	120 (110–140)
		0.400	1.2	0.00095	0.0014	0.0019	0.0024	0.0028	0.0036	395 (370 – 450)
K5	E	0.400	1.1	0.026	0.038	0.050	0.065	0.080	0.10	155 (140–170)
		0.400	1.1	0.0010	0.0015	0.0020	0.0026	0.0032	0.0040	510 (460 – 550)
K6	E	0.400	1.1	0.028	0.044	0.060	0.070	0.085	0.11	220 (190 – 250)
		0.400	1.1	0.0011	0.0017	0.0024	0.0028	0.0034	0.0044	720 (630 – 820)
K7	E	0.400	1.1	0.026	0.038	0.050	0.065	0.080	0.10	195 (170 – 220)
		0.400	1.1	0.0010	0.0015	0.0020	0.0026	0.0032	0.0040	640 (560–720)

For cutting data recalculations, see pages 445 - 452

SMG = Seco material group
Coolant = A=air D=dry E=emulsion M=mist spray
v_c = m/min (sf/min)
f_z = mm/tooth (in/tooth)
a_p = mm/DC (in/DC) = factor
a_e = mm/DC (in/DC) = factor
All cutting data are target values

Cutting data – JS553 Side milling – Inch

SMG		a _e /DC	a _p /DC	f _z						v _c
				1/8	3/16	1/4	5/16	3/8	1/2	
N1	E	0.500 0,500	1.0 1,0	0.025 0,0010	0.038 0,0015	0.050 0,0020	0.065 0,0026	0.075 0,0030	0.10 0,0040	620 (520–720) 2025 (1800–2300)
N2	E	0.500 0,500	1.0 1,0	0.025 0,0010	0.038 0,0015	0.050 0,0020	0.065 0,0026	0.075 0,0030	0.10 0,0040	400 (340–460) 1300 (1200–1500)
N3	E	0.500 0,500	1.0 1,0	0.025 0,0010	0.038 0,0015	0.050 0,0020	0.065 0,0026	0.075 0,0030	0.10 0,0040	265 (230–300) 870 (760–980)
N11	E	0.500 0,500	1.1 1,1	0.025 0,0010	0.038 0,0015	0.050 0,0020	0.065 0,0026	0.075 0,0030	0.10 0,0040	310 (260–350) 1025 (860–1100)
S1	E	0.150 0,150	0.50 0,50	0.028 0,0011	0.042 0,0017	0.055 0,0022	0.070 0,0028	0.085 0,0034	0.11 0,0044	43 (26–60) 140 (86–190)
S2	E	0.150 0,150	0.50 0,50	0.028 0,0011	0.042 0,0017	0.055 0,0022	0.070 0,0028	0.085 0,0034	0.11 0,0044	35 (21–48) 115 (69–150)
S3	E	0.150 0,150	0.50 0,50	0.026 0,0010	0.038 0,0015	0.050 0,0020	0.065 0,0026	0.075 0,0030	0.10 0,0040	30 (19–42) 100 (63–130)
S11	E	0.400 0,400	1.0 1,0	0.019 0,00075	0.030 0,0012	0.038 0,0015	0.048 0,0019	0.060 0,0024	0.075 0,0030	110 (78–130) 360 (260–420)
S12	E	0.400 0,400	1.0 1,0	0.019 0,00075	0.030 0,0012	0.038 0,0015	0.048 0,0019	0.060 0,0024	0.075 0,0030	85 (60–100) 280 (200–320)
S13	E	0.400 0,400	1.0 1,0	0.017 0,00065	0.025 0,0010	0.034 0,0013	0.042 0,0017	0.050 0,0020	0.065 0,0026	65 (48–84) 215 (160–270)
H5	M/A/D	0.200 0,200	0.90 0,90	0.020 0,00080	0.032 0,0013	0.042 0,0017	0.050 0,0020	0.060 0,0024	0.080 0,0032	75 (62–91) 245 (210–290)
H8	M/A/D	0.200 0,200	0.90 0,90	0.016 0,00065	0.024 0,00095	0.032 0,0013	0.040 0,0016	0.048 0,0019	0.060 0,0024	80 (65–96) 260 (220–310)
H21	M/A/D	0.200 0,200	0.90 0,90	0.016 0,00065	0.024 0,00095	0.032 0,0013	0.040 0,0016	0.048 0,0019	0.060 0,0024	80 (65–96) 260 (220–310)
H31	M/A/D	0.200 0,200	0.90 0,90	0.016 0,00065	0.024 0,00095	0.032 0,0013	0.040 0,0016	0.048 0,0019	0.060 0,0024	60 (49–72) 195 (170–230)
TS1	A	0.500 0,500	1.2 1,2	0.032 0,0013	0.048 0,0019	0.065 0,0026	0.080 0,0032	0.095 0,0038	0.12 0,0048	290 (180–400) 950 (600–1300)
TP1	A	0.500 0,500	1.2 1,2	0.032 0,0013	0.048 0,0019	0.065 0,0026	0.080 0,0032	0.095 0,0038	0.12 0,0048	300 (180–410) 980 (600–1300)
GR1	A	0.500 0,500	1.2 1,2	0.032 0,0013	0.048 0,0019	0.065 0,0026	0.080 0,0032	0.095 0,0038	0.12 0,0048	580 (470–690) 1900 (1600–2200)

For cutting data recalculations, see pages 445 - 452

SMG = Seco material group
Coolant = A=air D=dry E=emulsion M=mist spray
v_c = m/min (sf/min)
f_z = mm/tooth (in/tooth)
a_p = mm/DC (in/DC) = factor
a_e = mm/DC (in/DC) = factor
All cutting data are target values

Universal
Steel and cast iron
Stainless steel and S-materials
Non ferrous
Hard
Plastic and chip
Graphite
Mimimaster Plus
Mimimaster

Cutting data – JS553 Slot milling – Inch

SMG		a _p /DC	f _z						v _c
			1/8	3/16	1/4	5/16	3/8	1/2	
P1	M/A/D/E	1.0	0.022	0.034	0.044	0.055	0.065	0.090	195 (170 – 220)
		1,0	0,00085	0,0013	0,0017	0,0022	0,0026	0,0036	640 (560 – 720)
P2	M/A/D/E	1.0	0.022	0.034	0.044	0.055	0.065	0.090	190 (170 – 210)
		1,0	0,00085	0,0013	0,0017	0,0022	0,0026	0,0036	620 (560 – 680)
P3	M/A/D/E	1.0	0.022	0.034	0.044	0.055	0.065	0.090	165 (140 – 180)
		1,0	0,00085	0,0013	0,0017	0,0022	0,0026	0,0036	540 (460 – 590)
P4	M/A/D/E	1.0	0.022	0.034	0.044	0.055	0.065	0.090	145 (130 – 160)
		1,0	0,00085	0,0013	0,0017	0,0022	0,0026	0,0036	475 (430 – 520)
P5	M/A/D/E	1.0	0.022	0.034	0.044	0.055	0.065	0.090	135 (120 – 150)
		1,0	0,00085	0,0013	0,0017	0,0022	0,0026	0,0036	445 (400 – 490)
P6	M/A/D/E	1.0	0.022	0.034	0.044	0.055	0.065	0.090	155 (140 – 170)
		1,0	0,00085	0,0013	0,0017	0,0022	0,0026	0,0036	510 (460 – 550)
P7	M/A/D/E	1.0	0.022	0.034	0.044	0.055	0.065	0.090	145 (130 – 160)
		1,0	0,00085	0,0013	0,0017	0,0022	0,0026	0,0036	475 (430 – 520)
P8	M/A/D/E	1.0	0.022	0.034	0.044	0.055	0.065	0.090	135 (120 – 150)
		1,0	0,00085	0,0013	0,0017	0,0022	0,0026	0,0036	445 (400 – 490)
P11	M/A/D/E	0.80	0.016	0.024	0.032	0.040	0.048	0.065	130 (120 – 140)
		0,80	0,00065	0,00095	0,0013	0,0016	0,0019	0,0026	425 (400 – 450)
P12	M/A/D/E	0.80	0.016	0.024	0.032	0.040	0.048	0.065	80 (69 – 87)
		0,80	0,00065	0,00095	0,0013	0,0016	0,0019	0,0026	260 (230 – 280)
M1	E	0.80	0.016	0.024	0.032	0.040	0.048	0.065	95 (85 – 100)
		0,80	0,00065	0,00095	0,0013	0,0016	0,0019	0,0026	310 (280 – 320)
M2	E	0.80	0.016	0.024	0.032	0.040	0.048	0.065	80 (69 – 87)
		0,80	0,00065	0,00095	0,0013	0,0016	0,0019	0,0026	260 (230 – 280)
M3	E	0.70	0.013	0.019	0.026	0.032	0.038	0.050	48 (39 – 58)
		0,70	0,00050	0,00075	0,0010	0,0013	0,0015	0,0020	155 (130 – 190)
M4	E	0.70	0.013	0.019	0.026	0.032	0.038	0.050	36 (30 – 43)
		0,70	0,00050	0,00075	0,0010	0,0013	0,0015	0,0020	120 (99 – 140)
M5	E	0.70	0.013	0.019	0.026	0.032	0.038	0.050	30 (25 – 36)
		0,70	0,00050	0,00075	0,0010	0,0013	0,0015	0,0020	100 (83 – 110)
K1	E	1.0	0.016	0.024	0.032	0.040	0.048	0.065	145 (140 – 170)
		1,0	0,00065	0,00095	0,0013	0,0016	0,0019	0,0026	475 (460 – 550)
K2	E	1.0	0.016	0.024	0.032	0.040	0.048	0.065	125 (120 – 150)
		1,0	0,00065	0,00095	0,0013	0,0016	0,0019	0,0026	410 (400 – 490)
K3	E	1.0	0.016	0.024	0.032	0.040	0.048	0.065	110 (110 – 120)
		1,0	0,00065	0,00095	0,0013	0,0016	0,0019	0,0026	360 (370 – 390)
K4	E	1.0	0.016	0.024	0.032	0.040	0.048	0.065	105 (96 – 120)
		1,0	0,00065	0,00095	0,0013	0,0016	0,0019	0,0026	345 (320 – 390)
K5	E	0.80	0.016	0.024	0.032	0.040	0.048	0.065	135 (120 – 150)
		0,80	0,00065	0,00095	0,0013	0,0016	0,0019	0,0026	445 (400 – 490)
K6	E	0.80	0.016	0.024	0.032	0.040	0.048	0.065	200 (180 – 230)
		0,80	0,00065	0,00095	0,0013	0,0016	0,0019	0,0026	660 (600 – 750)
K7	E	0.80	0.016	0.024	0.032	0.040	0.048	0.065	175 (150 – 190)
		0,80	0,00065	0,00095	0,0013	0,0016	0,0019	0,0026	570 (500 – 620)

For cutting data recalculations, see pages 445 - 452

SMG = Seco material group
Coolant = A=air D=dry E=emulsion M=mist spray
v_c = m/min (sf/min)
f_z = mm/tooth (in/tooth)
a_p = mm/DC (in/DC) = factor
a_e = mm/DC (in/DC) = factor
All cutting data are target values

Cutting data – JS553 Slot milling – Inch

SMG		a _p /DC	f _z						v _c
			1/8	3/16	1/4	5/16	3/8	1/2	
N1	E	0.70	0.016	0.024	0.032	0.040	0.048	0.065	580 (490 – 670)
		0.70	0,00065	0,00095	0,0013	0,0016	0,0019	0,0026	1900 (1700 – 2100)
N2	E	0.70	0.016	0.024	0.032	0.040	0.048	0.065	375 (320 – 430)
		0.70	0,00065	0,00095	0,0013	0,0016	0,0019	0,0026	1225 (1100–1400)
N3	E	0.70	0.016	0.024	0.032	0.040	0.048	0.065	250 (210 – 290)
		0.70	0,00065	0,00095	0,0013	0,0016	0,0019	0,0026	820 (690 – 950)
N11	E	0.60	0.016	0.024	0.032	0.040	0.048	0.065	290 (250 – 330)
		0.60	0,00065	0,00095	0,0013	0,0016	0,0019	0,0026	950 (830–1000)
S1	E	0.30	0.010	0.015	0.020	0.025	0.030	0.040	34 (21 – 47)
		0.30	0,00040	0,00060	0,00080	0,0010	0,0012	0,0016	110 (69–150)
S2	E	0.30	0.010	0.015	0.020	0.025	0.030	0.040	27 (17 – 38)
		0.30	0,00040	0,00060	0,00080	0,0010	0,0012	0,0016	90 (56–120)
S3	E	0.30	0.010	0.015	0.020	0.025	0.030	0.040	23 (15 – 32)
		0.30	0,00040	0,00060	0,00080	0,0010	0,0012	0,0016	75 (50–100)
S11	E	0.50	0.019	0.028	0.038	0.048	0.055	0.075	85 (63–110)
		0.50	0,00075	0,0011	0,0015	0,0019	0,0022	0,0030	280 (210 – 360)
S12	E	0.50	0.019	0.028	0.038	0.048	0.055	0.075	65 (48 – 86)
		0.50	0,00075	0,0011	0,0015	0,0019	0,0022	0,0030	215 (160 – 280)
S13	E	0.50	0.017	0.025	0.034	0.042	0.050	0.065	55 (39 – 69)
		0.50	0,00065	0,0010	0,0013	0,0017	0,0020	0,0026	180 (130 – 220)
H5	M/A/D	0.50	0.0065	0.0095	0.013	0.016	0.019	0.026	65 (52–77)
		0.50	0,00026	0,00038	0,00050	0,00065	0,00075	0,0010	215 (180 – 250)
H8	M/A/D	0.50	0.0065	0.0095	0.013	0.016	0.019	0.026	65 (52–77)
		0.50	0,00026	0,00038	0,00050	0,00065	0,00075	0,0010	215 (180 – 250)
H21	M/A/D	0.50	0.0065	0.0095	0.013	0.016	0.019	0.026	65 (52–77)
		0.50	0,00026	0,00038	0,00050	0,00065	0,00075	0,0010	215 (180 – 250)
H31	M/A/D	0.50	0.0065	0.0095	0.013	0.016	0.019	0.026	49 (39 – 58)
		0.50	0,00026	0,00038	0,00050	0,00065	0,00075	0,0010	160 (130–190)
TS1	A	1.0	0.032	0.048	0.065	0.080	0.095	0.12	245 (150 – 340)
		1.0	0,0013	0,0019	0,0026	0,0032	0,0038	0,0048	800 (500–1100)
TP1	A	1.0	0.032	0.048	0.065	0.080	0.095	0.12	250 (160 – 350)
		1.0	0,0013	0,0019	0,0026	0,0032	0,0038	0,0048	820 (530–1100)
GR1	A	1.0	0.032	0.048	0.065	0.080	0.095	0.12	490 (400 – 580)
		1.0	0,0013	0,0019	0,0026	0,0032	0,0038	0,0048	1600 (1400–1900)

For cutting data recalculations, see pages 445 - 452

SMG = Seco material group
 Coolant = A=air D=dry E=emulsion M=mist spray
 v_c= m/min (sf/min)
 f_z = mm/tooth (in/tooth)
 a_p = mm/DC (in/DC) = factor
 a_e = mm/DC (in/DC) = factor
 All cutting data are target values

Universal
Steel and cast iron
Stainless steel and S-materials
Non ferrous
Hard
Plastic and chip
Graphite
Mimimaster Plus
Mimimaster

JS554

High performance – Universal – Square – 4 Flutes – Cylindrical – Sharp

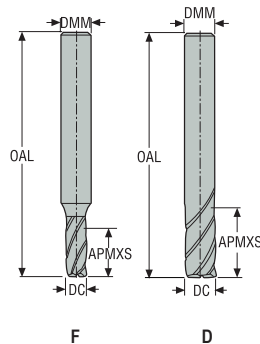

- Tolerances:
- DMM=h5
- DC=e7
- Regrind possible if DC is $\geq \varnothing 6$

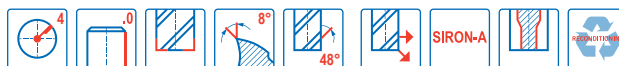

Designation	Item number	Length index	Tool shape	DC	DMM	APMXS	OAL	PCEDC	Cylindrical
				mm	mm	mm	mm		
554030SZ4.0-SIRON-A	02733453	2	F	3,0	6,0	7,0	50,0	4	■
554040SZ4.0-SIRON-A	02733458	2	F	4,0	6,0	10,0	55,0	4	■
554050SZ4.0-SIRON-A	02733812	2	F	5,0	6,0	12,0	55,0	4	■
554060SZ4.0-SIRON-A	02733814	2	D	6,0	6,0	14,0	55,0	4	■
554080SZ4.0-SIRON-A	02733815	2	D	8,0	8,0	18,0	60,0	4	■
554100SZ4.0-SIRON-A	02733816	2	D	10,0	10,0	22,0	70,0	4	■

■ Stocked standard.

Universal

Steel and cast iron

Stainless steel and S-materials

Non ferrous

Hard

Plastic and cfrp

Graphite

Minimaster Plus

Minimaster

JS554

High performance – Universal – Square – 4 Flutes – Cylindrical – Chamfer

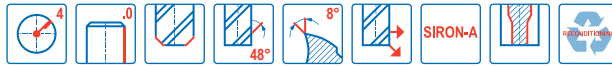
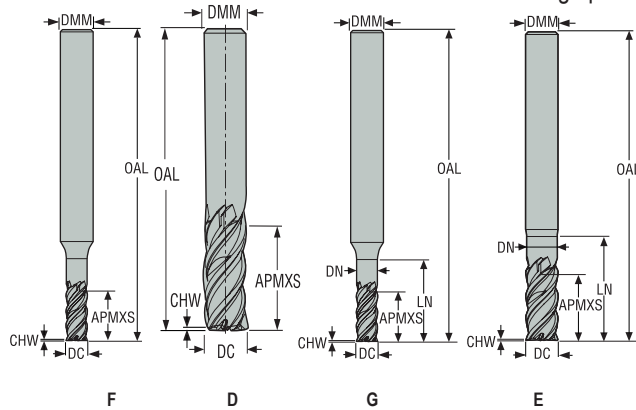

- Tolerances:
- DMM=h5
- DC=e7
- Regrind possible if DC is $\geq \varnothing 6$

Designation	Item number	Length index	Tool shape	DC	DMM	APMXS	OAL	LN	DN	CHW	PCEDC	Cylindrical
				mm	mm	mm	mm	mm	mm	mm		
JS554030G2C.0Z4-SIRA	03029956	2	G	3,0	6,0	8,0	57,0	10,0	2,85	0,035	4	■
554030Z4.0-SIRON-A	02733455	2	F	3,0	6,0	7,0	50,0	8,7	3,0	0,035	4	■
JS554040G2C.0Z4-SIRA	03029957	2	G	4,0	6,0	10,0	57,0	13,0	3,8	0,045	4	■
554040Z4.0-SIRON-A	02733459	2	F	4,0	6,0	10,0	55,0	11,7	4,0	0,045	4	■
JS554050G2C.0Z4-SIRA	03029958	2	G	5,0	6,0	12,0	57,0	16,0	4,75	0,055	4	■
554050Z4.0-SIRON-A	02733813	2	F	5,0	6,0	12,0	55,0	13,7	5,0	0,055	4	■
JS554060E2C.0Z4-SIRA	03029959	2	E	6,0	6,0	14,0	57,0	18,0	5,7	0,075	4	■
554060Z4.0-SIRON-A	02679503	2	D	6,0	6,0	14,0	55,0	-	-	0,075	4	■
JS554080E2C.0Z4-SIRA	03029961	2	E	8,0	8,0	18,0	63,0	25,0	7,6	0,1	4	■
554080Z4.0-SIRON-A	02679512	2	D	8,0	8,0	18,0	60,0	-	-	0,1	4	■
JS554100E2C.0Z4-SIRA	03029963	2	E	10,0	10,0	22,0	72,0	29,0	9,5	0,125	4	■
554100Z4.0-SIRON-A	02679537	2	D	10,0	10,0	22,0	70,0	-	-	0,125	4	■
JS554120E2C.0Z4-SIRA	03029966	2	E	12,0	12,0	26,0	83,0	35,0	11,4	0,15	4	■
554120Z4.0-SIRON-A	02679548	2	D	12,0	12,0	26,0	80,0	-	-	0,15	4	■
JS554160E2C.0Z4-SIRA	03029970	2	E	16,0	16,0	34,0	92,0	42,0	15,2	0,2	4	■
554160Z4.0-SIRON-A	02679560	2	D	16,0	16,0	34,0	90,0	-	-	0,2	4	■
JS554200E2C.0Z4-SIRA	03029972	2	E	20,0	20,0	42,0	109,0	54,0	19,0	0,25	4	■
554200Z4.0-SIRON-A	02679566	2	D	20,0	20,0	42,0	100,0	-	-	0,25	4	■
554250Z4.0-SIRON-A	02679573	2	D	25,0	25,0	52,0	125,0	-	-	0,3	4	■
554L030Z4.0-SIRON-A	02733818	3	F	3,0	6,0	12,0	55,0	13,7	3,0	0,035	4	■
554L040Z4.0-SIRON-A	02733823	3	F	4,0	6,0	16,0	60,0	17,7	4,0	0,045	4	■
554L050Z4.0-SIRON-A	02733825	3	F	5,0	6,0	20,0	65,0	21,7	5,0	0,055	4	■
554L060Z4.0-SIRON-A	02733828	3	D	6,0	6,0	23,0	65,0	-	-	0,075	4	■
554L080Z4.0-SIRON-A	02733830	3	D	8,0	8,0	32,0	75,0	-	-	0,1	4	■
554L100Z4.0-SIRON-A	02733832	3	D	10,0	10,0	40,0	85,0	-	-	0,125	4	■
554L120Z4.0-SIRON-A	02733834	3	D	12,0	12,0	45,0	100,0	-	-	0,15	4	■
554L160Z4.0-SIRON-A	02733836	3	D	16,0	16,0	55,0	115,0	-	-	0,2	4	■
554L200Z4.0-SIRON-A	02733838	3	D	20,0	20,0	65,0	125,0	-	-	0,25	4	■
554L250Z4.0-SIRON-A	02733841	3	D	25,0	25,0	85,0	150,0	-	-	0,3	4	■

■ Stocked standard.

Universal
Steel and cast iron
Stainless steel and S-materials
Non ferrous
Hard
Plastic and chip
Graphite
Minimaster Plus
Minimaster

JS554

High performance – Universal – Square – 4 Flutes – Cylindrical – Corner radius

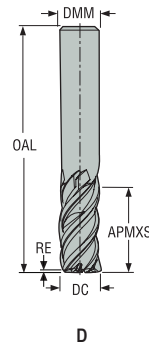

- Tolerances:
- DMM= h5
- DC= e7
- RE= ±0,2 mm
- Regrind possible if DC is ≥Ø6

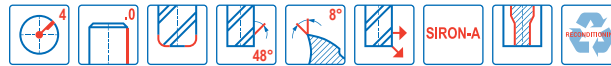

Designation	Item number	Length index	Tool shape	DC	DMM	APMXS	OAL	RE	PCEDC	Cylindrical
				mm	mm	mm	mm	mm		
554060R020Z4.0-SIRON-A	02679507	2	D	6,0	6,0	14,0	55,0	0,2	4	■
554080R050Z4.0-SIRON-A	02679514	2	D	8,0	8,0	18,0	60,0	0,5	4	■
554100R050Z4.0-SIRON-A	02679540	2	D	10,0	10,0	22,0	70,0	0,5	4	■
554100R100Z4.0-SIRON-A	02679544	2	D	10,0	10,0	22,0	70,0	1,0	4	■
554120R050Z4.0-SIRON-A	02679552	2	D	12,0	12,0	26,0	80,0	0,5	4	■
554120R100Z4.0-SIRON-A	02679557	2	D	12,0	12,0	26,0	80,0	1,0	4	■
554160R050Z4.0-SIRON-A	02679562	2	D	16,0	16,0	34,0	90,0	0,5	4	■
554160R100Z4.0-SIRON-A	02679564	2	D	16,0	16,0	34,0	90,0	1,0	4	■
554160R200Z4.0-SIRON-A	02810437	2	D	16,0	16,0	34,0	90,0	2,0	4	■
554160R310Z4.0-SIRON-A	02810439	2	D	16,0	16,0	34,0	90,0	3,1	4	■
554160R400Z4.0-SIRON-A	02810441	2	D	16,0	16,0	34,0	90,0	4,0	4	■
554200R050Z4.0-SIRON-A	02679568	2	D	20,0	20,0	42,0	100,0	0,5	4	■
554200R100Z4.0-SIRON-A	02679571	2	D	20,0	20,0	42,0	100,0	1,0	4	■
554200R250Z4.0-SIRON-A	02810443	2	D	20,0	20,0	42,0	100,0	2,5	4	■
554200R310Z4.0-SIRON-A	02810445	2	D	20,0	20,0	42,0	100,0	3,1	4	■
554200R400Z4.0-SIRON-A	02810447	2	D	20,0	20,0	42,0	100,0	4,0	4	■
554250R050Z4.0-SIRON-A	02679575	2	D	25,0	25,0	52,0	125,0	0,5	4	■
554250R100Z4.0-SIRON-A	02679577	2	D	25,0	25,0	52,0	125,0	1,0	4	■
554250R310Z4.0-SIRON-A	02810449	2	D	25,0	25,0	52,0	125,0	3,1	4	■
554250R400Z4.0-SIRON-A	02810452	2	D	25,0	25,0	52,0	125,0	4,0	4	■

■ Stocked standard.

JS554

High performance– Universal – Square – 4 Flutes – Cylindrical – Corner radius

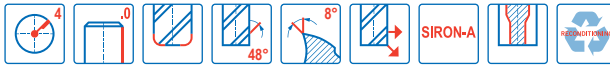
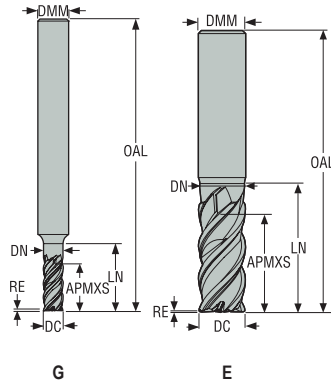

- Tolerances:
- DMM= h5
- DC= e7
- RE= ±0,2 mm
- Regrind possible if DC is ≥Ø6

Designation	Item number	Length index	Tool shape	DC	DMM	APMXS	OAL	LN	DN	RE	PCEDC	Cylindrical
				mm	mm	mm	mm	mm	mm	mm		
JS554030G2R015.0Z4-SIRA	02881697	2	G	3,0	6,0	7,0	57,0	10,0	2,85	0,15	4	■
JS554040G2R020.0Z4-SIRA	02881698	2	G	4,0	6,0	10,0	57,0	13,0	3,8	0,2	4	■
JS554050G2R020.0Z4-SIRA	02881699	2	G	5,0	6,0	12,0	57,0	16,0	4,75	0,2	4	■
JS554060E2R020.0Z4-SIRA	03029960	2	E	6,0	6,0	14,0	57,0	18,0	5,7	0,2	4	■
JS554060E2R050.0Z4-SIRA	02881700	2	E	6,0	6,0	14,0	57,0	18,0	5,7	0,5	4	■
JS554060E2R100.0Z4-SIRA	03029948	2	E	6,0	6,0	14,0	57,0	18,0	5,7	1,0	4	■
JS554080E2R050.0Z4-SIRA	03029962	2	E	8,0	8,0	18,0	63,0	25,0	7,6	0,5	4	■
JS554080E2R100.0Z4-SIRA	02881701	2	E	8,0	8,0	18,0	63,0	25,0	7,6	1,0	4	■
JS554100E2R050.0Z4-SIRA	03029964	2	E	10,0	10,0	22,0	72,0	29,0	9,5	0,5	4	■
JS554100E2R100.0Z4-SIRA	03029965	2	E	10,0	10,0	22,0	72,0	29,0	9,5	1,0	4	■
JS554100E2R200.0Z4-SIRA	02881702	2	E	10,0	10,0	22,0	72,0	29,0	9,5	2,0	4	■
JS554100E2R250.0Z4-SIRA	03029949	2	E	10,0	10,0	22,0	72,0	29,0	9,5	2,5	4	■
JS554120E2R050.0Z4-SIRA	03029968	2	E	12,0	12,0	26,0	83,0	35,0	11,4	0,5	4	■
JS554120E2R100.0Z4-SIRA	03029969	2	E	12,0	12,0	26,0	83,0	35,0	11,4	1,0	4	■
JS554120E2R200.0Z4-SIRA	02881703	2	E	12,0	12,0	26,0	83,0	35,0	11,4	2,0	4	■
JS554120E2R250.0Z4-SIRA	02881704	2	E	12,0	12,0	26,0	83,0	35,0	11,4	2,5	4	■
JS554120E2R300.0Z4-SIRA	03029950	2	E	12,0	12,0	26,0	83,0	35,0	11,4	3,0	4	■
JS554160E2R050.0Z4-SIRA	03029971	2	E	16,0	16,0	34,0	92,0	42,0	15,2	0,5	4	■
JS554160E2R600.0Z4-SIRA	03093685	2	E	16,0	16,0	34,0	92,0	42,0	15,2	6,0	4	■
JS554200E2R200.0Z4-SIRA	02881705	2	E	20,0	20,0	42,0	110,0	54,0	19,0	2,0	4	■
JS554200E2R600.0Z4-SIRA	03029951	2	E	20,0	20,0	42,0	109,0	54,0	19,0	6,0	4	■
JS554250E2R600.0Z4-SIRA	03093686	2	E	25,0	25,0	52,0	125,0	65,0	23,8	6,0	4	■

■ Stocked standard.

Universal

Steel and cast iron

Stainless steel and S-materials

Non ferrous

Hard

Plastic and chip

Graphite

Minimaster Plus

Minimaster

JS554

High performance – Universal – Square – 4 Flutes – Weldon – Sharp

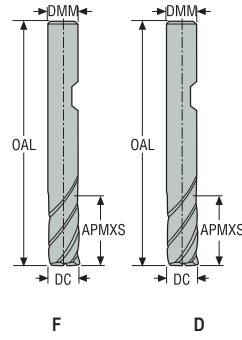

- Tolerances:
- DMM=h5
- DC=e7
- Regrind possible if DC is $\geq \phi 6$

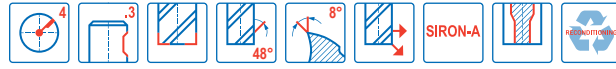

Designation	Item number	Length index	Tool shape	DC	DMM	APMXS	OAL	PCEDC	Weldon
				mm	mm	mm	mm		
554030SZ4.0-SIRON-AW	02733844	2	F	3,0	6,0	7,0	50,0	4	<input type="checkbox"/>
554040SZ4.0-SIRON-AW	02733846	2	F	4,0	6,0	10,0	55,0	4	<input type="checkbox"/>
554050SZ4.0-SIRON-AW	02733847	2	F	5,0	6,0	12,0	55,0	4	<input type="checkbox"/>
554060SZ4.0-SIRON-AW	02733848	2	D	6,0	6,0	14,0	55,0	4	<input type="checkbox"/>
554080SZ4.0-SIRON-AW	02733849	2	D	8,0	8,0	18,0	60,0	4	<input type="checkbox"/>
554100SZ4.0-SIRON-AW	02733850	2	D	10,0	10,0	22,0	70,0	4	<input type="checkbox"/>

Weldon available. Delivery time is 3 days.

Universal

Steel and cast iron

Stainless steel and S-materials

Non ferrous

Hard

Plastic and cfrp

Graphite

Minimaster Plus

Minimaster

JS554

High performance – Universal – Square – 4 Flutes – Weldon – Chamfer

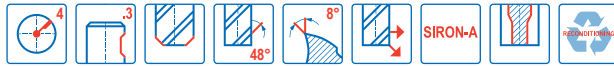
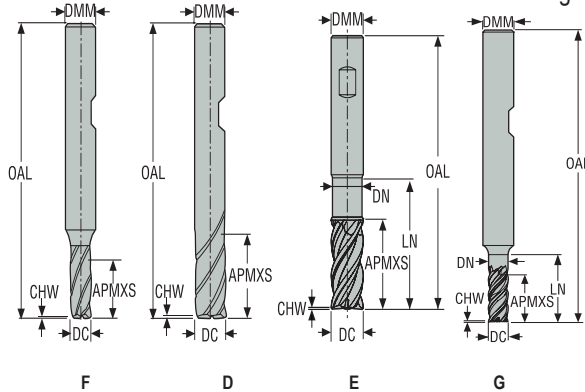

- Tolerances:
- DMM=h5
- DC=e7
- Regrind possible if DC is $\geq \phi 6$

Designation	Item number	Length index	Tool shape	DC	DMM	APMXS	OAL	LN	DN	CHW	PCEDC	Weldon
				mm	mm	mm	mm	mm	mm	mm		
JS554030G2C.3Z4-SIRA	03029973	2	G	3,0	6,0	8,0	57,0	10,0	2,85	0,035	4	□
554030Z4.3-SIRON-A	02733450	2	F	3,0	6,0	7,0	50,0	8,7	3,0	0,035	4	■
JS554040G2C.3Z4-SIRA	03029974	2	G	4,0	6,0	10,0	57,0	13,0	3,8	0,045	4	□
554040Z4.3-SIRON-A	02733456	2	F	4,0	6,0	10,0	55,0	11,7	4,0	0,045	4	■
JS554050G2C.3Z4-SIRA	03029975	2	G	5,0	6,0	12,0	57,0	16,0	4,75	0,055	4	□
554050Z4.3-SIRON-A	02733461	2	F	5,0	6,0	12,0	55,0	13,7	5,0	0,055	4	■
JS554060E2C.3Z4-SIRA	03029976	2	E	6,0	6,0	14,0	57,0	18,0	5,7	0,075	4	□
554060Z4.3-SIRON-A	02679502	2	D	6,0	6,0	14,0	55,0	-	-	0,075	4	■
JS554080E2C.3Z4-SIRA	03029978	2	E	8,0	8,0	18,0	63,0	25,0	7,6	0,1	4	□
554080Z4.3-SIRON-A	02679511	2	D	8,0	8,0	18,0	60,0	-	-	0,1	4	■
JS554100E2C.3Z4-SIRA	03029980	2	E	10,0	10,0	22,0	72,0	29,0	9,5	0,125	4	□
554100Z4.3-SIRON-A	02679535	2	D	10,0	10,0	22,0	70,0	-	-	0,125	4	■
JS554120E2C.3Z4-SIRA	03029983	2	E	12,0	12,0	26,0	83,0	35,0	11,4	0,15	4	□
554120Z4.3-SIRON-A	02679547	2	D	12,0	12,0	26,0	80,0	-	-	0,15	4	■
JS554160E2C.3Z4-SIRA	03029986	2	E	16,0	16,0	34,0	92,0	42,0	15,2	0,2	4	□
554160Z4.3-SIRON-A	02679559	2	D	16,0	16,0	34,0	90,0	-	-	0,2	4	■
JS554200E2C.3Z4-SIRA	03029988	2	E	20,0	20,0	42,0	109,0	54,0	19,0	0,25	4	□
554200Z4.3-SIRON-A	02679565	2	D	20,0	20,0	42,0	100,0	-	-	0,25	4	■
554250Z4.3-SIRON-A	02679572	2	D	25,0	25,0	52,0	125,0	-	-	0,3	4	■
554L030Z4.3-SIRON-A	02733817	3	F	3,0	6,0	12,0	55,0	13,7	3,0	0,035	4	■
554L040Z4.3-SIRON-A	02733820	3	F	4,0	6,0	16,0	60,0	17,7	4,0	0,045	4	■
554L050Z4.3-SIRON-A	02733824	3	F	5,0	6,0	20,0	65,0	21,7	5,0	0,055	4	■
554L060Z4.3-SIRON-A	02733827	3	D	6,0	6,0	23,0	65,0	-	-	0,075	4	■
554L080Z4.3-SIRON-A	02733829	3	D	8,0	8,0	32,0	75,0	-	-	0,1	4	■
554L100Z4.3-SIRON-A	02733831	3	D	10,0	10,0	40,0	85,0	-	-	0,125	4	■
554L120Z4.3-SIRON-A	02733833	3	D	12,0	12,0	45,0	100,0	-	-	0,15	4	■
554L160Z4.3-SIRON-A	02733835	3	D	16,0	16,0	55,0	115,0	-	-	0,2	4	■
554L200Z4.3-SIRON-A	02733837	3	D	20,0	20,0	65,0	125,0	-	-	0,25	4	■
554L250Z4.3-SIRON-A	02733839	3	D	25,0	25,0	85,0	150,0	-	-	0,3	4	■

■ Stocked standard. □ Weldon available. Delivery time is 3 days.

Universal

Steel and cast iron

Stainless steel and S-materials

Non ferrous

Hard

Plastic and chip

Graphite

Minimaster Plus

Minimaster

JS554

High performance – Universal – Square – 4 Flutes – Weldon – Corner radius

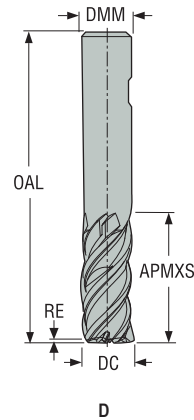

- Tolerances:
- DMM= h5
- DC= e7
- RE= ±0,2 mm
- Regrind possible if DC is ≥Ø6

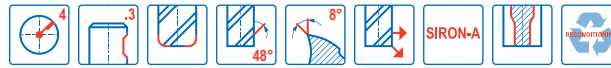

Designation	Item number	Length index	Tool shape	DC	DMM	APMXS	OAL	RE	PCEDC	Weldon
				mm	mm	mm	mm	mm		
554060R020Z4.3-SIRON-A	02679506	2	D	6,0	6,0	14,0	55,0	0,2	4	■
554080R050Z4.3-SIRON-A	02679513	2	D	8,0	8,0	18,0	60,0	0,5	4	■
554100R050Z4.3-SIRON-A	02679539	2	D	10,0	10,0	22,0	70,0	0,5	4	■
554100R100Z4.3-SIRON-A	02679542	2	D	10,0	10,0	22,0	70,0	1,0	4	■
554120R050Z4.3-SIRON-A	02679549	2	D	12,0	12,0	26,0	80,0	0,5	4	■
554120R100Z4.3-SIRON-A	02679554	2	D	12,0	12,0	26,0	80,0	1,0	4	■
554160R050Z4.3-SIRON-A	02679561	2	D	16,0	16,0	34,0	90,0	0,5	4	■
554160R100Z4.3-SIRON-A	02679563	2	D	16,0	16,0	34,0	90,0	1,0	4	■
554160R200Z4.3-SIRON-A	02810436	2	D	16,0	16,0	34,0	90,0	2,0	4	■
554160R310Z4.3-SIRON-A	02810438	2	D	16,0	16,0	34,0	90,0	3,1	4	■
554160R400Z4.3-SIRON-A	02810440	2	D	16,0	16,0	34,0	90,0	4,0	4	■
554200R050Z4.3-SIRON-A	02679567	2	D	20,0	20,0	42,0	100,0	0,5	4	■
554200R100Z4.3-SIRON-A	02679570	2	D	20,0	20,0	42,0	100,0	1,0	4	■
554200R250Z4.3-SIRON-A	02810442	2	D	20,0	20,0	42,0	100,0	2,5	4	■
554200R310Z4.3-SIRON-A	02810444	2	D	20,0	20,0	42,0	100,0	3,1	4	■
554200R400Z4.3-SIRON-A	02810446	2	D	20,0	20,0	42,0	100,0	4,0	4	■
554250R050Z4.3-SIRON-A	02679574	2	D	25,0	25,0	52,0	125,0	0,5	4	■
554250R100Z4.3-SIRON-A	02679576	2	D	25,0	25,0	52,0	125,0	1,0	4	■
554250R310Z4.3-SIRON-A	02810448	2	D	25,0	25,0	52,0	125,0	3,1	4	■
554250R400Z4.3-SIRON-A	02810451	2	D	25,0	25,0	52,0	125,0	4,0	4	■

■ Stocked standard.

JS554

High performance – Universal – Square – 4 Flutes – Weldon – Corner radius

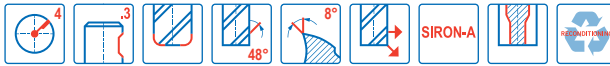
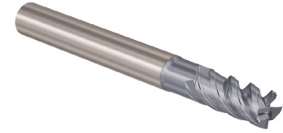
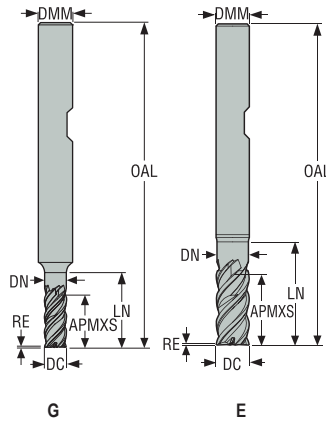

- Tolerances:
- DMM= h5
- DC= e7
- RE= ±0,2 mm
- Regrind possible if DC is ≥Ø6

Designation	Item number	Length index	Tool shape	DC	DMM	APMXS	OAL	LN	DN	RE	PCEDC	Weldon
				mm	mm	mm	mm	mm	mm	mm		
JS554030G2R015.3Z4-SIRA	02881706	2	G	3,0	6,0	7,0	57,0	10,0	2,85	0,15	4	<input type="checkbox"/>
JS554040G2R020.3Z4-SIRA	02881946	2	G	4,0	6,0	10,0	57,0	13,0	3,8	0,2	4	<input type="checkbox"/>
JS554050G2R020.3Z4-SIRA	02881708	2	G	5,0	6,0	12,0	57,0	16,0	4,75	0,2	4	<input type="checkbox"/>
JS554060E2R020.3Z4-SIRA	03029977	2	E	6,0	6,0	14,0	57,0	18,0	5,7	0,2	4	<input type="checkbox"/>
JS554060E2R050.3Z4-SIRA	02881709	2	E	6,0	6,0	14,0	57,0	18,0	5,7	0,5	4	<input type="checkbox"/>
JS554060E2R100.3Z4-SIRA	03029952	2	E	6,0	6,0	14,0	57,0	18,0	5,7	1,0	4	<input type="checkbox"/>
JS554080E2R050.3Z4-SIRA	03029979	2	E	8,0	8,0	18,0	63,0	25,0	7,6	0,5	4	<input type="checkbox"/>
JS554080E2R100.3Z4-SIRA	02881710	2	E	8,0	8,0	18,0	63,0	25,0	7,6	1,0	4	<input type="checkbox"/>
JS554100E2R050.3Z4-SIRA	03029981	2	E	10,0	10,0	22,0	72,0	29,0	9,5	0,5	4	<input type="checkbox"/>
JS554100E2R100.3Z4-SIRA	03029982	2	E	10,0	10,0	22,0	72,0	29,0	9,5	1,0	4	<input type="checkbox"/>
JS554100E2R200.3Z4-SIRA	02881711	2	E	10,0	10,0	22,0	72,0	29,0	9,5	2,0	4	<input type="checkbox"/>
JS554100E2R250.3Z4-SIRA	03029953	2	E	10,0	10,0	22,0	72,0	29,0	9,5	2,5	4	<input type="checkbox"/>
JS554120E2R050.3Z4-SIRA	03029984	2	E	12,0	12,0	26,0	83,0	35,0	11,4	0,5	4	<input checked="" type="checkbox"/>
JS554120E2R100.3Z4-SIRA	03029985	2	E	12,0	12,0	26,0	83,0	35,0	11,4	1,0	4	<input type="checkbox"/>
JS554120E2R200.3Z4-SIRA	02881712	2	E	12,0	12,0	26,0	83,0	35,0	11,4	2,0	4	<input type="checkbox"/>
JS554120E2R250.3Z4-SIRA	02881713	2	E	12,0	12,0	26,0	83,0	35,0	11,4	2,5	4	<input type="checkbox"/>
JS554120E2R300.3Z4-SIRA	03029954	2	E	12,0	12,0	26,0	83,0	35,0	11,4	3,0	4	<input type="checkbox"/>
JS554160E2R050.3Z4-SIRA	03029987	2	E	16,0	16,0	34,0	92,0	42,0	15,2	0,5	4	<input type="checkbox"/>
JS554160E2R600.3Z4-SIRA	03093687	2	E	16,0	16,0	34,0	92,0	42,0	15,2	6,0	4	<input type="checkbox"/>
JS554200E2R200.3Z4-SIRA	02881714	2	E	20,0	20,0	42,0	110,0	54,0	19,0	2,0	4	<input type="checkbox"/>
JS554200E2R600.3Z4-SIRA	03029955	2	E	20,0	20,0	42,0	109,0	54,0	19,0	6,0	4	<input type="checkbox"/>
JS554250E2R600.3Z4-SIRA	03093688	2	E	25,0	25,0	52,0	125,0	65,0	23,8	6,0	4	<input type="checkbox"/>

■ Stocked standard. Weldon available. Delivery time is 3 days.

Universal

Steel and cast iron

Stainless steel and S-materials

Non ferrous

Hard

Plastic and chip

Graphite

Minimaster Plus

Minimaster

JS554

High performance – Universal – Square – 4 Flutes – Cylindrical – Chamfer – Inch

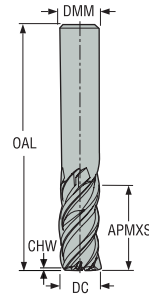

D

- Tolerances:
- DMM=h5
- DC=e7
- Regrind possible

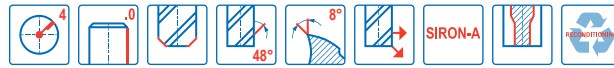

Designation	Item number	Length index	Tool shape	DC	DMM	APMXS	OAL	CHW	PCEDC	Cylindrical
				Inch	Inch	Inch	Inch	Inch		
5540250Z4.0-SIRON-A	02711329	2	D	0.250	0.250	0.500	2.500	0.003	4	■
5540312Z4.0-SIRON-A	02711340	2	D	0.313	0.313	0.625	2.500	0.004	4	■
5540375Z4.0-SIRON-A	02711344	2	D	0.375	0.375	0.750	3.000	0.005	4	■
5540500Z4.0-SIRON-A	02711611	2	D	0.500	0.500	1.000	3.500	0.006	4	■
5540625Z4.0-SIRON-A	02711626	2	D	0.625	0.625	1.250	3.750	0.008	4	■
5540750Z4.0-SIRON-A	02711643	2	D	0.750	0.750	1.500	4.000	0.010	4	■
5541000Z4.0-SIRON-A	02711660	2	D	1.000	1.000	2.000	5.000	0.012	4	■

■ Stocked standard.

Universal

Steel and cast iron

Stainless steel and S-materials

Non ferrous

Hard

Plastic and cfrp

Graphite

Minimaster Plus

Minimaster

JS554

High performance – Universal – Square – 4 Flutes – Cylindrical – Corner radius – Inch

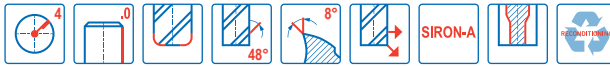
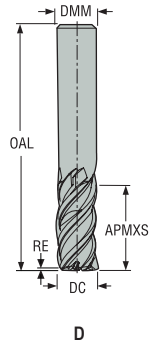

- Tolerances:
- DMM=h5
- DC=e7
- RE= ±.0008 inch
- Regrind possible

Designation	Item number	Length index	Tool shape	DC	DMM	APMXS	OAL	RE	PCEDC	Cylindrical
				Inch	Inch	Inch	Inch	Inch		
5540250R015Z4.0-SIRON-A	02711335	2	D	0.250	0.250	0.500	2.500	0.015	4	■
5540312R015Z4.0-SIRON-A	02711341	2	D	0.313	0.313	0.625	2.500	0.015	4	■
5540375R015Z4.0-SIRON-A	02711588	2	D	0.375	0.375	0.750	3.000	0.015	4	■
5540375R030Z4.0-SIRON-A	02711589	2	D	0.375	0.375	0.750	3.000	0.030	4	■
5540500R015Z4.0-SIRON-A	02711614	2	D	0.500	0.500	1.000	3.500	0.015	4	■
5540500R030Z4.0-SIRON-A	02711616	2	D	0.500	0.500	1.000	3.500	0.030	4	■
5540500R125Z4.0-SIRON-A	02842370	2	D	0.500	0.500	1.000	3.500	0.125	4	■
5540625R015Z4.0-SIRON-A	02711629	2	D	0.625	0.625	1.250	3.750	0.015	4	■
5540625R030Z4.0-SIRON-A	02711631	2	D	0.625	0.625	1.250	3.750	0.030	4	■
5540625R125Z4.0-SIRON-A	02842371	2	D	0.625	0.625	1.250	3.750	0.125	4	■
5540750R030Z4.0-SIRON-A	02711647	2	D	0.750	0.750	1.500	4.000	0.030	4	■
5540750R060Z4.0-SIRON-A	02711655	2	D	0.750	0.750	1.500	4.000	0.060	4	■

■ Stocked standard.

Universal

Steel and cast iron

Stainless steel and S-materials

Non ferrous

Hard

Plastic and cfrp

Graphite

Minimaster Plus

Minimaster

JS554

High performance – Universal – Square – 4 Flutes – Weldon – Chamfer – Inch

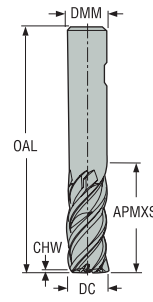

D

- Tolerances:
- DMM=h5
- DC=e7
- Regrind possible

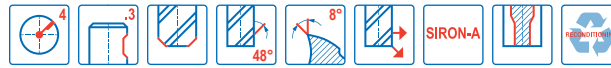

Designation	Item number	Length index	Tool shape	DC	DMM	APMXS	OAL	CHW	PCEDC	Weldon
				Inch	Inch	Inch	Inch	Inch		
5540500Z4, 3-SIRON-A	02711608	2	D	0.500	0.500	1.000	3.500	0.006	4	■
5540750Z4, 3-SIRON-A	02711632	2	D	0.750	0.750	1.500	4.000	0.010	4	■

■ Stocked standard.

Universal

Steel and cast iron

Stainless steel and S-materials

Non ferrous

Hard

Plastic and cfrp

Graphite

Minimaster Plus

Minimaster

JS554

High performance – Universal – Square – 4 Flutes – Weldon – Corner radius – Inch

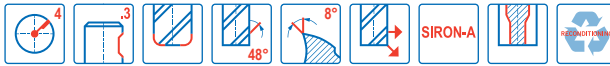
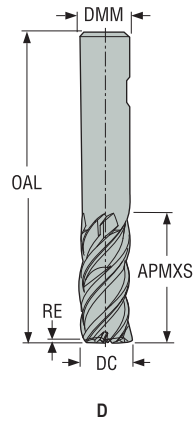

- Tolerances:
- DMM=h5
- DC=e7
- RE= ±.0008 inch
- Re grind possible

Designation	Item number	Length index	Tool shape	DC	DMM	APMXS	OAL	RE	PCEDC	Weldon
				Inch	Inch	Inch	Inch	Inch		
5540500R015Z4.3-SIRON-A	02711613	2	D	0.500	0.500	1.000	3.500	0.015	4	■
5540500R030Z4.3-SIRON-A	02711615	2	D	0.500	0.500	1.000	3.500	0.030	4	■
5540500R125Z4.3-SIRON-A	02856456	2	D	0.500	0.500	1.000	3.500	0.125	4	□
5540625R125Z4.3-SIRON-A	02856457	2	D	0.625	0.625	1.250	3.750	0.125	4	□
5541000R060Z4.3-SIRON-A	02711663	2	D	1.000	1.000	2.000	5.000	0.060	4	■

■ Stocked standard. □ Weldon available. Delivery time is 3 days.

Universal
Steel and cast iron
Stainless steel and S-materials
Non ferrous
Hard
Plastic and cfrp
Graphite
Minimaster Plus
Minimaster

Cutting data – JS554 Side milling roughing

SMG	Coolant	a _e /DC	a _p /DC	f _z										v _c
				3	4	5	6	8	10	12	16	20	25	
P1	M/A/D/E	0.400	1.0	0.030	0.040	0.050	0.060	0.080	0.10	0.12	0.15	0.17	0.19	215 (190 – 240)
		0.400	1.0	0.0012	0.0016	0.0020	0.0024	0.0032	0.0040	0.0048	0.0060	0.0065	0.0075	710 (630 – 780)
P2	M/A/D/E	0.400	1.0	0.030	0.040	0.050	0.060	0.080	0.10	0.12	0.15	0.17	0.19	210 (190 – 240)
		0.400	1.0	0.0012	0.0016	0.0020	0.0024	0.0032	0.0040	0.0048	0.0060	0.0065	0.0075	690 (630 – 780)
P3	M/A/D/E	0.400	1.0	0.028	0.038	0.048	0.055	0.075	0.095	0.11	0.14	0.16	0.18	185 (160 – 200)
		0.400	1.0	0.0011	0.0015	0.0019	0.0022	0.0030	0.0038	0.0044	0.0055	0.0065	0.0070	610 (530 – 650)
P4	M/A/D/E	0.400	1.0	0.028	0.038	0.046	0.055	0.075	0.095	0.11	0.14	0.16	0.18	160 (140 – 180)
		0.400	1.0	0.0011	0.0015	0.0018	0.0022	0.0030	0.0038	0.0044	0.0055	0.0065	0.0070	520 (460 – 590)
P5	M/A/D/E	0.400	1.0	0.028	0.036	0.046	0.055	0.075	0.090	0.11	0.13	0.16	0.18	155 (140 – 170)
		0.400	1.0	0.0011	0.0014	0.0018	0.0022	0.0030	0.0036	0.0044	0.0050	0.0065	0.0070	510 (460 – 550)
P6	M/A/D/E	0.400	1.0	0.028	0.036	0.046	0.055	0.075	0.090	0.11	0.13	0.15	0.17	175 (160 – 200)
		0.400	1.0	0.0011	0.0014	0.0018	0.0022	0.0030	0.0036	0.0044	0.0050	0.0060	0.0065	570 (530 – 650)
P7	M/A/D/E	0.400	1.0	0.028	0.036	0.046	0.055	0.075	0.090	0.11	0.13	0.15	0.17	165 (150 – 180)
		0.400	1.0	0.0011	0.0014	0.0018	0.0022	0.0030	0.0036	0.0044	0.0050	0.0060	0.0065	540 (500 – 590)
P8	M/A/D/E	0.400	1.0	0.028	0.038	0.048	0.055	0.075	0.095	0.11	0.14	0.16	0.18	155 (140 – 170)
		0.400	1.0	0.0011	0.0015	0.0019	0.0022	0.0030	0.0038	0.0044	0.0055	0.0065	0.0070	510 (460 – 550)
P11	M/A/D/E	0.400	1.0	0.026	0.036	0.044	0.055	0.070	0.090	0.11	0.13	0.15	0.17	140 (130 – 150)
		0.400	1.0	0.0010	0.0014	0.0017	0.0022	0.0028	0.0036	0.0044	0.0050	0.0060	0.0065	460 (430 – 490)
P12	M/A/D/E	0.400	1.0	0.018	0.024	0.030	0.036	0.048	0.060	0.070	0.090	0.10	0.12	90 (79 – 100)
		0.400	1.0	0.00070	0.00095	0.0012	0.0014	0.0019	0.0024	0.0028	0.0036	0.0040	0.0048	295 (260 – 320)
M1	E	0.400	1.0	0.020	0.026	0.034	0.040	0.055	0.065	0.080	0.10	0.11	0.13	110 (96 – 120)
		0.400	1.0	0.00080	0.0010	0.0013	0.0016	0.0022	0.0026	0.0032	0.0040	0.0044	0.0050	360 (320 – 390)
M2	E	0.400	1.0	0.018	0.024	0.030	0.036	0.048	0.060	0.070	0.090	0.10	0.12	90 (79 – 100)
		0.400	1.0	0.00070	0.00095	0.0012	0.0014	0.0019	0.0024	0.0028	0.0036	0.0040	0.0048	295 (260 – 320)
M3	E	0.400	0.90	0.015	0.020	0.025	0.030	0.040	0.050	0.060	0.075	0.085	0.095	55 (45 – 66)
		0.400	0.90	0.00060	0.00080	0.0010	0.0012	0.0016	0.0020	0.0024	0.0030	0.0034	0.0038	180 (150 – 210)
M4	E	0.400	0.90	0.013	0.018	0.022	0.026	0.036	0.044	0.055	0.065	0.075	0.085	43 (35 – 51)
		0.400	0.90	0.00050	0.00070	0.00085	0.0010	0.0014	0.0017	0.0022	0.0026	0.0030	0.0034	140 (120 – 160)
M5	E	0.400	0.90	0.013	0.018	0.022	0.026	0.036	0.044	0.055	0.065	0.075	0.085	36 (29 – 42)
		0.400	0.90	0.00050	0.00070	0.00085	0.0010	0.0014	0.0017	0.0022	0.0026	0.0030	0.0034	120 (96 – 130)
K1	E	0.400	1.2	0.024	0.032	0.040	0.048	0.065	0.080	0.095	0.12	0.14	0.16	175 (160 – 190)
		0.400	1.2	0.00095	0.0013	0.0016	0.0019	0.0026	0.0032	0.0038	0.0048	0.0055	0.0065	570 (530 – 620)
K2	E	0.400	1.2	0.022	0.030	0.038	0.044	0.060	0.075	0.090	0.11	0.13	0.14	155 (140 – 170)
		0.400	1.2	0.00085	0.0012	0.0015	0.0017	0.0024	0.0030	0.0036	0.0044	0.0050	0.0055	510 (460 – 550)
K3	E	0.400	1.2	0.022	0.030	0.038	0.044	0.060	0.075	0.090	0.11	0.13	0.14	130 (120 – 140)
		0.400	1.2	0.00085	0.0012	0.0015	0.0017	0.0024	0.0030	0.0036	0.0044	0.0050	0.0055	425 (400 – 450)
K4	E	0.400	1.2	0.022	0.030	0.038	0.044	0.060	0.075	0.090	0.11	0.13	0.14	125 (110 – 140)
		0.400	1.2	0.00085	0.0012	0.0015	0.0017	0.0024	0.0030	0.0036	0.0044	0.0050	0.0055	410 (370 – 450)
K5	E	0.400	1.0	0.024	0.032	0.040	0.048	0.065	0.080	0.095	0.12	0.14	0.16	155 (140 – 170)
		0.400	1.0	0.00095	0.0013	0.0016	0.0019	0.0026	0.0032	0.0038	0.0048	0.0055	0.0065	510 (460 – 550)
K6	E	0.400	1.0	0.028	0.036	0.046	0.055	0.070	0.090	0.11	0.13	0.15	0.17	220 (190 – 250)
		0.400	1.0	0.0011	0.0014	0.0018	0.0022	0.0028	0.0036	0.0044	0.0050	0.0060	0.0065	720 (630 – 820)
K7	E	0.400	1.0	0.024	0.032	0.040	0.048	0.065	0.080	0.095	0.12	0.14	0.16	195 (170 – 220)
		0.400	1.0	0.00095	0.0013	0.0016	0.0019	0.0026	0.0032	0.0038	0.0048	0.0055	0.0065	640 (560 – 720)

For cutting data recalculations, see pages 445 - 452

SMG = Seco material group
Coolant = A=air D=dry E=emulsion M=mist spray
v_c = m/min (sf/min)
f_z = mm (in/tooth)
a_p = mm/DC (in/DC) = factor
a_e = mm/DC (in/DC) = factor
All cutting data are target values

Cutting data – JS554 Side milling roughing

SMG		a _e /DC	a _p /DC	f _z										v _c
				3	4	5	6	8	10	12	16	20	25	
N1	E	0.500	0.90	0.024	0.032	0.040	0.048	0.065	0.080	0.095	0.12	0.13	0.15	610 (510–710)
		0,500	0,90	0,00095	0,0013	0,0016	0,0019	0,0026	0,0032	0,0038	0,0048	0,0050	0,0060	2000 (1700 – 2300)
N2	E	0.500	0.90	0.024	0.032	0.040	0.048	0.065	0.080	0.095	0.12	0.13	0.15	390 (330 – 450)
		0,500	0,90	0,00095	0,0013	0,0016	0,0019	0,0026	0,0032	0,0038	0,0048	0,0050	0,0060	1275 (1100–1400)
N11	E	0.500	1.1	0.024	0.032	0.040	0.048	0.065	0.080	0.095	0.12	0.13	0.15	320 (270 – 370)
		0,500	1,1	0,00095	0,0013	0,0016	0,0019	0,0026	0,0032	0,0038	0,0048	0,0050	0,0060	1050 (890–1200)
S11	E	0.400	0.70	0.018	0.024	0.030	0.036	0.048	0.060	0.070	0.090	0.10	0.12	100 (72–120)
		0,400	0,70	0,00070	0,00095	0,0012	0,0014	0,0019	0,0024	0,0028	0,0036	0,0040	0,0048	330 (240 – 390)
S12	E	0.400	0.70	0.018	0.024	0.030	0.036	0.048	0.060	0.070	0.090	0.10	0.12	75 (56 – 99)
		0,400	0,70	0,00070	0,00095	0,0012	0,0014	0,0019	0,0024	0,0028	0,0036	0,0040	0,0048	245 (190 – 320)
S13	E	0.400	0.70	0.016	0.022	0.026	0.032	0.042	0.055	0.065	0.080	0.090	0.10	60 (44–78)
		0,400	0,70	0,00065	0,00085	0,0010	0,0013	0,0017	0,0022	0,0026	0,0032	0,0036	0,0040	195 (150 – 250)
H5	M/A/D	0.200	0.90	0.022	0.030	0.038	0.046	0.060	0.075	0.090	0.11	0.13	0.14	75 (59 – 88)
		0,200	0,90	0,00085	0,0012	0,0015	0,0018	0,0024	0,0030	0,0036	0,0044	0,0050	0,0055	245 (200 – 280)
H8	M/A/D	0.200	0.90	0.017	0.022	0.028	0.034	0.046	0.055	0.070	0.085	0.095	0.11	80 (63 – 93)
		0,200	0,90	0,00065	0,00085	0,0011	0,0013	0,0018	0,0022	0,0028	0,0034	0,0038	0,0044	260 (210 – 300)
H11	M/A/D	0.200	0.90	0.022	0.030	0.038	0.046	0.060	0.075	0.090	0.11	0.13	0.14	95 (75–110)
		0,200	0,90	0,00085	0,0012	0,0015	0,0018	0,0024	0,0030	0,0036	0,0044	0,0050	0,0055	310 (250 – 360)
H12	M/A/D	0.200	0.90	0.017	0.022	0.028	0.034	0.046	0.055	0.070	0.085	0.095	0.11	90 (73–100)
		0,200	0,90	0,00065	0,00085	0,0011	0,0013	0,0018	0,0022	0,0028	0,0034	0,0038	0,0044	295 (240 – 320)
H21	M/A/D	0.200	0.90	0.017	0.022	0.028	0.034	0.046	0.055	0.070	0.085	0.095	0.11	155 (110–190)
		0,200	0,90	0,00065	0,00085	0,0011	0,0013	0,0018	0,0022	0,0028	0,0034	0,0038	0,0044	510 (370 – 620)
TS1	A	0.500	1.0	0.030	0.040	0.050	0.060	0.080	0.10	0.12	0.15	0.17	0.19	285 (180 – 400)
		0,500	1,0	0,0012	0,0016	0,0020	0,0024	0,0032	0,0040	0,0048	0,0060	0,0065	0,0075	940 (600–1300)
TP1	A	0.500	1.0	0.030	0.040	0.050	0.060	0.080	0.10	0.12	0.15	0.17	0.19	295 (180 – 410)
		0,500	1,0	0,0012	0,0016	0,0020	0,0024	0,0032	0,0040	0,0048	0,0060	0,0065	0,0075	970 (600–1300)
GR1	A	0.500	1.1	0.030	0.040	0.050	0.060	0.080	0.10	0.12	0.15	0.17	0.19	580 (470 – 690)
		0,500	1,1	0,0012	0,0016	0,0020	0,0024	0,0032	0,0040	0,0048	0,0060	0,0065	0,0075	1900 (1600 – 2200)

For cutting data recalculations, see pages 445 - 452

SMG = Seco material group
 Coolant = A=air D=dry E=emulsion M=mist spray
 v_c = m/min (sf/min)
 f_z = mm (in/tooth)
 a_p = mm/DC (in/DC) = factor
 a_e = mm/DC (in/DC) = factor
 All cutting data are target values

Universal
Steel and cast iron
Stainless steel and S-materials
Non ferrous
Hard
Plastic and chip
Graphite
Mimimaster Plus
Mimimaster

Cutting data – JS554 Slot milling

SMG	Coolant	a _p /DC	f _z										v _c
			3	4	5	6	8	10	12	16	20	25	
P1	M/A/D/E	1.0	0.018	0.024	0.030	0.036	0.048	0.060	0.070	0.095	0.12	0.15	195 (170—220)
		1.0	0,00070	0,00095	0,0012	0,0014	0,0019	0,0024	0,0028	0,0038	0,0048	0,0060	640 (560—720)
P2	M/A/D/E	1.0	0.018	0.024	0.030	0.036	0.048	0.060	0.070	0.095	0.12	0.15	190 (170—210)
		1.0	0,00070	0,00095	0,0012	0,0014	0,0019	0,0024	0,0028	0,0038	0,0048	0,0060	620 (560—680)
P3	M/A/D/E	1.0	0.018	0.024	0.030	0.036	0.048	0.060	0.070	0.095	0.12	0.15	165 (140—180)
		1.0	0,00070	0,00095	0,0012	0,0014	0,0019	0,0024	0,0028	0,0038	0,0048	0,0060	540 (460—590)
P4	M/A/D/E	1.0	0.018	0.024	0.030	0.036	0.048	0.060	0.070	0.095	0.12	0.15	145 (130—160)
		1.0	0,00070	0,00095	0,0012	0,0014	0,0019	0,0024	0,0028	0,0038	0,0048	0,0060	475 (430—520)
P5	M/A/D/E	1.0	0.018	0.024	0.030	0.036	0.048	0.060	0.070	0.095	0.12	0.15	135 (120—150)
		1.0	0,00070	0,00095	0,0012	0,0014	0,0019	0,0024	0,0028	0,0038	0,0048	0,0060	445 (400—490)
P6	M/A/D/E	1.0	0.018	0.024	0.030	0.036	0.048	0.060	0.070	0.095	0.12	0.15	155 (140—170)
		1.0	0,00070	0,00095	0,0012	0,0014	0,0019	0,0024	0,0028	0,0038	0,0048	0,0060	510 (460—550)
P7	M/A/D/E	1.0	0.018	0.024	0.030	0.036	0.048	0.060	0.070	0.095	0.12	0.15	145 (130—160)
		1.0	0,00070	0,00095	0,0012	0,0014	0,0019	0,0024	0,0028	0,0038	0,0048	0,0060	475 (430—520)
P8	M/A/D/E	1.0	0.018	0.024	0.030	0.036	0.048	0.060	0.070	0.095	0.12	0.15	135 (120—150)
		1.0	0,00070	0,00095	0,0012	0,0014	0,0019	0,0024	0,0028	0,0038	0,0048	0,0060	445 (400—490)
P11	M/A/D/E	0.80	0.012	0.016	0.020	0.024	0.032	0.040	0.048	0.065	0.080	0.10	130 (120—140)
		0.80	0,00048	0,00065	0,00080	0,00095	0,0013	0,0016	0,0019	0,0026	0,0032	0,0040	425 (400—450)
P12	M/A/D/E	0.80	0.012	0.016	0.020	0.024	0.032	0.040	0.048	0.065	0.080	0.10	80 (69—87)
		0.80	0,00048	0,00065	0,00080	0,00095	0,0013	0,0016	0,0019	0,0026	0,0032	0,0040	260 (230—280)
M1	E	0.80	0.012	0.016	0.020	0.024	0.032	0.040	0.048	0.065	0.080	0.10	95 (85—100)
		0.80	0,00048	0,00065	0,00080	0,00095	0,0013	0,0016	0,0019	0,0026	0,0032	0,0040	310 (280—320)
M2	E	0.80	0.012	0.016	0.020	0.024	0.032	0.040	0.048	0.065	0.080	0.10	80 (69—87)
		0.80	0,00048	0,00065	0,00080	0,00095	0,0013	0,0016	0,0019	0,0026	0,0032	0,0040	260 (230—280)
M3	E	0.60	0.0095	0.013	0.016	0.019	0.025	0.032	0.038	0.050	0.065	0.080	48 (39—57)
		0.60	0,00038	0,00050	0,00065	0,00075	0,0010	0,0013	0,0015	0,0020	0,0026	0,0032	155 (130—180)
M4	E	0.60	0.0095	0.013	0.016	0.019	0.025	0.032	0.038	0.050	0.065	0.080	36 (29—43)
		0.60	0,00038	0,00050	0,00065	0,00075	0,0010	0,0013	0,0015	0,0020	0,0026	0,0032	120 (96—140)
M5	E	0.60	0.0095	0.013	0.016	0.019	0.025	0.032	0.038	0.050	0.065	0.080	30 (25—36)
		0.60	0,00038	0,00050	0,00065	0,00075	0,0010	0,0013	0,0015	0,0020	0,0026	0,0032	100 (83—110)
K1	E	1.0	0.015	0.020	0.025	0.030	0.040	0.050	0.060	0.080	0.10	0.13	155 (140—170)
		1.0	0,00060	0,00080	0,0010	0,0012	0,0016	0,0020	0,0024	0,0032	0,0040	0,0050	510 (460—550)
K2	E	1.0	0.015	0.020	0.025	0.030	0.040	0.050	0.060	0.080	0.10	0.13	135 (120—150)
		1.0	0,00060	0,00080	0,0010	0,0012	0,0016	0,0020	0,0024	0,0032	0,0040	0,0050	445 (400—490)
K3	E	1.0	0.015	0.020	0.025	0.030	0.040	0.050	0.060	0.080	0.10	0.13	115 (110—120)
		1.0	0,00060	0,00080	0,0010	0,0012	0,0016	0,0020	0,0024	0,0032	0,0040	0,0050	375 (370—390)
K4	E	1.0	0.015	0.020	0.025	0.030	0.040	0.050	0.060	0.080	0.10	0.13	110 (96—120)
		1.0	0,00060	0,00080	0,0010	0,0012	0,0016	0,0020	0,0024	0,0032	0,0040	0,0050	360 (320—390)
K5	E	0.70	0.015	0.020	0.025	0.030	0.040	0.050	0.060	0.080	0.10	0.13	135 (120—150)
		0.70	0,00060	0,00080	0,0010	0,0012	0,0016	0,0020	0,0024	0,0032	0,0040	0,0050	445 (400—490)
K6	E	0.70	0.015	0.020	0.025	0.030	0.040	0.050	0.060	0.080	0.10	0.13	200 (180—220)
		0.70	0,00060	0,00080	0,0010	0,0012	0,0016	0,0020	0,0024	0,0032	0,0040	0,0050	660 (600—720)
K7	E	0.70	0.015	0.020	0.025	0.030	0.040	0.050	0.060	0.080	0.10	0.13	175 (150—190)
		0.70	0,00060	0,00080	0,0010	0,0012	0,0016	0,0020	0,0024	0,0032	0,0040	0,0050	570 (500—620)

For cutting data recalculations, see pages 445 - 452

SMG = Seco material group
Coolant = A=air D=dry E=emulsion M=mist spray
v_c = m/min (sf/min)
f_z = mm/tooth (in/tooth)
a_p = mm/DC (in/DC) = factor
a_e = mm/DC (in/DC) = factor
All cutting data are target values

Cutting data – JS554 Slot milling

SMG		a _p /DC	f _z										v _c
			3	4	5	6	8	10	12	16	20	25	
N1	E	0.50	0.015	0.020	0.025	0.030	0.040	0.050	0.060	0.080	0.10	0.13	570 (480 – 670)
		0,50	0,00060	0,00080	0,0010	0,0012	0,0016	0,0020	0,0024	0,0032	0,0040	0,0050	1875 (1600 – 2100)
N2	E	0.50	0.015	0.020	0.025	0.030	0.040	0.050	0.060	0.080	0.10	0.13	370 (310 – 430)
		0,50	0,00060	0,00080	0,0010	0,0012	0,0016	0,0020	0,0024	0,0032	0,0040	0,0050	1225 (1100–1400)
N3	E	0.50	0.015	0.020	0.025	0.030	0.040	0.050	0.060	0.080	0.10	0.13	245 (210 – 280)
		0,50	0,00060	0,00080	0,0010	0,0012	0,0016	0,0020	0,0024	0,0032	0,0040	0,0050	800 (690 – 910)
N11	E	0.60	0.018	0.024	0.030	0.036	0.048	0.060	0.070	0.095	0.12	0.15	290 (250 – 330)
		0,60	0,00070	0,00095	0,0012	0,0014	0,0019	0,0024	0,0028	0,0038	0,0048	0,0060	950 (830–1000)
S1	E	0.30	0.0095	0.013	0.016	0.019	0.025	0.032	0.038	0.050	0.065	0.080	30 (25 – 34)
		0,30	0,00038	0,00050	0,00065	0,00075	0,0010	0,0013	0,0015	0,0020	0,0026	0,0032	100 (83–110)
S2	E	0.30	0.0095	0.013	0.016	0.019	0.025	0.032	0.038	0.050	0.065	0.080	27 (17 – 38)
		0,30	0,00038	0,00050	0,00065	0,00075	0,0010	0,0013	0,0015	0,0020	0,0026	0,0032	90 (56–120)
S3	E	0.30	0.0095	0.013	0.016	0.019	0.025	0.032	0.038	0.050	0.065	0.080	23 (15 – 32)
		0,30	0,00038	0,00050	0,00065	0,00075	0,0010	0,0013	0,0015	0,0020	0,0026	0,0032	75 (50–100)
S11	E	0.50	0.012	0.016	0.020	0.025	0.032	0.040	0.050	0.065	0.080	0.10	85 (63–110)
		0,50	0,00048	0,00065	0,00080	0,0010	0,0013	0,0016	0,0020	0,0026	0,0032	0,0040	280 (210 – 360)
S12	E	0.50	0.012	0.016	0.020	0.025	0.032	0.040	0.050	0.065	0.080	0.10	65 (48 – 86)
		0,50	0,00048	0,00065	0,00080	0,0010	0,0013	0,0016	0,0020	0,0026	0,0032	0,0040	215 (160 – 280)
S13	E	0.50	0.012	0.016	0.020	0.025	0.032	0.040	0.050	0.065	0.080	0.10	50 (38 – 66)
		0,50	0,00048	0,00065	0,00080	0,0010	0,0013	0,0016	0,0020	0,0026	0,0032	0,0040	165 (130 – 210)
H5	M/A/D	0.40	0.0060	0.0080	0.010	0.012	0.016	0.020	0.025	0.032	0.040	0.050	65 (52–76)
		0,40	0,00024	0,00032	0,00040	0,00048	0,00065	0,00080	0,0010	0,0013	0,0016	0,0020	215 (180 – 240)
H8	M/A/D	0.40	0.0060	0.0080	0.010	0.012	0.016	0.020	0.025	0.032	0.040	0.050	65 (52–76)
		0,40	0,00024	0,00032	0,00040	0,00048	0,00065	0,00080	0,0010	0,0013	0,0016	0,0020	215 (180 – 240)
H11	M/A/D	0.40	0.0060	0.0080	0.010	0.012	0.016	0.020	0.025	0.032	0.040	0.050	80 (66 – 97)
		0,40	0,00024	0,00032	0,00040	0,00048	0,00065	0,00080	0,0010	0,0013	0,0016	0,0020	260 (220 – 310)
H12	M/A/D	0.40	0.0060	0.0080	0.010	0.012	0.016	0.020	0.025	0.032	0.040	0.050	75 (60 – 89)
		0,40	0,00024	0,00032	0,00040	0,00048	0,00065	0,00080	0,0010	0,0013	0,0016	0,0020	245 (200 – 290)
H21	M/A/D	0.40	0.0060	0.0080	0.010	0.012	0.016	0.020	0.025	0.032	0.040	0.050	125 (90–160)
		0,40	0,00024	0,00032	0,00040	0,00048	0,00065	0,00080	0,0010	0,0013	0,0016	0,0020	410 (300 – 520)
TS1	A	0.70	0.030	0.040	0.050	0.060	0.080	0.10	0.12	0.15	0.17	0.19	240 (150 – 330)
		0,70	0,0012	0,0016	0,0020	0,0024	0,0032	0,0040	0,0048	0,0060	0,0065	0,0075	790 (500–1000)
TP1	A	0.70	0.030	0.040	0.050	0.060	0.080	0.10	0.12	0.15	0.17	0.19	250 (150 – 340)
		0,70	0,0012	0,0016	0,0020	0,0024	0,0032	0,0040	0,0048	0,0060	0,0065	0,0075	820 (500–1100)
GR1	A	0.80	0.030	0.040	0.050	0.060	0.080	0.10	0.12	0.15	0.17	0.19	485 (390 – 580)
		0,80	0,0012	0,0016	0,0020	0,0024	0,0032	0,0040	0,0048	0,0060	0,0065	0,0075	1600 (1300–1900)

For cutting data recalculations, see pages 445 - 452

SMG = Seco material group
 Coolant = A=air D=dry E=emulsion M=mist spray
 v_c = m/min (sf/min)
 f_z = mm/tooth (in/tooth)
 a_p = mm/DC (in/DC) = factor
 a_e = mm/DC (in/DC) = factor
 All cutting data are target values

Universal
Steel and cast iron
Stainless steel and S-materials
Non ferrous
Hard
Plastic and chip
Graphite
Mimimaster Plus
Mimimaster

Cutting data – JS554 Side milling roughing – Inch

SMG	Coolant	a _p /DC	a _e /DC	f _z							v _c
				1/4	5/16	3/8	1/2	5/8	3/4	1	
P1	M/A/D/E	0.400	1.0	0.065	0.080	0.095	0.12	0.14	0.16	0.19	215 (190 – 240)
		0,400	1,0	0,0026	0,0032	0,0038	0,0048	0,0055	0,0065	0,0075	710 (630 – 780)
P2	M/A/D/E	0.400	1.0	0.065	0.080	0.095	0.13	0.15	0.17	0.20	210 (190 – 240)
		0,400	1,0	0,0026	0,0032	0,0038	0,0050	0,0060	0,0065	0,0080	690 (630 – 780)
P3	M/A/D/E	0.400	1.0	0.060	0.075	0.090	0.12	0.14	0.16	0.18	185 (160 – 200)
		0,400	1,0	0,0024	0,0030	0,0036	0,0048	0,0055	0,0065	0,0070	610 (530 – 650)
P4	M/A/D/E	0.400	1.0	0.060	0.075	0.090	0.12	0.14	0.15	0.18	160 (140 – 180)
		0,400	1,0	0,0024	0,0030	0,0036	0,0048	0,0055	0,0060	0,0070	520 (460 – 590)
P5	M/A/D/E	0.400	1.0	0.060	0.075	0.085	0.11	0.13	0.15	0.18	155 (140 – 170)
		0,400	1,0	0,0024	0,0030	0,0034	0,0044	0,0050	0,0060	0,0070	510 (460 – 550)
P6	M/A/D/E	0.400	1.0	0.060	0.070	0.085	0.11	0.13	0.15	0.18	175 (160 – 200)
		0,400	1,0	0,0024	0,0028	0,0034	0,0044	0,0050	0,0060	0,0070	570 (530 – 650)
P7	M/A/D/E	0.400	1.0	0.060	0.070	0.085	0.11	0.13	0.15	0.18	165 (150 – 180)
		0,400	1,0	0,0024	0,0028	0,0034	0,0044	0,0050	0,0060	0,0070	540 (500 – 590)
P8	M/A/D/E	0.400	1.0	0.060	0.075	0.090	0.12	0.14	0.16	0.18	155 (140 – 170)
		0,400	1,0	0,0024	0,0030	0,0036	0,0048	0,0055	0,0065	0,0070	510 (460 – 550)
P11	M/A/D/E	0.400	1.0	0.055	0.070	0.085	0.11	0.13	0.15	0.17	140 (130 – 150)
		0,400	1,0	0,0022	0,0028	0,0034	0,0044	0,0050	0,0060	0,0065	460 (430 – 490)
P12	M/A/D/E	0.400	1.0	0.038	0.048	0.060	0.075	0.090	0.10	0.12	90 (79 – 100)
		0,400	1,0	0,0015	0,0019	0,0024	0,0030	0,0036	0,0040	0,0048	295 (260 – 320)
M1	E	0.400	1.0	0.042	0.055	0.065	0.085	0.10	0.11	0.13	110 (96 – 120)
		0,400	1,0	0,0017	0,0022	0,0026	0,0034	0,0040	0,0044	0,0050	360 (320 – 390)
M2	E	0.400	1.0	0.038	0.048	0.060	0.075	0.090	0.10	0.12	90 (79 – 100)
		0,400	1,0	0,0015	0,0019	0,0024	0,0030	0,0036	0,0040	0,0048	295 (260 – 320)
M3	E	0.400	0.90	0.032	0.040	0.048	0.065	0.075	0.085	0.10	55 (45 – 66)
		0,400	0,90	0,0013	0,0016	0,0019	0,0026	0,0030	0,0034	0,0040	180 (150 – 210)
M4	E	0.400	0.90	0.028	0.036	0.042	0.055	0.065	0.075	0.085	43 (35 – 51)
		0,400	0,90	0,0011	0,0014	0,0017	0,0022	0,0026	0,0030	0,0034	140 (120 – 160)
M5	E	0.400	0.90	0.028	0.036	0.042	0.055	0.065	0.075	0.085	36 (29 – 42)
		0,400	0,90	0,0011	0,0014	0,0017	0,0022	0,0026	0,0030	0,0034	120 (96 – 130)
K1	E	0.400	1.2	0.050	0.065	0.080	0.10	0.12	0.13	0.16	175 (160 – 190)
		0,400	1,2	0,0020	0,0026	0,0032	0,0040	0,0048	0,0050	0,0065	570 (530 – 620)
K2	E	0.400	1.2	0.048	0.060	0.070	0.090	0.11	0.12	0.14	155 (140 – 170)
		0,400	1,2	0,0019	0,0024	0,0028	0,0036	0,0044	0,0048	0,0055	510 (460 – 550)
K3	E	0.400	1.2	0.048	0.060	0.070	0.090	0.11	0.12	0.14	130 (120 – 140)
		0,400	1,2	0,0019	0,0024	0,0028	0,0036	0,0044	0,0048	0,0055	425 (400 – 450)
K4	E	0.400	1.2	0.048	0.060	0.070	0.090	0.11	0.12	0.14	125 (110 – 140)
		0,400	1,2	0,0019	0,0024	0,0028	0,0036	0,0044	0,0048	0,0055	410 (370 – 450)
K5	E	0.400	1.0	0.050	0.065	0.080	0.10	0.12	0.13	0.16	155 (140 – 170)
		0,400	1,0	0,0020	0,0026	0,0032	0,0040	0,0048	0,0050	0,0065	510 (460 – 550)
K6	E	0.400	1.0	0.055	0.070	0.085	0.11	0.13	0.15	0.17	220 (190 – 250)
		0,400	1,0	0,0022	0,0028	0,0034	0,0044	0,0050	0,0060	0,0065	720 (630 – 820)
K7	E	0.400	1.0	0.050	0.065	0.080	0.10	0.12	0.13	0.16	195 (170 – 220)
		0,400	1,0	0,0020	0,0026	0,0032	0,0040	0,0048	0,0050	0,0065	640 (560 – 720)

For cutting data recalculations, see pages 445 - 452

SMG = Seco material group
Coolant = A=air D=dry E=emulsion M=mist spray
v_c = m/min (sf/min)
f_z = mm/tooth (in/tooth)
a_p = mm/DC (in/DC) = factor
a_e = mm/DC (in/DC) = factor
All cutting data are target values

Cutting data – JS554 Side milling roughing – Inch

SMG		a _e /DC	a _p /DC	f _z							v _c
				1/4	5/16	3/8	1/2	5/8	3/4	1	
N1	E	0.500	0.90	0.050	0.065	0.075	0.10	0.12	0.13	0.15	610 (510–710)
		0,500	0,90	0,0020	0,0026	0,0030	0,0040	0,0048	0,0050	0,0060	2000 (1700 – 2300)
N2	E	0.500	0.90	0.050	0.065	0.075	0.10	0.12	0.13	0.15	390 (330 – 450)
		0,500	0,90	0,0020	0,0026	0,0030	0,0040	0,0048	0,0050	0,0060	1275 (1100–1400)
N3	E	0.500	0.90	0.050	0.065	0.075	0.10	0.12	0.13	0.15	260 (220 – 300)
		0,500	0,90	0,0020	0,0026	0,0030	0,0040	0,0048	0,0050	0,0060	850 (730 – 980)
N11	E	0.500	1.1	0.050	0.065	0.075	0.10	0.12	0.13	0.15	320 (270 – 370)
		0,500	1,1	0,0020	0,0026	0,0030	0,0040	0,0048	0,0050	0,0060	1050 (890–1200)
S1	E	0.150	0.50	0.055	0.070	0.085	0.11	0.13	0.14	0.17	38 (32 – 44)
		0,150	0,50	0,0022	0,0028	0,0034	0,0044	0,0050	0,0055	0,0065	125 (110–140)
S2	E	0.150	0.50	0.055	0.070	0.085	0.11	0.13	0.14	0.17	35 (21 – 48)
		0,150	0,50	0,0022	0,0028	0,0034	0,0044	0,0050	0,0055	0,0065	115 (69–150)
S3	E	0.150	0.50	0.050	0.065	0.075	0.10	0.12	0.13	0.16	30 (19 – 42)
		0,150	0,50	0,0020	0,0026	0,0030	0,0040	0,0048	0,0050	0,0065	100 (63–130)
S11	E	0.400	0.70	0.038	0.048	0.060	0.075	0.090	0.10	0.12	100 (72–120)
		0,400	0,70	0,0015	0,0019	0,0024	0,0030	0,0036	0,0040	0,0048	330 (240 – 390)
S12	E	0.400	0.70	0.038	0.048	0.060	0.075	0.090	0.10	0.12	75 (56 – 99)
		0,400	0,70	0,0015	0,0019	0,0024	0,0030	0,0036	0,0040	0,0048	245 (190 – 320)
S13	E	0.400	0.70	0.034	0.042	0.050	0.065	0.080	0.090	0.10	60 (44–78)
		0,400	0,70	0,0013	0,0017	0,0020	0,0026	0,0032	0,0036	0,0040	195 (150 – 250)
H5	M/A/D	0.200	0.90	0.048	0.060	0.070	0.095	0.11	0.12	0.15	75 (59 – 88)
		0,200	0,90	0,0019	0,0024	0,0028	0,0038	0,0044	0,0048	0,0060	245 (200 – 280)
H8	M/A/D	0.200	0.90	0.036	0.046	0.055	0.070	0.085	0.095	0.11	80 (63 – 93)
		0,200	0,90	0,0014	0,0018	0,0022	0,0028	0,0034	0,0038	0,0044	260 (210 – 300)
H21	M/A/D	0.200	0.90	0.036	0.046	0.055	0.070	0.085	0.095	0.11	155 (110–190)
		0,200	0,90	0,0014	0,0018	0,0022	0,0028	0,0034	0,0038	0,0044	510 (370 – 620)
H31	M/A/D	0.200	0.90	0.032	0.040	0.048	0.060	0.075	0.080	0.095	60 (48–71)
		0,200	0,90	0,0013	0,0016	0,0019	0,0024	0,0030	0,0032	0,0038	195 (160 – 230)
TS1	A	0.500	1.0	0.065	0.080	0.095	0.12	0.15	0.16	0.19	285 (180 – 410)
		0,500	1,0	0,0026	0,0032	0,0038	0,0048	0,0060	0,0065	0,0075	940 (600–1300)
TP1	A	0.500	1.0	0.065	0.080	0.095	0.12	0.15	0.16	0.19	295 (180 – 410)
		0,500	1,0	0,0026	0,0032	0,0038	0,0048	0,0060	0,0065	0,0075	970 (600–1300)
GR1	A	0.500	1.1	0.065	0.080	0.095	0.12	0.15	0.16	0.19	580 (470 – 690)
		0,500	1,1	0,0026	0,0032	0,0038	0,0048	0,0060	0,0065	0,0075	1900 (1600 – 2200)

For cutting data recalculations, see pages 445 - 452

SMG = Seco material group
 Coolant = A=air D=dry E=emulsion M=mist spray
 v_c = m/min (sf/min)
 f_z = mm/tooth (in/tooth)
 a_p = mm/DC (in/DC) = factor
 a_e = mm/DC (in/DC) = factor
 All cutting data are target values

Universal
Steel and cast iron
Stainless steel and S-materials
Non ferrous
Hard
Plastic and cfrp
Graphite
Mimimaster Plus
Mimimaster

Cutting data – JS554 Slot milling – Inch

SMG		a _p /DC	f _z							v _c
			1/4	5/16	3/8	1/2	5/8	3/4	1	
P1	M/A/D/E	1.0	0.038	0.048	0.055	0.075	0.095	0.11	0.15	195 (170 – 220)
		1.0	0.0015	0.0019	0.0022	0.0030	0.0038	0.0044	0.0060	640 (560 – 720)
P2	M/A/D/E	1.0	0.038	0.048	0.055	0.075	0.095	0.11	0.15	190 (170 – 210)
		1.0	0.0015	0.0019	0.0022	0.0030	0.0038	0.0044	0.0060	620 (560 – 680)
P3	M/A/D/E	1.0	0.038	0.048	0.055	0.075	0.095	0.11	0.15	165 (140 – 180)
		1.0	0.0015	0.0019	0.0022	0.0030	0.0038	0.0044	0.0060	540 (460 – 590)
P4	M/A/D/E	1.0	0.038	0.048	0.055	0.075	0.095	0.11	0.15	145 (130 – 160)
		1.0	0.0015	0.0019	0.0022	0.0030	0.0038	0.0044	0.0060	475 (430 – 520)
P5	M/A/D/E	1.0	0.038	0.048	0.055	0.075	0.095	0.11	0.15	135 (120 – 150)
		1.0	0.0015	0.0019	0.0022	0.0030	0.0038	0.0044	0.0060	445 (400 – 490)
P6	M/A/D/E	1.0	0.038	0.048	0.055	0.075	0.095	0.11	0.15	155 (140 – 170)
		1.0	0.0015	0.0019	0.0022	0.0030	0.0038	0.0044	0.0060	510 (460 – 550)
P7	M/A/D/E	1.0	0.038	0.048	0.055	0.075	0.095	0.11	0.15	145 (130 – 160)
		1.0	0.0015	0.0019	0.0022	0.0030	0.0038	0.0044	0.0060	475 (430 – 520)
P8	M/A/D/E	1.0	0.038	0.048	0.055	0.075	0.095	0.11	0.15	135 (120 – 150)
		1.0	0.0015	0.0019	0.0022	0.0030	0.0038	0.0044	0.0060	445 (400 – 490)
P11	M/A/D/E	0.80	0.025	0.032	0.038	0.050	0.065	0.075	0.10	130 (120 – 140)
		0.80	0.0010	0.0013	0.0015	0.0020	0.0026	0.0030	0.0040	425 (400 – 450)
P12	M/A/D/E	0.80	0.025	0.032	0.038	0.050	0.065	0.075	0.10	80 (69 – 87)
		0.80	0.0010	0.0013	0.0015	0.0020	0.0026	0.0030	0.0040	260 (230 – 280)
M1	E	0.80	0.025	0.032	0.038	0.050	0.065	0.075	0.10	95 (85 – 100)
		0.80	0.0010	0.0013	0.0015	0.0020	0.0026	0.0030	0.0040	310 (280 – 320)
M2	E	0.80	0.025	0.032	0.038	0.050	0.065	0.075	0.10	80 (69 – 87)
		0.80	0.0010	0.0013	0.0015	0.0020	0.0026	0.0030	0.0040	260 (230 – 280)
M3	E	0.60	0.020	0.025	0.030	0.040	0.050	0.060	0.080	48 (39 – 57)
		0.60	0.00080	0.0010	0.0012	0.0016	0.0020	0.0024	0.0032	155 (130 – 180)
M4	E	0.60	0.020	0.025	0.030	0.040	0.050	0.060	0.080	36 (29 – 43)
		0.60	0.00080	0.0010	0.0012	0.0016	0.0020	0.0024	0.0032	120 (96 – 140)
M5	E	0.60	0.020	0.025	0.030	0.040	0.050	0.060	0.080	30 (25 – 36)
		0.60	0.00080	0.0010	0.0012	0.0016	0.0020	0.0024	0.0032	100 (83 – 110)
K1	E	1.0	0.032	0.040	0.048	0.065	0.080	0.095	0.13	155 (140 – 170)
		1.0	0.0013	0.0016	0.0019	0.0026	0.0032	0.0038	0.0050	510 (460 – 550)
K2	E	1.0	0.032	0.040	0.048	0.065	0.080	0.095	0.13	135 (120 – 150)
		1.0	0.0013	0.0016	0.0019	0.0026	0.0032	0.0038	0.0050	445 (400 – 490)
K3	E	1.0	0.032	0.040	0.048	0.065	0.080	0.095	0.13	115 (110 – 120)
		1.0	0.0013	0.0016	0.0019	0.0026	0.0032	0.0038	0.0050	375 (370 – 390)
K4	E	1.0	0.032	0.040	0.048	0.065	0.080	0.095	0.13	110 (96 – 120)
		1.0	0.0013	0.0016	0.0019	0.0026	0.0032	0.0038	0.0050	360 (320 – 390)
K5	E	0.70	0.032	0.040	0.048	0.065	0.080	0.095	0.13	135 (120 – 150)
		0.70	0.0013	0.0016	0.0019	0.0026	0.0032	0.0038	0.0050	445 (400 – 490)
K6	E	0.70	0.032	0.040	0.048	0.065	0.080	0.095	0.13	200 (180 – 220)
		0.70	0.0013	0.0016	0.0019	0.0026	0.0032	0.0038	0.0050	660 (600 – 720)
K7	E	0.70	0.032	0.040	0.048	0.065	0.080	0.095	0.13	175 (150 – 190)
		0.70	0.0013	0.0016	0.0019	0.0026	0.0032	0.0038	0.0050	570 (500 – 620)

For cutting data recalculations, see pages 445 - 452

SMG = Seco material group
Coolant = A=air D=dry E=emulsion M=mist spray
v_c = m/min (sf/min)
f_z = mm/tooth (in/tooth)
a_p = mm/DC (in/DC) = factor
a_e = mm/DC (in/DC) = factor
All cutting data are target values

Cutting data – JS554 Slot milling – Inch

SMG		a _p /DC	f _z							v _c
			1/4	5/16	3/8	1/2	5/8	3/4	1	
N1	E	0.50	0.032	0.040	0.048	0.065	0.080	0.095	0.13	570 (480 – 670)
		0,50	0,0013	0,0016	0,0019	0,0026	0,0032	0,0038	0,0050	1875 (1600 – 2100)
N2	E	0.50	0.032	0.040	0.048	0.065	0.080	0.095	0.13	370 (310 – 430)
		0,50	0,0013	0,0016	0,0019	0,0026	0,0032	0,0038	0,0050	1225 (1100–1400)
N3	E	0.50	0.032	0.040	0.048	0.065	0.080	0.095	0.13	245 (210 – 280)
		0,50	0,0013	0,0016	0,0019	0,0026	0,0032	0,0038	0,0050	800 (690 – 910)
N11	E	0.60	0.038	0.048	0.055	0.075	0.095	0.11	0.15	290 (250 – 330)
		0,60	0,0015	0,0019	0,0022	0,0030	0,0038	0,0044	0,0060	950 (830–1000)
S1	E	0.30	0.020	0.025	0.030	0.040	0.050	0.060	0.080	30 (25 – 34)
		0,30	0,00080	0,0010	0,0012	0,0016	0,0020	0,0024	0,0032	100 (83–110)
S2	E	0.30	0.020	0.025	0.030	0.040	0.050	0.060	0.080	27 (17 – 38)
		0,30	0,00080	0,0010	0,0012	0,0016	0,0020	0,0024	0,0032	90 (56–120)
S3	E	0.30	0.020	0.025	0.030	0.040	0.050	0.060	0.080	23 (15 – 32)
		0,30	0,00080	0,0010	0,0012	0,0016	0,0020	0,0024	0,0032	75 (50–100)
S11	E	0.50	0.026	0.032	0.038	0.050	0.065	0.080	0.10	85 (63–110)
		0,50	0,0010	0,0013	0,0015	0,0020	0,0026	0,0032	0,0040	280 (210 – 360)
S12	E	0.50	0.026	0.032	0.038	0.050	0.065	0.080	0.10	65 (48 – 86)
		0,50	0,0010	0,0013	0,0015	0,0020	0,0026	0,0032	0,0040	215 (160 – 280)
S13	E	0.50	0.026	0.032	0.038	0.050	0.065	0.080	0.10	50 (38 – 66)
		0,50	0,0010	0,0013	0,0015	0,0020	0,0026	0,0032	0,0040	165 (130 – 210)
H5	M/A/D	0.40	0.013	0.016	0.019	0.026	0.032	0.038	0.050	65 (52–76)
		0,40	0,00050	0,00065	0,00075	0,0010	0,0013	0,0015	0,0020	215 (180 – 240)
H8	M/A/D	0.40	0.013	0.016	0.019	0.026	0.032	0.038	0.050	65 (52–76)
		0,40	0,00050	0,00065	0,00075	0,0010	0,0013	0,0015	0,0020	215 (180 – 240)
H21	M/A/D	0.40	0.013	0.016	0.019	0.026	0.032	0.038	0.050	125 (90–160)
		0,40	0,00050	0,00065	0,00075	0,0010	0,0013	0,0015	0,0020	410 (300 – 520)
H31	M/A/D	0.40	0.013	0.016	0.019	0.026	0.032	0.038	0.050	48 (39 – 57)
		0,40	0,00050	0,00065	0,00075	0,0010	0,0013	0,0015	0,0020	155 (130–180)
TS1	A	0.70	0.065	0.080	0.095	0.12	0.15	0.16	0.19	240 (150 – 330)
		0,70	0,0026	0,0032	0,0038	0,0048	0,0060	0,0065	0,0075	790 (500–1000)
TP1	A	0.70	0.065	0.080	0.095	0.12	0.15	0.16	0.19	250 (150 – 340)
		0,70	0,0026	0,0032	0,0038	0,0048	0,0060	0,0065	0,0075	820 (500–1100)
GR1	A	0.80	0.065	0.080	0.095	0.12	0.15	0.16	0.19	485 (390 – 580)
		0,80	0,0026	0,0032	0,0038	0,0048	0,0060	0,0065	0,0075	1600 (1300–1900)

For cutting data recalculations, see pages 445 - 452

SMG = Seco material group
 Coolant = A=air D=dry E=emulsion M=mist spray
 v_c= m/min (sf/min)
 f_z = mm/tooth (in/tooth)
 a_p = mm/DC (in/DC) = factor
 a_e = mm/DC (in/DC) = factor
 All cutting data are target values

Universal
Steel and cast iron
Stainless steel and S-materials
Non ferrous
Hard
Plastic and cfrp
Graphite
Mimimaster Plus
Mimimaster

JS554-3C

Advanced roughing – Universal – Square – 4 Flutes – Cylindrical – Chamfer

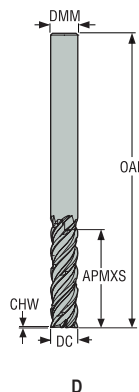

- Tolerances:
- DMM= h5
- DC= e7
- Chip splitters
- Regrind possible if DC is $\geq \varnothing 6$



Designation	Item number	Length index	Tool shape	Chip splitters	DC	DMM	APMXS	OAL	CHW	PCEDC	Cylindrical
					mm	mm	mm	mm	mm		
JS554060D3C.0Z4C-SIRA	02810475	3	D	■	6,0	6,0	23,0	65,0	0,075	4	■
JS554080D3C.0Z4C-SIRA	02810477	3	D	■	8,0	8,0	32,0	75,0	0,1	4	■
JS554100D3C.0Z4C-SIRA	02810479	3	D	■	10,0	10,0	40,0	85,0	0,125	4	■
JS554120D3C.0Z4C-SIRA	02810481	3	D	■	12,0	12,0	45,0	100,0	0,15	4	■
JS554160D3C.0Z4C-SIRA	02810483	3	D	■	16,0	16,0	55,0	115,0	0,2	4	■
JS554200D3C.0Z4C-SIRA	02810485	3	D	■	20,0	20,0	65,0	125,0	0,25	4	■
JS554250D3C.0Z4C-SIRA	02810486	3	D	■	25,0	25,0	85,0	150,0	0,3	4	■

■ Stocked standard.

Universal

Steel and cast iron

Stainless steel and S-materials

Non ferrous

Hard

Plastic and cfrp

Graphite

Minimaster Plus

Minimaster

JS554-3C

Advanced roughing – Universal – Square – 4 Flutes – Weldon – Chamfer

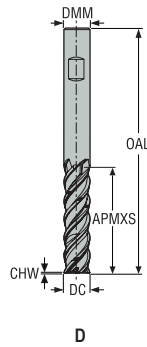

- Tolerances:
- DMM= h5
- DC= e7
- Chip splitters
- Regrind possible if DC is ≥Ø6

Designation	Item number	Length index	Tool shape	Chip splitters	DC	DMM	APMXS	OAL	CHW	PCEDC	Weldon
					mm	mm	mm	mm	mm		
JS554060D3C.3Z4C-SIRA	02810474	3	D	■	6,0	6,0	23,0	65,0	0,075	4	■
JS554080D3C.3Z4C-SIRA	02810476	3	D	■	8,0	8,0	32,0	75,0	0,1	4	■
JS554100D3C.3Z4C-SIRA	02810478	3	D	■	10,0	10,0	40,0	85,0	0,125	4	■
JS554120D3C.3Z4C-SIRA	02810480	3	D	■	12,0	12,0	45,0	100,0	0,15	4	■
JS554160D3C.3Z4C-SIRA	02810482	3	D	■	16,0	16,0	55,0	115,0	0,2	4	■
JS554200D3C.3Z4C-SIRA	02810484	3	D	■	20,0	20,0	65,0	125,0	0,25	4	■
JS554250D3C.3Z4C-SIRA	02810487	3	D	■	25,0	25,0	85,0	150,0	0,3	4	■

■ Stocked standard.

Universal

Steel and cast iron

Stainless steel and S-materials

Non ferrous

Hard

Plastic and CFRP

Graphite

Minimaster Plus

Minimaster

Cutting data – JS554-3C Advanced roughing

SMG		a _p /DC	a _e /DC	f _z							v _c
				6	8	10	12	16	20	25	
P1	M/A/D/E	0.100	3.6	0.065	0.085	0.11	0.13	0.16	0.18	0.20	350 (320 – 380)
		0,100	3,6	0,0026	0,0034	0,0044	0,0050	0,0065	0,0070	0,0080	1150 (1100–1200)
P2	M/A/D/E	0.100	3.6	0.065	0.090	0.11	0.13	0.16	0.19	0.22	340 (310 – 370)
		0,100	3,6	0,0026	0,0036	0,0044	0,0050	0,0065	0,0075	0,0085	1125 (1100–1200)
P3	M/A/D/E	0.100	3.6	0.060	0.085	0.10	0.12	0.15	0.18	0.20	295 (270 – 320)
		0,100	3,6	0,0024	0,0034	0,0040	0,0048	0,0060	0,0070	0,0080	970 (890–1000)
P4	M/A/D/E	0.100	3.6	0.060	0.080	0.10	0.12	0.15	0.17	0.19	260 (240 – 280)
		0,100	3,6	0,0024	0,0032	0,0040	0,0048	0,0060	0,0065	0,0075	850 (790 – 910)
P5	M/A/D/E	0.100	3.6	0.060	0.080	0.10	0.12	0.15	0.17	0.19	250 (230 – 270)
		0,100	3,6	0,0024	0,0032	0,0040	0,0048	0,0060	0,0065	0,0075	820 (760 – 880)
P6	M/A/D/E	0.100	3.6	0.060	0.080	0.10	0.12	0.15	0.17	0.19	280 (260 – 300)
		0,100	3,6	0,0024	0,0032	0,0040	0,0048	0,0060	0,0065	0,0075	920 (860 – 980)
P7	M/A/D/E	0.100	3.6	0.060	0.080	0.10	0.12	0.15	0.17	0.19	265 (240 – 290)
		0,100	3,6	0,0024	0,0032	0,0040	0,0048	0,0060	0,0065	0,0075	870 (790 – 950)
P8	M/A/D/E	0.100	3.6	0.060	0.085	0.10	0.12	0.15	0.18	0.20	250 (230 – 270)
		0,100	3,6	0,0024	0,0034	0,0040	0,0048	0,0060	0,0070	0,0080	820 (760 – 880)
P11	M/A/D/E	0.100	3.6	0.070	0.095	0.12	0.14	0.19	0.24	0.28	245 (230 – 270)
		0,100	3,6	0,0028	0,0038	0,0048	0,0055	0,0075	0,0095	0,011	800 (760 – 880)
P12	M/A/D/E	0.100	3.6	0.060	0.080	0.10	0.12	0.15	0.17	0.19	150 (140–160)
		0,100	3,6	0,0024	0,0032	0,0040	0,0048	0,0060	0,0065	0,0075	490 (460 – 520)
M1	E	0.100	3.6	0.065	0.090	0.11	0.13	0.16	0.19	0.22	180 (160 – 210)
		0,100	3,6	0,0026	0,0036	0,0044	0,0050	0,0065	0,0075	0,0085	590 (530 – 680)
M2	E	0.100	3.6	0.060	0.080	0.10	0.12	0.15	0.17	0.19	150 (130–170)
		0,100	3,6	0,0024	0,0032	0,0040	0,0048	0,0060	0,0065	0,0075	490 (430 – 550)
M3	E	0.100	3.6	0.060	0.080	0.10	0.12	0.15	0.17	0.19	100 (90–100)
		0,100	3,6	0,0024	0,0032	0,0040	0,0048	0,0060	0,0065	0,0075	330 (300 – 320)
M4	E	0.100	3.6	0.050	0.070	0.085	0.10	0.13	0.15	0.17	75 (70 – 85)
		0,100	3,6	0,0020	0,0028	0,0034	0,0040	0,0050	0,0060	0,0065	245 (230 – 270)
M5	E	0.100	3.6	0.050	0.070	0.085	0.10	0.13	0.15	0.17	65 (59–71)
		0,100	3,6	0,0020	0,0028	0,0034	0,0040	0,0050	0,0060	0,0065	215 (200 – 230)
K1	E	0.100	3.6	0.065	0.090	0.11	0.13	0.16	0.19	0.22	340 (310 – 370)
		0,100	3,6	0,0026	0,0036	0,0044	0,0050	0,0065	0,0075	0,0085	1125 (1100–1200)
K2	E	0.100	3.6	0.060	0.080	0.10	0.12	0.15	0.17	0.19	185 (160 – 210)
		0,100	3,6	0,0024	0,0032	0,0040	0,0048	0,0060	0,0065	0,0075	610 (530 – 680)
K3	E	0.100	3.6	0.060	0.080	0.10	0.12	0.15	0.17	0.19	255 (240 – 280)
		0,100	3,6	0,0024	0,0032	0,0040	0,0048	0,0060	0,0065	0,0075	840 (790 – 910)
K4	E	0.100	3.6	0.060	0.080	0.10	0.12	0.15	0.17	0.19	245 (220 – 260)
		0,100	3,6	0,0024	0,0032	0,0040	0,0048	0,0060	0,0065	0,0075	800 (730 – 850)
K5	E	0.100	3.6	0.055	0.070	0.090	0.11	0.13	0.15	0.17	150 (140–160)
		0,100	3,6	0,0022	0,0028	0,0036	0,0044	0,0050	0,0060	0,0065	490 (460 – 520)
K6	E	0.100	3.6	0.060	0.080	0.10	0.12	0.15	0.17	0.19	215 (200 – 230)
		0,100	3,6	0,0024	0,0032	0,0040	0,0048	0,0060	0,0065	0,0075	710 (660–750)
K7	E	0.100	3.6	0.055	0.070	0.090	0.11	0.13	0.15	0.17	190 (180 – 200)
		0,100	3,6	0,0022	0,0028	0,0036	0,0044	0,0050	0,0060	0,0065	620 (600 – 650)

For cutting data recalculations, see pages 445 - 452

SMG = Seco material group
Coolant = A=air D=dry E=emulsion M=mist spray
v_c = m/min (sf/min)
f_z = mm (in/tooth)
a_p = mm/DC (in/DC) = factor
a_e = mm/DC (in/DC) = factor
All cutting data are target values

Cutting data – JS554-3C Advanced roughing

SMG	Coolant	a _e /DC	a _p /DC	f _z						v _c	
				6	8	10	12	16	20		25
N1	E	0.100	3.6	0.060	0.080	0.10	0.12	0.15	0.17	0.19	750 (650 – 840)
		0,100	3,6	0,0024	0,0032	0,0040	0,0048	0,0060	0,0065	0,0075	2450 (2200 – 2700)
N2	E	0.100	3.6	0.060	0.080	0.10	0.12	0.15	0.17	0.19	480 (420 – 540)
		0,100	3,6	0,0024	0,0032	0,0040	0,0048	0,0060	0,0065	0,0075	1575 (1400–1700)
N3	E	0.100	3.6	0.060	0.080	0.10	0.12	0.15	0.17	0.19	320 (280 – 360)
		0,100	3,6	0,0024	0,0032	0,0040	0,0048	0,0060	0,0065	0,0075	1050 (920–1100)
N11	E	0.100	3.6	0.060	0.080	0.10	0.12	0.15	0.17	0.19	375 (330 – 420)
		0,100	3,6	0,0024	0,0032	0,0040	0,0048	0,0060	0,0065	0,0075	1225 (1100–1300)
S1	E	0.0500	3.6	0.048	0.065	0.080	0.095	0.12	0.14	0.15	50 (40 – 60)
		0,0500	3,6	0,0019	0,0026	0,0032	0,0038	0,0048	0,0055	0,0060	165 (140–190)
S2	E	0.0500	3.6	0.048	0.065	0.080	0.095	0.12	0.14	0.15	40 (33 – 48)
		0,0500	3,6	0,0019	0,0026	0,0032	0,0038	0,0048	0,0055	0,0060	130 (110–150)
S3	E	0.0500	3.6	0.048	0.065	0.080	0.095	0.12	0.14	0.15	25 (20 – 29)
		0,0500	3,6	0,0019	0,0026	0,0032	0,0038	0,0048	0,0055	0,0060	80 (66 – 95)
S11	E	0.100	3.6	0.048	0.065	0.080	0.095	0.12	0.14	0.15	195 (130 – 220)
		0,100	3,6	0,0019	0,0026	0,0032	0,0038	0,0048	0,0055	0,0060	640 (430–720)
S12	E	0.100	3.6	0.048	0.065	0.080	0.095	0.12	0.14	0.15	150 (100–160)
		0,100	3,6	0,0019	0,0026	0,0032	0,0038	0,0048	0,0055	0,0060	490 (330 – 520)
S13	E	0.100	3.6	0.042	0.055	0.070	0.085	0.10	0.12	0.13	120 (80–130)
		0,100	3,6	0,0017	0,0022	0,0028	0,0034	0,0040	0,0048	0,0050	395 (270 – 420)
H5	M/A/D	0.0500	3.6	0.030	0.040	0.050	0.060	0.075	0.085	0.095	200 (190 – 220)
		0,0500	3,6	0,0012	0,0016	0,0020	0,0024	0,0030	0,0034	0,0038	660 (630–720)
H8	M/A/D	0.0500	3.6	0.022	0.030	0.038	0.046	0.055	0.065	0.075	210 (190 – 220)
		0,0500	3,6	0,00085	0,0012	0,0015	0,0018	0,0022	0,0026	0,0030	690 (630–720)
H11	M/A/D	0.0500	3.6	0.030	0.040	0.050	0.060	0.075	0.085	0.095	255 (240 – 280)
		0,0500	3,6	0,0012	0,0016	0,0020	0,0024	0,0030	0,0034	0,0038	840 (790 – 910)
H12	M/A/D	0.100	3.6	0.032	0.042	0.050	0.060	0.075	0.090	0.10	205 (190 – 220)
		0,100	3,6	0,0013	0,0017	0,0020	0,0024	0,0030	0,0036	0,0040	670 (630–720)
H21	M/A/D	0.0500	3.6	0.022	0.030	0.038	0.046	0.055	0.065	0.075	210 (190 – 220)
		0,0500	3,6	0,00085	0,0012	0,0015	0,0018	0,0022	0,0026	0,0030	690 (630–720)

For cutting data recalculations, see pages 445 - 452

SMG = Seco material group
 Coolant = A=air D=dry E=emulsion M=mist spray
 v_c = m/min (sf/min)
 f_z = mm (in/tooth)
 a_p = mm/DC (in/DC) = factor
 a_e = mm/DC (in/DC) = factor
 All cutting data are target values

Universal
Steel and cast iron
Stainless steel and S-materials
Non ferrous
Hard
Plastic and chip
Graphite
Minimaster Plus
Minimaster

JS564

Advanced roughing – Universal – Square – 4 Flutes – Cylindrical – Chamfer

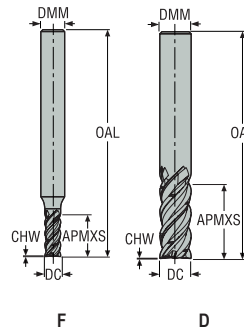
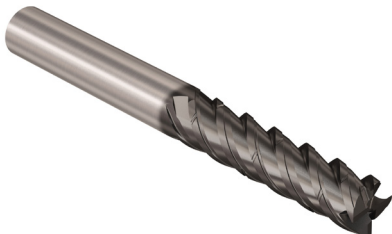

- Tolerances:
- DMM= h5
- DC= e7
- Chip splitters
- Regrind possible if DC is $\geq \varnothing 8$

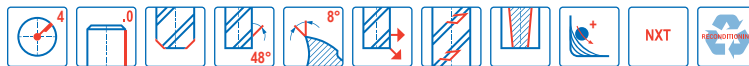

Designation	Item number	Length index	Tool shape	Chip splitters	DC	DMM	APMXS	OAL	CHW	PCEDC	Cylindrical
					mm	mm	mm	mm	mm		
JS564030F2C.0Z4C-NXT	03067338	2	F	■	3,0	6,0	7,0	57,0	0,04	4	■
JS564040F2C.0Z4C-NXT	03067339	2	F	■	4,0	6,0	10,0	57,0	0,05	4	■
JS564050F2C.0Z4C-NXT	03067340	2	F	■	5,0	6,0	12,5	57,0	0,06	4	■
JS564060D2C.0Z4C-NXT	03067341	2	D	■	6,0	6,0	15,0	57,0	0,075	4	■
JS564080D2C.0Z4C-NXT	03067342	2	D	■	8,0	8,0	20,0	63,0	0,1	4	■
JS564100D2C.0Z4C-NXT	03067343	2	D	■	10,0	10,0	25,0	72,0	0,125	4	■
JS564120D2C.0Z4C-NXT	03067344	2	D	■	12,0	12,0	30,0	83,0	0,15	4	■
JS564160D2C.0Z4C-NXT	03067345	2	D	■	16,0	16,0	40,0	99,0	0,2	4	■
JS564200D2C.0Z4C-NXT	03067346	2	D	■	20,0	20,0	50,0	114,0	0,25	4	■
JS564060D3C.0Z4C-NXT	03067347	3	D	■	6,0	6,0	23,0	64,0	0,075	4	■
JS564080D3C.0Z4C-NXT	03067348	3	D	■	8,0	8,0	32,0	74,0	0,1	4	■
JS564100D3C.0Z4C-NXT	03067349	3	D	■	10,0	10,0	40,0	88,0	0,125	4	■
JS564120D3C.0Z4C-NXT	03067350	3	D	■	12,0	12,0	45,0	99,0	0,15	4	■
JS564160D3C.0Z4C-NXT	03067351	3	D	■	16,0	16,0	55,0	114,0	0,2	4	■
JS564200D3C.0Z4C-NXT	03067352	3	D	■	20,0	20,0	65,0	126,0	0,25	4	■

■ Stocked standard.

Universal

Steel and cast iron

Stainless steel and S-materials

Non ferrous

Hard

Plastic and cfrp

Graphite

Minimaster Plus

Minimaster

JS564

Advanced roughing – Universal – Square – 4 Flutes – Weldon – Chamfer

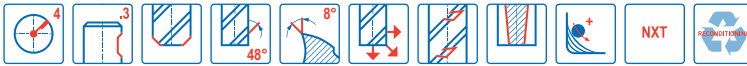
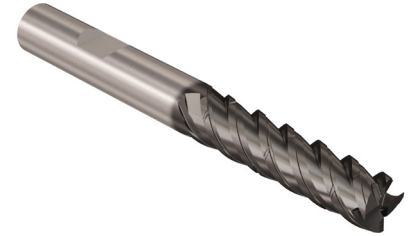
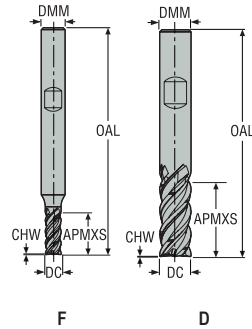

- Tolerances:
- DMM= h5
- DC= e7
- Chip splitters
- Regrind possible if DC is $\geq \varnothing 8$

Designation	Item number	Length index	Tool shape	Chip splitters	DC	DMM	APMXS	OAL	CHW	PCEDC	Weldon
					mm	mm	mm	mm	mm		
JS564030F2C.3Z4C-NXT	03067353	2	F	■	3,0	6,0	7,0	57,0	0,04	4	■
JS564040F2C.3Z4C-NXT	03067354	2	F	■	4,0	6,0	10,0	57,0	0,05	4	■
JS564050F2C.3Z4C-NXT	03067355	2	F	■	5,0	6,0	12,5	57,0	0,06	4	■
JS564060D2C.3Z4C-NXT	03067356	2	D	■	6,0	6,0	15,0	57,0	0,075	4	■
JS564080D2C.3Z4C-NXT	03067357	2	D	■	8,0	8,0	20,0	63,0	0,1	4	■
JS564100D2C.3Z4C-NXT	03067358	2	D	■	10,0	10,0	25,0	72,0	0,125	4	■
JS564120D2C.3Z4C-NXT	03067359	2	D	■	12,0	12,0	30,0	83,0	0,15	4	■
JS564160D2C.3Z4C-NXT	03067360	2	D	■	16,0	16,0	40,0	99,0	0,2	4	■
JS564200D2C.3Z4C-NXT	03067361	2	D	■	20,0	20,0	50,0	114,0	0,25	4	■
JS564060D3C.3Z4C-NXT	03067362	3	D	■	6,0	6,0	23,0	64,0	0,075	4	■
JS564080D3C.3Z4C-NXT	03067363	3	D	■	8,0	8,0	32,0	74,0	0,1	4	■
JS564100D3C.3Z4C-NXT	03067364	3	D	■	10,0	10,0	40,0	88,0	0,125	4	■
JS564120D3C.3Z4C-NXT	03067365	3	D	■	12,0	12,0	45,0	99,0	0,15	4	■
JS564160D3C.3Z4C-NXT	03067366	3	D	■	16,0	16,0	55,0	114,0	0,2	4	■
JS564200D3C.3Z4C-NXT	03067367	3	D	■	20,0	20,0	65,0	126,0	0,25	4	■

■ Stocked standard.

Universal

Steel and cast iron

Stainless steel and S-materials

Non ferrous

Hard

Plastic and chip

Graphite

Minimaster Plus

Minimaster

Cutting data – JS564 Side milling advanced roughing

SMG	Coolant	a _e /DC	a _p /DC	f _z								v _c
				4	5	6	8	10	12	16	20	
P1	E/M/A/D	0.150	2.4	0.042	0.055	0.065	0.085	0.11	0.13	0.16	0.18	305 (270 – 340)
		0.150	2.4	0.0017	0.0022	0.0026	0.0034	0.0044	0.0050	0.0065	0.0070	1000 (890 – 1100)
P2	E/M/A/D	0.150	2.4	0.044	0.055	0.065	0.085	0.11	0.13	0.16	0.18	295 (260 – 330)
		0.150	2.4	0.0017	0.0022	0.0026	0.0034	0.0044	0.0050	0.0065	0.0070	970 (860 – 1000)
P3	E/M/A/D	0.150	2.4	0.040	0.050	0.060	0.080	0.10	0.12	0.15	0.17	260 (230 – 290)
		0.150	2.4	0.0016	0.0020	0.0024	0.0032	0.0040	0.0048	0.0060	0.0065	850 (760 – 950)
P4	E/M/A/D	0.150	2.4	0.040	0.050	0.060	0.080	0.10	0.12	0.15	0.17	230 (200 – 250)
		0.150	2.4	0.0016	0.0020	0.0024	0.0032	0.0040	0.0048	0.0060	0.0065	750 (660 – 820)
P5	E/M/A/D	0.150	2.4	0.040	0.050	0.060	0.080	0.10	0.12	0.15	0.17	215 (190 – 240)
		0.150	2.4	0.0016	0.0020	0.0024	0.0032	0.0040	0.0048	0.0060	0.0065	710 (630 – 780)
P6	E/M/A/D	0.150	2.4	0.040	0.050	0.060	0.080	0.10	0.12	0.15	0.17	240 (210 – 270)
		0.150	2.4	0.0016	0.0020	0.0024	0.0032	0.0040	0.0048	0.0060	0.0065	790 (690 – 880)
P7	E/M/A/D	0.150	2.4	0.040	0.050	0.060	0.080	0.10	0.12	0.15	0.17	230 (200 – 250)
		0.150	2.4	0.0016	0.0020	0.0024	0.0032	0.0040	0.0048	0.0060	0.0065	750 (660 – 820)
P8	E/M/A/D	0.150	2.4	0.042	0.050	0.060	0.085	0.10	0.12	0.15	0.18	215 (190 – 240)
		0.150	2.4	0.0017	0.0020	0.0024	0.0034	0.0040	0.0048	0.0060	0.0070	710 (630 – 780)
P11	E/M/A/D	0.150	2.4	0.060	0.075	0.090	0.12	0.15	0.17	0.22	0.25	200 (180 – 220)
		0.150	2.4	0.0024	0.0030	0.0036	0.0048	0.0060	0.0065	0.0085	0.010	660 (600 – 720)
P12	E/M/A/D	0.150	2.4	0.040	0.050	0.060	0.080	0.10	0.12	0.15	0.17	130 (120 – 140)
		0.150	2.4	0.0016	0.0020	0.0024	0.0032	0.0040	0.0048	0.0060	0.0065	425 (400 – 450)
M1	E	0.150	2.4	0.044	0.055	0.065	0.090	0.11	0.13	0.16	0.19	195 (170 – 210)
		0.150	2.4	0.0017	0.0022	0.0026	0.0036	0.0044	0.0050	0.0065	0.0075	640 (560 – 680)
M2	E	0.150	2.4	0.040	0.050	0.060	0.080	0.10	0.12	0.15	0.17	160 (140 – 170)
		0.150	2.4	0.0016	0.0020	0.0024	0.0032	0.0040	0.0048	0.0060	0.0065	520 (460 – 550)
M3	E	0.100	2.4	0.040	0.050	0.060	0.080	0.10	0.12	0.15	0.17	130 (110 – 140)
		0.100	2.4	0.0016	0.0020	0.0024	0.0032	0.0040	0.0048	0.0060	0.0065	425 (370 – 450)
M4	E	0.100	2.4	0.040	0.050	0.060	0.080	0.10	0.12	0.15	0.17	130 (110 – 140)
		0.100	2.4	0.0016	0.0020	0.0024	0.0032	0.0040	0.0048	0.0060	0.0065	425 (370 – 450)
M5	E	0.100	2.4	0.040	0.050	0.060	0.080	0.10	0.12	0.15	0.17	110 (92 – 120)
		0.100	2.4	0.0016	0.0020	0.0024	0.0032	0.0040	0.0048	0.0060	0.0065	360 (310 – 390)
K1	E	0.150	2.4	0.044	0.055	0.065	0.090	0.11	0.13	0.16	0.19	260 (230 – 290)
		0.150	2.4	0.0017	0.0022	0.0026	0.0036	0.0044	0.0050	0.0065	0.0075	850 (760 – 950)
K2	E	0.150	2.4	0.040	0.050	0.060	0.080	0.10	0.12	0.15	0.17	230 (200 – 250)
		0.150	2.4	0.0016	0.0020	0.0024	0.0032	0.0040	0.0048	0.0060	0.0065	750 (660 – 820)
K3	E	0.150	2.4	0.040	0.050	0.060	0.080	0.10	0.12	0.15	0.17	195 (170 – 210)
		0.150	2.4	0.0016	0.0020	0.0024	0.0032	0.0040	0.0048	0.0060	0.0065	640 (560 – 680)
K4	E	0.150	2.4	0.040	0.050	0.060	0.080	0.10	0.12	0.15	0.17	185 (170 – 200)
		0.150	2.4	0.0016	0.0020	0.0024	0.0032	0.0040	0.0048	0.0060	0.0065	610 (560 – 650)
K5	E	0.150	2.4	0.036	0.044	0.055	0.070	0.090	0.11	0.13	0.15	115 (99 – 120)
		0.150	2.4	0.0014	0.0017	0.0022	0.0028	0.0036	0.0044	0.0050	0.0060	375 (330 – 390)
K6	E	0.150	2.4	0.040	0.050	0.060	0.080	0.10	0.12	0.15	0.17	165 (150 – 180)
		0.150	2.4	0.0016	0.0020	0.0024	0.0032	0.0040	0.0048	0.0060	0.0065	540 (500 – 590)
K7	E	0.150	2.4	0.036	0.044	0.055	0.070	0.090	0.11	0.13	0.15	145 (130 – 160)
		0.150	2.4	0.0014	0.0017	0.0022	0.0028	0.0036	0.0044	0.0050	0.0060	475 (430 – 520)

For cutting data recalculations, see pages 445 - 452

SMG = Seco material group
Coolant = A=air D=dry E=emulsion M=mist spray
v_c = m/min (sf/min)
f_z = mm (in/tooth)
a_p = mm/DC (in/DC) = factor
a_e = mm/DC (in/DC) = factor
All cutting data are target values

Cutting data – JS564 Side milling advanced roughing

SMG		a _p /DC	a _e /DC	f _z								v _c
				4	5	6	8	10	12	16	20	
N1	E	0.150	2.4	0.040	0.050	0.060	0.080	0.10	0.12	0.15	0.17	700 (600–790)
		0.150	2.4	0.0016	0.0020	0.0024	0.0032	0.0040	0.0048	0.0060	0.0065	2300 (2000 – 2500)
N2	E	0.150	2.4	0.040	0.050	0.060	0.080	0.10	0.12	0.15	0.17	450 (390 – 510)
		0.150	2.4	0.0016	0.0020	0.0024	0.0032	0.0040	0.0048	0.0060	0.0065	1475 (1300–1600)
N3	E	0.100	2.4	0.040	0.050	0.060	0.080	0.10	0.12	0.15	0.17	500 (400 – 590)
		0.100	2.4	0.0016	0.0020	0.0024	0.0032	0.0040	0.0048	0.0060	0.0065	1650 (1400–1900)
N11	E	0.150	2.4	0.040	0.050	0.060	0.080	0.10	0.12	0.15	0.17	350 (300 – 390)
		0.150	2.4	0.0016	0.0020	0.0024	0.0032	0.0040	0.0048	0.0060	0.0065	1150 (990–1200)
S1	E	0.0300	2.4	0.030	0.038	0.046	0.060	0.075	0.090	0.11	0.13	60 (37 – 86)
		0.0300	2.4	0.0012	0.0015	0.0018	0.0024	0.0030	0.0036	0.0044	0.0050	195 (130 – 280)
S2	E	0.0300	2.4	0.030	0.038	0.046	0.060	0.075	0.090	0.11	0.13	50 (30 – 69)
		0.0300	2.4	0.0012	0.0015	0.0018	0.0024	0.0030	0.0036	0.0044	0.0050	165 (99 – 220)
S3	E	0.0300	2.4	0.028	0.034	0.042	0.055	0.070	0.085	0.10	0.12	43 (26 – 60)
		0.0300	2.4	0.0011	0.0013	0.0017	0.0022	0.0028	0.0034	0.0040	0.0048	140 (86–190)
S11	E	0.0800	2.4	0.028	0.034	0.042	0.055	0.070	0.085	0.10	0.12	160 (140–180)
		0.0800	2.4	0.0011	0.0013	0.0017	0.0022	0.0028	0.0034	0.0040	0.0048	520 (460 – 590)
S12	E	0.0800	2.4	0.028	0.034	0.042	0.055	0.070	0.085	0.10	0.12	125 (110–140)
		0.0800	2.4	0.0011	0.0013	0.0017	0.0022	0.0028	0.0034	0.0040	0.0048	410 (370 – 450)
S13	E	0.0800	2.4	0.028	0.034	0.042	0.055	0.070	0.085	0.10	0.12	125 (110–140)
		0.0800	2.4	0.0011	0.0013	0.0017	0.0022	0.0028	0.0034	0.0040	0.0048	410 (370 – 450)
H8	M/A/D	0.0500	2.4	0.022	0.026	0.032	0.042	0.055	0.065	0.080	0.090	160 (140–180)
		0.0500	2.4	0.00085	0.0010	0.0013	0.0017	0.0022	0.0026	0.0032	0.0036	520 (460 – 590)
H21	M/A/D	0.0500	2.4	0.022	0.026	0.032	0.042	0.055	0.065	0.080	0.090	160 (140–180)
		0.0500	2.4	0.00085	0.0010	0.0013	0.0017	0.0022	0.0026	0.0032	0.0036	520 (460 – 590)
H31	M/A/D	0.0500	2.4	0.018	0.024	0.028	0.036	0.046	0.055	0.070	0.080	125 (110–140)
		0.0500	2.4	0.00070	0.00095	0.0011	0.0014	0.0018	0.0022	0.0028	0.0032	410 (370 – 450)

For cutting data recalculations, see pages 445 - 452

SMG = Seco material group
 Coolant = A=air D=dry E=emulsion M=mist spray
 v_c = m/min (sf/min)
 f_z = mm (in/tooth)
 a_p = mm/DC (in/DC) = factor
 a_e = mm/DC (in/DC) = factor
 All cutting data are target values

Universal
Steel and cast iron
Stainless steel and S-materials
Non ferrous
Hard
Plastic and cfrp
Graphite
Mimimaster Plus
Mimimaster

JS565

Advanced roughing – Universal – Square – 5 Flutes – Cylindrical – Chamfer

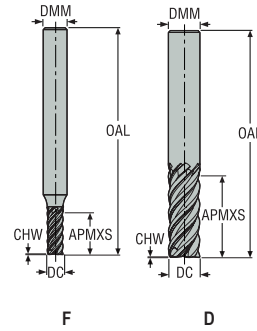
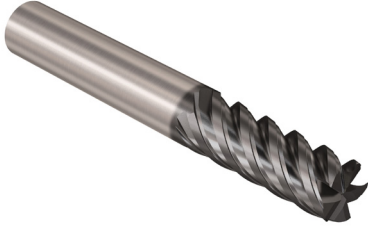

- Tolerances:
- DMM= h5
- DC= e7
- PCEDC5= no chip splitters
- PCEDC5C= with chip splitters
- Regrind possible if DC is $\geq \varnothing 8$



Designation	Item number	Length index	Tool shape	Chip splitters	DC	DMM	APMXS	OAL	CHW	PCEDC	Cylindrical
					mm	mm	mm	mm	mm		
JS565040F2C.0Z5-NXT	03067369	2	F	–	4,0	6,0	10,0	57,0	0,05	5	■
JS565040F2C.0Z5C-NXT	03067378	2	F	■	4,0	6,0	10,0	57,0	0,05	5	■
JS565050F2C.0Z5-NXT	03067370	2	F	–	5,0	6,0	12,5	57,0	0,06	5	■
JS565050F2C.0Z5C-NXT	03067379	2	F	■	5,0	6,0	12,5	57,0	0,06	5	■
JS565060D2C.0Z5-NXT	03067371	2	D	–	6,0	6,0	15,0	57,0	0,075	5	■
JS565060D2C.0Z5C-NXT	03067380	2	D	■	6,0	6,0	15,0	57,0	0,075	5	■
JS565080D2C.0Z5-NXT	03067372	2	D	–	8,0	8,0	20,0	63,0	0,1	5	■
JS565080D2C.0Z5C-NXT	03067381	2	D	■	8,0	8,0	20,0	63,0	0,1	5	■
JS565100D2C.0Z5-NXT	03067373	2	D	–	10,0	10,0	25,0	72,0	0,125	5	■
JS565100D2C.0Z5C-NXT	03067382	2	D	■	10,0	10,0	25,0	72,0	0,125	5	■
JS565120D2C.0Z5-NXT	03067374	2	D	–	12,0	12,0	30,0	83,0	0,15	5	■
JS565120D2C.0Z5C-NXT	03067383	2	D	■	12,0	12,0	30,0	83,0	0,15	5	■
JS565160D2C.0Z5-NXT	03067375	2	D	–	16,0	16,0	40,0	99,0	0,2	5	■
JS565160D2C.0Z5C-NXT	03067384	2	D	■	16,0	16,0	40,0	99,0	0,2	5	■
JS565200D2C.0Z5-NXT	03067376	2	D	–	20,0	20,0	50,0	114,0	0,25	5	■
JS565200D2C.0Z5C-NXT	03067385	2	D	■	20,0	20,0	50,0	114,0	0,25	5	■
JS565060D3C.0Z5C-NXT	03067386	3	D	■	6,0	6,0	23,0	64,0	0,075	5	■
JS565080D3C.0Z5C-NXT	03067387	3	D	■	8,0	8,0	32,0	74,0	0,1	5	■
JS565100D3C.0Z5C-NXT	03067388	3	D	■	10,0	10,0	40,0	88,0	0,125	5	■
JS565120D3C.0Z5C-NXT	03067389	3	D	■	12,0	12,0	45,0	99,0	0,15	5	■
JS565160D3C.0Z5C-NXT	03067390	3	D	■	16,0	16,0	55,0	114,0	0,2	5	■
JS565200D3C.0Z5C-NXT	03067391	3	D	■	20,0	20,0	65,0	126,0	0,25	5	■

■ Stocked standard.

JS565

Advanced roughing – Universal – Square – 5 Flutes – Weldon – Chamfer

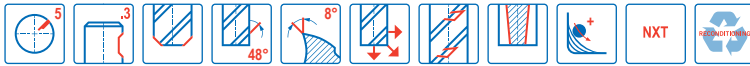
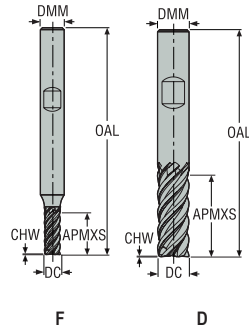

- Tolerances:
- DMM= h5
- DC= e7
- PCEDC5= no chip splitters
- PCEDC5C= with chip splitters
- Regrind possible if DC is $\geq \varnothing 8$

Designation	Item number	Length index	Tool shape	Chip splitters	DC	DMM	APMXS	OAL	CHW	PCEDC	Weldon
					mm	mm	mm	mm	mm		
JS565040F2C.3Z5-NXT	03067393	2	F	–	4,0	6,0	10,0	57,0	0,05	5	■
JS565040F2C.3Z5C-NXT	03067402	2	F	■	4,0	6,0	10,0	57,0	0,05	5	■
JS565050F2C.3Z5-NXT	03067394	2	F	–	5,0	6,0	12,5	57,0	0,06	5	■
JS565050F2C.3Z5C-NXT	03067403	2	F	■	5,0	6,0	12,5	57,0	0,06	5	■
JS565060D2C.3Z5-NXT	03067395	2	D	–	6,0	6,0	15,0	57,0	0,075	5	■
JS565060D2C.3Z5C-NXT	03067404	2	D	■	6,0	6,0	15,0	57,0	0,075	5	■
JS565080D2C.3Z5-NXT	03067396	2	D	–	8,0	8,0	20,0	63,0	0,1	5	■
JS565080D2C.3Z5C-NXT	03067405	2	D	■	8,0	8,0	20,0	63,0	0,1	5	■
JS565100D2C.3Z5-NXT	03067397	2	D	–	10,0	10,0	25,0	72,0	0,125	5	■
JS565100D2C.3Z5C-NXT	03067406	2	D	■	10,0	10,0	25,0	72,0	0,125	5	■
JS565120D2C.3Z5-NXT	03067398	2	D	–	12,0	12,0	30,0	83,0	0,15	5	■
JS565120D2C.3Z5C-NXT	03067407	2	D	■	12,0	12,0	30,0	83,0	0,15	5	■
JS565160D2C.3Z5-NXT	03067399	2	D	–	16,0	16,0	40,0	99,0	0,2	5	■
JS565160D2C.3Z5C-NXT	03067408	2	D	■	16,0	16,0	40,0	99,0	0,2	5	■
JS565200D2C.3Z5-NXT	03067400	2	D	–	20,0	20,0	50,0	114,0	0,25	5	■
JS565200D2C.3Z5C-NXT	03067409	2	D	■	20,0	20,0	50,0	114,0	0,25	5	■
JS565060D3C.3Z5C-NXT	03067410	3	D	■	6,0	6,0	23,0	64,0	0,075	5	■
JS565080D3C.3Z5C-NXT	03067411	3	D	■	8,0	8,0	32,0	74,0	0,1	5	■
JS565100D3C.3Z5C-NXT	03067412	3	D	■	10,0	10,0	40,0	88,0	0,125	5	■
JS565120D3C.3Z5C-NXT	03067413	3	D	■	12,0	12,0	45,0	99,0	0,15	5	■
JS565160D3C.3Z5C-NXT	03067414	3	D	■	16,0	16,0	55,0	114,0	0,2	5	■
JS565200D3C.3Z5C-NXT	03067415	3	D	■	20,0	20,0	65,0	126,0	0,25	5	■

■ Stocked standard.

Universal

Steel and cast iron

Stainless steel and S-materials

Non ferrous

Hard

Plastic and chip

Graphite

Minimaster Plus

Minimaster

Cutting data – JS565 Side milling advanced roughing

SMG	Coolant	a _e /DC	a _p /DC	f _z								v _c
				4	5	6	8	10	12	16	20	
P1	E/M/A/D	0.100	2.4	0.050	0.065	0.075	0.10	0.13	0.15	0.19	0.22	325 (270 – 340)
		0,100	2,4	0,0020	0,0026	0,0030	0,0040	0,0050	0,0060	0,0075	0,0085	1075 (890 – 1100)
P2	E/M/A/D	0.100	2.4	0.050	0.065	0.080	0.10	0.13	0.15	0.19	0.22	315 (260 – 330)
		0,100	2,4	0,0020	0,0026	0,0032	0,0040	0,0050	0,0060	0,0075	0,0085	1025 (860 – 1000)
P3	E/M/A/D	0.100	2.4	0.048	0.060	0.075	0.10	0.12	0.14	0.18	0.20	280 (230 – 290)
		0,100	2,4	0,0019	0,0024	0,0030	0,0040	0,0048	0,0055	0,0070	0,0080	920 (760 – 950)
P4	E/M/A/D	0.100	2.4	0.048	0.060	0.070	0.095	0.12	0.14	0.18	0.20	245 (200 – 250)
		0,100	2,4	0,0019	0,0024	0,0028	0,0038	0,0048	0,0055	0,0070	0,0080	800 (660 – 820)
P5	E/M/A/D	0.100	2.4	0.048	0.060	0.070	0.095	0.12	0.14	0.18	0.20	230 (190 – 240)
		0,100	2,4	0,0019	0,0024	0,0028	0,0038	0,0048	0,0055	0,0070	0,0080	750 (630 – 780)
P6	E/M/A/D	0.100	2.4	0.048	0.060	0.070	0.095	0.12	0.14	0.17	0.20	260 (210 – 270)
		0,100	2,4	0,0019	0,0024	0,0028	0,0038	0,0048	0,0055	0,0065	0,0080	850 (690 – 880)
P7	E/M/A/D	0.100	2.4	0.048	0.060	0.070	0.095	0.12	0.14	0.17	0.20	245 (200 – 250)
		0,100	2,4	0,0019	0,0024	0,0028	0,0038	0,0048	0,0055	0,0065	0,0080	800 (660 – 820)
P8	E/M/A/D	0.100	2.4	0.050	0.060	0.075	0.10	0.12	0.15	0.18	0.22	230 (190 – 240)
		0,100	2,4	0,0020	0,0024	0,0030	0,0040	0,0048	0,0060	0,0070	0,0085	750 (630 – 780)
P11	E/M/A/D	0.100	2.4	0.060	0.075	0.090	0.12	0.15	0.18	0.24	0.30	225 (190 – 230)
		0,100	2,4	0,0024	0,0030	0,0036	0,0048	0,0060	0,0070	0,0095	0,012	740 (630 – 750)
P12	E/M/A/D	0.100	2.4	0.048	0.060	0.070	0.095	0.12	0.14	0.18	0.20	140 (120 – 140)
		0,100	2,4	0,0019	0,0024	0,0028	0,0038	0,0048	0,0055	0,0070	0,0080	460 (400 – 450)
M1	E	0.100	2.4	0.055	0.065	0.080	0.11	0.13	0.16	0.19	0.22	205 (180 – 210)
		0,100	2,4	0,0022	0,0026	0,0032	0,0044	0,0050	0,0065	0,0075	0,0085	670 (600 – 680)
M2	E	0.100	2.4	0.048	0.060	0.070	0.095	0.12	0.14	0.18	0.20	170 (140 – 170)
		0,100	2,4	0,0019	0,0024	0,0028	0,0038	0,0048	0,0055	0,0070	0,0080	560 (460 – 550)
M3	E	0.100	2.4	0.040	0.050	0.060	0.080	0.10	0.12	0.15	0.17	130 (110 – 140)
		0,100	2,4	0,0016	0,0020	0,0024	0,0032	0,0040	0,0048	0,0060	0,0065	425 (370 – 450)
M4	E	0.100	2.4	0.040	0.050	0.060	0.080	0.10	0.12	0.15	0.17	130 (110 – 140)
		0,100	2,4	0,0016	0,0020	0,0024	0,0032	0,0040	0,0048	0,0060	0,0065	425 (370 – 450)
M5	E	0.100	2.4	0.040	0.050	0.060	0.080	0.10	0.12	0.15	0.17	110 (92 – 120)
		0,100	2,4	0,0016	0,0020	0,0024	0,0032	0,0040	0,0048	0,0060	0,0065	360 (310 – 390)
K1	E	0.100	2.4	0.055	0.065	0.080	0.11	0.13	0.16	0.19	0.22	275 (230 – 290)
		0,100	2,4	0,0022	0,0026	0,0032	0,0044	0,0050	0,0065	0,0075	0,0085	900 (760 – 950)
K2	E	0.100	2.4	0.048	0.060	0.070	0.095	0.12	0.14	0.18	0.20	245 (200 – 250)
		0,100	2,4	0,0019	0,0024	0,0028	0,0038	0,0048	0,0055	0,0070	0,0080	800 (660 – 820)
K3	E	0.100	2.4	0.048	0.060	0.070	0.095	0.12	0.14	0.18	0.20	205 (170 – 210)
		0,100	2,4	0,0019	0,0024	0,0028	0,0038	0,0048	0,0055	0,0070	0,0080	670 (560 – 680)
K4	E	0.100	2.4	0.048	0.060	0.070	0.095	0.12	0.14	0.18	0.20	200 (170 – 200)
		0,100	2,4	0,0019	0,0024	0,0028	0,0038	0,0048	0,0055	0,0070	0,0080	660 (560 – 650)
K5	E	0.100	2.4	0.044	0.055	0.065	0.085	0.11	0.13	0.16	0.18	120 (98 – 120)
		0,100	2,4	0,0017	0,0022	0,0026	0,0034	0,0044	0,0050	0,0065	0,0070	395 (330 – 390)
K6	E	0.100	2.4	0.048	0.060	0.070	0.095	0.12	0.14	0.18	0.20	175 (150 – 180)
		0,100	2,4	0,0019	0,0024	0,0028	0,0038	0,0048	0,0055	0,0070	0,0080	570 (500 – 590)
K7	E	0.100	2.4	0.044	0.055	0.065	0.085	0.11	0.13	0.16	0.18	155 (130 – 160)
		0,100	2,4	0,0017	0,0022	0,0026	0,0034	0,0044	0,0050	0,0065	0,0070	510 (430 – 520)

For cutting data recalculations, see pages 445 - 452

SMG = Seco material group
Coolant = A=air D=dry E=emulsion M=mist spray
v_c = m/min (sf/min)
f_z = mm (in/tooth)
a_p = mm/DC (in/DC) = factor
a_e = mm/DC (in/DC) = factor
All cutting data are target values

Cutting data – JS565 Side milling advanced roughing

SMG		a _p /DC	a _e /DC	f _z								v _c
				4	5	6	8	10	12	16	20	
N1	E	0.100	2.4	0.048	0.060	0.070	0.095	0.12	0.14	0.18	0.20	740 (600–790)
		0,100	2,4	0,0019	0,0024	0,0028	0,0038	0,0048	0,0055	0,0070	0,0080	2425 (2000 – 2500)
N2	E	0.100	2.4	0.048	0.060	0.070	0.095	0.12	0.14	0.18	0.20	475 (390 – 510)
		0,100	2,4	0,0019	0,0024	0,0028	0,0038	0,0048	0,0055	0,0070	0,0080	1550 (1300–1600)
N3	E	0.100	2.4	0.040	0.050	0.060	0.080	0.10	0.12	0.15	0.17	500 (400 – 590)
		0,100	2,4	0,0016	0,0020	0,0024	0,0032	0,0040	0,0048	0,0060	0,0065	1650 (1400–1900)
N11	E	0.100	2.4	0.048	0.060	0.070	0.095	0.12	0.14	0.18	0.20	370 (300 – 390)
		0,100	2,4	0,0019	0,0024	0,0028	0,0038	0,0048	0,0055	0,0070	0,0080	1225 (990–1200)
S1	E	0.0300	2.4	0.028	0.034	0.042	0.055	0.070	0.085	0.10	0.12	60 (38 – 86)
		0,0300	2,4	0,0011	0,0013	0,0017	0,0022	0,0028	0,0034	0,0040	0,0048	195 (130 – 280)
S2	E	0.0300	2.4	0.028	0.034	0.042	0.055	0.070	0.085	0.10	0.12	50 (30–70)
		0,0300	2,4	0,0011	0,0013	0,0017	0,0022	0,0028	0,0034	0,0040	0,0048	165 (99 – 220)
S3	E	0.0300	2.4	0.026	0.032	0.038	0.050	0.065	0.075	0.095	0.11	43 (27 – 60)
		0,0300	2,4	0,0010	0,0013	0,0015	0,0020	0,0026	0,0030	0,0038	0,0044	140 (89–190)
S11	E	0.0800	2.4	0.028	0.034	0.042	0.055	0.070	0.085	0.10	0.12	160 (140–180)
		0,0800	2,4	0,0011	0,0013	0,0017	0,0022	0,0028	0,0034	0,0040	0,0048	520 (460 – 590)
S12	E	0.0800	2.4	0.028	0.034	0.042	0.055	0.070	0.085	0.10	0.12	125 (110–140)
		0,0800	2,4	0,0011	0,0013	0,0017	0,0022	0,0028	0,0034	0,0040	0,0048	410 (370 – 450)
S13	E	0.0800	2.4	0.028	0.034	0.042	0.055	0.070	0.085	0.10	0.12	125 (110–140)
		0,0800	2,4	0,0011	0,0013	0,0017	0,0022	0,0028	0,0034	0,0040	0,0048	410 (370 – 450)
H8	M/A/D	0.0500	2.4	0.022	0.026	0.032	0.042	0.055	0.065	0.080	0.090	160 (140–180)
		0,0500	2,4	0,00085	0,0010	0,0013	0,0017	0,0022	0,0026	0,0032	0,0036	520 (460 – 590)
H21	M/A/D	0.0500	2.4	0.024	0.028	0.034	0.046	0.060	0.070	0.085	0.10	155 (140–180)
		0,0500	2,4	0,00095	0,0011	0,0013	0,0018	0,0024	0,0028	0,0034	0,0040	510 (460 – 590)
H31	M/A/D	0.0500	2.4	0.020	0.025	0.030	0.040	0.050	0.060	0.075	0.085	120 (110–140)
		0,0500	2,4	0,00080	0,0010	0,0012	0,0016	0,0020	0,0024	0,0030	0,0034	395 (370 – 450)

For cutting data recalculations, see pages 445 - 452

SMG = Seco material group
 Coolant = A=air D=dry E=emulsion M=mist spray
 v_c = m/min (sf/min)
 f_z = mm (in/tooth)
 a_p = mm/DC (in/DC) = factor
 a_e = mm/DC (in/DC) = factor
 All cutting data are target values

Universal
Steel and cast iron
Stainless steel and S-materials
Non ferrous
Hard
Plastic and CFRP
Graphite
Mimimaster Plus
Mimimaster

JS520

High performance – Universal – Square – 5-8 Flutes – Cylindrical – Chamfer

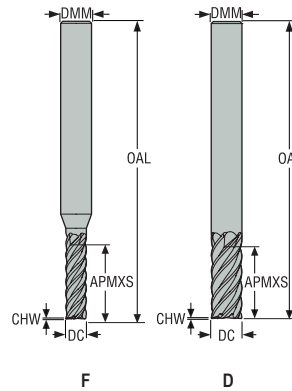

- Tolerances:
- DMM=h5
- DC=e7
- Regrind possible if DC is $\geq \phi 6$

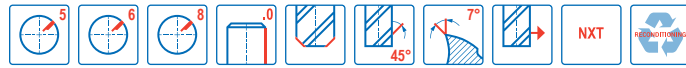

Designation	Item number	Length index	Tool shape	DC	DMM	APMXS	OAL	CHW	PCEDC	Cylindrical
				mm	mm	mm	mm	mm		
JS520040F2C.0Z5-NXT	02927474	2	F	4,0	6,0	10,0	57,0	0,04	5	■
JS520050F2C.0Z5-NXT	02927476	2	F	5,0	6,0	12,0	57,0	0,05	5	■
JS520060D2C.0Z5-NXT	02927478	2	D	6,0	6,0	15,0	57,0	0,06	5	■
JS520060D2C.0Z6-NXT	02927479	2	D	6,0	6,0	15,0	57,0	0,06	6	■
JS520080D2C.0Z5-NXT	02927482	2	D	8,0	8,0	20,0	63,0	0,08	5	■
JS520080D2C.0Z6-NXT	02927483	2	D	8,0	8,0	20,0	63,0	0,08	6	■
JS520100D2C.0Z6-NXT	02927486	2	D	10,0	10,0	25,0	72,0	0,1	6	■
JS520120D2C.0Z6-NXT	02927488	2	D	12,0	12,0	25,0	83,0	0,12	6	■
JS520140D2C.0Z6-NXT	02927490	2	D	14,0	14,0	30,0	83,0	0,14	6	■
JS520160D2C.0Z6-NXT	02927491	2	D	16,0	16,0	30,0	92,0	0,16	6	■
JS520160D2C.0Z8-NXT	02927492	2	D	16,0	16,0	30,0	92,0	0,16	8	■
JS520200D2C.0Z8-NXT	02927495	2	D	20,0	20,0	35,0	104,0	0,2	8	■
JS520250D2C.0Z8-NXT	02927497	2	D	25,0	25,0	50,0	125,0	0,25	8	■
JS520040F3C.0Z5-NXT	02927475	3	F	4,0	6,0	15,0	57,0	0,04	5	■
JS520050F3C.0Z5-NXT	02927477	3	F	5,0	6,0	19,0	57,0	0,05	5	■
JS520060D3C.0Z5-NXT	02927480	3	D	6,0	6,0	20,0	63,0	0,06	5	■
JS520060D3C.0Z6-NXT	02927481	3	D	6,0	6,0	20,0	63,0	0,06	6	■
JS520080D3C.0Z5-NXT	02927484	3	D	8,0	8,0	30,0	80,0	0,08	5	■
JS520080D3C.0Z6-NXT	02927485	3	D	8,0	8,0	30,0	80,0	0,08	6	■
JS520100D3C.0Z6-NXT	02927487	3	D	10,0	10,0	40,0	89,0	0,1	6	■
JS520120D3C.0Z6-NXT	02927489	3	D	12,0	12,0	45,0	100,0	0,12	6	■
JS520160D3C.0Z6-NXT	02927493	3	D	16,0	16,0	65,0	125,0	0,16	6	■
JS520160D3C.0Z8-NXT	02927494	3	D	16,0	16,0	65,0	125,0	0,16	8	■
JS520200D3C.0Z8-NXT	02927496	3	D	20,0	20,0	65,0	125,0	0,2	8	■
JS520250D3C.0Z8-NXT	02927498	3	D	25,0	25,0	75,0	150,0	0,25	8	■

■ Stocked standard.

JS520

High performance – Universal – Square – 5-8 Flutes – Weldon – Chamfer

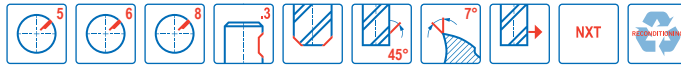
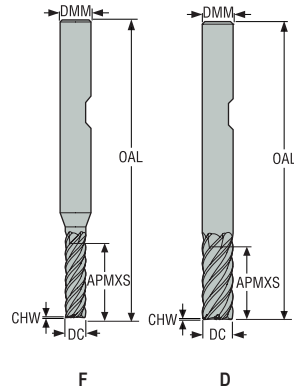

- Tolerances:
- DMM=h5
- DC=e7
- Regrind possible if DC is ≥Ø6

Designation	Item number	Length index	Tool shape	DC	DMM	APMXS	OAL	CHW	PCEDC	Weldon
				mm	mm	mm	mm	mm		
JS520040F2C.3Z5-NXT	02927499	2	F	4,0	6,0	10,0	57,0	0,04	5	<input type="checkbox"/>
JS520050F2C.3Z5-NXT	02927501	2	F	5,0	6,0	12,0	57,0	0,05	5	<input type="checkbox"/>
JS520060D2C.3Z5-NXT	02927503	2	D	6,0	6,0	15,0	57,0	0,06	5	<input type="checkbox"/>
JS520060D2C.3Z6-NXT	02927504	2	D	6,0	6,0	15,0	57,0	0,06	6	<input type="checkbox"/>
JS520080D2C.3Z5-NXT	02927507	2	D	8,0	8,0	20,0	63,0	0,08	5	<input type="checkbox"/>
JS520080D2C.3Z6-NXT	02927508	2	D	8,0	8,0	20,0	63,0	0,08	6	<input type="checkbox"/>
JS520100D2C.3Z6-NXT	02927511	2	D	10,0	10,0	25,0	72,0	0,1	6	<input type="checkbox"/>
JS520120D2C.3Z6-NXT	02927513	2	D	12,0	12,0	25,0	83,0	0,12	6	<input type="checkbox"/>
JS520140D2C.3Z6-NXT	02927515	2	D	14,0	14,0	30,0	83,0	0,14	6	<input type="checkbox"/>
JS520160D2C.3Z6-NXT	02927516	2	D	16,0	16,0	30,0	92,0	0,16	6	<input type="checkbox"/>
JS520160D2C.3Z8-NXT	02927517	2	D	16,0	16,0	30,0	92,0	0,16	8	<input checked="" type="checkbox"/>
JS520200D2C.3Z8-NXT	02927520	2	D	20,0	20,0	35,0	104,0	0,2	8	<input checked="" type="checkbox"/>
JS520250D2C.3Z8-NXT	02927522	2	D	25,0	25,0	50,0	125,0	0,25	8	<input type="checkbox"/>
JS520040F3C.3Z5-NXT	02927500	3	F	4,0	6,0	15,0	57,0	0,04	5	<input type="checkbox"/>
JS520050F3C.3Z5-NXT	02927502	3	F	5,0	6,0	19,0	57,0	0,05	5	<input type="checkbox"/>
JS520060D3C.3Z5-NXT	02927505	3	D	6,0	6,0	20,0	63,0	0,06	5	<input type="checkbox"/>
JS520060D3C.3Z6-NXT	02927506	3	D	6,0	6,0	20,0	63,0	0,06	6	<input type="checkbox"/>
JS520080D3C.3Z5-NXT	02927509	3	D	8,0	8,0	30,0	80,0	0,08	5	<input type="checkbox"/>
JS520080D3C.3Z6-NXT	02927510	3	D	8,0	8,0	30,0	80,0	0,08	6	<input type="checkbox"/>
JS520100D3C.3Z6-NXT	02927512	3	D	10,0	10,0	40,0	89,0	0,1	6	<input type="checkbox"/>
JS520120D3C.3Z6-NXT	02927514	3	D	12,0	12,0	45,0	100,0	0,12	6	<input type="checkbox"/>
JS520160D3C.3Z6-NXT	02927518	3	D	16,0	16,0	65,0	125,0	0,16	6	<input type="checkbox"/>
JS520160D3C.3Z8-NXT	02927519	3	D	16,0	16,0	65,0	125,0	0,16	8	<input type="checkbox"/>
JS520200D3C.3Z8-NXT	02927521	3	D	20,0	20,0	65,0	125,0	0,2	8	<input type="checkbox"/>
JS520250D3C.3Z8-NXT	02927523	3	D	25,0	25,0	75,0	150,0	0,25	8	<input type="checkbox"/>

■ Stocked standard. □ Weldon available. Delivery time is 3 days.

Universal

Steel and cast iron

Stainless steel and S-materials

Non ferrous

Hard

Plastic and chip

Graphite

Minimaster Plus

Minimaster

Cutting data – JS520 Side milling

SMG		a _e /DC	a _p /DC	f _z										v _c
				4	5	6	8	10	12	14	16	20	25	
P1	E/M/A	0.100	2.0	0.034	0.044	0.050	0.070	0.085	0.10	0.12	0.13	0.15	0.17	180 (120 – 250)
		0,100	2,0	0,0013	0,0017	0,0020	0,0028	0,0034	0,0040	0,0048	0,0050	0,0060	0,0065	590 (400 – 820)
P2	E/M/A	0.100	2.0	0.036	0.044	0.055	0.070	0.090	0.10	0.12	0.13	0.15	0.17	175 (110 – 240)
		0,100	2,0	0,0014	0,0017	0,0022	0,0028	0,0036	0,0040	0,0048	0,0050	0,0060	0,0065	570 (370 – 780)
P3	E/M/A	0.100	2.0	0.034	0.042	0.050	0.065	0.085	0.10	0.11	0.12	0.14	0.16	155 (95 – 210)
		0,100	2,0	0,0013	0,0017	0,0020	0,0026	0,0034	0,0040	0,0044	0,0048	0,0055	0,0065	510 (320 – 680)
P4	E/M/A	0.100	2.0	0.032	0.040	0.048	0.065	0.080	0.095	0.11	0.12	0.14	0.16	135 (84 – 180)
		0,100	2,0	0,0013	0,0016	0,0019	0,0026	0,0032	0,0038	0,0044	0,0048	0,0055	0,0065	445 (280 – 590)
P5	E/M/A	0.100	2.0	0.032	0.040	0.048	0.065	0.080	0.095	0.11	0.12	0.14	0.15	130 (81 – 180)
		0,100	2,0	0,0013	0,0016	0,0019	0,0026	0,0032	0,0038	0,0044	0,0048	0,0055	0,0060	425 (270 – 590)
P6	E/M/A	0.100	2.0	0.032	0.040	0.048	0.065	0.080	0.095	0.11	0.12	0.13	0.15	145 (90 – 200)
		0,100	2,0	0,0013	0,0016	0,0019	0,0026	0,0032	0,0038	0,0044	0,0048	0,0050	0,0060	475 (300 – 650)
P7	E/M/A	0.100	2.0	0.032	0.040	0.048	0.065	0.080	0.095	0.11	0.12	0.13	0.15	140 (85 – 190)
		0,100	2,0	0,0013	0,0016	0,0019	0,0026	0,0032	0,0038	0,0044	0,0048	0,0050	0,0060	460 (280 – 620)
P8	E/M/A	0.100	2.0	0.034	0.042	0.050	0.065	0.085	0.10	0.11	0.12	0.14	0.16	130 (80 – 170)
		0,100	2,0	0,0013	0,0017	0,0020	0,0026	0,0034	0,0040	0,0044	0,0048	0,0055	0,0065	425 (270 – 550)
P11	E/M/A	0.100	2.0	0.046	0.060	0.070	0.095	0.12	0.14	0.16	0.17	0.20	0.22	195 (160 – 230)
		0,100	2,0	0,0018	0,0024	0,0028	0,0038	0,0048	0,0055	0,0065	0,0065	0,0080	0,0085	640 (530 – 750)
P12	E/M/A	0.100	2.0	0.032	0.040	0.048	0.065	0.080	0.095	0.11	0.12	0.14	0.15	125 (100 – 140)
		0,100	2,0	0,0013	0,0016	0,0019	0,0026	0,0032	0,0038	0,0044	0,0048	0,0055	0,0060	410 (330 – 450)
M1	E/M/A	0.100	2.0	0.036	0.044	0.055	0.070	0.090	0.10	0.12	0.13	0.15	0.17	150 (130 – 180)
		0,100	2,0	0,0014	0,0017	0,0022	0,0028	0,0036	0,0040	0,0048	0,0050	0,0060	0,0065	490 (430 – 590)
M2	E/M/A	0.100	2.0	0.032	0.040	0.048	0.065	0.080	0.095	0.11	0.12	0.14	0.15	125 (100 – 150)
		0,100	2,0	0,0013	0,0016	0,0019	0,0026	0,0032	0,0038	0,0044	0,0048	0,0055	0,0060	410 (330 – 490)
M3	E/M/A	0.100	2.0	0.032	0.040	0.048	0.065	0.080	0.095	0.11	0.12	0.14	0.15	100 (75 – 120)
		0,100	2,0	0,0013	0,0016	0,0019	0,0026	0,0032	0,0038	0,0044	0,0048	0,0055	0,0060	330 (250 – 390)
M4	E/M/A	0.100	2.0	0.028	0.034	0.042	0.055	0.070	0.085	0.095	0.10	0.12	0.13	75 (58 – 96)
		0,100	2,0	0,0011	0,0013	0,0017	0,0022	0,0028	0,0034	0,0038	0,0040	0,0048	0,0050	245 (200 – 310)
M5	E/M/A	0.100	2.0	0.028	0.034	0.042	0.055	0.070	0.085	0.095	0.10	0.12	0.13	65 (49 – 80)
		0,100	2,0	0,0011	0,0013	0,0017	0,0022	0,0028	0,0034	0,0038	0,0040	0,0048	0,0050	215 (170 – 260)
K1	E/M/A	0.100	2.0	0.036	0.044	0.055	0.070	0.090	0.10	0.12	0.13	0.15	0.17	175 (110 – 240)
		0,100	2,0	0,0014	0,0017	0,0022	0,0028	0,0036	0,0040	0,0048	0,0050	0,0060	0,0065	570 (370 – 780)
K2	E/M/A	0.100	2.0	0.032	0.040	0.048	0.065	0.080	0.095	0.11	0.12	0.14	0.15	155 (97 – 210)
		0,100	2,0	0,0013	0,0016	0,0019	0,0026	0,0032	0,0038	0,0044	0,0048	0,0055	0,0060	510 (320 – 680)
K3	E/M/A	0.100	2.0	0.032	0.040	0.048	0.065	0.080	0.095	0.11	0.12	0.14	0.15	135 (82 – 180)
		0,100	2,0	0,0013	0,0016	0,0019	0,0026	0,0032	0,0038	0,0044	0,0048	0,0055	0,0060	445 (270 – 590)
K4	E/M/A	0.100	2.0	0.032	0.040	0.048	0.065	0.080	0.095	0.11	0.12	0.14	0.15	125 (79 – 170)
		0,100	2,0	0,0013	0,0016	0,0019	0,0026	0,0032	0,0038	0,0044	0,0048	0,0055	0,0060	410 (260 – 550)
K5	E/M/A	0.100	2.0	0.028	0.036	0.044	0.060	0.070	0.085	0.095	0.11	0.12	0.14	75 (48 – 100)
		0,100	2,0	0,0011	0,0014	0,0017	0,0024	0,0028	0,0034	0,0038	0,0044	0,0048	0,0055	245 (160 – 320)
K6	E/M/A	0.100	2.0	0.032	0.040	0.048	0.065	0.080	0.095	0.11	0.12	0.14	0.15	110 (69 – 150)
		0,100	2,0	0,0013	0,0016	0,0019	0,0026	0,0032	0,0038	0,0044	0,0048	0,0055	0,0060	360 (230 – 490)
K7	E/M/A	0.100	2.0	0.028	0.036	0.044	0.060	0.070	0.085	0.095	0.11	0.12	0.14	100 (62 – 130)
		0,100	2,0	0,0011	0,0014	0,0017	0,0024	0,0028	0,0034	0,0038	0,0044	0,0048	0,0055	330 (210 – 420)

For cutting data recalculations, see pages 445 - 452

SMG = Seco material group
Coolant = A=air D=dry E=emulsion M=mist spray
v_c = m/min (sf/min)
f_z = mm (in/tooth)
a_p = mm/DC (in/DC) = factor
a_e = mm/DC (in/DC) = factor
All cutting data are target values

Cutting data – JS520 Side milling

SMG		a _e /DC	a _p /DC	f _z										v _c
				4	5	6	8	10	12	14	16	20	25	
N1	E/M/A	0.100	2.0	0.032	0.040	0.048	0.065	0.080	0.095	0.11	0.12	0.14	0.15	500 (450 – 550)
		0,100	2,0	0,0013	0,0016	0,0019	0,0026	0,0032	0,0038	0,0044	0,0048	0,0055	0,0060	1650 (1500–1800)
N2	E/M/A	0.100	2.0	0.032	0.040	0.048	0.065	0.080	0.095	0.11	0.12	0.14	0.15	320 (290 – 350)
		0,100	2,0	0,0013	0,0016	0,0019	0,0026	0,0032	0,0038	0,0044	0,0048	0,0055	0,0060	1050 (960–1100)
N3	E/M/A	0.100	2.0	0.032	0.040	0.048	0.065	0.080	0.095	0.11	0.12	0.14	0.15	215 (200 – 230)
		0,100	2,0	0,0013	0,0016	0,0019	0,0026	0,0032	0,0038	0,0044	0,0048	0,0055	0,0060	710 (660–750)
N11	E/M/A	0.100	2.0	0.032	0.040	0.048	0.065	0.080	0.095	0.11	0.12	0.14	0.15	400 (350 – 450)
		0,100	2,0	0,0013	0,0016	0,0019	0,0026	0,0032	0,0038	0,0044	0,0048	0,0055	0,0060	1300 (1200–1400)
S1	E/M/A	0.0600	2.0	0.020	0.025	0.030	0.040	0.050	0.060	0.065	0.075	0.085	0.095	75 (63 – 86)
		0,0600	2,0	0,00080	0,0010	0,0012	0,0016	0,0020	0,0024	0,0026	0,0030	0,0034	0,0038	245 (210 – 280)
S2	E/M/A	0.0600	2.0	0.020	0.025	0.030	0.040	0.050	0.060	0.065	0.075	0.085	0.095	60 (50 – 70)
		0,0600	2,0	0,00080	0,0010	0,0012	0,0016	0,0020	0,0024	0,0026	0,0030	0,0034	0,0038	195 (170 – 220)
S3	E/M/A	0.0600	2.0	0.020	0.025	0.030	0.040	0.050	0.060	0.065	0.075	0.085	0.095	40 (30 – 49)
		0,0600	2,0	0,00080	0,0010	0,0012	0,0016	0,0020	0,0024	0,0026	0,0030	0,0034	0,0038	130 (99–160)
S11	E/M/A	0.100	2.0	0.032	0.040	0.048	0.065	0.080	0.095	0.11	0.12	0.14	0.15	105 (92–110)
		0,100	2,0	0,0013	0,0016	0,0019	0,0026	0,0032	0,0038	0,0044	0,0048	0,0055	0,0060	345 (310 – 360)
S12	E/M/A	0.100	2.0	0.032	0.040	0.048	0.065	0.080	0.095	0.11	0.12	0.14	0.15	80 (71 – 90)
		0,100	2,0	0,0013	0,0016	0,0019	0,0026	0,0032	0,0038	0,0044	0,0048	0,0055	0,0060	260 (240 – 290)
S13	E/M/A	0.100	2.0	0.028	0.034	0.042	0.055	0.070	0.085	0.095	0.10	0.12	0.13	65 (56–71)
		0,100	2,0	0,0011	0,0013	0,0017	0,0022	0,0028	0,0034	0,0038	0,0040	0,0048	0,0050	215 (190 – 230)
H5	M/A	0.0600	2.0	0.030	0.038	0.046	0.060	0.075	0.090	0.10	0.11	0.13	0.14	125 (64–180)
		0,0600	2,0	0,0012	0,0015	0,0018	0,0024	0,0030	0,0036	0,0040	0,0044	0,0050	0,0055	410 (210 – 590)
H8	M/A	0.0600	2.0	0.024	0.028	0.034	0.046	0.060	0.070	0.075	0.085	0.10	0.11	130 (66–190)
		0,0600	2,0	0,00095	0,0011	0,0013	0,0018	0,0024	0,0028	0,0030	0,0034	0,0040	0,0044	425 (220 – 620)
H11	M/A	0.0600	2.0	0.030	0.038	0.046	0.060	0.075	0.090	0.10	0.11	0.13	0.14	160 (81 – 240)
		0,0600	2,0	0,0012	0,0015	0,0018	0,0024	0,0030	0,0036	0,0040	0,0044	0,0050	0,0055	520 (270–780)
H12	M/A	0.0600	2.0	0.024	0.028	0.034	0.046	0.060	0.070	0.075	0.085	0.10	0.11	150 (76 – 220)
		0,0600	2,0	0,00095	0,0011	0,0013	0,0018	0,0024	0,0028	0,0030	0,0034	0,0040	0,0044	490 (250–720)
H21	M/A	0.0600	2.0	0.024	0.028	0.034	0.046	0.060	0.070	0.075	0.085	0.10	0.11	130 (66–190)
		0,0600	2,0	0,00095	0,0011	0,0013	0,0018	0,0024	0,0028	0,0030	0,0034	0,0040	0,0044	425 (220 – 620)
H31	M/A	0.0600	2.0	0.020	0.025	0.030	0.040	0.050	0.060	0.065	0.075	0.085	0.095	100 (51–150)
		0,0600	2,0	0,00080	0,0010	0,0012	0,0016	0,0020	0,0024	0,0026	0,0030	0,0034	0,0038	330 (170 – 490)
TS1	A/D	0.100	2.0	0.032	0.040	0.048	0.065	0.080	0.095	0.11	0.12	0.14	0.15	500 (450 – 550)
		0,100	2,0	0,0013	0,0016	0,0019	0,0026	0,0032	0,0038	0,0044	0,0048	0,0055	0,0060	1650 (1500–1800)
TP1	A/D	0.100	2.0	0.032	0.040	0.048	0.065	0.080	0.095	0.11	0.12	0.14	0.15	395 (350 – 440)
		0,100	2,0	0,0013	0,0016	0,0019	0,0026	0,0032	0,0038	0,0044	0,0048	0,0055	0,0060	1300 (1200–1400)
GR1	A/D	0.100	2.0	0.032	0.040	0.048	0.065	0.080	0.095	0.11	0.12	0.14	0.15	500 (450 – 550)
		0,100	2,0	0,0013	0,0016	0,0019	0,0026	0,0032	0,0038	0,0044	0,0048	0,0055	0,0060	1650 (1500–1800)

For cutting data recalculations, see pages 445 - 452

SMG = Seco material group
 Coolant = A=air D=dry E=emulsion M=mist spray
 v_c = m/min (sf/min)
 f_z = mm (in/tooth)
 a_p = mm/DC (in/DC) = factor
 a_e = mm/DC (in/DC) = factor
 All cutting data are target values

Universal
 Steel and cast iron
 Stainless steel and S-materials
 Non ferrous
 Hard
 Plastic and chip
 Graphite
 Mimimaster Plus
 Mimimaster

JS522

High performance – Universal – Square – 2 Flutes – High shoulder – Cylindrical – Corner radius

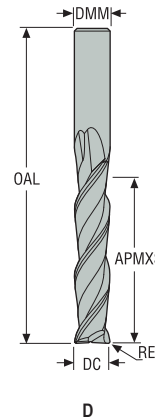

- Tolerances:
- Run-out= Ø6-Ø8 <0,01, Ø10-Ø12 <0,015, Ø16-Ø32 <0,02
- DMM= h5
- DC= -0,02/-0,04 mm
- RE= 0,1+0,1 mm, RE= 0,5 ±0,03 mm
- RE= 3,1 ±0,05 mm, RE= 4 ±0,05 mm
- RE= 6 ±0,05 mm

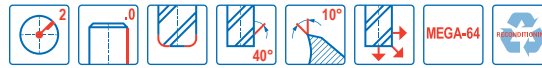

Designation	Item number	Length index	Tool shape	DC	DMM	APMXS	OAL	RE	PCEDC	Cylindrical
				mm	mm	mm	mm	mm		
522060R010Z2.0-MEGA-64	02747756	4	D	6,0	6,0	30,0	80,0	0,1	2	■
522080R010Z2.0-MEGA-64	02747763	4	D	8,0	8,0	40,0	85,0	0,1	2	■
522100R010Z2.0-MEGA-64	02747765	4	D	10,0	10,0	50,0	100,0	0,1	2	■
522120R010Z2.0-MEGA-64	02747766	4	D	12,0	12,0	60,0	115,0	0,1	2	■
522160R050Z2.0-MEGA-64	02747767	4	D	16,0	16,0	80,0	150,0	0,5	2	■
522160R310Z2.0-MEGA-64	02747768	4	D	16,0	16,0	80,0	150,0	3,1	2	■
JS522160D4R600.0Z2-M64	03093681	4	D	16,0	16,0	80,0	150,0	6,0	2	■
522200R050Z2.0-MEGA-64	02747769	4	D	20,0	20,0	100,0	175,0	0,5	2	■
522200R310Z2.0-MEGA-64	02747770	4	D	20,0	20,0	100,0	175,0	3,1	2	■
JS522200D4R600.0Z2-M64	03093682	4	D	20,0	20,0	100,0	175,0	6,0	2	■
522250R050Z2.0-MEGA-64	02747771	4	D	25,0	25,0	125,0	205,0	0,5	2	■
522250R310Z2.0-MEGA-64	02747772	4	D	25,0	25,0	125,0	205,0	3,1	2	■
522250R400Z2.0-MEGA-64	02747773	4	D	25,0	25,0	125,0	205,0	4,0	2	■
JS522250D4R600.0Z2-M64	03093683	4	D	25,0	25,0	125,0	205,0	6,0	2	■
522320R050Z2.0-MEGA-64	02747774	4	D	32,0	32,0	160,0	245,0	0,5	2	■
522320R400Z2.0-MEGA-64	02747775	4	D	32,0	32,0	160,0	245,0	4,0	2	■
JS522320D4R600.0Z2-M64	03093684	4	D	32,0	32,0	160,0	245,0	6,0	2	■

■ Stocked standard.

*JS522 long flute finisher, with its special geometry designed to machine high shoulders with excellent surface finish and perpendicularity.

Cutting data – JS522 Side milling semi finishing

SMG		a _p /DC	a _e /DC	f _z								v _c
				6	8	10	12	16	20	25	32	
P1	E/M/A	0.0500	4.0	0.046	0.060	0.075	0.090	0.11	0.13	0.14	0.16	160 (140–170)
		0,0500	4,0	0,0018	0,0024	0,0030	0,0036	0,0044	0,0050	0,0055	0,0065	520 (460 – 550)
P2	E/M/A	0.0500	4.0	0.046	0.060	0.075	0.090	0.11	0.13	0.15	0.17	155 (140–170)
		0,0500	4,0	0,0018	0,0024	0,0030	0,0036	0,0044	0,0050	0,0060	0,0065	510 (460 – 550)
P3	E/M/A	0.0500	4.0	0.044	0.060	0.075	0.085	0.11	0.12	0.14	0.16	165 (150–180)
		0,0500	4,0	0,0017	0,0024	0,0030	0,0034	0,0044	0,0048	0,0055	0,0065	540 (500 – 590)
P4	E/M/A	0.0500	4.0	0.042	0.055	0.070	0.085	0.10	0.12	0.14	0.15	145 (130–160)
		0,0500	4,0	0,0017	0,0022	0,0028	0,0034	0,0040	0,0048	0,0055	0,0060	475 (430 – 520)
P5	E/M/A	0.0500	4.0	0.042	0.055	0.070	0.085	0.10	0.12	0.13	0.15	140 (130–160)
		0,0500	4,0	0,0017	0,0022	0,0028	0,0034	0,0040	0,0048	0,0050	0,0060	460 (430 – 520)
P6	E/M/A	0.0500	4.0	0.042	0.055	0.070	0.080	0.10	0.12	0.13	0.15	120 (110–140)
		0,0500	4,0	0,0017	0,0022	0,0028	0,0032	0,0040	0,0048	0,0050	0,0060	395 (370 – 450)
P7	E/M/A	0.0500	4.0	0.042	0.055	0.070	0.080	0.10	0.12	0.13	0.15	115 (95–130)
		0,0500	4,0	0,0017	0,0022	0,0028	0,0032	0,0040	0,0048	0,0050	0,0060	375 (320 – 420)
P8	E/M/A	0.0500	4.0	0.044	0.060	0.075	0.085	0.11	0.12	0.14	0.16	105 (89–120)
		0,0500	4,0	0,0017	0,0024	0,0030	0,0034	0,0044	0,0048	0,0055	0,0065	345 (300 – 390)
P11	E/M/A	0.0500	4.0	0.060	0.080	0.10	0.12	0.15	0.17	0.20	0.22	105 (87–120)
		0,0500	4,0	0,0024	0,0032	0,0040	0,0048	0,0060	0,0065	0,0080	0,0085	345 (290 – 390)
P12	E/M/A	0.0500	4.0	0.042	0.055	0.070	0.085	0.10	0.12	0.13	0.15	65 (55–75)
		0,0500	4,0	0,0017	0,0022	0,0028	0,0034	0,0040	0,0048	0,0050	0,0060	215 (190 – 240)
M1	E/M/A	0.0500	4.0	0.046	0.060	0.075	0.090	0.11	0.13	0.15	0.17	110 (86–130)
		0,0500	4,0	0,0018	0,0024	0,0030	0,0036	0,0044	0,0050	0,0060	0,0065	360 (290 – 420)
M2	E/M/A	0.0500	4.0	0.042	0.055	0.070	0.085	0.10	0.12	0.13	0.15	90 (71–110)
		0,0500	4,0	0,0017	0,0022	0,0028	0,0034	0,0040	0,0048	0,0050	0,0060	295 (240 – 360)
M3	E/M/A	0.0500	4.0	0.042	0.055	0.070	0.085	0.10	0.12	0.13	0.15	80 (61–100)
		0,0500	4,0	0,0017	0,0022	0,0028	0,0034	0,0040	0,0048	0,0050	0,0060	260 (210 – 320)
M4	E/M/A	0.0500	4.0	0.036	0.048	0.060	0.070	0.090	0.10	0.12	0.13	60 (47–76)
		0,0500	4,0	0,0014	0,0019	0,0024	0,0028	0,0036	0,0040	0,0048	0,0050	195 (160 – 240)
M5	E/M/A	0.0500	4.0	0.036	0.048	0.060	0.070	0.090	0.10	0.12	0.13	50 (39–63)
		0,0500	4,0	0,0014	0,0019	0,0024	0,0028	0,0036	0,0040	0,0048	0,0050	165 (130 – 200)
K1	E/M/A	0.0500	4.0	0.046	0.060	0.075	0.090	0.11	0.13	0.15	0.17	120 (100–130)
		0,0500	4,0	0,0018	0,0024	0,0030	0,0036	0,0044	0,0050	0,0060	0,0065	395 (330 – 420)
K2	E/M/A	0.0500	4.0	0.042	0.055	0.070	0.085	0.10	0.12	0.13	0.15	105 (87–120)
		0,0500	4,0	0,0017	0,0022	0,0028	0,0034	0,0040	0,0048	0,0050	0,0060	345 (290 – 390)
K3	E/M/A	0.0500	4.0	0.042	0.055	0.070	0.085	0.10	0.12	0.13	0.15	90 (74–100)
		0,0500	4,0	0,0017	0,0022	0,0028	0,0034	0,0040	0,0048	0,0050	0,0060	295 (250 – 320)
K4	E/M/A	0.0500	4.0	0.042	0.055	0.070	0.085	0.10	0.12	0.13	0.15	85 (71–98)
		0,0500	4,0	0,0017	0,0022	0,0028	0,0034	0,0040	0,0048	0,0050	0,0060	280 (240 – 320)
K5	E/M/A	0.0500	4.0	0.038	0.050	0.065	0.075	0.090	0.11	0.12	0.14	100 (81–120)
		0,0500	4,0	0,0015	0,0020	0,0026	0,0030	0,0036	0,0044	0,0048	0,0055	330 (270 – 390)
K6	E/M/A	0.0500	4.0	0.042	0.055	0.070	0.085	0.10	0.12	0.13	0.15	150 (120–170)
		0,0500	4,0	0,0017	0,0022	0,0028	0,0034	0,0040	0,0048	0,0050	0,0060	490 (400 – 550)
K7	E/M/A	0.0500	4.0	0.038	0.050	0.065	0.075	0.090	0.11	0.12	0.14	130 (110–150)
		0,0500	4,0	0,0015	0,0020	0,0026	0,0030	0,0036	0,0044	0,0048	0,0055	425 (370 – 490)

For cutting data recalculations, see pages 445 - 452

SMG = Seco material group
 Coolant = A=air D=dry E=emulsion M=mist spray
 v_c = m/min (sf/min)
 f_z = mm (in/tooth)
 a_p = mm/DC (in/DC) = factor
 a_e = mm/DC (in/DC) = factor
 All cutting data are target values

Universal
 Steel and cast iron
 Stainless steel and S-materials
 Non ferrous
 Hard
 Plastic and chip
 Graphite
 Mimimaster Plus
 Mimimaster

Cutting data – JS522 Side milling semi finishing

Universal	SMG	Coolant	a _p /DC	a _p /DC	f _z							v _c	
					6	8	10	12	16	20	25		32
Steel and cast iron	N1	E/M/A	0.0500	4.0	0.042	0.055	0.070	0.085	0.10	0.12	0.13	0.15	400 (310 – 500)
			0,0500	4,0	0,0017	0,0022	0,0028	0,0034	0,0040	0,0048	0,0050	0,0060	1300 (1100–1600)
Steel and cast iron	N2	E/M/A	0.0500	4.0	0.042	0.055	0.070	0.085	0.10	0.12	0.13	0.15	300 (210 – 400)
			0,0500	4,0	0,0017	0,0022	0,0028	0,0034	0,0040	0,0048	0,0050	0,0060	980 (690–1300)
Steel and cast iron	N3	E/M/A	0.0500	4.0	0.042	0.055	0.070	0.085	0.10	0.12	0.13	0.15	200 (140 – 260)
			0,0500	4,0	0,0017	0,0022	0,0028	0,0034	0,0040	0,0048	0,0050	0,0060	660 (460 – 850)
Steel and cast iron	N11	E/M/A	0.0500	4.0	0.042	0.055	0.070	0.085	0.10	0.12	0.13	0.15	300 (260 – 350)
			0,0500	4,0	0,0017	0,0022	0,0028	0,0034	0,0040	0,0048	0,0050	0,0060	980 (860–1100)
Steel and cast iron	S1	E/M/A	0.0500	4.0	0.018	0.024	0.030	0.036	0.044	0.050	0.055	0.065	48 (39 – 57)
			0,0500	4,0	0,00070	0,00095	0,0012	0,0014	0,0017	0,0020	0,0022	0,0026	155 (130–180)
Steel and cast iron	S2	E/M/A	0.0500	4.0	0.018	0.024	0.030	0.036	0.044	0.050	0.055	0.065	39 (31 – 46)
			0,0500	4,0	0,00070	0,00095	0,0012	0,0014	0,0017	0,0020	0,0022	0,0026	130 (110–150)
Stainless steel and S-materials	S3	E/M/A	0.0300	4.0	0.018	0.024	0.030	0.036	0.044	0.050	0.055	0.065	42 (32 – 51)
			0,0300	4,0	0,00070	0,00095	0,0012	0,0014	0,0017	0,0020	0,0022	0,0026	140 (110–160)
Stainless steel and S-materials	S11	E/M/A	0.0500	4.0	0.042	0.055	0.070	0.085	0.10	0.12	0.13	0.15	125 (100–140)
			0,0500	4,0	0,0017	0,0022	0,0028	0,0034	0,0040	0,0048	0,0050	0,0060	410 (330–450)
Stainless steel and S-materials	S12	E/M/A	0.0500	4.0	0.042	0.055	0.070	0.085	0.10	0.12	0.13	0.15	95 (77–110)
			0,0500	4,0	0,0017	0,0022	0,0028	0,0034	0,0040	0,0048	0,0050	0,0060	310 (260–360)
Stainless steel and S-materials	S13	E/M/A	0.0500	4.0	0.036	0.048	0.060	0.070	0.090	0.10	0.12	0.13	75 (61 – 90)
			0,0500	4,0	0,0014	0,0019	0,0024	0,0028	0,0036	0,0040	0,0048	0,0050	245 (210–290)
Non ferrous	TS1	A/D	0.0500	4.0	0.042	0.055	0.070	0.085	0.10	0.12	0.13	0.15	500 (410 – 600)
			0,0500	4,0	0,0017	0,0022	0,0028	0,0034	0,0040	0,0048	0,0050	0,0060	1650 (1400–1900)
			0.0500	4.0	0.042	0.055	0.070	0.085	0.10	0.12	0.13	0.15	400 (310 – 500)
Non ferrous	TP1	A/D	0.0500	4.0	0.042	0.055	0.070	0.085	0.10	0.12	0.13	0.15	400 (310 – 500)
			0,0500	4,0	0,0017	0,0022	0,0028	0,0034	0,0040	0,0048	0,0050	0,0060	1300 (1100–1600)
			0.0500	4.0	0.042	0.055	0.070	0.085	0.10	0.12	0.13	0.15	500 (410 – 600)
Non ferrous	GR1	A/D	0.0500	4.0	0.042	0.055	0.070	0.085	0.10	0.12	0.13	0.15	500 (410 – 600)
			0,0500	4,0	0,0017	0,0022	0,0028	0,0034	0,0040	0,0048	0,0050	0,0060	1650 (1400–1900)
			0.0500	4.0	0.042	0.055	0.070	0.085	0.10	0.12	0.13	0.15	500 (410 – 600)

For cutting data recalculations, see pages 445 - 452

SMG = Seco material group
Coolant = A=air D=dry E=emulsion M=mist spray
v_c = m/min (sf/min)
f_z = mm (in/tooth)
a_p = mm/DC (in/DC) = factor
a_e = mm/DC (in/DC) = factor
All cutting data are target values

JS532

High performance – Universal – Ball nose – 2 Flutes – Cylindrical

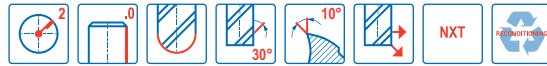
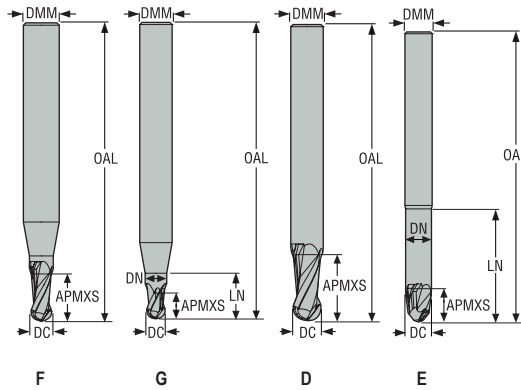

- Tolerances:
- DMM=h5
- DC=e8
- RE= ±0,01 mm
- Regrind possible if DC is ≥Ø6

Designation	Item number	Length index	Tool shape	DC	DMM	APMXS	OAL	LN	DN	RE	PCEDC	Cylindrical
				mm	mm	mm	mm	mm	mm	mm	mm	
JS532010F1B.0Z2-NXT	02928193	1	F	1,0	3,0	2,0	38,0	3,1	1,0	0,5	2	■
JS532015F1B.0Z2-NXT	02928194	1	F	1,5	3,0	3,0	38,0	4,6	1,5	0,75	2	■
JS532020F1B.0Z2-NXT	02928195	1	F	2,0	3,0	4,0	38,0	6,1	2,0	1,0	2	■
JS532025F1B.0Z2-NXT	02928197	1	F	2,5	3,0	5,0	38,0	7,1	2,5	1,25	2	■
JS532030D1B.0Z2-NXT	02928199	1	D	3,0	3,0	6,0	38,0	-	-	1,5	2	■
JS532035F1B.0Z2-NXT	02928202	1	F	3,5	6,0	7,0	57,0	9,6	3,5	1,75	2	■
JS532040F1B.0Z2-NXT	02928203	1	F	4,0	6,0	8,0	57,0	10,75	4,0	2,0	2	■
JS532045F1B.0Z2-NXT	02928206	1	F	4,5	6,0	9,0	57,0	11,75	4,5	2,25	2	■
JS532050F1B.0Z2-NXT	02928207	1	F	5,0	6,0	10,0	57,0	12,75	5,0	2,5	2	■
JS532060D1B.0Z2-NXT	02928210	1	D	6,0	6,0	12,0	57,0	-	-	3,0	2	■
JS532080D1B.0Z2-NXT	02928213	1	D	8,0	8,0	16,0	63,0	-	-	4,0	2	■
JS532100D1B.0Z2-NXT	02928216	1	D	10,0	10,0	20,0	72,0	-	-	5,0	2	■
JS532120D1B.0Z2-NXT	02928219	1	D	12,0	12,0	24,0	83,0	-	-	6,0	2	■
JS532160D1B.0Z2-NXT	02928222	1	D	16,0	16,0	32,0	92,0	-	-	8,0	2	■
JS532200D1B.0Z2-NXT	02928225	1	D	20,0	20,0	40,0	104,0	-	-	10,0	2	■
JS532020G2B.0Z2-NXT	02928196	2	G	2,0	3,0	2,0	38,0	8,0	1,9	1,0	2	■
JS532030E2B.0Z2-NXT	02928200	2	E	3,0	3,0	3,0	38,0	10,0	2,85	1,5	2	■
JS532040G2B.0Z2-NXT	02928204	2	G	4,0	6,0	4,0	57,0	15,0	3,8	2,0	2	■
JS532050G2B.0Z2-NXT	02928208	2	G	5,0	6,0	5,0	57,0	20,0	4,8	2,5	2	■
JS532060E2B.0Z2-NXT	02928211	2	E	6,0	6,0	6,0	63,0	25,0	5,7	3,0	2	■
JS532080E2B.0Z2-NXT	02928214	2	E	8,0	8,0	8,0	80,0	35,0	7,6	4,0	2	■
JS532100E2B.0Z2-NXT	02928217	2	E	10,0	10,0	10,0	82,0	40,0	9,5	5,0	2	■
JS532120E2B.0Z2-NXT	02928220	2	E	12,0	12,0	12,0	100,0	50,0	11,4	6,0	2	■
JS532160E2B.0Z2-NXT	02928223	2	E	16,0	16,0	16,0	125,0	72,0	15,2	8,0	2	■
JS532030E3B.0Z2-NXT	02928201	3	E	3,0	3,0	3,0	52,0	20,0	2,85	1,5	2	■
JS532040G3B.0Z2-NXT	02928205	3	G	4,0	6,0	4,0	63,0	24,0	3,8	2,0	2	■
JS532050G3B.0Z2-NXT	02928209	3	G	5,0	6,0	5,0	75,0	35,0	4,8	2,5	2	■
JS532060E3B.0Z2-NXT	02928212	3	E	6,0	6,0	6,0	80,0	42,0	5,7	3,0	2	■
JS532080E3B.0Z2-NXT	02928215	3	E	8,0	8,0	8,0	100,0	60,0	7,6	4,0	2	■
JS532100E3B.0Z2-NXT	02928218	3	E	10,0	10,0	10,0	125,0	80,0	9,5	5,0	2	■
JS532120E3B.0Z2-NXT	02928221	3	E	12,0	12,0	12,0	125,0	75,0	11,4	6,0	2	■
JS532160E3B.0Z2-NXT	02928224	3	E	16,0	16,0	16,0	150,0	100,0	15,2	8,0	2	■

■ Stocked standard.

Universal

Steel and cast iron

Stainless steel and S-materials

Non ferrous

Hard

Plastic and chip

Graphite

Minimaster Plus

Minimaster

JS532

High performance – Universal – Ball nose – 2 Flutes – Weldon

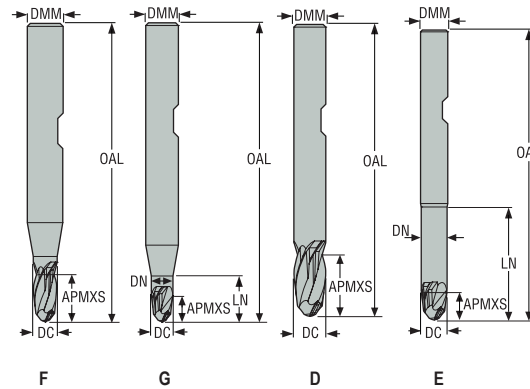

- Tolerances:
- DMM=h5
- DC=e8
- RE= ±0,01 mm
- Regrind possible if DC is ≥Ø6

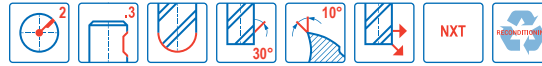

Designation	Item number	Length index	Tool shape	DC	DMM	APMXS	OAL	LN	DN	RE	PCEDC	Weldon
				mm	mm	mm	mm	mm	mm	mm		
JS532035F1B.3Z2-NXT	02928254	1	F	3,5	6,0	7,0	57,0	9,6	3,5	1,75	2	<input type="checkbox"/>
JS532040F1B.3Z2-NXT	02928255	1	F	4,0	6,0	8,0	57,0	10,75	4,0	2,0	2	<input type="checkbox"/>
JS532045F1B.3Z2-NXT	02928258	1	F	4,5	6,0	9,0	57,0	11,75	4,5	2,25	2	<input type="checkbox"/>
JS532050F1B.3Z2-NXT	02928259	1	F	5,0	6,0	10,0	57,0	12,75	5,0	2,5	2	<input type="checkbox"/>
JS532060D1B.3Z2-NXT	02928263	1	D	6,0	6,0	12,0	57,0	-	-	3,0	2	<input type="checkbox"/>
JS532080D1B.3Z2-NXT	02928266	1	D	8,0	8,0	16,0	63,0	-	-	4,0	2	<input type="checkbox"/>
JS532100D1B.3Z2-NXT	02928269	1	D	10,0	10,0	20,0	72,0	-	-	5,0	2	<input type="checkbox"/>
JS532120D1B.3Z2-NXT	02928272	1	D	12,0	12,0	24,0	83,0	-	-	6,0	2	<input type="checkbox"/>
JS532160D1B.3Z2-NXT	02928275	1	D	16,0	16,0	32,0	92,0	-	-	8,0	2	<input type="checkbox"/>
JS532200D1B.3Z2-NXT	02928278	1	D	20,0	20,0	40,0	104,0	-	-	10,0	2	<input type="checkbox"/>
JS532040G2B.3Z2-NXT	02928256	2	G	4,0	6,0	4,0	57,0	18,0	3,8	2,0	2	<input type="checkbox"/>
JS532050G2B.3Z2-NXT	02928260	2	G	5,0	6,0	5,0	57,0	18,0	4,8	2,5	2	<input type="checkbox"/>
JS532060E2B.3Z2-NXT	02928264	2	E	6,0	6,0	6,0	63,0	25,0	5,7	3,0	2	<input type="checkbox"/>
JS532080E2B.3Z2-NXT	02928267	2	E	8,0	8,0	8,0	80,0	35,0	7,6	4,0	2	<input type="checkbox"/>
JS532100E2B.3Z2-NXT	02928270	2	E	10,0	10,0	10,0	82,0	40,0	9,5	5,0	2	<input type="checkbox"/>
JS532120E2B.3Z2-NXT	02928273	2	E	12,0	12,0	12,0	100,0	50,0	11,4	6,0	2	<input type="checkbox"/>
JS532160E2B.3Z2-NXT	02928276	2	E	16,0	16,0	16,0	125,0	70,0	15,2	8,0	2	<input type="checkbox"/>
JS532040G3B.3Z2-NXT	02928257	3	G	4,0	6,0	4,0	63,0	24,0	3,8	2,0	2	<input type="checkbox"/>
JS532050G3B.3Z2-NXT	02928261	3	G	5,0	6,0	5,0	75,0	35,0	4,8	2,5	2	<input type="checkbox"/>
JS532060E3B.3Z2-NXT	02928265	3	E	6,0	6,0	6,0	80,0	42,0	5,7	3,0	2	<input type="checkbox"/>
JS532080E3B.3Z2-NXT	02928268	3	E	8,0	8,0	8,0	100,0	60,0	7,6	4,0	2	<input type="checkbox"/>
JS532100E3B.3Z2-NXT	02928271	3	E	10,0	10,0	10,0	125,0	80,0	9,5	5,0	2	<input type="checkbox"/>
JS532120E3B.3Z2-NXT	02928274	3	E	12,0	12,0	12,0	125,0	75,0	11,4	6,0	2	<input type="checkbox"/>
JS532160E3B.3Z2-NXT	02928277	3	E	16,0	16,0	16,0	150,0	100,0	15,2	8,0	2	<input type="checkbox"/>

Weldon available. Delivery time is 3 days.

Cutting data – JS532 Copy milling roughing

SMG		a _e /DC	a _p /DC	f _z												v _c
				1	2	3	4	5	6	8	10	12	16	20		
P1	M/A/D/E	0.200	0.20	0.0060	0.012	0.018	0.024	0.030	0.036	0.048	0.060	0.070	0.095	0.11	205 (140–180)	
		0.200	0.20	0.00024	0.00048	0.00070	0.00095	0.0012	0.0014	0.0019	0.0024	0.0028	0.0038	0.0044	670 (460 – 590)	
P2	M/A/D/E	0.200	0.20	0.0060	0.012	0.018	0.024	0.030	0.036	0.048	0.060	0.070	0.095	0.11	200 (130–180)	
		0.200	0.20	0.00024	0.00048	0.00070	0.00095	0.0012	0.0014	0.0019	0.0024	0.0028	0.0038	0.0044	660 (430 – 590)	
P3	M/A/D/E	0.200	0.20	0.0060	0.012	0.018	0.024	0.030	0.036	0.048	0.060	0.070	0.095	0.11	170 (110–150)	
		0.200	0.20	0.00024	0.00048	0.00070	0.00095	0.0012	0.0014	0.0019	0.0024	0.0028	0.0038	0.0044	560 (370 – 490)	
P4	M/A/D/E	0.200	0.20	0.0060	0.012	0.018	0.024	0.030	0.036	0.048	0.060	0.070	0.095	0.10	150 (97–130)	
		0.200	0.20	0.00024	0.00048	0.00070	0.00095	0.0012	0.0014	0.0019	0.0024	0.0028	0.0038	0.0040	490 (320 – 420)	
P5	M/A/D/E	0.200	0.20	0.0060	0.012	0.018	0.024	0.030	0.036	0.048	0.060	0.070	0.090	0.10	145 (93–130)	
		0.200	0.20	0.00024	0.00048	0.00070	0.00095	0.0012	0.0014	0.0019	0.0024	0.0028	0.0036	0.0040	475 (310 – 420)	
P6	M/A/D/E	0.200	0.20	0.0060	0.012	0.018	0.024	0.030	0.036	0.048	0.060	0.070	0.090	0.10	160 (110–140)	
		0.200	0.20	0.00024	0.00048	0.00070	0.00095	0.0012	0.0014	0.0019	0.0024	0.0028	0.0036	0.0040	520 (370 – 450)	
P7	M/A/D/E	0.200	0.20	0.0060	0.012	0.018	0.024	0.030	0.036	0.048	0.060	0.070	0.090	0.10	150 (98–140)	
		0.200	0.20	0.00024	0.00048	0.00070	0.00095	0.0012	0.0014	0.0019	0.0024	0.0028	0.0036	0.0040	490 (330 – 450)	
P8	M/A/D/E	0.200	0.20	0.0060	0.012	0.018	0.024	0.030	0.036	0.048	0.060	0.070	0.095	0.11	145 (93–130)	
		0.200	0.20	0.00024	0.00048	0.00070	0.00095	0.0012	0.0014	0.0019	0.0024	0.0028	0.0038	0.0044	475 (310 – 420)	
P11	M/A/D/E	0.100	0.10	0.0060	0.012	0.018	0.024	0.030	0.036	0.048	0.060	0.070	0.095	0.12	170 (110–150)	
		0.100	0.10	0.00024	0.00048	0.00070	0.00095	0.0012	0.0014	0.0019	0.0024	0.0028	0.0038	0.0048	560 (370 – 490)	
P12	M/A/D/E	0.100	0.10	0.0060	0.012	0.018	0.024	0.030	0.036	0.048	0.060	0.070	0.095	0.12	100 (64 – 92)	
		0.100	0.10	0.00024	0.00048	0.00070	0.00095	0.0012	0.0014	0.0019	0.0024	0.0028	0.0038	0.0048	330 (210 – 300)	
M1	E	0.100	0.10	0.0060	0.012	0.018	0.024	0.030	0.036	0.048	0.060	0.070	0.095	0.12	195 (170 – 220)	
		0.100	0.10	0.00024	0.00048	0.00070	0.00095	0.0012	0.0014	0.0019	0.0024	0.0028	0.0038	0.0048	640 (560–720)	
M2	E	0.100	0.10	0.0060	0.012	0.018	0.024	0.030	0.036	0.048	0.060	0.070	0.095	0.12	115 (93–130)	
		0.100	0.10	0.00024	0.00048	0.00070	0.00095	0.0012	0.0014	0.0019	0.0024	0.0028	0.0038	0.0048	375 (310 – 420)	
M3	E	0.100	0.10	0.0050	0.010	0.015	0.020	0.025	0.030	0.040	0.050	0.060	0.080	0.095	95 (73–110)	
		0.100	0.10	0.00020	0.00040	0.00060	0.00080	0.0010	0.0012	0.0016	0.0020	0.0024	0.0032	0.0038	310 (240 – 360)	
M4	E	0.100	0.10	0.0048	0.0095	0.014	0.019	0.024	0.028	0.038	0.048	0.055	0.070	0.080	70 (55 – 85)	
		0.100	0.10	0.00019	0.00038	0.00055	0.00075	0.00095	0.0011	0.0015	0.0019	0.0022	0.0028	0.0032	230 (190 – 270)	
M5	E	0.100	0.10	0.0048	0.0095	0.014	0.019	0.024	0.028	0.038	0.048	0.055	0.070	0.080	60 (46–71)	
		0.100	0.10	0.00019	0.00038	0.00055	0.00075	0.00095	0.0011	0.0015	0.0019	0.0022	0.0028	0.0032	195 (160 – 230)	
K1	E	0.200	0.20	0.0060	0.012	0.018	0.024	0.030	0.036	0.048	0.060	0.070	0.090	0.10	195 (180 – 210)	
		0.200	0.20	0.00024	0.00048	0.00070	0.00095	0.0012	0.0014	0.0019	0.0024	0.0028	0.0036	0.0040	640 (600 – 680)	
K2	E	0.200	0.20	0.0055	0.011	0.016	0.022	0.028	0.032	0.044	0.055	0.065	0.085	0.095	170 (160–180)	
		0.200	0.20	0.00022	0.00044	0.00065	0.00085	0.0011	0.0013	0.0017	0.0022	0.0026	0.0034	0.0038	560 (530 – 590)	
K3	E	0.200	0.20	0.0055	0.011	0.016	0.022	0.028	0.032	0.044	0.055	0.065	0.085	0.095	145 (130–150)	
		0.200	0.20	0.00022	0.00044	0.00065	0.00085	0.0011	0.0013	0.0017	0.0022	0.0026	0.0034	0.0038	475 (430 – 490)	
K4	E	0.200	0.20	0.0055	0.011	0.016	0.022	0.028	0.032	0.044	0.055	0.065	0.085	0.095	140 (130–150)	
		0.200	0.20	0.00022	0.00044	0.00065	0.00085	0.0011	0.0013	0.0017	0.0022	0.0026	0.0034	0.0038	460 (430 – 490)	
K5	E	0.100	0.10	0.0050	0.010	0.015	0.020	0.025	0.030	0.040	0.050	0.060	0.080	0.095	165 (150–180)	
		0.100	0.10	0.00020	0.00040	0.00060	0.00080	0.0010	0.0012	0.0016	0.0020	0.0024	0.0032	0.0038	540 (500 – 590)	
K6	E	0.100	0.10	0.0050	0.010	0.015	0.020	0.025	0.030	0.040	0.050	0.060	0.080	0.10	245 (220 – 270)	
		0.100	0.10	0.00020	0.00040	0.00060	0.00080	0.0010	0.0012	0.0016	0.0020	0.0024	0.0032	0.0040	800 (730 – 880)	
K7	E	0.100	0.10	0.0050	0.010	0.015	0.020	0.025	0.030	0.040	0.050	0.060	0.080	0.095	210 (190 – 230)	
		0.100	0.10	0.00020	0.00040	0.00060	0.00080	0.0010	0.0012	0.0016	0.0020	0.0024	0.0032	0.0038	690 (630–750)	

For cutting data recalculations, see pages 445 - 452

SMG = Seco material group
 Coolant = A=air D=dry E=emulsion M=mist spray
 v_c = m/min (sf/min)
 f_z = mm (in/tooth)
 a_p = mm/DC (in/DC) = factor
 a_e = mm/DC (in/DC) = factor
 All cutting data are target values

Universal
Steel and cast iron
Stainless steel and S-materials
Non ferrous
Hard
Plastic and chip
Graphite
Mimimaster Plus
Mimimaster

Cutting data – JS532 Copy milling roughing

Universal	SMG	Coolant	a _e /DC	a _p /DC	f _z										v _c	
					1	2	3	4	5	6	8	10	12	16		20
Steel and cast iron	N1	E	0.200	0.30	0.0080	0.016	0.024	0.032	0.038	0.046	0.060	0.080	0.095	0.11	0.13	610 (520–710)
			0.200	0.30	0,00032	0,00065	0,00095	0,0013	0,0015	0,0018	0,0024	0,0032	0,0038	0,0044	0,0050	2000 (1800 – 2300)
	N2	E	0.200	0.30	0.0080	0.016	0.024	0.032	0.038	0.046	0.060	0.080	0.095	0.11	0.13	395 (330 – 450)
			0.200	0.30	0,00032	0,00065	0,00095	0,0013	0,0015	0,0018	0,0024	0,0032	0,0038	0,0044	0,0050	1300 (1100–1400)
Stainless steel and S-materials	N3	E	0.200	0.30	0.0080	0.016	0.024	0.032	0.038	0.046	0.060	0.080	0.095	0.11	0.13	260 (220 – 300)
			0.200	0.30	0,00032	0,00065	0,00095	0,0013	0,0015	0,0018	0,0024	0,0032	0,0038	0,0044	0,0050	850 (730 – 980)
	N11	E	0.200	0.30	0.0050	0.010	0.016	0.020	0.026	0.032	0.040	0.050	0.060	0.075	0.090	415 (370 – 460)
			0.200	0.30	0,00020	0,00040	0,00065	0,00080	0,0010	0,0013	0,0016	0,0020	0,0024	0,0030	0,0036	1350 (1300–1500)
	S1	E	0.150	0.10	0.0040	0.0080	0.012	0.016	0.020	0.024	0.032	0.040	0.048	0.065	0.080	60 (52–72)
			0.150	0.10	0,00016	0,00032	0,00048	0,00065	0,00080	0,00095	0,0013	0,0016	0,0019	0,0026	0,0032	195 (180 – 230)
	S2	E	0.150	0.10	0.0040	0.0080	0.012	0.016	0.020	0.024	0.032	0.040	0.048	0.065	0.080	50 (42 – 58)
			0.150	0.10	0,00016	0,00032	0,00048	0,00065	0,00080	0,00095	0,0013	0,0016	0,0019	0,0026	0,0032	165 (140–190)
S3	E	0.100	0.10	0.0036	0.0070	0.010	0.014	0.018	0.020	0.028	0.036	0.042	0.055	0.060	32 (22 – 42)	
		0.100	0.10	0,00014	0,00028	0,00040	0,00055	0,00070	0,00080	0,0011	0,0014	0,0017	0,0022	0,0024	105 (73–130)	
S11	E	0.200	0.20	0.0060	0.012	0.018	0.024	0.030	0.036	0.048	0.060	0.070	0.090	0.10	105 (94–110)	
		0.200	0.20	0,00024	0,00048	0,00070	0,00095	0,0012	0,0014	0,0019	0,0024	0,0028	0,0036	0,0040	345 (310 – 360)	
S12	E	0.200	0.20	0.0060	0.012	0.018	0.024	0.030	0.036	0.048	0.060	0.070	0.090	0.10	80 (72 – 92)	
		0.200	0.20	0,00024	0,00048	0,00070	0,00095	0,0012	0,0014	0,0019	0,0024	0,0028	0,0036	0,0040	260 (240 – 300)	
S13	E	0.200	0.20	0.0055	0.011	0.016	0.022	0.026	0.032	0.042	0.055	0.060	0.080	0.090	65 (57–72)	
		0.200	0.20	0,00022	0,00044	0,00065	0,00085	0,0010	0,0013	0,0017	0,0022	0,0024	0,0032	0,0036	215 (190 – 230)	
Non ferrous	TS1	A	0.200	0.40	0.0075	0.015	0.024	0.030	0.038	0.046	0.065	0.075	0.090	0.12	0.13	610 (570 – 660)
			0.200	0.40	0,00030	0,00060	0,00095	0,0012	0,0015	0,0018	0,0026	0,0030	0,0036	0,0048	0,0050	2000 (1900 – 2100)
	TP1	A	0.200	0.40	0.0075	0.015	0.024	0.030	0.038	0.046	0.065	0.075	0.090	0.12	0.13	610 (570 – 660)
0.200			0.40	0,00030	0,00060	0,00095	0,0012	0,0015	0,0018	0,0026	0,0030	0,0036	0,0048	0,0050	2000 (1900 – 2100)	
GR1	A	0.200	0.40	0.0075	0.015	0.024	0.030	0.038	0.046	0.065	0.075	0.090	0.12	0.13	610 (570 – 660)	
			0.200	0.40	0,00030	0,00060	0,00095	0,0012	0,0015	0,0018	0,0026	0,0030	0,0036	0,0048	0,0050	2000 (1900 – 2100)

For cutting data recalculations, see pages 445 - 452

SMG = Seco material group
Coolant = A=air D=dry E=emulsion M=mist spray
v_c = m/min (sf/min)
f_z = mm (in/tooth)
a_p = mm/DC (in/DC) = factor
a_e = mm/DC (in/DC) = factor
All cutting data are target values

JS533

High performance – Universal – Ball nose – 3 Flutes – Cylindrical

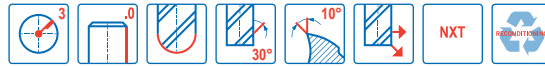
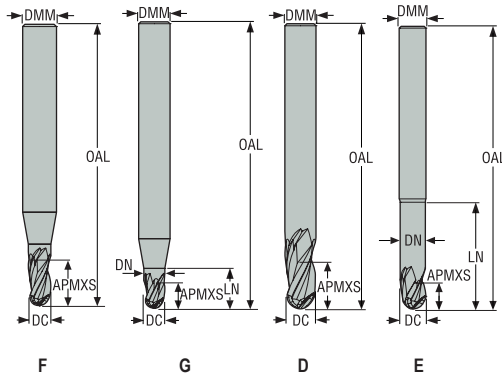

- Tolerances:
- DMM=h5
- DC=e8
- RE= ±0,01 mm
- Regrind possible if DC is ≥Ø6

Designation	Item number	Length index	Tool shape	DC	DMM	APMXS	OAL	LN	DN	RE	PCEDC	Cylindrical
				mm	mm	mm	mm	mm	mm	mm		
JS533010F1B.0Z3-NXT	02928284	1	F	1,0	3,0	2,0	38,0	3,0	1,05	0,5	3	■
JS533015F1B.0Z3-NXT	02928286	1	F	1,5	3,0	3,0	38,0	4,6	1,55	0,75	3	■
JS533020F1B.0Z3-NXT	02928287	1	F	2,0	3,0	4,0	38,0	5,6	2,05	1,0	3	■
JS533030D1B.0Z3-NXT	02928289	1	D	3,0	3,0	6,0	38,0	–	–	1,5	3	■
JS533040F1B.0Z3-NXT	02928291	1	F	4,0	6,0	8,0	57,0	10,75	4,05	2,0	3	■
JS533050F1B.0Z3-NXT	02928293	1	F	5,0	6,0	10,0	57,0	13,75	5,05	2,5	3	■
JS533060D1B.0Z3-NXT	02928295	1	D	6,0	6,0	12,0	57,0	–	–	3,0	3	■
JS533080D1B.0Z3-NXT	02928297	1	D	8,0	8,0	16,0	63,0	–	–	4,0	3	■
JS533100D1B.0Z3-NXT	02928299	1	D	10,0	10,0	20,0	72,0	–	–	5,0	3	■
JS533120D1B.0Z3-NXT	02928301	1	D	12,0	12,0	24,0	83,0	–	–	6,0	3	■
JS533160D1B.0Z3-NXT	02928303	1	D	16,0	16,0	32,0	110,0	–	–	8,0	3	■
JS533200D1B.0Z3-NXT	02928305	1	D	20,0	20,0	40,0	125,0	–	–	10,0	3	■
JS533020G2B.0Z3-NXT	02928288	2	G	2,0	3,0	2,0	38,0	7,0	1,9	1,0	3	■
JS533030E2B.0Z3-NXT	02928290	2	E	3,0	3,0	3,0	38,0	9,0	2,85	1,5	3	■
JS533040G2B.0Z3-NXT	02928292	2	G	4,0	6,0	4,0	57,0	15,0	3,8	2,0	3	■
JS533050G2B.0Z3-NXT	02928294	2	G	5,0	6,0	5,0	57,0	15,0	4,8	2,5	3	■
JS533060E2B.0Z3-NXT	02928296	2	E	6,0	6,0	6,0	63,0	25,0	5,7	3,0	3	■
JS533080E2B.0Z3-NXT	02928298	2	E	8,0	8,0	8,0	80,0	35,0	7,6	4,0	3	■
JS533100E2B.0Z3-NXT	02928300	2	E	10,0	10,0	10,0	89,0	40,0	9,5	5,0	3	■
JS533120E2B.0Z3-NXT	02928302	2	E	12,0	12,0	12,0	100,0	50,0	11,4	6,0	3	■
JS533160E2B.0Z3-NXT	02928304	2	E	16,0	16,0	16,0	125,0	70,0	15,2	8,0	3	■

■ Stocked standard.

Universal

Steel and cast iron

Stainless steel and S-materials

Non ferrous

Hard

Plastic and chip

Graphite

Minimaster Plus

Minimaster

JS533

High performance – Universal – Ball nose – 3 Flutes – Weldon

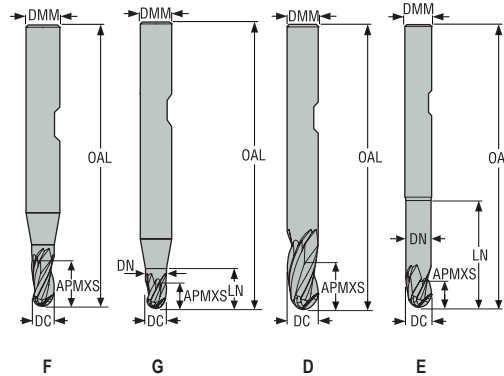

- Tolerances:
- DMM=h5
- DC=e8
- RE= ±0,01 mm
- Regrind possible if DC is ≥Ø6

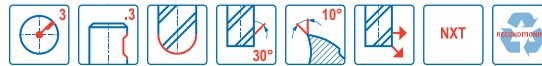

Designation	Item number	Length index	Tool shape	DC	DMM	APMXS	OAL	LN	DN	RE	PCEDC	Weldon
				mm	mm	mm	mm	mm	mm	mm		
JS533040F1B.3Z3-NXT	02928323	1	F	4,0	6,0	8,0	57,0	10,75	4,05	2,0	3	<input type="checkbox"/>
JS533050F1B.3Z3-NXT	02928325	1	F	5,0	6,0	10,0	57,0	13,75	5,05	2,5	3	<input type="checkbox"/>
JS533060D1B.3Z3-NXT	02928326	1	D	6,0	6,0	12,0	57,0	–	–	3,0	3	<input type="checkbox"/>
JS533080D1B.3Z3-NXT	02928328	1	D	8,0	8,0	16,0	63,0	–	–	4,0	3	<input type="checkbox"/>
JS533100D1B.3Z3-NXT	02928330	1	D	10,0	10,0	20,0	72,0	–	–	5,0	3	<input type="checkbox"/>
JS533120D1B.3Z3-NXT	02928332	1	D	12,0	12,0	24,0	83,0	–	–	6,0	3	<input type="checkbox"/>
JS533160D1B.3Z3-NXT	02928334	1	D	16,0	16,0	32,0	109,0	–	–	8,0	3	<input type="checkbox"/>
JS533200D1B.3Z3-NXT	02928336	1	D	20,0	20,0	40,0	125,0	–	–	10,0	3	<input type="checkbox"/>
JS533040G2B.3Z3-NXT	02928324	2	G	4,0	6,0	4,0	57,0	15,0	3,8	2,0	3	<input type="checkbox"/>
JS533050G2B.3Z3-NXT	02928341	2	G	5,0	6,0	5,0	57,0	15,0	4,8	2,5	3	<input type="checkbox"/>
JS533060E2B.3Z3-NXT	02928327	2	E	6,0	6,0	6,0	63,0	25,0	5,7	3,0	3	<input type="checkbox"/>
JS533080E2B.3Z3-NXT	02928329	2	E	8,0	8,0	8,0	80,0	35,0	7,6	4,0	3	<input type="checkbox"/>
JS533100E2B.3Z3-NXT	02928331	2	E	10,0	10,0	10,0	89,0	40,0	9,5	5,0	3	<input type="checkbox"/>
JS533120E2B.3Z3-NXT	02928333	2	E	12,0	12,0	12,0	100,0	50,0	11,4	6,0	3	<input type="checkbox"/>
JS533160E2B.3Z3-NXT	02928335	2	E	16,0	16,0	16,0	122,0	70,0	15,2	8,0	3	<input type="checkbox"/>

Weldon available. Delivery time is 3 days.

Cutting data – JS533 Copy milling roughing

SMG		a _e /DC	a _p /DC	f _z											v _c
				1	2	3	4	5	6	8	10	12	16	20	
P1	M/A/D/E	0.0300	0.80	0.0032	0.0065	0.0095	0.013	0.016	0.019	0.026	0.032	0.038	0.048	0.055	200 (180 – 220)
		0,0300	0,80	0,00013	0,00026	0,00038	0,00050	0,00065	0,00075	0,0010	0,0013	0,0015	0,0019	0,0022	660 (600–720)
P2	M/A/D/E	0.0300	0.80	0.0034	0.0065	0.010	0.013	0.017	0.020	0.026	0.034	0.038	0.048	0.055	195 (170 – 220)
		0,0300	0,80	0,00013	0,00026	0,00040	0,00050	0,00065	0,00080	0,0010	0,0013	0,0015	0,0019	0,0022	640 (560–720)
P3	M/A/D/E	0.0300	0.80	0.0032	0.0060	0.0095	0.013	0.016	0.019	0.025	0.032	0.036	0.046	0.055	165 (150–180)
		0,0300	0,80	0,00013	0,00024	0,00038	0,00050	0,00065	0,00075	0,0010	0,0013	0,0014	0,0018	0,0022	540 (500 – 590)
P4	M/A/D/E	0.0300	0.80	0.0030	0.0060	0.0090	0.012	0.015	0.018	0.025	0.030	0.036	0.044	0.050	145 (130–160)
		0,0300	0,80	0,00012	0,00024	0,00036	0,00048	0,00060	0,00070	0,0010	0,0012	0,0014	0,0017	0,0020	475 (430 – 520)
P5	M/A/D/E	0.0300	0.80	0.0030	0.0060	0.0090	0.012	0.015	0.018	0.024	0.030	0.036	0.044	0.050	140 (130–160)
		0,0300	0,80	0,00012	0,00024	0,00036	0,00048	0,00060	0,00070	0,00095	0,0012	0,0014	0,0017	0,0020	460 (430 – 520)
P6	M/A/D/E	0.0300	0.80	0.0030	0.0060	0.0090	0.012	0.015	0.018	0.024	0.030	0.034	0.044	0.050	155 (140–170)
		0,0300	0,80	0,00012	0,00024	0,00036	0,00048	0,00060	0,00070	0,00095	0,0012	0,0013	0,0017	0,0020	510 (460 – 550)
P7	M/A/D/E	0.0300	0.80	0.0030	0.0060	0.0090	0.012	0.015	0.018	0.024	0.030	0.034	0.044	0.050	150 (130–160)
		0,0300	0,80	0,00012	0,00024	0,00036	0,00048	0,00060	0,00070	0,00095	0,0012	0,0013	0,0017	0,0020	490 (430 – 520)
P8	M/A/D/E	0.0300	0.80	0.0032	0.0060	0.0095	0.013	0.016	0.019	0.025	0.032	0.036	0.046	0.055	140 (120–150)
		0,0300	0,80	0,00013	0,00024	0,00038	0,00050	0,00065	0,00075	0,0010	0,0013	0,0014	0,0018	0,0022	460 (400 – 490)
P11	M/A/D/E	0.0300	0.80	0.0044	0.0090	0.013	0.018	0.022	0.026	0.036	0.044	0.050	0.065	0.075	140 (130–160)
		0,0300	0,80	0,00017	0,00036	0,00050	0,00070	0,00085	0,0010	0,0014	0,0017	0,0020	0,0026	0,0030	460 (430 – 520)
P12	M/A/D/E	0.0300	0.80	0.0030	0.0060	0.0090	0.012	0.015	0.018	0.024	0.030	0.036	0.044	0.050	85 (73 – 97)
		0,0300	0,80	0,00012	0,00024	0,00036	0,00048	0,00060	0,00070	0,00095	0,0012	0,0014	0,0017	0,0020	280 (240 – 310)
M1	E	0.0300	0.80	0.0034	0.0065	0.010	0.013	0.017	0.020	0.026	0.034	0.038	0.048	0.055	125 (99–140)
		0,0300	0,80	0,00013	0,00026	0,00040	0,00050	0,00065	0,00080	0,0010	0,0013	0,0015	0,0019	0,0022	410 (330 – 450)
M2	E	0.0300	0.80	0.0030	0.0060	0.0090	0.012	0.015	0.018	0.024	0.030	0.036	0.044	0.050	100 (80–120)
		0,0300	0,80	0,00012	0,00024	0,00036	0,00048	0,00060	0,00070	0,00095	0,0012	0,0014	0,0017	0,0020	330 (270 – 390)
M3	E	0.0300	0.80	0.0030	0.0060	0.0090	0.012	0.015	0.018	0.024	0.030	0.036	0.044	0.050	70 (50–90)
		0,0300	0,80	0,00012	0,00024	0,00036	0,00048	0,00060	0,00070	0,00095	0,0012	0,0014	0,0017	0,0020	230 (170 – 290)
M4	E	0.0300	0.80	0.0026	0.0050	0.0080	0.011	0.013	0.016	0.022	0.026	0.030	0.038	0.044	55 (38–67)
		0,0300	0,80	0,00010	0,00020	0,00032	0,00044	0,00050	0,00065	0,00085	0,0010	0,0012	0,0015	0,0017	180 (130 – 210)
M5	E	0.0300	0.80	0.0026	0.0050	0.0080	0.011	0.013	0.016	0.022	0.026	0.030	0.038	0.044	44 (32–56)
		0,0300	0,80	0,00010	0,00020	0,00032	0,00044	0,00050	0,00065	0,00085	0,0010	0,0012	0,0015	0,0017	145 (110–180)
K1	E	0.0300	0.80	0.0040	0.0080	0.012	0.016	0.020	0.024	0.032	0.040	0.046	0.060	0.070	145 (130–160)
		0,0300	0,80	0,00016	0,00032	0,00048	0,00065	0,00080	0,00095	0,0013	0,0016	0,0018	0,0024	0,0028	475 (430 – 520)
K2	E	0.0300	0.80	0.0036	0.0075	0.011	0.015	0.018	0.022	0.030	0.036	0.042	0.055	0.060	125 (110–140)
		0,0300	0,80	0,00014	0,00030	0,00044	0,00060	0,00070	0,00085	0,0012	0,0014	0,0017	0,0022	0,0024	410 (370 – 450)
K3	E	0.0300	0.80	0.0050	0.010	0.015	0.020	0.025	0.030	0.040	0.050	0.060	0.075	0.085	105 (91–110)
		0,0300	0,80	0,00020	0,00040	0,00060	0,00080	0,0010	0,0012	0,0016	0,0020	0,0024	0,0030	0,0034	345 (300 – 360)
K4	E	0.0300	0.80	0.0050	0.010	0.015	0.020	0.025	0.030	0.040	0.050	0.060	0.075	0.085	120 (100–140)
		0,0300	0,80	0,00020	0,00040	0,00060	0,00080	0,0010	0,0012	0,0016	0,0020	0,0024	0,0030	0,0034	395 (330 – 450)
K5	E	0.0300	0.80	0.0044	0.0090	0.013	0.018	0.022	0.026	0.036	0.044	0.055	0.065	0.075	70 (61–84)
		0,0300	0,80	0,00017	0,00036	0,00050	0,00070	0,00085	0,0010	0,0014	0,0017	0,0022	0,0026	0,0030	230 (210 – 270)
K6	E	0.0300	0.80	0.0050	0.010	0.015	0.020	0.025	0.030	0.040	0.050	0.060	0.075	0.085	105 (89–120)
		0,0300	0,80	0,00020	0,00040	0,00060	0,00080	0,0010	0,0012	0,0016	0,0020	0,0024	0,0030	0,0034	345 (300 – 390)
K7	E	0.0300	0.80	0.0044	0.0090	0.013	0.018	0.022	0.026	0.036	0.044	0.055	0.065	0.075	155 (130–180)
		0,0300	0,80	0,00017	0,00036	0,00050	0,00070	0,00085	0,0010	0,0014	0,0017	0,0022	0,0026	0,0030	510 (430 – 590)

For cutting data recalculations, see pages 445 - 452

SMG = Seco material group
 Coolant = A=air D=dry E=emulsion M=mist spray
 v_c = m/min (sf/min)
 f_z = mm (in/tooth)
 a_p = mm/DC (in/DC) = factor
 a_e = mm/DC (in/DC) = factor
 All cutting data are target values

Universal
Steel and cast iron
Stainless steel and S-materials
Non ferrous
Hard
Plastic and chip
Graphite
Mimimaster Plus
Mimimaster

Cutting data – JS533 Copy milling roughing

SMG		a _e /DC	a _p /DC	f _z											v _c
				1	2	3	4	5	6	8	10	12	16	20	
N1	E	0.0300	0.80	0.0050	0.010	0.015	0.020	0.025	0.030	0.040	0.050	0.060	0.075	0.085	800 (700 – 900)
		0,0300	0,80	0,00020	0,00040	0,00060	0,00080	0,0010	0,0012	0,0016	0,0020	0,0024	0,0030	0,0034	2625 (2300 – 2900)
N2	E	0.0300	0.80	0.0050	0.010	0.015	0.020	0.025	0.030	0.040	0.050	0.060	0.075	0.085	510 (450 – 570)
		0,0300	0,80	0,00020	0,00040	0,00060	0,00080	0,0010	0,0012	0,0016	0,0020	0,0024	0,0030	0,0034	1675 (1500–1800)
N3	E	0.0300	0.80	0.0050	0.010	0.015	0.020	0.025	0.030	0.040	0.050	0.060	0.075	0.085	345 (300 – 380)
		0,0300	0,80	0,00020	0,00040	0,00060	0,00080	0,0010	0,0012	0,0016	0,0020	0,0024	0,0030	0,0034	1125 (990–1200)
N11	E	0.0300	0.80	0.0040	0.0080	0.012	0.016	0.020	0.024	0.032	0.040	0.046	0.060	0.070	400 (350 – 450)
		0,0300	0,80	0,00016	0,00032	0,00048	0,00065	0,00080	0,00095	0,0013	0,0016	0,0018	0,0024	0,0028	1300 (1200–1400)
S1	E	0.0300	0.80	0.0030	0.0060	0.0090	0.012	0.015	0.018	0.024	0.030	0.036	0.044	0.050	100 (90 – 110)
		0,0300	0,80	0,00012	0,00024	0,00036	0,00048	0,00060	0,00070	0,00095	0,0012	0,0014	0,0017	0,0020	330 (300 – 360)
S2	E	0.0300	0.80	0.0030	0.0060	0.0090	0.012	0.015	0.018	0.024	0.030	0.036	0.044	0.050	80 (73 – 88)
		0,0300	0,80	0,00012	0,00024	0,00036	0,00048	0,00060	0,00070	0,00095	0,0012	0,0014	0,0017	0,0020	260 (240 – 280)
S11	E	0.0300	0.80	0.0030	0.0060	0.0090	0.012	0.015	0.018	0.024	0.030	0.036	0.044	0.050	130 (120 – 140)
		0,0300	0,80	0,00012	0,00024	0,00036	0,00048	0,00060	0,00070	0,00095	0,0012	0,0014	0,0017	0,0020	425 (400 – 450)
S12	E	0.0300	0.80	0.0030	0.0060	0.0090	0.012	0.015	0.018	0.024	0.030	0.036	0.044	0.050	100 (91 – 110)
		0,0300	0,80	0,00012	0,00024	0,00036	0,00048	0,00060	0,00070	0,00095	0,0012	0,0014	0,0017	0,0020	330 (300 – 360)
S13	E	0.0300	0.80	0.0026	0.0050	0.0080	0.011	0.013	0.016	0.022	0.026	0.030	0.038	0.044	80 (70 – 85)
		0,0300	0,80	0,00010	0,00020	0,00032	0,00044	0,00050	0,00065	0,00085	0,0010	0,0012	0,0015	0,0017	260 (230 – 270)
TS1	A	0.0300	0.80	0.0040	0.0080	0.012	0.016	0.020	0.024	0.032	0.040	0.046	0.060	0.070	800 (760 – 850)
		0,0300	0,80	0,00016	0,00032	0,00048	0,00065	0,00080	0,00095	0,0013	0,0016	0,0018	0,0024	0,0028	2625 (2500 – 2700)
TP1	A	0.0300	0.80	0.0040	0.0080	0.012	0.016	0.020	0.024	0.032	0.040	0.046	0.060	0.070	800 (760 – 850)
		0,0300	0,80	0,00016	0,00032	0,00048	0,00065	0,00080	0,00095	0,0013	0,0016	0,0018	0,0024	0,0028	2625 (2500 – 2700)
GR1	A	0.0300	0.80	0.0040	0.0080	0.012	0.016	0.020	0.024	0.032	0.040	0.046	0.060	0.070	800 (760 – 850)
		0,0300	0,80	0,00016	0,00032	0,00048	0,00065	0,00080	0,00095	0,0013	0,0016	0,0018	0,0024	0,0028	2625 (2500 – 2700)

For cutting data recalculations, see pages 445 - 452

SMG = Seco material group

Coolant = A=air D=dry E=emulsion M=mist spray

v_c = m/min (sf/min)

f_z = mm (in/tooth)

a_p = mm/DC (in/DC) = factor

a_e = mm/DC (in/DC) = factor

All cutting data are target values

JS534

High performance – Universal – Ball nose – 4 Flutes – Cylindrical

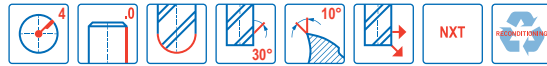
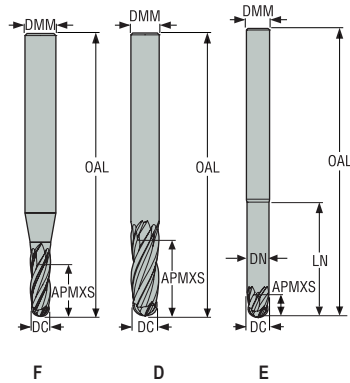

- Tolerances:
- DMM=h5
- DC=e8
- RE= ±0,01 mm
- Regrind possible if DC is ≥Ø6

Designation	Item number	Length index	Tool shape	DC	DMM	APMXS	OAL	LN	DN	RE	PCEDC	Cylindrical
				mm	mm	mm	mm	mm	mm	mm		
JS534020F1B.0Z4-NXT	02928366	1	F	2,0	3,0	6,0	38,0	6,7	2,05	1,0	4	■
JS534030D1B.0Z4-NXT	02928367	1	D	3,0	3,0	9,0	38,0	–	–	1,5	4	■
JS534040F1B.0Z4-NXT	02928368	1	F	4,0	6,0	12,0	57,0	14,0	4,05	2,0	4	■
JS534050F1B.0Z4-NXT	02928370	1	F	5,0	6,0	15,0	57,0	17,0	5,05	2,5	4	■
JS534060D1B.0Z4-NXT	02928372	1	D	6,0	6,0	18,0	57,0	–	–	3,0	4	■
JS534080D1B.0Z4-NXT	02928375	1	D	8,0	8,0	24,0	69,0	–	–	4,0	4	■
JS534100D1B.0Z4-NXT	02928378	1	D	10,0	10,0	30,0	82,0	–	–	5,0	4	■
JS534120D1B.0Z4-NXT	02928381	1	D	12,0	12,0	36,0	100,0	–	–	6,0	4	■
JS534160D1B.0Z4-NXT	02928384	1	D	16,0	16,0	48,0	110,0	–	–	8,0	4	■
JS534200D1B.0Z4-NXT	02928387	1	D	20,0	20,0	60,0	125,0	–	–	10,0	4	■
JS534040F2B.0Z4-NXT	02928369	2	F	4,0	6,0	20,0	63,0	22,0	4,05	2,0	4	■
JS534050F2B.0Z4-NXT	02928371	2	F	5,0	6,0	25,0	75,0	27,0	5,05	2,5	4	■
JS534060D2B.0Z4-NXT	02928373	2	D	6,0	6,0	30,0	75,0	–	–	3,0	4	■
JS534080D2B.0Z4-NXT	02928376	2	D	8,0	8,0	40,0	80,0	–	–	4,0	4	■
JS534100D2B.0Z4-NXT	02928379	2	D	10,0	10,0	50,0	100,0	–	–	5,0	4	■
JS534120D2B.0Z4-NXT	02928382	2	D	12,0	12,0	60,0	125,0	–	–	6,0	4	■
JS534160D2B.0Z4-NXT	02928385	2	D	16,0	16,0	80,0	130,0	–	–	8,0	4	■
JS534060E3B.0Z4-NXT	02928374	3	E	6,0	6,0	6,0	75,0	30,0	5,7	3,0	4	■
JS534080E3B.0Z4-NXT	02928377	3	E	8,0	8,0	8,0	80,0	40,0	7,6	4,0	4	■
JS534100E3B.0Z4-NXT	02928380	3	E	10,0	10,0	10,0	100,0	50,0	9,7	5,0	4	■
JS534120E3B.0Z4-NXT	02928383	3	E	12,0	12,0	12,0	125,0	60,0	11,4	6,0	4	■
JS534160E3B.0Z4-NXT	02928386	3	E	16,0	16,0	16,0	130,0	80,0	15,2	8,0	4	■
JS534200E3B.0Z4-NXT	02928388	3	E	20,0	20,0	20,0	150,0	100,0	19,0	10,0	4	■

■ Stocked standard.

Universal

Steel and cast iron

Stainless steel and S-materials

Non ferrous

Hard

Plastic and chip

Graphite

Minimaster Plus

Minimaster

JS534

High performance – Universal – Ball nose – 4 Flutes – Weldon

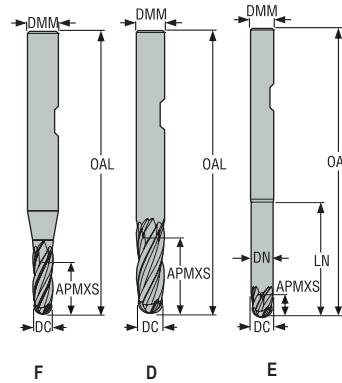

- Tolerances:
- DMM=h5
- DC=e8
- RE= ±0,01 mm
- Regrind possible if DC is ≥Ø6

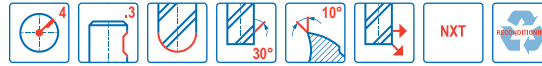

Designation	Item number	Length index	Tool shape	DC	DMM	APMXS	OAL	LN	DN	RE	PCEDC	Weldon
				mm	mm	mm	mm	mm	mm	mm		
JS534040F1B.3Z4-NXT	02928390	1	F	4,0	6,0	12,0	57,0	14,0	4,05	2,0	4	<input type="checkbox"/>
JS534050F1B.3Z4-NXT	02928392	1	F	5,0	6,0	15,0	57,0	17,0	5,05	2,5	4	<input type="checkbox"/>
JS534060D1B.3Z4-NXT	02928394	1	D	6,0	6,0	18,0	57,0	-	-	3,0	4	<input type="checkbox"/>
JS534080D1B.3Z4-NXT	02928397	1	D	8,0	8,0	24,0	69,0	-	-	4,0	4	<input type="checkbox"/>
JS534100D1B.3Z4-NXT	02928400	1	D	10,0	10,0	30,0	82,0	-	-	5,0	4	<input type="checkbox"/>
JS534120D1B.3Z4-NXT	02928403	1	D	12,0	12,0	36,0	100,0	-	-	6,0	4	<input type="checkbox"/>
JS534160D1B.3Z4-NXT	02928406	1	D	16,0	16,0	48,0	110,0	-	-	8,0	4	<input type="checkbox"/>
JS534200D1B.3Z4-NXT	02928409	1	D	20,0	20,0	60,0	125,0	-	-	10,0	4	<input type="checkbox"/>
JS534040F2B.3Z4-NXT	02928391	2	F	4,0	6,0	20,0	63,0	22,0	4,05	2,0	4	<input type="checkbox"/>
JS534050F2B.3Z4-NXT	02928393	2	F	5,0	6,0	25,0	75,0	27,0	5,05	2,5	4	<input type="checkbox"/>
JS534060D2B.3Z4-NXT	02928395	2	D	6,0	6,0	30,0	75,0	-	-	3,0	4	<input type="checkbox"/>
JS534080D2B.3Z4-NXT	02928398	2	D	8,0	8,0	40,0	80,0	-	-	4,0	4	<input type="checkbox"/>
JS534100D2B.3Z4-NXT	02928401	2	D	10,0	10,0	50,0	100,0	-	-	5,0	4	<input type="checkbox"/>
JS534120D2B.3Z4-NXT	02928404	2	D	12,0	12,0	60,0	125,0	-	-	6,0	4	<input type="checkbox"/>
JS534160D2B.3Z4-NXT	02928407	2	D	16,0	16,0	80,0	130,0	-	-	8,0	4	<input type="checkbox"/>
JS534060E3B.3Z4-NXT	02928396	3	E	6,0	6,0	6,0	75,0	30,0	5,7	3,0	4	<input type="checkbox"/>
JS534080E3B.3Z4-NXT	02928399	3	E	8,0	8,0	8,0	80,0	40,0	7,6	4,0	4	<input type="checkbox"/>
JS534100E3B.3Z4-NXT	02928402	3	E	10,0	10,0	10,0	100,0	50,0	9,7	5,0	4	<input type="checkbox"/>
JS534120E3B.3Z4-NXT	02928405	3	E	12,0	12,0	12,0	125,0	60,0	11,4	6,0	4	<input type="checkbox"/>
JS534160E3B.3Z4-NXT	02928408	3	E	16,0	16,0	16,0	130,0	80,0	15,2	8,0	4	<input type="checkbox"/>
JS534200E3B.3Z4-NXT	02928410	3	E	20,0	20,0	20,0	150,0	100,0	19,0	10,0	4	<input type="checkbox"/>

Weldon available. Delivery time is 3 days.

Cutting data – JS534 Copy milling roughing

SMG	Coolant	a _e /DC	a _p /DC	f _z										v _c
				2	3	4	5	6	8	10	12	16	20	
P1	M/A/D/E	0.0300	4.0	0.0085	0.013	0.017	0.022	0.026	0.034	0.044	0.050	0.065	0.075	345 (310 – 370)
		0,0300	4,0	0,00034	0,00050	0,00065	0,00085	0,0010	0,0013	0,0017	0,0020	0,0026	0,0030	1125 (1100–1200)
P2	M/A/D/E	0.0300	4.0	0.0090	0.013	0.018	0.022	0.026	0.036	0.044	0.050	0.065	0.075	335 (300 – 360)
		0,0300	4,0	0,00036	0,00050	0,00070	0,00085	0,0010	0,0014	0,0017	0,0020	0,0026	0,0030	1100 (990–1100)
P3	M/A/D/E	0.0300	4.0	0.0085	0.012	0.017	0.020	0.025	0.034	0.042	0.050	0.060	0.070	290 (260 – 310)
		0,0300	4,0	0,00034	0,00048	0,00065	0,00080	0,0010	0,0013	0,0017	0,0020	0,0024	0,0028	950 (860–1000)
P4	M/A/D/E	0.0300	4.0	0.0080	0.012	0.016	0.020	0.024	0.032	0.040	0.048	0.060	0.070	255 (230 – 280)
		0,0300	4,0	0,00032	0,00048	0,00065	0,00080	0,00095	0,0013	0,0016	0,0019	0,0024	0,0028	840 (760 – 910)
P5	M/A/D/E	0.0300	4.0	0.0080	0.012	0.016	0.020	0.024	0.032	0.040	0.048	0.060	0.070	245 (220 – 260)
		0,0300	4,0	0,00032	0,00048	0,00065	0,00080	0,00095	0,0013	0,0016	0,0019	0,0024	0,0028	800 (730 – 850)
P6	M/A/D/E	0.0300	4.0	0.0080	0.012	0.016	0.020	0.024	0.032	0.040	0.046	0.060	0.065	230 (210 – 250)
		0,0300	4,0	0,00032	0,00048	0,00065	0,00080	0,00095	0,0013	0,0016	0,0018	0,0024	0,0026	750 (690 – 820)
P7	M/A/D/E	0.0300	4.0	0.0080	0.012	0.016	0.020	0.024	0.032	0.040	0.046	0.060	0.065	220 (200 – 240)
		0,0300	4,0	0,00032	0,00048	0,00065	0,00080	0,00095	0,0013	0,0016	0,0018	0,0024	0,0026	720 (660–780)
P8	M/A/D/E	0.0300	4.0	0.0085	0.012	0.017	0.020	0.025	0.034	0.042	0.050	0.060	0.070	205 (190 – 220)
		0,0300	4,0	0,00034	0,00048	0,00065	0,00080	0,0010	0,0013	0,0017	0,0020	0,0024	0,0028	670 (630–720)
P11	M/A/D/E	0.0300	4.0	0.010	0.015	0.020	0.025	0.030	0.040	0.050	0.060	0.080	0.10	210 (190 – 230)
		0,0300	4,0	0,00040	0,00060	0,00080	0,0010	0,0012	0,0016	0,0020	0,0024	0,0032	0,0040	690 (630–750)
P12	M/A/D/E	0.0300	4.0	0.0080	0.012	0.016	0.020	0.024	0.032	0.040	0.048	0.060	0.070	125 (120–130)
		0,0300	4,0	0,00032	0,00048	0,00065	0,00080	0,00095	0,0013	0,0016	0,0019	0,0024	0,0028	410 (400 – 420)
M1	E	0.0300	4.0	0.0090	0.013	0.018	0.022	0.026	0.036	0.044	0.050	0.065	0.075	180 (160 – 200)
		0,0300	4,0	0,00036	0,00050	0,00070	0,00085	0,0010	0,0014	0,0017	0,0020	0,0026	0,0030	590 (530 – 650)
M2	E	0.0300	4.0	0.0080	0.012	0.016	0.020	0.024	0.032	0.040	0.048	0.060	0.070	145 (130–160)
		0,0300	4,0	0,00032	0,00048	0,00065	0,00080	0,00095	0,0013	0,0016	0,0019	0,0024	0,0028	475 (430 – 520)
M3	E	0.0300	4.0	0.0080	0.012	0.016	0.020	0.024	0.032	0.040	0.048	0.060	0.070	155 (140–180)
		0,0300	4,0	0,00032	0,00048	0,00065	0,00080	0,00095	0,0013	0,0016	0,0019	0,0024	0,0028	510 (460 – 590)
M4	E	0.0300	4.0	0.0070	0.010	0.014	0.017	0.020	0.028	0.034	0.042	0.050	0.060	120 (100–130)
		0,0300	4,0	0,00028	0,00040	0,00055	0,00065	0,00080	0,0011	0,0013	0,0017	0,0020	0,0024	395 (330 – 420)
M5	E	0.0300	4.0	0.0070	0.010	0.014	0.017	0.020	0.028	0.034	0.042	0.050	0.060	100 (83–110)
		0,0300	4,0	0,00028	0,00040	0,00055	0,00065	0,00080	0,0011	0,0013	0,0017	0,0020	0,0024	330 (280 – 360)
K1	E	0.0300	4.0	0.0080	0.012	0.016	0.020	0.024	0.032	0.040	0.048	0.060	0.070	245 (220 – 260)
		0,0300	4,0	0,00032	0,00048	0,00065	0,00080	0,00095	0,0013	0,0016	0,0019	0,0024	0,0028	800 (730 – 850)
K2	E	0.0300	4.0	0.0075	0.011	0.015	0.018	0.022	0.030	0.036	0.042	0.055	0.060	215 (200 – 230)
		0,0300	4,0	0,00030	0,00044	0,00060	0,00070	0,00085	0,0012	0,0014	0,0017	0,0022	0,0024	710 (660–750)
K3	E	0.0300	4.0	0.0080	0.012	0.016	0.020	0.024	0.032	0.040	0.048	0.060	0.070	180 (160–190)
		0,0300	4,0	0,00032	0,00048	0,00065	0,00080	0,00095	0,0013	0,0016	0,0019	0,0024	0,0028	590 (530 – 620)
K4	E	0.0300	4.0	0.0080	0.012	0.016	0.020	0.024	0.032	0.040	0.048	0.060	0.070	170 (160–180)
		0,0300	4,0	0,00032	0,00048	0,00065	0,00080	0,00095	0,0013	0,0016	0,0019	0,0024	0,0028	560 (530 – 590)
K5	E	0.0300	4.0	0.0070	0.011	0.014	0.018	0.022	0.028	0.036	0.042	0.055	0.060	200 (180 – 220)
		0,0300	4,0	0,00028	0,00044	0,00055	0,00070	0,00085	0,0011	0,0014	0,0017	0,0022	0,0024	660 (600–720)
K6	E	0.0300	4.0	0.0080	0.012	0.016	0.020	0.024	0.032	0.040	0.048	0.060	0.070	295 (260 – 330)
		0,0300	4,0	0,00032	0,00048	0,00065	0,00080	0,00095	0,0013	0,0016	0,0019	0,0024	0,0028	970 (860–1000)
K7	E	0.0300	4.0	0.0070	0.011	0.014	0.018	0.022	0.028	0.036	0.042	0.055	0.060	260 (230 – 280)
		0,0300	4,0	0,00028	0,00044	0,00055	0,00070	0,00085	0,0011	0,0014	0,0017	0,0022	0,0024	850 (760 – 910)

For cutting data recalculations, see pages 445 - 452

SMG = Seco material group
 Coolant = A=air D=dry E=emulsion M=mist spray
 v_c = m/min (sf/min)
 f_z = mm (in/tooth)
 a_p = mm/DC (in/DC) = factor
 a_e = mm/DC (in/DC) = factor
 All cutting data are target values

Universal
Steel and cast iron
Stainless steel and S-materials
Non ferrous
Hard
Plastic and chip
Graphite
Mimimaster Plus
Mimimaster

Cutting data – JS534 Copy milling roughing

Universal	SMG		a _e /DC	a _p /DC	f _z										v _c
					2	3	4	5	6	8	10	12	16	20	
Steel and cast iron	N1	E	0.0300	4.0	0.0080	0.012	0.016	0.020	0.024	0.032	0.040	0.048	0.060	0.070	1025 (910–1100)
			0,0300	4,0	0,00032	0,00048	0,00065	0,00080	0,00095	0,0013	0,0016	0,0019	0,0024	0,0028	3375 (3000 – 3600)
	N2	E	0.0300	4.0	0.0080	0.012	0.016	0.020	0.024	0.032	0.040	0.048	0.060	0.070	910 (780–1000)
Stainless steel and S-materials	N3	E	0.0300	4.0	0.0080	0.012	0.016	0.020	0.024	0.032	0.040	0.048	0.060	0.070	600 (520 – 690)
			0,0300	4,0	0,00032	0,00048	0,00065	0,00080	0,00095	0,0013	0,0016	0,0019	0,0024	0,0028	1975 (1800 – 2200)
	N11	E	0.0300	4.0	0.0080	0.012	0.016	0.020	0.024	0.032	0.040	0.048	0.060	0.070	500 (440 – 560)
Non ferrous	S1	E	0.0300	4.0	0.0080	0.012	0.016	0.020	0.024	0.032	0.040	0.048	0.060	0.070	110 (88–110)
			0,0300	4,0	0,00032	0,00048	0,00065	0,00080	0,00095	0,0013	0,0016	0,0019	0,0024	0,0028	360 (290 – 360)
	S2	E	0.0300	4.0	0.0080	0.012	0.016	0.020	0.024	0.032	0.040	0.048	0.060	0.070	90 (71 – 90)
Hard	S3	E	0.0300	4.0	0.0080	0.012	0.016	0.020	0.024	0.032	0.040	0.048	0.060	0.070	85 (63 – 87)
			0,0300	4,0	0,00032	0,00048	0,00065	0,00080	0,00095	0,0013	0,0016	0,0019	0,0024	0,0028	280 (210 – 280)
	S11	E	0.0300	4.0	0.0080	0.012	0.016	0.020	0.024	0.032	0.040	0.048	0.060	0.070	185 (150–180)
Plastic and cfrp	S12	E	0.0300	4.0	0.0080	0.012	0.016	0.020	0.024	0.032	0.040	0.048	0.060	0.070	140 (120–140)
			0,0300	4,0	0,00032	0,00048	0,00065	0,00080	0,00095	0,0013	0,0016	0,0019	0,0024	0,0028	460 (400 – 450)
	S13	E	0.0300	4.0	0.0070	0.010	0.014	0.017	0.020	0.028	0.034	0.042	0.050	0.060	110 (91–110)
Graphite	TS1	A	0.0300	4.0	0.0080	0.012	0.016	0.020	0.024	0.032	0.040	0.048	0.060	0.070	900 (840 – 960)
			0,0300	4,0	0,00032	0,00048	0,00065	0,00080	0,00095	0,0013	0,0016	0,0019	0,0024	0,0028	2950 (2800 – 3100)
	TP1	A	0.0300	4.0	0.0080	0.012	0.016	0.020	0.024	0.032	0.040	0.048	0.060	0.070	900 (840 – 960)
Minimaster Plus	GR1	A	0.0300	4.0	0.0080	0.012	0.016	0.020	0.024	0.032	0.040	0.048	0.060	0.070	900 (840 – 960)
			0,0300	4,0	0,00032	0,00048	0,00065	0,00080	0,00095	0,0013	0,0016	0,0019	0,0024	0,0028	2950 (2800 – 3100)
	GR1	A	0.0300	4.0	0.0080	0.012	0.016	0.020	0.024	0.032	0.040	0.048	0.060	0.070	900 (840 – 960)
Minimaster	GR1	A	0.0300	4.0	0.0080	0.012	0.016	0.020	0.024	0.032	0.040	0.048	0.060	0.070	900 (840 – 960)
			0,0300	4,0	0,00032	0,00048	0,00065	0,00080	0,00095	0,0013	0,0016	0,0019	0,0024	0,0028	2950 (2800 – 3100)
	GR1	A	0.0300	4.0	0.0080	0.012	0.016	0.020	0.024	0.032	0.040	0.048	0.060	0.070	900 (840 – 960)

For cutting data recalculations, see pages 445 - 452

SMG = Seco material group
Coolant = A=air D=dry E=emulsion M=mist spray
v_c = m/min (sf/min)
f_z = mm (in/tooth)
a_p = mm/DC (in/DC) = factor
a_e = mm/DC (in/DC) = factor
All cutting data are target values

JS506

General purpose – Universal – Chamfer – 3-4 Flutes – Cylindrical

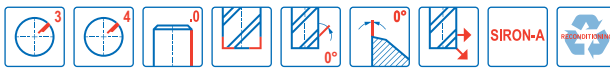
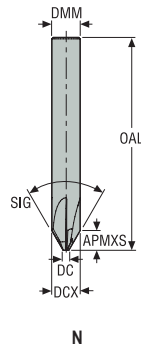

- Tolerances:
- DMM=h5
- SIG= ±0,5°
- Regrind possible if DMM is ≥Ø6

Designation	Item number	Length index	Tool shape	DC	DCX	DMM	APMXS	OAL	SIG°	PCEDC	Cylindrical
				mm	mm	mm	mm	mm			
JS506030N2CZ3.0-SIRA	02881622	2	N	0,6	3,0	3,0	2,0	50,0	60,0	3	■
JS506040N2CZ3.0-SIRA	02881623	2	N	0,8	4,0	4,0	2,7	50,0	60,0	3	■
JS506060N2CZ4.0-SIRA	02881624	2	N	1,2	6,0	6,0	4,1	57,0	60,0	4	■
JS506080N2CZ4.0-SIRA	02881626	2	N	1,6	8,0	8,0	5,5	63,0	60,0	4	■
JS506100N2CZ4.0-SIRA	02881628	2	N	2,0	10,0	10,0	6,9	72,0	60,0	4	■
JS506120N2CZ4.0-SIRA	02881630	2	N	2,4	12,0	12,0	8,3	83,0	60,0	4	■

■ Stocked standard.

Universal

Steel and cast iron

Stainless steel and S-materials

Non ferrous

Hard

Plastic and CFRP

Graphite

Minimaster Plus

Minimaster

JS506

General purpose – Universal – Chamfer – 3-4 Flutes – Weldon

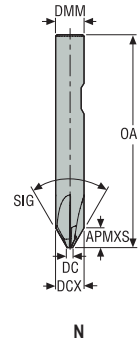

- Tolerances:
- DMM=h5
- SIG= ±0,5°
- Regrind possible if DMM is ≥Ø6

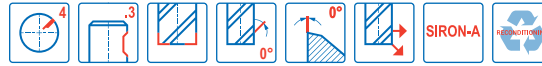

Designation	Item number	Length index	Tool shape	DC	DCX	DMM	APMXS	OAL	SIG°	PCEDC	Weldon
				mm	mm	mm	mm	mm			
JS506060N2CZ4.3-SIRA	02881625	2	N	1,2	6,0	6,0	4,1	57,0	60,0	4	■
JS506080N2CZ4.3-SIRA	02881627	2	N	1,6	8,0	8,0	5,5	63,0	60,0	4	■
JS506100N2CZ4.3-SIRA	02881629	2	N	2,0	10,0	10,0	6,9	72,0	60,0	4	■
JS506120N2CZ4.3-SIRA	02881631	2	N	2,4	12,0	12,0	8,3	83,0	60,0	4	■

■ Stocked standard.

Universal

Steel and cast iron

Stainless steel and S-materials

Non ferrous

Hard

Plastic and cfrp

Graphite

Minimaster Plus

Minimaster

Cutting data – JS506 Chamfering

SMG		a _e /DC	a _p /DC	f _z						v _c
				3	4	6	8	10	12	
P1	M/A/D/E	0.100	0.55	0.022	0.028	0.042	0.055	0.070	0.080	200 (180 – 220)
		0,100	0,55	0,00085	0,0011	0,0017	0,0022	0,0028	0,0032	660 (600–720)
P2	M/A/D/E	0.100	0.55	0.022	0.028	0.042	0.055	0.070	0.085	195 (180 – 220)
		0,100	0,55	0,00085	0,0011	0,0017	0,0022	0,0028	0,0034	640 (600–720)
P3	M/A/D/E	0.100	0.55	0.020	0.026	0.040	0.055	0.065	0.080	170 (150–190)
		0,100	0,55	0,00080	0,0010	0,0016	0,0022	0,0026	0,0032	560 (500 – 620)
P4	M/A/D/E	0.100	0.55	0.020	0.026	0.040	0.055	0.065	0.080	150 (130–160)
		0,100	0,55	0,00080	0,0010	0,0016	0,0022	0,0026	0,0032	490 (430 – 520)
P5	M/A/D/E	0.100	0.55	0.019	0.026	0.038	0.050	0.065	0.075	140 (130–160)
		0,100	0,55	0,00075	0,0010	0,0015	0,0020	0,0026	0,0030	460 (430 – 520)
P6	M/A/D/E	0.100	0.55	0.019	0.025	0.038	0.050	0.065	0.075	160 (140–180)
		0,100	0,55	0,00075	0,0010	0,0015	0,0020	0,0026	0,0030	520 (460 – 590)
P7	M/A/D/E	0.100	0.55	0.019	0.025	0.038	0.050	0.065	0.075	150 (140–170)
		0,100	0,55	0,00075	0,0010	0,0015	0,0020	0,0026	0,0030	490 (460 – 550)
P8	M/A/D/E	0.100	0.55	0.020	0.026	0.040	0.055	0.065	0.080	140 (130–160)
		0,100	0,55	0,00080	0,0010	0,0016	0,0022	0,0026	0,0032	460 (430 – 520)
P11	M/A/D/E	0.100	0.55	0.019	0.025	0.038	0.050	0.065	0.075	145 (130–160)
		0,100	0,55	0,00075	0,0010	0,0015	0,0020	0,0026	0,0030	475 (430 – 520)
P12	M/A/D/E	0.100	0.55	0.013	0.017	0.026	0.034	0.044	0.050	85 (75 – 97)
		0,100	0,55	0,00050	0,00065	0,0010	0,0013	0,0017	0,0020	280 (250 – 310)
M1	E/M/A	0.100	0.55	0.022	0.028	0.042	0.055	0.070	0.085	120 (95–140)
		0,100	0,55	0,00085	0,0011	0,0017	0,0022	0,0028	0,0034	395 (320 – 450)
M2	E/M/A	0.100	0.55	0.019	0.026	0.038	0.050	0.065	0.075	95 (76–110)
		0,100	0,55	0,00075	0,0010	0,0015	0,0020	0,0026	0,0030	310 (250 – 360)
M3	E/M/A	0.100	0.55	0.019	0.026	0.038	0.050	0.065	0.075	60 (43 – 80)
		0,100	0,55	0,00075	0,0010	0,0015	0,0020	0,0026	0,0030	195 (150 – 260)
M4	E/M/A	0.100	0.55	0.017	0.022	0.034	0.046	0.055	0.065	46 (33 – 60)
		0,100	0,55	0,00065	0,00085	0,0013	0,0018	0,0022	0,0026	150 (110–190)
M5	E/M/A	0.100	0.55	0.017	0.022	0.034	0.046	0.055	0.065	39 (27 – 50)
		0,100	0,55	0,00065	0,00085	0,0013	0,0018	0,0022	0,0026	130 (89–160)
K1	A/D/M/E	0.100	0.55	0.022	0.028	0.042	0.055	0.070	0.085	200 (180 – 220)
		0,100	0,55	0,00085	0,0011	0,0017	0,0022	0,0028	0,0034	660 (600–720)
K2	A/D/M/E	0.100	0.55	0.019	0.026	0.038	0.050	0.065	0.075	170 (150–190)
		0,100	0,55	0,00075	0,0010	0,0015	0,0020	0,0026	0,0030	560 (500 – 620)
K3	A/D/M/E	0.100	0.55	0.019	0.026	0.038	0.050	0.065	0.075	145 (130–160)
		0,100	0,55	0,00075	0,0010	0,0015	0,0020	0,0026	0,0030	475 (430 – 520)
K4	A/D/M/E	0.100	0.55	0.019	0.026	0.038	0.050	0.065	0.075	140 (130–150)
		0,100	0,55	0,00075	0,0010	0,0015	0,0020	0,0026	0,0030	460 (430 – 490)
K5	A/D/M/E	0.100	0.55	0.018	0.024	0.034	0.046	0.060	0.070	85 (72 – 93)
		0,100	0,55	0,00070	0,00095	0,0013	0,0018	0,0024	0,0028	280 (240 – 300)
K6	A/D/M/E	0.100	0.55	0.019	0.026	0.038	0.050	0.065	0.075	125 (110–130)
		0,100	0,55	0,00075	0,0010	0,0015	0,0020	0,0026	0,0030	410 (370 – 420)
K7	A/D/M/E	0.100	0.55	0.018	0.024	0.034	0.046	0.060	0.070	105 (92–120)
		0,100	0,55	0,00070	0,00095	0,0013	0,0018	0,0024	0,0028	345 (310 – 390)

For cutting data recalculations, see pages 445 - 452

SMG = Seco material group
 Coolant = A=air D=dry E=emulsion M=mist spray
 v_c = m/min (sf/min)
 f_z = mm (in/tooth)
 a_p = mm/DC (in/DC) = factor
 a_e = mm/DC (in/DC) = factor
 All cutting data are target values

Universal
Steel and cast iron
Stainless steel and S-materials
Non ferrous
Hard
Plastic and chip
Graphite
Mimimaster Plus
Mimimaster

Cutting data – JS506 Chamfering

Universal	SMG		a _p /DC	a _e /DC	f _z						v _c
					3	4	6	8	10	12	
Steel and cast iron	N1	E/M/A	0.100	0.55	0.019	0.026	0.038	0.050	0.065	0.075	475 (430 – 520)
			0,100	0,55	0,00075	0,0010	0,0015	0,0020	0,0026	0,0030	1550 (1500–1700)
	N2	E/M/A	0.100	0.55	0.019	0.026	0.038	0.050	0.065	0.075	305 (280 – 330)
			0,100	0,55	0,00075	0,0010	0,0015	0,0020	0,0026	0,0030	1000 (920–1000)
Stainless steel and S-materials	N3	E/M/A	0.100	0.55	0.019	0.026	0.038	0.050	0.065	0.075	205 (190 – 220)
			0,100	0,55	0,00075	0,0010	0,0015	0,0020	0,0026	0,0030	670 (630–720)
	N11	E/M/A	0.100	0.55	0.019	0.026	0.038	0.050	0.065	0.075	270 (250 – 290)
			0,100	0,55	0,00075	0,0010	0,0015	0,0020	0,0026	0,0030	890 (830 – 950)
Non ferrous	S1	E	0.100	0.55	0.020	0.028	0.042	0.055	0.070	0.080	41 (14 – 68)
			0,100	0,55	0,00080	0,0011	0,0017	0,0022	0,0028	0,0032	135 (46 – 220)
	S2	E	0.100	0.55	0.020	0.028	0.042	0.055	0.070	0.080	33 (12 – 55)
			0,100	0,55	0,00080	0,0011	0,0017	0,0022	0,0028	0,0032	110 (40–180)
Hard	S3	E	0.100	0.55	0.019	0.026	0.038	0.050	0.065	0.075	28 (9.5 – 47)
			0,100	0,55	0,00075	0,0010	0,0015	0,0020	0,0026	0,0030	90 (32–150)
	S11	E	0.100	0.55	0.019	0.026	0.038	0.050	0.065	0.075	95 (68–110)
			0,100	0,55	0,00075	0,0010	0,0015	0,0020	0,0026	0,0030	310 (230–360)
Plastic and cfrp	S12	E	0.100	0.55	0.019	0.026	0.038	0.050	0.065	0.075	70 (53 – 90)
			0,100	0,55	0,00075	0,0010	0,0015	0,0020	0,0026	0,0030	230 (180 – 290)
	S13	E	0.100	0.55	0.017	0.022	0.034	0.046	0.055	0.065	55 (41 – 69)
			0,100	0,55	0,00065	0,00085	0,0013	0,0018	0,0022	0,0026	180 (140 – 220)
Graphite	H5	M/A/D	0.0500	1.5	0.015	0.020	0.030	0.040	0.050	0.060	65 (45 – 83)
			0,0500	1,5	0,00060	0,00080	0,0012	0,0016	0,0020	0,0024	215 (150 – 270)
	H8	M/A/D	0.0500	1.5	0.011	0.015	0.022	0.030	0.038	0.044	60 (44 – 81)
			0,0500	1,5	0,00044	0,00060	0,00085	0,0012	0,0015	0,0017	195 (150 – 260)
Minimaster Plus	H11	M/A/D	0.0500	1.5	0.015	0.020	0.030	0.040	0.050	0.060	80 (57–100)
			0,0500	1,5	0,00060	0,00080	0,0012	0,0016	0,0020	0,0024	260 (190 – 320)
	H12	M/A/D	0.0500	1.5	0.011	0.015	0.022	0.030	0.038	0.044	70 (51 – 94)
			0,0500	1,5	0,00044	0,00060	0,00085	0,0012	0,0015	0,0017	230 (170 – 300)
Minimaster	H21	M/A/D	0.0500	1.5	0.011	0.015	0.022	0.030	0.038	0.044	60 (44 – 81)
			0,0500	1,5	0,00044	0,00060	0,00085	0,0012	0,0015	0,0017	195 (150 – 260)
	TS1	A/D	0.100	0.55	0.019	0.026	0.038	0.050	0.065	0.075	475 (430 – 520)
			0,100	0,55	0,00075	0,0010	0,0015	0,0020	0,0026	0,0030	1550 (1500–1700)
TP1	A/D	0.100	0.55	0.019	0.026	0.038	0.050	0.065	0.075	475 (430 – 520)	
		0,100	0,55	0,00075	0,0010	0,0015	0,0020	0,0026	0,0030	1550 (1500–1700)	
GR1	A/D	0.100	0.55	0.019	0.026	0.038	0.050	0.065	0.075	475 (430 – 520)	
			0,100	0,55	0,00075	0,0010	0,0015	0,0020	0,0026	0,0030	1550 (1500–1700)

For cutting data recalculations, see pages 445 - 452

SMG = Seco material group
Coolant = A=air D=dry E=emulsion M=mist spray
v_c = m/min (sf/min)
f_z = mm (in/tooth)
a_p = mm/DC (in/DC) = factor
a_e = mm/DC (in/DC) = factor
All cutting data are target values

JS509

General purpose – Universal – Chamfer – 3-4 Flutes – Cylindrical

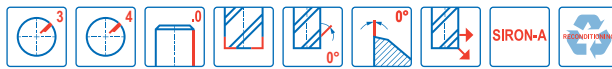
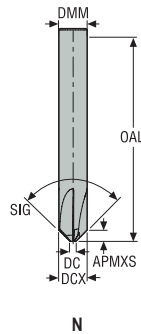

- Tolerances:
- DMM=h5
- SIG= ±0,5°
- Regrind possible if DMM is ≥Ø6

Designation	Item number	Length index	Tool shape	DC	DCX	DMM	APMXS	OAL	SIG°	PCEDC	Cylindrical
				mm	mm	mm	mm	mm			
JS509030N2CZ3.0-SIRA	02881634	2	N	0,6	3,0	3,0	1,2	50,0	90,0	3	■
JS509040N2CZ3.0-SIRA	02881635	2	N	0,8	4,0	4,0	1,6	50,0	90,0	3	■
JS509060N2CZ4.0-SIRA	02881636	2	N	1,2	6,0	6,0	2,4	57,0	90,0	4	■
JS509080N2CZ4.0-SIRA	02881638	2	N	1,6	8,0	8,0	3,2	63,0	90,0	4	■
JS509100N2CZ4.0-SIRA	02881640	2	N	2,0	10,0	10,0	4,0	72,0	90,0	4	■
JS509120N2CZ4.0-SIRA	02881642	2	N	2,4	12,0	12,0	4,8	83,0	90,0	4	■

■ Stocked standard.

Universal

Steel and cast iron

Stainless steel and S-materials

Non ferrous

Hard

Plastic and cfrp

Graphite

Minimaster Plus

Minimaster

JS509

General purpose – Universal – Chamfer – 3-4 Flutes – Weldon

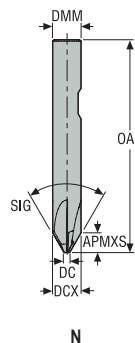

- Tolerances:
- DMM=h5
- SIG= ±0,5°
- Regrind possible if DMM is ≥Ø6

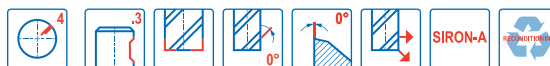

Designation	Item number	Length index	Tool shape	DC	DCX	DMM	APMXS	OAL	SIG°	PCEDC	Weldon
				mm	mm	mm	mm	mm			
JS509060N2CZ4.3-SIRA	02881637	2	N	1,2	6,0	6,0	2,4	57,0	90,0	4	■
JS509080N2CZ4.3-SIRA	02881639	2	N	1,6	8,0	8,0	3,2	63,0	90,0	4	■
JS509100N2CZ4.3-SIRA	02881641	2	N	2,0	10,0	10,0	4,0	72,0	90,0	4	■
JS509120N2CZ4.3-SIRA	02881643	2	N	2,4	12,0	12,0	4,8	83,0	90,0	4	■

■ Stocked standard.

Universal

Steel and cast iron

Stainless steel and S-materials

Non ferrous

Hard

Plastic and cfrp

Graphite

Minimaster Plus

Minimaster

Cutting data – JS509 Chamfering

SMG		a _e /DC	a _p /DC	f _z						v _c
				3	4	6	8	10	12	
P1	M/A/D/E	0.100	0.55	0.034	0.044	0.065	0.090	0.11	0.13	380 (340 – 430)
		0,100	0,55	0,0013	0,0017	0,0026	0,0036	0,0044	0,0050	1250 (1200–1400)
P2	M/A/D/E	0.100	0.55	0.034	0.044	0.065	0.090	0.11	0.13	370 (330 – 420)
		0,100	0,55	0,0013	0,0017	0,0026	0,0036	0,0044	0,0050	1225 (1100–1300)
P3	M/A/D/E	0.100	0.55	0.032	0.042	0.065	0.085	0.11	0.12	320 (280 – 360)
		0,100	0,55	0,0013	0,0017	0,0026	0,0034	0,0044	0,0048	1050 (920–1100)
P4	M/A/D/E	0.100	0.55	0.032	0.042	0.060	0.085	0.10	0.12	280 (250 – 310)
		0,100	0,55	0,0013	0,0017	0,0024	0,0034	0,0040	0,0048	920 (830–1000)
P5	M/A/D/E	0.100	0.55	0.030	0.040	0.060	0.085	0.10	0.12	270 (240 – 300)
		0,100	0,55	0,0012	0,0016	0,0024	0,0034	0,0040	0,0048	890 (830 – 980)
P6	M/A/D/E	0.100	0.55	0.030	0.040	0.060	0.080	0.10	0.12	305 (270 – 340)
		0,100	0,55	0,0012	0,0016	0,0024	0,0032	0,0040	0,0048	1000 (890–1100)
P7	M/A/D/E	0.100	0.55	0.030	0.040	0.060	0.080	0.10	0.12	285 (250 – 320)
		0,100	0,55	0,0012	0,0016	0,0024	0,0032	0,0040	0,0048	940 (830–1000)
P8	M/A/D/E	0.100	0.55	0.032	0.042	0.065	0.085	0.11	0.12	270 (240 – 300)
		0,100	0,55	0,0013	0,0017	0,0026	0,0034	0,0044	0,0048	890 (790 – 980)
P11	M/A/D/E	0.100	0.55	0.030	0.040	0.060	0.080	0.10	0.12	280 (250 – 310)
		0,100	0,55	0,0012	0,0016	0,0024	0,0032	0,0040	0,0048	920 (830–1000)
P12	M/A/D/E	0.100	0.55	0.020	0.028	0.042	0.055	0.070	0.080	165 (150–180)
		0,100	0,55	0,00080	0,0011	0,0017	0,0022	0,0028	0,0032	540 (500 – 590)
M1	E/M/A	0.100	0.55	0.034	0.044	0.065	0.090	0.11	0.13	220 (180 – 260)
		0,100	0,55	0,0013	0,0017	0,0026	0,0036	0,0044	0,0050	720 (600 – 850)
M2	E/M/A	0.100	0.55	0.030	0.040	0.060	0.085	0.10	0.12	180 (150 – 210)
		0,100	0,55	0,0012	0,0016	0,0024	0,0034	0,0040	0,0048	590 (500 – 680)
M3	E/M/A	0.100	0.55	0.030	0.040	0.060	0.085	0.10	0.12	115 (81–150)
		0,100	0,55	0,0012	0,0016	0,0024	0,0034	0,0040	0,0048	375 (270 – 490)
M4	E/M/A	0.100	0.55	0.026	0.036	0.055	0.070	0.090	0.10	90 (61–110)
		0,100	0,55	0,0010	0,0014	0,0022	0,0028	0,0036	0,0040	295 (210 – 360)
M5	E/M/A	0.100	0.55	0.026	0.036	0.055	0.070	0.090	0.10	75 (51 – 95)
		0,100	0,55	0,0010	0,0014	0,0022	0,0028	0,0036	0,0040	245 (170 – 310)
K1	A/D/M/E	0.100	0.55	0.034	0.044	0.065	0.090	0.11	0.13	375 (330 – 420)
		0,100	0,55	0,0013	0,0017	0,0026	0,0036	0,0044	0,0050	1225 (1100–1300)
K2	A/D/M/E	0.100	0.55	0.030	0.040	0.060	0.085	0.10	0.12	325 (290 – 360)
		0,100	0,55	0,0012	0,0016	0,0024	0,0034	0,0040	0,0048	1075 (960–1100)
K3	A/D/M/E	0.100	0.55	0.030	0.040	0.060	0.085	0.10	0.12	275 (240 – 310)
		0,100	0,55	0,0012	0,0016	0,0024	0,0034	0,0040	0,0048	900 (790–1000)
K4	A/D/M/E	0.100	0.55	0.030	0.040	0.060	0.085	0.10	0.12	265 (230 – 290)
		0,100	0,55	0,0012	0,0016	0,0024	0,0034	0,0040	0,0048	870 (760 – 950)
K5	A/D/M/E	0.100	0.55	0.028	0.036	0.055	0.075	0.090	0.11	155 (140–170)
		0,100	0,55	0,0011	0,0014	0,0022	0,0030	0,0036	0,0044	510 (460 – 550)
K6	A/D/M/E	0.100	0.55	0.030	0.040	0.060	0.085	0.10	0.12	230 (210 – 260)
		0,100	0,55	0,0012	0,0016	0,0024	0,0034	0,0040	0,0048	750 (690 – 850)
K7	A/D/M/E	0.100	0.55	0.028	0.036	0.055	0.075	0.090	0.11	200 (180 – 220)
		0,100	0,55	0,0011	0,0014	0,0022	0,0030	0,0036	0,0044	660 (600–720)

For cutting data recalculations, see pages 445 - 452

SMG = Seco material group
 Coolant = A=air D=dry E=emulsion M=mist spray
 v_c = m/min (sf/min)
 f_z = mm (in/tooth)
 a_p = mm/DC (in/DC) = factor
 a_e = mm/DC (in/DC) = factor
 All cutting data are target values

Universal
Steel and cast iron
Stainless steel and S-materials
Non ferrous
Hard
Plastic and chip
Graphite
Mimimaster Plus
Mimimaster

Cutting data – JS509 Chamfering

Universal	SMG		a _p /DC	a _e /DC	f _z						v _c
					3	4	6	8	10	12	
Steel and cast iron	N1	E/M/A	0.100	0.55	0.030	0.040	0.060	0.085	0.10	0.12	900 (810 – 980)
			0,100	0,55	0,0012	0,0016	0,0024	0,0034	0,0040	0,0048	2950 (2700 – 3200)
	N2	E/M/A	0.100	0.55	0.030	0.040	0.060	0.085	0.10	0.12	580 (530 – 630)
			0,100	0,55	0,0012	0,0016	0,0024	0,0034	0,0040	0,0048	1900 (1800 – 2000)
Stainless steel and S-materials	N3	E/M/A	0.100	0.55	0.030	0.040	0.060	0.085	0.10	0.12	385 (350 – 420)
			0,100	0,55	0,0012	0,0016	0,0024	0,0034	0,0040	0,0048	1275 (1200–1300)
	N11	E/M/A	0.100	0.55	0.030	0.040	0.060	0.085	0.10	0.12	510 (470 – 560)
			0,100	0,55	0,0012	0,0016	0,0024	0,0034	0,0040	0,0048	1675 (1600–1800)
Non ferrous	S1	E	0.100	0.55	0.017	0.022	0.032	0.044	0.055	0.065	70 (24–110)
			0,100	0,55	0,00065	0,00085	0,0013	0,0017	0,0022	0,0026	230 (79 – 360)
	S2	E	0.100	0.55	0.017	0.022	0.032	0.044	0.055	0.065	55 (19 – 94)
			0,100	0,55	0,00065	0,00085	0,0013	0,0017	0,0022	0,0026	180 (63 – 300)
Hard	S3	E	0.100	0.55	0.015	0.020	0.030	0.042	0.050	0.060	49 (17 – 80)
			0,100	0,55	0,00060	0,00080	0,0012	0,0017	0,0020	0,0024	160 (56 – 260)
	S11	E	0.100	0.55	0.030	0.040	0.060	0.085	0.10	0.12	175 (130 – 220)
			0,100	0,55	0,0012	0,0016	0,0024	0,0034	0,0040	0,0048	570 (430–720)
Plastic and cfrp	S12	E	0.100	0.55	0.030	0.040	0.060	0.085	0.10	0.12	135 (99–170)
			0,100	0,55	0,0012	0,0016	0,0024	0,0034	0,0040	0,0048	445 (330 – 550)
	S13	E	0.100	0.55	0.026	0.036	0.055	0.070	0.090	0.10	105 (77–130)
			0,100	0,55	0,0010	0,0014	0,0022	0,0028	0,0036	0,0040	345 (260 – 420)
Graphite	H5	M/A/D	0.0500	1.2	0.020	0.026	0.040	0.050	0.065	0.075	115 (80–140)
			0,0500	1,2	0,00080	0,0010	0,0016	0,0020	0,0026	0,0030	375 (270 – 450)
	H8	M/A/D	0.0500	1.2	0.015	0.020	0.030	0.040	0.050	0.060	110 (78–140)
			0,0500	1,2	0,00060	0,00080	0,0012	0,0016	0,0020	0,0024	360 (260 – 450)
Minimaster Plus	H11	M/A/D	0.0500	1.2	0.020	0.026	0.040	0.050	0.065	0.075	145 (110–190)
			0,0500	1,2	0,00080	0,0010	0,0016	0,0020	0,0026	0,0030	475 (370 – 620)
	H12	M/A/D	0.0500	1.2	0.015	0.020	0.030	0.040	0.050	0.060	130 (91–170)
			0,0500	1,2	0,00060	0,00080	0,0012	0,0016	0,0020	0,0024	425 (300 – 550)
Minimaster	H21	M/A/D	0.0500	1.2	0.015	0.020	0.030	0.040	0.050	0.060	110 (78–140)
			0,0500	1,2	0,00060	0,00080	0,0012	0,0016	0,0020	0,0024	360 (260 – 450)
	TS1	A/D	0.100	0.55	0.030	0.040	0.060	0.085	0.10	0.12	900 (810 – 980)
			0,100	0,55	0,0012	0,0016	0,0024	0,0034	0,0040	0,0048	2950 (2700 – 3200)
TP1	A/D	0.100	0.55	0.030	0.040	0.060	0.085	0.10	0.12	900 (810 – 980)	
		0,100	0,55	0,0012	0,0016	0,0024	0,0034	0,0040	0,0048	2950 (2700 – 3200)	
GR1	A/D	0.100	0.55	0.030	0.040	0.060	0.085	0.10	0.12	900 (810 – 980)	
			0,100	0,55	0,0012	0,0016	0,0024	0,0034	0,0040	0,0048	2950 (2700 – 3200)

For cutting data recalculations, see pages 445 - 452

SMG = Seco material group
 Coolant = A=air D=dry E=emulsion M=mist spray
 v_c = m/min (sf/min)
 f_z = mm (in/tooth)
 a_p = mm/DC (in/DC) = factor
 a_e = mm/DC (in/DC) = factor
 All cutting data are target values

JH910

High speed – Universal – Square – 3 Flutes – Cylindrical – Corner radius

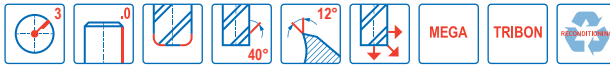
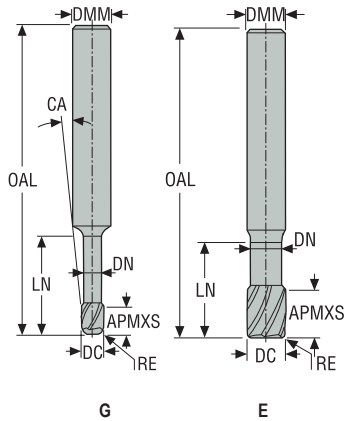

- Tolerances:
- DMM= h5
- DC= -0,02/-0,04 mm
- RE= ±0,05 mm
- Re grind possible if DC is ≥Ø6

Designation	Item number	Length index	Tool shape	DC	DMM	APMXS	OAL	LN	DN	RE	CA	PCEDC	Cylindrical
				mm	mm	mm	mm	mm	mm	mm	mm	mm	mm
910020R020-MEGA	00020058	2	G	2,0	3,0	3,0	40,0	6,0	1,9	0,2	3,5	3	■
910025R020-MEGA	00020065	2	G	2,5	3,0	4,0	40,0	6,0	2,4	0,2	2,0	3	■
910025R020-TRIBON	00020174	2	G	2,5	3,0	4,0	40,0	6,0	2,4	0,2	2,0	3	■
910030R010-MEGA	00020073	2	E	3,0	3,0	4,0	40,0	7,0	2,8	0,1	-	3	■
910030R020-MEGA	00020142	2	E	3,0	3,0	4,0	40,0	7,0	2,8	0,2	-	3	■
910035R020-MEGA	00020144	2	G	3,5	6,0	5,0	50,0	9,0	3,2	0,2	6,0	3	■
910040R020-MEGA	00020151	2	G	4,0	6,0	5,0	50,0	9,0	3,7	0,2	5,0	3	■
910040R030-MEGA	00020152	2	G	4,0	6,0	5,0	50,0	9,0	3,7	0,3	5,0	3	■
910040R050-MEGA	00020155	2	G	4,0	6,0	5,0	50,0	9,0	3,7	0,5	5,0	3	■
910050R020-MEGA	00020159	2	G	5,0	6,0	6,0	50,0	11,0	4,6	0,2	2,5	3	■
910060R020-MEGA	00020160	2	E	6,0	6,0	7,0	60,0	14,0	5,6	0,2	-	3	■
910060R030-MEGA	00020161	2	E	6,0	6,0	7,0	60,0	14,0	5,6	0,3	-	3	■
910060R050-MEGA	00020162	2	E	6,0	6,0	7,0	60,0	14,0	5,6	0,5	-	3	■
910060R050-TRIBON	00021539	2	E	6,0	6,0	7,0	60,0	14,0	5,6	0,5	-	3	■
910080R020-MEGA	00020163	2	E	8,0	8,0	9,0	60,0	18,0	7,4	0,2	-	3	■
910080R050-MEGA	00020164	2	E	8,0	8,0	9,0	60,0	18,0	7,4	0,5	-	3	■
910100R020-MEGA	00020165	2	E	10,0	10,0	12,0	70,0	25,0	9,4	0,2	-	3	■
910100R050-MEGA	00020166	2	E	10,0	10,0	12,0	70,0	25,0	9,4	0,5	-	3	■
910100R050-TRIBON	00021726	2	E	10,0	10,0	12,0	70,0	25,0	9,4	0,5	-	3	■
910100R100-MEGA	00020167	2	E	10,0	10,0	12,0	70,0	25,0	9,4	1,0	-	3	■
910120R050-MEGA	00020168	2	E	12,0	12,0	15,0	80,0	30,0	11,4	0,5	-	3	■
910120R100-MEGA	00020169	2	E	12,0	12,0	15,0	80,0	30,0	11,4	1,0	-	3	■

■ Stocked standard.

Universal
Steel and cast iron
Stainless steel and S-materials
Non ferrous
Hard
Plastic and cfrp
Graphite
Minimaster Plus
Minimaster

JH910

High speed – Universal – Square – 3 Flutes – Cylindrical – Corner radius

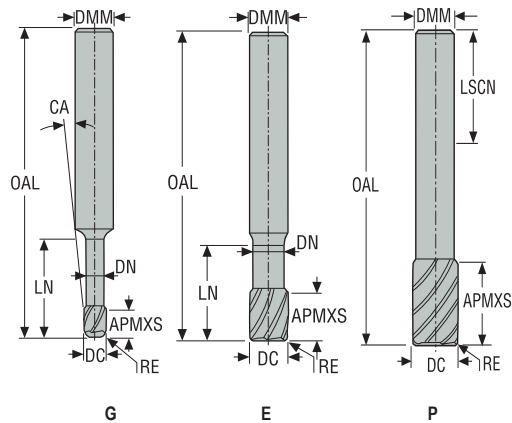

- Tolerances:
- DMM= h5
- DC= -0,02/-0,04 mm
- RE= ±0,05 mm
- Regrind possible if DC is ≥Ø6(G+E)

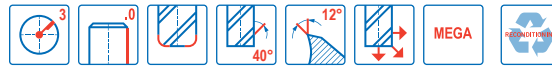

Designation	Item number	Length index	Tool shape	DC	DMM	APMXS	OAL	LN	DN	RE	CA	LSCN	PCEDC	Cylindrical
				mm	mm	mm	mm	mm	mm	mm	mm	mm	mm	mm
910L020-MEGA	00022002	3	G	2,0	3,0	3,0	60,0	10,0	1,9	0,2	2,5	28,0	3	■
910L030-MEGA	00022003	3	E	3,0	3,0	4,0	60,0	14,0	2,8	0,2	–	28,0	3	■
910L040-MEGA	00022004	3	G	4,0	6,0	5,0	65,0	18,0	3,7	0,2	3,0	36,0	3	■
910L050-MEGA	00022005	3	G	5,0	6,0	6,0	65,0	22,0	4,6	0,2	1,5	36,0	3	■
910L060-MEGA	00022006	3	E	6,0	6,0	7,0	80,0	26,0	5,6	0,3	–	36,0	3	■
910L080-MEGA	00022007	3	E	8,0	8,0	9,0	85,0	36,0	7,4	0,5	–	36,0	3	■
910L100-MEGA	00022009	3	E	10,0	10,0	12,0	100,0	45,0	9,4	0,5	–	40,0	3	■
910L120-MEGA	00022011	3	E	12,0	12,0	15,0	125,0	54,0	11,4	0,5	–	45,0	3	■
910L160-MEGA	00022013	3	E	16,0	16,0	18,0	125,0	65,0	15,4	1,0	–	48,0	3	■
910RS070-MEGA	00021772	4	P	7,0	6,0	8,0	100,0	–	6,0	0,3	–	36,0	3	■
910RS090-MEGA	00021781	4	P	9,0	8,0	11,0	100,0	–	8,0	0,5	–	36,0	3	■
910RS110-MEGA	00021782	4	P	11,0	10,0	13,0	125,0	–	10,0	0,5	–	40,0	3	■
910RS130-MEGA	00021784	4	P	13,0	12,0	16,0	150,0	–	12,0	0,6	–	45,0	3	■
910RS170-MEGA	00021800	4	P	17,0	16,0	20,0	150,0	–	16,0	0,6	–	48,0	3	■

■ Stocked standard.

Universal

Steel and cast iron

Stainless steel and S-materials

Non ferrous

Hard

Plastic and cfrp

Graphite

Minimaster Plus

Minimaster

JH930

High speed – Universal – Square – 5-8 Flutes – Cylindrical – Corner radius

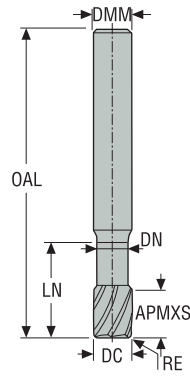

E

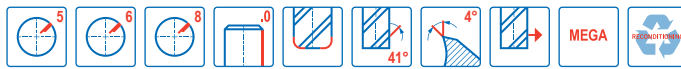

- Tolerances:
- DMM= h5
- DC= -0,02/-0,04 mm
- RE= ±0,05 mm
- Regrind possible if DC is ≥Ø6



Designation	Item number	Length index	Tool shape	DC	DMM	APMXS	OAL	LN	DN	RE	PCEDC	Cylindrical
				mm	mm	mm	mm	mm	mm	mm		
930060R020-MEGA	00022026	2	E	6,0	6,0	9,0	55,0	15,0	5,6	0,2	5	■
930060R050-MEGA	00022027	2	E	6,0	6,0	9,0	55,0	15,0	5,6	0,5	5	■
930080R020-MEGA	00022028	2	E	8,0	8,0	12,0	60,0	18,0	7,4	0,2	5	■
930080R050-MEGA	00022029	2	E	8,0	8,0	12,0	60,0	18,0	7,4	0,5	5	■
930100R030-MEGA	00022030	2	E	10,0	10,0	15,0	70,0	25,0	9,4	0,3	6	■
930100R100-MEGA	00022031	2	E	10,0	10,0	15,0	70,0	25,0	9,4	1,0	6	■
930120R050-MEGA	00022033	2	E	12,0	12,0	18,0	80,0	30,0	11,4	0,5	6	■
930120R100-MEGA	00022034	2	E	12,0	12,0	18,0	80,0	30,0	11,4	1,0	6	■
930160R050-MEGA	00022035	2	E	16,0	16,0	24,0	90,0	35,0	15,4	0,5	8	■
930160R100-MEGA	00022040	2	E	16,0	16,0	24,0	90,0	35,0	15,4	1,0	8	■
930200R050-MEGA	00022044	2	E	20,0	20,0	30,0	100,0	38,0	19,2	0,5	8	■

■ Stocked standard.

Universal

Steel and cast iron

Stainless steel and S-materials

Non ferrous

Hard

Plastic and cfrp

Graphite

Minimaster Plus

Minimaster

Cutting data – JH930 Side milling

SMG		a _p /DC	a _e /DC	f _z						v _c
				6	8	10	12	16	20	
P1	M/E/A	0.0400 0,0400	0.70 0,70	0.065 0,0026	0.085 0,0034	0.11 0,0044	0.13 0,0050	0.16 0,0065	0.18 0,0070	440 (370 – 490) 1450 (1300 – 1600)
P2	M/E/A	0.0400 0,0400	0.70 0,70	0.065 0,0026	0.090 0,0036	0.11 0,0044	0.13 0,0050	0.16 0,0065	0.19 0,0075	430 (360 – 480) 1400 (1200 – 1500)
P3	M/E/A	0.0400 0,0400	0.70 0,70	0.060 0,0024	0.085 0,0034	0.10 0,0040	0.12 0,0048	0.15 0,0060	0.18 0,0070	375 (320 – 420) 1225 (1100 – 1300)
P4	M/E/A	0.0400 0,0400	0.70 0,70	0.060 0,0024	0.080 0,0032	0.10 0,0040	0.12 0,0048	0.15 0,0060	0.17 0,0065	330 (280 – 370) 1075 (920 – 1200)
P5	M/E/A	0.0400 0,0400	0.70 0,70	0.060 0,0024	0.080 0,0032	0.10 0,0040	0.12 0,0048	0.15 0,0060	0.17 0,0065	315 (270 – 350) 1025 (890 – 1100)
P6	M/E/A	0.0400 0,0400	0.70 0,70	0.060 0,0024	0.080 0,0032	0.10 0,0040	0.12 0,0048	0.15 0,0060	0.17 0,0065	355 (300 – 390) 1175 (990 – 1200)
P7	M/E/A	0.0400 0,0400	0.70 0,70	0.060 0,0024	0.080 0,0032	0.10 0,0040	0.12 0,0048	0.15 0,0060	0.17 0,0065	335 (280 – 370) 1100 (920 – 1200)
P8	M/E/A	0.0400 0,0400	0.70 0,70	0.060 0,0024	0.085 0,0034	0.10 0,0040	0.12 0,0048	0.15 0,0060	0.18 0,0070	315 (270 – 350) 1025 (890 – 1100)
P11	M/E/A	0.0400 0,0400	0.70 0,70	0.060 0,0024	0.080 0,0032	0.10 0,0040	0.12 0,0048	0.15 0,0060	0.17 0,0065	325 (280 – 360) 1075 (920 – 1100)
P12	M/E/A	0.0400 0,0400	0.70 0,70	0.040 0,0016	0.055 0,0022	0.070 0,0028	0.080 0,0032	0.10 0,0040	0.11 0,0044	200 (170 – 220) 660 (560 – 720)
K1	E/M/A	0.0400 0,0400	0.70 0,70	0.060 0,0024	0.080 0,0032	0.10 0,0040	0.12 0,0048	0.15 0,0060	0.17 0,0065	255 (210 – 300) 840 (690 – 980)
K2	E/M/A	0.0400 0,0400	0.70 0,70	0.055 0,0022	0.075 0,0030	0.090 0,0036	0.11 0,0044	0.13 0,0050	0.15 0,0060	225 (180 – 260) 740 (600 – 850)
K3	E/M/A	0.0400 0,0400	0.70 0,70	0.055 0,0022	0.075 0,0030	0.090 0,0036	0.11 0,0044	0.13 0,0050	0.15 0,0060	190 (160 – 220) 620 (530 – 720)
K4	E/M/A	0.0400 0,0400	0.70 0,70	0.055 0,0022	0.075 0,0030	0.090 0,0036	0.11 0,0044	0.13 0,0050	0.15 0,0060	180 (150 – 210) 590 (500 – 680)
K5	E/M/A	0.0300 0,0300	0.50 0,50	0.060 0,0024	0.080 0,0032	0.10 0,0040	0.12 0,0048	0.15 0,0060	0.17 0,0065	205 (160 – 250) 670 (530 – 820)
K6	E/M/A	0.0300 0,0300	0.50 0,50	0.065 0,0026	0.090 0,0036	0.11 0,0044	0.13 0,0050	0.16 0,0065	0.19 0,0075	300 (230 – 370) 980 (760 – 1200)
K7	E/M/A	0.0300 0,0300	0.50 0,50	0.060 0,0024	0.080 0,0032	0.10 0,0040	0.12 0,0048	0.15 0,0060	0.17 0,0065	260 (200 – 320) 850 (660 – 1000)
S1	E/M/A	0.0300 0,0300	0.44 0,44	0.055 0,0022	0.070 0,0028	0.090 0,0036	0.11 0,0044	0.13 0,0050	0.15 0,0060	80 (62 – 100) 260 (210 – 320)
S2	E/M/A	0.0300 0,0300	0.44 0,44	0.055 0,0022	0.070 0,0028	0.090 0,0036	0.11 0,0044	0.13 0,0050	0.15 0,0060	65 (50 – 82) 215 (170 – 260)
S3	E/M/A	0.0200 0,0200	0.70 0,70	0.055 0,0022	0.070 0,0028	0.090 0,0036	0.11 0,0044	0.13 0,0050	0.15 0,0060	41 (31 – 50) 135 (110 – 160)
S11	E/M/A	0.0400 0,0400	0.70 0,70	0.060 0,0024	0.080 0,0032	0.10 0,0040	0.12 0,0048	0.15 0,0060	0.17 0,0065	160 (140 – 180) 520 (460 – 590)
S12	E/M/A	0.0400 0,0400	0.70 0,70	0.060 0,0024	0.080 0,0032	0.10 0,0040	0.12 0,0048	0.15 0,0060	0.17 0,0065	120 (110 – 140) 395 (370 – 450)
S13	E/M/A	0.0400 0,0400	0.70 0,70	0.050 0,0020	0.070 0,0028	0.085 0,0034	0.10 0,0040	0.13 0,0050	0.15 0,0060	95 (81 – 110) 310 (270 – 360)
H3	M/A	0.0200 0,0200	0.50 0,50	0.018 0,00070	0.024 0,00095	0.030 0,0012	0.036 0,0014	0.044 0,0017	0.050 0,0020	55 (41 – 71) 180 (140 – 230)
H5	M/A	0.0300 0,0300	0.50 0,50	0.024 0,00095	0.032 0,0013	0.040 0,0016	0.048 0,0019	0.060 0,0024	0.070 0,0028	250 (210 – 300) 820 (690 – 980)
H7	M/A	0.0200 0,0200	0.50 0,50	0.018 0,00070	0.024 0,00095	0.030 0,0012	0.036 0,0014	0.044 0,0017	0.050 0,0020	55 (41 – 71) 180 (140 – 230)
H8	M/A	0.0300 0,0300	0.50 0,50	0.018 0,00070	0.024 0,00095	0.030 0,0012	0.036 0,0014	0.044 0,0017	0.050 0,0020	255 (210 – 300) 840 (690 – 980)
H11	M/A	0.0300 0,0300	0.50 0,50	0.024 0,00095	0.032 0,0013	0.040 0,0016	0.048 0,0019	0.060 0,0024	0.070 0,0028	320 (260 – 380) 1050 (860 – 1200)
H12	M/A	0.0400 0,0400	0.70 0,70	0.030 0,0012	0.042 0,0017	0.050 0,0020	0.060 0,0024	0.075 0,0030	0.085 0,0034	270 (220 – 320) 890 (730 – 1000)
H21	M/A	0.0300 0,0300	0.50 0,50	0.018 0,00070	0.024 0,00095	0.030 0,0012	0.036 0,0014	0.044 0,0017	0.050 0,0020	255 (210 – 300) 840 (690 – 980)
H31	M/A	0.0300 0,0300	0.50 0,50	0.024 0,00095	0.032 0,0013	0.040 0,0016	0.048 0,0019	0.060 0,0024	0.070 0,0028	155 (130 – 180) 510 (430 – 590)

For cutting data recalculations, see pages 445 - 452

SMG = Seco material group
Coolant = A=air D=dry E=emulsion M=mist spray
v_c = m/min (sf/min)
f_z = mm (in/tooth)
a_p = mm/DC (in/DC) = factor
a_e = mm/DC (in/DC) = factor
All cutting data are target values

JH970

High speed – Universal – Ball nose – 2 Flutes – Cylindrical

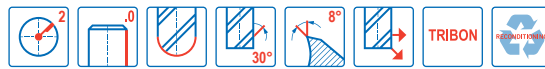
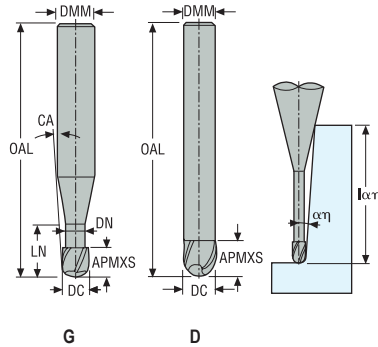

- Tolerances:
- DMM= h5
- DC= -0,02/-0,04 mm
- RE= ±0,05 mm
- Regrind possible if DC is ≥Ø6

Designation	Item number	Length index	Tool shape	DC	DMM	APMXS	OAL	LN	DN	CA°	PCEDC	WDX0*	WDX05*	WDX1*	WDX15*	WDX2*	WDX3*	Cylindrical
				mm	mm	mm	mm	mm	mm	mm		mm	mm	mm	mm	mm	mm	
970021-TRIBON	02452881	1	G	2,0	3,0	3,0	50,0	10,0	1,9	2,5	2	10,0	11,0	11,5	12,1	12,8	-	■
970031-TRIBON	02452882	1	D	3,0	3,0	4,5	50,0	-	-	-	2	4,5	-	-	-	-	-	■
970041-TRIBON	02452883	1	D	4,0	4,0	6,0	60,0	-	-	-	2	6,0	-	-	-	-	-	■
970051-TRIBON	02452884	1	D	5,0	5,0	7,5	60,0	-	-	-	2	7,5	-	-	-	-	-	■
970061-TRIBON	02452885	1	D	6,0	6,0	9,0	75,0	-	-	-	2	9,0	-	-	-	-	-	■
970020-TRIBON	02452886	2	G	2,0	6,0	3,0	60,0	4,0	1,9	8,0	2	4,0	4,7	4,9	5,1	5,4	6,0	■
970025-TRIBON	02452887	2	G	2,5	6,0	4,0	60,0	5,0	2,4	7,5	2	5,0	5,7	6,0	6,2	6,5	7,3	■
970030-TRIBON	02452888	2	G	3,0	6,0	4,5	60,0	6,0	2,8	5,5	2	6,0	7,4	7,8	8,3	9,0	10,6	■
970035-TRIBON	02452889	2	G	3,5	6,0	5,0	60,0	7,0	3,2	4,5	2	7,0	8,8	9,4	10,0	10,7	12,8	■
970040-TRIBON	02452890	2	G	4,0	6,0	6,0	60,0	8,0	3,7	3,0	2	8,0	10,8	11,9	13,3	15,2	-	■
970050-TRIBON	02452891	2	G	5,0	6,0	7,5	60,0	10,0	4,6	2,0	2	10,0	13,6	15,0	16,8	-	-	■
970060-TRIBON	02452892	2	G	6,0	8,0	9,0	75,0	12,0	5,6	2,5	2	12,0	15,8	17,4	19,4	22,2	-	■
970080-TRIBON	02452893	2	D	8,0	8,0	12,0	75,0	-	-	-	2	12,0	-	-	-	-	-	■
970100-TRIBON	02452894	2	D	10,0	10,0	15,0	80,0	-	-	-	2	15,0	-	-	-	-	-	■
970120-TRIBON	02452895	2	D	12,0	12,0	18,0	90,0	-	-	-	2	18,0	-	-	-	-	-	■
970160-TRIBON	02452896	2	D	16,0	16,0	24,0	100,0	-	-	-	2	24,0	-	-	-	-	-	■
970L020-TRIBON	02452899	3	G	2,0	6,0	3,0	80,0	4,0	1,9	8,0	2	4,0	4,7	4,9	5,1	5,4	6,0	■
970L030-TRIBON	02452900	3	G	3,0	6,0	4,5	80,0	6,0	2,8	5,5	2	6,0	7,4	7,8	8,3	9,0	10,6	■
970L040-TRIBON	02452901	3	G	4,0	6,0	6,0	80,0	8,0	3,7	3,0	2	8,0	10,8	11,9	13,3	15,2	-	■
970L050-TRIBON	02452902	3	G	5,0	6,0	7,5	100,0	10,0	4,6	2,0	2	10,0	13,6	15,0	16,8	-	-	■
970L060-TRIBON	02452903	3	G	6,0	8,0	9,0	100,0	12,0	5,6	2,5	2	12,0	15,8	17,4	19,4	22,2	-	■
970L080-TRIBON	02452904	3	D	8,0	8,0	12,0	110,0	-	-	-	2	12,0	-	-	-	-	-	■
970L100-TRIBON	02452905	3	D	10,0	10,0	15,0	125,0	-	-	-	2	15,0	-	-	-	-	-	■
970L120-TRIBON	02452906	3	D	12,0	12,0	18,0	125,0	-	-	-	2	18,0	-	-	-	-	-	■
970L160-TRIBON	02452907	3	D	16,0	16,0	24,0	150,0	-	-	-	2	24,0	-	-	-	-	-	■

■ Stocked standard.

For WDX values: Max. cut depth rel. to αη (lαη, ref)*

Universal

Steel and cast iron

Stainless steel and S-materials

Non ferrous

Hard

Plastic and chip

Graphite

Minimaster Plus

Minimaster

Cutting data – JH970 Copy milling roughing

SMG		a _p /DC	a _r /DC	f _z									v _c
				2	3	4	5	6	8	10	12	16	
P1	M	0.350	0.070	0.040	0.060	0.080	0.10	0.12	0.16	0.20	0.24	0.32	245 (220 — 270)
		0,350	0,070	0,0016	0,0024	0,0032	0,0040	0,0048	0,0065	0,0080	0,0095	0,013	800 (730 — 880)
P2	M	0.350	0.070	0.040	0.060	0.080	0.10	0.12	0.16	0.20	0.24	0.32	240 (210 — 270)
		0,350	0,070	0,0016	0,0024	0,0032	0,0040	0,0048	0,0065	0,0080	0,0095	0,013	790 (690 — 880)
P3	M	0.350	0.070	0.040	0.060	0.080	0.10	0.12	0.16	0.20	0.24	0.32	205 (180 — 230)
		0,350	0,070	0,0016	0,0024	0,0032	0,0040	0,0048	0,0065	0,0080	0,0095	0,013	670 (600 — 750)
P4	M	0.350	0.070	0.040	0.060	0.080	0.10	0.12	0.16	0.20	0.24	0.32	180 (160 — 200)
		0,350	0,070	0,0016	0,0024	0,0032	0,0040	0,0048	0,0065	0,0080	0,0095	0,013	590 (530 — 650)
P5	M	0.350	0.070	0.040	0.060	0.080	0.10	0.12	0.16	0.20	0.24	0.32	170 (150 — 190)
		0,350	0,070	0,0016	0,0024	0,0032	0,0040	0,0048	0,0065	0,0080	0,0095	0,013	560 (500 — 620)
P6	M	0.350	0.070	0.040	0.060	0.080	0.10	0.12	0.16	0.20	0.24	0.32	195 (170 — 210)
		0,350	0,070	0,0016	0,0024	0,0032	0,0040	0,0048	0,0065	0,0080	0,0095	0,013	640 (560 — 680)
P7	M	0.350	0.070	0.040	0.060	0.080	0.10	0.12	0.16	0.20	0.24	0.32	185 (160 — 200)
		0,350	0,070	0,0016	0,0024	0,0032	0,0040	0,0048	0,0065	0,0080	0,0095	0,013	610 (530 — 650)
P8	M	0.350	0.070	0.040	0.060	0.080	0.10	0.12	0.16	0.20	0.24	0.32	170 (150 — 190)
		0,350	0,070	0,0016	0,0024	0,0032	0,0040	0,0048	0,0065	0,0080	0,0095	0,013	560 (500 — 620)
P11	M	0.350	0.070	0.040	0.060	0.080	0.10	0.12	0.16	0.20	0.24	0.32	180 (160 — 200)
		0,350	0,070	0,0016	0,0024	0,0032	0,0040	0,0048	0,0065	0,0080	0,0095	0,013	590 (530 — 650)
P12	M	0.350	0.070	0.040	0.060	0.080	0.10	0.12	0.16	0.20	0.24	0.32	105 (91 — 110)
		0,350	0,070	0,0016	0,0024	0,0032	0,0040	0,0048	0,0065	0,0080	0,0095	0,013	345 (300 — 360)
M1	M	0.170	1.0	0.020	0.030	0.040	0.050	0.060	0.080	0.10	0.12	0.16	95 (85 — 110)
		0,170	1,0	0,00080	0,0012	0,0016	0,0020	0,0024	0,0032	0,0040	0,0048	0,0065	310 (280 — 360)
M2	M	0.170	1.0	0.020	0.030	0.040	0.050	0.060	0.080	0.10	0.12	0.15	80 (69 — 89)
		0,170	1,0	0,00080	0,0012	0,0016	0,0020	0,0024	0,0032	0,0040	0,0048	0,0060	260 (230 — 290)
M3	M	0.130	1.0	0.022	0.032	0.042	0.055	0.065	0.085	0.11	0.13	0.15	65 (57 — 76)
		0,130	1,0	0,00085	0,0013	0,0017	0,0022	0,0026	0,0034	0,0044	0,0050	0,0060	215 (190 — 240)
M4	M	0.130	1.0	0.019	0.028	0.038	0.046	0.055	0.075	0.095	0.11	0.14	50 (44 — 59)
		0,130	1,0	0,00075	0,0011	0,0015	0,0018	0,0022	0,0030	0,0038	0,0044	0,0055	165 (150 — 190)
M5	M	0.130	1.0	0.019	0.028	0.038	0.046	0.055	0.075	0.095	0.11	0.14	43 (37 — 49)
		0,130	1,0	0,00075	0,0011	0,0015	0,0018	0,0022	0,0030	0,0038	0,0044	0,0055	140 (130 — 160)
S1	E	0.150	0.065	0.040	0.060	0.080	0.10	0.12	0.16	0.20	0.24	0.30	50 (42 — 62)
		0,150	0,065	0,0016	0,0024	0,0032	0,0040	0,0048	0,0065	0,0080	0,0095	0,012	165 (140 — 200)
S2	E	0.150	0.065	0.040	0.060	0.080	0.10	0.12	0.16	0.20	0.24	0.30	42 (34 — 50)
		0,150	0,065	0,0016	0,0024	0,0032	0,0040	0,0048	0,0065	0,0080	0,0095	0,012	140 (120 — 160)
S3	E	0.120	0.060	0.040	0.060	0.080	0.10	0.12	0.16	0.20	0.24	0.30	31 (21 — 41)
		0,120	0,060	0,0016	0,0024	0,0032	0,0040	0,0048	0,0065	0,0080	0,0095	0,012	100 (69 — 130)
S11	E	0.350	0.15	0.012	0.018	0.024	0.030	0.036	0.048	0.060	0.070	0.095	105 (89 — 110)
		0,350	0,15	0,00048	0,00070	0,00095	0,0012	0,0014	0,0019	0,0024	0,0028	0,0038	345 (300 — 360)
S12	E	0.350	0.15	0.012	0.018	0.024	0.030	0.036	0.048	0.060	0.070	0.095	80 (69 — 91)
		0,350	0,15	0,00048	0,00070	0,00095	0,0012	0,0014	0,0019	0,0024	0,0028	0,0038	260 (230 — 290)
S13	E	0.350	0.15	0.012	0.018	0.024	0.030	0.036	0.048	0.060	0.070	0.095	60 (54 — 70)
		0,350	0,15	0,00048	0,00070	0,00095	0,0012	0,0014	0,0019	0,0024	0,0028	0,0038	195 (180 — 220)

For cutting data recalculations, see pages 445 - 452

SMG = Seco material group
Coolant = A=air D=dry E=emulsion M=mist spray
v_c = m/min (sf/min)
f_z = mm (in/tooth)
a_p = mm/DC (in/DC) = factor
a_r = mm/DC (in/DC) = factor
All cutting data are target values

JHF980

High feed – Universal – 2-5 Flutes – Cylindrical – Corner radius

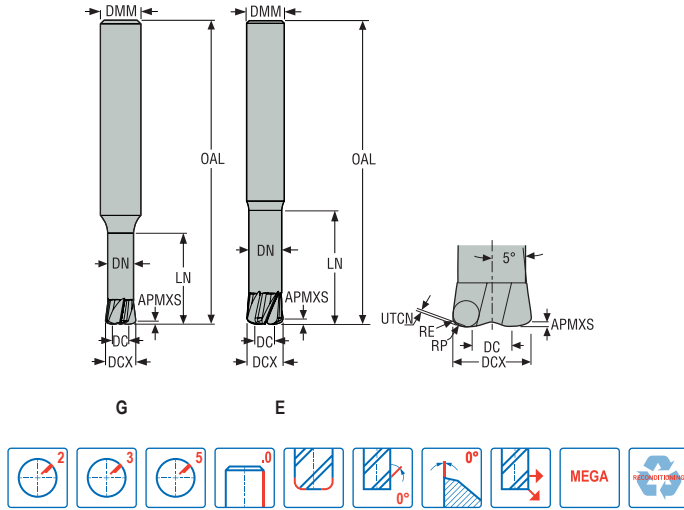

- Tolerances:
- DMM= h5
- DC= -0,02/-0,04 mm
- RE= ±0,05 mm
- CA= collision angle
- Regrind possible if DC is ≥Ø6

Designation	Item number	Length index	Tool shape	DCX	DC	DMM	APMXS	OAL	LN	DN	RE	RP	UTCN	CEDC	Cylindrical
				mm	mm	mm	mm	mm	mm	mm	mm	mm	mm		
980K080Z3-MEGA	02587115	1	E	8,0	4,0	8,0	0,4	70,0	12,0	3,0	0,6	0,935	0,198	3	■
JHF980080E1H.0Z5-MEGA	03003384	1	E	8,0	4,0	8,0	0,4	70,0	12,0	7,0	0,6	0,935	0,198	5	■
980K100Z3-MEGA	02587117	1	E	10,0	5,0	10,0	0,45	80,0	15,0	3,8	0,8	1,176	0,232	3	■
JHF980100E1H.0Z5-MEGA	03003385	1	E	10,0	5,0	10,0	0,45	80,0	15,0	8,8	0,8	1,176	0,232	5	■
980K120Z3-MEGA	02587118	1	E	12,0	6,0	12,0	0,5	80,0	18,0	4,6	1,0	1,417	0,265	3	■
JHF980120E1H.0Z5-MEGA	03003386	1	E	12,0	6,0	12,0	0,5	80,0	18,0	10,6	1,0	1,417	0,265	5	■
980010-MEGA	02587111	2	G	1,0	0,5	6,0	0,07	40,0	3,0	0,7	0,07	0,127	0,028	2	■
980015-MEGA	02511199	2	G	1,5	0,75	6,0	0,1	40,0	4,5	1,2	0,1	0,183	0,043	2	■
980020-MEGA	02511221	2	G	2,0	1,0	6,0	0,15	40,0	6,0	1,7	0,15	0,269	0,055	2	■
980030-MEGA	02511224	2	G	3,0	1,5	6,0	0,2	50,0	9,0	2,6	0,2	0,366	0,085	2	■
JHF980030G2H.0Z4-MEGA	03003387	2	G	3,0	1,5	6,0	0,2	50,0	9,0	2,6	0,2	0,366	0,085	4	■
980040-MEGA	02511229	2	G	4,0	2,0	6,0	0,25	60,0	12,0	3,5	0,3	0,503	0,107	2	■
JHF980040G2H.0Z4-MEGA	03003388	2	G	4,0	2,0	6,0	0,25	60,0	12,0	3,5	0,3	0,503	0,107	4	■
980050-MEGA	02511233	2	G	5,0	2,5	6,0	0,3	60,0	15,0	4,4	0,4	0,641	0,128	2	■
JHF980050G2H.0Z4-MEGA	03003389	2	G	5,0	2,5	6,0	0,3	60,0	15,0	4,4	0,4	0,641	0,128	4	■
980060-MEGA	02511314	2	G	6,0	3,0	8,0	0,35	60,0	18,0	5,2	0,5	0,778	0,15	2	■
JHF980060G2H.0Z4-MEGA	03003390	2	G	6,0	3,0	8,0	0,35	60,0	18,0	5,2	0,5	0,778	0,15	4	■
980080-MEGA	02511322	2	E	8,0	4,0	8,0	0,4	70,0	24,0	7,0	0,6	0,935	0,198	2	■
JHF980080E2H.0Z5-MEGA	03003391	2	E	8,0	4,0	8,0	0,4	70,0	24,0	7,0	0,6	0,935	0,198	5	■
980100-MEGA	02511341	2	E	10,0	5,0	10,0	0,45	80,0	30,0	8,8	0,8	1,176	0,232	2	■
980100Z3-MEGA	02511342	2	E	10,0	5,0	10,0	0,45	80,0	30,0	8,8	0,8	1,176	0,232	3	■
JHF980100E2H.0Z5-MEGA	03003392	2	E	10,0	5,0	10,0	0,45	80,0	30,0	8,8	0,8	1,176	0,232	5	■
980120-MEGA	02511346	2	E	12,0	6,0	12,0	0,5	80,0	36,0	10,6	1,0	1,417	0,265	2	■
980120Z3-MEGA	02511347	2	E	12,0	6,0	12,0	0,5	80,0	36,0	10,6	1,0	1,417	0,265	3	■
JHF980120E2H.0Z5-MEGA	03003393	2	E	12,0	6,0	12,0	0,5	80,0	36,0	10,6	1,0	1,417	0,265	5	■

■ Stocked standard.
*UTCN=uncut-thickness

Universal
Steel and cast iron
Stainless steel and S-materials
Non ferrous
Hard
Plastic and cfrp
Graphite
Minimaster Plus
Minimaster

JHF980

High feed – Universal – 2-5 Flutes – Cylindrical – Corner radius

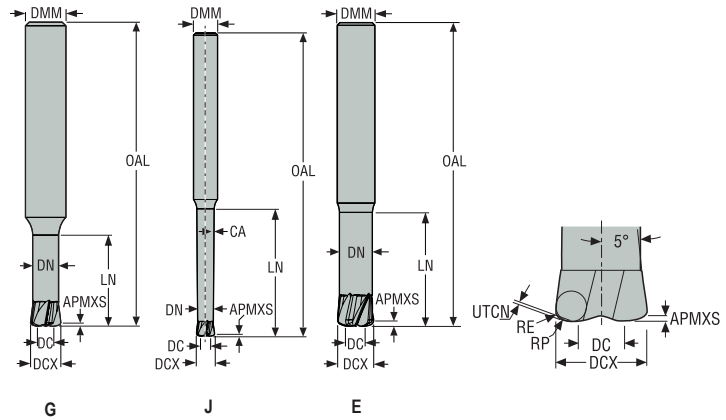

- Tolerances:
- DMM= h5
- DC= -0,02/-0,04 mm
- RE= ±0,05 mm
- CA= collision angle
- Regrind possible if DC is ≥Ø6

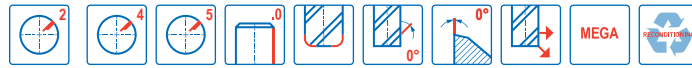

Designation	Item number	Length index	Tool shape	DCX	DC	DMM	APMXS	OAL	LN	DN	RE	RP	UTCN	CA	NA	CEDC	Cylindrical
				mm	mm	mm	mm	mm	mm	mm	mm	mm	mm	mm	mm	mm	mm
980ML010-MEGA	02587113	3	G	1,0	0,5	6,0	0,07	40,0	5,0	0,7	0,07	0,127	0,028	15,5	0,0	2	■
980ML015-MEGA	02511219	3	G	1,5	0,75	6,0	0,1	40,0	7,5	1,2	0,1	0,183	0,043	10,5	0,0	2	■
980ML020-MEGA	02511222	3	G	2,0	1,0	6,0	0,15	40,0	10,0	1,7	0,15	0,269	0,055	8,0	0,0	2	■
JHF980020G3H.0Z4-MEGA	03003394	3	G	2,0	1,0	6,0	0,15	40,0	10,0	1,7	0,15	0,269	0,055	8,46	0,0	4	■
980ML030-MEGA	02511225	3	G	3,0	1,5	6,0	0,2	50,0	15,0	2,6	0,2	0,366	0,085	5,0	0,0	2	■
JHF980030G3H.0Z4-MEGA	03003395	3	G	3,0	1,5	6,0	0,2	50,0	15,0	2,6	0,2	0,366	0,085	4,79	0,0	4	■
980ML040-MEGA	02511231	3	G	4,0	2,0	6,0	0,25	70,0	20,0	3,5	0,3	0,503	0,107	2,5	0,0	2	■
JHF980040G3H.0Z4-MEGA	03003396	3	G	4,0	2,0	6,0	0,25	70,0	20,0	3,5	0,3	0,503	0,107	2,59	0,0	4	■
980ML050-MEGA	02511234	3	G	5,0	2,5	6,0	0,3	80,0	25,0	4,4	0,4	0,641	0,128	1,5	0,0	2	■
JHF980050G3H.0Z4-MEGA	03003397	3	G	5,0	2,5	6,0	0,3	80,0	25,0	4,4	0,4	0,641	0,128	1,12	0,0	4	■
980ML060-MEGA	02511315	3	G	6,0	3,0	8,0	0,35	80,0	30,0	5,2	0,5	0,778	0,15	2,0	0,0	2	■
JHF980060G3H.0Z4-MEGA	03003398	3	G	6,0	3,0	8,0	0,35	80,0	30,0	5,2	0,5	0,778	0,15	1,8	0,0	4	■
980ML080-MEGA	02511338	3	E	8,0	4,0	8,0	0,4	80,0	40,0	7,0	0,6	0,935	0,198	-	0,0	2	■
JHF980080E3H.0Z5-MEGA	03003399	3	E	8,0	4,0	8,0	0,4	80,0	40,0	7,0	0,6	0,935	0,198	-	0,0	5	■
980ML100-MEGA	02511344	3	E	10,0	5,0	10,0	0,45	90,0	50,0	8,8	0,8	1,176	0,232	-	0,0	2	■
JHF980100E3H.0Z5-MEGA	03003400	3	E	10,0	5,0	10,0	0,45	90,0	50,0	8,8	0,8	1,176	0,232	-	0,0	5	■
980ML120-MEGA	02511348	3	E	12,0	6,0	12,0	0,5	110,0	60,0	10,6	1,0	1,417	0,265	-	0,0	2	■
JHF980120E3H.0Z5-MEGA	03003401	3	E	12,0	6,0	12,0	0,5	110,0	60,0	10,6	1,0	1,417	0,265	-	0,0	5	■
980TL010-MEGA	02587114	4	J	1,0	0,5	6,0	0,07	40,0	7,0	0,7	0,07	0,127	0,028	13,0	0,5	2	■
980TL015-MEGA	02511220	4	J	1,5	0,75	6,0	0,1	40,0	10,5	1,2	0,1	0,183	0,043	8,5	0,5	2	■
980TL020-MEGA	02511223	4	J	2,0	1,0	6,0	0,15	50,0	14,0	1,7	0,15	0,269	0,055	6,5	0,5	2	■
980TL030-MEGA	02511226	4	J	3,0	1,5	6,0	0,2	60,0	21,0	2,6	0,2	0,366	0,085	3,5	0,5	2	■
JHF980030J4H.0Z4-MEGA	03003402	4	J	3,0	1,5	6,0	0,2	60,0	21,0	2,6	0,2	0,366	0,085	3,63	0,5	4	■
980TL040-MEGA	02511232	4	J	4,0	2,0	6,0	0,25	80,0	28,0	3,5	0,3	0,503	0,107	2,0	0,5	2	■
JHF980040J4H.0Z4-MEGA	03003403	4	J	4,0	2,0	6,0	0,25	80,0	28,0	3,5	0,3	0,503	0,107	1,93	0,5	4	■
980TL050-MEGA	02511240	4	J	5,0	2,5	6,0	0,3	90,0	35,0	4,4	0,4	0,641	0,128	1,0	0,5	2	■
JHF980050J4H.0Z4-MEGA	03003404	4	J	5,0	2,5	6,0	0,3	90,0	35,0	4,4	0,4	0,641	0,128	0,82	0,5	4	■
980TL060-MEGA	02511321	4	J	6,0	3,0	8,0	0,35	100,0	42,0	5,2	0,5	0,778	0,15	1,5	0,5	2	■
JHF980060J4H.0Z4-MEGA	03003405	4	J	6,0	3,0	8,0	0,35	100,0	42,0	5,2	0,5	0,778	0,15	1,33	0,5	4	■
980TL080-MEGA	02511340	4	E	8,0	4,0	8,0	0,4	100,0	56,0	7,0	0,6	0,935	0,198	-	0,5	2	■
JHF980080E4H.0Z5-MEGA	03003406	4	E	8,0	4,0	8,0	0,4	100,0	56,0	7,0	0,6	0,935	0,198	-	0,0	5	■
980TL100-MEGA	02511345	4	E	10,0	5,0	10,0	0,45	110,0	70,0	8,8	0,8	1,176	0,232	-	0,5	2	■
JHF980100E4H.0Z5-MEGA	03003407	4	E	10,0	5,0	10,0	0,45	110,0	70,0	8,8	0,8	1,176	0,232	-	0,0	5	■
980TL120-MEGA	02511349	4	E	12,0	6,0	12,0	0,5	130,0	84,0	10,6	1,0	1,417	0,265	-	0,5	2	■
JHF980120E4H.0Z5-MEGA	03003408	4	E	12,0	6,0	12,0	0,5	130,0	84,0	10,6	1,0	1,417	0,265	-	0,0	5	■

■ Stocked standard. *UTCN=uncut-thickness

J29

General purpose – Universal – Engraving – 1 Flute – Cylindrical

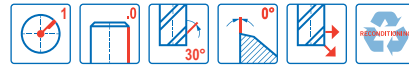
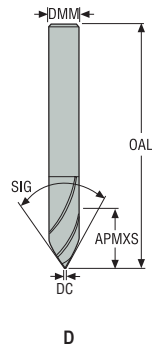

- Tolerances:
- DMM=h5
- Regrind possible if DC is $\geq \varnothing 6$

Designation	Item number	Length index	Tool shape	DC	DMM	APMXS	OAL	SIG°	PCEDC	Cylindrical
				mm	mm	mm	mm			
29030	00029373	2	D	0,2	3,0	2,6	40,0	60,0	1	■
29040	00029381	2	D	0,2	4,0	3,5	50,0	60,0	1	■
29060	00029396	2	D	0,2	6,0	5,2	50,0	60,0	1	■

■ Stocked standard.

Universal

Steel and cast iron

Stainless steel and S-materials

Non ferrous

Hard

Plastic and cfrp

Graphite

Minimaster Plus

Minimaster

Cutting data – J29 Slot milling

Universal	SMG		a _p /DC	f _z			v _c
				3	4	6	
Steel and cast iron	P1	E	0.50	0.24	0.26	0.28	42 (32 – 63)
			0.50	0,0095	0,010	0,011	140 (110 – 200)
Steel and cast iron	P2	E	0.50	0.24	0.26	0.30	41 (32 – 61)
			0.50	0,0095	0,010	0,012	135 (110 – 200)
Steel and cast iron	P3	E	0.50	0.24	0.25	0.28	36 (28 – 54)
			0.50	0,0095	0,010	0,011	120 (92–170)
Steel and cast iron	P4	E	0.50	0.22	0.24	0.26	31 (24 – 47)
			0.50	0,0085	0,0095	0,010	100 (79–150)
Steel and cast iron	P5	E	0.50	0.22	0.24	0.26	30 (23 – 45)
			0.50	0,0085	0,0095	0,010	100 (76–140)
Steel and cast iron	P6	E	0.50	0.22	0.24	0.26	34 (26 – 51)
			0.50	0,0085	0,0095	0,010	110 (86–160)
Stainless steel and S-materials	P7	E	0.50	0.22	0.24	0.26	32 (25 – 48)
			0.50	0,0085	0,0095	0,010	105 (83–150)
Stainless steel and S-materials	P8	E	0.50	0.24	0.25	0.28	30 (23 – 45)
			0.50	0,0095	0,010	0,011	100 (76–140)
Stainless steel and S-materials	P11	E	0.50	0.22	0.24	0.26	31 (24 – 46)
			0.50	0,0085	0,0095	0,010	100 (79–150)
Stainless steel and S-materials	P12	E	0.50	0.15	0.16	0.18	19 (15 – 29)
			0.50	0,0060	0,0065	0,0070	60 (50 – 95)
Non ferrous	M1	E	0.50	0.22	0.24	0.26	30 (23 – 45)
			0.50	0,0085	0,0095	0,010	100 (76–140)
Non ferrous	M2	E	0.50	0.22	0.24	0.26	30 (23 – 45)
			0.50	0,0085	0,0095	0,010	100 (76–140)
Non ferrous	M3	E	0.50	0.18	0.19	0.22	24 (18 – 35)
			0.50	0,0070	0,0075	0,0085	80 (60–110)
Non ferrous	M4	E	0.50	0.16	0.17	0.18	18 (14 – 27)
			0.50	0,0065	0,0065	0,0070	60 (46 – 88)
Non ferrous	M5	E	0.50	0.16	0.17	0.18	15 (12 – 22)
			0.50	0,0065	0,0065	0,0070	49 (40–72)
Hard	K1	E	0.50	0.22	0.24	0.26	30 (23 – 45)
			0.50	0,0085	0,0095	0,010	100 (76–140)
Hard	K2	E	0.50	0.20	0.22	0.24	26 (21 – 40)
			0.50	0,0080	0,0085	0,0095	85 (69–130)
Hard	K3	E	0.50	0.20	0.22	0.24	22 (17 – 33)
			0.50	0,0080	0,0085	0,0095	70 (56–100)
Hard	K4	E	0.50	0.20	0.22	0.24	21 (17 – 32)
			0.50	0,0080	0,0085	0,0095	70 (56–100)
Hard	K5	E	0.50	0.18	0.20	0.22	13 (9.8–19)
			0.50	0,0070	0,0080	0,0085	43 (33 – 62)
Hard	K6	E	0.50	0.20	0.22	0.24	19 (15 – 28)
			0.50	0,0080	0,0085	0,0095	60 (50 – 91)
Hard	K7	E	0.50	0.18	0.20	0.22	16 (13 – 25)
			0.50	0,0070	0,0080	0,0085	50 (43 – 82)

For cutting data recalculations, see pages 445 - 452

SMG = Seco material group
Coolant = A=air D=dry E=emulsion M=mist spray
v_c = m/min (sf/min)
f_z = mm/tooth (in/tooth)
a_p = mm/DC (in/DC) = factor
a_e = mm/DC (in/DC) = factor
All cutting data are target values

Cutting data – J29 Slot milling

SMG		a _p /DC	f _z			v _c
			3	4	6	
N1	E	0.50	0.22	0.24	0.26	30 (23 – 45)
		0,50	0,0085	0,0095	0,010	100 (76–140)
N2	E	0.50	0.22	0.24	0.26	19 (15 – 29)
		0,50	0,0085	0,0095	0,010	60 (50 – 95)
N3	E	0.50	0.22	0.24	0.26	13 (9.8–19)
		0,50	0,0085	0,0095	0,010	43 (33 – 62)
N11	E	0.50	0.22	0.24	0.26	17 (14 – 26)
		0,50	0,0085	0,0095	0,010	55 (46 – 85)
S1	E	0.50	0.24	0.26	0.28	43 (33 – 64)
		0,50	0,0095	0,010	0,011	140 (110 – 200)
S2	E	0.50	0.24	0.26	0.28	34 (27 – 51)
		0,50	0,0095	0,010	0,011	110 (89–160)
S3	E	0.50	0.22	0.24	0.26	30 (23 – 45)
		0,50	0,0085	0,0095	0,010	100 (76–140)
S11	E	0.50	0.22	0.24	0.26	39 (30 – 59)
		0,50	0,0085	0,0095	0,010	130 (99–190)
S12	E	0.50	0.22	0.24	0.26	30 (23 – 45)
		0,50	0,0085	0,0095	0,010	100 (76–140)
S13	E	0.50	0.19	0.20	0.24	24 (18 – 35)
		0,50	0,0075	0,0080	0,0095	80 (60–110)
H5	M/A/D	0.50	0.22	0.24	0.26	30 (23 – 45)
		0,50	0,0085	0,0095	0,010	100 (76–140)
H8	M/A/D	0.50	0.17	0.18	0.20	32 (24 – 47)
		0,50	0,0065	0,0070	0,0080	105 (79–150)
H11	M/A/D	0.50	0.22	0.24	0.26	39 (30 – 58)
		0,50	0,0085	0,0095	0,010	130 (99–190)
H12	M/A/D	0.50	0.12	0.12	0.14	12 (9.1–18)
		0,50	0,0048	0,0048	0,0055	39 (30 – 59)
H21	M/A/D	0.50	0.17	0.18	0.20	32 (24 – 47)
		0,50	0,0065	0,0070	0,0080	105 (79–150)
H31	M/A/D	0.50	0.15	0.16	0.17	24 (19 – 36)
		0,50	0,0060	0,0065	0,0065	80 (63–110)
TS1	E	0.50	0.22	0.24	0.26	30 (23 – 45)
		0,50	0,0085	0,0095	0,010	100 (76–140)
TP1	E	0.50	0.22	0.24	0.26	30 (23 – 45)
		0,50	0,0085	0,0095	0,010	100 (76–140)
GR1	D	0.50	0.22	0.24	0.26	30 (23 – 45)
		0,50	0,0085	0,0095	0,010	100 (76–140)

For cutting data recalculations, see pages 445 - 452

SMG = Seco material group
 Coolant = A=air D=dry E=emulsion M=mist spray
 v_c = m/min (sf/min)
 f_z = mm/tooth (in/tooth)
 a_p = mm/DC (in/DC) = factor
 a_e = mm/DC (in/DC) = factor
 All cutting data are target values

Universal
Steel and cast iron
Stainless steel and S-materials
Non ferrous
Hard
Plastic and chip
Graphite
Minimaster Plus
Minimaster

J36

General purpose – Universal – Square – 3 Flutes – Cylindrical – Corner radius

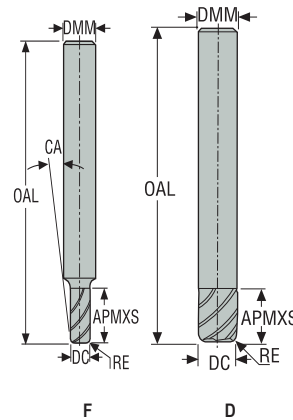

- Tolerances:
- DMM= h5
- DC= Ø2-Ø6= -0,02/-0,034 mm
- DC= Ø8-Ø20= -0,02/-0,044 mm
- RE= Ø2-Ø12= +0,05 mm
- RE= Ø14-Ø20= +0,1 mm
- Regrind possible if DC is ≥Ø6

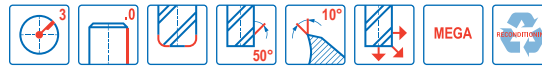

Designation	Item number	Length index	Tool shape	DC	DMM	APMXS	OAL	RE	CA	PCEDC	Cylindrical
				mm	mm	mm	mm	mm	mm		
36020-MEGA	00025621	2	F	2,0	3,0	9,0	40,0	0,1	2,5	3	■
36030-MEGA	00025626	2	D	3,0	3,0	12,0	40,0	0,1	-	3	■
36040-MEGA	00025628	2	D	4,0	4,0	14,0	50,0	0,1	-	3	■
36050-MEGA	00025651	2	D	5,0	5,0	20,0	50,0	0,1	-	3	■
36060-MEGA	00025663	2	D	6,0	6,0	20,0	65,0	0,1	-	3	■
36080-MEGA	00025674	2	D	8,0	8,0	20,0	65,0	0,2	-	3	■
36100-MEGA	00025680	2	D	10,0	10,0	25,0	75,0	0,2	-	3	■
36120-MEGA	00025681	2	D	12,0	12,0	25,0	75,0	0,2	-	3	■
36140-MEGA	00025684	2	D	14,0	14,0	30,0	90,0	0,5	-	3	■
36160-MEGA	00025689	2	D	16,0	16,0	30,0	90,0	0,5	-	3	■
36200-MEGA	00025692	2	D	20,0	20,0	40,0	100,0	0,5	-	3	■

■ Stocked standard.

Universal

Steel and cast iron

Stainless steel and S-materials

Non ferrous

Hard

Plastic and cfrp

Graphite

Minimaster Plus

Minimaster

Cutting data – J36 Side milling

SMG		a _e /DC	a _p /DC	f _z											v _c
				2	3	4	5	6	8	10	12	14	16	20	
P1	E	0.200	1.0	0.013	0.019	0.026	0.032	0.038	0.050	0.065	0.075	0.085	0.095	0.11	200 (170 – 220)
		0.200	1.0	0.00050	0.00075	0.0010	0.0013	0.0015	0.0020	0.0026	0.0030	0.0034	0.0038	0.0044	660 (560–720)
P2	E	0.200	1.0	0.013	0.020	0.026	0.034	0.040	0.055	0.065	0.080	0.090	0.095	0.11	190 (170 – 210)
		0.200	1.0	0.00050	0.00080	0.0010	0.0013	0.0016	0.0022	0.0026	0.0032	0.0036	0.0038	0.0044	620 (560 – 680)
P3	E	0.200	1.0	0.012	0.019	0.025	0.032	0.038	0.050	0.060	0.075	0.085	0.090	0.11	170 (150–190)
		0.200	1.0	0.00048	0.00075	0.0010	0.0013	0.0015	0.0020	0.0024	0.0030	0.0034	0.0036	0.0044	560 (500 – 620)
P4	E	0.200	1.0	0.012	0.018	0.024	0.030	0.036	0.048	0.060	0.070	0.080	0.090	0.10	150 (130–160)
		0.200	1.0	0.00048	0.00070	0.00095	0.0012	0.0014	0.0019	0.0024	0.0028	0.0032	0.0036	0.0040	490 (430 – 520)
P5	E	0.200	1.0	0.012	0.018	0.024	0.030	0.036	0.048	0.060	0.070	0.080	0.090	0.10	140 (130–160)
		0.200	1.0	0.00048	0.00070	0.00095	0.0012	0.0014	0.0019	0.0024	0.0028	0.0032	0.0036	0.0040	460 (430 – 520)
P6	E	0.200	1.0	0.012	0.018	0.024	0.030	0.036	0.048	0.060	0.070	0.080	0.085	0.10	160 (140–180)
		0.200	1.0	0.00048	0.00070	0.00095	0.0012	0.0014	0.0019	0.0024	0.0028	0.0032	0.0034	0.0040	520 (460 – 590)
P7	E	0.200	1.0	0.012	0.018	0.024	0.030	0.036	0.048	0.060	0.070	0.080	0.085	0.10	150 (130–170)
		0.200	1.0	0.00048	0.00070	0.00095	0.0012	0.0014	0.0019	0.0024	0.0028	0.0032	0.0034	0.0040	490 (430 – 550)
P8	E	0.200	1.0	0.012	0.019	0.025	0.032	0.038	0.050	0.060	0.075	0.085	0.090	0.11	140 (130–160)
		0.200	1.0	0.00048	0.00075	0.0010	0.0013	0.0015	0.0020	0.0024	0.0030	0.0034	0.0036	0.0044	460 (430 – 520)
P11	E	0.200	1.0	0.012	0.018	0.024	0.030	0.036	0.048	0.060	0.070	0.080	0.085	0.10	145 (130–160)
		0.200	1.0	0.00048	0.00070	0.00095	0.0012	0.0014	0.0019	0.0024	0.0028	0.0032	0.0034	0.0040	475 (430 – 520)
P12	E	0.200	1.0	0.0080	0.012	0.016	0.020	0.024	0.032	0.040	0.048	0.055	0.060	0.070	90 (79–100)
		0.200	1.0	0.00032	0.00048	0.00065	0.00080	0.00095	0.0013	0.0016	0.0019	0.0022	0.0024	0.0028	295 (260 – 320)
M1	E	0.200	1.0	0.014	0.020	0.028	0.034	0.042	0.055	0.070	0.085	0.095	0.10	120 (93–140)	
		0.200	1.0	0.00055	0.00080	0.0011	0.0013	0.0017	0.0022	0.0028	0.0034	0.0038	0.0040	0.0048	395 (310 – 450)
M2	E	0.200	1.0	0.013	0.019	0.025	0.032	0.038	0.050	0.065	0.075	0.085	0.095	0.11	95 (77–110)
		0.200	1.0	0.00050	0.00075	0.0010	0.0013	0.0015	0.0020	0.0026	0.0030	0.0034	0.0038	0.0044	310 (260 – 360)
M3	E	0.100	1.0	0.010	0.015	0.020	0.025	0.030	0.040	0.050	0.060	0.065	0.075	0.085	75 (56 – 95)
		0.100	1.0	0.00040	0.00060	0.00080	0.0010	0.0012	0.0016	0.0020	0.0024	0.0026	0.0030	0.0034	245 (190 – 310)
M4	E	0.100	1.0	0.0085	0.013	0.017	0.022	0.026	0.034	0.044	0.050	0.060	0.065	0.075	60 (43–73)
		0.100	1.0	0.00034	0.00050	0.00065	0.00085	0.0010	0.0013	0.0017	0.0020	0.0024	0.0026	0.0030	195 (150 – 230)
M5	E	0.100	1.0	0.0085	0.013	0.017	0.022	0.026	0.034	0.044	0.050	0.060	0.065	0.075	48 (36 – 60)
		0.100	1.0	0.00034	0.00050	0.00065	0.00085	0.0010	0.0013	0.0017	0.0020	0.0024	0.0026	0.0030	155 (120–190)
K1	E	0.200	1.0	0.012	0.018	0.024	0.030	0.036	0.048	0.060	0.070	0.080	0.090	0.10	140 (130–160)
		0.200	1.0	0.00048	0.00070	0.00095	0.0012	0.0014	0.0019	0.0024	0.0028	0.0032	0.0036	0.0040	460 (430 – 520)
K2	E	0.200	1.0	0.011	0.016	0.022	0.028	0.032	0.044	0.055	0.065	0.075	0.080	0.090	125 (110–140)
		0.200	1.0	0.00044	0.00065	0.00085	0.0011	0.0013	0.0017	0.0022	0.0026	0.0030	0.0032	0.0036	410 (370 – 450)
K3	E	0.200	1.0	0.011	0.016	0.022	0.028	0.032	0.044	0.055	0.065	0.075	0.080	0.090	105 (91–120)
		0.200	1.0	0.00044	0.00065	0.00085	0.0011	0.0013	0.0017	0.0022	0.0026	0.0030	0.0032	0.0036	345 (300 – 390)
K4	E	0.200	1.0	0.011	0.016	0.022	0.028	0.032	0.044	0.055	0.065	0.075	0.080	0.090	100 (87–110)
		0.200	1.0	0.00044	0.00065	0.00085	0.0011	0.0013	0.0017	0.0022	0.0026	0.0030	0.0032	0.0036	330 (290 – 360)
K5	E	0.200	1.0	0.010	0.015	0.020	0.025	0.030	0.040	0.050	0.060	0.065	0.070	0.085	60 (53 – 69)
		0.200	1.0	0.00040	0.00060	0.00080	0.0010	0.0012	0.0016	0.0020	0.0024	0.0026	0.0028	0.0034	195 (180 – 220)
K6	E	0.200	1.0	0.011	0.016	0.022	0.028	0.032	0.044	0.055	0.065	0.075	0.080	0.090	90 (76–100)
		0.200	1.0	0.00044	0.00065	0.00085	0.0011	0.0013	0.0017	0.0022	0.0026	0.0030	0.0032	0.0036	295 (250 – 320)
K7	E	0.200	1.0	0.010	0.015	0.020	0.025	0.030	0.040	0.050	0.060	0.065	0.070	0.085	80 (67 – 89)
		0.200	1.0	0.00040	0.00060	0.00080	0.0010	0.0012	0.0016	0.0020	0.0024	0.0026	0.0028	0.0034	260 (220 – 290)

For cutting data recalculations, see pages 445 - 452

SMG = Seco material group
 Coolant = A=air D=dry E=emulsion M=mist spray
 v_c = m/min (sf/min)
 f_z = mm (in/tooth)
 a_p = mm/DC (in/DC) = factor
 a_e = mm/DC (in/DC) = factor
 All cutting data are target values

Universal
Steel and cast iron
Stainless steel and S-materials
Non ferrous
Hard
Plastic and chip
Graphite
Mimimaster Plus
Mimimaster

Cutting data – J36 Side milling

SMG		a _e /DC	a _p /DC	f _z											v _c
				2	3	4	5	6	8	10	12	14	16	20	
N1	E	0.400	1.0	0.020	0.030	0.040	0.050	0.060	0.080	0.10	0.12	0.13	0.15	0.17	620 (520–710)
		0,400	1,0	0,00080	0,0012	0,0016	0,0020	0,0024	0,0032	0,0040	0,0048	0,0050	0,0060	0,0065	2025 (1800 – 2300)
N2	E	0.400	1.0	0.020	0.030	0.040	0.050	0.060	0.080	0.10	0.12	0.13	0.15	0.17	395 (340 – 460)
		0,400	1,0	0,00080	0,0012	0,0016	0,0020	0,0024	0,0032	0,0040	0,0048	0,0050	0,0060	0,0065	1300 (1200–1500)
N3	E	0.400	1.0	0.020	0.030	0.040	0.050	0.060	0.080	0.10	0.12	0.13	0.15	0.17	265 (230 – 300)
		0,400	1,0	0,00080	0,0012	0,0016	0,0020	0,0024	0,0032	0,0040	0,0048	0,0050	0,0060	0,0065	870 (760 – 980)
N11	E	0.300	1.0	0.012	0.018	0.024	0.030	0.036	0.048	0.060	0.070	0.080	0.090	0.10	305 (260 – 350)
		0,300	1,0	0,00048	0,00070	0,00095	0,0012	0,0014	0,0019	0,0024	0,0028	0,0032	0,0036	0,0040	1000 (860–1100)
S1	E	0.100	1.0	0.0060	0.0090	0.012	0.015	0.018	0.024	0.030	0.036	0.040	0.044	0.050	75 (62 – 85)
		0,100	0,90	0,00024	0,00036	0,00048	0,00060	0,00070	0,00095	0,0012	0,0014	0,0016	0,0017	0,0020	245 (210 – 270)
S2	E	0.100	1.0	0.0060	0.0090	0.012	0.015	0.018	0.024	0.030	0.036	0.040	0.044	0.050	60 (50 – 68)
		0,100	0,90	0,00024	0,00036	0,00048	0,00060	0,00070	0,00095	0,0012	0,0014	0,0016	0,0017	0,0020	195 (170 – 220)
S3	E	0.100	1.0	0.0040	0.0060	0.0080	0.010	0.012	0.016	0.020	0.024	0.026	0.030	0.034	40 (30 – 49)
		0,100	0,90	0,00016	0,00024	0,00032	0,00040	0,00048	0,00065	0,00080	0,00095	0,0010	0,0012	0,0013	130 (99–160)
S11	E	0.250	1.1	0.011	0.016	0.022	0.026	0.032	0.042	0.055	0.065	0.070	0.080	0.090	105 (91–110)
		0,250	1,1	0,00044	0,00065	0,00085	0,0010	0,0013	0,0017	0,0022	0,0026	0,0028	0,0032	0,0036	345 (300 – 360)
S12	E	0.250	1.1	0.011	0.016	0.022	0.026	0.032	0.042	0.055	0.065	0.070	0.080	0.090	80 (70 – 89)
		0,250	1,1	0,00044	0,00065	0,00085	0,0010	0,0013	0,0017	0,0022	0,0026	0,0028	0,0032	0,0036	260 (230 – 290)
S13	E	0.250	1.1	0.0095	0.014	0.019	0.024	0.028	0.038	0.046	0.055	0.060	0.070	0.080	65 (56–71)
		0,250	1,1	0,00038	0,00055	0,00075	0,00095	0,0011	0,0015	0,0018	0,0022	0,0024	0,0028	0,0032	215 (190 – 230)
TS1	A	0.400	1.0	0.020	0.030	0.040	0.050	0.060	0.080	0.10	0.12	0.13	0.15	0.17	500 (460 – 550)
		0,400	1,0	0,00080	0,0012	0,0016	0,0020	0,0024	0,0032	0,0040	0,0048	0,0050	0,0060	0,0065	1650 (1600–1800)
TP1	A	0.400	1.0	0.020	0.030	0.040	0.050	0.060	0.080	0.10	0.12	0.13	0.15	0.17	500 (460 – 550)
		0,400	1,0	0,00080	0,0012	0,0016	0,0020	0,0024	0,0032	0,0040	0,0048	0,0050	0,0060	0,0065	1650 (1600–1800)

For cutting data recalculations, see pages 445 - 452

SMG = Seco material group
 Coolant = A=air D=dry E=emulsion M=mist spray
 v_c = m/min (sf/min)
 f_z = mm (in/tooth)
 a_p = mm/DC (in/DC) = factor
 a_e = mm/DC (in/DC) = factor
 All cutting data are target values

HK

General purpose – Universal – Conical – 3-4 Flutes – Cylindrical – Tapered sharp

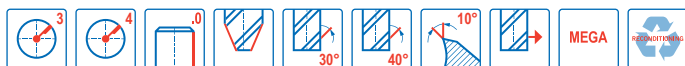
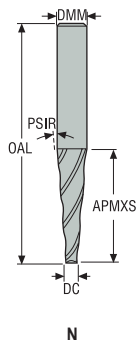

- Tolerances:
- DMM= h5
- DC= HKM= +0,07/+0,03 mm
- DC= HK= +0,1/0 mm
- PSIR= ±0,1°
- Regrind possible if DMM is ≥Ø6

Designation	Item number	Length index	Tool shape	DC	DMM	APMXS	OAL	PSIR°	PCEDC	Cylindrical
				mm	mm	mm	mm			
HK010-040-MEGA	00028431	2	N	4,0	5,0	20,0	60,0	1,0	3	■
HK010-060-MEGA	00028441	2	N	6,0	8,0	30,0	75,0	1,0	3	■
HK010-080-MEGA	00028445	2	N	8,0	10,0	30,0	80,0	1,0	4	■
HK010-100-MEGA	00028451	2	N	10,0	12,0	30,0	80,0	1,0	4	■

■ Stocked standard.

For cutting data, please see My Pages – Suggest on www.secotools.com

Universal

Steel and cast iron

Stainless steel and S-materials

Non ferrous

Hard

Plastic and cfrp

Graphite

Minimaster Plus

Minimaster

HK

General purpose – Universal – Conical – 3-4 Flutes – Cylindrical – Tapered sharp

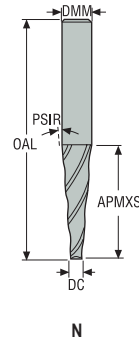

- Tolerances:
- DMM= h5
- DC= HKM= +0,07/+0,03 mm
- DC= HK= +0,1/0 mm
- PSIR= ±0,1°
- Regrind possible if DMM is ≥Ø6



Designation	Item number	Length index	Tool shape	DC	DMM	APMXS	OAL	PSIR°	PCEDC	Cylindrical
				mm	mm	mm	mm	–		
HK020-040-MEGA	00028666	2	N	4,0	6,0	20,0	65,0	2,0	3	■
HK020-050-MEGA	00028669	2	N	5,0	8,0	30,0	75,0	2,0	3	■
HK020-100-MEGA	00028694	2	N	10,0	12,0	28,0	80,0	2,0	4	■

■ Stocked standard.
For cutting data, please see My Pages – Suggest on www.secotools.com

Universal

Steel and cast iron

Stainless steel and S-materials

Non ferrous

Hard

Plastic and cfrp

Graphite

Minimaster Plus

Minimaster

HKM-HK

General purpose – Universal – Conical – 2-4 Flutes – Cylindrical – Tapered sharp

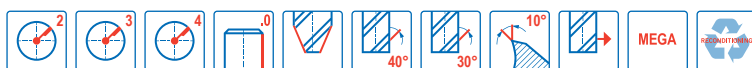
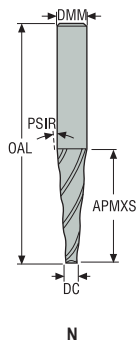

- Tolerances:
- DMM= h5
- DC= HKM= +0,07/+0,03 mm
- DC= HK= +0,1/0 mm
- PSIR= ±0,1°
- Regrind possible if DMM is ≥Ø6

Designation	Item number	Length index	Tool shape	DC	DMM	APMXS	OAL	PSIR°	PCEDC	Cylindrical
				mm	mm	mm	mm	–		
HKM030-015-MEGA	00028738	2	N	1,5	3,0	6,0	40,0	3,0	2	■
HK030-025-MEGA	00028741	2	N	2,5	6,0	20,0	65,0	3,0	3	■
HK030-033-MEGA	00028744	2	N	3,0	8,0	30,0	75,0	3,0	3	■
HK030-065-MEGA	00028759	2	N	6,0	12,0	55,0	110,0	3,0	3	■
HK030-083-MEGA	00028771	2	N	8,0	12,0	30,0	80,0	3,0	4	■

■ Stocked standard.

For cutting data, please see My Pages – Suggest on www.secotools.com

Universal

Steel and cast iron

Stainless steel and S-materials

Non ferrous

Hard

Plastic and cfrp

Graphite

Minimaster Plus

Minimaster

HKM-HK

General purpose – Universal – Conical – 2-4 Flutes – Cylindrical – Tapered sharp

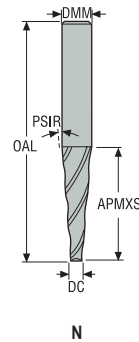

- Tolerances:
- DMM= h5
- DC= HKM= +0,07/+0,03 mm
- DC= HK= +0,1/0 mm
- PSIR= ±0,1°
- Regrind possible if DMM is ≥Ø6

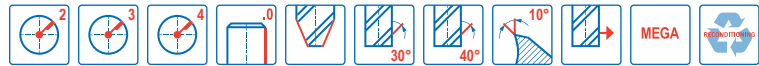

Designation	Item number	Length index	Tool shape	DC	DMM	APMXS	OAL	PSIR°	PCEDC	Cylindrical
				mm	mm	mm	mm	–		
HKM050-010-MEGA	00028947	2	N	1,0	3,0	4,0	40,0	5,0	2	■
HKM050-015-MEGA	00028952	2	N	1,5	3,0	6,0	40,0	5,0	2	■
HKM050-020-MEGA	00028954	2	N	2,0	4,0	10,0	50,0	5,0	2	■
HKM050-025-MEGA	00028958	2	N	2,5	5,0	10,0	50,0	5,0	2	■
HK050-025-MEGA	00028960	2	N	2,5	6,0	20,0	65,0	5,0	3	■
HK050-032-MEGA	00028972	2	N	3,0	8,0	28,0	70,0	5,0	3	■
HK050-0420-MEGA	00028998	2	N	4,0	8,0	22,0	65,0	5,0	3	■
HK050-050-MEGA	00029012	2	N	5,0	12,0	40,0	100,0	5,0	3	■
HK050-063-MEGA	00029014	2	N	6,0	12,0	32,0	90,0	5,0	3	■
HK050-065-MEGA	00029017	2	N	6,0	16,0	55,0	110,0	5,0	3	■
HK050-103-MEGA	00029020	2	N	10,0	16,0	32,0	90,0	5,0	4	■
HK050-105-MEGA	00029025	2	N	10,0	20,0	55,0	115,0	5,0	4	■

■ Stocked standard.
For cutting data, please see My Pages – Suggest on www.secotools.com

Universal

Steel and cast iron

Stainless steel and S-materials

Non ferrous

Hard

Plastic and cfrp

Graphite

Minimaster Plus

Minimaster

HK

General purpose – Universal – Conical – 3 Flutes – Cylindrical – Tapered sharp

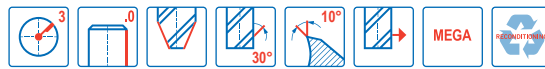
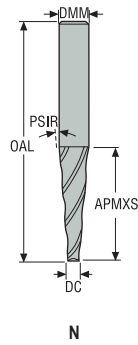

- Tolerances:
- DMM= h5
- DC= +0,1/0 mm
- PSIR= ±0,1°
- Re grind possible if DMM is ≥Ø6

Designation	Item number	Length index	Tool shape	DC	DMM	APMXS	OAL	PSIR°	PCEDC	Cylindrical
				mm	mm	mm	mm	–		
HK070-025-MEGA	00029030	2	N	2,5	8,0	22,0	65,0	7,0	3	■
HK070-050-MEGA	00029034	2	N	5,0	12,0	28,0	80,0	7,0	3	■

■ Stocked standard.

For cutting data, please see My Pages – Suggest on www.secotools.com

Universal

Steel and cast iron

Stainless steel and S-materials

Non ferrous

Hard

Plastic and cfrp

Graphite

Minimaster Plus

Minimaster

HK

General purpose – Universal – Conical – 4 Flutes – Cylindrical – Tapered sharp

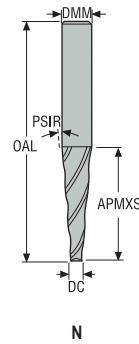

- Tolerances:
- DMM= h5
- DC= +0,1/0 mm
- PSIR= ±0,1°
- Regrind possible if DMM is ≥Ø6

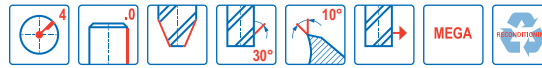

Designation	Item number	Length index	Tool shape	DC	DMM	APMXS	OAL	PSIR°	PCEDC	Cylindrical
HK080-083-MEGA	00029041	2	N	8,0	18,0	35,0	90,0	8,0	4	■

■ Stocked standard.
For cutting data, please see My Pages – Suggest on www.secotools.com

Universal

Steel and cast iron

Stainless steel and S-materials

Non ferrous

Hard

Plastic and cfrp

Graphite

Minimaster Plus

Minimaster

HK

General purpose – Universal – Conical – 3-4 Flutes – Cylindrical – Tapered sharp

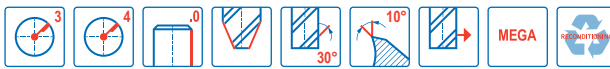
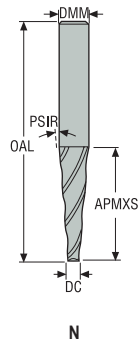

- Tolerances:
- DMM= h5
- DC= +0,1/0 mm
- PSIR= ±0,1°
- Re grind possible if DMM is ≥Ø6

Designation	Item number	Length index	Tool shape	DC	DMM	APMXS	OAL	PSIR°	PCEDC	Cylindrical
				mm	mm	mm	mm	–		
HK100-025-MEGA	00029052	2	N	2,5	10,0	20,0	75,0	10,0	3	■
HK100-030-MEGA	00029066	2	N	3,0	14,0	30,0	90,0	10,0	3	■
HK100-050-MEGA	00029069	2	N	5,0	16,0	30,0	90,0	10,0	3	■
HK100-080-MEGA	00029083	2	N	8,0	20,0	32,0	90,0	10,0	4	■

■ Stocked standard.

For cutting data, please see My Pages – Suggest on www.secotools.com

Universal

Steel and cast iron

Stainless steel and S-materials

Non ferrous

Hard

Plastic and cfrp

Graphite

Minimaster Plus

Minimaster

HK

General purpose – Universal – Conical – 3 Flutes – Cylindrical – Tapered sharp

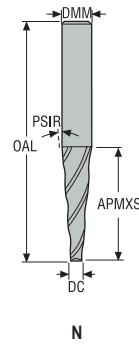

- Tolerances:
- DMM= h5
- DC= +0,1/0 mm
- PSIR= ±0,1°
- Regrind possible if DMM is ≥Ø6

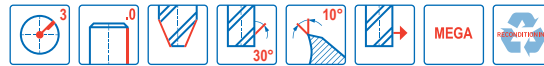

Designation	Item number	Length index	Tool shape	DC	DMM	APMXS	OAL	PSIR°	PCEDC	Cylindrical
				mm	mm	mm	mm	–		
HK110-020-MEGA	00029110	2	N	2,0	10,0	20,0	75,0	11,0	3	■
HK110-050-MEGA	00029117	2	N	5,0	14,0	20,0	80,0	11,0	3	■

■ Stocked standard.

For cutting data, please see My Pages – Suggest on www.secotools.com

Universal

Steel and cast iron

Stainless steel and S-materials

Non ferrous

Hard

Plastic and cfrp

Graphite

Minimaster Plus

Minimaster

HK

General purpose – Universal – Conical – 3-4 Flutes – Cylindrical – Tapered sharp

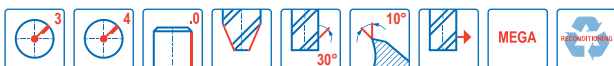
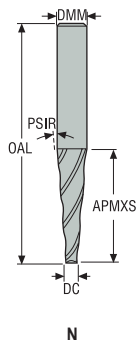

- Tolerances:
- DMM= h5
- DC= +0,1/0 mm
- PSIR= ±0,1°
- Regrind possible if DMM is ≥Ø6

Designation	Item number	Length index	Tool shape	DC	DMM	APMXS	OAL	PSIR°	PCEDC	Cylindrical
				mm	mm	mm	mm	–		
HK150-025	00029119	2	N	2,5	14,0	20,0	80,0	15,0	3	■
HK150-025-MEGA	00029151	2	N	2,5	14,0	20,0	80,0	15,0	3	■
HK150-040	00029124	2	N	4,0	12,0	15,0	65,0	15,0	3	■
HK150-040-MEGA	00029154	2	N	4,0	12,0	15,0	65,0	15,0	3	■
HK150-0651	00029133	2	N	6,5	12,0	10,0	65,0	15,0	3	■
HK150-0652	00029138	2	N	6,5	20,0	25,0	90,0	15,0	3	■
HK150-0651-MEGA	00029160	2	N	6,5	12,0	10,0	65,0	15,0	3	■
HK150-0652-MEGA	00029161	2	N	6,5	20,0	25,0	90,0	15,0	3	■
HK150-080	00029149	2	N	8,0	20,0	20,0	80,0	15,0	4	■
HK150-080-MEGA	00029162	2	N	8,0	20,0	20,0	80,0	15,0	4	■

■ Stocked standard.

For cutting data, please see My Pages – Suggest on www.secotools.com

Universal

Steel and cast iron

Stainless steel and S-materials

Non ferrous

Hard

Plastic and chip

Graphite

Minimaster Plus

Minimaster

HK

General purpose – Universal – Conical – 3-4 Flutes – Cylindrical – Tapered sharp

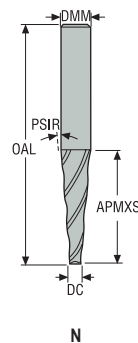

- Tolerances:
- DMM= h5
- DC= +0,1/0 mm
- PSIR= ±0,1°
- Regrind possible if DMM is ≥Ø6

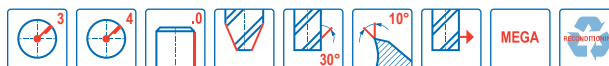

Designation	Item number	Length index	Tool shape	DC	DMM	APMXS	OAL	PSIR°	PCEDC	Cylindrical
				mm	mm	mm	mm	–		
HK200-025	00029165	2	N	2,5	10,0	10,0	75,0	20,0	3	■
HK200-025-MEGA	00029168	2	N	2,5	10,0	10,0	75,0	20,0	3	■
HK200-045	00029166	2	N	4,5	16,0	15,0	90,0	20,0	4	■
HK200-045-MEGA	00029203	2	N	4,5	16,0	15,0	90,0	20,0	4	■

■ Stocked standard.

For cutting data, please see My Pages – Suggest on www.secotools.com

Universal

Steel and cast iron

Stainless steel and S-materials

Non ferrous

Hard

Plastic and cfrp

Graphite

Minimaster Plus

Minimaster

HK

General purpose – Universal – Conical – 3-4 Flutes – Cylindrical – Tapered sharp

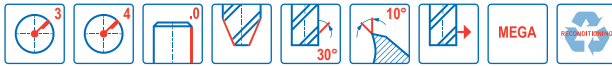
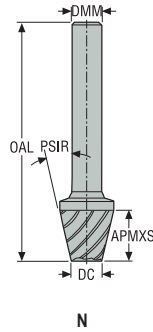

- Tolerances:
- DMM= h5
- DC= +0,1/0 mm
- PSIR= ±0,1°
- Regrind possible if DMM is ≥Ø6

Designation	Item number	Length index	Tool shape	DC	DMM	APMXS	OAL	PSIR°	PCEDC	Cylindrical
				mm	mm	mm	mm	–		
HK300-025	00029208	2	N	2,5	10,0	10,0	75,0	30,0	3	■
HK300-025-MEGA	00029211	2	N	2,5	10,0	10,0	75,0	30,0	3	■
HK300-045	00029210	2	N	4,5	16,0	16,0	90,0	30,0	4	■
HK300-045-MEGA	00029212	2	N	4,5	16,0	16,0	90,0	30,0	4	■

■ Stocked standard.
For cutting data, please see My Pages – Suggest on www.secotools.com

Universal

Steel and cast iron

Stainless steel and S-materials

Non ferrous

Hard

Plastic and cfrp

Graphite

Minimaster Plus

Minimaster

HK

General purpose – Universal – Conical – 3-4 Flutes – Cylindrical – Tapered sharp

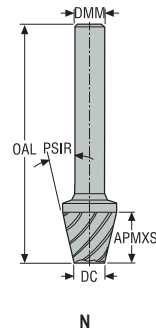

- Tolerances:
- DMM= h5
- DC= +0,1/0 mm
- PSIR= ±0,1°
- Regrind possible if DMM is ≥Ø6

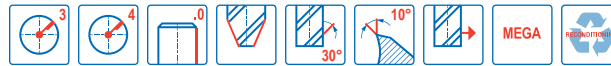

Designation	Item number	Length index	Tool shape	DC	DMM	APMXS	OAL	PSIR°	PCEDC	Cylindrical
				mm	mm	mm	mm	–		
HK450-025	00029215	2	N	2,5	12,0	10,0	75,0	45,0	3	■
HK450-025-MEGA	00029229	2	N	2,5	12,0	10,0	75,0	45,0	3	■
HK450-045	00029217	2	N	4,5	16,0	16,0	90,0	45,0	4	■
HK450-045-MEGA	00029232	2	N	4,5	16,0	16,0	90,0	45,0	4	■

■ Stocked standard.
For cutting data, please see My Pages – Suggest on www.secotools.com

Universal

Steel and cast iron

Stainless steel and S-materials

Non ferrous

Hard

Plastic and cfrp

Graphite

Minimaster Plus

Minimaster

V31

General purpose – Universal – Concave – 4 Flutes – Cylindrical

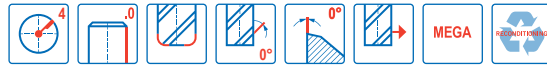
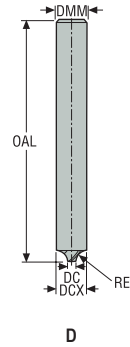

- Tolerances:
- DMM= h5
- DC= ±0,04 mm
- RE= ±0,02 mm
- Re grind possible if DC is ≥Ø6

Designation	Item number	Length index	Tool shape	DC	DCX	DMM	APMXS	OAL	RE	PCEDC	Cylindrical
				mm	mm	mm	mm	mm	mm	mm	
31100-MEGA	00029307	2	D	4,0	6,0	6,0	1,0	64,0	1,0	4	■
31200-MEGA	00029315	2	D	4,0	8,0	8,0	2,0	75,0	2,0	4	■
31300-MEGA	00029326	2	D	4,0	10,0	10,0	3,0	75,0	3,0	4	■
31400-MEGA	00029328	2	D	4,0	12,0	12,0	4,0	75,0	4,0	4	■
31050-MEGA	00029285	2	D	5,0	6,0	6,0	0,5	64,0	0,5	4	■
31150-MEGA	00029313	2	D	5,0	8,0	8,0	1,5	75,0	1,5	4	■
31250-MEGA	00029324	2	D	5,0	10,0	10,0	2,5	75,0	2,5	4	■
31350-MEGA	00029327	2	D	5,0	12,0	12,0	3,5	75,0	3,5	4	■
31500-MEGA	00029330	2	D	6,0	16,0	16,0	5,0	75,0	5,0	4	■
31600-MEGA	00029331	2	D	8,0	20,0	20,0	6,0	80,0	6,0	4	■
31999-MEGA	00029335	2	D	8,0	28,0	25,0	10,0	80,0	10,0	4	■
31800-MEGA	00029333	2	D	9,0	25,0	25,0	8,0	75,0	8,0	4	■

■ Stocked standard.

Universal

Steel and cast iron

Stainless steel and S-materials

Non ferrous

Hard

Plastic and chip

Graphite

Minimaster Plus

Minimaster

Cutting data – V31 Side milling roughing

Universal	SMG	a _p /D_c	f _z								v _c		
			6	8	10	12	16	20	25	28			
Steel and cast iron	P1	E/M/A	0,24	0,024	0,032	0,040	0,048	0,065	0,080	0,095	0,10	290 (195 – 310)	
			0,24	0,00095	0,0013	0,0016	0,0019	0,0026	0,0032	0,0038	0,004	950 (640 – 1100)	
	P2	E/M/A	0,24	0,024	0,034	0,042	0,050	0,065	0,080	0,095	0,10	280 (190 – 305)	
			0,24	0,00095	0,0013	0,0017	0,0022	0,0026	0,0032	0,0038	0,004	910 (620 – 1000)	
	P3	E/M/A	0,24	0,024	0,032	0,040	0,046	0,060	0,075	0,090	0,095	240 (165 – 260)	
			0,24	0,00095	0,0013	0,0016	0,0018	0,0024	0,003	0,0036	0,0038	790 (540 – 850)	
	P4	E/M/A	0,24	0,022	0,030	0,038	0,046	0,060	0,075	0,090	0,095	210 (145 – 230)	
			0,24	0,00085	0,0012	0,0015	0,0018	0,0024	0,003	0,0036	0,0038	680 (475 – 760)	
	P5	E/M/A	0,24	0,022	0,030	0,038	0,046	0,060	0,075	0,085	0,095	205 (135 – 220)	
			0,24	0,00085	0,0012	0,0015	0,0018	0,0024	0,003	0,0034	0,0038	670 (445 – 730)	
	P6	E/M/A	0,24	0,022	0,030	0,038	0,044	0,060	0,075	0,085	0,095	230 (155 – 245)	
			0,24	0,00085	0,0012	0,0015	0,0017	0,0024	0,003	0,0050	0,0038	760 (510 – 800)	
P7	E/M/A	0,24	0,022	0,030	0,038	0,044	0,060	0,075	0,085	0,095	215 (145 – 230)		
		0,24	0,00085	0,0012	0,0015	0,0017	0,0024	0,003	0,0050	0,0038	710 (475 – 760)		
P8	E/M/A	0,24	0,024	0,032	0,040	0,046	0,060	0,075	0,090	0,095	205 (140 – 220)		
		0,24	0,00095	0,0013	0,0016	0,0018	0,0024	0,003	0,0036	0,0038	670 (460 – 730)		
P11	E/M/A	0,24	0,022	0,030	0,038	0,044	0,060	0,075	0,085	0,095	210 (140 – 225)		
		0,24	0,00085	0,0012	0,0015	0,0017	0,0024	0,003	0,0050	0,0038	680 (460 – 740)		
Non ferrous	M1	E/M/A	0,24	0,024	0,034	0,042	0,050	0,065	0,080	0,095	0,10	255 (170 – 270)	
			0,24	0,00095	0,0013	0,0017	0,0022	0,0026	0,0032	0,0038	0,004	840 (560 – 890)	
	M2	E/M/A	0,24	0,022	0,030	0,038	0,046	0,060	0,075	0,085	0,095	205 (135 – 220)	
			0,24	0,00085	0,0012	0,0015	0,0018	0,0024	0,003	0,0050	0,0038	670 (445 – 730)	
	M3	E/M/A	0,24	0,018	0,024	0,030	0,036	0,048	0,060	0,070	0,075	150 (105 – 165)	
			0,24	0,0007	0,00095	0,0012	0,0014	0,0019	0,0024	0,0028	0,003	490 (345 – 540)	
	M4	E/M/A	0,24	0,016	0,020	0,026	0,032	0,042	0,050	0,060	0,065	110 (75 – 120)	
			0,24	0,00065	0,0008	0,0010	0,0013	0,0017	0,0022	0,0024	0,0026	360 (250 – 400)	
	M5	E/M/A	0,24	0,016	0,020	0,026	0,032	0,042	0,050	0,060	0,065	95 (65 – 100)	
			0,24	0,00065	0,0008	0,0010	0,0013	0,0017	0,0022	0,0024	0,0026	310 (220 – 320)	
	Hard	K1	E/M/A	0,24	0,022	0,030	0,038	0,046	0,060	0,075	0,085	0,095	205 (135 – 220)
				0,24	0,00085	0,0012	0,0015	0,0018	0,0024	0,003	0,0050	0,0038	670 (445 – 730)
K2		E/M/A	0,24	0,020	0,028	0,034	0,040	0,055	0,065	0,080	0,085	175 (120 – 190)	
			0,24	0,0008	0,0011	0,0013	0,0016	0,0022	0,0026	0,0032	0,0050	570 (400 – 620)	
K3		E/M/A	0,24	0,020	0,028	0,034	0,040	0,055	0,065	0,080	0,085	150 (100 – 160)	
			0,24	0,0008	0,0011	0,0013	0,0016	0,0022	0,0026	0,0032	0,0050	490 (320 – 530)	
K4		E/M/A	0,24	0,020	0,028	0,034	0,040	0,055	0,065	0,080	0,085	140 (95 – 150)	
			0,24	0,0008	0,0011	0,0013	0,0016	0,0022	0,0026	0,0032	0,0050	460 (310 – 490)	
K5		E/M/A	0,24	0,018	0,024	0,030	0,036	0,050	0,060	0,070	0,075	85 (55 – 90)	
			0,24	0,0007	0,00095	0,0012	0,0014	0,0022	0,0024	0,0028	0,003	280 (180 – 300)	
K6		E/M/A	0,24	0,020	0,028	0,034	0,040	0,055	0,065	0,080	0,085	125 (85 – 135)	
			0,24	0,0008	0,0011	0,0013	0,0016	0,0022	0,0026	0,0032	0,0050	410 (280 – 445)	
K7	E/M/A	0,24	0,018	0,024	0,030	0,036	0,050	0,060	0,070	0,075	105 (70 – 115)		
		0,24	0,0007	0,00095	0,0012	0,0014	0,0022	0,0024	0,0028	0,003	345 (220 – 375)		

For cutting data recalculations, see pages 445 - 452

SMG = Seco material group
Coolant = A=air D=dry E=emulsion M=mist spray
v_c = m/min (sf/min)
f_z = mm (in/tooth)
a_p = mm/DC (in/DC) = factor
a_e = mm/DC (in/DC) = factor
All cutting data are target values

Cutting data – V31 Side milling roughing

SMG		a _p /D _c	f _z								v _c
			6	8	10	12	16	20	25	28	
N1	E/M/A	0,24	0,022	0,030	0,038	0,046	0,060	0,075	0,085	0,095	315 (215 – 340)
		0,24	0,00085	0,0012	0,0015	0,0018	0,0024	0,003	0,0050	0,0038	1025 (710–1125)
N2	E/M/A	0,24	0,022	0,030	0,038	0,046	0,060	0,075	0,085	0,095	205 (135 – 220)
		0,24	0,00085	0,0012	0,0015	0,0018	0,0024	0,003	0,0050	0,0038	670 (445–730)
N3	E/M/A	0,24	0,022	0,030	0,038	0,046	0,060	0,075	0,085	0,095	135 (90–145)
		0,24	0,00085	0,0012	0,0015	0,0018	0,0024	0,003	0,0050	0,0038	445 (300 – 475)
N11	E/M/A	0,24	0,022	0,030	0,038	0,046	0,060	0,075	0,085	0,095	205 (135 – 220)
		0,24	0,00085	0,0012	0,0015	0,0018	0,0024	0,003	0,0050	0,0038	670 (445–730)
S1	E/M/A	0,24	0,024	0,032	0,040	0,048	0,065	0,080	0,095	0,10	205 (140 – 220)
		0,24	0,00095	0,0013	0,0016	0,0019	0,0026	0,0032	0,0038	0,004	670 (460–730)
S2	E/M/A	0,24	0,024	0,032	0,040	0,048	0,065	0,080	0,095	0,10	205 (140 – 220)
		0,24	0,00095	0,0013	0,0016	0,0019	0,0026	0,0032	0,0038	0,004	670 (460–730)
S3	E/M/A	0,24	0,022	0,030	0,038	0,046	0,060	0,075	0,085	0,095	205 (135 – 220)
		0,24	0,00085	0,0012	0,0015	0,0018	0,0024	0,003	0,0050	0,0038	670 (445–730)
S11	E/M/A	0,24	0,022	0,030	0,038	0,046	0,060	0,075	0,085	0,095	265 (180 – 285)
		0,24	0,00085	0,0012	0,0015	0,0018	0,0024	0,003	0,0050	0,0038	870 (590 – 940)
S12	E/M/A	0,24	0,022	0,030	0,038	0,046	0,060	0,075	0,085	0,095	205 (135 – 220)
		0,24	0,00085	0,0012	0,0015	0,0018	0,0024	0,003	0,0050	0,0038	670 (445–730)
S13	E/M/A	0,24	0,020	0,026	0,032	0,040	0,050	0,065	0,075	0,080	155 (105–165)
		0,24	0,0008	0,0010	0,0013	0,0016	0,0022	0,0026	0,003	0,0032	510 (345 – 540)
H5	M/A	0,24	0,034	0,046	0,055	0,070	0,090	0,11	0,13	0,14	275 (185 – 295)
		0,24	0,0013	0,0018	0,0022	0,0028	0,0036	0,0044	0,0050	0,0055	900 (610 – 950)
H8	M/A	0,24	0,026	0,034	0,044	0,050	0,070	0,085	0,10	0,11	270 (185 – 290)
		0,24	0,0010	0,0013	0,0017	0,0022	0,0028	0,0050	0,004	0,0044	890 (610 – 950)
H21	M/A	0,24	0,026	0,034	0,044	0,050	0,070	0,085	0,10	0,11	270 (185 – 290)
		0,24	0,0010	0,0013	0,0017	0,0022	0,0028	0,0050	0,004	0,0044	890 (610 – 950)
H31	M/A	0,24	0,022	0,030	0,038	0,046	0,060	0,075	0,085	0,095	205 (135 – 220)
		0,24	0,00085	0,0012	0,0015	0,0018	0,0024	0,003	0,0050	0,0038	670 (445–730)
TS1	A/D	0,24	0,022	0,030	0,038	0,046	0,060	0,075	0,085	0,095	205 (135 – 220)
		0,24	0,00085	0,0012	0,0015	0,0018	0,0024	0,003	0,0050	0,0038	670 (445–730)
TP1	A/D	0,24	0,022	0,030	0,038	0,046	0,060	0,075	0,085	0,095	205 (135 – 220)
		0,24	0,00085	0,0012	0,0015	0,0018	0,0024	0,003	0,0050	0,0038	670 (445–730)
GR1	A/D	0,24	0,022	0,030	0,038	0,046	0,060	0,075	0,085	0,095	205 (135 – 220)
		0,24	0,00085	0,0012	0,0015	0,0018	0,0024	0,003	0,0050	0,0038	670 (445–730)

For cutting data recalculations, see pages 445 - 452

SMG = Seco material group
 Coolant = A=air D=dry E=emulsion M=mist spray
 v_c = m/min (sf/min)
 f_z = mm (in/tooth)
 a_p = mm/DC (in/DC) = factor
 a_e = mm/DC (in/DC) = factor
 All cutting data are target values

Universal
Steel and cast iron
Stainless steel and S-materials
Non ferrous
Hard
Plastic and chip
Graphite
Mimimaster Plus
Mimimaster

JME542

Miniature – Universal – Square – 2 Flutes – DMM 4 – Cylindrical – Sharp or corner radius

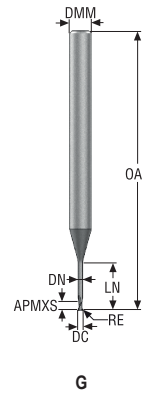

- Tolerances:
- Run-out= <0,007 mm
- DMM= h5
- DC= Ø0,2-Ø0,4= 0,-0,01 mm
- DC= Ø0,5-Ø3,0= 0,-0,013 mm
- RE= ±0,005 mm

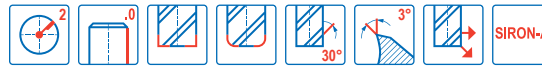

Designation	Item number	Length	Tool index shape	DC	DMM	APMXS	OAL	LN	DN	RE	PCEDC	CA°	WDX0*	WDX05*	WDX1*	WDX15*	WDX2*	WDX3*	Cylindrical
JME542002G1S.0Z2-SIRA	03171095	1	G	0,2	4,0	0,3	45,0	0,4	0,18	-	2	14,41	0,56	0,63	0,69	0,75	0,81	0,91	■
JME542003G1S.0Z2-SIRA	03171096	1	G	0,3	4,0	0,45	45,0	0,6	0,28	-	2	14,0	0,76	0,85	0,92	0,99	1,06	1,17	■
JME542004G1S.0Z2-SIRA	03171128	1	G	0,4	4,0	0,6	45,0	0,8	0,37	-	2	13,5	1,12	1,19	1,26	1,32	1,38	1,49	■
JME542005G1R005.0Z2-SIRA	03171097	1	G	0,5	4,0	0,8	45,0	1,0	0,46	0,05	2	13,17	1,32	1,4	1,47	1,54	1,61	1,73	■
JME542006G1R005.0Z2-SIRA	03171098	1	G	0,6	4,0	0,9	45,0	1,2	0,56	0,05	2	12,76	1,52	1,61	1,69	1,77	1,84	1,97	■
JME542008G1R005.0Z2-SIRA	03171129	1	G	0,8	4,0	1,2	45,0	1,6	0,76	0,05	2	11,96	1,92	2,03	2,13	2,22	2,3	2,46	■
JME542010G1R010.0Z2-SIRA	03171099	1	G	1,0	4,0	1,5	50,0	2,0	0,95	0,1	2	11,22	2,32	2,45	2,56	2,65	2,74	2,94	■
JME542012G1R010.0Z2-SIRA	03171100	1	G	1,2	4,0	1,8	50,0	2,4	1,15	0,1	2	10,43	2,77	2,87	2,99	3,1	3,2	3,43	■
JME542015G1R015.0Z2-SIRA	03171130	1	G	1,5	4,0	2,3	50,0	3,0	1,45	0,15	2	9,2	3,47	3,61	3,73	3,85	3,98	4,26	■
JME542005G3R005.0Z2-SIRA	03171102	3	G	0,5	4,0	0,8	45,0	2,5	0,46	0,05	2	11,03	2,82	2,98	3,1	3,21	3,32	3,56	■
JME542006G3R005.0Z2-SIRA	03171103	3	G	0,6	4,0	0,9	45,0	3,0	0,56	0,05	2	10,36	3,32	3,5	3,64	3,76	3,89	4,18	■
JME542008G3R005.0Z2-SIRA	03171131	3	G	0,8	4,0	1,2	45,0	4,0	0,76	0,05	2	9,14	4,32	4,54	4,7	4,86	5,03	5,4	■
JME542010G3R010.0Z2-SIRA	03171104	3	G	1,0	4,0	1,5	50,0	5,0	0,95	0,1	2	8,09	5,32	5,58	5,77	5,96	6,16	6,61	■
JME542012G3R010.0Z2-SIRA	03171105	3	G	1,2	4,0	1,8	50,0	6,0	1,15	0,1	2	7,13	6,32	6,62	6,83	7,06	7,3	7,84	■
JME542015G3R015.0Z2-SIRA	03171132	3	G	1,5	4,0	2,3	50,0	7,5	1,45	0,15	2	5,89	7,82	8,16	8,43	8,7	9,0	9,66	■
JME542020G3R015.0Z2-SIRA	03171106	3	G	2,0	4,0	3,0	50,0	10,0	1,94	0,15	2	4,14	10,47	10,83	11,18	11,55	11,95	12,83	■
JME542025G3R015.0Z2-SIRA	03171108	3	G	2,5	4,0	3,8	50,0	12,5	2,4	0,15	2	2,79	12,97	13,41	13,84	14,3	14,79	-	■
JME542030G3R015.0Z2-SIRA	03171134	3	G	3,0	4,0	4,5	60,0	15,0	2,85	0,15	2	1,67	15,68	16,17	16,69	17,24	-	-	■
JME542005G4R005.0Z2-SIRA	03171109	4	G	0,5	4,0	0,8	45,0	4,0	0,46	0,05	2	9,49	4,32	4,54	4,7	4,86	5,03	5,4	■
JME542006G4R005.0Z2-SIRA	03171110	4	G	0,6	4,0	0,9	45,0	5,0	0,56	0,05	2	8,56	5,32	5,58	5,77	5,96	6,17	6,62	■
JME542008G4R005.0Z2-SIRA	03171135	4	G	0,8	4,0	1,2	45,0	7,0	0,76	0,05	2	7,05	7,32	7,65	7,9	8,16	8,44	9,07	■
JME542010G4R010.0Z2-SIRA	03171111	4	G	1,0	4,0	1,5	50,0	8,5	0,95	0,1	2	6,1	8,82	9,2	9,49	9,81	10,15	10,9	■
JME542012G4R010.0Z2-SIRA	03171112	4	G	1,2	4,0	1,8	50,0	10,0	1,15	0,1	2	5,27	10,32	10,75	11,09	11,46	11,85	12,73	■
JME542015G4R015.0Z2-SIRA	03171136	4	G	1,5	4,0	2,3	50,0	12,0	1,45	0,15	2	4,29	12,47	12,9	13,31	13,75	14,22	15,27	■
JME542020G4R015.0Z2-SIRA	03171113	4	G	2,0	4,0	3,0	60,0	16,0	1,94	0,15	2	2,9	16,47	17,02	17,57	18,15	18,78	-	■
JME542025G4R015.0Z2-SIRA	03171114	4	G	2,5	4,0	3,8	60,0	20,0	2,4	0,15	2	1,88	20,47	21,15	21,83	22,55	-	-	■
JME542030G4R015.0Z2-SIRA	03171137	4	G	3,0	4,0	4,5	70,0	24,0	2,85	0,15	2	1,1	24,68	25,45	26,27	-	-	-	■
JME542015G5R015.0Z2-SIRA	03171115	5	G	1,5	4,0	2,3	60,0	15,0	1,45	0,15	2	3,64	15,47	15,99	16,5	17,05	17,64	18,95	■
JME542020G5R015.0Z2-SIRA	03171116	5	G	2,0	4,0	3,0	60,0	20,0	1,94	0,15	2	2,41	20,47	21,15	21,83	22,55	23,33	-	■
JME542025G5R015.0Z2-SIRA	03171138	5	G	2,5	4,0	3,8	70,0	25,0	2,4	0,15	2	1,54	25,47	26,3	27,15	28,06	-	-	■
JME542030G5R015.0Z2-SIRA	03171117	5	G	3,0	4,0	4,5	70,0	30,0	2,85	0,15	2	0,9	30,68	31,64	-	-	-	-	■
JME542015G6R015.0Z2-SIRA	03171118	6	G	1,5	4,0	2,3	70,0	22,5	1,45	0,15	2	2,64	22,97	23,73	24,49	25,29	26,18	-	■
JME542020G6R015.0Z2-SIRA	03171139	6	G	2,0	4,0	3,0	70,0	30,0	1,94	0,15	2	1,7	30,47	31,46	32,48	33,56	-	-	■
JME542025G6R015.0Z2-SIRA	03171119	6	G	2,5	4,0	3,8	80,0	37,5	2,4	0,15	2	1,07	37,97	39,2	40,46	-	-	-	■
JME542030G6R015.0Z2-SIRA	03171120	6	G	3,0	4,0	4,5	90,0	45,0	2,85	0,15	2	0,61	45,68	47,11	-	-	-	-	■

■ Stocked standard.

For WDX values: Max. cut depth rel. to α_1 (α_1 , ref)*

JME562

Miniature – Universal – Square – 2 Flutes – DMM 6 – Cylindrical – Corner radius

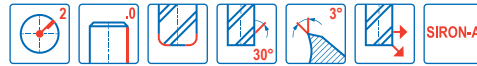
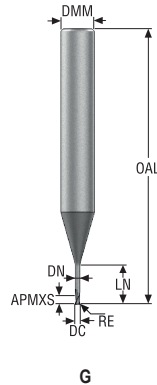

- Tolerances:
- Run-out= <0,007 mm
- DMM= h5
- DC= Ø0,5-Ø3,0= 0,-0,013 mm
- RE= ±0,005 mm

Designation	Item number	Length	Tool index shape	DC	DMM	APMXS	OAL	LN	DN	RE	PCEDC	CA°	WDX0*	WDX05*	WDX1*	WDX15*	WDX2*	WDX3*	Cylindrical
				mm	mm	mm	mm	mm	mm	mm	mm	mm							
JME562005G2R005.0Z2-SIRA	03171145	2	G	0,5	6,0	0,8	50,0	1,5	0,46	0,05	2	13,48	1,82	1,93	2,02	2,1	2,18	2,34	■
JME562006G2R005.0Z2-SIRA	03171146	2	G	0,6	6,0	0,9	50,0	2,0	0,56	0,05	2	12,9	2,32	2,45	2,56	2,66	2,75	2,95	■
JME562008G2R005.0Z2-SIRA	03171147	2	G	0,8	6,0	1,2	50,0	2,5	0,76	0,05	2	12,28	2,82	2,98	3,1	3,21	3,32	3,56	■
JME562010G2R010.0Z2-SIRA	03171148	2	G	1,0	6,0	1,5	50,0	4,0	0,95	0,1	2	10,85	4,32	4,54	4,7	4,86	5,02	5,39	■
JME562012G2R010.0Z2-SIRA	03171150	2	G	1,2	6,0	1,8	50,0	4,5	1,15	0,1	2	10,31	4,82	5,06	5,23	5,41	5,59	6,0	■
JME562015G2R015.0Z2-SIRA	03171151	2	G	1,5	6,0	2,3	50,0	5,0	1,45	0,15	2	9,67	5,47	5,68	5,86	6,05	6,25	6,71	■
JME562018G2R015.0Z2-SIRA	03171152	2	G	1,8	6,0	2,7	50,0	5,4	1,75	0,15	2	9,12	5,87	6,09	6,28	6,49	6,71	7,2	■
JME562020G2R015.0Z2-SIRA	03171153	2	G	2,0	6,0	3,0	50,0	6,0	1,94	0,15	2	8,53	6,47	6,71	6,92	7,15	7,39	7,93	■
JME562025G2R015.0Z2-SIRA	03171154	2	G	2,5	6,0	3,8	60,0	7,5	2,4	0,15	2	7,15	7,97	8,26	8,52	8,8	9,1	9,77	■
JME562030G2R015.0Z2-SIRA	03171155	2	G	3,0	6,0	4,5	60,0	9,0	2,85	0,15	2	5,81	9,68	9,98	10,3	10,64	11,01	11,82	■
JME562005G4R005.0Z2-SIRA	03171156	4	G	0,5	6,0	0,8	50,0	3,5	0,46	0,05	2	11,54	3,82	4,02	4,17	4,31	4,46	4,79	■
JME562006G4R005.0Z2-SIRA	03171157	4	G	0,6	6,0	0,9	50,0	4,2	0,56	0,05	2	10,93	4,52	4,75	4,92	5,08	5,26	5,64	■
JME562008G4R005.0Z2-SIRA	03171158	4	G	0,8	6,0	1,2	50,0	5,6	0,76	0,05	2	9,81	5,92	6,2	6,41	6,62	6,85	7,36	■
JME562010G4R010.0Z2-SIRA	03171159	4	G	1,0	6,0	1,5	50,0	7,0	0,95	0,1	2	8,86	7,32	7,65	7,9	8,16	8,44	9,06	■
JME562012G4R010.0Z2-SIRA	03171160	4	G	1,2	6,0	1,8	50,0	8,4	1,15	0,1	2	8,0	8,72	9,1	9,39	9,7	10,03	10,77	■
JME562015G4R015.0Z2-SIRA	03171162	4	G	1,5	6,0	2,3	50,0	10,5	1,45	0,15	2	6,86	10,97	11,35	11,71	12,1	12,52	13,44	■
JME562020G4R015.0Z2-SIRA	03171163	4	G	2,0	6,0	3,0	60,0	14,0	1,94	0,15	2	5,36	14,47	14,96	15,44	15,95	16,5	17,72	■
JME562025G4R015.0Z2-SIRA	03171164	4	G	2,5	6,0	3,8	65,0	17,5	2,4	0,15	2	4,18	17,97	18,57	19,17	19,8	20,49	22,0	■
JME562030G4R015.0Z2-SIRA	03171165	4	G	3,0	6,0	4,5	70,0	21,0	2,85	0,15	2	3,22	21,68	22,36	23,08	23,85	24,67	26,5	■
JME562005G5R005.0Z2-SIRA	03171166	5	G	0,5	6,0	0,8	50,0	5,0	0,46	0,05	2	10,42	5,32	5,58	5,77	5,96	6,17	6,62	■
JME562006G5R005.0Z2-SIRA	03171167	5	G	0,6	6,0	0,9	50,0	6,0	0,56	0,05	2	9,71	6,32	6,62	6,83	7,06	7,31	7,85	■
JME562008G5R005.0Z2-SIRA	03171168	5	G	0,8	6,0	1,2	50,0	8,0	0,76	0,05	2	8,48	8,32	8,68	8,96	9,26	9,58	10,29	■
JME562010G5R010.0Z2-SIRA	03171169	5	G	1,0	6,0	1,5	50,0	10,0	0,95	0,1	2	7,48	10,32	10,75	11,09	11,46	11,85	12,73	■
JME562012G5R010.0Z2-SIRA	03171170	5	G	1,2	6,0	1,8	50,0	12,0	1,15	0,1	2	6,62	12,32	12,81	13,22	13,66	14,13	15,18	■
JME562015G5R015.0Z2-SIRA	03171171	5	G	1,5	6,0	2,3	60,0	15,0	1,45	0,15	2	5,54	15,47	15,99	16,5	17,05	17,64	18,95	■
JME562020G5R015.0Z2-SIRA	03171172	5	G	2,0	6,0	3,0	60,0	20,0	1,94	0,15	2	4,19	20,47	21,15	21,83	22,55	23,33	25,06	■
JME562025G5R015.0Z2-SIRA	03171173	5	G	2,5	6,0	3,8	70,0	25,0	2,4	0,15	2	3,19	25,47	26,3	27,15	28,06	29,03	31,18	■
JME562030G5R015.0Z2-SIRA	03171174	5	G	3,0	6,0	4,5	70,0	30,0	2,85	0,15	2	2,41	30,68	31,64	32,66	33,75	34,92	-	■

■ Stocked standard.
For WDX values: Max. cut depth rel. to αη (αη, ref)*

Universal
Steel and cast iron
Stainless steel and S-materials
Non ferrous
Hard
Plastic and chip
Graphite
Minimaster Plus
Minimaster

JME562

Miniature – Universal – Square – 2 Flutes – DMM 6 – Cylindrical – Corner radius

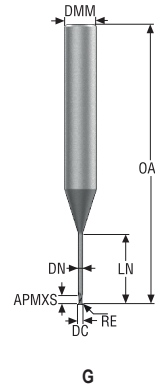

- Tolerances:
- Run-out= <0,007 mm
- DMM= h5
- DC= Ø1,0-Ø3,0= 0,-0,013 mm
- RE= ±0,005 mm

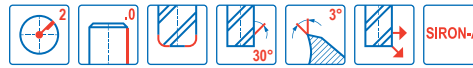

Designation	Item number	Length	Tool index shape	DC	DMM	APMXS	OAL	LN	DN	RE	PCEDC	CA°	WDX0*	WDX05*	WDX1*	WDX15*	WDX2*	WDX3*	Cylindrical
JME562010G6R010.0Z2-SIRA	03171175	6	G	1,0	6,0	1,5	60,0	15,0	0,95	0,1	2	5,94	15,32	15,9	16,41	16,96	17,55	18,85	■
JME562012G6R010.0Z2-SIRA	03171176	6	G	1,2	6,0	1,8	60,0	18,0	1,15	0,1	2	5,14	18,32	19,0	19,61	20,26	20,96	22,52	■
JME562015G6R015.0Z2-SIRA	03171177	6	G	1,5	6,0	2,3	70,0	22,5	1,45	0,15	2	4,2	22,97	23,73	24,49	25,31	26,18	28,12	■
JME562020G6R015.0Z2-SIRA	03171178	6	G	2,0	6,0	3,0	80,0	30,0	1,94	0,15	2	3,07	30,47	31,46	32,48	33,56	34,72	37,3	■
JME562025G6R015.0Z2-SIRA	03171179	6	G	2,5	6,0	3,8	80,0	37,5	2,4	0,15	2	2,28	37,97	39,2	40,46	41,81	43,26	-	■
JME562030G6R015.0Z2-SIRA	03171180	6	G	3,0	6,0	4,5	90,0	45,0	2,85	0,15	2	1,7	45,68	47,11	48,63	50,26	-	-	■
JME562010G7R010.0Z2-SIRA	03171181	7	G	1,0	6,0	1,5	60,0	20,0	0,95	0,1	2	4,93	20,32	21,06	21,74	22,46	23,24	24,97	■
JME562012G7R010.0Z2-SIRA	03171182	7	G	1,2	6,0	1,8	80,0	24,0	1,15	0,1	2	4,2	24,32	25,18	26,0	26,87	27,79	29,86	■
JME562015G7R015.0Z2-SIRA	03171183	7	G	1,5	6,0	2,3	80,0	30,0	1,45	0,15	2	3,38	30,47	31,46	32,48	33,56	34,72	37,3	■
JME562020G7R015.0Z2-SIRA	03171184	7	G	2,0	6,0	3,0	80,0	40,0	1,94	0,15	2	2,42	40,47	41,78	43,12	44,56	46,11	-	■
JME562025G7R015.0Z2-SIRA	03171185	7	G	2,5	6,0	3,8	90,0	50,0	2,4	0,15	2	1,78	50,47	52,09	53,77	55,57	-	-	■
JME562030G7R015.0Z2-SIRA	03171186	7	G	3,0	6,0	4,5	100,0	60,0	2,85	0,15	2	1,31	60,68	62,58	64,61	-	-	-	■

■ Stocked standard.
For WDX values: Max. cut depth rel. to αη (αη, ref)*

JMB542

Miniature – Universal – Ball nose – 2 Flutes – DMM 4 – Cylindrical

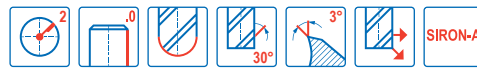
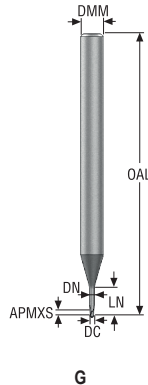

- Tolerances:
- Run-out=<0,007 mm
- DMM= h5
- DC= Ø0,-0,01 mm
- RE= ±0,005 mm

Designation	Item number	Length	Tool index shape	DC	DMM	APMXS	OAL	LN	DN	RE	PCEDC	CA°	WDX0*	WDX05*	WDX1*	WDX15*	WDX2*	WDX3*	Cylindrical
				mm	mm	mm	mm	mm	mm	mm	mm	mm	mm	mm	mm	mm	mm	mm	mm
JMB542002G1B.0Z2-SIRA	03171221	1	G	0,2	4,0	0,2	45,0	0,4	0,18	0,1	2	14,57	0,56	0,62	0,67	0,73	0,78	0,88	■
JMB542003G1B.0Z2-SIRA	03171222	1	G	0,3	4,0	0,3	45,0	0,6	0,28	0,15	2	14,24	0,76	0,83	0,9	0,96	1,02	1,13	■
JMB542004G1B.0Z2-SIRA	03171223	1	G	0,4	4,0	0,4	45,0	0,8	0,37	0,2	2	13,81	1,12	1,18	1,24	1,29	1,35	1,45	■
JMB542005G1B.0Z2-SIRA	03171224	1	G	0,5	4,0	0,5	45,0	1,0	0,46	0,25	2	13,47	1,32	1,39	1,45	1,51	1,57	1,68	■
JMB542006G1B.0Z2-SIRA	03171225	1	G	0,6	4,0	0,6	45,0	1,2	0,56	0,3	2	13,14	1,52	1,59	1,67	1,73	1,8	1,92	■
JMB542008G1B.0Z2-SIRA	03171226	1	G	0,8	4,0	0,8	45,0	1,6	0,76	0,4	2	12,46	1,92	2,01	2,1	2,17	2,25	2,39	■
JMB542010G1B.0Z2-SIRA	03171228	1	G	1,0	4,0	1,0	50,0	2,0	0,95	0,5	2	11,77	2,23	2,43	2,52	2,61	2,69	2,85	■
JMB542012G1B.0Z2-SIRA	03171229	1	G	1,2	4,0	1,2	50,0	2,4	1,15	0,6	2	11,07	2,72	2,84	2,95	3,04	3,13	3,32	■
JMB542015G1B.0Z2-SIRA	03171230	1	G	1,5	4,0	1,5	50,0	3,0	1,45	0,75	2	9,88	3,47	3,59	3,69	3,79	3,89	4,13	■
JMB542005G3B.0Z2-SIRA	03171231	3	G	0,5	4,0	0,5	45,0	2,5	0,46	0,25	2	11,25	2,82	2,97	3,09	3,19	3,29	3,52	■
JMB542006G3B.0Z2-SIRA	03171233	3	G	0,6	4,0	0,6	45,0	3,0	0,56	0,3	2	10,61	3,32	3,49	3,62	3,74	3,86	4,12	■
JMB542008G3B.0Z2-SIRA	03171234	3	G	0,8	4,0	0,8	45,0	4,0	0,76	0,4	2	9,44	4,32	4,53	4,68	4,83	4,98	5,32	■
JMB542010G3B.0Z2-SIRA	03171235	3	G	1,0	4,0	1,0	50,0	5,0	0,95	0,5	2	8,38	5,32	5,56	5,74	5,92	6,11	6,53	■
JMB542012G3B.0Z2-SIRA	03171236	3	G	1,2	4,0	1,2	50,0	6,0	1,15	0,6	2	7,44	6,32	6,6	6,8	7,01	7,23	7,73	■
JMB542015G3B.0Z2-SIRA	03171237	3	G	1,5	4,0	1,5	50,0	7,5	1,45	0,75	2	6,13	7,97	8,24	8,48	8,74	9,02	9,64	■
JMB542020G3B.0Z2-SIRA	03171238	3	G	2,0	4,0	2,0	50,0	10,0	1,94	1,0	2	4,4	10,47	10,81	11,13	11,47	11,83	12,64	■
JMB542025G3B.0Z2-SIRA	03171239	3	G	2,5	4,0	2,5	50,0	12,5	2,4	1,25	2	3,0	12,97	13,38	13,77	14,19	14,64	-	■
JMB542030G3B.0Z2-SIRA	03171240	3	G	3,0	4,0	3,0	60,0	15,0	2,85	1,5	2	1,81	15,68	16,13	16,6	17,11	-	-	■
JMB542005G4B.0Z2-SIRA	03171241	4	G	0,5	4,0	0,5	45,0	4,0	0,46	0,25	2	9,65	4,32	4,53	4,69	4,84	5,0	5,36	■
JMB542006G4B.0Z2-SIRA	03171242	4	G	0,6	4,0	0,6	45,0	5,0	0,56	0,3	2	8,74	5,32	5,57	5,75	5,94	6,13	6,57	■
JMB542008G4B.0Z2-SIRA	03171243	4	G	0,8	4,0	0,8	45,0	7,0	0,76	0,4	2	7,23	7,32	7,64	7,88	8,13	8,4	8,99	■
JMB542010G4B.0Z2-SIRA	03171244	4	G	1,0	4,0	1,0	50,0	8,5	0,95	0,5	2	6,27	8,82	9,19	9,47	9,77	10,09	10,81	■
JMB542012G4B.0Z2-SIRA	03171245	4	G	1,2	4,0	1,2	50,0	10,0	1,15	0,6	2	5,44	10,32	10,73	11,06	11,41	11,79	12,62	■
JMB542015G4B.0Z2-SIRA	03171246	4	G	1,5	4,0	1,5	50,0	12,0	1,45	0,75	2	4,44	12,47	12,88	13,27	13,69	14,14	15,14	■
JMB542020G4B.0Z2-SIRA	03171247	4	G	2,0	4,0	2,0	60,0	16,0	1,94	1,0	2	3,02	16,47	17,0	17,51	18,07	18,66	19,98	■
JMB542025G4B.0Z2-SIRA	03171248	4	G	2,5	4,0	2,5	60,0	20,0	2,4	1,25	2	1,97	20,47	21,11	21,76	22,45	-	-	■
JMB542030G4B.0Z2-SIRA	03171249	4	G	3,0	4,0	3,0	70,0	24,0	2,85	1,5	2	1,16	24,68	25,41	26,19	-	-	-	■
JMB542015G5B.0Z2-SIRA	03171250	5	G	1,5	4,0	1,5	60,0	15,0	1,45	0,75	2	3,75	15,47	15,97	16,47	16,99	17,56	18,81	■
JMB542020G5B.0Z2-SIRA	03171251	5	G	2,0	4,0	2,0	60,0	20,0	1,94	1,0	2	2,5	20,47	21,12	21,77	22,47	23,22	-	■
JMB542025G5B.0Z2-SIRA	03171252	5	G	2,5	4,0	2,5	70,0	25,0	2,4	1,25	2	1,61	25,47	26,27	27,08	27,95	-	-	■
JMB542030G5B.0Z2-SIRA	03171253	5	G	3,0	4,0	3,0	70,0	30,0	2,85	1,5	2	0,93	30,68	31,6	-	-	-	-	■
JMB542015G6B.0Z2-SIRA	03171254	6	G	1,5	4,0	1,5	70,0	22,5	1,45	0,75	2	2,7	22,97	23,71	24,45	25,25	26,1	-	■
JMB542020G6B.0Z2-SIRA	03171255	6	G	2,0	4,0	2,0	70,0	30,0	1,94	1,0	2	1,74	30,47	31,43	32,42	33,48	-	-	■
JMB542025G6B.0Z2-SIRA	03171256	6	G	2,5	4,0	2,5	80,0	37,5	2,4	1,25	2	1,1	37,97	39,16	40,39	-	-	-	■
JMB542030G6B.0Z2-SIRA	03171257	6	G	3,0	4,0	3,0	90,0	45,0	2,85	1,5	2	0,63	45,68	47,07	-	-	-	-	■

■ Stocked standard.
For WDX values: Max. cut depth rel. to αη (λαη, ref)*

JME564

Miniature – Universal – Square – 4 Flutes – DMM 6 – Cylindrical – Corner radius

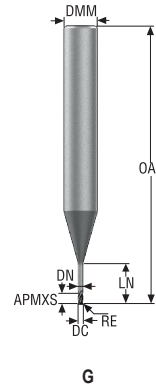

- Tolerances:
- Run-out= <math><0-0,007\text{ mm}</math>
- DMM= h5
- DC= $\varnothing 0,5-\varnothing 3,0 = 0,-0,013\text{ mm}</math>$
- RE= $\pm 0,005\text{ mm}</math>$

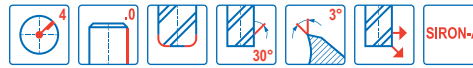

Designation	Item number	Length	Tool index shape	DC	DMM	APMXS	OAL	LN	DN	RE	PCEDC	CA°	WDX0*	WDX05*	WDX1*	WDX15*	WDX2*	WDX3*	Cylindrical
JME564005G2R005.0Z4-SIRA	03227166	2	G	0,5	6,0	1,0	50,0	1,5	0,46	0,05	4	13,48	1,82	1,93	2,02	2,1	2,18	2,34	■
JME564006G2R005.0Z4-SIRA	03227271	2	G	0,6	6,0	1,2	50,0	2,0	0,56	0,05	4	12,9	2,32	2,45	2,56	2,66	2,75	2,95	■
JME564008G2R005.0Z4-SIRA	03171194	2	G	0,8	6,0	1,6	50,0	2,5	0,76	0,05	4	12,28	2,82	2,98	3,1	3,21	3,32	3,56	■
JME564010G2R010.0Z4-SIRA	03171195	2	G	1,0	6,0	2,0	50,0	4,0	0,95	0,1	4	10,85	4,32	4,54	4,7	4,86	5,02	5,39	■
JME564012G2R010.0Z4-SIRA	03171196	2	G	1,2	6,0	2,4	50,0	4,5	1,15	0,1	4	10,31	4,82	5,06	5,23	5,41	5,59	6,0	■
JME564015G2R015.0Z4-SIRA	03171197	2	G	1,5	6,0	3,0	50,0	5,0	1,45	0,15	4	9,67	5,47	5,68	5,86	6,05	6,25	6,71	■
JME564020G2R015.0Z4-SIRA	03171198	2	G	2,0	6,0	4,0	50,0	6,0	1,94	0,15	4	8,53	6,47	6,71	6,92	7,15	7,39	7,93	■
JME564025G2R015.0Z4-SIRA	03171199	2	G	2,5	6,0	5,0	60,0	7,5	2,4	0,15	4	7,15	7,97	8,26	8,52	8,8	9,1	9,77	■
JME564030G2R015.0Z4-SIRA	03171200	2	G	3,0	6,0	6,0	60,0	9,0	2,85	0,15	4	5,81	9,68	9,98	10,3	10,64	11,01	11,82	■
JME564005G4R005.0Z4-SIRA	03171201	4	G	0,5	6,0	1,0	50,0	3,5	0,46	0,05	4	11,54	3,82	4,02	4,17	4,32	4,46	4,79	■
JME564006G4R005.0Z4-SIRA	03171202	4	G	0,6	6,0	1,2	50,0	4,2	0,56	0,05	4	10,93	4,52	4,75	4,92	5,08	5,26	5,64	■
JME564008G4R005.0Z4-SIRA	03171203	4	G	0,8	6,0	1,6	50,0	5,6	0,76	0,05	4	9,81	5,92	6,2	6,41	6,62	6,85	7,36	■
JME564010G4R010.0Z4-SIRA	03171204	4	G	1,0	6,0	2,0	50,0	7,0	0,95	0,1	4	8,86	7,32	7,65	7,9	8,16	8,44	9,06	■
JME564012G4R010.0Z4-SIRA	03171205	4	G	1,2	6,0	2,4	50,0	8,4	1,15	0,1	4	8,0	8,72	9,1	9,39	9,7	10,03	10,77	■
JME564015G4R015.0Z4-SIRA	03171206	4	G	1,5	6,0	3,0	50,0	10,5	1,45	0,15	4	6,86	10,97	11,35	11,71	12,1	12,52	13,44	■
JME564020G4R015.0Z4-SIRA	03171207	4	G	2,0	6,0	4,0	60,0	14,0	1,94	0,15	4	5,36	14,47	14,96	15,44	15,95	16,5	17,72	■
JME564025G4R015.0Z4-SIRA	03171208	4	G	2,5	6,0	5,0	60,0	17,5	2,4	0,15	4	4,18	17,97	18,57	19,17	19,8	20,49	22,0	■
JME564030G4R015.0Z4-SIRA	03171209	4	G	3,0	6,0	6,0	70,0	21,0	2,85	0,15	4	3,22	21,68	22,36	23,08	23,85	24,67	26,5	■

■ Stocked standard.
For WDX values: Max. cut depth rel. to α_{η} ($\alpha_{\eta, ref}$)*

JMB562

Miniature – Universal – Ball nose – 2 Flutes – DMM6 – Cylindrical

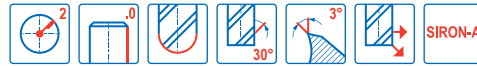

- Tolerances:
- Run-out=<0,007 mm
- DMM= h5
- DC= \varnothing 0,-0,01 mm
- RE= \pm 0,005 mm

Designation	Item number	Length index	Tool shape	DC	DMM	APMXS	OAL	LN	DN	RE	PCEDC	CA°	WDX0°	WDX05°	WDX1°	WDX15°	WDX2°	WDX3°	Cylindrical
JMB562005G2B.0Z2-SIRA	03171261	2	G	0,5	6,0	0,5	50,0	1,5	0,46	0,25	2	13,69	1,82	1,91	2,0	2,08	2,15	2,3	■
JMB562006G2B.0Z2-SIRA	03171262	2	G	0,6	6,0	0,6	50,0	2,0	0,56	0,3	2	13,13	2,32	2,44	2,54	2,63	2,72	2,9	■
JMB562008G2B.0Z2-SIRA	03171263	2	G	0,8	6,0	0,8	50,0	2,5	0,76	0,4	2	12,6	2,82	2,96	3,07	3,18	3,27	3,49	■
JMB562010G2B.0Z2-SIRA	03171264	2	G	1,0	6,0	1,0	50,0	4,0	0,95	0,5	2	11,15	4,32	4,52	4,68	4,68	4,97	5,3	■
JMB562012G2B.0Z2-SIRA	03171265	2	G	1,2	6,0	1,2	50,0	4,5	1,15	0,6	2	10,67	4,82	5,04	5,2	5,36	5,52	5,89	■
JMB562015G2B.0Z2-SIRA	03171266	2	G	1,5	6,0	1,5	50,0	5,0	1,45	0,75	2	10,07	5,47	5,66	5,82	5,99	6,17	6,58	■
JMB562018G2B.0Z2-SIRA	03171267	2	G	1,8	6,0	1,8	50,0	5,4	1,75	0,9	2	9,61	5,87	6,07	6,23	6,41	6,61	7,03	■
JMB562020G2B.0Z2-SIRA	03171268	2	G	2,0	6,0	2,0	50,0	6,0	1,94	1,0	2	9,05	6,47	6,68	6,87	7,06	7,28	7,75	■
JMB562025G2B.0Z2-SIRA	03171269	2	G	2,5	6,0	2,5	60,0	7,5	2,4	1,25	2	7,71	7,97	8,22	8,45	8,69	8,95	9,53	■
JMB562030G2B.0Z2-SIRA	03171270	2	G	3,0	6,0	3,0	60,0	9,0	2,85	1,5	2	6,35	9,68	9,94	10,21	10,51	10,82	11,52	■
JMB562005G4B.0Z2-SIRA	03171271	4	G	0,5	6,0	0,5	50,0	3,5	0,46	0,25	2	11,7	3,82	4,01	4,16	4,29	4,43	4,74	■
JMB562006G4B.0Z2-SIRA	03171272	4	G	0,6	6,0	0,6	50,0	4,2	0,56	0,3	2	11,1	4,52	4,74	4,9	5,06	5,22	5,59	■
JMB562008G4B.0Z2-SIRA	03171273	4	G	0,8	6,0	0,8	50,0	5,6	0,76	0,4	2	10,02	5,92	6,19	6,39	6,59	6,8	7,28	■
JMB562010G4B.0Z2-SIRA	03171274	4	G	1,0	6,0	1,0	50,0	7,0	0,95	0,5	2	9,06	7,32	7,64	7,87	8,12	8,38	8,97	■
JMB562012G4B.0Z2-SIRA	03171275	4	G	1,2	6,0	1,2	50,0	8,4	1,15	0,6	2	8,22	8,72	9,08	9,35	9,65	9,96	10,66	■
JMB562015G4B.0Z2-SIRA	03171276	4	G	1,5	6,0	1,5	50,0	10,5	1,45	0,75	2	7,07	10,97	11,33	11,67	12,04	12,43	13,31	■
JMB562020G4B.0Z2-SIRA	03171277	4	G	2,0	6,0	2,0	60,0	14,0	1,94	1,0	2	5,57	14,47	14,93	15,38	15,87	16,38	17,54	■
JMB562025G4B.0Z2-SIRA	03171278	4	G	2,5	6,0	2,5	65,0	17,5	2,4	1,25	2	4,38	17,97	18,53	19,1	19,69	20,34	21,76	■
JMB562030G4B.0Z2-SIRA	03171279	4	G	3,0	6,0	3,0	70,0	21,0	2,85	1,5	2	3,38	21,68	22,32	22,99	23,71	24,49	26,21	■
JMB562005G5B.0Z2-SIRA	03171280	5	G	0,5	6,0	0,5	50,0	5,0	0,46	0,25	2	10,54	5,32	5,57	5,76	5,94	6,14	6,58	■
JMB562006G5B.0Z2-SIRA	03171281	5	G	0,6	6,0	0,6	50,0	6,0	0,56	0,3	2	9,85	6,32	6,61	6,82	7,04	7,27	7,79	■
JMB562008G5B.0Z2-SIRA	03171282	5	G	0,8	6,0	0,8	50,0	8,0	0,76	0,4	2	8,64	8,32	8,67	8,94	9,23	9,54	10,22	■
JMB562010G5B.0Z2-SIRA	03171283	5	G	1,0	6,0	1,0	50,0	10,0	0,95	0,5	2	7,63	10,32	10,73	11,06	11,42	11,8	12,64	■
JMB562012G5B.0Z2-SIRA	03171284	5	G	1,2	6,0	1,2	50,0	12,0	1,15	0,6	2	6,77	12,32	12,79	13,19	13,61	14,06	15,07	■
JMB562015G5B.0Z2-SIRA	03171285	5	G	1,5	6,0	1,5	60,0	15,0	1,45	0,75	2	5,68	15,47	15,97	16,47	16,99	17,56	18,81	■
JMB562020G5B.0Z2-SIRA	03171287	5	G	2,0	6,0	2,0	60,0	20,0	1,94	1,0	2	4,32	20,47	21,12	21,77	22,47	23,22	24,88	■
JMB562025G5B.0Z2-SIRA	03171288	5	G	2,5	6,0	2,5	70,0	25,0	2,4	1,25	2	3,3	25,47	26,27	27,08	27,95	28,88	30,94	■
JMB562030G5B.0Z2-SIRA	03171289	5	G	3,0	6,0	3,0	70,0	30,0	2,85	1,5	2	2,5	30,68	31,6	32,58	33,62	34,73	-	■

■ Stocked standard.
For WDX values: Max. cut depth rel. to $\alpha\eta$ ($\alpha\eta$, ref)*

Universal
Steel and cast iron
Stainless steel and S-materials
Non ferrous
Hard
Plastic and chip
Graphite
Minimaster Plus
Minimaster

JMB562

Miniature – Universal – Ball nose – 2 Flutes – DMM 6 – Cylindrical

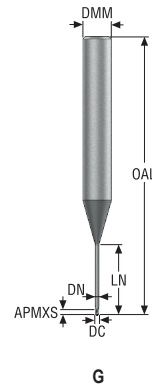

- Tolerances:
- Run-out=<0,007 mm
- DMM= h5
- DC= Ø0,-0,01 mm
- RE= ±0,005 mm

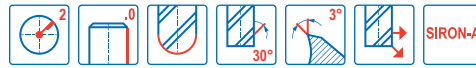

Designation	Item number	Length index	Tool shape	DC	DMM	APMXS	OAL	LN	DN	RE	PCEDC	CA°	WDX0*	WDX05*	WDX1*	WDX15*	WDX2*	WDX3*	Cylindrical
				mm	mm	mm	mm	mm	mm	mm	mm	mm	mm	mm	mm	mm	mm	mm	mm
JMB562010G6B.0Z2-SIRA	03171290	6	G	1,0	6,0	1,0	60,0	15,0	0,95	0,5	2	6,04	15,32	15,89	16,39	16,92	17,49	18,76	■
JMB562012G6B.0Z2-SIRA	03171291	6	G	1,2	6,0	1,2	60,0	18,0	1,15	0,6	2	5,24	18,32	18,98	19,58	20,21	20,89	22,41	■
JMB562015G6B.0Z2-SIRA	03171292	6	G	1,5	6,0	1,5	70,0	22,5	1,45	0,75	2	4,28	22,97	23,71	24,45	25,25	26,1	27,99	■
JMB562020G6B.0Z2-SIRA	03171293	6	G	2,0	6,0	2,0	80,0	30,0	1,94	1,0	2	3,14	30,47	31,43	32,42	33,48	34,6	37,11	■
JMB562025G6B.0Z2-SIRA	03171294	6	G	2,5	6,0	2,5	80,0	37,5	2,4	1,25	2	2,34	37,97	39,16	40,39	41,7	43,11	-	■
JMB562030G6B.0Z2-SIRA	03171295	6	G	3,0	6,0	3,0	90,0	45,0	2,85	1,5	2	1,74	45,68	47,07	48,55	50,13	-	-	■
JMB562010G7B.0Z2-SIRA	03171296	7	G	1,0	6,0	1,0	60,0	20,0	0,95	0,5	2	4,99	20,32	21,05	21,71	22,42	23,19	24,88	■
JMB562012G7B.0Z2-SIRA	03171297	7	G	1,2	6,0	1,2	80,0	24,0	1,15	0,6	2	4,27	24,32	25,17	25,97	26,82	27,73	29,75	■
JMB562015G7B.0Z2-SIRA	03171298	7	G	1,5	6,0	1,5	80,0	30,0	1,45	0,75	2	3,43	30,47	31,44	32,44	33,5	34,64	37,17	■
JMB562020G7B.0Z2-SIRA	03171299	7	G	2,0	6,0	2,0	80,0	40,0	1,94	1,0	2	2,47	40,47	41,75	43,07	44,48	45,99	-	■
JMB562025G7B.0Z2-SIRA	03171300	7	G	2,5	6,0	2,5	90,0	50,0	2,4	1,25	2	1,81	50,47	52,05	53,7	55,46	-	-	■
JMB562030G7B.0Z2-SIRA	03171301	7	G	3,0	6,0	3,0	100,0	60,0	2,85	1,5	2	1,34	60,68	62,54	64,52	-	-	-	■

■ Stocked standard.
For WDX values: Max. cut depth rel. to α₁ (α₁, ref)*

Universal

Steel and cast iron

Stainless steel and S-materials

Non ferrous

Hard

Plastic and CFRP

Graphite

Minimaster Plus

Minimaster

Cutting data – JMB562 Copy milling roughing

Table with columns: SMG, Coolant, ap/DC, ap/DC, fz (0.2-3.0), vc. Rows include material groups like P1-P12, M1-M5, N1-N3, S11-S13, H3-H8, H11-H12, H21, H31, and GR1. Material categories on the right include Universal, Steel and cast iron, Stainless steel and S-materials, Non ferrous, Hard, Plastic and chip, Graphite, Mimimaster Plus, and Mimimaster.

Table based on LV1, please recalc based on length version chosen. See page(s) 445 - 452

SMG = Seco material group
Coolant = A=air D=dry E=emulsion M=mist spray
vc= m/min (sf/min)
fz = mm (in/tooth)
ap = mm/DC (in/DC) = factor
aa = mm/DC (in/DC) = factor
All cutting data are target values

JMB563

Miniature – Universal – Ball nose – 3 Flutes – DMM 6 – Cylindrical

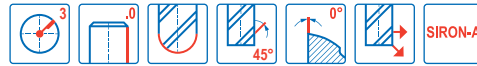
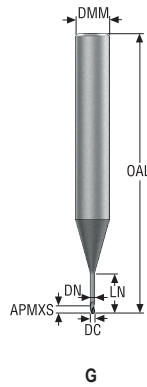

- Tolerances:
- Run-out=<0,007 mm
- DMM= h5
- DC= Ø0,-0.02 mm
- RE= ±0,01 mm

Designation	Item number	Length index	Tool shape	DC	DMM	APMXS	OAL	LN	DN	RE	PCEDC	CA°	WDX0°	WDX05°	WDX1°	WDX15°	WDX2°	WDX3°	Cylindrical
				mm	mm	mm	mm	mm	mm	mm	mm	mm	mm	mm	mm	mm	mm	mm	mm
JMB563010G2B.0Z3-SIRA	03171307	2	G	1,0	6,0	1,0	50,0	4,0	0,95	0,5	3	11,15	4,32	4,52	4,68	4,68	4,97	5,3	■
JMB563012G2B.0Z3-SIRA	03171308	2	G	1,2	6,0	1,2	50,0	4,5	1,15	0,6	3	10,67	4,82	5,04	5,2	5,36	5,52	5,89	■
JMB563015G2B.0Z3-SIRA	03171309	2	G	1,5	6,0	1,5	50,0	5,0	1,45	0,75	3	10,07	5,47	5,66	5,82	5,99	6,17	6,58	■
JMB563020G2B.0Z3-SIRA	03171310	2	G	2,0	6,0	2,0	50,0	6,0	1,94	1,0	3	9,05	6,47	6,68	6,87	7,06	7,28	7,75	■
JMB563025G2B.0Z3-SIRA	03171311	2	G	2,5	6,0	2,5	60,0	7,5	2,4	1,25	3	7,71	7,97	8,22	8,45	8,69	8,95	9,53	■
JMB563030G2B.0Z3-SIRA	03171312	2	G	3,0	6,0	3,0	60,0	9,0	2,85	1,5	3	6,35	9,68	9,94	10,21	10,51	10,83	11,52	■
JMB563010G4B.0Z3-SIRA	03171316	4	G	1,0	6,0	1,0	50,0	7,0	0,95	0,5	3	9,06	7,32	7,64	7,87	8,12	8,38	8,97	■
JMB563012G4B.0Z3-SIRA	03171317	4	G	1,2	6,0	1,2	50,0	8,4	1,15	0,6	3	8,22	8,72	9,08	9,35	9,65	9,96	10,66	■
JMB563015G4B.0Z3-SIRA	03171318	4	G	1,5	6,0	1,5	50,0	10,5	1,45	0,75	3	7,07	10,97	11,33	11,67	12,04	12,43	13,31	■
JMB563020G4B.0Z3-SIRA	03171319	4	G	2,0	6,0	2,0	60,0	14,0	1,94	1,0	3	5,57	14,47	14,93	15,38	15,87	16,38	17,54	■
JMB563025G4B.0Z3-SIRA	03171320	4	G	2,5	6,0	2,5	60,0	17,5	2,4	1,25	3	4,38	17,97	18,53	19,1	19,69	20,34	21,76	■
JMB563030G4B.0Z3-SIRA	03171321	4	G	3,0	6,0	3,0	70,0	21,0	2,85	1,5	3	3,38	21,68	22,32	22,99	23,71	24,49	26,21	■

■ Stocked standard.
For WDX values: Max. cut depth rel. to αη ((αη, ref)°)

Universal
Steel and cast iron
Stainless steel and S-materials
Non ferrous
Hard
Plastic and chip
Graphite
Minimaster Plus
Minimaster

Cutting data – JMB563 Copy milling roughing

SMG		a _p /DC	a _e /DC	f _z						v _c
				1	1.2	1.5	2.0	2.5	3.0	
P1	M/E/A	0.0500	0.11	0.020	0.024	0.030	0.040	0.050	0.060	370 (340 – 410)
		0,0500	0,11	0,00080	0,00095	0,0012	0,0016	0,0020	0,0024	1225 (1200–1300)
P2	M/E/A	0.0500	0.11	0.020	0.024	0.030	0.040	0.050	0.060	360 (330 – 400)
		0,0500	0,11	0,00080	0,00095	0,0012	0,0016	0,0020	0,0024	1175 (1100–1300)
P3	M/E/A	0.0500	0.11	0.020	0.024	0.030	0.040	0.050	0.060	310 (280 – 340)
		0,0500	0,11	0,00080	0,00095	0,0012	0,0016	0,0020	0,0024	1025 (920–1100)
P4	M/E/A	0.0500	0.11	0.020	0.024	0.030	0.040	0.050	0.060	275 (250 – 300)
		0,0500	0,11	0,00080	0,00095	0,0012	0,0016	0,0020	0,0024	900 (830 – 980)
P5	M/E/A	0.0500	0.11	0.020	0.024	0.030	0.040	0.050	0.060	260 (240 – 290)
		0,0500	0,11	0,00080	0,00095	0,0012	0,0016	0,0020	0,0024	850 (790 – 950)
P6	M/E/A	0.0500	0.11	0.020	0.024	0.030	0.040	0.050	0.060	295 (270 – 320)
		0,0500	0,11	0,00080	0,00095	0,0012	0,0016	0,0020	0,0024	970 (890–1000)
P7	M/E/A	0.0500	0.11	0.020	0.024	0.030	0.040	0.050	0.060	275 (250 – 300)
		0,0500	0,11	0,00080	0,00095	0,0012	0,0016	0,0020	0,0024	900 (830 – 980)
P8	M/E/A	0.0500	0.11	0.020	0.024	0.030	0.040	0.050	0.060	260 (240 – 290)
		0,0500	0,11	0,00080	0,00095	0,0012	0,0016	0,0020	0,0024	850 (790 – 950)
P11	M/E/A	0.0500	0.11	0.020	0.024	0.030	0.040	0.050	0.060	270 (240 – 290)
		0,0500	0,11	0,00080	0,00095	0,0012	0,0016	0,0020	0,0024	890 (790 – 950)
P12	M/E/A	0.0500	0.11	0.020	0.024	0.030	0.040	0.050	0.060	160 (150–170)
		0,0500	0,11	0,00080	0,00095	0,0012	0,0016	0,0020	0,0024	520 (500 – 550)
M1	E/M/A	0.0250	0.11	0.020	0.024	0.030	0.040	0.050	0.060	220 (180 – 250)
		0,0250	0,11	0,00080	0,00095	0,0012	0,0016	0,0020	0,0024	720 (600 – 820)
M2	E/M/A	0.0250	0.11	0.020	0.024	0.030	0.040	0.050	0.060	175 (150 – 200)
		0,0250	0,11	0,00080	0,00095	0,0012	0,0016	0,0020	0,0024	570 (500 – 650)
M3	E/M/A	0.0250	0.11	0.020	0.024	0.030	0.040	0.050	0.060	175 (150 – 200)
		0,0250	0,11	0,00080	0,00095	0,0012	0,0016	0,0020	0,0024	570 (500 – 650)
M4	E/M/A	0.0250	0.11	0.020	0.024	0.030	0.040	0.050	0.060	130 (110–150)
		0,0250	0,11	0,00080	0,00095	0,0012	0,0016	0,0020	0,0024	425 (370 – 490)
M5	E/M/A	0.0250	0.11	0.020	0.024	0.030	0.040	0.050	0.060	110 (90–120)
		0,0250	0,11	0,00080	0,00095	0,0012	0,0016	0,0020	0,0024	360 (300 – 390)
N1	E/M/A	0.100	0.50	0.019	0.022	0.028	0.032	0.036	0.040	500 (440 – 560)
		0,100	0,50	0,00075	0,00085	0,0011	0,0013	0,0014	0,0016	1650 (1500–1800)
N2	E/M/A	0.100	0.50	0.020	0.024	0.030	0.040	0.050	0.060	500 (440 – 560)
		0,100	0,50	0,00080	0,00095	0,0012	0,0016	0,0020	0,0024	1650 (1500–1800)
N3	E/M/A	0.100	0.50	0.020	0.024	0.030	0.040	0.050	0.060	335 (300 – 370)
		0,100	0,50	0,00080	0,00095	0,0012	0,0016	0,0020	0,0024	1100 (990–1200)
N11	E/M/A	0.100	0.50	0.025	0.030	0.038	0.050	0.060	0.075	440 (380 – 500)
		0,100	0,50	0,0010	0,0012	0,0015	0,0020	0,0024	0,0030	1450 (1300–1600)
S11	E/M/A	0.0250	0.26	0.020	0.024	0.030	0.040	0.050	0.060	300 (260 – 340)
		0,0250	0,26	0,00080	0,00095	0,0012	0,0016	0,0020	0,0024	980 (860–1100)
S12	E/M/A	0.0250	0.26	0.020	0.024	0.030	0.040	0.050	0.060	230 (200 – 260)
		0,0250	0,26	0,00080	0,00095	0,0012	0,0016	0,0020	0,0024	750 (660 – 850)
S13	E/M/A	0.0250	0.26	0.020	0.024	0.030	0.040	0.050	0.060	180 (160 – 200)
		0,0250	0,26	0,00080	0,00095	0,0012	0,0016	0,0020	0,0024	590 (530 – 650)
H3	M/A	0.0250	0.028	0.018	0.022	0.026	0.036	0.044	0.055	125 (93–150)
		0,0250	0,028	0,00070	0,00085	0,0010	0,0014	0,0017	0,0022	410 (310 – 490)
H5	M/A	0.0500	0.070	0.020	0.024	0.030	0.040	0.050	0.060	230 (210 – 260)
		0,0500	0,070	0,00080	0,00095	0,0012	0,0016	0,0020	0,0024	750 (690 – 850)
H7	M/A	0.0250	0.028	0.018	0.022	0.026	0.036	0.044	0.055	125 (93–150)
		0,0250	0,028	0,00070	0,00085	0,0010	0,0014	0,0017	0,0022	410 (310 – 490)
H8	M/A	0.0500	0.070	0.020	0.024	0.030	0.040	0.050	0.060	230 (210 – 260)
		0,0500	0,070	0,00080	0,00095	0,0012	0,0016	0,0020	0,0024	750 (690 – 850)
H11	M/A	0.0500	0.070	0.020	0.024	0.030	0.040	0.050	0.060	295 (260 – 330)
		0,0500	0,070	0,00080	0,00095	0,0012	0,0016	0,0020	0,0024	970 (860–1000)
H12	M/A	0.0500	0.070	0.020	0.024	0.030	0.040	0.050	0.060	270 (240 – 300)
		0,0500	0,070	0,00080	0,00095	0,0012	0,0016	0,0020	0,0024	890 (790 – 980)
H21	M/A	0.0500	0.070	0.020	0.024	0.030	0.040	0.050	0.060	230 (210 – 260)
		0,0500	0,070	0,00080	0,00095	0,0012	0,0016	0,0020	0,0024	750 (690 – 850)
H31	M/A	0.0500	0.070	0.020	0.024	0.030	0.040	0.050	0.060	175 (160–190)
		0,0500	0,070	0,00080	0,00095	0,0012	0,0016	0,0020	0,0024	570 (530 – 620)
GR1	A	0.500	0.24	0.015	0.018	0.022	0.030	0.038	0.044	385 (330 – 430)
		0,500	0,24	0,00060	0,00070	0,00085	0,0012	0,0015	0,0017	1275 (1100–1400)

Table based on LV1, please recalc based on length version chosen. See page(s) 445 - 452

SMG = Seco material group
Coolant = A=air D=dry E=emulsion M=mist spray
v_c = m/min (sf/min)
f_z = mm (in/tooth)
a_p = mm/DC (in/DC) = factor
a_e = mm/DC (in/DC) = factor
All cutting data are target values



STEEL AND CAST IRON

Seco offers a complete range of high performance solid carbide square shoulder end mills, ballnose cutters and finish end mills for high productivity in steel and cast iron.

- JHP993, JHP951 and JH142 for chamfer or radius type.
- JH970, JH112, JH150, JH160 for ball-nose type.

Universal

Steel and cast iron

Stainless steel and
S-materials

Non ferrous

Hard

Plastic and cfrp

Graphite









Minimaster Plus

Minimaster

Universal		Tool selection Steel and cast iron					
Steel and cast iron							
Stainless steel and S-materials							
Non ferrous		Name	JHP993	JHP951	JH142	JH970	
Hard		Page(s)	184	190	194, 355	135, 135, 197	
Plastic and cfrp		Family name	HPM	HPM	HSM/TORNADO	HSM/TORNADO	
Graphite		Type of mill					
Minimaster Plus		Shank	Cylindrical	<input checked="" type="checkbox"/>	<input checked="" type="checkbox"/>	<input checked="" type="checkbox"/>	<input checked="" type="checkbox"/>
Minimaster			Weldon	<input checked="" type="checkbox"/>	<input checked="" type="checkbox"/>	<input type="checkbox"/>	<input type="checkbox"/>
		Number of Flutes	3,4,5	3,4,5	2-4-5-6	2	
		ICC					
		Diameter range	Metric	4-25	3-20	2-12	2-16
			Inch				
		Length availability					
			2,3	2	2,3,6	1,2,3	
		Operation					
		SMG					
		P1	<input checked="" type="checkbox"/>	<input checked="" type="checkbox"/>	<input checked="" type="checkbox"/>	<input checked="" type="checkbox"/>	
		P2	<input checked="" type="checkbox"/>	<input checked="" type="checkbox"/>	<input checked="" type="checkbox"/>	<input checked="" type="checkbox"/>	
		P3	<input checked="" type="checkbox"/>	<input checked="" type="checkbox"/>	<input checked="" type="checkbox"/>	<input checked="" type="checkbox"/>	
		P4	<input checked="" type="checkbox"/>	<input checked="" type="checkbox"/>	<input checked="" type="checkbox"/>	<input checked="" type="checkbox"/>	
		P5	<input checked="" type="checkbox"/>	<input checked="" type="checkbox"/>	<input checked="" type="checkbox"/>	<input checked="" type="checkbox"/>	
		P6	<input checked="" type="checkbox"/>	<input checked="" type="checkbox"/>	<input checked="" type="checkbox"/>	<input checked="" type="checkbox"/>	
		P7	<input checked="" type="checkbox"/>	<input checked="" type="checkbox"/>	<input checked="" type="checkbox"/>	<input checked="" type="checkbox"/>	
		P8	<input checked="" type="checkbox"/>	<input checked="" type="checkbox"/>	<input checked="" type="checkbox"/>	<input checked="" type="checkbox"/>	
		P11-12	<input type="checkbox"/>	<input type="checkbox"/>	<input checked="" type="checkbox"/>	<input type="checkbox"/>	
		K1	<input checked="" type="checkbox"/>	<input checked="" type="checkbox"/>	<input checked="" type="checkbox"/>	<input checked="" type="checkbox"/>	
		K2	<input checked="" type="checkbox"/>	<input checked="" type="checkbox"/>	<input checked="" type="checkbox"/>	<input checked="" type="checkbox"/>	
		K3	<input checked="" type="checkbox"/>	<input checked="" type="checkbox"/>	<input checked="" type="checkbox"/>	<input checked="" type="checkbox"/>	
		K4	<input checked="" type="checkbox"/>	<input checked="" type="checkbox"/>	<input checked="" type="checkbox"/>	<input checked="" type="checkbox"/>	
		K5	<input checked="" type="checkbox"/>	<input checked="" type="checkbox"/>	<input checked="" type="checkbox"/>	<input checked="" type="checkbox"/>	
		K6	<input checked="" type="checkbox"/>	<input checked="" type="checkbox"/>	<input checked="" type="checkbox"/>	<input checked="" type="checkbox"/>	
		K7	<input checked="" type="checkbox"/>	<input checked="" type="checkbox"/>	<input checked="" type="checkbox"/>	<input checked="" type="checkbox"/>	

■ Stock standard □ Weldon available, delivery time is 3 days.
● Preferred choice ○ Alternative choice

Tool selection Steel and cast iron

				
Name		JH112	JH150	JH160
Page(s)		199, 358	361	363
Family name		HSM/TORNADO	HSM/TORNADO	HSM/TORNADO
Type of mill				
Shank	Cylindrical	■	■	■
	Weldon			
Number of Flutes		2	4	4
ICC				
Diameter range	Metric	2-12	6-12	3-12
	Inch			
Length availability				
		1,2,3,4,5,6	2	2
Operation				
SMG				
P1				●
P2				●
P3				●
P4				●
P5				●
P6				●
P7				●
P8				●
P11-12				○
K1		●	●	
K2		●	●	
K3		●	●	
K4		●	●	
K5		●	●	
K6		●	●	
K7		●	●	

■ Stock standard □ Weldon available, delivery time is 3 days.
● Preferred choice ○ Alternative choice

Universal
Steel and cast iron
Stainless steel and S-materials
Non ferrous
Hard
Plastic and cfrp
Graphite
Minimaster Plus
Minimaster

JHP993

High performance – Steel – Square – 3-5 Flutes – Cylindrical – Chamfer

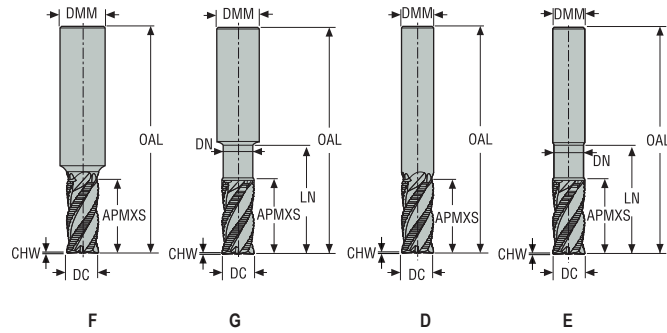

- Tolerances:
- DMM=h5
- DC=-0,02/-0,1 mm
- CHW= ±0,05 mm
- Regrind possible if DC is ≥ϕ6

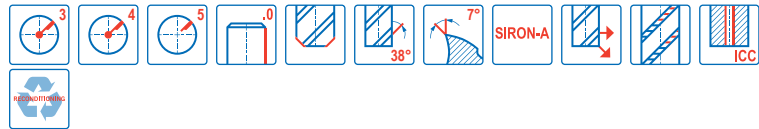

Designation	Item number	Length index	Tool shape	ICC	DC	DMM	APMXS	OAL	LN	DN	CHW	PCEDC	Cylindrical
					mm	mm	mm	mm	mm	mm	mm	mm	mm
JHP993040F2C.0Z3-SIRA	02826806	2	F	-	4,0	6,0	10,0	50,0	12,56	4,0	0,15	3	■
JHP993050F2C.0Z4-SIRA	02826808	2	F	-	5,0	6,0	12,0	55,0	14,75	5,0	0,15	4	■
JHP993060D2C.0Z4-SIRA	02826809	2	D	-	6,0	6,0	14,0	55,0	-	-	0,2	4	■
JHP993075F2C.0Z4-SIRA	02826811	2	F	-	7,5	8,0	17,0	60,0	-	7,5	0,2	4	■
JHP993080D2C.0Z4A-SIRA	02826814	2	D	■	8,0	8,0	18,0	60,0	-	-	0,2	4	■
JHP993080D2C.0Z4-SIRA	02826812	2	D	-	8,0	8,0	18,0	60,0	-	-	0,2	4	■
JHP993095F2C.0Z4-SIRA	02826816	2	F	-	9,5	10,0	20,0	70,0	-	9,5	0,2	4	■
JHP993100D2C.0Z4A-SIRA	02826818	2	D	■	10,0	10,0	22,0	70,0	-	-	0,2	4	■
JHP993100D2C.0Z4-SIRA	02826817	2	D	-	10,0	10,0	22,0	70,0	-	-	0,2	4	■
JHP993115F2C.0Z4-SIRA	02826820	2	F	-	11,5	12,0	25,0	80,0	-	11,5	0,2	4	■
JHP993120D2C.0Z4A-SIRA	02826822	2	D	■	12,0	12,0	26,0	80,0	-	-	0,2	4	■
JHP993120D2C.0Z4-SIRA	02826821	2	D	-	12,0	12,0	26,0	80,0	-	-	0,2	4	■
JHP993140D2C.0Z4-SIRA	02826824	2	D	-	14,0	14,0	30,0	80,0	-	-	0,3	4	■
JHP993160D2C.0Z4A-SIRA	02856501	2	D	■	16,0	16,0	34,0	90,0	-	-	0,3	4	■
JHP993160D2C.0Z4-SIRA	02856499	2	D	-	16,0	16,0	34,0	90,0	-	-	0,3	4	■
JHP993160D2C.0Z5-SIRA	02826825	2	D	-	16,0	16,0	34,0	90,0	-	-	0,3	5	■
JHP993200D2C.0Z4A-SIRA	02856506	2	D	■	20,0	20,0	42,0	100,0	-	-	0,5	4	■
JHP993200D2C.0Z4-SIRA	02856505	2	D	-	20,0	20,0	42,0	100,0	-	-	0,5	4	■
JHP993200D2C.0Z5-SIRA	02826828	2	D	-	20,0	20,0	42,0	100,0	-	-	0,5	5	■
JHP993250D2C.0Z4A-SIRA	02856510	2	D	■	25,0	25,0	52,0	125,0	-	-	0,5	4	■
JHP993040G3C.0Z3-SIRA	02826807	3	G	-	4,0	6,0	10,0	55,0	15,0	3,7	0,15	3	■
JHP993060E3C.0Z4-SIRA	02826810	3	E	-	6,0	6,0	14,0	65,0	24,0	5,6	0,2	4	■
JHP993080E3C.0Z4-SIRA	02826815	3	E	-	8,0	8,0	18,0	70,0	32,0	7,4	0,2	4	■
JHP993100E3C.0Z4-SIRA	02826819	3	E	-	10,0	10,0	22,0	85,0	40,0	9,4	0,2	4	■
JHP993120E3C.0Z4-SIRA	02826823	3	E	-	12,0	12,0	26,0	100,0	50,0	11,4	0,2	4	■
JHP993160E3C.0Z4-SIRA	02856502	3	E	-	16,0	16,0	34,0	110,0	60,0	15,4	0,3	4	■
JHP993200E3C.0Z4-SIRA	02856507	3	E	-	20,0	20,0	42,0	125,0	70,0	19,2	0,5	4	■

■ Stocked standard. ICC = Internal Coolant Channel

JHP993

High performance – Steel – Square – 3-5 Flutes – Weldon – Chamfer

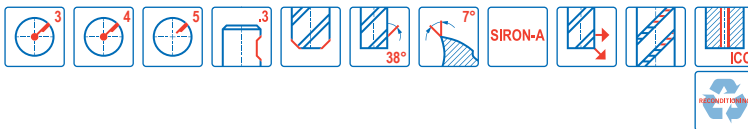
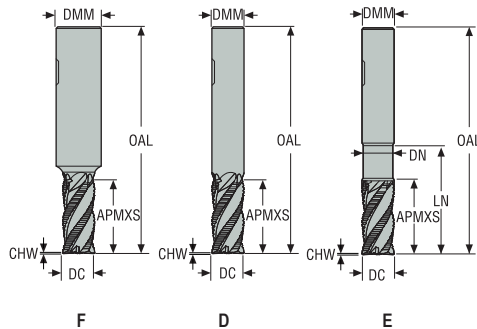

- Tolerances:
- DMM=h5
- DC=-0,02/-0,1 mm
- CHW= ±0,05 mm
- Regrind possible if DC is ≥Ø6

Designation	Item number	Length index	Tool shape	ICC	DC	DMM	APMXS	OAL	LN	DN	CHW	PCEDC	Weldon
					mm	mm	mm	mm	mm	mm	mm		
JHP993040F2C.3Z3-SIRA	02828150	2	F	–	4,0	6,0	10,0	50,0	12,56	4,0	0,15	3	■
JHP993050F2C.3Z4-SIRA	02828152	2	F	–	5,0	6,0	12,0	55,0	14,75	5,0	0,15	4	■
JHP993060D2C.3Z4-SIRA	02828153	2	D	–	6,0	6,0	14,0	55,0	–	–	0,2	4	■
JHP993075F2C.3Z4-SIRA	02828155	2	F	–	7,5	8,0	17,0	60,0	–	7,5	0,2	4	■
JHP993080D2C.3Z4A-SIRA	02828246	2	D	■	8,0	8,0	16,0	60,0	–	–	0,2	4	□
JHP993080D2C.3Z4-SIRA	02828156	2	D	–	8,0	8,0	18,0	60,0	–	–	0,2	4	■
JHP993095F2C.3Z4-SIRA	02828158	2	F	–	9,5	10,0	20,0	70,0	–	9,5	0,2	4	■
JHP993100D2C.3Z4A-SIRA	02828247	2	D	■	10,0	10,0	20,0	70,0	–	–	0,2	4	□
JHP993100D2C.3Z4-SIRA	02828159	2	D	–	10,0	10,0	22,0	70,0	–	–	0,2	4	■
JHP993120D2C.3Z4A-SIRA	02828248	2	D	■	12,0	12,0	26,0	80,0	–	–	0,2	4	□
JHP993120D2C.3Z4-SIRA	02828162	2	D	–	12,0	12,0	26,0	80,0	–	–	0,2	4	■
JHP993140D2C.3Z4-SIRA	02828164	2	D	–	14,0	14,0	30,0	80,0	–	–	0,3	4	■
JHP993160D2C.3Z4A-SIRA	02856512	2	D	■	16,0	16,0	34,0	90,0	–	–	0,3	4	□
JHP993160D2C.3Z4-SIRA	02856500	2	D	–	16,0	16,0	34,0	90,0	–	–	0,3	4	■
JHP993160D2C.3Z5-SIRA	02828165	2	D	–	16,0	16,0	34,0	90,0	–	–	0,3	5	■
JHP993200D2C.3Z4A-SIRA	02856513	2	D	■	20,0	20,0	42,0	100,0	–	–	0,5	4	■
JHP993200D2C.3Z4-SIRA	02856504	2	D	–	20,0	20,0	42,0	100,0	–	–	0,5	4	■
JHP993200D2C.3Z5-SIRA	02828167	2	D	–	20,0	20,0	42,0	100,0	–	–	0,5	5	■
JHP993250D2C.3Z4A-SIRA	02856514	2	D	■	25,0	25,0	52,0	125,0	–	–	0,5	4	□
JHP993250D2C.3Z4-SIRA	02856509	2	D	–	25,0	25,0	52,0	125,0	–	–	0,5	4	■
JHP993060E3C.3Z4-SIRA	02828154	3	E	–	6,0	6,0	14,0	65,0	24,0	5,6	0,2	4	■
JHP993080E3C.3Z4-SIRA	02828157	3	E	–	8,0	8,0	18,0	70,0	32,0	7,4	0,2	4	■
JHP993100E3C.3Z4-SIRA	02828160	3	E	–	10,0	10,0	22,0	85,0	40,0	9,4	0,2	4	■
JHP993120E3C.3Z4-SIRA	02828163	3	E	–	12,0	12,0	26,0	100,0	50,0	11,4	0,2	4	■
JHP993160E3C.3Z4-SIRA	02856503	3	E	–	16,0	16,0	34,0	110,0	60,0	15,4	0,3	4	■
JHP993200E3C.3Z4-SIRA	02856508	3	E	–	20,0	20,0	42,0	125,0	70,0	19,2	0,5	4	■
JHP993200E3C.3Z5-SIRA	02828168	3	E	–	20,0	20,0	42,0	125,0	70,0	19,2	0,5	5	■
JHP993250E3C.3Z4-SIRA	02856511	3	E	–	25,0	25,0	52,0	150,0	90,0	24,0	0,5	4	■

■ Stocked standard. □ Weldon available. Delivery time is 3 days.
ICC = Internal Coolant Channel

Universal

Steel and cast iron

Stainless steel and S-materials

Non ferrous

Hard

Plastic and chip

Graphite

Minimaster Plus

Minimaster

Cutting data – JHP993 Side milling PCEDC=3 and PCEDC=4

SMG	Coolant	a _p /DC	a _p /DC	f _z										v _c
				4	5	6	8	10	12	14	16	20	25	
P1	E/M/A	0.400	1.7	0.044	0.055	0.065	0.090	0.11	0.13	0.15	0.16	0.19	0.22	230 (200 — 260)
		0,400	1,7	0,0017	0,0022	0,0026	0,0036	0,0044	0,0050	0,0060	0,0065	0,0075	0,0085	750 (660 — 850)
P2	E/M/A	0.400	1.7	0.044	0.055	0.065	0.090	0.11	0.13	0.15	0.17	0.19	0.22	225 (200 — 250)
		0,400	1,7	0,0017	0,0022	0,0026	0,0036	0,0044	0,0050	0,0060	0,0065	0,0075	0,0085	740 (660 — 820)
P3	E/M/A	0.400	1.7	0.042	0.055	0.065	0.085	0.11	0.13	0.14	0.16	0.18	0.20	195 (170 — 220)
		0,400	1,7	0,0017	0,0022	0,0026	0,0034	0,0044	0,0050	0,0055	0,0065	0,0070	0,0080	640 (560 — 720)
P4	E/M/A	0.400	1.7	0.042	0.050	0.060	0.085	0.10	0.12	0.14	0.15	0.18	0.20	175 (150 — 190)
		0,400	1,7	0,0017	0,0020	0,0024	0,0034	0,0040	0,0048	0,0055	0,0060	0,0070	0,0080	570 (500 — 620)
P5	E/M/A	0.400	1.7	0.040	0.050	0.060	0.080	0.10	0.12	0.14	0.15	0.17	0.20	165 (150 — 190)
		0,400	1,7	0,0016	0,0020	0,0024	0,0032	0,0040	0,0048	0,0055	0,0060	0,0065	0,0080	540 (500 — 620)
P6	E/M/A	0.400	1.7	0.040	0.050	0.060	0.080	0.10	0.12	0.14	0.15	0.17	0.19	185 (160 — 210)
		0,400	1,7	0,0016	0,0020	0,0024	0,0032	0,0040	0,0048	0,0055	0,0060	0,0065	0,0075	610 (530 — 680)
P7	E/M/A	0.400	1.7	0.040	0.050	0.060	0.080	0.10	0.12	0.14	0.15	0.17	0.19	175 (160 — 200)
		0,400	1,7	0,0016	0,0020	0,0024	0,0032	0,0040	0,0048	0,0055	0,0060	0,0065	0,0075	570 (530 — 650)
P8	E/M/A	0.400	1.7	0.042	0.055	0.065	0.085	0.11	0.13	0.14	0.16	0.18	0.20	160 (140 — 180)
		0,400	1,7	0,0017	0,0022	0,0026	0,0034	0,0044	0,0050	0,0055	0,0065	0,0070	0,0080	520 (460 — 590)
P11	E/M/A	0.400	1.7	0.040	0.050	0.060	0.080	0.10	0.12	0.14	0.15	0.17	0.19	170 (150 — 190)
		0,400	1,7	0,0016	0,0020	0,0024	0,0032	0,0040	0,0048	0,0055	0,0060	0,0065	0,0075	560 (500 — 620)
P12	E/M/A	0.400	1.7	0.028	0.034	0.042	0.055	0.070	0.080	0.095	0.10	0.12	0.13	110 (95 — 120)
		0,400	1,7	0,0011	0,0013	0,0017	0,0022	0,0028	0,0032	0,0038	0,0040	0,0048	0,0050	360 (320 — 390)
K1	E/M/A	0.400	1.7	0.044	0.055	0.065	0.090	0.11	0.13	0.15	0.17	0.19	0.22	225 (200 — 250)
		0,400	1,7	0,0017	0,0022	0,0026	0,0036	0,0044	0,0050	0,0060	0,0065	0,0075	0,0085	740 (660 — 820)
K2	E/M/A	0.400	1.7	0.040	0.050	0.060	0.080	0.10	0.12	0.14	0.15	0.17	0.20	200 (180 — 220)
		0,400	1,7	0,0016	0,0020	0,0024	0,0032	0,0040	0,0048	0,0055	0,0060	0,0065	0,0080	660 (600 — 720)
K3	E/M/A	0.400	1.7	0.040	0.050	0.060	0.080	0.10	0.12	0.14	0.15	0.17	0.20	170 (150 — 190)
		0,400	1,7	0,0016	0,0020	0,0024	0,0032	0,0040	0,0048	0,0055	0,0060	0,0065	0,0080	560 (500 — 620)
K4	E/M/A	0.400	1.7	0.040	0.050	0.060	0.080	0.10	0.12	0.14	0.15	0.17	0.20	160 (140 — 180)
		0,400	1,7	0,0016	0,0020	0,0024	0,0032	0,0040	0,0048	0,0055	0,0060	0,0065	0,0080	520 (460 — 590)
K5	E/M/A	0.400	1.7	0.036	0.046	0.055	0.075	0.090	0.11	0.12	0.14	0.16	0.18	100 (86 — 110)
		0,400	1,7	0,0014	0,0018	0,0022	0,0030	0,0036	0,0044	0,0048	0,0055	0,0065	0,0070	330 (290 — 360)
K6	E/M/A	0.400	1.7	0.040	0.050	0.060	0.080	0.10	0.12	0.14	0.15	0.17	0.20	145 (130 — 160)
		0,400	1,7	0,0016	0,0020	0,0024	0,0032	0,0040	0,0048	0,0055	0,0060	0,0065	0,0080	475 (430 — 520)
K7	E/M/A	0.400	1.7	0.036	0.046	0.055	0.075	0.090	0.11	0.12	0.14	0.16	0.18	125 (110 — 140)
		0,400	1,7	0,0014	0,0018	0,0022	0,0030	0,0036	0,0044	0,0048	0,0055	0,0065	0,0070	410 (370 — 450)

For cutting data recalculations, see pages 445 - 452

SMG = Seco material group
Coolant = A=air D=dry E=emulsion M=mist spray
v_c = m/min (sf/min)
f_z = mm (in/tooth)
a_p = mm/DC (in/DC) = factor
a_s = mm/DC (in/DC) = factor
All cutting data are target values

Cutting data – JHP993 Side milling PCEDC=5 and PCEDC=6

SMG		a _e /DC	a _p /DC	f _z		v _c
				16	20	
P1	E/M/A	0.376	1.0	0.17	0.22	205 (180 – 230)
		0.376	1.0	0,0065	0,0085	670 (600–750)
P2	E/M/A	0.376	1.0	0.18	0.22	195 (170 – 220)
		0.376	1.0	0,0070	0,0085	640 (560–720)
P3	E/M/A	0.376	1.0	0.17	0.20	170 (150–190)
		0.376	1.0	0,0065	0,0080	560 (500 – 620)
P4	E/M/A	0.376	1.0	0.16	0.20	155 (140–170)
		0.376	1.0	0,0065	0,0080	510 (460 – 550)
P5	E/M/A	0.376	1.0	0.16	0.20	145 (130–160)
		0.376	1.0	0,0065	0,0080	475 (430 – 520)
P6	E/M/A	0.376	1.0	0.16	0.20	165 (150–180)
		0.376	1.0	0,0065	0,0080	540 (500 – 590)
P7	E/M/A	0.376	1.0	0.16	0.20	155 (140–170)
		0.376	1.0	0,0065	0,0080	510 (460 – 550)
P8	E/M/A	0.376	1.0	0.17	0.20	145 (130–160)
		0.376	1.0	0,0065	0,0080	475 (430 – 520)
P11	E/M/A	0.376	1.0	0.16	0.20	150 (130–170)
		0.376	1.0	0,0065	0,0080	490 (430 – 550)
P12	E/M/A	0.376	1.0	0.11	0.13	100 (85–110)
		0.376	1.0	0,0044	0,0050	330 (280 – 360)
K1	E/M/A	0.376	1.0	0.18	0.22	195 (170 – 220)
		0.376	1.0	0,0070	0,0085	640 (560–720)
K2	E/M/A	0.376	1.0	0.16	0.20	175 (160 – 200)
		0.376	1.0	0,0065	0,0080	570 (530 – 650)
K3	E/M/A	0.376	1.0	0.16	0.20	150 (130–170)
		0.376	1.0	0,0065	0,0080	490 (430 – 550)
K4	E/M/A	0.376	1.0	0.16	0.20	145 (130–160)
		0.376	1.0	0,0065	0,0080	475 (430 – 520)
K5	E/M/A	0.376	1.0	0.15	0.18	85 (75 – 99)
		0.376	1.0	0,0060	0,0070	280 (250 – 320)
K6	E/M/A	0.376	1.0	0.16	0.20	125 (110–140)
		0.376	1.0	0,0065	0,0080	410 (370 – 450)
K7	E/M/A	0.376	1.0	0.15	0.18	110 (96–120)
		0.376	1.0	0,0060	0,0070	360 (320 – 390)

For cutting data recalculations, see pages 445 - 452

SMG = Seco material group
 Coolant = A=air D=dry E=emulsion M=mist spray
 v_c= m/min (sf/min)
 f_z = mm (in/tooth)
 a_p = mm/DC (in/DC) = factor
 a_e = mm/DC (in/DC) = factor
 All cutting data are target values

Universal

Steel and cast iron

Stainless steel and S-materials

Non ferrous

Hard

Plastic and cfrp

Graphite

Minimaster Plus

Minimaster

Cutting data – JHP993 Slot milling PCEDC=3 and PCEDC=4

SMG	Coolant	a _p /DC	f _z										v _c
			4	5	6	8	10	12	14	16	20	25	
P1	E/M/A	1.5	0.032	0.040	0.048	0.065	0.080	0.095	0.11	0.13	0.16	0.20	200 (180 — 220)
		1,5	0,0013	0,0016	0,0019	0,0026	0,0032	0,0038	0,0044	0,0050	0,0065	0,0080	660 (600–720)
P2	E/M/A	1.5	0.032	0.040	0.048	0.065	0.080	0.095	0.11	0.13	0.16	0.20	195 (170 — 220)
		1,5	0,0013	0,0016	0,0019	0,0026	0,0032	0,0038	0,0044	0,0050	0,0065	0,0080	640 (560–720)
P3	E/M/A	1.5	0.032	0.040	0.048	0.065	0.080	0.095	0.11	0.13	0.16	0.20	165 (150–190)
		1,5	0,0013	0,0016	0,0019	0,0026	0,0032	0,0038	0,0044	0,0050	0,0065	0,0080	540 (500–620)
P4	E/M/A	1.5	0.032	0.040	0.048	0.065	0.080	0.095	0.11	0.13	0.16	0.20	145 (130–160)
		1,5	0,0013	0,0016	0,0019	0,0026	0,0032	0,0038	0,0044	0,0050	0,0065	0,0080	475 (430–520)
P5	E/M/A	1.5	0.032	0.040	0.048	0.065	0.080	0.095	0.11	0.13	0.16	0.19	140 (130–160)
		1,5	0,0013	0,0016	0,0019	0,0026	0,0032	0,0038	0,0044	0,0050	0,0065	0,0075	460 (430–520)
P6	E/M/A	1.5	0.032	0.040	0.048	0.065	0.080	0.095	0.11	0.13	0.16	0.19	155 (140–170)
		1,5	0,0013	0,0016	0,0019	0,0026	0,0032	0,0038	0,0044	0,0050	0,0065	0,0075	510 (460–550)
P7	E/M/A	1.5	0.032	0.040	0.048	0.065	0.080	0.095	0.11	0.13	0.16	0.19	150 (130–160)
		1,5	0,0013	0,0016	0,0019	0,0026	0,0032	0,0038	0,0044	0,0050	0,0065	0,0075	490 (430–520)
P8	E/M/A	1.5	0.032	0.040	0.048	0.065	0.080	0.095	0.11	0.13	0.16	0.20	140 (130–160)
		1,5	0,0013	0,0016	0,0019	0,0026	0,0032	0,0038	0,0044	0,0050	0,0065	0,0080	460 (430–520)
P11	E/M/A	1.5	0.032	0.040	0.048	0.065	0.080	0.095	0.11	0.13	0.16	0.19	145 (130–160)
		1,5	0,0013	0,0016	0,0019	0,0026	0,0032	0,0038	0,0044	0,0050	0,0065	0,0075	475 (430–520)
P12	E/M/A	1.5	0.028	0.034	0.040	0.055	0.070	0.080	0.090	0.10	0.12	0.13	90 (76–100)
		1,5	0,0011	0,0013	0,0016	0,0022	0,0028	0,0032	0,0036	0,0040	0,0048	0,0050	295 (250–320)
K1	E/M/A	1.5	0.032	0.040	0.048	0.065	0.080	0.095	0.11	0.13	0.16	0.20	195 (170 — 220)
		1,5	0,0013	0,0016	0,0019	0,0026	0,0032	0,0038	0,0044	0,0050	0,0065	0,0080	640 (560–720)
K2	E/M/A	1.5	0.032	0.040	0.048	0.065	0.080	0.095	0.11	0.13	0.16	0.19	170 (150–190)
		1,5	0,0013	0,0016	0,0019	0,0026	0,0032	0,0038	0,0044	0,0050	0,0065	0,0075	560 (500–620)
K3	E/M/A	1.5	0.032	0.040	0.048	0.065	0.080	0.095	0.11	0.13	0.16	0.19	145 (130–160)
		1,5	0,0013	0,0016	0,0019	0,0026	0,0032	0,0038	0,0044	0,0050	0,0065	0,0075	475 (430–520)
K4	E/M/A	1.5	0.032	0.040	0.048	0.065	0.080	0.095	0.11	0.13	0.16	0.19	135 (120–150)
		1,5	0,0013	0,0016	0,0019	0,0026	0,0032	0,0038	0,0044	0,0050	0,0065	0,0075	445 (400–490)
K5	E/M/A	1.5	0.032	0.040	0.048	0.065	0.080	0.095	0.11	0.13	0.15	0.17	80 (70 — 93)
		1,5	0,0013	0,0016	0,0019	0,0026	0,0032	0,0038	0,0044	0,0050	0,0060	0,0065	260 (230–300)
K6	E/M/A	1.5	0.032	0.040	0.048	0.065	0.080	0.095	0.11	0.13	0.16	0.19	120 (110–130)
		1,5	0,0013	0,0016	0,0019	0,0026	0,0032	0,0038	0,0044	0,0050	0,0065	0,0075	395 (370–420)
K7	E/M/A	1.5	0.032	0.040	0.048	0.065	0.080	0.095	0.11	0.13	0.15	0.17	105 (90–110)
		1,5	0,0013	0,0016	0,0019	0,0026	0,0032	0,0038	0,0044	0,0050	0,0060	0,0065	345 (300–360)

For cutting data recalculations, see pages 445 - 452

SMG = Seco material group
Coolant = A=air D=dry E=emulsion M=mist spray
v_c = m/min (sf/min)
f_z = mm (in/tooth)
a_p = mm/DC (in/DC) = factor
a_s = mm/DC (in/DC) = factor
All cutting data are target values

Cutting data – JHP993 Slot milling PCEDC=5 and PCEDC=6

SMG		a _p /DC		f _z		v _c
				16	20	
P1	E/M/A	0,44		0,17	0,20	160 (140–180)
		0,44		0,0065	0,0080	520 (460 – 590)
P2	E/M/A	0,44		0,17	0,22	155 (140–170)
		0,44		0,0065	0,0085	510 (460 – 550)
P3	E/M/A	0,44		0,16	0,20	135 (120–150)
		0,44		0,0065	0,0080	445 (400 – 490)
P4	E/M/A	0,44		0,16	0,20	120 (110–130)
		0,44		0,0065	0,0080	395 (370 – 420)
P5	E/M/A	0,44		0,16	0,19	115 (99–130)
		0,44		0,0065	0,0075	375 (330 – 420)
P6	E/M/A	0,44		0,16	0,19	130 (120–140)
		0,44		0,0065	0,0075	425 (400 – 450)
P7	E/M/A	0,44		0,16	0,19	120 (110–130)
		0,44		0,0065	0,0075	395 (370 – 420)
P8	E/M/A	0,44		0,16	0,20	115 (99–130)
		0,44		0,0065	0,0080	375 (330 – 420)
P11	E/M/A	0,44		0,16	0,19	120 (110–130)
		0,44		0,0065	0,0075	395 (370 – 420)
P12	E/M/A	0,44		0,11	0,13	80 (68 – 89)
		0,44		0,0044	0,0050	260 (230 – 290)
K1	E/M/A	0,44		0,17	0,22	160 (140–180)
		0,44		0,0065	0,0085	520 (460 – 590)
K2	E/M/A	0,44		0,16	0,19	140 (120–150)
		0,44		0,0065	0,0075	460 (400 – 490)
K3	E/M/A	0,44		0,16	0,19	120 (110–130)
		0,44		0,0065	0,0075	395 (370 – 420)
K4	E/M/A	0,44		0,16	0,19	115 (97–120)
		0,44		0,0065	0,0075	375 (320 – 390)
K5	E/M/A	0,44		0,14	0,17	70 (60–79)
		0,44		0,0055	0,0065	230 (200 – 250)
K6	E/M/A	0,44		0,16	0,19	100 (86–110)
		0,44		0,0065	0,0075	330 (290 – 360)
K7	E/M/A	0,44		0,14	0,17	90 (77–100)
		0,44		0,0055	0,0065	295 (260 – 320)

For cutting data recalculations, see pages 445 - 452

SMG = Seco material group
 Coolant = A=air D=dry E=emulsion M=mist spray
 v_c = m/min (sf/min)
 f_z = mm (in/tooth)
 a_p = mm/DC (in/DC) = factor
 a_e = mm/DC (in/DC) = factor
 All cutting data are target values

Universal

Steel and cast iron

Stainless steel and S-materials

Non ferrous

Hard

Plastic and cfrp

Graphite

Minimaster Plus

Minimaster

JHP951

High performance – Square – Steel – 3-5 Flutes – Cylindrical – Corner radius or chamfer

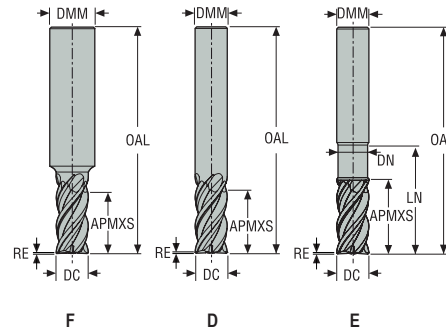

- Tolerances:
- DMM=h5
- DC=e7
- RE= ±0,02 mm
- Regrind possible if DC is ≥06

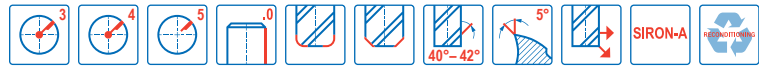

Designation	Item number	Length index	Tool shape	DC	DMM	APMXS	OAL	LN	DN	CHW	RE	PCEDC	Cylindrical
				mm	mm	mm	mm	mm	mm	mm	mm	mm	mm
JHP951030F2C.0Z3-SIRA	02828192	2	F	3,0	6,0	8,0	50,0	10,25	3,0	0,1	–	3	■
JHP951030F2R020.0Z3-SIRA	02828191	2	F	3,0	6,0	8,0	50,0	10,25	3,0	–	0,2	3	■
JHP951030F2R050.0Z3-SIRA	02828190	2	F	3,0	6,0	8,0	50,0	10,25	3,0	–	0,5	3	■
JHP951040F2C.0Z4-SIRA	02828197	2	F	4,0	6,0	10,0	55,0	13,25	4,0	0,15	–	4	■
JHP951040F2R020.0Z4-SIRA	02828194	2	F	4,0	6,0	10,0	55,0	13,25	4,0	–	0,2	4	■
JHP951040F2R050.0Z4-SIRA	02828195	2	F	4,0	6,0	10,0	55,0	13,25	4,0	–	0,5	4	■
JHP951050F2C.0Z4-SIRA	02828201	2	F	5,0	6,0	12,0	55,0	15,25	5,0	0,2	–	4	■
JHP951050F2R020.0Z4-SIRA	02828199	2	F	5,0	6,0	12,0	55,0	15,25	5,0	–	0,2	4	■
JHP951050F2R050.0Z4-SIRA	02828198	2	F	5,0	6,0	12,0	55,0	15,25	5,0	–	0,5	4	■
JHP951060D2C.0Z4-SIRA	02828205	2	D	6,0	6,0	14,0	55,0	–	–	0,2	–	4	■
JHP951060D2R020.0Z4-SIRA	02828203	2	D	6,0	6,0	14,0	55,0	–	–	–	0,2	4	■
JHP951060D2R050.0Z4-SIRA	02828202	2	D	6,0	6,0	14,0	55,0	–	–	–	0,5	4	■
JHP951080D2C.0Z4-SIRA	02828212	2	D	8,0	8,0	18,0	60,0	–	–	0,3	–	4	■
JHP951080D2R020.0Z4-SIRA	02828209	2	D	8,0	8,0	18,0	60,0	–	–	–	0,2	4	■
JHP951080D2R050.0Z4-SIRA	02828207	2	D	8,0	8,0	18,0	60,0	–	–	–	0,5	4	■
JHP951080D2R100.0Z4-SIRA	02828208	2	D	8,0	8,0	18,0	60,0	–	–	–	1,0	4	■
JHP951100E2C.0Z4-SIRA	02828218	2	E	10,0	10,0	22,0	70,0	28,0	9,4	0,3	–	4	■
JHP951100E2R050.0Z4-SIRA	02828216	2	E	10,0	10,0	22,0	70,0	28,0	9,4	–	0,5	4	■
JHP951100E2R100.0Z4-SIRA	02828214	2	E	10,0	10,0	22,0	70,0	28,0	9,4	–	1,0	4	■
JHP951120E2C.0Z4-SIRA	02828226	2	E	12,0	12,0	26,0	80,0	33,0	11,4	0,4	–	4	■
JHP951120E2R050.0Z4-SIRA	02828224	2	E	12,0	12,0	26,0	80,0	33,0	11,4	–	0,5	4	■
JHP951120E2R100.0Z4-SIRA	02828222	2	E	12,0	12,0	26,0	80,0	33,0	11,4	–	1,0	4	■
JHP951160E2C.0Z4-SIRA	02927873	2	E	16,0	16,0	34,0	90,0	40,0	15,0	0,5	–	4	■
JHP951160E2R050.0Z4-SIRA	02927875	2	E	16,0	16,0	34,0	90,0	40,0	15,0	–	0,5	4	■
JHP951160E2R100.0Z4-SIRA	02927876	2	E	16,0	16,0	34,0	90,0	40,0	15,0	–	1,0	4	■
JHP951160E2C.0Z5-SIRA	02828232	2	E	16,0	16,0	34,0	90,0	40,0	15,4	0,5	–	5	■
JHP951160E2R050.0Z5-SIRA	02828230	2	E	16,0	16,0	34,0	90,0	40,0	15,4	–	0,5	5	■
JHP951160E2R100.0Z5-SIRA	02828231	2	E	16,0	16,0	34,0	90,0	40,0	15,4	–	1,0	5	■

■ Stocked standard.

Universal

Steel and cast iron

Stainless steel and S-materials

Non ferrous

Hard

Plastic and cfrp

Graphite

Minimaster Plus

Minimaster

JHP951

High performance – Square – Steel – 3-5 Flutes – Weldon – Corner radius or chamfer

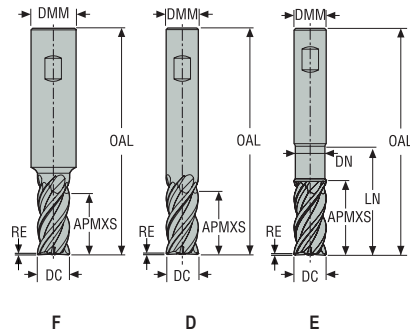

- Tolerances:
- DMM=h5
- DC=e7
- RE= ±0,02 mm
- Re grind possible if DC is ≥Ø6

Designation	Item number	Length index	Tool shape	DC	DMM	APMXS	OAL	LN	DN	CHW	RE	PCEDC	Weldon
				mm	mm	mm	mm	mm	mm	mm	mm	mm	mm
JHP951030F2C.3Z3-SIRA	02828193	2	F	3,0	6,0	8,0	50,0	10,25	3,0	0,1	-	3	■
JHP951030F2R020.3Z3-SIRA	02828260	2	F	3,0	6,0	8,0	50,0	10,25	3,0	-	0,2	3	■
JHP951030F2R050.3Z3-SIRA	02828259	2	F	3,0	6,0	8,0	50,0	10,25	3,0	-	0,5	3	□
JHP951040F2C.3Z4-SIRA	02828196	2	F	4,0	6,0	10,0	55,0	13,25	4,0	0,15	-	4	■
JHP951040F2R020.3Z4-SIRA	02828261	2	F	4,0	6,0	10,0	55,0	13,25	4,0	-	0,2	4	□
JHP951040F2R050.3Z4-SIRA	02828262	2	F	4,0	6,0	10,0	55,0	13,25	4,0	-	0,5	4	□
JHP951050F2C.3Z4-SIRA	02828200	2	F	5,0	6,0	12,0	55,0	15,25	5,0	0,2	-	4	■
JHP951050F2R020.3Z4-SIRA	02828264	2	F	5,0	6,0	12,0	55,0	15,25	5,0	-	0,2	4	□
JHP951050F2R050.3Z4-SIRA	02828263	2	F	5,0	6,0	12,0	55,0	15,25	5,0	-	0,5	4	□
JHP951060D2C.3Z4-SIRA	02828206	2	D	6,0	6,0	14,0	55,0	-	-	0,2	-	4	■
JHP951060D2R020.3Z4-SIRA	02828266	2	D	6,0	6,0	14,0	55,0	-	-	-	0,2	4	□
JHP951060D2R050.3Z4-SIRA	02828265	2	D	6,0	6,0	14,0	55,0	-	-	-	0,5	4	□
JHP951080D2C.3Z4-SIRA	02828210	2	D	8,0	8,0	18,0	60,0	-	-	0,3	-	4	■
JHP951080D2R020.3Z4-SIRA	02828269	2	D	8,0	8,0	18,0	60,0	-	-	-	0,2	4	□
JHP951080D2R050.3Z4-SIRA	02828267	2	D	8,0	8,0	18,0	60,0	-	-	-	0,5	4	■
JHP951080D2R100.3Z4-SIRA	02828268	2	D	8,0	8,0	18,0	60,0	-	-	-	1,0	4	□
JHP951100E2C.3Z4-SIRA	02828220	2	E	10,0	10,0	22,0	70,0	28,0	9,4	0,3	-	4	■
JHP951100E2R050.3Z4-SIRA	02828271	2	E	10,0	10,0	22,0	70,0	28,0	9,4	-	0,5	4	□
JHP951100E2R100.3Z4-SIRA	02828270	2	E	10,0	10,0	22,0	70,0	28,0	9,4	-	1,0	4	□
JHP951120E2C.3Z4-SIRA	02828228	2	E	12,0	12,0	26,0	80,0	33,0	11,4	0,4	-	4	■
JHP951120E2R050.3Z4-SIRA	02828273	2	E	12,0	12,0	26,0	80,0	33,0	11,4	-	0,5	4	□
JHP951120E2R100.3Z4-SIRA	02828272	2	E	12,0	12,0	26,0	80,0	33,0	11,4	-	1,0	4	□
JHP951160E2C.3Z4-SIRA	02927874	2	E	16,0	16,0	34,0	90,0	40,0	15,0	0,5	-	4	■
JHP951160E2R050.3Z4-SIRA	02927879	2	E	16,0	16,0	34,0	90,0	40,0	15,0	-	0,5	4	□
JHP951160E2R100.3Z4-SIRA	02927880	2	E	16,0	16,0	34,0	90,0	40,0	15,0	-	1,0	4	□
JHP951160E2C.3Z5-SIRA	02828233	2	E	16,0	16,0	34,0	90,0	40,0	15,4	0,5	-	5	■
JHP951160E2R050.3Z5-SIRA	02828275	2	E	16,0	16,0	34,0	90,0	40,0	15,4	-	0,5	5	□
JHP951160E2R100.3Z5-SIRA	02828276	2	E	16,0	16,0	34,0	90,0	40,0	15,4	-	1,0	5	□
JHP951200E2R050.3Z4-SIRA	02927877	2	E	20,0	20,0	42,0	100,0	48,0	19,0	-	0,5	4	■
JHP951200E2R100.3Z4-SIRA	02927878	2	E	20,0	20,0	42,0	100,0	48,0	19,0	-	1,0	4	■
JHP951200E2R050.3Z5-SIRA	02828235	2	E	20,0	20,0	42,0	100,0	48,0	19,4	-	0,5	5	■
JHP951200E2R100.3Z5-SIRA	02828234	2	E	20,0	20,0	42,0	100,0	48,0	19,4	-	1,0	5	■

■ Stocked standard. □ Weldon available. Delivery time is 3 days.

Universal

Steel and cast iron

Stainless steel and S-materials

Non ferrous

Hard

Plastic and chip

Graphite

Minimaster Plus

Minimaster

Cutting data – JHP951 Side milling

SMG		a _p /DC	a _r /DC	f _z									v _c
				3	4	5	6	8	10	12	16	20	
P1	E/M/A	0.400	1.7	0.034	0.044	0.055	0.065	0.090	0.11	0.13	0.16	0.19	230 (200 — 260)
		0,400	1,7	0,0013	0,0017	0,0022	0,0026	0,0036	0,0044	0,0050	0,0065	0,0075	750 (660 — 850)
P2	E/M/A	0.400	1.7	0.034	0.044	0.055	0.065	0.090	0.11	0.13	0.17	0.19	220 (200 — 250)
		0,400	1,7	0,0013	0,0017	0,0022	0,0026	0,0036	0,0044	0,0050	0,0065	0,0075	720 (660 — 820)
P3	E/M/A	0.400	1.7	0.032	0.042	0.055	0.065	0.085	0.11	0.13	0.16	0.18	190 (170 — 210)
		0,400	1,7	0,0013	0,0017	0,0022	0,0026	0,0034	0,0044	0,0050	0,0065	0,0070	620 (560 — 680)
P4	E/M/A	0.400	1.7	0.032	0.042	0.050	0.060	0.085	0.10	0.12	0.15	0.18	170 (150 — 190)
		0,400	1,7	0,0013	0,0017	0,0020	0,0024	0,0034	0,0040	0,0048	0,0060	0,0070	560 (500 — 620)
P5	E/M/A	0.400	1.7	0.030	0.040	0.050	0.060	0.080	0.10	0.12	0.15	0.17	165 (150 — 180)
		0,400	1,7	0,0012	0,0016	0,0020	0,0024	0,0032	0,0040	0,0048	0,0060	0,0065	540 (500 — 590)
P6	E/M/A	0.400	1.7	0.030	0.040	0.050	0.060	0.080	0.10	0.12	0.15	0.17	185 (160 — 210)
		0,400	1,7	0,0012	0,0016	0,0020	0,0024	0,0032	0,0040	0,0048	0,0060	0,0065	610 (530 — 680)
P7	E/M/A	0.400	1.7	0.030	0.040	0.050	0.060	0.080	0.10	0.12	0.15	0.17	175 (150 — 190)
		0,400	1,7	0,0012	0,0016	0,0020	0,0024	0,0032	0,0040	0,0048	0,0060	0,0065	570 (500 — 620)
P8	E/M/A	0.400	1.7	0.032	0.042	0.055	0.065	0.085	0.11	0.13	0.16	0.18	160 (140 — 180)
		0,400	1,7	0,0013	0,0017	0,0022	0,0026	0,0034	0,0044	0,0050	0,0065	0,0070	520 (460 — 590)
P11	E/M/A	0.400	1.7	0.030	0.040	0.050	0.060	0.080	0.10	0.12	0.15	0.17	170 (150 — 190)
		0,400	1,7	0,0012	0,0016	0,0020	0,0024	0,0032	0,0040	0,0048	0,0060	0,0065	560 (500 — 620)
P12	E/M/A	0.400	1.7	0.020	0.028	0.034	0.042	0.055	0.070	0.080	0.10	0.12	110 (94 — 120)
		0,400	1,7	0,00080	0,0011	0,0013	0,0017	0,0022	0,0028	0,0032	0,0040	0,0048	360 (310 — 390)
K1	E/M/A	0.400	1.7	0.034	0.044	0.055	0.065	0.090	0.11	0.13	0.17	0.19	225 (200 — 250)
		0,400	1,7	0,0013	0,0017	0,0022	0,0026	0,0036	0,0044	0,0050	0,0065	0,0075	740 (660 — 820)
K2	E/M/A	0.400	1.7	0.030	0.040	0.050	0.060	0.080	0.10	0.12	0.15	0.17	200 (180 — 220)
		0,400	1,7	0,0012	0,0016	0,0020	0,0024	0,0032	0,0040	0,0048	0,0060	0,0065	660 (600 — 720)
K3	E/M/A	0.400	1.7	0.030	0.040	0.050	0.060	0.080	0.10	0.12	0.15	0.17	170 (150 — 190)
		0,400	1,7	0,0012	0,0016	0,0020	0,0024	0,0032	0,0040	0,0048	0,0060	0,0065	560 (500 — 620)
K4	E/M/A	0.400	1.7	0.030	0.040	0.050	0.060	0.080	0.10	0.12	0.15	0.17	160 (140 — 180)
		0,400	1,7	0,0012	0,0016	0,0020	0,0024	0,0032	0,0040	0,0048	0,0060	0,0065	520 (460 — 590)
K5	E/M/A	0.400	1.7	0.028	0.036	0.046	0.055	0.075	0.090	0.11	0.14	0.16	100 (85 — 110)
		0,400	1,7	0,0011	0,0014	0,0018	0,0022	0,0030	0,0036	0,0044	0,0055	0,0065	330 (280 — 360)
K6	E/M/A	0.400	1.7	0.030	0.040	0.050	0.060	0.080	0.10	0.12	0.15	0.17	140 (130 — 160)
		0,400	1,7	0,0012	0,0016	0,0020	0,0024	0,0032	0,0040	0,0048	0,0060	0,0065	460 (430 — 520)
K7	E/M/A	0.400	1.7	0.028	0.036	0.046	0.055	0.075	0.090	0.11	0.14	0.16	125 (110 — 140)
		0,400	1,7	0,0011	0,0014	0,0018	0,0022	0,0030	0,0036	0,0044	0,0055	0,0065	410 (370 — 450)

For cutting data recalculations, see pages 445 - 452

SMG = Seco material group
Coolant = A=air D=dry E=emulsion M=mist spray
v_c = m/min (sf/min)
f_z = mm (in/tooth)
a_p = mm/DC (in/DC) = factor
a_r = mm/DC (in/DC) = factor
All cutting data are target values

Cutting data – JHP951 Slot milling

SMG		a _p /DC	f _z									v _c
			3	4	5	6	8	10	12	16	20	
P1	E/M/A	1.5	0.024	0.032	0.040	0.048	0.065	0.080	0.095	0.13	0.16	195 (170 – 220)
		1.5	0,00095	0,0013	0,0016	0,0019	0,0026	0,0032	0,0038	0,0050	0,0065	640 (560–720)
P2	E/M/A	1.5	0.024	0.032	0.040	0.048	0.065	0.080	0.095	0.13	0.16	190 (170 – 210)
		1.5	0,00095	0,0013	0,0016	0,0019	0,0026	0,0032	0,0038	0,0050	0,0065	620 (560 – 680)
P3	E/M/A	1.5	0.024	0.032	0.040	0.048	0.065	0.080	0.095	0.13	0.16	165 (150–180)
		1.5	0,00095	0,0013	0,0016	0,0019	0,0026	0,0032	0,0038	0,0050	0,0065	540 (500 – 590)
P4	E/M/A	1.5	0.024	0.032	0.040	0.048	0.065	0.080	0.095	0.13	0.16	145 (130–160)
		1.5	0,00095	0,0013	0,0016	0,0019	0,0026	0,0032	0,0038	0,0050	0,0065	475 (430 – 520)
P5	E/M/A	1.5	0.024	0.032	0.040	0.048	0.065	0.080	0.095	0.13	0.16	140 (120–150)
		1.5	0,00095	0,0013	0,0016	0,0019	0,0026	0,0032	0,0038	0,0050	0,0065	460 (400 – 490)
P6	E/M/A	1.5	0.024	0.032	0.040	0.048	0.065	0.080	0.095	0.13	0.16	155 (140–170)
		1.5	0,00095	0,0013	0,0016	0,0019	0,0026	0,0032	0,0038	0,0050	0,0065	510 (460 – 550)
P7	E/M/A	1.5	0.024	0.032	0.040	0.048	0.065	0.080	0.095	0.13	0.16	145 (130–160)
		1.5	0,00095	0,0013	0,0016	0,0019	0,0026	0,0032	0,0038	0,0050	0,0065	475 (430 – 520)
P8	E/M/A	1.5	0.024	0.032	0.040	0.048	0.065	0.080	0.095	0.13	0.16	140 (120–150)
		1.5	0,00095	0,0013	0,0016	0,0019	0,0026	0,0032	0,0038	0,0050	0,0065	460 (400 – 490)
P11	E/M/A	1.5	0.024	0.032	0.040	0.048	0.065	0.080	0.095	0.13	0.16	145 (130–160)
		1.5	0,00095	0,0013	0,0016	0,0019	0,0026	0,0032	0,0038	0,0050	0,0065	475 (430 – 520)
P12	E/M/A	1.5	0.020	0.028	0.034	0.040	0.055	0.070	0.080	0.10	0.12	85 (75 – 99)
		1.5	0,00080	0,0011	0,0013	0,0016	0,0022	0,0028	0,0032	0,0040	0,0048	280 (250 – 320)
K1	E/M/A	1.5	0.024	0.032	0.040	0.048	0.065	0.080	0.095	0.13	0.16	195 (170 – 220)
		1.5	0,00095	0,0013	0,0016	0,0019	0,0026	0,0032	0,0038	0,0050	0,0065	640 (560–720)
K2	E/M/A	1.5	0.024	0.032	0.040	0.048	0.065	0.080	0.095	0.13	0.16	170 (150–190)
		1.5	0,00095	0,0013	0,0016	0,0019	0,0026	0,0032	0,0038	0,0050	0,0065	560 (500 – 620)
K3	E/M/A	1.5	0.024	0.032	0.040	0.048	0.065	0.080	0.095	0.13	0.16	140 (130–160)
		1.5	0,00095	0,0013	0,0016	0,0019	0,0026	0,0032	0,0038	0,0050	0,0065	460 (430 – 520)
K4	E/M/A	1.5	0.024	0.032	0.040	0.048	0.065	0.080	0.095	0.13	0.16	135 (120–150)
		1.5	0,00095	0,0013	0,0016	0,0019	0,0026	0,0032	0,0038	0,0050	0,0065	445 (400 – 490)
K5	E/M/A	1.5	0.024	0.032	0.040	0.048	0.065	0.080	0.095	0.13	0.15	80 (70 – 92)
		1.5	0,00095	0,0013	0,0016	0,0019	0,0026	0,0032	0,0038	0,0050	0,0060	260 (230 – 300)
K6	E/M/A	1.5	0.024	0.032	0.040	0.048	0.065	0.080	0.095	0.13	0.16	120 (110–130)
		1.5	0,00095	0,0013	0,0016	0,0019	0,0026	0,0032	0,0038	0,0050	0,0065	395 (370 – 420)
K7	E/M/A	1.5	0.024	0.032	0.040	0.048	0.065	0.080	0.095	0.13	0.15	105 (89–110)
		1.5	0,00095	0,0013	0,0016	0,0019	0,0026	0,0032	0,0038	0,0050	0,0060	345 (300 – 360)

For cutting data recalculations, see pages 445 - 452

SMG = Seco material group
 Coolant = A=air D=dry E=emulsion M=mist spray
 v_c = m/min (sf/min)
 f_z = mm (in/tooth)
 a_p = mm/DC (in/DC) = factor
 a_e = mm/DC (in/DC) = factor
 All cutting data are target values

Universal

Steel and cast iron

Stainless steel and S-materials

Non ferrous

Hard

Plastic and chip

Graphite

Mimimaster Plus

Mimimaster

JH142

High speed – High precision – Torical – Hardened steel – 2-6 Flutes – Cylindrical – Corner radius

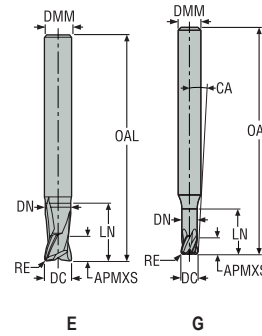
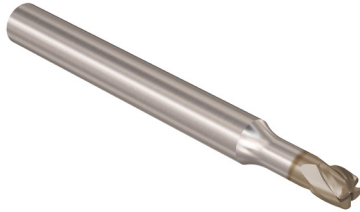

- Tolerances:
- Run-out= <0,005 mm
- DMM= h5
- DC= 0-0,01 mm
- RE= ±0,005 mm
- Regrind possible if DC is ≥Ø6

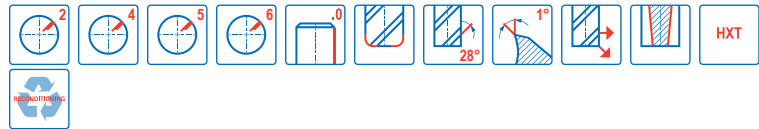

Designation	Item number	Length index	Tool shape	DC	DMM	APMXS	OAL	LN	DN	RE	CA°	PCEDC	WDX0*	WDX05*	WDX1*	WDX15*	WDX2*	WDX3*	Cylindrical
				mm	mm	mm	mm	mm	mm	mm									
JH142020G2R030.0Z2-HXT	02968223	2	G	2,0	4,0	2,0	40,0	6,0	1,9	0,3	6,64	2	6,63	6,96	7,21	7,43	7,62	7,96	■
JH142020G2R030.0Z4-HXT	02968224	2	G	2,0	4,0	2,0	40,0	6,0	1,9	0,3	6,64	4	6,63	6,96	7,21	7,43	7,62	7,96	■
JH142020G2R050.0Z2-HXT	02968225	2	G	2,0	4,0	2,0	40,0	6,0	1,9	0,5	6,79	2	6,63	6,95	7,2	7,41	7,6	7,93	■
JH142020G2R050.0Z4-HXT	02968226	2	G	2,0	4,0	2,0	40,0	6,0	1,9	0,5	6,79	4	6,63	6,95	7,2	7,41	7,6	7,93	■
JH142030G2R050.0Z2-HXT	02968227	2	G	3,0	4,0	3,0	40,0	8,0	2,8	0,5	2,95	2	8,92	9,23	9,48	9,71	9,91	10,26	■
JH142030G2R050.0Z4-HXT	02968228	2	G	3,0	4,0	3,0	40,0	8,0	2,8	0,5	2,95	4	8,92	9,23	9,48	9,71	9,91	10,26	■
JH142030G2R100.0Z2-HXT	02968229	2	G	3,0	4,0	3,0	40,0	8,0	2,8	1,0	3,1	2	8,92	9,21	9,46	9,67	9,87	10,21	■
JH142030G2R100.0Z4-HXT	02968230	2	G	3,0	4,0	3,0	40,0	8,0	2,8	1,0	3,1	4	8,92	9,21	9,46	9,67	9,87	10,21	■
JH142040G2R030.0Z2-HXT	02968231	2	G	4,0	6,0	4,0	50,0	8,0	3,7	0,3	5,34	2	9,13	9,4	9,64	9,84	10,03	10,37	■
JH142040G2R030.0Z4-HXT	02970110	2	G	4,0	6,0	4,0	50,0	8,0	3,7	0,3	5,34	4	9,13	9,4	9,64	9,84	10,03	10,37	■
JH142040G2R050.0Z4-HXT	02968232	2	G	4,0	6,0	4,0	50,0	8,0	3,7	0,5	5,44	4	9,13	9,4	9,63	9,83	10,02	10,35	■
JH142040G2R100.0Z4-HXT	02968233	2	G	4,0	6,0	4,0	50,0	8,0	3,7	1,0	5,69	4	9,13	9,38	9,6	9,8	9,98	10,3	■
JH142060E2R050.0Z4-HXT	02968235	2	E	6,0	6,0	6,0	50,0	12,0	5,6	0,5	-	4	12,0	-	-	-	-	-	■
JH142060E2R100.0Z4-HXT	02968237	2	E	6,0	6,0	6,0	50,0	12,0	5,6	1,0	-	4	12,0	-	-	-	-	-	■
JH142060E2R100.0Z5-HXT	02968238	2	E	6,0	6,0	6,0	50,0	12,0	5,6	1,0	-	5	12,0	-	-	-	-	-	■
JH142060E2R150.0Z5-HXT	02968240	2	E	6,0	6,0	6,0	50,0	12,0	5,6	1,5	-	5	12,0	-	-	-	-	-	■
JH142060E2R200.0Z5-HXT	02968241	2	E	6,0	6,0	6,0	50,0	12,0	5,6	2,0	-	5	12,0	-	-	-	-	-	■
JH142080E2R050.0Z5-HXT	02968242	2	E	8,0	8,0	8,0	60,0	16,0	7,4	0,5	-	5	16,0	-	-	-	-	-	■
JH142080E2R100.0Z5-HXT	02968243	2	E	8,0	8,0	8,0	60,0	16,0	7,4	1,0	-	5	16,0	-	-	-	-	-	■
JH142080E2R150.0Z5-HXT	02968244	2	E	8,0	8,0	8,0	60,0	16,0	7,4	1,5	-	5	16,0	-	-	-	-	-	■
JH142080E2R200.0Z5-HXT	02968245	2	E	8,0	8,0	8,0	60,0	16,0	7,4	2,0	-	5	16,0	-	-	-	-	-	■
JH142080E2R300.0Z5-HXT	02968246	2	E	8,0	8,0	8,0	60,0	16,0	7,4	3,0	-	5	16,0	-	-	-	-	-	■
JH142100E2R050.0Z5-HXT	02968247	2	E	10,0	10,0	10,0	70,0	20,0	9,4	0,5	-	5	20,0	-	-	-	-	-	■
JH142100E2R100.0Z5-HXT	02968248	2	E	10,0	10,0	10,0	70,0	20,0	9,4	1,0	-	5	20,0	-	-	-	-	-	■
JH142100E2R200.0Z5-HXT	02968249	2	E	10,0	10,0	10,0	70,0	20,0	9,4	2,0	-	5	20,0	-	-	-	-	-	■
JH142100E2R250.0Z5-HXT	02968250	2	E	10,0	10,0	10,0	70,0	20,0	9,4	2,5	-	5	20,0	-	-	-	-	-	■
JH142120E2R100.0Z6-HXT	02968251	2	E	12,0	12,0	12,0	75,0	24,0	11,4	1,0	-	6	24,0	-	-	-	-	-	■
JH142120E2R200.0Z6-HXT	02968252	2	E	12,0	12,0	12,0	75,0	24,0	11,4	2,0	-	6	24,0	-	-	-	-	-	■
JH142120E2R300.0Z6-HXT	02968253	2	E	12,0	12,0	12,0	75,0	24,0	11,4	3,0	-	6	24,0	-	-	-	-	-	■

■ Stocked standard. For WDX values: Max. cut depth rel. to αη (Iαη, ref)*

JH142

High speed – High precision – Torical – Hardened steel – 2-5 Flutes – Cylindrical – Corner radius

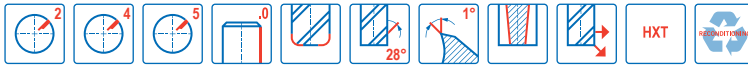
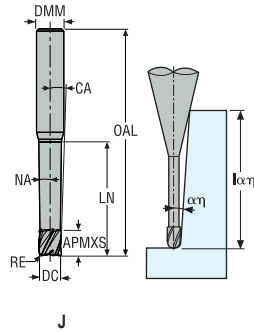

- Tolerances:
- Run-out= <0,005 mm
- DMM= h5
- DC= 0-0.01 mm
- RE= ±0,005 mm
- Regrind possible if DC is ≥Ø6

Designation	Item number	Length index	Tool shape	DC	DMM	APMXS	OAL	LN	DN	RE	CA°	PCEDC	WDX0*	WDX05*	WDX1*	WDX15*	WDX2*	WDX3*	Cylindrical
				mm	mm	mm	mm	mm	mm	mm	mm	mm	mm						
JH142020J3R030.0Z2-HXT	02968255	3	J	2,0	6,0	2,0	60,0	10,0	1,9	0,3	6,72	2	5,23	10,27	10,95	11,31	11,69	12,54	■
JH142020J3R030.0Z4-HXT	02968256	3	J	2,0	6,0	2,0	60,0	10,0	1,9	0,3	6,72	4	5,23	10,27	10,95	11,31	11,69	12,54	■
JH142020J3R050.0Z2-HXT	02968257	3	J	2,0	6,0	2,0	60,0	10,0	1,9	0,5	6,79	2	5,23	10,24	10,94	11,29	11,66	12,5	■
JH142020J3R050.0Z4-HXT	02968258	3	J	2,0	6,0	2,0	60,0	10,0	1,9	0,5	6,79	4	5,23	10,24	10,94	11,29	11,66	12,5	■
JH142030J3R050.0Z2-HXT	02968259	3	J	3,0	6,0	3,0	60,0	15,0	2,8	0,5	4,3	2	9,57	15,58	16,22	16,75	17,32	18,57	■
JH142030J3R050.0Z4-HXT	02968260	3	J	3,0	6,0	3,0	60,0	15,0	2,8	0,5	4,3	4	9,57	15,58	16,22	16,75	17,32	18,57	■
JH142030J3R100.0Z2-HXT	02968261	3	J	3,0	6,0	3,0	60,0	15,0	2,8	1,0	4,4	2	9,57	15,54	16,19	16,7	17,25	18,46	■
JH142030J3R100.0Z4-HXT	02968262	3	J	3,0	6,0	3,0	60,0	15,0	2,8	1,0	4,4	4	9,57	15,54	16,19	16,7	17,25	18,46	■
JH142040J3R030.0Z4-HXT	02970111	3	J	4,0	6,0	4,0	60,0	20,0	3,7	0,3	2,45	4	13,87	20,79	21,52	22,23	22,99	-	■
JH142040J3R030.0Z2-HXT	02968263	3	J	4,0	6,0	4,0	60,0	20,0	3,7	0,3	2,45	2	13,87	20,79	21,52	22,23	22,99	-	■
JH142040J3R050.0Z4-HXT	02968264	3	J	4,0	6,0	4,0	60,0	20,0	3,7	0,5	2,48	4	13,87	20,78	21,51	22,21	22,97	-	■
JH142040J3R050.0Z2-HXT	02968265	3	J	4,0	6,0	4,0	60,0	20,0	3,7	0,5	2,48	2	13,87	20,78	21,51	22,21	22,97	-	■
JH142040J3R100.0Z2-HXT	02968266	3	J	4,0	6,0	4,0	60,0	20,0	3,7	1,0	2,53	2	13,87	20,76	21,48	22,16	22,9	-	■
JH142040J3R100.0Z4-HXT	02968267	3	J	4,0	6,0	4,0	60,0	20,0	3,7	1,0	2,53	4	13,87	20,76	21,48	22,16	22,9	-	■
JH142060J3R050.0Z4-HXT	02968268	3	J	6,0	8,0	6,0	75,0	30,0	5,6	0,5	1,75	4	19,15	30,85	31,88	32,93	-	-	■
JH142060J3R050.0Z5-HXT	02968269	3	J	6,0	8,0	6,0	75,0	30,0	5,6	0,5	1,75	5	19,15	30,85	31,88	32,93	-	-	■
JH142060J3R100.0Z4-HXT	02968270	3	J	6,0	8,0	6,0	75,0	30,0	5,6	1,0	1,77	4	19,15	30,83	31,85	32,88	-	-	■
JH142060J3R100.0Z5-HXT	02968271	3	J	6,0	8,0	6,0	75,0	30,0	5,6	1,0	1,77	5	19,15	30,83	31,85	32,88	-	-	■
JH142060J3R150.0Z5-HXT	02968272	3	J	6,0	8,0	6,0	75,0	30,0	5,6	1,5	1,8	5	19,15	30,8	31,82	32,83	-	-	■
JH142060J3R200.0Z5-HXT	02968273	3	J	6,0	8,0	6,0	75,0	30,0	5,6	2,0	1,83	5	19,15	30,78	31,78	32,78	-	-	■
JH142080J3R050.0Z5-HXT	02968274	3	J	8,0	10,0	8,0	85,0	40,0	7,4	0,5	1,34	5	27,67	41,12	42,44	-	-	-	■
JH142080J3R100.0Z5-HXT	02968275	3	J	8,0	10,0	8,0	85,0	40,0	7,4	1,0	1,36	5	27,67	41,11	42,41	-	-	-	■
JH142080J3R150.0Z5-HXT	02968276	3	J	8,0	10,0	8,0	85,0	40,0	7,4	1,5	1,37	5	27,67	41,09	42,38	-	-	-	■
JH142080J3R200.0Z5-HXT	02968277	3	J	8,0	10,0	8,0	85,0	40,0	7,4	2,0	1,39	5	27,67	41,08	42,35	-	-	-	■
JH142100J3R050.0Z5-HXT	02968278	3	J	10,0	12,0	10,0	100,0	50,0	9,4	0,5	1,1	5	29,67	50,97	52,62	-	-	-	■
JH142100J3R100.0Z5-HXT	02968279	3	J	10,0	12,0	10,0	100,0	50,0	9,4	1,0	1,11	5	29,67	50,95	52,59	-	-	-	■
JH142100J3R200.0Z5-HXT	02968280	3	J	10,0	12,0	10,0	100,0	50,0	9,4	2,0	1,13	5	29,67	50,91	52,53	-	-	-	■
JH142020J6R030.0Z4-HXT	02968282	6	J	2,0	6,0	2,0	75,0	20,0	1,9	0,3	4,33	4	5,23	11,4	21,0	21,71	22,45	24,11	■
JH142020J6R050.0Z4-HXT	02968283	6	J	2,0	6,0	2,0	75,0	20,0	1,9	0,5	4,36	4	5,23	11,14	20,99	21,69	22,43	24,06	■
JH142030J6R050.0Z4-HXT	02968284	6	J	3,0	6,0	3,0	75,0	30,0	2,8	0,5	2,52	4	9,57	20,92	31,32	32,35	33,46	-	■
JH142030J6R100.0Z4-HXT	02968285	6	J	3,0	6,0	3,0	75,0	30,0	2,8	1,0	2,56	4	9,57	20,3	31,29	32,31	33,39	-	■
JH142040J6R030.0Z4-HXT	02968286	6	J	4,0	6,0	4,0	80,0	40,0	3,7	0,3	1,36	4	13,87	30,85	41,65	-	-	-	■
JH142040J6R050.0Z4-HXT	02968287	6	J	4,0	6,0	4,0	80,0	40,0	3,7	0,5	1,37	4	13,87	30,6	41,65	-	-	-	■
JH142040J6R100.0Z4-HXT	02968288	6	J	4,0	6,0	4,0	80,0	40,0	3,7	1,0	1,38	4	13,87	29,98	41,6	-	-	-	■

■ Stocked standard. For WDX values: Max. cut depth rel. to α1 (α1, ref)*

Universal
 Steel and cast iron
 Stainless steel and S-materials
 Non ferrous
 Hard
 Plastic and cfrp
 Graphite
 Minimaster Plus
 Minimaster

JH970

High speed – Universal – Ball nose – 2 Flutes – Cylindrical

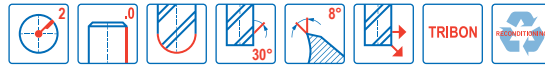
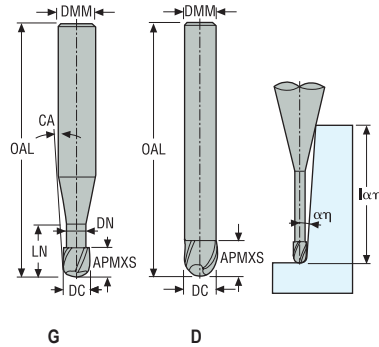

- Tolerances:
- DMM= h5
- DC= -0,02/-0,04 mm
- RE= ±0,01 mm
- Regrind possible if DC is ≥Ø6

Designation	Item number	Length index	Tool shape	DC	DMM	APMXS	OAL	LN	DN	CA°	PCEDC	WDX0*	WDX05*	WDX1*	WDX15*	WDX2*	WDX3*	Cylindrical
				mm	mm	mm	mm	mm	mm	mm	mm	mm	mm	mm	mm	mm	mm	
970021-TRIBON	02452881	1	G	2,0	3,0	3,0	50,0	10,0	1,9	2,5	2	10,0	11,0	11,5	12,1	12,8	-	■
970031-TRIBON	02452882	1	D	3,0	3,0	4,5	50,0	-	-	-	2	4,5	-	-	-	-	-	■
970041-TRIBON	02452883	1	D	4,0	4,0	6,0	60,0	-	-	-	2	6,0	-	-	-	-	-	■
970051-TRIBON	02452884	1	D	5,0	5,0	7,5	60,0	-	-	-	2	7,5	-	-	-	-	-	■
970061-TRIBON	02452885	1	D	6,0	6,0	9,0	75,0	-	-	-	2	9,0	-	-	-	-	-	■
970020-TRIBON	02452886	2	G	2,0	6,0	3,0	60,0	4,0	1,9	8,0	2	4,0	4,7	4,9	5,1	5,4	6,0	■
970025-TRIBON	02452887	2	G	2,5	6,0	4,0	60,0	5,0	2,4	7,5	2	5,0	5,7	6,0	6,2	6,5	7,3	■
970030-TRIBON	02452888	2	G	3,0	6,0	4,5	60,0	6,0	2,8	5,5	2	6,0	7,4	7,8	8,3	9,0	10,6	■
970035-TRIBON	02452889	2	G	3,5	6,0	5,0	60,0	7,0	3,2	4,5	2	7,0	8,8	9,4	10,0	10,7	12,8	■
970040-TRIBON	02452890	2	G	4,0	6,0	6,0	60,0	8,0	3,7	3,0	2	8,0	10,8	11,9	13,3	15,2	-	■
970050-TRIBON	02452891	2	G	5,0	6,0	7,5	60,0	10,0	4,6	2,0	2	10,0	13,6	15,0	16,8	-	-	■
970060-TRIBON	02452892	2	G	6,0	8,0	9,0	75,0	12,0	5,6	2,5	2	12,0	15,8	17,4	19,4	22,2	-	■
970080-TRIBON	02452893	2	D	8,0	8,0	12,0	75,0	-	-	-	2	12,0	-	-	-	-	-	■
970100-TRIBON	02452894	2	D	10,0	10,0	15,0	80,0	-	-	-	2	15,0	-	-	-	-	-	■
970120-TRIBON	02452895	2	D	12,0	12,0	18,0	90,0	-	-	-	2	18,0	-	-	-	-	-	■
970160-TRIBON	02452896	2	D	16,0	16,0	24,0	100,0	-	-	-	2	24,0	-	-	-	-	-	■
970L020-TRIBON	02452899	3	G	2,0	6,0	3,0	80,0	4,0	1,9	8,0	2	4,0	4,7	4,9	5,1	5,4	6,0	■
970L030-TRIBON	02452900	3	G	3,0	6,0	4,5	80,0	6,0	2,8	5,5	2	6,0	7,4	7,8	8,3	9,0	10,6	■
970L040-TRIBON	02452901	3	G	4,0	6,0	6,0	80,0	8,0	3,7	3,0	2	8,0	10,8	11,9	13,3	15,2	-	■
970L050-TRIBON	02452902	3	G	5,0	6,0	7,5	100,0	10,0	4,6	2,0	2	10,0	13,6	15,0	16,8	-	-	■
970L060-TRIBON	02452903	3	G	6,0	8,0	9,0	100,0	12,0	5,6	2,5	2	12,0	15,8	17,4	19,4	22,2	-	■
970L080-TRIBON	02452904	3	D	8,0	8,0	12,0	110,0	-	-	-	2	12,0	-	-	-	-	-	■
970L100-TRIBON	02452905	3	D	10,0	10,0	15,0	125,0	-	-	-	2	15,0	-	-	-	-	-	■
970L120-TRIBON	02452906	3	D	12,0	12,0	18,0	125,0	-	-	-	2	18,0	-	-	-	-	-	■
970L160-TRIBON	02452907	3	D	16,0	16,0	24,0	150,0	-	-	-	2	24,0	-	-	-	-	-	■

■ Stocked standard.
For WDX values: Max. cut depth rel. to α_n (lα_n, ref)*

Universal
Steel and cast iron
Stainless steel and S-materials
Non ferrous
Hard
Plastic and chip
Graphite
Minimaster Plus
Minimaster

Cutting data – JH970 Copy milling roughing

SMG		a _p /DC	a _r /DC	f _z									v _c
				2	3	4	5	6	8	10	12	16	
P1	M	0.350	0.070	0.040	0.060	0.080	0.10	0.12	0.16	0.20	0.24	0.32	245 (220 – 270)
		0,350	0,070	0,0016	0,0024	0,0032	0,0040	0,0048	0,0065	0,0080	0,0095	0,013	800 (730 – 880)
P2	M	0.350	0.070	0.040	0.060	0.080	0.10	0.12	0.16	0.20	0.24	0.32	240 (210 – 270)
		0,350	0,070	0,0016	0,0024	0,0032	0,0040	0,0048	0,0065	0,0080	0,0095	0,013	790 (690 – 880)
P3	M	0.350	0.070	0.040	0.060	0.080	0.10	0.12	0.16	0.20	0.24	0.32	205 (180 – 230)
		0,350	0,070	0,0016	0,0024	0,0032	0,0040	0,0048	0,0065	0,0080	0,0095	0,013	670 (600 – 750)
P4	M	0.350	0.070	0.040	0.060	0.080	0.10	0.12	0.16	0.20	0.24	0.32	180 (160 – 200)
		0,350	0,070	0,0016	0,0024	0,0032	0,0040	0,0048	0,0065	0,0080	0,0095	0,013	590 (530 – 650)
P5	M	0.350	0.070	0.040	0.060	0.080	0.10	0.12	0.16	0.20	0.24	0.32	170 (150 – 190)
		0,350	0,070	0,0016	0,0024	0,0032	0,0040	0,0048	0,0065	0,0080	0,0095	0,013	560 (500 – 620)
P6	M	0.350	0.070	0.040	0.060	0.080	0.10	0.12	0.16	0.20	0.24	0.32	195 (170 – 210)
		0,350	0,070	0,0016	0,0024	0,0032	0,0040	0,0048	0,0065	0,0080	0,0095	0,013	640 (560 – 680)
P7	M	0.350	0.070	0.040	0.060	0.080	0.10	0.12	0.16	0.20	0.24	0.32	185 (160 – 200)
		0,350	0,070	0,0016	0,0024	0,0032	0,0040	0,0048	0,0065	0,0080	0,0095	0,013	610 (530 – 650)
P8	M	0.350	0.070	0.040	0.060	0.080	0.10	0.12	0.16	0.20	0.24	0.32	170 (150 – 190)
		0,350	0,070	0,0016	0,0024	0,0032	0,0040	0,0048	0,0065	0,0080	0,0095	0,013	560 (500 – 620)
P11	M	0.350	0.070	0.040	0.060	0.080	0.10	0.12	0.16	0.20	0.24	0.32	180 (160 – 200)
		0,350	0,070	0,0016	0,0024	0,0032	0,0040	0,0048	0,0065	0,0080	0,0095	0,013	590 (530 – 650)
P12	M	0.350	0.070	0.040	0.060	0.080	0.10	0.12	0.16	0.20	0.24	0.32	105 (91 – 110)
		0,350	0,070	0,0016	0,0024	0,0032	0,0040	0,0048	0,0065	0,0080	0,0095	0,013	345 (300 – 360)
M1	M	0.170	1.0	0.020	0.030	0.040	0.050	0.060	0.080	0.10	0.12	0.16	95 (85 – 110)
		0,170	1,0	0,00080	0,0012	0,0016	0,0020	0,0024	0,0032	0,0040	0,0048	0,0065	310 (280 – 360)
M2	M	0.170	1.0	0.020	0.030	0.040	0.050	0.060	0.080	0.10	0.12	0.15	80 (69 – 89)
		0,170	1,0	0,00080	0,0012	0,0016	0,0020	0,0024	0,0032	0,0040	0,0048	0,0060	260 (230 – 290)
M3	M	0.130	1.0	0.022	0.032	0.042	0.055	0.065	0.085	0.11	0.13	0.15	65 (57 – 76)
		0,130	1,0	0,00085	0,0013	0,0017	0,0022	0,0026	0,0034	0,0044	0,0050	0,0060	215 (190 – 240)
M4	M	0.130	1.0	0.019	0.028	0.038	0.046	0.055	0.075	0.095	0.11	0.14	50 (44 – 59)
		0,130	1,0	0,00075	0,0011	0,0015	0,0018	0,0022	0,0030	0,0038	0,0044	0,0055	165 (150 – 190)
M5	M	0.130	1.0	0.019	0.028	0.038	0.046	0.055	0.075	0.095	0.11	0.14	43 (37 – 49)
		0,130	1,0	0,00075	0,0011	0,0015	0,0018	0,0022	0,0030	0,0038	0,0044	0,0055	140 (130 – 160)
S1	E	0.150	0.065	0.040	0.060	0.080	0.10	0.12	0.16	0.20	0.24	0.30	50 (42 – 62)
		0,150	0,065	0,0016	0,0024	0,0032	0,0040	0,0048	0,0065	0,0080	0,0095	0,012	165 (140 – 200)
S2	E	0.150	0.065	0.040	0.060	0.080	0.10	0.12	0.16	0.20	0.24	0.30	42 (34 – 50)
		0,150	0,065	0,0016	0,0024	0,0032	0,0040	0,0048	0,0065	0,0080	0,0095	0,012	140 (120 – 160)
S3	E	0.120	0.060	0.040	0.060	0.080	0.10	0.12	0.16	0.20	0.24	0.30	31 (21 – 41)
		0,120	0,060	0,0016	0,0024	0,0032	0,0040	0,0048	0,0065	0,0080	0,0095	0,012	100 (69 – 130)
S11	E	0.350	0.15	0.012	0.018	0.024	0.030	0.036	0.048	0.060	0.070	0.095	105 (89 – 110)
		0,350	0,15	0,00048	0,00070	0,00095	0,0012	0,0014	0,0019	0,0024	0,0028	0,0038	345 (300 – 360)
S12	E	0.350	0.15	0.012	0.018	0.024	0.030	0.036	0.048	0.060	0.070	0.095	80 (69 – 91)
		0,350	0,15	0,00048	0,00070	0,00095	0,0012	0,0014	0,0019	0,0024	0,0028	0,0038	260 (230 – 290)
S13	E	0.350	0.15	0.012	0.018	0.024	0.030	0.036	0.048	0.060	0.070	0.095	60 (54 – 70)
		0,350	0,15	0,00048	0,00070	0,00095	0,0012	0,0014	0,0019	0,0024	0,0028	0,0038	195 (180 – 220)

For cutting data recalculations, see pages 445 - 452

SMG = Seco material group
Coolant = A=air D=dry E=emulsion M=mist spray
v_c = m/min (sf/min)
f_z = mm (in/tooth)
a_p = mm/DC (in/DC) = factor
a_r = mm/DC (in/DC) = factor
All cutting data are target values

JH112

High speed – High precision – Hardened steel – Ball nose – 2 Flutes – Cylindrical

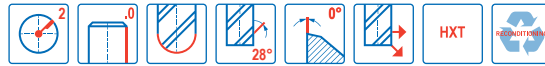
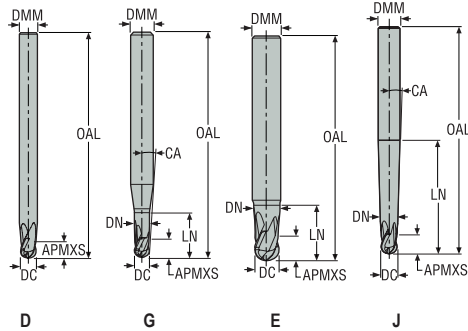

- Tolerances:
- Run-out= <0,005 mm
- DMM= h5
- DC= 0-0.01 mm
- RE= ±0,005 mm
- Regrind possible if DC is ≥Ø6

Designation	Item number	Length index	Tool shape	DC	DMM	APMXS	OAL	LN	DN	CA°	PCEDC	WDX0*	WDX05*	WDX1*	WDX15*	WDX2*	WDX3*	Cylindrical
				mm	mm	mm	mm	mm	mm									
JH112020G1B.0Z2-HXT	02970112	1	G	2,0	4,0	2,0	40,0	4,0	1,9	6,45	2	4,66	4,84	5,03	5,24	5,47	6,03	■
JH112030G1B.0Z2-HXT	02970113	1	G	3,0	4,0	3,0	40,0	6,0	2,8	3,3	2	6,96	7,29	7,66	8,08	8,56	9,78	■
JH112040D1B.0Z2-HXT	02970114	1	D	4,0	4,0	4,0	40,0	-	-	-	2	4,0	-	-	-	-	-	■
JH112050G1B.0Z2-HXT	02970115	1	G	5,0	6,0	5,0	50,0	10,0	4,6	2,0	2	12,09	12,96	14,01	15,29	16,89	-	■
JH112060D1B.0Z2-HXT	02970116	1	D	6,0	6,0	6,0	50,0	-	-	-	2	6,0	-	-	-	-	-	■
JH112080D1B.0Z2-HXT	02970117	1	D	8,0	8,0	8,0	65,0	-	-	-	2	8,0	-	-	-	-	-	■
JH112100D1B.0Z2-HXT	02970118	1	D	10,0	10,0	10,0	65,0	-	-	-	2	10,0	-	-	-	-	-	■
JH112020G2B.0Z2-HXT	02970119	2	G	2,0	3,0	2,0	50,0	10,0	1,9	2,5	2	10,79	11,1	11,42	11,77	-	-	■
JH112030D2B.0Z2-HXT	02970120	2	D	3,0	3,0	3,0	50,0	-	-	-	2	-	-	-	-	-	-	■
JH112040D2B.0Z2-HXT	02970121	2	D	4,0	4,0	4,0	60,0	-	-	-	2	4,0	-	-	-	-	-	■
JH112050D2B.0Z2-HXT	02970122	2	D	5,0	5,0	5,0	60,0	-	-	-	2	5,0	-	-	-	-	-	■
JH112060D2B.0Z2-HXT	02970123	2	D	6,0	6,0	6,0	75,0	-	-	-	2	6,0	-	-	-	-	-	■
JH112020G3B.0Z2-HXT	02970124	3	G	2,0	6,0	2,0	60,0	4,0	1,9	8,12	2	4,66	4,84	5,03	5,24	5,47	6,03	■
JH112025G3B.0Z2-HXT	02970125	3	G	2,5	6,0	2,5	60,0	5,0	2,4	7,39	2	5,66	5,87	6,1	6,36	6,64	7,31	■
JH112030G3B.0Z2-HXT	02970126	3	G	3,0	6,0	3,0	60,0	6,0	2,8	5,5	2	6,97	7,31	7,7	8,14	8,65	9,95	■
JH112035G3B.0Z2-HXT	02968289	3	G	3,5	6,0	3,5	65,0	7,0	3,2	3,81	2	8,62	9,24	9,99	10,9	12,05	15,49	■
JH112040G3B.0Z2-HXT	02970127	3	G	4,0	6,0	4,0	65,0	8,0	3,7	3,34	2	9,62	10,31	11,14	12,15	13,42	17,25	■
JH112050G3B.0Z2-HXT	02970128	3	G	5,0	6,0	5,0	65,0	10,0	4,6	2,0	2	12,09	12,96	14,01	15,29	16,89	-	■
JH112060G3B.0Z2-HXT	02970129	3	G	6,0	8,0	6,0	75,0	12,0	5,6	2,78	2	14,09	15,1	16,31	17,79	19,64	25,2	■
JH112080E3B.0Z2-HXT	02968290	3	E	8,0	8,0	8,0	75,0	16,0	7,4	-	2	16,0	-	-	-	-	-	■
JH112100E3B.0Z2-HXT	02968291	3	E	10,0	10,0	10,0	80,0	20,0	9,4	-	2	20,0	-	-	-	-	-	■
JH112120E3B.0Z2-HXT	02968292	3	E	12,0	12,0	12,0	90,0	24,0	11,4	-	2	24,0	-	-	-	-	-	■
JH112020G4B.0Z2-HXT	02970130	4	G	2,0	6,0	2,0	80,0	20,0	1,9	3,82	2	20,66	21,59	22,61	23,73	24,98	27,94	■
JH112030G4B.0Z2-HXT	02970131	4	G	3,0	6,0	3,0	80,0	20,0	2,8	2,91	2	20,97	22,18	23,55	25,11	26,92	31,51	■
JH112040G4B.0Z2-HXT	02970132	4	G	4,0	6,0	4,0	80,0	20,0	3,7	1,97	2	21,62	23,39	25,53	28,13	-	-	■
JH112050G4B.0Z2-HXT	02970133	4	G	5,0	6,0	5,0	100,0	50,0	4,6	0,53	2	52,09	56,58	-	-	-	-	■
JH112060D4B.0Z2-HXT	02968293	4	D	6,0	6,0	6,0	100,0	-	5,6	-	2	6,0	-	-	-	-	-	■
JH112080D4B.0Z2-HXT	02968294	4	D	8,0	8,0	8,0	110,0	-	7,4	-	2	8,0	-	-	-	-	-	■
JH112100D4B.0Z2-HXT	02968295	4	D	10,0	10,0	10,0	125,0	-	9,4	-	2	10,0	-	-	-	-	-	■
JH112120D4B.0Z2-HXT	02968296	4	D	12,0	12,0	12,0	125,0	-	11,4	-	2	12,0	-	-	-	-	-	■

■ Stocked standard.

For WDX values: Max. cut depth rel. to αη (lαη, ref)*

Universal

Steel and cast iron

Stainless steel and S-materials

Non ferrous

Hard

Plastic and chip

Graphite

Minimaster Plus

Minimaster

JH112

High speed – High precision – Hardened steel – Ball nose – 2 Flutes – Cylindrical

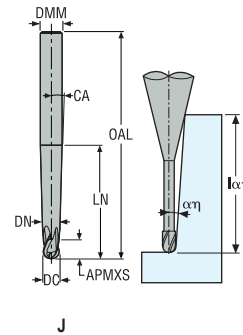

- Tolerances:
- Run-out= <0,005 mm
- DMM= h5
- DC= 0-0,01 mm
- RE= ±0,005 mm
- Regrind possible if DC is ≥Ø6

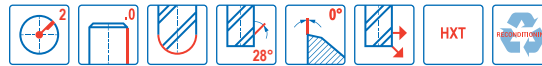

Designation	Item number	Length index	Tool shape	DC	DMM	APMXS	OAL	LN	DN	CA°	PCEDC	WDX0*	WDX05*	WDX1*	WDX15*	WDX2*	WDX3*	Cylindrical
				mm	mm	mm	mm	mm	mm	mm	mm	mm	mm	mm	mm	mm	mm	
JH112020J5B.0Z2-HXT	02970134	5	J	2,0	6,0	2,0	80,0	–	1,9	3,3	2	3,09	3,43	3,91	4,63	5,81	14,63	■
JH112030J5B.0Z2-HXT	02970135	5	J	3,0	6,0	3,0	80,0	–	2,8	2,2	2	5,7	6,75	8,51	12,03	22,61	–	■
JH112040J5B.0Z2-HXT	02970136	5	J	4,0	6,0	4,0	80,0	–	3,7	1,2	2	10,58	15,35	32,07	–	–	–	■
JH112050J5B.0Z2-HXT	02970137	5	J	5,0	8,0	5,0	100,0	–	4,6	1,6	2	11,47	14,56	20,93	41,46	–	–	■
JH112060J5B.0Z2-HXT	02970138	5	J	6,0	8,0	6,0	100,0	–	5,6	1,1	2	14,72	21,24	44,08	–	–	–	■
JH112080J5B.0Z2-HXT	02970139	5	J	8,0	10,0	8,0	125,0	–	7,4	1,0	2	20,71	29,7	59,65	–	–	–	■
JH112100J5B.0Z2-HXT	02970140	5	J	10,0	12,0	10,0	125,0	–	9,4	1,0	2	22,16	30,75	56,56	–	–	–	■
JH112060J6B.0Z2-HXT	02970141	6	J	6,0	10,0	6,0	125,0	–	5,6	2,0	2	11,59	13,99	18,22	27,78	69,22	–	■
JH112080J6B.0Z2-HXT	02970142	6	J	8,0	12,0	8,0	150,0	–	7,4	1,8	2	16,24	19,64	25,68	39,27	98,24	–	■
JH112100J6B.0Z2-HXT	02970143	6	J	10,0	12,0	10,0	150,0	–	9,4	0,8	2	26,26	43,99	–	–	–	–	■

■ Stocked standard.
For WDX values: Max. cut depth rel. to α₁ (α₁, ref)*

Universal

Steel and cast iron

Stainless steel and S-materials

Non ferrous

Hard

Plastic and cfrp

Graphite

Minimaster Plus

Minimaster

Cutting data – JH112 Copy milling finishing

SMG		a _p /DC	f _z										v _c
			2	2.5	3	3.5	4	5	6	8	10	12	
K1	E	0.30	0.030	0.038	0.044	0.050	0.060	0.075	0.090	0.12	0.15	0.18	520 (500–730)
		0,30	0,0012	0,0015	0,0017	0,0020	0,0024	0,0030	0,0036	0,0048	0,0060	0,0070	1700 (1700 – 2300)
K2	E	0.30	0.030	0.038	0.044	0.050	0.060	0.075	0.090	0.12	0.15	0.18	445 (430 – 630)
		0,30	0,0012	0,0015	0,0017	0,0020	0,0024	0,0030	0,0036	0,0048	0,0060	0,0070	1450 (1500 – 2000)
K3	E	0.30	0.030	0.038	0.044	0.050	0.060	0.075	0.090	0.12	0.15	0.18	380 (360 – 530)
		0,30	0,0012	0,0015	0,0017	0,0020	0,0024	0,0030	0,0036	0,0048	0,0060	0,0070	1250 (1200–1700)
K4	E	0.30	0.030	0.038	0.044	0.050	0.060	0.075	0.090	0.12	0.15	0.18	360 (350 – 510)
		0,30	0,0012	0,0015	0,0017	0,0020	0,0024	0,0030	0,0036	0,0048	0,0060	0,0070	1175 (1200–1600)
K5	E	0.30	0.030	0.038	0.044	0.050	0.060	0.075	0.090	0.12	0.15	0.18	415 (370 – 610)
		0,30	0,0012	0,0015	0,0017	0,0020	0,0024	0,0030	0,0036	0,0048	0,0060	0,0070	1350 (1300 – 2000)
K6	E	0.30	0.030	0.038	0.044	0.050	0.060	0.075	0.090	0.12	0.15	0.18	610 (550 – 900)
		0,30	0,0012	0,0015	0,0017	0,0020	0,0024	0,0030	0,0036	0,0048	0,0060	0,0070	2000 (1900 – 2900)
K7	E	0.30	0.030	0.038	0.044	0.050	0.060	0.075	0.090	0.12	0.15	0.18	680 (560–790)
		0,30	0,0012	0,0015	0,0017	0,0020	0,0024	0,0030	0,0036	0,0048	0,0060	0,0070	2225 (1900 – 2500)
H3	M	0.16	0.028	0.036	0.042	0.048	0.055	0.070	0.085	0.11	0.14	0.17	155 (150 – 230)
		0,16	0,0011	0,0014	0,0017	0,0019	0,0022	0,0028	0,0034	0,0044	0,0055	0,0065	510 (500–750)
H5	M	0.30	0.030	0.038	0.044	0.050	0.060	0.075	0.090	0.12	0.15	0.18	285 (240 – 330)
		0,30	0,0012	0,0015	0,0017	0,0020	0,0024	0,0030	0,0036	0,0048	0,0060	0,0070	940 (790–1000)
H7	M	0.16	0.028	0.036	0.042	0.048	0.055	0.070	0.085	0.11	0.14	0.17	155 (150 – 230)
		0,16	0,0011	0,0014	0,0017	0,0019	0,0022	0,0028	0,0034	0,0044	0,0055	0,0065	510 (500–750)
H8	M	0.30	0.030	0.038	0.044	0.050	0.060	0.075	0.090	0.12	0.15	0.18	285 (240 – 330)
		0,30	0,0012	0,0015	0,0017	0,0020	0,0024	0,0030	0,0036	0,0048	0,0060	0,0070	940 (790–1000)
H11	M	0.30	0.030	0.038	0.044	0.050	0.060	0.075	0.090	0.12	0.15	0.18	360 (300 – 420)
		0,30	0,0012	0,0015	0,0017	0,0020	0,0024	0,0030	0,0036	0,0048	0,0060	0,0070	1175 (990–1300)
H12	M	0.30	0.030	0.038	0.044	0.050	0.060	0.075	0.090	0.12	0.15	0.18	330 (280 – 380)
		0,30	0,0012	0,0015	0,0017	0,0020	0,0024	0,0030	0,0036	0,0048	0,0060	0,0070	1075 (920–1200)
H21	M	0.30	0.030	0.038	0.044	0.050	0.060	0.075	0.090	0.12	0.15	0.18	285 (240 – 330)
		0,30	0,0012	0,0015	0,0017	0,0020	0,0024	0,0030	0,0036	0,0048	0,0060	0,0070	940 (790–1000)
H31	M	0.30	0.026	0.032	0.040	0.046	0.050	0.065	0.080	0.10	0.13	0.16	300 (290 – 430)
		0,30	0,0010	0,0013	0,0016	0,0018	0,0020	0,0026	0,0032	0,0040	0,0050	0,0065	980 (960–1400)

For cutting data recalculations, see pages 445 - 452

SMG = Seco material group
 Coolant = A=air D=dry E=emulsion M=mist spray
 v_c = m/min (sf/min)
 f_z = mm (in/tooth)
 a_p = mm/DC (in/DC) = factor
 a_e = mm/DC (in/DC) = factor
 All cutting data are target values

Universal
 Steel and cast iron
 Stainless steel and S-materials
 Non ferrous
 Hard
 Plastic and chip
 Graphite
 Mimimaster Plus
 Mimimaster

Cutting data – JH112 Copy milling roughing

SMG	Coolant	a _e /DC	a _p /DC	f _z										v _c
				2	2.5	3	3.5	4	5	6	8	10	12	
K1	E	0.250	0.15	0.030	0.038	0.044	0.050	0.060	0.075	0.090	0.12	0.15	0.18	315 (310 – 450)
		0.250	0.15	0.0012	0.0015	0.0017	0.0020	0.0024	0.0030	0.0036	0.0048	0.0060	0.0070	1025 (1100–1400)
K2	E	0.250	0.15	0.028	0.036	0.044	0.050	0.060	0.070	0.085	0.12	0.14	0.17	280 (270 – 390)
		0.250	0.15	0.0011	0.0014	0.0017	0.0020	0.0024	0.0028	0.0034	0.0048	0.0055	0.0065	920 (890–1200)
K3	E	0.250	0.15	0.028	0.036	0.044	0.050	0.060	0.070	0.085	0.12	0.14	0.17	235 (230 – 330)
		0.250	0.15	0.0011	0.0014	0.0017	0.0020	0.0024	0.0028	0.0034	0.0048	0.0055	0.0065	770 (760–1000)
K4	E	0.250	0.15	0.028	0.036	0.044	0.050	0.060	0.070	0.085	0.12	0.14	0.17	225 (220 – 320)
		0.250	0.15	0.0011	0.0014	0.0017	0.0020	0.0024	0.0028	0.0034	0.0048	0.0055	0.0065	740 (730–1000)
K5	E	0.160	0.15	0.030	0.038	0.044	0.050	0.060	0.075	0.090	0.12	0.15	0.18	280 (250 – 410)
		0.160	0.15	0.0012	0.0015	0.0017	0.0020	0.0024	0.0030	0.0036	0.0048	0.0060	0.0070	920 (830–1300)
K6	E	0.160	0.15	0.030	0.038	0.044	0.050	0.060	0.075	0.090	0.12	0.15	0.18	415 (370 – 610)
		0.160	0.15	0.0012	0.0015	0.0017	0.0020	0.0024	0.0030	0.0036	0.0048	0.0060	0.0070	1350 (1300 – 2000)
K7	E	0.250	0.10	0.030	0.038	0.044	0.050	0.060	0.075	0.090	0.12	0.15	0.18	420 (350 – 490)
		0.250	0.10	0.0012	0.0015	0.0017	0.0020	0.0024	0.0030	0.0036	0.0048	0.0060	0.0070	1375 (1200–1600)
H3	M	0.120	0.040	0.028	0.036	0.042	0.048	0.055	0.070	0.085	0.11	0.14	0.17	110 (100–160)
		0.120	0.040	0.0011	0.0014	0.0017	0.0019	0.0022	0.0028	0.0034	0.0044	0.0055	0.0065	360 (330 – 520)
H5	M	0.250	0.10	0.030	0.038	0.044	0.050	0.060	0.075	0.090	0.12	0.15	0.18	175 (150 – 200)
		0.250	0.10	0.0012	0.0015	0.0017	0.0020	0.0024	0.0030	0.0036	0.0048	0.0060	0.0070	570 (500 – 650)
H7	M	0.120	0.040	0.028	0.036	0.042	0.048	0.055	0.070	0.085	0.11	0.14	0.17	110 (100–160)
		0.120	0.040	0.0011	0.0014	0.0017	0.0019	0.0022	0.0028	0.0034	0.0044	0.0055	0.0065	360 (330 – 520)
H8	M	0.250	0.10	0.030	0.038	0.044	0.050	0.060	0.075	0.090	0.12	0.15	0.18	175 (150 – 200)
		0.250	0.10	0.0012	0.0015	0.0017	0.0020	0.0024	0.0030	0.0036	0.0048	0.0060	0.0070	570 (500 – 650)
H11	M	0.250	0.10	0.030	0.038	0.044	0.050	0.060	0.075	0.090	0.12	0.15	0.18	225 (190 – 260)
		0.250	0.10	0.0012	0.0015	0.0017	0.0020	0.0024	0.0030	0.0036	0.0048	0.0060	0.0070	740 (630 – 850)
H12	M	0.250	0.10	0.030	0.038	0.044	0.050	0.060	0.075	0.090	0.12	0.15	0.18	205 (170 – 240)
		0.250	0.10	0.0012	0.0015	0.0017	0.0020	0.0024	0.0030	0.0036	0.0048	0.0060	0.0070	670 (560–780)
H21	M	0.250	0.10	0.030	0.038	0.044	0.050	0.060	0.075	0.090	0.12	0.15	0.18	175 (150 – 200)
		0.250	0.10	0.0012	0.0015	0.0017	0.0020	0.0024	0.0030	0.0036	0.0048	0.0060	0.0070	570 (500 – 650)
H31	M	0.200	0.10	0.026	0.032	0.040	0.046	0.050	0.065	0.080	0.10	0.13	0.16	200 (200 – 280)
		0.200	0.10	0.0010	0.0013	0.0016	0.0018	0.0020	0.0026	0.0032	0.0040	0.0050	0.0065	660 (660 – 910)

For cutting data recalculations, see pages 445 - 452

SMG = Seco material group

Coolant = A=air D=dry E=emulsion M=mist spray

v_c = m/min (sf/min)

f_z = mm (in/tooth)

a_p = mm/DC (in/DC) = factor

a_e = mm/DC (in/DC) = factor

All cutting data are target values

JH150

High speed – Hardened steel – Ball nose – 4 Flutes – Cylindrical

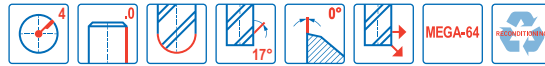
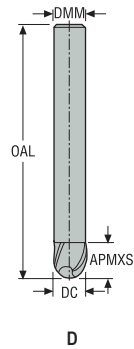

- Tolerances:
- DMM= h5
- DC= -0,02/-0,04 mm
- RE= ±0,01 mm
- Re grind possible if DC is ≥Ø6

Designation	Ordering No.	Length index	Tool shape	DC	DMM	APMXS	OAL	PCEDC	Cylindrical
				mm	mm	mm	mm		
150060-MEGA-64	00019198	2	D	6,0	6,0	6,0	80,0	4	■
150080-MEGA-64	00019208	2	D	8,0	8,0	8,0	85,0	4	■
150100-MEGA-64	00019219	2	D	10,0	10,0	10,0	100,0	4	■
150120-MEGA-64	00019254	2	D	12,0	12,0	12,0	100,0	4	■

■ Stocked standard.

Universal

Steel and cast iron

Stainless steel and S-materials

Non ferrous

Hard

Plastic and cfrp

Graphite

Minimaster Plus

Minimaster

Cutting data – JH150 Copy milling roughing

SMG		a _e /DC	a _p /DC	f _z				v _c
				6	8	10	12	
K1	A	0.300	0.15	0.10	0.14	0.17	0.20	290 (310 – 370)
		0,300	0,15	0,0040	0,0055	0,0065	0,0080	950 (1100 – 1200)
K2	A	0.300	0.15	0.10	0.14	0.17	0.20	250 (270 – 320)
		0,300	0,15	0,0040	0,0055	0,0065	0,0080	820 (890 – 1000)
K3	A	0.300	0.15	0.10	0.14	0.17	0.20	210 (230 – 270)
		0,300	0,15	0,0040	0,0055	0,0065	0,0080	690 (760 – 880)
K5	A	0.200	0.15	0.10	0.14	0.17	0.20	255 (270 – 330)
		0,200	0,15	0,0040	0,0055	0,0065	0,0080	840 (890 – 1000)
K6	A	0.200	0.15	0.10	0.14	0.17	0.20	375 (390 – 500)
		0,200	0,15	0,0040	0,0055	0,0065	0,0080	1225 (1300 – 1600)
K7	A	0.200	0.15	0.10	0.14	0.17	0.20	325 (340 – 430)
		0,200	0,15	0,0040	0,0055	0,0065	0,0080	1075 (1200 – 1400)
H3	M	0.0500	0.020	0.085	0.11	0.14	0.17	85 (88 – 120)
		0,0500	0,020	0,0034	0,0044	0,0055	0,0065	280 (290 – 390)
H5	M	0.200	0.060	0.10	0.14	0.17	0.20	180 (160 – 200)
		0,200	0,060	0,0040	0,0055	0,0065	0,0080	590 (530 – 650)
H7	M	0.0500	0.020	0.085	0.11	0.14	0.17	85 (88 – 120)
		0,0500	0,020	0,0034	0,0044	0,0055	0,0065	280 (290 – 390)
H8	M	0.200	0.060	0.10	0.14	0.17	0.20	180 (160 – 200)
		0,200	0,060	0,0040	0,0055	0,0065	0,0080	590 (530 – 650)
H11	M	0.200	0.060	0.10	0.14	0.17	0.20	230 (210 – 250)
		0,200	0,060	0,0040	0,0055	0,0065	0,0080	750 (690 – 820)
H12	M	0.200	0.060	0.10	0.14	0.17	0.20	210 (190 – 230)
		0,200	0,060	0,0040	0,0055	0,0065	0,0080	690 (630 – 750)
H21	M	0.200	0.060	0.10	0.14	0.17	0.20	180 (160 – 200)
		0,200	0,060	0,0040	0,0055	0,0065	0,0080	590 (530 – 650)
H31	M	0.150	0.060	0.090	0.12	0.15	0.18	125 (130 – 180)
		0,150	0,060	0,0036	0,0048	0,0060	0,0070	410 (430 – 590)

For cutting data recalculations, see pages 445 - 452

SMG = Seco material group
Coolant = A=air D=dry E=emulsion M=mist spray
v_c = m/min (sf/min)
f_z = mm (in/tooth)
a_p = mm/DC (in/DC) = factor
a_e = mm/DC (in/DC) = factor
All cutting data are target values

JH160

High speed – Hardened steel – Ball nose – 4 Flutes – Cylindrical

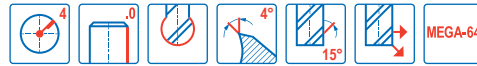
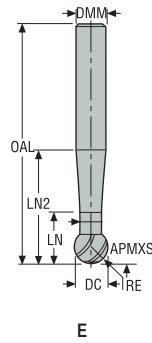

- Tolerances:
- DMM= h5
- DC= 0,02/-0,06 mm
- SA=250°

Designation	Item number	Length index	Tool shape	DC	DMM	APMXS	OAL	LN	LN2	DN	RE	PCEDC	Cylindrical
				mm	mm	mm	mm	mm	mm	mm	mm	mm	mm
160030-MEGA-64	00040365	2	E	3,0	3,0	2,3	60,0	4,5	9,0	1,8	1,5	4	■
160040-MEGA-64	00040366	2	E	4,0	4,0	3,1	60,0	5,6	11,0	2,4	2,0	4	■
160050-MEGA-64	00040367	2	E	5,0	5,0	3,9	70,0	6,4	13,0	3,0	2,5	4	■
160060-MEGA-64	00040368	2	E	6,0	6,0	4,7	80,0	9,7	17,3	3,6	3,0	4	■
160080-MEGA-64	00040369	2	E	8,0	8,0	6,2	85,0	11,2	21,3	4,8	4,0	4	■
160100-MEGA-64	00040370	2	E	10,0	10,0	7,8	100,0	15,6	27,9	6,0	5,0	4	■
160120-MEGA-64	00040371	2	E	12,0	12,0	9,4	125,0	17,2	31,8	7,2	6,0	4	■

■ Stocked standard.

Universal

Steel and cast iron

Stainless steel and S-materials

Non ferrous

Hard

Plastic and CFRP

Graphite

Minimaster Plus

Minimaster

Cutting data – JH160 Copy milling finishing

SMG		a _p /DC	a _r /DC	f _z								v _c
				3	4	5	6	8	10	12		
P1	M/E/A	0.0200	0.024	0.050	0.070	0.085	0.10	0.14	0.17	0.20	550 (450–700)	
		0,0200	0,024	0,0020	0,0028	0,0034	0,0040	0,0055	0,0065	0,0080	1800 (1500 – 2200)	
P2	M/E/A	0.0200	0.024	0.050	0.070	0.085	0.10	0.14	0.17	0.20	530 (440 – 680)	
		0,0200	0,024	0,0020	0,0028	0,0034	0,0040	0,0055	0,0065	0,0080	1750 (1500 – 2200)	
P3	M/E/A	0.0200	0.024	0.050	0.070	0.085	0.10	0.14	0.17	0.20	460 (380 – 590)	
		0,0200	0,024	0,0020	0,0028	0,0034	0,0040	0,0055	0,0065	0,0080	1500 (1300–1900)	
P4	M/E/A	0.0200	0.024	0.050	0.070	0.085	0.10	0.14	0.17	0.20	405 (340 – 520)	
		0,0200	0,024	0,0020	0,0028	0,0034	0,0040	0,0055	0,0065	0,0080	1325 (1200–1700)	
P5	M/E/A	0.0200	0.024	0.050	0.070	0.085	0.10	0.14	0.17	0.20	385 (320 – 490)	
		0,0200	0,024	0,0020	0,0028	0,0034	0,0040	0,0055	0,0065	0,0080	1275 (1100–1600)	
P6	M/E/A	0.0200	0.024	0.050	0.070	0.085	0.10	0.14	0.17	0.20	430 (360 – 560)	
		0,0200	0,024	0,0020	0,0028	0,0034	0,0040	0,0055	0,0065	0,0080	1400 (1200–1800)	
P7	M/E/A	0.0200	0.024	0.050	0.070	0.085	0.10	0.14	0.17	0.20	410 (340 – 520)	
		0,0200	0,024	0,0020	0,0028	0,0034	0,0040	0,0055	0,0065	0,0080	1350 (1200–1700)	
P8	M/E/A	0.0200	0.024	0.050	0.070	0.085	0.10	0.14	0.17	0.20	385 (320 – 490)	
		0,0200	0,024	0,0020	0,0028	0,0034	0,0040	0,0055	0,0065	0,0080	1275 (1100–1600)	
P11	M/E/A	0.0200	0.024	0.050	0.070	0.085	0.10	0.14	0.17	0.20	395 (330 – 510)	
		0,0200	0,024	0,0020	0,0028	0,0034	0,0040	0,0055	0,0065	0,0080	1300 (1100–1600)	
P12	M/E/A	0.0200	0.024	0.050	0.070	0.085	0.10	0.14	0.17	0.20	235 (200 – 300)	
		0,0200	0,024	0,0020	0,0028	0,0034	0,0040	0,0055	0,0065	0,0080	770 (660 – 980)	
H3	M/E/A	0.0100	0.0075	0.040	0.050	0.065	0.080	0.10	0.13	0.16	85 (91–110)	
		0,0100	0,0075	0,0016	0,0020	0,0026	0,0032	0,0040	0,0050	0,0065	280 (300 – 360)	
H5	M/E/A	0.0100	0.016	0.040	0.050	0.065	0.080	0.10	0.13	0.16	340 (320 – 360)	
		0,0100	0,016	0,0016	0,0020	0,0026	0,0032	0,0040	0,0050	0,0065	1125 (1100–1100)	
H7	M/E/A	0.0100	0.0075	0.040	0.050	0.065	0.080	0.10	0.13	0.16	85 (91–110)	
		0,0100	0,0075	0,0016	0,0020	0,0026	0,0032	0,0040	0,0050	0,0065	280 (300 – 360)	
H8	M/E/A	0.0100	0.016	0.040	0.050	0.065	0.080	0.10	0.13	0.16	340 (320 – 360)	
		0,0100	0,016	0,0016	0,0020	0,0026	0,0032	0,0040	0,0050	0,0065	1125 (1100–1100)	
H11	M/E/A	0.0100	0.016	0.040	0.050	0.065	0.080	0.10	0.13	0.16	430 (400 – 460)	
		0,0100	0,016	0,0016	0,0020	0,0026	0,0032	0,0040	0,0050	0,0065	1400 (1400–1500)	
H12	M/E/A	0.0200	0.024	0.050	0.070	0.085	0.10	0.14	0.17	0.20	355 (340 – 380)	
		0,0200	0,024	0,0020	0,0028	0,0034	0,0040	0,0055	0,0065	0,0080	1175 (1200–1200)	
H21	M/E/A	0.0100	0.016	0.040	0.050	0.065	0.080	0.10	0.13	0.16	340 (320 – 360)	
		0,0100	0,016	0,0016	0,0020	0,0026	0,0032	0,0040	0,0050	0,0065	1125 (1100–1100)	
H31	M/E/A	0.0100	0.016	0.040	0.050	0.065	0.080	0.10	0.13	0.16	165 (180 – 210)	
		0,0100	0,016	0,0016	0,0020	0,0026	0,0032	0,0040	0,0050	0,0065	540 (600 – 680)	

For cutting data recalculations, see pages 445 - 452

SMG = Seco material group
Coolant = A=air D=dry E=emulsion M=mist spray
v_c = m/min (sf/min)
f_z = mm (in/tooth)
a_p = mm/DC (in/DC) = factor
a_r = mm/DC (in/DC) = factor
All cutting data are target values



STAINLESS AND S-MATERIALS

Seco offers a complete range of high performance solid carbide square shoulder end mills, ballnose cutters and finish end mills for high productivity in stainless steel and ISO S-materials.

- JS754, JS755, JS720, JHP750, JHP760, JHP770, JHP780, JCG790, JH770, JH740, JH710, JH790, JH730, JHP994 and JCO710 for chamfer or radius type.
- JS730, JH780, JH720, JH721 and JH722 for ball-nose type.

Universal

Steel and cast iron

Stainless steel and
S-materials

Non ferrous

Hard

Plastic and CFRP

Graphite

Minimaster Plus

Minimaster





































Universal
 Steel and cast iron
 Stainless steel and S-materials
 Non ferrous
 Hard
 Plastic and cfrp
 Graphite
 Minimaster Plus
 Minimaster

Tool selection Stainless and S-materials

Name		JS754	JS755	JS720	JS730	JHP750	JHP760	JHP770
Page(s)		211	228	239	249	253	256	260
Family name		JS ²	JS ²	JS ²	JS ²	HPM	HPM	HPM
Type of mill								
Shank	Cylindrical	■	■	■	■	■	■	■
	Weldon	■	■	■	□	■	■	■
	SafeLock	□	□	□	□			□
Number of Flutes		4	5	6-9	6	2,3,4	2,4	4-5
ICC		■					■	■
Diameter range	Metric	3-25	6-25	6-25	6-25	2-20	4-25	6-25
	Inch							
Length availability								
		2,3	2,3	2,3	2,3	1,2	2,4	2
Operation								
SMG								
M1		●	●	●	●		●	
M2		●	●	●	●		●	
M3		●	●	●	●		●	
M4		●	●	●	●		●	
M5		●	●	●	●		●	
S1		●	●			●		
S2		●	●			●		
S3		●	●			●		
S11		●	●	●	●	●		●
S12		●	●	●	●	●		●
S13		●	●	●	●	●		●

■ Stock standard □ Weldon available, delivery time is 3 days. □ Safe-Lock available, delivery time is 6 days
 ● Preferred choice ○ Alternative choice

Tool selection Stainless and S-materials

								
								
Name		JHP780	JCG790	JH770	JH740	JH710	JH790	JH730
Page(s)		267	272	274	276	278	280	282
Family name		HPM	Ceramic	HSM/TORNADO	HSM/TORNADO	HSM/TORNADO	HSM/TORNADO	HSM/TORNADO
Type of mill								
Shank	Cylindrical	■	■	■	■	■	■	■
	Weldon	■						
	SafeLock	□						
Number of Flutes		4	5-6	3,4,5,6	4-5	5	6	6-7
ICC		■						
Diameter range	Metric	6-25	6-25	3-10	6-10	6-8	9,5	8-10
	Inch							
Length availability								
		2	2	2	2	2	2-3	2
Operation								
								
SMG								
M1								
M2								
M3								
M4								
M5								
S1		•	•					
S2		•	•	•	•	•	•	•
S3		•	•					
S11				•	•	•	•	•
S12				•	•	•	•	•
S13								

■ Stock standard □ Weldon available, delivery time is 3 days. □ Safe-Lock available, delivery time is 6 days
● Preferred choice ○ Alternative choice

Universal
Steel and cast iron
Stainless steel and S-materials
Non ferrous
Hard
Plastic and cfrp
Graphite
Minimaster Plus
Minimaster

Universal
Steel and cast iron
Stainless steel and S-materials
Non ferrous
Hard
Plastic and cfrp
Graphite
Minimaster Plus
Minimaster

Tool selection Stainless and S-materials							
Name	JHP994	JH780	JH720	JH721	JH722	JCO710	
Page(s)	284	286	288	290	292	294	
Family name	HPM	HSM/TORNADO	HSM/TORNADO	HSM/TORNADO	HSM/TORNADO	HSS-Co	
Type of mill							
Shank	Cylindrical	■	■	■	■		
	Weldon					■	
	Safelock						
Number of Flutes	4	4	3	6	6	4-6	
ICC							
Diameter range	Metric	6-10	1,83-4,89	2-16	6-8	10	16-40
	Inch						
Length availability							
		3	2	2	2	2	2,4
Operation							
SMG							
M1			●			●	
M2			●			●	
M3			●			●	
M4			●			●	
M5			●			●	
S1			○				
S2	●	●	○	●	●		
S3			○				
S11	●		●	●	●	●	
S12	●	●	●	●	●	●	
S13			●			●	

■ Stock standard □ Weldon available, delivery time is 3 days.
● Preferred choice ○ Alternative choice

JS754

High performance – Square – ISO– M and ISO– S – 4 Flutes – Cylindrical – Chamfer

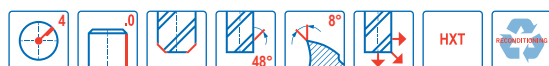
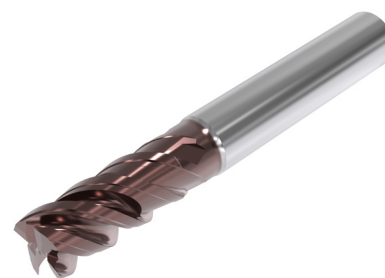
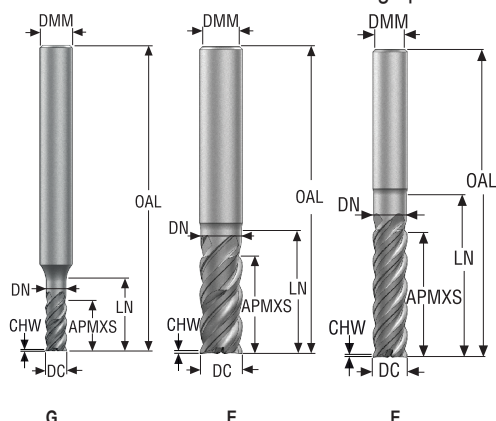

- Tolerances:
- DMM= h5
- DC= e7
- Regrind possible if DC is $\geq \varnothing 6$

Designation	Item number	Length index	Tool shape	DC	DMM	APMXS	OAL	LN	DN	CHW	PCEDC	Cylindrical
				mm	mm	mm	mm	mm	mm	mm		
JS754030G2C.0Z4-HXT	03186807	2	G	3,0	6,0	6,0	57,0	10,0	2,85	0,035	4	■
JS754040G2C.0Z4-HXT	03186808	2	G	4,0	6,0	8,0	57,0	13,0	3,8	0,045	4	■
JS754050G2C.0Z4-HXT	03186809	2	G	5,0	6,0	10,0	57,0	16,0	4,75	0,055	4	■
JS754060E2C.0Z4-HXT	03186810	2	E	6,0	6,0	12,0	57,0	18,0	5,7	0,075	4	■
JS754080E2C.0Z4-HXT	03186811	2	E	8,0	8,0	16,0	63,0	25,0	7,6	0,1	4	■
JS754100E2C.0Z4-HXT	03186812	2	E	10,0	10,0	20,0	72,0	29,0	9,5	0,125	4	■
JS754120E2C.0Z4-HXT	03186813	2	E	12,0	12,0	24,0	83,0	35,0	11,4	0,15	4	■
JS754160E2C.0Z4-HXT	03186814	2	E	16,0	16,0	32,0	92,0	42,0	15,2	0,2	4	■
JS754200E2C.0Z4-HXT	03186815	2	E	20,0	20,0	40,0	104,0	51,0	19,0	0,25	4	■
JS754250E2C.0Z4-HXT	03186816	2	E	25,0	25,0	50,0	121,0	65,0	23,8	0,3	4	■
JS754060E3C.0Z4-HXT	03186823	3	E	6,0	6,0	21,0	65,0	26,0	5,7	0,075	4	■
JS754080E3C.0Z4-HXT	03186824	3	E	8,0	8,0	32,0	75,0	37,0	7,6	0,1	4	■
JS754100E3C.0Z4-HXT	03186825	3	E	10,0	10,0	40,0	89,0	47,0	9,5	0,125	4	■
JS754120E3C.0Z4-HXT	03186826	3	E	12,0	12,0	45,0	100,0	53,0	11,4	0,15	4	■
JS754160E3C.0Z4-HXT	03186827	3	E	16,0	16,0	55,0	115,0	65,0	15,2	0,2	4	■
JS754200E3C.0Z4-HXT	03186828	3	E	20,0	20,0	61,0	125,0	72,0	19,0	0,25	4	■
JS754250E3C.0Z4-HXT	03186829	3	E	25,0	25,0	85,0	153,0	94,0	23,8	0,3	4	■

■ Stocked standard.

Universal

Steel and cast iron

Stainless steel and S-materials

Non ferrous

Hard

Plastic and chip

Graphite

Minimaster Plus

Minimaster

JS754

High performance – Square – ISO– M and ISO– S – 4 Flutes – Cylindrical – Chamfer – Chip splitters

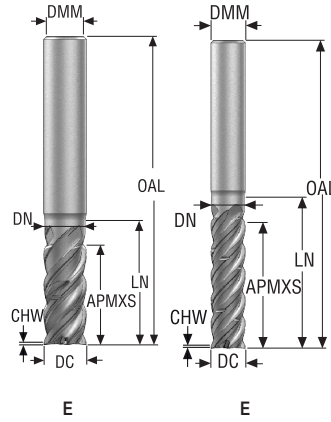

- Tolerances:
- DMM= h5
- DC= e7
- Chip splitters
- Regrind possible if DC is $\geq \varnothing 6$

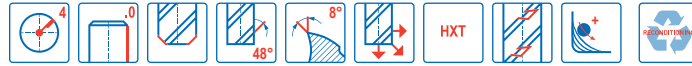

Designation	Item number	Length index	Tool shape	Chip splitters	DC	DMM	APMXS	OAL	LN	DN	CHW	PCEDC	Cylindrical
					mm	mm	mm	mm	mm	mm	mm		
JS754100E2C.0Z4C-HXT	03186817	2	E	■	10,0	10,0	20,0	72,0	29,0	9,5	0,125	4	■
JS754120E2C.0Z4C-HXT	03186818	2	E	■	12,0	12,0	24,0	83,0	35,0	11,4	0,15	4	■
JS754060E3C.0Z4C-HXT	03200550	3	E	■	6,0	6,0	21,0	65,0	26,0	5,7	0,075	4	■
JS754080E3C.0Z4C-HXT	03200551	3	E	■	8,0	8,0	32,0	75,0	37,0	7,6	0,1	4	■
JS754100E3C.0Z4C-HXT	03186830	3	E	■	10,0	10,0	40,0	89,0	47,0	9,5	0,125	4	■
JS754120E3C.0Z4C-HXT	03186831	3	E	■	12,0	12,0	45,0	100,0	53,0	11,4	0,15	4	■
JS754160E3C.0Z4C-HXT	03186832	3	E	■	16,0	16,0	55,0	115,0	65,0	15,2	0,2	4	■
JS754200E3C.0Z4C-HXT	03186833	3	E	■	20,0	20,0	61,0	125,0	72,0	19,0	0,25	4	■

■ Stocked standard.

Universal

Steel and cast iron

Stainless steel and S-materials

Non ferrous

Hard

Plastic and cfrp

Graphite

Minimaster Plus

Minimaster

JS754

High performance – Square – ISO– M and ISO– S – 4 Flutes – Cylindrical – Chamfer – ICC

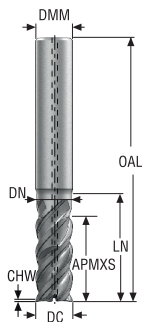

E

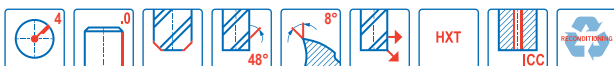

- Tolerances:
- DMM= h5
- DC= e7
- Regrind possible if DC is $\geq \varnothing 6$

Designation	Item number	Length index	Tool shape	ICC	DC	DMM	APMXS	OAL	LN	DN	CHW	PCEDC	Cylindrical
					mm	mm	mm	mm	mm	mm	mm		
JS754060E2C.0Z4A-HXT	03186834	2	E	■	6,0	6,0	12,0	57,0	18,0	5,7	0,075	4	■
JS754080E2C.0Z4A-HXT	03186835	2	E	■	8,0	8,0	16,0	63,0	25,0	7,6	0,1	4	■
JS754100E2C.0Z4A-HXT	03186836	2	E	■	10,0	10,0	20,0	72,0	29,0	9,5	0,125	4	■
JS754120E2C.0Z4A-HXT	03186837	2	E	■	12,0	12,0	24,0	83,0	35,0	11,4	0,15	4	■
JS754160E2C.0Z4A-HXT	03186838	2	E	■	16,0	16,0	32,0	92,0	42,0	15,2	0,2	4	■
JS754200E2C.0Z4A-HXT	03186839	2	E	■	20,0	20,0	40,0	104,0	51,0	19,0	0,25	4	■

■ Stocked standard. ICC = Internal Coolant Channel

Universal

Steel and cast iron

Stainless steel and S-materials

Non ferrous

Hard

Plastic and cfrp

Graphite

Minimaster Plus

Minimaster

JS754

High performance – Square – ISO– M and ISO– S – 4 Flutes – Cylindrical – Corner radius

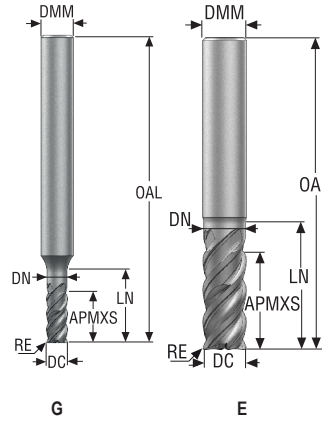
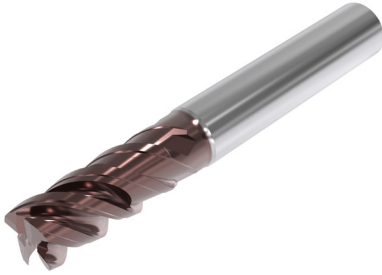

- Tolerances:
- DMM= h5
- DC= e7
- RE= ±0,01 mm
- Regrind possible if DC is ≥Ø6

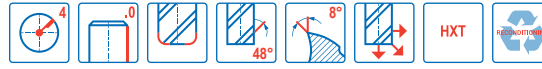

Designation	Item number	Length index	Tool shape	DC	DMM	APMXS	OAL	LN	DN	RE	PCEDC	Cylindrical
				mm	mm	mm	mm	mm	mm	mm		
JS754030G2R020.0Z4-HXT	03186840	2	G	3,0	6,0	6,0	57,0	10,0	2,85	0,2	4	■
JS754040G2R020.0Z4-HXT	03186841	2	G	4,0	6,0	8,0	57,0	13,0	3,8	0,2	4	■
JS754050G2R020.0Z4-HXT	03186842	2	G	5,0	6,0	10,0	57,0	16,0	4,75	0,2	4	■
JS754060E2R020.0Z4-HXT	03186843	2	E	6,0	6,0	12,0	57,0	18,0	5,7	0,2	4	■
JS754060E2R050.0Z4-HXT	03186844	2	E	6,0	6,0	12,0	57,0	18,0	5,7	0,5	4	■
JS754060E2R100.0Z4-HXT	03186845	2	E	6,0	6,0	12,0	57,0	18,0	5,7	1,0	4	■
JS754080E2R050.0Z4-HXT	03186846	2	E	8,0	8,0	16,0	63,0	25,0	7,6	0,5	4	■
JS754080E2R100.0Z4-HXT	03186847	2	E	8,0	8,0	16,0	63,0	25,0	7,6	1,0	4	■
JS754100E2R050.0Z4-HXT	03186848	2	E	10,0	10,0	20,0	72,0	29,0	9,5	0,5	4	■
JS754100E2R100.0Z4-HXT	03186849	2	E	10,0	10,0	20,0	72,0	29,0	9,5	1,0	4	■
JS754100E2R150.0Z4-HXT	03200552	2	E	10,0	10,0	20,0	72,0	29,0	9,5	1,5	4	■
JS754100E2R200.0Z4-HXT	03186850	2	E	10,0	10,0	20,0	72,0	29,0	9,5	2,0	4	■
JS754100E2R300.0Z4-HXT	03186851	2	E	10,0	10,0	20,0	72,0	29,0	9,5	3,0	4	■
JS754120E2R050.0Z4-HXT	03186852	2	E	12,0	12,0	24,0	83,0	35,0	11,4	0,5	4	■
JS754120E2R100.0Z4-HXT	03186853	2	E	12,0	12,0	24,0	83,0	35,0	11,4	1,0	4	■
JS754120E2R150.0Z4-HXT	03200553	2	E	12,0	12,0	24,0	83,0	35,0	11,4	1,5	4	■
JS754120E2R200.0Z4-HXT	03186854	2	E	12,0	12,0	24,0	83,0	35,0	11,4	2,0	4	■
JS754120E2R300.0Z4-HXT	03186855	2	E	12,0	12,0	24,0	83,0	35,0	11,4	3,0	4	■
JS754160E2R050.0Z4-HXT	03186856	2	E	16,0	16,0	32,0	92,0	42,0	15,2	0,5	4	■
JS754160E2R100.0Z4-HXT	03186857	2	E	16,0	16,0	32,0	92,0	42,0	15,2	1,0	4	■
JS754160E2R200.0Z4-HXT	03186858	2	E	16,0	16,0	32,0	92,0	42,0	15,2	2,0	4	■
JS754160E2R300.0Z4-HXT	03186859	2	E	16,0	16,0	32,0	92,0	42,0	15,2	3,0	4	■
JS754160E2R400.0Z4-HXT	03186860	2	E	16,0	16,0	32,0	92,0	42,0	15,2	4,0	4	■
JS754160E2R600.0Z4-HXT	03186861	2	E	16,0	16,0	32,0	92,0	42,0	15,2	6,0	4	■
JS754200E2R050.0Z4-HXT	03186862	2	E	20,0	20,0	40,0	104,0	51,0	19,0	0,5	4	■
JS754200E2R100.0Z4-HXT	03186863	2	E	20,0	20,0	40,0	104,0	51,0	19,0	1,0	4	■
JS754200E2R200.0Z4-HXT	03186864	2	E	20,0	20,0	40,0	104,0	51,0	19,0	2,0	4	■
JS754200E2R300.0Z4-HXT	03186865	2	E	20,0	20,0	40,0	104,0	51,0	19,0	3,0	4	■
JS754200E2R400.0Z4-HXT	03186866	2	E	20,0	20,0	40,0	104,0	51,0	19,0	4,0	4	■
JS754200E2R600.0Z4-HXT	03186867	2	E	20,0	20,0	40,0	104,0	51,0	19,0	6,0	4	■

■ Stocked standard.

JS754

High performance – Square – ISO– M and ISO– S – 4 Flutes – Cylindrical – Corner radius

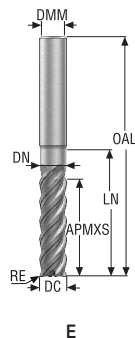

E

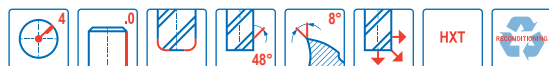

- Tolerances:
- DMM= h5
- DC= e7
- RE= ±0,01 mm
- Re grind possible if DC is ≥Ø6

Designation	Item number	Length index	Tool shape	DC	DMM	APMXS	OAL	LN	DN	RE	PCEDC	Cylindrical
				mm	mm	mm	mm	mm	mm	mm		
JS754060E3R020.0Z4-HXT	03186873	3	E	6,0	6,0	21,0	65,0	26,0	5,7	0,2	4	■
JS754060E3R050.0Z4-HXT	03186874	3	E	6,0	6,0	21,0	65,0	26,0	5,7	0,5	4	■
JS754060E3R100.0Z4-HXT	03186875	3	E	6,0	6,0	21,0	65,0	26,0	5,7	1,0	4	■
JS754080E3R050.0Z4-HXT	03186876	3	E	8,0	8,0	32,0	75,0	37,0	7,6	0,5	4	■
JS754080E3R100.0Z4-HXT	03186877	3	E	8,0	8,0	32,0	75,0	37,0	7,6	1,0	4	■
JS754100E3R050.0Z4-HXT	03186878	3	E	10,0	10,0	40,0	89,0	47,0	9,5	0,5	4	■
JS754100E3R100.0Z4-HXT	03186879	3	E	10,0	10,0	40,0	89,0	47,0	9,5	1,0	4	■
JS754100E3R200.0Z4-HXT	03186880	3	E	10,0	10,0	40,0	89,0	47,0	9,5	2,0	4	■
JS754100E3R300.0Z4-HXT	03186881	3	E	10,0	10,0	40,0	89,0	47,0	9,5	3,0	4	■
JS754120E3R050.0Z4-HXT	03186882	3	E	12,0	12,0	45,0	100,0	53,0	11,4	0,5	4	■
JS754120E3R100.0Z4-HXT	03186883	3	E	12,0	12,0	45,0	100,0	53,0	11,4	1,0	4	■
JS754120E3R200.0Z4-HXT	03186884	3	E	12,0	12,0	45,0	100,0	53,0	11,4	2,0	4	■
JS754120E3R300.0Z4-HXT	03186885	3	E	12,0	12,0	45,0	100,0	53,0	11,4	3,0	4	■
JS754160E3R050.0Z4-HXT	03186886	3	E	16,0	16,0	55,0	115,0	65,0	15,2	0,5	4	■
JS754160E3R100.0Z4-HXT	03186887	3	E	16,0	16,0	55,0	115,0	65,0	15,2	1,0	4	■
JS754160E3R200.0Z4-HXT	03186888	3	E	16,0	16,0	55,0	115,0	65,0	15,2	2,0	4	■
JS754160E3R300.0Z4-HXT	03186889	3	E	16,0	16,0	55,0	115,0	65,0	15,2	3,0	4	■
JS754160E3R400.0Z4-HXT	03186890	3	E	16,0	16,0	55,0	115,0	65,0	15,2	4,0	4	■
JS754160E3R600.0Z4-HXT	03186891	3	E	16,0	16,0	55,0	115,0	65,0	15,2	6,0	4	■
JS754200E3R050.0Z4-HXT	03186892	3	E	20,0	20,0	61,0	125,0	72,0	19,0	0,5	4	■
JS754200E3R100.0Z4-HXT	03186893	3	E	20,0	20,0	61,0	125,0	72,0	19,0	1,0	4	■
JS754200E3R200.0Z4-HXT	03186894	3	E	20,0	20,0	61,0	125,0	72,0	19,0	2,0	4	■
JS754200E3R300.0Z4-HXT	03186895	3	E	20,0	20,0	61,0	125,0	72,0	19,0	3,0	4	■
JS754200E3R400.0Z4-HXT	03186896	3	E	20,0	20,0	61,0	125,0	72,0	19,0	4,0	4	■
JS754200E3R600.0Z4-HXT	03186897	3	E	20,0	20,0	61,0	125,0	72,0	19,0	6,0	4	■

■ Stocked standard.

Universal

Steel and cast iron

Stainless steel and S-materials

Non ferrous

Hard

Plastic and chip

Graphite

Minimaster Plus

Minimaster

JS754

High performance – Square – ISO– M and ISO– S – 4 Flutes – Weldon – Chamfer

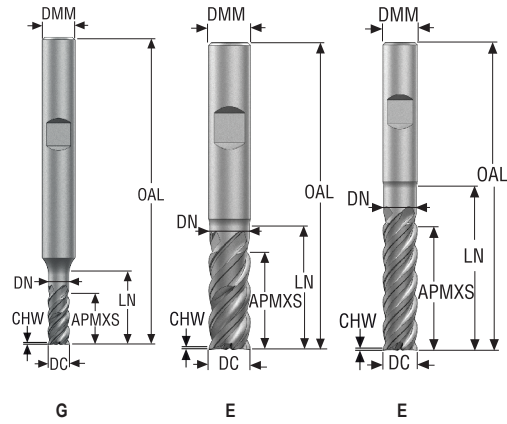
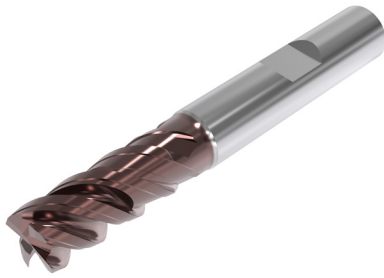

- Tolerances:
- DMM= h5
- DC= e7
- Regrind possible if DC is $\geq \phi 6$

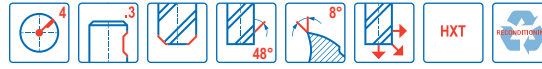

Designation	Item number	Length index	Tool shape	DC	DMM	APMXS	OAL	LN	DN	CHW	PCEDC	Weldon
				mm	mm	mm	mm	mm	mm	mm		
JS754030G2C.3Z4-HXT	03186975	2	G	3,0	6,0	6,0	57,0	10,0	2,85	0,035	4	<input type="checkbox"/>
JS754040G2C.3Z4-HXT	03186976	2	G	4,0	6,0	8,0	57,0	13,0	3,8	0,045	4	<input type="checkbox"/>
JS754050G2C.3Z4-HXT	03186977	2	G	5,0	6,0	10,0	57,0	16,0	4,75	0,055	4	<input type="checkbox"/>
JS754060E2C.3Z4-HXT	03186978	2	E	6,0	6,0	12,0	57,0	18,0	5,7	0,075	4	<input checked="" type="checkbox"/>
JS754080E2C.3Z4-HXT	03186979	2	E	8,0	8,0	16,0	63,0	25,0	7,6	0,1	4	<input checked="" type="checkbox"/>
JS754100E2C.3Z4-HXT	03186980	2	E	10,0	10,0	20,0	72,0	29,0	9,5	0,125	4	<input checked="" type="checkbox"/>
JS754120E2C.3Z4-HXT	03186981	2	E	12,0	12,0	24,0	83,0	35,0	11,4	0,15	4	<input checked="" type="checkbox"/>
JS754160E2C.3Z4-HXT	03186982	2	E	16,0	16,0	32,0	92,0	42,0	15,2	0,2	4	<input checked="" type="checkbox"/>
JS754200E2C.3Z4-HXT	03186983	2	E	20,0	20,0	40,0	104,0	51,0	19,0	0,25	4	<input checked="" type="checkbox"/>
JS754250E2C.3Z4-HXT	03186984	2	E	25,0	25,0	50,0	121,0	65,0	23,8	0,3	4	<input checked="" type="checkbox"/>
JS754060E3C.3Z4-HXT	03186990	3	E	6,0	6,0	21,0	65,0	26,0	5,7	0,075	4	<input checked="" type="checkbox"/>
JS754080E3C.3Z4-HXT	03186991	3	E	8,0	8,0	32,0	75,0	37,0	7,6	0,1	4	<input checked="" type="checkbox"/>
JS754100E3C.3Z4-HXT	03186992	3	E	10,0	10,0	40,0	89,0	47,0	9,5	0,125	4	<input checked="" type="checkbox"/>
JS754120E3C.3Z4-HXT	03186993	3	E	12,0	12,0	45,0	100,0	53,0	11,4	0,15	4	<input checked="" type="checkbox"/>
JS754160E3C.3Z4-HXT	03186994	3	E	16,0	16,0	55,0	115,0	65,0	15,2	0,2	4	<input checked="" type="checkbox"/>
JS754200E3C.3Z4-HXT	03186995	3	E	20,0	20,0	61,0	125,0	72,0	19,0	0,25	4	<input checked="" type="checkbox"/>
JS754250E3C.3Z4-HXT	03186996	3	E	25,0	25,0	85,0	153,0	94,0	23,8	0,3	4	<input checked="" type="checkbox"/>

■ Stocked standard. □ Weldon available. Delivery time is 3 days.

JS754

High performance – Square – ISO– M and ISO– S – 4 Flutes – Weldon – Chamfer – Chip splitters

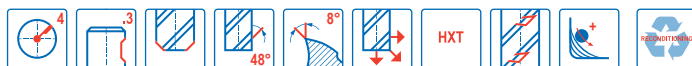
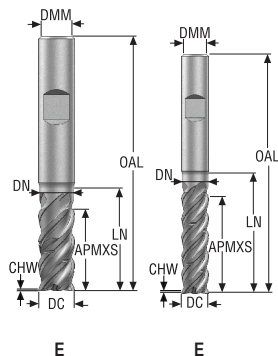

- Tolerances:
- DMM= h5
- DC= e7
- Chip splitters
- Regrind possible if DC is $\geq \varnothing 6$

Designation	Item number	Length index	Tool shape	Chip splitters	DC	DMM	APMXS	OAL	LN	DN	CHW	PCEDC	Weldon
					mm	mm	mm	mm	mm	mm	mm		
JS754100E2C.3Z4C-HXT	03186985	2	E	■	10,0	10,0	20,0	72,0	29,0	9,5	0,125	4	■
JS754120E2C.3Z4C-HXT	03186986	2	E	■	12,0	12,0	24,0	83,0	35,0	11,4	0,15	4	■
JS754060E3C.3Z4C-HXT	03200562	3	E	■	6,0	6,0	21,0	65,0	26,0	5,7	0,075	4	■
JS754080E3C.3Z4C-HXT	03200563	3	E	■	8,0	8,0	32,0	75,0	37,0	7,6	0,1	4	■
JS754100E3C.3Z4C-HXT	03186997	3	E	■	10,0	10,0	40,0	89,0	47,0	9,5	0,125	4	■
JS754120E3C.3Z4C-HXT	03186998	3	E	■	12,0	12,0	45,0	100,0	53,0	11,4	0,15	4	■
JS754160E3C.3Z4C-HXT	03186999	3	E	■	16,0	16,0	55,0	115,0	65,0	15,2	0,2	4	■
JS754200E3C.3Z4C-HXT	03187000	3	E	■	20,0	20,0	61,0	125,0	72,0	19,0	0,25	4	■

■ Stocked standard.

Universal

Steel and cast iron

Stainless steel and S-materials

Non ferrous

Hard

Plastic and chip

Graphite

Minimaster Plus

Minimaster

JS754

High performance – Square – ISO– M and ISO– S – 4 Flutes – Weldon – Chamfer – ICC

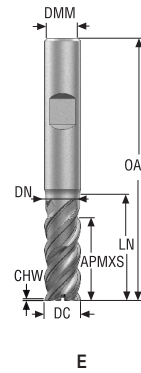
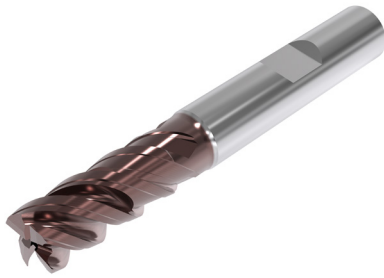

- Tolerances:
- DMM= h5
- DC= e7
- Regrind possible if DC is $\geq \phi 6$

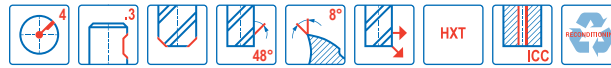

Designation	Item number	Length index	Tool shape	ICC	DC	DMM	APMXS	OAL	LN	DN	CHW	PCEDC	Weldon
					mm	mm	mm	mm	mm	mm	mm		
JS754060E2C.3Z4A-HXT	03187001	2	E	■	6,0	6,0	12,0	57,0	18,0	5,7	0,075	4	■
JS754080E2C.3Z4A-HXT	03187002	2	E	■	8,0	8,0	16,0	63,0	25,0	7,6	0,1	4	■
JS754100E2C.3Z4A-HXT	03187003	2	E	■	10,0	10,0	20,0	72,0	29,0	9,5	0,125	4	■
JS754120E2C.3Z4A-HXT	03187004	2	E	■	12,0	12,0	24,0	83,0	35,0	11,4	0,15	4	■
JS754160E2C.3Z4A-HXT	03187005	2	E	■	16,0	16,0	32,0	92,0	42,0	15,2	0,2	4	■
JS754200E2C.3Z4A-HXT	03187006	2	E	■	20,0	20,0	40,0	104,0	51,0	19,0	0,25	4	■

■ Stocked standard. ICC = Internal Coolant Channel

Universal

Steel and cast iron

Stainless steel and S-materials

Non ferrous

Hard

Plastic and cfrp

Graphite

Minimaster Plus

Minimaster

JS754

High performance – Square – ISO– M and ISO– S – 4 Flutes – Weldon – Corner radius

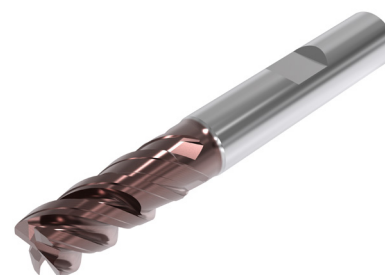
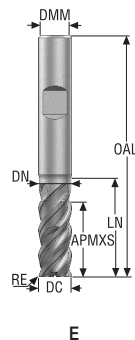

- Tolerances:
- DMM= h5
- DC= e7
- RE= ±0,01 mm
- Re grind possible if DC is ≥Ø6

Designation	Item number	Length index	Tool shape	DC	DMM	APMXS	OAL	LN	DN	RE	PCEDC	Weldon
				mm	mm	mm	mm	mm	mm	mm		
JS754030G2R020.3Z4-HXT	03187007	2	G	3,0	6,0	6,0	57,0	10,0	2,85	0,2	4	<input type="checkbox"/>
JS754040G2R020.3Z4-HXT	03187008	2	G	4,0	6,0	8,0	57,0	13,0	3,8	0,2	4	<input type="checkbox"/>
JS754050G2R020.3Z4-HXT	03187009	2	G	5,0	6,0	10,0	57,0	16,0	4,75	0,2	4	<input type="checkbox"/>
JS754060E2R020.3Z4-HXT	03187010	2	E	6,0	6,0	12,0	57,0	18,0	5,7	0,2	4	<input checked="" type="checkbox"/>
JS754060E2R050.3Z4-HXT	03187011	2	E	6,0	6,0	12,0	57,0	18,0	5,7	0,5	4	<input checked="" type="checkbox"/>
JS754060E2R100.3Z4-HXT	03187012	2	E	6,0	6,0	12,0	57,0	18,0	5,7	1,0	4	<input checked="" type="checkbox"/>
JS754080E2R050.3Z4-HXT	03187013	2	E	8,0	8,0	16,0	63,0	25,0	7,6	0,5	4	<input checked="" type="checkbox"/>
JS754080E2R100.3Z4-HXT	03187014	2	E	8,0	8,0	16,0	63,0	25,0	7,6	1,0	4	<input checked="" type="checkbox"/>
JS754100E2R050.3Z4-HXT	03187015	2	E	10,0	10,0	20,0	72,0	29,0	9,5	0,5	4	<input checked="" type="checkbox"/>
JS754100E2R100.3Z4-HXT	03187016	2	E	10,0	10,0	20,0	72,0	29,0	9,5	1,0	4	<input checked="" type="checkbox"/>
JS754100E2R150.3Z4-HXT	03200564	2	E	10,0	10,0	20,0	72,0	29,0	9,5	1,5	4	<input checked="" type="checkbox"/>
JS754100E2R200.3Z4-HXT	03187017	2	E	10,0	10,0	20,0	72,0	29,0	9,5	2,0	4	<input checked="" type="checkbox"/>
JS754100E2R300.3Z4-HXT	03187018	2	E	10,0	10,0	20,0	72,0	29,0	9,5	3,0	4	<input checked="" type="checkbox"/>
JS754120E2R050.3Z4-HXT	03187019	2	E	12,0	12,0	24,0	83,0	35,0	11,4	0,5	4	<input checked="" type="checkbox"/>
JS754120E2R100.3Z4-HXT	03187020	2	E	12,0	12,0	24,0	83,0	35,0	11,4	1,0	4	<input checked="" type="checkbox"/>
JS754120E2R150.3Z4-HXT	03200565	2	E	12,0	12,0	24,0	83,0	35,0	11,4	1,5	4	<input checked="" type="checkbox"/>
JS754120E2R200.3Z4-HXT	03187021	2	E	12,0	12,0	24,0	83,0	35,0	11,4	2,0	4	<input checked="" type="checkbox"/>
JS754120E2R300.3Z4-HXT	03187022	2	E	12,0	12,0	24,0	83,0	35,0	11,4	3,0	4	<input checked="" type="checkbox"/>
JS754160E2R050.3Z4-HXT	03187023	2	E	16,0	16,0	32,0	92,0	42,0	15,2	0,5	4	<input checked="" type="checkbox"/>
JS754160E2R100.3Z4-HXT	03187024	2	E	16,0	16,0	32,0	92,0	42,0	15,2	1,0	4	<input checked="" type="checkbox"/>
JS754160E2R200.3Z4-HXT	03187025	2	E	16,0	16,0	32,0	92,0	42,0	15,2	2,0	4	<input checked="" type="checkbox"/>
JS754160E2R300.3Z4-HXT	03187026	2	E	16,0	16,0	32,0	92,0	42,0	15,2	3,0	4	<input checked="" type="checkbox"/>
JS754160E2R400.3Z4-HXT	03187027	2	E	16,0	16,0	32,0	92,0	42,0	15,2	4,0	4	<input checked="" type="checkbox"/>
JS754160E2R600.3Z4-HXT	03187028	2	E	16,0	16,0	32,0	92,0	42,0	15,2	6,0	4	<input checked="" type="checkbox"/>
JS754200E2R050.3Z4-HXT	03187029	2	E	20,0	20,0	40,0	104,0	51,0	19,0	0,5	4	<input checked="" type="checkbox"/>
JS754200E2R100.3Z4-HXT	03187030	2	E	20,0	20,0	40,0	104,0	51,0	19,0	1,0	4	<input checked="" type="checkbox"/>
JS754200E2R200.3Z4-HXT	03187031	2	E	20,0	20,0	40,0	104,0	51,0	19,0	2,0	4	<input checked="" type="checkbox"/>
JS754200E2R300.3Z4-HXT	03187032	2	E	20,0	20,0	40,0	104,0	51,0	19,0	3,0	4	<input checked="" type="checkbox"/>
JS754200E2R400.3Z4-HXT	03187033	2	E	20,0	20,0	40,0	104,0	51,0	19,0	4,0	4	<input checked="" type="checkbox"/>
JS754200E2R600.3Z4-HXT	03187034	2	E	20,0	20,0	40,0	104,0	51,0	19,0	6,0	4	<input checked="" type="checkbox"/>

■ Stocked standard. □ Weldon available. Delivery time is 3 days.

Universal

Steel and cast iron

Stainless steel and S-materials

Non ferrous

Hard

Plastic and chip

Graphite

Minimaster Plus

Minimaster

JS754

High performance – Square – ISO– M and ISO– S – 4 Flutes – Weldon – Corner radius

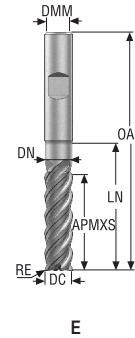

- Tolerances:
- DMM= h5
- DC= e7
- RE= ±0,01 mm
- Regrind possible if DC is ≥Ø6

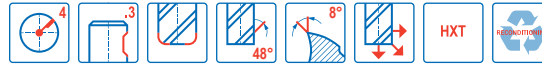

Designation	Item number	Length index	Tool shape	DC	DMM	APMXS	OAL	LN	DN	RE	PCEDC	Weldon
				mm	mm	mm	mm	mm	mm	mm		
JS754060E3R020.3Z4-HXT	03187040	3	E	6,0	6,0	21,0	65,0	26,0	5,7	0,2	4	<input type="checkbox"/>
JS754060E3R050.3Z4-HXT	03187041	3	E	6,0	6,0	21,0	65,0	26,0	5,7	0,5	4	<input type="checkbox"/>
JS754060E3R100.3Z4-HXT	03187042	3	E	6,0	6,0	21,0	65,0	26,0	5,7	1,0	4	<input type="checkbox"/>
JS754080E3R050.3Z4-HXT	03187043	3	E	8,0	8,0	32,0	75,0	37,0	7,6	0,5	4	<input type="checkbox"/>
JS754080E3R100.3Z4-HXT	03187044	3	E	8,0	8,0	32,0	75,0	37,0	7,6	1,0	4	<input type="checkbox"/>
JS754100E3R050.3Z4-HXT	03187045	3	E	10,0	10,0	40,0	89,0	47,0	9,5	0,5	4	<input type="checkbox"/>
JS754100E3R100.3Z4-HXT	03187046	3	E	10,0	10,0	40,0	89,0	47,0	9,5	1,0	4	<input type="checkbox"/>
JS754100E3R200.3Z4-HXT	03187047	3	E	10,0	10,0	40,0	89,0	47,0	9,5	2,0	4	<input type="checkbox"/>
JS754100E3R300.3Z4-HXT	03187049	3	E	10,0	10,0	40,0	89,0	47,0	9,5	3,0	4	<input type="checkbox"/>
JS754120E3R050.3Z4-HXT	03187050	3	E	12,0	12,0	45,0	100,0	53,0	11,4	0,5	4	<input type="checkbox"/>
JS754120E3R100.3Z4-HXT	03187051	3	E	12,0	12,0	45,0	100,0	53,0	11,4	1,0	4	<input type="checkbox"/>
JS754120E3R200.3Z4-HXT	03187052	3	E	12,0	12,0	45,0	100,0	53,0	11,4	2,0	4	<input type="checkbox"/>
JS754120E3R300.3Z4-HXT	03187053	3	E	12,0	12,0	45,0	100,0	53,0	11,4	3,0	4	<input type="checkbox"/>
JS754160E3R050.3Z4-HXT	03187054	3	E	16,0	16,0	55,0	115,0	65,0	15,2	0,5	4	<input type="checkbox"/>
JS754160E3R100.3Z4-HXT	03187055	3	E	16,0	16,0	55,0	115,0	65,0	15,2	1,0	4	<input type="checkbox"/>
JS754160E3R200.3Z4-HXT	03187056	3	E	16,0	16,0	55,0	115,0	65,0	15,2	2,0	4	<input type="checkbox"/>
JS754160E3R300.3Z4-HXT	03187057	3	E	16,0	16,0	55,0	115,0	65,0	15,2	3,0	4	<input type="checkbox"/>
JS754160E3R400.3Z4-HXT	03187058	3	E	16,0	16,0	55,0	115,0	65,0	15,2	4,0	4	<input type="checkbox"/>
JS754160E3R600.3Z4-HXT	03187059	3	E	16,0	16,0	55,0	115,0	65,0	15,2	6,0	4	<input type="checkbox"/>
JS754200E3R050.3Z4-HXT	03187060	3	E	20,0	20,0	61,0	125,0	72,0	19,0	0,5	4	<input type="checkbox"/>
JS754200E3R100.3Z4-HXT	03187061	3	E	20,0	20,0	61,0	125,0	72,0	19,0	1,0	4	<input type="checkbox"/>
JS754200E3R200.3Z4-HXT	03187062	3	E	20,0	20,0	61,0	125,0	72,0	19,0	2,0	4	<input type="checkbox"/>
JS754200E3R300.3Z4-HXT	03187063	3	E	20,0	20,0	61,0	125,0	72,0	19,0	3,0	4	<input type="checkbox"/>
JS754200E3R400.3Z4-HXT	03187064	3	E	20,0	20,0	61,0	125,0	72,0	19,0	4,0	4	<input type="checkbox"/>
JS754200E3R600.3Z4-HXT	03187065	3	E	20,0	20,0	61,0	125,0	72,0	19,0	6,0	4	<input type="checkbox"/>

Weldon available. Delivery time is 3 days.

JS754

High performance – Square – ISO– M and ISO– S – 4 Flutes – Safelock – Chamfer

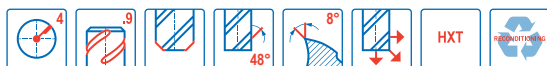
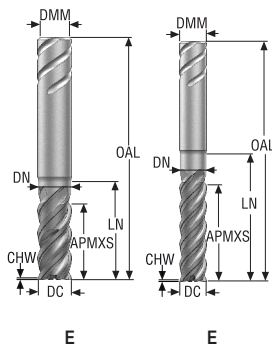

- Tolerances:
- DMM= h5
- DC= e7
- Regrind possible if DC is $\geq \varnothing 6$

Designation	Item number	Length index	Tool shape	DC	DMM	APMXS	OAL	LN	DN	CHW	PCEDC	Safelock
				mm	mm	mm	mm	mm	mm	mm		
JS754060E2C.9Z4-HXT	03187144	2	E	6,0	6,0	12,0	57,0	18,0	5,7	0,075	4	<input type="checkbox"/>
JS754080E2C.9Z4-HXT	03187145	2	E	8,0	8,0	16,0	63,0	25,0	7,6	0,1	4	<input type="checkbox"/>
JS754100E2C.9Z4-HXT	03187146	2	E	10,0	10,0	20,0	72,0	29,0	9,5	0,125	4	<input type="checkbox"/>
JS754120E2C.9Z4-HXT	03187147	2	E	12,0	12,0	24,0	83,0	35,0	11,4	0,15	4	<input type="checkbox"/>
JS754160E2C.9Z4-HXT	03187148	2	E	16,0	16,0	32,0	92,0	42,0	15,2	0,2	4	<input type="checkbox"/>
JS754200E2C.9Z4-HXT	03187149	2	E	20,0	20,0	40,0	104,0	51,0	19,0	0,25	4	<input type="checkbox"/>
JS754250E2C.9Z4-HXT	03187150	2	E	25,0	25,0	50,0	121,0	65,0	23,8	0,3	4	<input type="checkbox"/>
JS754060E3C.9Z4-HXT	03187153	3	E	6,0	6,0	21,0	65,0	26,0	5,7	0,075	4	<input type="checkbox"/>
JS754080E3C.9Z4-HXT	03187154	3	E	8,0	8,0	32,0	75,0	37,0	7,6	0,1	4	<input type="checkbox"/>
JS754100E3C.9Z4-HXT	03187155	3	E	10,0	10,0	40,0	89,0	47,0	9,5	0,125	4	<input type="checkbox"/>
JS754120E3C.9Z4-HXT	03187156	3	E	12,0	12,0	45,0	100,0	53,0	11,4	0,15	4	<input type="checkbox"/>
JS754160E3C.9Z4-HXT	03187157	3	E	16,0	16,0	55,0	115,0	65,0	15,2	0,2	4	<input type="checkbox"/>
JS754200E3C.9Z4-HXT	03187158	3	E	20,0	20,0	61,0	125,0	72,0	19,0	0,25	4	<input type="checkbox"/>
JS754250E3C.9Z4-HXT	03187159	3	E	25,0	25,0	85,0	153,0	94,0	23,8	0,3	4	<input type="checkbox"/>

Safelock available. Delivery time is 6 days.

Universal

Steel and cast iron

Stainless steel and S-materials

Non ferrous

Hard

Plastic and chip

Graphite

Minimaster Plus

Minimaster

JS754

High performance – Square – ISO– M and ISO– S – 4 Flutes – Safelock – Chamfer – Chip splitters

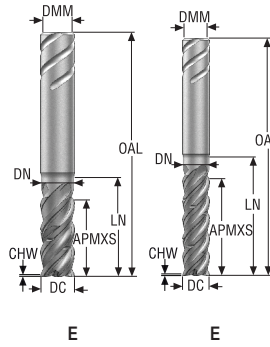

- Tolerances:
- DMM= h5
- DC= e7
- Chip splitters
- Regrind possible if DC is $\geq \varnothing 6$



Designation	Item number	Length index	Tool shape	Chip splitters	DC	DMM	APMXS	OAL	LN	DN	CHW	PCEDC	Safelock
					mm	mm	mm	mm	mm	mm	mm		
JS754100E2C.9Z4C-HXT	03187151	2	E	■	10,0	10,0	20,0	72,0	29,0	9,5	0,125	4	<input type="checkbox"/>
JS754120E2C.9Z4C-HXT	03187152	2	E	■	12,0	12,0	24,0	83,0	35,0	11,4	0,15	4	<input type="checkbox"/>
JS754060E3C.9Z4C-HXT	03200571	3	E	■	6,0	6,0	21,0	65,0	26,0	5,7	0,075	4	<input type="checkbox"/>
JS754080E3C.9Z4C-HXT	03200572	3	E	■	8,0	8,0	32,0	75,0	37,0	7,6	0,1	4	<input type="checkbox"/>
JS754100E3C.9Z4C-HXT	03187160	3	E	■	10,0	10,0	40,0	89,0	47,0	9,5	0,125	4	<input type="checkbox"/>
JS754120E3C.9Z4C-HXT	03187161	3	E	■	12,0	12,0	45,0	100,0	53,0	11,4	0,15	4	<input type="checkbox"/>
JS754160E3C.9Z4C-HXT	03187162	3	E	■	16,0	16,0	55,0	115,0	65,0	15,2	0,2	4	<input type="checkbox"/>
JS754200E3C.9Z4C-HXT	03187163	3	E	■	20,0	20,0	61,0	125,0	72,0	19,0	0,25	4	<input type="checkbox"/>

Safelock available. Delivery time is 6 days.

Universal

Steel and cast iron

Stainless steel and S-materials

Non ferrous

Hard

Plastic and cfrp

Graphite

Minimaster Plus

Minimaster

JS754

High performance – Square – ISO– M and ISO– S – 4 Flutes – Safelock – Chamfer – ICC

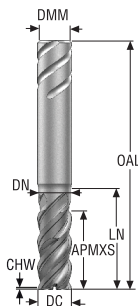

E

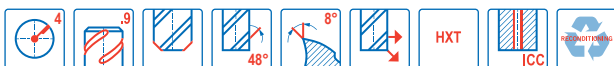

- Tolerances:
- DMM= h5
- DC= e7
- Regrind possible if DC is $\geq \varnothing 6$

Designation	Item number	Length index	Tool shape	ICC	DC	DMM	APMXS	OAL	LN	DN	CHW	PCEDC	Safelock
					mm	mm	mm	mm	mm	mm	mm		
JS754060E2C.9Z4A-HXT	03187164	2	E	■	6,0	6,0	12,0	57,0	18,0	5,7	0,075	4	<input type="checkbox"/>
JS754080E2C.9Z4A-HXT	03187165	2	E	■	8,0	8,0	16,0	63,0	25,0	7,6	0,1	4	<input type="checkbox"/>
JS754100E2C.9Z4A-HXT	03187166	2	E	■	10,0	10,0	20,0	72,0	29,0	9,5	0,125	4	<input type="checkbox"/>
JS754120E2C.9Z4A-HXT	03187167	2	E	■	12,0	12,0	24,0	83,0	35,0	11,4	0,15	4	<input type="checkbox"/>
JS754160E2C.9Z4A-HXT	03187168	2	E	■	16,0	16,0	32,0	92,0	42,0	15,2	0,2	4	<input type="checkbox"/>
JS754200E2C.9Z4A-HXT	03187169	2	E	■	20,0	20,0	40,0	104,0	51,0	19,0	0,25	4	<input type="checkbox"/>

Safelock available. Delivery time is 6 days.

ICC = Internal Coolant Channel

Universal

Steel and cast iron

Stainless steel and S-materials

Non ferrous

Hard

Plastic and cfrp

Graphite

Minimaster Plus

Minimaster

JS754

High performance – Square – ISO– M and ISO– S – 4 Flutes – Safelock – Corner radius

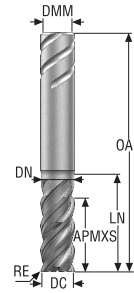

E

- Tolerances:
- DMM= h5
- DC= e7
- RE= ±0,01 mm
- Regrind possible if DC is ≥Ø6

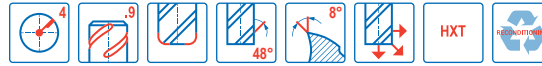

Designation	Item number	Length index	Tool shape	DC	DMM	APMXS	OAL	LN	DN	RE	PCEDC	Safelock
				mm	mm	mm	mm	mm	mm	mm		
JS754060E2R020.9Z4-HXT	03187170	2	E	6,0	6,0	12,0	57,0	18,0	5,7	0,2	4	<input type="checkbox"/>
JS754060E2R050.9Z4-HXT	03187171	2	E	6,0	6,0	12,0	57,0	18,0	5,7	0,5	4	<input type="checkbox"/>
JS754060E2R100.9Z4-HXT	03187172	2	E	6,0	6,0	12,0	57,0	18,0	5,7	1,0	4	<input type="checkbox"/>
JS754080E2R050.9Z4-HXT	03187173	2	E	8,0	8,0	16,0	63,0	25,0	7,6	0,5	4	<input type="checkbox"/>
JS754080E2R100.9Z4-HXT	03187174	2	E	8,0	8,0	16,0	63,0	25,0	7,6	1,0	4	<input type="checkbox"/>
JS754100E2R050.9Z4-HXT	03187175	2	E	10,0	10,0	20,0	72,0	29,0	9,5	0,5	4	<input type="checkbox"/>
JS754100E2R100.9Z4-HXT	03187176	2	E	10,0	10,0	20,0	72,0	29,0	9,5	1,0	4	<input type="checkbox"/>
JS754100E2R150.9Z4-HXT	03200573	2	E	10,0	10,0	20,0	72,0	29,0	9,5	1,5	4	<input type="checkbox"/>
JS754100E2R200.9Z4-HXT	03187177	2	E	10,0	10,0	20,0	72,0	29,0	9,5	2,0	4	<input type="checkbox"/>
JS754100E2R300.9Z4-HXT	03187178	2	E	10,0	10,0	20,0	72,0	29,0	9,5	3,0	4	<input type="checkbox"/>
JS754120E2R050.9Z4-HXT	03187179	2	E	12,0	12,0	24,0	83,0	35,0	11,4	0,5	4	<input type="checkbox"/>
JS754120E2R100.9Z4-HXT	03187180	2	E	12,0	12,0	24,0	83,0	35,0	11,4	1,0	4	<input type="checkbox"/>
JS754120E2R150.9Z4-HXT	03200832	2	E	12,0	12,0	24,0	83,0	35,0	11,4	1,5	4	<input type="checkbox"/>
JS754120E2R200.9Z4-HXT	03187181	2	E	12,0	12,0	24,0	83,0	35,0	11,4	2,0	4	<input type="checkbox"/>
JS754120E2R300.9Z4-HXT	03187182	2	E	12,0	12,0	24,0	83,0	35,0	11,4	3,0	4	<input type="checkbox"/>
JS754160E2R050.9Z4-HXT	03187183	2	E	16,0	16,0	32,0	92,0	42,0	15,2	0,5	4	<input type="checkbox"/>
JS754160E2R100.9Z4-HXT	03187184	2	E	16,0	16,0	32,0	92,0	42,0	15,2	1,0	4	<input type="checkbox"/>
JS754160E2R200.9Z4-HXT	03187185	2	E	16,0	16,0	32,0	92,0	42,0	15,2	2,0	4	<input type="checkbox"/>
JS754160E2R300.9Z4-HXT	03187186	2	E	16,0	16,0	32,0	92,0	42,0	15,2	3,0	4	<input type="checkbox"/>
JS754160E2R400.9Z4-HXT	03187187	2	E	16,0	16,0	32,0	92,0	42,0	15,2	4,0	4	<input type="checkbox"/>
JS754160E2R600.9Z4-HXT	03187188	2	E	16,0	16,0	32,0	92,0	42,0	15,2	6,0	4	<input type="checkbox"/>
JS754200E2R050.9Z4-HXT	03187189	2	E	20,0	20,0	40,0	104,0	51,0	19,0	0,5	4	<input type="checkbox"/>
JS754200E2R100.9Z4-HXT	03187190	2	E	20,0	20,0	40,0	104,0	51,0	19,0	1,0	4	<input type="checkbox"/>
JS754200E2R200.9Z4-HXT	03187191	2	E	20,0	20,0	40,0	104,0	51,0	19,0	2,0	4	<input type="checkbox"/>
JS754200E2R300.9Z4-HXT	03187192	2	E	20,0	20,0	40,0	104,0	51,0	19,0	3,0	4	<input type="checkbox"/>
JS754200E2R400.9Z4-HXT	03187193	2	E	20,0	20,0	40,0	104,0	51,0	19,0	4,0	4	<input type="checkbox"/>
JS754200E2R600.9Z4-HXT	03187194	2	E	20,0	20,0	40,0	104,0	51,0	19,0	6,0	4	<input type="checkbox"/>

Safelock available. Delivery time is 6 days.

JS754

High performance – Square – ISO– M and ISO– S – 4 Flutes – Safelock – Corner radius

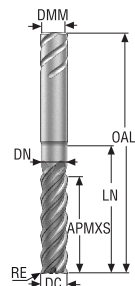

E

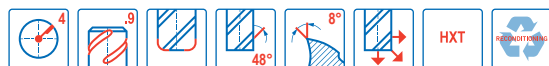

- Tolerances:
- DMM= h5
- DC= e7
- RE= ±0,01 mm
- Re grind possible if DC is ≥Ø6

Designation	Item number	Length index	Tool shape	DC	DMM	APMXS	OAL	LN	DN	RE	PCEDC	Safelock
				mm	mm	mm	mm	mm	mm	mm		
JS754060E3R020.9Z4-HXT	03187197	3	E	6,0	6,0	21,0	65,0	26,0	5,7	0,2	4	<input type="checkbox"/>
JS754060E3R050.9Z4-HXT	03187198	3	E	6,0	6,0	21,0	65,0	26,0	5,7	0,5	4	<input type="checkbox"/>
JS754060E3R100.9Z4-HXT	03187199	3	E	6,0	6,0	21,0	65,0	26,0	5,7	1,0	4	<input type="checkbox"/>
JS754080E3R050.9Z4-HXT	03187200	3	E	8,0	8,0	32,0	75,0	37,0	7,6	0,5	4	<input type="checkbox"/>
JS754080E3R100.9Z4-HXT	03187201	3	E	8,0	8,0	32,0	75,0	37,0	7,6	1,0	4	<input type="checkbox"/>
JS754100E3R050.9Z4-HXT	03187202	3	E	10,0	10,0	40,0	89,0	47,0	9,5	0,5	4	<input type="checkbox"/>
JS754100E3R100.9Z4-HXT	03187203	3	E	10,0	10,0	40,0	89,0	47,0	9,5	1,0	4	<input type="checkbox"/>
JS754100E3R200.9Z4-HXT	03187204	3	E	10,0	10,0	40,0	89,0	47,0	9,5	2,0	4	<input type="checkbox"/>
JS754100E3R300.9Z4-HXT	03187205	3	E	10,0	10,0	40,0	89,0	47,0	9,5	3,0	4	<input type="checkbox"/>
JS754120E3R050.9Z4-HXT	03187206	3	E	12,0	12,0	45,0	100,0	53,0	11,4	0,5	4	<input type="checkbox"/>
JS754120E3R100.9Z4-HXT	03187207	3	E	12,0	12,0	45,0	100,0	53,0	11,4	1,0	4	<input type="checkbox"/>
JS754120E3R200.9Z4-HXT	03187208	3	E	12,0	12,0	45,0	100,0	53,0	11,4	2,0	4	<input type="checkbox"/>
JS754120E3R300.9Z4-HXT	03187209	3	E	12,0	12,0	45,0	100,0	53,0	11,4	3,0	4	<input type="checkbox"/>
JS754160E3R050.9Z4-HXT	03187210	3	E	16,0	16,0	55,0	115,0	65,0	15,2	0,5	4	<input type="checkbox"/>
JS754160E3R100.9Z4-HXT	03187211	3	E	16,0	16,0	55,0	115,0	65,0	15,2	1,0	4	<input type="checkbox"/>
JS754160E3R200.9Z4-HXT	03187212	3	E	16,0	16,0	55,0	115,0	65,0	15,2	2,0	4	<input type="checkbox"/>
JS754160E3R300.9Z4-HXT	03187213	3	E	16,0	16,0	55,0	115,0	65,0	15,2	3,0	4	<input type="checkbox"/>
JS754160E3R400.9Z4-HXT	03187214	3	E	16,0	16,0	55,0	115,0	65,0	15,2	4,0	4	<input type="checkbox"/>
JS754160E3R600.9Z4-HXT	03187215	3	E	16,0	16,0	55,0	115,0	65,0	15,2	6,0	4	<input type="checkbox"/>
JS754200E3R050.9Z4-HXT	03187216	3	E	20,0	20,0	61,0	125,0	72,0	19,0	0,5	4	<input type="checkbox"/>
JS754200E3R100.9Z4-HXT	03187217	3	E	20,0	20,0	61,0	125,0	72,0	19,0	1,0	4	<input type="checkbox"/>
JS754200E3R200.9Z4-HXT	03187218	3	E	20,0	20,0	61,0	125,0	72,0	19,0	2,0	4	<input type="checkbox"/>
JS754200E3R300.9Z4-HXT	03187219	3	E	20,0	20,0	61,0	125,0	72,0	19,0	3,0	4	<input type="checkbox"/>
JS754200E3R400.9Z4-HXT	03187220	3	E	20,0	20,0	61,0	125,0	72,0	19,0	4,0	4	<input type="checkbox"/>
JS754200E3R600.9Z4-HXT	03187221	3	E	20,0	20,0	61,0	125,0	72,0	19,0	6,0	4	<input type="checkbox"/>

Safelock available. Delivery time is 6 days.

Universal

Steel and cast iron

Stainless steel and S-materials

Non ferrous

Hard

Plastic and chip

Graphite

Minimaster Plus

Minimaster

Universal
Steel and cast iron
Stainless steel and S-materials
Non ferrous
Hard
Plastic and cfrp
Graphite
Minimaster Plus
Minimaster

Cutting data – JS754 Side milling roughing

SMG		a _e /DC	a _p /DC	f _z										v _c
				3	4	5	6	8	10	12	16	20	25	
P11	M/A/D/E	0.400	0.80	0.026	0.036	0.044	0.055	0.070	0.090	0.11	0.13	0.15	0.17	165 (130–180)
		0.400	0.80	0.0010	0.0014	0.0017	0.0022	0.0028	0.0036	0.0044	0.0050	0.0060	0.0065	540 (430–590)
P12	M/A/D/E	0.400	0.80	0.018	0.024	0.030	0.036	0.048	0.060	0.070	0.090	0.10	0.12	105 (83–120)
		0.400	0.80	0.00070	0.00095	0.0012	0.0014	0.0019	0.0024	0.0028	0.0036	0.0040	0.0048	345 (280–390)
M1	E	0.400	1.0	0.020	0.026	0.034	0.040	0.055	0.065	0.080	0.10	0.11	0.13	110 (96–130)
		0.400	1.0	0.00080	0.0010	0.0013	0.0016	0.0022	0.0026	0.0032	0.0040	0.0044	0.0050	360 (320–420)
M2	E	0.400	1.0	0.018	0.024	0.030	0.036	0.048	0.060	0.070	0.090	0.10	0.12	90 (79–110)
		0.400	1.0	0.00070	0.00095	0.0012	0.0014	0.0019	0.0024	0.0028	0.0036	0.0040	0.0048	295 (260–360)
M3	E	0.400	0.90	0.015	0.020	0.025	0.030	0.040	0.050	0.060	0.075	0.085	0.095	60 (44–76)
		0.400	0.90	0.00060	0.00080	0.0010	0.0012	0.0016	0.0020	0.0024	0.0030	0.0034	0.0038	195 (150–240)
M4	E	0.400	0.90	0.013	0.018	0.022	0.026	0.036	0.044	0.055	0.065	0.075	0.085	46 (34–59)
		0.400	0.90	0.00050	0.00070	0.00085	0.0010	0.0014	0.0017	0.0022	0.0026	0.0030	0.0034	150 (120–190)
M5	E	0.400	0.90	0.013	0.018	0.022	0.026	0.036	0.044	0.055	0.065	0.075	0.085	39 (29–49)
		0.400	0.90	0.00050	0.00070	0.00085	0.0010	0.0014	0.0017	0.0022	0.0026	0.0030	0.0034	130 (96–160)
S1	E	0.150	0.50	0.026	0.034	0.044	0.050	0.070	0.085	0.10	0.13	0.15	0.17	50 (26–68)
		0.150	0.50	0.0010	0.0013	0.0017	0.0020	0.0028	0.0034	0.0040	0.0050	0.0060	0.0065	165 (86–220)
S2	E	0.150	0.50	0.026	0.034	0.044	0.050	0.070	0.085	0.10	0.13	0.15	0.17	41 (21–55)
		0.150	0.50	0.0010	0.0013	0.0017	0.0020	0.0028	0.0034	0.0040	0.0050	0.0060	0.0065	135 (69–180)
S3	E	0.150	0.50	0.024	0.032	0.040	0.048	0.065	0.080	0.095	0.12	0.14	0.15	36 (19–48)
		0.150	0.50	0.00095	0.0013	0.0016	0.0019	0.0026	0.0032	0.0038	0.0048	0.0055	0.0060	120 (63–150)
S11	E	0.400	0.70	0.018	0.024	0.030	0.036	0.048	0.060	0.070	0.090	0.10	0.12	110 (73–140)
		0.400	0.70	0.00070	0.00095	0.0012	0.0014	0.0019	0.0024	0.0028	0.0036	0.0040	0.0048	360 (240–450)
S12	E	0.400	0.70	0.018	0.024	0.030	0.036	0.048	0.060	0.070	0.090	0.10	0.12	85 (56–110)
		0.400	0.70	0.00070	0.00095	0.0012	0.0014	0.0019	0.0024	0.0028	0.0036	0.0040	0.0048	280 (190–360)
S13	E	0.400	0.70	0.016	0.022	0.026	0.032	0.042	0.055	0.065	0.080	0.090	0.10	65 (44–87)
		0.400	0.70	0.00065	0.00085	0.0010	0.0013	0.0017	0.0022	0.0026	0.0032	0.0036	0.0040	215 (150–280)

Cutting data – JS754 Slot milling

SMG		a _p /DC	f _z										v _c
			3	4	5	6	8	10	12	16	20	25	
P11	M/A/D/E	0.80	0.015	0.020	0.025	0.030	0.040	0.050	0.060	0.080	0.10	0.13	150 (120–170)
		0.80	0.00060	0.00080	0.0010	0.0012	0.0016	0.0020	0.0024	0.0032	0.0040	0.0050	490 (400–550)
P12	M/A/D/E	0.80	0.015	0.020	0.025	0.030	0.040	0.050	0.060	0.080	0.10	0.11	90 (69–100)
		0.80	0.00060	0.00080	0.0010	0.0012	0.0016	0.0020	0.0024	0.0032	0.0040	0.0044	295 (230–320)
M1	E	0.80	0.012	0.016	0.020	0.024	0.032	0.040	0.048	0.065	0.080	0.10	95 (85–120)
		0.80	0.00048	0.00065	0.00080	0.00095	0.0013	0.0016	0.0019	0.0026	0.0032	0.0040	310 (280–390)
M2	E	0.80	0.012	0.016	0.020	0.024	0.032	0.040	0.048	0.065	0.080	0.10	80 (69–97)
		0.80	0.00048	0.00065	0.00080	0.00095	0.0013	0.0016	0.0019	0.0026	0.0032	0.0040	260 (230–310)
M3	E	0.60	0.0095	0.012	0.015	0.019	0.025	0.030	0.038	0.050	0.060	0.075	55 (39–67)
		0.60	0.00038	0.00048	0.00060	0.00075	0.0010	0.0012	0.0015	0.0020	0.0024	0.0030	180 (130–210)
M4	E	0.60	0.0095	0.012	0.015	0.019	0.025	0.030	0.038	0.050	0.060	0.075	40 (29–50)
		0.60	0.00038	0.00048	0.00060	0.00075	0.0010	0.0012	0.0015	0.0020	0.0024	0.0030	130 (96–160)
M5	E	0.60	0.0095	0.012	0.015	0.019	0.025	0.030	0.038	0.050	0.060	0.075	33 (25–42)
		0.60	0.00038	0.00048	0.00060	0.00075	0.0010	0.0012	0.0015	0.0020	0.0024	0.0030	110 (83–130)
S1	E	0.30	0.0095	0.012	0.015	0.019	0.025	0.030	0.038	0.050	0.060	0.075	41 (21–54)
		0.30	0.00038	0.00048	0.00060	0.00075	0.0010	0.0012	0.0015	0.0020	0.0024	0.0030	135 (69–170)
S2	E	0.30	0.0095	0.012	0.015	0.019	0.025	0.030	0.038	0.050	0.060	0.075	33 (17–43)
		0.30	0.00038	0.00048	0.00060	0.00075	0.0010	0.0012	0.0015	0.0020	0.0024	0.0030	110 (56–140)
S3	E	0.30	0.0095	0.012	0.015	0.019	0.025	0.030	0.038	0.050	0.060	0.075	28 (15–37)
		0.30	0.00038	0.00048	0.00060	0.00075	0.0010	0.0012	0.0015	0.0020	0.0024	0.0030	90 (50–120)
S11	E	0.50	0.012	0.016	0.020	0.025	0.032	0.042	0.050	0.065	0.080	0.10	95 (63–120)
		0.50	0.00048	0.00065	0.00080	0.0010	0.0013	0.0017	0.0020	0.0026	0.0032	0.0040	310 (210–390)
S12	E	0.50	0.012	0.016	0.020	0.025	0.032	0.042	0.050	0.065	0.080	0.10	70 (48–95)
		0.50	0.00048	0.00065	0.00080	0.0010	0.0013	0.0017	0.0020	0.0026	0.0032	0.0040	230 (160–310)
S13	E	0.50	0.012	0.016	0.020	0.025	0.032	0.042	0.050	0.065	0.080	0.10	55 (38–74)
		0.50	0.00048	0.00065	0.00080	0.0010	0.0013	0.0017	0.0020	0.0026	0.0032	0.0040	180 (130–240)

If radius exceeds 15% of value DC please reduce fz with 20%

For cutting data recalculations, see pages 445 - 452

SMG = Seco material group

Coolant = A=air D=dry E=emulsion M=mist spray

v_c = m/min (sf/min)

f_z = mm (in/tooth)

a_p = mm/DC (in/DC) = factor

a_e = mm/DC (in/DC) = factor

All cutting data are target values

Cutting data – JS754_2C Advanced roughing $a_p/DC=0,05-0,1$

SMG		a_p/DC	a_p/DC	f_z		v_c
				10	12	
P11	M/A/D/E	0.100	2.0	0.15	0.17	265 (220 – 290)
		0,100	2,0	0,0060	0,0065	870 (730 – 950)
P12	M/A/D/E	0.100	2.0	0.10	0.12	170 (150–190)
		0,100	2,0	0,0040	0,0048	560 (500 – 620)
M1	E	0.100	2.0	0.11	0.13	205 (180 – 230)
		0,100	2,0	0,0044	0,0050	670 (600–750)
M2	E	0.100	2.0	0.10	0.12	170 (150–190)
		0,100	2,0	0,0040	0,0048	560 (500 – 620)
M3	E	0.100	2.0	0.10	0.12	130 (120–150)
		0,100	2,0	0,0040	0,0048	425 (400 – 490)
M4	E	0.100	2.0	0.085	0.10	100 (86–110)
		0,100	2,0	0,0034	0,0040	330 (290 – 360)
M5	E	0.100	2.0	0.085	0.10	85 (72 – 96)
		0,100	2,0	0,0034	0,0040	280 (240 – 310)
S1	E	0.0500	2.0	0.085	0.10	70 (43 – 99)
		0,0500	2,0	0,0034	0,0040	230 (150 – 320)
S2	E	0.0500	2.0	0.085	0.10	60 (35 – 80)
		0,0500	2,0	0,0034	0,0040	195 (120 – 260)
S3	E	0.0500	2.0	0.080	0.095	50 (31–70)
		0,0500	2,0	0,0032	0,0038	165 (110 – 220)
S11	E	0.0800	2.0	0.070	0.085	165 (140–190)
		0,0800	2,0	0,0028	0,0034	540 (460 – 620)
S12	E	0.0800	2.0	0.070	0.085	125 (110–150)
		0,0800	2,0	0,0028	0,0034	410 (370 – 490)
S13	E	0.0800	2.0	0.060	0.070	100 (84–110)
		0,0800	2,0	0,0024	0,0028	330 (280 – 360)

Cutting data – JS754_3C Advanced roughing $a_p/DC=0,05-0,1$

SMG		a_p/DC	a_p/DC	f_z						v_c
				6	8	10	12	16	20	
P11	M/A/D/E	0.100	4.0	0.090	0.12	0.15	0.17	0.22	0.25	265 (220 – 290)
		0,100	4,0	0,0036	0,0048	0,0060	0,0065	0,0085	0,010	870 (730 – 950)
P12	M/A/D/E	0.100	4.0	0.060	0.080	0.10	0.12	0.15	0.17	170 (140–180)
		0,100	4,0	0,0024	0,0032	0,0040	0,0048	0,0060	0,0065	560 (460 – 590)
M1	E	0.100	4.0	0.065	0.090	0.11	0.13	0.16	0.19	205 (170 – 230)
		0,100	4,0	0,0026	0,0036	0,0044	0,0050	0,0065	0,0075	670 (560–750)
M2	E	0.100	4.0	0.060	0.080	0.10	0.12	0.15	0.17	170 (140–190)
		0,100	4,0	0,0024	0,0032	0,0040	0,0048	0,0060	0,0065	560 (460 – 620)
M3	E	0.100	4.0	0.060	0.080	0.10	0.12	0.15	0.17	130 (110–150)
		0,100	4,0	0,0024	0,0032	0,0040	0,0048	0,0060	0,0065	425 (370 – 490)
M4	E	0.100	4.0	0.050	0.070	0.085	0.10	0.13	0.15	100 (86–110)
		0,100	4,0	0,0020	0,0028	0,0034	0,0040	0,0050	0,0060	330 (290 – 360)
M5	E	0.100	4.0	0.050	0.070	0.085	0.10	0.13	0.15	85 (72 – 96)
		0,100	4,0	0,0020	0,0028	0,0034	0,0040	0,0050	0,0060	280 (240 – 310)
S1	E	0.0500	4.0	0.050	0.070	0.085	0.10	0.13	0.15	70 (43 – 99)
		0,0500	4,0	0,0020	0,0028	0,0034	0,0040	0,0050	0,0060	230 (150 – 320)
S2	E	0.0500	4.0	0.050	0.070	0.085	0.10	0.13	0.15	55 (35 – 80)
		0,0500	4,0	0,0020	0,0028	0,0034	0,0040	0,0050	0,0060	180 (120 – 260)
S3	E	0.0500	4.0	0.048	0.065	0.080	0.095	0.12	0.14	50 (30–70)
		0,0500	4,0	0,0019	0,0026	0,0032	0,0038	0,0048	0,0055	165 (99 – 220)
S11	E	0.0800	4.0	0.042	0.055	0.070	0.085	0.10	0.12	165 (140–190)
		0,0800	4,0	0,0017	0,0022	0,0028	0,0034	0,0040	0,0048	540 (460 – 620)
S12	E	0.0800	4.0	0.042	0.055	0.070	0.085	0.10	0.12	125 (110–150)
		0,0800	4,0	0,0017	0,0022	0,0028	0,0034	0,0040	0,0048	410 (370 – 490)
S13	E	0.0800	4.0	0.036	0.048	0.060	0.070	0.090	0.10	100 (84–110)
		0,0800	4,0	0,0014	0,0019	0,0024	0,0028	0,0036	0,0040	330 (280 – 360)

If radius exceeds 15% of value DC please reduce fz with 20%

For cutting data recalculations, see pages 445 - 452.

SMG = Seco material group
Coolant = A=air D=dry E=emulsion M=mist spray
 v_c = m/min (sf/min)
 f_z = mm (in/tooth)
 a_p = mm/DC (in/DC) = factor
 a_e = mm/DC (in/DC) = factor
All cutting data are target values

JS755

High performance – Square – ISO– M and ISO– S – 5 Flutes – Cylindrical – Chamfer

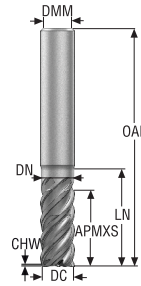

E

- Tolerances:
- DMM= h5
- DC= e7
- Regrind possible if DC is $\geq \phi 6$

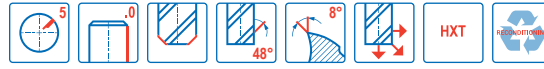

Designation	Item number	Length index	Tool shape	DC	DMM	APMXS	OAL	LN	DN	CHW	PCEDC	Cylindrical
				mm	mm	mm	mm	mm	mm	mm		
JS755060E2C.0Z5-HXT	03186907	2	E	6,0	6,0	12,0	57,0	18,0	5,7	0,075	5	■
JS755080E2C.0Z5-HXT	03186908	2	E	8,0	8,0	16,0	63,0	25,0	7,6	0,1	5	■
JS755100E2C.0Z5-HXT	03186909	2	E	10,0	10,0	20,0	72,0	29,0	9,5	0,125	5	■
JS755120E2C.0Z5-HXT	03186910	2	E	12,0	12,0	24,0	83,0	35,0	11,4	0,15	5	■
JS755160E2C.0Z5-HXT	03186911	2	E	16,0	16,0	32,0	92,0	42,0	15,2	0,2	5	■
JS755200E2C.0Z5-HXT	03186912	2	E	20,0	20,0	40,0	104,0	51,0	19,0	0,25	5	■
JS755250E2C.0Z5-HXT	03186913	2	E	25,0	25,0	50,0	121,0	65,0	23,8	0,3	5	■
JS755060E3C.0Z5-HXT	03186914	3	E	6,0	6,0	21,0	65,0	26,0	5,7	0,075	5	■
JS755080E3C.0Z5-HXT	03186915	3	E	8,0	8,0	32,0	75,0	37,0	7,6	0,1	5	■
JS755100E3C.0Z5-HXT	03186916	3	E	10,0	10,0	40,0	89,0	47,0	9,5	0,125	5	■
JS755120E3C.0Z5-HXT	03186917	3	E	12,0	12,0	45,0	100,0	53,0	11,4	0,15	5	■
JS755160E3C.0Z5-HXT	03186918	3	E	16,0	16,0	55,0	115,0	65,0	15,2	0,2	5	■
JS755200E3C.0Z5-HXT	03186919	3	E	20,0	20,0	61,0	125,0	72,0	19,0	0,25	5	■
JS755250E3C.0Z5-HXT	03186920	3	E	25,0	25,0	85,0	153,0	94,0	23,8	0,3	5	■

■ Stocked standard.

JS755

High performance - Square – ISO– M and ISO– S – 5 Flutes – Cylindrical – Chamfer – Chip splitters

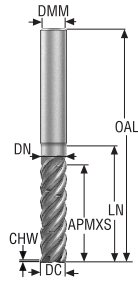

E



- Tolerances:
- DMM= h5
- DC= e7
- Chip splitters
- Regrind possible if DC is $\geq \varnothing 6$

Designation	Item number	Length index	Tool shape	Chip splitters	DC	DMM	APMXS	OAL	LN	DN	CHW	PCEDC	Cylindrical
					mm	mm	mm	mm	mm	mm	mm		
JS755100E3C.0Z5C-HXT	03186921	3	E	■	10,0	10,0	40,0	89,0	47,0	9,5	0,125	5	■
JS755120E3C.0Z5C-HXT	03186922	3	E	■	12,0	12,0	45,0	100,0	53,0	11,4	0,15	5	■
JS755160E3C.0Z5C-HXT	03186923	3	E	■	16,0	16,0	55,0	115,0	65,0	15,2	0,2	5	■
JS755200E3C.0Z5C-HXT	03186924	3	E	■	20,0	20,0	61,0	125,0	72,0	19,0	0,25	5	■

■ Stocked standard.

Universal

Steel and cast iron

Stainless steel and S-materials

Non ferrous

Hard

Plastic and cfrp

Graphite

Minimaster Plus

Minimaster

JS755

High performance – Square – ISO– M and ISO– S – 5 Flutes – Cylindrical – Corner radius

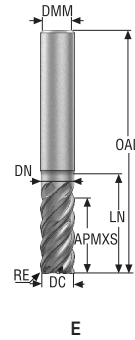

- Tolerances:
- DMM= h5
- DC= e7
- RE= ±0,01 mm
- Regrind possible if DC is ≥Ø6

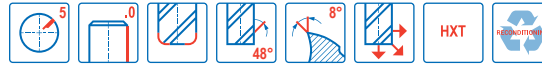

Designation	Item number	Length index	Tool shape	DC	DMM	APMXS	OAL	LN	DN	RE	PCEDC	Cylindrical
				mm	mm	mm	mm	mm	mm	mm		
JS755060E2R020.0Z5-HXT	03186925	2	E	6,0	6,0	12,0	57,0	18,0	5,7	0,2	5	■
JS755060E2R050.0Z5-HXT	03186926	2	E	6,0	6,0	12,0	57,0	18,0	5,7	0,5	5	■
JS755060E2R100.0Z5-HXT	03186927	2	E	6,0	6,0	12,0	57,0	18,0	5,7	1,0	5	■
JS755080E2R050.0Z5-HXT	03186928	2	E	8,0	8,0	16,0	63,0	25,0	7,6	0,5	5	■
JS755080E2R100.0Z5-HXT	03186929	2	E	8,0	8,0	16,0	63,0	25,0	7,6	1,0	5	■
JS755100E2R050.0Z5-HXT	03186930	2	E	10,0	10,0	20,0	72,0	29,0	9,5	0,5	5	■
JS755100E2R100.0Z5-HXT	03186931	2	E	10,0	10,0	20,0	72,0	29,0	9,5	1,0	5	■
JS755100E2R200.0Z5-HXT	03186932	2	E	10,0	10,0	20,0	72,0	29,0	9,5	2,0	5	■
JS755100E2R300.0Z5-HXT	03186933	2	E	10,0	10,0	20,0	72,0	29,0	9,5	3,0	5	■
JS755120E2R050.0Z5-HXT	03186934	2	E	12,0	12,0	24,0	83,0	35,0	11,4	0,5	5	■
JS755120E2R100.0Z5-HXT	03186935	2	E	12,0	12,0	24,0	83,0	35,0	11,4	1,0	5	■
JS755120E2R200.0Z5-HXT	03186936	2	E	12,0	12,0	24,0	83,0	35,0	11,4	2,0	5	■
JS755120E2R300.0Z5-HXT	03186937	2	E	12,0	12,0	24,0	83,0	35,0	11,4	3,0	5	■
JS755160E2R050.0Z5-HXT	03186938	2	E	16,0	16,0	32,0	92,0	42,0	15,2	0,5	5	■
JS755160E2R100.0Z5-HXT	03186939	2	E	16,0	16,0	32,0	92,0	42,0	15,2	1,0	5	■
JS755160E2R600.0Z5-HXT	03186940	2	E	16,0	16,0	32,0	92,0	42,0	15,2	6,0	5	■
JS755200E2R050.0Z5-HXT	03186941	2	E	20,0	20,0	40,0	104,0	51,0	19,0	0,5	5	■
JS755200E2R100.0Z5-HXT	03186942	2	E	20,0	20,0	40,0	104,0	51,0	19,0	1,0	5	■
JS755200E2R600.0Z5-HXT	03186943	2	E	20,0	20,0	40,0	104,0	51,0	19,0	6,0	5	■

■ Stocked standard.

JS755

High performance – Square – ISO– M and ISO– S – 5 Flutes – Cylindrical – Corner radius

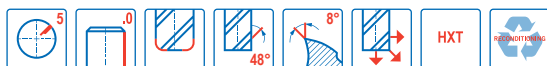
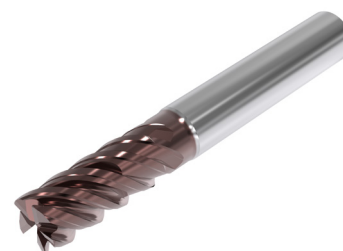
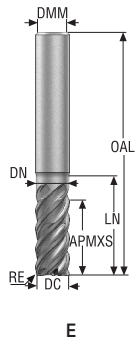

- Tolerances:
- DMM= h5
- DC= e7
- RE= ±0,01 mm
- Regrind possible if DC is ≥Ø6

Designation	Item number	Length index	Tool shape	DC	DMM	APMXS	OAL	LN	DN	RE	PCEDC	Cylindrical
				mm	mm	mm	mm	mm	mm	mm		
JS755060E3R020.0Z5-HXT	03186946	3	E	6,0	6,0	21,0	65,0	26,0	5,7	0,2	5	■
JS755060E3R050.0Z5-HXT	03186947	3	E	6,0	6,0	21,0	65,0	26,0	5,7	0,5	5	■
JS755060E3R100.0Z5-HXT	03186948	3	E	6,0	6,0	21,0	65,0	26,0	5,7	1,0	5	■
JS755080E3R050.0Z5-HXT	03186949	3	E	8,0	8,0	32,0	75,0	37,0	7,6	0,5	5	■
JS755080E3R100.0Z5-HXT	03186950	3	E	8,0	8,0	32,0	75,0	37,0	7,6	1,0	5	■
JS755100E3R050.0Z5-HXT	03186951	3	E	10,0	10,0	40,0	89,0	47,0	9,5	0,5	5	■
JS755100E3R100.0Z5-HXT	03186952	3	E	10,0	10,0	40,0	89,0	47,0	9,5	1,0	5	■
JS755100E3R200.0Z5-HXT	03186953	3	E	10,0	10,0	40,0	89,0	47,0	9,5	2,0	5	■
JS755100E3R300.0Z5-HXT	03186954	3	E	10,0	10,0	40,0	89,0	47,0	9,5	3,0	5	■
JS755120E3R050.0Z5-HXT	03186955	3	E	12,0	12,0	45,0	100,0	53,0	11,4	0,5	5	■
JS755120E3R100.0Z5-HXT	03186956	3	E	12,0	12,0	45,0	100,0	53,0	11,4	1,0	5	■
JS755120E3R200.0Z5-HXT	03186957	3	E	12,0	12,0	45,0	100,0	53,0	11,4	2,0	5	■
JS755120E3R300.0Z5-HXT	03186958	3	E	12,0	12,0	45,0	100,0	53,0	11,4	3,0	5	■
JS755160E3R050.0Z5-HXT	03186959	3	E	16,0	16,0	55,0	115,0	65,0	15,2	0,5	5	■
JS755160E3R600.0Z5-HXT	03186960	3	E	16,0	16,0	55,0	115,0	65,0	15,2	6,0	5	■
JS755200E3R050.0Z5-HXT	03186961	3	E	20,0	20,0	61,0	125,0	72,0	19,0	0,5	5	■
JS755200E3R600.0Z5-HXT	03186962	3	E	20,0	20,0	61,0	125,0	72,0	19,0	6,0	5	■

■ Stocked standard.

Universal

Steel and cast iron

Stainless steel and S-materials

Non ferrous

Hard

Plastic and chip

Graphite

Minimaster Plus

Minimaster

JS755

High performance – Square – ISO– M and ISO– S – 5 Flutes – Weldon – Chamfer

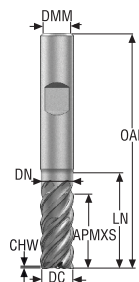

E

- Tolerances:
- DMM= h5
- DC= e7
- Regrind possible if DC is ≥ 06

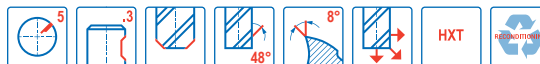

Designation	Item number	Length index	Tool shape	DC	DMM	APMXS	OAL	LN	DN	CHW	PCEDC	Weldon
				mm	mm	mm	mm	mm	mm	mm		
JS755060E2C.3Z5-HXT	03187083	2	E	6,0	6,0	12,0	57,0	18,0	5,7	0,075	5	■
JS755080E2C.3Z5-HXT	03187084	2	E	8,0	8,0	16,0	63,0	25,0	7,6	0,1	5	■
JS755100E2C.3Z5-HXT	03187085	2	E	10,0	10,0	20,0	72,0	29,0	9,5	0,125	5	■
JS755120E2C.3Z5-HXT	03187086	2	E	12,0	12,0	24,0	83,0	35,0	11,4	0,15	5	■
JS755160E2C.3Z5-HXT	03187087	2	E	16,0	16,0	32,0	92,0	42,0	15,2	0,2	5	■
JS755200E2C.3Z5-HXT	03187088	2	E	20,0	20,0	40,0	104,0	51,0	19,0	0,25	5	■
JS755250E2C.3Z5-HXT	03187089	2	E	25,0	25,0	50,0	121,0	65,0	23,8	0,3	5	■
JS755060E3C.3Z5-HXT	03187090	3	E	6,0	6,0	21,0	65,0	26,0	5,7	0,075	5	■
JS755080E3C.3Z5-HXT	03187091	3	E	8,0	8,0	32,0	75,0	37,0	7,6	0,1	5	■
JS755100E3C.3Z5-HXT	03187092	3	E	10,0	10,0	40,0	89,0	47,0	9,5	0,125	5	■
JS755120E3C.3Z5-HXT	03187093	3	E	12,0	12,0	45,0	100,0	53,0	11,4	0,15	5	■
JS755160E3C.3Z5-HXT	03187094	3	E	16,0	16,0	55,0	115,0	65,0	15,2	0,2	5	■
JS755200E3C.3Z5-HXT	03187095	3	E	20,0	20,0	61,0	125,0	72,0	19,0	0,25	5	■
JS755250E3C.3Z5-HXT	03187096	3	E	25,0	25,0	85,0	153,0	94,0	23,8	0,3	5	■

■ Stocked standard.

JS755

High performance – Square – ISO- M and ISO- S – 5 Flutes – Weldon – Chamfer – Chip splitters

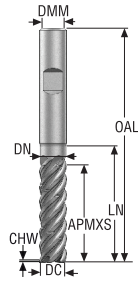

E



- Tolerances:
- DMM= h5
- DC= e7
- Chip splitters
- Regrind possible if DC is $\geq \varnothing 6$

Designation	Item number	Length index	Tool shape	Chip splitters	DC	DMM	APMXS	OAL	LN	DN	CHW	PCEDC	Weldon
					mm	mm	mm	mm	mm	mm	mm	mm	
JS755100E3C.3Z5C-HXT	03187097	3	E	■	10,0	10,0	40,0	89,0	47,0	9,5	0,125	5	■
JS755120E3C.3Z5C-HXT	03187098	3	E	■	12,0	12,0	45,0	100,0	53,0	11,4	0,15	5	■
JS755160E3C.3Z5C-HXT	03187099	3	E	■	16,0	16,0	55,0	115,0	65,0	15,2	0,2	5	■
JS755200E3C.3Z5C-HXT	03187100	3	E	■	20,0	20,0	61,0	125,0	72,0	19,0	0,25	5	■

■ Stocked standard.

Universal

Steel and cast iron

Stainless steel and S-materials

Non ferrous

Hard

Plastic and cfrp

Graphite

Minimaster Plus

Minimaster

JS755

High performance – Square – ISO– M and ISO– S – 5 Flutes – Weldon – Corner radius

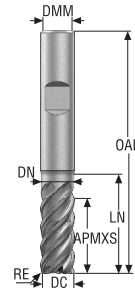

E

- Tolerances:
- DMM= h5
- DC= e7
- RE= ±0,01 mm
- Regrind possible if DC is ≥Ø6

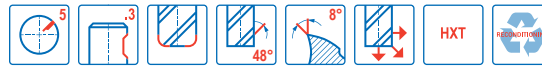

	Designation	Item number	Length index	Tool shape	DC	DMM	APMXS	OAL	LN	DN	RE	PCEDC	Weldon
					mm	mm	mm	mm	mm	mm	mm		
Hard	JS755060E2R020.3Z5-HXT	03187101	2	E	6,0	6,0	12,0	57,0	18,0	5,7	0,2	5	■
	JS755060E2R050.3Z5-HXT	03187102	2	E	6,0	6,0	12,0	57,0	18,0	5,7	0,5	5	■
	JS755060E2R100.3Z5-HXT	03187103	2	E	6,0	6,0	12,0	57,0	18,0	5,7	1,0	5	■
	JS755080E2R050.3Z5-HXT	03187104	2	E	8,0	8,0	16,0	63,0	25,0	7,6	0,5	5	■
	JS755080E2R100.3Z5-HXT	03187105	2	E	8,0	8,0	16,0	63,0	25,0	7,6	1,0	5	■
Plastic and cfrp	JS755100E2R050.3Z5-HXT	03187106	2	E	10,0	10,0	20,0	72,0	29,0	9,5	0,5	5	■
	JS755100E2R100.3Z5-HXT	03187107	2	E	10,0	10,0	20,0	72,0	29,0	9,5	1,0	5	■
	JS755100E2R200.3Z5-HXT	03187108	2	E	10,0	10,0	20,0	72,0	29,0	9,5	2,0	5	■
	JS755100E2R300.3Z5-HXT	03187109	2	E	10,0	10,0	20,0	72,0	29,0	9,5	3,0	5	■
	JS755120E2R050.3Z5-HXT	03187110	2	E	12,0	12,0	24,0	83,0	35,0	11,4	0,5	5	■
	JS755120E2R100.3Z5-HXT	03187111	2	E	12,0	12,0	24,0	83,0	35,0	11,4	1,0	5	■
	JS755120E2R200.3Z5-HXT	03187112	2	E	12,0	12,0	24,0	83,0	35,0	11,4	2,0	5	■
	JS755120E2R300.3Z5-HXT	03187113	2	E	12,0	12,0	24,0	83,0	35,0	11,4	3,0	5	■
Graphite	JS755160E2R050.3Z5-HXT	03187114	2	E	16,0	16,0	32,0	92,0	42,0	15,2	0,5	5	■
	JS755160E2R100.3Z5-HXT	03187115	2	E	16,0	16,0	32,0	92,0	42,0	15,2	1,0	5	■
	JS755160E2R600.3Z5-HXT	03187116	2	E	16,0	16,0	32,0	92,0	42,0	15,2	6,0	5	■
	JS755200E2R050.3Z5-HXT	03187117	2	E	20,0	20,0	40,0	104,0	51,0	19,0	0,5	5	■
	JS755200E2R100.3Z5-HXT	03187118	2	E	20,0	20,0	40,0	104,0	51,0	19,0	1,0	5	■
Minimaster Plus	JS755200E2R600.3Z5-HXT	03187119	2	E	20,0	20,0	40,0	104,0	51,0	19,0	6,0	5	■
	JS755060E3R020.3Z5-HXT	03187122	3	E	6,0	6,0	21,0	65,0	26,0	5,7	0,2	5	□
	JS755060E3R050.3Z5-HXT	03187123	3	E	6,0	6,0	21,0	65,0	26,0	5,7	0,5	5	□
	JS755060E3R100.3Z5-HXT	03187124	3	E	6,0	6,0	21,0	65,0	26,0	5,7	1,0	5	□
	JS755080E3R050.3Z5-HXT	03187125	3	E	8,0	8,0	32,0	75,0	37,0	7,6	0,5	5	□
	JS755080E3R100.3Z5-HXT	03187126	3	E	8,0	8,0	32,0	75,0	37,0	7,6	1,0	5	□
	JS755100E3R050.3Z5-HXT	03187127	3	E	10,0	10,0	40,0	89,0	47,0	9,5	0,5	5	□
	JS755100E3R100.3Z5-HXT	03187128	3	E	10,0	10,0	40,0	89,0	47,0	9,5	1,0	5	□
Minimaster	JS755100E3R200.3Z5-HXT	03187129	3	E	10,0	10,0	40,0	89,0	47,0	9,5	2,0	5	□
	JS755100E3R300.3Z5-HXT	03187130	3	E	10,0	10,0	40,0	89,0	47,0	9,5	3,0	5	□
	JS755120E3R050.3Z5-HXT	03187131	3	E	12,0	12,0	45,0	100,0	53,0	11,4	0,5	5	□
	JS755120E3R100.3Z5-HXT	03187132	3	E	12,0	12,0	45,0	100,0	53,0	11,4	1,0	5	□
	JS755120E3R200.3Z5-HXT	03187133	3	E	12,0	12,0	45,0	100,0	53,0	11,4	2,0	5	□
	JS755120E3R300.3Z5-HXT	03187134	3	E	12,0	12,0	45,0	100,0	53,0	11,4	3,0	5	□
	JS755160E3R050.3Z5-HXT	03187135	3	E	16,0	16,0	55,0	115,0	65,0	15,2	0,5	5	□
	JS755160E3R600.3Z5-HXT	03187136	3	E	16,0	16,0	55,0	115,0	65,0	15,2	6,0	5	□
	JS755200E3R050.3Z5-HXT	03187137	3	E	20,0	20,0	61,0	125,0	72,0	19,0	0,5	5	□
	JS755200E3R600.3Z5-HXT	03187138	3	E	20,0	20,0	61,0	125,0	72,0	19,0	6,0	5	□

■ Stocked standard. □ Weldon available. Delivery time is 3 days.

JS755

High performance – Square – ISO– M and ISO– S – 5 Flutes – Safelock – Chamfer

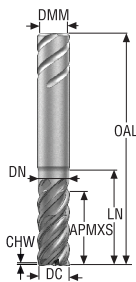

E

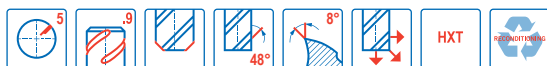

- Tolerances:
- DMM= h5
- DC= e7
- Regrind possible if DC is $\geq \varnothing 6$

Designation	Item number	Length index	Tool shape	DC	DMM	APMXS	OAL	LN	DN	CHW	PCEDC	Safelock
				mm	mm	mm	mm	mm	mm	mm		
JS755060E2C.9Z5-HXT	03187235	2	E	6,0	6,0	12,0	57,0	18,0	5,7	0,075	5	<input type="checkbox"/>
JS755080E2C.9Z5-HXT	03187236	2	E	8,0	8,0	16,0	63,0	25,0	7,6	0,1	5	<input type="checkbox"/>
JS755100E2C.9Z5-HXT	03187237	2	E	10,0	10,0	20,0	72,0	29,0	9,5	0,125	5	<input type="checkbox"/>
JS755120E2C.9Z5-HXT	03187238	2	E	12,0	12,0	24,0	83,0	35,0	11,4	0,15	5	<input type="checkbox"/>
JS755160E2C.9Z5-HXT	03187239	2	E	16,0	16,0	32,0	92,0	42,0	15,2	0,2	5	<input type="checkbox"/>
JS755200E2C.9Z5-HXT	03187240	2	E	20,0	20,0	40,0	104,0	51,0	19,0	0,25	5	<input type="checkbox"/>
JS755250E2C.9Z5-HXT	03187241	2	E	25,0	25,0	50,0	121,0	65,0	23,8	0,3	5	<input type="checkbox"/>
JS755060E3C.9Z5-HXT	03187242	3	E	6,0	6,0	21,0	65,0	26,0	5,7	0,075	5	<input type="checkbox"/>
JS755080E3C.9Z5-HXT	03187243	3	E	8,0	8,0	32,0	75,0	37,0	7,6	0,1	5	<input type="checkbox"/>
JS755100E3C.9Z5-HXT	03187244	3	E	10,0	10,0	40,0	89,0	47,0	9,5	0,125	5	<input type="checkbox"/>
JS755120E3C.9Z5-HXT	03187245	3	E	12,0	12,0	45,0	100,0	53,0	11,4	0,15	5	<input type="checkbox"/>
JS755160E3C.9Z5-HXT	03187246	3	E	16,0	16,0	55,0	115,0	65,0	15,2	0,2	5	<input type="checkbox"/>
JS755200E3C.9Z5-HXT	03187247	3	E	20,0	20,0	61,0	125,0	72,0	19,0	0,25	5	<input type="checkbox"/>
JS755250E3C.9Z5-HXT	03187248	3	E	25,0	25,0	85,0	153,0	94,0	23,8	0,3	5	<input type="checkbox"/>

Safelock available. Delivery time is 6 days.

Universal

Steel and cast iron

Stainless steel and S-materials

Non ferrous

Hard

Plastic and cfrp

Graphite

Minimaster Plus

Minimaster

JS755

High performance – Square – ISO– M and ISO– S – 5 Flutes – Safelock – Chamfer – Chip splitters

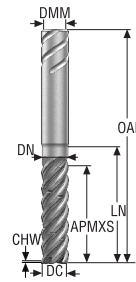

E

- Tolerances:
- DMM= h5
- DC= e7
- Chip splitters
- Regrind possible if DC is $\geq \varnothing 6$

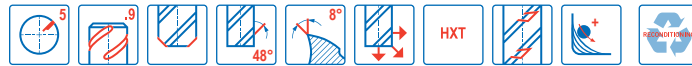

Designation	Item number	Length index	Tool shape	Chip splitters	DC	DMM	APMXS	OAL	LN	DN	CHW	PCEDC	Safelock
					mm	mm	mm	mm	mm	mm	mm	mm	
JS755100E3C.9Z5C-HXT	03187249	3	E	■	10,0	10,0	40,0	89,0	47,0	9,5	0,125	5	<input type="checkbox"/>
JS755120E3C.9Z5C-HXT	03187250	3	E	■	12,0	12,0	45,0	100,0	53,0	11,4	0,15	5	<input type="checkbox"/>
JS755160E3C.9Z5C-HXT	03187252	3	E	■	16,0	16,0	55,0	115,0	65,0	15,2	0,2	5	<input type="checkbox"/>
JS755200E3C.9Z5C-HXT	03187253	3	E	■	20,0	20,0	61,0	125,0	72,0	19,0	0,25	5	<input type="checkbox"/>

Safelock available. Delivery time is 6 days.

Universal

Steel and cast iron

Stainless steel and S-materials

Non ferrous

Hard

Plastic and cfrp

Graphite

Minimaster Plus

Minimaster

JS755

High performance – Square – ISO– M and ISO– S – 5 Flutes – Safelock – Corner radius

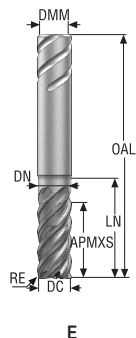

E

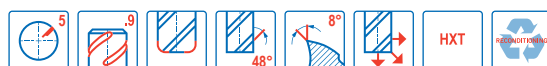

- Tolerances:
- DMM= h5
- DC= e7
- RE= ±0,01 mm
- Regrind possible if DC is ≥Ø6

Designation	Item number	Length index	Tool shape	DC	DMM	APMXS	OAL	LN	DN	RE	PCEDC	Safelock
				mm	mm	mm	mm	mm	mm	mm	mm	mm
JS755060E2R020.9Z5-HXT	03187254	2	E	6,0	6,0	12,0	57,0	18,0	5,7	0,2	5	<input type="checkbox"/>
JS755060E2R050.9Z5-HXT	03187255	2	E	6,0	6,0	12,0	57,0	18,0	5,7	0,5	5	<input type="checkbox"/>
JS755060E2R100.9Z5-HXT	03187256	2	E	6,0	6,0	12,0	57,0	18,0	5,7	1,0	5	<input type="checkbox"/>
JS755080E2R050.9Z5-HXT	03187257	2	E	8,0	8,0	16,0	63,0	25,0	7,6	0,5	5	<input type="checkbox"/>
JS755080E2R100.9Z5-HXT	03187258	2	E	8,0	8,0	16,0	63,0	25,0	7,6	1,0	5	<input type="checkbox"/>
JS755100E2R050.9Z5-HXT	03187259	2	E	10,0	10,0	20,0	72,0	29,0	9,5	0,5	5	<input type="checkbox"/>
JS755100E2R100.9Z5-HXT	03187260	2	E	10,0	10,0	20,0	72,0	29,0	9,5	1,0	5	<input type="checkbox"/>
JS755100E2R200.9Z5-HXT	03187261	2	E	10,0	10,0	20,0	72,0	29,0	9,5	2,0	5	<input type="checkbox"/>
JS755100E2R300.9Z5-HXT	03187262	2	E	10,0	10,0	20,0	72,0	29,0	9,5	3,0	5	<input type="checkbox"/>
JS755120E2R050.9Z5-HXT	03187263	2	E	12,0	12,0	24,0	83,0	35,0	11,4	0,5	5	<input type="checkbox"/>
JS755120E2R100.9Z5-HXT	03187264	2	E	12,0	12,0	24,0	83,0	35,0	11,4	1,0	5	<input type="checkbox"/>
JS755120E2R200.9Z5-HXT	03187265	2	E	12,0	12,0	24,0	83,0	35,0	11,4	2,0	5	<input type="checkbox"/>
JS755120E2R300.9Z5-HXT	03187266	2	E	12,0	12,0	24,0	83,0	35,0	11,4	3,0	5	<input type="checkbox"/>
JS755160E2R050.9Z5-HXT	03187267	2	E	16,0	16,0	32,0	92,0	42,0	15,2	0,5	5	<input type="checkbox"/>
JS755160E2R100.9Z5-HXT	03187269	2	E	16,0	16,0	32,0	92,0	42,0	15,2	1,0	5	<input type="checkbox"/>
JS755160E2R600.9Z5-HXT	03187270	2	E	16,0	16,0	32,0	92,0	42,0	15,2	6,0	5	<input type="checkbox"/>
JS755200E2R050.9Z5-HXT	03187271	2	E	20,0	20,0	40,0	104,0	51,0	19,0	0,5	5	<input type="checkbox"/>
JS755200E2R100.9Z5-HXT	03187272	2	E	20,0	20,0	40,0	104,0	51,0	19,0	1,0	5	<input type="checkbox"/>
JS755200E2R600.9Z5-HXT	03187273	2	E	20,0	20,0	40,0	104,0	51,0	19,0	6,0	5	<input type="checkbox"/>
JS755060E3R020.9Z5-HXT	03187276	3	E	6,0	6,0	21,0	65,0	26,0	5,7	0,2	5	<input type="checkbox"/>
JS755060E3R050.9Z5-HXT	03187277	3	E	6,0	6,0	21,0	65,0	26,0	5,7	0,5	5	<input type="checkbox"/>
JS755060E3R100.9Z5-HXT	03187279	3	E	6,0	6,0	21,0	65,0	26,0	5,7	1,0	5	<input type="checkbox"/>
JS755080E3R050.9Z5-HXT	03187280	3	E	8,0	8,0	32,0	75,0	37,0	7,6	0,5	5	<input type="checkbox"/>
JS755080E3R100.9Z5-HXT	03187281	3	E	8,0	8,0	32,0	75,0	37,0	7,6	1,0	5	<input type="checkbox"/>
JS755100E3R050.9Z5-HXT	03187282	3	E	10,0	10,0	40,0	89,0	47,0	9,5	0,5	5	<input type="checkbox"/>
JS755100E3R100.9Z5-HXT	03187283	3	E	10,0	10,0	40,0	89,0	47,0	9,5	1,0	5	<input type="checkbox"/>
JS755100E3R200.9Z5-HXT	03187284	3	E	10,0	10,0	40,0	89,0	47,0	9,5	2,0	5	<input type="checkbox"/>
JS755100E3R300.9Z5-HXT	03187285	3	E	10,0	10,0	40,0	89,0	47,0	9,5	3,0	5	<input type="checkbox"/>
JS755120E3R050.9Z5-HXT	03187286	3	E	12,0	12,0	45,0	100,0	53,0	11,4	0,5	5	<input type="checkbox"/>
JS755120E3R100.9Z5-HXT	03187287	3	E	12,0	12,0	45,0	100,0	53,0	11,4	1,0	5	<input type="checkbox"/>
JS755120E3R200.9Z5-HXT	03187288	3	E	12,0	12,0	45,0	100,0	53,0	11,4	2,0	5	<input type="checkbox"/>
JS755120E3R300.9Z5-HXT	03187289	3	E	12,0	12,0	45,0	100,0	53,0	11,4	3,0	5	<input type="checkbox"/>
JS755160E3R050.9Z5-HXT	03187290	3	E	16,0	16,0	55,0	115,0	65,0	15,2	0,5	5	<input type="checkbox"/>
JS755160E3R600.9Z5-HXT	03187291	3	E	16,0	16,0	55,0	115,0	65,0	15,2	6,0	5	<input type="checkbox"/>
JS755200E3R050.9Z5-HXT	03187292	3	E	20,0	20,0	61,0	125,0	72,0	19,0	0,5	5	<input type="checkbox"/>
JS755200E3R600.9Z5-HXT	03187293	3	E	20,0	20,0	61,0	125,0	72,0	19,0	6,0	5	<input type="checkbox"/>

Safelock available. Delivery time is 6 days.

Universal

Steel and cast iron

Stainless steel and S-materials

Non ferrous

Hard

Plastic and chip

Graphite

Minimaster Plus

Minimaster

Cutting data – JS755 Side milling roughing

SMG		a _e /DC	a _p /DC	f _z							v _c
				6	8	10	12	16	20	25	
P11	M/A/D/E	0.400	1.1	0.044	0.060	0.075	0.085	0.11	0.12	0.14	135 (97–150)
		0,400	1,1	0,0017	0,0024	0,0030	0,0034	0,0044	0,0048	0,0055	445 (320–490)
P12	M/A/D/E	0.400	1.1	0.030	0.040	0.050	0.060	0.075	0.085	0.095	85 (63–99)
		0,400	1,1	0,0012	0,0016	0,0020	0,0024	0,0030	0,0034	0,0038	280 (210–320)
M1	E	0.400	1.1	0.032	0.044	0.055	0.065	0.080	0.095	0.11	170 (150–190)
		0,400	1,1	0,0013	0,0017	0,0022	0,0026	0,0032	0,0038	0,0044	560 (500–620)
M2	E	0.400	1.1	0.030	0.040	0.050	0.060	0.075	0.085	0.095	140 (120–150)
		0,400	1,1	0,0012	0,0016	0,0020	0,0024	0,0030	0,0034	0,0038	460 (400–490)
M3	E	0.400	1.1	0.030	0.040	0.050	0.060	0.075	0.085	0.095	110 (92–120)
		0,400	1,1	0,0012	0,0016	0,0020	0,0024	0,0030	0,0034	0,0038	360 (310–390)
M4	E	0.400	1.1	0.026	0.034	0.044	0.050	0.065	0.075	0.085	85 (71–95)
		0,400	1,1	0,0010	0,0013	0,0017	0,0020	0,0026	0,0030	0,0034	280 (240–310)
M5	E	0.400	1.1	0.026	0.034	0.044	0.050	0.065	0.075	0.085	70 (59–79)
		0,400	1,1	0,0010	0,0013	0,0017	0,0020	0,0026	0,0030	0,0034	230 (200–250)
S1	E	0.0300	2.0	0.046	0.060	0.075	0.090	0.11	0.13	0.14	70 (48–110)
		0,0300	2,0	0,0018	0,0024	0,0030	0,0036	0,0044	0,0050	0,0055	230 (160–360)
S2	E	0.0300	2.0	0.046	0.060	0.075	0.090	0.11	0.13	0.14	60 (39–89)
		0,0300	2,0	0,0018	0,0024	0,0030	0,0036	0,0044	0,0050	0,0055	195 (130–290)
S3	E	0.0300	2.0	0.042	0.055	0.070	0.085	0.10	0.12	0.13	50 (34–78)
		0,0300	2,0	0,0017	0,0022	0,0028	0,0034	0,0040	0,0048	0,0050	165 (120–250)
S11	E	0.400	1.1	0.030	0.040	0.050	0.060	0.075	0.085	0.095	140 (120–160)
		0,400	1,1	0,0012	0,0016	0,0020	0,0024	0,0030	0,0034	0,0038	460 (400–520)
S12	E	0.400	1.1	0.030	0.040	0.050	0.060	0.075	0.085	0.095	110 (91–120)
		0,400	1,1	0,0012	0,0016	0,0020	0,0024	0,0030	0,0034	0,0038	360 (300–390)
S13	E	0.400	1.1	0.026	0.034	0.044	0.050	0.065	0.075	0.085	85 (73–100)
		0,400	1,1	0,0010	0,0013	0,0017	0,0020	0,0026	0,0030	0,0034	280 (240–320)

Cutting data – JS755_3C Advanced roughing a_e/DC=0,05-0,1

SMG		a _e /DC	a _p /DC	f _z				v _c
				10	12	16	20	
P11	M/A/D/E	0.100	4.0	0.15	0.17	0.22	0.25	265 (220–290)
		0,100	4,0	0,0060	0,0065	0,0085	0,010	870 (730–950)
P12	M/A/D/E	0.100	4.0	0.10	0.12	0.15	0.17	170 (140–180)
		0,100	4,0	0,0040	0,0048	0,0060	0,0065	560 (460–590)
M1	E	0.100	4.0	0.11	0.13	0.16	0.19	205 (170–220)
		0,100	4,0	0,0044	0,0050	0,0065	0,0075	670 (560–720)
M2	E	0.100	4.0	0.10	0.12	0.15	0.17	170 (140–180)
		0,100	4,0	0,0040	0,0048	0,0060	0,0065	560 (460–590)
M3	E	0.100	4.0	0.10	0.12	0.15	0.17	130 (110–140)
		0,100	4,0	0,0040	0,0048	0,0060	0,0065	425 (370–450)
M4	E	0.100	4.0	0.085	0.10	0.13	0.15	100 (85–110)
		0,100	4,0	0,0034	0,0040	0,0050	0,0060	330 (280–360)
M5	E	0.100	4.0	0.085	0.10	0.13	0.15	85 (71–96)
		0,100	4,0	0,0034	0,0040	0,0050	0,0060	280 (240–310)
S1	E	0.0500	4.0	0.085	0.10	0.13	0.15	70 (43–99)
		0,0500	4,0	0,0034	0,0040	0,0050	0,0060	230 (150–320)
S2	E	0.0500	4.0	0.085	0.10	0.13	0.15	55 (35–80)
		0,0500	4,0	0,0034	0,0040	0,0050	0,0060	180 (120–260)
S3	E	0.0500	4.0	0.080	0.095	0.12	0.14	50 (31–70)
		0,0500	4,0	0,0032	0,0038	0,0048	0,0055	165 (110–220)
S11	E	0.0800	4.0	0.070	0.085	0.10	0.12	160 (140–190)
		0,0800	4,0	0,0028	0,0034	0,0040	0,0048	520 (460–620)
S12	E	0.0800	4.0	0.070	0.085	0.10	0.12	125 (110–140)
		0,0800	4,0	0,0028	0,0034	0,0040	0,0048	410 (370–450)
S13	E	0.0800	4.0	0.060	0.070	0.090	0.10	100 (83–110)
		0,0800	4,0	0,0024	0,0028	0,0036	0,0040	330 (280–360)

If radius exceeds 15% of value DC please reduce fz with 20%

For cutting data recalculations, see pages 445 - 452.

SMG = Seco material group
Coolant = A=air D=dry E=emulsion M=mist spray
v_c = m/min (sf/min)
f_z = mm (in/tooth)
a_p = mm/DC (in/DC) = factor
a_e = mm/DC (in/DC) = factor
All cutting data are target values

JS720

High performance – Titanium – Square – 6 Flutes – Cylindrical – Corner radius

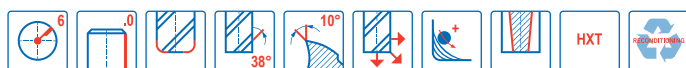
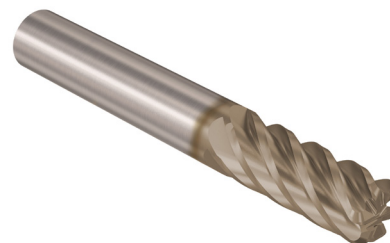
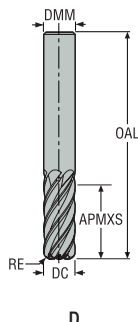

- Tolerances:
- DMM= h5
- DC= e7
- RE= ±0,02 mm
- Regrind possible if DC is ≥Ø6

Designation	Item number	Length index	Tool shape	DC	DMM	APMXS	OAL	RE	PCEDC	Cylindrical
				mm	mm	mm	mm	mm		
JS720060D2R050.0Z6-HXT	03060293	2	D	6,0	6,0	17,0	57,0	0,5	6	■
JS720060D2R100.0Z6-HXT	03060294	2	D	6,0	6,0	17,0	57,0	1,0	6	■
JS720080D2R050.0Z6-HXT	03060295	2	D	8,0	8,0	23,0	63,0	0,5	6	■
JS720080D2R100.0Z6-HXT	03061294	2	D	8,0	8,0	23,0	63,0	1,0	6	■
JS720100D2R050.0Z6-HXT	03060296	2	D	10,0	10,0	26,0	72,0	0,5	6	■
JS720100D2R100.0Z6-HXT	03060298	2	D	10,0	10,0	26,0	72,0	1,0	6	■
JS720100D2R200.0Z6-HXT	03060299	2	D	10,0	10,0	26,0	72,0	2,0	6	■
JS720100D2R300.0Z6-HXT	03060300	2	D	10,0	10,0	26,0	72,0	3,0	6	■
JS720120D2R050.0Z6-HXT	03060301	2	D	12,0	12,0	30,0	83,0	0,5	6	■
JS720120D2R100.0Z6-HXT	03060304	2	D	12,0	12,0	30,0	83,0	1,0	6	■
JS720120D2R200.0Z6-HXT	03060305	2	D	12,0	12,0	30,0	83,0	2,0	6	■
JS720120D2R300.0Z6-HXT	03060306	2	D	12,0	12,0	30,0	83,0	3,0	6	■
JS720160D2R050.0Z6-HXT	03060307	2	D	16,0	16,0	44,0	99,0	0,5	6	■
JS720160D2R100.0Z6-HXT	03060309	2	D	16,0	16,0	44,0	99,0	1,0	6	■
JS720160D2R200.0Z6-HXT	03060310	2	D	16,0	16,0	44,0	99,0	2,0	6	■
JS720160D2R300.0Z6-HXT	03060311	2	D	16,0	16,0	44,0	99,0	3,0	6	■
JS720160D2R400.0Z6-HXT	03060312	2	D	16,0	16,0	44,0	99,0	4,0	6	■
JS720160D2R600.0Z6-HXT	03060313	2	D	16,0	16,0	44,0	99,0	6,0	6	■
JS720250D2R300.0Z6-HXT	03169498	2	D	25,0	25,0	50,0	125,0	3,0	6	■
JS720160D3R300.0Z6-HXT	03169497	3	D	16,0	16,0	65,0	130,0	3,0	6	■
JS720200D3R050.0Z6-HXT	03060314	3	D	20,0	20,0	62,0	121,0	0,5	6	■
JS720200D3R100.0Z6-HXT	03060316	3	D	20,0	20,0	62,0	121,0	1,0	6	■
JS720200D3R200.0Z6-HXT	03060317	3	D	20,0	20,0	62,0	121,0	2,0	6	■
JS720200D3R300.0Z6-HXT	03060318	3	D	20,0	20,0	62,0	121,0	3,0	6	■
JS720200D3R400.0Z6-HXT	03060319	3	D	20,0	20,0	62,0	121,0	4,0	6	■
JS720200D3R500.0Z6-HXT	03060320	3	D	20,0	20,0	62,0	121,0	5,0	6	■
JS720200D3R600.0Z6-HXT	03060321	3	D	20,0	20,0	62,0	121,0	6,0	6	■
JS720250D3R050.0Z6-HXT	03060322	3	D	25,0	25,0	78,0	146,0	0,5	6	■
JS720250D3R100.0Z6-HXT	03060323	3	D	25,0	25,0	78,0	146,0	1,0	6	■
JS720250D3R200.0Z6-HXT	03060324	3	D	25,0	25,0	78,0	146,0	2,0	6	■
JS720250D3R300.0Z6-HXT	03060325	3	D	25,0	25,0	78,0	146,0	3,0	6	■
JS720250D3R400.0Z6-HXT	03060326	3	D	25,0	25,0	78,0	146,0	4,0	6	■
JS720250D3R600.0Z6-HXT	03060327	3	D	25,0	25,0	78,0	146,0	6,0	6	■

■ Stocked standard.

Universal

Steel and cast iron

Stainless steel and S-materials

Non ferrous

Hard

Plastic and cfrp

Graphite

Minimaster Plus

Minimaster

JS720

High performance – Titanium – Square – 6 Flutes – Cylindrical – Corner radius – Chip splitters

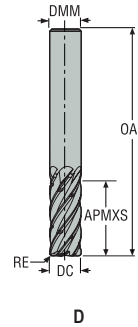
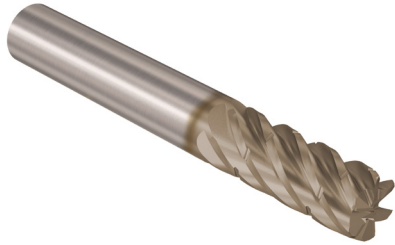

- Tolerances:
- DMM= h5
- DC= e7
- RE= ±0,02 mm
- Chip splitters
- Regrind possible if DC is ≥Ø6

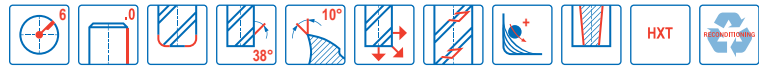

Designation	Item number	Length index	Tool shape	Chip splitters	DC	DMM	APMXS	OAL	RE	PCEDC	Cylindrical
					mm	mm	mm	mm	mm		
JS720100D2R050.0Z6C-HXT	03060297	2	D	■	10,0	10,0	26,0	72,0	0,5	6	■
JS720120D2R050.0Z6C-HXT	03060302	2	D	■	12,0	12,0	30,0	83,0	0,5	6	■
JS720120D2R100.0Z6C-HXT	03298280	2	D	■	12,0	12,0	30,0	83,0	1,0	6	■
JS720120D2R200.0Z6C-HXT	03298281	2	D	■	12,0	12,0	30,0	83,0	2,0	6	■
JS720120D2R250.0Z6C-HXT	03298282	2	D	■	12,0	12,0	30,0	83,0	2,5	6	■
JS720120D2R300.0Z6C-HXT	03298283	2	D	■	12,0	12,0	30,0	83,0	3,0	6	■
JS720120D2R310.0Z6C-HXT	03298284	2	D	■	12,0	12,0	30,0	83,0	3,1	6	■
JS720160D2R050.0Z6C-HXT	03060308	2	D	■	16,0	16,0	44,0	99,0	0,5	6	■
JS720160D2R100.0Z6C-HXT	03298285	2	D	■	16,0	16,0	44,0	99,0	1,0	6	■
JS720160D2R200.0Z6C-HXT	03298286	2	D	■	16,0	16,0	44,0	99,0	2,0	6	■
JS720160D2R250.0Z6C-HXT	03298287	2	D	■	16,0	16,0	44,0	99,0	2,5	6	■
JS720160D2R300.0Z6C-HXT	03298288	2	D	■	16,0	16,0	44,0	99,0	3,0	6	■
JS720160D2R310.0Z6C-HXT	03298289	2	D	■	16,0	16,0	44,0	99,0	3,1	6	■
JS720160D2R400.0Z6C-HXT	03298290	2	D	■	16,0	16,0	44,0	99,0	4,0	6	■
JS720160D2R600.0Z6C-HXT	03298291	2	D	■	16,0	16,0	44,0	99,0	6,0	6	■
JS720200D3R050.0Z6C-HXT	03060315	3	D	■	20,0	20,0	62,0	121,0	0,5	6	■
JS720200D3R100.0Z6C-HXT	03298292	3	D	■	20,0	20,0	62,0	121,0	1,0	6	■
JS720200D3R200.0Z6C-HXT	03298293	3	D	■	20,0	20,0	62,0	121,0	2,0	6	■
JS720200D3R250.0Z6C-HXT	03298294	3	D	■	20,0	20,0	62,0	121,0	2,5	6	■
JS720200D3R300.0Z6C-HXT	03298295	3	D	■	20,0	20,0	62,0	121,0	3,0	6	■
JS720200D3R310.0Z6C-HXT	03298296	3	D	■	20,0	20,0	62,0	121,0	3,1	6	■
JS720200D3R400.0Z6C-HXT	03298297	3	D	■	20,0	20,0	62,0	121,0	4,0	6	■
JS720200D3R500.0Z6C-HXT	03298298	3	D	■	20,0	20,0	62,0	121,0	5,0	6	■
JS720200D3R600.0Z6C-HXT	03298299	3	D	■	20,0	20,0	62,0	121,0	6,0	6	■
JS720250D3R050.0Z6C-HXT	03066270	3	D	■	25,0	25,0	78,0	146,0	0,5	6	■
JS720250D3R100.0Z6C-HXT	03298300	3	D	■	25,0	25,0	78,0	146,0	1,0	6	■
JS720250D3R200.0Z6C-HXT	03298301	3	D	■	25,0	25,0	78,0	146,0	2,0	6	■
JS720250D3R300.0Z6C-HXT	03298302	3	D	■	25,0	25,0	78,0	146,0	3,0	6	■
JS720250D3R400.0Z6C-HXT	03298303	3	D	■	25,0	25,0	78,0	146,0	4,0	6	■
JS720250D3R600.0Z6C-HXT	03298304	3	D	■	25,0	25,0	78,0	146,0	6,0	6	■

■ Stocked standard.

JS720

High performance – Titanium – Square – 9 Flutes – Cylindrical – Corner radius

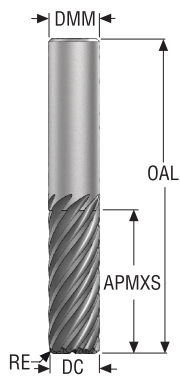

D

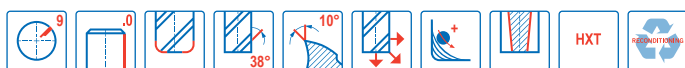

- Tolerances:
- DMM= h5
- DC= e7
- RE= ±0,02 mm
- Re grind possible if DC is ≥Ø6

Designation	Item number	Length index	Tool shape	DC	DMM	APMXS	OAL	RE	PCEDC	Cylindrical
				mm	mm	mm	mm	mm		
JS720160D2R100.0Z9-HXT	10008152	2	D	16,0	16,0	44,0	99,0	1,0	9	■
JS720160D2R200.0Z9-HXT	10008153	2	D	16,0	16,0	44,0	99,0	2,0	9	■
JS720160D2R300.0Z9-HXT	10008154	2	D	16,0	16,0	44,0	99,0	3,0	9	■
JS720250D2R100.0Z9-HXT	10008155	2	D	25,0	25,0	50,0	125,0	1,0	9	■
JS720250D2R200.0Z9-HXT	10008156	2	D	25,0	25,0	50,0	125,0	2,0	9	■
JS720250D2R300.0Z9-HXT	10008157	2	D	25,0	25,0	50,0	125,0	3,0	9	■
JS720160D3R100.0Z9-HXT	10008158	3	D	16,0	16,0	65,0	130,0	1,0	9	■
JS720160D3R200.0Z9-HXT	10008159	3	D	16,0	16,0	65,0	130,0	2,0	9	■
JS720160D3R300.0Z9-HXT	10008160	3	D	16,0	16,0	65,0	130,0	3,0	9	■
JS720200D3R100.0Z9-HXT	10008161	3	D	20,0	20,0	62,0	121,0	1,0	9	■
JS720200D3R200.0Z9-HXT	10008162	3	D	20,0	20,0	62,0	121,0	2,0	9	■
JS720200D3R300.0Z9-HXT	10008163	3	D	20,0	20,0	62,0	121,0	3,0	9	■
JS720250D3R100.0Z9-HXT	10008164	3	D	25,0	25,0	78,0	146,0	1,0	9	■
JS720250D3R200.0Z9-HXT	10008165	3	D	25,0	25,0	78,0	146,0	2,0	9	■
JS720250D3R300.0Z9-HXT	10008166	3	D	25,0	25,0	78,0	146,0	3,0	9	■

■ Stocked standard.

Universal

Steel and cast iron

Stainless steel and S-materials

Non ferrous

Hard

Plastic and cfrp

Graphite

Minimaster Plus

Minimaster

JS720

High performance – Titanium – Square – 6 Flutes – Weldon – Corner radius

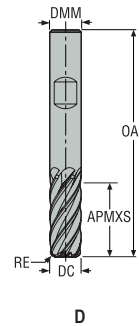
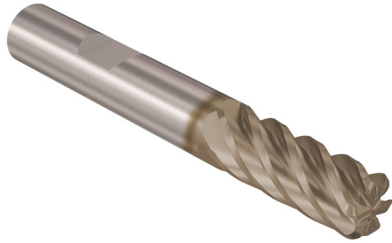

- Tolerances:
- DMM= h5
- DC= e7
- RE= ±0,02 mm
- Regrind possible if DC is ≥Ø6

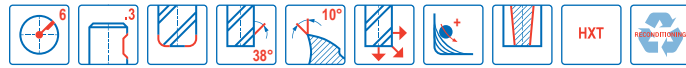

	Designation	Item number	Length index	Tool shape	DC	DMM	APMXS	OAL	RE	PCEDC	Weldon
					mm	mm	mm	mm	mm		
Universal	JS720060D2R050.3Z6-HXT	03060339	2	D	6,0	6,0	17,0	57,0	0,5	6	<input type="checkbox"/>
	JS720060D2R100.3Z6-HXT	03060340	2	D	6,0	6,0	17,0	57,0	1,0	6	<input type="checkbox"/>
Steel and cast iron	JS720080D2R050.3Z6-HXT	03060341	2	D	8,0	8,0	23,0	63,0	0,5	6	<input type="checkbox"/>
	JS720080D2R100.3Z6-HXT	03061295	2	D	8,0	8,0	23,0	63,0	1,0	6	<input type="checkbox"/>
Stainless steel and S-materials	JS720100D2R050.3Z6-HXT	03060342	2	D	10,0	10,0	26,0	72,0	0,5	6	<input type="checkbox"/>
	JS720100D2R100.3Z6-HXT	03060344	2	D	10,0	10,0	26,0	72,0	1,0	6	<input type="checkbox"/>
Non ferrous	JS720100D2R200.3Z6-HXT	03060345	2	D	10,0	10,0	26,0	72,0	2,0	6	<input type="checkbox"/>
	JS720100D2R300.3Z6-HXT	03060346	2	D	10,0	10,0	26,0	72,0	3,0	6	<input type="checkbox"/>
Hard	JS720120D2R050.3Z6-HXT	03060347	2	D	12,0	12,0	30,0	83,0	0,5	6	<input type="checkbox"/>
	JS720120D2R100.3Z6-HXT	03060349	2	D	12,0	12,0	30,0	83,0	1,0	6	<input type="checkbox"/>
Plastic and cfrp	JS720120D2R200.3Z6-HXT	03060350	2	D	12,0	12,0	30,0	83,0	2,0	6	<input type="checkbox"/>
	JS720120D2R300.3Z6-HXT	03060351	2	D	12,0	12,0	30,0	83,0	3,0	6	<input type="checkbox"/>
Graphite	JS720160D2R050.3Z6-HXT	03060352	2	D	16,0	16,0	44,0	99,0	0,5	6	<input type="checkbox"/>
	JS720160D2R100.3Z6-HXT	03060354	2	D	16,0	16,0	44,0	99,0	1,0	6	<input type="checkbox"/>
Minimaster Plus	JS720160D2R200.3Z6-HXT	03060355	2	D	16,0	16,0	44,0	99,0	2,0	6	<input type="checkbox"/>
	JS720160D2R300.3Z6-HXT	03060356	2	D	16,0	16,0	44,0	99,0	3,0	6	<input type="checkbox"/>
Minimaster	JS720160D2R400.3Z6-HXT	03060357	2	D	16,0	16,0	44,0	99,0	4,0	6	<input type="checkbox"/>
	JS720160D2R600.3Z6-HXT	03060358	2	D	16,0	16,0	44,0	99,0	6,0	6	<input type="checkbox"/>
	JS720200D3R050.3Z6-HXT	03060359	3	D	20,0	20,0	62,0	121,0	0,5	6	<input type="checkbox"/>
	JS720200D3R100.3Z6-HXT	03060361	3	D	20,0	20,0	62,0	121,0	1,0	6	<input type="checkbox"/>
	JS720200D3R200.3Z6-HXT	03060362	3	D	20,0	20,0	62,0	121,0	2,0	6	<input type="checkbox"/>
	JS720200D3R300.3Z6-HXT	03060363	3	D	20,0	20,0	62,0	121,0	3,0	6	<input checked="" type="checkbox"/>
	JS720200D3R400.3Z6-HXT	03060364	3	D	20,0	20,0	62,0	121,0	4,0	6	<input type="checkbox"/>
	JS720200D3R500.3Z6-HXT	03060365	3	D	20,0	20,0	62,0	121,0	5,0	6	<input type="checkbox"/>
	JS720200D3R600.3Z6-HXT	03060366	3	D	20,0	20,0	62,0	121,0	6,0	6	<input type="checkbox"/>
	JS720250D3R050.3Z6-HXT	03060367	3	D	25,0	25,0	78,0	146,0	0,5	6	<input type="checkbox"/>
	JS720250D3R100.3Z6-HXT	03060368	3	D	25,0	25,0	78,0	146,0	1,0	6	<input type="checkbox"/>
	JS720250D3R200.3Z6-HXT	03060369	3	D	25,0	25,0	78,0	146,0	2,0	6	<input type="checkbox"/>
	JS720250D3R300.3Z6-HXT	03060370	3	D	25,0	25,0	78,0	146,0	3,0	6	<input type="checkbox"/>
	JS720250D3R400.3Z6-HXT	03060371	3	D	25,0	25,0	78,0	146,0	4,0	6	<input checked="" type="checkbox"/>
	JS720250D3R600.3Z6-HXT	03060372	3	D	25,0	25,0	78,0	146,0	6,0	6	<input type="checkbox"/>

■ Stocked standard. □ Weldon available. Delivery time is 3 days.

JS720

High performance – Titanium – Square – 6 Flutes – Weldon – Corner radius – Chip splitters

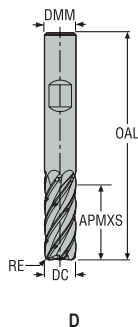

Universal

Steel and cast iron

Stainless steel and S-materials

Non ferrous

Hard

Plastic and chip

Graphite

Minimaster Plus

Minimaster



- Tolerances:
- DMM= h5
- DC= e7
- RE= ±0,02 mm
- Chip splitters
- Regrind possible if DC is ≥Ø6

Designation	Item number	Length index	Tool shape	Chip splitters	DC	DMM	APMXS	OAL	RE	PCEDC	Weldon
					mm	mm	mm	mm	mm		
JS720100D2R050.3Z6C-HXT	03060343	2	D	■	10,0	10,0	26,0	72,0	0,5	6	□
JS720120D2R050.3Z6C-HXT	03060348	2	D	■	12,0	12,0	30,0	83,0	0,5	6	□
JS720120D2R100.3Z6C-HXT	03298308	2	D	■	12,0	12,0	30,0	83,0	1,0	6	□
JS720120D2R200.3Z6C-HXT	03298309	2	D	■	12,0	12,0	30,0	83,0	2,0	6	□
JS720120D2R250.3Z6C-HXT	03298310	2	D	■	12,0	12,0	30,0	83,0	2,5	6	□
JS720120D2R300.3Z6C-HXT	03298311	2	D	■	12,0	12,0	30,0	83,0	3,0	6	□
JS720120D2R310.3Z6C-HXT	03298312	2	D	■	12,0	12,0	30,0	83,0	3,1	6	□
JS720160D2R050.3Z6C-HXT	03060353	2	D	■	16,0	16,0	44,0	99,0	0,5	6	■
JS720160D2R100.3Z6C-HXT	03298313	2	D	■	16,0	16,0	44,0	99,0	1,0	6	■
JS720160D2R200.3Z6C-HXT	03298314	2	D	■	16,0	16,0	44,0	99,0	2,0	6	■
JS720160D2R250.3Z6C-HXT	03298315	2	D	■	16,0	16,0	44,0	99,0	2,5	6	■
JS720160D2R300.3Z6C-HXT	03298316	2	D	■	16,0	16,0	44,0	99,0	3,0	6	■
JS720160D2R310.3Z6C-HXT	03298317	2	D	■	16,0	16,0	44,0	99,0	3,1	6	■
JS720160D2R400.3Z6C-HXT	03298318	2	D	■	16,0	16,0	44,0	99,0	4,0	6	■
JS720160D2R600.3Z6C-HXT	03298319	2	D	■	16,0	16,0	44,0	99,0	6,0	6	■
JS720200D3R050.3Z6C-HXT	03060360	3	D	■	20,0	20,0	62,0	121,0	0,5	6	■
JS720200D3R100.3Z6C-HXT	03298320	3	D	■	20,0	20,0	62,0	121,0	1,0	6	■
JS720200D3R200.3Z6C-HXT	03298321	3	D	■	20,0	20,0	62,0	121,0	2,0	6	■
JS720200D3R250.3Z6C-HXT	03298322	3	D	■	20,0	20,0	62,0	121,0	2,5	6	■
JS720200D3R300.3Z6C-HXT	03298323	3	D	■	20,0	20,0	62,0	121,0	3,0	6	■
JS720200D3R310.3Z6C-HXT	03298324	3	D	■	20,0	20,0	62,0	121,0	3,1	6	■
JS720200D3R400.3Z6C-HXT	03298325	3	D	■	20,0	20,0	62,0	121,0	4,0	6	■
JS720200D3R500.3Z6C-HXT	03298326	3	D	■	20,0	20,0	62,0	121,0	5,0	6	■
JS720200D3R600.3Z6C-HXT	03298327	3	D	■	20,0	20,0	62,0	121,0	6,0	6	■
JS720250D3R050.3Z6C-HXT	03066460	3	D	■	25,0	25,0	78,0	146,0	0,5	6	■
JS720250D3R100.3Z6C-HXT	03298328	3	D	■	25,0	25,0	78,0	146,0	1,0	6	■
JS720250D3R200.3Z6C-HXT	03298329	3	D	■	25,0	25,0	78,0	146,0	2,0	6	■
JS720250D3R300.3Z6C-HXT	03298330	3	D	■	25,0	25,0	78,0	146,0	3,0	6	■
JS720250D3R400.3Z6C-HXT	03298331	3	D	■	25,0	25,0	78,0	146,0	4,0	6	■
JS720250D3R600.3Z6C-HXT	03298332	3	D	■	25,0	25,0	78,0	146,0	6,0	6	■

■ Stocked standard. □ Weldon available. Delivery time is 3 days.

JS720

High performance – Titanium – Square – 9 Flutes – Weldon – Corner radius

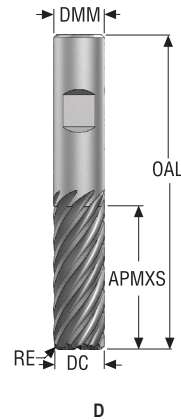

- Tolerances:
- DMM= h5
- DC= e7
- RE= ±0,02 mm
- Regrind possible if DC is ≥Ø6

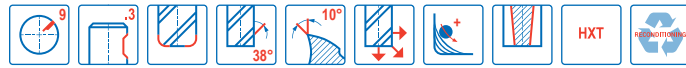

Designation	Item number	Length index	Tool shape	DC	DMM	APMXS	OAL	RE	PCEDC	Weldon
				mm	mm	mm	mm	mm		
JS720160D2R100.3Z9-HXT	10008279	2	D	16,0	16,0	44,0	99,0	1,0	9	<input type="checkbox"/>
JS720160D2R200.3Z9-HXT	10008280	2	D	16,0	16,0	44,0	99,0	2,0	9	<input type="checkbox"/>
JS720160D2R300.3Z9-HXT	10008281	2	D	16,0	16,0	44,0	99,0	3,0	9	<input type="checkbox"/>
JS720250D2R100.3Z9-HXT	10008282	2	D	25,0	25,0	50,0	125,0	1,0	9	<input type="checkbox"/>
JS720250D2R200.3Z9-HXT	10008283	2	D	25,0	25,0	50,0	125,0	2,0	9	<input type="checkbox"/>
JS720250D2R300.3Z9-HXT	10008284	2	D	25,0	25,0	50,0	125,0	3,0	9	<input type="checkbox"/>
JS720160D3R100.3Z9-HXT	10008285	3	D	16,0	16,0	65,0	130,0	1,0	9	<input type="checkbox"/>
JS720160D3R200.3Z9-HXT	10008286	3	D	16,0	16,0	65,0	130,0	2,0	9	<input type="checkbox"/>
JS720160D3R300.3Z9-HXT	10008287	3	D	16,0	16,0	65,0	130,0	3,0	9	<input type="checkbox"/>
JS720200D3R100.3Z9-HXT	10008288	3	D	20,0	20,0	62,0	121,0	1,0	9	<input type="checkbox"/>
JS720200D3R200.3Z9-HXT	10008289	3	D	20,0	20,0	62,0	121,0	2,0	9	<input type="checkbox"/>
JS720200D3R300.3Z9-HXT	10008290	3	D	20,0	20,0	62,0	121,0	3,0	9	<input type="checkbox"/>
JS720250D3R100.3Z9-HXT	10008292	3	D	25,0	25,0	78,0	146,0	1,0	9	<input type="checkbox"/>
JS720250D3R200.3Z9-HXT	10008293	3	D	25,0	25,0	78,0	146,0	2,0	9	<input type="checkbox"/>
JS720250D3R300.3Z9-HXT	10008294	3	D	25,0	25,0	78,0	146,0	3,0	9	<input type="checkbox"/>

Weldon available. Delivery time is 3 days.

JS720

High performance – Titanium – Square – 6 Flutes – Safelock – Corner radius

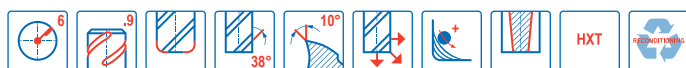
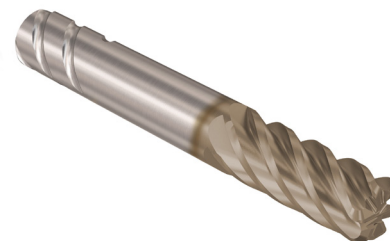
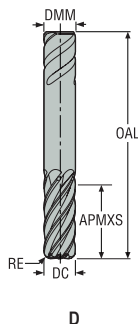

- Tolerances:
- DMM= h5
- DC= e7
- RE= ±0,02 mm
- Regrind possible if DC is ≥Ø6

Designation	Item number	Length index	Tool shape	DC	DMM	APMXS	OAL	RE	PCEDC	Safelock
				mm	mm	mm	mm	mm	mm	
JS720060D2R050.9Z6-HXT	03060374	2	D	6,0	6,0	17,0	57,0	0,5	6	<input type="checkbox"/>
JS720060D2R100.9Z6-HXT	03060375	2	D	6,0	6,0	17,0	57,0	1,0	6	<input type="checkbox"/>
JS720080D2R050.9Z6-HXT	03060376	2	D	8,0	8,0	23,0	63,0	0,5	6	<input type="checkbox"/>
JS720080D2R100.9Z6-HXT	03061296	2	D	8,0	8,0	23,0	63,0	1,0	6	<input type="checkbox"/>
JS720100D2R050.9Z6-HXT	03060377	2	D	10,0	10,0	26,0	72,0	0,5	6	<input type="checkbox"/>
JS720100D2R100.9Z6-HXT	03060379	2	D	10,0	10,0	26,0	72,0	1,0	6	<input type="checkbox"/>
JS720100D2R200.9Z6-HXT	03060380	2	D	10,0	10,0	26,0	72,0	2,0	6	<input type="checkbox"/>
JS720100D2R300.9Z6-HXT	03060381	2	D	10,0	10,0	26,0	72,0	3,0	6	<input type="checkbox"/>
JS720120D2R050.9Z6-HXT	03060382	2	D	12,0	12,0	30,0	83,0	0,5	6	<input type="checkbox"/>
JS720120D2R100.9Z6-HXT	03060384	2	D	12,0	12,0	30,0	83,0	1,0	6	<input type="checkbox"/>
JS720120D2R200.9Z6-HXT	03060385	2	D	12,0	12,0	30,0	83,0	2,0	6	<input type="checkbox"/>
JS720120D2R300.9Z6-HXT	03060386	2	D	12,0	12,0	30,0	83,0	3,0	6	<input type="checkbox"/>
JS720160D2R050.9Z6-HXT	03060387	2	D	16,0	16,0	44,0	99,0	0,5	6	<input type="checkbox"/>
JS720160D2R100.9Z6-HXT	03060389	2	D	16,0	16,0	44,0	99,0	1,0	6	<input type="checkbox"/>
JS720160D2R200.9Z6-HXT	03060390	2	D	16,0	16,0	44,0	99,0	2,0	6	<input type="checkbox"/>
JS720160D2R300.9Z6-HXT	03060391	2	D	16,0	16,0	44,0	99,0	3,0	6	<input type="checkbox"/>
JS720160D2R400.9Z6-HXT	03060392	2	D	16,0	16,0	44,0	99,0	4,0	6	<input type="checkbox"/>
JS720160D2R600.9Z6-HXT	03060393	2	D	16,0	16,0	44,0	99,0	6,0	6	<input type="checkbox"/>
JS720200D3R050.9Z6-HXT	03060394	3	D	20,0	20,0	62,0	121,0	0,5	6	<input type="checkbox"/>
JS720200D3R100.9Z6-HXT	03060396	3	D	20,0	20,0	62,0	121,0	1,0	6	<input type="checkbox"/>
JS720200D3R200.9Z6-HXT	03060397	3	D	20,0	20,0	62,0	121,0	2,0	6	<input type="checkbox"/>
JS720200D3R300.9Z6-HXT	03060398	3	D	20,0	20,0	62,0	121,0	3,0	6	<input type="checkbox"/>
JS720200D3R400.9Z6-HXT	03060399	3	D	20,0	20,0	62,0	121,0	4,0	6	<input type="checkbox"/>
JS720200D3R500.9Z6-HXT	03060400	3	D	20,0	20,0	62,0	121,0	5,0	6	<input type="checkbox"/>
JS720200D3R600.9Z6-HXT	03060401	3	D	20,0	20,0	62,0	121,0	6,0	6	<input type="checkbox"/>
JS720250D3R050.9Z6-HXT	03060402	3	D	25,0	25,0	78,0	146,0	0,5	6	<input type="checkbox"/>
JS720250D3R100.9Z6-HXT	03060403	3	D	25,0	25,0	78,0	146,0	1,0	6	<input type="checkbox"/>
JS720250D3R200.9Z6-HXT	03060404	3	D	25,0	25,0	78,0	146,0	2,0	6	<input type="checkbox"/>
JS720250D3R300.9Z6-HXT	03060405	3	D	25,0	25,0	78,0	146,0	3,0	6	<input type="checkbox"/>
JS720250D3R400.9Z6-HXT	03060406	3	D	25,0	25,0	78,0	146,0	4,0	6	<input type="checkbox"/>
JS720250D3R600.9Z6-HXT	03060407	3	D	25,0	25,0	78,0	146,0	6,0	6	<input type="checkbox"/>

Safelock available. Delivery time is 6 days.

Universal

Steel and cast iron

Stainless steel and S-materials

Non ferrous

Hard

Plastic and cfrp

Graphite

Minimaster Plus

Minimaster

JS720

High performance – Titanium – Square – 6 Flutes – Safelock – Corner radius – Chip splitters

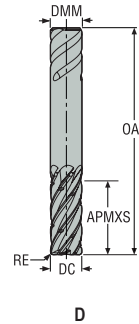
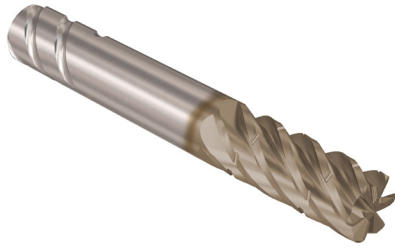

- Tolerances:
- DMM= h5
- DC= e7
- RE= ±0,02 mm
- Chip splitters
- Regrind possible if DC is ≥Ø6

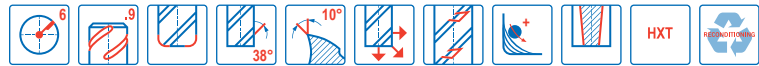

Designation	Item number	Length index	Tool shape	Chip splitters	DC	DMM	APMXS	OAL	RE	PCEDC	Safelock
					mm	mm	mm	mm	mm		
JS720100D2R050.9Z6C-HXT	03060378	2	D	■	10,0	10,0	26,0	72,0	0,5	6	■
JS720120D2R050.9Z6C-HXT	03060383	2	D	■	12,0	12,0	30,0	83,0	0,5	6	■
JS720120D2R100.9Z6C-HXT	03298334	2	D	■	12,0	12,0	30,0	83,0	1,0	6	■
JS720120D2R200.9Z6C-HXT	03298335	2	D	■	12,0	12,0	30,0	83,0	2,0	6	■
JS720120D2R250.9Z6C-HXT	03298336	2	D	■	12,0	12,0	30,0	83,0	2,5	6	■
JS720120D2R300.9Z6C-HXT	03298337	2	D	■	12,0	12,0	30,0	83,0	3,0	6	■
JS720120D2R310.9Z6C-HXT	03298338	2	D	■	12,0	12,0	30,0	83,0	3,1	6	■
JS720160D2R050.9Z6C-HXT	03060388	2	D	■	16,0	16,0	44,0	99,0	0,5	6	■
JS720160D2R100.9Z6C-HXT	03298339	2	D	■	16,0	16,0	44,0	99,0	1,0	6	■
JS720160D2R200.9Z6C-HXT	03298340	2	D	■	16,0	16,0	44,0	99,0	2,0	6	■
JS720160D2R250.9Z6C-HXT	03298341	2	D	■	16,0	16,0	44,0	99,0	2,5	6	■
JS720160D2R300.9Z6C-HXT	03298342	2	D	■	16,0	16,0	44,0	99,0	3,0	6	■
JS720160D2R310.9Z6C-HXT	03298343	2	D	■	16,0	16,0	44,0	99,0	3,1	6	■
JS720160D2R400.9Z6C-HXT	03298344	2	D	■	16,0	16,0	44,0	99,0	4,0	6	■
JS720160D2R600.9Z6C-HXT	03298345	2	D	■	16,0	16,0	44,0	99,0	6,0	6	■
JS720200D3R050.9Z6C-HXT	03060395	3	D	■	20,0	20,0	62,0	121,0	0,5	6	■
JS720200D3R100.9Z6C-HXT	03298346	3	D	■	20,0	20,0	62,0	121,0	1,0	6	■
JS720200D3R200.9Z6C-HXT	03298347	3	D	■	20,0	20,0	62,0	121,0	2,0	6	■
JS720200D3R250.9Z6C-HXT	03298348	3	D	■	20,0	20,0	62,0	121,0	2,5	6	■
JS720200D3R300.9Z6C-HXT	03298349	3	D	■	20,0	20,0	62,0	121,0	3,0	6	■
JS720200D3R310.9Z6C-HXT	03298350	3	D	■	20,0	20,0	62,0	121,0	3,1	6	■
JS720200D3R400.9Z6C-HXT	03298351	3	D	■	20,0	20,0	62,0	121,0	4,0	6	■
JS720200D3R500.9Z6C-HXT	03298352	3	D	■	20,0	20,0	62,0	121,0	5,0	6	■
JS720200D3R600.9Z6C-HXT	03298353	3	D	■	20,0	20,0	62,0	121,0	6,0	6	■
JS720250D3R050.9Z6C-HXT	03066461	3	D	■	25,0	25,0	78,0	146,0	0,5	6	■
JS720250D3R100.9Z6C-HXT	03298354	3	D	■	25,0	25,0	78,0	146,0	1,0	6	■
JS720250D3R200.9Z6C-HXT	03298355	3	D	■	25,0	25,0	78,0	146,0	2,0	6	■
JS720250D3R300.9Z6C-HXT	03298356	3	D	■	25,0	25,0	78,0	146,0	3,0	6	■
JS720250D3R400.9Z6C-HXT	03298357	3	D	■	25,0	25,0	78,0	146,0	4,0	6	■
JS720250D3R600.9Z6C-HXT	03298358	3	D	■	25,0	25,0	78,0	146,0	6,0	6	■

■ Stocked standard.

JS720

High performance – Titanium – Square – 9 Flutes – Safelock – Corner radius

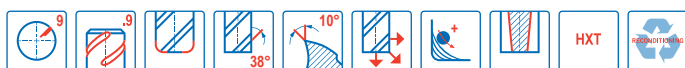
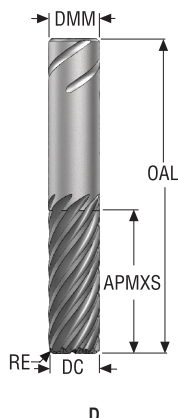

- Tolerances:
- DMM= h5
- DC= e7
- RE= ±0,02 mm
- Re grind possible if DC is ≥Ø6

Designation	Item number	Length index	Tool shape	DC	DMM	APMXS	OAL	RE	PCEDC	Safelock
				mm	mm	mm	mm	mm		
JS720160D2R100.9Z9-HXT	10008295	2	D	16,0	16,0	44,0	99,0	1,0	9	<input type="checkbox"/>
JS720160D2R200.9Z9-HXT	10008296	2	D	16,0	16,0	44,0	99,0	2,0	9	<input type="checkbox"/>
JS720160D2R300.9Z9-HXT	10008297	2	D	16,0	16,0	44,0	99,0	3,0	9	<input type="checkbox"/>
JS720250D2R100.9Z9-HXT	10008298	2	D	25,0	25,0	50,0	125,0	1,0	9	<input type="checkbox"/>
JS720250D2R200.9Z9-HXT	10008299	2	D	25,0	25,0	50,0	125,0	2,0	9	<input type="checkbox"/>
JS720250D2R300.9Z9-HXT	10008300	2	D	25,0	25,0	50,0	125,0	3,0	9	<input type="checkbox"/>
JS720160D3R100.9Z9-HXT	10008301	3	D	16,0	16,0	65,0	130,0	1,0	9	<input type="checkbox"/>
JS720160D3R200.9Z9-HXT	10008302	3	D	16,0	16,0	65,0	130,0	2,0	9	<input type="checkbox"/>
JS720160D3R300.9Z9-HXT	10008303	3	D	16,0	16,0	65,0	130,0	3,0	9	<input type="checkbox"/>
JS720200D3R100.9Z9-HXT	10008304	3	D	20,0	20,0	62,0	121,0	1,0	9	<input type="checkbox"/>
JS720200D3R200.9Z9-HXT	10008305	3	D	20,0	20,0	62,0	121,0	2,0	9	<input type="checkbox"/>
JS720200D3R300.9Z9-HXT	10008306	3	D	20,0	20,0	62,0	121,0	3,0	9	<input type="checkbox"/>
JS720250D3R100.9Z9-HXT	10008307	3	D	25,0	25,0	78,0	146,0	1,0	9	<input type="checkbox"/>
JS720250D3R200.9Z9-HXT	10008308	3	D	25,0	25,0	78,0	146,0	2,0	9	<input type="checkbox"/>
JS720250D3R300.9Z9-HXT	10008309	3	D	25,0	25,0	78,0	146,0	3,0	9	<input type="checkbox"/>

Safelock available. Delivery time is 6 days.

Universal

Steel and cast iron

Stainless steel and S-materials

Non ferrous

Hard

Plastic and chip

Graphite

Minimaster Plus

Minimaster

Cutting data – JS720 Side milling PCEDC =6

SMG		a _p /DC	a _r /DC	f _z							v _c
				6	8	10	12	16	20	25	
M1	E	0.400	1.1	0.032	0.044	0.055	0.065	0.080	0.095	0.11	110 (85–140)
		0,400	1,1	0,0013	0,0017	0,0022	0,0026	0,0032	0,0038	0,0044	360 (280 – 450)
M2	E	0.400	1.1	0.030	0.040	0.050	0.060	0.075	0.085	0.095	90 (70–110)
		0,400	1,1	0,0012	0,0016	0,0020	0,0024	0,0030	0,0034	0,0038	295 (230 – 360)
M3	E	0.400	1.1	0.030	0.040	0.050	0.060	0.075	0.085	0.095	70 (55–99)
		0,400	1,1	0,0012	0,0016	0,0020	0,0024	0,0030	0,0034	0,0038	230 (190 – 320)
M4	E	0.400	1.1	0.030	0.040	0.050	0.060	0.075	0.085	0.095	105 (78–120)
		0,400	1,1	0,0012	0,0016	0,0020	0,0024	0,0030	0,0034	0,0038	260 (200 – 320)
M5	E	0.400	1.1	0.030	0.040	0.050	0.060	0.075	0.085	0.095	65 (50–83)
		0,400	1,1	0,0012	0,0016	0,0020	0,0024	0,0030	0,0034	0,0038	215 (170 – 270)
S11	E	0.400	1.1	0.030	0.040	0.050	0.060	0.075	0.085	0.095	105 (78–120)
		0,400	1,1	0,0012	0,0016	0,0020	0,0024	0,0030	0,0034	0,0038	345 (260 – 390)
S12	E	0.400	1.1	0.030	0.040	0.050	0.060	0.075	0.085	0.095	80 (60–99)
		0,400	1,1	0,0012	0,0016	0,0020	0,0024	0,0030	0,0034	0,0038	260 (200 – 320)
S13	E	0.400	1.1	0.030	0.040	0.050	0.060	0.075	0.085	0.095	80 (60–99)
		0,400	1,1	0,0012	0,0016	0,0020	0,0024	0,0030	0,0034	0,0038	260 (200 – 320)

Cutting data – JS720 Side milling advanced roughing a_p/DC=0,07 PCEDC =6

SMG		a _p /DC	f _z							v _c
			6	8	10	12	16	20	25	
M1	E	1.9	0.065	0.085	0.11	0.13	0.16	0.18	0.20	140 (110–180)
		1,9	0,0026	0,0034	0,0044	0,0050	0,0065	0,0070	0,0080	460 (370 – 590)
M2	E	1.9	0.060	0.080	0.095	0.12	0.14	0.16	0.19	115 (91–150)
		1,9	0,0024	0,0032	0,0038	0,0048	0,0055	0,0065	0,0075	375 (300 – 490)
M3	E	1.9	0.060	0.080	0.095	0.12	0.14	0.16	0.19	90 (72–120)
		1,9	0,0024	0,0032	0,0038	0,0048	0,0055	0,0065	0,0075	295 (240 – 390)
M4	E	1.9	0.060	0.080	0.095	0.12	0.14	0.16	0.19	105 (78–120)
		1,9	0,0024	0,0032	0,0038	0,0048	0,0055	0,0065	0,0075	345 (260 – 390)
M5	E	1.9	0.060	0.080	0.095	0.12	0.14	0.16	0.19	85 (65–100)
		1,9	0,0024	0,0032	0,0038	0,0048	0,0055	0,0065	0,0075	280 (220 – 320)
S11	E	1.9	0.060	0.080	0.095	0.12	0.14	0.16	0.19	135 (110–160)
		1,9	0,0024	0,0032	0,0038	0,0048	0,0055	0,0065	0,0075	445 (370 – 520)
S12	E	1.9	0.060	0.080	0.095	0.12	0.14	0.16	0.19	105 (78–120)
		1,9	0,0024	0,0032	0,0038	0,0048	0,0055	0,0065	0,0075	345 (260 – 390)
S13	E	1.9	0.060	0.080	0.095	0.12	0.14	0.16	0.19	105 (78–120)
		1,9	0,0024	0,0032	0,0038	0,0048	0,0055	0,0065	0,0075	345 (260 – 390)

Cutting data – JS720 Side milling advanced roughing a_p/DC=0,07 PCEDC =9

SMG		a _p /DC	f _z			v _c
			16	20	25	
M1	E	2.0	0.16	0.18	0.20	125 (98–160)
		2,0	0,0065	0,0070	0,0080	410 (330 – 520)
M2	E	2.0	0.14	0.16	0.19	105 (82–130)
		2,0	0,0055	0,0065	0,0075	345 (270 – 420)
M3	E	2.0	0.14	0.16	0.19	80 (64–110)
		2,0	0,0055	0,0065	0,0075	260 (210 – 360)
M4	E	2.0	0.14	0.16	0.19	95 (70–110)
		2,0	0,0055	0,0065	0,0075	310 (230 – 360)
M5	E	2.0	0.14	0.16	0.19	75 (59–96)
		2,0	0,0055	0,0065	0,0075	245 (200 – 310)
S11	E	2.0	0.14	0.16	0.19	120 (91–150)
		2,0	0,0055	0,0065	0,0075	395 (300 – 490)
S12	E	2.0	0.14	0.16	0.19	95 (70–110)
		2,0	0,0055	0,0065	0,0075	310 (230 – 360)
S13	E	2.0	0.14	0.16	0.19	95 (70–110)
		2,0	0,0055	0,0065	0,0075	310 (230 – 360)

For cutting data recalculations, see pages 445 - 452.

SMG = Seco material group
Coolant = A=air D=dry E=emulsion M=mist spray
v_c = m/min (sf/min)
f_z = mm (in/tooth)
a_p = mm/DC (in/DC) = factor
a_r = mm/DC (in/DC) = factor
All cutting data are target values

JS730

High performance – Titanium – Ball nose – 6 Flutes – Cylindrical

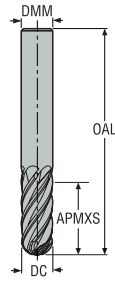

D

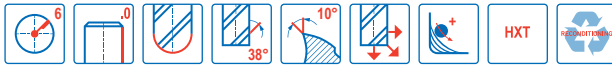
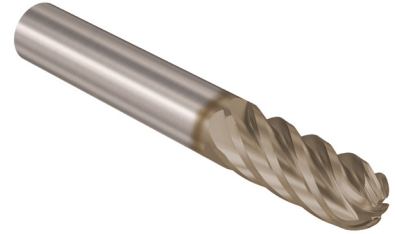

- Tolerances:
- DMM= h5
- DC= e7
- RE= ±0,02 mm
- Two flutes to centre
- Regrind possible if DC is ≥Ø6

Designation	Item number	Length index	Tool shape	DC	DMM	APMXS	OAL	PCEDC	Cylindrical
				mm	mm	mm	mm		
JS730060D2B.0Z6-HXT	03067605	2	D	6,0	6,0	17,0	57,0	6	■
JS730080D2B.0Z6-HXT	03067606	2	D	8,0	8,0	23,0	63,0	6	■
JS730100D2B.0Z6-HXT	03067607	2	D	10,0	10,0	26,0	72,0	6	■
JS730120D2B.0Z6-HXT	03067608	2	D	12,0	12,0	30,0	83,0	6	■
JS730160D2B.0Z6-HXT	03067609	2	D	16,0	16,0	44,0	99,0	6	■
JS730200D3B.0Z6-HXT	03067610	3	D	20,0	20,0	62,0	121,0	6	■
JS730250D3B.0Z6-HXT	03067611	3	D	25,0	25,0	78,0	146,0	6	■

■ Stocked standard.

Universal

Steel and cast iron

Stainless steel and S-materials

Non ferrous

Hard

Plastic and CFRP

Graphite

Minimaster Plus

Minimaster

JS730

High performance – Titanium – Ball nose – 6 Flutes – Weldon

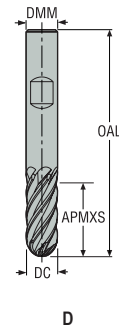
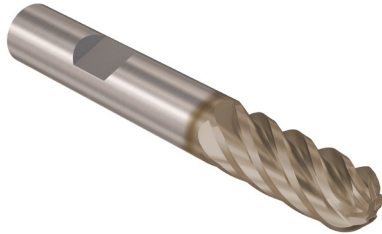

- Tolerances:
- DMM= h5
- DC= e7
- RE= ±0,02 mm
- Two flutes to centre
- Regrind possible if DC is ≥Ø6

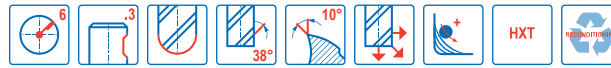

Designation	Item number	Length index	Tool shape	DC	DMM	APMXS	OAL	PCEDC	Weldon
				mm	mm	mm	mm		
JS730060D2B.3Z6-HXT	03067778	2	D	6,0	6,0	17,0	57,0	6	<input type="checkbox"/>
JS730080D2B.3Z6-HXT	03067779	2	D	8,0	8,0	23,0	63,0	6	<input type="checkbox"/>
JS730100D2B.3Z6-HXT	03067780	2	D	10,0	10,0	26,0	72,0	6	<input type="checkbox"/>
JS730120D2B.3Z6-HXT	03067781	2	D	12,0	12,0	30,0	83,0	6	<input type="checkbox"/>
JS730160D2B.3Z6-HXT	03067782	2	D	16,0	16,0	44,0	99,0	6	<input type="checkbox"/>
JS730200D3B.3Z6-HXT	03067783	3	D	20,0	20,0	62,0	121,0	6	<input type="checkbox"/>
JS730250D3B.3Z6-HXT	03067784	3	D	25,0	25,0	78,0	146,0	6	<input type="checkbox"/>

Weldon available. Delivery time is 3 days.

Universal

Steel and cast iron

Stainless steel and S-materials

Non ferrous

Hard

Plastic and cfrp

Graphite

Minimaster Plus

Minimaster

JS730

High performance – Titanium – Ball nose – 6 Flutes – Safelock

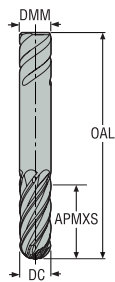

D

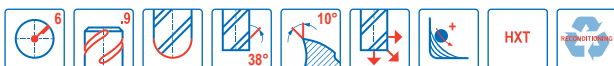

- Tolerances:
- DMM= h5
- DC= e7
- RE= ±0,02 mm
- Two flutes to centre
- Regrind possible if DC is ≥Ø6

Designation	Item number	Length index	Tool shape	DC	DMM	APMXS	OAL	PCEDC	Safelock
				mm	mm	mm	mm		
JS730060D2B.9Z6-HXT	03067785	2	D	6,0	6,0	17,0	57,0	6	<input type="checkbox"/>
JS730080D2B.9Z6-HXT	03067786	2	D	8,0	8,0	23,0	63,0	6	<input type="checkbox"/>
JS730100D2B.9Z6-HXT	03067787	2	D	10,0	10,0	26,0	72,0	6	<input type="checkbox"/>
JS730120D2B.9Z6-HXT	03067788	2	D	12,0	12,0	30,0	83,0	6	<input type="checkbox"/>
JS730160D2B.9Z6-HXT	03067789	2	D	16,0	16,0	44,0	99,0	6	<input type="checkbox"/>
JS730200D3B.9Z6-HXT	03067790	3	D	20,0	20,0	62,0	121,0	6	<input type="checkbox"/>
JS730250D3B.9Z6-HXT	03067791	3	D	25,0	25,0	78,0	146,0	6	<input type="checkbox"/>

Safelock available. Delivery time is 6 days.

Universal

Steel and cast iron

Stainless steel and S-materials

Non ferrous

Hard

Plastic and chip

Graphite

Minimaster Plus

Minimaster

Cutting data – JS730 Side milling roughing

SMG		a _p /DC	a _r /DC	f _z							v _c
				6	8	10	12	16	20	25	
M1	E	0.100	1.8	0.048	0.065	0.080	0.095	0.12	0.14	0.15	135 (87–140)
		0,100	1,8	0,0019	0,0026	0,0032	0,0038	0,0048	0,0055	0,0060	445 (290 – 450)
M2	E	0.100	1.8	0.048	0.065	0.080	0.095	0.12	0.14	0.15	110 (70–110)
		0,100	1,8	0,0019	0,0026	0,0032	0,0038	0,0048	0,0055	0,0060	360 (230 – 360)
M3	E	0.100	1.8	0.048	0.065	0.080	0.095	0.12	0.14	0.15	85 (55 – 99)
		0,100	1,8	0,0019	0,0026	0,0032	0,0038	0,0048	0,0055	0,0060	280 (190 – 320)
M4	E	0.100	1.8	0.042	0.055	0.070	0.085	0.10	0.12	0.13	90 (57–100)
		0,100	1,8	0,0017	0,0022	0,0028	0,0034	0,0040	0,0048	0,0050	295 (190 – 320)
M5	E	0.100	1.8	0.042	0.055	0.070	0.085	0.10	0.12	0.13	75 (47 – 85)
		0,100	1,8	0,0017	0,0022	0,0028	0,0034	0,0040	0,0048	0,0050	245 (160 – 270)
S11	E	0.300	1.2	0.030	0.040	0.050	0.060	0.075	0.085	0.095	130 (79–130)
		0,300	1,2	0,0012	0,0016	0,0020	0,0024	0,0030	0,0034	0,0038	425 (260 – 420)
S12	E	0.300	1.2	0.030	0.040	0.050	0.060	0.075	0.085	0.095	100 (61–100)
		0,300	1,2	0,0012	0,0016	0,0020	0,0024	0,0030	0,0034	0,0038	330 (210 – 320)
S13	E	0.300	1.2	0.026	0.034	0.044	0.050	0.065	0.075	0.085	100 (62–100)
		0,300	1,2	0,0010	0,0013	0,0017	0,0020	0,0026	0,0030	0,0034	330 (210 – 320)

Cutting data – JS730 Side milling advanced roughing a_p/DC=0,07

SMG		a _p /DC	f _z							v _c
			6	8	10	12	16	20	25	
M1	E	1.9	0.055	0.075	0.095	0.11	0.14	0.16	0.18	145 (91–150)
		1,9	0,0022	0,0030	0,0038	0,0044	0,0055	0,0065	0,0070	475 (300 – 490)
M2	E	1.9	0.055	0.075	0.095	0.11	0.14	0.16	0.18	115 (73–120)
		1,9	0,0022	0,0030	0,0038	0,0044	0,0055	0,0065	0,0070	375 (240 – 390)
M3	E	1.9	0.055	0.075	0.095	0.11	0.14	0.16	0.18	90 (58–100)
		1,9	0,0022	0,0030	0,0038	0,0044	0,0055	0,0065	0,0070	295 (200 – 320)
M4	E	1.9	0.050	0.065	0.080	0.095	0.12	0.14	0.16	95 (59–100)
		1,9	0,0020	0,0026	0,0032	0,0038	0,0048	0,0055	0,0065	310 (200 – 320)
M5	E	1.9	0.050	0.065	0.080	0.095	0.12	0.14	0.16	80 (50 – 89)
		1,9	0,0020	0,0026	0,0032	0,0038	0,0048	0,0055	0,0065	260 (170 – 290)
S11	E	1.9	0.050	0.070	0.085	0.10	0.13	0.15	0.17	150 (94–150)
		1,9	0,0020	0,0028	0,0034	0,0040	0,0050	0,0060	0,0065	490 (310 – 490)
S12	E	1.9	0.050	0.070	0.085	0.10	0.13	0.15	0.17	115 (72–110)
		1,9	0,0020	0,0028	0,0034	0,0040	0,0050	0,0060	0,0065	375 (240 – 360)
S13	E	1.9	0.046	0.060	0.075	0.090	0.11	0.13	0.15	120 (74–120)
		1,9	0,0018	0,0024	0,0030	0,0036	0,0044	0,0050	0,0060	395 (250 – 390)

For cutting data recalculations, see pages 445 - 452

SMG = Seco material group
Coolant = A=air D=dry E=emulsion M=mist spray
v_c = m/min (sf/min)
f_z = mm (in/tooth)
a_p = mm/DC (in/DC) = factor
a_r = mm/DC (in/DC) = factor
All cutting data are target values

JHP750

High performance – Titanium – Square – 2-4 Flutes – Cylindrical – Corner radius

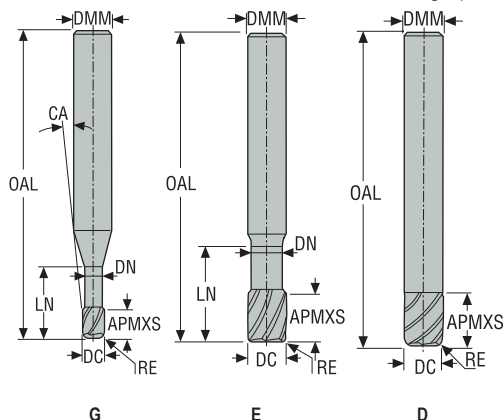

- Tolerances:
- DMM=h5
- DC=-0,02/-0,04 mm
- RE= ±0,02 mm
- Re grind possible if DC is ≥Ø6

Designation	Item number	Length index	Tool shape	DC	DMM	APMXS	OAL	LN	DN	RE	CA	PCEDC	Cylindrical
				mm	mm	mm	mm	mm	mm	mm	°		
750K080R040.0-TRIBON	02528232	1	D	8,0	8,0	16,0	55,0	-	-	0,4	-	4	■
750K100R040.0-TRIBON	02528234	1	D	10,0	10,0	20,0	65,0	-	-	0,4	-	4	■
750K100R150.0-TRIBON	02528236	1	D	10,0	10,0	20,0	65,0	-	-	1,5	-	4	■
750K120R040.0-TRIBON	02528238	1	D	12,0	12,0	24,0	75,0	-	-	0,4	-	4	■
750K120R150.0-TRIBON	02528242	1	D	12,0	12,0	24,0	75,0	-	-	1,5	-	4	■
750K160R040.0-TRIBON	02528244	1	D	16,0	16,0	32,0	90,0	-	-	0,4	-	4	■
750K160R150.0-TRIBON	02528250	1	D	16,0	16,0	32,0	90,0	-	-	1,5	-	4	■
750K200R080.0-TRIBON	02528253	1	D	20,0	20,0	40,0	100,0	-	-	0,8	-	4	■
750020R020.0-TRIBON	02510010	2	G	2,0	3,0	3,0	40,0	6,0	1,9	0,2	4,0	2	■
750030R020.0-TRIBON	02510012	2	E	3,0	3,0	4,5	40,0	9,0	2,8	0,2	-	2	■
750040R020.0-TRIBON	02510013	2	G	4,0	6,0	6,0	40,0	9,0	3,7	0,2	5,0	2	■
750050R030.0-TRIBON	02510043	2	G	5,0	6,0	7,5	40,0	9,0	4,6	0,3	3,0	2	■
750060R030.0-TRIBON	02510044	2	E	6,0	6,0	9,0	50,0	19,0	5,6	0,3	-	3	■
750080R040.0-TRIBON	02510045	2	E	8,0	8,0	16,0	60,0	24,0	7,4	0,4	-	4	■
750100R040.0-TRIBON	02510046	2	E	10,0	10,0	20,0	70,0	30,0	9,4	0,4	-	4	■
750100R080.0-TRIBON	02510049	2	E	10,0	10,0	20,0	70,0	30,0	9,4	0,8	-	4	■
750100R200.0-TRIBON	02510053	2	E	10,0	10,0	20,0	70,0	30,0	9,4	2,0	-	4	■
750120R040.0-TRIBON	02510057	2	E	12,0	12,0	24,0	80,0	35,0	11,4	0,4	-	4	■
750120R080.0-TRIBON	02510060	2	E	12,0	12,0	24,0	80,0	35,0	11,4	0,8	-	4	■
750120R200.0-TRIBON	02510063	2	E	12,0	12,0	24,0	80,0	35,0	11,4	2,0	-	4	■
750120R310.0-TRIBON	02510065	2	E	12,0	12,0	24,0	80,0	35,0	11,4	3,1	-	4	■
750140R080.0-TRIBON	02510067	2	E	14,0	14,0	28,0	90,0	45,0	13,4	0,8	-	4	■
750160R040.0-TRIBON	02510071	2	E	16,0	16,0	32,0	100,0	52,0	15,4	0,4	-	4	■
750160R080.0-TRIBON	02510073	2	E	16,0	16,0	32,0	100,0	52,0	15,4	0,8	-	4	■
750160R200.0-TRIBON	02510077	2	E	16,0	16,0	32,0	100,0	52,0	15,4	2,0	-	4	■
750200R080.0-TRIBON	02510085	2	E	20,0	20,0	40,0	125,0	75,0	19,4	0,8	-	4	■
750200R200.0-TRIBON	02510087	2	E	20,0	20,0	40,0	125,0	75,0	19,4	2,0	-	4	■

■ Stocked standard.

Universal

Steel and cast iron

Stainless steel and S-materials

Non ferrous

Hard

Plastic and chip

Graphite

Minimaster Plus

Minimaster

JHP750

High performance – Titanium – Square – 2-4 Flutes – Weldon – Corner radius

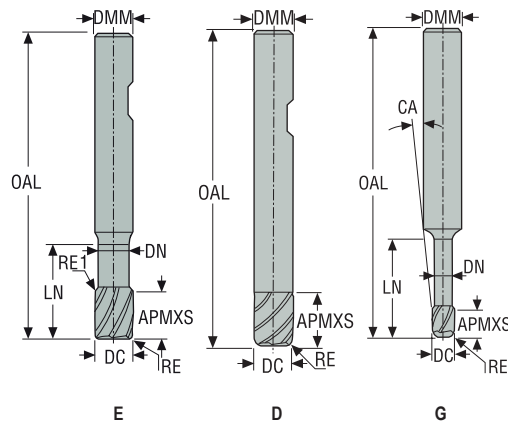

- Tolerances:
- DMM=h5
- DC=-0,02/-0,04 mm
- RE= ±0,02 mm
- Regrind possible if DC is ≥06

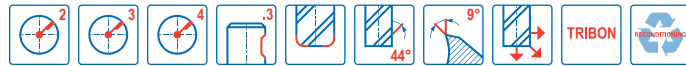

Designation	Item number	Length index	Tool shape	DC	DMM	APMXS	OAL	LN	DN	RE	CA	PCEDC	Weldon
				mm	mm	mm	mm	mm	mm	mm	mm	mm	mm
750K080R040-TRIBON	02528231	1	D	8,0	8,0	16,0	55,0	-	-	0,4	-	4	■
750K100R040-TRIBON	02528233	1	D	10,0	10,0	20,0	65,0	-	-	0,4	-	4	■
750K100R150-TRIBON	02528235	1	D	10,0	10,0	20,0	65,0	-	-	1,5	-	4	■
750K120R040-TRIBON	02528237	1	D	12,0	12,0	24,0	75,0	-	-	0,4	-	4	■
750K120R150-TRIBON	02528240	1	D	12,0	12,0	24,0	75,0	-	-	1,5	-	4	■
750K160R040-TRIBON	02528243	1	D	16,0	16,0	32,0	90,0	-	-	0,4	-	4	■
750K160R150-TRIBON	02528249	1	D	16,0	16,0	32,0	90,0	-	-	1,5	-	4	■
750K200R080-TRIBON	02528251	1	D	20,0	20,0	40,0	100,0	-	-	0,8	-	4	■
750040R020.0-TRIBONW	02669407	2	G	4,0	6,0	6,0	40,0	9,0	3,7	0,2	5,0	2	□
750050R030.0-TRIBONW	02669408	2	G	5,0	6,0	7,5	40,0	9,0	4,6	0,3	3,0	2	□
750060R030.0-TRIBONW	02669409	2	E	6,0	6,0	9,0	50,0	19,0	5,6	0,3	-	3	□
750080R040-TRIBON	02528258	2	E	8,0	8,0	16,0	60,0	24,0	7,4	0,4	-	4	■
750100R040-TRIBON	02510047	2	E	10,0	10,0	20,0	70,0	30,0	9,4	0,4	-	4	■
750100R080-TRIBON	02510048	2	E	10,0	10,0	20,0	70,0	30,0	9,4	0,8	-	4	■
750100R200-TRIBON	02510052	2	E	10,0	10,0	20,0	70,0	30,0	9,4	2,0	-	4	■
750120R040-TRIBON	02510056	2	E	12,0	12,0	24,0	80,0	35,0	11,4	0,4	-	4	■
750120R080-TRIBON	02510058	2	E	12,0	12,0	24,0	80,0	35,0	11,4	0,8	-	4	■
750120R200-TRIBON	02510062	2	E	12,0	12,0	24,0	80,0	35,0	11,4	2,0	-	4	■
750120R310-TRIBON	02510064	2	E	12,0	12,0	24,0	80,0	35,0	11,4	3,1	-	4	■
750140R080-TRIBON	02510066	2	E	14,0	14,0	28,0	90,0	45,0	13,4	0,8	-	4	■
750160R040-TRIBON	02510070	2	E	16,0	16,0	32,0	100,0	52,0	15,4	0,4	-	4	■
750160R080-TRIBON	02510072	2	E	16,0	16,0	32,0	100,0	52,0	15,4	0,8	-	4	■
750160R200-TRIBON	02510076	2	E	16,0	16,0	32,0	100,0	52,0	15,4	2,0	-	4	■
750200R080-TRIBON	02510084	2	E	20,0	20,0	40,0	125,0	75,0	19,4	0,8	-	4	■
750200R200-TRIBON	02510086	2	E	20,0	20,0	40,0	125,0	75,0	19,4	2,0	-	4	■

■ Stocked standard. □ Weldon available. Delivery time is 3 days.
Remark: if comerradius is >15% of DC then a_p=-30%, f_z=-20%

Cutting data – JHP750 Side milling

SMG		a _e /DC	a _p /DC	f _z											v _c
				2	3	4	5	6	8	10	12	14	16	20	
S1	E/M/A	0.0600	1.2	0.016	0.024	0.032	0.040	0.048	0.065	0.080	0.095	0.11	0.12	0.14	48 (33 – 64)
		0,0600	1,2	0,00065	0,00095	0,0013	0,0016	0,0019	0,0026	0,0032	0,0038	0,0044	0,0048	0,0055	155 (110 – 200)
S2	E/M/A	0.0600	1.2	0.016	0.024	0.032	0.040	0.048	0.065	0.080	0.095	0.11	0.12	0.14	39 (26 – 51)
		0,0600	1,2	0,00065	0,00095	0,0013	0,0016	0,0019	0,0026	0,0032	0,0038	0,0044	0,0048	0,0055	130 (86 – 160)
S3	E/M/A	0.0400	1.2	0.012	0.018	0.024	0.030	0.036	0.048	0.060	0.070	0.080	0.090	0.10	33 (26 – 50)
		0,0400	1,2	0,00048	0,00070	0,00095	0,0012	0,0014	0,0019	0,0024	0,0028	0,0032	0,0036	0,0040	110 (86 – 160)
S11	E/M/A	0.0800	1.2	0.016	0.024	0.032	0.040	0.048	0.065	0.080	0.095	0.11	0.12	0.14	145 (130 – 180)
S12	E/M/A	0.0800	1.2	0.016	0.024	0.032	0.040	0.048	0.065	0.080	0.095	0.11	0.12	0.14	110 (95 – 140)
		0,0800	1,2	0,00065	0,00095	0,0013	0,0016	0,0019	0,0026	0,0032	0,0038	0,0044	0,0048	0,0055	360 (320 – 450)
S13	E/M/A	0.0800	1.2	0.014	0.020	0.028	0.034	0.042	0.055	0.070	0.085	0.095	0.10	0.12	85 (75 – 110)
		0,0800	1,2	0,00055	0,00080	0,0011	0,0013	0,0017	0,0022	0,0028	0,0034	0,0038	0,0040	0,0048	280 (250 – 360)

Cutting data – JHP750 Slot milling

SMG		a _p /DC	f _z											v _c
			2	3	4	5	6	8	10	12	14	16	20	
S1	E/M/A	0.44	0.0075	0.011	0.015	0.019	0.022	0.030	0.038	0.044	0.050	0.055	0.065	30 (20 – 39)
		0,44	0,00030	0,00044	0,00060	0,00075	0,00085	0,0012	0,0015	0,0017	0,0020	0,0022	0,0026	100 (66 – 120)
S2	E/M/A	0.44	0.0075	0.011	0.015	0.019	0.022	0.030	0.038	0.044	0.050	0.055	0.065	24 (17 – 32)
		0,44	0,00030	0,00044	0,00060	0,00075	0,00085	0,0012	0,0015	0,0017	0,0020	0,0022	0,0026	80 (56 – 100)
S3	E/M/A	0.36	0.0046	0.0070	0.0095	0.012	0.014	0.019	0.024	0.028	0.032	0.034	0.040	20 (15 – 29)
		0,36	0,00018	0,00028	0,00038	0,00048	0,00055	0,00075	0,00095	0,0011	0,0013	0,0013	0,0016	65 (50 – 95)
S11	E/M/A	0.60	0.0085	0.013	0.017	0.022	0.026	0.034	0.044	0.050	0.055	0.065	0.075	90 (78 – 110)
		0,60	0,00034	0,00050	0,00065	0,00085	0,0010	0,0013	0,0017	0,0020	0,0022	0,0026	0,0030	295 (260 – 360)
S12	E/M/A	0.60	0.0085	0.013	0.017	0.022	0.026	0.034	0.044	0.050	0.055	0.065	0.075	70 (60 – 89)
		0,60	0,00034	0,00050	0,00065	0,00085	0,0010	0,0013	0,0017	0,0020	0,0022	0,0026	0,0030	230 (200 – 290)
S13	E/M/A	0.60	0.0075	0.011	0.015	0.019	0.022	0.030	0.038	0.044	0.050	0.055	0.065	55 (48 – 71)
		0,60	0,00030	0,00044	0,00060	0,00075	0,00085	0,0012	0,0015	0,0017	0,0020	0,0022	0,0026	180 (160 – 230)

For cutting data recalculations, see pages 445 - 452.

SMG = Seco material group

Coolant = A=air D=dry E=emulsion M=mist spray

v_c = m/min (sf/min)

f_z = mm (in/tooth)

a_p = mm/DC (in/DC) = factor

a_e = mm/DC (in/DC) = factor

All cutting data are target values

Universal
Steel and cast iron
Stainless steel and S-materials
Non ferrous
Hard
Plastic and chip
Graphite
Minimaster Plus
Minimaster

JHP760

High performance – Superalloy – Square – 2-4 Flutes – Cylindrical – Corner radius – ICC

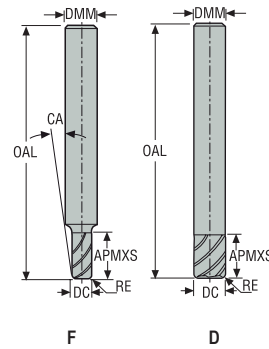

- Tolerances:
- DMM=h5
- DC=-0,02/-0,04 mm
- RE= ±0,03 mm
- Regrind possible if DC is ≥Ø6

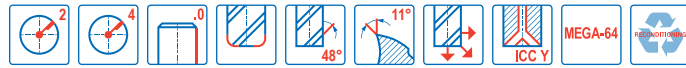

Designation	Item number	Length index	Tool shape	ICC	DC	DMM	APMXS	OAL	RE	CA°	PCEDC	Cylindrical
					mm	mm	mm	mm	mm			
760040R040Z2.0A-MEGA-64	02623413	2	F	■	4,0	6,0	8,0	50,0	0,4	4,0°	2	■
760040R020Z2.0A-MEGA-64	02734051	2	F	■	4,0	6,0	8,0	50,0	0,2	4,0°	2	■
760050R020Z2.0A-MEGA-64	02734052	2	F	■	5,0	6,0	10,0	50,0	0,2	2,0°	2	■
760050R040Z2.0A-MEGA-64	02623435	2	F	■	5,0	6,0	10,0	50,0	0,4	2,0°	2	■
760060R020Z4.0A-MEGA-64	02734053	2	D	■	6,0	6,0	12,0	50,0	0,2	-	4	■
760060R040Z4.0A-MEGA-64	02623433	2	D	■	6,0	6,0	12,0	50,0	0,4	-	4	■
760080R040Z4.0A-MEGA-64	02623436	2	D	■	8,0	8,0	16,0	55,0	0,4	-	4	■
760080R100Z4.0A-MEGA-64	02623437	2	D	■	8,0	8,0	16,0	55,0	1,0	-	4	■
760100R040Z4.0A-MEGA-64	02623460	2	D	■	10,0	10,0	20,0	65,0	0,4	-	4	■
760100R100Z4.0A-MEGA-64	02623463	2	D	■	10,0	10,0	20,0	65,0	1,0	-	4	■
760100R150Z4.0A-MEGA-64	02623466	2	D	■	10,0	10,0	20,0	65,0	1,5	-	4	■
760120R040Z4.0A-MEGA-64	02623819	2	D	■	12,0	12,0	24,0	75,0	0,4	-	4	■
760120R100Z4.0A-MEGA-64	02623825	2	D	■	12,0	12,0	24,0	75,0	1,0	-	4	■
760120R150Z4.0A-MEGA-64	02623828	2	D	■	12,0	12,0	24,0	75,0	1,5	-	4	■
760120R310Z4.0A-MEGA-64	02623833	2	D	■	12,0	12,0	24,0	75,0	3,1	-	4	■
760200R040Z4.0A-MEGA-64	02734055	2	D	■	20,0	20,0	45,0	100,0	0,4	-	4	■
760200R080Z4.0A-MEGA-64	02623852	2	D	■	20,0	20,0	45,0	100,0	0,8	-	4	■
760L080R040Z4.0A-MEGA-64	02623438	3	D	■	8,0	8,0	28,0	65,0	0,4	-	4	■
760L100R040Z4.0A-MEGA-64	02623461	3	D	■	10,0	10,0	36,0	75,0	0,4	-	4	■
760L100R100Z4.0A-MEGA-64	02623464	3	D	■	10,0	10,0	36,0	75,0	1,0	-	4	■
760L100R150Z4.0A-MEGA-64	02623467	3	D	■	10,0	10,0	36,0	75,0	1,5	-	4	■
760L100R200Z4.0A-MEGA-64	02623472	3	D	■	10,0	10,0	36,0	75,0	2,0	-	4	■
760L100R310Z4.0A-MEGA-64	02623807	3	D	■	10,0	10,0	36,0	75,0	3,1	-	4	■
760L120R040Z4.0A-MEGA-64	02623821	3	D	■	12,0	12,0	42,0	90,0	0,4	-	4	■
760L120R100Z4.0A-MEGA-64	02623826	3	D	■	12,0	12,0	42,0	90,0	1,0	-	4	■
760L120R150Z4.0A-MEGA-64	02623829	3	D	■	12,0	12,0	42,0	90,0	1,5	-	4	■
760L120R400Z4.0A-MEGA-64	02623838	3	D	■	12,0	12,0	42,0	90,0	4,0	-	4	■
760L160R040Z4.0A-MEGA-64	02623840	3	D	■	16,0	16,0	50,0	100,0	0,4	-	4	■
760L160R100Z4.0A-MEGA-64	02623842	3	D	■	16,0	16,0	50,0	100,0	1,0	-	4	■
760L160R150Z4.0A-MEGA-64	02623844	3	D	■	16,0	16,0	50,0	100,0	1,5	-	4	■

■ Stocked standard.
ICC = Internal Coolant Channel

JHP760

High performance – Superalloy – Square – 2-4 Flutes – Weldon – Corner radius – ICC

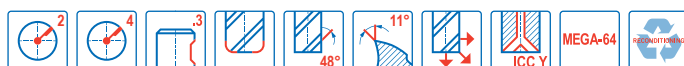
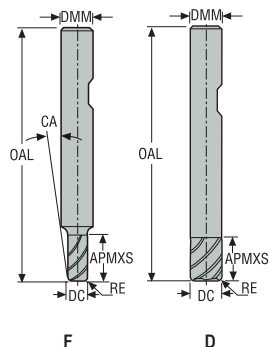

- Tolerances:
- DMM=h5
- DC=-0,02/-0,4 mm
- RE= ±0,03 mm
- Re grind possible if DC is ≥Ø6

Designation	Item number	Length index	Tool shape	ICC	DC	DMM	APMXS	OAL	RE	CA°	PCEDC	Weldon
					mm	mm	mm	mm	mm			
760040R020Z2.0A-MEGA-64W	02734065	2	F	■	4,0	6,0	8,0	50,0	0,2	4,0 °	2	□
760040R040Z2.0A-MEGA-64W	02669339	2	F	■	4,0	6,0	8,0	50,0	0,4	4,0 °	2	□
760050R020Z2.0A-MEGA-64W	02734068	2	F	■	5,0	6,0	10,0	50,0	0,2	2,0 °	2	□
760050R040Z2.0A-MEGA-64W	02669340	2	F	■	5,0	6,0	10,0	50,0	0,4	2,0 °	2	□
760060R020Z4.0A-MEGA-64W	02734069	2	D	■	6,0	6,0	12,0	50,0	0,2	-	4	□
760060R040Z4.0A-MEGA-64W	02669341	2	D	■	6,0	6,0	12,0	50,0	0,4	-	4	□
760080R040Z4.0A-MEGA-64W	02669343	2	D	■	8,0	8,0	16,0	55,0	0,4	-	4	□
760080R100Z4.0A-MEGA-64W	02669344	2	D	■	8,0	8,0	16,0	55,0	1,0	-	4	□
760100R040Z4A-MEGA-64	02623442	2	D	■	10,0	10,0	20,0	65,0	0,4	-	4	■
760100R100Z4A-MEGA-64	02623462	2	D	■	10,0	10,0	20,0	65,0	1,0	-	4	■
760100R150Z4A-MEGA-64	02623465	2	D	■	10,0	10,0	20,0	65,0	1,5	-	4	■
760120R040Z4A-MEGA-64	02623817	2	D	■	12,0	12,0	24,0	75,0	0,4	-	4	■
760120R100Z4A-MEGA-64	02623824	2	D	■	12,0	12,0	24,0	75,0	1,0	-	4	■
760120R150Z4A-MEGA-64	02623827	2	D	■	12,0	12,0	24,0	75,0	1,5	-	4	■
760120R400Z4A-MEGA-64	02623835	2	D	■	12,0	12,0	24,0	75,0	4,0	-	4	■
760160R040Z4A-MEGA-64	02623839	2	D	■	16,0	16,0	40,0	90,0	0,4	-	4	■
760160R100Z4A-MEGA-64	02623841	2	D	■	16,0	16,0	40,0	90,0	1,0	-	4	■
760160R150Z4A-MEGA-64	02623843	2	D	■	16,0	16,0	40,0	90,0	1,5	-	4	■
760160R200Z4A-MEGA-64	02623845	2	D	■	16,0	16,0	40,0	90,0	2,0	-	4	■
760200R040Z4A-MEGA-64	02734054	2	D	■	20,0	20,0	45,0	100,0	0,4	-	4	■
760200R080Z4A-MEGA-64	02623851	2	D	■	20,0	20,0	45,0	100,0	0,8	-	4	■

■ Stocked standard. □ Weldon available. Delivery time is 3 days.
ICC = Internal Coolant Channel

Universal

Steel and cast iron

Stainless steel and S-materials

Non ferrous

Hard

Plastic and chip

Graphite

Minimaster Plus

Minimaster

JHP760

High performance – Superalloy – Square – 2-4 Flutes – Weldon – Corner radius – ICC

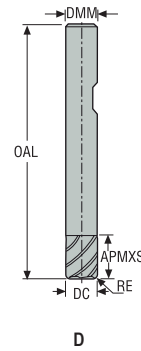

- Tolerances:
- DMM=h5
- DC=-0,02/-0,4 mm
- RE= ±0,03 mm
- Regrind possible if DC is ≥Ø6

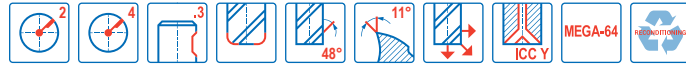

Designation	Item number	Length index	Tool shape	ICC	DC	DMM	APMXS	OAL	RE	PCEDC	Weldon
					mm	mm	mm	mm	mm		
760L080R040Z4.0A-MEGA-64W	02720459	3	D	■	8,0	8,0	28,0	65,0	0,4	4	<input type="checkbox"/>
760L100R040Z4.0A-MEGA-64W	02669345	3	D	■	10,0	10,0	36,0	75,0	0,4	4	<input type="checkbox"/>
760L100R100Z4.0A-MEGA-64W	02669346	3	D	■	10,0	10,0	36,0	75,0	1,0	4	<input type="checkbox"/>
760L100R150Z4.0A-MEGA-64W	02669347	3	D	■	10,0	10,0	36,0	75,0	1,5	4	<input type="checkbox"/>
760L100R200Z4.0A-MEGA-64W	02669348	3	D	■	10,0	10,0	36,0	75,0	2,0	4	<input type="checkbox"/>
760L120R040Z4.0A-MEGA-64W	02669350	3	D	■	12,0	12,0	42,0	90,0	0,4	4	<input type="checkbox"/>
760L120R100Z4.0A-MEGA-64W	02669351	3	D	■	12,0	12,0	42,0	90,0	1,0	4	<input type="checkbox"/>
760L120R150Z4.0A-MEGA-64W	02669352	3	D	■	12,0	12,0	42,0	90,0	1,5	4	<input type="checkbox"/>
760L160R040Z4.0A-MEGA-64W	02669356	3	D	■	16,0	16,0	50,0	100,0	0,4	4	<input type="checkbox"/>
760L160R100Z4.0A-MEGA-64W	02669357	3	D	■	16,0	16,0	50,0	100,0	1,0	4	<input type="checkbox"/>
760L160R150Z4.0A-MEGA-64W	02669358	3	D	■	16,0	16,0	50,0	100,0	1,5	4	<input type="checkbox"/>

Weldon available. Delivery time is 3 days.
ICC = Internal Coolant Channel

Cutting data – JHP760 Side milling

SMG		a _e /DC	a _p /DC	f _z									v _c
				4	5	6	8	10	12	16	20	25	
M1	E	0.300	1.5	0.036	0.044	0.055	0.070	0.090	0.10	0.13	0.15	0.17	120 (97–130)
		0,300	1,5	0,0014	0,0017	0,0022	0,0028	0,0036	0,0040	0,0050	0,0060	0,0065	395 (320 – 420)
M2	E	0.300	1.5	0.032	0.040	0.048	0.065	0.080	0.095	0.12	0.13	0.15	100 (81–110)
		0,300	1,5	0,0013	0,0016	0,0019	0,0026	0,0032	0,0038	0,0048	0,0050	0,0060	330 (270 – 360)
M3	E	0.300	1.4	0.026	0.032	0.038	0.050	0.065	0.075	0.095	0.11	0.12	75 (58 – 91)
		0,300	1,4	0,0010	0,0013	0,0015	0,0020	0,0026	0,0030	0,0038	0,0044	0,0048	245 (200 – 290)
M4	E	0.300	1.4	0.022	0.028	0.034	0.046	0.055	0.065	0.085	0.095	0.11	60 (45–70)
		0,300	1,4	0,00085	0,0011	0,0013	0,0018	0,0022	0,0026	0,0034	0,0038	0,0044	195 (150 – 220)
M5	E	0.300	1.4	0.022	0.028	0.034	0.046	0.055	0.065	0.085	0.095	0.11	48 (37 – 59)
		0,300	1,4	0,00085	0,0011	0,0013	0,0018	0,0022	0,0026	0,0034	0,0038	0,0044	155 (130–190)

Cutting data – JHP760 Slot milling

SMG		a _p /DC	f _z									v _c
			4	5	6	8	10	12	16	20	25	
M1	E	1.0	0.016	0.020	0.024	0.032	0.040	0.048	0.065	0.080	0.10	110 (92–130)
		1,0	0,00065	0,00080	0,00095	0,0013	0,0016	0,0019	0,0026	0,0032	0,0040	360 (310 – 420)
M2	E	1.0	0.016	0.020	0.024	0.032	0.040	0.048	0.065	0.080	0.10	90 (74–100)
		1,0	0,00065	0,00080	0,00095	0,0013	0,0016	0,0019	0,0026	0,0032	0,0040	295 (250 – 320)
M3	E	0.80	0.012	0.015	0.018	0.024	0.030	0.036	0.048	0.060	0.075	70 (54 – 85)
		0,80	0,00048	0,00060	0,00070	0,00095	0,0012	0,0014	0,0019	0,0024	0,0030	230 (180 – 270)
M4	E	0.80	0.012	0.015	0.018	0.024	0.030	0.036	0.048	0.060	0.075	50 (40 – 63)
		0,80	0,00048	0,00060	0,00070	0,00095	0,0012	0,0014	0,0019	0,0024	0,0030	165 (140 – 200)
M5	E	0.80	0.012	0.015	0.018	0.024	0.030	0.036	0.048	0.060	0.075	43 (34 – 53)
		0,80	0,00048	0,00060	0,00070	0,00095	0,0012	0,0014	0,0019	0,0024	0,0030	140 (120–170)

For cutting data recalculations, see pages 445 - 452.

SMG = Seco material group

Coolant = A=air D=dry E=emulsion M=mist spray

v_c = m/min (sf/min)

f_z = mm (in/tooth)

a_p = mm/DC (in/DC) = factor

a_e = mm/DC (in/DC) = factor

All cutting data are target values

Universal
Steel and cast iron
Stainless steel and S-materials
Non ferrous
Hard
Plastic and chip
Graphite
Minimaster Plus
Minimaster

JHP770

High performance – Titanium – Square – 4-5 Flutes – Cylindrical – Corner radius – ICC

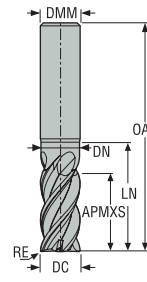

E

- Tolerances:
- DMM= h5
- DC= e7
- RE= ±0,02 mm
- Regrind possible if DC is ≥Ø6

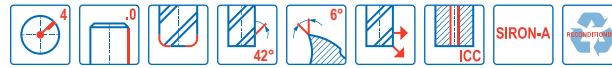

Designation	Item number	Length index	Tool shape	ICC	DC	DMM	APMXS	OAL	LN	DN	RE	PCEDC	Cylindrical
					mm	mm	mm	mm	mm	mm	mm		
JHP770060E2R030.0Z4A-SIRA	02760645	2	E	■	6,0	6,0	12,0	60,0	18,0	5,6	0,3	4	■
JHP770080E2R040.0Z4A-SIRA	02760653	2	E	■	8,0	8,0	16,0	65,0	24,0	7,4	0,4	4	■
JHP770080E2R050.0Z4A-SIRA	02823416	2	E	■	8,0	8,0	16,0	65,0	24,0	7,4	0,5	4	■
JHP770100E2R040.0Z4A-SIRA	02760654	2	E	■	10,0	10,0	20,0	75,0	30,0	9,4	0,4	4	■
JHP770100E2R050.0Z4A-SIRA	02823417	2	E	■	10,0	10,0	20,0	75,0	30,0	9,4	0,5	4	■
JHP770120E2R040.0Z4A-SIRA	02760656	2	E	■	12,0	12,0	24,0	90,0	36,0	11,4	0,4	4	■
JHP770120E2R050.0Z4A-SIRA	02823419	2	E	■	12,0	12,0	24,0	90,0	36,0	11,4	0,5	4	■
JHP770120E2R100.0Z4A-SIRA	02823420	2	E	■	12,0	12,0	24,0	90,0	36,0	11,4	1,0	4	■
JHP770120E2R250.0Z4A-SIRA	02760659	2	E	■	12,0	12,0	24,0	90,0	36,0	11,4	2,5	4	■
JHP770140E2R050.0Z4A-SIRA	02823421	2	E	■	14,0	14,0	28,0	95,0	42,0	13,4	0,5	4	■
JHP770160E2R040.0Z4A-SIRA	02760661	2	E	■	16,0	16,0	32,0	100,0	45,0	15,4	0,4	4	■
JHP770160E2R050.0Z4A-SIRA	02823422	2	E	■	16,0	16,0	32,0	100,0	45,0	15,4	0,5	4	■
JHP770160E2R080.0Z4A-SIRA	02760662	2	E	■	16,0	16,0	32,0	100,0	45,0	15,4	0,8	4	■
JHP770160E2R100.0Z4A-SIRA	02823423	2	E	■	16,0	16,0	32,0	100,0	45,0	15,4	1,0	4	■
JHP770160E2R250.0Z4A-SIRA	02760663	2	E	■	16,0	16,0	32,0	100,0	45,0	15,4	2,5	4	■
JHP770160E2R310.0Z4A-SIRA	02760664	2	E	■	16,0	16,0	32,0	100,0	45,0	15,4	3,1	4	■
JHP770160E2R400.0Z4A-SIRA	02760665	2	E	■	16,0	16,0	32,0	100,0	45,0	15,4	4,0	4	■
JHP770200E2R050.0Z4A-SIRA	02823424	2	E	■	20,0	20,0	40,0	115,0	55,0	19,4	0,5	4	■
JHP770200E2R100.0Z4A-SIRA	02823425	2	E	■	20,0	20,0	40,0	115,0	55,0	19,4	1,0	4	■
JHP770200E2R250.0Z4A-SIRA	02760668	2	E	■	20,0	20,0	40,0	115,0	55,0	19,4	2,5	4	■
JHP770200E2R310.0Z4A-SIRA	02760669	2	E	■	20,0	20,0	40,0	115,0	55,0	19,4	3,1	4	■
JHP770200E2R400.0Z4A-SIRA	02760670	2	E	■	20,0	20,0	40,0	115,0	55,0	19,4	4,0	4	■

■ Stocked standard.

Remark: if comerradius is >15% of DC → a_p=-30%, f_z=-20%

ICC = Internal Coolant Channel

JHP770

High performance – Titanium – Square – 4-5 Flutes – Cylindrical – Corner radius – ICC

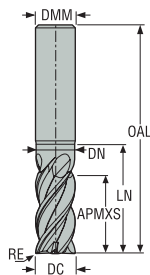

E

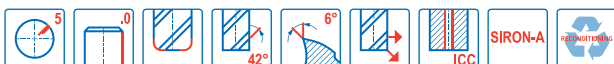

- Tolerances:
- DMM= h5
- DC= e7
- RE= ±0,02 mm
- Regrind possible if DC is ≥Ø6

Designation	Item number	Length index	Tool shape	ICC	DC	DMM	APMXS	OAL	LN	DN	RE	PCEDC	Cylindrical
					mm	mm	mm	mm	mm	mm	mm		
JHP770160E2R050.0Z5A-SIRA	02810129	2	E	■	16,0	16,0	32,0	100,0	45,0	15,4	0,5	5	■
JHP770160E2R100.0Z5A-SIRA	02810130	2	E	■	16,0	16,0	32,0	100,0	45,0	15,4	1,0	5	■
JHP770160E2R250.0Z5A-SIRA	02810131	2	E	■	16,0	16,0	32,0	100,0	45,0	15,4	2,5	5	■
JHP770160E2R310.0Z5A-SIRA	02810132	2	E	■	16,0	16,0	32,0	100,0	45,0	15,4	3,1	5	■
JHP770160E2R400.0Z5A-SIRA	02810133	2	E	■	16,0	16,0	32,0	100,0	45,0	15,4	4,0	5	■
JHP770160E2R600.0Z5A-SIRA	03093701	2	E	■	16,0	16,0	32,0	100,0	45,0	15,4	6,0	5	■
JHP770200E2R050.0Z5A-SIRA	02810134	2	E	■	20,0	20,0	40,0	115,0	55,0	19,4	0,5	5	■
JHP770200E2R100.0Z5A-SIRA	02810135	2	E	■	20,0	20,0	40,0	115,0	55,0	19,4	1,0	5	■
JHP770200E2R250.0Z5A-SIRA	02810136	2	E	■	20,0	20,0	40,0	115,0	55,0	19,4	2,5	5	■
JHP770200E2R310.0Z5A-SIRA	02810137	2	E	■	20,0	20,0	40,0	115,0	55,0	19,4	3,1	5	■
JHP770200E2R400.0Z5A-SIRA	02810138	2	E	■	20,0	20,0	40,0	115,0	55,0	19,4	4,0	5	■
JHP770200E2R600.0Z5A-SIRA	03093702	2	E	■	20,0	20,0	40,0	115,0	55,0	19,4	6,0	5	■
JHP770250E2R050.0Z5A-SIRA	02810139	2	E	■	25,0	25,0	50,0	130,0	65,0	24,4	0,5	5	■
JHP770250E2R310.0Z5A-SIRA	02810141	2	E	■	25,0	25,0	50,0	130,0	65,0	24,4	3,1	5	■

■ Stocked standard.

Remark: if corner radius is >15% of DC → a_p=-30%, f_z=-20%
ICC = Internal Coolant Channel

Universal

Steel and cast iron

Stainless steel and S-materials

Non ferrous

Hard

Plastic and chip

Graphite

Minimaster Plus

Minimaster

JHP770

High performance – Titanium – Square – 4-5 Flutes – Weldon – Corner radius – ICC

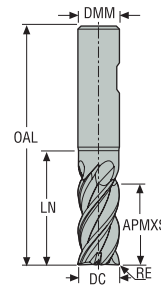

E

- Tolerances:
- DMM= h5
- DC= e7
- RE= ±0,02 mm
- Regrind possible if DC is ≥Ø6

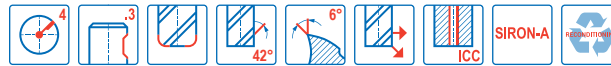

Designation	Item number	Length index	Tool shape	ICC	DC	DMM	APMXS	OAL	LN	DN	RE	PCEDC	Weldon
					mm	mm	mm	mm	mm	mm	mm		
JHP770060E2R030.3Z4A-SIRA	02760796	2	E	■	6,0	6,0	12,0	60,0	18,0	5,6	0,3	4	■
JHP770080E2R040.3Z4A-SIRA	02760799	2	E	■	8,0	8,0	16,0	65,0	24,0	7,4	0,4	4	□
JHP770080E2R050.3Z4A-SIRA	02823428	2	E	■	8,0	8,0	16,0	65,0	24,0	7,4	0,5	4	■
JHP770100E2R040.3Z4A-SIRA	02760801	2	E	■	10,0	10,0	20,0	75,0	30,0	9,4	0,4	4	□
JHP770100E2R050.3Z4A-SIRA	02823429	2	E	■	10,0	10,0	20,0	75,0	30,0	9,4	0,5	4	■
JHP770120E2R040.3Z4A-SIRA	02760803	2	E	■	12,0	12,0	24,0	90,0	36,0	11,4	0,4	4	□
JHP770120E2R050.3Z4A-SIRA	02823431	2	E	■	12,0	12,0	24,0	90,0	36,0	11,4	0,5	4	■
JHP770120E2R100.3Z4A-SIRA	02823432	2	E	■	12,0	12,0	24,0	90,0	36,0	11,4	1,0	4	■
JHP770120E2R250.3Z4A-SIRA	02760805	2	E	■	12,0	12,0	24,0	90,0	36,0	11,4	2,5	4	□
JHP770140E2R050.3Z4A-SIRA	02823433	2	E	■	14,0	14,0	28,0	95,0	42,0	13,4	0,5	4	■
JHP770160E2R040.3Z4A-SIRA	02760807	2	E	■	16,0	16,0	32,0	100,0	45,0	15,4	0,4	4	□
JHP770160E2R050.3Z4A-SIRA	02823434	2	E	■	16,0	16,0	32,0	100,0	45,0	15,4	0,5	4	■
JHP770160E2R080.3Z4A-SIRA	02760809	2	E	■	16,0	16,0	32,0	100,0	45,0	15,4	0,8	4	□
JHP770160E2R100.3Z4A-SIRA	02823435	2	E	■	16,0	16,0	32,0	100,0	45,0	15,4	1,0	4	■
JHP770160E2R250.3Z4A-SIRA	02760810	2	E	■	16,0	16,0	32,0	100,0	45,0	15,4	2,5	4	■
JHP770160E2R310.3Z4A-SIRA	02760811	2	E	■	16,0	16,0	32,0	100,0	45,0	15,4	3,1	4	□
JHP770160E2R400.3Z4A-SIRA	02760817	2	E	■	16,0	16,0	32,0	100,0	45,0	15,4	4,0	4	□
JHP770200E2R050.3Z4A-SIRA	02823436	2	E	■	20,0	20,0	40,0	115,0	55,0	19,4	0,5	4	■
JHP770200E2R100.3Z4A-SIRA	02823437	2	E	■	20,0	20,0	40,0	115,0	55,0	19,4	1,0	4	■
JHP770200E2R250.3Z4A-SIRA	02760823	2	E	■	20,0	20,0	40,0	115,0	55,0	19,4	2,5	4	□
JHP770200E2R310.3Z4A-SIRA	02760824	2	E	■	20,0	20,0	40,0	115,0	55,0	19,4	3,1	4	□
JHP770200E2R400.3Z4A-SIRA	02760825	2	E	■	20,0	20,0	40,0	115,0	55,0	19,4	4,0	4	□

■ Stocked standard. □ Weldon available. Delivery time is 3 days.
Remark: if comerradius is >15% of DC → a_p=-30%, f_z=-20%
ICC = Internal Coolant Channel

JHP770

High performance – Titanium – Square – 4-5 Flutes – Weldon – Corner radius – ICC

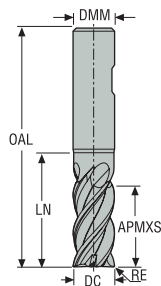

E

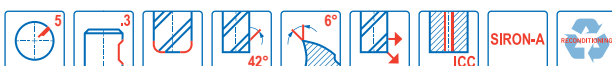

- Tolerances:
- DMM= h5
- DC= e7
- RE= ±0,02 mm
- Regrind possible if DC is ≥Ø6

Designation	Item number	Length index	Tool shape	ICC	DC	DMM	APMXS	OAL	LN	DN	RE	PCEDC	Weldon
					mm	mm	mm	mm	mm	mm	mm		
JHP770160E2R050.3Z5A-SIRA	02810143	2	E	■	16,0	16,0	32,0	100,0	45,0	15,4	0,5	5	■
JHP770160E2R100.3Z5A-SIRA	02810144	2	E	■	16,0	16,0	32,0	100,0	45,0	15,4	1,0	5	■
JHP770160E2R250.3Z5A-SIRA	02810145	2	E	■	16,0	16,0	32,0	100,0	45,0	15,4	2,5	5	□
JHP770160E2R310.3Z5A-SIRA	02810146	2	E	■	16,0	16,0	32,0	100,0	45,0	15,4	3,1	5	■
JHP770160E2R400.3Z5A-SIRA	02810147	2	E	■	16,0	16,0	32,0	100,0	45,0	15,4	4,0	5	□
JHP770160E2R600.3Z5A-SIRA	03093711	2	E	■	16,0	16,0	32,0	100,0	45,0	15,4	6,0	5	□
JHP770200E2R050.3Z5A-SIRA	02810148	2	E	■	20,0	20,0	40,0	115,0	55,0	19,4	0,5	5	■
JHP770200E2R100.3Z5A-SIRA	02810149	2	E	■	20,0	20,0	40,0	115,0	55,0	19,4	1,0	5	■
JHP770200E2R250.3Z5A-SIRA	02810150	2	E	■	20,0	20,0	40,0	115,0	55,0	19,4	2,5	5	□
JHP770200E2R310.3Z5A-SIRA	02810151	2	E	■	20,0	20,0	40,0	115,0	55,0	19,4	3,1	5	■
JHP770200E2R400.3Z5A-SIRA	02810152	2	E	■	20,0	20,0	40,0	115,0	55,0	19,4	4,0	5	■
JHP770200E2R600.3Z5A-SIRA	03093713	2	E	■	20,0	20,0	40,0	115,0	55,0	19,4	6,0	5	□
JHP770250E2R050.3Z5A-SIRA	02810153	2	E	■	25,0	25,0	50,0	130,0	65,0	24,4	0,5	5	■
JHP770250E2R100.3Z5A-SIRA	02810154	2	E	■	25,0	25,0	50,0	130,0	65,0	24,4	1,0	5	■
JHP770250E2R310.3Z5A-SIRA	02810155	2	E	■	25,0	25,0	50,0	130,0	65,0	24,4	3,1	5	□

■ Stocked standard. □ Weldon available. Delivery time is 3 days.
Remark: if corner radius is >15% of DC → a_p=-30%, f_z=-20%
ICC = Internal Coolant Channel

Universal

Steel and cast iron

Stainless steel and S-materials

Non ferrous

Hard

Plastic and chip

Graphite

Minimaster Plus

Minimaster

JHP770

High performance – Titanium – Square – 4-5 Flutes – Safelock – Corner radius – ICC

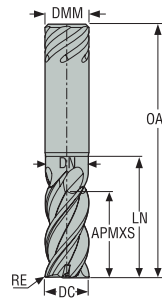

E

- Tolerances:
- DMM= h5
- DC= e7
- RE= ±0,02 mm
- Regrind possible if DC is ≥06

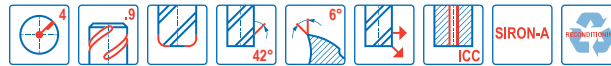

Designation	Item number	Length index	Tool shape	ICC	DC	DMM	APMXS	OAL	LN	DN	RE	PCEDC	Safelock
					mm	mm	mm	mm	mm	mm	mm		
JHP770060E2R030.9Z4A-SIRA	02927936	2	E	■	6,0	6,0	12,0	60,0	18,0	6,0	0,3	4	<input type="checkbox"/>
JHP770080E2R040.9Z4A-SIRA	02927937	2	E	■	8,0	8,0	16,0	65,0	24,0	7,0	0,4	4	<input type="checkbox"/>
JHP770080E2R050.9Z4A-SIRA	02927938	2	E	■	8,0	8,0	16,0	65,0	24,0	7,0	0,5	4	<input type="checkbox"/>
JHP770100E2R040.9Z4A-SIRA	02927939	2	E	■	10,0	10,0	20,0	75,0	30,0	9,0	0,4	4	<input type="checkbox"/>
JHP770100E2R050.9Z4A-SIRA	02927940	2	E	■	10,0	10,0	20,0	75,0	30,0	9,0	0,5	4	<input type="checkbox"/>
JHP770120E2R040.9Z4A-SIRA	02927943	2	E	■	12,0	12,0	24,0	90,0	36,0	11,0	0,4	4	<input type="checkbox"/>
JHP770120E2R050.9Z4A-SIRA	02927944	2	E	■	12,0	12,0	24,0	90,0	36,0	11,0	0,5	4	<input type="checkbox"/>
JHP770120E2R100.9Z4A-SIRA	02927946	2	E	■	12,0	12,0	24,0	90,0	36,0	11,0	1,0	4	<input type="checkbox"/>
JHP770120E2R250.9Z4A-SIRA	02927947	2	E	■	12,0	12,0	24,0	90,0	36,0	11,0	2,5	4	<input type="checkbox"/>
JHP770140E2R050.9Z4A-SIRA	02927950	2	E	■	14,0	14,0	28,0	95,0	42,0	13,0	0,5	4	<input type="checkbox"/>
JHP770160E2R040.9Z4A-SIRA	02927948	2	E	■	16,0	16,0	32,0	100,0	45,0	15,0	0,4	4	<input type="checkbox"/>
JHP770160E2R080.9Z4A-SIRA	02927951	2	E	■	16,0	16,0	32,0	100,0	45,0	15,0	0,8	4	<input type="checkbox"/>
JHP770160E2R100.9Z4A-SIRA	02927952	2	E	■	16,0	16,0	32,0	100,0	45,0	15,0	1,0	4	<input type="checkbox"/>
JHP770160E2R250.9Z4A-SIRA	02927954	2	E	■	16,0	16,0	32,0	100,0	45,0	15,0	2,5	4	<input type="checkbox"/>
JHP770160E2R310.9Z4A-SIRA	02927956	2	E	■	16,0	16,0	32,0	100,0	45,0	15,0	3,1	4	<input type="checkbox"/>
JHP770160E2R400.9Z4A-SIRA	02927958	2	E	■	16,0	16,0	32,0	100,0	45,0	15,0	4,0	4	<input type="checkbox"/>
JHP770160E2R050.9Z4A-SIRA	02927978	2	E	■	16,0	16,0	32,0	100,0	45,0	15,0	0,5	4	<input type="checkbox"/>
JHP770200E2R050.9Z4A-SIRA	02927960	2	E	■	20,0	20,0	40,0	115,0	55,0	19,0	0,5	4	<input type="checkbox"/>
JHP770200E2R100.9Z4A-SIRA	02927962	2	E	■	20,0	20,0	40,0	115,0	55,0	19,0	1,0	4	<input type="checkbox"/>
JHP770200E2R250.9Z4A-SIRA	02927964	2	E	■	20,0	20,0	40,0	115,0	55,0	19,0	2,5	4	<input type="checkbox"/>
JHP770200E2R310.9Z4A-SIRA	02927966	2	E	■	20,0	20,0	40,0	115,0	55,0	19,0	3,1	4	<input type="checkbox"/>
JHP770200E2R400.9Z4A-SIRA	02927968	2	E	■	20,0	20,0	40,0	115,0	55,0	19,0	4,0	4	<input type="checkbox"/>

Safelock available. Delivery time is 6 days.

Remark: if comerradius is >15% of DC → a_p=-30%, f_z=-20%

ICC = Internal Coolant Channel

JHP770

High performance – Titanium – Square – 4-5 Flutes – Safelock – Corner radius – ICC

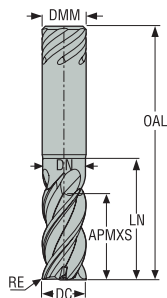

E

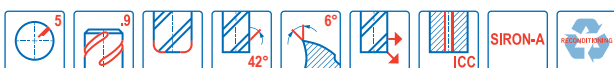
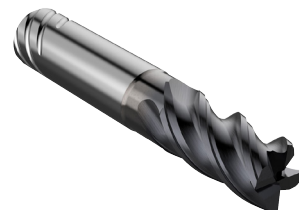

- Tolerances:
- DMM= h5
- DC= e7
- RE= ±0,02 mm
- Re grind possible if DC is ≥Ø6

Designation	Item number	Length index	Tool shape	ICC	DC	DMM	APMXS	OAL	LN	DN	RE	PCEDC	Safelock
					mm	mm	mm	mm	mm	mm	mm		
JHP770160E2R050.9Z5A-SIRA	02927949	2	E	■	16,0	16,0	32,0	100,0	45,0	15,0	0,5	5	<input type="checkbox"/>
JHP770160E2R100.9Z5A-SIRA	02927953	2	E	■	16,0	16,0	32,0	100,0	45,0	15,0	1,0	5	<input type="checkbox"/>
JHP770160E2R250.9Z5A-SIRA	02927955	2	E	■	16,0	16,0	32,0	100,0	45,0	15,0	2,5	5	<input type="checkbox"/>
JHP770160E2R310.9Z5A-SIRA	02927957	2	E	■	16,0	16,0	32,0	100,0	45,0	15,0	3,1	5	<input type="checkbox"/>
JHP770160E2R400.9Z5A-SIRA	02927959	2	E	■	16,0	16,0	32,0	100,0	45,0	15,0	4,0	5	<input type="checkbox"/>
JHP770160E2R600.9Z5A-SIRA	03093712	2	E	■	16,0	16,0	32,0	100,0	45,0	15,4	6,0	5	<input type="checkbox"/>
JHP770200E2R050.9Z5A-SIRA	02927961	2	E	■	20,0	20,0	40,0	115,0	55,0	19,0	0,5	5	<input type="checkbox"/>
JHP770200E2R100.9Z5A-SIRA	02927963	2	E	■	20,0	20,0	40,0	115,0	55,0	19,0	1,0	5	<input type="checkbox"/>
JHP770200E2R250.9Z5A-SIRA	02927965	2	E	■	20,0	20,0	40,0	115,0	55,0	19,0	2,5	5	<input type="checkbox"/>
JHP770200E2R310.9Z5A-SIRA	02927967	2	E	■	20,0	20,0	40,0	115,0	55,0	19,0	3,1	5	<input type="checkbox"/>
JHP770200E2R400.9Z5A-SIRA	02927969	2	E	■	20,0	20,0	40,0	115,0	55,0	19,0	4,0	5	<input type="checkbox"/>
JHP770200E2R600.9Z5A-SIRA	03093714	2	E	■	20,0	20,0	40,0	115,0	55,0	19,4	6,0	5	<input type="checkbox"/>
JHP770250E2R050.9Z5A-SIRA	02927971	2	E	■	25,0	25,0	50,0	130,0	65,0	24,0	0,5	5	<input type="checkbox"/>
JHP770250E2R310.9Z5A-SIRA	02927974	2	E	■	25,0	25,0	50,0	130,0	65,0	24,0	3,1	5	<input type="checkbox"/>

Safelock available. Delivery time is 6 days.

Remark: if corner radius is >15% of DC → a_p=-30%, f_z=-20%

ICC = Internal Coolant Channel

Universal

Steel and cast iron

Stainless steel and S-materials

Non ferrous

Hard

Plastic and chip

Graphite

Minimaster Plus

Minimaster

Universal
Steel and cast iron
Cutting data – JHP770 Side milling

SMG		a _p /DC	a _p /DC	f _z								v _c
				6	8	10	12	14	16	20	25	
S11	E	0.400	1.8	0.050	0.065	0.080	0.095	0.11	0.12	0.14	0.16	120 (110–130)
		0,400	1,6	0,0020	0,0026	0,0032	0,0038	0,0044	0,0048	0,0055	0,0065	395 (370 – 420)
S12	E	0.400	1.8	0.050	0.065	0.080	0.095	0.11	0.12	0.14	0.16	90 (80–100)
		0,400	1,6	0,0020	0,0026	0,0032	0,0038	0,0044	0,0048	0,0055	0,0065	295 (270 – 320)
S13	E	0.400	1.8	0.042	0.055	0.070	0.085	0.095	0.11	0.12	0.14	75 (64 – 81)
		0,400	1,6	0,0017	0,0022	0,0028	0,0034	0,0038	0,0044	0,0048	0,0055	245 (210 – 260)

Stainless steel and S-materials
Cutting data – JHP770 Slot milling

SMG		a _p /DC	f _z								v _c
			6	8	10	12	14	16	20	25	
S11	E	1.6	0.030	0.040	0.050	0.060	0.070	0.080	0.10	0.13	105 (94–120)
		1,6	0,0012	0,0016	0,0020	0,0024	0,0028	0,0032	0,0040	0,0050	345 (310 – 390)
S12	E	1.6	0.030	0.040	0.050	0.060	0.070	0.080	0.10	0.13	80 (72 – 92)
		1,6	0,0012	0,0016	0,0020	0,0024	0,0028	0,0032	0,0040	0,0050	260 (240 – 300)
S13	E	1.6	0.030	0.040	0.050	0.060	0.070	0.080	0.10	0.13	65 (56–71)
		1,6	0,0012	0,0016	0,0020	0,0024	0,0028	0,0032	0,0040	0,0050	215 (190 – 230)

For cutting data recalculations, see pages 445 - 452.

SMG = Seco material group

Coolant = A=air D=dry E=emulsion M=mist spray

v_c = m/min (sf/min)

f_z = mm (in/tooth)

a_p = mm/DC (in/DC) = factor

a_e = mm/DC (in/DC) = factor

All cutting data are target values

JHP780

High performance – Superalloy – Square – 4-Flutes – Cylindrical – Corner radius – ICC

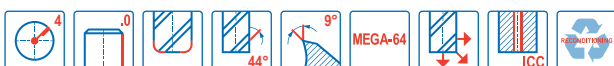
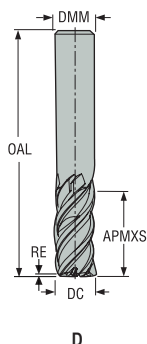

- Tolerances:
- DMM=h5
- DC=e7
- RE= ±0,02 mm
- Re grind possible if DC is ≥Ø6

Designation	Item number	Length index	Tool shape	ICC	DC	DMM	APMXS	OAL	LN	DN	RE	PCEDC	Cylindrical
					mm	mm	mm	mm	mm	mm	mm		
JHP780060D1R030.0Z4A-M64	03134984	1	D	■	6,0	6,0	7,5	47,0	-	-	0,3	4	■
JHP780060D1R080.0Z4A-M64	03134985	1	D	■	6,0	6,0	7,5	47,0	-	-	0,8	4	■
JHP780080D1R040.0Z4A-M64	03134986	1	D	■	8,0	8,0	10,0	50,0	-	-	0,4	4	■
JHP780080D1R080.0Z4A-M64	03134987	1	D	■	8,0	8,0	10,0	50,0	-	-	0,8	4	■
JHP780100D1R040.0Z4A-M64	03134988	1	D	■	10,0	10,0	12,5	57,0	-	-	0,4	4	■
JHP780100D1R080.0Z4A-M64	03134989	1	D	■	10,0	10,0	12,5	57,0	-	-	0,8	4	■
JHP780120D1R040.0Z4A-M64	03134990	1	D	■	12,0	12,0	15,0	65,0	-	-	0,4	4	■
JHP780120D1R080.0Z4A-M64	03134991	1	D	■	12,0	12,0	15,0	65,0	-	-	0,8	4	■

■ Stocked standard.
ICC = Internal Coolant Channel

Universal

Steel and cast iron

Stainless steel and S-materials

Non ferrous

Hard

Plastic and chip

Graphite

Minimaster Plus

Minimaster

JHP780

High performance – Superalloy – Square – 4-Flutes – Cylindrical – Corner radius – ICC

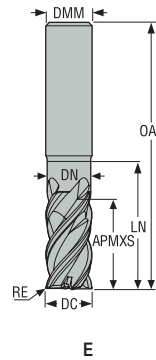

- Tolerances:
- DMM=h5
- DC=e7
- RE= ±0,02 mm
- Regrind possible if DC is ≥Ø6

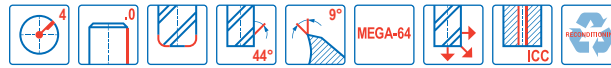

Designation	Item number	Length index	Tool shape	ICC	DC	DMM	APMXS	OAL	LN	DN	RE	PCEDC	Cylindrical
					mm	mm	mm	mm	mm	mm	mm		
JHP780060E2R030.0Z4-M64	03134992	2	E	■	6,0	6,0	12,0	60,0	18,0	5,6	0,3	4	■
JHP780060E2R030.0Z4-M64	02760834	2	E	–	6,0	6,0	12,0	60,0	18,0	5,6	0,3	4	■
JHP780080E2R040.0Z4-M64	03134993	2	E	■	8,0	8,0	16,0	65,0	24,0	7,4	0,4	4	■
JHP780080E2R040.0Z4-M64	02760842	2	E	–	8,0	8,0	16,0	65,0	24,0	7,4	0,4	4	■
JHP780100E2R040.0Z4-M64	03134994	2	E	■	10,0	10,0	20,0	75,0	30,0	9,4	0,4	4	■
JHP780100E2R040.0Z4-M64	02760846	2	E	–	10,0	10,0	20,0	75,0	30,0	9,4	0,4	4	■
JHP780100E2R080.0Z4-M64	03134995	2	E	■	10,0	10,0	20,0	75,0	30,0	9,4	0,8	4	■
JHP780100E2R080.0Z4-M64	02760847	2	E	–	10,0	10,0	20,0	75,0	30,0	9,4	0,8	4	■
JHP780120E2R040.0Z4-M64	03134996	2	E	■	12,0	12,0	24,0	90,0	36,0	11,4	0,4	4	■
JHP780120E2R040.0Z4-M64	02760848	2	E	–	12,0	12,0	24,0	90,0	36,0	11,4	0,4	4	■
JHP780120E2R080.0Z4-M64	03134997	2	E	■	12,0	12,0	24,0	90,0	36,0	11,4	0,8	4	■
JHP780120E2R080.0Z4-M64	02760849	2	E	–	12,0	12,0	24,0	90,0	36,0	11,4	0,8	4	■
JHP780120E2R150.0Z4-M64	02760850	2	E	–	12,0	12,0	24,0	90,0	36,0	11,4	1,5	4	■
JHP780120E2R250.0Z4-M64	02760851	2	E	–	12,0	12,0	24,0	90,0	36,0	11,4	2,5	4	■
JHP780140E2R040.0Z4-M64	02760852	2	E	–	14,0	14,0	28,0	95,0	42,0	13,4	0,4	4	■
JHP780160E2R040.0Z4-M64	03135000	2	E	■	16,0	16,0	32,0	100,0	45,0	15,4	0,4	4	■
JHP780160E2R040.0Z4-M64	02760853	2	E	–	16,0	16,0	32,0	100,0	45,0	15,4	0,4	4	■
JHP780160E2R080.0Z4-M64	03135001	2	E	■	16,0	16,0	32,0	100,0	45,0	15,4	0,8	4	■
JHP780160E2R080.0Z4-M64	02760861	2	E	–	16,0	16,0	32,0	100,0	45,0	15,4	0,8	4	■
JHP780160E2R310.0Z4-M64	02760862	2	E	–	16,0	16,0	32,0	100,0	45,0	15,4	3,1	4	■
JHP780160E2R400.0Z4-M64	02760863	2	E	–	16,0	16,0	32,0	100,0	45,0	15,4	4,0	4	■
JHP780200E2R040.0Z4-M64	02760865	2	E	–	20,0	20,0	40,0	115,0	55,0	19,4	0,4	4	■
JHP780200E2R080.0Z4-M64	02760866	2	E	–	20,0	20,0	40,0	115,0	55,0	19,4	0,8	4	■
JHP780200E2R310.0Z4-M64	02760867	2	E	–	20,0	20,0	40,0	115,0	55,0	19,4	3,1	4	■
JHP780200E2R400.0Z4-M64	02760868	2	E	–	20,0	20,0	40,0	115,0	55,0	19,4	4,0	4	■
JHP780250E2R080.0Z4-M64	02760870	2	E	–	25,0	25,0	50,0	130,0	65,0	24,4	0,8	4	■

■ Stocked standard.
ICC = Internal Coolant Channel

JHP780

High performance – Superalloy – Square – 4-Flutes – Weldon – Corner radius – ICC

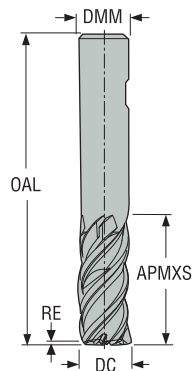

D

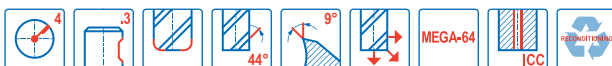

- Tolerances:
- DMM=h5
- DC=e7
- RE= ±0,02 mm
- Re grind possible if DC is ≥Ø6

Designation	Item number	Length index	Tool shape	ICC	DC	DMM	APMXS	OAL	LN	DN	RE	PCEDC	Weldon
					mm	mm	mm	mm	mm	mm	mm		
JHP780060D1R030.3Z4A-M64	03135445	1	D	■	6,0	6,0	7,5	47,0	-	-	0,3	4	■
JHP780060D1R080.3Z4A-M64	03135446	1	D	■	6,0	6,0	7,5	47,0	-	-	0,8	4	■
JHP780080D1R040.3Z4A-M64	03135447	1	D	■	8,0	8,0	10,0	50,0	-	-	0,4	4	■
JHP780080D1R080.3Z4A-M64	03135449	1	D	■	8,0	8,0	10,0	50,0	-	-	0,8	4	■
JHP780100D1R040.3Z4A-M64	03135450	1	D	■	10,0	10,0	12,5	57,0	-	-	0,4	4	■
JHP780100D1R080.3Z4A-M64	03135451	1	D	■	10,0	10,0	12,5	57,0	-	-	0,8	4	■
JHP780120D1R040.3Z4A-M64	03135452	1	D	■	12,0	12,0	15,0	65,0	-	-	0,4	4	■
JHP780120D1R080.3Z4A-M64	03135453	1	D	■	12,0	12,0	15,0	65,0	-	-	0,8	4	■

■ Stocked standard.
ICC = Internal Coolant Channel

Universal

Steel and cast iron

Stainless steel and S-materials

Non ferrous

Hard

Plastic and chip

Graphite

Minimaster Plus

Minimaster

JHP780

High performance – Superalloy – Square – 4-Flutes – Weldon – Corner radius – ICC

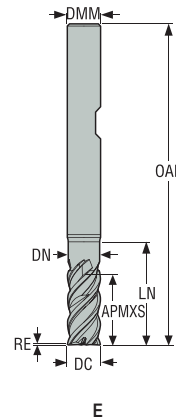

- Tolerances:
- DMM=h5
- DC=e7
- RE= ±0,02 mm
- Regrind possible if DC is ≥Ø6

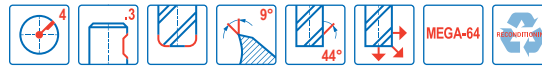

Designation	Item number	Length index	Tool shape	DC	DMM	APMXS	OAL	LN	DN	RE	PCEDC	Weldon
				mm	mm	mm	mm	mm	mm	mm		
JHP780060E2R030.3Z4-M64	02760878	2	E	6,0	6,0	12,0	60,0	18,0	5,6	0,3	4	■
JHP780060E2R030.3Z4A-M64	03135454	2	E	6,0	6,0	12,0	60,0	18,0	5,6	0,3	4	■
JHP780080E2R040.3Z4-M64	02760879	2	E	8,0	8,0	16,0	65,0	24,0	7,4	0,4	4	■
JHP780080E2R040.3Z4A-M64	03135455	2	E	8,0	8,0	16,0	65,0	24,0	7,4	0,4	4	■
JHP780100E2R040.3Z4-M64	02760880	2	E	10,0	10,0	20,0	75,0	30,0	9,4	0,4	4	■
JHP780100E2R040.3Z4A-M64	03135456	2	E	10,0	10,0	20,0	75,0	30,0	9,4	0,4	4	■
JHP780100E2R080.3Z4-M64	02760881	2	E	10,0	10,0	20,0	75,0	30,0	9,4	0,8	4	■
JHP780100E2R080.3Z4A-M64	03135457	2	E	10,0	10,0	20,0	75,0	30,0	9,4	0,8	4	■
JHP780120E2R040.3Z4-M64	02760883	2	E	12,0	12,0	24,0	90,0	36,0	11,4	0,4	4	■
JHP780120E2R040.3Z4A-M64	03134998	2	E	12,0	12,0	24,0	90,0	36,0	11,4	0,4	4	■
JHP780120E2R080.3Z4-M64	02760885	2	E	12,0	12,0	24,0	90,0	36,0	11,4	0,8	4	■
JHP780120E2R080.3Z4A-M64	03134999	2	E	12,0	12,0	24,0	90,0	36,0	11,4	0,8	4	■
JHP780120E2R150.3Z4-M64	02760887	2	E	12,0	12,0	24,0	90,0	36,0	11,4	1,5	4	■
JHP780120E2R250.3Z4-M64	02766989	2	E	12,0	12,0	24,0	90,0	36,0	11,4	2,5	4	■
JHP780140E2R040.3Z4-M64	02760888	2	E	14,0	14,0	28,0	95,0	42,0	13,4	0,4	4	■
JHP780160E2R040.3Z4-M64	02760889	2	E	16,0	16,0	32,0	100,0	45,0	15,4	0,4	4	■
JHP780160E2R080.3Z4-M64	03135002	2	E	16,0	16,0	32,0	100,0	45,0	15,4	0,4	4	■
JHP780160E2R080.3Z4A-M64	02760890	2	E	16,0	16,0	32,0	100,0	45,0	15,4	0,8	4	■
JHP780160E2R080.3Z4A-M64	03135003	2	E	16,0	16,0	32,0	100,0	45,0	15,4	0,8	4	■
JHP780160E2R400.3Z4-M64	02760893	2	E	16,0	16,0	32,0	100,0	45,0	15,4	4,0	4	■
JHP780200E2R040.3Z4-M64	02760894	2	E	20,0	20,0	40,0	115,0	55,0	19,4	0,4	4	■
JHP780200E2R080.3Z4-M64	02760896	2	E	20,0	20,0	40,0	115,0	55,0	19,4	0,8	4	■
JHP780200E2R310.3Z4-M64	02760897	2	E	20,0	20,0	40,0	115,0	55,0	19,4	3,1	4	■
JHP780200E2R400.3Z4-M64	02760898	2	E	20,0	20,0	40,0	115,0	55,0	19,4	4,0	4	■
JHP780250E2R040.3Z4-M64	02760900	2	E	25,0	25,0	50,0	130,0	65,0	24,4	0,4	4	■
JHP780250E2R080.3Z4-M64	02760901	2	E	25,0	25,0	50,0	130,0	65,0	24,4	0,8	4	■

■ Stocked standard.

Cutting data – JHP780 Side milling

SMG		a _p /DC	a _p /DC	f _z								v _c
				6	8	10	12	14	16	20	25	
S1	E	0.300	1.0	0.036	0.048	0.060	0.070	0.080	0.090	0.10	0.12	50 (45 – 59)
		0.300	1.0	0.0014	0.0019	0.0024	0.0028	0.0032	0.0036	0.0040	0.0048	165 (150–190)
S2	E	0.300	1.0	0.036	0.048	0.060	0.070	0.080	0.090	0.10	0.12	42 (36 – 47)
		0.300	1.0	0.0014	0.0019	0.0024	0.0028	0.0032	0.0036	0.0040	0.0048	140 (120–150)
S3	E	0.300	0.80	0.036	0.048	0.060	0.070	0.080	0.090	0.10	0.11	28 (23 – 33)
		0.300	0.80	0.0014	0.0019	0.0024	0.0028	0.0032	0.0036	0.0040	0.0044	90 (76–100)

Cutting data – JHP780 Slot milling

SMG		a _p /DC	a _p /DC	f _z								v _c
				6	8	10	12	14	16	20	25	
S1	E	0.80	0.020	0.028	0.034	0.042	0.048	0.055	0.070	0.085	43 (38 – 49)	
		0.80	0.00080	0.0011	0.0013	0.0017	0.0019	0.0022	0.0028	0.0034	140 (130–160)	
S2	E	0.80	0.020	0.028	0.034	0.042	0.048	0.055	0.070	0.085	35 (30 – 40)	
		0.80	0.00080	0.0011	0.0013	0.0017	0.0019	0.0022	0.0028	0.0034	115 (99–130)	
S3	E	0.60	0.012	0.016	0.020	0.025	0.028	0.032	0.040	0.050	26 (21 – 30)	
		0.60	0.00048	0.00065	0.00080	0.0010	0.0011	0.0013	0.0016	0.0020	85 (69 – 98)	

For cutting data recalculations, see pages 445 - 452.

SMG = Seco material group
Coolant = A=air D=dry E=emulsion M=mist spray
v_c = m/min (sf/min)
f_z = mm (in/tooth)
a_p = mm/DC (in/DC) = factor
a_e = mm/DC (in/DC) = factor
All cutting data are target values

Universal
Steel and cast iron
Stainless steel and S-materials
Non ferrous
Hard
Plastic and cfrp
Graphite
Minimaster Plus
Minimaster

JCG790

High performance – Square – Superalloy – 5-6 Flutes – Cylindrical – Corner radius

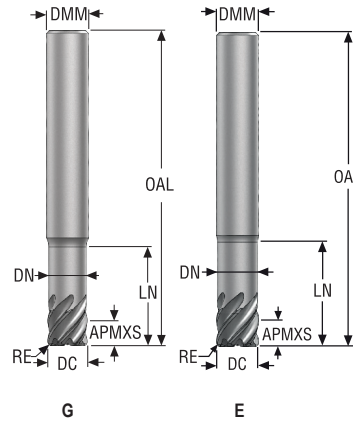
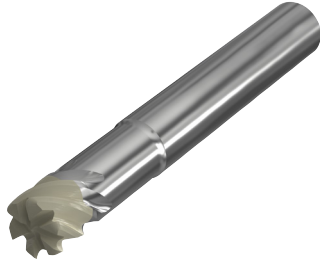

- Tolerances:
- DMM= h5
- DC= -0,02/-0,1 mm
- RE= ±0,05 mm

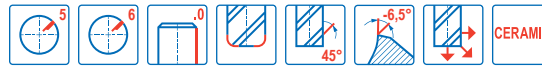

Designation	Item number	Length index	Tool shape	DC	DMM	APMXS	OAL	DN	LN	RE	PCEDC	Cylindrical
				mm	mm	mm	mm	mm	mm	mm		
JCG790060E2R050.0Z5	10010512	2	E	6,0	6,0	6,0	59,0	5,7	15,0	0,5	5	■
JCG790080E2R050.0Z5	10010513	2	E	8,0	8,0	6,0	67,0	7,6	20,0	0,5	5	■
JCG790094G2R100.0Z6	10010514	2	G	9,4	10,0	6,0	75,0	9,0	23,5	1,0	6	■
JCG790100E2R100.0Z6	10010515	2	E	10,0	10,0	6,0	75,0	9,5	25,0	1,0	6	■
JCG790114G2R150.0Z6	10010516	2	G	11,4	12,0	6,0	82,0	10,9	28,5	1,5	6	■
JCG790120E2R150.0Z6	10010517	2	E	12,0	12,0	6,0	82,0	11,4	30,0	1,5	6	■
JCG790160E2R200.0Z6	10010518	2	E	16,0	16,0	8,0	93,0	15,2	40,0	2,0	6	■
JCG790200E2R300.0Z6	10010519	2	E	20,0	20,0	8,0	103,0	19,0	50,0	3,0	6	■
JCG790250E2R400.0Z6	10010520	2	E	25,0	25,0	8,0	108,0	23,8	50,0	4,0	6	■

■ Stocked standard.

Universal

Steel and cast iron

Stainless steel and S-materials

Non ferrous

Hard

Plastic and cfrp

Graphite

Minimaster Plus

Minimaster

Cutting data – JCG790 Side milling roughing

SMG		a _p /DC	apmxs	f _z						v _c	
				6	8	10	12	16	20		25
S1	A/D	0.0500	1	0.018	0.024	0.030	0.036	0.048	0.060	0.075	830 (420–1300)
		0,0500	1	0,00070	0,00095	0,0012	0,0014	0,0019	0,0024	0,0030	2725 (1400 – 4200)
S2	A/D	0.0500	1	0.018	0.024	0.030	0.036	0.048	0.060	0.075	670 (340–1100)
		0,0500	1	0,00070	0,00095	0,0012	0,0014	0,0019	0,0024	0,0030	2200 (1200 – 3600)
S3	A/D	0.0500	1	0.018	0.024	0.030	0.036	0.048	0.060	0.075	570 (290 – 950)
		0,0500	1	0,00070	0,00095	0,0012	0,0014	0,0019	0,0024	0,0030	1875 (960 – 3100)

Cutting data – JCG790 Slot milling

SMG		a _p /DC	f _z						v _c	
			6	8	10	12	16	20		25
S1	A/D	0.05	0.018	0.024	0.030	0.036	0.048	0.060	0.075	830 (420–1300)
		0,05	0,00070	0,00095	0,0012	0,0014	0,0019	0,0024	0,0030	2725 (1400 – 4200)
S2	A/D	0.05	0.018	0.024	0.030	0.036	0.048	0.060	0.075	670 (340–1100)
		0,05	0,00070	0,00095	0,0012	0,0014	0,0019	0,0024	0,0030	2200 (1200 – 3600)
S3	A/D	0.05	0.018	0.024	0.030	0.036	0.048	0.060	0.075	570 (290 – 950)
		0,05	0,00070	0,00095	0,0012	0,0014	0,0019	0,0024	0,0030	1875 (960 – 3100)

For cutting data recalculations, see pages 445 - 452.

SMG = Seco material group
Coolant = A=air D=dry E=emulsion M=mist spray
v_c = m/min (sf/min)
f_z = mm (in/tooth)
a_p = mm/DC (in/DC) = factor
a_s = mm/DC (in/DC) = factor
All cutting data are target values

Universal
Steel and cast iron
Stainless steel and S-materials
Non ferrous
Hard
Plastic and cfrp
Graphite
Minimaster Plus
Minimaster

JH770

High speed – CoCr/Titanium – Square – 3-4-5-6 Flutes – Cylindrical – Corner radius

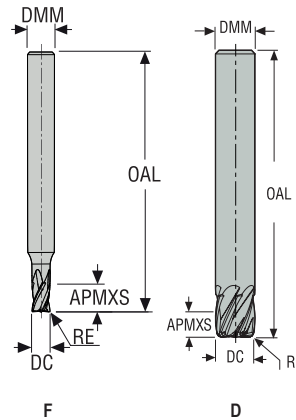

- Tolerances:
- DMM= h5
- DC= e7
- RE= ±0,02 mm
- Regrind possible if DC is ≥Ø6

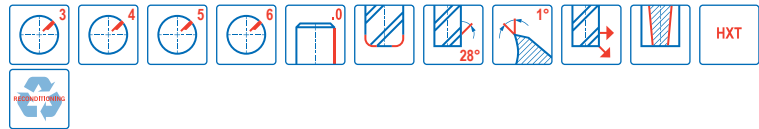

Designation	Item number	Length index	Tool shape	DC	DMM	APMXS	OAL	RE	PCEDC	Cylindrical
				mm	mm	mm	mm	mm		
JH770030F2R020.0Z3-HXT	03320783	2	F	3,0	6,0	5,0	58,0	0,2	3	■
JH770040F2R020.0Z4-HXT	03320784	2	F	4,0	6,0	6,0	58,0	0,2	4	■
JH770050F2R020.0Z4-HXT	10000170	2	F	5,0	6,0	7,0	58,0	0,2	4	■
JH770060D2R050.0Z4-HXT	03127351	2	D	6,0	6,0	8,0	50,0	0,5	4	■
JH770080D2R050.0Z4-HXT	03127352	2	D	8,0	8,0	10,0	58,0	0,5	4	■
JH770080D2R050.0Z5-HXT	03127354	2	D	8,0	8,0	10,0	58,0	0,5	5	■
JH770080D2R100.0Z4-HXT	03127353	2	D	8,0	8,0	10,0	58,0	1,0	4	■
JH770080D2R100.0Z5-HXT	03127355	2	D	8,0	8,0	10,0	58,0	1,0	5	■
JH770080D2R100.0Z6-HXT	03127356	2	D	8,0	8,0	10,0	58,0	1,0	6	■
JH770100D2R100.0Z5-HXT	03127357	2	D	10,0	10,0	12,0	66,0	1,0	5	■
JH770100D2R100.0Z6-HXT	03127358	2	D	10,0	10,0	12,0	66,0	1,0	6	■

■ Stocked standard.

Universal

Steel and cast iron

Stainless steel and S-materials

Non ferrous

Hard

Plastic and cfrp

Graphite

Minimaster Plus

Minimaster

Cutting data – JH770 Side milling roughing PCEDC 3 and 4

SMG		a _e /DC		f _z				v _c
				3	4	6	8	
S2	E	0.750	0.12	0.015	0.020	0.030	0.040	50 (42 – 62)
		0,750	0,12	0,00060	0,00080	0,0012	0,0016	165 (140 – 200)
S11	E	0.250	0.32	0.0075	0.010	0.015	0.020	65 (53 – 91)
		0,250	0,32	0,00030	0,00040	0,00060	0,00080	215 (180 – 290)
S12	E	0.250	0.32	0.0075	0.010	0.015	0.020	50 (41 – 70)
		0,250	0,32	0,00030	0,00040	0,00060	0,00080	165 (140 – 220)

Cutting data – JH770 Side milling roughing PCEDC 6

SMG		a _e /DC		f _z		v _c
				8	10	
S2	E	0.750	0.12	0.050	0.060	55 (43 – 64)
		0,750	0,12	0,0020	0,0024	180 (150 – 200)
S11	E	0.250	0.32	0.022	0.026	65 (54 – 93)
		0,250	0,32	0,00085	0,0010	215 (180 – 300)
S12	E	0.250	0.32	0.022	0.026	50 (42 – 71)
		0,250	0,32	0,00085	0,0010	165 (140 – 230)

For cutting data recalculations, see pages 445 - 452.

SMG = Seco material group
Coolant = A=air D=dry E=emulsion M=mist spray
v_c = m/min (sf/min)
f_z = mm (in/tooth)
a_p = mm/DC (in/DC) = factor
a_e = mm/DC (in/DC) = factor
All cutting data are target values

Universal

Steel and cast iron

Stainless steel and S-materials

Non ferrous

Hard

Plastic and cfrp

Graphite

Minimaster Plus

Minimaster

JH740

High speed – CoCr/Titanium – Bottom finisher – 4-5 Flutes – Cylindrical – Corner radius

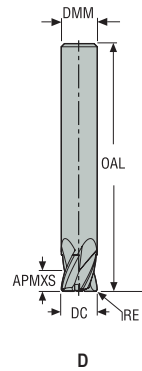
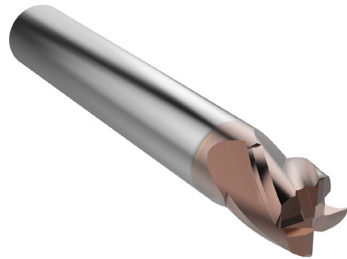

- Tolerances:
- DMM=h5
- DC=e7
- RE= ±0,02 mm
- Regrind possible if DC is ≥Ø6

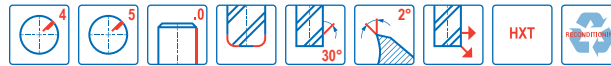

Designation	Item number	Length index	Tool shape	DC	DMM	APMXS	OAL	RE	PCEDC	Cylindrical
				mm	mm	mm	mm	mm		
JH740060D2R025.0Z4-HXT	03127359	2	D	6,0	6,0	6,0	50,0	0,25	4	■
JH740060D2R050.0Z4-HXT	03127360	2	D	6,0	6,0	6,0	50,0	0,5	4	■
JH740080D2R025.0Z4-HXT	03127361	2	D	8,0	8,0	8,0	58,0	0,25	4	■
JH740080D2R050.0Z4-HXT	03127362	2	D	8,0	8,0	8,0	58,0	0,5	4	■
JH740100D2R025.0Z5-HXT	03127363	2	D	10,0	10,0	10,0	66,0	0,25	5	■
JH740100D2R050.0Z5-HXT	03127364	2	D	10,0	10,0	10,0	66,0	0,5	5	■

■ Stocked standard.

Cutting data – JH740 Face finishing PCEDC 4

SMG		a_e/DC	a_p/DC	f_z		v_c
				6	8	
S2	E	0.500	0.0060	0.044	0.060	50 (40 – 59)
		0.500	0.0060	0.0017	0.0024	165 (140–190)
S11	E	0.500	0.0060	0.044	0.060	65 (52–77)
		0.500	0.0060	0.0017	0.0024	215 (180 – 250)
S12	E	0.500	0.0060	0.044	0.060	50 (40 – 59)
		0.500	0.0060	0.0017	0.0024	165 (140–190)

Cutting data – JH740 Face finishing PCEDC 5

SMG		a_e/DC	a_p/DC	f_z	v_c
				10	
S2	E	0.500	0.0065	0.046	48 (39 – 58)
		0.500	0.0065	0.0018	155 (130–190)
S11	E	0.500	0.0065	0.046	65 (51–75)
		0.500	0.0065	0.0018	215 (170 – 240)
S12	E	0.500	0.0065	0.046	48 (39 – 58)
		0.500	0.0065	0.0018	155 (130–190)

SMG = Seco material group
Coolant = A=air D=dry E=emulsion M=mist spray
 v_c = m/min (sf/min)
 f_z = mm (in/tooth)
 a_p = mm/DC (in/DC) = factor
 a_e = mm/DC (in/DC) = factor
All cutting data are target values

Universal
Steel and cast iron
Stainless steel and S-materials
Non ferrous
Hard
Plastic and cfrp
Graphite
Minimaster Plus
Minimaster

JH710

High speed – CoCr/Titanium – Square – 5 Flutes – Cylindrical – Corner radius

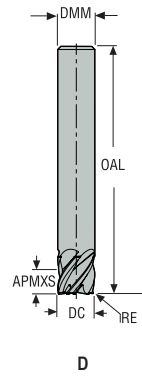
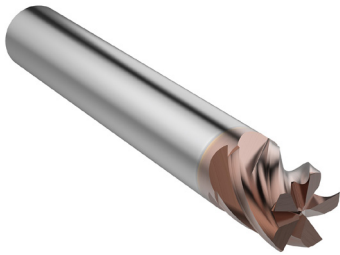

- Tolerances:
- DMM=h5
- DC=e7
- RE= ±0,02 mm
- Regrind possible if DC is ≥Ø6

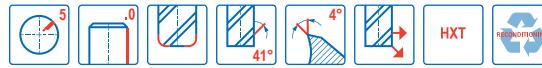

Designation	Item number	Length index	Tool shape	DC	DMM	APMXS	OAL	RE	PCEDC	Cylindrical
				mm	mm	mm	mm	mm		
JH710060D2R025.0Z5-HXT	03127365	2	D	6,0	6,0	6,0	57,0	0,25	5	■
JH710060D2R050.0Z5-HXT	03127366	2	D	6,0	6,0	6,0	57,0	0,5	5	■
JH710080D2R025.0Z5-HXT	03127367	2	D	8,0	8,0	8,0	63,0	0,25	5	■
JH710080D2R050.0Z5-HXT	03127368	2	D	8,0	8,0	8,0	63,0	0,5	5	■
JH710080D2R100.0Z5-HXT	03127369	2	D	8,0	8,0	8,0	63,0	1,0	5	■

■ Stocked standard.

Universal

Steel and cast iron

Stainless steel and S-materials

Non ferrous

Hard

Plastic and cfrp

Graphite

Minimaster Plus

Minimaster

Cutting data – JH710 Side milling finishing

SMG		a_e/DC	a_p/DC	f_z		v_c
				6	8	
S2	E	0.00810	0.60	0.034	0.044	100 (79–110)
		0,00810	0,60	0,0013	0,0017	330 (260 – 360)
S11	E	0.00810	0.60	0.036	0.046	180 (160 – 200)
		0,00810	0,60	0,0014	0,0018	590 (530 – 650)
S12	E	0.00810	0.60	0.036	0.046	135 (120–150)
		0,00810	0,60	0,0014	0,0018	445 (400 – 490)

SMG = Seco material group
 Coolant = A=air D=dry E=emulsion M=mist spray
 v_c = m/min (*sf/min*)
 f_z = mm (*in/tooth*)
 a_p = mm/DC (*in/DC*) = factor
 a_e = mm/DC (*in/DC*) = factor
 All cutting data are target values

- Universal
- Steel and cast iron
- Stainless steel and S-materials
- Non ferrous
- Hard
- Plastic and cfrp
- Graphite
- Minimaster Plus
- Minimaster

JH790

High speed – CoCr/Titanium – T Cutter – 6 Flutes – Cylindrical

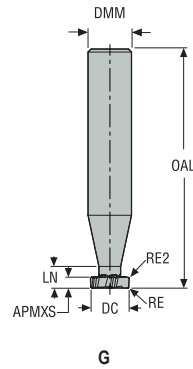
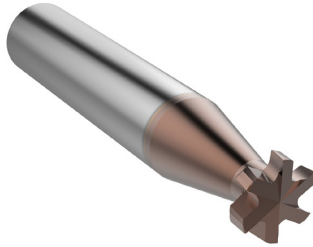

- Tolerances:
- DMM=h5
- DC= ±0,02 mm
- RE= ±0,02 mm
- Regrind possible if DC is ≥Ø6

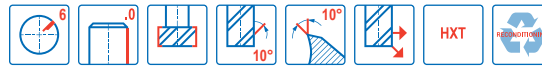

Designation	Item number	Length index	Tool shape	DC	DMM	APMXS	OAL	LN	RE	RE2	PCEDC	Cylindrical
				mm	mm	mm	mm	mm	mm	mm		
JH790095G2R025.0Z6-HXT	03127370	2	G	9,5	10,0	2,0	66,0	5,0	0,25	0,25	6	■
JH790095G2R050.0Z6-HXT	03127371	2	G	9,5	10,0	2,0	66,0	5,0	0,5	0,5	6	■
JH790095G3R025.0Z6-HXT	03127372	3	G	9,5	10,0	2,54	66,0	5,0	0,25	0,25	6	■
JH790095G3R050.0Z6-HXT	03127373	3	G	9,5	10,0	2,54	66,0	5,0	0,5	0,5	6	■

■ Stocked standard.

Universal

Steel and cast iron

Stainless steel and S-materials

Non ferrous

Hard

Plastic and cfrp

Graphite

Minimaster Plus

Minimaster

Cutting data – JH790 (T) Side milling roughing

SMG		a_e/DC		a_p/DC		f_z		v_c	
						9.5			
S2	E	0.189		0.19		0.030		39 (31 – 50)	
		0,189		0,19		0,0012		130 (110–160)	
S11	E	0.189		0.19		0.022		85 (66–100)	
		0,189		0,19		0,00085		280 (220 – 320)	
S12	E	0.189		0.19		0.022		65 (51 – 80)	
		0,189		0,19		0,00085		215 (170 – 260)	

SMG = Seco material group
Coolant = A=air D=dry E=emulsion M=mist spray
 v_c = m/min (sf/min)
 f_z = mm (in/tooth)
 a_p = mm/DC (in/DC) = factor
 a_e = mm/DC (in/DC) = factor
All cutting data are target values

Universal

Steel and cast iron

Stainless steel and S-materials

Non ferrous

Hard

Plastic and cfrp

Graphite

Minimaster Plus

Minimaster

JH730

High speed – CoCr/Titanium – Square – 6-7 Flutes – Cylindrical – Corner radius

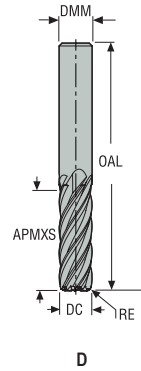
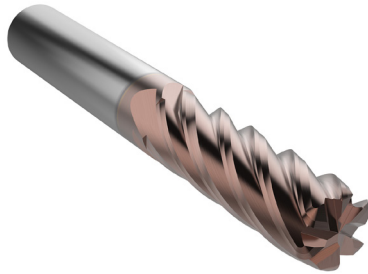

- Tolerances:
- DMM=h5
- DC=e7
- RE= ±0,02 mm
- Regrind possible if DC is ≥Ø6

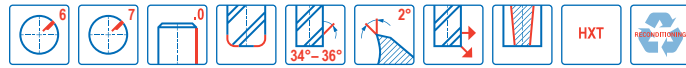

Designation	Item number	Length index	Tool shape	DC	DMM	APMXS	OAL	RE	PCEDC	Cylindrical
				mm	mm	mm	mm	mm		
JH730080D2R050.0Z6-HXT	03127375	2	D	8,0	8,0	25,0	63,0	0,5	6	■
JH730080D2R100.0Z6-HXT	03127377	2	D	8,0	8,0	25,0	63,0	1,0	6	■
JH730080D2R150.0Z6-HXT	03127378	2	D	8,0	8,0	25,0	63,0	1,5	6	■
JH730080D2R200.0Z6-HXT	03127379	2	D	8,0	8,0	25,0	63,0	2,0	6	■
JH730100D2R100.0Z7-HXT	03127380	2	D	10,0	10,0	31,0	72,0	1,0	7	■
JH730100D2R250.0Z7-HXT	03127381	2	D	10,0	10,0	31,0	72,0	2,5	7	■

■ Stocked standard.

Universal

Steel and cast iron

Stainless steel and S-materials

Non ferrous

Hard

Plastic and cfrp

Graphite

Minimaster Plus

Minimaster

Cutting data – JH730 Side milling finishing

SMG		a_e/DC	a_p/DC	f_z		v_c
				8	10	
S2	E	0.0625	1.8	0.020	0.025	80 (63 – 93)
		0,0625	1,8	0,00080	0,0010	260 (210 – 300)
S11	E	0.0625	1.8	0.016	0.020	135 (110–160)
		0,0625	1,8	0,00065	0,00080	445 (370 – 520)
S12	E	0.0625	1.8	0.016	0.020	105 (83–120)
		0,0625	1,8	0,00065	0,00080	345 (280 – 390)

For cutting data recalculations, see pages 445 - 452

SMG = Seco material group
Coolant = A=air D=dry E=emulsion M=mist spray
 v_c = m/min (sf/min)
 f_z = mm (in/tooth)
 a_p = mm/DC (in/DC) = factor
 a_e = mm/DC (in/DC) = factor
All cutting data are target values

- Universal
- Steel and cast iron
- Stainless steel and S-materials
- Non ferrous
- Hard
- Plastic and cfrp
- Graphite
- Minimaster Plus
- Minimaster

JHP994

High performance – CoCr/Titanium – Square – 4 Flutes – Cylindrical – Chamfer

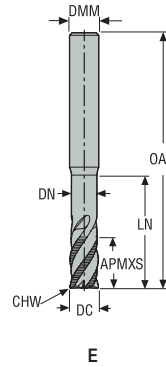

- Tolerances:
- DMM=h5
- DC=-0,02/-0,1 mm
- CHW=0/-0,1 mm
- Regrind possible if DC is $\geq \phi 6$

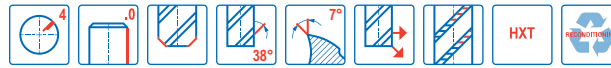

Designation	Item number	Length index	Tool shape	DC	DMM	APMXS	OAL	LN	DN	CHW	PCEDC	Cylindrical
				mm	mm	mm	mm	mm	mm	mm		
JHP994060E3C.0Z4-HXT	03127382	3	E	6,0	6,0	14,0	63,0	24,0	5,6	0,2	4	■
JHP994080E3C.0Z4-HXT	03127383	3	E	8,0	8,0	18,0	69,0	32,0	7,4	0,2	4	■
JHP994100E3C.0Z4-HXT	03127384	3	E	10,0	10,0	22,0	88,0	40,0	9,4	0,2	4	■

■ Stocked standard.

Universal

Steel and cast iron

Stainless steel and S-materials

Non ferrous

Hard

Plastic and cfrp

Graphite

Minimaster Plus

Minimaster

Cutting data – JHP994 Side milling roughing

SMG		a _e /DC	a _p /DC	f _z			v _c
				6	8	10	
S2	E	0.0480	2.0	0.025	0.032	0.042	55 (40 – 69)
		0,0480	2,0	0,0010	0,0013	0,0017	180 (140 – 220)
S11	E	0.450	0.60	0.025	0.034	0.042	50 (39–77)
		0,450	0,60	0,0010	0,0013	0,0017	165 (130 – 250)
S12	E	0.450	0.60	0.025	0.034	0.042	40 (30 – 59)
		0,450	0,60	0,0010	0,0013	0,0017	130 (99–190)

Cutting data – JHP994 Slot milling

SMG		a _p /DC	f _z			v _c
			6	8	10	
S2	E	2.0	0.011	0.014	0.018	33 (24 – 41)
		2,0	0,00044	0,00055	0,00070	110 (79–130)
S11	E	0.60	0.025	0.034	0.042	42 (32 – 63)
		0,60	0,0010	0,0013	0,0017	140 (110 – 200)
S12	E	0.60	0.025	0.034	0.042	33 (25 – 48)
		0,60	0,0010	0,0013	0,0017	110 (83–150)

SMG = Seco material group
Coolant = A=air D=dry E=emulsion M=mist spray
v_c = m/min (sf/min)
f_z = mm (in/tooth)
a_p = mm/DC (in/DC) = factor
a_e = mm/DC (in/DC) = factor
All cutting data are target values

Universal
Steel and cast iron
Stainless steel and S-materials
Non ferrous
Hard
Plastic and cfrp
Graphite
Minimaster Plus
Minimaster

JH780

High speed – CoCr/Titanium – Tapered ball nose – 4 Flutes – Cylindrical

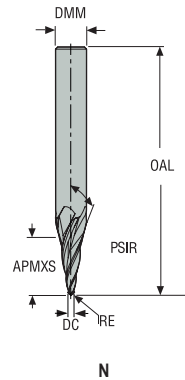
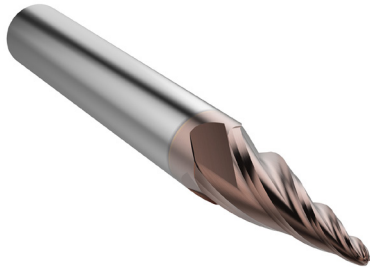

- Tolerances:
- DMM=h5
- DC= ±0,04 mm
- RE= ±0,01 mm
- Regrind possible if DMM is ≥Ø6

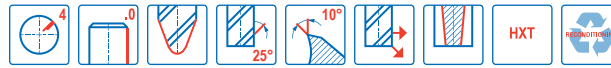

Designation	Item number	Length index	Tool shape	DC	DMM	APMXS	OAL	RE	PSIR	PCEDC	Cylindrical
				mm	mm	mm	mm	mm	mm	mm	
JH780018N2R100.0Z4-HXT	03127386	2	N	1,827	8,0	23,5	63,0	1,0	5,1838	4	■
JH780028N2R150.0Z4-HXT	03127387	2	N	2,803	8,0	23,5	63,0	1,5	3,8915	4	■
JH780038N2R200.0Z4-HXT	03127388	2	N	3,823	8,0	23,5	63,0	2,0	2,5972	4	■
JH780049N2R250.0Z4-HXT	03127389	2	N	4,888	8,0	23,5	63,0	2,5	1,3003	4	■

■ Stocked standard.

Universal

Steel and cast iron

Stainless steel and S-materials

Non ferrous

Hard

Plastic and cfrp

Graphite

Minimaster Plus

Minimaster

Cutting data – JH780 Side milling

SMG		a_p/DC	a_e/DC	f_z				v_c
				1.8	2.8	3.8	4.9	
S2	E	0.0510	4.2	0.0080	0.012	0.017	0.022	70 (54 – 86)
		0,0510	4,2	0,00032	0,00048	0,00065	0,00085	230 (180 – 280)
S12	E	0.0510	4.2	0.0060	0.0090	0.013	0.016	95 (76 – 110)
		0,0510	4,2	0,00024	0,00036	0,00050	0,00065	310 (250 – 360)

For cutting data recalculations, see pages 445 - 452.

SMG = Seco material group
Coolant = A=air D=dry E=emulsion M=mist spray
 v_c = m/min (sf/min)
 f_z = mm (in/tooth)
 a_p = mm/DC (in/DC) = factor
 a_e = mm/DC (in/DC) = factor
All cutting data are target values

- Universal
- Steel and cast iron
- Stainless steel and S-materials
- Non ferrous
- Hard
- Plastic and cfrp
- Graphite
- Minimaster Plus
- Minimaster

JH720

High speed – Titanium – Ball nose – 3 Flutes – Cylindrical

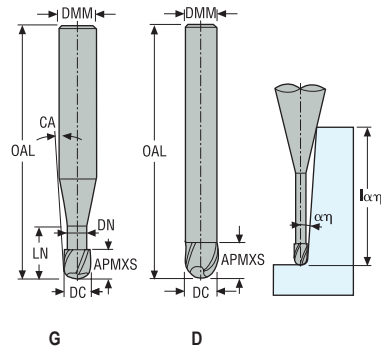

- Tolerances:
- DMM=h5
- DC=-0,02/-0,04 mm
- RE= ±0,01 mm
- Regrind possible if DC is ≥Ø6

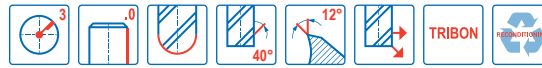

Designation	Item number	Length index	Tool shape	DC	DMM	APMXS	OAL	LN	LN2	DN	CA°	PCEDC	WDX0*	WDX05*	WDX1*	WDX15*	WDX2*	WDX3*	Cylindrical
				mm	mm	mm	mm	mm	mm	mm	mm	mm	mm	mm	mm	mm	mm	mm	
720020-TRIBON	00019845	2	G	2,0	6,0	3,0	60,0	6,0	18,1	1,9	7,0	3	6,5	7,0	7,4	7,7	8,2	9,2	■
720025-TRIBON	00019867	2	G	2,5	6,0	4,0	60,0	6,0	16,7	2,4	6,5	3	6,5	7,0	7,3	7,7	8,1	9,1	■
720030-TRIBON	00019906	2	G	3,0	6,0	4,5	60,0	6,5	19,1	2,8	5,0	3	7,0	8,2	8,7	9,3	10,0	11,9	■
720035-TRIBON	00019909	2	G	3,5	6,0	5,0	65,0	7,0	23,5	3,2	3,5	3	7,5	10,0	11,0	12,4	14,1	20,4	■
720040-TRIBON	00019918	2	G	4,0	6,0	6,0	65,0	8,0	21,6	3,7	3,0	3	8,5	11,1	12,2	13,7	15,6	-	■
720050-TRIBON	00019965	2	G	5,0	6,0	7,5	65,0	10,0	18,5	4,6	2,0	3	10,5	13,9	15,3	17,1	-	-	■
720060-TRIBON	00019990	2	D	6,0	6,0	9,0	75,0	-	-	-	-	3	9,0	-	-	-	-	-	■
720080-TRIBON	00020040	2	D	8,0	8,0	12,0	75,0	-	-	-	-	3	12,0	-	-	-	-	-	■
720100-TRIBON	00020043	2	D	10,0	10,0	15,0	80,0	-	-	-	-	3	15,0	-	-	-	-	-	■
720120-TRIBON	00020045	2	D	12,0	12,0	18,0	90,0	-	-	-	-	3	18,0	-	-	-	-	-	■
720160-TRIBON	00020048	2	D	16,0	16,0	24,0	100,0	-	-	-	-	3	24,0	-	-	-	-	-	■

■ Stocked standard.
 For WDX values: Max. cut depth rel. to α_n (α_n, ref)*

Universal

Steel and cast iron

Stainless steel and S-materials

Non ferrous

Hard

Plastic and cfrp

Graphite

Minimaster Plus

Minimaster

Cutting data – JH720 Side milling roughing

SMG		a _e /DC	a _p /DC	f _z											v _c
				2	2.5	3	3.5	4	5	6	8	10	12	16	
M1	M/E/A	0.200	1.2	0.0080	0.010	0.012	0.014	0.016	0.020	0.024	0.032	0.040	0.048	0.060	85 (62–110)
		0.200	1.2	0.00032	0.00040	0.00048	0.00055	0.00065	0.00080	0.00095	0.0013	0.0016	0.0019	0.0024	280 (210 – 360)
M2	M/E/A	0.200	1.2	0.0070	0.0090	0.011	0.013	0.014	0.018	0.022	0.028	0.036	0.044	0.055	70 (51 – 91)
		0.200	1.2	0.00028	0.00036	0.00044	0.00050	0.00055	0.00070	0.00085	0.0011	0.0014	0.0017	0.0022	230 (170 – 290)
M3	M/E/A	0.200	1.2	0.0080	0.010	0.012	0.014	0.016	0.020	0.024	0.032	0.040	0.048	0.060	65 (46 – 84)
		0.200	1.2	0.00032	0.00040	0.00048	0.00055	0.00065	0.00080	0.00095	0.0013	0.0016	0.0019	0.0024	215 (160 – 270)
M4	M/E/A	0.200	1.2	0.0070	0.0090	0.011	0.012	0.014	0.018	0.022	0.028	0.036	0.042	0.050	49 (35 – 64)
		0.200	1.2	0.00028	0.00036	0.00044	0.00048	0.00055	0.00070	0.00085	0.0011	0.0014	0.0017	0.0020	160 (120 – 200)
M5	M/E/A	0.200	1.2	0.0070	0.0090	0.011	0.012	0.014	0.018	0.022	0.028	0.036	0.042	0.050	41 (29 – 53)
		0.200	1.2	0.00028	0.00036	0.00044	0.00048	0.00055	0.00070	0.00085	0.0011	0.0014	0.0017	0.0020	135 (96–170)
N1	E/M/A	0.400	1.2	0.020	0.025	0.030	0.036	0.040	0.050	0.060	0.080	0.10	0.12	0.15	600 (500 – 690)
		0.400	1.2	0.00080	0.0010	0.0012	0.0014	0.0016	0.0020	0.0024	0.0032	0.0040	0.0048	0.0060	1975 (1700 – 2200)
N2	E/M/A	0.400	1.2	0.016	0.020	0.024	0.028	0.032	0.040	0.048	0.065	0.080	0.095	0.12	500 (400 – 600)
		0.400	1.2	0.00065	0.00080	0.00095	0.0011	0.0013	0.0016	0.0019	0.0026	0.0032	0.0038	0.0048	1650 (1400–1900)
N11	E/M/A	0.300	1.2	0.012	0.015	0.018	0.022	0.024	0.030	0.036	0.048	0.060	0.070	0.090	300 (260 – 340)
		0.300	1.2	0.00048	0.00060	0.00070	0.00085	0.00095	0.0012	0.0014	0.0019	0.0024	0.0028	0.0036	980 (860–1100)
S1	E/M/A	0.100	1.2	0.0065	0.0080	0.0095	0.011	0.013	0.016	0.019	0.026	0.032	0.038	0.048	43 (29 – 57)
		0.100	1.2	0.00026	0.00032	0.00038	0.00044	0.00050	0.00065	0.00075	0.0010	0.0013	0.0015	0.0019	140 (96–180)
S2	E/M/A	0.100	1.2	0.0065	0.0080	0.0095	0.011	0.013	0.016	0.019	0.026	0.032	0.038	0.048	35 (24 – 46)
		0.100	1.2	0.00026	0.00032	0.00038	0.00044	0.00050	0.00065	0.00075	0.0010	0.0013	0.0015	0.0019	115 (79–150)
S3	E/M/A	0.100	1.2	0.0060	0.0075	0.0090	0.011	0.012	0.015	0.018	0.024	0.030	0.036	0.044	30 (21 – 39)
		0.100	1.2	0.00024	0.00030	0.00036	0.00044	0.00048	0.00060	0.00070	0.00095	0.0012	0.0014	0.0017	100 (69–120)
S11	E/M/A	0.300	1.2	0.010	0.013	0.015	0.018	0.020	0.025	0.030	0.040	0.050	0.060	0.075	90 (79–100)
		0.300	1.2	0.00040	0.00050	0.00060	0.00070	0.00080	0.0010	0.0012	0.0016	0.0020	0.0024	0.0030	295 (260 – 320)
S12	E/M/A	0.300	1.2	0.010	0.013	0.015	0.018	0.020	0.025	0.030	0.040	0.050	0.060	0.075	70 (61 – 80)
		0.300	1.2	0.00040	0.00050	0.00060	0.00070	0.00080	0.0010	0.0012	0.0016	0.0020	0.0024	0.0030	230 (210 – 260)
S13	E/M/A	0.300	1.2	0.0085	0.011	0.013	0.015	0.017	0.022	0.026	0.034	0.044	0.050	0.065	55 (48 – 63)
		0.300	1.2	0.00034	0.00044	0.00050	0.00060	0.00065	0.00085	0.0010	0.0013	0.0017	0.0020	0.0026	180 (160 – 200)
TS1	A	0.400	1.2	0.020	0.025	0.030	0.036	0.040	0.050	0.060	0.080	0.10	0.12	0.15	500 (400 – 600)
		0.400	1.2	0.00080	0.0010	0.0012	0.0014	0.0016	0.0020	0.0024	0.0032	0.0040	0.0048	0.0060	1650 (1400–1900)
TP1	M	0.400	1.2	0.020	0.025	0.030	0.036	0.040	0.050	0.060	0.080	0.10	0.12	0.15	500 (400 – 600)
		0.400	1.2	0.00080	0.0010	0.0012	0.0014	0.0016	0.0020	0.0024	0.0032	0.0040	0.0048	0.0060	1650 (1400–1900)

For cutting data recalculations, see pages 445 - 452.

SMG = Seco material group
Coolant = A=air D=dry E=emulsion M=mist spray
v_c = m/min (sf/min)
f_z = mm (in/tooth)
a_p = mm/DC (in/DC) = factor
a_e = mm/DC (in/DC) = factor
All cutting data are target values

Universal
Steel and cast iron
Stainless steel and S-materials
Non ferrous
Hard
Plastic and chip
Graphite
Mimimaster Plus
Mimimaster

JH721

High speed – CoCr/Titanium – Ball nose – 6 Flutes – Cylindrical

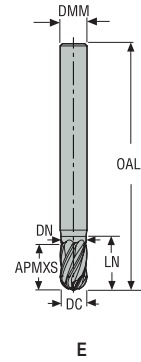
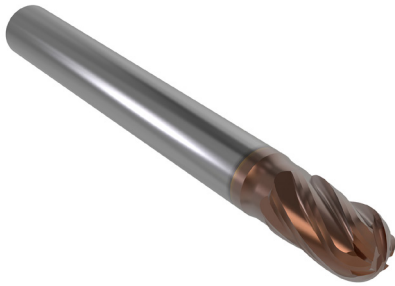

- Tolerances:
- DMM=h5
- DC=e7
- RE= ±0,02 mm
- Regrind possible if DC is ≥Ø6

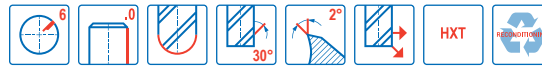

Designation	Item number	Length index	Tool shape	DC	DMM	APMXS	OAL	LN	DN	PCEDC	Cylindrical
				mm	mm	mm	mm	mm	mm		
JH721060E2B.0Z6-HXT	03127390	2	E	6,0	6,0	10,0	57,0	12,0	5,6	6	■
JH721080E2B.0Z6-HXT	03127391	2	E	8,0	8,0	13,0	58,0	16,0	7,4	6	■

■ Stocked standard.

Universal

Steel and cast iron

Stainless steel and S-materials

Non ferrous

Hard

Plastic and cfrp

Graphite

Minimaster Plus

Minimaster

Cutting data – JH721 Copy milling finishing

SMG		a_e/DC	a_p/DC	f_z		v_c
				6	8	
S2	E	0,0424	0,040	0,032	0,042	120 (110–140)
		0,0424	0,040	0,0013	0,0017	395 (370 – 450)
S11	E	0,0424	0,040	0,032	0,042	210 (140 – 230)
		0,0424	0,040	0,0013	0,0017	690 (460–750)
S12	E	0,0424	0,040	0,032	0,042	160 (110–180)
		0,0424	0,040	0,0013	0,0017	520 (370 – 590)

SMG = Seco material group
 Coolant = A=air D=dry E=emulsion M=mist spray
 v_c = m/min (sf/min)
 f_z = mm (in/tooth)
 a_p = mm/DC (in/DC) = factor
 a_e = mm/DC (in/DC) = factor
 All cutting data are target values

- Universal
- Steel and cast iron
- Stainless steel and S-materials
- Non ferrous
- Hard
- Plastic and cfrp
- Graphite
- Minimaster Plus
- Minimaster

JH722

High speed – CoCr/Titanium – Ball nose – 6 Flutes – Cylindrical

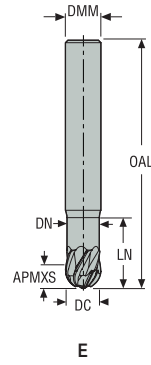
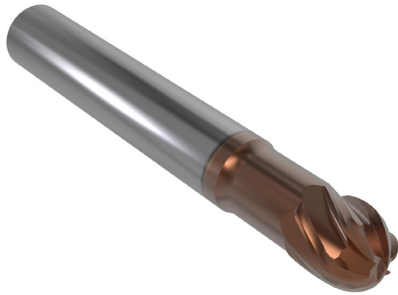

- Tolerances:
- DMM=h5
- DC=e7
- RE= ±0,01 mm
- Regrind possible if DC is ≥Ø6

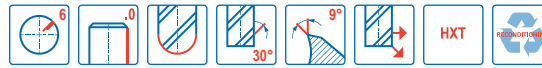

Designation	Item number	Length index	Tool shape	DC	DMM	APMXS	OAL	LN	DN	PCEDC	Cylindrical
				mm	mm	mm	mm	mm	mm		
JH722100E2B.0Z6-HXT	03127392	2	E	10,0	10,0	10,0	72,0	20,0	9,4	6	■

■ Stocked standard.

Universal

Steel and cast iron

Stainless steel and S-materials

Non ferrous

Hard

Plastic and cfrp

Graphite

Minimaster Plus

Minimaster

Cutting data – JH722 Copy milling finishing

SMG		a_e/DC		a_p/DC		f_z		v_c	
S2	E	0.0500		0.15		0.065		125 (110–150)	
		0,0500		0,15		0,0026		410 (370 – 490)	
S11	E	0.0500		0.15		0.048		210 (190 – 230)	
		0,0500		0,15		0,0019		690 (630–750)	
S12	E	0.0500		0.15		0.048		160 (150–180)	
		0,0500		0,15		0,0019		520 (500 – 590)	

SMG = Seco material group
 Coolant = A=air D=dry E=emulsion M=mist spray
 v_c = m/min (sf/min)
 f_z = mm (in/tooth)
 a_p = mm/DC (in/DC) = factor
 a_e = mm/DC (in/DC) = factor
 All cutting data are target values

Universal

Steel and cast iron

Stainless steel and S-materials

Non ferrous

Hard

Plastic and cfrp

Graphite

Minimaster Plus

Minimaster

JCO710

High performance – Titanium – Square – 4-6 Flutes – Weldon – Corner radius

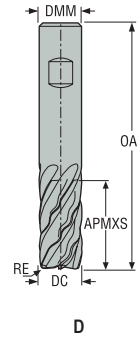

- Tolerances:
- DMM= h6
- DC= k10
- RE= ±0,05 mm
- Regrind possible if DC is ≥Ø6

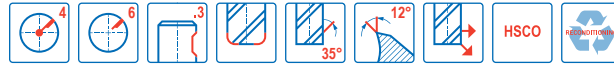

Designation	Item number	Length index	Tool shape	DC	DMM	APMXS	OAL	RE	PCEDC	Weldon
				mm	mm	mm	mm	mm		
JCO710160D2R100.3Z4	02810493	2	D	16,0	16,0	32,0	92,0	1,0	4	■
JCO710160D2R250.3Z4	02810494	2	D	16,0	16,0	32,0	92,0	2,5	4	■
JCO710160D2R400.3Z4	02810496	2	D	16,0	16,0	32,0	92,0	4,0	4	■
JCO710200D2R100.3Z4	02810497	2	D	20,0	20,0	38,0	114,0	1,0	4	■
JCO710200D2R400.3Z4	02810500	2	D	20,0	20,0	38,0	114,0	4,0	4	■
JCO710250D2R100.3Z6	02810501	2	D	25,0	25,0	45,0	121,0	1,0	6	■
JCO710320D2R100.3Z6	02810504	2	D	32,0	32,0	53,0	132,0	1,0	6	■
JCO710320D2R400.3Z6	02810505	2	D	32,0	32,0	53,0	132,0	4,0	6	■

■ Stocked standard.

Universal

Steel and cast iron

Stainless steel and S-materials

Non ferrous

Hard

Plastic and cfrp

Graphite

Minimaster Plus

Minimaster

Cutting data – JCO710 Side milling roughing PCEDC4 LV2

SMG		a _e /DC	a _p /DC	f _z				v _c
				16	20	25	32	
M1	E	0.500	1.2	0.065	0.080	0.095	0.11	21 (15 – 28)
		0,500	1,2	0,0026	0,0032	0,0038	0,0044	70 (50 – 91)
M2	E	0.500	1.2	0.060	0.075	0.085	0.10	17 (12 – 23)
		0,500	1,2	0,0024	0,0030	0,0034	0,0040	55 (40 – 75)
S11	E	0.500	1.1	0.0060	0.0075	0.0085	0.010	13 (9.4 – 18)
		0,500	1,1	0,00024	0,00030	0,00034	0,00040	43 (31 – 59)
S12	E	0.500	1.1	0.0060	0.0075	0.0085	0.010	10 (7.3 – 14)
		0,500	1,1	0,00024	0,00030	0,00034	0,00040	33 (24 – 45)
S13	E	0.500	1.1	0.0050	0.0065	0.0075	0.0090	7 (5.7 – 11)
		0,500	1,1	0,00020	0,00026	0,00030	0,00036	23 (19 – 36)

Cutting data – JCO710 Side milling roughing PCEDC6 LV2

SMG		a _e /DC	a _p /DC	f _z				v _c
				20	25	32	40	
M1	E	0.480	1.2	0.090	0.11	0.14	0.16	18 (13 – 24)
		0,480	1,2	0,0036	0,0044	0,0055	0,0065	60 (43 – 78)
M2	E	0.480	1.2	0.080	0.10	0.12	0.15	15 (11 – 20)
		0,480	1,2	0,0032	0,0040	0,0048	0,0060	49 (37 – 65)
S11	E	0.480	1.2	0.075	0.095	0.12	0.14	11 (7.9 – 15)
		0,480	1,2	0,0030	0,0038	0,0048	0,0055	36 (26 – 49)
S12	E	0.480	1.2	0.075	0.095	0.12	0.14	8 (6.1 – 12)
		0,480	1,2	0,0030	0,0038	0,0048	0,0055	26 (21 – 39)
S13	E	0.480	1.2	0.065	0.085	0.10	0.12	6 (4.9 – 9.6)
		0,480	1,2	0,0026	0,0034	0,0040	0,0048	20 (17 – 31)

Cutting data – JCO710 Slot milling PCEDC4 LV2

SMG		a _p /DC	f _z				v _c
			16	20	25	32	
M1	E	1.0	0.050	0.060	0.080	0.10	19 (13 – 24)
		1,0	0,0020	0,0024	0,0032	0,0040	60 (43 – 78)
M2	E	1.0	0.050	0.060	0.080	0.10	15 (10 – 20)
		1,0	0,0020	0,0024	0,0032	0,0040	49 (33 – 65)
M3	E	0.50	0.046	0.055	0.065	0.080	10 (7.1 – 15)
		0,50	0,0018	0,0022	0,0026	0,0032	33 (24 – 49)
M4	E	0.50	0.040	0.050	0.060	0.070	8 (5.4 – 11)
		0,50	0,0016	0,0020	0,0024	0,0028	26 (18 – 36)
M5	E	0.50	0.040	0.050	0.060	0.070	6 (4.5 – 9.6)
		0,50	0,0016	0,0020	0,0024	0,0028	20 (15 – 31)
S11	E	0.75	0.0060	0.0075	0.0085	0.010	10 (7.8 – 15)
		0,75	0,00024	0,00030	0,00034	0,00040	33 (26 – 49)
S12	E	0.75	0.0060	0.0075	0.0085	0.010	8 (6.0 – 11)
		0,75	0,00024	0,00030	0,00034	0,00040	26 (20 – 36)
S13	E	0.75	0.0050	0.0065	0.0075	0.0090	6 (4.7 – 9.3)
		0,75	0,00020	0,00026	0,00030	0,00036	20 (16 – 30)

When JCO + SIRA is applied: v_c table * 1.2

For cutting data recalculations, see pages 445 - 452.

SMG = Seco material group

Coolant = A=air D=dry E=emulsion M=mist spray

v_c = m/min (sf/min)

f_z = mm (in/tooth)

a_p = mm/DC (in/DC) = factor

a_e = mm/DC (in/DC) = factor

All cutting data are target values

Universal
Steel and cast iron
Stainless steel and S-materials
Non ferrous
Hard
Plastic and cfrp
Graphite
Minimaster Plus
Minimaster



























Universal
Steel and cast iron
Stainless steel and S-materials
Non ferrous
Hard
Plastic and cfrp
Graphite
Minimaster Plus
Minimaster



NON FERROUS























Seco offers a complete range of high performance solid carbide square shoulder end mills, ballnose cutters and finish end mills for high productivity for non ferrous materials.

- JS412 and JS413 for sharp corner type.
- JS452, JS453, JHP490, JH40, JH421, JM403/404/406, JH410 and JH440 for radius type.
- JH450, JH460 and JM413/416 for ball-nose type.

Tool selection Non ferrous						
						
						
Name	JS412	JS413	JS452	JS453	JHP490	
Page(s)	300	303	306	311	316	
Family name	JS ²	JS ²	JS ²	JS ²	HPM	
Type of mill						
Shank	Cylindrical	■	■	■	■	
	Weldon	■	■	□	□	
	Safelock				□	
Number of Flutes	2	3	2	3	2-3	
ICC					■	
Diameter range	Metric	2-20	2-20	2-20	2-20	10-25
	Inch					
Length availability						
		2	2,3	2,3	2,3	2,3,4
Operation						
						
SMG						
N1	●	●	●	●	●	
N2	●	●	●	●	●	
N3	●	●	●	●	●	
TS1	●	●	●	●		
TP1	●	●	●	●		

■ Stock standard □ Weldon available, delivery time is 3 days. □ Safe-Lock available, delivery time is 6 days
● Preferred choice ○ Alternative choice















Universal
Steel and cast iron
Stainless steel and S-materials
Non ferrous
Hard
Plastic and cfrp
Graphite
Minimaster Plus
Minimaster

		Tool selection Non ferrous			
Universal					
Steel and cast iron					
Stainless steel and S-materials					
Non ferrous					
Hard					
Plastic and cfrp					
Graphite					
Minimaster Plus					
Minimaster					
Name		JH40	JH410	JH421	JH440
Page(s)		320	327	323	329
Family name		HSM/TORNADO	HSM/TORNADO	HSM/TORNADO	HSM/TORNADO
Type of mill					
Shank	Cylindrical	<input checked="" type="checkbox"/>	<input checked="" type="checkbox"/>	<input checked="" type="checkbox"/>	<input checked="" type="checkbox"/>
	Weldon	<input type="checkbox"/>	<input type="checkbox"/>	<input type="checkbox"/>	<input type="checkbox"/>
	Safelock	<input type="checkbox"/>	<input type="checkbox"/>	<input type="checkbox"/>	<input type="checkbox"/>
Number of Flutes		2	1	2	2
ICC				<input checked="" type="checkbox"/>	
Diameter range	Metric	2-20	2-17	2-25	6-8
	Inch				
Length availability					
		1,2,3	2,3	2	2
Operation					
					
SMG					
N1		<input checked="" type="checkbox"/>	<input checked="" type="checkbox"/>	<input checked="" type="checkbox"/>	<input checked="" type="checkbox"/>
N2		<input type="checkbox"/>	<input type="checkbox"/>	<input type="checkbox"/>	<input checked="" type="checkbox"/>
N3		<input type="checkbox"/>	<input type="checkbox"/>	<input type="checkbox"/>	<input checked="" type="checkbox"/>
TS1		<input checked="" type="checkbox"/>	<input checked="" type="checkbox"/>	<input checked="" type="checkbox"/>	<input checked="" type="checkbox"/>
TP1		<input type="checkbox"/>	<input type="checkbox"/>	<input checked="" type="checkbox"/>	<input checked="" type="checkbox"/>

■ Stock standard □ Weldon available, delivery time is 3 days.

● Preferred choice ○ Alternative choice

Tool selection Non ferrous

				
Name	JH450	JH460	JM403/404/406	JM413/416
Page(s)	331	333	335	337
Family name	HSM/TORNADO	HSM/TORNADO	MINI	MINI
Type of mill				
Shank	Cylindrical	■	■	■
	Weldon			
	Safelock			
Number of Flutes	2	2	1	2
ICC				
Diameter range	Metric	2-20	3-12	0,5-2
	Inch			
Length availability				
		2,3	2	2,5
Operation				
				
SMG				
N1	●	●	●	●
N2	●		●	●
N3	●		●	●
TS1	●	●		●
TP1	●	●		●

■ Stock standard □ Weldon available, delivery time is 3 days.
● Preferred choice ○ Alternative choice

Universal
Steel and cast iron
Stainless steel and S-materials
Non ferrous
Hard
Plastic and cfrp
Graphite
Minimaster Plus
Minimaster

JS412

General purpose – Aluminium – Square – 2 Flutes – Cylindrical – Sharp

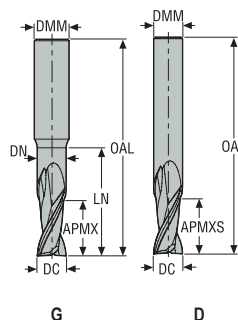

- Tolerances:
- DMM= h5
- DC= e8
- Regrind possible if DC is $\geq \phi 6$

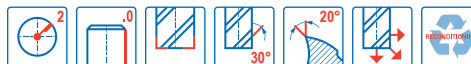

Designation	Item number	Length index	Tool shape	DC	DMM	APMXS	OAL	DN	LN	PCEDC	Cylindrical
				mm	mm	mm	mm	mm	mm		
JS412020G2SZ2.0	02881760	2	G	2,0	6,0	4,0	57,0	1,9	7,0	2	■
JS412030G2SZ2.0	02881761	2	G	3,0	6,0	6,0	57,0	2,8	10,0	2	■
JS412040G2SZ2.0	02881762	2	G	4,0	6,0	8,0	57,0	3,8	14,0	2	■
JS412050G2SZ2.0	02881763	2	G	5,0	6,0	10,0	57,0	4,7	17,0	2	■
JS412060D2SZ2.0	02881764	2	D	6,0	6,0	12,0	57,0	–	–	2	■
JS412080D2SZ2.0	02881765	2	D	8,0	8,0	16,0	63,0	–	–	2	■
JS412100D2SZ2.0	02881766	2	D	10,0	10,0	20,0	75,0	–	–	2	■
JS412120D2SZ2.0	02881767	2	D	12,0	12,0	24,0	88,0	–	–	2	■
JS412160D2SZ2.0	02881769	2	D	16,0	16,0	32,0	100,0	–	–	2	■
JS412200D2SZ2.0	02881770	2	D	20,0	20,0	40,0	124,0	–	–	2	■

■ Stocked standard.

JS412

General purpose – Aluminium – Square – 2 Flutes – Weldon – Sharp

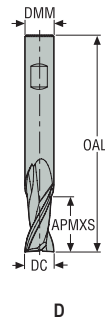

D

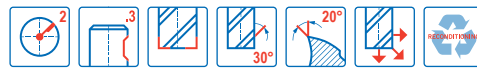

- Tolerances:
- DMM= h5
- DC= e8
- Regrind possible if DC is $\geq \varnothing 6$

Designation	Item number	Length index	Tool shape	DC	DMM	APMXS	OAL	PCEDC	Weldon
				mm	mm	mm	mm		
JS412060D2SZ2.3	02881771	2	D	6,0	6,0	12,0	57,0	2	■
JS412080D2SZ2.3	02881772	2	D	8,0	8,0	16,0	63,0	2	■
JS412100D2SZ2.3	02881773	2	D	10,0	10,0	20,0	75,0	2	■
JS412120D2SZ2.3	02881774	2	D	12,0	12,0	24,0	88,0	2	■
JS412160D2SZ2.3	02881776	2	D	16,0	16,0	32,0	100,0	2	■
JS412200D2SZ2.3	02881777	2	D	20,0	20,0	40,0	124,0	2	■

■ Stocked standard.

Universal

Steel and cast iron

Stainless steel and S-materials

Non ferrous

Hard

Plastic and cfrp

Graphite

Minimaster Plus

Minimaster

Cutting data – JS412 Side milling

SMG		a _e /DC	a _p /DC	f _z										v _c
				2	3	4	5	6	8	10	12	16	20	
N1	E/M/A	0.400	1.5	0.026	0.038	0.050	0.065	0.080	0.10	0.13	0.15	0.19	0.22	590 (470–700)
		0,400	1,5	0,0010	0,0015	0,0020	0,0026	0,0032	0,0040	0,0050	0,0060	0,0075	0,0085	1925 (1600 – 2200)
N2	E/M/A	0.300	1.4	0.026	0.040	0.050	0.065	0.080	0.10	0.13	0.16	0.19	0.22	475 (360 – 590)
		0,300	1,4	0,0010	0,0016	0,0020	0,0026	0,0032	0,0040	0,0050	0,0065	0,0075	0,0085	1550 (1200–1900)
TS1	A/D	0.400	1.5	0.024	0.036	0.048	0.060	0.070	0.095	0.12	0.14	0.18	0.20	600 (480–710)
		0,400	1,5	0,00095	0,0014	0,0019	0,0024	0,0028	0,0038	0,0048	0,0055	0,0070	0,0080	1975 (1600 – 2300)
TP1	A/D	0.400	1.5	0.024	0.036	0.048	0.060	0.070	0.095	0.12	0.14	0.18	0.20	500 (380 – 630)
		0,400	1,5	0,00095	0,0014	0,0019	0,0024	0,0028	0,0038	0,0048	0,0055	0,0070	0,0080	1650 (1300 – 2000)

Cutting data – JS412 Slot milling

SMG		a _p /DC	f _z										v _c
			2	3	4	5	6	8	10	12	16	20	
N1	E	1.2	0.020	0.030	0.040	0.050	0.060	0.080	0.10	0.12	0.16	0.20	500 (410 – 590)
		1,2	0,00080	0,0012	0,0016	0,0020	0,0024	0,0032	0,0040	0,0048	0,0065	0,0080	1650 (1400–1900)
N2	E	1.0	0.016	0.024	0.032	0.040	0.048	0.065	0.080	0.095	0.13	0.16	400 (310 – 500)
		1,0	0,00065	0,00095	0,0013	0,0016	0,0019	0,0026	0,0032	0,0038	0,0050	0,0065	1300 (1100–1600)
TS1	A	1.2	0.020	0.030	0.040	0.050	0.060	0.080	0.10	0.12	0.16	0.20	500 (410 – 590)
		1,2	0,00080	0,0012	0,0016	0,0020	0,0024	0,0032	0,0040	0,0048	0,0065	0,0080	1650 (1400–1900)
TP1	A	1.2	0.020	0.030	0.040	0.050	0.060	0.080	0.10	0.12	0.16	0.20	420 (320 – 520)
		1,2	0,00080	0,0012	0,0016	0,0020	0,0024	0,0032	0,0040	0,0048	0,0065	0,0080	1375 (1100–1700)

For cutting data recalculations, see pages 445 - 452.

SMG = Seco material group
Coolant = A=air D=dry E=emulsion M=mist spray
v_c = m/min (sf/min)
f_z = mm (in/tooth)
a_p = mm/DC (in/DC) = factor
a_e = mm/DC (in/DC) = factor
All cutting data are target values

JS413

General purpose – Aluminium – Square – 3 Flutes – Cylindrical – Sharp

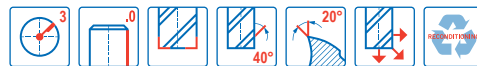
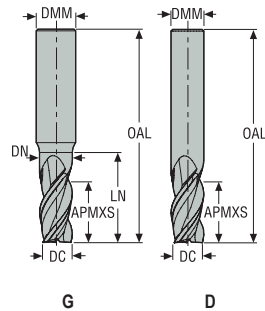

- Tolerances:
- DMM= h5
- DC= e8
- Regrind possible if DC is $\geq \varnothing 6$

Designation	Item number	Length index	Tool shape	DC	DMM	APMXS	OAL	DN	LN	PCEDC	Cylindrical
				mm	mm	mm	mm	mm	mm		
JS413020G2SZ3.0	02881797	2	G	2,0	6,0	4,0	57,0	1,9	7,0	3	■
JS413030G2SZ3.0	02881798	2	G	3,0	6,0	6,0	57,0	2,8	10,0	3	■
JS413040G2SZ3.0	02881799	2	G	4,0	6,0	8,0	57,0	3,8	14,0	3	■
JS413050G2SZ3.0	02881800	2	G	5,0	6,0	10,0	57,0	4,7	17,0	3	■
JS413060D2SZ3.0	02881801	2	D	6,0	6,0	12,0	57,0	-	-	3	■
JS413080D2SZ3.0	02881802	2	D	8,0	8,0	16,0	63,0	-	-	3	■
JS413100D2SZ3.0	02881803	2	D	10,0	10,0	20,0	72,0	-	-	3	■
JS413120D2SZ3.0	02881804	2	D	12,0	12,0	24,0	88,0	-	-	3	■
JS413160D2SZ3.0	02881806	2	D	16,0	16,0	32,0	100,0	-	-	3	■
JS413200D2SZ3.0	02881807	2	D	20,0	20,0	40,0	124,0	-	-	3	■
JS413060D3SZ3.0	02881815	3	D	6,0	6,0	24,0	70,0	-	-	3	■
JS413080D3SZ3.0	02881816	3	D	8,0	8,0	32,0	85,0	-	-	3	■
JS413100D3SZ3.0	02881817	3	D	10,0	10,0	40,0	100,0	-	-	3	■
JS413120D3SZ3.0	02881818	3	D	12,0	12,0	50,0	115,0	-	-	3	■
JS413160D3SZ3.0	02881820	3	D	16,0	16,0	55,0	125,0	-	-	3	■
JS413200D3SZ3.0	02881821	3	D	20,0	20,0	75,0	150,0	-	-	3	■

■ Stocked standard.

Universal

Steel and cast iron

Stainless steel and S-materials

Non ferrous

Hard

Plastic and CFRP

Graphite

Minimaster Plus

Minimaster

JS413

General purpose – Aluminium – Square – 3 Flutes – Weldon – Sharp

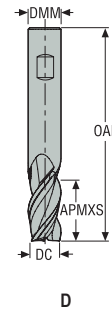

- Tolerances:
- DMM= h5
- DC= e8
- Regrind possible if DC is $\geq \varnothing 6$

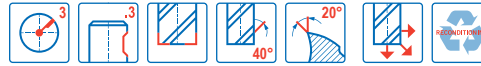

Designation	Item number	Length index	Tool shape	DC	DMM	APMXS	OAL	PCEDC	Weldon
				mm	mm	mm	mm		
JS413060D2SZ3.3	02881808	2	D	6,0	6,0	12,0	57,0	3	■
JS413080D2SZ3.3	02881809	2	D	8,0	8,0	16,0	63,0	3	■
JS413100D2SZ3.3	02881810	2	D	10,0	10,0	20,0	72,0	3	■
JS413120D2SZ3.3	02881811	2	D	12,0	12,0	24,0	88,0	3	■
JS413160D2SZ3.3	02881813	2	D	16,0	16,0	32,0	100,0	3	■
JS413200D2SZ3.3	02881814	2	D	20,0	20,0	40,0	124,0	3	■
JS413060D3SZ3.3	02881955	3	D	6,0	6,0	24,0	70,0	3	□
JS413080D3SZ3.3	02881956	3	D	8,0	8,0	32,0	85,0	3	□
JS413100D3SZ3.3	02881957	3	D	10,0	10,0	40,0	100,0	3	□
JS413120D3SZ3.3	02881958	3	D	12,0	12,0	50,0	115,0	3	□
JS413160D3SZ3.3	02881960	3	D	16,0	16,0	55,0	125,0	3	□
JS413200D3SZ3.3	02881961	3	D	20,0	20,0	75,0	150,0	3	□

■ Stocked standard. □ Weldon available. Delivery time is 3 days.

Cutting data – JS413 Side milling

SMG		a _e /DC	a _p /DC	f _z										v _c
				2	3	4	5	6	8	10	12	16	20	
N1	E/M/A	0.400	1.5	0.024	0.036	0.048	0.060	0.070	0.095	0.12	0.14	0.18	0.20	600 (480–710)
		0,400	1,5	0,00095	0,0014	0,0019	0,0024	0,0028	0,0038	0,0048	0,0055	0,0070	0,0080	1975 (1600 – 2300)
N2	E/M/A	0.300	1.5	0.024	0.036	0.048	0.060	0.070	0.095	0.12	0.14	0.18	0.20	470 (360 – 580)
		0,300	1,5	0,00095	0,0014	0,0019	0,0024	0,0028	0,0038	0,0048	0,0055	0,0070	0,0080	1550 (1200–1900)
N3	E/M/A	0.300	1.5	0.024	0.036	0.048	0.060	0.070	0.095	0.12	0.14	0.18	0.20	315 (240 – 390)
		0,300	1,5	0,00095	0,0014	0,0019	0,0024	0,0028	0,0038	0,0048	0,0055	0,0070	0,0080	1025 (790–1200)
TS1	A/D	0.400	1.5	0.022	0.034	0.044	0.055	0.065	0.090	0.11	0.13	0.17	0.19	610 (500–730)
		0,400	1,5	0,00085	0,0013	0,0017	0,0022	0,0026	0,0036	0,0044	0,0050	0,0065	0,0075	2000 (1700 – 2300)
TP1	A/D	0.400	1.5	0.022	0.034	0.044	0.055	0.065	0.090	0.11	0.13	0.17	0.19	330 (250 – 410)
		0,400	1,5	0,00085	0,0013	0,0017	0,0022	0,0026	0,0036	0,0044	0,0050	0,0065	0,0075	1075 (830–1300)

Cutting data – JS413 Slot milling

SMG		a _p /DC	f _z										v _c
			2	3	4	5	6	8	10	12	16	20	
N1	E	1.0	0.020	0.030	0.040	0.050	0.060	0.080	0.10	0.12	0.16	0.20	500 (400 – 600)
		1,0	0,00080	0,0012	0,0016	0,0020	0,0024	0,0032	0,0040	0,0048	0,0065	0,0080	1650 (1400–1900)
N2	E	1.0	0.014	0.022	0.028	0.036	0.042	0.055	0.070	0.085	0.11	0.14	400 (300 – 490)
		1,0	0,00055	0,00085	0,0011	0,0014	0,0017	0,0022	0,0028	0,0034	0,0044	0,0055	1300 (990–1600)
N3	E	1.0	0.014	0.022	0.028	0.036	0.042	0.055	0.070	0.085	0.11	0.14	265 (200 – 330)
		1,0	0,00055	0,00085	0,0011	0,0014	0,0017	0,0022	0,0028	0,0034	0,0044	0,0055	870 (660–1000)
TS1	A	1.0	0.020	0.030	0.040	0.050	0.060	0.080	0.10	0.12	0.16	0.19	500 (400 – 600)
		1,0	0,00080	0,0012	0,0016	0,0020	0,0024	0,0032	0,0040	0,0048	0,0065	0,0075	1650 (1400–1900)
TP1	A	1.0	0.020	0.030	0.040	0.050	0.060	0.080	0.10	0.12	0.16	0.19	270 (210 – 330)
		1,0	0,00080	0,0012	0,0016	0,0020	0,0024	0,0032	0,0040	0,0048	0,0065	0,0075	890 (690–1000)

For cutting data recalculations, see pages 445 - 452.

SMG = Seco material group
 Coolant = A=air D=dry E=emulsion M=mist spray
 v_c = m/min (sf/min)
 f_z = mm (in/tooth)
 a_p = mm/DC (in/DC) = factor
 a_e = mm/DC (in/DC) = factor
 All cutting data are target values

Universal
Steel and cast iron
Stainless steel and S-materials
Non ferrous
Hard
Plastic and chip
Graphite
Minimaster Plus
Minimaster

JS452

High performance – Aluminium – Square – 2 Flutes – Cylindrical – Corner radius or chamfer

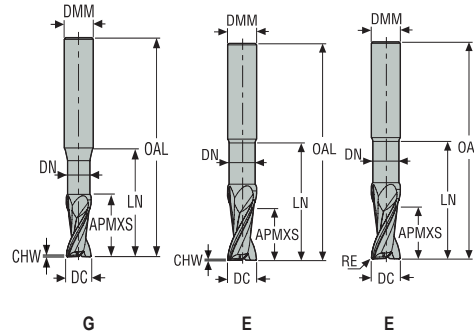

- Tolerances:
- DMM= h5
- DC= e7
- RE= ±0,02
- CHW= +0,04 mm
- Regrind possible if DC is ≥Ø6

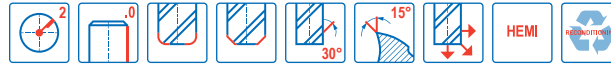

Designation	Item number	Length index	Tool shape	DC	DMM	APMXS	OAL	LN	DN	CHW	RE	PCEDC	Cylindrical
				mm	mm	mm	mm	mm	mm	mm	mm	mm	
JS452020G2CZ2.0-HEMI	02881848	2	G	2,0	6,0	4,0	57,0	8,0	1,9	0,1	–	2	■
JS452030G2CZ2.0-HEMI	02881849	2	G	3,0	6,0	6,0	57,0	10,0	2,8	0,1	–	2	■
JS452040G2CZ2.0-HEMI	02881850	2	G	4,0	6,0	8,0	57,0	14,0	3,8	0,1	–	2	■
JS452050G2CZ2.0-HEMI	02881851	2	G	5,0	6,0	8,0	57,0	17,0	4,7	0,1	–	2	■
JS452060E2CZ2.0-HEMI	02881852	2	E	6,0	6,0	12,0	57,0	19,0	5,7	0,1	–	2	■
JS452060E2R050Z2.0-HEMI	02881853	2	E	6,0	6,0	12,0	57,0	19,0	5,7	–	0,5	2	■
JS452060E2R100Z2.0-HEMI	02881854	2	E	6,0	6,0	12,0	57,0	19,0	5,7	–	1,0	2	■
JS452080E2CZ2.0-HEMI	02881778	2	E	8,0	8,0	16,0	63,0	24,0	7,6	0,1	–	2	■
JS452080E2R050Z2.0-HEMI	02881855	2	E	8,0	8,0	16,0	63,0	24,0	7,6	–	0,5	2	■
JS452080E2R100Z2.0-HEMI	02881779	2	E	8,0	8,0	16,0	63,0	24,0	7,6	–	1,0	2	■
JS452100E2CZ2.0-HEMI	02881856	2	E	10,0	10,0	20,0	72,0	29,0	9,5	0,1	–	2	■
JS452100E2R050Z2.0-HEMI	02881857	2	E	10,0	10,0	20,0	72,0	29,0	9,5	–	0,5	2	■
JS452100E2R100Z2.0-HEMI	02881858	2	E	10,0	10,0	20,0	72,0	29,0	9,5	–	1,0	2	■
JS452120E2CZ2.0-HEMI	02881859	2	E	12,0	12,0	24,0	88,0	37,0	11,4	0,1	–	2	■
JS452120E2R050Z2.0-HEMI	02881860	2	E	12,0	12,0	24,0	88,0	37,0	11,4	–	0,5	2	■
JS452120E2R100Z2.0-HEMI	02881861	2	E	12,0	12,0	24,0	88,0	37,0	11,4	–	1,0	2	■
JS452120E2R200Z2.0-HEMI	02881780	2	E	12,0	12,0	24,0	88,0	37,0	11,4	–	2,0	2	■
JS452140E2CZ2.0-HEMI	02881862	2	E	14,0	14,0	28,0	88,0	41,0	13,3	0,1	–	2	■
JS452160E2CZ2.0-HEMI	02881863	2	E	16,0	16,0	32,0	100,0	48,0	15,2	0,1	–	2	■
JS452160E2R050Z2.0-HEMI	02881864	2	E	16,0	16,0	32,0	100,0	48,0	15,2	–	0,5	2	■
JS452160E2R100Z2.0-HEMI	02881782	2	E	16,0	16,0	32,0	100,0	48,0	15,2	–	1,0	2	■
JS452160E2R200Z2.0-HEMI	02881783	2	E	16,0	16,0	32,0	100,0	48,0	15,2	–	2,0	2	■
JS452160E2R400Z2.0-HEMI	02881785	2	E	16,0	16,0	32,0	100,0	48,0	15,2	–	4,0	2	■
JS452200E2CZ2.0-HEMI	02881865	2	E	20,0	20,0	36,0	110,0	57,0	19,0	0,1	–	2	■
JS452200E2R050Z2.0-HEMI	02881866	2	E	20,0	20,0	36,0	110,0	57,0	19,0	–	0,5	2	■
JS452200E2R100Z2.0-HEMI	02881768	2	E	20,0	20,0	36,0	110,0	57,0	19,0	–	1,0	2	■

■ Stocked standard.

JS452

High performance – Aluminium – Square – 2 Flutes – Cylindrical – Corner radius

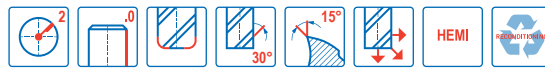
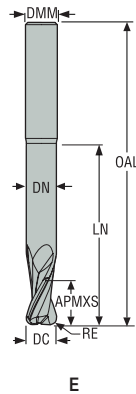

- Tolerances:
- DMM= h5
- DC= e8
- RE= ±0,02 mm
- Regrind possible if DC is ≥Ø6

Designation	Item number	Length index	Tool shape	DC	DMM	APMXS	OAL	LN	DN	RE	PCEDC	Cylindrical
				mm	mm	mm	mm	mm	mm	mm		
JS452080E3R020.0Z2-HEMI	03003413	3	E	8,0	8,0	12,0	79,0	41,0	7,6	0,2	2	■
JS452100E3R050.0Z2-HEMI	03003415	3	E	10,0	10,0	15,0	99,0	57,0	9,5	0,5	2	■
JS452120E3R050.0Z2-HEMI	03003419	3	E	12,0	12,0	18,0	119,0	72,0	11,4	0,5	2	■
JS452160E3R050.0Z2-HEMI	03003426	3	E	16,0	16,0	24,0	129,0	79,0	15,2	0,5	2	■
JS452200E3R050.0Z2-HEMI	03003433	3	E	20,0	20,0	30,0	164,0	111,0	19,0	0,5	2	■

■ Stocked standard.

Universal

Steel and cast iron

Stainless steel and S-materials

Non ferrous

Hard

Plastic and cfrp

Graphite

Minimaster Plus

Minimaster

JS452

High performance – Aluminium – Square – 2 Flutes – Weldon – Corner radius or chamfer

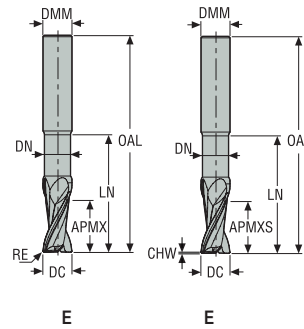

- Tolerances:
- DMM= h5
- DC= e7
- RE= ±0,02
- CHW= +0,04 mm
- Regrind possible if DC is ≥Ø6

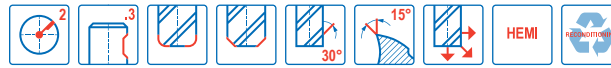

Designation	Item number	Length index	Tool shape	DC	DMM	APMXS	OAL	LN	DN	CHW	RE	PCEDC	Weldon
				mm	mm	mm	mm	mm	mm	mm	mm		
JS452060E2CZ2.3-HEMI	02881867	2	E	6,0	6,0	12,0	57,0	19,0	5,7	0,1	–	2	<input type="checkbox"/>
JS452060E2R050Z2.3-HEMI	02881868	2	E	6,0	6,0	12,0	57,0	19,0	5,7	–	0,5	2	<input type="checkbox"/>
JS452060E2R100Z2.3-HEMI	02881869	2	E	6,0	6,0	12,0	57,0	19,0	5,7	–	1,0	2	<input type="checkbox"/>
JS452080E2CZ2.3-HEMI	02881947	2	E	8,0	8,0	16,0	63,0	24,0	7,6	0,1	–	2	<input type="checkbox"/>
JS452080E2R050Z2.3-HEMI	02881870	2	E	8,0	8,0	16,0	63,0	24,0	7,6	–	0,5	2	<input type="checkbox"/>
JS452080E2R100Z2.3-HEMI	02922247	2	E	8,0	8,0	16,0	63,0	24,0	7,6	–	1,0	2	<input type="checkbox"/>
JS452100E2CZ2.3-HEMI	02881871	2	E	10,0	10,0	20,0	72,0	29,0	9,5	0,1	–	2	<input type="checkbox"/>
JS452100E2R050Z2.3-HEMI	02881872	2	E	10,0	10,0	20,0	72,0	29,0	9,5	–	0,5	2	<input type="checkbox"/>
JS452100E2R100Z2.3-HEMI	02881873	2	E	10,0	10,0	20,0	72,0	29,0	9,5	–	1,0	2	<input type="checkbox"/>
JS452120E2CZ2.3-HEMI	02881874	2	E	12,0	12,0	24,0	88,0	37,0	11,4	0,1	–	2	<input type="checkbox"/>
JS452120E2R050Z2.3-HEMI	02881875	2	E	12,0	12,0	24,0	88,0	37,0	11,4	–	0,5	2	<input type="checkbox"/>
JS452120E2R100Z2.3-HEMI	02881876	2	E	12,0	12,0	24,0	88,0	37,0	11,4	–	1,0	2	<input type="checkbox"/>
JS452120E2R200Z2.3-HEMI	02881948	2	E	12,0	12,0	24,0	88,0	37,0	11,4	–	2,0	2	<input type="checkbox"/>
JS452140E2CZ2.3-HEMI	02881877	2	E	14,0	14,0	28,0	88,0	41,0	13,3	0,1	–	2	<input type="checkbox"/>
JS452160E2CZ2.3-HEMI	02881878	2	E	16,0	16,0	32,0	100,0	48,0	15,2	0,1	–	2	<input type="checkbox"/>
JS452160E2R050Z2.3-HEMI	02881879	2	E	16,0	16,0	32,0	100,0	48,0	15,2	–	0,5	2	<input type="checkbox"/>
JS452160E2R100Z2.3-HEMI	02881949	2	E	16,0	16,0	32,0	100,0	48,0	15,2	–	1,0	2	<input type="checkbox"/>
JS452160E2R200Z2.3-HEMI	02881950	2	E	16,0	16,0	32,0	100,0	48,0	15,2	–	2,0	2	<input type="checkbox"/>
JS452160E2R400Z2.3-HEMI	02881952	2	E	16,0	16,0	32,0	100,0	48,0	15,2	–	4,0	2	<input type="checkbox"/>
JS452200E2CZ2.3-HEMI	02881880	2	E	20,0	20,0	36,0	110,0	57,0	19,0	0,1	–	2	<input type="checkbox"/>
JS452200E2R050Z2.3-HEMI	02881881	2	E	20,0	20,0	36,0	110,0	57,0	19,0	–	0,5	2	<input type="checkbox"/>
JS452200E2R100Z2.3-HEMI	02881953	2	E	20,0	20,0	36,0	110,0	57,0	19,0	–	1,0	2	<input type="checkbox"/>

Weldon available. Delivery time is 3 days.

JS452

High performance – Aluminium – Square – 2 Flutes – Weldon – Corner radius

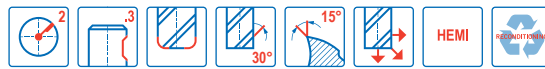
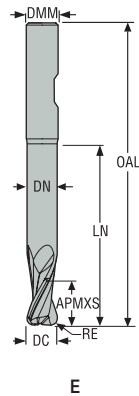

- Tolerances:
- DMM= h5
- DC= e7
- RE= ±0,02 mm
- Regrind possible if DC is ≥Ø6

Designation	Item number	Length index	Tool shape	DC	DMM	APMXS	OAL	LN	DN	RE	PCEDC	Weldon
				mm	mm	mm	mm	mm	mm	mm		
JS452080E3R020.3Z2-HEMI	03003447	3	E	8,0	8,0	12,0	79,0	41,0	7,6	0,2	2	<input type="checkbox"/>
JS452100E3R050.3Z2-HEMI	03003449	3	E	10,0	10,0	15,0	99,0	57,0	9,5	0,5	2	<input type="checkbox"/>
JS452120E3R050.3Z2-HEMI	03003453	3	E	12,0	12,0	18,0	119,0	72,0	11,4	0,5	2	<input type="checkbox"/>
JS452160E3R050.3Z2-HEMI	03003460	3	E	16,0	16,0	24,0	129,0	79,0	15,2	0,5	2	<input type="checkbox"/>
JS452200E3R050.3Z2-HEMI	03003467	3	E	20,0	20,0	30,0	164,0	111,0	19,0	0,5	2	<input type="checkbox"/>

Weldon available. Delivery time is 3 days.

Universal

Steel and cast iron

Stainless steel and S-materials

Non ferrous

Hard

Plastic and cfrp

Graphite

Minimaster Plus

Minimaster

Cutting data – JS452 Side milling roughing

SMG		a _e /DC	a _p /DC	f _z											v _c
				2	3	4	5	6	8	10	12	14	16	20	
N1	E/M/A	0.400	1.5	0.030	0.046	0.060	0.075	0.090	0.12	0.15	0.18	0.20	0.22	0.25	560 (450—670)
		0,400	1,5	0,0012	0,0018	0,0024	0,0030	0,0036	0,0048	0,0060	0,0070	0,0080	0,0085	0,010	1825 (1500—2100)
N2	E/M/A	0.300	1.5	0.024	0.036	0.048	0.060	0.070	0.095	0.12	0.14	0.16	0.18	0.20	485 (370—600)
		0,300	1,5	0,00095	0,0014	0,0019	0,0024	0,0028	0,0038	0,0048	0,0055	0,0065	0,0070	0,0080	1600 (1300–1900)
N3	E/M/A	0.300	1.5	0.024	0.036	0.048	0.060	0.070	0.095	0.12	0.14	0.16	0.18	0.20	325 (250—400)
		0,300	1,5	0,00095	0,0014	0,0019	0,0024	0,0028	0,0038	0,0048	0,0055	0,0065	0,0070	0,0080	1075 (830–1300)
TS1	A/D	0.400	1.5	0.030	0.046	0.060	0.075	0.090	0.12	0.15	0.18	0.20	0.22	0.25	560 (450—670)
		0,400	1,5	0,0012	0,0018	0,0024	0,0030	0,0036	0,0048	0,0060	0,0070	0,0080	0,0085	0,010	1825 (1500—2100)
TP1	A/D	0.400	1.5	0.030	0.046	0.060	0.075	0.090	0.12	0.15	0.18	0.20	0.22	0.25	450 (340—560)
		0,400	1,5	0,0012	0,0018	0,0024	0,0030	0,0036	0,0048	0,0060	0,0070	0,0080	0,0085	0,010	1475 (1200–1800)

Cutting data – JS452 Slot milling*

SMG		a _p /DC	f _z											v _c
			2	3	4	5	6	8	10	12	14	16	20	
N1	E	1.5	0.020	0.030	0.040	0.050	0.060	0.080	0.10	0.12	0.14	0.16	0.20	500 (410—590)
		1,5	0,00080	0,0012	0,0016	0,0020	0,0024	0,0032	0,0040	0,0048	0,0055	0,0065	0,0080	1650 (1400–1900)
N2	E	1.2	0.016	0.024	0.032	0.040	0.048	0.065	0.080	0.095	0.11	0.13	0.16	400 (310—500)
		1,2	0,00065	0,00095	0,0013	0,0016	0,0019	0,0026	0,0032	0,0038	0,0044	0,0050	0,0065	1300 (1100–1600)
N3	E	1.2	0.016	0.024	0.032	0.040	0.048	0.065	0.080	0.095	0.11	0.13	0.16	265 (210—330)
		1,2	0,00065	0,00095	0,0013	0,0016	0,0019	0,0026	0,0032	0,0038	0,0044	0,0050	0,0065	870 (690–1000)
TS1	A	1.5	0.020	0.030	0.040	0.050	0.060	0.080	0.10	0.12	0.14	0.16	0.20	500 (410—590)
		1,5	0,00080	0,0012	0,0016	0,0020	0,0024	0,0032	0,0040	0,0048	0,0055	0,0065	0,0080	1650 (1400–1900)
TP1	A	1.5	0.020	0.030	0.040	0.050	0.060	0.080	0.10	0.12	0.14	0.16	0.20	400 (310—500)
		1,5	0,00080	0,0012	0,0016	0,0020	0,0024	0,0032	0,0040	0,0048	0,0055	0,0065	0,0080	1300 (1100–1600)

Remark: if cornerradius is >15% of DC then a_p= -30%, f_z= -20%
For cutting data recalculations, see pages 445 - 452.

SMG = Seco material group
Coolant = A=air D=dry E=emulsion M=mist spray
v_c = m/min (sf/min)
f_z = mm (in/tooth)
a_p = mm/DC (in/DC) = factor
a_e = mm/DC (in/DC) = factor
All cutting data are target values

JS453

High performance – Aluminium – Square – 3 Flutes – Cylindrical – Corner radius or chamfer

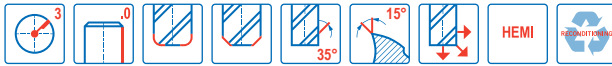
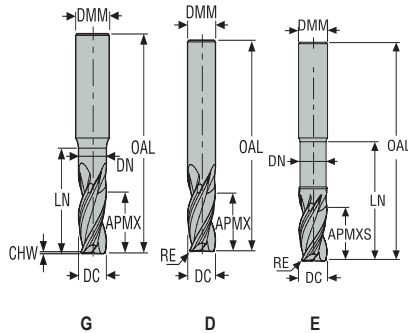

- Tolerances:
- DMM=h5
- DC=e7
- RE= ±0,02 mm
- CHW= +0,04 mm
- Regrind possible if DC is ≥Ø6

Designation	Item number	Length index	Tool shape	DC	DMM	APMXS	OAL	LN	DN	CHW	RE	PCEDC	Cylindrical
				mm	mm	mm	mm	mm	mm	mm	mm		
JS453020G2CZ3.0-HEMI	02881896	2	G	2,0	6,0	4,0	57,0	7,0	1,9	0,1	-	3	■
JS453030G2CZ3.0-HEMI	02881897	2	G	3,0	6,0	6,0	57,0	10,0	2,85	0,1	-	3	■
JS453040G2CZ3.0-HEMI	02881898	2	G	4,0	6,0	8,0	57,0	13,0	3,8	0,1	-	3	■
JS453050G2CZ3.0-HEMI	02881899	2	G	5,0	6,0	10,0	57,0	14,0	4,75	0,1	-	3	■
JS453060D2CZ3.0-HEMI	02881900	2	D	6,0	6,0	12,0	57,0	-	-	0,1	-	3	■
JS453060D2R050Z3.0-HEMI	02881901	2	D	6,0	6,0	12,0	57,0	-	-	-	0,5	3	■
JS453080D2CZ3.0-HEMI	02881812	2	D	8,0	8,0	16,0	63,0	-	-	0,1	-	3	■
JS453080D2R050Z3.0-HEMI	02881902	2	D	8,0	8,0	16,0	63,0	-	-	-	0,5	3	■
JS453100D2CZ3.0-HEMI	02881903	2	D	10,0	10,0	20,0	72,0	-	-	0,1	-	3	■
JS453100D2R050Z3.0-HEMI	02881904	2	D	10,0	10,0	20,0	72,0	-	-	-	0,5	3	■
JS453120D2CZ3.0-HEMI	02881905	2	D	12,0	12,0	24,0	88,0	-	-	0,1	-	3	■
JS453120D2R050Z3.0-HEMI	02881906	2	D	12,0	12,0	24,0	88,0	-	-	-	0,5	3	■
JS453120E2R300.0Z3-HEMI	02905280	2	E	12,0	12,0	24,0	88,0	37,0	11,4	-	3,0	3	■
JS453140D2CZ3.0-HEMI	02881907	2	D	14,0	14,0	28,0	88,0	-	-	0,1	-	3	■
JS453160D2CZ3.0-HEMI	02881908	2	D	16,0	16,0	32,0	100,0	-	-	0,1	-	3	■
JS453160D2R050Z3.0-HEMI	02881909	2	D	16,0	16,0	32,0	100,0	-	-	-	0,5	3	■
JS453160E2R100.0Z3-HEMI	02905281	2	E	16,0	16,0	32,0	100,0	48,0	15,2	-	1,0	3	■
JS453160E2R200.0Z3-HEMI	02905282	2	E	16,0	16,0	32,0	100,0	48,0	15,2	-	2,0	3	■
JS453160E2R250.0Z3-HEMI	02905283	2	E	16,0	16,0	32,0	100,0	48,0	15,2	-	2,5	3	■
JS453160E2R300.0Z3-HEMI	02905284	2	E	16,0	16,0	32,0	100,0	48,0	15,2	-	3,0	3	■
JS453160E2R400.0Z3-HEMI	02905285	2	E	16,0	16,0	32,0	100,0	48,0	15,2	-	4,0	3	■
JS453200E2C.0Z3-HEMI	02905286	2	E	20,0	20,0	36,0	110,0	57,0	19,0	0,1	-	3	■
JS453200E2R050.0Z3-HEMI	02905287	2	E	20,0	20,0	36,0	110,0	57,0	19,0	-	0,5	3	■
JS453200E2R100.0Z3-HEMI	02905288	2	E	20,0	20,0	36,0	110,0	57,0	19,0	-	1,0	3	■
JS453200E2R200.0Z3-HEMI	02905289	2	E	20,0	20,0	36,0	110,0	57,0	19,0	-	2,0	3	■
JS453200E2R300.0Z3-HEMI	02905291	2	E	20,0	20,0	36,0	110,0	57,0	19,0	-	3,0	3	■
JS453200E2R400.0Z3-HEMI	02905292	2	E	20,0	20,0	36,0	110,0	57,0	19,0	-	4,0	3	■

■ Stocked standard.

Universal

Steel and cast iron

Stainless steel and S-materials

Non ferrous

Hard

Plastic and chip

Graphite

Minimaster Plus

Minimaster

JS453

High performance – Aluminium – Square – 3 Flutes – Cylindrical – Corner radius or chamfer

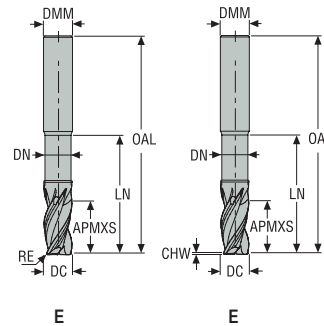

- Tolerances:
- DMM= h5
- DC = e7
- RE= ±0,02 mm
- CHW= +0,04 mm
- Regrind possible if DC is ≥Ø6

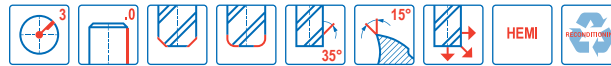

Designation	Item number	Length index	Tool shape	DC	DMM	APMXS	OAL	LN	DN	CHW	RE	PCEDC	Cylindrical
				mm	mm	mm	mm	mm	mm	mm	mm		
JS453120E3R300.0Z3-HEMI	02905294	3	E	12,0	12,0	24,0	110,0	54,0	11,4	–	3,0	3	■
JS453160E3R100.0Z3-HEMI	02905295	3	E	16,0	16,0	32,0	125,0	77,0	15,2	–	1,0	3	■
JS453160E3R200.0Z3-HEMI	02905296	3	E	16,0	16,0	32,0	125,0	77,0	15,2	–	2,0	3	■
JS453160E3R300.0Z3-HEMI	02905298	3	E	16,0	16,0	32,0	125,0	77,0	15,2	–	3,0	3	■
JS453160E3R400.0Z3-HEMI	02905299	3	E	16,0	16,0	32,0	125,0	77,0	15,2	–	4,0	3	■
JS453200E3C.0Z3-HEMI	02905300	3	E	20,0	20,0	36,0	150,0	90,0	19,0	0,1	–	3	■
JS453200E3R050.0Z3-HEMI	02905301	3	E	20,0	20,0	36,0	150,0	90,0	19,0	–	0,5	3	■
JS453200E3R100.0Z3-HEMI	02905302	3	E	20,0	20,0	36,0	150,0	90,0	19,0	–	1,0	3	■
JS453200E3R200.0Z3-HEMI	02905303	3	E	20,0	20,0	36,0	150,0	90,0	19,0	–	2,0	3	■
JS453200E3R300.0Z3-HEMI	02905305	3	E	20,0	20,0	36,0	150,0	90,0	19,0	–	3,0	3	■
JS453200E3R400.0Z3-HEMI	02905306	3	E	20,0	20,0	36,0	150,0	90,0	19,0	–	4,0	3	■

■ Stocked standard.

Universal

Steel and cast iron

Stainless steel and S-materials

Non ferrous

Hard

Plastic and cfrp

Graphite

Minimaster Plus

Minimaster

JS453

High performance – Aluminium – Square – 3 Flutes – Weldon – Corner radius or chamfer

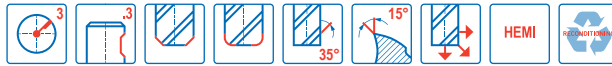
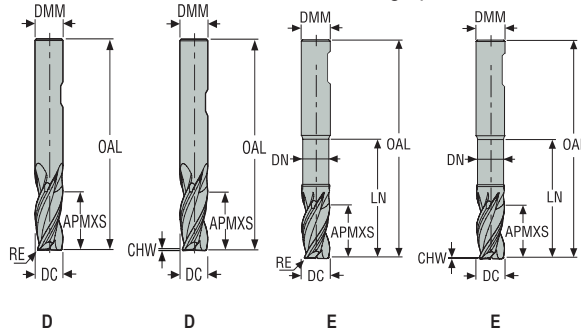

- Tolerances:
- DMM=h5
- DC=e7
- CHW= ±0,02 mm
- Regrind possible if DC is ≥Ø6

Designation	Item number	Length index	Tool shape	DC	DMM	APMXS	OAL	LN	DN	CHW	RE	PCEDC	Weldon
				mm	mm	mm	mm	mm	mm	mm	mm	mm	
JS453060D2CZ3.3-HEMI	02881910	2	D	6,0	6,0	12,0	57,0	-	-	0,1	-	3	<input type="checkbox"/>
JS453060D2R050Z3.3-HEMI	02881911	2	D	6,0	6,0	12,0	57,0	-	-	-	0,5	3	<input type="checkbox"/>
JS453080D2CZ3.3-HEMI	02881964	2	D	8,0	8,0	16,0	63,0	-	-	0,1	-	3	<input type="checkbox"/>
JS453080D2R050Z3.3-HEMI	02881954	2	D	8,0	8,0	16,0	63,0	-	-	-	0,5	3	<input type="checkbox"/>
JS453100D2CZ3.3-HEMI	02881913	2	D	10,0	10,0	20,0	72,0	-	-	0,1	-	3	<input type="checkbox"/>
JS453100D2R050Z3.3-HEMI	02881914	2	D	10,0	10,0	20,0	72,0	-	-	-	0,5	3	<input type="checkbox"/>
JS453120D2CZ3.3-HEMI	02881915	2	D	12,0	12,0	24,0	88,0	-	-	0,1	-	3	<input type="checkbox"/>
JS453120D2R050Z3.3-HEMI	02881916	2	D	12,0	12,0	24,0	88,0	-	-	-	0,5	3	<input type="checkbox"/>
JS453120E2R300.3Z3-HEMI	02905308	2	E	12,0	12,0	24,0	88,0	37,0	11,4	-	3,0	3	<input type="checkbox"/>
JS453140D2CZ3.3-HEMI	02881917	2	D	14,0	14,0	28,0	88,0	-	-	0,1	-	3	<input type="checkbox"/>
JS453160D2CZ3.3-HEMI	02881918	2	D	16,0	16,0	32,0	100,0	-	-	0,1	-	3	<input type="checkbox"/>
JS453160D2R050Z3.3-HEMI	02881919	2	D	16,0	16,0	32,0	100,0	-	-	-	0,5	3	<input type="checkbox"/>
JS453160E2R100.3Z3-HEMI	02905309	2	E	16,0	16,0	32,0	100,0	48,0	15,2	-	1,0	3	<input type="checkbox"/>
JS453160E2R200.3Z3-HEMI	02905310	2	E	16,0	16,0	32,0	100,0	48,0	15,2	-	2,0	3	<input type="checkbox"/>
JS453160E2R250.3Z3-HEMI	02905311	2	E	16,0	16,0	32,0	100,0	48,0	15,2	-	2,5	3	<input type="checkbox"/>
JS453160E2R300.3Z3-HEMI	02905312	2	E	16,0	16,0	32,0	100,0	48,0	15,2	-	3,0	3	<input type="checkbox"/>
JS453160E2R400.3Z3-HEMI	02905313	2	E	16,0	16,0	32,0	100,0	48,0	15,2	-	4,0	3	<input type="checkbox"/>
JS453200E2C.3Z3-HEMI	02905314	2	E	20,0	20,0	36,0	110,0	57,0	19,0	0,1	-	3	<input type="checkbox"/>
JS453200E2R050.3Z3-HEMI	02905315	2	E	20,0	20,0	36,0	110,0	57,0	19,0	-	0,5	3	<input type="checkbox"/>
JS453200E2R100.3Z3-HEMI	02905316	2	E	20,0	20,0	36,0	110,0	57,0	19,0	-	1,0	3	<input type="checkbox"/>
JS453200E2R200.3Z3-HEMI	02905317	2	E	20,0	20,0	36,0	110,0	57,0	19,0	-	2,0	3	<input type="checkbox"/>
JS453200E2R300.3Z3-HEMI	02905319	2	E	20,0	20,0	36,0	110,0	57,0	19,0	-	3,0	3	<input type="checkbox"/>
JS453200E2R400.3Z3-HEMI	02905320	2	E	20,0	20,0	36,0	110,0	57,0	19,0	-	4,0	3	<input type="checkbox"/>

Weldon available. Delivery time is 3 days.

Universal

Steel and cast iron

Stainless steel and S-materials

Non ferrous

Hard

Plastic and chip

Graphite

Minimaster Plus

Minimaster

JS453

High performance – Aluminium – Square – 3 Flutes – Weldon – Corner radius or chamfer

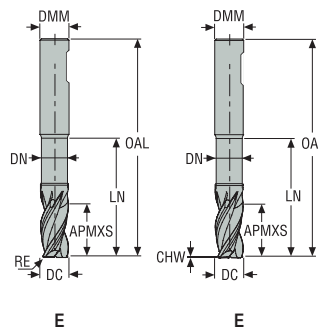

- Tolerances:
- DMM= h5
- DC = e7
- RE= ±0,02 mm
- CHW= +0,04 mm
- Regrind possible if DC is ≥Ø6

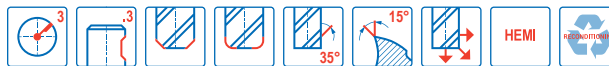

Designation	Item number	Length index	Tool shape	DC	DMM	APMXS	OAL	LN	DN	CHW	RE	PCEDC	Weldon
				mm	mm	mm	mm	mm	mm	mm	mm		
JS453120E3R300.3Z3-HEMI	02905322	3	E	12,0	12,0	24,0	110,0	54,0	11,4	–	3,0	3	<input type="checkbox"/>
JS453160E3R100.3Z3-HEMI	02905323	3	E	16,0	16,0	32,0	125,0	77,0	15,2	–	1,0	3	<input type="checkbox"/>
JS453160E3R200.3Z3-HEMI	02905324	3	E	16,0	16,0	32,0	125,0	77,0	15,2	–	2,0	3	<input type="checkbox"/>
JS453160E3R300.3Z3-HEMI	02905326	3	E	16,0	16,0	32,0	125,0	77,0	15,2	–	3,0	3	<input type="checkbox"/>
JS453160E3R400.3Z3-HEMI	02905327	3	E	16,0	16,0	32,0	125,0	77,0	15,2	–	4,0	3	<input type="checkbox"/>
JS453200E3C.3Z3-HEMI	02905328	3	E	20,0	20,0	36,0	150,0	90,0	19,0	0,1	–	3	<input type="checkbox"/>
JS453200E3R050.3Z3-HEMI	02905329	3	E	20,0	20,0	36,0	150,0	90,0	19,0	–	0,5	3	<input type="checkbox"/>
JS453200E3R100.3Z3-HEMI	02905330	3	E	20,0	20,0	36,0	150,0	90,0	19,0	–	1,0	3	<input type="checkbox"/>
JS453200E3R200.3Z3-HEMI	02905331	3	E	20,0	20,0	36,0	150,0	90,0	19,0	–	2,0	3	<input type="checkbox"/>
JS453200E3R300.3Z3-HEMI	02905333	3	E	20,0	20,0	36,0	150,0	90,0	19,0	–	3,0	3	<input type="checkbox"/>
JS453200E3R400.3Z3-HEMI	02905334	3	E	20,0	20,0	36,0	150,0	90,0	19,0	–	4,0	3	<input type="checkbox"/>

Weldon available. Delivery time is 3 days.

Cutting data – JS453 Side milling

SMG		a _e /DC	a _p /DC	f _z											v _c
				2	3	4	5	6	8	10	12	14	16	20	
N1	E/M/A	0.400	1.5	0.030	0.046	0.060	0.075	0.090	0.12	0.15	0.18	0.20	0.22	0.25	560 (450 – 660)
		0.400	1,5	0,0012	0,0018	0,0024	0,0030	0,0036	0,0048	0,0060	0,0070	0,0080	0,0085	0,010	1825 (1500 – 2100)
N2	E/M/A	0.300	1.5	0.024	0.036	0.048	0.060	0.070	0.095	0.12	0.14	0.16	0.18	0.20	480 (370 – 600)
		0.300	1,5	0,00095	0,0014	0,0019	0,0024	0,0028	0,0038	0,0048	0,0055	0,0065	0,0070	0,0080	1575 (1300–1900)
N3	E/M/A	0.300	1.5	0.024	0.036	0.048	0.060	0.070	0.095	0.12	0.14	0.16	0.18	0.20	320 (250 – 400)
		0.300	1,5	0,00095	0,0014	0,0019	0,0024	0,0028	0,0038	0,0048	0,0055	0,0065	0,0070	0,0080	1050 (830–1300)
TS1	A/D	0.400	1.5	0.030	0.046	0.060	0.075	0.090	0.12	0.15	0.18	0.20	0.22	0.25	560 (450 – 660)
		0.400	1,5	0,0012	0,0018	0,0024	0,0030	0,0036	0,0048	0,0060	0,0070	0,0080	0,0085	0,010	1825 (1500 – 2100)
TP1	A/D	0.400	1.5	0.030	0.046	0.060	0.075	0.090	0.12	0.15	0.18	0.20	0.22	0.25	445 (340 – 550)
		0.400	1,5	0,0012	0,0018	0,0024	0,0030	0,0036	0,0048	0,0060	0,0070	0,0080	0,0085	0,010	1450 (1200–1800)

Cutting data – JS453 Slot milling

SMG		a _p /DC	f _z											v _c
			2	3	4	5	6	8	10	12	14	16	20	
N1	E	1.5	0.020	0.030	0.040	0.050	0.060	0.080	0.10	0.12	0.14	0.16	0.20	500 (410 – 590)
		1,5	0,00080	0,0012	0,0016	0,0020	0,0024	0,0032	0,0040	0,0048	0,0055	0,0065	0,0080	1650 (1400–1900)
N2	E	1.2	0.016	0.024	0.032	0.040	0.048	0.065	0.080	0.095	0.11	0.13	0.16	400 (300 – 490)
		1,2	0,00065	0,00095	0,0013	0,0016	0,0019	0,0026	0,0032	0,0038	0,0044	0,0050	0,0065	1300 (990–1600)
N3	E	1.2	0.016	0.024	0.032	0.040	0.048	0.065	0.080	0.095	0.11	0.13	0.16	265 (200 – 330)
		1,2	0,00065	0,00095	0,0013	0,0016	0,0019	0,0026	0,0032	0,0038	0,0044	0,0050	0,0065	870 (660–1000)
TS1	A	1.5	0.020	0.030	0.040	0.050	0.060	0.080	0.10	0.12	0.14	0.16	0.20	500 (410 – 590)
		1,5	0,00080	0,0012	0,0016	0,0020	0,0024	0,0032	0,0040	0,0048	0,0055	0,0065	0,0080	1650 (1400–1900)
TP1	A	1.5	0.020	0.030	0.040	0.050	0.060	0.080	0.10	0.12	0.14	0.16	0.20	400 (300 – 500)
		1,5	0,00080	0,0012	0,0016	0,0020	0,0024	0,0032	0,0040	0,0048	0,0055	0,0065	0,0080	1300 (990–1600)

For cutting data recalculations, see pages 445 - 452.

SMG = Seco material group
 Coolant = A=air D=dry E=emulsion M=mist spray
 v_c = m/min (sf/min)
 f_z = mm (in/tooth)
 a_p = mm/DC (in/DC) = factor
 a_e = mm/DC (in/DC) = factor
 All cutting data are target values

Universal
 Steel and cast iron
 Stainless steel and S-materials
 Non ferrous
 Hard
 Plastic and cfrp
 Graphite
 Mimimaster Plus
 Mimimaster

JHP490

High performance – Aluminium – Square – 2-3 Flutes – Cylindrical – Corner radius – ICC

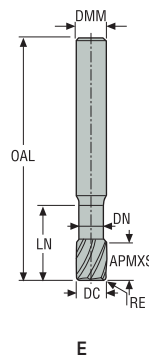

- Tolerances:
- DMM=h5
- DC=-0,02/-0,1 mm
- RE= ±0,05 mm
- Regrind possible if DC is ≥Ø6

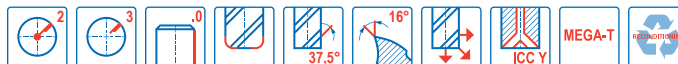

Designation	Item number	Length index	Tool shape	ICC	DC	DMM	APMXS	OAL	LN	DN	RE	PCEDC	Cylindrical
					mm	mm	mm	mm	mm	mm	mm		
490V100R050Z2.0A-MEGA-T	02623870	2	E	■	10,0	10,0	12,0	65,0	20,0	9,0	0,5	2	■
490V120R200Z2.0A-MEGA-T	02623883	2	E	■	12,0	12,0	14,0	75,0	24,0	11,0	2,0	2	■
490V160R050Z3.0A-MEGA-T	02623889	2	E	■	16,0	16,0	18,0	85,0	32,0	14,5	0,5	3	■
490V200R050Z3.0A-MEGA-T	02623908	2	E	■	20,0	20,0	22,0	100,0	40,0	18,0	0,5	3	■
490V250R050Z3.0A-MEGA-T	02623926	2	E	■	25,0	25,0	27,0	125,0	50,0	23,0	0,5	3	■
490VL100R100Z2.0A-MEGA-T	02623876	3	E	■	10,0	10,0	22,0	85,0	42,0	9,0	1,0	2	■
490VL120R050Z3.0A-MEGA-T	02623880	3	E	■	12,0	12,0	14,0	95,0	40,0	11,0	0,5	3	■
490VL120R100Z2.0A-MEGA-T	02623886	3	E	■	12,0	12,0	26,0	95,0	50,0	11,0	1,0	2	■
490VL160R050Z3.0A-MEGA-T	02623891	3	E	■	16,0	16,0	18,0	95,0	45,0	14,5	0,5	3	■
490VL200R200Z3.0A-MEGA-T	02623916	3	E	■	20,0	20,0	42,0	125,0	65,0	18,0	2,0	3	■
490VXL250R050Z3.0A-MEGA-T	02623927	4	E	■	25,0	25,0	50,0	125,0	75,0	23,0	0,5	3	■

■ Stocked standard.
ICC = Internal Coolant Channel

Universal

Steel and cast iron

Stainless steel and S-materials

Non ferrous

Hard

Plastic and cfrp

Graphite

Minimaster Plus

Minimaster

JHP490

High performance – Aluminium – Square – 2-3 Flutes – Weldon – Corner radius – ICC

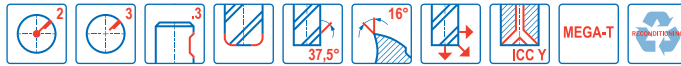
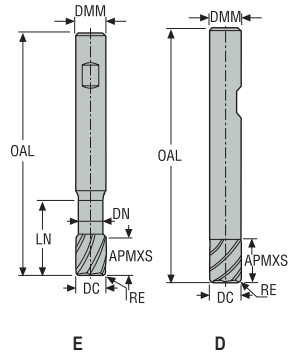

- Tolerances:
- DMM=h5
- DC=-0,02/-0,1 mm
- RE= ±0,05 mm
- Re grind possible if DC is ≥Ø6

Designation	Item number	Length index	Tool shape	ICC	DC	DMM	APMXS	OAL	LN	DN	RE	PCEDC	Weldon
					mm	mm	mm	mm	mm	mm	mm		
490V120R200Z2.0A-MEGA-TW	02669371	2	E	■	12,0	12,0	14,0	75,0	24,0	11,0	2,0	2	□
490160R200Z3A-MEGA-T	02623898	2	D	■	16,0	16,0	34,0	95,0	-	-	2,0	3	■
490V160R050Z3A-MEGA-T	02623888	2	E	■	16,0	16,0	18,0	85,0	32,0	14,5	0,5	3	■
490V200R050Z3A-MEGA-T	02623907	2	E	■	20,0	20,0	22,0	100,0	40,0	18,0	0,5	3	■
490V250R050Z3A-MEGA-T	02623925	2	E	■	25,0	25,0	27,0	125,0	50,0	23,0	0,5	3	■
490VL100R100Z2.0A-MEGA-TW	02669368	3	E	■	10,0	10,0	22,0	85,0	42,0	9,0	1,0	2	□
490VL120R050Z3.0A-MEGA-TW	02669374	3	E	■	12,0	12,0	14,0	95,0	40,0	11,0	0,5	3	□
490VL120R100Z2.0A-MEGA-TW	02669375	3	E	■	12,0	12,0	26,0	95,0	50,0	11,0	1,0	2	□
490VL160R050Z3.0A-MEGA-TW	02669382	3	E	■	16,0	16,0	18,0	95,0	45,0	14,5	0,5	3	□
490VL200R200Z3.0A-MEGA-TW	02669388	3	E	■	20,0	20,0	42,0	125,0	65,0	18,0	2,0	3	□
490VXL250R050Z3.0A-MEGA-TW	02669397	4	E	■	25,0	25,0	50,0	125,0	75,0	23,0	0,5	3	□

■ Stocked standard. □ Weldon available. Delivery time is 3 days.
ICC = Internal Coolant Channel

Universal

Steel and cast iron

Stainless steel and S-materials

Non ferrous

Hard

Plastic and chip

Graphite

Minimaster Plus

Minimaster

JHP490

High performance – Aluminium – Square – 2-3 Flutes – Safelock – Corner radius – ICC

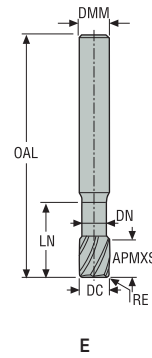

- Tolerances:
- DMM=h5
- DC=-0,02/-0,1 mm
- RE= ±0,05 mm
- Regrind possible if DC is ≥Ø6

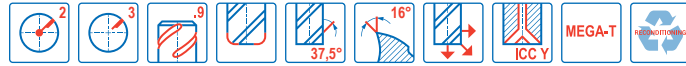

Designation	Item number	Length index	Tool shape	ICC	DC	DMM	APMXS	OAL	LN	DN	RE	PCEDC	Safelock
					mm	mm	mm	mm	mm	mm	mm		
490V100R050Z2.9A-MEGA-T	02927984	2	E	■	10,0	10,0	12,0	65,0	20,0	9,0	0,5	2	<input type="checkbox"/>
490V120R200Z2.9A-MEGA-T	02927988	2	E	■	12,0	12,0	14,0	75,0	24,0	11,0	2,0	2	<input type="checkbox"/>
490V160R050Z3.9A-MEGA-T	02927990	2	E	■	16,0	16,0	18,0	85,0	32,0	14,0	0,5	3	<input type="checkbox"/>
490V200R050Z3.9A-MEGA-T	02927992	2	E	■	20,0	20,0	22,0	100,0	40,0	18,0	0,5	3	<input type="checkbox"/>
490V250R050Z3.9A-MEGA-T	02927993	2	E	■	25,0	25,0	27,0	125,0	50,0	23,0	0,5	3	<input type="checkbox"/>
490VL100R100Z2.9A-MEGA-T	02927994	3	E	■	10,0	10,0	22,0	85,0	42,0	9,0	1,0	2	<input type="checkbox"/>
490VL120R050Z3.9A-MEGA-T	02927995	3	E	■	12,0	12,0	14,0	95,0	40,0	11,0	0,5	3	<input type="checkbox"/>
490VL120R100Z2.9A-MEGA-T	02927996	3	E	■	12,0	12,0	26,0	95,0	50,0	11,0	1,0	2	<input type="checkbox"/>
490VL160R050Z3.9A-MEGA-T	02927997	3	E	■	16,0	16,0	18,0	95,0	32,0	14,0	0,5	3	<input type="checkbox"/>
490VL200R200Z3.9A-MEGA-T	02927998	3	E	■	20,0	20,0	42,0	125,0	65,0	18,0	2,0	3	<input type="checkbox"/>
490VXL250R050Z3.9A-MEGA-T	02927999	4	E	■	25,0	25,0	50,0	125,0	75,0	23,0	0,5	3	<input type="checkbox"/>

Safelock available. Subject to change, refer to current Price and Stock List.
ICC = Internal Coolant Channel

Universal

Steel and cast iron

Stainless steel and S-materials

Non ferrous

Hard

Plastic and cfrp

Graphite

Minimaster Plus

Minimaster

Cutting data – JHP490 Side milling roughing

SMG		a _p /DC	a _p /DC	f _z					v _c
				10	12	16	20	25	
N1	E/M/A	0.500	1.1	0.20	0.24	0.30	0.34	0.38	700 (550 – 860)
		0.500	1,0	0,0080	0,0095	0,012	0,013	0,015	2325 (1900 – 2800)
N2	E/M/A	0.500	1.1	0.20	0.24	0.30	0.34	0.38	455 (350 – 550)
		0.500	1,0	0,0080	0,0095	0,012	0,013	0,015	1500 (1200–1800)
N3	E/M/A	0.500	1.1	0.20	0.24	0.30	0.34	0.38	540 (440 – 650)
		0.500	1,0	0,0080	0,0095	0,012	0,013	0,015	1775 (1500 – 2100)

Cutting data – JHP490 Slot milling

SMG		a _p /DC	a _p /DC	f _z					v _c
				10	12	16	20	25	
N1	E/M/A	1.0	0.15	0.15	0.18	0.24	0.30	0.38	650 (500–790)
		1,0	0,0060	0,0070	0,0095	0,012	0,015	2125 (1700 – 2500)	
N2	E/M/A	1.0	0.15	0.15	0.18	0.24	0.30	0.38	420 (330 – 510)
		1,0	0,0060	0,0070	0,0095	0,012	0,015	1375 (1100–1600)	
N3	E/M/A	1.0	0.15	0.15	0.18	0.24	0.30	0.38	500 (400 – 590)
		1,0	0,0060	0,0070	0,0095	0,012	0,015	1650 (1400–1900)	

For cutting data recalculations, see pages 445 - 452.

SMG = Seco material group
 Coolant = A=air D=dry E=emulsion M=mist spray
 v_c = m/min (sf/min)
 f_z = mm (in/tooth)
 a_p = mm/DC (in/DC) = factor
 a_e = mm/DC (in/DC) = factor
 All cutting data are target values

Universal
 Steel and cast iron
 Stainless steel and S-materials
 Non ferrous
 Hard
 Plastic and cfrp
 Graphite
 Minimaster Plus
 Minimaster

JH40

High performance – Aluminium – Square – 2 Flutes – Cylindrical – Corner radius

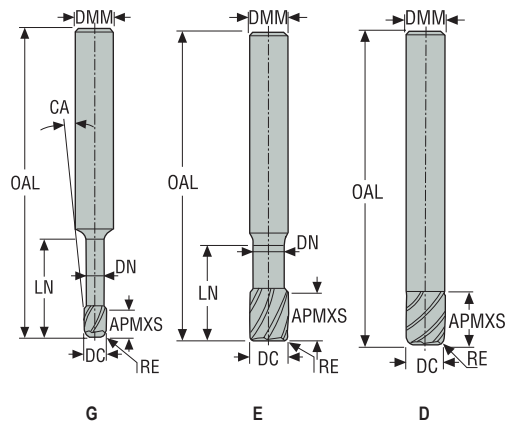

- Tolerances:
- DMM=h5
- DC=-0,02/-0,04 mm
- RE= ±0,1 mm
- Regrind possible if DC is ≥Ø6

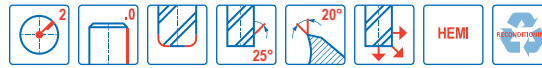

Designation	Item number	Length index	Tool shape	DC	DMM	APMXS	OAL	LN	DN	RE	CA°	PCEDC	Cylindrical
				mm	mm	mm	mm	mm	mm	mm	mm		
40K060-HEMI	00022089	1	D	6,0	6,0	13,0	50,0	–	–	0,1	–	2	■
40K080-HEMI	00022090	1	D	8,0	8,0	13,0	50,0	–	–	0,1	–	2	■
40K100-HEMI	00022091	1	D	10,0	10,0	16,0	50,0	–	–	0,1	–	2	■
40K120-HEMI	00022092	1	D	12,0	12,0	16,0	65,0	–	–	0,1	–	2	■
40020-HEMI	00022093	2	G	2,0	3,0	3,0	40,0	6,0	1,9	0,1	3,5	2	■
40030-HEMI	00022094	2	E	3,0	3,0	4,0	40,0	8,0	2,9	0,1	–	2	■
40040-HEMI	00022095	2	E	4,0	4,0	5,0	50,0	12,0	3,8	0,1	–	2	■
40050-HEMI	00022120	2	E	5,0	5,0	8,0	50,0	14,0	4,8	0,1	–	2	■
40060-HEMI	00022250	2	E	6,0	6,0	8,0	65,0	18,0	5,7	0,1	–	2	■
40080-HEMI	00022580	2	E	8,0	8,0	10,0	70,0	22,0	7,7	0,1	–	2	■
40100-HEMI	00022663	2	E	10,0	10,0	14,0	80,0	28,0	9,7	0,1	–	2	■
40120-HEMI	00022667	2	E	12,0	12,0	16,0	90,0	35,0	11,5	0,1	–	2	■
40160-HEMI	00022668	2	E	16,0	16,0	20,0	90,0	40,0	15,5	0,1	–	2	■
40200-HEMI	00022701	2	E	20,0	20,0	25,0	100,0	50,0	19,5	0,1	–	2	■

■ Stocked standard.

JH40

High performance – Aluminium – Square – 2 Flutes – Cylindrical – Corner radius

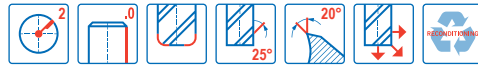
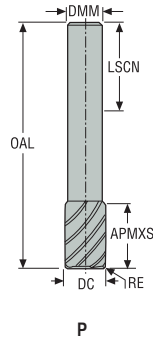

- Tolerances:
- DMM= h5
- DC= -0,02/-0,04 mm
- RE= ±0,1 mm
- Regrind possible if DC is ≥Ø6

Designation	Item number	Length index	Tool shape	DC	DMM	APMXS	OAL	LSCN	RE	PCEDC	Cylindrical
				mm	mm	mm	mm	mm	mm	mm	
40020-RS	02479642	2	P	2,0	1,9	3,0	40,0	28,0	0,1	2	■
40030-RS	02479643	2	P	3,0	2,9	4,0	60,0	28,0	0,1	2	■
40040-RS	02479644	2	P	4,0	3,8	5,0	60,0	28,0	0,1	2	■
40050-RS	02479645	2	P	5,0	4,8	8,0	70,0	28,0	0,1	2	■
40060-RS	02479646	2	P	6,0	5,8	8,0	65,0	36,0	0,1	2	■
40080-RS	02479647	2	P	8,0	7,8	10,0	70,0	36,0	0,1	2	■
40100-RS	02479648	2	P	10,0	9,7	14,0	100,0	40,0	0,1	2	■
40120-RS	02479649	2	P	12,0	11,7	16,0	90,0	45,0	0,1	2	■
40L060-RS	02479650	3	P	6,0	5,8	8,0	100,0	36,0	0,1	2	■
40L080-RS	02479651	3	P	8,0	7,8	10,0	100,0	36,0	0,1	2	■
40L120-RS	02479652	3	P	12,0	11,7	16,0	125,0	45,0	0,1	2	■
40L160-RS	02479653	3	P	16,0	15,7	20,0	125,0	48,0	0,1	2	■
40L200-RS	02479654	3	P	20,0	19,7	25,0	125,0	50,0	0,1	2	■

■ Stocked standard.

Universal

Steel and cast iron

Stainless steel and S-materials

Non ferrous

Hard

Plastic and CFRP

Graphite

Minimaster Plus

Minimaster

Universal
Steel and cast iron
Cutting data – JH40 Side milling

SMG		a _e /DC	a _p /DC	f _z										v _c
				2	3	4	5	6	8	10	12	16	20	
N1	E/M/A	0.400	1.2	0.030	0.046	0.060	0.075	0.090	0.12	0.15	0.18	0.22	0.25	730 (610 – 840)
		0.400	1.2	0.0012	0.0018	0.0024	0.0030	0.0036	0.0048	0.0060	0.0070	0.0085	0.010	2400 (2100 – 2700)
N11	E/M/A	0.400	1.0	0.030	0.046	0.060	0.075	0.090	0.12	0.15	0.18	0.22	0.26	425 (320 – 520)
		0.400	1.0	0.0012	0.0018	0.0024	0.0030	0.0036	0.0048	0.0060	0.0070	0.0085	0.010	1400 (1100–1700)
TS1	A	0.400	1.2	0.030	0.046	0.060	0.075	0.090	0.12	0.15	0.18	0.22	0.25	730 (610 – 840)
		0.400	1.2	0.0012	0.0018	0.0024	0.0030	0.0036	0.0048	0.0060	0.0070	0.0085	0.010	2400 (2100 – 2700)

Stainless steel and S-materials
Cutting data – JH40 Slot milling

SMG		a _p /DC	f _z										v _c
			2	3	4	5	6	8	10	12	16	20	
N1	E/M/A	0.60	0.026	0.040	0.050	0.065	0.080	0.10	0.13	0.16	0.20	0.25	600 (510–700)
		0.60	0.0010	0.0016	0.0020	0.0026	0.0032	0.0040	0.0050	0.0065	0.0080	0.010	1975 (1700 – 2200)
N11	E/M/A	0.40	0.016	0.024	0.032	0.040	0.048	0.065	0.080	0.095	0.13	0.16	400 (310 – 500)
		0.40	0.00065	0.00095	0.0013	0.0016	0.0019	0.0026	0.0032	0.0038	0.0050	0.0065	1300 (1100–1600)
TS1	A	1.0	0.026	0.040	0.050	0.065	0.080	0.10	0.13	0.16	0.20	0.25	600 (510–700)
		1.0	0.0010	0.0016	0.0020	0.0026	0.0032	0.0040	0.0050	0.0065	0.0080	0.010	1975 (1700 – 2200)

For cutting data recalculations, see pages 445 - 452.

SMG = Seco material group
Coolant = A=air D=dry E=emulsion M=mist spray
v_c = m/min (sf/min)
f_z = mm (in/tooth)
a_p = mm/DC (in/DC) = factor
a_e = mm/DC (in/DC) = factor
All cutting data are target values

JH421

High performance – Aluminium – Square – 2 Flutes – Cylindrical – Corner radius – ICC

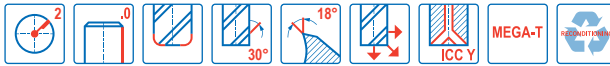
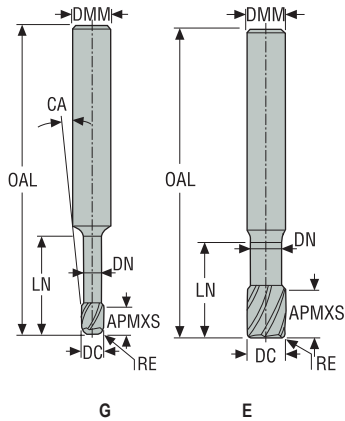

- Tolerances:
- DMM=h5
- DC=-0,02/-0,04 mm
- RE= ±0,05 mm
- Re grind possible if DC is ≥Ø6

Designation	Item number	Length index	Tool shape	ICC	DC	DMM	APMXS	OAL	LN	DN	RE	CA°	PCEDC	Cylindrical
					mm	mm	mm	mm	mm	mm	mm	mm	mm	mm
421020R020Z2-MEGA-T	02434927	2	G	–	2,0	3,0	3,0	40,0	8,0	1,8	0,2	3,0	2	■
421030R020Z2-MEGA-T	02434939	2	E	–	3,0	3,0	4,0	40,0	12,0	2,7	0,2	–	2	■
421040R020Z2-MEGA-T	02434940	2	G	–	4,0	6,0	5,0	50,0	16,0	3,6	0,2	3,0	2	■
421040R030Z2-MEGA-T	02434941	2	G	–	4,0	6,0	5,0	50,0	16,0	3,6	0,3	3,0	2	■
421050R100Z2-MEGA-T	02434942	2	G	–	5,0	6,0	6,0	50,0	18,0	4,5	1,0	1,5	2	■
421060R025Z2-MEGA-T	02434946	2	E	–	6,0	6,0	8,0	50,0	20,0	5,4	0,25	–	2	■
421060R050Z2-MEGA-T	02434947	2	E	–	6,0	6,0	8,0	50,0	20,0	5,4	0,5	–	2	■
421060R100Z2-MEGA-T	02434958	2	E	–	6,0	6,0	8,0	50,0	20,0	5,4	1,0	–	2	■
421080R030Z2-MEGA-T	02434960	2	E	–	8,0	8,0	10,0	65,0	30,0	7,2	0,3	–	2	■
421080R060Z2-MEGA-T	02434964	2	E	–	8,0	8,0	10,0	65,0	30,0	7,2	0,6	–	2	■
421080R100Z2-MEGA-T	02434967	2	E	–	8,0	8,0	10,0	65,0	30,0	7,2	1,0	–	2	■
421100R030Z2-MEGA-T	02434968	2	E	–	10,0	10,0	12,0	80,0	36,0	9,0	0,3	–	2	■
421100R080Z2-MEGA-T	02434970	2	E	–	10,0	10,0	12,0	80,0	36,0	9,0	0,8	–	2	■
421100R150Z2-MEGA-T	02434971	2	E	–	10,0	10,0	12,0	80,0	36,0	9,0	1,5	–	2	■
421100R250Z2-MEGA-T	02438614	2	E	–	10,0	10,0	12,0	80,0	36,0	9,0	2,5	–	2	■
421100R310Z2-MEGA-T	02438683	2	E	–	10,0	10,0	12,0	80,0	36,0	9,0	3,1	–	2	■
421120R030Z2-MEGA-T	02434983	2	E	–	12,0	12,0	14,0	90,0	40,0	11,0	0,3	–	2	■
421120R050Z2-MEGA-T	02434986	2	E	–	12,0	12,0	14,0	90,0	40,0	11,0	0,5	–	2	■
421120R100Z2-MEGA-T	02434988	2	E	–	12,0	12,0	14,0	90,0	40,0	11,0	1,0	–	2	■
421120R150Z2-MEGA-T	02434989	2	E	–	12,0	12,0	14,0	90,0	40,0	11,0	1,5	–	2	■
421120R200Z2-MEGA-T	02434990	2	E	–	12,0	12,0	14,0	90,0	40,0	11,0	2,0	–	2	■
421120R250Z2AMEGA-T	02435008	2	E	■	12,0	12,0	14,0	90,0	40,0	11,0	2,5	–	2	■
421120R250Z2-MEGA-T	02435007	2	E	–	12,0	12,0	14,0	90,0	40,0	11,0	2,5	–	2	■
421120R310Z2-MEGA-T	02435009	2	E	–	12,0	12,0	14,0	90,0	40,0	11,0	3,1	–	2	■

■ Stocked standard.
ICC = Internal Coolant Channel

Universal

Steel and cast iron

Stainless steel and S-materials

Non ferrous

Hard

Plastic and chip

Graphite

Minimaster Plus

Minimaster

JH421

High performance – Aluminium – Square – 2 Flutes – Cylindrical – Corner radius – ICC

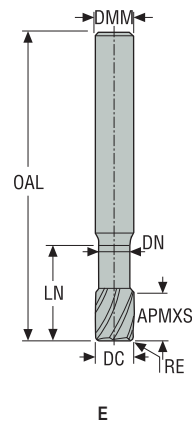

- Tolerances:
- DMM=h5
- DC=-0,02/-0,04 mm
- RE= ±0,05 mm
- Regrind possible if DC is ≥Ø6

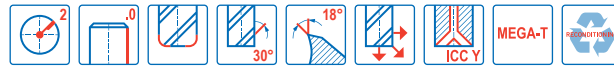

Designation	Item number	Length index	Tool shape	ICC	DC	DMM	APMXS	OAL	LN	DN	RE	PCEDC	Cylindrical
					mm	mm	mm	mm	mm	mm	mm		
421160R050Z2-MEGA-T	02435010	2	E	-	16,0	16,0	18,0	100,0	45,0	14,5	0,5	2	■
421160R130Z2-MEGA-T	02435011	2	E	-	16,0	16,0	18,0	100,0	45,0	14,5	1,3	2	■
421160R200Z2-MEGA-T	02435014	2	E	-	16,0	16,0	18,0	100,0	45,0	14,5	2,0	2	■
421160R250Z2-MEGA-T	02435020	2	E	■	16,0	16,0	18,0	100,0	45,0	14,5	2,5	2	■
421160R310Z2-MEGA-T	02435036	2	E	-	16,0	16,0	18,0	100,0	45,0	14,5	3,1	2	■
421160R400Z2-MEGA-T	02438684	2	E	■	16,0	16,0	18,0	100,0	45,0	14,5	4,0	2	■
421160R400Z2-MEGA-T	02435039	2	E	-	16,0	16,0	18,0	100,0	45,0	14,5	4,0	2	■
421200R160Z2-MEGA-T	02435042	2	E	-	20,0	20,0	24,0	100,0	45,0	18,0	1,6	2	■
421200R200Z2-MEGA-T	02435044	2	E	-	20,0	20,0	24,0	100,0	45,0	18,0	2,0	2	■
421200R250Z2-MEGA-T	02438685	2	E	■	20,0	20,0	24,0	100,0	45,0	18,0	2,5	2	■
421200R250Z2-MEGA-T	02435046	2	E	-	20,0	20,0	24,0	100,0	45,0	18,0	2,5	2	■
421200R310Z2-MEGA-T	02435049	2	E	-	20,0	20,0	24,0	100,0	45,0	18,0	3,1	2	■
421200R400Z2-MEGA-T	02435051	2	E	-	20,0	20,0	24,0	100,0	45,0	18,0	4,0	2	■
421200R500Z2-MEGA-T	02435055	2	E	-	20,0	20,0	24,0	100,0	45,0	18,0	5,0	2	■
421200R600Z2-MEGA-T	02435056	2	E	-	20,0	20,0	24,0	100,0	45,0	18,0	6,0	2	■
421250R500Z2-MEGA-T	02435065	2	E	-	25,0	25,0	30,0	100,0	45,0	23,0	5,0	2	■

■ Stocked standard.
ICC = Internal Coolant Channel

JH421

High performance – Aluminium – Square – 2 Flutes – Cylindrical – Corner radius – ICC

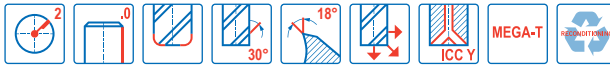
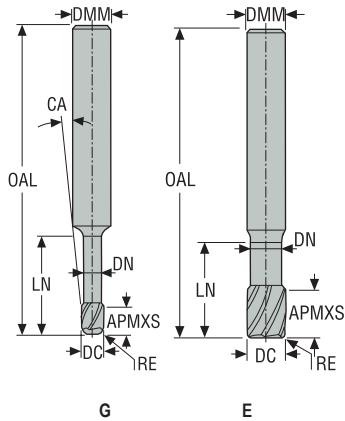

- Tolerances:
- DMM=h5
- DC=-0,02/-0,04 mm
- RE= ±0,05 mm
- Re grind possible if DC is ≥Ø6

Designation	Item number	Length index	Tool shape	ICC	DC	DMM	APMXS	OAL	LN	DN	RE	CA°	PCEDC	Cylindrical
					mm	mm	mm	mm	mm	mm	mm			
421L080R020Z2-MEGA-T	02435068	3	E	–	8,0	8,0	6,0	75,0	40,0	7,2	0,2	–	2	■
421L100R050Z2-MEGA-T	02435070	3	E	–	10,0	10,0	8,0	90,0	50,0	9,0	0,5	–	2	■
421L100R250Z2-MEGA-T	02435074	3	E	–	10,0	10,0	8,0	90,0	50,0	9,0	2,5	–	2	■
421L100R310Z2-MEGA-T	02438690	3	E	–	10,0	10,0	8,0	90,0	50,0	9,0	3,1	–	2	■
421L120R050Z2-MEGA-T	02435340	3	E	–	12,0	12,0	10,0	110,0	70,0	11,0	0,5	–	2	■
421L120R100Z2-MEGA-T	02435343	3	E	–	12,0	12,0	10,0	110,0	70,0	11,0	1,0	–	2	■
421L120R200Z2-MEGA-T	02435373	3	E	–	12,0	12,0	10,0	110,0	70,0	11,0	2,0	–	2	■
421L120R250Z2-MEGA-T	02435374	3	E	–	12,0	12,0	10,0	110,0	70,0	11,0	2,5	–	2	■
421L120R310Z2-MEGA-T	02438692	3	E	–	12,0	12,0	10,0	110,0	70,0	11,0	3,1	–	2	■
421L140R050Z2-MEGA-T	02462710	3	G	–	14,0	16,0	12,0	110,0	70,0	13,0	0,5	1,0	2	■
421L140R310Z2-MEGA-T	02462712	3	G	–	14,0	16,0	12,0	110,0	70,0	13,0	3,1	1,0	2	■
421L160R050Z2-MEGA-T	02435375	3	E	–	16,0	16,0	13,0	125,0	80,0	14,5	0,5	–	2	■
421L160R100Z2-MEGA-T	02435380	3	E	–	16,0	16,0	13,0	125,0	80,0	14,5	1,0	–	2	■
421L160R200Z2-MEGA-T	02435381	3	E	–	16,0	16,0	13,0	125,0	80,0	14,5	2,0	–	2	■
421L160R250Z2AMEGA-T	02435383	3	E	■	16,0	16,0	13,0	125,0	80,0	14,5	2,5	–	2	■
421L160R250Z2-MEGA-T	02435382	3	E	–	16,0	16,0	13,0	125,0	80,0	14,5	2,5	–	2	■
421L160R310Z2-MEGA-T	02435384	3	E	–	16,0	16,0	13,0	125,0	80,0	14,5	3,1	–	2	■
421L160R400Z2AMEGA-T	02435386	3	E	■	16,0	16,0	13,0	125,0	80,0	14,5	4,0	–	2	■
421L200R050Z2-MEGA-T	02435387	3	E	–	20,0	20,0	16,0	150,0	100,0	18,0	0,5	–	2	■
421L200R200Z2-MEGA-T	02435391	3	E	–	20,0	20,0	16,0	150,0	100,0	18,0	2,0	–	2	■
421L200R310Z2-MEGA-T	02435398	3	E	–	20,0	20,0	16,0	150,0	100,0	18,0	3,1	–	2	■
421L200R500Z2-MEGA-T	02435401	3	E	–	20,0	20,0	16,0	150,0	100,0	18,0	5,0	–	2	■

■ Stocked standard.
ICC = Internal Coolant Channel

Universal

Steel and cast iron

Stainless steel and S-materials

Non ferrous

Hard

Plastic and chip

Graphite

Minimaster Plus

Minimaster

Cutting data – JH421 Side milling

SMG		a _e /DC	a _p /DC	f _z												v _c
				2	3	4	5	6	8	10	12	14	16	20	25	
N1	E/M/A	0.400	1.0	0.030	0.044	0.060	0.075	0.090	0.12	0.15	0.18	0.20	0.22	0.25	0.28	620 (520–720)
		0,400	1,0	0,0012	0,0017	0,0024	0,0030	0,0036	0,0048	0,0060	0,0070	0,0080	0,0085	0,010	0,011	2025 (1800 – 2300)
N11	E/M/A	0.400	1.0	0.020	0.030	0.040	0.050	0.060	0.080	0.10	0.12	0.13	0.15	0.17	0.19	410 (310 – 510)
		0,400	1,0	0,00080	0,0012	0,0016	0,0020	0,0024	0,0032	0,0040	0,0048	0,0050	0,0060	0,0065	0,0075	1350 (1100–1600)
TS1	A	0.400	1.0	0.030	0.044	0.060	0.075	0.090	0.12	0.15	0.18	0.20	0.22	0.25	0.28	620 (520–720)
		0,400	1,0	0,0012	0,0017	0,0024	0,0030	0,0036	0,0048	0,0060	0,0070	0,0080	0,0085	0,010	0,011	2025 (1800 – 2300)
TP1	M	0.400	1.0	0.024	0.036	0.048	0.060	0.070	0.095	0.12	0.14	0.16	0.18	0.20	0.24	410 (310 – 500)
		0,400	1,0	0,00095	0,0014	0,0019	0,0024	0,0028	0,0038	0,0048	0,0055	0,0065	0,0070	0,0080	0,0095	1350 (1100–1600)

Cutting data – JH421 Slot milling

SMG		a _p /DC	f _z												v _c
			2	3	4	5	6	8	10	12	14	16	20	25	
N1	E/M/A	0.50	0.014	0.022	0.028	0.036	0.042	0.055	0.070	0.085	0.10	0.11	0.14	0.18	610 (510–700)
		0,50	0,00055	0,00085	0,0011	0,0014	0,0017	0,0022	0,0028	0,0034	0,0040	0,0044	0,0055	0,0070	2000 (1700 – 2200)
N11	E/M/A	0.50	0.0080	0.012	0.016	0.020	0.025	0.032	0.040	0.050	0.055	0.065	0.080	0.10	405 (310 – 500)
		0,50	0,00032	0,00048	0,00065	0,00080	0,0010	0,0013	0,0016	0,0020	0,0022	0,0026	0,0032	0,0040	1325 (1100–1600)
TS1	A	0.50	0.014	0.022	0.028	0.036	0.042	0.055	0.070	0.085	0.10	0.11	0.14	0.18	610 (510–700)
		0,50	0,00055	0,00085	0,0011	0,0014	0,0017	0,0022	0,0028	0,0034	0,0040	0,0044	0,0055	0,0070	2000 (1700 – 2200)
TP1	M	0.50	0.010	0.015	0.020	0.025	0.030	0.040	0.050	0.060	0.070	0.080	0.10	0.13	405 (310 – 500)
		0,50	0,00040	0,00060	0,00080	0,0010	0,0012	0,0016	0,0020	0,0024	0,0028	0,0032	0,0040	0,0050	1325 (1100–1600)

For cutting data recalculations, see pages 445 - 452.

SMG = Seco material group
Coolant = A=air D=dry E=emulsion M=mist spray
v_c = m/min (sf/min)
f_z = mm (in/tooth)
a_p = mm/DC (in/DC) = factor
a_e = mm/DC (in/DC) = factor
All cutting data are target values

JH410

High performance – Aluminium – Square – 1 Flute – Cylindrical – Corner radius

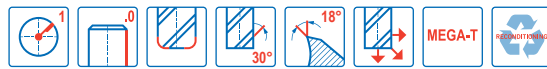
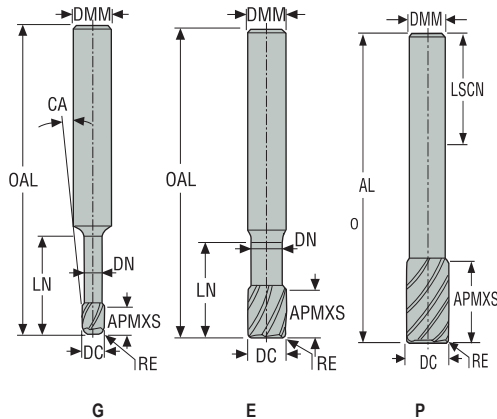

- Tolerances:
- DMM= h5
- DC= ±0,05 mm
- RE= ±0,05 mm
- Re grind possible if DC is ≥Ø6

Designation	Item number	Length index	Tool shape	DC	DMM	APMXS	OAL	LN	LSCN	DN	RE	CA°	PCEDC	Cylindrical
				mm	mm	mm	mm	mm	mm	mm	mm	mm	mm	
410020R050-MEGA-T	02451548	2	G	2,0	6,0	3,0	50,0	6,0	36,0	1,7	0,5	12,0	1	■
410ML020R050-MEGA-T	02451577	2	G	2,0	6,0	3,0	50,0	12,0	36,0	1,7	0,5	7,5	1	■
410030R050-MEGA-T	02451578	2	G	3,0	6,0	4,0	50,0	8,0	36,0	2,7	0,5	7,5	1	■
410ML030R050-MEGA-T	02451580	2	G	3,0	6,0	4,0	60,0	15,0	36,0	2,7	0,5	5,0	1	■
410040R050-MEGA-T	02451581	2	G	4,0	6,0	5,0	60,0	8,0	36,0	3,6	0,5	5,5	1	■
410ML040R050-MEGA-T	02451585	2	G	4,0	6,0	5,0	60,0	15,0	36,0	3,6	0,5	3,5	1	■
410TL040R050-MEGA-T	02451582	2	G	4,0	6,0	5,0	60,0	21,0	36,0	3,6	0,5	2,5	1	■
410050R050-MEGA-T	02451586	2	G	5,0	6,0	7,0	65,0	11,0	36,0	4,5	0,5	2,5	1	■
410ML050R050-MEGA-T	02451589	2	G	5,0	6,0	7,0	65,0	18,0	36,0	4,5	0,5	1,5	1	■
410TL050R050-MEGA-T	02451587	2	G	5,0	6,0	7,0	65,0	26,0	36,0	4,5	0,5	1,5	1	■
410060R050-MEGA-T	02451591	2	E	6,0	6,0	8,0	70,0	11,0	36,0	5,3	0,5	-	1	■
410ML060R050-MEGA-T	02451593	2	E	6,0	6,0	8,0	70,0	18,0	36,0	5,3	0,5	-	1	■
410TL060R050-MEGA-T	02451592	2	E	6,0	6,0	8,0	70,0	31,0	36,0	5,3	0,5	-	1	■
410070RSR050-MEGA-T	02451594	2	P	7,0	6,0	9,0	65,0	-	36,0	-	0,5	-	1	■
410090RSR050-MEGA-T	02451596	2	P	9,0	8,0	11,0	65,0	-	36,0	-	0,5	-	1	■
410110RSR050-MEGA-T	02451598	2	P	11,0	10,0	13,0	70,0	-	40,0	-	0,5	-	1	■
410130RSR100-MEGA-T	02451600	2	P	13,0	12,0	15,0	70,0	-	45,0	-	1,0	-	1	■
410150RSR100-MEGA-T	02451603	2	P	15,0	14,0	17,0	80,0	-	45,0	-	1,0	-	1	■
410170RSR100-MEGA-T	02451605	2	P	17,0	16,0	19,0	80,0	-	48,0	-	1,0	-	1	■
410L070RSR200-MEGA-T	02451595	3	P	7,0	6,0	9,0	85,0	-	36,0	-	2,0	-	1	■
410L090RSR200-MEGA-T	02451597	3	P	9,0	8,0	11,0	85,0	-	36,0	-	2,0	-	1	■
410L110RSR200-MEGA-T	02451599	3	P	11,0	10,0	13,0	90,0	-	40,0	-	2,0	-	1	■
410L130RSR200-MEGA-T	02451601	3	P	13,0	12,0	15,0	90,0	-	45,0	-	2,0	-	1	■
410L150RSR200-MEGA-T	02451604	3	P	15,0	14,0	17,0	110,0	-	45,0	-	2,0	-	1	■
410L170RSR200-MEGA-T	02451606	3	P	17,0	16,0	19,0	110,0	-	48,0	-	2,0	-	1	■

■ Stocked standard.

Universal

Steel and cast iron

Stainless steel and S-materials

Non ferrous

Hard

Plastic and chip

Graphite

Minimaster Plus

Minimaster

Cutting data – JH410 Side milling roughing

SMG		a _e /DC	a _p /DC	f _z											v _c
				2	3	4	5	6	7	9	11	13	15	17	
N1	E/M/A	0.410	1.0	0.070	0.11	0.14	0.18	0.22	0.25	0.32	0.40	0.46	0.50	0.55	710 (600 – 820)
		0,410	1,0	0,0028	0,0044	0,0055	0,0070	0,0085	0,010	0,013	0,016	0,018	0,020	0,022	2325 (2000 – 2600)
N11	E/M/A	0.318	0.65	0.026	0.040	0.055	0.065	0.080	0.095	0.12	0.15	0.17	0.19	0.22	495 (380 – 610)
		0,318	0,65	0,0010	0,0016	0,0022	0,0026	0,0032	0,0038	0,0048	0,0060	0,0065	0,0075	0,0085	1625 (1300 – 2000)
TS1	A	0.410	1.0	0.070	0.11	0.14	0.18	0.22	0.25	0.32	0.40	0.46	0.50	0.55	710 (600 – 820)
		0,410	1,0	0,0028	0,0044	0,0055	0,0070	0,0085	0,010	0,013	0,016	0,018	0,020	0,022	2325 (2000 – 2600)

Cutting data – JH410 Slot milling

SMG		a _p /DC	f _z											v _c
			2	3	4	5	6	7	9	11	13	15	17	
N1	E/M/A	0.75	0.055	0.080	0.11	0.14	0.16	0.19	0.25	0.30	0.36	0.40	0.46	630 (530–730)
		0,75	0,0022	0,0032	0,0044	0,0055	0,0065	0,0075	0,010	0,012	0,014	0,016	0,018	2075 (1800 – 2300)
N11	E/M/A	0.36	0.018	0.028	0.036	0.046	0.055	0.065	0.080	0.10	0.12	0.14	0.15	420 (320 – 520)
		0,36	0,00070	0,0011	0,0014	0,0018	0,0022	0,0026	0,0032	0,0040	0,0048	0,0055	0,0060	1375 (1100–1700)
TS1	A	1.0	0.055	0.080	0.11	0.14	0.16	0.19	0.25	0.30	0.36	0.40	0.46	630 (530–730)
		1,0	0,0022	0,0032	0,0044	0,0055	0,0065	0,0075	0,010	0,012	0,014	0,016	0,018	2075 (1800 – 2300)

For cutting data recalculations, see pages 445 - 452.

SMG = Seco material group
Coolant = A=air D=dry E=emulsion M=mist spray

v_c = m/min (sf/min)

f_z = mm (in/tooth)

a_p = mm/DC (in/DC) = factor

a_e = mm/DC (in/DC) = factor

All cutting data are target values

JH440

High speed – Aluminium – Square – 2 Flutes – Cylindrical – Corner radius

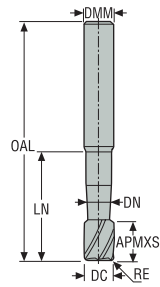

E

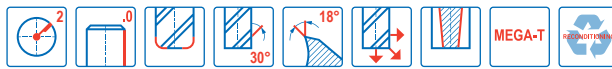

- Tolerances:
- DMM=h5
- DC=-0,02/-0,4 mm
- RE= ±0,05 mm
- Re grind possible if DC is ≥Ø6

Designation	Item number	Length index	Tool shape	DC	DMM	APMXS	OAL	LN	DN	RE	PCEDC	Cylindrical
				mm	mm	mm	mm	mm	mm	mm		
440060-MEGA-T	00022702	2	E	6,0	6,0	8,0	60,0	30,0	5,4	1,5	2	■
440080-MEGA-T	00022865	2	E	8,0	8,0	10,0	60,0	30,0	7,2	2,0	2	■

■ Stocked standard.

Universal

Steel and cast iron

Stainless steel and S-materials

Non ferrous

Hard

Plastic and cfrp

Graphite

Minimaster Plus

Minimaster

Cutting data – JH440 Copy milling roughing

SMG		a _e /DC	a _p /DC	f _z		v _c
				6	8	
N1	E/M/A	0.300 0,300	0.50 0,50	0.080 0,0032	0.10 0,0040	780 (650 – 900) 2550 (2200 – 2900)
N2	E/M/A	0.300 0,300	0.50 0,50	0.060 0,0024	0.080 0,0032	510 (390 – 640) 1675 (1300 – 2000)
N3	E/M/A	0.300 0,300	0.50 0,50	0.060 0,0024	0.080 0,0032	340 (260 – 420) 1125 (860 – 1300)
N11	E/M/A	0.300 0,300	0.50 0,50	0.060 0,0024	0.080 0,0032	255 (130 – 370) 840 (430 – 1200)
TS1	A	0.300 0,300	0.50 0,50	0.080 0,0032	0.10 0,0040	780 (650 – 900) 2550 (2200 – 2900)
TP1	A	0.300 0,300	0.60 0,60	0.060 0,0024	0.080 0,0032	510 (380 – 630) 1675 (1300 – 2000)

For cutting data recalculations, see pages 445 - 452.

SMG = Seco material group
Coolant = A=air D=dry E=emulsion M=mist spray
v_c = m/min (sf/min)
f_z = mm (in/tooth)
a_p = mm/DC (in/DC) = factor
a_e = mm/DC (in/DC) = factor
All cutting data are target values

JH450

High speed – Aluminium – Ball nose – 2 Flutes – Cylindrical

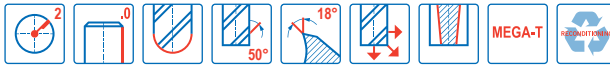
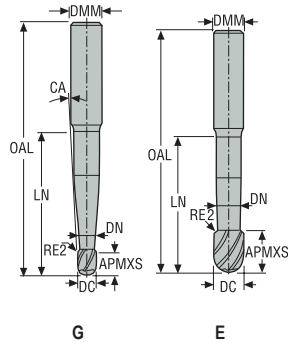

- Tolerances:
- DMM= h5
- DC= -0,02/-0,04 mm
- RE= ±0,02 mm
- Re grind possible if DC is ≥Ø6

Designation	Item number	Length index	Tool shape	DC	DMM	APMXS	OAL	LN	DN	RE2	CA°	PCEDC	Cylindrical
				mm	mm	mm	mm	mm	mm	mm			
450020-MEGA-T	00022977	2	G	2,0	3,0	1,75	40,0	10,0	1,8	1,0	3,0	2	■
450030-MEGA-T	00022978	2	E	3,0	3,0	2,5	40,0	12,0	2,7	2,0	-	2	■
450040-MEGA-T	00022979	2	G	4,0	6,0	3,5	50,0	21,0	3,6	2,0	3,0	2	■
450050-MEGA-T	00022980	2	G	5,0	6,0	4,5	50,0	22,5	4,5	2,0	2,0	2	■
450060-MEGA-T	00023020	2	E	6,0	6,0	5,5	55,0	25,0	5,4	2,0	-	2	■
450080-MEGA-T	00023032	2	E	8,0	8,0	7,0	65,0	30,0	7,2	2,0	-	2	■
450100-MEGA-T	00023040	2	E	10,0	10,0	8,5	75,0	35,0	9,0	3,0	-	2	■
450120-MEGA-T	00029842	2	E	12,0	12,0	10,5	75,0	40,0	11,0	3,0	-	2	■
450160-MEGA-T	00023050	2	E	16,0	16,0	14,0	90,0	50,0	14,5	4,0	-	2	■
450200-MEGA-T	00023053	2	E	20,0	20,0	17,0	100,0	50,0	18,0	4,0	-	2	■
450L100-MEGA-T	00023056	3	G	10,0	12,0	8,5	125,0	50,0	9,0	3,0	1,5	2	■
450L120-MEGA-T	00023091	3	E	12,0	12,0	10,5	150,0	60,0	11,0	3,0	-	2	■
450L160-MEGA-T	00023095	3	E	16,0	16,0	14,0	150,0	70,0	14,5	4,0	-	2	■

■ Stocked standard.

Universal

Steel and cast iron

Stainless steel and S-materials

Non ferrous

Hard

Plastic and cfrp

Graphite

Minimaster Plus

Minimaster

Cutting data – JH450 Copy milling roughing

SMG		a _e /DC	a _p /DC	f _z										v _c
				2	3	4	5	6	8	10	12	16	20	
N1	E/M/A	0.400	0.24	0.040	0.060	0.080	0.10	0.12	0.16	0.20	0.24	0.32	0.40	690 (670 – 930)
		0.400	0.24	0.0016	0.0024	0.0032	0.0040	0.0048	0.0065	0.0080	0.0095	0.013	0.016	2275 (2200 – 3000)
N2	E/M/A	0.300	0.24	0.040	0.060	0.080	0.10	0.12	0.16	0.20	0.24	0.32	0.40	470 (410 – 680)
		0.300	0.24	0.0016	0.0024	0.0032	0.0040	0.0048	0.0065	0.0080	0.0095	0.013	0.016	1550 (1400 – 2200)
N3	E/M/A	0.300	0.24	0.040	0.060	0.080	0.10	0.12	0.16	0.20	0.24	0.32	0.40	315 (280 – 450)
		0.300	0.24	0.0016	0.0024	0.0032	0.0040	0.0048	0.0065	0.0080	0.0095	0.013	0.016	1025 (920 – 1400)
N11	E/M/A	0.300	0.24	0.040	0.060	0.080	0.10	0.12	0.16	0.20	0.24	0.32	0.38	470 (420 – 680)
		0.300	0.24	0.0016	0.0024	0.0032	0.0040	0.0048	0.0065	0.0080	0.0095	0.013	0.015	1550 (1400 – 2200)
TS1	A	0.500	0.50	0.040	0.060	0.080	0.10	0.12	0.16	0.20	0.24	0.30	0.34	700 (630 – 860)
		0.500	0.50	0.0016	0.0024	0.0032	0.0040	0.0048	0.0065	0.0080	0.0095	0.012	0.013	2300 (2100 – 2800)
TP1	M	0.300	0.24	0.040	0.060	0.080	0.10	0.12	0.16	0.20	0.24	0.32	0.38	470 (410 – 680)
		0.300	0.24	0.0016	0.0024	0.0032	0.0040	0.0048	0.0065	0.0080	0.0095	0.013	0.015	1550 (1400 – 2200)

For cutting data recalculations, see pages 445 - 452.

SMG = Seco material group

Coolant = A=air D=dry E=emulsion M=mist spray

v_c = m/min (sf/min)

f_z = mm (in/tooth)

a_p = mm/DC (in/DC) = factor

a_e = mm/DC (in/DC) = factor

All cutting data are target values

JH460

High speed – Aluminium – Ball nose – 2 Flutes – Cylindrical

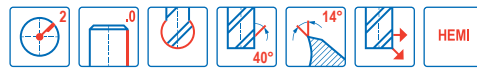
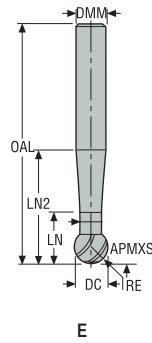

- Tolerances:
- DMM=h5
- DC=-0,02/-0,06 mm
- RE= ±0.02 mm
- SA=250°

Designation	Item number	Length index	Tool shape	DC	DMM	APMXS	OAL	LN	LN2	DN	RE	PCEDC	Cylindrical
				mm	mm	mm	mm	mm	mm	mm	mm		
460030-HEMI	00040372	2	E	3,0	3,0	2,3	60,0	4,8	9,9	1,5	1,5	2	■
460040-HEMI	00040373	2	E	4,0	4,0	3,1	60,0	5,6	12,1	2,0	2,0	2	■
460050-HEMI	00040376	2	E	5,0	5,0	3,9	70,0	6,4	14,4	2,5	2,5	2	■
460060-HEMI	00040377	2	E	6,0	6,0	4,7	80,0	9,7	19,1	3,0	3,0	2	■
460080-HEMI	00040378	2	E	8,0	8,0	6,2	85,0	11,2	23,6	4,0	4,0	2	■
460100-HEMI	00040379	2	E	10,0	10,0	7,8	100,0	15,6	30,8	5,0	5,0	2	■
460120-HEMI	00040380	2	E	12,0	12,0	9,4	125,0	17,2	35,3	6,0	6,0	2	■

■ Stocked standard.

Universal

Steel and cast iron

Stainless steel and S-materials

Non ferrous

Hard

Plastic and CFRP

Graphite

Minimaster Plus

Minimaster

Cutting data – JH460 Copy milling roughing

SMG		a _p /DC	a _r /DC	f _z							v _c
				3	4	5	6	8	10	12	
N1	E/MA	0.500	0.20	0.055	0.075	0.095	0.11	0.15	0.19	0.22	590 (500 – 680)
		0,500	0,20	0,0022	0,0030	0,0038	0,0044	0,0060	0,0075	0,0085	1925 (1700 – 2200)
N11	E/MA	0.300	0.20	0.046	0.065	0.080	0.095	0.13	0.16	0.18	610 (510–700)
		0,300	0,20	0,0018	0,0026	0,0032	0,0038	0,0050	0,0065	0,0070	2000 (1700 – 2200)
S11	E/MA	0.300	0.20	0.034	0.044	0.055	0.065	0.090	0.11	0.13	120 (110–130)
		0,300	0,20	0,0013	0,0017	0,0022	0,0026	0,0036	0,0044	0,0050	395 (370 – 420)
S12	E/MA	0.300	0.20	0.034	0.044	0.055	0.065	0.090	0.11	0.13	90 (82–100)
		0,300	0,20	0,0013	0,0017	0,0022	0,0026	0,0036	0,0044	0,0050	295 (270 – 320)
S13	E/MA	0.300	0.20	0.030	0.038	0.048	0.060	0.075	0.095	0.11	75 (65 – 81)
		0,300	0,20	0,0012	0,0015	0,0019	0,0024	0,0030	0,0038	0,0044	245 (220 – 260)
TS1	A	0.500	0.50	0.055	0.070	0.13	0.15	0.20	0.25	0.30	620 (520–720)
		0,500	0,50	0,0022	0,0028	0,0050	0,0060	0,0080	0,010	0,012	2025 (1800 – 2300)
TP1	M	0.300	0.20	0.046	0.065	0.080	0.095	0.13	0.16	0.18	405 (360 – 450)
		0,300	0,20	0,0018	0,0026	0,0032	0,0038	0,0050	0,0065	0,0070	1325 (1200–1400)

For cutting data recalculations, see pages 445 - 452.

SMG = Seco material group
Coolant = A=air D=dry E=emulsion M=mist spray
v_c = m/min (sf/min)
f_z = mm (in/tooth)
a_p = mm/DC (in/DC) = factor
a_r = mm/DC (in/DC) = factor
All cutting data are target values

JM403/JM404/JM406

Miniature – Aluminium – Square – 1 Flute – Cylindrical – Corner radius

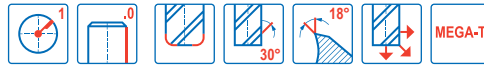
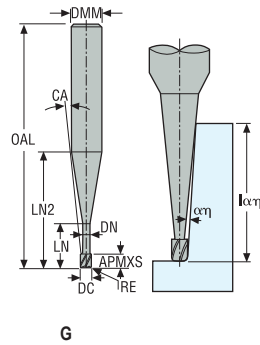

- Tolerances:
- Run-out=<0,005 mm
- DMM= h5
- DC= Ø0,5-Ø0,6= -0,005/-0,013 mm
- DC= Ø0,8-Ø2,0= -0,005/-0,015 mm
- RE= ±0,01 mm

Designation	Item number	Length index	Tool shape	DC	DMM	APMXS	OAL	LN	LN2	DN	RE	PCEDC	CA°	WDX0°	WDX05°	WDX1°*	WDX15°*	WDX2°*	WDX3°*	Cylindrical
				mm	mm	mm	mm	mm	mm	mm	mm	mm	mm	mm	mm	mm	mm	mm	mm	mm
403ML005R005-MEGA-T	02568434	2	G	0,5	3,0	0,5	40,0	1,5	6,7	0,45	0,05	1	11,0	1,5	1,6	1,7	1,7	1,8	1,9	■
403ML008R005-MEGA-T	02568450	2	G	0,8	3,0	0,8	40,0	2,5	7,1	0,75	0,05	1	9,0	2,5	2,6	2,7	2,8	2,9	3,2	■
403ML010R010-MEGA-T	02568456	2	G	1,0	3,0	1,0	40,0	4,0	8,3	0,95	0,1	1	7,5	4,0	4,2	4,3	4,5	4,6	5,0	■
406ML015R010-MEGA-T	02568478	5	G	1,5	6,0	1,5	50,0	5,0	14,0	1,4	0,1	1	9,5	5,1	5,3	5,5	5,7	5,9	6,4	■
404ML020R010-MEGA-T	02577246	5	G	2,0	4,0	2,0	40,0	6,0	10,4	1,9	0,1	1	6,0	6,1	6,3	6,6	6,8	7,0	7,6	■

■ Stocked standard.

For WDX values: Max. cut depth rel. to αη (lαη, ref)*

Universal

Steel and cast iron

Stainless steel and S-materials

Non ferrous

Hard

Plastic and CFRP

Graphite

Minimaster Plus

Minimaster

Cutting data – JM403/JM404/406 Side milling

SMG		a _e /DC	a _p /DC	f _z					v _c
				0.5	0.8	1	1.5	2	
N1	E	0.500	0.70	0.015	0.024	0.030	0.042	0.050	365 (310 – 420)
		0,500	0,70	0,00060	0,00095	0,0012	0,0017	0,0020	1200 (1100–1300)
N2	E	0.500	0.70	0.015	0.024	0.030	0.042	0.050	235 (200 – 270)
		0,500	0,70	0,00060	0,00095	0,0012	0,0017	0,0020	770 (660 – 880)
N3	E	0.500	0.70	0.015	0.024	0.030	0.042	0.050	155 (140–180)
		0,500	0,70	0,00060	0,00095	0,0012	0,0017	0,0020	510 (460 – 590)

Cutting data – JM403/JM404/406 Slot milling

SMG		a _p /DC	f _z					v _c
			0.5	0.8	1	1.5	2	
N1	E	0.40	0.015	0.025	0.030	0.044	0.050	315 (270 – 360)
		0,40	0,00060	0,0010	0,0012	0,0017	0,0020	1025 (890–1100)
N2	E	0.40	0.015	0.025	0.030	0.044	0.050	200 (170 – 230)
		0,40	0,00060	0,0010	0,0012	0,0017	0,0020	660 (560–750)
N3	E	0.40	0.015	0.025	0.030	0.044	0.050	135 (120–150)
		0,40	0,00060	0,0010	0,0012	0,0017	0,0020	445 (400 – 490)

For cutting data recalculations, see pages 445 - 452.

SMG = Seco material group
Coolant = A=air D=dry E=emulsion M=mist spray
v_c = m/min (sf/min)
f_z = mm (in/tooth)
a_p = mm/DC (in/DC) = factor
a_e = mm/DC (in/DC) = factor
All cutting data are target values

JM413/JM416

Miniature – Aluminium – Ball nose – 2 Flute – Cylindrical

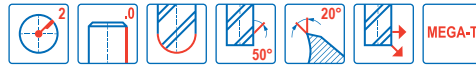
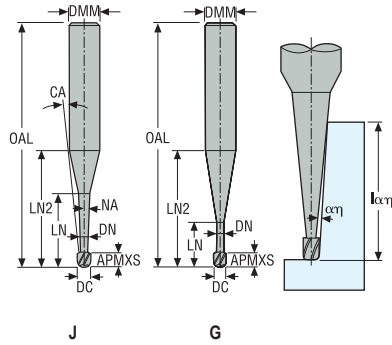

- Tolerances:
- Run-out=<0,005 mm
- DMM=h5
- DC <0,6=-0,005/-0,013 mm, DC ≥0,6=-0,005/-0,015 mm
- RE= ±0,005 mm

Designation	Item number	Length index	Tool shape	DC	DMM	APMXS	OAL	LN	LN2	DN	RE	PCEDC	CA°	WDX0*	WDX05*	WDX1*	WDX15*	WDX2*	WDX3*	Cylindrical
				mm	mm	mm	mm	mm	mm	mm	mm	mm	mm	mm	mm	mm	mm	mm	mm	mm
413ML005TN-MEGA-T	02568709	2	J	0,5	3,0	0,375	40,0	1,5	6,6	0,45	0,25	2	11,5	1,5	1,5	1,6	1,6	1,7	1,8	■
413L005-MEGA-T	02568711	3	G	0,5	3,0	0,375	40,0	2,5	7,7	0,45	0,25	2	10,0	2,5	2,6	2,7	2,8	2,9	3,1	■
413L008-MEGA-T	02568727	3	G	0,8	3,0	0,6	40,0	4,0	8,6	0,75	0,4	2	8,0	4,0	4,2	4,3	4,4	4,6	4,9	■
413L010-MEGA-T	02568736	3	G	1,0	3,0	0,75	40,0	5,0	9,3	0,95	0,5	2	7,0	5,0	5,2	5,4	5,5	5,7	6,2	■
416L015-MEGA-T	02568772	3	G	1,5	6,0	1,125	50,0	7,5	16,5	1,4	0,75	2	8,5	7,6	7,9	8,1	8,4	8,7	9,3	■
416L020-MEGA-T	02568779	3	G	2,0	6,0	1,5	50,0	10,0	18,1	1,9	1,0	2	7,0	10,1	10,4	10,8	11,1	11,5	12,4	■

■ Stocked standard.

For WDX values: Max. cut depth rel. to $\alpha\eta$ ($l\alpha\eta$, ref)*

Universal

Steel and cast iron

Stainless steel and S-materials

Non ferrous

Hard

Plastic and cfrp

Graphite

Minimaster Plus

Minimaster

Cutting data – JM413/416 Copy milling roughing

SMG		a _e /DC	a _p /DC	f _z					v _c
				0,5	0,8	1	1,5	2	
N1	E	0.300	0.30	0.030	0.048	0.060	0.085	0.10	385 (370 – 510)
		0,300	0,30	0,0012	0,0019	0,0024	0,0034	0,0040	1275 (1300–1600)
N2	E	0.300	0.30	0.030	0.048	0.060	0.085	0.10	245 (240 – 320)
		0,300	0,30	0,0012	0,0019	0,0024	0,0034	0,0040	800 (790–1000)
N3	E	0.300	0.30	0.030	0.048	0.060	0.085	0.10	165 (160 – 210)
		0,300	0,30	0,0012	0,0019	0,0024	0,0034	0,0040	540 (530 – 680)
N11	E	0.300	0.30	0.030	0.048	0.060	0.085	0.10	320 (300 – 430)
		0,300	0,30	0,0012	0,0019	0,0024	0,0034	0,0040	1050 (990–1400)
TS1	A	0.300	0.30	0.030	0.048	0.060	0.085	0.10	385 (370 – 510)
		0,300	0,30	0,0012	0,0019	0,0024	0,0034	0,0040	1275 (1300–1600)
TP1	A	0.300	0.30	0.030	0.048	0.060	0.085	0.10	385 (370 – 510)
		0,300	0,30	0,0012	0,0019	0,0024	0,0034	0,0040	1275 (1300–1600)

For cutting data recalculations, see pages 445 - 452.

SMG = Seco material group
Coolant = A=air D=dry E=emulsion M=mist spray
v_c = m/min (sf/min)
f_z = mm (in/tooth)
a_p = mm/DC (in/DC) = factor
a_e = mm/DC (in/DC) = factor
All cutting data are target values



HARD

Seco offers a complete range of high performance solid carbide square shoulder end mills, ballnose cutters and finish end mills for high productivity for hardened steel.

- JHP170, JHF181, JH120, JH130, JH930, JH142, JME142 and JME144 for radius type.
- JH112, JH150, JH160 and JMB112 for ball-nose type.

Universal

Steel and cast iron

Stainless steel and S-materials

Non ferrous

Hard

Plastic and cfrp

Graphite

Minimaster Plus

Minimaster

		Tool selection Hard					
Universal							
Steel and cast iron							
Stainless steel and S-materials							
Name		JHP170	JHF181	JH120	JH130	JH930	JH142
Page(s)		342	345	348	350	133, 133, 352	194, 194, 355
Family name		HPM	HFM	HSM/TORNADO	HSM/TORNADO	HSM/TORNADO	HSM/TORNADO
Type of mill							
Shank	Cylindrical	■	■	■	■	■	■
	Weldon	■					
Number of Flutes		3-4	3-4-5	4	5-6, 8	5,6,8	2-4-5-6
ICC			■				
Diameter range	Metric	2-20	1-10	2-16	6-20	6-20	2-12
	Inch						
Length availability							
			1,2,3,4			2	2,3,6
Operation							
SMG							
H3		●	●	●	●	●	●
H5		●	●	●	●	●	●
H7		●	●	●	●	●	●
H8		●	●	●	●	●	●
H11		●	●	●	●	●	●
H12		●	●	●	●	●	●
H21		●	●	●	●	●	●
H31		●	●	●	●	●	●

■ Stock standard □ Weldon available, delivery time is 3 days.
● Preferred choice ○ Alternative choice

Minimaster

Tool selection Hard							
							
Name	JH112	JH150	JH160	JME142	JME144	JMB112	
Page(s)	199, 199, 358	361	363	365	370	372	
Family name	HSM/TORNADO	HSM/TORNADO	HSM/TORNADO	MINI	MINI	MINI	
Type of mill							
Shank	Cylindrical	■	■	■	■	■	
	Weldon						
Number of Flutes	2	4	4	2	4	2	
ICC							
Diameter range	Metric	2-12	6-12	3-12	0,2- 3,0	1,0- 3,0	0,2- 3,0
	Inch						
Length availability							
		1,2,3,4,5,6	2	2	1,2,3,4,5,6	2,3,4	1,2,3,4,5,6
Operation							
							
							
SMG							
H3	●	●	●	●	●	●	
H5	●	●	●	●	●	●	
H7	●	●	●	●	●	●	
H8	●	●	●	●	●	●	
H11		●	●	●	●	●	
H12		●	●	●	●	●	
H21	●	●	●	●	●	●	
H31	●	●	●	●	●	●	

■ Stock standard □ Weldon available, delivery time is 3 days.

● Preferred choice ○ Alternative choice

Universal
Steel and cast iron
Stainless steel and S-materials
Non ferrous
Hard
Plastic and cfrp
Graphite
Minimaster Plus
Minimaster

JHP170

High performance – Hardened steel – Square – 3-4 Flutes – Cylindrical – Corner radius or chamfer

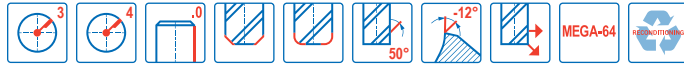
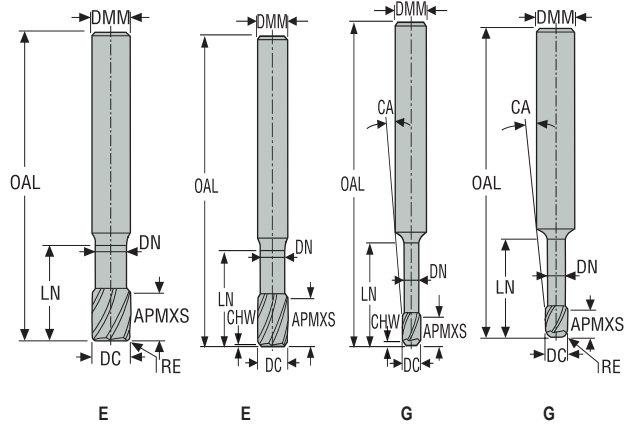

- Tolerances:
- DMM= h5
- DC= -0,02/-0,04 mm
- CHW= Ø2- Ø4=+0,05 mm
- CHW= Ø5-Ø16=+0,1 mm
- RE= ±0,05 mm
- Regrind possible if DC is ≥Ø6

Designation	Item number	Length index	Tool shape	DC	DMM	APMXS	OAL	LN	DN	CHW	RE	CA°	PCEDC	Cylindrical
				mm	mm	mm	mm	mm	mm	mm	mm	mm		
170020.0-MEGA-64	02462685	2	G	2,0	6,0	2,0	50,0	4,0	1,9	0,08	–	14,5	3	■
170020R020.0-MEGA-64	02587615	2	G	2,0	6,0	2,0	50,0	4,0	1,9	–	0,2	14,5	3	■
170020R050.0-MEGA-64	02587617	2	G	2,0	6,0	2,0	50,0	4,0	1,9	–	0,5	15,0	3	■
170030.0-MEGA-64	02462686	2	G	3,0	6,0	3,0	50,0	6,0	2,8	0,08	–	9,0	3	■
170030R020.0-MEGA-64	02587618	2	G	3,0	6,0	3,0	50,0	6,0	2,8	–	0,2	9,5	3	■
170030R050.0-MEGA-64	02587619	2	G	3,0	6,0	3,0	50,0	6,0	2,8	–	0,5	9,5	3	■
170040.0-MEGA-64	02462687	2	G	4,0	6,0	4,0	50,0	8,0	3,7	0,1	–	5,5	4	■
170040R020.0-MEGA-64	02587620	2	G	4,0	6,0	4,0	50,0	8,0	3,7	–	0,2	5,5	4	■
170040R050.0-MEGA-64	02587621	2	G	4,0	6,0	4,0	50,0	8,0	3,7	–	0,5	5,5	4	■
170050.0-MEGA-64	02462688	2	G	5,0	6,0	5,0	50,0	10,0	4,6	0,12	–	2,5	4	■
170050R020.0-MEGA-64	02587622	2	G	5,0	6,0	5,0	50,0	10,0	4,6	–	0,2	2,5	4	■
170050R050.0-MEGA-64	02587623	2	G	5,0	6,0	5,0	50,0	10,0	4,6	–	0,5	2,5	4	■
170060.0-MEGA-64	02462689	2	E	6,0	6,0	6,0	50,0	11,5	5,6	0,14	–	–	4	■
170060R020.0-MEGA-64	02587624	2	E	6,0	6,0	6,0	50,0	11,5	5,6	–	0,2	–	4	■
170060R050.0-MEGA-64	02587625	2	E	6,0	6,0	6,0	50,0	11,5	5,6	–	0,5	–	4	■
170080.0-MEGA-64	02462690	2	E	8,0	8,0	8,0	55,0	16,0	7,4	0,16	–	–	4	■
170080R020.0-MEGA-64	02587626	2	E	8,0	8,0	8,0	55,0	16,0	7,4	–	0,2	–	4	■
170080R050.0-MEGA-64	02587627	2	E	8,0	8,0	8,0	55,0	16,0	7,4	–	0,5	–	4	■
170080R100.0-MEGA-64	02587628	2	E	8,0	8,0	8,0	55,0	16,0	7,4	–	1,0	–	4	■
170100.0-MEGA-64	02462691	2	E	10,0	10,0	10,0	65,0	22,0	9,4	0,18	–	–	4	■
170100R050.0-MEGA-64	02587629	2	E	10,0	10,0	10,0	65,0	22,0	9,4	–	0,5	–	4	■
170100R100.0-MEGA-64	02587630	2	E	10,0	10,0	10,0	65,0	22,0	9,4	–	1,0	–	4	■
170120.0-MEGA-64	02462692	2	E	12,0	12,0	12,0	75,0	27,0	11,4	0,2	–	–	4	■
170120R050.0-MEGA-64	02587631	2	E	12,0	12,0	12,0	75,0	27,0	11,4	–	0,5	–	4	■
170120R100.0-MEGA-64	02587632	2	E	12,0	12,0	12,0	75,0	27,0	11,4	–	1,0	–	4	■
170160.0-MEGA-64	02462693	2	E	16,0	16,0	16,0	80,0	29,0	15,4	0,3	–	–	4	■
170160R050.0-MEGA-64	02587633	2	E	16,0	16,0	16,0	80,0	29,0	15,4	–	0,5	–	4	■

■ Stocked standard.

JHP170

High performance – Hardened steel – Square – 3-4 Flutes – Weldon – Corner radius or chamfer

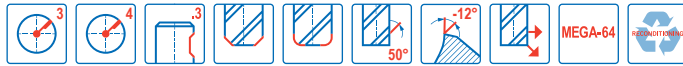
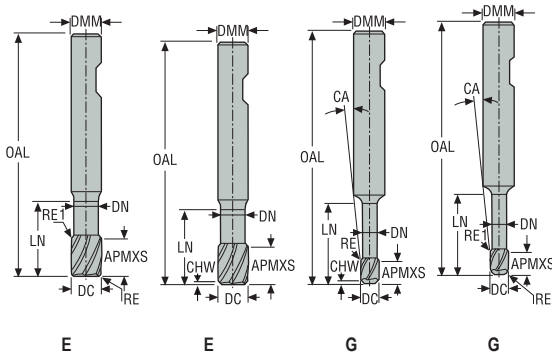

- Tolerances:
- DMM= h5
- DC= -0,02/-0,04 mm
- CHW= $\varnothing 2-\varnothing 4=+0,05$ mm
- CHW= $\varnothing 5-\varnothing 16= +0,1$ mm
- RE= $\pm 0,05$ mm
- Regrind possible if DC is $\geq \varnothing 6$

Designation	Item number	Length index	Tool shape	DC	DMM	APMXS	OAL	LN	DN	CHW	RE	CA°	PCEDC	Weldon
				mm	mm	mm	mm	mm	mm	mm	mm	mm	mm	mm
170020-MEGA-64	02452924	2	G	2,0	6,0	2,0	50,0	4,0	1,9	0,08	-	14,5	3	■
170020R020.0-MEGA-64W	02669319	2	G	2,0	6,0	2,0	50,0	4,0	1,9	-	0,2	-	3	□
170020R050.0-MEGA-64W	02669320	2	G	2,0	6,0	2,0	50,0	4,0	1,9	-	0,5	-	3	□
170030-MEGA-64	02452925	2	G	3,0	6,0	3,0	50,0	6,0	2,8	0,08	-	9,0	3	■
170030R020.0-MEGA-64W	02669321	2	G	3,0	6,0	3,0	50,0	6,0	2,8	-	0,2	-	3	□
170030R050.0-MEGA-64W	02669322	2	G	3,0	6,0	3,0	50,0	6,0	2,8	-	0,5	-	3	□
170040-MEGA-64	02452927	2	G	4,0	6,0	4,0	50,0	8,0	3,7	0,1	-	5,5	4	■
170040R020.0-MEGA-64W	02669323	2	G	4,0	6,0	4,0	50,0	8,0	3,7	-	0,2	-	4	□
170040R050.0-MEGA-64W	02669324	2	G	4,0	6,0	4,0	50,0	8,0	3,7	-	0,5	-	4	□
170050-MEGA-64	02452928	2	G	5,0	6,0	5,0	50,0	10,0	4,6	0,12	-	2,5	4	■
170050R020.0-MEGA-64W	02669325	2	G	5,0	6,0	5,0	50,0	10,0	4,6	-	0,2	-	4	□
170050R050.0-MEGA-64W	02669326	2	G	5,0	6,0	5,0	50,0	10,0	4,6	-	0,5	-	4	□
170060-MEGA-64	02452929	2	E	6,0	6,0	6,0	50,0	11,5	5,6	0,14	-	-	4	■
170060R020.0-MEGA-64W	02669327	2	E	6,0	6,0	6,0	50,0	11,5	5,6	-	0,2	-	4	□
170060R050.0-MEGA-64W	02669328	2	E	6,0	6,0	6,0	50,0	11,5	5,6	-	0,5	-	4	□
170080-MEGA-64	02452930	2	E	8,0	8,0	8,0	55,0	16,0	7,4	0,16	-	-	4	■
170080R020.0-MEGA-64W	02669329	2	E	8,0	8,0	8,0	55,0	16,0	7,4	-	0,2	-	4	□
170080R050.0-MEGA-64W	02669331	2	E	8,0	8,0	8,0	55,0	16,0	7,4	-	0,5	-	4	□
170080R100.0-MEGA-64W	02669332	2	E	8,0	8,0	8,0	55,0	16,0	7,4	-	1,0	-	4	□
170100-MEGA-64	02452931	2	E	10,0	10,0	10,0	65,0	22,0	9,4	0,18	-	-	4	■
170100R050.0-MEGA-64W	02669333	2	E	10,0	10,0	10,0	65,0	22,0	9,4	-	0,5	-	4	□
170100R100.0-MEGA-64W	02669334	2	E	10,0	10,0	10,0	65,0	22,0	9,4	-	1,0	-	4	□
170120-MEGA-64	02452932	2	E	12,0	12,0	12,0	75,0	27,0	11,4	0,2	-	-	4	■
170120R050.0-MEGA-64W	02669335	2	E	12,0	12,0	12,0	75,0	27,0	11,4	-	0,5	-	4	□
170120R100.0-MEGA-64W	02669336	2	E	12,0	12,0	12,0	75,0	27,0	11,4	-	1,0	-	4	□
170160-MEGA-64	02452933	2	E	16,0	16,0	16,0	80,0	29,0	15,4	0,3	-	-	4	■
170160R050.0-MEGA-64W	02669337	2	E	16,0	16,0	16,0	80,0	29,0	15,4	-	0,5	-	4	□
170200R050-MEGA-64	02611637	2	E	20,0	20,0	20,0	100,0	40,0	19,2	-	0,5	-	4	■

■ Stocked standard. □ Weldon available. Delivery time is 3 days.

Universal

Steel and cast iron

Stainless steel and S-materials

Non ferrous

Hard

Plastic and chip

Graphite

Minimaster Plus

Minimaster

Cutting data – JHP170 Side milling

SMG		a _e /DC	a _p /DC	f _z										v _c
				2	3	4	5	6	8	10	12	16	20	
H3	M	0.150	0.60	0.0055	0.0085	0.011	0.014	0.017	0.022	0.028	0.034	0.042	0.048	29 (22 – 35)
		0,150	0,60	0,00022	0,00034	0,00044	0,00055	0,00065	0,00085	0,0011	0,0013	0,0017	0,0019	95 (73 – 110)
H5	M	0.300	0.80	0.012	0.018	0.024	0.030	0.036	0.048	0.060	0.070	0.090	0.10	60 (56 – 68)
		0,300	0,80	0,00048	0,00070	0,00095	0,0012	0,0014	0,0019	0,0024	0,0028	0,0036	0,0040	195 (190 – 220)
H7	M	0.150	0.60	0.0055	0.0085	0.011	0.014	0.017	0.022	0.028	0.034	0.042	0.048	29 (22 – 35)
		0,150	0,60	0,00022	0,00034	0,00044	0,00055	0,00065	0,00085	0,0011	0,0013	0,0017	0,0019	95 (73 – 110)
H8	M	0.300	0.80	0.0090	0.014	0.018	0.022	0.028	0.036	0.046	0.055	0.065	0.080	65 (59 – 71)
		0,300	0,80	0,00036	0,00055	0,00070	0,00085	0,0011	0,0014	0,0018	0,0022	0,0026	0,0032	215 (200 – 230)
H11	M	0.300	0.80	0.012	0.018	0.024	0.030	0.036	0.048	0.060	0.070	0.090	0.10	80 (71 – 86)
		0,300	0,80	0,00048	0,00070	0,00095	0,0012	0,0014	0,0019	0,0024	0,0028	0,0036	0,0040	260 (240 – 280)
H12	M	0.300	0.80	0.0090	0.014	0.018	0.022	0.028	0.036	0.046	0.055	0.065	0.080	75 (69 – 83)
		0,300	0,80	0,00036	0,00055	0,00070	0,00085	0,0011	0,0014	0,0018	0,0022	0,0026	0,0032	245 (230 – 270)
H21	M	0.300	0.80	0.0090	0.014	0.018	0.022	0.028	0.036	0.046	0.055	0.065	0.080	65 (59 – 71)
		0,300	0,80	0,00036	0,00055	0,00070	0,00085	0,0011	0,0014	0,0018	0,0022	0,0026	0,0032	215 (200 – 230)
H31	M	0.300	0.80	0.012	0.018	0.024	0.030	0.036	0.048	0.060	0.070	0.090	0.10	60 (56 – 68)
		0,300	0,80	0,00048	0,00070	0,00095	0,0012	0,0014	0,0019	0,0024	0,0028	0,0036	0,0040	195 (190 – 220)

Cutting data – JHP170 Slot milling

SMG		a _p /DC	f _z										v _c
			2	3	4	5	6	8	10	12	16	20	
H3	M	0.40	0.0040	0.0060	0.0080	0.010	0.012	0.016	0.020	0.024	0.030	0.034	20 (16 – 25)
		0,40	0,00016	0,00024	0,00032	0,00040	0,00048	0,00065	0,00080	0,00095	0,0012	0,0013	65 (53 – 82)
H5	M	0.60	0.0080	0.012	0.016	0.020	0.025	0.032	0.040	0.050	0.065	0.080	50 (46 – 55)
		0,60	0,00032	0,00048	0,00065	0,00080	0,0010	0,0013	0,0016	0,0020	0,0026	0,0032	165 (160 – 180)
H7	M	0.40	0.0040	0.0060	0.0080	0.010	0.012	0.016	0.020	0.024	0.030	0.034	20 (16 – 25)
		0,40	0,00016	0,00024	0,00032	0,00040	0,00048	0,00065	0,00080	0,00095	0,0012	0,0013	65 (53 – 82)
H8	M	0.60	0.0080	0.012	0.016	0.020	0.025	0.032	0.040	0.050	0.060	0.070	50 (46 – 55)
		0,60	0,00032	0,00048	0,00065	0,00080	0,0010	0,0013	0,0016	0,0020	0,0024	0,0028	165 (160 – 180)
H11	M	0.60	0.0080	0.012	0.016	0.020	0.025	0.032	0.040	0.050	0.065	0.080	65 (58 – 70)
		0,60	0,00032	0,00048	0,00065	0,00080	0,0010	0,0013	0,0016	0,0020	0,0026	0,0032	215 (200 – 220)
H12	M	0.60	0.0080	0.012	0.016	0.020	0.025	0.032	0.040	0.050	0.060	0.070	60 (53 – 64)
		0,60	0,00032	0,00048	0,00065	0,00080	0,0010	0,0013	0,0016	0,0020	0,0024	0,0028	195 (180 – 200)
H21	M	0.60	0.0080	0.012	0.016	0.020	0.025	0.032	0.040	0.050	0.060	0.070	50 (46 – 55)
		0,60	0,00032	0,00048	0,00065	0,00080	0,0010	0,0013	0,0016	0,0020	0,0024	0,0028	165 (160 – 180)
H31	M	0.60	0.0080	0.012	0.016	0.020	0.025	0.032	0.040	0.050	0.065	0.080	50 (46 – 55)
		0,60	0,00032	0,00048	0,00065	0,00080	0,0010	0,0013	0,0016	0,0020	0,0026	0,0032	165 (160 – 180)

For cutting data recalculations, see pages 445 - 452.

SMG = Seco material group

Coolant = A=air D=dry E=emulsion M=mist spray

v_c = m/min (sf/min)

f_z = mm (in/tooth)

a_p = mm/DC (in/DC) = factor

a_e = mm/DC (in/DC) = factor

All cutting data are target values

JHF181

High feed – Hardened steel – Square – 3-5 Flutes – Cylindrical – Corner radius – ICC

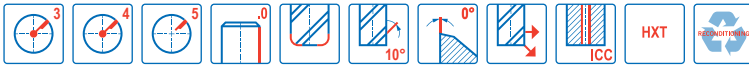
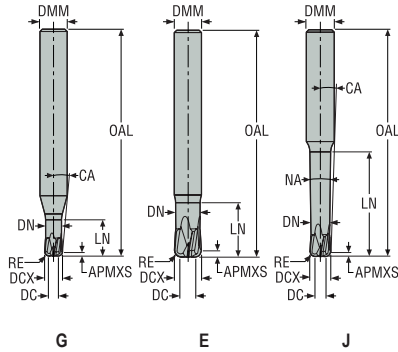

- Tolerances:
- DMM=h5
- DC=-0,02/-0,04 mm
- RE= ±0,01 mm
- Regrind possible if DC is ≥Ø6

Designation	Item number	Length index	Tool shape	ICC	DCX	DC	DMM	APMXS	OAL	LN	DN	NA	RE	CA°	PCEDC	Cylindrical
					mm	mm	mm	mm	mm	mm	mm	mm	mm	mm	mm	mm
JHF181020G1R050.0Z4-HXT	03067297	1	G	-	2,0	1,0	6,0	0,5	50,0	4,0	1,8	15,0	0,5	10,0	4	■
JHF181030G1R075.0Z4-HXT	03067298	1	G	-	3,0	1,5	6,0	0,75	50,0	6,0	2,7	15,0	0,75	7,5	4	■
JHF181040G1R100.0Z4-HXT	03067299	1	G	-	4,0	2,0	6,0	1,0	50,0	8,0	3,6	15,0	1,0	5,0	4	■
JHF181060E1R150.0Z4-HXT	03067300	1	E	-	6,0	3,0	6,0	1,5	50,0	12,0	5,4	0,0	1,5	-	4	■
JHF181080E1R200.0Z4-HXT	03067301	1	E	-	8,0	4,0	8,0	2,0	55,0	16,0	7,3	0,0	2,0	-	4	■
JHF181100E1R200.0Z4-HXT	03067302	1	E	-	10,0	6,0	10,0	2,0	65,0	20,0	9,2	0,0	2,0	-	4	■
JHF181100E1R200.0Z5-HXT	03067303	1	E	-	10,0	6,0	10,0	2,0	65,0	20,0	9,2	0,0	2,0	-	5	■
JHF181120E1R300.0Z4-HXT	03067304	1	E	-	12,0	6,0	12,0	3,0	75,0	24,0	11,0	0,0	3,0	-	4	■
JHF181120E1R300.0Z5-HXT	03067305	1	E	-	12,0	6,0	12,0	3,0	75,0	24,0	11,0	0,0	3,0	-	5	■
JHF181160E1R300.0Z4-HXT	03067306	1	E	-	16,0	10,0	16,0	3,0	80,0	32,0	14,8	0,0	3,0	-	4	■
JHF181020G2R050.0Z4-HXT	03067307	2	G	-	2,0	1,0	6,0	0,5	50,0	8,0	1,8	15,0	0,5	7,5	4	■
JHF181030G2R075.0Z4-HXT	03067308	2	G	-	3,0	1,5	6,0	0,75	50,0	12,0	2,7	15,0	0,75	5,0	4	■
JHF181040G2R100.0Z4-HXT	03067309	2	G	-	4,0	2,0	6,0	1,0	50,0	16,0	3,6	15,0	1,0	3,0	4	■
JHF181060E2R150.0Z4A-HXT	03067311	2	E	■	6,0	3,0	6,0	1,5	65,0	24,0	5,4	0,0	1,5	-	4	■
JHF181060E2R150.0Z4-HXT	03067310	2	E	-	6,0	3,0	6,0	1,5	65,0	24,0	5,4	0,0	1,5	-	4	■
JHF181080E2R200.0Z4A-HXT	03067313	2	E	■	8,0	4,0	8,0	2,0	70,0	32,0	7,3	0,0	2,0	-	4	■
JHF181080E2R200.0Z4-HXT	03067312	2	E	-	8,0	4,0	8,0	2,0	70,0	32,0	7,3	0,0	2,0	-	4	■
JHF181100E2R200.0Z4A-HXT	03067315	2	E	■	10,0	6,0	10,0	2,0	85,0	40,0	9,2	0,0	2,0	-	4	■
JHF181100E2R200.0Z4-HXT	03067314	2	E	-	10,0	6,0	10,0	2,0	85,0	40,0	9,2	0,0	2,0	-	4	■
JHF181120E2R300.0Z4A-HXT	03067317	2	E	■	12,0	6,0	12,0	3,0	100,0	48,0	11,0	0,0	3,0	-	4	■
JHF181120E2R300.0Z4-HXT	03067316	2	E	-	12,0	6,0	12,0	3,0	100,0	48,0	11,0	0,0	3,0	-	4	■
JHF181020J3R050.0Z4-HXT	03067318	3	J	-	2,0	1,0	6,0	0,5	50,0	10,0	1,8	0,9	0,5	6,8	4	■
JHF181030J3R075.0Z4-HXT	03067319	3	J	-	3,0	1,5	6,0	0,75	50,0	15,0	2,7	0,9	0,75	4,4	4	■
JHF181040J3R100.0Z4-HXT	03067320	3	J	-	4,0	2,0	6,0	1,0	60,0	20,0	3,6	0,9	1,0	2,6	4	■
JHF181060J3R150.0Z4-HXT	03067321	3	J	-	6,0	3,0	8,0	1,5	65,0	30,0	5,4	0,9	1,5	1,9	4	■
JHF181080J3R200.0Z4-HXT	03067325	3	J	-	8,0	4,0	10,0	2,0	85,0	40,0	7,3	0,9	2,0	1,5	4	■
JHF181100J3R200.0Z4-HXT	03067327	3	J	-	10,0	6,0	12,0	2,0	100,0	50,0	9,2	0,9	2,0	1,2	4	■
JHF181020J4R050.0Z3-HXT	03067329	4	J	-	2,0	1,0	6,0	0,5	50,0	14,0	1,8	0,9	0,5	5,6	3	■
JHF181030J4R075.0Z3-HXT	03067330	4	J	-	3,0	1,5	6,0	0,75	60,0	21,0	2,7	0,9	0,75	3,4	3	■
JHF181040J4R100.0Z3-HXT	03067331	4	J	-	4,0	2,0	6,0	1,0	65,0	28,0	3,6	0,9	1,0	2,0	3	■
JHF181060J4R150.0Z3-HXT	03067332	4	J	-	6,0	3,0	8,0	1,5	80,0	42,0	5,4	0,9	1,5	1,4	3	■
JHF181080J4R200.0Z3-HXT	03067333	4	J	-	8,0	4,0	10,0	2,0	100,0	56,0	7,3	0,9	2,0	1,1	3	■
JHF181100J4R200.0Z3-HXT	03067334	4	J	-	10,0	6,0	12,0	2,0	125,0	70,0	9,2	0,9	2,0	0,9	3	■

■ Stocked standard.

Universal
Steel and cast iron
Stainless steel and S-materials
Non ferrous
Hard
Plastic and chip
Graphite
Minimaster Plus
Minimaster

JH120

High speed – Hardened steel – Square – 4 Flutes – Cylindrical – Corner radius

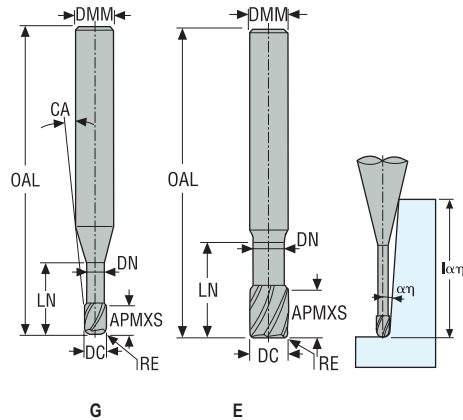

- Tolerances:
- DMM=h5
- DC=-0,02/-0,04 mm
- RE= ±0,05 mm
- Regrind possible if DC is ≥Ø6

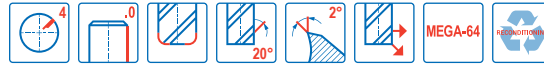

Designation	Item number	Length index	Tool shape	DC	DMM	APMXS	OAL	LN	DN	RE	CA°	PCEDC	WDX0*	WDX05*	WDX1*	WDX15*	WDX2*	WDX3*	Cylindrical
				mm	mm	mm	mm	mm	mm	mm	mm	mm	mm	mm	mm	mm	mm	mm	
120020-MEGA-64	00019437	2	G	2,0	6,0	2,5	50,0	5,0	1,9	0,2	10,5	4	5,0	5,4	5,6	5,7	5,9	6,2	■
120025-MEGA-64	00019448	2	G	2,5	6,0	3,0	50,0	6,0	2,4	0,25	8,5	4	6,0	6,4	6,6	6,8	7,0	7,5	■
120030-MEGA-64	00019450	2	G	3,0	6,0	4,0	50,0	7,0	2,8	0,3	7,0	4	7,0	7,7	8,0	8,2	8,5	9,2	■
120035-MEGA-64	00019460	2	G	3,5	6,0	4,5	50,0	8,0	3,2	0,35	5,5	4	8,0	9,0	9,3	9,7	10,0	10,9	■
120040-MEGA-64	00019462	2	G	4,0	6,0	5,0	50,0	9,0	3,7	0,4	4,5	4	9,0	10,0	10,4	10,8	11,2	12,2	■
120050-MEGA-64	00019476	2	G	5,0	6,0	6,0	50,0	12,0	4,6	0,5	2,5	4	12,0	13,0	13,4	13,7	14,1	14,9	■
120060-MEGA-64	00019479	2	E	6,0	6,0	7,0	55,0	14,0	5,6	0,6	-	4	14,0	-	-	-	-	-	■
120080-MEGA-64	00019481	2	E	8,0	8,0	10,0	60,0	18,0	7,4	0,8	-	4	18,0	-	-	-	-	-	■
120100-MEGA-64	00019494	2	E	10,0	10,0	12,0	70,0	25,0	9,4	1,0	-	4	25,0	-	-	-	-	-	■
120120-MEGA-64	00019501	2	E	12,0	12,0	15,0	80,0	30,0	11,4	1,2	-	4	30,0	-	-	-	-	-	■
120160-MEGA-64	00019503	2	E	16,0	16,0	18,0	90,0	35,0	15,4	1,6	-	4	35,0	-	-	-	-	-	■

■ Stocked standard.
For WDX values: Max. cut depth rel. to α_1 (α_1 , ref)*

Universal

Steel and cast iron

Stainless steel and S-materials

Non ferrous

Hard

Plastic and cfrp

Graphite

Minimaster Plus

Minimaster

JH130

High speed – Hardened steel – Square – 5-8 Flutes – Cylindrical – Corner radius

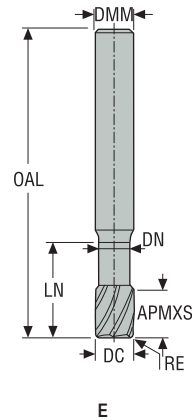

- Tolerances:
- DMM=h5
- DC=-0,02/-0,04 mm
- RE= ±0,05 mm
- Regrind possible if DC is ≥Ø6

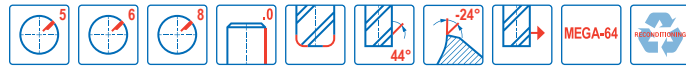

Designation	Item number	Length index	Tool shape	DC	DMM	APMXS	OAL	LN	DN	RE	PCEDC	Cylindrical
				mm	mm	mm	mm	mm	mm	mm		
130060-MEGA-64	00019504	2	E	6,0	6,0	6,0	55,0	12,0	5,6	0,2	5	■
130080-MEGA-64	00019507	2	E	8,0	8,0	8,0	60,0	16,0	7,4	0,2	5	■
130100-MEGA-64	00019511	2	E	10,0	10,0	10,0	70,0	20,0	9,4	0,3	6	■
130120-MEGA-64	00019512	2	E	12,0	12,0	12,0	80,0	24,0	11,4	0,5	6	■
130160-MEGA-64	00019514	2	E	16,0	16,0	16,0	90,0	30,0	15,4	0,5	8	■
130200-MEGA-64	00019542	2	E	20,0	20,0	20,0	100,0	35,0	19,2	0,5	8	■

■ Stocked standard.

Universal

Steel and cast iron

Stainless steel and S-materials

Non ferrous

Hard

Plastic and cfrp

Graphite

Minimaster Plus

Minimaster

Cutting data – JH130 Side milling finishing

SMG		a _e /DC	a _p /DC	f _z						v _c
				6	8	10	12	16	20	
H3	M	0.0300	0.50	0.013	0.018	0.022	0.026	0.032	0.038	85 (73 — 93)
		<i>0.0300</i>	<i>0.50</i>	<i>0,00050</i>	<i>0,00070</i>	<i>0,00085</i>	<i>0,0010</i>	<i>0,0013</i>	<i>0,0015</i>	280 (240 — 300)
H5	M	0.0300	1.0	0.032	0.042	0.050	0.060	0.075	0.090	255 (240 — 270)
		<i>0.0300</i>	<i>1,0</i>	<i>0,0013</i>	<i>0,0017</i>	<i>0,0020</i>	<i>0,0024</i>	<i>0,0030</i>	<i>0,0036</i>	840 (790 — 880)
H7	M	0.0300	0.50	0.013	0.018	0.022	0.026	0.032	0.038	85 (73 — 93)
		<i>0.0300</i>	<i>0.50</i>	<i>0,00050</i>	<i>0,00070</i>	<i>0,00085</i>	<i>0,0010</i>	<i>0,0013</i>	<i>0,0015</i>	280 (240 — 300)
H8	M	0.0300	1.0	0.024	0.032	0.040	0.046	0.060	0.065	260 (240 — 270)
		<i>0.0300</i>	<i>1,0</i>	<i>0,00095</i>	<i>0,0013</i>	<i>0,0016</i>	<i>0,0018</i>	<i>0,0024</i>	<i>0,0026</i>	850 (790 — 880)
H11	M	0.0300	1.0	0.032	0.042	0.050	0.060	0.075	0.090	320 (300 — 340)
		<i>0.0300</i>	<i>1,0</i>	<i>0,0013</i>	<i>0,0017</i>	<i>0,0020</i>	<i>0,0024</i>	<i>0,0030</i>	<i>0,0036</i>	1050 (990 — 1100)
H12	M	0.0300	1.0	0.024	0.032	0.040	0.046	0.060	0.065	300 (280 — 320)
		<i>0.0300</i>	<i>1,0</i>	<i>0,00095</i>	<i>0,0013</i>	<i>0,0016</i>	<i>0,0018</i>	<i>0,0024</i>	<i>0,0026</i>	980 (920 — 1000)
H21	M	0.0300	1.0	0.024	0.032	0.040	0.046	0.060	0.065	260 (240 — 270)
		<i>0.0300</i>	<i>1,0</i>	<i>0,00095</i>	<i>0,0013</i>	<i>0,0016</i>	<i>0,0018</i>	<i>0,0024</i>	<i>0,0026</i>	850 (790 — 880)
H31	M	0.0300	1.0	0.030	0.040	0.050	0.060	0.075	0.085	155 (140 — 170)
		<i>0.0300</i>	<i>1,0</i>	<i>0,0012</i>	<i>0,0016</i>	<i>0,0020</i>	<i>0,0024</i>	<i>0,0030</i>	<i>0,0034</i>	510 (460 — 550)

Cutting data – JH130 Side milling roughing

SMG		a _e /DC	a _p /DC	f _z						v _c
				6	8	10	12	16	20	
H3	M	0.0300	0.50	0.013	0.018	0.022	0.026	0.032	0.038	85 (73 — 93)
		<i>0.0300</i>	<i>0.50</i>	<i>0,00050</i>	<i>0,00070</i>	<i>0,00085</i>	<i>0,0010</i>	<i>0,0013</i>	<i>0,0015</i>	280 (240 — 300)
H5	M	0.0300	1.0	0.032	0.042	0.050	0.060	0.075	0.090	255 (240 — 270)
		<i>0.0300</i>	<i>1,0</i>	<i>0,0013</i>	<i>0,0017</i>	<i>0,0020</i>	<i>0,0024</i>	<i>0,0030</i>	<i>0,0036</i>	840 (790 — 880)
H7	M	0.0300	0.50	0.013	0.018	0.022	0.026	0.032	0.038	85 (73 — 93)
		<i>0.0300</i>	<i>0.50</i>	<i>0,00050</i>	<i>0,00070</i>	<i>0,00085</i>	<i>0,0010</i>	<i>0,0013</i>	<i>0,0015</i>	280 (240 — 300)
H8	M	0.0300	1.0	0.024	0.032	0.040	0.046	0.060	0.065	260 (240 — 270)
		<i>0.0300</i>	<i>1,0</i>	<i>0,00095</i>	<i>0,0013</i>	<i>0,0016</i>	<i>0,0018</i>	<i>0,0024</i>	<i>0,0026</i>	850 (790 — 880)
H11	M	0.0300	1.0	0.032	0.042	0.050	0.060	0.075	0.090	320 (300 — 340)
		<i>0.0300</i>	<i>1,0</i>	<i>0,0013</i>	<i>0,0017</i>	<i>0,0020</i>	<i>0,0024</i>	<i>0,0030</i>	<i>0,0036</i>	1050 (990 — 1100)
H12	M	0.0300	1.0	0.024	0.032	0.040	0.046	0.060	0.065	300 (280 — 320)
		<i>0.0300</i>	<i>1,0</i>	<i>0,00095</i>	<i>0,0013</i>	<i>0,0016</i>	<i>0,0018</i>	<i>0,0024</i>	<i>0,0026</i>	980 (920 — 1000)
H21	M	0.0300	1.0	0.024	0.032	0.040	0.046	0.060	0.065	260 (240 — 270)
		<i>0.0300</i>	<i>1,0</i>	<i>0,00095</i>	<i>0,0013</i>	<i>0,0016</i>	<i>0,0018</i>	<i>0,0024</i>	<i>0,0026</i>	850 (790 — 880)
H31	M	0.0300	1.0	0.030	0.040	0.050	0.060	0.075	0.085	155 (140 — 170)
		<i>0.0300</i>	<i>1,0</i>	<i>0,0012</i>	<i>0,0016</i>	<i>0,0020</i>	<i>0,0024</i>	<i>0,0030</i>	<i>0,0034</i>	510 (460 — 550)

For cutting data recalculations, see pages 445 - 452.

SMG = Seco material group

Coolant = A=air D=dry E=emulsion M=mist spray

v_c = m/min (sf/min)

f_z = mm (in/tooth)

a_p = mm/DC (in/DC) = factor

a_e = mm/DC (in/DC) = factor

All cutting data are target values

Universal
Steel and cast iron
Stainless steel and S-materials
Non ferrous
Hard
Plastic and chip
Graphite
Minimaster Plus
Minimaster

JH930

High speed – Universal – Square – 5-8 Flutes – Cylindrical – Corner radius

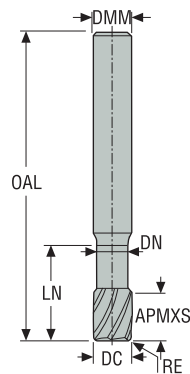

E

- Tolerances:
- DMM=h5
- DC=-0,02/-0,04 mm
- RE= ±0,05 mm
- Regrind possible if DC is ≥Ø6



Designation	Item number	Length index	Tool shape	DC	DMM	APMXS	OAL	LN	DN	RE	PCEDC	Cylindrical
				mm	mm	mm	mm	mm	mm	mm		
930060R020-MEGA	00022026	2	E	6,0	6,0	9,0	55,0	15,0	5,6	0,2	5	■
930060R050-MEGA	00022027	2	E	6,0	6,0	9,0	55,0	15,0	5,6	0,5	5	■
930080R020-MEGA	00022028	2	E	8,0	8,0	12,0	60,0	18,0	7,4	0,2	5	■
930080R050-MEGA	00022029	2	E	8,0	8,0	12,0	60,0	18,0	7,4	0,5	5	■
930100R030-MEGA	00022030	2	E	10,0	10,0	15,0	70,0	25,0	9,4	0,3	6	■
930100R100-MEGA	00022031	2	E	10,0	10,0	15,0	70,0	25,0	9,4	1,0	6	■
930120R050-MEGA	00022033	2	E	12,0	12,0	18,0	80,0	30,0	11,4	0,5	6	■
930120R100-MEGA	00022034	2	E	12,0	12,0	18,0	80,0	30,0	11,4	1,0	6	■
930160R050-MEGA	00022035	2	E	16,0	16,0	24,0	90,0	35,0	15,4	0,5	8	■
930160R100-MEGA	00022040	2	E	16,0	16,0	24,0	90,0	35,0	15,4	1,0	8	■
930200R050-MEGA	00022044	2	E	20,0	20,0	30,0	100,0	38,0	19,2	0,5	8	■

■ Stocked standard.

JH112

High speed – High precision – Hardened steel – Ball nose – 2 Flutes – Cylindrical

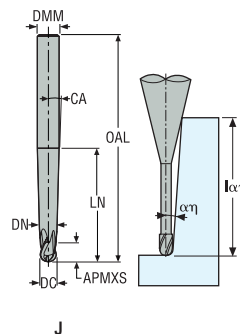

- Tolerances:
- Run-out= <0,005 mm
- DMM= h5
- DC= 0-0,01 mm
- RE= ±0,005 mm
- Regrind possible if DC is ≥Ø6

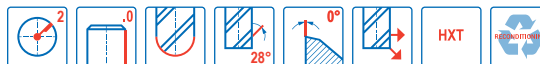

Designation	Item number	Length index	Tool shape	DC	DMM	APMXS	OAL	DN	NA°	CA°	PCEDC	WDX0*	WDX05*	WDX1*	WDX15*	WDX2*	WDX3*	Cylindrical
				mm	mm	mm	mm	mm	mm	mm	mm	mm	mm	mm	mm	mm	mm	
JH112020J5B.0Z2-HXT	02970134	5	J	2,0	6,0	2,0	80,0	1,9	3,55	3,3	2	3,09	3,43	3,91	4,63	5,81	14,63	■
JH112030J5B.0Z2-HXT	02970135	5	J	3,0	6,0	3,0	80,0	2,8	2,5	2,2	2	5,7	6,75	8,51	12,03	22,61	-	■
JH112040J5B.0Z2-HXT	02970136	5	J	4,0	6,0	4,0	80,0	3,7	1,4	1,2	2	10,58	15,35	32,07	-	-	-	■
JH112050J5B.0Z2-HXT	02970137	5	J	5,0	8,0	5,0	100,0	4,6	1,95	1,6	2	11,47	14,56	20,93	41,46	-	-	■
JH112060J5B.0Z2-HXT	02970138	5	J	6,0	8,0	6,0	100,0	5,6	1,4	1,1	2	14,72	21,24	44,08	-	-	-	■
JH112080J5B.0Z2-HXT	02970139	5	J	8,0	10,0	8,0	125,0	7,4	1,43	1,0	2	20,71	29,7	59,65	-	-	-	■
JH112100J5B.0Z2-HXT	02970140	5	J	10,0	12,0	10,0	125,0	9,4	1,5	1,0	2	22,16	30,75	56,56	-	-	-	■
JH112060J6B.0Z2-HXT	02970141	6	J	6,0	10,0	6,0	125,0	5,6	2,3	2,0	2	11,59	13,99	18,22	27,78	69,22	-	■
JH112080J6B.0Z2-HXT	02970142	6	J	8,0	12,0	8,0	150,0	7,4	2,3	1,8	2	16,24	19,64	25,68	39,27	98,24	-	■
JH112100J6B.0Z2-HXT	02970143	6	J	10,0	12,0	10,0	150,0	9,4	1,1	0,8	2	26,26	43,99	-	-	-	-	■

■ Stocked standard.
For WDX values: Max. cut depth rel. to α₁ (α₁, ref)*

Universal

Steel and cast iron

Stainless steel and S-materials

Non ferrous

Hard

Plastic and cfrp

Graphite

Minimaster Plus

Minimaster

Cutting data – JH112 Copy milling finishing

SMG		a _p /DC	f _z										v _c
			2	2.5	3	3.5	4	5	6	8	10	12	
K1	E	0.30	0.030	0.038	0.044	0.050	0.060	0.075	0.090	0.12	0.15	0.18	520 (500–730)
		0,30	0,0012	0,0015	0,0017	0,0020	0,0024	0,0030	0,0036	0,0048	0,0060	0,0070	1700 (1700–2300)
K2	E	0.30	0.030	0.038	0.044	0.050	0.060	0.075	0.090	0.12	0.15	0.18	445 (430–630)
		0,30	0,0012	0,0015	0,0017	0,0020	0,0024	0,0030	0,0036	0,0048	0,0060	0,0070	1450 (1500–2000)
K3	E	0.30	0.030	0.038	0.044	0.050	0.060	0.075	0.090	0.12	0.15	0.18	380 (360–530)
		0,30	0,0012	0,0015	0,0017	0,0020	0,0024	0,0030	0,0036	0,0048	0,0060	0,0070	1250 (1200–1700)
K4	E	0.30	0.030	0.038	0.044	0.050	0.060	0.075	0.090	0.12	0.15	0.18	360 (350–510)
		0,30	0,0012	0,0015	0,0017	0,0020	0,0024	0,0030	0,0036	0,0048	0,0060	0,0070	1175 (1200–1600)
K5	E	0.30	0.030	0.038	0.044	0.050	0.060	0.075	0.090	0.12	0.15	0.18	415 (370–610)
		0,30	0,0012	0,0015	0,0017	0,0020	0,0024	0,0030	0,0036	0,0048	0,0060	0,0070	1350 (1300–2000)
K6	E	0.30	0.030	0.038	0.044	0.050	0.060	0.075	0.090	0.12	0.15	0.18	610 (550–900)
		0,30	0,0012	0,0015	0,0017	0,0020	0,0024	0,0030	0,0036	0,0048	0,0060	0,0070	2000 (1900–2900)
K7	E	0.30	0.030	0.038	0.044	0.050	0.060	0.075	0.090	0.12	0.15	0.18	680 (560–790)
		0,30	0,0012	0,0015	0,0017	0,0020	0,0024	0,0030	0,0036	0,0048	0,0060	0,0070	2225 (1900–2500)
H3	M	0.16	0.028	0.036	0.042	0.048	0.055	0.070	0.085	0.11	0.14	0.17	155 (150–230)
		0,16	0,0011	0,0014	0,0017	0,0019	0,0022	0,0028	0,0034	0,0044	0,0055	0,0065	510 (500–750)
H5	M	0.30	0.030	0.038	0.044	0.050	0.060	0.075	0.090	0.12	0.15	0.18	285 (240–330)
		0,30	0,0012	0,0015	0,0017	0,0020	0,0024	0,0030	0,0036	0,0048	0,0060	0,0070	940 (790–1000)
H7	M	0.16	0.028	0.036	0.042	0.048	0.055	0.070	0.085	0.11	0.14	0.17	155 (150–230)
		0,16	0,0011	0,0014	0,0017	0,0019	0,0022	0,0028	0,0034	0,0044	0,0055	0,0065	510 (500–750)
H8	M	0.30	0.030	0.038	0.044	0.050	0.060	0.075	0.090	0.12	0.15	0.18	285 (240–330)
		0,30	0,0012	0,0015	0,0017	0,0020	0,0024	0,0030	0,0036	0,0048	0,0060	0,0070	940 (790–1000)
H11	M	0.30	0.030	0.038	0.044	0.050	0.060	0.075	0.090	0.12	0.15	0.18	360 (300–420)
		0,30	0,0012	0,0015	0,0017	0,0020	0,0024	0,0030	0,0036	0,0048	0,0060	0,0070	1175 (990–1300)
H12	M	0.30	0.030	0.038	0.044	0.050	0.060	0.075	0.090	0.12	0.15	0.18	330 (280–380)
		0,30	0,0012	0,0015	0,0017	0,0020	0,0024	0,0030	0,0036	0,0048	0,0060	0,0070	1075 (920–1200)
H21	M	0.30	0.030	0.038	0.044	0.050	0.060	0.075	0.090	0.12	0.15	0.18	285 (240–330)
		0,30	0,0012	0,0015	0,0017	0,0020	0,0024	0,0030	0,0036	0,0048	0,0060	0,0070	940 (790–1000)
H31	M	0.30	0.026	0.032	0.040	0.046	0.050	0.065	0.080	0.10	0.13	0.16	300 (290–430)
		0,30	0,0010	0,0013	0,0016	0,0018	0,0020	0,0026	0,0032	0,0040	0,0050	0,0065	980 (960–1400)

For cutting data recalculations, see pages 445 - 452

SMG = Seco material group
 Coolant = A=air D=dry E=emulsion M=mist spray
 v_c = m/min (sf/min)
 f_z = mm (in/tooth)
 a_p = mm/DC (in/DC) = factor
 a_e = mm/DC (in/DC) = factor
 All cutting data are target values



Cutting data – JH112 Copy milling roughing

SMG		a _e /DC	a _p /DC	f _z										v _c
				2	2.5	3	3.5	4	5	6	8	10	12	
K1	E	0.250	0.15	0.030	0.038	0.044	0.050	0.060	0.075	0.090	0.12	0.15	0.18	315 (310—450)
		0,250	0,15	0,0012	0,0015	0,0017	0,0020	0,0024	0,0030	0,0036	0,0048	0,0060	0,0070	1025 (1100–1400)
K2	E	0.250	0.15	0.028	0.036	0.044	0.050	0.060	0.070	0.085	0.12	0.14	0.17	280 (270—390)
		0,250	0,15	0,0011	0,0014	0,0017	0,0020	0,0024	0,0028	0,0034	0,0048	0,0055	0,0065	920 (890–1200)
K3	E	0.250	0.15	0.028	0.036	0.044	0.050	0.060	0.070	0.085	0.12	0.14	0.17	235 (230—330)
		0,250	0,15	0,0011	0,0014	0,0017	0,0020	0,0024	0,0028	0,0034	0,0048	0,0055	0,0065	770 (760–1000)
K4	E	0.250	0.15	0.028	0.036	0.044	0.050	0.060	0.070	0.085	0.12	0.14	0.17	225 (220—320)
		0,250	0,15	0,0011	0,0014	0,0017	0,0020	0,0024	0,0028	0,0034	0,0048	0,0055	0,0065	740 (730–1000)
K5	E	0.160	0.15	0.030	0.038	0.044	0.050	0.060	0.075	0.090	0.12	0.15	0.18	280 (250—410)
		0,160	0,15	0,0012	0,0015	0,0017	0,0020	0,0024	0,0030	0,0036	0,0048	0,0060	0,0070	920 (830–1300)
K6	E	0.160	0.15	0.030	0.038	0.044	0.050	0.060	0.075	0.090	0.12	0.15	0.18	415 (370—610)
		0,160	0,15	0,0012	0,0015	0,0017	0,0020	0,0024	0,0030	0,0036	0,0048	0,0060	0,0070	1350 (1300—2000)
K7	E	0.250	0.10	0.030	0.038	0.044	0.050	0.060	0.075	0.090	0.12	0.15	0.18	420 (350—490)
		0,250	0,10	0,0012	0,0015	0,0017	0,0020	0,0024	0,0030	0,0036	0,0048	0,0060	0,0070	1375 (1200–1600)
H3	M	0.120	0.040	0.028	0.036	0.042	0.048	0.055	0.070	0.085	0.11	0.14	0.17	110 (100–160)
		0,120	0,040	0,0011	0,0014	0,0017	0,0019	0,0022	0,0028	0,0034	0,0044	0,0055	0,0065	360 (330—520)
H5	M	0.250	0.10	0.030	0.038	0.044	0.050	0.060	0.075	0.090	0.12	0.15	0.18	175 (150—200)
		0,250	0,10	0,0012	0,0015	0,0017	0,0020	0,0024	0,0030	0,0036	0,0048	0,0060	0,0070	570 (500—650)
H7	M	0.120	0.040	0.028	0.036	0.042	0.048	0.055	0.070	0.085	0.11	0.14	0.17	110 (100–160)
		0,120	0,040	0,0011	0,0014	0,0017	0,0019	0,0022	0,0028	0,0034	0,0044	0,0055	0,0065	360 (330—520)
H8	M	0.250	0.10	0.030	0.038	0.044	0.050	0.060	0.075	0.090	0.12	0.15	0.18	175 (150—200)
		0,250	0,10	0,0012	0,0015	0,0017	0,0020	0,0024	0,0030	0,0036	0,0048	0,0060	0,0070	570 (500—650)
H11	M	0.250	0.10	0.030	0.038	0.044	0.050	0.060	0.075	0.090	0.12	0.15	0.18	225 (190—260)
		0,250	0,10	0,0012	0,0015	0,0017	0,0020	0,0024	0,0030	0,0036	0,0048	0,0060	0,0070	740 (630—850)
H12	M	0.250	0.10	0.030	0.038	0.044	0.050	0.060	0.075	0.090	0.12	0.15	0.18	205 (170—240)
		0,250	0,10	0,0012	0,0015	0,0017	0,0020	0,0024	0,0030	0,0036	0,0048	0,0060	0,0070	670 (560–780)
H21	M	0.250	0.10	0.030	0.038	0.044	0.050	0.060	0.075	0.090	0.12	0.15	0.18	175 (150—200)
		0,250	0,10	0,0012	0,0015	0,0017	0,0020	0,0024	0,0030	0,0036	0,0048	0,0060	0,0070	570 (500—650)
H31	M	0.200	0.10	0.026	0.032	0.040	0.046	0.050	0.065	0.080	0.10	0.13	0.16	200 (200—280)
		0,200	0,10	0,0010	0,0013	0,0016	0,0018	0,0020	0,0026	0,0032	0,0040	0,0050	0,0065	660 (660—910)

For cutting data recalculations, see pages 445 - 452

SMG = Seco material group

Coolant = A=air D=dry E=emulsion M=mist spray

v_c = m/min (sf/min)

f_z = mm (in/tooth)

a_p = mm/DC (in/DC) = factor

a_e = mm/DC (in/DC) = factor

All cutting data are target values

JH150

High speed – Hardened steel – Ball nose – 4 Flutes – Cylindrical

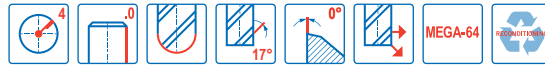
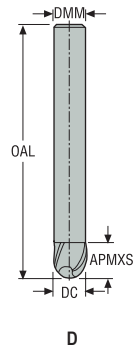

- Tolerances:
- DMM= h5
- DC= -0,02/-0,04 mm
- RE= ±0,01 mm
- Regrind possible if DC is ≥Ø6

Designation	Item number	Length index	Tool shape	DC	DMM	APMXS	OAL	PCEDC	Cylindrical
				mm	mm	mm	mm		
150060-MEGA-64	00019198	2	D	6,0	6,0	6,0	80,0	4	■
150080-MEGA-64	00019208	2	D	8,0	8,0	8,0	85,0	4	■
150100-MEGA-64	00019219	2	D	10,0	10,0	10,0	100,0	4	■
150120-MEGA-64	00019254	2	D	12,0	12,0	12,0	100,0	4	■

■ Stocked standard.

Universal

Steel and cast iron

Stainless steel and S-materials

Non ferrous

Hard

Plastic and cfrp

Graphite

Minimaster Plus

Minimaster

Cutting data – JH150 Copy milling roughing

SMG		a _e /DC	a _p /DC	f _z				v _c
				6	8	10	12	
K1	A	0.300	0.15	0.10	0.14	0.17	0.20	290 (310 – 370)
		0,300	0,15	0,0040	0,0055	0,0065	0,0080	950 (1100 – 1200)
K2	A	0.300	0.15	0.10	0.14	0.17	0.20	250 (270 – 320)
		0,300	0,15	0,0040	0,0055	0,0065	0,0080	820 (890 – 1000)
K3	A	0.300	0.15	0.10	0.14	0.17	0.20	210 (230 – 270)
		0,300	0,15	0,0040	0,0055	0,0065	0,0080	690 (760 – 880)
K5	A	0.200	0.15	0.10	0.14	0.17	0.20	255 (270 – 330)
		0,200	0,15	0,0040	0,0055	0,0065	0,0080	840 (890 – 1000)
K6	A	0.200	0.15	0.10	0.14	0.17	0.20	375 (390 – 500)
		0,200	0,15	0,0040	0,0055	0,0065	0,0080	1225 (1300 – 1600)
K7	A	0.200	0.15	0.10	0.14	0.17	0.20	325 (340 – 430)
		0,200	0,15	0,0040	0,0055	0,0065	0,0080	1075 (1200 – 1400)
H3	M	0.0500	0.020	0.085	0.11	0.14	0.17	85 (88 – 120)
		0,0500	0,020	0,0034	0,0044	0,0055	0,0065	280 (290 – 390)
H5	M	0.200	0.060	0.10	0.14	0.17	0.20	180 (160 – 200)
		0,200	0,060	0,0040	0,0055	0,0065	0,0080	590 (530 – 650)
H7	M	0.0500	0.020	0.085	0.11	0.14	0.17	85 (88 – 120)
		0,0500	0,020	0,0034	0,0044	0,0055	0,0065	280 (290 – 390)
H8	M	0.200	0.060	0.10	0.14	0.17	0.20	180 (160 – 200)
		0,200	0,060	0,0040	0,0055	0,0065	0,0080	590 (530 – 650)
H11	M	0.200	0.060	0.10	0.14	0.17	0.20	230 (210 – 250)
		0,200	0,060	0,0040	0,0055	0,0065	0,0080	750 (690 – 820)
H12	M	0.200	0.060	0.10	0.14	0.17	0.20	210 (190 – 230)
		0,200	0,060	0,0040	0,0055	0,0065	0,0080	690 (630 – 750)
H21	M	0.200	0.060	0.10	0.14	0.17	0.20	180 (160 – 200)
		0,200	0,060	0,0040	0,0055	0,0065	0,0080	590 (530 – 650)
H31	M	0.150	0.060	0.090	0.12	0.15	0.18	125 (130 – 180)
		0,150	0,060	0,0036	0,0048	0,0060	0,0070	410 (430 – 590)

For cutting data recalculations, see pages 445 - 452

SMG = Seco material group
Coolant = A=air D=dry E=emulsion M=mist spray
v_c = m/min (sf/min)
f_z = mm (in/tooth)
a_p = mm/DC (in/DC) = factor
a_e = mm/DC (in/DC) = factor
All cutting data are target values

JH160

High speed – Hardened steel – Ball nose – 4 Flutes – Cylindrical

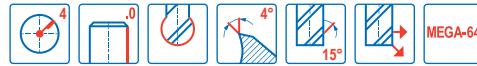
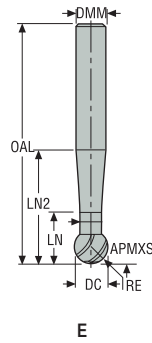

- Tolerances:
- DMM= h5
- DC= 0,02/-0,06 mm
- SA=250°

Designation	Item number	Length index	Tool shape	DC	DMM	APMXS	OAL	LN	LN2	DN	RE	PCEDC	Cylindrical
				mm	mm	mm	mm	mm	mm	mm	mm	mm	mm
160030-MEGA-64	00040365	2	E	3,0	3,0	2,3	60,0	4,5	9,0	1,8	1,5	4	■
160040-MEGA-64	00040366	2	E	4,0	4,0	3,1	60,0	5,6	11,0	2,4	2,0	4	■
160050-MEGA-64	00040367	2	E	5,0	5,0	3,9	70,0	6,4	13,0	3,0	2,5	4	■
160060-MEGA-64	00040368	2	E	6,0	6,0	4,7	80,0	9,7	17,3	3,6	3,0	4	■
160080-MEGA-64	00040369	2	E	8,0	8,0	6,2	85,0	11,2	21,3	4,8	4,0	4	■
160100-MEGA-64	00040370	2	E	10,0	10,0	7,8	100,0	15,6	27,9	6,0	5,0	4	■
160120-MEGA-64	00040371	2	E	12,0	12,0	9,4	125,0	17,2	31,8	7,2	6,0	4	■

■ Stocked standard.

Universal

Steel and cast iron

Stainless steel and S-materials

Non ferrous

Hard

Plastic and CFRP

Graphite

Minimaster Plus

Minimaster

Cutting data – JH160 Copy milling finishing

SMG		a_p /DC	a_r /DC	f_z								v_c
				3	4	5	6	8	10	12		
P1	M/E/A	0.0200	0.024	0.050	0.070	0.085	0.10	0.14	0.17	0.20	550 (450–700)	
		0,0200	0,024	0,0020	0,0028	0,0034	0,0040	0,0055	0,0065	0,0080	1800 (1500 – 2200)	
P2	M/E/A	0.0200	0.024	0.050	0.070	0.085	0.10	0.14	0.17	0.20	530 (440 – 680)	
		0,0200	0,024	0,0020	0,0028	0,0034	0,0040	0,0055	0,0065	0,0080	1750 (1500 – 2200)	
P3	M/E/A	0.0200	0.024	0.050	0.070	0.085	0.10	0.14	0.17	0.20	460 (380 – 590)	
		0,0200	0,024	0,0020	0,0028	0,0034	0,0040	0,0055	0,0065	0,0080	1500 (1300–1900)	
P4	M/E/A	0.0200	0.024	0.050	0.070	0.085	0.10	0.14	0.17	0.20	405 (340 – 520)	
		0,0200	0,024	0,0020	0,0028	0,0034	0,0040	0,0055	0,0065	0,0080	1325 (1200–1700)	
P5	M/E/A	0.0200	0.024	0.050	0.070	0.085	0.10	0.14	0.17	0.20	385 (320 – 490)	
		0,0200	0,024	0,0020	0,0028	0,0034	0,0040	0,0055	0,0065	0,0080	1275 (1100–1600)	
P6	M/E/A	0.0200	0.024	0.050	0.070	0.085	0.10	0.14	0.17	0.20	430 (360 – 560)	
		0,0200	0,024	0,0020	0,0028	0,0034	0,0040	0,0055	0,0065	0,0080	1400 (1200–1800)	
P7	M/E/A	0.0200	0.024	0.050	0.070	0.085	0.10	0.14	0.17	0.20	410 (340 – 520)	
		0,0200	0,024	0,0020	0,0028	0,0034	0,0040	0,0055	0,0065	0,0080	1350 (1200–1700)	
P8	M/E/A	0.0200	0.024	0.050	0.070	0.085	0.10	0.14	0.17	0.20	385 (320 – 490)	
		0,0200	0,024	0,0020	0,0028	0,0034	0,0040	0,0055	0,0065	0,0080	1275 (1100–1600)	
P11	M/E/A	0.0200	0.024	0.050	0.070	0.085	0.10	0.14	0.17	0.20	395 (330 – 510)	
		0,0200	0,024	0,0020	0,0028	0,0034	0,0040	0,0055	0,0065	0,0080	1300 (1100–1600)	
P12	M/E/A	0.0200	0.024	0.050	0.070	0.085	0.10	0.14	0.17	0.20	235 (200 – 300)	
		0,0200	0,024	0,0020	0,0028	0,0034	0,0040	0,0055	0,0065	0,0080	770 (660 – 980)	
H3	M/E/A	0.0100	0.0075	0.040	0.050	0.065	0.080	0.10	0.13	0.16	85 (91–110)	
		0,0100	0,0075	0,0016	0,0020	0,0026	0,0032	0,0040	0,0050	0,0065	280 (300 – 360)	
H5	M/E/A	0.0100	0.016	0.040	0.050	0.065	0.080	0.10	0.13	0.16	340 (320 – 360)	
		0,0100	0,016	0,0016	0,0020	0,0026	0,0032	0,0040	0,0050	0,0065	1125 (1100–1100)	
H7	M/E/A	0.0100	0.0075	0.040	0.050	0.065	0.080	0.10	0.13	0.16	85 (91–110)	
		0,0100	0,0075	0,0016	0,0020	0,0026	0,0032	0,0040	0,0050	0,0065	280 (300 – 360)	
H8	M/E/A	0.0100	0.016	0.040	0.050	0.065	0.080	0.10	0.13	0.16	340 (320 – 360)	
		0,0100	0,016	0,0016	0,0020	0,0026	0,0032	0,0040	0,0050	0,0065	1125 (1100–1100)	
H11	M/E/A	0.0100	0.016	0.040	0.050	0.065	0.080	0.10	0.13	0.16	430 (400 – 460)	
		0,0100	0,016	0,0016	0,0020	0,0026	0,0032	0,0040	0,0050	0,0065	1400 (1400–1500)	
H12	M/E/A	0.0200	0.024	0.050	0.070	0.085	0.10	0.14	0.17	0.20	355 (340 – 380)	
		0,0200	0,024	0,0020	0,0028	0,0034	0,0040	0,0055	0,0065	0,0080	1175 (1200–1200)	
H21	M/E/A	0.0100	0.016	0.040	0.050	0.065	0.080	0.10	0.13	0.16	340 (320 – 360)	
		0,0100	0,016	0,0016	0,0020	0,0026	0,0032	0,0040	0,0050	0,0065	1125 (1100–1100)	
H31	M/E/A	0.0100	0.016	0.040	0.050	0.065	0.080	0.10	0.13	0.16	165 (180 – 210)	
		0,0100	0,016	0,0016	0,0020	0,0026	0,0032	0,0040	0,0050	0,0065	540 (600 – 680)	

For cutting data recalculations, see pages 445 - 452

SMG = Seco material group
Coolant = A=air D=dry E=emulsion M=mist spray
 v_c = m/min (sf/min)
 f_z = mm (in/tooth)
 a_p = mm/DC (in/DC) = factor
 a_r = mm/DC (in/DC) = factor
All cutting data are target values

JME142

Miniature – Hardened steel – Square – 2 Flutes – Cylindrical – Corner radius

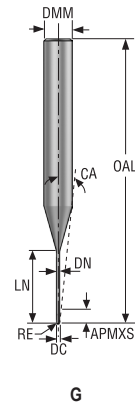

- Tolerances:
- Run-out= <0,005 mm
- DMM = h5
- DC <0,6 = 0-0,008 mm DC>0,6 = 0-0,01 mm
- RE = ±0,005 mm

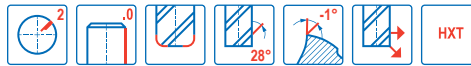

Designation	Item number	Length index	Tool shape	DC	DMM	APMXS	OAL	LN	DN	RE	PCEDC	CA°	WDX0*	WDX05*	WDX1*	WDX15*	WDX2*	WDX3*	Cylindrical
				mm	mm	mm	mm	mm	mm	mm									
JME142018G4R005Z2.0-HXT	03205176	4	G	1,8	6,0	1,35	60,0	18,0	1,75	0,05	2	4,68	18,32	19,0	19,61	20,27	20,97	22,53	■
JME142018G4R010Z2.0-HXT	03205179	4	G	1,8	6,0	1,35	60,0	18,0	1,75	0,1	2	4,69	18,32	19,0	19,61	20,26	20,96	22,52	■
JME142020G4R005Z2.0-HXT	03205182	4	G	2,0	6,0	1,5	60,0	20,0	1,94	0,05	2	4,19	20,35	21,08	21,76	22,49	23,27	25,0	■
JME142020G4R010Z2.0-HXT	03205187	4	G	2,0	6,0	1,5	60,0	20,0	1,94	0,1	2	4,19	20,35	21,08	21,76	22,48	23,26	24,99	■
JME142020G4R020Z2.0-HXT	03205190	4	G	2,0	6,0	1,5	60,0	20,0	1,94	0,2	2	4,21	20,35	21,07	21,75	22,47	23,25	24,97	■
JME142025G4R005Z2.0-HXT	03205194	4	G	2,5	6,0	1,875	65,0	25,0	2,4	0,05	2	3,18	25,47	26,31	27,16	28,07	29,04	31,2	■
JME142025G4R010Z2.0-HXT	03205197	4	G	2,5	6,0	1,875	65,0	25,0	2,4	0,1	2	3,19	25,47	26,31	27,16	28,06	29,03	31,19	■
JME142025G4R020Z2.0-HXT	03205200	4	G	2,5	6,0	1,875	65,0	25,0	2,4	0,2	2	3,2	25,47	26,3	27,15	28,05	29,02	31,17	■
JME142030G4R010Z2.0-HXT	03205207	4	G	3,0	6,0	2,25	80,0	30,0	2,85	0,1	2	2,41	30,59	31,55	32,57	33,66	34,83	-	■
JME142030G4R020Z2.0-HXT	03205210	4	G	3,0	6,0	2,25	80,0	30,0	2,85	0,2	2	2,42	30,59	31,55	32,57	33,65	34,81	-	■
JME142030G4R030Z2.0-HXT	03205213	4	G	3,0	6,0	2,25	80,0	30,0	2,85	0,3	2	2,42	30,59	31,55	32,56	33,64	34,8	-	■
JME142010G5R005Z2.0-HXT	03205143	5	G	1,0	6,0	0,75	60,0	15,0	0,95	0,05	2	5,93	15,32	15,9	16,42	16,97	17,55	18,86	■
JME142015G5R005Z2.0-HXT	03205165	5	G	1,5	6,0	1,125	80,0	22,5	1,45	0,05	2	4,2	22,82	23,64	24,4	25,22	26,09	28,04	■
JME142020G5R005Z2.0-HXT	03205183	5	G	2,0	6,0	1,5	80,0	30,0	1,94	0,05	2	3,07	30,35	31,39	32,41	33,49	34,65	37,24	■
JME142030G5R005Z2.0-HXT	03205203	5	G	3,0	6,0	2,25	90,0	45,0	2,85	0,05	2	1,7	45,59	47,03	48,55	50,17	-	-	■
JME142010G6R005Z2.0-HXT	03205144	6	G	1,0	6,0	0,75	60,0	20,0	0,95	0,05	2	4,92	20,32	21,06	21,74	22,47	23,25	24,98	■
JME142015G6R005Z2.0-HXT	03205166	6	G	1,5	6,0	1,125	80,0	30,0	1,45	0,05	2	3,37	30,32	31,37	32,39	33,47	34,63	37,21	■
JME142020G6R005Z2.0-HXT	03205184	6	G	2,0	6,0	1,5	80,0	40,0	1,94	0,05	2	2,42	40,35	41,71	43,06	44,5	46,04	-	■
JME142030G6R005Z2.0-HXT	03205204	6	G	3,0	6,0	2,25	90,0	60,0	2,85	0,05	2	1,31	60,59	62,5	64,52	-	-	-	■

■ Stocked standard.
For WDX values: Max. cut depth rel. to αη (αη, ref)*

Cutting data – JME144 Side milling roughing

SMG		a _p /DC	a _p /DC	f _z					v _c
				1.0	1.2	1.5	2.0	3	
H3	M/A	0.0500	0.095	0.013	0.016	0.020	0.026	0.040	95 (65–120)
		0,0500	0,095	0,00050	0,00065	0,00080	0,0010	0,0016	310 (220 – 390)
H5	M/A	0.0500	0.22	0.014	0.017	0.020	0.028	0.042	165 (140–190)
		0,0500	0,22	0,00055	0,00065	0,00080	0,0011	0,0017	540 (460 – 620)
H7	M/A	0.0500	0.095	0.013	0.016	0.020	0.026	0.040	95 (65–120)
		0,0500	0,095	0,00050	0,00065	0,00080	0,0010	0,0016	310 (220 – 390)
H8	M/A	0.0500	0.22	0.014	0.017	0.020	0.028	0.042	165 (140–190)
		0,0500	0,22	0,00055	0,00065	0,00080	0,0011	0,0017	540 (460 – 620)
H11	M/A	0.0500	0.22	0.014	0.017	0.020	0.028	0.042	210 (180 – 240)
		0,0500	0,22	0,00055	0,00065	0,00080	0,0011	0,0017	690 (600 – 780)
H12	M/A	0.0500	0.22	0.014	0.017	0.020	0.028	0.042	190 (160 – 220)
		0,0500	0,22	0,00055	0,00065	0,00080	0,0011	0,0017	620 (530 – 720)
H21	M/A	0.0500	0.22	0.014	0.017	0.020	0.028	0.042	165 (140–190)
		0,0500	0,22	0,00055	0,00065	0,00080	0,0011	0,0017	540 (460 – 620)
H31	M/A	0.0500	0.22	0.014	0.017	0.020	0.028	0.042	125 (110–140)
		0,0500	0,22	0,00055	0,00065	0,00080	0,0011	0,0017	410 (370 – 450)

Cutting data – JME144 Slot milling

SMG		a _p /DC	f _z					v _c
			1.0	1.2	1.5	2.0	3,0	
H3	M/A	0.0090	0.0065	0.0075	0.0095	0.013	0.019	65 (43 – 84)
		0,0090	0,00026	0,00030	0,00038	0,00050	0,00075	215 (150 – 270)
H5	M/A	0.019	0.012	0.014	0.018	0.024	0.036	115 (96–130)
		0,019	0,00048	0,00055	0,00070	0,00095	0,0014	375 (320 – 420)
H7	M/A	0.0090	0.0065	0.0075	0.0095	0.013	0.019	65 (43 – 84)
		0,0090	0,00026	0,00030	0,00038	0,00050	0,00075	215 (150 – 270)
H8	M/A	0.019	0.012	0.014	0.018	0.024	0.036	115 (96–130)
		0,019	0,00048	0,00055	0,00070	0,00095	0,0014	375 (320 – 420)
H11	M/A	0.019	0.012	0.014	0.018	0.024	0.036	150 (130–170)
		0,019	0,00048	0,00055	0,00070	0,00095	0,0014	490 (430 – 550)
H12	M/A	0.019	0.012	0.014	0.018	0.024	0.036	135 (120–160)
		0,019	0,00048	0,00055	0,00070	0,00095	0,0014	445 (400 – 520)
H21	M/A	0.019	0.012	0.014	0.018	0.024	0.036	115 (96–130)
		0,019	0,00048	0,00055	0,00070	0,00095	0,0014	375 (320 – 420)
H31	M/A	0.019	0.012	0.014	0.018	0.024	0.036	90 (73–100)
		0,019	0,00048	0,00055	0,00070	0,00095	0,0014	295 (240 – 320)

For cutting data recalculations, see pages 445 - 452.

SMG = Seco material group
Coolant = A=air D=dry E=emulsion M=mist spray
v_c = m/min (sf/min)
f_z = mm (in/tooth)
a_p = mm/DC (in/DC) = factor
a_s = mm/DC (in/DC) = factor
All cutting data are target values

Universal
Steel and cast iron
Stainless steel and S-materials
Non ferrous
Hard
Plastic and cfrp
Graphite
Minimaster Plus
Minimaster

JMB112

Miniature – Hardened steel – Ball nose – 2 Flutes – Cylindrical

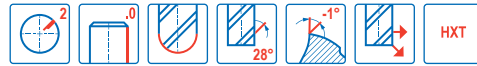
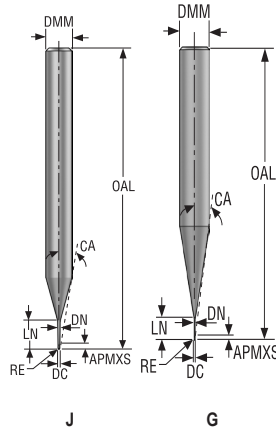

- Tolerances:
- Run-out= <0,005 mm
- DMM=h5
- DC <0,6 = 0-0,008 mm DC>0,6 = 0-0,01 mm
- RE= ±0,004 mm

Designation	Item number	Length index	Tool shape	DC	DMM	APMXS	OAL	LN	DN	RE	PCEDC	CA°	WDX0°	WDX05°	WDX1°	WDX15°	WDX2°	WDX3°	Cylindrical
				mm	mm	mm	mm	mm	mm	mm									
JMB112005J3BZ2.0-HXT	03204973	3	J	0,5	4,0	0,5	40,0	2,5	0,46	0,25	2	11,49	1,54	2,63	2,85	2,99	3,11	3,32	■
JMB112005G3BZ2.0-HXT	03204974	3	G	0,5	6,0	0,5	50,0	3,5	0,46	0,25	2	8,81	3,78	3,99	4,18	4,38	4,61	5,15	■
JMB112006J3BZ2.0-HXT	03204980	3	J	0,6	4,0	0,6	40,0	3,0	0,56	0,3	2		1,57	3,07	3,36	3,52	3,65	3,9	■
JMB112006G3BZ2.0-HXT	03204981	3	G	0,6	6,0	0,6	50,0	4,0	0,56	0,3	2	8,56	4,27	4,51	4,72	4,94	5,2	5,81	■
JMB112008J3BZ2.0-HXT	03204987	3	J	0,8	4,0	0,8	40,0	4,0	0,76	0,4	2	9,67	1,77	3,52	4,38	4,57	4,72	5,05	■
JMB112008G3BZ2.0-HXT	03204988	3	G	0,8	6,0	0,8	50,0	5,5	0,76	0,4	2	10,1	5,77	6,06	6,26	6,46	6,67	7,14	■
JMB112010J3BZ2.0-HXT	03204994	3	J	1,0	4,0	1,0	40,0	5,0	0,95	0,5	2	8,6	2,29	4,57	5,43	5,64	5,82	6,22	■
JMB112010G3BZ2.0-HXT	03204995	3	G	1,0	6,0	1,0	50,0	7,0	0,95	0,5	2	9,06	7,32	7,64	7,87	8,12	8,38	8,97	■
JMB112012J3BZ2.0-HXT	03205003	3	J	1,2	4,0	1,2	50,0	6,0	1,15	0,6	2	7,65	2,49	4,9	6,45	6,68	6,89	7,36	■
JMB112012G3BZ2.0-HXT	03205004	3	G	1,2	6,0	1,2	50,0	8,0	1,15	0,6	2	8,42	8,32	8,67	8,93	9,21	9,51	10,17	■
JMB112015J3BZ2.0-HXT	03205012	3	J	1,5	4,0	1,5	40,0	7,5	1,45	0,75	2	6,4	2,78	5,33	7,97	8,24	8,5	9,08	■
JMB112015G3BZ2.0-HXT	03205013	3	G	1,5	6,0	1,5	50,0	10,0	1,45	0,75	2	7,31	10,32	10,72	11,05	11,39	11,76	12,59	■
JMB112018J3BZ2.0-HXT	03205020	3	J	1,8	4,0	1,8	50,0	9,0	1,75	0,9	2	5,28	3,08	5,81	9,49	9,8	10,11	10,8	■
JMB112018G3BZ2.0-HXT	03205021	3	G	1,8	6,0	1,8	50,0	12,0	1,75	0,9	2	6,35	12,32	12,78	13,17	13,58	14,02	15,0	■
JMB112020J3BZ2.0-HXT	03205026	3	J	2,0	4,0	2,0	50,0	10,0	1,94	1,0	2	4,61	3,6	6,86	10,53	10,86	11,21	11,97	■
JMB112020G3BZ2.0-HXT	03205027	3	G	2,0	6,0	2,0	50,0	12,0	1,94	1,0	2	6,19	12,35	12,8	13,18	13,59	14,03	15,0	■
JMB112025J3BZ2.0-HXT	03205034	3	J	2,5	4,0	2,5	50,0	12,5	2,4	1,25	2	3,13	5,4	10,6	13,15	13,55	13,97	14,92	■
JMB112025G3BZ2.0-HXT	03205035	3	G	2,5	6,0	2,5	50,0	15,0	2,4	1,25	2	4,91	15,47	15,96	16,43	16,94	17,49	18,71	■
JMB112030J3BZ2.0-HXT	03205039	3	J	3,0	4,0	3,0	50,0	15,0	2,85	1,5	2	1,91	7,53	15,03	15,77	16,25	-	-	■
JMB112030G3BZ2.0-HXT	03205040	3	G	3,0	6,0	3,0	60,0	15,0	2,85	1,5	2	4,41	15,59	16,04	16,51	17,01	17,55	18,76	■

■ Stocked standard.
For WDX values: Max. cut depth rel. to αη ((αη, ref)*)

Universal
Steel and cast iron
Stainless steel and S-materials
Non ferrous
Hard
Plastic and chip
Graphite
Minimaster Plus
Minimaster

Cutting data – JMB112 Copy milling roughing

SMG		a _e /DC	a _p /DC	f _z													v _c
				0.2	0.3	0.4	0.5	0.6	0.8	1	1.2	1.5	1.8	2	2.5	3	
H3	M	0.0500	0.30	0.0036	0.0055	0.0070	0.0090	0.011	0.014	0.018	0.022	0.026	0.032	0.036	0.044	0.048	150 (130–170)
		0,0500	0,30	0,00014	0,00022	0,00028	0,00036	0,00044	0,00055	0,00070	0,00085	0,0010	0,0013	0,0014	0,0017	0,0019	490 (430 – 550)
H5	M	0.0500	0.44	0.0040	0.0060	0.0080	0.010	0.012	0.016	0.020	0.024	0.030	0.036	0.040	0.050	0.060	220 (200 – 240)
		0,0500	0,44	0,00016	0,00024	0,00032	0,00040	0,00048	0,00065	0,00080	0,00095	0,0012	0,0014	0,0016	0,0020	0,0024	720 (660–780)
H7	M	0.0500	0.30	0.0036	0.0055	0.0070	0.0090	0.011	0.014	0.018	0.022	0.026	0.032	0.036	0.044	0.048	150 (130–170)
		0,0500	0,30	0,00014	0,00022	0,00028	0,00036	0,00044	0,00055	0,00070	0,00085	0,0010	0,0013	0,0014	0,0017	0,0019	490 (430 – 550)
H8	M	0.0500	0.44	0.0040	0.0060	0.0080	0.010	0.012	0.016	0.020	0.024	0.030	0.036	0.040	0.048	0.050	220 (200 – 240)
		0,0500	0,44	0,00016	0,00024	0,00032	0,00040	0,00048	0,00065	0,00080	0,00095	0,0012	0,0014	0,0016	0,0019	0,0020	720 (660–780)
H11	M	0.0500	0.44	0.0040	0.0060	0.0080	0.010	0.012	0.016	0.020	0.024	0.030	0.036	0.040	0.050	0.060	280 (250 – 310)
		0,0500	0,44	0,00016	0,00024	0,00032	0,00040	0,00048	0,00065	0,00080	0,00095	0,0012	0,0014	0,0016	0,0020	0,0024	920 (830–1000)
H12	M	0.0500	0.44	0.0040	0.0060	0.0080	0.010	0.012	0.016	0.020	0.024	0.030	0.036	0.040	0.048	0.050	255 (230 – 280)
		0,0500	0,44	0,00016	0,00024	0,00032	0,00040	0,00048	0,00065	0,00080	0,00095	0,0012	0,0014	0,0016	0,0019	0,0020	840 (760 – 910)
H21	M	0.0500	0.44	0.0040	0.0060	0.0080	0.010	0.012	0.016	0.020	0.024	0.030	0.036	0.040	0.048	0.050	220 (200 – 240)
		0,0500	0,44	0,00016	0,00024	0,00032	0,00040	0,00048	0,00065	0,00080	0,00095	0,0012	0,0014	0,0016	0,0019	0,0020	720 (660–780)
H31	M	0.0500	0.44	0.0040	0.0060	0.0080	0.010	0.012	0.016	0.020	0.024	0.030	0.034	0.036	0.042	0.044	165 (150–180)
		0,0500	0,44	0,00016	0,00024	0,00032	0,00040	0,00048	0,00065	0,00080	0,00095	0,0012	0,0013	0,0014	0,0017	0,0017	540 (500 – 590)

For cutting data recalculations, see pages 445 - 452.

SMG = Seco material group
 Coolant = A=air D=dry E=emulsion M=mist spray
 v_c = m/min (sf/min)
 f_z = mm (in/tooth)
 a_p = mm/DC (in/DC) = factor
 a_e = mm/DC (in/DC) = factor
 All cutting data are target values

Universal
Steel and cast iron
Stainless steel and S-materials
Non ferrous
Hard
Plastic and cfrp
Graphite
Mimimaster Plus
Mimimaster



PLASTIC AND CFRP

Seco presents a complete solid carbide end mill product range for the machining of glass and carbon fiber reinforced plastics. It consists of diamond-coated and uncoated solid carbide and PCD end mills incorporating different geometries as well as with PCD-brazed cutting edges. This is a product range offering optimized tools for difficult cutting conditions on challenging workpiece materials.

- JC860, JC870, JC871, JC899, JPD890, J93F and J28 for sharp corner type.
- JC845, JC880, JC885 and JC898 for radius type.
- JC875, JC876, JC877 and JPD880 with 45° chamfer type.
- JC850 and JPD850 for ball-nose type.

Universal

Steel and cast iron

Stainless steel and S-materials

Non ferrous

Hard

























Plastic and cfrp

Graphite

Minimaster Plus

Minimaster







































Tool selection Plastic and cfrp

						
Name		JC845	JC850	JC860	JC870	JC871
Page(s)		380	382	384	386	392
Family name		COMPOSITE	COMPOSITE	COMPOSITE	COMPOSITE	COMPOSITE
Type of mill						
Shank	Cylindrical	■	■	■	■	■
	Weldon					
Number of Flutes		3	4	5,6,8,9	2	2
ICC						
Diameter range	Metric	6-8	3-12	6-12	3-12	3-12
	Inch				1/4 -1/2	1/4 -1/2
Length availability						
		2	2	2	2	2
Operation						
						
						
SMG						
TS1						
TS2		●	●	●	●	●
TS3		●	●	●	●	●
TP1						
TP2		●	●	●	●	●
TP3		●	●	●	●	●
Honeycomb*				●	●	●

■ Stock standard □ Weldon available, delivery time is 3 days.
● Preferred choice ○ Alternative choice

























Universal
Steel and cast iron
Stainless steel and S-materials
Non ferrous
Hard
Plastic and cfrp
Graphite
Minimaster Plus
Minimaster

Tool selection Plastic and cfrp

								
Name		JC875	JC876	JC877	JC880	JC885	JC898	JC899
Page(s)		398	402	406	410	412	414	416
Family name		COMPOSITE	COMPOSITE	COMPOSITE	COMPOSITE	COMPOSITE	COMPOSITE	COMPOSITE
Type of mill								
Shank	Cylindrical	■	■	■	■	■	■	■
	Weldon							
Number of Flutes		5,6,10	6,8,10,12,14	6,8,10,12,14	4	4	4	4
ICC							■	
Diameter range	Metric	3-10	3-12	3-12	4-20	4-10	8-15	8,5 - 14,8
	Inch	1/4 - 1/2	1/4-1/2	1/4-1/2				3/8
Length availability								
		2	2	2	2	2	3	3,4
Operation								
								
SMG								
TS1								
TS2		●	●	●	●	●		
TS3		●	●	●	●	●		
TP1								
TP2		●	●	●	●	●		
TP3		●	●	●	●	●		
Honeycomb*								

■ Stock standard □ Weldon available, delivery time is 3 days.

● Preferred choice ○ Alternative choice

Tool selection Plastic and cfrp						
						
Name	JPD850	JPD880	JPD890	J93F	J28	
Page(s)	419	421	423	425	427	
Family name	PCD	PCD	PCD	VHM	VHM	
Type of mill						
Shank	Cylindrical	■	■	■	■	
	Weldon					
Number of Flutes	2	3	2	2	1	
ICC	■	■	■			
Diameter range	Metric	4-10	6-16	6-12	1,5-20	2-12
	Inch					
Length availability						
	2	2,3	2,3	2,3,4	2	
Operation						
						
						
SMG						
TS1				●	●	
TS2	●	●	●			
TS3	●	●	●			
TP1				●		
TP2	●	●	●			
TP3	●	●	●			
Honeycomb*						

■ Stock standard □ Weldon available, delivery time is 3 days.
● Preferred choice ○ Alternative choice

Universal
Steel and cast iron
Stainless steel and S-materials
Non ferrous
Hard
Plastic and cfrp
Graphite
Minimaster Plus
Minimaster

JC845

Composite – Compression – 3 Flutes – Cylindrical – Corner radius

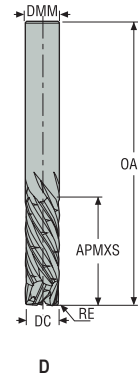

- Tolerances:
- DMM= h5
- DC= -0,02/-0,04 mm
- RE= ±0,01 mm

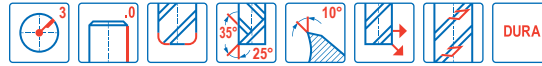

Designation	Item number	Length index	Tool shape	DC	DMM	APMXS	OAL	RE	PCEDC	Cylindrical
				mm	mm	mm	mm	mm		
JC845060D2R050.0Z3-DURA	02843006	2	D	6,0	6,0	18,0	65,0	0,5	3	■
JC845080D2R050.0Z3-DURA	02843007	2	D	8,0	8,0	24,0	75,0	0,5	3	■

■ Stocked standard.

Universal

Steel and cast iron

Stainless steel and S-materials

Non ferrous

Hard

Plastic and cfrp

Graphite

Minimaster Plus

Minimaster

Cutting data – JC845 Side milling roughing

SMG		a _p /DC	a _p /DC	f _z		v _c
				6	8	
TS2	E/A/D	0.376	1.5	0.038	0.050	185 (130 – 240)
		0.376	1.5	0,0015	0,0020	610 (430–780)
TS3	E/A/D	0.376	1.4	0.038	0.050	125 (87–160)
		0.376	1.4	0,0015	0,0020	410 (290 – 520)
TP2	E/A/D	0.376	1.5	0.038	0.050	125 (87–180)
		0.376	1.5	0,0015	0,0020	410 (290 – 590)
TP3	E/A/D	0.376	1.4	0.038	0.050	85 (62–110)
		0.376	1.4	0,0015	0,0020	280 (210 – 360)

Cutting data – JC845 Slot milling

SMG		a _p /DC	f _z		v _c
			6	8	
TS2	E/A/D	1.0	0.025	0.032	160 (110 – 210)
		1,0	0,0010	0,0013	520 (370 – 680)
TS3	E/A/D	0.75	0.025	0.032	105 (76–130)
		0,75	0,0010	0,0013	345 (250 – 420)
TP2	E/A/D	1.0	0.025	0.032	105 (75–160)
		1,0	0,0010	0,0013	345 (250 – 520)
TP3	E/A/D	0.75	0.025	0.032	75 (54 – 96)
		0,75	0,0010	0,0013	245 (180 – 310)

For cutting data recalculations, see pages 445 - 452.

SMG = Seco material group
Coolant = A=air D=dry E=emulsion M=mist spray
v_c= m/min (sf/min)
f_z = mm (in/tooth)
a_p = mm/DC (in/DC) = factor
a_s = mm/DC (in/DC) = factor
All cutting data are target values

Universal
Steel and cast iron
Stainless steel and S-materials
Non ferrous
Hard
Plastic and cfrp
Graphite
Minimaster Plus
Minimaster

JC850

Composite – Ball nose – 4 Flutes – Cylindrical

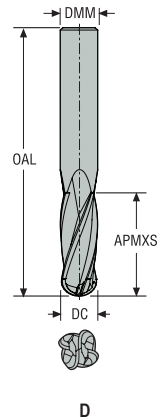

- Tolerances:
- DMM=h5
- DC=-0,02/-0,04 mm
- RE= ±0,02 mm

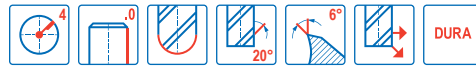

Designation	Item number	Length index	Tool shape	DC	DMM	APMXS	OAL	PCEDC	Cylindrical
				mm	mm	mm	mm		
850030Z4.0-DURA	02719949	2	D	3,0	3,0	9,0	50,0	4	■
850040Z4.0-DURA	02719952	2	D	4,0	4,0	12,0	50,0	4	■
850060Z4.0-DURA	02719953	2	D	6,0	6,0	18,0	65,0	4	■
850080Z4.0-DURA	02719954	2	D	8,0	8,0	24,0	70,0	4	■
850100Z4.0-DURA	02719955	2	D	10,0	10,0	30,0	85,0	4	■
850120Z4.0-DURA	02719956	2	D	12,0	12,0	36,0	100,0	4	■

■ Stocked standard.

Universal

Steel and cast iron

Stainless steel and S-materials

Non ferrous

Hard

Plastic and cfrp

Graphite

Minimaster Plus

Minimaster

Cutting data – JC850 Copy milling

SMG		a _e /DC	a _p /DC	f _z						v _c
				3	4	6	8	10	12	
TS2	E/A/D	0.200	2.0	0.030	0.040	0.060	0.080	0.10	0.12	265 (220 – 320)
		0,200	2,0	0,0012	0,0016	0,0024	0,0032	0,0040	0,0048	870 (730–1000)
TS3	E/A/D	0.200	2.0	0.024	0.032	0.048	0.065	0.080	0.095	160 (110 – 210)
		0,200	2,0	0,00095	0,0013	0,0019	0,0026	0,0032	0,0038	520 (370 – 680)
TP2	E/A/D	0.200	2.0	0.030	0.040	0.060	0.080	0.10	0.12	215 (110 – 320)
		0,200	2,0	0,0012	0,0016	0,0024	0,0032	0,0040	0,0048	710 (370–1000)
TP3	E/A/D	0.200	2.0	0.024	0.032	0.048	0.065	0.080	0.095	105 (54–150)
		0,200	2,0	0,00095	0,0013	0,0019	0,0026	0,0032	0,0038	345 (180 – 490)

For cutting data recalculations, see pages 445 - 452.

SMG = Seco material group
Coolant = A=air D=dry E=emulsion M=mist spray
v_c = m/min (sf/min)
f_z = mm (in/tooth)
a_p = mm/DC (in/DC) = factor
a_e = mm/DC (in/DC) = factor
All cutting data are target values

Universal

Steel and cast iron

Stainless steel and S-materials

Non ferrous

Hard

Plastic and cfrp

Graphite

Minimaster Plus

Minimaster

JC860

Honeycomb – Square – 5-9 Flutes – Cylindrical – Sharp

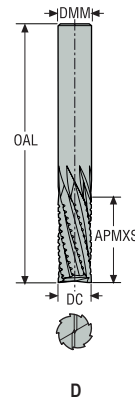

- Tolerances:
- DMM=h5
- DC= -0.02-0.08 mm
- FCEDC=frontal teeth

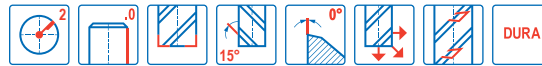

Designation	Item number	Length index	Tool shape	DC	DMM	APMXS	OAL	FCEDC	PCEDC	Cylindrical
				mm	mm	mm	mm			
860060Z5.0-DURA	02720211	2	D	6,0	6,0	18,0	70,0	2	5	■
860080Z6.0-DURA	02720212	2	D	8,0	8,0	24,0	80,0	2	6	■
860100Z8.0-DURA	02720216	2	D	10,0	10,0	30,0	90,0	2	8	■
860120Z9.0-DURA	02720217	2	D	12,0	12,0	36,0	110,0	2	9	■

■ Stocked standard.

Universal

Steel and cast iron

Stainless steel and S-materials

Non ferrous

Hard

Plastic and cfrp

Graphite

Minimaster Plus

Minimaster

Cutting data – JC860 Side milling roughing

SMG		a _e /DC	a _p /DC	f _z				v _c
				6	8	10	12	
TS2	E/A/D	0.100	1.0	0.024	0.032	0.040	0.048	235 (200 – 270)
		0,100	1,0	0,00095	0,0013	0,0016	0,0019	770 (660 – 880)
TS3	E/A/D	0.100	1.0	0.024	0.032	0.040	0.048	160 (130–180)
		0,100	1,0	0,00095	0,0013	0,0016	0,0019	520 (430 – 590)
TP2	E/A/D	0.100	1.0	0.024	0.032	0.040	0.048	165 (130 – 200)
		0,100	1,0	0,00095	0,0013	0,0016	0,0019	540 (430 – 650)
TP3	E/A/D	0.100	1.0	0.024	0.032	0.040	0.048	65 (50–110)
		0,100	1,0	0,00095	0,0013	0,0016	0,0019	215 (170 – 360)

Cutting data – JC860 Slot milling

SMG		a _p /DC	f _z				v _c
			6	8	10	12	
TS2	E/A/D	0.50	0.012	0.016	0.020	0.025	160 (140–180)
		0,50	0,00048	0,00065	0,00080	0,0010	520 (460 – 590)
TS3	E/A/D	0.50	0.012	0.016	0.020	0.025	105 (85–120)
		0,50	0,00048	0,00065	0,00080	0,0010	345 (280 – 390)
TP2	E/A/D	0.50	0.012	0.016	0.020	0.025	110 (84–130)
		0,50	0,00048	0,00065	0,00080	0,0010	360 (280 – 420)
TP3	E/A/D	0.50	0.012	0.016	0.020	0.025	44 (34–78)
		0,50	0,00048	0,00065	0,00080	0,0010	145 (120 – 250)

For cutting data recalculations, see pages 445 - 452.

SMG = Seco material group
Coolant = A=air D=dry E=emulsion M=mist spray
v_c = m/min (sf/min)
f_z = mm (in/tooth)
a_p = mm/DC (in/DC) = factor
a_e = mm/DC (in/DC) = factor
All cutting data are target values

Universal
Steel and cast iron
Stainless steel and S-materials
Non ferrous
Hard
Plastic and cfrp
Graphite
Minimaster Plus
Minimaster

JC870

Composite – Router – Square – Cylindrical – Sharp

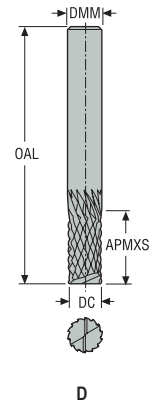

- Tolerances:
- DMM=h5
- DC=-0,02/-0,08 mm
- Router (downcut)*

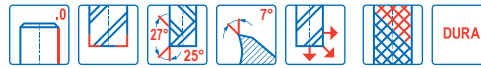

Designation	Item number	Length index	Tool shape	DC	DMM	APMXS	OAL	FCEDC	Cylindrical
				mm	mm	mm	mm		
870030.0-DURA	02720219	2	D	3,0	3,0	9,0	50,0	2	■
870040.0-DURA	02720226	2	D	4,0	4,0	12,0	50,0	2	■
870060.0-DURA	02720228	2	D	6,0	6,0	18,0	65,0	2	■
870080.0-DURA	02720229	2	D	8,0	8,0	24,0	75,0	2	■
870100.0-DURA	02720231	2	D	10,0	10,0	30,0	85,0	2	■
870120.0-DURA	02720232	2	D	12,0	12,0	36,0	100,0	2	■

■ Stocked standard.

*Downcut indicates flute geometries that are combined to create small down forces that assist with maintaining component clamping, particularly where vacuum clamping is employed.

Universal

Steel and cast iron

Stainless steel and S-materials

Non ferrous

Hard

Plastic and cfrp

Graphite

Minimaster Plus

Minimaster

JC870

Composite – Router – Square – Cylindrical – Sharp – Inch

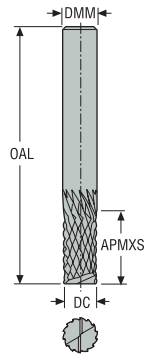

D

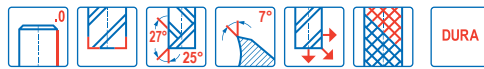

- Tolerances:
- DMM= h5
- DC= -0,02/-0,08 mm
- Router (downcut)*

Designation	Item number	Length index	Tool shape	DC	DMM	APMXS	OAL	FCEDC	Cylindrical
				Inch	Inch	Inch	Inch		
8700250.0-DURA	02720784	2	D	0.250	0.250	0.750	2.250	2	■
8700375.0-DURA	02720785	2	D	0.375	0.375	1.250	3.500	2	■

■ Stocked standard.

*Downcut indicates flute geometries that are combined to create small down forces that assist with maintaining component clamping, particularly where vacuum clamping is employed.

Universal

Steel and cast iron

Stainless steel and S-materials

Non ferrous

Hard

Plastic and cfrp

Graphite

Minimaster Plus

Minimaster

JC870

Composite – Router – Square – Cylindrical – Sharp

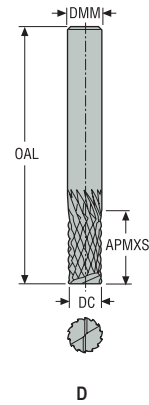

- Tolerances:
- DMM=h5
- DC=-0,02/-0,08 mm
- Router (downcut)*

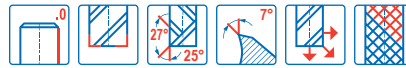

Designation	Item number	Length index	Tool shape	DC	DMM	APMXS	OAL	FCEDC	Cylindrical
				mm	mm	mm	mm		
870030.0	02742789	2	D	3,0	3,0	9,0	50,0	2	■
870040.0	02742792	2	D	4,0	4,0	12,0	50,0	2	■
870050.0	02742793	2	D	5,0	5,0	15,0	50,0	2	■
870060.0	02742794	2	D	6,0	6,0	18,0	65,0	2	■
870080.0	02742795	2	D	8,0	8,0	24,0	75,0	2	■
870100.0	02742796	2	D	10,0	10,0	30,0	85,0	2	■
870120.0	02742797	2	D	12,0	12,0	36,0	100,0	2	■

■ Stocked standard.

*Downcut indicates flute geometries that are combined to create small down forces that assist with maintaining component clamping, particularly where vacuum clamping is employed.

Universal

Steel and cast iron

Stainless steel and S-materials

Non ferrous

Hard

Plastic and cfrp

Graphite

Minimaster Plus

Minimaster

JC870

Composite – Router – Square – Cylindrical – Sharp – Inch

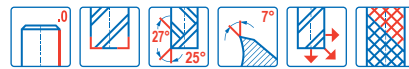
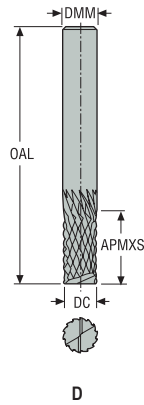

- Tolerances:
- DMM= h5
- DC= - .0008 / -.0015 inch
- Router (downcut)*

Designation	Item number	Length index	Tool shape	DC	DMM	APMXS	OAL	FCEDC	Cylindrical
				Inch	Inch	Inch	Inch		
8700250.0	02742798	2	D	0.250	0.250	0.750	2.250	2	■
8700500.0	02742800	2	D	0.500	0.500	1.500	4.250	2	■

■ Stocked standard.

*Downcut indicates flute geometries that are combined to create small down forces that assist with maintaining component clamping, particularly where vacuum clamping is employed.

Universal

Steel and cast iron

Stainless steel and S-materials

Non ferrous

Hard

Plastic and cfrp

Graphite

Minimaster Plus

Minimaster

Cutting data – JC870 Side milling roughing

SMG		a _p /DC	a _r /DC	f _z							v _c
				3	4	5	6	8	10	12	
TS2	E/A/D	0.350	2.0	0.0095	0.013	0.016	0.019	0.025	0.032	0.038	175 (150 – 200)
		0,350	2,0	0,00038	0,00050	0,00065	0,00075	0,0010	0,0013	0,0015	570 (500 – 650)
TS3	E/A/D	0.350	2.0	0.0095	0.013	0.016	0.019	0.025	0.032	0.038	115 (94 – 130)
		0,350	2,0	0,00038	0,00050	0,00065	0,00075	0,0010	0,0013	0,0015	375 (310 – 420)
TP2	E/A/D	0.350	2.0	0.0095	0.013	0.016	0.019	0.025	0.032	0.038	115 (88 – 140)
		0,350	2,0	0,00038	0,00050	0,00065	0,00075	0,0010	0,0013	0,0015	375 (290 – 450)
TP3	E/A/D	0.350	2.0	0.0095	0.013	0.016	0.019	0.025	0.032	0.038	46 (36 – 81)
		0,350	2,0	0,00038	0,00050	0,00065	0,00075	0,0010	0,0013	0,0015	150 (120 – 260)

Cutting data – JC870 Slot milling

SMG		a _p /DC	f _z							v _c
			3	4	5	6	8	10	12	
TS2	E/A/D	1.0	0.0060	0.0080	0.010	0.012	0.016	0.020	0.025	145 (130 – 170)
		1,0	0,00024	0,00032	0,00040	0,00048	0,00065	0,00080	0,0010	475 (430 – 550)
TS3	E/A/D	1.0	0.0060	0.0080	0.010	0.012	0.016	0.020	0.025	100 (79 – 110)
		1,0	0,00024	0,00032	0,00040	0,00048	0,00065	0,00080	0,0010	330 (260 – 360)
TP2	E/A/D	1.0	0.0060	0.0080	0.010	0.012	0.016	0.020	0.025	100 (74 – 120)
		1,0	0,00024	0,00032	0,00040	0,00048	0,00065	0,00080	0,0010	330 (250 – 390)
TP3	E/A/D	1.0	0.0060	0.0080	0.010	0.012	0.016	0.020	0.025	39 (30 – 68)
		1,0	0,00024	0,00032	0,00040	0,00048	0,00065	0,00080	0,0010	130 (99 – 220)

For cutting data recalculations, see pages 445 - 452.

SMG = Seco material group
Coolant = A=air D=dry E=emulsion M=mist spray
v_c = m/min (sf/min)
f_z = mm (in/tooth)
a_p = mm/DC (in/DC) = factor
a_r = mm/DC (in/DC) = factor
All cutting data are target values

Cutting data – JC870 Side milling roughing – Inch

SMG		a _p /DC		f _z			v _c
				1/4	3/8	1/2	
TS2	E/A/D	0.350	2.0	0.020	0.030	0.038	175 (150 – 200)
		0,350	2,0	0,00080	0,0012	0,0015	570 (500 – 650)
TS3	E/A/D	0.350	2.0	0.020	0.030	0.038	115 (94 – 130)
		0,350	2,0	0,00080	0,0012	0,0015	375 (310 – 420)
TP2	E/A/D	0.350	2.0	0.020	0.030	0.038	115 (88 – 140)
		0,350	2,0	0,00080	0,0012	0,0015	375 (290 – 450)
TP3	E/A/D	0.350	2.0	0.020	0.030	0.038	46 (36 – 81)
		0,350	2,0	0,00080	0,0012	0,0015	150 (120 – 260)

Cutting data – JC870 Slot milling – Inch

SMG		a _p /DC		f _z			v _c
				1/4	3/8	1/2	
TS2	E/A/D	1.0	0.013	0.019	0.026	145 (130 – 170)	
		1,0	0,00050	0,00075	0,0010	475 (430 – 550)	
TS3	E/A/D	1.0	0.013	0.019	0.026	100 (79 – 110)	
		1,0	0,00050	0,00075	0,0010	330 (260 – 360)	
TP2	E/A/D	1.0	0.013	0.019	0.026	100 (74 – 120)	
		1,0	0,00050	0,00075	0,0010	330 (250 – 390)	
TP3	E/A/D	1.0	0.013	0.019	0.026	39 (30 – 68)	
		1,0	0,00050	0,00075	0,0010	130 (99 – 220)	

For cutting data recalculations, see pages 445 - 452.

SMG = Seco material group
Coolant = A=air D=dry E=emulsion M=mist spray
v_c = m/min (sf/min)
f_z = mm/tooth (in/tooth)
a_p = mm/DC (in/DC) = factor
a_e = mm/DC (in/DC) = factor
All cutting data are target values

Universal

Steel and cast iron

Stainless steel and S-materials

Non ferrous

Hard

Plastic and cfrp

Graphite

Minimaster Plus

Minimaster

JC871

Composite – Router – Square – Cylindrical – Sharp

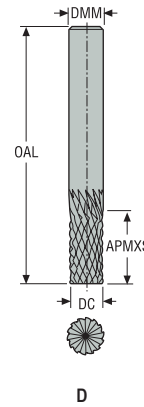

- Tolerances:
- DMM= h5
- DC= -0,02/-0,08 mm
- Router (downcut)*

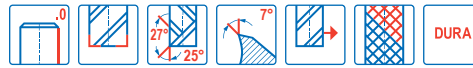

Designation	Item number	Length index	Tool shape	DC	DMM	APMXS	OAL	Cylindrical
				mm	mm	mm	mm	
871030.0-DURA	02720249	2	D	3,0	3,0	9,0	50,0	■
871040.0-DURA	02720250	2	D	4,0	4,0	12,0	50,0	■
871060.0-DURA	02720252	2	D	6,0	6,0	18,0	65,0	■
871080.0-DURA	02720253	2	D	8,0	8,0	24,0	75,0	■
871100.0-DURA	02720254	2	D	10,0	10,0	30,0	85,0	■
871120.0-DURA	02720257	2	D	12,0	12,0	36,0	100,0	■

■ Stocked standard.

*Downcut indicates flute geometries that are combined to create small down forces that assist with maintaining component clamping, particularly where vacuum clamping is employed.

Universal

Steel and cast iron

Stainless steel and S-materials

Non ferrous

Hard

Plastic and cfrp

Graphite

Minimaster Plus

Minimaster

JC871

Composite – Router – Square – Cylindrical – Sharp – Inch

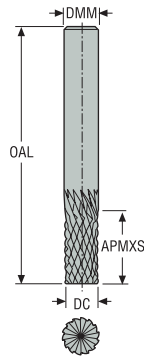

D

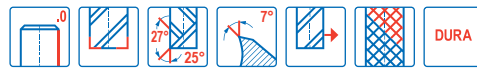

- Tolerances:
- DMM= h5
- DC= -.0008 / -.0015 inch
- Router (downcut)*

Designation	Item number	Length index	Tool shape	DC	DMM	APMXS	OAL	Cylindrical
				Inch	Inch	Inch	Inch	
8710250.0-DURA	02720788	2	D	0.250	0.250	0.750	2.250	■
8710375.0-DURA	02720789	2	D	0.375	0.375	1.250	3.500	■
8710500.0-DURA	02720790	2	D	0.500	0.500	1.500	4.250	■

■ Stocked standard.

*Downcut indicates flute geometries that are combined to create small down forces that assist with maintaining component clamping, particularly where vacuum clamping is employed.

Universal

Steel and cast iron

Stainless steel and S-materials

Non ferrous

Hard

Plastic and cfrp

Graphite

Minimaster Plus

Minimaster

JC871

Composite – Router – Square – Cylindrical – Sharp

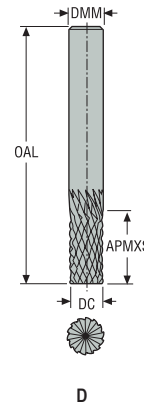

- Tolerances:
- DMM= h5
- DC= -0,02/-0,04 mm
- Router (downcut)*

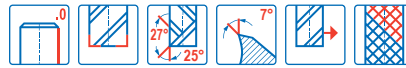

Designation	Item number	Length index	Tool shape	DC	DMM	APMXS	OAL	Cylindrical
				mm	mm	mm	mm	
871030.0	02742801	2	D	3,0	3,0	9,0	50,0	■
871040.0	02742803	2	D	4,0	4,0	12,0	50,0	■
871060.0	02742806	2	D	6,0	6,0	18,0	65,0	■
871080.0	02742807	2	D	8,0	8,0	24,0	75,0	■
871100.0	02742808	2	D	10,0	10,0	30,0	85,0	■
871120.0	02742809	2	D	12,0	12,0	36,0	100,0	■

■ Stocked standard.

*Downcut indicates flute geometries that are combined to create small down forces that assist with maintaining component clamping, particularly where vacuum clamping is employed.

Universal

Steel and cast iron

Stainless steel and S-materials

Non ferrous

Hard

Plastic and cfrp

Graphite

Minimaster Plus

Minimaster

JC871

Composite – Router – Square – Cylindrical – Sharp – Inch

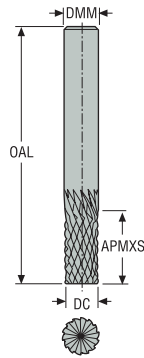

D

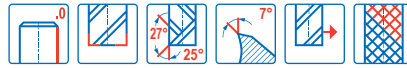

- Tolerances:
- DMM=h5
- DC=-0,02/-0,08 mm
- Router (downcut)*

Designation	Item number	Length index	Tool shape	DC	DMM	APMXS	OAL	Cylindrical
				Inch	Inch	Inch	Inch	
8710500.0	02742814	2	D	0.500	0.500	1.500	4.250	■

■ Stocked standard.

*Downcut indicates flute geometries that are combined to create small down forces that assist with maintaining component clamping, particularly where vacuum clamping is employed.

Universal

Steel and cast iron

Stainless steel and S-materials

Non ferrous

Hard

Plastic and cfrp

Graphite

Minimaster Plus

Minimaster

Cutting data – JC871 Side milling roughing

SMG		a _p /DC	a _r /DC	f _z							v _c
				3	4	5	6	8	10	12	
TS2	E/A/D	0.350	2.0	0.0095	0.013	0.016	0.019	0.025	0.032	0.038	175 (150 – 200)
		0,350	2,0	0,00038	0,00050	0,00065	0,00075	0,0010	0,0013	0,0015	570 (500 – 650)
TS3	E/A/D	0.350	2.0	0.0095	0.013	0.016	0.019	0.025	0.032	0.038	115 (94 – 130)
		0,350	2,0	0,00038	0,00050	0,00065	0,00075	0,0010	0,0013	0,0015	375 (310 – 420)
TP2	E/A/D	0.350	2.0	0.0095	0.013	0.016	0.019	0.025	0.032	0.038	115 (88 – 140)
		0,350	2,0	0,00038	0,00050	0,00065	0,00075	0,0010	0,0013	0,0015	375 (290 – 450)
TP3	E/A/D	0.350	2.0	0.0095	0.013	0.016	0.019	0.025	0.032	0.038	46 (36 – 81)
		0,350	2,0	0,00038	0,00050	0,00065	0,00075	0,0010	0,0013	0,0015	150 (120 – 260)

Cutting data – JC871 Slot milling

SMG		a _p /DC	f _z							v _c
			3	4	5	6	8	10	12	
TS2	E/A/D	1.0	0.0060	0.0080	0.010	0.012	0.016	0.020	0.025	155 (140 – 180)
		1,0	0,00024	0,00032	0,00040	0,00048	0,00065	0,00080	0,0010	510 (460 – 590)
TS3	E/A/D	1.0	0.0060	0.0080	0.010	0.012	0.016	0.020	0.025	105 (84 – 120)
		1,0	0,00024	0,00032	0,00040	0,00048	0,00065	0,00080	0,0010	345 (280 – 390)
TP2	E/A/D	1.0	0.0060	0.0080	0.010	0.012	0.016	0.020	0.025	105 (79 – 130)
		1,0	0,00024	0,00032	0,00040	0,00048	0,00065	0,00080	0,0010	345 (260 – 420)
TP3	E/A/D	1.0	0.0060	0.0080	0.010	0.012	0.016	0.020	0.025	40 (31 – 70)
		1,0	0,00024	0,00032	0,00040	0,00048	0,00065	0,00080	0,0010	130 (110 – 220)

For cutting data recalculations, see pages 445 - 452.

SMG = Seco material group
Coolant = A=air D=dry E=emulsion M=mist spray
v_c = m/min (sf/min)
f_z = mm (in/tooth)
a_p = mm/DC (in/DC) = factor
a_r = mm/DC (in/DC) = factor
All cutting data are target values

Cutting data – JC871 Side milling roughing – Inch

SMG		a _p /DC		f _z			v _c
				1/4	3/8	1/2	
TS2	E/A/D	0.350	2.0	0.020	0.030	0.038	175 (150 – 200)
		0,350	2,0	0,00080	0,0012	0,0015	570 (500 – 650)
TS3	E/A/D	0.350	2.0	0.020	0.030	0.038	115 (94 – 130)
		0,350	2,0	0,00080	0,0012	0,0015	375 (310 – 420)
TP2	E/A/D	0.350	2.0	0.020	0.030	0.038	115 (88 – 140)
		0,350	2,0	0,00080	0,0012	0,0015	375 (290 – 450)
TP3	E/A/D	0.350	2.0	0.020	0.030	0.038	46 (36 – 81)
		0,350	2,0	0,00080	0,0012	0,0015	150 (120 – 260)

Cutting data – JC871 Slot milling – Inch

SMG		a _p /DC	f _z			v _c
			1/4	3/8	1/2	
TS2	E/A/D	1.0	0.013	0.019	0.026	145 (130 – 170)
		1,0	0,00050	0,00075	0,0010	475 (430 – 550)
TS3	E/A/D	1.0	0.013	0.019	0.026	100 (79 – 110)
		1,0	0,00050	0,00075	0,0010	330 (260 – 360)
TP2	E/A/D	1.0	0.013	0.019	0.026	100 (74 – 120)
		1,0	0,00050	0,00075	0,0010	330 (250 – 390)
TP3	E/A/D	1.0	0.013	0.019	0.026	39 (30 – 68)
		1,0	0,00050	0,00075	0,0010	130 (99 – 220)

For cutting data recalculations, see pages 445 - 452.

SMG = Seco material group
Coolant = A=air D=dry E=emulsion M=mist spray
v_c = m/min (sf/min)
f_z = mm/tooth (in/tooth)
a_p = mm/DC (in/DC) = factor
a_e = mm/DC (in/DC) = factor
All cutting data are target values

Universal
Steel and cast iron
Stainless steel and S-materials
Non ferrous
Hard
Plastic and cfrp
Graphite
Minimaster Plus
Minimaster

JC875

Composite – Square – 5-10 Flutes – Cylindrical – Chamfer

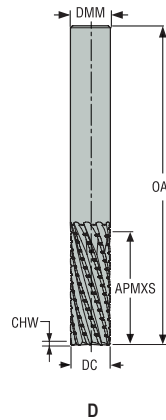

- Tolerances:
- DMM=h5
- DC=-0,02/-0,08 mm

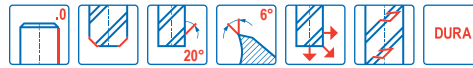

Designation	Item number	Length index	Tool shape	DC	DMM	APMXS	OAL	CHW	PCEDC	Cylindrical
				mm	mm	mm	mm	mm		
JC875030D2.0-DURA	02968155	2	D	3,0	3,0	9,0	50,0	0,05	5	■
JC875050D2.0-DURA	02968157	2	D	5,0	5,0	15,0	50,0	0,05	6	■
JC875060D2.0-DURA	02968158	2	D	6,0	6,0	18,0	65,0	0,06	6	■
JC875080D2.0-DURA	02968159	2	D	8,0	8,0	24,0	70,0	0,08	10	■
JC875100D2.0-DURA	02968160	2	D	10,0	10,0	30,0	80,0	0,1	10	■

■ Stocked standard.

Universal

Steel and cast iron

Stainless steel and S-materials

Non ferrous

Hard

Plastic and cfrp

Graphite

Minimaster Plus

Minimaster

JC875

Composite – Square – 6-10 Flutes – Cylindrical – Chamfer – Inch

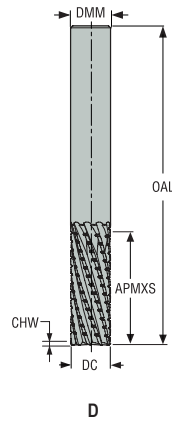

D

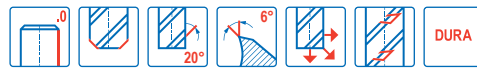

- Tolerances:
- DMM=h5
- DC=-0,02/-0,08 mm



Designation	Item number	Length index	Tool shape	DC	DMM	APMXS	OAL	CHW	PCEDC	Cylindrical
				Inch	Inch	Inch	Inch	Inch		
JC875.250D2.0-DURA	02968162	2	D	0.250	0.250	0.750	3.000	0.002	6	■

■ Stocked standard.

Universal

Steel and cast iron

Stainless steel and S-materials

Non ferrous

Hard

Plastic and cfrp

Graphite

Minimaster Plus

Minimaster

Cutting data – JC875 Side milling roughing

SMG	PICT_Coolant	a _e /DC	a _p /DC	f _z					v _c
				3	5	6	8	10	
TS2	E/A/D	0.350	2.0	0.0095	0.016	0.019	0.025	0.032	190 (160 – 220)
		0,350	2,0	0,00038	0,00065	0,00075	0,0010	0,0013	620 (530 – 720)
TS3	E/A/D	0.350	2.0	0.0095	0.016	0.019	0.025	0.032	130 (110 – 150)
		0,350	2,0	0,00038	0,00065	0,00075	0,0010	0,0013	425 (370 – 490)
TP2	E/A/D	0.350	2.0	0.0095	0.016	0.019	0.025	0.032	130 (96 – 150)
		0,350	2,0	0,00038	0,00065	0,00075	0,0010	0,0013	425 (320 – 490)
TP3	E/A/D	0.350	2.0	0.0095	0.016	0.019	0.025	0.032	50 (39 – 89)
		0,350	2,0	0,00038	0,00065	0,00075	0,0010	0,0013	165 (130 – 290)

Cutting data – JC875 Slot milling

SMG	PICT_Coolant	a _p /DC	f _z					v _c
			3	5	6	8	10	
TS2	E/A/D	1.0	0.0060	0.010	0.012	0.016	0.020	160 (140 – 180)
		1,0	0,00024	0,00040	0,00048	0,00065	0,00080	520 (460 – 590)
TS3	E/A/D	1.0	0.0060	0.010	0.012	0.016	0.020	105 (86 – 120)
		1,0	0,00024	0,00040	0,00048	0,00065	0,00080	345 (290 – 390)
TP2	E/A/D	1.0	0.0060	0.010	0.012	0.016	0.020	105 (81 – 130)
		1,0	0,00024	0,00040	0,00048	0,00065	0,00080	345 (270 – 420)
TP3	E/A/D	1.0	0.0060	0.010	0.012	0.016	0.020	42 (33 – 74)
		1,0	0,00024	0,00040	0,00048	0,00065	0,00080	140 (110 – 240)

For cutting data recalculations, see pages 445 - 452.

SMG = Seco material group
Coolant = A=air D=dry E=emulsion M=mist spray
v_c = m/min (sf/min)
f_z = mm (in/tooth)
a_p = mm/DC (in/DC) = factor
a_e = mm/DC (in/DC) = factor
All cutting data are target values

Cutting data – JC875 Side milling – Inch

SMG	PICT_Coolant	a _e /DC	a _p /DC	f _z			v _c
				1/4	3/8	1/2	
TS2	E/A/D	0.350	2.0	0.020	0.030	0.038	190 (160 – 220)
		0,350	2,0	0,00080	0,0012	0,0015	620 (530–720)
TS3	E/A/D	0.350	2.0	0.020	0.030	0.038	130 (110–150)
		0,350	2,0	0,00080	0,0012	0,0015	425 (370 – 490)
TP2	E/A/D	0.350	2.0	0.020	0.030	0.038	130 (96–150)
		0,350	2,0	0,00080	0,0012	0,0015	425 (320 – 490)
TP3	E/A/D	0.350	2.0	0.020	0.030	0.038	50 (39 – 89)
		0,350	2,0	0,00080	0,0012	0,0015	165 (130 – 290)

Cutting data – JC875 Slot milling – Inch

SMG	PICT_Coolant	a _p /DC	f _z			v _c
			1/4	3/8	1/2	
TS2	E/A/D	1.0	0.013	0.019	0.026	160 (140–180)
		1,0	0,00050	0,00075	0,0010	520 (460 – 590)
TS3	E/A/D	1.0	0.013	0.019	0.026	105 (86–120)
		1,0	0,00050	0,00075	0,0010	345 (290 – 390)
TP2	E/A/D	1.0	0.013	0.019	0.026	105 (81–130)
		1,0	0,00050	0,00075	0,0010	345 (270 – 420)
TP3	E/A/D	1.0	0.013	0.019	0.026	42 (33–74)
		1,0	0,00050	0,00075	0,0010	140 (110 – 240)

For cutting data recalculations, see pages 445 - 452.

SMG = Seco material group
Coolant = A=air D=dry E=emulsion M=mist spray
v_c = m/min (sf/min)
f_z = mm/tooth (in/tooth)
a_p = mm/DC (in/DC) = factor
a_e = mm/DC (in/DC) = factor
All cutting data are target values

Universal
Steel and cast iron
Stainless steel and S-materials
Non ferrous
Hard
Plastic and cfrp
Graphite
Minimaster Plus
Minimaster

JC876

Composite – Square – 6-14 Flutes – Cylindrical – Chamfer

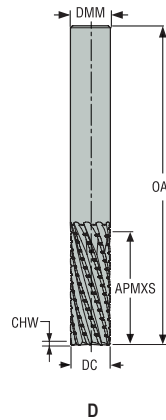

- Tolerances:
- DMM=h5
- DC=-0,02 -0,08 mm
- Left hand helix

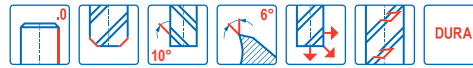

Designation	Item number	Length index	Tool shape	DC	DMM	APMXS	OAL	CHW	PCEDC	Cylindrical
				mm	mm	mm	mm	mm		
JC876030D2C.0Z6-DURA	03135004	2	D	3,0	3,0	7,5	50,0	0,035	6	■
JC876040D2C.0Z6-DURA	03135005	2	D	4,0	4,0	10,0	54,0	0,045	6	■
JC876060D2C.0Z8-DURA	03135006	2	D	6,0	6,0	15,0	62,0	0,075	8	■
JC876060D2C.0Z10-DURA	03135007	2	D	6,0	6,0	15,0	62,0	0,075	10	■
JC876080D2C.0Z10-DURA	03135009	2	D	8,0	8,0	20,0	70,0	0,1	10	■
JC876100D2C.0Z12-DURA	03135011	2	D	10,0	10,0	25,0	82,0	0,125	12	■
JC876120D2C.0Z14-DURA	03135012	2	D	12,0	12,0	30,0	95,0	0,15	14	■

■ Stocked standard.

Universal

Steel and cast iron

Stainless steel and S-materials

Non ferrous

Hard

Plastic and cfrp

Graphite

Minimaster Plus

Minimaster

JC876

Composite – Square – 8-14 Flutes – Cylindrical – Chamfer – Inch

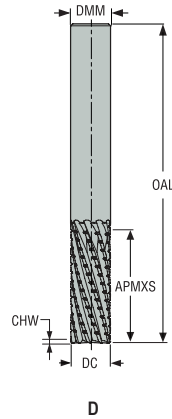

D

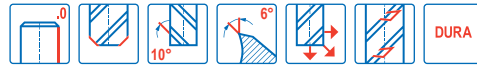

- Tolerances:
- DMM=h5
- DC=-0,02 -0,08 mm
- Left hand helix



Designation	Item number	Length index	Tool shape	DC	DMM	APMXS	OAL	CHW	PCEDC	Cylindrical
				Inch	Inch	Inch	Inch	Inch		
JC876.250D2C.0Z8-DURA	03135125	2	D	0.250	0.250	0.625	2.500	0.003	8	■
JC876.375D2C.0Z12-DURA	03135127	2	D	0.375	0.375	1.000	3.000	0.005	12	■

■ Stocked standard.

Universal

Steel and cast iron

Stainless steel and S-materials

Non ferrous

Hard

Plastic and cfrp

Graphite

Minimaster Plus

Minimaster

Cutting data – JC876 Side milling roughing

SMG	PICT_Coolant	a _p /DC	a _p /DC	f _z						v _c
				3	4	6	8	10	12	
TS2	E/A/D	0.334	1.7	0.0095	0.013	0.019	0.026	0.032	0.038	220 (190 – 250)
		0,334	1,7	0,00038	0,00050	0,00075	0,0010	0,0013	0,0015	720 (630 – 820)
TS3	E/A/D	0.334	1.7	0.0095	0.013	0.019	0.026	0.032	0.038	145 (120 – 170)
		0,334	1,7	0,00038	0,00050	0,00075	0,0010	0,0013	0,0015	475 (400 – 550)
TP2	E/A/D	0.334	1.7	0.0095	0.013	0.019	0.026	0.032	0.038	145 (110 – 180)
		0,334	1,7	0,00038	0,00050	0,00075	0,0010	0,0013	0,0015	475 (370 – 590)
TP3	E/A/D	0.334	1.7	0.0095	0.013	0.019	0.026	0.032	0.038	75 (44 – 100)
		0,334	1,7	0,00038	0,00050	0,00075	0,0010	0,0013	0,0015	245 (150 – 320)

Cutting data – JC876 Slot milling

SMG	PICT_Coolant	a _p /DC	f _z						v _c
			3	4	6	8	10	12	
TS2	E/A/D	1.0	0.0060	0.0080	0.012	0.016	0.020	0.025	175 (150 – 200)
		1,0	0,00024	0,00032	0,00048	0,00065	0,00080	0,0010	570 (500 – 650)
TS3	E/A/D	1.0	0.0060	0.0080	0.012	0.016	0.020	0.025	115 (94 – 140)
		1,0	0,00024	0,00032	0,00048	0,00065	0,00080	0,0010	375 (310 – 450)
TP2	E/A/D	1.0	0.0060	0.0080	0.012	0.016	0.020	0.025	115 (88 – 140)
		1,0	0,00024	0,00032	0,00048	0,00065	0,00080	0,0010	375 (290 – 450)
TP3	E/A/D	1.0	0.0060	0.0080	0.012	0.016	0.020	0.025	60 (36 – 81)
		1,0	0,00024	0,00032	0,00048	0,00065	0,00080	0,0010	195 (120 – 260)

For cutting data recalculations, see pages 445 - 452.

SMG = Seco material group
Coolant = A=air D=dry E=emulsion M=mist spray
v_c = m/min (sf/min)
f_z = mm (in/tooth)
a_p = mm/DC (in/DC) = factor
a_e = mm/DC (in/DC) = factor
All cutting data are target values

Cutting data – JC876 Side milling roughing – Inch

SMG	PICT_Coolant	a _e /DC	a _p /DC	f _z			v _c
				1/4	3/8	1/2	
TS2	E/A/D	0.334	1.7	0.020	0.030	0.040	220 (190 – 250)
		0,334	1,7	0,00080	0,0012	0,0016	720 (630 – 820)
TS3	E/A/D	0.334	1.7	0.020	0.030	0.040	145 (120–170)
		0,334	1,7	0,00080	0,0012	0,0016	475 (400 – 550)
TP2	E/A/D	0.334	1.7	0.020	0.030	0.040	145 (110–180)
		0,334	1,7	0,00080	0,0012	0,0016	475 (370 – 590)
TP3	E/A/D	0.334	1.7	0.020	0.030	0.040	75 (44–100)
		0,334	1,7	0,00080	0,0012	0,0016	245 (150 – 320)

Cutting data – JC876 Slot milling – Inch

SMG	PICT_Coolant	a _p /DC	f _z			v _c
			1/4	3/8	1/2	
TS2	E/A/D	1.0	0.013	0.019	0.026	175 (150 – 200)
		1,0	0,00050	0,00075	0,0010	570 (500 – 650)
TS3	E/A/D	1.0	0.013	0.019	0.026	115 (94–140)
		1,0	0,00050	0,00075	0,0010	375 (310 – 450)
TP2	E/A/D	1.0	0.013	0.019	0.026	115 (88–140)
		1,0	0,00050	0,00075	0,0010	375 (290 – 450)
TP3	E/A/D	1.0	0.013	0.019	0.026	60 (36 – 81)
		1,0	0,00050	0,00075	0,0010	195 (120 – 260)

For cutting data recalculations, see pages 445 - 452.

SMG = Seco material group
Coolant = A=air D=dry E=emulsion M=mist spray
v_c = m/min (sf/min)
f_z = mm/tooth (in/tooth)
a_p = mm/DC (in/DC) = factor
a_e = mm/DC (in/DC) = factor
All cutting data are target values

Universal

Steel and cast iron

Stainless steel and S-materials

Non ferrous

Hard

Plastic and cfrp

Graphite

Minimaster Plus

Minimaster

JC877

Composite – Square – 6-14 Flutes – Cylindrical – Chamfer

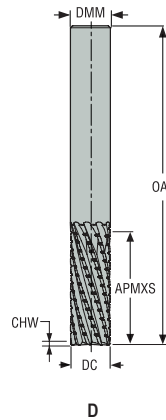

D

- Tolerances:
- DMM=h5
- DC=-0,02, -0,08 mm
- Left hand helix

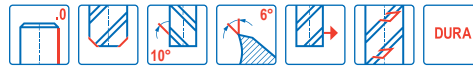

Designation	Item number	Length index	Tool shape	DC	DMM	APMXS	OAL	CHW	PCEDC	Cylindrical
				mm	mm	mm	mm	mm		
JC877030D2C.0Z6-DURA	03135013	2	D	3,0	3,0	9,0	50,0	0,035	6	■
JC877040D2C.0Z6-DURA	03135014	2	D	4,0	4,0	12,0	54,0	0,045	6	■
JC877060D2C.0Z8-DURA	03135015	2	D	6,0	6,0	18,0	62,0	0,075	8	■
JC877060D2C.0Z10-DURA	03135016	2	D	6,0	6,0	18,0	62,0	0,075	10	■
JC877080D2C.0Z10-DURA	03135018	2	D	8,0	8,0	24,0	70,0	0,1	10	■
JC877100D2C.0Z12-DURA	03135020	2	D	10,0	10,0	30,0	82,0	0,125	12	■
JC877120D2C.0Z14-DURA	03135021	2	D	12,0	12,0	36,0	95,0	0,15	14	■

■ Stocked standard.

Universal

Steel and cast iron

Stainless steel and S-materials

Non ferrous

Hard

Plastic and cfrp

Graphite

Minimaster Plus

Minimaster

JC877

Composite – Square – 8-14 Flutes – Cylindrical – Chamfer – Inch

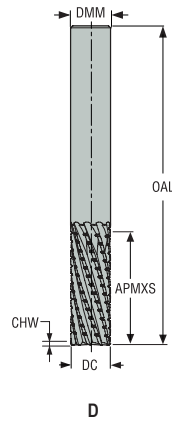

D

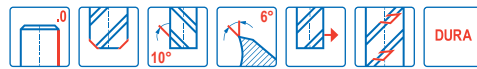

- Tolerances:
- DMM=h5
- DC=-0,02, -0,08 mm
- Left hand helix

Designation	Item number	Length index	Tool shape	DC	DMM	APMXS	OAL	CHW	PCEDC	Cylindrical
				Inch	Inch	Inch	Inch	Inch		
JC877.250D2C.0Z8-DURA	03135129	2	D	0.250	0.250	0.750	2.500	0.003	8	■

■ Stocked standard.

Universal

Steel and cast iron

Stainless steel and S-materials

Non ferrous

Hard

Plastic and cfrp

Graphite

Minimaster Plus

Minimaster

Cutting data – JC877 Side milling roughing

SMG	PICT_Coolant	a _p /DC	a _r /DC	f _z						v _c
				3	4	6	8	10	12	
TS2	E/A/D	0.334	2.0	0.0095	0.013	0.019	0.026	0.032	0.038	195 (170 – 220)
		0,334	2,0	0,00038	0,00050	0,00075	0,0010	0,0013	0,0015	640 (560–720)
TS3	E/A/D	0.334	2.0	0.0095	0.013	0.019	0.026	0.032	0.038	130 (110–150)
		0,334	2,0	0,00038	0,00050	0,00075	0,0010	0,0013	0,0015	425 (370 – 490)
TP2	E/A/D	0.334	2.0	0.0095	0.013	0.019	0.026	0.032	0.038	130 (98–160)
		0,334	2,0	0,00038	0,00050	0,00075	0,0010	0,0013	0,0015	425 (330 – 520)
TP3	E/A/D	0.334	2.0	0.0095	0.013	0.019	0.026	0.032	0.038	65 (40 – 91)
		0,334	2,0	0,00038	0,00050	0,00075	0,0010	0,0013	0,0015	215 (140 – 290)

Cutting data – JC877 Slot milling

SMG	PICT_Coolant	a _p /DC	f _z						v _c
			3	4	6	8	10	12	
TS2	E/A/D	1,0	0,0060	0,0080	0,012	0,016	0,020	0,025	170 (150 – 200)
		1,0	0,0060	0,0080	0,012	0,016	0,020	0,025	115 (92–130)
TP2	E/A/D	1,0	0,0060	0,0080	0,012	0,016	0,020	0,025	115 (86–140)
		1,0	0,0060	0,0080	0,012	0,016	0,020	0,025	55 (35 – 80)

For cutting data recalculations, see pages 445 - 452.

SMG = Seco material group
Coolant = A=air D=dry E=emulsion M=mist spray
v_c = m/min (sf/min)
f_z = mm (in/tooth)
a_p = mm/DC (in/DC) = factor
a_e = mm/DC (in/DC) = factor
All cutting data are target values

Cutting data – JC877 Side milling roughing – Inch

SMG	PICT_Coolant	a _e /DC	a _p /DC	f _z			v _c
				1/4	3/8	1/2	
TS2	E/A/D	0.334	2.0	0.020	0.030	0.040	195 (170 – 220)
		0,334	2,0	0,00080	0,0012	0,0016	640 (560–720)
TS3	E/A/D	0.334	2.0	0.020	0.030	0.040	130 (110–150)
		0,334	2,0	0,00080	0,0012	0,0016	425 (370 – 490)
TP2	E/A/D	0.334	2.0	0.020	0.030	0.040	130 (98–160)
		0,334	2,0	0,00080	0,0012	0,0016	425 (330 – 520)
TP3	E/A/D	0.334	2.0	0.020	0.030	0.040	65 (40 – 91)
		0,334	2,0	0,00080	0,0012	0,0016	215 (140 – 290)

Cutting data – JC877 Slot milling – Inch

SMG	PICT_Coolant	a _p /DC	f _z			v _c
			1/4	3/8	1/2	
TS2	E/A/D	1.0	0.013	0.019	0.026	160 (140–180)
		1,0	0,00050	0,00075	0,0010	520 (460 – 590)
TS3	E/A/D	1.0	0.013	0.019	0.026	105 (85–120)
		1,0	0,00050	0,00075	0,0010	345 (280 – 390)
TP2	E/A/D	1.0	0.013	0.019	0.026	105 (80–130)
		1,0	0,00050	0,00075	0,0010	345 (270 – 420)
TP3	E/A/D	1.0	0.013	0.019	0.026	55 (32–74)
		1,0	0,00050	0,00075	0,0010	180 (110 – 240)

For cutting data recalculations, see pages 445 - 452.

SMG = Seco material group
Coolant = A=air D=dry E=emulsion M=mist spray
v_c= m/min (sf/min)
f_z = mm/tooth (in/tooth)
a_p = mm/DC (in/DC) = factor
a_e = mm/DC (in/DC) = factor
All cutting data are target values

Universal
Steel and cast iron
Stainless steel and S-materials
Non ferrous
Hard
Plastic and cfrp
Graphite
Minimaster Plus
Minimaster

JC880

Composite – Square – 4 Flutes – Cylindrical – Corner radius

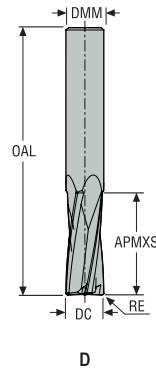

- Tolerances:
- DMM=h5
- DC=-0,02/-0,04 mm
- RE=±0,01 mm

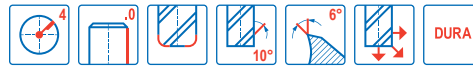

Designation	Item number	Length index	Tool shape	DC	DMM	APMXS	OAL	RE	PCEDC	Cylindrical
				mm	mm	mm	mm	mm		
880040R020Z4.0-DURA	02843012	2	D	4,0	4,0	12,0	50,0	0,2	4	■
880050R020Z4.0-DURA	02843013	2	D	5,0	5,0	15,0	50,0	0,2	4	■
880060R020Z4.0-DURA	02720258	2	D	6,0	6,0	18,0	65,0	0,2	4	■
880080R020Z4.0-DURA	02720259	2	D	8,0	8,0	24,0	70,0	0,2	4	■
880100R020Z4.0-DURA	02720260	2	D	10,0	10,0	30,0	80,0	0,2	4	■
880120R020Z4.0-DURA	02720261	2	D	12,0	12,0	36,0	100,0	0,2	4	■
880160R020Z4.0-DURA	02720262	2	D	16,0	16,0	48,0	110,0	0,2	4	■
880200R020Z4.0-DURA	02720263	2	D	20,0	20,0	60,0	130,0	0,2	4	■

■ Stocked standard.

Cutting data – JC880 Side milling roughing

SMG		a _p /DC	a _p /DC	f _z							v _c
				4	6	8	10	12	16	20	
TS2	E/A/D	0.400	1.9	0.024	0.036	0.048	0.060	0.070	0.090	0.10	190 (160 – 210)
		0,400	1,9	0,00095	0,0014	0,0019	0,0024	0,0028	0,0036	0,0040	620 (530 – 680)
TS3	E/A/D	0.300	2.0	0.017	0.025	0.034	0.042	0.050	0.060	0.070	130 (93 – 170)
		0,300	2,0	0,00065	0,0010	0,0013	0,0017	0,0020	0,0024	0,0028	425 (310 – 550)
TP2	E/A/D	0.400	1.9	0.024	0.036	0.048	0.060	0.070	0.090	0.10	125 (95 – 150)
		0,400	1,9	0,00095	0,0014	0,0019	0,0024	0,0028	0,0036	0,0040	410 (320 – 490)
TP3	E/A/D	0.300	2.0	0.017	0.025	0.034	0.042	0.050	0.060	0.070	50 (40 – 92)
		0,300	2,0	0,00065	0,0010	0,0013	0,0017	0,0020	0,0024	0,0028	165 (140 – 300)

Cutting data – JC880 Slot milling

SMG		a _p /DC	f _z								v _c
			4	5	6	8	10	12	16	20	
TS2	E/A/D	1.0	0.024	0.030	0.036	0.048	0.060	0.070	0.090	0.10	150 (130 – 170)
		1,0	0,00095	0,0012	0,0014	0,0019	0,0024	0,0028	0,0036	0,0040	490 (430 – 550)
TS3	E/A/D	1.0	0.015	0.019	0.022	0.030	0.038	0.044	0.055	0.065	100 (71 – 130)
		1,0	0,00060	0,00075	0,00085	0,0012	0,0015	0,0017	0,0022	0,0026	330 (240 – 420)
TP2	E/A/D	1.0	0.024	0.030	0.036	0.048	0.060	0.070	0.090	0.10	100 (76 – 120)
		1,0	0,00095	0,0012	0,0014	0,0019	0,0024	0,0028	0,0036	0,0040	330 (250 – 390)
TP3	E/A/D	1.0	0.015	0.019	0.022	0.030	0.038	0.044	0.055	0.065	40 (31 – 70)
		1,0	0,00060	0,00075	0,00085	0,0012	0,0015	0,0017	0,0022	0,0026	130 (110 – 220)

For cutting data recalculations, see pages 445 - 452.

SMG = Seco material group
Coolant = A=air D=dry E=emulsion M=mist spray
v_c = m/min (sf/min)
f_z = mm (in/tooth)
a_p = mm/DC (in/DC) = factor
a_s = mm/DC (in/DC) = factor
All cutting data are target values

Universal
Steel and cast iron
Stainless steel and S-materials
Non ferrous
Hard
Plastic and cfrp
Graphite
Minimaster Plus
Minimaster

JC885

Composite – Square – 4 Flutes – Cylindrical – Corner radius

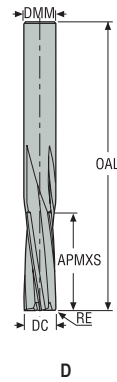

- Tolerances:
- DMM=h5
- DC=-0,02/-0,04 mm
- RE=±0,01 mm

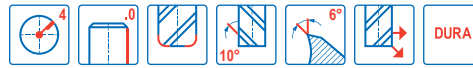

Designation	Item number	Length index	Tool shape	DC	DMM	APMXS	OAL	RE	PCEDC	Cylindrical
				mm	mm	mm	mm	mm		
JC885040D2R020.0Z4-DURA	02843014	2	D	4,0	4,0	12,0	50,0	0,2	4	■
JC885060D2R020.0Z4-DURA	02843016	2	D	6,0	6,0	18,0	70,0	0,2	4	■
JC885080D2R020.0Z4-DURA	02843017	2	D	8,0	8,0	24,0	80,0	0,2	4	■

■ Stocked standard.

Universal

Steel and cast iron

Stainless steel and S-materials

Non ferrous

Hard

Plastic and cfrp

Graphite

Minimaster Plus

Minimaster

Cutting data – JC885 Side milling roughing

SMG		a _p /DC	a _p /DC	f _z				v _c
				4	6	8	10	
TS2	E/A/D	0.400	2.0	0.024	0.036	0.048	0.060	190 (160 – 210)
		0.400	2.0	0,00095	0,0014	0,0019	0,0024	620 (530 – 680)
TS3	E/A/D	0.300	2.0	0.017	0.025	0.034	0.042	130 (99 – 170)
		0,300	2,0	0,00065	0,0010	0,0013	0,0017	425 (330 – 550)
TP2	E/A/D	0.400	2.0	0.024	0.036	0.048	0.060	125 (94 – 150)
		0,400	2,0	0,00095	0,0014	0,0019	0,0024	410 (310 – 490)
TP3	E/A/D	0.300	2.0	0.017	0.025	0.034	0.042	50 (33 – 92)
		0,300	2,0	0,00065	0,0010	0,0013	0,0017	165 (110 – 300)

Cutting data – JC885 Slot milling

SMG		a _p /DC	f _z				v _c
			4	6	8	10	
TS2	E/A/D	1.0	0.024	0.036	0.048	0.060	150 (130 – 170)
		1,0	0,00095	0,0014	0,0019	0,0024	490 (430 – 550)
TS3	E/A/D	0.70	0.015	0.022	0.030	0.038	100 (76 – 130)
		0,70	0,00060	0,00085	0,0012	0,0015	330 (250 – 420)
TP2	E/A/D	1.0	0.024	0.036	0.048	0.060	100 (75 – 120)
		1,0	0,00095	0,0014	0,0019	0,0024	330 (250 – 390)
TP3	E/A/D	0.70	0.015	0.022	0.030	0.038	40 (26 – 70)
		0,70	0,00060	0,00085	0,0012	0,0015	130 (86 – 220)

For cutting data recalculations, see pages 445 - 452.

SMG = Seco material group
Coolant = A=air D=dry E=emulsion M=mist spray
v_c = m/min (sf/min)
f_z = mm (in/tooth)
a_p = mm/DC (in/DC) = factor
a_e = mm/DC (in/DC) = factor
All cutting data are target values

Universal
Steel and cast iron
Stainless steel and S-materials
Non ferrous
Hard
Plastic and cfrp
Graphite
Minimaster Plus
Minimaster

JC898

High feed – Stacked materials – Corner radius – 4 Flutes – Cylindrical – Corner radius

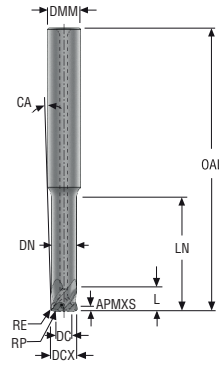

G

- Tolerances:
- DMM=h5
- DC= e7
- RE= ±0,1 mm
- CA= collision angle

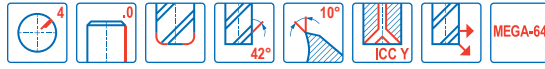

Designation	Item number	Length index	Tool shape	ICC	DC	DCX	DMM	APMXS	L	OAL	LN	DN	RE	RP	CA°	PCEDC	Cylindrical
					mm	mm	mm	mm	mm	mm	mm	mm	mm	mm	mm	mm	mm
JC898080G3HZ4A.0-M64	03245308	3	G	■	4,0	8,0	10,0	0,43	6,0	88,0	35,0	7,6	0,5	0,87	1,5°	4	■
JC898150G3HZ4A.0-M64	03245309	3	G	■	7,5	15,0	16,0	0,796	12,0	125,0	70,0	14,3	0,94	1,63	0,4°	4	■

■ Stocked standard.

Universal

Steel and cast iron

Stainless steel and S-materials

Non ferrous

Hard

Plastic and cfrp

Graphite

Minimaster Plus

Minimaster

Cutting data – JC898 Side milling

SMG		a _p /DCX		f _z		v _c
				8	15	
S12+TS2/TP2	D	0,30	0,020	0,1	0,15	90 (80-120)
		0,30	0,020	0,0040	0,0060	300 (270-400)
TP2+TS2/TP2	D	0,30	0,034	0,12	0,25	120 (90-150)
		0,30	0,034	0,0048	0,0100	400 (300-490)

Cutting data – JC898 Slot milling

SMG		a _p /DCX		f _z		v _c
				8	15	
S12+TP2/TS2	D	0.020	0.08	0.10		90 (80-120)
		0.020	0.0032	0.0040		300 (270-400)
N1+TP2/TS2	D	0.034	0.1	0.10		120 (90-150)
		0.034	0.0040	0.0040		400 (300-490)

For cutting data recalculations, see pages 445 - 452.

SMG = Seco material group
Coolant = A=air D=dry E=emulsion M=mist spray
v_c = m/min (sf/min)
f_z = mm (in/tooth)
a_p = mm/DC (in/DC) = factor
a_e = mm/DC (in/DC) = factor
All cutting data are target values

Universal

Steel and cast iron

Stainless steel and S-materials

Non ferrous

Hard

Plastic and cfrp

Graphite

Minimaster Plus

Minimaster

JC899

High performance – Stacked materials – Square – 4 Flutes – Cylindrical – Sharp

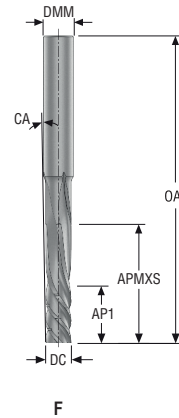

F

- Tolerances:
- DMM=h5
- DC= ±0,02 mm
- CA= collision angle

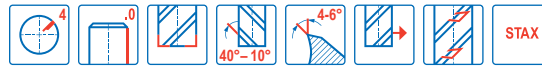

Designation	Item number	Length index	Tool shape	Chip splitters	DC	DMM	APMXS	AP1	OAL	CA°	PCEDC	Cylindrical
					mm	mm	mm	mm	mm			
JC899085F3S.0Z4-STAX	03245482	3	F	■	8,5	10,0	38,0	19,0	100,0	0,8 °	4	■
JC899148F3S.0Z4-STAX	03245480	3	F	■	14,8	16,0	55,0	30,0	150,0	0,53 °	4	■
JC899148F4S.0Z4-STAX	03245481	4	F	■	14,8	16,0	62,0	37,0	150,0	0,48 °	4	■

■ Stocked standard.

Universal

Steel and cast iron

Stainless steel and S-materials

Non ferrous

Hard

Plastic and cfrp

Graphite

Minimaster Plus

Minimaster

JC899

High performance – Stacked materials – Square – 4 Flutes – Cylindrical – Sharp – Inch

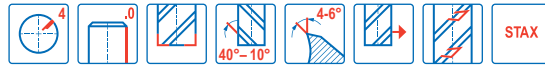
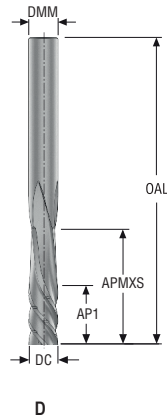

- Tolerances:
- DMM=h5
- DC= ±0,0008 Inch

Designation	Item number	Length index	Tool shape	Chip splitters	DC	DMM	APMXS	AP1	OAL	PCEDC	Cylindrical
					Inch	Inch	Inch	Inch	Inch		
JC8990375D4S.0Z4-STAX	03245483	4	D	■	0.373	0.375	1.500	0.625	4.000	4	■

■ Stocked standard.

Universal

Steel and cast iron

Stainless steel and S-materials

Non ferrous

Hard

Plastic and cfrp

Graphite

Minimaster Plus

Minimaster

Cutting data – JC899 Finishing

SMG		a _e /DC		a _p /DC		f _z		v _c	
						8.5	14.8		
S12+TP2/TS2	D	0,025	0,025	4,0	4,0	0,04	0,075	40 (30 – 50)	140 (100–170)
N1+TP2/TS2	D	0,025	0,025	4,0	4,0	0,06	0,09	60 (50–75)	200 (170 – 250)
						0,0016	0,0030		
						0,0032	0,0036		

Cutting data – JC899 Finishing – Inch

SMG		a _e /DC		a _p /DC		f _z		v _c	
						3/8			
S12+TP2/TS2	D	0,025	0,025	4,0	4,0	0,05	0,0022	40 (30 – 50)	140 (100–170)
N1+TP2/TS2	D	0,025	0,025	4,0	4,0	0,07	0,0028	60 (50–75)	200 (170 – 250)

For cutting data recalculations, see pages 445 - 452.

SMG = Seco material group
Coolant = A=air D=dry E=emulsion M=mist spray
v_c = m/min (sf/min)
f_z = mm (in/tooth)
a_p = mm/DC (in/DC) = factor
a_e = mm/DC (in/DC) = factor
All cutting data are target values

JPD850

Composite – Ball nose – 2 Flutes – Cylindrical – ICC

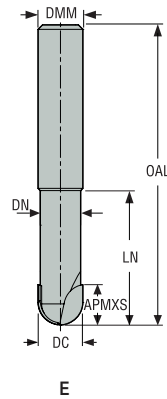

E

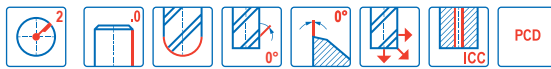

- Tolerances:
- DMM=h5
- DC= h10
- ICC= 2 straight channels

Designation	Item number	Length index	Tool shape	ICC	DC	DMM	APMXS	OAL	LN	DN	PCEDC	Cylindrical
					mm	mm	mm	mm	mm	mm		
JPD850040G2B.0Z2A	02968182	2	G	■	4,0	6,0	6,0	58,0	12,0	3,8	2	■
JPD850050G2B.0Z2A	02968183	2	G	■	5,0	6,0	6,0	58,0	15,0	4,8	2	■
JPD850060E2B.0Z2A	02968184	2	E	■	6,0	6,0	7,0	58,0	18,0	5,4	2	■
JPD850080E2B.0Z2A	02968185	2	E	■	8,0	8,0	8,0	64,0	24,0	7,2	2	■
JPD850100E2B.0Z2A	02968186	2	E	■	10,0	10,0	10,0	73,0	30,0	9,0	2	■

■ Stocked standard.
ICC = Internal Coolant Channel

Universal

Steel and cast iron

Stainless steel and S-materials

Non ferrous

Hard

Plastic and cfrp

Graphite

Minimaster Plus

Minimaster

Cutting data – JPD850 Copy milling

SMG	PICT_Coolant	a _e /DC	a _p /DC	f _z					v _c
				4	5	6	8	10	
TS2	E/A/D	0.200	0.50	0.040	0.048	0.060	0.080	0.10	550 (470 – 820)
		0,200	0,50	0,0016	0,0019	0,0024	0,0032	0,0040	1800 (1600 – 2600)
TS3	E/A/D	0.200	0.50	0.040	0.048	0.060	0.080	0.10	310 (270 – 460)
		0,200	0,50	0,0016	0,0019	0,0024	0,0032	0,0040	1025 (890 – 1500)
TP2	E/A/D	0.200	0.50	0.040	0.048	0.060	0.080	0.10	890 (750 – 1300)
		0,200	0,50	0,0016	0,0019	0,0024	0,0032	0,0040	2925 (2500 – 4200)
TP3	E/A/D	0.200	0.50	0.040	0.048	0.060	0.080	0.10	580 (500 – 870)
		0,200	0,50	0,0016	0,0019	0,0024	0,0032	0,0040	1900 (1700 – 2800)

For cutting data recalculations, see pages 445 - 452.

SMG = Seco material group

Coolant = A=air D=dry E=emulsion M=mist spray

v_c = m/min (sf/min)

f_z = mm (in/tooth)

a_p = mm/DC (in/DC) = factor

a_e = mm/DC (in/DC) = factor

All cutting data are target values

Universal

Steel and cast iron

Stainless steel and S-materials

Non ferrous

Hard

Plastic and cfrp

Graphite

Minimaster Plus

Minimaster

JPD880

Composite – Square – 3 Flutes – Cylindrical – Chamfer – ICC

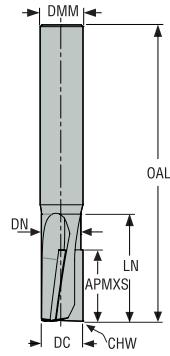

E



- Tolerances:
- DMM=h5
- DC=h10
- ICC=Y

Designation	Item number	Length index	Tool shape	ICC	DC	DMM	APMXS	OAL	LN	DN	CHW	PCEDC	Cylindrical
					mm	mm	mm	mm	mm	mm	mm		
JPD880060G2C.0Z3A	02968190	2	G	■	6,0	8,0	13,0	64,0	20,0	5,3	0,1	3	■
JPD880080E2C.0Z3A	02968191	2	E	■	8,0	8,0	15,0	64,0	20,0	7,3	0,1	3	■
JPD880100E2C.0Z3A	02968192	2	E	■	10,0	10,0	13,0	73,0	30,0	9,2	0,1	3	■
JPD880120E2C.0Z3A	02968194	2	E	■	12,0	12,0	13,0	83,0	30,0	11,0	0,1	3	■
JPD880160E2C.0Z3A	02968196	2	E	■	16,0	16,0	13,0	90,0	35,0	14,8	0,1	3	■
JPD880100E3C.0Z3A	02968193	3	E	■	10,0	10,0	20,0	73,0	30,0	9,2	0,1	3	■
JPD880160E3C.0Z3A	02968197	3	E	■	16,0	16,0	20,0	90,0	35,0	14,8	0,1	3	■

■ Stocked standard.
ICC = Internal Coolant Channel

Universal

Steel and cast iron

Stainless steel and S-materials

Non ferrous

Hard

Plastic and cfrp

Graphite

Minimaster Plus

Minimaster

Cutting data – JPD880 Side milling

SMG	PICT_Coolant	a _e /DC	a _p /DC	f _z					v _c
				6	8	10	12	16	
TS2	E/A/D	0.300	1.2	0.060	0.080	0.10	0.12	0.15	510 (430–750)
		0,300	1,2	0,0024	0,0032	0,0040	0,0048	0,0060	1675 (1500 – 2400)
TS3	E/A/D	0.300	1.2	0.060	0.080	0.10	0.12	0.15	275 (230 – 410)
		0,300	1,2	0,0024	0,0032	0,0040	0,0048	0,0060	900 (760–1300)
TP2	E/A/D	0.300	1.2	0.060	0.080	0.10	0.12	0.15	810 (680 – 940)
		0,300	1,2	0,0024	0,0032	0,0040	0,0048	0,0060	2650 (2300 – 3000)
TP3	E/A/D	0.300	1.2	0.060	0.080	0.10	0.12	0.15	520 (440–780)
		0,300	1,2	0,0024	0,0032	0,0040	0,0048	0,0060	1700 (1500 – 2500)

Cutting data – JPD880 Slot milling

SMG	PICT_Coolant	a _p /DC	f _z					v _c
			6	8	10	12	16	
TS2	E/A/D	1.0	0.055	0.075	0.090	0.11	0.14	385 (330 – 570)
		1,0	0,0022	0,0030	0,0036	0,0044	0,0055	1275 (1100–1800)
TS3	E/A/D	1.0	0.055	0.075	0.090	0.11	0.14	210 (180 – 310)
		1,0	0,0022	0,0030	0,0036	0,0044	0,0055	690 (600–1000)
TP2	E/A/D	1.0	0.055	0.075	0.090	0.11	0.14	620 (520–710)
		1,0	0,0022	0,0030	0,0036	0,0044	0,0055	2025 (1800 – 2300)
TP3	E/A/D	1.0	0.055	0.075	0.090	0.11	0.14	395 (340 – 590)
		1,0	0,0022	0,0030	0,0036	0,0044	0,0055	1300 (1200–1900)

For cutting data recalculations, see pages 445 - 452.

SMG = Seco material group
Coolant = A=air D=dry E=emulsion M=mist spray
v_c = m/min (sf/min)
f_z = mm (in/tooth)
a_p = mm/DC (in/DC) = factor
a_e = mm/DC (in/DC) = factor
All cutting data are target values

JPD890

Composite – Square – 2 Flutes – Cylindrical – Chamfer – ICC

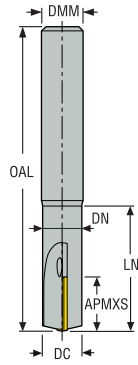

E

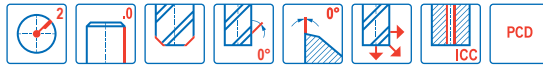

- Tolerances:
- DMM=h5
- DC=h10
- ICC=2 straight channels

Designation	Item number	Length index	Tool shape	ICC	DC	DMM	APMXS	OAL	LN	DN	CHW	PCEDC	Cylindrical
					mm	mm	mm	mm	mm	mm	mm		
JPD890060G2S.0Z2A	02791382	2	G	■	6,0	8,0	13,0	64,0	20,0	5,4	0,1	2	■
JPD890080E2S.0Z2A	02791383	2	E	■	8,0	8,0	15,0	64,0	20,0	7,4	0,1	2	■
JPD890100E2S.0Z2A	02791384	2	E	■	10,0	10,0	13,0	73,0	30,0	9,4	0,1	2	■
JPD890120E2S.0Z2A	02791386	2	E	■	12,0	12,0	13,0	83,0	30,0	11,4	0,1	2	■
JPD890100E3S.0Z2A	02791385	3	E	■	10,0	10,0	20,0	73,0	30,0	9,4	0,1	2	■
JPD890120E3S.0Z2A	02791387	3	E	■	12,0	12,0	20,0	83,0	30,0	11,4	0,1	2	■

■ Stocked standard.
ICC = Internal Coolant Channel

Universal

Steel and cast iron

Stainless steel and S-materials

Non ferrous

Hard

Plastic and cfrp

Graphite

Minimaster Plus

Minimaster

Universal
Steel and cast iron
Cutting data – JPD890 Side milling

SMG	PICT_Coolant	a _e /DC	a _p /DC	f _z				v _c
				6	8	10	12	
TS2	E/A/D	0.300	1.2	0.12	0.16	0.20	0.24	415 (360 – 620)
		0,300	1,2	0,0048	0,0065	0,0080	0,0095	1350 (1200 – 2000)
TS3	E/A/D	0.200	1.2	0.060	0.080	0.10	0.12	305 (260 – 450)
		0,200	1,2	0,0024	0,0032	0,0040	0,0048	1000 (860 – 1400)
TP2	E/A/D	0.300	1.2	0.12	0.16	0.20	0.24	670 (560 – 770)
		0,300	1,2	0,0048	0,0065	0,0080	0,0095	2200 (1900 – 2500)
TP3	E/A/D	0.200	1.2	0.060	0.080	0.10	0.12	580 (490 – 860)
		0,200	1,2	0,0024	0,0032	0,0040	0,0048	1900 (1700 – 2800)

Stainless steel and S-materials
Non ferrous
Cutting data – JPD890 Slot milling

SMG	PICT_Coolant	a _p /DC	f _z				v _c
			6	8	10	12	
TS2	E/A/D	1.0	0.060	0.080	0.10	0.12	375 (320 – 550)
		1,0	0,0024	0,0032	0,0040	0,0048	1225 (1100 – 1800)
TS3	E/A/D	1.0	0.042	0.055	0.070	0.085	225 (190 – 330)
		1,0	0,0017	0,0022	0,0028	0,0034	740 (630 – 1000)
TP2	E/A/D	1.0	0.060	0.080	0.10	0.12	600 (500 – 690)
		1,0	0,0024	0,0032	0,0040	0,0048	1975 (1700 – 2200)
TP3	E/A/D	1.0	0.042	0.055	0.070	0.085	420 (360 – 630)
		1,0	0,0017	0,0022	0,0028	0,0034	1375 (1200 – 2000)

For cutting data recalculations, see pages 445 - 452.

Hard
SMG = Seco material group
Coolant = A=air D=dry E=emulsion M=mist spray
v_c = m/min (sf/min)
f_z = mm (in/tooth)
a_p = mm/DC (in/DC) = factor
a_e = mm/DC (in/DC) = factor
All cutting data are target values

J93F

General purpose – Plastic – Square – 2 Flutes – Cylindrical – Sharp

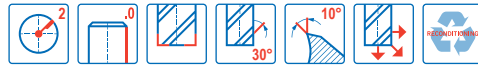
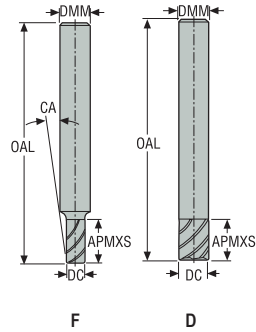

- Tolerances:
- DMM= h5
- DC= $\varnothing 1\text{-}\varnothing 6 = -0,02/-0,034$ mm
- DC= $\varnothing 8\text{-}\varnothing 20 = -0,02/-0,044$ mm
- Regrind possible if DC is $\geq \varnothing 6$

Designation	Item number	Length index	Tool shape	DC	DMM	APMXS	OAL	CA	PCEDC	Cylindrical
				mm	mm	mm	mm	mm		
93015-F	02605874	2	F	1,5	3,0	6,0	40,0	4,0	2	■
93020-F	02605888	2	F	2,0	3,0	9,0	40,0	2,5	2	■
93030-F	02606060	2	D	3,0	3,0	12,0	40,0	-	2	■
93040-F	02606061	2	D	4,0	4,0	14,0	50,0	-	2	■
93060-F	02606063	2	D	6,0	6,0	20,0	65,0	-	2	■
93080-F	02606064	2	D	8,0	8,0	20,0	70,0	-	2	■
93100-F	02606065	2	D	10,0	10,0	25,0	80,0	-	2	■
93120-F	02606066	2	D	12,0	12,0	25,0	90,0	-	2	■
93160-F	02606068	2	D	16,0	16,0	30,0	90,0	-	2	■
93L060-F	02606071	3	D	6,0	6,0	40,0	100,0	-	2	■
93L080-F	02606072	3	D	8,0	8,0	40,0	100,0	-	2	■
93L100-F	02606073	3	D	10,0	10,0	40,0	100,0	-	2	■
93L120-F	02606074	3	D	12,0	12,0	45,0	100,0	-	2	■
93L160-F	02606077	3	D	16,0	16,0	45,0	100,0	-	2	■
93L200-F	02606078	3	D	20,0	20,0	55,0	125,0	-	2	■
93XL120-F	02606079	4	D	12,0	12,0	30,0	150,0	-	2	■
93XL160-F	02606080	4	D	16,0	16,0	65,0	150,0	-	2	■
93XL200-F	02606081	4	D	20,0	20,0	65,0	150,0	-	2	■

■ Stocked standard.

Universal

Steel and cast iron

Stainless steel and S-materials

Non ferrous

Hard

Plastic and cfrp

Graphite

Minimaster Plus

Minimaster

Universal
Cutting data – J93F Side milling

SMG		a _e /DC	a _p /DC	f _z										v _c
				1.5	2	3	4	6	8	10	12	16	20	
TS1	A	0.400	1.4	0.015	0.020	0.030	0.040	0.060	0.080	0.10	0.12	0.15	0.17	590 (480–710)
		0,400	1,4	0,00060	0,00080	0,0012	0,0016	0,0024	0,0032	0,0040	0,0048	0,0060	0,0065	1925 (1600 – 2300)
TP1	A	0.400	1.4	0.015	0.020	0.030	0.040	0.060	0.080	0.10	0.12	0.15	0.17	570 (460 – 680)
		0,400	1,4	0,00060	0,00080	0,0012	0,0016	0,0024	0,0032	0,0040	0,0048	0,0060	0,0065	1875 (1600 – 2200)

Steel and cast iron
Stainless steel and S-materials
Cutting data – J93F Slot milling

SMG		a _p /DC	f _z										v _c
			1.5	2	3	4	6	8	10	12	16	20	
TS1	A	0.50	0.012	0.016	0.024	0.032	0.048	0.065	0.080	0.095	0.13	0.16	500 (400 – 590)
		0,50	0,00048	0,00065	0,00095	0,0013	0,0019	0,0026	0,0032	0,0038	0,0050	0,0065	1650 (1400–1900)
TP1	A	0.50	0.012	0.016	0.024	0.032	0.048	0.065	0.080	0.095	0.13	0.16	485 (390 – 580)
		0,50	0,00048	0,00065	0,00095	0,0013	0,0019	0,0026	0,0032	0,0038	0,0050	0,0065	1600 (1300–1900)

For cutting data recalculations, see pages 445 - 452.

Non ferrous
SMG = Seco material group
Coolant = A=air D=dry E=emulsion M=mist spray
v_c = m/min (sf/min)
f_z = mm (in/tooth)
a_p = mm/DC (in/DC) = factor
a_e = mm/DC (in/DC) = factor
All cutting data are target values

J28

General purpose – Plastic – Square – 1 Flute – Cylindrical – Sharp

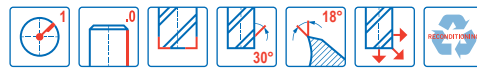
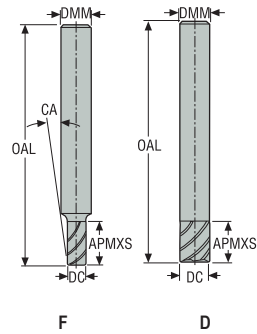

- Tolerances:
- DMM= h5
- DC= $\varnothing 2\text{-}\varnothing 6 = -0,02/-0,034$ mm
- DC= $\varnothing 8\text{-}\varnothing 12 = -0,02/-0,044$ mm
- Regrind possible if DC is $\geq \varnothing 6$

Designation	Item number	Length index	Tool shape	DC	DMM	APMXS	OAL	CA	PCEDC	Cylindrical
				mm	mm	mm	mm	mm		
28020	00029348	2	F	2,0	3,0	4,0	40,0	3,0	1	■
28030	00029353	2	D	3,0	3,0	10,0	40,0	–	1	■
28040	00029361	2	D	4,0	4,0	14,0	50,0	–	1	■
28050	00029363	2	D	5,0	5,0	16,0	60,0	–	1	■
28060	00029366	2	D	6,0	6,0	20,0	65,0	–	1	■
28080	00029369	2	D	8,0	8,0	25,0	75,0	–	1	■
28100	00029370	2	D	10,0	10,0	25,0	75,0	–	1	■
28120	00029372	2	D	12,0	12,0	25,0	75,0	–	1	■

■ Stocked standard.

Universal

Steel and cast iron

Stainless steel and S-materials

Non ferrous

Hard

Plastic and cfrp

Graphite

Minimaster Plus

Minimaster

Universal
Cutting data – J28 Side milling $a_p/DC=0,4$

SMG		a_p/DC	a_p/DC	f_z								v_c
				2	3	4	5	6	8	10	12	
TS1	A/D	0.300 0,300	1.5 1,5	0.026 0,0010	0.040 0,0016	0.050 0,0020	0.065 0,0026	0.080 0,0032	0.10 0,0040	0.13 0,0050	0.16 0,0065	490 (370 — 610) 1600 (1300 — 2000)

Steel and cast iron
Cutting data – J28 Slot milling

SMG		a_p/DC	f_z								v_c
			2	3	4	5	6	8	10	12	
TS1	A/D	1.0 1,0	0.018 0,00070	0.026 0,0010	0.036 0,0014	0.044 0,0017	0.055 0,0022	0.070 0,0028	0.090 0,0036	0.11 0,0044	400 (310 — 490) 1300 (1100–1600)

For cutting data recalculations, see pages 445 - 452.

SMG = Seco material group

Coolant = A=air D=dry E=emulsion M=mist spray

v_c = m/min (sf/min)

f_z = mm/tooth (in/tooth)

a_p = mm/DC (in/DC) = factor

a_e = mm/DC (in/DC) = factor

All cutting data are target values



GRAPHITE

Seco diamond-coated solid carbide end mills are designed specifically for machining graphite. They offer up to 10 times more tool life than milling cutters with conventional coatings. Available in a variety of geometries and an extensive diameter range, these tools feature the best possible substrate to ensure the perfect adhesion of the diamond coating across a range of cutting parameters.

- JD620, JD630, JD640 and JME642 for radius type.
- JD660 and JMB642 for ball-nose type.

Universal

Steel and cast iron

Stainless steel and S-materials

Non ferrous



















Hard

Plastic and cfrp











Graphite

Minimaster Plus

Minimaster

Universal		Tool selection Graphite			
Steel and cast iron					
Stainless steel and S-materials					
Non ferrous					
Hard					
Plastic and cfrp					
Graphite					
Minimaster Plus					
Minimaster					
Name		JD620	JD630	JD640	JD660
Page(s)		432	434	436	[XXX]-[XXX]
Family name		DIAMOND	DIAMOND	DIAMOND	DIAMOND
Type of mill					
Shank	Cylindrical	■	■	■	■
	Weldon				
Number of Flutes		2	3	4	2
ICC					
Diameter range	Metric	3-12	3-8	6-12	3-6
	Inch				
Length availability					
		2,3,4	2,3,4	2,3,4	1,2,3,4
Operation					
					
					
SMG					
GR		●	●	●	●

■ Stock standard □ Weldon available, delivery time is 3 days.
● Preferred choice ○ Alternative choice

Tool selection Graphite		
		
Name	JME642	JMB642
Page(s)	440	442
Family name	MINI DIAMOND	MINI DIAMOND
Type of mill		
Shank	Cylindrical	■
	Weldon	
Number of Flutes	2	2
ICC		
Diameter range	Metric	0,2-2,0
	Inch	
Length availability		
	1,3,5,6,7	1,3,5,6,7
Operation		
		
		
SMG		
GR	●	●

■ Stock standard □ Weldon available, delivery time is 3 days.
● Preferred choice ○ Alternative choice

Universal

Steel and cast iron

Stainless steel and S-materials

Non ferrous

Hard

Plastic and cfrp

Graphite

Minimaster Plus

Minimaster

JD620

Diamond – Graphite – Square – 2 Flutes – Cylindrical – Corner radius

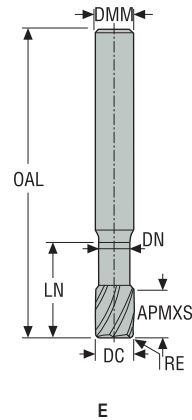

- Tolerances:
- Run-out= <0,01 mm
- DMM= h5
- DC= -0,02/-0,04 mm
- RE= ±0,05 mm

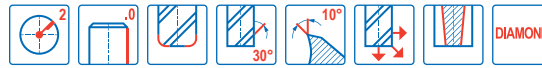

Designation	Item number	Length index	Tool shape	DC	DMM	APMXS	OAL	LN	DN	RE	PCEDC	Cylindrical
				mm	mm	mm	mm	mm	mm	mm		
620V030R050-DIAMOND	00023425	2	E	3,0	3,0	5,0	60,0	30,0	2,85	0,5	2	■
620V040R050-DIAMOND	00023427	2	E	4,0	4,0	5,0	60,0	30,0	3,85	0,5	2	■
620V060R050-DIAMOND	00023429	2	E	6,0	6,0	10,0	80,0	40,0	5,8	0,5	2	■
620V080R050-DIAMOND	00023431	2	E	8,0	8,0	10,0	80,0	40,0	7,7	0,5	2	■
620V100R050-DIAMOND	00023435	2	E	10,0	10,0	10,0	80,0	40,0	9,7	0,5	2	■
620V120R050-DIAMOND	00023437	2	E	12,0	12,0	10,0	80,0	40,0	11,7	0,5	2	■
620VL060R050-DIAMOND	00023444	3	E	6,0	6,0	10,0	100,0	70,0	5,8	0,5	2	■
620VL080R050-DIAMOND	00023446	3	E	8,0	8,0	10,0	100,0	70,0	7,8	0,5	2	■
620VL080R100-DIAMOND	00023447	3	E	8,0	8,0	10,0	100,0	70,0	7,8	1,0	2	■
620VL100R050-DIAMOND	00023448	3	E	10,0	10,0	10,0	100,0	70,0	9,8	0,5	2	■
620VL100R100-DIAMOND	00023449	3	E	10,0	10,0	10,0	100,0	70,0	9,8	1,0	2	■
620VL120R050-DIAMOND	00023450	3	E	12,0	12,0	10,0	100,0	70,0	11,8	0,5	2	■
620VL120R100-DIAMOND	00023451	3	E	12,0	12,0	10,0	100,0	70,0	11,7	1,0	2	■
620VSL100R100-DIAMOND	00023452	4	E	10,0	10,0	10,0	150,0	100,0	9,8	1,0	2	■
620VSL120R100-DIAMOND	00023453	4	E	12,0	12,0	10,0	150,0	100,0	11,8	1,0	2	■

■ Stocked standard.

Cutting data – JD620 Side milling

SMG		a _e /DC	a _p /DC	f _z						v _c
				3	4	6	8	10	12	
GR1	D	0.500	0.50	0.030	0.040	0.060	0.080	0.10	0.12	690 (580 – 800) 2275 (2000 – 2600)
		0,500	0,50	0,0012	0,0016	0,0024	0,0032	0,0040	0,0048	

Cutting data – JD620 Slot milling

SMG		a _p /DC	f _z						v _c
			3	4	6	8	10	12	
GR1	D	0.50	0.024	0.032	0.048	0.065	0.080	0.095	610 (520–710) 2000 (1800 – 2300)
		0,50	0,00095	0,0013	0,0019	0,0026	0,0032	0,0038	

For cutting data recalculations, see pages 445 - 452.

SMG = Seco material group
 Coolant = A=air D=dry E=emulsion M=mist spray
 v_c = m/min (sf/min)
 f_z = mm (in/tooth)
 a_p = mm/DC (in/DC) = factor
 a_e = mm/DC (in/DC) = factor
 All cutting data are target values

Universal
Steel and cast iron
Stainless steel and S-materials
Non ferrous
Hard
Plastic and cfrp
Graphite
Minimaster Plus
Minimaster

JD630

Diamond – Graphite – Square – 3 Flutes – Cylindrical – Corner radius

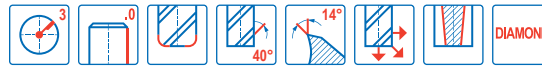
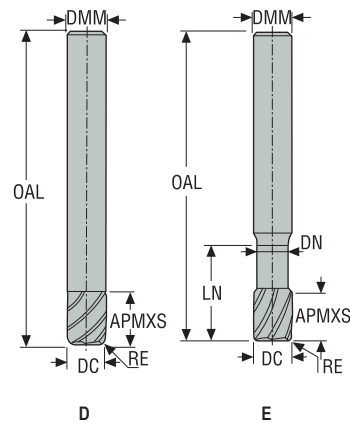

- Tolerances:
- Run-out= <0,01 mm
- DMM= h5
- DC= -0,02/-0,04 mm
- RE= ±0,05 mm

Designation	Item number	Length index	Tool shape	DC	DMM	APMXS	OAL	LN	DN	RE	PCEDC	Cylindrical
				mm	mm	mm	mm	mm	mm	mm		
630030R015-DIAMOND	00023454	2	D	3,0	3,0	12,0	40,0	-	-	0,15	3	■
630040R020-DIAMOND	00023456	2	D	4,0	4,0	14,0	50,0	-	-	0,2	3	■
630050R030-DIAMOND	00023457	2	D	5,0	5,0	16,0	50,0	-	-	0,3	3	■
630060R030-DIAMOND	00023458	2	D	6,0	6,0	20,0	65,0	-	-	0,3	3	■
630080R050-DIAMOND	00023459	2	D	8,0	8,0	20,0	65,0	-	-	0,5	3	■
630V030R030-DIAMOND	00023464	3	E	3,0	3,0	5,0	40,0	15,0	2,9	0,3	3	■
630VL030R020-DIAMOND	00023467	3	E	3,0	3,0	5,0	60,0	25,0	2,9	0,2	3	■
630V040R030-DIAMOND	00023465	3	E	4,0	4,0	5,0	50,0	20,0	3,9	0,3	3	■
630VL040R020-DIAMOND	00023470	4	E	4,0	4,0	5,0	60,0	30,0	3,9	0,2	3	■
630VL050R020-DIAMOND	00023471	4	E	5,0	5,0	6,0	70,0	40,0	4,9	0,2	3	■
630VL060R050-DIAMOND	00023472	4	E	6,0	6,0	10,0	100,0	60,0	5,9	0,5	3	■

■ Stocked standard.

Cutting data – JD630 Side milling

SMG		a _p /DC		f _z					v _c
				3	4	5	6	8	
GR1	D	0.500	1.0	0.030	0.040	0.050	0.060	0.080	680 (580–790) 2225 (2000 – 2500)
		0,500	1,0	0,0012	0,0016	0,0020	0,0024	0,0032	

Cutting data – JD630 Slot milling

SMG		a _p /DC		f _z					v _c
				3	4	5	6	8	
GR1	D	0.50	0.024	0.032	0.040	0.048	0.065	620 (520–720) 2025 (1800 – 2300)	
		0,50	0,00095	0,0013	0,0016	0,0019	0,0026		

For cutting data recalculations, see pages 445 - 452.

SMG = Seco material group
 Coolant = A=air D=dry E=emulsion M=mist spray
 v_c = m/min (sf/min)
 f_z = mm (in/tooth)
 a_p = mm/DC (in/DC) = factor
 a_e = mm/DC (in/DC) = factor
 All cutting data are target values

Universal
Steel and cast iron
Stainless steel and S-materials
Non ferrous
Hard
Plastic and cfrp
Graphite
Minimaster Plus
Minimaster

JD640

Diamond – Graphite – Square – 4 Flutes – Cylindrical – Corner radius

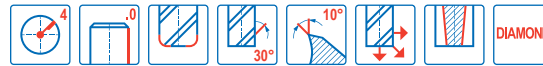
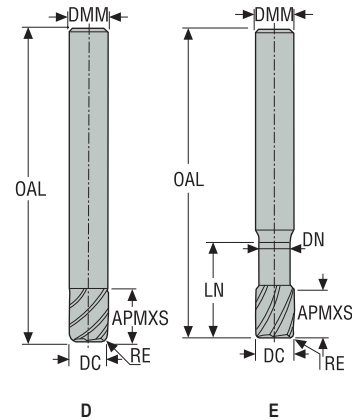

- Tolerances:
- Run-out= <0,01 mm
- DMM= h5
- DC= -0,02/-0,04 mm
- RE= ±0,05 mm

Designation	Item number	Length index	Tool shape	DC	DMM	APMXS	OAL	LN	DN	RE	PCEDC	Cylindrical
				mm	mm	mm	mm	mm	mm	mm		
640100R050-DIAMOND	00023474	2	D	10,0	10,0	25,0	75,0	–	–	0,5	4	■
640120R050-DIAMOND	00023475	2	D	12,0	12,0	25,0	80,0	–	–	0,5	4	■
640V060R050-DIAMOND	00023479	3	E	6,0	6,0	10,0	80,0	40,0	5,9	0,5	4	■
640V080R050-DIAMOND	00023480	3	E	8,0	8,0	10,0	80,0	40,0	7,8	0,5	4	■
640VL080R100-DIAMOND	00023485	3	E	8,0	8,0	10,0	100,0	60,0	7,8	1,0	4	■
640V100R050-DIAMOND	00023481	3	E	10,0	10,0	12,0	80,0	40,0	9,8	0,5	4	■
640V100R100-DIAMOND	00039781	3	E	10,0	10,0	12,0	80,0	40,0	9,8	1,0	4	■
640V120R050-DIAMOND	00023483	3	E	12,0	12,0	15,0	80,0	40,0	11,8	0,5	4	■
640V120R100-DIAMOND	00023484	3	E	12,0	12,0	15,0	80,0	40,0	11,8	1,0	4	■
640VL100R050-DIAMOND	00023486	4	E	10,0	10,0	12,0	125,0	80,0	9,8	0,5	4	■
640VL100R100-DIAMOND	02462696	4	E	10,0	10,0	12,0	125,0	80,0	9,7	1,0	4	■
640VL120R050-DIAMOND	02462698	4	E	12,0	12,0	15,0	125,0	80,0	11,7	0,5	4	■
640VL120R100-DIAMOND	00023487	4	E	12,0	12,0	15,0	125,0	80,0	11,8	1,0	4	■

■ Stocked standard.

Cutting data – JD640 Side milling

SMG		a _p /DC	a _p /DC	f _z				v _c
				6	8	10	12	
GR1	D	0.500	1.0	0.060	0.080	0.10	0.12	680 (570–780)
		0,500	1,0	0,0024	0,0032	0,0040	0,0048	2225 (1900 – 2500)

Cutting data – JD640 Slot milling

SMG		a _p /DC	f _z				v _c
			6	8	10	12	
GR1	D	0.50	0.048	0.065	0.080	0.095	610 (520–710)
		0,50	0,0019	0,0026	0,0032	0,0038	2000 (1800 – 2300)

For cutting data recalculations, see pages 445 - 452.

SMG = Seco material group
 Coolant = A=air D=dry E=emulsion M=mist spray
 v_c = m/min (sf/min)
 f_z = mm (in/tooth)
 a_p = mm/DC (in/DC) = factor
 a_e = mm/DC (in/DC) = factor
 All cutting data are target values

Universal
Steel and cast iron
Stainless steel and S-materials
Non ferrous
Hard
Plastic and cfrp
Graphite
Minimaster Plus
Minimaster

JD660

Diamond – Graphite – Ball nose – 2 Flutes – Cylindrical

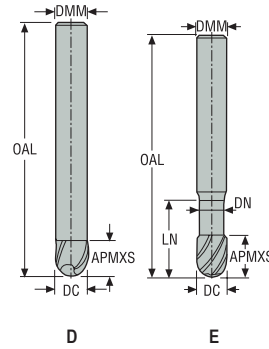

- Tolerances:
- Run-out=<0,01 mm
- DMM=h5
- DC= -0,02/-0,04 mm
- RE= ±0,01 mm
- B=0,9°

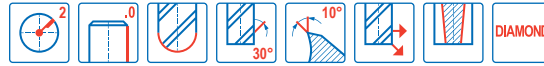

Designation	Item number	Length index	Tool shape	DC	DMM	APMXS	OAL	LN	DN	RE	PCEDC	Cylindrical
				mm	mm	mm	mm	mm	mm	mm		
660030-DIAMOND	00023488	1	D	3,0	3,0	8,0	40,0	-	-	1,5	2	■
660040-DIAMOND	00023489	1	D	4,0	4,0	14,0	50,0	-	-	2,0	2	■
660060-DIAMOND	00023491	1	D	6,0	6,0	20,0	65,0	-	-	3,0	2	■
660V030-DIAMOND	00023501	2	E	3,0	3,0	6,0	40,0	15,0	2,9	1,5	2	■
660V040-DIAMOND	00023502	2	E	4,0	4,0	6,0	40,0	15,0	3,9	2,0	2	■
660V060-DIAMOND	00023505	2	E	6,0	6,0	10,0	65,0	35,0	5,9	3,0	2	■
660L030-DIAMOND	00023494	3	D	3,0	3,0	20,0	60,0	-	-	1,5	2	■
660L040-DIAMOND	00023496	3	D	4,0	4,0	30,0	60,0	-	-	2,0	2	■
660L060-DIAMOND	00023498	3	D	6,0	6,0	40,0	100,0	-	-	3,0	2	■
660VL030-DIAMOND	00023511	4	E	3,0	3,0	6,0	60,0	30,0	2,9	1,5	2	■
660VL040-DIAMOND	00023512	4	E	4,0	4,0	6,0	60,0	30,0	3,9	2,0	2	■
660VL060-DIAMOND	00023516	4	E	6,0	6,0	10,0	100,0	70,0	5,8	3,0	2	■

■ Stocked standard.

Universal

Steel and cast iron

Stainless steel and S-materials

Non ferrous

Hard

Plastic and cfrp

Graphite

Minimaster Plus

Minimaster

Cutting data – JD660 Copy milling roughing

SMG		a_e/DC		a_p/DC		f_z			v_c
						3	4	6	
GR1	D	0.400		2.4		0.024	0.032	0.046	920 (780–1000)
		0.400		2.4		0.00095	0.0013	0.0018	3025 (2600 – 3200)

For cutting data recalculations, see pages 445 - 452.

SMG = Seco material group
 Coolant = A=air D=dry E=emulsion M=mist spray
 v_c = m/min (sf/min)
 f_z = mm/tooth (in/tooth)
 a_p = mm/DC (in/DC) = factor
 a_e = mm/DC (in/DC) = factor
 All cutting data are target values

Universal

Steel and cast iron

Stainless steel and S-materials

Non ferrous

Hard

Plastic and cfrp

Graphite

Minimaster Plus

Minimaster

JME642

Miniature – Graphite – Square – Diamond – 2 Flutes – DMM 4 – Cylindrical – Corner radius

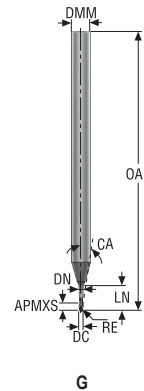

- Tolerances:
- Run-out= <0,005 mm
- DMM= h5
- DC= 0,-0,015 mm
- RE= ±0,007 mm

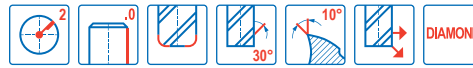

Designation	Item number	Length index	Tool shape	DC	DMM	APMXS	OAL	LN	DN	RE	PCEDC	CA°	WDX0*	WDX05*	WDX1*	WDX15*	WDX2*	WDX3*	Cylindrical
				mm	mm	mm	mm	mm	mm	mm	mm	mm	mm	mm	mm	mm	mm	mm	
JME642002G1R002.0Z2-DIA	03215524	1	G	0,2	4,0	0,3	40,0	0,4	0,18	0,02	2	14,32	0,59	0,65	0,72	0,78	0,84	0,95	■
JME642003G1R002.0Z2-DIA	03215525	1	G	0,3	4,0	0,5	40,0	0,5	0,28	0,02	2	14,1	0,74	0,81	0,87	0,94	1,0	1,11	■
JME642004G1R004.0Z2-DIA	03215526	1	G	0,4	4,0	0,6	40,0	2,0	0,37	0,04	2	11,67	2,29	2,44	2,57	2,68	2,78	2,96	■
JME642005G3R005.0Z2-DIA	03215527	3	G	0,5	4,0	0,7	40,0	2,5	0,45	0,05	2	10,97	2,83	3,0	3,13	3,25	3,36	3,56	■
JME642006G3R006.0Z2-DIA	03215528	3	G	0,6	4,0	1,0	60,0	3,0	0,55	0,06	2	10,31	3,33	3,52	3,67	3,8	3,92	4,13	■
JME642008G3R008.0Z2-DIA	03215529	3	G	0,8	4,0	1,2	60,0	4,0	0,75	0,08	2	9,31	4,33	4,57	4,74	4,89	5,02	5,25	■
JME642010G3R010.0Z2-DIA	03215530	3	G	1,0	4,0	1,6	60,0	5,0	0,95	0,1	2	8,04	5,33	5,61	5,81	5,97	6,12	6,37	■
JME642012G3R012.0Z2-DIA	03215531	3	G	1,2	4,0	1,6	60,0	6,0	1,15	0,12	2	7,09	6,33	6,65	6,87	7,05	7,2	7,46	■
JME642015G3R015.0Z2-DIA	03215532	3	G	1,5	4,0	2,4	60,0	7,5	1,4	0,15	2	5,8	7,99	8,29	8,52	8,71	8,87	9,36	■
JME642020G3R015.0Z2-DIA	03236441	3	G	2,0	4,0	2,2	60,0	10,0	1,9	0,15	2	4,11	10,53	10,88	11,22	11,55	11,99	12,87	■
JME642020G3R020.0Z2-DIA	03215533	3	G	2,0	4,0	3,0	60,0	10,0	1,9	0,2	2	4,11	10,49	10,87	11,13	11,35	11,53	12,48	■
JME642005G5R005.0Z2-DIA	03215534	5	G	0,5	4,0	0,7	40,0	4,0	0,45	0,05	2	9,43	4,33	4,57	4,74	4,89	5,03	5,26	■
JME642006G5R006.0Z2-DIA	03215535	5	G	0,6	4,0	1,0	60,0	5,0	0,55	0,06	2	8,5	5,33	5,61	5,81	5,98	6,12	6,37	■
JME642008G5R008.0Z2-DIA	03215536	5	G	0,8	4,0	1,2	60,0	7,0	0,75	0,08	2	7,02	7,33	7,68	7,92	8,12	8,28	8,72	■
JME642010G5R010.0Z2-DIA	03215537	5	G	1,0	4,0	1,6	60,0	8,5	0,95	0,1	2	6,06	8,33	9,23	9,5	9,71	9,89	10,59	■
JME642012G5R012.0Z2-DIA	03215538	5	G	1,2	4,0	1,6	60,0	10,0	1,15	0,12	2	5,23	10,33	10,78	11,07	11,3	11,5	12,46	■
JME642015G5R015.0Z2-DIA	03215539	5	G	1,5	4,0	2,4	60,0	12,0	1,4	0,15	2	4,25	12,49	12,92	13,22	13,32	13,84	14,99	■
JME642020G5R015.0Z2-DIA	03236442	5	G	2,0	4,0	2,2	60,0	16,0	1,9	0,15	2	2,87	16,53	17,06	17,61	18,91	18,82	-	■
JME642020G5R020.0Z2-DIA	03215540	5	G	2,0	4,0	3,0	60,0	16,0	1,9	0,2	2	2,87	16,49	17,02	17,36	17,77	18,45	-	■
JME642010G6R010.0Z2-DIA	03215541	6	G	1,0	4,0	1,6	60,0	12,0	0,95	0,1	2	4,86	12,33	12,84	13,16	13,4	13,81	14,96	■
JME642015G6R015.0Z2-DIA	03215542	6	G	1,5	4,0	2,4	50,0	18,0	1,4	0,15	2	3,13	18,49	19,07	19,43	19,99	20,76	22,49	■
JME642020G6R020.0Z2-DIA	03215543	6	G	2,0	4,0	3,0	60,0	25,0	1,9	0,2	2	1,97	25,49	26,21	26,78	27,77	28,83	-	■
JME642020G7R020.0Z2-DIA	03215544	7	G	2,0	4,0	3,0	60,0	30,0	1,9	0,2	2	1,68	30,49	31,03	32,13	33,32	-	-	■

■ Stocked standard.

For WDX values: Max. cut depth rel. to α₁ (α₁, ref)*

Cutting data – JME642/JME662 Side milling roughing

SMG		a _e /DC	a _p /DC	f _z										v _c
				0.2	0.3	0.4	0.5	0.6	0.8	1	1.2	1.5	2	
GR1	D	0.300	0.80	0.024	0.036	0.044	0.048	0.055	0.060	0.065	0.070	0.075	0.085	175 (130 – 370) 570 (430–1200)
		0,300	0,80	0,00095	0,0014	0,0017	0,0019	0,0022	0,0024	0,0026	0,0028	0,0030	0,0034	

Cutting data – JME642 Slot milling

SMG		a _p /DC	f _z										v _c
			0.2	0.3	0.4	0.5	0.6	0.8	1	1.2	1.5	2	
GR1	D	0.30	0.022	0.032	0.040	0.046	0.050	0.055	0.065	0.065	0.075	0.080	140 (110 – 300) 460 (370 – 980)
		0,30	0,00085	0,0013	0,0016	0,0018	0,0020	0,0022	0,0026	0,0026	0,0030	0,0032	

Table based on LV3, please recalc based on length version chosen. See page(s) 445 - 452.

SMG = Seco material group
 Coolant = A=air D=dry E=emulsion M=mist spray
 v_c = m/min (sf/min)
 f_z = mm (in/tooth)
 a_p = mm/DC (in/DC) = factor
 a_e = mm/DC (in/DC) = factor
 All cutting data are target values

Universal
Steel and cast iron
Stainless steel and S-materials
Non ferrous
Hard
Plastic and cfrp
Graphite
Minimaster Plus
Minimaster

JMB642/JMB662

Miniature – Graphite – Ball nose – Diamond – 2 Flutes – DMM 4-6 – Cylindrical

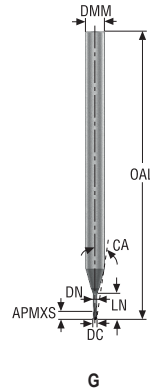

- Tolerances:
- Run-out= <0,005 mm
- DMM= h5
- DC= 0,-0,015 mm
- RE= ±0,007 mm

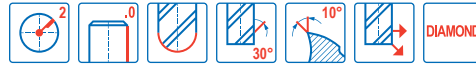

Designation	Item number	Length index	Tool shape	DC	DMM	APMXS	OAL	LN	DN	RE	PCEDC	CA°	WDX0*	WDX05*	WDX1*	WDX15*	WDX2*	WDX3*	Cylindrical
				mm	mm	mm	mm	mm	mm	mm	mm	mm	mm	mm	mm	mm	mm	mm	
JMB642002G1B.0Z2-DIA	03215373	1	G	0,2	4,0	0,3	40,0	0,4	0,18	0,1	2	14,5	0,59	0,65	0,7	0,76	0,81	0,92	■
JMB642003G1B.0Z2-DIA	03215374	1	G	0,3	4,0	0,5	40,0	0,6	0,28	0,15	2		0,74	0,8	0,86	0,91	0,97	1,07	■
JMB642004G1B.0Z2-DIA	03215375	1	G	0,4	4,0	2,0	40,0	0,8	0,37	0,2	2	13,8	2,29	2,43	2,55	2,66	2,76	2,93	■
JMB642005G3B.0Z2-DIA	03215376	3	G	0,5	4,0	0,7	40,0	2,5	0,45	0,25	2	11,19	2,83	2,99	3,12	3,23	3,34	3,52	■
JMB642006G3B.0Z2-DIA	03215377	3	G	0,6	4,0	1,0	60,0	3,0	0,55	0,3	2		3,33	3,51	3,65	3,78	3,89	4,09	■
JMB642008G3B.0Z2-DIA	03215378	3	G	0,8	4,0	1,2	60,0	4,0	0,75	0,4	2	9,38	4,33	4,55	4,72	4,86	4,99	5,21	■
JMB642010G3B.0Z2-DIA	03215379	3	G	1,0	4,0	1,6	60,0	5,0	0,95	0,5	2	8,33	5,33	5,59	5,78	5,94	6,08	6,32	■
JMB642012G3B.0Z2-DIA	03215380	3	G	1,2	4,0	1,6	60,0	6,0	1,15	0,6	2	7,38	6,33	6,63	6,84	7,01	7,16	7,41	■
JMB642015G3B.0Z2-DIA	03215381	3	G	1,5	4,0	2,4	60,0	7,5	1,4	0,75	2	6,08	7,99	8,28	8,49	8,67	8,83	9,33	■
JMB642020G3B.0Z2-DIA	03215382	3	G	2,0	4,0	3,0	60,0	10,0	1,9	1,0	2	4,35	10,49	10,84	11,1	11,3	11,5	12,44	■
JMB662030G3B.0Z2-DIA	03215384	3	G	3,0	6,0	3,0	60,0	15,0	2,8	1,5	2	4,38	15,71	16,1	16,39	16,67	17,3	18,72	■
JMB642005G5B.0Z2-DIA	03215387	5	G	0,5	4,0	0,7	40,0	4,0	0,45	0,25	2	9,6	4,33	4,56	4,73	4,88	5,01	5,23	■
JMB642006G5B.0Z2-DIA	03215388	5	G	0,6	4,0	1,0	60,0	5,0	0,55	0,3	2	8,68	5,33	5,6	5,79	5,96	6,1	6,34	■
JMB642008G5B.0Z2-DIA	03215389	5	G	0,8	4,0	1,2	60,0	7,0	0,75	0,4	2	7,18	7,33	7,67	7,91	8,09	8,26	8,7	■
JMB642010G5B.0Z2-DIA	03215390	5	G	1,0	4,0	1,6	60,0	8,5	0,95	0,5	2	6,22	8,83	9,22	9,48	9,68	9,86	10,57	■
JMB642012G5B.0Z2-DIA	03215391	5	G	1,2	4,0	1,6	60,0	10,0	1,15	0,6	2	5,4	10,33	10,77	11,05	11,27	11,49	12,44	■
JMB642015G5B.0Z2-DIA	03215392	5	G	1,5	4,0	2,4	60,0	12,0	1,4	0,75	2	4,4	12,49	12,91	13,19	13,42	13,81	14,96	■
JMB642020G5B.0Z2-DIA	03215393	5	G	2,0	4,0	3,0	60,0	16,0	1,9	1,0	2	2,99	16,49	17,0	17,33	17,75	18,42	19,94	■
JMB662030G5B.0Z2-DIA	03215395	5	G	3,0	6,0	3,0	60,0	24,0	2,8	1,5	2	3,0	24,71	25,28	25,73	26,67	27,68	29,97	■
JMB642010G6B.0Z2-DIA	03215396	6	G	1,0	4,0	1,6	60,0	12,0	0,95	0,5	2	4,96	12,33	12,83	13,14	13,38	13,8	14,94	■
JMB642015G6B.0Z2-DIA	03215397	6	G	1,5	4,0	2,4	60,0	18,0	1,4	0,75	2	3,21	18,49	19,05	19,41	19,97	20,74	22,45	■
JMB642020G6B.0Z2-DIA	03215398	6	G	2,0	4,0	3,0	60,0	25,0	1,9	1,0	2	2,03	25,49	26,2	26,76	27,75	28,81	-	■
JMB642020G7B.0Z2-DIA	03215399	7	G	2,0	4,0	3,0	60,0	30,0	1,9	1,0	2	1,72	30,49	31,29	32,12	33,3	-	-	■

■ Stocked standard.
For WDX values: Max. cut depth rel. to α₁ (α₁, ref)*

Cutting data – JMB642/662 Side milling roughing

SMG		a _e /DC	a _p /DC	f _z										v _c
				0.2	0.3	0.4	0.5	0.6	0.8	1	1.2	1.5	2	
GR1	D	0.300	0.50	0.0024	0.0036	0.0048	0.0060	0.0070	0.0095	0.012	0.014	0.017	0.020	250 (200 – 300) 820 (660 – 980)
		0,300	0,50	0,000095	0,00014	0,00019	0,00024	0,00028	0,00038	0,00048	0,00055	0,00065	0,00080	

Cutting data – JMB642/662 Copy milling roughing

SMG		a _e /DC	a _p /DC	f _z										v _c
				0.2	0.3	0.4	0.5	0.6	0.8	1	1.2	1.5	2	
GR1	D	0.300	0.50	0.0024	0.0036	0.0048	0.0060	0.0070	0.0095	0.012	0.014	0.017	0.020	250 (200 – 300) 820 (660 – 980)
		0,300	0,50	0,000095	0,00014	0,00019	0,00024	0,00028	0,00038	0,00048	0,00055	0,00065	0,00080	



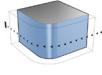
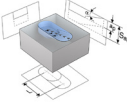

Table based on LV3, please recalc based on length version chosen. See page(s) 445 - 452 [XXX]-[XXX]

SMG = Seco material group
 Coolant = A=air D=dry E=emulsion M=mist spray
 v_c = m/min (sf/min)
 f_z = mm (in/tooth)
 a_p = mm/DC (in/DC) = factor
 a_e = mm/DC (in/DC) = factor
 All cutting data are target values

Universal
Steel and cast iron
Stainless steel and S-materials
Non ferrous
Hard
Plastic and cfrp
Graphite
Minimaster Plus
Minimaster



Recalculation

Use original standard version side rough cutting data then recalculate parameters!										Use original standard version slotting cutting data then recalculate parameters!													
Straight	Slotting		Side rough			Side finish				Ramping		Helical			Drilling								
							a_p	f_z	a_e	f_z	a_p	v_c	a_e (% of DC)	f_z	a_p	a_p	f_z	f_z	$a_p/360^\circ$ (% of DC)	hole \varnothing (\geq % of DC)	f_z	a_p (% of DC)	
										$\leq 30^\circ$ *													
JS412 LV2	100	100	100	100	100	140	3	40	120	80	100	50	10	130	50	100							
										$\leq 10^\circ$ *													
JS413 LV2	100	100	100	100	100	150	3	40	120	70	50	50	10	130	X	X							
JS413 LV3	X	X	25	60	240	120	3	40	230	70	50	50	10	130	X	X							
										$\leq 30^\circ$ *													
JS452 LV2	100	100	100	100	100	140	3	35	120	70	100	50	10	130	50	100							
JS452 LV3	50	60	75	60	50	120	3	40	100	70	70	50	10	130	20	10							
										$\leq 10^\circ$ *													
JS453 LV2	100	100	100	100	100	140	3	35	120	70	50	50	10	130	20	10							
JS453 LV3	X	X	25	60	240	120	3	40	230	70	70	50	10	130	20	10							
										$\leq 30^\circ$ *													
JS512 LV2	100	100	100	100	100	110	3	65	125	40	40	100	3	130	40	40							
JS512 LV3	30	100	25	50	170	110	3	65	210	X	X	X	X	X	X	X							
JS512 LV4	X	X	X	X	X	70	3	65	290	X	X	X	X	X	X	X							
										$\leq 5^\circ$ *													
JS513 LV2	100	100	100	100	100	110	3	85	150	100	100	100	3	130	50	40							
JS513 LV3	30	100	30	50	200	110	3	85	250	X	X	X	X	X	X	X							
JS513 LV4	X	X	X	X	X	70	3	85	350	X	X	X	X	X	X	X							
										$\leq 5^\circ$ *													
JS514 LV2	100	100	100	100	100	110	3	60	150	100	100	100	3	130	X	X							
JS514 LV3	X	X	25	50	200	110	3	60	250	X	X	X	X	X	X	X							
JS514 LV4	X	X	X	X	X	70	3	60	350	X	X	X	X	X	X	X							
										$\leq 45^\circ$ *													
JS553 LV2	100	100	100	100	100	110	3	55	150	50	55	35	3	130	35	50							
JS553 LV3	40	60	40	105	200	110	3	55	250	50	15	35	3	130	35	50							
										$\leq 5^\circ$ *													
JS554 LV2	100	100	100	100	100	110	3	53	150	100	100	100	3	130	X	X							
JS554 LV3	40	60	38	105	200	110	3	53	250	50	50	60	3	130	X	X							
										$\leq 5^\circ$ *													
JS564 LV2	X	X	100	100	100	110	3	55	100	X	X	100	2	130	X	X							
JS564 LV3	X	X	38	105	140	110	3	55	140	X	X	60	1.5	130	X	X							
										$\leq 5^\circ$ *													
JS565 LV2	X	X	100	100	100	110	3	55	100	X	X	100	2	130	X	X							
JS565 LV3	X	X	38	105	140	110	3	55	140	X	X	60	1.5	130	X	X							

*Max ramping angle

All values are percentages of original (100%) cutting data.

Recalculation

Use original standard version side rough cutting data then recalculate parameters!										Use original standard version slotting cutting data then recalculate parameters!							
Straight	Slotting		Side rough			Side finish					Ramping		Helical			Drilling	
	a_p	f_z	a_e	f_z	a_p	v_c	a_e (% of DC)	f_z	a_p	a_p	f_z	f_z	$a_p/360^\circ$ (% of DC)	hole \varnothing (\geq % of DC)	f_z	a_p (% of DC)	
										$\leq 45^\circ *$							
J28 LV2	100	100	100	100	100	140	3	100	135	40	25	100	10	130	25	60	
										$\leq X^\circ *$							
J36 LV2	X	X	100	100	100	120	3	85	150	X	X	X	X	X	X	X	
										$\leq 20^\circ *$							
J93F LV2	100	100	100	100	100	133	3	40	100	100	100	100	3	130	25	30	
										$\leq 1^\circ$							
JH120 LV2	100	100	100	100	100	120	3	120	80	17	100	100	2	130	X	X	
										$\leq X^\circ *$							
JH130 LV2	X	X	100	100	100	120	3	120	80	X	X	X	X	X	X	X	
										$\leq X^\circ *$							
JH142 LV2	X	X	100	100	100	110	3	80	70	X	X	30	2	130	X	X	
JH142 LV3	X	X	100	100	100	110	3	80	70	X	X	20	1	130	X	X	
JH142 LV6	X	X	100	100	100	110	3	80	70	X	X	10	1	130	X	X	
										$\leq 45^\circ *$							
JH830 LV2	100	100	100	100	100	110	3	110	80	9	135	135	3	130	X	X	
										$\leq X^\circ *$							
JH910 LV2	100	100	100	100	100	125	4	100	80	15	140	140	3	130	X	X	
JH910 LV3	80	80	100	80	80	125	4	80	65	10	110	110	3	130	X	X	
										$\leq X^\circ *$							
JH930 LV2	X	X	100	100	100	125	2	30	100	X	X	X	X	X	X	X	

*Max ramping angle

All values are percentages of original (100%) cutting data.

Recalculation

Use original standard version side rough cutting data then recalculate parameters!										Use original standard version slotting cutting data then recalculate parameters!								
Straight	Slotting		Side rough			Side finish				Ramping		Helical			Drilling			
	a _p	f _z	a _e	f _z	a _p	v _c	a _e (% of DC)	f _z	a _p	a _p	f _z	f _z	a _p /360° (% of DC)	hole Ø (≥ % of DC)	f _z	a _p (% of DC)		
										≤ 5°*								
JH40	100	100	100	100	100	100	3	35	100	83	55	55	25	130	55	80		
LV2	100	100	100	100	100	100	3	35	100	83	55	55	25	130	55	80		
LV3	100	100	100	100	100	100	3	35	100	83	55	55	25	130	55	80		
										≤ 45°*								
JH410	100	100	100	100	100	125	2	25	100	100	67	67	40	130	67	80		
LV2	75	60	80	60	100	125	2	25	100	60	40	40	40	130	40	50		
LV2 (ML)	125	100	100	100	100	100	2	100	100	100	50	100	40	130	150	80		
LV2 (TL)	125	100	100	100	100	100	2	100	100	100	50	100	40	130	150	80		
LV2 (RS)	125	100	100	100	100	100	2	100	100	100	50	100	40	130	150	80		
LV3 (RS)	95	95	80	100	100	100	2	100	100	50	50	50	40	130	75	40		
										≤ 45°*								
JH421	100	100	100	100	100	100	4	35	100	100	100	100	25	130	45	80		
LV2	100	100	100	100	100	100	4	35	100	100	100	100	25	130	45	80		
										≤ 30°*								
JH440	100	100	100	100	100	125	3	40	100	100	100	100	5	130	X	X		
LV2	100	100	100	100	100	125	3	40	100	100	100	100	5	130	X	X		
										≤ 5°*								
JHP750	115	120	115	115	100	100	2	145	100	100	120	120	3	130	10	70		
LV1	100	100	100	100	100	100	2	145	100	100	100	100	3	130	10	60		
LV2	100	100	100	100	100	100	2	145	100	100	100	100	3	130	10	60		
										≤ 5°*								
JHP951	100	100	100	100	100	158	2	50	113	20	100	125	3	130	6	20		
LV2	100	100	100	100	100	158	2	50	113	20	100	125	3	130	6	20		
										≤ 10°*								
JHP993	100	100	100	100	100	X	X	X	X	30	100	100	3	130	4	40		
LV2	80	80	80	80	80	X	X	X	X	20	80	80	3	130	3	30		
LV3	80	80	80	80	80	X	X	X	X	20	80	80	3	130	3	30		
										≤ X°*								
JS520	X	X	100	100	100	133	2	65	100	X	X	X	X	X	X	X		
LV2	X	X	X	X	X	133	2	65	175	X	X	X	X	X	X	X		
LV3	X	X	X	X	X	133	2	65	175	X	X	X	X	X	X	X		
										≤ X°*								
JS522	X	X	100	100	100	129	2	140	100	X	X	X	X	X	X	X		
LV4	X	X	100	100	100	129	2	140	100	X	X	X	X	X	X	X		
										≤ X°*								
JS720	X	X	100	100	100	110	2	65	100	X	X	100	2	130	X	X		
LV2	X	X	100	100	100	110	2	65	100	X	X	100	2	130	X	X		
LV3	X	X	100	100	100	110	2	65	100	X	X	100	2	130	X	X		
										≤ X°*								
JS754	100	100	100	100	100	110	3	55	150	100	100	100	3	130	X	X		
LV2	40	60	38	105	200	110	3	55	250	50	50	60	3	130	X	X		
LV3	40	60	38	105	200	110	3	55	250	50	50	60	3	130	X	X		
										≤ X°*								
JS755	100	100	100	100	100	110	3	55	150	100	100	100	3	130	X	X		
LV2	40	60	38	105	200	110	3	55	250	50	50	60	3	130	X	X		
LV3	40	60	38	105	200	110	3	55	250	50	50	60	3	130	X	X		

*Max ramping angle
All values are percentages of original (100%) cutting data.







Recalculation

Use original standard version side rough cutting data then recalculate parameters!										Use original standard version side milling cutting data then recalculate parameters!													
Straight	Slotting		Side rough			Side finish				Ramping		Helical			Drilling								
							a_p	f_z	a_e	f_z	a_p	v_c	a_e (% of DC)	f_z	a_p	a_p	f_z	f_z	$a_p/360^\circ$ (% of DC)	hole \varnothing (\geq % of DC)	f_z	a_p (% of DC)	
										$\leq X^\circ$													
JME542-JME562-JME564										$\leq X^\circ$													
LV1	100	100	100	100	100	125	2	150	5	X	X	X	X	X	X	X	X	X	X	X	X	X	X
LV2	63	100	100	100	65	125	2	150	3	X	X	X	X	X	X	X	X	X	X	X	X	X	X
LV3	25	100	100	100	25	125	2	150	1	X	X	X	X	X	X	X	X	X	X	X	X	X	X
LV4 (TL)	18	100	100	100	20	125	2	150	1	X	X	X	X	X	X	X	X	X	X	X	X	X	X
LV4 (XL)	12	100	100	100	10	125	2	150	1	X	X	X	X	X	X	X	X	X	X	X	X	X	X
LV5	10	100	100	100	10	125	2	150	1	X	X	X	X	X	X	X	X	X	X	X	X	X	X
LV6	4	100	100	100	5	125	2	150	1	X	X	X	X	X	X	X	X	X	X	X	X	X	X
LV7	2	100	100	100	2	125	2	150	1	X	X	X	X	X	X	X	X	X	X	X	X	X	X
										$\leq X^\circ$													
JME142-JME144										$\leq X^\circ$													
LV1	100	100	100	100	100	100	2	150	5	X	X	X	X	X	X	X	X	X	X	X	X	X	X
LV2	85	85	100	100	63	100	2	150	3	X	X	X	X	X	X	X	X	X	X	X	X	X	X
LV3	75	75	100	100	25	100	2	150	1	X	X	X	X	X	X	X	X	X	X	X	X	X	X
LV4	60	60	100	100	20	100	2	150	1	X	X	X	X	X	X	X	X	X	X	X	X	X	X
LV5	50	50	100	100	10	100	2	150	1	X	X	X	X	X	X	X	X	X	X	X	X	X	X
LV6	40	40	100	100	5	100	2	150	1	X	X	X	X	X	X	X	X	X	X	X	X	X	X
										$\leq X^\circ$													
JM403-JM404-JM406										$\leq X^\circ$													
LV1	100	100	100	100	100	X	X	X	X	X	X	X	X	X	X	X	X	X	X	X	X	X	X
LV2	100	75	100	75	100	X	X	X	X	X	X	X	X	X	X	X	X	X	X	X	X	X	X
LV3 (L)	100	75	100	75	90	X	X	X	X	X	X	X	X	X	X	X	X	X	X	X	X	X	X
LV3 (TL)	90	75	100	75	70	X	X	X	X	X	X	X	X	X	X	X	X	X	X	X	X	X	X
LV4 (XL)	75	75	100	75	70	X	X	X	X	X	X	X	X	X	X	X	X	X	X	X	X	X	X
LV4 (SL)	75	75	100	75	45	X	X	X	X	X	X	X	X	X	X	X	X	X	X	X	X	X	X
LV5	50	50	100	50	30	X	X	X	X	X	X	X	X	X	X	X	X	X	X	X	X	X	X
										≤ 2													
JME642										≤ 2													
LV1	100	100	100	100	100	100	2	85	200	X	X	X	X	X	X	X	X	X	X	X	X	X	X
LV3	100	100	100	100	100	100	2	85	200	X	X	X	X	X	X	X	X	X	X	X	X	X	X
LV5	30	100	60	100	100	100	2	85	200	X	X	X	X	X	X	X	X	X	X	X	X	X	X
LV6	30	100	60	100	100	100	2	85	200	X	X	X	X	X	X	X	X	X	X	X	X	X	X
LV7	30	100	60	100	100	100	2	85	200	X	X	X	X	X	X	X	X	X	X	X	X	X	X
										$\leq 5^\circ$													
JC898										$\leq 5^\circ$													
LV3	X	X	100	100	100	X	X	X	X	X	50	80	3	130-160	X	X	X	X	X	X	X	X	X
JC899										$\leq 5^\circ$													
LV3	X	X	100	100	100	100	3	50	100	X	X	X	X	X	X	X	X	X	X	X	X	X	X

*Max ramping angle

All values are percentages of original (100%) cutting data.

Recalculation

Use original standard version side rough cutting data then recalculate parameters!										Use original standard version slotting cutting data then recalculate parameters!							
Straight	Slotting		Side rough			Side finish					Ramping		Helical			Drilling	
																	
	a_p	f_z	a_e	f_z	a_p	v_c	a_e (% of DC)	f_z	a_p	a_p	f_z	f_z	$a_p/360^\circ$ (% of DC)	hole \varnothing (\geq % of DC)	f_z	a_p (% of DC)	
										$\leq 1^\circ$							
JHP170 LV2	100	100	100	100	100	130	3	175	80	100	100	100	2	130	X	X	
										$\leq 30^\circ$							
JHP490 LV2	100	100	100	100	100	X	X	X	X	50	50	35	5	130	30	50	
JHP490 LV2 (E-Shape)	100	75	100	100	100	X	X	X	X	50	50	35	5	130	30	50	
JHP490 LV3	100	75	80	100	100	X	X	X	X	50	50	35	5	130	30	50	
JHP490 LV4	150	75	80	100	100	X	X	X	X	50	50	35	5	130	30	50	
										$\leq 5^\circ$							
JHP760 LV2	100	100	100	100	100	140	2	125	15	30	100	100	3	130	10	50	
JHP760 LV3	50	50	100	50	50	140	2	125	15	15	50	50	3	130	5	25	
										$\leq 15^\circ$							
JHP770 LV2	100	100	100	100	100	170	3	125	100	100	40	40	3	130	X	X	
										$\leq 5^\circ$							
JHP780 LV1	100	100	100	100	100	160	2	135	140	100	100	35	3	130	35	50	
JHP780 LV2	100	100	100	100	100	160	2	135	140	100	100	35	3	130	35	50	
										$\leq X^\circ$							
JD620 LV2	100	100	100	100	100	100	2	110	4	X	X	X	X	X	X	X	
JD620 LV3	100	100	100	100	100	100	2	110	4	X	X	X	X	X	X	X	
JD620 LV4	20	100	60	100	60	100	2	110	4	X	X	X	X	X	X	X	
										$\leq X^\circ$							
JD630 LV2	100	100	100	100	100	100	2	110	4	X	X	X	X	X	X	X	
JD630 LV3	100	100	100	100	100	100	2	110	4	X	X	X	X	X	X	X	
JD630 LV4	100	100	100	100	100	100	2	110	4	X	X	X	X	X	X	X	
										$\leq X^\circ$							
JD640 LV2	100	100	100	100	100	100	2	110	4	X	X	X	X	X	X	X	
JD640 LV3	100	100	100	100	100	100	2	110	4	X	X	X	X	X	X	X	
JD640 LV4	100	100	100	100	100	100	2	110	4	X	X	X	X	X	X	X	

*Max ramping angle

All values are percentages of original (100%) cutting data.





Recalculation

Use original standard version side rough cutting data then recalculate parameters!										Use original standard version slotting cutting data then recalculate parameters!									
Straight	Slotting		Side rough			Side finish					Ramping		Helical			Plunging			
	a_p	f_z	a_e	f_z	a_p	v_c	a_e (% of DC)	f_z	a_p	a_p	f_z	f_z	$a_p/360^\circ$ (% of DC)	hole \varnothing (\geq % of DC)	v_c	a_e (% of DC)	f_z	a_e -sd (% of DC)	
JHF181																			
LV1	100	100	100	100	100	X	X	X	X	X	X	100	3,4	130	X	X	X	X	
LV2	80	85	100	85	80	X	X	X	X	X	X	85	3,0	130	X	X	X	X	
LV3	60	70	100	70	60	X	X	X	X	X	X	70	2,5	130	X	X	X	X	
										$\leq 1,5^\circ$ *									
JHF980																			
LV1	100	100	100	100	100	X	X	X	X	100	100	100	3	130	70	30	33	200	
LV2	100	100	100	100	100	X	X	X	X	100	100	100	3	130	70	30	33	200	
LV3	80	85	80	85	80	X	X	X	X	80	85	85	3	130	70	30	33	200	
LV4	50	70	50	70	60	X	X	X	X	60	70	70	3	130	70	30	33	200	

*Max ramping angle

All values are percentages of original (100%) cutting data.

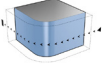
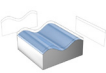
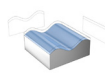
Recalculation

Use original standard version cutting data then recalculate parameters!										Use original standard version slotting cutting data then recalculate parameters!										
BALL	Slotting		Side rough			Side finish					Copy milling roughing			Copy milling finishing				Helical		
																				
	a_p	f_z	a_e	f_z	a_p	v_c	a_e (% of DC)	f_z	a_p	a_e	f_z	a_p	v_c	a_e (% of DC)	f_z	a_p	f_z	$a_p/360^\circ$ (% of DC)	hole \varnothing (\geq % of DC)	
JS532																				
LV1	X	X	100	100	100	125	3	125	10	X	X	X	X	X	X	X	75	5	130	
LV2	X	X	70	100	70	125	3	125	10	X	X	X	X	X	X	X	75	5	130	
LV3	X	X	X	X	X	125	3	125	10	X	X	X	X	X	X	X	X	X	X	
JS533																				
LV1	X	X	100	100	100	125	3	125	15	X	X	X	X	X	X	X	75	5	130	
LV2	X	X	75	75	75	125	3	125	15	X	X	X	X	X	X	X	75	5	130	
JS534																				
LV1	X	X	100	100	100	125	3	170	20	X	X	X	X	X	X	X	100	3	130	
LV2	X	X	70	100	70	125	3	170	20	X	X	X	X	X	X	X	100	3	130	
LV3	X	X	70	100	70	125	3	170	20	X	X	X	X	X	X	X	100	3	130	
JH970																				
LV2	X	X	100	100	100	155	2	30	15	X	X	X	X	X	X	X	40	3	130	
JH720																				
LV2	X	X	100	100	100	125	2	90	75	X	X	X	X	X	X	X	40	3	130	
JH112																				
LV1	X	X	100	100	100	110	2	70	100	X	X	X	X	X	X	X	20	2	130	
LV2	X	X	100	100	100	110	2	70	100	X	X	X	X	X	X	X	20	2	130	
LV3	X	X	100	100	100	110	1,6	55	100	X	X	X	X	X	X	X	X	X	X	
LV4	X	X	100	100	100	130	1,4	55	100	X	X	X	X	X	X	X	X	X	X	
LV5	X	X	100	100	100	130	1,4	50	100	X	X	X	X	X	X	X	X	X	X	
LV6	X	X	100	100	100	130	1	35	100	X	X	X	X	X	X	X	X	X	X	
JH150																				
LV2	X	X	100	100	100	165	1	90	35	X	X	X	X	X	X	X	30	2	130	

*Max ramping angle

All values are percentages of original (100%) cutting data.

Recalculation

Use original standard version side rough cutting data then recalculate parameters!										Use original standard version slotting cutting data then recalculate parameters!										
BALL	Slotting		Side rough			Side finish					Copy milling roughing			Copy milling finishing				Helical		
	a_p	f_z	a_e	f_z	a_p	v_c	a_e (% of DC)	f_z	a_p	a_e	f_z	a_p	v_c	a_e (% of DC)	f_z	a_p	f_z	$a_p/360^\circ$ (% of DC)	hole \varnothing (\geq % of DC)	
JH160 Standard (2)	X	X	X	X	X	X	X	X	X	X	X	X	X	X	X	X	X	X	X	
JH450 Standard (2)	X	X	100	100	100	120	5	90	25	X	X	X	X	X	X	X	45	5	130	
JH460 Standard (2)	X	X	100	100	100	120	5	90	25	X	X	X	X	X	X	X	X	X	X	
JMB542-JMB562- JMB563																				
LV1	100	100	X	X	X	X	X	X	X	100	100	100	125	2	150	5	X	X	X	
LV2	65	100	X	X	X	X	X	X	X	100	100	63	125	2	150	3	X	X	X	
LV3	26	100	X	X	X	X	X	X	X	100	100	25	125	2	150	1	X	X	X	
LV4 (TL)	20	100	X	X	X	X	X	X	X	100	100	19	125	2	150	1	X	X	X	
LV4 (XL)	12	100	X	X	X	X	X	X	X	100	100	12	125	2	150	1	X	X	X	
LV5	10	100	X	X	X	X	X	X	X	100	100	10	125	2	150	1	X	X	X	
LV6	4	100	X	X	X	X	X	X	X	100	100	4	125	2	150	1	X	X	X	
LV7	2	100	X	X	X	X	X	X	X	100	100	2	125	2	150	1	X	X	X	
JMB112																				
LV1	100	100	X	X	X	X	X	X	X	100	100	100	118	2	120	5	X	X	X	
LV2	65	100	X	X	X	X	X	X	X	64	85	85	118	2	120	3	X	X	X	
LV3	26	100	X	X	X	X	X	X	X	56	75	75	118	2	120	1	X	X	X	
LV4	20	100	X	X	X	X	X	X	X	45	60	60	118	2	120	1	X	X	X	
LV5	10	100	X	X	X	X	X	X	X	38	50	50	118	2	120	1	X	X	X	
LV6	4	100	X	X	X	X	X	X	X	30	40	40	118	2	120	1	X	X	X	
JM413-JM416																				
LV1	X	X	100	100	100	100	5	40	35	X	X	X	X	X	X	X	X	X	X	
LV2	X	X	100	60	100	100	5	40	15	X	X	X	X	X	X	X	X	X	X	
LV3	X	X	100	80	100	100	5	40	15	X	X	X	X	X	X	X	X	X	X	
LV4	X	X	100	60	75	100	5	40	10	X	X	X	X	X	X	X	X	X	X	
JMB642																				
LV1	100	100	100	100	100	100	2	85	200	X	X	X	X	X	X	X	X	X	X	
LV3	100	100	100	100	100	100	2	85	200	X	X	X	X	X	X	X	X	X	X	
LV5	30	100	60	100	100	100	2	85	200	X	X	X	X	X	X	X	X	X	X	
LV6	30	100	60	100	100	100	2	85	200	X	X	X	X	X	X	X	X	X	X	
LV7	30	100	60	100	100	100	2	85	200	X	X	X	X	X	X	X	X	X	X	
	≤ 2																			
JD660																				
LV1	X	X	100	100	100	100	2	100	100	X	X	X	X	X	X	X	X	X	X	
LV2	X	X	100	100	100	100	2	100	100	X	X	X	X	X	X	X	X	X	X	
LV3	X	X	100	100	100	100	2	100	100	X	X	X	X	X	X	X	X	X	X	
LV4	X	X	100	100	100	100	2	100	100	X	X	X	X	X	X	X	X	X	X	
LV5	X	X	100	100	100	100	2	100	100	X	X	X	X	X	X	X	X	X	X	

*Max ramping angle

All values are percentages of original (100%) cutting data.

Nomenclature and formulae

RPM	
$n = \frac{v_c \cdot 1000}{\pi \cdot D_c}$	(rev/min)
Cutting speed	
$v_c = \frac{n \cdot \pi \cdot D_c}{1000}$	(m/min)
Feed speed	
$v_f = n \cdot z_n \cdot f_z$	(mm/min)
Feed per revolution	
$f = z_n \cdot f_z$	(mm/rev)
Metal removal rate	
$Q = \frac{a_e \cdot a_p \cdot v_f}{1000}$	(cm ³ /min)
Cutting speed and RPM for copying	
$v_c = \frac{n \cdot \pi \cdot D_w}{1000}$	(m/min)
$n = \frac{v_c \cdot 1000}{\pi \cdot D_w}$	(RPM)
$D_w = 2 \cdot \sqrt{a_p (D_c - a_p)}$	(mm)

Calculation of a_p vs. overhang length:

If the overhang length (XS) is longer than 4 x DC and Cylindrical shanks are used it is important to adopt another depth of cut (a_p) value than that indicated in the table.

Use the following formula to calculate the new a_p value

$$a_{p,new} = a_p \times (4 \times DC / XS)^2$$

Profile height
$H = \frac{D_c}{2} - \frac{\sqrt{D_c^2 - a_e^2}}{2}$
$D_w = 2 \cdot \sqrt{a_p (D_c - a_p)} \quad (\text{mm})$

Profile height H (um)

DC	Pitch a_e (μm)						
	0,06	0,08	0,11	0,15	0,20	0,3	0,45
1	0,90	1,60	3,00	5,70	10,0	23,0	53,0
2	0,45	0,80	1,50	2,80	5,0	11,0	26,0
4	0,23	0,40	0,76	1,40	2,5	5,60	13,0
6	0,15	0,27	0,50	0,94	1,7	3,80	8,40
8	0,11	0,20	0,38	0,70	1,3	2,80	6,30
10	0,09	0,16	0,30	0,56	1,0	2,30	5,10
12	0,08	0,13	0,25	0,47	0,83	1,90	4,20

- a_p = Depth of cut mm/axial depth of cut (mm)
- a_e = Width of cut mm/radial depth of cut (mm)
- DC = Cutter diameter
- f = Feed per revolution (mm/rev)
- f_z = Feed per tooth (mm/tooth)
- z_n = No. of teeth
- n = RPM (rev/min)
- Q = Material removal rate (cm³/min)
- v_c = Cutting speed (m/min)
- v_f = Feed speed (mm/min)
- D_w = Working diameter

Operation recommendations

Ramping method

The table below shows the feed rate percentage to use at certain ramping angles

Recommended diameter of hole for helical interpolation ramping

Diameter of end mill DC	Diameter of hole
1-2,5	1,4 x DC
3-6	1,3 x DC
8-12	1,2 x DC
16-32	1,15 x DC

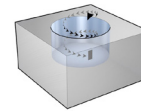

Trochoidal method

The figure below shows a method often called the trochoidal method for milling slots

Recommendation of width of slot

Diameter of end mill DC	Slot width
1-2,5	1,8 x DC
3-6	1,6 x DC
8-12	1,4 x DC
16-32	1,2 x DC

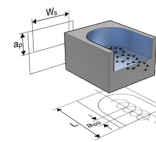

Measurement drawing should be read as follows:

DMM	=	Shank diameter
CHW	=	Chamfer
DC	=	Milling cutting diameter
M	=	Minimum clamping length
OAL	=	Total length
LN	=	Maximum milling cutter depth
APMXS	=	Effective cutting length
RE	=	Corner radius
RE2	=	Radius behind the cutting edge
DN	=	Neck reduction

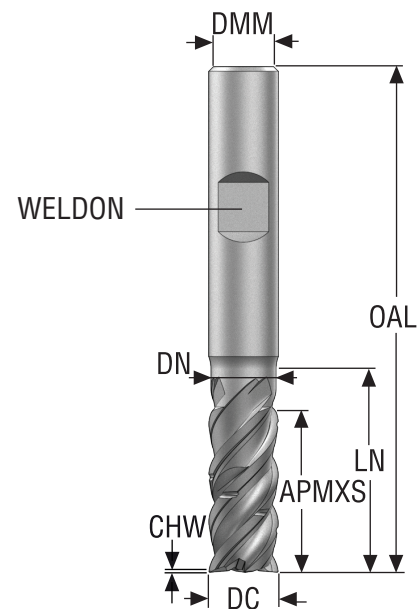



MINIMASTER™ PLUS

Minimaster™ Plus is the next generation line of end mills with replaceable fluted inserts. This replaceable cutting head tool system builds on the success of the industry leading Minimaster™ system and reaches the highest level of precision and productivity.

- Square Shoulder range: 10-16 mm (.375 - .625 inch)
- Ballnose range: 10-16 mm (.375 - .625 inch)
- Center Drilling/Chamfering range: 10-16 mm (.375 - .625 inch)
- High Feed range: 10-16 mm (.375 - .625 inch)

Universal

Steel and cast iron

Stainless steel and S-materials

Non ferrous

Hard

Plastic and cfrp

Graphite

Minimaster Plus

Minimaster

Code keys

Code key shanks

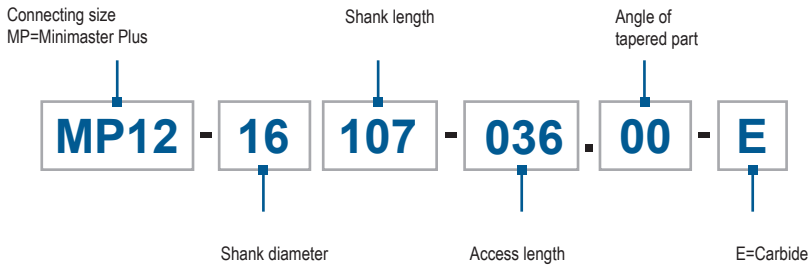

Code key inserts

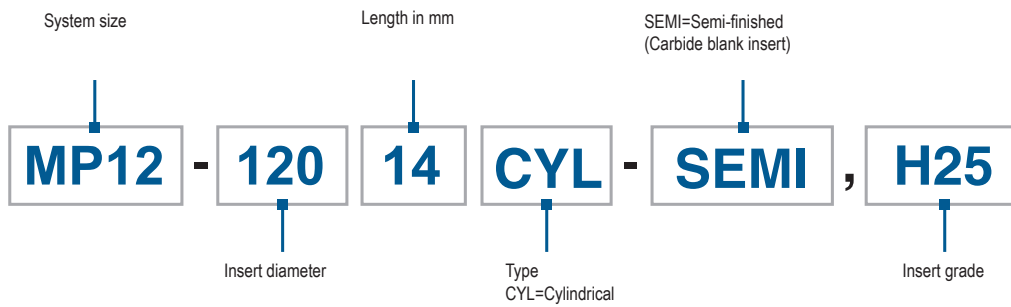
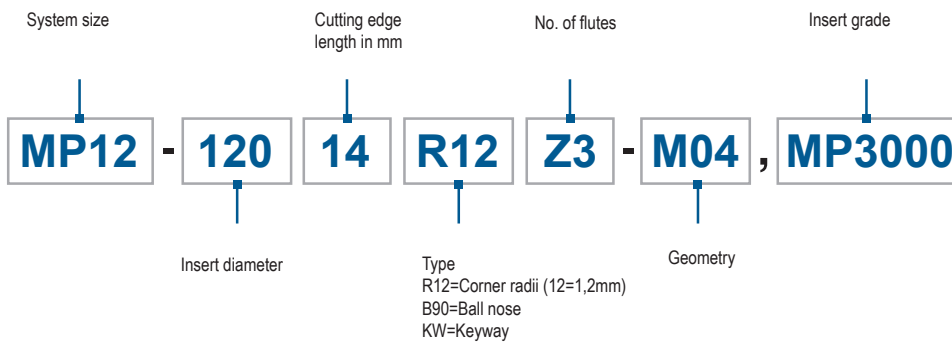

Internal through coolant

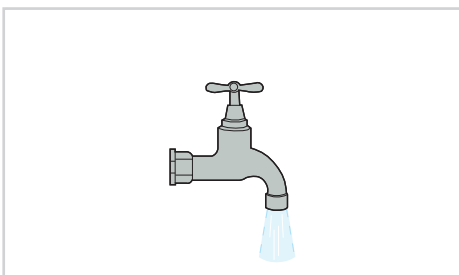

Selection guide

1. Select taper size

The design of the workpiece and the machining operations determines suitable taper size. Select the largest possible taper size for best strength and stability.

2. Select insert

- a. Use the tables beginning on page 616 to classify the workpiece material into a Seco material group.
- b. Look up the pages for the selected taper size and choose a suitable insert in the insert selection table.

3. Select shank

- a. Look up the pages for the selected taper size and choose a suitable shank in the tool data table.
- b. Always choose the shortest shank possible to achieve the best possible stability.

Note! Carbide shanks are to be used for Finishing/Semi finishing operations only.

4. Select cutting data

- a. Cutting speed recommendations are found in the cutting data tables for each selected taper size. Cutting data recommendations are based on stable conditions and might therefore need to be adjusted depending on the stability in the application (tooling, machine & workpiece fixturing). General rule for max ap in slotting is $DC \cdot 0.3 = \text{Max APMXS}$. (See figure 1)
- b. Feed and cutting speed recommendations are found in the cutting data conversion table.
- c. Maximum RPM that for safety reasons should never be exceeded.
- d. If the cutter is not fully engaged the feed per tooth and the cutting speed should be increased compared to the recommendations for a fully engaged cutter. The reason for that is to keep the average chip thickness and the working temperature in the cutting zone.
- e. Divide the radial depth of cut with the cutter diameter to get the actual cutter engagement percentage ($ae/DC\%$), for ball nose cutters use the effective working diameter D_w instead of DC (See figure 2 & 6)
- f. Use the percentage to get a correct feed per tooth and cutting speed recommendation for the actual cutter engagement.

5. General

- When milling in corners and bottoms of cavities the feed rate should be reduced due to the increase of the average chip thickness. Use the feed per tooth recommendations for a fully engaged cutter.
- When steep down copying with an angle bigger than 40° or steep up copying with an angle bigger than 30° in combination with small depths of cut, use the diameter (DC) as working diameter instead of D_w .
- When calculating feed per revolution and feed speed, always use the ZAFP-value. That is the effective number of teeth to use for cutting data calculations. The ZAFP-value can be found in the insert selection table.

Note! There will be a deterioration in the surface finish on the workpiece when the feed rate is increased. (See figure 3 & 5)

Minimaster Plus figures

Universal	Figure 1	Figure 2
Steel and cast iron		
Stainless steel and S-materials	Figure 3	Figure 4
Non ferrous		
Hard	Figure 5	Figure 6
Plastic and cfrp		
Graphite		
Minimaster Plus		
Minimaster		

Torque wrench information and user instruction

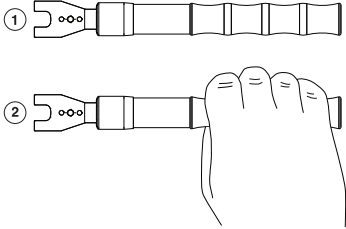
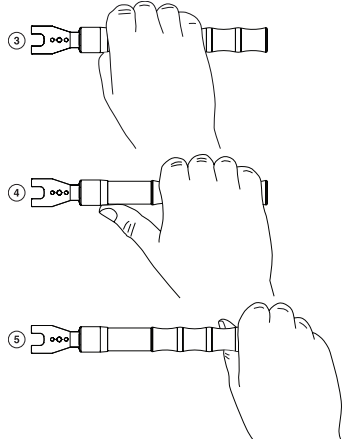
Torque wrench	
	<p>We recommend a torque wrench when mounting the insert for best precision and extended tool life.</p> <p>Different torque values for assembly</p> <ul style="list-style-type: none"> - MP10: 11Nm - MP12: 15Nm - MP16: 19Nm <p>Do not use worn out replaceable blades.</p> <p>Note: Torque wrenches and standard keys must be ordered separately!</p>
	<p>Use the arched handle (fig. 1) to grip the wrench by hand as shown (fig. 2)</p>
	<p>Do not grip the wrench as shown on figure 3-5, there is a risk that the applied torque might be incorrect and the insert will not be properly seated.</p>

Universal

Steel and cast iron

Stainless steel and S-materials

Non ferrous

Hard

Plastic and CFRP

Graphite

Minimaster Plus

Minimaster

MP10 Shank – Metric

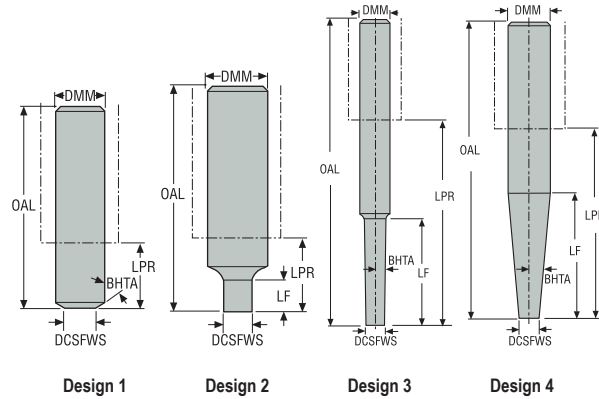

- Cylindrical shank DMM with tolerance h5, compatible for Shrinkfit

Designation	ShankType	DCSFWS	DMM	OAL	LPR	LF	RPMX	BHTA°	Design	Weight
		mm	mm	mm	mm	mm				kg
MP10-10055-010.00	Cylindrical	9,8	10,0	55,0	15,0	10,0	80000	0,0	2	✓ 0,1
MP10-16068-000.60	Cylindrical	9,5	16,0	68,0	20,0	0,0	80000	60,0	1	✓ 0,2
MP10-16073-015.00	Cylindrical	9,8	16,0	73,0	25,0	15,0	80000	0,0	2	✓ 0,1
MP10-16118-035.01	Cylindrical	9,5	16,0	118,0	70,0	35,0	80000	1,0	3	✓ 0,2
MP10-16158-060.01	Cylindrical	9,5	16,0	158,0	110,0	60,0	80000	1,0	3	✓ 0,2
MP10-20100-045.03	Cylindrical	9,5	20,0	100,0	50,0	45,0	80000	3,0	3	✓ 0,2
MP10-20140-085.03	Cylindrical	9,5	20,0	140,0	90,0	85,0	80000	3,0	3	✓ 0,3
MP10-20140-090.05	Cylindrical	9,5	20,0	140,0	90,0	60,0	80000	5,0	4	✓ 0,3
MP10-12095-030.00-E	Cylindrical Carbide	9,8	12,0	95,0	50,0	30,0	80000	0,0	2	✓ 0,2
MP10-12105-040.00-E	Cylindrical Carbide	9,8	12,0	105,0	60,0	40,0	80000	0,0	2	✓ 0,2
MP10-12125-060.00-E	Cylindrical Carbide	9,8	12,0	125,0	80,0	60,0	80000	0,0	2	✓ 0,2
MP10-16120-050.01-E	Cylindrical Carbide	9,5	16,0	120,0	72,0	50,0	80000	1,0	3	✓ 0,3
MP10-16150-080.01-E	Cylindrical Carbide	9,5	16,0	150,0	102,0	80,0	80000	1,0	3	✓ 0,3
MP10-16170-100.01-E	Cylindrical Carbide	9,5	16,0	170,0	122,0	100,0	80000	1,0	3	✓ 0,4
MP10-16140-092.03-E	Cylindrical Carbide	9,5	16,0	140,0	92,0	62,0	80000	3,0	4	✓ 0,4
MP10-16170-122.03-E	Cylindrical Carbide	9,5	16,0	170,0	122,0	62,0	80000	3,0	4	✓ 0,4

Accessories

Key	Replacement blade	Torque key
MP1016	MP00-10M	MP00-10.110

Blades are included with the torque key

MP10 Shank – Inch

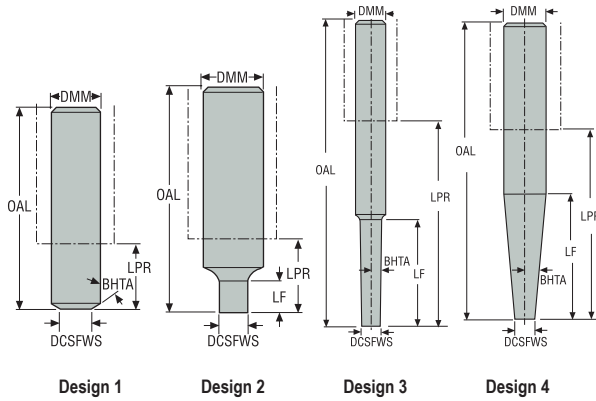

• Cylindrical shank DMM with tolerance h5, compatible for Shrinkfit

Designation	ShankType	DCSFWS	DMM	OAL	LPR	LF	RPMX	BHTA°	Design	Weight
		Inch	Inch	Inch	Inch	Inch				lbs
MP10-0372.1-0.39.00	Cylindrical	0.370	0.375	2.122	0.591	0.394	80000	0,0	2	0.220
MP10-0622.6-0.00.60	Cylindrical	0.374	0.625	2.662	0.787	–	80000	60,0	1	0.220
MP10-0622.8-0.59.00	Cylindrical	0.370	0.625	2.859	0.984	0.591	80000	0,0	2	0.220
MP10-0624.6-1.37.01	Cylindrical	0.374	0.625	4.631	2.756	1.378	80000	1,0	3	0.440
MP10-0626.2-2.36.01	Cylindrical	0.374	0.625	6.206	4.331	2.362	80000	1,0	3	0.440
MP10-0753.9-1.80.03	Cylindrical	0.374	0.750	3.969	1.969	1.799	80000	3,0	3	0.440
MP10-0755.5-3.40.03	Cylindrical	0.374	0.750	5.543	3.543	3.402	80000	3,0	4	0.660
MP10-0755.5-3.54.05	Cylindrical	0.374	0.750	5.543	3.543	2.150	80000	5,0	4	0.660
MP10-0504.8-2.36.00-E	Cylindrical Carbide	0.370	0.500	4.900	3.150	2.362	80000	0,0	2	0.440

Accessories

Key	Replacement blade	Torque key
MP1016	MP00-10M	MP00-10.110

Blades are included with the torque key

Universal

Steel and cast iron

Stainless steel and S-materials

Non ferrous

Hard

Plastic and cfrp

Graphite

Minimaster Plus

Minimaster

MP10 High feed

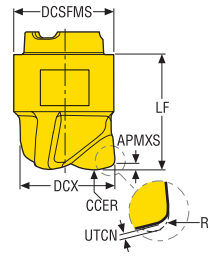

• For insert selection and cutting data recommendations, see page(s) 471-472

Z3



Designation	DCX	DC	APMXS	DCSFMS	CCER	RP	LF	UTCN	RMPX°	C min	C max	ZEFP		Grades	
														Coated	
	mm <i>Inch</i>	mm <i>Inch</i>	mm <i>Inch</i>	mm <i>Inch</i>	mm <i>Inch</i>	mm <i>Inch</i>	mm <i>Inch</i>	mm <i>Inch</i>						MP3000	F40M
MP10-1000.6HFZ3-MD08	10,0 0.394	5,0 0.197	0,6 0.024	9,6 0.378	6,2 0.244	1,13 0.044	11,0 0.433	0,32 0.013	5,0	10,9	14,8	3	✓	■	
MP10-0950.6HFZ3-MD08	9,525 0.375	4,55 0.179	0,6 0.024	9,4 0.370	6,2 0.244	1,13 0.044	11,0 0.433	0,32 0.013	5,0	10,4	13,4	3	✓	■	

Universal

Steel and cast iron

Stainless steel and S-materials

Non ferrous

Hard

Plastic and cfrp

Graphite

Minimaster Plus

Minimaster

MP10 Square shoulder

Slotting and contouring

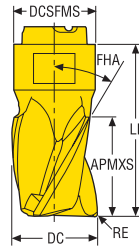

• For insert selection and cutting data recommendations, see page(s) 473-474

Z3



Designation	DC	APMXS	RE	DCSFMS	LF	FHA°	RMPX°	C min	C max	ZEFP		Grades	
												Coated	
	mm Inch	mm Inch	mm Inch	mm Inch	mm Inch							MP3000	F40M
MP10-09807KWZ3-E03	9,8 0.386	7,0 0.276	0,3 0.012	9,6 0.378	16,0 0.630	30	15,0	12,0	18,8	3	✓		■
MP10-10007R04Z3-E03	10,0 0.394	7,0 0.276	0,4 0.016	9,6 0.378	16,0 0.630	30	15,0	12,2	19,0	3	✓		■
MP10-10007R04Z3-M03	10,0 0.394	7,0 0.276	0,4 0.016	9,6 0.378	16,0 0.630	30	15,0	12,2	19,0	3	✓	■	
MP10-10007R05Z3-E03	10,0 0.394	7,0 0.276	0,5 0.020	9,6 0.378	16,0 0.630	30	15,0	12,2	18,8	3	✓		■
MP10-10007R08Z3-E03	10,0 0.394	7,0 0.276	0,8 0.031	9,6 0.378	16,0 0.630	30	15,0	12,2	18,2	3	✓		■
MP10-10007R08Z3-M03	10,0 0.394	7,0 0.276	0,8 0.031	9,6 0.378	16,0 0.630	30	15,0	12,2	18,2	3	✓	■	
MP10-10007R20Z3-E03	10,0 0.394	7,0 0.276	2,0 0.079	9,6 0.378	16,0 0.630	30	15,0	12,2	15,8	3	✓		■
MP10-10007R31Z3-E03	10,0 0.394	7,0 0.276	3,1 0.122	9,6 0.378	16,0 0.630	30	15,0	12,2	13,6	3	✓		■

Universal

Steel and cast iron

Stainless steel and S-materials

Non ferrous

Hard

Plastic and cfrp

Graphite

Minimaster Plus

Minimaster

MP10 Square shoulder

Slotting and contouring

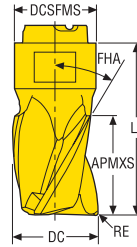

• For insert selection and cutting data recommendations, see page(s) 473-474

Z3



Designation	DC	APMXS	RE	DCSFMS	LF	FHA°	RMPX°	C min	C max	ZEFP		Grades	
												Coated	
	mm Inch	mm Inch	mm Inch	mm Inch	mm Inch							MP3000	F40M
MP10-09812KWZ3-E03	9,8 0.386	12,0 0.472	0,3 0.012	9,6 0.378	21,0 0.827	30	15,0	12,0	18,8	3	✓		■
MP10-10012R04Z3-E03	10,0 0.394	12,0 0.472	0,4 0.016	9,6 0.378	21,0 0.827	30	15,0	12,2	19,0	3	✓		■
MP10-10012R04Z3-M03	10,0 0.394	12,0 0.472	0,4 0.016	9,6 0.378	21,0 0.827	30	15,0	12,2	19,0	3	✓	■	
MP10-10012R05Z3-E03	10,0 0.394	12,0 0.472	0,5 0.020	9,6 0.378	21,0 0.827	30	15,0	12,2	18,8	3	✓		■
MP10-10012R08Z3-E03	10,0 0.394	12,0 0.472	0,8 0.031	9,6 0.378	21,0 0.827	30	15,0	12,2	18,2	3	✓		■
MP10-10012R08Z3-M03	10,0 0.394	12,0 0.472	0,8 0.031	9,6 0.378	21,0 0.827	30	15,0	12,2	18,2	3	✓	■	
MP10-10012R20Z3-E03	10,0 0.394	12,0 0.472	2,0 0.079	9,6 0.378	21,0 0.827	30	15,0	12,2	15,8	3	✓		■
MP10-10012R31Z3-E03	10,0 0.394	12,0 0.472	3,1 0.122	9,6 0.378	21,0 0.827	30	15,0	12,2	13,6	3	✓		■
MP10-09512R04Z3-E03	9,525 0.375	12,0 0.472	0,4 0.016	9,6 0.378	21,0 0.827	30	15,0	11,6	18,0	3	✓		■
MP10-09512R04Z3-M03	9,525 0.375	12,0 0.472	0,4 0.016	9,6 0.378	21,0 0.827	30	15,0	11,6	18,0	3	✓	■	
MP10-09512R08Z3-E03	9,525 0.375	12,0 0.472	0,8 0.031	9,6 0.378	21,0 0.827	30	15,0	11,6	17,2	3	✓		■
MP10-09512R08Z3-M03	9,525 0.375	12,0 0.472	0,8 0.031	9,6 0.378	21,0 0.827	30	15,0	11,6	17,2	3	✓	■	
MP10-09512R16Z3-E03	9,525 0.375	12,0 0.472	1,6 0.063	9,6 0.378	21,0 0.827	30	15,0	11,6	15,6	3	✓		■
MP10-09512R31Z3-E03	9,525 0.375	12,0 0.472	3,1 0.122	9,6 0.378	21,0 0.827	30	15,0	11,6	12,6	3	✓		■

MP10 Square shoulder

Slotting and contouring

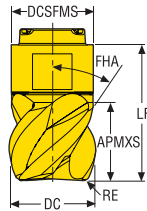

• For insert selection and cutting data recommendations, see page(s) 473-474

Z4



Designation	DC	APMXS	RE	DCSFMS	LF	FHA°	RMPX°	ZEFP		Grades	
										Coated	
	mm Inch	mm Inch	mm Inch	mm Inch	mm Inch					MP3000	F40M
MP10-10007R04Z4-M02	10,0 0.394	7,0 0.276	0,4 0.016	9,6 0.378	16,0 0.630	50	15,0	4		■	
MP10-10007R05Z4-E02	10,0 0.394	7,0 0.276	0,5 0.020	9,6 0.378	16,0 0.630	50	15,0	4			■
MP10-10007R08Z4-E02	10,0 0.394	7,0 0.276	0,8 0.031	9,6 0.378	16,0 0.630	50	15,0	4			■
MP10-10007R08Z4-M02	10,0 0.394	7,0 0.276	0,8 0.031	9,6 0.378	16,0 0.630	50	15,0	4		■	
MP10-10007R16Z4-E02	10,0 0.394	7,0 0.276	1,6 0.063	9,6 0.378	16,0 0.630	50	15,0	4			■
MP10-10012R04Z4-E02	10,0 0.394	12,0 0.472	0,4 0.016	9,6 0.378	21,0 0.827	50	15,0	4			■
MP10-10012R04Z4-M02	10,0 0.394	12,0 0.472	0,4 0.016	9,6 0.378	21,0 0.827	50	15,0	4		■	
MP10-10012R05Z4-E02	10,0 0.394	12,0 0.472	0,5 0.020	9,6 0.378	21,0 0.827	50	15,0	4			■
MP10-10012R08Z4-E02	10,0 0.394	12,0 0.472	0,8 0.031	9,6 0.378	21,0 0.827	50	15,0	4			■
MP10-10012R08Z4-M02	10,0 0.394	12,0 0.472	0,8 0.031	9,6 0.378	21,0 0.827	50	15,0	4		■	
MP10-10012R16Z4-E02	10,0 0.394	12,0 0.472	1,6 0.063	9,6 0.378	21,0 0.827	50	15,0	4			■
MP10-09512R04Z4-E02	9,525 0.375	12,0 0.472	0,4 0.016	9,6 0.378	21,0 0.827	50	15,0	4			■
MP10-09512R04Z4-M02	9,525 0.375	12,0 0.472	0,4 0.016	9,6 0.378	21,0 0.827	50	15,0	4		■	
MP10-09512R08Z4-E02	9,525 0.375	12,0 0.472	0,8 0.031	9,6 0.378	21,0 0.827	50	15,0	4			■
MP10-09512R08Z4-M02	9,525 0.375	12,0 0.472	0,8 0.031	9,6 0.378	21,0 0.827	50	15,0	4		■	

Universal

Steel and cast iron

Stainless steel and S-materials

Non ferrous

Hard

Plastic and chip

Graphite

Minimaster Plus

Minimaster

MP10 Square shoulder

Contouring only

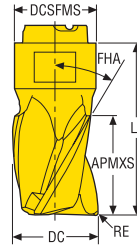

• For insert selection and cutting data recommendations, see page(s) 473-474

Z5



Designation	DC	APMXS	RE	DCSFMS	LF	FHA°	ZEPF		Grades	
									Coated	
	mm <i>Inch</i>	mm <i>Inch</i>	mm <i>Inch</i>	mm <i>Inch</i>	mm <i>Inch</i>				MP3000	F40M
MP10-10012R04Z5-M02	10,0 0.394	12,0 0.472	0,4 0.016	9,6 0.378	21,0 0.827	40	5		■	
MP10-09512R04Z5-M02	9,525 0.375	12,0 0.472	0,4 0.016	9,6 0.378	21,0 0.827	40	5		■	

Universal

Steel and cast iron

Stainless steel and S-materials

Non ferrous

Hard

Plastic and cfrp

Graphite

Minimaster Plus

Minimaster

MP10 Ball nose design

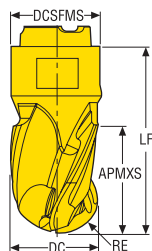

• For insert selection and cutting data recommendations, see page(s) 475-476

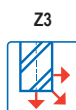

Designation	DC	APMXS	RE	DCSFMS	LF	FHA°	RMPX°	ZFP		Grades	
										Coated	
	mm Inch	mm Inch	mm Inch	mm Inch	mm Inch					MP3000	F40M
MP10-10007B90Z3-E03	10,0 0.394	7,0 0.276	5,0 0.197	9,6 0.378	16,0 0.630	30	15,0	3	✓		■
MP10-10007B90Z3-M03	10,0 0.394	7,0 0.276	5,0 0.197	9,6 0.378	16,0 0.630	30	15,0	3	✓	■	
MP10-10012B90Z3-E03	10,0 0.394	12,0 0.472	5,0 0.197	9,6 0.378	21,0 0.827	30	15,0	3	✓		■
MP10-10012B90Z3-M03	10,0 0.394	12,0 0.472	5,0 0.197	9,6 0.378	21,0 0.827	30	15,0	3	✓	■	
MP10-10007B90Z4-E02	10,0 0.394	7,0 0.276	5,0 0.197	9,6 0.378	16,0 0.630	20	15,0	4			■
MP10-10007B90Z4-M02	10,0 0.394	7,0 0.276	5,0 0.197	9,6 0.378	16,0 0.630	20	15,0	4		■	
MP10-09507B90Z3-E03	9,525 0.375	7,0 0.276	4,7625 0.188	9,4 0.370	16,0 0.630	30	15,0	3	✓		■
MP10-09507B90Z3-M03	9,525 0.375	7,0 0.276	4,7625 0.188	9,4 0.370	16,0 0.630	30	15,0	3	✓	■	
MP10-09512B90Z3-E03	9,525 0.375	12,0 0.472	4,7625 0.188	9,6 0.378	21,0 0.827	30	15,0	3	✓		■
MP10-09512B90Z3-M03	9,525 0.375	12,0 0.472	4,7625 0.188	9,6 0.378	21,0 0.827	30	15,0	3	✓	■	
MP10-09507B90Z4-E02	9,525 0.375	7,0 0.276	4,7625 0.188	9,4 0.370	16,0 0.630	20	15,0	4			■
MP10-09507B90Z4-M02	9,525 0.375	7,0 0.276	4,7625 0.188	9,4 0.370	16,0 0.630	20	15,0	4		■	

Universal

Steel and cast iron

Stainless steel and S-materials

Non ferrous

Hard

Plastic and cfrp

Graphite

Minimaster Plus

Minimaster

MP10 Centre drilling/Chamfering

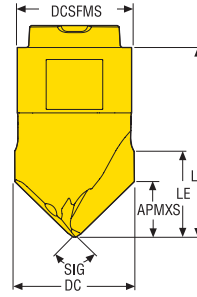

• For insert selection and cutting data recommendations, see page(s) 477-478



Designation	DC	APMXS	DCSFMS	LE	LF	SIG°	ZEFP		Grades	
									MP3000	F40M
	mm <i>Inch</i>	mm <i>Inch</i>	mm <i>Inch</i>	mm <i>Inch</i>	mm <i>Inch</i>					
MP10-10006C90Z2-M03	10,0 <i>0.394</i>	4,6 <i>0.181</i>	9,6 <i>0.378</i>	7,1 <i>0.280</i>	16,0 <i>0.630</i>	90,0	2	✓		■

Universal

Steel and cast iron

Stainless steel and S-materials

Non ferrous

Hard

Plastic and cfrp

Graphite

Minimaster Plus

Minimaster

MP10 Chamfering

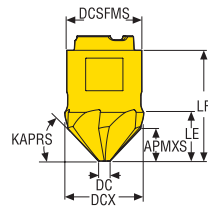

• For insert selection and cutting data recommendations, see page(s) 479-480

Z6



Designation	DCX	DC	APMXS	DCSFMS	LE	LF	KAPRS°	ZEFP		Grades	
										MP3000	Coated F40M
MP10-10006C90Z6-M03	10,1 0.398	1,95 0.077	4,0 0.157	9,6 0.378	5,9 0.232	14,5 0.571	45,0	6			■

Universal

Steel and cast iron

Stainless steel and S-materials

Non ferrous

Hard

Plastic and cfrp

Graphite

Minimaster Plus

Minimaster

MP10 Cylindrical blanks

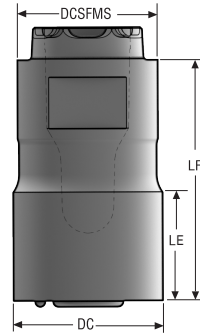

- Cylindrical carbide blanks for production of own geometries



Designation	DC		DCSFMS		LE		LF		Grades	
	mm	Inch	mm	Inch	mm	Inch	mm	Inch	Uncoated	H25
MP10-10007CYL-SEMI	10,15	0.400	9,6	0.378	7,3	0.287	16,3	0.642		■
MP10-10012CYL-SEMI	10,15	0.400	9,6	0.378	12,4	0.488	21,3	0.839		■

MP10 High feed milling – Insert selection – mm/inch

SMG		a _p	f _z			
			100%	70%	30%	20%
P1	MP10-1000.6HFZ3-MD08 MP3000	0,42	0,46	0,46	0,60	0,75
		0,017	0,018	0,018	0,024	0,030
P2	MP10-1000.6HFZ3-MD08 MP3000	0,42	0,46	0,48	0,60	0,75
		0,017	0,018	0,019	0,024	0,030
P3	MP10-1000.6HFZ3-MD08 MP3000	0,42	0,44	0,44	0,60	0,70
		0,017	0,017	0,017	0,024	0,028
P4	MP10-1000.6HFZ3-MD08 MP3000	0,42	0,44	0,44	0,55	0,70
		0,017	0,017	0,017	0,022	0,028
P5	MP10-1000.6HFZ3-MD08 MP3000	0,42	0,42	0,42	0,55	0,70
		0,017	0,017	0,017	0,022	0,028
P6	MP10-1000.6HFZ3-MD08 MP3000	0,42	0,42	0,42	0,55	0,70
		0,017	0,017	0,017	0,022	0,028
P7	MP10-1000.6HFZ3-MD08 MP3000	0,42	0,42	0,42	0,55	0,70
		0,017	0,017	0,017	0,022	0,028
P8	MP10-1000.6HFZ3-MD08 MP3000	0,42	0,44	0,44	0,60	0,70
		0,017	0,017	0,017	0,024	0,028
P11	MP10-1000.6HFZ3-MD08 MP3000	0,42	0,42	0,42	0,55	0,70
		0,017	0,017	0,017	0,022	0,028
P12	MP10-0950.6HFZ3-MD08 MP3000	0,34	0,30	0,30	0,38	0,46
		0,013	0,012	0,012	0,015	0,018
M1	MP10-1000.6HFZ3-MD08 MP3000	0,42	0,46	0,48	0,60	0,75
		0,017	0,018	0,019	0,024	0,030
M2	MP10-1000.6HFZ3-MD08 MP3000	0,42	0,42	0,42	0,55	0,70
		0,017	0,017	0,017	0,022	0,028
M3	MP10-1000.6HFZ3-MD08 MP3000	0,34	0,36	0,34	0,44	0,55
		0,013	0,014	0,013	0,017	0,022
M4	MP10-1000.6HFZ3-MD08 MP3000	0,25	0,32	0,30	0,38	0,46
		0,010	0,013	0,012	0,015	0,018
M5	MP10-1000.6HFZ3-MD08 MP3000	0,25	0,32	0,30	0,38	0,46
		0,010	0,013	0,012	0,015	0,018
K1	MP10-1000.6HFZ3-MD08 MP3000	0,42	0,46	0,48	0,60	0,75
		0,017	0,018	0,019	0,024	0,030
K2	MP10-1000.6HFZ3-MD08 MP3000	0,42	0,42	0,42	0,55	0,70
		0,017	0,017	0,017	0,022	0,028
K3	MP10-1000.6HFZ3-MD08 MP3000	0,42	0,42	0,42	0,55	0,70
		0,017	0,017	0,017	0,022	0,028
K4	MP10-1000.6HFZ3-MD08 MP3000	0,42	0,42	0,42	0,55	0,70
		0,017	0,017	0,017	0,022	0,028
K5	MP10-1000.6HFZ3-MD08 MP3000	0,42	0,38	0,38	0,50	0,60
		0,017	0,015	0,015	0,020	0,024
K6	MP10-1000.6HFZ3-MD08 MP3000	0,42	0,42	0,42	0,55	0,70
		0,017	0,017	0,017	0,022	0,028
K7	MP10-1000.6HFZ3-MD08 MP3000	0,42	0,38	0,38	0,50	0,60
		0,017	0,015	0,015	0,020	0,024
N1	MP10-1000.6HFZ3-MD08 MP3000	0,42	0,60	0,60	0,80	1,0
		0,017	0,024	0,024	0,032	0,040
N2	MP10-1000.6HFZ3-MD08 MP3000	0,42	0,60	0,60	0,80	1,0
		0,017	0,024	0,024	0,032	0,040
N3	MP10-1000.6HFZ3-MD08 MP3000	0,42	0,60	0,60	0,80	1,0
		0,017	0,024	0,024	0,032	0,040
N11	MP10-1000.6HFZ3-MD08 MP3000	0,42	0,60	0,60	0,80	1,0
		0,017	0,024	0,024	0,032	0,040
S1	MP10-1000.6HFZ3-MD08 MP3000	0,25	0,32	0,30	0,38	0,46
		0,010	0,013	0,012	0,015	0,018
S2	MP10-1000.6HFZ3-MD08 MP3000	0,25	0,32	0,30	0,38	0,46
		0,010	0,013	0,012	0,015	0,018
S3	MP10-1000.6HFZ3-MD08 MP3000	0,25	0,30	0,28	0,36	0,44
		0,010	0,012	0,011	0,014	0,017
S11	MP10-1000.6HFZ3-MD08 MP3000	0,30	0,36	0,34	0,44	0,55
		0,012	0,014	0,013	0,017	0,022
S12	MP10-1000.6HFZ3-MD08 MP3000	0,30	0,36	0,34	0,44	0,55
		0,012	0,014	0,013	0,017	0,022
S13	MP10-1000.6HFZ3-MD08 MP3000	0,25	0,32	0,30	0,38	0,46
		0,010	0,013	0,012	0,015	0,018
H5	MP10-1000.6HFZ3-MD08 MP3000	0,34	0,30	0,30	0,38	0,46
		0,013	0,012	0,012	0,015	0,018
H8	MP10-1000.6HFZ3-MD08 MP3000	0,30	0,24	0,22	0,28	0,34
		0,012	0,0095	0,0085	0,011	0,013
H11	MP10-1000.6HFZ3-MD08 MP3000	0,34	0,30	0,30	0,38	0,46
		0,013	0,012	0,012	0,015	0,018
H12	MP10-1000.6HFZ3-MD08 MP3000	0,30	0,24	0,22	0,28	0,34
		0,012	0,0095	0,0085	0,011	0,013
H21	MP10-1000.6HFZ3-MD08 MP3000	0,30	0,24	0,22	0,28	0,34
		0,012	0,0095	0,0085	0,011	0,013

SMG = Seco material group
 f_z = mm/tooth (in/tooth), v_c = m/min (sf/min), a_p/DC = %
 All cutting data are start values

Universal
 Steel and cast iron
 Stainless steel and S-materials
 Non ferrous
 Hard
 Plastic and chip
 Graphite
 Minimaster Plus
 Minimaster

MP10 High feed milling – Cutting data $v_c = (m/min)/(sf/min)$

	SMG	MP3000			
		100%	70%	30%	20%
Universal	P1	250	305	355	370
		820	1000	1175	1225
Steel and cast iron	P2	245	295	345	360
		800	970	1125	1175
Stainless steel and S-materials	P3	215	260	295	315
		710	850	970	1025
	P4	190	230	265	275
		620	750	870	900
	P5	180	220	255	265
		590	720	840	870
	P6	205	245	285	295
		670	800	940	970
	P7	190	235	270	280
		620	770	890	920
	P8	180	220	250	265
		590	720	820	870
	P11	185	225	260	275
		610	740	850	900
	P12	120	145	165	175
		395	475	540	570
Non ferrous	M1	185	220	255	270
		610	720	840	890
	M2	150	185	210	220
		490	610	690	720
	M3	120	145	170	180
		395	475	560	590
	M4	95	115	130	140
		310	375	425	460
	M5	80	95	110	115
		260	310	360	375
Hard	K1	195	235	275	285
		640	770	900	940
	K2	170	210	240	250
		560	690	790	820
	K3	145	175	205	215
		475	570	670	710
Plastic and cfrp	K4	140	170	195	205
		460	560	640	670
	K5	85	105	120	125
		280	345	395	410
	K6	120	150	170	180
		395	490	560	590
	K7	110	130	150	160
		360	425	490	520
Graphite	N1	1450	1750	2025	2100
		4750	5750	6650	6900
	N2	580	710	810	850
		1900	2325	2650	2800
	N3	390	470	540	570
		1275	1550	1775	1875
	N11	445	540	620	650
		1450	1775	2025	2125
Minimaster Plus	S1	45	55	60	65
		150	180	195	215
	S2	36	42	49	50
		120	140	160	165
	S3	31	37	43	45
		100	120	140	150
	S11	60	75	85	90
		195	245	280	295
	S12	43	50	60	60
		140	165	195	195
Minimaster	S13	25	30	34	36
		80	100	110	120
	H5	37	45	50	55
		120	150	165	180
	H8	39	47	55	60
		130	155	180	195
	H11	48	55	65	70
		155	180	215	230
	H12	75	90	105	110
		245	295	345	360
	H21	39	47	55	60
		130	155	180	195

MP10 Slot and Side milling – Insert selection – mm/Inch

SMG		a _p	f _z			
			100%	30%	10%	5%
P1	MP10-10007R04Z3-M03 MP3000	3,5 0.14	0,042 0.0017	0,046 0.0018	0,070 0.0028	0,10 0.0040
P2	MP10-10007R04Z3-M03 MP3000	3,5 0.14	0,044 0.0017	0,048 0.0019	0,070 0.0028	0,10 0.0040
P3	MP10-10007R04Z3-M03 MP3000	3,5 0.14	0,040 0.0016	0,044 0.0017	0,070 0.0028	0,095 0.0038
P4	MP10-10007R04Z3-M03 MP3000	3,5 0.14	0,040 0.0016	0,044 0.0017	0,065 0.0026	0,095 0.0038
P5	MP10-10007R04Z3-M03 MP3000	3,5 0.14	0,040 0.0016	0,042 0.0017	0,065 0.0026	0,090 0.0036
P6	MP10-10007R04Z3-M03 MP3000	3,5 0.14	0,038 0.0015	0,042 0.0017	0,065 0.0026	0,090 0.0036
P7	MP10-10007R04Z3-M03 MP3000	3,5 0.14	0,038 0.0015	0,042 0.0017	0,065 0.0026	0,090 0.0036
P8	MP10-10007R04Z3-M03 MP3000	3,5 0.14	0,040 0.0016	0,044 0.0017	0,070 0.0028	0,095 0.0038
P11	MP10-10007R04Z3-M03 MP3000	3,5 0.14	0,038 0.0015	0,042 0.0017	0,065 0.0026	0,090 0.0036
P12	MP10-10007R04Z3-M03 MP3000	2,5 0.10	0,026 0.0010	0,030 0.0012	0,044 0.0017	0,060 0.0024
M1	MP10-10007R04Z3-E03 F40M	3,5 0.14	0,044 0.0017	0,048 0.0019	0,070 0.0028	0,10 0.0040
M2	MP10-10007R04Z3-E03 F40M	3,5 0.14	0,040 0.0016	0,042 0.0017	0,065 0.0026	0,090 0.0036
M3	MP10-10007R04Z3-E03 F40M	2,5 0.10	0,032 0.0013	0,034 0.0013	0,055 0.0022	0,075 0.0030
M4	MP10-10007R04Z3-E03 F40M	2,0 0.080	0,028 0.0011	0,030 0.0012	0,046 0.0018	0,065 0.0026
M5	MP10-10007R04Z3-E03 F40M	2,0 0.080	0,028 0.0011	0,030 0.0012	0,046 0.0018	0,065 0.0026
K1	MP10-10007R04Z3-M03 MP3000	3,5 0.14	0,044 0.0017	0,048 0.0019	0,070 0.0028	0,10 0.0040
K2	MP10-10007R04Z3-M03 MP3000	3,5 0.14	0,040 0.0016	0,042 0.0017	0,065 0.0026	0,090 0.0036
K3	MP10-10007R04Z3-M03 MP3000	3,5 0.14	0,040 0.0016	0,042 0.0017	0,065 0.0026	0,090 0.0036
K4	MP10-10007R04Z3-M03 MP3000	3,5 0.14	0,040 0.0016	0,042 0.0017	0,065 0.0026	0,090 0.0036
K5	MP10-10007R04Z3-M03 MP3000	3,5 0.14	0,036 0.0014	0,038 0.0015	0,060 0.0024	0,080 0.0032
K6	MP10-10007R04Z3-M03 MP3000	3,5 0.14	0,040 0.0016	0,042 0.0017	0,065 0.0026	0,090 0.0036
K7	MP10-10007R04Z3-M03 MP3000	3,5 0.14	0,036 0.0014	0,038 0.0015	0,060 0.0024	0,080 0.0032
N1	MP10-10007R04Z3-E03 F40M	3,5 0.14	0,055 0.0022	0,060 0.0024	0,090 0.0036	0,13 0.0050
N2	MP10-10007R04Z3-E03 F40M	3,5 0.14	0,055 0.0022	0,060 0.0024	0,090 0.0036	0,13 0.0050
N3	MP10-10007R04Z3-E03 F40M	3,5 0.14	0,055 0.0022	0,060 0.0024	0,090 0.0036	0,13 0.0050
N11	MP10-10007R04Z3-E03 F40M	3,5 0.14	0,055 0.0022	0,060 0.0024	0,090 0.0036	0,13 0.0050
S1	MP10-10007R04Z3-E03 F40M	2,0 0.080	0,028 0.0011	0,030 0.0012	0,046 0.0018	0,065 0.0026
S2	MP10-10007R04Z3-E03 F40M	2,0 0.080	0,028 0.0011	0,030 0.0012	0,046 0.0018	0,065 0.0026
S3	MP10-10007R04Z3-E03 F40M	2,0 0.080	0,026 0.0010	0,028 0.0011	0,042 0.0017	0,060 0.0024
S11	MP10-10007R04Z3-E03 F40M	2,5 0.10	0,032 0.0013	0,034 0.0013	0,055 0.0022	0,075 0.0030
S12	MP10-10007R04Z3-E03 F40M	2,5 0.10	0,032 0.0013	0,034 0.0013	0,055 0.0022	0,075 0.0030
S13	MP10-10007R04Z3-E03 F40M	2,0 0.080	0,028 0.0011	0,030 0.0012	0,046 0.0018	0,065 0.0026
H5	MP10-10007R04Z3-M03 MP3000	2,5 0.10	0,026 0.0010	0,030 0.0012	0,044 0.0017	0,060 0.0024
H8	MP10-10007R04Z3-M03 MP3000	2,5 0.10	0,020 0.00080	0,022 0.00085	0,034 0.0013	0,048 0.0019
H11	MP10-10007R04Z3-M03 MP3000	2,5 0.10	0,026 0.0010	0,030 0.0012	0,044 0.0017	0,060 0.0024
H12	MP10-10007R04Z3-M03 MP3000	2,5 0.10	0,020 0.00080	0,022 0.00085	0,034 0.0013	0,048 0.0019
H21	MP10-10007R04Z3-M03 MP3000	2,5 0.10	0,020 0.00080	0,022 0.00085	0,034 0.0013	0,048 0.0019

SMG = Seco material group
f_z = mm/tooth (in/tooth), v_c = m/min (sf/min), a_p/DC = %
All cutting data are start values

Universal
Steel and cast iron
Stainless steel and S-materials
Non ferrous
Hard
Plastic and chip
Graphite
Minimaster Plus
Minimaster

MP10 Slot and Side milling – Cutting data $v_c = (m/min)/(sf/min)$

SMG	MP3000				F40M			
	100%	30%	10%	5%	100%	30%	10%	5%
P1	265	345	405	435	250	325	380	410
	870	1125	1325	1425	820	1075	1250	1350
P2	255	335	395	425	240	315	370	400
	840	1100	1300	1400	790	1025	1225	1300
P3	225	290	340	365	210	275	320	345
	740	950	1125	1200	690	900	1050	1125
P4	195	255	300	325	185	240	285	305
	640	840	980	1075	610	790	940	1000
P5	190	245	290	310	175	235	270	295
	620	800	950	1025	570	770	890	970
P6	215	275	325	350	200	260	305	330
	710	900	1075	1150	660	850	1000	1075
P7	200	260	305	330	190	245	290	310
	660	850	1000	1075	620	800	950	1025
P8	190	245	285	310	175	230	270	290
	620	800	940	1025	570	750	890	950
P11	195	255	295	320	185	240	280	305
	640	840	970	1050	610	790	920	1000
P12	125	160	185	200	115	150	175	190
	410	520	610	660	375	490	570	620
M1	190	250	295	315	195	255	300	320
	620	820	970	1025	640	840	980	1050
M2	155	205	240	260	160	210	245	265
	510	670	790	850	520	690	800	870
M3	125	165	190	205	125	165	195	210
	410	540	620	670	410	540	640	690
M4	95	125	145	155	100	125	145	160
	310	410	475	510	330	410	475	520
M5	80	105	120	130	80	105	125	135
	260	345	395	425	260	345	410	445
K1	200	265	310	335	190	250	295	315
	660	870	1025	1100	620	820	970	1025
K2	180	235	275	295	170	220	260	280
	590	770	900	970	560	720	850	920
K3	150	200	230	250	140	185	220	235
	490	660	750	820	460	610	720	770
K4	145	190	220	240	135	180	210	225
	475	620	720	790	445	590	690	740
K5	85	115	135	145	80	110	125	135
	280	375	445	475	260	360	410	445
K6	125	165	195	210	120	155	185	200
	410	540	640	690	395	510	610	660
K7	110	145	170	185	105	140	160	175
	360	475	560	610	345	460	520	570
N1	1525	2000	2350	2525	1450	1875	2225	2375
	5000	6550	7700	8275	4750	6150	7300	7800
N2	620	810	950	1025	580	760	900	960
	2025	2650	3125	3375	1900	2500	2950	3150
N3	410	540	630	680	390	510	600	640
	1350	1775	2075	2225	1275	1675	1975	2100
N11	470	610	720	780	445	580	680	730
	1550	2000	2350	2550	1450	1900	2225	2400
S1	45	60	70	75	46	60	70	75
	150	195	230	245	150	195	230	245
S2	36	47	55	60	37	48	55	60
	120	155	180	195	120	155	180	195
S3	31	41	47	50	32	42	48	50
	100	135	155	165	105	140	155	165
S11	65	80	95	105	65	85	100	105
	215	260	310	345	215	280	330	345
S12	44	55	65	70	45	60	70	75
	145	180	215	230	150	195	230	245
S13	25	33	38	41	26	33	39	42
	80	110	125	135	85	110	130	140
H5	38	49	60	60	39	50	60	65
	125	160	195	195	130	165	195	215
H8	40	50	60	65	40	50	60	65
	130	165	195	215	130	165	195	215
H11	49	65	75	80	49	65	75	80
	160	215	245	260	160	215	245	260
H12	75	100	115	125	70	95	110	115
	245	330	375	410	230	310	360	375
H21	40	50	60	65	40	50	60	65
	130	165	195	215	130	165	195	215

MP10 Copy milling – Cutting data $v_c = (m/min)/(sf/min)$

SMG	MP3000					F40M				
	100%	30%	10%	5%	2%	100%	30%	10%	5%	2%
P1	275	330	360	385	385	260	310	340	365	365
	900	1075	1175	1275	1275	850	1025	1125	1200	1200
P2	265	320	345	375	375	250	300	325	355	355
	870	1050	1125	1225	1225	820	980	1075	1175	1175
P3	230	280	300	325	325	220	265	285	310	305
	750	920	980	1075	1075	720	870	940	1025	1000
P4	205	245	265	290	290	195	230	250	270	270
	670	800	870	950	950	640	750	820	890	890
P5	195	235	255	275	275	185	220	240	260	260
	640	770	840	900	900	610	720	790	850	850
P6	220	265	285	310	310	205	250	270	295	290
	720	870	940	1025	1025	670	820	890	970	950
P7	205	250	270	295	290	195	235	255	275	275
	670	820	890	970	950	640	770	840	900	900
P8	195	235	255	275	270	185	220	240	260	255
	640	770	840	900	890	610	720	790	850	840
P11	200	245	265	285	285	190	230	250	270	265
	660	800	870	940	940	620	750	820	890	870
P12	125	155	160	175	175	120	145	155	165	165
	410	510	520	570	570	395	475	510	540	540
M1	200	240	260	280	280	205	245	265	285	285
	660	790	850	920	920	670	800	870	940	940
M2	165	195	215	230	230	165	200	215	235	235
	540	640	710	750	750	540	660	710	770	770
M3	130	160	165	180	180	135	160	170	185	185
	425	520	540	590	590	445	520	560	610	610
M4	100	125	125	140	140	105	125	130	140	140
	330	410	410	460	460	345	410	425	460	460
M5	85	100	105	115	115	85	105	110	115	115
	280	330	345	375	375	280	345	360	375	375
K1	210	255	275	300	300	200	240	260	280	280
	690	840	900	980	980	660	790	850	920	920
K2	185	220	245	260	260	175	210	230	245	245
	610	720	800	850	850	570	690	750	800	800
K3	155	190	205	220	220	150	180	195	210	210
	510	620	670	720	720	490	590	640	690	690
K4	150	180	195	210	210	140	170	185	200	200
	490	590	640	690	690	460	560	610	660	660
K5	90	110	120	125	130	85	105	110	120	120
	295	360	395	410	425	280	345	360	395	395
K6	130	160	175	185	185	125	150	165	175	175
	425	520	570	610	610	410	490	540	570	570
K7	115	140	150	165	165	110	130	145	155	155
	375	460	490	540	540	360	425	475	510	510
N1	1600	1925	2100	2275	2250	1500	1825	1975	2150	2125
	5250	6325	6900	7475	7375	4925	6000	6475	7050	6975
N2	650	780	840	920	900	610	730	800	860	850
	2125	2550	2750	3025	2950	2000	2400	2625	2825	2800
N3	430	520	560	610	600	405	490	530	580	570
	1400	1700	1825	2000	1975	1325	1600	1750	1900	1875
N11	490	590	640	700	690	465	560	610	660	650
	1600	1925	2100	2300	2275	1525	1825	2000	2175	2125
S1	47	55	60	65	65	48	60	60	65	65
	155	180	195	215	215	155	195	195	215	215
S2	38	46	48	50	50	39	47	49	55	55
	125	150	155	165	165	130	155	160	180	180
S3	33	40	41	45	45	34	41	42	46	46
	110	130	135	150	150	110	135	140	150	150
S11	65	80	85	90	90	70	85	85	95	95
	215	260	280	295	295	230	280	280	310	310
S12	46	55	60	65	65	47	55	60	65	65
	150	180	195	215	215	155	180	195	215	215
S13	27	32	33	36	36	27	33	34	37	37
	90	105	110	120	120	90	110	110	120	120
H5	39	48	50	55	55	40	48	50	55	55
	130	155	165	180	180	130	155	165	180	180
H8	41	50	50	55	55	41	50	50	55	55
	135	165	165	180	180	135	165	165	180	180
H11	50	60	65	70	70	50	60	65	70	70
	165	195	215	230	230	165	195	215	230	230
H12	80	95	100	110	110	75	90	95	100	100
	260	310	330	360	360	245	295	310	330	330
H21	41	50	50	55	55	41	50	50	55	55
	135	165	165	180	180	135	165	165	180	180

MP10 Centre drilling – Insert selection – mm/Inch

SMG		f_z	a_{so}
			100%
P1	MP10-10006C90Z2-M03 F40M	0,042 0,0017	3,0 0,12
P2	MP10-10006C90Z2-M03 F40M	0,042 0,0017	3,0 0,12
P3	MP10-10006C90Z2-M03 F40M	0,040 0,0016	3,0 0,12
P4	MP10-10006C90Z2-M03 F40M	0,040 0,0016	3,0 0,12
P5	MP10-10006C90Z2-M03 F40M	0,040 0,0016	3,0 0,12
P6	MP10-10006C90Z2-M03 F40M	0,038 0,0015	3,0 0,12
P7	MP10-10006C90Z2-M03 F40M	0,038 0,0015	3,0 0,12
P8	MP10-10006C90Z2-M03 F40M	0,040 0,0016	3,0 0,12
P11	MP10-10006C90Z2-M03 F40M	0,038 0,0015	3,0 0,12
P12	MP10-10006C90Z2-M03 F40M	0,026 0,0010	2,0 0,080
M1	MP10-10006C90Z2-M03 F40M	0,042 0,0017	3,0 0,12
M2	MP10-10006C90Z2-M03 F40M	0,040 0,0016	3,0 0,12
M3	MP10-10006C90Z2-M03 F40M	0,032 0,0013	2,0 0,080
M4	MP10-10006C90Z2-M03 F40M	0,028 0,0011	1,7 0,065
M5	MP10-10006C90Z2-M03 F40M	0,028 0,0011	1,7 0,065
K1	MP10-10006C90Z2-M03 F40M	0,042 0,0017	3,0 0,12
K2	MP10-10006C90Z2-M03 F40M	0,040 0,0016	3,0 0,12
K3	MP10-10006C90Z2-M03 F40M	0,040 0,0016	3,0 0,12
K4	MP10-10006C90Z2-M03 F40M	0,040 0,0016	3,0 0,12
K5	MP10-10006C90Z2-M03 F40M	0,036 0,0014	3,0 0,12
K6	MP10-10006C90Z2-M03 F40M	0,040 0,0016	3,0 0,12
K7	MP10-10006C90Z2-M03 F40M	0,036 0,0014	3,0 0,12
N1	MP10-10006C90Z2-M03 F40M	0,055 0,0022	3,0 0,12
N2	MP10-10006C90Z2-M03 F40M	0,055 0,0022	3,0 0,12
N3	MP10-10006C90Z2-M03 F40M	0,055 0,0022	3,0 0,12
N11	MP10-10006C90Z2-M03 F40M	0,055 0,0022	3,0 0,12
S1	MP10-10006C90Z2-M03 F40M	0,028 0,0011	1,7 0,065
S2	MP10-10006C90Z2-M03 F40M	0,028 0,0011	1,7 0,065
S3	MP10-10006C90Z2-M03 F40M	0,025 0,0010	1,7 0,065
S11	MP10-10006C90Z2-M03 F40M	0,032 0,0013	1,9 0,075
S12	MP10-10006C90Z2-M03 F40M	0,032 0,0013	1,9 0,075
S13	MP10-10006C90Z2-M03 F40M	0,028 0,0011	1,7 0,065
H5	MP10-10006C90Z2-M03 F40M	0,026 0,0010	2,0 0,080
H8	MP10-10006C90Z2-M03 F40M	0,020 0,00080	1,9 0,075
H11	MP10-10006C90Z2-M03 F40M	0,026 0,0010	2,0 0,080
H12	MP10-10006C90Z2-M03 F40M	0,020 0,00080	1,9 0,075
H21	MP10-10006C90Z2-M03 F40M	0,020 0,00080	1,9 0,075

SMG = Seco material group
 f_z = mm/tooth (in/tooth), v_c = m/min (sf/min), a_g/DC = %
 All cutting data are start values

Universal
 Steel and cast iron
 Stainless steel and S-materials
 Non ferrous
 Hard
 Plastic and cfrp
 Graphite
 Minimaster Plus
 Minimaster

MP10 Centre drilling – Cutting data $v_c = (m/min)/(sf/min)$

	MP10 Centre drilling – Cutting data $v_c = (m/min)/(sf/min)$		
	SMG	F40M	
Universal		100%	
	P1	305 1000	
Steel and cast iron	P2	295 970	
	P3	260 850	
	P4	225 740	
	P5	215 710	
	P6	245 800	
	P7	230 750	
Stainless steel and S-materials	P8	215 710	
	P11	225 740	
	P12	135 445	
	M1	240 790	
	M2	195 640	
Non ferrous	M3	150 490	
	M4	110 360	
	M5	95 310	
	K1	235 770	
Hard	K2	205 670	
	K3	175 570	
	K4	165 540	
	K5	100 330	
	K6	145 475	
	K7	130 425	
	Graphite	N1	1775 5825
N2		710 2325	
N3		475 1550	
N11		540 1775	
Minimaster Plus		S1	50 165
	S2	42 140	
	S3	36 120	
	S11	75 245	
	S12	50 165	
	S13	29 95	
	Minimaster	H5	45 150
		H8	46 150
		H11	55 180
		H12	85 280
		H21	46 150

MP10 Chamfering – Insert selection – mm/Inch

SMG		a _p	f _z				
			100%	50%	30%	20%	10%
P1	MP10-10006C90Z2-M03 F40M	2,0	0,060	0,060	0,060	0,060	0,075
		0,080	0,0024	0,0024	0,0024	0,0024	0,0030
P2	MP10-10006C90Z2-M03 F40M	2,0	0,060	0,060	0,060	0,060	0,075
		0,080	0,0024	0,0024	0,0024	0,0024	0,0030
P3	MP10-10006C90Z2-M03 F40M	2,0	0,055	0,055	0,055	0,055	0,070
		0,080	0,0022	0,0022	0,0022	0,0022	0,0028
P4	MP10-10006C90Z2-M03 F40M	2,0	0,055	0,055	0,055	0,055	0,070
		0,080	0,0022	0,0022	0,0022	0,0022	0,0028
P5	MP10-10006C90Z2-M03 F40M	2,0	0,055	0,055	0,055	0,055	0,065
		0,080	0,0022	0,0022	0,0022	0,0022	0,0026
P6	MP10-10006C90Z2-M03 F40M	2,0	0,055	0,055	0,055	0,055	0,065
		0,080	0,0022	0,0022	0,0022	0,0022	0,0026
P7	MP10-10006C90Z2-M03 F40M	2,0	0,055	0,055	0,055	0,055	0,065
		0,080	0,0022	0,0022	0,0022	0,0022	0,0026
P8	MP10-10006C90Z2-M03 F40M	2,0	0,055	0,055	0,055	0,055	0,070
		0,080	0,0022	0,0022	0,0022	0,0022	0,0028
P11	MP10-10006C90Z2-M03 F40M	2,0	0,055	0,055	0,055	0,055	0,065
		0,080	0,0022	0,0022	0,0022	0,0022	0,0026
P12	MP10-10006C90Z2-M03 F40M	1,8	0,038	0,038	0,038	0,038	0,046
		0,070	0,0015	0,0015	0,0015	0,0015	0,0018
M1	MP10-10006C90Z2-M03 F40M	2,0	0,060	0,060	0,060	0,060	0,075
		0,080	0,0024	0,0024	0,0024	0,0024	0,0030
M2	MP10-10006C90Z2-M03 F40M	2,0	0,055	0,055	0,055	0,055	0,065
		0,080	0,0022	0,0022	0,0022	0,0022	0,0026
M3	MP10-10006C90Z2-M03 F40M	1,8	0,044	0,044	0,044	0,044	0,055
		0,070	0,0017	0,0017	0,0017	0,0017	0,0022
M4	MP10-10006C90Z2-M03 F40M	1,3	0,038	0,038	0,038	0,038	0,048
		0,050	0,0015	0,0015	0,0015	0,0015	0,0019
M5	MP10-10006C90Z2-M03 F40M	1,3	0,038	0,038	0,038	0,038	0,048
		0,050	0,0015	0,0015	0,0015	0,0015	0,0019
K1	MP10-10006C90Z2-M03 F40M	2,0	0,060	0,060	0,060	0,060	0,075
		0,080	0,0024	0,0024	0,0024	0,0024	0,0030
K2	MP10-10006C90Z2-M03 F40M	2,0	0,055	0,055	0,055	0,055	0,065
		0,080	0,0022	0,0022	0,0022	0,0022	0,0026
K3	MP10-10006C90Z2-M03 F40M	2,0	0,055	0,055	0,055	0,055	0,065
		0,080	0,0022	0,0022	0,0022	0,0022	0,0026
K4	MP10-10006C90Z2-M03 F40M	2,0	0,055	0,055	0,055	0,055	0,065
		0,080	0,0022	0,0022	0,0022	0,0022	0,0026
K5	MP10-10006C90Z2-M03 F40M	2,0	0,050	0,050	0,050	0,050	0,060
		0,080	0,0020	0,0020	0,0020	0,0020	0,0024
K6	MP10-10006C90Z2-M03 F40M	2,0	0,055	0,055	0,055	0,055	0,065
		0,080	0,0022	0,0022	0,0022	0,0022	0,0026
K7	MP10-10006C90Z2-M03 F40M	2,0	0,050	0,050	0,050	0,050	0,060
		0,080	0,0020	0,0020	0,0020	0,0020	0,0024
N1	MP10-10006C90Z2-M03 F40M	2,0	0,075	0,075	0,075	0,075	0,095
		0,080	0,0030	0,0030	0,0030	0,0030	0,0038
N2	MP10-10006C90Z2-M03 F40M	2,0	0,075	0,075	0,075	0,075	0,095
		0,080	0,0030	0,0030	0,0030	0,0030	0,0038
N3	MP10-10006C90Z2-M03 F40M	2,0	0,075	0,075	0,075	0,075	0,095
		0,080	0,0030	0,0030	0,0030	0,0030	0,0038
N11	MP10-10006C90Z2-M03 F40M	2,0	0,075	0,075	0,075	0,075	0,095
		0,080	0,0030	0,0030	0,0030	0,0030	0,0038
S1	MP10-10006C90Z2-M03 F40M	1,3	0,038	0,038	0,038	0,038	0,048
		0,050	0,0015	0,0015	0,0015	0,0015	0,0019
S2	MP10-10006C90Z2-M03 F40M	1,3	0,038	0,038	0,038	0,038	0,048
		0,050	0,0015	0,0015	0,0015	0,0015	0,0019
S3	MP10-10006C90Z2-M03 F40M	1,3	0,036	0,036	0,036	0,036	0,044
		0,050	0,0014	0,0014	0,0014	0,0014	0,0017
S11	MP10-10006C90Z2-M03 F40M	1,5	0,044	0,044	0,044	0,044	0,055
		0,060	0,0017	0,0017	0,0017	0,0017	0,0022
S12	MP10-10006C90Z2-M03 F40M	1,5	0,044	0,044	0,044	0,044	0,055
		0,060	0,0017	0,0017	0,0017	0,0017	0,0022
S13	MP10-10006C90Z2-M03 F40M	1,3	0,038	0,038	0,038	0,038	0,048
		0,050	0,0015	0,0015	0,0015	0,0015	0,0019
H5	MP10-10006C90Z2-M03 F40M	1,8	0,038	0,038	0,038	0,038	0,046
		0,070	0,0015	0,0015	0,0015	0,0015	0,0018
H8	MP10-10006C90Z2-M03 F40M	1,5	0,028	0,028	0,028	0,028	0,034
		0,060	0,0011	0,0011	0,0011	0,0011	0,0013
H11	MP10-10006C90Z2-M03 F40M	1,8	0,038	0,038	0,038	0,038	0,046
		0,070	0,0015	0,0015	0,0015	0,0015	0,0018
H12	MP10-10006C90Z2-M03 F40M	1,5	0,028	0,028	0,028	0,028	0,034
		0,060	0,0011	0,0011	0,0011	0,0011	0,0013
H21	MP10-10006C90Z2-M03 F40M	1,5	0,028	0,028	0,028	0,028	0,034
		0,060	0,0011	0,0011	0,0011	0,0011	0,0013

SMG = Seco material group
 f_z = mm/tooth (in/tooth), v_c = m/min (sf/min), a_p/DC = %
 All cutting data are start values

Universal
Steel and cast iron
Stainless steel and S-materials
Non ferrous
Hard
Plastic and chip
Graphite
Minimaster Plus
Minimaster

MP10 Chamfering – Cutting data $v_c = (m/min)/(sf/min)$

	SMG	F40M				
		100%	50%	30%	20%	10%
Universal	P1	330	300	360	395	465
		1075	980	1175	1300	1525
Steel and cast iron	P2	320	290	350	385	455
		1050	950	1150	1275	1500
Stainless steel and S-materials	P3	285	255	305	340	395
		940	840	1000	1125	1300
	P4	250	225	270	300	350
		820	740	890	980	1150
	P5	240	215	260	285	335
		790	710	850	940	1100
	P6	265	240	290	320	380
		870	790	950	1050	1250
	P7	250	230	275	300	355
		820	750	900	980	1175
	P8	240	215	260	285	330
		790	710	850	940	1075
	P11	245	220	265	295	345
		800	720	870	970	1125
	P12	155	140	160	175	220
		510	460	520	570	720
Non ferrous	M1	260	235	280	310	365
		850	770	920	1025	1200
	M2	215	195	230	255	305
		710	640	750	840	1000
	M3	170	150	175	195	240
		560	490	570	640	790
	M4	130	110	125	140	185
		425	360	410	460	610
	M5	105	90	105	120	155
		345	295	345	395	510
Hard	K1	255	230	275	305	360
		840	750	900	1000	1175
	K2	225	205	245	270	320
		740	670	800	890	1050
	K3	190	175	205	230	270
		620	570	670	750	890
Plastic and cfrp	K4	180	165	200	220	260
		590	540	660	720	850
	K5	110	100	120	135	155
		360	330	395	445	510
	K6	160	145	175	190	230
		520	475	570	620	750
	K7	140	130	155	170	200
		460	425	510	560	660
Graphite	N1	1925	1725	2075	2300	2700
		6325	5650	6800	7550	8850
	N2	770	690	840	930	1100
		2525	2275	2750	3050	3600
	N3	520	465	560	620	730
		1700	1525	1825	2025	2400
	N11	590	530	640	710	830
		1925	1750	2100	2325	2725
Minimaster Plus	S1	60	50	60	65	85
		195	165	195	215	280
	S2	48	41	47	55	70
		155	135	155	180	230
	S3	42	36	41	46	60
		140	120	135	150	195
	S11	85	75	85	95	120
		280	245	280	310	395
	S12	60	50	60	65	85
		195	165	195	215	280
Minimaster	S13	34	29	33	37	48
		110	95	110	120	155
	H5	50	46	50	60	75
		165	150	165	195	245
	H8	55	47	55	60	75
		180	155	180	195	245
	H11	65	60	65	75	90
		215	195	215	245	295
	H12	95	85	95	110	135
		310	280	310	360	445
	H21	55	47	55	60	75
		180	155	180	195	245

MP12 Shank – Metric

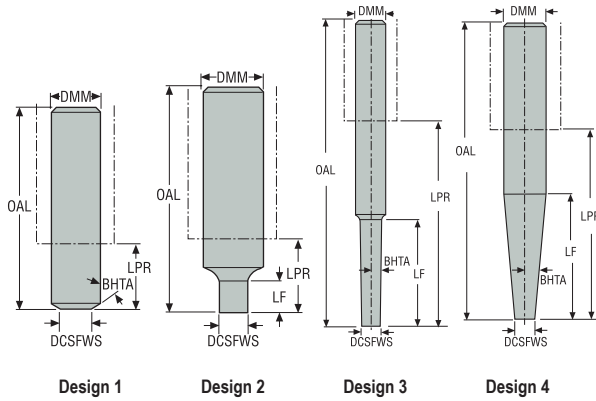

• Cylindrical shank DMM with tolerance h5, compatible for Shrinkfit

Designation	ShankType	DCSFWS	DMM	OAL	LPR	LF	RPMX	BHTA°	Design	Weight
		mm	mm	mm	mm	mm				kg
MP12-12060-012.00	Cylindrical	11,5	12,0	60,0	15,0	12,0	72700	0,0	2	0,1
MP12-16068-000.60	Cylindrical	11,5	16,0	68,0	20,0	0,0	72700	60,0	1	0,2
MP12-16078-018.00	Cylindrical	11,5	16,0	78,0	30,0	18,0	72700	0,0	2	0,1
MP12-16153-042.01	Cylindrical	11,5	16,0	153,0	105,0	42,0	72700	1,0	3	0,2
MP12-20170-072.01	Cylindrical	11,5	20,0	170,0	120,0	72,0	72700	1,0	3	0,3
MP12-20110-055.03	Cylindrical	11,5	20,0	110,0	60,0	55,0	72700	3,0	3	0,2
MP12-20150-100.03	Cylindrical	11,5	20,0	150,0	100,0	81,1	72700	3,0	3	0,3
MP12-20155-105.05	Cylindrical	11,5	20,0	155,0	105,0	48,6	72700	5,0	4	0,4
MP12-16107-036.00-E	Cylindrical Carbide	11,5	16,0	107,0	59,0	36,0	72700	0,0	2	0,3
MP12-16120-048.00-E	Cylindrical Carbide	11,5	16,0	120,0	72,0	48,0	72700	0,0	2	0,3
MP12-16150-072.00-E	Cylindrical Carbide	11,5	16,0	150,0	102,0	72,0	72700	0,0	2	0,3
MP12-16120-060.01-E	Cylindrical Carbide	11,5	16,0	120,0	72,0	60,0	72700	1,0	3	0,3
MP12-16150-096.01-E	Cylindrical Carbide	11,5	16,0	150,0	102,0	96,0	72700	1,0	3	0,4
MP12-16175-120.01-E	Cylindrical Carbide	11,5	16,0	175,0	127,0	120,0	72700	1,0	3	0,4
MP12-16155-107.03-E	Cylindrical Carbide	11,5	16,0	155,0	107,0	42,9	72700	3,0	4	0,4
MP12-16180-132.03-E	Cylindrical Carbide	11,5	16,0	180,0	132,0	42,9	72700	3,0	4	0,5

Accessories

Key	Replacement blade	Torque key
MP1016	MP00-12M	MP00-12.150

Blades are included with the torque key

Universal
Steel and cast iron
Stainless steel and S-materials
Non ferrous
Hard
Plastic and chip
Graphite
Minimaster Plus
Minimaster

MP12 Shank – Inch

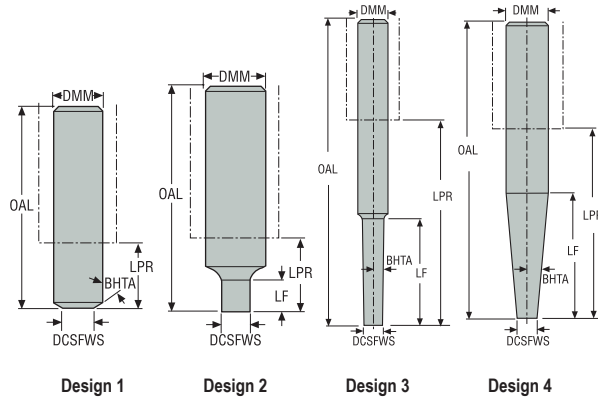

- Cylindrical shank DMM with tolerance h5, compatible for Shrinkfit

Designation	ShankType	DCSFWS	DMM	OAL	LPR	LF	RPMX	BHTA°	Design	Weight
		Inch	Inch	Inch	Inch	Inch	Inch			lbs
MP12-0502.3-0.47.00	Cylindrical	0.453	0.500	2.341	0.591	0.472	72700	0,0	2	✓ 0.220
MP12-0622.6-0.00.60	Cylindrical	0.453	0.625	2.662	0.787	–	72700	60,0	1	✓ 0.220
MP12-0623.0-0.70.00	Cylindrical	0.453	0.625	3.056	1.181	0.709	72700	0,0	2	✓ 0.220
MP12-0626.0-1.65.01	Cylindrical	0.453	0.625	6.009	4.134	1.654	72700	1,0	3	✓ 0.440
MP12-0754.3-2.20.03	Cylindrical	0.453	0.750	4.362	2.362	2.201	72700	3,0	3	✓ 0.440
MP12-0755.9-3.93.03	Cylindrical	0.453	0.750	5.937	3.937	2.835	72700	3,0	3	✓ 0.660
MP12-0756.1-4.13.05	Cylindrical	0.453	0.750	6.134	4.134	1.697	72700	5,0	4	✓ 0.660
MP12-0756.7-2.83.01	Cylindrical	0.453	0.750	6.724	4.724	2.835	72700	1,0	4	✓ 0.660
MP12-0627.0-5.19.03-E	Cylindrical Carbide	0.453	0.625	7.072	5.197	1.654	72700	3,0	4	✓ 1.100
MP12-0625.8-2.83.00-E	Cylindrical Carbide	0.453	0.625	5.891	4.016	2.835	72700	0,0	2	✓ 0.660

Accessories

Key	Replacement blade	Torque key
MP1016	MP00-12M	MP00-12.150

Blades are included with the torque key

Universal

Steel and cast iron

Stainless steel and S-materials

Non ferrous

Hard

Plastic and cfrp

Graphite

Minimaster Plus

Minimaster

MP12 High feed

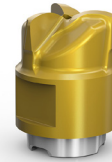
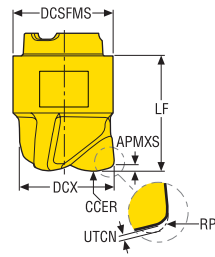

• For insert selection and cutting data recommendations, see page(s) 492-493

Z3



Designation	DCX	DC	APMXS	DCSFMS	CCER	RP	LF	UTCN	RMPX°	C min	C max	ZEFP		Grades	
														Coated	
	mm <i>Inch</i>	mm <i>Inch</i>	mm <i>Inch</i>	mm <i>Inch</i>	mm <i>Inch</i>	mm <i>Inch</i>	mm <i>Inch</i>	mm <i>Inch</i>						MP3000	F40M
MP12-1200.7HFZ3-MD10	12,0 0.472	6,0 0.236	0,7 0.028	11,52 0.454	7,5 0.295	1,66 0.065	13,3 0.524	0,33 0.013	5,0	13,1	17,8	3	✓	■	
MP12-1270.7HFZ3-MD10	12,7 0.500	6,7 0.264	0,7 0.028	11,52 0.454	7,5 0.295	1,66 0.065	13,3 0.524	0,32 0.013	5,0	13,8	19,2	3	✓	■	

Universal

Steel and cast iron

Stainless steel and S-materials

Non ferrous

Hard

Plastic and cfrp

Graphite

Minimaster Plus

Minimaster

MP12 Square shoulder

Slotting and contouring

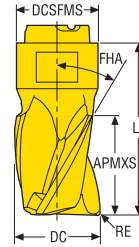

• For insert selection and cutting data recommendations, see page(s) 494-495

Z3



Designation	DC	APMXS	RE	DCSFMS	FHA°	LF	RMPX°	C min	C max	ZEFP		Grades	
												Coated	
	mm Inch	mm Inch	mm Inch	mm Inch	mm Inch	mm Inch						MP3000	F40M
MP12-12008R04Z3-E04	12,0 0.472	8,0 0.315	0,4 0.016	11,5 0.453	30 1.181	18,8 0.740	15,0	14,6	23,0	3	✓		■
MP12-12008R04Z3-M04	12,0 0.472	8,0 0.315	0,4 0.016	11,5 0.453	30 1.181	18,8 0.740	15,0	14,6	23,0	3	✓	■	
MP12-12008R05Z3-E04	12,0 0.472	8,0 0.315	0,5 0.020	11,5 0.453	30 1.181	18,8 0.740	15,0	14,6	22,8	3	✓		■
MP12-12008R08Z3-E04	12,0 0.472	8,0 0.315	0,8 0.031	11,5 0.453	30 1.181	18,8 0.740	15,0	14,6	22,2	3	✓		■
MP12-12008R08Z3-M04	12,0 0.472	8,0 0.315	0,8 0.031	11,5 0.453	30 1.181	18,8 0.740	15,0	14,6	22,2	3	✓	■	
MP12-12008R16Z3-E04	12,0 0.472	8,0 0.315	1,6 0.063	11,5 0.453	30 1.181	18,8 0.740	15,0	14,6	20,6	3	✓		■
MP12-12008R31Z3-E04	12,0 0.472	8,0 0.315	3,1 0.122	11,5 0.453	30 1.181	18,8 0.740	15,0	14,6	17,6	3	✓		■
MP12-12708R08Z3-M04	12,7 0.500	8,0 0.315	0,8 0.031	11,5 0.453	30 1.181	18,8 0.740	15,0	15,4	23,6	3	✓	■	

MP12 Square shoulder

Slotting and contouring

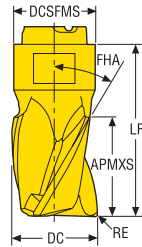

• For insert selection and cutting data recommendations, see page(s) 494-495

Z3



Designation	DC	APMXS	RE	DCSFMS	FHA°	LF	RMPX°	C min	C max	ZEFP		Grades	
												MP3000	F40M
	mm Inch	mm Inch	mm Inch	mm Inch	mm Inch	mm Inch							
MP12-11714KWZ3-E04	11,7 0.461	14,0 0.551	0,3 0.012	11,5 0.453	30 1.181	24,0 0.945	15,0	14,2	22,6	3	✓		■
MP12-12014R04Z3-E04	12,0 0.472	14,0 0.551	0,4 0.016	11,5 0.453	30 1.181	24,0 0.945	15,0	14,6	23,0	3	✓		■
MP12-12014R04Z3-M04	12,0 0.472	14,0 0.551	0,4 0.016	11,5 0.453	30 1.181	24,0 0.945	15,0	14,6	23,0	3	✓	■	
MP12-12014R05Z3-E04	12,0 0.472	14,0 0.551	0,5 0.020	11,5 0.453	30 1.181	24,0 0.945	15,0	14,6	22,8	3	✓		■
MP12-12014R08Z3-M04	12,0 0.472	14,0 0.551	0,8 0.031	11,5 0.453	30 1.181	24,0 0.945	15,0	14,6	22,2	3	✓	■	
MP12-12014R12Z3-E04	12,0 0.472	14,0 0.551	1,2 0.047	11,5 0.453	30 1.181	24,0 0.945	15,0	14,6	21,4	3	✓		■
MP12-12014R12Z3-M04	12,0 0.472	14,0 0.551	1,2 0.047	11,5 0.453	30 1.181	24,0 0.945	15,0	14,6	21,4	3	✓	■	
MP12-12014R20Z3-E04	12,0 0.472	14,0 0.551	2,0 0.079	11,5 0.453	30 1.181	24,0 0.945	15,0	14,6	19,8	3	✓		■
MP12-12014R31Z3-E04	12,0 0.472	14,0 0.551	3,1 0.122	11,5 0.453	30 1.181	24,0 0.945	15,0	14,6	17,6	3	✓		■
MP12-12714R04Z3-E04	12,7 0.500	14,0 0.551	0,4 0.016	11,5 0.453	30 1.181	24,0 0.945	15,0	15,4	24,4	3	✓		■
MP12-12714R04Z3-M04	12,7 0.500	14,0 0.551	0,4 0.016	11,5 0.453	30 1.181	24,0 0.945	15,0	15,4	24,4	3	✓	■	
MP12-12714R08Z3-E04	12,7 0.500	14,0 0.551	0,8 0.031	11,5 0.453	30 1.181	24,0 0.945	15,0	15,4	23,6	3	✓		■
MP12-12714R08Z3-M04	12,7 0.500	14,0 0.551	0,8 0.031	11,5 0.453	30 1.181	24,0 0.945	15,0	15,4	23,6	3	✓	■	
MP12-12714R16Z3-E04	12,7 0.500	14,0 0.551	1,6 0.063	11,5 0.453	30 1.181	24,0 0.945	15,0	15,4	23,9	3	✓		■
MP12-12714R31Z3-E04	12,7 0.500	14,0 0.551	3,1 0.122	11,5 0.453	30 1.181	24,0 0.945	15,0	15,4	22,0	3	✓		■

Universal

Steel and cast iron

Stainless steel and S-materials

Non ferrous

Hard

Plastic and cfrp

Graphite

Minimaster Plus

Minimaster

MP12 Square shoulder

Slotting and contouring

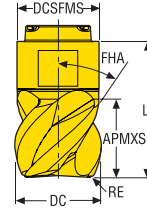

• For insert selection and cutting data recommendations, see page(s) 494-495

Z4



Designation	DC	APMXS	RE	DCSFMS	FHA°	LF	RMPX°	C min	C max	ZEFP	Grades	
											MP3000	F40M
	mm Inch	mm Inch	mm Inch	mm Inch	mm Inch	mm Inch						
MP12-12008R04Z4-M03	12,0 0.472	8,0 0.315	0,4 0.016	11,5 0.453	50 1.969	18,8 0.740	15,0	14,6	23,0	4	■	
MP12-12008R05Z4-E03	12,0 0.472	8,0 0.315	0,5 0.020	11,5 0.453	50 1.969	18,8 0.740	15,0	14,6	22,8	4		■
MP12-12008R08Z4-E03	12,0 0.472	8,0 0.315	0,8 0.031	11,5 0.453	50 1.969	18,8 0.740	15,0	14,6	22,2	4		■
MP12-12008R08Z4-M03	12,0 0.472	8,0 0.315	0,8 0.031	11,5 0.453	50 1.969	18,8 0.740	15,0	14,6	22,2	4	■	
MP12-12008R12Z4-M03	12,0 0.472	8,0 0.315	1,2 0.047	11,5 0.453	50 1.969	18,8 0.740	15,0	14,6	21,4	4	■	
MP12-12008R24Z4-E03	12,0 0.472	8,0 0.315	2,4 0.094	11,5 0.453	50 1.969	18,8 0.740	15,0	14,6	19,0	4		■
MP12-12014R04Z4-M03	12,0 0.472	14,0 0.551	0,4 0.016	11,5 0.453	50 1.969	24,0 0.945	15,0	14,6	23,0	4	■	
MP12-12014R05Z4-E03	12,0 0.472	14,0 0.551	0,5 0.020	11,5 0.453	50 1.969	24,0 0.945	15,0	14,6	22,8	4		■
MP12-12014R08Z4-E03	12,0 0.472	14,0 0.551	0,8 0.031	11,5 0.453	50 1.969	24,0 0.945	15,0	14,6	22,2	4		■
MP12-12014R08Z4-M03	12,0 0.472	14,0 0.551	0,8 0.031	11,5 0.453	50 1.969	24,0 0.945	15,0	14,6	22,2	4	■	
MP12-12014R12Z4-E03	12,0 0.472	14,0 0.551	1,2 0.047	11,5 0.453	50 1.969	24,0 0.945	15,0	14,6	21,4	4		■
MP12-12014R12Z4-M03	12,0 0.472	14,0 0.551	1,2 0.047	11,5 0.453	50 1.969	24,0 0.945	15,0	14,6	21,4	4	■	
MP12-12014R16Z4-E03	12,0 0.472	14,0 0.551	1,6 0.063	11,5 0.453	50 1.969	24,0 0.945	15,0	14,6	20,6	4		■
MP12-12714R04Z4-E03	12,7 0.500	14,0 0.551	0,4 0.016	11,5 0.453	50 1.969	24,0 0.945	15,0	15,4	24,4	4		■
MP12-12714R04Z4-M03	12,7 0.500	14,0 0.551	0,4 0.016	11,5 0.453	50 1.969	24,0 0.945	15,0	15,4	24,4	4	■	
MP12-12714R08Z4-E03	12,7 0.500	14,0 0.551	0,8 0.031	11,5 0.453	50 1.969	24,0 0.945	15,0	15,4	23,9	4		■
MP12-12714R08Z4-M03	12,7 0.500	14,0 0.551	0,8 0.031	11,5 0.453	50 1.969	24,0 0.945	15,0	15,4	23,6	4	■	

MP12 Square shoulder

Contouring only

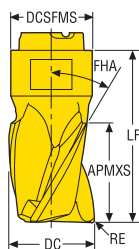

• For insert selection and cutting data recommendations, see page(s) 494-495

Z6



Designation	DC	APMXS	RE	DCSFMS	LF	FHA°	ZEFP		Grades	
									Coated	
	mm Inch	mm Inch	mm Inch	mm Inch	mm Inch				MP3000	F40M
MP12-12014R04Z6-M03	12,0 0.472	14,0 0.551	0,4 0.016	11,5 0.453	24,0 0.945	40	6		■	
MP12-12714R04Z6-M03	12,7 0.500	14,0 0.551	0,4 0.016	11,5 0.453	24,0 0.945	40	6		■	

Universal

Steel and cast iron

Stainless steel and S-materials

Non ferrous

Hard

Plastic and cfrp

Graphite

Minimaster Plus

Minimaster

MP12 Ball nose design

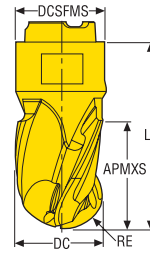

• For insert selection and cutting data recommendations, see page(s) 496-497

Z3



Z4



Designation	DC	APMXS	RE	DCSFMS	LF	FHA°	RMPX°	ZEFP		Grades	
										Coated	
	mm Inch	mm Inch	mm Inch	mm Inch	mm Inch					MP3000	F40M
MP12-12008B90Z3-E04	12,0 0.472	8,0 0.315	6,0 0.236	11,5 0.453	18,8 0.740	30	15,0	3	✓		■
MP12-12008B90Z3-M04	12,0 0.472	8,0 0.315	6,0 0.236	11,5 0.453	18,8 0.740	30	15,0	3	✓	■	
MP12-12014B90Z3-E04	12,0 0.472	14,0 0.551	6,0 0.236	11,5 0.453	24,0 0.945	30	15,0	3	✓		■
MP12-12014B90Z3-M04	12,0 0.472	14,0 0.551	6,0 0.236	11,5 0.453	24,0 0.945	30	15,0	3	✓	■	
MP12-12008B90Z4-E03	12,0 0.472	8,0 0.315	6,0 0.236	11,5 0.453	18,7 0.736	20	15,0	4			■
MP12-12008B90Z4-M03	12,0 0.472	8,0 0.315	6,0 0.236	11,5 0.453	18,7 0.736	20	15,0	4		■	
MP12-12708B90Z3-E04	12,7 0.500	8,0 0.315	6,35 0.250	11,5 0.453	18,8 0.740	30	15,0	3	✓		■
MP12-12708B90Z3-M04	12,7 0.500	8,0 0.315	6,35 0.250	11,5 0.453	18,8 0.740	30	15,0	3	✓	■	
MP12-12714B90Z3-E04	12,7 0.500	14,0 0.551	6,35 0.250	11,5 0.453	24,0 0.945	30	15,0	3	✓		■
MP12-12714B90Z3-M04	12,7 0.500	14,0 0.551	6,35 0.250	11,5 0.453	24,0 0.945	30	15,0	3	✓	■	
MP12-12708B90Z4-E03	12,7 0.500	8,0 0.315	6,35 0.250	11,5 0.453	18,7 0.736	20	15,0	4			■
MP12-12708B90Z4-M03	12,7 0.500	8,0 0.315	6,35 0.250	11,5 0.453	18,7 0.736	20	15,0	4		■	

MP12 Centre drilling/Chamfering

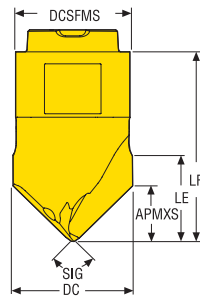

• For insert selection and cutting data recommendations, see page(s) 498-499

Z2



Designation	DC	APMXS	DCSFMS	LE	LF	SIG°	ZEFP		Grades	
									MP3000	Coated
	mm Inch	mm Inch	mm Inch	mm Inch	mm Inch					F40M
MP12-12007C90Z2-M04	12,0 0.472	5,6 0.220	11,5 0.453	8,7 0.343	19,0 0.748	90,0	2	✓		■

Universal

Steel and cast iron

Stainless steel and S-materials

Non ferrous

Hard

Plastic and cfrp

Graphite

Minimaster Plus

Minimaster

MP12 Chamfering

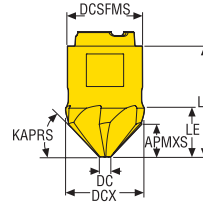

• For insert selection and cutting data recommendations, see page(s) 500-501

Z6



Designation	DCX	DC	APMXS	DCSFMS	LE	LF	KAPRS°	ZEPF		Grades	
										MP3000	F40M
	mm Inch	mm Inch	mm Inch	mm Inch	mm Inch	mm Inch					
MP12-12007C90Z6-M04	12,1 0.476	2,95 0.116	4,4 0.173	11,5 0.453	7,5 0.295	18,0 0.709	45,0	6			■

Universal

Steel and cast iron

Stainless steel and S-materials

Non ferrous

Hard

Plastic and cfrp

Graphite

Minimaster Plus

Minimaster

MP12 Cylindrical blanks

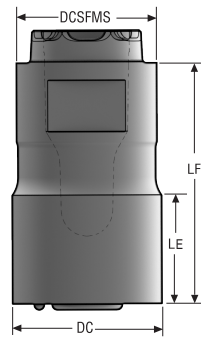

- Cylindrical carbide blanks for production of own geometries



Designation	DC	DCSFMS	LE	LF		Grades
						Uncoated
	mm Inch	mm Inch	mm Inch	mm Inch		H25
MP12-12008CYL-SEMI	12,95 0.510	11,5 0.453	9,4 0.370	19,35 0.762		■
MP12-12014CYL-SEMI	12,95 0.510	11,5 0.453	14,3 0.563	24,15 0.951		■

Universal

Steel and cast iron

Stainless steel and S-materials

Non ferrous

Hard

Plastic and cfrp

Graphite

Minimaster Plus

Minimaster

MP12 High feed milling – Insert selection – mm/Inch

SMG		a _p	f _z			
			100%	70%	30%	20%
P1	MP12-1200.7HFZ3-MD10 MP3000	0,48	0,55	0,55	0,70	0,90
		0,019	0,022	0,022	0,028	0,036
P2	MP12-1200.7HFZ3-MD10 MP3000	0,48	0,55	0,55	0,75	0,90
		0,019	0,022	0,022	0,030	0,036
P3	MP12-1200.7HFZ3-MD10 MP3000	0,48	0,55	0,55	0,70	0,85
		0,019	0,022	0,022	0,028	0,034
P4	MP12-1200.7HFZ3-MD10 MP3000	0,48	0,50	0,50	0,70	0,85
		0,019	0,020	0,020	0,028	0,034
P5	MP12-1200.7HFZ3-MD10 MP3000	0,48	0,50	0,50	0,65	0,80
		0,019	0,020	0,020	0,026	0,032
P6	MP12-1200.7HFZ3-MD10 MP3000	0,48	0,50	0,50	0,65	0,80
		0,019	0,020	0,020	0,026	0,032
P7	MP12-1200.7HFZ3-MD10 MP3000	0,48	0,50	0,50	0,65	0,80
		0,019	0,020	0,020	0,026	0,032
P8	MP12-1200.7HFZ3-MD10 MP3000	0,48	0,55	0,55	0,70	0,85
		0,019	0,022	0,022	0,028	0,034
P11	MP12-1200.7HFZ3-MD10 MP3000	0,48	0,50	0,50	0,65	0,80
		0,019	0,020	0,020	0,026	0,032
P12	MP12-1200.7HFZ3-MD10 MP3000	0,40	0,36	0,34	0,44	0,55
		0,016	0,014	0,013	0,017	0,022
M1	MP12-1200.7HFZ3-MD10 MP3000	0,48	0,55	0,55	0,75	0,90
		0,019	0,022	0,022	0,030	0,036
M2	MP12-1200.7HFZ3-MD10 MP3000	0,48	0,50	0,50	0,65	0,80
		0,019	0,020	0,020	0,026	0,032
M3	MP12-1200.7HFZ3-MD10 MP3000	0,40	0,42	0,42	0,55	0,65
		0,016	0,017	0,017	0,022	0,026
M4	MP12-1200.7HFZ3-MD10 MP3000	0,30	0,36	0,36	0,46	0,55
		0,012	0,014	0,014	0,018	0,022
M5	MP12-1200.7HFZ3-MD10 MP3000	0,30	0,36	0,36	0,46	0,55
		0,012	0,014	0,014	0,018	0,022
K1	MP12-1200.7HFZ3-MD10 MP3000	0,48	0,55	0,55	0,75	0,90
		0,019	0,022	0,022	0,030	0,036
K2	MP12-1200.7HFZ3-MD10 MP3000	0,48	0,50	0,50	0,65	0,80
		0,019	0,020	0,020	0,026	0,032
K3	MP12-1200.7HFZ3-MD10 MP3000	0,48	0,50	0,50	0,65	0,80
		0,019	0,020	0,020	0,026	0,032
K4	MP12-1200.7HFZ3-MD10 MP3000	0,48	0,50	0,50	0,65	0,80
		0,019	0,020	0,020	0,026	0,032
K5	MP12-1200.7HFZ3-MD10 MP3000	0,48	0,46	0,46	0,60	0,75
		0,019	0,018	0,018	0,024	0,030
K6	MP12-1200.7HFZ3-MD10 MP3000	0,48	0,50	0,50	0,65	0,80
		0,019	0,020	0,020	0,026	0,032
K7	MP12-1200.7HFZ3-MD10 MP3000	0,48	0,46	0,46	0,60	0,75
		0,019	0,018	0,018	0,024	0,030
N1	MP12-1200.7HFZ3-MD10 MP3000	0,48	0,70	0,70	0,95	1,2
		0,019	0,028	0,028	0,038	0,048
N2	MP12-1200.7HFZ3-MD10 MP3000	0,48	0,70	0,70	0,95	1,2
		0,019	0,028	0,028	0,038	0,048
N3	MP12-1200.7HFZ3-MD10 MP3000	0,48	0,70	0,70	0,95	1,2
		0,019	0,028	0,028	0,038	0,048
N11	MP12-1200.7HFZ3-MD10 MP3000	0,48	0,70	0,70	0,95	1,2
		0,019	0,028	0,028	0,038	0,048
S1	MP12-1200.7HFZ3-MD10 MP3000	0,30	0,36	0,36	0,46	0,55
		0,012	0,014	0,014	0,018	0,022
S2	MP12-1200.7HFZ3-MD10 MP3000	0,30	0,36	0,36	0,46	0,55
		0,012	0,014	0,014	0,018	0,022
S3	MP12-1200.7HFZ3-MD10 MP3000	0,30	0,34	0,34	0,42	0,50
		0,012	0,013	0,013	0,017	0,020
S11	MP12-1200.7HFZ3-MD10 MP3000	0,34	0,42	0,42	0,55	0,65
		0,013	0,017	0,017	0,022	0,026
S12	MP12-1200.7HFZ3-MD10 MP3000	0,34	0,42	0,42	0,55	0,65
		0,013	0,017	0,017	0,022	0,026
S13	MP12-1200.7HFZ3-MD10 MP3000	0,30	0,36	0,36	0,46	0,55
		0,012	0,014	0,014	0,018	0,022
H5	MP12-1200.7HFZ3-MD10 MP3000	0,40	0,36	0,34	0,44	0,55
		0,016	0,014	0,013	0,017	0,022
H8	MP12-1200.7HFZ3-MD10 MP3000	0,34	0,28	0,26	0,34	0,40
		0,013	0,011	0,010	0,013	0,016
H11	MP12-1200.7HFZ3-MD10 MP3000	0,40	0,36	0,34	0,44	0,55
		0,016	0,014	0,013	0,017	0,022
H12	MP12-1200.7HFZ3-MD10 MP3000	0,34	0,28	0,26	0,34	0,40
		0,013	0,011	0,010	0,013	0,016
H21	MP12-1200.7HFZ3-MD10 MP3000	0,34	0,28	0,26	0,34	0,40
		0,013	0,011	0,010	0,013	0,016

SMG = Seco material group
f_z = mm/tooth (in/tooth), v_c = m/min (sf/min), a_p/DC = %
All cutting data are start values

MP12 High feed milling – Cutting data $v_c = (m/min)/(sf/min)$

SMG	MP3000			
	100%	70%	30%	20%
P1	240	295	340	355
	790	970	1125	1175
P2	235	285	325	345
	770	940	1075	1125
P3	205	245	285	300
	670	800	940	980
P4	185	220	250	265
	610	720	820	870
P5	175	210	245	255
	570	690	800	840
P6	195	240	275	290
	640	790	900	950
P7	185	225	260	275
	610	740	850	900
P8	170	205	240	255
	560	670	790	840
P11	180	220	250	265
	590	720	820	870
P12	115	140	160	170
	375	460	520	560
M1	175	215	245	260
	570	710	800	850
M2	145	175	205	215
	475	570	670	710
M3	120	140	160	170
	395	460	520	560
M4	95	110	125	135
	310	360	410	445
M5	80	90	105	110
	260	295	345	360
K1	185	225	260	275
	610	740	850	900
K2	165	200	230	245
	540	660	750	800
K3	140	170	195	205
	460	560	640	670
K4	135	160	190	195
	445	520	620	640
K5	80	100	115	120
	260	330	375	395
K6	120	145	165	175
	395	475	540	570
K7	105	125	145	150
	345	410	475	490
N1	1400	1700	1925	2025
	4600	5575	6325	6650
N2	560	680	780	820
	1825	2225	2550	2700
N3	375	455	520	540
	1225	1500	1700	1775
N11	430	520	600	620
	1400	1700	1975	2025
S1	44	50	60	60
	145	165	195	195
S2	35	41	47	50
	115	135	155	165
S3	31	36	42	44
	100	120	140	145
S11	60	70	80	85
	195	230	260	280
S12	42	49	55	60
	140	160	180	195
S13	25	29	33	35
	80	95	110	115
H5	36	44	50	55
	120	145	165	180
H8	39	46	55	55
	130	150	180	180
H11	46	55	65	65
	150	180	215	215
H12	75	90	100	110
	245	295	330	360
H21	39	46	55	55
	130	150	180	180

Universal
Steel and cast iron
Stainless steel and S-materials
Non ferrous
Hard
Plastic and cfrp
Graphite
Minimaster Plus
Minimaster

MP12 Slot and Side milling – Insert selection – mm/Inch

Universal	SMG		a _p		f _z			
					100%	30%	10%	5%
Steel and cast iron	P1	MP12-12008R04Z3-M04 MP3000	4,0	0,055	0,060	0,095	0,13	
			0,16	0,0022	0,0024	0,0038	0,0050	
	P2	MP12-12008R04Z3-M04 MP3000	4,0	0,055	0,065	0,095	0,13	
			0,16	0,0022	0,0026	0,0038	0,0050	
	P3	MP12-12008R04Z3-M04 MP3000	4,0	0,055	0,060	0,090	0,13	
			0,16	0,0022	0,0024	0,0036	0,0050	
	P4	MP12-12008R04Z3-M04 MP3000	4,0	0,055	0,060	0,090	0,12	
			0,16	0,0022	0,0024	0,0036	0,0048	
	P5	MP12-12008R04Z3-M04 MP3000	4,0	0,050	0,055	0,090	0,12	
			0,16	0,0020	0,0022	0,0036	0,0048	
	P6	MP12-12008R04Z3-M04 MP3000	4,0	0,050	0,055	0,085	0,12	
			0,16	0,0020	0,0022	0,0034	0,0048	
	P7	MP12-12008R04Z3-M04 MP3000	4,0	0,050	0,055	0,085	0,12	
			0,16	0,0020	0,0022	0,0034	0,0048	
	P8	MP12-12008R04Z3-M04 MP3000	4,0	0,055	0,060	0,090	0,13	
			0,16	0,0022	0,0024	0,0036	0,0050	
	P11	MP12-12008R04Z3-M04 MP3000	4,0	0,050	0,055	0,085	0,12	
			0,16	0,0020	0,0022	0,0034	0,0048	
	P12	MP12-12008R08Z3-M04 MP3000	3,0	0,036	0,040	0,060	0,085	
			0,12	0,0014	0,0016	0,0024	0,0034	
	M1	MP12-12008R04Z3-E04 F40M	4,0	0,055	0,065	0,095	0,13	
			0,16	0,0022	0,0026	0,0038	0,0050	
	M2	MP12-12008R04Z3-E04 F40M	4,0	0,050	0,055	0,090	0,12	
			0,16	0,0020	0,0022	0,0036	0,0048	
	M3	MP12-12008R04Z3-E04 F40M	3,0	0,042	0,046	0,070	0,095	
			0,12	0,0017	0,0018	0,0028	0,0038	
	M4	MP12-12008R04Z3-E04 F40M	2,5	0,036	0,040	0,060	0,085	
			0,10	0,0014	0,0016	0,0024	0,0034	
	M5	MP12-12008R04Z3-E04 F40M	2,5	0,036	0,040	0,060	0,085	
			0,10	0,0014	0,0016	0,0024	0,0034	
	K1	MP12-12008R04Z3-M04 MP3000	4,0	0,055	0,065	0,095	0,13	
			0,16	0,0022	0,0026	0,0038	0,0050	
	K2	MP12-12008R04Z3-M04 MP3000	4,0	0,050	0,055	0,090	0,12	
			0,16	0,0020	0,0022	0,0036	0,0048	
	K3	MP12-12008R04Z3-M04 MP3000	4,0	0,050	0,055	0,090	0,12	
			0,16	0,0020	0,0022	0,0036	0,0048	
	K4	MP12-12008R04Z3-M04 MP3000	4,0	0,050	0,055	0,090	0,12	
			0,16	0,0020	0,0022	0,0036	0,0048	
	K5	MP12-12008R04Z3-M04 MP3000	4,0	0,048	0,050	0,080	0,11	
			0,16	0,0019	0,0020	0,0032	0,0044	
	K6	MP12-12008R04Z3-M04 MP3000	4,0	0,050	0,055	0,090	0,12	
			0,16	0,0020	0,0022	0,0036	0,0048	
	K7	MP12-12008R04Z3-M04 MP3000	4,0	0,048	0,050	0,080	0,11	
			0,16	0,0019	0,0020	0,0032	0,0044	
	N1	MP12-12008R04Z3-E04 F40M	4,0	0,075	0,080	0,12	0,17	
			0,16	0,0030	0,0032	0,0048	0,0065	
	N2	MP12-12008R04Z3-E04 F40M	4,0	0,075	0,080	0,12	0,17	
			0,16	0,0030	0,0032	0,0048	0,0065	
	N3	MP12-12008R04Z3-E04 F40M	4,0	0,075	0,080	0,12	0,17	
			0,16	0,0030	0,0032	0,0048	0,0065	
	N11	MP12-12008R04Z3-E04 F40M	4,0	0,075	0,080	0,12	0,17	
			0,16	0,0030	0,0032	0,0048	0,0065	
	S1	MP12-12008R04Z3-E04 F40M	2,5	0,036	0,040	0,060	0,085	
			0,10	0,0014	0,0016	0,0024	0,0034	
	S2	MP12-12008R04Z3-E04 F40M	2,5	0,036	0,040	0,060	0,085	
			0,10	0,0014	0,0016	0,0024	0,0034	
	S3	MP12-12008R04Z3-E04 F40M	2,5	0,034	0,038	0,055	0,080	
			0,10	0,0013	0,0015	0,0022	0,0032	
	S11	MP12-12008R04Z3-E04 F40M	2,5	0,042	0,046	0,070	0,095	
			0,10	0,0017	0,0018	0,0028	0,0038	
	S12	MP12-12008R04Z3-E04 F40M	2,5	0,042	0,046	0,070	0,095	
			0,10	0,0017	0,0018	0,0028	0,0038	
	S13	MP12-12008R04Z3-E04 F40M	2,5	0,036	0,040	0,060	0,085	
			0,10	0,0014	0,0016	0,0024	0,0034	
	H5	MP12-12008R04Z3-M04 MP3000	3,0	0,036	0,038	0,060	0,080	
			0,12	0,0014	0,0015	0,0024	0,0032	
	H8	MP12-12008R04Z3-M04 MP3000	2,5	0,028	0,030	0,046	0,065	
			0,10	0,0011	0,0012	0,0018	0,0026	
	H11	MP12-12008R04Z3-M04 MP3000	3,0	0,036	0,038	0,060	0,080	
			0,12	0,0014	0,0015	0,0024	0,0032	
	H12	MP12-12008R04Z3-M04 MP3000	2,5	0,028	0,030	0,046	0,065	
			0,10	0,0011	0,0012	0,0018	0,0026	
	H21	MP12-12008R04Z3-M04 MP3000	2,5	0,028	0,030	0,046	0,065	
			0,10	0,0011	0,0012	0,0018	0,0026	

SMG = Seco material group
f_z = mm/tooth (in/tooth), v_c = m/min (sf/min), a_p/DC = %
All cutting data are start values

MP12 Slot and Side milling – Cutting data $v_c = (m/min)/(sf/min)$

SMG	MP3000				F40M									
	100%	30%	10%	5%	100%	30%	10%	5%						
P1	250	325	380	415	235	310	360	390	Universal					
	820	1075	1250	1350	770	1025	1175	1275						
P2	240	315	370	405	225	295	350	380		Steel and cast iron				
	790	1025	1225	1325	740	970	1150	1250						
P3	210	275	320	345	200	260	305	325			Stainless steel and S-materials			
	690	900	1050	1125	660	850	1000	1075						
P4	185	240	285	310	175	230	270	295				Non ferrous		
	610	790	940	1025	570	750	890	970						
P5	180	235	275	295	170	220	260	280					Hard	
	590	770	900	970	560	720	850	920						
P6	200	265	310	330	190	250	290	315						Plastic and cfrp
	660	870	1025	1075	620	820	950	1025						
P7	190	250	290	315	180	235	275	295	Graphite					
	620	820	950	1025	590	770	900	970						
P8	175	230	270	290	165	215	255	275		Minimaster Plus				
	570	750	890	950	540	710	840	900						
P11	185	240	280	305	175	230	265	290			Minimaster			
	610	790	920	1000	570	750	870	950						
P12	115	150	175	195	110	145	165	180						
	375	490	570	640	360	475	540	590						
M1	180	235	275	300	180	240	280	305						
	590	770	900	980	590	790	920	1000						
M2	150	195	230	245	150	200	235	250						
	490	640	750	800	490	660	770	820						
M3	120	155	180	195	120	155	185	200						
	395	510	590	640	395	510	610	660						
M4	90	120	140	150	95	120	140	155						
	295	395	460	490	310	395	460	510						
M5	75	100	115	125	75	100	120	125						
	245	330	375	410	245	330	395	410						
K1	190	250	295	320	180	235	275	300						
	620	820	970	1050	590	770	900	980						
K2	170	220	260	280	160	210	245	265						
	560	720	850	920	520	690	800	870						
K3	145	190	220	240	135	180	210	225						
	475	620	720	790	445	590	690	740						
K4	140	180	210	225	130	170	200	215						
	460	590	690	740	425	560	660	710						
K5	85	110	125	135	80	105	120	130						
	280	360	410	445	260	345	395	425						
K6	120	160	185	200	115	150	175	190						
	395	520	610	660	375	490	570	620						
K7	105	140	160	175	100	130	155	165						
	345	460	520	570	330	425	510	540						
N1	1425	1875	2200	2375	1350	1775	2100	2250						
	4675	6150	7225	7800	4425	5825	6900	7375						
N2	570	760	890	960	540	720	840	910						
	1875	2500	2925	3150	1775	2350	2750	2975						
N3	385	500	600	640	360	475	560	610						
	1275	1650	1975	2100	1175	1550	1825	2000						
N11	440	580	680	730	415	540	640	690						
	1450	1900	2225	2400	1350	1775	2100	2275						
S1	43	55	65	70	43	55	65	70						
	140	180	215	230	140	180	215	230						
S2	34	45	50	55	35	46	55	55						
	110	150	165	180	115	150	180	180						
S3	30	39	46	49	31	40	46	50						
	100	130	150	160	100	130	150	165						
S11	60	80	90	100	60	80	95	100						
	195	260	295	330	195	260	310	330						
S12	42	55	65	70	42	55	65	70						
	140	180	215	230	140	180	215	230						
S13	24	31	36	39	24	32	37	40						
	80	100	120	130	80	105	120	130						
H5	36	47	55	60	36	48	55	60						
	120	155	180	195	120	155	180	195						
H8	38	49	55	60	38	50	60	60						
	125	160	180	195	125	165	195	195						
H11	46	60	70	75	46	60	70	75						
	150	195	230	245	150	195	230	245						
H12	70	95	110	120	70	90	105	110						
	230	310	360	395	230	295	345	360						
H21	38	49	55	60	38	50	60	60						
	125	160	180	195	125	165	195	195						

MP12 Copy milling – Insert selection – mm/Inch

SMG		a _p	f _z				
			100%	30%	10%	5%	2%
P1	MP12-12008B90Z3-M04 MP3000	4,0	0,065	0,065	0,10	0,14	0,22
		0.16	0.0026	0.0026	0.0040	0.0055	0.0085
P2	MP12-12008B90Z3-M04 MP3000	4,0	0,065	0,070	0,10	0,14	0,22
		0.16	0.0026	0.0028	0.0040	0.0055	0.0085
P3	MP12-12008B90Z3-M04 MP3000	4,0	0,060	0,065	0,095	0,13	0,22
		0.16	0.0024	0.0026	0.0038	0.0050	0.0085
P4	MP12-12008B90Z3-M04 MP3000	4,0	0,060	0,065	0,095	0,13	0,22
		0.16	0.0024	0.0026	0.0038	0.0050	0.0085
P5	MP12-12008B90Z3-M04 MP3000	4,0	0,060	0,060	0,090	0,13	0,20
		0.16	0.0024	0.0024	0.0036	0.0050	0.0080
P6	MP12-12008B90Z3-M04 MP3000	4,0	0,060	0,060	0,090	0,13	0,20
		0.16	0.0024	0.0024	0.0036	0.0050	0.0080
P7	MP12-12008B90Z3-M04 MP3000	4,0	0,060	0,060	0,090	0,13	0,20
		0.16	0.0024	0.0024	0.0036	0.0050	0.0080
P8	MP12-12008B90Z3-M04 MP3000	4,0	0,060	0,065	0,095	0,13	0,22
		0.16	0.0024	0.0026	0.0038	0.0050	0.0085
P11	MP12-12008B90Z3-M04 MP3000	4,0	0,060	0,060	0,090	0,13	0,20
		0.16	0.0024	0.0024	0.0036	0.0050	0.0080
P12	MP12-12008B90Z3-M04 MP3000	3,0	0,044	0,044	0,060	0,085	0,14
		0.12	0.0017	0.0017	0.0024	0.0034	0.0055
M1	MP12-12008B90Z3-E04 F40M	4,0	0,065	0,070	0,10	0,14	0,22
		0.16	0.0026	0.0028	0.0040	0.0055	0.0085
M2	MP12-12008B90Z3-E04 F40M	4,0	0,060	0,060	0,090	0,13	0,20
		0.16	0.0024	0.0024	0.0036	0.0050	0.0080
M3	MP12-12008B90Z3-E04 F40M	3,0	0,050	0,050	0,075	0,10	0,16
		0.12	0.0020	0.0020	0.0030	0.0040	0.0065
M4	MP12-12008B90Z3-E04 F40M	2,5	0,046	0,046	0,065	0,090	0,14
		0.10	0.0018	0.0018	0.0026	0.0036	0.0055
M5	MP12-12008B90Z3-E04 F40M	2,5	0,046	0,046	0,065	0,090	0,14
		0.10	0.0018	0.0018	0.0026	0.0036	0.0055
K1	MP12-12008B90Z3-M04 MP3000	4,0	0,065	0,070	0,10	0,14	0,22
		0.16	0.0026	0.0028	0.0040	0.0055	0.0085
K2	MP12-12008B90Z3-M04 MP3000	4,0	0,060	0,060	0,090	0,13	0,20
		0.16	0.0024	0.0024	0.0036	0.0050	0.0080
K3	MP12-12008B90Z3-M04 MP3000	4,0	0,060	0,060	0,090	0,13	0,20
		0.16	0.0024	0.0024	0.0036	0.0050	0.0080
K4	MP12-12008B90Z3-M04 MP3000	4,0	0,060	0,060	0,090	0,13	0,20
		0.16	0.0024	0.0024	0.0036	0.0050	0.0080
K5	MP12-12008B90Z3-M04 MP3000	4,0	0,055	0,055	0,085	0,11	0,18
		0.16	0.0022	0.0022	0.0034	0.0044	0.0070
K6	MP12-12008B90Z3-M04 MP3000	4,0	0,060	0,060	0,090	0,13	0,20
		0.16	0.0024	0.0024	0.0036	0.0050	0.0080
K7	MP12-12008B90Z3-M04 MP3000	4,0	0,055	0,055	0,085	0,11	0,18
		0.16	0.0022	0.0022	0.0034	0.0044	0.0070
N1	MP12-12008B90Z3-E04 F40M	4,0	0,085	0,085	0,13	0,18	0,30
		0.16	0.0034	0.0034	0.0050	0.0070	0.012
N2	MP12-12008B90Z3-E04 F40M	4,0	0,085	0,085	0,13	0,18	0,30
		0.16	0.0034	0.0034	0.0050	0.0070	0.012
N3	MP12-12008B90Z3-E04 F40M	4,0	0,085	0,085	0,13	0,18	0,30
		0.16	0.0034	0.0034	0.0050	0.0070	0.012
N11	MP12-12008B90Z3-E04 F40M	4,0	0,085	0,085	0,13	0,18	0,30
		0.16	0.0034	0.0034	0.0050	0.0070	0.012
S1	MP12-12008B90Z3-E04 F40M	2,5	0,046	0,046	0,065	0,090	0,14
		0.10	0.0018	0.0018	0.0026	0.0036	0.0055
S2	MP12-12008B90Z3-E04 F40M	2,5	0,046	0,046	0,065	0,090	0,14
		0.10	0.0018	0.0018	0.0026	0.0036	0.0055
S3	MP12-12008B90Z3-E04 F40M	2,5	0,042	0,044	0,060	0,080	0,13
		0.10	0.0017	0.0017	0.0024	0.0032	0.0050
S11	MP12-12008B90Z3-E04 F40M	2,5	0,055	0,050	0,075	0,10	0,16
		0.10	0.0022	0.0020	0.0030	0.0040	0.0065
S12	MP12-12008B90Z3-E04 F40M	2,5	0,055	0,050	0,075	0,10	0,16
		0.10	0.0022	0.0020	0.0030	0.0040	0.0065
S13	MP12-12008B90Z3-E04 F40M	2,5	0,046	0,046	0,065	0,090	0,14
		0.10	0.0018	0.0018	0.0026	0.0036	0.0055
H5	MP12-12008B90Z3-M04 MP3000	3,0	0,044	0,044	0,060	0,085	0,14
		0.12	0.0017	0.0017	0.0024	0.0034	0.0055
H8	MP12-12008B90Z3-M04 MP3000	2,5	0,034	0,034	0,048	0,065	0,10
		0.10	0.0013	0.0013	0.0019	0.0026	0.0040
H11	MP12-12008B90Z3-M04 MP3000	3,0	0,044	0,044	0,060	0,085	0,14
		0.12	0.0017	0.0017	0.0024	0.0034	0.0055
H12	MP12-12008B90Z3-M04 MP3000	2,5	0,034	0,034	0,048	0,065	0,10
		0.10	0.0013	0.0013	0.0019	0.0026	0.0040
H21	MP12-12008B90Z3-M04 MP3000	2,5	0,034	0,034	0,048	0,065	0,10
		0.10	0.0013	0.0013	0.0019	0.0026	0.0040

SMG = Seco material group
f_z = mm/tooth (in/tooth), v_c = m/min (sf/min), a_p/DC = %
All cutting data are start values

MP12 Copy milling – Cutting data $v_c = (m/min)/(sf/min)$

SMG	MP3000					F40M				
	100%	30%	10%	5%	2%	100%	30%	10%	5%	2%
P1	265	320	345	375	370	250	300	325	355	350
	870	1050	1125	1225	1225	820	980	1075	1175	1150
P2	255	310	330	360	360	240	295	315	340	340
	840	1025	1075	1175	1175	790	970	1025	1125	1125
P3	220	265	290	315	315	210	255	270	295	295
	720	870	950	1025	1025	690	840	890	970	970
P4	195	240	255	275	275	185	225	240	260	260
	640	790	840	900	900	610	740	790	850	850
P5	190	230	245	265	265	175	215	230	250	250
	620	750	800	870	870	570	710	750	820	820
P6	210	255	275	300	295	200	240	260	285	280
	690	840	900	980	970	660	790	850	940	920
P7	200	240	260	285	280	190	230	245	265	265
	660	790	850	940	920	620	750	800	870	870
P8	185	225	240	265	265	175	210	230	250	250
	610	740	790	870	870	570	690	750	820	820
P11	195	235	250	275	270	185	220	240	260	255
	640	770	820	900	890	610	720	790	850	840
P12	120	150	160	170	170	115	140	150	160	160
	395	490	520	560	560	375	460	490	520	520
M1	190	230	250	270	270	190	235	255	275	275
	620	750	820	890	890	620	770	840	900	900
M2	155	190	205	225	220	160	195	210	225	225
	510	620	670	740	720	520	640	690	740	740
M3	125	155	160	175	175	130	155	165	180	175
	410	510	520	570	570	425	510	540	590	570
M4	100	120	125	135	135	100	120	125	135	135
	330	395	410	445	445	330	395	410	445	445
M5	85	100	105	110	110	85	100	105	115	115
	280	330	345	360	360	280	330	345	375	375
K1	200	245	265	285	285	190	235	250	270	270
	660	800	870	940	940	620	770	820	890	890
K2	180	215	230	255	250	170	205	220	240	235
	590	710	750	840	820	560	670	720	790	770
K3	150	185	195	215	210	140	175	185	200	200
	490	610	640	710	690	460	570	610	660	660
K4	145	175	185	205	205	135	165	175	195	190
	475	570	610	670	670	445	540	570	640	620
K5	85	105	115	125	125	80	100	105	115	115
	280	345	375	410	410	260	330	345	375	375
K6	125	155	165	180	180	120	145	155	170	170
	410	510	540	590	590	395	475	510	560	560
K7	110	135	145	160	155	105	130	135	150	150
	360	445	475	520	510	345	425	445	490	490
N1	1525	1850	1975	2150	2150	1450	1750	1875	2025	2025
	5000	6075	6475	7050	7050	4750	5750	6150	6650	6650
N2	620	750	800	870	870	580	710	760	820	820
	2025	2450	2625	2850	2850	1900	2325	2500	2700	2700
N3	410	500	530	580	580	390	470	500	550	550
	1350	1650	1750	1900	1900	1275	1550	1650	1800	1800
N11	470	570	610	660	660	445	540	580	620	630
	1550	1875	2000	2175	2175	1450	1775	1900	2025	2075
S1	46	55	60	65	60	47	55	60	65	65
	150	180	195	215	195	155	180	195	215	215
S2	37	45	47	50	50	38	45	47	50	50
	120	150	155	165	165	125	150	155	165	165
S3	32	39	40	44	44	33	40	41	45	44
	105	130	130	145	145	110	130	135	150	145
S11	65	80	80	90	90	65	80	85	90	90
	215	260	260	295	295	215	260	280	295	295
S12	44	55	55	60	60	45	55	60	60	60
	145	180	180	195	195	150	180	195	195	195
S13	26	31	33	35	35	27	32	33	36	36
	85	100	110	115	115	90	105	110	120	120
H5	38	47	49	55	55	38	47	49	55	55
	125	155	160	180	180	125	155	160	180	180
H8	40	48	50	55	55	40	49	50	55	55
	130	155	165	180	180	130	160	165	180	180
H11	48	60	60	65	70	49	60	65	70	70
	155	195	195	215	230	160	195	215	230	230
H12	75	95	95	105	105	70	85	90	100	100
	245	310	310	345	345	230	280	295	330	330
H21	40	48	50	55	55	40	49	50	55	55
	130	155	165	180	180	130	160	165	180	180

Universal
Steel and cast iron
Stainless steel and S-materials
Non ferrous
Hard
Plastic and chip
Graphite
Minimaster Plus
Minimaster

MP12 Centre drilling – Insert selection – mm/Inch

SMG		f_z	a_{so}
			100%
P1	MP12-12007C90Z2-M04 F40M	0,055 0.0022	3,5 0.14
P2	MP12-12007C90Z2-M04 F40M	0,055 0.0022	3,5 0.14
P3	MP12-12007C90Z2-M04 F40M	0,055 0.0022	3,5 0.14
P4	MP12-12007C90Z2-M04 F40M	0,055 0.0022	3,5 0.14
P5	MP12-12007C90Z2-M04 F40M	0,050 0.0020	3,5 0.14
P6	MP12-12007C90Z2-M04 F40M	0,050 0.0020	3,5 0.14
P7	MP12-12007C90Z2-M04 F40M	0,050 0.0020	3,5 0.14
P8	MP12-12007C90Z2-M04 F40M	0,055 0.0022	3,5 0.14
P11	MP12-12007C90Z2-M04 F40M	0,050 0.0020	3,5 0.14
P12	MP12-12007C90Z2-M04 F40M	0,036 0.0014	2,5 0.10
M1	MP12-12007C90Z2-M04 F40M	0,055 0.0022	3,5 0.14
M2	MP12-12007C90Z2-M04 F40M	0,050 0.0020	3,5 0.14
M3	MP12-12007C90Z2-M04 F40M	0,042 0.0017	2,5 0.10
M4	MP12-12007C90Z2-M04 F40M	0,036 0.0014	2,0 0.080
M5	MP12-12007C90Z2-M04 F40M	0,036 0.0014	2,0 0.080
K1	MP12-12007C90Z2-M04 F40M	0,055 0.0022	3,5 0.14
K2	MP12-12007C90Z2-M04 F40M	0,050 0.0020	3,5 0.14
K3	MP12-12007C90Z2-M04 F40M	0,050 0.0020	3,5 0.14
K4	MP12-12007C90Z2-M04 F40M	0,050 0.0020	3,5 0.14
K5	MP12-12007C90Z2-M04 F40M	0,046 0.0018	3,5 0.14
K6	MP12-12007C90Z2-M04 F40M	0,050 0.0020	3,5 0.14
K7	MP12-12007C90Z2-M04 F40M	0,046 0.0018	3,5 0.14
N1	MP12-12007C90Z2-M04 F40M	0,075 0.0030	3,5 0.14
N2	MP12-12007C90Z2-M04 F40M	0,075 0.0030	3,5 0.14
N3	MP12-12007C90Z2-M04 F40M	0,075 0.0030	3,5 0.14
N11	MP12-12007C90Z2-M04 F40M	0,075 0.0030	3,5 0.14
S1	MP12-12007C90Z2-M04 F40M	0,036 0.0014	2,0 0.080
S2	MP12-12007C90Z2-M04 F40M	0,036 0.0014	2,0 0.080
S3	MP12-12007C90Z2-M04 F40M	0,034 0.0013	2,0 0.080
S11	MP12-12007C90Z2-M04 F40M	0,042 0.0017	2,5 0.10
S12	MP12-12007C90Z2-M04 F40M	0,042 0.0017	2,5 0.10
S13	MP12-12007C90Z2-M04 F40M	0,036 0.0014	2,0 0.080
H5	MP12-12007C90Z2-M04 F40M	0,036 0.0014	2,5 0.10
H8	MP12-12007C90Z2-M04 F40M	0,028 0.0011	2,5 0.10
H11	MP12-12007C90Z2-M04 F40M	0,036 0.0014	2,5 0.10
H12	MP12-12007C90Z2-M04 F40M	0,028 0.0011	2,5 0.10
H21	MP12-12007C90Z2-M04 F40M	0,028 0.0011	2,5 0.10

SMG = Seco material group
 f_z = mm/tooth (in/tooth), v_c = m/min (sf/min), a_e/DC = %
 All cutting data are start values

MP12 Centre drilling – Cutting data $v_c = (m/min)/(sf/min)$

SMG	F40M		
	v_c (m/min)	v_c (sf/min)	
	100%		Universal
P1	275	900	
P2	265	870	Steel and cast iron
P3	235	770	
P4	205	670	
P5	195	640	
P6	220	720	
P7	205	670	
P8	195	640	
P11	200	660	
P12	125	410	
M1	215	710	Non ferrous
M2	175	570	
M3	140	460	
M4	105	345	
M5	85	280	
K1	210	690	Hard
K2	185	610	
K3	155	510	
K4	150	490	Plastic and cfrp
K5	90	295	
K6	130	425	
K7	120	395	
N1	1575	5175	Graphite
N2	640	2100	
N3	425	1400	
N11	490	1600	
S1	49	160	Minimaster Plus
S2	39	130	
S3	34	110	
S11	70	230	
S12	48	155	
S13	27	90	
H5	42	140	
H8	43	140	
H11	55	180	
H12	80	260	
H21	43	140	

MP12 Chamfering – Insert selection – mm/Inch

SMG		a_p	f_z				
			100%	50%	30%	20%	10%
P1	MP12-12007C90Z2-M04 F40M	2,5	0,080	0,080	0,080	0,080	0,10
		0,10	0,0032	0,0032	0,0032	0,0032	0,0040
P2	MP12-12007C90Z2-M04 F40M	2,5	0,080	0,080	0,080	0,080	0,10
		0,10	0,0032	0,0032	0,0032	0,0032	0,0040
P3	MP12-12007C90Z2-M04 F40M	2,5	0,075	0,075	0,075	0,075	0,095
		0,10	0,0030	0,0030	0,0030	0,0030	0,0038
P4	MP12-12007C90Z2-M04 F40M	2,5	0,075	0,075	0,075	0,075	0,095
		0,10	0,0030	0,0030	0,0030	0,0030	0,0038
P5	MP12-12007C90Z2-M04 F40M	2,5	0,075	0,075	0,075	0,075	0,090
		0,10	0,0030	0,0030	0,0030	0,0030	0,0036
P6	MP12-12007C90Z2-M04 F40M	2,5	0,075	0,075	0,075	0,075	0,090
		0,10	0,0030	0,0030	0,0030	0,0030	0,0036
P7	MP12-12007C90Z2-M04 F40M	2,5	0,075	0,075	0,075	0,075	0,090
		0,10	0,0030	0,0030	0,0030	0,0030	0,0036
P8	MP12-12007C90Z2-M04 F40M	2,5	0,075	0,075	0,075	0,075	0,095
		0,10	0,0030	0,0030	0,0030	0,0030	0,0038
P11	MP12-12007C90Z2-M04 F40M	2,5	0,075	0,075	0,075	0,075	0,090
		0,10	0,0030	0,0030	0,0030	0,0030	0,0036
P12	MP12-12007C90Z2-M04 F40M	2,0	0,050	0,050	0,050	0,050	0,060
		0,080	0,0020	0,0020	0,0020	0,0020	0,0024
M1	MP12-12007C90Z2-M04 F40M	2,5	0,080	0,080	0,080	0,080	0,10
		0,10	0,0032	0,0032	0,0032	0,0032	0,0040
M2	MP12-12007C90Z2-M04 F40M	2,5	0,075	0,075	0,075	0,075	0,090
		0,10	0,0030	0,0030	0,0030	0,0030	0,0036
M3	MP12-12007C90Z2-M04 F40M	2,0	0,060	0,060	0,060	0,060	0,075
		0,080	0,0024	0,0024	0,0024	0,0024	0,0030
M4	MP12-12007C90Z2-M04 F40M	1,6	0,050	0,050	0,050	0,050	0,065
		0,065	0,0020	0,0020	0,0020	0,0020	0,0026
M5	MP12-12007C90Z2-M04 F40M	1,6	0,050	0,050	0,050	0,050	0,065
		0,065	0,0020	0,0020	0,0020	0,0020	0,0026
K1	MP12-12007C90Z2-M04 F40M	2,5	0,080	0,080	0,080	0,080	0,10
		0,10	0,0032	0,0032	0,0032	0,0032	0,0040
K2	MP12-12007C90Z2-M04 F40M	2,5	0,075	0,075	0,075	0,075	0,090
		0,10	0,0030	0,0030	0,0030	0,0030	0,0036
K3	MP12-12007C90Z2-M04 F40M	2,5	0,075	0,075	0,075	0,075	0,090
		0,10	0,0030	0,0030	0,0030	0,0030	0,0036
K4	MP12-12007C90Z2-M04 F40M	2,5	0,075	0,075	0,075	0,075	0,090
		0,10	0,0030	0,0030	0,0030	0,0030	0,0036
K5	MP12-12007C90Z2-M04 F40M	2,5	0,065	0,065	0,065	0,065	0,085
		0,10	0,0026	0,0026	0,0026	0,0026	0,0034
K6	MP12-12007C90Z2-M04 F40M	2,5	0,075	0,075	0,075	0,075	0,090
		0,10	0,0030	0,0030	0,0030	0,0030	0,0036
K7	MP12-12007C90Z2-M04 F40M	2,5	0,065	0,065	0,065	0,065	0,085
		0,10	0,0026	0,0026	0,0026	0,0026	0,0034
N1	MP12-12007C90Z2-M04 F40M	2,5	0,10	0,10	0,10	0,10	0,13
		0,10	0,0040	0,0040	0,0040	0,0040	0,0050
N2	MP12-12007C90Z2-M04 F40M	2,5	0,10	0,10	0,10	0,10	0,13
		0,10	0,0040	0,0040	0,0040	0,0040	0,0050
N3	MP12-12007C90Z2-M04 F40M	2,5	0,10	0,10	0,10	0,10	0,13
		0,10	0,0040	0,0040	0,0040	0,0040	0,0050
N11	MP12-12007C90Z2-M04 F40M	2,5	0,10	0,10	0,10	0,10	0,13
		0,10	0,0040	0,0040	0,0040	0,0040	0,0050
S1	MP12-12007C90Z2-M04 F40M	1,6	0,050	0,050	0,050	0,050	0,065
		0,065	0,0020	0,0020	0,0020	0,0020	0,0026
S2	MP12-12007C90Z2-M04 F40M	1,6	0,050	0,050	0,050	0,050	0,065
		0,065	0,0020	0,0020	0,0020	0,0020	0,0026
S3	MP12-12007C90Z2-M04 F40M	1,6	0,048	0,048	0,048	0,048	0,060
		0,065	0,0019	0,0019	0,0019	0,0019	0,0024
S11	MP12-12007C90Z2-M04 F40M	1,9	0,060	0,060	0,060	0,060	0,075
		0,075	0,0024	0,0024	0,0024	0,0024	0,0030
S12	MP12-12007C90Z2-M04 F40M	1,9	0,060	0,060	0,060	0,060	0,075
		0,075	0,0024	0,0024	0,0024	0,0024	0,0030
S13	MP12-12007C90Z2-M04 F40M	1,6	0,050	0,050	0,050	0,050	0,065
		0,065	0,0020	0,0020	0,0020	0,0020	0,0026
H5	MP12-12007C90Z2-M04 F40M	2,0	0,050	0,050	0,050	0,050	0,060
		0,080	0,0020	0,0020	0,0020	0,0020	0,0024
H8	MP12-12007C90Z2-M04 F40M	1,9	0,038	0,038	0,038	0,038	0,048
		0,075	0,0015	0,0015	0,0015	0,0015	0,0019
H11	MP12-12007C90Z2-M04 F40M	2,0	0,050	0,050	0,050	0,050	0,060
		0,080	0,0020	0,0020	0,0020	0,0020	0,0024
H12	MP12-12007C90Z2-M04 F40M	1,9	0,038	0,038	0,038	0,038	0,048
		0,075	0,0015	0,0015	0,0015	0,0015	0,0019
H21	MP12-12007C90Z2-M04 F40M	1,9	0,038	0,038	0,038	0,038	0,048
		0,075	0,0015	0,0015	0,0015	0,0015	0,0019

SMG = Seco material group
 f_z = mm/tooth (in/tooth), v_c = m/min (sf/min), a_p/DC = %
 All cutting data are start values

MP12 Chamfering – Cutting data $v_c = (m/min)/(sf/min)$

SMG	F40M				
	100%	50%	30%	20%	10%
P1	300	275	330	365	430
	980	900	1075	1200	1400
P2	290	270	320	355	415
	950	890	1050	1175	1350
P3	255	235	280	310	360
	840	770	920	1025	1175
P4	225	210	250	275	320
	740	690	820	900	1050
P5	215	200	235	260	310
	710	660	770	850	1025
P6	240	225	265	295	345
	790	740	870	970	1125
P7	225	210	250	275	325
	740	690	820	900	1075
P8	215	200	235	260	305
	710	660	770	850	1000
P11	220	205	245	270	320
	720	670	800	890	1050
P12	140	125	150	165	205
	460	410	490	540	670
M1	235	220	260	285	335
	770	720	850	940	1100
M2	190	180	215	235	280
	620	590	710	770	920
M3	150	135	165	180	220
	490	445	540	590	720
M4	115	100	115	130	170
	375	330	375	425	560
M5	95	85	95	110	140
	310	280	310	360	460
K1	230	215	255	280	330
	750	710	840	920	1075
K2	200	190	225	250	295
	660	620	740	820	970
K3	170	160	190	210	250
	560	520	620	690	820
K4	165	150	180	200	235
	540	490	590	660	770
K5	100	95	110	125	145
	330	310	360	410	475
K6	145	135	160	175	210
	475	445	520	570	690
K7	130	120	145	160	185
	425	395	475	520	610
N1	1725	1600	1900	2100	2450
	5650	5250	6225	6900	8050
N2	690	640	770	850	990
	2275	2100	2525	2800	3250
N3	460	430	510	570	660
	1500	1400	1675	1875	2175
N11	530	490	590	650	750
	1750	1600	1925	2125	2450
S1	55	47	55	60	80
	180	155	180	195	260
S2	44	38	44	50	65
	145	125	145	165	215
S3	38	33	38	43	55
	125	110	125	140	180
S11	75	70	80	85	110
	245	230	260	280	360
S12	55	47	55	60	75
	180	155	180	195	245
S13	30	27	30	35	45
	100	90	100	115	150
H5	46	42	50	55	70
	150	140	165	180	230
H8	49	44	50	55	70
	160	145	165	180	230
H11	60	55	65	70	85
	195	180	215	230	280
H12	85	80	90	100	125
	280	260	295	330	410
H21	49	44	50	55	70
	160	145	165	180	230

Universal
Steel and cast iron
Stainless steel and S-materials
Non ferrous
Hard
Plastic and cfrp
Graphite
Minimaster Plus
Minimaster

MP16 Shank – Metric

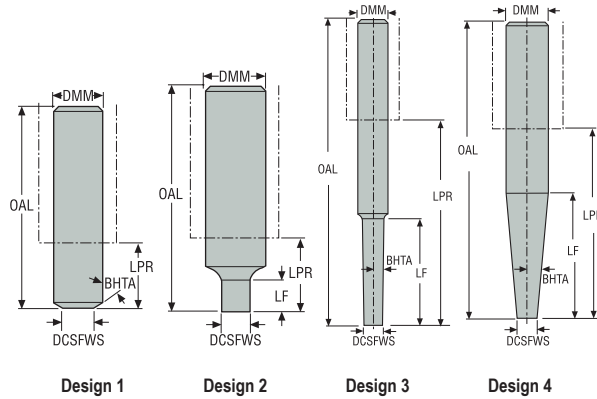

- Cylindrical shank DMM with tolerance h5, compatible for Shrinkfit

Designation	ShankType	DCSFWS	DMM	OAL	LPR	LF	RPMX	BHTA°	Design	Weight
		mm	mm	mm	mm	mm				kg
MP16-16068-016.00	Cylindrical	15,2	16,0	68,0	20,0	16,0	63600	0,0	2	0,1
MP16-20070-000.60	Cylindrical	15,2	20,0	70,0	20,0	0,0	63600	60,0	1	0,2
MP16-20090-024.00	Cylindrical	15,2	20,0	90,0	40,0	24,0	63600	0,0	2	0,2
MP16-20190-056.01	Cylindrical	15,2	20,0	190,0	140,0	56,0	63600	1,0	3	0,4
MP16-20195-095.01	Cylindrical	15,2	20,0	195,0	145,0	95,0	63600	1,0	3	0,4
MP16-25136-075.03	Cylindrical	15,2	25,0	136,0	80,0	75,0	63600	3,0	3	0,4
MP16-25181-125.03	Cylindrical	15,2	25,0	181,0	125,0	93,5	63600	3,0	4	0,6
MP16-25181-125.05	Cylindrical	15,2	25,0	181,0	125,0	56,0	63600	5,0	4	0,6
MP16-16126-048.00-E	Cylindrical Carbide	15,2	16,0	126,0	78,0	48,0	63600	0,0	2	0,4
MP16-16140-064.00-E	Cylindrical Carbide	15,2	16,0	140,0	92,0	64,0	63600	0,0	2	0,4
MP16-16180-096.00-E	Cylindrical Carbide	15,2	16,0	180,0	132,0	96,0	63600	0,0	2	0,5
MP16-20135-080.01-E	Cylindrical Carbide	15,2	20,0	135,0	85,0	80,0	63600	1,0	3	0,5
MP16-20180-128.01-E	Cylindrical Carbide	15,2	20,0	180,0	130,0	128,0	63600	1,0	3	0,7
MP16-20200-150.01-E	Cylindrical Carbide	15,2	20,0	200,0	150,0	137,5	63600	1,0	4	0,8
MP16-20180-130.03-E	Cylindrical Carbide	15,2	20,0	180,0	130,0	45,8	63600	3,0	4	0,8
MP16-20210-160.03-E	Cylindrical Carbide	15,2	20,0	210,0	160,0	45,8	63600	3,0	4	0,9

Accessories

Key	Replacement blade	Torque key
MP1016	MP00-16M	MP00-16.190

Blades are included with the torque key

MP16 Shank – Inch

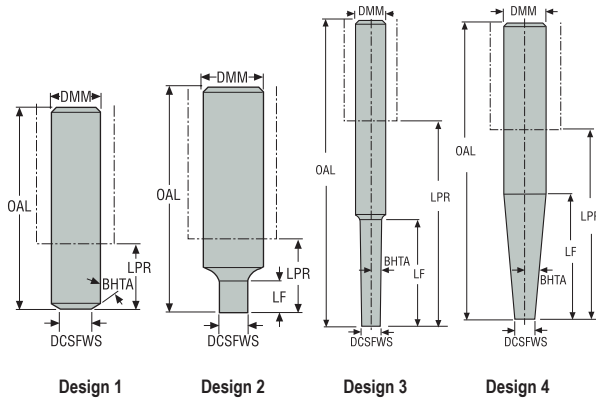

• Cylindrical shank DMM with tolerance h5, compatible for Shrinkfit

Designation	ShankType	DCSFWS	DMM	OAL	LPR	LF	RPMX	BHTA°	Design	Weight
		Inch	Inch	Inch	Inch	Inch				lbs
MP16-0622.6-0.63.00	Cylindrical	0.598	0.625	2.662	0.787	0.630	63600	0,0	2	0.220
MP16-0752.7-0.00.60	Cylindrical	0.598	0.750	2.787	0.787	–	63600	60,0	1	1.540
MP16-0753.5-0.94.00	Cylindrical	0.598	0.750	3.575	1.575	0.945	63600	0,0	2	0.440
MP16-0757.5-2.20.01	Cylindrical	0.598	0.750	7.512	5.512	2.205	63600	1,0	3	0.880
MP16-0757.7-3.74.01	Cylindrical	0.598	0.750	7.709	5.709	3.740	63600	1,0	3	0.880
MP16-1007.1-4.92.05	Cylindrical	0.598	1.000	7.171	4.921	2.295	63600	5,0	4	0.440
MP16-0627.0-3.77.00-E	Cylindrical Carbide	0.598	0.625	7.072	5.197	3.780	63600	0,0	2	1.100
MP16-0757.9-5.90.01-E	Cylindrical Carbide	0.598	0.750	7.906	5.906	4.342	63600	1,0	4	1.540
MP16-0758.2-6.29.03-E	Cylindrical Carbide	0.598	0.750	8.299	6.299	1.446	63600	3,0	4	1.760

Accessories

Key	Replacement blade	Torque key
MP1016	MP00-16M	MP00-16.190

Blades are included with the torque key

Universal

Steel and cast iron

Stainless steel and S-materials

Non ferrous

Hard

Plastic and cfrp

Graphite

Minimaster Plus

Minimaster

MP16 High feed

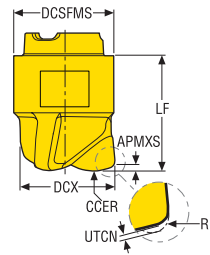

• For insert selection and cutting data recommendations, see page(s) 512-513

Z3



Designation	DCX	DC	APMXS	DCSFMS	CCER	RP	LF	UTCN	RMPX°	C min	C max	ZEFP		Grades	
														Coated	
	mm <i>Inch</i>	mm <i>Inch</i>	mm <i>Inch</i>	mm <i>Inch</i>	mm <i>Inch</i>	mm <i>Inch</i>	mm <i>Inch</i>	mm <i>Inch</i>						MP3000	F40M
MP16-1600.9HFZ3-MD12	16,0 0.630	8,0 0.315	0,9 0.035	15,4 0.606	7,8 0.307	1,79 0.070	18,5 0.728	0,46 0.018	5,0	17,3	23,8	3	✓	■	
MP16-1580.9HFZ3-MD12	15,875 0.625	7,88 0.310	0,9 0.035	15,4 0.606	7,8 0.307	1,79 0.070	18,5 0.728	0,46 0.018	5,0	17,2	23,5	3	✓	■	

Universal

Steel and cast iron

Stainless steel and S-materials

Non ferrous

Hard

Plastic and cfrp

Graphite

Minimaster Plus

Minimaster

MP16 Square shoulder

Slotting and contouring

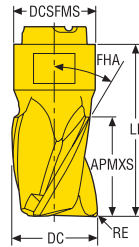

• For insert selection and cutting data recommendations, see page(s) 514-515

Z3



Designation	DC	APMXS	RE	DCSFMS	FHA°	LF	RMPX°	C min	C max	ZEFP	Grades		
											Coated		
	mm Inch	mm Inch	mm Inch	mm Inch	mm Inch	mm Inch					MP3000	F40M	
MP16-16010R04Z3-M05	16,0 0.630	10,0 0.394	0,4 0.016	15,4 0.606	30 1.181	24,6 0.969	15,0	19,4	31,0	3	✓	■	
MP16-16010R05Z3-E05	16,0 0.630	10,0 0.394	0,5 0.020	15,4 0.606	30 1.181	24,6 0.969	15,0	19,4	30,8	3	✓		■
MP16-16010R08Z3-E05	16,0 0.630	10,0 0.394	0,8 0.031	15,4 0.606	30 1.181	24,6 0.969	15,0	19,4	30,0	3	✓		■
MP16-16010R08Z3-M05	16,0 0.630	10,0 0.394	0,8 0.031	15,4 0.606	30 1.181	24,6 0.969	15,0	19,4	30,0	3	✓	■	
MP16-16010R12Z3-E05	16,0 0.630	10,0 0.394	1,2 0.047	15,4 0.606	30 1.181	24,6 0.969	15,0	19,4	29,4	3	✓		■
MP16-16010R20Z3-E05	16,0 0.630	10,0 0.394	2,0 0.079	15,4 0.606	30 1.181	24,6 0.969	15,0	19,4	27,8	3	✓		■
MP16-16010R31Z3-E05	16,0 0.630	10,0 0.394	3,1 0.122	15,4 0.606	30 1.181	24,6 0.969	15,0	19,4	25,6	3	✓		■
MP16-15719KWZ3-E05	15,7 0.618	19,0 0.748	0,3 0.012	15,4 0.606	30 1.181	32,6 1.283	15,0	19,0	29,6	3	✓		■
MP16-16019R04Z3-M05	16,0 0.630	19,0 0.748	0,4 0.016	15,4 0.606	30 1.181	32,6 1.283	15,0	19,4	31,0	3	✓	■	
MP16-16019R05Z3-E05	16,0 0.630	19,0 0.748	0,5 0.020	15,4 0.606	30 1.181	32,6 1.283	15,0	19,4	30,8	3	✓		■
MP16-16019R08Z3-E05	16,0 0.630	19,0 0.748	0,8 0.031	15,4 0.606	30 1.181	32,6 1.283	15,0	19,4	30,2	3	✓		■
MP16-16019R08Z3-M05	16,0 0.630	19,0 0.748	0,8 0.031	15,4 0.606	30 1.181	32,6 1.283	15,0	19,4	30,2	3	✓	■	
MP16-16019R20Z3-E05	16,0 0.630	19,0 0.748	2,0 0.079	15,4 0.606	30 1.181	32,6 1.283	15,0	19,4	27,8	3	✓		■
MP16-16019R31Z3-E05	16,0 0.630	19,0 0.748	3,1 0.122	15,4 0.606	30 1.181	32,6 1.283	15,0	19,4	25,6	3	✓		■
MP16-15919R04Z3-E05	15,875 0.625	19,0 0.748	0,4 0.016	15,4 0.606	30 1.181	32,6 1.283	15,0	19,3	30,7	3	✓		■
MP16-15919R04Z3-M05	15,875 0.625	19,0 0.748	0,4 0.016	15,4 0.606	30 1.181	32,6 1.283	15,0	19,3	30,7	3	✓	■	
MP16-15919R08Z3-E05	15,875 0.625	19,0 0.748	0,8 0.031	15,4 0.606	30 1.181	32,6 1.283	15,0	19,3	29,9	3	✓		■
MP16-15919R08Z3-M05	15,875 0.625	19,0 0.748	0,8 0.031	15,4 0.606	30 1.181	32,6 1.283	15,0	19,3	29,9	3	✓	■	
MP16-15919R31Z3-E05	15,875 0.625	19,0 0.748	3,1 0.122	15,4 0.606	30 1.181	32,6 1.283	15,0	19,3	25,3	3	✓		■

Universal

Steel and cast iron

Stainless steel and S-materials

Non ferrous

Hard

Plastic and cfrp

Graphite

Minimaster Plus

Minimaster

MP16 Square shoulder

Slotting and contouring

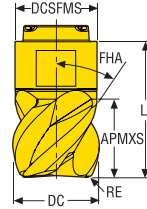

• For insert selection and cutting data recommendations, see page(s) 514-515

Z4



Designation	DC	APMXS	RE	DCSFMS	FHA°	LF	RMPX°	C min	C max	ZEFP	Grades	
											MP3000	F40M
	mm Inch	mm Inch	mm Inch	mm Inch	mm Inch	mm Inch						
MP16-16010R04Z4-M04	16,0 0.630	10,0 0.394	0,4 0.016	15,4 0.606	50 1.969	24,6 0.969	15,0	19,4	31,0	4	■	
MP16-16010R05Z4-E04	16,0 0.630	10,0 0.394	0,5 0.020	15,4 0.606	50 1.969	24,6 0.969	15,0	19,4	30,8	4		■
MP16-16010R08Z4-E04	16,0 0.630	10,0 0.394	0,8 0.031	15,4 0.606	50 1.969	24,6 0.969	15,0	19,4	30,2	4		■
MP16-16010R08Z4-M04	16,0 0.630	10,0 0.394	0,8 0.031	15,4 0.606	50 1.969	24,6 0.969	15,0	19,4	30,2	4	■	
MP16-16010R16Z4-M04	16,0 0.630	10,0 0.394	1,6 0.063	15,4 0.606	50 1.969	24,6 0.969	15,0	19,4	28,6	4	■	
MP16-16010R31Z4-E04	16,0 0.630	10,0 0.394	3,1 0.122	15,4 0.606	50 1.969	24,6 0.969	15,0	19,4	25,6	4		■
MP16-16019R04Z4-E04	16,0 0.630	19,0 0.748	0,4 0.016	15,4 0.606	50 1.969	32,6 1.283	15,0	19,4	31,0	4		■
MP16-16019R04Z4-M04	16,0 0.630	19,0 0.748	0,4 0.016	15,4 0.606	50 1.969	32,6 1.283	15,0	19,4	31,0	4	■	
MP16-16019R05Z4-E04	16,0 0.630	19,0 0.748	0,5 0.020	15,4 0.606	50 1.969	32,6 1.283	15,0	19,4	30,8	4		■
MP16-16019R08Z4-E04	16,0 0.630	19,0 0.748	0,8 0.031	15,4 0.606	50 1.969	32,6 1.283	15,0	19,4	30,2	4		■
MP16-16019R08Z4-M04	16,0 0.630	19,0 0.748	0,8 0.031	15,4 0.606	50 1.969	32,6 1.283	15,0	19,4	30,2	4	■	
MP16-16019R16Z4-E04	16,0 0.630	19,0 0.748	1,6 0.063	15,4 0.606	50 1.969	32,6 1.283	15,0	19,4	28,6	4		■
MP16-16019R20Z4-E04	16,0 0.630	19,0 0.748	2,0 0.079	15,4 0.606	50 1.969	32,6 1.283	15,0	19,4	27,8	4		■
MP16-15919R04Z4-E04	15,875 0.625	19,0 0.748	0,4 0.016	15,4 0.606	50 1.969	32,6 1.283	15,0	19,3	30,7	4		■
MP16-15919R04Z4-M04	15,875 0.625	19,0 0.748	0,4 0.016	15,4 0.606	50 1.969	32,6 1.283	15,0	19,3	30,7	4	■	
MP16-15919R08Z4-E04	15,875 0.625	19,0 0.748	0,8 0.031	15,4 0.606	50 1.969	32,6 1.283	15,0	19,3	29,9	4		■
MP16-15919R08Z4-M04	15,875 0.625	19,0 0.748	0,8 0.031	15,4 0.606	50 1.969	32,6 1.283	15,0	19,3	29,9	4	■	

MP16 Square shoulder

Contouring only

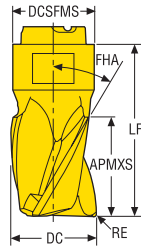

• For insert selection and cutting data recommendations, see page(s) 514-515

Z6/Z8



Designation	DC	APMXS	RE	DCSFMS	LF	FHA°	ZEFP		Grades	
									Coated	
	mm Inch	mm Inch	mm Inch	mm Inch	mm Inch				MP3000	F40M
MP16-16019R04Z6-M04	16,0 0.630	19,0 0.748	0,4 0.016	15,4 0.606	32,6 1.283	40	6	✓	■	
MP16-16019R04Z8-M04	16,0 0.630	19,0 0.748	0,4 0.016	15,4 0.606	32,6 1.283	40	8	✓	■	
MP16-15919R04Z6-M04	15,875 0.625	19,0 0.748	0,4 0.016	15,4 0.606	32,6 1.283	40	6	✓	■	

Universal

Steel and cast iron

Stainless steel and S-materials

Non ferrous

Hard

Plastic and cfrp

Graphite

Minimaster Plus

Minimaster

MP16 Ball nose design

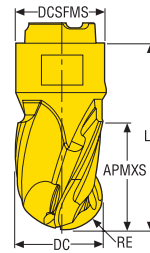

• For insert selection and cutting data recommendations, see page(s) 516-517

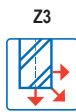

Designation	DC	APMXS	RE	DCSFMS	LF	FHA°	RMPX°	ZEFP		Grades	
										MP3000	F40M
	mm Inch	mm Inch	mm Inch	mm Inch	mm Inch						
MP16-16010B90Z3-E05	16,0 0.630	10,0 0.394	8,0 0.315	15,4 0.606	24,6 0.969	30	15,0	3	✓		■
MP16-16010B90Z3-M05	16,0 0.630	10,0 0.394	8,0 0.315	15,4 0.606	24,6 0.969	30	15,0	3	✓	■	
MP16-16019B90Z3-E05	16,0 0.630	19,0 0.748	8,0 0.315	15,4 0.606	32,6 1.283	30	15,0	3	✓		■
MP16-16019B90Z3-M05	16,0 0.630	19,0 0.748	8,0 0.315	15,4 0.606	32,6 1.283	30	15,0	3	✓	■	
MP16-16010B90Z4-E04	16,0 0.630	10,0 0.394	8,0 0.315	15,4 0.606	24,6 0.969	20	15,0	4			■
MP16-16010B90Z4-M04	16,0 0.630	10,0 0.394	8,0 0.315	15,4 0.606	24,6 0.969	20	15,0	4		■	
MP16-15910B90Z3-E05	15,875 0.625	10,0 0.394	7,9375 0.313	15,4 0.606	24,6 0.969	30	15,0	3	✓		■
MP16-15910B90Z3-M05	15,875 0.625	10,0 0.394	7,9375 0.313	15,4 0.606	24,6 0.969	30	15,0	3	✓	■	
MP16-15919B90Z3-E05	15,875 0.625	19,0 0.748	7,9375 0.313	15,4 0.606	32,6 1.283	30	15,0	3	✓		■
MP16-15919B90Z3-M05	15,875 0.625	19,0 0.748	7,9375 0.313	15,4 0.606	32,6 1.283	30	15,0	3	✓	■	
MP16-15910B90Z4-E04	15,875 0.625	10,0 0.394	7,9375 0.313	15,4 0.606	24,6 0.969	20	15,0	4			■
MP16-15910B90Z4-M04	15,875 0.625	10,0 0.394	7,9375 0.313	15,4 0.606	24,6 0.969	20	15,0	4		■	

MP16 Centre drilling/Chamfering

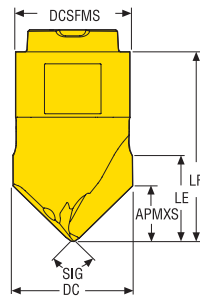

• For insert selection and cutting data recommendations, see page(s) 518-519

Z2



Designation	DC	APMXS	DCSFMS	LE	LF	SIG°	ZEFP		Grades	
									MP3000	Coated
	mm Inch	mm Inch	mm Inch	mm Inch	mm Inch				MP3000	F40M
MP16-16009C90Z2-M05	16.0 0.630	7.4 0.291	15.4 0.606	12.0 0.472	26.4 1.039	90,0	2	✓		■

Universal

Steel and cast iron

Stainless steel and S-materials

Non ferrous

Hard

Plastic and cfrp

Graphite

Minimaster Plus

Minimaster

MP16 Chamfering

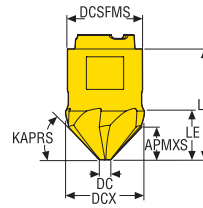

• For insert selection and cutting data recommendations, see page(s) 520-521

Z6



Designation	DCX	DC	APMXS	DCSFMS	LE	LF	KAPRS°	ZEPF		Grades	
										MP3000	Coated
	mm <i>Inch</i>	mm <i>Inch</i>	mm <i>Inch</i>	mm <i>Inch</i>	mm <i>Inch</i>	mm <i>Inch</i>				MP3000	F40M
MP16-16009C90Z6-M05	16,4 <i>0.646</i>	3,95 <i>0.156</i>	6,0 <i>0.236</i>	15,4 <i>0.606</i>	10,4 <i>0.409</i>	23,5 <i>0.925</i>	45,0	6			■

Universal

Steel and cast iron

Stainless steel and S-materials

Non ferrous

Hard

Plastic and cfrp

Graphite

Minimaster Plus

Minimaster

MP16 Cylindrical blanks

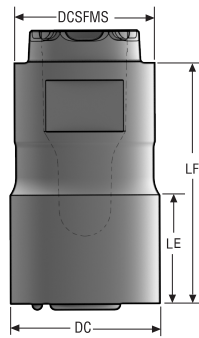

• Cylindrical carbide blanks for production of own geometries



Designation	DC		DCSFMS		LE		LF		Grades	
	mm	Inch	mm	Inch	mm	Inch	mm	Inch	Uncoated	
MP16-16010CYL-SEMI	16,4	0.646	15,4	0.606	11,4	0.449	24,8	0.976		H25
MP16-16019CYL-SEMI	16,4	0.646	15,4	0.606	19,5	0.768	32,85	1.293	✓	

Universal

Steel and cast iron

Stainless steel and S-materials

Non ferrous

Hard

Plastic and cfrp

Graphite

Minimaster Plus

Minimaster

MP16 High feed milling – Insert selection – mm/Inch

Universal	SMG		a_p				f_z					
				100%	70%	30%	20%					
Steel and cast iron	P1	MP16-1600.9HFZ3-MD12 MP3000	0,65 0,026	0,60 0,024	0,65 0,026	0,85 0,034	1,0 0,040					
	P2	MP16-1600.9HFZ3-MD12 MP3000	0,65 0,026	0,65 0,026	0,65 0,026	0,85 0,034	1,0 0,040					
	P3	MP16-1600.9HFZ3-MD12 MP3000	0,65 0,026	0,60 0,024	0,60 0,024	0,80 0,032	1,0 0,040					
	P4	MP16-1600.9HFZ3-MD12 MP3000	0,65 0,026	0,60 0,024	0,60 0,024	0,80 0,032	0,95 0,038					
	P5	MP16-1600.9HFZ3-MD12 MP3000	0,65 0,026	0,60 0,024	0,60 0,024	0,75 0,030	0,95 0,038					
	P6	MP16-1600.9HFZ3-MD12 MP3000	0,65 0,026	0,55 0,022	0,60 0,024	0,75 0,030	0,95 0,038					
	P7	MP16-1600.9HFZ3-MD12 MP3000	0,65 0,026	0,55 0,022	0,60 0,024	0,75 0,030	0,95 0,038					
	P8	MP16-1600.9HFZ3-MD12 MP3000	0,65 0,026	0,60 0,024	0,60 0,024	0,80 0,032	1,0 0,040					
	P11	MP16-1600.9HFZ3-MD12 MP3000	0,65 0,026	0,55 0,022	0,60 0,024	0,75 0,030	0,95 0,038					
	P12	MP16-1600.9HFZ3-MD12 MP3000	0,50 0,020	0,44 0,017	0,40 0,016	0,50 0,020	0,60 0,024					
	Non ferrous	M1	MP16-1600.9HFZ3-MD12 MP3000	0,65 0,026	0,65 0,026	0,65 0,026	0,85 0,034	1,0 0,040				
		M2	MP16-1600.9HFZ3-MD12 MP3000	0,65 0,026	0,60 0,024	0,60 0,024	0,75 0,030	0,95 0,038				
M3		MP16-1600.9HFZ3-MD12 MP3000	0,50 0,020	0,55 0,022	0,46 0,018	0,60 0,024	0,75 0,030					
M4		MP16-1600.9HFZ3-MD12 MP3000	0,38 0,015	0,48 0,019	0,40 0,016	0,55 0,022	0,65 0,026					
M5		MP16-1600.9HFZ3-MD12 MP3000	0,38 0,015	0,48 0,019	0,40 0,016	0,55 0,022	0,65 0,026					
Hard	K1	MP16-1600.9HFZ3-MD12 MP3000	0,65 0,026	0,65 0,026	0,65 0,026	0,85 0,034	1,0 0,040					
	K2	MP16-1600.9HFZ3-MD12 MP3000	0,65 0,026	0,60 0,024	0,60 0,024	0,75 0,030	0,95 0,038					
	K3	MP16-1600.9HFZ3-MD12 MP3000	0,65 0,026	0,60 0,024	0,60 0,024	0,75 0,030	0,95 0,038					
	K4	MP16-1600.9HFZ3-MD12 MP3000	0,65 0,026	0,60 0,024	0,60 0,024	0,75 0,030	0,95 0,038					
	K5	MP16-1600.9HFZ3-MD12 MP3000	0,65 0,026	0,50 0,020	0,50 0,020	0,70 0,028	0,85 0,034					
	K6	MP16-1600.9HFZ3-MD12 MP3000	0,65 0,026	0,60 0,024	0,60 0,024	0,75 0,030	0,95 0,038					
	K7	MP16-1600.9HFZ3-MD12 MP3000	0,65 0,026	0,50 0,020	0,50 0,020	0,70 0,028	0,85 0,034					
Plastic and cfrp	N1	MP16-1600.9HFZ3-MD12 MP3000	0,65 0,026	0,80 0,032	0,80 0,032	1,1 0,044	1,4 0,055					
	N2	MP16-1600.9HFZ3-MD12 MP3000	0,65 0,026	0,80 0,032	0,80 0,032	1,1 0,044	1,4 0,055					
	N3	MP16-1600.9HFZ3-MD12 MP3000	0,65 0,026	0,80 0,032	0,80 0,032	1,1 0,044	1,4 0,055					
Graphite	N11	MP16-1600.9HFZ3-MD12 MP3000	0,65 0,026	0,80 0,032	0,80 0,032	1,1 0,044	1,4 0,055					
	S1	MP16-1600.9HFZ3-MD12 MP3000	0,38 0,015	0,48 0,019	0,40 0,016	0,55 0,022	0,65 0,026					
	S2	MP16-1600.9HFZ3-MD12 MP3000	0,38 0,015	0,48 0,019	0,40 0,016	0,55 0,022	0,65 0,026					
Minimaster Plus	S3	MP16-1600.9HFZ3-MD12 MP3000	0,38 0,015	0,44 0,017	0,38 0,015	0,50 0,020	0,60 0,024					
	S11	MP16-1600.9HFZ3-MD12 MP3000	0,44 0,017	0,55 0,022	0,46 0,018	0,60 0,024	0,75 0,030					
	S12	MP16-1600.9HFZ3-MD12 MP3000	0,44 0,017	0,55 0,022	0,46 0,018	0,60 0,024	0,75 0,030					
	S13	MP16-1600.9HFZ3-MD12 MP3000	0,38 0,015	0,48 0,019	0,40 0,016	0,55 0,022	0,65 0,026					
	H5	MP16-1600.9HFZ3-MD12 MP3000	0,50 0,020	0,44 0,017	0,40 0,016	0,50 0,020	0,60 0,024					
Minimaster	H8	MP16-1600.9HFZ3-MD12 MP3000	0,44 0,017	0,34 0,013	0,30 0,012	0,40 0,016	0,46 0,018					
	H11	MP16-1600.9HFZ3-MD12 MP3000	0,50 0,020	0,44 0,017	0,40 0,016	0,50 0,020	0,60 0,024					
	H12	MP16-1600.9HFZ3-MD12 MP3000	0,44 0,017	0,34 0,013	0,30 0,012	0,40 0,016	0,46 0,018					
	H21	MP16-1600.9HFZ3-MD12 MP3000	0,44 0,017	0,34 0,013	0,30 0,012	0,40 0,016	0,46 0,018					

SMG = Seco material group
 f_z = mm/tooth (in/tooth), v_c = m/min (sf/min), a_p/DC = %
 All cutting data are start values

MP16 High feed milling – Cutting data $v_c = (m/min)/(sf/min)$

SMG	MP3000			
	100%	70%	30%	20%
P1	225	270	315	335
	740	890	1025	1100
P2	215	265	305	325
	710	870	1000	1075
P3	190	230	265	280
	620	750	870	920
P4	165	205	235	250
	540	670	770	820
P5	160	195	230	240
	520	640	750	790
P6	180	220	255	265
	590	720	840	870
P7	170	205	240	250
	560	670	790	820
P8	160	195	225	235
	520	640	740	770
P11	165	200	235	245
	540	660	770	800
P12	105	130	150	160
	345	425	490	520
M1	160	195	230	245
	520	640	750	800
M2	130	165	190	200
	425	540	620	660
M3	105	135	155	160
	345	445	510	520
M4	85	105	115	125
	280	345	375	410
M5	70	85	100	105
	230	280	330	345
K1	170	210	240	255
	560	690	790	840
K2	150	185	215	225
	490	610	710	740
K3	125	155	185	190
	410	510	610	620
K4	120	150	175	180
	395	490	570	590
K5	75	95	105	110
	245	310	345	360
K6	105	130	155	160
	345	425	510	520
K7	95	120	135	145
	310	395	445	475
N1	1275	1550	1775	1850
	4175	5075	5825	6075
N2	510	630	720	750
	1675	2075	2350	2450
N3	340	420	480	500
	1125	1375	1575	1650
N11	390	480	550	570
	1275	1575	1800	1875
S1	40	48	55	60
	130	155	180	195
S2	32	39	44	47
	105	130	145	155
S3	28	34	39	41
	90	110	130	135
S11	55	65	75	80
	180	215	245	260
S12	38	46	55	55
	125	150	180	180
S13	22	27	31	33
	70	90	100	110
H5	33	41	47	50
	110	135	155	165
H8	36	43	50	55
	120	140	165	180
H11	42	50	60	65
	140	165	195	215
H12	70	85	95	100
	230	280	310	330
H21	36	43	50	55
	120	140	165	180

Universal
Steel and cast iron
Stainless steel and S-materials
Non ferrous
Hard
Plastic and cfrp
Graphite
Minimaster Plus
Minimaster

MP16 Slot and Side milling – Insert selection – mm/inch

	SMG			f _z				
				100%	30%	10%	5%	
Universal	P1	MP16-16010R04Z3-M05 MP3000	5,0	0,070	0,075	0,12	0,16	
			0,20	0,0028	0,0030	0,0048	0,0065	
	P2	MP16-16010R04Z3-M05 MP3000	5,0	0,070	0,080	0,12	0,17	
			0,20	0,0028	0,0032	0,0048	0,0065	
	P3	MP16-16010R04Z3-M05 MP3000	5,0	0,070	0,075	0,11	0,16	
			0,20	0,0028	0,0030	0,0044	0,0065	
	P4	MP16-16010R04Z3-M05 MP3000	5,0	0,065	0,075	0,11	0,16	
			0,20	0,0026	0,0030	0,0044	0,0065	
	P5	MP16-16010R04Z3-M05 MP3000	5,0	0,065	0,070	0,11	0,15	
			0,20	0,0026	0,0028	0,0044	0,0060	
	P6	MP16-16010R04Z3-M05 MP3000	5,0	0,065	0,070	0,11	0,15	
			0,20	0,0026	0,0028	0,0044	0,0060	
P7	MP16-16010R04Z3-M05 MP3000	5,0	0,065	0,070	0,11	0,15		
		0,20	0,0026	0,0028	0,0044	0,0060		
P8	MP16-16010R04Z3-M05 MP3000	5,0	0,070	0,075	0,11	0,16		
		0,20	0,0028	0,0030	0,0044	0,0065		
P11	MP16-16010R04Z3-M05 MP3000	5,0	0,065	0,070	0,11	0,15		
		0,20	0,0026	0,0028	0,0044	0,0060		
P12	MP16-16010R04Z3-M05 MP3000	4,0	0,044	0,048	0,075	0,10		
		0,16	0,0017	0,0019	0,0030	0,0040		
Steel and cast iron	M1	MP16-16010R05Z3-E05 F40M	5,0	0,070	0,080	0,12	0,17	
			0,20	0,0028	0,0032	0,0048	0,0065	
	M2	MP16-16010R05Z3-E05 F40M	5,0	0,065	0,070	0,11	0,15	
			0,20	0,0026	0,0028	0,0044	0,0060	
	M3	MP16-16010R05Z3-E05 F40M	4,0	0,050	0,055	0,085	0,12	
0,16			0,0020	0,0022	0,0034	0,0048		
M4	MP16-16010R05Z3-E05 F40M	3,0	0,046	0,050	0,075	0,11		
		0,12	0,0018	0,0020	0,0030	0,0044		
M5	MP16-16010R05Z3-E05 F40M	3,0	0,046	0,050	0,075	0,11		
		0,12	0,0018	0,0020	0,0030	0,0044		
Non ferrous	K1	MP16-16010R04Z3-M05 MP3000	5,0	0,070	0,080	0,12	0,17	
			0,20	0,0028	0,0032	0,0048	0,0065	
	K2	MP16-16010R04Z3-M05 MP3000	5,0	0,065	0,070	0,11	0,15	
			0,20	0,0026	0,0028	0,0044	0,0060	
	K3	MP16-16010R04Z3-M05 MP3000	5,0	0,065	0,070	0,11	0,15	
			0,20	0,0026	0,0028	0,0044	0,0060	
	K4	MP16-16010R04Z3-M05 MP3000	5,0	0,065	0,070	0,11	0,15	
0,20			0,0026	0,0028	0,0044	0,0060		
K5	MP16-16010R04Z3-M05 MP3000	5,0	0,060	0,065	0,10	0,14		
		0,20	0,0024	0,0026	0,0040	0,0055		
K6	MP16-16010R04Z3-M05 MP3000	5,0	0,065	0,070	0,11	0,15		
		0,20	0,0026	0,0028	0,0044	0,0060		
K7	MP16-16010R04Z3-M05 MP3000	5,0	0,060	0,065	0,10	0,14		
		0,20	0,0024	0,0026	0,0040	0,0055		
Hard	N1	MP16-16010R05Z3-E05 F40M	5,0	0,090	0,10	0,15	0,22	
			0,20	0,0036	0,0040	0,0060	0,0085	
	N2	MP16-16010R05Z3-E05 F40M	5,0	0,090	0,10	0,15	0,22	
			0,20	0,0036	0,0040	0,0060	0,0085	
N3	MP16-16010R05Z3-E05 F40M	5,0	0,090	0,10	0,15	0,22		
		0,20	0,0036	0,0040	0,0060	0,0085		
Plastic and CFRP	N11	MP16-16010R05Z3-E05 F40M	5,0	0,090	0,10	0,15	0,22	
			0,20	0,0036	0,0040	0,0060	0,0085	
	S1	MP16-16010R05Z3-E05 F40M	3,0	0,046	0,050	0,075	0,11	
			0,12	0,0018	0,0020	0,0030	0,0044	
	S2	MP16-16010R05Z3-E05 F40M	3,0	0,046	0,050	0,075	0,11	
			0,12	0,0018	0,0020	0,0030	0,0044	
	S3	MP16-16010R05Z3-E05 F40M	3,0	0,042	0,046	0,070	0,10	
			0,12	0,0017	0,0018	0,0028	0,0040	
	Minimaster Plus	S11	MP16-16010R05Z3-E05 F40M	3,5	0,055	0,055	0,085	0,12
				0,14	0,0022	0,0022	0,0034	0,0048
S12		MP16-16010R05Z3-E05 F40M	3,5	0,055	0,055	0,085	0,12	
Minimaster	S13	MP16-16010R05Z3-E05 F40M	0,14	0,0022	0,0022	0,0034	0,0048	
			3,0	0,046	0,050	0,075	0,11	
	S13	MP16-16010R05Z3-E05 F40M	0,12	0,0018	0,0020	0,0030	0,0044	
Graphite	H5	MP16-16010R04Z3-M05 MP3000	4,0	0,044	0,048	0,075	0,10	
			0,16	0,0017	0,0019	0,0030	0,0040	
	H8	MP16-16010R04Z3-M05 MP3000	3,5	0,034	0,038	0,055	0,080	
			0,14	0,0013	0,0015	0,0022	0,0032	
	H11	MP16-16010R04Z3-M05 MP3000	4,0	0,044	0,048	0,075	0,10	
			0,16	0,0017	0,0019	0,0030	0,0040	
Minimaster Plus	H12	MP16-16010R04Z3-M05 MP3000	3,5	0,034	0,038	0,055	0,080	
			0,14	0,0013	0,0015	0,0022	0,0032	
	H21	MP16-16010R04Z3-M05 MP3000	3,5	0,034	0,038	0,055	0,080	
			0,14	0,0013	0,0015	0,0022	0,0032	

SMG = Seco material group
f_z = mm/tooth (in/tooth), v_c = m/min (sf/min), a_g/DC = %
All cutting data are start values

MP16 Slot and Side milling – Cutting data $v_c = (m/min)/(sf/min)$

SMG	MP3000				F40M			
	100%	30%	10%	5%	100%	30%	10%	5%
P1	235	310	360	395	225	295	340	375
	770	1025	1175	1300	740	970	1125	1225
P2	230	300	350	380	215	280	335	360
	750	980	1150	1250	710	920	1100	1175
P3	195	260	310	330	185	245	290	315
	640	850	1025	1075	610	800	950	1025
P4	175	230	270	290	165	215	255	275
	570	750	890	950	540	710	840	900
P5	170	220	260	280	160	210	245	265
	560	720	850	920	520	690	800	870
P6	190	250	290	315	180	235	275	300
	620	820	950	1025	590	770	900	980
P7	180	235	275	300	170	225	260	285
	590	770	900	980	560	740	850	940
P8	165	220	260	280	155	205	245	265
	540	720	850	920	510	670	800	870
P11	175	230	265	290	165	215	255	275
	570	750	870	950	540	710	840	900
P12	110	145	170	185	105	140	160	175
	360	475	560	610	345	460	520	570
M1	170	225	265	285	175	225	270	290
	560	740	870	940	570	740	890	950
M2	140	185	215	235	145	190	220	240
	460	610	710	770	475	620	720	790
M3	115	150	175	190	115	150	175	190
	375	490	570	620	375	490	570	620
M4	85	115	135	145	90	115	135	145
	280	375	445	475	295	375	445	475
M5	75	95	110	120	75	95	115	120
	245	310	360	395	245	310	375	395
K1	180	235	280	300	170	225	265	285
	590	770	920	980	560	740	870	940
K2	160	210	245	270	150	200	235	255
	520	690	800	890	490	660	770	840
K3	135	180	210	225	130	170	195	215
	445	590	690	740	425	560	640	710
K4	130	170	200	215	120	160	190	205
	425	560	660	710	395	520	620	670
K5	80	105	120	130	75	95	115	125
	260	345	395	425	245	310	375	410
K6	115	150	175	190	110	140	165	180
	375	490	570	620	360	460	540	590
K7	100	130	155	165	95	125	145	160
	330	425	510	540	310	410	475	520
N1	1350	1775	2100	2250	1275	1675	1975	2125
	4425	5825	6900	7375	4175	5500	6475	6975
N2	550	720	850	910	520	680	800	860
	1800	2350	2800	2975	1700	2225	2625	2825
N3	365	475	560	600	345	450	530	570
	1200	1550	1825	1975	1125	1475	1750	1875
N11	415	540	640	690	395	520	610	650
	1350	1775	2100	2275	1300	1700	2000	2125
S1	41	55	60	65	42	55	65	70
	135	180	195	215	140	180	215	230
S2	33	43	50	55	34	44	50	55
	110	140	165	180	110	145	165	180
S3	29	38	44	47	29	38	45	48
	95	125	145	155	95	125	150	155
S11	60	75	90	95	60	75	90	95
	195	245	295	310	195	245	295	310
S12	40	50	60	65	40	55	60	65
	130	165	195	215	130	180	195	215
S13	23	30	35	38	23	31	36	38
	75	100	115	125	75	100	120	125
H5	35	45	55	60	35	46	55	60
	115	150	180	195	115	150	180	195
H8	36	47	55	60	37	48	55	60
	120	155	180	195	120	155	180	195
H11	44	60	65	75	45	60	70	75
	145	195	215	245	150	195	230	245
H12	70	90	105	115	65	85	100	110
	230	295	345	375	215	280	330	360
H21	36	47	55	60	37	48	55	60
	120	155	180	195	120	155	180	195

Universal
 Steel and cast iron
 Stainless steel and S-materials
 Non ferrous
 Hard
 Plastic and CFRP
 Graphite
 Minimaster Plus
 Minimaster

MP16 Copy milling – Insert selection – mm/Inch

Material	SMG	a_p	f_z					
			100%	30%	10%	5%	2%	
Universal	P1	MP16-16010B90Z3-M05 MP3000	5,0 0,20	0,080 0,0032	0,085 0,0034	0,12 0,0048	0,17 0,0065	0,28 0,011
		P2	MP16-16010B90Z3-M05 MP3000	5,0 0,20	0,085 0,0034	0,085 0,0034	0,13 0,0050	0,18 0,0070
P3	MP16-16010B90Z3-M05 MP3000			5,0 0,20	0,080 0,0032	0,080 0,0032	0,12 0,0048	0,17 0,0065
		P4	MP16-16010B90Z3-M05 MP3000	5,0 0,20	0,075 0,0030	0,080 0,0032	0,12 0,0048	0,16 0,0065
P5	MP16-16010B90Z3-M05 MP3000			5,0 0,20	0,075 0,0030	0,080 0,0032	0,12 0,0048	0,16 0,0065
		P6	MP16-16010B90Z3-M05 MP3000	5,0 0,20	0,075 0,0030	0,080 0,0032	0,11 0,0044	0,16 0,0065
P7	MP16-16010B90Z3-M05 MP3000			5,0 0,20	0,075 0,0030	0,080 0,0032	0,11 0,0044	0,16 0,0065
		P8	MP16-16010B90Z3-M05 MP3000	5,0 0,20	0,080 0,0032	0,080 0,0032	0,12 0,0048	0,17 0,0065
Stainless steel and S-materials	P11			MP16-16010B90Z3-M05 MP3000	5,0 0,20	0,075 0,0030	0,080 0,0032	0,11 0,0044
		P12	MP16-16010B90Z3-M05 MP3000		4,0 0,16	0,055 0,0022	0,055 0,0022	0,080 0,0032
Non ferrous	M1			MP16-16010B90Z3-E05 F40M	5,0 0,20	0,085 0,0034	0,085 0,0034	0,13 0,0050
		M2	MP16-16010B90Z3-E05 F40M		5,0 0,20	0,075 0,0030	0,080 0,0032	0,12 0,0048
	M3			MP16-16010B90Z3-E05 F40M	4,0 0,16	0,065 0,0026	0,065 0,0026	0,090 0,0036
		M4	MP16-16010B90Z3-E05 F40M		3,0 0,12	0,060 0,0024	0,060 0,0024	0,080 0,0032
	M5			MP16-16010B90Z3-E05 F40M	3,0 0,12	0,060 0,0024	0,060 0,0024	0,080 0,0032
Hard	K1	MP16-16010B90Z3-M05 MP3000	5,0 0,20	0,085 0,0034	0,085 0,0034	0,13 0,0050	0,18 0,0070	0,28 0,011
			K2	MP16-16010B90Z3-M05 MP3000	5,0 0,20	0,075 0,0030	0,080 0,0032	0,12 0,0048
	K3	MP16-16010B90Z3-M05 MP3000			5,0 0,20	0,075 0,0030	0,080 0,0032	0,12 0,0048
			K4	MP16-16010B90Z3-M05 MP3000	5,0 0,20	0,075 0,0030	0,080 0,0032	0,12 0,0048
	K5	MP16-16010B90Z3-M05 MP3000			5,0 0,20	0,070 0,0028	0,070 0,0028	0,10 0,0040
			K6	MP16-16010B90Z3-M05 MP3000	5,0 0,20	0,075 0,0030	0,080 0,0032	0,12 0,0048
	K7	MP16-16010B90Z3-M05 MP3000			5,0 0,20	0,070 0,0028	0,070 0,0028	0,10 0,0040
Plastic and cfrp	N1	MP16-16010B90Z3-E05 F40M	5,0 0,20	0,11 0,0044	0,11 0,0044	0,16 0,0065	0,22 0,0085	0,38 0,015
			N2	MP16-16010B90Z3-E05 F40M	5,0 0,20	0,11 0,0044	0,11 0,0044	0,16 0,0065
	N3	MP16-16010B90Z3-E05 F40M			5,0 0,20	0,11 0,0044	0,11 0,0044	0,16 0,0065
			N11	MP16-16010B90Z3-E05 F40M	5,0 0,20	0,11 0,0044	0,11 0,0044	0,16 0,0065
Graphite	S1	MP16-16010B90Z3-E05 F40M	3,0 0,12	0,060 0,0024	0,060 0,0024	0,080 0,0032	0,11 0,0044	0,18 0,0070
			S2	MP16-16010B90Z3-E05 F40M	3,0 0,12	0,060 0,0024	0,060 0,0024	0,080 0,0032
	S3	MP16-16010B90Z3-E05 F40M			3,0 0,12	0,055 0,0022	0,055 0,0022	0,075 0,0030
Minimaster Plus	S11	MP16-16010B90Z3-E05 F40M	3,5 0,14	0,065 0,0026	0,065 0,0026	0,090 0,0036	0,13 0,0050	0,20 0,0080
			S12	MP16-16010B90Z3-E05 F40M	3,5 0,14	0,065 0,0026	0,065 0,0026	0,090 0,0036
	S13	MP16-16010B90Z3-E05 F40M			3,0 0,12	0,060 0,0024	0,060 0,0024	0,080 0,0032
Minimaster	H5	MP16-16010B90Z3-M05 MP3000	4,0 0,16	0,055 0,0022	0,055 0,0022	0,080 0,0032	0,11 0,0044	0,17 0,0065
			H8	MP16-16010B90Z3-M05 MP3000	3,5 0,14	0,042 0,0017	0,042 0,0017	0,060 0,0024
	H11	MP16-16010B90Z3-M05 MP3000			4,0 0,16	0,055 0,0022	0,055 0,0022	0,080 0,0032
			H12	MP16-16010B90Z3-M05 MP3000	3,5 0,14	0,042 0,0017	0,042 0,0017	0,060 0,0024
	H21	MP16-16010B90Z3-M05 MP3000			3,5 0,14	0,042 0,0017	0,042 0,0017	0,060 0,0024

SMG = Seco material group
 f_z = mm/tooth (in/tooth), v_c = m/min (sf/min), a_p/DC = %
 All cutting data are start values

MP16 Centre drilling – Insert selection – mm/Inch

SMG		f_z	a_{so}
			100%
P1	MP16-16009C90Z2-M05 F40M	0,070 0.0028	4,5 0.18
P2	MP16-16009C90Z2-M05 F40M	0,070 0.0028	4,5 0.18
P3	MP16-16009C90Z2-M05 F40M	0,070 0.0028	4,5 0.18
P4	MP16-16009C90Z2-M05 F40M	0,065 0.0026	4,5 0.18
P5	MP16-16009C90Z2-M05 F40M	0,065 0.0026	4,5 0.18
P6	MP16-16009C90Z2-M05 F40M	0,065 0.0026	4,5 0.18
P7	MP16-16009C90Z2-M05 F40M	0,065 0.0026	4,5 0.18
P8	MP16-16009C90Z2-M05 F40M	0,070 0.0028	4,5 0.18
P11	MP16-16009C90Z2-M05 F40M	0,065 0.0026	4,5 0.18
P12	MP16-16009C90Z2-M05 F40M	0,044 0.0017	3,5 0.14
M1	MP16-16009C90Z2-M05 F40M	0,070 0.0028	4,5 0.18
M2	MP16-16009C90Z2-M05 F40M	0,065 0.0026	4,5 0.18
M3	MP16-16009C90Z2-M05 F40M	0,050 0.0020	3,5 0.14
M4	MP16-16009C90Z2-M05 F40M	0,046 0.0018	2,5 0.10
M5	MP16-16009C90Z2-M05 F40M	0,046 0.0018	2,5 0.10
K1	MP16-16009C90Z2-M05 F40M	0,070 0.0028	4,5 0.18
K2	MP16-16009C90Z2-M05 F40M	0,065 0.0026	4,5 0.18
K3	MP16-16009C90Z2-M05 F40M	0,065 0.0026	4,5 0.18
K4	MP16-16009C90Z2-M05 F40M	0,065 0.0026	4,5 0.18
K5	MP16-16009C90Z2-M05 F40M	0,060 0.0024	4,5 0.18
K6	MP16-16009C90Z2-M05 F40M	0,065 0.0026	4,5 0.18
K7	MP16-16009C90Z2-M05 F40M	0,060 0.0024	4,5 0.18
N1	MP16-16009C90Z2-M05 F40M	0,090 0.0036	4,5 0.18
N2	MP16-16009C90Z2-M05 F40M	0,090 0.0036	4,5 0.18
N3	MP16-16009C90Z2-M05 F40M	0,090 0.0036	4,5 0.18
N11	MP16-16009C90Z2-M05 F40M	0,090 0.0036	4,5 0.18
S1	MP16-16009C90Z2-M05 F40M	0,046 0.0018	2,5 0.10
S2	MP16-16009C90Z2-M05 F40M	0,046 0.0018	2,5 0.10
S3	MP16-16009C90Z2-M05 F40M	0,042 0.0017	2,5 0.10
S11	MP16-16009C90Z2-M05 F40M	0,050 0.0020	3,0 0.12
S12	MP16-16009C90Z2-M05 F40M	0,050 0.0020	3,0 0.12
S13	MP16-16009C90Z2-M05 F40M	0,046 0.0018	2,5 0.10
H5	MP16-16009C90Z2-M05 F40M	0,044 0.0017	3,5 0.14
H8	MP16-16009C90Z2-M05 F40M	0,034 0.0013	3,0 0.12
H11	MP16-16009C90Z2-M05 F40M	0,044 0.0017	3,5 0.14
H12	MP16-16009C90Z2-M05 F40M	0,034 0.0013	3,0 0.12
H21	MP16-16009C90Z2-M05 F40M	0,034 0.0013	3,0 0.12

SMG = Seco material group
 f_z = mm/tooth (in/tooth), v_c = m/min (sf/min), a_e/DC = %
 All cutting data are start values

MP16 Centre drilling – Cutting data $v_c = (m/min)/(sf/min)$

SMG	F40M		
	v_c (m/min)	v_c (sf/min)	
	100%		Universal
P1	290	950	
P2	285	940	Steel and cast iron
P3	250	820	
P4	220	720	
P5	210	690	
P6	235	770	
P7	225	740	
P8	210	690	
P11	220	720	
P12	140	460	
M1	230	750	Non ferrous
M2	190	620	
M3	150	490	
M4	115	375	
M5	95	310	
K1	225	740	Hard
K2	200	660	
K3	170	560	
K4	160	520	Plastic and cfrp
K5	100	330	
K6	145	475	
K7	125	410	
N1	1650	5425	Graphite
N2	670	2200	
N3	445	1450	
N11	510	1675	
S1	55	180	Minimaster Plus
S2	43	140	
S3	37	120	
S11	75	245	
S12	50	165	
S13	30	100	
H5	46	150	Minimaster
H8	48	155	
H11	60	195	
H12	85	280	
H21	48	155	

MP16 Chamfering – Insert selection – mm/Inch

SMG		a _p	f _z				
			100%	50%	30%	20%	10%
P1	MP16-16009C90Z2-M05 F40M	3,5	0,10	0,10	0,10	0,10	0,12
		0,14	0,0040	0,0040	0,0040	0,0040	0,0048
P2	MP16-16009C90Z2-M05 F40M	3,5	0,10	0,10	0,10	0,10	0,12
		0,14	0,0040	0,0040	0,0040	0,0040	0,0048
P3	MP16-16009C90Z2-M05 F40M	3,5	0,095	0,095	0,095	0,095	0,12
		0,14	0,0038	0,0038	0,0038	0,0038	0,0048
P4	MP16-16009C90Z2-M05 F40M	3,5	0,095	0,095	0,095	0,095	0,11
		0,14	0,0038	0,0038	0,0038	0,0038	0,0044
P5	MP16-16009C90Z2-M05 F40M	3,5	0,090	0,090	0,090	0,090	0,11
		0,14	0,0036	0,0036	0,0036	0,0036	0,0044
P6	MP16-16009C90Z2-M05 F40M	3,5	0,090	0,090	0,090	0,090	0,11
		0,14	0,0036	0,0036	0,0036	0,0036	0,0044
P7	MP16-16009C90Z2-M05 F40M	3,5	0,090	0,090	0,090	0,090	0,11
		0,14	0,0036	0,0036	0,0036	0,0036	0,0044
P8	MP16-16009C90Z2-M05 F40M	3,5	0,095	0,095	0,095	0,095	0,12
		0,14	0,0038	0,0038	0,0038	0,0038	0,0048
P11	MP16-16009C90Z2-M05 F40M	3,5	0,090	0,090	0,090	0,090	0,11
		0,14	0,0036	0,0036	0,0036	0,0036	0,0044
P12	MP16-16009C90Z2-M05 F40M	3,0	0,065	0,065	0,065	0,065	0,075
		0,12	0,0026	0,0026	0,0026	0,0026	0,0030
M1	MP16-16009C90Z2-M05 F40M	3,5	0,10	0,10	0,10	0,10	0,12
		0,14	0,0040	0,0040	0,0040	0,0040	0,0048
M2	MP16-16009C90Z2-M05 F40M	3,5	0,090	0,090	0,090	0,090	0,11
		0,14	0,0036	0,0036	0,0036	0,0036	0,0044
M3	MP16-16009C90Z2-M05 F40M	3,0	0,075	0,075	0,075	0,075	0,090
		0,12	0,0030	0,0030	0,0030	0,0030	0,0036
M4	MP16-16009C90Z2-M05 F40M	2,0	0,065	0,065	0,065	0,065	0,080
		0,080	0,0026	0,0026	0,0026	0,0026	0,0032
M5	MP16-16009C90Z2-M05 F40M	2,0	0,065	0,065	0,065	0,065	0,080
		0,080	0,0026	0,0026	0,0026	0,0026	0,0032
K1	MP16-16009C90Z2-M05 F40M	3,5	0,10	0,10	0,10	0,10	0,12
		0,14	0,0040	0,0040	0,0040	0,0040	0,0048
K2	MP16-16009C90Z2-M05 F40M	3,5	0,090	0,090	0,090	0,090	0,11
		0,14	0,0036	0,0036	0,0036	0,0036	0,0044
K3	MP16-16009C90Z2-M05 F40M	3,5	0,090	0,090	0,090	0,090	0,11
		0,14	0,0036	0,0036	0,0036	0,0036	0,0044
K4	MP16-16009C90Z2-M05 F40M	3,5	0,090	0,090	0,090	0,090	0,11
		0,14	0,0036	0,0036	0,0036	0,0036	0,0044
K5	MP16-16009C90Z2-M05 F40M	3,5	0,085	0,085	0,085	0,085	0,10
		0,14	0,0034	0,0034	0,0034	0,0034	0,0040
K6	MP16-16009C90Z2-M05 F40M	3,5	0,090	0,090	0,090	0,090	0,11
		0,14	0,0036	0,0036	0,0036	0,0036	0,0044
K7	MP16-16009C90Z2-M05 F40M	3,5	0,085	0,085	0,085	0,085	0,10
		0,14	0,0034	0,0034	0,0034	0,0034	0,0040
N1	MP16-16009C90Z2-M05 F40M	3,5	0,13	0,13	0,13	0,13	0,16
		0,14	0,0050	0,0050	0,0050	0,0050	0,0065
N2	MP16-16009C90Z2-M05 F40M	3,5	0,13	0,13	0,13	0,13	0,16
		0,14	0,0050	0,0050	0,0050	0,0050	0,0065
N3	MP16-16009C90Z2-M05 F40M	3,5	0,13	0,13	0,13	0,13	0,16
		0,14	0,0050	0,0050	0,0050	0,0050	0,0065
N11	MP16-16009C90Z2-M05 F40M	3,5	0,13	0,13	0,13	0,13	0,16
		0,14	0,0050	0,0050	0,0050	0,0050	0,0065
S1	MP16-16009C90Z2-M05 F40M	2,0	0,065	0,065	0,065	0,065	0,080
		0,080	0,0026	0,0026	0,0026	0,0026	0,0032
S2	MP16-16009C90Z2-M05 F40M	2,0	0,065	0,065	0,065	0,065	0,080
		0,080	0,0026	0,0026	0,0026	0,0026	0,0032
S3	MP16-16009C90Z2-M05 F40M	2,0	0,060	0,060	0,060	0,060	0,070
		0,080	0,0024	0,0024	0,0024	0,0024	0,0028
S11	MP16-16009C90Z2-M05 F40M	2,5	0,075	0,075	0,075	0,075	0,090
		0,10	0,0030	0,0030	0,0030	0,0030	0,0036
S12	MP16-16009C90Z2-M05 F40M	2,5	0,075	0,075	0,075	0,075	0,090
		0,10	0,0030	0,0030	0,0030	0,0030	0,0036
S13	MP16-16009C90Z2-M05 F40M	2,0	0,065	0,065	0,065	0,065	0,080
		0,080	0,0026	0,0026	0,0026	0,0026	0,0032
H5	MP16-16009C90Z2-M05 F40M	3,0	0,065	0,065	0,065	0,065	0,075
		0,12	0,0026	0,0026	0,0026	0,0026	0,0030
H8	MP16-16009C90Z2-M05 F40M	2,5	0,048	0,048	0,048	0,048	0,060
		0,10	0,0019	0,0019	0,0019	0,0019	0,0024
H11	MP16-16009C90Z2-M05 F40M	3,0	0,065	0,065	0,065	0,065	0,075
		0,12	0,0026	0,0026	0,0026	0,0026	0,0030
H12	MP16-16009C90Z2-M05 F40M	2,5	0,048	0,048	0,048	0,048	0,060
		0,10	0,0019	0,0019	0,0019	0,0019	0,0024
H21	MP16-16009C90Z2-M05 F40M	2,5	0,048	0,048	0,048	0,048	0,060
		0,10	0,0019	0,0019	0,0019	0,0019	0,0024

SMG = Seco material group
f_z = mm/tooth (in/tooth), v_c = m/min (sf/min), a_p/DC = %
All cutting data are start values

MP16 Chamfering – Cutting data $v_c = (m/min)/(sf/min)$

SMG	F40M				
	100%	50%	30%	20%	10%
P1	290	270	315	350	415
	950	890	1025	1150	1350
P2	285	260	310	345	400
	940	850	1025	1125	1300
P3	250	230	270	300	345
	820	750	890	980	1125
P4	220	200	235	265	310
	720	660	770	870	1025
P5	210	195	230	255	295
	690	640	750	840	970
P6	235	220	260	285	335
	770	720	850	940	1100
P7	225	205	245	270	315
	740	670	800	890	1025
P8	210	190	225	250	290
	690	620	740	820	950
P11	220	200	235	260	305
	720	660	770	850	1000
P12	140	125	140	160	195
	460	410	460	520	640
M1	230	210	250	275	325
	750	690	820	900	1075
M2	190	175	205	230	265
	620	570	670	750	870
M3	150	135	155	175	215
	490	445	510	570	710
M4	115	95	115	125	165
	375	310	375	410	540
M5	95	80	95	105	135
	310	260	310	345	445
K1	225	205	245	270	320
	740	670	800	890	1050
K2	200	185	220	240	280
	660	610	720	790	920
K3	170	155	185	205	240
	560	510	610	670	790
K4	160	150	175	195	230
	520	490	570	640	750
K5	100	90	105	120	140
	330	295	345	395	460
K6	145	130	155	170	200
	475	425	510	560	660
K7	125	115	135	150	175
	410	375	445	490	570
N1	1650	1500	1800	2000	2325
	5425	4925	5900	6550	7625
N2	670	610	720	810	940
	2200	2000	2350	2650	3075
N3	445	405	485	540	630
	1450	1325	1600	1775	2075
N11	510	465	550	610	720
	1675	1525	1800	2000	2350
S1	55	44	55	60	75
	180	145	180	195	245
S2	43	35	43	47	60
	140	115	140	155	195
S3	37	31	38	42	55
	120	100	125	140	180
S11	75	65	75	85	110
	245	215	245	280	360
S12	50	45	50	60	75
	165	150	165	195	245
S13	30	25	30	33	43
	100	80	100	110	140
H5	46	41	47	55	65
	150	135	155	180	215
H8	48	42	48	55	70
	155	140	155	180	230
H11	60	50	60	70	85
	195	165	195	230	280
H12	85	75	85	100	125
	280	245	280	330	410
H21	48	42	48	55	70
	155	140	155	180	230

Universal
Steel and cast iron
Stainless steel and S-materials
Non ferrous
Hard
Plastic and cfrp
Graphite
Minimaster Plus
Minimaster

Universal
Steel and cast iron
Stainless steel and S-materials
Non ferrous
Hard
Plastic and cfrp
Graphite
Minimaster Plus
Minimaster



MINIMASTER™

Minimaster™ is a unique, versatile end milling system that can combine different solutions for optimum accessibility and maximum stability and security.

The flexible two-piece design combines shanks and inserts to save time, money and create a versatile tool that enables users to find a solution for almost every application – whether they need to minimize the overhang, attain maximum stability, or more.

- Square Shoulder range: 6-20 mm (.25 - .75 inch)
- Ballnose range: 6-20 mm (.25 - .75 inch)
- Center Drilling/Chamfering range: 6-19,05mm (.25 - .750 inch)
- High Feed range: 8-12 mm (.375 - .625 inch)
- Plunging range: 6-16 mm (.25 - .625 inch)
- Concave Radius range: 12 mm (.472 inch)

Code keys

Shanks

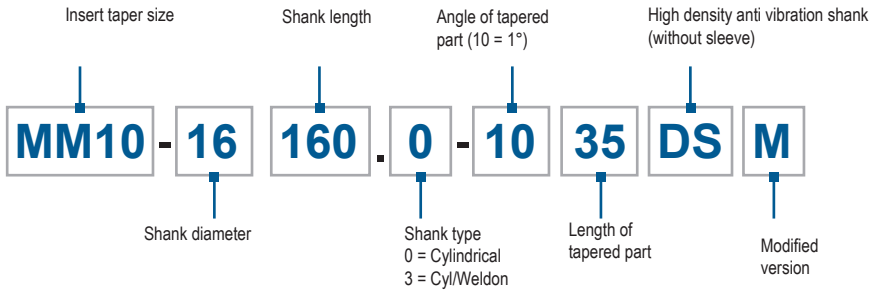

3-flute Minimaster inserts

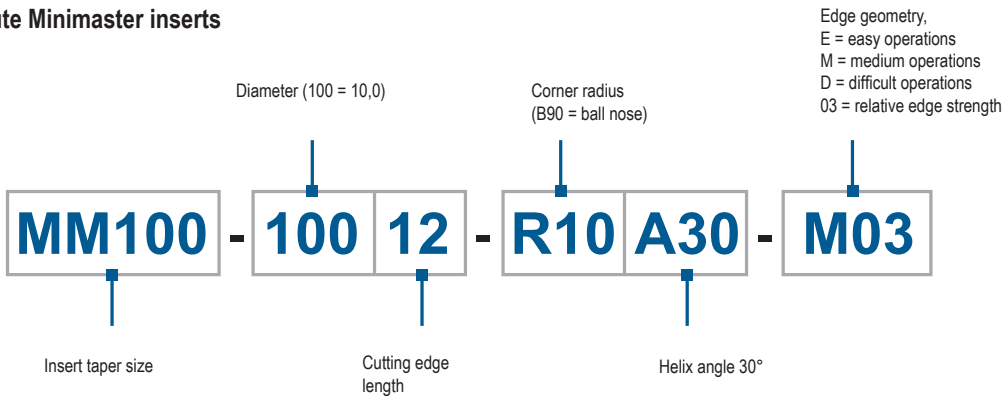

2-flute Minimaster inserts

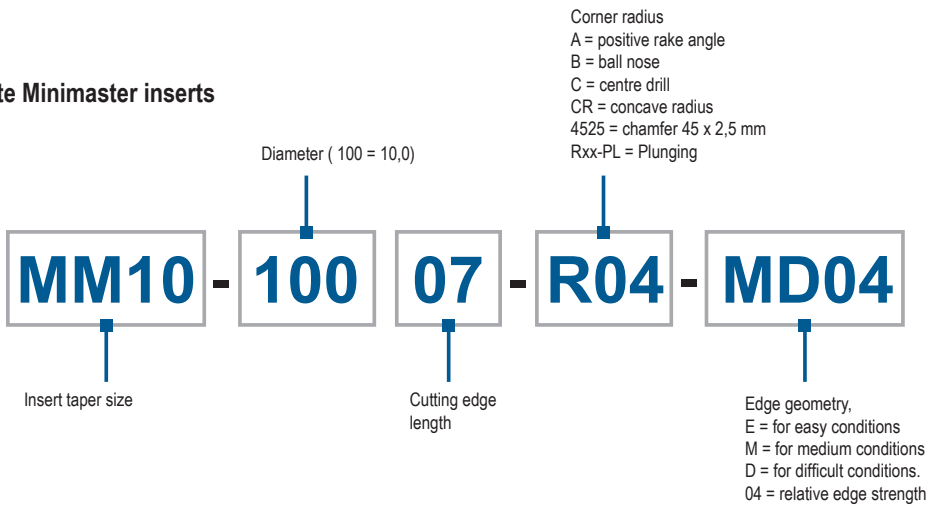

Note that parts of the code can vary for different types of insert or shanks

Internal through coolant



Universal

Steel and cast iron

Stainless steel and S-materials

Non ferrous

Hard

Plastic and CFRP

Graphite

Minimaster Plus

Minimaster

Mounting instructions for 2-flute Minimaster

Torque wrench	
<p>Sleeve Shank Tension screw Insert</p>	<p>The sleeve must be securely tightened in the shank before the tension screw and insert are fitted. If the wrench cannot be used for changing the insert (If the insert has broken off or jammed in the shank) , the sleeve can be released, which will also release the insert. Use Allen key (turn it anti-clockwise) to back off the sleeve until the insert is free. Re-tighten the sleeve in the shank before fitting the tension screw and the new insert. For 3-flute Minimaster another key (MM0416) must be used (Key grip on hexagonal part of the insert.)</p>
	<p>Make sure that the wrench is used correctly</p>
	<p>If the wrench is used on the wrong side, it will cause damage</p>
	<p>Do not use excessive force</p>
	<p>Normal hand-power is quite sufficient</p>

Selection guide

1. Select taper size

The design of the workpiece and the machining operations determines suitable taper size. Select the largest possible taper size for best strength and stability.

2. Select insert

- Use the tables beginning on page 616 to classify the workpiece material into a Seco material group.
- Look up the pages for the selected taper size and choose a suitable insert in the insert selection table.

3. Select shank

- Look up the pages for the selected taper size and choose a suitable shank in the tool data table.
- Always choose the shortest shank possible to achieve the best possible stability.

4. Select cutting data

- Cutting speed recommendations are found in the cutting data tables for each selected taper size. Cutting data recommendations are based on stable conditions and might therefore need to be adjusted depending on the stability in the application (tooling, machine & workpiece fixturing). General rule for max ap in slotting is $DC \cdot 0.3 = \text{Max APMXS}$. (See figure 1)
- Feed and cutting speed recommendations are found in the cutting data conversion table.
- Maximum RPM that for safety reasons should never be exceeded, are shown on page [XXX].
- If the cutter is not fully engaged the feed per tooth and the cutting speed should be increased compared to the recommendations for a fully engaged cutter. The reason for that is to keep the average chip thickness and the working temperature in the cutting zone.
- Divide the radial depth of cut with the cutter diameter to get the actual cutter engagement percentage ($a_e/DC\%$), for ball nose cutters use the effective working diameter D_w instead of DC (See figure 2 & 6)
- Use the percentage to get a correct feed per tooth and cutting speed recommendation for the actual cutter engagement.

5. General





- When milling in corners and bottoms of cavities the feed rate should be reduced due to the increase of the average chip thickness. Use the feed per tooth recommendations for a fully engaged cutter.
- When steep down copying with an angle bigger than 40° or steep up copying with an angle bigger than 30° in combination with small depths of cut, use the diameter (DC) as working diameter instead of D_w .
- When calculating feed per revolution and feed speed, always use the ZAFP-value. That is the effective number of teeth to use for cutting data calculations. The ZAFP-value can be found in the insert selection table.

Note! There will be a deterioration in the surface finish on the workpiece when the feed rate is increased. (See figure 3 & 5)

Minimaster figures

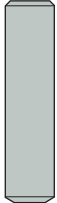
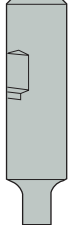
Universal	Figure 1	Figure 2
Steel and cast iron		
Stainless steel and S-materials	Figure 3	Figure 4
Non ferrous		
Hard	Figure 5	Figure 6
Plastic and cfrp		

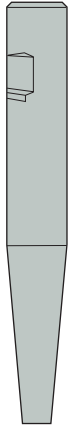
Shank design

Design 1, Keyway shank	Design 2, Cylindrical/Weldon back end and 90° front
	
Design 3, Cylindrical/Weldon back end tapered front 87°/89°	Design 4, Cylindrical/Weldon back end tapered front 80°/85°/87°
	
Design 5, Cylindrical back end double tapered front end 89°/85°	
	

- Universal
- Steel and cast iron
- Stainless steel and S-materials
- Non ferrous
- Hard
- Plastic and cfrp
- Graphite
- Minimaster Plus
- Minimaster

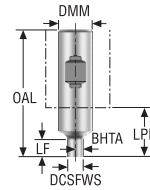

MM06 Shank – Metric



Designation	Item number	ShankType	DCSFWS	DMM	OAL	LF	LPR	BHTA°	Design		RPMX	Weight	Spare part no.
												mm	
MM06-12070.3-0005	75080695	Weldon	5,75	12,0	70,0	5,0	25,0	0,0	2	✓	80000	0,1	1
MM06-16075.3-3009	75080696	Weldon	5,75	16,0	75,0	9,0	27,0	3,0	3	✓	80000	0,1	1
MM06-16110.3-5058	75080697	Weldon	5,75	16,0	110,0	58,6	62,0	5,0	4	✓	80000	0,2	4
MM06-10040.0-0007	00094747	Cylindrical	5,75	10,0	40,0	7,0	7,0	0,0	2	✓	80000	0,1	2
MM06-12065.0-0000	75080694	Cylindrical	5,7	12,0	65,0	0,0	15,0	60,0	1	✓	80000	0,1	1
MM06-16140.0-1020M	00027102	Cylindrical	5,75	16,0	140,0	20,0	92,0	1,0	3	✓	80000	0,2	5
MM06-16140.0-1035M	00027103	Cylindrical	5,75	16,0	140,0	35,0	92,0	1,0	3	✓	80000	0,2	6
MM06-16140.0-1050M	00094748	Cylindrical	5,75	16,0	140,0	50,0	92,0	1,0	3	✓	80000	0,2	6
MM06-10050.0-0007DS	02580666	Cylindrical Densimet	5,75	10,0	50,0	7,0	7,0	0,0	2	✓	80000	0,1	3
MM06-10075.0-3041DS	02580701	Cylindrical Densimet	5,75	10,0	75,0	40,5	35,0	3,0	4	✓	80000	0,1	3
MM06-10100.0-1035DS	02580713	Cylindrical Densimet	5,75	10,0	100,0	35,0	60,0	1,0	3	✓	80000	0,1	3
MM06-12120.0-1050DS	02580714	Cylindrical Densimet	5,75	12,0	120,0	50,0	75,0	1,0	3	✓	80000	0,2	3
MM06-16090.0-0012DS	02580670	Cylindrical Densimet	5,75	16,0	90,0	12,0	42,0	0,0	2	✓	80000	0,3	3
MM06-16095.0-0024DS	02580673	Cylindrical Densimet	5,75	16,0	95,0	24,0	47,0	0,0	2	✓	80000	0,3	3
MM06-16140.0-1050DS	02580717	Cylindrical Densimet	5,75	16,0	140,0	50,0	92,0	1,0	3	✓	80000	0,3	3
MM06-16140.0-1035DS	02580716	Cylindrical Densimet	5,75	16,0	140,0	35,0	92,0	1,0	3	✓	80000	0,4	3
MM06-20250.0-1035DS	02580718	Cylindrical Densimet	5,75	20,0	250,0	35,0	190,0	1,0	5	✓	80000	1,0	3

Spare Parts

Accessories

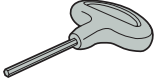
For cutter	Sleeve	Tension screw	Sleeve key
1	 MM-035046	 MM06-03518	 H05-4
4	MM-035091	MM06-03518	H05-4
2	MM-035023	MM06-03518	H05-4
5	MM-035046	MM06-03544	H05-4
6	MM-035046	MM06-03564	H05-4
3	-	MM06-03518	-

MM06 Shank – Inch

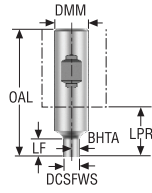

Designation	Item number	ShankType	DCSFWS	DMM	OAL	LF	LPR	BHTA°	Design	RPMX	Weight	Spare part no.
MM06-0.50-2.8-3-0002	00096108	Weldon	0.224	0.500	2.756	0.197	0.984	0,0	2	80000	0.220	1
MM06-0.62-3.0-3-3003	00096116	Weldon	0.224	0.625	2.953	0.354	1.063	3,0	1	80000	0.220	1
MM06-0.62-4.3-3-5022	00096117	Weldon	0.224	0.625	4.331	2.291	2.441	5,0	2	80000	0.440	4
MM06-0.38-1.6-0-0002	00096107	Cylindrical	0.224	0.375	1.575	0.276	0.276	0,0	2	80000	0.220	2
MM06-0.50-2.6-0-0000	00096106	Cylindrical	0.224	0.500	2.559	-	0.787	60,0	1	80000	0.220	1
MM06-0.62-5.5-0-1007	00096111	Cylindrical	0.224	0.625	5.512	0.787	3.622	1,0	3	80000	0.440	5
MM06-0.62-5.5-0-1013	00096112	Cylindrical	0.224	0.625	5.512	1.378	3.622	1,0	3	80000	0.440	6
MM06-0.62-5.5-0-1019	00096114	Cylindrical	0.224	0.625	5.512	1.969	3.622	1,0	3	80000	0.440	6
MM06-0.62-3.5-0-0004DS	02593394	Cylindrical Densimet	0.224	0.625	3.543	0.472	1.654	0,0	2	80000	0.660	3
MM06-0.62-3.7-0-0009DS	02593395	Cylindrical Densimet	0.224	0.625	3.740	0.945	1.850	0,0	2	80000	0.660	3
MM06-0.62-5.5-0-1013DS	02593396	Cylindrical Densimet	0.224	0.625	5.512	1.378	3.622	1,0	3	80000	0.880	3
MM06-0.62-5.5-0-1019DS	02593397	Cylindrical Densimet	0.224	0.625	5.512	1.969	3.622	1,0	3	80000	0.660	3
MM06-0.75-10.0-0-1013DS	02593399	Cylindrical Densimet	0.224	0.750	9.843	1.378	7.874	1,0	5	80000	1.980	3

Spare Parts

Accessories

For cutter	Sleeve	Tension screw	Sleeve key
1	MM-035046	MM06-03518	H05-4
4	MM-035091	MM06-03518	H05-4
2	MM-035023	MM06-03518	H05-4
5	MM-035046	MM06-03544	H05-4
6	MM-035046	MM06-03564	H05-4
3	-	MM06-03518	-

Universal

Steel and cast iron

Stainless steel and S-materials

Non ferrous

Hard

Plastic and chip

Graphite

Minimaster Plus

Minimaster

Slot milling/square shoulder milling

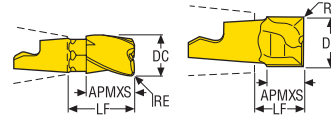

• For Torque keys and torque values, see page 615

Designation	DC	APMXS	RE	LF	RMPX°	C min	C max	FHA°	ZEPF	Wrench		Grades			
												Coated			
	mm Inch	mm Inch	mm Inch	mm Inch								T60M	F15M	F30M	F40M
MM06-06007-A30-E02	6,0 0.236	7,5 0.295	0,0 0.0	9,9 0.390	15,0	7,4	11,8	30	3	MM0416	✓			■	
MM06-06007-R05A30-M02	6,0 0.236	7,5 0.295	0,5 0.020	9,9 0.390	15,0	7,4	10,8	30	3	MM0416	✓				■
MM06-06007-R10A30-E02	6,0 0.236	7,5 0.295	1,0 0.039	9,9 0.390	15,0	7,4	9,8	30	3	MM0416	✓			■	
MM06-06007-R10A30-M02	6,0 0.236	7,5 0.295	1,0 0.039	9,9 0.390	15,0	7,4	9,8	30	3	MM0416	✓				■
MM06-06007-R10A30-D02	6,0 0.236	7,5 0.295	1,0 0.039	9,9 0.390	15,0	7,4	9,8	30	3	MM0416	✓			■	
MM06-06007-R20A30-M02	6,0 0.236	7,5 0.295	2,0 0.079	9,9 0.390	15,0	7,4	7,8	30	3	MM0416	✓				■
MM06-06407-A30-E02	6,35 0.250	7,5 0.295	0,0 0.0	9,9 0.390	15,0	7,8	12,5	30	3	MM0416	✓			■	
MM06-06407-R04A30-M02	6,35 0.250	7,5 0.295	0,4 0.016	9,9 0.390	15,0	7,8	11,7	30	3	MM0416	✓				■
MM06-06407-R08A30-M02	6,35 0.250	7,5 0.295	0,8 0.031	9,9 0.390	15,0	7,8	10,9	30	3	MM0416	✓				■
MM06-06004-M02	6,0 0.236	4,1 0.161	0,0 0.0	5,1 0.201	15,0	7,4	11,8	0	2	MM0612		■			
MM06-06004-R04-MD02	6,0 0.236	4,1 0.161	0,4 0.016	5,1 0.201	15,0	7,4	11,0	0	2	MM0612		■		■	
MM06-06004-R10-MD02	6,0 0.236	4,1 0.161	1,0 0.039	5,1 0.201	15,0	7,4	9,8	0	2	MM0612				■	
MM06-05807-R02A30-M02	5,8 0.228	7,5 0.295	0,2 0.008	9,9 0.390	15,0	7,2	11,0	30	3	MM0416	✓				■
MM06-05804T-R02-D02	5,8 0.228	4,1 0.161	0,2 0.008	5,1 0.201	15,0	7,2	11,0	0	2	MM0612		■			

Centre drilling

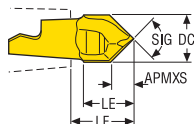

• For Torque keys and torque values, see page 615

Designation	DC	APMXS	LE	LF	SIG°	ZEFP	Wrench 	Grades			
								T60M	F15M	F30M	F40M
MM06-06003-C90-M02	6,0 0.236	2,86 0.113	6,0 0.236	7,12 0.280	90,0	2	MM0612	■			
MM06-06003-C120-M02	6,0 0.236	1,6 0.063	6,27 0.247	7,19 0.283	120,0	2	MM0612	■			

Chamfering

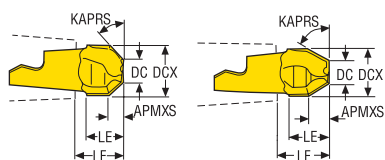

• For Torque keys and torque values, see page 615

Designation	DCX	DC	APMXS	LE	LF	KAPRS°	ZEFP	Wrench 	Grades			
									T60M	F15M	F30M	F40M
MM06-06004-4515-E02	6,0 0.236	1,8 0.071	2,1 0.083	4,0 0.157	5,1 0.201	45,0	2	MM0612	■			
MM06-06004-6015-E02	6,0 0.236	3,14 0.124	2,4 0.094	4,6 0.181	5,75 0.226	60,0	2	MM0612	■			

Double chamfering

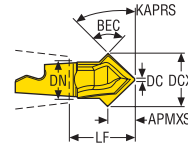

• For Torque keys and torque values, see page 615

Designation	DCX	DC	APMXS	LF	DN	BEC°	KAPRS°	ZEFP	Wrench	Grades			
										T60M	F15M	F30M	F40M
MM06-08008-D4510P-M02	8,0 0.315	0,6 0.024	3,7 0.146	8,5 0.335	6,0 0.236	90,0	45,0	2	MM0612		■		

Plunge milling

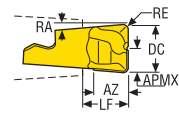

• For Torque keys and torque values, see page 615

Designation	DC	APMXE	RE	AZ	LF	RA°	ZEFP	Wrench	Grades			
									T60M	F15M	F30M	F40M
MM06-06004-R10-PL-MD02	6,0 0.236	3,0 0.118	1,0 0.039	4,3 0.169	5,08 0.200	5,0	2	MM0612			■	

Precision inserts for semi-finishing in all materials

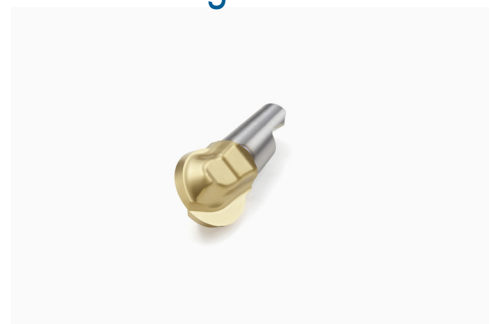
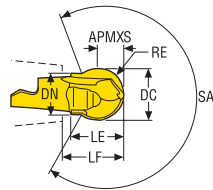

• For Torque keys and torque values, see page 615

Designation	DC	APMXS	RE	LE	LF	DN	SA°	ZEPF	Wrench	Grades			
										T60M	F15M	F30M	F40M
MM06-08008-B120PF-M01	8,0 <i>0.315</i>	4,0 <i>0.157</i>	4,0 <i>0.157</i>	8,0 <i>0.315</i>	8,73 <i>0.344</i>	6,0 <i>0.236</i>	263,0	2	MM0612		■		
MM06-08008-B120P-M03	8,0 <i>0.315</i>	4,0 <i>0.157</i>	4,0 <i>0.157</i>	8,0 <i>0.315</i>	8,73 <i>0.344</i>	6,0 <i>0.236</i>	263,0	2	MM0612			■	

Universal

Steel and cast iron

Stainless steel and S-materials

Non ferrous

Hard

Plastic and cfrp

Graphite

Minimaster Plus

Minimaster

Copy milling

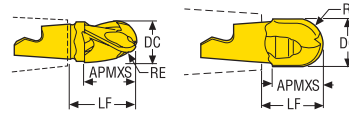

• For Torque keys and torque values, see page 615

Designation	DC	APMXS	RE	LF	FHA°	ZEP	Wrench	Grades			
								Coated			
	mm Inch	mm Inch	mm Inch	mm Inch				T60M	F15M	F30M	F40M
MM06-06007-B90A30-E02	6,0 0.236	7,4 0.291	3,0 0.118	9,85 0.388	30,0	3	MM0416 ✓			■	
MM06-06007-B90A30-M02	6,0 0.236	7,4 0.291	3,0 0.118	9,85 0.388	30,0	3	MM0416 ✓				■
MM06-06006-B90-MD02	6,0 0.236	6,1 0.240	3,0 0.118	7,06 0.278	0,0	2	MM0612	■		■	
MM06-06006-B90S-E02	6,0 0.236	6,1 0.240	3,0 0.118	7,06 0.278	0,0	2	MM0612			■	
MM06-06406-B90S-E02	6,35 0.250	6,3 0.248	3,175 0.125	7,24 0.285	0,0	2	MM0612			■	
MM06-06006-B90P-M02	6,0 0.236	5,2 0.205	3,0 0.118	7,04 0.277	0,0	2	MM0612			■	
MM06-06406-B90P-M02	6,35 0.250	5,4 0.213	3,175 0.125	7,22 0.284	0,0	2	MM0612			■	
MM06-06006-B90PF-M01	6,0 0.236	5,2 0.205	3,0 0.118	7,04 0.277	0,0	2	MM0612		■		

MM06 - Slot and Side milling – Insert selection – mm/Inch

SMG		a _p	f _z			
			100%	40%	20%	10%
P1	MM06-06007-R05A30-M02 F40M	1,3	0,030	0,030	0,036	0,048
		0,050	0,0012	0,0012	0,0014	0,0019
P2	MM06-06007-R05A30-M02 F40M	1,3	0,030	0,030	0,036	0,048
		0,050	0,0012	0,0012	0,0014	0,0019
P3	MM06-06007-R05A30-M02 F40M	1,3	0,028	0,028	0,034	0,046
		0,050	0,0011	0,0011	0,0013	0,0018
P4	MM06-06007-R05A30-M02 F40M	1,3	0,028	0,028	0,034	0,044
		0,050	0,0011	0,0011	0,0013	0,0017
P5	MM06-06007-R05A30-M02 F40M	1,3	0,028	0,028	0,032	0,044
		0,050	0,0011	0,0011	0,0013	0,0017
P6	MM06-06007-R05A30-M02 F40M	1,3	0,028	0,028	0,032	0,044
		0,050	0,0011	0,0011	0,0013	0,0017
P7	MM06-06007-R05A30-M02 F40M	1,3	0,028	0,028	0,032	0,044
		0,050	0,0011	0,0011	0,0013	0,0017
P8	MM06-06007-R05A30-M02 F40M	1,3	0,028	0,028	0,034	0,046
		0,050	0,0011	0,0011	0,0013	0,0018
P11	MM06-06007-R05A30-M02 F40M	1,3	0,028	0,028	0,032	0,044
		0,050	0,0011	0,0011	0,0013	0,0017
P12	MM06-06007-R05A30-M02 F40M	1,0	0,020	0,020	0,022	0,030
		0,040	0,00080	0,00080	0,00085	0,0012
M1	MM06-06007-R05A30-M02 F40M	1,3	0,030	0,030	0,036	0,048
		0,050	0,0012	0,0012	0,0014	0,0019
M2	MM06-06007-R05A30-M02 F40M	1,3	0,028	0,028	0,032	0,044
		0,050	0,0011	0,0011	0,0013	0,0017
M3	MM06-06007-R05A30-M02 F40M	1,0	0,024	0,024	0,026	0,036
		0,040	0,00095	0,00095	0,0010	0,0014
M4	MM06-06007-R05A30-M02 F40M	0,80	0,022	0,020	0,024	0,030
		0,032	0,00085	0,00080	0,00095	0,0012
M5	MM06-06007-R05A30-M02 F40M	0,80	0,022	0,020	0,024	0,030
		0,032	0,00085	0,00080	0,00095	0,0012
K1	MM06-06007-R10A30-D02 F30M	1,3	0,036	0,034	0,038	0,050
		0,050	0,0014	0,0013	0,0015	0,0020
K2	MM06-06007-R10A30-D02 F30M	1,3	0,032	0,032	0,034	0,044
		0,050	0,0013	0,0013	0,0013	0,0017
K3	MM06-06007-R10A30-D02 F30M	1,3	0,032	0,032	0,034	0,044
		0,050	0,0013	0,0013	0,0013	0,0017
K4	MM06-06007-R10A30-D02 F30M	1,3	0,032	0,032	0,034	0,044
		0,050	0,0013	0,0013	0,0013	0,0017
K5	MM06-06007-R10A30-D02 F30M	1,3	0,030	0,028	0,030	0,040
		0,050	0,0012	0,0011	0,0012	0,0016
K6	MM06-06007-R10A30-D02 F30M	1,3	0,032	0,032	0,034	0,044
		0,050	0,0013	0,0013	0,0013	0,0017
K7	MM06-06007-R10A30-D02 F30M	1,3	0,030	0,028	0,030	0,040
		0,050	0,0012	0,0011	0,0012	0,0016
N1	MM06-06007-R10A30-E02 F30M	1,3	0,046	0,044	0,048	0,065
		0,050	0,0018	0,0017	0,0019	0,0026
N2	MM06-06007-R10A30-E02 F30M	1,3	0,046	0,044	0,048	0,065
		0,050	0,0018	0,0017	0,0019	0,0026
N3	MM06-06007-R10A30-E02 F30M	1,3	0,046	0,044	0,048	0,065
		0,050	0,0018	0,0017	0,0019	0,0026
N11	MM06-06007-R10A30-E02 F30M	1,3	0,046	0,044	0,048	0,065
		0,050	0,0018	0,0017	0,0019	0,0026
S1	MM06-06007-R10A30-D02 F30M	0,80	0,028	0,026	0,025	0,032
		0,032	0,0011	0,0010	0,0010	0,0013
S2	MM06-06007-R10A30-D02 F30M	0,80	0,026	0,025	0,025	0,032
		0,032	0,0010	0,0010	0,0010	0,0013
S3	MM06-06007-R10A30-D02 F30M	0,80	0,026	0,025	0,024	0,028
		0,032	0,0010	0,0010	0,00095	0,0012
S11	MM06-06007-R05A30-M02 F40M	0,90	0,024	0,024	0,026	0,036
		0,036	0,00095	0,00095	0,0010	0,0014
S12	MM06-06007-R05A30-M02 F40M	0,90	0,024	0,024	0,026	0,036
		0,036	0,00095	0,00095	0,0010	0,0014
S13	MM06-06007-R05A30-M02 F40M	0,80	0,022	0,020	0,024	0,030
		0,032	0,00085	0,00080	0,00095	0,0012
H5	MM06-06007-R10A30-D02 F30M	1,0	0,025	0,024	0,024	0,030
		0,040	0,0010	0,00095	0,00095	0,0012
H8	MM06-06007-R10A30-D02 F30M	0,90	0,020	0,019	0,018	0,024
		0,036	0,00080	0,00075	0,00070	0,00095
H11	MM06-06007-R10A30-D02 F30M	1,0	0,025	0,024	0,024	0,030
		0,040	0,0010	0,00095	0,00095	0,0012
H12	MM06-06007-R10A30-D02 F30M	0,90	0,020	0,019	0,018	0,024
		0,036	0,00080	0,00075	0,00070	0,00095
H21	MM06-06007-R10A30-D02 F30M	0,90	0,020	0,019	0,018	0,024
		0,036	0,00080	0,00075	0,00070	0,00095

SMG = Seco material group
 f_z = mm/tooth (in/tooth), v_c = m/min (sf/min), a_p/DC = %
 All cutting data are start values

Universal
 Steel and cast iron
 Stainless steel and S-materials
 Non ferrous
 Hard
 Plastic and chip
 Graphite
 Minimaster Plus
 Minimaster

MM06 - Slot and Side milling – Cutting data $v_c = (m/min)/(sf/min)$

SMG	F30M				F40M				T60M			
	100%	40%	20%	10%	100%	40%	20%	10%	100%	40%	20%	10%
P1	280	350	395	435	270	335	375	415	220	270	300	330
	920	1150	1300	1425	890	1100	1225	1350	720	890	980	1075
P2	275	340	380	420	260	325	365	400	210	260	295	320
	900	1125	1250	1375	850	1075	1200	1300	690	850	970	1050
P3	240	295	330	365	225	285	315	350	185	230	255	280
	790	970	1075	1200	740	940	1025	1150	610	750	840	920
P4	210	260	295	320	200	250	280	305	160	200	225	245
	690	850	970	1050	660	820	920	1000	520	660	740	800
P5	200	250	280	310	190	240	265	295	155	190	215	235
	660	820	920	1025	620	790	870	970	510	620	710	770
P6	225	285	315	345	215	270	300	330	175	215	240	265
	740	940	1025	1125	710	890	980	1075	570	710	790	870
P7	215	265	295	325	205	255	285	310	165	205	230	250
	710	870	970	1075	670	840	940	1025	540	670	750	820
P8	200	250	280	305	190	240	265	290	155	190	215	235
	660	820	920	1000	620	790	870	950	510	620	710	770
P11	210	260	290	320	200	245	275	305	160	200	220	245
	690	850	950	1050	660	800	900	1000	520	660	720	800
P12	130	160	175	195	125	150	170	185	100	125	135	150
	425	520	570	640	410	490	560	610	330	410	445	490
M1	—	—	—	—	210	265	295	320	170	210	235	260
	—	—	—	—	690	870	970	1050	560	690	770	850
M2	—	—	—	—	175	215	240	265	140	170	195	210
	—	—	—	—	570	710	790	870	460	560	640	690
M3	—	—	—	—	135	165	190	205	110	135	150	165
	—	—	—	—	445	540	620	670	360	445	490	540
M4	—	—	—	—	105	130	145	155	85	105	115	125
	—	—	—	—	345	425	475	510	280	345	375	410
M5	—	—	—	—	85	105	120	130	70	85	95	105
	—	—	—	—	280	345	395	425	230	280	310	345
K1	215	270	305	335	205	260	290	315	165	210	230	255
	710	890	1000	1100	670	850	950	1025	540	690	750	840
K2	190	235	265	295	180	225	255	280	150	180	205	225
	620	770	870	970	590	740	840	920	490	590	670	740
K3	160	200	225	250	155	190	215	235	125	155	175	190
	520	660	740	820	510	620	710	770	410	510	570	620
K4	155	190	215	235	145	180	205	225	120	145	165	180
	510	620	710	770	475	590	670	740	395	475	540	590
K5	95	115	130	145	90	110	125	135	70	90	100	110
	310	375	425	475	295	360	410	445	230	295	330	360
K6	135	170	190	210	130	160	180	200	105	130	145	160
	445	560	620	690	425	520	590	660	345	425	475	520
K7	120	150	165	180	115	140	160	175	90	115	125	140
	395	490	540	590	375	460	520	570	295	375	410	460
N1	1650	2050	2325	2525	1575	1975	2200	2400	1275	1575	1775	1950
	5425	6725	7625	8275	5175	6475	7225	7875	4175	5175	5825	6400
N2	670	830	930	1025	640	790	890	970	510	640	710	790
	2200	2725	3050	3375	2100	2600	2925	3175	1675	2100	2325	2600
N3	445	560	620	680	425	530	590	650	340	425	475	530
	1450	1825	2025	2225	1400	1750	1925	2125	1125	1400	1550	1750
N11	510	630	710	780	485	600	680	740	390	485	540	600
	1675	2075	2325	2550	1600	1975	2225	2425	1275	1600	1775	1975
S1	50	65	70	75	49	60	65	75	39	49	55	60
	165	215	230	245	160	195	215	245	130	160	180	195
S2	41	50	55	60	39	48	55	60	32	39	44	48
	135	165	180	195	130	155	180	195	105	130	145	155
S3	36	44	49	55	34	42	47	50	27	34	38	41
	120	145	160	180	110	140	155	165	90	110	125	135
S11	—	—	—	—	70	85	95	105	55	70	75	85
	—	—	—	—	230	280	310	345	180	230	245	280
S12	—	—	—	—	48	60	65	70	38	48	55	60
	—	—	—	—	155	195	215	245	125	155	180	195
S13	—	—	—	—	27	34	38	41	22	27	30	33
	—	—	—	—	90	110	125	135	70	90	100	110
H5	43	55	60	65	41	50	55	60	33	41	45	50
	140	180	195	215	135	165	180	195	110	135	150	165
H8	44	55	60	65	42	50	60	65	34	42	47	50
	145	180	195	215	140	165	195	215	110	140	155	165
H11	55	65	75	85	50	65	70	80	42	50	60	65
	180	215	245	280	165	215	230	260	140	165	195	215
H12	80	95	110	120	75	90	105	115	60	75	85	90
	260	310	360	395	245	295	345	375	195	245	280	295
H21	44	55	60	65	42	50	60	65	34	42	47	50
	145	180	195	215	140	165	195	215	110	140	155	165

MM06 Z3-Copy milling – Insert selection – Roughing – mm/Inch

SMG		a _p	f _z			
			100%	40%	20%	10%
P1	MM06-06007-B90A30-M02 F40M	1,3	0,036	0,034	0,036	0,048
		0,050	0,0014	0,0013	0,0014	0,0019
P2	MM06-06007-B90A30-M02 F40M	1,3	0,036	0,034	0,036	0,048
		0,050	0,0014	0,0013	0,0014	0,0019
P3	MM06-06007-B90A30-M02 F40M	1,3	0,034	0,034	0,034	0,046
		0,050	0,0013	0,0013	0,0013	0,0018
P4	MM06-06007-B90A30-M02 F40M	1,3	0,034	0,032	0,034	0,044
		0,050	0,0013	0,0013	0,0013	0,0017
P5	MM06-06007-B90A30-M02 F40M	1,3	0,032	0,032	0,034	0,044
		0,050	0,0013	0,0013	0,0013	0,0017
P6	MM06-06007-B90A30-M02 F40M	1,3	0,032	0,032	0,034	0,044
		0,050	0,0013	0,0013	0,0013	0,0017
P7	MM06-06007-B90A30-M02 F40M	1,3	0,032	0,032	0,034	0,044
		0,050	0,0013	0,0013	0,0013	0,0017
P8	MM06-06007-B90A30-M02 F40M	1,3	0,034	0,034	0,034	0,046
		0,050	0,0013	0,0013	0,0013	0,0018
P11	MM06-06007-B90A30-M02 F40M	1,3	0,032	0,032	0,034	0,044
		0,050	0,0013	0,0013	0,0013	0,0017
P12	MM06-06007-B90A30-M02 F40M	1,0	0,024	0,024	0,024	0,030
		0,040	0,00095	0,00085	0,00095	0,0012
M1	MM06-06007-B90A30-M02 F40M	1,3	0,036	0,034	0,036	0,048
		0,050	0,0014	0,0013	0,0014	0,0019
M2	MM06-06007-B90A30-M02 F40M	1,3	0,032	0,032	0,034	0,044
		0,050	0,0013	0,0013	0,0013	0,0017
M3	MM06-06007-B90A30-M02 F40M	1,0	0,028	0,026	0,028	0,036
		0,040	0,0011	0,0010	0,0011	0,0014
M4	MM06-06007-B90A30-M02 F40M	0,80	0,025	0,025	0,025	0,030
		0,032	0,0010	0,0010	0,0010	0,0013
M5	MM06-06007-B90A30-M02 F40M	0,80	0,025	0,025	0,025	0,030
		0,032	0,0010	0,0010	0,0010	0,0013
K1	MM06-06007-B90A30-E02 F30M	1,3	0,036	0,034	0,036	0,048
		0,050	0,0014	0,0013	0,0014	0,0019
K2	MM06-06007-B90A30-E02 F30M	1,3	0,032	0,032	0,034	0,044
		0,050	0,0013	0,0013	0,0013	0,0017
K3	MM06-06007-B90A30-E02 F30M	1,3	0,032	0,032	0,034	0,044
		0,050	0,0013	0,0013	0,0013	0,0017
K4	MM06-06007-B90A30-E02 F30M	1,3	0,032	0,032	0,034	0,044
		0,050	0,0013	0,0013	0,0013	0,0017
K5	MM06-06007-B90A30-M02 F40M	1,3	0,030	0,028	0,030	0,040
		0,050	0,0012	0,0011	0,0012	0,0016
K6	MM06-06007-B90A30-M02 F40M	1,3	0,032	0,032	0,034	0,044
		0,050	0,0013	0,0013	0,0013	0,0017
K7	MM06-06007-B90A30-M02 F40M	1,3	0,030	0,028	0,030	0,040
		0,050	0,0012	0,0011	0,0012	0,0016
N1	MM06-06007-B90A30-E02 F30M	1,3	0,046	0,044	0,046	0,060
		0,050	0,0018	0,0017	0,0018	0,0024
N2	MM06-06007-B90A30-E02 F30M	1,3	0,046	0,044	0,046	0,060
		0,050	0,0018	0,0017	0,0018	0,0024
N3	MM06-06007-B90A30-E02 F30M	1,3	0,046	0,044	0,046	0,060
		0,050	0,0018	0,0017	0,0018	0,0024
N11	MM06-06007-B90A30-E02 F30M	1,3	0,046	0,044	0,046	0,060
		0,050	0,0018	0,0017	0,0018	0,0024
S1	MM06-06007-B90A30-M02 F40M	0,80	0,025	0,025	0,025	0,030
		0,032	0,0010	0,0010	0,0010	0,0013
S2	MM06-06007-B90A30-M02 F40M	0,80	0,025	0,025	0,025	0,030
		0,032	0,0010	0,0010	0,0010	0,0013
S3	MM06-06007-B90A30-M02 F40M	0,80	0,024	0,022	0,022	0,028
		0,032	0,00095	0,00085	0,00085	0,0012
S11	MM06-06007-B90A30-M02 F40M	0,90	0,028	0,028	0,028	0,036
		0,036	0,0011	0,0011	0,0011	0,0014
S12	MM06-06007-B90A30-M02 F40M	0,90	0,028	0,028	0,028	0,036
		0,036	0,0011	0,0011	0,0011	0,0014
S13	MM06-06007-B90A30-M02 F40M	0,80	0,025	0,025	0,025	0,030
		0,032	0,0010	0,0010	0,0010	0,0013
H5	MM06-06007-B90A30-E02 F30M	1,0	0,024	0,022	0,024	0,030
		0,040	0,00095	0,00085	0,00095	0,0012
H8	MM06-06007-B90A30-E02 F30M	0,90	0,018	0,018	0,018	0,022
		0,036	0,00070	0,00070	0,00070	0,00095
H11	MM06-06007-B90A30-E02 F30M	1,0	0,024	0,022	0,024	0,030
		0,040	0,00095	0,00085	0,00095	0,0012
H12	MM06-06007-B90A30-E02 F30M	0,90	0,018	0,018	0,018	0,022
		0,036	0,00070	0,00070	0,00070	0,00095
H21	MM06-06007-B90A30-E02 F30M	0,90	0,018	0,018	0,018	0,022
		0,036	0,00070	0,00070	0,00070	0,00095

SMG = Seco material group
 f_z = mm/tooth (in/tooth), v_c = m/min (sf/min), a_p/DC = %
 All cutting data are start values

Universal
 Steel and cast iron
 Stainless steel and S-materials
 Non ferrous
 Hard
 Plastic and chip
 Graphite
 Minimaster Plus
 Minimaster

MM06 Z3-Copy milling – Insert selection – Finishing – mm/inch

SMG		a_p		f_z			
				15%	10%	5%	2%
P1	MM06-06007-B90A30-E02 F30M	1,3	0,040	0,048	0,065	0,11	
		0,050	0,0016	0,0019	0,0026	0,0044	
P2	MM06-06007-B90A30-E02 F30M	1,3	0,040	0,048	0,065	0,11	
		0,050	0,0016	0,0019	0,0026	0,0044	
P3	MM06-06007-B90A30-E02 F30M	1,3	0,038	0,046	0,065	0,10	
		0,050	0,0015	0,0018	0,0026	0,0040	
P4	MM06-06007-B90A30-E02 F30M	1,3	0,038	0,044	0,060	0,10	
		0,050	0,0015	0,0017	0,0024	0,0040	
P5	MM06-06007-B90A30-E02 F30M	1,3	0,036	0,044	0,060	0,10	
		0,050	0,0014	0,0017	0,0024	0,0040	
P6	MM06-06007-B90A30-E02 F30M	1,3	0,036	0,044	0,060	0,10	
		0,050	0,0014	0,0017	0,0024	0,0040	
P7	MM06-06007-B90A30-E02 F30M	1,3	0,036	0,044	0,060	0,10	
		0,050	0,0014	0,0017	0,0024	0,0040	
P8	MM06-06007-B90A30-E02 F30M	1,3	0,038	0,046	0,065	0,10	
		0,050	0,0015	0,0018	0,0026	0,0040	
P11	MM06-06007-B90A30-E02 F30M	1,3	0,036	0,044	0,060	0,10	
		0,050	0,0014	0,0017	0,0024	0,0040	
P12	MM06-06007-B90A30-E02 F30M	1,0	0,026	0,030	0,042	0,065	
		0,040	0,0010	0,0012	0,0017	0,0026	
M1	MM06-06007-B90A30-E02 F30M	1,3	0,040	0,048	0,065	0,11	
		0,050	0,0016	0,0019	0,0026	0,0044	
M2	MM06-06007-B90A30-E02 F30M	1,3	0,036	0,044	0,060	0,10	
		0,050	0,0014	0,0017	0,0024	0,0040	
M3	MM06-06007-B90A30-E02 F30M	1,0	0,030	0,036	0,048	0,080	
		0,040	0,0012	0,0014	0,0019	0,0032	
M4	MM06-06007-B90A30-E02 F30M	0,80	0,026	0,030	0,042	0,070	
		0,032	0,0010	0,0013	0,0017	0,0028	
M5	MM06-06007-B90A30-E02 F30M	0,80	0,026	0,030	0,042	0,070	
		0,032	0,0010	0,0013	0,0017	0,0028	
K1	MM06-06007-B90A30-E02 F30M	1,3	0,040	0,048	0,065	0,11	
		0,050	0,0016	0,0019	0,0026	0,0044	
K2	MM06-06007-B90A30-E02 F30M	1,3	0,036	0,044	0,060	0,10	
		0,050	0,0014	0,0017	0,0024	0,0040	
K3	MM06-06007-B90A30-E02 F30M	1,3	0,036	0,044	0,060	0,10	
		0,050	0,0014	0,0017	0,0024	0,0040	
K4	MM06-06007-B90A30-E02 F30M	1,3	0,036	0,044	0,060	0,10	
		0,050	0,0014	0,0017	0,0024	0,0040	
K5	MM06-06007-B90A30-E02 F30M	1,3	0,034	0,040	0,055	0,090	
		0,050	0,0013	0,0016	0,0022	0,0036	
K6	MM06-06007-B90A30-E02 F30M	1,3	0,036	0,044	0,060	0,10	
		0,050	0,0014	0,0017	0,0024	0,0040	
K7	MM06-06007-B90A30-E02 F30M	1,3	0,034	0,040	0,055	0,090	
		0,050	0,0013	0,0016	0,0022	0,0036	
N1	MM06-06007-B90A30-E02 F30M	1,3	0,050	0,060	0,085	0,14	
		0,050	0,0020	0,0024	0,0034	0,0055	
N2	MM06-06007-B90A30-E02 F30M	1,3	0,050	0,060	0,085	0,14	
		0,050	0,0020	0,0024	0,0034	0,0055	
N3	MM06-06007-B90A30-E02 F30M	1,3	0,050	0,060	0,085	0,14	
		0,050	0,0020	0,0024	0,0034	0,0055	
N11	MM06-06007-B90A30-E02 F30M	1,3	0,050	0,060	0,085	0,14	
		0,050	0,0020	0,0024	0,0034	0,0055	
S1	MM06-06007-B90A30-E02 F30M	0,80	0,026	0,030	0,042	0,070	
		0,032	0,0010	0,0013	0,0017	0,0028	
S2	MM06-06007-B90A30-E02 F30M	0,80	0,026	0,030	0,042	0,070	
		0,032	0,0010	0,0013	0,0017	0,0028	
S3	MM06-06007-B90A30-E02 F30M	0,80	0,025	0,028	0,040	0,065	
		0,032	0,0010	0,0012	0,0016	0,0026	
S11	MM06-06007-B90A30-E02 F30M	0,90	0,030	0,036	0,048	0,080	
		0,036	0,0012	0,0014	0,0019	0,0032	
S12	MM06-06007-B90A30-E02 F30M	0,90	0,030	0,036	0,048	0,080	
		0,036	0,0012	0,0014	0,0019	0,0032	
S13	MM06-06007-B90A30-E02 F30M	0,80	0,026	0,030	0,042	0,070	
		0,032	0,0010	0,0013	0,0017	0,0028	
H5	MM06-06007-B90A30-E02 F30M	1,0	0,026	0,030	0,042	0,065	
		0,040	0,0010	0,0012	0,0017	0,0026	
H8	MM06-06007-B90A30-E02 F30M	0,90	0,020	0,022	0,032	0,050	
		0,036	0,00080	0,00095	0,0013	0,0020	
H11	MM06-06007-B90A30-E02 F30M	1,0	0,026	0,030	0,042	0,065	
		0,040	0,0010	0,0012	0,0017	0,0026	
H12	MM06-06007-B90A30-E02 F30M	0,90	0,020	0,022	0,032	0,050	
		0,036	0,00080	0,00095	0,0013	0,0020	
H21	MM06-06007-B90A30-E02 F30M	0,90	0,020	0,022	0,032	0,050	
		0,036	0,00080	0,00095	0,0013	0,0020	

SMG = Seco material group
 f_z = mm/tooth (in/tooth), v_c = m/min (sf/min), a_p/DC = %
 All cutting data are start values

MM06 Z3-Copy milling – Cutting data $v_c = (m/min)/(sf/min)$

SMG	F30M					F40M				
	100%	20%	10%	5%	2%	100%	20%	10%	5%	2%
P1	295	350	370	405	400	280	330	355	385	380
	970	1150	1225	1325	1300	920	1075	1175	1275	1250
P2	285	340	360	395	390	275	325	345	375	370
	940	1125	1175	1300	1275	900	1075	1125	1225	1225
P3	250	295	315	340	340	235	280	300	320	325
	820	970	1025	1125	1125	770	920	980	1050	1075
P4	220	260	275	300	300	210	245	265	285	285
	720	850	900	980	980	690	800	870	940	940
P5	210	245	265	285	285	200	235	250	275	270
	690	800	870	940	940	660	770	820	900	890
P6	235	275	295	320	320	225	265	285	305	305
	770	900	970	1050	1050	740	870	940	1000	1000
P7	225	260	280	305	300	210	250	265	290	285
	740	850	920	1000	980	690	820	870	950	940
P8	210	245	265	285	285	200	235	250	270	270
	690	800	870	940	940	660	770	820	890	890
P11	215	255	270	295	295	205	240	260	280	280
	710	840	890	970	970	670	790	850	920	920
P12	135	160	165	180	180	125	150	160	170	170
	445	520	560	590	590	410	490	520	560	560
M1	230	275	290	315	315	220	260	280	300	300
	750	900	950	1025	1025	720	850	920	980	980
M2	190	220	240	260	255	180	210	225	245	245
	620	720	790	850	840	590	690	740	800	800
M3	150	180	185	200	200	140	170	175	190	190
	490	590	610	660	660	460	560	590	620	620
M4	105	145	140	150	150	100	135	135	145	145
	345	475	490	490	490	330	445	460	475	475
M5	85	120	115	125	125	85	115	110	120	120
	280	395	410	410	410	280	375	395	395	395
K1	230	270	285	310	310	215	255	275	295	295
	750	890	940	1025	1025	710	840	900	970	970
K2	200	235	250	270	270	190	225	240	260	255
	660	770	820	890	890	620	740	790	850	840
K3	170	200	210	230	230	160	190	200	220	220
	560	660	690	750	750	520	620	660	720	720
K4	160	190	205	220	220	155	180	195	210	210
	520	620	670	720	720	510	590	640	690	690
K5	95	115	120	130	130	90	110	115	125	125
	310	375	395	425	425	295	360	375	410	410
K6	140	165	180	195	190	135	160	170	185	185
	460	540	590	640	620	445	520	560	610	610
K7	125	145	155	170	170	120	140	150	160	160
	410	475	510	560	560	395	460	490	520	520
N1	1750	2075	2200	2375	2375	1675	1975	2100	2275	2250
	5750	6800	7225	7800	7800	5500	6475	6900	7475	7375
N2	710	830	890	960	950	670	790	850	920	910
	2325	2725	2925	3150	3125	2200	2600	2800	3025	2975
N3	470	560	590	640	640	450	530	570	610	610
	1550	1825	1925	2100	2100	1475	1750	1875	2000	2000
N11	540	630	680	730	730	510	600	650	700	690
	1775	2075	2225	2400	2400	1675	1975	2125	2300	2275
S1	49	65	65	70	70	46	65	65	70	65
	160	215	230	230	230	150	215	215	230	215
S2	39	55	55	55	55	37	50	50	55	55
	130	180	180	180	180	120	165	180	180	180
S3	34	47	46	50	49	32	44	44	47	47
	110	155	155	165	160	105	145	150	155	155
S11	75	95	95	100	100	70	90	90	95	95
	245	310	310	330	330	230	295	295	310	310
S12	50	65	65	70	70	48	60	60	65	65
	165	215	215	230	230	155	195	215	215	215
S13	27	38	37	40	40	26	36	35	38	38
	90	125	130	130	130	85	120	120	125	125
H5	44	55	55	60	60	42	50	55	55	55
	145	180	180	195	195	140	165	180	180	180
H8	44	55	55	60	60	42	55	55	60	60
	145	180	195	195	195	140	180	180	195	195
H11	55	70	70	75	75	55	65	65	70	75
	180	230	230	245	245	180	215	230	230	245
H12	80	100	100	110	110	75	95	95	105	105
	260	330	345	360	360	245	310	330	345	345
H21	44	55	55	60	60	42	55	55	60	60
	145	180	195	195	195	140	180	180	195	195

Universal
Steel and cast iron
Stainless steel and S-materials
Non ferrous
Hard
Plastic and cfrp
Graphite
Minimaster Plus
Minimaster

MM06 Z2-Copy milling – Insert selection – Roughing – mm/Inch

SMG		a_p		f_z			
				100%	40%	20%	10%
P1	MM06-06006-B90S-E02 F30M	2,5	0,030	0,032	0,036	0,048	
		0,10	0,0012	0,0013	0,0014	0,0019	
P2	MM06-06006-B90S-E02 F30M	2,5	0,032	0,032	0,036	0,048	
		0,10	0,0013	0,0013	0,0014	0,0019	
P3	MM06-06006-B90S-E02 F30M	2,5	0,030	0,030	0,034	0,046	
		0,10	0,0012	0,0012	0,0013	0,0018	
P4	MM06-06006-B90-MD02 F30M	2,5	0,030	0,030	0,034	0,044	
		0,10	0,0012	0,0012	0,0013	0,0017	
P5	MM06-06006-B90-MD02 F30M	2,5	0,028	0,028	0,034	0,044	
		0,10	0,0011	0,0011	0,0013	0,0017	
P6	MM06-06006-B90-MD02 F30M	2,5	0,028	0,028	0,032	0,044	
		0,10	0,0011	0,0011	0,0013	0,0017	
P7	MM06-06006-B90-MD02 F30M	2,5	0,028	0,028	0,032	0,044	
		0,10	0,0011	0,0011	0,0013	0,0017	
P8	MM06-06006-B90-MD02 F30M	2,5	0,030	0,030	0,034	0,046	
		0,10	0,0012	0,0012	0,0013	0,0018	
P11	MM06-06006-B90-MD02 F30M	2,5	0,028	0,028	0,032	0,044	
		0,10	0,0011	0,0011	0,0013	0,0017	
P12	MM06-06006-B90-MD02 F30M	2,0	0,020	0,020	0,024	0,030	
		0,080	0,00080	0,00080	0,00095	0,0012	
M1	MM06-06006-B90S-E02 F30M	2,5	0,032	0,032	0,036	0,048	
		0,10	0,0013	0,0013	0,0014	0,0019	
M2	MM06-06006-B90S-E02 F30M	2,5	0,028	0,028	0,034	0,044	
		0,10	0,0011	0,0011	0,0013	0,0017	
M3	MM06-06006-B90S-E02 F30M	2,0	0,024	0,024	0,028	0,036	
		0,080	0,00095	0,00095	0,0011	0,0014	
M4	MM06-06006-B90-MD02 F30M	1,5	0,022	0,022	0,024	0,030	
		0,060	0,00085	0,00085	0,00095	0,0013	
M5	MM06-06006-B90-MD02 F30M	1,5	0,022	0,022	0,024	0,030	
		0,060	0,00085	0,00085	0,00095	0,0013	
K1	MM06-06006-B90S-E02 F30M	2,5	0,032	0,032	0,036	0,048	
		0,10	0,0013	0,0013	0,0014	0,0019	
K2	MM06-06006-B90S-E02 F30M	2,5	0,028	0,028	0,034	0,044	
		0,10	0,0011	0,0011	0,0013	0,0017	
K3	MM06-06006-B90S-E02 F30M	2,5	0,028	0,028	0,034	0,044	
		0,10	0,0011	0,0011	0,0013	0,0017	
K4	MM06-06006-B90S-E02 F30M	2,5	0,028	0,028	0,034	0,044	
		0,10	0,0011	0,0011	0,0013	0,0017	
K5	MM06-06006-B90S-E02 F30M	2,5	0,026	0,026	0,030	0,040	
		0,10	0,0010	0,0010	0,0012	0,0016	
K6	MM06-06006-B90-MD02 F30M	2,5	0,028	0,028	0,034	0,044	
		0,10	0,0011	0,0011	0,0013	0,0017	
K7	MM06-06006-B90-MD02 F30M	2,5	0,026	0,026	0,030	0,040	
		0,10	0,0010	0,0010	0,0012	0,0016	
N1	MM06-06006-B90S-E02 F30M	2,5	0,040	0,040	0,046	0,060	
		0,10	0,0016	0,0016	0,0018	0,0024	
N2	MM06-06006-B90S-E02 F30M	2,5	0,040	0,040	0,046	0,060	
		0,10	0,0016	0,0016	0,0018	0,0024	
N3	MM06-06006-B90S-E02 F30M	2,5	0,040	0,040	0,046	0,060	
		0,10	0,0016	0,0016	0,0018	0,0024	
N11	MM06-06006-B90S-E02 F30M	2,5	0,040	0,040	0,046	0,060	
		0,10	0,0016	0,0016	0,0018	0,0024	
S1	MM06-06006-B90-MD02 F30M	1,5	0,022	0,022	0,024	0,030	
		0,060	0,00085	0,00085	0,00095	0,0013	
S2	MM06-06006-B90-MD02 F30M	1,5	0,022	0,022	0,024	0,030	
		0,060	0,00085	0,00085	0,00095	0,0013	
S3	MM06-06006-B90-MD02 F30M	1,5	0,020	0,020	0,022	0,028	
		0,060	0,00080	0,00080	0,00085	0,0012	
S11	MM06-06006-B90-MD02 F30M	1,7	0,025	0,024	0,028	0,036	
		0,065	0,0010	0,00095	0,0011	0,0014	
S12	MM06-06006-B90-MD02 F30M	1,7	0,025	0,024	0,028	0,036	
		0,065	0,0010	0,00095	0,0011	0,0014	
S13	MM06-06006-B90-MD02 F30M	1,5	0,022	0,022	0,024	0,030	
		0,060	0,00085	0,00085	0,00095	0,0013	
H5	MM06-06006-B90-MD02 F30M	2,0	0,020	0,020	0,024	0,030	
		0,080	0,00080	0,00080	0,00095	0,0012	
H8	MM06-06006-B90-MD02 F30M	1,7	0,016	0,016	0,018	0,022	
		0,065	0,00065	0,00065	0,00070	0,00095	
H11	MM06-06006-B90-MD02 F30M	2,0	0,020	0,020	0,024	0,030	
		0,080	0,00080	0,00080	0,00095	0,0012	
H12	MM06-06006-B90-MD02 F30M	1,7	0,016	0,016	0,018	0,022	
		0,065	0,00065	0,00065	0,00070	0,00095	
H21	MM06-06006-B90-MD02 F30M	1,7	0,016	0,016	0,018	0,022	
		0,065	0,00065	0,00065	0,00070	0,00095	

SMG = Seco material group
 f_z = mm/tooth (in/tooth), v_c = m/min (sf/min), a_p/DC = %
 All cutting data are start values

MM06 Z2-Copy milling – Insert selection – Finishing – mm/Inch

SMG		a _p	f _z			
			15%	10%	5%	2%
P1	MM06-06006-B90PF-M01 F15M	2,0	0,020	0,024	0,034	0,055
		0.080	0.00080	0.00095	0.0013	0.0022
P2	MM06-06006-B90PF-M01 F15M	2,0	0,020	0,024	0,034	0,055
		0.080	0.00080	0.00095	0.0013	0.0022
P3	MM06-06006-B90PF-M01 F15M	2,0	0,020	0,024	0,032	0,050
		0.080	0.00080	0.00095	0.0013	0.0020
P4	MM06-06006-B90PF-M01 F15M	2,0	0,019	0,022	0,032	0,050
		0.080	0.00075	0.00085	0.0013	0.0020
P5	MM06-06006-B90PF-M01 F15M	2,0	0,019	0,022	0,030	0,048
		0.080	0.00075	0.00085	0.0012	0.0019
P6	MM06-06006-B90PF-M01 F15M	2,0	0,019	0,022	0,030	0,048
		0.080	0.00075	0.00085	0.0012	0.0019
P7	MM06-06006-B90PF-M01 F15M	2,0	0,019	0,022	0,030	0,048
		0.080	0.00075	0.00085	0.0012	0.0019
P8	MM06-06006-B90PF-M01 F15M	2,0	0,020	0,024	0,032	0,050
		0.080	0.00080	0.00095	0.0013	0.0020
P11	MM06-06006-B90PF-M01 F15M	2,0	0,019	0,022	0,030	0,048
		0.080	0.00075	0.00085	0.0012	0.0019
P12	MM06-06006-B90PF-M01 F15M	1,7	0,013	0,015	0,020	0,032
		0.065	0.00050	0.00060	0.00080	0.0013
M1	MM06-06006-B90PF-M01 F15M	2,0	0,020	0,024	0,034	0,055
		0.080	0.00080	0.00095	0.0013	0.0022
M2	MM06-06006-B90PF-M01 F15M	2,0	0,019	0,022	0,030	0,048
		0.080	0.00075	0.00085	0.0012	0.0019
M3	MM06-06006-B90PF-M01 F15M	1,7	0,015	0,018	0,025	0,038
		0.065	0.00060	0.00070	0.0010	0.0015
M4	MM06-06006-B90PF-M01 F15M	1,2	0,014	0,016	0,022	0,034
		0.048	0.00055	0.00065	0.00085	0.0013
M5	MM06-06006-B90PF-M01 F15M	1,2	0,014	0,016	0,022	0,034
		0.048	0.00055	0.00065	0.00085	0.0013
K1	MM06-06006-B90PF-M01 F15M	2,0	0,020	0,024	0,034	0,055
		0.080	0.00080	0.00095	0.0013	0.0022
K2	MM06-06006-B90PF-M01 F15M	2,0	0,019	0,022	0,030	0,048
		0.080	0.00075	0.00085	0.0012	0.0019
K3	MM06-06006-B90PF-M01 F15M	2,0	0,019	0,022	0,030	0,048
		0.080	0.00075	0.00085	0.0012	0.0019
K4	MM06-06006-B90PF-M01 F15M	2,0	0,019	0,022	0,030	0,048
		0.080	0.00075	0.00085	0.0012	0.0019
K5	MM06-06006-B90PF-M01 F15M	2,0	0,017	0,020	0,028	0,044
		0.080	0.00065	0.00080	0.0011	0.0017
K6	MM06-06006-B90PF-M01 F15M	2,0	0,019	0,022	0,030	0,048
		0.080	0.00075	0.00085	0.0012	0.0019
K7	MM06-06006-B90PF-M01 F15M	2,0	0,017	0,020	0,028	0,044
		0.080	0.00065	0.00080	0.0011	0.0017
N1	MM06-06006-B90PF-M01 F15M	2,0	0,026	0,032	0,044	0,070
		0.080	0.0010	0.0013	0.0017	0.0028
N2	MM06-06006-B90PF-M01 F15M	2,0	0,026	0,032	0,044	0,070
		0.080	0.0010	0.0013	0.0017	0.0028
N3	MM06-06006-B90PF-M01 F15M	2,0	0,026	0,032	0,044	0,070
		0.080	0.0010	0.0013	0.0017	0.0028
N11	MM06-06006-B90PF-M01 F15M	2,0	0,026	0,032	0,044	0,070
		0.080	0.0010	0.0013	0.0017	0.0028
S1	MM06-06006-B90PF-M01 F15M	1,2	0,014	0,016	0,022	0,034
		0.048	0.00055	0.00065	0.00085	0.0013
S2	MM06-06006-B90PF-M01 F15M	1,2	0,013	0,014	0,020	0,032
		0.048	0.00050	0.00060	0.00080	0.0013
S3	MM06-06006-B90PF-M01 F15M	1,5	0,015	0,018	0,025	0,038
		0.060	0.00060	0.00070	0.0010	0.0015
S11	MM06-06006-B90PF-M01 F15M	1,5	0,015	0,018	0,025	0,038
		0.060	0.00060	0.00070	0.0010	0.0015
S12	MM06-06006-B90PF-M01 F15M	1,2	0,014	0,016	0,022	0,034
		0.048	0.00055	0.00065	0.00085	0.0013
S13	MM06-06006-B90PF-M01 F15M	1,7	0,013	0,015	0,020	0,032
		0.065	0.00050	0.00060	0.00080	0.0013
H5	MM06-06006-B90PF-M01 F15M	1,5	0,010	0,012	0,016	0,025
		0.060	0.00040	0.00048	0.00065	0.0010
H8	MM06-06006-B90PF-M01 F15M	1,7	0,013	0,015	0,020	0,032
		0.065	0.00050	0.00060	0.00080	0.0013
H11	MM06-06006-B90PF-M01 F15M	1,5	0,010	0,012	0,016	0,025
		0.060	0.00040	0.00048	0.00065	0.0010
H12	MM06-06006-B90PF-M01 F15M	1,5	0,010	0,012	0,016	0,025
		0.060	0.00040	0.00048	0.00065	0.0010
H21	MM06-06006-B90PF-M01 F15M	1,5	0,010	0,012	0,016	0,025
		0.060	0.00040	0.00048	0.00065	0.0010





SMG = Seco material group
 f_z = mm/tooth (in/tooth), v_c = m/min (sf/min), a_p/DC = %
 All cutting data are start values

Universal
 Steel and cast iron
 Stainless steel and S-materials
 Non ferrous
 Hard
 Plastic and chip
 Graphite
 Minimaster Plus
 Minimaster

MM06 Z2-Copy milling – Cutting data $v_c = (m/min)/(sf/min)$

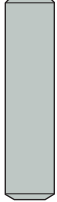
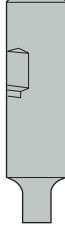
SMG	F15M					F30M					T60M					
	100%	20%	10%	5%	2%	100%	20%	10%	5%	2%	100%	20%	10%	5%	2%	
Universal	P1	325	415	430	470	465	275	345	375	405	405	225	280	305	330	325
		1075	1350	1400	1550	1525	900	1125	1225	1325	1325	740	920	1000	1075	1075
Steel and cast iron	P2	320	400	420	455	455	265	335	365	395	395	215	270	295	320	320
		1050	1300	1375	1500	1500	870	1100	1200	1300	1300	710	890	970	1050	1050
Steel and cast iron	P3	275	345	360	395	395	230	290	315	340	340	190	235	255	275	275
		900	1125	1175	1300	1300	750	950	1025	1125	1125	620	770	840	900	900
Steel and cast iron	P4	240	305	320	345	345	205	255	280	305	300	165	205	225	245	245
		790	1000	1050	1125	1125	670	840	920	1000	980	540	670	740	800	800
Steel and cast iron	P5	230	290	305	330	330	195	245	265	290	290	160	200	215	235	235
		750	950	1000	1075	1075	640	800	870	950	950	520	660	710	770	770
Steel and cast iron	P6	260	330	345	370	370	220	275	300	325	325	180	225	245	265	260
		850	1075	1125	1225	1225	720	900	980	1075	1075	590	740	800	870	850
Stainless steel and S-materials	P7	245	310	325	350	350	210	260	285	305	305	170	210	230	250	245
		800	1025	1075	1150	1150	690	850	940	1000	1000	560	690	750	820	800
Stainless steel and S-materials	P8	230	290	305	330	330	195	245	265	285	290	160	200	215	230	235
		750	950	1000	1075	1075	640	800	870	940	950	520	660	710	750	770
Stainless steel and S-materials	P11	240	300	315	340	340	200	255	275	300	295	165	205	220	240	240
		790	980	1025	1125	1125	660	840	900	980	970	540	670	720	790	790
Stainless steel and S-materials	P12	145	185	190	205	205	130	160	170	180	180	105	130	135	145	145
		475	610	620	670	670	425	520	560	590	590	345	425	445	475	475
Non ferrous	M1	255	325	340	365	365	215	270	295	320	315	175	220	240	260	255
		840	1075	1125	1200	1200	710	890	970	1050	1025	570	720	790	850	840
Non ferrous	M2	210	265	275	300	300	175	220	240	260	260	145	180	195	210	210
		690	870	900	980	980	570	720	790	850	850	475	590	640	690	690
Non ferrous	M3	165	210	210	230	230	140	180	185	205	200	115	145	150	165	165
		540	690	710	750	750	460	590	620	670	660	375	475	510	540	540
Non ferrous	M4	125	160	160	170	170	110	140	140	155	155	90	115	115	125	125
		410	520	560	560	560	360	460	490	510	510	295	375	395	410	410
Non ferrous	M5	105	135	130	145	145	95	120	120	130	130	75	95	95	105	105
		345	445	475	475	475	310	395	410	425	425	245	310	330	345	345
Hard	K1	250	320	335	360	360	210	265	290	315	310	170	215	235	255	250
		820	1050	1100	1175	1175	690	870	950	1025	1025	560	710	770	840	820
Hard	K2	220	275	290	315	315	185	230	255	275	275	150	190	205	220	220
		720	900	950	1025	1025	610	750	840	900	900	490	620	670	720	720
Hard	K3	185	235	245	265	265	160	195	215	230	230	130	160	175	190	185
		610	770	800	870	870	520	640	710	750	750	425	520	570	620	610
Hard	K4	175	225	235	255	255	150	185	205	220	220	120	150	165	180	180
		570	740	770	840	840	490	610	670	720	720	395	490	540	590	590
Hard	K5	105	135	140	150	150	90	115	125	135	135	75	90	100	110	105
		345	445	460	490	490	295	375	410	445	445	245	295	330	360	345
Hard	K6	155	195	205	225	225	135	165	180	195	195	105	135	145	160	155
		510	640	670	740	740	445	540	590	640	640	345	445	475	520	510
Hard	K7	135	170	180	195	195	115	145	155	170	170	95	115	125	140	140
		445	560	590	640	640	375	475	510	560	560	310	375	410	460	460
Plastic and cfrp	K8	1975	2475	2600	2800	2800	1625	2050	2225	2400	2375	1325	1650	1800	1950	1925
		6475	8125	8525	9175	9175	5325	6725	7300	7875	7800	4350	5425	5900	6400	6325
Plastic and cfrp	K9	790	1000	1050	1125	1125	660	820	900	970	960	530	670	730	790	780
		2600	3275	3450	3700	3700	2175	2700	2950	3175	3150	1750	2200	2400	2600	2550
Plastic and cfrp	K10	530	670	700	760	750	440	550	600	650	640	355	445	485	520	520
		1750	2200	2300	2500	2450	1450	1800	1975	2125	2100	1175	1450	1600	1700	1700
Plastic and cfrp	K11	600	760	800	860	860	500	630	680	740	730	405	510	550	600	590
		1975	2500	2625	2825	2825	1650	2075	2225	2425	2400	1325	1675	1800	1975	1925
Minimaster Plus	S1	60	75	75	80	80	50	65	65	70	70	42	55	55	60	60
		195	245	260	260	260	165	215	230	230	230	140	180	180	195	195
Minimaster Plus	S2	47	60	60	65	65	42	55	55	60	60	34	43	43	47	47
		155	195	215	215	215	140	180	180	195	195	110	140	150	155	155
Minimaster Plus	S3	41	50	50	55	55	36	46	46	50	50	29	37	38	40	40
		135	165	180	180	180	120	150	160	165	165	95	120	130	130	130
Minimaster Plus	S11	85	105	105	115	115	75	95	95	105	100	60	75	75	85	85
		280	345	360	375	375	245	310	310	345	330	195	245	260	280	280
Minimaster Plus	S12	55	75	75	80	80	50	65	65	70	70	41	55	55	55	55
		180	245	245	260	260	165	215	215	230	230	135	180	180	180	180
Minimaster Plus	S13	33	42	42	45	45	29	37	37	40	40	24	30	30	33	33
		110	140	150	150	150	95	120	130	130	130	80	100	105	110	110
Minimaster	H5	48	60	60	65	65	42	55	55	60	60	34	43	45	49	49
		155	195	215	215	215	140	180	180	195	195	110	140	150	160	160
Minimaster	H8	48	60	60	65	65	44	55	55	60	60	36	46	46	50	50
		155	195	215	215	215	145	180	195	195	195	120	150	155	165	165
Minimaster	H11	60	80	80	85	85	55	70	70	75	75	44	55	55	60	60
		195	260	260	280	280	180	230	230	245	245	145	180	195	195	195
Minimaster	H12	85	110	110	120	120	80	100	100	110	110	65	80	85	90	90
		280	360	375	395	395	260	330	345	360	360	215	260	280	295	295
Minimaster	H21	48	60	60	65	65	44	55	55	60	60	36	46	46	50	50
		155	195	215	215	215	145	180	195	195	195	120	150	155	165	165

Shank design

Design 1, Keyway shank	Design 2, Cylindrical/Weldon back end and 90° front
	
Design 3, Cylindrical/Weldon back end tapered front 87°/89°	Design 4, Cylindrical/Weldon back end tapered front 80°/85°/87°
	
Design 5, Cylindrical back end double tapered front end 89°/85°	
	

- Universal
- Steel and cast iron
- Stainless steel and S-materials
- Non ferrous
- Hard
- Plastic and cfrp
- Graphite
- Minimaster Plus
- Minimaster

MM08 Shank – Metric

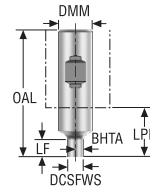

• For ISO attribute explanation, see page [XXX]

Designation	Item number	ShankType	DCSFWS	DMM	OAL	LF	LPR	BHTA°	Design		RPMX	Weight	Spare part no.
MM08-16070.3-0007	75034241	Weldon	7,6	16,0	70,0	7,6	22,0	0,0	2	✓	80000	0,1	1
MM08-16075.3-3012	75034242	Weldon	7,6	16,0	75,0	12,0	27,0	3,0	3	✓	80000	0,1	1
MM08-16120.3-5048M	00042863	Weldon	7,6	16,0	120,0	48,0	72,0	5,0	4	✓	80000	0,2	5
MM08-10040.0-0007	00083980	Cylindrical	7,6	10,0	40,0	7,0	7,0	0,0	2	✓	80000	0,1	2
MM08-12065.0-0000	75034240	Cylindrical	7,6	12,0	65,0	0,0	20,0	60,0	1	✓	80000	0,1	1
MM08-16150.0-1030M	00094751	Cylindrical	7,6	16,0	150,0	30,0	102,0	1,0	3	✓	80000	0,2	5
MM08-16150.0-1050M	00094752	Cylindrical	7,6	16,0	150,0	50,0	102,0	1,0	3	✓	80000	0,2	4
MM08-16150.0-1070M	00094754	Cylindrical	7,6	16,0	150,0	70,0	102,0	1,0	3	✓	80000	0,2	4
MM08-10050.0-0007DS	02580665	Cylindrical Densimet	7,6	10,0	50,0	7,0	10,0	0,0	2	✓	80000	0,1	3
MM08-10080.0-3023DS	02580702	Cylindrical Densimet	7,6	10,0	80,0	22,9	40,0	3,0	4	✓	80000	0,1	3
MM08-12100.0-1035DS	02580719	Cylindrical Densimet	7,6	12,0	100,0	35,0	55,0	1,0	3	✓	80000	0,2	3
MM08-12120.0-1050DS	02580720	Cylindrical Densimet	7,6	12,0	120,0	50,0	75,0	1,0	3	✓	80000	0,2	3
MM08-16085.0-0016DS	02580675	Cylindrical Densimet	7,6	16,0	85,0	16,0	37,0	0,0	2	✓	80000	0,3	3
MM08-16100.0-0032DS	02580687	Cylindrical Densimet	7,6	16,0	100,0	32,0	52,0	0,0	2	✓	80000	0,3	3
MM08-16150.0-1050DS	02580722	Cylindrical Densimet	7,6	16,0	150,0	50,0	102,0	1,0	3	✓	80000	0,4	3
MM08-16150.0-1070DS	02580727	Cylindrical Densimet	7,6	16,0	150,0	70,0	102,0	1,0	3	✓	80000	0,3	3

Spare Parts

Accessories

For cutter	Sleeve	Tension screw	Sleeve key
1	MM-05044	MM08-0524	H05-4
5	MM-05044	MM08-0543	H05-4
2	MM-05019	MM08-0524	H05-4
4	MM-05044	MM08-0582	H05-4
3	-	MM08-0524	-

MM08 Shank – Inch

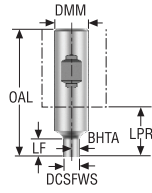

• For ISO attribute explanation, see page [XXX]

Designation	Item number	ShankType	DCSFWS	DMM	OAL	LF	LPR	BHTA°	Design		RPMX	Weight	Spare part no.
			Inch	Inch	Inch	Inch	Inch					lbs	
MM08-0.62-2.8-3-0003	75054600	Weldon	0.299	0.625	2.756	0.299	0.866	0,0	2	✓	80000	0.220	1
MM08-0.62-3.0-3-3004	75054601	Weldon	0.299	0.625	2.953	0.472	1.063	3,0	3	✓	80000	0.220	1
MM08-0.62-4.7-3-5018	75054602	Weldon	0.299	0.625	4.724	1.850	2.835	5,0	4	✓	80000	0.440	2
MM08-0.38-1.6-0-0002	00096119	Cylindrical	0.299	0.375	1.575	0.276	0.276	0,0	2	✓	80000	0.220	3
MM08-0.50-2.6-0-0000	75054599	Cylindrical	0.299	0.500	2.559	–	0.787	60,0	1	✓	80000	0.220	1
MM08-0.62-5.9-0-1011	75054604	Cylindrical	0.299	0.625	5.906	1.181	4.016	1,0	3	✓	80000	0.440	2
MM08-0.62-3.3-0-0006DS	02593402	Cylindrical Densimet	0.299	0.625	3.346	0.630	1.457	0,0	2	✓	80000	0.660	4
MM08-0.62-4.0-0-0012DS	02593403	Cylindrical Densimet	0.299	0.625	3.937	1.260	2.047	0,0	2	✓	80000	0.660	4
MM08-0.62-5.9-0-1019DS	02593407	Cylindrical Densimet	0.299	0.625	5.906	1.969	4.016	1,0	3	✓	80000	0.880	4
MM08-0.62-5.9-0-1027DS	02593410	Cylindrical Densimet	0.299	0.625	5.906	2.756	4.016	1,0	3	✓	80000	0.660	4
MM08-0.75-10.0-0-1019DS	02593413	Cylindrical Densimet	0.299	0.750	9.843	1.969	7.874	1,0	5	✓	80000	1.980	4

Spare Parts

Accessories

For cutter	Sleeve	Tension screw	Sleeve key
1	 MM-05044	 MM08-0524	 H05-4
2	 MM-05044	 MM08-0543	 H05-4
3	 MM-05019	 MM08-0524	 H05-4
4	 –	 MM08-0524	 –

Universal

Steel and cast iron

Stainless steel and S-materials

Non ferrous

Hard

Plastic and cfrp

Graphite

Minimaster Plus

Minimaster

Slot milling/square shoulder milling

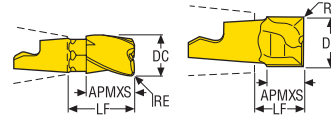

• For Torque keys and torque values, see page 615

Designation	DC	APMXS	RE	LF	RMPX°	C min	C max	FHA°	ZEPF	Wrench		Grades			
												Coated			
	mm Inch	mm Inch	mm Inch	mm Inch								T60M	F15M	F30M	F40M
MM08-08009-A30-E03	8,0 0.315	10,0 0.394	0,0 0.0	13,0 0.512	15,0	9,8	15,0	30	3	MM0416	✓			■	
MM08-08009-R05A30-M03	8,0 0.315	10,0 0.394	0,5 0.020	13,0 0.512	15,0	9,8	14,8	30	3	MM0416	✓				■
MM08-08009-R10A30-D03	8,0 0.315	10,0 0.394	1,0 0.039	13,0 0.512	15,0	9,8	13,8	30	3	MM0416	✓			■	
MM08-08009-R10A30-E03	8,0 0.315	10,0 0.394	1,0 0.039	13,0 0.512	15,0	9,8	13,8	30	3	MM0416	✓			■	
MM08-08009-R10A30-M03	8,0 0.315	10,0 0.394	1,0 0.039	13,0 0.512	15,0	9,8	13,8	30	3	MM0416	✓				■
MM08-08009-R20A30-M03	8,0 0.315	10,0 0.394	2,0 0.079	13,0 0.512	15,0	9,8	11,8	30	3	MM0416	✓				■
MM08-08009-R30A30-M03	8,0 0.315	10,0 0.394	3,0 0.118	13,0 0.512	15,0	9,8	9,8	30	3	MM0416	✓				■
MM08-08005-M03	8,0 0.315	5,5 0.217	0,0 0.0	6,8 0.268	15,0	9,8	15,8	0	2	MM0612		■			
MM08-08005-R04-MD03	8,0 0.315	5,5 0.217	0,4 0.016	6,8 0.268	15,0	9,8	15,0	0	2	MM0612		■		■	
MM08-08005-R04P-M02	8,0 0.315	5,4 0.213	0,4 0.016	6,7 0.264	15,0	9,8	15,0	0	2	MM0612				■	
MM08-08005-R10-MD03	8,0 0.315	5,4 0.213	1,0 0.039	6,8 0.268	15,0	9,8	13,8	0	2	MM0612				■	
MM08-08005-R04A8-E03	8,0 0.315	5,4 0.213	0,4 0.016	6,7 0.264	15,0	9,8	15,0	8	2	MM0612		■		■	
MM08-07809-R02A30-M03	7,8 0.307	10,0 0.394	0,2 0.008	13,0 0.512	15,0	9,6	15,0	30	3	MM0416	✓				■
MM08-07805T-R02-D03	7,8 0.307	5,4 0.213	0,2 0.008	6,8 0.268	15,0	9,6	15,0	0	2	MM0612		■			

Centre drilling

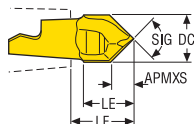

• For Torque keys and torque values, see page 615

Designation	DC	APMXS	LE	LF	SIG°	ZEFP	Wrench 	Grades			
								T60M	F15M	F30M	F40M
MM08-08004-C90-M03	8,0 0.315	3,79 0.149	8,0 0.315	9,5 0.374	90,0	2	MM0612	■			
MM08-08006-C120-M03	8,0 0.315	2,15 0.085	8,32 0.328	9,46 0.372	120,0	2	MM0612	■			

Chamfering

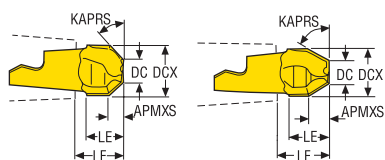

• For Torque keys and torque values, see page 615

Designation	DCX	DC	APMXS	LE	LF	KAPRS°	ZEFP	Wrench 	Grades			
									T60M	F15M	F30M	F40M
MM08-08005-4520-E03	8,0 0.315	3,87 0.152	2,1 0.083	5,5 0.217	6,7 0.264	45,0	2	MM0612	■			
MM08-08006-6030-E03	8,0 0.315	4,19 0.165	3,3 0.130	6,45 0.254	7,66 0.302	60,0	2	MM0612	■			

Universal

Steel and cast iron

Stainless steel and S-materials

Non ferrous

Hard

Plastic and cfrp

Graphite

Minimaster Plus

Minimaster

Plunge milling

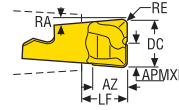

• For Torque keys and torque values, see page 615

Designation	DC	APMXE	RE	AZ	LF	RA°	ZEFP	Wrench	Grades				
									Coated	T60M	F15M	F30M	F40M
	mm Inch	mm Inch	mm Inch	mm Inch	mm Inch								
MM08-08005-R10-PL-MD03	8,0 0.315	4,0 0.157	1,0 0.039	5,7 0.224	6,78 0.267	5,0	2	MM0612			■		

Precision inserts for semi-finishing in all materials

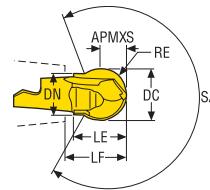

• For Torque keys and torque values, see page 615

Designation	DC	APMXS	RE	LE	LF	DN	SA°	ZEFP	Wrench	Grades			
										Coated	T60M	F15M	F30M
	mm Inch	mm Inch	mm Inch	mm Inch	mm Inch	mm Inch							
MM08-10010-B120PF-M02	10,0 0.394	5,0 0.197	5,0 0.197	10,0 0.394	10,97 0.432	8,0 0.315	254,0	2	MM0612		■		
MM08-10010-B120P-M04	10,0 0.394	5,0 0.197	5,0 0.197	10,0 0.394	10,97 0.432	8,0 0.315	254,0	2	MM0612			■	

Copy milling

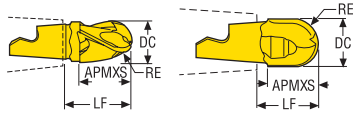

• For Torque keys and torque values, see page 615

Designation	DC	APMXS	RE	LF	FHA°	ZEFP	Wrench	Wrench	Grades			
									T60M	F15M	F30M	F40M
MM08-08009-B90A30-E03	8,0 0.315	10,0 0.394	4,0 0.157	13,0 0.512	30,0	3	MM0416	✓			■	
MM08-08009-B90A30-M03	8,0 0.315	10,0 0.394	4,0 0.157	13,0 0.512	30,0	3	MM0416	✓				■
MM08-08008-B90-MD03	8,0 0.315	8,1 0.319	4,0 0.157	9,42 0.371	0,0	2	MM0612		■		■	
MM08-08008-B90S-E03	8,0 0.315	8,1 0.319	4,0 0.157	9,42 0.371	0,0	2	MM0612				■	
MM08-08008-B90P-M03	8,0 0.315	6,9 0.272	4,0 0.157	9,39 0.370	0,0	2	MM0612				■	
MM08-08008-B90PF-M01	8,0 0.315	6,9 0.272	4,0 0.157	9,39 0.370	0,0	2	MM0612			■		

High feed

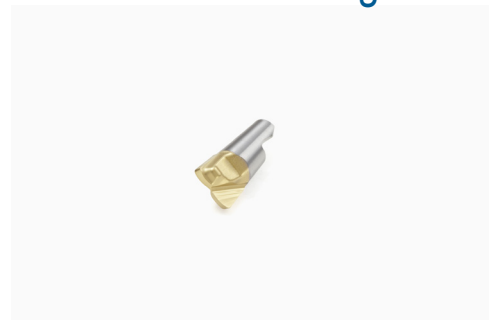
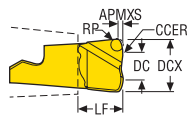

• For Torque keys and torque values, see page 615

Designation	DCX	DC	APMXS	RP	CCER	LF	RMPX°	C min	C max	ZEFP	Wrench	Wrench	Grades			
													T60M	F15M	F30M	F40M
MM08-08.40-HF-MD06	8,0 0.315	4,0 0.157	0,37 0.015	0,88 0.035	4,0 0.157	6,84 0.269	5,0	9,8	14,6	2	MM0612			■		

Universal

Steel and cast iron

Stainless steel and S-materials

Non ferrous

Hard

Plastic and cfrp

Graphite

Minimaster Plus

Minimaster

MM08 - Slot and Side milling – Insert selection – mm/Inch

SMG		a _p	f _z			
			100%	40%	20%	10%
P1	MM08-08009-R05A30-M03 F40M	1,8	0,044	0,044	0,055	0,070
		0,070	0,0017	0,0017	0,0022	0,0028
P2	MM08-08009-R05A30-M03 F40M	1,8	0,044	0,046	0,055	0,070
		0,070	0,0017	0,0018	0,0022	0,0028
P3	MM08-08009-R05A30-M03 F40M	1,8	0,042	0,042	0,050	0,070
		0,070	0,0017	0,0017	0,0020	0,0028
P4	MM08-08009-R05A30-M03 F40M	1,8	0,042	0,042	0,050	0,065
		0,070	0,0017	0,0017	0,0020	0,0026
P5	MM08-08009-R05A30-M03 F40M	1,8	0,040	0,042	0,050	0,065
		0,070	0,0016	0,0017	0,0020	0,0026
P6	MM08-08009-R05A30-M03 F40M	1,8	0,040	0,040	0,048	0,065
		0,070	0,0016	0,0016	0,0019	0,0026
P7	MM08-08009-R05A30-M03 F40M	1,8	0,040	0,040	0,048	0,065
		0,070	0,0016	0,0016	0,0019	0,0026
P8	MM08-08009-R05A30-M03 F40M	1,8	0,042	0,042	0,050	0,070
		0,070	0,0017	0,0017	0,0020	0,0028
P11	MM08-08009-R05A30-M03 F40M	1,8	0,040	0,040	0,048	0,065
		0,070	0,0016	0,0016	0,0019	0,0026
P12	MM08-08009-R05A30-M03 F40M	1,4	0,028	0,028	0,034	0,044
		0,055	0,0011	0,0011	0,0013	0,0017
M1	MM08-08009-R05A30-M03 F40M	1,8	0,044	0,046	0,055	0,070
		0,070	0,0017	0,0018	0,0022	0,0028
M2	MM08-08009-R05A30-M03 F40M	1,8	0,040	0,042	0,050	0,065
		0,070	0,0016	0,0017	0,0020	0,0026
M3	MM08-08009-R05A30-M03 F40M	1,4	0,034	0,034	0,040	0,055
		0,055	0,0013	0,0013	0,0016	0,0022
M4	MM08-08009-R05A30-M03 F40M	1,0	0,030	0,030	0,034	0,046
		0,040	0,0012	0,0012	0,0013	0,0018
M5	MM08-08009-R05A30-M03 F40M	1,0	0,030	0,030	0,034	0,046
		0,040	0,0012	0,0012	0,0013	0,0018
K1	MM08-08009-R10A30-E03 F30M	1,8	0,050	0,048	0,055	0,075
		0,070	0,0020	0,0019	0,0022	0,0030
K2	MM08-08009-R10A30-E03 F30M	1,8	0,044	0,044	0,050	0,065
		0,070	0,0017	0,0017	0,0020	0,0026
K3	MM08-08009-R10A30-E03 F30M	1,8	0,044	0,044	0,050	0,065
		0,070	0,0017	0,0017	0,0020	0,0026
K4	MM08-08009-R10A30-E03 F30M	1,8	0,044	0,044	0,050	0,065
		0,070	0,0017	0,0017	0,0020	0,0026
K5	MM08-08009-R10A30-D03 F30M	1,8	0,040	0,040	0,046	0,060
		0,070	0,0016	0,0016	0,0018	0,0024
K6	MM08-08009-R10A30-D03 F30M	1,8	0,044	0,044	0,050	0,065
		0,070	0,0017	0,0017	0,0020	0,0026
K7	MM08-08009-R10A30-D03 F30M	1,8	0,040	0,040	0,046	0,060
		0,070	0,0016	0,0016	0,0018	0,0024
N1	MM08-08009-R10A30-E03 F30M	1,8	0,060	0,060	0,070	0,095
		0,070	0,0024	0,0024	0,0028	0,0038
N2	MM08-08009-R10A30-E03 F30M	1,8	0,060	0,060	0,070	0,095
		0,070	0,0024	0,0024	0,0028	0,0038
N3	MM08-08009-R10A30-E03 F30M	1,8	0,060	0,060	0,070	0,095
		0,070	0,0024	0,0024	0,0028	0,0038
N11	MM08-08009-R10A30-E03 F30M	1,8	0,060	0,060	0,070	0,095
		0,070	0,0024	0,0024	0,0028	0,0038
S1	MM08-08009-R10A30-D03 F30M	1,0	0,038	0,036	0,036	0,046
		0,040	0,0015	0,0014	0,0014	0,0019
S2	MM08-08009-R10A30-D03 F30M	1,0	0,038	0,036	0,036	0,046
		0,040	0,0015	0,0014	0,0014	0,0019
S3	MM08-08009-R10A30-D03 F30M	1,0	0,036	0,034	0,034	0,042
		0,040	0,0014	0,0013	0,0013	0,0017
S11	MM08-08009-R05A30-M03 F40M	1,2	0,034	0,034	0,040	0,055
		0,048	0,0013	0,0013	0,0016	0,0022
S12	MM08-08009-R05A30-M03 F40M	1,2	0,034	0,034	0,040	0,055
		0,048	0,0013	0,0013	0,0016	0,0022
S13	MM08-08009-R05A30-M03 F40M	1,0	0,030	0,030	0,034	0,046
		0,040	0,0012	0,0012	0,0013	0,0018
H5	MM08-08009-R10A30-E03 F30M	1,4	0,032	0,032	0,034	0,044
		0,055	0,0013	0,0013	0,0013	0,0018
H8	MM08-08009-R10A30-E03 F30M	1,2	0,026	0,025	0,026	0,034
		0,048	0,0010	0,0010	0,0010	0,0013
H11	MM08-08009-R10A30-E03 F30M	1,4	0,032	0,032	0,034	0,044
		0,055	0,0013	0,0013	0,0013	0,0018
H12	MM08-08009-R10A30-E03 F30M	1,2	0,026	0,025	0,026	0,034
		0,048	0,0010	0,0010	0,0010	0,0013
H21	MM08-08009-R10A30-E03 F30M	1,2	0,026	0,025	0,026	0,034
		0,048	0,0010	0,0010	0,0010	0,0013

SMG = Seco material group
f_z = mm/tooth (in/tooth), v_c = m/min (sf/min), a_g/DC = %
All cutting data are start values

MM08 - Slot and Side milling – Cutting data $v_c = (m/min)/(sf/min)$

SMG	F30M				F40M				T60M			
	100%	40%	20%	10%	100%	40%	20%	10%	100%	40%	20%	10%
P1	265	330	370	410	255	315	350	385	205	250	280	310
	870	1075	1225	1350	840	1025	1150	1275	670	820	920	1025
P2	255	320	360	390	245	305	340	375	195	245	275	300
	840	1050	1175	1275	800	1000	1125	1225	640	800	900	980
P3	225	280	315	340	215	265	295	325	170	210	240	260
	740	920	1025	1125	710	870	970	1075	560	690	790	850
P4	195	245	275	300	190	235	260	290	150	185	210	230
	640	800	900	980	620	770	850	950	490	610	690	750
P5	190	235	265	290	180	225	250	275	145	180	200	220
	620	770	870	950	590	740	820	900	475	590	660	720
P6	215	265	295	325	205	255	280	310	160	200	225	250
	710	870	970	1075	670	840	920	1025	520	660	740	820
P7	200	250	280	310	190	240	265	290	155	190	215	235
	660	820	920	1025	620	790	870	950	510	620	710	770
P8	190	235	265	285	180	225	250	270	145	180	200	220
	620	770	870	940	590	740	820	890	475	590	660	720
P11	195	245	270	300	185	230	260	285	150	185	210	230
	640	800	890	980	610	750	850	940	490	610	690	750
P12	120	150	170	185	115	145	160	175	95	115	130	145
	395	490	560	610	375	475	520	570	310	375	425	475
M1	—	—	—	—	200	245	275	305	160	195	220	240
	—	—	—	—	660	800	900	1000	520	640	720	790
M2	—	—	—	—	165	200	225	250	130	160	180	200
	—	—	—	—	540	660	740	820	425	520	590	660
M3	—	—	—	—	130	160	175	195	105	130	145	155
	—	—	—	—	425	520	570	640	345	425	475	510
M4	—	—	—	—	100	120	135	150	80	100	110	120
	—	—	—	—	330	395	445	490	260	330	360	395
M5	—	—	—	—	80	100	115	125	65	85	90	100
	—	—	—	—	260	330	375	410	215	280	295	330
K1	205	255	285	310	195	240	270	300	155	195	215	235
	670	840	940	1025	640	790	890	980	510	640	710	770
K2	180	225	250	275	170	210	235	260	135	170	190	210
	590	740	820	900	560	690	770	850	445	560	620	690
K3	155	190	210	235	145	180	200	220	115	145	160	180
	510	620	690	770	475	590	660	720	375	475	520	590
K4	145	180	200	225	140	170	190	210	110	140	155	170
	475	590	660	740	460	560	620	690	360	460	510	560
K5	90	110	120	135	85	105	115	125	65	85	95	100
	295	360	395	445	280	345	375	410	215	280	310	330
K6	130	160	180	195	120	150	170	185	95	120	135	150
	425	520	590	640	395	490	560	610	310	395	445	490
K7	115	140	155	170	110	135	150	165	85	105	120	130
	375	460	510	560	360	445	490	540	280	345	395	425
N1	1550	1950	2150	2350	1475	1850	2025	2250	1175	1475	1625	1800
	5075	6400	7050	7700	4850	6075	6650	7375	3850	4850	5325	5900
N2	630	780	870	950	600	750	820	910	475	590	660	720
	2075	2550	2850	3125	1975	2450	2700	2975	1550	1925	2175	2350
N3	420	520	580	630	400	495	550	610	315	395	440	485
	1375	1700	1900	2075	1300	1625	1800	2000	1025	1300	1450	1600
N11	480	600	660	720	455	570	630	690	360	455	500	550
	1575	1975	2175	2350	1500	1875	2075	2275	1175	1500	1650	1800
S1	48	60	65	75	46	55	65	70	37	46	50	55
	155	195	215	245	150	180	215	230	120	150	165	180
S2	39	48	55	60	37	46	50	55	30	37	41	45
	130	155	180	195	120	150	165	180	100	120	135	150
S3	34	42	47	50	32	40	45	49	26	32	36	39
	110	140	155	165	105	130	150	160	85	105	120	130
S11	—	—	—	—	65	80	90	100	50	65	75	80
	—	—	—	—	215	260	295	330	165	215	245	260
S12	—	—	—	—	45	55	60	70	36	45	50	55
	—	—	—	—	150	180	195	230	120	150	165	180
S13	—	—	—	—	26	32	36	39	21	26	29	31
	—	—	—	—	85	105	120	130	70	85	95	100
H5	41	50	55	60	39	48	55	60	31	39	43	47
	135	165	180	195	130	155	180	195	100	130	140	155
H8	42	50	60	65	40	50	55	60	33	40	45	49
	140	165	195	215	130	165	180	195	110	130	150	160
H11	50	65	70	80	49	60	70	75	39	49	55	60
	165	215	230	260	160	195	230	245	130	160	180	195
H12	75	95	105	115	70	90	100	110	60	70	80	90
	245	310	345	375	230	295	330	360	195	230	260	295
H21	42	50	60	65	40	50	55	60	33	40	45	49
	140	165	195	215	130	165	180	195	110	130	150	160

Universal
Steel and cast iron
Stainless steel and S-materials
Non ferrous
Hard
Plastic and chip
Graphite
Minimaster Plus
Minimaster

MM08 Z3 – Copy milling – Insert selection – Roughing – mm/Inch

SMG		a_p		f_z			
				100%	40%	20%	10%
P1	MM08-08009-B90A30-M03 F40M	1,8	0,055	0,050	0,055	0,070	
		0,070	0,0022	0,020	0,022	0,028	
P2	MM08-08009-B90A30-M03 F40M	1,8	0,055	0,050	0,055	0,070	
		0,070	0,0022	0,020	0,022	0,028	
P3	MM08-08009-B90A30-M03 F40M	1,8	0,050	0,050	0,050	0,070	
		0,070	0,0020	0,020	0,020	0,028	
P4	MM08-08009-B90A30-M03 F40M	1,8	0,050	0,048	0,050	0,065	
		0,070	0,0020	0,019	0,020	0,026	
P5	MM08-08009-B90A30-M03 F40M	1,8	0,048	0,048	0,050	0,065	
		0,070	0,0019	0,019	0,020	0,026	
P6	MM08-08009-B90A30-M03 F40M	1,8	0,048	0,048	0,050	0,065	
		0,070	0,0019	0,019	0,020	0,026	
P7	MM08-08009-B90A30-M03 F40M	1,8	0,048	0,048	0,050	0,065	
		0,070	0,0019	0,019	0,020	0,026	
P8	MM08-08009-B90A30-M03 F40M	1,8	0,050	0,050	0,050	0,070	
		0,070	0,0020	0,020	0,020	0,028	
P11	MM08-08009-B90A30-M03 F40M	1,8	0,048	0,048	0,050	0,065	
		0,070	0,0019	0,019	0,020	0,026	
P12	MM08-08009-B90A30-M03 F40M	1,4	0,034	0,034	0,034	0,044	
		0,055	0,0013	0,013	0,013	0,017	
M1	MM08-08009-B90A30-M03 F40M	1,8	0,055	0,050	0,055	0,070	
		0,070	0,0022	0,020	0,022	0,028	
M2	MM08-08009-B90A30-M03 F40M	1,8	0,048	0,048	0,050	0,065	
		0,070	0,0019	0,019	0,020	0,026	
M3	MM08-08009-B90A30-M03 F40M	1,4	0,040	0,040	0,040	0,055	
		0,055	0,0016	0,016	0,016	0,022	
M4	MM08-08009-B90A30-M03 F40M	1,0	0,038	0,036	0,036	0,046	
		0,040	0,0015	0,014	0,014	0,019	
M5	MM08-08009-B90A30-M03 F40M	1,0	0,038	0,036	0,036	0,046	
		0,040	0,0015	0,014	0,014	0,019	
K1	MM08-08009-B90A30-E03 F30M	1,8	0,055	0,050	0,055	0,070	
		0,070	0,0022	0,020	0,022	0,028	
K2	MM08-08009-B90A30-E03 F30M	1,8	0,048	0,048	0,050	0,065	
		0,070	0,0019	0,019	0,020	0,026	
K3	MM08-08009-B90A30-E03 F30M	1,8	0,048	0,048	0,050	0,065	
		0,070	0,0019	0,019	0,020	0,026	
K4	MM08-08009-B90A30-E03 F30M	1,8	0,048	0,048	0,050	0,065	
		0,070	0,0019	0,019	0,020	0,026	
K5	MM08-08009-B90A30-M03 F40M	1,8	0,044	0,042	0,046	0,060	
		0,070	0,0017	0,017	0,018	0,024	
K6	MM08-08009-B90A30-M03 F40M	1,8	0,048	0,048	0,050	0,065	
		0,070	0,0019	0,019	0,020	0,026	
K7	MM08-08009-B90A30-M03 F40M	1,8	0,044	0,042	0,046	0,060	
		0,070	0,0017	0,017	0,018	0,024	
N1	MM08-08009-B90A30-E03 F30M	1,8	0,070	0,065	0,070	0,090	
		0,070	0,0028	0,026	0,028	0,036	
N2	MM08-08009-B90A30-E03 F30M	1,8	0,070	0,065	0,070	0,090	
		0,070	0,0028	0,026	0,028	0,036	
N3	MM08-08009-B90A30-E03 F30M	1,8	0,070	0,065	0,070	0,090	
		0,070	0,0028	0,026	0,028	0,036	
N11	MM08-08009-B90A30-E03 F30M	1,8	0,070	0,065	0,070	0,090	
		0,070	0,0028	0,026	0,028	0,036	
S1	MM08-08009-B90A30-M03 F40M	1,0	0,038	0,036	0,036	0,046	
		0,040	0,0015	0,014	0,014	0,019	
S2	MM08-08009-B90A30-M03 F40M	1,0	0,038	0,036	0,036	0,046	
		0,040	0,0015	0,014	0,014	0,019	
S3	MM08-08009-B90A30-M03 F40M	1,0	0,036	0,034	0,034	0,042	
		0,040	0,0014	0,013	0,013	0,017	
S11	MM08-08009-B90A30-M03 F40M	1,2	0,042	0,040	0,042	0,055	
		0,048	0,0017	0,016	0,017	0,022	
S12	MM08-08009-B90A30-M03 F40M	1,2	0,042	0,040	0,042	0,055	
		0,048	0,0017	0,016	0,017	0,022	
S13	MM08-08009-B90A30-M03 F40M	1,0	0,038	0,036	0,036	0,046	
		0,040	0,0015	0,014	0,014	0,019	
H5	MM08-08009-B90A30-E03 F30M	1,4	0,034	0,034	0,034	0,044	
		0,055	0,0013	0,013	0,013	0,017	
H8	MM08-08009-B90A30-E03 F30M	1,2	0,028	0,026	0,026	0,034	
		0,048	0,0011	0,010	0,010	0,013	
H11	MM08-08009-B90A30-E03 F30M	1,4	0,034	0,034	0,034	0,044	
		0,055	0,0013	0,013	0,013	0,017	
H12	MM08-08009-B90A30-E03 F30M	1,2	0,028	0,026	0,026	0,034	
		0,048	0,0011	0,010	0,010	0,013	
H21	MM08-08009-B90A30-E03 F30M	1,2	0,028	0,026	0,026	0,034	
		0,048	0,0011	0,010	0,010	0,013	

SMG = Seco material group
 f_z = mm/tooth (in/tooth), v_c = m/min (sf/min), a_p/DC = %
 All cutting data are start values

MM08 Z3 – Copy milling – Insert selection – Finishing – mm/Inch

SMG		a _p	f _z			
			15%	10%	5%	2%
P1	MM08-08009-B90A30-E03 F30M	1,8	0,060	0,070	0,10	0,16
		0,070	0,0024	0,0028	0,0040	0,0065
P2	MM08-08009-B90A30-E03 F30M	1,8	0,060	0,070	0,10	0,17
		0,070	0,0024	0,0028	0,0040	0,0065
P3	MM08-08009-B90A30-E03 F30M	1,8	0,060	0,070	0,095	0,16
		0,070	0,0024	0,0028	0,0038	0,0065
P4	MM08-08009-B90A30-E03 F30M	1,8	0,055	0,065	0,095	0,15
		0,070	0,0022	0,0026	0,0038	0,0060
P5	MM08-08009-B90A30-E03 F30M	1,8	0,055	0,065	0,090	0,15
		0,070	0,0022	0,0026	0,0036	0,0060
P6	MM08-08009-B90A30-E03 F30M	1,8	0,055	0,065	0,090	0,15
		0,070	0,0022	0,0026	0,0036	0,0060
P7	MM08-08009-B90A30-E03 F30M	1,8	0,055	0,065	0,090	0,15
		0,070	0,0022	0,0026	0,0036	0,0060
P8	MM08-08009-B90A30-E03 F30M	1,8	0,060	0,070	0,095	0,16
		0,070	0,0024	0,0028	0,0038	0,0065
P11	MM08-08009-B90A30-E03 F30M	1,8	0,055	0,065	0,090	0,15
		0,070	0,0022	0,0026	0,0036	0,0060
P12	MM08-08009-B90A30-E03 F30M	1,4	0,038	0,044	0,060	0,10
		0,055	0,0015	0,0017	0,0024	0,0040
M1	MM08-08009-B90A30-E03 F30M	1,8	0,060	0,070	0,10	0,17
		0,070	0,0024	0,0028	0,0040	0,0065
M2	MM08-08009-B90A30-E03 F30M	1,8	0,055	0,065	0,090	0,15
		0,070	0,0022	0,0026	0,0036	0,0060
M3	MM08-08009-B90A30-E03 F30M	1,4	0,046	0,055	0,075	0,12
		0,055	0,0018	0,0022	0,0030	0,0048
M4	MM08-08009-B90A30-E03 F30M	1,0	0,040	0,046	0,065	0,10
		0,040	0,0016	0,0019	0,0026	0,0040
M5	MM08-08009-B90A30-E03 F30M	1,0	0,040	0,046	0,065	0,10
		0,040	0,0016	0,0019	0,0026	0,0040
K1	MM08-08009-B90A30-E03 F30M	1,8	0,060	0,070	0,10	0,17
		0,070	0,0024	0,0028	0,0040	0,0065
K2	MM08-08009-B90A30-E03 F30M	1,8	0,055	0,065	0,090	0,15
		0,070	0,0022	0,0026	0,0036	0,0060
K3	MM08-08009-B90A30-E03 F30M	1,8	0,055	0,065	0,090	0,15
		0,070	0,0022	0,0026	0,0036	0,0060
K4	MM08-08009-B90A30-E03 F30M	1,8	0,055	0,065	0,090	0,15
		0,070	0,0022	0,0026	0,0036	0,0060
K5	MM08-08009-B90A30-E03 F30M	1,8	0,050	0,060	0,080	0,13
		0,070	0,0020	0,0024	0,0032	0,0050
K6	MM08-08009-B90A30-E03 F30M	1,8	0,055	0,065	0,090	0,15
		0,070	0,0022	0,0026	0,0036	0,0060
K7	MM08-08009-B90A30-E03 F30M	1,8	0,050	0,060	0,080	0,13
		0,070	0,0020	0,0024	0,0032	0,0050
N1	MM08-08009-B90A30-E03 F30M	1,8	0,080	0,090	0,13	0,22
		0,070	0,0032	0,0036	0,0050	0,0085
N2	MM08-08009-B90A30-E03 F30M	1,8	0,080	0,090	0,13	0,22
		0,070	0,0032	0,0036	0,0050	0,0085
N3	MM08-08009-B90A30-E03 F30M	1,8	0,080	0,090	0,13	0,22
		0,070	0,0032	0,0036	0,0050	0,0085
N11	MM08-08009-B90A30-E03 F30M	1,8	0,080	0,090	0,13	0,22
		0,070	0,0032	0,0036	0,0050	0,0085
S1	MM08-08009-B90A30-E03 F30M	1,0	0,040	0,046	0,065	0,10
		0,040	0,0016	0,0019	0,0026	0,0040
S2	MM08-08009-B90A30-E03 F30M	1,0	0,040	0,046	0,065	0,10
		0,040	0,0016	0,0019	0,0026	0,0040
S3	MM08-08009-B90A30-E03 F30M	1,0	0,038	0,042	0,060	0,095
		0,040	0,0015	0,0017	0,0024	0,0038
S11	MM08-08009-B90A30-E03 F30M	1,2	0,046	0,055	0,075	0,12
		0,048	0,0018	0,0022	0,0030	0,0048
S12	MM08-08009-B90A30-E03 F30M	1,2	0,046	0,055	0,075	0,12
		0,048	0,0018	0,0022	0,0030	0,0048
S13	MM08-08009-B90A30-E03 F30M	1,0	0,040	0,046	0,065	0,10
		0,040	0,0016	0,0019	0,0026	0,0040
H5	MM08-08009-B90A30-E03 F30M	1,4	0,038	0,044	0,060	0,10
		0,055	0,0015	0,0017	0,0024	0,0040
H8	MM08-08009-B90A30-E03 F30M	1,2	0,030	0,034	0,048	0,075
		0,048	0,0012	0,0013	0,0019	0,0030
H11	MM08-08009-B90A30-E03 F30M	1,4	0,038	0,044	0,060	0,10
		0,055	0,0015	0,0017	0,0024	0,0040
H12	MM08-08009-B90A30-E03 F30M	1,2	0,030	0,034	0,048	0,075
		0,048	0,0012	0,0013	0,0019	0,0030
H21	MM08-08009-B90A30-E03 F30M	1,2	0,030	0,034	0,048	0,075
		0,048	0,0012	0,0013	0,0019	0,0030

SMG = Seco material group
 f_z = mm/tooth (in/tooth), v_c = m/min (sf/min), a_p/DC = %
 All cutting data are start values

Universal
 Steel and cast iron
 Stainless steel and S-materials
 Non ferrous
 Hard
 Plastic and chip
 Graphite
 Minimaster Plus
 Minimaster

MM08 Z3 – Copy milling – Cutting data $v_c = (m/min)/(sf/min)$

SMG	F30M					F40M				
	100%	20%	10%	5%	2%	100%	20%	10%	5%	2%
P1	280	330	355	380	380	265	315	335	360	360
	920	1075	1175	1250	1250	870	1025	1100	1175	1175
P2	270	325	345	370	365	260	310	325	350	350
	890	1075	1125	1225	1200	850	1025	1075	1150	1150
P3	235	280	295	320	320	225	270	280	305	300
	770	920	970	1050	1050	740	890	920	1000	980
P4	210	250	265	280	280	200	235	250	270	270
	690	820	870	920	920	660	770	820	890	890
P5	200	235	250	270	270	190	225	240	260	255
	660	770	820	890	890	620	740	790	850	840
P6	225	265	280	305	305	215	255	270	290	290
	740	870	920	1000	1000	710	840	890	950	950
P7	210	250	265	290	285	200	240	255	275	270
	690	820	870	950	940	660	790	840	900	890
P8	200	235	250	270	265	190	225	235	255	255
	660	770	820	890	870	620	740	770	840	840
P11	205	245	260	280	275	195	230	245	265	265
	670	800	850	920	900	640	750	800	870	870
P12	130	155	160	175	175	125	150	155	165	165
	425	510	520	570	570	410	490	510	540	540
M1	220	260	275	300	295	210	250	265	285	280
	720	850	900	980	970	690	820	870	940	920
M2	180	215	225	245	245	170	205	215	235	230
	590	710	740	800	800	560	670	710	770	750
M3	145	170	175	190	190	135	165	170	180	180
	475	560	570	620	620	445	540	560	590	590
M4	100	135	135	145	145	95	130	130	140	140
	330	445	475	475	475	310	425	445	460	460
M5	80	115	115	120	120	80	110	105	115	115
	260	375	395	395	395	260	360	375	375	375
K1	215	255	270	295	290	205	245	260	280	275
	710	840	890	970	950	670	800	850	920	900
K2	190	225	240	260	255	180	215	225	245	245
	620	740	790	850	840	590	710	740	800	800
K3	160	190	200	220	215	155	180	190	210	205
	520	620	660	720	710	510	590	620	690	670
K4	155	180	190	210	205	145	175	185	200	195
	510	590	620	690	670	475	570	610	660	640
K5	90	110	115	125	125	90	105	110	120	120
	295	360	375	410	410	295	345	360	395	395
K6	135	160	170	185	180	130	150	160	175	175
	445	520	560	610	590	425	490	520	570	570
K7	120	140	150	160	160	110	135	140	155	155
	395	460	490	520	520	360	445	460	510	510
N1	1625	1950	2075	2225	2200	1550	1850	1975	2125	2100
	5325	6400	6800	7300	7225	5075	6075	6475	6975	6900
N2	660	790	830	900	890	630	750	790	850	840
	2175	2600	2725	2950	2925	2075	2450	2600	2800	2750
N3	440	520	560	600	590	420	500	530	570	560
	1450	1700	1825	1975	1925	1375	1650	1750	1875	1825
N11	500	600	640	680	670	480	570	610	650	640
	1650	1975	2100	2225	2200	1575	1875	2000	2125	2100
S1	46	65	65	70	70	44	60	60	65	65
	150	215	215	230	230	145	195	215	215	215
S2	37	50	50	55	55	35	49	48	50	50
	120	165	180	180	180	115	160	165	165	165
S3	32	45	44	48	48	31	43	42	45	45
	105	150	155	155	155	100	140	150	150	150
S11	70	90	90	95	95	65	85	85	90	90
	230	295	295	310	310	215	280	280	295	295
S12	49	60	60	65	65	47	60	60	65	65
	160	195	215	215	215	155	195	195	215	215
S13	26	36	35	38	38	25	34	34	36	37
	85	120	125	125	125	80	110	120	120	120
H5	43	50	55	60	55	41	49	50	55	55
	140	165	180	195	180	135	160	165	180	180
H8	43	55	55	60	60	41	50	50	55	55
	140	180	180	195	195	135	165	180	180	180
H11	55	65	70	75	75	50	60	65	70	70
	180	215	230	245	245	165	195	215	230	230
H12	75	95	100	105	105	75	95	95	100	100
	245	310	330	345	345	245	310	310	330	330
H21	43	55	55	60	60	41	50	50	55	55
	140	180	180	195	195	135	165	180	180	180

MM08 Z2 – Copy milling – Insert selection – Roughing – mm/Inch

SMG		a _p	f _z			
			100%	40%	20%	10%
P1	MM08-08008-B90S-E03 F30M	3,0	0,048	0,046	0,055	0,070
		0.12	0.0019	0.0018	0.0022	0.0028
P2	MM08-08008-B90S-E03 F30M	3,0	0,048	0,048	0,055	0,075
		0.12	0.0019	0.0019	0.0022	0.0030
P3	MM08-08008-B90S-E03 F30M	3,0	0,046	0,044	0,050	0,070
		0.12	0.0018	0.0017	0.0020	0.0028
P4	MM08-08008-B90-MD03 F30M	3,0	0,044	0,044	0,050	0,070
		0.12	0.0017	0.0017	0.0020	0.0028
P5	MM08-08008-B90-MD03 F30M	3,0	0,044	0,042	0,050	0,065
		0.12	0.0017	0.0017	0.0020	0.0026
P6	MM08-08008-B90-MD03 F30M	3,0	0,044	0,042	0,050	0,065
		0.12	0.0017	0.0017	0.0020	0.0026
P7	MM08-08008-B90-MD03 F30M	3,0	0,044	0,042	0,050	0,065
		0.12	0.0017	0.0017	0.0020	0.0026
P8	MM08-08008-B90-MD03 F30M	3,0	0,046	0,044	0,050	0,070
		0.12	0.0018	0.0017	0.0020	0.0028
P11	MM08-08008-B90-MD03 F30M	3,0	0,044	0,042	0,050	0,065
		0.12	0.0017	0.0017	0.0020	0.0026
P12	MM08-08008-B90-MD03 F30M	2,5	0,030	0,030	0,034	0,044
		0.10	0.0012	0.0012	0.0013	0.0018
M1	MM08-08008-B90S-E03 F30M	3,0	0,048	0,048	0,055	0,075
		0.12	0.0019	0.0019	0.0022	0.0030
M2	MM08-08008-B90S-E03 F30M	3,0	0,044	0,042	0,050	0,065
		0.12	0.0017	0.0017	0.0020	0.0026
M3	MM08-08008-B90S-E03 F30M	2,5	0,036	0,036	0,040	0,055
		0.10	0.0014	0.0014	0.0016	0.0022
M4	MM08-08008-B90-MD03 F30M	1,9	0,034	0,034	0,036	0,046
		0.075	0.0013	0.0013	0.0014	0.0019
M5	MM08-08008-B90-MD03 F30M	1,9	0,034	0,034	0,036	0,046
		0.075	0.0013	0.0013	0.0014	0.0019
K1	MM08-08008-B90S-E03 F30M	3,0	0,048	0,048	0,055	0,075
		0.12	0.0019	0.0019	0.0022	0.0030
K2	MM08-08008-B90S-E03 F30M	3,0	0,044	0,042	0,050	0,065
		0.12	0.0017	0.0017	0.0020	0.0026
K3	MM08-08008-B90S-E03 F30M	3,0	0,044	0,042	0,050	0,065
		0.12	0.0017	0.0017	0.0020	0.0026
K4	MM08-08008-B90S-E03 F30M	3,0	0,044	0,042	0,050	0,065
		0.12	0.0017	0.0017	0.0020	0.0026
K5	MM08-08008-B90-MD03 F30M	3,0	0,040	0,038	0,046	0,060
		0.12	0.0016	0.0015	0.0018	0.0024
K6	MM08-08008-B90-MD03 F30M	3,0	0,044	0,042	0,050	0,065
		0.12	0.0017	0.0017	0.0020	0.0026
K7	MM08-08008-B90-MD03 F30M	3,0	0,040	0,038	0,046	0,060
		0.12	0.0016	0.0015	0.0018	0.0024
N1	MM08-08008-B90S-E03 F30M	3,0	0,060	0,060	0,070	0,095
		0.12	0.0024	0.0024	0.0028	0.0038
N2	MM08-08008-B90S-E03 F30M	3,0	0,060	0,060	0,070	0,095
		0.12	0.0024	0.0024	0.0028	0.0038
N3	MM08-08008-B90S-E03 F30M	3,0	0,060	0,060	0,070	0,095
		0.12	0.0024	0.0024	0.0028	0.0038
N11	MM08-08008-B90S-E03 F30M	3,0	0,060	0,060	0,070	0,095
		0.12	0.0024	0.0024	0.0028	0.0038
S1	MM08-08008-B90-MD03 F30M	1,9	0,034	0,034	0,036	0,046
		0.075	0.0013	0.0013	0.0014	0.0019
S2	MM08-08008-B90-MD03 F30M	1,9	0,032	0,030	0,034	0,042
		0.075	0.0013	0.0012	0.0013	0.0017
S3	MM08-08008-B90-MD03 F30M	2,5	0,036	0,036	0,042	0,055
		0.10	0.0014	0.0014	0.0017	0.0022
S11	MM08-08008-B90-MD03 F30M	2,5	0,036	0,036	0,042	0,055
		0.10	0.0014	0.0014	0.0017	0.0022
S12	MM08-08008-B90-MD03 F30M	2,5	0,036	0,036	0,042	0,055
		0.10	0.0014	0.0014	0.0017	0.0022
S13	MM08-08008-B90-MD03 F30M	1,9	0,034	0,034	0,036	0,046
		0.075	0.0013	0.0013	0.0014	0.0019
H5	MM08-08008-B90-MD03 F30M	2,5	0,030	0,030	0,034	0,044
		0.10	0.0012	0.0012	0.0013	0.0018
H8	MM08-08008-B90-MD03 F30M	2,5	0,024	0,024	0,026	0,034
		0.10	0.00095	0.00095	0.0010	0.0013
H11	MM08-08008-B90-MD03 F30M	2,5	0,030	0,030	0,034	0,044
		0.10	0.0012	0.0012	0.0013	0.0018
H12	MM08-08008-B90-MD03 F30M	2,5	0,024	0,024	0,026	0,034
		0.10	0.00095	0.00095	0.0010	0.0013
H21	MM08-08008-B90-MD03 F30M	2,5	0,024	0,024	0,026	0,034
		0.10	0.00095	0.00095	0.0010	0.0013

SMG = Seco material group
 f_z = mm/tooth (in/tooth), v_c = m/min (sf/min), a_p/DC = %
 All cutting data are start values

Universal
 Steel and cast iron
 Stainless steel and S-materials
 Non ferrous
 Hard
 Plastic and chip
 Graphite
 Minimaster Plus
 Minimaster

MM08 Z2 – Copy milling – Insert selection – Finishing – mm/Inch

SMG		a _p	f _z			
			15%	10%	5%	2%
P1	MM08-08008-B90PF-M01 F15M	3,0	0,020	0,024	0,032	0,050
		0.12	0.00080	0.00095	0.0013	0.0020
P2	MM08-08008-B90PF-M01 F15M	3,0	0,020	0,024	0,034	0,055
		0.12	0.00080	0.00095	0.0013	0.0022
P3	MM08-08008-B90PF-M01 F15M	3,0	0,019	0,022	0,032	0,050
		0.12	0.00075	0.00085	0.0013	0.0020
P4	MM08-08008-B90PF-M01 F15M	3,0	0,019	0,022	0,030	0,048
		0.12	0.00075	0.00085	0.0012	0.0019
P5	MM08-08008-B90PF-M01 F15M	3,0	0,019	0,022	0,030	0,048
		0.12	0.00075	0.00085	0.0012	0.0019
P6	MM08-08008-B90PF-M01 F15M	3,0	0,018	0,022	0,030	0,048
		0.12	0.00070	0.00085	0.0012	0.0019
P7	MM08-08008-B90PF-M01 F15M	3,0	0,018	0,022	0,030	0,048
		0.12	0.00070	0.00085	0.0012	0.0019
P8	MM08-08008-B90PF-M01 F15M	3,0	0,019	0,022	0,032	0,050
		0.12	0.00075	0.00085	0.0013	0.0020
P11	MM08-08008-B90PF-M01 F15M	3,0	0,018	0,022	0,030	0,048
		0.12	0.00070	0.00085	0.0012	0.0019
P12	MM08-08008-B90PF-M01 F15M	2,0	0,013	0,015	0,020	0,032
		0.080	0.00050	0.00060	0.00080	0.0013
M1	MM08-08008-B90PF-M01 F15M	3,0	0,020	0,024	0,034	0,055
		0.12	0.00080	0.00095	0.0013	0.0022
M2	MM08-08008-B90PF-M01 F15M	3,0	0,019	0,022	0,030	0,048
		0.12	0.00075	0.00085	0.0012	0.0019
M3	MM08-08008-B90PF-M01 F15M	2,0	0,015	0,018	0,024	0,038
		0.080	0.00060	0.00070	0.00095	0.0015
M4	MM08-08008-B90PF-M01 F15M	1,7	0,014	0,015	0,022	0,034
		0.065	0.00055	0.00065	0.00085	0.0013
M5	MM08-08008-B90PF-M01 F15M	1,7	0,014	0,015	0,022	0,034
		0.065	0.00055	0.00065	0.00085	0.0013
K1	MM08-08008-B90PF-M01 F15M	3,0	0,020	0,024	0,034	0,055
		0.12	0.00080	0.00095	0.0013	0.0022
K2	MM08-08008-B90PF-M01 F15M	3,0	0,019	0,022	0,030	0,048
		0.12	0.00075	0.00085	0.0012	0.0019
K3	MM08-08008-B90PF-M01 F15M	3,0	0,019	0,022	0,030	0,048
		0.12	0.00075	0.00085	0.0012	0.0019
K4	MM08-08008-B90PF-M01 F15M	3,0	0,019	0,022	0,030	0,048
		0.12	0.00075	0.00085	0.0012	0.0019
K5	MM08-08008-B90PF-M01 F15M	3,0	0,017	0,020	0,028	0,044
		0.12	0.00065	0.00080	0.0011	0.0017
K6	MM08-08008-B90PF-M01 F15M	3,0	0,019	0,022	0,030	0,048
		0.12	0.00075	0.00085	0.0012	0.0019
K7	MM08-08008-B90PF-M01 F15M	3,0	0,017	0,020	0,028	0,044
		0.12	0.00065	0.00080	0.0011	0.0017
N1	MM08-08008-B90PF-M01 F15M	3,0	0,026	0,030	0,042	0,070
		0.12	0.0010	0.0012	0.0017	0.0028
N2	MM08-08008-B90PF-M01 F15M	3,0	0,026	0,030	0,042	0,070
		0.12	0.0010	0.0012	0.0017	0.0028
N3	MM08-08008-B90PF-M01 F15M	3,0	0,026	0,030	0,042	0,070
		0.12	0.0010	0.0012	0.0017	0.0028
N11	MM08-08008-B90PF-M01 F15M	3,0	0,026	0,030	0,042	0,070
		0.12	0.0010	0.0012	0.0017	0.0028
S1	MM08-08008-B90PF-M01 F15M	1,7	0,014	0,015	0,022	0,034
		0.065	0.00055	0.00065	0.00085	0.0013
S2	MM08-08008-B90PF-M01 F15M	1,7	0,014	0,015	0,022	0,034
		0.065	0.00055	0.00065	0.00085	0.0013
S3	MM08-08008-B90PF-M01 F15M	1,7	0,013	0,014	0,020	0,030
		0.065	0.00050	0.00060	0.00080	0.0012
S11	MM08-08008-B90PF-M01 F15M	1,9	0,015	0,018	0,024	0,038
		0.075	0.00060	0.00070	0.00095	0.0015
S12	MM08-08008-B90PF-M01 F15M	1,9	0,015	0,018	0,024	0,038
		0.075	0.00060	0.00070	0.00095	0.0015
S13	MM08-08008-B90PF-M01 F15M	1,7	0,014	0,015	0,022	0,034
		0.065	0.00055	0.00065	0.00085	0.0013
H5	MM08-08008-B90PF-M01 F15M	2,0	0,013	0,015	0,020	0,032
		0.080	0.00050	0.00060	0.00080	0.0013
H8	MM08-08008-B90PF-M01 F15M	1,9	0,010	0,011	0,016	0,025
		0.075	0.00040	0.00048	0.00065	0.0010
H11	MM08-08008-B90PF-M01 F15M	2,0	0,013	0,015	0,020	0,032
		0.080	0.00050	0.00060	0.00080	0.0013
H12	MM08-08008-B90PF-M01 F15M	1,9	0,010	0,011	0,016	0,025
		0.075	0.00040	0.00048	0.00065	0.0010
H21	MM08-08008-B90PF-M01 F15M	1,9	0,010	0,011	0,016	0,025
		0.075	0.00040	0.00048	0.00065	0.0010

SMG = Seco material group
f_z = mm/tooth (in/tooth), v_c = m/min (sf/min), a_g/DC = %
All cutting data are start values

MM08 High-Feed – Insert selection – mm/Inch

SMG		a_p	f_z				
			100%	70%	30%	20%	
Universal	P1	MM08-08.40-HF-MD06 F30M	0,26	0,32	0,32	0,42	0,50
			0,010	0,013	0,013	0,017	0,020
	P2	MM08-08.40-HF-MD06 F30M	0,26	0,32	0,32	0,42	0,50
			0,010	0,013	0,013	0,017	0,020
	P3	MM08-08.40-HF-MD06 F30M	0,26	0,30	0,30	0,40	0,48
			0,010	0,012	0,012	0,016	0,019
	P4	MM08-08.40-HF-MD06 F30M	0,26	0,30	0,30	0,38	0,48
			0,010	0,012	0,012	0,015	0,019
	P5	MM08-08.40-HF-MD06 F30M	0,26	0,28	0,30	0,38	0,46
			0,010	0,011	0,012	0,015	0,018
	P6	MM08-08.40-HF-MD06 F30M	0,26	0,28	0,28	0,38	0,46
			0,010	0,011	0,011	0,015	0,018
P7	MM08-08.40-HF-MD06 F30M	0,26	0,28	0,28	0,38	0,46	
		0,010	0,011	0,011	0,015	0,018	
P8	MM08-08.40-HF-MD06 F30M	0,26	0,30	0,30	0,40	0,48	
		0,010	0,012	0,012	0,016	0,019	
P11	MM08-08.40-HF-MD06 F30M	0,26	0,28	0,28	0,38	0,46	
		0,010	0,011	0,011	0,015	0,018	
P12	MM08-08.40-HF-MD06 F30M	0,20	0,20	0,20	0,25	0,30	
		0,0080	0,0080	0,0080	0,010	0,012	
Steel and cast iron	M1	MM08-08.40-HF-MD06 F30M	0,26	0,32	0,32	0,42	0,50
			0,010	0,013	0,013	0,017	0,020
	M2	MM08-08.40-HF-MD06 F30M	0,26	0,28	0,30	0,38	0,46
			0,010	0,011	0,012	0,015	0,018
	M3	MM08-08.40-HF-MD06 F30M	0,20	0,24	0,24	0,30	0,36
		0,0080	0,0095	0,0095	0,012	0,014	
M4	MM08-08.40-HF-MD06 F30M	0,16	0,20	0,20	0,26	0,32	
		0,0065	0,0080	0,0080	0,010	0,013	
M5	MM08-08.40-HF-MD06 F30M	0,16	0,20	0,20	0,26	0,32	
		0,0065	0,0080	0,0080	0,010	0,013	
Non ferrous	K1	MM08-08.40-HF-MD06 F30M	0,26	0,32	0,32	0,42	0,50
			0,010	0,013	0,013	0,017	0,020
	K2	MM08-08.40-HF-MD06 F30M	0,26	0,28	0,30	0,38	0,46
			0,010	0,011	0,012	0,015	0,018
	K3	MM08-08.40-HF-MD06 F30M	0,26	0,28	0,30	0,38	0,46
		0,010	0,011	0,012	0,015	0,018	
K4	MM08-08.40-HF-MD06 F30M	0,26	0,28	0,30	0,38	0,46	
		0,010	0,011	0,012	0,015	0,018	
Hard	K5	MM08-08.40-HF-MD06 F30M	0,26	0,26	0,26	0,34	0,42
			0,010	0,010	0,010	0,013	0,017
	K6	MM08-08.40-HF-MD06 F30M	0,26	0,28	0,30	0,38	0,46
			0,010	0,011	0,012	0,015	0,018
	K7	MM08-08.40-HF-MD06 F30M	0,26	0,26	0,26	0,34	0,42
		0,010	0,010	0,010	0,013	0,017	
Plastic and cfrp	N1	MM08-08.40-HF-MD06 F30M	0,26	0,40	0,40	0,55	0,70
			0,010	0,016	0,016	0,022	0,028
	N2	MM08-08.40-HF-MD06 F30M	0,26	0,40	0,40	0,55	0,70
			0,010	0,016	0,016	0,022	0,028
	N3	MM08-08.40-HF-MD06 F30M	0,26	0,40	0,40	0,55	0,70
		0,010	0,016	0,016	0,022	0,028	
Graphite	N11	MM08-08.40-HF-MD06 F30M	0,26	0,40	0,40	0,55	0,70
			0,010	0,016	0,016	0,022	0,028
	S1	MM08-08.40-HF-MD06 F30M	0,16	0,20	0,20	0,26	0,32
			0,0065	0,0080	0,0080	0,010	0,013
	S2	MM08-08.40-HF-MD06 F30M	0,16	0,20	0,20	0,26	0,32
		0,0065	0,0080	0,0080	0,010	0,013	
S3	MM08-08.40-HF-MD06 F30M	0,16	0,19	0,19	0,24	0,30	
		0,0065	0,0075	0,0075	0,0095	0,012	
Minimaster Plus	S11	MM08-08.40-HF-MD06 F30M	0,18	0,24	0,24	0,30	0,36
			0,0070	0,0095	0,0095	0,012	0,014
	S12	MM08-08.40-HF-MD06 F30M	0,18	0,24	0,24	0,30	0,36
			0,0070	0,0095	0,0095	0,012	0,014
	S13	MM08-08.40-HF-MD06 F30M	0,16	0,20	0,20	0,26	0,32
		0,0065	0,0080	0,0080	0,010	0,013	
Minimaster	H5	MM08-08.40-HF-MD06 F30M	0,20	0,20	0,20	0,25	0,30
			0,0080	0,0080	0,0080	0,010	0,012
	H8	MM08-08.40-HF-MD06 F30M	0,18	0,16	0,15	0,19	0,24
			0,0070	0,0065	0,0060	0,0075	0,0095
	H11	MM08-08.40-HF-MD06 F30M	0,20	0,20	0,20	0,25	0,30
		0,0080	0,0080	0,0080	0,010	0,012	
H12	MM08-08.40-HF-MD06 F30M	0,18	0,16	0,15	0,19	0,24	
		0,0070	0,0065	0,0060	0,0075	0,0095	
H21	MM08-08.40-HF-MD06 F30M	0,18	0,16	0,15	0,19	0,24	
		0,0070	0,0065	0,0060	0,0075	0,0095	



SMG = Seco material group
 f_z = mm/tooth (in/tooth), v_c = m/min (sf/min), a_p/DC = %
 All cutting data are start values

MM08 High-Feed – Cutting data $v_c = (m/min)/(sf/min)$

SMG	F30M			
	100%	70%	30%	20%
P1	250	305	350	375
	820	1000	1150	1225
P2	245	300	345	365
	800	980	1125	1200
P3	215	260	300	315
	710	850	980	1025
P4	190	230	265	275
	620	750	870	900
P5	180	220	255	265
	590	720	840	870
P6	205	250	285	300
	670	820	940	980
P7	190	235	270	285
	620	770	890	940
P8	180	220	250	265
	590	720	820	870
P11	185	230	260	275
	610	750	850	900
P12	120	145	165	175
	395	475	540	570
M1	195	240	275	295
	640	790	900	970
M2	165	195	230	240
	540	640	750	790
M3	130	155	180	190
	425	510	590	620
M4	100	120	140	145
	330	395	460	475
M5	85	100	115	120
	280	330	375	395
K1	195	235	270	290
	640	770	890	950
K2	170	210	240	255
	560	690	790	840
K3	145	175	205	215
	475	570	670	710
K4	140	170	195	205
	460	560	640	670
K5	85	105	120	125
	280	345	395	410
K6	125	150	170	180
	410	490	560	590
K7	110	130	150	160
	360	425	490	520
N1	1475	1800	2050	2125
	4850	5900	6725	6975
N2	590	720	820	860
	1925	2350	2700	2825
N3	395	480	550	570
	1300	1575	1800	1875
N11	450	550	630	650
	1475	1800	2075	2125
S1	48	55	65	70
	155	180	215	230
S2	39	46	50	55
	130	150	165	180
S3	33	40	46	48
	110	130	150	155
S11	65	80	90	95
	215	260	295	310
S12	46	55	65	65
	150	180	215	215
S13	27	32	36	38
	90	105	120	125
H5	40	47	55	60
	130	155	180	195
H8	41	50	55	60
	135	165	180	195
H11	50	60	70	75
	165	195	230	245
H12	75	90	100	105
	245	295	330	345
H21	41	50	55	60
	135	165	180	195

Universal
Steel and cast iron
Stainless steel and S-materials
Non ferrous
Hard
Plastic and cfrp
Graphite
Minimaster Plus
Minimaster

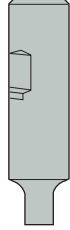
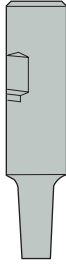
Shank design

Universal	Design 1, Keyway shank	Design 2, Cylindrical/Weldon back end and 90° front
Steel and cast iron		
Stainless steel and S-materials		
Non ferrous	Design 3, Cylindrical/Weldon back end tapered front 87°/89°	Design 4, Cylindrical/Weldon back end tapered front 80°/85°/87°
Hard		
Plastic and cfrp	Design 5, Cylindrical back end double tapered front end 89°/85°	
Graphite		
Minimaster Plus		
Minimaster		

MM10 Shank – Metric

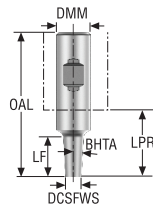

• For ISO attribute explanation, see page [XXX]

Designation	Item number	ShankType	DCSFWS	DMM	OAL	LF	LPR	BHTA°	Design		RPMX	Weight	Spare part no.
MM10-20075.3-0010	75012787	Weldon	9,5	20,0	75,0	10,0	25,0	0,0	2	✓	80000	0,2	4
MM10-20085.3-3023	75012788	Weldon	9,5	20,0	85,0	23,0	35,0	3,0	3	✓	80000	0,2	4
MM10-20140.3-5060	75012789	Weldon	9,5	20,0	140,0	60,0	90,0	5,0	4	✓	80000	0,3	5
MM10-10045.0-0007	00083979	Cylindrical	9,6	10,0	45,0	7,0	7,0	0,0	2	✓	80000	0,1	2
MM10-16065.0-0000	75004925	Cylindrical	9,5	16,0	65,0	0,0	17,0	60,0	1	✓	80000	0,1	1
MM10-16160.0-1035M	00094757	Cylindrical	9,5	16,0	160,0	35,0	112,0	1,0	3	✓	80000	0,2	6
MM10-16160.0-1055M	00094758	Cylindrical	9,5	16,0	160,0	55,0	112,0	1,0	3	✓	80000	0,2	7
MM10-16160.0-1075M	00094760	Cylindrical	9,5	16,0	160,0	75,0	112,0	1,0	3	✓	80000	0,2	7
MM10-32250.0-10063	75069366	Cylindrical	9,5	32,0	250,0	63,8	190,0	10,0	4	✓	80000	1,3	5
MM10-12060.0-0007DS	02580667	Cylindrical Densimet	9,6	12,0	60,0	7,0	15,0	0,0	2	✓	76300	0,1	3
MM10-12085.0-3024DS	02580704	Cylindrical Densimet	9,5	12,0	85,0	23,8	40,0	3,0	4	✓	76300	0,2	3
MM10-12100.0-1035DS	02580733	Cylindrical Densimet	9,5	12,0	100,0	35,0	55,0	1,0	3	✓	76300	0,2	3
MM10-14120.0-1050DS	02580736	Cylindrical Densimet	9,5	14,0	120,0	50,0	75,0	1,0	3	✓	76300	0,3	3
MM10-16085.0-0020DS	02580688	Cylindrical Densimet	9,5	16,0	85,0	20,0	37,0	0,0	2	✓	76300	0,3	3
MM10-16105.0-0040DS	02580689	Cylindrical Densimet	9,5	16,0	105,0	40,0	57,0	0,0	2	✓	76300	0,3	3
MM10-16160.0-1055DS	02580748	Cylindrical Densimet	9,5	16,0	160,0	55,0	112,0	1,0	3	✓	76300	0,4	3
MM10-16160.0-1075DS	02580749	Cylindrical Densimet	9,5	16,0	160,0	75,0	112,0	1,0	3	✓	76300	0,4	3
MM10-20250.0-1055DS	02580750	Cylindrical Densimet	9,5	20,0	250,0	55,0	200,0	1,0	5	✓	76300	1,0	3

Spare Parts

Accessories

For cutter	Sleeve	Tension screw	Sleeve key
4	 MM-06048	 MM10-0627	 H06-4
5	MM-06116	MM10-0627	H06-4
2	MM-06020	MM10-0627	H05-4
1	MM-06032	MM10-0627	H06-4
6	MM-06048	MM10-0651	H06-4
7	MM-06032	MM10-0688	H06-4
3	–	MM10-061027	–

Universal

Steel and cast iron

Stainless steel and S-materials

Non ferrous

Hard

Plastic and chip

Graphite

Minimaster Plus

Minimaster

MM10 Shank – Inch

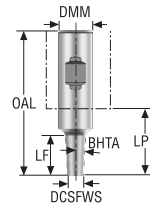



• For ISO attribute explanation, see page [XXX]

Designation	Item number	ShankType	DCSFWS	DMM	OAL	LF	LPR	BHTA°	Design		RPMX	Weight	Spare part no.
MM10-0.75-3.0-3-0004	75015052	Weldon	0.360	0.750	2.953	0.394	0.984	0,0	2	✓	80000	0.440	3
MM10-0.75-3.3-3-3009	75015053	Weldon	0.374	0.750	3.346	0.906	1.378	3,0	3	✓	80000	0.440	3
MM10-0.75-5.5-3-5021	75015054	Weldon	0.374	0.750	5.512	2.150	3.543	5,0	4	✓	80000	0.660	5
MM10-0.38-1.8-0-0002	00096126	Cylindrical	0.360	0.375	1.772	0.276	0.276	0,0	2	✓	80000	0.220	2
MM10-0.62-2.6-0-0000	75005069	Cylindrical	0.374	0.625	2.559	–	0.669	60,0	1	✓	80000	0.220	1
MM10-0.62-6.3-0-1021	75054608	Cylindrical	0.360	0.625	6.299	2.165	4.409	1,0	3	✓	80000	0.440	7
MM10-1.25-10.0-0-10024	00096132	Cylindrical	0.374	1.250	9.843	2.484	7.480	10,0	4	✓	80000	2.870	5
MM10-0.75-10.0-0-1021DS	02593420	Cylindrical Densimet	0.360	0.750	9.843	2.165	7.874	1,0	5	✓	76300	1.980	4
MM10-0.75-4.1-0-0015DS	02593422	Cylindrical Densimet	0.360	0.750	4.134	1.575	2.165	0,0	2	✓	76300	0.880	4

Spare Parts

Accessories

For cutter	Sleeve	Tension screw	Sleeve key
3	 MM-06048	 MM10-0627	H06-4
5	MM-06116	MM10-0627	H06-4
2	MM-06020	MM10-0627	H05-4
1	MM-06032	MM10-0627	H06-4
7	MM-06032	MM10-0688	H06-4
4	–	MM10-061027	–

Slot milling/square shoulder milling

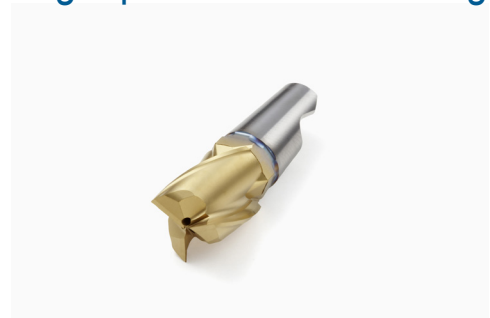
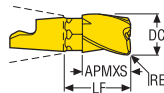

• For Torque keys and torque values, see page 615

Designation	DC	APMXS	RE	LF	RMPX°	C min	C max	FHA°	ZEFP	Wrench		Grades			
												Coated			
												T60M	F15M	F30M	F40M
	mm Inch	mm Inch	mm Inch	mm Inch											
MM10-10012-A30-E03	10,0 0.394	11,8 0.465	0,0 0.0	15,72 0.619	15,0	12,2	19,8	30	3	MM0416	✓			■	
MM10-10012-R05A30-M03	10,0 0.394	11,8 0.465	0,5 0.020	15,72 0.619	15,0	12,2	18,8	30	3	MM0416	✓				■
MM10-10012-R10A30-D03	10,0 0.394	11,8 0.465	1,0 0.039	15,72 0.619	15,0	12,2	17,8	30	3	MM0416	✓			■	
MM10-10012-R10A30-E03	10,0 0.394	11,8 0.465	1,0 0.039	15,72 0.619	15,0	12,2	17,8	30	3	MM0416	✓			■	
MM10-10012-R10A30-M03	10,0 0.394	11,8 0.465	1,0 0.039	15,72 0.619	15,0	12,2	17,8	30	3	MM0416	✓				■
MM10-10012-R20A30-M03	10,0 0.394	11,8 0.465	2,0 0.079	15,72 0.619	15,0	12,2	15,8	30	3	MM0416	✓				■
MM10-10012-R30A30-M03	10,0 0.394	11,8 0.465	3,0 0.118	15,72 0.619	15,0	12,2	13,8	30	3	MM0416	✓				■
MM10-09512-R03A30-M03	9,525 0.375	11,8 0.465	0,3 0.012	15,72 0.619	15,0	11,6	18,2	30	3	MM0416	✓				■
MM10-09512-A30-E03	9,525 0.375	11,8 0.465	0,0 0.0	15,72 0.619	15,0	11,6	18,8	30	3	MM0416	✓			■	
MM10-09512-R04A30-M03	9,525 0.375	11,8 0.465	0,4 0.016	15,72 0.619	15,0	11,6	18,0	30	3	MM0416	✓				■
MM10-09512-R08A30-M03	9,525 0.375	11,8 0.465	0,8 0.031	15,72 0.619	15,0	11,6	17,2	30	3	MM0416	✓				■
MM10-09512-R16A30-M03	9,525 0.375	11,8 0.465	1,6 0.063	15,72 0.619	15,0	11,6	15,6	30	3	MM0416	✓				■

Universal

Steel and cast iron

Stainless steel and S-materials

Non ferrous

Hard

Plastic and chip

Graphite

Minimaster Plus

Minimaster

Slot milling/square shoulder milling

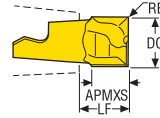

• For Torque keys and torque values, see page 615

Designation	DC	APMXS	RE	LF	RMPX°	C min	C max	FHA°	ZEPF	Wrench	Grades			
											Coated			
	mm Inch	mm Inch	mm Inch	mm Inch							T60M	F15M	F30M	F40M
MM10-10007-M03	10,0 0.394	6,9 0.272	0,0 NaN	8,5 0.335	15,0	12,2	19,8	0	2	MM0612	■			
MM10-10007-R04-MD04	10,0 0.394	6,8 0.268	0,4 0.016	8,49 0.334	15,0	12,2	19,0	0	2	MM0612	■		■	
MM10-10007-R04P-M03	10,0 0.394	6,7 0.264	0,4 0.016	8,38 0.330	15,0	12,2	19,0	0	2	MM0612			■	
MM10-10007-R10-MD04	10,0 0.394	6,8 0.268	1,0 0.039	8,48 0.334	15,0	12,2	17,8	0	2	MM0612	■		■	
MM10-10007-R20-MD04	10,0 0.394	6,8 0.268	2,0 0.079	8,46 0.333	15,0	12,2	15,8	0	2	MM0612			■	
MM10-10007-R30-MD04	10,0 0.394	6,8 0.268	3,0 0.118	8,44 0.332	15,0	12,2	13,8	0	2	MM0612			■	
MM10-09510-M03	9,525 0.375	6,8 0.268	0,0 NaN	8,5 0.335	15,0	11,6	18,8	0	2	MM0612	■			
MM10-09510-R04-MD04	9,525 0.375	6,8 0.268	0,4 0.016	8,49 0.334	15,0	11,6	18,0	0	2	MM0612	■			
MM10-10007-R04A8-E03	10,0 0.394	6,6 0.260	0,4 0.016	8,44 0.332	15,0	12,2	19,0	8	2	MM0612	■		■	
MM10-09510-R08A8-E03	9,525 0.375	6,6 0.260	0,8 0.031	8,37 0.330	15,0	11,6	17,2	8	2	MM0612			■	
MM10-09807T-R03-D04	9,8 0.386	6,8 0.268	0,3 0.012	8,49 0.334	15,0	11,9	18,8	0	2	MM0612	■			

Centre drilling

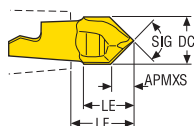

• For Torque keys and torque values, see page 615

Designation	DC	APMXS	LE	LF	SIG°	ZEFP	Wrench 	Grades			
								T60M	F15M	F30M	F40M
MM10-10005-C90-M03	10,0 0.394	4,69 0.185	10,0 0.394	11,8 0.465	90,0	2	MM0612	■			
MM10-10007-C120-M03	10,0 0.394	2,7 0.106	10,4 0.409	11,8 0.465	120,0	2	MM0612	■			

Chamfering

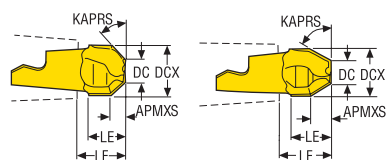

• For Torque keys and torque values, see page 615

Designation	DCX	DC	APMXS	LE	LF	KAPRS°	ZEFP	Wrench 	Grades			
									T60M	F15M	F30M	F40M
MM10-10007-4525-E03	10,0 0.394	4,82 0.190	2,6 0.102	6,94 0.273	8,48 0.334	45,0	2	MM0612	■			
MM10-10008-6040-E03	10,0 0.394	5,24 0.206	4,0 0.157	8,05 0.317	9,6 0.378	60,0	2	MM0612	■			

Plunge milling

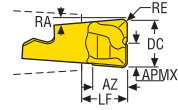

• For Torque keys and torque values, see page 615

Designation	DC	APMXE	RE	AZ	LF	RA°	ZEFP	Wrench	Grades			
									Coated			
	mm Inch	mm Inch	mm Inch	mm Inch	mm Inch				T60M	F15M	F30M	F40M
MM10-10007-R10-PL-MD04	10,0 0.394	5,0 0.197	1,0 0.039	7,1 0.280	8,48 0.334	5,0	2	MM0612			■	

Precision inserts for semi-finishing in all materials

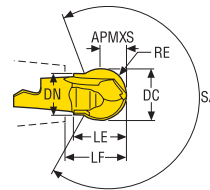

• For Torque keys and torque values, see page 615

Designation	DC	APMXS	RE	LE	LF	DN	SA°	ZEFP	Wrench	Grades			
										Coated			
	mm Inch	mm Inch	mm Inch	mm Inch	mm Inch	mm Inch				T60M	F15M	F30M	F40M
MM10-12712-B120PF-M03	12,7 0.500	6,35 0.250	6,35 0.250	12,4 0.488	13,56 0.534	10,0 0.394	256,0	2	MM0612		■		
MM10-12012-B120P-M05	12,0 0.472	6,0 0.236	6,0 0.236	12,0 0.472	13,2 0.520	10,0 0.394	247,0	2	MM0612			■	
MM10-12712-B120P-M05	12,7 0.500	6,35 0.250	6,35 0.250	12,4 0.488	13,56 0.534	10,0 0.394	256,0	2	MM0612			■	

Copy milling

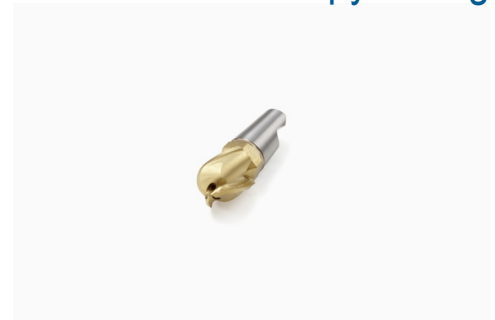
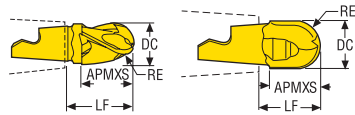

• For Torque keys and torque values, see page 615

Designation	DC	APMXS	RE	LF	FHA°	ZEFP	Wrench		Grades			
									Coated			
									T60M	F15M	F30M	F40M
MM10-10012-B90A30-E03	10,0 0.394	11,8 0.465	5,0 0.197	15,72 0.619	30,0	3	MM0416	✓			■	
MM10-10012-B90A30-M03	10,0 0.394	11,8 0.465	5,0 0.197	15,72 0.619	30,0	3	MM0416	✓				■
MM10-10012-B90A30-D03	10,0 0.394	11,8 0.465	5,0 0.197	15,72 0.619	30,0	3	MM0416	✓			■	
MM10-10010-B90-MD04	10,0 0.394	10,2 0.402	5,0 0.197	11,77 0.463	0,0	2	MM0612		■		■	
MM10-10010-B90S-E04	10,0 0.394	10,2 0.402	5,0 0.197	11,77 0.463	0,0	2	MM0612				■	
MM10-10010-B90P-M04	10,0 0.394	8,73 0.344	5,0 0.197	11,74 0.462	0,0	2	MM0612				■	
MM10-10010-B90PF-M02	10,0 0.394	8,73 0.344	5,0 0.197	11,74 0.462	0,0	2	MM0612			■		
MM10-09510-B90P-M04	9,525 0.375	8,7 0.343	4,763 0.188	11,74 0.462	0,0	2	MM0612		■		■	

Universal

Steel and cast iron

Stainless steel and S-materials

Non ferrous

Hard

Plastic and chip

Graphite

Minimaster Plus

Minimaster

High feed

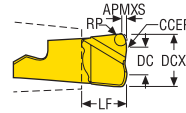

• For Torque keys and torque values, see page 615

Designation	DCX	DC	APMXS	RP	CCER	LF	RMPX°	C min	C max	ZEFP	Wrench	Grades			
												Coated			
	mm <i>Inch</i>	mm <i>Inch</i>	mm <i>Inch</i>	mm <i>Inch</i>	mm <i>Inch</i>	mm <i>Inch</i>						T60M	F15M	F30M	F40M
MM10-10.50-HF-MD08	10,0 <i>0.394</i>	5,0 <i>0.197</i>	0,44 <i>0.017</i>	1,13 <i>0.044</i>	5,0 <i>0.197</i>	8,5 <i>0.335</i>	5,0	12,2	18,2	2	MM0612		■	■	

Universal

Steel and cast iron

Stainless steel and S-materials

Non ferrous

Hard

Plastic and cfrp

Graphite

Minimaster Plus

Minimaster

MM10 - Slot and Side milling – Insert selection – mm/Inch

SMG		a _p	f _z			
			100%	40%	20%	10%
P1	MM10-10012-R05A30-M03 F40M	2,0	0,044	0,044	0,055	0,070
		0.080	0.0017	0.0017	0.0022	0.0028
P2	MM10-10012-R05A30-M03 F40M	2,0	0,044	0,044	0,055	0,070
		0.080	0.0017	0.0017	0.0022	0.0028
P3	MM10-10012-R05A30-M03 F40M	2,0	0,042	0,042	0,050	0,070
		0.080	0.0017	0.0017	0.0020	0.0028
P4	MM10-10012-R05A30-M03 F40M	2,0	0,042	0,042	0,050	0,065
		0.080	0.0017	0.0017	0.0020	0.0026
P5	MM10-10012-R05A30-M03 F40M	2,0	0,040	0,040	0,050	0,065
		0.080	0.0016	0.0016	0.0020	0.0026
P6	MM10-10012-R05A30-M03 F40M	2,0	0,040	0,040	0,048	0,065
		0.080	0.0016	0.0016	0.0019	0.0026
P7	MM10-10012-R05A30-M03 F40M	2,0	0,040	0,040	0,048	0,065
		0.080	0.0016	0.0016	0.0019	0.0026
P8	MM10-10012-R05A30-M03 F40M	2,0	0,042	0,042	0,050	0,070
		0.080	0.0017	0.0017	0.0020	0.0028
P11	MM10-10012-R05A30-M03 F40M	2,0	0,040	0,040	0,048	0,065
		0.080	0.0016	0.0016	0.0019	0.0026
P12	MM10-10012-R05A30-M03 F40M	1,7	0,028	0,028	0,034	0,044
		0.065	0.0011	0.0011	0.0013	0.0017
M1	MM10-10012-R05A30-M03 F40M	2,0	0,044	0,044	0,055	0,070
		0.080	0.0017	0.0017	0.0022	0.0028
M2	MM10-10012-R05A30-M03 F40M	2,0	0,040	0,040	0,050	0,065
		0.080	0.0016	0.0016	0.0020	0.0026
M3	MM10-10012-R05A30-M03 F40M	1,7	0,032	0,032	0,040	0,050
		0.065	0.0013	0.0013	0.0016	0.0020
M4	MM10-10012-R05A30-M03 F40M	1,2	0,030	0,030	0,034	0,046
		0.048	0.0012	0.0012	0.0013	0.0018
M5	MM10-10012-R05A30-M03 F40M	1,2	0,030	0,030	0,034	0,046
		0.048	0.0012	0.0012	0.0013	0.0018
K1	MM10-10012-R10A30-E03 F30M	2,0	0,048	0,048	0,055	0,075
		0.080	0.0019	0.0019	0.0022	0.0030
K2	MM10-10012-R10A30-E03 F30M	2,0	0,044	0,042	0,050	0,065
		0.080	0.0017	0.0017	0.0020	0.0026
K3	MM10-10012-R10A30-E03 F30M	2,0	0,044	0,042	0,050	0,065
		0.080	0.0017	0.0017	0.0020	0.0026
K4	MM10-10012-R10A30-E03 F30M	2,0	0,044	0,042	0,050	0,065
		0.080	0.0017	0.0017	0.0020	0.0026
K5	MM10-10012-R10A30-D03 F30M	2,0	0,040	0,038	0,044	0,060
		0.080	0.0016	0.0015	0.0017	0.0024
K6	MM10-10012-R10A30-D03 F30M	2,0	0,044	0,042	0,050	0,065
		0.080	0.0017	0.0017	0.0020	0.0026
K7	MM10-10012-R10A30-D03 F30M	2,0	0,040	0,038	0,044	0,060
		0.080	0.0016	0.0015	0.0017	0.0024
N1	MM10-10012-R10A30-E03 F30M	2,0	0,060	0,060	0,070	0,095
		0.080	0.0024	0.0024	0.0028	0.0038
N2	MM10-10012-R10A30-E03 F30M	2,0	0,060	0,060	0,070	0,095
		0.080	0.0024	0.0024	0.0028	0.0038
N3	MM10-10012-R10A30-E03 F30M	2,0	0,060	0,060	0,070	0,095
		0.080	0.0024	0.0024	0.0028	0.0038
N11	MM10-10012-R10A30-E03 F30M	2,0	0,060	0,060	0,070	0,095
		0.080	0.0024	0.0024	0.0028	0.0038
S1	MM10-10012-R10A30-D03 F30M	1,2	0,036	0,034	0,036	0,046
		0.048	0.0014	0.0013	0.0014	0.0018
S2	MM10-10012-R10A30-D03 F30M	1,2	0,036	0,034	0,036	0,046
		0.048	0.0014	0.0013	0.0014	0.0018
S3	MM10-10012-R10A30-D03 F30M	1,2	0,032	0,032	0,034	0,042
		0.048	0.0013	0.0013	0.0013	0.0017
S11	MM10-10012-R05A30-M03 F40M	1,4	0,034	0,034	0,040	0,050
		0.055	0.0013	0.0013	0.0016	0.0020
S12	MM10-10012-R05A30-M03 F40M	1,4	0,034	0,034	0,040	0,050
		0.055	0.0013	0.0013	0.0016	0.0020
S13	MM10-10012-R05A30-M03 F40M	1,2	0,030	0,030	0,034	0,046
		0.048	0.0012	0.0012	0.0013	0.0018
H5	MM10-10012-R10A30-D03 F30M	1,7	0,030	0,030	0,034	0,044
		0.065	0.0012	0.0012	0.0013	0.0017
H8	MM10-10012-R10A30-D03 F30M	1,4	0,025	0,024	0,026	0,034
		0.055	0.0010	0.00095	0.0010	0.0013
H11	MM10-10012-R10A30-D03 F30M	1,7	0,030	0,030	0,034	0,044
		0.065	0.0012	0.0012	0.0013	0.0017
H12	MM10-10012-R10A30-D03 F30M	1,4	0,025	0,024	0,026	0,034
		0.055	0.0010	0.00095	0.0010	0.0013
H21	MM10-10012-R10A30-D03 F30M	1,4	0,025	0,024	0,026	0,034
		0.055	0.0010	0.00095	0.0010	0.0013

SMG = Seco material group
 f_z = mm/tooth (in/tooth), v_c = m/min (sf/min), a_p/DC = %
 All cutting data are start values

Universal
 Steel and cast iron
 Stainless steel and S-materials
 Non ferrous
 Hard
 Plastic and chip
 Graphite
 Minimaster Plus
 Minimaster

MM10 - Slot and Side milling – Cutting data $v_c = (m/min)/(sf/min)$

SMG	F30M				F40M				T60M			
	100%	40%	20%	10%	100%	40%	20%	10%	100%	40%	20%	10%
P1	265	330	365	405	250	315	345	385	190	240	270	295
	870	1075	1200	1325	820	1025	1125	1275	620	790	890	970
P2	260	320	360	390	245	305	340	375	185	235	260	290
	850	1050	1175	1275	800	1000	1125	1225	610	770	850	950
P3	225	280	315	340	215	265	295	325	165	205	230	250
	740	920	1025	1125	710	870	970	1075	540	670	750	820
P4	200	245	275	305	190	235	260	290	145	180	200	225
	660	800	900	1000	620	770	850	950	475	590	660	740
P5	190	235	265	290	180	225	250	275	140	175	195	215
	620	770	870	950	590	740	820	900	460	570	640	710
P6	215	265	295	325	205	250	280	310	155	195	220	240
	710	870	970	1075	670	820	920	1025	510	640	720	790
P7	200	250	280	310	190	240	265	290	145	185	205	225
	660	820	920	1025	620	790	870	950	475	610	670	740
P8	190	235	265	285	180	225	250	270	140	175	190	210
	620	770	870	940	590	740	820	890	460	570	620	690
P11	195	245	270	300	185	230	260	285	140	180	200	220
	640	800	890	980	610	750	850	940	460	590	660	720
P12	125	150	170	185	115	145	160	175	90	115	125	140
	410	490	560	610	375	475	520	570	295	375	410	460
M1	—	—	—	—	200	245	275	305	150	190	210	235
	—	—	—	—	660	800	900	1000	490	620	690	770
M2	—	—	—	—	165	200	225	250	125	155	175	190
	—	—	—	—	540	660	740	820	410	510	570	620
M3	—	—	—	—	130	160	175	195	100	125	140	155
	—	—	—	—	425	520	570	640	330	410	460	510
M4	—	—	—	—	100	120	135	150	75	95	105	115
	—	—	—	—	330	395	445	490	245	310	345	375
M5	—	—	—	—	80	100	115	125	65	80	90	95
	—	—	—	—	260	330	375	410	215	260	295	310
K1	205	255	285	310	195	240	270	300	150	185	205	230
	670	840	940	1025	640	790	890	980	490	610	670	750
K2	180	225	250	275	170	215	235	260	130	165	185	200
	590	740	820	900	560	710	770	850	425	540	610	660
K3	150	190	210	235	145	180	200	220	110	140	155	170
	490	620	690	770	475	590	660	720	360	460	510	560
K4	145	180	200	225	140	170	190	210	105	130	150	165
	475	590	660	740	460	560	620	690	345	425	490	540
K5	90	110	125	135	85	105	115	125	65	80	90	100
	295	360	410	445	280	345	375	410	215	260	295	330
K6	130	160	180	195	120	150	170	185	95	115	130	145
	425	520	590	640	395	490	560	610	310	375	425	475
K7	110	140	155	170	105	135	150	165	85	105	115	125
	360	460	510	560	345	445	490	540	280	345	375	410
N1	1550	1925	2150	2350	1475	1825	2025	2250	1125	1400	1550	1725
	5075	6325	7050	7700	4850	6000	6650	7375	3700	4600	5075	5650
N2	630	780	870	950	600	740	820	910	450	570	630	690
	2075	2550	2850	3125	1975	2425	2700	2975	1475	1875	2075	2275
N3	415	520	580	630	395	495	550	610	300	380	420	460
	1350	1700	1900	2075	1300	1625	1800	2000	980	1250	1375	1500
N11	475	590	660	720	455	570	620	690	345	430	480	530
	1550	1925	2175	2350	1500	1875	2025	2275	1125	1400	1575	1750
S1	48	60	65	75	46	55	65	70	36	45	50	55
	155	195	215	245	150	180	215	230	120	150	165	180
S2	38	48	55	60	37	46	50	55	29	36	40	44
	125	155	180	195	120	150	165	180	95	120	130	145
S3	34	42	47	50	32	40	45	49	25	32	35	38
	110	140	155	165	105	130	150	160	80	105	115	125
S11	—	—	—	—	65	80	90	100	50	65	70	75
	—	—	—	—	215	260	295	330	165	215	230	245
S12	—	—	—	—	45	55	60	70	35	43	49	55
	—	—	—	—	150	180	195	230	115	140	160	180
S13	—	—	—	—	26	32	36	39	20	25	28	30
	—	—	—	—	85	105	120	130	65	80	90	100
H5	41	50	55	60	39	48	55	60	30	38	42	46
	135	165	180	195	130	155	180	195	100	125	140	150
H8	42	50	60	65	40	50	55	60	31	39	44	48
	140	165	195	215	130	165	180	195	100	130	145	155
H11	50	65	70	80	49	60	70	75	38	48	55	60
	165	215	230	260	160	195	230	245	125	155	180	195
H12	75	95	105	115	70	90	100	110	55	70	80	85
	245	310	345	375	230	295	330	360	180	230	260	280
H21	42	50	60	65	40	50	55	60	31	39	44	48
	140	165	195	215	130	165	180	195	100	130	145	155

MM10 Z3 – Copy milling – Insert selection – Roughing – mm/Inch

SMG		a _p	f _z			
			100%	40%	20%	10%
P1	MM10-10012-B90A30-M03 F40M	2,0	0,055	0,050	0,055	0,070
		0.080	0.0022	0.0020	0.0022	0.0028
P2	MM10-10012-B90A30-M03 F40M	2,0	0,055	0,050	0,055	0,075
		0.080	0.0022	0.0020	0.0022	0.0030
P3	MM10-10012-B90A30-M03 F40M	2,0	0,050	0,050	0,050	0,070
		0.080	0.0020	0.0020	0.0020	0.0028
P4	MM10-10012-B90A30-M03 F40M	2,0	0,050	0,048	0,050	0,065
		0.080	0.0020	0.0019	0.0020	0.0026
P5	MM10-10012-B90A30-M03 F40M	2,0	0,050	0,048	0,050	0,065
		0.080	0.0020	0.0019	0.0020	0.0026
P6	MM10-10012-B90A30-M03 F40M	2,0	0,050	0,048	0,050	0,065
		0.080	0.0020	0.0019	0.0020	0.0026
P7	MM10-10012-B90A30-M03 F40M	2,0	0,050	0,048	0,050	0,065
		0.080	0.0020	0.0019	0.0020	0.0026
P8	MM10-10012-B90A30-M03 F40M	2,0	0,050	0,050	0,050	0,070
		0.080	0.0020	0.0020	0.0020	0.0028
P11	MM10-10012-B90A30-M03 F40M	2,0	0,050	0,048	0,050	0,065
		0.080	0.0020	0.0019	0.0020	0.0026
P12	MM10-10012-B90A30-M03 F40M	1,7	0,034	0,034	0,034	0,044
		0.065	0.0013	0.0013	0.0013	0.0018
M1	MM10-10012-B90A30-M03 F40M	2,0	0,055	0,050	0,055	0,075
		0.080	0.0022	0.0020	0.0022	0.0030
M2	MM10-10012-B90A30-M03 F40M	2,0	0,050	0,048	0,050	0,065
		0.080	0.0020	0.0019	0.0020	0.0026
M3	MM10-10012-B90A30-M03 F40M	1,7	0,042	0,040	0,042	0,055
		0.065	0.0017	0.0016	0.0017	0.0022
M4	MM10-10012-B90A30-M03 F40M	1,2	0,038	0,036	0,036	0,046
		0.048	0.0015	0.0014	0.0014	0.0019
M5	MM10-10012-B90A30-M03 F40M	1,2	0,038	0,036	0,036	0,046
		0.048	0.0015	0.0014	0.0014	0.0019
K1	MM10-10012-B90A30-E03 F30M	2,0	0,055	0,050	0,055	0,075
		0.080	0.0022	0.0020	0.0022	0.0030
K2	MM10-10012-B90A30-E03 F30M	2,0	0,050	0,048	0,050	0,065
		0.080	0.0020	0.0019	0.0020	0.0026
K3	MM10-10012-B90A30-E03 F30M	2,0	0,050	0,048	0,050	0,065
		0.080	0.0020	0.0019	0.0020	0.0026
K4	MM10-10012-B90A30-E03 F30M	2,0	0,050	0,048	0,050	0,065
		0.080	0.0020	0.0019	0.0020	0.0026
K5	MM10-10012-B90A30-D03 F30M	2,0	0,044	0,042	0,046	0,060
		0.080	0.0017	0.0017	0.0018	0.0024
K6	MM10-10012-B90A30-D03 F30M	2,0	0,050	0,048	0,050	0,065
		0.080	0.0020	0.0019	0.0020	0.0026
K7	MM10-10012-B90A30-D03 F30M	2,0	0,044	0,042	0,046	0,060
		0.080	0.0017	0.0017	0.0018	0.0024
N1	MM10-10012-B90A30-E03 F30M	2,0	0,070	0,065	0,070	0,095
		0.080	0.0028	0.0026	0.0028	0.0038
N2	MM10-10012-B90A30-E03 F30M	2,0	0,070	0,065	0,070	0,095
		0.080	0.0028	0.0026	0.0028	0.0038
N3	MM10-10012-B90A30-E03 F30M	2,0	0,070	0,065	0,070	0,095
		0.080	0.0028	0.0026	0.0028	0.0038
N11	MM10-10012-B90A30-E03 F30M	2,0	0,070	0,065	0,070	0,095
		0.080	0.0028	0.0026	0.0028	0.0038
S1	MM10-10012-B90A30-D03 F30M	1,2	0,038	0,036	0,036	0,046
		0.048	0.0015	0.0014	0.0014	0.0019
S2	MM10-10012-B90A30-D03 F30M	1,2	0,038	0,036	0,036	0,046
		0.048	0.0015	0.0014	0.0014	0.0019
S3	MM10-10012-B90A30-D03 F30M	1,2	0,036	0,034	0,034	0,042
		0.048	0.0014	0.0013	0.0013	0.0017
S11	MM10-10012-B90A30-M03 F40M	1,4	0,042	0,042	0,042	0,055
		0.055	0.0017	0.0017	0.0017	0.0022
S12	MM10-10012-B90A30-M03 F40M	1,4	0,042	0,042	0,042	0,055
		0.055	0.0017	0.0017	0.0017	0.0022
S13	MM10-10012-B90A30-M03 F40M	1,2	0,038	0,036	0,036	0,046
		0.048	0.0015	0.0014	0.0014	0.0019
H5	MM10-10012-B90A30-D03 F30M	1,7	0,034	0,034	0,034	0,044
		0.065	0.0013	0.0013	0.0013	0.0018
H8	MM10-10012-B90A30-D03 F30M	1,4	0,028	0,026	0,026	0,034
		0.055	0.0011	0.0010	0.0010	0.0013
H11	MM10-10012-B90A30-D03 F30M	1,7	0,034	0,034	0,034	0,044
		0.065	0.0013	0.0013	0.0013	0.0018
H12	MM10-10012-B90A30-D03 F30M	1,4	0,028	0,026	0,026	0,034
		0.055	0.0011	0.0010	0.0010	0.0013
H21	MM10-10012-B90A30-D03 F30M	1,4	0,028	0,026	0,026	0,034
		0.055	0.0011	0.0010	0.0010	0.0013

SMG = Seco material group
 f_z = mm/tooth (in/tooth), v_c = m/min (sf/min), a_p/DC = %
 All cutting data are start values

Universal
 Steel and cast iron
 Stainless steel and S-materials
 Non ferrous
 Hard
 Plastic and chip
 Graphite
 Minimaster Plus
 Minimaster

MM10 Z3 – Copy milling – Insert selection – Finishing – mm/inch

SMG		a_p		f_z			
				15%	10%	5%	2%
P1	MM10-10012-B90A30-E03 F30M	2,0	0,060	0,070	0,10	0,16	
		0,080	0,0024	0,0028	0,0040	0,0065	
P2	MM10-10012-B90A30-E03 F30M	2,0	0,060	0,075	0,10	0,16	
		0,080	0,0024	0,0030	0,0040	0,0065	
P3	MM10-10012-B90A30-E03 F30M	2,0	0,060	0,070	0,095	0,15	
		0,080	0,0024	0,0028	0,0038	0,0060	
P4	MM10-10012-B90A30-E03 F30M	2,0	0,055	0,065	0,095	0,15	
		0,080	0,0022	0,0026	0,0038	0,0060	
P5	MM10-10012-B90A30-E03 F30M	2,0	0,055	0,065	0,090	0,15	
		0,080	0,0022	0,0026	0,0036	0,0060	
P6	MM10-10012-B90A30-E03 F30M	2,0	0,055	0,065	0,090	0,15	
		0,080	0,0022	0,0026	0,0036	0,0060	
P7	MM10-10012-B90A30-E03 F30M	2,0	0,055	0,065	0,090	0,15	
		0,080	0,0022	0,0026	0,0036	0,0060	
P8	MM10-10012-B90A30-E03 F30M	2,0	0,060	0,070	0,095	0,15	
		0,080	0,0024	0,0028	0,0038	0,0060	
P11	MM10-10012-B90A30-E03 F30M	2,0	0,055	0,065	0,090	0,15	
		0,080	0,0022	0,0026	0,0036	0,0060	
P12	MM10-10012-B90A30-E03 F30M	1,7	0,038	0,044	0,060	0,10	
		0,065	0,0015	0,0018	0,0024	0,0040	
M1	MM10-10012-B90A30-E03 F30M	2,0	0,060	0,075	0,10	0,16	
		0,080	0,0024	0,0030	0,0040	0,0065	
M2	MM10-10012-B90A30-E03 F30M	2,0	0,055	0,065	0,090	0,15	
		0,080	0,0022	0,0026	0,0036	0,0060	
M3	MM10-10012-B90A30-E03 F30M	1,7	0,046	0,055	0,075	0,12	
		0,065	0,0018	0,0022	0,0030	0,0048	
M4	MM10-10012-B90A30-E03 F30M	1,2	0,040	0,046	0,065	0,10	
		0,048	0,0016	0,0019	0,0026	0,0040	
M5	MM10-10012-B90A30-E03 F30M	1,2	0,040	0,046	0,065	0,10	
		0,048	0,0016	0,0019	0,0026	0,0040	
K1	MM10-10012-B90A30-E03 F30M	2,0	0,060	0,075	0,10	0,16	
		0,080	0,0024	0,0030	0,0040	0,0065	
K2	MM10-10012-B90A30-E03 F30M	2,0	0,055	0,065	0,090	0,15	
		0,080	0,0022	0,0026	0,0036	0,0060	
K3	MM10-10012-B90A30-E03 F30M	2,0	0,055	0,065	0,090	0,15	
		0,080	0,0022	0,0026	0,0036	0,0060	
K4	MM10-10012-B90A30-E03 F30M	2,0	0,055	0,065	0,090	0,15	
		0,080	0,0022	0,0026	0,0036	0,0060	
K5	MM10-10012-B90A30-E03 F30M	2,0	0,050	0,060	0,080	0,13	
		0,080	0,0020	0,0024	0,0032	0,0050	
K6	MM10-10012-B90A30-E03 F30M	2,0	0,055	0,065	0,090	0,15	
		0,080	0,0022	0,0026	0,0036	0,0060	
K7	MM10-10012-B90A30-E03 F30M	2,0	0,050	0,060	0,080	0,13	
		0,080	0,0020	0,0024	0,0032	0,0050	
N1	MM10-10012-B90A30-E03 F30M	2,0	0,080	0,095	0,13	0,22	
		0,080	0,0032	0,0038	0,0050	0,0085	
N2	MM10-10012-B90A30-E03 F30M	2,0	0,080	0,095	0,13	0,22	
		0,080	0,0032	0,0038	0,0050	0,0085	
N3	MM10-10012-B90A30-E03 F30M	2,0	0,080	0,095	0,13	0,22	
		0,080	0,0032	0,0038	0,0050	0,0085	
N11	MM10-10012-B90A30-E03 F30M	2,0	0,080	0,095	0,13	0,22	
		0,080	0,0032	0,0038	0,0050	0,0085	
S1	MM10-10012-B90A30-E03 F30M	1,2	0,040	0,046	0,065	0,10	
		0,048	0,0016	0,0019	0,0026	0,0040	
S2	MM10-10012-B90A30-E03 F30M	1,2	0,040	0,046	0,065	0,10	
		0,048	0,0016	0,0019	0,0026	0,0040	
S3	MM10-10012-B90A30-E03 F30M	1,2	0,038	0,042	0,060	0,095	
		0,048	0,0015	0,0017	0,0024	0,0038	
S11	MM10-10012-B90A30-E03 F30M	1,4	0,046	0,055	0,075	0,12	
		0,055	0,0018	0,0022	0,0030	0,0048	
S12	MM10-10012-B90A30-E03 F30M	1,4	0,046	0,055	0,075	0,12	
		0,055	0,0018	0,0022	0,0030	0,0048	
S13	MM10-10012-B90A30-E03 F30M	1,2	0,040	0,046	0,065	0,10	
		0,048	0,0016	0,0019	0,0026	0,0040	
H5	MM10-10012-B90A30-E03 F30M	1,7	0,038	0,044	0,060	0,10	
		0,065	0,0015	0,0018	0,0024	0,0040	
H8	MM10-10012-B90A30-E03 F30M	1,4	0,030	0,034	0,048	0,075	
		0,055	0,0012	0,0013	0,0019	0,0030	
H11	MM10-10012-B90A30-E03 F30M	1,7	0,038	0,044	0,060	0,10	
		0,065	0,0015	0,0018	0,0024	0,0040	
H12	MM10-10012-B90A30-E03 F30M	1,4	0,030	0,034	0,048	0,075	
		0,055	0,0012	0,0013	0,0019	0,0030	
H21	MM10-10012-B90A30-E03 F30M	1,4	0,030	0,034	0,048	0,075	
		0,055	0,0012	0,0013	0,0019	0,0030	

SMG = Seco material group
 f_z = mm/tooth (in/tooth), v_c = m/min (sf/min), a_p/DC = %
 All cutting data are start values

MM10 Z3 – Copy milling – Cutting data $v_c = (m/min)/(sf/min)$

SMG	F30M					F40M				
	100%	20%	10%	5%	2%	100%	20%	10%	5%	2%
P1	280	330	355	380	380	270	310	335	365	360
	920	1075	1175	1250	1250	890	1025	1100	1200	1175
P2	275	320	340	370	370	260	305	325	355	355
	900	1050	1125	1225	1225	850	1000	1075	1175	1175
P3	240	280	295	320	320	230	265	280	305	305
	790	920	970	1050	1050	750	870	920	1000	1000
P4	210	245	265	285	285	200	235	250	270	270
	690	800	870	940	940	660	770	820	890	890
P5	200	235	250	275	270	190	225	240	260	260
	660	770	820	900	890	620	740	790	850	850
P6	225	265	285	305	305	215	250	270	290	290
	740	870	940	1000	1000	710	820	890	950	950
P7	215	250	265	290	285	205	235	255	275	275
	710	820	870	950	940	670	770	840	900	900
P8	200	235	250	270	270	190	225	235	260	260
	660	770	820	890	890	620	740	770	850	850
P11	205	240	260	280	280	195	230	245	265	265
	670	790	850	920	920	640	750	800	870	870
P12	130	160	160	175	175	125	150	155	165	165
	425	520	520	570	570	410	490	510	540	540
M1	220	255	275	300	300	210	245	260	285	285
	720	840	900	980	980	690	800	850	940	940
M2	180	210	225	245	245	175	200	215	235	230
	590	690	740	800	800	570	660	710	770	750
M3	145	175	175	190	190	135	165	170	185	180
	475	570	590	620	620	445	540	560	610	590
M4	95	140	135	145	145	95	130	130	140	140
	310	460	475	475	475	310	425	445	460	460
M5	80	115	115	120	120	75	110	105	115	115
	260	375	395	395	395	245	360	375	375	375
K1	220	255	270	295	295	205	240	255	280	280
	720	840	890	970	970	670	790	840	920	920
K2	190	220	240	260	255	180	210	230	245	245
	620	720	790	850	840	590	690	750	800	800
K3	160	190	200	220	215	155	180	195	210	205
	520	620	660	720	710	510	590	640	690	670
K4	155	180	195	210	205	145	170	185	200	195
	510	590	640	690	670	475	560	610	660	640
K5	95	110	115	125	125	90	105	110	120	120
	310	360	375	410	410	295	345	360	395	395
K6	135	160	170	185	185	130	150	160	175	175
	445	520	560	610	610	425	490	520	570	570
K7	120	140	150	160	160	115	130	140	155	155
	395	460	490	520	520	375	425	460	510	510
N1	1650	1925	2050	2225	2200	1575	1825	1950	2125	2100
	5425	6325	6725	7300	7225	5175	6000	6400	6975	6900
N2	670	780	830	900	890	640	740	790	860	850
	2200	2550	2725	2950	2925	2100	2425	2600	2825	2800
N3	445	520	550	600	590	425	495	530	570	560
	1450	1700	1800	1975	1925	1400	1625	1750	1875	1825
N11	510	590	630	690	680	485	560	600	650	650
	1675	1925	2075	2275	2225	1600	1825	1975	2125	2125
S1	45	65	65	70	70	43	60	60	65	65
	150	215	215	230	230	140	195	215	215	215
S2	37	50	50	55	55	35	49	48	50	50
	120	165	180	180	180	115	160	165	165	165
S3	32	45	44	48	48	30	43	42	46	45
	105	150	155	155	155	100	140	150	150	150
S11	70	90	90	95	95	65	85	85	90	90
	230	295	295	310	310	215	280	280	295	295
S12	48	60	60	65	65	45	60	60	65	65
	155	195	215	215	215	150	195	195	215	215
S13	26	36	36	38	38	24	34	34	37	37
	85	120	125	125	125	80	110	120	120	120
H5	43	55	55	60	55	41	50	50	55	55
	140	180	180	195	180	135	165	165	180	180
H8	41	55	55	60	60	39	50	50	55	55
	135	180	180	195	195	130	165	180	180	180
H11	55	65	70	75	75	50	65	65	70	70
	180	215	230	245	245	165	215	215	230	230
H12	75	100	100	105	105	70	95	95	100	100
	245	330	330	345	345	230	310	310	330	330
H21	41	55	55	60	60	39	50	50	55	55
	135	180	180	195	195	130	165	180	180	180

Universal
Steel and cast iron
Stainless steel and S-materials
Non ferrous
Hard
Plastic and chip
Graphite
Minimaster Plus
Minimaster

MM10 Z2 – Copy milling – Insert selection – Roughing – mm/inch

SMG		a _p	f _z				
			100%	40%	20%	10%	
Universal	P1	MM10-10010-B90S-E04 F30M	4,0	0,060	0,060	0,070	0,095
			0,16	0,0024	0,0024	0,0028	0,0038
Steel and cast iron	P2	MM10-10010-B90S-E04 F30M	4,0	0,065	0,065	0,075	0,095
			0,16	0,0026	0,0026	0,0030	0,0038
	P3	MM10-10010-B90S-E04 F30M	4,0	0,060	0,060	0,070	0,090
			0,16	0,0024	0,0024	0,0028	0,0036
	P4	MM10-10010-B90-MD04 F30M	4,0	0,060	0,060	0,070	0,090
			0,16	0,0024	0,0024	0,0028	0,0036
	P5	MM10-10010-B90-MD04 F30M	4,0	0,060	0,055	0,065	0,090
			0,16	0,0024	0,0022	0,0026	0,0036
	P6	MM10-10010-B90-MD04 F30M	4,0	0,055	0,055	0,065	0,085
			0,16	0,0022	0,0022	0,0026	0,0034
Stainless steel and S-materials	P7	MM10-10010-B90-MD04 F30M	4,0	0,055	0,055	0,065	0,085
			0,16	0,0022	0,0022	0,0026	0,0034
	P8	MM10-10010-B90-MD04 F30M	4,0	0,060	0,060	0,070	0,090
			0,16	0,0024	0,0024	0,0028	0,0036
	P11	MM10-10010-B90-MD04 F30M	4,0	0,055	0,055	0,065	0,085
			0,16	0,0022	0,0022	0,0026	0,0034
	P12	MM10-10010-B90-MD04 F30M	3,5	0,040	0,040	0,046	0,060
			0,14	0,0016	0,0016	0,0018	0,0024
	M1	MM10-10010-B90S-E04 F30M	4,0	0,065	0,065	0,075	0,095
			0,16	0,0026	0,0026	0,0030	0,0038
Non ferrous	M2	MM10-10010-B90S-E04 F30M	4,0	0,060	0,055	0,065	0,090
			0,16	0,0024	0,0022	0,0026	0,0036
	M3	MM10-10010-B90S-E04 F30M	3,5	0,048	0,048	0,055	0,070
			0,14	0,0019	0,0019	0,0022	0,0028
	M4	MM10-10010-B90-MD04 F30M	2,5	0,044	0,044	0,048	0,060
			0,10	0,0017	0,0017	0,0019	0,0026
	M5	MM10-10010-B90-MD04 F30M	2,5	0,044	0,044	0,048	0,060
			0,10	0,0017	0,0017	0,0019	0,0026
Hard	K1	MM10-10010-B90S-E04 F30M	4,0	0,065	0,065	0,075	0,095
			0,16	0,0026	0,0026	0,0030	0,0038
	K2	MM10-10010-B90S-E04 F30M	4,0	0,060	0,055	0,065	0,090
			0,16	0,0024	0,0022	0,0026	0,0036
	K3	MM10-10010-B90S-E04 F30M	4,0	0,060	0,055	0,065	0,090
			0,16	0,0024	0,0022	0,0026	0,0036
	K4	MM10-10010-B90S-E04 F30M	4,0	0,060	0,055	0,065	0,090
			0,16	0,0024	0,0022	0,0026	0,0036
	K5	MM10-10010-B90-MD04 F30M	4,0	0,050	0,050	0,060	0,080
			0,16	0,0020	0,0020	0,0024	0,0032
Plastic and cfrp	K6	MM10-10010-B90-MD04 F30M	4,0	0,060	0,055	0,065	0,090
			0,16	0,0024	0,0022	0,0026	0,0036
	K7	MM10-10010-B90-MD04 F30M	4,0	0,050	0,050	0,060	0,080
			0,16	0,0020	0,0020	0,0024	0,0032
Graphite	N1	MM10-10010-B90S-E04 F30M	4,0	0,080	0,080	0,095	0,12
			0,16	0,0032	0,0032	0,0038	0,0048
	N2	MM10-10010-B90S-E04 F30M	4,0	0,080	0,080	0,095	0,12
			0,16	0,0032	0,0032	0,0038	0,0048
	N3	MM10-10010-B90S-E04 F30M	4,0	0,080	0,080	0,095	0,12
			0,16	0,0032	0,0032	0,0038	0,0048
	N11	MM10-10010-B90S-E04 F30M	4,0	0,080	0,080	0,095	0,12
			0,16	0,0032	0,0032	0,0038	0,0048
Minimaster Plus	S1	MM10-10010-B90S-E04 F30M	2,5	0,044	0,044	0,048	0,060
			0,10	0,0017	0,0017	0,0019	0,0026
	S2	MM10-10010-B90S-E04 F30M	2,5	0,044	0,044	0,048	0,060
			0,10	0,0017	0,0017	0,0019	0,0026
	S3	MM10-10010-B90S-E04 F30M	2,5	0,042	0,042	0,044	0,055
			0,10	0,0017	0,0017	0,0017	0,0024
	S11	MM10-10010-B90S-E04 F30M	3,0	0,048	0,048	0,055	0,070
			0,12	0,0019	0,0019	0,0022	0,0028
	S12	MM10-10010-B90S-E04 F30M	3,0	0,048	0,048	0,055	0,070
			0,12	0,0019	0,0019	0,0022	0,0028
	S13	MM10-10010-B90S-E04 F30M	2,5	0,044	0,044	0,048	0,060
			0,10	0,0017	0,0017	0,0019	0,0026
Minimaster	H5	MM10-10010-B90-MD04 F30M	3,5	0,040	0,040	0,046	0,060
			0,14	0,0016	0,0016	0,0018	0,0024
	H8	MM10-10010-B90-MD04 F30M	3,0	0,032	0,032	0,036	0,046
			0,12	0,0013	0,0013	0,0014	0,0018
	H11	MM10-10010-B90-MD04 F30M	3,5	0,040	0,040	0,046	0,060
			0,14	0,0016	0,0016	0,0018	0,0024
	H12	MM10-10010-B90-MD04 F30M	3,0	0,032	0,032	0,036	0,046
			0,12	0,0013	0,0013	0,0014	0,0018
	H21	MM10-10010-B90-MD04 F30M	3,0	0,032	0,032	0,036	0,046
			0,12	0,0013	0,0013	0,0014	0,0018

SMG = Seco material group
f_z = mm/tooth (in/tooth), v_c = m/min (sf/min), a_g/DC = %
All cutting data are start values

MM10 Z2 – Copy milling – Insert selection – Finishing – mm/Inch

SMG		a _p	f _z			
			15%	10%	5%	2%
P1	MM10-10010-B90PF-M02 F15M	3,5 0.14	0,040 0.0016	0,048 0.0019	0,065 0.0026	0,11 0.0044
P2	MM10-10010-B90PF-M02 F15M	3,5 0.14	0,042 0.0017	0,048 0.0019	0,070 0.0028	0,11 0.0044
P3	MM10-10010-B90PF-M02 F15M	3,5 0.14	0,038 0.0015	0,046 0.0018	0,065 0.0026	0,10 0.0040
P4	MM10-10010-B90PF-M02 F15M	3,5 0.14	0,038 0.0015	0,046 0.0018	0,065 0.0026	0,10 0.0040
P5	MM10-10010-B90PF-M02 F15M	3,5 0.14	0,038 0.0015	0,044 0.0017	0,060 0.0024	0,10 0.0040
P6	MM10-10010-B90PF-M02 F15M	3,5 0.14	0,038 0.0015	0,044 0.0017	0,060 0.0024	0,095 0.0038
P7	MM10-10010-B90PF-M02 F15M	3,5 0.14	0,038 0.0015	0,044 0.0017	0,060 0.0024	0,095 0.0038
P8	MM10-10010-B90PF-M02 F15M	3,5 0.14	0,038 0.0015	0,046 0.0018	0,065 0.0026	0,10 0.0040
P11	MM10-10010-B90PF-M02 F15M	3,5 0.14	0,038 0.0015	0,044 0.0017	0,060 0.0024	0,095 0.0038
P12	MM10-10010-B90PF-M02 F15M	3,0 0.12	0,026 0.0010	0,030 0.0012	0,042 0.0017	0,065 0.0026
M1	MM10-10010-B90PF-M02 F15M	3,5 0.14	0,042 0.0017	0,048 0.0019	0,070 0.0028	0,11 0.0044
M2	MM10-10010-B90PF-M02 F15M	3,5 0.14	0,038 0.0015	0,044 0.0017	0,060 0.0024	0,10 0.0040
M3	MM10-10010-B90PF-M02 F15M	3,0 0.12	0,030 0.0012	0,036 0.0014	0,048 0.0019	0,075 0.0030
M4	MM10-10010-B90PF-M02 F15M	2,0 0.080	0,028 0.0011	0,030 0.0013	0,042 0.0017	0,070 0.0028
M5	MM10-10010-B90PF-M02 F15M	2,0 0.080	0,028 0.0011	0,030 0.0013	0,042 0.0017	0,070 0.0028
K1	MM10-10010-B90PF-M02 F15M	3,5 0.14	0,042 0.0017	0,048 0.0019	0,070 0.0028	0,11 0.0044
K2	MM10-10010-B90PF-M02 F15M	3,5 0.14	0,038 0.0015	0,044 0.0017	0,060 0.0024	0,10 0.0040
K3	MM10-10010-B90PF-M02 F15M	3,5 0.14	0,038 0.0015	0,044 0.0017	0,060 0.0024	0,10 0.0040
K4	MM10-10010-B90PF-M02 F15M	3,5 0.14	0,038 0.0015	0,044 0.0017	0,060 0.0024	0,10 0.0040
K5	MM10-10010-B90PF-M02 F15M	3,5 0.14	0,034 0.0013	0,040 0.0016	0,055 0.0022	0,085 0.0034
K6	MM10-10010-B90PF-M02 F15M	3,5 0.14	0,038 0.0015	0,044 0.0017	0,060 0.0024	0,10 0.0040
K7	MM10-10010-B90PF-M02 F15M	3,5 0.14	0,034 0.0013	0,040 0.0016	0,055 0.0022	0,085 0.0034
N1	MM10-10010-B90PF-M02 F15M	3,5 0.14	0,050 0.0020	0,060 0.0024	0,085 0.0034	0,14 0.0055
N2	MM10-10010-B90PF-M02 F15M	3,5 0.14	0,050 0.0020	0,060 0.0024	0,085 0.0034	0,14 0.0055
N3	MM10-10010-B90PF-M02 F15M	3,5 0.14	0,050 0.0020	0,060 0.0024	0,085 0.0034	0,14 0.0055
N11	MM10-10010-B90PF-M02 F15M	3,5 0.14	0,050 0.0020	0,060 0.0024	0,085 0.0034	0,14 0.0055
S1	MM10-10010-B90PF-M02 F15M	2,0 0.080	0,028 0.0011	0,030 0.0013	0,042 0.0017	0,070 0.0028
S2	MM10-10010-B90PF-M02 F15M	2,0 0.080	0,028 0.0011	0,030 0.0013	0,042 0.0017	0,070 0.0028
S3	MM10-10010-B90PF-M02 F15M	2,0 0.080	0,025 0.0010	0,028 0.0012	0,040 0.0016	0,065 0.0026
S11	MM10-10010-B90PF-M02 F15M	2,5 0.10	0,030 0.0012	0,036 0.0014	0,048 0.0019	0,075 0.0030
S12	MM10-10010-B90PF-M02 F15M	2,5 0.10	0,030 0.0012	0,036 0.0014	0,048 0.0019	0,075 0.0030
S13	MM10-10010-B90PF-M02 F15M	2,0 0.080	0,028 0.0011	0,030 0.0013	0,042 0.0017	0,070 0.0028
H5	MM10-10010-B90PF-M02 F15M	3,0 0.12	0,026 0.0010	0,030 0.0012	0,042 0.0017	0,065 0.0026
H8	MM10-10010-B90PF-M02 F15M	2,5 0.10	0,020 0.00080	0,022 0.00095	0,032 0.0013	0,050 0.0020
H11	MM10-10010-B90PF-M02 F15M	3,0 0.12	0,026 0.0010	0,030 0.0012	0,042 0.0017	0,065 0.0026
H12	MM10-10010-B90PF-M02 F15M	2,5 0.10	0,020 0.00080	0,022 0.00095	0,032 0.0013	0,050 0.0020
H21	MM10-10010-B90PF-M02 F15M	2,5 0.10	0,020 0.00080	0,022 0.00095	0,032 0.0013	0,050 0.0020

SMG = Seco material group
f_z = mm/tooth (in/tooth), v_c = m/min (sf/min), a_p/DC = %
All cutting data are start values

Universal
Steel and cast iron
Stainless steel and S-materials
Non ferrous
Hard
Plastic and chip
Graphite
Minimaster Plus
Minimaster

MM10 Z2 – Copy milling – Cutting data $v_c = (m/min)/(sf/min)$

	SMG	F15M					F30M					T60M				
		100%	20%	10%	5%	2%	100%	20%	10%	5%	2%	100%	20%	10%	5%	2%
Universal	P1	305	390	405	440	440	250	320	340	370	365	205	260	275	300	295
		1000	1275	1325	1450	1450	820	1050	1125	1225	1200	670	850	900	980	970
Steel and cast iron	P2	295	380	395	425	425	240	305	330	355	355	195	250	270	285	285
		970	1250	1300	1400	1400	790	1000	1075	1175	1175	640	820	890	940	940
Stainless steel and S-materials	P3	260	330	340	370	370	210	265	285	310	310	170	215	235	250	250
		850	1075	1125	1225	1225	690	870	940	1025	1025	560	710	770	820	820
	P4	225	290	300	325	325	185	235	255	270	275	150	190	205	220	220
		740	950	980	1075	1075	610	770	840	890	900	490	620	670	720	720
	P5	215	275	290	315	310	175	225	240	265	260	145	185	195	215	210
		710	900	950	1025	1025	570	740	790	870	850	475	610	640	710	690
	P6	245	310	325	350	350	200	255	275	295	295	165	205	220	240	235
		800	1025	1075	1150	1150	660	840	900	970	970	540	670	720	790	770
	P7	230	295	305	330	330	190	240	260	280	275	155	195	210	225	225
		750	970	1000	1075	1075	620	790	850	920	900	510	640	690	740	740
	P8	215	275	290	310	310	175	225	240	260	260	145	180	195	210	210
		710	900	950	1025	1025	570	740	790	850	850	475	590	640	690	690
	P11	225	285	295	325	320	185	235	250	270	270	150	190	205	220	215
		740	940	970	1075	1050	610	770	820	890	890	490	620	670	720	710
	P12	140	175	180	195	195	120	150	155	170	170	95	120	125	135	135
		460	570	610	640	640	395	490	510	560	560	310	395	410	445	445
Non ferrous	M1	240	305	320	345	345	195	245	265	285	285	160	200	215	230	230
		790	1000	1050	1125	1125	640	800	870	940	940	520	660	710	750	750
	M2	195	250	260	280	280	160	205	215	235	235	130	165	175	190	190
		640	820	850	920	920	520	670	710	770	770	425	540	570	620	620
	M3	155	200	200	220	220	130	165	175	185	185	105	135	140	150	150
		510	660	670	720	720	425	540	570	610	610	345	445	460	490	490
	M4	120	155	155	165	165	105	135	130	145	140	85	105	105	115	115
		395	510	560	540	540	345	445	460	475	460	280	345	375	375	375
	M5	100	130	130	140	140	85	110	110	120	120	70	90	90	95	95
		330	425	460	460	460	280	360	375	395	395	230	295	310	310	310
Hard	K1	235	300	315	335	335	190	245	260	280	280	155	195	210	225	225
		770	980	1025	1100	1100	620	800	850	920	920	510	640	690	740	740
	K2	205	265	275	295	295	170	215	230	250	250	135	175	185	200	200
		670	870	900	970	970	560	710	750	820	820	445	570	610	660	660
	K3	175	225	230	250	250	140	180	195	210	210	115	150	155	170	170
		570	740	750	820	820	460	590	640	690	690	375	490	510	560	560
	K4	165	215	220	240	240	135	175	185	200	200	110	140	150	165	160
		540	710	720	790	790	445	570	610	660	660	360	460	490	540	520
	K5	100	130	135	145	145	85	105	110	120	120	70	85	90	100	100
		330	425	445	475	475	280	345	360	395	395	230	280	295	330	330
	K6	145	185	195	210	210	120	155	165	180	175	95	125	130	145	145
		475	610	640	690	690	395	510	540	590	570	310	410	425	475	475
	K7	130	165	170	185	185	105	135	145	155	155	85	110	115	125	125
		425	540	560	610	610	345	445	475	510	510	280	360	375	410	410
Graphite	N1	1800	2300	2425	2600	2600	1450	1825	1975	2150	2100	1175	1475	1600	1725	1700
		5900	7550	7950	8525	8525	4750	6000	6475	7050	6900	3850	4850	5250	5650	5575
	N2	730	930	970	1050	1050	590	740	800	870	850	475	600	650	700	680
		2400	3050	3175	3450	3450	1925	2425	2625	2850	2800	1550	1975	2125	2300	2225
	N3	485	620	650	700	700	390	495	530	580	560	315	400	435	465	455
		1600	2025	2125	2300	2300	1275	1625	1750	1900	1825	1025	1300	1425	1525	1500
	N11	550	710	740	800	800	450	570	610	660	640	360	460	495	530	520
		1800	2325	2425	2625	2625	1475	1875	2000	2175	2100	1175	1500	1625	1750	1700
Minimaster Plus	S1	55	70	70	80	75	48	60	60	65	65	39	50	50	55	55
		180	230	260	260	245	155	195	215	215	215	130	165	180	180	180
	S2	46	60	60	65	60	39	50	50	55	55	32	40	40	43	43
		150	195	215	215	195	130	165	180	180	180	105	130	140	140	140
	S3	40	50	50	55	55	34	43	43	47	46	27	35	35	38	38
		130	165	180	180	180	110	140	150	155	150	90	115	120	125	125
	S11	80	100	100	110	110	65	85	85	95	95	55	70	70	75	75
		260	330	360	360	360	215	280	295	310	310	180	230	245	245	245
	S12	55	70	70	75	75	47	60	60	65	65	38	48	49	55	55
		180	230	245	245	245	155	195	195	215	215	125	155	165	180	180
	S13	32	41	40	44	43	27	35	35	37	37	22	28	28	30	30
		105	135	145	145	140	90	115	120	120	120	70	90	100	100	100
Minimaster	H5	46	60	60	65	65	39	50	50	55	55	32	41	42	45	45
		150	195	195	215	215	130	165	165	180	180	105	135	140	150	150
	H8	48	60	60	65	65	41	55	55	60	60	33	43	43	47	47
		155	195	215	215	215	135	180	180	195	195	110	140	150	155	155
	H11	60	75	75	85	85	50	65	65	70	70	40	50	55	60	60
		195	245	260	280	280	165	215	215	230	230	130	165	180	195	195
	H12	85	110	110	120	120	75	95	95	105	105	60	75	80	85	85
		280	360	375	395	395	245	310	330	345	345	195	245	260	280	280
	H21	48	60	60	65	65	41	55	55	60	60	33	43	43	47	47
		155	195	215	215	215	135	180	180	195	195	110	140	150	155	155

MM10 High-Feed – Insert selection – mm/inch

SMG		a _p	f _z			
			100%	70%	30%	20%
P1	MM10-10.50-HF-MD08 F30M	0,30	0,48	0,48	0,65	0,80
		0.012	0.019	0.019	0.026	0.032
P2	MM10-10.50-HF-MD08 F30M	0,30	0,50	0,50	0,65	0,80
		0.012	0.020	0.020	0.026	0.032
P3	MM10-10.50-HF-MD08 F30M	0,30	0,46	0,46	0,60	0,75
		0.012	0.018	0.018	0.024	0.030
P4	MM10-10.50-HF-MD08 F30M	0,30	0,46	0,46	0,60	0,75
		0.012	0.018	0.018	0.024	0.030
P5	MM10-10.50-HF-MD08 F30M	0,30	0,44	0,46	0,60	0,75
		0.012	0.017	0.018	0.024	0.030
P6	MM10-10.50-HF-MD08 F30M	0,30	0,44	0,44	0,60	0,75
		0.012	0.017	0.017	0.024	0.030
P7	MM10-10.50-HF-MD08 F30M	0,30	0,44	0,44	0,60	0,75
		0.012	0.017	0.017	0.024	0.030
P8	MM10-10.50-HF-MD08 F30M	0,30	0,46	0,46	0,60	0,75
		0.012	0.018	0.018	0.024	0.030
P11	MM10-10.50-HF-MD08 F30M	0,30	0,44	0,44	0,60	0,75
		0.012	0.017	0.017	0.024	0.030
P12	MM10-10.50-HF-MD08 F30M	0,25	0,30	0,30	0,40	0,48
		0.010	0.012	0.012	0.016	0.019
M1	MM10-10.50-HF-MD08 F30M	0,30	0,50	0,50	0,65	0,80
		0.012	0.020	0.020	0.026	0.032
M2	MM10-10.50-HF-MD08 F30M	0,30	0,44	0,46	0,60	0,75
		0.012	0.017	0.018	0.024	0.030
M3	MM10-10.50-HF-MD08 F30M	0,25	0,36	0,36	0,46	0,55
		0.010	0.014	0.014	0.018	0.022
M4	MM10-10.50-HF-MD08 F30M	0,18	0,32	0,32	0,40	0,50
		0.0070	0.013	0.013	0.016	0.020
M5	MM10-10.50-HF-MD08 F30M	0,18	0,32	0,32	0,40	0,50
		0.0070	0.013	0.013	0.016	0.020
K1	MM10-10.50-HF-MD08 F30M	0,30	0,50	0,50	0,65	0,80
		0.012	0.020	0.020	0.026	0.032
K2	MM10-10.50-HF-MD08 F30M	0,30	0,44	0,46	0,60	0,75
		0.012	0.017	0.018	0.024	0.030
K3	MM10-10.50-HF-MD08 F30M	0,30	0,44	0,46	0,60	0,75
		0.012	0.017	0.018	0.024	0.030
K4	MM10-10.50-HF-MD08 F30M	0,30	0,44	0,46	0,60	0,75
		0.012	0.017	0.018	0.024	0.030
K5	MM10-10.50-HF-MD08 F30M	0,30	0,40	0,40	0,55	0,65
		0.012	0.016	0.016	0.022	0.026
K6	MM10-10.50-HF-MD08 F30M	0,30	0,44	0,46	0,60	0,75
		0.012	0.017	0.018	0.024	0.030
K7	MM10-10.50-HF-MD08 F30M	0,30	0,40	0,40	0,55	0,65
		0.012	0.016	0.016	0.022	0.026
N1	MM10-10.50-HF-MD08 F30M	0,30	0,65	0,65	0,85	1,1
		0.012	0.026	0.026	0.034	0.044
N2	MM10-10.50-HF-MD08 F30M	0,30	0,65	0,65	0,85	1,1
		0.012	0.026	0.026	0.034	0.044
N3	MM10-10.50-HF-MD08 F30M	0,30	0,65	0,65	0,85	1,1
		0.012	0.026	0.026	0.034	0.044
N11	MM10-10.50-HF-MD08 F30M	0,30	0,65	0,65	0,85	1,1
		0.012	0.026	0.026	0.034	0.044
S1	MM10-10.50-HF-MD08 F30M	0,18	0,32	0,32	0,40	0,50
		0.0070	0.013	0.013	0.016	0.020
S2	MM10-10.50-HF-MD08 F30M	0,18	0,32	0,32	0,40	0,50
		0.0070	0.013	0.013	0.016	0.020
S3	MM10-10.50-HF-MD08 F30M	0,18	0,30	0,30	0,38	0,46
		0.0070	0.012	0.012	0.015	0.018
S11	MM10-10.50-HF-MD08 F30M	0,22	0,36	0,36	0,46	0,55
		0.0085	0.014	0.014	0.018	0.022
S12	MM10-10.50-HF-MD08 F30M	0,22	0,36	0,36	0,46	0,55
		0.0085	0.014	0.014	0.018	0.022
S13	MM10-10.50-HF-MD08 F30M	0,18	0,32	0,32	0,40	0,50
		0.0070	0.013	0.013	0.016	0.020
H5	MM10-10.50-HF-MD08 F15M	0,25	0,30	0,30	0,40	0,48
		0.010	0.012	0.012	0.016	0.019
H8	MM10-10.50-HF-MD08 F15M	0,22	0,24	0,24	0,30	0,36
		0.0085	0.0095	0.0095	0.012	0.014
H11	MM10-10.50-HF-MD08 F15M	0,25	0,30	0,30	0,40	0,48
		0.010	0.012	0.012	0.016	0.019
H12	MM10-10.50-HF-MD08 F15M	0,22	0,24	0,24	0,30	0,36
		0.0085	0.0095	0.0095	0.012	0.014
H21	MM10-10.50-HF-MD08 F15M	0,22	0,24	0,24	0,30	0,36
		0.0085	0.0095	0.0095	0.012	0.014





SMG = Seco material group
f_z = mm/tooth (in/tooth), v_c = m/min (sf/min), a_p/DC = %
All cutting data are start values

Universal
Steel and cast iron
Stainless steel and S-materials
Non ferrous
Hard
Plastic and chip
Graphite
Minimaster Plus
Minimaster

MM10 High-Feed – Cutting data $v_c = (m/min)/(sf/min)$

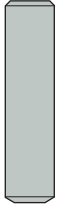
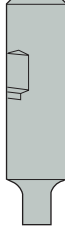
SMG	F15M				F30M				
	100%	70%	30%	20%	100%	70%	30%	20%	
Universal	P1	—	—	—	230	280	325	340	
		—	—	—	750	920	1075	1125	
Steel and cast iron	P2	—	—	—	225	270	315	330	
		—	—	—	740	890	1025	1075	
	P3	—	—	—	195	240	275	290	
		—	—	—	640	790	900	950	
	P4	—	—	—	170	210	240	255	
Stainless steel and S-materials		—	—	—	560	690	790	840	
	P5	—	—	—	165	200	230	240	
		—	—	—	540	660	750	790	
	P6	—	—	—	185	225	260	270	
		—	—	—	610	740	850	890	
	P7	—	—	—	175	215	245	255	
		—	—	—	570	710	800	840	
	P8	—	—	—	165	200	230	240	
		—	—	—	540	660	750	790	
	P11	—	—	—	170	210	240	250	
		—	—	—	560	690	790	820	
	P12	—	—	—	110	135	150	160	
	—	—	—	360	445	490	520		
Non ferrous	M1	—	—	—	180	220	255	265	
		—	—	—	590	720	840	870	
	M2	—	—	—	150	180	210	220	
		—	—	—	490	590	690	720	
	M3	—	—	—	120	145	165	175	
	—	—	—	395	475	540	570		
Hard	M4	—	—	—	95	110	130	135	
		—	—	—	310	360	425	445	
	M5	—	—	—	80	95	110	115	
		—	—	—	260	310	360	375	
	K1	190	230	270	280	175	215	250	260
	620	750	890	920	570	710	820	850	
K2	170	205	235	245	160	190	220	230	
	560	670	770	800	520	620	720	750	
Plastic and cfrp	K3	145	175	200	210	135	160	185	195
		475	570	660	690	445	520	610	640
	K4	135	165	190	200	125	155	175	185
		445	540	620	660	410	510	570	610
	K5	85	100	115	125	75	95	105	115
		280	330	375	410	245	310	345	375
	K6	120	145	170	175	110	135	155	165
	395	475	560	570	360	445	510	540	
Graphite	K7	105	130	150	155	100	120	140	145
		345	425	490	510	330	395	460	475
	N1	—	—	—	—	1325	1600	1850	1925
		—	—	—	—	4350	5250	6075	6325
	N2	—	—	—	—	530	650	750	780
	—	—	—	—	1750	2125	2450	2550	
Minimaster Plus	N3	—	—	—	—	355	430	500	520
		—	—	—	—	1175	1400	1650	1700
	N11	—	—	—	—	405	495	570	590
		—	—	—	—	1325	1625	1875	1925
	S1	—	—	—	—	45	50	60	65
	—	—	—	—	150	165	195	215	
Minimaster	S2	—	—	—	—	36	42	49	50
		—	—	—	—	120	140	160	165
	S3	—	—	—	—	31	37	42	45
		—	—	—	—	100	120	140	150
	S11	—	—	—	—	60	75	85	90
		—	—	—	—	195	245	280	295
	S12	—	—	—	—	43	50	60	60
		—	—	—	—	140	165	195	195
	S13	—	—	—	—	25	29	34	36
		—	—	—	—	80	95	110	120
	H5	40	48	55	60	37	44	50	55
		130	155	180	195	120	145	165	180
	H8	42	50	55	60	39	46	55	55
	140	165	180	195	130	150	180	180	
Universal	H11	50	60	70	75	47	55	65	70
		165	195	230	245	155	180	215	230
	H12	75	90	105	110	70	85	95	100
		245	295	345	360	230	280	310	330
	H21	42	50	55	60	39	46	55	55
	140	165	180	195	130	150	180	180	

Shank design

Design 1, Keyway shank	Design 2, Cylindrical/Weldon back end and 90° front
	
Design 3, Cylindrical/Weldon back end tapered front 87°/89°	Design 4, Cylindrical/Weldon back end tapered front 80°/85°/87°
	
Design 5, Cylindrical back end double tapered front end 89°/85°	
	

Universal
Steel and cast iron
Stainless steel and S-materials
Non ferrous
Hard
Plastic and cfrp
Graphite
Minimaster Plus
Minimaster

MM12 Shank – Metric

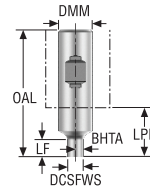

• For ISO attribute explanation, see page [XXX]

Designation	Item number	ShankType	DCSFWS	DMM	OAL	LF	LPR	BHTA°	Design		RPMX	Weight	Spare part no.
			mm	mm	mm	mm	mm					kg	
MM12-20080.3-0012	75012864	Weldon	11,4	20,0	80,0	12,0	30,0	0,0	2	✓	80000	0,2	4
MM12-20095.3-3027	75012865	Weldon	11,4	20,0	95,0	27,0	45,0	3,0	3	✓	80000	0,2	4
MM12-20150.3-5049	75012866	Weldon	11,4	20,0	150,0	49,1	100,0	5,0	4	✓	80000	0,3	5
MM12-12055.0-0008	00083978	Cylindrical	11,5	12,0	55,0	8,5	10,0	0,0	2	✓	80000	0,1	2
MM12-16065.0-0000	75004926	Cylindrical	11,4	16,0	65,0	0,0	17,0	60,0	1	✓	80000	0,1	1
MM12-16170.0-1040	75034505	Cylindrical	11,4	16,0	170,0	40,0	122,0	1,0	3	✓	80000	0,2	5
MM12-16170.0-1060	75034506	Cylindrical	11,4	16,0	170,0	60,0	122,0	1,0	3	✓	80000	0,2	5
MM12-16170.0-1080	75034507	Cylindrical	11,4	16,0	170,0	80,0	122,0	1,0	3	✓	80000	0,2	5
MM12-12070.0-0008DS	02580668	Cylindrical Densimet	11,5	12,0	70,0	8,5	25,0	0,0	2	✓	63600	0,1	3
MM12-16095.0-0024DS	02580690	Cylindrical Densimet	11,4	16,0	95,0	24,0	47,0	0,0	2	✓	63600	0,3	3
MM12-16090.0-3044DS	02580705	Cylindrical Densimet	11,4	16,0	90,0	43,9	42,0	3,0	4	✓	63600	0,3	3
MM12-16120.0-1045DS	02580752	Cylindrical Densimet	11,4	16,0	120,0	45,0	72,0	1,0	3	✓	63600	0,3	3
MM12-16115.0-0048DS	02580691	Cylindrical Densimet	11,4	16,0	115,0	48,0	67,0	0,0	2	✓	63600	0,3	3
MM12-16170.0-1060DS	02580753	Cylindrical Densimet	11,4	16,0	170,0	60,0	122,0	1,0	3	✓	63600	0,5	3
MM12-16170.0-1080DS	02580755	Cylindrical Densimet	11,4	16,0	170,0	80,0	122,0	1,0	3	✓	63600	0,5	3
MM12-20250.0-1060DS	02580756	Cylindrical Densimet	11,4	20,0	250,0	60,0	200,0	1,0	5	✓	63600	1,0	3

Spare Parts

Accessories

For cutter	Sleeve	Tension screw	Sleeve key
4	MM-06048	MM12-0637	H06-4
5	MM-06116	MM12-0637	H06-4
2	MM-06020	MM12-0637	H05-4
1	MM-06032	MM12-0637	H06-4
3	-	MM12-061037	-

MM12 Shank – Inch

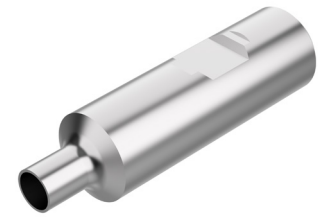
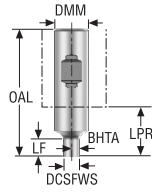

• For ISO attribute explanation, see page [XXX]

Designation	Item number	ShankType	DCSFWS	DMM	OAL	LF	LPR	BHTA°	Design		RPMX	Weight	Spare part no.
			Inch	Inch	Inch	Inch	Inch					lbs	
MM12-0.75-3.1-3-0004	75015055	Weldon	0.449	0.750	3.150	0.472	1.181	0,0	2	✓	80000	0.440	3
MM12-0.75-3.7-3-3010	75015056	Weldon	0.449	0.750	3.740	1.063	1.772	3,0	3	✓	80000	0.440	3
MM12-0.75-5.9-3-5017	75015057	Weldon	0.449	0.750	5.906	1.720	3.937	5,0	4	✓	80000	0.660	5
MM12-0.50-2.2-0-0003	00096133	Cylindrical	0.453	0.500	2.165	0.335	0.394	0,0	2	✓	80000	0.220	2
MM12-0.62-2.6-0-0000	75005070	Cylindrical	0.449	0.625	2.559	–	0.669	60,0	1	✓	80000	0.220	1
MM12-0.62-6.7-0-1015	75054728	Cylindrical	0.449	0.625	6.693	1.575	4.803	1,0	3	✓	80000	0.660	5
MM12-0.62-6.7-0-1023	75054729	Cylindrical	0.449	0.625	6.693	2.362	4.803	1,0	3	✓	80000	0.440	5
MM12-0.62-6.7-0-1023DS	02593423	Cylindrical Densimet	0.449	0.625	6.693	2.362	4.803	1,0	3	✓	63600	1.100	4
MM12-0.62-6.7-0-1031DS	02593426	Cylindrical Densimet	0.449	0.625	6.693	3.150	4.803	1,0	3	✓	63600	1.100	4
MM12-0.75-10.0-0-1023DS	02593427	Cylindrical Densimet	0.449	0.750	9.843	2.362	7.874	1,0	5	✓	63600	2.200	4
MM12-0.75-3.8-0-0009DS	02593428	Cylindrical Densimet	0.449	0.750	3.740	0.945	1.772	0,0	2	✓	63600	0.880	4
MM12-0.75-4.5-0-0018DS	02593430	Cylindrical Densimet	0.449	0.750	4.528	1.890	2.559	0,0	2	✓	63600	0.880	4

Spare Parts

Accessories

For cutter	Sleeve	Tension screw	Sleeve key
3	 MM-06048	 MM12-0637	 H06-4
5	MM-06116	MM12-0637	H06-4
2	MM-06020	MM12-0637	H05-4
1	MM-06032	MM12-0637	H06-4
4	–	MM12-061037	–

Universal

Steel and cast iron

Stainless steel and S-materials

Non ferrous

Hard

Plastic and chip

Graphite

Minimaster Plus

Minimaster

Slot milling/square shoulder milling

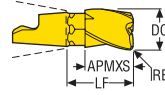

• For Torque keys and torque values, see page 615

Designation	DC	APMXS	RE	LF	RMPX°	C min	C max	FHA°	ZEPF	Wrench		Grades			
												Coated			
	mm Inch	mm Inch	mm Inch	mm Inch								T60M	F15M	F30M	F40M
MM12-12015-A30-E04	12,0 0.472	15,35 0.604	0,0 0.0	19,9 0.783	15,0	14,6	23,8	30	3	MM0416	✓			■	
MM12-12015-R05A30-M04	12,0 0.472	15,35 0.604	0,5 0.020	19,9 0.783	15,0	14,6	22,8	30	3	MM0416	✓				■
MM12-12015-R10A30-E04	12,0 0.472	15,35 0.604	1,0 0.039	19,9 0.783	15,0	14,6	21,8	30	3	MM0416	✓			■	
MM12-12015-R10A30-M04	12,0 0.472	15,35 0.604	1,0 0.039	19,9 0.783	15,0	14,6	21,8	30	3	MM0416	✓				■
MM12-12015-R15A30-D04	12,0 0.472	15,35 0.604	1,5 0.059	19,9 0.783	15,0	14,6	20,8	30	3	MM0416	✓			■	
MM12-12015-R20A30-M04	12,0 0.472	15,35 0.604	2,0 0.079	19,9 0.783	15,0	14,6	19,8	30	3	MM0416	✓				■
MM12-12015-R30A30-E04	12,0 0.472	15,3 0.602	3,0 0.118	19,9 0.783	15,0	14,6	17,8	30	3	MM0416	✓			■	
MM12-12015-R30A30-M04	12,0 0.472	15,35 0.604	3,0 0.118	19,9 0.783	15,0	14,6	17,8	30	3	MM0416	✓				■
MM12-12015-R40A30-M04	12,0 0.472	15,35 0.604	4,0 0.157	19,9 0.783	15,0	14,6	15,8	30	3	MM0416	✓				■
MM12-11715-R03A30-M04	11,7 0.461	15,35 0.604	0,3 0.012	19,9 0.783	15,0	14,2	22,6	30	3	MM0416	✓				■
MM12-12715-A30-E04	12,7 0.500	15,35 0.604	0,0 0.0	19,9 0.783	15,0	15,4	25,2	30	3	MM0416	✓			■	
MM12-12715-R08A30-M04	12,7 0.500	15,35 0.604	0,8 0.031	19,9 0.783	15,0	15,4	23,6	30	3	MM0416	✓				■
MM12-12715-R16A30-M04	12,7 0.500	15,35 0.604	1,6 0.063	19,9 0.783	15,0	15,4	22,0	30	3	MM0416	✓				■

Slot milling/square shoulder milling

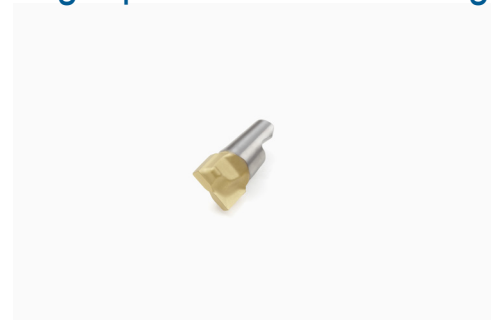
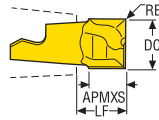

• For Torque keys and torque values, see page 615

Designation	DC	APMXS	RE	LF	RMPX°	C min	C max	FHA°	ZEFP	Wrench	Grades			
											Coated			
											T60M	F15M	F30M	F40M
MM12-12008-M04	12,0 0.472	8,2 0.323	0,0 NaN	10,2 0.402	15,0	14,6	23,8	0	2	MM0612	■			
MM12-12008-R08-MD05	12,0 0.472	8,2 0.323	0,8 0.031	10,18 0.401	15,0	14,6	22,2	0	2	MM0612	■		■	
MM12-12008-R08A8-E04	12,0 0.472	8,1 0.319	0,8 0.031	10,15 0.400	15,0	14,6	22,2	8	2	MM0612	■			
MM12-12008-R08P-M04	12,0 0.472	8,1 0.319	0,8 0.031	10,05 0.396	15,0	14,6	22,2	0	2	MM0612			■	
MM12-12008-R20-MD05	12,0 0.472	8,2 0.323	2,0 0.079	10,16 0.400	15,0	14,6	19,8	0	2	MM0612			■	
MM12-12008-R30-MD05	12,0 0.472	8,2 0.323	3,0 0.118	10,14 0.399	15,0	14,6	17,8	0	2	MM0612			■	
MM12-14009-M04	14,0 0.551	9,3 0.366	0,0 NaN	11,26 0.443	15,0	17,0	27,8	0	2	MM1420	■			
MM12-14009-R08-MD05	14,0 0.551	9,3 0.366	0,8 0.031	11,26 0.443	15,0	17,0	26,2	0	2	MM1420	■		■	
MM12-14009-R08A8-E04	14,0 0.551	9,2 0.362	0,8 0.031	11,06 0.435	15,0	17,0	26,2	8	2	MM1420	■		■	
MM12-12708-M04	12,7 0.500	9,3 0.366	0,0 NaN	11,25 0.443	15,0	15,4	25,2	0	2	MM1420	■			
MM12-12708-R08-MD05	12,7 0.500	9,3 0.366	0,8 0.031	11,23 0.442	15,0	15,4	23,6	0	2	MM1420	■			
MM12-12708-R08P-M04	12,7 0.500	9,3 0.366	0,8 0.031	11,23 0.442	15,0	15,4	23,6	0	2	MM1420			■	
MM12-12708-R32-MD05	12,7 0.500	9,3 0.366	3,175 0.125	11,18 0.440	15,0	15,4	18,8	0	2	MM1420			■	
MM12-11708T-R03-D05	11,7 0.461	8,2 0.323	0,3 0.012	10,18 0.401	15,0	14,2	22,6	0	2	MM0612	■			
MM12-13709T-R03-D05	13,7 0.539	9,3 0.366	0,3 0.012	11,25 0.443	15,0	16,6	26,6	0	2	MM1420	■			

Universal

Steel and cast iron

Stainless steel and S-materials

Non ferrous

Hard

Plastic and chip

Graphite

Minimaster Plus

Minimaster

Centre drilling

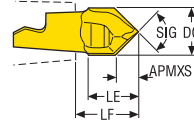

• For Torque keys and torque values, see page 615

Designation	DC	APMXS	LE	LF	SIG°	ZFP	Wrench	Grades			
								T60M	F15M	F30M	F40M
MM12-12006-C90-M04	12,0 0.472	5,65 0.222	12,65 0.498	14,64 0.576	90,0	2	MM0612	■			

Plunge milling

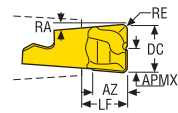

• For Torque keys and torque values, see page 615

Designation	DC	APMXE	RE	AZ	LF	RA°	ZFP	Wrench	Grades			
									T60M	F15M	F30M	F40M
MM12-12008-R10-PL-MD05	12,0 0.472	6,0 0.236	1,0 0.039	8,5 0.335	10,2 0.402	5,0	2	MM0612			■	

Concave radius

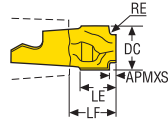

• For Torque keys and torque values, see page 615

Designation	DC	APMXS	RE	LF	ZEPF	Wrench 	Grades			
							T60M	F15M	F30M	F40M
MM12-12010-CR10-MD05	12,0 0.472	2,2 0.087	1,0 0.039	12,14 0.478	2	MM0612	■			
MM12-12010-CR20-MD05	12,0 0.472	2,4 0.094	2,0 0.079	12,25 0.482	2	MM0612	■			
MM12-12010-CR30-MD05	12,0 0.472	3,3 0.130	3,0 0.118	12,2 0.480	2	MM0612	■			

Double chamfering

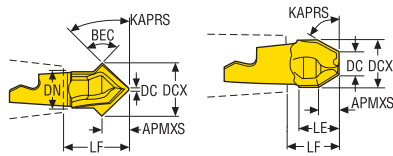

• For Torque keys and torque values, see page 615

Designation	DCX	DC	APMXS	LF	DN	BEC°	KAPRS°	ZEPF	Wrench 	Grades			
										T60M	F15M	F30M	F40M
MM12-16016-D3020P-M02	16,0 0.630	1,0 0.039	4,3 0.169	15,2 0.598	11,5 0.453	60,0	30,0	2	MM1420		■		
MM12-16016-D4520P-M02	16,0 0.630	1,0 0.039	7,5 0.295	17,2 0.677	11,5 0.453	90,0	45,0	2	MM1420		■		

Universal

Steel and cast iron

Stainless steel and S-materials

Non ferrous

Hard

Plastic and cfrp

Graphite

Minimaster Plus

Minimaster

Precision inserts for semi-finishing in all materials

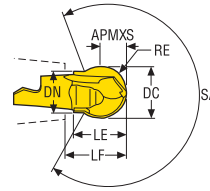

• For Torque keys and torque values, see page 615

Designation	DC	APMXS	RE	LE	LF	DN	SA°	ZEFP	Wrench 	Grades			
										T60M	F15M	F30M	F40M
	mm <i>Inch</i>	mm <i>Inch</i>	mm <i>Inch</i>	mm <i>Inch</i>	mm <i>Inch</i>	mm <i>Inch</i>							
MM12-14014-B120P-M05	14,0 <i>0.551</i>	7,0 <i>0.276</i>	7,0 <i>0.276</i>	14,0 <i>0.551</i>	15,45 <i>0.608</i>	12,0 <i>0.472</i>	242,0	2	MM1420			■	
MM12-16016-B120P-M07	16,0 <i>0.630</i>	8,0 <i>0.315</i>	8,0 <i>0.315</i>	16,0 <i>0.630</i>	17,46 <i>0.687</i>	12,0 <i>0.472</i>	263,0	2	MM1420			■	
MM12-16016-B120PF-M03	16,0 <i>0.630</i>	8,0 <i>0.315</i>	8,0 <i>0.315</i>	16,0 <i>0.630</i>	17,46 <i>0.687</i>	12,0 <i>0.472</i>	263,0	2	MM1420		■		

Universal

Steel and cast iron

Stainless steel and S-materials

Non ferrous

Hard

Plastic and cfrp

Graphite

Minimaster Plus

Minimaster

Copy milling

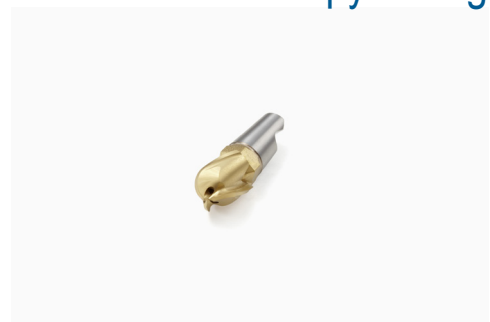
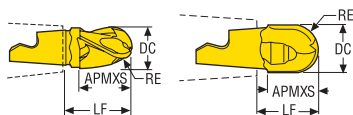

• For Torque keys and torque values, see page 615

Designation	DC	APMXS	RE	LF	FHA°	ZEFP	Wrench		Grades			
									Coated			
									T60M	F15M	F30M	F40M
MM12-12015-B90A30-E04	12,0 0.472	15,3 0.602	6,0 0.236	19,9 0.783	30,0	3	MM0416	✓			■	
MM12-12015-B90A30-M04	12,0 0.472	15,3 0.602	6,0 0.236	19,9 0.783	30,0	3	MM0416	✓				■
MM12-12715-B90A30-M04	12,7 0.500	15,3 0.602	6,35 0.250	19,75 0.778	30,0	3	MM0416	✓				■
MM12-12012-B90-MD05	12,0 0.472	12,2 0.480	6,0 0.236	14,12 0.556	0,0	2	MM0612		■		■	
MM12-12012-B90S-E05	12,0 0.472	12,3 0.484	6,0 0.236	14,12 0.556	0,0	2	MM0612				■	
MM12-14014-B90S-E05	14,0 0.551	14,1 0.555	7,0 0.276	15,92 0.627	0,0	2	MM1420				■	
MM12-12012-B90P-M05	12,0 0.472	10,4 0.409	6,0 0.236	14,09 0.555	0,0	2	MM0612				■	
MM12-12713-B90P-M05	12,7 0.500	12,2 0.480	6,35 0.250	15,92 0.627	0,0	2	MM1420		■		■	
MM12-12012-B90PF-M02	12,0 0.472	10,4 0.409	6,0 0.236	14,09 0.555	0,0	2	MM0612			■		

Universal

Steel and cast iron

Stainless steel and S-materials

Non ferrous

Hard

Plastic and chip

Graphite

Minimaster Plus

Minimaster

High feed

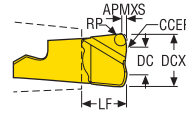

• For Torque keys and torque values, see page 615

Designation	DCX	DC	APMXS	RP	CCER	LF	RMPX°	C min	C max	ZEFP	Wrench	Grades			
												Coated			
	mm Inch	mm Inch	mm Inch	mm Inch	mm Inch	mm Inch						T60M	F15M	F30M	F40M
MM12-12.60-HF-MD10	12,0 0.472	6,0 0.236	0,51 0.020	1,21 0.048	6,5 0.256	10,25 0.404	5,0	14,6	22,2	2	MM0612		■	■	

Universal

Steel and cast iron

Stainless steel and S-materials

Non ferrous

Hard

Plastic and cfrp

Graphite

Minimaster Plus

Minimaster

MM12 - Slot and Side milling – Insert selection – mm/Inch

SMG		a _p	f _z			
			100%	40%	20%	10%
P1	MM12-12015-R05A30-M04 F40M	2,5	0,055	0,060	0,070	0,095
		0.10	0.0022	0.0024	0.0028	0.0038
P2	MM12-12015-R05A30-M04 F40M	2,5	0,060	0,060	0,070	0,095
		0.10	0.0024	0.0024	0.0028	0.0038
P3	MM12-12015-R05A30-M04 F40M	2,5	0,055	0,055	0,070	0,090
		0.10	0.0022	0.0022	0.0028	0.0036
P4	MM12-12015-R05A30-M04 F40M	2,5	0,055	0,055	0,065	0,090
		0.10	0.0022	0.0022	0.0026	0.0036
P5	MM12-12015-R05A30-M04 F40M	2,5	0,055	0,055	0,065	0,085
		0.10	0.0022	0.0022	0.0026	0.0034
P6	MM12-12015-R05A30-M04 F40M	2,5	0,050	0,055	0,065	0,085
		0.10	0.0020	0.0022	0.0026	0.0034
P7	MM12-12015-R05A30-M04 F40M	2,5	0,050	0,055	0,065	0,085
		0.10	0.0020	0.0022	0.0026	0.0034
P8	MM12-12015-R05A30-M04 F40M	2,5	0,055	0,055	0,070	0,090
		0.10	0.0022	0.0022	0.0028	0.0036
P11	MM12-12015-R05A30-M04 F40M	2,5	0,050	0,055	0,065	0,085
		0.10	0.0020	0.0022	0.0026	0.0034
P12	MM12-12015-R05A30-M04 F40M	2,0	0,036	0,036	0,044	0,060
		0.080	0.0014	0.0014	0.0017	0.0024
M1	MM12-12015-R05A30-M04 F40M	2,5	0,060	0,060	0,070	0,095
		0.10	0.0024	0.0024	0.0028	0.0038
M2	MM12-12015-R05A30-M04 F40M	2,5	0,055	0,055	0,065	0,085
		0.10	0.0022	0.0022	0.0026	0.0034
M3	MM12-12015-R05A30-M04 F40M	2,0	0,042	0,044	0,050	0,070
		0.080	0.0017	0.0017	0.0020	0.0028
M4	MM12-12015-R05A30-M04 F40M	1,6	0,038	0,038	0,046	0,060
		0.065	0.0015	0.0015	0.0018	0.0024
M5	MM12-12015-R05A30-M04 F40M	1,6	0,038	0,038	0,046	0,060
		0.065	0.0015	0.0015	0.0018	0.0024
K1	MM12-12015-R10A30-E04 F30M	2,5	0,060	0,060	0,070	0,095
		0.10	0.0024	0.0024	0.0028	0.0038
K2	MM12-12015-R10A30-E04 F30M	2,5	0,055	0,055	0,065	0,090
		0.10	0.0022	0.0022	0.0026	0.0036
K3	MM12-12015-R10A30-E04 F30M	2,5	0,055	0,055	0,065	0,090
		0.10	0.0022	0.0022	0.0026	0.0036
K4	MM12-12015-R10A30-E04 F30M	2,5	0,055	0,055	0,065	0,090
		0.10	0.0022	0.0022	0.0026	0.0036
K5	MM12-12015-R15A30-D04 F30M	2,5	0,055	0,055	0,060	0,080
		0.10	0.0022	0.0022	0.0024	0.0032
K6	MM12-12015-R15A30-D04 F30M	2,5	0,060	0,060	0,065	0,090
		0.10	0.0024	0.0024	0.0026	0.0036
K7	MM12-12015-R15A30-D04 F30M	2,5	0,055	0,055	0,060	0,080
		0.10	0.0022	0.0022	0.0024	0.0032
N1	MM12-12015-R10A30-E04 F30M	2,5	0,080	0,080	0,090	0,12
		0.10	0.0032	0.0032	0.0036	0.0048
N2	MM12-12015-R10A30-E04 F30M	2,5	0,080	0,080	0,090	0,12
		0.10	0.0032	0.0032	0.0036	0.0048
N3	MM12-12015-R10A30-E04 F30M	2,5	0,080	0,080	0,090	0,12
		0.10	0.0032	0.0032	0.0036	0.0048
N11	MM12-12015-R10A30-E04 F30M	2,5	0,080	0,080	0,090	0,12
		0.10	0.0032	0.0032	0.0036	0.0048
S1	MM12-12015-R15A30-D04 F30M	1,6	0,050	0,048	0,048	0,060
		0.065	0.0020	0.0019	0.0019	0.0026
S2	MM12-12015-R15A30-D04 F30M	1,6	0,050	0,048	0,048	0,060
		0.065	0.0020	0.0019	0.0019	0.0026
S3	MM12-12015-R15A30-D04 F30M	1,6	0,046	0,044	0,044	0,055
		0.065	0.0018	0.0017	0.0017	0.0024
S11	MM12-12015-R05A30-M04 F40M	1,9	0,044	0,044	0,050	0,070
		0.075	0.0017	0.0017	0.0020	0.0028
S12	MM12-12015-R05A30-M04 F40M	1,9	0,044	0,044	0,050	0,070
		0.075	0.0017	0.0017	0.0020	0.0028
S13	MM12-12015-R05A30-M04 F40M	1,6	0,038	0,038	0,046	0,060
		0.065	0.0015	0.0015	0.0018	0.0024
H5	MM12-12015-R15A30-D04 F30M	2,0	0,044	0,042	0,046	0,060
		0.080	0.0017	0.0017	0.0018	0.0024
H8	MM12-12015-R15A30-D04 F30M	1,9	0,034	0,034	0,036	0,046
		0.075	0.0013	0.0013	0.0014	0.0018
H11	MM12-12015-R15A30-D04 F30M	2,0	0,044	0,042	0,046	0,060
		0.080	0.0017	0.0017	0.0018	0.0024
H12	MM12-12015-R15A30-D04 F30M	1,9	0,034	0,034	0,036	0,046
		0.075	0.0013	0.0013	0.0014	0.0018
H21	MM12-12015-R15A30-D04 F30M	1,9	0,034	0,034	0,036	0,046
		0.075	0.0013	0.0013	0.0014	0.0018

SMG = Seco material group
f_z = mm/tooth (in/tooth), v_c = m/min (sf/min), a_p/DC = %
All cutting data are start values

Universal
Steel and cast iron
Stainless steel and S-materials
Non ferrous
Hard
Plastic and chip
Graphite
Minimaster Plus
Minimaster

MM12 - Slot and Side milling – Cutting data $v_c = (m/min)/(sf/min)$

SMG	F30M				F40M				T60M			
	100%	40%	20%	10%	100%	40%	20%	10%	100%	40%	20%	10%
P1	250	315	350	385	240	300	335	365	185	225	255	280
	820	1025	1150	1275	790	980	1100	1200	610	740	840	920
P2	245	305	340	375	235	290	325	355	175	220	250	275
	800	1000	1125	1225	770	950	1075	1175	570	720	820	900
P3	210	265	295	325	200	250	280	310	155	195	215	235
	690	870	970	1075	660	820	920	1025	510	640	710	770
P4	190	235	260	285	180	225	250	270	135	170	190	210
	620	770	850	940	590	740	820	890	445	560	620	690
P5	180	225	250	275	170	215	240	260	130	160	180	200
	590	740	820	900	560	710	790	850	425	520	590	660
P6	205	250	280	310	195	240	270	295	150	185	205	225
	670	820	920	1025	640	790	890	970	490	610	670	740
P7	190	240	265	295	180	225	255	280	140	175	195	215
	620	790	870	970	590	740	840	920	460	570	640	710
P8	175	220	245	275	170	210	235	260	130	160	180	200
	570	720	800	900	560	690	770	850	425	520	590	660
P11	185	230	260	285	175	220	245	270	135	170	190	210
	610	750	850	940	570	720	800	890	445	560	620	690
P12	115	145	165	180	110	140	155	170	85	110	120	130
	375	475	540	590	360	460	510	560	280	360	395	425
M1	200	245	275	300	190	235	260	285	140	180	200	220
	660	800	900	980	620	770	850	940	460	590	660	720
M2	160	200	225	245	155	195	215	235	120	145	165	180
	520	660	740	800	510	640	710	770	395	475	540	590
M3	130	160	175	195	125	150	170	185	95	120	135	145
	425	520	570	640	410	490	560	610	310	395	445	475
M4	100	125	140	150	95	115	130	145	75	90	100	110
	330	410	460	490	310	375	425	475	245	295	330	360
M5	80	100	115	125	80	95	110	120	60	75	85	95
	260	330	375	410	260	310	360	395	195	245	280	310
K1	195	240	270	295	185	230	255	280	140	175	195	220
	640	790	890	970	610	750	840	920	460	570	640	720
K2	170	215	240	260	165	205	225	245	125	155	175	190
	560	710	790	850	540	670	740	800	410	510	570	620
K3	145	180	200	220	140	170	190	210	105	130	145	160
	475	590	660	720	460	560	620	690	345	425	475	520
K4	140	170	190	210	130	165	185	200	100	125	140	155
	460	560	620	690	425	540	610	660	330	410	460	510
K5	85	105	115	125	80	100	110	120	60	75	85	95
	280	345	375	410	260	330	360	395	195	245	280	310
K6	120	150	170	185	115	145	160	175	90	110	125	135
	395	490	560	610	375	475	520	570	295	360	410	445
K7	105	135	150	165	100	125	140	155	80	100	110	120
	345	445	490	540	330	410	460	510	260	330	360	395
N1	1450	1800	2025	2225	1375	1725	1925	2125	1050	1300	1450	1600
	4750	5900	6650	7300	4500	5650	6325	6975	3450	4275	4750	5250
N2	580	730	820	900	560	690	780	860	420	530	590	650
	1900	2400	2700	2950	1825	2275	2550	2825	1375	1750	1925	2125
N3	390	485	550	600	370	460	520	570	280	350	395	435
	1275	1600	1800	1975	1225	1500	1700	1875	920	1150	1300	1425
N11	445	550	620	690	425	530	590	650	320	405	450	495
	1450	1800	2025	2275	1400	1750	1925	2125	1050	1325	1475	1625
S1	46	55	65	70	44	55	60	65	34	43	47	50
	150	180	215	230	145	180	195	215	110	140	155	165
S2	37	46	50	55	35	44	49	55	28	34	38	42
	120	150	165	180	115	145	160	180	90	110	125	140
S3	32	40	45	50	31	38	43	47	24	30	33	37
	105	130	150	165	100	125	140	155	80	100	110	120
S11	65	80	90	100	60	75	85	95	48	60	65	75
	215	260	295	330	195	245	280	310	155	195	215	245
S12	45	55	60	70	43	55	60	65	33	41	47	50
	150	180	195	230	140	180	195	215	110	135	155	165
S13	26	32	36	40	25	31	34	38	19	24	27	29
	85	105	120	130	80	100	110	125	60	80	90	95
H5	39	49	55	60	37	46	50	55	29	36	40	44
	130	160	180	195	120	150	165	180	95	120	130	145
H8	41	50	55	60	39	48	55	60	30	37	42	46
	135	165	180	195	130	155	180	195	100	120	140	150
H11	49	60	70	75	47	60	65	70	37	46	50	55
	160	195	230	245	155	195	215	230	120	150	165	180
H12	75	90	100	110	70	85	95	105	55	65	75	85
	245	295	330	360	230	280	310	345	180	215	245	280
H21	41	50	55	60	39	48	55	60	30	37	42	46
	135	165	180	195	130	155	180	195	100	120	140	150

MM12 Z3 – Copy milling – Insert selection – Roughing – mm/Inch

SMG		a _p	f _z			
			100%	40%	20%	10%
P1	MM12-12015-B90A30-M04 F40M	2,5	0,070	0,070	0,070	0,095
		0.10	0.0028	0.0028	0.0028	0.0038
P2	MM12-12015-B90A30-M04 F40M	2,5	0,070	0,070	0,075	0,095
		0.10	0.0028	0.0028	0.0030	0.0038
P3	MM12-12015-B90A30-M04 F40M	2,5	0,070	0,065	0,070	0,090
		0.10	0.0028	0.0026	0.0028	0.0036
P4	MM12-12015-B90A30-M04 F40M	2,5	0,065	0,065	0,070	0,090
		0.10	0.0026	0.0026	0.0028	0.0036
P5	MM12-12015-B90A30-M04 F40M	2,5	0,065	0,065	0,065	0,090
		0.10	0.0026	0.0026	0.0026	0.0036
P6	MM12-12015-B90A30-M04 F40M	2,5	0,065	0,065	0,065	0,085
		0.10	0.0026	0.0026	0.0026	0.0034
P7	MM12-12015-B90A30-M04 F40M	2,5	0,065	0,065	0,065	0,085
		0.10	0.0026	0.0026	0.0026	0.0034
P8	MM12-12015-B90A30-M04 F40M	2,5	0,070	0,065	0,070	0,090
		0.10	0.0028	0.0026	0.0028	0.0036
P11	MM12-12015-B90A30-M04 F40M	2,5	0,065	0,065	0,065	0,085
		0.10	0.0026	0.0026	0.0026	0.0034
P12	MM12-12015-B90A30-M04 F40M	2,0	0,046	0,044	0,046	0,060
		0.080	0.0018	0.0017	0.0018	0.0024
M1	MM12-12015-B90A30-M04 F40M	2,5	0,070	0,070	0,075	0,095
		0.10	0.0028	0.0028	0.0030	0.0038
M2	MM12-12015-B90A30-M04 F40M	2,5	0,065	0,065	0,065	0,090
		0.10	0.0026	0.0026	0.0026	0.0036
M3	MM12-12015-B90A30-M04 F40M	2,0	0,055	0,055	0,055	0,070
		0.080	0.0022	0.0022	0.0022	0.0028
M4	MM12-12015-B90A30-M04 F40M	1,6	0,050	0,048	0,048	0,060
		0.065	0.0020	0.0019	0.0019	0.0026
M5	MM12-12015-B90A30-M04 F40M	1,6	0,050	0,048	0,048	0,060
		0.065	0.0020	0.0019	0.0019	0.0026
K1	MM12-12015-B90A30-E04 F30M	2,5	0,070	0,070	0,075	0,095
		0.10	0.0028	0.0028	0.0030	0.0038
K2	MM12-12015-B90A30-E04 F30M	2,5	0,065	0,065	0,065	0,090
		0.10	0.0026	0.0026	0.0026	0.0036
K3	MM12-12015-B90A30-E04 F30M	2,5	0,065	0,065	0,065	0,090
		0.10	0.0026	0.0026	0.0026	0.0036
K4	MM12-12015-B90A30-E04 F30M	2,5	0,065	0,065	0,065	0,090
		0.10	0.0026	0.0026	0.0026	0.0036
K5	MM12-12015-B90A30-M04 F40M	2,5	0,060	0,055	0,060	0,080
		0.10	0.0024	0.0022	0.0024	0.0032
K6	MM12-12015-B90A30-M04 F40M	2,5	0,065	0,065	0,065	0,090
		0.10	0.0026	0.0026	0.0026	0.0036
K7	MM12-12015-B90A30-M04 F40M	2,5	0,060	0,055	0,060	0,080
		0.10	0.0024	0.0022	0.0024	0.0032
N1	MM12-12015-B90A30-E04 F30M	2,5	0,090	0,090	0,095	0,12
		0.10	0.0036	0.0036	0.0038	0.0048
N2	MM12-12015-B90A30-E04 F30M	2,5	0,090	0,090	0,095	0,12
		0.10	0.0036	0.0036	0.0038	0.0048
N3	MM12-12015-B90A30-E04 F30M	2,5	0,090	0,090	0,095	0,12
		0.10	0.0036	0.0036	0.0038	0.0048
N11	MM12-12015-B90A30-E04 F30M	2,5	0,090	0,090	0,095	0,12
		0.10	0.0036	0.0036	0.0038	0.0048
S1	MM12-12015-B90A30-M04 F40M	1,6	0,050	0,048	0,048	0,060
		0.065	0.0020	0.0019	0.0019	0.0026
S2	MM12-12015-B90A30-M04 F40M	1,6	0,050	0,048	0,048	0,060
		0.065	0.0020	0.0019	0.0019	0.0026
S3	MM12-12015-B90A30-M04 F40M	1,6	0,046	0,046	0,046	0,055
		0.065	0.0018	0.0018	0.0018	0.0024
S11	MM12-12015-B90A30-M04 F40M	1,9	0,055	0,055	0,055	0,070
		0.075	0.0022	0.0022	0.0022	0.0028
S12	MM12-12015-B90A30-M04 F40M	1,9	0,055	0,055	0,055	0,070
		0.075	0.0022	0.0022	0.0022	0.0028
S13	MM12-12015-B90A30-M04 F40M	1,6	0,050	0,048	0,048	0,060
		0.065	0.0020	0.0019	0.0019	0.0026
H5	MM12-12015-B90A30-E04 F30M	2,0	0,046	0,044	0,046	0,060
		0.080	0.0018	0.0017	0.0018	0.0024
H8	MM12-12015-B90A30-E04 F30M	1,9	0,036	0,036	0,036	0,046
		0.075	0.0014	0.0014	0.0014	0.0018
H11	MM12-12015-B90A30-E04 F30M	2,0	0,046	0,044	0,046	0,060
		0.080	0.0018	0.0017	0.0018	0.0024
H12	MM12-12015-B90A30-E04 F30M	1,9	0,036	0,036	0,036	0,046
		0.075	0.0014	0.0014	0.0014	0.0018
H21	MM12-12015-B90A30-E04 F30M	1,9	0,036	0,036	0,036	0,046
		0.075	0.0014	0.0014	0.0014	0.0018

SMG = Seco material group
 f_z = mm/tooth (in/tooth), v_c = m/min (sf/min), a_p/DC = %
 All cutting data are start values

Universal
 Steel and cast iron
 Stainless steel and S-materials
 Non ferrous
 Hard
 Plastic and chip
 Graphite
 Minimaster Plus
 Minimaster

MM12 Z3 – Copy milling – Insert selection – Finishing – mm/inch

SMG		a_p		f_z			
				15%	10%	5%	2%
P1	MM12-12015-B90A30-E04 F30M	2,5	0,080	0,095	0,13	0,22	
		0,10	0,0032	0,0038	0,0050	0,0085	
P2	MM12-12015-B90A30-E04 F30M	2,5	0,080	0,095	0,13	0,22	
		0,10	0,0032	0,0038	0,0050	0,0085	
P3	MM12-12015-B90A30-E04 F30M	2,5	0,075	0,090	0,13	0,20	
		0,10	0,0030	0,0036	0,0050	0,0080	
P4	MM12-12015-B90A30-E04 F30M	2,5	0,075	0,090	0,12	0,20	
		0,10	0,0030	0,0036	0,0048	0,0080	
P5	MM12-12015-B90A30-E04 F30M	2,5	0,075	0,090	0,12	0,20	
		0,10	0,0030	0,0036	0,0048	0,0080	
P6	MM12-12015-B90A30-E04 F30M	2,5	0,075	0,085	0,12	0,19	
		0,10	0,0030	0,0034	0,0048	0,0075	
P7	MM12-12015-B90A30-E04 F30M	2,5	0,075	0,085	0,12	0,19	
		0,10	0,0030	0,0034	0,0048	0,0075	
P8	MM12-12015-B90A30-E04 F30M	2,5	0,075	0,090	0,13	0,20	
		0,10	0,0030	0,0036	0,0050	0,0080	
P11	MM12-12015-B90A30-E04 F30M	2,5	0,075	0,085	0,12	0,19	
		0,10	0,0030	0,0034	0,0048	0,0075	
P12	MM12-12015-B90A30-E04 F30M	2,0	0,050	0,060	0,080	0,13	
		0,080	0,0020	0,0024	0,0032	0,0050	
M1	MM12-12015-B90A30-E04 F30M	2,5	0,080	0,095	0,13	0,22	
		0,10	0,0032	0,0038	0,0050	0,0085	
M2	MM12-12015-B90A30-E04 F30M	2,5	0,075	0,090	0,12	0,20	
		0,10	0,0030	0,0036	0,0048	0,0080	
M3	MM12-12015-B90A30-E04 F30M	2,0	0,060	0,070	0,095	0,16	
		0,080	0,0024	0,0028	0,0038	0,0065	
M4	MM12-12015-B90A30-E04 F30M	1,6	0,055	0,060	0,085	0,14	
		0,065	0,0022	0,0026	0,0034	0,0055	
M5	MM12-12015-B90A30-E04 F30M	1,6	0,055	0,060	0,085	0,14	
		0,065	0,0022	0,0026	0,0034	0,0055	
K1	MM12-12015-B90A30-E04 F30M	2,5	0,080	0,095	0,13	0,22	
		0,10	0,0032	0,0038	0,0050	0,0085	
K2	MM12-12015-B90A30-E04 F30M	2,5	0,075	0,090	0,12	0,20	
		0,10	0,0030	0,0036	0,0048	0,0080	
K3	MM12-12015-B90A30-E04 F30M	2,5	0,075	0,090	0,12	0,20	
		0,10	0,0030	0,0036	0,0048	0,0080	
K4	MM12-12015-B90A30-E04 F30M	2,5	0,075	0,090	0,12	0,20	
		0,10	0,0030	0,0036	0,0048	0,0080	
K5	MM12-12015-B90A30-E04 F30M	2,5	0,065	0,080	0,11	0,18	
		0,10	0,0026	0,0032	0,0044	0,0070	
K6	MM12-12015-B90A30-E04 F30M	2,5	0,075	0,090	0,12	0,20	
		0,10	0,0030	0,0036	0,0048	0,0080	
K7	MM12-12015-B90A30-E04 F30M	2,5	0,065	0,080	0,11	0,18	
		0,10	0,0026	0,0032	0,0044	0,0070	
N1	MM12-12015-B90A30-E04 F30M	2,5	0,10	0,12	0,17	0,28	
		0,10	0,0040	0,0048	0,0065	0,011	
N2	MM12-12015-B90A30-E04 F30M	2,5	0,10	0,12	0,17	0,28	
		0,10	0,0040	0,0048	0,0065	0,011	
N3	MM12-12015-B90A30-E04 F30M	2,5	0,10	0,12	0,17	0,28	
		0,10	0,0040	0,0048	0,0065	0,011	
N11	MM12-12015-B90A30-E04 F30M	2,5	0,10	0,12	0,17	0,28	
		0,10	0,0040	0,0048	0,0065	0,011	
S1	MM12-12015-B90A30-E04 F30M	1,6	0,055	0,060	0,085	0,14	
		0,065	0,0022	0,0026	0,0034	0,0055	
S2	MM12-12015-B90A30-E04 F30M	1,6	0,055	0,060	0,085	0,14	
		0,065	0,0022	0,0026	0,0034	0,0055	
S3	MM12-12015-B90A30-E04 F30M	1,6	0,050	0,055	0,080	0,13	
		0,065	0,0020	0,0024	0,0032	0,0050	
S11	MM12-12015-B90A30-E04 F30M	1,9	0,060	0,070	0,095	0,16	
		0,075	0,0024	0,0028	0,0038	0,0065	
S12	MM12-12015-B90A30-E04 F30M	1,9	0,060	0,070	0,095	0,16	
		0,075	0,0024	0,0028	0,0038	0,0065	
S13	MM12-12015-B90A30-E04 F30M	1,6	0,055	0,060	0,085	0,14	
		0,065	0,0022	0,0026	0,0034	0,0055	
H5	MM12-12015-B90A30-E04 F30M	2,0	0,050	0,060	0,080	0,13	
		0,080	0,0020	0,0024	0,0032	0,0050	
H8	MM12-12015-B90A30-E04 F30M	1,9	0,040	0,046	0,065	0,10	
		0,075	0,0016	0,0018	0,0026	0,0040	
H11	MM12-12015-B90A30-E04 F30M	2,0	0,050	0,060	0,080	0,13	
		0,080	0,0020	0,0024	0,0032	0,0050	
H12	MM12-12015-B90A30-E04 F30M	1,9	0,040	0,046	0,065	0,10	
		0,075	0,0016	0,0018	0,0026	0,0040	
H21	MM12-12015-B90A30-E04 F30M	1,9	0,040	0,046	0,065	0,10	
		0,075	0,0016	0,0018	0,0026	0,0040	

SMG = Seco material group
 f_z = mm/tooth (in/tooth), v_c = m/min (sf/min), a_p/DC = %
 All cutting data are start values

MM12 Z3 – Copy milling – Cutting data $v_c = (m/min)/(sf/min)$

SMG	F30M					F40M				
	100%	20%	10%	5%	2%	100%	20%	10%	5%	2%
P1	270	315	335	365	360	255	300	320	345	340
	890	1025	1100	1200	1175	840	980	1050	1125	1125
P2	265	305	325	355	350	250	290	310	335	330
	870	1000	1075	1175	1150	820	950	1025	1100	1075
P3	225	265	285	305	305	215	255	270	290	290
	740	870	940	1000	1000	710	840	890	950	950
P4	200	235	250	270	270	190	225	235	260	255
	660	770	820	890	890	620	740	770	850	840
P5	195	225	240	260	255	185	215	225	245	245
	640	740	790	850	840	610	710	740	800	800
P6	215	255	270	290	290	205	240	255	275	275
	710	840	890	950	950	670	790	840	900	900
P7	205	240	255	275	275	195	230	240	260	260
	670	790	840	900	900	640	750	790	850	850
P8	190	225	240	255	255	180	215	225	245	245
	620	740	790	840	840	590	710	740	800	800
P11	200	235	245	265	265	190	220	235	255	255
	660	770	800	870	870	620	720	770	840	840
P12	125	150	155	170	165	120	140	145	160	160
	410	490	510	560	540	395	460	490	520	520
M1	210	245	265	285	280	200	235	250	270	270
	690	800	870	940	920	660	770	820	890	890
M2	175	205	215	235	230	165	195	205	220	220
	570	670	710	770	750	540	640	670	720	720
M3	140	165	170	185	185	130	155	160	175	175
	460	540	560	610	610	425	510	540	570	570
M4	100	130	130	140	140	95	125	125	135	135
	330	425	460	460	460	310	410	425	445	445
M5	80	110	110	115	115	80	105	105	110	110
	260	360	375	375	375	260	345	360	360	360
K1	210	240	260	280	275	200	230	245	265	265
	690	790	850	920	900	660	750	800	870	870
K2	185	215	225	245	245	175	205	215	235	230
	610	710	740	800	800	570	670	710	770	750
K3	155	180	190	210	205	145	175	180	200	195
	510	590	620	690	670	475	570	590	660	640
K4	150	175	180	200	195	140	165	175	190	185
	490	570	590	660	640	460	540	570	620	610
K5	90	105	110	120	120	85	100	105	115	115
	295	345	360	395	395	280	330	345	375	375
K6	130	155	160	175	175	125	145	155	165	165
	425	510	520	570	570	410	475	510	540	540
K7	115	135	140	155	155	110	125	135	145	145
	375	445	460	510	510	360	410	445	475	475
N1	1575	1825	1950	2100	2100	1500	1750	1850	2000	2000
	5175	6000	6400	6900	6900	4925	5750	6075	6550	6550
N2	640	740	790	850	840	610	700	750	810	800
	2100	2425	2600	2800	2750	2000	2300	2450	2650	2625
N3	425	495	530	570	560	405	470	500	540	540
	1400	1625	1750	1875	1825	1325	1550	1650	1775	1775
N11	485	560	600	650	640	460	540	570	620	610
	1600	1825	1975	2125	2100	1500	1775	1875	2025	2000
S1	46	60	60	65	65	44	60	60	65	60
	150	195	215	215	215	145	195	195	215	195
S2	37	50	49	55	55	35	47	47	50	50
	120	165	165	180	180	115	155	165	165	165
S3	32	43	43	46	46	31	41	41	44	44
	105	140	150	150	150	100	135	140	145	145
S11	70	85	85	95	90	65	80	80	90	90
	230	280	295	310	295	215	260	280	295	295
S12	48	60	60	65	65	46	55	55	60	60
	155	195	195	215	215	150	180	195	195	195
S13	26	35	34	37	37	25	33	33	35	35
	85	115	120	120	120	80	110	115	115	115
H5	42	50	50	55	55	40	47	49	55	55
	140	165	165	180	180	130	155	160	180	180
H8	42	55	55	55	55	40	50	50	55	55
	140	180	180	180	180	130	165	165	180	180
H11	55	65	65	70	70	50	60	60	65	65
	180	215	215	230	230	165	195	195	215	215
H12	75	95	95	105	105	75	90	90	100	100
	245	310	330	345	345	245	295	310	330	330
H21	42	55	55	55	55	40	50	50	55	55
	140	180	180	180	180	130	165	165	180	180

Universal
Steel and cast iron
Stainless steel and S-materials
Non ferrous
Hard
Plastic and chip
Graphite
Minimaster Plus
Minimaster

MM12 Z2 – Copy milling – Insert selection – Roughing – mm/inch

SMG		a _p	f _z			
			100%	40%	20%	10%
P1	MM12-12012-B90S-E05 F30M	5,0	0,075	0,080	0,090	0,12
		0,20	0,0030	0,0032	0,0036	0,0048
P2	MM12-12012-B90S-E05 F30M	5,0	0,080	0,080	0,090	0,12
		0,20	0,0032	0,0032	0,0036	0,0048
P3	MM12-12012-B90S-E05 F30M	5,0	0,075	0,075	0,085	0,11
		0,20	0,0030	0,0030	0,0034	0,0044
P4	MM12-12012-B90-MD05 F30M	5,0	0,075	0,075	0,085	0,11
		0,20	0,0030	0,0030	0,0034	0,0044
P5	MM12-12012-B90-MD05 F30M	5,0	0,070	0,070	0,085	0,11
		0,20	0,0028	0,0028	0,0034	0,0044
P6	MM12-12012-B90-MD05 F30M	5,0	0,070	0,070	0,080	0,11
		0,20	0,0028	0,0028	0,0032	0,0044
P7	MM12-12012-B90-MD05 F30M	5,0	0,070	0,070	0,080	0,11
		0,20	0,0028	0,0028	0,0032	0,0044
P8	MM12-12012-B90-MD05 F30M	5,0	0,075	0,075	0,085	0,11
		0,20	0,0030	0,0030	0,0034	0,0044
P11	MM12-12012-B90-MD05 F30M	5,0	0,070	0,070	0,080	0,11
		0,20	0,0028	0,0028	0,0032	0,0044
P12	MM12-12012-B90-MD05 F30M	4,0	0,050	0,050	0,060	0,075
		0,16	0,0020	0,0020	0,0024	0,0030
M1	MM12-12012-B90S-E05 F30M	5,0	0,080	0,080	0,090	0,12
		0,20	0,0032	0,0032	0,0036	0,0048
M2	MM12-12012-B90S-E05 F30M	5,0	0,070	0,070	0,085	0,11
		0,20	0,0028	0,0028	0,0034	0,0044
M3	MM12-12012-B90S-E05 F30M	4,0	0,060	0,060	0,070	0,090
		0,16	0,0024	0,0024	0,0028	0,0036
M4	MM12-12012-B90-MD05 F30M	3,0	0,055	0,055	0,060	0,075
		0,12	0,0022	0,0022	0,0024	0,0032
M5	MM12-12012-B90-MD05 F30M	3,0	0,055	0,055	0,060	0,075
		0,12	0,0022	0,0022	0,0024	0,0032
K1	MM12-12012-B90S-E05 F30M	5,0	0,080	0,080	0,090	0,12
		0,20	0,0032	0,0032	0,0036	0,0048
K2	MM12-12012-B90S-E05 F30M	5,0	0,070	0,070	0,085	0,11
		0,20	0,0028	0,0028	0,0034	0,0044
K3	MM12-12012-B90S-E05 F30M	5,0	0,070	0,070	0,085	0,11
		0,20	0,0028	0,0028	0,0034	0,0044
K4	MM12-12012-B90S-E05 F30M	5,0	0,070	0,070	0,085	0,11
		0,20	0,0028	0,0028	0,0034	0,0044
K5	MM12-12012-B90-MD05 F30M	5,0	0,065	0,065	0,075	0,10
		0,20	0,0026	0,0026	0,0030	0,0040
K6	MM12-12012-B90-MD05 F30M	5,0	0,070	0,070	0,085	0,11
		0,20	0,0028	0,0028	0,0034	0,0044
K7	MM12-12012-B90-MD05 F30M	5,0	0,065	0,065	0,075	0,10
		0,20	0,0026	0,0026	0,0030	0,0040
N1	MM12-12012-B90S-E05 F30M	5,0	0,10	0,10	0,12	0,15
		0,20	0,0040	0,0040	0,0048	0,0060
N2	MM12-12012-B90S-E05 F30M	5,0	0,10	0,10	0,12	0,15
		0,20	0,0040	0,0040	0,0048	0,0060
N3	MM12-12012-B90S-E05 F30M	5,0	0,10	0,10	0,12	0,15
		0,20	0,0040	0,0040	0,0048	0,0060
N11	MM12-12012-B90S-E05 F30M	5,0	0,10	0,10	0,12	0,15
		0,20	0,0040	0,0040	0,0048	0,0060
S1	MM12-12012-B90-MD05 F30M	3,0	0,055	0,055	0,060	0,075
		0,12	0,0022	0,0022	0,0024	0,0032
S2	MM12-12012-B90-MD05 F30M	3,0	0,055	0,055	0,060	0,075
		0,12	0,0022	0,0022	0,0024	0,0032
S3	MM12-12012-B90-MD05 F30M	3,0	0,050	0,050	0,055	0,070
		0,12	0,0020	0,0020	0,0022	0,0030
S11	MM12-12012-B90-MD05 F30M	3,5	0,060	0,060	0,070	0,090
		0,14	0,0024	0,0024	0,0028	0,0036
S12	MM12-12012-B90-MD05 F30M	3,5	0,060	0,060	0,070	0,090
		0,14	0,0024	0,0024	0,0028	0,0036
S13	MM12-12012-B90-MD05 F30M	3,0	0,055	0,055	0,060	0,075
		0,12	0,0022	0,0022	0,0024	0,0032
H5	MM12-12012-B90-MD05 F30M	4,0	0,050	0,050	0,060	0,075
		0,16	0,0020	0,0020	0,0024	0,0030
H8	MM12-12012-B90-MD05 F30M	3,5	0,040	0,040	0,044	0,055
		0,14	0,0016	0,0016	0,0017	0,0024
H11	MM12-12012-B90-MD05 F30M	4,0	0,050	0,050	0,060	0,075
		0,16	0,0020	0,0020	0,0024	0,0030
H12	MM12-12012-B90-MD05 F30M	3,5	0,040	0,040	0,044	0,055
		0,14	0,0016	0,0016	0,0017	0,0024
H21	MM12-12012-B90-MD05 F30M	3,5	0,040	0,040	0,044	0,055
		0,14	0,0016	0,0016	0,0017	0,0024

SMG = Seco material group
f_z = mm/tooth (in/tooth), v_c = m/min (sf/min), a_p/DC = %
All cutting data are start values

MM12 Z2 – Copy milling – Insert selection – Finishing – mm/Inch

SMG		a _p	f _z			
			15%	10%	5%	2%
P1	MM12-12012-B90PF-M02 F15M	4,0	0,040	0,048	0,065	0,11
		0.16	0.0016	0.0019	0.0026	0.0044
P2	MM12-12012-B90PF-M02 F15M	4,0	0,042	0,048	0,070	0,11
		0.16	0.0017	0.0019	0.0028	0.0044
P3	MM12-12012-B90PF-M02 F15M	4,0	0,040	0,046	0,065	0,10
		0.16	0.0016	0.0018	0.0026	0.0040
P4	MM12-12012-B90PF-M02 F15M	4,0	0,038	0,046	0,065	0,10
		0.16	0.0015	0.0018	0.0026	0.0040
P5	MM12-12012-B90PF-M02 F15M	4,0	0,038	0,044	0,060	0,095
		0.16	0.0015	0.0017	0.0024	0.0038
P6	MM12-12012-B90PF-M02 F15M	4,0	0,038	0,044	0,060	0,095
		0.16	0.0015	0.0017	0.0024	0.0038
P7	MM12-12012-B90PF-M02 F15M	4,0	0,038	0,044	0,060	0,095
		0.16	0.0015	0.0017	0.0024	0.0038
P8	MM12-12012-B90PF-M02 F15M	4,0	0,040	0,046	0,065	0,10
		0.16	0.0016	0.0018	0.0026	0.0040
P11	MM12-12012-B90PF-M02 F15M	4,0	0,038	0,044	0,060	0,095
		0.16	0.0015	0.0017	0.0024	0.0038
P12	MM12-12012-B90PF-M02 F15M	3,5	0,026	0,030	0,042	0,065
		0.14	0.0010	0.0012	0.0017	0.0026
M1	MM12-12012-B90PF-M02 F15M	4,0	0,042	0,048	0,070	0,11
		0.16	0.0017	0.0019	0.0028	0.0044
M2	MM12-12012-B90PF-M02 F15M	4,0	0,038	0,044	0,060	0,095
		0.16	0.0015	0.0017	0.0024	0.0038
M3	MM12-12012-B90PF-M02 F15M	3,5	0,030	0,036	0,050	0,075
		0.14	0.0012	0.0014	0.0020	0.0030
M4	MM12-12012-B90PF-M02 F15M	2,5	0,028	0,032	0,042	0,065
		0.10	0.0011	0.0013	0.0017	0.0026
M5	MM12-12012-B90PF-M02 F15M	2,5	0,028	0,032	0,042	0,065
		0.10	0.0011	0.0013	0.0017	0.0026
K1	MM12-12012-B90PF-M02 F15M	4,0	0,042	0,048	0,070	0,11
		0.16	0.0017	0.0019	0.0028	0.0044
K2	MM12-12012-B90PF-M02 F15M	4,0	0,038	0,044	0,060	0,095
		0.16	0.0015	0.0017	0.0024	0.0038
K3	MM12-12012-B90PF-M02 F15M	4,0	0,038	0,044	0,060	0,095
		0.16	0.0015	0.0017	0.0024	0.0038
K4	MM12-12012-B90PF-M02 F15M	4,0	0,038	0,044	0,060	0,095
		0.16	0.0015	0.0017	0.0024	0.0038
K5	MM12-12012-B90PF-M02 F15M	4,0	0,034	0,040	0,055	0,085
		0.16	0.0013	0.0016	0.0022	0.0034
K6	MM12-12012-B90PF-M02 F15M	4,0	0,038	0,044	0,060	0,095
		0.16	0.0015	0.0017	0.0024	0.0038
K7	MM12-12012-B90PF-M02 F15M	4,0	0,034	0,040	0,055	0,085
		0.16	0.0013	0.0016	0.0022	0.0034
N1	MM12-12012-B90PF-M02 F15M	4,0	0,055	0,060	0,085	0,14
		0.16	0.0022	0.0024	0.0034	0.0055
N2	MM12-12012-B90PF-M02 F15M	4,0	0,055	0,060	0,085	0,14
		0.16	0.0022	0.0024	0.0034	0.0055
N3	MM12-12012-B90PF-M02 F15M	4,0	0,055	0,060	0,085	0,14
		0.16	0.0022	0.0024	0.0034	0.0055
N11	MM12-12012-B90PF-M02 F15M	4,0	0,055	0,060	0,085	0,14
		0.16	0.0022	0.0024	0.0034	0.0055
S1	MM12-12012-B90PF-M02 F15M	2,5	0,028	0,032	0,042	0,065
		0.10	0.0011	0.0013	0.0017	0.0026
S2	MM12-12012-B90PF-M02 F15M	2,5	0,028	0,032	0,042	0,065
		0.10	0.0011	0.0013	0.0017	0.0026
S3	MM12-12012-B90PF-M02 F15M	2,5	0,025	0,028	0,040	0,065
		0.10	0.0010	0.0012	0.0016	0.0026
S11	MM12-12012-B90PF-M02 F15M	3,0	0,030	0,036	0,050	0,075
		0.12	0.0012	0.0014	0.0020	0.0030
S12	MM12-12012-B90PF-M02 F15M	3,0	0,030	0,036	0,050	0,075
		0.12	0.0012	0.0014	0.0020	0.0030
S13	MM12-12012-B90PF-M02 F15M	2,5	0,028	0,032	0,042	0,065
		0.10	0.0011	0.0013	0.0017	0.0026
H5	MM12-12012-B90PF-M02 F15M	3,5	0,026	0,030	0,042	0,065
		0.14	0.0010	0.0012	0.0017	0.0026
H8	MM12-12012-B90PF-M02 F15M	3,0	0,020	0,024	0,032	0,050
		0.12	0.00080	0.00095	0.0013	0.0020
H11	MM12-12012-B90PF-M02 F15M	3,5	0,026	0,030	0,042	0,065
		0.14	0.0010	0.0012	0.0017	0.0026
H12	MM12-12012-B90PF-M02 F15M	3,0	0,020	0,024	0,032	0,050
		0.12	0.00080	0.00095	0.0013	0.0020
H21	MM12-12012-B90PF-M02 F15M	3,0	0,020	0,024	0,032	0,050
		0.12	0.00080	0.00095	0.0013	0.0020

SMG = Seco material group
f_z = mm/tooth (in/tooth), v_c = m/min (sf/min), a_p/DC = %
All cutting data are start values

Universal
Steel and cast iron
Stainless steel and S-materials
Non ferrous
Hard
Plastic and chip
Graphite
Minimaster Plus
Minimaster

MM12 Z2 – Copy milling – Cutting data $v_c = (m/min)/(sf/min)$

SMG	F15M					F30M					T60M				
	100%	20%	10%	5%	2%	100%	20%	10%	5%	2%	100%	20%	10%	5%	2%
P1	310	390	410	445	440	240	300	325	350	345	195	240	265	285	280
	1025	1275	1350	1450	1450	790	980	1075	1150	1125	640	790	870	940	920
P2	300	380	400	430	430	230	290	315	340	340	185	235	255	275	275
	980	1250	1300	1400	1400	750	950	1025	1125	1125	610	770	840	900	900
P3	260	330	345	370	370	200	255	275	295	295	160	205	225	240	240
	850	1075	1125	1225	1225	660	840	900	970	970	520	670	740	790	790
P4	230	290	305	325	330	175	225	245	260	260	145	180	195	210	210
	750	950	1000	1075	1075	570	740	800	850	850	475	590	640	690	690
P5	220	275	290	315	315	170	215	235	255	250	140	170	190	205	200
	720	900	950	1025	1025	560	710	770	840	820	460	560	620	670	660
P6	245	310	325	355	355	190	240	260	285	280	155	195	210	230	225
	800	1025	1075	1175	1175	620	790	850	940	920	510	640	690	750	740
P7	230	295	310	335	335	180	230	245	270	265	145	185	200	215	215
	750	970	1025	1100	1100	590	750	800	890	870	475	610	660	710	710
P8	215	275	290	310	315	170	215	235	250	250	135	170	190	200	200
	710	900	950	1025	1025	560	710	770	820	820	445	560	620	660	660
P11	225	285	300	325	325	175	220	240	260	255	140	180	195	210	210
	740	940	980	1075	1075	570	720	790	850	840	460	590	640	690	690
P12	140	180	180	195	200	115	145	150	165	160	95	120	120	135	130
	460	590	610	640	660	375	475	510	540	520	310	395	410	445	425
M1	240	305	320	345	345	185	235	255	275	270	150	190	205	225	220
	790	1000	1050	1125	1125	610	770	840	900	890	490	620	670	740	720
M2	195	250	260	285	285	155	190	210	225	225	125	155	170	185	180
	640	820	850	940	940	510	620	690	740	740	410	510	560	610	590
M3	155	200	205	220	220	125	160	165	180	180	100	130	135	145	145
	510	660	670	720	720	410	520	560	590	590	330	425	445	475	475
M4	120	155	155	165	165	100	130	130	135	140	80	105	105	110	110
	395	510	540	540	540	330	425	445	445	460	260	345	360	360	360
M5	100	130	130	140	140	85	110	105	115	115	70	85	85	95	95
	330	425	460	460	460	280	360	375	375	375	230	280	295	310	310
K1	235	300	315	340	340	180	230	250	270	270	145	185	205	220	215
	770	980	1025	1125	1125	590	750	820	890	890	475	610	670	720	710
K2	205	265	275	300	300	160	200	220	240	235	130	165	180	195	190
	670	870	900	980	980	520	660	720	790	770	425	540	590	640	620
K3	175	225	235	255	255	135	170	185	205	200	110	140	150	165	165
	570	740	770	840	840	445	560	610	670	660	360	460	490	540	540
K4	165	215	225	240	240	130	165	180	195	190	105	130	145	155	155
	540	710	740	790	790	425	540	590	640	620	345	425	475	510	510
K5	100	130	135	145	145	80	100	110	115	115	65	80	85	95	95
	330	425	445	475	475	260	330	360	375	375	215	260	280	310	310
K6	145	185	195	215	215	115	145	155	170	170	95	115	125	140	135
	475	610	640	710	710	375	475	510	560	560	310	375	410	460	445
K7	130	165	170	185	185	100	125	140	150	150	80	105	110	120	120
	425	540	560	610	610	330	410	460	490	490	260	345	360	395	395
N1	1825	2300	2425	2625	2600	1375	1725	1900	2025	2000	1100	1400	1525	1650	1625
	6000	7550	7950	8600	8525	4500	5650	6225	6650	6550	3600	4600	5000	5425	5325
N2	730	930	980	1050	1050	550	690	760	820	810	450	560	620	660	660
	2400	3050	3225	3450	3450	1800	2275	2500	2700	2650	1475	1825	2025	2175	2175
N3	490	620	650	710	700	370	465	510	550	540	300	375	410	440	440
	1600	2025	2125	2325	2300	1225	1525	1675	1800	1775	980	1225	1350	1450	1450
N11	560	710	750	810	800	425	530	580	620	620	340	430	470	500	500
	1825	2325	2450	2650	2625	1400	1750	1900	2025	2025	1125	1400	1550	1650	1650
S1	55	70	70	80	80	47	60	60	65	65	38	49	48	50	50
	180	230	260	260	260	155	195	215	215	215	125	160	165	165	165
S2	45	60	60	65	65	38	49	48	50	50	31	39	39	42	42
	150	195	215	215	215	125	160	165	165	165	100	130	135	140	140
S3	39	50	50	55	55	33	43	42	45	45	27	34	34	37	36
	130	165	180	180	180	110	140	145	150	150	90	110	120	120	120
S11	80	105	105	110	110	65	85	85	90	90	55	70	70	75	75
	260	345	360	360	360	215	280	280	295	295	180	230	230	245	245
S12	55	70	70	75	75	45	60	60	65	60	37	47	47	50	50
	180	230	245	245	245	150	195	195	215	195	120	155	160	165	165
S13	32	41	40	44	44	26	34	34	36	36	21	28	27	29	29
	105	135	145	145	145	85	110	120	120	120	70	90	95	95	95
H5	46	60	60	65	65	38	48	50	55	55	31	39	41	44	44
	150	195	195	215	215	125	155	165	180	180	100	130	135	145	145
H8	48	60	60	65	65	40	50	50	55	55	33	42	42	46	45
	155	195	215	215	215	130	165	180	180	180	110	140	140	150	150
H11	60	75	75	85	85	49	60	65	70	70	39	50	50	55	55
	195	245	260	280	280	160	195	215	230	230	130	165	165	180	180
H12	85	110	110	120	120	70	95	95	100	100	60	75	75	80	80
	280	360	375	395	395	230	310	310	330	330	195	245	260	260	260
H21	48	60	60	65	65	40	50	50	55	55	33	42	42	46	45
	155	195	215	215	215	130	165	180	180	180	110	140	140	150	150

MM12 High-Feed – Insert selection – mm/inch

SMG		a_p	f_z			
			100%	70%	30%	20%
P1	MM12-12.60-HF-MD10 F30M	0,36 0.014	0,55 0.022	0,55 0.022	0,75 0.030	0,95 0.038
P2	MM12-12.60-HF-MD10 F30M	0,36 0.014	0,55 0.022	0,60 0.024	0,75 0.030	0,95 0.038
P3	MM12-12.60-HF-MD10 F30M	0,36 0.014	0,55 0.022	0,55 0.022	0,70 0.028	0,90 0.036
P4	MM12-12.60-HF-MD10 F30M	0,36 0.014	0,55 0.022	0,55 0.022	0,70 0.028	0,90 0.036
P5	MM12-12.60-HF-MD10 F30M	0,36 0.014	0,50 0.020	0,55 0.022	0,70 0.028	0,85 0.034
P6	MM12-12.60-HF-MD10 F30M	0,36 0.014	0,50 0.020	0,50 0.020	0,70 0.028	0,85 0.034
P7	MM12-12.60-HF-MD10 F30M	0,36 0.014	0,50 0.020	0,50 0.020	0,70 0.028	0,85 0.034
P8	MM12-12.60-HF-MD10 F30M	0,36 0.014	0,55 0.022	0,55 0.022	0,70 0.028	0,90 0.036
P11	MM12-12.60-HF-MD10 F30M	0,36 0.014	0,50 0.020	0,50 0.020	0,70 0.028	0,85 0.034
P12	MM12-12.60-HF-MD10 F30M	0,28 0.011	0,36 0.014	0,36 0.014	0,46 0.018	0,55 0.022
M1	MM12-12.60-HF-MD10 F30M	0,36 0.014	0,55 0.022	0,60 0.024	0,75 0.030	0,95 0.038
M2	MM12-12.60-HF-MD10 F30M	0,36 0.014	0,50 0.020	0,55 0.022	0,70 0.028	0,85 0.034
M3	MM12-12.60-HF-MD10 F30M	0,28 0.011	0,42 0.017	0,42 0.017	0,55 0.022	0,65 0.026
M4	MM12-12.60-HF-MD10 F30M	0,22 0.0085	0,36 0.014	0,36 0.014	0,48 0.019	0,60 0.024
M5	MM12-12.60-HF-MD10 F30M	0,22 0.0085	0,36 0.014	0,36 0.014	0,48 0.019	0,60 0.024
K1	MM12-12.60-HF-MD10 F30M	0,36 0.014	0,55 0.022	0,60 0.024	0,75 0.030	0,95 0.038
K2	MM12-12.60-HF-MD10 F30M	0,36 0.014	0,50 0.020	0,55 0.022	0,70 0.028	0,85 0.034
K3	MM12-12.60-HF-MD10 F30M	0,36 0.014	0,50 0.020	0,55 0.022	0,70 0.028	0,85 0.034
K4	MM12-12.60-HF-MD10 F30M	0,36 0.014	0,50 0.020	0,55 0.022	0,70 0.028	0,85 0.034
K5	MM12-12.60-HF-MD10 F30M	0,36 0.014	0,48 0.019	0,48 0.019	0,60 0.024	0,75 0.030
K6	MM12-12.60-HF-MD10 F30M	0,36 0.014	0,50 0.020	0,55 0.022	0,70 0.028	0,85 0.034
K7	MM12-12.60-HF-MD10 F30M	0,36 0.014	0,48 0.019	0,48 0.019	0,60 0.024	0,75 0.030
N1	MM12-12.60-HF-MD10 F30M	0,36 0.014	0,75 0.030	0,75 0.030	1,0 0.040	1,3 0.050
N2	MM12-12.60-HF-MD10 F30M	0,36 0.014	0,75 0.030	0,75 0.030	1,0 0.040	1,3 0.050
N3	MM12-12.60-HF-MD10 F30M	0,36 0.014	0,75 0.030	0,75 0.030	1,0 0.040	1,3 0.050
N11	MM12-12.60-HF-MD10 F30M	0,36 0.014	0,75 0.030	0,75 0.030	1,0 0.040	1,3 0.050
S1	MM12-12.60-HF-MD10 F30M	0,22 0.0085	0,36 0.014	0,36 0.014	0,48 0.019	0,60 0.024
S2	MM12-12.60-HF-MD10 F30M	0,22 0.0085	0,36 0.014	0,36 0.014	0,48 0.019	0,60 0.024
S3	MM12-12.60-HF-MD10 F30M	0,22 0.0085	0,34 0.013	0,34 0.013	0,44 0.017	0,55 0.022
S11	MM12-12.60-HF-MD10 F30M	0,25 0.010	0,42 0.017	0,42 0.017	0,55 0.022	0,65 0.026
S12	MM12-12.60-HF-MD10 F30M	0,25 0.010	0,42 0.017	0,42 0.017	0,55 0.022	0,65 0.026
S13	MM12-12.60-HF-MD10 F30M	0,22 0.0085	0,36 0.014	0,36 0.014	0,48 0.019	0,60 0.024
H5	MM12-12.60-HF-MD10 F15M	0,28 0.011	0,36 0.014	0,36 0.014	0,46 0.018	0,55 0.022
H8	MM12-12.60-HF-MD10 F15M	0,25 0.010	0,28 0.011	0,28 0.011	0,36 0.014	0,42 0.017
H11	MM12-12.60-HF-MD10 F15M	0,28 0.011	0,36 0.014	0,36 0.014	0,46 0.018	0,55 0.022
H12	MM12-12.60-HF-MD10 F15M	0,25 0.010	0,28 0.011	0,28 0.011	0,36 0.014	0,42 0.017
H21	MM12-12.60-HF-MD10 F15M	0,25 0.010	0,28 0.011	0,28 0.011	0,36 0.014	0,42 0.017



SMG = Seco material group
 f_z = mm/tooth (in/tooth), v_c = m/min (sf/min), a_p/DC = %
 All cutting data are start values

Universal
 Steel and cast iron
 Stainless steel and S-materials
 Non ferrous
 Hard
 Plastic and chip
 Graphite
 Minimaster Plus
 Minimaster

MM12 High-Feed – Cutting data $v_c = (m/min)/(sf/min)$

SMG	F15M				F30M				
	100%	70%	30%	20%	100%	70%	30%	20%	
Universal	P1	—	—	—	225	275	315	330	
		—	—	—	740	900	1025	1075	
Steel and cast iron	P2	—	—	—	220	265	310	320	
		—	—	—	720	870	1025	1050	
	P3	—	—	—	190	230	270	280	
		—	—	—	620	750	890	920	
	P4	—	—	—	165	205	235	245	
Stainless steel and S-materials		—	—	—	540	670	770	800	
	P5	—	—	—	165	195	225	240	
		—	—	—	540	640	740	790	
	P6	—	—	—	185	225	255	270	
		—	—	—	610	740	840	890	
	P7	—	—	—	170	210	240	255	
		—	—	—	560	690	790	840	
	P8	—	—	—	160	195	225	235	
		—	—	—	520	640	740	770	
	P11	—	—	—	165	205	235	245	
		—	—	—	540	670	770	800	
	P12	—	—	—	110	130	150	160	
	—	—	—	360	425	490	520		
Non ferrous	M1	—	—	—	175	215	250	260	
		—	—	—	570	710	820	850	
	M2	—	—	—	145	175	205	215	
		—	—	—	475	570	670	710	
	M3	—	—	—	120	140	165	175	
	—	—	—	395	460	540	570		
Hard	M4	—	—	—	95	110	125	130	
		—	—	—	310	360	410	425	
	M5	—	—	—	80	90	105	110	
		—	—	—	260	295	345	360	
	K1	185	225	260	275	175	210	245	255
	610	740	850	900	570	690	800	840	
Plastic and cfrp	K2	165	200	230	245	155	185	215	225
		540	660	750	800	510	610	710	740
	K3	140	170	195	205	130	155	180	190
		460	560	640	670	425	510	590	620
	K4	135	160	185	195	125	150	175	185
		445	520	610	640	410	490	570	610
	K5	80	100	115	120	75	90	105	110
	260	330	375	395	245	295	345	360	
Graphite	K6	120	140	165	175	110	130	155	160
		395	460	540	570	360	425	510	520
	K7	105	125	145	155	95	115	135	145
		345	410	475	510	310	375	445	475
	N1	—	—	—	—	1275	1575	1800	1875
		—	—	—	—	4175	5175	5900	6150
	N2	—	—	—	—	520	630	730	750
	—	—	—	—	1700	2075	2400	2450	
Minimaster Plus	N3	—	—	—	—	345	420	485	500
		—	—	—	—	1125	1375	1600	1650
	N11	—	—	—	—	395	480	550	570
		—	—	—	—	1300	1575	1800	1875
	S1	—	—	—	—	44	50	60	60
	—	—	—	—	145	165	195	195	
Minimaster	S2	—	—	—	—	35	41	47	50
		—	—	—	—	115	135	155	165
	S3	—	—	—	—	31	36	42	44
		—	—	—	—	100	120	140	145
	S11	—	—	—	—	60	70	85	90
	—	—	—	—	195	230	280	295	
Minimaster	S12	—	—	—	—	42	50	55	60
		—	—	—	—	140	165	180	195
	S13	—	—	—	—	25	29	33	35
		—	—	—	—	80	95	110	115
	H5	39	46	55	55	36	43	50	55
		130	150	180	180	120	140	165	180
	H8	41	49	55	60	38	45	50	55
		135	160	180	195	125	150	165	180
H11		49	60	70	70	46	55	65	65
		160	195	230	230	150	180	215	215
H12		75	90	100	105	70	80	95	100
		245	295	330	345	230	260	310	330
H21		41	49	55	60	38	45	50	55
		135	160	180	195	125	150	165	180

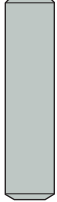
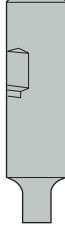
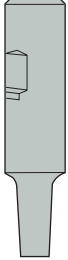
Shank design

Design 1, Keyway shank	Design 2, Cylindrical/Weldon back end and 90° front
	
Design 3, Cylindrical/Weldon back end tapered front 87°/89°	Design 4, Cylindrical/Weldon back end tapered front 80°/85°/87°
	
Design 5, Cylindrical back end double tapered front end 89°/85°	
	

- Universal
- Steel and cast iron
- Stainless steel and S-materials
- Non ferrous
- Hard
- Plastic and cfrp
- Graphite
- Minimaster Plus
- Minimaster

MM16 Shank – Metric

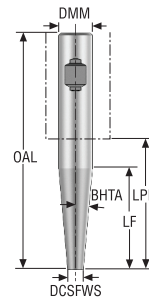

• For ISO attribute explanation, see page [XXX]

Designation	Item number	ShankType	DCSFWS	DMM	OAL	LF	LPR	BHTA°	Design		RPMX	Weight	Spare part no.
			mm	mm	mm	mm	mm					kg	
MM16-20115.3-3045	75014109	Weldon	15,2	20,0	115,0	45,8	65,0	3,0	4	✓	63600	0,3	3
MM16-25100.3-0019	75012790	Weldon	15,2	25,0	100,0	19,0	94,0	0,0	2	✓	63600	0,3	3
MM16-25115.3-3035	75012791	Weldon	15,2	25,0	115,0	35,0	59,0	3,0	3	✓	63600	0,3	3
MM16-25170.3-5056	75012792	Weldon	15,2	25,0	170,0	56,0	114,0	5,0	4	✓	63600	0,6	4
MM16-16070.0-0011M	00023547	Cylindrical	15,2	16,0	70,0	11,3	22,0	0,0	2	✓	63600	0,1	1
MM16-20070.0-0000	00023548	Cylindrical	15,2	20,0	70,0	0,0	20,0	60,0	1	✓	63600	0,2	1
MM16-20190.0-1055M	00094766	Cylindrical	15,2	20,0	190,0	55,0	140,0	1,0	3	✓	63600	0,4	5
MM16-20190.0-1075M	00094768	Cylindrical	15,2	20,0	190,0	75,0	140,0	1,0	3	✓	63600	0,4	5
MM16-20190.0-1095M	00094770	Cylindrical	15,2	20,0	190,0	95,0	140,0	1,0	3	✓	63600	0,4	6
MM16-25170.0-1060	00094767	Cylindrical	19,0	25,0	170,0	60,0	114,0	1,0	3	✓	63600	0,5	5
MM16-32250.0-10047	75069368	Cylindrical	15,2	32,0	250,0	47,6	190,0	10,0	4	✓	63600	1,3	4
MM16-16150.0-0080DS	02580692	Cylindrical Densimet	15,2	16,0	150,0	80,0	102,0	0,0	2	✓	47600	0,4	2
MM16-20080.0-0011DS	02580669	Cylindrical Densimet	15,2	20,0	80,0	11,3	30,0	0,0	2	✓	47600	0,4	2
MM16-20150.0-0038DS	02580695	Cylindrical Densimet	15,2	20,0	150,0	38,0	100,0	0,0	2	✓	47600	0,6	2
MM16-20160.0-0076DS	02580699	Cylindrical Densimet	15,2	20,0	160,0	76,0	110,0	0,0	2	✓	47600	0,6	2
MM16-20130.0-1045DS	02580757	Cylindrical Densimet	15,2	20,0	130,0	45,0	80,0	1,0	3	✓	47600	0,5	2
MM16-20190.0-1075DS	02580758	Cylindrical Densimet	15,2	20,0	190,0	75,0	140,0	1,0	3	✓	47600	0,8	2
MM16-20190.0-1095DS	02580760	Cylindrical Densimet	15,2	20,0	190,0	95,0	140,0	1,0	3	✓	47600	0,8	2
MM16-25250.0-1075DS	02580761	Cylindrical Densimet	15,2	25,0	250,0	75,0	194,0	1,0	5	✓	47600	1,6	2

Spare Parts

For cutter	Sleeve	Tension screw
3	MM-10062	MM16-1045
4	MM-10132	MM16-1045
1	MM-10030	MM16-1045
5	MM-10062	MM16-1093
6	MM-10062	MM16-10113
2	-	MM16-1045

MM16 Shank – Inch

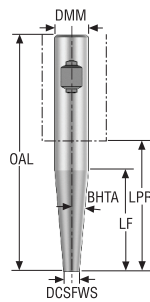

• For ISO attribute explanation, see page [XXX]

Designation	Item number	ShankType	DCSFWS	DMM	OAL	LF	LPR	BHTA°	Design		RPMX	Weight	Spare part no.
			Inch	Inch	Inch	Inch	Inch					lbs	
MM16-0.75-4.5-3-3018	75054603	Weldon	0.598	0.750	4.528	1.445	2.559	3,0	3	✓	63600	0.440	4
MM16-1.00-3.9-3-0007	75015058	Weldon	0.598	1.000	3.937	0.748	1.732	0,0	2	✓	63600	0.880	4
MM16-1.00-4.5-3-3013	75015059	Weldon	0.598	1.000	4.528	1.378	2.323	3,0	3	✓	63600	0.880	4
MM16-1.00-6.7-3-5022	75015060	Weldon	0.598	1.000	6.693	2.295	4.488	5,0	4	✓	63600	1.320	5
MM16-0.62-2.8-0M-0004	00037209	Cylindrical	0.598	0.625	2.756	0.445	0.866	0,0	2	✓	63600	0.220	1
MM16-0.75-2.8-0-0000	00037175	Cylindrical	0.598	0.750	2.756	–	0.787	60,0	1	✓	63600	0.440	1
MM16-0.75-7.5-0-1021	75054731	Cylindrical	0.598	0.750	7.480	2.165	5.512	1,0	3	✓	63600	0.880	6
MM16-0.75-7.5-0-1037	75054733	Cylindrical	0.598	0.750	7.480	3.740	5.512	1,0	3	✓	63600	0.880	7
MM16-0.75-7.5-0-1029DS	02567719	Cylindrical Densimet	0.598	0.750	7.480	2.953	5.512	1,0	3	✓	47600	1.760	3
MM16-0.75-7.5-0-1037DS	02593431	Cylindrical Densimet	0.598	0.750	7.480	3.740	5.512	1,0	3	✓	47600	1.540	3
MM16-1.00-5.9-0-0015DS	02593433	Cylindrical Densimet	0.598	1.000	5.906	1.496	3.701	0,0	2	✓	47600	2.200	3
MM16-1.00-6.3-0-0030DS	02593434	Cylindrical Densimet	0.598	1.000	6.299	2.992	4.094	0,0	2	✓	47600	1.980	3

Spare Parts

For cutter	Sleeve	Tension screw
4	MM-10062	MM16-1045
5	MM-10132	MM16-1045
1	MM-10030	MM16-1045
6	MM-10062	MM16-1093
7	MM-10062	MM16-10113
3	–	MM16-1045

Universal

Steel and cast iron

Stainless steel and S-materials

Non ferrous

Hard

Plastic and chip

Graphite

Minimaster Plus

Minimaster

Slot milling/square shoulder milling

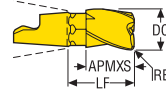

• For Torque keys and torque values, see page 615

Designation	DC	APMXS	RE	LF	RMPX°	C min	C max	FHA°	ZEFP	Wrench		Grades			
												Coated			
	mm Inch	mm Inch	mm Inch	mm Inch								T60M	F15M	F30M	F40M
MM16-15719-R03A30-M06	15,7 0.618	19,05 0.750	0,3 0.012	24,5 0.965	15,0	19,0	30,6	30	3	MM0416	✓				■
MM16-16019-A30-E06	16,0 0.630	19,05 0.750	0,0 0.0	24,5 0.965	15,0	19,4	31,8	30	3	MM0416	✓			■	
MM16-16019-R05A30-M06	16,0 0.630	19,05 0.750	0,5 0.020	24,5 0.965	15,0	19,4	30,8	30	3	MM0416	✓				■
MM16-16019-R10A30-E06	16,0 0.630	19,05 0.750	1,0 0.039	24,5 0.965	15,0	19,4	29,8	30	3	MM0416	✓			■	
MM16-16019-R10A30-M06	16,0 0.630	19,05 0.750	1,0 0.039	24,5 0.965	15,0	19,4	29,8	30	3	MM0416	✓				■
MM16-16019-R20A30-M06	16,0 0.630	19,05 0.750	2,0 0.079	24,5 0.965	15,0	19,4	27,8	30	3	MM0416	✓				■
MM16-16019-R30A30-E06	16,0 0.630	19,05 0.750	3,0 0.118	24,5 0.965	15,0	19,4	25,8	30	3	MM0416	✓			■	
MM16-16019-R30A30-M06	16,0 0.630	19,05 0.750	3,0 0.118	24,5 0.965	15,0	19,4	25,8	30	3	MM0416	✓				■
MM16-16019-R40A30-M06	16,0 0.630	19,05 0.750	4,0 0.157	24,5 0.965	15,0	19,4	23,8	30	3	MM0416	✓				■
MM16-16019-R50A30-M06	16,0 0.630	19,05 0.750	5,0 0.197	24,5 0.965	15,0	19,4	21,8	30	3	MM0416	✓				■
MM16-16019-R60A30-M06	16,0 0.630	19,05 0.750	6,0 0.236	24,5 0.965	15,0	19,4	19,8	30	3	MM0416	✓				■
MM16-20015-A30-E06	20,0 0.787	15,0 0.591	0,0 0.0	20,15 0.793	15,0	24,2	39,8	30	3	MM0416	✓			■	
MM16-20015-R05A30-M06	20,0 0.787	15,0 0.591	0,5 0.020	20,15 0.793	15,0	24,2	38,8	30	3	MM0416	✓				■
MM16-20015-R10A30-M06	20,0 0.787	15,0 0.591	1,0 0.039	20,15 0.793	15,0	24,2	37,8	30	3	MM0416	✓				■
MM16-20015-R20A30-D06	20,0 0.787	15,0 0.591	2,0 0.079	20,15 0.793	15,0	24,2	35,8	30	3	MM0416	✓			■	
MM16-20015-R30A30-M06	20,0 0.787	15,0 0.591	3,0 0.118	20,15 0.793	15,0	24,2	33,8	30	3	MM0416	✓				■
MM16-20015-R50A30-M06	20,0 0.787	15,0 0.591	5,0 0.197	20,15 0.793	15,0	24,2	29,8	30	3	MM0416	✓				■
MM16-15919-R08A30-M06	15,875 0.625	19,05 0.750	0,8 0.031	24,5 0.965	15,0	19,2	29,9	30	3	MM0416	✓				■

Slot milling/square shoulder milling

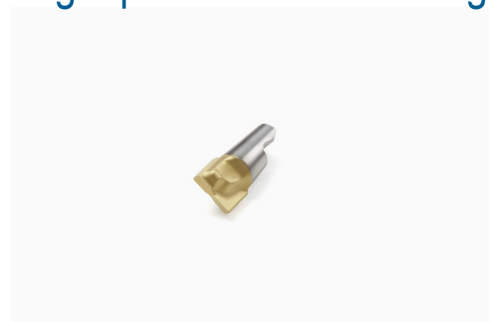
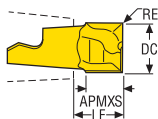

• For Torque keys and torque values, see page 615

Designation	DC	APMXS	RE	LF	RMPX°	C min	C max	FHA°	ZEFP	Wrench	Grades			
											Coated			
											T60M	F15M	F30M	F40M
MM16-15711T-R03-D07	15,7 0.618	11,0 0.433	0,3 0.012	13,6 0.535	15,0	19,0	30,6	0	2	MM1420	■			
MM16-16011-M06	16,0 0.630	11,0 0.433	0,0 NaN	13,6 0.535	15,0	19,4	31,8	0	2	MM1420	■			
MM16-16011-R08A8-E06	16,0 0.630	10,5 0.413	0,8 0.031	13,62 0.536	15,0	19,4	30,2	8	2	MM1420	■		■	
MM16-16011-R08-MD07	16,0 0.630	11,0 0.433	0,8 0.031	13,58 0.535	15,0	19,4	30,2	0	2	MM1420	■		■	
MM16-16011-R08P-M05	16,0 0.630	10,8 0.425	0,8 0.031	13,41 0.528	15,0	19,4	30,2	0	2	MM1420			■	
MM16-16011-R20-MD07	16,0 0.630	10,9 0.429	2,0 0.079	13,55 0.533	15,0	19,4	27,8	0	2	MM1420			■	
MM16-16011-R30-MD07	16,0 0.630	10,9 0.429	3,0 0.118	13,54 0.533	15,0	19,4	25,8	0	2	MM1420			■	
MM16-16011-R40-MD07	16,0 0.630	10,9 0.429	4,0 0.157	13,52 0.532	15,0	19,4	23,8	0	2	MM1420	■			
MM16-16011-R50-MD07	16,0 0.630	10,9 0.429	5,0 0.197	13,5 0.531	15,0	19,4	21,8	0	2	MM1420	■			
MM16-20013-R08A8-E06	20,0 0.787	12,7 0.500	0,8 0.031	15,42 0.607	15,0	24,2	38,2	8	2	MM1420	■		■	
MM16-19013-R08A8-E06	19,05 0.750	12,7 0.500	0,8 0.031	15,39 0.606	15,0	23,1	36,3	8	2	MM1420			■	

Universal

Steel and cast iron

Stainless steel and S-materials

Non ferrous

Hard

Plastic and chip

Graphite

Minimaster Plus

Minimaster

Centre drilling

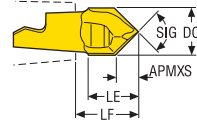

• For Torque keys and torque values, see page 615

Designation	DC	APMXS	LE	LF	SIG°	ZEFP	Wrench	Grades					
								Coated	T60M	F15M	F30M	F40M	
	mm Inch	mm Inch	mm Inch	mm Inch									
MM16-16008-C90-M06	16,0 0.630	7,53 0.296	16,7 0.657	19,2 0.756	90,0	2	MM1420	■					
MM16-16011-C120-M06	16,0 0.630	4,3 0.169	16,64 0.655	18,9 0.744	120,0	2	MM1420	■					
MM16-19019-C90	19,05 0.750	9,6 0.378	20,3 0.799	22,15 0.872	90,0	2	MM1420	■					

Chamfering

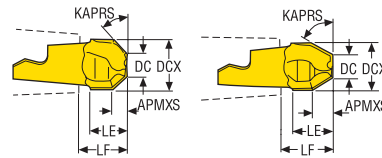
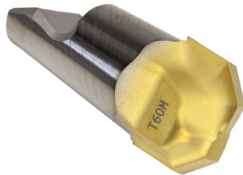

• For Torque keys and torque values, see page 615

Designation	DCX	DC	APMXS	LE	LF	KAPRS°	ZEFP	Wrench	Grades				
									Coated	T60M	F15M	F30M	F40M
	mm Inch	mm Inch	mm Inch	mm Inch	mm Inch								
MM16-16011-4540-E06	16,0 0.630	7,69 0.303	3,9 0.154	10,9 0.429	13,25 0.522	45,0	2	MM1420	■				
MM16-16012-6060-E06	16,0 0.630	8,38 0.330	6,7 0.264	12,9 0.508	15,3 0.602	60,0	2	MM1420	■				

Plunge milling

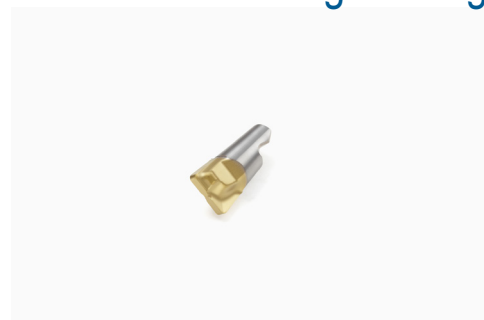
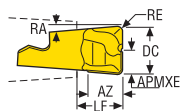

• For Torque keys and torque values, see page 615

Designation	DC	APMXE	RE	AZ	LF	RA°	ZEFP	Wrench	Grades			
									T60M	F15M	F30M	F40M
MM16-16011-R10-PL-MD07	16,0 0.630	8,0 0.315	1,0 0.039	11,3 0.445	11,3 0.445	5,0	2	MM1420			■	
MM16-16011-R20-PL-MD07	16,0 0.630	8,0 0.315	2,0 0.079	11,3 0.445	11,3 0.445	5,0	2	MM1420			■	

Precision inserts for semi-finishing in all materials

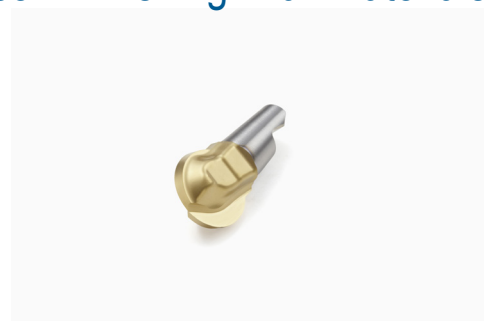
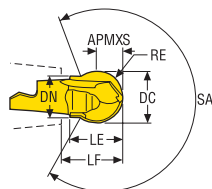

• For Torque keys and torque values, see page 615

Designation	DC	APMXS	RE	LE	LF	DN	SA°	ZEFP	Wrench	Grades			
										T60M	F15M	F30M	F40M
MM16-20020-B120PF-M04	20,0 0.787	10,0 0.394	10,0 0.394	20,0 0.787	21,94 0.864	15,9 0.626	254,0	2	MM1420		■		
MM16-20020-B120P-M07	20,0 0.787	10,0 0.394	10,0 0.394	20,0 0.787	21,94 0.864	15,9 0.626	254,0	2	MM1420			■	

Universal

Steel and cast iron

Stainless steel and S-materials

Non ferrous

Hard

Plastic and cfrp

Graphite

Minimaster Plus

Minimaster

Copy milling

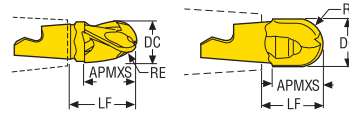

• For Torque keys and torque values, see page 615

Designation	DC	APMXS	RE	LF	FHA°	ZEP	Wrench	Grades			
								T60M	F15M	F30M	F40M
MM16-16019-B90A30-E06	16,0 0.630	19,0 0.748	8,0 0.315	24,5 0.965	30,0	3	MM0416 ✓			■	
MM16-20015-B90A30-E06	20,0 0.787	15,0 0.591	10,0 0.394	20,15 0.793	30,0	3	MM0416 ✓			■	
MM16-16019-B90A30-M06	16,0 0.630	19,0 0.748	8,0 0.315	24,5 0.965	30,0	3	MM0416 ✓				■
MM16-20015-B90A30-M06	20,0 0.787	15,0 0.591	10,0 0.394	20,15 0.793	30,0	3	MM0416 ✓				■
MM16-16016-B90-MD07	16,0 0.630	16,2 0.638	8,0 0.315	18,4 0.724	0,0	2	MM1420	■		■	
MM16-20020-B90-MD07	20,0 0.787	20,3 0.799	10,0 0.394	22,15 0.872	0,0	2	MM1420	■		■	
MM16-16016-B90P-M07	16,0 0.630	13,8 0.543	8,0 0.315	18,4 0.724	0,0	2	MM1420			■	
MM16-20020-B90P-M07	20,0 0.787	17,4 0.685	10,0 0.394	22,12 0.871	0,0	2	MM1420			■	
MM16-15916-B90P-M07	15,875 0.625	13,8 0.543	7,938 0.313	18,4 0.724	0,0	2	MM1420			■	
MM16-19020-B90P-M07	19,05 0.750	7,4 0.291	9,525 0.375	22,12 0.871	0,0	2	MM1420	■			
MM16-16016-B90PF-M03	16,0 0.630	13,8 0.543	8,0 0.315	18,4 0.724	0,0	2	MM1420		■		

MM16 - Slot and Side milling – Insert selection – mm/Inch

SMG		a _p	f _z			
			100%	40%	20%	10%
P1	MM16-16019-R05A30-M06 F40M	3,5 0.14	0,085 0.0034	0,085 0.0034	0,11 0.0044	0,14 0.0055
P2	MM16-16019-R05A30-M06 F40M	3,5 0.14	0,085 0.0034	0,090 0.0036	0,11 0.0044	0,14 0.0055
P3	MM16-16019-R05A30-M06 F40M	3,5 0.14	0,080 0.0032	0,085 0.0034	0,10 0.0040	0,14 0.0055
P4	MM16-16019-R05A30-M06 F40M	3,5 0.14	0,080 0.0032	0,080 0.0032	0,10 0.0040	0,13 0.0050
P5	MM16-16019-R05A30-M06 F40M	3,5 0.14	0,080 0.0032	0,080 0.0032	0,10 0.0040	0,13 0.0050
P6	MM16-16019-R05A30-M06 F40M	3,5 0.14	0,080 0.0032	0,080 0.0032	0,095 0.0038	0,13 0.0050
P7	MM16-16019-R05A30-M06 F40M	3,5 0.14	0,080 0.0032	0,080 0.0032	0,095 0.0038	0,13 0.0050
P8	MM16-16019-R05A30-M06 F40M	3,5 0.14	0,080 0.0032	0,085 0.0034	0,10 0.0040	0,14 0.0055
P11	MM16-16019-R05A30-M06 F40M	3,5 0.14	0,080 0.0032	0,080 0.0032	0,095 0.0038	0,13 0.0050
P12	MM16-16019-R05A30-M06 F40M	2,5 0.10	0,055 0.0022	0,055 0.0022	0,065 0.0026	0,090 0.0036
M1	MM16-16019-R05A30-M06 F40M	3,5 0.14	0,085 0.0034	0,090 0.0036	0,11 0.0044	0,14 0.0055
M2	MM16-16019-R05A30-M06 F40M	3,5 0.14	0,080 0.0032	0,080 0.0032	0,10 0.0040	0,13 0.0050
M3	MM16-16019-R05A30-M06 F40M	2,5 0.10	0,065 0.0026	0,065 0.0026	0,080 0.0032	0,10 0.0040
M4	MM16-16019-R05A30-M06 F40M	2,0 0.080	0,055 0.0022	0,055 0.0022	0,070 0.0028	0,090 0.0036
M5	MM16-16019-R05A30-M06 F40M	2,0 0.080	0,055 0.0022	0,055 0.0022	0,070 0.0028	0,090 0.0036
K1	MM16-16019-R10A30-E06 F30M	3,5 0.14	0,090 0.0036	0,090 0.0036	0,11 0.0044	0,14 0.0055
K2	MM16-16019-R10A30-E06 F30M	3,5 0.14	0,080 0.0032	0,080 0.0032	0,10 0.0040	0,13 0.0050
K3	MM16-16019-R10A30-E06 F30M	3,5 0.14	0,080 0.0032	0,080 0.0032	0,10 0.0040	0,13 0.0050
K4	MM16-16019-R10A30-E06 F30M	3,5 0.14	0,080 0.0032	0,080 0.0032	0,10 0.0040	0,13 0.0050
K5	MM16-16019-R10A30-M06 F40M	3,5 0.14	0,075 0.0030	0,075 0.0030	0,090 0.0036	0,12 0.0048
K6	MM16-16019-R10A30-M06 F40M	3,5 0.14	0,080 0.0032	0,080 0.0032	0,10 0.0040	0,13 0.0050
K7	MM16-16019-R10A30-M06 F40M	3,5 0.14	0,075 0.0030	0,075 0.0030	0,090 0.0036	0,12 0.0048
N1	MM16-16019-R10A30-E06 F30M	3,5 0.14	0,11 0.0044	0,11 0.0044	0,14 0.0055	0,18 0.0070
N2	MM16-16019-R10A30-E06 F30M	3,5 0.14	0,11 0.0044	0,11 0.0044	0,14 0.0055	0,18 0.0070
N3	MM16-16019-R10A30-E06 F30M	3,5 0.14	0,11 0.0044	0,11 0.0044	0,14 0.0055	0,18 0.0070
N11	MM16-16019-R10A30-E06 F30M	3,5 0.14	0,11 0.0044	0,11 0.0044	0,14 0.0055	0,18 0.0070
S1	MM16-16019-R05A30-M06 F40M	2,0 0.080	0,055 0.0022	0,055 0.0022	0,070 0.0028	0,090 0.0036
S2	MM16-16019-R05A30-M06 F40M	2,0 0.080	0,055 0.0022	0,055 0.0022	0,070 0.0028	0,090 0.0036
S3	MM16-16019-R05A30-M06 F40M	2,0 0.080	0,050 0.0020	0,055 0.0022	0,065 0.0026	0,085 0.0034
S11	MM16-16019-R05A30-M06 F40M	2,5 0.10	0,065 0.0026	0,065 0.0026	0,080 0.0032	0,10 0.0040
S12	MM16-16019-R05A30-M06 F40M	2,5 0.10	0,065 0.0026	0,065 0.0026	0,080 0.0032	0,10 0.0040
S13	MM16-16019-R05A30-M06 F40M	2,0 0.080	0,055 0.0022	0,055 0.0022	0,070 0.0028	0,090 0.0036
H5	MM16-16019-R10A30-E06 F30M	2,5 0.10	0,055 0.0022	0,055 0.0022	0,065 0.0026	0,090 0.0036
H8	MM16-16019-R10A30-E06 F30M	2,5 0.10	0,044 0.0017	0,044 0.0017	0,050 0.0020	0,070 0.0028
H11	MM16-16019-R10A30-E06 F30M	2,5 0.10	0,055 0.0022	0,055 0.0022	0,065 0.0026	0,090 0.0036
H12	MM16-16019-R10A30-E06 F30M	2,5 0.10	0,044 0.0017	0,044 0.0017	0,050 0.0020	0,070 0.0028
H21	MM16-16019-R10A30-E06 F30M	2,5 0.10	0,044 0.0017	0,044 0.0017	0,050 0.0020	0,070 0.0028

SMG = Seco material group
f_z = mm/tooth (in/tooth), v_c = m/min (sf/min), a_p/DC = %
All cutting data are start values

Universal
Steel and cast iron
Stainless steel and S-materials
Non ferrous
Hard
Plastic and chip
Graphite
Minimaster Plus
Minimaster

MM16 - Slot and Side milling – Cutting data $v_c = (m/min)/(sf/min)$

SMG	F30M				F40M				T60M			
	100%	40%	20%	10%	100%	40%	20%	10%	100%	40%	20%	10%
Universal P1	230	285	315	350	215	270	300	335	200	250	275	310
	750	940	1025	1150	710	890	980	1100	660	820	900	1025
Steel and cast iron P2	220	275	310	345	210	260	290	325	195	240	270	295
	720	900	1025	1125	690	850	950	1075	640	790	890	970
P3	195	240	270	295	185	225	255	280	170	210	235	260
	640	790	890	970	610	740	840	920	560	690	770	850
P4	170	215	240	265	160	205	225	250	150	185	205	225
	560	710	790	870	520	670	740	820	490	610	670	740
P5	165	205	230	250	155	195	215	240	140	175	200	220
	540	670	750	820	510	640	710	790	460	570	660	720
P6	185	230	260	285	175	215	245	270	160	200	220	245
	610	750	850	940	570	710	800	890	520	660	720	800
Stainless steel and S-materials P7	175	220	245	265	165	205	230	255	150	190	210	235
	570	720	800	870	540	670	750	840	490	620	690	770
P8	160	205	230	250	155	190	215	235	140	175	200	215
	520	670	750	820	510	620	710	770	460	570	660	710
P11	170	210	235	260	160	200	225	245	145	185	205	225
	560	690	770	850	520	660	740	800	475	610	670	740
P12	110	135	150	165	105	130	145	155	95	120	130	145
	360	445	490	540	345	425	475	510	310	395	425	475
Non ferrous M1	180	225	250	275	170	210	235	260	155	190	215	240
	590	740	820	900	560	690	770	850	510	620	710	790
M2	150	185	205	225	140	175	195	215	125	160	180	200
	490	610	670	740	460	570	640	710	410	520	590	660
M3	120	150	165	180	110	140	155	175	105	130	145	155
	395	490	540	590	360	460	510	570	345	425	475	510
M4	90	115	130	140	85	110	120	135	80	100	110	120
	295	375	425	460	280	360	395	445	260	330	360	395
M5	75	95	105	115	75	90	100	110	65	85	95	100
	245	310	345	375	245	295	330	360	215	280	310	330
Hard K1	175	220	245	270	165	205	230	260	150	190	210	235
	570	720	800	890	540	670	750	850	490	620	690	770
K2	155	195	215	240	145	185	205	225	135	170	190	210
	510	640	710	790	475	610	670	740	445	560	620	690
K3	130	165	185	205	125	155	175	190	115	145	160	175
	425	540	610	670	410	510	570	620	375	475	520	570
K4	125	160	175	195	120	150	165	185	110	135	150	170
	410	520	570	640	395	490	540	610	360	445	490	560
K5	75	95	105	115	75	90	100	110	65	80	95	100
	245	310	345	375	245	295	330	360	215	260	310	330
K6	110	140	155	170	105	130	145	160	95	120	135	150
	360	460	510	560	345	425	475	520	310	395	445	490
K7	100	120	135	150	95	115	130	140	85	105	120	130
	330	395	445	490	310	375	425	460	280	345	395	425
Graphite N1	1325	1650	1825	2025	1225	1550	1725	1925	1125	1425	1575	1750
	4350	5425	6000	6650	4025	5075	5650	6325	3700	4675	5175	5750
N2	530	670	730	820	500	630	690	770	455	570	640	700
	1750	2200	2400	2700	1650	2075	2275	2525	1500	1875	2100	2300
N3	355	445	490	540	335	420	465	520	305	385	425	470
	1175	1450	1600	1775	1100	1375	1525	1700	1000	1275	1400	1550
N11	405	510	560	620	380	475	530	590	345	435	485	540
	1325	1675	1825	2025	1250	1550	1750	1925	1125	1425	1600	1775
Minimaster Plus S1	43	55	60	65	41	50	55	60	38	46	50	55
	140	180	195	215	135	165	180	195	125	150	165	180
S2	35	43	48	55	33	41	45	50	30	37	42	46
	115	140	155	180	110	135	150	165	100	120	140	150
S3	30	38	42	46	29	35	40	44	27	33	37	40
	100	125	140	150	95	115	130	145	90	110	120	130
S11	60	75	85	90	55	70	80	90	50	65	75	80
	195	245	280	295	180	230	260	295	165	215	245	260
S12	42	50	60	65	39	49	55	60	36	45	50	55
	140	165	195	215	130	160	180	195	120	150	165	180
S13	24	30	34	37	23	29	32	35	21	26	29	32
	80	100	110	120	75	95	105	115	70	85	95	105
H5	36	45	50	55	34	43	48	50	31	39	44	48
	120	150	165	180	110	140	155	165	100	130	145	155
H8	38	47	55	60	36	45	50	55	33	41	46	50
	125	155	180	195	120	150	165	180	110	135	150	165
H11	46	60	65	70	43	55	60	65	40	50	55	60
	150	195	215	230	140	180	195	215	130	165	180	195
H12	70	85	95	105	65	80	90	100	60	75	85	90
	230	280	310	345	215	260	295	330	195	245	280	295
H21	38	47	55	60	36	45	50	55	33	41	46	50
	125	155	180	195	120	150	165	180	110	135	150	165

MM16 Z3 – Copy milling – Insert selection – Roughing – mm/Inch

SMG		a _p	f _z			
			100%	40%	20%	10%
P1	MM16-16019-B90A30-M06 F40M	3,5	0,11	0,10	0,11	0,14
		0,14	0,0044	0,0040	0,0044	0,0055
P2	MM16-16019-B90A30-M06 F40M	3,5	0,11	0,10	0,11	0,15
		0,14	0,0044	0,0040	0,0044	0,0060
P3	MM16-16019-B90A30-M06 F40M	3,5	0,10	0,10	0,10	0,14
		0,14	0,0040	0,0040	0,0040	0,0055
P4	MM16-16019-B90A30-M06 F40M	3,5	0,10	0,095	0,10	0,13
		0,14	0,0040	0,0038	0,0040	0,0050
P5	MM16-16019-B90A30-M06 F40M	3,5	0,10	0,095	0,10	0,13
		0,14	0,0040	0,0038	0,0040	0,0050
P6	MM16-16019-B90A30-M06 F40M	3,5	0,095	0,095	0,10	0,13
		0,14	0,0038	0,0038	0,0040	0,0050
P7	MM16-16019-B90A30-M06 F40M	3,5	0,095	0,095	0,10	0,13
		0,14	0,0038	0,0038	0,0040	0,0050
P8	MM16-16019-B90A30-M06 F40M	3,5	0,10	0,10	0,10	0,14
		0,14	0,0040	0,0040	0,0040	0,0055
P11	MM16-16019-B90A30-M06 F40M	3,5	0,095	0,095	0,10	0,13
		0,14	0,0038	0,0038	0,0040	0,0050
P12	MM16-16019-B90A30-M06 F40M	2,5	0,070	0,070	0,070	0,090
		0,10	0,0028	0,0028	0,0028	0,0036
M1	MM16-16019-B90A30-M06 F40M	3,5	0,11	0,10	0,11	0,15
		0,14	0,0044	0,0040	0,0044	0,0060
M2	MM16-16019-B90A30-M06 F40M	3,5	0,10	0,095	0,10	0,13
		0,14	0,0040	0,0038	0,0040	0,0050
M3	MM16-16019-B90A30-M06 F40M	2,5	0,085	0,080	0,080	0,11
		0,10	0,0034	0,0032	0,0032	0,0044
M4	MM16-16019-B90A30-M06 F40M	2,0	0,075	0,075	0,075	0,090
		0,080	0,0030	0,0030	0,0030	0,0038
M5	MM16-16019-B90A30-M06 F40M	2,0	0,075	0,075	0,075	0,090
		0,080	0,0030	0,0030	0,0030	0,0038
K1	MM16-16019-B90A30-E06 F30M	3,5	0,11	0,10	0,11	0,15
		0,14	0,0044	0,0040	0,0044	0,0060
K2	MM16-16019-B90A30-E06 F30M	3,5	0,10	0,095	0,10	0,13
		0,14	0,0040	0,0038	0,0040	0,0050
K3	MM16-16019-B90A30-E06 F30M	3,5	0,10	0,095	0,10	0,13
		0,14	0,0040	0,0038	0,0040	0,0050
K4	MM16-16019-B90A30-E06 F30M	3,5	0,10	0,095	0,10	0,13
		0,14	0,0040	0,0038	0,0040	0,0050
K5	MM16-16019-B90A30-E06 F30M	3,5	0,090	0,085	0,090	0,12
		0,14	0,0036	0,0034	0,0036	0,0048
K6	MM16-16019-B90A30-E06 F30M	3,5	0,10	0,095	0,10	0,13
		0,14	0,0040	0,0038	0,0040	0,0050
K7	MM16-16019-B90A30-E06 F30M	3,5	0,090	0,085	0,090	0,12
		0,14	0,0036	0,0034	0,0036	0,0048
N1	MM16-16019-B90A30-E06 F30M	3,5	0,14	0,13	0,14	0,19
		0,14	0,0055	0,0050	0,0055	0,0075
N2	MM16-16019-B90A30-E06 F30M	3,5	0,14	0,13	0,14	0,19
		0,14	0,0055	0,0050	0,0055	0,0075
N3	MM16-16019-B90A30-E06 F30M	3,5	0,14	0,13	0,14	0,19
		0,14	0,0055	0,0050	0,0055	0,0075
N11	MM16-16019-B90A30-E06 F30M	3,5	0,14	0,13	0,14	0,19
		0,14	0,0055	0,0050	0,0055	0,0075
S1	MM16-16019-B90A30-M06 F40M	2,0	0,075	0,075	0,075	0,090
		0,080	0,0030	0,0030	0,0030	0,0038
S2	MM16-16019-B90A30-M06 F40M	2,0	0,070	0,070	0,070	0,085
		0,080	0,0028	0,0028	0,0028	0,0036
S3	MM16-16019-B90A30-M06 F40M	2,5	0,085	0,080	0,085	0,11
		0,10	0,0034	0,0032	0,0034	0,0044
S11	MM16-16019-B90A30-M06 F40M	2,5	0,085	0,080	0,085	0,11
		0,10	0,0034	0,0032	0,0034	0,0044
S12	MM16-16019-B90A30-M06 F40M	2,0	0,075	0,075	0,075	0,090
		0,080	0,0030	0,0030	0,0030	0,0038
S13	MM16-16019-B90A30-M06 F40M	2,0	0,070	0,070	0,070	0,090
		0,080	0,0028	0,0028	0,0028	0,0036
H5	MM16-16019-B90A30-E06 F30M	2,5	0,055	0,050	0,055	0,070
		0,10	0,0022	0,0020	0,0022	0,0028
H8	MM16-16019-B90A30-E06 F30M	2,5	0,055	0,050	0,055	0,070
		0,10	0,0022	0,0020	0,0022	0,0028
H11	MM16-16019-B90A30-E06 F30M	2,5	0,070	0,070	0,070	0,090
		0,10	0,0028	0,0028	0,0028	0,0036
H12	MM16-16019-B90A30-E06 F30M	2,5	0,055	0,050	0,055	0,070
		0,10	0,0022	0,0020	0,0022	0,0028
H21	MM16-16019-B90A30-E06 F30M	2,5	0,055	0,050	0,055	0,070
		0,10	0,0022	0,0020	0,0022	0,0028

SMG = Seco material group
 f_z = mm/tooth (in/tooth), v_c = m/min (sf/min), a_p/DC = %
 All cutting data are start values

Universal
 Steel and cast iron
 Stainless steel and S-materials
 Non ferrous
 Hard
 Plastic and chip
 Graphite
 Minimaster Plus
 Minimaster

MM16 Z3 – Copy milling – Insert selection – Finishing – mm/Inch

SMG		a_p		f_z			
				15%	10%	5%	2%
P1	MM16-16019-B90A30-E06 F30M	3,5	0,12	0,14	0,20	0,32	
		0,14	0,0048	0,0055	0,0080	0,013	
P2	MM16-16019-B90A30-E06 F30M	3,5	0,12	0,15	0,20	0,34	
		0,14	0,0048	0,0060	0,0080	0,013	
P3	MM16-16019-B90A30-E06 F30M	3,5	0,12	0,14	0,19	0,32	
		0,14	0,0048	0,0055	0,0075	0,013	
P4	MM16-16019-B90A30-E06 F30M	3,5	0,11	0,13	0,19	0,30	
		0,14	0,0044	0,0050	0,0075	0,012	
P5	MM16-16019-B90A30-E06 F30M	3,5	0,11	0,13	0,18	0,30	
		0,14	0,0044	0,0050	0,0070	0,012	
P6	MM16-16019-B90A30-E06 F30M	3,5	0,11	0,13	0,18	0,30	
		0,14	0,0044	0,0050	0,0070	0,012	
P7	MM16-16019-B90A30-E06 F30M	3,5	0,11	0,13	0,18	0,30	
		0,14	0,0044	0,0050	0,0070	0,012	
P8	MM16-16019-B90A30-E06 F30M	3,5	0,12	0,14	0,19	0,32	
		0,14	0,0048	0,0055	0,0075	0,013	
P11	MM16-16019-B90A30-E06 F30M	3,5	0,11	0,13	0,18	0,30	
		0,14	0,0044	0,0050	0,0070	0,012	
P12	MM16-16019-B90A30-E06 F30M	2,5	0,075	0,090	0,12	0,20	
		0,10	0,0030	0,0036	0,0048	0,0080	
M1	MM16-16019-B90A30-E06 F30M	3,5	0,12	0,15	0,20	0,34	
		0,14	0,0048	0,0060	0,0080	0,013	
M2	MM16-16019-B90A30-E06 F30M	3,5	0,11	0,13	0,18	0,30	
		0,14	0,0044	0,0050	0,0070	0,012	
M3	MM16-16019-B90A30-E06 F30M	2,5	0,090	0,11	0,15	0,24	
		0,10	0,0036	0,0044	0,0060	0,0095	
M4	MM16-16019-B90A30-E06 F30M	2,0	0,080	0,090	0,13	0,20	
		0,080	0,0032	0,0038	0,0050	0,0080	
M5	MM16-16019-B90A30-E06 F30M	2,0	0,080	0,090	0,13	0,20	
		0,080	0,0032	0,0038	0,0050	0,0080	
K1	MM16-16019-B90A30-E06 F30M	3,5	0,12	0,15	0,20	0,34	
		0,14	0,0048	0,0060	0,0080	0,013	
K2	MM16-16019-B90A30-E06 F30M	3,5	0,11	0,13	0,18	0,30	
		0,14	0,0044	0,0050	0,0070	0,012	
K3	MM16-16019-B90A30-E06 F30M	3,5	0,11	0,13	0,18	0,30	
		0,14	0,0044	0,0050	0,0070	0,012	
K4	MM16-16019-B90A30-E06 F30M	3,5	0,11	0,13	0,18	0,30	
		0,14	0,0044	0,0050	0,0070	0,012	
K5	MM16-16019-B90A30-E06 F30M	3,5	0,10	0,12	0,17	0,26	
		0,14	0,0040	0,0048	0,0065	0,010	
K6	MM16-16019-B90A30-E06 F30M	3,5	0,11	0,13	0,18	0,30	
		0,14	0,0044	0,0050	0,0070	0,012	
K7	MM16-16019-B90A30-E06 F30M	3,5	0,10	0,12	0,17	0,26	
		0,14	0,0040	0,0048	0,0065	0,010	
N1	MM16-16019-B90A30-E06 F30M	3,5	0,16	0,19	0,26	0,44	
		0,14	0,0065	0,0075	0,010	0,017	
N2	MM16-16019-B90A30-E06 F30M	3,5	0,16	0,19	0,26	0,44	
		0,14	0,0065	0,0075	0,010	0,017	
N3	MM16-16019-B90A30-E06 F30M	3,5	0,16	0,19	0,26	0,44	
		0,14	0,0065	0,0075	0,010	0,017	
N11	MM16-16019-B90A30-E06 F30M	3,5	0,16	0,19	0,26	0,44	
		0,14	0,0065	0,0075	0,010	0,017	
S1	MM16-16019-B90A30-E06 F30M	2,0	0,080	0,090	0,13	0,20	
		0,080	0,0032	0,0038	0,0050	0,0080	
S2	MM16-16019-B90A30-E06 F30M	2,0	0,080	0,090	0,13	0,20	
		0,080	0,0032	0,0038	0,0050	0,0080	
S3	MM16-16019-B90A30-E06 F30M	2,0	0,075	0,085	0,12	0,19	
		0,080	0,0030	0,0036	0,0048	0,0075	
S11	MM16-16019-B90A30-E06 F30M	2,5	0,090	0,11	0,15	0,24	
		0,10	0,0036	0,0044	0,0060	0,0095	
S12	MM16-16019-B90A30-E06 F30M	2,5	0,090	0,11	0,15	0,24	
		0,10	0,0036	0,0044	0,0060	0,0095	
S13	MM16-16019-B90A30-E06 F30M	2,0	0,080	0,090	0,13	0,20	
		0,080	0,0032	0,0038	0,0050	0,0080	
H5	MM16-16019-B90A30-E06 F30M	2,5	0,075	0,090	0,12	0,20	
		0,10	0,0030	0,0036	0,0048	0,0080	
H8	MM16-16019-B90A30-E06 F30M	2,5	0,060	0,070	0,095	0,15	
		0,10	0,0024	0,0028	0,0038	0,0060	
H11	MM16-16019-B90A30-E06 F30M	2,5	0,075	0,090	0,12	0,20	
		0,10	0,0030	0,0036	0,0048	0,0080	
H12	MM16-16019-B90A30-E06 F30M	2,5	0,060	0,070	0,095	0,15	
		0,10	0,0024	0,0028	0,0038	0,0060	
H21	MM16-16019-B90A30-E06 F30M	2,5	0,060	0,070	0,095	0,15	
		0,10	0,0024	0,0028	0,0038	0,0060	

SMG = Seco material group
 f_z = mm/tooth (in/tooth), v_c = m/min (sf/min), a_e/DC = %
 All cutting data are start values

MM16 Z3 – Copy milling – Cutting data $v_c = (m/min)/(sf/min)$

SMG	F30M					F40M					
	100%	20%	10%	5%	2%	100%	20%	10%	5%	2%	
P1	245	295	310	335	335	235	280	295	320	320	Universal
	800	970	1025	1100	1100	770	920	970	1050	1050	
P2	240	285	300	325	320	230	270	285	310	305	Steel and cast iron
	790	940	980	1075	1050	750	890	940	1025	1000	
P3	210	250	260	285	280	200	240	250	270	265	Steel and cast iron
	690	820	850	940	920	660	790	820	890	870	
P4	185	220	235	250	250	175	210	225	240	240	Steel and cast iron
	610	720	770	820	820	570	690	740	790	790	
P5	175	210	225	240	240	170	200	215	230	230	Steel and cast iron
	570	690	740	790	790	560	660	710	750	750	
P6	200	235	250	270	270	190	225	240	260	255	Steel and cast iron
	660	770	820	890	890	620	740	790	850	840	
P7	190	225	235	255	255	180	210	225	245	240	Stainless steel and S-materials
	620	740	770	840	840	590	690	740	800	790	
P8	175	210	220	240	235	170	200	210	230	225	Stainless steel and S-materials
	570	690	720	790	770	560	660	690	750	740	
P11	185	215	230	250	245	175	205	220	235	235	Stainless steel and S-materials
	610	710	750	820	800	570	670	720	770	770	
P12	115	145	145	160	155	110	140	140	150	150	Stainless steel and S-materials
	375	475	475	520	510	360	460	460	490	490	
M1	195	230	240	265	260	185	220	230	250	245	Non ferrous
	640	750	790	870	850	610	720	750	820	800	
M2	160	190	200	220	215	150	180	190	205	205	Non ferrous
	520	620	660	720	710	490	590	620	670	670	
M3	130	160	160	170	170	120	150	150	165	165	Non ferrous
	425	520	520	560	560	395	490	490	540	540	
M4	90	125	125	130	135	85	120	115	125	125	Non ferrous
	295	410	425	425	445	280	395	410	410	410	
M5	75	105	100	110	110	70	100	100	105	105	Non ferrous
	245	345	360	360	360	230	330	345	345	345	
K1	190	225	235	260	255	180	215	225	245	245	Hard
	620	740	770	850	840	590	710	740	800	800	
K2	170	200	210	230	225	160	190	200	220	215	Hard
	560	660	690	750	740	520	620	660	720	710	
K3	140	170	180	195	190	135	160	170	185	185	Hard
	460	560	590	640	620	445	520	560	610	610	
K4	135	160	170	185	185	130	155	165	175	175	Hard
	445	520	560	610	610	425	510	540	570	570	
K5	85	100	105	110	110	80	95	100	105	105	Hard
	280	330	345	360	360	260	310	330	345	345	
K6	120	140	150	165	160	115	135	145	155	155	Plastic and chip
	395	460	490	540	520	375	445	475	510	510	
K7	105	125	130	145	145	100	120	125	135	135	Plastic and chip
	345	410	425	475	475	330	395	410	445	445	
N1	1425	1700	1775	1925	1900	1350	1625	1700	1850	1800	Graphite
	4675	5575	5825	6325	6225	4425	5325	5575	6075	5900	
N2	580	690	720	780	770	550	650	680	740	730	Graphite
	1900	2275	2350	2550	2525	1800	2125	2225	2425	2400	
N3	385	455	480	520	510	365	435	455	495	485	Graphite
	1275	1500	1575	1700	1675	1200	1425	1500	1625	1600	
N11	440	520	550	600	580	420	495	520	570	560	Graphite
	1450	1700	1800	1975	1900	1375	1625	1700	1875	1825	
S1	42	60	55	60	60	40	55	55	60	60	Minimaster Plus
	140	195	195	195	195	130	180	195	195	195	
S2	34	48	46	50	50	33	45	44	47	48	Minimaster Plus
	110	155	160	165	165	110	150	155	155	155	
S3	30	41	40	43	43	28	39	38	41	41	Minimaster Plus
	100	135	140	140	140	90	130	135	135	135	
S11	65	80	80	85	85	60	80	75	85	80	Minimaster Plus
	215	260	280	280	280	195	260	260	280	260	
S12	45	55	55	60	60	43	55	55	55	55	Minimaster Plus
	150	180	195	195	195	140	180	180	180	180	
S13	24	33	32	35	35	23	32	31	33	33	Minimaster Plus
	80	110	110	115	115	75	105	110	110	110	
H5	39	48	48	55	50	37	46	46	50	50	Minimaster
	130	155	160	180	165	120	150	150	165	165	
H8	40	50	50	55	55	38	49	48	50	50	Minimaster
	130	165	165	180	180	125	160	165	165	165	
H11	50	60	60	65	65	47	60	60	65	65	Minimaster
	165	195	195	215	215	155	195	195	215	215	
H12	70	90	90	100	100	70	85	85	95	95	Minimaster
	230	295	310	330	330	230	280	295	310	310	
H21	40	50	50	55	55	38	49	48	50	50	Minimaster
	130	165	165	180	180	125	160	165	165	165	

MM16 Z2 – Copy milling – Insert selection – Roughing – mm/inch

SMG		a _p	f _z			
			100%	40%	20%	10%
P1	MM16-16016-B90-MD07 F30M	6,0	0,11	0,11	0,13	0,17
		0.24	0.0044	0.0044	0.0050	0.0065
P2	MM16-16016-B90-MD07 F30M	6,0	0,11	0,11	0,13	0,17
		0.24	0.0044	0.0044	0.0050	0.0065
P3	MM16-16016-B90-MD07 F30M	6,0	0,11	0,10	0,12	0,16
		0.24	0.0044	0.0040	0.0048	0.0065
P4	MM16-16016-B90-MD07 F30M	6,0	0,10	0,10	0,12	0,16
		0.24	0.0040	0.0040	0.0048	0.0065
P5	MM16-16016-B90-MD07 F30M	6,0	0,10	0,10	0,12	0,15
		0.24	0.0040	0.0040	0.0048	0.0060
P6	MM16-16016-B90-MD07 F30M	6,0	0,10	0,10	0,12	0,15
		0.24	0.0040	0.0040	0.0048	0.0060
P7	MM16-16016-B90-MD07 F30M	6,0	0,10	0,10	0,12	0,15
		0.24	0.0040	0.0040	0.0048	0.0060
P8	MM16-16016-B90-MD07 F30M	6,0	0,11	0,10	0,12	0,16
		0.24	0.0044	0.0040	0.0048	0.0065
P11	MM16-16016-B90-MD07 F30M	6,0	0,10	0,10	0,12	0,15
		0.24	0.0040	0.0040	0.0048	0.0060
P12	MM16-16016-B90-MD07 F30M	5,0	0,070	0,070	0,080	0,10
		0.20	0.0028	0.0028	0.0032	0.0044
M1	MM16-16016-B90-MD07 F30M	6,0	0,11	0,11	0,13	0,17
		0.24	0.0044	0.0044	0.0050	0.0065
M2	MM16-16016-B90-MD07 F30M	6,0	0,10	0,10	0,12	0,15
		0.24	0.0040	0.0040	0.0048	0.0060
M3	MM16-16016-B90-MD07 F30M	5,0	0,085	0,080	0,095	0,12
		0.20	0.0034	0.0032	0.0038	0.0050
M4	MM16-16016-B90-MD07 F30M	4,0	0,080	0,080	0,085	0,11
		0.16	0.0032	0.0032	0.0034	0.0044
M5	MM16-16016-B90-MD07 F30M	4,0	0,080	0,080	0,085	0,11
		0.16	0.0032	0.0032	0.0034	0.0044
K1	MM16-16016-B90-MD07 F30M	6,0	0,11	0,11	0,13	0,17
		0.24	0.0044	0.0044	0.0050	0.0065
K2	MM16-16016-B90-MD07 F30M	6,0	0,10	0,10	0,12	0,15
		0.24	0.0040	0.0040	0.0048	0.0060
K3	MM16-16016-B90-MD07 F30M	6,0	0,10	0,10	0,12	0,15
		0.24	0.0040	0.0040	0.0048	0.0060
K4	MM16-16016-B90-MD07 F30M	6,0	0,10	0,10	0,12	0,15
		0.24	0.0040	0.0040	0.0048	0.0060
K5	MM16-16016-B90-MD07 F30M	6,0	0,090	0,090	0,11	0,14
		0.24	0.0036	0.0036	0.0044	0.0055
K6	MM16-16016-B90-MD07 F30M	6,0	0,10	0,10	0,12	0,15
		0.24	0.0040	0.0040	0.0048	0.0060
K7	MM16-16016-B90-MD07 F30M	6,0	0,090	0,090	0,11	0,14
		0.24	0.0036	0.0036	0.0044	0.0055
N1	MM16-16016-B90PF-M03 F15M	6,0	0,060	0,060	0,070	0,095
		0.24	0.0024	0.0024	0.0028	0.0038
N2	MM16-16016-B90PF-M03 F15M	6,0	0,060	0,060	0,070	0,095
		0.24	0.0024	0.0024	0.0028	0.0038
N3	MM16-16016-B90PF-M03 F15M	6,0	0,060	0,060	0,070	0,095
		0.24	0.0024	0.0024	0.0028	0.0038
N11	MM16-16016-B90PF-M03 F15M	6,0	0,060	0,060	0,070	0,095
		0.24	0.0024	0.0024	0.0028	0.0038
S1	MM16-16016-B90-MD07 F30M	4,0	0,080	0,080	0,085	0,11
		0.16	0.0032	0.0032	0.0034	0.0044
S2	MM16-16016-B90-MD07 F30M	4,0	0,080	0,080	0,085	0,11
		0.16	0.0032	0.0032	0.0034	0.0044
S3	MM16-16016-B90-MD07 F30M	4,0	0,070	0,070	0,080	0,10
		0.16	0.0028	0.0028	0.0032	0.0040
S11	MM16-16016-B90-MD07 F30M	4,5	0,085	0,085	0,095	0,12
		0.18	0.0034	0.0034	0.0038	0.0050
S12	MM16-16016-B90-MD07 F30M	4,5	0,085	0,085	0,095	0,12
		0.18	0.0034	0.0034	0.0038	0.0050
S13	MM16-16016-B90-MD07 F30M	4,0	0,080	0,080	0,085	0,11
		0.16	0.0032	0.0032	0.0034	0.0044
H5	MM16-16016-B90-MD07 F30M	5,0	0,070	0,070	0,080	0,10
		0.20	0.0028	0.0028	0.0032	0.0044
H8	MM16-16016-B90-MD07 F30M	4,5	0,055	0,055	0,060	0,080
		0.18	0.0022	0.0022	0.0024	0.0032
H11	MM16-16016-B90-MD07 F30M	5,0	0,070	0,070	0,080	0,10
		0.20	0.0028	0.0028	0.0032	0.0044
H12	MM16-16016-B90-MD07 F30M	4,5	0,055	0,055	0,060	0,080
		0.18	0.0022	0.0022	0.0024	0.0032
H21	MM16-16016-B90-MD07 F30M	4,5	0,055	0,055	0,060	0,080
		0.18	0.0022	0.0022	0.0024	0.0032

SMG = Seco material group
f_z = mm/tooth (in/tooth), v_c = m/min (sf/min), a_p/DC = %
All cutting data are start values

MM16 Z2 – Copy milling – Insert selection – Finishing – mm/Inch

SMG		a _p	f _z			
			15%	10%	5%	2%
P1	MM16-16016-B90PF-M03 F15M	6,0 0.24	0,060 0.0024	0,070 0.0028	0,10 0.0040	0,16 0.0065
P2	MM16-16016-B90PF-M03 F15M	6,0 0.24	0,060 0.0024	0,075 0.0030	0,10 0.0040	0,16 0.0065
P3	MM16-16016-B90PF-M03 F15M	6,0 0.24	0,060 0.0024	0,070 0.0028	0,095 0.0038	0,15 0.0060
P4	MM16-16016-B90PF-M03 F15M	6,0 0.24	0,055 0.0022	0,070 0.0028	0,095 0.0038	0,15 0.0060
P5	MM16-16016-B90PF-M03 F15M	6,0 0.24	0,055 0.0022	0,065 0.0026	0,090 0.0036	0,15 0.0060
P6	MM16-16016-B90PF-M03 F15M	6,0 0.24	0,055 0.0022	0,065 0.0026	0,090 0.0036	0,14 0.0055
P7	MM16-16016-B90PF-M03 F15M	6,0 0.24	0,055 0.0022	0,065 0.0026	0,090 0.0036	0,14 0.0055
P8	MM16-16016-B90PF-M03 F15M	6,0 0.24	0,060 0.0024	0,070 0.0028	0,095 0.0038	0,15 0.0060
P11	MM16-16016-B90PF-M03 F15M	6,0 0.24	0,055 0.0022	0,065 0.0026	0,090 0.0036	0,14 0.0055
P12	MM16-16016-B90PF-M03 F15M	4,5 0.18	0,038 0.0015	0,046 0.0018	0,060 0.0024	0,10 0.0040
M1	MM16-16016-B90PF-M03 F15M	6,0 0.24	0,060 0.0024	0,075 0.0030	0,10 0.0040	0,16 0.0065
M2	MM16-16016-B90PF-M03 F15M	6,0 0.24	0,055 0.0022	0,065 0.0026	0,090 0.0036	0,15 0.0060
M3	MM16-16016-B90PF-M03 F15M	4,5 0.18	0,046 0.0018	0,055 0.0022	0,075 0.0030	0,12 0.0048
M4	MM16-16016-B90PF-M03 F15M	3,5 0.14	0,040 0.0016	0,046 0.0019	0,065 0.0026	0,10 0.0040
M5	MM16-16016-B90PF-M03 F15M	3,5 0.14	0,040 0.0016	0,046 0.0019	0,065 0.0026	0,10 0.0040
K1	MM16-16016-B90PF-M03 F15M	6,0 0.24	0,060 0.0024	0,075 0.0030	0,10 0.0040	0,16 0.0065
K2	MM16-16016-B90PF-M03 F15M	6,0 0.24	0,055 0.0022	0,065 0.0026	0,090 0.0036	0,15 0.0060
K3	MM16-16016-B90PF-M03 F15M	6,0 0.24	0,055 0.0022	0,065 0.0026	0,090 0.0036	0,15 0.0060
K4	MM16-16016-B90PF-M03 F15M	6,0 0.24	0,055 0.0022	0,065 0.0026	0,090 0.0036	0,15 0.0060
K5	MM16-16016-B90PF-M03 F15M	6,0 0.24	0,050 0.0020	0,060 0.0024	0,085 0.0034	0,13 0.0050
K6	MM16-16016-B90PF-M03 F15M	6,0 0.24	0,050 0.0022	0,060 0.0026	0,085 0.0036	0,13 0.0060
K7	MM16-16016-B90PF-M03 F15M	6,0 0.24	0,050 0.0020	0,060 0.0024	0,085 0.0034	0,13 0.0050
N1	MM16-16016-B90PF-M03 F15M	6,0 0.24	0,080 0.0032	0,095 0.0038	0,13 0.0050	0,20 0.0080
N2	MM16-16016-B90PF-M03 F15M	6,0 0.24	0,080 0.0032	0,095 0.0038	0,13 0.0050	0,20 0.0080
N3	MM16-16016-B90PF-M03 F15M	6,0 0.24	0,080 0.0032	0,095 0.0038	0,13 0.0050	0,20 0.0080
N11	MM16-16016-B90PF-M03 F15M	6,0 0.24	0,080 0.0032	0,095 0.0038	0,13 0.0050	0,20 0.0080
S1	MM16-16016-B90PF-M03 F15M	3,5 0.14	0,040 0.0016	0,046 0.0019	0,065 0.0026	0,10 0.0040
S2	MM16-16016-B90PF-M03 F15M	3,5 0.14	0,040 0.0016	0,046 0.0019	0,065 0.0026	0,10 0.0040
S3	MM16-16016-B90PF-M03 F15M	3,5 0.14	0,038 0.0015	0,044 0.0017	0,060 0.0024	0,095 0.0038
S11	MM16-16016-B90PF-M03 F15M	4,0 0.16	0,046 0.0018	0,055 0.0022	0,075 0.0030	0,12 0.0048
S12	MM16-16016-B90PF-M03 F15M	4,0 0.16	0,046 0.0018	0,055 0.0022	0,075 0.0030	0,12 0.0048
S13	MM16-16016-B90PF-M03 F15M	3,5 0.14	0,040 0.0016	0,046 0.0019	0,065 0.0026	0,10 0.0040
H5	MM16-16016-B90PF-M03 F15M	4,5 0.18	0,038 0.0015	0,046 0.0018	0,060 0.0024	0,10 0.0040
H8	MM16-16016-B90PF-M03 F15M	4,0 0.16	0,030 0.0012	0,034 0.0014	0,048 0.0019	0,075 0.0030
H11	MM16-16016-B90PF-M03 F15M	4,5 0.18	0,038 0.0015	0,046 0.0018	0,060 0.0024	0,10 0.0040
H12	MM16-16016-B90PF-M03 F15M	4,0 0.16	0,030 0.0012	0,034 0.0014	0,048 0.0019	0,075 0.0030
H21	MM16-16016-B90PF-M03 F15M	4,0 0.16	0,030 0.0012	0,034 0.0014	0,048 0.0019	0,075 0.0030

SMG = Seco material group
 f_z = mm/tooth (in/tooth), v_c = m/min (sf/min), a_p/DC = %
 All cutting data are start values

Universal
 Steel and cast iron
 Stainless steel and S-materials
 Non ferrous
 Hard
 Plastic and chip
 Graphite
 Minimaster Plus
 Minimaster



MM16 Z2 – Copy milling – Cutting data v_c = (m/min)/(sf/min)

	SMG	F15M					F30M					T60M				
		100%	20%	10%	5%	2%	100%	20%	10%	5%	2%	100%	20%	10%	5%	2%
Universal	P1	285	360	390	420	415	225	280	300	325	325	185	225	245	265	265
		940	1175	1275	1375	1350	740	920	980	1075	1075	610	740	800	870	870
Steel and cast iron	P2	275	350	375	405	405	220	270	295	315	315	180	220	240	255	255
		900	1150	1225	1325	1325	720	890	970	1025	1025	590	720	790	840	840
	P3	240	305	325	355	355	190	240	255	280	275	155	195	210	225	225
		790	1000	1075	1175	1175	620	790	840	920	900	510	640	690	740	740
	P4	215	270	285	310	310	170	210	225	245	245	140	170	185	200	195
		710	890	940	1025	1025	560	690	740	800	800	460	560	610	660	640
	P5	205	255	275	300	295	165	200	220	235	230	130	160	175	190	190
		670	840	900	980	970	540	660	720	770	750	425	520	570	620	620
	P6	230	290	310	335	335	180	225	245	265	265	150	180	200	215	215
		750	950	1025	1100	1100	590	740	800	870	870	490	590	660	710	710
Stainless steel and S-materials	P7	215	275	290	315	315	170	210	230	250	250	140	170	190	200	200
		710	900	950	1025	1025	560	690	750	820	820	460	560	620	660	660
	P8	200	255	275	295	295	160	200	215	235	230	130	160	175	190	190
		660	840	900	970	970	520	660	710	770	750	425	520	570	620	620
	P11	210	265	285	310	310	165	205	225	240	240	135	165	180	195	195
		690	870	940	1025	1025	540	670	740	790	790	445	540	590	640	640
	P12	135	175	175	190	190	110	140	145	155	155	90	110	115	125	125
		445	570	590	620	620	360	460	475	510	510	295	360	375	410	410
Non ferrous	M1	225	285	300	330	325	175	220	235	255	250	145	180	190	205	205
		740	940	980	1075	1075	570	720	770	840	820	475	590	620	670	670
	M2	185	230	250	270	265	145	180	195	210	210	120	145	160	170	170
		610	750	820	890	870	475	590	640	690	690	395	475	520	560	560
	M3	150	190	195	210	210	120	150	155	170	170	95	125	125	135	135
		490	620	660	690	690	395	490	520	560	560	310	410	425	445	445
	M4	115	150	150	160	160	95	125	120	130	130	75	100	95	105	105
		375	490	520	520	520	310	410	425	425	425	245	330	345	345	345
	M5	95	125	125	135	135	80	100	100	110	110	65	85	80	90	85
		310	410	445	445	445	260	330	345	360	360	215	280	280	295	280
Hard	K1	220	280	295	320	320	175	215	235	250	250	140	175	190	205	200
		720	920	970	1050	1050	570	710	770	820	820	460	570	620	670	660
	K2	195	245	260	285	280	155	190	210	220	220	125	155	170	180	180
		640	800	850	940	920	510	620	690	720	720	410	510	560	590	590
	K3	165	205	220	240	240	130	160	175	190	185	105	130	140	150	150
		540	670	720	790	790	425	520	570	620	610	345	425	460	490	490
	K4	155	195	210	230	225	125	155	170	180	180	100	125	135	145	145
		510	640	690	750	740	410	510	560	590	590	330	410	445	475	475
Plastic and cfrp	K5	95	120	125	135	140	75	95	100	110	110	60	75	80	90	90
		310	395	410	445	460	245	310	330	360	360	195	245	260	295	295
	K6	135	175	185	200	200	110	135	150	160	155	90	110	120	130	125
		445	570	610	660	660	360	445	490	520	510	295	360	395	425	410
	K7	120	150	165	175	175	95	120	130	140	140	80	95	105	115	115
		395	490	540	570	570	310	395	425	460	460	260	310	345	375	375
Graphite	N1	1675	2125	2250	2450	2450	1300	1625	1725	1875	1850	1050	1325	1400	1525	1500
		5500	6975	7375	8050	8050	4275	5325	5650	6150	6075	3450	4350	4600	5000	4925
	N2	680	860	910	990	990	530	660	700	760	750	425	530	570	620	610
		2225	2825	2975	3250	3250	1750	2175	2300	2500	2450	1400	1750	1875	2025	2000
	N3	450	570	610	660	660	350	435	465	510	500	285	355	380	410	405
		1475	1875	2000	2175	2175	1150	1425	1525	1675	1650	940	1175	1250	1350	1325
	N11	520	650	690	750	760	400	500	530	580	570	325	405	430	470	465
		1700	2125	2275	2450	2500	1300	1650	1750	1900	1875	1075	1325	1400	1550	1525
Minimaster Plus	S1	55	70	70	75	75	44	55	55	60	60	36	46	45	49	49
		180	230	245	245	245	145	180	195	195	195	120	150	160	160	160
	S2	44	55	55	60	60	35	46	45	49	49	29	37	36	40	39
		145	180	195	195	195	115	150	155	160	160	95	120	130	130	130
	S3	38	49	48	50	50	31	40	39	43	43	25	32	32	35	35
		125	160	165	165	165	100	130	140	140	140	80	105	110	115	115
	S11	75	100	100	105	105	60	80	80	85	85	50	65	65	70	70
		245	330	345	345	345	195	260	260	280	280	165	215	215	230	230
	S12	55	70	70	75	75	43	55	55	60	60	35	44	44	48	48
		180	230	230	245	245	140	180	180	195	195	115	145	150	155	155
Minimaster	S13	31	39	39	42	42	25	32	31	34	34	20	26	25	28	28
		100	130	140	140	140	80	105	110	110	110	65	85	90	90	90
	H5	45	55	60	65	65	36	46	48	50	50	30	37	39	41	41
		150	180	195	215	215	120	150	155	165	165	100	120	130	135	135
	H8	46	60	60	65	65	39	50	50	55	55	31	40	40	44	43
		150	195	215	215	215	130	165	165	180	180	100	130	140	145	140
	H11	55	75	75	80	80	46	60	60	65	65	38	47	49	55	50
		180	245	245	260	260	150	195	195	215	215	125	155	165	180	165
	H12	85	105	105	115	115	70	90	90	95	95	55	70	70	80	80
		280	345	375	375	375	230	295	310	310	310	180	230	245	260	260
	H21	46	60	60	65	65	39	50	50	55	55	31	40	40	44	43
		150	195	215	215	215	130	165	165	180	180	100	130	140	145	140

Torque wrench and Max RPM information

Torque wrench	
<p>Recommended RPM for all Seco cutters are shown on each catalogue page. Normally there is no need for balancing tools for RPM up to 10 000. However in some cases balancing is necessary, for instance when using heavy tools and tool holders in small machines</p>	
<p>Torque wrench with fixed torque values to ensure the correct tightening force when mounting the Minimaster insert into its holder. Dynamometric keys are calibrated according to ISO 6789. Code key: MM02-4006 MM02 = 2-flute (MM03 = 3-flute) 40 = Torque value 4 Nm 06 = Insert size</p>	<p>Over 10 000 RPM: We recommend balancing of tool and tool holders at least separately. Over 20 000 RPM: Both tool and tool holders must be balanced at least separately. Over 30 000 RPM: Tool and tool holders must be balanced as a unit. The max RPM in the tables should never be exceeded.)</p>

2 flute inserts

Insert size	Torque wrench (including key end)	Replaceable key end	Torque value
			
MM06	MM02-4006	MM02-06	4 Nm
MM08	MM02-8008	MM02-08	8 Nm
MM10	MM02-1201012	MM02-1012	12 Nm
MM12	MM02-1201012	MM02-1012	12 Nm
MM12 DC= Ø 14,0	MM02-16014	MM02-14	16 Nm
MM12 DCX= Ø 16,0	MM02-1601620	MM02-1620	16 Nm
MM16	MM02-1601620	MM02-1620	16 Nm

3 flute inserts

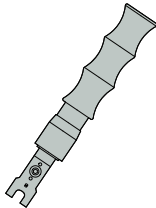
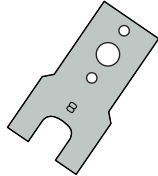
Insert size	Torque wrench (including key end)	Replaceable key end	Torque value
			
MM06	MM03-4006	MM03-06	4 Nm
MM08	MM03-8008	MM03-08	8 Nm
MM10	MM03-1201012	MM03-1012	12 Nm
MM12	MM03-1201012	MM03-1012	12 Nm
MM16	MM03-16016	MM03-16	16 Nm

Universal
Steel and cast iron
Stainless steel and S-materials
Non ferrous
Hard
Plastic and cfrp
Graphite
Minimaster Plus
Minimaster

Steels, ferritic and martensitic stainless steels

SMG	Description	Properties	Reference	$k_{c1.1}$	m_c
P1	Free-cutting steels	$360 < R_m < 880$	11 SMn30 $R_m = 385 \text{ N/mm}^2$	1500	0,14
P2	Low-alloy ferritic steels, C < 0.25%wt Low-alloy weldable general structural steels	$320 < R_m < 600$	S235JRG2 $R_m = 420 \text{ N/mm}^2$	1600	0,23
P3	Ferritic & ferritic/pearlitic steels, C < 0.25%wt Weldable general structural steels Case-hardening steels	$430 < R_m < 610$	16 MnCr 5 $R_m = 550 \text{ N/mm}^2$	1800	0,14
P4	Low-alloy general structural steels, $0.25\% < C < 0.67\%$ wt Low-alloy Quench & Temper steels	$520 < R_m < 1200$	C 45E $R_m = 660 \text{ N/mm}^2$	2000	0,15
P5	Structural steels, $0.25\% < C < 0.67\%$ wt Quench & Temper steels	$550 < R_m < 1200$	42 CrMo 4 $R_m = 700 \text{ N/mm}^2$	2020	0,18
P6	Low-alloy through-hardening steels, C > 0.67%wt Low-alloy spring and bearing steels	$520 < R_m < 1200$	C 100S $R_m = 600 \text{ N/mm}^2$	2100	0,17
P7	Through-hardening steels, C > 0.67%wt Spring and bearing steels	$600 < R_m < 1200$	100 Cr 6 $R_m = 650 \text{ N/mm}^2$	2160	0,17
P8	Tool steels High Speed Steels (HSS)	$600 < R_m < 1200$	X 40 CrMoV 5 1 $R_m = 700 \text{ N/mm}^2$	2400	0,20
P11	Ferritic & martensitic stainless steels	$415 < R_m < 1200$	X 20 Cr 13 $R_m = 675 \text{ N/mm}^2$	2000	0,15
P12	Maraging and precipitation-hardening stainless steels	$500 < R_m < 1200$	X 5 CrNiCuNb 16 4 $R_m = 1100 \text{ N/mm}^2$	2100	0,17

Free-cutting, austenitic and duplex stainless steels

SMG	Description	Properties	Reference	$k_{c1.1}$	m_c
M1	Free-cutting austenitic stainless steels		X 10 CrNiS 18 9	1700	0,14
M2	Low-alloy austenitic stainless steels		X 5 CrNi 18 10	1920	0,18
M3	Medium-alloy austenitic stainless steels		X 2 CrNiMo 18 14 3	2070	0,17
M4	High-alloy austenitic and duplex stainless steels		X 2 CrNiMoN 22 5 3	2230	0,16
M5	Difficult high-alloy austenitic and duplex stainless steels		X 2 CrNiMoN 25 7 4	2510	0,13

Cast irons

SMG	Description	Properties	Reference	$k_{c1.1}$	m_c
K1	Grey cast irons (GCI)		EN-GJL-250	930	0,32
K2	Compacted graphite irons (CGI)		EN-GJV-400	1000	0,35
K3	Malleable cast irons (MCI)		EN-GJMB-550-4	1050	0,37
K4	Nodular cast irons (SGI)		EN-GJS-500-7	1160	0,37
K5	Austempered ductile irons (ADI)		EN-GJS-1000-5		
K6	Austenitic lamellar cast irons		EN-GJLA-XNiCuCr15-6-2		
K7	Austenitic nodular cast irons		EN-GJSA-XNiMn23-4		

Non-ferrous metals

SMG	Description	Properties	Reference	$k_{c1.1}$	m_c
N1	Aluminium alloys, Si < 9%		AW-7075		
N2	Aluminium alloys, 9% < Si < 16%		AC-44200 Si = 12%		
N3	Aluminium alloys, Si > 16%		AlSi17Cu5		
N11	Copper alloys		CW614N	740	0,26

Superalloys and titanium

SMG	Description	Properties	Reference	$k_{c1.1}$	m_c
S1	Iron-based superalloys		Discolloy		
S2	Cobalt-based superalloys		Stellite 21		
S3	Nickel-based superalloys		Inconel 718	2530	0,21
S11	Titanium, low alloyed, (α)		Ti		
S12	Titanium, medium alloyed, (α + β)		TiAl6V4	1500	0,24
S13	Titanium, high alloyed, (near β and β)		Ti10V2Fe3Al		

Hard materials

SMG	Description	Properties	Reference	$k_{c1.1}$	m_c
H3	Case-hardened steels	58 < HRC < 62	16 MnCr 5 60 HRC	2070	0,14
H5	Quenched & Tempered steels	38 < HRC < 56	42 CrMo 4 50 HRC	2320	0,18
H7	Quenched & Tempered steels Bearing steels	56 < HRC < 64	100 Cr 6 60 HRC	2480	0,17
H8	Tool steels High Speed Steels (HSS)	38 < HRC < 64	X 40 CrMoV 5 1 50 HRC	2750	0,20
H11	Martensitic stainless steels	38 < HRC < 50	X 20 Cr 13 45 HRC	2300	0,15
H12	Maraged and precipitation- hardened stainless steels	1200 < R_m < 1650	X 5 CrNiCuNb 16 4 $R_m = 1450 \text{ N/mm}^2$	2410	0,17
H21	Manganese steels	23 < HRC < 64	X 120 Mn 12 50 HRC		
H31	White cast irons	50 < HRC < 64	EN-GJN-HV600(XCr11) 55 HRC		

Other difficult materials

SMG	Description	Properties	Reference	$k_{c1.1}$	m_c
PM1	Low-alloy PM-materials		F-0008 Fe-0.7C		
PM2	Medium-alloy PM-materials		FLC-4608 Fe2Cu1.8Ni 0.5Mo0.2Mn0.8C		
PM3	High-alloy PM-materials Exhaust valve seat materials, etc.				
HF1	Hardfacing alloys Welded or plasma-deposited iron-based alloys				
HF2	Hardfacing alloys Welded or plasma-deposited cobalt- and nickel-based alloys				
CC1	Sintered tungsten carbide		G50		

Plastics and Composites

SMG	Description	Properties	Reference	$k_{c1.1}$	m_c
TS1	Thermosetting polymers		Urea formaldehyde (UF)		
TS2	Thermosetting carbon-fibre composites		T300 T700 T800 HTA-S IMA - Epoxy (M21)...		
TS3	Thermosetting glass-fibre composites		Epoxy - HX..(42..)E glass (7781...)...		
TS4	Thermosetting aramide-fibre composites		Kevlar 49		
TP1	Thermoplastic polymers		Polycarbonate (PC)		
TP2	Thermoplastic carbon-fibre composites		PPS/PEEK - T300..		
TP3	Thermoplastic glass-fibre composites		PPS/PEEK - E glass or A glass...		
TP4	Thermoplastic aramide-fibre composites				

Graphite

SMG	Description	Properties	Reference	$k_{c1.1}$	m_c
GR1	Graphite		R 8500		

SMG

SMG	EN	EN-Nr	W.-Nr	DIN	AFNOR	BS	UNI	JIS	SS	UNS	
P1	11 SMn 30	1.0715	1.0715	9 SMn 28	S 250	230 M 07	CF 9 SMn 28	SUM 22	1912	G12130	
	11 SMnPb 30	1.0718	1.0718	9 SMnPb 28	S 250 Pb		CF 9 SMnPb 28	SUM 22 L	1914	G12134	
	10 S 20	1.0721	1.0721	10 S 20	10 F 1	210 M 15	CF 10 S 20				
			1.0722	10 SPb 20	10 PbF 2		CF 10 SPb 20				
	15 SMn 13	1.0725	1.0723	15 S 20		210 A 15		SUM 32	1922		
	35 S20	1.0726	1.0726	35 S 20	35 MF 4	212 M 36			1957	G11400	
	46 S20	1.0727	1.0727	46 S 20	46 MF 4	212 M 44			1973	G11460	
	11 SMn 37	1.0736	1.0736	9 SMn 36	S 300	240 M 07	CF 9 SMn 36			G12150	
11 SMn 37	1.0736	1.0736	9 SMn 36	S 300	240 M 07	CF 9 SMn 36			G12150		
P2	S235JR	1.0037	1.0037	St 37-2	E 24-2		Fe 360 B	STKM 12 C	1311		
	S235JRG2	1.0038	1.0116	St 37-3	E 24-3, E 24-4	4360-40 C	Fe 360 D FF		1312, 1313		
	S275J2G3	1.0144	1.0144	St 44-3 N	E 28-3, E 28-4	4360-43 C	Fe 430 D FF	SM 41 C	1412, 1414		
	C 10	1.0301	1.0301	C 10	34 C 10, XC 10	045 M 10	C 10	S 10 C		G10100	
			1.0401	C 15	37 C 12, XC 18	080 M 15	C 15, C 16		1350	G10170	
	C22	1.0402	1.0402	C 22	C 20	050 A 20	C 20, C 21		1450	G10200	
	S355JR	1.0570	1.0570	St 52-3	E 36-3, E 36-4	4360-50 C	Fe 510 B	SM 50 YA	2172, 2132		
	C 15R	1.1141	1.1141	Ck 15	XC 15, XC 18	080 M 15	C 15, C 16	S 15 C, S 15 CK	1370	G10170	
		1.1158	Ck 25	XC 25	060 A 25	C 25	S 25 C		G10250		
		1.2162	21 MnCr 5	20 NC 5			SCR 420 H				
P3	16 Mo 3	1.5415	1.5415	15 Mo 3	15 D 3	1501-240	16 Mo 3		2912		
			1.5423	16 Mo 5		1503-245-420	16 Mo 5	SB 450 M		G45200	
	14 NiCr 14	1.5752	1.5752	14 NiCr 14	12 NC 15	655 M 13		SNC 815 (H)		G33106	
			1.5919	15 CrNi 6	16 NC 6	S 107	16 CrNi 4				
	18 NiCrMo 7 6	1.6587	1.6587	18 CrNiMo 7 6	18 NCD 6	820 A 16	18 NiCrMo 7				
	16 MnCr 5	1.7131	1.7131	16 MnCr 5	16 MC 5	527 M 17	16 MnCr 5	SCR 415	2511	G51170	
	16 MnCrS 5	1.7139	1.7139	16 MnCrS 5							
	20 MnCr 5	1.7147	1.7147	20 MnCr 5	20 MC 5		20 MnCr 5	SMnC 420 (H)		G51200	
	20 MnCrS 5	1.7149	1.7149	20 MnCrS 5	20 MnCrS 5			SMnC 21 H			
13 CrMo 4 5	1.7335	1.7335	13 CrMo 4 4	15 CD 3.5	1501-620 Gr. 27	14 CrMo 4 5		2216			
		1.7337	16 CrMo 4 4	15 CD 4.5	1501-620 Gr. 27	14 CrMo 4 5		2216			
10 CrMo 9 10	1.7380	1.7380	10 CrMo 9 10	10 CD 9.10	1501-622 Gr. 31	12 CrMo 9 10		2218	J21890		
P4	C35		1.0501	C 35	55 C 35	060 A 35	C 35		1550	G10350	
	E 335	1.0503	1.0503	C 45	65 C 45	80 M 46	C 45	S 45 C	1650	G10430	
	C40		1.0511	C 40	60 C 40	080 M 40		S 40 C			
	E 360	1.0070	1.0535	St 70-2	A 70-2		Fe 690		1655		
	C60	1.0601	1.0601	C 60	CC 55	080 A 62	C 60			G10600	
			1.1157	40 Mn 4	35 M 5	150 M 36				G10390	
	G 28 Mn6	1.1165	1.1165	30 Mn 5		120 M 36		SMn 1 H, SCMn 2		G13300	
	C 35E	1.1181	1.1181	Ck 35	XC 38 H1	080 M 36	C 35	S 35 C	1572	G10340	
	C 45E	1.1191	1.1191	Ck 45	XC 42	080 M 46	C 45	S 45 C	1672	G10420	
	C 60E	1.1221	1.1221	Ck 60	XC 60	080 A 62	C 60	S 58 C	1665, 1678	G10640	
			1.1740	C 60 W	Y3 55			SK 7			
	P5	55 SiCr7	1.7100	1.0904	55 Si 7	55 S 7	250 A 53	55 Si 8		2085, 2090	
			1.2330	35 CrMo 4	34 CD 4	708 A 37	35 CrMo 4			T51620	
			1.2542	45 WCrV 7			BS 1	45 WCrV 8 KU		2710	T41901
			1.2714	56 NiCrMoV 7			BH 224-5	56 NiCrMoV7-KU	SKT 4		T61206
			1.5121	46 MnSi 4							
			1.5710	36 NiCr 6	35 NC 6	640 A 35			SNC 236		
			1.5736	36 NiCr 10	35 NC 11			35 NiCr 9	SNC 631 (H)		
36 CrNiMo 4			1.6511	36 CrNiMo 4	40 NCD 3	816 M 40	38 NiCrMo 4 (KB)				G98400
34 CrNiMo 6		1.6582	1.6582	34 CrNiMo 6	35 NCD 6	817 M 40	35 NiCrMo 6 (KW)		SNCM 447	2541	G43400
34 Cr 4		1.7033	1.7033	34 Cr 4	32 C 4	530 A 32	34 Cr 4 (KB)	SCR 430 (H)			G51320
41 Cr 4		1.7035	1.7035	41 Cr 4	42 C 4	530 M 40	41 Cr 4	SCR 440 (H)			G51400
25 CrMo 4		1.7218	1.7218	25 CrMo 4	25 CD 4 S	708 M 25	25 CrMo 4 (KB)	SCM 425	2225		G41300
42 CrMo 4		1.7225	1.7225	42 CrMo 4	42 CD 4	708 M 40	42 CrMo 4	SCM 440 (H)	2244		G41400
42 CrMo 4	1.7225	1.7225	42 CrMo 4	42 CD 4	708 M 40	42 CrMo 4	SCM 440 (H)	2244		G41400	
		1.7361	32 CrMo 12	30 CD 12	722 M 24	32 CrMo 12		2240			
50 CrV 4	1.8159	1.8159	50 CrV 4	50 CV 4	735 A 50	51 CrV 4	SUP 10	2230		H61500	
41 CrAlMo 7 10	1.8509	1.8509	41 CrAlMo 7	40 CAD 6.12	905 M 39	41 CrAlMo 7	SACM 645	2940		K24065	
C 67S	1.1231	1.1231	Ck 67	XC 68	060 A 67	C 70			1770	G10700	
C 100S	1.1274	1.1274	Ck 101		060 A 96		SUP 4	1870		G10950	
C 105U	1.1545	1.1545	C 105 W1	Y1 105		C 100 KU		1880			
		1.1645	C 105 W2	Y1 105		C 100 KU	SK 3				
		1.1663	C 125 W	Y2 120		C 120 KU	SK 2				

SMG

U.N.E./ I.H.A.	AISI / ASTM	GOST	ČSN	Misc. Brands	Condition	Structure
	1213				Annealed	
	12 L 13				Annealed	
	1108				Annealed	
	11 L 08				Annealed	
					Annealed	
	1140	40			Annealed	
	1146				Annealed	
	1215				Annealed	
	12 L 14				Annealed	
		16D			Annealed	
	A573 Grade 58	18kp	11 378		Annealed	
	A573 Grade 70	St14kP	11 448		Annealed	
	1010	10			Annealed	
F.1110	1015	15			Annealed	
	1020, 1023	20	12 024		Annealed	
		17G1S	11 523		Annealed	
F.1511	1015	15			Annealed	
F.1120	1025	25			Annealed	
					Annealed	
	A204 Grade A		15 020		Annealed	
	4520				Annealed	
	3310, 9314	20X2H4A	16 420		Annealed	
	4320		16 220		Annealed	
					Annealed	
F.1516	5115	12KHN2	14 220		Annealed	
		18HG			Annealed	
	5120	20KH	14 221		Annealed	
	5120 H	20KH			Annealed	
	A182-F11, A182-F12	12KHM	15 121		Annealed	
	A387 Grade 12 Cl. 2				Annealed	
F.155	A182-F22	12KH8	15 313		Annealed	
F.1130	1035	35	12 040		Annealed	
F.5110	1045	45	12 050		Annealed	
	1040	40	12 041		Annealed	
F.1150	1055	55			Annealed	
	1060	60	12 061		Annealed	
	1039	40G			Annealed	
	1330	30G2			Annealed	
F.1135	1035	35			Annealed	
F.1140	1045	45	12 050		Annealed	
F.1150	1064	60			Annealed	
	1060	60			Annealed	
F.144	9255	55S2			Annealed	
F.1250	4135	35KHM			Annealed	
F.5241	S1	5KHV2S			Annealed	
	L6	5KHNV			Annealed	
	5045				Annealed	
	3135				Quenched & Tempered	
	3435				Annealed	
	9840				Quenched & Tempered	
F.1280	4340	38H2N2MA	16 343		Annealed	
	5132	35KH			Quenched & Tempered	
	5140	40H	14 140		Quenched & Tempered	
F.1251	4130	20KHM	15 130		Quenched & Tempered	
F.1252	4142, 4140	38HM	15 142		Annealed	
F.1252	4142, 4140	38HM	15 142		Quenched & Tempered	
					Quenched & Tempered	
F.143	6150	50KHFA	15 260		Quenched & Tempered	
F.1740	A355 Cl. A				Annealed	
F.5103	1070	70			Annealed	
F.5117	1095				Annealed	
F.5118	W1	U10A			Annealed	
		U10			Annealed	
	W1	U13			Annealed	

SMG

SMG	EN	EN-Nr	W.-Nr	DIN	AFNOR	BS	UNI	JIS	SS	UNS	
P7	107 CrV 3	1.2210	1.2210	115 CrV 3	100 C 3		107 CrV 3 KU			T61202	
			1.2510	100 MnCrW 4	90 MWCV 5	BO 1	95 MnWCr 5 KU	SKS 3	2140	T31501	
	90 MnCrV 8	1.2842	1.2842	90 MnCrV 8	90 MV 8	BO 2	90 MnVCr 8 KU			T31502	
	100 Cr 6	1.3505	1.3505	100 Cr 6	100 C 6	534 A 99	100 Cr 6	SUJ 2	2258	G51986	
P8	X 210 Cr 12	1.2080	1.2080	X 210 Cr 12	Z 200 C 12	BD 3	X 210 Cr 13 KU	SKD 1		T30403	
			1.2343	X 38 CrMoV 5 1	Z 38 CDV 5	BH 11	X 37 CrMoV 5 1 KU	SKD 6		T20811	
	X 40 CrMoV 5 1	1.2344	1.2344	X 40 CrMoV 5 1	Z 40 CDV 5	BH 13	X 40 CrMo 5 1 1 KU	SKD 61	2242	T20813	
	X 100 CrMoV 5	1.2363	1.2363	X 100 CrMoV 5 1	Z 100 CDV 5	BA 2	X 100 CrMoV 5 1 KU	SKD 12	2260	T30102	
			1.2365	X 32 CrMoV 3 3	32 DCV 28	BH 10	30 CrMoV 12 27 KU	SKD 7		T20810	
			1.2436	X 210 CrW 12			X 215 CrW 12 1 KU	SKD 2		2312	
			1.2601	X 165 CrMoV 12			X 165 CrMoV 12 KU			2310	
			1.2713	55 NiCrMoV 6	55 NCDV 7			SKT 4		T61206	
	HS 6-5-2-5	1.3243	1.3243	S 6-5-2-5	Z 85 WDKCV 06-05-05-04-02		HS 6-5-2-5	SKH 55		2723	
	HS 2-10-1-8	1.3247	1.3247	S 2-10-1-8	Z 110 DKCWV 09-08-04	BM 42	HS 2-9-1-8	SKH 51			T11342
	HS 18-1-2-5	1.3255	1.3255	S 18-1-2-5	Z 80 WKCV 18-05-04-01	BT 4	HS 18-1-1-5	SKH 3			T12004
HS 6-5-2	1.3343	1.3343	S 6-5-2	Z 85 WDCV 06-05-04-02	BM 2	HS 6-5-2	SKH 9, SKH 51		2722	T11302	
HS 2-9-2	1.3348	1.3348	S 2-9-2	Z 100 DCWW 09-04-02-02		HS 2-9-2	SKH 58		2782	T11307	
HS 18-0-1	1.3355	1.3355	S 18-0-1	Z 80 WCV 18-04-01	BT 1	HS 18-0-1	SKH 2			T12001	
P11	X 6 Cr 13	1.4000	1.4000	X 6 Cr 13	Z 6 C 12	403 S 17	X 6 Cr 13	SUS 403	2301	S41008	
	X 12 Cr 13	1.4006	1.4006	X 10 Cr 13	Z 10 C 13	410 S 21	X 12 Cr 13	SUS 410	2302	S41000	
	X 6 Cr 17	1.4016	1.4016	X 6 Cr 17	Z 8 C 17	430 S 15	X 8 Cr 17	SUS 430	2320	S43000	
	X 20 Cr 13	1.4021	1.4021	X 20 Cr 13	Z 20 C 13	420 S 37	X 20 Cr 13	SUS 420 J 1	2303	S42000	
	X 39 Cr 13	1.4031	1.4031	X 40 Cr 13	Z 40 C 14	420 S 45	X 40 Cr 14	SUS 420	2304	S40280	
	X 70 CrMo 15	1.4109	1.4109	X 65 CrMo 14	Z 70 D 14			SUS 440 A		S44002	
	X 90 CrMoV 18	1.4112	1.4112	X 90 CrMoV 18	Z 2 CND 18 05	409 S 19	X CrTi 12	SUS 440 B	2327	S44003	
	X 105 CrMo 17	1.4125	1.4125	X 105 CrMo 17	Z 100 CD 17		X 105 CrMo 17	SUS 440 C		S44004	
	X 3 CrNiMo 13 3	1.4313	1.4313	X 5 CrNi 13 4	Z 5 CN 13 4	425 C 11	X 6 CrNi 13 04	SCS 5		2385	S41500
	X 18 CrNi 28	1.4749	1.4749	X 18 CrNi 28	Z 18 C 25					2322	S44600
	P12	X 6 NiCrTiMoV 25 15	1.4534	1.4534	X 3 CrNiMoAl 13 8 2						S13800
		X 4 CrNiCuNb 16 4	1.4540	1.4540	X 4 CrNiCuNb 16 4						S15500
		1.4540	1.4540	X 4 CrNiCuNb 16 4	Z 4 CNUNb 16.4 M					S15500	
X 4 CrNiCuNb 16 4		1.4540	1.4540	X 4 CrNiCuNb 16 4						S15500	
X 5 CrNiCuNb 16 4		1.4542	1.4542	X 5 CrNiCuNb 16 4				SUS 630		S17400	
X 5 CrNiCuNb 17 4		1.4548	1.4548	X 5 CrNiCuNb 17 4	Z 6 CNU 17.4			SCS 24, SUS 630		S17400	
X 7 CrNiAl 17 7		1.4564	1.4564	X 7 CrNiAl 17 7	Z 9 CAN 17.7	301 S 81	X 7 CrNiAl 17 7	SUS 631	2388	S17700	
X 2 NiCoMoTi 18 12 4		1.6356	1.6356	X 2 NiCoMoTi 18 12 4						K93160	
X 2 NiCoMoTi 18 9 5		1.6358	1.6358	X 2 NiCoMoTi 18 9 5	Z 2 NKD 19-09					K93120	
X 2 NiCoMo 18 9 5		1.6358	1.6358	X 2 NiCoMoTi 18 9 5	Z 2 NKD 19-09					K93120	
X 2 NiCoMo 18 8 5		1.6359	1.6359	X 2 NiCoMo 18 8 5		S 162				K92890	
X 2 NiCoMo 18 8 5		1.6359	1.6359	X 2 NiCoMo 18 8 5		S 162				K92890	
M1		X 10 CrNiS 18 9	1.4305	1.4305	X 10 CrNiS 18 9	Z 10 CNF 18.09	303 S 31	X 10 CrNi 18 09	SUS 303	2346	S30300
		X 2 CrNi 19 11	1.4306	1.4306	X 2 CrNi 19 11	Z 2 CN 18.10	304 S 12	X 3 CrNi 18 11	SUS 304 L	2352	S30403
M2	X 5 CrNi 18 10	1.4301	1.4301	X 5 CrNi 18 10	Z 6 CN 18.09	304 S 31	X 5 CrNi 18 11	SUS 304	2333	S30400	
	X 5 CrNiMo 17 12 2	1.4401	1.4401	X 5 CrNiMo 17 12 2	Z 3 CND 17.11.1	316 S 31	X 5 CrNiMo 17 12	SUS 316	2347	S31600	
	X 6 CrNiNb 18 10	1.4550	1.4550	X 6 CrNiNb 18 10	Z 6 CNNb 18.10	347 S 31	X 6 CrNiNb 18 11	SUS 347		S34700	
	X 9 CrNi 18 8	1.4310	1.4310	X 12 CrNi 17 7	Z 12 CN 17.07	301 S 21	X 12 CrNi 17 07	SUS 301	(2331)	S30100	
	X 12 CrNi 18 8	1.4300	1.4300	X 12 CrNi 18 8	Z 12 CN 18	302 S 25		SUS 302		S30200	
	X 2 CrNiMo 18 14 3	1.4435	1.4435	X 2 CrNiMo 18 14 3	Z 2 CND 17.13	316 S 12	X 2 CrNiMo 17 13 2	SCS 16, SUS 316 L	2353	S31603	
M3	X 2 CrNiMoN 17 13 3	1.4429	1.4429	X 2 CrNiMoN 17 13 3	Z 2 CND 17.13 Az	316 S 62	X 2 CrNiMoN 17 13 3	SUS 316 LN		S31653	
	X 2 CrNiN 18 10	1.4311	1.4311	X 2 CrNiN 19 11	Z 2 CN 18.10 Az	304 S 62	X 2 CrNiN 18 11	SUS 304 LN		S30453	
	X 3 CrNiMo 18 12 3	1.4466	1.4466	X 5 CrNi 18 15		317 S 16	X 5 CrNi 18 15	SUS 317		S31700	
	X 9 CrNiSiN 21 11 2	1.4835	1.4893	X 9 CrNiSiN 21 11 2		310 S 31			2368	S30815	
	X 12 CrNi 25 21	1.4335	1.4335	X 12 CrNi 25 21	Z 12 CN 25.20	310 S 24	X 6 CrNi 26 20	SUH 310, SUS 310 S		2361	S31008
M4	X 2 CrNiMoN 22 5 3	1.4462	1.4462	X 2 CrNiMoN 22 5	Z 2 CND 22.05 Az	332 S 15	X 2 CrNiMoN 22 5			2377	S31803
	X 2 CrNiMoSi 19 5	1.4424	1.4417	X 2 CrNiMoSi 19 5	Z 2 CND 18.05.03					2376	S31500
	X 2 NiCrMoCu 25 20 5	1.4539	1.4539	X 2 NiCrMoCu 25 20 5	Z 2 NCDU 25 20	904 S 13				2562	N08904
	X 3 CrNiMo 27 5 2	1.4460	1.4460	X 4 CrNiMo 27 5 2	Z 3 CND 25.7 Az		X 3 CrNiMo 27 5 2	SUS 329 J 1		2324	S32900
M5	X 5 CrNiCuNb 16 4	1.4980	1.4943	X 4 NiCrTi 25 15	Z 6 NCTDV 25.15	HR 51		SUH 660		2570	S66286
	X 1 CrNiMoN 20 18 7	1.4547	1.4529	X 1 CrNiMoN 20 18 7	Z 1 CNDU 20.18.05 Az		X 1 CrNiMoN 20 18 7			2778	S31254
	X 1 CrNiMoN 25 22 8	1.4652	1.4652	X 2 CrNiMoN 25 22 7							S32654
	X 10 NiCrAlTi 32 20	1.4876	1.4876	X 10 NiCrAlTi 32 20	Z 10 NC 32.21			NCF 800			N08800
	X 2 CrNiMoN 25 7 4	1.4410	1.4410	X 2 CrNiMoN 25 7 4	Z 3 CND 25.07 Az		X 2 CrNiMoN 25 7 4			2328	S32750

SMG

U.N.E./ I.H.A.	AISI / ASTM	GOST	ČSN	Misc. Brands	Condition	Structure
F.520L	L2	11KHF			Annealed	
F.5220	O1	9KHVG			Annealed	
	O2	9G2F			Annealed	
F.5230	S2100	SHKH15	14 109		Annealed	
F.5212	D3	KH12			Annealed	
	H11	4KH5MFS			Annealed	
F.5318	H13	4KH5MF1S			Annealed	
F.5227	A2	9KH5VF			Annealed	
	H10	3KH3M3F			Annealed	
F.5213		KH12			Annealed	
		KH12MF			Annealed	
F.520.S	L6	5KHNM			Annealed	
F.5613	M35	R6M5K5			Annealed	
	M42	R2AM9K5			Annealed	
	T4	R18K5F2			Annealed	
F.5603	M2	R6M5			Annealed	
	M7				Annealed	
	T1	R18			Annealed	
	403	08KH13			Annealed	Ferritic
F.3401	410, CA-15	12KH13, 08KH13			Annealed	Martensitic
F.3113	430	12KH17			Annealed	Ferritic
F.5261	420	20KH13	17 022		Annealed	Martensitic
F.3404	420	40KH13			Annealed	Martensitic
	440 A				Annealed	Martensitic
	440 B	95KH18			Annealed	Martensitic
	440 C	95KH18			Annealed	Martensitic
	A182 F6NM			F6NM	Annealed	Martensitic
	446	15KH28			Annealed	Ferritic
	XM-13			PH 13-8 Mo	Solution annealed	Austenitic
	XM-12			15-5 PH	H1150	Martensitic
	XM-12			15-5 PH	Solution annealed	Martensitic
	XM-12			15-5 PH	H1025	Martensitic
	SAE 630			17-4 PH	H1150	Martensitic
	630			17-4 PH	Solution annealed	Martensitic
	631	09KH17N7YU1		17-7 PH	Solution annealed	Austenitic/Ferritic
	AMS 6515			Marage 350	Solution annealed	Martensitic
	AMS 6521			Marage 300	Solution annealed	Martensitic
	AMS 6514			Marage 300, Vascomax C300	Solution annealed	Martensitic
	AMS 6512			Marage 250	Solution annealed	Martensitic
	AMS 6512			Marage 250, Vascomax C250	Solution annealed	Martensitic
F.3508	303	12KH19N9			Annealed	Austenitic
F.3504	304 L	03KH18N11			Annealed	Austenitic
F.3504	304	08KH18N10	17 240		Annealed	Austenitic
F.3534	316	08KH17H13M2T	17 346		Annealed	Austenitic
F.3524	347	08KH18N12B			Annealed	Austenitic
F.3517	301	07KH16N6			Annealed	Austenitic
	302	12KH18N9			Annealed	Austenitic
F.3533	(316 L)	03KH17N14M3	17 349		Annealed	Austenitic
	316 LN	03KH16N15M3			Annealed	Austenitic
F.3541	304 LN	03KH18N11			Annealed	Austenitic
	317	08KH17H15M3T			Annealed	Austenitic
				253 MA	Annealed	Austenitic
	310 S	12KH25N20			Annealed	Austenitic
	329 LN			SAF 2205	Annealed	Duplex
				3RE60	Annealed	Duplex
	904L				Annealed	Super austenitic
	329				Annealed	Duplex
	660			A286	Solution annealed	Austenitic
				254 SMO	Annealed	Super austenitic
				654 SMO	Annealed	Super austenitic
				Alloy 800	Annealed	Austenitic
	F 53			SAF 2507	Annealed	Super duplex

SMG

SMG	EN	EN-Nr	W-Nr	DIN	AFNOR	BS	UNI	JIS	SS	UNS	
K1	EN-GJL-150	0.6150	0.6150	GG-15	Fl 15 D	Grade 150	G15	FC 150	01 15-00	F11601	
	EN-GJL-200	0.6200	0.6200	GG-20	Fl 20 D	Grade 220	G20	FC 200	01 20-00	F12101	
	EN-GJL-250	0.6250	0.6250	GG-25	Fl 25 D	Grade 260	G25	FC 250	01 25-00	F12401	
	EN-GJL-350	0.6350	0.6350	GG-35	Fl 35 D	Grade 350	G35	FC 350	01 35-00	F13502	
	EN-GJL-215			GG-220 HB					02 19		
K2	EN-GJV-300			GJV-300							
	EN-GJV-350			GJV-350							
	EN-GJV-400			GJV-400							
	EN-GJV-450			GJV-450							
	EN-GJV-500			GJV-500							
K3	EN-GJMB-550-4	0.8155		GTS-55-04	P 540/5	P 540/5	P 55-04	PCMP55-04	08 54-00	F24130	
K4	EN-GJS-350-22	0.7033	0.7033	GGG-35.3	FGS 370-17	Grade 350/22		FCD 350-22L	07 17-15		
	EN-GJS-400-15	0.7040	0.7040	GGG-40	FGS 400-12	Grade 420/12	GS 400-12	FCD 400-18L	07 17-02	F32800	
	EN-GJS-400-18	0.7043	0.7043	GGG-40.3	FGS 370-17	Grade 370/17	GSO 42/17		07 17-12	F32800	
	EN-GJS-500-7	0.7050	0.7050	GGG-50	FGS 500-7	Grade 500/7	GS 500-7	FCD 500-7	07 27-02	F33800	
	EN-GJS-600-3	0.7060	0.7060	GGG-60	FGS 600-3	Grade 600/3	GS 600-3	FCD 600-3	07 32-03	F34100	
	EN-GJS-700-2	0.7070	0.7070	GGG-70	FGS 700-2	Grade 700/2	GS 700-2	FCD 700-2	07 37-01	F34800	
K5	EN-GJS-1000-5			GJS-1000-5						ADI grade 5	
	EN-GJS-1200-2			GJS-1200-2						ADI grade 2	
	EN-GJS-1400-1			GJS-1400-1						ADI grade 3	
	EN-GJS-800-8			GJS-800-8						ADI grade 4	
K6	EN-GJLA-XNiCr 20-2	0.6660	0.6660	GGL-NiCr 20 2	FGL Ni20 Cr2	Grade F2			05 23-00	F41002	
	EN-GJLA-XNiCr 30-3	0.6676	0.6676	GGL-NiCr 30 3	FGL Ni30 Cr3	Grade F3				F41004	
	EN-GJLA-XNiCuCr 15-6-2	0.6655	0.6655	GGL-NiCuCr 15 6 2	FGL Ni15 Cu6 Cr2	Grade F1				F41000	
K7	EN-GJSA-XNiMn 13-7	0.7652	0.7652	GGG-NiMn 13 7	FGS Ni13 Mn7	Grade S6			07 72-00		
	EN-GJSA-XNiCr 20-2	0.7660	0.7660	GGG-NiCr 20 2	FGS Ni20 Cr2	Grade S2				F43000	
	EN-GJSA-XNiMn 23-4	0.7673	0.7673	GGG-NiMn 23 4	FGS Ni23 Mn4	Grade S2M				F43010	
	EN-GJSA-XNiCr 30-3	0.7676	0.7676	GGG-NiCr 30 3	FGS Ni30 Cr3	Grade S3				F43003	
	EN-GJSA-XNi 35	0.7683	0.7683	GGG-Ni 35	FGS Ni35					F43006	
N1	AW-1050A	Al99.5	3.0255	Al99.5	A-5/1050A	1B		(A1050)	4007	AA1050A	
	AW-2011	AlCuBiPb	3.1655	AlCuBiPb	A-U5PbBi/2011	FC1		A2011	4355	AA2011	
	AW-2014	AlCuSiMn	3.1255	AlCuSiMn	A-U4SG/2014	H15			4338	AA2014	
	AW-5005	AlMg1	3.3315	AlMg1	A-G0.6	N41			4106	AA5005	
	AW-6060	AlMgSi0.5	3.3206	AlMgSi0.5	A-GS/6060	(H9)			4103	AA6060	
	AW-6063	AlMgSi0.7	3.3210	AlMgSi0.7	A-GSUC/6061	(H10)		(A6063)	4104, 4107	AA6005	
	AW-3103	AlMn1	3.0515	AlMn1		N3			4054	AA3103	
	AW-3003	AlMn1Cu	3.0517	AlMn1Cu	A-M1/3003			A3003		AA3003	
	AW-7020	AlZn4.5Mg1	3.4335	AlZn4.5Mg1	A-Z5G/7020	H17			4425	AA7020	
	AW-7075		3.4365	AlZnMgCu1.5	A-Z5GU/7075	2L95/2L96			A7075	AA7075	
	AC-42000		3.2341	G-AlSi5Mg	A-S7G	LM25	3599		AC 4C	4244	
	AC-46200	AlSi8Cu3(Si)	3.2161	G-AlSi8Cu3						4251	A13800
	Mg-P-63	MgAl6Zn	3.5612	G-MgAl6Zn	G-A6-Z1	MAG-E-121					M11600
	Mg-P-61	MgAl8Zn	3.5812	G-MgAl8Zn	(G-A7-Z1)						
	MN65120	MgSe3Zn2Zr1	3.5103	G-MgSe3Zn2Zr1	ZRE1	MAG6-TE					M12330
	AC-43400	AlSi10Mg(Fe)	3.2381	G-AlSi10Mg	A-S10G	LM9				4253	A13600
	AC-44200	AlSi12	3.2382	GD-AlSi12							
	AW-6082	AlMgSi1	3.2315	AlMgSi1	A-SGM0.7/6082	H30				4212	AA6082
	N3	AlSi17Cu5							ADC14		
	N11	CC331G		2.0940.01	CuAl10Fe	CuAl10Fe	AB1			5710	C95200
CC333G			2.0975.01	CuAl10Ni	CuAl10Ni5Fe5	AB2			5716	C95500	
		CuNi10Fe1Mn	2.0872	CuNi10Fe1Mn	CuNi10Fe1Mn	CN102			5667	C70600	
				CuNi10Zn45							
		CW408J	2.0790	CuNi18Zn19Pb	CuNi18Zn19Pb1						C76300
CW352H			2.1176	CuPb10Sn	CuSn10Pb10	LB2			5640	C93700	
CC480K			2.1050.01	CuSn10	CuSn10	CT1			5443	C90700	
			2.1087	CuSn10Zn					5458	C90500	
CW452K		CuSn6	2.1020	CuSn6	CuSn6	PB103	C5191		5428	C51900	
CW502L		CuZn15	2.0240	CuZn15	CuZn15	CZ102	C2300		5112	C23000	
CW706R		CuZn28Sn1	2.0470	CuZn28Sn1	CuZn29Sn1				5220	C44300	
CW508L		CuZn37	2.0321	CuZn37	CuZn37	CZ108			5150	C27200	
CW717R		CuZn38Sn1	2.0530	CuZn38Sn1						C46400	
CW614N		CuZn39Pb3	2.0401	CuZn39Pb3	CuZn39Pb3	CZ121			5170	C38500	
CW612N		CuZn40Pb2	2.0402	CuZn40Pb2	CuZn39Pb2	CZ120			5168	C37800	
CW622N		CuZn44Pb2	2.0410	CuZn44Pb2		CZ104			5272	C68700	

SMG

SMG	EN	EN-Nr	W.-Nr	DIN	AFNOR	BS	UNI	JIS	SS	UNS	
S1											
S2											
S3	NiMo30		2.4810							N10002	
	NiMo16Cr15W		2.4819							N10276	
	NiCr19Fe19Nb5Mo3		2.4668							N07718	
			2.4669							N07750	
	NiCr20TiAl		2.4631							N07080	
	NiCr19Co18Mo4Ti3Al3									N07500	
	NiCr20Co13Mo4Ti3Al		2.4654							N07001	
S11			3.7024							R54620	
S12										R56320	
	TiAl6V4		3.7164							R56400	
S13				TiV10Fe2Al3							
H3	16 MnCr 5	1.7131	1.7131	16 MnCr 5	16 MC 5	527 M 17	16 MnCr 5	SCR 415	2511	G51170	
H5	C 67S	1.1231	1.1231	Ck 67	XC 68	060 A 67	C 70		1770	G10700	
	C 75S	1.1248	1.1248	Ck 75	XC 75	060 A 78	C 75		1774, 1778	G10780	
	C 100S	1.1274	1.1274	Ck 101		060 A 96		SUP 4	1870	G10950	
	C 105U	1.1545	1.1545	C 105 W1	Y1 105				1880		
			1.2550		60 WCrV 7	55 WC 20					
	55 Cr 3	1.7176	1.7176	55 Cr 3	55 C 3	527 A 60	55 Cr 3	SUP 9 (A)	2253	G51550	
H7	42 CrMo 4	1.7225	1.7225	42 CrMo 4	42 CD 4	708 M 40	42 CrMo 4	SCM 440 (H)	2244	G41400	
	107 CrV 3	1.2210	1.2210	115 CrV 3	100 C 3		107 CrV 3 KU			T61202	
			1.2510		100 MnCrW 4	90 MWCV 5	BO 1	95 MnWCr 5 KU	SKS 3	2140	T31501
	90 MnCrV 8	1.2842	1.2842	90 MnCrV 8	90 MV 8	BO 2	90 MnVCr 8 KU			T31502	
	100 Cr 6	1.3505	1.3505	100 Cr 6	100 C 6	534 A 99	100 Cr 6	SUJ 2	2258	G51986	
	X 40 CrMoV 5 1	1.2344	1.2344	X 40 CrMoV 5 1	Z 40 CDV 5	BH 13	X 40 CrMo 5 1 1 KU	SKD 61		2242	T20813
H8	X 100 CrMoV 5	1.2363	1.2363	X 100 CrMoV 5 1	Z 100 CDV 5	BA 2	X 100 CrMoV 5 1 KU	SKD 12		2260	T30102
	X 155 CrVMo 12 1		1.2379	X 155 CrVMo 12 1	Z 160 CDV 12	BD 2	X 155 CrVMo 12 1 KU	SKD 11			T30402
			1.2436		X 210 CrW 12			X 215 CrW 12 1 KU	SKD 2		2312
			1.2601		X 165 CrMoV 12			X 165 CrMoV 12 KU			2310
			1.2713		55 NiCrMoV 6	55 NCDV 7			SKT 4		T61206
	HS 6-5-2-5	1.3243	1.3243	S 6-5-2-5	Z 85 WDKCV 06-05-05-04-02		HS 6-5-2-5	SKH 55		2723	
H11	HS 2-10-1-8	1.3247	1.3247	S 2-10-1-8	Z 110 DKCWV 09-08-	BM 42	HS 2-9-1-8	SKH 51			T11342
	HS 18-0-1	1.3355	1.3355	S 18-0-1	Z 80 WCV 18-04-01	BT 1	HS 18-0-1	SKH 2			T12001
	X 20 Cr 13	1.4021	1.4021	X 20 Cr 13	Z 20 C 13	420 S 37	X 20 Cr 13	SUS 420 J 1	2303		S42000
	X 70 CrMo 15	1.4109	1.4109	X 65 CrMo 14	Z 70 D 14			SUS 440 A			S44002
	X 90 CrMoV 18	1.4112	1.4112	X 90 CrMoV 18	Z 2 CND 18 05	409 S 19	X CrTi 12	SUS 440 B	2327		S44003
	X 105 CrMo 17	1.4125	1.4125	X 105 CrMo 17	Z 100 CD 17		X 105 CrMo 17	SUS 440 C			S44004
H12	X 4 CrNiCuNb 16 4	1.4540	1.4540	X 4 CrNiCuNb 16 4							S15500
	X 5 CrNiCuNb 16 4	1.4542	1.4542	X 5 CrNiCuNb 16 4				SUS 630			S17400
	X 5 CrNiCuNb 16 4	1.4542	1.4542	X 5 CrNiCuNb 16 4				SUS 630			S17400
	X 7 CrNiAl 17 7	1.4568	1.4568	X 7 CrNiAl 17 7	Z 9 CAN 17.7	301 S 81	X 7 CrNiAl 17 7	SUS 631	2388		S17700
	X 8 CrNiMoAl 15 7 5	1.4574	1.4574	X 8 CrNiMoAl 15 7 5							S15700
	X 6 NiCrTiMoV 25 15	1.4980	1.4943	X 4 NiCrTi 25 15	Z 6 NCTDV 25.15	HR 51		SUH 660	2570		S66286
	X 2 NiCoMo 18 8 5	1.6359	1.6359	X 2 NiCoMo 18 8 5		S 162					K92890
	X 2 NiCoMoTi 18 9 5	1.6358	1.6358	X 2 NiCoMoTi 18 9 5	Z 2 NKD 19-09						K93120
	X 2 NiCoMoTi 18 9 5	1.6358	1.6358	X 2 NiCoMoTi 18 9 5	Z 2 NKD 19-09						K93120
	X 2 NiCoMoTi 18 12 4	1.6356	1.6356	X 2 NiCoMoTi 18 12 4							K93160
H21	X 120 Mn 12	1.3401	1.3401	X 120 Mn 12	Z 120 M 12	BW 10		SC MnH 1	2183		
H31	EN-GJN-HV520	0.9620	0.9620	G-X330 NiCr 4 2	FB Ni4 Cr2 BC	Grade 2 A				05 12-00	F45001
	EN-GJN-HV550	0.9625	0.9625	G-X260 NiCr 4 2	FB Ni4 Cr2 HC	Grade 2 B				05 13-00	F45000
	EN-GJN-HV600(XCr11)	0.9630	0.9630	G-X300 CrNiSi 9 5 2	FB Cr9 Ni5	Grade 2 C, D, E				04 57-00	F45003

SMG

U.N.E./ I.H.A.	AISI / ASTM	GOST	ČSN	Misc. Brands	Condition	Structure
				Discalloy	Precipitation hardened	
				Haynes 25		
				Stellite 21		
				Hastelloy C		
		KHN65MV		Hastelloy C-276		
				IN 100		
				Inconel 718		
				Inconel X-750	Solution annealed	
				Nimonic 80A		
				René 41		
				Udimet 500		
				Waspalloy		
				Ti	Commercially pure	Ti (α)
	AMS 4919			Ti 6-2-4-2	Annealed	Ti (α)
	AMS 4943			Ti 3Al-2.5V (grd 9)	Annealed	Ti (α+β)
	AMS 4920, Grade 5	VT6		Ti 6Al-4V	Annealed	Ti (α+β)
	AMS 4986			Ti 10V-2Fe-3Al	Annealed	Ti (β)
F.1516	5115	12KH2	14 220		Case hardened	
F.5103	1070	70			Quenched & Tempered	
F.5107	1078, 1080	75			Quenched & Tempered	
F.5117	1095				Quenched & Tempered	
F.5118	W1	U10A			Quenched & Tempered	
	S1	5KHV2SF			Quenched & Tempered	
	5155				Quenched & Tempered	
F.1252	4142, 4140	38HM	15 142		Quenched & Tempered	
F.520L	L2	11KHF			Quenched & Tempered	
F.5220	O1	9KHVG			Quenched & Tempered	
	O2	9G2F			Quenched & Tempered	
F.5230	52100	SHKH15	14 109		Quenched & Tempered	
F.5318	H13	4KH5MF1S			Quenched & Tempered	
F.5227	A2	9KH5VF			Quenched & Tempered	
F.5211	D2	KH12MF			Quenched & Tempered	
F.5213		KH12			Quenched & Tempered	
		KH12MF			Quenched & Tempered	
F.520.S	L6	5KHNM			Quenched & Tempered	
F.5613	M35	R6M5K5			Quenched & Tempered	
	M42	R2AM9K5			Quenched & Tempered	
	T1	R18			Quenched & Tempered	
F.5261	420	20KH13	17 022		Quenched & Tempered	Martensitic
	440 A				Quenched & Tempered	Martensitic
	440 B	95KH18			Quenched & Tempered	Martensitic
	440 C	95KH18			Quenched & Tempered	Martensitic
	XM-12			15-5 PH	H900	Martensitic
	SAE 630			17-4 PH	H1025	Martensitic
	SAE 630			17-4 PH	H900	Martensitic
	AMS 5528	09KH17N7YU1		17-7 PH	TH1050	Martensitic
	632			PH 15-7 Mo	TH1050	Martensitic
	660			A286	Precipitation hardened	Austenitic
	AMS 6512			Marage 250	Precipitation hardened	Martensitic
	AMS 6521			Marage 300	Precipitation hardened	Martensitic
	AMS 6521			Marage 300	Precipitation hardened	Martensitic
	AMS 6515			Marage 350	Precipitation hardened	Martensitic
	A128 Grade A			Hadfield		
	A532 IB (NiCr-LC)			Ni-Hard 2		White cast iron
	A532 IA (NiCr-HC)			Ni-Hard 1		White cast iron
	A532 ID (Ni-HiCr)			Ni-Hard 4		White cast iron

This work is published with the understanding that Seco Tools and its editors are supplying information aimed to present a general orientation and direction of metal cutting and related sciences. If professional services are required for specific applications, the assistance of an appropriate professional should be acquired.

The information is provided “as is”; Seco Tools and its editors disclaim all representations and warranties, express or implied, of any kind, including, without limitations, any warranties of merchantability, fitness for a particular purpose, title, or non-infringement. In no event will Seco Tools or its editors be liable to any party for any direct, indirect, special or other consequential damages for any use of the information, even if Seco Tools or its editors are advised of the possibility of such damage.

The information provided herein is for reference purposes only. Actual prices, specifications, and product descriptions are finalised at the time of sale and may vary by location. The information provided herein is subject to change without prior notice.

WWW.SECOTOOLS.COM

10033456, ST20206742 GB,
© SECO TOOLS AB, 2020. All rights reserved.
Technical specifications are subject to
change without notice.