

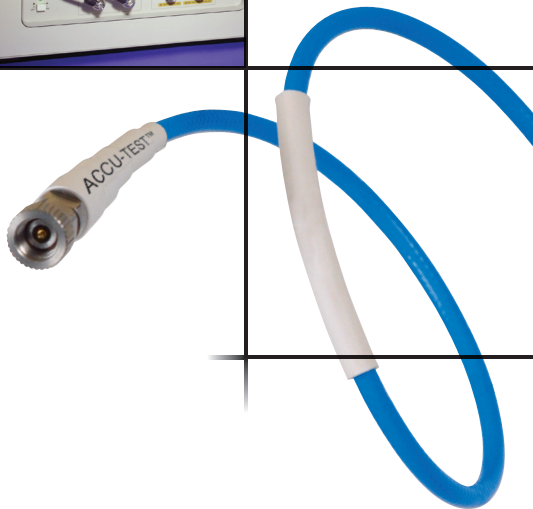

TELEDYNE
STORM MICROWAVE
Everywhereyoulook™

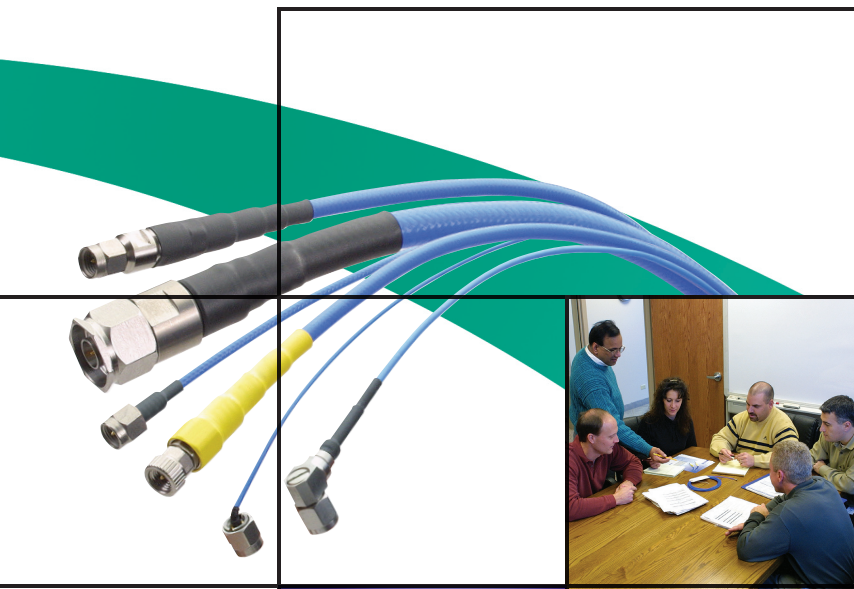

MICROWAVE:
TEST & MEASUREMENT PRODUCTS

10221



TELEDYNE
STORM PRODUCTS
A Teledyne Technologies Company

INTRODUCTION

Who We Are; History, Quality, Vision, and Markets. 4-5

THE CUSTOMER EXPERIENCE 6-9

PRODUCT FAMILY APPLICATION GUIDE 10

CABLE SELECTION CHART 11

PERFORMANCE & DESIGN CONSIDERATIONS

Customer Specified Options 12

Strain Relief/Connectorizing 13

Phase Related Options 14-15

VSWR Performance 16

Dielectric Options 17

PRODUCT LINES

PHASE STABLE FLEXIBLE — INTRODUCTION 19

Armoring & Ruggedizing 20

PHASE MASTER® — FEATURES & BENEFITS / CABLE CONSTRUCTION 21

0.190" Diameter Cable : PHASE MASTER® 190

Technical Information 22-23

Part Numbering 24

ACCU-TEST® – FEATURES & BENEFITS / CABLE CONSTRUCTION 25

0.150" Diameter Cable : ACCU-TEST® 150

Technical Information 26-27

Part Numbering 28

0.200" Diameter Cable : ACCU-TEST® 200

Technical Information 29-30

Part Numbering 31

LOW LOSS FLEXIBLE — INTRODUCTION / FEATURES & BENEFITS. 33

Cable Construction 34

Armoring & Ruggedizing 35

0.125" Diameter Cable : TRUE BLUE® 125

Technical Information 36-37

Part Numbering 38

0.205" Diameter Cable : TRUE BLUE® 205

Technical Information 39-40

Part Numbering 41

0.290" Diameter Cable : TRUE BLUE® 290

Technical Information 42-43

Part Numbering 44

0.420" Diameter Cable : TRUE BLUE® 420

Technical Information 45-46

Part Numbering 47

STORM FLEX™ — INTRODUCTION	49
MINIATURE / SEMI-RIGID REPLACEMENT	
STORM FLEX™ 047 — FEATURES & BENEFITS / CABLE CONSTRUCTION.	51
0.055" Diameter Cable : STORM FLEX™ 047	
<i>Technical Information</i>	<i>52-53</i>
Storm Flex™ 047 Express	
<i>Part Numbering</i>	<i>54</i>
Storm Flex™ 047	
<i>Part Numbering</i>	<i>55</i>
STORM FLEX™ 086 & 141 — FEATURES & BENEFITS / CABLE CONSTRUCTION	57
0.096" Diameter Cable : STORM FLEX™ 086	
<i>Technical Information</i>	<i>58-59</i>
Storm Flex™ 086 Express	
<i>Part Numbering</i>	<i>60</i>
Storm Flex™ 086	
<i>Part Numbering</i>	<i>61</i>
0.160" Diameter Cable : STORM FLEX™ 141	
<i>Technical Information</i>	<i>62-63</i>
Storm Flex™ 086 Express	
<i>Part Numbering</i>	<i>64</i>
Storm Flex™ 086	
<i>Part Numbering</i>	<i>65</i>
QUICK-CONNECTING ADAPTERS — INTRODUCTION / FEATURES & BENEFITS	67
SMA Quick-Connects	
<i>Technical Information</i>	<i>68</i>
N Quick-Connects	
<i>Technical Information</i>	<i>69</i>
TNC Quick-Connects	
<i>Technical Information</i>	<i>70</i>
7/16 Quick-Connects	
<i>Technical Information</i>	<i>71</i>
CONNECTOR FREQUENCY CHART	72
ENGINEERING INFORMATION	73
MICROWAVE CABLE ASSEMBLY CARE AND HANDLING	74
DESIGN WORKSHEET	75
ORDERING AND SERVICE INFORMATION	76

Please contact us if the products featured in this catalog do not meet your specific needs. As a solutions provider, we can modify existing cables or design new ones to satisfy unique system requirements.

Also available: High Performance Interconnect Products Catalog

GPO®, GPPO®, and GMS® are registered trademarks of Corning Gilbert, Inc.

www.teledynestorm.com/microwave ■ 630.754.3300



WHO WE ARE

Your projects are important. You need to know that the company you deal with and the products they provide will perform to your satisfaction now and over the long run.

Storm Products Company has been providing just such service and products for more than 40 years. We are well known not only for quality products but for quality customer relations based on an ongoing commitment to honesty and integrity.



**TELEDYNE
STORM PRODUCTS**

A Teledyne Technologies Company

"...combining leading technology with the Storm legacy of responsive, flexible, committed customer service."

STORM PRODUCTS COMPANY has been providing wire, cable, and interconnect solutions since Al Storm founded the company in the early 1950s. One of the early pioneers in the wire and cable distribution business, Storm Products was among the first to offer value-added services as part of the distribution activity—delivering just what the customer wanted, when they wanted it.

Storm Products soon moved from distribution to manufacturing and, in the late 1970s, Storm Products expanded its operations to include microwave cable and cable assembly products.

STORM PRODUCTS—MICROWAVE, located near Chicago, Illinois, was one of the first companies to offer high performance flexible and semi-rigid RF/microwave cable assemblies with low density, tape-wrapped dielectric. Today, Storm Microwave brings decades of microwave transmission line design experience to the table in solving design engineers' interconnect problems—combining leading technology with the Storm legacy of responsive, flexible, committed customer service.

ISO 9001

We actively work to stay on top of and implement those new and improved technologies and processes that will translate into better performance for your end product.

Storm Products is dedicated to developing and improving our quality system, and our ISO 9001 registration reflects a continuing commitment to quality in areas ranging from design to production, sales to shipping.



Quality Policy:

"To meet or exceed our customers' expectations at all times in terms of time, value, and performance."

OUR VISION

Within the high performance interconnect solutions market, become the most desirable company to do business with by delivering levels of value unmatched by the competition. Our value is based on responsiveness, process and product innovation, and an unwavering focus on meeting customer expectations.

TO MOVE TOWARD OUR VISION, WE:

- ❑ Operate based on an up-front, clear understanding of time, cost, and product performance expectations.
- ❑ Support development projects with timely mechanical mockups, functional prototypes, and technical data.
- ❑ Leverage existing product designs whenever possible to compress schedules, reduce development costs, and increase reliability.
- ❑ Maintain a dedicated product development staff focused on delivering new product technologies to satisfy unique project needs.
- ❑ Deliver cost-effective, reliable product on schedule, via a comprehensive process control system and select use of statistical techniques.



MARKET FOCUS

STORM PRODUCTS FOCUSES ON THE FOLLOWING MARKETS

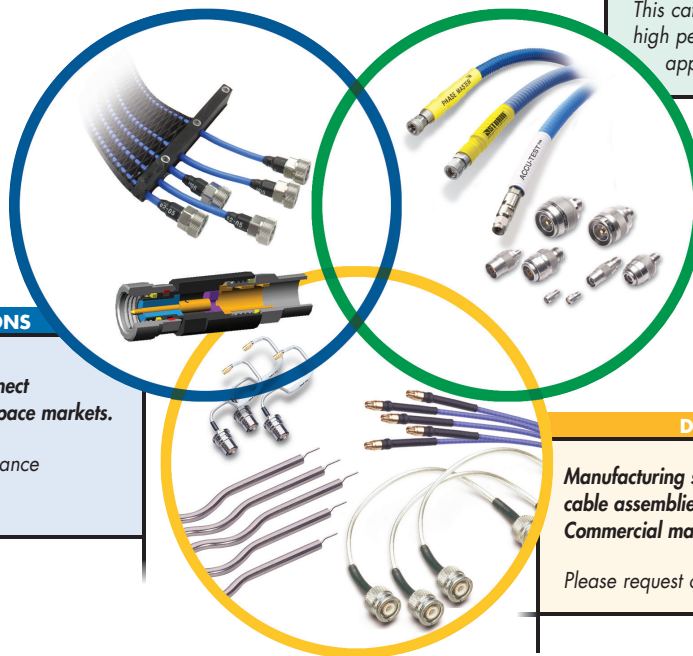

CATALOG ITEMS FOR TEST & MEASUREMENT

Standard or customized microwave cable assemblies and accessories for test and measurement applications in Defense and Commercial markets.

This catalog is geared to customers requiring high performance cable assemblies for those applications.

CUSTOM SOLUTIONS

Customized microwave interconnect solutions for Defense and Aerospace markets.

Please request our High Performance Interconnect Products Catalog.

DEFINED BOMs

Manufacturing services involving microwave cable assemblies for Defense and select Commercial markets.

Please request our Capabilities Brochure.

Put Storm Products to work for you. Call us today to discuss your project.

THE CUSTOMER EXPERIENCE

A BEST-FIT PROCESS

The elements of Storm's vision—responsiveness, product & process innovation, and an unwavering focus on meeting customer expectations—are an integral part of the Storm customer experience.

Examine that experience, and see what other have to say about it, on the next four pages. See why "best fit" means more to us than just offering you the right product. It also means offering you the right services and support for your unique needs.

INTERACTIVE WEBSITE

To provide a measure of application engineering that's available on your schedule, Storm Products' Web site includes an **Interactive Product Finder** that walks you through a range of configuration options to arrive at a best-fit product.

To ensure no surprises, a brief specification summary is displayed for the exact configuration you've selected. And, if you're interested in the configuration's electrical performance at a specific frequency or temperature, Storm's **on-line insertion loss calculators** will provide exactly the information you require.

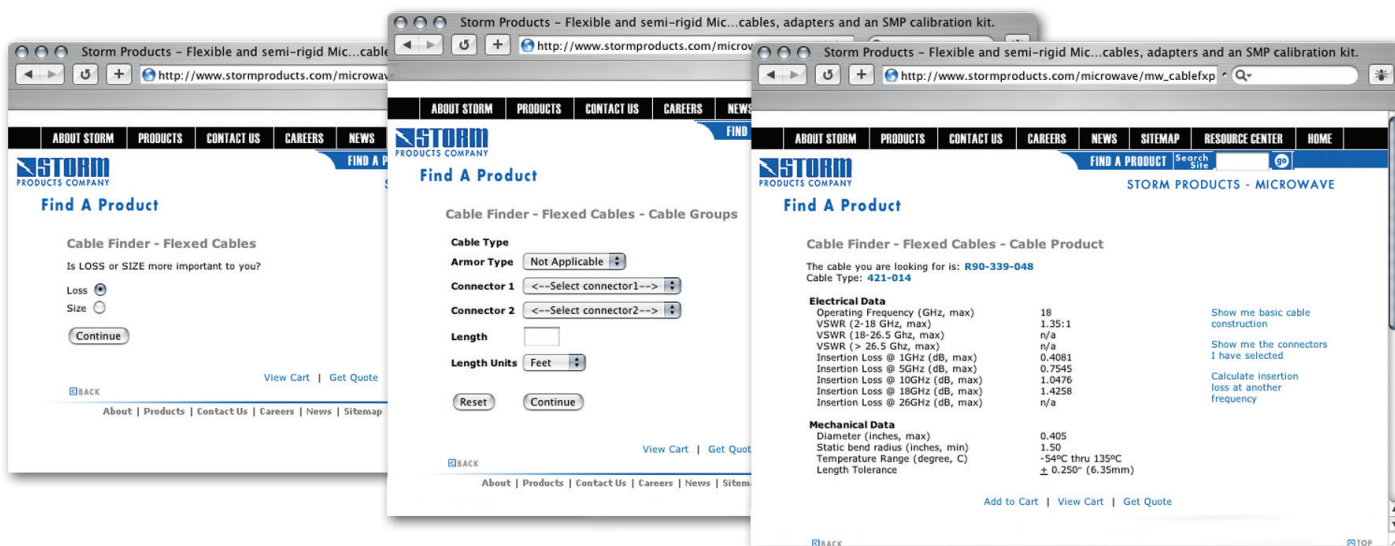

RESPONSIVENESS

Making the customer's life easier is a challenge Storm celebrates every day...

After a rigorous six-month evaluation, a major wireless network equipment OEM selects Storm Products' True Blue® cable assemblies for use on their latest production test racks. At Storm, celebrating takes a back seat to ramping up production—the customer has an immediate need for several hundred assemblies.

Storm is able to meet the challenging deadline, supplying the cable assemblies on schedule less than two weeks after being selected as the supplier.

WHAT OUR CUSTOMERS SAY:

"...few suppliers give us this level of service!"
 "...I really appreciate it when a supplier takes the time to figure out the losses for me rather than just sending a data sheet and I have to do it."
 "...you guys are doing a great job...very responsive on the quotes...keep up the good work!"

APPLICATION ENGINEERING

For those preferring personal assistance, Storm's application engineering staff is focused on solving your problems. To minimize delays, we begin by gaining a clear understanding of your time, cost, and performance expectations.

With that information in hand, the focus shifts to translating those needs into product requirements—and a product capable of meeting them. Often, Storm responds with product samples so you can confirm that our product will work in your exact application.

This process is accelerated by our knowledge of and experience in the high frequency test & measurement industry, both supplying product to end users and making precise measurements internally.



CABLE CONSTRUCTION & MANUFACTURE

Known around the world for durable constructions that stand the test of time, Storm manufactures all its own cable. This is done with close attention to every detail and under precise controls, ensuring the highest levels of consistency and performance you can depend on.

Leveraging 20 years of test & measurement experience with our True Blue® products (90 series), we are continually expanding our product line to address evolving test challenges. Products such as Phase Master®, Accu-Test®, and Storm Flex™ 047 Express are examples of this sort of product development focus.

OPTIMIZED CABLE/ CONNECTOR INTERFACE

Experienced users know that most microwave test & measurement cable assemblies fail at the point where the cable attaches to the connector. Storm's flexible cable assemblies feature a superior, time-proven connector attachment method that increases connector retention and extends product life.

Precision connector interfaces ensure repeatable, consistent results, while stainless steel connector constructions minimize performance degradation due to wear from frequent mate and de-mate cycles.

QUALITY

Reduced downtime & operating costs are "built in" to Storm cable assemblies...

A major producer of wireless networking gear looks to Storm for help after experiencing frequent cable assembly failures on their factory floor using another company's product. The assemblies were failing at the connector attachment point. Problem solving begins with a site visit by Storm to investigate how the cable assemblies are being handled. Storm then recommends a product solution and supplies sample assemblies for evaluation.

Based on initial results, one full line is converted to Storm assemblies. Over time, every new line is outfitted with Storm's product...resulting in significant reductions in downtime and operating costs.

WHAT OUR CUSTOMERS SAY:

"...I thought we would buy these cable assemblies from supplier A, but the engineer said you guys make a better cable assembly, so he said to buy from Storm."
"...we didn't think you stood a chance against Supplier B. Your quality surprised the Air Force and us."



THE CUSTOMER EXPERIENCE : PRODUCTS & SERVICES

OFF-THE-SHELF CABLE ASSEMBLY OPTIONS

To help you meet today's demanding project and production schedules, Storm offers a substantial number of frequently purchased assembly configurations from stock.

Available with a number of common connector combinations and in a variety of convenient lengths, these assemblies are a cost-effective solution to many test & measurement challenges.

To keep procurement-related costs low, Storm responds to quote requests for standard test & measurement products in 30 minutes or less. We also take VISA, MasterCard, and American Express to simplify the purchase process on small volume orders.



CONFIGURED CABLE ASSEMBLY OPTIONS

When an off-the-shelf configuration won't do, Storm responds equally fast to provide quotations on test & measurement cable assemblies configured exactly the way you want them.

With a number of product lines, cable sizes, connector types, and armor options, we have solutions to suit a wide variety of testing challenges and budgets.

SUPPLY CHAIN SERVICES

Storm is as capable of supporting your supply chain needs as we are your technical requirements. To maximize flexibility in today's rapidly changing environment, we offer the convenience of options such as contingency and consignment stock.

Further reducing non-value added costs on your end, we—and our partners—have participated in Ship-to-Stock, Ship-to-Line, and JIT programs with a number of customers around the world.



GLOBAL SUPPORT

For over ten years, Storm has been solving test & measurement problems in the United Kingdom, Europe, and Scandinavia with production, technical support, and sales provided by our licensed partner, Reynolds Industries Ltd and Reynolds Industries SA.

In addition, Storm's test & measurement products are available through local representatives and agents in a number of other countries throughout the world. Visit Storm's website at www.stormproducts.com to find an outlet near you.

PRODUCT & PROCESS INNOVATION

Products Storm-designed to satisfy unique project needs...

A major producer of defense electronics equipment needs a product that will perform to strict specifications within a highly critical, phase-sensitive test system.

Storm's Phase Master® assemblies—developed as a result of in-depth analysis of high performance market needs—prove a perfect solution to the customer's problem.

WHAT OUR CUSTOMERS SAY:

"...PhaseMaster™ was flatter across the band, was more flexible and had better performance than [other similar] cables."

"...the StormFlex™ 047 cables you supplied to us solved a very difficult spur problem for us."

TEST & MEASUREMENT CAPABILITIES

- VSWR
- Insertion loss
- Electrical length
- Phase tracking
- Additive phase noise
- Shielding effectiveness
- Electrical length vs. temperature
- Electrical length vs. flexure
- Impedance
- Capacitance
- Dielectric withstanding voltage
- Tensile strength/connector retention
- Mechanical measurements
- Interface gaging
- Thermal exposure
- Thermal shock
- Return loss
- Outgassing
- Insulation resistance
- Contact resistance (micro ohm)
- Insertion loss vs. temp
- Insertion loss vs. flex
- Vibration
- Shock
- Crush resistance
- Flex life

RELATIVE EXPENSE OF CABLE ASSEMBLY

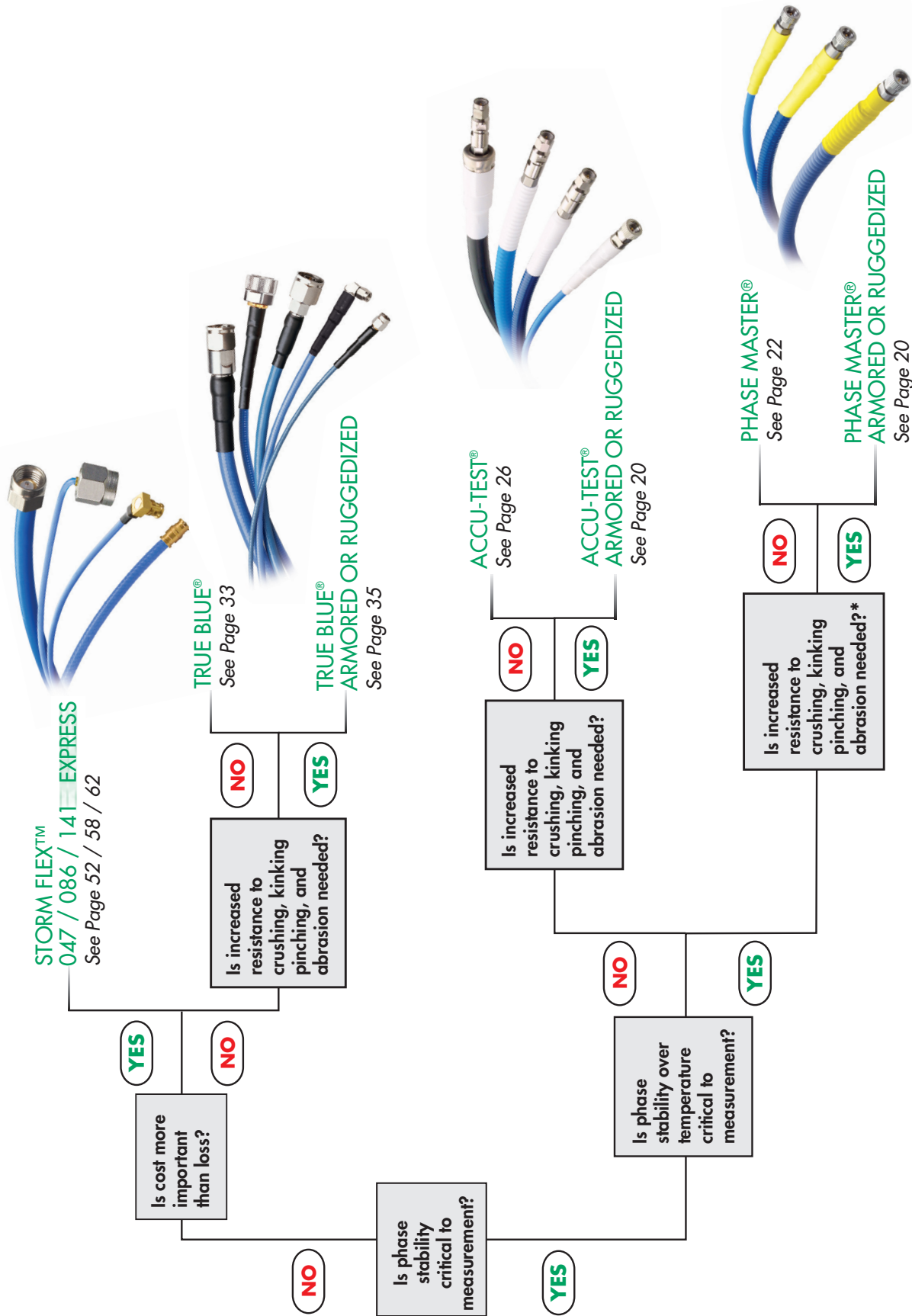

* When using Phase Master®, Storm recommends armored or ruggedized versions for most environments.

CABLE SELECTION CHART

This cable selection chart is provided to assist you in choosing a cable to best fit your application. Please contact us if you have questions or if you do not see a cable presented in the catalog that meets your needs. As a solutions provider, we can modify existing cables as a cost effective way to meet your unique system requirements, or we can design new cables as needed.

50 Ohm Flexible Cables

ATTRIBUTE	PP. 19-31				PP. 33-47				PP. 49-65		
	PHASE STABLE				LOW LOSS				MINIATURE / SR REPLACEMENT		
	PHASE MASTER 190	ACCU-TEST 150	ACCU-TEST 200	TRUE BLUE 125	TRUE BLUE 205	TRUE BLUE 290	TRUE BLUE 420	STORM FLEX 047	STORM FLEX 086	STORM FLEX 141	
Diameter (in) (mm)	0.190 4.83	0.150 3.81	0.200 5.08	0.125 3.18	0.205 5.21	0.290 7.37	0.420 10.67	0.055 1.40	0.096 2.44	0.160 4.06	
Operating Frequency (Max, GHz.)	26.5	40	26.5	50	26.5	19.8	12	50	50	26.5	
Attenuation-Nom @ 2 GHz (dB/ft)	0.110	0.190	0.155	0.230	0.110	0.078	0.054	0.59	0.28	0.17	
Attenuation-Nom @ 10 GHz (dB/ft)	0.260	0.440	0.359	0.52	0.26	0.19	0.13	1.37	0.68	0.43	
Attenuation-Nom @ 18 GHz (dB/ft)	0.360	0.600	0.492	0.71	0.36	0.26	-	1.89	0.95	0.61	
Power Handling-Avg. (watts @ 1 GHz)	700	358	682	280	750	1400	1700	50	125	282	
Phase vs. Temp Stability (ppm, nom)	500	2900	2100	2800	2100	1600	1500	6000	4700	4900	
Phase vs. Flex Stability* (deg @ 18 GHz, nom)	3.00	2.00	2.00	3.50	3.25	4.50	3.50†	0.70	1.00	0.24	
Bend Radius-Min	DYNAMIC (in) (mm)		2.20 55.88	1.25 31.75	2.10 53.34	2.90 73.66	4.00 101.60	0.60 15.24	1.00 25.40	1.50 38.10	
	STATIC (in) (mm)		1.00 25.40	0.50 12.70	1.00 25.40	1.50 38.10	2.50 63.50	0.100 2.54	0.187 4.75	0.320 8.13	
Shielding Effectiveness-Min (dB @ 1 GHz)	-105	-100	-100	-90	-90	-90	-90	-85 or better	-90 or better	-90 or better	
Weight (grams/ft) (grams/m)	16.65 54.63	11.50 37.73	20.00 65.62	8.00 26.25	20.00 65.62	36.00 118.11	85.00 278.87	1.54 5.05	5.25 17.22	13.4 43.95	
Velocity of Propagation (%)	81.5	72.0	72.0	74.0	75.0	76.0	77.0	70.5	70.5	70.5	
Temperature Range (deg C)	-54 to +150†	-54 to +150	-54 to +150	-54 to +150	-54 to +150	-54 to +150	-54 to +125	-85 to +125	-54 to +125	-54 to +125	

* ± 90° Bends; for specific test parameters, call Storm
 † Subject to connector choice
 # At 12 GHz
 Specifications subject to change without notice.

TEST AND MEASUREMENT PRODUCTS

CUSTOMER SPECIFIED OPTIONS

Since we understand that “one size” doesn’t always meet your needs, Storm Products provides test & measurement products tailored to suit specific requirements... often with little in the way of price premiums.

Examples of this include:

Special Marking or Labeling



Special/Serialized Test Data

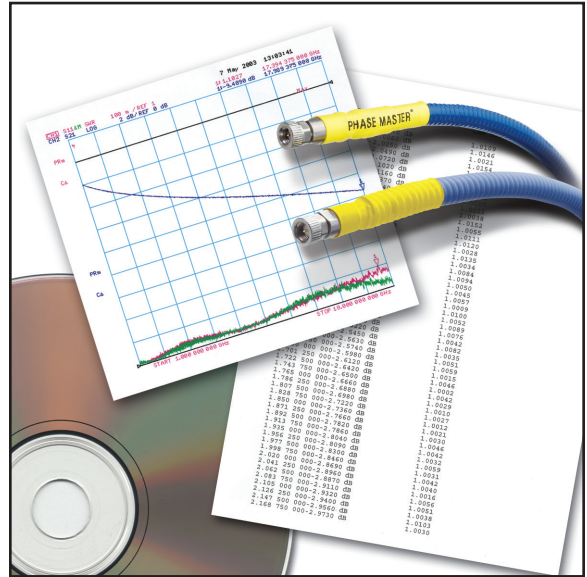

Variety Of Angled Connector Options



Phase/Amplitude Tracking

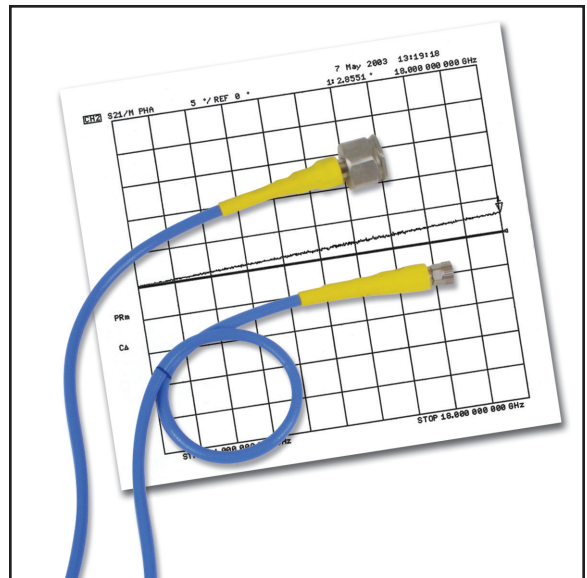

Built to last

Storm Products' test & measurement cable assemblies are known industry wide for their unique combination of durability and high performance. Normally, the weakest point in microwave cable assemblies is the junction between cable and connector...the figure below illustrates a handful of key features which combine to make Storm's test & measurement cable assemblies a favorite for test & measurement professionals around the world.

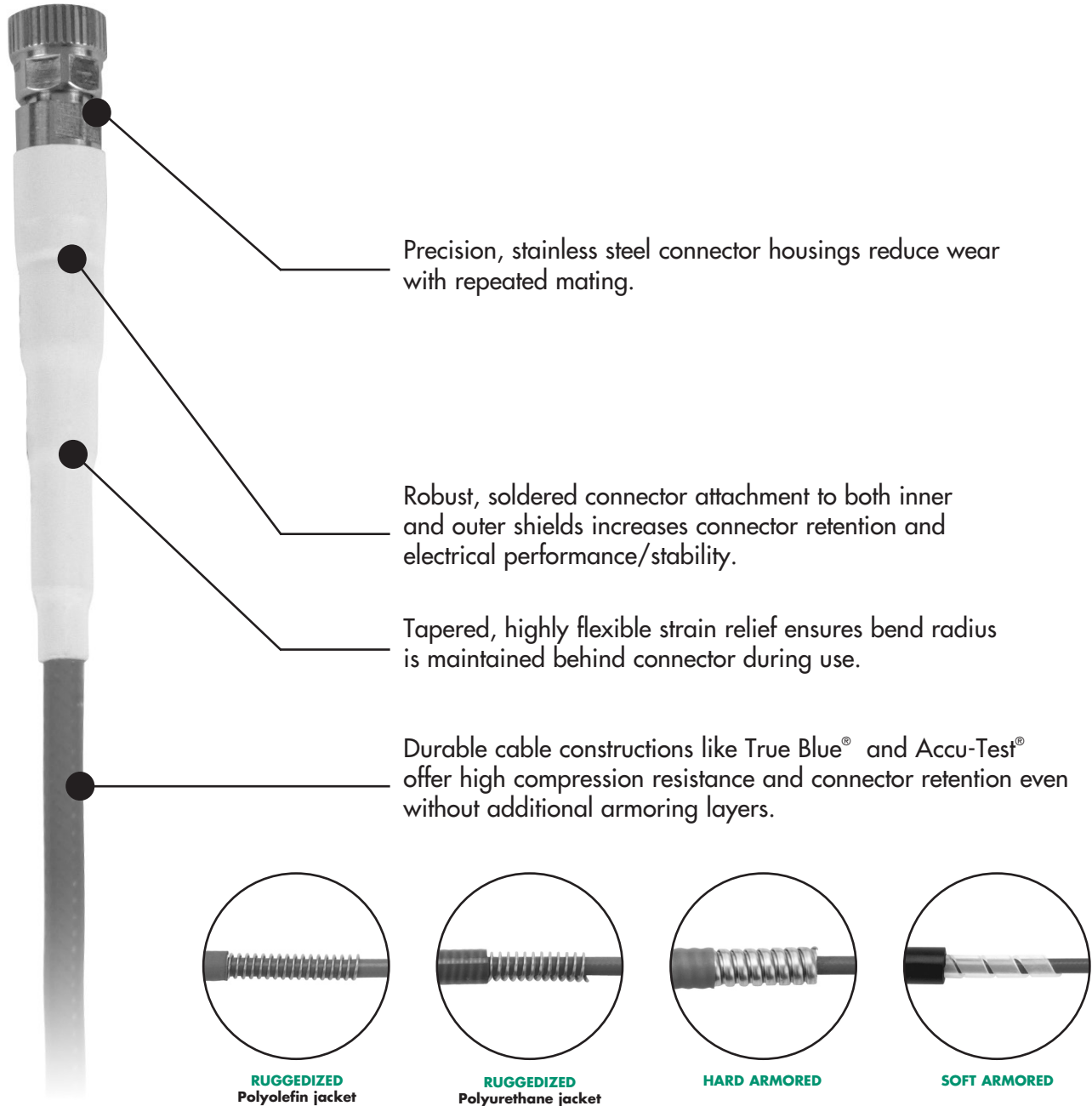

A full range of armoring options offers additional protection when more rugged handling is expected, ensuring reliable results over time.

Storm Products provides a wide variety of high performance products used in applications where electrical length or phase performance is critical to system performance. A brief discussion of specification options is outlined below. For additional assistance, please contact us.

▣ ELECTRICAL LENGTH MATCH BETWEEN ASSEMBLIES — RELATIVE PHASE MATCH

This is typically specified in one of two ways: $\pm XX$ pS or $\pm X^\circ$ @ YY GHz, relative to a “designated standard” cable assembly within the production batch.

PROs

- ~ Typically lowest unit cost, shortest lead time
- ~ Typically easier to correlate results
- ~ Less effort to properly specify

CONs

- ~ Requires replacement of set, rather than single cable

▣ ELECTRICAL LENGTH MATCH BETWEEN ASSEMBLIES — ABSOLUTE PHASE MATCH

This is typically specified in one of two ways: XX nS \pm XX pS or $X, XXX^\circ \pm X^\circ$ @ YY GHz. In lieu of specifying an insertion phase, master standard cable may be built and maintained. This is used most frequently in higher volume applications.

PROs

- ~ Allows later replacement of single damaged or worn cable assembly
- ~ Logistics easier because all cable assemblies are interchangeable

CONs

- ~ Typically higher unit cost, more effort to properly specify
- ~ More effort to correlate results
- ~ Extra expense if master standard cable assembly is built & maintained

▣ ELECTRICAL LENGTH TRACKING BETWEEN ASSEMBLIES OVER TEMPERATURE

This is typically specified as XXX ppm \pm XXX ppm relative to cable assembly electrical length @ 25° C. Generally required when cable assemblies may be at different temperatures within a system and phase is critical. Usually done as a qualification test, not an acceptance test.

PROs

- ~ Reduces or eliminates need to calibrate system over time, temperature
- ~ Reduces need for thermal management of system

CONs

- ~ Requires most effort to correlate results
- ~ Difficult to validate accurately on short cable assemblies

All numbers are for reference only. Actual values depend on cable, cable length, & frequency.

Relative Phase Match

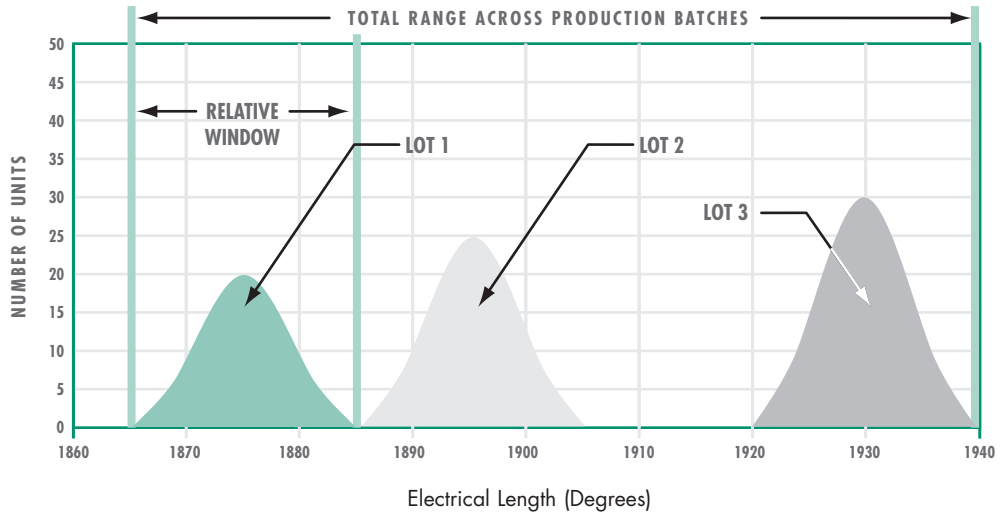

Absolute Phase Match

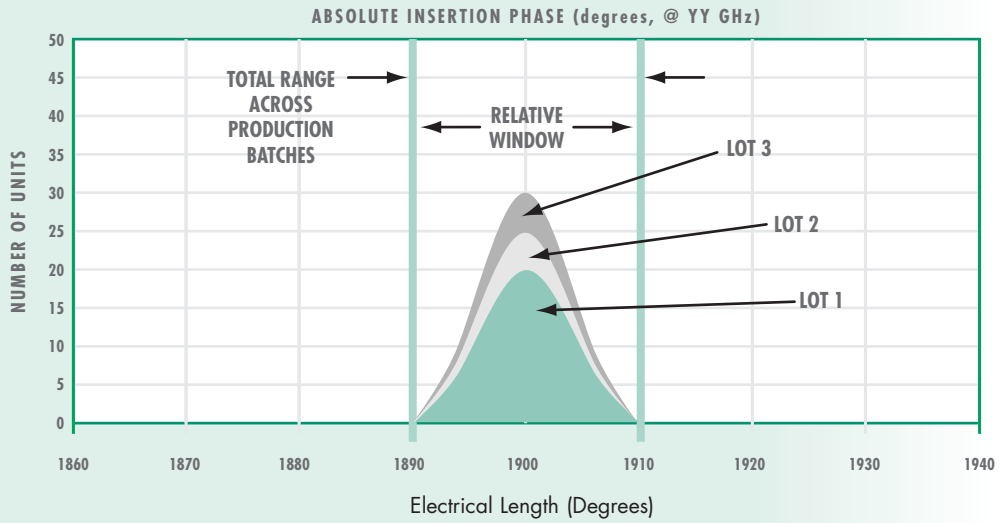

Electrical Length vs. Temperature

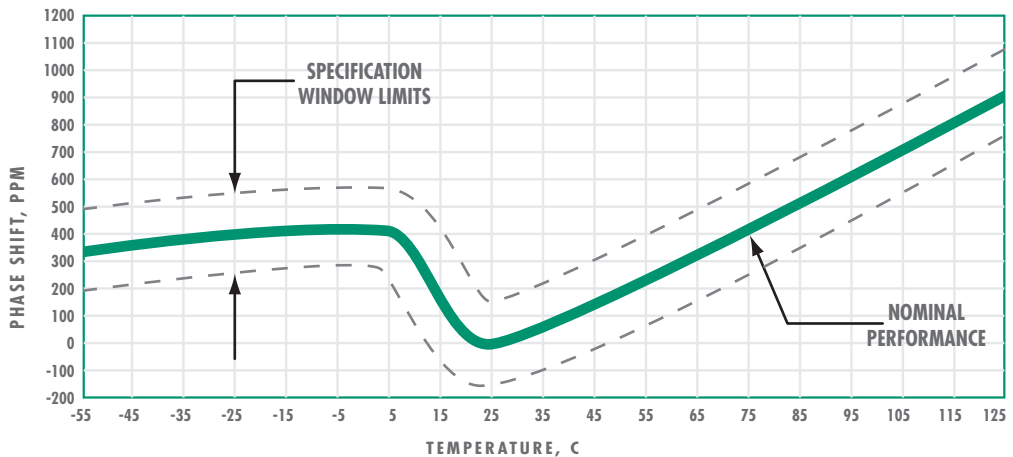

PHASE RELATED OPTIONS

VSWR PERFORMANCE

Assembly VSWR (return loss) is influenced by a number of factors including cable construction, assembly length, connector type and configuration (i.e., straight or angled), frequency range, and bend configuration (in semi-rigid assemblies).

FACTORS

KEY DRIVERS

- **CABLE CONSTRUCTION**
 - ~ Stranded or solid conductor
 - ~ Solid or tape-wrapped dielectric
 - ~ Shield construction
 - ~ Deployed configuration

- **ASSEMBLY LENGTH**
 - ~ Length > 4 feet

- **CONNECTOR TYPE**
 - ~ Size mismatch
(i.e., small connector/large cable)
 - ~ Air vs. PTFE interface

- **CONNECTOR CONFIGURATION**
 - ~ Angled or straight
 - ~ Blindmate or threaded
 - ~ High power

VSWR TO RETURN LOSS CONVERSION	
VSWR	RETURN LOSS
1.05:1	-32.25
1.10:1	-26.45
1.15:1	-23.12
1.20:1	-20.83
1.25:1	-19.09

VSWR TO RETURN LOSS CONVERSION	
VSWR	RETURN LOSS
1.30:1	-17.70
1.35:1	-16.54
1.40:1	-15.56
1.45:1	-14.72
1.50:1	-13.98

Measured VSWR performance is also impacted by differences in equipment and test methods. As a result, it is not within the scope of this catalog to provide VSWR specifications that account for every possible combination of factors.

For convenience sake, the following table may be used as a general guideline:

CABLE LENGTH	FREQUENCY (GHz)	2 STRAIGHT		1 STRAIGHT / 1 ANGLED		2 ANGLED	
		MAX	BEST	MAX	BEST	MAX	BEST
< 48"	2 to 18	1.35:1	1.15:1	1.35:1	1.20:1	1.40:1	1.25:1
≥ 48"	2 to 18	1.35:1	1.15:1	1.40:1	1.20:1	1.45:1	1.25:1
< 48"	18 to 26.5	1.35:1	1.15:1	1.40:1	1.25:1	1.50:1	1.30:1
≥ 48"	18 to 26.5	1.40:1	1.20:1	1.45:1	1.25:1	1.55:1	1.30:1
< 48"	26.5 to 50	1.45:1	1.20:1	-	-	-	-
≥ 48"	26.5 to 50	1.50:1	1.20:1	-	-	-	-

Once specific assembly requirements and test methods are established, it is often possible to guarantee improved VSWR performance. Contact us for more specific information.

Each time we develop a new product, we consider a number of dielectric options in order to provide the most cost-effective solution possible.

- SOLID PTFE** Solid PTFE has been used in RF and microwave cables longer than either low loss, low density or microporous PTFE. Typically extruded, solid PTFE dielectrics are very consistent in terms of dielectric constant over length as well as from lot to lot. Solid PTFE has a dielectric constant of 2.02 and a loss tangent of 0.00022.

Mechanically, solid PTFE dielectrics are very durable and compression resistant. Chemically, the dielectric material is exceptionally inert, offering excellent resistance to many chemicals.

Thermally, solid PTFE dielectrics have a sharp “knee” in their CTE profile around room temperature. They also exhibit a substantial amount of volumetric expansion when exposed to extreme temperatures, particularly during soldering operations.

- LOW LOSS, LOW DENSITY PTFE**

Low loss, low density dielectrics have been used for over 20 years in RF and microwave cables. They may be tape wrapped or extruded, and typically yield greater variation in dielectric constant over length and between lots than solid PTFE dielectrics do. Low loss, low density dielectrics typically range in dielectric constant from 1.6 to 1.8 and have a loss tangent of 0.00005. The result is much lower loss at microwave frequencies than solid PTFE offers.

Mechanically, low loss, low density dielectrics are nearly as compression resistant as solid PTFE, but much more so than microporous options. Low loss, low density dielectrics will “wick” solvents and fluids, so careful consideration must be given to the cable assembly design and manufacture.

Thermally, low loss, low density PTFE dielectrics have a smaller “knee” in their CTE profile around room temperature. Unlike solid PTFE dielectrics, they remain stable when exposed to extreme temperatures, allowing them to be used for higher power applications.

- MICROPOROUS OR EXPANDED PTFE**

Microporous PTFE dielectrics have been used for over 20 years in RF and microwave cables. They may be tape wrapped or extruded, and typically yield greater variation in dielectric constant over length and between lots. Microporous dielectrics typically range in dielectric constant from 1.3 to 1.5 and have a loss tangent of 0.00005. This means that, for a given cable size, microporous PTFE will yield lower loss than low loss, low density PTFE.

Mechanically, microporous dielectrics are fairly soft, requiring careful handling or some form of ruggedization. Microporous dielectrics will “wick” solvents and fluids, so careful consideration must be given to the cable assembly design and manufacture.

Thermally, microporous PTFE dielectrics have the smallest “knee” in their CTE profile around room temperature. This makes them an ideal choice where electrical length stability is critical. Like low loss, low density PTFE dielectrics, they remain stable when exposed to extreme temperatures, and this allows them to be used for higher power applications.

Storm Products' **PHASE STABLE FLEXIBLE** assemblies are designed to offer superior electrical performance and durability for a variety of test & measurement applications. The phase stable family of products includes two lines.

The **Phase Master®** line is the logical choice for applications requiring a combination of low loss and superior phase stability over temperature and flexure. Phase Master's enhanced phase stability is a result of Storm's MicroForm™ technology—a unique application of materials and production techniques offering a breakthrough in superior product price-to-performance.

The **Accu-Test®** product line can be counted on to deliver excellent phase and amplitude stability at room temperature, while providing unmatched levels of cost effectiveness. Accu-Test® also offers worry-free handling with a durable construction that resists kinking, crushing, and connector pull-off, even in non-ruggedized configurations.

Both Phase Master® & Accu-Test® assemblies are available in non-ruggedized, ruggedized, and armored versions to provide different degrees of protection based on the exact usage. The Accu-Test® and Phase Master® lines are also available with a variety of connector configurations and can be phase matched on request. As with all our products, they can be customized to meet your specific test & measurement requirements.

0.190" Diameter : PHASE MASTER® 190	22–24
0.150" Diameter : ACCU-TEST® 150	26–28
0.200" Diameter : ACCU-TEST® 200	29–31

PHASE MASTER® 190 0.190" DIAMETER



ACCU-TEST® 150 0.150" DIAMETER



ACCU-TEST® 200 0.200" DIAMETER



PHASE
STABLE
INTRO

PHASE STABLE FLEXIBLE : INTRODUCTION

ARMORING & RUGGEDIZING OPTIONS

RUGGEDIZED

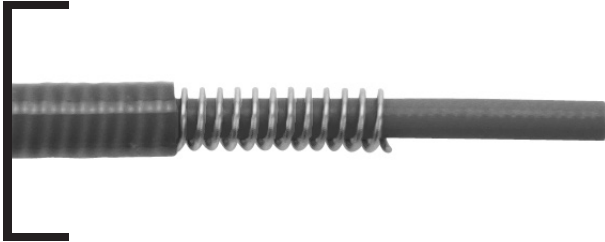

Designed for applications where weight, flexibility, and abrasion resistance are critical and moderate compression resistance is required (300 lbs/in). The cable is covered with a flexible wound helix of passivated stainless steel wire and an extruded polyurethane jacket. Temperature range -54° C to +100° C.

Cable	Weight*	Diameter	Min. bend rad.
PM 190R	31.9 gr/ft	0.360"	1.0"
AT 150R	26.40 gr/ft	0.360"	1.0"
AT 200R	34.90 gr/ft	0.360"	1.0"

* Includes cable

HARD ARMORED

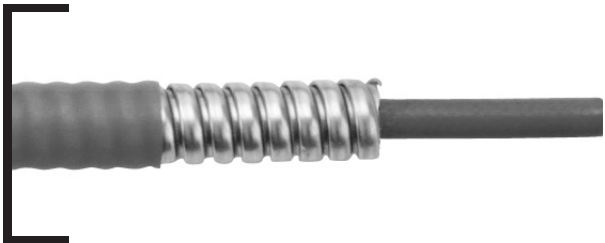

Designed for both inside and outside environments where the application requires the ultimate in cut and crush resistance (500 lbs/in). This cable is covered with a stainless steel interlocked armor; an additional polyolefin jacket is standard. Temperature range -54° C to +135° C.

Cable	Weight*	Diameter	Min. bend rad.
PM 190A	51.6 gr/ft	0.420"	1.75"
AT 150A	46.10 gr/ft	0.420"	1.75"
AT 200A	54.60 gr/ft	0.420"	1.75"

* Includes cable

SOFT ARMORED



For applications requiring abrasion resistance combined with improved compression resistance (400 lbs/in). Product still remains very flexible. The FEP-jacketed cable is protected with a high density polyethylene anti-compression helix that is covered with a tough fuel and oil resistant Neoprene™ synthetic rubber. Per MIL-R-6855, Class 2, Grade 60. Temperature: -54° C thru +100° C.

Cable	Weight*	Diameter	Min. bend rad.
AT 200SA	56.50 gr/ft	0.505"	1.75"

* Includes cable

CABLE CONSTRUCTION

FEATURES

- ▣ *MicroForm™ construction*

- ▣ *Robust connector attachment/captivation*

- ▣ *Crush & kink-resistant armoring options*

BENEFITS

- ~ *Less frequent calibration required due to flatter phase versus temperature profile*
- ~ *More precise measurements due to reduced phase shift versus flexure*
- ~ *Reduced insertion loss and increased amplitude stability versus flexure*
- ~ *Problem hook-ups made easier because of increased cable flexibility*

- ~ *Increased electrical stability over time and handling*
- ~ *Increased assembly life due to increased connector retention and assembly durability*

- ~ *Increased assembly life in applications where cable assemblies will be handled frequently*

MicroForm™ Construction

High performance shielding technology combined with a unique composition of dielectric materials results in superior cable performance. Performance is further enhanced by our robust production process.

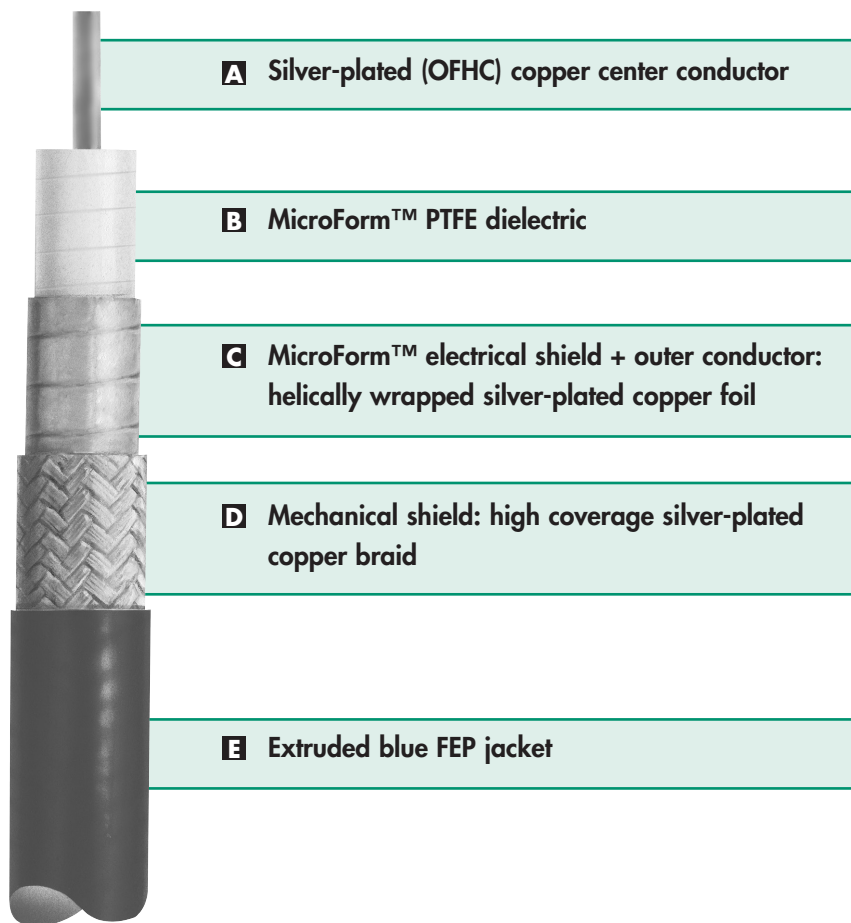

0.190" Diameter Cable : TECHNICAL INFORMATION

MECHANICAL SPECS

Cable Diameter, nominal	0.190 in
Bend Radius	
dynamic	2.2 in
static	1.0 in
Operating Temperature	-54° C to +150° C*
Weight	16.65 g/ft
Inner Conductor Type	solid SPC
Dielectric	MicroForm™ PTFE
Connector Retention, minimum	35.0 lbs

* Subject to connector choice.

ELECTRICAL SPECS

Frequency Range	DC to 26.5 GHz
Impedance	50 ±2 ohms
Capacitance, nominal	24 pF/ft
Time Delay, nominal	1.25 nsec/ft
Shielding Effectiveness, min (@ 1 GHz)	-105 dB

Power ratings (next page) are conservative; actual ratings depend on specific application. Please consult us regarding your application.

Specifications subject to change without notice.

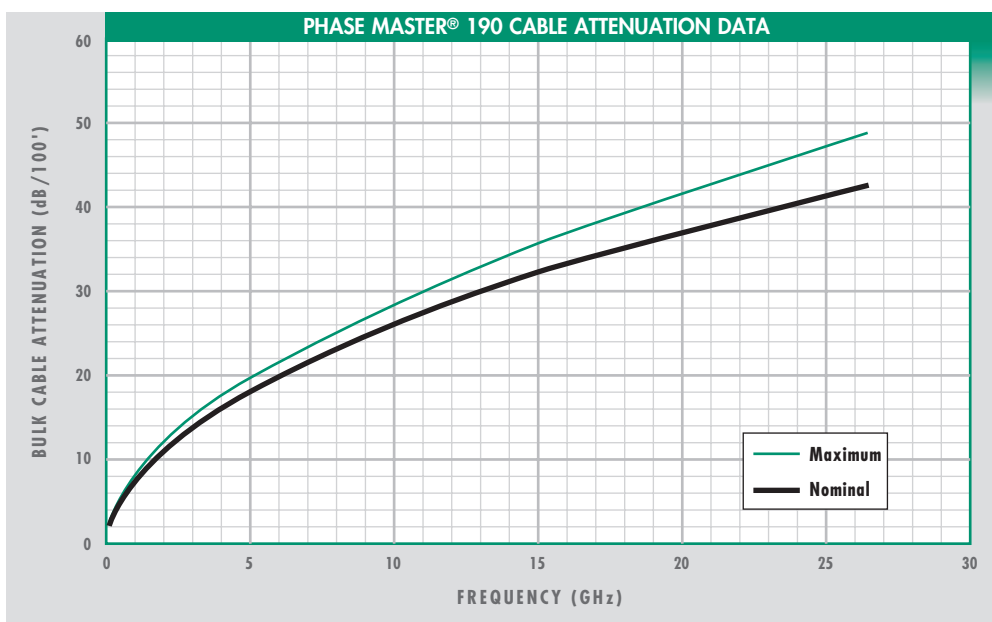

For cable assembly insertion loss, call us or visit our Web site, www.teledynestorm.com/microwave

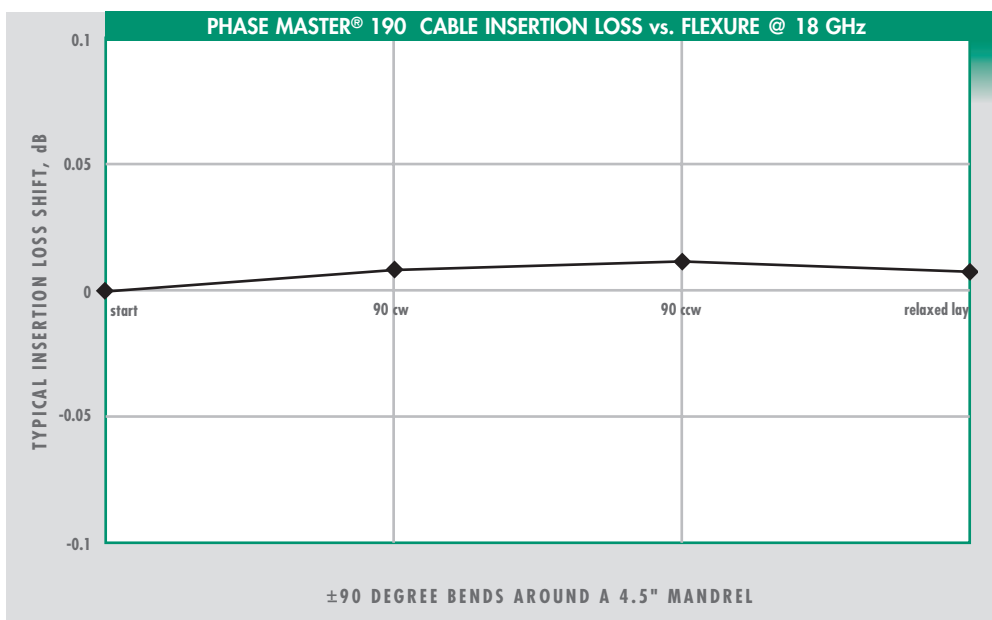

±90 DEGREE BENDS AROUND A 4.5" MANDREL

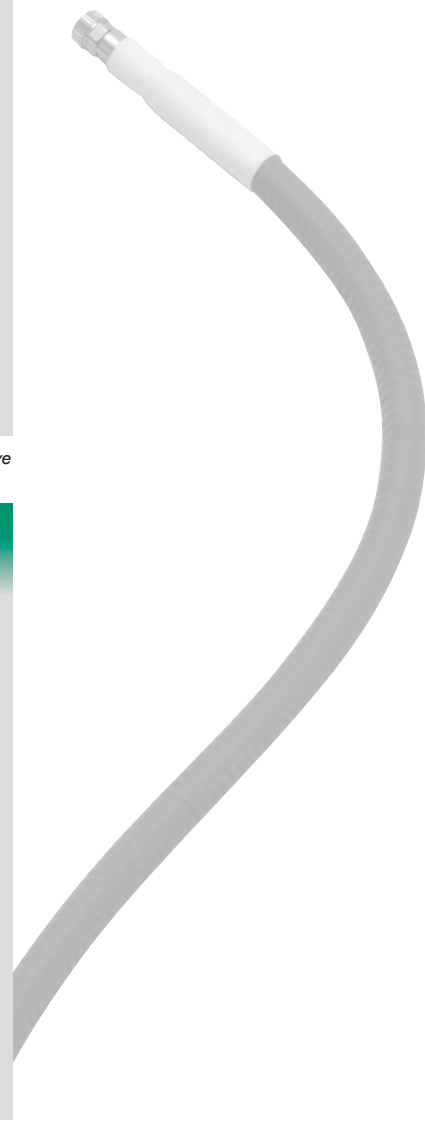

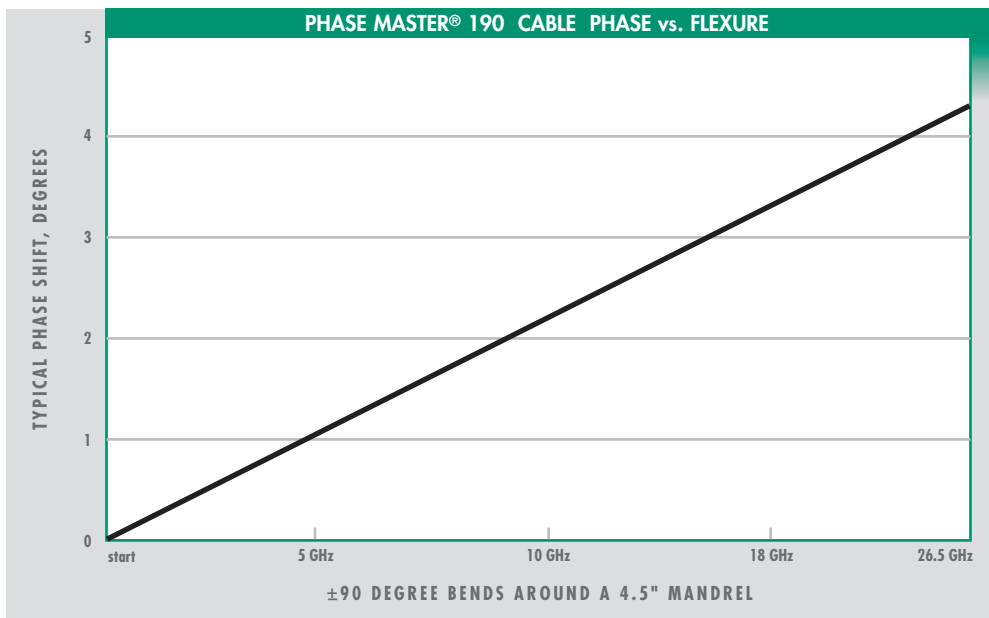
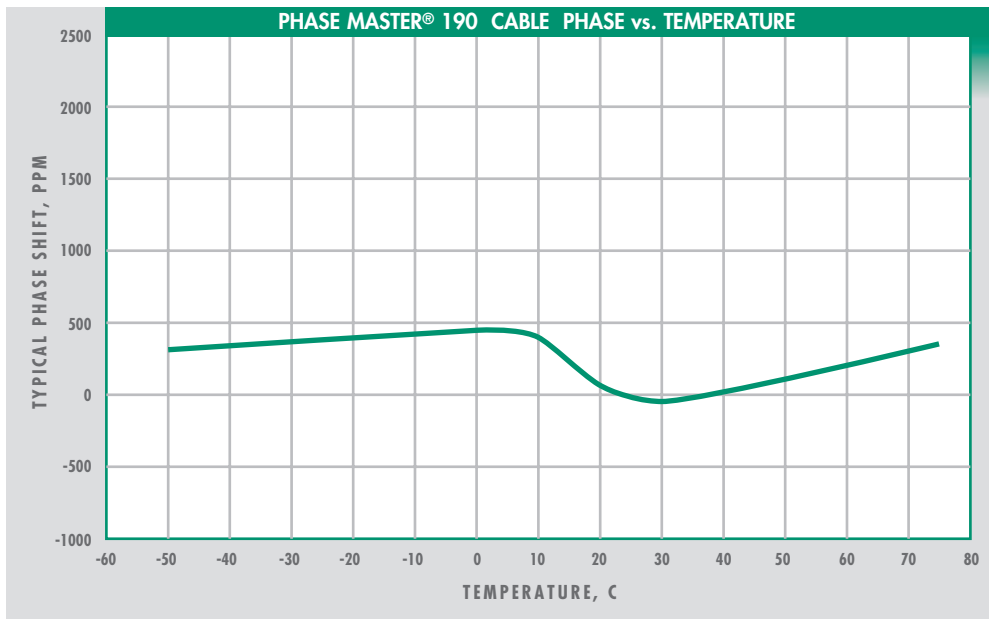
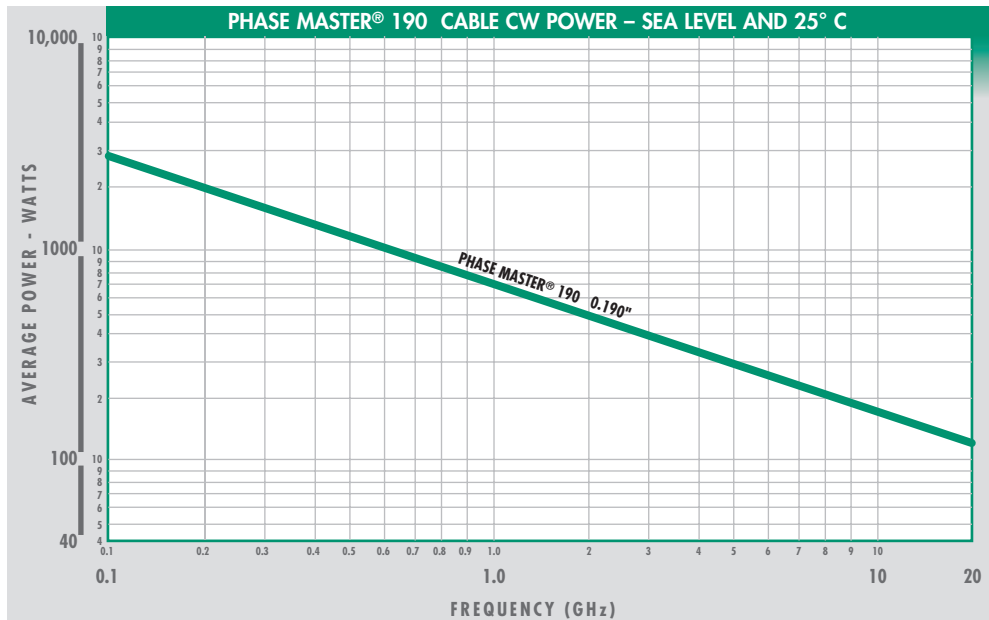

PHASE STABLE FLEXIBLE
0.190" Diam : TECHNICAL INFORMATION

ORDERING INFORMATION: Part Number Designation

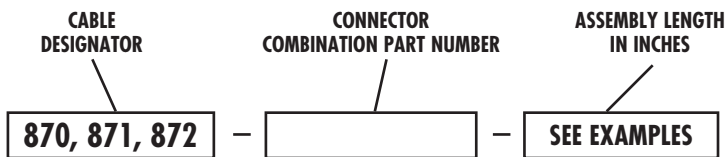

870 - PM 190 (Unarmored)

871 - PM 190A (Hard Armored; polyolefin jacket)

872 - PM 190R (Ruggedized; polyurethane jacket)

EXAMPLES:

870-0036-048 = Unarmored Phase Master® 190, 3.5 mm SP to 3.5 mm SP (assembly operates to 26.5 GHz), **48 inches**

872-0019-120 = Ruggedized Phase Master® 190, 7 mm to N SP (assembly operates to 18 GHz), **120 inches**

ASSEMBLY LENGTH TOLERANCES	
LENGTH	TOLERANCE
≤12"	±.125"
12" ≤120"	±.250"
120" ≤240"	±.500"
240" ≤360"	±1.00"

Length measured from connector end to connector end

CONNECTOR CODES	
SP	Straight Plug
SJ	Straight Jack
NMD	Ruggedized Test Port Connector

CONNECTOR COMBINATION PART NUMBERS*

		CONNECTOR OPERATING FREQUENCY							
		26.5 GHz				18 GHz			
		3.5 mm NMD SJ	3.5 mm SP	3.5 mm SJ	SMA SP	SMA SJ	7 mm	N SP	TNC SP
26.5 GHz	3.5 mm NMD SJ	0010	0034	0035	0004	0044	0023	0018	0014
	3.5 mm SP	0034	0036	0037	0028	0045	0038	0032	0030
	3.5 mm SJ	0035	0037	0039	0029	0046	0040	0033	0031
	SMA SP	0004	0028	0029	0001	0041	0012	0003	0002
18 GHz	SMA SJ	0044	0045	0046	0041	0048	0047	0043	0042
	7 mm	0023	0038	0040	0012	0047	0011	0019	0015
	N SP	0018	0032	0033	0003	0043	0019	0008	0006
	TNC SP	0014	0030	0031	0002	0042	0015	0006	0005

* Other connector styles available, including #8 Pin and Socket 38999; consult Storm

TYPICAL VSWR PERFORMANCE

FREQUENCY (GHz)	2 STRAIGHT CONNECTORS	1 STRAIGHT / 1 ANGLED	2 ANGLED CONNECTORS
Up to 3	1.10:1	1.12:1	1.15:1
3 to 18	1.15:1	1.20:1	1.25:1
18 to 26.5	1.25:1	N/A	N/A

Once specific assembly requirements and test methods are established, it is often possible to guarantee improved VSWR performance. Contact us for more specific information.

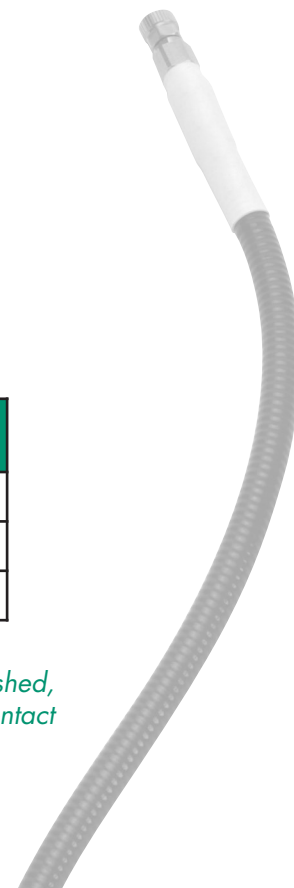

CABLE CONSTRUCTION

FEATURES

- ☑ Accu-Test® Construction
- ☑ Robust connector attachment/captivation
- ☑ Crush & kink resistant armoring options

BENEFITS

- ~ Calibration accuracy is maintained due to reduced phase shift versus flexure
- ~ Added durability
- ~ Increased electrical stability over time and handling
- ~ Increased assembly life due to increased connector retention and assembly durability
- ~ Increased life in applications where cable assemblies will be handled frequently

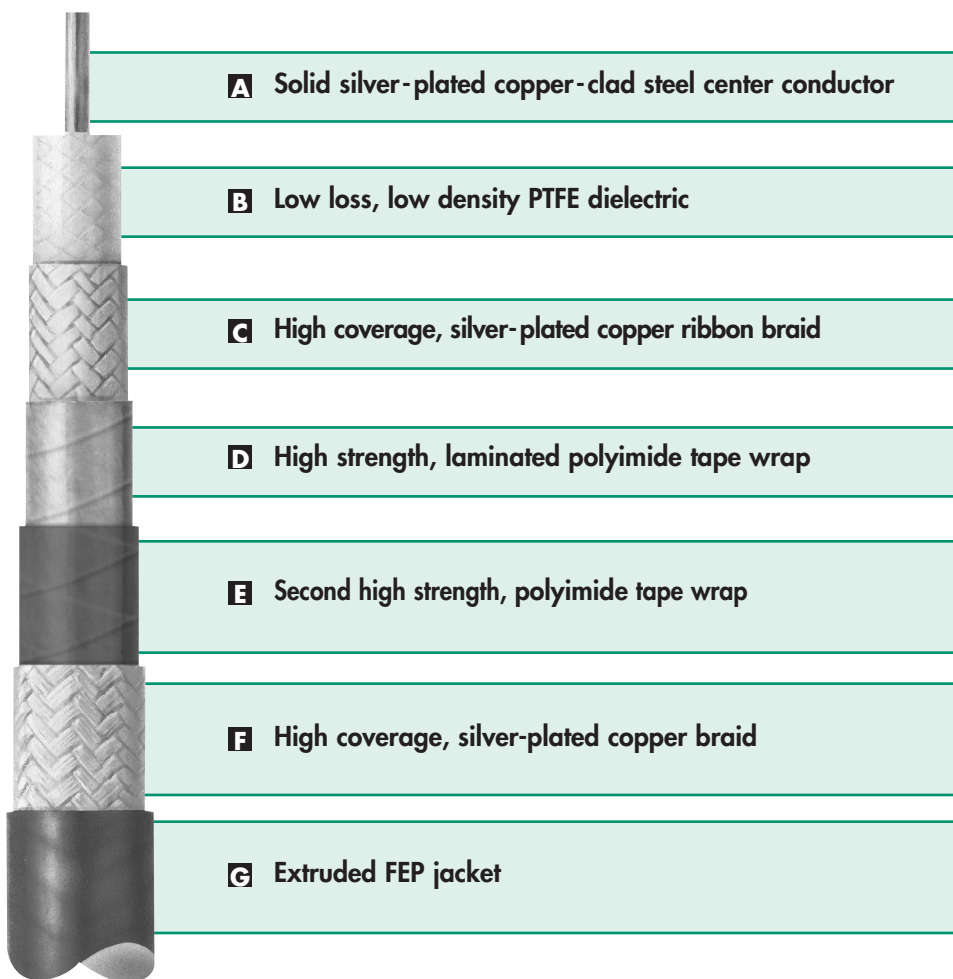

PHASE MASTER 190
ACCU-TEST 150

PHASE STABLE FLEXIBLE
0.190" Diam : PART NUMBERING ☑ ACCU-TEST® CABLE CONSTRUCTION

0.150" Diameter Cable : TECHNICAL INFORMATION

MECHANICAL SPECS

Cable Diameter, nominal	0.150 in
Bend Radius	
dynamic	1.5 in
static	1.0 in
Operating Temperature	-54° C to +150° C
Weight	11.5 g/ft
Inner Conductor Type	solid SPC
Dielectric	low loss, low density
Connector Retention, minimum	35.0 lbs

ELECTRICAL SPECS

Frequency Range	DC to 40 GHz
Impedance	50 ±2 ohms
Capacitance, nominal	27.5 pF/ft
Time Delay, nominal	1.39 nsec/ft
Shielding Effectiveness, min (@ 1 GHz)	> -100 dB

Power ratings (next page) are conservative; actual ratings depend on specific application. Please consult us regarding your application.

Specifications subject to change without notice.

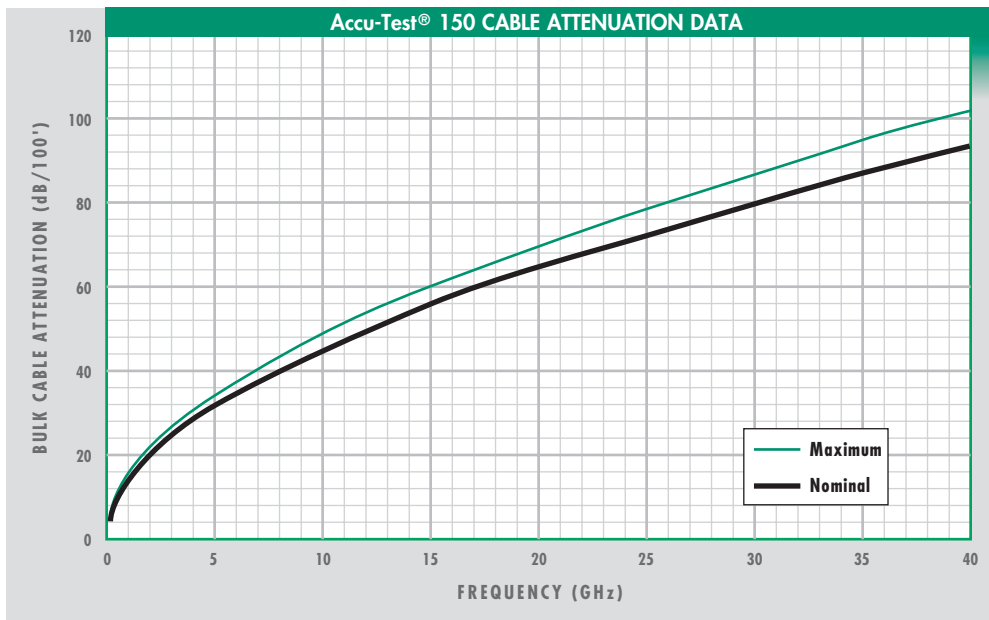

For cable assembly insertion loss, call us or visit our Web site, www.teledynestorm.com/microwave

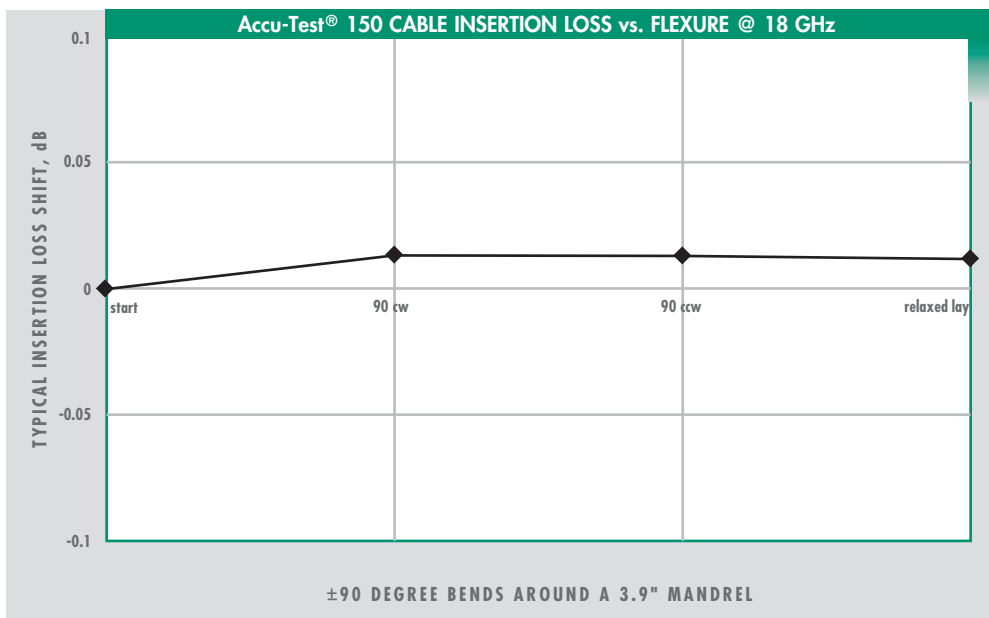

±90 DEGREE BENDS AROUND A 3.9" MANDREL

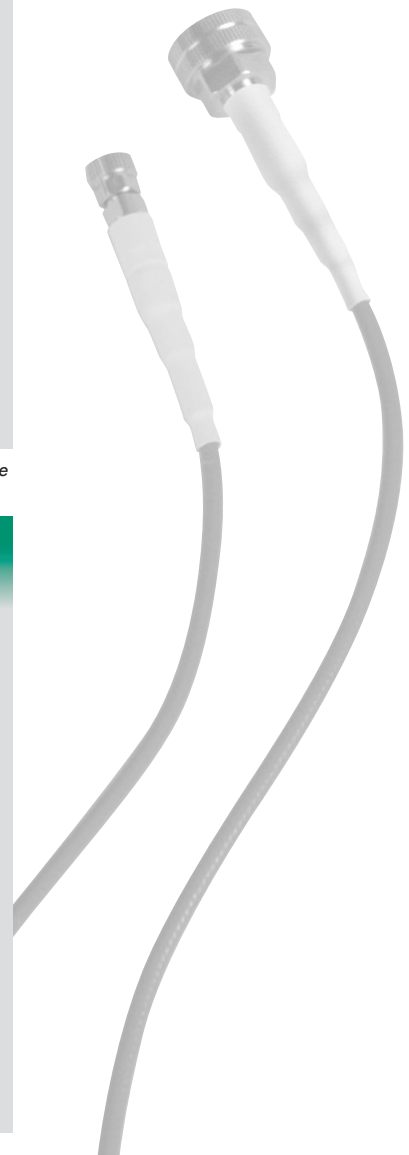

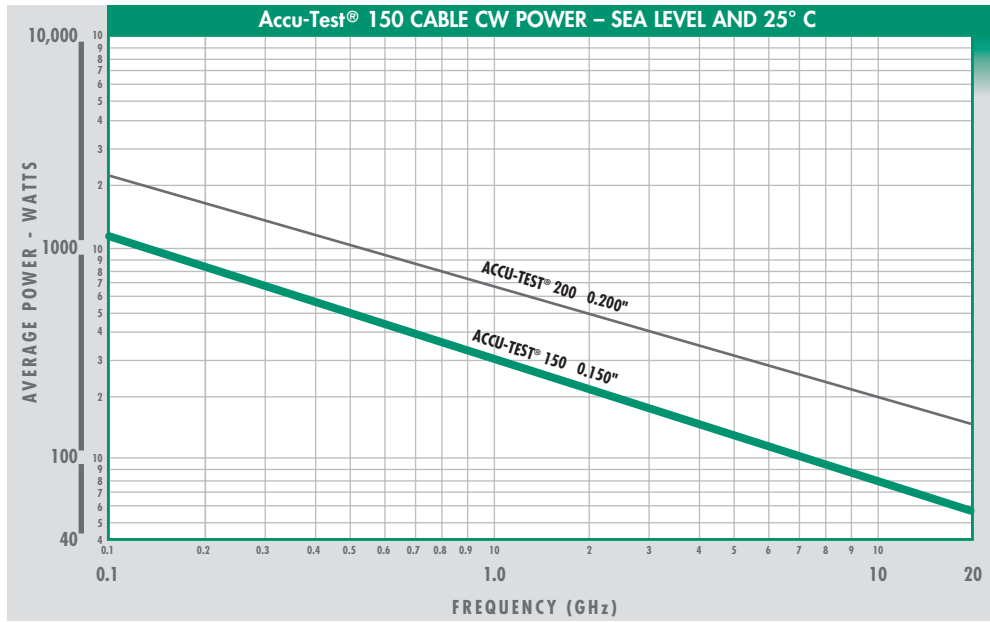

ACCU-TEST 150

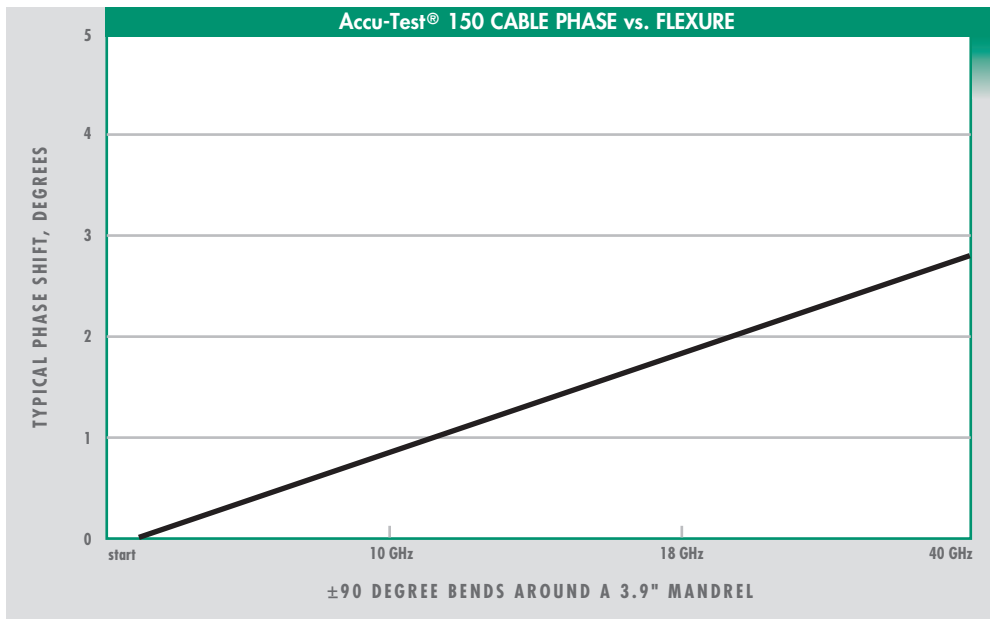

**PHASE STABLE FLEXIBLE
0.150" Diam : TECHNICAL INFORMATION**



ORDERING INFORMATION: Part Number Designation

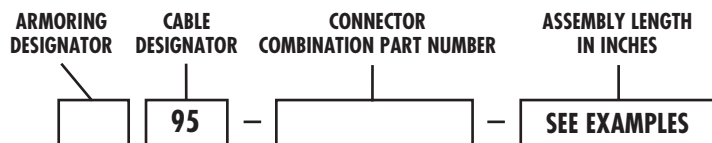

Armoring Designator

- O** Unarmored
- R** Ruggedized (polyurethane jacket)
- A** Hard Armored (polyolefin jacket)

EXAMPLES:

095-0002-048 = Unarmored Accu-Test® 150, 2.4 mm NMD SJ to 2.9 mm SP (assembly operates to 40 GHz), 48 inches

R95-0004-120 = Ruggedized Accu-Test® 150, 2.9 mm SP to 2.9 mm SP (assembly operates to 40 GHz), 120 inches

ASSEMBLY LENGTH TOLERANCES	
LENGTH	TOLERANCE
≤12"	±.125"
12" ≤120"	±.250"
120" ≤240"	±.500"
240" ≤360"	±1.00"
360" ≤480"	±1.50"
480" ≤600"	±2.00"
600" ≤900"	±3.00"
900" ≤1200"	±4.00"

Length measured from connector end to connector end

CONNECTOR CODES	
SP	Straight Plug
SJ	Straight Jack
NMD	Ruggedized Test Port Connector

CONNECTOR COMBINATION PART NUMBERS*

CONNECTOR OPERATING FREQUENCY

40 GHz

	2.4 mm SP	2.4 mm NMD SJ	2.9 mm SP	2.9 mm SJ
2.4 mm SP	0007	0008	0009	0010
2.4 mm NMD SJ	0008	0001	0002	0003
2.9 mm SP	0009	0002	0004	0005
2.9 mm SJ	0010	0003	0005	0006

* Other connector styles available; consult Storm

TYPICAL VSWR PERFORMANCE

FREQUENCY (GHz)	2 STRAIGHT CONNECTORS
Up to 3	1.10:1
3 to 18	1.15:1
18 to 26.5	1.25:1
26.5 to 40	1.30:1

Once specific assembly requirements and test methods are established, it is often possible to guarantee improved VSWR performance. Contact us for more specific information.



0.200" Diameter Cable : TECHNICAL INFORMATION

MECHANICAL SPECS	
Cable Diameter, nominal	0.200 in
Bend Radius	2.0 in
<i>dynamic</i>	1.0 in
<i>static</i>	
Operating Temperature	-54° C to +150° C
Weight	20.0 g/ft
Inner Conductor Type	solid SPCCS
Dielectric	low loss, low density
Connector Retention, minimum	60.0 lbs

ELECTRICAL SPECS	
Frequency Range	DC to 26.5 GHz
Impedance	50 ±2 ohms
Capacitance, nominal	27.5 pF/ft
Time Delay, nominal	1.39 nsec/ft
Shielding Effectiveness, min (@ 1 GHz)	> -100 dB

Power ratings (next page) are conservative; actual ratings depend on specific application. Please consult us regarding your application.

Specifications subject to change without notice.

ACCU-TEST 150
ACCU-TEST 200

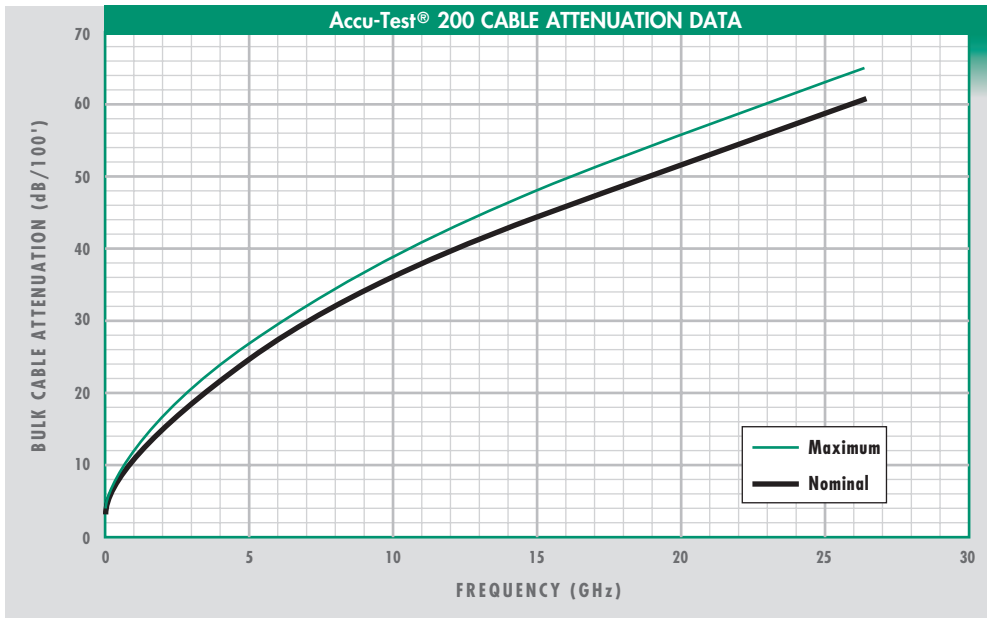

For cable assembly insertion loss, call us or visit our Web site, www.teledynestorm.com/microwave

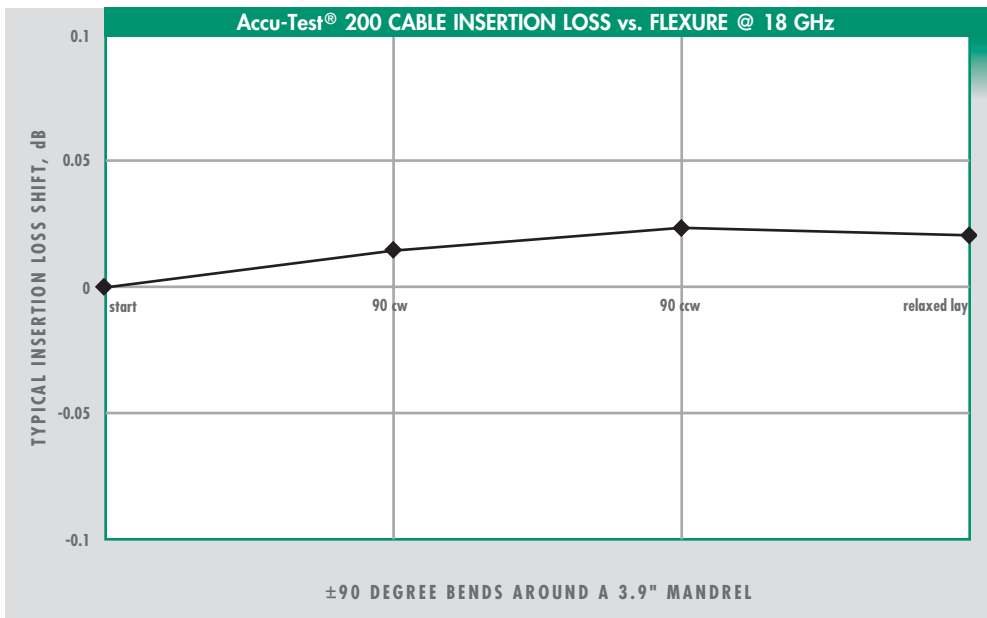

±90 DEGREE BENDS AROUND A 3.9" MANDREL



PHASE STABLE FLEXIBLE
0.150" Diam : PART NUMBERING ▣ 0.200" Diam : TECHNICAL INFORMATION

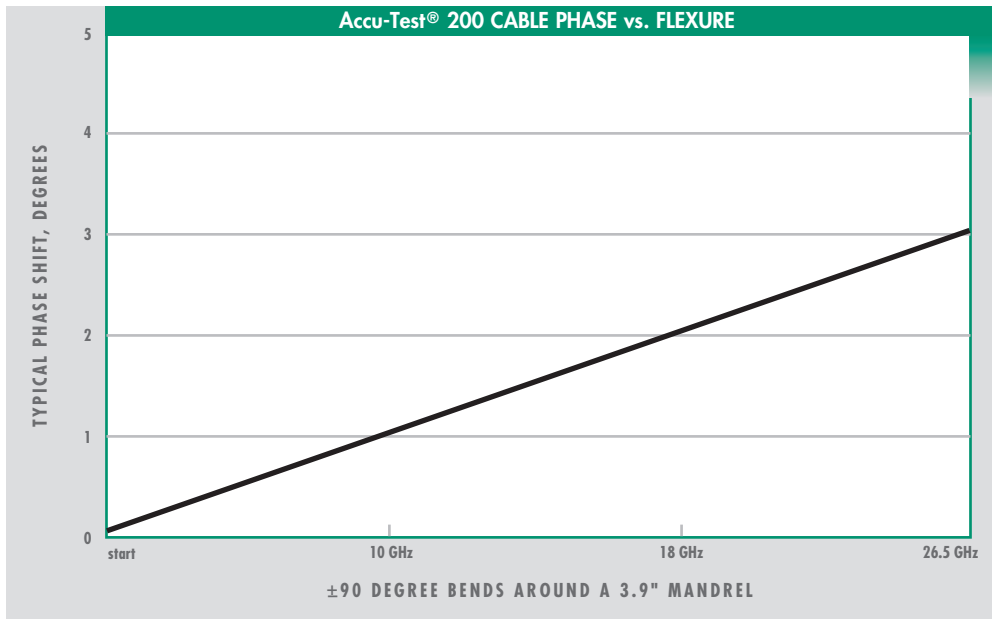
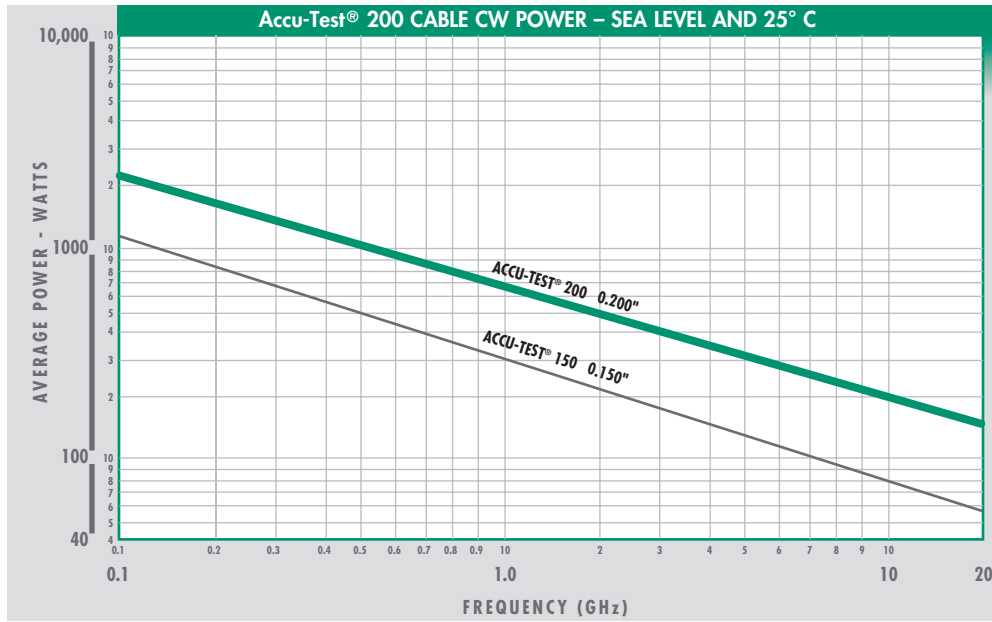

ORDERING INFORMATION: Part Number Designation

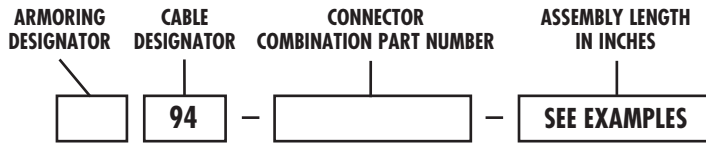

Armoring Designator

- Leave Blank for Unarmored
- R Ruggedized (polyurethane jacket)
- A Hard Armored (polyolefin jacket)
- SA Soft Armored (Neoprene™ jacket)

EXAMPLES:

- 94-230-048 = Unarmored Accu-Test® 200, 7 mm to N SP (assembly operates to 18 GHz), 48 inches
- SA94-240-120 = Soft Armored Accu-Test® 200, 3.5 mm SP to 3.5 mm SP (assembly operates to 26.5 GHz), 120 inches

ASSEMBLY LENGTH TOLERANCES	
LENGTH	TOLERANCE
≤ 12"	±.125"
12" ≤ 120"	±.250"
120" ≤ 240"	±.500"
240" ≤ 360"	±1.00"
360" ≤ 480"	±1.50"
480" ≤ 600"	±2.00"
600" ≤ 900"	±3.00"
900" ≤ 1200"	±4.00"

Length measured from connector end to connector end

CONNECTOR CODES	
SP	Straight Plug
SJ	Straight Jack
RAP	Right Angle Plug

CONNECTOR COMBINATION PART NUMBERS*

		CONNECTOR OPERATING FREQUENCY							
		26.5 GHz				18 GHz			
		3.5 mm SP	3.5 mm SJ	7 mm	SMA SP	SMA RAP	SMA SJ	N SP	TNC SP
26.5 GHz	3.5 mm SP	240	245	241	204	246	242	229	217
	3.5 mm SJ	245	285	255	209	286	264	234	222
	7 mm SP	241	255	251	205	256	252	230	218
	SMA SP	204	209	205	201	210	206	203	202
18 GHz	SMA RAP	246	286	256	210	291	265	235	223
	SMA SJ	242	264	252	206	265	261	231	219
	N SP	229	234	230	203	235	231	228	216
	TNC SP	217	222	218	202	223	219	216	215

* Other connector styles available; consult Storm

TYPICAL VSWR PERFORMANCE

FREQUENCY (GHz)	2 STRAIGHT CONNECTORS	1 STRAIGHT / 1 ANGLED	2 ANGLED CONNECTORS
Up to 3	1.10:1	1.12:1	1.15:1
3 to 18	1.15:1	1.20:1	1.25:1
18 to 26.5	1.25:1	N/A	N/A

Once specific assembly requirements and test methods are established, it is often possible to guarantee improved VSWR performance. Contact us for more specific information.

ACCU-TEST 200

PHASE STABLE FLEXIBLE 0.200" Diam : TECHNICAL INFORMATION PART NUMBERING

LOW LOSS FLEXIBLE

Storm Products' **TRUE BLUE®** line of high performance test & measurement cable assemblies provides an unmatched combination of low loss, durability, and value. With a variety of standard assemblies and connector combinations available covering frequencies from DC to 50 GHz, True Blue® products are ideally suited for many demanding test & measurement applications. Custom connector configurations are also available upon request.

All True Blue® cable assemblies feature the same durable, low density PTFE dielectric combined with our proven Quadraform shield. Our time-tested construction and tightly controlled production processes ensure an outstanding combination of electrical and mechanical performance specifications. To suit applications requiring greater durability, True Blue® cable assemblies are available with standard armoring or ruggedizing layers. Phase and amplitude matching are available on request.

FEATURES

- *Compression resistant low loss, low density dielectric*
- *Quadraform™ shielding*
- *Highly reliable soldered connections*
- *Various standard connector options and a number of ready-to-ship standard cable assemblies*

BENEFITS

- ~ *Low insertion loss and excellent amplitude stability*
- ~ *Cable assemblies less prone to damage during handling, without extra armoring layers*
- ~ *Low insertion loss and excellent amplitude stability*
- ~ *Longer cable assembly life due to greater connector retention*
- ~ *Laminate construction provides low signal leakage*
- ~ *Low insertion loss and excellent amplitude stability*
- ~ *Longer cable assembly life due to greater connector retention*
- ~ *Reduced lead time for configured assemblies*
- ~ *Cost-effective, same day shipment options for standard configurations*

0.125" Diameter : **TRUE BLUE® 125** 36-38
 0.205" Diameter : **TRUE BLUE® 205** 39-41
 0.290" Diameter : **TRUE BLUE® 290** 42-44
 0.420" Diameter : **TRUE BLUE® 420** 45-47

**TRUE BLUE® 125
0.125" DIAMETER**



**TRUE BLUE® 205
0.205" DIAMETER**

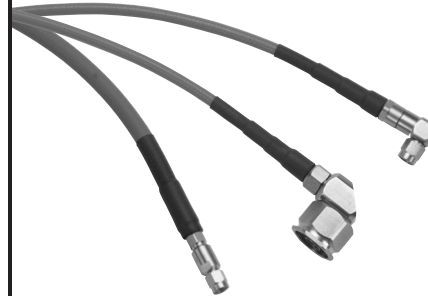

**TRUE BLUE® 290
0.290" DIAMETER**



**TRUE BLUE® 420
0.420" DIAMETER**

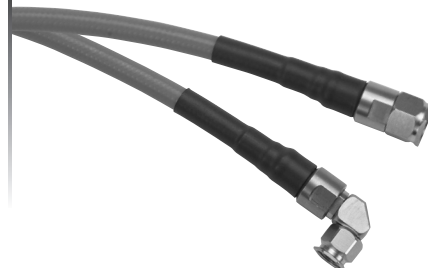

**LOW
LOSS
INTRO**

LOW LOSS FLEXIBLE : INTRODUCTION

CABLE CONSTRUCTION

Our flexible low loss microwave cables are built to withstand mechanical abuse without loss of performance. However, for extra rough applications Storm offers the additional protection of ruggedizing, armoring, and soft armoring.

A silver-plated copper conductor is insulated with a tough, low density PTFE dielectric that is then shielded with multiple outer conductor layers and insulated with FEP, an inert jacketing material.

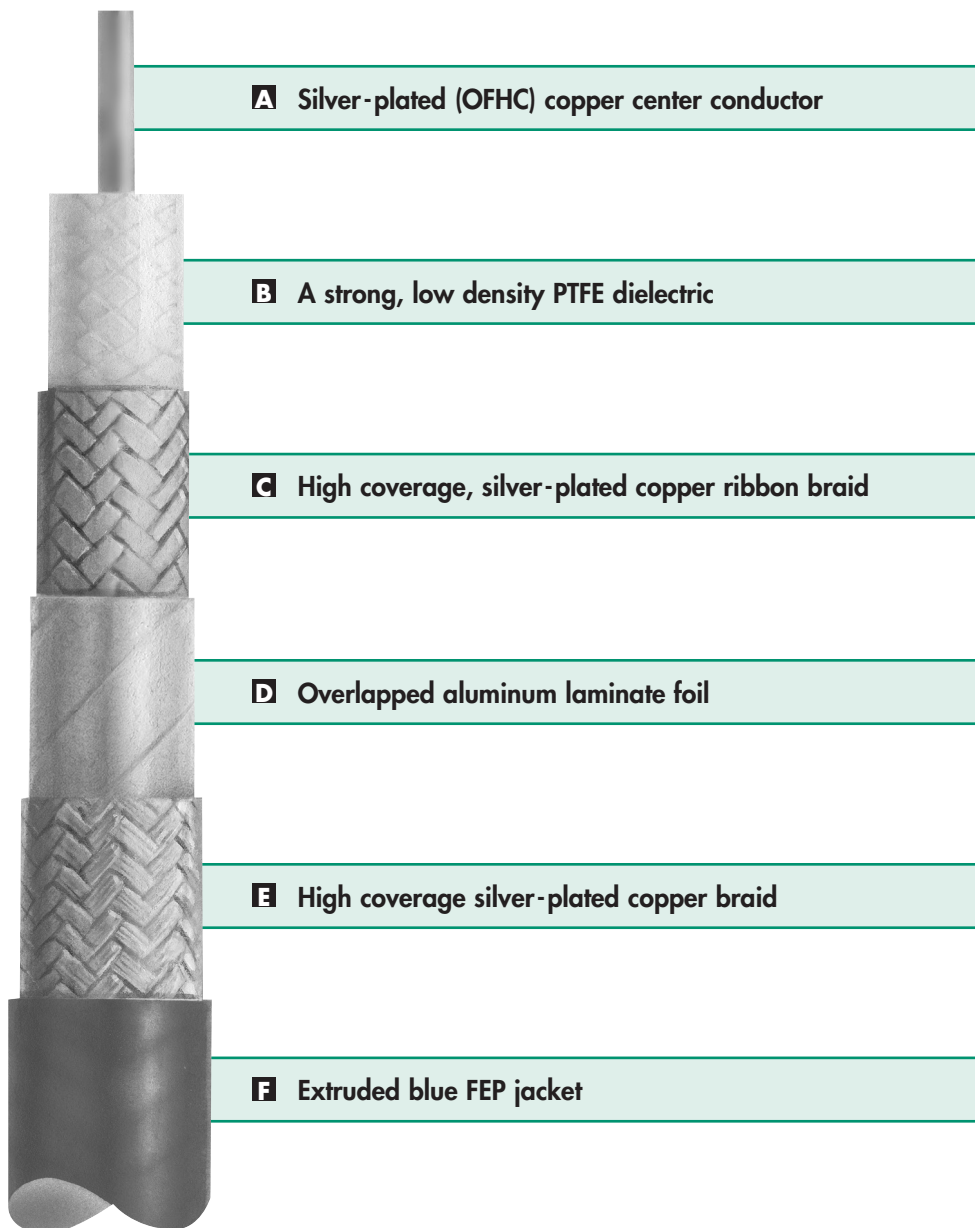

ARMORING & RUGGEDIZING OPTIONS

Cable types other than True Blue® 205 and True Blue® 290 armored or ruggedized on request. Consult us for options.

RUGGEDIZED – Polyolefin jacket



For applications requiring a slightly greater amount of compression resistance (300 lbs/in), but where weight and flexibility are also critical. The cable is covered with a flexible wound helix of passivated stainless steel wire and a cross-linked polyolefin jacket. Temperature: -54° C thru +135° C.

Cable	Weight *	Diameter	Min. bend rad.
TB 205	42 gr/ft	0.340"	1.0"
TB 290	60 gr/ft	0.405"	1.5"

* Includes cable

RUGGEDIZED – Polyurethane jacket

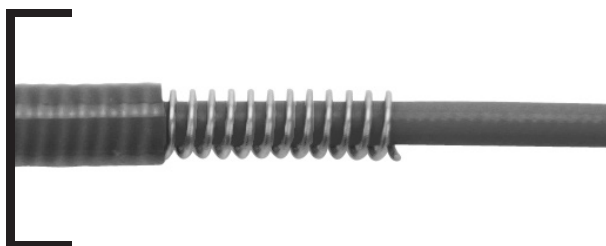

For applications similar to the above, where weight, flexibility, and moderate compression resistance (300 lbs/in) are important, but where abrasion resistance is also critical. The cable is covered with a flexible wound helix of passivated stainless steel wire and an extruded polyurethane jacket. Temperature: -54° C thru +100° C.

Cable	Weight *	Diameter	Min. bend rad.
TB 205	35 gr/ft	0.350"	1.0"
TB 290	55 gr/ft	0.422"	1.5"

* Includes cable

HARD ARMORED

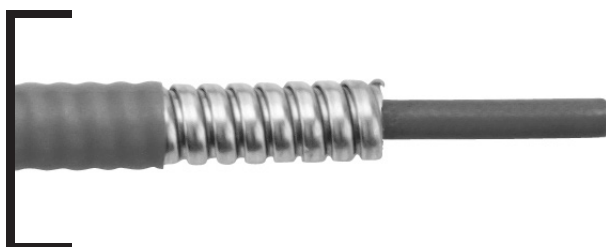

Designed for both inside and outside environments where flexibility and weight are not as critical, but where the application requires the ultimate in cut and crush resistance (500 lbs/in). The cable is covered with a stainless steel interlocked armor; an additional cross-linked polyolefin jacket is standard on lengths up to 50 feet. Temperature: -54° C thru +135° C.

Cable	Weight *	Diameter	Min. bend rad.
TB 205	55 gr/ft	0.420"	1.75"
TB 290	78 gr/ft	0.530"	1.75"

* Includes cable

SOFT ARMORED



For applications requiring abrasion resistance combined with improved compression resistance (400 lbs/in). Product still remains very flexible. The FEP-jacketed cable is protected with a high density polyethylene anti-compression helix (205 only) that is covered with a tough fuel and oil resistant Neoprene™ synthetic rubber. Per MIL-R-6855, Class 2, Grade 60. Temperature: -54° C thru +100° C.

Cable	Weight *	Diameter	Min. bend rad.
TB 205	58 gr/ft	0.505"	1.75"
TB 290	68 gr/ft	0.470"	1.75"

* Includes cable

0.125" Diameter Cable : TECHNICAL INFORMATION

MECHANICAL SPECS

Cable Diameter, nominal	0.125 in
Bend Radius	1.25 in
<i>dynamic</i>	1.25 in
<i>static</i>	0.50 in
Operating Temperature	-54° C to +150° C
Weight	8.0 g/ft
Inner Conductor Type	solid SPC
Dielectric	low density PTFE
Connector Retention, minimum	30.0 lbs

ELECTRICAL SPECS

Frequency Range	DC to 50 GHz
Impedance	50 ±2 ohms
Capacitance, nominal	27.5 pF/ft
Time Delay, nominal	1.38 nsec/ft
Shielding Effectiveness, min (@ 1 GHz)	-90 dB

Power ratings (next page) are conservative; actual ratings depend on specific application. Please consult us regarding your application.

Specifications subject to change without notice.

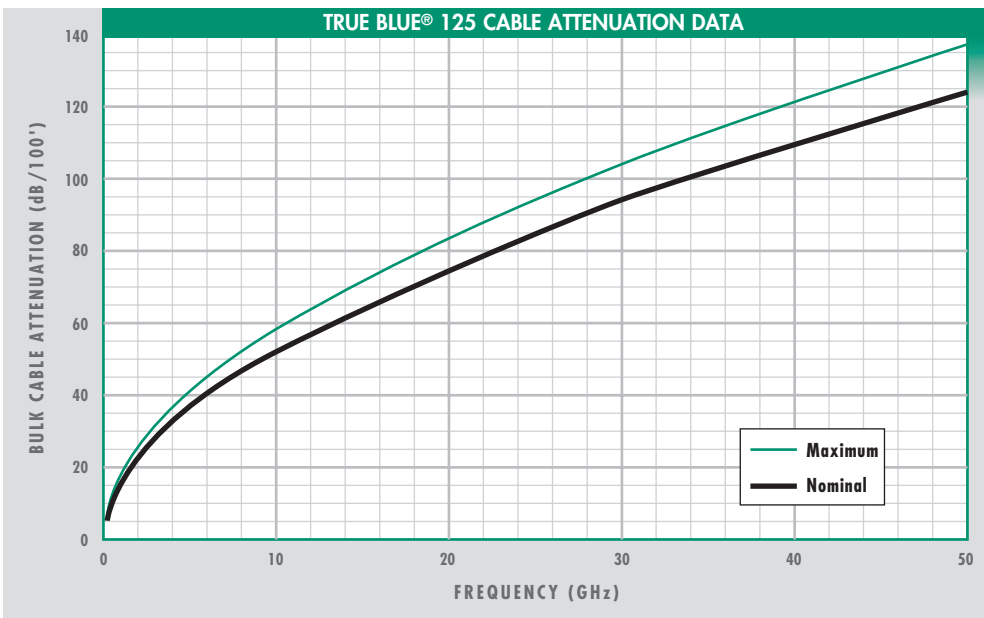

For cable assembly insertion loss, call us or visit our Web site, www.teledynestorm.com/microwave

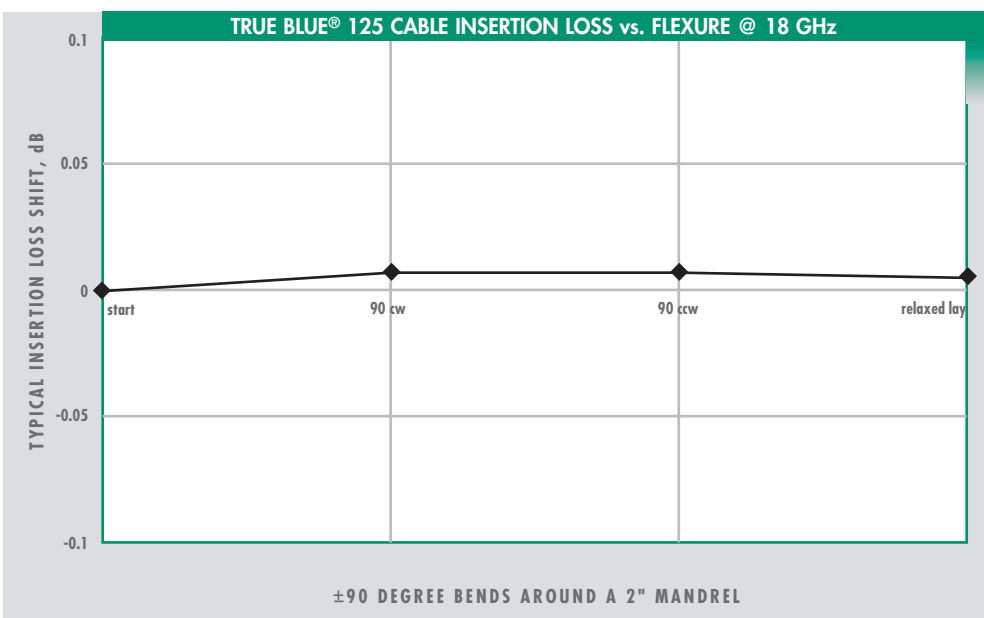

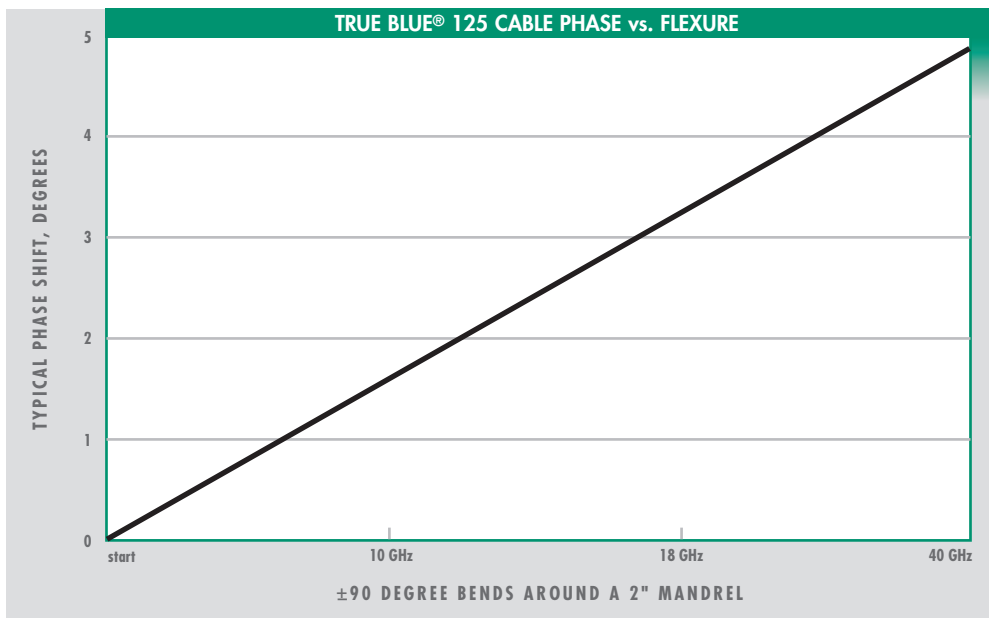
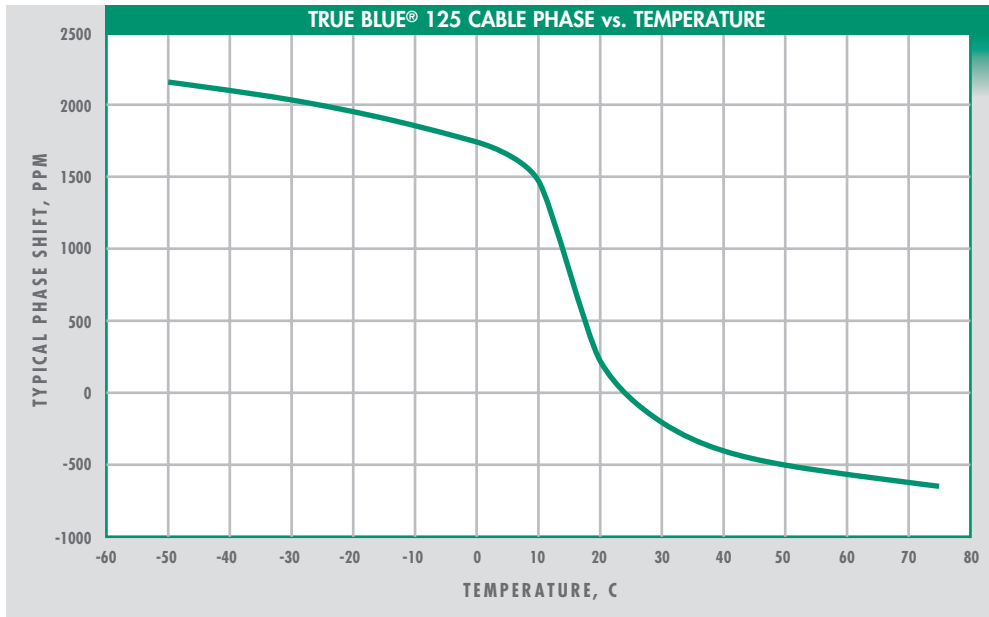
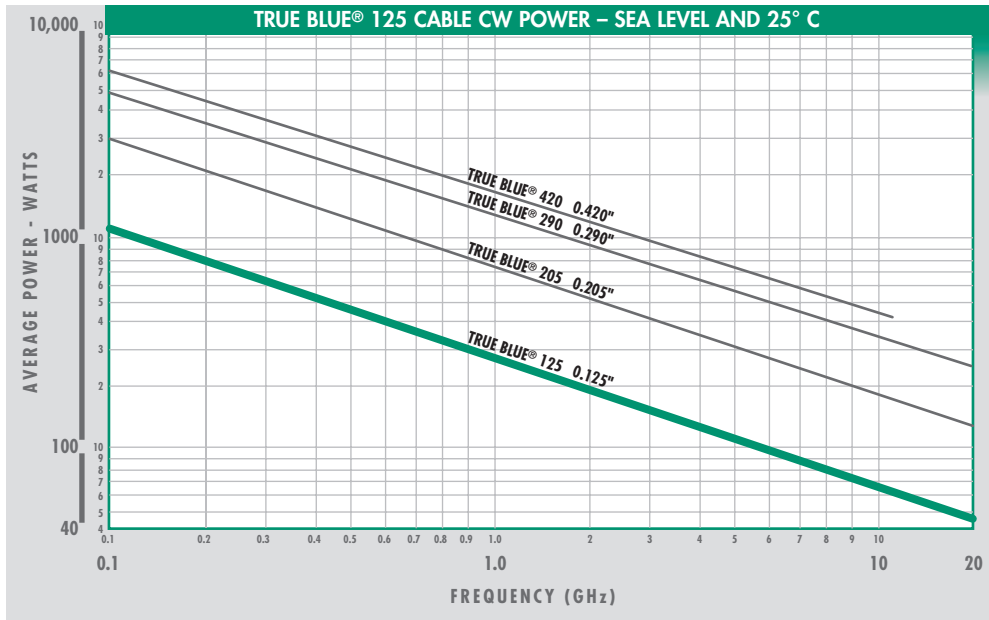

LOW LOSS
0.125\" Diam : TECHNICAL INFORMATION

ORDERING INFORMATION: Part Number Designation

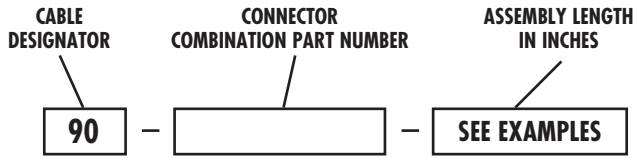

This cable type may be armored or ruggedized on request. Consult us for options.

EXAMPLES:

90-1396-048 = Unarmored True Blue® 125, 2.4 mm SP to 2.4 mm SP (assembly operates to 50 GHz), 48 inches

90-2350-120 = Unarmored True Blue® 125, SMA SP to 3.5 mm SJ (assembly operates to 18 GHz), 120 inches

ASSEMBLY LENGTH TOLERANCES	
LENGTH	TOLERANCE
≤12"	±.125"
12" ≤120"	±.250"
120" ≤240"	±.500"
240" ≤360"	±1.00"
360" ≤480"	±1.50"
480" ≤600"	±2.00"

Length measured from connector end to connector end

CONNECTOR CODES	
SP	Straight Plug
SJ	Straight Jack
RAP	Right Angle Plug

CONNECTOR COMBINATION PART NUMBERS*

	CONNECTOR OPERATING FREQUENCY							
	50 GHz	40 GHz	26.5 GHz	18 GHz				
	2.4 mm SP	2.4 mm SJ	2.9 mm SP	2.9 mm SJ	3.5 mm SP	SMA SP	SMA RAP	
50 GHz	2.4 mm SP	1396	1502	1394	2344	2341	2342	2343
	2.4 mm SJ	1502	1648	2348	2349	2345	2346	2347
40 GHz	2.9 mm SP	1394	2348	941	1116	1127	2353	2355
	2.9 mm SJ	2344	2349	1116	942	2352	2354	2356
26.5 GHz	3.5 mm SP	2341	2345	1127	2352	223	2350	2351
18 GHz	SMA SP	2342	2346	2353	2354	2350	011	069
	SMA RAP	2343	2347	2355	2356	2351	069	070

* Other connector styles available; consult Storm

TYPICAL VSWR PERFORMANCE

FREQUENCY (GHz)	2 STRAIGHT CONNECTORS	1 STRAIGHT / 1 ANGLED	2 ANGLED CONNECTORS
Up to 3	1.10:1	1.12:1	1.15:1
3 to 18	1.15:1	1.20:1	1.25:1
18 to 26.5	1.25:1	N/A	N/A
26.5 to 50	1.30:1	N/A	N/A

Once specific assembly requirements and test methods are established, it is often possible to guarantee improved VSWR performance. Contact us for more specific information.

0.205" Diameter Cable : TECHNICAL INFORMATION

MECHANICAL SPECS	
Cable Diameter, nominal	0.205 in
Bend Radius	2.1 in
<i>dynamic</i>	1.0 in
<i>static</i>	
Operating Temperature	-54° C to +150° C
Weight	20.0 g/ft
Inner Conductor Type	solid SPC
Dielectric	low density PTFE
Connector Retention, minimum	40.0 lbs

ELECTRICAL SPECS	
Frequency Range	DC to 26.5 GHz
Impedance	50 ±2 ohms
Capacitance, nominal	27.7 pF/ft
Time Delay, nominal	1.39 nsec/ft
Shielding Effectiveness, min (@ 1 GHz)	-90 dB

Power ratings (next page) are conservative; actual ratings depend on specific application. Please consult us regarding your application.

Specifications subject to change without notice.

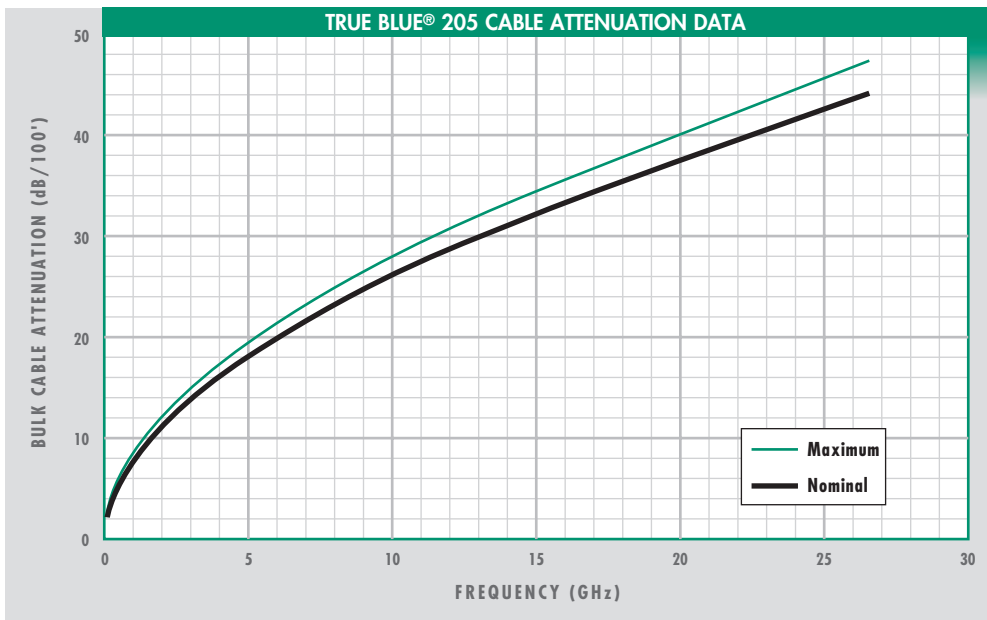

For cable assembly insertion loss, call us or visit our Web site, www.teledynestorm.com/microwave

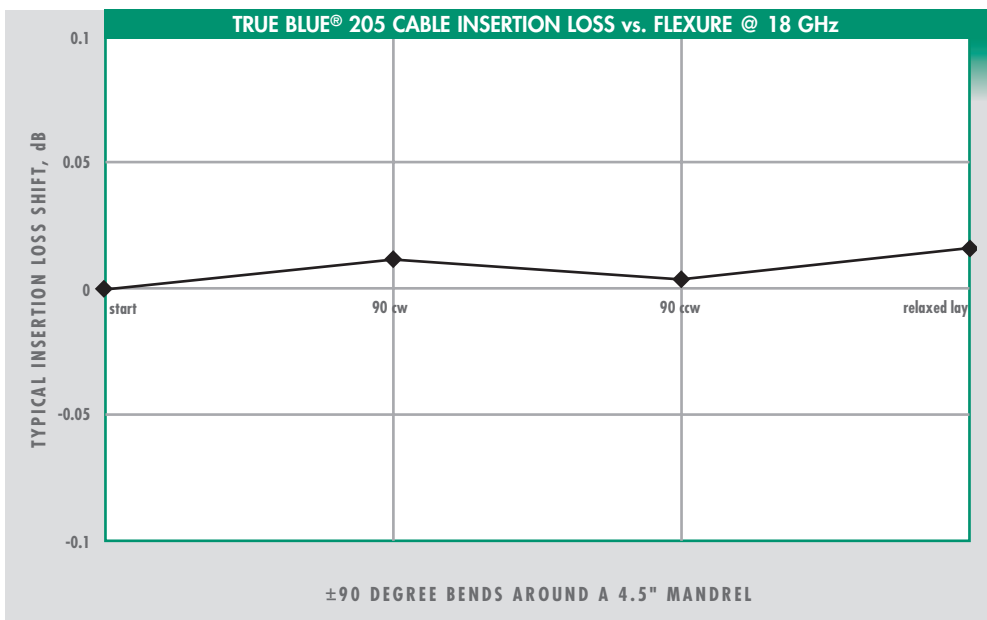

**TRUE BLUE 125
TRUE BLUE 205**

**LOW LOSS
0.125" Diam : PART NUMBERING ▣ 0.205" Diam : TECH INFO**

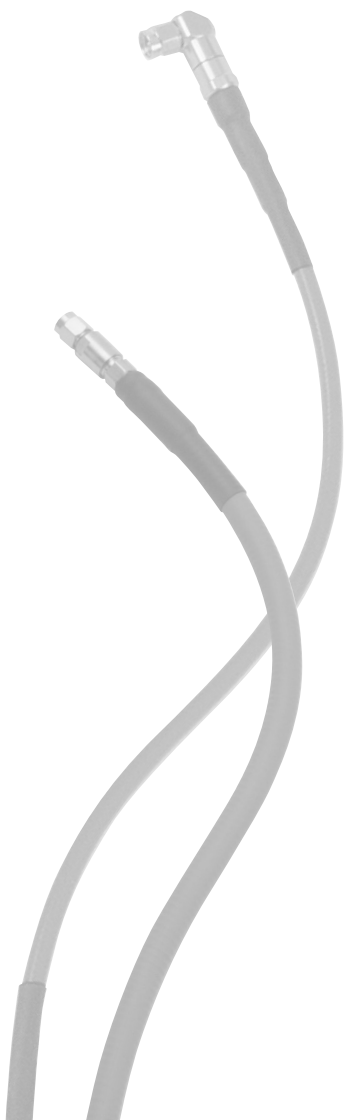

TRUE BLUE® 205 : 0.205" Diam : TECHNICAL INFORMATION

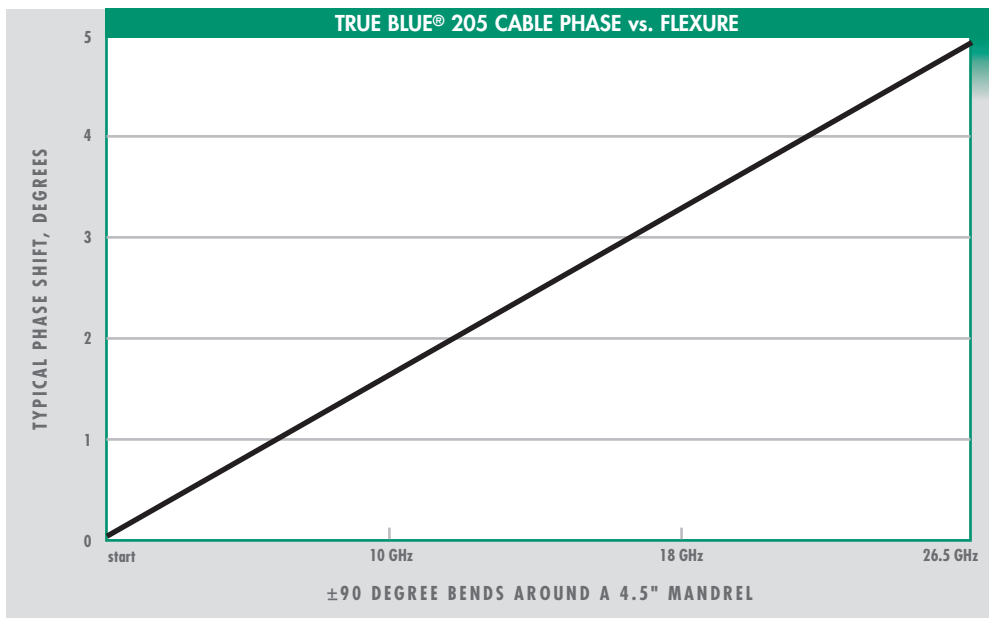
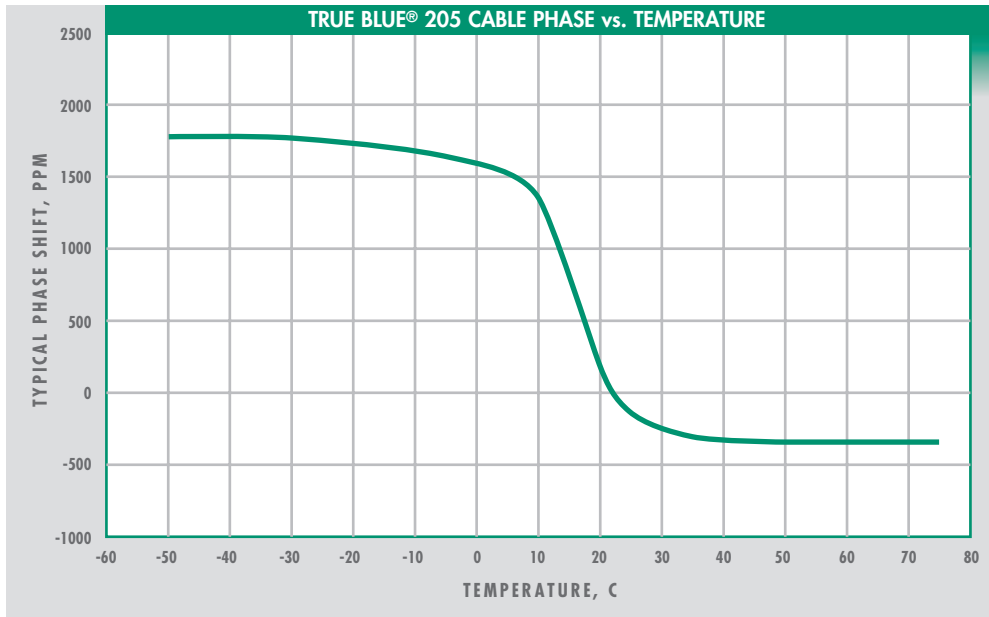
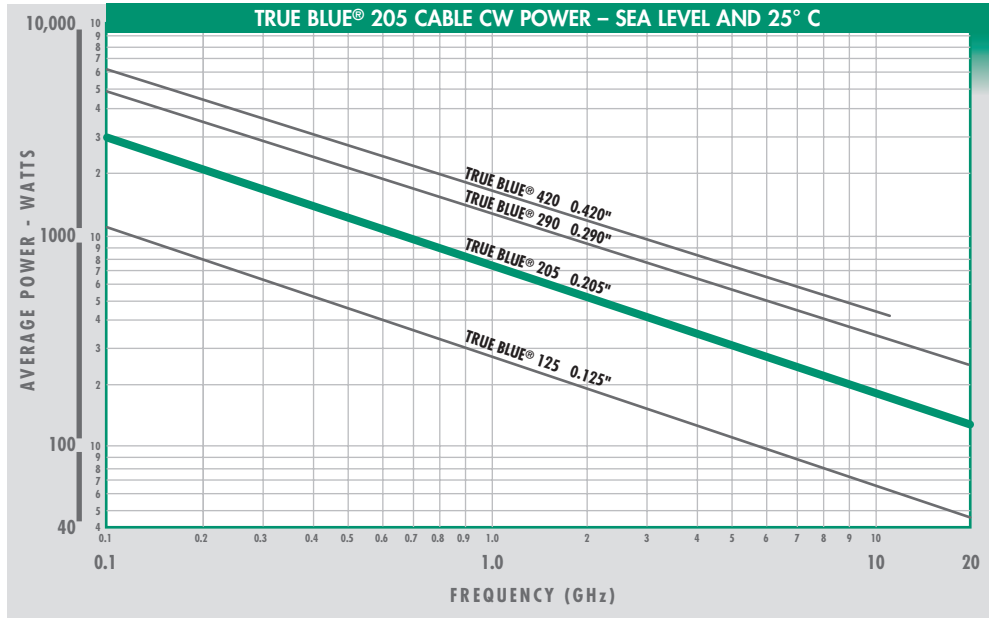

TRUE BLUE® 205 : 0.205" Diam : PART NUMBERING

ORDERING INFORMATION: Part Number Designation

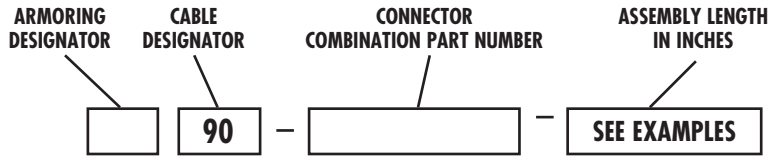

Armoring Designator

- Leave Blank for Unarmored
- R Ruggedized (polyolefin jacket)
- PR Ruggedized (polyurethane jacket)
- A Hard Armored (polyolefin jacket)
- SA Soft Armored (Neoprene™ jacket)

ASSEMBLY LENGTH TOLERANCES	
LENGTH	TOLERANCE
≤ 12"	±.125"
12" ≤ 120"	±.250"
120" ≤ 240"	±.500"
240" ≤ 360"	±1.00"
360" ≤ 480"	±1.50"
480" ≤ 600"	±2.00"
600" ≤ 900"	±3.00"
900" ≤ 1200"	±4.00"

Length measured from connector end to connector end

EXAMPLES:

90-245-045 = Unarmored True Blue® 205, 3.5 mm SP to 7 mm (assembly operates to 18 GHz), 48 inches

PR90-660-120 = Ruggedized (polyurethane jacket) True Blue® 205, 3.5 mm SP to 3.5 mm SJ (assembly operates to 26.5 GHz), 120 inches

CONNECTOR CODES	
SP	Straight Plug
SJ	Straight Jack
RAP	Right-Angle Plug
BFJ	Bulkhead Feedthru Jack

TRUE BLUE 205

CONNECTOR COMBINATION PART NUMBERS*

	CONNECTOR OPERATING FREQUENCY																
	26.5 GHz				18 GHz								4 GHz				
	3.5 mm SP	3.5 mm SJ	7mm	SMA SP	SMA RAP	SMA SJ	SMA BFJ	N SP	N RAP	N SJ	N BFJ	TNC SP	TNC RAP	TNC SJ	TNC BFJ	BNC SP	
26.5 GHz	3.5mm SP	221	660	245	246	2399	2400	2401	348	2404	2405	2406	696	2403	697	2407	694
	3.5mm SJ	660	962	2390	824	2408	2409	2410	2415	2416	2417	2418	2412	2413	2414	2419	2470
	7mm	245	2390	222	491	346	313	2391	247	2395	2396	2397	240	2393	2394	2398	2469
	SMA SP	246	824	491	010	066	095	096	077	102	101	103	097	099	098	100	693
	SMA RAP	2399	2408	346	066	067	261	265	264	272	266	255	242	271	2422	238	487
	SMA SJ	2400	2409	313	095	261	079	986	2427	274	2428	2429	2424	2425	2426	2430	2471
	SMA BFJ	2401	2410	2391	096	265	986	080	843	844	2435	2436	2432	2433	2434	2437	2472
18 GHz	N SP	348	2415	247	077	264	2427	843	088	076	092	093	094	718	340	2454	2476
	N RAP	2404	2416	2395	102	272	274	844	076	090	273	576	226	823	2451	2455	2477
	N SJ	2405	2417	2396	101	266	2428	2435	092	273	089	2456	2447	2449	2452	2457	2478
	N BFJ	2406	2418	2397	103	255	2429	2436	093	576	2456	091	227	2450	093	2458	2479
	TNC SP	696	2412	240	097	242	2424	2432	094	226	2447	227	081	086	085	087	2473
	TNC RAP	2403	2413	2393	099	271	2425	2433	718	823	2449	2450	086	083	2448	537	2474
	TNC SJ	697	2414	2394	098	2422	2426	2434	340	2451	2452	093	085	2448	082	2453	2475
4 GHz	TNC BFJ	2407	2419	2398	100	238	2430	2437	2454	2455	2457	2458	087	537	2453	084	2480
	BNC SP	694	2470	2469	693	487	2471	2472	2476	2477	2478	2479	2473	2474	2475	2480	664

* Other connector styles available; consult Storm

TYPICAL VSWR PERFORMANCE

FREQUENCY (GHz)	2 STRAIGHT CONNECTORS	1 STRAIGHT / 1 ANGLED	2 ANGLED CONNECTORS
Up to 3	1.10:1	1.12:1	1.15:1
3 to 18	1.15:1	1.20:1	1.25:1
18 to 26.5	1.25:1	N/A	N/A

LOW LOSS : 0.205" Diam : TECH INFO PART NUMBERING

0.290" Diameter Cable : TECHNICAL INFORMATION

MECHANICAL SPECS

Cable Diameter, nominal	0.290 in
Bend Radius	
<i>dynamic</i>	2.9 in
<i>static</i>	1.5 in
Operating Temperature	-54° C to +150° C
Weight	36.0 g/ft
Inner Conductor Type	solid SPC
Dielectric	low density PTFE
Connector Retention, minimum	50.0 lbs

ELECTRICAL SPECS

Frequency Range	DC to 19.8 GHz
Impedance	50 ±2 ohms
Capacitance, nominal	26.8 pF/ft
Time Delay, nominal	1.37 nsec/ft
Shielding Effectiveness, min (@ 1 GHz)	-90 dB

Power ratings (next page) are conservative; actual ratings depend on specific application. Please consult us regarding your application.

Specifications subject to change without notice.

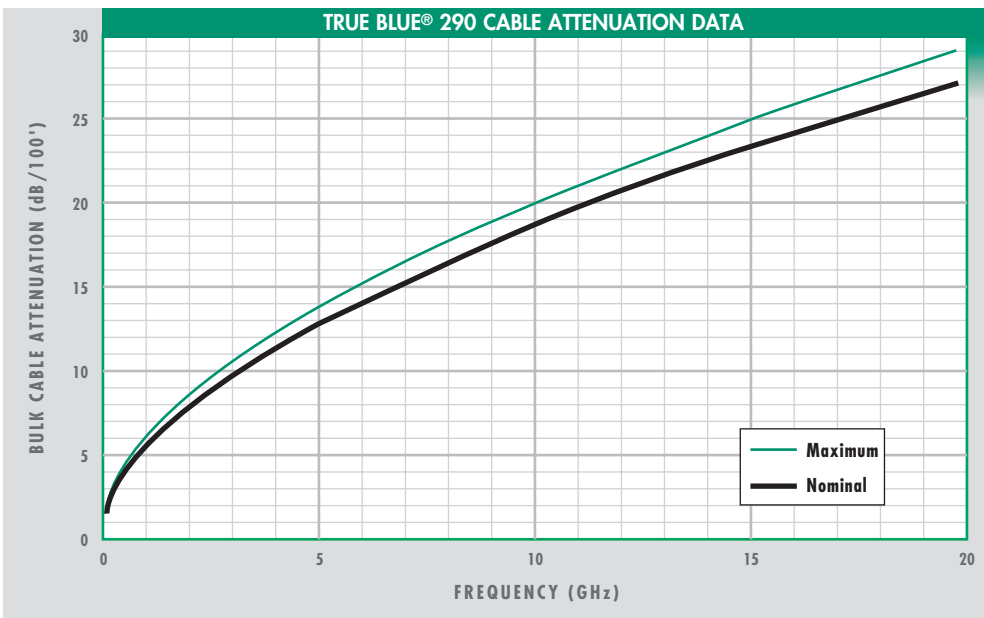

For cable assembly insertion loss, call us or visit our Web site, www.teledynestorm.com/microwave

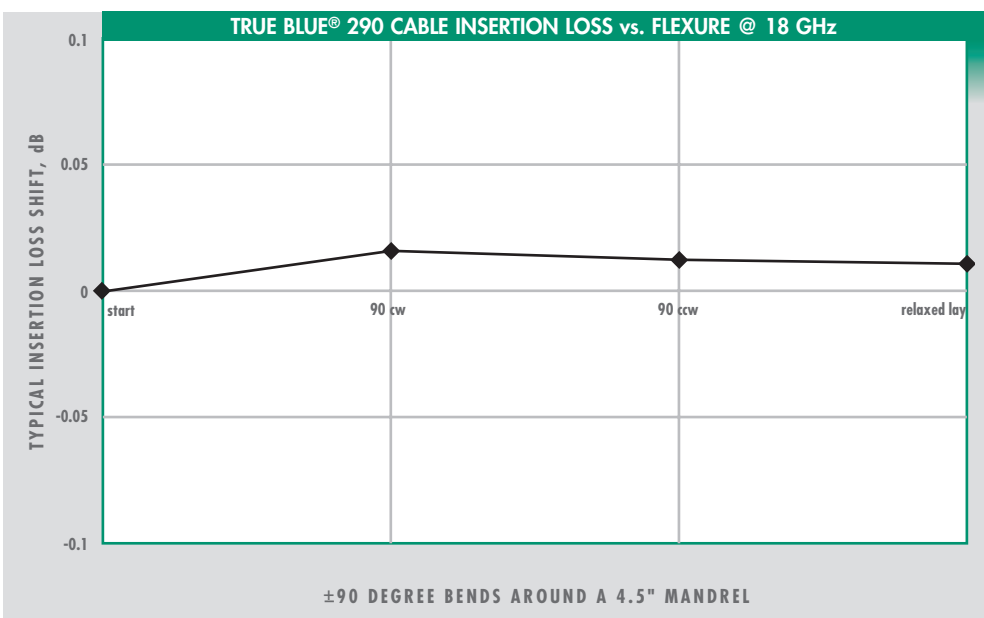

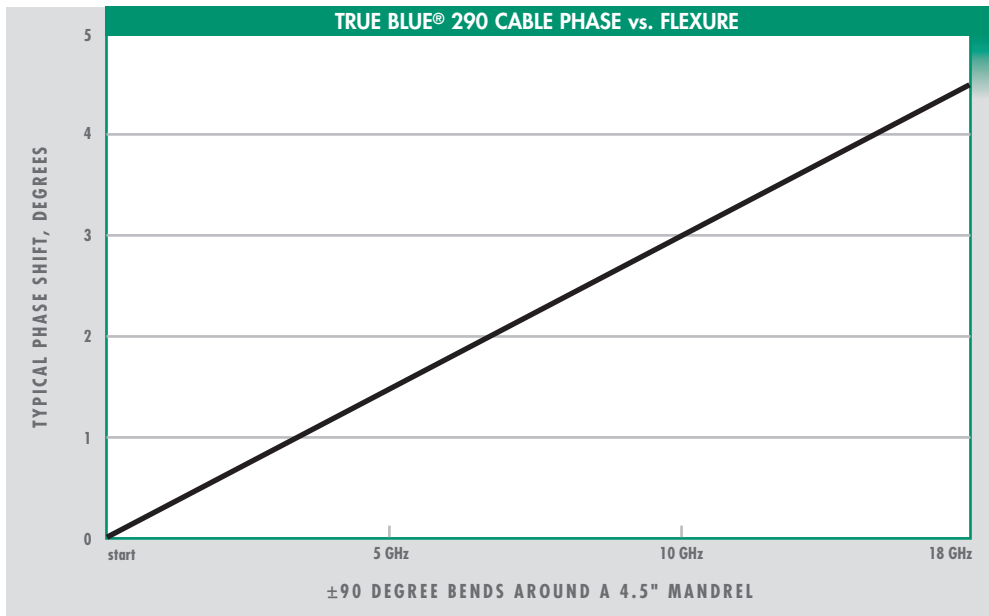
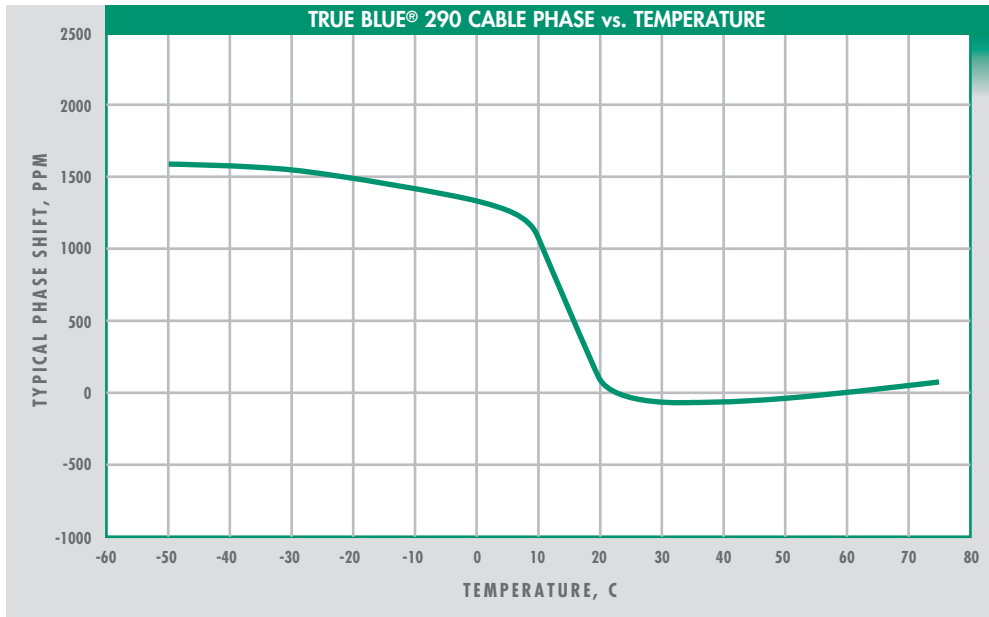
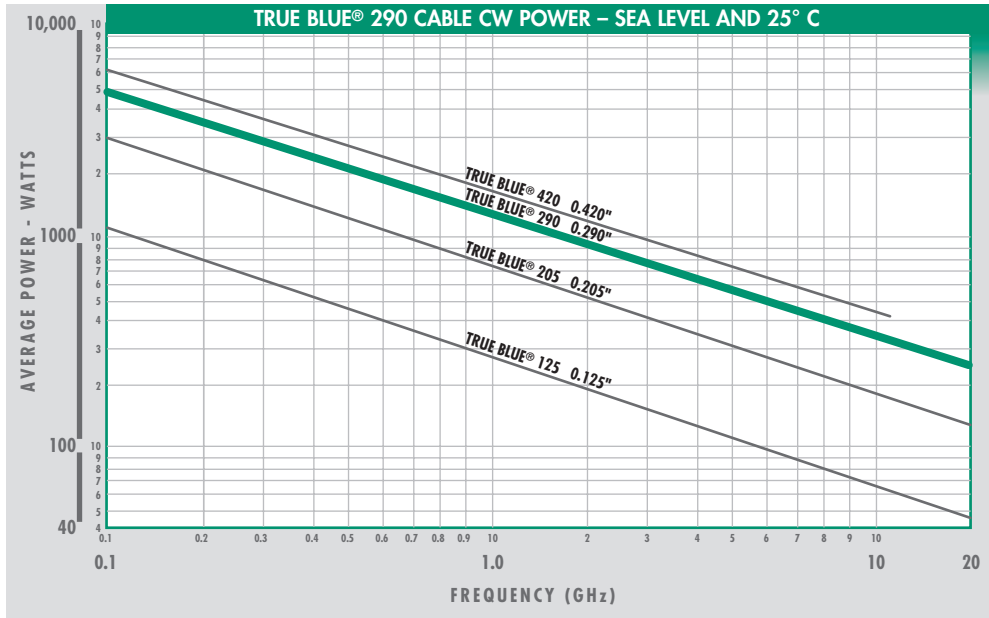

LOW LOSS
0.290" Diam : TECHNICAL INFORMATION

ORDERING INFORMATION: Part Number Designation

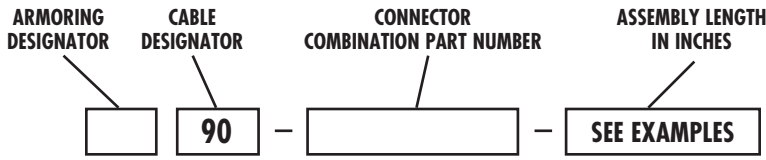

Armoring Designator

- Leave Blank for Unarmored
- R Ruggedized (polyolefin jacket)
- PR Ruggedized (polyurethane jacket)
- A Hard Armored (polyolefin jacket)
- SA Soft Armored (Neoprene™ jacket)

ASSEMBLY LENGTH TOLERANCES	
LENGTH	TOLERANCE
≤12"	±.125"
12" ≤120"	±.250"
120" ≤240"	±.500"
240" ≤360"	±1.00"
360" ≤480"	±1.50"
480" ≤600"	±2.00"
600" ≤900"	±3.00"
900" ≤1200"	±4.00"

Length measured from connector end to connector end

EXAMPLES:

- 90-294-048 = Unarmored True Blue® 290, 7 mm to N SJ (assembly operates to 18 GHz), 48 inches
- A90-189-120 = Hard Armored True Blue® 290, SMA RAP to SMA RAP (assembly operates to 18 GHz), 120 inches

CONNECTOR CODES	
SP	Straight Plug
SJ	Straight Jack
RAP	Right-Angle Plug
BFJ	Bulkhead Feedthru Jack

CONNECTOR OPERATING FREQUENCY
18 GHz

CONNECTOR COMBINATION PART NUMBERS*

	7 mm	SMA SP	SMA RAP	SMA SJ	SMA BFJ	N SP	N RAP	N SJ	N BFJ	TNC SP	TNC RAP	TNC BFJ
7mm	220	270	2357	2363	2364	248	434	294	2367	339	2365	2366
SMA SP	270	014	200	199	201	206	208	207	209	202	204	205
SMA RAP	2357	200	189	2358	881	535	388	2362	738	2359	2360	2361
SMA SJ	2363	199	2358	188	2368	538	2372	2373	2374	2369	2370	2371
SMA BFJ	2364	201	881	2368	190	2378	2379	2380	2381	2375	2376	2377
N SP	248	206	535	538	2378	195	214	213	215	216	531	929
N RAP	434	208	388	2372	2379	214	197	2387	2388	217	550	2385
N SJ	294	207	2362	2373	2380	213	2387	196	2389	312	2383	2386
N BFJ	2367	209	738	2374	2381	215	2388	2389	198	218	2384	937
TNC SP	339	202	2359	2369	2375	216	217	312	218	191	211	212
TNC RAP	2365	204	2360	2370	2376	531	550	2383	2384	211	193	2382
TNC BFJ	2366	205	2361	2371	2377	929	2385	2386	937	212	2382	194

* Other connector styles available; consult Storm

TYPICAL VSWR PERFORMANCE

FREQUENCY (GHz)	2 STRAIGHT CONNECTORS	1 STRAIGHT / 1 ANGLED	2 ANGLED CONNECTORS
Up to 3	1.10:1	1.12:1	1.15:1
3 to 18	1.15:1	1.20:1	1.25:1

Once specific assembly requirements and test methods are established, it is often possible to guarantee improved VSWR performance. Contact us for more specific information.

0.420" Diameter Cable : TECHNICAL INFORMATION

MECHANICAL SPECS	
Cable Diameter, nominal	0.420 in
Bend Radius	4.0 in
<i>dynamic</i>	4.0 in
<i>static</i>	2.5 in
Operating Temperature	-54° C to +150° C
Weight	85.0 g/ft
Inner Conductor Type	solid SPC
Dielectric	low density PTFE
Connector Retention, minimum	50.0 lbs

ELECTRICAL SPECS	
Frequency Range	DC to 12 GHz
Impedance	50 ±2 ohms
Capacitance, nominal	26.5 pF/ft
Time Delay, nominal	1.35 nsec/ft
Shielding Effectiveness, min (@ 1 GHz)	-90 dB

Power ratings (next page) are conservative; actual ratings depend on specific application. Please consult us regarding your application.

Specifications subject to change without notice.

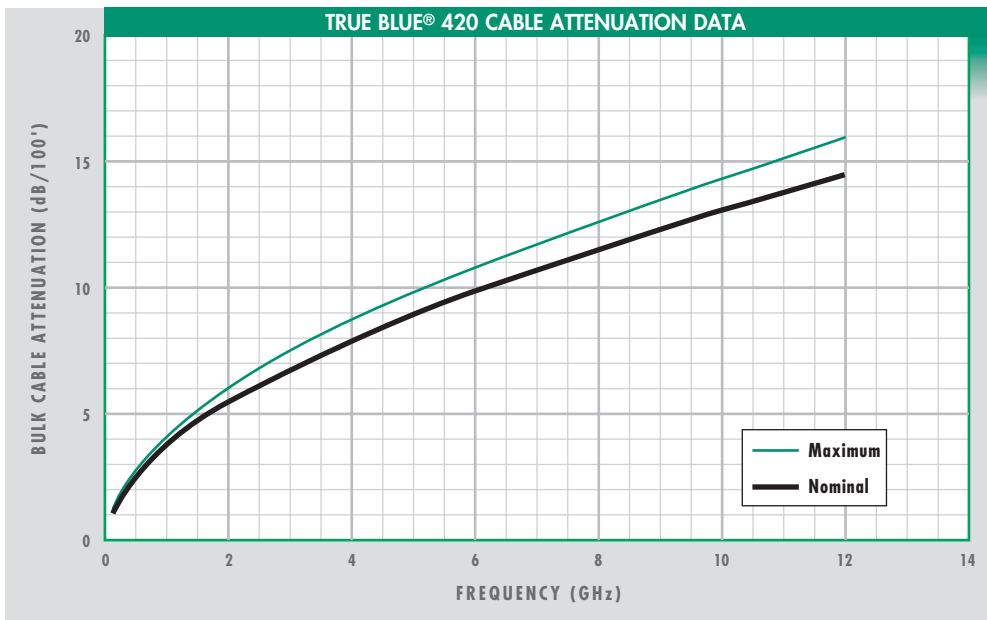

For cable assembly insertion loss, call us or visit our Web site, www.teledynestorm.com/microwave

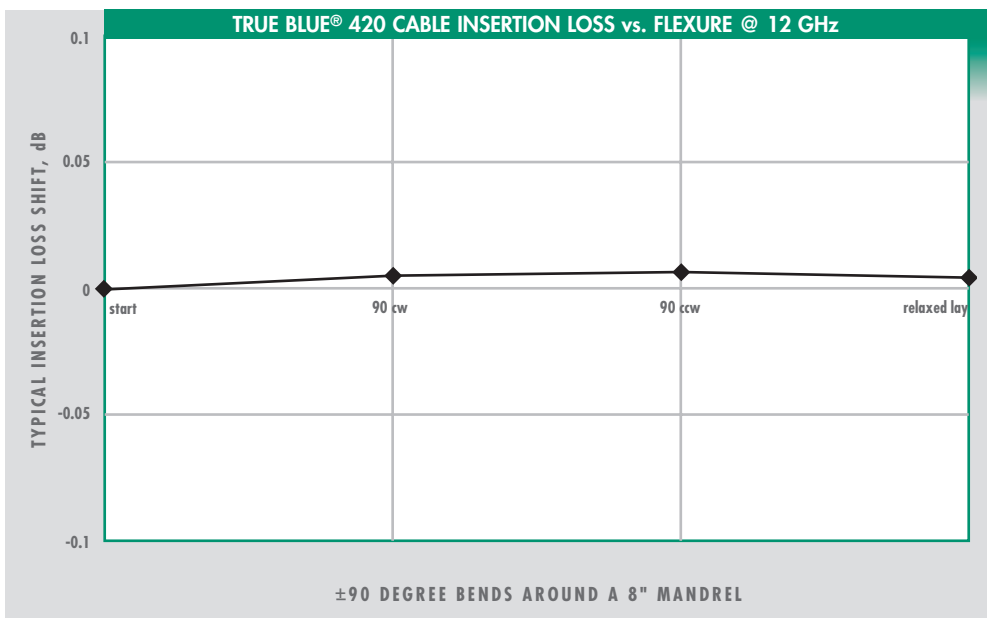

**TRUE BLUE 290
TRUE BLUE 420**

**LOW LOSS
0.290" Diam : PART NUMBERING ▣ 0.420" Diam : TECH INFO**

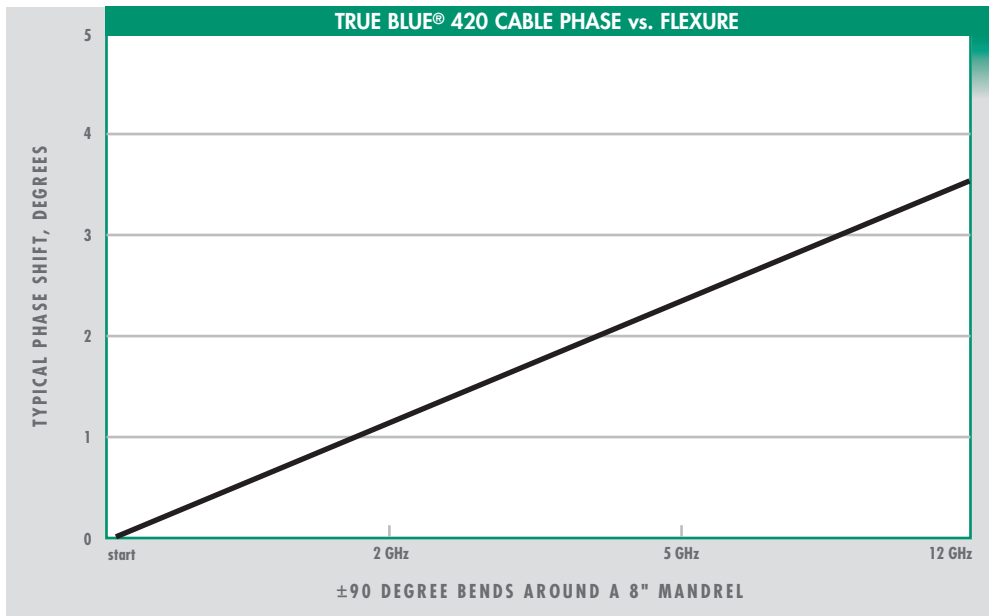
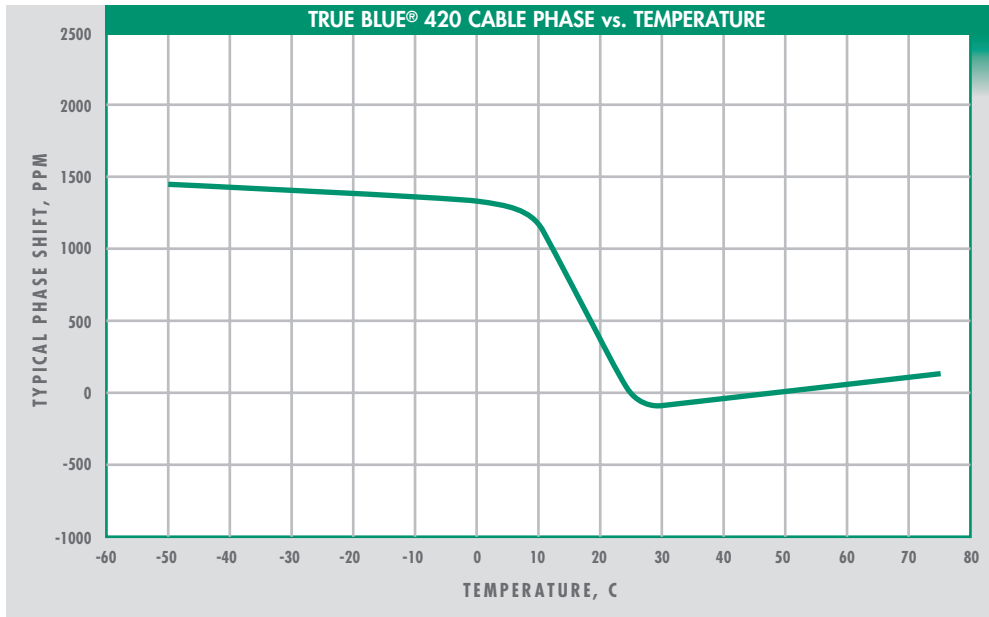
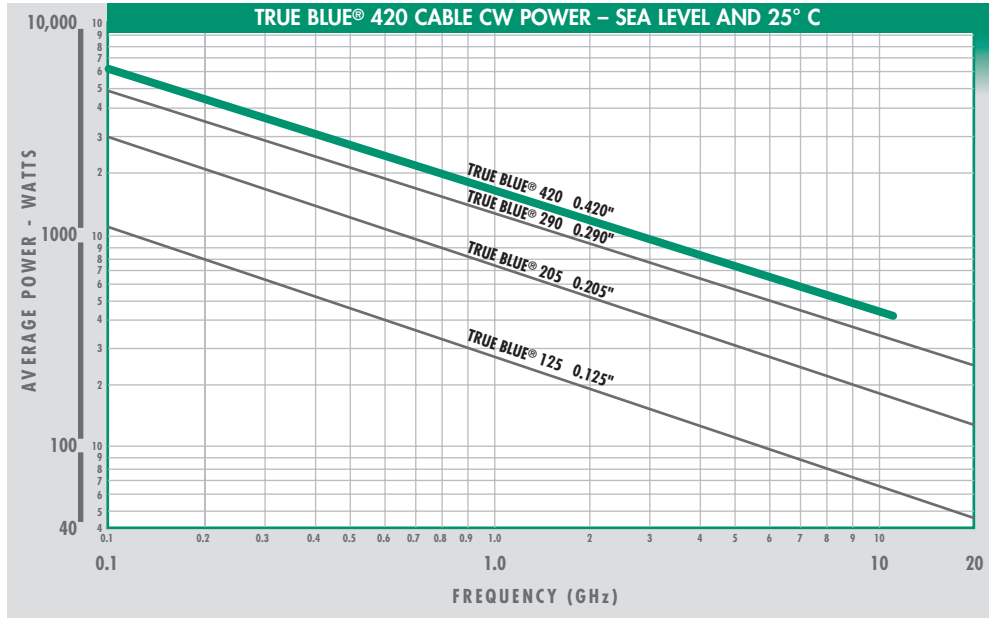

ORDERING INFORMATION: Part Number Designation

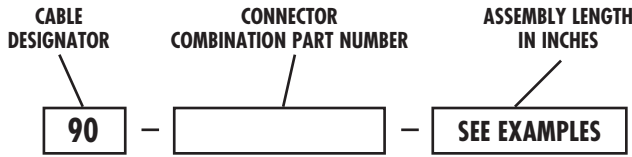

This cable type may be armorized or ruggedized on request. Consult us for options.

EXAMPLES:

90-078-048 = Unarmored True Blue® 420, N SP to N SP (assembly operates to 12 GHz), 48 inches

90-144-120 = Unarmored True Blue® 420, SMA SP to TNC SP (assembly operates to 12 GHz), 120 inches

ASSEMBLY LENGTH TOLERANCES	
LENGTH	TOLERANCE
≤12"	±.125"
12" ≤120"	±.250"
120" ≤240"	±.500"
240" ≤360"	±1.00"
360" ≤480"	±1.50"
480" ≤600"	±2.00"
600" ≤900"	±3.00"
900" ≤1200"	±4.00"

Length measured from connector end to connector end

CONNECTOR CODES	
SP	Straight Plug
RAP	Right-Angle Plug
BFJ	Bulkhead Feedthru Jack

CONNECTOR COMBINATION PART NUMBERS*

		CONNECTOR OPERATING FREQUENCY						
		12 GHz						
12 GHz	SMA SP	N SP	N RAP	N BFJ	TNC SP	TNC RAP	SC SP	
	SMA SP	012	148	150	151	144	146	2332
	N SP	148	078	156	157	158	761	2333
	N RAP	150	156	139	2337	072	737	2339
	N BFJ	151	157	2337	140	159	2335	2338
	TNC SP	144	158	072	159	075	153	2334
	TNC RAP	146	761	737	2335	153	073	2336
	SC SP	2332	2333	2339	2338	2334	2336	2340

* Other connector styles available; consult Storm

TYPICAL VSWR PERFORMANCE

FREQUENCY (GHz)	2 STRAIGHT CONNECTORS	1 STRAIGHT / 1 ANGLED	2 ANGLED CONNECTORS
Up to 3	1.10:1	1.12:1	1.15:1
3 to 12	1.15:1	1.20:1	1.25:1

Once specific assembly requirements and test methods are established, it is often possible to guarantee improved VSWR performance. Contact us for more specific information.

TRUE BLUE 420

LOW LOSS 0.420" Diam : TECHNICAL INFORMATION PART NUMBERING

0.055" Diameter : STORM FLEX™ 047... 51-55

0.096" Diameter : STORM FLEX™ 086... 57-61

0.160" Diameter : STORM FLEX™ 141... 62-65

Built For Use . . . Built To Last.

Storm Product's **STORM FLEX™** assemblies are designed to be durable and to provide consistent performance with flexure. Storm Flex™ cables readily accommodate tight bends near the connector and demonstrate superior connector retention.

Additionally, when used as alternatives to 0.047", 0.086", and 0.141" semi-rigid cable, Storm Flex™ cables eliminate costs associated with time-consuming cable layout.

Storm Flex™ 047 & 086

With 0.055" and 0.096" diameters, durable construction, and low profiles in SMA SP configuration, Storm Flex™ 047 and 086 **miniature assemblies** offer superior electrical performance in a trouble-free compact assembly.

Storm Flex™ 141

Combining flexibility and durability with a larger diameter (0.160"), Storm Flex™ 141 maintains excellent electrical characteristics through multiple flexures and offers a **high strength flexible replacement for RG 402** semi-rigid cable.

Need it NOW?

For common applications requiring a combination of electrical stability, durability, and short right-angle clearance, the **Storm Flex™ Express** line comes in standard lengths with SMA male connectors.

For applications requiring unique lengths or connectors, the **original Storm Flex™** line can be configured to meet your requirements.

STORM FLEX™ 047 EXPRESS STORM FLEX™ 047 0.055" DIAMETER



STORM FLEX™ 086 EXPRESS STORM FLEX™ 086 0.096" DIAMETER



STORM FLEX™ 141 EXPRESS STORM FLEX™ 141 0.160" DIAMETER



STORM
FLEX™
INTRO

STORM FLEX™ : INTRODUCTION

0.055" Diameter Cable : CABLE CONSTRUCTION

FEATURES

- ▣ Solid PTFE dielectric

- ▣ Ultra-high strength, multi-layer outer braid

- ▣ 0.055" overall diameter

- ▣ Wide range of low profile SMA, GPO®, and GPPO® connectors

BENEFITS

- ~ High compression resistance
- ~ Greater durability

- ~ Eliminates cable breakage associated with repeated handling of small flexible and semi-conformable cable types
- ~ Greater than -85 dB shielding effectiveness through 18 Ghz

- ~ Provides alternative to 0.047" semi-rigid cable – eliminating costs associated with time-consuming cable layout

- ~ Cable assemblies solve tough packaging challenges

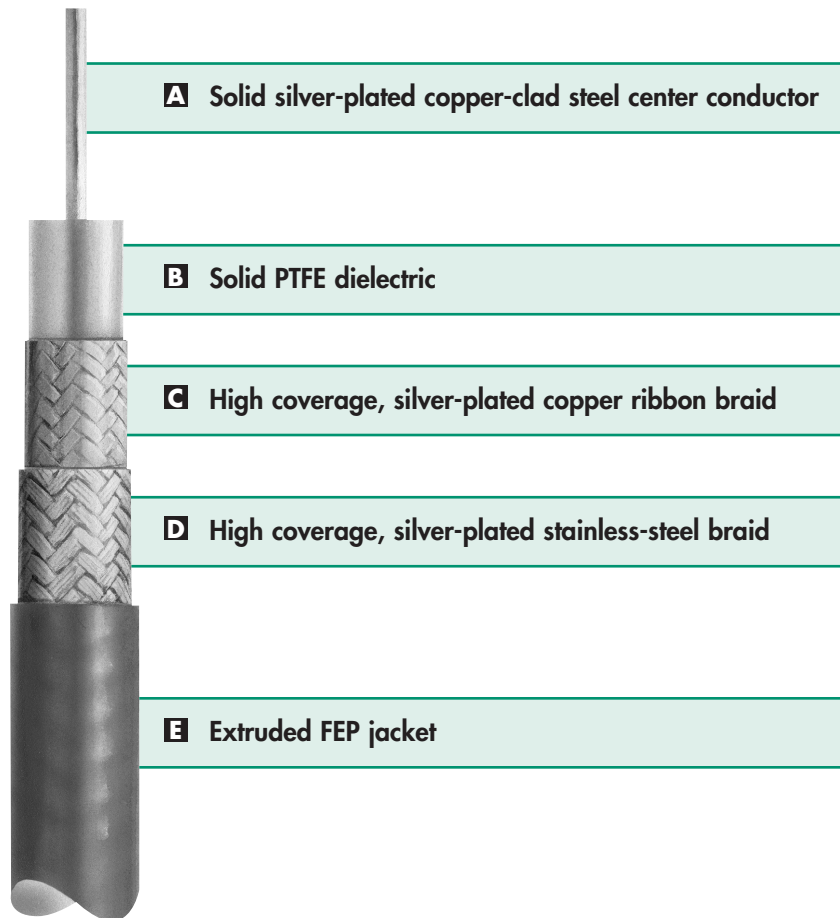

0.055" Diameter Cable : TECHNICAL INFORMATION

MECHANICAL SPECS

Cable Diameter, nominal	0.055 in
Bend Radius	
<i>dynamic</i>	0.6 in
<i>static</i>	0.1 in
Operating Temperature	-54° C to +125° C
Weight	1.54 g/ft
Inner Conductor Type	solid SPCCS
Dielectric	solid PTFE
Connector Retention, minimum	
straight pull	10.0 lbs
right-angle pull	5.0 lbs

ELECTRICAL SPECS

Frequency Range	DC to 50 GHz
Impedance	50 ±2 ohms
Capacitance, nominal	28.9 pF/ft
Time Delay, nominal	1.45 nsec/ft
Shielding Effectiveness, min (@ 0 to 18 GHz)	-85 dB or better

Specifications subject to change without notice.

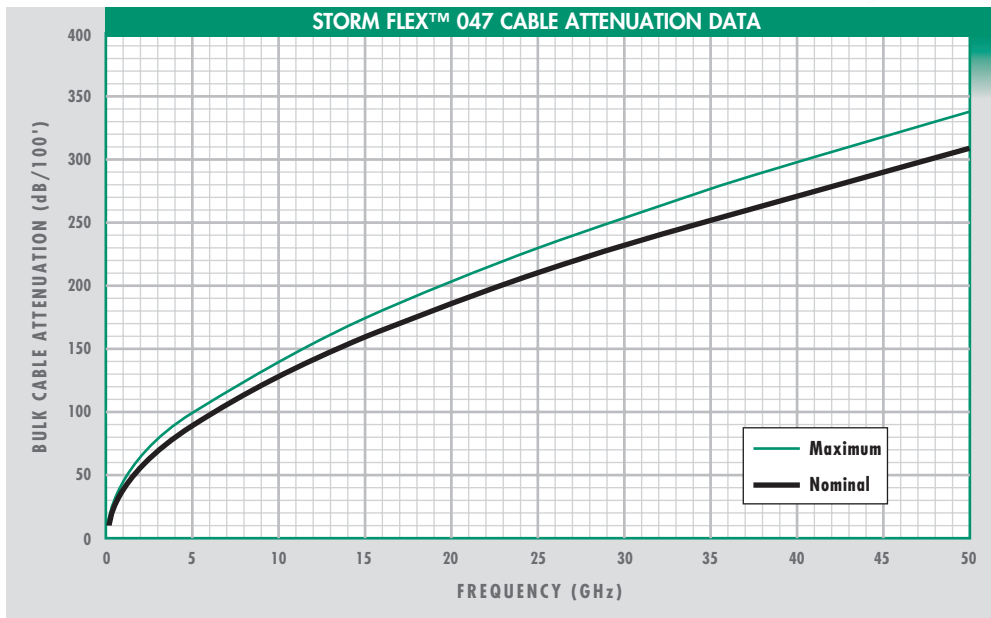

For cable assembly insertion loss, call us or visit our Web site, www.teledynestorm.com/microwave

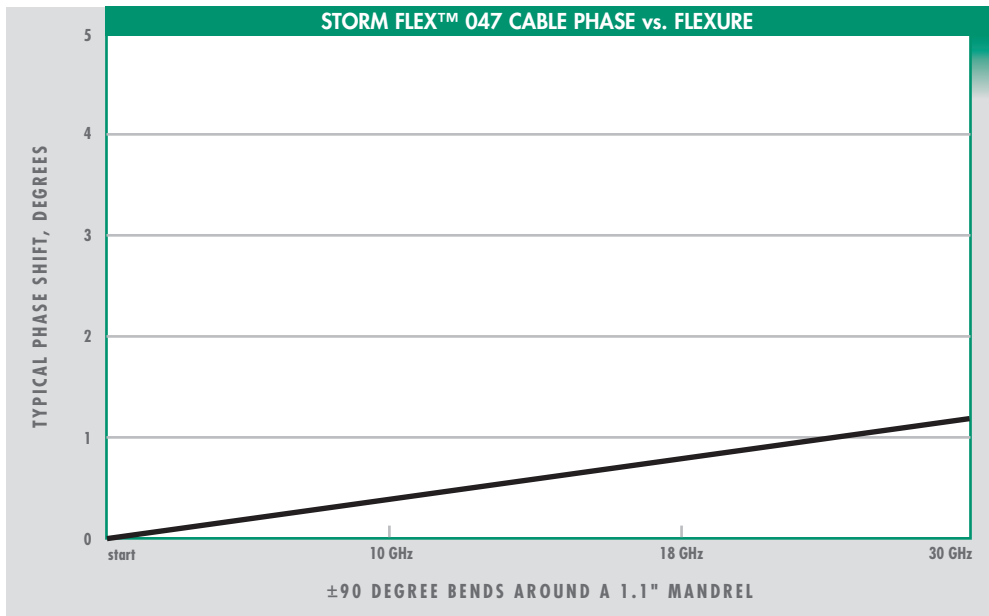
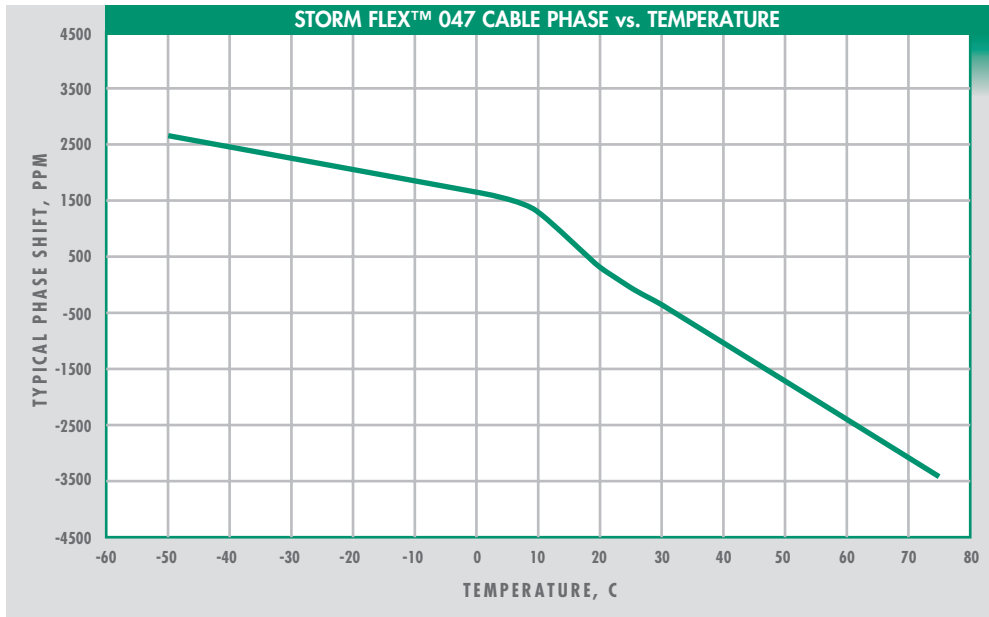
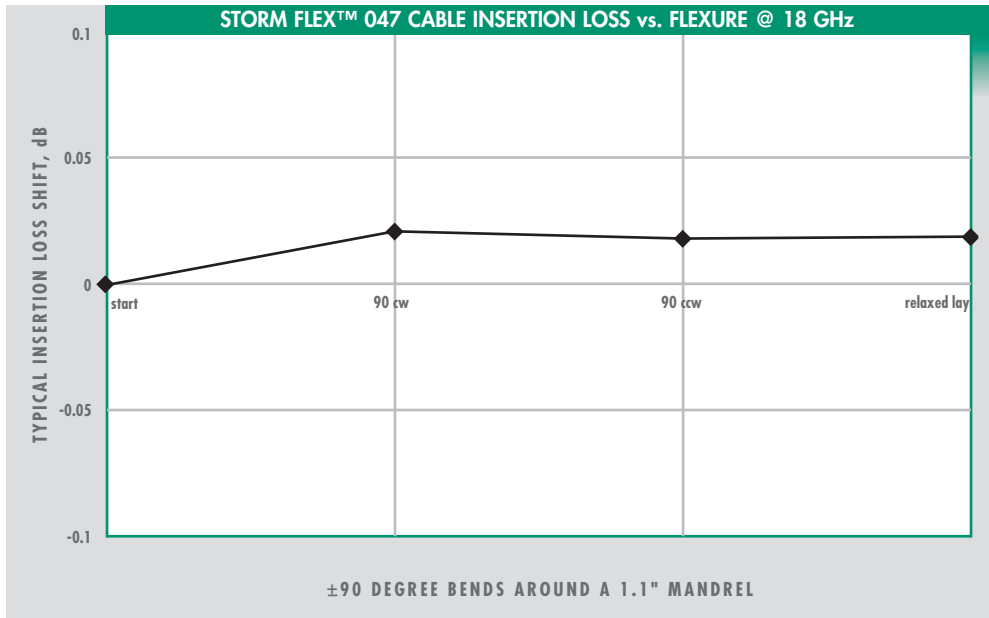

STORM FLEX 047

STORM FLEX™ Diam : TECHNICAL INFORMATION

The **STORM FLEX™ 047 EXPRESS** line of cable assemblies offers the convenience and cost-effectiveness of rapid, off-the-shelf fulfillment combined with uncompromised electrical stability and durability.

Storm Flex™ Express assemblies are available in a variety of standard lengths, terminated with ultra-precision SMA straight plug connectors that operate to 18 GHz.

■ **ORDERING INFORMATION: Part Number Designation**
See chart below for part numbers.

Part Number w/ SMA SP	Length (in/mm) ±0.125/3.18	2 GHz	10 GHz	18 GHz
		VSWR, Typical		
		1.07:1	1.15:1	1.15:1
		INSERTION LOSS Nominal (dB)		
900-0202-002.5	2.50/63.50	0.20	0.42	0.58
900-0202-003	3.00/76.20	0.22	0.48	0.66
900-0202-003.5	3.50/88.90	0.25	0.54	0.74
900-0202-004	4.00/101.60	0.27	0.59	0.82
900-0202-006	6.00/152.40	0.37	0.82	1.13
900-0202-008	8.00/203.20	0.47	1.05	1.45
900-0202-010	10.00/254.00	0.56	1.28	1.77
900-0202-012	12.00/304.80	0.66	1.51	2.08
900-0202-014	14.00/355.60	0.76	1.74	2.40
900-0202-016	16.00/406.40	0.86	1.97	2.71

ORDERING INFORMATION: Part Number Designation

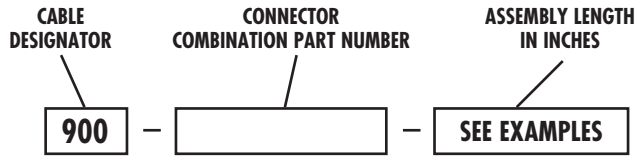

ASSEMBLY LENGTH TOLERANCES	
LENGTH	TOLERANCE
≤ 12"	±.125"
12" ≤ 120"	±.250"
120" ≤ 240"	±.500"
240" ≤ 360"	±1.00"

Length measured from connector end to connector end

CONNECTOR CODES	
SP	Straight Plug
SJ	Straight Jack
RAJ	Right-Angle Jack

EXAMPLES:

900-0622-048 = Storm Flex™ 047, GPO® SJ to GPPO® RAJ (assembly operates to 18 GHz), 48 inches

900-0202-120 = Storm Flex™ 047, SMA SP to SMA SP (assembly operates to 18 GHz), 120 inches

CONNECTOR COMBINATION PART NUMBERS*

	CONNECTOR OPERATING FREQUENCY								
	50 GHz	40 GHz	26.5 GHz		18 GHz				
	2.4 mm SP	GPPO® SJ	SMA SP	SSMA SP	SMA SP	GPPO® RAJ	GPO® SJ	GPO® RAJ	
50 GHz	2.4 mm SP	4040	2140	0340	3040	0240	2240	0640	0940
40 GHz	GPPO® SJ	2140	2121	0321	2130	0221	2122	0621	0921
26.5 GHz	SMA SP	0340	0321	0303	0330				
	SSMA SP	3040	2130	0330	3030	0230	2230	0630	0930
18 GHz	SMA SP	0240	0221		0230	0202	0222	0206	0209
	GPPO® RAJ	2240	2122		2230	0222	2222	0622	0922
	GPO® SJ	0640	0621		0630	0206	0622	0606	0609
	GPO® RAJ	0940	0921		0930	0209	0922	0609	0909

* Other connector styles available; consult Storm

TYPICAL VSWR PERFORMANCE

COUPLED CONNECTORS (SMA, SSMA, 2.4 mm)			
FREQUENCY (GHz)	2 STRAIGHT	1 STRAIGHT / 1 ANGLED	2 ANGLED
Up to 3	1.07:1	1.10:1	1.12:1
3 to 18	1.20:1	1.25:1	1.30:1

PUSH-ON CONNECTORS (GPO®, GPPO®)			
FREQUENCY (GHz)	2 STRAIGHT	1 STRAIGHT / 1 ANGLED	2 ANGLED
Up to 3	1.07:1	1.10:1	1.12:1
3 to 18	1.30:1	1.35:1	1.40:1

For VSWRs above 18 GHz, consult Storm.

0.096" & 0.160" Diameter Cable : CABLE CONSTRUCTION

FEATURES

- ☑ Solid PTFE dielectric

- ☑ Ultra-high strength, multi-layer outer braid

- ☑ 0.096" & 0.160" diameters

- ☑ Wide range of low profile SMA, GPO®, and GPPO® connectors

BENEFITS

- ~ High compression resistance
- ~ Greater durability

- ~ Eliminates cable breakage associated with repeated bending and handling.
- ~ Greater than -90 dB shielding effectiveness through 18 Ghz

- ~ Provides alternatives to 0.086" & 0.141" semi-rigid cable – eliminating costs associated with time-consuming cable layout

- ~ Cable assemblies solve tough packaging challenges

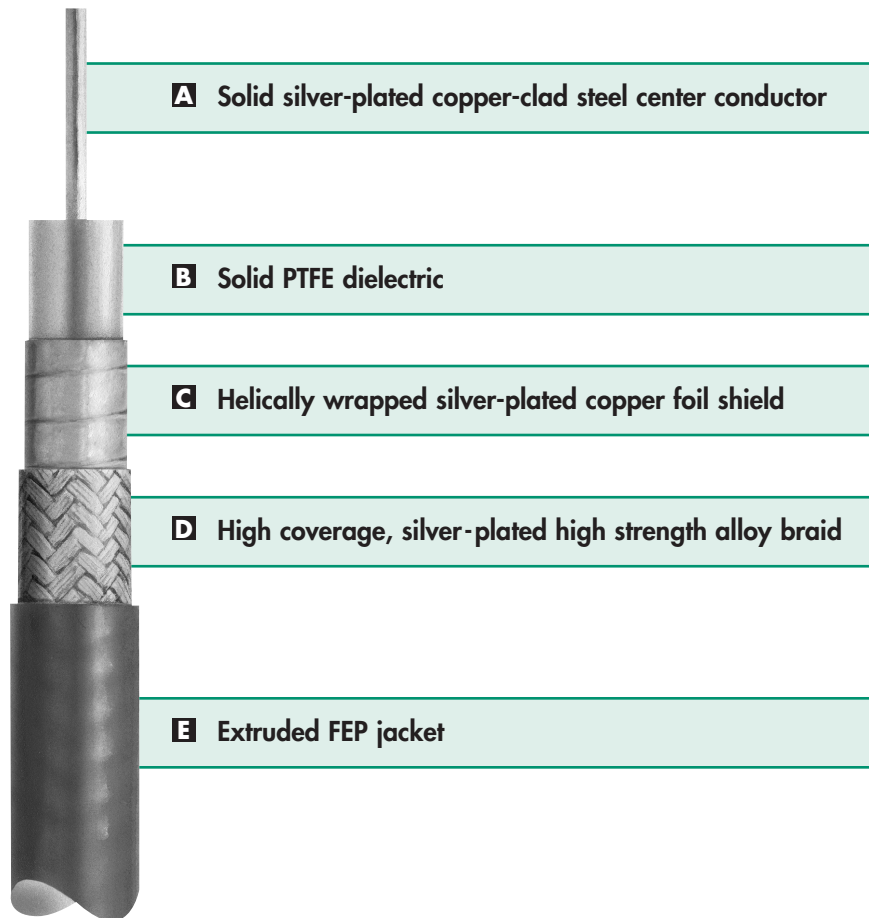

0.096" Diameter Cable : TECHNICAL INFORMATION

MECHANICAL SPECS

Cable Diameter, nominal	0.096 in
Bend Radius <i>dynamic</i>	1.0 in
<i>static</i>	0.187 in
Operating Temperature	-54° C to +125° C
Weight	5.25 g/ft
Inner Conductor Type	solid SPCCS
Dielectric	solid PTFE
Connector Retention, minimum straight pull	10.0 lbs
right-angle pull	10.0 lbs

ELECTRICAL SPECS

Frequency Range	DC to 50 GHz
Impedance	50 ±2 ohms
Capacitance, nominal	28.9 pF/ft
Time Delay, nominal	1.45 nsec/ft
Shielding Effectiveness, min (@ 0 to 18 GHz)	-90 dB or better

Specifications subject to change without notice.

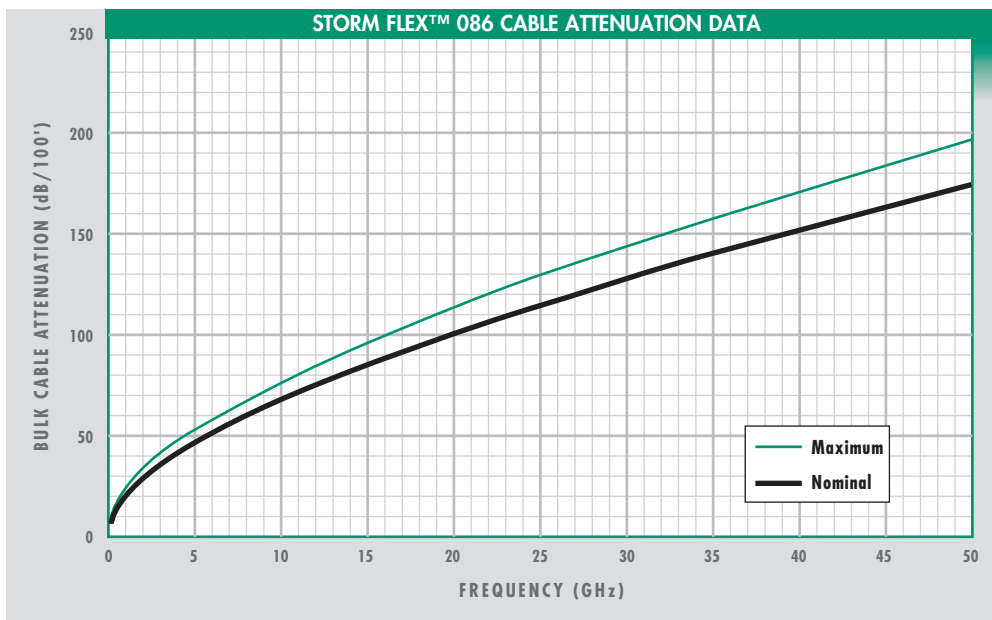

For cable assembly insertion loss, call us or visit our Web site, www.teledynestorm.com/microwave

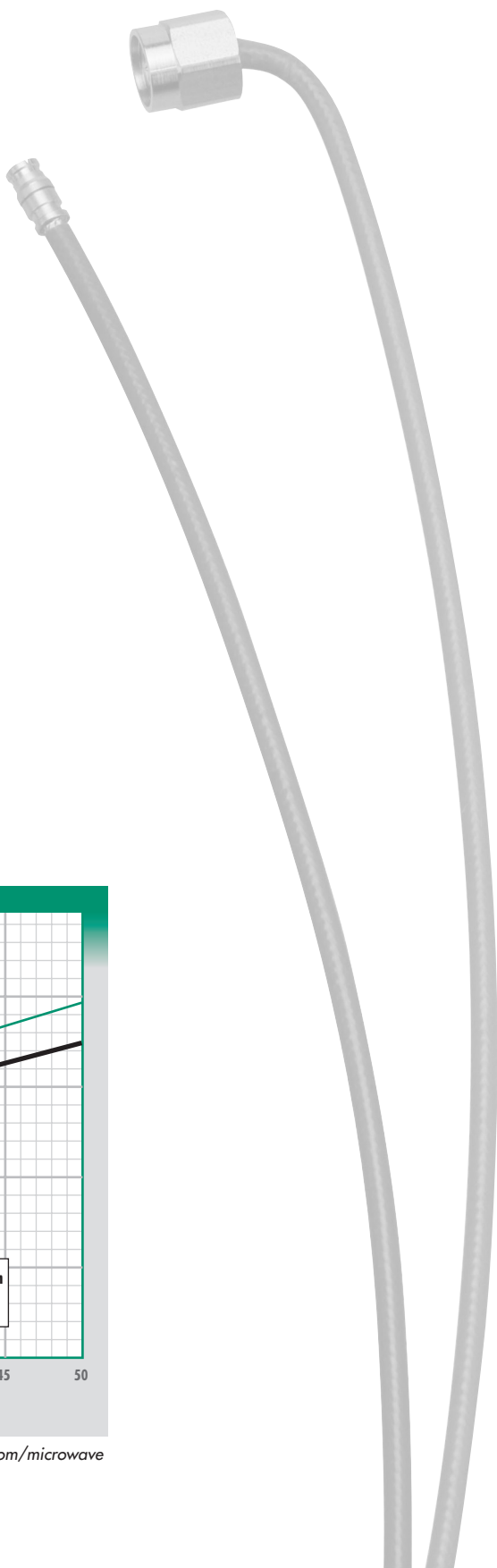

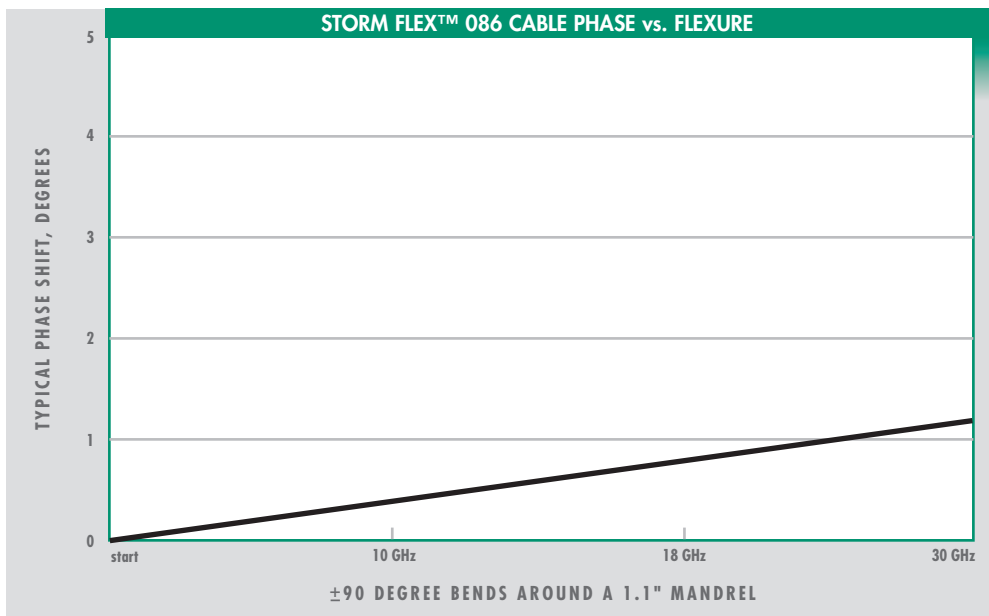
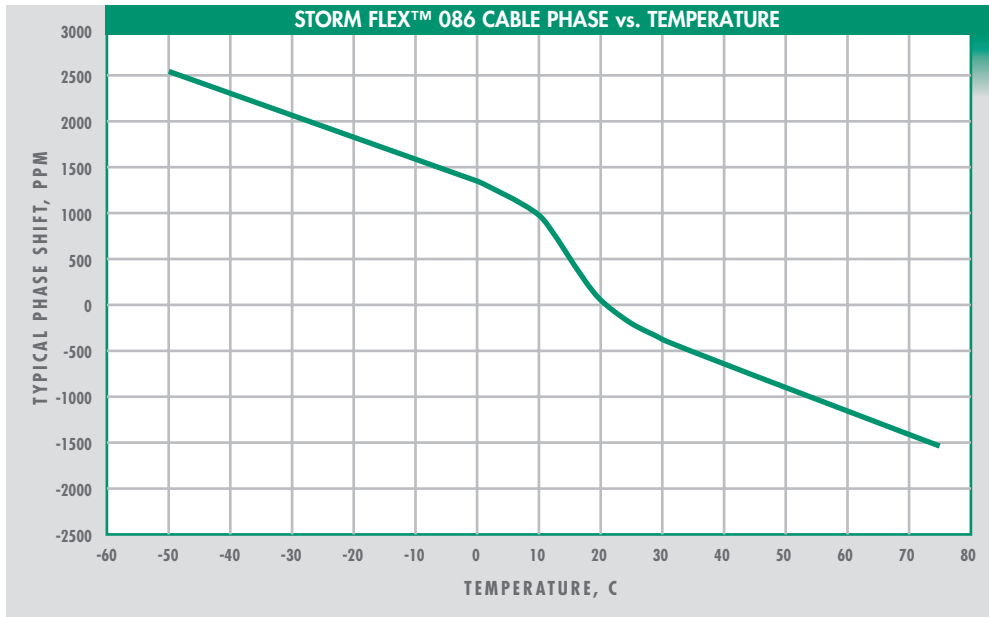
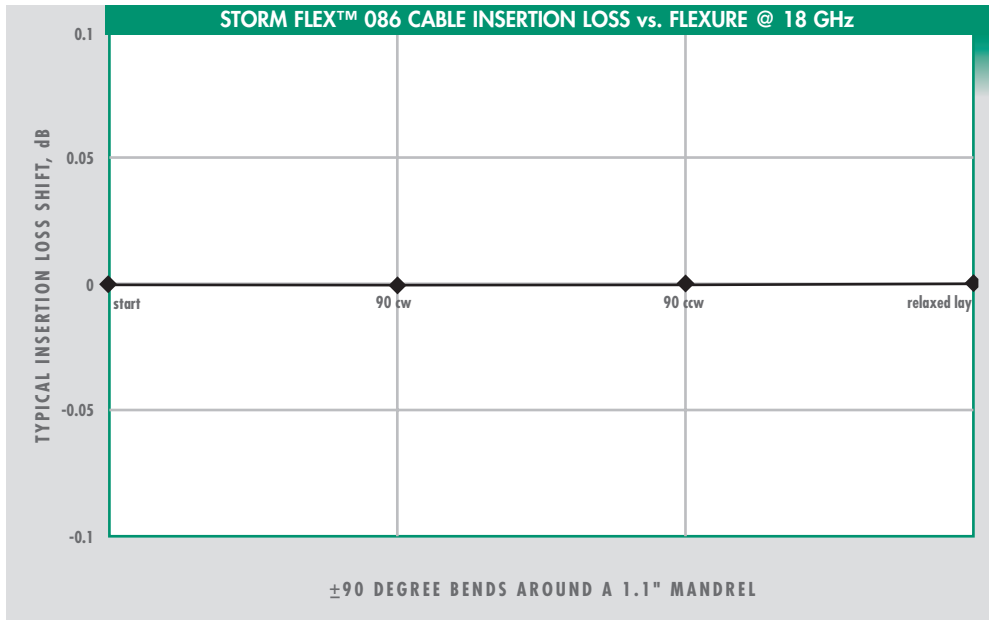

STORM FLEX 086

STORM FLEX™
0.096" Diam : TECHNICAL INFORMATION

The **STORM FLEX™ 086 EXPRESS** line of cable assemblies offers the convenience and cost-effectiveness of rapid, off-the-shelf fulfillment combined with uncompromised electrical stability and durability.

Storm Flex™ Express assemblies are available in a variety of standard lengths, terminated with ultra-precision SMA straight plug connectors that operate to 18 GHz.

■ **ORDERING INFORMATION: Part Number Designation**

See chart below for part numbers.

Part Number w/ SMA SP	Length (in/mm) ±0.125/3.18	2 GHz	10 GHz	18 GHz
		VSWR, Typical		
		1.05:1	1.10:1	1.16:1
		INSERTION LOSS Nominal (dB)		
910-0202-004	4.00/101.60	0.17	0.36	0.51
910-0202-004.5	4.50/114.30	0.18	0.38	0.55
910-0202-005	5.00/127.00	0.19	0.41	0.59
910-0202-005.5	5.50/139.70	0.20	0.44	0.63
910-0202-006	6.00/152.40	0.22	0.47	0.66
910-0202-007	7.00/177.80	0.24	0.53	0.74
910-0202-008	8.00/203.20	0.26	0.58	0.82
910-0202-009	9.00/228.60	0.29	0.64	0.90
910-0202-010	10.00/254.00	0.31	0.70	0.98
910-0202-012	12.00/304.80	0.36	0.81	1.14
910-0202-014	14.00/355.60	0.40	0.92	1.30
910-0202-016	16.00/406.40	0.45	1.03	1.46
910-0202-018	18.00/457.20	0.50	1.15	1.61

ORDERING INFORMATION: Part Number Designation

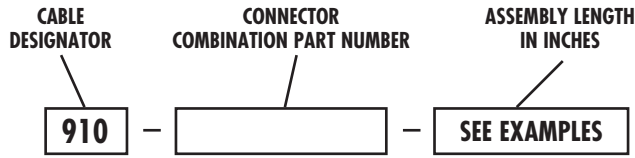

ASSEMBLY LENGTH TOLERANCES	
LENGTH	TOLERANCE
≤ 12"	±.125"
12" ≤ 120"	±.250"
120" ≤ 240"	±.500"
240" ≤ 360"	±1.00"

Length measured from connector end to connector end

CONNECTOR CODES	
SP	Straight Plug
SJ	Straight Jack
RAJ	Right-Angle Jack

EXAMPLES:

910-0303-006 = Storm Flex™ 086, SMA SP to SMA SP (assembly operates to 26.5 GHz), 6 inches

910-0202-024 = Storm Flex™ 086, SMA SP to SMA SP (assembly operates to 18 GHz), 24 inches

CONNECTOR COMBINATION PART NUMBERS*

		CONNECTOR OPERATING FREQUENCY									
		50 GHz	40 GHz	26.5 GHz		18 GHz					
		2.4 mm SP	2.9 mm SP	SMA SP	SSMA SP	SMA SP	SMA SJ	GPO® SJ	GPO® RAJ	GPPO® SJ	
50 GHz		2.4 mm SP	4040	3740	0340	3040	0240	0440	0640	0740	2140
40 GHz		2.9 mm SP	3740	3737	0337	3037	0237	0437	0637	0737	2137
26.5 GHz		SMA SP	0340	0337	0303	0330					
		SSMA SP	3040	3037	0330	3030	0230	0430	0630	0730	2130
18 GHz		SMA SP	0240	0237		0230	0202	0204	0206	0207	0221
		SMA SJ	0440	0437		0430	0204	0404	0406	0407	0421
		GPO® SJ	0640	0637		0630	0206	0406	0606	0607	0621
		GPO® RAJ	0740	0737		0730	0207	0407	0607	0707	0721
		GPPO® SJ	2140	2137		2130	0221	0421	0621	0721	2121

* Other connector styles available; consult Storm

TYPICAL VSWR PERFORMANCE

COUPLED CONNECTORS (SMA, SSMA, 2.4 mm)			
FREQUENCY (GHz)	2 STRAIGHT	1 STRAIGHT / 1 ANGLED	2 ANGLED
Up to 3	1.07:1	1.10:1	1.12:1
3 to 18	1.20:1	1.25:1	1.30:1

PUSH-ON CONNECTORS (GPO®, GPPO®)			
FREQUENCY (GHz)	2 STRAIGHT	1 STRAIGHT / 1 ANGLED	2 ANGLED
Up to 3	1.07:1	1.10:1	1.12:1
3 to 18	1.30:1	1.35:1	1.40:1

For VSWRs above 18 GHz, consult Storm.

STORM FLEX 086 & 086 EXPRESS

STORM FLEX™ 0.096" Diam : PART NUMBERING

0.160" Diameter Cable : TECHNICAL INFORMATION

MECHANICAL SPECS

Cable Diameter, nominal	0.160 in
Bend Radius <i>dynamic</i>	1.5 in
<i>static</i>	0.320 in
Operating Temperature	-54° C to +125° C
Weight	13.4 g/ft
Inner Conductor Type	solid SPCCS
Dielectric	solid PTFE
Connector Retention, minimum straight pull	40.0 lbs
right-angle pull	15.0 lbs

ELECTRICAL SPECS

Frequency Range	DC to 26.5 GHz
Impedance	50 ±2 ohms
Capacitance, nominal	29 pF/ft
Time Delay, nominal	1.44 nsec/ft
Shielding Effectiveness, min (@ 0 to 18 GHz)	-90 dB or better

Specifications subject to change without notice.

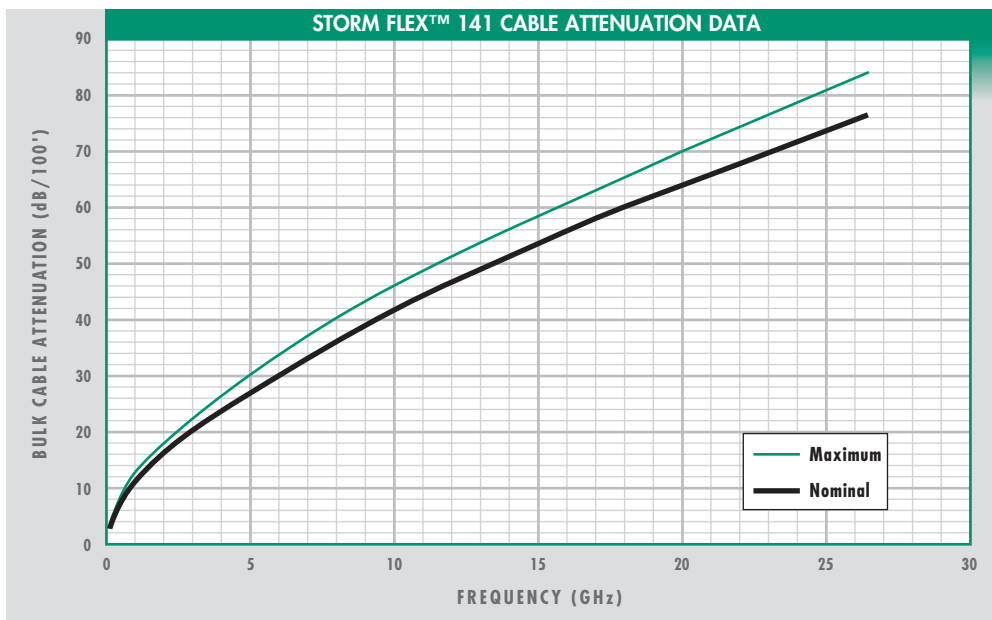

For cable assembly insertion loss, call us or visit our Web site, www.teledynestorm.com/microwave



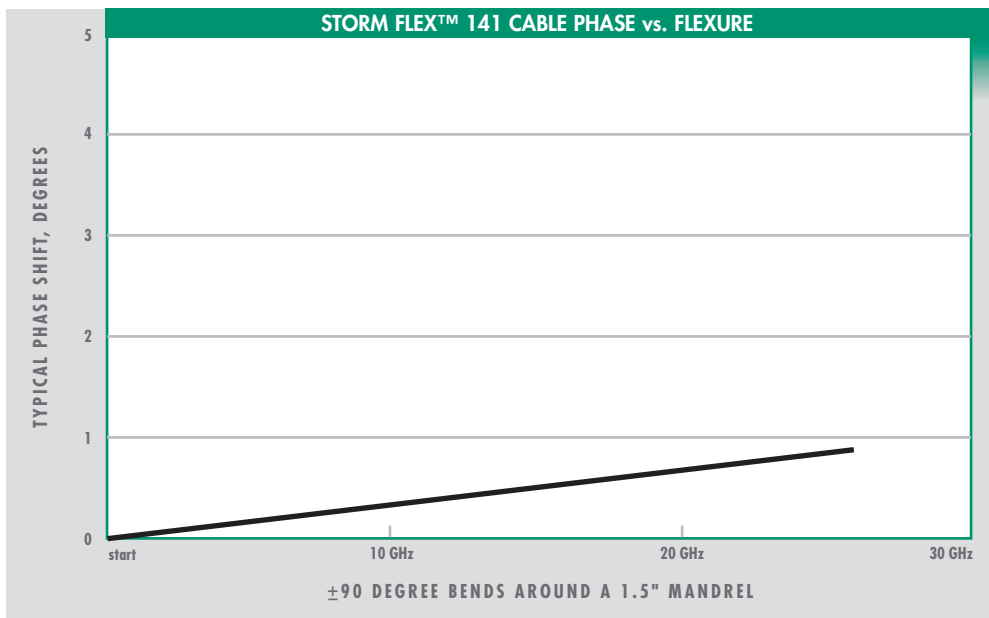
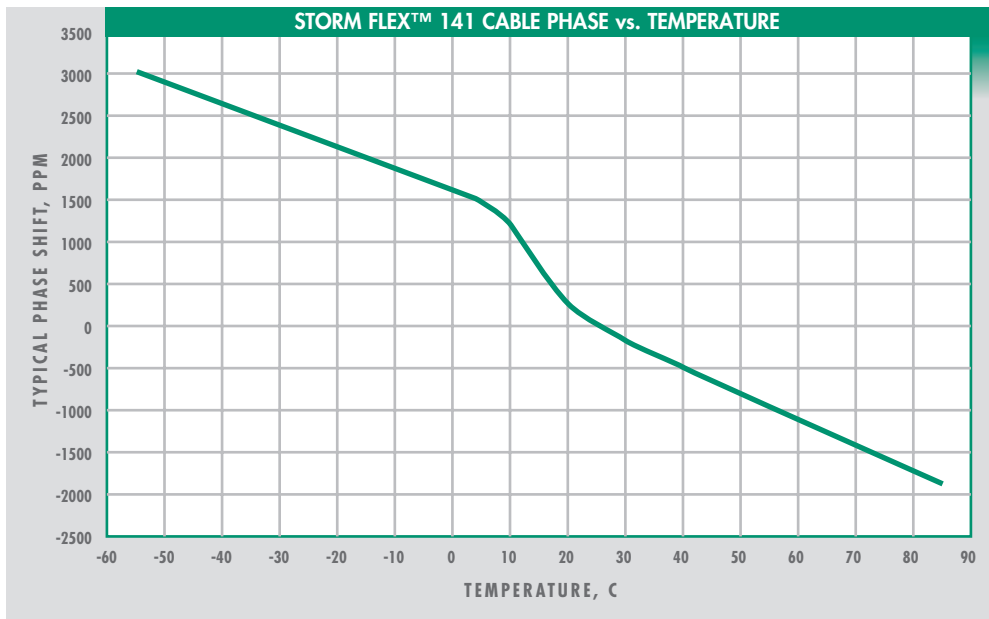
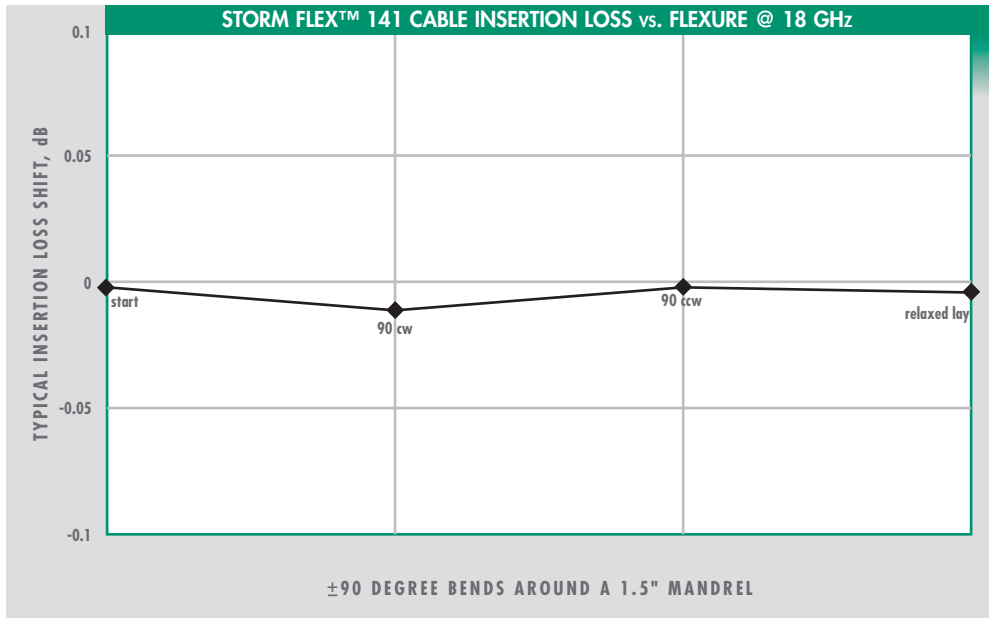

STORM FLEX 141

**STORM FLEX™
0.160" Diam : TECHNICAL INFORMATION**

The **STORM FLEX™ 141 EXPRESS** line of cable assemblies offers the convenience and cost-effectiveness of rapid, off-the-shelf fulfillment combined with uncompromised electrical stability and durability.

Storm Flex™ Express assemblies are available in a variety of standard lengths, terminated with ultra-precision SMA straight plug connectors that operate to 18 GHz.

■ **ORDERING INFORMATION: Part Number Designation**

See chart below for part numbers.

Part Number w/ SMA SP	Length (in/mm) ±0.125/3.18	2 GHz	10 GHz	18 GHz
		VSWR, Typical		
		1.03:1	1.06:1	1.10:1
		INSERTION LOSS Nominal (dB)		
920-0202-004	4.00/101.60	0.08	0.18	0.26
920-0202-005	5.00/127.00	0.10	0.22	0.31
920-0202-006	6.00/152.40	0.11	0.25	0.36
920-0202-008	8.00/203.20	0.14	0.32	0.46
920-0202-010	10.00/254.00	0.17	0.39	0.56
920-0202-012	12.00/304.80	0.20	0.47	0.66
920-0202-014	14.00/355.60	0.23	0.54	0.76
920-0202-016	16.00/406.40	0.25	0.61	0.86
920-0202-018	18.00/457.20	0.28	0.68	0.97
920-0202-018	24.00/609.60	0.37	0.89	1.27

ORDERING INFORMATION: Part Number Designation

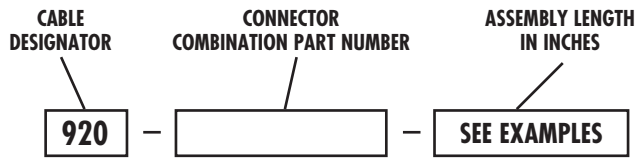

EXAMPLES:

920-0204-014 = Storm Flex™ 141, SMA SP [with center conductor of cable used as contact] to SMA SJ (assembly operates to 18 GHz), 14 inches

920-0412-014 = Storm Flex™ 141, SMA SJ [with separate contact] to SMA SP (assembly operates to 18 GHz), 14 inches

ASSEMBLY LENGTH TOLERANCES	
LENGTH	TOLERANCE
≤ 12"	±.125"
12" ≤ 120"	±.250"
120" ≤ 240"	±.500"
240" ≤ 360"	±1.00"

Length measured from connector end to connector end

CONNECTOR CODES	
SP	Straight Plug
SJ	Straight Jack
RAP	Right-Angle Plug

CONNECTOR COMBINATION PART NUMBERS*

	CONNECTOR OPERATING FREQUENCY				
	26.5 GHz	18 GHz	18 GHz	12 GHz	12 GHz
	SMA SP†	SMA SP†	SMA SJ	N SP	SMA RAP
26.5 GHz	SMA SP†	0303			
	SMA SP†		0202	0204	0250 0205
18 GHz	SMA SJ		0204	0404	0450 0405
	N SP		0250	0450	5050 0550
12 GHz	SMA RAP		0205	0405	0550 0505

† Center conductor of cable used as contact.

For 18 GHz SMA SP connector with separate contact, use connector combination part numbers at right.

	18 GHz
	SMA SP
18 GHz	SMA SP 1212
	SMA SJ 0412
	N SP 1250
12 GHz	SMA RAP 0512

* Other connector styles available; Consult Storm.

TYPICAL VSWR PERFORMANCE

FREQUENCY (GHz)	COUPLED CONNECTORS (SMA, N)		
	2 STRAIGHT	1 STRAIGHT / 1 ANGLED	2 ANGLED
Up to 3	1.05:1	1.15:1	1.20:1
3 to 18	1.30:1	1.35:1*	1.35:1*

* @12 GHz

For VSWRs above 18 GHz, consult Storm.

Increase throughput with these labor-saving **QUICK-CONNECTING ADAPTERS**. The adapters are designed so that the quick-connecting male end of the adapter fits directly onto standard female connectors. This eliminates repeated and time-consuming tightening, torquing and loosening of connectors during test.

In comparing connection times, the quick-connecting adapters took only 1/3 the time of standard threaded adapters, with a resulting three-fold increase in throughput.

N, TNC, and 7/16 adapters are available in both locking and non-locking versions. SMA adapters are non-locking only and are available with either standard or reverse polarity. All of the quick-connecting adapters offer repeatability through a minimum of 500 mating cycles.

FEATURES

- ▣ Unique interface design
- ▣ Quick-connecting and disconnecting
- ▣ Repeatable performance

BENEFITS

- ~ Eliminates repeated, time-consuming tightening, torquing, and loosening during test
- ~ Reduces test times
- ~ Increases throughput
- ~ Eliminates a potential source of introduced error during test
- ~ Accurate testing through a minimum of 500 mating cycles

SMA QUICK-CONNECTS 68
 N QUICK-CONNECTS 69
 TNC QUICK-CONNECTS 70
 7/16 QUICK-CONNECTS 71

SMA QUICK-CONNECTS



N QUICK-CONNECTS



TNC QUICK-CONNECTS



7/ 16 QUICK-CONNECTS



QUICK
CONNECTS
INTRO

QUICK-CONNECTING ADAPTERS
INTRODUCTION

QUICK-CONNECTING ADAPTERS

SMA QUICK-CONNECTS

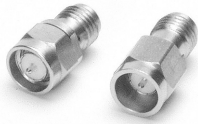

MECHANICAL

Temperature (C°)	-65 to +165
Durability (cycles, minimum)	500

ELECTRICAL

Impedance	50 Ohms
Frequency Range	DC to 26.5 GHz
VSWR (maximum)	
DC - 18.0 Ghz	1.15:1
18 - 26.5 Ghz	1.20:1
Attenuation (maximum @ 18 Ghz)	0.3 dB
Contact Resistance (maximum)	0.003 Ohms
RF Leakage (maximum)	-80 dB to 3.0 GHz
	-65 dB to 26.5 GHz
Dielectric Withstanding (minimum)	1500 VRMS, 60 Hz
RF High Potential (minimum)	1000 VRMS @ 5 Mhz

MATERIALS

Body	Stainless Steel
Center Contact	Beryllium Copper
Outer Conductor	Beryllium Copper

FINISH

Center Contact	Gold Plate
Body	Passivated
Outer Conductor	Gold Plate

Specifications subject to change without notice.

All figures are nominal unless otherwise stated.

Dimensions are subject to change without notification.

Non-Locking versions shown.
Full locking version **not** available.

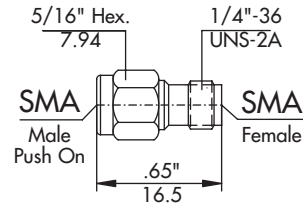

SMA (M) to SMA (F)

8001-SM21-02
8001-RM21-02*

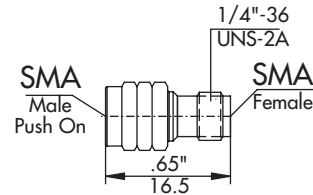

SMA (M) to SMA (F)

8003-SM21-02
8003-RM21-02*

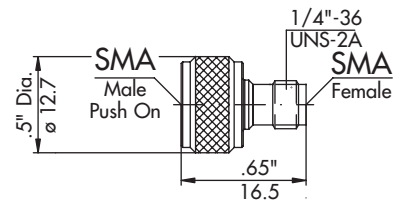

Easier handling with enlarged coupling nut.

SMA (M) to SMA (F)

8005-SM21-02
8005-RM21-02*

*Reverse polarity SMA quick-connecting adaptors.

Dimensions shown are inches over millimeters. Interfaces are per MIL-C-39012, MIL-C-87104/2, MIL-C-3643, MIL-STD-348, IEC-169-7, IEC-457-2, DIN 47223, DIN 47226, DIN 47298, where applicable. Call STORM for further information.

QUICK-CONNECTING ADAPTERS

N QUICK-CONNECTS



Locking versions shown.

Non-Locking versions available; see website.

MECHANICAL	
Temperature (C°)	-54 to +80
Durability (cycles, minimum)	500

ELECTRICAL	
Impedance	50 Ohms
Frequency Range	DC to 18 GHz
VSWR (maximum)	1.15:1
Attenuation (maximum @ 18 GHz)	0.2 dB
Contact Resistance (maximum)	0.001 Ohms
RF Leakage (maximum)	-90 dB to 3.0 GHz -75 dB to 18.0 GHz
Dielectric Withstanding (minimum)	2500 VRMS, 60 Hz
RF High Potential (minimum)	1500 VRMS @ 5 Mhz

MATERIALS	
Body	Stainless Steel
Center Contact	Beryllium Copper
Outer Conductor	Beryllium Copper

FINISH	
Center Contact	Gold Plate
Body	Passivated
Outer Conductor	Gold Plate

Specifications subject to change without notice.
 All figures are nominal unless otherwise stated.
 Dimensions are subject to change without notification.

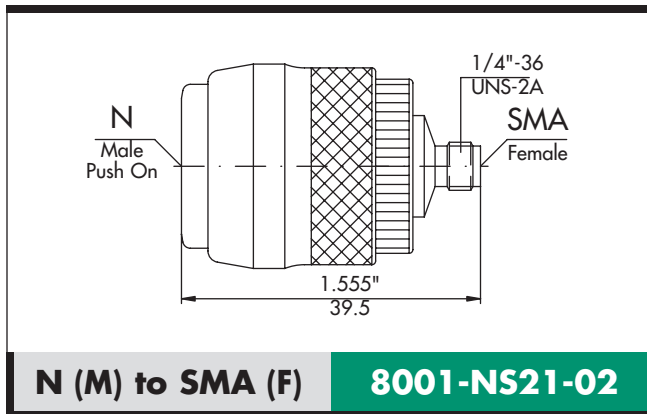

N (M) to SMA (F) 8001-NS21-02

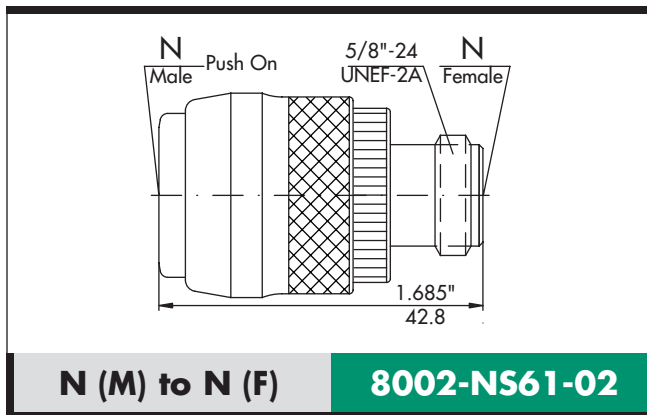

N (M) to N (F) 8002-NS61-02

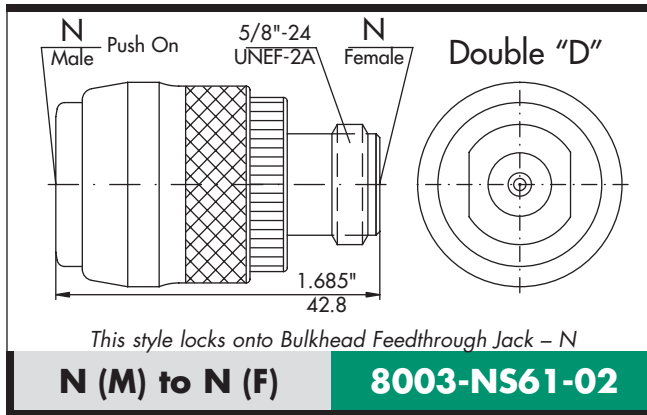

N (M) to N (F) 8003-NS61-02

N QUICK-CONNECTS

ADAPTERS

ADAPTERS : SMA QUICK-CONNECTS

Dimensions shown are inches over millimeters. Interfaces are per MIL-C-39012, MIL-C-87104/2, MIL-C-3643, MIL-STD-348, IEC-169-7, IEC-457-2, DIN 47223, DIN 47226, DIN 47298, where applicable. Call STORM for further information.

QUICK-CONNECTING ADAPTERS

TNC QUICK-CONNECTS



Locking versions shown.

Non-Locking versions available; see website.

MECHANICAL

Temperature (C°)	-54 to +80
Durability (cycles, minimum)	500

ELECTRICAL

Impedance	50 Ohms
Frequency Range	DC to 18 GHz
VSWR (maximum)	1.15:1
Attenuation (maximum @ 18 GHz)	0.2 dB
Contact Resistance (maximum)	0.001 Ohms
RF Leakage (maximum)	-90 dB to 3.0 GHz -65 dB to 18.0 GHz
Dielectric Withstanding (minimum)	2500 VRMS, 60 Hz
RF High Potential (minimum)	1500 VRMS @ 5 Mhz

MATERIALS

Body	Stainless Steel
Center Contact	Beryllium Copper
Outer Conductor	Beryllium Copper

FINISH

Center Contact	Gold Plate
Body	Passivated
Outer Conductor	Gold Plate

Specifications subject to change without notice.

All figures are nominal unless otherwise stated.

Dimensions are subject to change without notification.

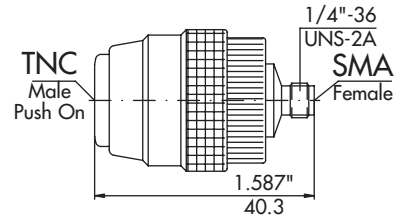

TNC (M) to SMA (F) 8001-TS21-02

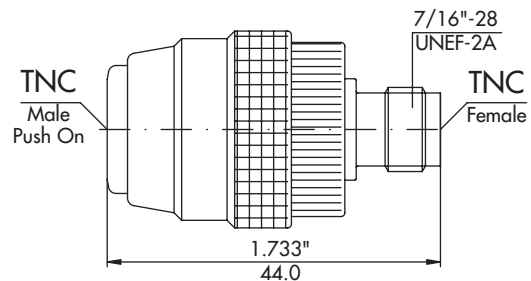

TNC (M) to TNC (F) 8001-TS41-02

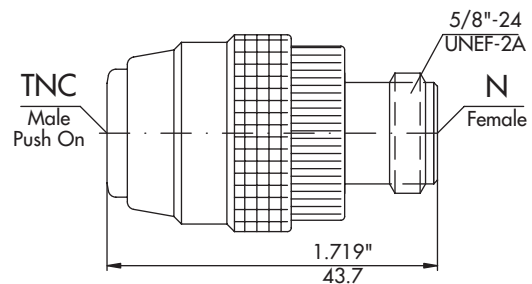

TNC (M) to N (F) 8001-TS61-02

Dimensions shown are inches over millimeters. Interfaces are per MIL-C-39012, MIL-C-87104/2, MIL-C-3643, MIL-STD-348, IEC-169-7, IEC-457-2, DIN 47223, DIN 47226, DIN 47298, where applicable. Call STORM for further information.

QUICK-CONNECTING ADAPTERS

7/16 QUICK-CONNECTS



Locking versions shown.

Non-Locking versions available; see website.

MECHANICAL	
Temperature (C°)	-54 to +80
Durability (cycles, minimum)	500

ELECTRICAL	
Impedance	50 Ohms
Frequency Range	DC to 7.5 GHz
VSWR (maximum)	1.10:1
Attenuation (maximum @ 7.5 GHz)	0.15 dB
Contact Resistance (maximum)	0.001 Ohms
RF Leakage (maximum)	-90 dB to 3.0 GHz -80 dB to 7.5 GHz
Dielectric Withstanding (minimum)	3000 VRMS, 60 Hz
RF High Potential (minimum)	4000 VRMS @ 5 Mhz

MATERIALS	
Body	Stainless Steel
Center Contact	Beryllium Copper
Outer Conductor	Stainless Steel

FINISH	
Center Contact	Gold Plate
Body	Passivated
Outer Conductor	Passivated

Specifications subject to change without notice.

All figures are nominal unless otherwise stated.

Dimensions are subject to change without notification.

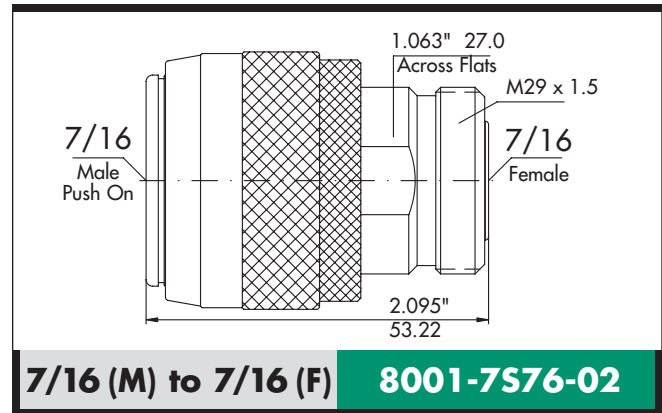

Also available with silver-plated brass outer conductor for reduced intermodulation requirements. PN: 8001-7S76-13

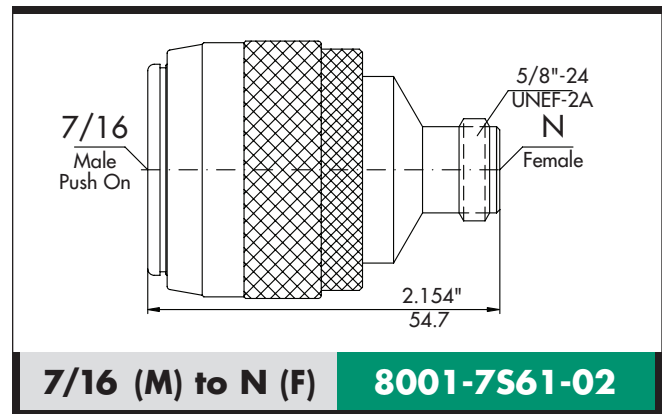

7/16 QUICK-CONNECTS

ADAPTERS

ADAPTERS : TNC QUICK-CONNECTS

Dimensions shown are inches over millimeters. Interfaces are per MIL-C-39012, MIL-C-87104/2, MIL-C-3643, MIL-STD-348, IEC-169-7, IEC-457-2, DIN 47223, DIN 47226, DIN 47298, where applicable. Call STORM for further information.

CONNECTOR FREQUENCY CHART

CONNECTOR TYPE	OPERATIONAL RANGE
2.4 mm GPPO® (SSMP) – select versions	50 GHz
2.9 mm (K) GPO® (SMP) – select versions SSMA	40 GHz
3.5 mm GMS® Precision SMA	26.5 GHz
7 mm GPO® (SMP) GPPO® (SSMP) Precision N Precision TNC SC SMA	18 GHz
BNC – select versions HN SMB	4 GHz

GPO®, GPPO®, and GMS® are registered trademarks of Corning Gilbert, Inc.

USEFUL CONVERSION FORMULAE

TO CONVERT...

FROM TO	TO FROM	MULTIPLY BY DIVIDE BY
µm	mils	.03937
mm	in	.03937
cm	in	.39370
m	ft	3.2808
km	ft	3280.8
km	mi	.62137
kg	lbs	2.2046
kg/km	lbs/1000 ft	.67197
N	lbs	.22492
N-m	ft-lbs	.73793
kPa	PSI	.14511
°F	°C	Subtract 32 (then divide by 1.8)
°C	°F	Multiply by 1.8 (then add 32)

USEFUL DESIGN FORMULAE

Characteristic Impedance

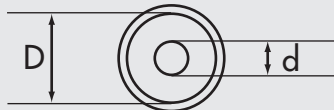

$$Z_o = \frac{138}{\sqrt{\epsilon_r}} \log \left(\frac{D}{d} \right)$$

Where ϵ_r = dielectric constant

Velocity of Propagation

$$V_p (\%) = \frac{1}{\sqrt{\epsilon_r}} \times 100$$

Capacitance

$$C \text{ (pF/ft)} = \frac{7.35}{\log_{10} \frac{D}{d}} \epsilon_r$$

Cutoff Frequency

$$F \text{ (GHz)} \approx \frac{7.52}{\sqrt{\epsilon_r} (D+d)}$$

Delay

$$T = 1.016 \sqrt{\epsilon_r} \dots \text{ns/ft}$$

MICROWAVE CABLE ASSEMBLY CARE & HANDLING

Storm microwave coaxial cable assemblies will last longer and provide better performance when properly used and cared for. It is important to routinely clean the connectors and inspect the assembly for damage.

CABLE ASSEMBLY ROUTING & HANDLING

Care should be taken to avoid bending the assemblies beyond the minimum bend radius guidelines. Failure to do so will destroy the cable.

Twisting the cable should be avoided. Excessive twist can damage the cable assembly at the cable/connector interface. Even low-force torsion can affect electrical performance and cause connections to loosen.

Cable assemblies should be stored in a coiled configuration. When you need to use the cable, simply unroll it.

Avoid pinching or crushing the cable assembly. Never pull equipment around by the cable, and never expect the cable to support equipment or devices.

CABLE ASSEMBLY MATING & DE-MATING

Contact pins and dielectrics can be damaged if the connectors are misaligned during the mating process. Make sure that the mating interfaces are parallel and aligned while mating the connectors.

You can usually feel if the pins are aligned or not. When you sense that they are aligned, gently turn the coupling nut until mating is complete.

Insufficient coupling torque can produce inaccurate results, and over-torque coupling can damage the cable assembly and connecting equipment. When mating the connector, firmly hold the body of the connector to keep it from rotating. If the connector bodies are allowed to rotate during mating & de-mating, the plating and surface finish of the outer and inner contacts can be damaged. Also, rotation of the connector body transfers unwanted torque to the cable assembly.

Torque wrenches, set to the correct torque, should be used to mate a connector with wrench flats. To mate connectors with knurled nuts, use your fingers. **Never use pliers to tighten any connector.** Listed below are recommended coupling torque values for popular connectors.

CONNECTOR	COUPLING TORQUE
7 mm, N, Precision N, TNC	12 to 15 in-lbs
2.4 mm, 2.9 mm, 3.5 mm, SMA	8 to 10 in-lbs

CONNECTOR INTERFACE CLEANING

Clean interfaces extend connector life and provide more accurate, repeatable measurements. Moisten a clean, lint-free swab using isopropyl alcohol, remove any excess alcohol, wipe the interface components as required to eliminate debris, then blow-dry the interface with filtered compressed air or nitrogen. Re-inspect the connector to verify that the interface is clean and ready for use. Remember to clean the mating connectors, as they may be the source of debris.

The use of connector end caps is recommended when cables are not in use.

Please copy this sheet, fill out, and fax to us at 630-754-3500. We will respond within 24 hours of receiving your information. Or, call us at 888-347-8676 (toll free); 630-754-3300; or visit us on the Web at www.teledynestorm.com/microwave.

▣ GENERAL INFORMATION

Company: _____
 Name: _____
 Address: _____
 Phone: _____ E-mail: _____

▣ ELECTRICAL REQUIREMENTS

Frequency range: _____
 Insertion loss: _____
 VSWR: _____
 Power handling: _____ CW or Peak (circle one)
 Phase matching required? Define: _____
 Other requirements? _____

▣ MECHANICAL REQUIREMENTS

Assembly length (in/mm; ft/m): _____
 Connector 1: _____ Connector 2: _____
 Maximum outside cable diameter (in/mm): _____
 Minimum bend radius (in/mm): _____

▣ ENVIRONMENTAL CONSIDERATIONS

Inside/Outside use: _____
 Temperature: _____
 Pressure: _____
 Flexure: _____
 Vibration: _____
 Other: _____

▣ APPLICATION

Military, mobile telecom, wireline telecom, etc.: _____
 Program: _____
 Number of assemblies: _____
 Quote required? Yes No
 Samples required? Yes No How many? _____ By when? _____

ORDERING INFORMATION

Standard or custom microwave cable assemblies can be ordered directly from Storm Products or through any Storm Products Representative. Contact us directly at:

Teledyne Storm Products–Microwave
10221 Werch Drive
Woodridge, IL 60517

Phone: 888.347.8676 (toll free) or 630.754.3300

Fax: 630.754.3500

e-mail: storm_microwave@teledyne.com

TERMS

Formal price quotations are valid for 30 days unless otherwise specified in writing. Payment is Net 30 Days from time of invoice, subject to credit approval. We reserve the right to alter the terms and fix a limit of credit.

PAYMENTS

Storm accepts checks, ACH, wire transfers, American Express, Mastercard, and Visa.

Remit checks to:

15363 Collections Center Drive
Chicago, IL 60693

Remit wire transfers and ACH payments to:

Bank of America, NY
Teledyne Storm Products, Inc.
Account # 12331-59961
ABA Wires: 026009593
ABA ACH: 121000358
Ref. Invoice Number(s): _____



For microwave product billing issues contact Teledyne Storm Products, Woodridge, IL, at 888.347.8676 (toll free) or 630.754.3300.

SHIPPING

Shipments are FOB Woodridge, IL. Excess transportation costs resulting from special routing, requested by the Buyer, shall be billed not subject to discount.

WARRANTY

One year on materials and workmanship.

RETURN POLICY

Returns will not be accepted without Return Merchandise Authorization (RMA). Contact Teledyne Storm Products' Woodridge facility to obtain an RMA number. Normal policy is to issue a credit and rebill.



CONTACT TELEDYNE STORM MICROWAVE TO REQUEST OUR:
High Performance Interconnect Products Catalog



10221 Werch Drive ■ Woodridge, Illinois 60517
Tel 630.754.3300 ■ Fax 630.754.3500
Toll Free 888.347.8676
storm_microwave@teledyne.com

www.teledynestorm.com/microwave

AS9100/ISO 9001 REGISTERED

Printed in U.S.A.
02/13