

323F L

Hydraulic Excavator

2017



Engine

Engine Model	Cat® C7.1 ACERT™	
Power – ISO 14396	122 kW	164 PS
Power – ISO 9249	120 kW	161 PS

Drive

Maximum Travel Speed	5.5 km/h
Maximum Drawbar Pull	205 kN

Weight

Minimum Operating Weight	22 600 kg
Maximum Operating Weight	25 700 kg

If you are in the business of road construction, underground utilities, or commercial and residential site development, you need the versatile Cat 323F L in your fleet.

The Cat 323F L is a purpose-built machine powered by a fuel-efficient C7.1 ACERT engine that meets EU Stage IV emission standards. With plenty of counterweight, robust structures, a state-of-the-art hydraulic system, and Cat Grade Control Depth and Slope you can move tons of material – literally – all day long with tremendous stability, speed, and precision.

When you add in a quiet operator environment that keeps you comfortable and productive, easy-to-reach service points that make your routine maintenance fast and simple, and multiple Cat work tools that help you take on a variety of tasks, you just won't find a better, more efficient 23-ton excavator – any place, anywhere.

Contents

Cat Connect Technologies.....	4
Fuel Efficient	6
Operator Station.....	7
Reliable and Productive.....	8
Heavy Configuration	9
Front Linkage	10
Durable Structures	11
Serviceable	12
Safe Work Environment.....	13
Attachments.....	14
Sustainability	16
Complete Customer Care.....	16
Specifications.....	17
Standard Equipment.....	32
Optional Equipment.....	33
Notes.....	34





CAT

CAT
323F



Cat Connect Technologies

Monitor, manage, and enhance your job site operations

Cat CONNECT makes smart use of technology and services to improve your job site efficiency. Using the data from technology-equipped machines, you'll get more information and insight into your equipment and operations than ever before.

Cat Connect technologies offer improvements in these key areas:



EQUIPMENT
MANAGEMENT

Equipment Management – increase uptime and reduce operating costs.



PRODUCTIVITY

Productivity – monitor production and manage job site efficiency.



SAFETY

Safety – enhance job site awareness to keep your people and equipment safe.



LINK Technologies

LINK technologies like Product Link™ are deeply integrated into your machine and wirelessly communicate key information, including location, hours, fuel usage, idle time, and event codes.

Product Link/VisionLink®

Easy access to Product Link data via the online VisionLink user interface can help you see how your machine or fleet is performing. You can use this information to make timely, fact-based decisions that can boost job site efficiency and productivity and lower costs.

GRADE Technologies

Grade technologies combine digital design data and in-cab guidance to help you reach target grade quickly and accurately with minimal staking and checking. That means you'll be more productive, complete jobs faster in fewer passes, and use less fuel for a lower cost.

Cat Grade Control Depth & Slope

The factory-integrated Cat Grade Control system, standard on the 323F with Reach boom and 2.9 m and 2.5 m sticks, delivers 2D bucket tip elevation guidance to the cab to help operators create precise planes and slopes with ease. Real-time bucket tip elevation guidance on the easy-to-read standard cab monitor indicates how much to cut or fill. Fast response sensors deliver immediate feedback. Integrated joystick buttons help operators make quick adjustments to maintain consistent, quality grades. Built-in alerts can be set to warn the operator if the linkage or bucket approaches a predefined elevation or depth like when working in areas with low ceilings or digging near water lines. Staking and checking is minimized, which reduces ground crews and enhances job site safety. The system works best in simple 2D applications such as digging basements or grading steep embankments. You can easily upgrade to AccuGrade™ when 3D control is required.

Cat AccuGrade

The dealer-installed AccuGrade system provides 3D guidance for making complex cuts and contours, eliminating the need for staking and checking. A dedicated monitor displays a digital design plan with 3D bucket tip positioning and elevation guidance, indicating precisely where to work and how much to cut or fill. The plug-and-play capability on the 323F L simplifies upgrading. Choose from satellite (GNSS) control for large projects with complex designs or total station (UTS) systems in areas with limited reception.



Fuel Efficient

Powerful and fuel efficient to meet your expectations

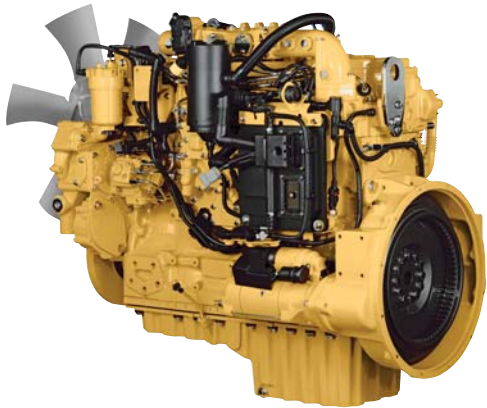

Proven Technology

Every Stage IV ACERT engine is equipped with a combination of proven electronic, fuel, air, and aftertreatment components. Applying these time-tested technologies lets us meet your high expectations for productivity, fuel efficiency, reliability, and service life. Following are the results you can expect:

- **Improved fluid efficiency of up to 5%** over Stage IIIB products, including Diesel Exhaust Fluid (DEF) consumption.
- **High performance** across a variety of applications.
- **Enhanced reliability** through commonality and simplicity of design.
- **Maximized uptime and reduced cost** with world-class Cat dealer support.
- **Minimized impact** on emission systems – with no operator interaction required.
- **Durability** with long service life.
- **Better fuel economy** with minimized maintenance costs.
- **Same great power** and response.

Cat NO_x Reduction System

The Cat NO_x Reduction System captures and cools a small quantity of exhaust gas and then routes it back into the combustion chamber to drive down temperatures and reduce NO_x emissions. The result of more than a decade of Caterpillar engineering research into this technology is the most reliable system of its type.

Diesel Exhaust Fluid (DEF)

Cat engines equipped with an SCR system inject DEF into the exhaust to reduce NO_x emissions. DEF is a precisely mixed solution of 32.5% high purity chemical grade urea and 67.5% de-ionized water. DEF used in Cat SCR systems must meet the requirements outlined in the International Organization for Standardization (ISO) standard 22241-1. ISO 22241-1 requirements are met by many brands of DEF, including those that carry the AdBlue or API certifications.

Fuel Savers That Add Up

The 323F L consumes up to 10% less fuel than the previous series model, and lowering engine speed without impacting production is one of the key contributors. Automatic engine speed control also contributes by lowering rpm when the machine doesn't need it for work. Automatic engine idle shutdown turns the engine off when it's been idling for more than a specified amount of time that you can set through the monitor. Plus you have a choice of three power modes – high power, standard power, and eco mode. Simply change between modes through the console switch panel to meet the work needs in front of you. Collectively, all of these benefits add up to reduced fuel consumption, reduced exhaust and sound emissions, reduced repair and maintenance costs, and increased engine life for you.

A Cool Design For Any Temperature

A side-by-side cooling system allows you to put the machine to work in extremely hot and cold conditions. The system is completely separated from the engine compartment to reduce noise and heat. Plus it features easy-to-clean cores and a variable-speed fan that runs only when needed to ensure maximum efficiency.

Biodiesel Not A Problem

The C7.1 ACERT engine can run on up to B20 biodiesel that meets ASTM 6751 standards – all to give you more potential fuel-saving flexibility.

Operator Station

Comfort and convenience to keep you productive

A Safe, Quiet Cab

The ROPS cab provides you with a safe working environment. It also contributes to your comfort because it's attached to a reinforced frame with special viscous mounts that limit vibration and unnecessary sound. Add in special roof lining and sealing and you have a cab that's as quiet inside as today's top pickup trucks.

Comfortable Seat Options

The seat range includes air suspension, heated, and air cooled options. All seats include a reclining back, upper and lower slide adjustments, and height and tilt angle adjustments to meet your needs for maximum comfort.

A Cool & Warm Environment

The automatic climate control system features multiple air outlets with filtered ventilation. Air flows on the floor, behind the seat, and in front of you to make your work in either hot or cold weather much more pleasant and productive.

Controls Just For You

The right and left joystick consoles can be adjusted to improve your comfort and productivity during the course of a day. Also, the right joystick features a button that will reduce engine speed when you are not working to help save fuel. Touch it once and speed reduces; touch it again and speed increases for normal operation.

A Helpful Monitor

The LCD monitor is easy to see and navigate. Programmable in up to 44 languages to meet today's diverse workforce, the monitor clearly displays critical information you need to operate efficiently and effectively. Plus it projects the image from the standard rearview and side-view cameras to help you see what's going on around you so you can work more effectively and efficiently.

Ample Storage & Auxiliary Power

Storage spaces are located in the front, rear, and side consoles of the cab. A drink holder accommodates a large mug, and a shelf behind the seat stores large lunch or toolboxes. Two 12-volt power supply sockets are conveniently located near the key storage areas for charging your electronic devices like an MP3 player, a cell phone, or a tablet.



Reliable and Productive

Power to move your material with speed and precision

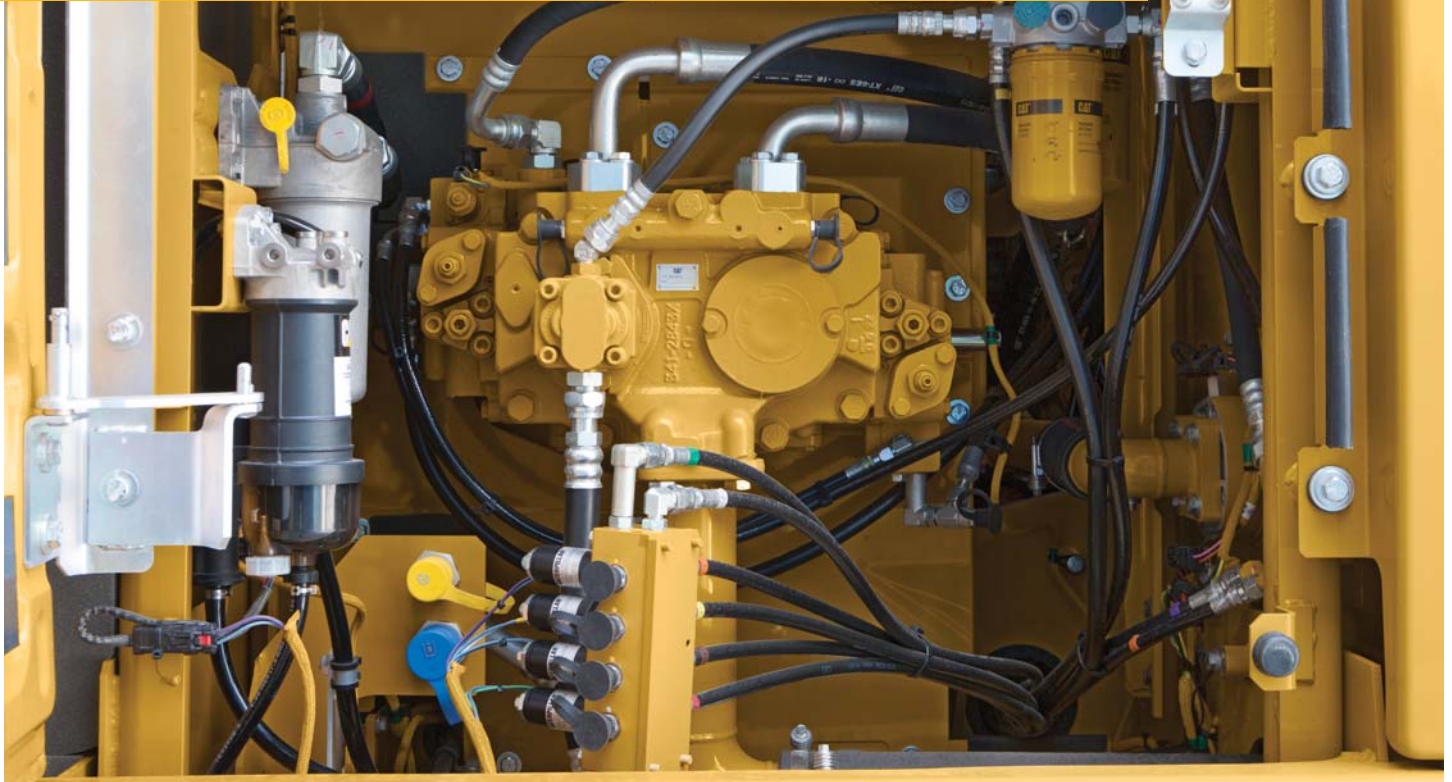

A Powerful, Efficient Design

When it comes to moving heavy material quickly and efficiently, you need hydraulic horsepower – the type of ground-breaking power the 323F L can deliver. Major hydraulic components like pumps and valves are located close together so shorter tubes and lines can be used. This design leads to less friction loss, reduced pressure drops, and more power to the ground for the work you need to get done.

Control Like No Other

Controllability is one of the main attributes of Cat excavators, and one of the key contributors to this is the main control valve. The valve opens slowly when your range of joystick lever movement is small and opens rapidly when movement is high. It puts flow where you need it when you need it, which leads to smoother operation, greater efficiency, and lower fuel consumption.

Auxiliary Hydraulics For Added Versatility

Auxiliary hydraulics give you greater tool versatility so you can take on more work with just one machine, and there are several options from which you can choose. A quick coupler circuit, for example, will allow you to switch from one tool to another in a matter of minutes – all from the comfort and convenience of the cab.

Boom & Stick Oil Re-Circulation For Added Efficiency

The 323F L regenerates the flow of oil from the head end of the boom and stick cylinders to the rod end of the boom and stick cylinders during the work cycle to save energy and improve fuel efficiency. It's optimized for any dial speed setting you select, which results in less pressure loss for higher controllability, more productivity, and lower operating costs for you.



Heavy Configuration

More brawn for your bigger jobs



More Lift

If your jobs require a lot of heavy lifting, look into the 323F L heavy counterweight configuration. This machine features nearly 5350 kg of weight out back – roughly 1250 kg more than our standard 323F L. It also has a reinforced frame to support the additional weight. The benefit to you is a well-designed, well-balanced machine that will lift up to 20 percent more weight out front and over the side than our standard model.

More Stability

With the heavy counterweight, you get a more stable platform for working with larger tools like a rotating coupler, multi-processor, and high-capacity buckets. It also helps keep the machine flat on its tracks when you are picking and placing large pipe and trench boxes, concrete construction barriers, and other heavy materials.

More Reach

If reach is what you need, you can stretch your working envelope with the 2.9 m stick. Built specifically for the heavy counterweight configuration, this stick combined with a heavy-duty boom will give you over 6710 mm of dig depth and 9850 mm of reach, making it ideal for deep sewer applications.



Front Linkage

Options to take on your far-reaching and up-close tasks

Built To Last

The 323F is offered with a range of booms and sticks. Each is built with internal baffle plates for added durability, and each undergoes ultrasound inspection to ensure weld quality and reliability. Large box-section structures with thick, multi-plate fabrications, castings, and forgings are used in high-stress areas such as the boom nose, boom foot, boom cylinder, and stick foot to improve durability. The boom nose pin is a captured flag design for enhanced durability.

Booms, Sticks and Bucket Linkage For Any Job

R = Reach

The Reach boom R5.7 m is best used for reach applications where conditions are optimal such as excavating basements, trenching for utility lines, and working in sewer applications.

VA = Variable Angle

This configuration offers superb flexibility and versatility in the working envelope. Boom position can be adjusted from 90° when fully retracted to 165° and fully extended. With full extension, the working range gives maximum reach. When retracted, it can work closer to its tracks, increase lifting capacity, and work in confined areas.

Longer sticks are better when you need to dig deep or load trucks. Shorter sticks provide greater breakout force.

SLR = Super Long Reach

This configuration offers 15.7 m horizontal reach with 11.7 m digging depth. It is perfectly suited for forming slopes and cleaning settlement tanks and ponds.

Talk to your Cat dealer to pick the best front linkage for your specific line of work.

Durable Structures

Designed to work in your rugged applications



Robust Frame

The 323F L is a well-built machine designed to give you a very long service life. The upper frame has mountings made specifically to support the heavy-duty cab; it is also reinforced around key areas that take on stress like the boom foot and skirt. Massive bolts are used to attach the track frames to the body, and additional bolts are used to increase the machine's digging force, which leads to more productivity for you.

Stable Undercarriage

The 323F L undercarriage contributes significantly to its outstanding stability and durability. Track shoes, links, rollers, idlers, and final drives are all built with long-lasting, high-tensile-strength steel. Cat Grease Lubricated Track 2 (GLT2) track link protects moving parts by keeping water, debris, and dust out and grease sealed in, which delivers longer wear life and reduced noise when traveling on either a flat, heavy bed of rock or a steep, wet field of mud.

Counterweight Options

Depending on the configuration you choose, two counterweight options (4.1 mt, 5.35 mt) are available for the Reach and VA configurations, and a 4.7 mt counterweight comes with the Super Long Reach fronts. All are built with thick steel plates and reinforced fabrications to make them less susceptible to damage, and all have curved surfaces that match the machine's sleek, smooth appearance along with integrated housings to help protect the standard rearview and side-view cameras.



Serviceable

Designed to make your maintenance quick and easy

Safe, Convenient Access

You can reach most routine maintenance items like fluid taps and grease points from the safety and convenience of ground level. You will also find filters banked together for higher service efficiency. Compartments feature wide service doors designed to help prevent debris entry, and they also securely latch in place to help make your service work simpler.

A Cool Design

The high-ambient cooling system features a fuel-saving variable-speed fan and a side-by-side-mounted radiator and oil and air coolers for easy cleaning. Wider clearance between the two makes blowing off debris easy for you, which can help improve your machine's reliability and performance.

A Fresh Idea

When you select ventilation inside the cab, outside air enters through the fresh air filter. The filter is conveniently located on the side of the cab to make it easy to reach and replace, and it is protected by a lockable door that can be opened with the engine key.

More Service Benefits

Filters are banked together to enhance service efficiency. The fuel tank's drain cock makes it easy and simple for you to remove water and sediment during routine maintenance. Plus an integrated fuel level indicator pops up to help you reduce the possibility of fuel tank overfilling.

Smart Refuel

Smart refuel is an on-board pump system that lets you fill the machine quickly from an external source like a fuel drum. What's smart about it is that it automatically stops when the fuel tank is full or the fuel source is empty, eliminating guess work and premature pump wear.

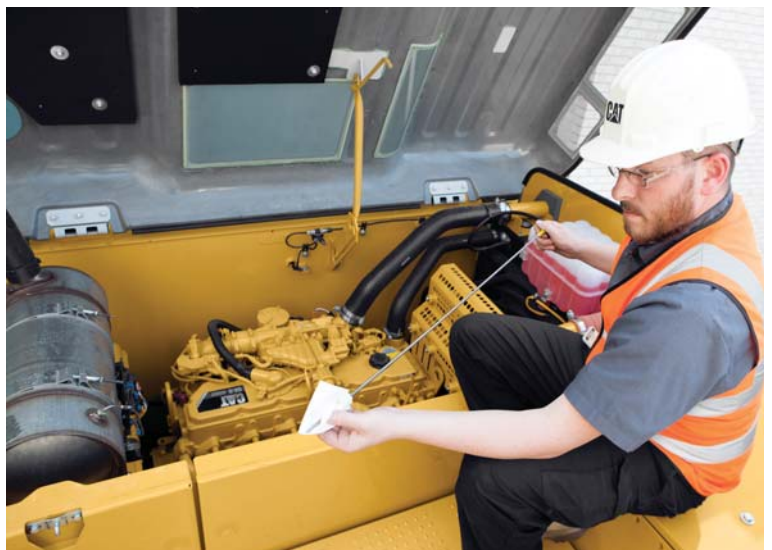
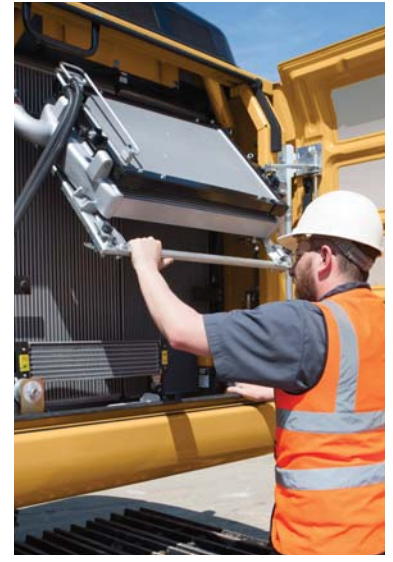

Safe Work Environment

Features to help protect you day in and day out



A Safe, Quiet Cab

The ROPS cab provides you with a safe working environment when properly seated and belted. It also contributes to your comfort because it's attached to a reinforced frame with special viscous mounts that limit vibration and unnecessary sound. Add in special roof lining and sealing and you have a cab that's as quiet inside as any of today's top pickup trucks.

Secure Contact Points

Multiple large steps get you into the cab as well as a leg up to the compartments. Extended hand and guard rails allow you to safely climb to the upper deck. Anti-skid plates reduce your slipping hazards in all types of weather conditions, and they can be removed for cleaning.

Great Views

Ample glass gives you excellent visibility out front and to the side, and the standard rearview and side-view cameras give you a clear field of view behind and on the boom side of the machine through the cab monitor. The available split-configuration windshield features an upper window with handles that make it easy to slide and store above you and a lower window that can be removed and stored on the inside wall of the cab. The large skylight also serves as an emergency exit and provides you with enhanced overhead visibility.

Smart Lighting

Halogen lights provide plenty of illumination, and the cab and boom lights can be programmed to stay on for up to 90 seconds after the engine has been turned off to help you safely exit the machine.

Attachments

Tools to make you productive and profitable





Get The Most Out Of One Machine

You can easily expand the performance of your machine by utilizing any of the variety of attachments offered by Cat Work Tools.

Change Jobs Quickly & Accurately

CW dedicated or Pin Grabber couplers allow you to switch tools for the job at hand with incredible ease and speed, helping to maximize your uptime. Caterpillar's optional tool control system takes it a step further by adding best-in-class accuracy because it can store the flows and pressures of up to 10 different work tools. Simply select the tool you need through the monitor and go to work – quickly and efficiently.

Dig, Finish, Load & Compact

A wide range of buckets dig everything from top soil to harsh, abrasive material. For finishing and grading work, compact and shallow ditch cleaning buckets fit the need. A Cat compactor prepares the area for the next phase of construction.

Break, Demolish & Scrap

A hydraulic hammer equips your machine for breaking rock in quarries and preparing trenches on construction sites. Taking down bridge pillars and heavily reinforced concrete is no problem. Multi-processor, pulverizer, and shear attachments take your machine into structure demolition jobs and process the debris for reuse and recycle.

Move & Handle

For constant material handling, a grapple is your solution. Choose from three different styles for picking, sorting, and loading trash, demolition debris, or recyclables.

Set Up Your Machine For Profitability

Your Cat dealer can install hydraulic kits to properly operate all Cat Work Tool attachments – maximizing the machine's uptime and your profits. All Cat Work Tool attachments are supported by the same Cat dealer network as your Cat machine.



1) CW Dedicated Quick Coupler 2) Pin Grabber Coupler
3) Cat General Duty (GD) 4) Heavy Duty (HD)
5) Severe Duty (SD) 6) Extreme Duty (XD)



Sustainability

Generations ahead in every way

- The C7.1 ACERT engine meets Stage IV emission standards.
- The 323F L burns less fuel than the 323E L model it replaces resulting in reduced emissions.
- Cat Grade Control Depth and Slope is standard, improving job site efficiency.
- The machine has the flexibility of running on either ultra-low-sulfur diesel (ULSD) fuel with 10 ppm of sulfur or less or biodiesel (up to B20) fuel blended with ULSD.
- A ground-level overfill indicator rises when the tank is full to help the operator avoid spilling.
- The QuickEvac™ option ensures fast, easy, and secure changing of engine and hydraulic oil.
- The machine is built to be rebuilt with major structures and components capable of being remanufactured to reduce waste and replacement costs.
- Overall, the 323F L is an efficient, productive machine that's designed to conserve our natural resources for generations ahead.

Complete Customer Care

Support you can count on

Worldwide Parts Availability

Cat dealers utilize a worldwide parts network to maximize your machines' uptime. Plus they can help you save money with Cat remanufactured components.

Financial Options Just For You

Consider financing options and day-to-day operating costs. Look at dealer services that can be included in the machine's cost to yield lower owning and operating costs over time.

Support Agreements To Fit Your Needs

Cat dealers offer a variety of customer support agreements and work with you to develop a plan to meet your specific needs. These plans can cover the entire machine, including attachments, to help protect your investment.

What's Best For You Today...And Tomorrow

Repair, rebuild, or replace? Your Cat dealer can help you evaluate the cost involved so you can make the best choice for your business.



323F L Hydraulic Excavator Specifications

Engine

Engine Model	Cat C7.1 ACERT	
Net Power – ISO 9249	120 kW	161 PS
Power – ISO 14396	122 kW	164 PS
Engine rpm		
Operation	1,500 rpm	
Travel	1,800 rpm	
Bore	105 mm	
Stroke	135 mm	
Displacement	7.1 L	

- The 323F L meets Stage IV emission standards.
- No engine power derating required below 3000 m altitude.
- Power rating at 1,800 rpm.

Weights

Minimum Operating Weight	22 600 kg
• 4.1 t Counterweight, R5.7 m Boom, R2.5 m Stick, GD 1.3 m ³ Bucket (kg), 600 mm HD TG Track Shoes.	
Maximum Operating Weight	25 700 kg
• 5.35 t Counterweight, VA Boom, R2.9 m Stick, GD 1.3 m ³ Bucket (kg), 790 mm HD TG Track Shoes.	

Track

Track Options	600, 700, 790 mm
Number of Shoes (each side)	49
Number of Track Rollers (each side)	8
Number of Carrier Rollers (each side)	2

Swing Mechanism

Swing Speed	11.0 rpm
Maximum Swing Torque	72 kN·m

Drive

Maximum Gradeability	35°/70%
Maximum Travel Speed	5.5 km/h
Maximum Drawbar Pull	205 kN

Hydraulic System

Main System	
Maximum Flow (2 pumps)	2 × 212 L/min
Maximum Pressure – Equipment/Travel	35 000 kPa
Maximum Pressure – Equipment – Heavy Lift Mode	38 000 kPa
Maximum Pressure – Swing	25 500 kPa
Pilot System Maximum Flow for Implement	20 L/min
Pilot System Maximum Pressure	3920 kPa
Boom Cylinder – Bore	120 mm
Boom Cylinder – Stroke	1260 mm
Stick Cylinder – Bore	140 mm
Stick Cylinder – Stroke	1504 mm
Bucket Cylinder – Bore	120 mm
Bucket Cylinder – Stroke	1104 mm

Service Refill Capacities

Fuel Tank Capacity	410 L
Cooling System	30 L
Engine Oil	25 L
Swing Drive (each)	8 L
Final Drive (each)	8 L
Hydraulic System (including tank)	260 L
Hydraulic Tank	159 L
DEF Tank	20 L

Sound Performance

Exterior Sound Power Level (ISO 6395)	100 dB(A)
Interior Sound Pressure Level (ISO 6396)	68 dB(A)

- When properly installed and maintained, the cab offered by Caterpillar, when tested with doors and windows closed according to ANSI/SAE J1166 OCT98, meets the requirements for operator sound exposure limits in effect at time of manufacture.
- Hearing protection may be needed when operating with an open operator station and cab (when not properly maintained or doors/windows open) for extended periods or in a noisy environment.

Standards

Brakes	ISO 10265 2008
Cab/FOGS	ISO 10262 1998
Cab/ROPS	ISO 12117-2 2008

323F L Hydraulic Excavator Specifications

Dimensions

All dimensions are approximate.

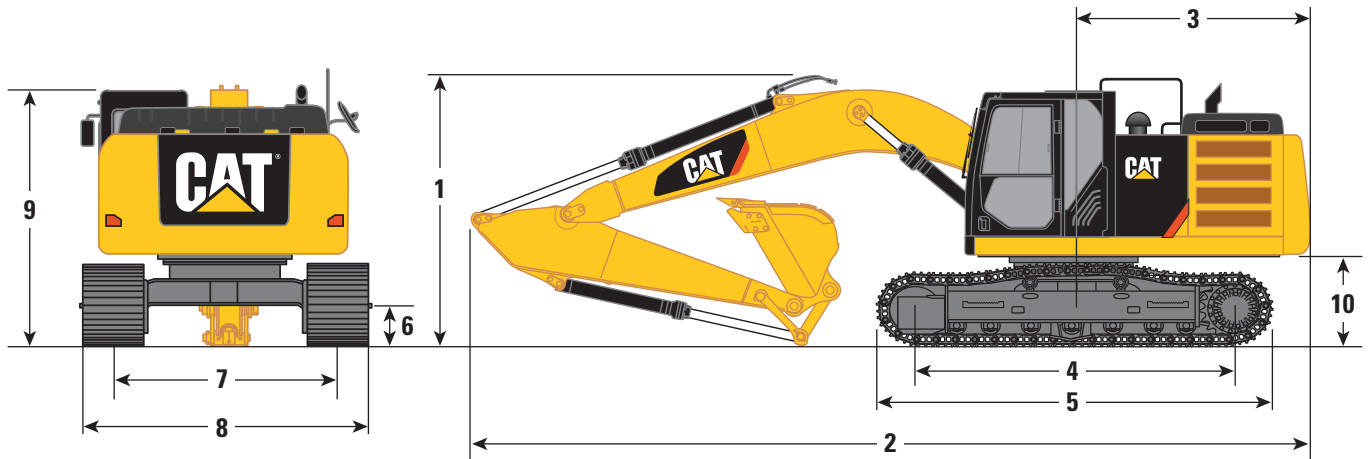

Boom Options	HD Reach Boom 5.7 m		Variable Angle Boom 2.4 m Stub 3.3 m Fore		Super Long Reach 8.85 m
	R2.9	R2.5	R2.9	R2.5	SLR 6.28 m
Stick Options					
1 Shipping Height	3130 mm	3050 mm	3010 mm	3020 mm	3210 mm
2 Shipping Length	9540 mm	9450 mm	9780 mm	9820 mm	12 750 mm
3 Tail Swing Radius	2830 mm	2830 mm	2830 mm	2830 mm	2830 mm
4 Length to Center of Rollers – Long Undercarriage	3650 mm	3650 mm	3650 mm	3650 mm	3650 mm
5 Track Length – Long Undercarriage	4460 mm	4460 mm	4460 mm	4460 mm	4460 mm
6 Ground Clearance	450 mm	450 mm	450 mm	450 mm	450 mm
7 Track Gauge – Long Undercarriage (shipping)	2380 mm	2380 mm	2380 mm	2380 mm	2380 mm
8 Transport Width – Long Undercarriage					
600 mm Shoes	2980 mm	2980 mm	2980 mm	2980 mm	2980 mm
700 mm Shoes	3080 mm	3080 mm	3080 mm	3080 mm	3080 mm
790 mm Shoes	3170 mm	3170 mm	3170 mm	3170 mm	3170 mm
9 Handrail Height	3010 mm	3010 mm	3010 mm	3010 mm	3010 mm
10 Counterweight Clearance	1020 mm	1020 mm	1020 mm	1020 mm	1020 mm
Bucket Type	GD	GD	GD	GD	GD
Bucket Capacity	1.30 m ³	1.30 m ³	1.30 m ³	1.30 m ³	0.53 m ³
Bucket Tip Radius	1560 mm	1560 mm	1560 mm	1560 mm	1230 mm

Dimensions may vary depending on bucket selection.

323F L Hydraulic Excavator Specifications

Working Ranges

All dimensions are approximate.

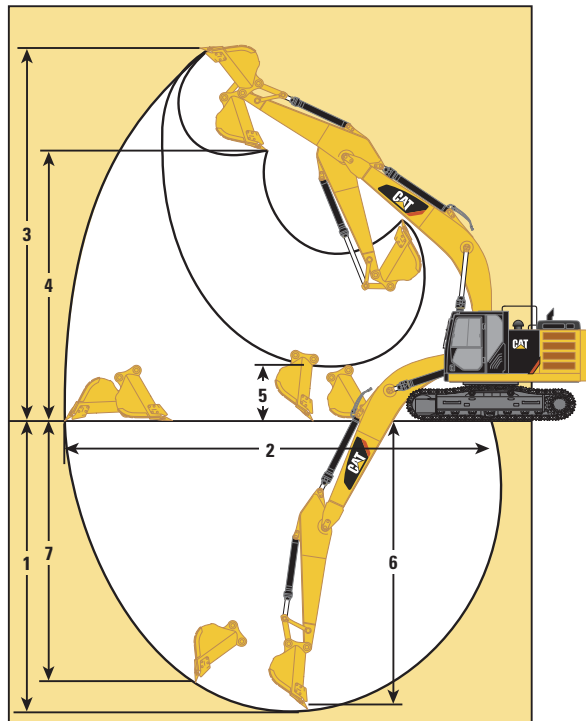

Boom Options	HD Reach Boom 5.7 m		Variable Angle Boom 2.4 m Stub/3.3 m Fore	
Stick Options	R2.9	R2.5	R2.9	R2.5
1 Maximum Digging Depth	6710 mm	6290 mm	6680 mm	6270 mm
2 Maximum Reach at Ground Line	9850 mm	9450 mm	10 200 mm	9800 mm
3 Maximum Cutting Height	9450 mm	9240 mm	11 520 mm	11 180 mm
4 Maximum Loading Height	6500 mm	6300 mm	8410 mm	8070 mm
5 Minimum Loading Height	2180 mm	2600 mm	3270 mm	3670 mm
6 Maximum Depth Cut for 2440 mm Level Bottom	6540 mm	6100 mm	6580 mm	6170 mm
7 Maximum Vertical Wall Digging Depth	5610 mm	5210 mm	5290 mm	4890 mm
Bucket Digging Force (ISO)	140 kN	140 kN	140 kN	140 kN
Stick Digging Force (ISO)	107 kN	118 kN	107 kN	118 kN
Bucket Type	GD	GD	GD	GD
Bucket Capacity	1.3 m ³	1.3 m ³	1.3 m ³	1.3 m ³
Bucket Tip Radius	1560 mm	1560 mm	1560 mm	1560 mm

Dimensions may vary depending on bucket selection.

323F L Hydraulic Excavator Specifications

Working Ranges

All dimensions are approximate.

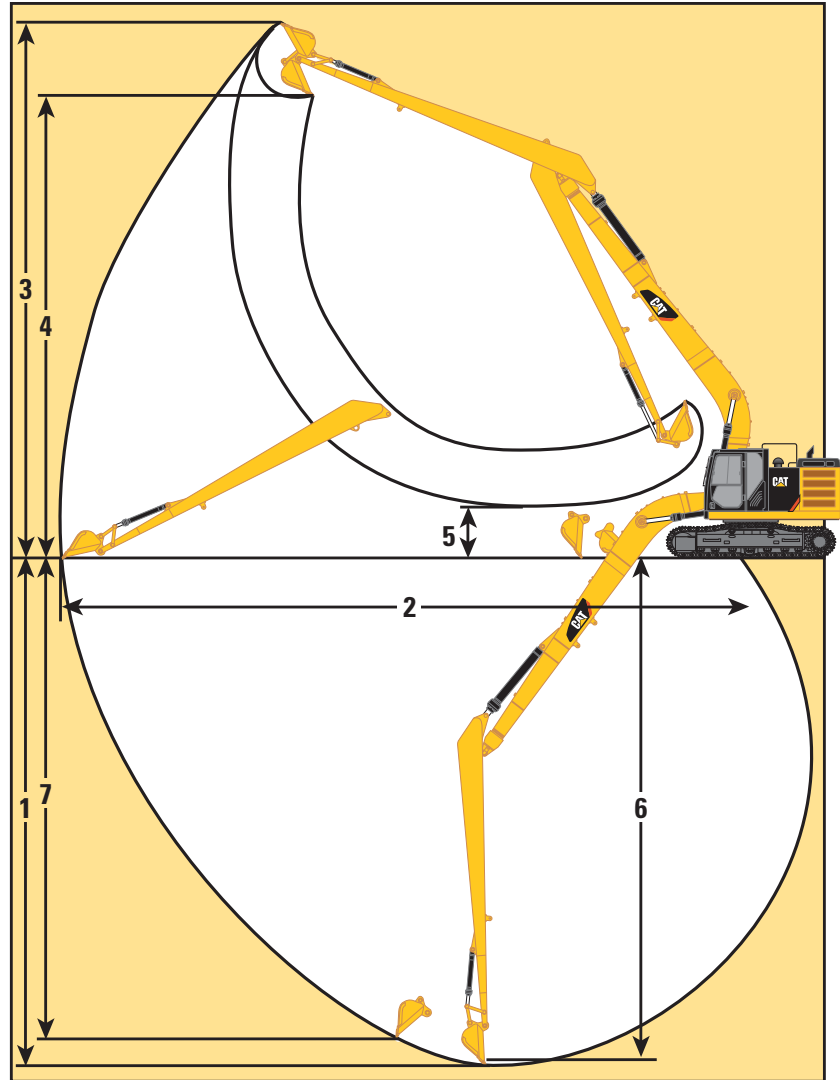

Boom Option

Super Long Reach Boom

8.85 m

Stick Option

SLR

6.28 m

1 Maximum Digging Depth	11 690 mm
2 Maximum Reach at Ground Level	15 720 mm
3 Maximum Cutting Height	13 590 mm
4 Maximum Loading Height	11 290 mm
5 Minimum Loading Height	2090 mm
6 Maximum Depth Cut for 2440 mm Level Bottom	11 280 mm
7 Maximum Vertical Wall Digging Depth	10 670 mm
Bucket Digging Force (ISO)	61 kN
Stick Digging Force (ISO)	49 kN
Bucket Type	GD
Bucket Capacity	0.53 m ³
Bucket Tip Radius	1230 mm

Dimensions may vary depending on bucket selection.

323F L Hydraulic Excavator Specifications

Operating Weights and Ground Pressures

	790 mm Shoes (HD)		700 mm Shoes (HD)		600 mm Shoes (HD)	
	Weight	Ground Pressure	Weight	Ground Pressure	Weight	Ground Pressure
	kg	kPa	kg	kPa	kg	kPa
4.1 mt Counterweight, R5.7 Boom						
R2.9 Stick, GD 1.3 m ³ Bucket	23 400	37.0	23 100	41.2	22 700	47.2
R2.5 Stick, GD 1.3 m ³ Bucket	23 400	37.0	23 100	41.2	22 600	47.0
5.35 mt Counterweight, R5.7 Boom						
R2.9 Stick, GD 1.3 m ³ Bucket	24 900	39.3	24 600	43.9	24 200	50.3
R2.5 Stick, GD 1.3 m ³ Bucket	24 800	39.2	24 500	43.7	24 100	50.1
5.35 mt Counterweight, VA Boom						
R2.9 Stick, GD 1.3 m ³ Bucket	25 700	40.6	25 400	45.3	25 000	52.0
R2.5 Stick, GD 1.3 m ³ Bucket	25 700	40.6	25 400	45.3	25 000	52.0
4.7 mt Counterweight, SLR Boom						
SLR Stick, GD 0.53 m ³ Bucket	24 600	38.7	24 300	43.1	23 900	49.5

Major Component Weights

	kg
Upper Structure with 4.1 mt Counterweight (for use with Reach boom)	11 190
Upper Structure with 4.7 mt Counterweight (for use with SLR fronts)	11 790
Upper Structure with 5.35 mt Counterweight (for use with Reach/VA booms)	12 650
Lower Structure with 790 mm Triple Grouser HD Shoes	8320
Lower Structure with 700 mm Triple Grouser HD Shoes	8030
Lower Structure with 600 mm Triple Grouser HD Shoes	7620
HD Reach Boom (includes lines, pins, two boom cylinders, stick cylinder)	2010
HD Reach Boom, for use with 5.35 mt Counterweight Configuration (includes lines, pins, two boom cylinders, stick cylinder)	2100
Variable Angle Boom (includes lines, pins, two boom cylinders, VA boom cylinder, stick cylinder)	2880
Super Long Reach Boom (includes lines, pins, two boom cylinders, stick cylinder)	2740
R2.9 Stick (includes lines, pins, bucket cylinder and linkage)	980
R2.5 Stick (includes lines, pins, bucket cylinder and linkage)	960
Super Long Reach Stick (includes lines, pins, bucket cylinder and linkage)	1330
GD 1.3 m ³ Bucket	880
GD 0.53 m ³ Bucket	400

323F L Hydraulic Excavator Specifications

HD Reach Boom Lift Capacities – Counterweight: 4.1 mt – without Bucket – Heavy Lift ON

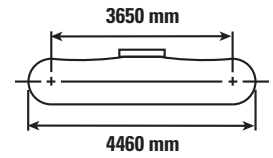
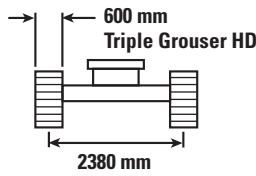
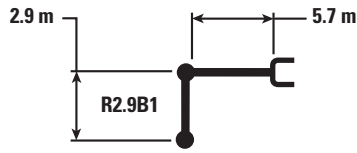

		1500 mm		3000 mm		4500 mm		6000 mm		7500 mm		mm		
7500 mm	kg							*4950	*4950			*4300	*4300	6150
6000 mm	kg							*5400	*5400			*3950	*3950	7290
4500 mm	kg							*5950	5550	*5600	3950	*3900	3550	7990
3000 mm	kg					*8650	8050	*6800	5300	5900	3850	*4000	3250	8360
1500 mm	kg					*10 500	7550	*7750	5050	5750	3700	*4200	3150	8450
0 mm	kg			*6600	*6600	*11 500	7250	7800	4900	5650	3600	*4650	3200	8260
-1500 mm	kg	*7050	*7050	*11 400	*11 400	*11 650	7200	7750	4800	5650	3600	5350	3450	7780
-3000 mm	kg	*12 100	*12 100	*15 450	14 000	*10 900	7250	7800	4850			6350	4050	6950
-4500 mm	kg			*12 350	*12 350	*8850	7450					*6700	5550	5600



ISO 10567



*Indicates that the load is limited by hydraulic lifting capacity rather than tipping load. The above loads are in compliance with hydraulic excavator lift capacity standard ISO 10567:2007. They do not exceed 87% of hydraulic lifting capacity or 75% of tipping load. Weight of all lifting accessories must be deducted from the above lifting capacities. Lifting capacities are based on the machine standing on a firm, uniform supporting surface. The use of a work tool attachment point to handle/lift objects, could affect the machine lift performance.

Lift capacity stays with ±5% for all available track shoes.

Always refer to the appropriate Operation and Maintenance Manual for specific product information.

323F L Hydraulic Excavator Specifications

HD Reach Boom Lift Capacities – Counterweight: 4.1 mt – without Bucket – Heavy Lift ON

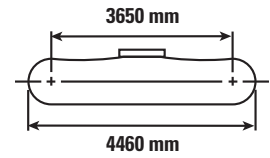
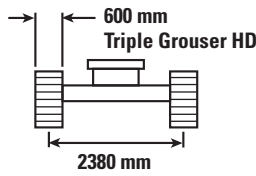
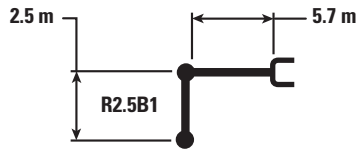

Reach (mm)	Unit	3000 mm		4500 mm		6000 mm		7500 mm		mm		
7500 mm	kg									*5150	*5150	5600
6000 mm	kg					*5850	5600			*4750	4550	6830
4500 mm	kg			*7350	*7350	*6300	5450	*5200	3850	*4650	3800	7570
3000 mm	kg			*9250	7900	*7150	5250	5850	3800	*4750	3450	7960
1500 mm	kg			*10 900	7450	7950	5000	5750	3700	*5050	3350	8050
0 mm	kg			*11 650	7250	7800	4850	5650	3600	5300	3400	7860
-1500 mm	kg	*12 000	*12 000	*11 500	7200	7750	4850			5800	3700	7350
-3000 mm	kg	*14 450	14 100	*10 500	7300	*7750	4900			*6950	4500	6470
-4500 mm	kg			*7850	7600					*6800	6600	4980



ISO 10567



*Indicates that the load is limited by hydraulic lifting capacity rather than tipping load. The above loads are in compliance with hydraulic excavator lift capacity standard ISO 10567:2007. They do not exceed 87% of hydraulic lifting capacity or 75% of tipping load. Weight of all lifting accessories must be deducted from the above lifting capacities. Lifting capacities are based on the machine standing on a firm, uniform supporting surface. The use of a work tool attachment point to handle/lift objects, could affect the machine lift performance.

Lift capacity stays with ±5% for all available track shoes.

Always refer to the appropriate Operation and Maintenance Manual for specific product information.

323F L Hydraulic Excavator Specifications

HD Reach Boom Lift Capacities – Counterweight: 5.35 mt – without Bucket – Heavy Lift ON

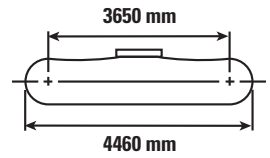
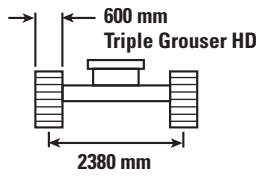
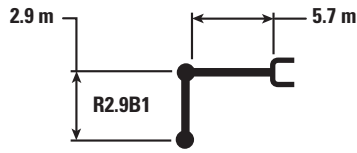

		1500 mm		3000 mm		4500 mm		6000 mm		7500 mm		mm		
7500 mm	kg							*4950	*4950			*4300	*4300	6150
6000 mm	kg							*5400	*5400			*3950	*3950	7290
4500 mm	kg							*5950	*5950	*5600	4550	*3900	*3900	7990
3000 mm	kg					*8650	*8650	*6800	6100	*5950	4450	*4000	3800	8360
1500 mm	kg					*10 500	8700	*7750	5850	*6400	4300	*4200	3650	8450
0 mm	kg			*6600	*6600	*11 500	8450	*8400	5700	6450	4250	*4650	3750	8260
-1500 mm	kg	*7050	*7050	*11 400	*11 400	*11 650	8350	*8600	5600	6400	4200	*5500	4000	7780
-3000 mm	kg	*12 100	*12 100	*15 450	*15 450	*10 900	8400	*8100	5650			*6650	4700	6950
-4500 mm	kg			*12 300	*12 300	*8850	8650					*6700	6400	5600



ISO 10567



*Indicates that the load is limited by hydraulic lifting capacity rather than tipping load. The above loads are in compliance with hydraulic excavator lift capacity standard ISO 10567:2007. They do not exceed 87% of hydraulic lifting capacity or 75% of tipping load. Weight of all lifting accessories must be deducted from the above lifting capacities. Lifting capacities are based on the machine standing on a firm, uniform supporting surface. The use of a work tool attachment point to handle/lift objects, could affect the machine lift performance.

Lift capacity stays with ±5% for all available track shoes.

Always refer to the appropriate Operation and Maintenance Manual for specific product information.

323F L Hydraulic Excavator Specifications

HD Reach Boom Lift Capacities – Counterweight: 5.35 mt – without Bucket – Heavy Lift ON

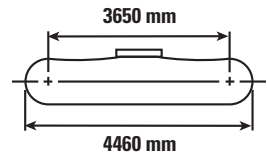
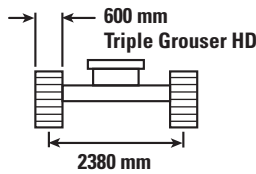
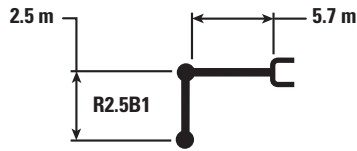

Reach (mm)	Unit	3000 mm		4500 mm		6000 mm		7500 mm		mm		
												mm
7500 mm	kg									*5150	*5150	5600
6000 mm	kg					*5850	*5850			*4750	*4750	6830
4500 mm	kg			*7350	*7350	*6300	6250	*5200	4450	*4650	4400	7570
3000 mm	kg			*9250	9050	*7150	6050	*6200	4400	*4750	4000	7960
1500 mm	kg			*10 900	8600	*8000	5800	6500	4300	*5050	3900	8050
0 mm	kg			*11 650	8400	*8550	5650	6400	4250	*5650	4000	7860
-1500 mm	kg	*12 000	*12 000	*11 500	8350	*8550	5600			6600	4350	7350
-3000 mm	kg	*14 450	*14 450	*10 500	8450	*7750	5700			*6950	5200	6470
-4500 mm	kg			*7850	*7850					*6800	*6800	4980



ISO 10567



*Indicates that the load is limited by hydraulic lifting capacity rather than tipping load. The above loads are in compliance with hydraulic excavator lift capacity standard ISO 10567:2007. They do not exceed 87% of hydraulic lifting capacity or 75% of tipping load. Weight of all lifting accessories must be deducted from the above lifting capacities. Lifting capacities are based on the machine standing on a firm, uniform supporting surface. The use of a work tool attachment point to handle/lift objects, could affect the machine lift performance.

Lift capacity stays with $\pm 5\%$ for all available track shoes.

Always refer to the appropriate Operation and Maintenance Manual for specific product information.

323F L Hydraulic Excavator Specifications

Variable Angle Boom Lift Capacities – Counterweight: 5.35 mt – without Bucket – Heavy Lift ON

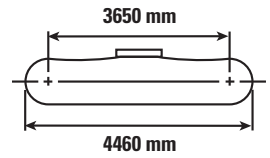
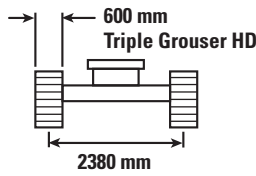
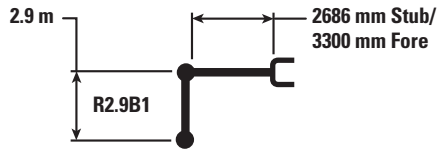

		1500 mm		3000 mm		4500 mm		6000 mm		7500 mm		mm		
9000 mm	kg					*5400	*5400					*5450	*5450	4880
7500 mm	kg					*7400	*7400	*4600	*4600			*4650	*4650	6620
6000 mm	kg					*7500	*7500	*5200	*5200	*4400	*4400	*4350	4300	7690
4500 mm	kg			*11 600	*11 600	*7300	*7300	*5200	*5200	*4450	4400	*4250	3700	8350
3000 mm	kg			*11 000	*11 000	*7050	*7050	*5200	*5200	*4700	4250	*4300	3400	8710
1500 mm	kg			*6600	*6600	*7650	*7650	*5900	5600	*5250	4100	*4500	3250	8790
0 mm	kg	*7350	*7350	*6000	*6000	*9950	7950	*6850	5350	*5900	4000	*4900	3300	8610
-1500 mm	kg	*9050	*9050	*9300	*9300	*11 200	7850	*8300	5300	6200	3950	*5450	3550	8160
-3000 mm	kg	*14 300	*14 300	*12 800	*12 800	*8850	8000	*6900	5350			*4800	4150	7340
-4500 mm	kg	*22 350	*22 350	*13 100	*13 100	*8350	8250					*6950	6500	5350



ISO 10567



*Indicates that the load is limited by hydraulic lifting capacity rather than tipping load. The above loads are in compliance with hydraulic excavator lift capacity standard ISO 10567:2007. They do not exceed 87% of hydraulic lifting capacity or 75% of tipping load. Weight of all lifting accessories must be deducted from the above lifting capacities. Lifting capacities are based on the machine standing on a firm, uniform supporting surface. The use of a work tool attachment point to handle/lift objects, could affect the machine lift performance. VA cylinder is flexible.

Lift capacity stays with ±5% for all available track shoes.

Always refer to the appropriate Operation and Maintenance Manual for specific product information.

323F L Hydraulic Excavator Specifications

Variable Angle Boom Lift Capacities – Counterweight: 5.35 mt – without Bucket – Heavy Lift ON

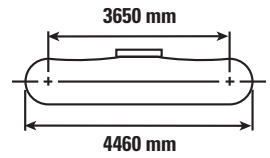
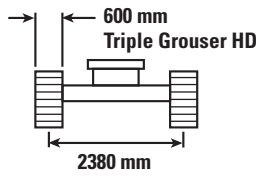
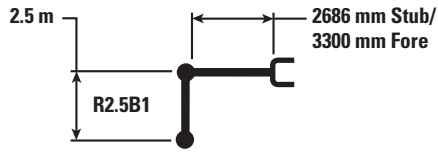

		1500 mm		3000 mm		4500 mm		6000 mm		7500 mm		mm		
9000 mm	kg											*6700	*6700	4110
7500 mm	kg					*7500	*7500	*5600	*5600			*5500	*5500	6080
6000 mm	kg					*7500	*7500	*5200	*5200			*5050	4650	7230
4500 mm	kg			*11 400	*11 400	*7300	*7300	*5050	*5050	*5100	4350	*4950	3950	7930
3000 mm	kg			*10 200	*10 200	*7100	*7100	*5500	*5500	*5350	4200	*5050	3600	8300
1500 mm	kg			*7450	*7450	*8250	8150	*6200	5500	*6100	4050	*5300	3500	8390
0 mm	kg	*10 200	*10 200	*6700	*6700	*10 700	7900	*7200	5350	6250	4000	5550	3550	8210
-1500 mm	kg	*11 300	*11 300	*10 250	*10 250	*10 550	7900	*8300	5300	*6050	4000	*5600	3850	7720
-3000 mm	kg	*17 550	*17 550	*13 050	*13 050	*8300	8050	*6200	5400			*5350	4650	6770
-4500 mm	kg	*24 300	*24 300	*13 350	*13 350							*9350	*9350	4140



ISO 10567



*Indicates that the load is limited by hydraulic lifting capacity rather than tipping load. The above loads are in compliance with hydraulic excavator lift capacity standard ISO 10567:2007. They do not exceed 87% of hydraulic lifting capacity or 75% of tipping load. Weight of all lifting accessories must be deducted from the above lifting capacities. Lifting capacities are based on the machine standing on a firm, uniform supporting surface. The use of a work tool attachment point to handle/lift objects, could affect the machine lift performance. VA cylinder is flexible.

Lift capacity stays with ±5% for all available track shoes.

Always refer to the appropriate Operation and Maintenance Manual for specific product information.

323F L Hydraulic Excavator Specifications

Super Long Reach Boom Lift Capacities – Counterweight: 4.7 mt – without Bucket – Heavy Lift OFF

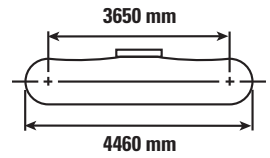
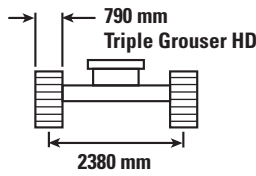
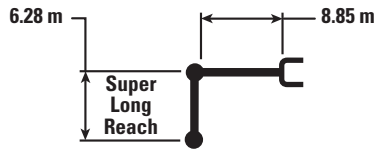

Reach (mm)	Unit	1500 mm		3000 mm		4500 mm		6000 mm		7500 mm		mm		
12 000 mm	kg											*1250	*1250	10 350
10 500 mm	kg											*1150	*1150	11 660
9000 mm	kg											*1100	*1100	12 660
7500 mm	kg											*1100	*1100	13 410
6000 mm	kg											*1100	*1100	13 970
4500 mm	kg											*1100	*1100	14 340
3000 mm	kg			*4700	*4700	*6050	*6050	*4450	*4450	*3650	*3650	*1150	*1150	14 550
1500 mm	kg					*6750	*6750	*5300	4950	*4150	3650	*1200	*1200	14 600
0 mm	kg			*2000	*2000	*4650	*4650	*5900	4500	*4550	3350	*1250	*1250	14 490
-1500 mm	kg	*2050	*2050	*2700	*2700	*4650	*4650	*6300	4200	*4850	3150	*1350	1300	14 230
-3000 mm	kg	*2850	*2850	*3500	*3500	*5200	*5200	*6450	4100	*5050	3050	*1500	1350	13 790
-4500 mm	kg	*3650	*3650	*4400	*4400	*6050	*6050	*6450	4050	*5050	3000	*1700	1400	13 170
-6000 mm	kg	*4550	*4550	*5400	*5400	*7200	6250	*6200	4100	*4950	3000	*2000	1600	12 340
-7500 mm	kg	*5500	*5500	*6550	*6550	*7350	6450	*5700	4200	*4600	3100	*2500	1850	11 240
-9000 mm	kg			*7950	*7950	*6200	*6200	*4900	4400	*3950	3200	*2700	2300	9800



ISO 10567



*Indicates that the load is limited by hydraulic lifting capacity rather than tipping load. The above loads are in compliance with hydraulic excavator lift capacity standard ISO 10567:2007. They do not exceed 87% of hydraulic lifting capacity or 75% of tipping load. Weight of all lifting accessories must be deducted from the above lifting capacities. Lifting capacities are based on the machine standing on a firm, uniform supporting surface. The use of a work tool attachment point to handle/lift objects, could affect the machine lift performance.

Lift capacity stays with ±5% for all available track shoes.

Always refer to the appropriate Operation and Maintenance Manual for specific product information.

323F L Hydraulic Excavator Specifications

Super Long Reach Boom Lift Capacities – Counterweight: 4.7 mt – without Bucket – Heavy Lift OFF

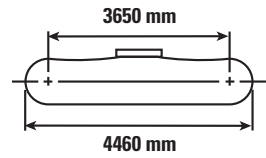
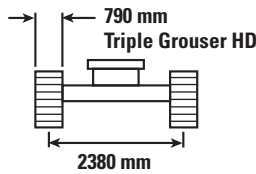
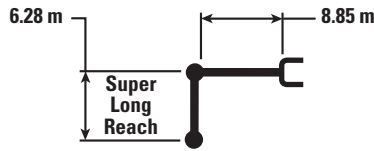

Reach (mm)	Unit	9000 mm		10 500 mm		12 000 mm		13 500 mm		mm		
12 000 mm	kg									*1250	*1250	10 350
10 500 mm	kg			*2200	*2200					*1150	*1150	11 660
9000 mm	kg			*2200	*2200	*2000	*2000			*1100	*1100	12 660
7500 mm	kg			*2250	*2250	*2250	2150			*1100	*1100	13 410
6000 mm	kg			*2400	*2400	*2300	2100	*1850	1650	*1100	*1100	13 970
4500 mm	kg	*2800	*2800	*2600	2550	*2400	2000	*2300	1600	*1100	*1100	14 340
3000 mm	kg	*3150	3050	*2800	2400	*2550	1900	*2400	1550	*1150	*1150	14 550
1500 mm	kg	*3450	2850	*3000	2250	*2700	1800	2450	1500	*1200	*1200	14 600
0 mm	kg	*3750	2650	*3200	2100	*2850	1750	2400	1450	*1250	*1250	14 490
-1500 mm	kg	*3950	2500	3350	2000	2750	1650	2350	1400	*1350	1300	14 230
-3000 mm	kg	4050	2400	3250	1950	2750	1600	*2300	1350	*1500	1350	13 790
-4500 mm	kg	4000	2350	3250	1900	2700	1600			*1700	1400	13 170
-6000 mm	kg	4000	2350	3250	1950	2750	1650			*2000	1600	12 340
-7500 mm	kg	*3750	2400	*3050	2000					*2500	1850	11 240
-9000 mm	kg	*3150	2550							*2700	2300	9800



ISO 10567



*Indicates that the load is limited by hydraulic lifting capacity rather than tipping load. The above loads are in compliance with hydraulic excavator lift capacity standard ISO 10567:2007. They do not exceed 87% of hydraulic lifting capacity or 75% of tipping load. Weight of all lifting accessories must be deducted from the above lifting capacities. Lifting capacities are based on the machine standing on a firm, uniform supporting surface. The use of a work tool attachment point to handle/lift objects, could affect the machine lift performance.

Lift capacity stays with ±5% for all available track shoes.

Always refer to the appropriate Operation and Maintenance Manual for specific product information.

323F L Hydraulic Excavator Specifications

Work Tool Offering Guide*

Boom Type	Reach Boom		Reach Boom		Variable Angle Boom		Variable Angle Boom	
Stick Type	R2.5		R2.9		R2.5		R2.9	
Counterweight	4100 kg	5350 kg	4100 kg	5350 kg	4100 kg	5350 kg	4100 kg	5350 kg
Hydraulic Hammer					H120Es H130Es			
Multi-Processor					MP318 CC Jaw MP318 D Jaw MP318 P Jaw MP318 U Jaw MP318 S Jaw			
Crusher					P315			
Pulverizer					P215			
Demolition and Sorting Grapple (D – Demolition shells, R – Recycling shells, WH – Waste Handling shells, fixed CAN – fixed hinge plates for CW quick coupler usage)	G320B- D/R	G320B- D/R			G315B-D/R G315B-WH G315B-D/R fixed CAN G320B- D/R	G320B- D/R	G320B- D/R	G320B- D/R
Scrap and Demolition Shear	S340B	S340B	S340B	S340B	S320B S325B			
Compactor (Vibratory Plate)					CVP110			
Orange Peel Grapple								
Pin Grabber Coupler	Cat-PG							
Dedicated Quick Coupler	CW-40 CW-40s CWAC-40 (autoconnect)							

These work tools are available for the 323F L.
Consult your Cat dealer for proper match.

*Matches are dependent on excavator configurations. Consult your Cat dealer to determine what is offered in your area and for proper work tool match.

323F L Hydraulic Excavator Specifications

Bucket Specifications and Compatibility

Shoes						600 mm TG				600 mm TG		600 mm TG	
Counterweight						4.1 mt		5.35 mt		5.35 mt		4.7 mt	
Boom						Reach				Variable Angle		Super Long Reach	
	Linkage	Width	Capacity	Weight	Fill	R2.5	R2.9	R2.5	R2.9	R2.5	R2.9	R6.3	
		mm	m ³	kg	%								
Without Quick Coupler													
Cat General Duty (GD)	B	600	0.46	549	100%	●	●	●	●	●	●		
	B	750	0.64	620	100%	●	●	●	●	●	●		
	B	900	0.81	666	100%	●	●	●	●	●	●		
	B	1200	1.19	800	100%	●	●	●	●	●	●		
	B	1300	1.30	832	100%	●	⊙	●	●	●	⊙		
	B	1400	1.43	867	100%	⊙	⊖	●	●	⊙	⊙		
Heavy Duty (HD)	B	1200	1.19	906	100%	●	●	●	●	●	●		
	B	1200	1.19	917	100%	●	⊙	●	●	●	●		
	B	1200	1.19	970	100%	●	⊙	●	●	●	●		
	B	1300	1.30	960	100%	⊙	⊙	●	●	●	⊙		
Severe Duty (SD)	B	1050	1.00	962	90%	●	●	●	●	●	●		
Cat General Duty (GD)	A	900	0.53	403	100%							◇	
Ditch Cleaning (DC)	A	1200	0.57	388	100%							◇	
Maximum load pin-on (payload + bucket)						kg	3539	3291	4160	3878	3595	3355	917
With Pin Grabber Coupler													
Cat General Duty (GD)	B	600	0.46	549	100%	●	●	●	●	●	●		
	B	750	0.64	620	100%	●	●	●	●	●	●		
	B	900	0.81	666	100%	●	●	●	●	●	●		
	B	1200	1.19	800	100%	⊙	⊙	●	●	●	⊙		
	B	1300	1.30	832	100%	⊙	⊖	●	●	⊙	⊖		
	B	1400	1.43	867	100%	⊖	○	●	⊙	⊖	⊖		
Heavy Duty (HD)	B	1050	1.00	879	100%	●	●	●	●	●	●		
	B	1200	1.19	906	100%	⊙	⊖	●	●	⊙	⊙		
	B	1200	1.19	917	100%	⊙	⊖	●	●	⊙	⊖		
	B	1200	1.19	970	100%	⊙	⊖	●	●	⊙	⊖		
	B	1300	1.30	960	100%	⊖	⊖	●	⊙	⊖	⊖		
Severe Duty (SD)	B	1050	1.00	962	90%	●	●	●	●	●	●		
Maximum load pin-on (payload + bucket)						kg	3129	2881	3750	3468	3185	2945	507
With Quick Coupler (CW40, CW40s)													
Cat General Duty (GD)	B	600	0.46	502	100%	●	●	●	●	●	●		
	B	750	0.64	587	100%	●	●	●	●	●	●		
	B	900	0.81	653	100%	●	●	●	●	●	●		
	B	1200	1.19	767	100%	●	⊙	●	●	●	⊙		
	B	1300	1.30	798	100%	⊙	⊙	●	●	⊙	⊙		
	B	1400	1.43	834	100%	⊙	⊖	●	⊙	⊙	⊖		
Heavy Duty (HD)	B	600	0.46	584	100%	●	●	●	●	●	●		
	B	1200	1.19	873	100%	●	⊙	●	●	●	⊙		
	B	1300	1.30	927	100%	⊙	⊖	●	●	⊙	⊖		
Maximum load with coupler (payload + bucket)						kg	3287	3039	3908	3626	3343	3103	665

Maximum Material Density:

- 2100 kg/m³
- ⊙ 1800 kg/m³
- ⊖ 1500 kg/m³
- 1200 kg/m³
- ◇ 900 kg/m³

The above loads are in compliance with hydraulic excavator standard EN474, they do not exceed 87% of hydraulic lifting capacity or 75% of tipping capacity with front linkage fully extended at ground line with bucket curled.

Capacity based on ISO 7451.

Bucket weight with Cat General Duty tips.

Caterpillar recommends using appropriate work tools to maximize the value customers receive from our products. Use of work tools, including buckets, which are outside of Caterpillar's recommendations or specifications for weight, dimensions, flows, pressures, etc. may result in less-than-optimal performance, including but not limited to reductions in production, stability, reliability, and component durability. Improper use of a work tool resulting in sweeping, prying, twisting and/or catching of heavy loads will reduce the life of the boom and stick.

323F L Standard Equipment

Standard Equipment

Standard equipment may vary. Consult your Cat dealer for details.

ENGINE

- C7.1 ACERT
- Meets Stage IV emission standards
- 4600 m altitude capability with derate from 3000 m
- One touch low idle with automatic engine speed control
- Electric refueling pump with auto shut off
- Radial seal air filter
- Air precleaner
- Side-by-side cooling system
- Standard, economy and high power modes
- Two-speed travel
- 52° C high ambient cooling capability, with derate from 48° C
- Variable fan speed control with viscous clutch
- Three stage fuel filtration system with water separator and indicator

HYDRAULIC SYSTEM

- Electric boom regeneration circuit
- Stick regeneration circuit
- Reverse swing dampening valve
- High-performance hydraulic return filter
- Capability of installing additional auxiliary circuits
- Up to B20 bio oil capable
- Heavy lift mode

CAB

- ROPS certified cab
- Mirrors
- Pressurized operator station with positive filtration
- Laminated glass front upper window and tempered other windows
- Sliding upper door window (left-hand cab door)
- Removable lower windshield with in cab storage bracket
- Openable skylight as emergency exit

- Interior:
 - Glass-breaking safety hammer
 - Coat hook
 - Beverage holder
 - Literature holder
 - Interior lighting
 - AM/FM radio mounting (DIN size)
 - Two 12V stereo speakers
 - Storage shelf suitable for lunch or toolbox
 - Power supply with 12V, two power outlets (10 amp)
 - Thumb wheel modulation joystick for use with combined auxiliary control
 - Sun screen
 - Straight travel pedal
 - Air conditioner, heater and defroster with climate control
- Seat:
 - Seat belt, 50 mm
 - Adjustable armrest
 - Height adjustable joystick consoles
 - Neutral lever (lock out) for all controls
 - Travel control pedals with removable hand levers
 - Capability of installing two additional pedals
 - Two speed travel
 - Floor mat, washable
 - Adjustable high-back, heated seat with air suspension
- Monitor:
 - Clock
 - Video ready
 - Color LCD display with warning, filter/fluid change, and working hour information
 - Language display (full graphic and full color display)
 - Machine condition, error code and tool mode setting information
 - Start-up level check for engine oil, engine coolant and hydraulic oil
 - Warning, filter/fluid change and working hour information
 - Fuel consumption meter
- Windshield:
 - 70-30 split, sliding, removable lower windshield with in cab storage bracket
 - One piece front windshield

UNDERCARRIAGE/UPPERFRAME

- Grease Lubricated Track resin seal
- Heavy duty track rollers
- Swivel guard
- Heavy duty bottom guard

ELECTRICAL

- 115 amp alternator
- Circuit breaker
- Capability to electrically connect a beacon
- Standard battery, maintenance free

INTEGRATED TECHNOLOGIES

- Product Link
- Cat Grade Control Depth and Slope

SERVICE & MAINTENANCE

- Engine oil, fuel, and hydraulic oil filters grouped for ease of maintenance
- Sampling ports for Scheduled Oil Sampling (S·O·SSM)
- Tilt-up air-to-air aftercooler (ATAAC) and swing-out type A/C condenser for easy maintenance

SAFETY

- Integrated rearview and RH side-view cameras (ISO 5006)
- RH hand rail (ISO 2867) and RH side mirrors
- Anti-skid plates on service platform
- Neutral lever (lock out) for all controls
- Engine shut off switch in cab, ground level accessible
- Signaling/warning horn
- Safety hammer for cab evacuation

Optional Equipment

Optional equipment may vary. Consult your Cat dealer for details.

ENGINE/HYDRAULICS

- Preventive maintenance, quick drains, engine and hydraulic oil (QuickEvac)

ELECTRICAL

- Cold weather starting package, -32° C

HYDRAULIC SYSTEM

- HP hydraulic lines for boom and stick
- MP hydraulic lines for boom and stick
- QC hydraulic lines for boom and stick
- QC control

TRACKS

- 600 mm triple grouser HD shoes
- 700 mm triple grouser HD shoes
- 790 mm triple grouser HD shoes

FRONT LINKAGE

- 5.7 m Reach boom (with BLCV/SLCV/SmartBoom™)
 - R2.9 stick (with or without Cat Grade Control)
 - R2.5 stick (with or without Cat Grade Control)
- VA boom (with BLCV/SLCV/SmartBoom)
 - R2.9 stick
 - R2.5 stick
- Super Long Reach front parts
- Bucket linkage
 - B1 linkage with lifting eye
 - A linkage without lifting eye
- CW dedicated or Pin Grabber quick coupler

GUARDS

- Track guiding guards:
 - Segmented, two pieces
- FOGS capability
- Vandalism guard capability

COUNTERWEIGHT

- 4100 kg or 5350 kg (with Reach fronts)
- 5350 kg (with VA fronts)
- 4700 kg (with SLR fronts)

DEALER INSTALLED KITS AND ATTACHMENTS

- CGC SEA (Software Enabled Attachment)
- Cold weather field installation retrofit kit package
- Rain protector for front windshield
- Seat belt, retractable (50 mm width)
- Seat belt, retractable (76 mm width)
- FOGS retrofit kit package
- Mesh for front guard retrofit kit package
- Mesh guard, lower half front
- Mesh for front guard retrofit package
- Precleaner for aircleaner
- Security system (MSS)
- DEF tank guard
- Side rubber bumper

For more complete information on Cat products, dealer services, and industry solutions, visit us on the web at www.cat.com

© 2016 Caterpillar
All rights reserved

Materials and specifications are subject to change without notice. Featured machines in photos may include additional equipment. See your Cat dealer for available options.

CAT, CATERPILLAR, SAFETY.CAT.COM, their respective logos, "Caterpillar Yellow" and the "Power Edge" trade dress, as well as corporate and product identity used herein, are trademarks of Caterpillar and may not be used without permission.

VisionLink is a trademark of Trimble Navigation Limited, registered in the United States and in other countries.

AEHQ7834-02
Replaces AEHQ7834-01
(EU)

