



# UNIDRIVE M200 & M300

## Manufacturing Automation drives

Flexible machine integration through communications and enhance throughput with Machine Safety for open loop applications



- Unidrive M100
- III → Unidrive M200
- III → Unidrive M300
- Unidrive M400
- Unidrive M600
- Unidrive M700
- Unidrive M800

0.25 kW - 22 kW Heavy Duty  
(0.33 hp - 30 hp)  
100 V | 200 V | 400 V | 575 V



The Unidrive M Manufacturing Automation drive family

## Unidrive M – A Manufacturing Automation drive family tailored to customer needs

Led by the results of extensive customer-driven market research, we have tailored seven Unidrive M feature-sets to specific application needs identified within Manufacturing Automation. The Unidrive M200 adds useful networking capability, additional I/O and improved motor control performance for open loop applications to the family. It also provides an easy upgrade for existing Commander SK users. The Unidrive M300 adds integrated Machine Safety for open loop applications.

For more information on the full Unidrive M family, please download the Unidrive M Overview brochure or the 'Discover Unidrive M' App (available on the App Store, Android and online) via [www.UnidriveM.com](http://www.UnidriveM.com).



# Unidrive M200 and M300 features

M201 variant has additional speed reference potentiometer

Optional AI-485 Adaptor for RS485 communications

Optional AI-Back-up Adaptor allows the drive to use an SD card for parameter cloning and acts as an input for 24 V back-up



LED keypad fitted as standard for quick commissioning and easy use

Optional IP66 rated Remote keypad also available with intuitive plain text multilingual back-lit LCD display for rapid set-up and superior diagnostics

Dual onboard Safe Torque Off (STO) terminals for easy SIL3 conformity (M300 only)

User-friendly control connections

Conventional surface and DIN rail mounting (DIN rail mounting available on size 1 and 2 only)

Drive rated to IP21 / UL open class (NEMA 1) on size 1 to 4 as standard

Conduit kits are available to meet UL Type 1 rating

Easy-to-remove terminal cover with tool-less close system (patent pending)



Easy-to-disconnect internal EMC filter\*

User-friendly power connections\*

Robust cable management system providing grounding point for shielded control and power cables

Typical System Integration (SI) option module

System Integration (SI) module slot for communications and additional I/O

\*Features and their locations vary on some drive sizes

## Unidrive M200 and M300 AC drives at a glance:

### Unidrive M200

#### Flexible machine integration through communications

M200 delivers substantial communication and application integration through optional RS485 plus a wide range of industry standard fieldbus and I/O SI modules. Enhances machine up-time and performance with its remote control monitoring and diagnostics possibilities.

### Unidrive M300

#### Enhance throughput with Machine Safety

M300 helps machine builders maximize up-time and meet modern functional safety standards. Dual onboard Safe Torque Off (STO) inputs offer easy SIL3 conformity and reduce the need for external components, minimizing overall machine dimensions and costs.



#### Enhance productivity through easy integration with automation systems and reduce machine downtime

Unidrive M200 and M300 provide optional RS485 communications and a port for a System Integration (SI) option module. SI modules include Ethernet, EtherCAT, PROFIBUS, DeviceNet and CANopen network communications, and additional I/O. These allow remote control and diagnostics across different networks.

#### Maximize throughput and easily meet machine safety requirements

Unidrive M300 has onboard dual Safe Torque Off (STO) inputs for easy safety system integration, eliminating external components such as contactors. Compliance with SIL3 is simple while machine productivity is enhanced.

#### Maximize productivity with high performance control of AC motors

Unidrive M200 and M300's advanced RFC control algorithm ensures maximum stability and machine control. It provides a

high bandwidth motor control algorithm with 166  $\mu$ s current loop update rates and 180 % motor overload for heavy industrial machinery applications.

#### Robust design

Using extensive customer research, Unidrive M200 and M300 have been designed and tested for leading reliability in manufacturing environments. It features:

- Unique advanced cooling design featuring a patented flow system that helps cool the drive more effectively while protecting internal components
- Conformally coated PCBs
- 180 % overload for 3 s or 150 % for 60 s
- Wide supply voltage tolerance
- Drive meets IP21 as standard
- Higher temperature operation with de-rating
- Intelligent 3 speed user-replaceable cooling fan with patented fan-fail detection circuit



### Quick and easy to install and configure

Unidrive M200 and M300 have a fixed LED keypad as standard and the 10 most commonly used parameters listed on the front of the drive. Software tools, alternative keypads and memory storage devices provide easy and fast access to Unidrive M's machine control features for configuration, monitoring and diagnostics.

### Fast parameter transfer without mains power

For fast, serial machine production the AI-Back-up Adaptor option plugs into the top of the drive to allow configuration settings to be copied without the need to apply mains power. Files are stored on an SD memory card for easy handling.

### Reduce machine size and cost

Unidrive M200 and M300's compact drive dimensions are among the smallest in class at every power rating. They provide a powerful and economical Manufacturing Automation solution.

### Powerful and easy field service and upgrade

The M200 is designed to extend the field service life of previous

generations of products by providing the easiest possible upgrade for OEM machine designs and end user installations which currently use Commander SK drives. Upgrade features include:

- Compatible dimensions
- Support for the import of Commander SK parameter files and drive cloning

### Typical applications:

**M200:** Speed control for conveyors, fans, positive displacement pumps and mixers, where their functions are controlled remotely via fieldbus or Ethernet communications.

**M300:** Speed control for material transport and cutting, woodworking and machine tools where protection to people or assets is required to SIL3.





**Pharmaceutical mixer granulator**

## Power System Flexibility

Unidrive M's power stage enhances flexibility and energy efficiency :

- Low losses, up to 98 % efficient.
- Low power standby mode. In some applications, drives can sit idle for significant periods; M200 and M300's reduced standby power saves energy.
- Intelligently controlled 3-speed cooling fan adjusts to the motor load and environmental conditions. This results in power saving, extended fan life and reduced acoustic noise.
- Silent motor operation with high PWM switching frequencies up to 16 kHz.

Motor control modes include:

Control Mode	Features
Open loop vector or V/Hz induction motor control	Open loop motor control for induction motors, providing good performance and the easiest configuration. V/Hz can be used in multi-motor systems.
<b>Enhanced</b> open loop Rotor Flux Control for induction motors (RFC-A)	High performance speed and torque control through an advanced vector algorithm, utilizing current feedback to greatly enhance performance for all induction motor sizes without the need for a feedback device.



Extensive testing has confirmed that Unidrive M's many innovative and protective design features have enhanced reliability in the most challenging of Manufacturing Automation environments and extended product lifetime.

**Material handling application**

# Unidrive M200 and M300 option choices and terminal layout

## Control Mode

1. Open loop vector or V/Hz induction motor control
2. Open loop Rotor Flux Control for induction motors (RFC-A)

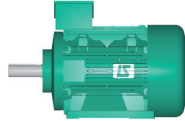

## Input/Output

SI-I/O



- 4 x Digital I/O
- 3 x Analog input (default) / Digital input
- 1 x Analog output (default) / Digital input
- 2 x Relay

Standard



- 3 x Analog I/O
- 5 x Digital I/O
- 2 x STO (M300 only)
- 1 x Relay (size 1 to 4)
- 2 x Relay (size 5 to 9)

## Communications

AI-485 Adaptor



SI-EtherCAT



SI-PROFIBUS



SI-Ethernet



SI-DeviceNet



SI-CANopen



## DC back up power supply



AI-Back-up Adaptor  
(Input for 24 V back-up)

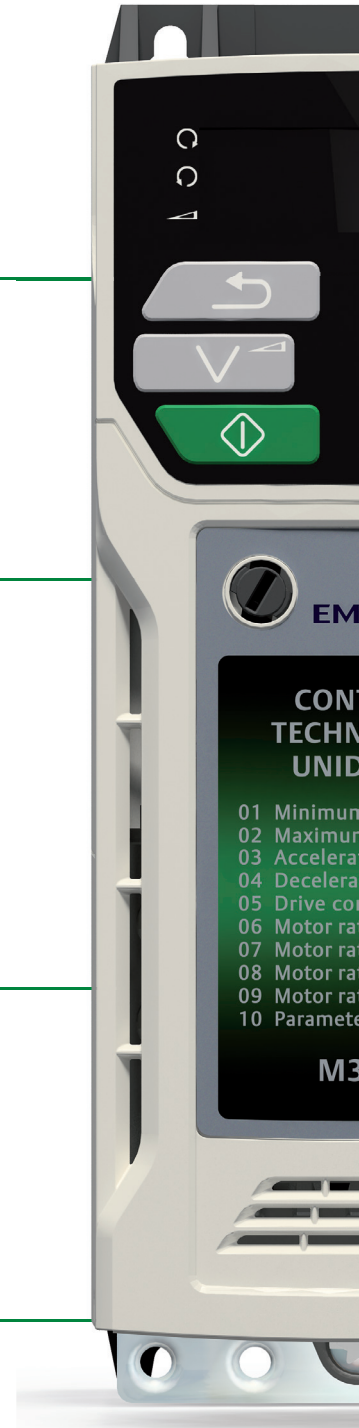





## Optional Drive Programming and Operator Interface

Unidrive M Connect



Fixed LED keypad



M201 - Fixed LED keypad with speed reference potentiometer



Operator Interface



AI-Back-up Adaptor (provides SD card usage)



Remote Keypad (LCD)



## Terminal Layout

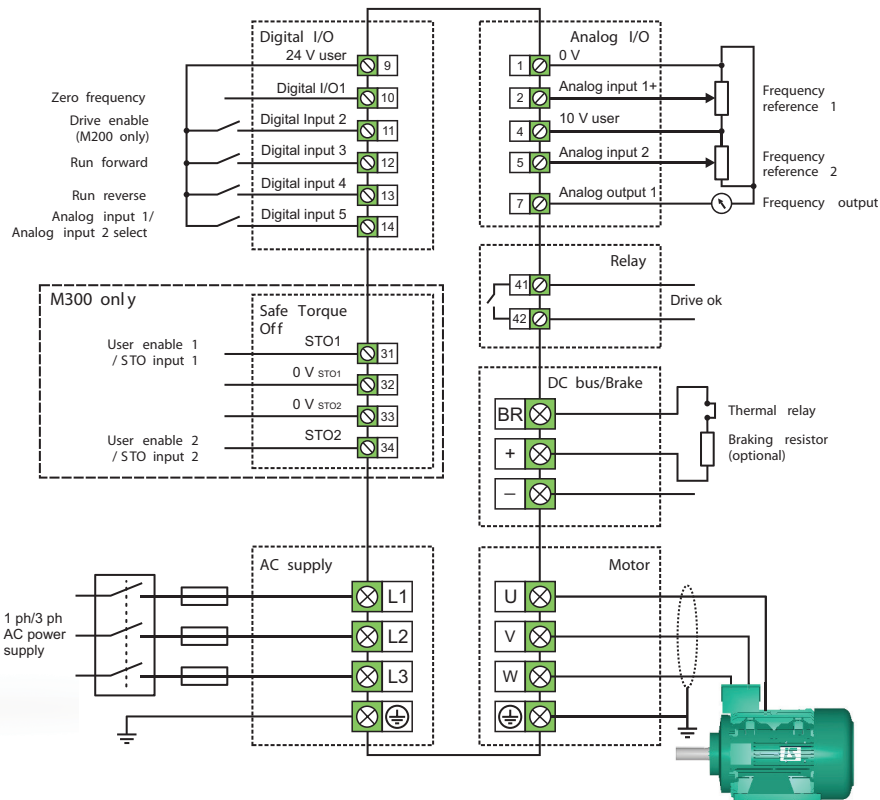





**Wood cutting at furniture manufacturer**

**Fast and Easy access for Commissioning, Monitoring and Diagnostics**  
 Unidrive M keypads, memory devices and software tools make it easy to access Unidrive M200 and M300's full feature set, allowing users to optimize drive tuning, back-up the configuration set and troubleshoot more quickly.

### User interface options

Unidrive M benefits from a number of optional keypad choices to meet your application needs.

Type		Benefit
Fixed LED keypad (M200 and M300)		Simple LED keypad fitted as standard for quick and easy commissioning and use.
Fixed LED keypad with speed reference potentiometer (M201)		Simple LED keypad with user friendly speed reference potentiometer for quick and easy commissioning and use.
Remote Keypad (All)		Remote mountable, intuitive plain text, multi-language LCD keypad for rapid set-up and superior diagnostics (using the AI-485 Adaptor along with a common comms lead). Rated to IP66.

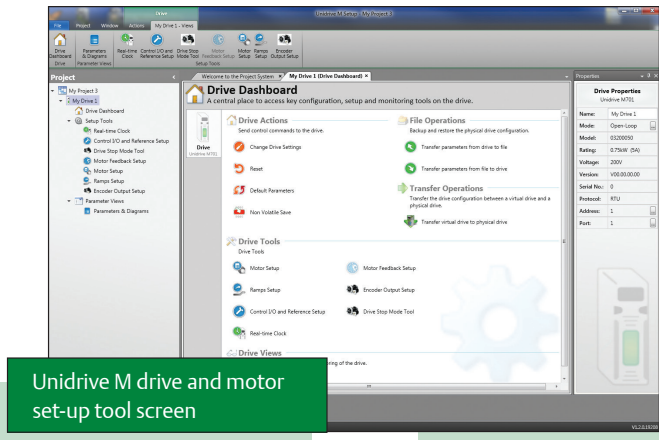

## Unidrive M Connect commissioning tool

Based on Control Techniques' 25 years of experience, Unidrive M Connect is our latest drive configuration tool for commissioning, optimizing and monitoring drive/system performance. Its development draws from extensive user research, using human centered design principles to give the ultimate user experience:

- Fast task based commissioning and easy maintenance of the Unidrive M family is simplified via familiar Windows interface
- Intuitive graphical tools enhance and simplify user experience
- For experienced users, dynamic drive logic diagrams and enhanced searchable listings are present
- Drive and motor performance can be optimized with minimal specialized drive knowledge
- Tool is scalable to match application requirements
- Supports the import of Commander SK parameter files and allows full drive cloning (i.e. parameter sets and application program)
- Multiple simultaneous communications channels for a more complete overview of the system
- Drive discovery gives the ability to find drives on a network automatically without the user having to specify their addresses
- Automatic RTU baud rate scanning on the M200 and M300 RS485 connection

## Portable SD memory card

Unidrive M200 and M300 uses popular SD cards for quick and easy parameter and program storage using the AI-Back-up Adaptor. SD cards provide a huge memory capability allowing a complete system reload if required and can be easily pre-programmed on a common PC.

## Performance motor control

Control Techniques' unique motor control algorithms combined with the latest microprocessor technology ensure that Unidrive M200 and M300 offers high stability and bandwidth for many industrial motor types. This enables you to maximize machine throughput and efficiency in every application using open loop AC induction motors.

## Unidrive M200 and M300 feature and specification table

Performance	Current loop update: 166 $\mu$ s
	Heavy Duty peak rating: 180 % (3 s), 150 % (60 s)
	Maximum output frequency: 550 Hz
	Switching frequency range: 0.67, 1, 2, 3, 4, 6, 8, 12, 16 kHz (3 kHz default)
Mechanical attributes	DIN rail mountable (size 1 and 2)
	Commander SK compatible mechanical footprint either as standard or with conversion plates
Parameter back-up	Serial port cloning (using optional AI-485 Adaptor)
	SD card (using optional AI-Back-up Adaptor)
Onboard I/O	2 x Analog inputs, 1 x Analog output
	4 x Digital inputs, 1 x Bidirectional digital input or output
	1 x Relay output (size 1 to 4), 2 x Relay outputs (size 5 and 6)
Machine safety	2 x Safe Torque Off (STO) inputs (M300 only)
Back-up power	24 V control back-up (using optional AI-Back-up Adaptor)
Other	Temperature controlled fan with standby (off)
	User replaceable fan(s)
	Conformal coating
	Standby mode (energy saving)
	User defined security levels (e.g. restricted access or read-only parameters via user defined security code)

# Unidrive M200 and M300 ratings and specifications

100/120 Vac ±10 %							
Order Code	Supply Phases	Heavy Duty			Normal Duty		
		Max Continuous Current (A)	Motor Shaft Power (kW)	Motor Shaft Power (HP)	Max Continuous Current (A)	Motor Shaft Power (kW)	Motor Shaft Power (HP)
Mx0x-011 00017	1	1.7	0.25	0.33	For Normal Duty applications, use Heavy Duty ratings.		
Mx0x-011 00024	1	2.4	0.37	0.5			
Mx0x-021 00042	1	4.2	0.75	1			
Mx0x-021 00056	1	5.6	1.1	1.5			

200/240 Vac ±10 %							
Order Code	Supply Phases	Heavy Duty			Normal Duty		
		Max Continuous Current (A)	Motor Shaft Power (kW)	Motor Shaft Power (HP)	Max Continuous Current (A)	Motor Shaft Power (kW)	Motor Shaft Power (HP)
Mx0x-012 00017	1	1.7	0.25	0.33	For Normal Duty applications, use Heavy Duty ratings.		
Mx0x-012 00024	1	2.4	0.37	0.5			
Mx0x-012 00033	1	3.3	0.55	0.75			
Mx0x-012 00042	1	4.2	0.75	1			
Mx0x-022 00024	1/3	2.4	0.37	0.5			
Mx0x-022 00033	1/3	3.3	0.55	0.75			
Mx0x-022 00042	1/3	4.2	0.75	1			
Mx0x-022 00056	1/3	5.6	1.1	1.5			
Mx0x-022 00075	1/3	7.5	1.5	2			
Mx0x-032 00100	1/3	10	2.2	3			
Mx0x-042 00133	1/3	13.3	3	3			
Mx0x-042 00176	3	17.6	4	5			
Mx0x-052 00250	3	25	5.5	7.5		30	7.5
Mx0x-062 00330	3	33	7.5	10	50	11	15
Mx0x-062 00440	3	44	11	15	58	15	20

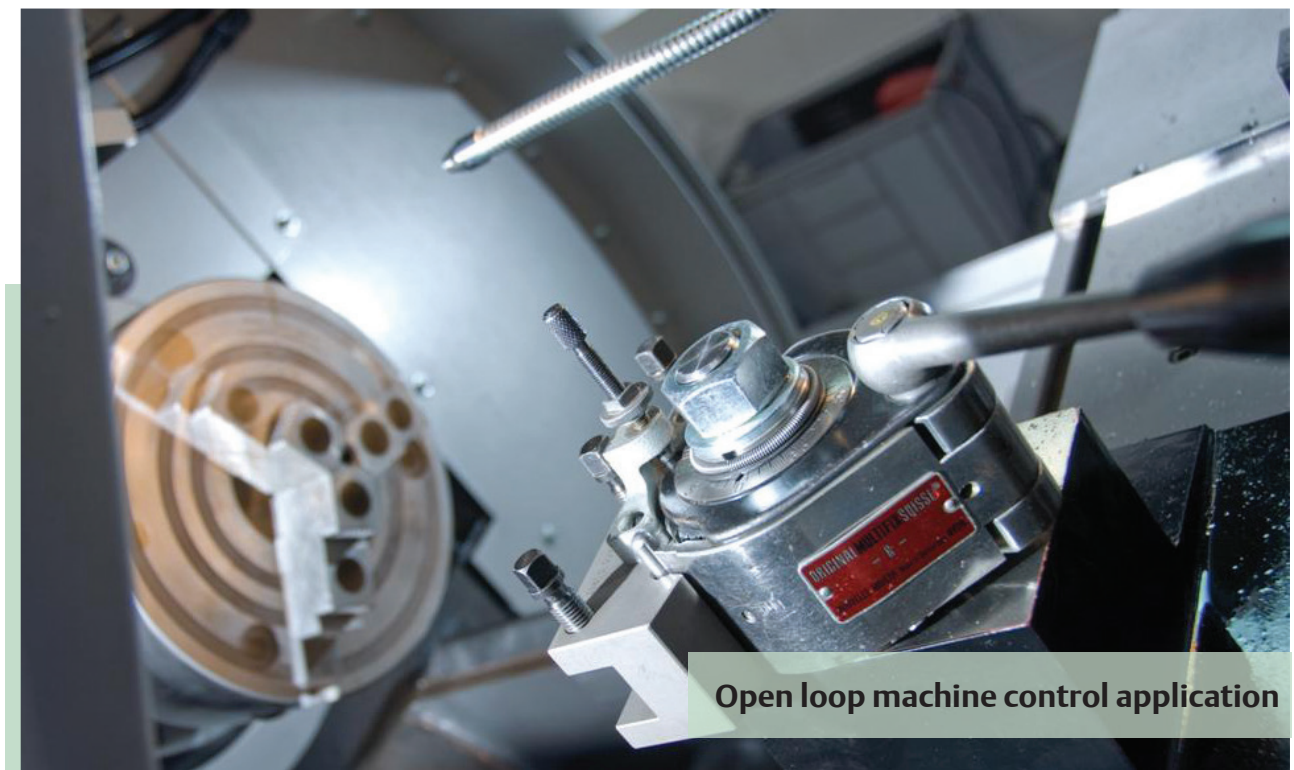

Open loop machine control application

380/480 Vac ±10 %							
Order Code	Supply Phases	Heavy Duty			Normal Duty		
		Max Continuous Current (A)	Motor Shaft Power (kW)	Motor Shaft Power (HP)	Max Continuous Current (A)	Motor Shaft Power (kW)	Motor Shaft Power (HP)
Mx0x-024 00013	3	1.3	0.37	0.5	For Normal Duty applications, use Heavy Duty ratings.		
Mx0x-024 00018	3	1.8	0.55	0.75			
Mx0x-024 00023	3	2.3	0.75	1			
Mx0x-024 00032	3	3.2	1.1	1.5			
Mx0x-024 00041	3	4.1	1.5	2			
Mx0x-034 00056	3	5.6	2.2	3			
Mx0x-034 00073	3	7.3	3	3			
Mx0x-034 00094	3	9.4	4	5			
Mx0x-044 00135	3	13.5	5.5	7.5			
Mx0x-044 00170	3	17	7.5	10			
Mx0x-054 00270	3	27	11	20		30	15
Mx0x-054 00300	3	30	15	20	30	15	20
Mx0x-064 00350	3	35	15	25	38	18.5	25
Mx0x-064 00420	3	42	18.5	30	48	22	30
Mx0x-064 00470	3	47	22	30	63	30	40

500/575 Vac ±10 %							
Drive	Supply Phases	Heavy Duty			Normal Duty		
		Max Continuous Current (A)	Typical Output (kW)	Motor Power (HP)	Max Continuous Current (A)	Typical Output (kW)	Motor Power (HP)
Mx0x-055 00030 A	3	3	1.5	2	3.9	2.2	3
Mx0x-055 00040 A	3	4	2.2	3	6.1	4	5
Mx0x-055 00069 A	3	6.9	4	5	10	5.5	7.5
Mx0x-065 00100 A	3	10	5.5	7.5	12	7.5	10
Mx0x-065 00150 A	3	15	7.5	10	17	11	15
Mx0x-065 00190 A	3	19	11	15	22	15	20
Mx0x-065 00230 A	3	23	15	20	27	18.5	25
Mx0x-065 00290 A	3	29	18.5	25	34	22	30
Mx0x-065 00350 A	3	35	22	30	43	30	40

## Heavy Duty

Suitable for demanding applications, current overload of 180 % (3 s) is available for dynamic loads.

## Normal Duty

Suitable for most applications, with a current overload capacity of 110 %.

## Key:

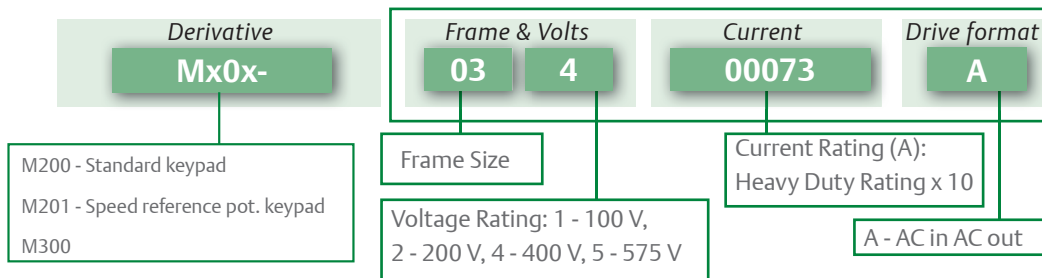

# Unidrive M200 and M300 ratings and specifications

## Environmental safety and electrical conformance

- Size 1 to 4: IP21 / UL open class (NEMA 1).  
IP20 when the AI-Back-up or AI-485 Adaptors are fitted.  
UL TYPE 1 compliance requires the appropriate Conduit kit to be fitted.
- Size 5 to 9: IP20 / UL open class (NEMA 1).  
UL TYPE 1 compliance requires the appropriate Conduit kit to be fitted.  
IP65 / UL TYPE 12 rating is achieved on the rear of the drive when through panel mounted.
- Ambient temperature -20 °C (-4 °F) to 40 °C (104 °F) as standard.  
Up to 60 °C (140 °F) with derating.
- Storage temperature -40 °C to 60 °C (-40 °F to 140 °F).
- Humidity 95 % maximum (non-condensing) at 40 °C (104 °F) in accordance with EN/IEC 60068-2-78 and ANSI/EIA-364-31.
- EN/IEC 60068-2-60, Method 4 Corrosive gas.
- Altitude: 0 to 3000 m (0 to 9843 ft), derate 1 % per 100 m (328 ft) between 1000 m and 3000 m (3281 ft and 9843 ft).
- Random Vibration: Tested in accordance with EN/IEC 60068-2-64 with SI and AI option modules fitted.
- Mechanical Shock: Tested in accordance with EN/IEC 60068-2-29.
- Electromagnetic Immunity complies with EN/IEC 61800-3 and EN/IEC 61000-6-2.
- With onboard EMC filter, complies with EN/IEC 61800-3 (2nd environment).
- EN/IEC 61000-6-3 and EN/IEC 61000-6-4 with optional footprint EMC filter.
- EN/IEC 60146-1-1 Supply conditions.
- EN/IEC 61800-5-1 Electrical Safety.
- EN/IEC 61131-2 I/O.
- Safe Torque Off, independently assessed by TÜV to EN/IEC 61800-5-2 SIL 3 and EN ISO 13849-1 PL<sub>e</sub>.
- UL 508C Electrical Safety.

## Dimensions and Weight



Frame Size		1	2	3	4	5	6
Dimensions (H x W x D)	mm	137 x 75 x 130	180 x 75 x 150	200 x 90 x 160	245 x 115 x 175	379 x 141 x 200	379 x 210 x 227
	in	5.4 x 3.0 x 5.1	7.1 x 3.0 x 5.9	7.9 x 3.5 x 6.3	9.7 x 4.5 x 6.9	14.9 x 5.6 x 7.9	14.9 x 8.3 x 8.9
Weight	kg (lb)	0.75 (1.65)	1.0 (2.2)	1.5 (3.3)	3.13 (6.9)	7.4 (16.3)	14 (30.9)

### Notes:

Height dimension (H) does not include mounting feet on sizes 1 to 4.

Additional distance should be added to the height dimension (H) when the following options are fitted:

- AI-Back-up Adaptor: 15 mm (0.59 in)
- AI-485 Adaptor: 26 mm (1.02 in)

## Optional keypad

Description	Order code
Remote Keypad	82500000000001

## Optional accessories

Description	Order code
AI-Back-up Adaptor	82500000000004
AI-485 Adaptor	82500000000003

## Conduit kit

When the following kits are fitted to the drive, it meets UL Type 1.

Frame size	Order code
1	3470-0091
2	3470-0094
3	3470-0098
4	3470-0102
5	3470-0069
6	3470-0059

## Internal brake resistor

Frame size	Order code
5	1299-0003

## Through hole kit

IP65 / UL TYPE 12 rating is achieved on the rear of the drive when through panel mounted using the following kits.

Frame size	Order code
5	3470-0067
6	3470-0055

## Retrofit mounting brackets

These mounting brackets ensure the drive can be mounted on existing Commander SK installations.

Frame size	Order code
3	3470-0097
4	3470-0101

## Fan replacement kit

Frame size	Order code
1	3470-0092
2	3470-0095
3	3470-0099
4	3470-0103

## Optional external EMC filters

Unidrive M built-in EMC filter complies with EN/IEC 61800-3. External EMC filters are required for compliance with EN/IEC 61000-6-4 as per the table below.

Frame size	Voltage	Phases	Type	Order code
1	All	1	Standard	4200-1000
		1	Low leakage	4200-1001
2	100 V	1	Standard	4200-2000
		1	Standard	4200-2001
	200 V	1	Low leakage	4200-2002
		3	Standard	4200-2003
		3	Low leakage	4200-2004
		3	Standard	4200-2005
400 V	3	Low leakage	4200-2006	
	200 V	1	Standard	4200-3000
1		Low leakage	4200-3001	
3		Standard	4200-3004	
3		Low leakage	4200-3005	
400 V	3	Standard	4200-3008	
	3	Low leakage	4200-3009	
4	200 V	1	Standard	4200-4000
		1	Low leakage	4200-4001
		3	Standard	4200-4002
		3	Low leakage	4200-4003
	400 V	3	Standard	4200-4004
		3	Low leakage	4200-4005
5	200 V	3	Standard	4200-0312
	400 V	3	Standard	4200-0402
	575 V	3	Standard	4200-0122
6	200 V	3	Standard	4200-2300
	400 V	3	Standard	4200-4800
	575 V	3	Standard	4200-3690

For a full list of patents and patent applications, visit [www.controltechniques.com/patents](http://www.controltechniques.com/patents).

