

fall line [CATALOG]



Tarantin
INDUSTRIES, INC.



800-922-0724 | www.TARANTIN.COM



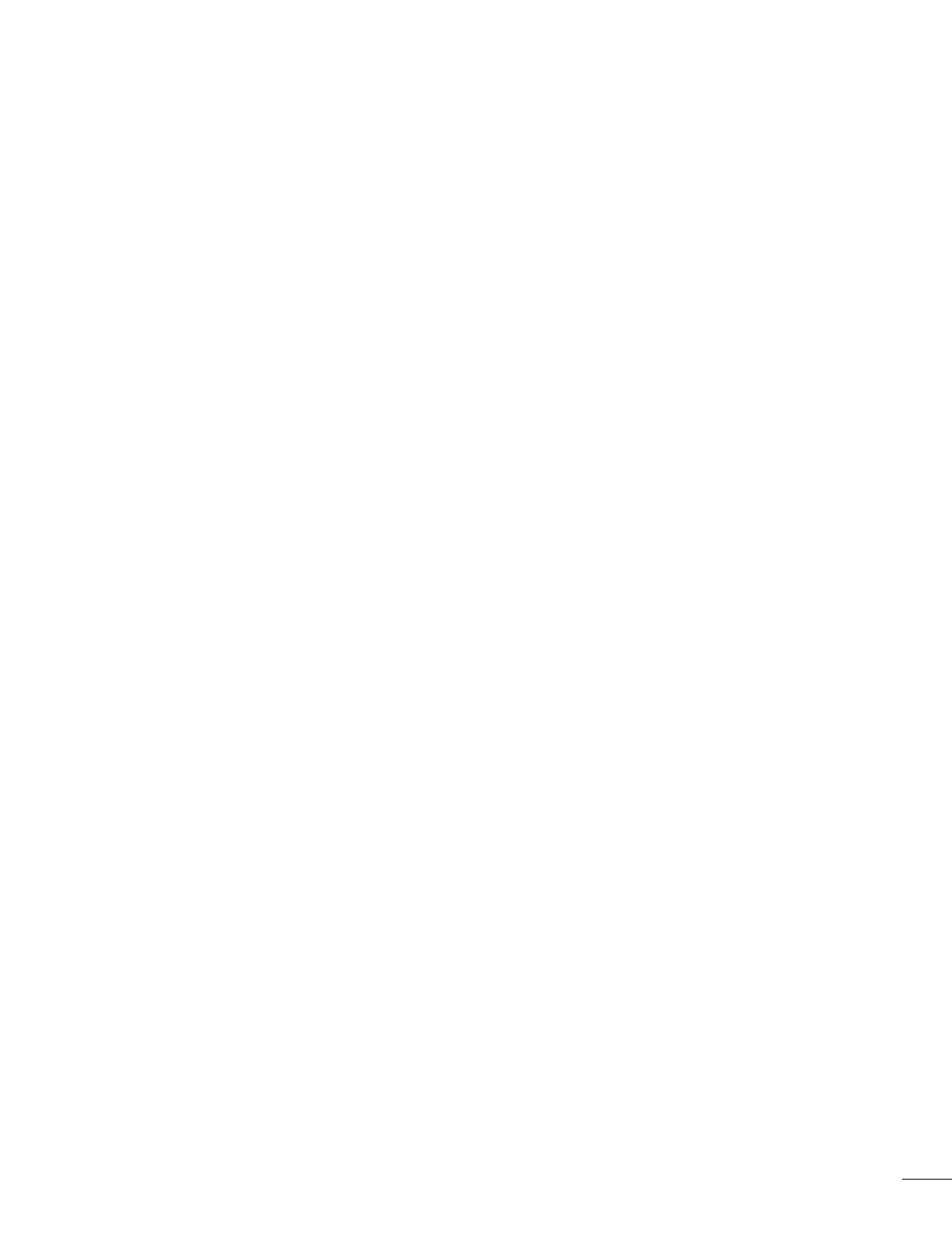

Table of Contents

Regulators.....	1 & 152
Valves.....	13
Repair Parts.....	43
Tanks.....	49
Signs&Decals.....	89
Pumps,Motors,&BypassValves.....	71
Plant Equipment.....	89
Compressors&Meters.....	91
PumpStations&Dispensers.....	100
Vaporizers.....	105
Washers&O-Rings.....	107
Service Equipment.....	108
Hose Reels.....	122
Pipe&Fittings.....	127
Hose&HoseFittings.....	147
Retail Accessories.....	152
Gauges.....	155
Outdoor Products.....	159
QuickReferenceGuide.....	163
Heaters.....	See Heater Catalog

**Pricing available online at
www.tarantin.com**



Download Our App - Order Parts Anywhere



A

- Adapters**
- Conversion98
- DOT.....104
- Excess Flow.....11
- Fill for Gas Mate.....104
- Hoses.....153
- Hose Ends.....27
- Inverted Flare.....10
- POL.....10, 31
- Pressure Tap.....156
- Swivel.....148, 150
- QCC Type 1.....104
- Anchoring**.....59
- Angle Valves**.....22
- Anode**
- Bags.....63
- Monitoring.....63
- Splice.....63
- Test Kit.....63, 116
- ASME Cylinders**.....58
- ASME Tanks**.....58, 60

B

- Back Check Valves**.....36
- Flanged Install.....36
- Sight Flow.....89
- Swing-Away.....36
- Ball Valves**.....23, 24
- Bearings**.....125
- Bleeder Valves**.....125
- Back Check Valves**.....36
- Flanged Install.....36
- Bot-L-Rench**.....121
- Brackets**
- Forklift.....56
- Hose Reels.....126
- Meters.....99
- Regulators.....2, 11
- Universal Mount.....143
- Wall.....143
- Z-Mounting.....153

- Brakes**
- Hose Reels.....126
- Broaches**.....110
- Bulk Storage Valves**...22
- Bypass**
- Blackmer.....88
- Pumps & Motors .71, 83

C

- Cabinets**.....55, 100
- Cable Controls**.....31
- Cable Guides**.....125
- Camping Acc.**...160, 161
- Caps**
- Valves.....28
- Pump Stations.....104
- Tanks.....50
- Weather, Valves.....20
- Carriers, Tank**.....108
- Chains**
- Bot-L-Wrench Vice..121
- Hose Reels.....124
- Chock Blocks**.....110
- Compressors**.....91
- Assembly.....99
- Conversion Adapt.....98
- Hand Pump.....93
- Portable.....92
- Repair Kit.....91
- Replacement Parts...98
- Service Valves.....99
- Strainers.....97
- Vapor Eliminator.....96
- Valves, 4-Way.....91
- Valves, Check.....97
- Valves, Differential.....97
- Ventur-Evac & Hose Kit 93
- Connectors**
- Hose & Fittings..148, 151
- Hose Ends.....31
- Plant Equipment.....89
- Tanks.....54
- Outdoor Products....161
- Pump Stations.....104

- Quick.....161
- Copper Tubing**..135, 136
- Couplings, Hose**.....149
- Covers**.....153
- Regulators.....2, 11
- Cylinders**
- ASME.....58
- DOT.....51, 57
- Forklift.....52, 53
- Special Application...51
- Cylinder Accessories**
- Cabinets.....55
- Carriers.....108
- Float Gauges.....56
- Movers.....108
- Purge Kit.....93
- Riser Pipe Clamp.....63
- Valves....12, 14, 15, 54
- Vises.....121
- Gauges**.....54
- Gauging Drill Set**.....111
- Gauging Reamer Kit**..110
- Globe Valves**.....22

D

- Decals**
- Cylinders.....64, 65
- Misc.....70
- Truck.....65-67
- Dials**
- Gauges.....157
- Float Gauges.....56
- Tanks.....62
- Taylor Visible.....56
- Digital Manometer**...114
- Digital Multimeter**....114
- Dispensers**
- Caps.....104
- Cabinet.....100
- Connectors.....104
- Stands.....103
- Stationary Tank Inverter104
- Steps.....103

E

- Emergency Response Kit** 113

F

- Ferrules**.....148
- Fire Extinguishers**....118
- Fittings**.....133-134, 154
- Acme Reducing.....28
- Butt Fusion.....141
- Galvanized.....129
- Hose.....148
- Insulation Sets.....130
- Mr. Heater.....161
- Pump Station.....104
- POL.....11
- Socket Fusion.....141

Flanges

- Insulation Sets.....130
- Termination.....136
- Flare Tower**.....117
- Flaring Tools**.....111
- Flexible Vent Kit**.....4
- Forklift Bracket**.....56
- Free All**.....117
- Freeze Valve**.....116
- Fusion**.....142

G

- Gauges**.....155
- Bulk Storage.....158
- Float.....56, 62
- Gaskets.....156
- Replacement Dials..157
- Rotogauges.....157
- Screws.....156
- Tanks.....54
- Thermometers...90, 156
- Universal Tech Kit...156
- Valves.....41
- Gas Detector**.....114-115
- Gaskets**
- Flexitallic.....130
- Gauges.....156



Tanks56	Sprockets124	Methanol Injector.....120	Schedule 40131
Gasket Sealer.....117	Switches.....124	Motors	Schedule 80127-128
Gloves.....118	Swivels.....125	Balance Seal Assem.73	Sediment Traps.....132
H		C9 to C4.....72	Socket Fusion141
Hand Pump93	I	Hose Reels.....124	Strap Handers132
Hand Trucks.....108	Inspection Mirror115	Movers, Tank108	Risers139-140
Handwheels.....148	Internal Valves37	Multimeter, Digital ...114	Tapping Tees140
Heaters	J	Multivalves	Tools143
Buddy Flex160	J-Clips.....135	External Relief.....17	TracPipe.....144-145
Portable Buddy.....160	K	Liquid Withdrawal.....15	Transitions.....139
Tank, Vaporizer.....105	Kits	Low Emmissions17	Tube Talon Holder ..135
Hoses	Automatic Changeover .3	Vapor Withdrawal.15-16	Unions132
LP Gas149-150	Cylinder Purge93	N	Pilot Cleaning Pump..115
Pump Station.....93, 103	Nipple101-102, 132	Nipples	Pin Vises110
Stainless Steel Braid..149	Orifice.....111	Kits132	Pipe Away2
UL and CSA150	Pump Repair82	Trays132	Pipe Thread.....117
Hose Accessories	Test116	O	Pit Gauge.....120
Outlet Box148	Two Stage Regulator ..2	O-Rings.....107	Plant Equipment
Hose Ends.....26-28, 31	Universal Tech156	Outdoor Products	Connectors.....89
Hose Parts	L	Camping Acc...160, 161	Nitrogen.....90
Barbs.....147	Leak Detector.....117	Connectors.....161	Scrubbers.....89
Connectors.....148, 151	Leak Test.....113	Gauges.....158	Strainers.....89
Couplings149	Lighters159	Lighters159	Valves89, 90
Ferrules148	Locks	Torches159	Plugs
Fittings.....148	Barrel & Key99	Outlet Box148	Bot-L-Wrench121
Handwheels148	Breakaway99	P	Plastic.....132
Hose Reels123	Tanks50	Paint.....119	POL104
Assemblies.....125, 126	M	Permasert.....138	Safety109
Bearings125	Match, Extend-A120	Pigtails.....9, 153	Plug, Chain, & Ring....28
Brackets126	Meters	Pipes & Fittings	PolyPipe136
Breaks126	Bars99	Copper Tubing 135, 136	Pumps
Cable Guides125	Brackets99	Electrofusion136	Blackmer88
Chains124	Conversion Adapt.....98	Butt Fusion.....141	Coro-Flow.....71, 73-74
Electrical.....124	Hand Pump93	Flanges130, 136	Large Capacity87
Guides.....126	Liquid.....94	Flexitallic Gaskets ...130	Medium Capacity87
Guidemaster.....126	MA7 & MA15.....95	Fusion142	Repair Kits.....82
Hose Stops.....125	Registers98	Galvanized129	Seal Assembly71
Hub Assembly125	Vapor.....99	J-Clips135	Small Capacity83-86
Motor124	Ventur-Evac & Hose Kit.93	Nipple Trays132	Valves71, 83, 88
Stops.....125	Manometer, Digital ...114	Permasert.....138	Z-Series.....75-81
Ratchets126	Maxitrol Regulators.....8	PolyPipe136	
Rewind Assemblies.126			Pump Stations
Risers125			Adapter QCC Type 1 .104
Roller Assemblies ...125			Cabinets.....100
			Caps104
			Connectors.....104

- Filling Valves 101-102
- Fittings..... 104
- Nipple Kits 101-102
- POL Plugs 104
- Scale 103
- Stands 103
- Stationary Tank Inverter 104
- Steps 103
- Valves, Quick Acting.. 104
- Purge-It-Safe 93**
- Purge-It-Vac 63, 93**
- Pneumatic Remote**
- Control 40**
- Pneumatic Tubing &**
- Fittings 39**
- Primer 120**
- Q**
- Quick Connectors. 28, 161**
- R**
- Ratchets 126**
- Reflective Triangles . 110**
- Regulators**
- Automatic Changeover . 3, 5, 152
- First Stage..... 1
- High Pressure . 6, 7, 152
- Maxitrol..... 8
- Second Stage..... 1, 4, 7
- Single Stage..... 5, 152
- Single Stage, Compact . 4
- Tobacco 1
- Twin Stage 5, 152
- Twin Stage, Compact.. 2
- Two Stage Kit..... 2
- Regulator Accessories**
- Adapter QCC Type 1 104
- Assembly..... 99
- Brackets 2, 11
- Covers 2, 11
- Flexible Vent Kit..... 4
- Nitrogen..... 90
- Pigtails..... 9
- Pipe Away 2
- Pressure Valve..... 9
- Suppressors 11
- Tee Blocks 10
- Valves, Vapor Relief ... 7
- Vent Pipe, 90° 2
- Registers, Meter 98**
- Relief Valves**
- ASME Containers..... 19
- Bonnets 20
- External Hydrostatic.. 18
- Internal Hydrostatic 18-19
- Large Storage 19
- Motor Fuel..... 20
- Multiport 21
- Small Storage..... 20
- Tanks 56
- Motorfuel Tanks 59
- Repair Kits 42-48**
- 7141M 14
- Compact Cylinder Valves 15
- Compressors..... 91
- Multivalve Liquid Withdrawal 15, 16
- Pump..... 82
- Replacement Dials**
- Gauges..... 157
- Float Gauges..... 56
- Tanks 62
- Taylor Visible..... 56
- Replacement Parts**
- Neptune..... 98
- Valve Gaskets..... 30
- Retail Accessories**
- Covers..... 153
- Regulators..... 152
- Risers..... 125, 139-140**
- Rotogauges 157**
- S**
- Scale 103**
- Schedule 40 131**
- Schedule 80 127-128**
- Screws 56, 156**
- Scrubbers 89, 106**
- Seal Assembly 71**
- Sediment Traps 132**
- Service Equipment**
- Broaches 110
- Bot-L-Rench 121
- Chock Blocks 110
- Cylinder Movers 108
- Emergency Response Kit 113
- Extend-A-Match 120
- Fire Extinguishers ... 118
- Flare Towers 117
- Flaring Tools 111
- Free All..... 117
- Freeze Valve 116
- Gas Detector 114-115
- Gasket Sealer 117
- Gauging Drill Set..... 111
- Gauging Reamer Kit. 110
- Gloves 118
- Hand Truck..... 108
- Inspection Mirror 115
- Leak Detector..... 117
- Leak Tester 113
- Manometer, Digital.. 114
- Methanol Injector..... 120
- Mover, Tank..... 108
- Multimeter, Digital ... 114
- Orifice Kits..... 111
- Paint..... 119
- Pilot Cleaning Pump. 115
- Pin Vises 110
- Pipe Thread..... 117
- Pit Gauge 120
- Plugs 109, 121, 132
- Primer..... 120
- QCC Valve 126
- Reflective Triangles. 110
- Scribe 120
- Seal Press..... 115
- Slings 109
- Stanchions 90
- Stamp Sets..... 120
- Straps..... 109
- Tank-Jak 109
- Tape, Teflon..... 117
- Tape, Wrapping..... 120
- Test Kit..... 116
- Thermocouples 110
- Vises 121
- Wrenches 110, 120-121
- Service Valves**
- DOT Forklift..... 54
- Flathead Lockwing 99
- Signs**
- Bulk Plant..... 67-70
- Truck 65-67
- Slings..... 109**
- Snubbers..... 156**
- Stanchions 90**
- Stationary Tank Inverter 104**
- Stamp Sets..... 120**
- Strainers 89, 97**
- Stands, Tank 103**
- Steps, Tank 103**
- Strap Hanger..... 132**
- Straps 109**
- Suppressors..... 11**
- Switch, Hose Reel 124**
- Swivel, Hose Reel..... 125**
- T**
- Tanks**
- Above Ground..... 61
- AG/UG..... 61
- ASME 58, 60
- DOT, Portable 49
- Forklift 52, 53
- Horizontal 61
- Mower 52
- Underground 61
- Special Application.... 51
- Tank Accessories**
- Cabinets..... 55
- Carriers 108



Locking Caps50
 Riser Pipe Clamp63
 Screw Cap.....50
 Screw on Collar.....50
 Stands103
 Steps103
Tank-Jak.....109
Tank Parts
 ChekLok.....62
 Connectors.....54
 Dials62
 Domes.....62
 Dome Pin62
 Electrode Extension ..63
 Filler Valves.....62
 Float Gauges.....62
 Forklift52, 53
 Gaskets56
 Gauges.....54, 62
 Horizontal61
 Multivalves62
 Relief Valves62
 Screws56
 Shrouds.....62
Tape
 Teflon117
 Wrapping.....120
Tapping Tees140
Tee Blocks10
Test Kit116
Thermocouples.....110
Thermometers
 Container.....156
 Storage Tanks.....90
 Tank Car156
Tools
 Pipes & Fittings143
 Wrenches 110, 120-121
Torches.....159
TracPipe144-145
Transitions139
Tube Talon Holder....135

U

Universal Mounting Bracket.....143
Universal Tech Kit....156

V

Vaporizers
 Direct Fired.....105
 Electric106
 Explosion Proof.....105
 Filtaire106
 Scrubbers.....106
 Waterbath.....106

Valves

4-Way91
 Angle22
 Back Check.....36, 89
 Ball23, 24
 Bobtail38
 Bypass, Blackmer88
 Bypass71, 83
 Bulk Storage.....22
 Cable Controls31
 Caps.....28
 Check97
 Cylinder12, 14, 15
 Differential97
 Double Check.....34, 35
 Emergency Shutoff...39
 ESV90
 Excess Flow32-34
 Filler62
 Freeze116
 Gauges.....41
 Globe.....22
 Hose End26-28
 Hydraulic Filling.....41
 Internal37
 Large Tanks38
 Liquid Transfers25
 Multi.....15-17, 24, 62
 Needle.....24
 Pneumatic Control....39
 Pressure.....9

Pump Filling101-102
 Transport.....38
 Relief. 18-21, 56, 59, 62
 Pull-Away40, 90
 Pneumatic39-40
 QCC121
 Quick Acting.....104
 Service54, 99
 Single Check.....35
 Swing Check89
 Vapor Relief7

Valve Accessories

Spare Gaskets30
 Tank Heater105
 Thermal Release.....31
 Weather Caps20

Vapor Eliminator.....96

Vent Kit, Flexible4

Vent Pipe, 90°.....2

Ventur-Evac & Hose Kit.93

Vises121

W

Wall Brackets.....143

Washers.....107

Wrapping Tape120

Wrenches

Acme J110
 Bot-L-Wrench121
 Offset, Remove Valves 121
 POL Flare.....120
 Spanner.....110

Z

Z-Mounting Bracket..153



Technical and Sales Training

TARANTIN INDUSTRIES provides technical and sales training at each of our locations on a monthly basis. The schedules are listed on the web site at www.tarantin.com, and registration is available on-line. This training is free of charge and conducted by qualified instructors, culminating with certificates of completion.



OUR TRAINING SESSIONS are conducted as hands-on courses. Our highly skilled technical training staff provides a full range of instruction from regulator and line sizing to heater installation, troubleshooting and repair, to very technical aspects of pump, vaporizer and LPG plant installations. We also offer training on sales, codes, emergency response, rules and regulations.

OUR ON-THE-ROAD SALESPeOPLE are factory trained on the products we sell. All members of the inside and outside sales team have been CETP trained in several modules. As a distributor we believe it is our responsibility to offer training on the products/items we sell to ensure trouble-free installation and reduce costs.



**To sign up
for our free
training
classes go to**

www.tarantin.com



RegO First Stage Regulators

First Stage Regulators, High Pressure Domestic

Provides accurate first stage regulation in two-stage bulk tank systems. Reduces tank pressure to an intermediate pressure of 5 to 10 PSIG. Also used to supply high pressure burners for applications like industrial furnaces or boilers. Domestic LP-gas installations, also incorporated in multiple cylinder installations.



LV3403TR



LV4403TR



PART NUMBER	INLET CONNECTION	OUTLET CONNECTION	ORIFICE SIZE	FACTORY DELIVERED PRESSURE	INTEGRAL ADJUSTMENT RANGE	RELIEF VALVE INCLUDED	VAPOR CAPACITY BTU/HR. PROPANE
LV3403TR	1/4" F.NPT	1/2" F.NPT	1/4"	10	5-10	Yes	1,500,000
LV3403TR9	F.POL	1/2" F.NPT	1/4"	10#	5-10#	Yes	1,500,000
LV4403TR4	1/2" F.NPT	1/2" F.NPT	1/4"	10	5-10	Yes	2,500,000*
LV4403SR4	1/2" F.NPT	1/2" F.NPT	1/4"	5	1-5	Yes	2,500,000*
LV4403TR9	F.POL	1/2" F.NPT	1/4"	10	5-10	Yes	2,500,000*
LV4403SR96	F.POL	3/4" F.NPT	1/4"	5	1-5	Yes	2,500,000*
LV4403TR96	F.POL	3/4" F.NPT	1/4"	10	5-10	Yes	2,500,000*
LV3403TRV9	1/4" F.NPT	1/2" F.NPT	1/4"	10	-	Yes	1,500,000**

* Maximum flow based on inlet pressure 20 PSIG higher than the regulator setting and delivery pressure 20% lower than the setting.

** Vent at 9 o'clock.

RegO Low Pressure Second Stage Regulators

Second Stage Regulators Low Pressure, Domestic

Reduces first stage pressure of 5 to 20 PSIG down to burner pressure, normally 11" WC. Ideal for medium commercial installations, multiple cylinder installations and normal domestic loads.

Backmount Design

Mounts directly to house line piping. Eliminates need for union joints and elbows and mounting brackets. Quick and easy to install.



LV4403B



LV5503B

PART NUMBER	INLET CONNECTION	OUTLET CONNECTION	ORIFICE SIZE	FACTORY DELIVERED PRESSURE	ADJUSTMENT RANGE	VENT POSITION	VAPOR CAPACITY BTU/HR. PROPANE
LV3403B4	1/2" F.NPT	1/2" F.NPT	7/32"	11" WC at 10 PSIG Inlet	9" to 13" WC	Inlet 3:00 Outlet 9:00	450,000
LV3403B44R	1/2" F.NPT	1/2" F.NPT	7/32"	11" WC at 10 PSIG Inlet	9" to 13" WC	Over Inlet	450,000
LV3403B46R	1/2" F.NPT	3/4" F.NPT	7/32"	11" WC at 10 PSIG Inlet	9" to 13" WC	Over Inlet	450,000
LV4403B4	1/2" F.NPT	1/2" F.NPT	#28 Drill	11" WC at 10 PSIG Inlet	9" to 13" WC	Over Inlet	935,000
LV4403B46	1/2" F.NPT	3/4" F.NPT	#28 Drill	11" WC at 10 PSIG Inlet	9" to 13" WC	Over Inlet	935,000
LV4403B46R*	1/2" F.NPT	3/4" F.NPT	#28 Drill	11" WC at 10 PSIG Inlet	9" to 13" WC	Over Inlet	935,000
LV4403B66	3/4" F.NPT	3/4" F.NPT	#28 Drill	11" WC at 10 PSIG Inlet	9" to 13" WC	Over Inlet	935,000
LV4403B66R*	3/4" F.NPT	3/4" F.NPT	#28 Drill	11" WC at 10 PSIG Inlet	9" to 13" WC	Over Inlet	935,000
LV5503B4	1/2" F.NPT	3/4" F.NPT	1/4"	11" WC at 10 PSIG Inlet	9" to 13" WC	Over Inlet	1,600,000
LV5503B6	3/4" F.NPT	3/4" F.NPT	1/4"	11" WC at 10 PSIG Inlet	9" to 13" WC	Over Inlet	1,600,000
LV5503B8	3/4" F.NPT	1" F.NPT	9/32"	11" WC at 10 PSIG Inlet	9" to 13" WC	Over Inlet	2,300,000
LV4403B66RA**	3/4" F.NPT	3/4" F.NPT	3/16"	11" WC at 10 PSIG Inlet	9" to 13" WC	Over Inlet	1,000,000
LV4403B66RAB**	3/4" F.NPT	3/4" F.NPT	3/16"	11" WC at 10 PSIG Inlet	9" to 13" WC	Over Inlet	1,000,000

* Backmount Design ** Sidemount Design

RegO Low Pressure Second Stage Tobacco Barn Regulator

Especially developed for drying barns in the tobacco industry. The LV5503G4 regulator will supply a steady and constant flow of fuel to as many as 12 to 20 burners throughout the barn.



LV5503G4



PART NUMBER	INLET CONNECTION	OUTLET CONNECTION	ORIFICE SIZE	FACTORY DELIVERED PRESSURE	ADJUSTMENT RANGE	VENT POSITION	VAPOR CAPACITY BTU/HR. PROPANE
LV5503G4	1/2" F.NPT	3/4" F.NPT	1/4"	15" WC at 15 PSI Inlet	8"-18" WC	Over Inlet	1,750,000

*Maximum flow is based on 15 PSIG inlet and 13" WC delivery pressure.

REGULATORS

RegO Compact Twin Stage Regulators

Compact Twin Stage Regulators

This compact two-stage regulator is designed to reduce container pressure down to 11" WC delivery pressure. It is ideal for "on-site" cylinder applications, such as homes, mobile homes and average domestic service including small ASME and 100 to 420 pound DOT cylinders.

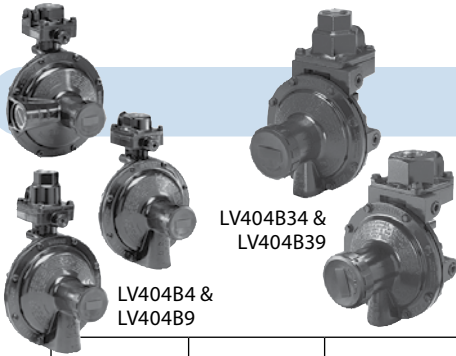

LV404B34 & LV404B39

LV404B4 & LV404B9

	PART NUMBER	INLET CONNECTION	OUTLET CONNECTION	ORIFICE SIZE	FACTORY DELIVERED PRESSURE*	ADJUSTMENT RANGE (2ND STAGE)	VENT POSITION (1ST STAGE)	VENT POSITION (2ND STAGE)	CAPACITY BTU/HR. PROPANE
LARGE	LV404B4	1/4" F.NPT	1/2" F.NPT	.219	11" WC at 100 PSIG Inlet	9"-13" WC	Down	Over Outlet	525,000
	LV404B4V9	1/4" F.NPT	1/2" F.NPT	.219	11" WC at 100 PSIG Inlet	9"-13" WC	9 o'clock	9 o'clock	525,000
	LV404B46	1/4" F.NPT	3/4" F.NPT	.219	11" WC at 100 PSIG Inlet	9"-13" WC	Down	Over Outlet	525,000
	LV404B46V9	1/4" F.NPT	3/4" F.NPT	.219	11" WC at 100 PSIG Inlet	9"-13" WC	9 o'clock	9 o'clock	525,000
	LV404B9	F.POL	1/2" F.NPT	.219	11" WC at 100 PSIG Inlet	9"-13" WC	Down	Over Outlet	525,000
	LV404B9V9	F.POL	1/2" F.NPT	.219	11" WC at 100 PSIG Inlet	9"-13" WC	9 o'clock	9 o'clock	525,000
	LV404B96	F.POL	3/4" F.NPT	.219	11" WC at 100 PSIG Inlet	9"-13" WC	Down	Over Outlet	525,000
	LV404B96V9	F.POL	3/4" F.NPT	.219	11" WC at 100 PSIG Inlet	9"-13" WC	9 o'clock	9 o'clock	525,000
SMALL	LV404B34	1/4" F.NPT	1/2" F.NPT	.100	11" WC at 100 PSIG Inlet	9"-13" WC	Rear	Over Outlet	450,000
	LV404B39	F.POL	1/2" F.NPT	.100	11" WC at 100 PSIG Inlet	9"-13" WC	Rear	Over Outlet	450,000
	LV404B34V9	1/4" F.NPT	1/2" F.NPT	.100	11" WC at 100 PSIG Inlet	9"-13" WC	Left	9 o'clock	450,000
	LV404B39V9	F.POL	1/2" F.NPT	.100	11" WC at 100 PSIG Inlet	9"-13" WC	Left	9 o'clock	450,000
	LV404Y9	F.POL	1/2" F.NPT	.219	2PSIG at 100 PSIG Inlet	1.8"-2.5" PSI	Down	Over Outlet	800,000**
	LV404Y39								650,000**

* Set at 100 PSIG inlet pressure to deliver gas from the second stage regulator at 11" WC.

** Maximum flow based on 25 PSIG inlet pressure and 9" WC delivery pressure.

Accessories

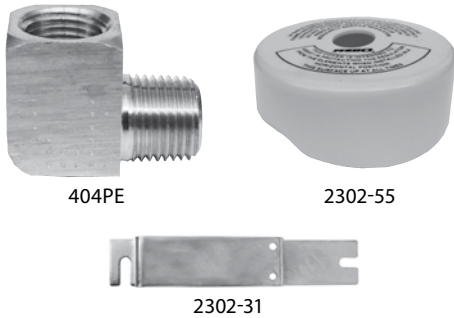

404PE

2302-55

2302-31

REGULATOR PART #	1ST STAGE PIPE-AWAY	2ND STAGE VINYL COVER	BRACKET	90° ELBOW VENT PIPE
LV404B4 - LV404B96V9	404PE	-	-	LV960-8R1
LV404B34	404PE	2302-55	2302-31	LV960-8R1
LV404B39	404PE	2302-55	2302-31	LV960-8R1
LV404B34V9	404PE	2302-55	2302-31	LV960-8R1
LV404B39V9	404PE	2302-55	2302-31	LV960-8R1

Regulator Screen Replacement Part: 4403-30

RegO Two Stage Regulator Kits

These outfits contain the equipment required to provide two-stage regulation.



LV4403B

LV4403TR9

KIT NUMBER	1ST STAGE REGULATOR INCLUDED		2ND STAGE REGULATOR INCLUDED		BRACKET INCLUDED	PIGTAIL INCLUDED	CAPACITY BTU/HR. PROPANE
	PART NUMBER	INLET X OUTLET	PART NUMBER	INLET X OUTLET			
5807	LV4403TR9	POL x 1/2" F.NPT	LV4403B4	1/2" x 1/2" F.NPT	2503-22	913PS12	935,000
5808	LV4403TR9	POL x 1/2" F.NPT	LV4403B46R	1/2" x 3/4" F.NPT	Not Required	913PS12	935,000
5820	LV4403TR96	POL x 3/4" F.NPT	LV4403B66R	3/4" x 3/4" F.NPT	Not Required	913PS12	935,000

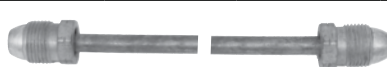

913PS12



2503-22



RegO Twin Stage Automatic Changeover Regulators

PART NUMBER	SERVICE & RESERVE INDICATOR	INLET CONNECTION	OUTLET CONNECTION	FACTORY DELIVERED PRESSURE*	ADJUSTMENT RANGE	VENT POSITION	CAPACITY BTU/HR. PROPANE**	BRACKET INCLUDED
7525B34	Integral	1/4" Inverted Flare	1/2" F.NPT	11" WC	9"-13" WC	Over Outlet	400,000	2302-31
7525B4	Integral	1/4" Inverted Flare	1/2" F.NPT	11" WC	9"-13" WC	Over Outlet	450,000	2503-22

* Set at 100 PSIG inlet pressure.

** Maximum flow based on 25 PSIG inlet pressure and 9" WC delivery pressure.

Application:

These combination automatic changeover, two stage regulators are especially suitable for homes, mobile homes, cottages, construction and other portable two cylinder installations. Empty containers may be replaced without interrupting customer's gas service.

Features:

- Automatic changeover switches from "service" to "reserve" cylinder automatically without interrupting service.
- The Second Stage Incorporates wide bonnet drip lip vent to guard against freeze-up when properly installed.
- With 15 PSIG inlet pressure, the second stage regulator is designed to not pass more than 2 PSIG with the seat disc removed.
- Allows "reserve" cylinder to supplement the flow of gas from the "service" cylinder during extreme load or severe cold conditions.
- Incorporates molded diaphragm in second stage regulators.
- Integral indicator gauge.
- Change over knob and indicator are integral to the first stage.
- Select brown finish on first stage.



7525B34



7525B4



2302-31



2503-22

RegO Twin Stage Automatic Changeover Regulator Kits

KIT NUMBER	AUTOMATIC CHANGEOVER INCLUDED	INLET CONNECTION	OUTLET CONNECTION	PIGTAILS INCLUDED (2)	HEX SIZE CONNECTORS	BRACKET INCLUDED	CAPACITY BTU/HR. PROPANE
5727B34	7525B34	1/4" Inverted Flare	1/2" F.NPT	912FS20	7/8" Short	2302-31	400,000
5754B4	7525B4	1/4" Inverted Flare	1/2" F.NPT	912FA20	1-1/8" Long	2503-22	450,000
5755B4	7525B4	1/4" Inverted Flare	1/2" F.NPT	912FS20	7/8" Short	2503-22	450,000

Features:

- Includes new pigtails. This helps insure that new pigtails are installed along with the regulator.
- Features, designs, and performance characteristics of the individual components may be found under the appropriate section of this catalog.



7525B34



7525B4



2503-22



2302-31



912FS20

REGULATORS

RegO Single Stage Compact Regulators

Designed for smaller outdoor grills and fish cookers.

Intended for use on small portable appliances that use 100,000 BTUs/hr. or less.

May not be used on fixed pipe systems per NFPA 58, 1995 edition.



PART NUMBER	CONNECTIONS		ORIFICE SIZE	FACTORY DELIVERY PRESSURE	ADJUSTMENT RANGE	BONNET VENT POSITION	VAPOR CAPACITY BTU/HR. PROPANE
	INLET	OUTLET					
302	1/4" F.NPT	3/8" F.NPT	#50 Drill	11" WC at 100 PSIG inlet	9-13" WC	Small Vent Above Inlet	125,000
302V	1/4" F.NPT	3/8" F.NPT	#50 Drill	11" WC at 100 PSIG inlet	9-13" WC	Drip Lip Above Inlet	125,000
302V9	1/4" F.NPT	3/8" F.NPT	#50 Drill	11" WC at 100 PSIG inlet	9-13" WC	Drip Lip at 9 o'clock	125,000
302V9LS	Soft POL w/o orifice	3/8" F.NPT	#50 Drill	11" WC at 100 PSIG inlet	9-13" WC	Drip Lip at 9 o'clock	125,000

RegO Second Stage Regulator For 2 PSIG Systems

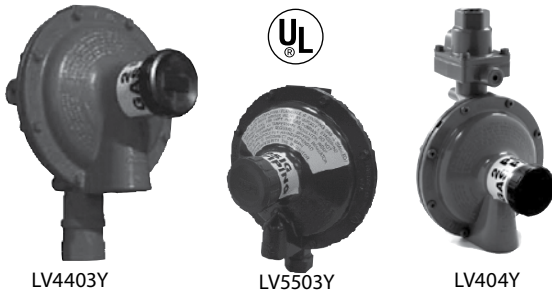

Designed to reduce first stage pressure of 10 PSIG down to 2 PSIG. A line pressure regulator is required downstream to reduce the 2 PSIG to a nominal 11" WC.

PART NUMBER	CONNECTION		ORIFICE SIZE	FACTORY DELIVERY PRESSURE	ADJUSTMENT RANGE	VENT POSITION	CAPACITY BTU/HR. PROPANE
	INLET	OUTLET					
LV404Y9	F.POL	1/2" F.NPT	.219	2 PSIG @ Tank Pressure	1.8" to 2.5" PSI	Down	800,000
LV4403Y46R*	1/2" F.NPT	3/4" F.NPT	1/4"	2 PSIG @10 PSIG Inlet	1.8" to 2.5" PSI	Over Inlet	1,000,000
LV5503Y6	3/4" FNPT	3/4" F.NPT	1/4"	2 PSIG @10 PSIG Inlet	-	Over Inlet	2,200,000
LV5503Y8	3/4" FNPT	1" F.NPT	9/32"	2 PSIG @10 PSIG Inlet	-	Over Inlet	2,200,000
LV4403Y4	1/2" F.NPT	1/2" F.NPT	1/4"	2 PSIG @10 PSIG Inlet	1.8" to 2.5" PSI	Over Inlet	1,000,000

*Backmount Design

Adjustable Flexible Vent Kit



PART NUMBER	TUBE LENGTH	END CONNECTORS	90° ELBOW	MOUNTING BRACKET
LV960-48	48"	2	1	3
LV960-72	72"			4
LV960-120	120"			5



Fairview Twin Stage Regulator



299-GR9959

The model GR-9950 and GR-9959 regulators combine both a high pressure first stage and a low pressure second stage regulator into a single unit. Ideally designed for RV applications, these regulators ensure a smooth and continuous flow of gas to all appliances.

SPECIFICATIONS:

- Zinc Die Cast
- Molded Rubber Diaphragms
- UL Listed
- 2nd Stage Relief Mechanism Per U.L. 144
- Adjusting Screw and Dust Cap Design

PART NUMBER	DESCRIPTION
290-GR9950	Vent Over Outlet
299-GR9959	9 o'clock Vent

Fairview Automatic Changeover Regulators

Low Pressure Two-Stage Automatic Changeover

Automatically redirects LP gas vapor flow from an empty designated service cylinder to a reserve cylinder without interruption of service. It features a green indicator dome which changes to red when the service cylinder needs to be refilled.

SPECIFICATIONS:

- Zinc Die Cast
- Molded Rubber Diaphragms
- UL Listed
- 2nd Stage Relief Mechanism Per U.L. 144
- Powder Coated



254-GR9984



912FS20



240-GR900



S42CC

PART NUMBER	DESCRIPTION
254-GR9984	Regulator
254-GR9984P	Regulator Carded
912FS20	1/4" Inv. Flare x POL 1/4" Tube with 7/8" Hex
240-GR900	Regulator Z-Bracket
S42CC	Connector 1/4" Inverted Flare x 1/4" MPT

Fairview Single Stage Regulators

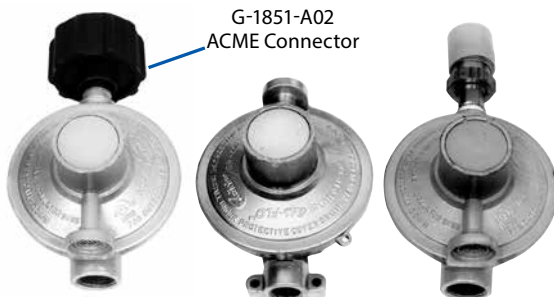

230-GR866
ACME Connector

230-GR800

230-GR856

Low Pressure Single-Stage Regulators

The model GR-800 regulator incorporates a drip lip vent and is ideally suited for use with portable devices.

SPECIFICATIONS:

- Zinc Die Cast
- Molded Rubber Diaphragm
- Underwriters Laboratories Listed
- Integral Pressure Relief

PART NUMBER	SIZE	BTU	VENT
230-GR866	1/4" x 3/8" with QCC	140,000	Drip Lip
230-GR800	1/4" x 3/8"	140,000	Drip Lip
230-GR856	1/4" x 3/8" POL	175,000	Drip Lip

High Pressure Industrial/Commercial Pounds-to-Pounds Regulators

Designed to reduce propane gas container pressure down to between 3 and 100 PSIG. Ideal for liquid or vapor service, they can be used in a variety of applications, including salamander heaters, weed burning torches, fish cookers, tar pot heaters and other industrial type services.

FEATURES:

- Provides high capacity performance at a reasonable price
- Suitable for both liquid and vapor service.
- Compact design provides easy installation
- Consistent delivery pressure, especially in cold weather, helps assure maximum performance from the second stage regulator

PART NUMBER	ADJUSTMENT METHOD	INLET & OUTLET	RECOMMENDED DELIVERY PRESSURE RANGE (PSIG)	CAPACITY*	CAPACITY**
597FA	Tee Handle	1/4" NPT	1-15	10	1,750,000
597FB	Tee Handle	1/4" NPT	10-30	20	3,000,000
597FC	Tee Handle	1/4" NPT	20-45	30	3,500,000
597FD	Tee Handle	1/4" NPT	40-100	40	4,500,000

* Set pressure established at 100 PSIG inlet and flow of 250,000 BTU/hr.

** Capacity determined at actual delivery pressure 20% less than set pressure with inlet pressure 20 PSIG higher than the set pressure.



597F

High Pressure Industrial / Commercial Regulators - LP Gas

Designed to reduce container pressure to between 3 and 125 PSIG. Precision-built with a multi-million BTU capacity. Ideal as a first stage regulator in large, multiple container operations. Also ideal for crop dryers, asphalt plants and "tar wagons." Large nozzle and straight through flow provides capacity and resistance to freezing up. Suitable for both liquid and vapor service. Can be readily fitted with a pressure gauge or 3139 series relief in 1/4" F.NPT port.

PART NUMBER	ADJUST METHOD	INLET & OUTLET CONN.	RECOMMENDED DELIVERY PRESSURE RANGE	WIDTH	HEIGHT (MAX.)	CAPACITY DETERMINED AT SET PRESSURE OF PSIG	CAPACITY*
1584VN	Tee Handle	1/2" F.NPT	3-30 PSIG	2 15/16"	4 7/8"	20	7,000,000
1584VL	Tee Handle	1/2" F.NPT	25-50 PSIG	2 15/16"	4 7/8"	30	7,500,000
1584VH	Tee Handle	1/2" F.NPT	45-125 PSIG	2 15/16"	4 7/8"	60	8,000,000
1586VN	Tee Handle	3/4" F.NPT	3-30 PSIG	3.5"	7"	20	11,000,000
1586VL	Tee Handle	3/4" F.NPT	25-50 PSIG	3.5"	7"	30	12,000,000
1586VH	Tee Handle	3/4" F.NPT	45-125 PSIG	3.5"	7"	60	14,000,000
1588VN	Tee Handle	1" F.NPT	3-30 PSIG	3.5"	7"	20	11,000,000
1588VL	Tee Handle	1" F.NPT	25-50 PSIG	3.5"	7"	30	12,000,000
1588VH	Tee Handle	1" F.NPT	45-125 PSIG	3.5"	7"	60	14,000,000

Care must be taken to prevent re-liquefaction of propane at normal temperatures by heat tracing or other effective means. Use of a relief valve downstream of these regulators is recommended in accordance with NFPA 58.

* Capacities determined at actual delivery pressure 20% less than set pressure with inlet pressure 20 PSIG higher than set pressure.



1584VN



High Pressure/High Temperature Industrial/Commercial Pounds-to-Pounds Regulators

Application:

Reduce LP-gas container pressures to between 3 and 50 PSIG. Ideal for crop drying, heat treating, asphalt batch mixing, and other large industrial and commercial load application utilizing high temperature LP gas or high temperature atmosphere under conditions up to 300°F. Also ideal as a first stage regulator in large multiple operations.

FEATURES:

- Diaphragm and seat materials are suitable for up to 300°F.
- High capacity and resistance to freeze ups.
- Suitable for both liquid and vapor service.
- zCan be fitted with a high pressure gauge in 1/4" F.NPT port. Recommended that these gauges use silver braze rather than soft solder construction.



PART NO.	SERVICE	ADJUSTMENT METHOD	INLET & OUTLET CONNECTIONS	RECOMMENDED DELIVERY PRESSURE RANGE (PSIG)	CAPACITY DETERMINED AT SET PRESSURE OF PSIG*	CAPACITY BTU/HR PROPANE**
X1584VL	LP-Gas	Tee Handle	1/2" F.NPT	25-50	30	7,500,000
X1586VL	LP-Gas	Tee Handle	3/4" F.NPT	25-50	30	12,000,000

* Set pressure is established with 100 PSIG inlet pressure and a flow of 500,000 BUT/hr propane.

** Capacities determined at actual delivery pressure 20% less than set pressure with inlet pressure 20# PSIG higher than set pressure.

NOTE: Care must be taken to prevent re-liquidation of propane at normal temperatures by heat tracing or other effective means. Use of a relief valve upstream or downstream of these regulators is recommended in accordance with NFPA 58.

Vapor Relief Valves for Pounds-to-Pounds Regulators

Application

Designed for use as a relief valve on first stage regulators that comply with the NFPA58 2.5.7.5 exception: "first stage regulators with a rated capacity of more than 500,000 BTU/hr. shall be permitted to have a separate relief valve."

FEATURES:

- Pop-action design keeps product loss to a minimum.
- Suitable for use downstream of 1580 series regulators on vapor systems to comply with NFPA 58.
- Install with either the regulator pressure gauge port or on a fitting downstream from the regulator outlet.
- Constructed of non-corrosive brass.



3139-18

PART NO.	RELIEF VALVE SETTING	REGULATOR SET PRESSURE	CONNECTION SIZE	HEIGHT	WIDTH
3139-18	18 PSIG	10 PSIG	1/4" M.NPT	2-27/32"	1-1/16"
3139-26	26 PSIG	15 PSIG	1/4" M.NPT	2-27/32"	1-1/16"
3139-38	38 PSIG	20 PSIG	1/4" M.NPT	2-27/32"	1-1/16"

Belgas Low Pressure Second Stage Regulators



B34 SERIES

Intermediate Commercial

B34: A versatile, large diaphragm-controlled regulator designed for commercial and industrial loads. It maintains accurate regulation on applications where frequent sudden load changes can occur.



B34SR SERIES

B38: Designed for use on large commercial and industrial loads. Large orifices are available (up to 1 3/8") for high capacity/low inlet pressure applications. An added feature is its massive relief capacity.



B38 SERIES

PART NO.	INLET	OUT	ORIFICE	ADJ RANGE	OUTLET PRESSURE SETTING	INTERNAL RELIEF VALVE	BTU/HR CAPACITY
B34SRQF-125	1-1/4"	1-1/4"	3/8" x 1/2"	8-12" WC	11" WC	Yes	5,019,000
B38RVJ-200	2"	2"	1"	1-2 PSI	2 PSI	Yes	12,800,000



B42 SERIES

Light Commercial

B42: Incorporates a molded diaphragm and increased lever ratio. The result is a lighter, more compact unit that provides the power, capacity, and relief performance of much larger regulators.



B42R SERIES

PART NO.	INLET	OUTLET	ORIFICE	ADJ. RANGE	OUTLET PRESSURE SETTING	INTERNAL RELIEF VALVE	BTU/HR CAPACITY
B42R-1/2	1/2"	1/2"	1/4"	6-16" WC	11" WC	Yes	1,331,000
B42R-1-1/4	1-1/4"	1-1/4"	3/8"	6-16" WC	11" WC	Yes	1,923,000



B42R SERIES

High Pressure Belgas Commercial/Industrial Pounds-to-Pounds Regulators



PART NUMBER	IN	OUT	ORIFICE	ADJ. RANGE	OUTLET PRESSURE	TYPE	BTU/HR CAPACITY
P627-3/4	3/4"	3/4"	1/2"	5-20 PSI	10PSI	Non Relief	10,851,000
R627-06-020-0-0-8-0-1-0	3/4"	3/4"		5-20 PSI		Relief	
P627-08-020-0-0-8-0-1-0	1"	1"	1/2"	5-20 PSI	10 PSI	Non Relief	10,867,000
P289-08-050-000-0-0	1"	1"		15-50 PSI	30 PSI	Relief	
P289-08-015-000-0-0	1"	1"		4-15 PSI		Relief	
R627-08-020-0-0-8-1-0	1"	1"		5-20 PSI		Relief	
P627-16-020-00-8-010	2"	2"	1/2"	5-20 PSI	10 PSI	Non Relief	10,263,000

Maxitrol Regulators

Maxitrol 325 Series Regulators

Use on residential, commercial, and industrial applications. Features a high leverage valve linkage assembly to deliver positive dead-end lock-up. Capable of precise regulating control from full flow down to pilot flow.

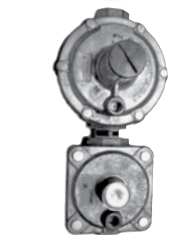
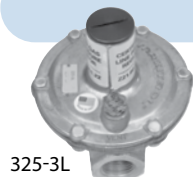

B Models:

Imblue Technology™ increases corrosion resistance and provides extra protection against the elements for regulators used in outdoor applications.

ALL MAXITROL REGULATORS COME WITH THE VENT LIMITER INSTALLED. ALSO AVAILABLE WITHOUT.



PART NUMBER.	INLET PSI	INSIDE VENT LIMITER	INLET OUTLET CONN.	OUTSIDE VENT PROTECTOR	SETTING OF SPRING	SPRING RANGE	BTU CAPACITY WITH SINGLE APPLIANCE	BTU CAPACITY ALL APPLIANCES COMBINE
325-3	2 PSI	12A09	3/8"	13A15	11" W.C.	7-11" W.C.	140,000	250,000
325-3L	2 PSI	12A09	1/2"	13A15	11" W.C.	7-11" W.C.	140,000	250,000
325-3BL	2 PSI	12A09	1/2"	13A15	11" W.C.	7-11" W.C.	140,000	250,000
325-5L	2 PSI	12A39	3/4"	13A15-5	11" W.C.	7-11" W.C.	300,000	600,000
325-5L-1	2 PSI	12A39	1"	13A15-5	11" W.C.	7-11" W.C.	300,000	600,000
325-5L-1/2	2 PSI	12A39	1/2"	13A15-5	11" W.C.	7-11" W.C.	300,000	600,000
325-5BL	2 PSI	12A39	3/4"	13A15-5	11" W.C.	7-11" W.C.	300,000	550,000
325-7AL	2 PSI	12A49	1 1/4"	13A25	11" W.C.	7-11" W.C.	1,250,000	1,250,000
325-9L	2 PSI	12A49	1 1/2"	13A25	11" W.C.	7-11" W.C.	3,600,000	3,622,500

Maxitrol Regulators with OPD

The 325 Series with OPDs features a high leverage valve linkage assembly to deliver positive dead-end lock-up. The regulators are capable of precise regulating control from full flow down to pilot flow.

PART NUMBER	OPD TYPE	INLET/OUTLET CONNECTION	SETTING OF SPRING	SPRING RANGE	BTU CAPACITY WITH SINGLE APPLIANCE	BTU CAPACITY ALL APPLIANCES COMBINED
325-3L48	w/OPD 48 attached	1/2"	11" W.C.	7-11" W.C.		200,000
325-5L48	w/OPD 48 attached	3/4"	11" W.C.	7-11" W.C.		235,000
325-5L600-3/4	w/OPD 600 attached	3/4"	11" W.C.	7-11" W.C.		425,000

Additional options available - contact a Tarantin representative for more information.



Pigtails

Pigtails are available in a variety of connections, sizes and styles. Care should always be taken in selecting the proper pigtail for a particular application.

Note: Tarantin Industries recommends a new pigtail be installed with every new and replaced regulator.

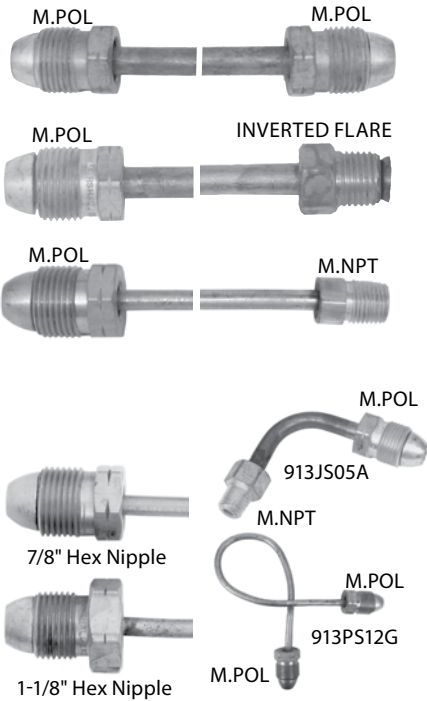

Straight Pigtails

CONNECTIONS	APPROX. LENGTH	PART NUMBER		
		1/4" TUBE		3/8" TUBE
		7/8" HEX SHORT NIPPLE	1 1/8" HEX LONG NIPPLE	7/8" HEX SHORT NIPPLE
M.POL x M.POL	5"	-	-	913PS05
	12"	912PS12	-	913PS12
	20"	912PS20	912PA20	913PS20
	30"	912PS30	-	913PS30
	36"	912PS36	912PA36	913PS36
	48"	912PS48	912PA48	913PS48
1/4" Inverted Flare x M.POL	12"	912FS12	-	-
	20"	912FS20	912FA20	-
	36"	912FS36	-	-
	48"	G-1674-48	-	-
1/4" M.NPT x M.POL	5"	-	-	913JS05
	12"	912JS12	-	913JS12
	20"	912JS20	912JA20	913JS20
	36"	912JS36	-	-
	48"	G-1662-48	-	-
1/2" M. NPT x M.POL	12"	-	-	913LS12

Bent Pigtails

CONNECTIONS	LENGTH	PART NUMBER		TYPE/DEGREE OF BEND
		3/8" TUBE	7/8" HEX SHORT NIPPLE	
1/4" M.NPT x M. POL	5"	913JS05A		90°
M. POL x M. POL	5"	913PS05A		90°
	12"	913PS12G		270° Right Hand

Electrically Isolated Pigtails

Primarily used on underground container installations to isolate the tank from the piping systems. They can also be used anywhere you need to electrically isolate the tank from the piping system.

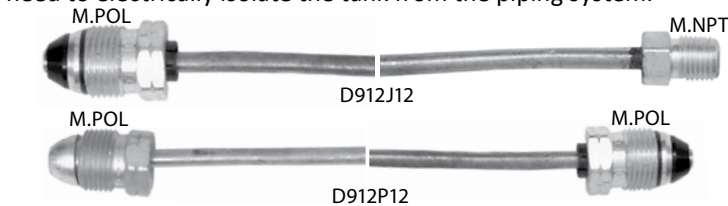

CONNECTIONS	LENGTH	PART NUMBER	
		7/8" HEX SHORT NIPPLE	
		1/4" TUBE	3/8" TUBE
M.POL x M.POL	12"	D912P12	D913P12
M.POL x M.POL	20"	D912P20	D913P20
M.POL x M.POL	30"	D912P30	D913P30
1/4" M.NPT x M.POL	12"	D912J12	D913J12
1/4" M.NPT x M.POL	20"	D912J20	D913J20
1/4" M.NPT x M.POL	30"	D912J30	D913J30

Presto-Tap Pigtails

Takes the place of a conventional pigtail. Allows a pressure test without disconnecting the pigtail from the tank. Saves time and cuts down on lost propane.

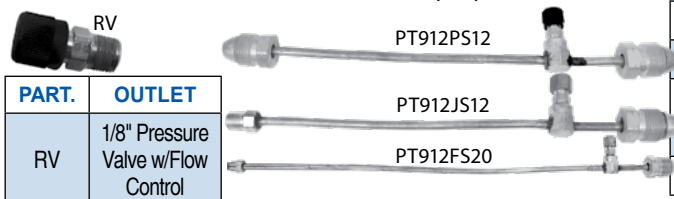

CONNECTIONS	LENGTH	PART NUMBER	
		3/8" TUBE • 7/8" HEX SHORT NIPPLE	
M. POL x M. POL	12"	PT912PS12	
M. POL x M. POL	20"	PT912PS20	
M. POL x M. POL	48"	PT912PS48	
1/4" M.NPT x M.POL	12"	PT912JS12	
1/4" M.NPT x M.POL	20"	PT912JS20	
1/4" Inv. Flare x M.POL	20"	PT912FS20	

Tee Blocks

Use with suitable pigtails to connect multiple cylinders together. Ideal for loads that require more than one cylinder to be in service at a time. Provides a three-way tee function when not equipped with an internal disc check.

PART NUMBER	PART NUMBER	CHECK	INLET	OUTLET
1350E	MSCP-1701B	No	FPOL	MPOL 7/8" Hexnut
1350R	1701A	Yes*	FPOL	MPOL 7/8" Hexnut
1450E	G-1701	No	1/4" IN FL	1/4" MPT
1450R	G-1700	Yes*	1/4" IN FL	1/4" MPT
-	1702A	Yes*	FPOL	MPOL 1 1/8" Hexnut
-	1702B	No	FPOL	MPOL 1 1/8" Hexnut
-	1701X	Ex Flow	FPOL	MPOL 7/8" Hexnut
-	1701F	No	FPOL	FPOL

* For use in systems that require uninterrupted gas service during cylinder exchange. Especially for summer cottages, mobile homes and single appliance loads. Floating disc check minimizes discharge of gas to the atmosphere when empty cylinder is being replaced.

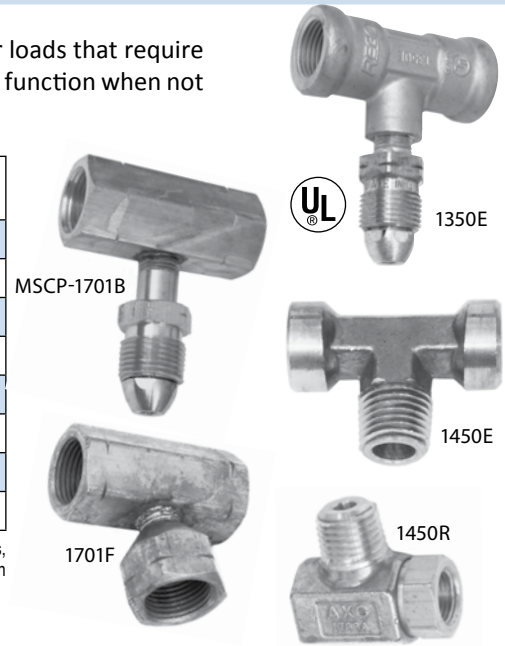

Single Piece POL Adapters

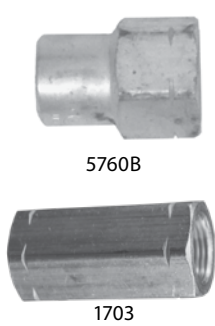

TYPE NUMBER BRASS	OTHER CONNECTION	CONNECTION
5760A	1/4" F.NPT	F.POL
5760B	3/8" F.NPT	F.POL
5760C	1/2" F.NPT	F.POL
5760D	3/4" F.NPT	F.POL
1703	F.POL	F.POL



TYPE NUMBER BRASS	OTHER CONNECTION	CONNECTION
2906A	1/4" F.NPT	M. POL
2906G	1/2" F.NPT	M. POL



TYPE NUMBER BRASS	OTHER CONNECTION	CONNECTION
5761A	1/4" M.NPT	F.POL
5761B	3/8" M.NPT	F.POL
5761C	1/2" M.NPT	F.POL
5761D	3/4" M.NPT	F.POL

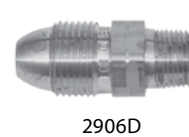

TYPE NUMBER BRASS	OTHER CONNECTION	CONNECTION
2906D	3/8" M.NPT	M.POL
BG20E	3/8" SAE FLARE	M.POL
BG20F	1/2" SAE FLARE	M.POL
BG20I	5/8" SAE FLARE	M.POL

Inverted Flare Adapters

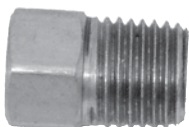

S42CC

PART NUMBER	OUTLET
S42CC	1/4" M. NPT x 1/4" F. Inverted Flare Inlet Adapter
RV	1/8" Pressure Valve w/Flow Control



RV



RegO POL Excess Flow Adapters

Designed for use on LP-gas ASME container manifolds where excess flow protection may be required for the vapor (POL) vapor outlet connections. POL X 1/2" MPT

3188A



PART NUMBER	APPROXIMATE CLOSING FLOWS				
	LIQUID CLOSING FLOW GPM	10 PSIG INLET	25 PSIG INLET	100 PSIG INLET	125 PSIG INLET
3188A	0.95	160	210	350	420
3188B	1.9	310	400	700	840
3188C	2.9	510	660	1180	1430

POL Inlet Fittings

All fittings have 1/4" M.NPT connections and are machined from brass with 7/8" Hex nut or handwheel.



PART NUMBER	PART NUMBER	DESCRIPTION
970	G-1675	Hard nose POL with wrench nut
970AX	G-1690	Hard nose POL with wrench nut and excess flow
970AS	G-1641	Soft nose POL with wrench nut and excess flow
3199W	G-1690	Heavy duty hard nose POL with wrench nut and excess flow
970AW	G-1654A	Soft nose POL with handwheel
-	G-1654	Soft nose POL with Black Plastic handwheel
970HT	-	Soft nose POL with handwheel and 60 DMS orifice
970S	G-1638	Soft nose POL with Wrench nut and 60 DMS orifice
-	737-5	POL Red Safety Plug with Strap

Suppressors



Attaches to the vent or vent piping to prevent pulsation, and protects against the accumulation of snow and ice on the vent opening. Equipped with a screen to exclude insects.

PART NO.	APPLICATION
1493	Installed directly on vent piping 3/8-1/2"
1493D	1/4" M.NPT Tailpiece

Brackets

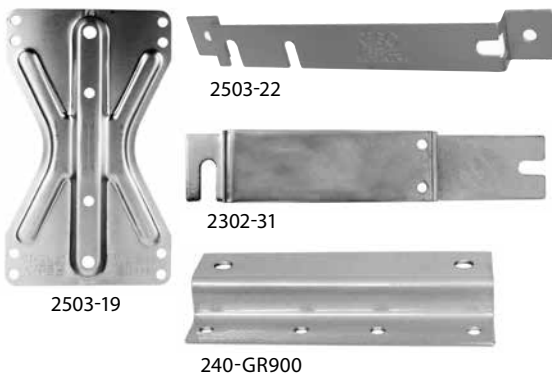

RegO brackets are especially designed for use in installing RegO regulators in applications requiring the use of a bracket.

PART NUMBER	MATERIAL	FOR USE WITH REGULATOR MODEL
2302-31	Cadmium Plated Steel	LV3403 & LV404B34 Series
2503-22	Cadmium Plated Steel	LV404, 2503, & LV4403 Series
2503-19	Aluminum	LV404, 2503, & LV4403 Series

PART NUMBER	APPLICATION
240-GR900	Z-Mounting Bracket Pre-drilled to attach to regulators horizontally or vertically. Allows the regulator to be mounted from the front to any surface

REGULATORS

Selecting a RegO® Regulator

In order to properly size the RegO® Regulator, find the total load of the installation. The total load is calculated by adding up the input ratings (BTU or CFH) of all appliances in the installation. Input ratings may be obtained from the nameplates on the appliances or from the manufacturers' literature.

Determine the type of regulation needed referring to the chart below.

TYPE OF SYSTEM	MAXIMUM LOAD	SUGGESTED REGULATOR
First Stage in a Two Stage System	1,500,000	LV3403TR
	2,500,000	LV4403SR Series LV4403TR Series
Second Stage in a Two Stage System	450,000	LV3403B Series
	935,000	LV4403B Series
	1,600,000	LV5503B4/B6
	2,300,000	LV5503B8
Second Stage in a 2 PSIG System	1,000,000	LV4403Y4/Y46R
	2,200,000	LV5503Y6/Y8
Integral Twin Stage	450,000	LV404B34/39 Series
	525,000	LV404B4/B9 Series
	800,000	LV404Y9
Automatic Changeover	200,000	7525B34 Series
	450,000	7525B4 Series

* See RegO L500 Catalog for inlet and delivery specifications.

Now determine which regulator in the Series would be most suitable. Turn to the individual product pages and refer to the Performance Curves. Check the performance of the regulator with your actual load conditions at the minimum LP-Gas inlet pressure for the regulator. Use the pressure corresponding to your lowest winter temperatures shown in the chart below or refer to the delivery pressure of your first stage regulator.

TEMPERATURE		APPROX. PRESSURE (PSIG)		TEMPERATURE		APPROX. PRESSURE (PSIG)	
°F	°C	PROPANE	BUTANE	°F	°C	PROPANE	BUTANE
-40	-40	3.6	-	40	4	72	3.0
-30	-34	8	-	50	10	86	6.9
-20	-29	13.5	-	60	16	102	12
-10	-23	23.3	-	70	21	127	17
0	-18	28	-	80	27	140	23
10	-12	37	-	90	32	165	29
20	-7	47	-	100	38	196	36
30	-1	58	-	110	43	220	45

Example for a First Stage Regulator

1. Assume a load of 500,000 BTU's per hour.
2. Assume a minimum delivery pressure of 9.5 PSIG.
3. Assume a minimum tank pressure of 15 PSIG.

4. For these conditions, refer to chart for the LV4403TR Series, First Stage Regulator, shown below.
5. Find the line on the chart corresponding to the lowest anticipated winter tank pressure (note that each performance line corresponds to and is marked with a different inlet pressure in PSIG).
6. Draw a vertical line upward from the point of assumed load (500,000 BTU's per hour) to intersect with the line corresponding to the lowest tank pressure.
7. Read horizontally from the intersection of these lines to the delivery pressure at the left side of the chart. In this example the delivery pressure will be 9.7 PSIG. Since the delivery pressure will be 9.7 PSIG at the maximum load conditions and lowest anticipated tank pressure, the regulator will be sized properly for the demand.

Example for a Second Stage Regulator

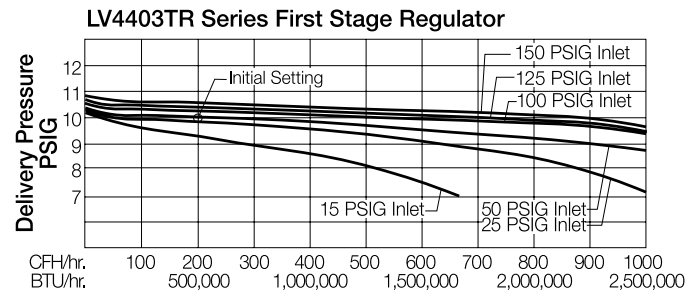

1. Assume load of 250,000 BTU's per hour.
2. Assume a minimum delivery pressure of 10" w.c.
3. Assume a minimum inlet pressure of 10 PSIG.
4. For these conditions, refer to chart for the LV4403B Series, Second Stage Regulator, shown below.
5. Find the line on the chart corresponding to the anticipated inlet pressure.
6. Draw a vertical line upward from the point of assumed load (250,000 BTU's per hour) to intersect with the line corresponding to the lowest inlet pressure.
7. Read horizontally from the intersection of these lines to the delivery pressure at the left side of the chart. In this example the delivery pressure will read 10.6" w.c. Since the delivery pressure will be 10.6" w.c. at the maximum load condition and lowest anticipated inlet pressure, the regulator is sized properly for the demand.

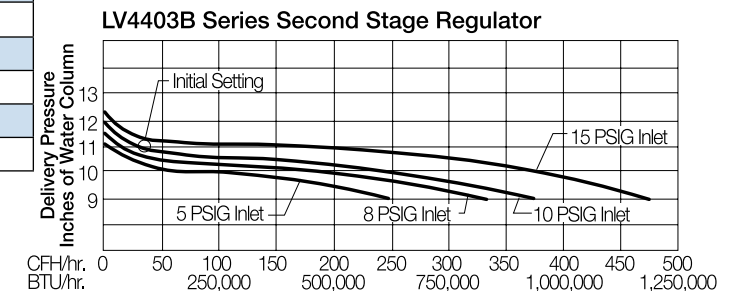

RegO Service Valves for ASME and DOT Containers or Piping Systems

Designed especially for vapor or liquid withdrawal service on ASME and DOT containers or in fuel line applications.



9101R1

PART NUMBER	BONNET TYPE	CONTAINER CONN.	SERVICE CONN.	LIQUID LEVEL VENT VALVE
901C1	Standard	3/4" M.NGT	F.POL CGA 510	No
9101C1	Standard	3/4" M.NGT	F.POL CGA 510	No
9101DT11.1	Standard	3/4" M.NGT	F.POL CGA 510	Yes
9101DT11.7	Standard	3/4" M.NGT	F.POL CGA 510	Yes
9101R1	MultiBonnet	3/4" M.NGT	F.POL CGA 510	No
9101RT11.1	MultiBonnet	3/4" M.NGT	F.POL CGA 510	Yes
9101RT11.7	MultiBonnet	3/4" M.NGT	F.POL CGA 510	Yes

NOTE: Since these valves have no integral pressure relief, they must be used on a container with an independent relief device sufficient for that tank's capacity.

RegO Service Valves for ASME Motor Fuel Containers

Designed specifically for vapor or liquid withdrawal service on ASME motor fuel containers.



9101H5

9101C5

9101Y5H

9101H6

PART NUMBER	CONTAINER CONNECTION	SERVICE CONNECTION	LIQUID WITHDRAWAL CONNECTION	CLOSING FLOW (LP-GAS)		
				VAPOR INLET		LIQUID GPM
				25 PSIG (SCFH)	100 PSIG (SCFH)	
9101C5	3/4" M.NGT	F. POL CGA 510	NONE	550 ***	1050 ***	2.6 ***
9101H5*	3/4" M.NGT	3/8" SAE Flare	NONE	765 **	1300 **	3.6 **
9101H6*	3/4" M.NGT	3/8" SAE Flare	1/4" NPT	550 ****	1050 ****	2.6 ****
9101Y5H*	3/4" M.NGT	60° Angle 3/8" SAE Flare	NONE	550 **	1050 **	3.6 **

* Heavy-duty models

** Based on 3/8" O.D. pigtail, 20" long or less, connected to valve outlet. For greater lengths, the pigtail must have a larger O.D.

*** Same as (**). In addition, 1/4" O.D. pigtails or POL connections for 1/4" O.D. should not be used with this valve.

**** Based on 3/8" O.D. pigtail; 20" long or less, connected to valve outlet. Also based on 1/4" pipe size dip tube, 42" long or less, attached to special inlet connection. For longer pigtail lengths, the diameter of the pigtail must be increased.

NOTE: These valves incorporate an excess flow valve.

RegO Service Valves for DOT Forklift Containers

Designed specifically for vapor or liquid withdrawal service on DOT forklift containers. Valves with 1.5 GPM closing flow are for use in small and medium size lift truck applications, while those with 2.6 GPM closing flow are for large lift trucks and gantry crane type vehicles.

Replacement Handwheel - Part Number: 9101-31



9101P5

9101P5HT

9101P6

9101P6H

PART NO.	CONTAINER CONN.	SERVICE CONN.	LIQUID WITHDRAWAL CONNECTION	CLOSING FLOW (LP-GAS)			APPROXIMATE FILLING RATE. LIQUID FLOW, GPM PRESSURE DROP ACROSS VALVE			
				VAPOR INLET		LIQUID (GPM)	10 PSIG	25 PSIG	50 PSIG	100 PSIG
				25 PSIG (SCFH)	100 PSIG (SCFH)					
9101P5	3/4" M.NGT	3/8" MPT	NONE	430	900	1.5	5.0	7.6	10.7	14.9
9101P5H	3/4" M.NGT	3/8" MPT	NONE	550	1050	2.6	5.0	7.6	10.7	14.9
9101P6	3/4" M.NGT	3/8" MPT	1/4" NPT	430	900	1.5	4.5	7.2	10.3	14.8
9101P6H	3/4" M.NGT	3/8" MPT	1/4" NPT	550	1050	2.6	4.5	7.2	10.3	14.8

NOTE: These valves incorporate an excess flow valve.

VALVES

Cylinder Valves

Replacement parts for all valves, see Repair Parts, pages 43-48.

ACME Check Connectors for Forklifts & Mowers



7141F



7141M

PART NUMBER	APPLICATION	TYPE	INLET	OUTLET	PROTECTIVE CAP*	
					RUBBER	BRASS
7141M	Service Valve	Forklifts	3/8" F.NPT	1 1/4" M.ACME	7141M-40	7141FP
7141F	Fuel Line	Forklifts	1 1/4" F.ACME	1/4" F.NPT	-	-
7142LM	Service Valve	Mowers	3/8" F.NPT	1 1/4" M.ACME		
7142LF	Fuel Line	Mowers	1 1/4" F.ACME	1/4" F.NPT		

*Recommended to minimize foreign material entering valves which could result in leakage.

Repair Parts for 7141M

PART NUMBER	DESCRIPTION
7141M-3R	RegO Flat Outer Washer
MSW-4	Flat Outer Washer
2114A	Inner O-ring

For washers & o-rings see page 107

RegO Heavy-Duty Cylinder Valves for Vapor Withdrawal



9103D04.2

This heavy duty cylinder valve is designed for vapor withdrawal of DOT cylinders up to 100 lbs. propane capacity. It is used in domestic hook-ups and RVs and as a heavy cylinder valve.

PART NUMBER	CONTAINER CONNECTION	SERVICE CONNECTION	FIXED LIQUID LEVEL VENT VALVE STYLE	DIP TUBE LENGTH W/DEFLECTOR	PRESSURE RELIEF VALVE SETTING	FOR USE IN CYLINDERS W/PROPANE CAPACITY UP TO:
9103D04.2	3/4" M.NGT	F. POL (CGA 510)	Knurled	4.2"	375 PSIG	100 lbs.
9103D10.6	3/4" M.NGT	F. POL (CGA 510)	Knurled	10.6"	375 PSIG	100 lbs.
9103D11.6	3/4" M.NGT	F. POL (CGA 510)	Knurled	11.6"	375 PSIG	100 lbs.

RegO Cylinder Valves for Liquid Withdrawal

Equipped with excess flow valves and liquid withdrawal tubes.



9107K8A

PART NUMBER	CONTAINER CONNECTION	SERVICE CONNECTION	FIXED LIQUID LEVEL VENT VALVE	DIP TUBE LENGTH W/DEFLECTOR	PRESSURE RELIEF VALVE SETTING	FOR USE IN CYLINDERS W/PROPANE CAPACITY UP TO:
9107K8A	3/4" M.NGT	CGA 555	Knurled	11.6"	375 PSIG	100 lbs.

See pages 43-48 for Repair Parts

RegO Cylinder Valve for RV and Small ASME System Vapor Withdrawal



Designed especially for vapor withdrawal service in small ASME containers with surface area up to 23.8 square feet. UL flow capacity is 645 CFM/air, per NFPA 58.

PART NUMBER	CONTAINER CONNECTION	SERVICE CONNECTION	FIXED LIQUID LEVEL VENT VALVE STYLE	PRESSURE RELIEF VALVE SETTING
9106CO	3/4" M. NGT	F. POL	NONE	312 PSIG

Compact Cylinder Valves with OPD and QCC Type 1

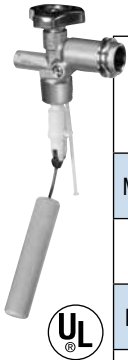

These valves are designed for use on DOT LP gas cylinders up to 40 lbs.

PART NUMBER	DIP TUBE LENGTH W/ DEFLECTOR	FOR USE ON DOT CYLINDERS UP TO:	CONTAINER CONNECTION	SERVICE CONNECTION TYPE	SERVICE CONNECTION DESCRIPTION	FIXED LIQUID LEVEL VENT VALVE STYLE	ACCESSORIES RELIEF VALVE SETTING
MSCP-VQCC-B.7	3.0"	5 lbs.	3/4" M. NGT	Type 1	1 15/16" M. ACME and F. POL CGA 791	Slotted	375 PSIG
MSCP-VQCC-O	4.0"	20 lbs.	3/4" M. NGT	Type 1	1 15/16" M. ACME and F. POL CGA 791	Slotted	375 PSIG
MSCP-VQCCB-2	4.8"	30 lbs.	3/4" M. NGT	Type 1	1 15/16" M. ACME and F. POL CGA 791	Slotted	375 PSIG
MSCP-VQCC-B.3	6.5"	40 lbs.	3/4" M. NGT	Type 1	1 15/16" M. ACME and F. POL CGA 791	Slotted	375 PSIG



Repair Parts for Compact Cylinder Valves

PART NUMBER	DESCRIPTION
3125-40P	Relief Cap
DC-QCC1	Dust Cover

Multivalves

RegO DOT & ASME Multivalve for Vapor Withdrawal



These Multivalves permit vapor withdrawal from DOT cylinders with up to 200 lbs. propane capacity.

PART NUMBER	CONTAINER CONNECTION	SERVICE CONNECTION	FILLING CONNECTION	FIXED LIQUID LEVEL VENT VALVE STYLE	DIP TUBE LENGTH W/DEFLECTOR	PRESSURE RELIEF VALVE SETTING
8555R10.6	3/4" M. NGT	F. POL	1 3/4" M. ACME (CGA 510)	Knurled	10.6"	375 PSIG
8555D10.6	3/4" M. NGT	F. POL	1 3/4" M. ACME (CGA 510)	Knurled	10.6"	375 PSIG
8555R11.6	3/4" M. NGT	F. POL	1 3/4" M. ACME (CGA 510)	Knurled	11.6"	375 PSIG
8555D11.6	3/4" M. NGT	F. POL	1 3/4" M. ACME (CGA 510)	Knurled	11.6"	375 PSIG
6555R11.6	3/4" M. NGT	F. POL	1 3/4" M. ACME (CGA 510)	Knurled	11.6"	250 PSIG

See pages 43-48 for Repair Parts

RegO DOT Multivalve for Liquid Withdrawal



This Multivalve permits liquid withdrawal from DOT cylinders with up to 100 lbs. propane capacity. Equipped with an excess flow valve and liquid withdrawal tube.

PART NUMBER	CONTAINER CONN.	SERVICE CONN.	FILLING CONN.	FIXED LIQUID LEVEL VENT VALVE STYLE	DIP TUBE LENGTH W/ DEFLECTOR	LIQUID WITHDRAWAL TUBE LENGTH	PRESSURE RELIEF VALVE SETTING	FOR USE IN CYLINDERS W/PROPANE CAPACITY UP TO:	LIQUID CLOSING FLOW (LP-GAS)
8555DL11.6	3/4" M. NGT	CGA 555	1 3/4" M. ACME	Knurled	11.6"	44"	375 PSIG	100 lbs.	1.7 GPM



PART NUMBER	DESCRIPTION
NP210	1/4" Male Liquid Nipple. 2" Long.
A948	F.POL x F-CGA555 Connector for Liquid Service
PC555	Brass Cap with Chain for CGA555

VALVES

Multivalves

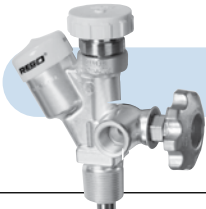

RegO DOT and ASME Multivalve for Vapor Withdrawal

These Multivalves permit vapor withdrawal from ASME containers up to 50 sq. ft. surface area and DOT containers up to 420 lbs. propane capacity.

PART NUMBER	APPLICATION	CONTAINER CONNECTION	SERVICE CONNECTION	FILLING CONNECTION	FIXED LIQUID LEVEL VENT VALVE STYLE	DIP TUBE LENGTH W/ DEFLECTOR	PRESSURE RELIEF VALVE SETTING	FOR USE IN DOT CYLINDERS W/PROPANE CAPACITY UP TO:**	FOR USE IN DOT CYLINDERS W/SURFACE AREA UP TO:***
6532R12.0	ASME*	3/4" M. NGT	F. POL (CGA 510)	1 3/4" M. ACME	Knurled	12.0"	250 PSIG	-	43 sq. ft.
6542R12.0	ASME*	1" M. NGT	F. POL (CGA 510)	1 3/4" M. ACME	Knurled	12.0"	250 PSIG	-	53 sq. ft.
6533R10.5	DOT	3/4" M. NGT	F. POL (CGA 510)	1 3/4" M. ACME	Knurled	10.5"	375 PSIG	420 lbs. Propane	-
6533A11.7	DOT	3/4" M. NGT	F. POL (CGA 510)	1 3/4" M. ACME	Knurled	11.7"	375 PSIG	420 lbs. Propane	-
6533R11.7	DOT	3/4" M. NGT	F. POL (CGA 510)	1 3/4" M. ACME	Knurled	11.7"	375 PSIG	420 lbs. Propane	-
6543A11.1	DOT	1" M. NGT	F. POL (CGA 510)	1 3/4" M. ACME	Knurled	11.1"	375 PSIG	420 lbs. Propane	-
6543R11.1	DOT	1" M. NGT	F. POL (CGA 510)	1 3/4" M. ACME	Knurled	11.1"	375 PSIG	420 lbs. Propane	-
6543A11.7	DOT	1" M. NGT	F. POL (CGA 510)	1 3/4" M. ACME	Knurled	11.7"	375 PSIG	420 lbs. Propane	-
6543R11.7	DOT	1" M. NGT	F. POL (CGA 510)	1 3/4" M. ACME	Knurled	11.7"	375 PSIG	420 lbs. Propane	-

* UL rated flow capacities are: 6532A12.0-1180 SCFM/air, 6542A12.0-1530 SCFM/air.

** Per CGA Pamphlet S-1.1.

*** From NFPA, Appendix D.

Repair Parts

PART NUMBER	DESCRIPTION
3131-54	Relief Valve Cap
MSCP-M3274-9P	Fill Valve Cap
9107-31	Replacement Handwheel

RegO ASME Multivalve for Vapor Withdrawal

These multivalves provide vapor withdrawal and filling of ASME containers. A separate pressure relief valve is required in addition to this valve. The MultiBonnet is standard on this valve.



PART NUMBER	CONTAINER CONNECTION	SERVICE CONNECTION	FILLING CONNECTION	VAPOR EQUALIZING CONNECTION		LIQUID LEVEL VENT VALVE STYLE	FIXED DIP TUBE* LENGTH
				CONNECTION SIZE	UL LISTED CLOSING FLOW		
8593AL16.0	1 1/2" M. NGT	F. POL (CGA 510)	1 3/4" M. ACME	1 1/4" M. ACME	4200 CFH at PSIG	Knurled	16"

*Dip tube not installed, may be cut by customer to desired length.

Since these multivalves have no integral pressure relief valves, they can be used on any ASME container with an independent relief device sufficient for that tank's capacity.

This style has a 1/8" F.NPT pressure test port. With the service valve closed the pressure test port will be isolated from the container. This will allow a high pressure leak test be conducted without disconnecting the pigtail from the service valve.

It is especially suited for vapor withdrawal of ASME containers where compact groupings of components are necessary. Separate filler valves and pressure relief valves are required.



PART NUMBER	CONTAINER CONNECTION	SERVICE CONNECTION	VAPOR EQUALIZING CONNECTION		FIXED LIQUID LEVEL VENT VALVE	DIP TUBE LENGTH	READY TO GO	PRESTO TAP
			CONNECTION SIZE	UL LISTED CLOSING FLOW				
7556R12.0*	3/4" M. NGT	F. POL (CGA 510)	1 1/4" M.ACME	4200 CFH @100 PSIG	Knurled	12"	Plugged	Without
PT7556R12.0							Yes	With

* MultiBonnet Design

Repair Parts

PART NUMBER	DESCRIPTION	FOR VALVE
3144-9P	Vapor Equalization Cap	8593AL16.0 7556R12.0 PT7556R12.0
MSCP-M3274-9P	Fill Valve Cap	8593AL16.0
9107-31	Replacement Handwheel	8593AL16.0 7556R12.0 PT7556R12.0

RegO External Relief Valves for ASME Containers and Bulk Plant Installations



AA3135



3135



W3132G

Designed for use as a primary relief valve on ASME above ground and underground containers, bulk plant installations and skid tanks. The 3131 Series may also be used as a primary or secondary relief valve on DOT cylinders, or as a hydrostatic relief valve.

PART NUMBER	START TO DISCHARGE SETTING PSIG	CONTAINER CONNECTION	OVERALL HEIGHT (APPROX.)	WRENCH HEX SECTION	FLOW CAPACITY SCFM/AIR		SUITABLE FOR TANKS W. SURFACE AREA UP TO: (A)	ACCESSORIES			
					UL AT 120% OF SET PRESSURE	ASME AT 120% OF SET PRESSURE		PROTECTIVE CAP	PIPEAWAY ADAPTER PART NUMBER	OUTLET SIZE	WEEP HOLE DEFLECTOR
3131G	250	3/4" M.NPT	3 7/16"	1 3/4"	2060	1939	85 sq. ft.	3131-40 (b)	-	-	-
W3132G	250	1" M.NPT	6 1/32"	2 3/8"	3340	-	154 sq. ft.	3132-54 (b)	3132-10	1 1/4" F.NPT	-
3132G	250	1 1/4" M.NPT	6 1/32"	2 3/8"	4130	-	200 sq. ft.	3132-54 (b)	-	-	-
T3132G	250	1 1/4" M.NPT	6 1/32"	2 3/8"	3790	-	180 sq. ft.	3132-54 (b)	3132-10	1 1/4" F.NPT	-
MV3132G	250	1 1/4" M.NPT	6 1/32"	2 3/8"	3995	-	190 sq. ft.	3132-54 (b)	-	-	-
3135G	250	1 1/4" M.NPT	5 21/32"	2 11/16"	5770	-	300 sq. ft.	3132-54 (b)	3135-10	2" F.NPT	-
3133G	250	1 1/2" M.NPT	5 15/16"	3 1/8"	6080	-	320 sq. ft.	3133-40 (b)	3133-10	2" F.NPT	-
A3149G	250	2 1/2" M.NPT	10 1/2"	4 1/8"	10390	9153	613 sq. ft.	3149-40	(c)	(c)	Included (d)

Anhydrous Ammonia Parts available upon request

"A" prefix – Products with this prefix are suitable for LP-gas or NH₃ service (i.e., contain no brass parts).

- (a) Per NFPA Pamphlet #58, Appendix D. Area shown is for UL or ASME flow rating —whichever is larger.
- (b) Cap supplied with chain.
- (c) Outlet 31/2-8N (F) thread, will accept 3" M. NPT pipe thread.
- (d) Weep hole deflector is Part No. A3134-11B.

RegO Low Emissions Underground Multivalve

These Multivalves are designed for use in single opening ASME containers equipped with a 2 1/2" M. NPT riser.

Features

- Combines low emission double back check filler valve, vapor equalizing valve, pressure relief valve, service valve, fixed liquid level gauge, "junior" sized float gauge flange opening and a plugged pressure gauge opening.
- Double back check filler valve is low emission, 2.13cc at disconnection no reduction in fill rates.
- Service valve features a Multibonnet® stem assembly that allows for repair without evacuating gas from the container.
- Designed for installation of a 1/8" F.NPT pressure gauge or pressure gauge connection like the Presto-Tap®.

Materials

- Body Forged Brass
- Hand-wheel Aluminum
- Valve Stems Brass
- O-rings Resilient Rubber
- Seat Disc (shutoff) Nylon
- Seat Disc (other) Resilient Rubber
- Relief Spring Stainless Steel



PART NUMBER	CONNECTIONS			VAPOR EQUALIZING CONNECTION		FLOAT GAUGE FLANGE OPENING	FIXED LIQUID LEVEL VENT VALVE STYLE	DIP TUBE LENGTH	PRESSURE RELIEF VALVE SETTING	UL LISTED RELIEF VALVE CAPACITY	FOR USE IN CONTAINERS W/SURFACE AREA UP TO:
	CONTAINER	SERVICE	FILLING	CONNECTION SIZE	UL LISTED CLOSING FLOW						
G8475RL	2 1/2" F.NPT	F.POL (CGA 510)	1 3/4" M.ACME	1 1/4" M.ACME	4200 CFH @ 100 PSIG	"JUNIOR" Size	Knurled	30**	250 PSIG	2020 SCFM/air	83 sq. ft. Above ground 276 sq. ft. Underground
G8475RLW	2 1/2" F.NPT	F.POL (CGA 510)	1 3/4" M.ACME	1 1/4" M.ACME	4200 CFH @ 100 PSIG	"JUNIOR" Size	Knurled	30**	250 PSIG	3995 SCFM/air	192 sq. ft. Above ground 639 sq. ft. Underground
PG8475RL	2 1/2" F.NPT	F.POL (CGA 510)	1 3/4" M.ACME	1 1/4" M.ACME	4200 CFH @ 100 PSIG	"JUNIOR" SIZE	YES	30**	250 PSIG	2020 SCFM/air	NA
PG8475RLW	2 1/2" F.NPT	F.POL (CGA 510)	1 3/4" M.ACME	1 1/4" M.ACME	4200 CFH @ 100 PSIG	"JUNIOR" Size	Knurled	30**	250 PSIG	3995 SCFM/air	192 sq. ft. Above ground 639 sq. ft. Underground

* Dip tube not installed, may be cut by customer to desired length.

VALVES

Relief Valves

RegO Fully Internal Pressure Relief Valve for DOT Forklift Cylinder



8545AKT

Designed for use as a primary relief valve on forklift cylinders, the 8545AK reduces the possibility of improper functioning of the relief mechanism due to foreign material build up.

PART NUMBER	CONTAINER TYPE	START TO DISCHARGE SETTING (PSIG)	CONTAINER CONNECTION	FLOW CAPACITY SCFM/AIR** (ECII® RATED AT 480 PSIG)
8545AK	DOT	375	3/4" M.NPT	400*

* Classified by U.L. in accordance with Compressed Gas Association Pamphlet S-1.1 Pressure Device Standards for Cylinders. Meets requirements for use on DOT containers with 262 pounds or less weight of water or 109 pounds or less of LP-Gas.

** Flow rates are shown for bare relief valves. Adapters and pipeways will reduce flow as discussed in forewording information.

Accessories

PART NUMBER	DESCRIPTION
7545-14***	45° Elbow
7545-12***	90° Elbow
11557-19	Protective Plug
F31638	Protective Cap

*** Order protective cap 7545-40.



7545-14A



7545-12

RegO External Hydrostatic Relief Valves



3127G



SS8022G

Designed especially for the protection of piping and shut-off valves where there is a possibility of trapping liquid LP-gas or anhydrous ammonia. They may be installed in pipelines and hoses located between shut-off valves or in the side boss of RegO shut-off valves.

PART NUMBER	START TO DISCHARGE SETTING (PSIG)	VALVE BODY MATERIAL	CONTAINER CONNECTION	HEIGHT (APPROX.)	WRENCH HEX SECTION	ACCESSORIES	
						PROTECTIVE CAP	PIEAWAY ADAPTER OR THREADS
SS8001G	250	Stainless Steel	1/4" M.NPT	7/8"	11/16"	8001-54*	-
SS8021G	250	Stainless Steel	1/4" M.NPT	1 3/8"	11/16"	8001-54	1/4" NPSM Thrds
SS8022G	250	Stainless Steel	1/2" M.NPT	1 3/8"	7/8"	8002-54*	3/8" NPT Thrds
3127G	250	Brass	1/4" M.NPT	1 31/32"	7/8"	9103-54*	-
3129G	250	Brass	1/2" M.NPT	2 19/32"	1 1/8"	3129-40P*	3129-10**
3127H	275	Brass	1/4" M.NPT	1 31/32"	7/8"	9103-54*	-
3129P	300	Brass	1/2" M.NPT	2 19/32"	1 1/8"	3129-40P*	3129-10**
3127J	350	Brass	1/4" M.NPT	1 31/32"	7/8"	9103-54*	-
3129J	350	Brass	1/2" M.NPT	2 19/32"	1 1/8"	3129-40P*	3129-10**
SS8001J	350	Stainless Steel	1/4" M.NPT	7/8"	11/16"	8001-54	-
SS8021J	350	Stainless Steel	1/4" M.NPT	1 3/8"	11/16"	8001-54	1/4" NPSM Thrds
SS8022J	350	Stainless Steel	1/2" M.NPT	1 3/8"	7/8"	8002-54*	3/8" NPT Thrds
3127K	375	Brass	1/4" M.NPT	1 31/32"	7/8"	9103-54*	-
3129K	375	Brass	1/2" M.NPT	2 19/32"	1 1/8"	3129-40P*	3129-10**
3125L	400	Brass	1/4" M.NPT	1 9/16"	5/8"	9103-54*	-
3127L	400	Brass	1/4" M.NPT	1 31/32"	7/8"	9103-54*	-
3129L	400	Brass	1/2" M.NPT	2 19/32"	1 1/8"	3129-40P*	3129-10**
SS8021L	400	Stainless Steel	1/4" M.NPT	1 3/8"	11/16"	8001-54	1/4" NPSM Thrds
SS8022L	400	Stainless Steel	1/2" M.NPT	1 3/8"	7/8"	8002-54*	3/8" NPT Thrds
3127U	450	Brass	1/4" M.NPT	1 31/32"	7/8"	9103-54*	-
3129U	450	Brass	1/2" M.NPT	2 19/32"	1 1/8"	3129-40P*	3129-10**
SS8001U	450	Stainless Steel	1/4" M.NPT	7/8"	11/16"	8001-54*	-
SS8021U	450	Stainless Steel	1/4" M.NPT	1 3/8"	11/16"	8001-54	1/4" NPSM Thrds
SS8022U	450	Stainless Steel	1/2" M.NPT	1 3/8"	7/8"	8002-54	3/8" NPT Thrds

* Included

** 1/2" F.NPT outlet connection

All RegO relief valves are tested before they leave the factory to assure reliability.

Relief Valves

RegO Internal Relief Valves for Transports and Delivery Trucks



A8434G

Fully Internal "Pop-Action" Pressure Relief Valves for Transports and Delivery Trucks

Designed specifically for use as a primary relief valve with ASME transports and delivery trucks with 2" and 3" NPT couplings. All stainless steel construction.

PART NUMBER	START TO DISCHARGE SETTING (PSIG)	CONTAINER CONNECTION M. NPT	FLOW CAPACITY SCFM/AIR		SUITABLE FOR TANKS WITH SURFACE AREA UP TO (SQ. FT.)	PROTECTIVE CAP (INCLUDED)
			UL (AT 120% OF SET PRESSURE)	ASME (AT 120% OF SET PRESSURE)		
A8434G	250	2"	3700	3456	175 SQ FT	A8434-11B
A8436G	250	3"	10210	9598	602 SQ FT	A8436-11B

Removal Tools

Assists with removing fully internal relief valves.

Part Number: A8434-40 for use on A8434G

Part Number: A8436-40 for use on A8436G

RegO Internal Relief Valves for ASME Containers



8685G

Semi-internal "Pop Action" Pressure Relief Valves

Designed for use as a primary relief valve on ASME containers such as 250, 500, and 1,000 gallon tanks.

PART NUMBER	START TO DISCHARGE SETTING (PSIG)	CONTAINER CONNECTION M. NPT	FLOW CAPACITY SCFM/AIR		SUITABLE FOR TANKS WITH SURFACE AREA UP TO (SQ. FT.)	PROTECTIVE CAP (INCLUDED)
			UL (AT 120% OF SET PRESSURE)	ASME (AT 120% OF SET PRESSURE)		
7583G	250	3/4"	1980	1806	80	7583-40
8684G	250	1"	2620	2565	113	8684-40
8685G	250	1 1/4"	4385	4035	212	7585-40

RegO Internal Relief Valves for Large Storage Containers



Semi-internal "Pop Action" Pressure Relief Valves

Designed especially for use as a primary relief valve on large stationary storage containers, these low profile relief valves are generally mounted in half couplings.

PART NUMBER	START TO DISCHARGE SETTING (PSIG)	CONTAINER CONNECTION M. NPT	FLOW CAPACITY SCFM/AIR		SUITABLE FOR TANKS WITH SURFACE AREAS UP TO:**
			UL (AT 120% OF SET PRESSURE)	ASME (AT 120% OF SET PRESSURE)	
7534G	250	2"	11,675	10,422	708 Sq. Ft.

* Flow rates shown are for bare relief valves. Adapters and pipeaways will reduce flow as discussed in the forewording information.

** Per NFPA Pamphlet #58, Appendix D. Area shown is for UL or ASME—whichever is larger.

Accessories

PROTECTIVE CAP	PIPEAWAY ADAPTER
7534-40	7534-20***

*** 3" F. NPT outlet connection.

Relief Valves

RegO Relief Valves for Motor Fuel Containers



Fully Internal "Pop Action"

Designed for use as a primary relief valve in smaller ASME and DOT motor fuel containers such as on tractors, lift trucks, cars and taxicabs.

PART NO.	CONTAINER TYPE	START TO DISCHARGE SETTING (PSIG)	CONTAINER CONN. M. NPT	OVERALL HEIGHT (APPROX)	HEIGHT ABOVE COUPLING (APPROX.)	HEX WRENCHING SECTION	FLOW CAPACITY SCFM/AIR****	
							UL (AT 120% OF SET PRESSURE)	ASME (AT 120% OF SET PRESSURE)
8544G	ASME	250	1"	5 7/16"	7/8"	1 5/16"	1020	936
8544	ASME	312	1"	5 7/16"	7/8"	1 5/16"	1282	1158
8544K	DOT/ASME	375	1"	5 7/16"	7/8"	1 5/16"	1545***	-



* 1" M. NPT outlet connection.

** 1 1/4" M. NPT outlet connection.

*** Rating also applies to DOT requirements.

**** Flow rates shown are for bare relief valves. Adapters and pipeaway will reduce flow.

Accessories



7544-11A

PIPEAWAY ADAPTER	DESCRIPTION	INCLUDED
7544-11A	Pipeaway Adapter	No
7544-41	Protective Cap	Yes

RegO Duo-port Pressure Relief Valve Manifolds for Small Storage Containers



Designed especially for use as a primary relief device on smaller stationary storage containers up to 1200 gallons water capacity, with 2" NPT threaded couplings.

PART NO.	START TO DISCHARGE SETTING (PSIG)	APPLICATION		CONTAINER FLANGE CONNECTION	RELIEF VALVE INCLUDED				FLOW CAPACITY SCFM/AIR** UL (AT 120% OF SET PRESSURE)
		LP-GAS	NH3		QTY	PART NO.	INLET CONN. M. NPT	ACCESSORY PIPEAWAY ADAPTERS*	
8542G	250	Yes	No	2"	2	3135MG	1 1/4"	3135-10	5250 (1)

* 2" F. NPT Outlet Connection

** Flow Rating based on number of relief valves indicated in parenthesis.

Relief Valve Cap - Part Number: 3135-54

The RegO Multiport makes changing storage tank relief valves a snap. No need to empty the tank!

Weather Caps

Provides protection of vertical relief valve riser pipes against rain and foreign material.



PART NUMBER	PIPE SIZE
P770-1-1/8	3/4"
P770-2-3/8	2"
P770-3-1/2	3"
P770-4-1/2	4"

Relief Valve Bonnets

Inexpensive, expendable relief valve cover. Fits most popular sizes. Meets NFPA requirements. Self venting and weather resistant.

Universal Relief Valve Cover



PART NUMBER	SIZE
85	1/2" - 3/4"
85A	3/4" - 1 1/4"

RegO Multiport Pressure Relief Valve Manifold Assemblies for Large Storage Containers

Designed especially for use as a primary relief device on large stationary pressurized storage containers with flanged openings. Incorporates an additional relief valve, not included in the flow rating, allowing for servicing or replacement of any one of the relief valves without evacuating the container. The handwheel on the manifold selectively closes off the entrance port to the relief valve being removed while the remaining relief valves provide protection for the container and its contents. All manifold flow ratings are based on flow through the relief valves after one has been removed for service or replacement.



PART NO.	START TO DISCHARGE SETTING (PSIG)	APPLICATION		CONTAINER FLANGE CONN.	QTY	RELIEF VALVE			ASME RATING FLOW CAPACITY SCFM/AIR** AT 120% OF SET PRESSURE
		LP-GAS	NH3			PART NO.	INLET CONN. M. NPT	ACCESSORIES PIPEAWAY ADAPTERS	
A8563AG	250	Yes	Yes	3"-300#*	3	A3149G	2 1/2"	3/2" (F) thread***	18,300 (2)
A8564AG	250	Yes	Yes	3"-300#*	4	A3149G	2 1/2"	3/2" (F) thread***	27,400 (3)
A8573AG	250	Yes	Yes	4"-300#	3	A3149G	2 1/2"	3/2" (F) thread***	18,300 (2)
A8574AG	250	Yes	Yes	4"-300#	4	A3149G	2 1/2"	3/2" (F) thread***	27,400 (3)

* For use with modified 300# ANSI flange with 4" port.

** Flow rating based on number of relief valves indicated in parenthesis . Flow rates shown are for bare relief valves. Adapters and pipeways will reduce flow rates as discussed in forewording information.

*** Outlet 3/2" (F) thread, will accept 3" M. NPT pipe thread.

*1 Special order, non-stock item.

Relief Valve Cap - Part Number: 3149-40

Multiport Manifolds for Storage Containers

Thumb Screw-8560-31

Screws(2)-7560-23

Washers(2)-1935-57

Stem Strap-7560-22

Handwheel-7560-15

Seat Insert-8560-27SS
DO NOT REMOVE

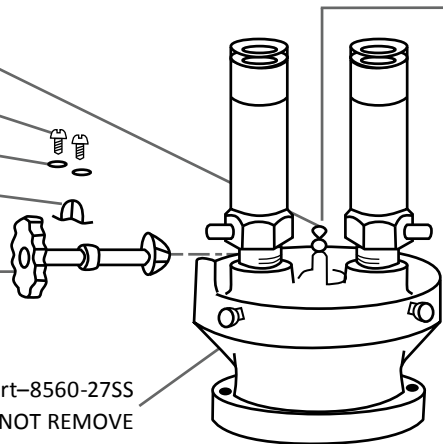

Gear Cover

Screw-7560-24

Lock Washer-1935-57

Socket Screws (2)-7560-25

Miter Gear-7560-9

Upper Washer*-8560-28T

Packing Gland*-9560-15SS

Pressure Seal Rings(2)*-8560-18T

Jam Ring*-8560-17T

Lower Washer-8560-9

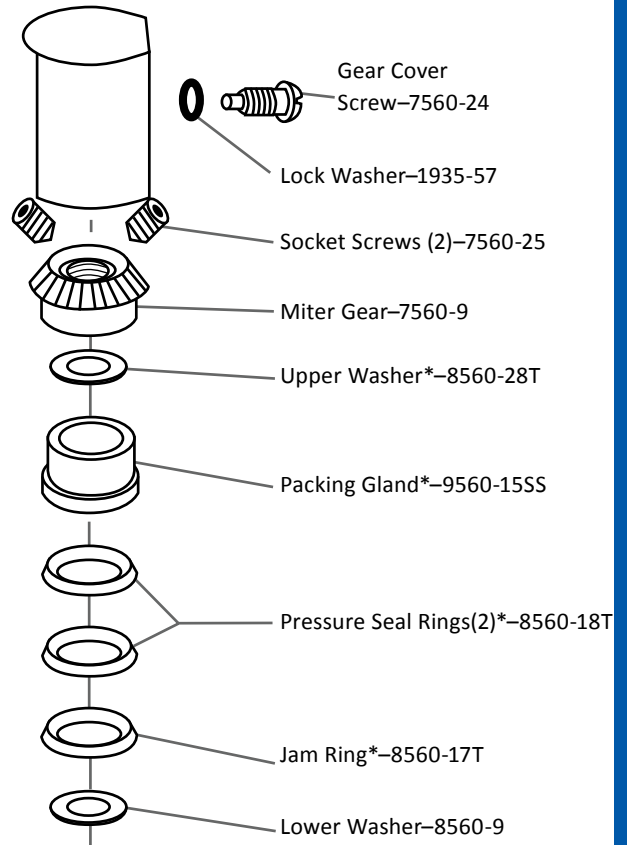

Multi-port Flange Repair Parts

PART NO.	CONTAINS	USE WITH:	CONNECTIONS TO:	NEEDED
7560-55	1-Bolt Stud and Nut	All ECII Multiports	Modified 3"-300# and 4" -ASA 300# Welding Neck Flange	8
7560-56	1-Bolt Stud and Nut	All ECII Multiports	Manifold Cover Plate	8
A3134-11B	Weep Hole Deflector	-	-	-
8560-26TP	Bleeder Valve	-	-	-

*Denotes parts that must be ordered for replacement.

VALVES

Globe & Angle Valves

We've got a globe, angle or ball valve to fit your application and budget.

RegO Flange Seal Globe and Angle Valves for Bulk Storage Containers, Filling Hoses and Plant Piping



A7704P



A7706P

Designed to assure positive shut-off and long maintenance-free service life in liquid or vapor service. Ideally suited for use on cylinder charging manifolds, truck filling hoses, bulk storage containers and plant piping.

PART NUMBER	CONFIGURATION	INLET & OUTLET CONNECTION	PRESSURE DROP (CV) (GPM/PROPANE)
A7704P	Globe	1/2" FPT	7.3
A7705P	Globe	3/4" FPT	11.5
A7704LP	Angle	1/2" FPT	12.3
A7706P	Angle	3/4" FPT	17.7

RegO "V"-ring Globe and Angle Valves for Bulk Storage Containers, Transports, Bobtails and Plant Piping

Specifically designed to assure positive shut-off and long maintenance-free service life in liquid or vapor service on bulk storage containers, transports, bobtails, cylinder filling plants and plant piping.



A7505AP



A7513AP



A7514AP



A7517AP

PART NUMBER	CONFIGURATION	INLET AND OUTLET CONNECTION	PORT DIAMETER
A7505AP	Globe	3/4" FNPT	3/4"
A7507AP	Globe	1" FNPT	1"
A7509BP	Globe	1 1/4" FNPT	1 1/4"
A7511AP	Globe	1 1/2" FNPT	1 1/2"
A7511FP	Globe	1 1/2" Flange	1 1/2"
A7513AP	Globe	2" FNPT	2"
A7513FP	Globe	2" Flange	2"
A7517AP	Globe	3" FNPT	3 1/8"
A7517FP	Globe	3" Flange	3 1/8"
A7506AP	Angle	3/4" FNPT	3/4"
A7508AP	Angle	1" FNPT	1"
A7510BP	Angle	1 1/4" FNPT	1 1/4"
A7512AP	Angle	1 1/2" FNPT	1 1/2"
A7514AP	Angle	2" FNPT	2"
A7514FP	Angle	2" Flange	2"
A7518AP	Angle	3" FNPT	3 1/8"
A7518FP	Angle	3" Flange	3 1/8"

Teflon seal discs available on request for most models.

See pages 43-48 for Bonnet Assemble Repair Kits

Ball Valves

Ball Valves



FLARE X FLARE

LEGEND PART NO.	INLET	OUTLET
102-312	3/8 M. Flare	3/8 M. Flare
102-313	1/2 M. Flare	1/2 M. Flare
102-314	5/8 M. Flare	5/8 M. Flare



T-HANDLE

T-HANDLES*		
LEGEND PART NO.	INLET	OUTLET
101-602	3/8 M. Flare	3/8 M. Flare
101-603	1/2 M. Flare	1/2 M. Flare
101-402	3/8 FPT	3/8 FPT
101-403	1/2 FPT	1/2 FPT
101-404	3/4 FPT	3/4 FPT



FPT X FLARE

MPT/FPT X FLARE		
LEGEND PART NO.	INLET	OUTLET
102-212	1/2 MPT	3/8 M. Flare
102-213	1/2 MPT	1/2 M. Flare
102-112	1/2 FPT	3/8 M. Flare
102-113	1/2 FPT	1/2 M. Flare
102-118	3/4 FPT	1/2 M. Flare
102-114	3/4 FPT	5/8 M. Flare
102-102	3/8 FPT	3/8 FPT
102-103	1/2 FPT	1/2 FPT
102-104	3/4 FPT	3/4 FPT



FLARE X FLARE

SIDE TAPS		
LEGEND PART NO.	INLET	OUTLET
102-522	3/8 M. Flare	3/8 M. Flare
102-523	1/2 M. Flare	1/2 M. Flare
102-524*	5/8 M. Flare	5/8 M. Flare
102-513	1/2 FPT	1/2 FPT
102-514	3/4 FPT	3/4 FPT
102-402*	3/8 M. Flare	3/8 M. Flare
102-403*	1/2 M. Flare	1/2 M. Flare

Jomar Ball Valves



101-602



102-512



102-402



102-103

LEGEND PART NO.	INLET	OUTLET
100-299	1/4" FPT	1/4" MPT
100-701	1/4" FPT	1/4" FPT
100-703	1/2" FPT	1/2" FPT
100-704	3/4" FPT	3/4" FPT
100-996	1 1/4" FPT	1 1/4" FPT
100-998	2" FPT	2" FPT
101-402	3/8" FPT	3/8" FPT
101-403	1/2" FPT	1/2" FPT
101-403DU	1/2" NPT	1/2" NPT
101-404	3/4" FPT	3/4" FPT
101-404DU	3/4" NPT	3/4" NPT
101-503	1/2" FPT	1/2" MFL
101-513DU	1/2" NPT	1/2" FLARE
101-602	3/8" MFL	3/8" MFL
101-603	1/2" MFL	1/2" MFL
101-998	2" SOLDER	2" SOLDER
102-303	1/2" FPT	1/2" FPT T-HAN
102-304	3/4" FPT	3/4" FPT T-HAN
102-402	3/8" MFL	3/8" MFL T-HAND W/ TAP
102-403	1/2" MFL	1/2" MFL T-HAND W/ TAP
102-512	1/2" FPT	3/8" MFL
102-524	5/8" MFL	5/8" MFL
241-004D*	3/4" FPT	3/4" FPT

* with insulated tail piece

Large Port Ball Valves

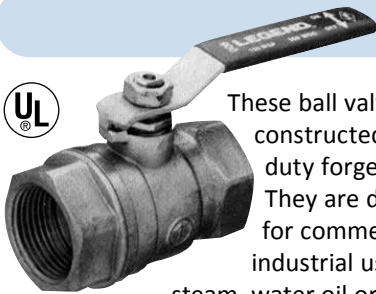

These ball valves are constructed of heavy duty forged brass. They are designed for commercial and industrial use on steam, water oil or gas. They are UL listed for LP gas service.

Pressure Rating

1/4" - 3/4" 600lbs. W.O.G. Non-Shock
1" - 2" 500lbs. W.O.G. Non-Shock

LEGEND PART NO.	INLET	OUTLET
101-101*	1/4"	1/4"
101-102	3/8"	3/8"
101-103	1/2"	1/2"
101-544	3/4"	3/4"
101-545	1"	1"
101-546	1 1/4"	1 1/4"
101-547	1 1/2"	1 1/2"
101-548	2"	2"

* Full port

** UL listed for 400 PSI LP gas service.

VALVES

Ball Valves

Apollo Bronze LP-Gas Ball Valves

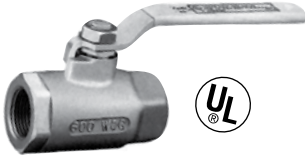

Features:

- For LP gas, natural gas, flammable liquids and heated oil
- Adjustable packing gland
- Reinforced TFE seals and seals
- Blow-out-proof stem design
- Large ports to reduce pressure drop
- 600 PSI WOG, 250 PSI LP gas, 150 PSI Saturated Steam

PART NUMBER	SIZE
80-101-01	1/4" FPT
80-102-01	3/8" FPT
80-103-01	1/2" FPT
80-104-01	3/4" FPT
80-105-01	1" FPT
80-106-01	1 1/4" FPT
80-107-01	1 1/2" FPT
80-108-01	2" FPT
80-100-01	3" FPT

The stainless steel ball valves below are rugged and very affordable. Call for pricing!

Apollo Carbon Steel Double Union End Ball Valves

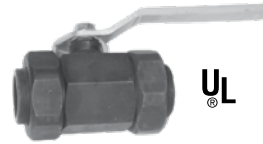

Apollo valves feature heavy duty quarter turn lever with steel barrel stock design and reinforced TFE seats and seals for ease of installation and maintenance. UL listed for LP gas.

600 PSI WOG, 250 PSI LP gas

PART NUMBER		SIZE
THREADED ENDS	WELD ENDS	
73-301-01	-	1/4"
73-302-01	-	3/8"
73-303-01	73-403-01	1/2"
73-304-01	73-404-01	3/4"
73-305-01	73-405-01	1"
73-306-01	73-406-01	1 1/4"
73-307-01	73-407-01	1 1/2"
73-308-01	73-408-01	2"

Jomar Screwed End Ball Valves

Features a 1/4 turn lever handle operated, CF8M Stainless steel, 3-piece, 4-bolt (swingout pattern), full port, solid ball, and a blow-out proof stem ball valve.

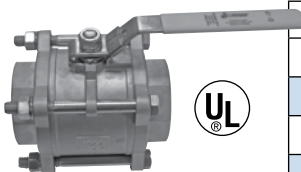

PART NUMBER	SIZE
500-303	1/2"
500-304	3/4"
500-305	1"
500-306	1-1/4"
500-307	1-1/2"
500-308	2"
500-310	3"

RegO Needle Valves



These valves are high quality, "true" throttling valves. Unlike most so-called needle valves, both the body seat and stem are tapered to provide fine, precise control over a wide range of adjustment without stem galling.

PART NO.	CONNECTIONS		HEIGHT	LENGTH
	INLET	OUTLET		
1224WA	1/4" M. NPT	1/4" M. NPT	1 9/16"	1 3/4"
1316WA	9/16"-18 L.H.	1/4" M. NPT	1 9/16"	1 3/4"
1318WA	1/4" M. NPT	9/16"-18 L.H.	1 9/16"	1 3/4"

Superior Brass Shut-off Valves

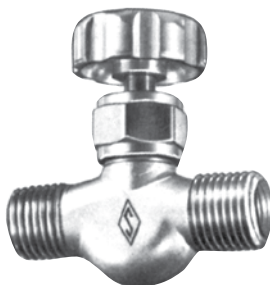

V88

PART NO.	INLET	OUTLET
V77	9/16"-18LH-M	1/4" MPT
V88	1/4" MPT	9/16"-18LH-M
V332	1/4" FPT	1/4" FPT
V333	1/4" MPT	1/4" MPT
V334	1/4" FPT	1/4" MPT
V335	1/4" MPT	1/4" FPT
V89	1/4" FNPT	9/16"-18LH

Delta Pacific Flanged Ball Valve

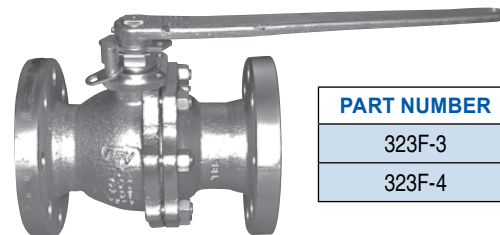

PART NUMBER	SIZE
323F-3	3"
323F-4	4"

RegO Multipurpose Valves

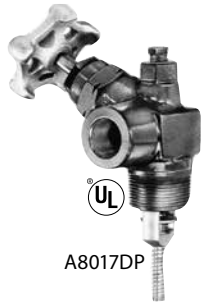

A8017DP

Designed especially for use as a high-capacity liquid withdrawal valve on LP gas. This valve incorporates an integral excess flow valve.

Liquid Withdrawal of LP-Gas

PART NUMBER	CONNECTION		APPROXIMATE EXCESS FLOW LIQUID CLOSING FLOW**
	INLET (M.NPT)	OUTLET (F.NPT)	
A8017DP	1 1/4"	1"	55 GPM
A8017DH*	1 1/4"	1"	49 GPM
A8017DLP	1 1/4"	3/4"	49 GPM

* Built-in back pressure check valve eliminates need for hydrostatic relief valve in downstream piping segment.

This valve has been updated to meet the changes in UL125 for anhydrous ammonia and LP gas.

It incorporates a soft seat back check in place of the excess flow valve.

Filling and Equalizing

PART NO.	CONNECTION		FILLING CAPACITY AT 20 PSIG PRESSURE DROP GPM/NH3
	INLET (M. NPT)	FILLING (M.ACME)	
A8016DBC	1 1/4"	1 3/4"	95



A8016DBC

Designed primarily for use as a combination filler and liquid withdrawal valve on three-opening applicator tanks.

Filling and Liquid Transfer

PART NUMBER	CONNECTION			FILLING CAPACITY AT 20 PSIG PRESSURE DROP GPM/NH3	APPROX. EXCESS FLOW LIQUID CLOSING FLOW GPM/NH3
	INLET (M. NPT)	OUTLET (F. NPT)	FILLING (M. ACME)		
A8018DP	1 1/4"	1"	1 3/4"	74	50

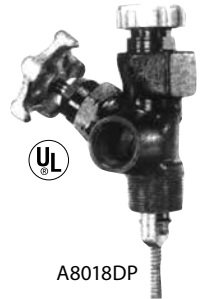

A8018DP

* Determined at 9 to 12 PSIG differential.

Replacement Parts

PART TYPE	PART NO.	FOR PART(S)
Handwheel	2507-15C	A8017DP
		A8017DH
		A8017DLP
		A8016DBC A8018DP
Cap and Chain Assembly	A8016-93	A8016DBC A8018DP

Accessories

PART NO.	DESCRIPTION
SS8001J	Hydrostatic Relief Valve
TSS3169	Valve Vent

RegO Flange Seal Liquid Transfer Angle Valves for Bulk Storage Containers



7550P

7550PX

These valves are designed especially for liquid transfer of LP gas from consumer bulk storage containers when used with a Chek-Lok or equipped with an integral excess flow valve. May also be used for vapor LP gas service.

PART NUMBER	CONNECTION		INTEGRAL EXCESS FLOW	FLOW AT 1 PSIG (CV) PRESSURE DROP* (GPM/PROPANE)	EXCESS FLOW APPROXIMATE CLOSING FLOW (GPM/PROPANE)**
	INLET (M. NPT)	OUTLET (F. NPT)			
7550P	3/4"	3/4"	No	13.3	-
A7550P	3/4"	3/4"	No	13.3	-
7550PX	3/4"	3/4"	Yes	-	16.0
A7550PX	3/4"	3/4"	Yes	-	16.0
7551P	3/4"	1/2"	No	8.9	-

* To obtain approximate flow at other than 1 PSIG pressure drops, multiply flow in table by square root of pressure drop. Example: 7550P @ 9 PSIG = 13.3 x $\sqrt{9}$ = 39.9 GMP/propane. For NH3 flow, multiply by .90.

Accessories

HYDROSTATIC RELIEF VALVE	VALVE VENT
SS8001J	TSS3169
3127U	3165
SS8001U	-

Hose End Valves

RegO Chek-Lok Valves



7590U with Cap



7590U-10 Union Style Adapter

Designed with unique 1 5/8" UNF threads on both Chek-Lok outlet and adapter inlet. This helps prevent activation of the Chek-Lok without use of the 7590U-10 adapter. Heavy duty construction between body and adapter provides stronger connections.

CHEK-LOK NUMBER	CONNECTION		BODY WRENCH HEX FLATS	APPROXIMATE EFFECTIVE LENGTH	WRENCH HEX FLATS	APPROXIMATE CLOSING FLOW, LIQUID GPM (PROPANE)*
	INLET	OUTLET				
7590U	3/4" M. NPT	1 5/8" UNF	1 5/8"	1 7/16"	1 5/16"	20
7591U	1 1/4" M. NPT	1 5/8" UNF	1 3/4"	1 11/16"	1 5/16"	35

* Based on horizontal installation of excess flow valve. Flows are slightly more when valves are installed with outlet up, and slightly less when installed with outlet down.

- Note: Multiply flow rate by .94 to determine liquid butane flow.
- Replacement Nylon Washer 8594-1A
- Replacement O-ring for 7590U-10 7590U-6
- Replacement Cap and Gasket 7590U-5A

Union Style Adapters for 7590U and 7591U

The 7590U-10 adapter must be used to connect to the 7590U and 7591U Chek-Lok. This insures a proper connection to open the check mechanism. A built in nylon gasket provides a gas tight seal.



7572C-14A



7572C-15A

ADAPTER NUMBER	CONNECTION		WRENCH HEX FLATS
	INLET	OUTLET	
7590U-10	1 5/8" UNF	3/4" F. NPT	1 3/4"
7572C-14A	3/4" MIP	3/4" FIP	-
7572C-15A	3/4" INM	3/4"	-

RegO Chek-Lok Liquid Evacuation Adapter for 7590U and 7591U Valves

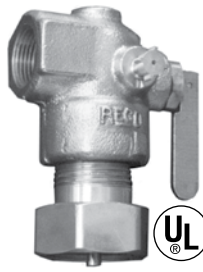

Designed specifically for use with RegO 7590U and 7591U Chek-Lok Excess Flow Valves. Adapter's operating handle opens and closes equalizing stem in the Chek-Lok valve. Eliminates gas flow through Chek-Lok valve when installing or removing adapter. Use of RegO adapter ensures proper connections and opening of the check mechanism.

ADAPTER NUMBER	CONNECTION		WRENCH HEX FLATS	APPROX LENGTH
	INLET	OUTLET		
7590U-20	1 5/8" F. UNF	3/4" F. NPT	1 3/4" F. NPT	4 1/8" F. NPT

Replacement Nylon Washer 8594-1A

RegO Unloading Adapters for Container Evacuation

Designed to provide an efficient means of evacuating an LP gas container for relocation or repair. They thread directly onto the 1 3/4" ACME male hose connection of RegO Filler Valves used on RegO Double Check Filler Valves and Multivalves.



3120



3121

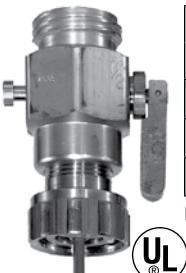

3119A



PART NUMBER	STYLE	CONNECTION	
		FILLER VALVE	HOSE
3119A	In-Line	1 3/4" F. ACME	1 3/4" M. ACME
3120	Angle	1 3/4" F. ACME	3/4" F. NPT
3121	Angle	1 3/4" F. ACME	3/4" F. ACME

Note: 3121 includes Handwheel

RegO Quick-acting Valves for Cylinder Filling Hoses

Designed primarily for use on cylinder charging hoses to provide fast, convenient shut-off and fast opening.



7901TA

PART NUMBER	CONNECTION		BODY MATERIAL	FLOW AT 1 PSIG (CV) PRESSURE DROP* (GPM/PROPANE)
	INLET (F. NPT)	OUTLET (F. NPT)		
7901T	1/4"	1/4"	Brass	1.95
A7553A	1/4"	1/4"	Ductile Iron	1.95
7901TA	3/8"	3/8"	Brass	1.95
7901TB	1/2"	1/4"	Brass	1.95
7901TC	1/2"	1/2"	Brass	1.95
7053T**	1/2"	1/2"	Brass	1.95

* To obtain approximate flow at other than 1 PSIG pressure drop, multiply flow in table by square root of pressure drop. Example: 7901T @ 9 PSIG = 1.95 x √9 = 5.85 GPM/propane. For NH3 flow, multiple propane flow by .90.

** Angle design

RegO Quick-acting Valves for Crop Driers and Filling Manifold Hoses

Provides instant shut-off and fast opening control on LP gas crop driers. Also ideal for charging manifold hoses, stationary fuel transfer hoses and other applications requiring quick, positive shut-off. Vent valved installed on downstream side on all valves.

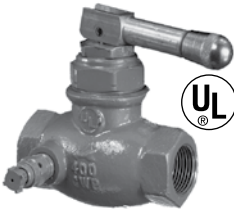

7554LV

PART NUMBER	INLET & OUTLET CONNECTION (F. NPT)	LOCKING HANDLE	FLOW AT 1 PSIG (CV) PRESSURE DROP* (GPM/PROPANE)
7554SAV	1/2"	No	7.3
7554LAV	1/2"	Yes	7.3
7554SV	3/4"	No	11.5
7554LV	3/4"	Yes	11.5

* To obtain approximate flow at other than 1 PSIG pressure drop, multiply flow in table by square root of pressure drop. Example: 7554LV @ 9 PSIG = 11.5 x √9 = 34.5 GPM/propane.

RegO Quick-acting Hose End Valves for Bobtail Delivery Trucks and Dispensing Stations

Designed especially for safe operator handling of LP gas in bobtail delivery truck, dispensing systems and anhydrous ammonia nurse tank service. These valves provide instant, full-on flow.



A7707L

PART NUMBER	INLET & OUTLET BODY DESIGN	CONN. (F. NPT)	LOCKING HANDLE	FLOW AT 1 PSIG (CV) PRESSURE DROP* (GPM/PROPANE)	COMPACT		EXTENDED
					BRASS	STEEL	STEEL
A7707L	Globe	1"	Yes	18.0	3175A	A3175A	A7575L4
A7708L	Angle	1"	Yes	22.0			

* To obtain approximate flow at other than 1 PSIG pressure drop, multiply flow in table by square root of pressure drop. Example: A7708L @ 9 PSIG = 22.0 x √9 = 66.0 GPM/propane. For NH3 flow, multiply propane flow by .90.

** Areas under EPA low emission guidelines and bobtails or dispensing stations filling motor fuel are required to use minimum loss valve such as the RegO A7797. See NFPA 58 for additional information.

RegO Hose End Valve Adapters

These adapters are designed with minimal flow restriction and recommended for use on the outlet of the LP gas delivery truck filler hose. Both incorporate a swivel female ACME connector.

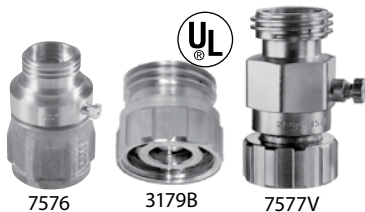

7576

3179B

7577V

PART NUMBER	BUILT-IN VENT VALVE	CONNECTION	
		FILLER VALVE	HOSE
7577V	Yes	1 3/4" F. ACME	1 3/4" M. ACME
3179B	No	1 3/4" F. ACME	1 3/4" M. ACME
7576	Yes	1 3/4" F. ACME	1 3/4" M. ACME

VALVES

Hose End Valves

RegO Quick-acting Minimum Loss Hose End Valves for Bobtail Delivery Trucks and Dispensing Stations



Loss at Disconnect is Now Less Than 2CC

Designed to vastly reduce the amount of product vented when disconnecting bobtail delivery trucks, dispensing systems and anhydrous ammonia nurse tanks.

PART NUMBER	CONNECTION		LOCKING HANDLE	FLOW AT 1 PSIG (CV) PRESSURE DROP* (GPM/PROPANE)
	INLET (F. NPT)	OUTLET (F. ACME)		
A7797A	1"	1 3/4"	Yes	16.0

* To obtain approximate flow at other than 1 PSIG pressure drop, multiply flow in table by square root of pressure drop. Example: A7797 @ 9 PSIG = 16.0 $\sqrt{.9}$ = 48.0 GPM/propane. For NH3 flow, multiply propane flow by .90

Why chance using an unproven design? Use the original A7797. Hose End Swivel Connectors

Allows hose end valve to swivel 360° No lubrication required.



JO-1

PART NUMBER	INLET-OUTLET	MAKE
105-1000	3/4" MNPT	Squibb
108	1" MNPT	Squibb
JO-1	1" MNPT	Full Circle

Repair Parts

PART NUMBER	DESCRIPTION
A7797-50	Repair Kit
A7797A-75	Bonnet and Stem Assembly
A7797-10M	Nozzle

Hose Reel

Zero Maintenance Design. Pre-Tapped for Relief Valve Field Repairable. UL listed



PART NUMBER	SIZE	DESCRIPTION
SMAC-112	1 1/2"	90 degree swivel
SMAC-200	2"	90 degree swivel
SMAC-112ST	1 1/2"	Straight swivel
SMAC-200ST	2"	Straight swivel
SMAC-112-SK	1 1/2"	Repair Kit
SMAC-200RSK	2"	Repair Kit

Other sizes and variations available



ME572

PART NUMBER	DESCRIPTION
ME572EXT	Fill Extensions
ME572EXTHD	Fill Extensions

RegO Hose End Filler Valve Extension Connectors

Designed especially for liquid filling and vapor equalization of LP gas and anhydrous ammonia.



A7571 Series

PART NUMBER	TYPE OF SERVICE	CONNECTION		APPROX. LENGTH
		HOSE (M. NPT)	COUPLING (F. ACME)	
A7575L2*	Liquid	1/2"	1 3/4"	7"
A7575L3	Liquid	3/4"	1 3/4"	7"
A7575L4	Liquid	1"	1 3/4"	7"
A7575L5**	Liquid	1 1/4"	1 3/4"	7"
A7571LA	Vapor	1/2"	1 3/4"	7"
A7571LB	Vapor	3/4"	1 3/4"	7"

* Includes 7199-33 adapter, shipped loose.

** Includes A7575L5-1 adapter, shipped loose.

RegO Hose End Filler Valve Connectors



Style A
For Liquid Filling



Style B
For Liquid Filling



Style C*
For Vapor Equalizing



Style D*
For Vapor Equalizing

PART NO.	MATERIAL	STYLE	CONNECTION		TAILPIECE BORE	HOSE END TO NUT	OVERALL LENGTH
			HOSE (M. NPT)	COUPLING (F. ACME)			
3175B	Brass	A	1/2"	1 3/4"	35/64"	2"	2 7/8"
3175	Brass	A	3/4"	1 3/4"	3/4"	2"	2 7/8"
3175A	Brass	A	1"	1 3/4"	3/4"	2"	2 7/8"
3185	Brass	B	1 1/4"	2 1/4"	1 3/16"	2 1/16"	3 1/8"
3195	Brass Nut & Steel Nipple	B	2"	3 1/4"	1 13/16"	2 1/8"	3 5/8"
A3175	Steel	A	3/4"	1 3/4"	3/4"	2"	2 7/8"
A3175A	Steel	A	1"	1 3/4"	3/4"	2"	2 7/8"
A3185	Steel	B	1 1/4"	2 1/4"	1 3/16"	2 1/8"	3 1/8"
A3195	Steel	B	2"	3 1/4"	1 13/16"	2 1/8"	3 5/8"
3171	Brass	C	3/8"	1 1/4"	13/32"	1 3/16"	2 7/16"
3171A	Brass	C	1/2"	1 1/4"	17/32"	1 3/16"	2 7/16"
3181	Brass	C	3/4"	1 3/4"	11/16"	2"	3 1/4"
3181A	Brass	C	1"	1 3/4"	15/16"	1 7/8"	3 1/8"
3191	Brass	D	1 1/4"	2 1/4"	1 3/16"	2 1/8"	3 5/16"

* Style C and D have nipple (not shown) required to open vapor equalizing check assembly.

Female ACME Caps

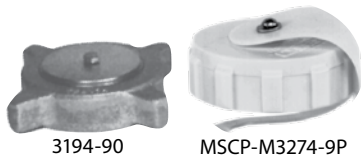

CAP WITH CHAIN & RING		CAP ONLY PART NO.	MATERIAL	THREAD CONNECTION
PART NO.	RING FITS PIPE TO:			
1708C	3/4"	-	Brass	F.POL (CGA510)
3144-91	3/4"	3144-9P	Cyclac	1 1/4" F. ACME
3174-91	3/4"	MSCP-M3274-9P	Cyclac	1 3/4" F. ACME
3174-93	1 1/4"	MSCP-M3274-9P	Cyclac	1 3/4" F. ACME
3175P	1 1/4"	-	Brass	1 3/4" F. ACME
7141FP	1 1/4"	-	Brass	1 1/4" F. ACME
3184-90	2"	-	Brass	2 1/4" F. ACME
3194-90	2"	-	Brass	3 1/4" F. ACME
A3184-90	2"	-	Steel	2 1/4" F. ACME
A3194-90	3"	-	Steel	3 1/4" F. ACME
ME106-01	3"	ME106	Cyclac	3 1/4" F. ACME
PC555	3/4"	-	Brass	F.CGA555

ACME Reducing Fittings



TYPE NUMBER		MALE ACME	FEMALE ACME
BRASS	STEEL		
M611	-	1 3/4"	2 1/4"
M612	-	1 3/4"	3 1/4"
5776	A5776	1 3/4"	3 1/4"
5778	-	2 1/4"	3 1/4"

RegO Plug, Chain and Ring Assembly

A plug to protect hose end on bulk plants and delivery hose.



PART NO.	CHAIN & RING	MATERIAL	M. ACME
C5763N	Yes	Nylon	1 1/4"
C5765N	Yes	Nylon	1 3/4"
5765PR	No	Brass	1 3/4"
C5767N	Yes	Nylon	2 1/4"
C5769N	Yes	Nylon	3 1/4"
3705RC	Yes	Brass	M.POL

QCC Type 1 Caps

Protects threads on OPD valves with QCC Type 1 connection.



PART NO.	DESCRIPTION	MATERIAL
907FP	1 5/16" Type 1	Brass
DC-QCC1	1 5/16" Type 1	Plastic
3174-93L	Cap with Lanyard	-
PPC3B	Tear Away Protective Cap	Plastic

Note: DC-QCC1 is a non-threaded dust cover.

RegO Male ACME X Female NPT Adapters

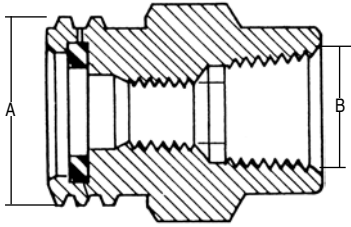

Gasket (Furnished with adapter)
ACME x Female NPT

PART NUMBER	MATERIAL	A M. ACME	B FNPT	SPARE GASKET PART NUMBER
M498-4/2	Brass	1 1/4"	1/4"	A2797-20R
M498-6/3	Brass	1 1/4"	3/8"	MSW-3
5764A	Brass	1 3/4"	1/4"	A2697-20R
5764B	Brass	1 3/4"	3/8"	A2697-20R
5764C	Brass	1 3/4"	1/2"	A2697-20R
5764D	Brass	1 3/4"	3/4"	A2697-20R
5764E	Brass	1 3/4"	1"	A2697-20R
5766E	Brass	2 1/4"	1"	A3184-8R
5766F	Brass	2 1/4"	1 1/4"	A3184-8R
5768G	Brass	3 1/4"	1 1/2"	A3194-8R
5768H	Brass	3 1/4"	2"	A3194-8R
5768J	Brass	3 1/4"	2 1/2"	A3194-8R
A5764D	Steel	1 3/4"	3/4"	A2697-20R
A5764E	Steel	1 3/4"	1"	A2697-20R
A5768H	Steel	3 1/4"	2"	A3194-8R

RegO Male ACME X Male NPT Adapters

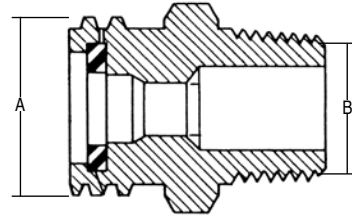

Gasket (Furnished with adapter)
ACME x Male NPT

PART NUMBER	MATERIAL	A M. ACME	B MNPT	SPARE GASKET PART NUMBER
M498-4/2	Brass	1 1/4"	1/2"	A2797-20R
M498-6/3	Brass	1 1/4"	3/4"	MSW-3
5763D	Brass	1 1/4"	3/4"	A2797-20R
5765D	Brass	1 3/4"	3/4"	A2697-20R
5765E	Brass	1 3/4"	1"	A2697-20R
5765F	Brass	1 3/4"	1 1/4"	A2697-20R
5767F	Brass	2 1/4"	1 1/4"	A3184-8R
5767G	Brass	2 1/4"	1 1/2"	A3184-8R
5767H	Brass	2 1/4"	2"	A3184-8R
5769H	Brass	3 1/4"	2"	A3194-8R
5769J	Brass	3 1/4"	2 1/2"	A3194-8R
5769K	Brass	3 1/4"	3"	A3194-8R
A5765C	Steel	1 3/4"	1/2"	A2697-20R
A5765D	Steel	1 3/4"	3/4"	A2697-20R
A5765E	Steel	1 3/4"	1"	A2697-20R
A5765F	Steel	1 3/4"	1 1/4"	A2697-20R
A5767F	Steel	2 1/4"	1 1/4"	A3184-8R
A5769H	Steel	3 1/4"	2"	A3194-8R
A5769K	Steel	3 1/4"	3"	A3194-8R

RegO Male ACME Adapters

PART NUMBER	MATERIAL	A M. ACME	SPARE GASKET PART NUMBER
5765M	Brass	1 3/4"	A2697-20R
5767M	Brass	2 1/4"	A3184-8R
5769M	Brass	3 1/4"	A3194-8R

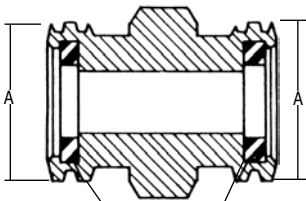

Gasket (Furnished with adapter)
ACME x ACME

RegO ACME Adapters

PART NUMBER	MATERIAL	A M. ACME	B THREAD	SPARE GASKET PART NUMBER
A5764W	Steel	1 3/4"	3/8"	A2697-20R

*3/8" -16 UNC Thread.

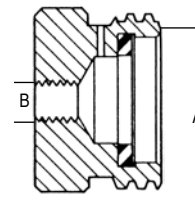

ACME x Miscellaneous
(Recommended for securing
hose-end valve when not in use).



Did you know RegO has the most complete line of plant equipment? Your salesman will be happy to make a safety inspection of your facility.

RegO Hose End Connectors for DOT Cylinder Filling

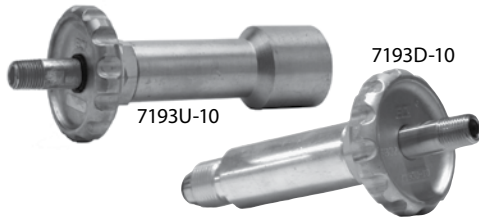

PART NUMBER	APPLICATION	CONNECTION		MATERIALS
		INLET	OUTLET	
7193D-10	Filling of DOT Cylinder with POL Connections	1/4" M. NPT	M. POL (CGA 510)	Brass and Stainless Steel
7193U-10	Filling of DOT Cylinder with Type 1 Connections	1/4" M. NPT	Type I Connection (1 5/16" F. ACME)	Brass

POL Adapter

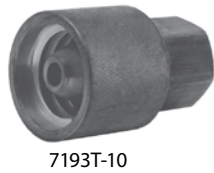

Adapts POL filler coupling to motor fuel tanks or multivalves. Every fill station and propane powered car should have one.

PART NUMBER	APPLICATION	CONNECTION		MATERIALS
		INLET	OUTLET	
7193T-10	Converts 7193D-10 Adapter from POL to Type 1 Connection	F. POL CGA 510	Type 1 Connection (1 5/16" F. ACME QCC1)	Brass

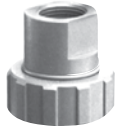

PART NUMBER	DESCRIPTION
MSCP-901H	F POL x 1-3/4" ACME adapter

RegO Hose End Connector for Forklift Cylinder Filling



The 7193L-10A is intended to be permanently attached to the filling hose. A 5760A adapter enables the 7193L-10A to be attached to the POL connection on the 7193D-10 at cylinder filling stations to allow for occasional filling of fork lift cylinders.

PART NUMBER	APPLICATION	INLET CONNECTION	OUTLET CONNECTION	BODY MATERIAL	ACCESSORIES ADAPTER
7193L-10A	Filling of Fork Lift Cylinders*	1/4" M. NPT	1 1/4" F. ACME	Brass	5760A

* 20CC loss at disconnect

Rego Remote Thermal Release for DOT MC331 Pressure Vessel



Designed especially for use with internal valves installed in DOT MC331 pressure vessels. The A3219RT provides a remote means of mechanical closure along with thermal protection, as required by DOT MC331.

PART NO.	FOR USE WITH	RELEASE TEMPERATURE	SPRING LOAD FULLY EXTENDED	AFTER 4" TRAVEL	MINIMUM NUMBER REQUIRED BY MC331
A3219RT	Internal Valves	212° F.	≈100 lbs.	≈50 lbs.	2

Rego Remote Cable Controls for Internal Valves

The 3200C Remote Cable Kit is designed especially for use with the 3200L Remote Operating Lever to operate internal valves from a remote location.

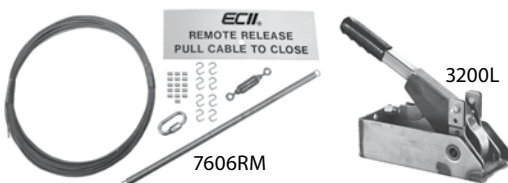

PART NUMBER	DESCRIPTION	CONTENTS
3200C	Remote Cable Kit	100 Foot Cable, 6 Cable Clamps, Quick Link, Sign, Fuse Link, Steel Nut and Bolt
3200L	Operating Lever	Lever Assembly
7606RM	Cable Release	Cable Release

VALVES

Excess Flow Valves

RegO Excess Flow Valves for Liquid or Vapor Service Line

For top installation, any position, in liquid or vapor service lines. Intended for long lines or branch piping where tank mounted excess flow valves won't do..



A1519A6



1519A2

PART NO.	BRASS OR STEEL	CONNECTION		APPROXIMATE CLOSING FLOWS*		
		INLET F. NPT	OUTLET F. NPT	LIQUID GPM (PROPANE)	VAPOR SCFH (PROPANE)	
					25 PSIG INLET	100 PSIG INLET
1519A2	Brass	1"	1"	25	5,000	8,800
A1519A2	Steel	1"	1"	25	5,000	8,800
1519A3	Brass	1 1/2"	1 1/2"	60	11,500	20,200
1519C2**	Brass	1 1/2"	male 1"	25	5,000	8,800
1519A4	Brass	2"	2"	100	19,000	34,500
A1519A4	Steel	2"	2"	100	19,000	34,500
1519B4	Brass	2"	2"	133	27,700	50,300
A1519B4	Steel	2"	2"	133	27,700	50,300
1519C4	Brass	2"	2"	170	28,590	48,600
A1519A6	Steel	3"	3"	225	45,000	82,000

* Based on horizontal installation of excess flow.

** Designed for top mounting in storage tank manhole covers for liquid or vapor applications. Inlet has 1" F.NPT optional dip pipe connection to withdraw liquid.

RegO Excess Flow Valves for Liquid or Vapor for Container or Line Applications

Designed for liquid or vapor use for filling, withdrawal and vapor equalizing in container or line applications.



PART NO.	BRASS OR STEEL	CONNECTION		APPROXIMATE CLOSING FLOWS*		
		INLET M. NPT	OUTLET F. NPT	LIQUID GPM (PROPANE)	VAPOR SCFH (PROPANE)	
					25 PSIG INLET	100 PSIG INLET
12472	Brass	3/4"	3/4"	4	1,050	1,700
3272E	Brass	3/4"	3/4"	10	2,100	3,700
3272F	Brass	3/4"	3/4"	15	2,800	5,000
3272G	Brass	3/4"	3/4"	20	3,700	6,900
A3272G	Steel	3/4"	3/4"	20	3,700	6,900
3282A	Brass	1 1/4"	1 1/4"	30	5,850	10,000
3282B	Brass	1 1/4"	1 1/4"	40	7,600	13,600
3282C	Brass	1 1/4"	1 1/4"	50	9,000	16,300
A3282C	Steel	1 1/4"	1 1/4"	50	9,000	16,300
7574	Brass	1 1/2"	1 1/2"	90	15,200	28,100
3292A	Brass	2"	2"	75	14,200	24,800
3292B	Brass	2"	2"	100	18,100	32,700
A3292B	Steel	2"	2"	100	18,100	32,700
A3292C	Steel	2"	2"	122	22,100	37,600

*Based on horizontal installation of excess flow.

RegO Excess Flow Valves for DOT Cylinders



3199W

Designed for use on portable systems with vapor or liquid.

PART NO.	CONNECTION		APPROXIMATE CLOSING FLOWS*		
	INLET	OUTLET	LIQUID GPM (PROPANE)	VAPOR SCFH (PROPANE)	
				25 PSIG INLET	100 PSIG INLET
3199W	M POL	1/4" M.NPT	.95	265	500

* Based on horizontal installation of excess flow.

RegO Excess Flow Valves for Container Service

Designed for mounting in threaded full or half couplings in container installations. They may be used for filling, withdrawal or vapor equalizing applications.



A7539



PART NUMBER	USE WITH THIS COUPLING TYPE	CONNECTION		APPROXIMATE CLOSING FLOWS*		
		INLET M. NPT	OUTLET NPT	LIQUID GPM (PROPANE)	VAPOR SCFH (PROPANE)	
					25 PSIG INLET	100 PSIG INLET
A8525	Half	1 1/4"	1 1/4" Female	35	12,540	21,560
A7537L4F	Full	2"	2" Male and 1 1/4" Female	75	13,000	25,600
A7537N4	Half	2"	2" Male and 1 1/4" Female	125	25,000	42,500
A7537N4F	Full	2"	2" Male and 1 1/4" Female	125	25,000	42,500
A7537P4	Half	2"	2" Male and 1 1/4" Female	150	30,500	52,000
A7537P4F	Full	2"	2" Male and 1 1/4" Female	150	30,500	52,000
A7539R6	Half	3"	3" Male and 2" Female	150	32,100	55,500
A7539R6F	Full	3"	3" Male and 2" Female	150	32,100	55,500
A7539T6	Half	3"	3" Male and 2" Female	200	39,400	68,300
A7539V6	Half	3"	3" Male and 2" Female	250	51,100	88,700
A7539V6F	Full	3"	3" Male and 2" Female	250	51,100	88,700

* Based on horizontal installation of excess flow valve. Flows are slightly more when valves are installed with outlet up; slightly less when installed with outlet down.

RegO Excess Flow Valves for Vapor or Liquid for Half and Full Couplings

Designed especially for filling, withdrawing or vapor equalizing in half and full coupling installations. Ideal for container service where welded-in dip pipes are not provided. For vapor use, mount in the bottom opening with a threaded dip pipe. For liquid use, mount in the top opening with a threaded dip pipe.



A2137A



PART NUMBER	INLET CONNECT		OUTLET CONNECTION	APPROXIMATE CLOSING FLOWS*		
	M. NPT	F. NPT		NPT	LIQUID GPM (PROPANE)	VAPOR SCFH (PROPANE)
			25 PSIG INLET			100 PSIG OUTLET
A2137	2"	1-1/4"	2" Male and 1 1/4" Female	50	10,000	17,000
A2137A	2"	1-1/4"	2" Male and 1 1/4" Female	70	14,000	25,000
2139	3"	2"	3" Male and 2" Female	125	26,500	46,000
2139A	3"	2"	3" Male and 2" Female	160	32,700	57,200

* Based on horizontal installation of excess flow valve. Flows are slightly more when valves are installed with outlet up; slightly less when installed with outlet down.

RegO Excess Flow Valve for Pressure Gauges

Designed for container use in pressure gauge installations to minimize excess gas discharge in the event the pressure gauge is sheared.



PART NUMBER	CONNECTION		WRENCH HEX FLATS	APPROXIMATE CLOSING FLOWS*		
	INLET M. NPT	OUTLET F. NPT		LIQUID GPM (PROPANE)	VAPOR SCFH (PROPANE)	
			CONNECTION		100 PSIG INLET	
2884D	3/4"	1/4"	1 1/16"	N/A	60	110

* Based on horizontal installation of excess flow valve. Flows are slightly more when valves are installed with outlet up; slightly less when installed with outlet down.

RegO Excess Flow Valves for Flange Mounting in Container Service



A3500

Designed for mounting in flanged tank connections with internal threads in the bottom of a container. They may be used in filling, withdrawal or vapor equalizing application. These valves provide high flow capacity with low pressure drop to minimize pump inlet line cavitation.

PART NUMBER	INLET CONNECTION M. NPT	FOR INSTALLATION	APPROXIMATE CLOSING FLOWS*		
			LIQUID GPM (PROPANE)	VAPOR SCFH (PROPANE)	
				25 PSIG INLET	100 PSIG INLET
A3500L4	2"	Slotted Body	75	13,000	22,500
A3500N4	2"	Slotted Body	125	25,000	42,500
A3500P4	2"	Slotted Body	150	30,500	52,000
A3500V6	3"	Slotted Body	250	51,100	88,700

* Based on horizontal installation of excess flow valve. Flows are slightly more when valves are installed with outlet up; slightly less when installed with outlet down.

RegO Excess Flow Valves for Liquid or Vapor Withdrawal

Designed for bottom mounting in consumer storage tanks for liquid service. They may also be top mounted for vapor service.



2723C

A8013D

PART NUMBER	CONNECTION		WRENCH HEX FLATS	APPROXIMATE CLOSING FLOWS*		
	INLET M. NPT	OUTLET M. NPT		LIQUID GPM (PROPANE)	VAPOR SCFH (PROPANE)	
					25 PSIG INLET	100 PSIG INLET
A8013D	1 1/4"	3/4"	1 7/8"	39	8,700	14,700
A8013DA	1 1/4"	1"	1 7/8"	44	8,700	14,700
A8013DB	1 1/4"	1 1/4"	1 7/8"	55	10,900	19,300
2723C	1 1/4"	3/4"	1 7/8"	20	3,900	6,900

* Based on horizontal installation of excess flow valve. Flows are slightly more when valves are installed with outlet up; slightly less when installed with outlet down.

POL Adapters with Excess Flow

Designed for use on LP Gas ASME container manifolds where excess flow protection maybe required for the vapor (POL) vapor outlet connections. POL X 1/2" MPT



3188B

PART NUMBER	LIQUID CLOSING FLOW GPM	APPROXIMATE CLOSING FLOWS			
		10 PSIG INLET	25 PSIG INLET	100 PSIG INLET	125 PSIG INLET
3188A	0.95	160	210	350	420
3188B	1.9	310	400	700	840
F202	1.9	-	-	-	-
3188C	2.9	510	660	1180	1430

RegO Double Check Filler Valves for ASME Tanks Low Emissions

Designed to provide fast filling of large motor fuel and ASME domestic tanks the 6579 series incorporates a swing-away lower check which greatly reduces pressure drop across the valve. This lower pressure drop promotes faster filling rates and greater efficiency resulting in more profitable operations.



L7579T

L6579

PART NUMBER		ACME HOSE CONNECTION	TANK CONNECTION M. NPT	WRENCH HEX FLATS	PROPANE LIQUID CAPACITY AT VARIOUS DIFFERENTIAL PRESSURES (GPM)				
CAP ONLY	CAP, CHAIN, AND RING				5 PSIG	10 PSIG	25 PSIG	50 PSIG	75 PSIG
L7579	L7579C	1 3/4"	1 1/4"	1 7/8"	50	70	111	157	192
L6579*	L6579C*	1 3/4"	1 1/4"	1 7/8"	78	110	174	246	301

* Swing-away lower back check valve design for higher filling rate.

NOTE: Multiply flow rate by .94 to determine liquid butane capacity.

Replacement Fill Cap – Part Number: MSCP-M3274-9P



RegO Double Check Filler Valve for Forklift, Motor Fuel and RV Tanks



7647SCT

Designed to provide fast filling of forklift, motor fuel, and recreational vehicle tanks.

PART NUMBER	STYLE	ACME HOSE CONNECTION	TANK CONNECTION M. NPT	PROPANE LIQUID CAPACITY AT VARIOUS DIFFERENTIAL PRESSURES (GPM)				
				10 PSIG	20 PSIG	30 PSIG	40 PSIG	50 PSIG
7647SC	w/Lanyard & Cap	1 3/4"	3/4"	14	20	24	27	50
7647DC	w/Lanyard & Cap	1 3/4" & F.POL	3/4"	14	20	24	27	50
7647H	Basic	1/2" FNPT	3/4"	14	20	24	27	50

Replacement Fill Cap – Part Number: MSCP-M3274-9P

RegO Double Check Filler Valves



7579S



Designed to provide fast filling of bobtails, transports and large bulk storage tanks.

PART NUMBER	CONNECTION		HEX FLATS	PROPANE LIQUID CAPACITY AT VARIOUS DIFFERENTIAL PRESSURES (GPM)				
	ACME HOSE	TANK WRENCH M. NPT		5 PSIG	10 PSIG	25 PSIG	50 PSIG	75 PSIG
				7579S*	1 3/4"	1 1/2"	2"	44
3197C**	3 1/4"	3"	4"	148	210	332	470	575

* Replacement Fill Valve Cap and Chain Part Number 3174-90; Cap Only MSCP-3274-9P

** Replacement Brass Cap and Chain 3174-90; Plastic Cap and Chain ME106-01; Plastic Cap Only ME106

RegO Single Check Filler Valves for Storage Tanks with Supplementary Back Check Valves



3174C



3194C/6584C

Designed to provide fast filling of bobtails, transports and large bulk storage tanks when used with RegO back check valves.

PART NUMBER	CONNECTION		PROPANE LIQUID CAPACITY AT VARIOUS DIFFERENTIAL PRESSURES (GPM)				FOR USE WITH BACK CHECK VALVE
	ACME HOSE	OUTLET M. NPT	5 PSIG	10 PSIG	25 PSIG	50 PSIG	
			3174C	1 3/4"	1 1/4"	23	
6584C	2 1/4"	2"	156	220	348	492	A3186
3194C	3 1/4"	3"	147	208	329	465	A3196

VALVES

Back Check Valves

RegO Back Pressure Check Valves



3146



A3276BC



A3187S

Provides protection of a container opening when desired flow is always into the vessel and may be used in line applications where flow must be limited to one direction.

PART NO.	BODY	CONNECTION		PROPANE LIQUID CAPACITY AT VARIOUS DIFFERENTIAL PRESSURE (GPM)			
		INLET F. NPT	OUTLET M. NPT	5 PSIG	10 PSIG	25 PSIG	50 PSIG
3146	Brass	3/4"	3/4"	11	16	25	36
3176	Brass	1 1/4"	1 1/4"	28	40	63	89
A3146	Steel	3/4"	3/4"	11	16	25	36
A3176	Steel	1 1/4"	1 1/4"	28	40	63	89
A3276BC*	Steel	1 1/4"	1 1/4"	32	45	73	103
A3186	Steel	2"	2"	124	175	276	391
A3187S*	Steel	2" M.NPT & 1 1/4" F.NPT	2" M.NPT & 1 1/4" F.NPT	60	110	225	350
A3196	Steel	3"	3"	297	420	664	939

*Soft seat

RegO Swing-away Back Pressure Check Valves

Designed to provide protection of a container opening when desired flow is always into the vessel. May be used in line applications where flow must be limited to one direction.



6586D

PART NUMBER	BODY	CONNECTION		PROPANE LIQUID CAPACITY AT VARIOUS DIFFERENTIAL PRESSURES (GPM)			
		INLET F. NPT	OUTLET M. NPT	5 PSIG	10 PSIG	25 PSIG	50 PSIG
6586D	Brass	2"	2"	190	270	420	600
A6586D	Steel	2"	2"	190	270	420	600

RegO Back Pressure Check Valves for Flanged Installation

Designed to provide high flow capacity and allow more efficient tank filling than conventional designs. All steel and stainless steel construction allows use in LP or NH3 service.



A3400L6

PART NUMBER	FLANGE CONNECTION M. NPT	WRENCH HEX FLATS	OVERALL LENGTH	PROPANE LIQUID CAPACITY AT VARIOUS DIFFERENTIAL PRESSURES (GPM)			
				5 PSIG	10 PSIG	25 PSIG	50 PSIG
A3400L4	2"	Slotted	5 1/4"	223	316	500	707
A3400L6	3"	Slotted	5 9/32"	424	600	949	1342

NOTE: For installation in flange tank connections with internal threads. Multiply flow rate by .94 to determine liquid butane capacity and by .90 for liquid anhydrous ammonia capacity.

Back Check with Sight Flow Indicator

RegO Sight Flow Indicator with Back Check



PART NO.	INLET/OUTLET
A7794	2" FNPT
A7796	3" FNPT

Replacement Parts

PART NO.	INLET/OUTLET
A7794-10	2" O-Ring
A7794-11	2" Replacement Glass
A7794-12K	2" Gasket

Replacement Parts

PART NO.	INLET/OUTLET
A7794-13	2" Retainer Ring
A7795-14	Screw Set
A7795-8	3" Indicator Assembly
A7795-10	3" O-Ring
A7795-11	3" Replacement Glass
A7795-12K	3" Gasket



Pump Out Adapter with 1" Sight Glass

SG100-C

Rego Threaded Internal Valves



A3209D050



A3209D

Designed primarily for use with LP gas and anhydrous ammonia as a main valve on small capacity pumping systems, NH₃ nurse tanks and in-line installations. It may also be installed in the vapor equalizing opening on bobtail delivery trucks.



A3213DT



A3212D250

Designed primarily for use with LP gas and anhydrous ammonia for liquid withdrawal; vapor transfer or vapor equalization of bobtail delivery trucks, transports, stationary storage tanks, and in-line installations. The valve may be operated manually by cable or pneumatically.

PART NUMBER	INLET CONNECTION M. NPT	OUTLET CONNECTION F. NPT	CLOSING FLOW (GPM) HALF COUPLING		CLOSING FLOW (GPM) FULL COUPLING	
			LP GAS	NH ₃	LP GAS	NH ₃
A3209D050	1 1/4"	1 1/4"	50	45	-	-
A3209D080	1 1/4"	1 1/4"	80	72	-	-
A3212R105	2"	2"	105	95	65	59
A3212R175	2"	2"	175	158	100	90
A3212R250	2"	2"	250	225	130	117
A3213D150	3"	3"	150	135	125	113
A3213D200	3"	3"	200	180	160	144
A3213D300	3"	3"	300	270	250	225
A3213D400	3"	3"	400	360	325	293
A3213RT150*	3"	3"	150	135	125	113
A3213DT200*	3"	3"	200	180	160	144
A3213DT300*	3"	3"	300	270	250	225
A3213DT400*	3"	3"	400	360	325	293

* Has two 3" outlets in T configuration.

Accessories

SERIES NUMBER	PNEUMATIC ACTUATOR	THERMAL LATCH
A3209	A3209PA	A3209TL
A3210	A3210PA-R1	Included
A3213	A3213PA*	A3213TL
A3212	A3212PA	A3212TL

* Thermal fuse installed complies with DOT thermal protection requirements.

See pages 43-48 for Repair Kit

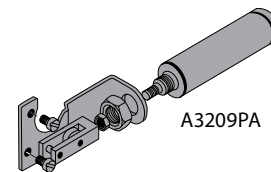

A3209PA

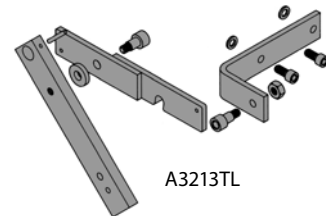

A3213TL

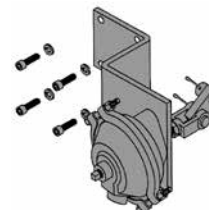

A3213PA

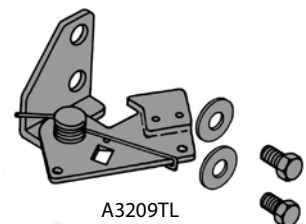

A3209TL

RegO Flomatic Internal Valves for Bobtail Delivery Trucks, Transports and Large Stationary Tanks

Designed primarily for LP gas and anhydrous ammonia liquid withdrawal on MC331 bobtail delivery trucks, transports and large stationary storage tanks with flanged connections. The valve is fully automatic, opening and closing as the pump is turned on or off. Unloading is quicker and turnaround faster to provide more profitable operation. The fully internal design reduces possibility of spillage that may result from a collision.



Supplied with A7853A 3-way valve, A7884-201 filter, studs, nuts and gaskets.

PART NUMBER	INLET CONNECTION ANSI FLANGE	OUTLET CONNECTION ANSI FLANGE	DIAMETER BORE
A7883FK	3" - 300#	3" - 300#	4 13/16"
A7884FK	4" - 300#	4" - 300#	5 13/16"

Accessories

FILTER	3-WAY VALVE
A7884-201	A7853A

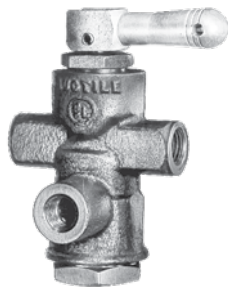

A7853A

PART NUMBER		FLOMATIC REPLACEMENT PARTS
A7883FK	A7884FK	DESCRIPTION
A7884-201	A7884-201	Filter
A7883-30	7565-48	Gasket (Bottom Flange)
A7884F-43	A7884F-43	Bolts with Nuts
A7883-29	7884-29	Gasket (Upper)
A7883F-37SS	A7883F-37SS	Guide-Pump Prime Valve
A7884-60	A7884-60	Pump Prime Valve Assembly
7884-33	7884-33	Gasket (Pump Prime Valve)
A7883F-33	A7883F-33	Stem Assembly
A7883-5	7884-5	Seat Disc
A7883-7T	7884-7T	X-Seal (Upper)
7884-6T	7884-6T	X-Seal (Lower)
A7883F-50	A7883F-50	Complete Rebuild Kit
A7883F-150	A7884F-150	Repair Kit
A7883F-80	A7884F-80	Lower Piston Rebuild Kit
A7853A-74	A7853A-74	Control Valve

This valve controls the sensing line to the Flomatic. Valve is held open by a cable with a fusible link and return spring. If fusible link melts, valve closes and causes Flomatic to lose its prime and valve closes.

Disposable filter removes contaminants as small as 20 microns from liquid in the sensing line preventing valve malfunction. Filter should be replaced at least once a year and immediately after every tank hydrostat.



A7884-201

RegO Emergency Shutoff Valves for Bulk Plants

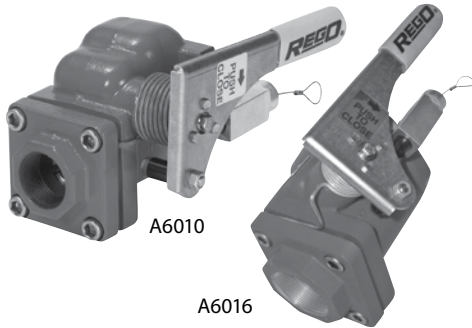

Especially designed for installation in liquid or vapor transfer lines at LP-gas bulk plants to provide for quick shut off of liquid or vapor flow in the event of an accidental pull-away or hose rupture.

PART NUMBER	FOR USE ONLY WITH	INLET & OUTLET CONNECTIONS	LIQUID FLOW @ 10 PSIG PRESSURE DROP (GPM)	
			LPG	NH3
A6010	LPG/NH3	1 1/4" F.NPT	259	233
A6016	LPG/NH3	2" F. NPT	711	640
A6024	LPG/NH3	3" F.NPT	1325	1173

ESV Pneumatic Controls

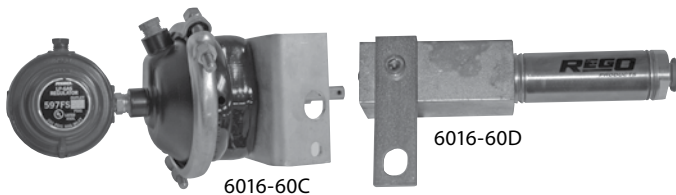

PART NUMBER	DESCRIPTION
7781AFPN-1	Cylinder assembly kit. Convert 7781AF ESVs to pneumatic shutdown.
6016-60D	Cylinder assembly kit. Converts 6016 ESVs to pneumatic shutdown.
6016-60C	Pneumatic remote for 6016. Open/close actuator.
7605PN-50	Pneumatic remote shutdown system kit, complete with 100' of tubing, fittings, 1 charging valve assembly and 1 remote shutdown valve assembly.
7605APN-8A	Extra shutdown valve assembly.
7605AP-16	1/4" tubing tee, w/nuts.
7605AP-15	1/8" NPT x 1/4" tubing, straight connector.

ESV Remote Cable Controls

PART NUMBER	DESCRIPTION
7609-50	Transfer hose cable release kit. Attaches to ESV and hose for automatic closing as hose stretches.

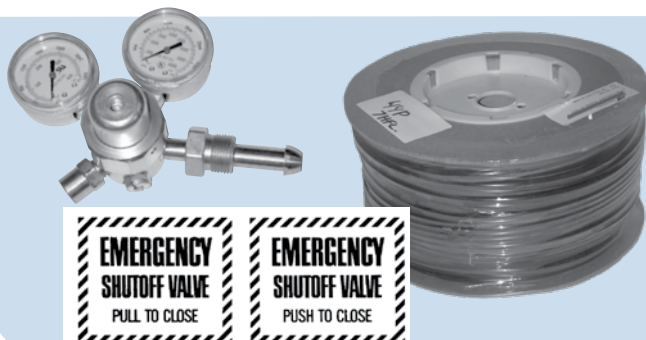

Fisher ESVs for Railroad Cars

Series N562 Snappy Joe ESVs are designed expressly for attachment to the shutoff valves on railroad tank cars. Usually three N562s will be used, two on the liquid lines and one on the vapor line. NFPA 58 regulations call for ESV protection on both sides of the transfer hose or piping. Hardened stainless steel F.NPT threads. Uses customer supplied Sch 80 nipple.



TYPE NUMBER	SHUTOFF NIPPLE LENGTH	VALVE CONNECTION	HOSE CONNECTION
N562-26	5.15"	2" FNPT	3 1/4" M. ACME

Pneumatic Tubing and Fittings

PART NO.	DESCRIPTION	SIZE
3331	3-Way Control Valve	1/4" FPT
44P	Poly Tubing	1/4" x 100'
44P-5C	Poly Tubing	1/4" x 500'
AP62P4	Union	1/4" Tube x 1/4" Tube
AP61P4	Nut & Ferrule	1/4" Tube
AP64P4	Tee	1/4" Tube
AP68P4X4	Adapter	1/4" Tube x 1/4" MPT
AP68P4X2	Adapter	1/4" Tube x 1/8" MPT
AQ65P4	90° Elbow	1/4" Tube x 1/4" Tube
P-81	Sign, Pull to Close	10" x 12"
P-82	Sign, Push to Close	10" x 12"

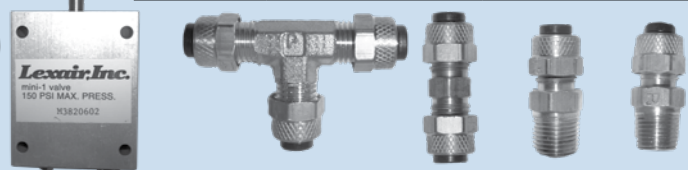

RegO Pneumatic Remote Control Kit

Control kit with components for connecting and charging the pneumatic controls from a source of compressed gas (air or nitrogen) to a RegO liquid or vapor ESV. Includes charging valves with low pressure indicator, operating valves, 100 feet of 1/4" plastic tubing and tube fittings.



PART NUMBER	DESCRIPTION
6016PN-50	Cylinder assembly kit for ESV pneumatic shutdown

Remote Components

PART NO.	DESCRIPTION
7605AP-10	Emergency Valve
7605AP-12	Charging Valve
7605AP-13	Tee
7605AP-14	Hex Nipple
7605AP-15	Tubing Connector
7605AP-16	Tubing Tee
7605A-17	Union (Plastic Tube)
7519-64	Indicator
7605AP-19	Bushing 1/8" x 1/4"

PART NO.	DESCRIPTION
7605AP-81	Bracket for emergency valve
7605AP-82	Bracket for charge valve
2303-3	Screw
7605A-BT	Black tubing 1/4" x 100'
7605PN-30	Instruction Sheet
7605APN-8A	Extra shutdown valve assembly
7605AP-16	1/4" tubing tee with nuts
7605AP-15	1/8" NPT x 1/4" tubing. Straight connector

RegO Pull-away Valves for Transfer Operations

Designed especially to provide pull-way protection for LP-gas and anhydrous ammonia transfer operations including transport and delivery truck loading and unloading, engine fuel container filling and miscellaneous cylinder filling operations.

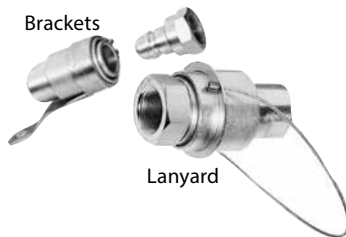

PART NUMBER	INLET/OUTLET CONNECTIONS (F. NPT)	DISCONNECT FORCE (APROX-LBS)	RECONNECT FORCE (APPROX-LBS)	MOUNTING CONNECTION
A2141A6	3/4"	130	80	Bracket
A2141A6L	3/4"	130	80	Lanyard
A2141A8	1"	75	50	Bracket
A2141A8L	1"	75	50	Lanyard
A2141A10	1 1/4"	160	25	Lanyard
A2141A16	2"	300	50	Lanyard

RegO Bleeder Valves

Especially designed to bleed off liquid or vapor pressures trapped in transfer lines. When installed in the downstream boss of RegO globe and angle valves used at the end of a liquid transfer hose, the bleeder valve allows for the controlled venting of the product and indicates to the operator that the valves are closed and he can disconnect the coupling. They may also be used as a fixed liquid level gauge where the dip tube is part of the container.

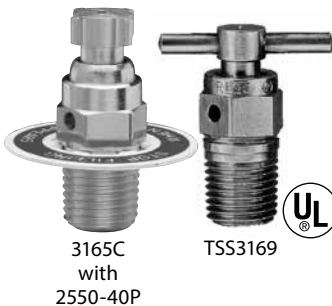

PART NUMBER	SERVICE	CONNECTION	ACTUATION	ACCESSORIES WARNING PLATE KIT
3165C	LP Gas Only	1/4" M.NPT	Knurled	2550-40P
TSS3169	LP Gas & NH ₃	1/4" M.NPT	Tee Handle	2550-40P
1931-24A	Thumbscrew Only	-	-	-
3162C-6	Thumbscrew Only	-	Square Head	-

3165C with 2550-40P

TSS3169





RegO Fixed Liquid Level Gauges



Especially designed to provide a visible warning when containers are filled to the maximum permitted filling level. At the start of the filling operation, with the vent stem opened, the valve discharges vapor. When the maximum permitted filling level is reached, the valve discharges liquid. These valves are normally furnished with a 12", 3/16" O.D. dip tube and incorporate a No. 54 drill size orifice. An optional instruction plate with "Stop Filling When Liquid Appears" may be ordered for use with these valves.

PART NUMBER	SERVICE	CONNECTION	ACTUATION	DIP TUBE LENGTH	ACCESSORIES WARNING PLATE KIT
3165CF05.6	LP Gas Only	1/4" M.NPT	Knurled	5.6"	2550-40P
3165CF12.0	LP Gas Only	1/4" M.NPT	Knurled	12"	2550-40P



3165CF12.0

RegO Hydraulic Automatic Cylinder Filling System

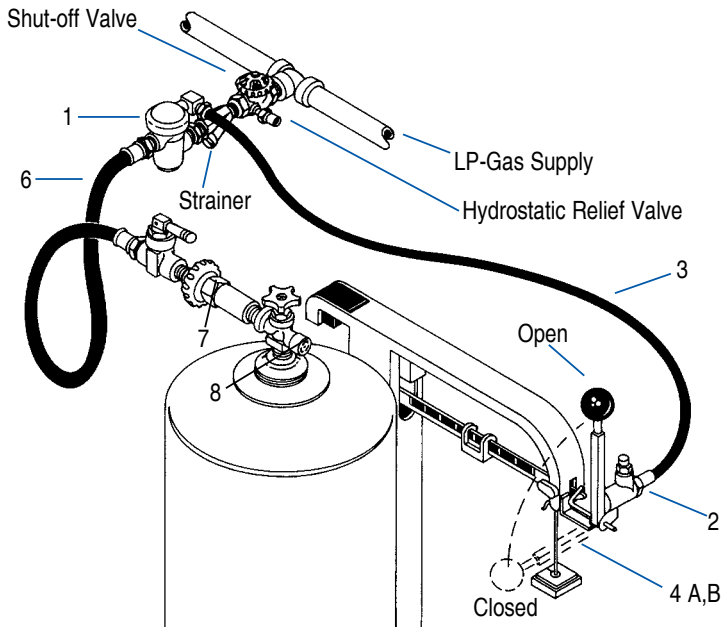

Designed to provide accurate, economical filling of LP-Gas DOT and fork lift cylinders by weight. Filling stops automatically as the total weight of the cylinders reaches the amount pre-set on the scale. One individual can efficiently handle up to four cylinder filling operations simultaneously, to maximize profits, increase efficiency and allow servicing of more customers.

KEY NO.	DESCRIPTION	SIZE	PART NUMBER
Assembly for Fairbanks Morse. Includes items 1 through 8 below.			7194MD
1	Propane Control Valve	1/2" NPT female with 1/8" NPT female hydraulic connection	7177
2	Master Cylinder, with Actuator lever	1/8" NPT hydraulic connection	7188
3	Hydraulic hose assembly	3/16" I.D. with 1/8" NPT male ends, 43 1/2" overall length	7194-1
4A	Bracket kit for Fairbanks Morse scales, complete with screws, washers, nuts, and instructions	----	7194M-3K
5	Can of hydraulic fluid, complete with filling spout	1 1/2 Ounce	7188-21
6	Propane filling hose assembly	1/2" I.D., with 1/2" NPT male ends. 50 1/2" overall length	7193-4
7	Quick-acting shut-off valve	1/2" NPT inlet X 1/4" NPT outlet	7901TB
8*	Soft nose cylinder connector	1/4" NPT male X POL male	7193D-10

*Any of the RegO hose end adapters for cylinder filling may be used with these systems.

RegO Repair Kits

REGO PART NO.	REPAIR KITS AVAILABLE	CONTENTS	INSTRUCTION SHEET
-	19100-50B	Complete bonnet assembly; bonnet/stem; o-ring; hand-wheel; self tapping screw	19100-300B
-	19104-80	Upper packing for 19104-50 seal rings for multibonnet only	19104-800
-	6542B-80	Gaskets; spring; spring guide; stem & seat disc assembly	-
-	7553T-80	Gasket; o-ring; seat disc 7553T-301	7553T-301
-	7579-80	Gaskets; spring; spring guide; stem and seat disc assembly	7579-300A
-	7193K-51	Check body and disc assembly; gasket; nipple; tailpiece; slip washer	-
-	8475-81A	Gaskets; spring stem & seat disc assembly	8475-300A
-	8475L-80	Gaskets; seat disc & retainer assembly; spring	-
-	8555-80	Gaskets; spring; spring guide; stem & seat disc assembly	-
-	8475-81A	Gaskets; spring stem and seat disc assembly	8475-300A
-	8475L-80	Gaskets; seat disc & retainer assembly spring	-
-	903-51	Bonnet stem seat disc assembly; small hand-wheel; self tapping screw	-
-	A7507A-20	Bonnet assembly	-
rings; seat disc; washer"	A7509-300	-	-
-	A7511F-20	Bonnet assembly	-
-	A7513F-20	Bonnet assembly	-
-	A7515-20	Bonnet assembly	-
-	A7707-75	Bonnet assembly	-
-	A7797A-4	Bonnet and lever assembly	-
-	A7883F-80	Bushing; cylinder cap screws; filters; gaskets; insert; o-rings; retaining ring; seal disc; v-ring; x-seals	7883-300
-	A7883F-150	Gaskets; seal disc; x-seal	7883-300
-	A7884F-80	Bushing; cylinder cap screws; filters; gaskets; insert; o-rings; retaining ring; seal disc; v-ring; x-seals	7883-300
-	A7884F-150	Gaskets; seal disc; x-seal	7883-300
-	7901-80	Gasket; o-ring seat disc retainer assembly	7901-301
-	L7579-80	Gaskets; spring stem and seat disc assembly	7579-300A
-	TA7513A-20	Bonnet assembly	-
-	TA7513F-20	Bonnet assembly	-
19104-50	19104-80	MultiBonnet replacement packing	
3100 Series	3100-81K	Conversion Kit: Bonnet and stem assembly, gasket	
	3100-80A	Diaphragm, bonnet, stem assembly	
	3100-80B	Diaphragm assembly, back seat, washer	
3121	3121-50	Hand wheel; screw; o-rings(2); bonnet gasket; bleeder stem	3121-300
6010	A6010-50	Spring washer (2); gasket (main seat) gasket (flange); pressure seal ring (2); jam ring; washer (teflon); spring lock washer; rubber boot; o-ring; cotter pin (2)	6010-303
	6010-80	Pressure seal ring (2); jam ring; washer; spring (seal housing); o-ring	6010-303
6016	A6016-50	Spring washer (2); gasket (main seat) gasket (flange); pressure seal ring (2); jam ring; washer (teflon); spring lock washer; rubber boot; o-ring; cotter pin (2)	6010-303
	6016-80	Pressure seal ring (2); jam ring; washer; spring (seal housing); o-ring	6010-303
6024	6024-50	Spring washer (2); gasket (main seat) gasket (flange); pressure seal ring (2); jam ring; washer (teflon); spring lock washer; rubber boot; o-ring; cotter pin (2)	6024-303
	6024-80	Pressure seal ring (2); jam ring; washer; spring (seal housing); o-ring	6024-303
6532A Series Filler Valve	6542B-50	Gaskets; spring; spring guide; stem and seat disc assembly; upper body	6542B-300
	6542B-80	Gaskets; spring; spring guide; stem and seat disc assembly	
6532A Series Service Valve	19104-50	Complete bonnet assembly; bonnet assembly; hand-wheel; self tapping screw	19104-300
6532R Series Filler Valve	6542B-50	Gaskets; spring; spring guide; stem and seat disc assembly; upper body	6542B-300
	6542B-80	Gaskets; spring; spring guide; stem and seat disc assembly	



RegO Repair Kits (cont.)

REGO PART NO.	REPAIR KITS AVAILABLE	CONTENTS	INSTRUCTION SHEET
6532R Series Service Valve	19104-50	Complete bonnet assembly; bonnet assembly; hand-wheel; self tapping screw	19104-300
6533A Series Filler Valve	6542B-50	Gaskets; spring; spring guide; stem and seat disc assembly; upper body	6542B-300
	6542B-80	Gaskets; spring; spring guide; stem and seat disc assembly	
6533A Series Service Valve	19104-50	Complete bonnet assembly; bonnet assembly; hand-wheel; self tapping screw	19104-300
6533R Series Filler Valve	6542B-50	Gaskets; spring; spring guide; stem and seat disc assembly; upper body	6542B-300
	6542B-80	Gaskets; spring; spring guide; stem and seat disc assembly	
6533R Series Service Valve	19104-50	Complete bonnet assembly; bonnet assembly; hand-wheel; self tapping screw	19104-300
6542A Series Filler Valve	6542B-50	Gaskets; spring; spring guide; stem and seat disc assembly; upper body	6542B-300
	6542B-80	Gaskets; spring; spring guide; stem and seat disc assembly	
6542A Series Service Valve	19104-50	Complete bonnet assembly; bonnet assembly; hand-wheel; self tapping screw	19104-300
6542R Series Filler Valve	6542B-50	Gaskets; spring; spring guide; stem and seat disc assembly; upper body	6542B-300
	6542B-80	Gaskets; spring; spring guide; stem and seat disc assembly	
6542R Series Service Valve	19104-50	Complete bonnet assembly; bonnet assembly; hand-wheel; self tapping screw	19104-300
6543A Series Filler Valve	6542B-50	Gaskets; spring; spring guide; stem and seat disc assembly; upper body	6542B-300
	6542B-80	Gaskets; spring; spring guide; stem and seat disc assembly	
6543A Series Service Valve	19104-50	Complete bonnet assembly; bonnet assembly; hand-wheel; self tapping screw	19104-300
6543R Series Filler Valve	6542B-50	Gaskets; spring; spring guide; stem and seat disc assembly; upper body	6542B-300
	6542B-80	Gaskets; spring; spring guide; stem and seat disc assembly	
6543R Series Service Valve	19104-50	Complete bonnet assembly; bonnet assembly; hand-wheel; self tapping screw	19104-300
6555 Series Filler Valve	8555-50	Gaskets; spring; spring guide; stem & seat disc assembly; upper body	8555-300
6555R Series Service Valve	19104-50	Complete multibonnet assembly-bonnet assembly; hand-wheel; self tapping screw	-
6555D Series Service Valve	19100-50B	Complete bonnet assembly; bonnet/stem; o-ring; hand-wheel; self tapping screw	9100-300B
6579	7579-50	Gaskets; spring; spring guide; stem and seat disc assembly; upper body	7579-300
7100 Series	3100-81K	Conversion Kit: Bonnet and stem assembly, gasket	
	3100-80A	Diaphragm, bonnet, stem assembly	
	3100-80B	Diaphragm assembly, back seat, washer	
7053T	7553T-50	Bonnet; gasket; lever assembly; seat retainer assembly; stem	7553T-300
7553T-80	7553T	Seal Disc, Seal Packing	
7141M	7141M-50	Seat disc and retainer; gasket; o-ring; retaining ring	7141M-300
7177	7177-50	Diaphragm; gasket; o-ring; seat disc; washer	-
7188	7188-50	Hydraulic fluid; o-rings; piston; spring; trip latch	7188-300
7193K-10B	7193K-50	7193K-51 assembly; adjusting screw; nut; spring; tee	-
7550P	7550-15	Bonnet assembly	-
7750UP	7550-15	Bonnet assembly	-
7551P	7550-15	Bonnet assembly	-
7554LV	7554L-20A	Bonnet assembly	-
7554LAV	7554L-20A	Bonnet assembly	-
7554SV	7554S-20	Bonnet assembly	-
7554SAV	7554S-20	Bonnet assembly	-

RegO Repair Kits (cont.)

REGO PART NO.	REPAIR KITS AVAILABLE	CONTENTS	INSTRUCTION SHEET
7556VR Series Service Valve	19104-50	Complete multibonnet assembly; bonnet assembly; hand-wheel; self tapping screw	19104-300
7556R Series Service Valve	19104-50	Complete multibonnet assembly; bonnet assembly; hand-wheel; self tapping screw	19104-300
7556VR Series Vapor Equalizing	8475-51A	Body; gaskets; spring; stem and seat disc assembly	8475-300
7556R Series Vapor Equalizing	8475-51A	Body; gaskets; spring; stem and seat disc assembly	8475-300
7573D	7573D-81	Gaskets; spring stem and seat disc assembly	7573D-300
7647S Series	7647B-80A	Gaskets; spring; seat disc retainer assembly	7647B-300A
7647SC	7647B-80 w/o filler body	Seat disc and retainer assembly, spring, gaskets, loctite cement	
7705P	7554-20	Bonnet Assembly	-
7901 Series	7901T-50	Bonnet assembly; gasket; lever	7901-300
8475 8477	8475-50L	Filler valve extension assembly	8475-300L
8542G Series	8540-50	Bleeder valve assemblies; packing gland; set screw; washer; key	8540-300
8542AG Series	8540-50	Bleeder valve assemblies; packing gland; set screw; washer; key	8540-300
8555D Service Valve	19100-50B	Complete bonnet assembly; bonnet stem; o-ring; hand-wheel; self tapping screw	19100-300B
8555D Series	3100-54	Relief valve cap	
	MSCP-M3274-9P	Fill valve cap	
	903-31	Replacement handwheel	
	10104-50	Bonnet assembly kits - Mug	
	6542 B-80	Bonnet assembly kits - Filler	
8555D Series Mfg'd 10/90 or before Filler Valve	6542B-50	Gaskets; spring; spring guide; stem & seat disc assembly; upper body	6542B-300
8555D Series Mfg'd after 10/90 Filler Valve	8555-50	Gaskets; spring; spring guide; stem & seat disc assembly; upper body	8555-300
8555DL Series	3100-54	Relief valve cap	
	MSCP-M3274-9P	Fill valve cap	
	9107-31	Replacement Handwheel	
8555DL Filler Valve	6542B-50	Gaskets; spring stem and seat disc assembly; upper body	6542B-300
8555DL Service Valve	19100-50B	Complete bonnet assembly; bonnet stem; o-ring; hand-wheel; self tapping screw	19100-300B
8555R Series	3100-54	Relief valve cap	
	MSCP-M3274-9P	Fill valve cap	
	903-31	Replacement handwheel	
	10104-50	Bonnet assembly kits - Mug	
	6542 B-80	Bonnet assembly kits - Filler	
8555R Service Valve	19104-50	Complete multibonnet assembly-bonnet assembly; hand-wheel; self tapping screw	19104-300
8555R Series Mfg'd 10/90 or before Filler Valve	6542B-50	Gaskets; spring; spring guide; stem & seat disc assembly; upper body	6542B-300
8555R Series Mfg'd after 10/90 Filler Valve	8555-50	Gaskets; spring; spring guide; stem & seat disc assembly; upper body	8555-300



RegO Repair Kits (cont.)

REGO PART NO.	REPAIR KITS AVAILABLE	CONTENTS	INSTRUCTION SHEET
8556 Service Valve	19101-50	Bonnet ,O-Ring, and Stem Assembly - Handwheel & Screw	19100-300B
8593AL Filler Valve	8475L-50	Upper body; gaskets; seat disc & retainer assembly; spring	8475-300F
8593AL Vapor Equalizing Valve	8475-51A	Body; gaskets; spring; stem & seat disc assembly	8475-300
8593AL Service Valve	19104-50	Complete multibonnet assembly-bonnet assembly; hand-wheel; self tapping screw	19104-300
901 Series	903-50	Bonnet stem seat disc assembly; large hand-wheel; self-tapping screw.	903-300
	903-51	Bonnet stem seat disc assembly; small hand-wheel; self-tapping screw.	
9100 Series	1900-50B	Bonnet assembly, handwheel, screw, washer	
	19104-50	MultiBonnet, handwheel, screw, ID Plate	
9101P Series (Forklift Service Valve)	19101-50	Complete bonnet assembly; bonnet stem; o-ring; smaller hand-wheel; self tapping screw	19101-300
9101C Series Service Valve	19104-50	Complete multibonnet assembly-bonnet assembly; hand-wheel; self tapping screw	19104-300
9101D Series Service Valve	19104-50	Complete multibonnet assembly-bonnet assembly; hand-wheel; self tapping screw	19104-300
9101H Series Service Valve	19104-50	Complete multibonnet assembly-bonnet assembly; hand-wheel; self tapping screw	19104-300
9101R Series Service Valve	19104-50	Complete multibonnet assembly-bonnet assembly; hand-wheel; self tapping screw	19104-300
9101Y Series Service Valve	19104-50	Complete multibonnet assembly-bonnet assembly; hand-wheel; self tapping screw	19104-300
9101P	19101-50	Bonnet and small handrail	
9102D Series	19101-50B	Complete bonnet assembly; bonnet/stem; o-ring; hand-wheel; self tapping screw	19100-300B
9101C Series Service Valve	19104-50	Complete multibonnet assembly-bonnet assembly; hand-wheel; self tapping screw	19104-300
9101D Series Service Valve	19104-50	Complete multibonnet assembly-bonnet assembly; hand-wheel; self tapping screw	19104-300
9102R Series	19104-50	Complete multibonnet assembly-bonnet assembly; hand-wheel; self tapping screw	19104-300
9103 Series	9107-31	Replacement Handwheel	
	9103-54	Relief Valve Cap	
	1931-24A	Replacement Thumb Screw	
9103T9F Service Valve	19101-50B	Complete bonnet assembly; bonnet/stem; o-ring; hand-wheel; self tapping screw	19100-300B
9104 Series	19100-1BXV	Bonnet, O-Ring & Stem Assembly	-
9106CO	903-50	Bonnet stem seat disc assembly; large hand-wheel; self tapping screw	-
9106 Series	9107-31	Replacement Handwheel	
	3100-54	Relief Valve Cap	
	1931-24A	Replacement Thumb Screw	
9107 Series	9107-31	Replacement Handwheel	
	3100-54	Relief Valve Cap	
	1931-24A	Replacement Thumb Screw	
9107K8 Series	19100-50B	Complete bonnet assembly; bonnet/stem; o-ring; hand-wheel; self tapping screw	19100-300B
9300Y/R	19104-50	Complete multibonnet assembly-bonnet assembly; hand-wheel; self tapping screw	19104-300

RegO Repair Kits (cont.)

REGO PART NO.	REPAIR KITS AVAILABLE	CONTENTS	INSTRUCTION SHEET
A2141A6	A2141A6-50	O-Ring seal for female connector	
	A2141A6M	Male connector	
A2141A6L	A2141A6-50	O-Ring seal for female connector	
	A2141A6M	Male connector	
A2141A8	A2141A8-50	O-Ring seal for female connector	A2141A-302
	A2141A8M	Male connector	A2141A-302
A2141A8L	A2141A8-50	O-Ring seal for female connector	A2141A-302
	A2141A8M	Male connector	A2141A-302
A2141A10	A2141A10-50	O-Ring seal for female connector	A2141A-303
	A2131A10M	Male connector	A2141A-303
A2141A16	A2141A16-50	O-Ring seal for female connector	A2141A-303
	A2141A16M	Male connector	A2141A-303
A3209D Series	A3209D-50	Wear button; retaining ring; main stem bearing; washer; jam ring pressure seal rings (2); main stem retaining ring; hex screw; poppet assembly; seat disc	A3209D-301
	A3209D-50T	Torsion Spring & Washer A3209D-303	A3209D-303
A3212R Series	A3212R-50	Gasket; spring; seal housing gasket; jam ring; pressure seal ring (2); o-ring; retaining ring; wear button; poppet assembly; o-ring; roll pin; cotter pin	A3212R-301
	A3213A-80	Pivot Shaft Repair - Jam ring, Pressure seal ring (2), o-ring	A3213A-302
A3213R Series	A3213R-50	Gasket; spring; seal housing gasket; jam ring; pressure seal ring (2); o-ring; ring; pressure seal ring (2); o-ring; retaining ring; wear button; poppet assembly; o-ring; roll pin; cotter pin	A3213R-301
	A3212A-80	Pivot Shaft Repair - Jam ring, Pressure seal ring (2), o-ring	A3212A-302
A3217A Series	A3217A-80G	Gasket; spring; seal housing gasket; jam ring; pressure seal ring (2); o-ring; ring; pressure seal ring (2); o-ring; retaining ring; wear button; poppet assembly; o-ring; roll pin; cotter pin	A3217A-302
	A3217F-50	Gasket; spring; seal housing gasket; jam ring; pressure seal ring (2); o-ring;	A3217F-300
A3219FA Series	A3219FA-80G	Bumper; cotter pins (3); dirt seal; inner and outer stem bearing; lever release spring; main seat disc; poppet seat disc; pivot pin locknut; poppet bearing; seal gland gasket; seat seal o-ring; stem; jam ring; stem o-ring; stem seal rings (3); stop screws; upper and lower flange seal gaskets	A3219FA-303G
A7505AP	A7505-20	Bonnet assembly	-
A7506AP	A7505-50	Gaskets; jam ring; o-ring; pressure seal rings; seat disc; washer	A7505-300
A7507AP	A7507-50	Gaskets; jam ring; o-ring; pressure seal rings; seat disc; washer	A7507-300
A7508AP	7507A-20	Bonnet assembly	-
A7509BP	A7509-50	Gaskets; jam ring; o-ring; pressure seal	-
A7510BP	7509B-20	Bonnet assembly	-
A7511AP	A7511-50	Gaskets; jam ring; o-ring; pressure seal rings; seat disc; washer	A7511-300
A7511FP	A7511-50	Gaskets; jam ring; o-ring; pressure seal rings; seat disc; washer	A7511-300
A7512AP	A7511-50	Gaskets; jam ring; o-ring; pressure seal rings; seat disc; washer	A7511-300
A7512FP	A7511-50	Gaskets; jam ring; o-ring; pressure seal rings; seat disc; washer	A7511-300
A7513AP	A7513-50	Gaskets; jam ring; o-ring; pressure seal rings; seat disc; washer	A7513-300
A7514AP	A7513-50	Gaskets; jam ring; o-ring; pressure seal rings; seat disc; washer	A7513-300
A7517AP	A7515-50	Gaskets; jam ring; o-ring; pressure seal rings; seat disc; washer	-
A7517FP	A7515-50	Gaskets; jam ring; o-ring; pressure seal rings; seat disc; washer	-
A7518AP	A7515-50	Gaskets; jam ring; o-ring; pressure seal rings; seat disc; washer	-
A7518FP	A7515-50	Gaskets; jam ring; o-ring; pressure seal rings; seat disc; washer	-
A7550P	A7550-15	Bonnet assembly	-
A7750UP	A7550-15	Bonnet assembly	-
A7551P	A7550-15	Bonnet assembly	-
A7553A	A7553A-50	Gaskets; jam ring; o-ring; pressure seal rings; seat disc; washer	A7553A-300
A7704 Series	A7705-50	Flange packing; friction washer; gaskets; seat disc	A7705-300



RegO Repair Kits (cont.)

REGO PART NO.	REPAIR KITS AVAILABLE	CONTENTS	INSTRUCTION SHEET
A7705 Series	A7705-50	Flange packing; friction washer; gaskets; seat disc	A7705-300
A7507/08 LHB, LHD, LHDM, A7707/08 Series	A7707-75	Stem, Bonney and Seal Housing, Assembly	
A7706 Series	A7705-50	Flange packing; friction washer; gaskets; seat disc	A7705-300
A7707L	A7707-50	Gaskets; groove pin; jam ring; o-ring; pressure seal rings; seat disc	A7707-300
A7708L	A7707-50	Gaskets; groove pin; jam ring; o-ring; pressure seal rings; seat disc	A7707-300
A7793A	A7797-50	Gaskets; groove pin; jam ring; o-ring; pressure seal rings; seat disc; washers	A7797-300
A7797	A7797-75	Stem, Bonnet and Level Assembly Washer, O-Ring Pressure	
	A7797-50	Seal Ring, Groove Pin Seat Disc, Jam Rig Washer, O-Ring Pressure	
	A7797-10M	ACME Coupler	
	A7507LH-8	Lever Arm	
	A7507LH-13	Groove Pin	
	A7507LH-11D	Bonnet Wear Washer	
A7797A	A7797-50	Gaskets; groove pin; jam ring; o-ring; pressure seal rings; seat disc; washers	A7797-300
A7853A	A7883F-50	Bleeder assembly; bushing; cap; cap screws; filters; gaskets; lock washers; needle valve kit; o-rings; retaining ring; roll pin; screen filter; seal; set screws; springs; stem assembly kit; v-ring; xseal	7883-300
A7884FK	A7883F-50	Bleeder assembly; bushing; cap; cap screws; filters; gaskets; lock washers; needle valve kit; o-rings; retaining ring; roll pin; screen filter; seal; set screws; springs; stem assembly kit; v-ring; xseal	7883-300
A8016DP	A8016B-50	Gaskets; jam ring; o-ring; pressure seal rings; seat disc; washer	A8016B-300
A8016DCB	A8016B-50	Gaskets; jam ring; o-ring; pressure seal rings; seat disc; washer	A8016B-300
A8017DP	A8016B-50	Gaskets; jam ring; o-ring; pressure seal rings; seat disc; washer	A8016B-300
A8017DLP	A8016B-50	Gaskets; jam ring; o-ring; pressure seal rings; seat disc; washer	A8016B-300
A8018DP	A8016B-50	Gaskets; jam ring; o-ring; pressure seal rings; seat disc; washer	A8016B-300
A8017DH	A8017BH-20R	Bonnet and stem assembly	A8017BH-300
A8560 Series	8560-50	Bleeder valve assemblies; seat ring assemblies; pressure seal rings; packing gland; jam ring; washer; gaskets	7564-300
A8570 Series	8560-50	Bleeder valve assemblies; seat ring assemblies; pressure seal rings; packing gland; jam ring; washer; gaskets	7564-300
AA6010	AA6010-50	Spring washer (2); sleeve insert (shaft) washer; spring (seal housing); jam ring; pressure seal ring (2); o-ring; gasket (flange); rubber boot;	6010-303
	AA6010-80	Pressure seal ring (2); jam ring; washer; spring (seal housing); o-ring	6010-303
AA6016	AA6016-50	Spring washer (2); sleeve insert (shaft) washer; spring (seal housing); jam ring; pressure seal ring (2); o-ring; gasket (flange); rubber boot;	6010-303
	AA6016-80	Pressure seal ring (2); jam ring; washer; spring (seal housing); o-ring	6010-303
AA6024	AA6024-50	Spring washer (2); sleeve insert (shaft) washer; spring (seal housing); jam ring; pressure seal ring (2); o-ring; gasket (flange); rubber boot;	6024-303
	AA6024-80	Pressure seal ring (2); jam ring; washer; spring (seal housing); o-ring	6024-303
AA8560 Series	8560-50	Bleeder valve assemblies; seat ring assemblies; pressure seal rings; packing gland; jam ring; washer; gaskets	7564-300
AA8570 Series	8560-50	Bleeder valve assemblies; seat ring assemblies; pressure seal rings; packing gland; jam ring; washer; gaskets	7564-300
AA8542UA Series	8540-50	Bleeder valve assemblies; packing gland; set screw; washer; key	8540-300

RegO Repair Kits (cont.)

REGO PART NO.	REPAIR KITS AVAILABLE	CONTENTS	INSTRUCTION SHEET
G8475RL	3131-40	Relief valve cap	
	MSCP-M3274-9P	Fill valve cap	
	3144-9P	Vapor equalization cap	
	8475-X30.0	Diptube	
	9107-31	Replacement handwheel	
G8475RL Filler Valve	8475L-50	Upper body; gaskets; seat disc & retainer assembly; spring	8475-300F
G8475RL Fixed Liquid Level Gauge	3165C	Fixed liquid level gauge valve	-
G8475RLW Filler Valve	8475L-50	Upper body; gaskets; seat disc & retainer assembly; spring	8475-300F
G8475RLW Fixed Liquid Level Gauge	3165C	Fixed liquid level gauge valve	-
G8475RL Valor Equalizing Valve	8475-51A	Body; gaskets; spring; stem & seat disc assembly	8475-300
G8475RLW Valor Equalizing Valve	8475-51A	Body; gaskets; spring; stem & seat disc assembly	8475-300
G8475RL Service Valve	19104-50	Complete multibonnet assembly-bonnet assembly; hand-wheel; self tapping screw	19104-300
G8475RLW Service Valve	19104-50	Complete multibonnet assembly-bonnet assembly; hand-wheel; self tapping screw	19104-300
L6579	7579-50	Filler body, seat disc and retainer assembly, spring, gaskets	
L7579	L7579-50	Gaskets; spring stem and seat disc assembly; upper body	7579-300
TA7034P	TA7034-50	Gaskets; jam ring; o-ring; pressure seal rings; seat disc; washer	TA7034-300
TA7034LP	TA7034-50	Gaskets; jam ring; o-ring; pressure seal rings; seat disc; washer	TA7034-300
TA7505AP	TA7034-50	Gaskets; jam ring; o-ring; pressure seal rings; seat disc; washer	TA7034-300
TA7506AP	TA7034-50	Gaskets; jam ring; o-ring; pressure seal rings; seat disc; washer	TA7034-300
TA7507AP	TA7507-50	Gaskets; jam ring; o-ring; pressure seal rings; seat disc; washer	TA7507-300
TA7509BP	TA7509B-50	Gaskets; jam ring; o-ring; pressure seal rings; seat disc; washer	TA7509B-300
TA7510BP	TA7509B-50	Gaskets; jam ring; o-ring; pressure seal rings; seat disc; washer	TA7509B-300
TA7511AP	TA7511A-50	Gaskets; jam ring; o-ring; pressure seal rings; seat disc; washer	TA7511-300
TA7511FP	TA7511A-50	Gaskets; jam ring; o-ring; pressure seal rings; seat disc; washer	TA7511-300
TA7512AP	TA7511A-50	Gaskets; jam ring; o-ring; pressure seal rings; seat disc; washer	TA7511-300
TA7512FP	TA7511A-50	Gaskets; jam ring; o-ring; pressure seal rings; seat disc; washer	TA7511-300
TA7513AP	TA7513A-50	Gaskets; jam ring; o-ring; pressure seal rings; seat disc; washer	TA7513A-300
TA7514AP	TA7513A-50	Gaskets; jam ring; o-ring; pressure seal rings; seat disc; washer	TA7513A-300
TA7513FP	TA7513A-50	Gaskets; jam ring; o-ring; pressure seal rings; seat disc; washer	TA7513A-300
TA7514FP	TA7513A-50	Gaskets; jam ring; o-ring; pressure seal rings; seat disc; washer	TA7513A-300
TA7517AP	TA7515A-50	Gaskets; jam ring; o-ring; pressure seal rings; seat disc; washer	TA7515A-300
TA7518FP	TA7515A-50	Gaskets; jam ring; o-ring; pressure seal rings; seat disc; washer	TA7515A-300
TA7894P	TA7894-50	Gaskets; jam ring; o-ring; pressure seal rings; seat disc; washer	TA7894-300

Manchester Portable DOT Vertical Steel Cylinders

5, 10, and 11 Pound Portable Cylinders

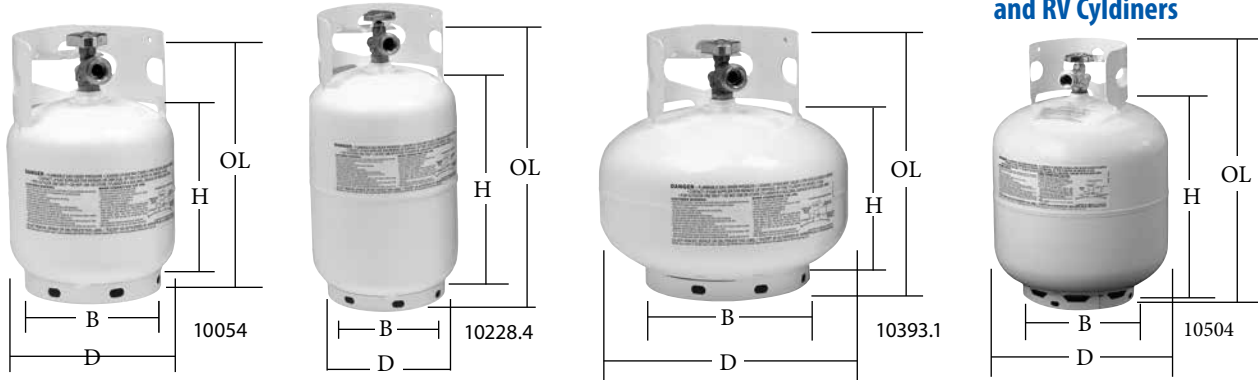

20 Pound Gas Grill and RV Cylinders



50, 60 and 100 Pound Cylinders

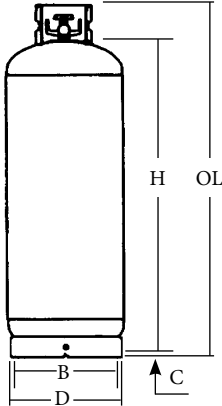

1436.4
Vapor Multivalve
POL Valve with
1 3/4" ACME Fill



100SLM
Liquid Withdrawal Valve
CGA555 Connection



100SLMM
Liquid Withdrawal Multivalve
CGA555 Connection
with 1 3/4" ACME Fill



Standard POL Valve
CGA510 Connection



Footring Powder Coated



PART NO.	SIZE	DESCRIPTION	C	OL	H	D	TW	WC	B
10054	5 LB	Vertical ACME/Type 1 w. OPD		12	8.62	8	9.5	13	6.5
10228.4	10 LB	Vertical ACME/Type 1 w. OPD		17.43	13.75	8.87	14	26.1	7.25
10393.1	11 LB	Vertical ACME/Type 1 w. OPD		12.38	8.37	12.16	13	25.4	7.93
10504	20 LB	Vertical ACME/Type 1 w. OPD for Gas Grill and RV		17.56	13.62	12.16	8	18	47.6
10834TC.1	20 LB	Vertical ACME/Type 1, Gauge w. OPD for Gas Grill and RV		17.56	13.62	12.16	8	19	47.6
1160.8	30 LB	Vertical ACME/Type 1 w. OPD		23.43	19.56	12.16	7.93	25.5	71.4
1166.2	30 LB	Vertical ACME/Type 1, Gauge w. OPD		23.43	19.56	12.16	7.93	26.6	71.4
1220TC.4	40 LB	Vertical ACME/Type 1 w. OPD		29.43	25.56	12.16	7.93	30.5	95.2
1222TC.4	40 LB	Vertical ACME/Type 1, Gauge w. OPD		29.43	25.56	12.16	7.93	30.5	95.2
1203TC.3	40 LB	Vertical ACME/Type 1, w. OPD (Large Foot Ring)		29.43	25.56	12.16	12	30.5	95.2
14861	50 LB	Outage, Collar Type with POL	.50	28.5	23.7	14.5	14	46	119
1426	60 LB	Outage, Collar Type with POL	1.06	43.12	37.37	12.16	12.16	46	143
1428	100 LB	Outage, Collar Type with POL	.50	46.31	41	15.06	14	70	238
1436.4	100 LB	Multivalve, Collar Type with POL White	.50	46.31	41	15.06	14	71	238
MSCP-100SLM	100 LB	Cylinder Collar w. liquid valve	.50	46.31	41	15.06	14	71	238
MSCP-100SLMM	100 LB	Cylinder Collar w. liquid multivalve	.50	46.31	41	15.06	14	71	238

Cylinders are manufactured to meet or exceed DOT Specification 4BA240 or 4BW240.

Order by phone: 800-922-0724

Locks



The easy to install 510 Saf-T-Lok securely locks POL service valves to prevent unauthorized hookups, reduce pilferage, and secures tanks after "out of gas" calls. Provides an effective credit control.

PART NO.	DESCRIPTION
510	POL-LOCK
510-K	POL-LOCK KEY
B531G & B827P-A0	POL Lock complete with lock and plug for LP outlet valve keyed alike (key not included)
S502K-C-BLUE	Key cut uniquely with code for each company.
S533G-LLVC-A0	1 3/4" ACME valve cap lock with brass cap and slip ring with lock keyed alike (key not included)

Tank and Cylinder Accessories

For use on cylinders during transportation. Also protects valve on construction sites as per DOT and OSHA requirements.

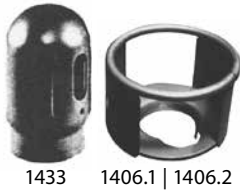

PART NO.	DESCRIPTION
1433	Screw cap, 3 1/2" thread
1406.1	Screw on collar (construction) fits over multivalve 3 1/2"
1406.2	Screw on collar (construction) fits over multivalve 3 1/8"

Break-away Locks



Hidden breakaway feature allows fire department or emergency response personnel access to valves, plant gates, etc. Lock shackle breaks away when struck with a hammer or chisel.

PART NUMBER	DESCRIPTION
500BRK	Break-away Lock; Keyed Alike

Locking Caps

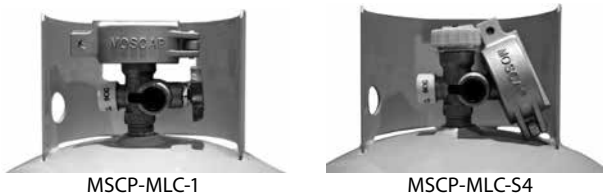

Encloses ACME thread or handwheel on valve to prevent tampering.

PART NUMBER	INSIDE DIAMETER	BOTTOM OPENING	HEIGHT	VALVE TYPE
MSCP-MLC-1	2 1/4"	1 1/2"	1 1/8"	FILLER
MSCP-MLC-S4	3"	1 3/8"	1"	100LB

Special Application Cylinders

Vertical Liquid Truck Cylinders

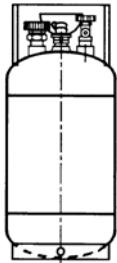

VAPOR OR LIQUID
14 LB

ORDER NUMBER	5305L	5306V
	14LB LP WITH FILL (LIQUID SERVICE)	14LB LP (VAPOR SERVICE)
Water Capacity (lbs.)	32.4	32.4
OAL	20.75	20.75
Cyl. Diameter	9.0	9.0
Guard Diameter	8.0	8.0
Foot Ring Diameter	8.0	8.0
Tare Weight, lbs.*	21.8	21.8

* Tare weight may vary slightly on individual cylinder.

** Special order

Manchester DOT Horizontal Cylinders

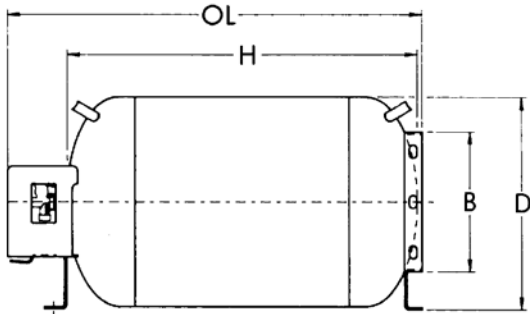

20 and 30 Pound Steel Cylinders

DESCRIPTION	PART NUMBER	OL	H	D	TW	WC	B
20LB ACME/Type 1, Gauge with OPD	10487TC	17.37	13.62	12.16	19.5	47.6	7.93
30LB ACME/Type 1 with OPD and Gauge	1175TC	23.43	19.56	12.16	27.7	71.4	7.93

Portable DOT Aluminum Cylinders



10 LB



20 LB

6, 10, 20, 30 and 40 Pound Vertical Aluminum Cylinders

DESCRIPTION	PART NO.	OL	H	D	TW	WC
10LB Vertical ACME/Type 1	9058TC.2	16.25	10.75	10.28	10.1	23.8
20LB Vertical ACME/Type 1	9060TC.1	20.06	15.1	12.125	14.1	47.6



10 and 20 Pound Horizontal Aluminum Cylinders

DESCRIPTION	PART NUMBER	OL	OH	WC
10LB Horizontal with OPD	9059TC.1	16.5	11	23.8
20LB Horizontal with OPD	9061TC.1	20.56	13	47.6

All cylinders on this page are manufactured to meet or exceed DOT Specification 4BA240 or 4BW240.

Propane Mower Cylinders

Features:

- Cylinders available for horizontal or vertical service, depending on application
- Standard fittings include: Safety Relief, Float Gauge, Fixed Liquid Level, Vapor Service, and ACME Fill Valves
- Collar painted green for product differentiation



PART NO.	SIZE	TYPE	WATER CAPACITY	LENGTH	HEIGHT	DIAMETER	TARE-WEIGHT
5456TC.3	20lb.	Steel	4.76 gal	13.6"	19"	12"	27 lb
9367	33.5lb.	Aluminum	8.0 gal	22.4"	28.3"	12"	25 lb
9368	43.5lb.	Aluminum	10.4 gal	28.8"	34.4"	12"	26 lb

Manchester Aluminum Forklift Cylinders

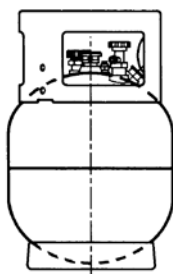

20 LB

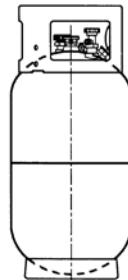

33.5 LB

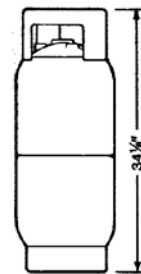

43.5 LB

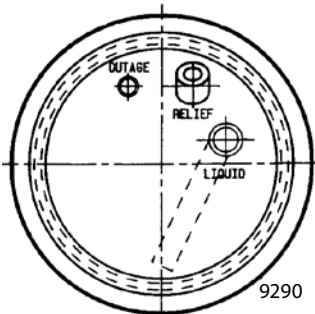

3 Hole Head
No Gauge

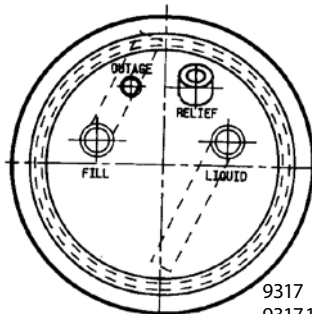

4 Hole Head
No Gauge

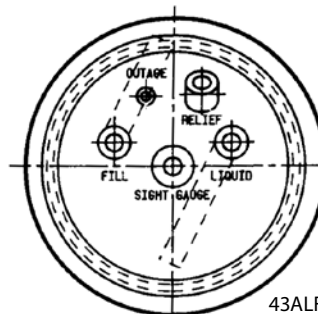

5 Hole Head
Code 12

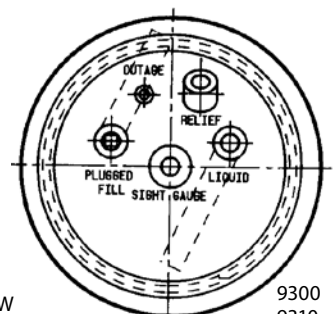

5 Hole Head
Plugged Fill
Code 13

PART NUMBER	LP CAP	OVER-ALL LENGTH	CYL DIAM.	GUARD DIAM.	FOOTRING DIAM.	TARE WT (LBS)	GAUGE	ACME CONN	WATER CAP (LBS)	ACME FAST FILL	10% OUTAGE
9285 Buffer/Vapor**	20LB	20.38	12.28	10.5	9.5	17	Yes	Yes	47.6	No	Yes
9287 Buffer/Vapor**	20LB	20.38	12.28	10.5	9.5	17	Yes	Yes	47.6	Yes	Yes
9305	20LB	20.38	12.28	10.5	9.5	17	Yes	Yes	47.6	Yes	Yes
9315	33.5LB	28.56	12.28	10.5	9.5	23.5	Yes	Yes	80	Yes	Yes
9161	43.5LB	33.94	12.28	10.5	9.5	25	Yes	Yes	105	Yes	Yes

NOTE: We are the largest warehouse for forklift cylinders. We can stamp your name on the collar.

* Has a plugged fill opening.

** Buffer tanks are for use in vertical position only.

These cylinders are manufactured to meet or exceed DOT Specification 4E240.

Manchester Steel Forklift Cylinders

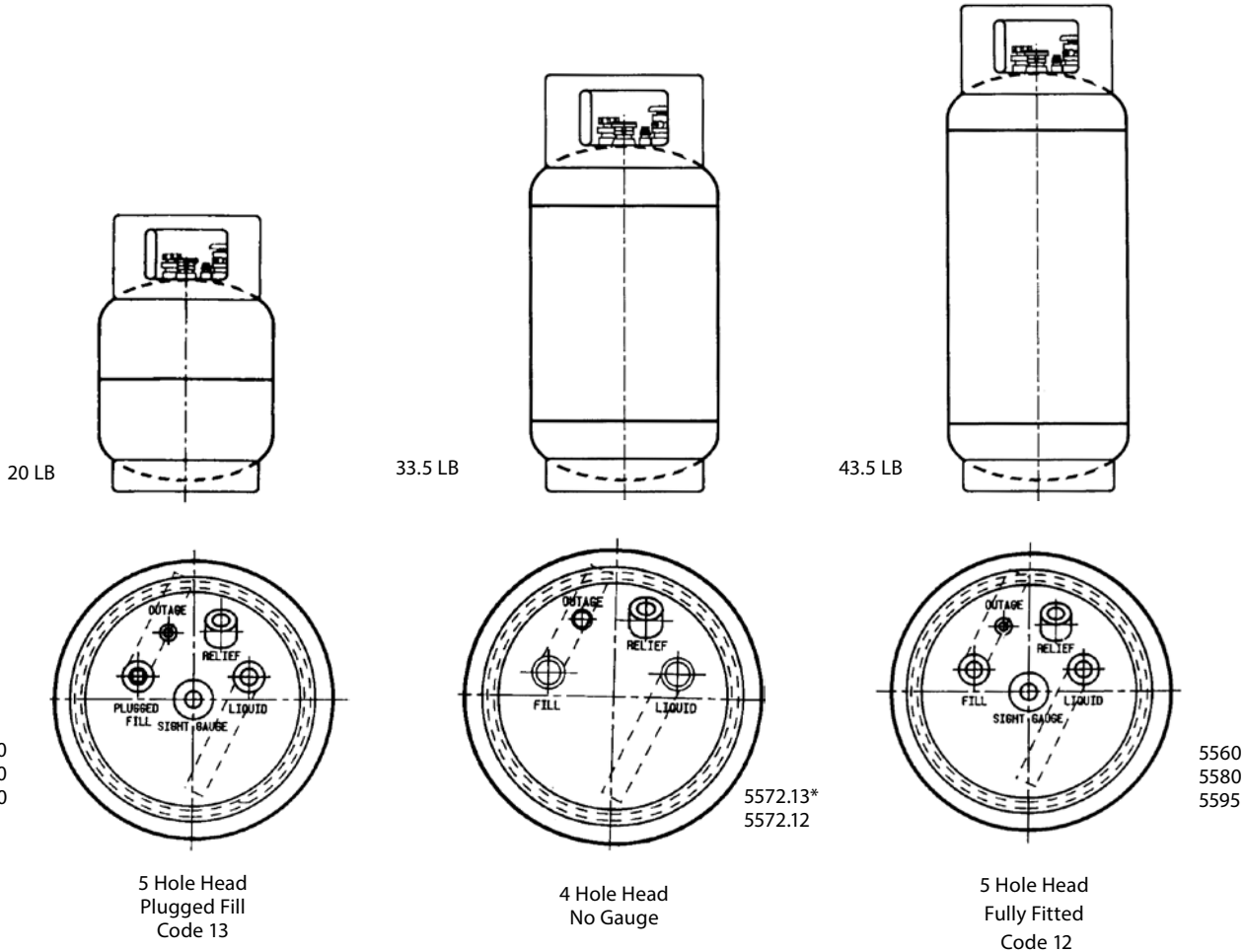

PART NUMBER	LP CAP	OVERALL LENGTH	CYL DIAM.	GUARD DIAM.	FOOTRING DIAM.	TARE WT (LBS)	GAUGE	ACME CONN	WATER CAP (LBS)	ACME FAST FILL	10% OUTAGE
5455 Buffer/Vapor	20LB	19.13	12.19	10.25	10.25	27	Yes	Yes	47.6	No	Yes
5456 Buffer/Vapor	20LB	19.13	12.19	10.25	10.25	27	Yes	Yes	47.6	Yes	Yes
5570	33.5LB	27.25	12.19	10.25	10.25	36	Yes	Yes	80	No	Yes
5580	33.5LB	27.25	12.19	10.25	10.25	36	Yes	Yes	80	Yes	Yes
5595	43.5LB	33.25	12.19	10.25	10.25	43	Yes	Yes	104	Yes	Yes

* Has plugged fill opening.

We are the largest warehouse for forklift cylinders. We can stamp your name on the collar.

All cylinders on this page are manufactured to meet or exceed DOT Specification 4BA240.

RegO Service Valves for Dot Forklift Cylinders



9101P5

Designed specifically for vapor or liquid withdrawal service on DOT forklift containers. Valves with 1.5 GPM closing flow are for use in small and medium size lift truck applications, while those with 2.6 GPM closing flow are for large lift trucks and gantry crane type vehicles.

PART NUMBER	CONTAINER CONNECTION	SERVICE CONNECTION	LIQUID WITHDRAWAL CONNECTION	CLOSING FLOW (LP-GAS) VAPOR			APPROXIMATE FILLING RATE LIQUID FLOW, GPM				
				25 PSIG INLET (SCFH)	100 PSIG INLET (SCFH)	LIQUID (GPM)	PRESSURE DROP ACROSS VALVE				
				10 PSIG	25 PSIG	50 PSIG	100 PSIG				
9101P5	3/4" M. NGT	3/8" M. NPT	None	430	900	1.5	5.0	7.6	10.7	14.9	
9101P5H	3/4" M. NGT	3/8" M. NPT	None	550	1050	2.6	5.0	7.6	10.7	14.9	
9101P6	3/4" M. NGT	3/8" M. NPT	1/4" NPT	430	900	1.5	4.5	7.2	10.3	14.8	
9101P6H	3/4" M. NGT	3/8" M. NPT	1/4" NPT	550	1050	2.6	4.5	7.2	10.3	14.8	

NOTE: These valves incorporate an excess flow valve.

Forklift & Mower Connectors

These brass connectors are specially designed to join the carburetor fuel line to the service valve on lift truck cylinders.



7141M



7141F

PART NUMBER	APPLICATION	TYPE	INLET	OUTLET	PROTECTIVE CAP*	
					RUBBER	BRASS
7141M	Service Valve	Forklift	3/8" F.NPT	1 1/4" M. ACME	7141M-40	7141FP
7141F	Fuel Line	Forklift	1 1/4" F.ACME	1/4" F.NPT	-	-
7142LM	Service Valve	Mower	3/8" F.NPT	1 1/4" M. ACME		
7142LF	Fuel Line	Mower	1 1/4" F.ACME	1/4" F.NPT		
V21502	Service Valve	Mower	3/8" F.NPT	1 1/4" M. ACME	-	-
V21503	Fuel Line	Mower	1 1/4" F.ACME	1/4" F.NPT	-	-

Accessories

PART NUMBER	DESCRIPTION
7141M-3R	RegO Flat Outer Washer
MSW-4	Flat Outer Washer
2114A	Inner O-Ring

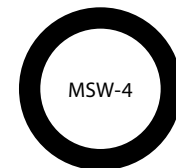

MSW-4

Fixed Liquid Level Gauges

PART NUMBER	DESCRIPTION
3165CF05.6	5.6" Dip Tube Supplied
3165C	Fixed Level Gauge
3162C-6	Thumb Screw Plug



3165CF05.6

RegO Double Backcheck Filler Valve

1 3/4" M. ACME x 3/4" MPT high capacity filling used on DOT and ASME containers for fast filling.



MSCP-M3274-9P



76475C
with everseal on threads

Cabinets

Construction

- All welded construction. No nuts and bolts to come loose.
- 1 1/2" angle frame.
- 1" angle shelves.
- 16 gauge steel roof.
- 16 gauge expanded metal sides and doors.

Features

- Lockable T-handle plus hasp for padlock.
- Tapered shelf front for easy cylinder placement.
- Heavy duty tubular hinge welded to frame and door.

33# Motor Fuel Cylinder Storage Cabinets – The "M" Series

Painted safety yellow rust inhibitor and includes 3 safety decals.

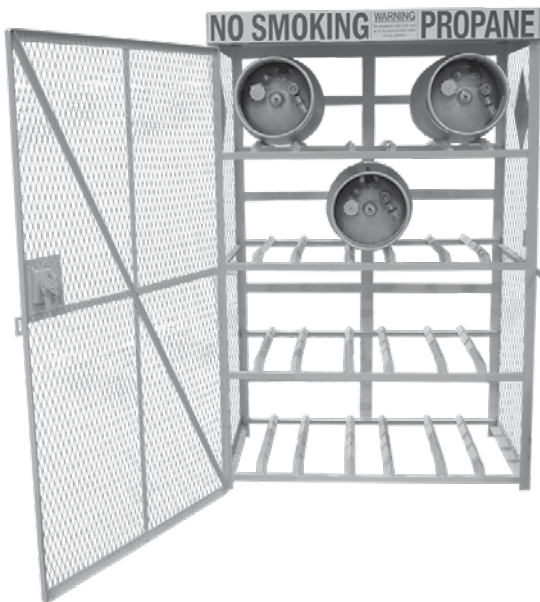

20# Cylinder Storage Cabinets – The "X" Series

Powder coated white. Other colors available and includes 2 safety decals plus place for sign. Sign not included.



PART NUMBER	NO. CYLS	DEEP	WIDE	HIGH
M-4	4	37"	30"	40"
M-6	6	37"	30"	55"
M-8	8	37"	30"	70"
M-12	12	37"	43"	70"
M-16	16	37"	60"	70"
M-24	24	37"	85"	70"

PART NUMBER	NO. CYLS	DEEP	WIDE	HIGH
X-8	8	27"	30"	50"
X-12	12	27"	43"	50"
X-16	16	27"	60"	50"
X-18	18	27"	43"	72"
X-24	24	27"	60"	72"
X-24L	24 (low profile)	27"	85"	50"
X-36	36	39"	50"	72"

Also Available: Cabinets that handle 20#, 30#, and 40# Cylinders

TANKS

Relief Valves



PART NUMBER	DESCRIPTION
8545AK	3/4" NPT Relief 375PSI
7545-14A	45° Pipe Away Adapter
7545-12	90° Pipe Away Adapter
7545-40	Rain Cap w/ Strap for 8545AK
9103-54	Raincap for 7545-14
3100-54	Cap for Relief Valve 8555 Series

Forklift Cylinder Brackets



PART NUMBER	CYLINDER SIZE	DESCRIPTION
TB-2	33 1/2 LB & 43 1/2 LB	Horizontal
TB-3	20 LB 33 1/2 LB	Vertical
TB2-60	Any	Toggle Latch Only

Replacement Dials For Rochester Float Gauges



PART NUMBER	DIAL SIZE	TYPE OF TANK
5-01791	Junior	33LB Universal

Taylor Visible Replacement Dials



PART NUMBER	DESCRIPTION
2733U-CV	JR Universal 33LB Motor Fuel
2743U-CV	JR Universal 43LB Motor Fuel

Screws and Gaskets

PART NUMBER	DESCRIPTION
MSCP-M40-414S	Junior Head Screw
40-415S	Senior Head Screw
40-416	Dial Screw
MSCP-15-004	Senior Gauge Gasket
MSCP-15-007	Junior Gauge Gasket



Float Gauges for forklift Cylinders

CYLINDER SIZE	PART NUMBER		
	JR. GAUGES	1 1/4" MPT	3/4" MPT
33 1/2 LB	JU160B	TU160B	UU160B
43 1/2 LB	JU212A	TU212A	

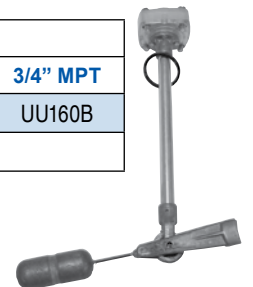



Did you know we have many remote pick-up yards where you can get a tank in a hurry? Call for the locations nearest you.

Manchester DOT Cylinders

Manchester ASME and DOT 200 and 420 offer the best finish and features in the industry.

- Large 16" Diameter Collar
- Large Vented Collar & Foot Ring
- Full Load Lift-Lugs
- Armor-Clad III Powder Coat Paint
- All Threads Sealed with Blue Everseal
- Heavy-Duty Hinged Lid
- 4 Hole Head Design
- HPPE Plastic Lids – No Rust or Dents
- Colors Available
- Vacuum Pre-purged

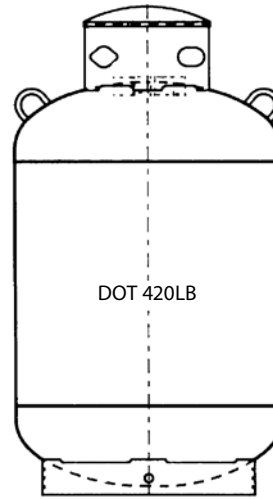
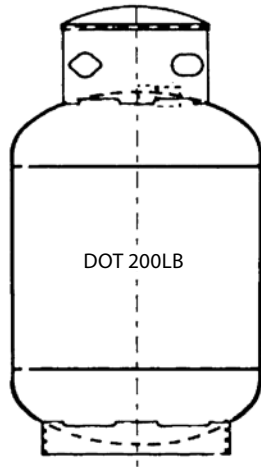

SPECIFICATION	DESCRIPTION
Water Capacity	476 lbs
Overall Length	42.12
Cylinder Diameter	24
Guard Diameter	14
Foot Ring Diameter	20
Tare Weight	147 lbs

SPECIFICATION	DESCRIPTION
Water Capacity	1000 lbs
Overall Length	53.25
Cylinder Diameter	30
Guard Diameter	16
Foot Ring Diameter	23.12
Tare Weight	270 lbs

PART NUMBER	COLOR
14205TC.11	White
14205.30	White
Upon Request	Special Color

PART NUMBER	COLOR
1499.102	White
1499TC.11	White
6762.11	White
Upon Request	Special Color

BASIC COMPARISON	DIAMETER	OL	WT	RETEST PERIOD	MATERIAL THICKNESS	NAMEPLATE	FINISH	TL	TRANSPORTATION WITH PROPANE	RELIEF VALVE PRESSURE
D.O.T. 420	30"	53.25"	270 lbs.	12/5 Yrs.		Stamped in Collar	Powder Coated Mastic Dip	99	Yes- 80%	375
A.S.M.E. 420	30"	53.25"	309	None	13% Heavier More Corrosion Protection	Stainless Steel Riveted in Collar	Powder Coated Mastic Dip	99	Yes- 80%	250

All cylinders on this page are manufactured to meet or exceed DOT Specification 4BW240.

Manchester ASME Tanks



- Large 16" Dia. Collar
- Large Vented Collar and Foot Ring
 - Full Load Lift-Lugs
- Armor-Clad III Powder Coat Paint
- All Threads Sealed with Blue Everseal
- Heavy-Duty Hinged Lid
- Stainless Steel Nameplate
- Optional Liquid Withdrawal
- Plastic Lids
- Colors Available
- Vacuum Pre-purged

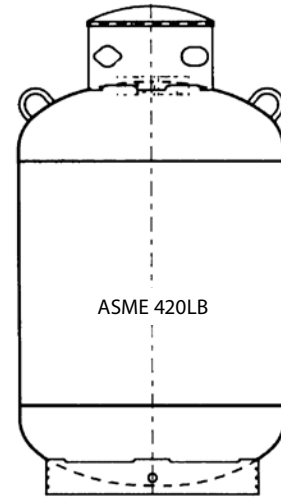
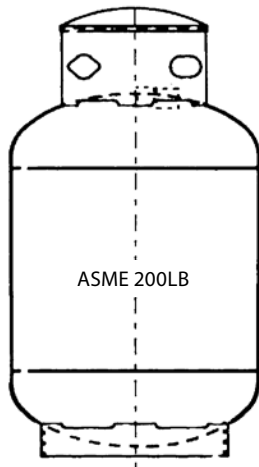

SPECIFICATION	DESCRIPTION
Water Capacity, GAL	57
Overall Length	42.4
Cylinder Diameter	24
Guard Diameter	14
Foot Ring Diameter	18
Tare Weight, Lbs.	172

SPECIFICATION	DESCRIPTION
Water Capacity, GAL	120
Overall Length	53.3
Cylinder Diameter	30
Guard Diameter	16
Foot Ring Diameter	24
Tare Weight, Lbs.	326

PART NUMBER	COLOR
6765.5	White
Upon Request	Special Color

PART NUMBER	COLOR
6762.8	White
Upon Request	Special Color

100 lb. ASME Manchester Mini

100lb ASME Manchester Mini

The Perfect Patio Solution

- Low center of gravity means more stability
- Wide 360° welded collar for safety and ease of installation
- Multivalve and gauge for onsite fill
- Vacuum purged
- HDPE lids

SPECIFICATION	
Overall Length	36.69"
Height	29.75"
Diameter	18"
WC	238 lb.
B	15.5"

TANK ACCESS	
PART NUMBER	DESCRIPTION
A79959	Black HDPE* Lid
A79959.2	White HDPE* Lid
A79958	Hinge
A59887	Clevis Pin
A59888	Cotter Pin

Available in a variety of colors
*High Density Polyetholene



Part Number: 68143

All cylinders on this page are manufactured to meet or exceed the American Society of Mechanical Engineers (ASME) specifications.



Accessories for Motorfuel Tanks



RegO Relief Valves – Fully Internal “Pop Action”

8543 Series relief valves are designed for use as a primary relief valve in larger ASME motor fuel containers such as on buses, trucks and construction equipment.

8544 Series relief valves are designed for use as a primary relief valve in smaller ASME and DOT motor fuel containers such as on tractors, lift trucks, cars and taxicabs.

PART NO.	CONTAINER TYPE	START TO DISCHARGE SETTING PSIG	CONTAINER CONNECTION M. NPT	OVERALL HEIGHT (APPROX.)	HEIGHT ABOVE COUPLING (APPROX.)	HEX WRENCHING SECTION	PIPE AWAY ADAPTER	CAP
8544T	ASME	312	1"	5 7/16"	7/8"	1 5/16"	7544-11A*	7544-41
8543T	ASME	312	1 1/4"	5 7/16"	7/8"	1 11/16"	7543-10**	7543-40C

* 1" MNPT Outlet Connection

** 1 1/4" MNPT Outlet Connection

Auto-stop Filler Valve



PART NO.	DESCRIPTION
V13414	CEODEUX 80% Stop-Fill Valve 3/4" MPT

* Requires a 3/4" fill valve.

V13414

Underground Anchoring Equipment

For 500 and 1000 Gallon Tanks

Designed to secure both 500 and 1000 gallon U/G Tanks



PART NUMBER	DESCRIPTION
UG-KIT	(2) 1/2" X 15 FT CABLES (4) 1/2" X 6 TURNBUCKLES (6) 1/2" CABLE CLIPS (4) 1/2" X 9" X 15" ANCHORS

Minuteman Tank Anchoring System for Flood Plain Tiedown

High waters can dislodge unanchored tanks causing spills, environmental and property damage.

- Loose tanks may explode causing injuries.
- Buried tanks can be pushed to the surface by the buoyant effect of soil saturated by water.
- Floating tanks become battering rams causing property damage.

PART NO.	DESCRIPTION	USE
1346	36" Earth Anchor w/ 4" & 6" Disks	Dense / Normal Soil
1593	36" Earth Anchor w/ 4" & 6" Disks & Stabilizer	Dense / Medium Soil
1284	50" Earth Anchor w/ Double 4" Disks	Loose to Medium Soil
2391	Dry Concrete Anchor w/ Bolt Expansion Sleeve	Concrete - Dry
2010- Minute	Split Bolt and Nut	All Anchors
2365	Stainless Steel Sling w/ Sheathed Strap & Seals	For Vertical Cylinders
2375	Stainless Steel Strap 100ft Roll	Note: 120 gal. to 350 gal. tanks need 1 strap and 2 anchors. 351 gal. tanks to 1500 gal. tanks require 2 straps and 4 anchors.
2382	Strap Sheathing- 200 Feet	
2730	Minute Man Drive Machine	
2741	Minute Man Anchor Adapter	

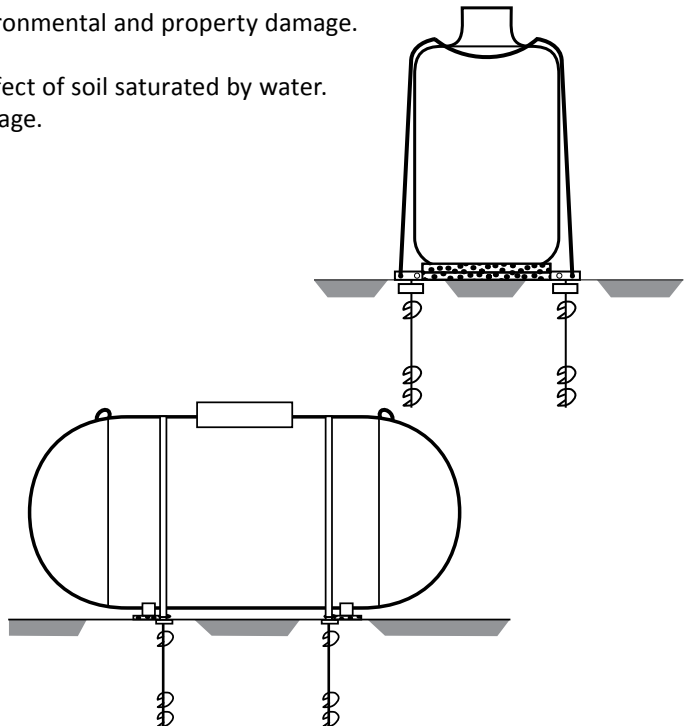

Manchester RV ASME Vapor Service Tanks



6814

Side Fit

(Valves are 90° on the horizontal line on the side of the tank)

PART #	WT.	SIZE	W.C.	LP CAP	APPLIANCE TYPE	BRACKET
6808	31	6" x 30"	3.3	2.64	Vapor	2 Top
6812	36	10" x 23"	6.9	5.52	Vapor	Channel
6815	44	10" x 32"	9.9	7.92	Vapor	Channel
68045	52	10" x 32"	9.9	7.92	Vapor	Channel
6801	45	12" x 24"	10.3	8.24	Vapor	Channel
6840	50	12" x 28"	12.2	9.76	Vapor	Channel
6802	60	12" x 32"	14.1	11.3	Vapor	Channel
6803	65	12" x 32"	14.1	11.3	Vapor	Rear Corner
6758	90	12" x 40"	17.9	14.3	Vapor	Top Blade
6819	82	12" x 42"	18.9	15.1	Vapor	Top Angle
6898	53	12" x 42"	18.9	15.1	Vapor Remote	Top
68028	75	12" x 42"	18.9	15.1	Vapor	Top Angle
6822	60	13" x 26"	13.2	10.6	Vapor	Top Angle
6823	71	13" x 34"	17.6	14.1	Vapor	Top Angle
6824	54	14" x 21"	11.9	9.52	Vapor	Top Angle
6761	70	14" x 30"	17.7	14.2	Vapor	Top Angle
6760	77	14" x 32"	19	15.2	Vapor	Top Angle
6826	69	14" x 34"	20.3	16.2	Vapor	Top Angle
6887	69	14" x 34"	20.3	16.2	Vapor Remote	Top Angle
6828	81	14" x 40"	24.2	19.4	Vapor	6 Corner
6829	83	14" x 40"	24.2	19.4	Vapor	Top Angle
6829.2	83	14" x 40"	24.2	19.4	Vapor Remote Solenoid	Top Angle
6804	89	14" x 40"	24.2	19.4	Vapor	Top Corner
6807	84	14" x 40"	24.2	19.4	Vapor	Wing
68119	84	14" x 40"	24.2	19.4	Vapor	Bottom Blade
6879	89	14" x 40"	24.2	19.4	Vapor	Top Angle
68037	103	14" x 47"	28.7	23	Vapor	Rear Blade
68072	109	14" x 47"	28.7	23	Vapor	Back Angle
6830	90	14" x 48"	29.3	23.4	Vapor	Top Angle
68120	98	14" x 48"	29.3	23.4	Vapor Remote Solenoid	BTM Teardrop
28001	104	14" x 48"	29.3	23.4	Vapor	Top Angle
6874.2	91	16" x 32"	24.5	24.5	Vapor, Remote Sender	Rear Blade
6809	106	16" x 33"	25.4	20.3	Vapor	Rear Angle

Side Fit (cont.)

(Valves are 90° on the horizontal line on the side of the tank)

PART #	WT	SIZE	W.C.	LP CAP	APPLIANCE TYPES	BRACKET
6841	116	16" x 40"	31.3	25	Vapor	Top Angle
6833	116	16" x 40"	31.3	25	Vapor	Rear Angle
6867	116	16" x 40"	31.3	25	Vapor Stop Fill	Top Angle
6845	120	16" x 42"	32.9	26.3	Vapor	Top Angle
68036	130	16" x 48"	38	30.4	Vapor	Back Angle
6866	136	16" x 48"	38	30.4	Vapor	Top Teardrop
6878	134	16" x 48"	38	30.4	Vapor	Top Angle
6878.1	134	16" x 48"	38	30.4	Vapor Remote	Top Angle
68053	137	16" x 48"	38	30.4	Vapor Service	Bottom Teardrop
68052	137	16" x 48"	38	30.4	Vapor Service Remote	Top Teardrop
68007	118	18" x 36"	34.9	27.9	Vapor	Top Teardrop
68026	125	18" x 36"	35.7	28.56	Vapor	Rear Angle
6837	149	18" x 48"	47.7	38.2	Vapor	Top Angle
6875	134	20" x 33"	38.7	31	Vapor	Bottom Teardrop
68124	143	20" x 36"	42.7	34.2	Vapor	Bottom Blade
6849.1	156	20" x 42"	50.6	40.5	Vapor	Top Angle

End Fit

(Valves are in the head)

PART #	WT	SIZE	W.C.	LP CAP	APPLIANCE TYPE	BRACKET
68140	140	14" x 85"	53.1	42.48	Vapor, Remote Sender	Bottom Angle
68154	138	16" x 50"	39.7	31.8	Vapor	Bottom Teardrop

Lower 45

(Valves are in the lower 45 position below the horizontal line)

PART #	WT	SIZE	W.C.	LP CAP	APPLIANCE TYPE	BRACKET
6811	45	8" x 42"	8.4	6.72	Vapor	Channel
6813	40	10" x 23"	6.9	5.52	Vapor	Channel
6814	54	10" x 32"	9.9	7.92	Vapor	Channel
6817	59	12" x 32"	14.1	11.3	Vapor	Channel
6820	73	12" x 42"	18.9	15.1	Vapor	6 Corner



PART NUMBER	DESCRIPTION
G12653	Dial, gauge ASME

Manchester Horizontal Tanks

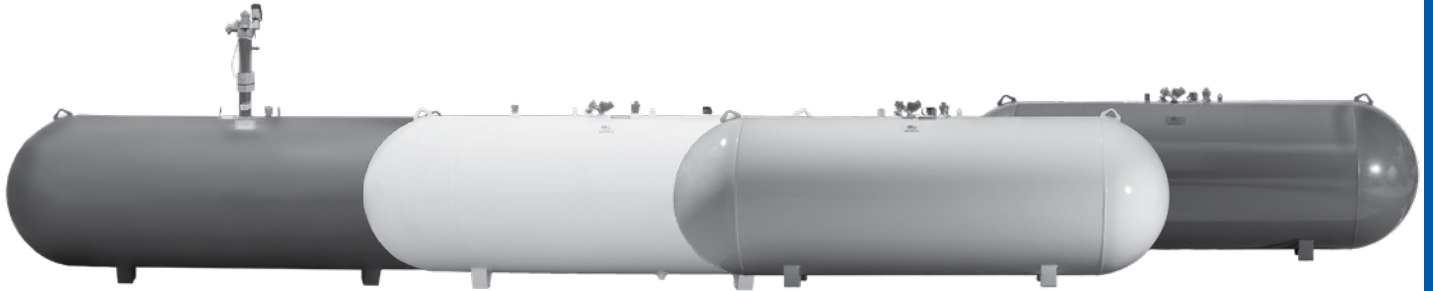

Underground

PART #	TANK TYPE	WATER CAPACITY*	OUTER DIA.	HEAD TYPE	TOTAL LENGTH**	RISER HEIGHT		LEG WIDTH**	LEG SPACING	WEIGHT	QUANTITY	
						SHORT	LONG				FULL LOAD	PER STACK
68288	120 gal. LR	120	24"	Ellip	5'6"	-	4'4 1/2"	10 1/8"	3'	313	63	9
68269	120 gal. SR	120	24"	Ellip	5'6"	3'8 1/16"	-	10 1/8"	3'	304	63	9
68289	250 gal. LR	250	30"	Hemi	7'10"	-	5' 5/8"	12 3/4"	6"	484	42	7
68271	250 gal. SR	250	30"	Hemi	7'10"	4'2 1/16"	-	12 3/4"	6"	475	42	7
68273	320 gal. LR	320	30"	Hemi	9'7"	-	5'1 7/16"	12 3/4"	4' 1/4"	597	35	7
68285	320 gal. SR	320	30"	Hemi	9'7"	4'2 7/8"	-	12 3/4"	4' 1/4"	593	35	7
68275	500 gal. LR	500	37.5"	Hemi	9'10"	-	5'8 3/4"	15"	5'	953	25	5
68286	500 gal. SR	500	37.5"	Hemi	9'10"	4'10 1/4"	-	15"	5'	949	25	5
68277	1000 gal. LR	1000	41"	Hemi	15'11"	-	6' 1/4"	16 1/4"	9'	1812	12	4
68287	1000 gal. SR	1000	41"	Hemi	15'11"	5'1 11/16"	-	16 1/4"	9'	1808	12	4

Above Ground

PART #	TANK SIZE	WATER CAPACITY*	OUTER DIA.**	HEAD TYPE	TOTAL LENGTH**	RISER HEIGHT**	LEG WIDTH**	LEG SPACING**	WT	QUANTITY	
										FULL LOAD	PER STACK
68268	120 GAL	120	24"	Ellip	5'6"	2' 9-3/8"	10 1/8"	3'	310	96	12
68270	250 GAL	250	30"	Hemi	7'10"	3' 3-3/8"	12 3/4"	6"	471	54	9
68272	320 GAL	320	30"	Hemi	9'7"	3' 3-11/16"	12 3/4"	4' 1/4"	566	45	9
68303	500 GAL	500	37.5"	Hemi	9'10"	3' 11-1/16"	15"	5'	920	30	6
68304	1000 GAL	1000	41"	Hemi	15'11"	4' 2-1/2"	16 1/4"	9'	1811	15	5

AG/UG

PART #	TANK TYPE	WATER CAPACITY	OUTER DIA.	HEAD TYPE	TOTAL LENGTH	OVERALL RISER HEIGHT	LEG WIDTH	LEG SPACING	WT	QUANTITY	
										FULL LOAD	PER STACK
68280	120 GAL - White	120	24"	Ellip	5' 6"	2' 11-7/8"	10-1/8"	3'	312	96	12
68280.6	120 GAL - Grey	120	24"	Ellip	5' 6"	2' 11-7/8"	10-1/8"	3'	312	96	12
68281	250 GAL - White	250	30"	Hemi	7' 10"	3' 5-7/8"	12-3/4"	3' 6"	473	54	9
68281.6	250 GAL - Grey	250	30"	Hemi	7' 10"	3' 5-7/8"	12-3/4"	3' 6"	473	54	9
68282	320 GAL - White	320	30"	Hemi	9' 7"	3' 6-9/16"	12-3/4"	4' 1/4"	567	45	9
68282.6	320 GAL - Grey	320	30"	Hemi	9' 7"	3' 6-9/16"	12-3/4"	4' 1/4"	567	45	9
68283	500 GAL - White	500	37.5"	Hemi	9' 10"	4' 2-7/16"	15"	5'	921	30	6
68283.6	500 GAL - Grey	500	37.5"	Hemi	9' 10"	4' 2-7/16"	15"	5'	921	30	6
68284	1000 GAL - White	1000	41"	Hemi	15' 11"	4' 5-3/8"	16-1/4"	9'	1812	15	5
68284.6	1000 GAL - Grey	1000	41"	Hemi	15' 11"	4' 5-3/8"	16-1/4"	9'	1812	15	5

TANKS



Manchester Horizontal Tank Parts

Underground Tank Parts

PART TYPE	PART #	120 LR	120 SR	250 LR	250 SR	320 LR	320 SR	500 LR	500 SR	1000 LR	1000 SR
Rego Multivalve	PG8475RL	X	X	X	X	X	X	X	X		
	PG8475RLW									X	X
Rego ChekLok	7590UT	X	X	X	X	X	X	X	X	X	X
Rochester Gauge	6281-04490	X	X								
	6281-00428									X	
	6281-04429							X			
	6281-04433								X		
	6281-04434										X
	6281-04534			X	X		X				
	6291-04432						X				
Rochester Replacement Dial	5-01813	X	X	X	X	X	X	X	X	X	X
UG Shroud	A98333	X		X		X		X		X	
	A98332		X		X		X		X		X

Above Ground Tank Parts

PART TYPE	PART #	120	250	320	500	1000
Rego Relief Valve	7583G	X	X	X		
	8684G				X	X
Rego ChekLok (Top)	7590U	X	X	X	X	X
Rego ChekLok (Bottom)	7591U	X	X	X	X	X
Rego Filler Valve	L7579C	X	X	X	X	X
Rego Multivalve	7556R12.0	X	X	X	X	
	PT7556R12.0					X
Rochester Float Gauge	B8981-04068	X				
	B8981-04067		X			
	B8981-04070B			X	X	
	B8981-04024					X
Rochester Replacement Dial	5-01749	X	X	X	X	X
AG Dome	A97043.18	X	X	X		
	A98233.18				X	X
Dome Pin	67980763	X	X	X	X	X

AG/UG Tank Parts

PART TYPE	PART #	120	250	320	500	1000
Rego Relief Valve	7583G	X	X	X		
	8684G				X	X
Rego ChekLok (Top)	7590U	X	X	X	X	X
Rego Filler Valve	L7579C	X	X	X	X	X
Rego Multivalve	PT7556R12.0	X	X	X	X	X
Rochester Float Gauge	B8981-04068	X				
	B8981-04067		X			
	B8981-04070B			X	X	
	B8981-0424					X
UG Dome	A98328	X	X	X	X	X
AG Dome	A97033.18	X	X			
	A97043.18			X		
	A98243.18				X	X
Dome Pin	67980763	X	X	X	X	X



Magnesium Anode Bag



5, 9, and 17lb anode with 10ft X #12 gauge electrical lead attached. Bagged and boxed for shipping protection.

Part Numbers:
MG-5LB
MG-9LB
MG-17LB

Purge-It-Vac Adapter

- No labor
- No wasted propane

The purge-it-vac allows you to insert methanol and your first fill of propane without disconnecting the adapter. The purge-it vac adapter is easy to use and meets NPGA #133-899a) on the purging of LP-Gas containers.



Part Number: Purge-It-Vac

Anode Monitoring Station

When buried in the ground, provides a central point where 4 underground tank anodes can be monitored.

- ABS plastic shaft
- PVC terminal board
- Heavy-duty cast iron cover and collar

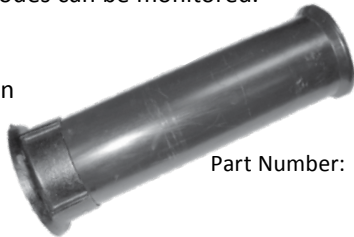

Part Number: NM-4

Electrode Extension



30" long intermediate electrode extension. Can be used with

MCM model ETM, I.A. and LC series meters or between the electrode and the standard electrode extension so that the electrode can be easily placed at the desired location inside manholes, water tanks, etc. Will fit through a 1" diameter augered hole.

Electrode Part Number: 16203 Cane Adapter Part Number: 16285

Anode Test Kit

Anode Test Kit includes:

- 6A half cell - reference electrode
- Digital multimeter w/wired probes
- Storage case

Part Number: ATK-1



Anode Splice

Utilized in conjunction with pre-mounted anode lead wires on Underground Tanks.



BSK-1

Includes burndy crimp and heat-shrink sleeve. Basic pliers or electrical crimp tool provide a solid connection.

PART NUMBER	DESCRIPTION
6A	6A Half Cell Reference Electrode (Flat Tip)
6B	6B Half Cell Reference Electrode (Pointed Tip)
16906	Copper Sulfate (12 oz.)
17105	Copper Sulfate Anti-Freeze
16281	Telescoping extension pole
16285	Bracket mounting adapter for telescoping extension pole
T&R50300	Copper Sulfate Crystals (1 lb. 3 oz.)
T&R50060	Flat tip assembly for 6A
TR50070	Pointed tip assembly for 6B
T&R50300	Copper sulfate crystals

Riser Pipe Clamp



Retrofit anode connection for existing or new underground tanks.

Part Number: RPC.1

Use the following legend for all signs and decals:

M	Metal (Aluminum)	A	6" Letters
S	Scotchlite Brand Reflective	B	4" Letters
V	Vinyl (Self-adhesive)	BB	3" Letters
P	Plastic	C	2" Letters
G	Magnetic	D	1" Letters

Cylinder Decals

DANGER - FLAMMABLE GAS UNDER PRESSURE - LEAKING LP-GAS CAN CAUSE A FIRE OR EXPLOSION IF IGNITED - CONTACT LP-GAS SUPPLIERS FOR REPAIRS OR DISPOSAL OF THIS CYLINDER OR UNUSED LP-GAS - FOR OUTDOOR USE ONLY - DO NOT USE OR STORE CYLINDER IN A BUILDING, GARAGE OR ENCLOSED AREA.

Customer Warning:

- Know the odor of LP-gas. Under certain circumstances, you may not be able to smell the odorant. If you hear or smell leaking LP-gas, immediately get everyone away from the cylinder and call the fire department.
- Caution your LP-gas supplier to:
 - purge the cylinder of trapped air prior to first filling
 - check the cylinder requalification date
 - be certain not to overfill the cylinder.
- LP-gas is heavier than air and can settle in low places while dissipating.
- Contact with the liquid contents of the cylinder will cause freeze burns to the skin.
- Do not allow children to tamper or play with the cylinder.
- When the cylinder is not connected for use, keep the valve turned off. If your cylinder valve looks like the POL TYPE (Figure 3) and is of 45 lb. LP-Gas capacity or less, the outlet must also be plugged.
- Do not use, store or transport cylinder where it could be exposed to high temperatures. Relief valve can open allowing a large amount of flammable gas to escape.
- When transporting, keep cylinder secured in an upright position with cylinder valve turned off. If the cylinder is of 45 lb. LP-Gas capacity or less and looks like the POL TYPE (Figure 3), the outlet must also be plugged.
- Self-contained outdoor cooking appliances must be limited to one cylinder of 20 lbs. LP-Gas capacity or less.

When Connecting for Use:

- Use only in compliance with applicable codes.
- Read and follow appliance manufacturer's instructions.
- Regulator has an external threaded coupling nut and the cylinder valve has large outside threads. Tighten the coupling nut by turning clockwise (TYPE 1-Figure 1).
- If regulator has a plug-in connection, pull valve sleeve back, insert male plug fully and release valve sleeve (TYPE 2-Figure 2). If the regulator has an external threaded coupling nut, it has left-hand threads and must be tightened by turning counter clockwise (POL TYPE-Figure 3).
- Turn off all valves on appliance.
- Do not check for gas leaks with a match or open flame.
- Apply soapy water at areas marked "X" after opening cylinder valve. If bubbles appear, close valve and have an LP-gas service person make needed repairs. Also check appliance valves and connections for leakage before lighting appliance.
- Light appliance(s) following manufacturer's instructions.
- When appliance(s) is not in use, keep cylinder valve closed.

DO NOT REMOVE, OBFUSCATE OR OBLITERATE THIS LABEL. EXCEPT AS AUTHORIZED BY NFPA 49 OR 49A 2.2 (in Canada).

DSP-5P-53R

V-56R

3-In-1 label for commercial portable cylinders
3 3/8" x 10"
100 pack

DANGER - FLAMMABLE GAS UNDER PRESSURE - LEAKING LP-GAS CAN CAUSE A FIRE OR EXPLOSION IF IGNITED - CONTACT LP-GAS SUPPLIERS FOR REPAIRS OR DISPOSAL OF THIS CYLINDER OR UNUSED LP-GAS - FOR OUTDOOR USE ONLY - DO NOT USE OR STORE CYLINDER IN A BUILDING, GARAGE OR ENCLOSED AREA.

Customer Warning:

- Know the odor of LP-gas. Under certain circumstances, you may not be able to smell the odorant. If you hear or smell leaking LP-gas, immediately get everyone away from the cylinder and call the fire department.
- Caution your LP-gas supplier to:
 - purge the cylinder of trapped air prior to first filling
 - check the cylinder requalification date
 - be certain not to overfill the cylinder.
- LP-gas is heavier than air and can settle in low places while dissipating.
- Contact with the liquid contents of the cylinder will cause freeze burns to the skin.
- Do not allow children to tamper or play with the cylinder.
- When the cylinder is not connected for use, keep the valve turned off. If your cylinder valve looks like the POL TYPE (Figure 3) and is of 45 lb. LP-Gas capacity or less, the outlet must also be plugged.
- Do not use, store or transport cylinder where it could be exposed to high temperatures. Relief valve can open allowing a large amount of flammable gas to escape.
- When transporting, keep cylinder secured in an upright position with cylinder valve turned off. If the cylinder is of 45 lb. LP-Gas capacity or less and looks like the POL TYPE (Figure 3), the outlet must also be plugged.
- Self-contained outdoor cooking appliances must be limited to one cylinder of 20 lbs. LP-Gas capacity or less.

When Connecting for Use:

- Use only in compliance with applicable codes.
- Read and follow appliance manufacturer's instructions.
- Regulator has an external threaded coupling nut and the cylinder valve has large outside threads. Tighten the coupling nut by turning clockwise (TYPE 1-Figure 1).
- If regulator has a plug-in connection, pull valve sleeve back, insert male plug fully and release valve sleeve (TYPE 2-Figure 2). If the regulator has an external threaded coupling nut, it has left-hand threads and must be tightened by turning counter clockwise (POL TYPE-Figure 3).
- Turn off all valves on appliance.
- Do not check for gas leaks with a match or open flame.
- Apply soapy water at areas marked "X" after opening cylinder valve. If bubbles appear, close valve and have an LP-gas service person make needed repairs. Also check appliance valves and connections for leakage before lighting appliance.
- Light appliance(s) following manufacturer's instructions.
- When appliance(s) is not in use, keep cylinder valve closed.

DO NOT REMOVE, OBFUSCATE OR OBLITERATE THIS LABEL. EXCEPT AS AUTHORIZED BY NFPA 49 OR 49A 2.2 (in Canada).

DSP-5P-53R

SP-53R

4" x 9"
Portable cylinder warning label "Duty to Warn"
Yellow vinyl printed black

EXTREMELY FLAMMABLE GAS

NFPA HAZARD RATING PROPANE

HEALTH HAZARD: 2, FIRE HAZARD: 4, REACTIVITY: 0

4 - Severe, 3 - Serious, 2 - Moderate, 1 - Slight, 0 - Minimal

—Extremely Flammable Gas
—Heavier than Air
—Simple Asphyxiant
—Oxidized to warn of its presence
—Contact with liquid will cause Freezing of Tissue
—P.E.L. 1000 PPM
—Store container outside and keep cool (under 130°F.)
—Turn off container valve when not in use

PERSONAL PROTECTION

Goggles, Gloves

CONSULT CORRESPONDING MSDS FOR FURTHER INFORMATION AND INSTRUCTIONS.

APPLX TO ALL PORTABLE CONTAINERS USED BY COMMERCIAL CUSTOMERS.

HZ 116

HZ-116

Printed blue, yellow, red and black
2 1/2" x 5"

PROPANE UN1075

KEEP OUT OF REACH OF CHILDREN

Flammable Gas Under Pressure - Do Not Store in Enclosed Areas - Use Only for Outdoor Use

DANGER Flammable Gas Under Pressure - Do Not Store in Enclosed Areas - Use Only for Outdoor Use

KEEP AWAY FROM HEAT, FLAME AND SPARKS

FLAMMABLE GAS 2

AA16

CS-33ROLL

White vinyl printed red and black
500 per roll

LIQUEFIED PETROLEUM GAS UN1075

FLAMMABLE GAS 2

M&J GAS CO. (414) 751-7011 (615) 675-0043

A-16

Minimum order 3,500
White vinyl printed red and black.
PLEASE SPECIFY STRAIGHT OR CURVED

LIQUEFIED PETROLEUM GAS UN1075

FLAMMABLE GAS 2

FLAMMABLE GAS NEVER USE OR STORE INDOORS

GAS INFLAMMABLE NUNCA SE USE O GUARDE ADENTRO

AA-16-BI

Minimum order 100
White vinyl printed red and black

PROPANE

NFPA HAZARD RATING: HEALTH HAZARD 2, FIRE HAZARD 4, REACTIVITY 0

—Extremely Flammable Gas
—Heavier than Air
—Simple Asphyxiant
—Oxidized to warn of its presence
—Contact with liquid will cause Freezing of Tissue
—P.E.L. 1000 PPM
—Store container outside and keep cool (under 130°F.)
—Turn off container valve when not in use

PERSONAL PROTECTION

Goggles, Gloves

CONSULT CORRESPONDING MSDS FOR FURTHER INFORMATION AND INSTRUCTIONS.

APPLX TO ALL PORTABLE CONTAINERS USED BY COMMERCIAL CUSTOMERS.

HZ 116

HZ116-GHS

10" x 3.75"
Custom Label

PROPANE UN1075

EXTREMELY FLAMMABLE GAS

FLAMMABLE GAS 2

DO NOT REMOVE THIS PRODUCT LABEL

CS-33-GHS

2.5" x 5.5"
Custom Label

EXTREMELY FLAMMABLE LIQUEFIED GAS

PROPANE UN1075

FLAMMABLE GAS 2

DO NOT REMOVE THIS PRODUCT LABEL

8-V56-R-GHS/HCS

10" x 3.75"
Custom Label

MONTH VISUAL YEAR

1 2	REQUALIFIER	09 10
3 4	IDENTIFICATION	11 12
5 6	NUMBER	13 14
7 8	V000000	15 16
9 10	E	17 18
11 12		19 20

DSP-5-C163

5-C163

Black on White Vinyl
3" x 1.875"

SECT 190-401 PERIODIC INSPECTION KIT

Test Date

NO. 11223344K
55667788T
99000VPILU

TYPE OF TEST PERFORMED AS ABOVE DATE

V-31

6" x 18"
Periodic Inspection Kit (Test Date)
Printed black

SECT 190-401 PERIODIC INSPECTION KIT

Retest Date

NO. 11223344K
55667788T
99000VPILU

TYPE OF TEST PERFORMED AS ABOVE DATE

V-32

5 Year Inspection Kit (Retest Date)
Printed black
6" x 18"

Decal on left 5 1/4" x 6 1/2"
This applies to tank. The numbers are removed from the right and placed in the slots provided for dates and letters for test performed.
All parts on kits are thermal die cut for individual removal of part.

Custom Signs Available. Call for a Quote.

Cylinder Decals (cont.)



V-59
Printed red
4" x 4"



5-C86
Black on White Vinyl
3" x 1.8756"

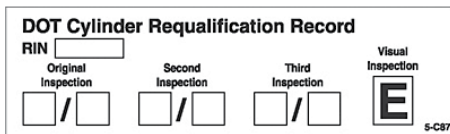

5-V87
Black on White Vinyl
1.5" x 5.25"



12-A-53
5" x 1 1/4"
Warning Decal
Printed black



AA-16
White vinyl printed red and black
Minimum order 100
Not available curved
3 3/4" x 2"

AA-16R
White vinyl printed red and black
500 per roll

Truck Decals & Signs



V-90

1" x 4"
Printed red



V-91



V90-5

Series of 5 labels
Each 1" x 4"
Printed red



V91-5



Printed red

V-28A 6 3/4" x 27 1/4"
V-28B 5" x 18"
V-28BB 4" x 14"
V-28C 3" x 12"
M-28A 6 3/4" x 27 1/4"

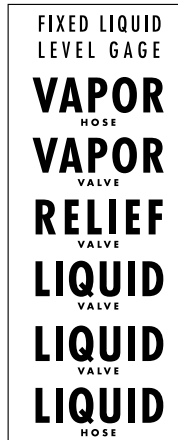

V-8
Series of 7 labels
Each 1" x 3"
Printed red

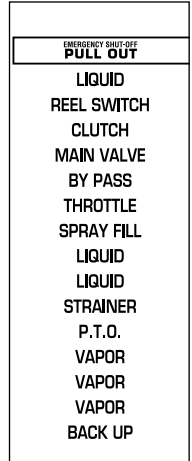

V-92

Series of 16 labels
Each 3/8" x 1 3/4"
Printed red



V-23A 6 3/4" x 27 1/2" **V23C** 3" x 14"
V-23B 4 3/4" x 27 1/4" **M-23B** 4 3/4" x 27 1/4"
V-23BB 4" x 22" **M-23BB** 4" x 22"
Printed red

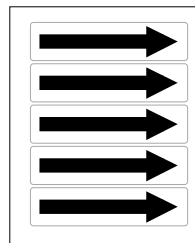

V98-5
1" x 4" on a 5" x 7" sheet
5 on a sheet
Red on white

Bobtail Piping and Control Decal

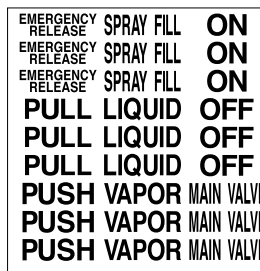

V-45
10" x 10" label sheet
Series of 27 labels
Each 1" x 3"
Printed red



V-49
10" x 42"
Printed red



NFPA-704B 7 1/2" x 7 1/2" **NFPA-704P** 7 1/2" x 7 1/2"

NFPA-704A
15" x 15"

NFPA warning storage tanks
Red, yellow, blue and black on white vinyl

Use the following legend for all signs and decals:

M	Metal (Aluminum)	A	6" Letters
S	Scotchlite Brand Reflective	B	4" Letters
V	Vinyl (Self-adhesive)	BB	3" Letters
P	Plastic	C	2" Letters
G	Magnetic	D	1" Letters

Truck Decals & Signs (cont.)

WE STOP AT ALL RR CROSSINGS

S-22B
4" x 36"
Reflective Railroad Crossing
Printed red



S-22C
8" x 12"
Printed white on red

FLAMMABLE GAS

M-17B 6" x 24" • **V-17A** 8" x 30"
V-17B 6" x 24" • **V-17C** 3" x 12"

Printed red

LIQUEFIED PETROLEUM GAS

V-302BB 4" x 36" • **V-302C** 3" x 24" • Printed red



V-52
Vinyl
P-52
Poly
10 3/4" x 10 3/4"
Printed red
V-59
4" x 4"
Printed red



V-66
6 1/2" x 2 3/4"
Printed red



V-65
4 1/2" x 2 3/4"
Printed red



V-47
Printed red
9" x 38"

111222
333444
555666
777888
999000

V-33
Number Sheet Only
Test/Retest kits for NQT/QT.
Each kit contains 2 thermal die-cut sheets
Printed black



LP Gas

PART NO.	DESCRIPTION
V-1075	Vinyl 1075
P-1075	Poly 1075
G-1075	Magnetic 1075
M-1075	Metal 1075



Residue

PART NO.	DESCRIPTION
V-1075-R	Vinyl 1075 Residue
P-1075-R	Poly 1075 Residue

10 3/4" x 10 3/4"
Printed red and black



V-83
7" x 8 1/2"
Printed red

V-83-CYL
7" x 8 1/2"
Printed red



S-500
3" x 4 1/2"
Diamond Shape
Black on reflective
Application instructions.



S-29
4" x 36"
Reflective Scotchlite
Printed red

Custom Signs Available. Call for a Quote.

Truck Decals & Signs (cont.)

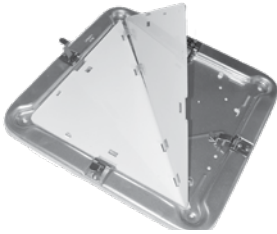

CG-126FO
13 1/2" x 13 1/2"
1075 Flipover sign



80SM
Placard holder
Aluminum

Bulk Plant/Pump Stations Signs



10-01-113
10" x 14"
Aluminum
Printed red and black



V-127
Red on White Vinyl
30" x 12" with
required 2" letters for
Emergency Remote
Shutdown Station

P-127
Red on White Plastic
30" x 12" with
required 2" letters for
Emergency Remote
Shutdown Station



V-81
10" x 12"
Pull to close
Printed red



V-82
10" x 12"
Push to close
Printed red



11A-P201
14" x 10"
Electrical
Printed Red



V-47
9" x 38"
Printed red



V-26A
12" x 18"

M-26A
24" x 36"
Printed red

LIQUID

V-90
1" x 4" • Printed red

VAPOR

V-91

**LIQUID
LIQUID
LIQUID
LIQUID**

V90-5

Series of 5 labels
Each 1" x 4" • Printed red

**VAPOR
VAPOR
VAPOR
VAPOR**

V91-5



V-49
10" x 42"
Printed red



V-28A 6 3/4" x 27 1/4"
V-28B 5" x 18"
V-28BB 4" x 14"
V-28C 3" x 12"
M-28A 6 3/4" x 27 1/4"
Printed red



V-23A 6 3/4" x 27 1/2" **V-23C** 3" x 14"
V-23B 4 3/4" x 27 1/4" **M-23B** 4 3/4" x 27 1/4"
V-23BB 4" x 22" **M-23BB** 4" x 22"
Printed red



V-202
9" x 27"
Printed orange



M-17B 6" x 24" • **V-17A** 8" x 30"
V-17B 6" x 24" • **V-17C** 3" x 12"
Printed red



V-302BB 4" x 36" • **V-302C** 3" x 24" • Printed red

Use the following legend for all signs and decals:

M	Metal (Aluminum)	A	6" Letters
S	Scotchlite Brand Reflective	B	4" Letters
V	Vinyl (Self-adhesive)	BB	3" Letters
P	Plastic	C	2" Letters
G	Magnetic	D	1" Letters



NFPA-704A

Warning Decal
15" x 15"

NFPA-704B

Warning Decal
7 1/2" x 7 1/2"

NFPA-704P

Warning Placard
7 1/2" x 7 1/2"

NFPA warning storage tanks
Red, yellow, blue and black
on white vinyl

Bulk Plant/Pump Stations Signs (cont.)



M-99

24" x 36"
Cylinder filling sign
Red and black
printed

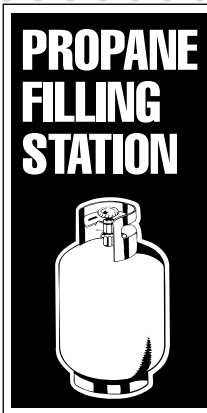

PART NO.	DESCRIPTION
M-93AX	Propane Exchange 2' x 4' Single Face*
M-93AX-D	Propane Exchange 2' x 4' Double Face*
M-97A	Propane Fill 2' x 4' Single Face*
M-97A-D	Propane Fill 2' x 4' Double Face*
M-97-D	In Spanish
M-97B	Propane Fill 3' x 6' Single Face*
M-97-BD	Propane Fill 3' x 6' Double Face*
M-97-FR	Frame Floor Style 2' x 4' with hardware
SF-1	Frame Ground Style 2' x 4'

* Printed blue

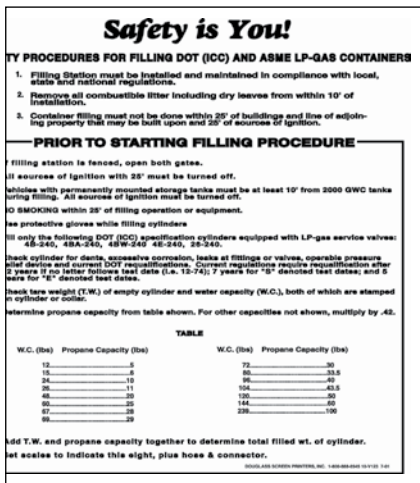
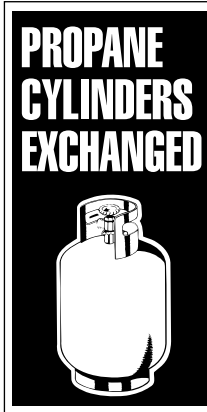

V-123

11" x 12"
Safety procedures for
filling DOT cylinders
Printed red

ALL GATES MUST BE OPEN BEFORE FILLING

M632

27 1/2" x 5 1/2"
Metal Gate Sign
Printed red



V-206 White
14" x 21 1/4"

V-206 Blue
14" x 21 1/4"
Printed red

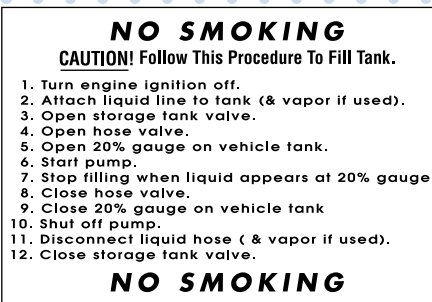

V-30

15" x 22"
Printed red and black

Custom Signs Available. Call for a Quote.

Bulk Plant/Pump Stations Signs (cont.)

NO SMOKING
within 25' of filling

**Filling Procedures ASME
(Perm Mounted) Containers**

1. Only ASME containers having a minimum design pressure of 250 PSI or 200 PSI under U-68 or U-69 may be filled.
2. Check that container is not already full to proper loading point (is there a cloud of visible vapor discharging from the fixed liquid level gauge vent valve?)
3. Open liquid outlet valve on storage tank and valve in by-pass return line.
4. Connect hose to container fill valve.
5. Start pump.
6. Open vent valve of fixed liquid level gauge.
7. Open valve on end of hose.
8. If container fill valve is hand operated, open valve.
9. Fill until vapor coming from vent valve is visible, then immediately turn off hose end valve and close vent valve.
10. Shut off pump.
11. Turn off container valve if hand operated.
12. Disconnect hose.
13. Check container valves for leaks.

WHEN FILLING IS COMPLETED OR WHEN STATION IS UNATTENDED

1. Shut off pump.
2. Close valves at storage tank.
3. Coil hose on rack inside fence protected area and install dust cap or plug in hose filling adaptor.
4. Lock fence protected area to secure installation against tampering.

V-122
11" x 12"
Printed red

**Filling Procedure
Portable Cylinders**

1. Open liquid outlet valve on storage tank and valves in by-pass return line.
2. Connect hose to cylinder fill valve.
3. Start pump.
4. Open valve on cylinder.
5. Open valve on end of hose.
6. Close hose valve as soon as scale beam or indicator tips.
7. Close cylinder valve.
8. Disconnect hose.
9. Check weight. Bleed off overfill at a safe location.
10. Check container valves for leaks.

OPERATOR MUST BE IN ATTENDANCE
DURING ENTIRE FILLING PROCEDURE.

V-121
11" x 12"
Printed red

Does your valve look like this?

If not, it may not comply with national fire and safety standards. The handwheel pictured is part of an "OPD": Overfilling Prevention Device. An OPD is a safety feature that helps reduce the number of cylinders overfilled. Overfilling of cylinders can result in the release of propane through the relief valve when the propane expands through heating. It can also create higher pressure delivery to appliances through the piping system.

Here's the facts you need to know!

- ◆ 4# - 40# new cylinders* manufactured after October 1, 1998 must have the OPD. The manufacture date is stamped on the cylinder collar.
- ◆ 4# - 40# cylinders * requalified after October 1, 1998 must have the OPD installed. Requalification is required 12 years after manufacture date and every 5 years thereafter.
- ◆ After April 1, 2002, all cylinders* must have OPDs and cannot be refilled without them.

*Exception: All cylinders used in industrial truck service (including forklift truck cylinders) and/or those used for industrial welding and cutting gases are exempt from these requirements.

Be safe!
Call your propane dealer now to get your cylinder fitted with the OPD

Copyright Douglas Brown Products, Inc. 1998 Call 1-800-888-8845 and ask for catalog number 11-01-01

P-111
16" x 20" OPD alert sign
4 holes and 2 colors
Printed red and blue

OUR COMPANY IS CONCERNED FOR
YOUR SAFETY

THE EMPLOYEE FILLING THIS PROPANE CYLINDER IS CERTIFIED BY ALL LOCAL, STATE & FEDERAL REGULATIONS TO FILL & MAKE A VISUAL INSPECTION IN ACCORDANCE WITH NFPA 58 STANDARDS & NPGA SAFETY BULLETIN NO. 118 PLEASE BY LAW NO EXCEPTION

✓ PROTECTIVE COLLAR
DOT 1-CYLINDERS WITHOUT PROTECTIVE COLLAR ARE NOT APPROVED FOR REFILL.

✓ EXCESSIVE RUST
DOT 1-CYLINDERS WITH EXCESSIVE RUST ARE NOT APPROVED FOR REFILL.

✓ FOOT RING
DOT 1-CYLINDERS WITHOUT FOOT RING ARE NOT APPROVED FOR REFILL.

✓ DOT LABELS
DOT 1-CYLINDERS WITHOUT DOT LABELS ARE NOT APPROVED FOR REFILL.

✓ GAS VALVE
DOT 1-CYLINDERS WITH A BENT OR DAMAGED GAS VALVE ARE NOT APPROVED FOR REFILL.

✓ POL PLUG FOR VALVE
DOT 1-CYLINDERS WITHOUT POL PLUGS ARE NOT APPROVED FOR REFILL.

✓ EXCESSIVE DENTS
DOT 1-CYLINDERS WITH EXCESSIVE DENTS ARE NOT APPROVED FOR REFILL.

✓ OK CYLINDERS WITH 4" PROTECTIVE COLLAR ARE NOT APPROVED FOR REFILL. THESE CYLINDERS MUST BE REQUALIFIED BY A QUALIFIED PROPANE DEALER 12 YEARS AFTER DATE OF MANUFACTURE AND EVERY 5 YEARS THEREAFTER.

NOTICE: OVER FILLING OF PROPANE CONTAINER IS IN VIOLATION OF STATE AND FEDERAL LAWS. STATE LAW PROHIBITS THE USE OF PROPANE CYLINDERS LARGER THAN THE POURED IN LIVING AREAS FOR COMFORT HEATING. WE REFUSE TO FILL CYLINDERS THAT ARE ATTENDED FOR THIS PURPOSE.

IMPORTANT: CONSUMER NOTICE: ALL PROPANE CYLINDERS FOR REFILL MUST HAVE A VISUAL EXTERNAL INSPECTION BY A QUALIFIED PROPANE DEALER 12 YEARS AFTER DATE OF MANUFACTURE AND EVERY 5 YEARS THEREAFTER.

REFERENCE: DOT AS PUBLISHED IN CODE OF FEDERAL REGULATIONS TITLE 49 PARTS 180-185 SPECIFICATIONS DOT-CC 48,48A,48B,48C AND 28-900 CYLINDERS WHEN USED IN PROPANE GAS SERVICE.

LAWS ARE MADE FOR YOUR SAFETY - LIVE CAREFULLY

V-21, P-21
18" x 24"
Printed red and black

P-21G
18" x 24"
Printed red and black
Includes Grommets

Do you have your OPD yet?

The Overfill Prevention Device (OPD) is a float-activated device designed to assist propane refilling to safe levels. In conformity with new codes, most consumer-style propane cylinders need to be equipped with the OPD.

Your cylinder may need an OPD as early as March, 1998!

For your safety the NFPA (National Fire Protection Association) has enacted the following code changes. Please read below to see if your cylinder is eligible for this code modification:

- ★ All DOT cylinders sizes 4# to 40# require an OPD. (Excludes any forklift, welding and cutting gas cylinders.)
- ★ Eligible DOT cylinders will require an OPD valve at DOT recertification beginning April 1998 through March, 2002. Recertification is a routine mechanical inspection that makes sure all components of a cylinder are free from defective parts and/or contaminants.
- ★ DOT recertification of a cylinder is required 12 years after the date of original manufacture, then every 5 years thereafter. (Photos at left demonstrate where to find this date stamp. Recertification dates also appear here.)
- ★ In April, 2002, all eligible cylinders will require an OPD Valve before filling.

Special cylinder identification stamp

New OPD valve

OPD stamped in brass

How to tell if your cylinder already has an OPD Valve:

Questions about your OPD valve? Ask your local propane distributor, or contact the consumer hotline: 1-800-296-0194

S35483
18" x 24"
OPD metal sign explains the new regulations for 4-40lb cylinders.

LP Gas

PART NO.	DESCRIPTION
V-1075	Vinyl 1075
P-1075	Poly 1075
G-1075	Magnetic 1075
M-1075	Metal 1075

Residue

PART NO.	DESCRIPTION
V-1075-R	Vinyl 1075 Residue
P-1075-R	Poly 1075 Residue

10 3/4" x 10 3/4"
Printed red and black

Order by phone: 800-922-0724

69

SIGNS & DECALS

SIGNS & DECALS

Custom Signs Available. Call for a Quote.

Use the following legend for all signs and decals:

M	Metal (Aluminum)	A	6" Letters
S	Scotchlite Brand Reflective	B	4" Letters
V	Vinyl (Self-adhesive)	BB	3" Letters
P	Plastic	C	2" Letters
G	Magnetic	D	1" Letters

Bulk Plant/Pump Stations Signs (cont.)

CYLINDER FILLING CAPACITY CHART

W.C.	LBS. PROPANE	W.C.	LBS. PROPANE
2.39	1	35.8	15
4.78	2	38.2	16
7.17	3	40.6	17
9.56	4	43.0	18
11.9	5	45.4	19
14.3	6	47.8	20
16.7	7	59.7	25
19.1	8	71.7	30
21.5	9	78.8	33
23.9	10	83.6	35
26.2	11	95.6	40
28.6	12	105.1	44
31.0	13	119.5	50
33.4	14	239	100

P-101

12 1/4" x 12"
Printed red/blue

Miscellaneous Decals



M5291

8" x 2 1/4"
White arrow on red



M5291WR

8" x 2 1/4"
White arrow on green



11-V-128

3 3/4" x 4"
Printed red

PROPANE GAS

PROPANETAG

100 per roll 1" x 6"
Black letters on a yellow background

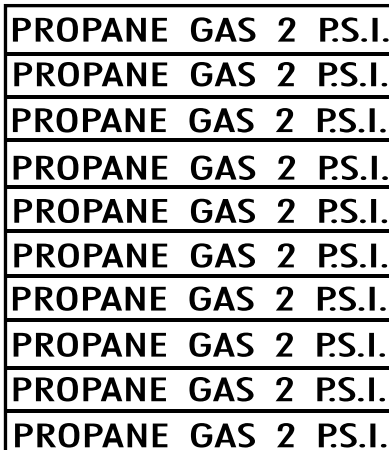

V-62

4" x 5 1/2"
Sheet of 10 labels
Each 3/8" x 3"
Black on yellow vinyl

FLAMMABLE

Printed red

V-24A 7" x 28"

V-24B 5" x 22"

V-24BB 4" x 22"

V-24C 3" x 14"

V-48 9" x 38"

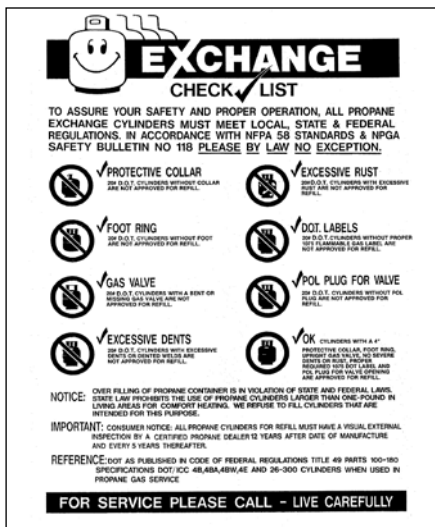

C-37G

Coroplast
12" x 24"

V-14

12" x 16"
Printed red and black



P-138

4" x 12"
Printed white on red.



Corken Seal Assembly

PART NO.	MODEL NUMBERS	SEAL SLEEVE	SEAL CLAMP RING	RETAINER RING	SEAL DRIVE PIN	CASE CLEARANCE SHIM		SEAL FOLLOWER	O-RING			SEAL	SHAFT KEY	PAN HEAD PHILLIPS SCREW 6-32X1/4	ROLL PIN
						0.002	0.003		TYPE 1	TYPE 2	TYPE 3				
113-CX	All C-F-DS-DL	1007-X	1008	-	1009	1014	1014-1	1080	2-018	2-224	2-246	2296-X_2	2497	7012-006NC025B (3)	-
5264X_3	All 150	5243	-	2760-88	-	5248		-	2-018	2-113	2-260	5242-X_3	4244	-	4984

Quantities larger than 1 are shown in parenthesis

Coro-Flo Pumps (C-Model)

Standard Close-Coupled Coro-Flo Pumps with Starters

PUMP	MOTOR			INLET	OUTLET	GPM 50 PSID
	HP	PH	VOLT			
C10	2	1	115/230	1 1/4"	1"	6.5
C12	2	1	115/230	1 1/2"	1"	15
C13	2	1	115/230	1 1/2"	1"	22
C14	3	3	230/460	1 1/2"	1"	32
C16	3	3	230/460	1 1/2"	1"	18

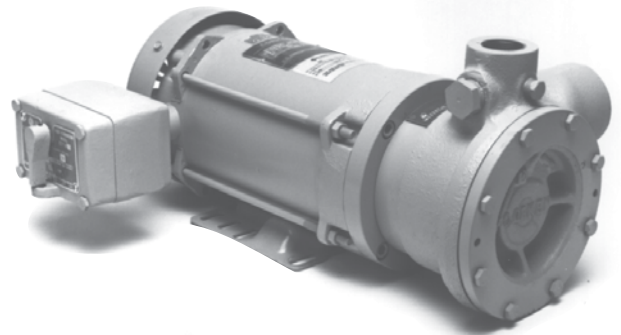

(a) These motors are listed by Underwriters' Laboratories, Inc. and CSA for Class 1, Group D, explosion-proof service.

Accessory Options

PART NUMBER	DESCRIPTION
B166B-.75BAU-Y	3/4" bypass valve purchased with C-Model pump
B166B-1BAU-Y	1" bypass valve purchased with C-Model pump
SM-30	Motor mounted switch

Part Options

PART NUMBER	DESCRIPTION
113-CXA	Mechanical seal (Buna-N)
2555	3/4 hp, 60 Hz Coro-Flo motor (REPLACED BY PART #2556)
2556	1 hp, 60 Hz Coro-Flo motor
4261	2 hp, 50/60 Hz Coro-Flo motor
2557	3hp, 50/60 Hz Coro-Flo motor

Electrical Options

PART NUMBER	DESCRIPTION
2277-X1	Motor mounted manual starter
2277-X2	Wall mounted manual starter
2277-X3	Motor mounted manual starter-2 hp
2275-X1	Switch assembly with heater-3/4 hp
2275-X2	Switch assembly with heater-1 hp
2275-X3	Switch assembly with heater-2 hp

Bypass Valves

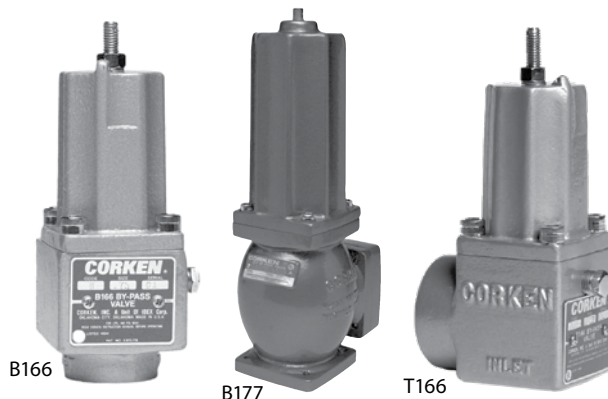

PART NUMBER	INLET	OUTLET	SLIP-ON WELD FLANGE	DIFF. PRES-SURE RANGE PSI (BAR)	O-RING MATERIAL OPTIONS
B166	3/4" 1"	3/4" 1"	No	25-225 (1.7 - 15.5)	Buna-N (standard), Neoprene, PTFE, Viton, ethylene-propylene
T166	1 1/4" 1 1/2"	1 1/4" 1 1/2"	No	25-225 (1.7 - 15.5)	
B177	1 1/4" 1 1/2" 2" 2 1/2"	1 1/4" 1 1/2" 2" 2 1/2"	2", 2 1/2"	20-160 (.7 - 11)	

Models C9 to C14-Parts Details

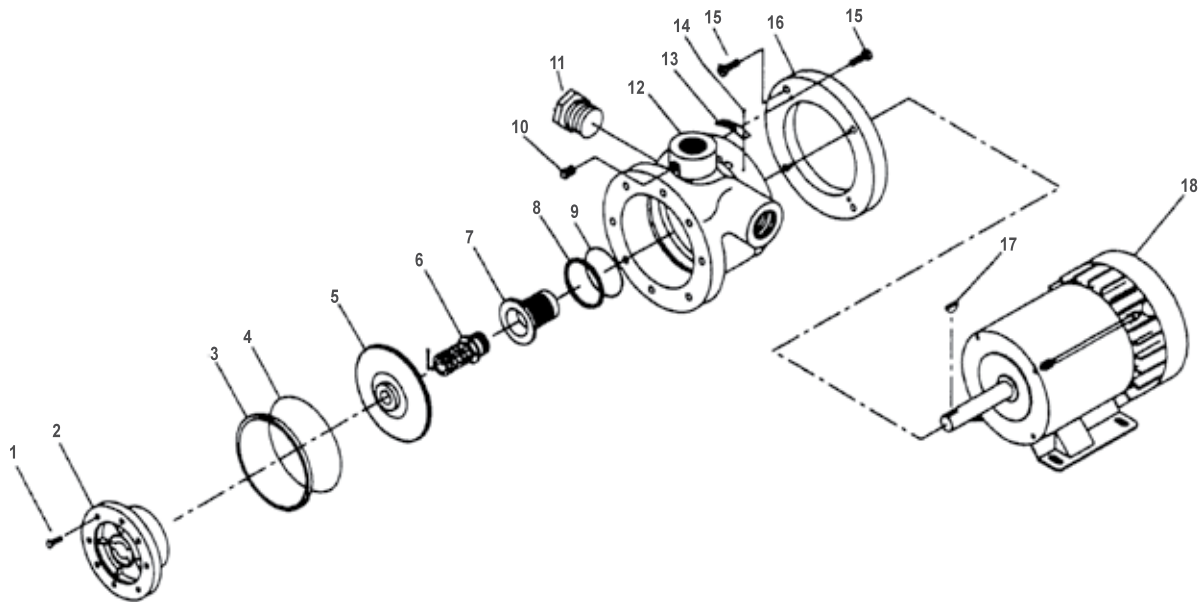

CAUTION: Always relieve pressure in the unit before attempting any repairs.

REF NO.	PART NO.	DESCRIPTION	QTY
1	7001-031NC100A	Hex head cap screw	8
2	1001-09	Cover—model 9	1
	1001-0	Cover—model 10	1
	1001-2	Cover—model 12	1
	1001-3	Cover—model 13	1
	1001-4	Cover—model 14	1
	1001-5	Cover—model 15	1
3	1014	Case clearance shim (.002" red)	As req.
	1014-1	Case clearance shim (.003"green)	
4	2-246_	Case O-ring (non-Teflon®)	1
	2-247E	Case O-ring Teflon®	
5	1003-09	Impeller, brass—model 9	1
	1003-0	Impeller, brass—model 10	1
	1003-2	Impeller, brass—model 12	1
	1003-3	Impeller, brass—model 13	1
	1003-4	Impeller, brass—model 14	1
	1003-5	Impeller, brass—model 15	1
6	113-CX_	Seal assembly	1
7	1004-1X	Seal housing, steel (non-Teflon® O-rings)	1
	1004-11X	Seal housing, SS (non-Teflon® O-rings)	1
	1004-2X	Seal housing, steel (Teflon® O-rings)	1
	1004-21X	Seal housing, steel (Teflon® O-rings)	1
	1004-21X	Seal housing, steel (Teflon® O-rings)	1
8	1013	Housing adjustment shim (0.010")	1
	1013-1	Housing adjustment shim (0.020")	

REF NO.	PART NO.	DESCRIPTION	QTY
9	2-224_	Housing O-ring	1
10	3442	Pipe plug, 1/4" NPT	1
11	3444	Pipe plug, 3/4" NPT	1
12	1002-09	Case—model 9	1
	1002-0	Case—model 10	1
	1002-2	Case—model 12	1
	1002-3	Case—model 13	1
	1002-4	Case—model 14	1
	1002-5	Case—model 15	1
13	1914-1	Nameplate	1
14	7012-006SF019E	Phillips head screw 6-32 X 1/4"	2
15	7002-037NC087A	Socket head cap screw	8
16	1015	Adapter ring	1
17	2497	Woodruff key, steel	1
	2497-1	Woodruff key, SS	1
18	2555	Motor 3/4 hp models 9, 10	1
	2556	Motor 1 hp model 12	1
	2557	Motor 3 hp models 14, 15	1
	2895	Motor 3/4 hp, obsolete models 9E, 10	1
	2896	Motor 1 1/2 hp, obsolete model 12E	1
	4261	Motor 2 hp model 13	1

Balanced Seal Assembly 113-CX

Models C9 to C15, DS/DL9 to DS/DL15, F9 to F15, F109 to F115

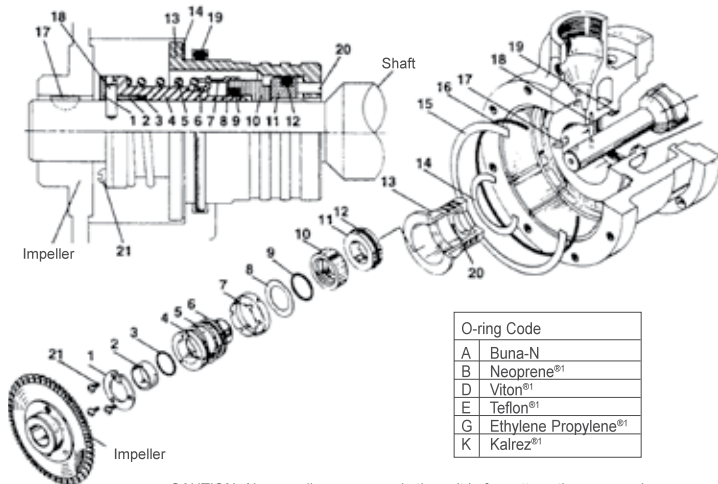

O-ring Code	
A	Buna-N
B	Neoprene ^{®1}
D	Viton ^{®1}
E	Teflon ^{®1}
G	Ethylene Propylene ^{®1}
K	Kalrez ^{®1}

CAUTION: Always relieve pressure in the unit before attempting any repairs.

REF NO.	PART NO.	DESCRIPTION	QTY
1	1008	Seal clamp ring	1
2	1080	Follower, aluminum	1
	1080-1	Follower, stainless steel	1
3	2-018_	Follower O-ring	1
4	1007	Seal sleeve, aluminum	1
	1007-2	Seal sleeve, stainless steel	1
5	2734	Spring	1
6	2735	Driveband	1
7	2736	Retainer	1
8	2737	Disc	1
9	2-118_	Rotor O-ring	1
	2343-X	Coro-seal (not shown)	1
11	2739	Seat, cast iron	1
	2739-1	Seat, ceramic	1
	2739-2	Seat, ni-resist	1
	2739-3	Seat, stainless steel	1
	2739-4	Seat, tungsten carbide	1
12	2-216_	Seat O-ring	1
13	1004-1X	Seal housing, steel (with pin)	1
	1004-11X	Seal housing, stainless steel (with pin)	1
	1004-2X	Seal housing, steel	1
	1004-21X	Seal housing, stainless steel	1
14	1013	Housing adjustment shim (0.010")	As req.
	1013-1	Housing adjustment shim (0.020")	As req.
15	1014	Case clearance shim (0.002)	As req.
	1014-1	Case clearance shim (0.020)	As req.
16	2-246	Case O-ring (Non-Teflon [®])	1
	2-247E	Case O-ring, Teflon [®]	1
17	2497	#5 Woodruff key, steel	1
	2497-1	#5 Woodruff key, stainless steel	1
18	1009	Seal drive pin	1
19	2-224_	Seal housing O-ring	1
20	3520	Roll pin (included with seal housing)	1
21	7012-006NC025B	Screw, 6-32 x 1/4" phillip pan head	3

ASSEMBLY NO.	ASSEMBLY NAME
113-CX_	Seal assembly with 1007-X, 1008, 1009, 1014, 1014-1, 1080, 2497, 2736, 2737, 2739-X, 2-018, 2-224, 2-246
1007-X	Seal sleeve assembly with 1007, 2734, 2735
1007-2X	Seal sleeve assembly, stainless steel, with 1007-2, 2734, 2735
2739-X_	Rotor-seat assembly, cast iron, with 2738, 2739, 2-118, 2-216
2739-1X_	Rotor-seat assembly, ceramic, with 2738, 2739-1, 2-118, 2-216
2739-2X_	Rotor-seat assembly, ni-resist, with 2738, 2739-2, 2-118, 2-216
2739-3X_	Rotor-seat assembly, stainless steel, with 2738, 2739-3, 2-118, 2-216
2739-4X_	Rotor-seat assembly, tungsten carbide, with 2738, 2739-4, 2-118, 2-216

Coro-Flo Pump Motors-Parts Details

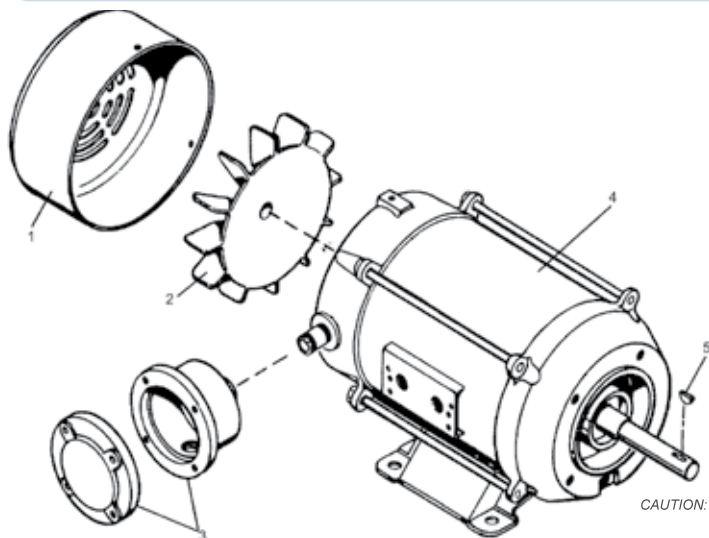

REF NO.	PART NO.	DESCRIPTION
1	2660-2	Fan guard, Franklin (models C9, C10, C12)
2	3547	Fan—Franklin (models C9, C10, C12)
3	2686-X	Conduit box assembly (model C14 only)
4	2555	Motor—3/4 hp (models C9, C10)
	2556	Motor—1 hp (model C12)
	2557	Motor—3 hp (model C14)
	4261	Motor—2 hp (model C13)
5	2497	Key

CAUTION: Always relieve pressure in the unit before attempting any repairs.

CAUTION: To help prevent shock or ignition of hazardous atmospheres, always disconnect and lock out power circuit.

Coro-Flo Pumps (Models 060 & 075 AutoGas)

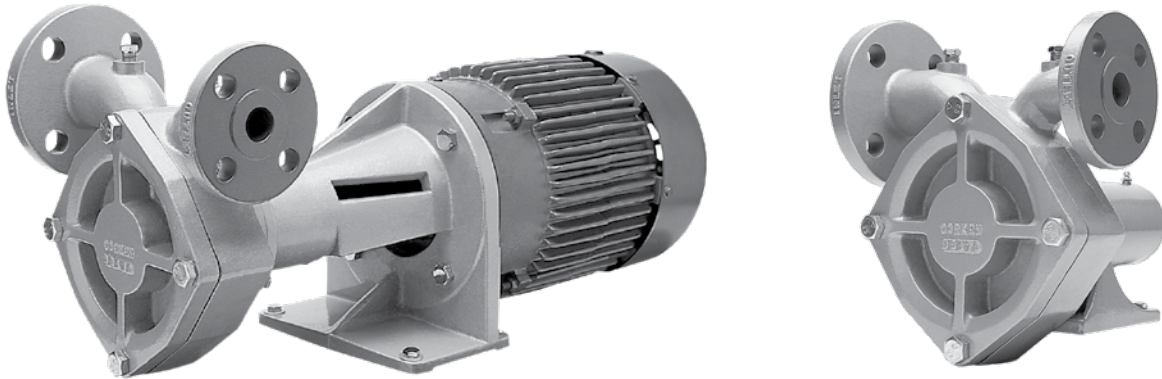

PART NUMBER	DESCRIPTION	INLET	OUTLET	MOUNTING OPTIONS		
				PART NUMBER	DESCRIPTION	MAXIMUM MOTOR FRAME SIZE
FF060	Frame mounted ANSI flange	1 1/2" ANSI*	1" ANSI*	101-14	Mounting set-up for direct drive. Includes steel baseplate, flexible coupling, and coupling guard. (pump and motor not included)	184T, 215T, 256T
FF075						
FD060	Frame mounted DIN flange	40 mm PN40 DIN 2635	25 mm PN40 DIN 2635			
FD075						
DLF060**	Direct mount pump with C-Face frame ANSI flange	1 1/2" ANSI*	1" ANSI*			
DLF075**						
DLD060**	Direct mount pump with C-Face frame DIN flange	40 mm PN40 DIN 2635	25 mm PN40 DIN 2635			
DLD075**						

*All standard ANSI port sizes are 300 lbs.

**Accommodates NEMA motors up to and including 10 hp (215 TC frame size).

PART NUMBER	DESCRIPTION	MODEL REFERENCE
SINGLE PHASE APPLICATIONS		
HDPFF060-1P53	Pump, 101 mounting, B166B-1CAU, 5 hp Exp. 60Hz 3 ph motor and Variable frequency drive	FF060CD6A
HDPDLF060-1P53	Pump, coupling, B166B-1CAU and 5 hp Exp. 60 Hz 3 ph C-face motor and Variable frequency drive	DLF060CD6A
HDPFF060-1P51	Pump, 101 mounting, B166B-1CAU and 5 hp Exp. 60Hz 1 ph motor	FF060CD6A
HDPDLF060-1P51	Pump, coupling, B166B-1CAU and 5 hp Exp. 60 Hz 1 ph C-face motor	DLF060CD6A
HDPFF075-1P75	Pump, 101 mounting, B166B-1CAU, 7.5 hp Exp. 60Hz motor and Variable frequency drive	FF075CD6A
HDPDLF0075-1P75	Pump, coupling, B166B-1CAU and 7.5 hp Exp. 60 Hz C-face motor and Variable frequency drive	DLF075CD6A
THREE PHASE APPLICATIONS		
HDPFF060-3P53	Pump, 101 mounting, B166B-1CAU and 5 hp Exp. 60Hz 3 ph motor	FF060CD6A
HDPDLF060-3P53	Pump, coupling, B166B-1CAU and 5 hp Exp. 60 Hz 3 ph C-face motor	DLF060CD6A
HDPFF075-3P75	Pump, 101 mounting, B166B-1CAU, 7.5 hp Exp. 60Hz motor	FF075CD6A
DLF075CD6A	Pump, coupling, B166B-1CAU and 7.5 hp Exp. 60 Hz C-face motor	DLF075CD6A

Part Options

PART NUMBER	DESCRIPTION	WORKS FOR
6133-X1	Companion Flange Kit (FF/DLF)	
1345-2	Coupling (182/184 TC NEMA frame size)	DLF060/DLF075
1345-1	Coupling (213/215 TC NEMA frame size)	DLF060/DLF075
1345	Special bore coupling (all other NEMA and IEC size C-face motors)	DLF/DLD060/DLD075

Z-Series Stationary Pumps



Coro-Vane Pumps

PART NUMBER	INLET	OUTLET	INTERNAL RELIEF VALVE
521	2 1/2" NPT	2" NPT	Yes
1021	3" NPT	3" NPT	Yes
F1021	3" ANSI 300 lb.	2 1/2" ANSI 300 lb.	No
Z2000	2" NPT	2" NPT	Yes
Z3500	3" NPT	3" NPT Elongated	Yes
Z4500	4" ANSI 300 lb.	3" ANSI 300 lb.	Yes

Part Options

PART NUMBERS	DESCRIPTION	MODEL NUMBER
2904-X2	Recommended Repair Kit - LPG/NH3 - Includes seals, blades, sideplates, bearings and gaskets	521
2906-X2		1021, F1021
2907-X3		F1521
3195-X2	Recommended Repair Kit - LPG/NH3 - Includes seals, blades, bearings and gaskets	Z3500
3197-X1		Z4500

Standard Mounting Options

PART NUMBER	DESCRIPTION	MODEL REFERENCE	MAX. DRIVER SIZE (HP)
103-9-	Mounting set-up for V-Belt Drive . Includes steel baseplate, adjustable motor slide base, V-belt drive and enclosed beltguard. PUMP AND MOTOR NOT INCLUDED	521 Z2000	254T (w/521)
103-10-			254T (Z2000)
		1021, F1021, Z3500	184T (w/1021)
			184T (w/F1021)
			184T (w/Z3500)
			215T (w/1021)
			215T (w/F1021)
			215T (w/Z3500)
			284T (w/1021)
284T (w/F1021)			
284T (w/Z3500)			
103-15-		Z4500	256T
284T			
102-	Mounting set-up for use with Engine Driver through " V-Belt Drive ". Includes steel baseplate, flexible coupling, and coupling guard. PUMP AND MOTOR NOT INCLUDED	521, Z2000, 1021, F1021	-

Industrial Mounting Options

PART NUMBER	DESCRIPTION	MODEL REFERENCE	MAX. DRIVER SIZE (HP)
101GRB-	Mounting set-up for Direct Drive . Includes size "B" gear reducer, steel baseplate mounting, reducer bracket, couplings and coupling guard. PUMP AND MOTOR NOT INCLUDED	521	182T-254T
101GRB-		Z2000	182T-254T
101GRB-		1021	182T-254T
101GRB-		F1021	182T-254T
101GRB-		Z3500	182T-254T
101GRB-		Z4500	182T-254T
101GRC-		Mounting set-up for Direct Drive . Includes size "C" gear reducer, steel baseplate mounting, reducer bracket, couplings and coupling guard. PUMP AND MOTOR NOT INCLUDED	521
101GRC-	Z2000		213T-324T
101GRC-	1021		213T-324T
101GRC-	F1021		213T-324T
101GRC-	Z3500		213T-324T
101GRC-	Z4500		213T-324T

Z-Series Stationary Pumps - Parts Details

Models 521 and 1021

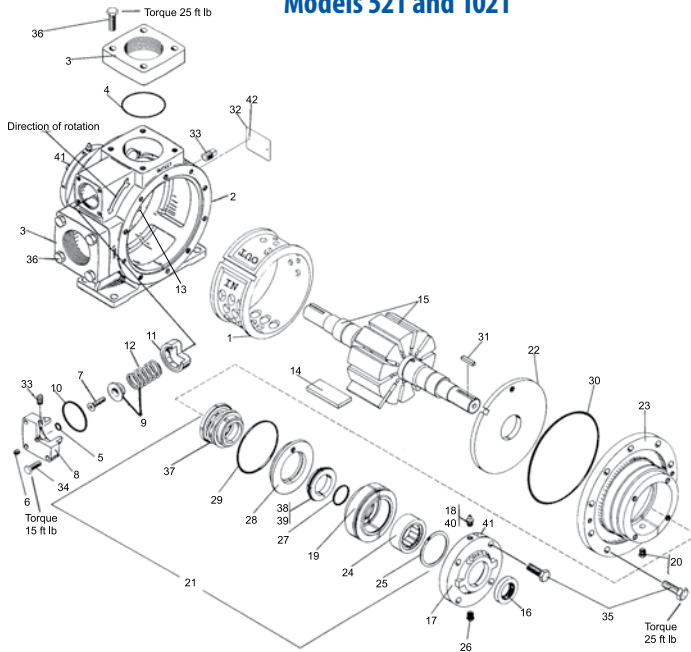

REF NO.	PART NO.	DESCRIPTION	QTY
1	1162-2	Cam (521)	1
	1201-2	Cam (1021)	1
2	2832	Case (521)	1
	2841	Case (1021)	1
3	1172-2.5	2.5" Flange (521)	1
		2" Flange (521)	1
		3" Flange (1021)	2
4	2-234_	Flange O-ring (521)	2
		Flange O-ring 3" (1021)	2
		Flange O-ring 4" (1021)	2
5	2-112_	Adjusting screw O-ring	1
6	2590	Flush seal plug 1/8" NPT	1
7	2252	Relief valve adjusting screw	1
8	1174	Valve cap (521)	1
		Valve cap (1021)	1
9	1242-X	Relief valve spring & guide (521)	1
		Relief valve spring & guide (1021)	1
10	2-224_	Relief valve cap O-ring (521)	1
		Relief valve cap O-ring (1021)	1
11	1241	Relief valve (521)	1
		Relief valve (1021)	1
12	1242	Relief valve spring (521)	1
		Relief valve spring (1021)	1
13	1170	Cam key (521)	1
		Cam key (1021)	1

REF NO.	PART NO.	DESCRIPTION	QTY
14	1168-7 1308-9	Blade (521)	10
		Blade (1021)	10
15	1166-1X1R 1208-1X1R	Rotor & shaft assembly (521)	1
		Rotor & shaft assembly (1021)	1
16	1358	Grease seal	2
17	1164-1	Bearing cap	2
18	2158	Grease zerk 1/8" NPT	2
19	1769	Bearing housing	2
20	1343	Relief fitting (seal vent)	2
21	1769-X 1769-XR	Seal assembly	2
		Seal assembly—replacement	2
22	1163-2 1209-1	Sideplate (521)	2
		Sideplate (1021)	2
23	1161-4 1205-4	Head (521)	2
		Head (1021)	2
24	2754-X 2755 2754	Roller bearing —complete	2
		Bearing inner race	2
		Bearing outer race	2
25	2760-244	Retainer ring	2
26	1343	Relief fitting (grease)	2
27	2-128_	Shaft O-ring	2
28	1882	Seat adapter plate	2
29	2-240_	Adapter plate O-ring	2
30	2-261_ 2-268_	Case O-ring (521)	2
		Case O-ring (1021)	2
31	2270	1/4" Key	2
32	2949	nameplate	1
33	3442	1/4" NPT plug	1
34	7001-031 NC125A 7001-037 NC125A	Hex hd bolt 5/16-18x1-1/4 (521)	4
		Hex hd bolt 3/8-16x1-1/4 (1021)	4
35	7001-037 NC125A 7001-037 NC125A	Hex hd bolt 3/8-16x1-1/4 (521)	28
		Hex hd bolt 3/8-16x1-1/4 (1021)	32
36	7001-037 NC150A	Hex head bolt 3/8-16x1-1/2	8
37	-----	Retainer	2
38	-----	Seal seat	2
39	2-227_	Seal seat O-ring	2
40	2159	Lubricap #2	2
41	1359	Lubrication instruction tag	2
42	7003-004 DR0198	Round head plated drive screw 4 x 3/16	2



Z-Series Stationary Pumps - Parts Details

Models F1021

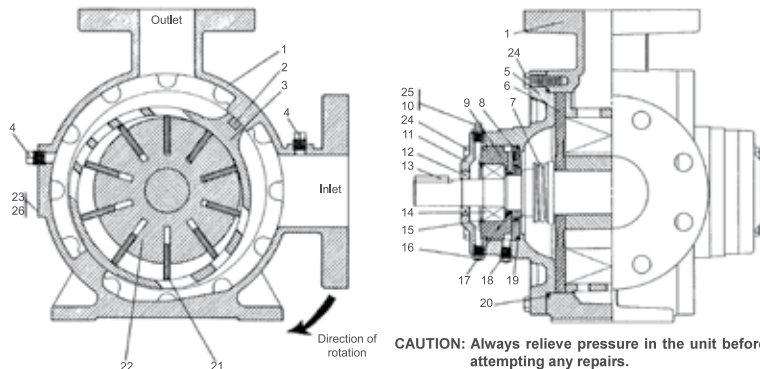

CAUTION: Always relieve pressure in the unit before attempting any repairs.

REF NO.	PART NO.	DESCRIPTION	QTY	REF NO.	PART NO.	DESCRIPTION	QTY
1	2433	Case	1	14	2754-X	Rikker bearing—complete Bearing inner race	2
2	1309	Cam key	1	15	2755	Bearing outer race	2
3	1201-2	Cam	1	16	2754		2
4	3442	1/4" NPT plug	2	17	2760-244	Retainer ring	1
5	1205-4	Head	2	18	1343	Relief fitting (grease)	2
6	1209-1 ⁵	Sideplate	2	19	2-128_4	Shaft O-ring	1
7	1769-X_1,2	Seal Assembly	2	20	1343	Relief fitting (seal vent)	1
	1769-XR_1,2	Seal replacement kit	2	21	2-240_2	Adapter plate O-ring	1
8	1822	Seat adapter plate	2	22	2-268_2	Case O-ring	2
9	1769	Bearing house	1	23	1308-9	Vane	10
10	2158	Grease zerk 1/8" NPT	1	24	1208-1X1R	Rotor and shaft assembly with 2755	1
11	1164-1	Bearing cap	2	25	2649	Nameplate	1
12	1358	Grease seal	1	26	7001-037 NC125A	Hex hd bolt 3/8-16x1-01/4"	32
13	2270	1/4" Key	1		2159	Lubricap #2	2
					7012-006 SF019E	Drive screw 6-32x3/16 pan head	6

Z-Series Truck Pumps



Part Options – Repair/Rebuild Kits Etc.

PART NUMBER	DESCRIPTION	MODEL REFERENCE
2904-X2	Recommended Repair Kit* - LPG/NH ₃ Includes seals, blades, sideplates, bearings and gaskets.	522
2906-X2		1022
3193-X1	Recommended Repair Kit* - LPG/NH ₃ Includes seals, blades, blade drivers, bearings and gaskets.	Z2000, ZH2000, ZX2000, ZXH20090
3195-X1		Z3200, ZH3200
3197-X1		Z4200, ZH4200, Z4500
3194-X1	Rebuild Kit* - LPG/NH ₃ Includes seals, blades, blade drivers, sideplates, cams, bearings, and gaskets.	Z2000, ZH2000, ZX2000, ZXH20090
3196-X1		Z3200, ZH3200
3198-X1		Z4200, ZH4200, Z4500
4915-X1	Adjustable bearing cap	522, 1022

PART NUMBER	INLET	OUTLET	AUXILLARY INLET	INTERNAL RELIEF VALVE
Z2000	2" NPT	2" NPT	None	150 psi
ZX2000	2" NPT	2" NPT	None	175 psi
Z3200	3" ANSI 300 lb.	2" EII	2" NPT	150 psi
Z4200	4" ANSI 300 lb.	Dual 2" NPT	2" NPT	150 psi

Accessory Options – Hydraulic Drive Adaptor Kits

PART NUMBER	DESCRIPTION	MODEL REFERENCE
4496-X1	Hydraulic drive adapter option***	Z2000, ZX2000, Z3200
4496-1X1		Z4200

Models Z/ZH/ZX/ZXH2000 – Parts Details

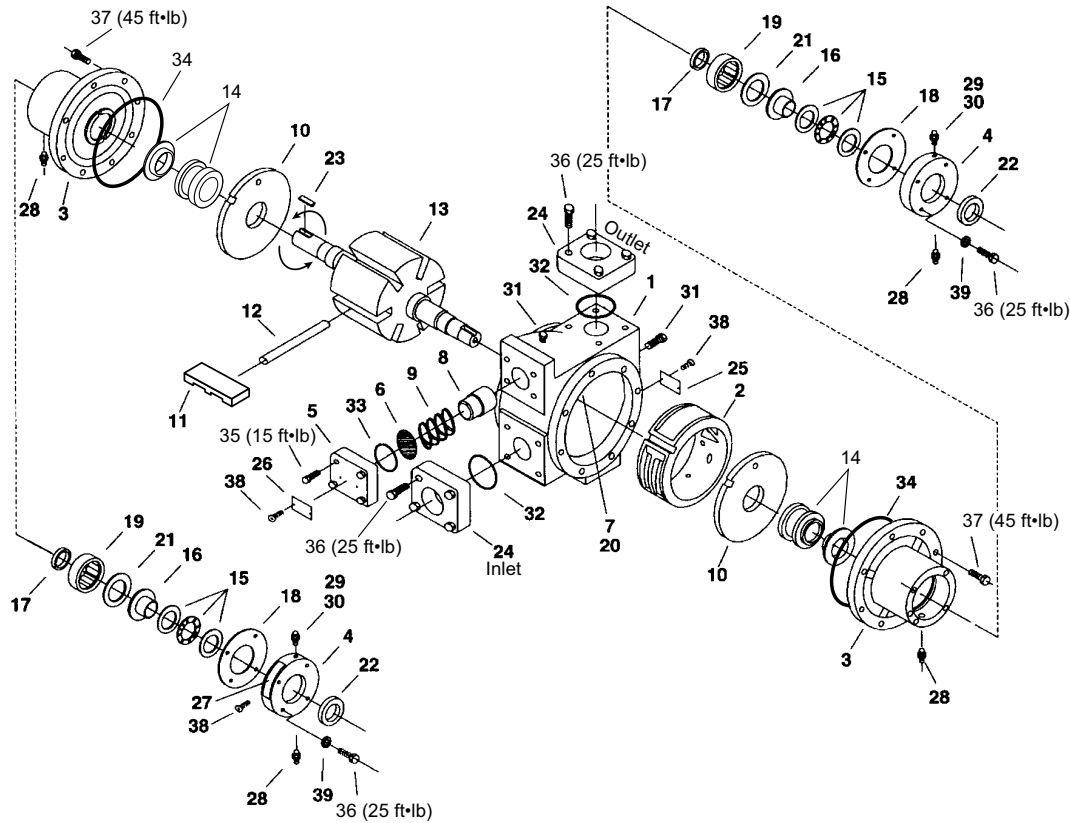

REF NO.	PART NO.	DESCRIPTION	QTY	REF NO.	PART NO.	DESCRIPTION	QTY
1	4413	Case	1	20	3253	Cam key pin	2
2	4414	Cam	1	21	2760-244	Retainer ring	2
3	4416	Head	2	22	4441	Grease seal	2
4	4417	Bearing cap	2	23	2270	Shaft keyz—1/4" x 1-9/16"	2
5	1174-3	Relief valve cap	1	24	4479-2	Flange—2" NPT	2
6	4282	Shim (for Z2000, ZH2000)	1	24	4479-2S	Flange—2" welded	
6		Shim (for ZX2000, ZXH2000)	3	25	2649	Nameplate	1
7	4424	Cam key	1	26	4248	Relief valve nameplate	1
8	4425	Relief valve	1	26	4248-1	Relief valve nameplate (for ZX2000, ZXH2000)	1
9	4426	Relief valve spring (for Z2000, ZH2000)	1	27	1359	Lubrication instruction plate	2
9	1240	Relief valve spring (for ZX2000, ZXH2000)	1	28	1343	1/8" NPT relief fitting	4
10	4427	Sideplate	2	29	2158	1/8" NPT grease zerk	2
11	4428	Vane ²	6	30	2159	Lubricap	2
12	4262-X	Vane driver	3	31	3442	1/4" NPT pipe plug	2
13	4430-X2R	Rotor—shaft assembly	1	32	2-231_	O-ring—flange	2
14	4431-X2R	Mechanical seal assembly	2	33	2-224_	O-ring—relief valve cap	1
15	4432	Thrust bearing assembly	2	34	2-261	O-ring—case	2
16	4435	Bearing race mounting ring	2	35	7001-031-NC125A	Bolt—hexagon head	4
17	4438	Grease seal	2	36	7001-037-NC150A	Bolt—hexagon head	16
18	4439	Bearing cap shim (.002) red	As req.	37	7001-043-NC125A	Bolt—hexagon head	16
18	4439-1	Bearing cap shim (.010) brown		38	7012-006-SF025E	Screw	8
18	4439-2	Bearing cap shim (.020) yellow		39	7206-037A	Lockwasher	8
19	2754-X	Bearing	2				

Models Z/ZH3500 – Parts Details

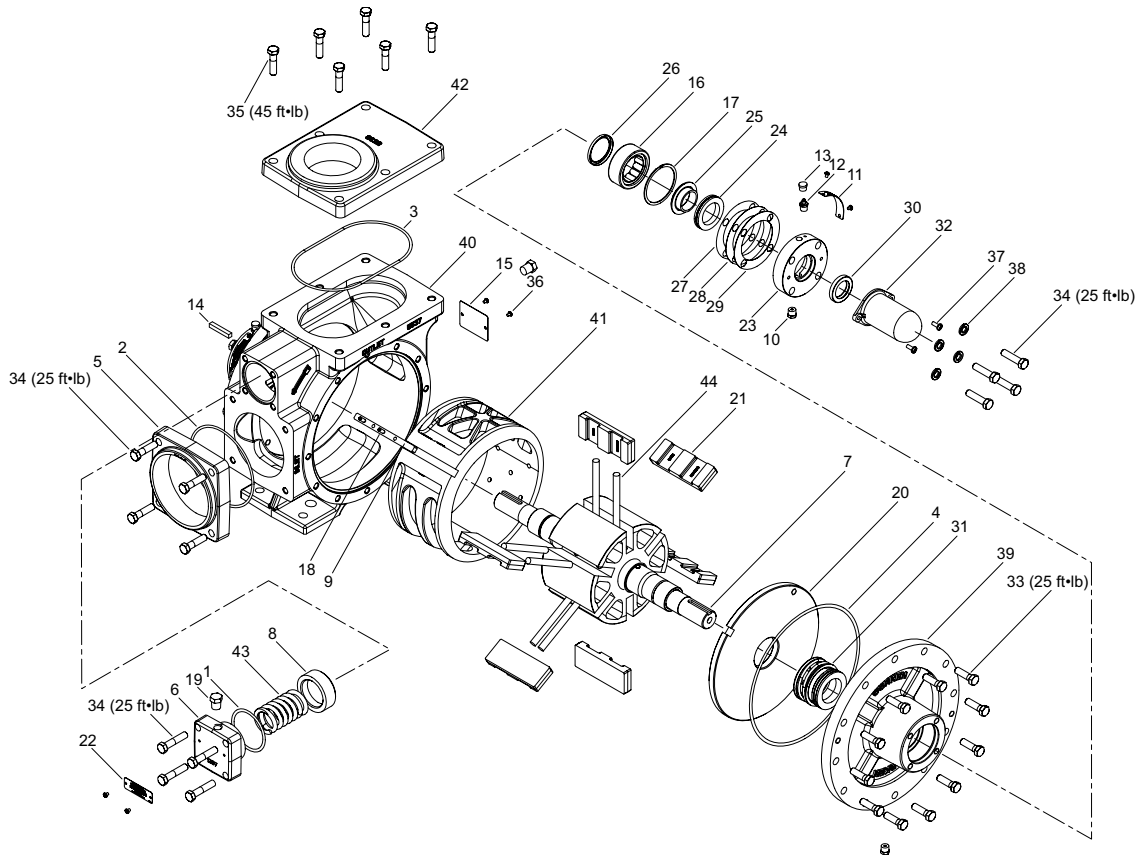

REF NO.	PART NO.	DESCRIPTION	QTY	REF NO.	PART NO.	DESCRIPTION	QTY
1	2-228	O-ring	1	22	4248	Relief valve warning tag	2
2	2-245	O-ring	1	23	4417	Bearing cap	2
3	2-259	O-ring	1	24	4432	Thrust bearing assembly	2
4	2-268	O-ring	2	25	4435	Thrust bearing mounting ring	2
5	1206-3	Inlet flange—3" NPT	1	26	4438	Grease seal / Oil seal	2
	1206-4	Inlet flange—4" NPT	1	27	4439	Bearing cap shim—0.002"	2
	1206-3S	Inlet flange—3" WF	1	28	4439-1	Bearing cap shim—0.010"	2
	1206-4	Inlet flange—4" WF	1	29	4439-2	Bearing cap shim—0.020"	2
6	1207-2	Relief valve cap	1	30	4441	Grease seal	2
7	1208-1X6R	Rotor shaft assembly	1	31	4431-X2	Mechanical seal assembly	2
8	1224	Relief valve	1	32	4985	Coro-Vane shaft cover	1
9	1309	Cam key	1	33	7001-037NC125A	Hex head bolt	24
10	1343	Grease relief fitting	4	34	7001-037NC150A	Hex head bolt	16
11	1359	Lubrication plate	2	35	7001-043NC150A	Hex head bolt	64
12	2158	Grease zerk	2	36	7012-006SF019E	Screw	9
13	2159	Lubricap	2	37	7012-010SF050E	Screw	2
14	2270	Shaft key—1/4"	1	38	7206-037A	Lock washer—0.375"	8
15	2649	Nameplate	1	39	5534	Head	2
16	2754	Outer bearing	2	40	5537	Case	1
17	2760-244	Retainer ring	2	41	5539	Cam	1
18	3253	Cam key pin	2	42	5538	Outlet flange—3" NPT Elongated	1
19	3442	Pipe plug—1/4" NPT	2		5538-3S	Outlet flange—3" WF Elongated	1
20	3935	Sideplate	2	43	5548	Spring	1
21	3936	Vane ³	6	44	5554-X	Vane driver	6

Models Z/ZH4200 – Parts Details

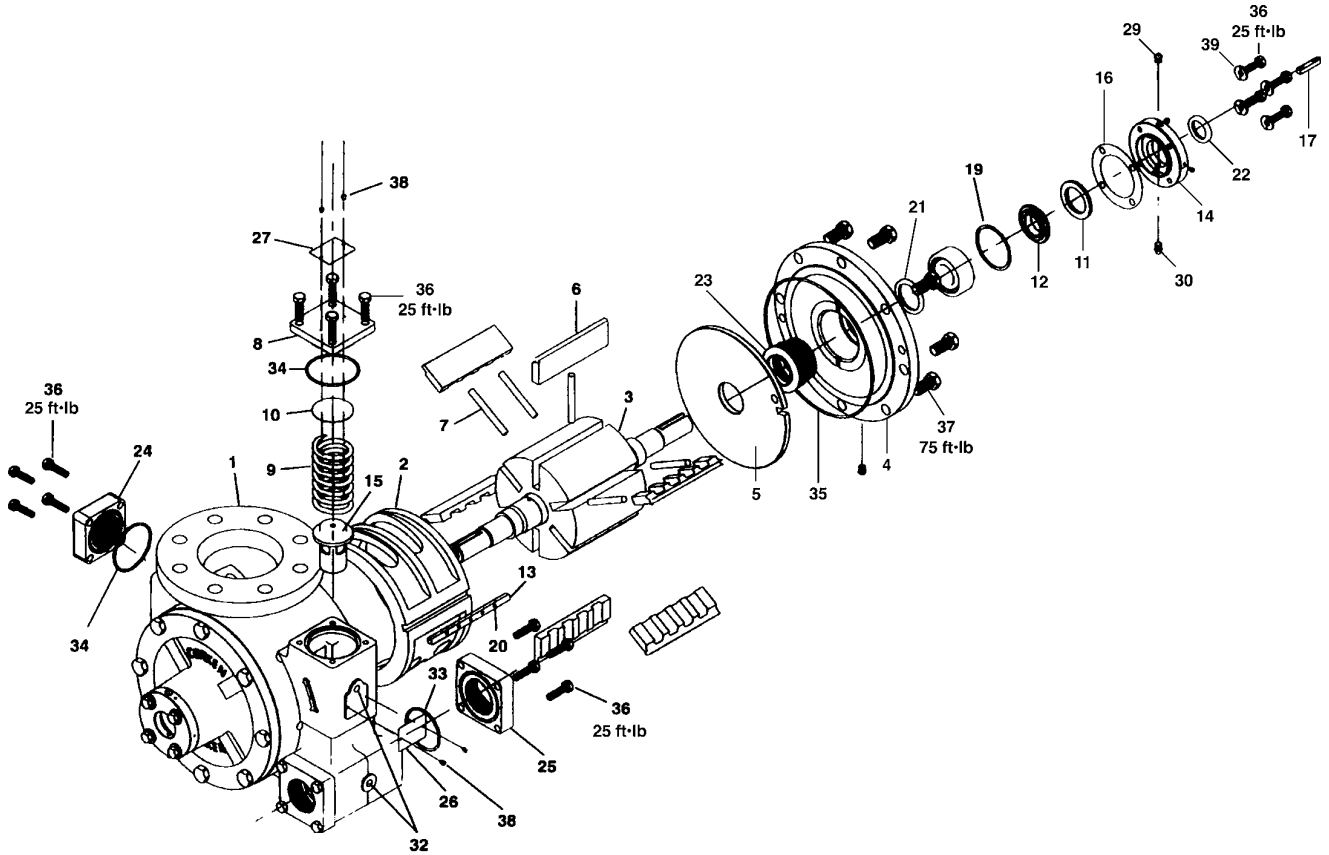

REF NO.	PART NO.	DESCRIPTION	QTY	REF NO.	PART NO.	DESCRIPTION	QTY
1	4442	Case	1	22	4463	Grease Seal	2
2	4443	CAM	1	23	4464-X_2	Mechanical Seal Assembly	2
3	4444-X2R	Rotor-Shaft Assembly	1	24	1172-2	AUX. Inlet Flange—2" NPT	1
4	4445	Head	2		1172-2S	AUX. Inlet Flange—2" WF	1
5	4446	Sideplate	2		1920-3	AUX. Inlet Flange—blind	1
6	4448	Vane	6	25	4479-2S	Discharge flange—2" WF	2
7	4449-X	Vane Driver	5		4981-2	Discharge flange—2" NPT	
8	4450	Relief Valve Cap	1	26	2649	Nameplate	1
9	4451	Relief Valve Spring	1	27	4248	Relief Valve Nameplate	1
10	4452	Shim	1	28	1359	Lubrication Instruction Plate	2
11	4453	Thrust Bearing Assembly	2	29	1343	1/8 NPT Relief Fitting	4
12	4454	Bearing Race Mounting Ring	2	30	2158	1/8 NPT Grease Zerk	2
13	4455	CAM Key	1	31	2159	Lubricap ²	2
14	4456	Bearing Cap	2	31	2159	Lubricap ²	2
15	4457	Relief Valve	1	32	3442	1/4 NPT Pipe Plug	2
	4458	Bearing Cap Shim (.002) red		33	2-231_	O-Ring Discharge Flange	2
16	4458-1	Bearing Cap Shim (.010) brown	As req.	34	2-234_	O-Ring Aux. Inlet Flange	1
	4458-2	Bearing Cap Shim (.020) yellow		35	2-270_	O-Ring- Case ²	2
17	4459	Shaft Key -5/16 x 1 3/4	1	36	7001-037NC150A	Bolt - Hexagon Head	24
18	4460-X	Roller Bearing	2	37	7001-062NC125A	Bolt - Hexagon Head	16
19	2760-283	Retainer Ring	2	38	7012-006SF019E	Screw	8
20	3253	CAM Key Pin	5	39	7206-037A	Lockwasher	8
21	4462	Grease Seal	2				

Models Z/ZH4500 – Parts Details

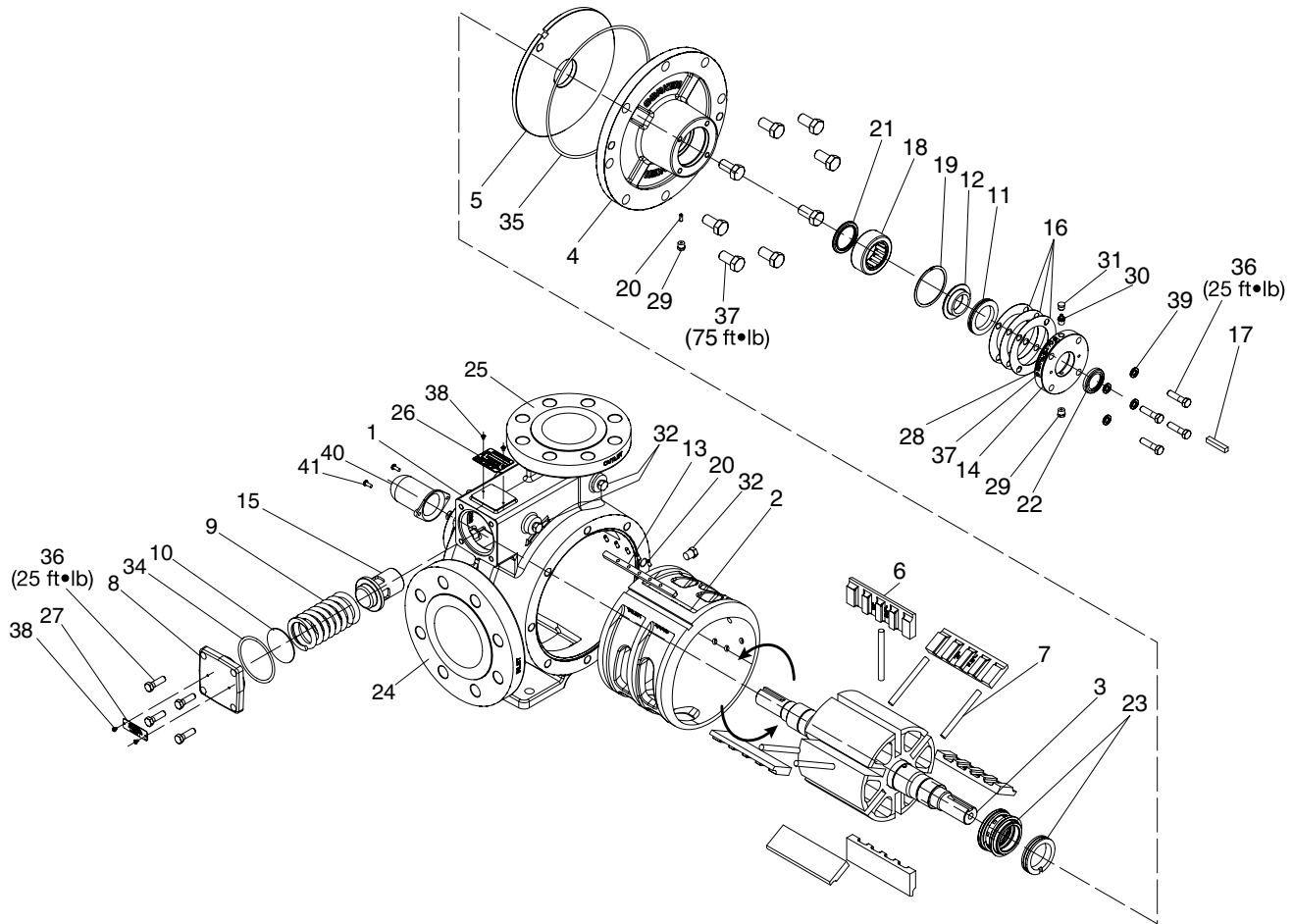

REF NO.	PART NO.	DESCRIPTION	QTY	REF NO.	PART NO.	DESCRIPTION	QTY
1	5522	Case	1	21	4462	Grease seal	2
2	4443	Cam	1	22	4463	Grease seal	2
3	4444-X2R	Rotor-shaft assembly	1	23	4464-X_2	Mechanical seal assembly ²	2
4	4445	Head	2	24	---	Inlet flange—4" ANSI	1
5	4446	Sideplate	2	25	---	Outlet flange—3" ANSI	2
6	4448	Vane	6	26	2649	Nameplate	1
7	4449-X	Vane driver	5	27	4248	Relief valve nameplate	1
8	4450	Relief valve cap	1	28	1359	Lubrication instruction plate	2
9	4451	Relief valve spring	1	29	1343	1/8 NPT relief fitting	4
10	4452	Shim	1	30	2158	1/8 NPT grease zerk	2
11	4453	Thrust bearing assembly	2	31	2159	Lubricap	2
12	4454	Bearing race mounting ring	2	32	3442	1/4 NPT pipe plug	2
13	4455	Cam key	1	33	2-231_	O-ring—discharge flange	2
14	4456	Bearing cap	2	34	2-234_	O-ring—auxiliary inlet flange	1
15	4457	Relief valve	1	35	2-270_	O-ring—case	2
16	4458	Bearing cap shim (.002) red	As req.	36	7001-037NC150A	Bolt—hexagon head	24
	4458-1	Bearing cap shim (.010) brown		37	7001-062NC125A	Bolt—hexagon head	16
	4458-2	Bearing cap shim (.020) yellow		38	7012-006SF019E	Screw	8
17	4459	Shaft key—5/16 x 1-3/4	1	39	7206-037A	Lockwasher	8
18	4460-X	Roller bearing	2	40	4985	Shaft cover	1
19	2760-283	Retainer ring	2	41	7012-010SF050E	Screw	2
20	3253	Cam key pin	5				

Repair Kits

-Pump Repair Kits

PART NO.	MODEL NUMBERS	SEAL ASSEMBLY	BEARINGS	GREASE SEALS	GREASE SEAL	BLADES	SIDEPLATES	FLANGE GASKET	CASE O-RING
2904-X2	521E, 522E, T522E, TR522E	1769-XRA (2)	2754-X (2)	1358 (2)	2014	1168-7 (10)	1163-2 (2)	2010 (3)	2-261A (2)
3109-X1	T522G, TR522G	1769-XRA (2)	2754-X (2)	1358 (2)	2014	4000 (6)	3932 (2)	2010 (2)	2-261A (2)
2905-X5	T722G, TR722G	1769-XRA (2)	2754-X (2)	1358 (2)	2014	3981 (6)	3932 (2)	2010 (2)	2-261A (2)
2906-X2	1021E, 1022E, F1021E, F1022E	1769-XRA (2)	2754-X (2)	1358 (2)	2014	1308-9 (10)	1209-1 (2)	-	2-268A (2)
2907-X3	F1521F, F1522F, T1522F, TR1522F	1769-XRA (2)	2754 (2)	1358 (2)	2014	3477 (6)	3476 L/R (1/1)	-	2-268A (2)
3193-X1	Z2000	4431-XA2	2754-X (2)	4441 (2)	-	4428 (6)	4427 (2)	-	2-261A (2)
3195-X1	Z3200	4431-XA2	2754-X (2)	4441 (2)	-	4232 (6)	4231 (2)	-	2-261A (2)
3197-X1	Z4200	4464-XA2	4460-X (2)	4463 (2)	-	4448 (6)	4446 (2)	-	2-270A (2)

Pump Repair Kits (continued)

PART NO.	MODEL NUMBERS	FLANGE O-RING			R.V. O-RING			ROTOR AND SHAFT		CAM
		TYPE 1	TYPE 2	TYPE 3	TYPE 1	TYPE 2	TYPE 3	TYPE 1	TYPE 2	
2904-X2	521E, 522E, T522E, TR522E	2-234A (2)	-	-	2-224A	2-112A	2-227A (2)	1166-1X1R	1166-1X2R	1162-2
3109-X1	T522G, TR522G	2-234A	-	-	-	-	2-227A (2)	-	116-1X8R	1162-2
2905-X5	T722G, TR722G	2-234A	-	-	-	-	2-227A (2)	-	3983-X2R	1849-1
2906-X2	1021E, 1022E, F1021E, F1022E	2-245A (2)	2-249A (2)	-	2-228A	2-112A	-	1208-1X1R	1208-1X2R	1201-2
2907-X3	F1521F, F1522F, T1522F, TR1522F	2-245A	2-234A (3)	2-249A	-	-	2-238A	3350-X1R	3350-X2R	1792-1
3193-X1	Z2000	2-231A (2)	-	-	2-224A	-	-	4430-X2R	-	4414
3195-X1	Z3200	2-234A (2)	-	-	2-224A	-	-	4495-X2R	-	4242
3197-X1	Z4200	2-231A	2-234A	-	2-234A	-	-	4444-X2R	-	4443

Pump Repair Kits (continued)

PART NUMBER	MODEL NUMBERS	MOUNTING RING	PIN DRIVERS	SHIM		
				0.002	0.010	0.020
2904-X2	521E, 522E, T522E, TR522E	-	-	-	-	-
3109-X1	T522G, TR522G	-	-	-	-	-
2905-X5	T722G, TR722G	-	-	-	-	-
2906-X2	1021E, 1022E, F1021E, F1022E	-	-	-	-	-
2907-X3	F1521F, F1522F, T1522F, TR1522F	-	-	-	-	-
3193-X1	Z2000	4432 (2)	4262-X (3)	4439 (8)	4439-1 (2)	4439-2 (2)
3195-X1	Z3200	4432 (2)	4262-X (3)	4439 (8)	4439-1 (2)	4439-2 (2)
3197-X1	Z4200	4453 (2)	4449-X (3)	4458 (8)	4458-1 (2)	4458-2 (2)

Quantities larger than 1 are shown in parenthesis



Small Capacity Stationary

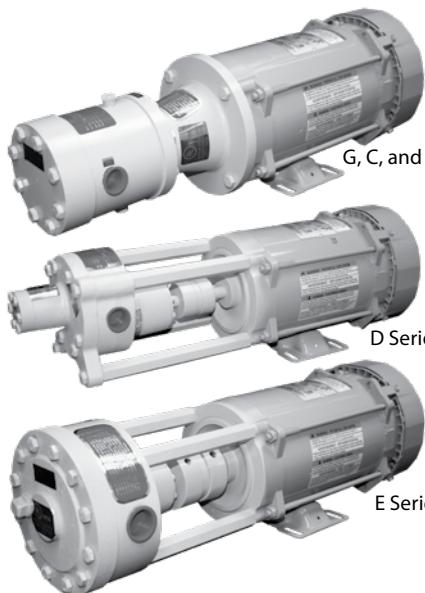

G, C, and M Series

D Series

E Series

PART NUMBER	DESCRIPTION	MOTOR	VOLT	WORKS WITH
MC-1Z	Pump only	-	-	-
MC1-M5B	Pump with Motor	1 1/2 HP	115/208/230	-
GC-1	Pump Only	-	-	-
GC-1LZ-EM1-3B	3/4" Pump with Superseal	1 HP	115/208/230	-
GC-1LZ-EM-6B	3/4" Pump with Superseal	1 1/2 HP	-	-
GC-1LZ-M	Pump with Motor	1 1/2 HP	115/208/230	
EG-1Z	Pump only	-	-	-
EG-1Z-M	Pump with Motor	1 HP	-	-
E-100ZX	Exchange, Shaft-Seal Assembly	-	-	EG-1
E-100HZX	Exchange, Shaft-Seal Assembly	-	-	EC-H
DW-1Z	Pump only	-	-	-
DW-1Z-M	Pump with Motor	1 HP	115/208/230	-
DW-HZ	Pump only	-	-	-
DW-HZ-M	Pump with Motor	1 1/2 HP	115/208/230	-

MODEL	MOTOR SPEED	AVERAGE DELIVERY RATE, 3600 RPM		INTERNAL BYPASS RELIEF SETTINGS	MAX. DIFFERENTIAL PRESSURE	INLET/OUTLET SIZE	MOTOR	PUMP ROTATION
		40 PSID	75 PSID					
GC-1*	3600 RPM	9 GPM	8 GPM	GC-1-90 psi MC-1 Adjustable	125 psi	3/4" FNPT	1 HP	GC-1-CW MC-1-CCW
MC-1*	3600 RPM	9 GPM	8 GPM	GC-1-90 psi MC-1 Adjustable	125 psi	3/4" FNPT	1 HP	GC-1-CW MC-1-CCW
GC-1LZ*	3600 RPM	11 GPM	9 GPM	150 psi	125 psi	3/4" FNPT	1 1/2 HP	CW
EG-1Z	3600 RPM	8 1/2 GPM	7 GPM	90 psi	125 psi	3/4" FNPT	1 HP	CW
ECH-1	3600 RPM	13 1/2 GPM	12 GPM	90 psi	125 psi	1" FNPT	1 1/2 HP	CW
DW-1	3600 RPM	8 1/2 GPM	7 GPM	90 psi	125 psi	3/4" FNPT	1 HP	CCW
DW-H	3600 RPM	13 1/2 GPM	12 GPM	90 psi	125 psi	1" FNPT	1 1/2 HP	CCW

*External bypass valve required with GC-1, MC-1, GC-1LZ

Accessory

PART NO.	SIZE
XS-52C	Switch

Smith Bypass Valves



PART NUMBER	SIZE	FLOW (GPM)
WW-120	1/2" x 1/2"	5 - 10
WW-340	3/4" x 3/4"	10-15
WW-100	1" x 1"	20-35
WW-114	1 1/4" x 1 1/4"	35-50
WW-112	1 1/2" x 1 1/2"	50-100
WW-200	2" x 2"	100-150
WW-212	2 1/2" x 2 1/2"	150-250



Scan QR for Smith Pumps training videos



Small Capacity Stationary – E Series Parts Detail

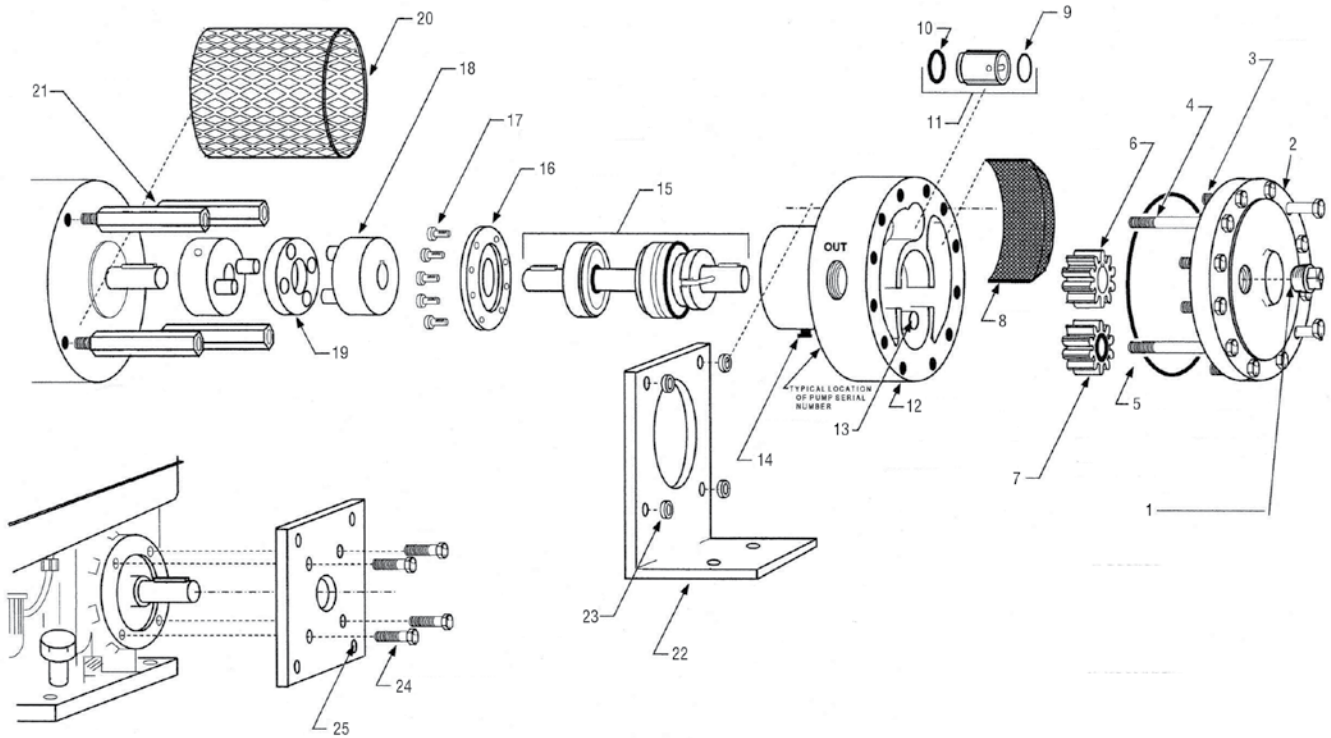

REF. NO.	PART NUMBER	DESCRIPTION	QTY
1	12 PLUG	3/4" NPT square head steel pipe plug for EG-1*	1
	34 PLUG	3/4" NPT square head steel pipe plug for EC-H*	1
2	E-2	Gear end cover	1
3	3/8-16Tx1-1/2L	Short GR.5 cap screws for gear and cover	8
4	3/8-16Tx3-1/2L	Long GR.5 cap screws for mounting to spacers	4
5	6230-28	O-ring for gear end cover	1
6	EG-5	Drive gear for EG-1	1
	EC-5H	Drive gear for EC-H	1
7	EG-6	Idler Gear w/ E-10 brushing for EG-1	1
	EC-6H	Idler Gear w/ E-10 brushing for EC-H	1
8	EC-21	Strainer screen	1
9	568-118	Top O-ring	1
10	6227-17	Bottom o-ring	1
11	E-20ASSY	Bypass valve cartridge (includes o-rings)	1
12	E-1	Main housing for EG-1	1
	E-1H	Main housing for EC-H	1
13	E-9	Idler Gear Shaft	1
14	105CUP	Leak detection port with bleeder cup	1

REF. NO.	PART NUMBER	DESCRIPTION	QTY
15	E-100	Shaft Seal Assembly for EG-1	1
	E100[H]	Shaft Seal Assembly for EC-H	1
16	E-15	Bearing Retainer Plate	1
17	10-32Tx1/2L	Fillister Head Screws for Bearing Retainer Plate	8
18	VC-20	Complete Drive Coupling (electric motor use) EG-1**	1
	VC-30	Complete Drive Coupling (electric motor use) EC-H**	1
19	FD-20	Coupling Insert for EG-1	1
	FD-30	Coupling Insert for EC-H	1
20	CG-E	Optional-Coupling Guard Screen	1
21	E-3	Mounting Spacers with Studs	4
22	E-52	Optional - Foot Mounting Bracket	1
23	R3-21	Spacers for Optional Foot Mount Bracket	4
24	5/16-24Tx1L	Gr.5 Cap Screws for Mounting Spacers (see 21)	4
25	---	Threaded Holes for E-3 Mounting Spacers (see 21)	4
26	E-51	Engine Adapter Plate	1



Scan QR for
Smith Pumps training videos

Small Capacity Stationary – GC and MC Series Parts Detail

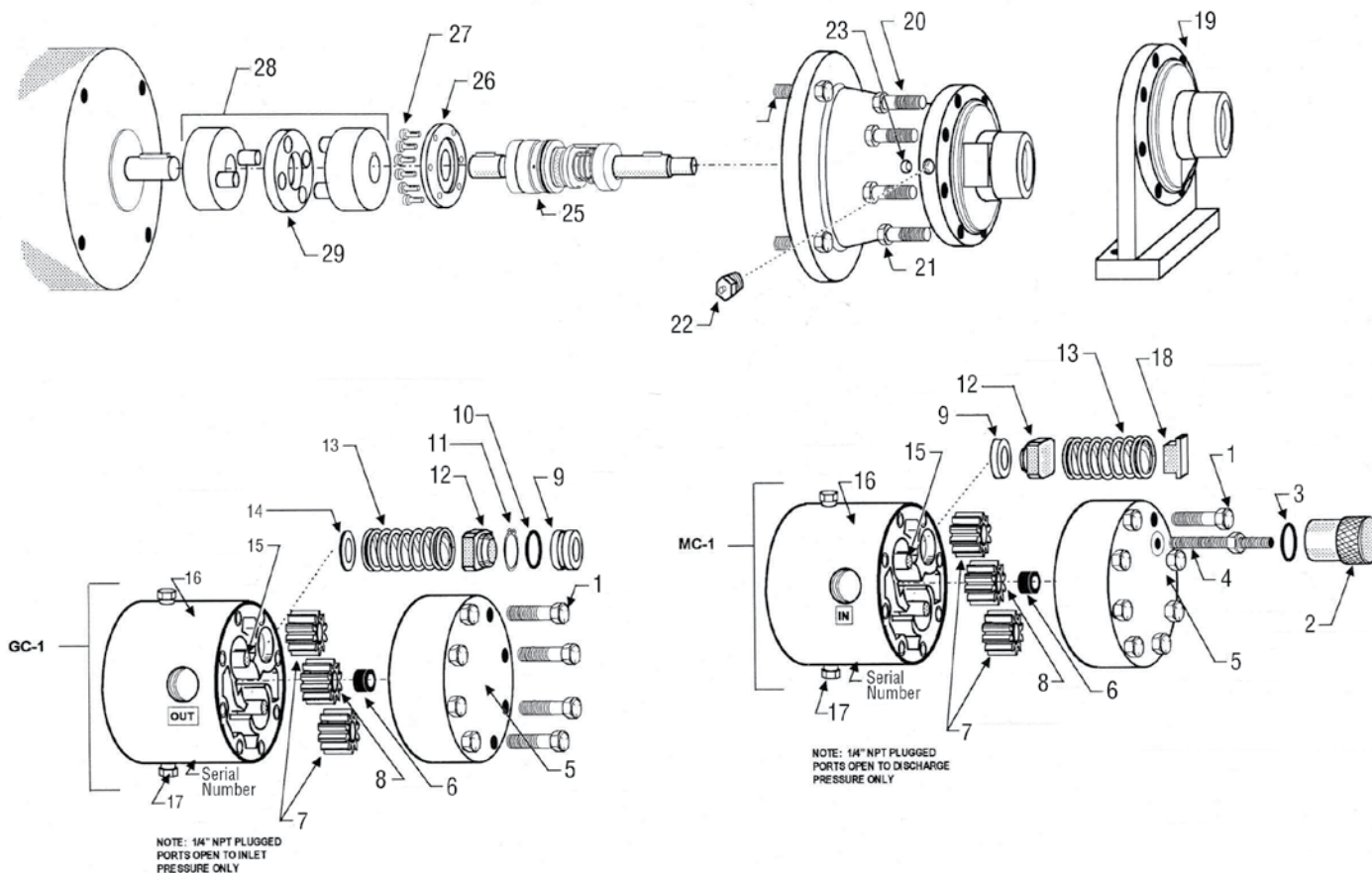

REF. NO.	PART NUMBER	DESCRIPTION	QTY	REF. NO.	PART NUMBER	DESCRIPTION	QTY
1	3/8-16Tx1-3/4L	Cap screws for gear end cover	8	17	14PLUG	1/4" Pipe plugs	2
2	649-30	Valve cap	1	18	649-40	Bypass valve spring retainer	1
3	6227-12	O-ring	1	19	649-3D**	Foot mount shaft end cover (optional)	1
4	649-42	Valve adjusting screw with nut	1	20	649-3C	Flanged shaft end cover mounts directly to fractional hp, NEMA C-face motor	1
5	649-42	Gear end cover for MC-1	11	21	3/8-16Tx1-1/4L	Cap screws	8
	649-2G	Gear end cover for GC-1		22	FITTING1827**	Optional leak detect port bleed fitting	1
6	649-11	Main shaft bushing for cover	1	23	649-15	Bearing retainer plate	1
7	649-6	Idler gears with bushing	2	24	3/8-16Tx1-1L	Cap screws for motor mounting	4
8	649-5	Drive gear	1	25	MC1-100	Shaft-seal assembly for GC-1 and MC-1	1
9	649-29S	Bypass valve seat, MC-1	1	26	649-15	Bearing retainer plate	1
	649-29	Bypass valve seat, GC-1		27	10-32Tx1/2L	Fillister head screws for bearing retainer plate	6
10	6227-14	O-ring for valve seat	1	28	VC-20	Complete drive coupling, 5/8" x 5/8"	1
11	5008-100	Lock ring	1	29	FD-20	Coupling insert	1
12	649-41	Bypass valve	1		FD-20T**	---	-
13	649-31	Bypass valve spring	1				
14	649-29A**	Bypass valve spring spacer (optional)	1				
15	649-9	Idler gear shafts	2				
16	649-1	Main Housing	1				

**Parts or model types for special or heavy duty applications



Scan QR for Smith Pumps training videos

Order by phone: 800-922-0724



Small Capacity Stationary – D Series Parts Detail

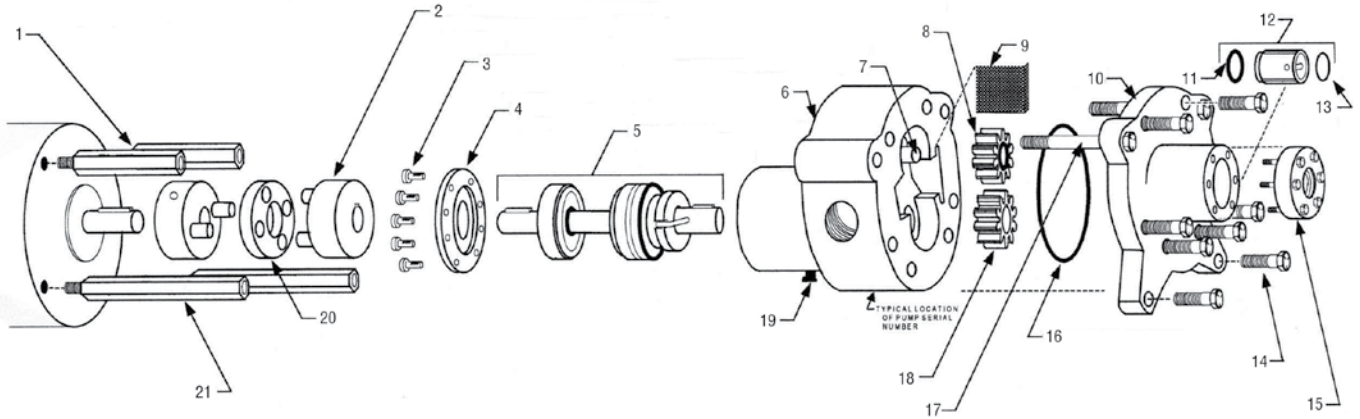

REF. NO.	PART NUMBER	DESCRIPTION	QTY	REF. NO.	PART NUMBER	DESCRIPTION	QTY
1	D-3S	Mounting Spacers (Short) with studs	2	12	E-20ASSY	Bypass valve cartridge (includes o-rings)	1
2	VC-20	Complete drive coupling (electric motor use)	1	13	568-118	Top o-ring	1
3	10-32Tx1/2L	Fillister head screws for bearing retainer plate	8	14	3/8-16Tx1-1/4L	Short GR.5 cap screws	8
				15	D-3	Bypass flange with 1/2" NPT outlet	1
4	E-15	Bearing retainer plate	1	16	6230-14	O-ring for gear end cover	1
5	E-100Z	Shaft - Seal assembly for DW-1Z	1	17	3/8-16Tx3-1/4L	Long GR.5 cap screws for mounting to spacers	2
	E-100HZ	Shaft - Seal assembly for DW-HZ					
6	D-1	Main Housing for DW-1Z	1	18	EG-5	Drive gear for DW-1Z	1
	D-1H	Main Housing for DW-HZ			EC-5H	Drive gear for DW-HZ	1
7	E-9	Idler Gear Shaft	1	19	105CUP	Leak detection port with bleeder cup	1
8	EG-6	Idler Gear w/ E-10 brushing for DW-1Z	1	20	FD-20	Coupling insert	1
	EC-6H	Idler Gear w/ E-10 brushing for DW-HZ		21	D-3L	Mounting spacers (long) with studs for DW-1Z	2
9	D-21	Strainer screen	1		D-3LH	Mounting spacers (long) with studs for DW-HZ	2
10	D-2	Gear end cover	1				
11	6227-17	Bottom o-ring	1				



Scan QR for
Smith Pumps training videos

Medium Capacity Stationary – Small Bulk Plant Installations

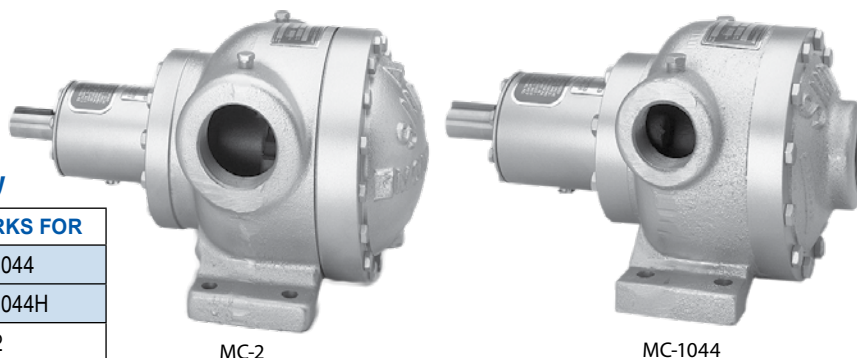

Scan QR for Smith Pumps training videos

Shaft Seal Assembly

PART NO.	WORKS FOR
MC-101	MC-1044
	MC-1044H
MC-102	MC-2

Parts

MODEL	DESCRIPTION	AVERAGE DELIVERY RATE, 1800 RPM		MAX. DIFFERENTIAL PRESSURE	INLET/OUTLET SIZE	MOTOR	PUMP ROTATION
		40 PSID	75 PSID				
MC-1044	Pump	17 GPM	14 GPM	125 psi	1½" FNPT	1½ HP to 40 psid, 2 HP over 75 psid	Reversible
MC-1044H	Pump	30 GPM	25 GPM	125 psi	1½" FNPT	2 HP to 40 psid, 3 HP over 75 psid	Reversible
MC-2	Pump	42 GPM	35 GPM	125 psi	2½" FNPT	3 HP to 40 psid, 5 HP over 75 psid	Reversible

Large Capacity Stationary – Heavy Duty

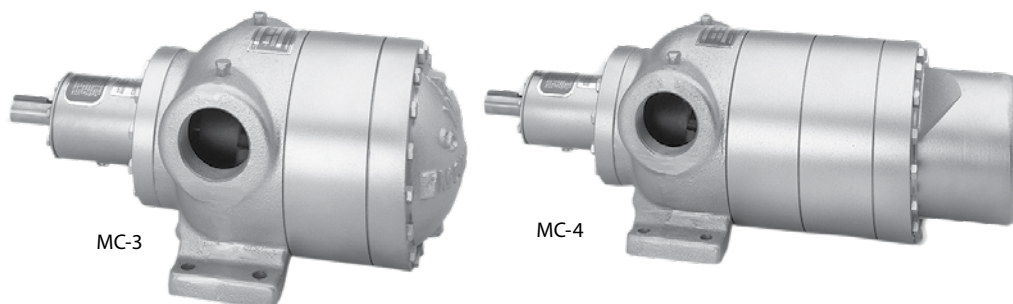

Scan QR for Smith Pumps training videos

Shaft Seal Assembly

PART NO.	WORKS FOR
MC-103	MC-3
MC-104	MC-4
MC-105	MC-5

Parts

MODEL	DESCRIPTION	AVERAGE DELIVERY RATE, 1800 RPM		MAX. DIFFERENTIAL PRESSURE	INLET/OUTLET SIZE	MOTOR	PUMP ROTATION
		40 PSID	75 PSID				
MC-3	Pump	84 GPM	70 GPM	125 psi	2 1/2" FNPT	5 HP TO 40 PSID, 7 1/2 HP OVER 75 PSID	Reversible
MC-4	Pump	125 GPM	105 GPM	125 psi	4" FNPT inlet, 2 1/2" FNTP Outlet	7 1/2 HP TO 40 PSID, 10 HP OVER 75 PSID	CCW
MC-5	Pump	167 GPM	142 GPM	125 psi	4" FNPT inlet, 2 1/2" FNTP Outlet	10 HP TO 40 PSID, 15 HP OVER 75 PSID	CCW



Blackmer Pumps and Kits

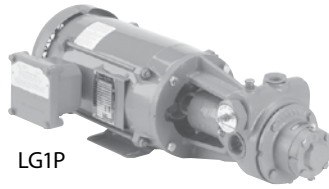

LGI1P



TLGF3

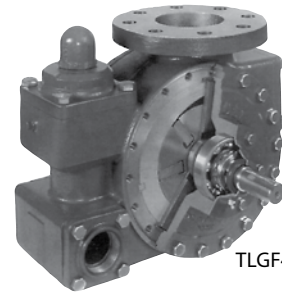

TLGF4A

Cylinder and Motor Fueling Pump

PART NUMBER	CAPACITY GPM PROPANE	INLET / OUTLET	MOTOR HP	MOTOR MOUNTING
LGF1	8	1"	1	C-Face
LGF1P	13	1"	1 1/2	C-Face
LGRLF1.25	16	1 1/4"	1 1/2	C-Face
LGLF1.25	21	1 1/4"	1 1/2	C-Face
LGL1.25	21	1 1/4"	1 1/2	Foot
LGL1.5	33	1 1/2"	3	Foot

Maintenance Kits

PART NUMBER	FOR PUMP
898994	LGF1E and PE - 4 Vane
898994	LGF1E and PE - 6 Vane
898917	LGRLF-1 1/4 - 4 Vane
898918	LGL-1 1/4 - 4 Vane
898919	LGL-1 1/2 - 4 Vane
898976	LGRLF-LGL 1 1/4 and LGL 1's - 8 Vane
898979	LGLD2E
898981	LGLD3E
898922	LGLD4
898980	TLGLF3C
898922	TLGLF4A
899224	TLGF4B

Stationary Pumps

PART NUMBER	CAPACITY GPM PROPANE	INLET / OUTLET	MOTOR HP	MOTOR MOUNTING
LGLD2E	67	2" NPT	2" NPT	5
LGLD3E	133	3" NPT	3" NPT	10
LGLD4	270	4" Flange	3" Flange	20

Truck Pumps

PART NUMBER	CAPACITY GPM PROPANE	INLET / OUTLET	MOTOR HP	MOTOR MOUNTING
TLGLF3	93	3" Flange	2" NPT	2" NPT
TLGLF4	280	4" Flange	2" NPT	Dual 2" NPT

Rebuild Kits

PART NUMBER	FOR PUMP
899076	LGRLF-1 1/4 - 4 Vane
899077	LGL-1 1/4 - 4 Vane
899078	LGL-1 1/2 - 4 Vane
899076	LGRLF- 1/4 - 8 Vane
899077	LGL-1 1/4 - 8 Vane
899078	LGL-1 1/2 - 8 Vane
899079	LGLD2E
889081	LGLD3E
899080	TLGLF3C
899022	TLGLF4A and LGLD-4
899124	TLGLF4B

Blackmer Bypass Valves



PART NO.	SIZE	PUMP SIZE	PRESSURE SETTING	ADJUST. RANGE	CAP.
BV-3/4	3/4"	1 1/4" - 1 1/2"	95 psi	70-100 psi	50 GPM
BV-1	1"	1 1/4" - 1 1/2"	95 psi	70-100 psi	50 GPM
BV-1 1/4	1 1/4"	1 1/2" - 2"	95 psi	70-100 psi	125 GPM
BV-1 1/2	1 1/2"	2" - 3"	95 psi	70-100 psi	125 GPM
BV-2-95	3"-4"	3" - 4"	95 psi	90-125 psi	225 GPM

We have everything you need to update your plant.
Call us for assistance!

Swing Check Valves

Swing check valves are used on compressor installations, multiple pump systems and on pumping systems with long discharge lines. Rated 1000 PSI at -20 degrees to 150 degrees F ASTM B-61



PART NO.	SIZE
B-375-3/4	3/4" FPT
B-375-1	1" FPT
B-375-1-1/4	1 1/4" FPT
B-375-1-1/2	1 1/2" FPT
B-375-2	2" FPT

Strainers

Protects your pump and meter from foreign material. Ductile iron body with stainless steel 40 mesh screen. Replacement screens and other mesh sizes are available.

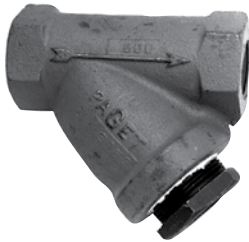

PART NUMBER	SIZE
N260-02	1/4" FPT
N260-04	1/2" FPT
N260-06	3/4" FPT
N260-08	1" FPT
N260-10	1 1/4" FPT
N260-12	1 1/2" FPT
N260-16	2" FPT
N260-16F	2" FLANGE
N260-24	3" FPT
N260-24F	3" FLANGE
N260-32F	4" FLANGE

Scrubbers

Remove heavy ends from propane vapor. Bottom drain. Top inlet and outlet.



PART NO.	DESCRIPTION	BTU
1 SCRUB	Scrubber 1" M.NPT	4,250,000
2 SCRUB	Scrubber 2" M.NPT	14,460,000
3 SCRUB	Scrubber 3" Flange	91,000,000

Rego Sight Flow with Back Check

The sight flow indicators on this page with the exception of the Taylor, function as a back check valve as well as a flow indicator. Only RegO lets you actually see the product flowing to provide maximum pump efficiency.



PART NO.	INLET/OUTLET
A7794	2" FNPT
A7796	3" FNPT

REPLACEMENT PARTS	
PART NO.	INLET/OUTLET
A7794-8	Indicator Assembly, 2"
A7794-9SS	SS Pin, 2"
A7794-10	O-ring, 2"
A7794-11	2" Replacement Glass (2 required)
A7794-12K	2" Gasket (2 required)
A7794-13	2" Retainer Ring (2 required)
A7795-14	Retainer Ring Set Screw 2" and 3"
A7795-8	Indicator Assembly, 3"
A7795-9SS	SS Pin, 3"
A7795-10	O-ring, 3"
A7795-11	3" Replacement Glass
A7795-12K	3" Gasket

Flexible Connectors

Stainless steel braid with schedule 80 nipples for liquid propane. Protects piping from vibration and thermal expansion. Should not be used to correct misaligned piping greater than 3/4" offset. 350 PSI or greater working pressure.



Other sizes available

PART NO.	SIZE	LENGTH
FLX1/2-12	1/2" MPT	12"
FLX3/4-12	3/4" MPT	12"
FLX1-12	1" MPT	12"
FLX1-1/4-12	1 1/4" MPT	12"
FLX1-1/4-18	1 1/4" MPT	18"
FLX1-1/2-12	1 1/2" MPT	12"
FLX1-1/2-18	1 1/2" MPT	18"
FLX2-18	2" MPT	18"
FLX2-18-HD**	2" MP	18"
FLX3-22*	3" MPT	22"
FLX2-18F	2" Flanged	18"
FLX3-18F*	3" Flanged	18"
FLX3-24-F*	3" Flanged	24"
FLX4-24F*	4: Flanged	24"

* Double braided
Available with weld and flange ends and in different lengths.
** Heavy Duty

If you don't see what you're looking for, call us. Our friendly Team Tarantin staff members are standing by to help you.

Breakaway Stanchion Bulk Truck and Transport

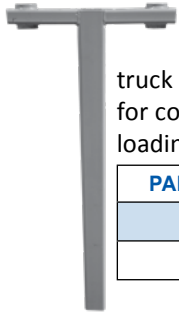

Our B-STAN provides two 2" outlet breakaway protection for standard bulk truck loading. The B-STAN-D has three 2" outlets for combination transport unloading and bobtail loading using a common vapor connection.

PART NUMBER	DESCRIPTION
B-STAN	4" x 4" x 6' Stanchion w/ 2 outlet
B-STAN-D	4" x 4" x 6' Stanchion w/ 3 outlet

3-Way Dump Valve for ESV Systems



This 3-way valve can be used for remote shutdown on pneumatic ESV systems. The 3 openings provide for supply pressure in, line out to ESV or internal valves and exhaust. Can be piped as "Push to Close" or "Pull to Close."

Part Number: 3331

Nitrogen Regulator



Economical, compact single stage design provides efficient and dependable control of inert, nitrogen gas for pneumatic systems controlling internal and ESV systems. Solid brass construction. CGA 580 connects to our Nitro Tank.

Part Number: RHP400

Pull-Away Valves for Transfer Operations

Designed to provide pull-way protection for LP-gas and anhydrous ammonia transfer operations including transport and delivery truck loading and unloading, engine fuel container filling and miscellaneous cylinder filling operations.



PART NO.	INLET OUTLET CONN.	DISCONNECT FORCE (APPROX-LBS)	RECONNECT FORCE (APPROX-LBS)	MOUNTING CONN
A2141A6	3/4" F.NPT	130	80	Bracket
A2141A6L	3/4" F.NPT	130	80	Lanyard
A2141A8	1" F.NPT	75	50	Bracket
A2141A8L	1" F.NPT	75	50	Lanyard
A2141A10	1 1/4" F.NPT	160	25	Lanyard
A2141A16	2" F.NPT	300	50	Lanyard

Storage Tank Thermometers

These storage tank thermometers feature a 3" diameter dial with calibration of -40 degrees to 160 degrees F. Sealed dial chamber is dust and waterproof.



MSCP-SSBT-3-4

75TH2R045CC (Thermowell)

PART NUMBER	STEM LENGTH	CONTAINER CONNECTION
MSCP-SSBT-3-4	4"	1/2" MNPT
MSCP-SSBT-3-6	6"	1/2" MNPT
75TH2R045CC	4 1/2"	3/4"



Corken Compressors

Compressors are extremely versatile as they can be used to transfer liquids between tanks, off-load liquids, recover residual vapor and evacuate vapors for cylinder maintenance. Many propane tanks such as railcars and buried tanks have top unloading connections. A compressor can be the perfect solution for transferring liquids to and from such tanks.

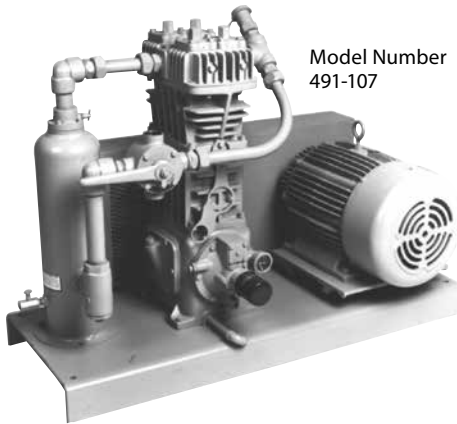

Model Number
491-107

Add 107 to the model number to include the following: complete gas compressor bulk plant unit with pressure gauges, steel base plate, liquid trap, 4-way valve, strainer, interconnecting piping, adjustable driver slide base, V-belt drive and enclosed belt guard – ready to receive an electric motor driver. Relief valve not included. Corken suggests a 250 PSI relief.

Mechanical Specifications

SPECIFICATIONS	MODEL SIZE			
	91	291	491	691
Number of Stages	1	1	1	1
Number of Cylinders	1	2	2	2
Bore of Cylinder, Inches (cm)	3 (76.2)	3 (76.2)	4 (101.6)	4 1/2 (114.3)
Stroke, inches (cm)	2 1/2 (63.5)	2 1/2 (63.5)	3 (76.2)	4 (101.6)
Min at 400 RPM	4 (113)	8 (227)	17 (481)	29 (821)
Max at 825 RPM	8 (227)	16 (453)	36 (1020)	60 (1699)
Max Discharge Pres. PSIG (bars)	335 (23.1)	335 (23.1)	335 (23.1)	335 (23.1)
Continuous Duty	5	5	5	5
Intermittent Duty	7	7	7	7
Maximum Allowable Driver Size, HP	7 1/2	15	15	30
Maximum Flow - Propane GPM (m3/hr)*	50 (11.4)	101 (22.9)	215 (48.8)	361 (82.0)

* Maximum flow is based on 825 RPM or maximum HP, 30 PSID. Capacities are based on 100°F and will vary depending on piping and conditions.
Use 5w30 or 10w30 Non-detergent motor oil.

Corken LPG Compressor Repair Kits

KIT NUMBER	3549-X1	3550-X1	3551-X1	3552-X1	3552-X2
FOR MODEL NUMBER	91J3	291	491	690K&P	691M
Suction Valve Assembly	3483-1X	3483-1X	2532-1X	3948-X	3948-X
Discharge Valve Assembly	3485-X	3485-X	2439-X	3857-X	3857-X
Connection Rod Bearing	1367	1367	1491	1719	3542
Packing Sets	1452-1X1	1452-1X1	1452-1X1	1725-2X	1725-2X
Piston Rings	1772	1772	1773	1739	1739
Ring Expander	1775	1775	1776	1740	1740
Gasket Set	2526-XA	1281-XA	1481-X6A	1744-X1A	1744-X3A

Corken 4-Way Valves

PART NUMBER	DESCRIPTION	USED WITH
3989-X	1" four way valve	Repair Kit 3122-X
3990-X	1 1/4" four way valve	Repair Kit 3123-X
4059-X	2" four way valve	Repair Kit 3130-X

COMPRESSORS & METERS

*Krug makes evacuating tanks in the field a snap...
saves wear and tear on your bobtails too!*

Krug Portable Compressor

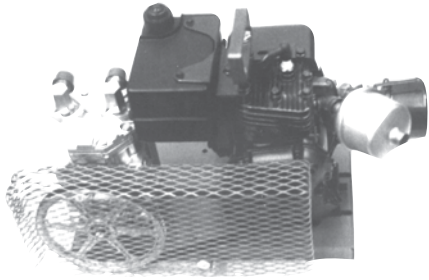

Tank Evacuation Vapor Compressor

Save your expensive truck pump from damage when evacuating tanks in the field at an 8 to 15 GPM flow rate. Uses include on-site upgrading or downgrading size of storage in the field, and emptying cylinders or tanks in need of repair. This compressor transfers liquid by increasing vapor pressure in the tank being emptied and decreasing it in the tank being filled. The liquid can be moved into a bulk truck or another bulk tank.

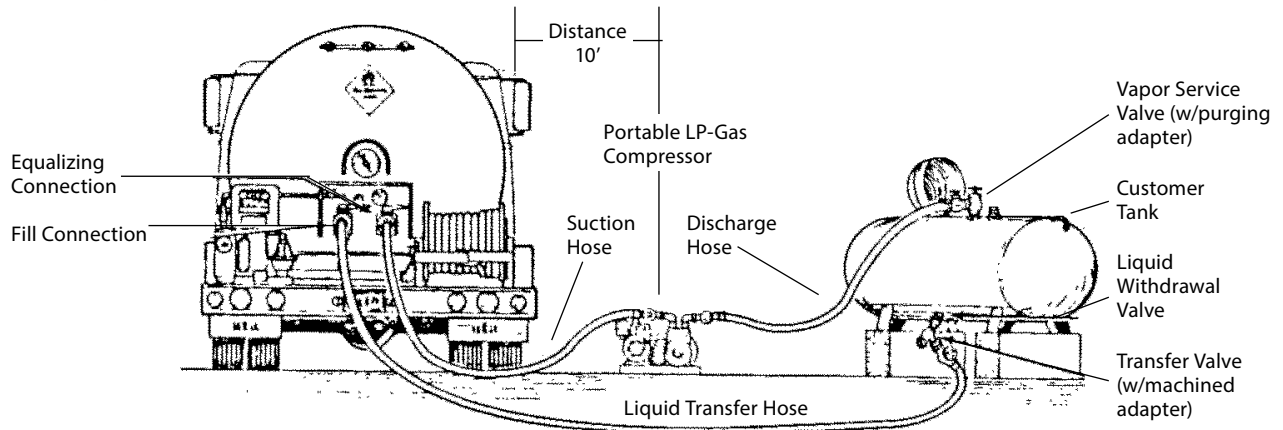

Using a Portable LP-Gas Compressor

Use 30w or 40w Non-detergent motor oil.

PART NO.	FUEL	INLET/OUTLET
H50LPH	Propane	1/2" NPT
*K-GAS	Gasoline	1/2" NPT
*K-EPM	1 HP Explosion Proof Electric Motor	1/2" NPT

* Complete unit-type indicated

Replacement Parts

PART NO.	COMPONENTS
16771	Compressor Only
PK-C	Valve/Hose Kit (see chart for components)
3x927	Pulley 8" Compressor
6K041-9	Electric Motor 1 HP
029-9888	Key Way for Compressor Pulley
4L390	Replacement Belt
35411	Shroud

Accessories

PART NO.	COMPONENTS
SG100-C	Pump out adapter wit Sight Glass
5776	1 3/4" M.ACME x 3/4" F.ACME Reducing adapter



SG100-C
Pump Out Adapter with Sight Glass

PK-C Includes:

PART NUMBER	QTY	DESCRIPTION
SG100-C	1	Pump Out Adapter w/ 1" Sight Glass
LPH-1/2X18P	2	18ft. 1/2" hoses w/ends LPH-1/2" X 18P
LPH-3/4X40P	1	40ft. 3/4" hose w/ends LPH-3/4" X 40P
3171A	1	1 1/4" F.ACME X 1/2" MPT
7572C-14A	1	Check Lok Adapter 3/4" MNPT X 3/4" FNPT
3175	2	1 3/4" F.ACME x 3/4" MPT
3175B	1	1 3/4" F.ACME X 1/2" MPT
75900-10	1	Check Lok Adapter (Union Style) 1 5/8" UNF X 3/4" FNPT
3127U	1	Hydrostatic Relief Valve 450 PSI 1/4" MPT
7550P	1	Transfer Valve 3/4"
5765D	1	1 3/4" M.ACME x 3/4" MPT
600120	1	Coupling SCH 80 3/4"
A7705P	1	Globe Valve 3/4" FPT
A7704P	2	Globe Valve 1/2" FPT



Purge-It-Vac Adapter



- No labor
- No wasted propane

The purge-it-vac allows you to insert methanol and your first fill of propane without disconnecting the adapter. The purge-it vac adapter is easy to use and meets NPGA #133-899a) on the purging of LP-Gas containers.

Part Number: Purge-It-Vac

Krug Hand Pump



Simple piston hand pump for uses in filling portable and motor fuel cylinders. Six gallon capacity at 40 strokes per minute. Can also be used to pump methanol into systems. No electricity required.

PART NUMBER	INLET	OUTLET
K-HP	1"FNPT	3/4" FNPT
K-HPRK	PUMP REPAIR KIT	-

Purge-It-Safe Cylinder Purge System



Part Number:
PURGE-IT-SAFE

Mounts with ease and makes purging of propane cylinders fast and easy! Utilizes vapor as per Pamphlet 58. 3-way valve system includes:

- RegO 3-way valve--A7853A
- Regulator with gauge--597FA
- 4' vent pipe
- Hose 12' with POL fill (2)

Purge Kit LP

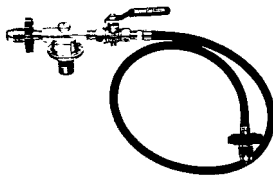

Mounts with ease and makes purging of propane cylinders fast and easy! 3-Way Valve utilizes vapor as per Pamphlet 58.

Part Number: PurgeKitLP

Pump Station Hose



Completely assembled and ready to use! Dispenser hose 1/2" x 18' with RegO Snap Acting Valve and POL Fill Adapter.

Part Number: PS-Hose

Ventur-Evac and Hose Kit



Developed and tested to provide safe, efficient and reliable use, the Ventur-Evac is the answer to the age old problem of propane tank evacuation.

Part Number: VENTUR-EVAC



Works with the Ventur-Evac.

Kit Includes

(1 each): 3121, 3127U, 3175B, 7550P
7590U-10, LPH-1/2X50P, LPH-3/4X50P, M498-4/2

(2 each): 3171A, 3175, 5765D,
600115, 600120, 80-104-01

Part Number: VENTUR-EVAC HOSE KIT



Liquid Meters

Designed for retail sales dispensing units, the Liqua-Tech Model LPM-102 offers the widest flow range (3-18gpm) available in a meter this size and contains all required accessories including vapor eliminator, strainer and differential valve. ATC available.



LPM-102 Flowmeter

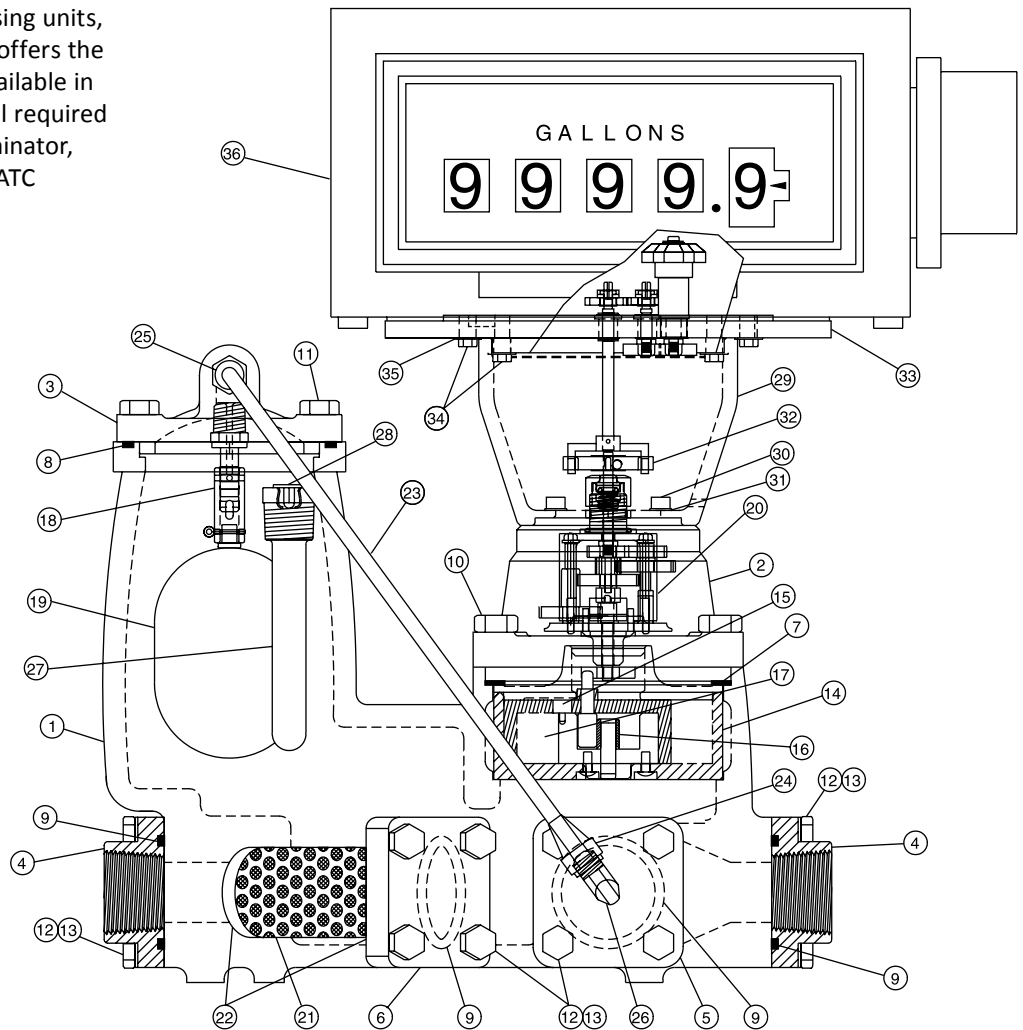

PART NUMBER	DESCRIPTION
090534-100	LPM-102 1" Meter

INDEX NO.	DESCRIPTION	PART NO.	INDEX NO.	DESCRIPTION	PART NO.	INDEX NO.	DESCRIPTION	PART NO.
	LPM-102 w/rest register (w/o temp comp) complete	L090028-101	12	Bolt, Hex Head, 5/16 NC x 1	L100063-26	26	900 Elbow, 1/8 NPT x 1/4 Tube	L087195-000
			13	Lockwasher, split 5/16	L100121-010	27	Thermowell	L086666-702
1	Main case housing	L400027-00	14	Measuring chamber	L042075-101	28	Cover, thermowell	L083732-000
2	Cover, main case	L087173-710	15	Seal pin	L042792-000	29	Register adapter tower	L886150-000
3	Cover, vapor eliminator	L087193-710	16	Roller, control	L042086-010	30	Sockethead screws, 10-32 x 3/8	L088524-010
4	Flanges, inlet/outlet	L087180-710	17	Diaphragm	L042791-000	31	Lock washers, split #10	L041211-000
5	Flange, differential valve	L087179-710	18	Vapor return valve	L087190-000	32	Star Drive, with set screw	L082976-001
6	Flange, strainer	L400025-001	19	Float	L087189-001	33	VRA-101-Register gear plate adapter (w/o Temp. comp)	L886101-001
7	Gasket, main case	L004861-016	20	Gear Train, 43.5 ratio, US Gal	L080905-017	34	Cap screws, 1/4-28 x 5/8	
8	O-ring, vapor eliminator flange	L100139-012	21	Stainer 80 Mesh	L101738-001		Drilled	L100061-101
9	O-ring, inlet/outlet flange	L100139-007	22	O-ring, strainer endcaps	L100139-006		Undrilled	L100061-100
10	Bolt, Hex Head 7/16 x 1-1/4		23	Tube assembly, vapor release	L087196-001	35	Lock washers, ext 1/4	L100123-100
	Drilled	L040237-005	24	Nut, flared	L087198-000	36	Register complete, Veeder Root (non printing)	Model # 788700-002
	Undrilled	L040237-004	25	Male connector, 1/8 NPT x 1/4 Tube	L084826-100			
11	Bolt, Hex Head , 3/8 NC x 1	L100067-027						



Krug makes evacuating tanks in the field a snap... Saves wear and tear on your bobtails too!

MA7 and MA15 Meters

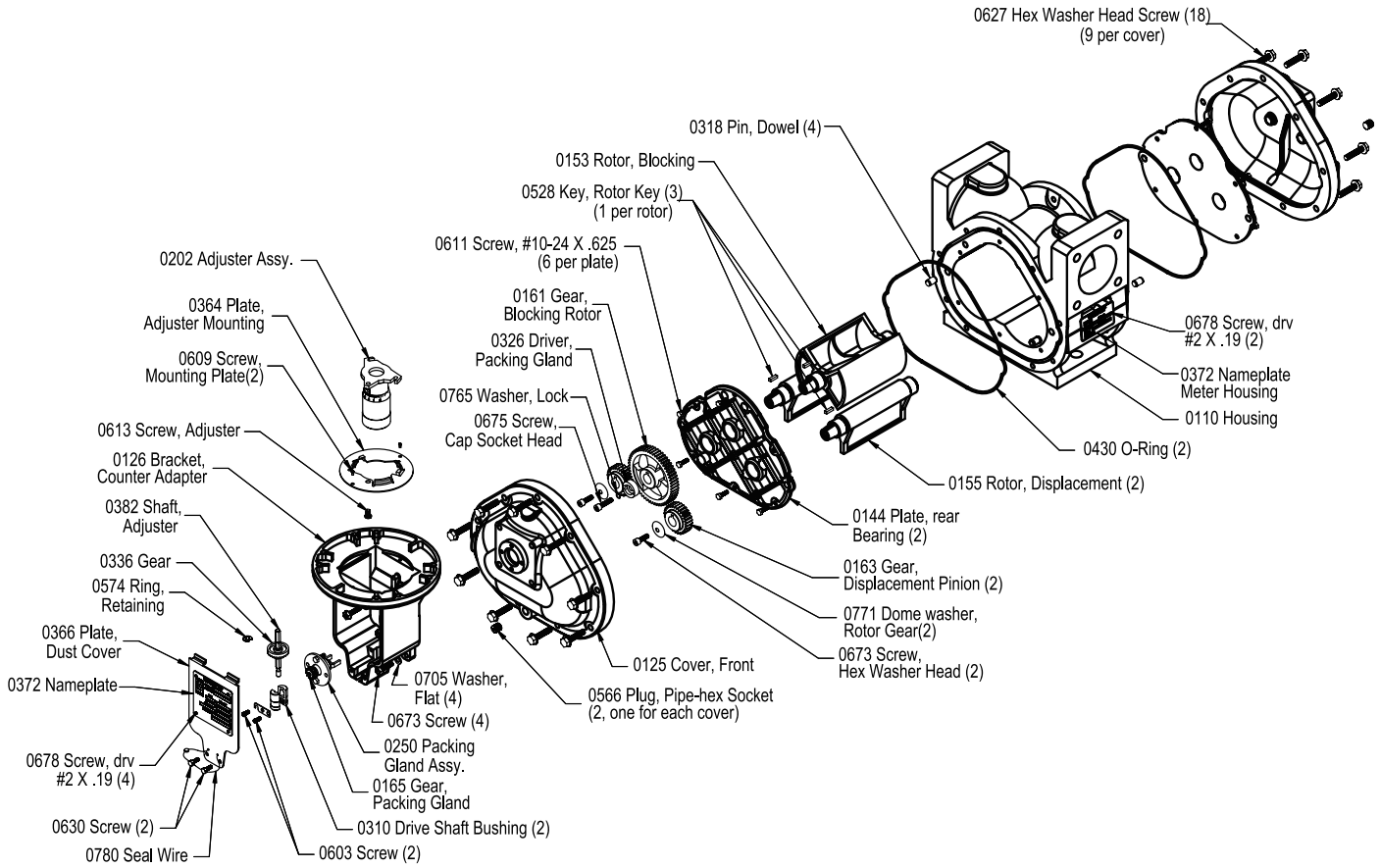

ITEM #	DESCRIPTION	MA7	MA15	ITEM #	DESCRIPTION	MA7	MA15
0110	Housing	49445	501154	0364	Adjuster Mounting Plate	-	42660
0123	Cover	48301	501033	0382	Adjuster Drive Shaft	48287	48287
0125	Rear Cover	48302	501034	0430	O-Ring	09258	09200
0144	Bearing Plate	47668	46732	0528	Key for Blocking and Displacement Rotors	48332	501030
0153	Blocking Rotor	48306	501026	0566	Pipe Plug	06790	06790
0155	Displacement Rotor	48366	501028	0574	Retaining Ring	02188	02188
0161	Gear	47633	47419	0609	Screw	-	00362
0163	Gear	47646	47422	0611	Screw	09079	09079
0202	Adjuster Assembly	49403	49403	0627	Screw	09080	09080
0250	Packing Gland	49561	48616	0630	Screw	09093	09093
0310	Adjuster Drive Bushing	41786	41786	0673	Screw	09027	09084
0326	Driver Packing Gland	48756	48756	0771	Washer	48348	48348
0366	Plate Assembly	49390	49390				

A8302 Optical Vapor Eliminator

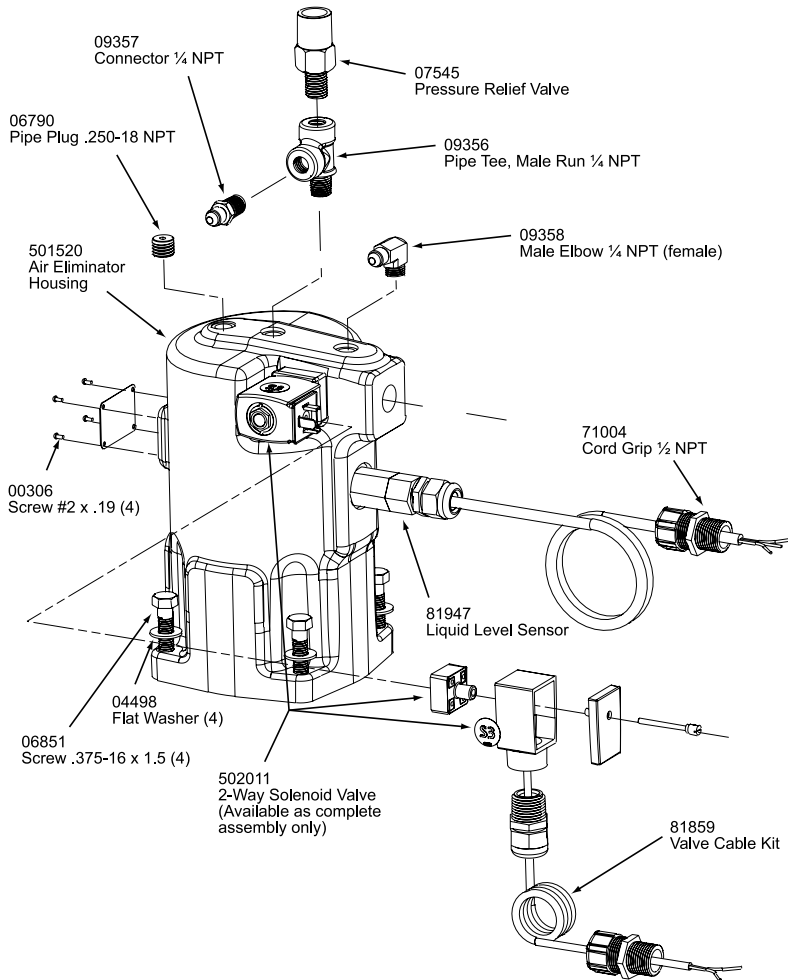

ITEM #	DESCRIPTION
00306	Screw #2 x .19
04498	Flat Washer
06790	Pipe Plug .250-18 NPT
06851	Screw .375-16 x 1/5
07545	Pressure Relief Valve
09356	Pipe Tee, Male Run 1/4 NPT
09357	Connector 1/4 NPT
09358	Male Elbow 1/4 NPT (female)
501520	Air Eliminator Housing
502011	2 Way Solenoid Valve
71004	Cord Grip 1/2 NPT
81859	Valve Cable Kit
81947	Liquid Level Sensor

A8340A Mechanical Vapor Eliminator

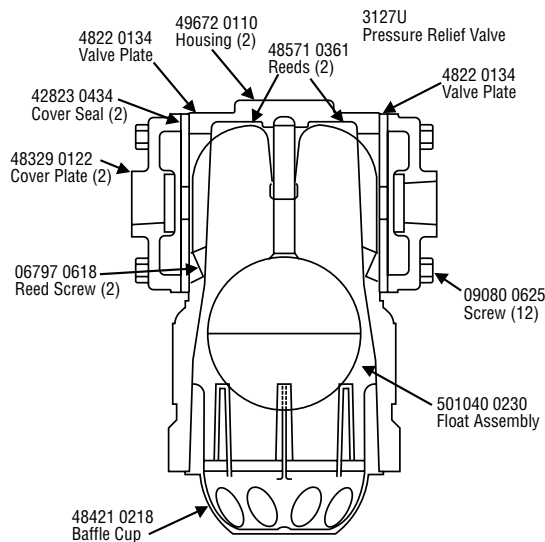

ITEM #	PART	DESCRIPTION
0110	49672	Housing
0361	48571	Reeds
0565	3127U	Pressure Relief Valve
0134	42822	Valve Plate - Standard Vent
0625	09080	Cover Screw
0230	501040	Float and Reed Assembly
0218	48421	Baffle Cup
0618	06797	Reed Screw
0122	48329	Cover Plate
0434	42823	Cover Seal
0136	42824	Valve Plate - Limited Bleed

FA-7 Strainer

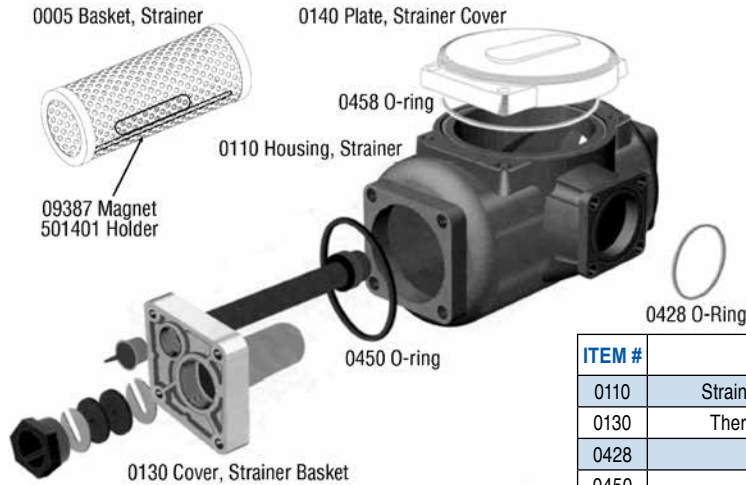

ITEM #	DESCRIPTION	A2343A	A3340A	A3366A
0110	Strainer Housing (Anodized Aluminum)	49425	49426	49426
0130	Thermowell Assembly (Strainer End)	45420	42987	49423
0428	O-Ring	06854	04474	04474
0450	O-Ring	09338	06798	09201
0458	O-Ring (Strainer Cover Plate)	09335	09335	09335
0140	Strainer Cover Plate (Aluminum)	48861	48299	-
0005	Basket Strainer, 40 Mesh SS	-	-	A3430
0005	Basket Strainer, 80 Mesh SS	A2431	A3431	A3431
0005	Basket Strainer, 100 Mesh SS	A2432	A3432	A3432

A2843 - Differential Valve

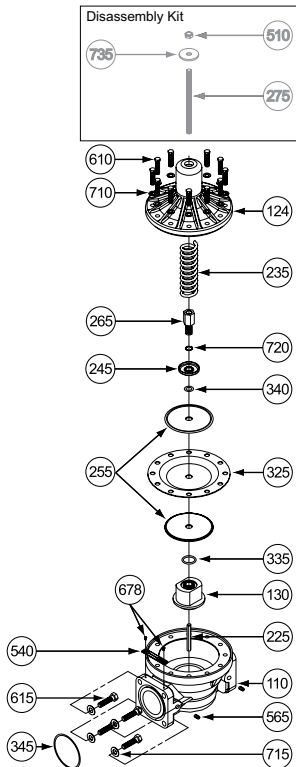

ITEM #	PART #	DESCRIPTION
110	47096	Valve Housing Assembly
124	47302	Valve Cover
130	49947	Piston
235	47305	Spring
245	47307	Spring Retainer
255	47308	Back-up Plate
265	47309	Stand-Off
275	47098	Rod Assembly
325	502078	Diaphragm
335	6856	O-Ring
340	7900	O-Ring
345	7838	O-Ring
510	6055	Nut
565	4759	Plug
610	4655	Screw
615	6851	Screw
678	00306S	Screw
710	9360	Flat Washer
715	4498	Flat Washer
720	6070	Lock Washer
735	6663	Flat Washer

A2885 - Check Valve

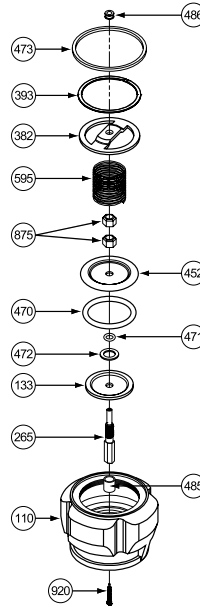

ITEM	DESCRIPTION	PART #
486	Bearing	-
473	O-Ring	06854
393	Spiral Retaining Ring	09137
382	Valve Spring Holder	48337
595	Compression Spring	09138
875	Self Locking Nut (2)	09143
452	O-Ring Retainer	47974
470	O-Ring	09131
471	O-Ring	09140
472	Spacer	47295
133	Piston	47975
265	Valve Stem	-
485	Bushing	07867
110	Check Valve Housing	47973
920	Valve Core	-

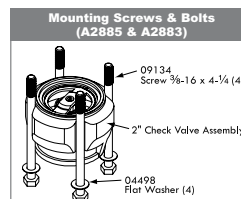

Liqua-Tech Replacement Parts for Neptune

PARTS DESCRIPTION	1"	1 1/4"	1 1/2"	2"
Measuring chamber complete	042075-101	043260-101	083271-101	045806-101
Gear train assembly	080905-017	083501-000	084981-000	083502-000
Strainer	087185-000	101433-704	101433-704	101462-004
Vapor release-lower valve housing complete w/float	087188-001	086797-001	086797-001	086798-001
Vapor release main valve complete	-	089274-006	089274-006	089274-006
Vapor check valve	-	084828-000	084828-000	084828-000
Float bulb only	-	082476-001	082476-001	082476-001
Inlet check valve complete	-	084983-704	084983-704	084813-702
U-cup seal	100025-002	100025-002	100025-002	100025-002
Temperature compensator	101080-005	086600-201	-	086702-301
Differential valve stem assembly	100028-011	083768-002	083768-002	083927-002
Reset knob kit improvement 600 reg	101035-005	-	-	-
Improvement kit 600 reg	101035-001	-	-	-
Register mounting studs	084435-000	084435-000	084435-000	084435-000
Thermometer well	086666-702	086666-702	086666-702	086666-702
Thermostat	086646-000	086646-000	086646-000	086646-000
Lower drive bracket comp. 200T gear	084913-000	084913-002	084913-002	084913-002
Lever arm assembly and mounting plate	086649-002	086649-002	086649-002	086649-002
Cover, lever arm mounting plate	086665-000	086665-000	086665-000	086665-000

Neptune - Veeder Root Conversion Adapters

PART NUMBER	DESCRIPTION
886100-002	1" Neptune
886101-001	1" Liqua-Tech
886105-001	3/4"-1" ATC Neptune & Liqua-Tech



Meter Registers

Veeder Root Registers



788700-002

Neptune Registers



600 SERIES



789002-002



800 SERIES

PART NUMBER	DESCRIPTION
788700-002	Veeder Root Register Only
789002-002*	V.R. Register Printer-Face Up Ticket - Right Hand**
100498-009	3/4" Neptune 631 (Code AEAAD)
100498-016	1" Neptune 631 (Code AAAAD)
880030-000	1 1/4-2" Neptune 833 (Code O)

* Factory rebuilt register available. Core return required.

** Left hand register available - special order.
Part Number: 789022-701

Non-locking insulated unions in the Pipe and Fittings Section.

Vapor Meters



Domestic and Commercial Meters

American Meter has a full line of vapor meters. Domestic and commercial meters are compact, lightweight, rugged die-cast aluminum alloy construction. Meters are temperature compensated for accurate measurement.

We carry a complete line of new and reconditioned vapor meters from 3/4" to 4" size. All meters are fully guaranteed for two years from date of installation.

Vapor Meters

PART NUMBER	METER CONNECTION	CONNECTION POSITION	WORKING PRESSURE	MAX INDEX READING	SCFH PROPANE	BTUS PROPANE	CFM AT 60°/11"WC	BTUS AT 60°/11"WC	CFM AT 60°/10 PSI	BTUS AT 60°/10 PSI
AM250	3/4" FNPT	SIDE	5#	Direct Read/CF	160	404,300	-	-	-	-
AC250	1" M. Connector	TOP	5#	Direct Read/CF	160	404,300	-	-	-	-
425HP	1 1/4" M. Connector	TOP	24#	Direct Read/CF	270	694,000	-	-	-	-
425	1 1/4" M. Connector	TOP	10#	Direct Read/CF	260	652,500	-	-	-	-
3000	2" OR 3" FNPT	SIDE	100#	Direct Read/CF	-	-	1860	4,650,000	2370	5,925,000
5000	3" OR 4" FNPT	SIDE	100#	Direct Read/CF	-	-	3100	7,750,000	3950	9,875,000

SPECIAL SIZES AND LARGER COMMERCIAL AND INDUSTRIAL VAPOR METERS AVAILABLE UPON REQUEST

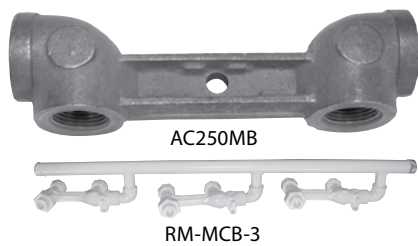

Meter Bars

PART NO.	DESCRIPTION
AC250MB	1" Meter Bar for AC250 Meters
RM-MCB-2	2 Meter Setup
RM-MCB-3	3 Meter Setup
20LT	Connectors 1"
30LT	Connectors 1" 1/4

Breakaway Lock

Hidden breakaway feature allows fire department or emergency response personnel access to valves, plant gates, etc. Lock shackle breaks away when struck with hammer or chisel. Part Number: 500BRK



Meter Bracket Kit

QTY	DESCRIPTION
1	Bracket UB55L
2	Nut 1/4" - 20 UNC, HH
1	U-Bolt LF, 1/4" - 20 UNC, 1 7/8" x 2 1/2"

Flathead Locking Service Valve 25 PSIG Bronze

Most often used with vapor meters but should be used on all installations to provide a convenient method to shut off and lock service line.



PART NUMBER	SIZE
10621-1/2	1/2"
10621-3/4	3/4"
10621-1	1"
10621-1-1/4	1 1/4"
10621-1-1/2	1 1/2"
10621-2	2"

Flathead Locking Service Valve 100 PSIG Black Iron

Includes insulated union. Needed any time metallic piping goes underground and enters a building.



PART NUMBER	SIZE
6266B-3/4	3/4"
6266B-1	1"

Barrel Lock and Key



Secures locking valves in closed position. Prevent unauthorized turn-ons when houses or apartments are vacated or when credit is a problem.

PART NUMBER	DESCRIPTION
93180800-X	Barrel Lock
93480800	Key for Barrel Lock

Meter Brackets

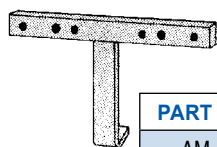

For American and Invensys vapor meters. Secures vapor meter to house or post.

PART NO.	SIZE
AM-B	American

Regulator Assembly LV4403B66RA REG, 6266B-3/4 Valve 2-4" Nipples

Save time and money with our assembled angle regulator manifold. Perfect for vapor meter installations.

PART NUMBER	SIZE
RP-750	3/4"
RP-750-NB	3/4"



Assembled Pump Station Cabinet

Now available fully assembled and ready to go!

Components

- Cabinet
- Tank Stands
- Corken Pump C12 with Switch
- Bypass Valve
- Liqua-Tech Meter
- Scale
- Piping Kit

Part Number: D2A-KIT-ALUM

Piping Kit includes:

- Internal Valve 1 1/4"
- Hydrostatic Relief Valve
- Angle Valve 3/4"
- Excess Flow Valve 3/4"
- Pullaway Valve 3/4"
- Y Strainer
- Flex Connector
- Forged Steel Fittings
- Schedule 80 Nipples

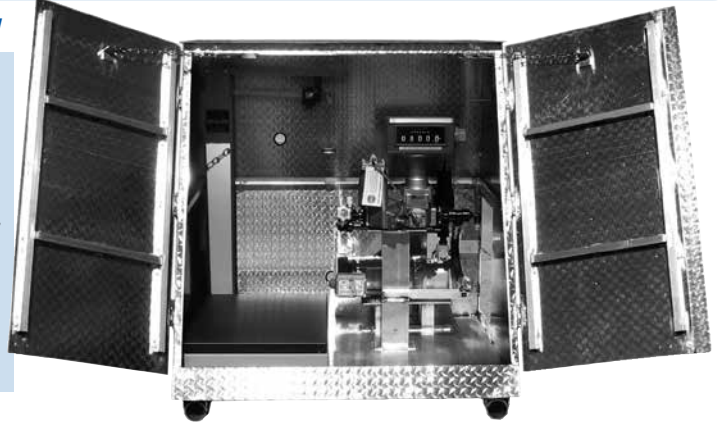

Pump Station Cabinet

Protect your pump, meter and scale with this dispensing cabinet.

Dimensions:

Height 45" • Width 45" • Depth 44"

Part Number: D-2-A ALUM

Cabinet Piping Kit

Includes all valves, hoses, strainer, flex line, fittings and nipples but not the major components.*

Part Number: TTC-K

*TTC-K does not include cabinet, stands, pump with switch and bypass, meter or scale.

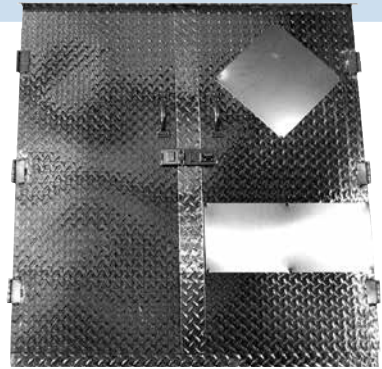

Dispensing Cabinets

Protect your pump and meter!

Dimensions:

Height 56 1/2" • Width 34 1/2" • Depth 16 1/2"

Cabinet only

Part Number: D-1-ALUM

Assembled Compact Pump Station Cabinet Components

- Cabinet
- Tank Stands
- Corken Pump C12 with Switch
- Bypass Valve
- Liqua-Tech Meter
- Piping Kit includes Internal Valve 1/14"

Part Number: D1-KIT-ALUM (not pictured) **Special Order**

Custom Cabinets available for other applications.



Need a Pump Station Quote?

Go to our website & click
"Pump Station Quote" in
the navigation

or

use the QR code to the
right and get your quote
today.





Basic Cylinder Filling Valve and Nipple Kit for Corken C-9, C-10 and C-12 Pumps

For installation under tank as pictured on the previous page. Kits are also available for forklift cylinder and motor fueling.

Corken Pump Options

Note: Customer supplies 2" pipe for tank stands, Type K Copper and Schedule 80 Black Iron Pipe as needed to suit application.

PART NUMBER	DESCRIPTION
PK-BK	Basic Valve & Nipple Kit
LCMK-01	Meter Piping Kit

PK-BK Basic Valve and Nipple Kit

LEGEND:

① = To be used on suction side of pump ② = To be used on discharge side of pump ③ = To be used on Pump Bypass system

QTY	PART NUMBER	DESCRIPTION
1	A3210A065	1 1/4" Internal Valve ①
15'	1/8-C	1/8" Galvanized Cable ①
4	1/8-CC	1/8" Cable Clamps ①
1	N260-10	1 1/4" Y Strainer ①
1	600520	3/4" Forged Steel Plug for Strainer ①
1	FLX1-1/4-12	1 1/4" SS Flex Line ①
1	603235	1 1/2" x 1 1/4" Forged Steel Bushing ①*
2	611029	1 1/4" Forged Steel 90° Ell ①
2	612235	1 1/4" x 3" Sch. 80 Nipple ①
2	612265	1 1/4" x 6" Sch. 80 Nipple ①
1	660130	1 1/4" Forged Steel Union ①
1	611160	1/4" Forged Steel 90° Street Ell ②
1	B25-G	1/4" x 1/4" Pressure Gauge Snubber ②
1	GS-400	400 PSI Pressure Gauge ②
2	3127U	1/4" Hydrostatic Relief Valve ②
1	611171	3/4" Forged Steel Tee ②
2	603125	3/4" x 1/4" Forged Steel Bushing ②
1	3272G	3/4" Excess Flow, 20 GPM ②
2	612105	3/4" x 2" Sch. 80 Nipple ②
3'	LPH-3/4"LT	3/4" x 3' Hose with Ends ②
1	A2141A6L	3/4" Breakaway ②
2	603145	3/4" x 1/2" Forged Steel Bushing ②③
18'	LPH-1/2"	1/2" x 18' Dispensing Hose with Ends ②
1	7901TB	1/2" x 1/4" Quick Acting Valve ②
1	7193D-10	POL x 1/4" POL Filler Coupling ②
1	7193T-10	QCC Type 1 x F.POL Filling Adapter ②
1	7550PX	3/4" Angle Valve with Excess Flow ③
1	49IK	5/8" Flare x 3/4" M.NPT Brass Adapter ③
1	45IIF	5/8" x 5/8" x 1/2" M.NPT Tee ③
4	NS4I	5/8" Forged Flare Nuts ③
1	BG20I	5/8" Flare x M. POL Adapter ③
1	620030	1" x 3/4" Sch. 80 Swage Nipple ③
1	600115	1/2" Forged Steel Coupling ③

* Omit for C-9 and C-10 Pump Installations

Tank Stands

PART NUMBER	DESCRIPTION
TS	Tank Stand Pair W/Meter Plate
TS-1	Tank Stand Pair No Meter Plate
TS-HD	Tank Stand Pair Heavy Duty 1800-1990
TPMP	Pump Plate
TST-1	Step

OPTIONAL Meter Piping Kit LCMK-01

For installation on tank stand plate

QTY	PART NUMBER	DESCRIPTION
1	A7506AP	3/4" Angle Valve
1	80-103-01	1/2" Ball Valve
1	3171A	1 1/4" Acme x 1/2" M.NPT Vapor Adapter
2	NS4E	3/8" Forged Flare
1	48EF	3/8" Flare x 1/2" M.NPT Adapter
1	48EC	3/8" Flare x 1/4" M.NPT Adapter
1	611014	1/2" Forged Steel 90° Ell
1	611019	3/4" Forged Steel 90° Ell
1	612050	1/2" x 2" Sch. 80 Nipple
2	612115	3/4" x 3" Sch. 80 Nipple
1	660120	3/4" Forged Steel Union

Basic Cylinder Filling Valve and Nipple Kit for Corken C-9, C-10 and C-12 Pumps (cont.)

Valving Kit PK-01

PART NUMBER	DESCRIPTION	QTY
A8017DP	Valve Liquid	1
N260-08	Strainer 1" F.NPT	1
FLX1-12	Flex Conn 1x12" SS	1
3272G	Excess Flow 3/4" MPT x FPT	1
LPH-1/2X10P	1/2" x 10' Hose w/crimped ends	1
7901TB	Quick Act Valve 1/2" x 1/4"	1
7193D-10	POL Fill Adapter	1
7550PX	Angle Trans Valve 3/4" w/excess flow	1
3127U	Hydrostatic Relief Valve	1
H124	Relief Valve 1/4" NPT	1
B25-G	Snubber 1/4" x 1/4"	1
GS-400	Gauge 0-400 1/4"	1
603170	1" x 3/4" Bushing	1
611160	1/4" F.S. 90° Street Ell	1

Pipe and Nipple Kit PF-01

PART NUMBER	DESCRIPTION	QTY
611024	Elbow SCH 80 1"	1
611081	Elbow 45 SCH 80 1"	1
612185	Nipple SCH 80 1" x 3"	1
660125	Union SCH 80 1"	1
612215	Nipple SCH 80 1" x 6"	1
603170	Bush Hex 80 1" x 3/4"	1
612115	Nipple SCH 80 3/4" x 3"	1
600609	Reduce Coup SCH 80 3/4" x 1/2"	1
48IF	Connector, 5/8" Flare x 1/2" M.NPT	1
NS4I	5/8" Flare Nut	1
48IK	Conn 5/8" Flare x 3/4" M.NPT	1
612170	Nipple SCH 80 1" Close	1

Hose Kit PF-01B

PART NUMBER	DESCRIPTION	QTY
LPH-3/4" LT	3/4" x 3' Hose w/ends	1
603145	Hex Bush SCH 80 3/4"x1/2"	1
611171	Tee SCH 80 3/4"	1
3127U	Hydrostatic Relief Valve	1
603125	Hex Bush 3/4" x 1/4"	1
612115	3/4" x 3" Nipple sch80	1

Meter Kit - NMK-01

PART NUMBER	DESCRIPTION	QTY
611170	Tee SCH 80 1/2"	1
612050	Nipple, SCH 80 1/2" x 2"	1
600515	Plug Hex SCH 80 1/2"	1
660120	Union SCH 80 3/4"	1
612115	Nipple SCH 80 3/4" x 3"	3
611019	Elbow SCH 80 3/4"	2
3171A	ACME Coupling 1 1/4" F.ACME x 1/2"	1
49EC	Elbow, 3/8" Flare x 1/4" M.NPT	1
48EF	Connector, 3/8" Flare x 1/2" M.NPT	1
102-103	Ball Valve 1/2"	1
612105	Nipple SCH 80 3/4" x 2"	1
NS4E	3/8" Flare Nut	2

Breakaway Kit PK-01A

PART NUMBER	DESCRIPTION	QTY
A2141A6	Pullaway Valve 3/4"	1
A214A6L	Pullaway Valve 3/4" with Lanyard	1



Tank Stands and Step

PART NUMBER	DESCRIPTION
TS	Tank Stand Pair w/Meter Plate
TS-1	Tank Stand Pair w/o Meter Plate
TS-HD	Tank Stand Pair Heavy Duty 1800-1990
TPMP	Pump Plate
TST-1	Step
HDP Plate	Dump plate to fit high differential pump
SUBSPP1	Tank Step 12" x 12" w/ 16" Riser

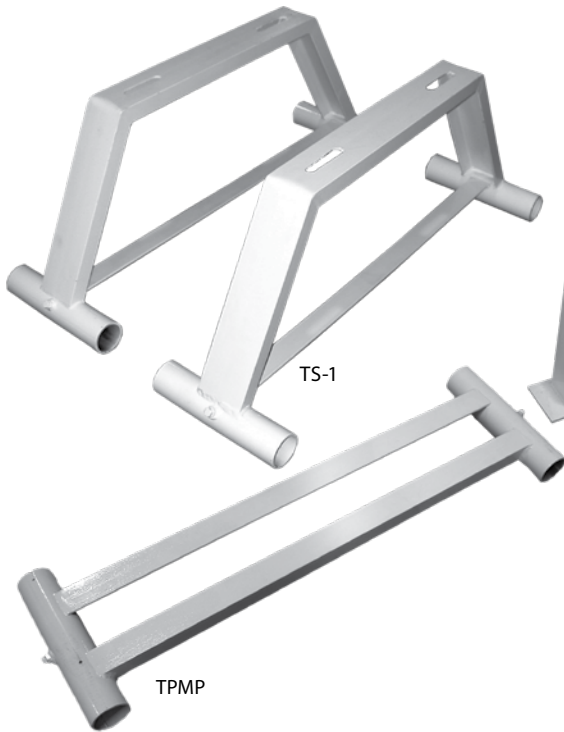
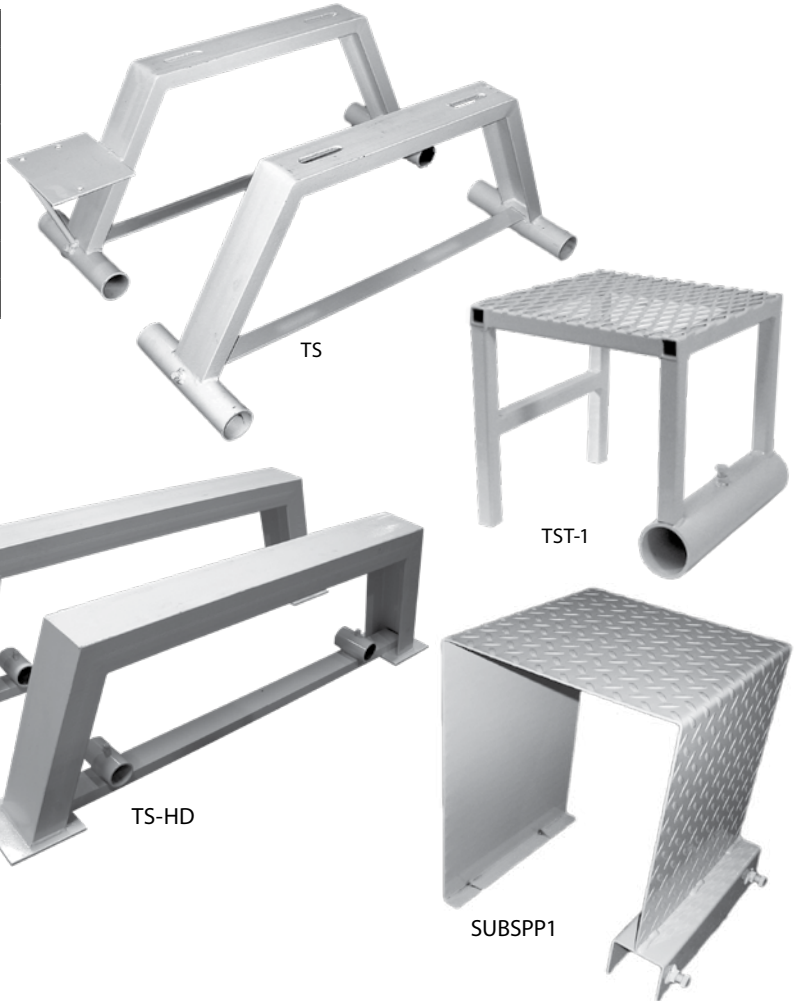

TPMP

TS-1

TS-HD

TS

TST-1

SUBSPP1

Detecto Portable Platform Scales

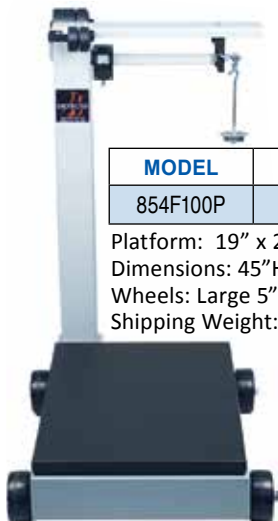

MODEL	CAPACITY	FRONT OF BEAM
854F100P	1000 lb	100 lb x .5 lb

Platform: 19" x 28"
 Dimensions: 45"H x 24"W x 35"D
 Wheels: Large 5" dia. Heavy duty rubolene wheels
 Shipping Weight: 132 lb.

Pump Station Hose

Completely assembled and ready to use! Dispenser hose 1/2" x 18 foot with RegO Snap Valve and POL Fill Adapter.

Part Number: PS-Hose



Cylinder Fill Accessories and Adapters



Threaded

Marshall Excelsior QCC Type 1 Regulator Adapter

PART NO.	DESCRIPTION	CAPACITY BTU/HR. PROPANE
G-1851-A02	Type 1 QCC x 1/4 MPT Black	0-70,000
G-1851-A03	Type 1 QCC x 1/4 MPT Green	71,000-200,000
G-1851-A04	Type 1 QCC x 1/4 MPT Red	201,000-400,000



QCC Type 1 Purge Fitting

Allows quick purging of QCC Type I Connection

Part Number: G-1850



Fill Adapter for Gas Mate II & Quick Disconnect Valve

Part Number: F276329



Gas Grill "Quick Connect"

1/4" Male Pipe x Male Plug

Part Number: F276328



QCC Dust Cap

Dust cap with lanyard for all QCC valves.

Part Number: DC-QCC1



POL Plug

Red plug cylinder valve with warning tag.

Part Number: 737-5

Gas Grill "Quick Connect Kit"

(POL x Connection, 1/4" x Plug) Eliminates wrenches; fits on all refillable propane cylinders. Provides plug in/plug out use of appliances such as torches, heaters, cookers, etc.

Part Number: F276330

Stationary Tank Inverter



- Capable of handling up to 420 lb cylinder
- 6 position
- Non-marring pads
- Safety-chain
- 4000# hydraulic jack
- 10,000# Strap
- Twin 100# adapter
- Factory assembled & tested

Part Number: DOT-INV.

RegO Hose End Connectors for DOT Cylinder Filling



PART NO.	USE	CONNECTION		MATERIALS
		INLET	OUTLET	
7193D-10	DOT Cylinders with POL Connections	1/4" M.NPT	M. POL (CGA 510)	Brass and Stainless Steel
7193U-10	DOT Cylinders with POL Connections	1/4" M.NPT	Type I Conn (1 5/16" F. ACME)	Brass
7193L-10A	DOT Fork Lift Cylinders	1/4" M.NPT	1 1/4" F.ACME	Brass

RegO Adapter for DOT Cylinder Filling

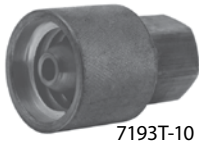

PART NO.	APPLICATION	CONNECTION		MATERIALS
		INLET	OUTLET	
7193T-10	Converts 7193D-10 Adapter from POL to a Type 1 Connection	F. POL CGA 510	Type 1 Conn (1 5/16" F. ACME)	Brass

RegO Quick-acting Valves for Cylinder Filling Hoses



Provides fast, convenient shut-off and fast opening.

PART NO.	CONNECTION		BODY MATERIAL	FLOW AT 1 PSIG (CV) PRESSURE DROP*
	INLET	OUTLET		
7901TB	1/2" F.NPT	1/4" F.NPT	Brass	1.95 GPM

* To obtain approximate flow at other than 1 PSIG pressure drop, multiply flow in table by square root of pressure drop. Example: 7901TB @ 9 PSIG = 1.95 x √9 = 5.85 GPM/propane. For NH3 flow, multiple propane flow by .90.



Adapts POL filler coupling to motor fuel tanks or multivalves.

PART NO.	DESCRIPTION
MSCP-901H	F POL x 1-3/4" F.ACME adapter

Call our Tech Service Department for installation guides or training.

Direct Fired LP-Gas Vaporizer, 40/40H & 80/40H



Algas Repair Parts

DESCRIPTION	PART NO.		
	40/40H	80/40H	120/60H
Master Spare Parts Kit (includes *kits below)	Pre 10/02 451-504-01	Pre 10/02 452-504-01	-
	Post 10/02 81111	Post 10/02 81112	-
*Thermocouple & Pilot Kit	3-0014	3-0013	41041
*Liquid Inlet Valve Kit	3-0016	3-0016	3-0016
*Capacity Control Valve Kit	3-0017	3-0017	3-0017
*Thermostat	41073	41073	41073
Pilot Assembly Pre '02	-	3-0644	-
Pilot Assembly Post '02	42008	41021	41021
Burner Tips Pre '02	40C14-6	40C14-6	-
Burner Tips Post '02	33581-10	33581-10	33581-10
Burner Regulators	34800	34800	34800



Algas Second Sun Flameless Catalytic Tank Heater



PART #	HEAT INPUT	ADDED VAPORIZATION
SS-30	30,000 BTU/h	2.2MMBTU/h @ -20° F
SS-10	10,000 BTU/h	0.5MMPTU/h @ -20° F

Torex Vertical Explosion Proof Electrical Vaporizer



MODEL NO.	VAPORIZATION	CAPACITY	LIQUID INLET	VAPOR OUTLET	DEPTH	WIDTH	HEIGHT	WEIGHT
TX25	12.5 Gallon/Hr.	1.14 M BTU/Hr.	3/4" FNPT	1" FNPT	11 1/4"	9 1/8"	41"	50 lbs
TX50	25 Gallon/Hr.	2.28 M BTU/Hr.	3/4" FNPT	1" FNPT	11 1/4"	9 1/8"	41"	65 lbs
TX100	50 Gallon/Hr.	4.55 M BTU/Hr.	3/4" FNPT	1" FNPT	11 1/4"	9 1/8"	41"	70 lbs
TX160	80 Gallon/Hr.	7.28 M BTU/Hr.	3/4" FNPT	1" FNPT	11 1/4"	9 1/8"	41"	110 lbs
TX240	120 Gallon/Hr.	10.93 M BTU/Hr.	3/4" FNPT	1" FNPT	11 1/4"	9 1/8"	41"	140 lbs
TX320	160 Gallon/Hr.	14.57 M BTU/Hr.	3/4" FNPT	1" FNPT	11 1/4"	9 1/8"	41"	160 lbs

Accessories

PART NO.	DESCRIPTION
41051	Economy Operation Valve (up to 160 GPH)
36923	Valve & Strainer Package
20437	Stand to Raise Unit 12'
5010-3003	Drain Valve Kit
64004	Balancing Orifice
43877	Pipeaway Adapter
41067	Remote Start/Stop Box

VAPORIZERS

Aquavaire Vertical Waterbath Vaporizers



PART NO.	VAPORIZATION GALLON/HR.	CAPACITY BTU/HR.	LIQUID INLET	VAPOR OUTLET	ELECTRICAL DATA			DIMENSIONS			WEIGHT (LBS.)
					PHASE	VOLTAGE	AMPS	D	W	H	
Q320V	320	29,120,000	3/4" FNPT	2" FNPT	1	120	8.9	69"	27"	70"	1,150
Q480V	480	43,680,000	3/4" FNPT	2" FNPT	1	120	8.9	72"	27"	79"	1,350
Q640V	640	58,240,000	3/4" FNPT	2" FNPT	1	120	10.4	74"	39"	75"	2,100
Q800V	800	72,800,000	1" FNPT	2" FNPT	1/3	120/240	9.1/4.8	74"	39"	88"	2,300
Q1120V	1,120	101,580,000	1" FNPT	2" FNPT	1/3	120/240	14.5/8.3	92"	55"	83"	7,100

Algas Filtaire



PART NO.	CAPACITY @ 20 PSIG	SIZE
F0.5	20 GPH	-
F4-ASME	102 GPH	1 1/2"
20540-ASME	230 GPH	2"
F8	405 GPH	3" 300 # Flange

Scrubbers

PART NO.	DESCRIPTION	BTU
1 SCRUB	Scrubber 1" M.NPT	4,250,000
2 SCRUB	Scrubber 2" M.NPT	14,460,000
3 SCRUB	Scrubber 3" Flange	91,000,000



Zimmer Electric Vaporizer

Zimmer Vaporizer

PART NO.	DESCRIPTION
Z40P-V1-R3	20 GPH Electric Vaporizer

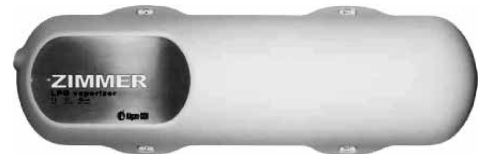

Accessories

PART NO.	DESCRIPTION
X1584MN	High Temperature 1/2" Regulator
80887	Tank Mounting Kit
80888	Tank Mounting Valve & Regulator Kit
80885	Wall Mount kit
80892	Strainer & Piping Kit for Wall Mount

Ransome Waterbath Vaporizers



PART NO.	W/ELECTRIC RELIGHT	CAPACITY GPH @ O.F.	CAPACITY BTU/HR.	DEPTH	WIDTH	HEIGHT	LIQUID INLET	VAPOR OUTLET	WEIGHT (LBS.)
RW100	-	100	9,170,000	20.5"	14"	48.5"	3/4"	1"	450
RW180	-	180	16,500,000	20.5"	14"	67.5"	3/4"	1"	750
-	RW360-E	360	33,010,000	21.5"	28"	69"	1"	2"	1390
-	RW540E	540	49,510,000	21.5"	42"	69"	1"	2"	1950
RW720	-	720	66,020,000	21.5"	56"	69"	1"	2"	2510

Washers and O-Rings

Washers – Actual Size

PART NUMBER	SIZE	USE
MSW-4	1-1/4" ACME	Fork Lift Connector
MSW-3	1-1/4" ACME	Filler Valve, Vapor Valve & Adapter Connections
MSW-2	1-3/4" ACME	Filler Valve, Vapor Valve & Adapter Connections
MSW-5	2-1/4" ACME	Filler Valve, Vapor Valve & Adapter Connections
MSW-6	3-1/4" ACME	Filler Valve, Vapor Valve & Adapter Connections

O-Rings – Actual Size

PART NUMBER	SIZE	USE
G-1653-3	POL	Soft Nose POL
2114A	1-1/4" ACME	For 7141M Connector
2-223A	2-1/4" ACME	Filler Valve, Vapor Valve & Adapter Connections
2-231	3-1/4" ACME	Filler Valve, Vapor Valve & Adapter Connections
2-238A	4-1/4" ACME	Filler Valve, Vapor Valve & Adapter Connections

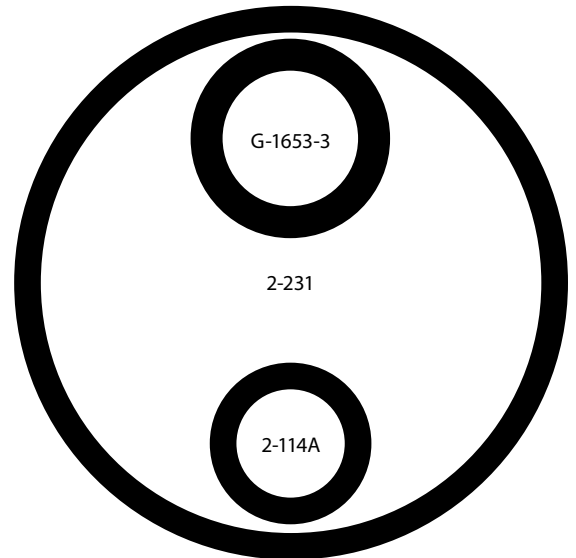
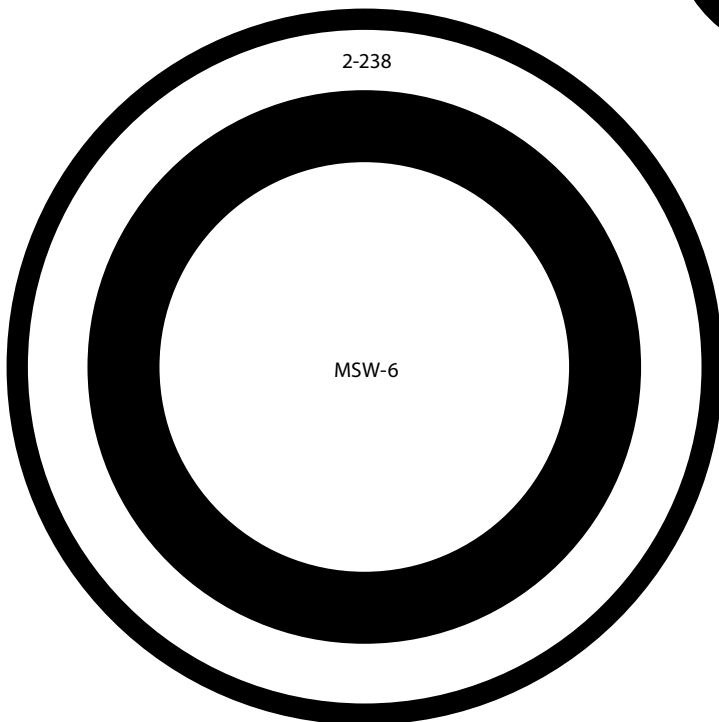
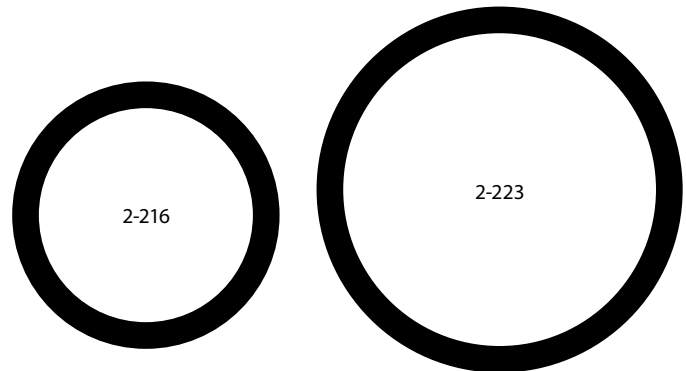
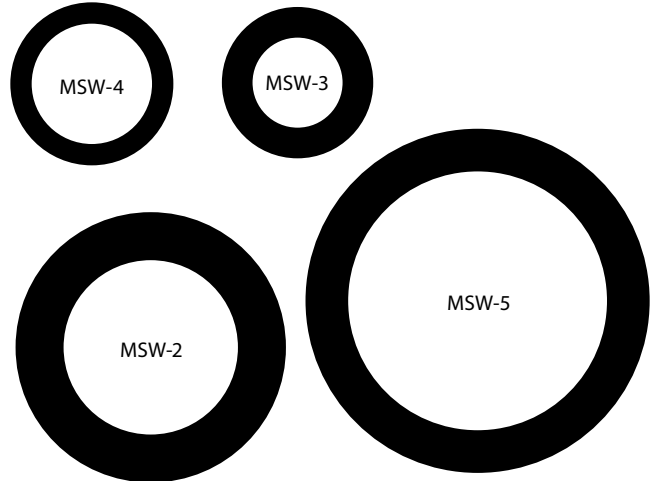

The EZTC717 Tank Carrier



EZTC717

Features:

- 360° Turning Radius
- Eaton Hydrostatic Transmission
- Cushioned Connection Points
- Automatic Emergency Shut Off
- 4-ply agricultural type tires
- Two 6,500 lbs breaking strength nylon straps with ratchet for wheel jack assembly
- One 18,000 lb breaking strength nylon straps with ratchet for power assembly

Specifications:

Weight: 419 Lbs
Height: 64 1/2" to top of Handle
Overall Width: 62"
Length: 67"
Construction: 100% Aluminum
Lift Capacity: 2,300 lbs

Handles horizontal ASME tanks up to 1,000 gallon capacity.

Tank and Cylinder Movers



RTC420NG3

Part Number: RTC420NG3 (pictured left)

Motorized dolly with gear drive transaxle for 420 LB (100 gal.) D.O.T. cylinders and 120 gal. horizontal storage tanks. One forward and one reverse gear. 5.0 HP Honda engine, Peerless transaxle.



RTC420M2



Part Number: RTC420M2 (pictured left)

Manual dolly for 420 LB D.O.T cylinders. Three wheel cart with strap, ratchet and hood grab strap for easy attachment. Single handle bar design.

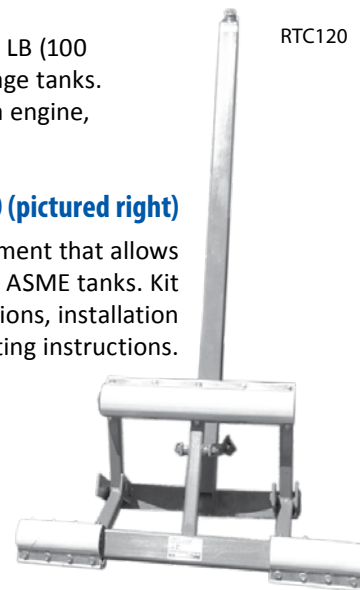

RTC120

Part Number: RTC120 (pictured right)

The RTC120 Adapter is a separate attachment that allows the RTC420 to spot 120 gal. horizontal ASME tanks. Kit includes adapter, strap, ratchet modifications, installation and operating instructions.

Hand Trucks

Part Number HT7-900-4P

Ideal for 420LB cylinders.

Tire and Wheel

Part Number: 101222



Motor Fuel Cylinder Cart

The RTC33-Scoop 33 LB. Motor Fuel Cylinder Dolly safely transports four stacked cylinders without the use of chain or straps to hold the cylinders on the cart. Scoop and go! Ideal for cylinder delivery trucks, loading docks, gas houses and factories.

Part Number: RTC33-SCOOP

Spare Tire Part Number: 354DC-TIRE



RTC33-SCOOP

Part Number HT7325-2

Ideal for 100, 200 or 300LB cylinders.

Tire and Wheel

Part Number: 101222



We have the tools you need to do the job right the first time!

Slings and Ratchet Straps

Permaloc Cable Bridle Slings

Galvanized aircraft quality, lifts up to 1000 gallon tanks.

2 Leg Sling

Lifting capacity 4,400 lbs. @60° angle.

Other lengths available.

Special orders and other sizes available upon request

PART NUMBERS	DESCRIPTION
5X5X2	3/8" x 5' cables
5X5X2S	3/8" x 5' nylon straps
7X7X2	3/8" x 7' cables
7X7X2S	3/8" x 7' nylon straps
10X10X2	3/8" x 10' cables
10X10X2S	3/8" x 10' nylon straps

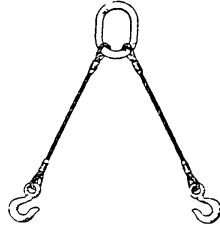

Round Slings

Useful in lifting cylinder and tanks up to 1,000 gallons.

Part Number: VR1X12 (12' Long)

Part Number: VR3X14 (14' Long)

Other sizes and lengths available.

See tag on strap for lifting capacity.

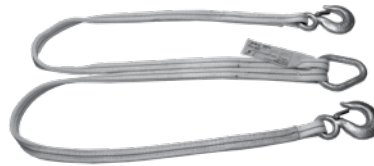

2" Web Straps with Ratchet

PART NUMBER	LENGTH	END HARDWARE	WORKING LOAD LIMIT
RTO-6	6"	E-Track	4500LB
51124	12'	Chain Extension	3335LB
51154	15'	Chain Extension	3335LB
045-002-15ET	15'	E-Track	1666 LB
51122	12'	Flat Hook	3335LB
51152	15'	Flat Hook	3335LB
51272	27'	Flat Hook	3335LB
51128	12'	Snap Hook	3335LB
51158	15'	Snap Hook	3335LB
51278	27'	Snap Hook	3335LB

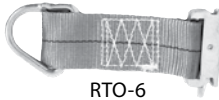

PART NO.	DESCRIPTION	MATERIAL
TC-1-A	Tank Saddle	Aluminum

Tank-Jak

The Tank-Jak is designed to provide a portable means of lifting propane tanks for leveling, painting, etc.

Lifting Capacity: 3000 LBS

Jack Travel: 13"

Part Number: TANK-JAK



Wood Safety Plugs

In the event of a valve being sheared off, hammering in a wood safety plug will allow you to remove the tank to a safe area.



PART NO.	DESCRIPTION
WP3/4X12	3/4" X 12" - Truck
WP1-1/2X12	1-1/2" X 12" - Truck
WP2-1/2X12	2-1/2" X 12" - Truck
WP3-1/2X24	3-1/2" X 24" - Plant
WP4-3/8X24	4-1/2" X 24" - Plant
WP HOLDER	For 3/4" -1-1/2 & 2-1/2" - Truck

SERVICE EQUIPMENT

Spanner Wrench



Acme "J" Wrench

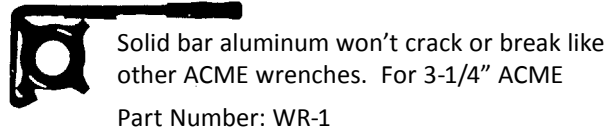

Reflective Triangles



Reflective traffic warning triangles (3) packaged in a handy carrying case. Fold down to an accessible size. Easily seen at great distances. Attractively priced!
Part Number: HWYTRI

Chock Blocks

Aluminum Magnesium Chock Blocks

Every bobtail and service truck in your fleet should have 2 chock blocks. See NFPA 58 6.3.8 or DOT Federal Motor Carrier Safety Regulations.



PART NUMBER	SIZE	H	W	L
HWC	Large	8"	8.5"	15"
HGS	Standard	8"	8.5"	12"
MWG	Medium	7"	6"	12"

Part Number: MTV Bracket for chocks

Thermocouples – Universal



PART NO.	LENGTH
LR1918	18"
LR1924	24"
LR1930	30"
LR1936	36"

Gauging Reamer Kit



Have the correct size reamer when you need it. Our kit contains 1 each of GR5020-GR5090 five cornered reamers in a slim plastic case.

PART NO.	DESCRIPTION
G5000	Gauging Reamer Kit
G6000	Plastic Case Only - Empty

Broaches and Pin Vises

Tapered Broaches

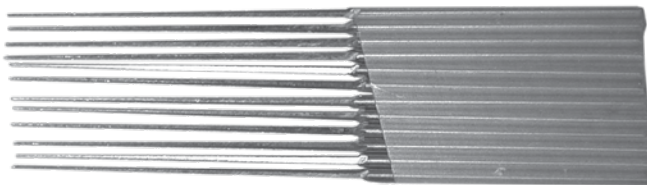

PART NUMBER	SIZE
GB1008	Tapered from .008" to .017"
GB1010	Tapered from .010" to .017"
GB1012	Tapered from .012" to .017"
GB3015	Tapered from .003" TO .013" A must for cleaning Pilot Orifices.



TL050 Burner Broach

For reaming and cleaning ports. Will fit with TL061 handpiece or TL072 pin vise. Tapers from 1/8" square. Tough and durable.



TL072 Pin Vise for Gauging Drills

For holding large and small gauging drills securely while reaming, prevents spinning. This tool is a must when using gauging drills.

Our press check adapter on page 113 is a low-cost alternative to expensive gadgets now on the market.

Flaring Tools

Rolo-Flair Tool



PART NO.	DESCRIPTION	TUBE SIZE O.D.
945TH	Flairing Tool	1/8"-3/4"

Swing-Release Flaring Tool



PART NO.	DESCRIPTION	TUBE SIZE O.D.
2.6033	Flairing Tool	3/16", 1/4", 5/16", 3/8", 1/2", 5/8"

Universal Flaring Tool



PART NO.	DESCRIPTION	TUBE SIZE O.D.
525-845	Flairing Tool	3/16" - 5/8"

One opening fits all sizes

Universal Two-Hand Bender for Soft Tubing

- Precision bends soft tubing up to 180° without crimping
- Use on 1/4" to 5/8" soft and medium-soft copper, brass, aluminum, steel and stainless steel tubing
- Marked at 30°, 45°, 60°, 90°, 120°, 135°, 150° and 180° for accuracy
- Lightweight, easy to handle with handles that prevent bruised and pinched knuckles!



Tube Cutter

Rollers have flair cut-off grooves, fold away reamer and spare cutting wheel.

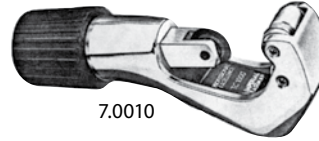

7.0010



7.001

PART NUMBER	DESCRIPTION
7.0010	Tube Cutter for 1/8"-1 1/8"
7.0007	Cutter Wheel for 7.0010 Tube Cutter
7.001	Imp. Tube Cutter 1/8"-5/8"



Spring Type Tube Bender

Budget priced tool for hand bending soft tubing to any shape without collapsing walls. Special spring steel, nickel finished. End belled for easy tube insertion.

PART NO.	SIZE	LENGTH	WEIGHT
LC630E	3/8"	10"	4 oz.
LC630F	1/2"	12"	6.5 oz.
LC630I	5/8"	12"	8 oz.

PART NUMBER	DESCRIPTION
2.5131	5/16" O.D. Bender
2.5142	1/2" O.D. Bender
2.5136	5/8" O.D. Bender

Orifice Kits and Gauging Drill Sets

Orifice Adapter Kit

This adapter kit will renew 80-90% of all orifices. Allows you to also adapt a natural gas orifice down to a smaller LP gas size. An essential item for your serviceman. Includes all tools needed to assemble MI100 adapters: Kit contains 100 each pf MI100-72; 1 each TL061, TL062, TL063, TL064, TL070 and TL074. In a plastic box.

PART NO.	DESCRIPTION
MIK100	Master Adapter Kit
SC100	Case only for MIK100
MI-100	#72 Orifice for MIK100



MI-131 – Serviceman's Orifice Assortment Kit

MI-135 – Special LP Plug and Cap Orifice Kit

G-4080 Gauging Drill Set

Durable heavy gauge plastic case with clasp, contains set of 41 gauging drills, sizes 40 through 80. Plus 1 G-3020 tapered broach. Snug fit can not fall out. Quick and easy drill removal and replacement.

Part Number: G-4080

G1939 Gauging Drill Set

Same as above, contains 21 drill sizes 19 through 39

Part Number: G1939

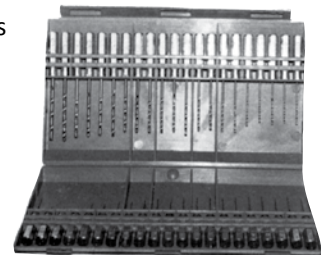

Leak Test



Dual Range UL-Tube and Inclined Manometer

Use as a regular U-tube manometer to read high-range pressure on the right leg, or as an inclined manometer to read low-range pressure on the bottom leg. Simply incline manometer until fluid level reads zero. No spirt level required. Magnetic clips hold the gauge in position on steel duct surface.

Part Number: 1227-16

Dual Range Manometer



Low Pressure Test Adapter

Flare fitting unit for testing pressure in copper tubing lines, when test connection on appliance is not accessible.

FOR USE WITH MANOMETER

PART NUMBER	DESCRIPTION
1328	3/8" O.D. Flare
1331	1/2" O.D. Flare
1332	5/8" O.D. Flare



Water Manometer

Includes: 2 magnetic mounting clips, tube clamp, 2 plastic carrying plugs, and 2 flexible plastic tubing connectors for attachment of 2 ft. 5/16" latex tubing. Fluorescent green dye concentrate furnished.

Part Number: 1222-16

Above water manometer with 2 ft. latex tubing.

Part Number: 1222-16-K



Manometer Kit

Kit includes 1211-16 slack-tube manometer, carrying case, green wetting agent, adapters and 3' hose. Manometers are as accurate as the finest laboratory "U" gauges—yet they are made to roll up compactly for easy carrying and to withstand rough usage.

Manometer Part Number: 1212

Hose Part Number: LATEX



Serviceman's Friend

For use with manometer and other applications. One end of fitting has 1/8" pipe thread, 1/4" pipe thread and special 5/16" x 32 thread. Opposite end has regular hose fitting, also 1/8" straight pipe thread. Hose can be used on either end.

Part Number: TL-051

Magnehelic Gauge



High accuracy within 2% of full scale. Frictionless Magnehelic® gage movement, it quickly indicates low air or non-corrosive gas pressures (either positive, vacuum or differential). Resists shock, vibration and over-pressures. No manometer fluid to evaporate, freeze or cause toxic or leveling problems.

Part Number: 2020



Pressure Gauge Snubber

Pressure snubber protects gauge from damaging surges and moderates pulsating at the gauge. Pressure snubber 1/4" male x 1/4" female with #54 drill hole.

Part Number: B25-G



Gauge Oil Red for Manometers

1 pint bottle

Freeze point -65°F

Part Number: A103



Pressure Gauge Adapter

Adapter with 1/4" gauge opening for indicating outlet pressure of a first stage regulator. 1/2" MNPT x 1/2" FNPT Adapter.

Part Number: 1494-1

Leak Test

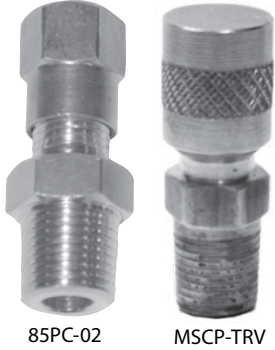

85PC-02

MSCP-TRV

Press Check Adapter

Designed for installation in 1/8" FP threaded opening, the PRESS-CHECK Adapter is the key to testing the gas distribution system without breaking the line. UL approved for use in propane vapor systems.

- Check Valve is UL approved for LPG service.
- Ambient temperature range -400 f to +2120 f.
- Operating pressure of 125# PSIG.
- Closing cap provides additional seal of 125# PSIG and is protected by a tamper resistant cap over.

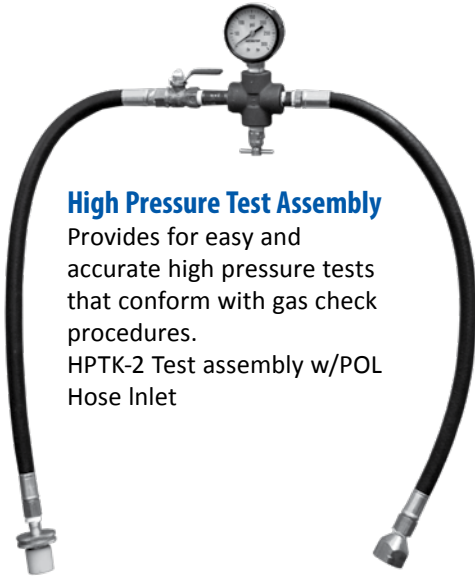

High Pressure Test Assembly

Provides for easy and accurate high pressure tests that conform with gas check procedures.
HPTK-2 Test assembly w/POL Hose Inlet



Low Pressure Test Kit

Kit includes a pressure gauge reading 0-35" W.C., plastic case and 30" long rubber tubing with bell end.

Part Number: 2434A

Replacement Parts

PART NUMBER	DESCRIPTION
2434A-11	Rubber Hose Tip
MSCP-CONE1-M	Rubber Cone Tip



High Pressure Test Assembly

For air testing of piping systems includes brass test block 3/4" female pipe x air valve and cap, and high pressure gauge.

Part Number: MSCP-HPTA-30

Range: 0-30

Gauge: PSI



High Pressure Test Block

MPOL x FPOL test block with 0-300 PSI gauge and bleeder.

Part Number: 2962

Emergency Response Kit



A complete package in a special toolbox that improves your ability to respond to propane emergencies. It is recommended for placement with key personnel in your company so that emergency response time is kept to a minimum.

Part Number: ERK-1 (Complete Kit)

Digital Manometers



TPI 600 Series

A convenient way for service and utility personnel to isolate difficult pressure troubles on propane and natural gas systems with a versatility that allows you to perform many critical safety checks with a single instrument.

PART NUMBER	INPUT TYPE	UNITS OF PRESSURE	RECORD MIN/MAX
610	Single	Single Unit of Pressure	Yes
620	Dual - Differential	Single Unit of Pressure	Yes

Accessories

PART NO.	DESCRIPTION
A901	Soft carrying case with shoulder strap

Applications

- Adjust appliance regulators
- Set delivery pressure
- Shut in Test
- Furnace pressure switches

Residential Gas Detectors



PART NO.	DETECTS	FEATURES
LP200	Natural Gas, Butane Propane	12 volt plug in
HS80504	Carbon Monoxide, Natural Gas, Propane	Eliminates false alarms, detector is tamper proof, self-diagnostic assures the unit is operating properly, two independent alarms

Digital Multimeters



Digital Clamp Meter

Measures: line and control circuit voltage, current draw of electric circuits, inrush current of motors, relays, and solenoids, and resistance of components. Tests: continuity in circuits and wires.

Part Number: 265

PART NUMBER	DIMENSIONS
120	6 x 3x 2
133	7.75 x 3.75 x 2.25



Combustible Gas Detectors



Part Number HXG-2D

- Meets UL 913 intrinsic safety
- 10 ppm sensitivity
- Instant response
- Electronic tick rate control
- Settable alarm
- Visual and Audible leak indicator
- 16" Gooseneck
- Soft zippered carrying case

Bar Probe Part Number: 28-44



Wohler Gas Sniffer

- Highly sensitive and quick responsive Gas Sniffer
- Additional LED lighting turns on automatically in dark places
- Twelve levels gas concentration, from 0 to 1200 ppm
- Acoustic signal and vibration alarm to display even the smallest leaks

Part Number: GS300



Wohler Digital Manometer

- Easy one button operation
- Extra wide pressure range
- Quick response time
- Switch on - Measure - Finished

Part Number: DM2000



Wohler Combustion Analyzer

- 48 month warranty
- Displays up to 14 measurement readings
- Intuitive to operate via on-screen keyboard
- Multistage filter technology incl. water stop filter

Part Number: 8390

Inspection Mirror, Seal Press, and Pilot Cleaning Pump

2" x 3 1/2" Inspection Mirror

Swivel head allows mirror to be positioned at any angle. Safely inspect relief valves and burners.

Part Number: 72-561



Hand Seal Press

Engraved digits. Maximum 3 digits per die. Required in most states to re-seal registers.

PART NO.	SIZE
HSP	5" Hand Seal Press
MS-8	8" Lead Meter Seal

Dies sold separately



Anode Test



Potential Meter

Performs required test for anodes, in a very simple manner.

Part Number: 4108

Closed Circuit Adapter

Used to make closed circuit tests of thermocouples and thermopiles with suitable millivolt test meters.

Thermocouple Adapter Part Number: 10-038



Anode Test Kit

Includes:

- 6A half cell – reference electrode
- Digital multimeter w/wired probes
- Storage case



Part Number: ATK-1

PART NUMBER	DESCRIPTION
6A	6A Half Cell Reference Electrode
16906	Copper Sulfate
17105	Copper Sulfate Anti-Freeze
T&R50060	Flat tip assembly for 6A
T&R50070	Pointed tip assembly for 6B
T&R50300	Copper sulfate crystals
T&R50404	Shunt .001 OHM orange

Freeze Valve

Used to test for water content.

AT-1000 Freeze Valve with AT-1016 Filter, AT-1011 Screen and AT-1019 Retaining Ring.

Part Number: AT1000



TEST IT Test Kit

Used to test propane deliveries for hydrogen sulfide, ammonia, oil and heavy hydrocarbons. Comes complete with instructions.

Part Number: PTK-1



PTK-1

PART NUMBER	DESCRIPTION
PTK-1	Complete TEST IT Test Kit
5-769-5	Utility Clamp
03-409-10B	Squeeze Bottle
11-838-21	8 oz. Plastic Bottle with Lid
13-5225-01	Litmus Paper, Red (for ammonia)
05-622	Centrifuge Tube
08-562-5B	Graduated Cylinder
T-415	6-1/2" Curved Tweezers
9-65081	Plastic Carrying Case
FP-1	Protective Foam Packaging
EP-1	V2 Sheet, Medium Emery Paper
GW-4	Number 4 Ground Wire
23-173	Monkey Grip Gloves
PTK-IN	TEST IT Instruction Sheet
13-5335-01	Lead Acetate Paper (for hydrogen sulfate)



Pipe Thread & Gasket Sealer

PLS2 Premium Thread Gasket Sealer



PART NO.	DESCRIPTION
PLS2-1/4PT	1/4 pint with brush top
PLS2-1PT	1 pint with brush top

Gasoila Soft Set with Teflon



PART NO.	DESCRIPTION
SS04	1/4 pint with brush top
SS08	1/2 pint with brush top
SS16	1 pint with brush top

Gasoila-NT



One pint with brush top blue, non-Teflon, grit-free sealant. Can be used on all metals.

Part Number: NT16

Free All



PART NO.	DESCRIPTION
FA06	Free All- Industrial strength deep penetrating oil. 6 oz..

Tape II Teflon Tape



PART NO.	DESCRIPTION
TT61	1/2" x 520" teflon thread sealer tape
TT54	3/4" x 520" teflon thread sealer tape
1901D	Tape Teflon 1/2" x 520"
1901E	Tape Teflon 3/4" x 520"
YT71	Tape, Yellow 1/2" x 520"
YT75	Tape, Yellow 1" x 520"
ZT13	Tape Teflon 3/4" x 520"
TT54	Tape Teflon 3/4" x 520"

Sherlock 5-Second Leak Detector



- Ideal for use with pressurized gas system.
- Ultra-sensitive to low pressure, minute leaks. Retains bubbles; bubble size indicates leak rate.
- Safe for use on polyethylene pipe and fittings as outlined in ASTM test D-1693.
- Service temperature range: -10° F to +160° F
- Wettable: fluid stays on metal longer, it can be used on vertical surfaces.

Part Number: 800-LS5

For Extra Cold Applications, use Extra Low Temp good to -55° F.

Part Number: 800-ELS5

PART NO.	SIZE	TYPE
300-L32	1 Pint Empty	Brush Top
800-LS3	1 Pint Empty	Spray Bottle
800-LS5	1 Gallon Low Temp	Jug
800-LS5-55	55 Gallon Low Temp	Drum
800-ELS5	1 Gallon Extra Low Temp	Jug

Manual Propane Flare Tower



PFM-25



PFM-16LPS

- Flare Up to 529 Gallons/HR
- No Electricity Required
- Compact & Portable Design
- Quick & Easy Setup
- Simple to Use
- Great for Emergency Evacuation Situations
- Stable & Sturdy Construction
- Made in the USA

PART NUMBER	DESCRIPTION
PFM-16LPS	1/2" Manual Flare
PFM-25	25' Hose Extension Kit

Gloves and Protective Sprays



Leather Palm Glove

General duty protective leather glove. Tuff stretch design—one size fits all. Packed 12 pairs per case.

Part Number: NO.1



Edmont Raised Finish Monkey Grip Glove

Provides excellent grip for easier, safer handling of wet and dry materials. Tough vinyl coating resists chemicals and abrasion. Comfortable non-woven lining to keep wetness on the outside, warmth and dryness inside. Orange colored, raised finish, large only.

Part Number: 23-173



Winter Tuf-Duk Glove

Same as above, with foam insulated fit and flexibility for non-slip handling of cylinders and for driving. Jersey lined for comfort, vinyl impregnated. Brown palm; yellow back.

Part Number: 31-791T-M (Medium)



Hydrex Gloves

Inner lining helps absorb excess perspiration during prolonged use keeping hands cooler, while significantly reducing hand fatigue. Cut resistant.

Part Number: 11-435-09

Part Number: 11-435-10



Halt! Dog Repellent

Complete with belt clip.

Part Number: HALT

Buy by the case and save!

Twelve 1½ ounce cans per case

Part Number: HALT-CASE



Bee Bopper

Wasp and Hornet Spray.

Part Number: BEEBOPPER

Buy by the case and save!

Twelve 14 ounce cans per case.

Part Number: BEEBOP-CASE

Tub O'Towels

Knocks out paint, ink, grease, tar and other tough messes. Gentle on hands and environmentally friendly.

Part Number: TUB O TOWELS



Fire Extinguishers

Amerex Fire Extinguishers



Multi-Purpose Dry Chemical
ABC Stored Pressure Fire Extinguishers-
For Use On Bobtails And Transports

- Multi-Purpose
- Dry Chemical
- ABC Rated
- All Steel
- Approved For Use On Propane Trucks

PART NO.	DESCRIPTION	RATING
417T	2.5 Fire Extinguisher with Bracket	1A;10BC
500	5 lb. Fire Extinguisher with Bracket	2A;10BC
456	10 lb. Fire Extinguisher	4A;80B:C
423	20 lb. Fire Extinguisher	20A;120BC
XTG-8	Cover-20 lb. Extinguisher	-
809	10 lb. Running Board Bracket	-
810	20 lb. Running Board Bracket	-
DT-102	Inspection Tag	-
MS-8	8" Tag Seal	-



Paint and Underground Tank Protection

Brushes

Wood Handle • Bristle Brush

2" Part Number: 603-2

3" Part Number: 603-3

4" Part Number: 603-4



Metal Paint Tray

- Heavy Duty
- Extra Deep
- Ladder Rack Legs

Part Number: 7645



Roller Frames

Heavy duty 5 wire cage frame for more even paint coverage. Plastic handle with threaded pistol grip.

Part Number: 7411



Rollers

9" Synthetic fabric roller with phenolic core for no solvent penetration.

Part Number: 7312-9



- Meets current OSHA & DOT specifications
- Proven performance with tanks
- Superb quality
- Conforms to VOC Regulations

TANK SOLAR WHITE

1 Gallon Part Number: B54W151-1G

5 Gallons Part Number: B54W151-5G

RUST ARRESTOR WHITE PRIMER

1 Gallon Part Number: B50W24-1G

5 Gallons Part Number: B50W24-5G

BRUSH ALUMINUM

1 Gallon Part Number: B71S200-1G

5 Gallons Part Number: B71S200-5G

TURPOLENE – Synthetic Thinner

1 Gallon Part Number: 130

SILVER GRAY

1 Gallon Part Number: 8538-1G

5 Gallons Part Number: 8538-5G

SAFETY YELLOW

1 Gallon Part Number: 850



ROSKOTE R28 Undercoat Tank Coatings

For use on underground tanks, one gallon will coat up to 1,000 gallon tank. Easy to apply and considered to be the best in the industry.

1 Gallon Pails Part Number: R28-1

5 Gallon Pails Part Number: R28-5

Thinner – For R28 Only

1 Gallon Pails Part Number: 11-1G

5 Gallon Pails Part Number: 11-5G

Tarlon Bottom Guard for Cylinders

Tarlon Black Mastic is for use on the bottoms of all above ground cylinders requiring corrosion protection. 100 Lb., 200 Lb. and 420 Lb. Note: Not for underground tank coating. See Roskote.

1 Gallon Part Number: 353-8-1G

Miscellaneous Paint Items

Bucket Bonnet Package of 3
Part Number: BB-1

Bucket Grid Screen
Part Number: BG-1

Empty 5 Gallon Bucket
Part Number: B-1



Tank Inspection and Recertification Tools

Methanol Injector

For use in the field on containers suspected of having moisture in them.

- Holds 5 ounces
- Empties in 5-10 strokes
- Check valve prevents backflow of propane pressure.



PART NUMBER	DESCRIPTION
METH-INJ	Methanol Injector W/Soft Hose Handwheel POL

CONTAINER TYPE	MINIMUM VOLUME METHANOL REQUIRED
100LB DOT Cylinder	1/8 pt. (2 fl. ozs.)
420LB DOT Cylinder	1/2 pt. (8 fl. ozs.)
500 gal. tank	5 pts. (2 1/2 qts.)
1000 gal. tank	10 pts. (1 1/4 gal.)
2000 gal. tank	20 pts. (2 1/2 gal.)

* Important - Avoid substitutes - they will not work. The secret of the effectiveness of methanol over all other alcohol is its high affinity for water plus a boiling point lower than all other alcohols, and most important: a boiling point lower than water.

Gravity Methanol Injector



- Easy to Use
- Inexpensive
- 1 Quart Capacity
- Connects to Vapor Equalizing Valve of ASME Tanks

Part Number: I-100

Pit Gauge

For accurate and convenient measuring of cylinder rust pits, gouges and dents as required for D.O.T. visual inspection of gas cylinders. Highly polished stainless steel gauge comes in pocket size leather case.



Fast and easy way to check rust pits.

Model # PG-1



Scribe with bent points .005 & .010

Part Number-NO.80NB

No. 80

Steel Stamp Sets

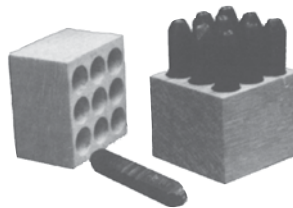

All sets include 0 to 9 and the letter "E."

Individual Letters and Numbers Available

1/4" Part Number: SS-0-9-1/4

3/8" Part Number: SS-0-9-3/8

3/16" Part Number: SS-0-9-3/16

Misc.

Greenline Pipeline Wrapping Tape

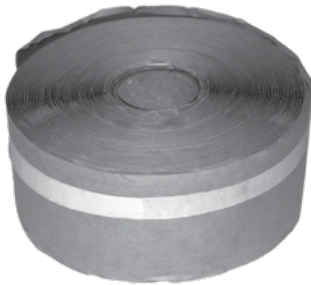

A cold applied, laminated tape for wrapping steel pipe for protection against underground corrosion.

2 in. x 50 ft.

Part Number: Greenline

4 in. x 50 ft.

Part Number: Greenline-4

Roybond Primer

To be used on pipe before applying tape.

Part Number: 747-1 (1 Gal.)

Part Number: 747-16 (16 oz. Aerosol)

POL Flare Wrench



Alloy steel, chrome plated with 7/8" and 1 1/8" openings. Call for other sizes.

Part Number: RF55

Extend-A-Match

Sturdy alligator clip extends to 26" to reach with matches or small parts.

Part Number: MSCP-HANDILITE





Tools and Accessories

Bot-L-Rench

For removing and installing valves in DOT cylinders and lift truck cylinders.

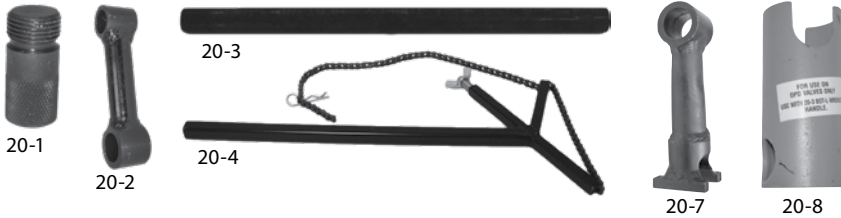

PART NUMBER	SIZE
20-1	Plug
20-2	Wrench
20-3	Handle
20-4	Chain Vise Assembly
20-7	Motor Fuel
20-8	QCC Valves

Offset Wrench for Removing Valves in Cylinders w/Collars



PART NO.	OPENING
907A	1 1/8"
908	1 1/4"
909	1 7/16"
909A	1 1/2"

OPD Wrench

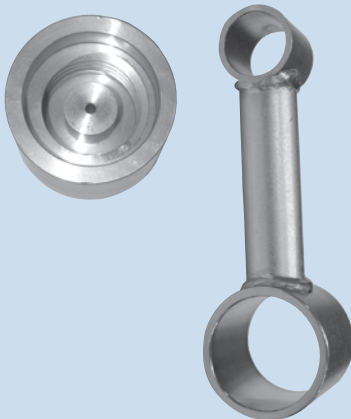

- Quickens installation and removal of QCC-1 cylinder valves from DOT containers
- Works on all style 1 (QCC-1) valves and fixed handwheel OPDs (mandated for all 5 to 40LB cylinders)
- Bleed orifice safety feature indicates pressure remaining in the cylinder before removing the valve
- Made from tough, durable alloy and forged steel

Part Number: TW-3

Wall Cylinder Vise Model CV-1



- Holds up to an 18" diameter cylinder
- Flexible heavy-duty, non-slip nylon straps prevent damage to cylinders
- Parts tray included
- Ships UPS!
- Minimal floor space needed

Part Number: CV-1

Cylinder Vise Model CVM-200



Holds 12" - 15" diameter sizes with easily adjustable snap-action latching and removable inserts.

Can be mounted on post or wall.

Part Number: CVM-200

Also available:
Optional Mounting Base,
Part Number: CVM 200-S

The Anatomy of a Hannay Hose Reel

- 1 **Bearings:** Weight of spool and hose is supported by bearings.
 - 1a **Back Bearing**
 - 1b **Front Bearing**
- 2 **Disc Rolled:** Edges prevent hose damage and add rigidity to disc. Additional strength is provided by a concentric rib.
- 3 **Drum:** Roll formed steel with full length weld.
- 4 **Tie Rods:** Join discs and drum to form spool. Reinforced with pipe spacers for rigidity and strength.
- 5 **Chain and Sprocket Drive:** Provides smooth positive rewinding on powered reels.
- 6 **Rewind Motor:** Electric rewind motor is shown. Compressed air or hydraulic motors can be used.
- 7 **Hub Assembly:** Includes the fluid hub, the outlet riser and the reel axle. Fluid passes from the swivel joint inlet through the hub assembly, to the hose.
 - 7a **Outlet Riser:** Contoured to match the curve of the reel drum so hose will wrap smoothly.
 - 7b **Fluid Hub**
- 8 **Swivel Joint Inlet:** Permits reel to rotate freely while connected to the fluid source. Joint is not used as a bearing. Straight or 90 degree swivel joints are available for most models. (Flexible connector must be used between swivel joint and inlet piping or warranty will be void.)
- 9 **Brake/Rewind Assembly:** Bevel gear rewind has an adjustable tension brake. Rewind and braking device vary with different models.

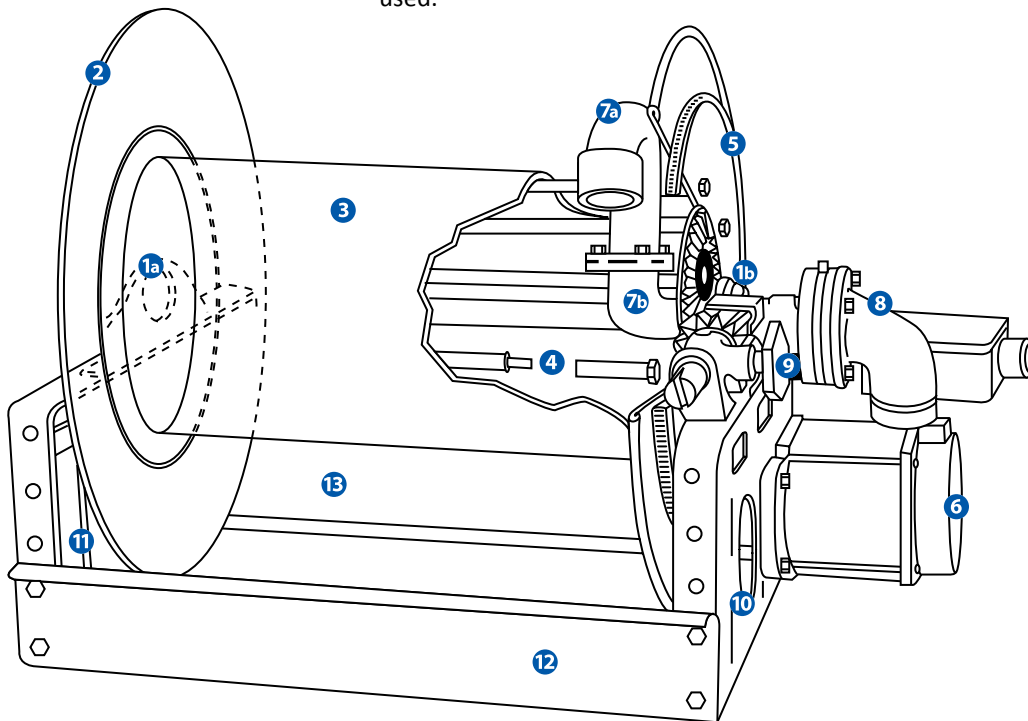

General Specifications of Hannay Hose Reels

Construction: Frames, discs and drum are fabricated of heavy gauge steel. Bearings are self aligning. Malleable iron and steel are used for hose reel hub assembly, outlet riser and swivel joints. Stainless steel, aluminum, bronze and other alloys, and special swivel joint packing, can be supplied to meet special requirements.

Finish: Standard finish is oven cured enamel. Finishes other than standard, such as special primers, polished aluminum, unpolished stainless steel and hot dipped galvanized may be specified at extra cost.

Temperatures & Pressures: Standard reel construction will handle most liquids or gases at temperatures ranging from -20 degrees to +400 degrees F (-29 degrees to +204 degrees C). Operating pressures available up to 10,000 psi (695 BAR) depending on the specific reel series. These operating pressures and temperatures are shown on descriptive pages in each product catalog. Reels to operate at pressures and temperatures other than standard are available at extra cost.

Shipping: Reels are shipped completely assembled, ready to install. Installation instructions are supplied with each reel.

Hannay Hose Reels

EPB

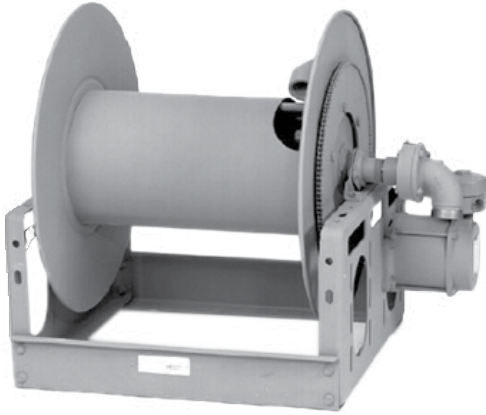

Optional auxiliary crank rewind available

EPBGMT

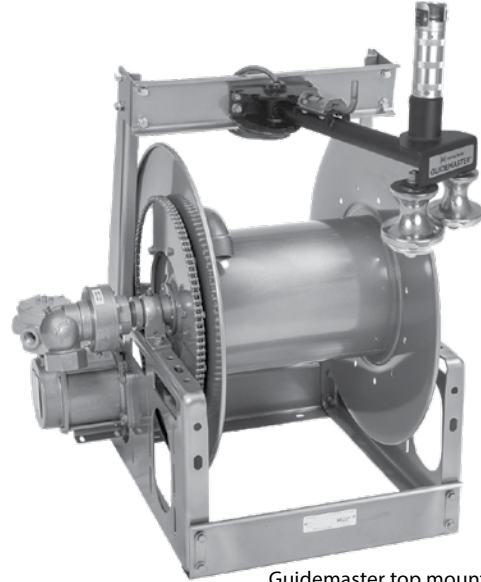

Guidemaster top mount

EPBGMB

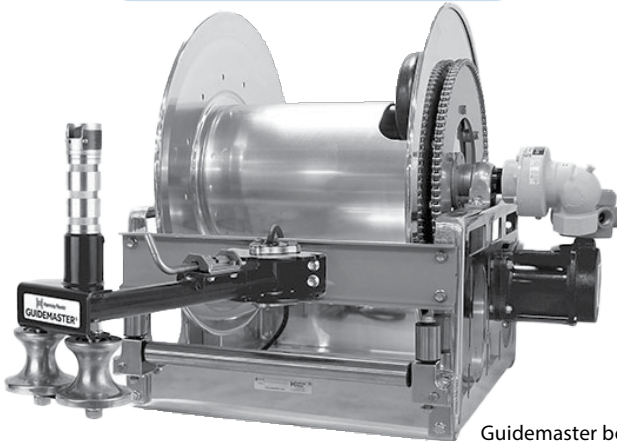

Guidemaster bottom mount

Helpful Information When Ordering:

- Entire model and serial numbers
- Size and location of inlet and outlet, as you face reel
- Motor location and voltage
- Special options
- 90° or straight swivel joint
- Hose I.D., O.D. and length

Call For Pricing For Complete Hose Reel

Static Grounding Reels

Safe and reliable for grounding bobbtails and transports



GR75-50

Standard Reel Box
Economy and Convenience



HGR-50-50

Heavy Duty Reel For
Extended Life and Durability

PART NUMBER	TYPE	CABLE		DIMENSION	
		LGTH	DIA	HEIGHT	WIDTH
GR75-20	Standard	20'	3/32"	6"	6 3/4"
GR75-50	Standard	50'	3/32"	7 3/4"	8 3/4"
HGR-50-50	Heavy Duty	50'	1/8"	17 1/2"	14 1/2"
HGR-100-100	Heavy Duty	100'	1/8"	17 1/2"	16 3/4"

HOSE REELS

Motors, Sprockets, Chains

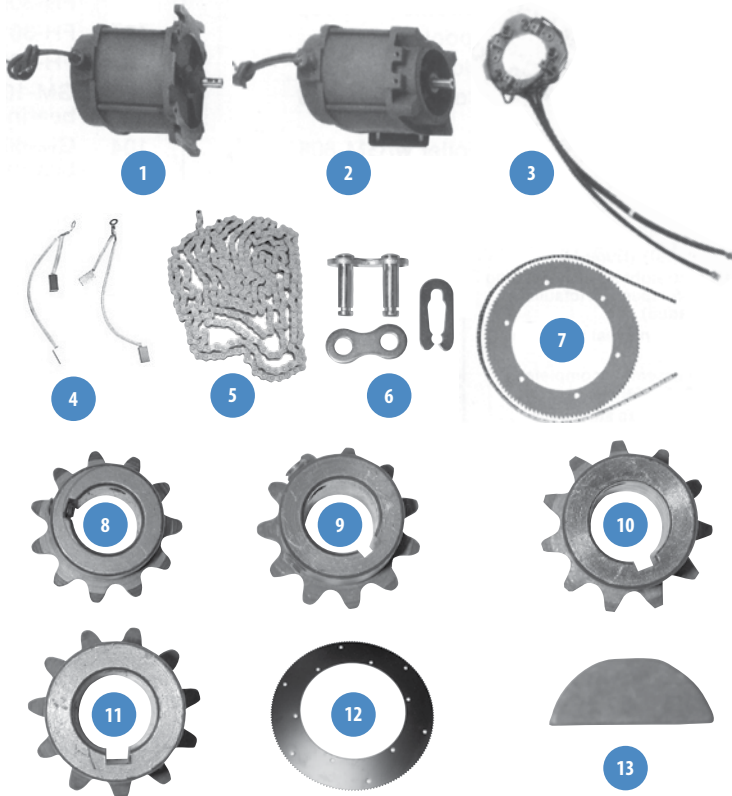

PART NUMBER	DESCRIPTION	PICTURE NUMBER
9915.0003	12 Volt Flange Mount Explosion Proof Motor	1
9915.0013	Short Shaft 12 Volt Base Mount	2
9915.0012	Long Shaft 12 Volt Base Mount	2
9916.0013	Brush Board Assembly (w/springs and brushes) for 12 Volt 1/2 HP Motor	3
9916.0070	Two Pairs of Brushes for 12 Volt Explosion Proof Motor (#57200)	4
9912.0001	10' Length #35 Chain w/Connecting Link	5
9912.0002	10' Length #40 Chain w/Connecting Link	5
9912.001	Connecting Link for #35 Chain	6
9910.1423	138T35 Disc Sprocket, 16-5/8" Diameter – Chain Not Included	7
9910.1116	11T35 Motor Sprocket, 3/4" Long	8
9910.1117	11T35 Motor Sprocket, 1 1/16" Long	9
9910.1118	11T35 Motor Sprocket, 1 5/16" Long	10
9910.1119	11T35 Motor Sprocket, 1 3/4" Long	11
9910.1526	Disc Sprocket 21 3/4" Diameter	12
9916.0080	3/16 X 3/4 Key for Explosion Proof Motor	13

Switches and Electrical



PART NUMBER	DESCRIPTION	PICTURE NUMBER
9917.0001	Red Dot EXPB-2A Switch (12 Volt)	1
9917.0014	Red Dot Internal Switch	2
9917.0015	Red Dot Repair Kit	3*
9917.0061	Red Dot 5-Port Round Junction Box/Cover	4*
9917.0062	#6 Wire Nut (For Red Dot Junction Box)	5*
9917.0063	Insulated "Bug" Connector	6*
9917.0025	12 Volt Solenoid (Diode-Suppressed)	7*
	specify SDLM Circuit Breaker (Specify Amperage)	8*
9917.0024	CB-2 Mounting Bracket (for Circuit Breaker)	9*
9917.0006	Push-Button 12 Volt Switch (Less Cap)	10
9917.0008	Rubber Cap (for Push Button Switch)	11*
9917.0200	EPS-1 Switch (used with Guidemaster)	12
9917.0207	EPS-2 Mounting Bracket (use with EPS-1)	13
9917.0208	Extension Bracket for EPS-2	14
9917.0205	Mounting Bracket for GM600 only for EPS1 or 3 switch	15*

* Not pictured

Also Available: MEP-GM1 Hose Reel Switch Cover

Don't see the Hannay part you need?
Give Team Tarantin a call and we'll
get it for you.

Swivels, Risers, Hub Assembly

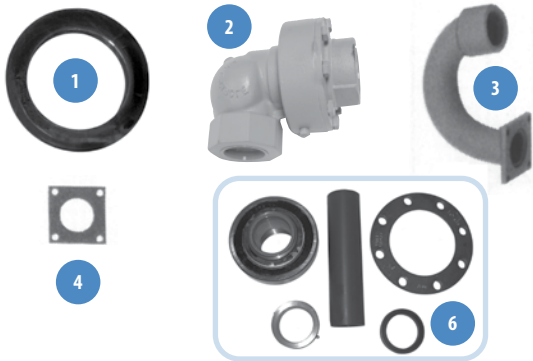

PART NUMBER	DESCRIPTION	PICTURE NUMBER
PK-01	1 1/2" PK-1 BUNA-N Packing (Merkel)	1*
SMAC-112	1 1/2" 900 FXF Full Circle Swivel	2
9901.376	1 1/2" FIPT Iron Flanged Riser	3
9965.0021	H-150G Gasket for 1 1/2" Riser	4
9901.2840	1 1/2" Hub Assy Complete (Specify Model)	5*
SMAC-112-SK	SMAC-112 Repair Kit	6*

* Not pictured

Roller Assemblies, Cable Guides, Hose Stops



PART NUMBER	DESCRIPTION	PICTURE NUMBER
specify	Top Wind FH-3 Mtg Brkt. (Specify Model)	1*
9939.0042	FH-3 Roller & Spool Assy (Specify Model)	2
9940.0012	FH-307 Delrin-Over-Steel Step Bolt	3
9940.0004	FH-309 Chrome Snap Cap	4
9940.0005	FH-301 Spool	5
9940.0006	FH-302 Block	6
9940.0007	FH-303-15 (1.5") Trunnion Bearing	7
9940.0008	FH-303-2 (2") Trunnion Bearing	8
9939.0062	Utility Hose Roller Assy "C" (Specify Model)	9*
9940.0076	EH-650 Mounting Block (Plated)	10
9939.0003	EH-714 Roller Assembly	11
9922.0011	HS-3 Hose Stop (Specify OD of Hose)	12
9922.0012	HS-45 Hose Stop (Specify OD of Hose)	13
9940.0016	FH-303 1 1/2" Trunnion Bearing (New Style) (No Through Hole)	14*
9939.0060	Utility Roller Assy (Specify Length)	15
9940.0014	7/16" Nylon Washer for FH Assy	16
9954.0009	7/16" Flat Washer	17

* Not pictured

Bearings

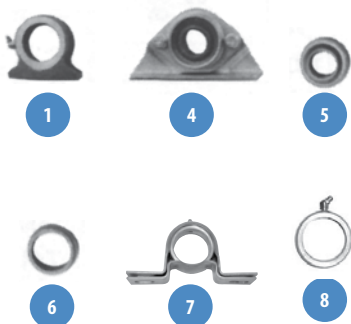

PART NUMBER	DESCRIPTION	SIZE	PICTURE NUMBER
9902.2100	H-4B Bronze Bearing	1 1/2"	1
9902.1200	Self Aligning Ball Bearing Complete	1/2"	2*
9902.1300	Self Aligning Ball Bearing Insert	1/2"	3*
9902.1400	Self Aligning Ball Bearing Complete	1"	4
9902.1500	Self Aligning Ball Bearing Insert	1"	5
9902.1610	Self Aligning Bronze Bearing Complete (E Coated)	1 1/2"	6
9902.1620	Self Aligning Bronze Bearing Complete (304SS)	1 1/2"	7
9902.1700	Self Aligning Bronze Bearing Complete Insert	1 1/2"	8
9902.17300	Self Aligning Bronze Bearing Insert	1"	9*

* Not pictured

Rewind Assemblies, Brakes, Ratchets

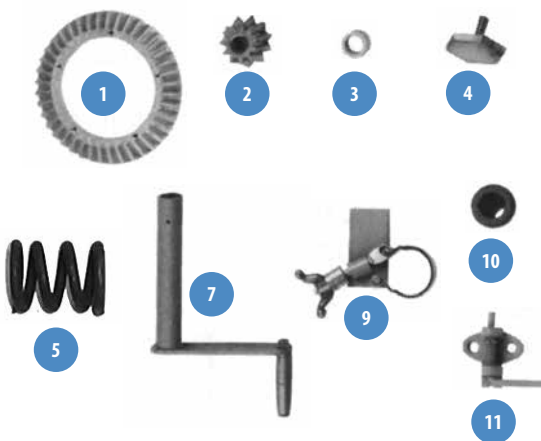

PART NUMBER	DESCRIPTION	PICTURE NUMBER
9914.0372	H-26 Ring Gear	1
9914.0393	H-27 Pinion Gear	2
9914.0351	Pinion Shaft Collar	3
9914.0413	H-30A Brake Wheel	4
9914.0451	H-31 Brake Spring	5*
9914.0433	H-3 Brake Pad	6*
9914.0011	H-18 Hand Crank	7
9947.0001	Manual Caliper Brake	8*
9947.0035	Comet Brake Assembly (IV Style)	9
9947.0038	Comet Brake IronHub (IV Style)	10
9965.003	PL-1 Pinlock	11

* Not pictured

Hose Reel Guides, Guidemaster Parts and Brackets

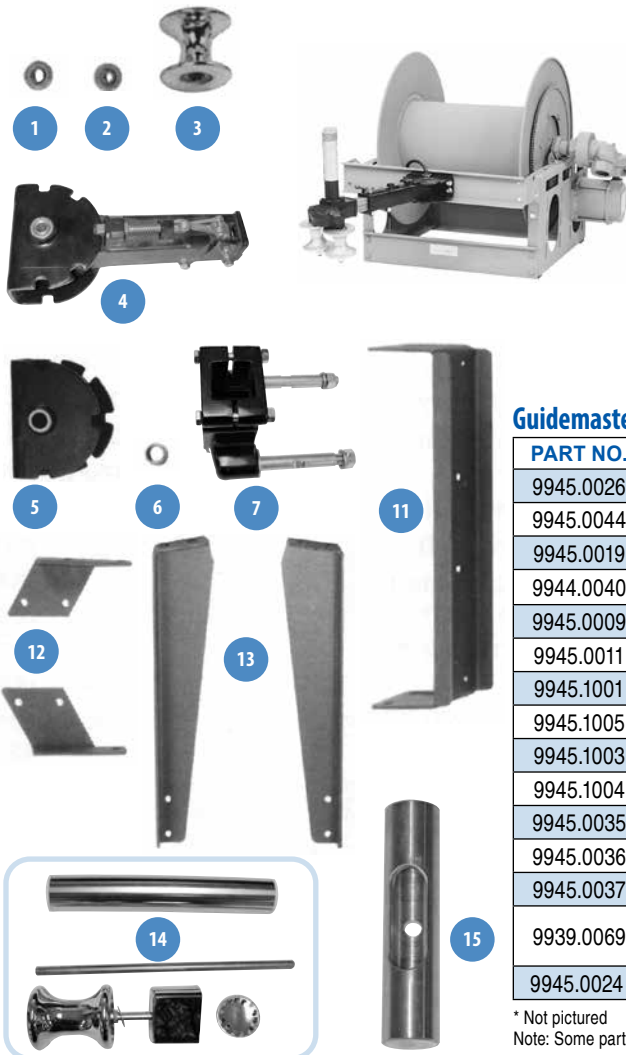

Hose Reel Guides

PART NO.	DESCRIPTION
9944.0019	304 SST GM Top Wind Bracket (5 pcs) ~SPEC Model
9944.0041	Roller Body Assy w/Rollers (Less Switch and Switch Bracket) for GM-700
9944.0043	Roller Body Assy w/Rollers & EPS-1 Switch for GM-700
9944.0124	GM-700 Guidemaster Only (w/EPS-1)
9944.0125	GM-700 w/Top Wind Brackets (w/EPS-1 Switch) ~SPEC Model
9944.0126	GM-700 w/Bottom Wind Brackets (w/EPS-1 Switch) W/SPL Assy "B" Rollers ~SPEC Model & Frame Style
9944.0127	GM-700 w/304 SST Top Wind Brackets (w/EPS-1) ~SPEC Model

Guidemaster Parts and Brackets

PART NO.	DESCRIPTION	PICTURE NO.
9945.0026	GM Ball Bearing (For GM Roller)	1
9945.0044	GM-108 Ball Bearing (for GM-109 Roller)	2
9945.0019	GM Roller w/GM Bearing	3
9944.0040	GM-700 Guide Arm Body Assy w/mtg Yoke	4
9945.0009	GM Mounting Yoke w/Bronze Bushing	5
9945.0011	GM Oil-Impregnated Bronze Bushing	6
9945.1001	GM Roller Body w/Mtg Bolts	7
9945.1005	GM Roller Mtg. Bolts	8*
9945.1003	Pinlock assy GM 700	9*
9945.1004	GM Roller Bolt Mounting Plate	10*
9945.0035	GM Cross Member Assembly (3 Pieces) (Specify Model)	11
9945.0036	GM Bottom Wind Brackets (Pair)	12
9945.0037	GM Top Wind Brackets (Pair)	13
9939.0069	Assy. "B" Roller for Bottom Wind Guidemaster Reels (Specify Model)	14
9945.0024	Pivot Pin	15

* Not pictured

Note: Some parts for GM-600 Guidemaster are still available

We're your headquarters for forged steel fittings and schedule 80 nipples.

Schedule 80 Forged Steel Reducing Fittings – Threaded



Swage Nipple

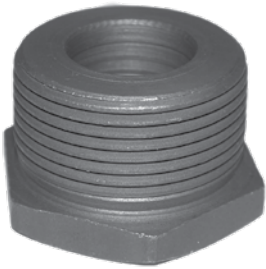

Hexagon Bushing



Reducer

MPT X FPT- NOMINAL PIPE SIZE	CONCENTRIC SWAGE NIPPLES SCHEDULE 80	HEX BUSHINGS 3000#	REDUCER COUPLINGS 3000#	ECCENTRIC SWAGE NIPPLES SCHEDULE 80
3/8" x 1/8"	-	-	600600	-
3/8" x 1/4"	-	603120	600601	-
1/2" x 1/4"	-	603135	600603	-
1/2" x 3/8"	-	603318	600604	-
3/4" x 1/4"	-	603125	600605	-
3/4" x 3/8"	620019	603122	-	-
3/4" x 1/2"	620020	603145	600609	-
1" x 1/4"	-	603155	600611	-
1" x 3/8"	-	603160	-	-
1" x 1/2"	620025	603165	600613	-
1" x 3/4"	620030	603170	600614	-
1 1/4" x 3/8"	-	603193	-	-
1 1/4" x 1/2"	620035	603190	60019	-
1 1/4" x 3/4"	620040	603195	600619	-
1 1/4" x 1"	620045	603200	600620	620045E
1 1/2" x 3/4"	-	603225	-	-
1 1/2" x 1"	620050	603230	600626	620050E
1 1/2" x 1 1/4"	620055	603235	600627	620055E
2" x 1/4"	-	603250	-	-
2" x 3/8"	-	603254	-	-
2" x 1/2"	620059	603255	600631	-
2" x 3/4"	620060	603260	600632	-
2" x 1"	620065	603265	600633	-
2" x 1 1/4"	620070	603270	600634	-
2" x 1 1/2"	620075	603275	600635	620075E
2 1/2" x 1 1/2"	620077	603318	600640	-
2 1/2" x 2"	620080	603320	-	-
3" x 3/4"	-	603360	-	-
3" x 1"	620090	-	-	-
3" x 1 1/2"	620085	603363	-	-
3" x 2"	620100	603365	600653	-
3" x 2 1/2"	620095	-	-	-

Other Sizes Available

Schedule 80 Forged Steel Fittings – Threaded

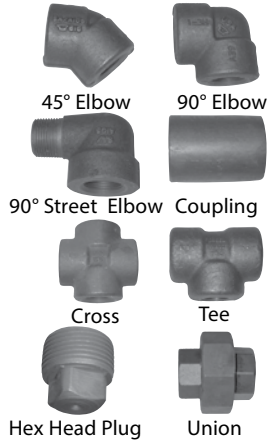

ITEM	PRESSURE	NORMAL PIPE SIZE									
		1/4	3/8	1/2	3/4	1	1 1/4	1 1/2	2	2 1/2	3
90° Elbow	2000#	611070	611071	611014	611019	611024	611029	611034	611039	611044	611049
45° Elbow	2000#	611104	611079	611115	611080	611081	611129	611134	611139	611141	611145
Tees	2000#	611168	611169	611170	611171	611173	611174	611176	611175	611177	611180
Crosses	2000#	611510	611511	611512	611516	611524	611531	611532	611533	611534	611535
90° Street Elbow	3000#	611160	611159	611162	611163	611164	611165	611166	611167	611158	611157
Couplings	3000#	600105	600110	600115	600120	600125	600130	600135	600140	600145	600150
Hex Head Plugs	3000#	600505	600510	600515	600520	600525	600530	600535	600540	600545	600550
Unions	3000#	660105	660110	660115	660120	660125	660130	660135	660140	660145	660150
Caps	3000#	600005	600010	600015	600020	600025	600030	600035	600040	600045	600050

Schedule 80 Forged Steel Fittings – Socket Weld

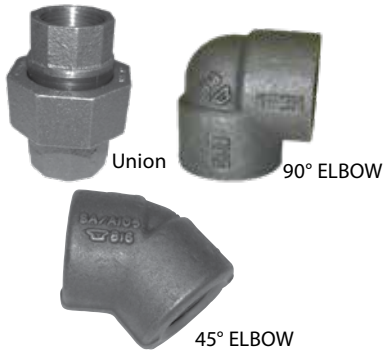

ITEM	PRESSURE	PIPE SIZE			
		1	1 1/4	1 1/2	2
45° Elbow	3000#	1-45SW	1 1/4-45SW	1 1/2-45SW	2-45SW
90° Elbow	3000#	1-90SW	1 1/4-90SW	1 1/2-90SW	2-90SW
Tee	3000#	1-T-SW	1 1/4-T-SW	1 1/2-T-SW	2-T-SW
Union	3000#	1-UNSW	1 1/4-UNSW	1 1/2-UNSW	2-UNSW
Cap	3000#	1-CAP-SW	1 1/4-CAP-SW	1 1/2-CAP-SW	2-CAP-SW
Reducing Insert	3000#	-	-	-	2X1 1/4SW-IS
	3000#	-	-	-	2X1 1/2SW-IS

Schedule 80 Nipples



ITEM	NORMAL PIPE SIZE									
	1/4	3/8	1/2	3/4	1	1 1/4	1 1/2	2	2 1/2	3
Close Nipple	612019	612020	612040	612095	612170	612220	612285	612335	612403	612405
1 1/2" Nipple	612008-2	-	-	612100	-	-	-	-	-	-
2" Nipple	612009	612024	612050	612105	612175	612225	612289	-	-	-
2 1/2" Nipple	612009-2	-	612050-2	612110	612180	612225-2	612289-2	612336-2	-	-
3" Nipple	612011	612026	612060	612115	612185	612235	612295	612350	614266	612408
3 1/2" Nipple	612011-2	612026-2	612065	612115-2	612190	612240	612300	612355	-	-
4" Nipple	612014	612027	612070	612125	612195	612245	612305	612360	612467	612410
4 1/2" Nipple	-	-	612075	612125-2	-	612245-2	612310	612360-2	-	-
5" Nipple	612017	612028	612080	612135	612205	612255	612315	612375	612468	612420
5 1/2" Nipple	-	-	612080-2	612135-2	-	612255-2	-	612-375-2	-	-
6" Nipple	612018	612029	612090	612145	612215	612265	612325	612385	612469	612430
8" Nipple	-	-	-	612150	612216	612270	-	612395	-	612450
9" Nipple	-	-	-	612151	-	-	612330	-	-	-
10" Nipple	-	-	-	-	-	612271	-	612387	-	-
12" Nipple	-	612035	-	612155	612275	612272	612333	612390	-	612454



Fittings Galvanized



Fittings - Galvanized

ITEM	PIPE SIZE								
	1/8	1/4	3/8	1/2	3/4	1	1 1/4	1 1/2	2
90° Elbow	44007	44008	44009	44010	44012	44013	-	44016	-
90° Elbow - Domestic	-	-	-	44010-DOM	44012-DOM	44013-DOM	-	-	-
90° Street Elbow	-	44032	44034	44035	44036	44037	-	-	-
90° Street Elbow - Domestic	-	-	-	44035-DOM	44036-DOM	-	-	-	-
45° Elbow	-	-	44041	44025	44026	44027	-	-	-
45° Street Elbow	-	-	-	44033	-	44038	-	-	-
Caps	44061	44062	44069	44070	44071	44072	-	-	44076
Caps - Domestic	-	-	-	44070-DOM	44071-DOM	-	-	-	-
Couplings	-	44081	44084	44085	44086	44087	-	-	-
Couplings - Domestic	-	-	-	44085-DOM	44086-DOM	-	-	-	-
Couplings - Merchant	-	-	46016	46017	46018	46019	-	-	-
Crosses	-	-	-	44120	44121	44122	-	-	-
Floor Flange	-	-	-	44116	44117	44118	-	-	-
Hex Head	-	44115	44109	44110	44111	44112	-	-	-
Hex Head - Domestic	-	-	-	44110-DOM	44111-DOM	-	-	-	-
Tees	44042	44043	-	44050	44051	44052	44044	44045	44046
Tees - Domestic	-	-	-	44050-DOM	44051-DOM	44052-DOM	-	-	-
Unions	-	-	44125	44126	44127	44128	-	-	44131
Unions - Domestic	-	-	-	44126-DOM	44127-DOM	44128-DOM	-	-	-

Reducing Fittings - Galvanized

ITEM	PIPE SIZE															
	1/4 X 1/8	3/8 X 1/4	3/8 X 1/2	1/2 X 1/8	1/2 X 1/4	1/2 X 3/8	3/4 X 1/4	3/4 X 3/8	3/4 X 1/2	1 X 1/2	1 X 3/8	1 X 3/4	1 1/4 X 3/4	1 1/2 X 3/4	1 1/2 X 1	2 X 1 1/2
Bushing	-	44104	-	44101	44100	44099	44106	44138	44097	44113	44108	44098	-	44546	44547	-
Coupling	44082	44083	44090	-	44088	44089	-	-	44095	44095-2	-	44096	44094	-	-	44091
Hex Bushing - Domestic	-	-	-	-	-	-	-	-	44097-DOM	-	-	44098-DOM	-	-	-	-
Reducer - Domestic	-	-	-	-	-	-	-	-	44095-DOM	-	-	-	-	-	-	-
90° Elbow	-	-	-	-	-	-	44018	-	-	44014	-	-	44015	-	-	-
Tee	-	-	-	-	-	-	-	-	44048	-	-	44053	-	-	-	-

300 Lb Forged Steel Flanges

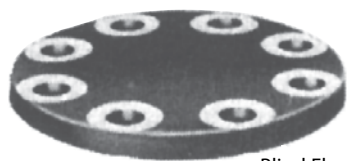

Blind Flange

Slip-On Flange



Flange Nuts, Bolts and Studs

High grade flange nuts, bolts and studs are available in 3" to 6" sizes.

TYPE	SIZE		
	2"	3"	4"
BLIND	F-2B	F-3B	F-4B
SLIP-ON	F-2	F-3	F-4
WELD NECK	F-2WN	F-3WN	F-4WN
THREAD	F-2T	F-3T	F-4T

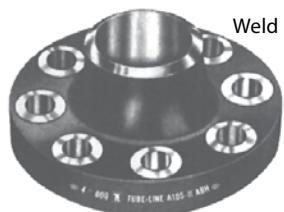

Weld Neck Flange

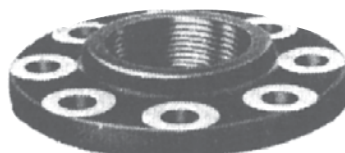

Screwed Flange

Other Sizes Available Upon Request

Flexitallic Style CG Gaskets



Gaskets

PART NUMBER	PIPE SIZE	ID	OD	CLASS
CG-3F	1 1/2"	2 1/8"	3 3/4"	300 LB
CG-3G	2"	2 3/4"	4 3/8"	300 LB
CG-3J	3"	4"	5 7/8"	300 LB
CG-3L	4"	5"	7 1/8"	300 LB
CG-3P	6"	7 3/16"	9 7/8"	300 LB
CG-1T	14"	14 5/8"	17 3/4"	150 LB
CG-1U	16"	16 5/8"	20 1/4"	150 LB
CG-1V	18"	18 11/16"	21 5/8"	150 LB
CG-1W	20"	20 11/16"	23 7/8"	150 LB

Other Sizes Available

Flange Insulation Sets

PART NUMBER	FOR FLANGE SIZE#	GASKET	CLASS
ENSW-1-1/2-3	1 1/2	Type E	300 LB
ENSW-1-1/4-3	1 1/4	Type E	300 LB
ENSW-2	2"	Type E	150 LB
ENSW-2-3	2"	Type E	300 LB
ENSW-3	3"	Type E	150 LB
ENSW-3-3	3"	Type E	300 LB
ENSW-4	4"	Type E	150 LB
ENSW-4-300	4"	Type E	300 LB
ENSW-5-300	5"	Type E	300 LB
ENSW-6	6"	Type E	150 LB
ENSW-6-300	6"	Type E	300 LB

For use in commercial, industrial, or plant applications where underground piping needs to be isolated from the tanks or the building.





Make your serviceman's job a little easier with our drip leg kits and nipple assortments

150LB Malleable Fittings for Schedule 40 Pipe



Tee



90° Elbow

ITEM	PIPE SIZE					
	3/8"	1/2"	3/4"	1"	1 1/4"	2"
90° Elbow	45009	45010	45012	45013	-	-
45° Elbow	45041	45025	45026	45027	-	-
Tees	45049	45050	45051	45052	-	-
90° Street Elbow	45034	45035	45036	45037	-	-
Coupling	45084	45085	45086	45087	-	-
Cap	45069	45070	45071	45072	-	-
Plug SQ Head	45109	45110	45111	45112	-	-
Union	45125	45126	45127	45128	-	-
Close Nipple	45407	45200	45226	45250	45270	45282
1 1/2 Nipple	-	45201	45227	-	-	-
2 Nipple	45409	45202	45228	45251	45275	-
2 1/2 Nipple	-	45203	45229	45258	45272	45284
3 Nipple	45410	45204	45230	45252	45276	45285
3 1/2 Nipple	-	45205	45231	45261	45277	45286
4 Nipple	45411	45206	45232	45253	45256	45287
4 1/2 Nipple	-	45207	45233	45263	45279	45288
5 Nipple	45412	45208	45234	45254	45280	45289
5 1/2 Nipple	-	45209	45235	45271	45281	45290
6 Nipple	45413	45210	45236	45255	45278	45291
8 Nipple	-	45211	45237	-	-	-
10 Nipple	-	45216	45417	-	45273	45283
12 Nipple	-	45225	45245	45264	45274	45292

Reducing Fittings

PIPE SIZE	BUSHING	COUPLING	REDUCING 90°
1/2 x 1/4	45100	-	
1/2 x 3/8	45099	45091	
3/4 x 3/8	45138	45092	
3/4 x 1/2	45097	45095	45028
1 x 1/2	-	45095-2	
1 x 3/4	45098	45096	45030
1 1/4 x 1/2	-	45093	
1 1/4 x 3/4	-	45094	

Note: 150# malleable for use with schedule 40 pipe.

PIPES & FITTINGS

We carry only forged flare nuts for you and your customers' safety.

Standard Sediment Traps



Tee, nipples and cap packaged in zip lock bag.

PART NUMBER	SIZE
DRIP-LEG 3/8	3/8"
DRIP-LEG 1/2	1/2"
DRIP-LEG 3/4	3/4"

Note: Schedule 40 nipples with 150# malleable fitting.

Dielectric Union



SIZE	VAPOR LINES	LIQUID LINES	DIELECTRIC
	150 LB WORKING PRESSURE	3000 LB WORKING PRESSURE	250 PSI
1/2"	1V-150-012	IU-3000-012	701-403
3/4"	1V-150-034	IU-3000-034	701-404
1"	1V-150-100	IU-3000-100	701-405
1 1/4"	1V-150-114	IU-3000-114	701-406
1 1/2"	-	IU-3000-112	701-407
2"	1V-150-200	IU-3000-200	701-408
3/4" x 3/8"	-	-	704-102
3/4" x 1/2"	-	-	704-103
3/4" x 5/8"	-	-	704-104

Nipple Trays/Dividers – All Steel



Nipple Tray

PART NO.	DESCRIPTION	DIMENSIONS		
		L	W	H
A3500F	1/2" Nipple Tray Holds 77 Nipples	11"	7 3/4"	6 3/4"
A3501K	3/4" Nipple Tray Holds 66 Nipples	12 3/4"	7 3/4"	6 3/4"

Nipple Kits

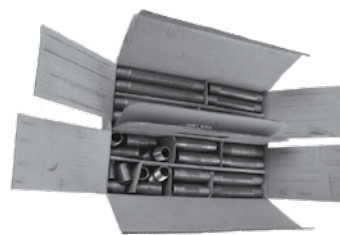

Schedule 40



Galvanized

PART NO.	DESCRIPTION	PIPE TYPE	# PER KIT
BLK66F	1/2" close-6"	Schedule 40	66
BLK66F-SCH80	1/2" close-6"	Schedule 80	10
BLK66K	3/4" close-6"	Schedule 40	66
BLK66K-SCH80	3/4" close-6"	Schedule 80	10
BLK66M	1" close-6"	Schedule 40	66
BLK66M-SCH80	1" close-6"	Schedule 80	10
BLK66N-SCH80	1 1/4" close-6"	Schedule 80	10
BLK66O-SCH80	1 1/2" close-6"	Schedule 80	10
BLK66P-SCH80	2" close-6"	Schedule 80	10
GALV66F	1/2" close-6"	Galvanized	66
GALV66K	3/4" close-6"	Galvanized	66
GALV66M	1" close-6"	Galvanized	66

Plastic Threaded Plug

Plastic plugs for cylinders without valves.



T-Series

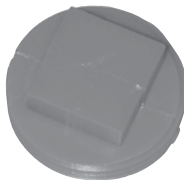

R-Series

PART NUMBER	DESCRIPTION
R1/2	1/2 NPT
R3/4	3/4 NPT
R1	1 NPT
T-6	3/8 M. Flare
T-7	1/2 M. Flare
T-8	5/8 M. Flare

2 Hole Pipe Strap Hanger

PART NUMBER	DESCRIPTION
G440-08	1/2"
G440-12	3/4"
G440-16	1"

Fittings

**Forged Flare Nut
NS4**



PART NUMBER	O.D. TUBE SIZE
NS4C	1/4"
NS4E	3/8"
NS4F	1/2"
NS4I	5/8"
NS4K	3/4"

**Full Union
No. 42**



PART NUMBER	O.D. TUBE SIZE
42C	1/4"
42E	3/8"
42F	1/2"
42I	5/8"

**3 Way Reducing Tee
No. 44**



PART NUMBER	O.D. TUBE SIZE		
	1	2	3
44EEC	3/8"	3/8"	1/4"
44FFE	1/2"	1/2"	3/8"
44FEF	1/2"	3/8"	1/2"
44FFE	1/2"	1/2"	3/8"
44FFI	1/2"	1/2"	5/8"
44IIE	5/8"	5/8"	3/8"
44IIF	5/8"	5/8"	1/2"
44EEF	3/8"	3/8"	1/2"

**Forged Reducing Flare Nut
NRS4**



PART NUMBER	O.D. TUBE SIZE
NRS4FE	1/2" x 3/8"
NRS4IE	5/8" x 3/8"
NRS4IF	5/8" x 1/2"

**Reducing Union
No. 42**



PART NUMBER	O.D. TUBE SIZE
42EC	3/8" x 1/4"
42FE	1/2" x 3/8"
42IE	5/8" x 3/8"
42IF	5/8" x 1/2"

**Forged 3 Way Tee
No. 44**



PART NUMBER	O.D. TUBE SIZE
44C	1/4"
44E	3/8"
44F	1/2"
44I	5/8"

**Flare Tee x Male IPT on
Branch No. 45**



PART NUMBER	O.D. TUBE X IPS
45EEE	3/8" x 3/8" x 3/8"
45EEF	3/8" x 3/8" x 1/2"
45FFE	1/2" x 1/2" x 3/8"
45FFF	1/2" x 1/2" x 1/2"
45IIF	5/8" x 5/8" x 1/2"

**Swivel Nuts
US4**



PART NUMBER	O.D. TUBE SIZE
US4C	1/4"
US4E	3/8"
US4F	1/2"
US4I	5/8"
US4K	3/4"
US4EC	3/8" x 1/4"
US4FE	1/2" x 3/8"
US4IF	5/8" x 1/2"

**Flare x Male 45° Elbow
No. 47**



PART NUMBER	O.D. TUBE X IPS
47EC	3/8" x 1/4"
47EF	3/8" x 1/2"
47FF	1/2" x 1/2"

**Flare x Female IPT Connector
No. 46**

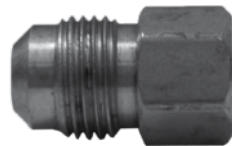

PART NUMBER	O.D. TUBE SIZE X IPS
46CC	1/4" x 1/4"
46EA	3/8" x 1/8"
46EC	3/8" x 1/4"
46EE	3/8" x 3/8"
46EF	3/8" x 1/2"
46EK	3/8" x 3/4"
46FC	1/2" x 1/4"
46FE	1/2" x 3/8"
46FF	1/2" x 1/2"
46FK	1/2" x 3/4"
46IE	5/8" x 3/8"
46IF	5/8" x 1/2"
46IK	5/8" x 3/4"

**Flare x Female Elbow
No. 54**



PART NUMBER	O.D. TUBE SIZE X IPS
54EC	3/8" x 1/4"
54EE	3/8" x 3/8"
54EF	3/8" x 1/2"
54EK	3/8" x 3/4"
54FC	1/2" x 1/4"
54FE	1/2" x 3/8"
54FF	1/2" x 1/2"
54FK	1/2" x 3/4"
54IE	5/8" x 3/8"
54IF	5/8" x 1/2"
54IK	5/8" x 3/4"

SAE Copper Seal Bonnet



PART NUMBER	O.D. TUBE X IPS	LINE SIZE
B1C	1/4"	3/8"
B1E	3/8"	1/2"
B1F	1/2"	5/8"
B1I	5/8"	3/4"

**Full Flare Elbow
No. 55**



PART NUMBER	O.D. TUBE SIZE
55C	1/4"
55E	3/8"
55F	1/2"
55I	5/8"
55K	3/4"
55EC	3/8" x 1/4"
55FE	1/2" x 3/8"
55IF	5/8" x 1/2"

PIPES & FITTINGS

Each year Tarantin puts on dozens of schools.
Pumps, meters, regulators, heaters, plastic pipe,
CSST or you name it; our people have the know-how.

Fittings

Flare x Male Elbow No.49



PART NUMBER	O.D. TUBE SIZE X IPS
49CA	1/4" x 1/8"
49CC	1/4" x 1/4"
49CE	1/4" x 3/8"
49CF	1/4" x 1/2"
49EA	3/8" x 1/8"
49EC	3/8" x 1/4"
49EE	3/8" x 3/8"
49EF	3/8" x 1/2"
49EK	3/8" x 3/4"
49FC	1/2" x 1/4"
49FE	1/2" x 3/8"
49FF	1/2" x 1/2"
49FK	1/2" x 3/4"
49IC	5/8" x 1/4"
49IE	5/8" x 3/8"
49IF	5/8" x 1/2"
49IK	5/8" x 3/4"
49KE	3/4" x 3/8"
49KK	3/4" x 3/4"

Flare x Male IPT Connector No. 48

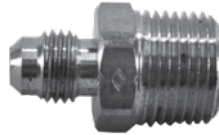

PART NUMBER	O.D. TUBE SIZE X IPS
48CA	1/4" x 1/8"
48CC	1/4" x 1/4"
48CE	1/4" x 3/8"
48CF	1/4" x 1/2"
48EA	3/8" x 1/8"
48EC	3/8" x 1/4"
48EE	3/8" x 3/8"
48EF	3/8" x 1/2"
48EK	3/8" x 3/4"
48FC	1/2" x 1/4"
48FE	1/2" x 3/8"
48FF	1/2" x 1/2"
48FK	1/2" x 3/4"
48IE	5/8" x 3/8"
48IF	5/8" x 1/2"
48IK	5/8" x 3/4"
48KF	3/4" x 1/2"
48KK	3/4" x 3/4"

Flare x Male Connector - Long Shank No. 48



PART NUMBER	O.D. TUBE SIZE X IPS
48F-6-6LS	3/8" x 3/8"
48F-6-8LS	3/8" x 1/2"
48F-8-6LS	1/2" x 3/8"
48F-8-8LS	1/2" x 1/2"

Full Flare Cross Reducing



PART NUMBER	O.D. TUBE SIZE
C1E	3/8"
C1F	1/2"
C1I	5/8"

Plastic Flare Plug

Dirt Seal Only
Do Not Use Under Pressure



PART NUMBER	FLARE
T-6	3/8"
T-7	1/2"
T-8	5/8"

Brass Flare Plug



PART NUMBER	O.D. TUBE SIZE
P2C	1/4"
P2E	3/8"
P2F	1/2"
P2I	5/8"

Flare Cap



PART NUMBER	O.D. TUBE SIZE
N5C	1/4"
N5E	3/8"
N5F	1/2"
N5I	5/8"

Male Flare X POL Adapter



PART NUMBER	SIZE
BG20E	POL x 3/8" M Flare
BG20F	POL x 1/2" M Flare
BG20I	POL x 5/8" M Flare

POL-Fittings



PART NUMBER	MATERIAL	DESCRIPTION
737-5	Plastic	Plug
G-1691	Brass	Plug
G-1699	Brass	Cap



Coated Copper Tubing



Copper has proven to be reliable and economical for propane installations for over 30 years. Now take the next step toward safer installations.

Advantages of coated copper tubing:

- Line marked for identification
- Marked for easy measuring
- Easy installation (labor savings)
- Flexible
- Fewer joints/fittings
- One person installation
- Minimal inventory space required
- No power needed to install

EASY TO IDENTIFY

- Permanent yellow polyethylene coating
- Continuous line marking
- Traceable back to origin of manufacturing
- Mill test reports available upon request

EASY TO INSTALL

- No additional training required for installation
- Flexible
- Easy to join
- Compact size
- Requires smaller and fewer tools than steel pipe
- Cleaner than threaded steel pipe

COST EFFICIENT

- Most economical line-marked tubing on the market
- Minimal labor costs due to quick and easy installation
- No on-site sleeving required for underground gas lines

RECYCLABLE

- Copper is fully recyclable

Refrigeration (O.D) Coated Copper Application Low Pressure	
PART NUMBER	DESCRIPTION
CCR-3/8X50	3/8" x 50'
CCR-3/8X100	3/8" x 100'
CCR-1/2X50	1/2" x 50'
CCR-1/2X100	1/2" x 100'
CCR-5/8X50	5/8" x 50'
CCR-5/8X100	5/8" x 100'

TYPE L (I.D.) Coated Copper Application High Pressure (UG)	
PART NUMBER	DESCRIPTION
CCL-1/4X60	1/4" x 60'
CCL-3/8X60	3/8" x 60'
CCL-3/8X100	3/8" x 100'
CCL-1/2X60	1/2" x 60'
CCL-1/2X100	1/2" x 100'
CCL-5/8X60	5/8" x 60'

Pipe Strap - Copper



Part Number: A440-1/2

J Clips for Copper Tubing



PART NUMBER	O.D. TUBE SIZE
MSCP-#1-J-CLIP	3/8" & 1/2" OD
MSCP-#2-J-CLIP	5/8" OD

Tube Talon Holder



PART NUMBER	HOLDER SIZE	O.D. TUBE SIZE
555-1	3/8"	1/2" Copper Tubing
555-2	1/2"	5/8" Copper Tubing
555-3	1/2"	1/2" CSST

PIPES & FITTINGS

However you need to get there – copper, coated copper, CSST or polyethylene pipe – we've got it for you.

Copper Tubing



Copper Refrigeration Tubing

For second stage pressure and indoor applications only. Measured in Outside Diameter (O.D.)

PART NUMBER		O.D.	I.D.	WALL
50 FT COIL	100 FT COIL			
REF-1/8-50	REF-1/8-100	1/8"	-	-
REF-1/4-50	REF-1/4-100	1/4"	-	-
REF-3/8-50	REF-3/8-100	3/8"	1/4"	0.032
REF-1/2-50	REF-1/2-100	1/2"	3/8"	0.032
REF-5/8-50	REF-5/8-100	5/8"	1/2"	0.035
REF-3/4-50	REF-3/4-100	3/4"	-	-

Copper Type L Tubing

First and second stage use, good for indoor and external installation. Measured in Inside Diameter (I.D.)

PART NUMBER		I.D.	O.D.	WALL
60 FT COIL	100 FT COIL			
TYL-1/4-60	TYL-1/4-100	1/4"	3/8"	0.03
TYL-3/8-60	TYL-3/8-100	3/8"	1/2"	0.035
TYL-1/2-60	TYL-1/2-100	1/2"	5/8"	0.04

Copper Type K Tubing

For all pressure including tank. Can be installed underground. For liquid applications. Measured in Inside Diameter (I.D.)

PART NUMBER		I.D.	O.D.	WALL
60 FT COIL	100 FT COIL			
TYK-1/4-60	TYK-1/4-100	1/4"	3/8"	0.035
TYK-3/8-60	TYK-3/8-100	3/8"	1/2"	0.049
TYK-1/2-60	TYK-1/2-100	1/2"	5/8"	0.049

Polyethylene Pipe



Polyethylene Pipe is a safe, economical system of running underground gas line that has been approved since 1979. Plastic Gas Pipe can be joined using mechanical fittings, butt fusion, socket fusion, sidewall fusion or electrofusion and should not be used with pressures exceeding 30 PSI. Pipe is manufactured and rated according to the following guidelines ASTM D 2513, ASTM F 678, ASTM D 3350, ASTM D 1248.

TUBING (CTS) PART NUMBER	SIZE-IN	SDR	OD	ID	MIN WALL THICK	APPROX WEIGHT - LBS/100	COIL OR JOINT LENGTH AVAILABLE
PP-1/2CTS	1/2" 5/8" OD	7	0.625	0.44	0.09	6.5	250'/500'
PP-1CTS	1" 1 1/8" OD	11.5	1.125	0.94	0.099	13.8	250'/500'
PIPE (IPS) PART NUMBER	SIZE-IN	SDR	OD	ID	MIN WALL THICK	APPROX WEIGHT - LBS/100	COIL OR JOINT LENGTH
PP-1/2IPS	1/2"	9.33	0.84	0.683	0.09	9	500'
PP-3/4IPS	3/4"	11	1.05	0.854	0.095	12.4	150'/250'/500'
PP-1IPS	1"	11	1.315	1.068	0.12	19.4	250'/500'
PP-1 1/4IPS	1 1/4"	10	1.66	1.349	0.166	34	250'/500'
PP-1-1/2IPS	1 1/2"	11	-	-	-	38.5	150'/500'
PP-2IPS	2"	11	2.375	1.93	0.216	63	150'/250'/500'
PP-3IPS-40	3"	11	3.5	2.845	0.318	138	40'
PP-4IPS	4"	11	4.5	3.752	0.409	228	40'

Copper Termination Flange



Transitions the copper tube back to standard pipe, reducing the amount of tubing required for a job and protecting the line from damage.

Part Number: 71900

Electrofusion Systems



Couplings have wide fusion zones and can be re-fused in case of electrical power interruption. The widest range of sizes available.

Call for more information on Electrofusion Systems.

LP Gas Vapor Line Sizing for Polyethylene Tubing

Sizing for vapor between 1st and 2nd stage regulators allowing a pressure drop of 1 PSI at 10 PSI setting.

TUBING LENGTH (FT)*	1/2" CTS SDR 7 (.090")	1/2" IPS SDR 9.3 (.090")	3/4" IPS SDR 11 (.095")	1" CTS SDR 11.5 (.099")	1" IPS SDR 11 (.119")	1 1/4" IPS SDR 10 (.166")	2" IPS SDR 11 (.216")
10	1406	4235	8940	10803	16486	28912	82488
20	944	2842	6001	7252	11067	19409	55373
30	747	2252	4753	5744	8766	15372	43858
40	634	1908	4029	4868	7429	13029	37171
50	557	1679	3544	4282	6535	11460	32695
60	502	1512	3191	3856	5884	10319	29441
70	459	1383	2920	3529	5385	9444	26944
80	425	1281	2704	3268	4987	8746	24953
90	397	1197	2527	3054	4661	8173	23319
100	374	1127	2379	2874	4387	7693	21948
125	329	991	2092	2528	3858	6766	19305
150	296	893	1884	2277	3474	6093	17384
175	271	817	1724	2084	3180	5576	15909
200	251	756	1597	1930	2945	5164	14733
225	235	707	1492	1803	2752	4826	13768
250	221	665	1405	1697	2590	4542	12959
275	209	630	1330	1607	2452	4300	12268
300	199	599	1265	1528	2332	4090	11669
350	182	548	1157	1399	2134	3743	10680
400	169	508	1072	1295	1976	3467	9890

* Note: The above numbers were calculated by using the Mueller formula (Mueller Co. - Decatur, IL) for high pressure installations of smooth pipe such as plastic, copper, brass, etc. carrying gas at pressures greater than 1 psig.

Easy-to-install Permasert System



1 Cut the tubing so that the end is square.



2 Wipe the tubing with a dry clean cloth & inspect for defects



3 Insert tube and rotate in chamfer tool until tube bottoms out.



4 Mark the stab depth.



5 Stab tubing into the coupling until it bottoms out.



6 Pressure test the finished joint according to your standard operating procedure.

Note: This quick-install image guide is for reference only. Permasert 2.0 couplings require training on the complete installation procedure before installing any Permasert 2.0 product.

Plastic Mechanical Fittings

Permasert Mechanical Couplings



SIZE-IN.	PART NO.
1/2" CTS	50100PC
1/2" IPS	50701PC
3/4" IPS	50030PC
1" CTS	50103PC
1" IPS	50601PC
1 1/4" IPS	50035010PC
1 1/2" IPS	50361PC
2" IPS	50314PC

Permasert Reducing Couplings



SIZE	PART NO.
1/2" IPS x 1" CTS	50755PC
1/2" IPS x 3/4" IPS	50756PC
1/2" IPS x 1" IPS	50621PC
1/2" CTS x 1" CTS	50149PC
1/2" CTS x 3/4" IPS	50969PC
1/2" CTS x 1" IPS	50641PC
3/4" IPS x 1" CTS	50148PC
1" CTS x 1 1/4" IPS	50192PC
1" IPS x 3/4" IPS	51432PC
1" IPS x 1" CTS	50623PC
1/2" IPS x 1/2" CTS	50751PC
1 1/4" IPS x 3/4" IPS	51677PC
1 1/4" IPS x 1" IPS	50343010PC
1 1/4" IPS x 2" IPS	50333010PC

Permasert Repair Couplings



SIZE	LENGTH	PART NO.
1/2" CTS	12"	50056PC
1/2" CTS	24"	50177PC
1/2" IPS	12"	50740PC
3/4" IPS	12"	50175PC
3/4" IPS	24"	50067030PC
1" CTS	12"	50172PC
1" IPS	12"	50640PC
1 1/4" IPS	13"	50320100PC
1 1/4" IPS	24"	50332PC
2" IPS	15"	50341PC

Plastic to Copper Transitions



SIZE	PART NO.
1/2" CTS x 3/8" FLARE	41007PS
1/2" CTS x 1/2" FLARE	41013PS
1/2" IPS x 1/2" FLARE	41140PS
1/2" CTS x 5/8" FLARE	41002PS
3/4" IPS x 1/2" FLARE	41133PS
3/4" IPS x 5/8" FLARE	41130PS
1" CTS x 1/2" FLARE	41153PS
1" CTS x 5/8" FLARE	41150PS

Permasert Blind End Caps

(Stop and Go – Both Ends Functional)



SIZE	PART NO.
1/2" CTS	50016PC
1/2" IPS	50716PC
3/4" IPS	50026PC
1" CTS	50045PC
1" IPS	51501PC
1 1/4" IPS	50033PC
2" IPS	50317PC

Permasert Three-Way Tees



SIZE	PART NO.
1/2" CTS	50199PC
1/2" IPS	50730100PC
3/4" IPS	50929PC
1" CTS	50292PC
1" IPS	50634PC
1 1/4" IPS	50327010PC
2" IPS	50316PC

Permasert Blind End Stubs

(Dead-End Fitting – One End Functional)



SIZE	PART NO.
1/2" CTS	50015PC
3/4" IPS	50809PC
1" CTS	50048PC
1" IPS	50612PC
1 1/4" IPS	50024100PC
2" IPS	51770PC

Permasert Three-Way Reducing Tees



SIZE	PART NO.
1/2" CTS x 1/2" CTS x 1" CTS	51335PC
3/4" IPS x 3/4" IPS x 1/2" CTS	50461PC
1" CTS x 1" CTS x 1/2" CTS	50451PC
1" IPS x 1" IPS x 1/2" CTS	50632PC
1" IPS x 1" IPS x 3/4" IPS	50635PC
1" IPS x 1" IPS x 1/2" IPS	50637PC
1 1/4" IPS x 1 1/4" IPS x 3/4" IPS	50992PC
1 1/4" IPS x 1" CTS x 1" CTS	51322PC
1 1/4" IPS x 1 1/4" IPS x 1" CTS	50328100PC
2" IPS x 2" IPS x 1" CTS	50348100PC
2" IPS x 2" IPS x 1" IPS	51283PC
2" IPS x 2" IPS x 1 1/4" IPS (SDR11)	51285PC
2" IPS x 2" IPS x 1 1/4" IPS (SDR10)	51323100PC

Permasert Elbows



SIZE	PART NO.
1/2" CTS	50294PC
1/2" IPS	50732100PC
3/4" IPS	51620PC
1" CTS	51333PC
1" IPS	50636PC
1 1/4" IPS	50325010PC
2" IPS	50315PC

Our "All Flex" risers can bend around the tank making a clean looking installation with no joint underground.

Risers and Transitions

Note: No Cathodic Protection Required - Casing is Coated

Anodeless Service Line Risers – Fusion Ends



PLASTIC INLET	PIPE OUTLET	VERT	HORIZ	PART NUMBER
1/2" CTS	3/4" MPT	18"	18"	75678
1/2" CTS	3/4" MPT	22"	18"	77202
1/2" CTS	3/4" MPT	30"	24"	75169
1/2" IPS	1/2" MPT	30"	25"	77221
1/2" IPS	3/4" MPT	30"	24"	79036
3/4" IPS	3/4" MPT	30"	24"	75251
1" CTS	3/4" MPT	30"	24"	77121
1" IPS	1" MPT	30"	24"	75751
1 1/4" IPS	1 1/4" MPT	30"	24"	75900
1 1/2" IPS	1 1/2" MPT	32"	32"	79799
2" IPS	2" MPT	30"	15"	79811

Anodeless Service Line Risers – Permasert Mechanical Ends



PLASTIC INLET	PIPE OUTLET	VERT	HORIZ	PART NUMBER
1/2" CTS	1/2" MPT	30"	24"	77253PM
1/2" CTS	3/4" MPT	22"	18"	77201PM
1/2" CTS	3/4" MPT	30"	24"	7718PM
3/4" IPS	3/4" MPT	30"	26"	79206PG
1" CTS	3/4" MPT	30"	24"	77120PG
1" IPS	1" MPT	30"	24"	79350PG
1 1/4" IPS	1 1/4" MPT	30"	24"	75901PG
1 1/2" IPS	1 1/2" MPT	32"	32"	79784PG
2" IPS	2" MPT	30"	15"	75906PG

Anodeless Service Line Risers – Permanent Mechanical Ends For Use with Underground Tanks



PLASTIC INLET	PIPE OUTLET	VERT	HORIZ	PART NUMBER
1/2" CTS	3/4" MPT	18"	18"	77195PM
1/2" CTS	1/2" MPT	18"	18"	77205PM

Transition Fittings

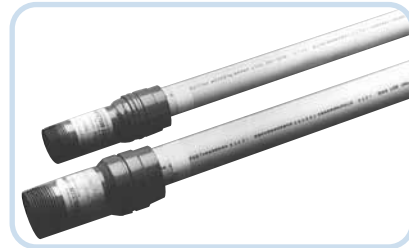

PLASTIC INLET	PIPE OUTLET	PART NUMBER
1/2" CTS	1/2" MPT	700004
1/2" CTS	3/4" MPT	700205
1/2" IPS	1/2" MPT	T-5000
1/2" IPS	1/2" MPT	70180*
3/4" IPS	3/4" MPT	700802
1" CTS	1" MPT	701407
1" IPS	1" MPT	701202
1 1/4" MPT	1 1/4" MPT	702205
1 1/2" IPS	1 1/2" MPT	702401
2" IPS	2" MPT	702602
3" IPS	3" MPT	702802

*25" length

PIPES & FITTINGS

Whether, it's plastic pipe for the 1st stage or CSST for the 2nd stage, Tarantin has what you need. Call us today!

PermaLock™ Mechanical Tapping Tees (PMTT)



Accessory

Tapping Tee Tool Kit
Part Number: 53913

PERMASERT OUTLET	MAIN SIZE	CUTTER SIZE	PART NUMBER
1/2" CTS	1 1/4" IPS	.55"	54201PL
1" CTS	1 1/4" IPS	.55"	54251PL
3/4" IPS	1 1/4" IPS	.55"	54290PL
1/2" CTS	2" IPS	.80"	55702PL
3/4" IPS	2" IPS	.80"	55901PL
1" CTS	2" IPS	.80"	55802PL
1" IPS	2" IPS	.80"	55951PL
1 1/4" IPS	2" IPS	.80"	55982PL
2" IPS	2" IPS	.80"	55990PL
1/2" CTS	4" IPS	.80"	55716PL
3/4" IPS	4" IPS	.80"	55902PL
1" CTS	4" IPS	.80"	55811PL
1" IPS	4" IPS	.80"	55953PL
1 1/4" IPS	4" IPS	.80"	55986PL
2" IPS	4" IPS	.80"	55992PL

Anodeless Servi-Sert™ Field-Assembled Risers

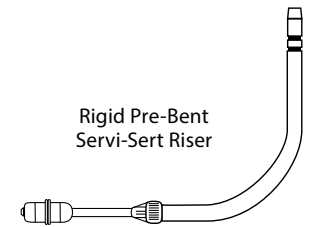
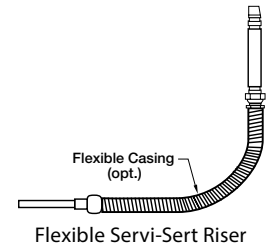

Rigid (Pre-Bent) w/Liners (Centering Sleeves)*



Stub-Flex w/Liners (Centering Sleeves)*



OUTLET	INLET	SDR/WALL	VERTICAL	HORIZONTAL	PART NUMBER
1/2" MPT	1/2" CTS	.090"	30"	24"	71350
3/4" MPT	1/2" CTS	.090"	30"	24"	71453
3/4" MPT	3/4" IPS	SDR 11	30"	24"	71304
1" MPT	1" CTS	.099"	30"	24"	71720

OUTLET	INLET	SDR/WALL	NIPPLE	FLEX	PART NUMBER
1/2" MPT	1/2" CTS	.090"	15"	36"	71351
3/4" MPT	1/2" CTS	.090"	15"	36"	71463
3/4" MPT	3/4" IPS	SDR 11	17 1/2"	36"	71721
1" MPT	1" CTS	.099"	17 1/2"	36"	71600
1" MPT	1" IPS	SDR 11	17 1/2"	36"	71731

Anodeless Servisert Field Assembled "All Flex" Risers* (w/Swivel Connector/Union)



These risers are field assembled by inserting polyethylene tubing from the roll thereby allowing a continuous service line with no connections underground.

OUTLET	INLET	SDR/WALL	LENGTH	PART NUMBER
1/2" MPT	1/2" CTS	.090"	84"	71353
1/2" MPT	1/2" CTS	.090"	36"	71354
3/4" MPT	1/2" IPS	SDR 9.33	36"	71271
3/4" MPT	1/2" CTS	.090"	84"	71355
3/4" MPT	1/2" CTS	.090"	60"	71461
3/4" MPT	1/2" CTS	.090"	36"	71356
3/4" MPT	3/4" IPS	SDR 11	84"	71412
3/4" MPT	3/4" IPS	SDR 11	60"	71411
3/4" MPT	3/4" IPS	SDR 11	36"	71410
1" MPT	1" CTS	SDR 11	36"	71200

Butt Fusion Fittings

90° Elbow

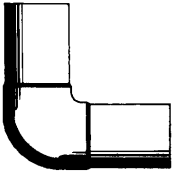

45° Elbow

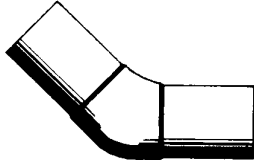

Cap



Flange Adapters

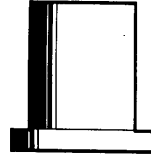

Tee

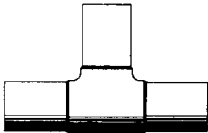

Reducer

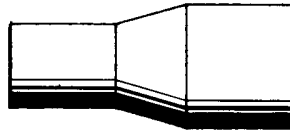

TYPE	NOM. SIZE-IN.	PART NUMBER
90° Elbow	2"	2-90L-B
45° Elbow	2"	2-45L-B
Cap	2"	2-EC-B
Flange Adapter	2" IPS x 6" Long	2X6-F-B
Tee	1"	1-TEE-B
Tee	2"	2-TEE-B
Reducer	2" x 1" IPS	2X1-RC-B
Reducer	2" IPS x 1-1/4" CTS	2X1 1/4-RC-B
Reducer	2" x 1-1/2"	2X1 1/2-RC-B

Socket Fusion Fittings

Couplings



Reducing Coupling

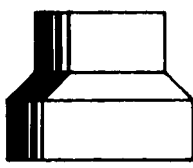

Branch Saddle

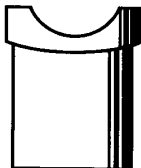

Tee



Reducing Tee

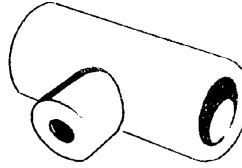

90° Fusion Elbow



Cap

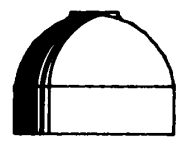

TYPE	NOM. SIZE-IN.	PART NO.
Coupling	1/2 CTS	1/2-SC-CTS
Coupling	1 CTS	1C-SC
Coupling	1/2 IPS	1/2-SC
Coupling	3/4 IPS	3/4-SC
Coupling	1 IPS	1-SC
Coupling	1 1/4 IPS	1 1/4-SC
Coupling	2 IPS	2-SC
Reducing Coupling	1/2 IPS x 1/2 CTS	1/2x1/2CRC
Reducing Coupling	3/4 IPS x 1/2 IPS	3/4x1/2RC
Reducing Coupling	3/4 IPS x 1/2 CTS	3/4x1/2CRC
Reducing Coupling	1 CTS x 1/2 CTS	1Cx1/2C-RC
Reducing Coupling	1 IPS x 1/2 CTS	1x1/2C-RC
Reducing Coupling	1 IPS x 1/2 IPS	1x1/2RC
Reducing Coupling	1 IPS x 1 CTS	1x1CRC
Reducing Coupling	1 IPS x 3/4 IPS	1x3/4RC
Reducing Coupling	1 1/4 IPS x 1 IPS	1 1/4x1RC
Reducing Coupling	1 1/4 IPS x 1 CTS	1 1/4x1C-RC
Reducing Coupling	2 IPS x 1 IPS	2x1RC
Reducing Coupling	2 IPS x 1 1/4 IPS	2x1 1/4RC
Branch Saddle	2 IPS x 1 1/4 IPS	2x1 1/4BS
Branch Saddle	3 IPS x 1 1/4 IPS	3x1 1/4BS
Branch Saddle	4 IPS x 1 1/4 IPS	4x1 1/4 BS
Branch Saddle	2 IPS x 2 IPS	2x2BS

TYPE	NOM. SIZE-IN.	PART NO.
Tee	1/2 CTS	1/2C-TEE
Tee	1 CTS	1C-TEE
Tee	1/2 IPS	1/2-TEE
Tee	3/4 IPS	3/4-TEE
Tee	1 IPS	1-TEE
Tee	1 1/4 IPS	1 1/4-TEE
Tee	2 IPS	2-TEE
Reducing Tee	1 IPS x 1 IPS x 1/2 IPS	1X1X1/2RT
Reducing Tee	1 IPS x 1 IPS x 1/2 CTS	1X1X1/2CRTCTS
90° Elbow	1/2 CTS	1/2C-90L
90° Elbow	1 CTS	1C-90L
90° Elbow	1/2 IPS	1/2-90L
90° Elbow	3/4 IPS	3/4-90L
90° Elbow	1 IPS	1-90L
90° Elbow	1 1/4 IPS	1 1/4-90L
90° Elbow	2 IPS	2-90L
Cap	1/2 CTS	1/2C-EC
Cap	1 CTS	1C-EC
Cap	1/2 IPS	1/2-EC
Cap	3/4 IPS	3/4-EC
Cap	1 IPS	1-EC
Cap	1 CTS	1C-EC
Cap	1 1/4 IPS	1 1/4-EC
Cap	1 3/4 CTS	1 3/4C-EC
Cap	2 IPS	2-EC

Electric Fusion Tools



MH3000-102



556-0022

PART NO.	MODEL TYPE	SOCKET FUSION	BUTT FUSION	SIDEWALL FUSION	WATTS	AMPS	VAC
MH3000-102	Model 2 Heating	1/2" CTS - 2" IPS	1/2" IPS - 3" IPS	1-1/4" - 8"	800	8	115
556-0022	Model 4SW Heating	1/2" IPS - 2" IPS	1/2" IPS - 4" IPS	1-1/2" - 8"	1600	14	115

Fusion Tools Gas Fired



2" Hot Head Part No. HH3000

Gas fired heating head.
Socket fusion
1/2" CTS-2" IPS
Tank not included.



Model 4 Gas Fired Combination Head Part No. 566-0023

Socket fusion
1/2" IPS-4" IPS
Butt fusion
1/2" IPS-4" IPS
Tank not included.

Accessories

Extended Handle

Fits Model 2 and Model 45W
Part No. HM3000-102

Nozzle Regulator

Fits Gas Fired Heaters
Part No. MM0120

Fusion Accessories

Socket Fusion Faces

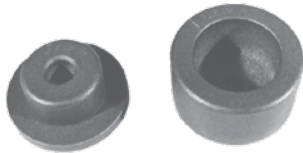

SIZE-IN.	PART NUMBER
1/2 CTS	CR0620
1/2 IPS	CR0500
3/4 IPS	CR0750
1 IPS	CR0010
1 CTS	CR0110
1 1/4 IPS	CR0120
2 IPS	CR0020
3 IPS	CR0030
4 IPS	CR0040

SIZE-IN.	PART NUMBER
1/2 CTS	SP2620
1/2 IPS	SP2500
3/4 IPS	SP2750
1 IPS	SP2010
1 CTS	SP2110
1 1/4 IPS	SP2120
2" IPS	SP2020
3" IPS	SP2030

Butt Fusion Faces

Call for proper sizing

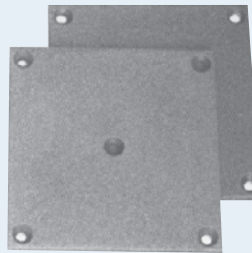

Cold Ring - A



Heater Muff Part No. HM 3000

Fits all heater tools.
Protects heater tool,
maintains temperature.



Tools and Accessories

Brackets

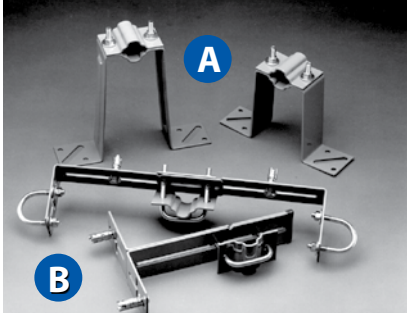

A Wall Brackets

SIZE	NOMINAL BUILDING OFFSET	PART NO.
3/4" - 2" IPS Casing	4"	74506
3/4" - 2" IPS Casing	9"	74491
3/4" - 2" IPS Casing	6"	74500
Bracket Kit Universal		74440

B Universal Mount Riser Bracket Kit

Fits 3/4" IPS - 2" IPS casing for foundation mount or remote meter installation.

Part No. 74440

Accessories	
Description	Part Number
Wall Mounting Hardware	
Includes Lead Anchors, Washers & Bolts	09800
5 Ft. Support Post	31733

Squeeze-Off Tool



Precision stops prevent over squeezing and damaging.

Designed for 1/2" IPS-2" IPS.

Part Number: 557-0006

Tee Handles

PART NO.	DESCRIPTION
SRVW15	Tee Handle Wrench for Shut-Off Valve 15" long
SRVW24	Tee Handle Wrench for Shut-Off 24" long
SRVW60	Tee Handle Wrench for Shut-Off 60" long

Box and Valve Support

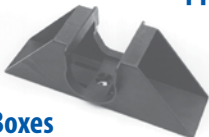

PART NO.	DESCRIPTION
VCS-5	Fits Valves 1/2"- 1/4"
VC9	Fits 2" Valves
VV8	Fits 3" Valves

Curb Boxes



PART NO.	DESCRIPTION
GIF2-2A	Cast Iron Collar, adjustable: 18-5/8" to 24", Fits 1/2"-1 1/4" valve

Our Assembly Tool is better than a second pair of hands! Kit contains everything needed to get the job done: 2" Chamfering Tool, Marking Pencil, and the 2" Perma-Snip Cutting Tool.

Part Number: 51050-K



Small



Medium



Large

Cutters

PART NO.	SIZE	SNIPS THROUGH	REPLACEMENT BLADES
55190	Small	1/8" - 1 1/4" OD	55200
55290	Medium	1/8" - 1 1/2" OD	55300
55291	Large	1/8" - 2 3/8" OD	57300

Chamfering Tools 2.0



PART#	SIZE	BLADE PART #
58500	1/2" CTS	51071
58501	1/2" IPS	51071
58502	3/4" CTS	51071
58503	3/4" IPS	51071
58504	1" CTS	51071
58505	1" IPS	51071
58506	1-1/4" CTS	51071
58507	1-1/4" IPS	51071
58508	1-1/2" IPS	51071
58509	2" IPS	52427

Permasert PSV™ Polyethylene Shut-off Valves Permasert Outlet Ends



SIZE-IN.	PART NO.
1/2" CTS	45051-P
3/4" IPS	45110-P
1" CTS	45071-P
1" IPS	45201-P
1 1/4" IPS	45170100
2" IPS	45600

Socket Fusion Shut-Off Valves Meets P.E. 2406 Spec



PART NUMBER	DESCRIPTION	CURB BOX
UGB1/2	1/2" U.G. Valve	CBA
U075IPS	3/4" U.G. Valve	CBA
U100IPS	1" U.G. Valve	CBA
U125IPS	1 1/4" U.G. Valve	CBA
UGV2	2" U.G. Valve	CBG
UGV3	3" U.G. Valve	CBG

Note: Butt Fusion Valves and larger sizes available—call.

Locator Tape Also available - No. 12 Tracer Wire



SIZE	PART NO.
Non-Metallic Locator Tape	715-CGT-31
Metallic Locator Tape	715-NCGT21

Metallic Tape buried 6" below grade allows detection with metal detector up to 12"

PERMASERT 2" Tool Kit



PIPES & FITTINGS



TracPipe Gas Piping – CSST

Counterstrike The First Flexible Gas Piping Available to Provide Enhanced Protection From Lightning. CounterStrike is a TracPipe patent-pending CSST innovation that is engineered to significantly decrease the potential for lightning induced damage to fuel gas piping systems.



FGP-CS-500-250

PART NUMBER	SIZE	REEL LENGTH
FGP-CS-375	3/8"	250 ft
FGP-CS-500	1/2"	100 ft / 250 ft
FGP-CS-750	3/4"	100 ft / 250 ft
FGP-CS-1000	1"	180 ft
FGP-CS-125	1 1/4"	150 ft
FGP-CS-150	1 1/2"	150 ft
FGP-CS-200	2"	150 ft

Counterstrike is sized exactly the same as conventional TracPipe and uses the same AutoFlare fittings.



AutoFlare Fittings – Reducing

PART NUMBER	TUBE SIZE IN.	PKG QTY
FGP-RST-500-750	1/2"-3/4"	24
FGP-RST-750-500	3/4"-1/2"	16
FGP-RST-1000-750	1"-3/4"	16



Auto Flare Fittings – Female Straight

PART NUMBER	TUBE SIZE IN.	PKG QTY
FGP-FSTF-375	3/8"	24
FGP-FSTF-500	1/2"	24
FGP-FSTF-750	3/4"	16
FGP-FSTF-1000	1"	16

Reducing Tees



PART NUMBER	TUBE SIZE IN.	PKG QTY
FGP-TF1000-T500	1 X 1 X 1/2	10
FGP-RT-1001	1 X 3/4 X 1/2	10
FGP-RT-752	3/4 X 1/2 X 1/2	12
FGP-TF750-T500	3/4 X 3/4 X 1/2	12
FGP-RT-1002	1 X 3/4 X 3/4	10

Tee – TracPipe by TracPipe Outlet



PART NUMBER	TUBE SIZE IN.	PKG QTY
FGP-TF500-T500	1/2"	14
FGP-TF750-T750	3/4"	12
FGP-TF1000-T1000	1"	10

Tee – TracPipe by Pipe Outlet



PART NO.	TUBE SIZE IN.	PKG QTY
FGP-T500-500	1/2 X 1/2	14
FGP-T750-500	3/4 X 1/2	12



Auto Flare Fittings – Straight

PART NUMBER	TUBE SIZE IN.	PKG QTY
FGP-FST-375	3/8"	24
FGP-FST-500	1/2"	24
FGP-FST-750	3/4"	16
FGP-FST-1000	1"	16
FGP-FST-1250	1 1/4"	6
FGP-FST-2000	2"	4



AutoSnap Fittings – Straight

PART NUMBER	TUBE SIZE IN.	PKG QTY
FGP-SFST-375	3/8"	24
FGP-SFST-500	1/2"	24
FGP-SFST-750	3/4"	16
FGP-SFST-1000	1"	16
FGP-SFST-1250	1 1/4"	6
FGP-SFST-2000	2"	4



Flange Fitting

PART NUMBER	TUBE SIZE IN.	PKG QTY
FGP-RFG-375	3/8"	12
FGP-RFG-500	1/2"	12
FGP-RFG-750	3/4"	8
FGP-RFG-1000	1"	8
FGP-RFG-1250	1 1/4"	4



Shutoff Valves

PART NO.	DESCRIPTION	SIZE IN.
FGP-WBV-500	5 PSI Ball Valve	1/2"
FGP-WBV-750	5 PSI Ball Valve	3/4"

TracPipe Gas Piping – CSST



Manifolds

PART NO.	DESCRIPTION	SIZE IN.
FGP-LC	Load Center with Bracket	-
FGP-MB2	Mainfold Bracket	-
FGP-MI-ST-500	Stackable Manifold 2 Ports	1/2" F x 1/2"
FGP-MI-ST-750	Stackable Manifold 2 Ports	3/4" F x 1/2"
FGP-MI-PC	Coated Manifold 4 Ports	3/4" x 1/2" x 1/2"



Cutting Tools

PART NO.	DESCRIPTION	SIZE IN.
FGP-TC-15	Small Cutter # 15	3/8"-1"
FGP-TC-151	Large Cutter # 151	3/8"-1 1/4"
FGP-TC-152	XL Cutter # 152	1 1/4"-2"
FGP-E-5272	Cutter Wheel for XL	1 1/4"-2"

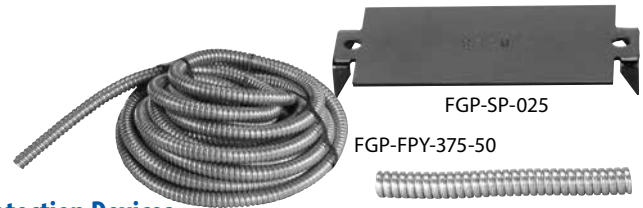

Protection Devices

PART NUMBER	DESCRIPTION	SIZE IN.	PKG QTY
FGP-SP-025	Quarter Striker Plate	3" x 2"	1
FGP-SP-050	Half Striker Plate	3" x 7"	1
FGP-SP-100	Full Striker Plate	3" x 12"	1
FGP-SP-617	Flat Striker Plate	6 1/2" x 17"	1
FGP-FPY-375-50	Conduit	3/4"	50 ft
FGP-FPY-500-50	Conduit	1"	50 ft
FGP-FPY-750-25	Conduit	1 1/4"	25 ft
FGP-FPY-1250-25	Conduit	2"	25 ft
FGP-FPY-375CT	Conduit	3/4"	50 pcs
FGP-FPY-500CT	Conduit	1"	50 pcs
FGP-FPY-750CT	Conduit	1 1/4"	50 pcs



Elbow Flange Fitting 90 degree

PART NO.	TUBE SIZE IN.	PKG QTY
FGP-ELS-5	1/2"	8

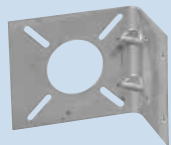

Flange Bracket

Part Number: FGP-TERM-BRAC

TracPipe PS-II



PART NUMBER	SIZE	REEL LENGTH
FGP-UGP-375	3/8"	250 ft
FGP-UGP-500	1/2"	250 ft
FGP-UGP-750	3/4"	250 ft
FGP-UGP-100	1"	250 ft
FGP-UGP-125	1 1/4"	150 ft
FGP-UGP-150	1 1/2"	150 ft
FGP-UGP-200	2"	150 ft

TracPipe PS-II is a pre-sleeved gas installation system for underground, rooftop, or exterior wall applications that is more cost effective and easier to install vs. the original TracPipe PS System.

NPT Male Adapters



PART NO.	SIZE	PKG SIZE
FGP-UGF-375	3/8"	25
FGP-UGF-500	1/2"	20
FGP-UGF-750	3/4"	16
FGP-UGF-1000	1"	9
FGP-UGF-1250	1 1/4"	9
FGP-UGF-1500	1 1/2"	9
FGP-UGF-2000	2"	5

Couplings



PART NUMBER	SIZE	PKG SIZE
FGP-UGC-375	3/8"	25
FGP-UGC-500	1/2"	20
FGP-UGC-750	3/4"	16
FGP-UGC-1000	1"	9
FGP-UGC-1250	1 1/4"	9
FGP-UGC-1500	1 1/2"	8
FGP-UGC-2000	2"	5

Sizing Table for Low Pressure Propane (Standard)

Maximum Capacity of Omegaflex Tracpipe™ in Thousands of BTU per Hour Propane Gas

Gas Pressure: 11 in. W.C. Pressure Drop: .05 in W.C. (based on a 1.52 Specific Gravity Gas)

SIZE	(EHD)	5	10	15	20	25	30	40	50	60	70	80	90	100	150	200	250	300
3/8"	15	99	69	55	49	42	39	33	30	26	25	23	22	20	15	14	12	11
1/2"	19	211	150	121	106	94	87	74	66	60	57	52	50	47	36	33	30	26
3/4"	25	456	325	267	232	209	191	166	149	136	126	118	112	106	87	76	68	62
1"	31	863	605	490	425	379	344	297	265	241	222	208	197	186	143	129	117	107
1-1/4"	37	1753	1247	1021	887	795	727	631	566	517	479	449	424	402	329	286	256	234
1-1/2"	46	2830	1993	1623	1404	1254	1143	988	884	805	745	696	656	621	506	438	390	357
2"	62	6547	4638	3791	3285	2940	2684	2327	2082	1902	1761	1647	1554	1475	1205	1045	934	854

EHD (Effective Hydraulic Diameter) A relative measure of Flow Capacity; This number is used to compare individual sizes between different manufactures. The higher the EHD number the greater flow capacity of the piping.

Sizing Table for Propane at 2 PSI

Maximum Capacity of Omegaflex Tracpipe™ in Thousands of BTU per Hour Propane Gas

Gas Pressure: 2 PSI Pressure Drop: 1 psi (based on a 1.52 Specific Gravity Gas)

SIZE	(EHD)	10	25	30	40	50	75	80	100	150	200	250	300	400	500
3/8"	15	558	347	316	271	243	196	189	169	137	118	105	96	82	72
1/2"	19	1106	701	640	554	496	406	393	350	287	248	222	203	175	158
3/4"	25	2282	1464	1340	1165	1046	859	833	748	614	534	479	439	381	342
1"	31	4720	2954	2692	2323	2072	1685	1629	1454	1182	1019	910	829	716	638
1-1/4"	37	8963	5714	5224	4537	4066	3332	3228	2893	2370	2058	1845	1687	1464	1312
1-1/2"	46	15174	9549	8708	7529	6726	5480	5303	4738	3860	3337	2981	2719	2351	2101
2"	62	34203	21680	19801	17159	15357	12551	12154	10877	8890	7705	6895	6296	5457	4883

Table does not include effect of pressure drop across the line regulator. If regulator loss exceeds 3/4 PSI (based on 8 inch outlet pressure) Do not use this chart. Pressure drops across a regulator vary with flow rate. FGP-REG-3P has a 3/4 PSI drop at a flow of 161 cubic feet per hour. CAUTION: capacities shown in table may exceed maximum capacity for a selected regulator.

EHD (Effective Hydraulic Diameter) A relative measure of Flow Capacity; This number is used to compare individual sizes between different manufactures. The higher the EHD number the greater flow capacity of the piping

Hose Barbs



Male MPT X Hose Barb

PART NUMBER	HOSE ID	THREAD SIZE
HC-4231	1/4"	1/8"
HC-4232	1/4"	1/4"
HC-4233	1/4"	3/8"
HC-4252	3/8"	1/4"
HC-4253	3/8"	3/8"
BG30FE	3/8"	1/2"



Female MPT X Hose Barb

PART NUMBER	HOSE ID	THREAD SIZE
HC-4631	1/4"	1/8"
HC-5632	1/4"	1/4"
BG-32EC	1/4"	3/8"
BG-32CE	3/8"	1/4"
BG-32EE	3/8"	3/8"
HC-4654	3/8"	1/2"



POL X Hose Barb

PART NUMBER	HOSE ID	PART TYPE
HC-5930	1/4"	POL, Full Flow
G-1683	1/4"	POL/Excess Flow 7/8 Hex
G-1684	1/4"	POL/Excess Flow 1 1/8 Hex
G-1656	1/4"	POL Soft Nose W/Handwheel
G-1655	1/4"	POL/Handwheel Excess Flow



18LH X Hose Barb (9/16")

PART NUMBER	HOSE ID	THREAD SIZE
A61	1/4"	Male 9/16-18LH



18LH Female X Hose Barb (9/16")

PART NUMBER	PART TYPE	THREAD SIZE
G-201	Nut	9/16-18LH
G-622	Stem	1/4 Hose
G-624	Stem	3/8 Hose



Male Flare X Hose Barb

PART NUMBER	HOSE ID	THREAD SIZE
HC-4835	1/4"	3/8" OD
HC-4855	3/8"	3/8" OD
HC-4857	3/8"	1/2" OD



Male Swivel Adapter X Hose Barb

PART NUMBER	DESCRIPTION
G-496	Male 1"-20 Swivel X 1/4" Hose Barb



Female Flare Swivel X Hose Barb

PART NUMBER	HOSE ID	THREAD SIZE
HC-4335	1/4"	3/8" OD
HC-4355	3/8"	3/8" OD
HC-4357	3/8"	1/2" OD



Male Inverted Flare X Hose Barb (1/4")

PART NUMBER	HOSE ID	THREAD SIZE
HC-5133	1/4"	1/4" Male Inv. Flare



Male Pipe X Hose Barb High Pressure Fittings

PART NUMBER	DESCRIPTION
HC-5232	1/4" Male Pipe Thread X 1/4" Hose Barb
HC-5233	3/8" Male Pipe Thread X 1/4" Hose Barb



Female Flare Swivel X Hose Barbs High Pressure Fittings

PART NUMBER	DESCRIPTION
HC-5335	3/8" Female Flare Adapter X 1/4" ID Hose Barb
HC-5333	1/4" Female Flare Adapter X 1/4" ID Hose Barb



Male Flare X Hose Barb High Pressure Fittings

PART NUMBER	DESCRIPTION
HC-5835	3/8" Male Flare Swivel X 1/4" ID Hose Barb

HOSE & HOSE FITTINGS

Don't see a part you are looking for? Call us! If we don't have it, we'll try to find it for you.

18LH Hose Connector (9/16")



G-203

PART NO.	THREAD SIZE
G-203	9/16" - 18LH X 9/16"
G-212	1/4" MPT X 9/16"
B51	3/8" MPT X 9/16"

Brass Hose Ferrules



PART NO.	INSIDE DIAM.	COMMON USAGE
7326	0.593	1/4" Single Braid
7327	0.625	1/4" Single Braid
7328	0.656	1/4" Double Braid
7329	0.687	1/4" Double Braid
7332	0.781	3/8" Single Braid
7333	0.812	3/8" Double Braid

Soft Nose Handwheel POL X Hose Barb High Pressure Fittings



PART NUMBER	DESCRIPTION
G-1656	Soft Nose with Handwheel X 1/4" ID Hose Barb
G-1655	Excess Flow Soft Nose POL With Handwheel X 1/4" Hose Barb

Female Swivel Adapter

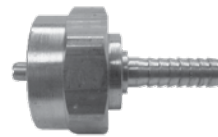

PART NUMBER	DESCRIPTION
G-484	Female 1" 20 Swivel X 1/4" Hose Barb

Hose Ferrule Crimping Tools

Bench Type



PARTNO.	DESCRIPTION
CR-100	Crimps Ferrules on 3/16", 1/4", 5/16" & 3/8" ID Hose

Vice Grip Type



PART NO.	DESCRIPTION
KT-28	Crimps 3/16" & 1/4" Hose
KT-29	Crimps 5/8" - 1 1/16"

QCC Fittings



PART NO.	DESCRIPTION	COLOR	BTU
G-1851-A02	Type 1 QCC x 1/4 MPT	Black	70k
G-1851-A03	Type 1 QCC x 1/4 MPT	Green	70-200k
G-1851-A04	Type 1 QCC x 1/4 MPT	Red	200-400k
G-1851-C02	Type 1 QCC x 1/4 HB	Black	70k
G-1851-C03	Type 1 QCC x 1/4 HB	Green	70-200k

Gas Outlet Box



Part Number: NG-OUTLET-1



Part Number: NG-OUTLET-2

PART NO.	DESCRIPTION
556#1793	3/8" x 12' Hose with Quick Disconnect
556#1791	1/2" x 12' Hose with Quick Disconnect
NG-OUTLET-1	Single outlet
NG-OUTLET-2	Dual outlet

Outlet Box



Universal 1 5/16" M. Acme/F. POL Outlet Connection
 Universal 1/2" FNPT Inlet Connection
 Universal Mounting Hinge
 For use with 0-250 PSI Inlet Pressure
 Weather resistant high density polyethylene case

SINGLE OUTLET PART NUMBER	DUAL OUTLET PART NUMBER	COLOR
ME951IVY	ME952IVY	Ivory
ME951BLK	ME952BLK	Black
ME951GRY	ME952GRY	Gray

Dayco L.P. Gas Hose



Service: A flexible, heavy duty high pressure hose for transfer of liquid or vapor propane or butane, in heater, torch, filling, delivery and unloading applications.

PART NUMBER	I.D. (IN.)	BRAID	O.D. (IN.)	APPROX. WT. PER 100 FT.	MAX RECOM. WP (PSI)
LPH-1/4INDB	1/4	2	5/8	16	350
LPH-3/8INDB	3/8	2	3/4	22	350
LPH-1/2IN	1/2	2	15/16	31	350
LPH-3/4IN	3/4	2	1 1/4	49	350
LPH-1IN	1	2	1 1/2	61	350
LPH-1-1/4IN	1 1/4	2	1 7/8	100	350
LPH-1-1/2IN	1 1/2	3	2 5/32	110	350
LPH-2IN	2	3	2 3/4	157	350

L.P. Gas Hose Stainless Steel Braid

Stainless steel wire braid reinforced hose with neoprene cover provides extra protection and hose life. For plant, transport, bobtail, flexible connectors.



PART NUMBER	I.D. (IN.)	BRAID	O.D. (IN.)	APPROX. WT. PER 100 FT.	MAX RECOM. WP (PSI)
LPH-1INLT	1	1	1 1/2	75	350
LPH-1-1/4INSS	1 1/4	1	1 3/4	92	350
LPH-1-1/2IN	1 1/2	1	2	113	350
LPH-2INSS	2	2	2 43/64	187	350

ANY LENGTH AVAILABLE WITH CRIMPED COUPLING EXCEPT 2". MINIMUM 12".

Stainless Steel Braid Hose with Cloth Cover for Motor Fuel



PART NUMBER	I.D. (IN.)	BRAID	O.D. (IN.)	APPROX. WT. PER 100 FT.	MIN. BEND RADIUS (IN.)	MAX RECOM. WP (PSI)
LPH-5/16SS	5/16	1	43/64	20	2	350

Stainless Braid Motor Fuel Hose Coupling



SS-FFL



SS-MPT



SSAFL-45



SSAFL-90

PART NUMBER	HOSE ID	THREAD SIZE
SS-MPT	5/16"	1/4" MPT
SS-FFL	5/16"	3/8" F. FLARE
SS-MFL	5/16"	3/8" M. FLARE
SSAFL-45	5/16"	3/8" F. FLARE 45°
SSAFL-90	5/16"	3/8" F. FLARE 90°

**Crimped
and
Tested**

L.P. Gas Hose with Crimped Hose Couplings

These hoses have hydraulically pressed-on ends, and the entire assembly is tested to meet current DOT standards with certificate.

For Bobtails



Ends: 1/2" MPT & 2" MPT

For Bulk Plants

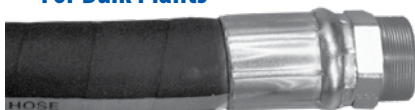

Ends: 1/4" MPT & 2" MPT

PART NUMBER	HOSE SIZE	LENGTH
LPH-3/4X100P	3/4"	100'
LPH-3/4X150P-T	3/4"	150'
LPH-1INX125P-T	1"	125'
LPH-1INX150P-T	1"	150'
LPH-1INX175P-T	1"	175'
I16C1500MP16M16	1"	125'
I16C1800MP16M16	1"	150'

PART NUMBER	HOSE SIZE	LENGTH
LPH-1-1/4X12P	1/4"	12'
LPH-2X12P	2"	12'
LPH-1-1/4X15P	1-1/4"	15'
LPH-2X15P	2"	15'
LPH-1-1/4X18P	1-1/4"	18'
LPH-2X18P	2"	18'

Swivel Hose Adapter Unions



MALE ADAPTER



FEMALE ADAPTER

MALE ADAPTER	FEMALE ADAPTER	SIZE
2045-8-8	0207-8-8	1/2"
2045-12-12	0207-12-12	3/4"
2045-16-16	0207-16-16	1"
2045-20-20	0207-20-20	1 1/4"
2045-24-24	0207-24-24	1 1/2"
2045-32-32	0207-32-32	2"

UL and C.S.A. Listed Hose Assemblies



360° OF CONFIDENCE

Thermoplastic hose assemblies are available in 1/4" and 3/8" I.D. sizes only. The hose has a working pressure of 350 PSI with a 1750 PSI burst rating. All assemblies up to 60 inches in length are dual (UL and C.S.A.) listed.

3/8" I.D. Assemblies [Ends: 3/8" M.P.T. x 3/8" Female Flare]

PART NUMBER	LENGTH	PART NUMBER	LENGTH
42610-24	24"	42610-40	40"
42610-30	30"	42610-48	48"
42610-36	36"		

3/8" I.D. Assemblies [Ends: 3/8" M.P.T. x 1/2" Female Flare]

PART NUMBER	LENGTH	PART NUMBER	LENGTH
42611-24	24"	42611-40	40"
42611-30	30"	42611-48	48"
42611-36	36"		

1/4" I.D. Assemblies [Ends: 3/8" M.P.T. x 3/8" Female Flare]

PART NUMBER	LENGTH	PART NUMBER	LENGTH
42410-24	24"	42410-48	48"
42410-36	36"		

1/4" I.D. Assemblies [Ends: 3/8" Female Flare On Both Ends]

PART NUMBER	LENGTH	PART NUMBER	LENGTH
42413-20	20"	42413-48	48"
42413-24	24"	42413-60	60"
42413-36	36"		

3/8" I.D. Assemblies [Ends: 3/8" Female Flare On Both Ends]

PART NUMBER	LENGTH	PART NUMBER	LENGTH
42613-12	12"	42613-48	48"
42613-24	24"	42613-60	60"
42613-36	36"	42613-144	144"



Stainless Steel Gas Appliance Connectors

Dormont residential connectors are durable, flexible, and easy to install...even in tight places. Designed with built-in safety features, Super-Safe connectors help prevent dangerous gas leaks and provide for a long and trouble-free service life. CSA design certified.

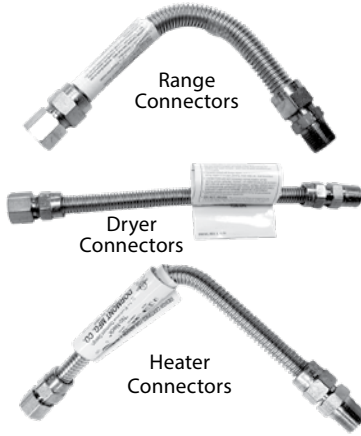

Range Connectors 5/8" O.D. (1/2" I.D.) 1/2" FPT x 1/2" MPT

PART NO.	LENGTH
1650NX12	12"
1650NX18	18"
1650NX24*	24"
1650NX30	30"
1650NX36*	36"
1650NX48	48"
1650NX60	60"

Dryer Connectors 1/2" O.D. (3/8" I.D.) 1/2" FPT x 1/2" MPT

PART NUMBER	LENGTH
1637NX12	12"
1637NX18	18"
1637NX24	24"
1637NX30	30"
1637NX36	36"
1637NX48	48"
1637NX60	60"
1637NX72	72"

Heater Connectors 3/8" O.D. (1/4" I.D.) 3/8" FPT x 3/8" MPT

PART NUMBER	LENGTH
1625NX12	12"
1625NX18	18"
1625NX24	24"
1625NX30	30"
1625NX36	36"
1625NX48	48"

* For 3/4" ends add - 3/4

Black Epoxy Coated Stainless Steel Gas Connectors

PART NUMBER	SIZE	LENGTH
20A-2132-18**	3/8" MIP x 1/2" FIP	18"
20A-2135-12*	3/8" MIP x 1/2" FIP	12"
20A-2135-18*	3/8" MIP x 1/2" FIP	18"
20A-2135-24*	3/8" MIP x 1/2" FIP	24"

These Dormont connectors are specifically designed for high temperature applications such as gas logs, fireplace inserts and free standing fireplaces.



* With ball valve
** Ball valve not included

Gas Connectors for Commercial Equipment

Dormont exclusive design is comprised of a corrugated stainless steel hose encased in a stainless steel braid and covered in a thick PVC coating. For moveable applications, a quick disconnect coupling is attached enabling commercial cooking equipment to be easily and safely disconnected for cleaning and service. A restraining device is required for moveable applications.

Dormont Gas Connector with Quick Disconnect Coupling



Restraining Device and Hardware



PART NUMBER	SIZE
RDC-24	For 24" Connector
RDC-36	For 36" Connector
RDC-48	For 48" Connector
RDC-60	For 60" & 72" Connector

Quick Disconnect Coupling



PART NUMBER	SIZE
B-37	3/8" FPT
A-50	1/2" FPT
A-75	3/4" FPT
A-100	1" FPT
A-125	1-1/4" FPT

PART NUMBER	SIZE	LENGTH
1650BPQX24	1/2"	24"
1650BPQX36	1/2"	36"
1650BPQX48	1/2"	48"
1650BPQX60	1/2"	60"
1650BPQX72	1/2"	72"
1675BPQX24	3/4"	24"
1675BPQX36	3/4"	36"
1675BPQX48	3/4"	48"
1675BPQX60	3/4"	60"
1675BPQX72	3/4"	72"
16100BPQX36	1"	36"
16100BPQX48	1"	48"
16100BPQX60	1"	60"
16100BPQX72	1"	72"

Twin Stage Regulator



The first stage features a lever arm design that improves both the efficiency and regulation. Combined with the second stage regulator, the overall performance assures even smoother and more continuous flow of gas to all appliances.

SPECIFICATIONS:

- Inlet: 1/4" FPT
- Outlet: 3/8" FPT
- 160,000 BTU Capacity

PART NUMBER	DESCRIPTION
290-GR9950	Vent Over Outlet
299-GR9959	9 O'clock Vent

Automatic Changeover Regulators



Combination automatic changeover two-stage regulator. Suitable for home and mobile homes. Empty containers may be replaced without interruption of gas service.

SPECIFICATIONS:

- 130,000 BTU Capacity
- Reserve Cylinder
- Inlet: 1/4" Female Inverted Flare
- Outlet: 3/8" FPT

PART NUMBER	DESCRIPTION
254-GR9984	Regulator

Single Stage Regulators

Single-Stage Regulators

230-00 low pressure, ideal for grills, small stoves and camping appliances when installed in compliance with N.F.P.A. Standards.

SPECIFICATIONS:

- 140,000 BTU Capacity
- Inlet: 1/4" FPT
- Outlet: 3/8" FPT



230-GR800 Drip Lip Vent
230-GR856 with POL installed



230-#1326
230-GR866
G-1851-A03 Handwheel

High Pressure LP Gas Regulators



130-GR610B Straight Through 10 PSI

SPECIFICATIONS:

- Inlet: 1/4" FPT
- Outlet : 1/4" FPT
- Dimensions: 2 1/2"H, 2 5/8"W, 3 1/8L, Wt. 8 OZ
- Non Relieving
- Underwriters Laboratories Listed



350-00 0-30PSI ADJ

*Need a regulator with larger capacity?
RegO regulators fit the bill.*

Rubber Pigtails

The flexible thermoplastic hose material used on pigtails and high pressure hoses is rated at 350 lbs working pressure and has a burst rating of 1750 PSI. End fittings are secured in place with proven, four jaw crimped, copper rings. Together they offer an assembly that meets all applicable UL and C.S.A. tests and requirements. All assemblies up to 60 inches in length are dual (UL and CSA Listed).



360° of confidence



Flexible Pigtail

Type 1 ACME x 1/4" inverted flare
Part Number: 40408-15



40403-15-9 Fullflow
POL X 1/4" Inverted
Flare



Flexible Pigtail

Type 1 ACME x 1/4" MPT
Part Number: 40409-15

1/4" I.D. Thermoplastic Pigtail POL x 1/4" Inverted Flare

PART NUMBER	LENGTH	PART NUMBER	LENGTH
40403-15	15"	40403-36	36"
40403-20	20"	40403-48	48"
40403-24	24"	40403-60	60"
40403-30	30"		



S42CC Hose End Conversion
Fitting 1/4" Female Inverted
Flare X 1/4" MPT

Regulator Covers



2nd Stage Regulator Cover
Part Number: H-200P

Brackets



PART NO.	DESCRIPTION
240-9900	Z-Mounting Bracket Pre-drilled to attach to all Marshall Brass Regulators horizontally or vertically. Allows the regulator to be mounted from the front to any surface.

Adapter Hoses

The 40407 adapter hose has a safe, convenient, "user friendly" design that makes it ideal for hooking up portable, high pressure propane appliances such as camp stoves, lanterns, and table top grills to large cylinders.



40407-60
40407-144
Appliance Adapter Hose
For Carded Add-9

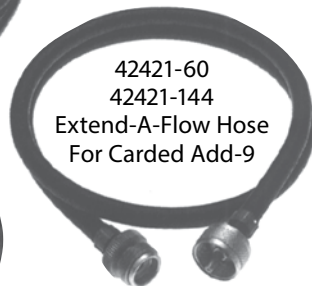

42421-60
42421-144
Extend-A-Flow Hose
For Carded Add-9



538-00
Extend-A-Flow Plus with
QCC Type 1 Connection

The 42421 Extend-A-Flow adapter hose is also designed to thread directly into the opening on the high pressure appliance. However, its other end is engineered to go into one of four adapter tee fittings. One end is 1" 20, male swivel for the appliance and the other is 1" 20, female swivel for the tee fitting connection.

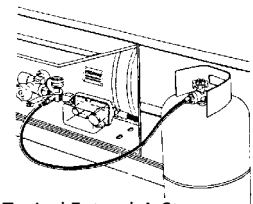

Typical Extend-A-Stay
Motorhome Installation

Extend-A-Stay

Standard Kit with 5 ft. hose and tee fitting
Part # 536-00

Deluxe Kit with tee fitting, 12 ft. hose and 5 ft. hose
Part # 537-00

Fittings



**Soft Nose Handwheel POL
x 1" 20 Male Adapter**

G-475 1" 20 male x 60 orifice
soft nose handwheel POL

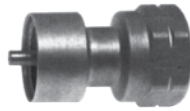

G-487 Reserve Cylinder Adapter
1" 20 female x female POL

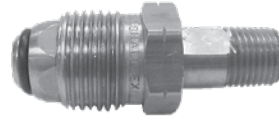

Soft Nose POL Assembly

G-1638 1/4" MPT x 60 orifice soft
nose POL



Soft Nose Handwheel POL

G-1654 1/4" MPT x soft nose full
flow POL with handwheel



G-413 TEE-FOR-TWO

G-1641 1/4" MPT x excess flow
soft nose POL

G-1653 1/4" MPT x excess flow
soft nose POL with handwheel



G-1700 1/4" female inverted
flare x 1/4" female inverted
flare x 1/4" MPT

G-1701 W/O check



**Brass POL Plug
G-1691**

G-1653A Same as G-1653 but with
brass handwheel

G-1645 9/16" 18 LH x excess flow
soft nose POL with handwheel



G-415 EXTEND-A-FLOW TEE

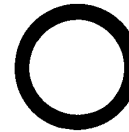

POL O-Ring

G-1653-3 Replaces O-ring
for soft nose POL



POL Assembly

G-1675 1/4" MPT x full flow
POL 7/8" hex nut

G-1685 1/4" MPT x full flow
POL 1 1/8" hex nut



G-203 Hose coupling 9/16"
18 LH both ends



G-2131 1/4" inverted flare plug

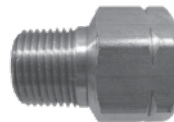

Female POL

G-415-2 Female POL x 1/4" MPT

G-1690 1/4" MPT x excess flow
POL 7/8" hex nut

G-1692 1/4" MPT x excess flow
POL 1 1/8" hex nut



G-491 3/8" male flare
x 1" 20 male



G-492 1/4" female pipe thread
x male 1" 20 thread with O-ring

G-1689 9/16" 18 LH x excess flow
POL 7/8" hex nut

G-1687 9/16" 18 LH x excess flow
POL 1 1/8" hex nut



G-488 1/4" MPT x female 1" 20



G-414 ADD-A-TEE



POL Nut

G-1643 Standard 7/8" hex nut

G-443-1 Heavy duty 1 1/8"
hex nut

G-1650 9/16" 18 LH x full flow
POL 7/8" hex nut

G-1651 9/16" 18 LH x full flow
POL 1 1/8" hex nut



G-493 9/16" 18 LH X 1" 20 male
thread with check valve
and O-ring

G-494 Same as above less
check valve

G-417 1/4" MPT x 1" 20 male
thread with check valve
and O-ring



G-212 9/16" 18 LH X 1/4" MPT



**Brass POL Cap
G-1699**



POL Nipple

G-1675-1 Standard POL Nipple
with wrench flats 1/4" MPT
x full flow

G-1648-1 Short POL nipple with
hex flats on nose 1/4" MPT
x full flow



G-420 EXTEND-A-STAY TEE

Gauges



MSCP-SG2.5-5



MSCP-SGC2-15



SIDE VIEW



MSCP-SGL2.5-30

STEEL CASE

PART NUMBER	RANGE	INLET	SIZE	CASE
MSCP-SG2.5-5	0-5#	1/4 Bottom	2 1/2"	STEEL
MSCP-SG2-15	0-15#	1/4 Bottom	2"	STEEL
MSCP-SG2-15-1/8	0-15#	1/4 Bottom	2"	STEEL
MSCP-SG2-30	0-30#	1/4 Bottom	2"	STEEL
MSCP-SG2-60	0-60#	1/4 Bottom	2"	STEEL
MSCP-SG2-100	0-100#	1/4 Bottom	2"	STEEL
MSCP-SG2-160	0-160#	1/4 Bottom	2"	STEEL
MSCP-SG2-200	0-200#	1/4 Bottom	2"	STEEL
MSCP-SG2.5-200	0-200#	1/4 Bottom	2"	STEEL
MSCP-SG2-300	0-300#	1/4 Bottom	2"	STEEL
MSCP-SG2-300-1/8	0-300#	1/4 Bottom	2"	STEEL
MSCP-SG2-400	0-400#	1/4 Bottom	2"	STEEL
MSCP-SGC2-15	0-15#	1/4 Back	2"	STEEL
MSCP-SGC2-30	0-30#	1/4 Back	2"	STEEL
MSCP-SGC2-60	0-60#	1/4 Back	2"	STEEL
MSCP-SGC2-100	0-100#	1/4 Back	2"	STEEL
MSCP-SGC2-160	0-160#	1/4 Back	2"	STEEL
MSCP-SGC2-200	0-200#	1/4 Back	2"	STEEL
MSCP-SGC2-300	0-300#	1/4 Back	2"	STEEL
MSCP-SGC1.5-300-1/8	0-300#	1/8 Back	2"	STEEL
MSCP-SGC2-400	0-400#	1/4 Back	2"	STEEL
MSCP-SGC2.5-400	0-400#	1/4 Back	2"	STEEL
MSCP-SG4.5-300	0-300#	1/4 Bottom	4 1/2"	STEEL
MSCP-SG4.5-400	0-400#	1/4 Bottom	4 1/2"	STEEL
MSCP-SG-2.5-35INWC	0-35WC	1/4 Bottom	2 1/2"	STEEL

STEEL CASE - LIQUID

PART NUMBER	RANGE	INLET	SIZE	CASE
MSCP-SGL2.5-15	0-15#	1/4 Bottom	2 1/2"	STEEL
MSCP-SGL2.5-30	0-30#	1/4 Bottom	2 1/2"	STEEL
MSCP-SGL2.5-60	0-60#	1/4 Bottom	2 1/2"	STEEL
MSCP-SGL2.5-300	0-300#	1/4 Bottom	2 1/2"	STEEL
MSCP-SGL2.5-400	0-400#	1/4 Bottom	2 1/2"	STEEL



MSCP-BG2-15

BRASS CASE

PART NUMBER	RANGE	INLET	SIZE	CASE
MSCP-BG2-15	0-15#	1/4 Bottom	2"	BRASS
MSCP-BG2-30	0-30#	1/4 Bottom	2"	BRASS
MSCP-BG2-60	0-60#	1/4 Bottom	2"	BRASS
MSCP-BG2-100	0-100#	1/4 Bottom	2"	BRASS
MSCP-BG2-300	0-300#	1/4 Bottom	2"	BRASS
MSCP-BG2-300-1/8	0-300#	1/8 Bottom	2"	BRASS
MSCP-BG2-400	0-400#	1/4 Bottom	2"	BRASS
MSCP-BGC2-15	0-15#	1/4 Back	2"	BRASS
MSCP-BGC2-30	0-30#	1/4 Back	2"	BRASS
MSCP-BGC2-60	0-60#	1/4 Back	2"	BRASS
MSCP-BGC2-100	0-100#	1/4 Back	2"	BRASS
MSCP-BGC2-300	0-300#	1/4 Back	2"	BRASS
MSCP-BGC2-400	0-400#	1/4 Back	2"	BRASS

Pressure Gauge Snubber

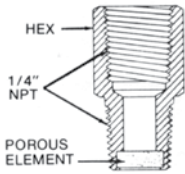

Pressure snubber protects gauge from damaging surges and moderates pulsating at the gauge.

PART NO.	DESCRIPTION
B25-G	1/4" X 1/4" Pressure Snubber, Filter
1449	1/4" X 1/4" Pressure Snubber, 54# Drill

Pressure Gauge Adapter



1/2" MNPT x 1/2" FNPT adapter with 1/4" gauge opening for indicating outlet pressure of a first stage regulator.

PART NUMBER	DESCRIPTION
J595	1/2" Gauge Adapter
1494-1	1/2" Gauge Adapter

Presto-Tap Universal Tech Kit



Universal Service-Tech-Kit

KIT INCLUDES

PART NUMBER	DESCRIPTION
6800-KG	PrestoTap gauge 300 PSI with retainer
PT-30KG	PrestoTap gauge 30 PSI with retainer
PT-5KG	PrestoTap gauge 5 PSI with retainer
PT-OZKG	PrestoTap 0-20 oz (0-35" WC) gauge with retainer
MHA-STRAIGHT	PrestoTap monometer hose adapter
316-ALLEN-WRENCH	PrestoTap allen wrench 3/16" hex key
UNIVERSAL FLEX HOSE	PrestoTap universal 36" flex hose kit
RV	PrestoTap adapter regulator valve

Pressure Tap Adapter



MSCP-TRV

Tank Car Thermometer



-30°F + 120°F Range

Thermometer Only – Part Number: MSCP-A12

Thermometer & Armor – Part Number: MSCP-A12-A

Screws and Gaskets



PART NUMBER	DESCRIPTION
MSCP-M40-414S	Junior Head Bolt
40-415S	Senior Head Bolt
40-416	Dial Screw
MSCP-15-007	Junior Gauge Gasket
MSCP-15-004	Senior Gauge Gasket

Container Thermometers



The 2-inch diameter dial is calibrated - 40° to 120° F. and - 40° to 50°C. The thermometers are dust-proof and moisture-proof.

TYPE NUMBER	CONTAINER CONNECTION	STEM LENGTH
MSCP-SSBT-3-4	1/2" MNPT	4"
MSCP-SSBT-3-6	1/2" MNPT	6"

Thermowell for MSCP-SSBT-3-6



Part Number: 75THR2R045CC

Replacement Dials

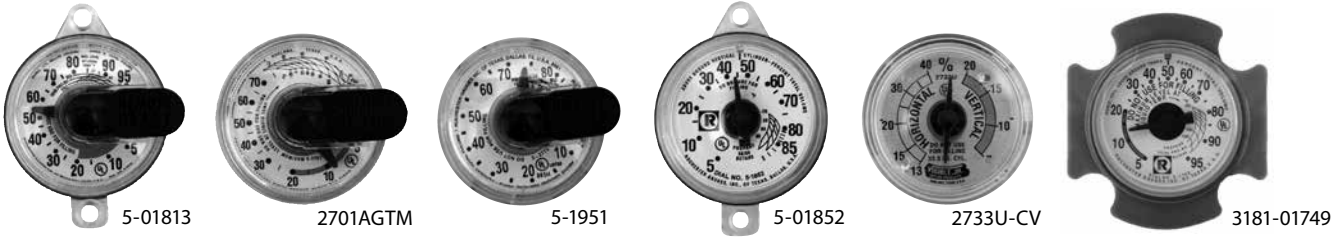

PART NO.	TANK	REMOTE READY	SETTING	TYPE	GUIDE HOLE	READS
5-01813	Underground Horizontal	Yes	2 Screw	JR	-	5% - 95%
2700CV	Underground Horizontal	No	Drop In	JR	94%	5% - 94%
130024	Underground Horizontal	Yes	Drop In	JR	10%	5% - 94%
2701AGTM	Aboveground Horizontal	Yes	Drop In	JR	5%	5% - 94%
2701CV	Aboveground Horizontal	No	Drop In	JR	5%	5% - 94%
5-01749	Aboveground Horizontal	Yes	2 Screw	JR	-	5% - 95%
5-00001	Aboveground Horizontal	No	2 Screw	SR	-	5% - 95%
5-01835	420# Vertical	Yes	2 Screw	JR	-	10% - 80%
5-1951	420# Vertical	Yes	Snap	JR	-	10% - 80%
2765CVLP	420# Vertical	No	Drop In	JR	80%	10% - 80%
5-00435	420# Vertical	Yes	2 Screw	SR	-	10% - 80%
130039	200# Vertical	Yes	Drop In	JR	5%	5% - 85%
5-01852	200# Vertical	No	2 Screw	JR	-	5% - 85%
2722CU	200# Vertical	No	Drop In	JR	85%	5% - 85%
G13088	100# Vertical	No	Snap On	JR	-	10% - 80%
5714SO2591	Forklift Cylinders	No	Snap On	JR	-	E-1/4-1/2-F
2733U-CV	Forklift Cylinders	No	Drop In	JR	7%	H=13%-40% V=7%-20%
5-01789	Forklift Cylinders	No	2 Screw	JR	-	E-1/4-1/2-3/4-F
5343SO1992	Forklift Cylinders	No	2 Screw	JR	-	H=1/8-1/4-3/8 V=1/8-1/4-3/8
3181-01749	Universal Dials	No	Drop In	JR	-	5% - 95%
3180-17001	Universal Dials	No	2 Screw	SR	-	5% - 95%

RegO Rotogages

Gauge Tube Dial (These Components Must Be Ordered Separately)

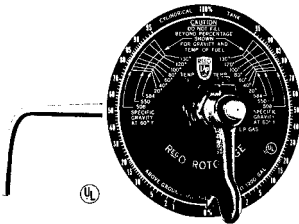

MODEL NO.	FOR TANKS	GAUGE	TUBE	DIAL
9091RM24	30-45"	A9091R	A9091-M24.0	A9091-18LX
9092RM36	46-61"	A9092R	A9091-M36.0	A9091-18LX
90903TSM48*	62-79"	A9093TS	A9091M48.0	A9091-18LX
9093RSM48**	62-79"	A9093RS	A9091M48.0	A9091-18LX
9094TSM60*	80-99"	A9094TS	A9091-M60.0	A9091-18LX
9094RSM60**	80-99"	A9094RS	A9091-M60.0	A9091-18LX
9095TSM72*	100-147"	A9095TS	A9091-M72.0	A9091-18LX
9095RSM72**	100-147"	A9095RS	A9091-M72.0	A9091-18LX

*TSM - supported design, mobile or stationary
 **RSM - stationary design only

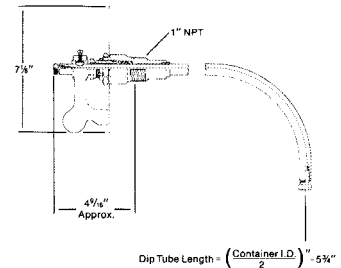

RegO Rotogage Replacement Parts

PART NO.	DESCRIPTION
A 3163-6	Stem Assembly
2092-13	Packing (2-Required)
8092-15	Packing Gland Nut
A9091-61T	Body Bushing (2 Required)
A9091-18LX	Dial (LP Only)

Usable in all gauges except those beginning with a part number of TA.

Bulk Storage Gauges

Rochester Magnetel

The 6340 series Magnetel Liquid Level Gauges are designed to accurately determine the percentage of tank volume in stationary storage applications. Gauges are U.L. listed for LP Gas and NH3 service. These models incorporate a zinc-plated steel counterbalance and a Alinco magnet with head and all other wetted parts made from 300 stainless steel. Gauges include gasket and set of 8 mounting studs and nuts.

PART NUMBER	DESCRIPTION
R6342-11-108	8" Dial, End Mount 108" Tank
6342-11-130	8" Dial, End Mount 130" Tank
6342-11-84	8" Dial, End Mount 84" Tank
22-29	2 1/2" M.NPT. Adapter*
5305	2" M.NPT Adapter
R0044-0403	Nut for Magnetel Bolt
R0056-00404	1/2" Magnetel Mounting Bolt
R0003-00005	8" Replacement Dial Glass
R0015-00010	Gasket, 8" Glass (2 required)
R0093-00403	8" Dial Chamber Mounting Bracket
R0015-00019	Spiral Wound Gasket

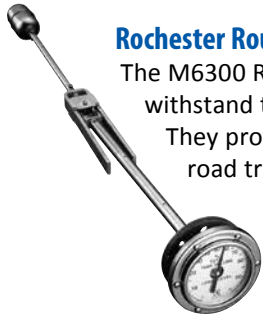

Rochester Rough Rider

The M6300 Rough Rider series gauges are designed to withstand the vibration and shock of mobile service. They provide unsurpassed service life in over-the-road transport of LP Gas and NH3 liquids. The M6300 provides continuous reading of tank contents in percentage of tank capacity. They include a zinc-plated steel counterbalance and an Alinco magnet with all other wetted parts made of 300 stainless steel.

PART NUMBER	DESCRIPTION
M6339-11-72	4" Dial, 72" Truck Tank
M6339-11-79	4" Dial, 79" Truck Tank
5-1262	Replacement 4" Dial Chamber
22-29	2 1/2" M.NPT. Adapter
5305	2" M.NPT Adapter*
R009300001	4" Dial Chamber Mounting Bracket
R0015-00451	Gasket, 4" Glass
R0015-00019	Spiral Wound Gasket
R0040-00413	4" Dial Screw

Squibb Master Visible

These float gauges feature a large 10" hermetically sealed dial face with a chrome retainer. Extremely heavy duty construction for storage tanks. Other sizes available. Gauges include spiroallic gasket and 8 mounting bolts.

PART NUMBER	DESCRIPTION
MD360C	10" Dial End Mount 108" Tank
MD430B	10" Dial End Mount 130" Tank
130219	Mounting Bolts
5305	2" M.NPT Adapter*
130035	Replacement 10" Dial
130040	Spiroallic Gasket
130201	10" Replacement Glass

* Requires specially ordered gauge with 2" dial float bulb.

The Roadmaster from Squibb Visible

Uniquely designed to withstand the tough shock and vibration associated with mobile service. Incorporates a special spring designed to substantially reduce stress on conventional float type gauges on mobile applications. 4" easy viewing dial. Ideal for new or replacement installations.

PART NUMBER	DESCRIPTION
RM1833	72" Diameter Mobile Tank
RM2438	84" Diameter Mobile Tank

Underground Storage Tank Gauges Available

Red Dragon Torches

Kit contains torch, hose, POL fitting, needle valve and spark lighter. Roofing and hand torch kits also contain regulator and gauge.



KIT NUMBER	TORCH ONLY	BTU/HR	OVERALL LENGTH	TYPE
VT2-23C	-	100,000	27 1/2"	Vapor
RT1-1/2-10C	RT1-1/2-10	50,000	15"	Roofing
VT1-1/2-12C	VT1-1/2-12	50,000	15"	Vapor
RT2-1/2-20C	RT2-1/2-20	200,000	29"	Roofing
VT2-1/2-30C	VT2-1/2-30	200,000	33"	Vapor
VT3-30C	VT3-30	500,000	33 1/2"	Vapor
VT3-60C	VT3-60	500,000	65"	Vapor
RT-COMBO	Kit RT1-1/2-10, RT2-1/2-20, quick connect, regulator, hose, POL, spark ignitor			
V-880P	Squeeze valve with adjustable pilot			

Nu-Way Torches

Cast Iron Head, Pipe Handle Adjusting Valve



PART NUMBER	BTU/HR	LENGTH
5-V	500,000	24"

*Whatever the job is we've got the torch to handle it.
From 26,000 BTUs to a whopping 500,000 BTUs.*

Manchester Propane Handburners



PART NUMBER	DESCRIPTION
8012	8 ft weed burning torch (similar design to 8061)
8061*	3 ft torch, hose, POL power jet 750,000 BTU
8062*	2 ft torch, hose, POL handi-boy 500,000 BTU
8069	Replacement handle

* Bubble pack kit

Gas Match Lighters



GM-3X

15" flexible nozzle bends into any shape, never blows out.
Part Number: GM-3X



GM-3

Long continuous spark, battery operated. Refillable.
Part Number: GM-3



GM-4

Medium refillable, white.
Part Number: GM-4

Multi-Fill Butane

Part Number: REFILL
2.75 oz.



OUTDOOR PRODUCTS



Everybody needs a Buddy. The Mr. Buddy heater uses revolutionary new heating technology. Check it out!

Mr. Heater / Propane Camping Heater

Portable Buddy

Instant Heat. Anytime! Anywhere!



- Safe for indoor and outdoor use
- 4,000 and 9,000 BTUs
- Heats up to 250 square feet
- ODS system
- Uses 1lb. disposable cylinder (not included) 3 to 6 hours
- AGA approved
- Optional hose with connector for use on 20lb. cylinder

Part Number: MH9B

Part Number: MH18B 18,000 BTU

Buddy FLEX® Heater

We updated our design to feature optimized wind barrier and



- pilot shield for maximum protection
- Safe for indoor and outdoor use
- Indoor Safe Radiant Heater
- 11,000 BTU Omni-directional Mesh Burner
- Integrated Heater and Accessory Controls
- Quick Connect Accessory Rail system
- Patented Thermal Shut-down System
- Integrated storage compartments

Part Number: MHBBFLEX

Mr. Heater / Propane Camping Accessories

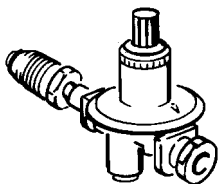

High Pressure Regulator with POL

Most commonly used on torches, fish cookers, smokers or other high pressure appliances.

Part Number: F273719

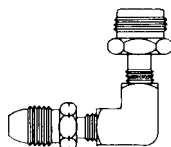

90 Degree Elbow (POL x 1"-20 Throwaway Cylinder Male)

Allows appliances designed for use on throwaway cylinder.

Part Number: F273760

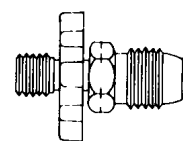

LP Gas Cylinder Adapter with Handwheel

Allows appliances designed for use on throwaway cylinders, and with a hose/regulator assembly.

LP Gas Cylinder Adapter without Handwheel

Part Number: F276132

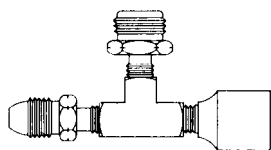

LP Gas Adapter Tee

Conveniently use your camper/trailer propane supply for lanterns, or tabletop barbecue at parks, campsites, rest stops, etc.

Part Number: F273751

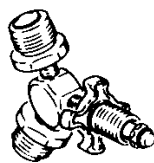

Propane Cylinder "Y" with Handwheel (2 1" - 20 Outlets)

Allows two appliances to be hooked up to a 20lb cylinder.

Part Number: F271715

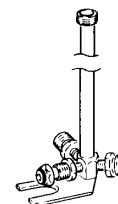

30" Distribution/Lantern Post (3 1" - 20 Outlets)

Use with F273710 - 11 hose assembly. Hook up 3 appliances to a single refillable 20lb propane cylinder.

Part Number: FL271731



Mr. Heater / Propane Camping Accessories

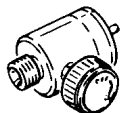

Post Adapter Valve

Allows use of 9/16" left hand hose assembly.

Part Number: F271725



Brass Cap

Fits all distribution posts, adapter tees, etc.; keeps dust and dirt from inside fittings.

Part Number: F276400

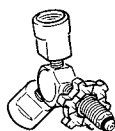

Propane "Y" Female Adapter with Handwheel (2-Female POLs x POL)

Allows two appliances to be hooked up to a bulk cylinder. (Use with F273701-02.)

Part Number: F271735



TankFoot Tank Stabilizer

Fits 20lb, 30lb, and 40lb tanks; reduces risk of tipping cylinder while transporting in your RV, pick-up, car etc.

Part Number: TF-01

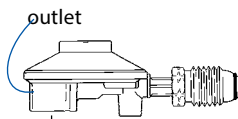

Low Pressure Regulator with POL (straight) (POL Inlet x 3/8" FP Outlet)

11" WC low pressure regulator will operate barbecue grills and low pressure appliances.

Part Number: F276136

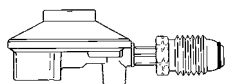

outlet

Low Pressure Regulator with POL (90 degrees)

11" WC low pressure regulator designed with 90 degree angle; will operate all standard barbecue grills and appliances.

Part Number: F273759

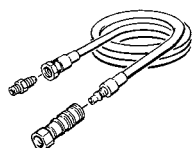

12' Natural Gas Patio Hose Assembly (3/8" Female Pipe Thread x 3/8" Male Flare Quick Connect/ Disconnect with Dust Plug and Cap)

Most commonly used on connecting natural gas barbecue grills attached to decks or patios to the supply from a house.

Part Number: F273720

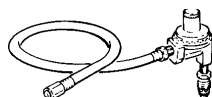

22" Universal Replacement Barbecue Hose and Regulator Assembly (POL x 3/8" Female Flare)

Fits most propane gas grills.

Part Number: F271160

As above with Type 1 QCC connection instead of POL

Part Number: F271161

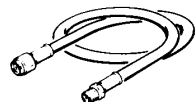

5' Hose Assembly (3/8" Female Pipe x 3/8" Male Pipe Thread)

Common assembly hose for hooking up low pressure appliances.

Part Number: F276124

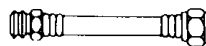

24" Universal Barbecue Hose Assembly (3/8" Male Pipe and 3/8" Female Flare)

Fits most standard barbecue gas grills.

Part Number: F273716

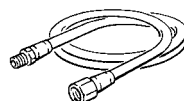

5' Hose Assembly (1/4" Male Pipe Thread x 1/4" Female Pipe Thread)

Most commonly used on weed burner, torch, fish cooker assembly.

Part Number: F273717

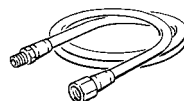

5' Propane Hose Assembly (1/4" Male Pipe Thread x 3/8" Female Flare)

Replaces most hose assemblies between regulator and fish cooker/smoker, torches, or other appliances.

Part Number: F273707

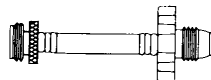

Hose Assembly (Soft Nose Excess Flow POL with Handwheel x Swivel 1"-20 Male Throwing Cylinder Adapter)

Mr. Heater's most popular hose; permits the use of larger propane cylinders on appliances designed for use with small disposable cylinders; convenient hand tightened swivel both ends.

5' Hose Assembly Part Number: F273701

12' Hose Assembly Part Number: F273702

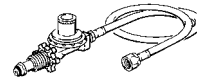

Propane Hose/Regulator Assembly (Regulator with POL and Handwheel x 3/8" Female Flair)

Connects low pressure portable propane appliances to a 20 lb. cylinder.

5' - Part Number: F273071

12' - Part Number: F273072

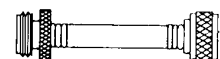

Hose Assembly (Swivel 1"-20 Male Throwing Cylinder Thread x Swivel 1"-20 Female Throwing Cylinder Thread)

Use with most distribution posts or "T" or "Y" connectors as well as 1 lb disposable cylinders.

5' - Part Number: F273710

12' - Part Number: F273711

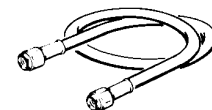

5' Appliance Extension Hose (9/16" - 18LH Thread, Female Fittings both ends)

Combine with Mr. Heater (F276154) nipple to make longer lengths;

use with F276129, F276130 to assemble F276122-23.

Part Number: F276148

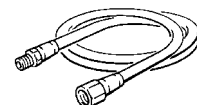

15' Propane Appliance Extension Hose Assembly (3/8" Male Pipe Thread x 3/8" Female Pipe Thread) (3/8" ID High Pressure Hose)

Use as an extension hose for portable propane appliances.

Part Number: F271470

As above with 1/4" Male Pipe Thread x 1/4" Female Pipe Thread (1/4" ID High Pressure Hose) - **Part Number: F271474**

OUTDOOR PRODUCTS

Don't forget to check our Heater and Hearth catalog for more items to enhance your summer.

Mr. Heater Brass Fittings and Accessories



POL with "O" Ring Seal without Handwheel (Brass POL Nut x 1/4" Male Pipe)
Fits all refillable propane cylinders and appliances with 1/4" female pipe inlet.
Part Number: F276139
As above with handwheel –
Part Number: F273756

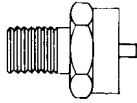

1" - 20 Female Throwaway Cylinder Adapter x 1/4" Male Pipe Thread
Part Number: F273754

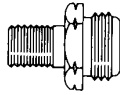

1" - 20 Male Throwaway Cylinder Adapter x 1/4" Male Pipe Thread
Part Number: F273755

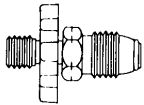

9/16" - 18 Left Hand POL With Restricted Flow with Handwheel
Part Number: F273757
As above without handwheel (wrench tighten)
Part Number: F276129

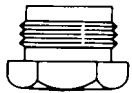

1" - 20 Male Throwaway Cylinder Adapter x 1/4" Female Pipe Thread
Part Number: F276140

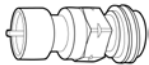

Propane "Steak Saver" Adapter (Female Throwaway Cylinder Thread x Female P.O.L. and QCC-1)
Most commonly used with 1 lb. bottles to grills or distribution posts to grills.
Part Number: F276171

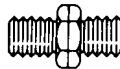

9/16" - 18 Left Hand Male Fittings
1/4" Male Pipe x 9/16" - 18 Left Hand Male
Part Number: F276152

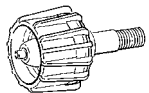

Appliance End Fitting (Coupling Nut x 1/4" Male Pipe Thread)
For type 1 (QCC-1) gas grill systems. For appliances with 80,000 BTUs or less.
Part Number: F276495

3/8" Male Pipe x 9/16" - 18 Left Hand Male
Part Number: F276153

9/16" - 18 Left Hand Male Both Ends Male x 9/16"
Part Number: F276154

Quick Connectors

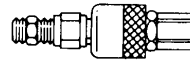

Quick Connector (1/4" Female Pipe x 1/4" Excess Flow Male Pipe)
Use with F276134, F276139, and F276140. CSA certified; UL listed.
Part Number: F276186

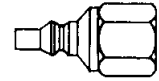

Cylinder Fill Plug - Gas Mate II
Allows filling of cylinder with quick connect (Gas Mate II F276330) kit in use. Please note: most LP filling stations have this plug.
Part Number: F276329



Quick Connector (3/8" Female Pipe x 3/8" Male Pipe)
CSA certified; UL listed.
Part Number: F276187

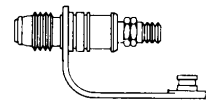

Gas Mate II "Quick Connect" Kit (POL x Connection) (1/4" x plug)
Eliminates wrenches; fits on all refillable propane cylinders; provides plug in/plug out use of appliances such as torches, heaters, cookers, etc.
Part Number: F276330

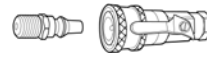

Propane or Natural Gas 1/4" Quick Connector with Shutoff Valve and Excess Flow Plug
(1/4" Male Pipe Thread x 1/4" Female Pipe Thread)
CSA certified; UL Approved.
Part Number: F276181

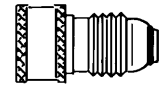

Gas Mate II "Quick Connect" Socket (only) (POL x Quick Connect)
Quick connect for those spare refillable cylinders. See F276330 description above.
Part Number: F276334

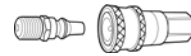

Propane or Natural Gas Connector (1/4" Male Pipe Thread x 1/4" Female Pipe Thread)
Part Number: F276190



Propane or Natural Gas Mate II Male Full Flow Plug (1/4" Male Pipe Thread x Male Plug)
For all appliances and all BTUs or high pressure appliances. Can be used with F276334 or can replace excess flow plug in F276186 and F276330 kits.
Part Number: F276281



Propane or Natural Gas Male Excess Flow Plug
(1/4" Male Pipe Thread x Male Plug Quick Connect Fitting) for appliances 80,000 BTUs or less. For use with F276334. CSA certified; UL Approved
Part Number: F276328

Mr. Heater Standard Replacement Parts

Safety Shutoff With orifice for all Mr. Heaters. **Part Number: F273116**

12.5" Thermocouple Lead Fits most Mr. Heater models. **Part Number: F273117**

Grid Screen Kit For most Mr. Heaters. **Part Number: F273164**

Hi-Med-Lo Regulator and Soft Nose Tank Union Assembly For MH12T, MH24T, and MH42T. **Part Number: F273606**

Hi-Med-Lo Regulator For MH12, MH12C. **Part Number: F273607**

Plastic Stand For 16.4 oz. and 14.3 oz. disposable cylinders. **Part Number: F275217**

Pump Station Tank Set Up

Tanks for Pump Stations

TANK SIZE	LENGTH	LIQ. OPENING	TOP VAPOR
500	119"	1 1/4"	3/4"
1000	193"	1 1/4"	3/4"

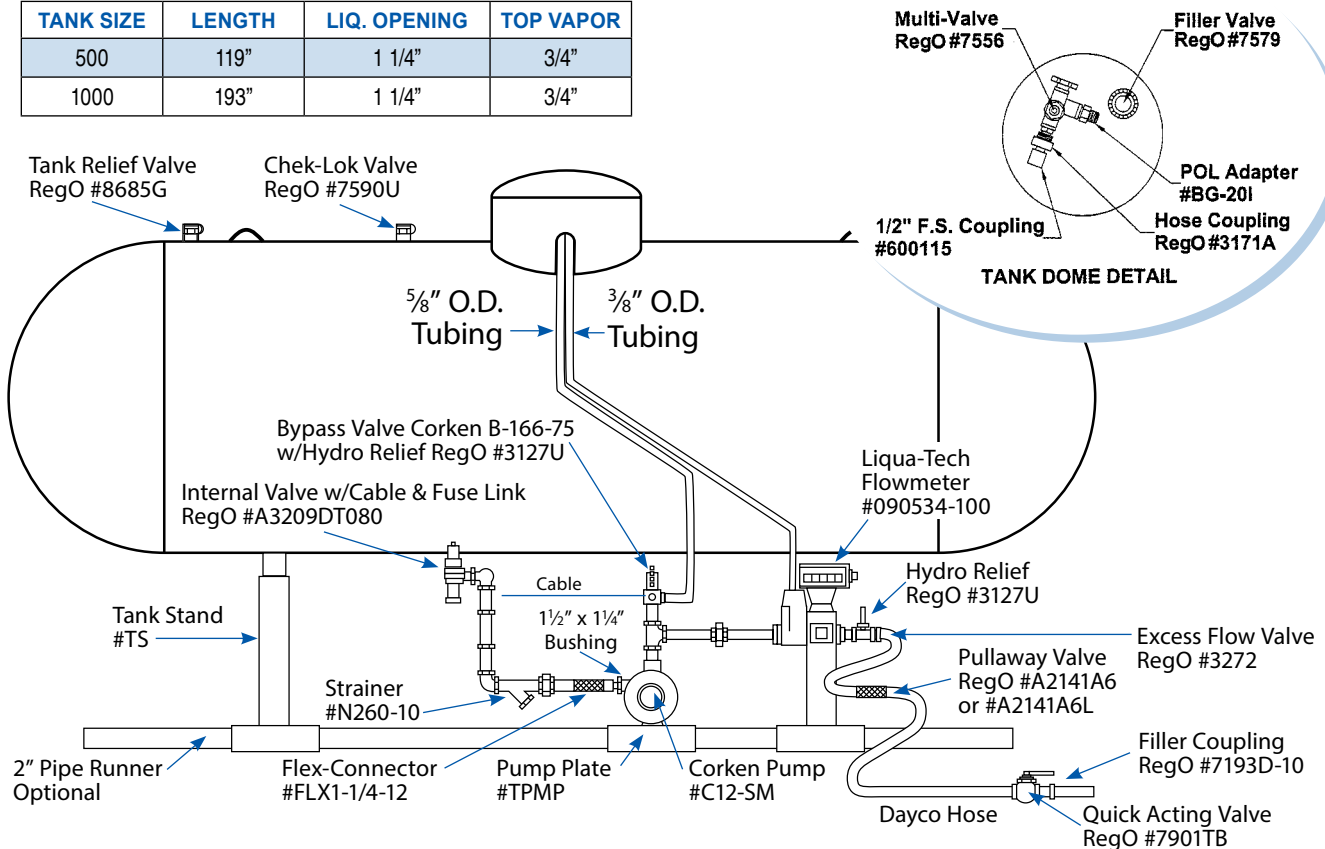

General Information for Pumping Station Design

1. Choose the proper size tank for the operation, with a 1000 gallon tank for a large industrial motor fueling or a 500 gallon tank for a small 20 LB. refilling.
2. Always use a tank with a bottom withdrawal, preferably a new one. If a used tank is to be used, remove as many heavy ends as possible.
3. Size the pump to the operation. Try to consider future expansion. If a meter is to be used, be sure to use a large enough pump, such as a Corken C12 or larger C13 or C14.
4. Couple the pump to an external by-pass, DO NOT rely on an internal by-pass on the pump.
5. If a meter is to be used be sure it is designed for the operation. Use Liqua-Tech LPM102 or Liquid Controls MA4.
6. Piping should be the same size as your pumps and meters, never smaller. Schedule 80 pipe and Type K copper tubing is required.
7. Safety is a major consideration. Be sure a fire extinguisher and proper warnings and decals are used.

Call or contact your Sales Representative at Tarantin Industries for further help in designing the best possible system for your operation.

Agricultural

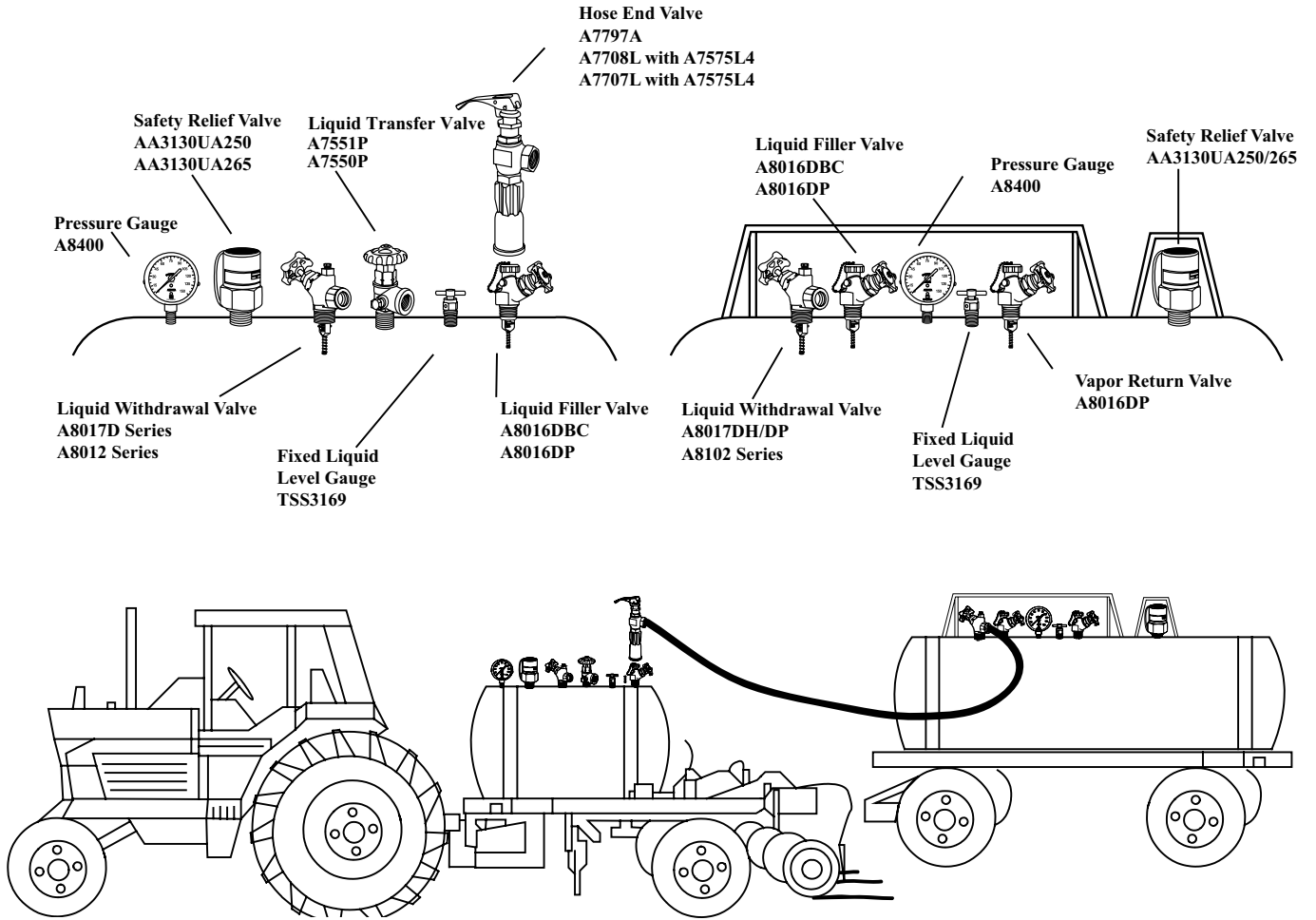

Disclaimer: The illustrations in this application guide are intended to inform a professional installer/system designer where our valves are generally installed on certain containers or applications. These illustrations are not intended for and must not be used for system design.

Bobtail Delivery Trucks

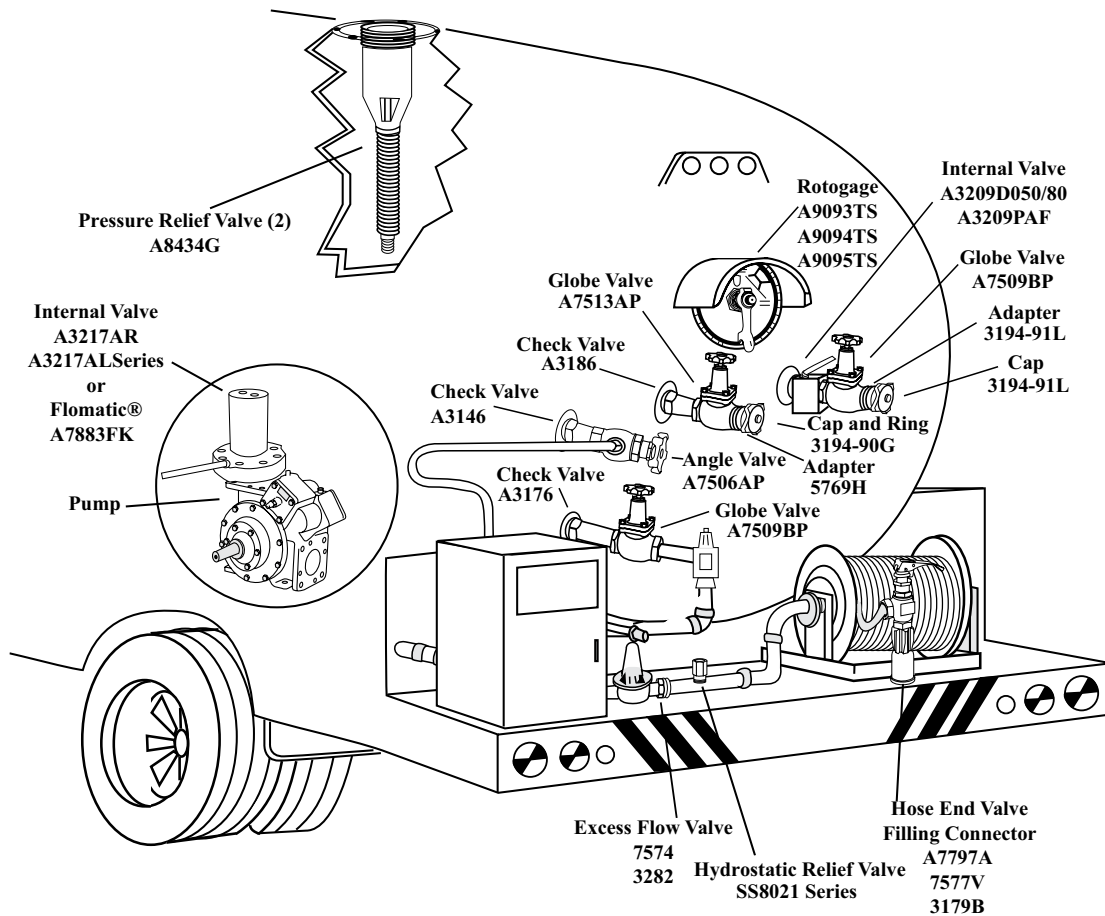

Disclaimer: The illustrations in this application guide are intended to inform a professional installer/system designer where our valves are generally installed on certain containers or applications. These illustrations are not intended for and must not be used for system design.

Bulk Storage Plants

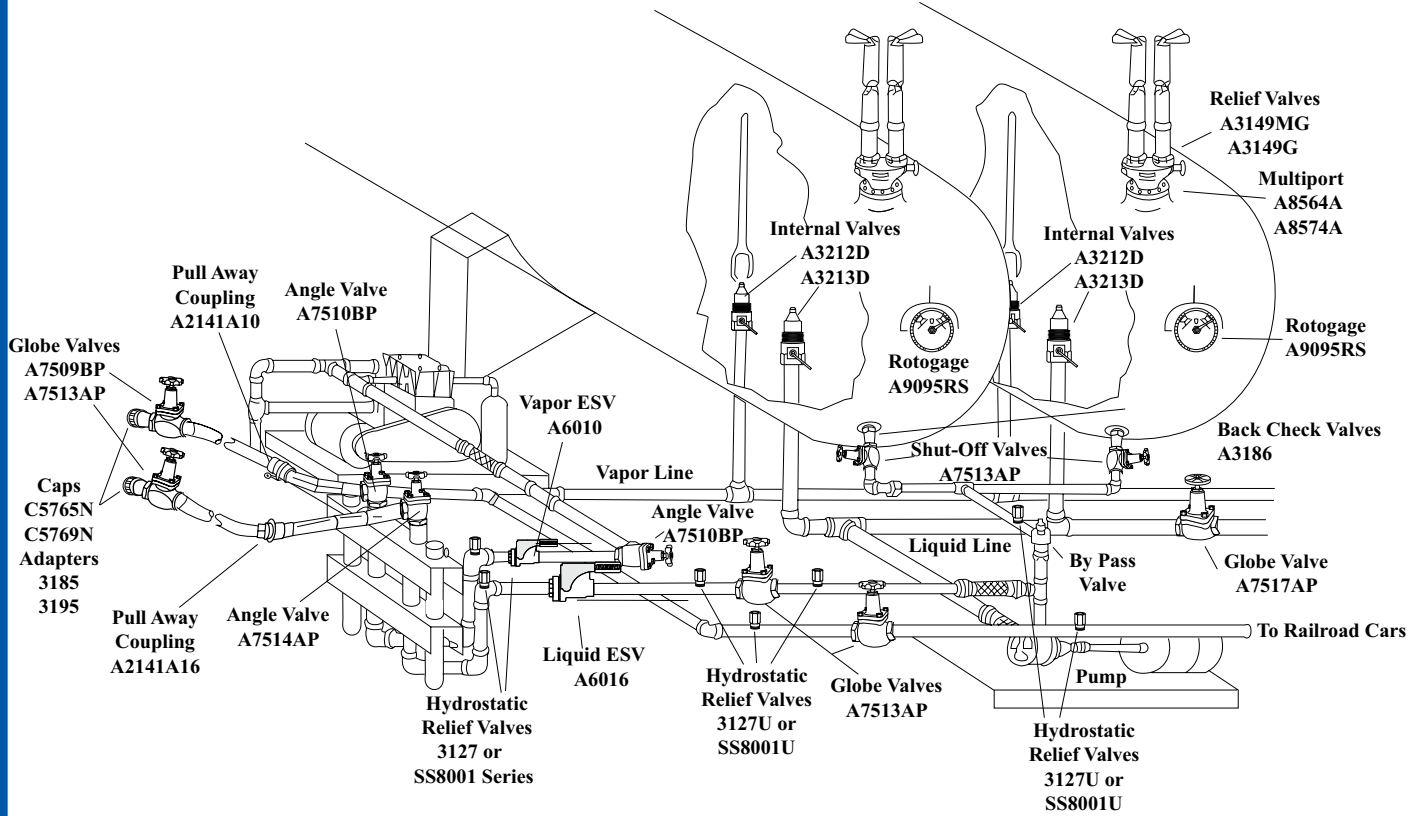

Disclaimer: The illustrations in this application guide are intended to inform a professional installer/system designer where our valves are generally installed on certain containers or applications. These illustrations are not intended for and must not be used for system design.

Bulk Transport Trucks

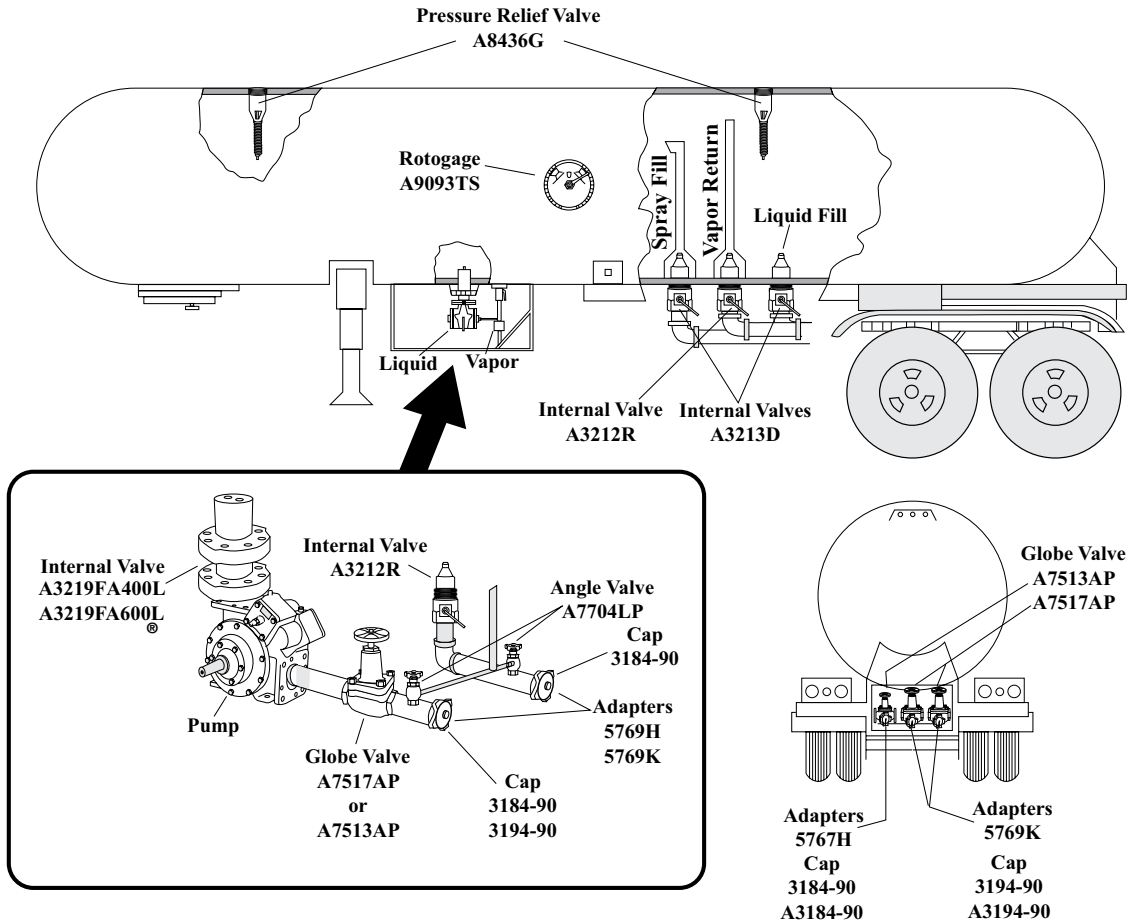

Disclaimer: The illustrations in this application guide are intended to inform a professional installer/system designer where our valves are generally installed on certain containers or applications. These illustrations are not intended for and must not be used for system design.

Cylinder Valve Applications

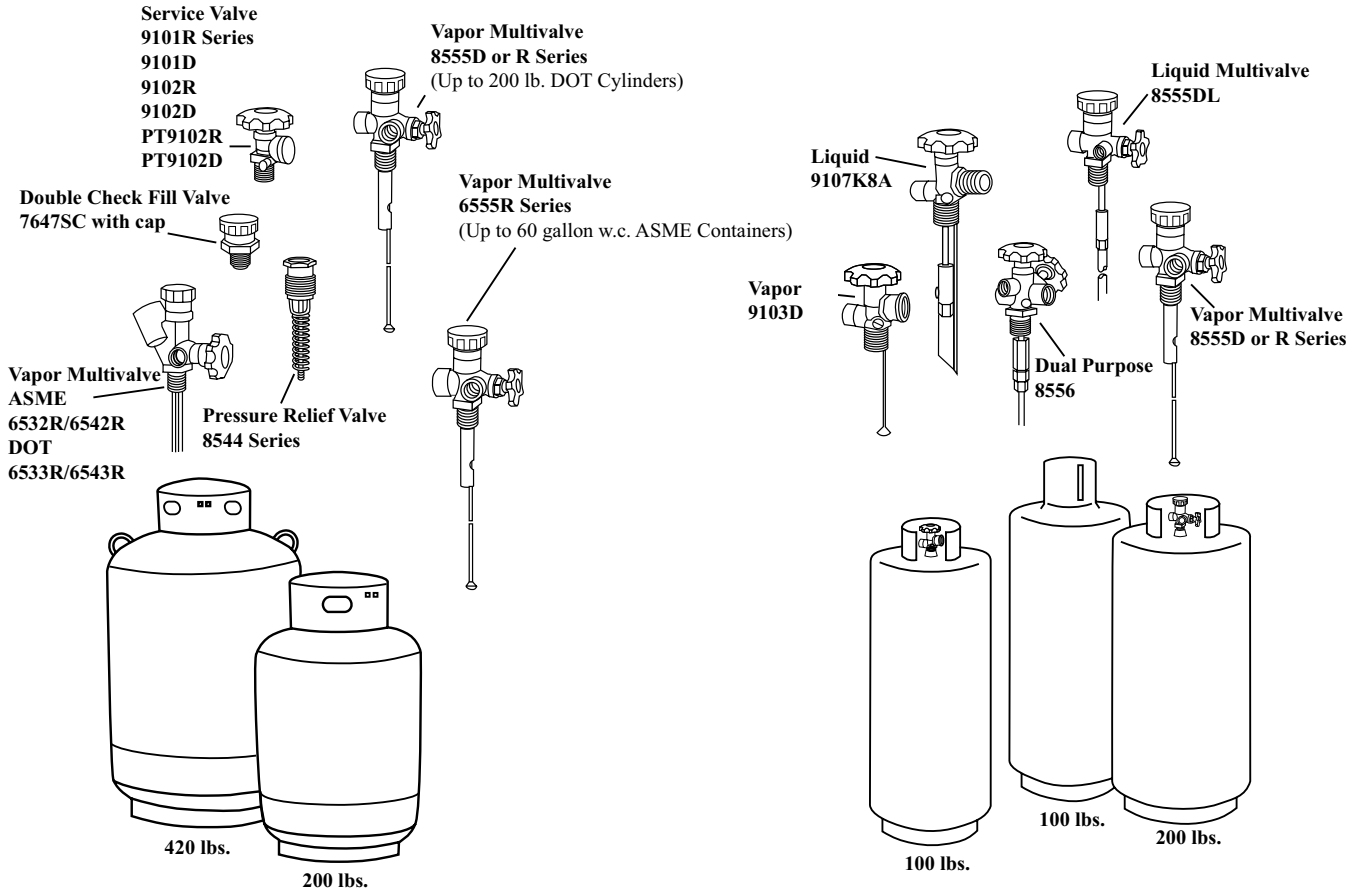

Disclaimer: The illustrations in this application guide are intended to inform a professional installer/system designer where our valves are generally installed on certain containers or applications. These illustrations are not intended for and must not be used for system design.

Domestic Installations

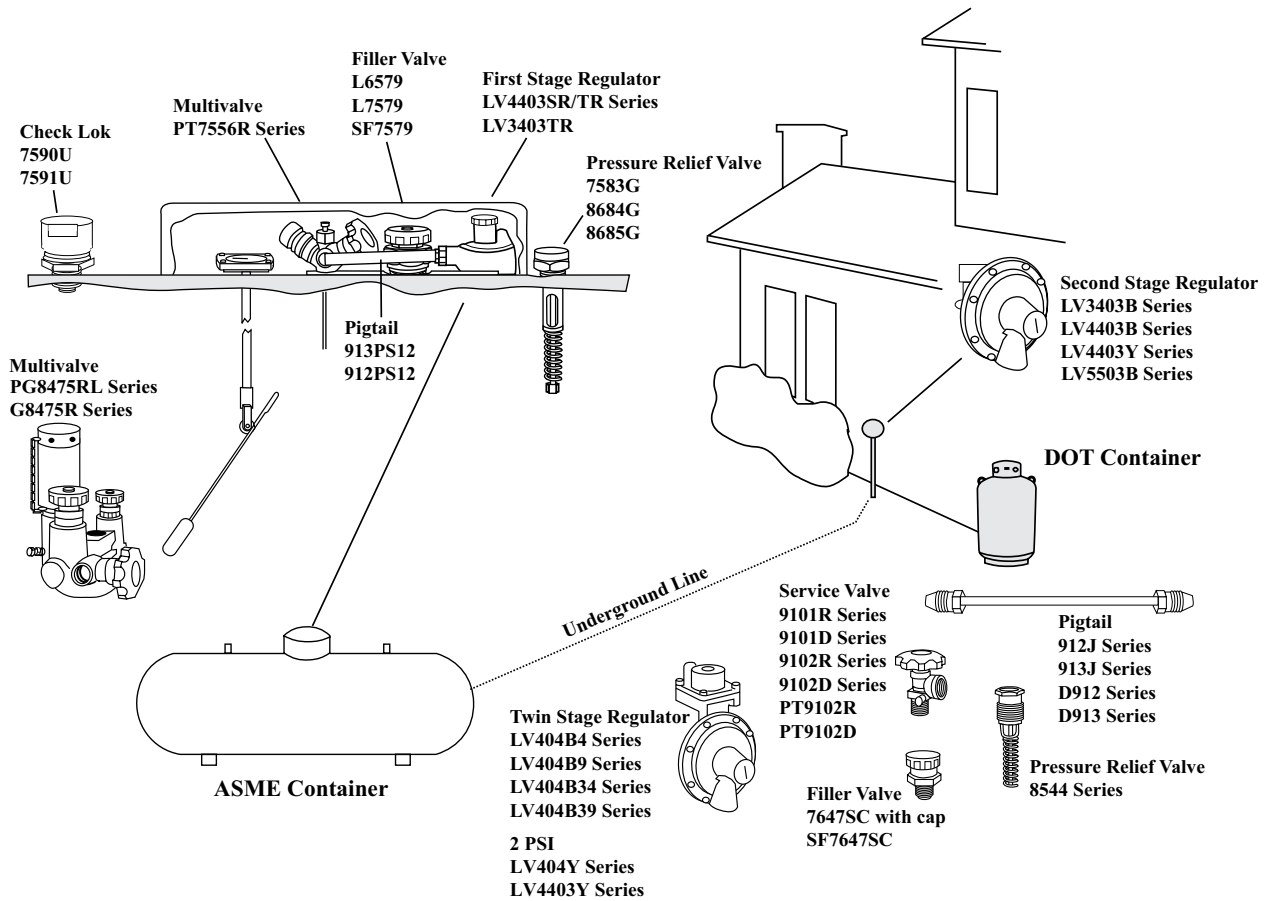

Disclaimer: The illustrations in this application guide are intended to inform a professional installer/system designer where our valves are generally installed on certain containers or applications. These illustrations are not intended for and must not be used for system design.

Emergency Shut Off Valves

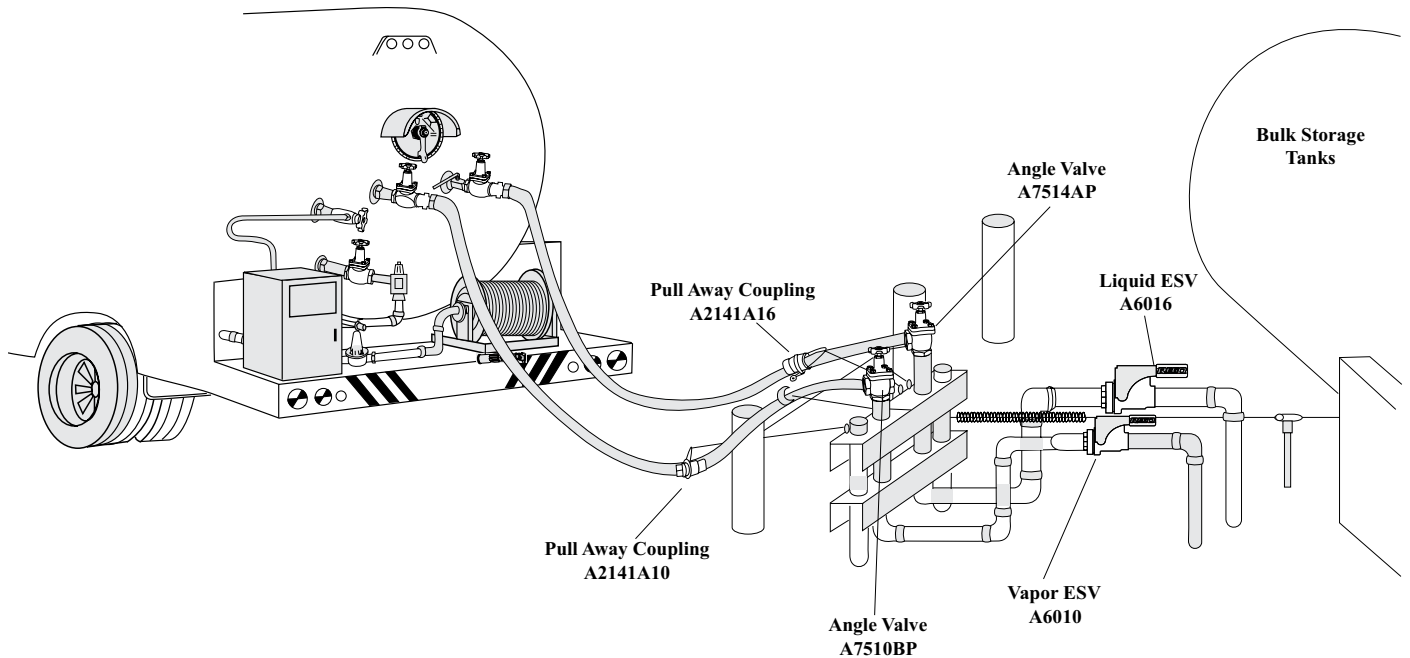

Disclaimer: The illustrations in this application guide are intended to inform a professional installer/system designer where our valves are generally installed on certain containers or applications. These illustrations are not intended for and must not be used for system design.

Motor Fuel Applications

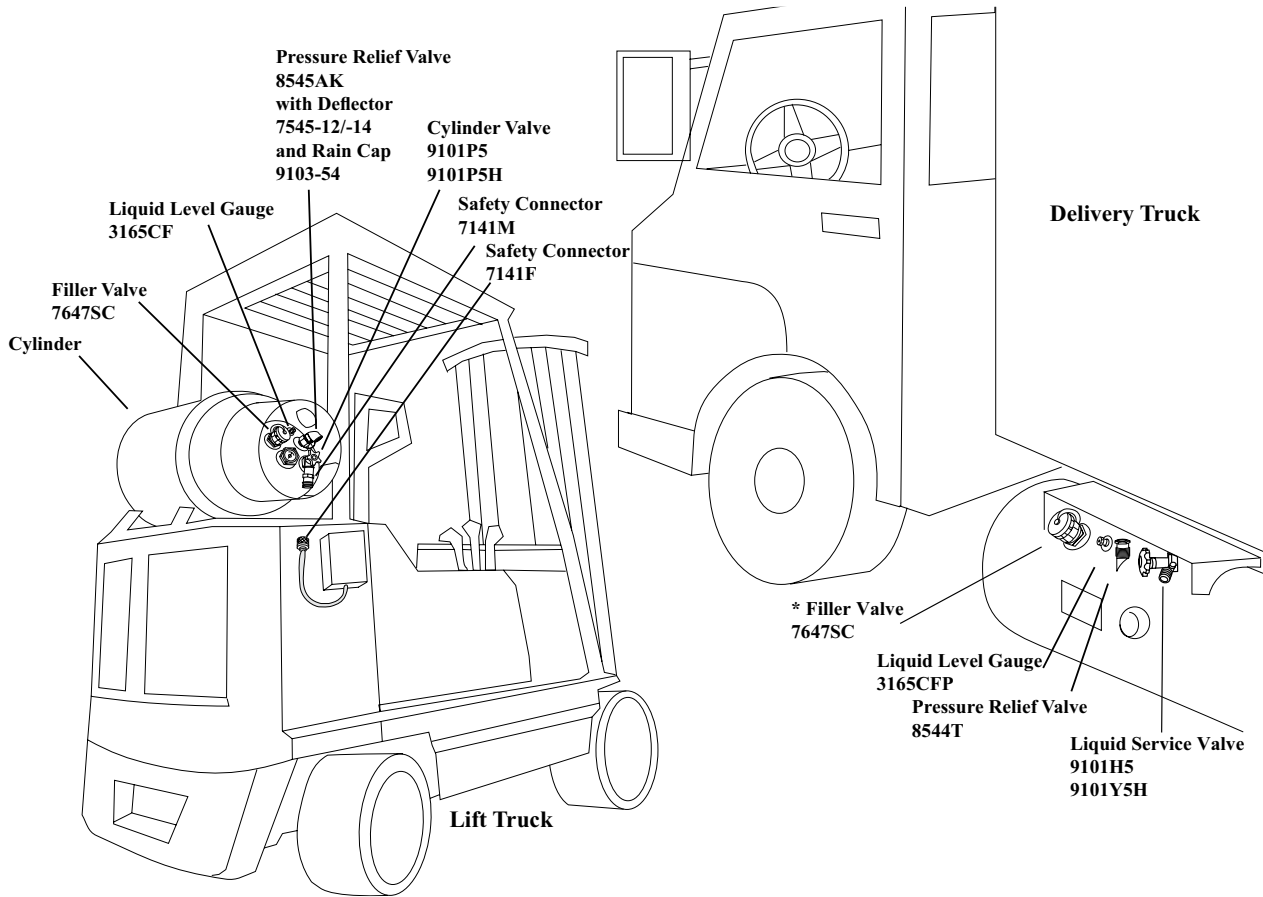

Disclaimer: The illustrations in this application guide are intended to inform a professional installer/system designer where our valves are generally installed on certain containers or applications. These illustrations are not intended for and must not be used for system design.

Anode Testing Procedure

PRESSURE FACTORS

POSITIVE DISPLACEMENT METER

Always caution Customers to open Inlet & Outlet valves extremely slowly when using elevated pressure.

POUNDS	FACTOR	POUNDS	FACTOR
0	0.998	41	3.76
1	1.05	42	3.83
2	1.11	43	3.9
3	1.18	44	3.97
4	1.25	45	4.03
5	1.32	46	4.1
6	1.39	47	4.17
7	1.45	48	4.24
8	1.52	49	4.3
9	1.59	50	4.37
10	1.66	51	4.44
11	1.72	52	4.51
12	1.79	53	4.58
13	1.86	54	4.64
14	1.93	55	4.71
15	2	56	4.78
16	2.06	57	4.85
17	2.13	58	4.92
18	2.2	59	4.98
19	2.27	60	5.05
20	2.34	61	5.12
21	2.4	62	5.19
22	2.47	63	5.26
23	2.54	64	5.32
24	2.61	65	5.39
25	2.68	66	5.46
26	2.74	67	5.53
27	2.81	68	5.59
28	2.88	69	5.66
29	2.95	70	5.73
30	3.01	71	5.8
31	3.08	72	5.87
32	3.15	73	5.93
33	3.22	74	6
34	3.29	75	6.07
35	3.35	76	6.14
36	3.42	77	6.21
37	3.49	78	6.27
38	3.56	79	6.34
39	3.63	80	6.41
40	3.69		

To convert to gallons multiply cubic feet by the lbs factor, and then divide the result by 36.28

Measuring Tank-to-Soil Cathodic Protection Potentials On Propane Tanks

Equipment: Digital Voltmeter, Test leads, Reference Electrode (Copper/Copper Sulfate half cell)

STEP 1:

Using a digital voltmeter select the 2 volt DC scale, Contact red test lead to the tank test point or an uncoated metallic area of the tank, preferably to the uncoated fill pipe. (Do not connect to shroud.) Note: If using a two-input analog meter, black lead will be connected to tank.

STEP 2:

Contact the black test lead from the meter to a charged reference electrode. (see charging electrode below) Note: If using a two-input analog meter, contact red lead to reference electrode.

STEP 3:

Remove protective cap from porous plug at bottom end of electrode. Place porous plug end into native earth directly above buried tank. Moisten soil with water or dig plug into soil if difficulty is encountered obtaining a reading.

STEP 4:

Observe meter reading and record. Reading should be at least -.850v or above. For other applicable criteria refer to NACE Standards RP0285-95 and RP0169-96, Corrosion Control of Underground Storage Tank Systems and Control of External Corrosion on Underground or Submerged Metallic Piping Systems.

Note: It is recognized through NACE that all readings be recorded as negative.

Charging Reference Electrode:

STEP 1:

Unscrew and remove porous plug end of new reference electrode. Add deionized or distilled water to the copper sulfate crystals, filling electrode completely. The solution will turn blue in color and there should always be excess crystals at the bottom of the tube. DO NOT USE TAP WATER.

STEP 2:

Replace porous plug end of electrode and place in an upright position so that the porous plug end is facing in the down position and let stand for 15 minutes before use. This will allow the porous plug to become completely saturated before use. Caution: Do not allow electrode to contact oil, road salts, or other substances that may contaminate the solution by absorption through porous plug.

Do not allow electrode to freeze.















TWO STAGE REGULATOR

Quick Reference Guide For **REGO** Regulators

MASTER DISTRIBUTOR

Make sure you are thoroughly trained before you attempt any regulator installation or maintenance. Improper conditions or procedures can cause accidents resulting in property damage and personal injury.

BTU Load		Then Choose Your Pigtails, Nuts, Fittings & Risers											
400,000 btu/hr. DISTANCE: 80 feet PIPE SIZE: 1/2" CTS Poly pipe or copper tubing @ 10 psi <i>If copper piping is chosen see "Copper Piping" for size & part number</i>		REGULATORS: LV3403TR 1/4" X 1/2" 1ST STAGE  LV4403B4 1/2" X 1/2" 2ND STAGE straight outlet 											
600,000 btu/hr. DISTANCE: 40 feet PIPE SIZE: 1/2" CTS Poly pipe or copper tubing @ 10 psi <i>If copper piping is chosen see "Copper Piping" for size & part number</i>		REGULATORS: LV3403TR 1/4" X 1/2" 1ST STAGE  LV4403B46R 1/2" X 3/4" 2ND STAGE back mounting 											
800,000 btu/hr. DISTANCE: 20 feet PIPE SIZE: 1/2" CTS Poly pipe or copper tubing @ 10 psi <i>If copper piping is chosen see "Copper Piping" for size & part number</i>		REGULATORS: LV3403TR 1/4" X 1/2" 1ST STAGE  LV4403B66 3/4" X 3/4" 2ND STAGE 											
1,000,000 btu/hr. DISTANCE: 15 feet PIPE SIZE: 1/2" CTS Poly pipe or copper tubing @ 10 psi <i>If copper piping is chosen see "Copper Piping" for size & part number</i>		REGULATORS: LV3403TR 1/4" X 1/2" 1ST STAGE  LV5503B6 3/4" X 3/4" 2ND STAGE straight outlet 											
2,000,000 btu/hr. DISTANCE: 10 feet PIPE SIZE: 5/8" Copper Tubing @ 10 psi <i>If copper piping is chosen see "Copper Piping" for size & part number</i>		REGULATORS: LV4403TR9 1/2" X 1/2" 1ST STAGE  LV5503B8 3/4" X 1" 2ND STAGE straight outlet 											
Presto-Tap Universal Service Tech Kit USES: <ul style="list-style-type: none"> Leak testing at tank pressure with Presto Tap pigtails. Determining 1st or 2nd stage regulator lock up Determining lock up and flow on Two Pound systems Low pressure leak testing Plug removal in regulators 		UNIVERSAL-SERVICE-TECH-KIT 											
PARTS INCLUDED: <ul style="list-style-type: none"> 6800-KG PT-30KG PT-5KG PT-OZ MHA-STRAIGHT 316 ALLEN KEY UNIVERSAL FLEX HOSE RV KIT BAG 		COPPER TUBING:  <table border="1"> <thead> <tr> <th>SIZE</th> <th>PART #</th> </tr> </thead> <tbody> <tr> <td>1/2" OD x 50'</td> <td>CCR-1/2X50</td> </tr> <tr> <td>1/2" OD x 100'</td> <td>CCR-1/2X100</td> </tr> <tr> <td>5/8" OD x 50'</td> <td>CCR-5/8X50</td> </tr> <tr> <td>5/8" OD x 100'</td> <td>CCR-5/8X100</td> </tr> </tbody> </table>		SIZE	PART #	1/2" OD x 50'	CCR-1/2X50	1/2" OD x 100'	CCR-1/2X100	5/8" OD x 50'	CCR-5/8X50	5/8" OD x 100'	CCR-5/8X100
SIZE	PART #												
1/2" OD x 50'	CCR-1/2X50												
1/2" OD x 100'	CCR-1/2X100												
5/8" OD x 50'	CCR-5/8X50												
5/8" OD x 100'	CCR-5/8X100												

See RegO's LP-GAS Serviceman's Manual L-545 for Examples & Reference Tables

TWIN STAGE REGULATOR

Quick Reference Guide For **REGO** Master Distributor Regulators

Make sure you are thoroughly trained before you attempt any regulator installation or maintenance. Improper conditions or procedures can cause accidents resulting in property damage and personal injury.

BTU Load

100,000 btu/hr.

DISTANCE: 10 feet
PIPE SIZE: 1/2" CTS
 Poly pipe or copper tubing @ 11" water column regulator set pressure

PIPE SIZE: 5/8" copper tubing @ 11" water column regulator set pressure

PIPE SIZE: 3/4" IPS Poly pipe @ 11" water column regulator set pressure

REGULATOR:
 LV404B34
 1/4" X 1/2"



DISTANCE: 35 feet **DISTANCE:** 100 feet
If copper piping is chosen see "Copper Piping" for size & part number

200,000 btu/hr.

DISTANCE: 10 feet
PIPE SIZE: 5/8" copper tubing @ 11" water column regulator set pressure

PIPE SIZE: 3/4" IPS Poly pipe @ 11" water column regulator set pressure

REGULATOR:
 LV404B34
 1/4" X 1/2"



DISTANCE: 50 feet
If copper piping is chosen see "Copper Piping" for size & part number

300,000 btu/hr.

DISTANCE: 30 feet
PIPE SIZE: 3/4" IPS Poly pipe @ 11" water column regulator set pressure

PIPE SIZE: 1" IPS Poly pipe @ 11" water column regulator set pressure

REGULATORS:

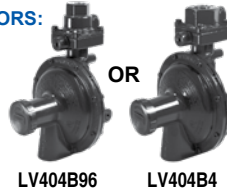

DISTANCE: 70 feet
If copper piping is chosen see "Copper Piping" for size & part number

400,000 btu/hr.

DISTANCE: 20 feet
PIPE SIZE: 3/4" IPS Poly pipe @ 11" water column regulator set pressure

PIPE SIZE: 1" IPS Poly pipe @ 11" water column regulator set pressure

REGULATORS:

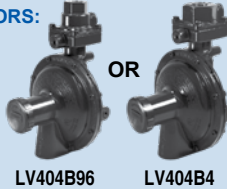

DISTANCE: 20 feet
If copper piping is chosen see "Copper Piping" for size & part number

Piping & Tubing Sizing Instructions

This method will assure the selection of the correct sizes of piping and tubing for LP Gas vapor systems. Piping between first and second stage regulators is considered, as well as low pressure (inches water column) piping between second stage, single stage, or integral twin stage regulators and appliances.

INSTRUCTIONS:

- Determine the total gas demand for the system by adding up the BTU/hr input from the appliance nameplates and adding demand as appropriate for future appliances.
- Second stage or integral twin stage piping:
 - Measure length of piping required from outlet of regulator to the appliance furthest away. No other length is necessary to do the sizing.
 - Make a simple sketch of the piping, as shown.
 - Determine the capacity to be handled by each section of piping. For example, the capacity of the line between A & B must handle the total demand of appliances A, B, & C; the capacity of the line from c to d must handle only appliance B, etc.
 - Select proper size of tubing or pipe for each

section of piping, using values in BTU/hr for the length determined from step #2-A. If exact length is not on chart, use next longer length. Do not use any other length for this purpose! Simply select the size that shows at least as much capacity as needed for each piping section.

- For piping between first and second stage regulators
 - For a system with only one second stage regulator, measure length of piping required between outlet of first stage and inlet of second stage regulators. Select piping or tubing required.
 - For systems with multiple second stage regulators, measure length of piping required to reach the second stage regulator that is furthest away. Make a simple sketch, and size each leg of piping using the table using values shown in column corresponding to the length as measured above, same as when handling second stage piping.

See Piping & Tubing Selection Guide Poster For Examples and Reference Tables or Rego's LP-GAS Serviceman's Manual L-545

Then Choose Your Pigtails, Nuts, Fittings & Risers

PIGTAILS:

TYPE	SIZE	PART #
1/4" x POL	3/8" tube x 12"	913JS12
1/4" x POL	1/4" tube x 12"	912JS12
1/4" x POL	3/8" tube x 5"	913JS05
1/4" x POL	1/4" tube x 5"	912JS05
POL x POL	3/8" tube x 12"	913PS12
POL x POL	1/4" tube x 12"	912PS12



NUTS:

SIZE	PART #
1/2" nut	NS4F
5/8" nut	NS4I

FITTINGS:

	SIZE		PART #
	MFL	MPT	
	1/2"	1/2"	48FF
	5/8"	1/2"	48IF

RISERS:

TYPE	SIZE	PART #
Flex	1/2" CTS x 1/2" CTS x 36"	71354
Flex	1/2" CTS x 1/2" CTS x 84"	71353
Flex	3/4" IPS x 3/4" IPS x 36"	71410
Flex	3/4" IPS x 3/4" IPS x 84"	71412
Hard	1" IPS x 1" MPT	78442



COPPER TUBING:

SIZE	PART #
1/2" OD x 50'	CCR-1/2 X 50
1/2" OD x 100'	CCR-1/2 X 100
5/8" OD x 50'	CCR-5/8 X 50
5/8" OD x 100'	CCR-5/8 X 100

TABLE 3

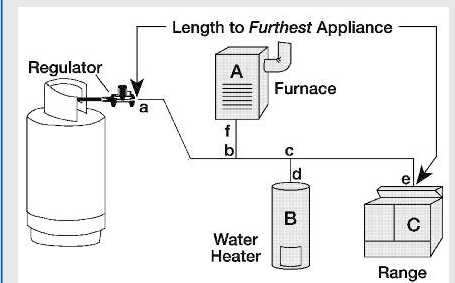

See Rego's LP-GAS Serviceman's Manual L-545 for Examples & Reference Tables



PIPING AND TUBING Quick Reference Guide

Gas piping and regulator installation should be done by a qualified technician. Improper installation can cause property damage and/or personal injury can occur.

Example 1: Determine the sizes of piping or tubing required for the twin-stage LP-Gas installation shown:

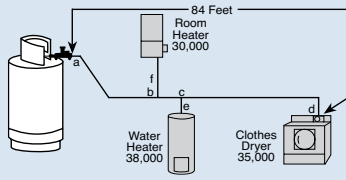

Total piping length = 84 ft (use Table 3 @ 90 ft)
 From a to b, demand = 38,000 + 35,000 + 35,000 = 108,000 BTU/hr; use 1" pipe
 From b to c, demand = 38,000 + 35,000 = 73,000 BTU/hr; use 1/2" pipe or 3/4" tubing
 From c to d, demand = 35,000 BTU/hr; use 1/2" pipe or 5/8" tubing
 From c to e, demand = 38,000 BTU/hr; use 1/2" pipe or 5/8" tubing
 From b to f, demand = 30,000 BTU/hr; use 1/2" pipe or 1/2" tubing

Example 2: Determine the sizes of piping or tubing required for the two-stage LP-Gas installation shown:
Total first stage piping length = 26 feet; first stage regulator setting is 10 PSIG (use Table 1 or 2 @ 30 ft)
 From aa to a, demand = 338,000 BTU/hr; use 1 1/2" pipe, 1/2" tubing, or 1/2" T plastic pipe.

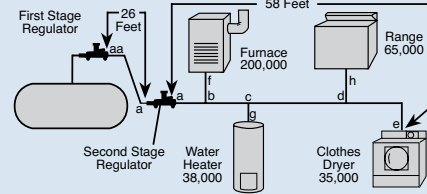

Total second stage piping length = 58 feet (use Table 3 @ 60 ft)
 From a to b, demand = 338,000 BTU/hr; use 1" pipe
 From b to c, demand = 138,000 BTU/hr; use 3/4" pipe or 7/8" tubing
 From c to d, demand = 100,000 BTU/hr; use 1/2" pipe or 3/4" tubing
 From d to e, demand = 35,000 BTU/hr; use 1/2" pipe or 1/2" tubing
 From b to f, demand = 200,000 BTU/hr; use 3/4" pipe or 7/8" tubing
 From c to g, demand = 38,000 BTU/hr; use 1/2" pipe or 1/2" tubing
 From d to h, demand = 65,000 BTU/hr; use 1/2" pipe or 5/8" tubing

First Stage Pipe Sizing (Between First and Second Stage Regulators)

10 PSIG Inlet with a 1 PSIG Pressure Drop

Maximum capacity of pipe or tubing in 1000's of BTU/hr of LP-Gas

SIZE OF PIPE OR COPPER TUBING, INCHES	LENGTH OF PIPE OR TUBING, FEET																				
	10	20	30	40	50	60	70	80	90	100	125	150	175	200	225	250	275	300	350	400	
COPPER TUBING (O.D.)	3/8"	558	383	309	265	235	213	196	182	171	161	142	130	118	111	104	90	89	89	82	76
	1/2"	1387	870	700	599	531	481	443	412	386	365	323	293	269	251	235	222	211	201	185	172
	5/8"	2360	1622	1303	1115	988	896	824	767	719	679	601	546	502	467	438	414	393	375	345	321
PIPE SIZE	3/4"	3993	2475	2205	1887	1672	1515	1394	1297	1217	1149	1018	923	843	790	740	700	664	634	584	543
	1/2"	3339	2295	1843	1577	1398	1267	1165	1084	1017	961	852	772	710	660	619	585	556	530	488	454
	3/4"	6982	4799	3854	3298	2923	2649	2437	2267	2127	2009	1780	1613	1484	1381	1296	1224	1162	1109	1020	949
	1"	13153	9040	7259	6213	5507	4989	4590	4270	4007	3785	3354	3039	2796	2601	2441	2305	2190	2089	1922	1788
	1-1/4"	27004	18560	14904	12756	11306	10244	9424	8767	8226	7770	6887	6240	5741	5340	5011	4733	4495	4289	3945	3670
	1-1/2"	40461	27809	22331	19113	16939	15348	14120	13136	12325	11642	10318	9349	8601	8002	7508	7092	6735	6426	5911	5499
2"	77924	53556	43008	36809	32623	29559	27194	25299	23737	22422	19871	18005	16564	15410	14459	13658	12971	12375	11385	10591	

*Total length of piping from outlet of first stage regulator to inlet of second stage regulator (or to inlet of second stage regulator furthest away).

Notes: 1) To allow 2 PSIG pressure drop, multiply total gas demand by .707, and use capacities from table.

2) For different first stage pressures, multiply total gas demand by the following factors, and use capacities from table.

Ex: 1,000,000 BTU load at 5 PSI: 1,000,000 (1.2) = 1,200,000 BTU then use chart bases on 1,200,000 BTU

First Stage Pressure PSIG	Multiply By
20	.844
15	.912
5	1.120

Data Calculated per NFPA #54 & 58

First Stage Plastic Tubing Sizing

10 PSIG Inlet with a 1 PSIG Pressure Drop

Maximum capacity of plastic tubing in 1000's of BTU/hr of LP-Gas

SIZE OF PLASTIC TUBING	NPS	SDR	LENGTH OF PIPE OR TUBING, FEET																			
			10	20	30	40	50	60	70	80	90	100	125	150	175	200	225	250	275	300	350	400
1/2T	7	1287	954	766	655	581	526	484	450	423	399	354	321	295	274	257	243	220	203	189	189	189
	11	7811	5389	4311	3690	3270	2963	2726	2536	2379	2248	1992	1805	1660	1545	1499	1369	1241	1141	1062	1062	1062
	1	14094	9687	7779	6658	5901	5346	4919	4578	4293	4044	3594	3257	2996	2787	2615	2470	2238	2059	1916	1916	1916
1-1/4	10	24416	16781	13476	11534	10222	9262	8521	7927	7438	7026	6226	5642	5190	4829	4531	4280	3878	3567	3318	3318	3318
	11	66251	45534	36566	31295	27737	25131	23120	21509	20181	19063	16895	15308	14084	13102	12293	11612	10521	9680	9005	9005	9005

*Total length of piping from outlet of first stage regulator to inlet of second stage regulator or to inlet of second stage regulator furthest away.

First Stage Pressure PSIG	Multiply By
20	.844
15	.912
5	1.120

Data Calculated per NFPA #54 & 58

Second Stage or Integral Twin Stage Pipe Sizing

11 Inches Water Column Inlet with a 1/2 Inch Water Column Drop

Maximum capacity of pipe or tubing in 1000's of BTU/hr of LP-Gas

SIZE OF PIPE OR COPPER TUBING, INCHES	LENGTH OF PIPE OR TUBING, FEET																				
	10	20	30	40	50	60	70	80	90	100	125	150	175	200	225	250	275	300	350	400	
COPPER TUBING (O.D.)	3/8	49	34	27	23	20	19	—	—	—	—	—	—	—	—	—	—	—	—	—	
	1/2	110	76	61	52	46	42	38	36	33	32	—	—	—	—	—	—	—	—	—	
	5/8	206	151	114	97	86	78	71	67	62	59	—	—	—	—	—	—	—	—	—	
	3/4	348	239	192	164	146	132	120	113	105	100	—	—	—	—	—	—	—	—	—	
PIPE SIZE	7/8	536	368	296	253	224	203	185	174	161	154	—	—	—	—	—	—	—	—	—	
	1/2	291	200	161	137	122	110	102	94	87	84	74	67	62	58	54	51	48	46	43	40
	3/4	608	418	226	287	255	231	212	198	185	175	155	141	129	120	113	107	101	97	89	83
	1	1146	788	632	541	480	435	400	372	349	330	292	265	244	227	213	201	191	182	167	156
	1-1/4	2353	1617	1299	1111	985	892	821	764	717	677	600	544	500	465	437	412	392	374	344	320
	1-1/2	3525	2423	1946	1665	1476	1337	1230	1144	1074	1014	899	815	749	697	654	618	587	560	515	479
2	6789	4666	3747	3207	2842	2575	2369	2204	2068	1954	1731	1569	1443	1343	1260	1190	1130	1078	992	923	

*Total length of piping from outlet of regulator to appliance furthest away.

Data Calculated per NFPA #54 & 58

RESIDENTIAL/COMMERCIAL

Quick Reference Guide For Perfection

Permasert® Polyethylene Mechanical Fittings and Risers

Make sure you are thoroughly trained before you attempt any regulator installations. Improper conditions or procedures can cause accidents resulting in property damage and personal injury.

Polyethylene piping systems shall be limited to: 1) Vapor service not exceeding 30 psig 2) Installation outdoors and underground with a minimum of 18" of cover, except the cover may be reduced to 12", if external damage to the pipe is not likely to result. Check your local codes.

Mechanical Couplings

PART #	SIZE	SDR/ WALL
50100	1/2" CTS	.090
50030	3/4" IPS	SDR 11
50601	1" IPS	
50035010	1-1/4" IPS	SDR 10
50314	2" IPS	SDR 11



Coppersert™ Copper to PE Fittings

SIZE	PART #
41007	1/2" CTS x 3/8" Flare
41013	1/2" CTS x 1/2" Flare
41002	1/2" CTS x 5/8" Flare
41130	3/4" IPS x 5/8" Flare
41150	1" CTS x 5/8" Flare



Permasert Three-Way Tees

PART #	SIZE	SDR/ WALL
50199	1/2" CTS	.090
50929	3/4" IPS	SDR 11
50634	1" IPS	
50327010	1-1/4" IPS	SDR 10
50316	2" IPS	SDR 11



Anodeless Service Line Risers

Permasert Mechanical Ends

PART #	OUTLET	INLET	SDR/ WALL	VERTICAL	HORIZONTAL
77253	1/2" MPT	1/2" CTS	.090	30"	24"
75192	3/4" MPT	1/2" CTS	.090	30"	24"
77201	3/4" MPT	1/2" CTS	.090	22"	18"
79209	3/4" MPT	3/4" IPS	SDR 11	30"	24"
78442	1" MPT	1" IPS	—	30"	24"
75901	1-1/4" MPT	1-1/4" IPS	—	30"	24"
75906	2" IPS	2" IPS	SDR 11	30"	15"

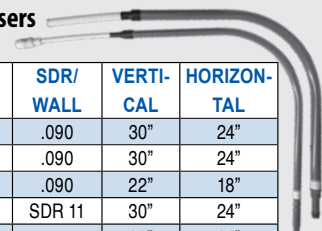

Polyethylene Piping

PART #	SIZE	COIL LENGTH	I.D.	NOMINAL O.D.	SDR	MINIMUM WALL THICKNESS
PP-1/2CTS	Medium density polyethylene piping	500 ft.	1/2"	0.625"	7	.090"
PP-3/4IPS			3/4"	1.050"	11	.095"
PP-1IPS			1"	1.315"		.120"
PP-1 1/4IPS			1-1/4"	1.660"	10	.166"
PP-2IPS		250 ft.	2"	2.375"	11	.216"



Anodeless Servi-Sert® Field-Assembled All-flex Risers* (with Swivel Connector/Union)

PART #	OUTLET	INLET	OVERALL LENGTH	
71353	1/2" MNPT	1/2 CTS Poly Pipe	84"	
71354			36"	
71355			84"	
71356			36"	
71412			3/4" IPS	84"
71410				36"
71411	60"			



Permasert Blind End Caps

Caps: stop & go - both ends function.

PART #	SIZE	SDR/ WALL
50461	3/4" IPS	SDR 11
50635	1" IPS	
50328100	1-1/4" IPS	SDR 10
51283	2" IPS	SDR 11
51323100		

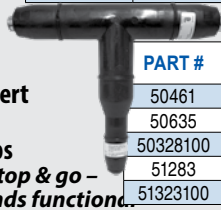

Permasert Three-Way Reducing Tees

PART #	SIZE	SDR/ WALL	SIZE	SDR/ WALL	SIZE	SDR/ WALL
50461	3/4" IPS	SDR 11	3/4" IPS	SDR 11	1/2" CTS	.090"
50635	1" IPS		1" IPS			
50328100	1-1/4" IPS	SDR 10	1-1/4" IPS	SDR 10	1" CTS	SDR 11
51283	2" IPS	SDR 11	2" IPS	SDR 11	1" IPS	
51323100			2" IPS	1-1/4" IPS		

Servi-Sert® Replacement Service Head Adaptors

PART #	OUTLET	INLET	Service head adaptors ONLY
71110	1/2" MNPT	1/2" CTS	Service head adaptors ONLY
71100	3/4" MNPT	2" IPS	
71161		3/4" IPS	

Approved by NFPA-58, 1998 Edition (Check Local Jurisdictions.)

Tools and Accessories

PART #	DESCRIPTION	SIZE
51016	Chamfering tool	1/2" CTS x 3/4" IPS
51008		3/4" IPS x 1" IPS
51028		1-1/4" IPS
51040		2" IPS
55290	Plastic cutter	Snips 1/8"-1 1/2" OD
55291		Snips 1/8"-2 3/8" OD

NOTE: The above part numbers represent our most popular components. For other sizes or custom configurations, please inquire.



Repair Couplings

PART #	SIZE	SDR/ WALL	LENGTH
50016	1/2" CTS	.090	12"
50026	3/4" IPS	SDR 11	
50033	1-1/4" IPS	SDR 10	
50317	2" IPS	SDR 11	
50320100	1-1/4" IPS	SDR 10	
50341	2" IPS	SDR 11	

NOTE: Polyethylene pipe/tubing shall be limited to vapor service, not exceeding 30 psig, and must be installed outdoors and underground.

Transition Fittings

PART #	DESCRIPTION	SIZE	APPROXIMATE DIMENSION
700004	Transition, threaded	1/2" MNPT x 1/2" CTS	16-1/2"
700205		3/4" MNPT x 1/2" CTS	16"
700802		3/4" MNPT x 3/4" IPS	17"
707202		1" MNPT x 1" IPS	17"
702205		1-1/4" MNPT x 1-1/4" IPS	16-1/2"
702602		2" MNPT x 2" IPS	18-1/2"



Permasert Reducing Couplings

PART #	SIZE	SDR/ WALL	SIZE	SDR/ WALL
50149	1/2" CTS	.090	1" CTS	.099"/.103"
50969			3/4" IPS	
51432	1" IPS	SDR 11	SDR 11	
50343010	1-1/4" IPS	SDR 10		1" IPS
50333010				2" IPS



Locator Tape and Wire

Tracer Tape should be placed in trench a minimum of 6" above polyethylene pipe. The metallic tape allows for easy location of plastic pipe with metal detector.

PART #	DESCRIPTION	COIL LENGTH
715-NCGT21	Metallic locator tape	2" x 1,000 ft. roll
NO.12	PE coated copper #12"	500 ft. roll



Permasert Elbows

PART #	SIZE	SDR/ WALL
50294	1/2" CTS	.090
51620	3/4" IPS	SDR 11
50636	1" IPS	
50325010	1-1/4" IPS	SDR 10
50315	2" IPS	SDR 11





2PSIG REGULATORS

Quick Reference Guide For 2 Stage or 3 Stage Systems

See Twin Regulators for Low Pressure Systems

2 Stage 10 PSIG System		3 Stage 2 PSIG System	
1st Stage LV3403TR 1,500,000 btu/hr. 1/4" F.NPT X 1/2" F.NPT		1st Stage LV3403TR 1,500,000 btu/hr. 1/4" F.NPT X 1/2" F.NPT	1st Stage LV4403TR9 2,500,000 btu/hr. F.POL X 1/2" F.NPT
1st Stage LV4403TR9 2,500,000 btu/hr. F.POL X 1/2" F.NPT		2nd Stage 2 PSI LV4403Y46R 1,000,000 btu/hr. 1/2" F.NPT X 3/4" F.NPT	2nd Stage 2 PSI LV5503Y6 2,200,000 btu/hr. 3/4" F.NPT X 3/4" F.NPT
2nd Stage LV3403B46R 450,000 btu/hr. 1/2" F.NPT X 3/4" F.NPT		3rd Stage 325-3L 250,000 btu/hr. 1/2" F.NPT X 1/2" F.NPT	
2nd Stage LV4403B66 950,000 btu/hr. 3/4" F.NPT X 3/4" F.NPT		325-5L 600,000 btu/hr. 1/2" F.NPT X 1/2" F.NPT	
		325-7AL 1,250,000 btu/hr. 1-1/4" F.NPT X 1-1/4" F.NPT	

See the Twin Regulator for Low Pressure Systems

2 PSIG Line Sizing Chart – Pipe & Copper

2 PSIG inlet with a .2 PSIG Pressure Drop

Maximum capacity of pipe or tubing in 1000's of BTU/hr of LP-Gas

SIZE OF PIPE OR COPPER TUBING, INCHES	LENGTH OF PIPE OR TUBING, FEET																					
	10	20	30	40	50	60	70	80	90	100	125	150	175	200	225	250	275	300	350	400		
COPPER TUBING (O.D.)	3/8"	176	121	97	83	74	67	61	57	54	51	45	41	37	35	33	31	29	28	26	24	
	1/2"	363	249	200	171	152	138	127	118	111	104	93	84	77	72	67	64	60	58	53	49	
	5/8"	738	507	407	349	309	280	258	240	225	212	188	171	157	146	137	129	123	117	108	100	
	3/4"	1290	887	712	609	540	489	450	419	393	371	329	298	274	255	239	226	215	205	188	175	
PIPE SIZE	1/2"	1140	784	629	539	477	432	398	370	347	328	291	263	242	225	212	200	190	181	167	155	
	3/4"	2384	1638	1316	1126	998	904	832	774	726	686	608	551	507	471	442	418	397	379	348	324	
	1"	4491	3086	2479	2120	1880	1703	1567	1458	1368	1292	1145	1038	955	888	833	787	748	713	656	610	
	1-1/4"	9215	6333	5087	4352	3858	3495	3215	2991	2806	2652	2350	2129	1963	1824	1710	1616	1539	1464	1345	1252	
	1-1/2"	13809	9491	7623	6521	5781	5235	4816	4480	4203	3973	3523	3191	2939	2731	2560	2420	2306	2194	2017	1878	
	2"	26597	18280	14683	12560	11135	10084	9277	8630	8096	7652	6848	6529	6096	5659	5259	4931	4661	4438	4223	3883	3615
	2-1/2"	42391	29135	23402	20019	17747	16075	14788	13756	12904	12197	10814	9795	9021	8384	7860	7429	7074	6731	6187	5761	
3"	74938	51504	41369	35389	31373	29784	27400	25488	23872	22563	19177	17316	15946	14820	13897	13135	12508	11901	10940	10186		

Data Calculated per NFPA #54 & 58

TWIN STAGE REGULATOR

Quick Reference Guide For **REGO** MASTER DISTRIBUTOR Regulators

Make sure you are thoroughly trained before you attempt any regulator installation or maintenance. Improper conditions or procedures can cause accidents resulting in property damage and personal injury.

BTU Load

100,000 btu/hr.

DISTANCE: 10 feet
PIPE SIZE: 1/2" CTS
Poly pipe or copper tubing @ 11" water column regulator set pressure

PIPE SIZE: 5/8" copper tubing @ 11" water column regulator set pressure

PIPE SIZE: 3/4" IPS Poly pipe @ 11" water column regulator set pressure

DISTANCE: 35 feet

DISTANCE: 100 feet

If copper piping is chosen see "Copper Piping" for size & part number

REGULATOR:

LV404B39
FPOL x 1/2 MPT



200,000 btu/hr.

DISTANCE: 10 feet
PIPE SIZE: 5/8" copper tubing @ 11" water column regulator set pressure

PIPE SIZE: 3/4" IPS Poly pipe @ 11" water column regulator set pressure

DISTANCE: 50 feet

If copper piping is chosen see "Copper Piping" for size & part number

REGULATOR:

LV404B39
FPOL x 1/2 MPT



300,000 btu/hr.

DISTANCE: 30 feet
PIPE SIZE: 3/4" IPS Poly pipe @ 11" water column regulator set pressure

PIPE SIZE: 1" IPS Poly pipe @ 11" water column regulator set pressure

DISTANCE: 70 feet

If copper piping is chosen see "Copper Piping" for size & part number

REGULATOR:

LV404B96
FPOL x 3/4 MPT



400,000 btu/hr.

DISTANCE: 20 feet
PIPE SIZE: 3/4" IPS Poly pipe @ 11" water column regulator set pressure

PIPE SIZE: 1" IPS Poly pipe @ 11" water column regulator set pressure

DISTANCE: 20 feet

If copper piping is chosen see "Copper Piping" for size & part number

REGULATOR:

LV404B96
FPOL x 3/4 MPT



Piping & Tubing Sizing Instructions

This method will assure the selection of the correct sizes of piping and tubing for LP gas vapor systems. Piping between first and second stage regulators is considered, as well as low pressure (inches water column) piping between second stage, single stage, or integral twin stage regulators and appliances.

INSTRUCTIONS:

- Determine the total gas demand for the system by adding up the BTU/hr input from the appliance nameplates and adding demand as appropriate for future appliances.
- Second stage or integral twin stage piping:
 - Measure length of piping required from outlet of regulator to the appliance furthest away. No other length is necessary to do the sizing.
 - Make a simple sketch of the piping, as shown.
 - Determine the capacity to be handled by each section of piping. For example, the capacity of the line between A & B must handle the total demand of appliances A, B, & C; the capacity of the line from c to d must handle only appliance B, etc.
 - Select proper size of tubing or pipe for each

section of piping, using values in BTU/hr for the length determined from step #2-A. If exact length is not on chart, use next longer length. Do not use any other length for this purpose! Simply select the size that shows at least as much capacity as needed for each piping section.

- For piping between first and second stage regulators

A. For a system with only one second stage regulator, measure length of piping required between outlet of first stage and inlet of second stage regulators. Select piping or tubing required.

B. For systems with multiple second stage regulators, measure length of piping required to reach the second stage regulator that is furthest away. Make a simple sketch, and size each leg of piping using the table using values shown in column corresponding to the length as measured above, same as when handling second stage piping.

See Piping & Tubing Selection Guide Poster For Examples and Reference Tables or Rego's LP-GAS Serviceman's Manual L-545

See Rego's LP-GAS Serviceman's Manual L-545 for Examples & Reference Tables

Then Choose Your Pigtails, Nuts, Fittings & Risers

PIGTAILS:

TYPE	SIZE	PART #
M.POL x M.POL	1/4" tube x 12"	912PS12
M.POL x M.POL	3/8" tube x 12"	913PS12
M.POL x M.POL	1/4" tube x 20"	912PS20
M.POL x M.POL	3/8" tube x 20"	913PS20
M.POL x M.POL	1/4" tube x 30"	912PS30
M.POL x M.POL	3/8" tube x 30"	913PS30



NUTS:



SIZE	PART #
1/2" nut	NS4F
5/8" nut	NS4I

FITTINGS:



	SIZE		PART #
	MFL	MPT	
1/2"	1/2"	48FF	
5/8"	1/2"	48IF	

RISERS:

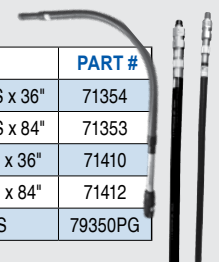

TYPE	SIZE	PART #
Flex	1/2" MPT x 1/2" CTS x 36"	71354
Flex	1/2" MPT x 1/2" CTS x 84"	71353
Flex	3/4" MPT x 3/4" IPS x 36"	71410
Flex	3/4" MPT x 3/4" IPS x 84"	71412
Hard	1" MPT x 1" IPS	79350PG

COPPER TUBING:



SIZE	PART #
1/2" OD x 50'	CCR-1/2 X 50
1/2" OD x 100'	CCR-1/2 X 100
5/8" OD x 50'	CCR-5/8 X 50
5/8" OD x 100'	CCR-5/8 X 100

TABLE 3

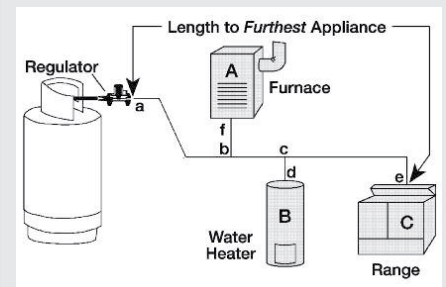



ASME TANK REFURBISH

Quick Reference Guide For **REGO** Valves

MASTER DISTRIBUTOR

Make sure you are thoroughly trained before you attempt any ASME tank maintenance. Improper conditions or procedures can cause accidents resulting in property damage and personal injury.

Tank configuration shown is appropriate for tanks built since the mid-1970's. If yours does not match, please call the Tarantin Industries location nearest you and we will be glad to help.

Chek Lok®

CHEK-LOK® NUMBER	INLET CONNECTION	INLET CONNECTION	APPROXIMATE CLOSING FLOW, LIQUID GPM (PROPANE)	ADAPT-ERS
7590U	3/4" M.NPT		20	7590U-10
7591U	1 1/4" M.NPT	1 5/8" UNF	35	7590U-20

Filler Valve

PART #	ACME HOSE CONNECTION	TANK CONNECTION M.NPT
7647SC	1 3/4"	3/4"
L7579	1 3/4"	1 1/4"
3174-9P	Cap	
3174-93L	Cap w/Lanyard	

Relief Valves

PART #	START TO DISCHARGE SETTING PSIG	CONTAINER CONNECTION M.NPT	FLOW CAPACITY SCFM/AIR		SUITABLE FOR TANKS W/SURFACE AREA UP TO:	RAIN CAPS
			UL (AT 120% OF SET PRES-SURE)	ASME (AT 120% OF SET PRES-SURE)		
7583G	250	3/4"	1980	1806	80 Sq. Ft.	7583-40X
8684G		1"	2620	2565	113 Sq. Ft.	8684-40
8685G		1 1/4"	4385	4035	212 Sq. Ft.	7583-40X
3132G			4130		200 Sq. Ft.	3132-54

Service Valve Repair Kits:

PART #	CONTAINER CONNECTION	SERVICE CONNECTION	FILLING CONNECTION	VAPOR EQUALIZING CONNECTION	FLOAT GAUGE FLANGE OPENING	FIXED LIQUID LEVEL VENT VALVE STYLE	PRESSURE RELIEF VALVE SETTING	FOR USE IN CONTAINERS W/SURFACE AREA UP TO:
G8475RL	2 1/2" F.NPT	F. POL (CGA 510)	1 3/4" M. ACME	1 1/4" M. ACME	Fits "JUNIOR" Size	Knurled	250 PSIG	83 sq. Ft. Above Ground
G8475RLW			N/A					276 sq. Ft. Underground
PG8475RL	3/4" M.NPT		N/A		N/A		N/A	192 sq. Ft. Above Ground
7556R12.0			1 3/4" M. ACME					N/A
8593AL16.0	1 1/2" M.NPT		1 3/4" M. ACME		N/A		N/A	N/A

Filler Valve Repair Kits:
 For L7579: L7579-80 Contains: Gaskets, seat disc and retainer assembly & spring.
 For L7647: L7647-80 Filler Valve Washers Pkg. of 25 A2697-20R

Service Valve Repair Kits:
 For G8475RL: 19104-50 Contains: MultiBonnet assembly, handwheel, nameplate, and self-tapping screw.
 Prior to 1962: 8100-50 Contains: Bonnet assembly.
 For 1370, 1480 Series, 2593/K, 2594/K Series: 3100-81K Contains: Bonnet and stem assembly

Domestic Tank Gauges

HOW TO ORDER A GAUGE:

- Determine Tank Type: Above Ground Under Ground
- Determine Gauge Head Type:

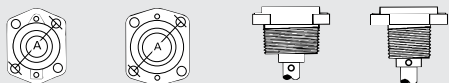

- JR - 4 bolt SR - 4 bolt 1-1/4" Thread 1" Thread
- A = 2-1/32 A = 2-1/2

- Determine Tank Diameter: D = _____"
- From Tank Data Plate or Measure Circumference (in inches) and divide by 3.14

- Determine Riser Height: H = _____"
- Note: Riser height is the distance, in inches, from tank surface to top of mounting flange or coupling for gauge.

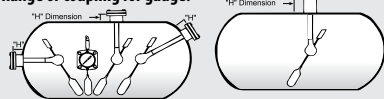

- Determine Mounting Position:
- Top Mount Angle Mount
 Side Mount End Mount

Note: Pivot point of float must be at center line of tank.

OR BUILD YOUR OWN WITH THE NEW R3G ADJUSTABLE LIQUID LEVEL GAUGE

in Junior & Senior Sizes:

- Select the Gauge Support Assembly
 - Select a Float:
- Common Junior & Senior Float Assemblies - Top Mount

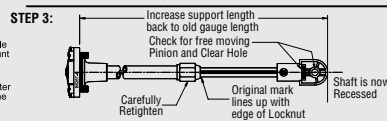
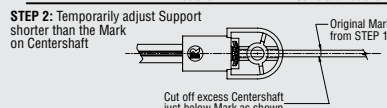
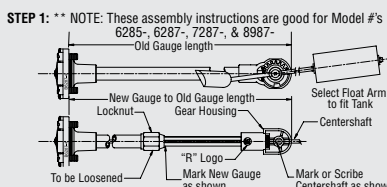

3. Assembly Instructions: Located to the right of the gauge OR the KIT Option:

Part #6287-00001K
 Includes: 1 Support Assembly (Jr. 4-Bolt) and 4 Float Assemblies to fit one 24", 30", 32", or 37.5" above ground tank.

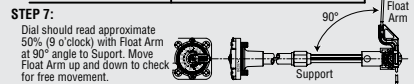
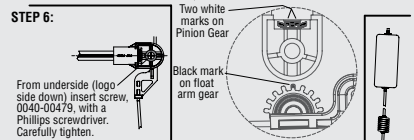
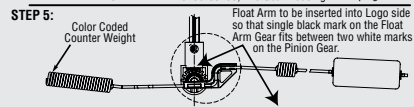

VAPORIZER INSTALLATION

(front side)

Quick Reference Guide For Vaporizers

Make sure you are thoroughly trained before you attempt any vaporizer installations. Improper conditions or procedures can cause accidents resulting in property damage and personal injury.

ALWAYS FOLLOW ORIGINAL EQUIPMENT MANUFACTURER'S GUIDELINES.

Typical Installation - Principal Features and Operating Characteristics

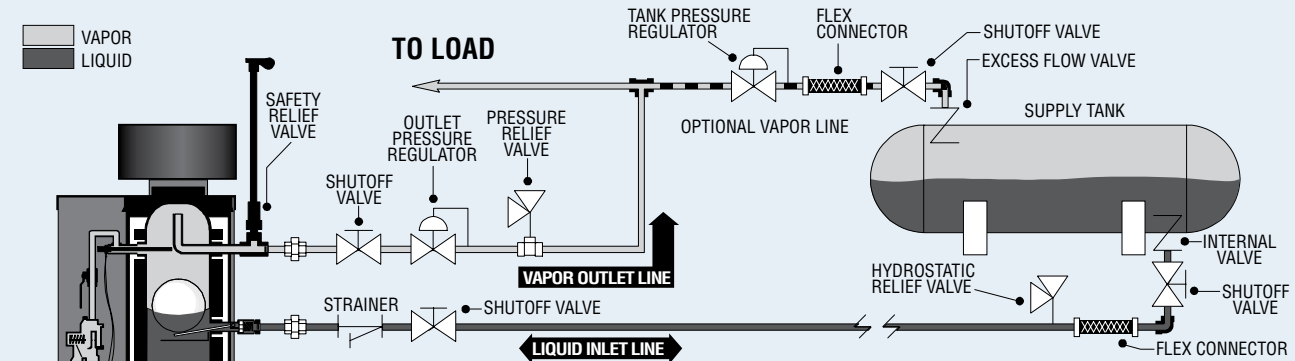

NOTES:

1. Equipment, piping and installation must be in accordance with provisions of NFPA58, and all applicable state, provincial and local codes.
2. Liquid pump may be required to provide sufficient pressure to inlet of vaporizer during conditions of low tank pressure.
3. Outlet pressure regulator should be no more than 24 inches from vaporizer outlet and located at or above centerline of vaporizer outlet.
4. Set tank pressure regulator 2 PSI lower than outlet pressure regulator.
5. Do not install a separator, dripleg or other liquid trap upstream of outlet pressure regulator.
6. Regulator outlet must be adjusted to a pressure below the vapor pressure of the saturated LP-Gas at lowest operating temperature or vapor may reliquefy in downstream piping.
7. Liquid piping system must allow for occasional reverse flow toward supply tank to prevent excessive pressures during operation.
8. Use proper excess flow for piping size transitions.

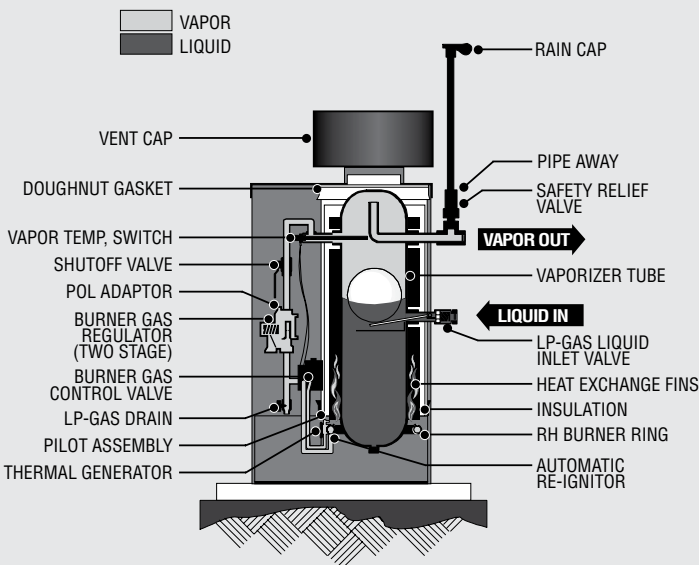

Why Use a Vaporizer?

- Pressure in the tank drops too low during cold weather.
- Storage is not big enough to supply the load under all conditions.
- Space restrictions do not allow for installations of additional tanks.
- Regulations will not allow a big enough tank or enough storage to handle the load with natural vaporization.
- Having a vaporizer eliminates recondensation of vapor to liquid in the supply lines.
- The storage tanks do not need to be kept 60-75% full during cold weather.

Vaporizer Liquid Line Sizing

GPH	DISTANCE - FROM STORAGE TO VAPORIZER, IN FEET					
	25'	50'	75'	100'	150'	200'
50	3/4"	3/4"	3/4"	3/4"	3/4"	3/4"
80	3/4"	3/4"	3/4"	3/4"	3/4"	3/4"
120	3/4"	3/4"	3/4"	3/4"	3/4"	3/4"
200	1"	1"	1"	1"	1"	1"
400	1"	1"	1"	1 1/4"	1 1/4"	1 1/4"
600	1"	1 1/4"	1 1/4"	1 1/4"	1 1/4"	1 1/2"
800	1 1/4"	1 1/4"	1 1/4"	1 1/4"	1 1/2"	1 1/2"
1000	1 1/4"	1 1/4"	1 1/2"	1 1/2"	1 1/2"	1 1/2"

1. Equivalent pipe lengths must be added for restrictions such as pipe fittings and valves, then added to total feet of pipe
 2. Chart is based on a pressure drop of 1 PSI
 3. Consult engineering for larger vaporizers or longer pipe runs



VAPORIZER INSTALLATION

(back side)

Quick Reference Guide For Vaporizers

Make sure you are thoroughly trained before you attempt any vaporizer installations. Improper conditions or procedures can cause accidents resulting in property damage and personal injury.

REGULATOR INSTALLATION GUIDELINES

RECOMMENDED INSTALLATION

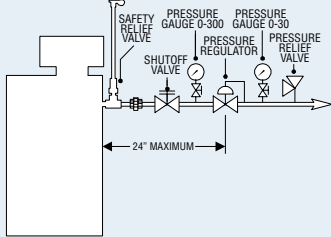

NOT RECOMMENDED

No isolation valve or pressure gauges.

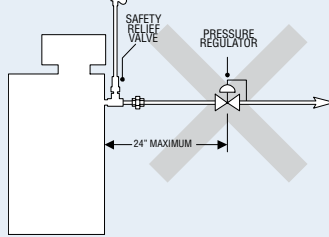

NOT RECOMMENDED

Regulator lower than vaporizer outlet.

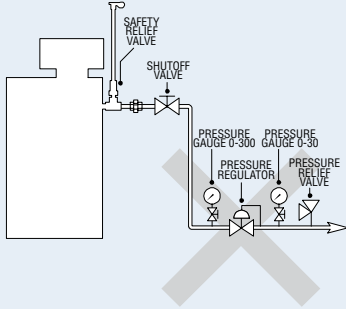

NOT RECOMMENDED

Regulator too far from vaporizer

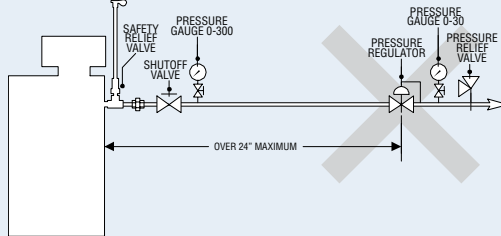

DRIP LEG INSTALLATION GUIDELINES

RECOMMENDED CONFIGURATION

Drip leg installed on low pressure side.

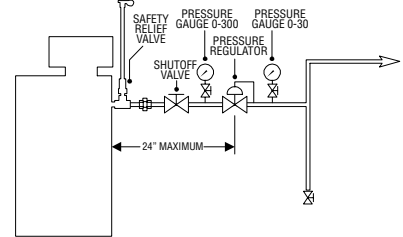

NOT RECOMMENDED

Not ideal configuration of drip leg.

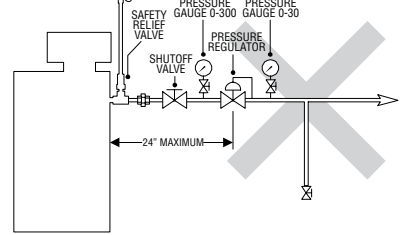

NOT RECOMMENDED

Vapor will recondense at no flow condition

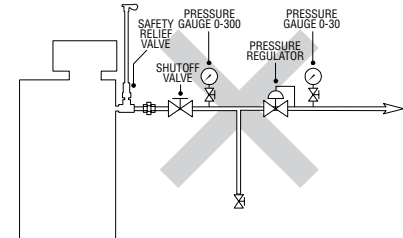

ONE 40/40H VAPORIZER IS EQUAL TO ...



FULL TANKS



TANKS 10% FULL

AT 40° F



TANKS 10% FULL

AT 20° F

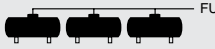

FULL TANKS

TANKS 10% FULL

AT 0° F



FULL TANKS

TANKS 10% FULL

AT -10° F



FULL TANKS

TANKS 10% FULL

AT -20° F



FULL TANKS

TANKS 10% FULL

AT -20° F



FULL TANKS

TANKS 10% FULL

AT -20° F



FULL TANKS

TANKS 10% FULL

AT -20° F



FULL TANKS

TANKS 10% FULL

AT -20° F



FULL TANKS

TANKS 10% FULL

AT -20° F



FULL TANKS

TANKS 10% FULL

AT -20° F

MY TRUCK WON'T PUMP!

This troubleshooting flow chart is provided as a condensed collection of various manufacturers' instructions. Use of this flow chart should NOT replace any specific warnings or installation and operation instructions provided from any manufacturer of equipment utilized on your truck. Make sure you are properly and thoroughly trained before attempting any repair, maintenance, or diagnostics. Perform any troubleshooting, repairs, or installations in accordance with each specific manufacturer's installation and operation instructions and procedures including your company's safety policy. Improper conditions or procedures can cause accidents resulting in property damage and personal injury.

WARNING: Before disassembly of any piping, hoses, or component connections, ensure all tank, piping, and equipment internal pressures have been purged of any pressure. Pressure must be at 00 (zero) PSI. Close all appropriate liquid and vapor lines between components and liquid or gas pressure sources, such as cargo tank, supply lines and discharge lines. Ensure that all sections of the tank, supply/discharge lines, and components (including pumps and meters) are purged of any pressure. Refer to each manufacturer's instructions for proper procedures. All activities must comply with NFPA 58, DOT, and all authorities having jurisdiction.

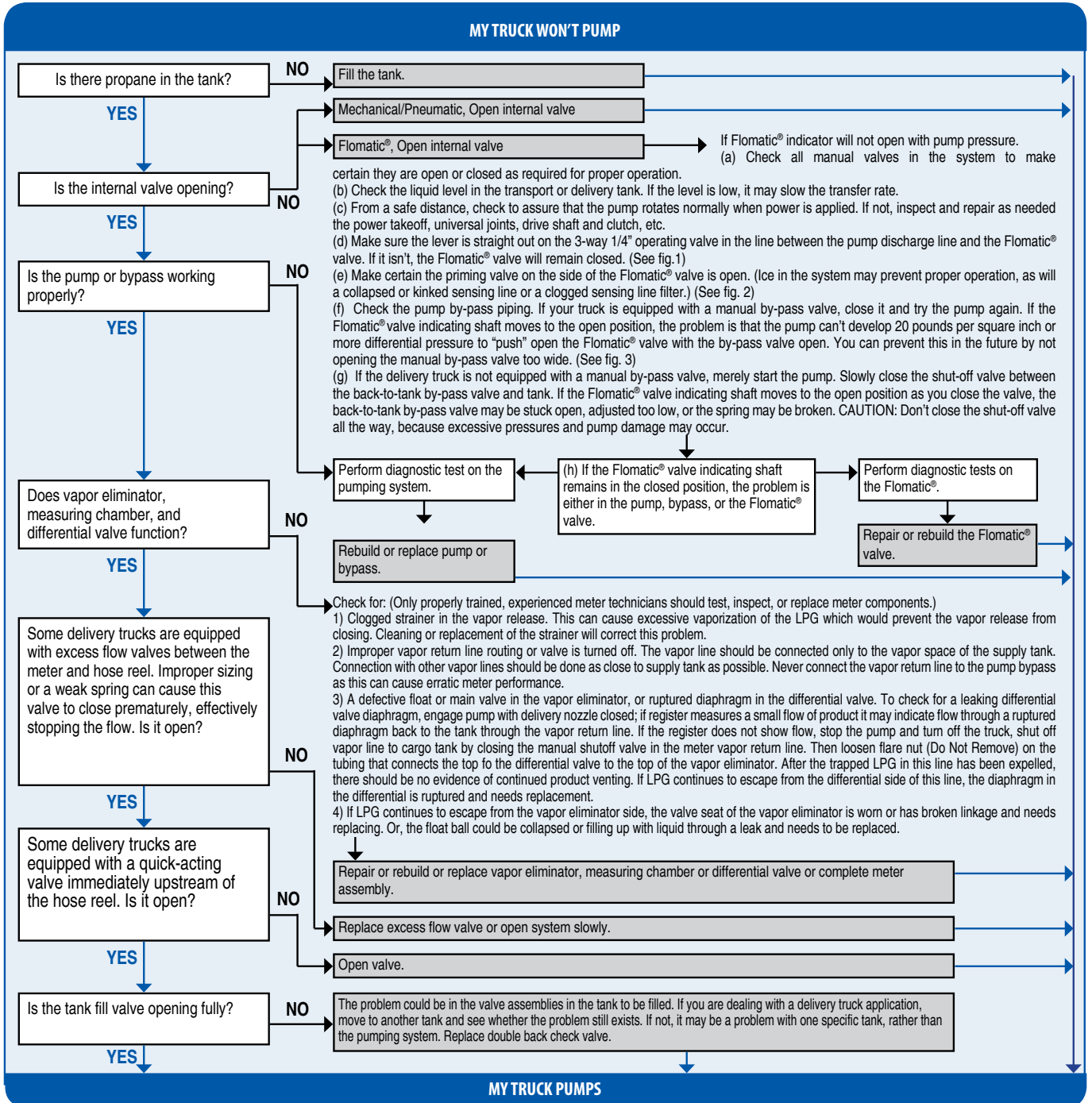



MY TRUCK WON'T PUMP!

MY TRUCK WON'T PUMP

USE EXTREME CARE AT ALL TIMES WHEN WORKING AROUND YOUR VEHICLE!

Watch out for drive shafts and moving parts. It is common knowledge that serious injury can result if any part of one's body or clothing is caught in moving machinery.

If you manually open the Flomatic® valve, you are responsible for safely unloading the liquid and closing the valve when you're through. If this procedure is being followed, under no circumstances must the valve be left unattended. The valve must never be permanently held in the open position.

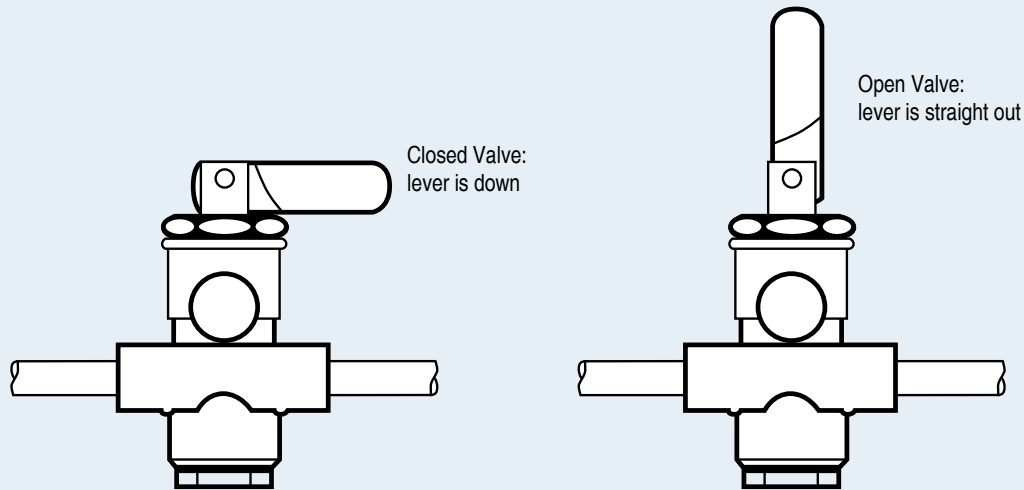

Figure 1 Operating Lever Positions

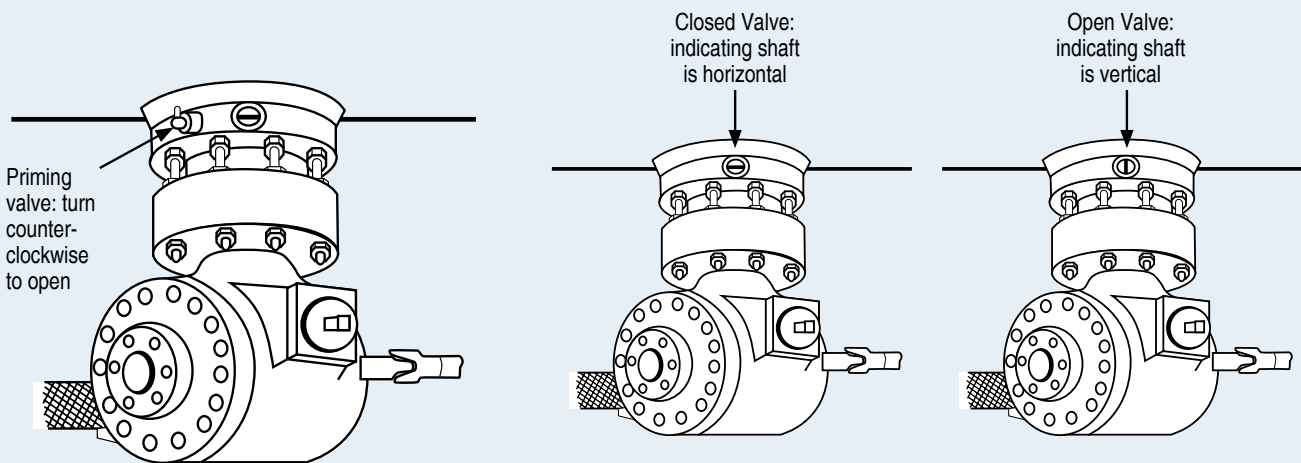

Figure 2

Figure 3 Flanged Flomatic Valve

MY TRUCK PUMPS

REPAIR KITS - Multivalves, Filler & Vapor Valves

Quick Reference Guide For **REGO** MASTER DISTRIBUTOR Repair Kits

Make sure you are thoroughly trained before you attempt any valve repair or maintenance. Improper conditions or procedures can cause accidents resulting in property damage and personal injury.

MULTIVALVES - FILLER VALVE 3		
PART NUMBER	KIT NUMBER	KIT CONTENTS
6532 Series 6533 Series 6542 Series 6543 Series 8555 Series* (Mfd. Oct. 1990 or before) 8555DL Series	6542B-50 w/upper body	Gaskets; spring; spring guide; stem and seat disc assembly; upper body
	6542B-80 w/o upper body	Gaskets; spring; spring guide; stem and seat disc assembly
6555 Series 8555 Series* (Mfd. after Oct. 1990)	8555-50 w/ upper body	Gaskets; spring; spring guide; stem and seat disc assembly; upper body
	8555-80 w/o upper body	Gaskets; spring; spring guide; stem and seat disc assembly
G8475 Series 8596AR16.0	8475-50 w/ upper body	Gaskets; seat disc & retainer assembly; spring; upper body
	8475-80 w/o upper body	Gaskets; seat disc & retainer assembly; spring

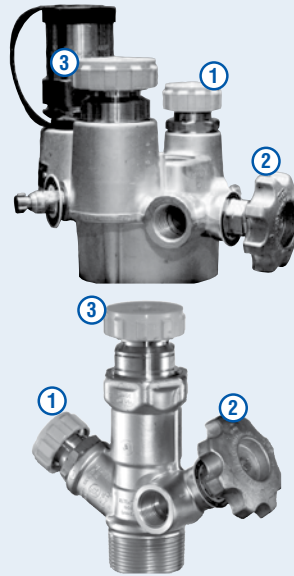

1 MULTIVALVES - VAPOR EQUALIZING		
PART NUMBER	KIT NUMBER	KIT CONTENTS
7556V Series G8475 Series 8593AR16.0	8475-51A	Body; gaskets; spring; stem and seat disc assembly
	8555-80 w/o upper body	Gaskets; spring; stem and seat disc assembly

2 MULTIVALVES - SERVICE VALVES		
PART NUMBER	KIT NUMBER	KIT CONTENTS
6532A Series, 6533A Series, 6542A Series, 6543A Series, 6555D Series, 7556V Series, 8555D Series, 8555DL Series	19100-50B	Bonnet; stem and o-ring assembly; handwheel; self-tapping screw
	19104-50	Complete MultiBonnet assembly-bonnet assembly; handwheel; nameplate; selftapping screw
6532R Series, 6533R Series, 6542R Series, 6543R Series, 6555R Series, 7556R Series, G8475R Series, 8555R Series, 8593AR16.0 Series, 9101R Series	19104-80	Upper packing with seal rings - For MultiBonnet only

FILLER VALVES		
PART NUMBER	KIT NUMBER	KIT CONTENTS
7547 Series (Obsolete)	7547B-80	Gaskets; spring; seat disc & retainer assembly
6579 7579	7579-50 w/ upper body	Gaskets; seat disc & retainer assembly; spring; upper body
	7579-80 w/o upper body	Gaskets; seat disc & retainer assembly; spring
7647 Series	7647B-80	Gaskets; spring; seat disc & retainer assembly

MULTIVALVES					
MULTIVALVE PART NO.	REPLACED BY	CONTAINER CONNECTION	REPAIR KITS		
			SERVICE VALVE	FILLER VALVE	VAPOR EQUALIZING
1470LV, 1480V, 1470W, 1480W	G8475RV, G8475RW	2-1/2" M.	3100-80A, bonnet-diaphragm-stem 3100-80B, diaphragm, washer 3100-81K, conversion, bonnet assy	1475-80, kit	2418-51, assy
2180	8555 for 200# Cyl, 6543 for 420# Cyl	3/4"	no repair parts available replace due to age		
2418	G8475RV	2-1/2" F.	7128-5, diaphragm assy	n/a	2418-51, assy
2465, 2486	G8475RV	2-1/2" F.	7128-5, diaphragm assy	n/a	
2550	G8475RV	2-1/2" M	7128-5, diaphragm assy	n/a	2418-51, assy
2555 Series	6532, 6533, 6542, 6543	3/4", 1"	replace due to age		
2557 Series	no replacement	1-1/2"	no repair parts available		
2577	6532, 6533, 6542, 6543	3/4", 1"	no repair parts available replace due to age		
2580, 2581	8555D/8555R	3/4"	no repair parts available		
2593, 2594	8593AL16.0	1-1/2"	3100-80A, bonnet-diaphragm-stem 3100-80B, diaphragm, washer 3100-81K, conversion, bonnet assy	1475-80, kit	2418-51, assy
2418-51, assy	8593AR16.0 not a direct replacement	1-1/2"	3100-80A, bonnet-diaphragm-stem 3100-80B, diaphragm, washer 3100-81K, conversion, bonnet assy	1475-80, kit	2418-51, assy
6477A	n/a	2-1/2" M.	8100-50, bonnet assy, handwheel	8475-50, -80	8475-51A, kit
6533D, 6542D, 6543D		3/4", 1"	903-50 (lg), 903-51 (sm), kits	6542-50, -80	
7555	8555D/R	3/4"	replace due to age		
7556, mfg before 1962		3/4"	8100-50, bonnet assy, handwheel		
G8475, mfg before 1962		2-1/2" F.	8100-50, bonnet assy, handwheel	8475-50, -80	8475-51A, kit
8477, mfg before 1962	G8475RV	2-1/2" F.	8100-50, bonnet assy, handwheel	8475-50, -80	8475-51A, kit
8484, mfg before 1962	no replacement*		8100-50, bonnet assy, handwheel		8475-51A, kit
8484A	no replacement*		19100-50B/19104-50, kit		8475-51A, kit
8555, mfg before 1962	8555D/R		no repair parts available replace due to age		
8555S			903-50 (lg), 903-51 (sm), kits	6542B-50, -80	
8593K, 8594K, mfg before 1962	8593AR16.0		8100-50, bonnet assy, handwheel	8475-50, -80	8475-51A, kit
8594	8593AR16.0		8100-50, bonnet assy, handwheel		
8594/K, mfg after 1962	8593AR16.0		19100-50B/19104-50, kit	8475-50, -80	8475-51A, kit

*Tanks equipped with obsolete 8484 & 8484A series valve can be retained in service. Please call your Tarantin for information.

Seal cap made of tough, resilient molded plastic. Protects threads and internal working parts. Caps are designed to contain normal tank pressures, and must be kept on valves at all times.

Long-wearing gasket permits handtight connection of cap and hose coupling

Safety groove is designed to shear below the ACME thread, leaving the valve seats closed and unaffected if the delivery truck pulls away with the hose connected.

Seat disc of special synthetic composition is extra thick for longer life.

Valve guide is precision machined to assure positive seal

Exclusive swing-away lower back check valve for extra fast filling is provided on Models 6579 and 6587. Differs from conventional design by swiveling to a vertical position when opened.

Seal cap made of tough, resilient molded plastic. Protects threads and internal working parts. Caps are designed to contain normal tank pressures, and must be kept on valves at all times.

Long-wearing gasket permits hand-tight connection of cap and hose coupling.

Seat disc of special synthetic composition is extra thick for longer life.

Valve guide is precision machined to assure positive seal.

VAPOR RETURN VALVES		
PART NUMBER	KIT NUMBER	KIT CONTENTS
7573A	7573A-81	Gaskets; spring; seat disc & retainer assembly



REPAIR KITS - Multivalves, Filler & Vapor Valves

Quick Reference Guide For **REGO** Repair Kits

MASTER DISTRIBUTOR

Make sure you are thoroughly trained before you attempt any valve repair or maintenance. Improper conditions or procedures can cause accidents resulting in property damage and personal injury.

CYLINDER AND SERVICE VALVES		
PART NUMBER	KIT NUMBER	KIT CONTENTS
901 Series 903 Series 9106CO	903-50	Bonnet; stem and disc assembly; large handwheel; self-tapping screw
	903-51	Bonnet; stem and disc assembly; small handwheel; self-tapping screw
9101 Series 9107K8A	19100-50B	Bonnet; stem and disc assembly; small handwheel; self-tapping screw
	19104-50	Complete MultiBonnet assembly-bonnet assembly; handwheel; nameplate; selftapping screw
3100 Series (Obsolete) 7100 Series (Obsolete)	3100-81K Conversion Kit	Bonnet and stem assembly; gasket (Conversion Assembly)
	3100-80A	Diaphragm; bonnet and stem assembly
	3100-80B	Diaphragm assembly, back seat; washer
9101P5 P5H	19100-50B	Bonnet; stem and seat disc assembly; large handwheel; self-tapping screw
	19101-50	Bonnet; stem and seat disc assembly; small handwheel; self-tapping screw

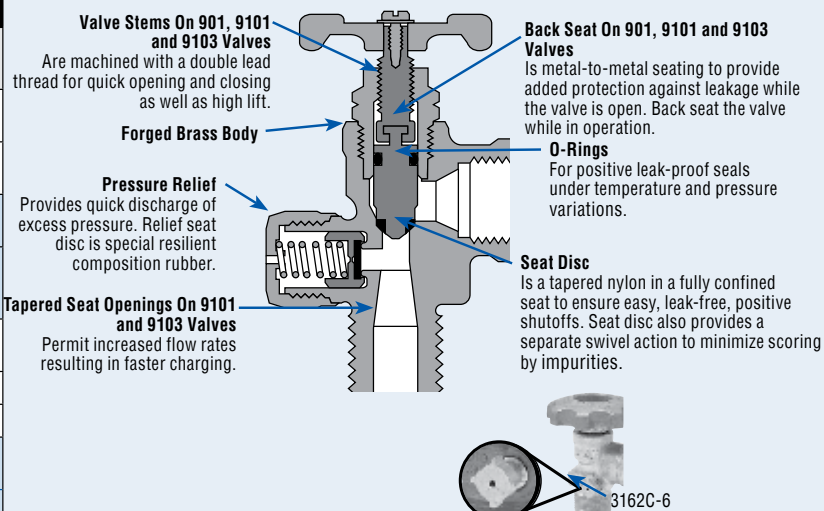

Design Features of the MultiBonnet®

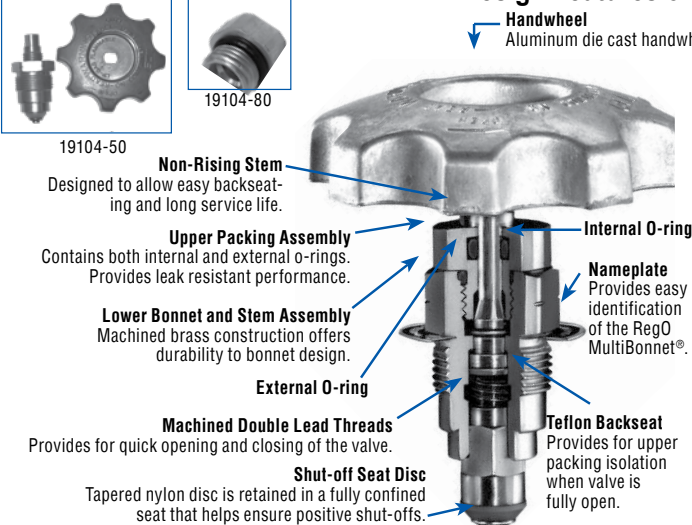

Features & Benefits

The MultiBonnet® is designed to allow quick and easy repair of bonnet packings in certain Multivalves® and service valves on active propane systems. It allows you to repair valve bonnet stem o-ring leaks in minutes, without interrupting gas service to your customers.

- Eliminates the need to evacuate tanks or cylinders to repair the MultiBonnet® packing.
- Two section design allows repair of MultiBonnet® assemblies on active propane systems without interruption in gas service or shutting off appliances downstream. This helps to prevent time consuming relighting of pilots, special appointments, and call backs.
- Cost of replacing the MultiBonnet® packing is only 1/3 as much as replacing a complete bonnet assembly—not including time cost savings, which can be substantial.
- Available on certain new Multivalves® and service valves as well as repair assemblies for many existing Rego® valves.
- UL listed as a component of valve assembly.

Here's How The MultiBonnet® Works

- When the valve is fully open, only the lower stem will rise and backseat against the teflon washer which isolates the upper packing.
- This allows you to remove the upper packing nut, which contains the o-rings, and replace it while the valve is fully open and gas service not interrupted.

Q. What valves can you use Multibonnet® on as a replacement?

A. Any valve that has the letter "R" suffix designation and the following:
6532A 6533A 6542A 6543A 7556VR G8475V
G8475W 8555D 8593A 9101C 9101D 9300Y

REPAIR KITS			
FIGURE NO.	PART NUMBER	DESCRIPTION	FITS VALVE
1	3100-80A	Bonnet	RegO 3100 & 7100 Series
2	3100-80B	Seat	RegO 3100 & 7100 Series
3	3100-81K	Conversion assembly. Converts 3100-80A from diaphragm to "O" Ring Seal.	
4	8100-50	Bonnet	RegO 8100 Series
5	19101-50	Bonnet	RegO 9100 Series Forklift
6	19104-50	Bonnet	RegO 9100 Series
7	19104-50	Packing for 19104-50 multibonnet	
8	19100-50B	Bonnet	RegO 9100 Series
9	903-50	Bonnet	RegO 900 Series
10	7128-5	Dia. Assy	Old style 2400 & 2500

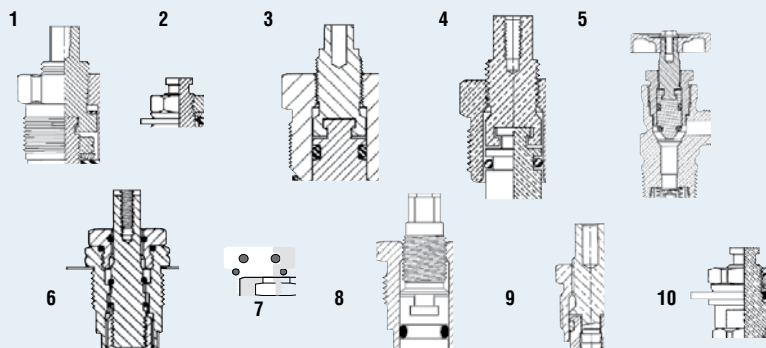

FORKLIFT CYLINDER MAINTENANCE

Quick Reference Guide For **REGO** Valves

Make sure you are thoroughly trained before you attempt any cylinder maintenance. Improper conditions or procedures can cause accidents resulting in property damage and personal injury.

Filler Valve

PART #	HOSE CONNECTION	TANK CONNECTION M.NPT
7647SC	1 3/4" ACME	3/4"
3174-9P	Cap Only	
3174-93L	Cap w/Lanyard	



A2697-20R Gasket (25)



7647SC

Filler Valve Repair Kits:

Part #7647B-80A Contains: Seat disc and retainer assembly, spring, gaskets, loctite cement.

Vent Valve

PART #	HOSE CONNECTION	TANK CONNECTION M.NPT
3165C	LP-Gas Only	1/4" M. NPT.
3165CP	w/ Warning Plate	1/4" M. NPT



3165CP

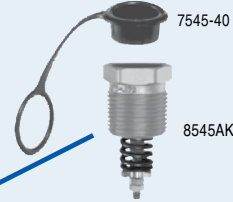

7545-40

8545AKT

Pressure Relief Valve

PART #	START TO DISCHARGE SETTING PSIG	CONTAINER CONNECTION M.NPT
8545AKT	375	3/4"
7545-40	Rain Cap	
7545-12	90° Elbow Adaptor	
7545-14	45° Elbow Adaptor	



9101P5H

Cylinder Valve

IMPROVED DESIGN Reduces handwheel damage due to stacking cylinders.

- Lower valve height.
- Smaller diameter handwheel.

PART #	CONTAINER CONNECTION	SERVICE CONNECTION	CLOSING FLOW (LP-GAS LIQUID (GPM))
9101P5H	3/4" M. NGT	3/8" M. NPT	2.6
9101P5	3/4" M. NGT	3/8" M. NPT	1.5

Cylinder Valve Repair Kit:

Part #19101-50 Contains: Bonnet, stem and O-ring assembly, handwheel (Part #9101-31), self-tapping screw

Safety Connector

PART #	APPLICATION	INLET	OUTLET
7141M	Service Valve	3/8" F. NPT	1 1/4" M. ACME
7141F	Fuel Line	1 1/4" F. ACME	1/4" F. NPT

Safety Connector Repair Kit:

Part #7141M-50 Contains: Check assembly, gasket, O-ring, retaining ring.



3125L

External Hydrostatic Relief Valve

PART #	START TO DISCHARGE SETTING PSIG	VALVE BODY MATERIAL	CONTAINER CONNECTION M.NPT	HEIGHT (APPROX.)	WRENCH HEX SECTION
3125L	400	Brass	1/4"	1 9/16"	5/8"
3125-40P	Protective Cap				

Forklift Cylinder Gauges



5-01791

Replacement Dials for Rochester Float Gauges

PART #	DIAL SIZE	TYPE OF TANK
5-01791	Junior	33LB Universal



2733U-CV



2743U-CV

Taylor Visible Replacement Dials

PART #	DESCRIPTION
2733U-CV	JR Universal 33LB Motor Fuel
2743U-CV	JR Universal 43LB Motor Fuel

CYLINDER SIZE	PART NUMBER		
	JR. GAUGES	1 1/2" MPT	3/4" MPT
33 1/2 LB	JU160B	TU160B	UU160B
43 1/2 LB	JU212A	TU212A	

JU160B

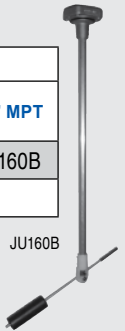



CONVERTING VOLUMES OF GAS (CFH TO CFH OR CFM TO CFM)		
MULTIPLY FLOW OF:	BY:	TO OBTAIN FLOW OF:
Air	0.707	Butane
	1.290	Natural Gas
	0.808	Propane
Butane	1.414	Air
	1.826	Natural Gas
	1.140	Propane
Natural Gas	0.775	Air
	0.547	Butane
	0.625	Propane
Propane	1.237	Air
	0.874	Butane
	1.598	Natural Gas

CONVERSION UNITS (PRESSURE)		
MULTIPLY:	BY:	TO OBTAIN:
Grams per sq. cm	0.0142	pounds per sq. in.
Inches of mercury	0.4912	pounds per sq. in.
Inches of mercury	1.133	feet of water
Inches of water	0.0361	pounds per sq. in.
Inches of water	0.0735	Inches of mercury
Inches of water	0.5781	ounces per sq. in.
Inches of water	5.204	pounds per sq. ft.
KPA	100	BAR
Kilograms per sq. cm	14.22	pounds per sq. in.
Kilograms per sq. m	0.2048	pounds per sq. ft.
Pounds per sq. in.	0.07031	kg per sq. cm.
Pounds per sq. in.	0.06804	atmospheres
Pounds per sq. in.	6.89	KPA
Pounds per sq. in.	2.036	Inches of mercury
Pounds per sq. in.	2.307	feet of water
Pounds per sq. in.	0.6897	BAR
Pounds per sq. in.	27.67	inches of water

CONVERSION UNITS (MISCELLANEOUS)		
MULTIPLY:	BY:	TO OBTAIN:
BTU	0.252	calories
Decitherm	10,000	BTU
Kilogram	2.205	pounds
Kilowatt Hour	3412	BTU
Ounces	28.35	grams
Pounds	0.4536	kilograms
Pounds	453.5924	grams
Pounds	21,591	LPG BTU
Therm	100,000	BTU
API Bbls	42	gallons (US)
Gallons of Propane	26.9	KWH
HP	746	KWH
HP (Steam)	42,418	BTU

VAPOR PRESSURE OF PROPANE							
TEMP.	PRES.	TEMP.	PRES.	TEMP.	PRES.	TEMP.	PRES.
110°F	220 psig	60°F	102 psig	20°F	47 psig	-20°F	13.5 psig
100°F	196 psig	50°F	86 psig	10°F	37 psig	-30°F	8 psig
90°F	165 psig	40°F	72 psig	0°F	28 psig	-40°F	3.6 psig
80°F	140 psig	30°F	58 psig	-10°F	23.3 psig	-44°F	0 psig
70°F	127 psig	-	-	-	-	-	-

BTU COMPARISON		
COMMON FUELS	PER GAL.	PER LB.
Propane	91,547	21,591
Butane	102,032	21,221
Gasoline	110,250	20,930
Fuel Oil	134,425	16,960

Propane Tank Conversion Charts

TEMPERATURE CONVERSION			
DEG. F	DEG. C.	DEG. F	DEG. C
-50	-46	60	15.6
-40	-40	70	21.1
-30	-34	80	26.7
-20	-29	90	32.2
-10	-23	100	37.8
0	-17.8	110	43
+10	-12.2	120	49
20	-6.7	130	54
30	-1.1	140	60
32	0	150	66
40	+4.4	160	71
50	10.0	170	77

CONVERSION UNITS (LENGTH)		
MULTIPLY:	BY:	TO OBTAIN:
Centimeters	0.3937	Inches
Feet	0.3048	Centimeters
Feet	304.8	Millimeters
Kilometer	0.6214	Miles
Meters	1.094	Grams
Meters	3.281	Kilograms
Meters	0.3937	Inches
Miles (nautical)	0.3048	Centimeters
Miles (statute)	304.8	Millimeters
Yards	0.6214	Miles
Yards	1.094	Grams

CONVERSION UNITS (VOLUME)		
MULTIPLY:	BY:	TO OBTAIN:
Cubic Centimeter	0.06103	cubic inches
Cubic Feet	0.0275	gallons (US)
Cubic Feet	28.316	liters
Cubic Feet	1728	cubic inches
Gallons (US)	36.39	cubic feet
Gallons (US)	3.785	liters
Gallons (US)	231	cubic inches
Liters	1.057	quarts
Liters	2.113	pints

APPROXIMATE VAPORIZATION BTU PER HOUR WITH 40% LIQUID IN TANK DOMESTIC SYSTEMS		
TANK SIZE WATER CAPACITY	PREVAILING AIR TEMPERATURE	
	20°F	60°F
120	290,304	290,304
250	406,080	721,920
325	514,100	937,900
500	634,032	1,127,168
1,000	1,088,472	1,978,051
2,000	2,128,897	4,257,795
6,000	4,262,400	6,393,600
8,000	5,060,000	7,590,000
10,000	6,230,400	9,345,600
12,000	7,400,000	11,100,000
15,000	8,080,000	11,120,000
18,000	8,500,000	12,120,000
20,000	9,500,000	14,250,000
30,000	11,800,000	17,700,000

AVERAGE PROPERTIES OF PROPANE	
Formula	C3H8
Boiling Point	-44 °F
Specific Gravity of Gas (Air = 1.00)	1.50
Specific Gravity of Liquid (Water = 1.00)	0.51
Lbs. per Gallon of Gas at 60°F	4.24
BTU per Gallon of Liquid at 60°F	91547
BTU per Lb. of Gas	21591
BTU per Cu. Ft. of Gas at 60°F	2516
Cu. Ft. of Vapor at 60°F/Gal. of Liquid at 60°F	36.39
Cu. Ft. of Vapor at 60°F/Lb. of Liquid at 60°F	8.547
Latent Heat of Vaporization at Boiling Point BTU/Gal.	785.0
Combustion Data: Cu. Ft. Air Required to Burn 1 Cu. Ft. Gas	23.86
Ignition Temperature in Air	920- 1120°F
Maximum Flame Temperature in Air	3595°F
Limits of Imflammability, Percentage of Gas in Air Mixture: at Lower Limit at Upper Limit	2.15% 9.6%
Octane Number (ISO - Octane = 100)	Over 100

TARANTIN

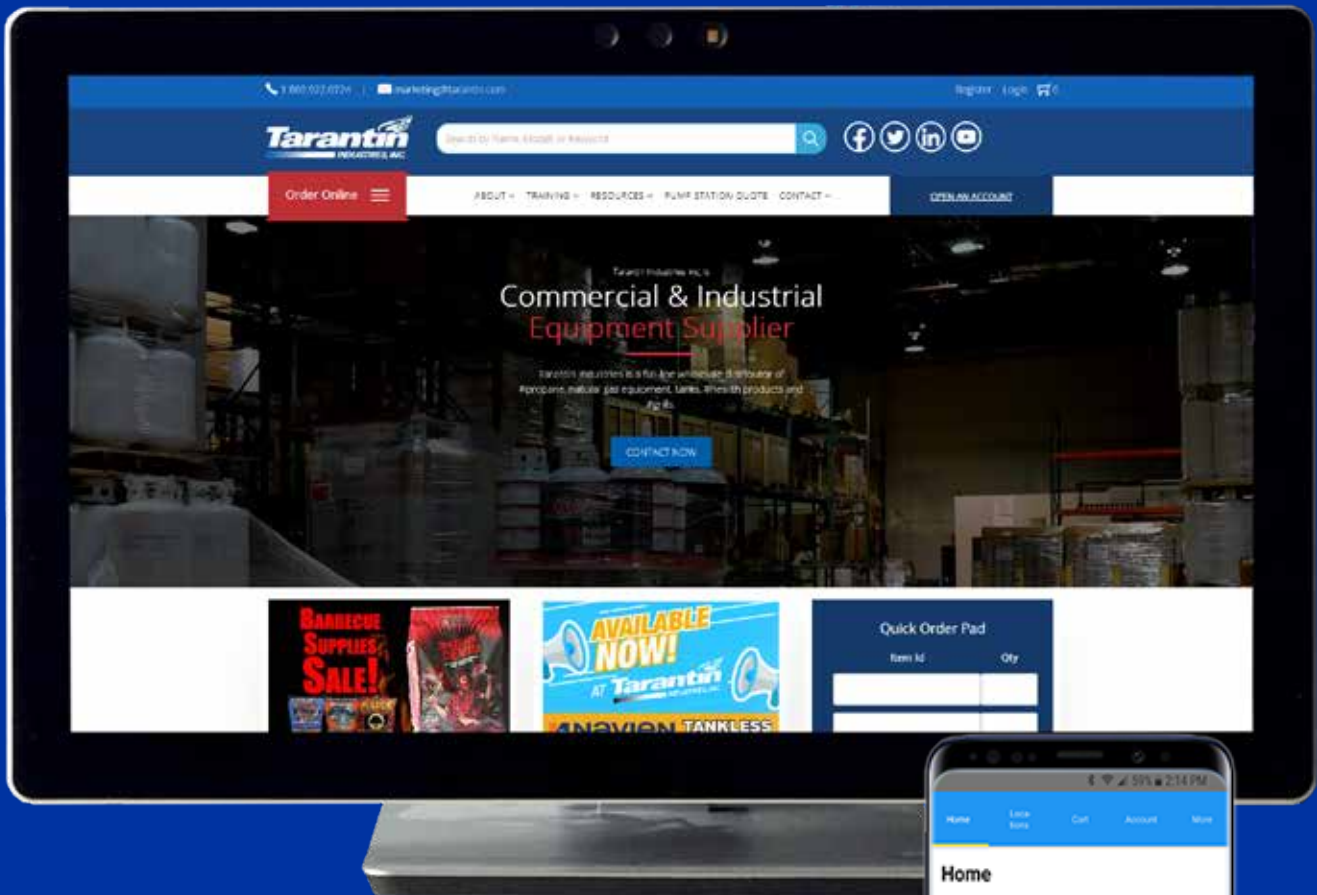

ONLINE

Ease of Ordering

Order parts In the field, in your warehouse, or anywhere! The app is tied into our parts database. **If you can find it on our website you can find it in our app.**

Warehouse Directions

Click on the address of the branch you're picking the parts up from and you're led to Google Maps.

My Account on the Go

Away from your office? Want to see your past orders or invoices? Have all of that information at your fingertips no matter where you are.

Download Our App - Order Wherever You Are



*or search "Tarantin"
GooglePlay or iTunes*

Tarantin

INDUSTRIES, INC.

CORPORATE HEADQUARTERS

1 NEW JERSEY BRANCH
86 VANDERVEER ROAD
FREEHOLD, NJ 07728
Fx: 732 780 5173

BRANCH LOCATIONS

2 NEW HAMPSHIRE BRANCH
20 COMMERCIAL DRIVE
BRENTWOOD, NH 03833
Fx: 603 679 4605

3 PENNSYLVANIA BRANCH
30 INDUSTRIAL ROAD
ELIZABETHTOWN, PA 17022
Fx: 717 361 0370

4 VIRGINIA BRANCH
9733 COACH ROAD
RICHMOND, VA 23237
Fx: 804 279 0206

5 ALABAMA BRANCH
240 OXMOOR COURT, SUITE 268
BIRMINGHAM, AL 35209
Fx: 877 769 1222

6 FLORIDA BRANCH
5050 STATE ROAD 206 WEST
ELKTON, FL 32033
Fx: 904 692 1068

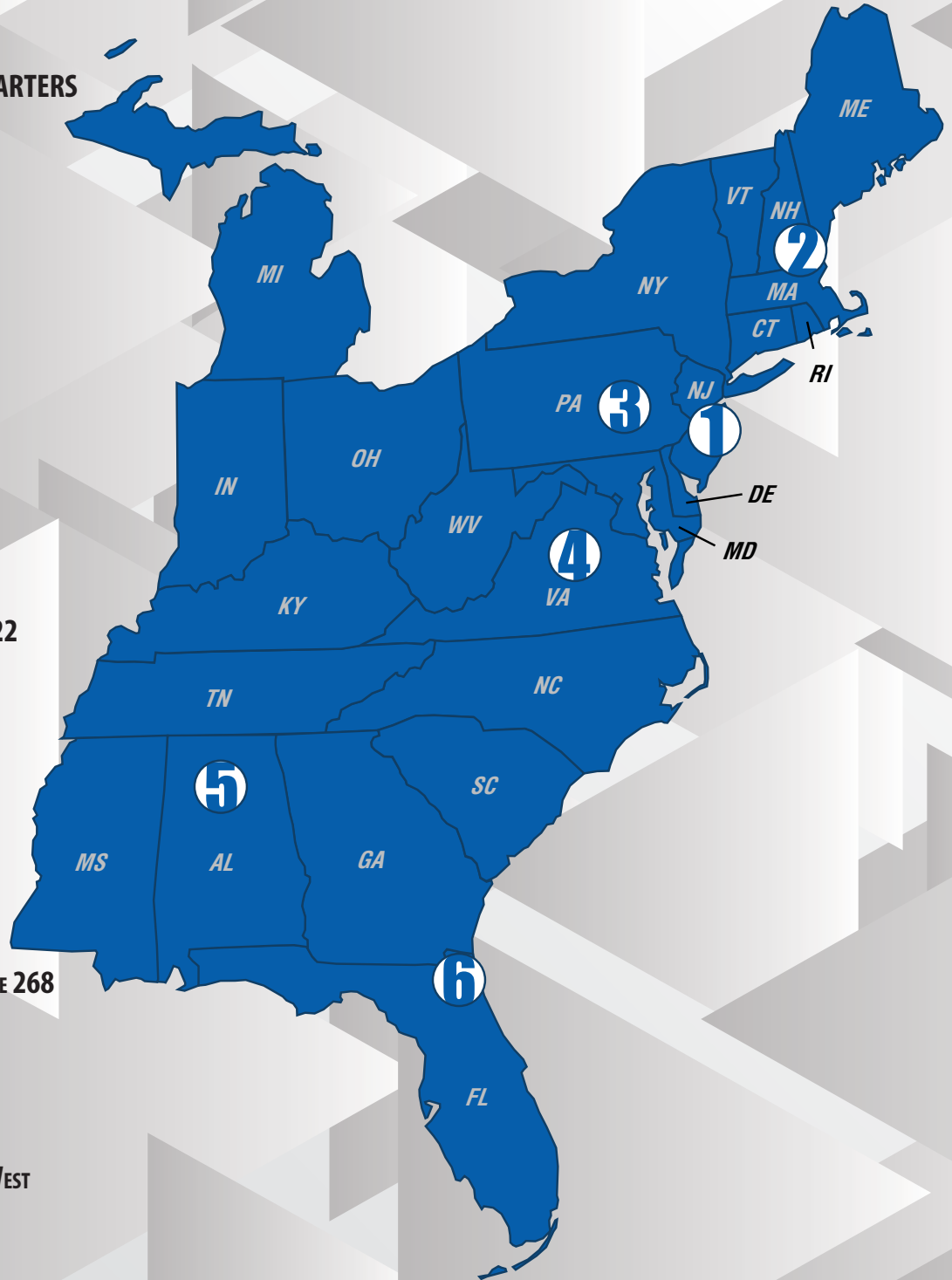

800-922-0724 | www.TARANTIN.COM

