







CONTENTS





● Products Guide	2	
Products Line Up	2	
Applications Guide	7	
Selection by Thickness	9	
Cross Reference	10	
Part Numbering	14	
<hr/>		
● EMI Suppression Filter	18	
Ferrite Chip Beads		
Ferrite Chip Bead Array		
Common Mode Chokes		
<hr/>		
● Chip Coils / Inductors	62	
For General Use (Multilayer/Wire wound)		
For High Frequency Use (Wire wound)		
Hearing Aid (HAC) Inductors		
<hr/>		
● Power Inductors / Chokes	92	
Multilayer Type Power Inductors		
Sealed Type Power Inductors		
Power Inductors		
Molding Type High Current Power Inductors		
<hr/>		
● Wireless Power Charging	198	
PTX		
CTX		
PRX		
<hr/>		
● LAN Transformer and LAN Transformer Modules	202	
<hr/>		
● Soldering and Mounting / Packaging	213	

- Please visit our website: www.tai-tech.com.tw for the latest specification.
- Detailed Specifications are available upon request.
- Customized specifications are available , please contact TAI-TECH for the details.
- 最新規格可瀏覽網站： www.tai-tech.com.tw
- 詳細規格可在需求時提供
- 特殊規格可開發，詳情請洽西北臺慶



Products Line Up

■ EMI Suppression Filters

SMD Type	Type	P/N	Size (mm)	Impedance Range (ohm)	Rated Current (mA)	*OP Temp.	Page
Ferrite Chip Beads FCM/HCB  FCA  BPH 	Normal	FCM-K	1005	30 – 1000	50 – 300	0	18
	High Freq.	FCM-M	1005	60 – 300	50 – 100	0	18
	High Current	HCB	1005	10 – 220	1500 – 3000	0	20
	Giga Hz	GHB	1005	600 – 1800	200 – 300	0	22
	Normal	FCM-K,H	1608	30 – 2000	150 – 700	0	23
	High Freq.	FCM-C	1608	10 – 1000	80 – 700	0	23
	High Current	HCB	1608	26 – 600	1000 – 6000	0	26
	Normal	FCM-K,H	2012	11 – 2000	250 – 900	0	28
	High Freq.	FCM-C,N	2012	7 – 1000	200 – 700	0	28
	High Current	HCB	2012	30 – 600	1000 – 3000	0	31
	Normal	FCM-K	3216	26 – 600	400 – 900	0	33
	High Current	HCB	3216	30 – 600	1000 – 3000	0	35
	Array Normal	FCA-K	3216	30 – 1000	150 – 500	0	37
	Array High Freq.	FCA-M	3216	30 – 300	200 – 400	0	37
	Ultra High Current	BPH	323023	23	15000	1	39
	Ultra High Current	BPH	403025	22	10000	1	39
	High Current	HCB	4516	60 – 80	3000 – 6000	0	40
	High Current	HCB	4532	80 – 1300	3000 – 6000	0	41
Ultra High Current	BPH	853025	45	13000	1	39	
Common Mode Chokes WCM-L2N  WCM-F2S HDMI/HSF DCM/ACM TCM 	USB 3.0/HDMI 2.0	HSF	1210	50 – 90	200 – 250	1	43
	Low Profile	WCM-L2N	2012	67-180	300-400	1	44
	Normal	WCM-F2S	2012	67 – 1000	100 – 400	1	44
	HDMI	HDMI	2012	67 – 90	400	1	47
	USB 3.0	HSF	2012	50 – 90	400	1	48
	3-Wires	TCM	252013	67	500	1	49
	Normal	WCM-F2S	3216	90 – 2200	200 – 400	1	50
	LAN, Low RDC	DCM	3216	60 uH	200	3	52
	Normal	WCM-F2S	3225	90 – 1000	400 – 1000	1	53
	3-Wires	TCM	322512	160 – 500	200 – 500	1	54
	CAN Bus, Ethernet	ACM	3225	100 uH	150	0,1	55
	LAN, Low RDC	DCM	3532	75 uH	300	3	56
	WCM-F2S	WCM-F2S	4532	90 – 800	1000 – 2000	1	57
	CAN Bus	LCM	4532	300-2000	200-300	1	58
	CAN Bus ,Ethernet	ACM	4532	11-200 uH	100-250	0,1	59
Balun	Balun Filter	BCM	2012	-	-	1	60

Note: Operating Temperature:

A: -55℃~+180℃, 0: -55℃~+150℃, 1: -40℃~+125℃, 2: -40℃~+105℃, 3: -40℃~+85℃.

Products Line Up

■ Chip Coils / Inductors







Applications	Type	P/N	Size (mm)	Inductance Range (uH)	Rated Current (mA)	*OP Temp.	Page
Inductors for General Use FCI  SWF-L  SWF-C  WIH 	Multilayer	FCI	1005	0.220 – 2.20	10 – 25	1	62
	Multilayer	FCI	1608	0.047 – 10.0	15 – 50	1	63
	Wire High Q	SWF-L	1608	0.047 – 10.0	270 – 1500	1	64
	Wire Low RDC	SWF-C	1608	0.047 – 10.0	180 – 1400	1	66
	Multilayer	FCI	201209	0.047 – 2.2	30 – 300	1	67
	Multilayer	FCI	201212	0.470 – 10.0	15 – 200	1	67
	Wire Low RDC	SWF-C	2012	0.470 – 33.0	145 – 750	1	68
	Wire Low RDC	SWF-C	2520	1.000 – 33.0	236 – 1000	1	69
	Multilayer	FCI	3216	0.047 – 10.0	25 – 300	1	70
	Wire Low RDC	SWF-C	3225	1.000 – 680	76 – 1200	1	71
	Wire	WIH	3225	10.0-220	60 – 200	1	72
Ceramic High Freq. Inductors SWI-P SWI  	Normal	SWI	0402	1.0 – 100(nH)	30 – 1360	1	73
	Low Profile	SWI-P	0603	2.0 – 360(nH)	150 – 700	1	75
	Normal	SWI	0603	2.0 – 390(nH)	100 – 700	1	76
	Normal	SWI	0805	2.8 – 1200(nH)	170 – 800	1	78
	Normal	SWI	1008	10– 10000(nH)	150 – 1000	1	80
Hearing Aid (HAC) Inductors PAS2016~4018  PAS4420~1225 	Z Type	PAS	2016	1000	20	1	82
		PAS	3010	280	50	1	83
		PAS	3012	680	80	1	84
		PAS	3015	1200	80	1	85
		PAS	4018	1000	69	1	86
	X/Y Type	PAS	4420	2500 – 3500	20 – 40	1	87
		PAS	6420	700 – 7500	10 – 80	1	88
		PAS	8027	4500-19000	20	1	89
		PAS	1225	1300 – 13000	30 – 60	1	90

Note: Operating Temperature:

A: -55°C~+180°C, 0: -55°C~+150°C, 1: -40°C~+125°C, 2: -40°C~+105°C, 3: -40°C~+85°C.

Products Line Up

■ Power Inductors

Description	Type	P/N	Size (mm)	Inductance (uH)	Irms (A)	Isat (A)	*OP Temp.	Page
Power Inductors	Sealed Low RDC	UHP	201610N	0.47 – 22.0	0.30 – 2.60	0.43 – 3.00	1	92
	Sealed High Current	DFP	201610T	0.24 – 2.20	1.70 – 4.40	2.10 – 5.10	1	93
HPC UHP	Sealed	AHP	201610F	0.24 – 4.70	1.60 – 5.70	1.60 – 7.50	1	94
DFP	Sealed High Current	AHP	201610H	0.24 – 4.70	1.10 – 5.60	1.60 – 7.50	1	96
	Sealed High Current	DFP	201612N	0.24 – 2.20	1.50 – 4.00	2.00 – 5.40	1	98
	Sealed	HPC	252008M	0.47 – 10.0	0.45 – 1.45	0.55 – 2.50	1	99
	Sealed	AHP	252008R	0.24 – 4.70	1.20 – 4.50	1.50 – 5.30	1	100
FPI	Sealed Low RDC	UHP	252010B	0.47 – 10.0	0.50 – 2.80	0.50 – 2.85	1	102
	Sealed High Current	DFP	252010N	0.24 – 2.20	1.80 – 3.60	2.40 – 4.80	1	103
	Sealed	AHP	252010F	0.24 – 4.70	1.70 – 5.50	1.70 – 9.50	1	104
	Sealed High Current	AHP	252010H	0.24 – 4.70	1.40 – 5.50	1.70 – 7.20	1	106
FWP	Sealed Low RDC	UHP	252012B	0.47 – 22.0	0.50 – 3.70	0.56 – 4.00	1	108
	Sealed High Current	DFP	252012T	0.24 – 2.20	2.30 – 4.70	2.70 – 8.00	1	109
	Sealed	AHP	252012R	0.24 – 10.0	1.00 – 5.50	1.40 – 8.00	1	110
	Sealed High Current	AHP	252012H	0.24 – 0.68	4.50 – 7.00	6.00 – 7.80	1	112
AHP	Sealed	HPC	3010T	1.00 – 22.0	0.75 – 2.50	0.55 – 2.20	1	114
	Sealed	HPC	3012T	1.00 – 22.0	0.70 – 2.20	0.55 – 2.20	1	115
	Molded	TMPC	0312H	0.47 – 10.0	1.00 – 5.00	1.40 – 7.20	1	116
	Sealed	HPC	3015T	1.00 – 47.0	0.40 – 2.20	0.35 – 2.20	1	117
TMPC	Normal	FPI	0302BM	1.00 – 120	IDC 0.14-1.50		1	118
	Normal	FWP	3216	0.47 – 22.0	0.16 – 0.70		1	119
	Molded	TMPC	0302H	0.10 – 10.0	1.40 – 10.5	1.60 – 14.0	1	120
	Sealed	HPC	4010T	1.00 – 22.0	0.80 – 2.30	0.60 – 2.40	1	121
TMPA	Sealed	HPC	4012T	1.00 – 22.0	0.72 – 2.50	0.60 – 3.30	1	122
	Molded	TMPC	0412HP	0.10 – 10.0	1.30 – 11.5	1.40 – 25.0	1	123
TMPV	Sealed	HPC	4018N	1.00 – 47.0	0.30 – 3.70	0.30 – 4.00	1	124
	Molded	TMPC	0402HP	0.33 – 22.0	1.20 – 10.0	1.40 – 18.0	1	125
	Molded High Temp. Low R	TMPF	0402A	0.10 – 2.20	5.60 – 18.0	6.50 – 38.0	0	126
	Molded High Temp. Low R	TMPF	0402LR	0.47 – 4.70	5.10 – 13.2	4.00 – 14.0	0	129
TBMA	Normal	FPI	0403BM	1.00 – 120	IDC 0.20-4.00		1	132

Note: Operating Temperature:

A: -55°C~+180°C, 0: -55°C~+150°C, 1: -40°C~+125°C, 2: -40°C~+105°C, 3: -40°C~+85°C.

Products Line Up

■ Power Inductors

Description	Type	P/N	Size (mm)	Inductance (uH)	Irms (A)	Isat (A)	*OP Temp.	Page
Power Inductors	Molded	TMPC	0512HP	0.10 – 10.0	1.50 – 14.0	1.80 – 14.5	1	134
	Molded	TMPC	0515HP	0.20 – 22.0	1.20 – 15.0	1.70 – 22.5	1	135
	Molded	TMPC	0518HP	0.33 – 15.0	1.70 – 11.0	2.30 – 15.0	1	136
HPC UHP	Sealed	HPC	5020N	1.00 – 47.0	0.70 – 4.10	0.70 – 5.00	1	137
	Molded High Temp. Low R	TMPF	0502A	0.15 – 1.50	8.80 – 18.8	13.3 – 30.0	0	139
DFP	Normal	FPI	0503BM	1.50 – 33.0	IDC 1.40-4.10		1	142
	Molded High Temp.	TMPA	0503S	0.47 – 10.0	3.80 – 13.5	2.5 – 10.0	0	143
FPI	Molded High Temp. Low R	TMPF	0503A	0.15 – 4.70	5.90 – 22.2	8.20 – 36.0	0	146
	Sealed	HPC	5040N	1.00 – 100	0.72 – 5.00	0.75 – 7.50	1	149
FWP	Normal	FPI	0504BM	1.00 – 120	IDC 0.60-3.50		1	151
	Molded	TMPC	0612H	0.22 – 10.0	1.80 – 11.0	2.50 – 19.0	1	153
AHP	Molded	TMPC	0615H	0.22 – 22.0	1.50 – 14.0	2.50 – 22.0	1	154
	Molded	TMPC	0618H	0.22 – 10.0	2.30 – 16.0	3.50 – 26.0	1	155
TMPC	Sealed	HPC	6020N	1.00 – 22.0	1.40 – 4.50	1.30 – 6.20	1	156
	Molded	TMPC	0602H	0.10 – 22.0	1.50 – 21.0	2.50 – 40.0	1	158
TMPC	Molded	TMPC	0624H	0.22 – 10.0	3.20 – 21.0	5.00 – 34.0	1	159
	Molded	TMPC	0603H	0.10 – 10.0	3.50 – 32.5	6.00 – 60.0	1	160
TMPC	Molded High Temp.	TMPA	0603S	0.15 – 22.0	2.50 – 30.0	3.00 – 40.0	0	161
	Molded High Temp. Low R	TMPF	0603A	0.18 – 4.50	7.00 – 32.0	8.00 – 36.0	0	164
TMPC	Molded Very High Temp.	TMPV	0603S	0.47 – 22.0	2.80 – 20.0	2.20 – 14.0	A	167
	Molded	TMPC	0604H	0.15 – 15.0	3.00 – 30.0	3.50 – 55.0	1	168
TMPC	Sealed	HPC	6045N	0.36 – 470	0.40 – 9.00	0.50-18.0	1	170
	Molded	TMPC	0605H	0.33 – 22.0	2.90 – 25.0	5.50 – 32.0	1	171
TMPC	Molded High Temp. Low R	TMPF	0605A	1.00 – 4.70	8.50 – 20.0	10.5 – 23.0	0	172
	Normal	FPI	0703BM	10.0 – 330	IDC 0.28-1.44		1	174
TMPC	Molded High Temp. Low R	TMPF	0703A	0.60 – 8.20	5.90 – 23.0	10.2 – 36.0	0	175
	Normal	FPI	0705BM	3.30 – 470	IDC 0.34-4.60		1	177
TMPC	Sealed	HPC	8040N	1.00 – 470	0.63 – 8.50	0.55 – 13.8	1	178
	Molded	TMPC	1004H	0.15 – 22.0	5.00 – 36.0	7.00 – 70.0	1	179
TMPC	Molded High Temp.	TMPA	1004S	0.15 – 22.0	5.00 – 44.0	6.20 – 82.0	0	180
	Molded Very High Temp.	TMPV	1004S	0.47 – 68.0	2.40 – 30.0	3.50 – 28.5	A	185
TBMA	Molded Twin Inductors	TBMA	1004P4	5.60 – 33.0	3.80 – 6.50	3.70 – 8.50	0	186

Note: Operating Temperature:

A: -55°C~+180°C, 0: -55°C~+150°C, 1: -40°C~+125°C, 2: -40°C~+105°C, 3: -40°C~+85°C.





TAI-TECH



All the data listed in this catalogue are for reference only, TAI-TECH reserves the right to alter or revise the specifications without prior notification.
For the latest specification, please visit our website: www.tai-tech.com.tw

Products Line Up

■ Power Inductors

Description	Type	P/N	Size (mm)	Inductance (uH)	I _{rms} (A)	I _{sat} (A)	*OP Temp.	Page
Power Inductor	Molded	TMPC	1005H	0.30 – 68.0	2.50 – 38.0	4.00 – 65.0	1	187
	Molded	TMPC	1235HP	0.10 – 10.0	7.00 – 43.0	14.0 – 84.0	1	188
TMPC 	Molded	TMPC	1205HP	0.20 – 22.0	6.50 – 52.0	10.0 – 110	1	189
	Molded	TMPC	1206HP	1.00 – 47.0	5.50 – 29.0	7.00 – 45.0	1	190
TMPA/V 	Molded	TMPC	1265HP	0.15 – 47.0	6.50 – 55.0	9.50 – 118	1	191
	Molded Very High Temp.	TMPV	1265S	0.22 – 22.0	8.30 – 66.0	5.50 – 68.0	A	192
	Molded	TMPC	1707HP	1.00 – 100	5.30 – 52.0	6.50 – 60.0	1	193
	Molded High Temp.	TMPA	2313SP	1.50 – 100	11.0 – 62.0	9.00 – 52.0	0	194

■ Wireless Power Charging

Description	Type	P/N	Size (mm)	Inductance (uH)	DCR (Ω)	Q Typ.	*OP Temp.	Page
Wireless Power Charging 	Transmitting	PTX	505035	6.6	0.037	90	3	198
			505040	6.0	0.020	60	3	
			505050	6.6	0.037	90	3	
			505055	6.0 – 24.0	0.02–0.056	60 – 110	3	
CTX 	Transmitting	CTX	505028	6.3	0.037	90	3	199
			505040	6.0	0.018	80	3	
PRX 	Receiving	PRX	383109	10.0	0.180	28	3	200
			423809	12.5	0.245	30	3	
			483209	10.5	0.236	28	3	

■ LAN Transformer

Description	Type	P/N	Size (mm)	Inductance Range (uH)	*OP Temp.	Page
LAN Transformer 	Normal	TXF	4532	350-380	3	202
			5353	380	3	203

■ LAN Transformer Modules

Description	Type	P/N	Package Size/Code	*OP Temp.	Page
LAN Transformer Modules 	C	LAN	12M162S	3	204
	C		16G241F/S	3	205
	L		12M162P	3	207
	L		16G241P/242P	3	209
	L		17G241P	3	211

Note: Operating Temperature:

A: -55°C~+180°C, 0: -55°C~+150°C, 1: -40°C~+125°C, 2: -40°C~+105°C, 3: -40°C~+85°C

Applications Guide

■ Automotive

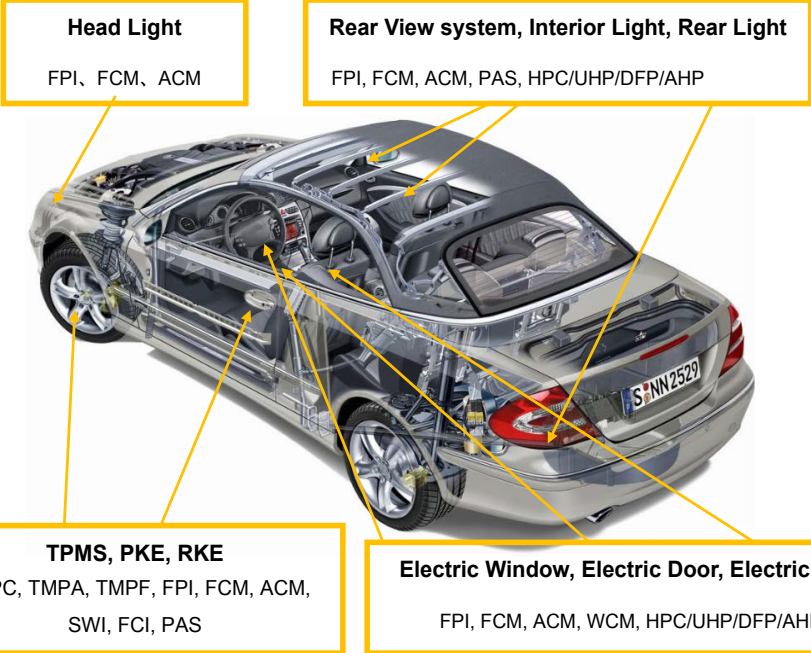

Application	Products	Comfort									
		Electric Window	Electric Seat	Electric Door	PKE	RKE	TPMS	Rear View system	Interior Light	Tail Light	Head Light
Inductors	SWI				✓	✓	✓				
	FCI				✓	✓	✓				
	SWI				✓	✓	✓				
	PAS				✓	✓	✓				
Power Circuit	TMPC/TMPA/TMPF										✓
	FPI	✓	✓	✓	✓	✓	✓	✓	✓	✓	✓
	HPC/UHP/DFP/AHP	✓	✓	✓	✓	✓	✓	✓	✓	✓	
Noise Suppression Products	FCM	✓	✓	✓	✓	✓	✓	✓	✓	✓	✓
	ACM	✓	✓	✓	✓	✓	✓	✓	✓	✓	✓
	WCM	✓	✓	✓							

Applications Guide

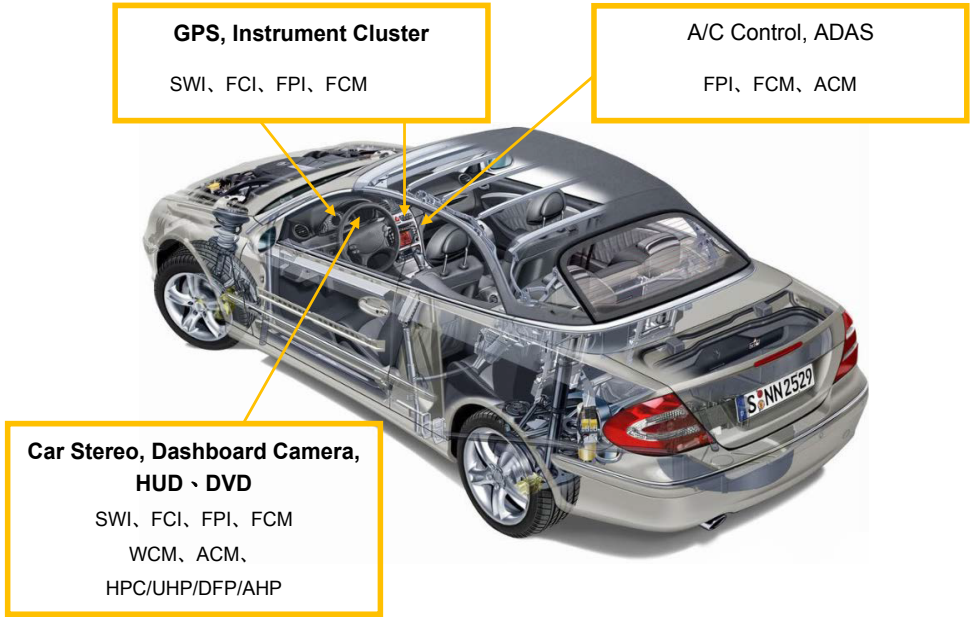

Application	Products	Infotainment						
		GPS	Instrument Cluster	Car Stereo	Dashboard Camera HUD	DVD	A/C Control	ADAS
Inductors	SWI	V	V	V	V	V		
	FCI	V	V	V	V	V		
	SWI	V	V	V	V	V		
	PAS							
Power Circuit	FPI	V	V	V	V	V	V	V
	HPC/UHP/DFP/AHP	V	V	V	V	V	V	V
	TMPA/TMPC/TMPF							
Noise Suppression Products	FCM	V	V	V	V	V	V	V
	ACM	V	V	V	V	V	V	V
	WCM			V	V	V		

Selection by Thickness

Chip Coils / Inductors

Thickness (mm)	Ferrite (Multilayer)	Ferrite (Wire wound)	High Frequency (Multilayer)	High Frequency (Wire wound)
0.33	-	-	-	-
0.60	FCI 1005	-	-	SWI 0402/SWI0402P
1.00	FCI 1608 / FCI 2012	SWF1608 L	-	-
1.20	-	SWF 1608C	-	SWI 0603F/SWI0603P
1.50	FCI 2012 / FCI 3216	SWF 2012C	-	SWI 0805U
2.20	-	SWF 2520C	-	SWI 1008U
2.50	-	SWF 3225C/WIH3225	-	-

Power Inductors

Thickness (mm)	Irms 1.0A max.	Irms 3.0A max.	Irms 5.0A max.	Irms 7.0A max.
0.80	HPC252008/CPI160808	-	AHP252008	-
1.00	CPI160809/2012/2016 CPI2520 DHP252010/3010	HPI252010 HPC3010/4010/6010 UHP201610/252010	DFP201610/252010 AHP201610 AHP252010	-
1.20	DHP252012/3012	HPC2012/3012/4012 HPC5012/6012 FPC4012	UHP252012 DFP201612/252012	AHP252012
1.50	-	HPC3015	-	-
1.80	FWP321516	HPC4018	-	-
2.00	FPI0302	-	HPC5020/HPC6020	-
2.30	-	-	-	-
3.00	-	FPI0403/FPI0503	-	HPC8030
3.50	-	-	-	-
4.00	-	FPI0504	-	-
4.50	-	-	-	HPC6045
Up to 5.00	-	-	-	-

Power Inductors

Thickness (mm)	Irms 10.0A max.	Irms 20.0A max.	Irms 30.0A	Irms 50.0A max.
1.00	-	-	-	-
1.20	TMPC0312	TMPC0412/0612	-	-
1.50	-	TMPC0515/0615	-	-
1.80	-	TMPC0518	TMPC0618	-
2.00	TMPC0302 TMPF0402	TMPC0402 TMPF0502	TMPC0502/0602	-
2.40	-	-	TMPC0624	-
3.00	TMPA0503	TMPF0603/0703 TMPV0603	TMPC0503 TMPA0603 TMPF0603	TMPC0603
3.50	-	-	-	TMPC1235
4.00	HPC8040	-	TMPV1004	TMPC0604/TMPC1004 TMPA1005
Up to 5.00	-	-	-	TMPC0605/1005/1205 TMPC1206/1265/1707 TMPV1265



Cross Reference

Ferrite Chip Beads

TAI-TECH	muRata	TDK	TAIYO YUDEN	Page
FCM1005	BLM15	MMZ1005	BK1005	18
HCB1005	BLM15KG/PX	MPZ1005	BKP1005	20
GHB1005	BLM15HD	MMZ1005-E	BKH1005	22
FCM1608	BLM18	MMZ1608	BK1608	23
HCB1608	BLM18KG	MPZ1608	BKP1608	26
FCM2012	BLM21	MMZ2012	BK2125	28
HCB2012	BLM21PG	MPZ2012	BKP2125	31
FCM3216	BLM31	-	-	33
HCB3216	BLM31PG	-	FBMH3216	35
FCA3216	BLA31	-	BK3216-4	37
HCB4516	BLM41PG	-	FBMH4516	40
HCB4532	-	-	FBMH4532	41

Common Mode Chokes

TAI-TECH	muRata	TDK	TAIYO YUDEN	Page
HSF1210	-	-	CM01	43
WCM2012	DLW21H/S	ACM2012	-	44
HDM12012	DLW21	ACM2012H	-	47
HSF2012	DLW21	-	-	48
TCM2520	-	ACM2520-3P	-	49
WCM3216	DLW31	-	-	50
TCM3225	-	-	-	54
ACM3225	-	ACT1210/1210L	-	55
LCM4532	DLW43	ACT45B	-	58
ACM4532	-	ACT45B/L	-	59

Chip Coils / Inductors

TAI-TECH	muRata	TDK	TAIYO YUDEN	CoilCraft	Page
FCI1005/1608/2012	LQM18N/21N	MLF1005/1608/2012	LK1005/1608/2125	-	62
SWF1608	-	-	-	0603LS	64
SWF2012	-	-	-	0805LS	67
SWF2520	-	-	-	1008LS	69
SWF3225	-	-	-	-	71
SWI0603	LQW18	-	-	0603CS	76
SWI0805U	LQW2B	-	-	0805CS	78
SWI1008U	LQW2U	-	-	1008CS	80
PAS4420	-	-	-	-	87
PAS6420	LQW72HN	-	-	-	88
PAS1225	LQW1202	-	-	-	90

Cross Reference

Power Inductors

TAI-TECH	TAIYO YUDEN	TDK	Panasonic	Cyntec	Page
UHP201610N	-	VLS201610	-	PSD20161T	92
DFP201610T	MAKK2016	-	-	PIFE20161T	93
DFP201612N	-	-	-	PIFE20161B	98
HPC252008M	-	VLS252008E	-	-	99
UHP252010B	-	VLS252010	-	PST25201T	102
DFP252010N	MAKK2520	-	-	PIFE25201T	103
UHP252012B	-	VLS252012	ELLYFJ	PST25201B	108
DFP252012T	MAMK2520	-	-	PIFE25201B	109
HPC3010T	NRH3010	VLS3010E	ELLVEG	PST031T	114
HPC3012T	NRH3012	VLS3012E	ELLVFG	PST031B	115
HPC3015T	NRH3015	VLS3015E	ELLVGG	-	117
HPC4010T	NRS4010	-	-	-	121
HPC4012T	NRS4012	VLS4012	ELL4FG	PST041B	122
HPC4018N	NRS4018	VLCF4018	ELL4LG	PST041H	124
HPC5020N	NRS5020	VLCF5020	ELL5PR	-	137
HPC5040N	NRS5040	-	-	PSI054T	149
HPC6020N	NRS6020	SLF6020	-	-	156
HPC6045N	NRS6045	VLP6045	-	PS064T	170
HPC8040N	NRS8040	VLP8040	-	-	178

Power Inductors

TAI-TECH	muRata	Taiyo	TDK	SUNLORD	Cyntec	Page
AHP201610F		MEKK2016T	VLS2016HBX	WPN201610-R		94
AHP201610H						96
AHP252008R	DFE252008C				SEDT25200H	100
AHP252010F			VLS252010HBX	WPN252010-HR		104
AHP252010H			VLS252010HBX		SEDM25201T	106
AHP252012R	1239-AS			WPN252012-H		110
AHP252012H	DFE252012P					112



Cross Reference

Power Inductors

TAI-TECH	SUMIDA	TDK	TOKO	Page
FWP3216	-	-	-	119
FPI0302	CD32			118
FPI0403	CD43			132
FPI0503				142
FPI0504	CD54			151
FPI0703	CD73			174
FPI0705	CD75			177

Power Inductors

TAI-TECH	VISHAY	TDK	TOKO	Cyntec	Page
TMPC0312H	IHLP-1212AB	SPM3012	FDSD0312	PIME031B	116
TMPC0302H	IHLP-1212BZ	-	-	-	120
TMPC0412HP	IHLP-1616AB	SPM4012	FDSD0412	PIMB041B	123
TMPC0402HP	IHLP-1616BZ	-	FDSD0420	PIMB042T	125
TMPC0512HP	IHLP-2020AB	SPM5012	FDSD0512	PIMB051B	134
TMPC0515HP	-	-	FDSD0515	PIME051E	135
TMPC0518HP	-	-	FDSD0518	PIMB051H	136
TMPC0612H	-	-	-	PIME061B	153
TMPC0615H	-	-	-	PIME061E	154
TMPC0618H	IHLP-2525AH	-	FDV0618	PIMB061H	155
TMPC0602H	-	-	FDV0620	-	158
TMPC0624H	IHLP-2525BD	-	-	PIMB062D	159
TMPC0603H	IHLP-2525CZ	SPM6530	FDV0630	PIMB063T	160
TMPC0604H	-	-	FDV0640	-	166
TMPC0605H	-	-	FDV0650	PIMB065T	171
TMPC1004H	IHLP-4040DZ	-	FDV1040	PIMB104T	179
TMPC1005H	-	-	-	PIMB104E	187
TMPC1235HP	IHLP-5050CE	-	-	PIMB133E	188
TMPC1205HP	IHLP-5050EZ	-	FDU1250	PIMB135T	189
TMPC1206HP	-	-	FDU1260	PIMB136T	190
TMPC1265HP	IHLP-5050FD	-	-	-	192
TMPC1707HP	IHLP-6767GZ	-	-	PIMB177T	193



Cross Reference

Power Inductors

TAI-TECH	VISHAY	Coil Craft	TOKO	Cyntec	Page
TMPF0402A		XAL4020			126
TMPF0402LR		XFL4020			129
TMPF0502A		XAL5020			139
TMPA0503S	IHLP2020CZ			PCMB503T	143
TMPF0503A		XAL5030			146
TMPA0603S	IHLP2525CZ			PCMB603T	161
TMPF0603A		XAL6030			164
TMPV0603S	IHLP-2525CZ-8A				167
TMPF0605A					172
TMPF0703A		XAL7030			175
TMPA1004S	IHLP4040DZ			PCMB104T	180
TMPV1004S	IHLP-4040DZ-8A				185
TBMA1004P4	IHLD-4032KB-5A				186
TMPV1265S	IHLP-5050FD-8A				192
TMPA2313S	IHLP8787MZ				194

LAN Transformer

TAI-TECH	TDK				Page
TXF453222	ACT4532M				202
TXF453229	ACT4532M				202
TXF535340					203

LAN Transformer Modules

TAI-TECH	BOTHHAND	PULSE			Page
LAN-12M162S					204
LAN-16G241F/S					205
LAN-12M162P	NS0013B				207
LAN-16G241P/242P	GST5009				209
LAN-17G241P		H5007NL			211



Part Numbering

■ Ferrite Chip Beads / Array

FCM **1608** **KV** - **121** **T** **06**

① ② ③ ④ ⑤ ⑥

① Series Name

Code	Series Name
FCM	Ferrite Chip Bead
GHB	GHz Ferrite Chip Bead
HCB/BPH	High Current Ferrite Chip Bead
FCA	Ferrite Chip Bead Array

② Dimension(AxB)

Code	Dimension(AxB)	EIA
1005	1.0mmX0.5mm	0402
1608	1.6mmx0.8mm	0603
2012	2.0mmx1.25mm	0805
3216	3.2mmx1.6mm	1206
4516	4.5mmx1.6mm	1806
4532	4.5mmx3.2mm	1812

③ Material Characteristics/Application , V: for Vehicle.

Code	Material Characteristics/Application	Series Name
H	for General Use	FCM-H
K	For Power Supplies	FCM-K,FCA-K
M	for High Speed Signal Lines	FCM-M,FCA-M
C, B		FCM-C, B
		HCB-K

④ Impedance

Code	Impedance(Ohm)
070	7Ω
700	70Ω
601	600Ω
202	2000Ω

⑤ Packaging

Code	Packaging
T	Plastic Taping(Φ 180mm)
B	Bulk

⑥ Rated Current

Code	Rated Current(mA)
02	200
05	500
20	2000
60	6000

■ Common Mode Choke Coils / Balun

WCM **2012** **F** **2** **S** **V** - **900** **T** **04**

① ② ③ ④ ⑤ ⑥ ⑦ ⑧ ⑨

① Series Name

Code	Common Mode Choke Coil
WCM	Winding Common Mode Filter for USB
HDMI	Winding Common Mode Filter for HDMI
HSF	Winding Common Mode Filter for USB
LCM	Winding Common Mode Filter
TCM	Tri-wired Common Mode Filter
ACM	Winding Common Mode Filter for Car
BCM	Balun Filter

② Dimension(AxB)

Code	Dimension(AxB)	EIA
1210	1.2mmx1.0mm	0504
2012	2.0mmx1.2mm	0805
3216	3.2mmx1.6mm	1206
3225	3.2mmx2.5mm	1210
4532	4.5mmx3.2mm	1812

③ Material Characteristics

Code	Material
F	Ferrite Material

④ Numbers of Signal Line

Code	Numbers of Signal Line
2	Two Lines
3	Three Lines
4	Four Lines

⑤ Type

Code	Type
S	Shielded Type
N	Non-Shielded Type

⑥ V: for Vehicle

⑦ Impedance

Code	Impedance(Ohm)
900	90Ω
121	120Ω
102	1000Ω

⑧ Packaging T: Taping and Reel

⑨ Rated Current

Code	Rated Current(mA)
02	200
10	1000

Part Numbering

■ Chip Coils / Inductors

FCI **2012** **V** - **100** **M**

① ② ③ ④ ⑤

① Series Name

Code	
FCI	Ferrite Chip Inductor
SWF	Wirewound Ferrite Chip Inductor
WIH	Wirewound Ferrite Chip Inductor
SWI	Wire Wound Ceramic Chip
PAS	Hearing Aid (HAC) Inductor

② Dimension(AxB)

Code	Dimension(AxB)	EIA
1005	1.0mmx0.5mm	0402
1608	1.6mmx0.8mm	0603
2012	2.0mmx1.2mm	0805
2520	2.5mmx2.0mm	1008
3216	3.2mmx1.6mm	1206
3225	3.2mmx2.5mm	1210
3010	3.0mmx3.0mmx1.0mm	1212
3012	3.0mmx3.0mmx1.2mm	1212
4420	4.4mmx2.0mm	1808
6420	6.4mmx2.0mm	2508

③ V: for Vehicle

④ Inductance

Code	Inductance
1N0	1.0nH
10N	10nH
R10	100nH
1R0	1.0uH
100	10uH
101	100uH

⑤ Inductance Tolerance

Code	Inductance Tolerance
B	±0.1nH
C	±0.2nH
S	±0.3nH
G	±2%
H	±3%
J	±5%
K	±10%
L	±15%
M	±20%
Y	±30%

■ Power Inductors / Chokes

HPC **201610** **NV** - **1R0** **M**

① ② ③ ④ ⑤

① Series Name

Code	
HPC	Sealed Type Power Inductor
UHP	
DFP	
AHP	

② Dimension(AxB)

Code	Dimension(AxB)	EIA
201610	2.0mmx1.6mm	0806
252010/12	2.5mmx2.0mm	1008
3010/12/15	3.0mmx3.0mm	1212
3216	3.2mmx1.6mm	1206
4010/12/18	4.0mmx4.0mm	1616
5020/40	5.0mmx5.0mm	2020
6020/45	6.0mmx6.0mm	2424
8040	8.0mmx8.0mm	3232

③ 1A5

③ Material

Code	Material
B	Ferrite/Metal Material for Wire wound Inductor
H	
M	
N	
T	
F	
V	For Vehicle

④ Inductance

Code	Inductance
R47	0.47uH
1R0	1.0uH
100	10uH
101	100uH

⑤ Inductance Tolerance

Code	Inductance Tolerance
K	±10%
M	±20%
Y	±30%

⑥ Rated Current

Code	Rated Current
0A6	0.60A
1A5	1.50A



TAI-TECH

All the data listed in this catalogue are for reference only, TAI-TECH reserves the right to alter or revise the specifications without prior notification.
For the latest specification, please visit our website: www.tai-tech.com.tw

Part Numbering

■ Power Inductors (Molding Type)

TMPC **0603** **HV** - **4R7** **M** - **D**

① ② ③ ④ ⑤ ⑥

① Series Name

Code	
TMPC	Molding Type Hi-Current Power
TMPA	
TMPF	Inductor

② Dimension(AxB)

Code	Dimension(AxB)	EIA
0312	3.0mmx3.0mm	1212
0412/02	4.0mmx4.0mm	1616
0512/15/18/02/03	5.0mmx5.0mm	2020
0612/18/24/03/05	6.0mmx6.0mm	2424
1004/05	10mmx10mm	4040
1235/05/06/65/07	12mmx12mm	4848
1707	17mmx17mm	6868

③ Material

Code	Material
F	Hi-Current Metal Material
H	
HP	

④ Inductance

Code	Inductance
R47	0.47uH
1R0	1.0uH
100	10uH
101	100uH

⑤ Inductance Tolerance

Code	Inductance Tolerance
M	±20%
Y	±30%

⑥ Control No.

■ LAN Transformer

TXF **453229** - **381** **NV** - **7P**

① ② ③ ④ ⑤

① Series Name

Code	
TXF	LAN Transformer

② Dimension(AxBxC)

Code	Dimension(AxBxC)	EIA
453222	4.5mmx3.2mmx2.2mm	1812
453229	4.5mmx3.2mmx2.9mm	1812
535340	5.3mmx5.3mmx4.0mm	2121

③ Inductance

Code	Inductance uH
381	380

④ Material

Code	Material
NV	Ferrite Material

⑤ Control No.

Code	Description
7P	7 Pins



EMI Suppression Filters

- **Ferrite Chip Beads**
FCM Series
- **GHz Ferrite Chip Beads**
GHB Series
- **High Current Ferrite Chip Beads**
HCB Series
- **Ultra High Current Ferrite Chip Beads**
BPH Series
- **Ferrite Chip Bead Arrays**
FCA Series
- **Wire wound Common Mode Chokes**
WCM L2N/F2S Series
HDMI Series
HSF Series
LCM Series
ACM Series
DCM Series
- **Tri-wires Common Mode Chokes**
TCM Series
- **Balun Filters**
BCM Series





■ Dimensions

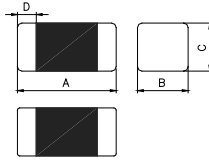

Chip Size	
A	1.00±0.10
B	0.50±0.10
C	0.50±0.10
D	0.25±0.10

Units: mm

■ Specifications

Part Number	Impedance (Ω)	Test Frequency (MHz)	DC Resistance (Ω) max.	Rated Current (mA) max.
FCM1005KV-300T03	30±25%	100	0.20	300
FCM1005KV-600T03	60±25%	100	0.25	300
FCM1005KV-121T01	120±25%	100	0.30	100
FCM1005KV-151T01	150±25%	100	0.30	100
FCM1005KV-221T01	220±25%	100	0.40	100
FCM1005KV-301T01	300±25%	100	0.50	100
FCM1005KV-471T01	470±25%	100	0.65	100
FCM1005KV-601T00	600±25%	100	0.80	80
FCM1005KV-102T00	1000±25%	100	1.20	50
FCM1005MV-600T01	60±25%	100	0.30	100
FCM1005MV-121T00	120±25%	100	0.45	80
FCM1005MV-221T00	220±25%	100	0.60	50
FCM1005MV-301T00	300±25%	100	0.75	50

■ Impedance-Frequency Characteristics (Typical)

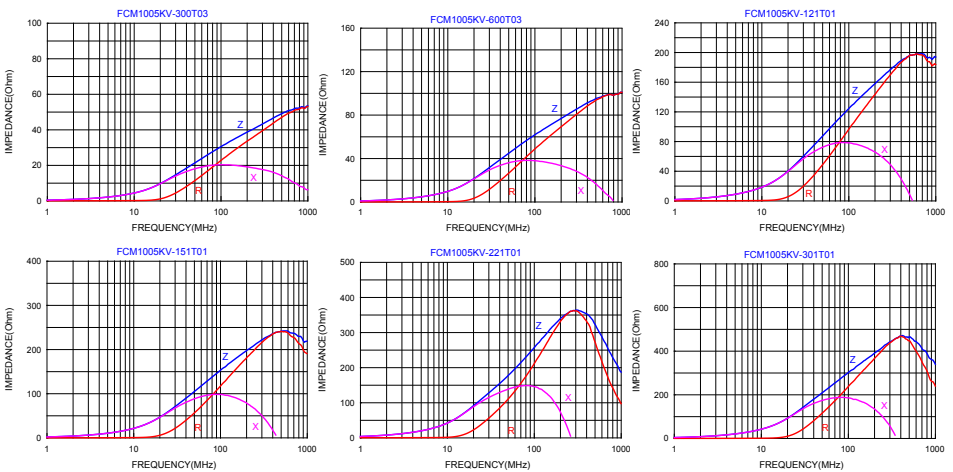



■ Impedance-Frequency Characteristics (Typical)

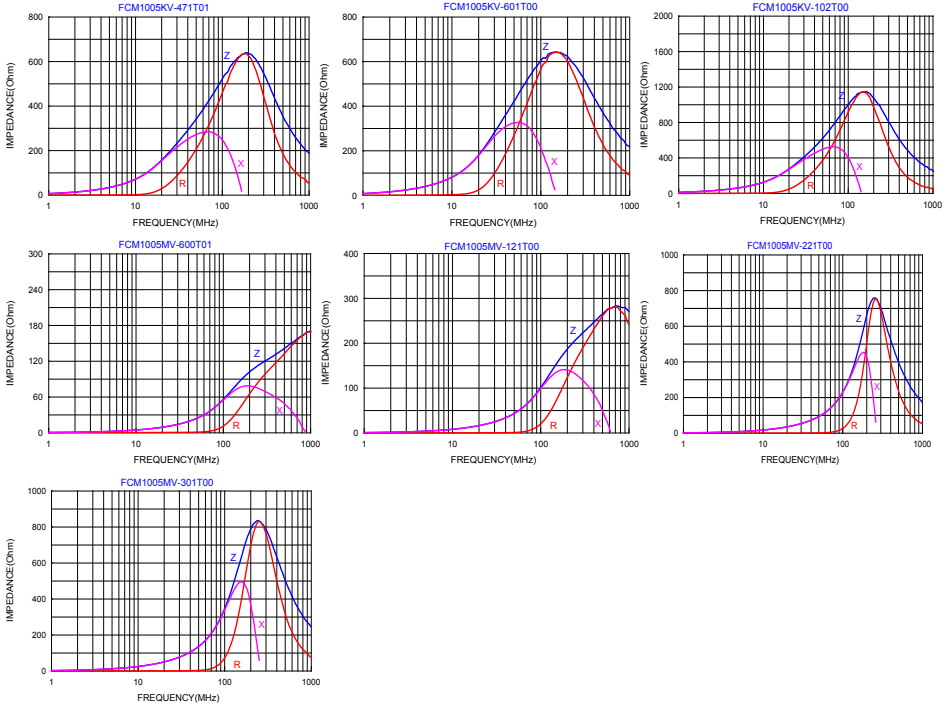



■ Dimensions

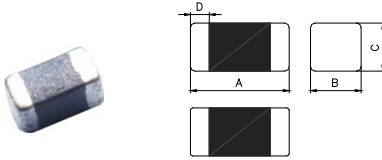

Chip Size	
A	1.00±0.10
B	0.50±0.10
C	0.50±0.10
D	0.25±0.10

Units: mm

■ Specifications

Part Number	Impedance (Ω)	Test Frequency (MHz)	DC Resistance (Ω) max.	Rated Current (mA) max.
HCB1005MV-100T25	10±25%	100	0.050	2500
HCB1005KV-121T20	120±25%	100	0.095	2000
HCB1005KV-221T15	220±25%	100	0.150	1500
HCB1005PV-330T30	33±25%	100	0.022	3000
HCB1005PV-600T25	60±25%	100	0.032	2500
HCB1005PV-800T23	80±25%	100	0.038	2300

■ Impedance-Frequency Characteristics (Typical)

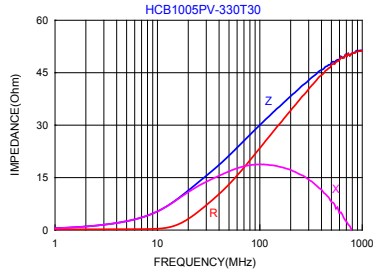
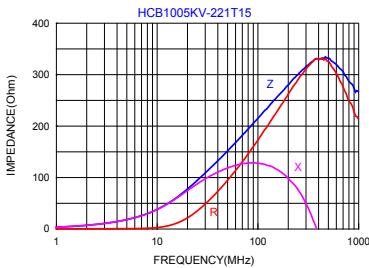
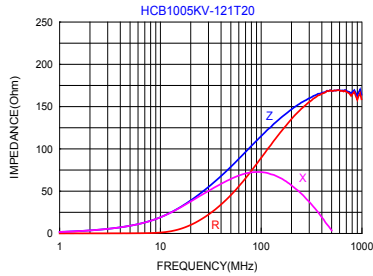
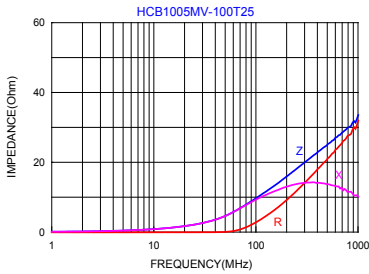



■ Impedance-Frequency Characteristics (Typical)

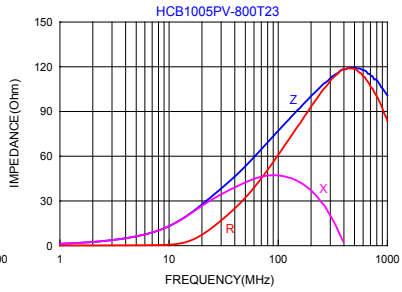
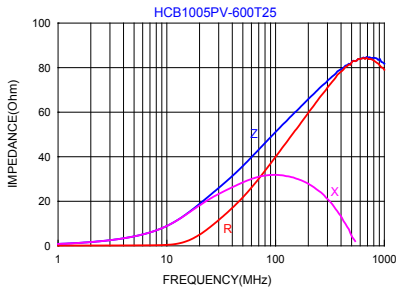

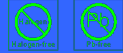

■ Dimensions

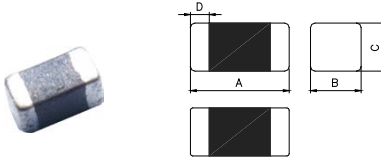

Chip Size	
A	1.00±0.10
B	0.50±0.10
C	0.50±0.10
D	0.25±0.10

Units: mm

■ Specifications

Part Number	Impedance(Ω)		DC Resistance (Ω) max.	Rated Current (mA) max.
	100MHz	1GHz		
GHB1005HV-601T03	600±25%	1400±40%	0.85	300
GHB1005HV-102T02	1000±25%	2000±40%	1.25	250
GHB1005HV-152T02	1500±25%	—	1.50	200
GHB1005HV-182T02	1800±25%	—	2.00	200

■ Impedance-Frequency Characteristics (Typical)

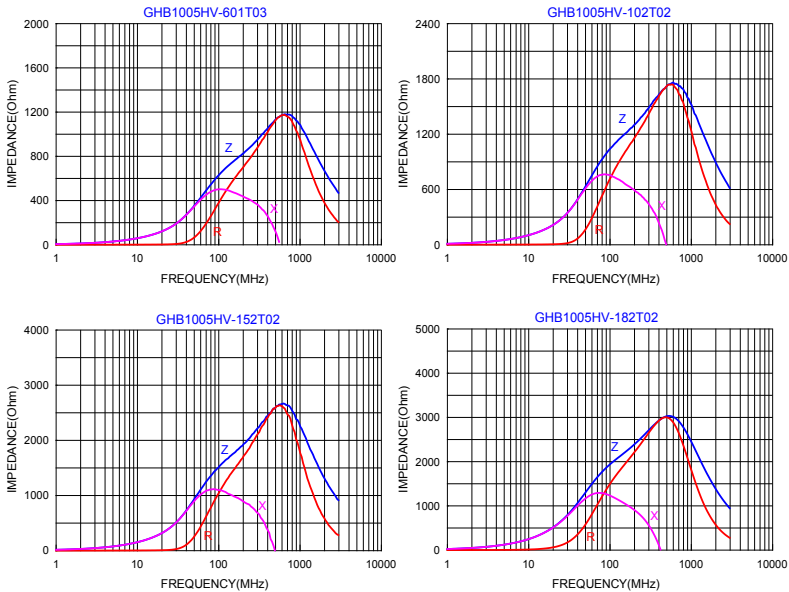



■ Dimensions

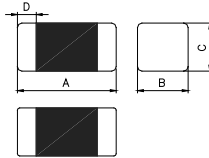

Chip Size	
A	1.60±0.15
B	0.80±0.15
C	0.80±0.15
D	0.30±0.20

Units: mm

■ Specifications

Part Number	Impedance (Ω)	Test Frequency (MHz)	DC Resistance (Ω) max.	Rated Current (mA) max.
FCM1608KV-300T07	30±25%	100	0.20	700
FCM1608KV-600T07	60±25%	100	0.20	700
FCM1608KV-121T06	120±25%	100	0.25	600
FCM1608KV-151T06	150±25%	100	0.25	600
FCM1608KV-221T05	220±25%	100	0.30	550
FCM1608KV-301T05	300±25%	100	0.35	500
FCM1608KV-471T03	470±25%	100	0.45	350
FCM1608KV-601T03	600±25%	100	0.50	350
FCM1608KV-102T02	1000±25%	100	0.70	200
FCM1608HV-152T02	1500±25%	100	1.00	200
FCM1608HV-202T01	2000±25%	100	1.20	150
FCM1608CV-100T07	10±25%	100	0.20	700
FCM1608CV-300T06	30±25%	100	0.25	600
FCM1608CV-600T06	60±25%	100	0.30	600
FCM1608CV-121T03	120±25%	100	0.40	300
FCM1608CV-151T03	150±25%	100	0.40	300
FCM1608CV-221T02	220±25%	100	0.60	250
FCM1608CV-301T02	300±25%	100	0.80	200
FCM1608CV-471T02	470±25%	100	0.85	200
FCM1608CV-601T01	600±25%	100	1.20	150
FCM1608CV-102T00	1000±25%	100	1.50	80

■ Impedance-Frequency Characteristics (Typical)

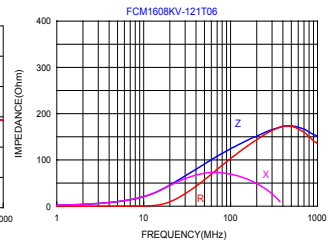
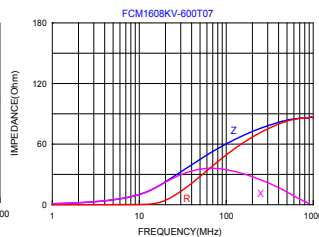
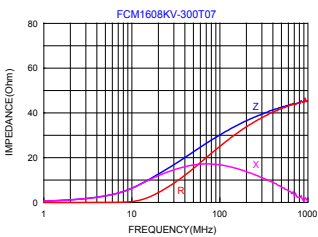



■ Impedance-Frequency Characteristics (Typical)

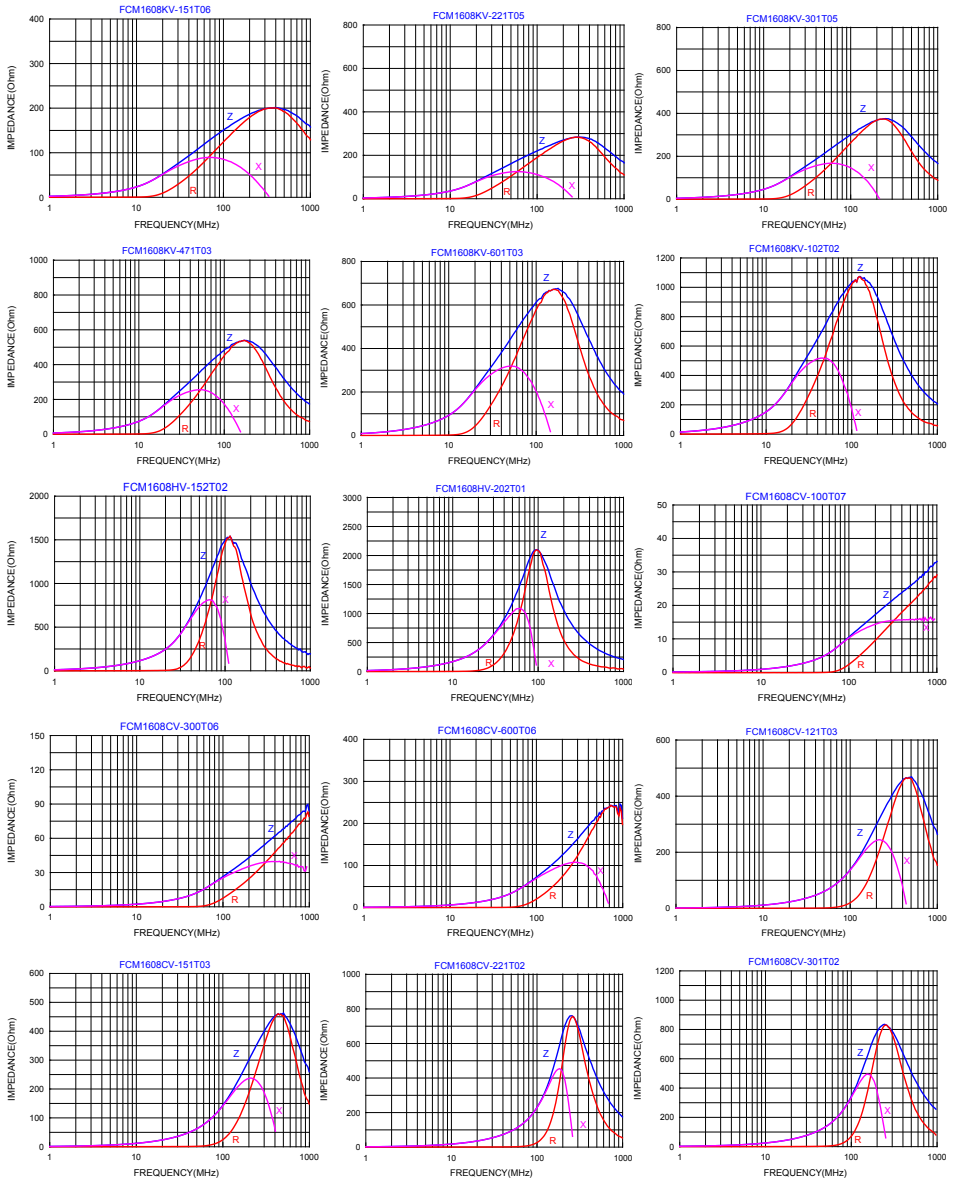



■ Impedance-Frequency Characteristics (Typical)

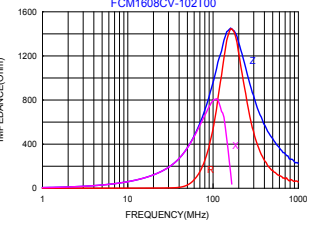
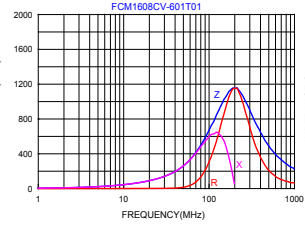
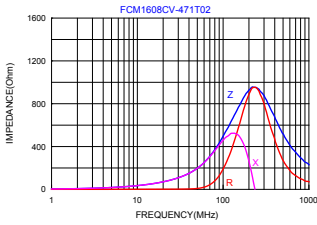



■ Dimensions

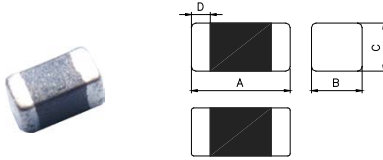

Chip Size	
A	1.60±0.15
B	0.80±0.15
C	0.80±0.15 0.60±0.15
D	0.30±0.20

Units: mm

■ Specifications

Part Number	Impedance (Ω)	Test Frequency (MHz)	DC Resistance (Ω) max.	Rated Current (mA) max.	Height (mm) max.
HCB1606ZV-260T60	26±25%	100	0.01	6000	0.75
HCB1608KV-300T30	30±25%	100	0.04	3000	0.95
HCB1608KV-800T30	80±25%	100	0.04	3000	0.95
HCB1608KV-121T20	120±25%	100	0.10	2000	0.95
HCB1608KV-151T20	150±25%	100	0.10	2000	0.95
HCB1608KV-221T20	220±25%	100	0.10	2000	0.95
HCB1608KV-301T10	300±25%	100	0.20	1000	0.95
HCB1608KV-471T10	470±25%	100	0.20	1000	0.95
HCB1608KV-601T10	600±25%	100	0.20	1000	0.95

■ Impedance-Frequency Characteristics (Typical)

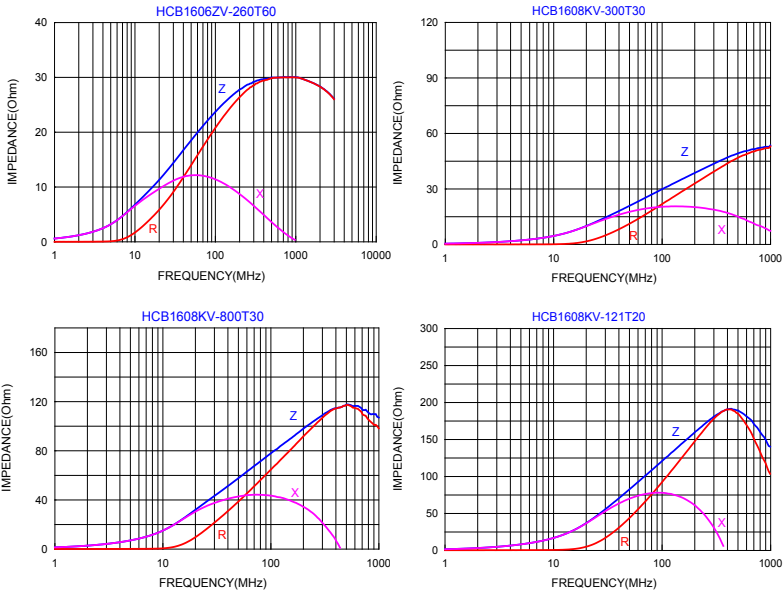



■ Impedance-Frequency Characteristics (Typical)

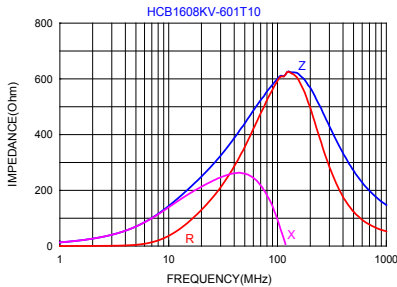
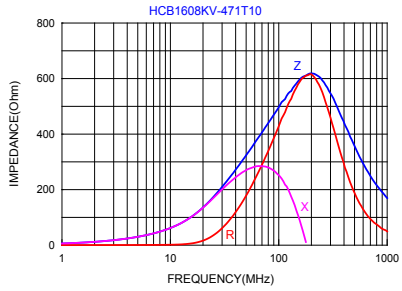
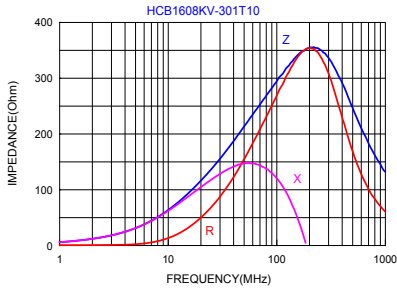
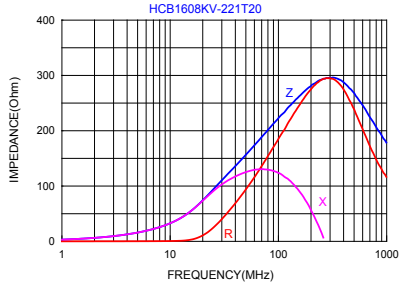
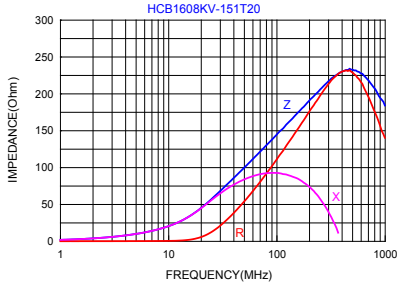



■ Dimensions

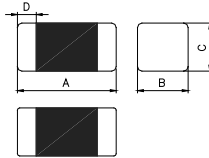

Chip Size	
A	2.00±0.20
B	1.25±0.20
C	0.85±0.20 1.25±0.20
D	0.50±0.30

Units: mm

■ Specifications

Part Number	Thickness C size (mm)	Impedance (Ω)	Test Frequency (MHz)	DC Resistance (Ω) max.	Rated Current (mA) max.
FCM2012KV-110T09	0.85±0.2	11±25%	100	0.10	900
FCM2012KV-170T06	0.85±0.2	17±25%	100	0.10	600
FCM2012KV-260T06	0.85±0.2	26±25%	100	0.10	600
FCM2012KV-300T06	0.85±0.2	30±25%	100	0.10	600
FCM2012KV-400T06	0.85±0.2	40±25%	100	0.10	600
FCM2012KV-600T09	0.85±0.2	60±25%	100	0.10	900
FCM2012KV-121T08	0.85±0.2	120±25%	100	0.20	800
FCM2012KV-151T08	0.85±0.2	150±25%	100	0.20	800
FCM2012KV-221T07	0.85±0.2	220±25%	100	0.30	750
FCM2012KV-301T07	0.85±0.2	300±25%	100	0.30	700
FCM2012KV-471T07	0.85±0.2	470±25%	100	0.35	700
FCM2012KV-601T05	0.85±0.2	600±25%	100	0.40	500
FCM2012KV-102T04	0.85±0.2	1000±25%	100	0.45	400
FCM2012HV-102T04	0.85±0.2	1000±25%	100	0.45	400
FCM2012HV-152T03	0.85±0.2	1500±25%	100	0.50	350
FCM2012HV-202T02	0.85±0.2	2000±25%	100	0.60	250
FCM2012NV-070T06	0.85±0.2	7±25%	100	0.10	600
FCM2012CV-300T07	0.85±0.2	30±25%	100	0.20	700
FCM2012CV-600T07	0.85±0.2	60±25%	100	0.20	700
FCM2012CV-121T06	0.85±0.2	120±25%	100	0.25	600
FCM2012CV-151T06	0.85±0.2	150±25%	100	0.25	600
FCM2012CV-221T04	0.85±0.2	220±25%	100	0.30	400
FCM2012CV-301T04	0.85±0.2	300±25%	100	0.35	400
FCM2012CV-471T04	1.25±0.2	470±25%	100	0.40	400
FCM2012CV-601T03	1.25±0.2	600±25%	100	0.45	300
FCM2012CV-102T02	1.25±0.2	1000±25%	100	0.50	200



■ Impedance-Frequency Characteristics (Typical)

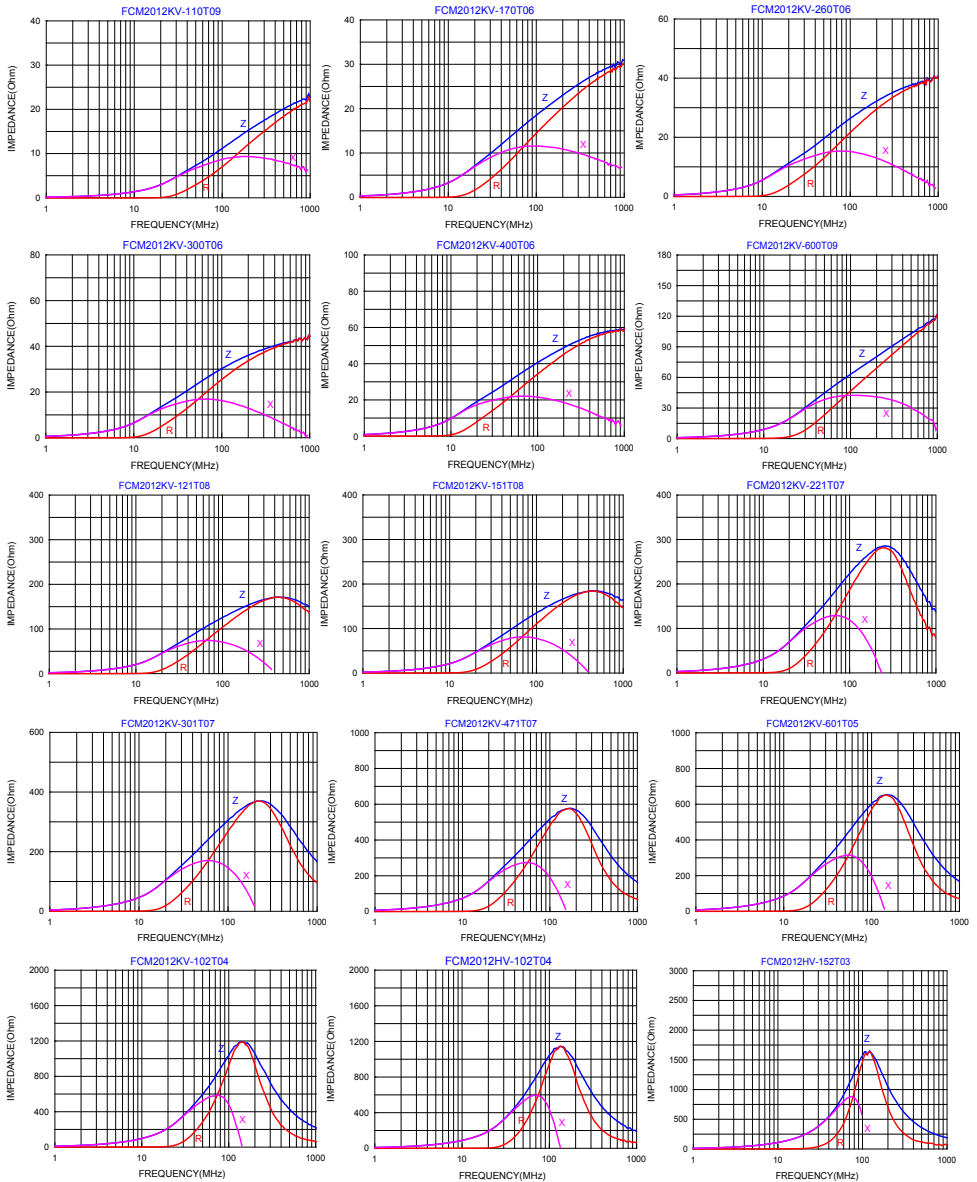



■ Impedance-Frequency Characteristics (Typical)

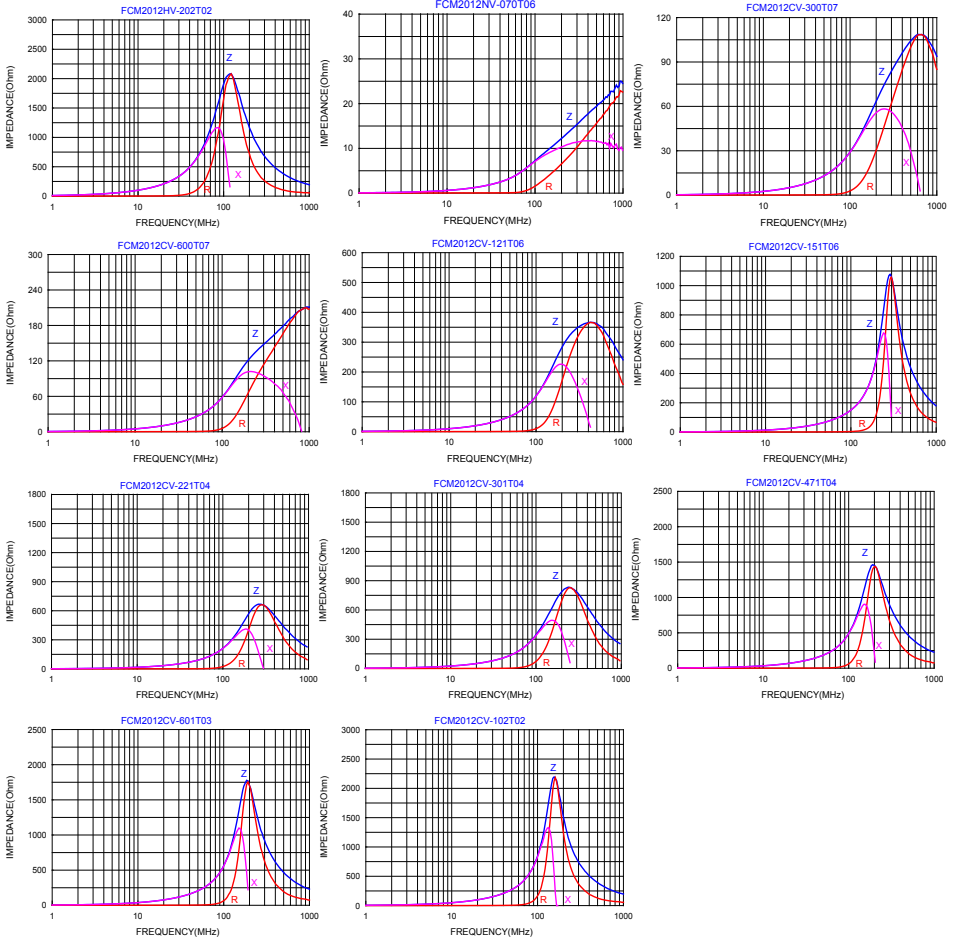



■ Dimensions

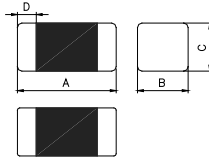

Chip Size	
A	2.00±0.20
B	1.25±0.20
C	0.85±0.20
D	0.50±0.30

Units: mm

■ Specifications

Part Number	Impedance (Ω)	Test Frequency (MHz)	DC Resistance (Ω) max.	Rated Current (mA) max.
HCB2012KV-300T30	30±25%	100	0.04	3000
HCB2012KV-800T30	80±25%	100	0.04	3000
HCB2012KV-121T20	120±25%	100	0.10	2000
HCB2012KV-151T20	150±25%	100	0.10	2000
HCB2012KV-221T20	220±25%	100	0.10	2000
HCB2012KV-301T10	300±25%	100	0.20	1000
HCB2012KV-471T10	470±25%	100	0.20	1000
HCB2012KV-601T10	600±25%	100	0.20	1000

■ Impedance-Frequency Characteristics (Typical)

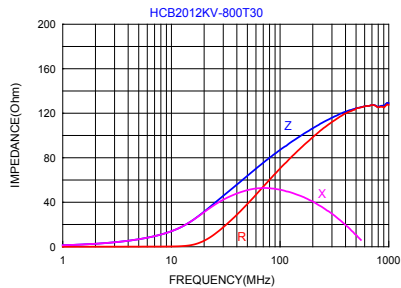
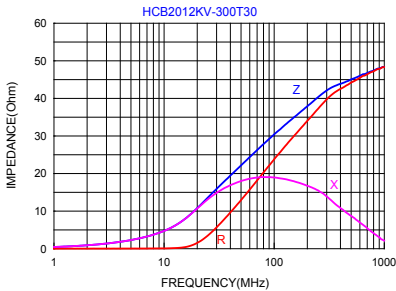



■ Impedance-Frequency Characteristics (Typical)

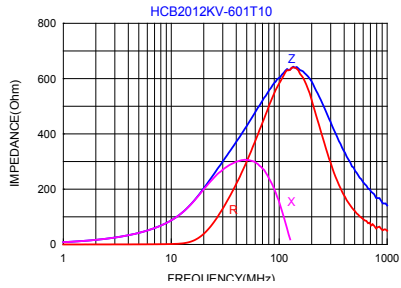
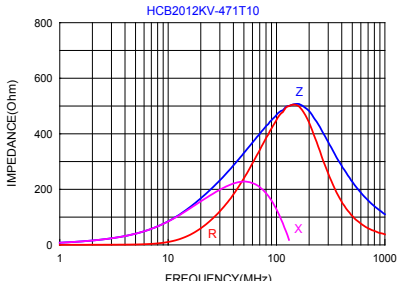
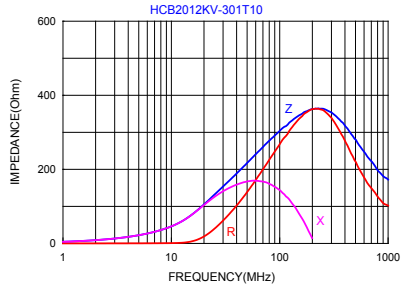
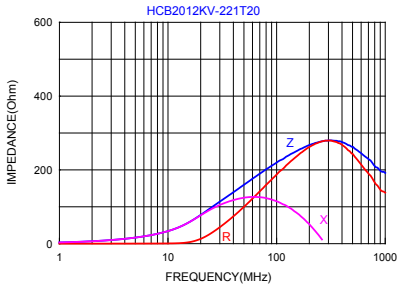
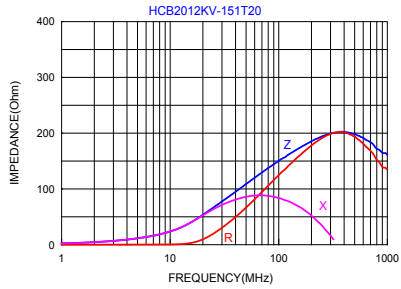
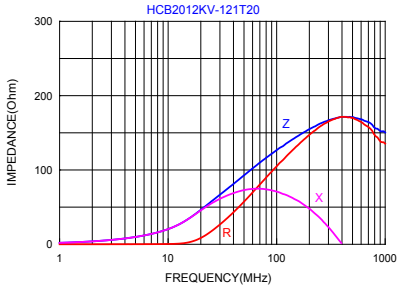



■ Dimensions

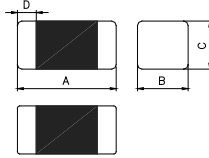

Chip Size	
A	3.20±0.20
B	1.60±0.20
C	1.10±0.20
D	0.50±0.30

Units: mm

■ Specifications

Part Number	Impedance (Ω)	Test Frequency (MHz)	DC Resistance (Ω) max.	Rated Current (mA) max.
FCM3216KV-260T05	26±25%	100	0.20	500
FCM3216KV-310T05	31±25%	100	0.20	500
FCM3216KV-420T05	42±25%	100	0.20	500
FCM3216KV-500T05	50±25%	100	0.20	500
FCM3216KV-700T05	70±25%	100	0.20	500
FCM3216KV-900T05	90±25%	100	0.20	500
FCM3216KV-121T09	120±25%	100	0.15	900
FCM3216KV-151T09	150±25%	100	0.15	900
FCM3216KV-201T06	200±25%	100	0.35	600
FCM3216KV-221T07	220±25%	100	0.35	700
FCM3216KV-301T07	300±25%	100	0.35	700
FCM3216KV-471T04	470±25%	100	0.35	400
FCM3216KV-601T04	600±25%	100	0.40	400

■ Impedance-Frequency Characteristics (Typical)

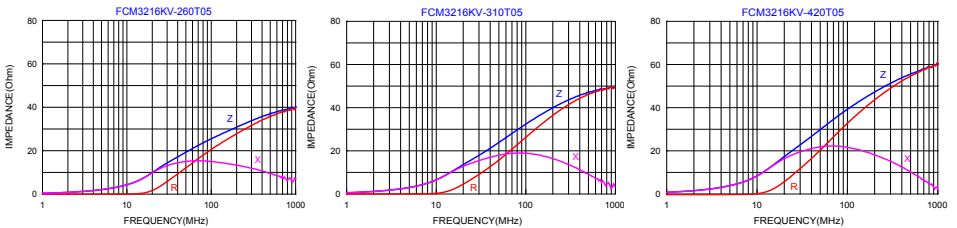



■ Impedance-Frequency Characteristics (Typical)

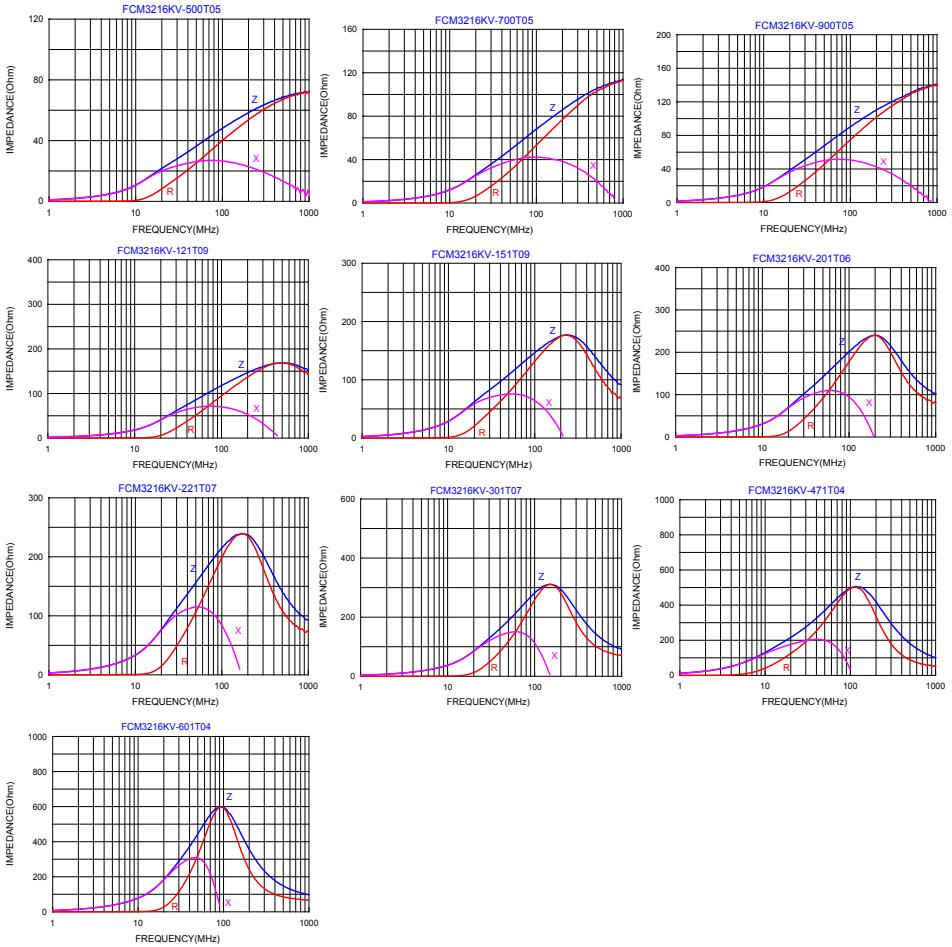



■ Dimensions

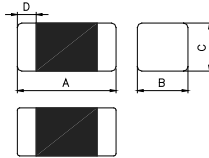

Chip Size	
A	3.20±0.20
B	1.60±0.20
C	1.10±0.20
D	0.50±0.30

Units: mm

■ Specifications

Part Number	Impedance (Ω)	Test Frequency (MHz)	DC Resistance (Ω) max.	Rated Current (mA) max.
HCB3216KV-300T30	30±25%	100	0.04	3000
HCB3216KV-500T30	50±25%	100	0.04	3000
HCB3216KV-800T30	80±25%	100	0.04	3000
HCB3216KV-121T20	120±25%	100	0.10	2000
HCB3216KV-151T20	150±25%	100	0.10	2000
HCB3216KV-301T10	300±25%	100	0.20	1000
HCB3216KV-471T10	470±25%	100	0.20	1000
HCB3216KV-501T30	500±25%	100	0.04	3000
HCB3216KV-601T20	600±25%	100	0.10	2000

■ Impedance-Frequency Characteristics (Typical)

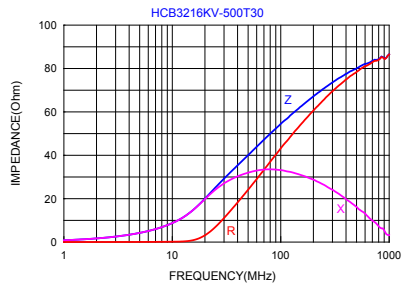
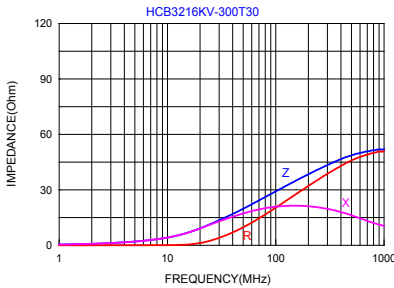



■ Impedance-Frequency Characteristics (Typical)

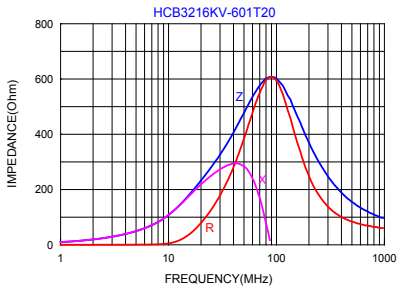
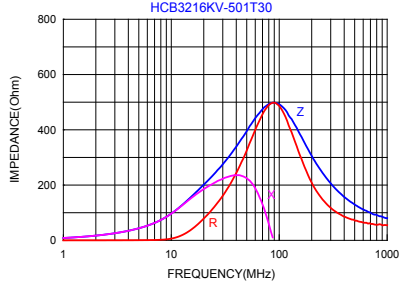
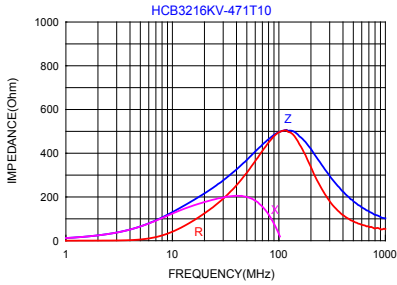
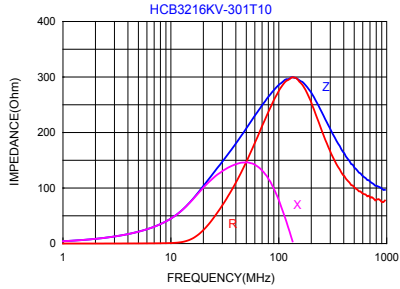
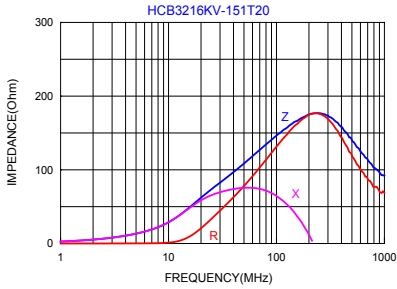
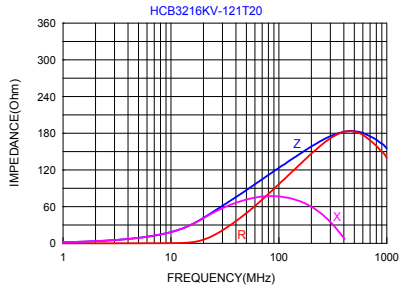
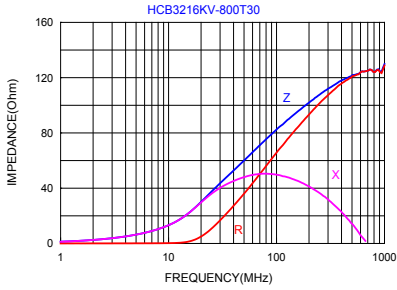



■ Dimensions

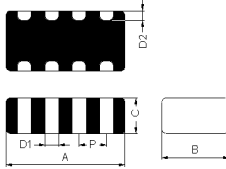

Chip Size	
A	3.20±0.20
B	1.60±0.20
C	0.90±0.20
D1	0.40±0.15
D2	0.30±0.10
P	0.80±0.10

Units: mm

■ Specifications

Part Number	Impedance (Ω)	Test Frequency (MHz)	DC Resistance (Ω) max.	Rated Current (mA) max.
FCA3216KV4-300T05	30±25%	100	0.20	500
FCA3216KV4-600T04	60±25%	100	0.25	400
FCA3216KV4-121T03	120±25%	100	0.30	350
FCA3216KV4-301T02	300±25%	100	0.40	250
FCA3216KV4-601T02	600±25%	100	0.50	200
FCA3216KV4-102T01	1000±25%	100	0.75	150
FCA3216MV4-300T04	30±25%	100	0.25	400
FCA3216MV4-600T03	60±25%	100	0.30	300
FCA3216MV4-121T02	120±25%	100	0.40	250
FCA3216MV4-301T02	300±25%	100	0.50	200

■ Impedance-Frequency Characteristics (Typical)

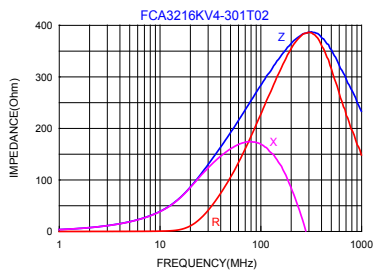
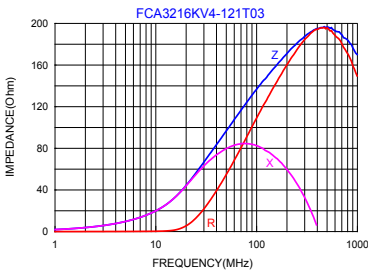
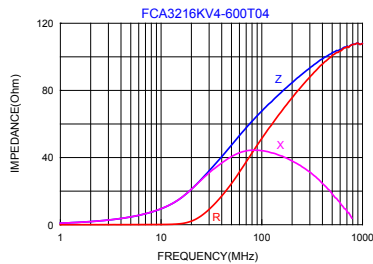
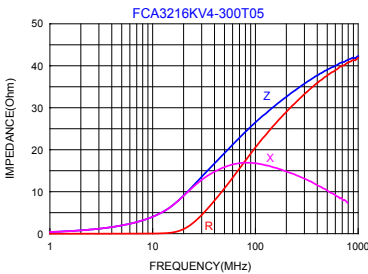



■ Impedance-Frequency Characteristics (Typical)

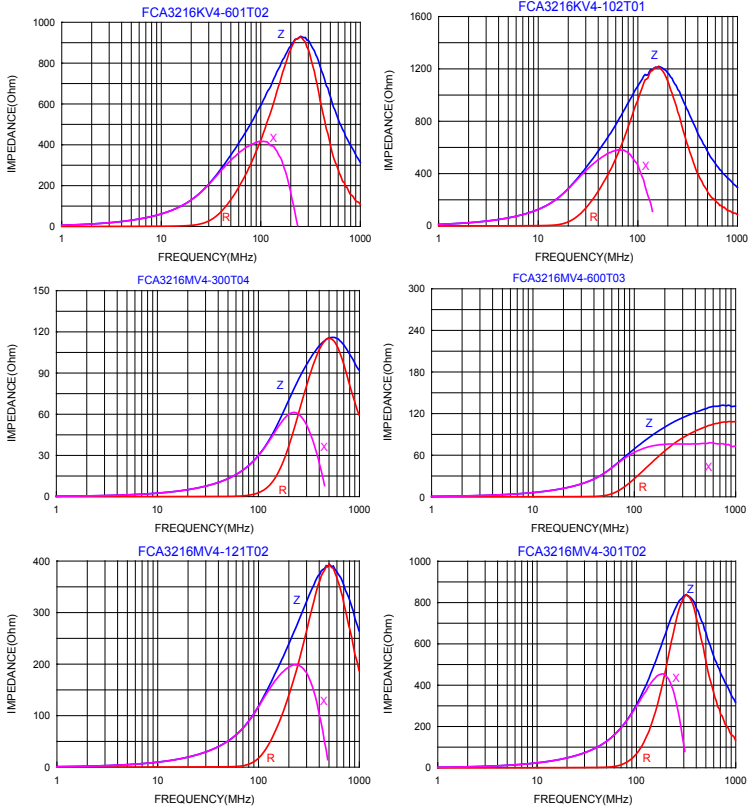



■ Dimensions

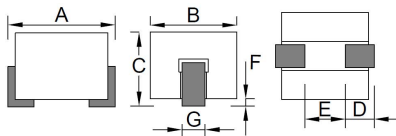

BPH 323023 PRODUCT SIZE						
A(mm)	B(mm)	C(mm)	D(mm)	E(mm)	F(mm)	G(mm)
3.08 +0.10/-0.15	2.9 ±0.10	2.20 ±0.10	0.8 ±0.20	1.2 Min.	0.00~0.11	0.85 ±0.10

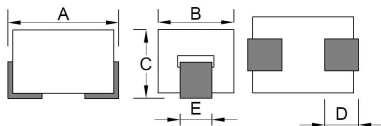

BPH403025 PRODUCT SIZE				
A(mm)	B(mm)	C(mm)	D(mm)	E(mm)
4.30~5.10	3.1 ±0.15	2.70~3.1	1.35±0.20	1.35±0.15

BPH853225 PRODUCT SIZE				
A(mm)	B(mm)	C(mm)	D(mm)	E(mm)
9.0 ±0.40	3.1 ±0.15	2.8 ±0.25	1.50±0.50	1.27±0.20

■ Specifications

Part Number	Impedance ohm at 25 MHz	Impedance ohm at 100 MHz	DC Resistance (mΩ) max.	Rated Current (A) max. ΔT= 40°C
BPH 323023W5V-390T	23±25%	39±25%	0.6	15
BPH 403025W4V-470T	22 min	47±20%	0.6	10
BPH 853225W4V-750T	45 min	75 min	1.0	13



■ Dimensions

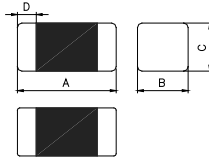

Chip Size	
A	4.50±0.20
B	1.60±0.20
C	1.60±0.20
D	0.50±0.30

Units: mm

■ Specifications

Part Number	Impedance (Ω)	Test Frequency (MHz)	DC Resistance (Ω) max.	Rated Current (mA) max.
HCB4516KV-600T60	60±25%	100	0.01	6000
HCB4516KV-800T30	80±25%	100	0.04	3000

■ Impedance-Frequency Characteristics (Typical)

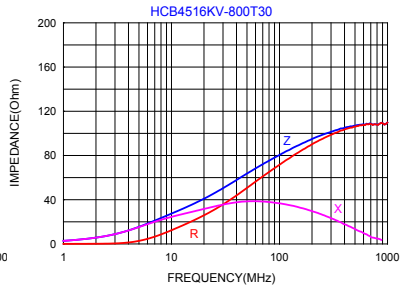
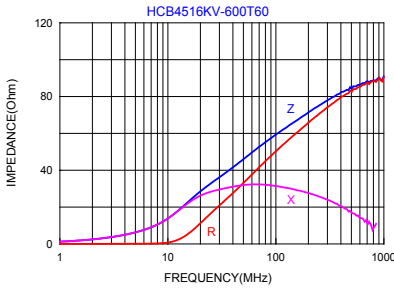



■ Dimensions

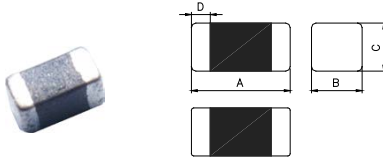

Chip Size	
A	4.50±0.20
B	3.20±0.20
C	1.50±0.20
D	0.50±0.30

Units: mm

■ Specifications

Part Number	Impedance (Ω)	Test Frequency (MHz)	DC Resistance (Ω) max.	Rated Current (mA) max.
HCB4532KV-800T60	80±25%	100	0.01	6000
HCB4532KV-121T50	120±25%	100	0.02	5000
HCB4532KV-131T30	130±25%	100	0.04	3000
HCB4532KV-151T50	150±25%	100	0.02	5000
HCB4532MV-681T40	680±25%	100	0.03	4000
HCB4532MV-132T30	1300±25%	100	0.06	3000

■ Impedance-Frequency Characteristics (Typical)

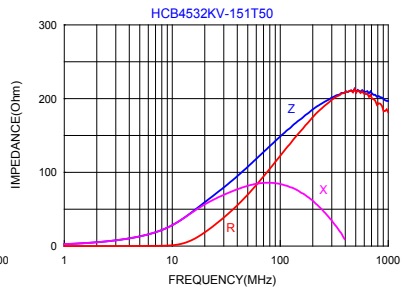
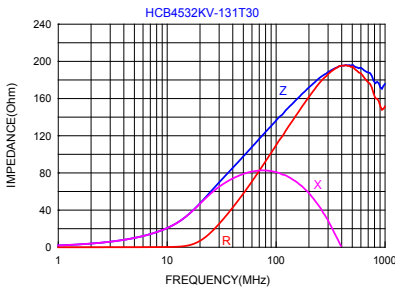
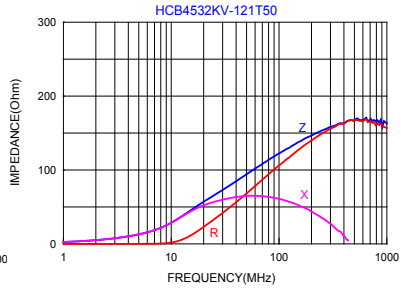
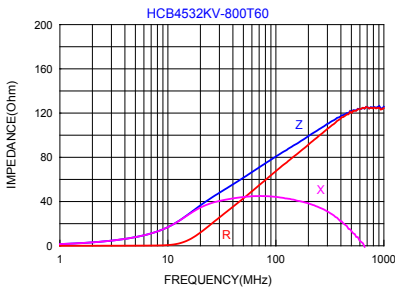



■ Impedance-Frequency Characteristics (Typical)

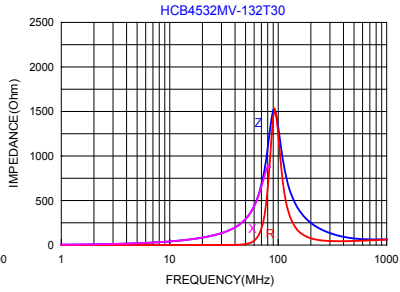
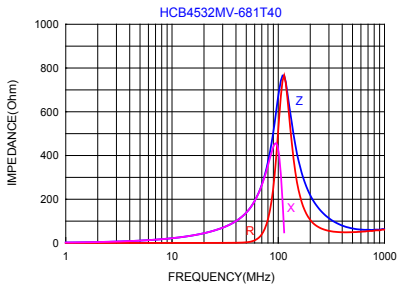



■ Dimensions

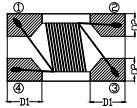
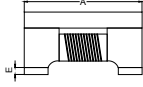

Chip Size	
A	1.20±0.20
B	1.00±0.20
C	0.90 max.
D1	0.35±0.10
D2	0.35±0.10
E	0.03 min.

Units: mm

■ Specifications

Part Number	Common mode Impedance (Ω)	Test Frequency (MHz)	DC Resistance (Ω) max.	Rated Current (mA)	Rated Volt. (Vdc)	Withstand Volt. (Vdc)	IR (Ω) min.
HSF1210F2SV-500T02	50±25%	100	0.30	250	50	125	10M
HSF1210F2SV-670T02	67±25%	100	0.30	250	50	125	10M
HSF1210F2SV-900T02	90±25%	100	0.40	200	50	125	10M

■ Impedance-Frequency Characteristics (Typical)

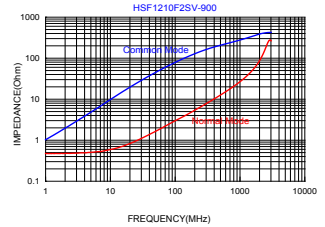
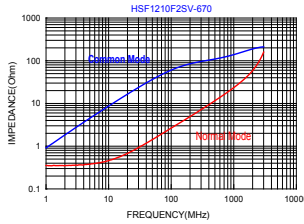
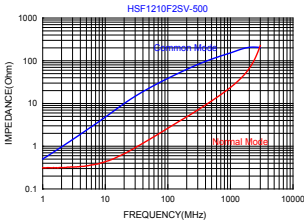

■ Insertion Loss Test (Typical)





■ Dimensions

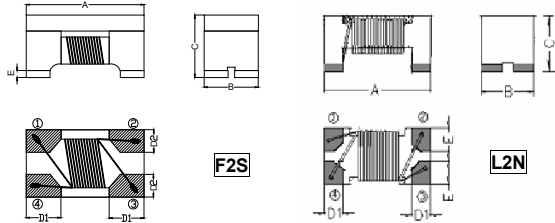

Series	A(mm)	B(mm)	C(mm)	D1(mm)	D2(mm)	E(mm)
F2S	2.0±0.2	1.2±0.2	1.2±0.2	0.50±0.1	0.51±0.1	0.15±0.1
L2N	2.0±0.2	1.2±0.2	0.9±0.1	0.50±0.1	-	0.51±0.1

Unit: mm

■ Specifications

Part Number	Common mode Impedance (Ω)	Test Frequency (MHz)	DC Resistance (Ω) max.	Rated Current (mA)max.	Rated Volt. (Vdc)max.	Withstand Volt. (Vdc) max.	IR (Ω) min.
WCM2012L2NV -670T04	67±25%	100	0.35	400	50	125	10M
WCM2012L2NV-900T04	90±25%	100	0.35	400	50	125	10M
WCM2012L2NV-121T03	120±25%	100	0.45	300	50	125	10M
WCM2012L2NV-181T03	180±25%	100	0.50	300	50	125	10M
WCM2012F2SV-670T04	67±25%	100	0.25	400	50	125	10M
WCM2012F2SV-900T04	90±25%	100	0.30	400	50	125	10M
WCM2012F2SV-121T04	120±25%	100	0.30	400	50	125	10M
WCM2012F2SV-161T03	160±25%	100	0.35	350	50	125	10M
WCM2012F2SV-181T03	180±25%	100	0.35	350	50	125	10M
WCM2012F2SV-201T03	200±25%	100	0.40	300	50	125	10M
WCM2012F2SV-221T03	220±25%	100	0.40	300	50	125	10M
WCM2012F2SV-261T03	260±25%	100	0.40	300	50	125	10M
WCM2012F2SV-361T03	360±25%	100	0.50	300	50	125	10M
WCM2012F2SV-601T03	600±25%	100	0.88	300	50	125	10M
WCM2012F2SV-102T01	1000±25%	100	1.30	100	50	125	10M



■ Impedance-Frequency Characteristics (Typical)

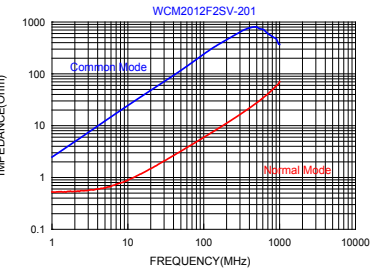
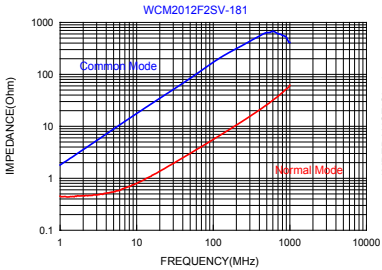
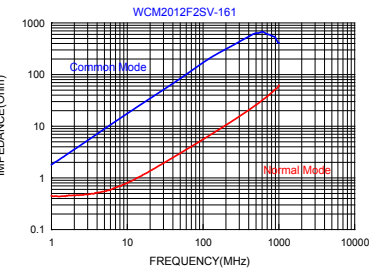
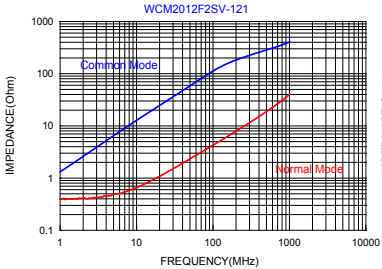
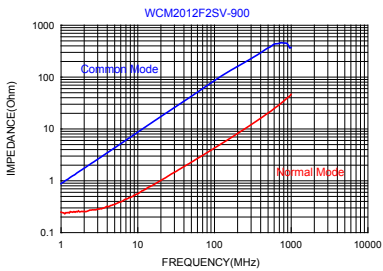
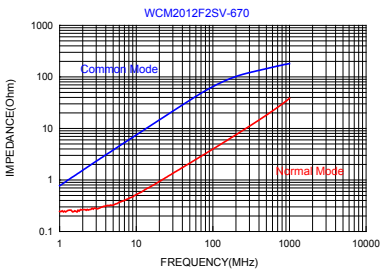
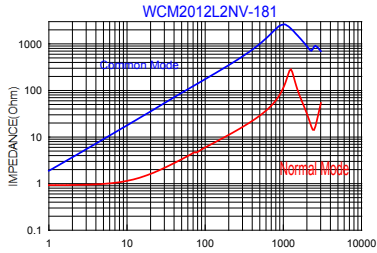
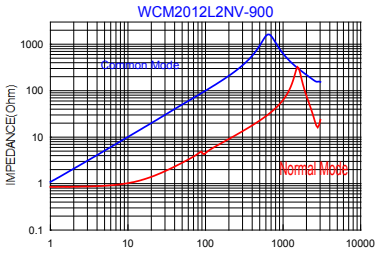



■ Impedance-Frequency Characteristics (Typical)

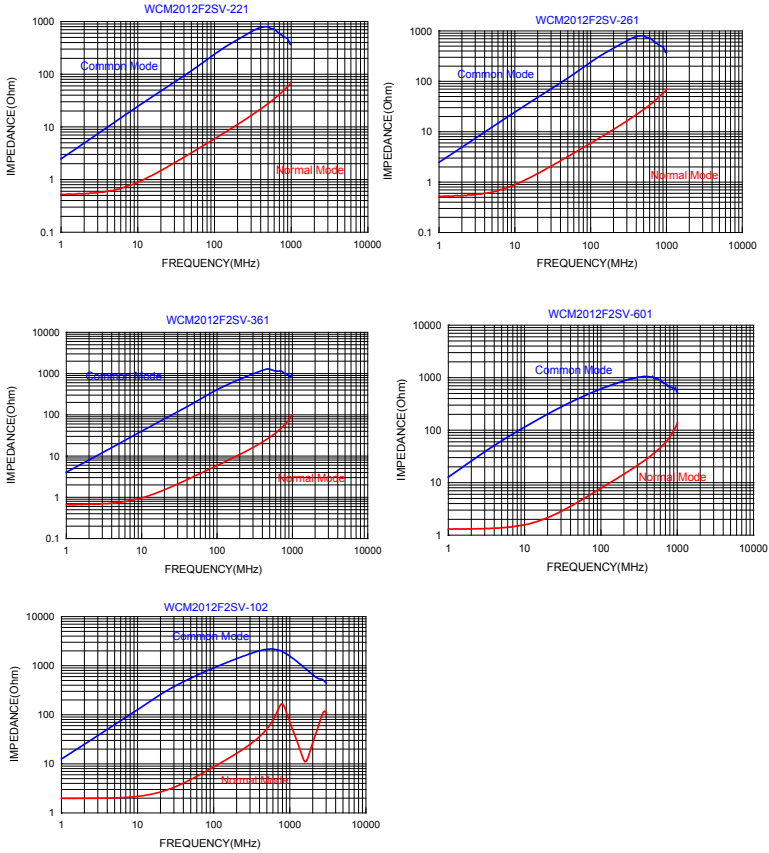



■ Dimensions

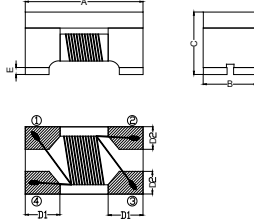

Chip Size	
A	2.00±0.20
B	1.20±0.20
C	1.20±0.20
D1	0.50±0.10
D2	0.51±0.10
E	0.15±0.10

Units: mm

■ Specifications

Part Number	Common mode Impedance (Ω)	Test Frequency (MHz)	DC Resistance (Ω) max.	Rated Current (mA)max.	Rated Volt. (Vdc)max.	Withstand Volt. (Vdc) max.	IR (Ω) min.
HDMI2012F2SV-670T04	67 typ. 50 min.	100	0.30	400	50	125	10M
HDMI2012F2SV-900T04	90 typ. 65 min.	100	0.30	400	50	125	10M

■ Impedance-Frequency Characteristics (Typical)

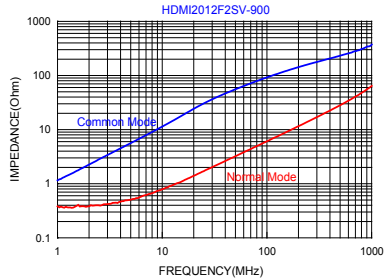
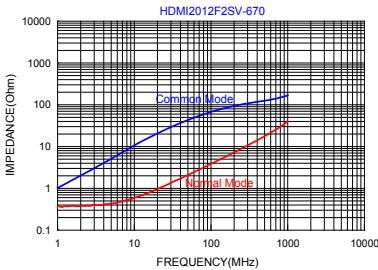

■ TDR Test and Eye Diagram Graphic Test

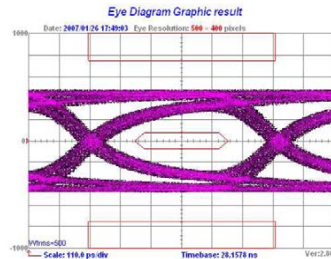
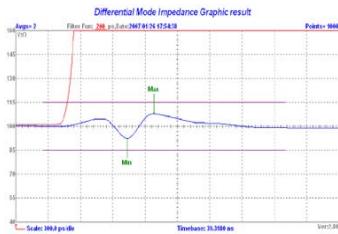



■ Dimensions

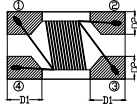
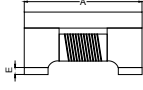

Chip Size	
A	2.00±0.20
B	1.20±0.20
C	1.20±0.20
D1	0.50±0.10
D2	0.50±0.10
E	0.15±0.10

Units: mm

■ Specifications

Part Number	Common mode Impedance (Ω)	Test Frequency (MHz)	DC Resistance (Ω) max.	Rated Current (mA)	Rated Volt. (Vdc)	Withstand Volt. (Vdc)	IR (Ω) min.
HSF2012F2SV-500T04	50±25%	100	0.25	400	50	125	10M
HSF2012F2SV-670T04	67±25%	100	0.30	400	50	125	10M
HSF2012F2SV-900T04	90±25%	100	0.30	400	50	125	10M

■ Impedance-Frequency Characteristics (Typical)

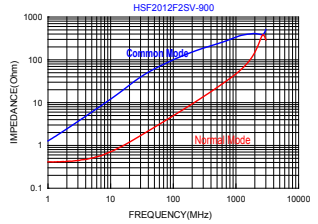
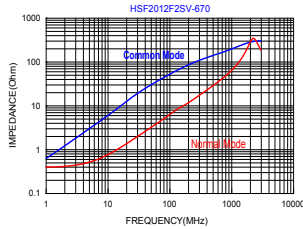
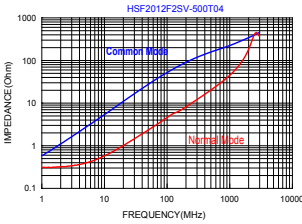

■ Insertion Loss Test (Typical)





■ Dimensions

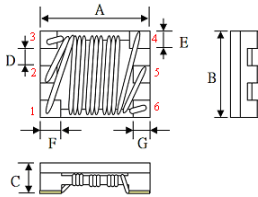

Chip Size	
A	2.50±0.20
B	2.00±0.20
C	1.30 max.
D	0.20±0.10
E	0.55±0.10
F	0.45±0.10
G	0.55±0.10

Units: mm

■ Specifications

Part Number	Common mode Impedance (Ω)	Test Frequency (MHz)	DC Resistance (Ω) max.	Rated Current (mA)max.	Rated Volt.(Vdc) max.	Withstand Volt.(Vdc) max.	IR (Ω) min.
TCM252013F3SFV-670T05	67±25%	100	0.2	500	50	125	10M

■ Impedance-Frequency Characteristics (Typical)

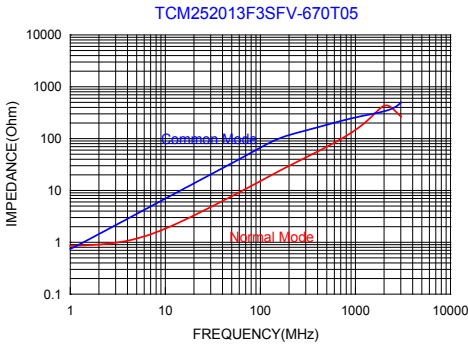

WCM 3216 Series (1206 inch -40~+125)



■ Dimensions

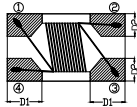
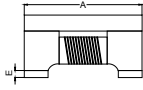

Chip Size	
A	3.20±0.20
B	1.60±0.20
C	2.00±0.20
D1	0.50±0.10
D2	0.50±0.10
E	0.15±0.10

Units: mm

■ Specifications

Part Number	Common mode Impedance (Ω)	Test Frequency (MHz)	DC Resistance (Ω) max.	Rated Current (mA)max.	Rated Volt. (Vdc)max.	Withstand Volt. (Vdc) max.	IR (Ω) min.
WCM3216F2SV-900T04	90±25%	100	0.30	400	50	125	10M
WCM3216F2SV-121T03	120±25%	100	0.30	350	50	125	10M
WCM3216F2SV-161T03	160±25%	100	0.40	350	50	125	10M
WCM3216F2SV-221T03	220±25%	100	0.45	300	50	125	10M
WCM3216F2SV-261T03	260±25%	100	0.50	300	50	125	10M
WCM3216F2SV-361T03	360±25%	100	0.60	300	50	125	10M
WCM3216F2SV-601T03	600±25%	100	0.80	300	50	125	10M
WCM3216F2SV-102T02	1000±25%	100	1.00	200	50	125	10M
WCM3216F2SV-222T02	2200±25%	100	1.20	200	50	125	10M

■ Impedance-Frequency Characteristics (Typical)

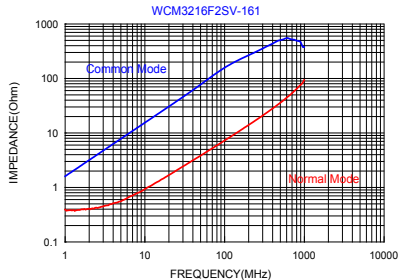
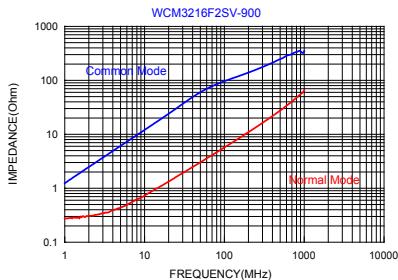



■ Impedance-Frequency Characteristics (Typical)

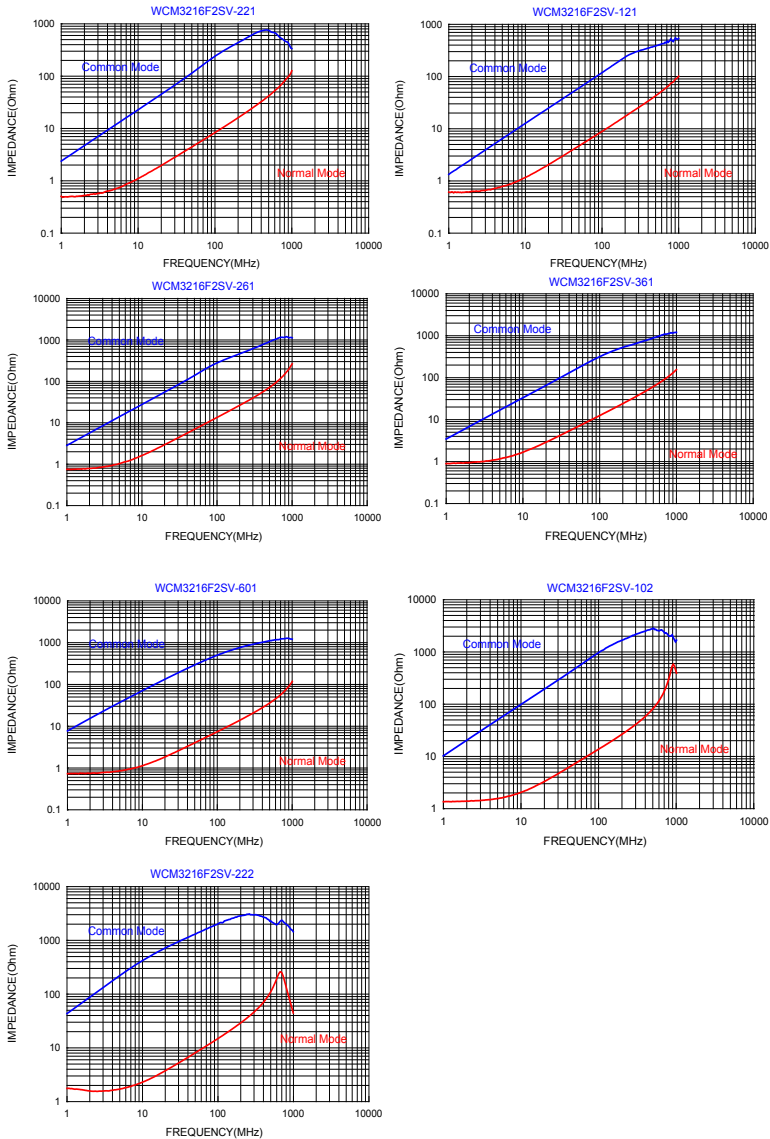

DCM 3216 Series (1206 inch -40~+85)

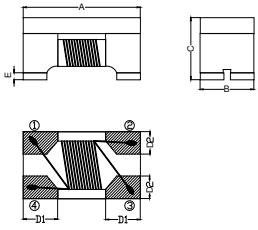

■ Dimensions

Dimensions	
A	3.40±0.20
B	1.60±0.20
C	2.00±0.20
D1	0.64±0.10
D2	0.66±0.10

Units: mm

■ Specifications

Part Number	Inductance (uH) [100kHz/0.1V] Min.	DC Resistance (Ω)Max.	Rated Current (mA)	Rated Volt. (Vdc)	Withstand Volt. (Vdc) max.	IR (Ω) min.
DCM321620F2SV-600T02	60	1.7	200	50	125	10M

■ Impedance-Frequency Characteristics (Typical)

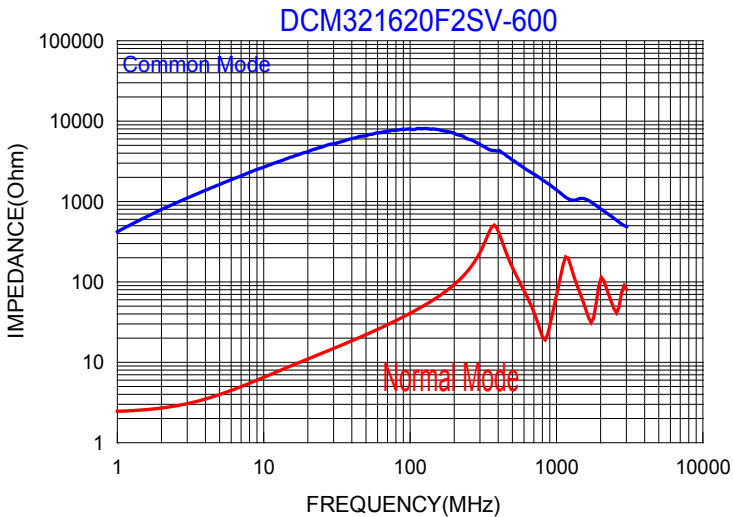



■ Dimensions

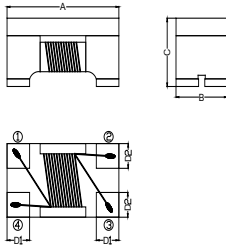

Chip Size	
A	3.20±0.20
B	2.50±0.20
C	2.20±0.20
D1	0.80±0.10
D2	0.90±0.10

Units: mm

■ Specifications

Part Number	Common mode Impedance (Ω)	Test Frequency (MHz)	DC Resistance (Ω) max.	Rated Current (mA)max.	Rated Volt. (Vdc)max.	Withstand Volt. (Vdc) max.	IR (Ω) min.
WCM3225F2SV-900T10	90±25%	100	0.050	1000	50	125	10M
WCM3225F2SV-601T10	600±25%	100	0.20	1000	50	125	10M
WCM3225F2SV-102T04	1000±25%	100	0.30	400	50	125	10M

■ Impedance-Frequency Characteristics (Typical)

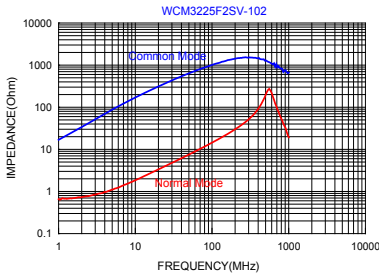
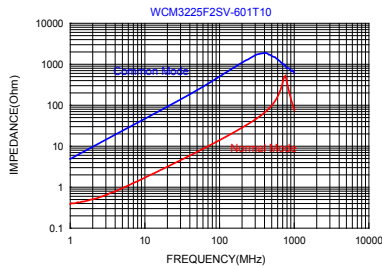
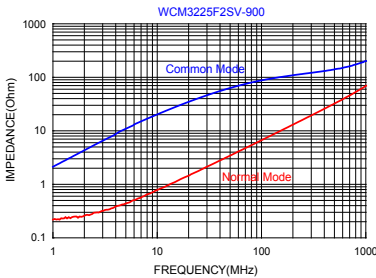



■ Dimensions

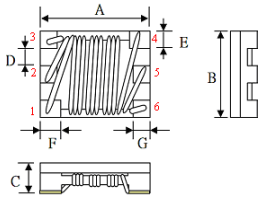

Chip Size	
A	3.20±0.20
B	2.50±0.20
C	1.30 max.
D	0.29±0.10
E	0.64±0.10
F	0.60±0.10
G	0.50±0.10

Units: mm

■ Specifications

Part Number	Common mode Impedance (Ω)	Test Frequency (MHz)	DC Resistance (Ω) max.	Rated Current (mA)max.	Rated Volt.(Vdc) max.	Withstand Volt. (Vdc) max.	IR (Ω) min.
TCM322512F3SFV-161T02	160±25%	100	0.21	200	50	125	10M
TCM322512F3SFV-501T05	500±25%	100	0.43	500	50	125	10M

■ Impedance-Frequency Characteristics (Typical)

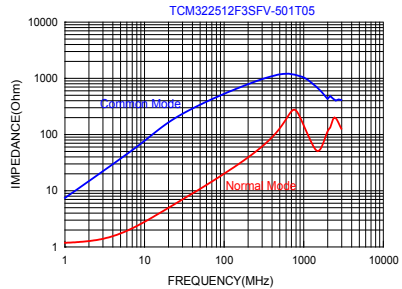
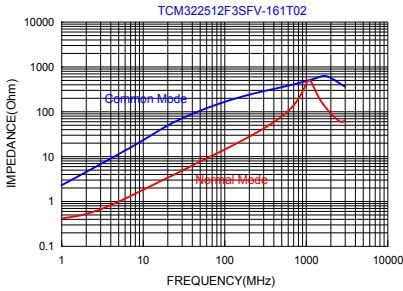

ACM 3225 Series (1210 inch)

(DV:-55~+150,WV:-40~+125)



■ Dimensions

Dimensions	
A	3.20±0.20
B	2.50±0.20
C	2.50 MAX
D1	0.70±0.10
D2	0.90±0.10
D3	0.60±0.10

Units: mm

■ Specifications

Part Number	Inductance (μ H)+50/-30% [100kHz/0.1V]	DC Resistance (Ω) max.	Rated Current (mA) max.	Rated voltage (Vdc) max.	IR (M Ω) min.
ACM3225F2DV-110T03	11	0.4	300	80	10
ACM3225F2DV-220T02	22	0.5	250	80	10
ACM3225F2DV-510T01	51	0.7	150	80	10
ACM3225F2DV-101T01	100	1.5	100	80	10
ACM3225F2WV-101T01	100	1.5	150	80	10
ACM3225F2WV-201T007	200 (+60%/-20%)	5.5	70	80	10

■ Impedance-Frequency Characteristics (Typical)

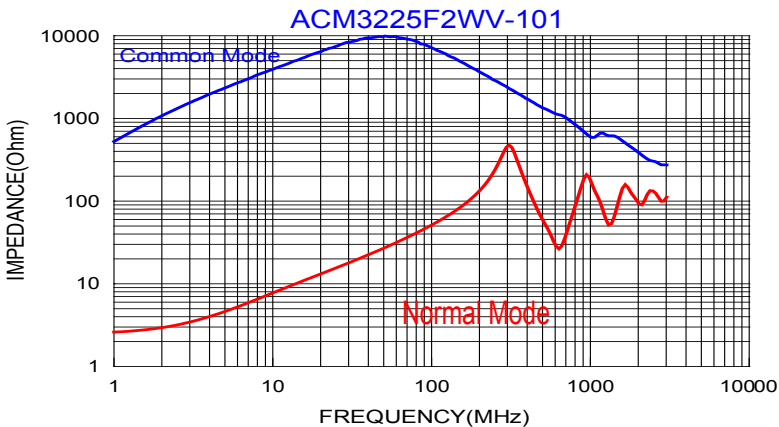

DCM 3532 Series (1412 inch -40~+85)

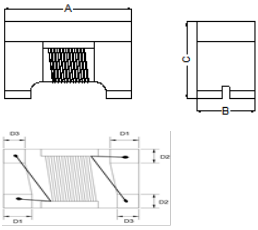

■ Dimensions

Dimensions	
A	3.50±0.20
B	3.20±0.20
C	2.30±0.20
D1	0.63±0.10
D2	1.18±0.10

Units: mm

■ Specifications

Part Number	Inductance (uH) [100kHz/0.1V] Min.	DC Resistance (Ω)Max.	Rated Current (mA)	Rated Volt. (Vdc)	Withstand Volt. (Vdc) max.	IR (Ω) min.
DCM3532F2SV-750T03	75	0.8	300	50	125	10M

■ Impedance-Frequency Characteristics (Typical)

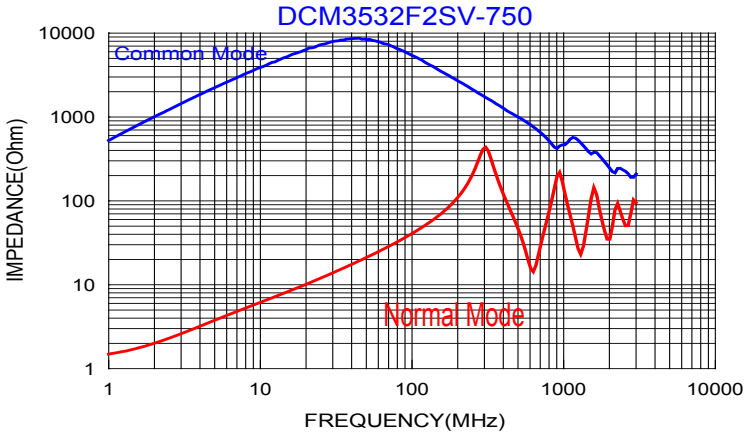

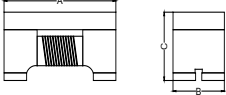
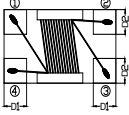

■ Dimensions

Chip Size	
A	4.50±0.20
B	3.20±0.20
C	2.80±0.20
D1	1.00±0.10
D2	1.20±0.10

Units: mm

■ Specifications

Part Number	Common mode Impedance (Ω)	Test Frequency (MHz)	DC Resistance (Ω) max.	Rated Current (mA)max.	Rated Volt. (Vdc)max.	Withstand Volt. (Vdc) max.	IR (Ω) min.
WCM4532F2SV-900T20	90±25%	100	0.05	2000	50	125	10M
WCM4532F2SV-601T15	600±25%	100	0.24	1500	50	125	10M
WCM4532F2SV-801T10	800±25%	100	0.24	1000	50	125	10M

■ Impedance-Frequency Characteristics (Typical)

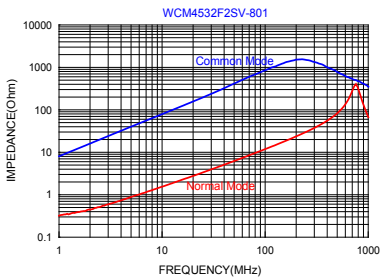
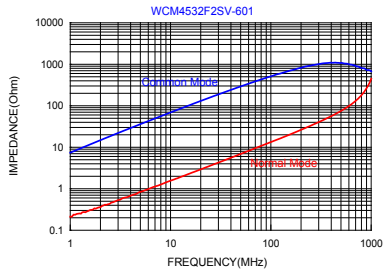
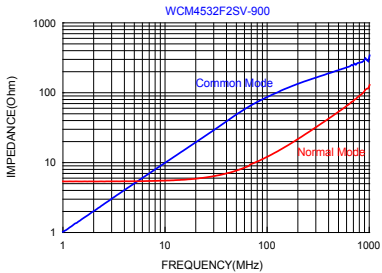

LCM 4532 Series (1812 inch -40~+125)



■ Dimensions

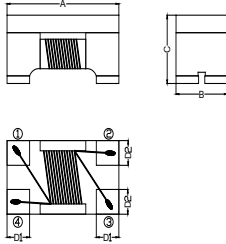

Chip Size	
A	4.50±0.20
B	3.20±0.20
C	2.80±0.20
D1	1.00±0.10
D2	1.20±0.10

Units: mm

■ Specifications

Part Number	Common mode Impedance (Ω) [10MHz]		Common mode Inductance (μH)+50/-30% [100kHz]	DC Resistance (Ω) max.	Rated Current (mA) max.	Rated Volt. (Vdc) max.	IR (Ω) min.
	min.	typ.					
LCM4532F2SV-110T03	300 min.	700 typ.	11	0.80	300	50	10M
LCM4532F2SV-220T02	500 min.	1000 typ.	22	2.65	200	50	10M
LCM4532F2SV-510T02	1000min.	2000typ.	51	3.50	200	50	10M
LCM4532F2SV-101T02	2000min.	5000typ.	100	8.90	200	50	10M

■ Impedance-Frequency Characteristics (Typical)

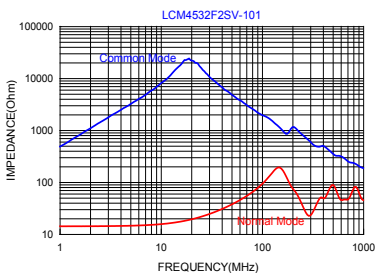
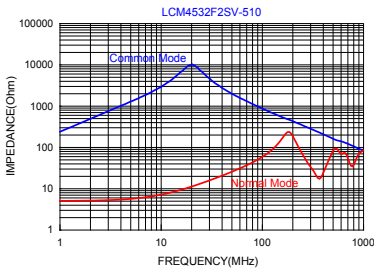
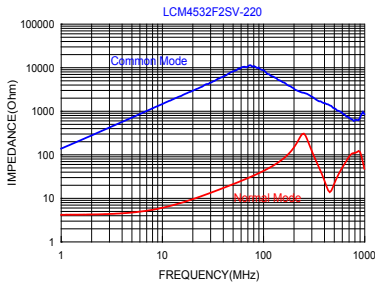
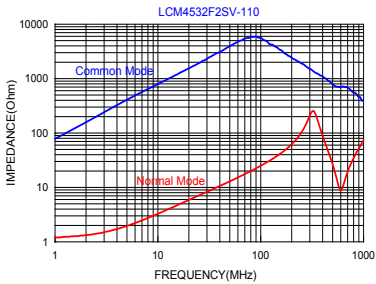

ACM 4532 Series

(1812 inch)
(NV:-55~+150,WV:-40~+125)



■ Dimensions

Dimensions	
A	4.50±0.20
B	3.20±0.20
C	2.80±0.15
D1	1.00±0.30
D2	0.90±0.30
D3	0.72±0.25

Units: mm

■ Specifications

Part Number	Common mode Impedance (Ω)[10MHz]		Inductance (μH)+50/-30% [100kHz]	DC Resistance (Ω) max.	Rated Current (mA)	Rated Volt. (Vdc)	IR (MΩ) min.
	300 min.	600 typ.					
ACM4532F2NV-110T02	300 min.	600 typ.	11	0.6	250	50	10
ACM4532F2NV-220T02	500 min.	1200 typ.	22	1.0	200	50	10
ACM4532F2NV-510T02	1000 min.	2800 typ.	51	1.0	200	50	10
ACM4532F2NV-101T01	2000 min.	5800 typ.	100	2.0	150	50	10
ACM4532F2WV-201T01	-	-	200 (+60/-20uH)	4.5	100	50	10

■ Impedance-Frequency Characteristics (Typical)

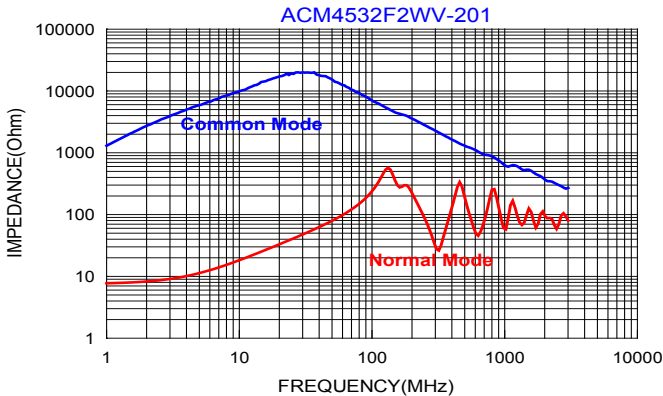



■ Dimensions

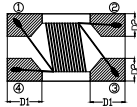
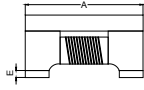

Chip Size	
A	2.00±0.20
B	1.20±0.20
C	1.20±0.20
D1	0.50±0.10
D2	0.51±0.10
E	0.15±0.10

Units: mm

■ Specifications

Part Number	UB/B Impedance (Ω)	Test Frequency (GHz)	DC Resistance (Ω) max.	Rated Power (dBm) max.	Rated Volt. (DCV) max.	With stand Volt. (DCV) max.	IR (Ω) min.	Insertion Loss (dB) 1 to 1.5 GHz	CMRR (dB) 1 to 1.5 GHz
BCM2012F2SV-75011-121	75/75	1-1.5	0.59	27	20	50	10M	1.4 max.	20 min.

■ Characteristics (Typical)

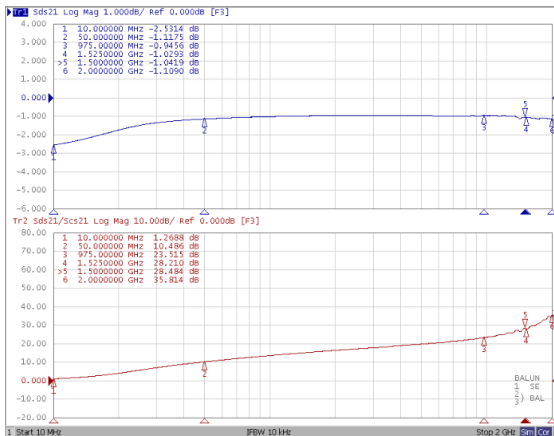



Chip Coils / Inductors

- **Multilayer Ferrite Chip Inductors**

- FCI Series

- **Wire wound Ferrite Chip Inductors**

- SWF-L Series

- SWF-C Series

- WIH Series

- **High Frequency Wirewound Chip Inductors**

- SWI-P Series

- SWI Series

- **Hearing Aid (HAC) Inductors**

- PAS Series



■ Dimensions

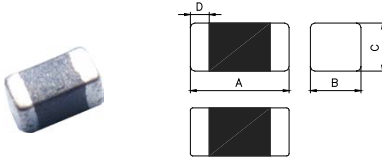

Chip Size	
A	1.00±0.10
B	0.50±0.10
C	0.50±0.10
D	0.25±0.10

Units: mm

■ Specifications

Part Number	Inductance(μH)		Q		Rated Current (mA) max.	DCR (Ω) max.	SRF (MHz) min.
	Tolerance	Test Frequency (Hz)	min.	Test Frequency (MHz)			
FCI1005V-R22K	0.22±10%	60mV / 25M	10	25	25	1.20	110
FCI1005V-1R0K	1.0±10%	60mV / 10M	20	10	15	0.90	40
FCI1005V-1R8K	1.8±10%	60mV / 10M	20	10	15	1.45	30
FCI1005V-2R2K	2.2±10%	60mV / 10M	20	10	10	1.70	28

■ Q vs Frequency, DC Bias Characteristics (Typical)

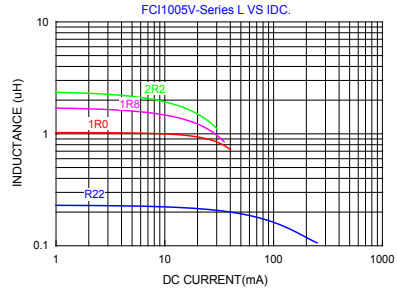
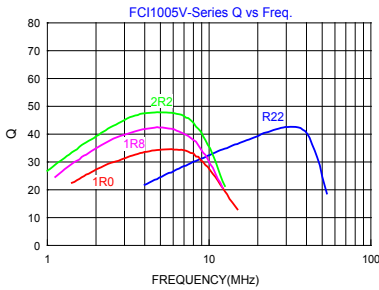



■ Dimensions

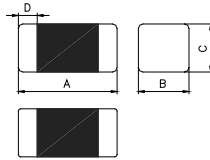

Chip Size		
A	1.60±0.15	1.80±0.15
B	0.80±0.15	
C	0.80±0.15	
D	0.30±0.20	

Units: mm

■ Specifications

Part Number	Thickness A Size(mm)	Inductance(μH)		Q		Rated Current (mA) max.	DCR (Ω) max.	SRF (MHz) min.
		Tolerance	Test Frequency (Hz)	min.	Test Frequency (MHz)			
FCI1608V-47N□	1.60±0.15	0.047	60mV / 50M	10	50	50	0.30	260
FCI1608V-68N□	1.60±0.15	0.068	60mV / 50M	10	50	50	0.30	250
FCI1608V-82N□	1.60±0.15	0.082	60mV / 50M	10	50	50	0.30	245
FCI1608V-R10□	1.60±0.15	0.10	60mV / 25M	15	25	50	0.50	240
FCI1608V-R12□	1.60±0.15	0.12	60mV / 25M	15	25	50	0.50	205
FCI1608V-R15□	1.60±0.15	0.15	60mV / 25M	15	25	50	0.60	180
FCI1608V-R18□	1.60±0.15	0.18	60mV / 25M	15	25	50	0.60	165
FCI1608V-R22□	1.60±0.15	0.22	60mV / 25M	15	25	50	0.80	150
FCI1608V-R27□	1.60±0.15	0.27	60mV / 25M	15	25	50	0.80	136
FCI1608V-R33□	1.60±0.15	0.33	60mV / 25M	15	25	35	0.85	125
FCI1608V-R39□	1.60±0.15	0.39	60mV / 25M	15	25	35	1.00	110
FCI1608V-R47□	1.60±0.15	0.47	60mV / 25M	15	25	35	1.35	105
FCI1608V-R56□	1.60±0.15	0.56	60mV / 25M	15	25	35	1.55	95
FCI1608V-R68□	1.60±0.15	0.68	60mV / 25M	15	25	35	1.70	80
FCI1608V-R82□	1.60±0.15	0.82	60mV / 25M	15	25	35	2.10	75
FCI1608V-1R0□	1.60±0.15	1.0	60mV / 10M	30	10	25	0.60	70
FCI1608V-1R5□	1.60±0.15	1.5	60mV / 10M	30	10	25	0.80	55
FCI1608V-1R8□	1.60±0.15	1.8	60mV / 10M	30	10	25	0.95	50
FCI1608V-2R2□	1.60±0.15	2.2	60mV / 10M	30	10	15	1.15	45
FCI1608V-3R3□	1.60±0.15	3.3	60mV / 10M	30	10	15	1.55	38
FCI1608V-4R7□	1.60±0.15	4.7	60mV / 10M	30	10	15	2.10	33
FCI1608TV-100□	1.80±0.15	10.0	60mV / 2M	30	2	15	2.55	17

□: K=±10%, L=±15%, M=±20%

■ Q vs Frequency, DC Bias Characteristics (Typical)

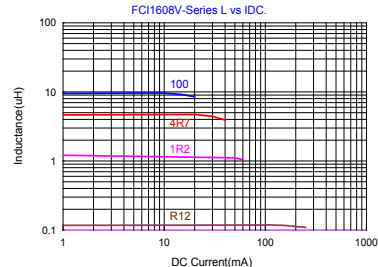
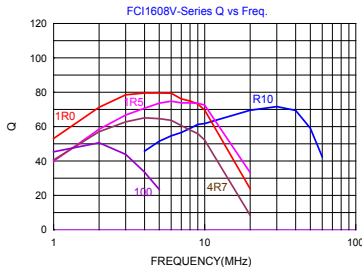



■ Dimensions

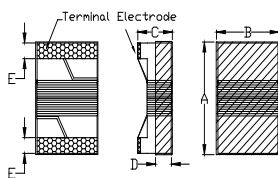

Dimensions		unit: mm
A	1.65±0.15	
B	1.15±0.15	
C	1.05±0.15	
D	0.38 ref.	
E	0.35±0.10	

■ Specifications

TAI-TECH Part Number	Inductance (uH)	Tolerance	Test Frequency (Hz)	Q Typ	Test Frequency (MHz)	SRF (MHz) typ.	DCR (Ω) max.	IDC (mA) max.
SWF1608LV-47N	0.047	K	0.5V/7.9M	17	7.9	1700	0.075	1500
SWF1608LV-72N	0.072	K	0.5V/7.9M	17	7.9	1700	0.12	1500
SWF1608LV-R10	0.1	K	0.5V/7.9M	17	7.9	1500	0.12	1500
SWF1608LV-R15	0.15	K	0.5V/7.9M	17	7.9	1350	0.15	1450
SWF1608LV-R18	0.18	K	0.5V/7.9M	17	7.9	1150	0.15	1400
SWF1608LV-R33	0.33	K	0.5V/7.9M	17	7.9	850	0.46	900
SWF1608LV-R39	0.39	K	0.5V/7.9M	17	7.9	810	0.51	1100
SWF1608LV-R47	0.47	K	0.5V/7.9M	17	7.9	720	0.62	1050
SWF1608LV-R56	0.56	K	0.5V/7.9M	17	7.9	600	0.44	850
SWF1608LV-R68	0.68	K	0.5V/7.9M	17	7.9	600	0.52	850
SWF1608LV-R82	0.82	K	0.5V/7.9M	17	7.9	480	0.69	750
SWF1608LV-R91	0.91	K	0.5V/7.9M	17	7.9	330	0.76	670
SWF1608LV-1R0	1.00	K	0.5V/7.9M	17	7.9	310	0.81	600
SWF1608LV-1R2	1.2	K	0.5V/7.9M	17	7.9	270	0.87	550
SWF1608LV-1R5	1.5	K	0.5V/7.9M	17	7.9	270	1.06	540
SWF1608LV-1R8	1.8	K	0.5V/7.9M	17	7.9	230	1.1	520
SWF1608LV-2R2	2.2	K	0.5V/7.9M	17	7.9	130	1.2	500
SWF1608LV-2R7	2.7	K	0.5V/7.9M	17	7.9	105	1.5	480
SWF1608LV-3R3	3.3	K	0.5V/7.9M	17	7.9	84	1.5	440
SWF1608LV-3R9	3.9	K	0.5V/7.9M	17	7.9	80	1.6	430
SWF1608LV-4R7	4.7	J,K	0.5V/7.9M	18	7.9	69	2.1	420
SWF1608LV-5R6	5.6	J,K	0.5V/7.9M	18	7.9	65	2.6	350
SWF1608LV-6R8	6.8	J,K	0.5V/7.9M	19	7.9	55	3.1	330
SWF1608LV-7R8	7.8	J,K	0.5V/7.9M	17	7.9	47	3.5	320
SWF1608LV-8R2	8.2	J,K	0.5V/7.9M	17	7.9	42	3.8	300
SWF1608LV-100	10	J,K	0.5V/7.9M	19	7.9	40	4.8	270



■ Impedance vs Frequency, DC Bias Characteristics (Typical)

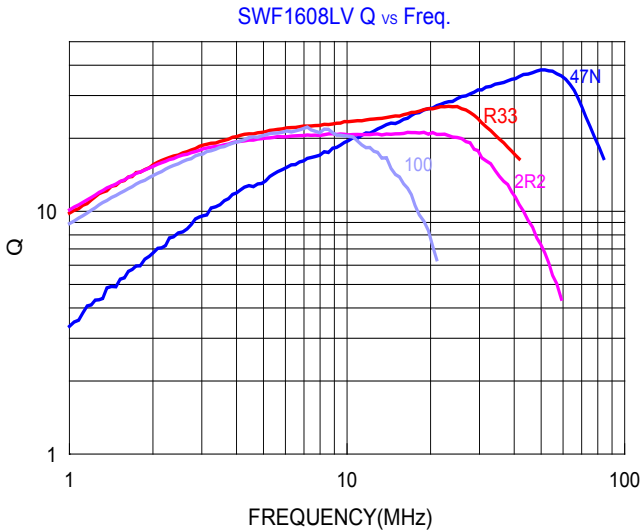
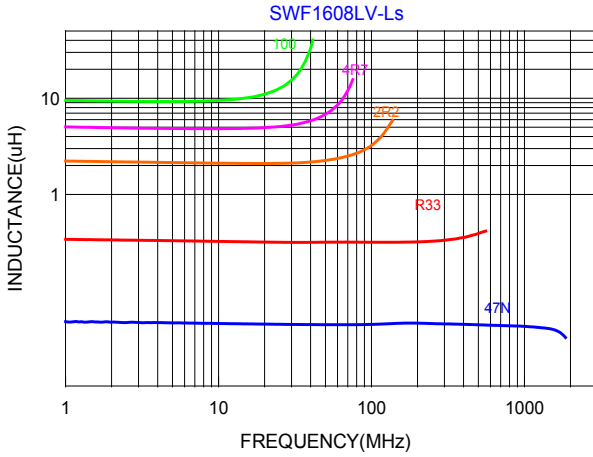



■ Dimensions

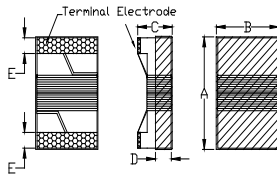
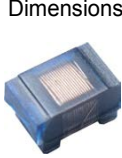

Chip Size	
A	1.80 max.
B	1.20 max.
C	1.20 max.
D	0.38 ref.
E	0.35±0.10

Units: mm

■ Specifications

Part Number	Inductance (uH)	Test Frequency (Hz)	Q min.	Test Frequency (MHz)	SRF (MHz) min.	DC Resistance (Ω) max.	Rated Current (mA) max.
SWF1608CV-47N□	0.047	0.5V/7.96M	10	7.96	1500	0.075	1400
SWF1608CV-R10□	0.10	0.5V/7.96M	10	7.96	1150	0.13	1400
SWF1608CV-R12□	0.12	0.5V/7.96M	10	7.96	1100	0.15	1400
SWF1608CV-R15□	0.15	0.5V/7.96M	10	7.96	1050	0.15	1300
SWF1608CV-R22□	0.22	0.5V/7.96M	10	7.96	800	0.15	950
SWF1608CV-R27□	0.27	0.5V/7.96M	10	7.96	775	0.20	710
SWF1608CV-R33□	0.33	0.5V/7.96M	10	7.96	725	0.35	620
SWF1608CV-R39□	0.39	0.5V/7.96M	10	7.96	620	0.39	600
SWF1608CV-R47□	0.47	0.5V/7.96M	10	7.96	540	0.43	570
SWF1608CV-R56□	0.56	0.5V/7.96M	10	7.96	525	0.47	550
SWF1608CV-R68□	0.68	0.5V/7.96M	10	7.96	460	0.52	470
SWF1608CV-R82□	0.82	0.5V/7.96M	10	7.96	410	0.69	400
SWF1608CV-1R0□	1.0	0.5V/7.96M	10	7.96	190	0.81	400
SWF1608CV-1R2□	1.2	0.5V/7.96M	10	7.96	160	0.87	370
SWF1608CV-1R5□	1.5	0.5V/7.96M	10	7.96	100	0.96	350
SWF1608CV-2R2□	2.2	0.5V/7.96M	10	7.96	68	1.20	320
SWF1608CV-3R3□	3.3	0.5V/7.96M	10	7.96	42	1.50	280
SWF1608CV-4R7□	4.7	0.5V/7.96M	10	7.96	34	2.10	260
SWF1608CV-6R8□	6.8	0.5V/7.96M	10	7.96	31	3.10	200
SWF1608CV-100□	10.0	0.5V/2.52M	10	2.52	25	4.80	180

□ : K=±10% , M=±20%

■ Impedance vs Frequency, DC Bias Characteristics (Typical)

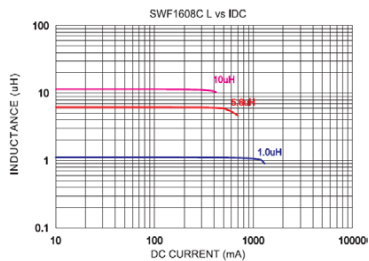
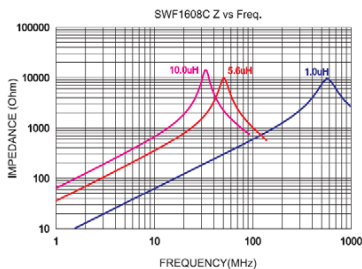



■ Dimensions

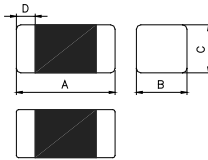

Chip Size	
A	2.00±0.20
B	1.25±0.20
C	0.85±0.20 1.25±0.20
D	0.50±0.30

Units: mm

■ Specifications

Part Number	Thickness C Size(mm)	Inductance(uH)		Q		Rated Current (mA) max.	DCR (Ω) max.	SRF (MHz) min.
		Tolerance	Test Frequency (Hz)	min.	Test Frequency (MHz)			
FCI2012V-47N□	0.85±0.20	0.047	60mV / 50M	15	50	300	0.20	320
FCI2012V-68N□	0.85±0.20	0.068	60mV / 50M	15	50	300	0.20	280
FCI2012V-82N□	0.85±0.20	0.082	60mV / 50M	15	50	300	0.20	255
FCI2012V-R10□	0.85±0.20	0.10	60mV / 25M	20	25	250	0.30	235
FCI2012V-R12□	0.85±0.20	0.12	60mV / 25M	20	25	250	0.30	220
FCI2012V-R15□	0.85±0.20	0.15	60mV / 25M	20	25	250	0.40	200
FCI2012V-R18□	0.85±0.20	0.18	60mV / 25M	20	25	250	0.40	185
FCI2012V-R22□	0.85±0.20	0.22	60mV / 25M	20	25	250	0.50	170
FCI2012V-R27□	0.85±0.20	0.27	60mV / 25M	20	25	250	0.50	150
FCI2012V-R33□	0.85±0.20	0.33	60mV / 25M	20	25	250	0.55	145
FCI2012V-R39□	0.85±0.20	0.39	60mV / 25M	25	25	200	0.65	135
FCI2012V-R47□	1.25±0.20	0.47	60mV / 25M	25	25	200	0.65	125
FCI2012V-R56□	1.25±0.20	0.56	60mV / 25M	25	25	150	0.75	115
FCI2012V-R68□	1.25±0.20	0.68	60mV / 25M	25	25	150	0.80	105
FCI2012V-1R0□	0.85±0.20	1.0	60mV / 10M	45	10	50	0.40	75
FCI2012V-1R5□	0.85±0.20	1.5	60mV / 10M	45	10	50	0.50	60
FCI2012V-1R8□	0.85±0.20	1.8	60mV / 10M	45	10	50	0.60	55
FCI2012V-2R2□	0.85±0.20	2.2	60mV / 10M	45	10	30	0.65	50
FCI2012V-2R7□	1.25±0.20	2.7	60mV / 10M	45	10	30	0.75	45
FCI2012V-3R3□	1.25±0.20	3.3	60mV / 10M	45	10	30	0.80	41
FCI2012V-4R7□	1.25±0.20	4.7	60mV / 10M	45	10	30	1.00	35
FCI2012V-100□	1.25±0.20	10.0	60mV / 2M	45	2	15	1.15	24

□: K=±10%, L=±15%, M=±20%

■ Q vs Frequency, DC Bias Characteristics (Typical)

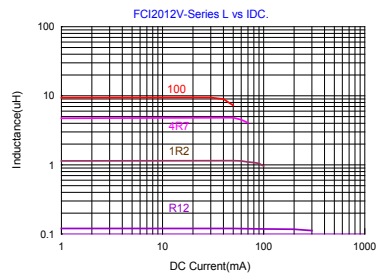
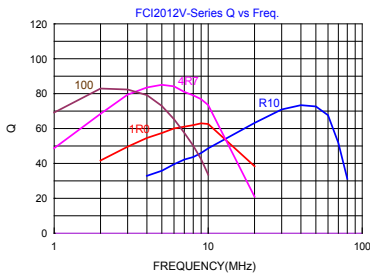



■ Dimensions

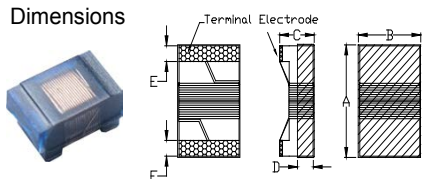

Chip Size	
A	2.40 max.
B	1.60 max.
C	1.40 max.
D	0.51 ref.
E	0.44±0.10

Units: mm

■ Specifications

Part Number	Inductance (uH)	Test Frequency (Hz)	Q min.	Test Frequency (MHz)	SRF (MHz) min.	DC Resistance (Ω) max.	Rated Current (mA) max.
SWF2012CV-R47	0.47	0.5V/7.96M	10	7.96	720	0.20	750
SWF2012CV-R56	0.56	0.5V/7.96M	10	7.96	665	0.21	730
SWF2012CV-R68	0.68	0.5V/7.96M	10	7.96	565	0.28	670
SWF2012CV-1R0	1.00	0.5V/7.96M	10	7.96	525	0.34	615
SWF2012CV-1R2	1.20	0.5V/7.96M	10	7.96	473	0.39	550
SWF2012CV-1R5	1.50	0.5V/7.96M	10	7.96	300	0.45	520
SWF2012CV-2R2	2.20	0.5V/7.96M	10	7.96	215	0.67	420
SWF2012CV-3R3	3.30	0.5V/7.96M	10	7.96	95	0.81	385
SWF2012CV-3R9	3.90	0.5V/7.96M	10	7.96	57	0.88	372
SWF2012CV-4R7	4.70	0.5V/7.96M	10	7.96	51	0.99	345
SWF2012CV-5R6	5.60	0.5V/7.96M	10	7.96	44	1.06	335
SWF2012CV-6R8	6.80	0.5V/7.96M	10	7.96	39	1.21	315
SWF2012CV-8R2	8.20	0.5V/7.96M	10	7.96	33	1.33	295
SWF2012CV-100	10.0	0.5V/2.52M	10	2.52	30	1.79	260
SWF2012CV-120	12.0	0.5V/2.52M	10	2.52	27	1.98	250
SWF2012CV-150	15.0	0.5V/2.52M	10	2.52	22	2.68	215
SWF2012CV-180	18.0	0.5V/2.52M	10	2.52	20	3.12	195
SWF2012CV-220	22.0	0.5V/2.52M	10	2.52	18	3.48	180
SWF2012CV-270	27.0	0.5V/2.52M	10	2.52	16	3.84	170
SWF2012CV-330	33.0	0.5V/2.52M	10	2.52	15	4.34	145

□ : K=±10%, M=±20%

■ Impedance vs Frequency, DC Bias Characteristics (Typical)

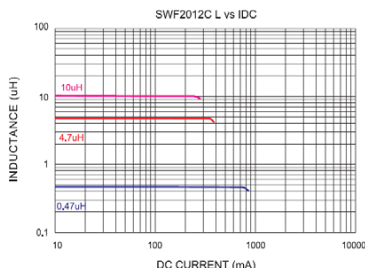
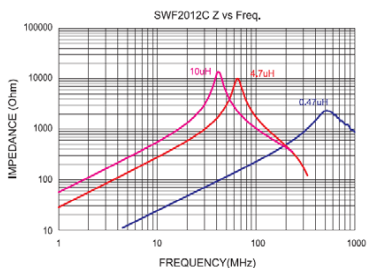



■ Dimensions

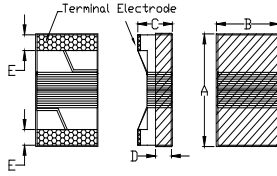
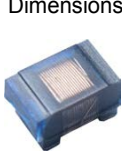

Chip Size	
A	2.90 max.
B	2.50 max.
C	2.10 max.
D	1.20 ref.
E	0.55±0.10

Units: mm

■ Specifications

Part Number	Inductance (uH)	Test Frequency (Hz)	Q min.	Test Frequency (MHz)	SRF (MHz) min.	DC Resistance (Ω) max.	Rated Current (mA) max.
SWF2520CV-1R0□	1.00	0.5V/7.96M	12	7.96	345	0.13	1000
SWF2520CV-1R5□	1.50	0.5V/7.96M	12	7.96	100	0.17	850
SWF2520CV-2R2□	2.20	0.5V/7.96M	12	7.96	78	0.21	775
SWF2520CV-3R3□	3.30	0.5V/7.96M	12	7.96	48	0.26	715
SWF2520CV-4R7□	4.70	0.5V/7.96M	12	7.96	46	0.52	505
SWF2520CV-6R8□	6.80	0.5V/7.96M	12	7.96	33	0.72	432
SWF2520CV-8R2□	8.20	0.5V/2.52M	12	2.52	30	0.76	410
SWF2520CV-100□	10.0	0.5V/2.52M	12	2.52	28	0.86	392
SWF2520CV-150□	15.0	0.5V/2.52M	12	2.52	21	1.09	342
SWF2520CV-220□	22.0	0.5V/2.52M	12	2.52	18	1.96	260
SWF2520CV-330□	33.0	0.5V/2.52M	12	2.52	15	2.47	236

□ : K=±10%, M=±20%

■ Impedance vs Frequency, DC Bias Characteristics (Typical)

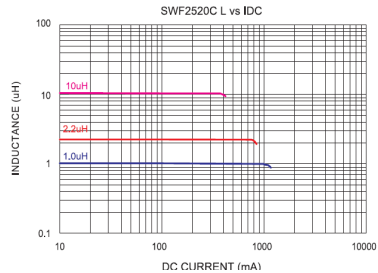
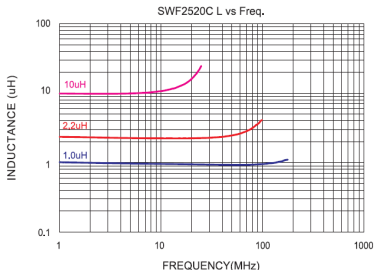



■ Dimensions

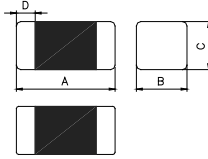

Chip Size	
A	3.20±0.20
B	1.60±0.20
C	1.10±0.30
D	0.50±0.30

Units: mm

■ Specifications

Part Number	Inductance(μH)		Q		Rated Current (mA) max.	DCR (Ω) max.	SRF (MHz) min.
	Tolerance	Test Frequency (Hz)	min.	Test Frequency (MHz)			
FCI3216V-47N□	0.047	60mV / 50M	20	50	300	0.15	320
FCI3216V-68N□	0.068	60mV / 50M	20	50	300	0.25	280
FCI3216V-R10□	0.10	60mV / 25M	20	25	250	0.25	235
FCI3216V-R12□	0.12	60mV / 25M	20	25	250	0.30	220
FCI3216V-R15□	0.15	60mV / 25M	20	25	250	0.30	200
FCI3216V-R18□	0.18	60mV / 25M	20	25	250	0.40	185
FCI3216V-R22□	0.22	60mV / 25M	20	25	250	0.40	170
FCI3216V-R27□	0.27	60mV / 25M	20	25	250	0.50	150
FCI3216V-R33□	0.33	60mV / 25M	20	25	250	0.50	145
FCI3216V-R39□	0.39	60mV / 25M	25	25	250	0.60	135
FCI3216V-R47□	0.47	60mV / 25M	25	25	200	0.60	125
FCI3216V-R56□	0.56	60mV / 25M	25	25	200	0.70	115
FCI3216V-R68□	0.68	60mV / 25M	25	25	150	0.80	105
FCI3216V-R82□	0.82	60mV / 25M	25	25	150	0.90	100
FCI3216V-1R0□	1.0	60mV / 10M	45	10	100	0.40	75
FCI3216V-1R2□	1.2	60mV / 10M	45	10	100	0.50	65
FCI3216V-1R5□	1.5	60mV / 10M	45	10	50	0.50	60
FCI3216V-2R2□	2.2	60mV / 10M	45	10	50	0.60	50
FCI3216V-3R3□	3.3	60mV / 10M	45	10	50	0.70	41
FCI3216V-4R7□	4.7	60mV / 10M	45	10	50	0.90	35
FCI3216V-100□	10.0	60mV / 2M	50	2	25	1.00	24

□: K=±10%, L=±15%, M=±20%

■ Q vs Frequency, DC Bias Characteristics (Typical)

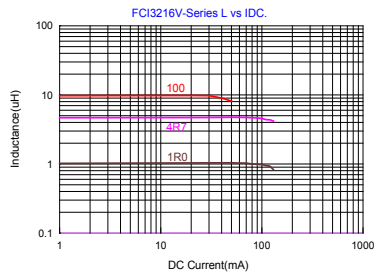
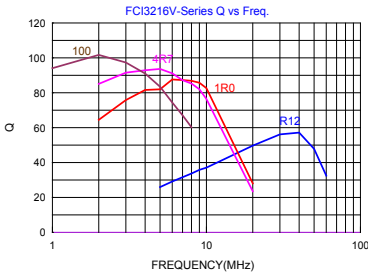



■ Dimensions

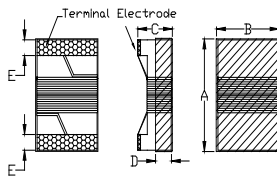
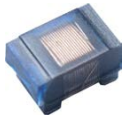

Chip Size	
A	3.60 max.
B	2.80 max.
C	2.60 max.
D	0.80 ref.
E	0.55±0.10

Units: mm

■ Specifications

Part Number	Inductance (uH)	Test Frequency (Hz)	Q min.	Test Frequency (MHz)	SRF (MHz) min.	DCR (Ω) max.	Rated Current (mA) max.
SWF3225CV-1R0□	1.00	0.5V/7.96M	10	7.96	290	0.12	1200
SWF3225CV-1R5□	1.50	0.5V/7.96M	10	7.96	260	0.13	1000
SWF3225CV-2R2□	2.20	0.5V/7.96M	10	7.96	190	0.17	880
SWF3225CV-3R3□	3.30	0.5V/7.96M	10	7.96	64	0.22	775
SWF3225CV-4R7□	4.70	0.5V/7.96M	10	7.96	54	0.26	710
SWF3225CV-6R8□	6.80	0.5V/7.96M	10	7.96	34	0.30	660
SWF3225CV-100□	10.0	0.5V/2.52M	10	2.52	25	0.39	570
SWF3225CV-150□	15.0	0.5V/2.52M	10	2.52	17	0.66	440
SWF3225CV-220□	22.0	0.5V/2.52M	10	2.52	16	0.82	400
SWF3225CV-330□	33.0	0.5V/2.52M	10	2.52	12	1.50	285
SWF3225CV-390□	39.0	0.5V/2.52M	10	2.52	12	1.66	270
SWF3225CV-470□	47.0	0.5V/2.52M	10	2.52	10	1.90	260
SWF3225CV-680□	68.0	0.5V/2.52M	10	2.52	9.0	2.29	235
SWF3225CV-101□	100.0	0.5V/1M	10	1.00	7.0	3.48	190
SWF3225CV-151□	150.0	0.5V/1M	10	1.00	5.0	6.55	140
SWF3225CV-221□	220.0	0.5V/1M	10	1.00	4.0	8.23	115
SWF3225CV-331□	330.0	0.5V/1M	10	1.00	2.8	13.7	98
SWF3225CV-471□	470.0	0.5V/1M	10	1.00	2.6	18.1	86
SWF3225CV-681□	680.0	0.5V/1M	10	1.00	2.3	22.0	76

□ : K=±10% , M=±20%

■ Impedance vs Frequency, DC Bias Characteristics (Typical)

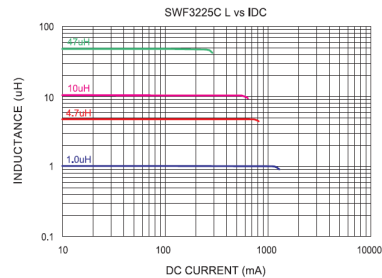
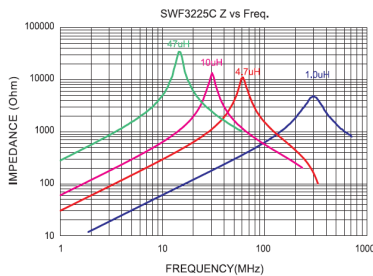



■ Dimensions

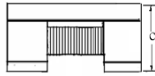

Dimension	unit: mm
A	3.25±0.15
B	2.50±0.15
C	2.30±0.15

■ Specifications

TAI-TECH Part Number	Inductance (uH)	Tolerance	Q min.	Test Frequency (MHz)	Rated Current (mA) max.	DCR (Ω) max.	SRF (MHz) min.
WIH 3225V-100□	10.0	K,M	15	2.52	240	0.36	30
WIH 3225V-220□	22.0	K,M	15	2.52	185	0.77	21
WIH 3225V-390□	39.0	K,M	15	2.52	145	1.90	11
WIH 3225V-470□	47.0	K,M	15	2.52	135	1.64	14
WIH 3225V-680□	68.0	K,M	15	2.52	105	2.8	12
WIH 3225V-151□	150.0	K,M	20	0.796	70	6.1	8
WIH 3225V-221□	220	K,M	20	0.796	60	8.4	7

Note:

Rated Current : Based on inductance change ($\Delta L/L0 : \leq 30\%$) @ ambient temp. 25°C

Rated Current (I_{rms}) : Based on temperature rise ($\Delta T : 40^\circ\text{C}$) Max



■ Dimensions

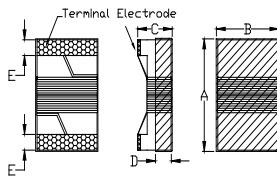

Chip Size	
A	1.09±0.10
B	0.60±0.10
C	0.56±0.10
D	0.20±0.15
E	0.23±0.10

Units: mm

■ Specifications

Part Number	Inductance (nH)	Tolerance	Q min.	Test Frequency (Hz)	I _{rms} (mA) max.	DCR (Ω) max.	SRF (GHz) min.
SWI0402V-1N0□	1.0	S.J	16	0.1V/250M	1360	0.045	12.7
SWI0402V-1N9□	1.9	S.J	16	0.1V/250M	1040	0.070	11.30
SWI0402V-2N0□	2.0	S.J	16	0.1V/250M	1040	0.070	11.10
SWI0402V-2N2□	2.2	S.J	19	0.1V/250M	960	0.070	10.80
SWI0402V-2N4□	2.4	S.J	15	0.1V/250M	790	0.068	10.50
SWI0402V-2N7□	2.7	S.J	16	0.1V/250M	640	0.120	10.40
SWI0402V-3N3□	3.3	S.J	19	0.1V/250M	840	0.066	7.00
SWI0402V-3N6□	3.6	S.J	19	0.1V/250M	840	0.066	6.80
SWI0402V-3N9□	3.9	S.J	19	0.1V/250M	840	0.066	6.00
SWI0402V-4N3□	4.3	S.J	18	0.1V/250M	700	0.091	6.00
SWI0402V-4N7□	4.7	S.J	15	0.1V/250M	640	0.130	4.77
SWI0402V-5N1□	5.1	S.J	20	0.1V/250M	800	0.083	4.80
SWI0402V-5N6□	5.6	S.J	20	0.1V/250M	760	0.083	4.80
SWI0402V-6N2□	6.2	J.K	20	0.1V/250M	760	0.083	4.80
SWI0402V-6N8□	6.8	J.K	20	0.1V/250M	680	0.083	4.80
SWI0402V-7N5□	7.5	J.K	22	0.1V/250M	680	0.100	4.80
SWI0402V-8N2□	8.2	J.K	22	0.1V/250M	680	0.100	4.40
SWI0402V-8N7□	8.7	J.K	18	0.1V/250M	480	0.200	4.10
SWI0402V-9N0□	9.0	J.K	22	0.1V/250M	680	0.100	4.16
SWI0402V-9N1□	9.1	J.K	22	0.1V/250M	680	0.100	4.16
SWI0402V-9N5□	9.5	J.K	18	0.1V/250M	480	0.200	4.00
SWI0402V-10N□	10	J.K	21	0.1V/250M	480	0.200	3.90
SWI0402V-11N□	11	J.K	24	0.1V/250M	640	0.120	3.68
SWI0402V-12N□	12	J.K	24	0.1V/250M	640	0.120	3.60
SWI0402V-13N□	13	J.K	24	0.1V/250M	440	0.210	3.45
SWI0402V-15N□	15	J.K	24	0.1V/250M	560	0.170	3.28
SWI0402V-16N□	16	J.K	24	0.1V/250M	560	0.220	3.10
SWI0402V-18N□	18	J.K	25	0.1V/250M	420	0.230	3.10
SWI0402V-19N□	19	J.K	24	0.1V/250M	480	0.200	3.04
SWI0402V-20N□	20	J.K	25	0.1V/250M	420	0.25	3.00
SWI0402V-22N□	22	J.K	25	0.1V/250M	400	0.30	2.80
SWI0402V-23N□	23	J.K	22	0.1V/250M	400	0.30	2.72
SWI0402V-24N□	24	J.K	25	0.1V/250M	400	0.30	2.70



■ Specifications

Part Number	Inductance (nH)	Tolerance	Q min.	Test Frequency (Hz)	I rms (mA) max.	DCR (Ω) max.	SRF (GHz) min.
SWI0402V-27N□	27	J.K	24	0.1V/250M	400	0.30	2.48
SWI0402V-30N□	30	J.K	25	0.1V/250M	400	0.35	2.35
SWI0402V-33N□	33	J.K	24	0.1V/250M	400	0.40	2.35
SWI0402V-36N□	36	J.K	24	0.1V/250M	320	0.44	2.32
SWI0402V-39N□	39	J.K	25	0.1V/250M	200	0.55	2.10
SWI0402V-40N□	40	J.K	24	0.1V/250M	320	0.44	2.24
SWI0402V-43N□	43	J.K	25	0.1V/250M	100	0.81	2.03
SWI0402V-47N□	47	J.K	20	0.1V/250M	150	0.83	2.10
SWI0402V-51N□	51	J.K	25	0.1V/250M	100	0.82	1.75
SWI0402V-56N□	56	J.K	22	0.1V/250M	100	0.97	1.76
SWI0402V-68N□	68	J.K	22	0.1V/250M	100	1.12	1.62
SWI0402V-82N□	82	J.K	20	0.1V/250M	50	1.55	1.26
SWI0402V-R10□	100	J.K	20	0.1V/250M	30	2.00	1.16

□ : S=±0.3nH , J=±5% , K=±10%

■ Impedance vs Frequency, DC Bias Characteristics (Typical)

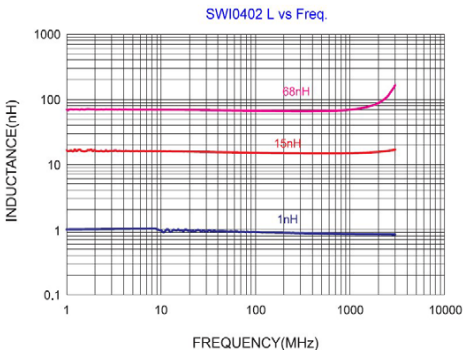
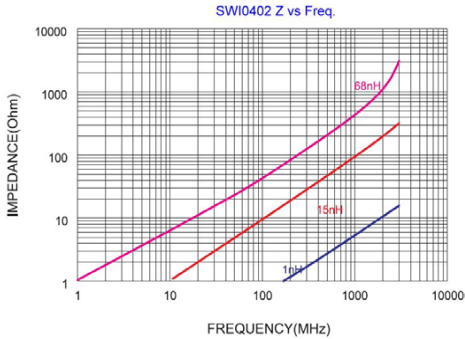



■ Dimensions

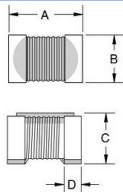

Chip Size	
A	1.55±0.20
B	0.96±0.20
C	0.90±0.20
D	0.38 ref.

Units: mm

■ Specifications

Part Number	Inductance (nH)	Tolerance	Test Frequency (Hz)	Q @ 250MHz min.	IDC (mA) max.	DCR (Ω) max.	SRF (MHz) min.
SWI0603PV-2N0□	2.0	C,S	0.1V/250M	13	700	0.07	8000
SWI0603PV-4N7□	4.7	C,S	0.1V/250M	20	700	0.12	5800
SWI0603PV-7N5□	7.5	J	0.1V/250M	30	750	0.13	4200
SWI0603PV-10N□	10	J	0.1V/250M	31	700	0.13	4800
SWI0603PV-12N□	12	J	0.1V/250M	35	700	0.13	4000
SWI0603PV-15N□	15	J	0.1V/250M	35	700	0.13	4000
SWI0603PV-23N□	23	J	0.1V/250M	38	700	0.25	2900
SWI0603PV-47N□	47	J	0.1V/200M	38	600	0.35	2000
SWI0603PV-56N□	56	J	0.1V/200M	38	600	0.37	1900
SWI0603PV-68N□	68	J	0.1V/200M	37	600	0.43	1700
SWI0603PV-82N□	82	J	0.1V/150M	34	400	0.71	1700
SWI0603PV-R10□	100	J	0.1V/150M	34	400	0.78	1400
SWI0603PV-R12□	120	J	0.1V/150M	32	300	0.84	1300
SWI0603PV-R14□	140	J	0.1V/150M	28	280	0.87	920
SWI0603PV-R15□	150	J	0.1V/150M	28	280	0.96	990
SWI0603PV-R27□	270	J	0.1V/100M	24	170	2.36	900
SWI0603PV-R36□	360	J	0.1V/100M	24	150	3.50	700

C=±0.2nH , S=±0.3nH , G=±2% , J=±5% , K=±10%

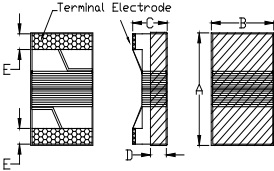

■ Dimensions

Chip Size	
A	1.80 max.
B	1.20 max.
C	1.20 max.
D	0.38 ref.
E	0.35±0.10

Units: mm

■ Specifications

Part Number	Inductance (nH)	Tolerance	Test Frequency (Hz)	Q @ 250MHz min.	I rms (mA) max.	DCR (Ω) max.	SRF (MHz) min.
SWI0603V-2N0□	2.0	C,S	0.1V/250M	13	700	0.07	8000
SWI0603V-3N9□	3.9	C,S	0.1V/250M	22	700	0.07	6900
SWI0603V-4N7□	4.7	C,J,K	0.1V/250M	20	700	0.12	5800
SWI0603V-6N8□	6.8	C,J,K	0.1V/250M	27	700	0.08	5800
SWI0603V-8N2□	8.2	C,J,K	0.1V/250M	30	700	0.13	4200
SWI0603V-10N□	10	J,K	0.1V/250M	31	700	0.13	4800
SWI0603V-12N□	12	J,K	0.1V/250M	35	700	0.13	4000
SWI0603V-15N□	15	J,K	0.1V/250M	35	700	0.13	4000
SWI0603V-18N□	18	J,K	0.1V/250M	35	700	0.16	3100
SWI0603V-22N□	22	J,K	0.1V/250M	38	700	0.23	3000
SWI0603V-24N□	24	J,K	0.1V/250M	38	700	0.13	2800
SWI0603V-27N□	27	J,K	0.1V/250M	40	600	0.14	2800
SWI0603V-33N□	33	J,K	0.1V/250M	40	600	0.22	2300
SWI0603V-39N□	39	J	0.1V/250M	40	600	0.30	2200
SWI0603V-47N□	47	J,K	0.1V/200M	38	600	0.35	2000
SWI0603V-56N□	56	J,K	0.1V/200M	38	600	0.37	1900
SWI0603V-68N□	68	J,K	0.1V/200M	37	600	0.43	1700
SWI0603V-72N□	72	J,K	0.1V/150M	34	400	0.42	1700
SWI0603V-82N□	82	J,K	0.1V/150M	34	400	0.71	1700
SWI0603V-R10□	100	J,K	0.1V/150M	34	400	0.78	1400
SWI0603V-R12□	120	J,K	0.1V/150M	32	300	0.84	1300
SWI0603V-R15□	150	J,K	0.1V/150M	28	280	0.96	990
SWI0603V-R18□	180	J,K	0.1V/100M	25	240	1.52	990
SWI0603V-R22□	220	J,K	0.1V/100M	25	200	2.02	900
SWI0603V-R27□	270	J,K	0.1V/100M	24	170	2.36	900
SWI0603V-R33□	330	J,K	0.1V/100M	24	185	3.40	700
SWI0603V-R39□	390	J,K	0.1V/100M	24	100	3.60	900

□: C=±0.2nH, S=±0.3nH, J=±5%, K=±10%



■ Impedance vs Frequency, DC Bias Characteristics (Typical)

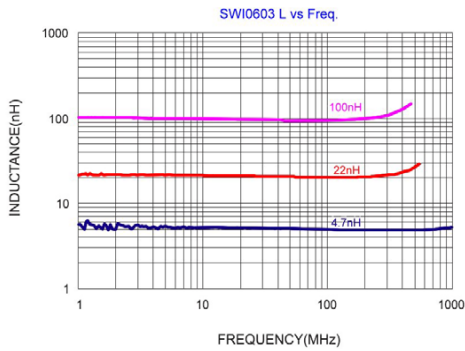
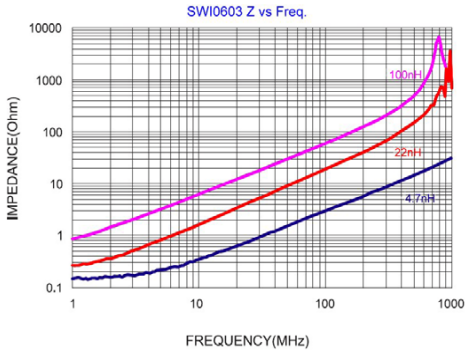



■ Dimensions

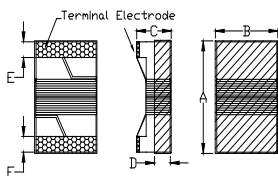

Chip Size	
A	2.29 max.
B	1.73 max.
C	1.52 max.
D	0.51 ref.
E	0.44±0.10

Units: mm

■ Specifications

Part Number	Inductance (nH)	Tolerance	Test Frequency (Hz)	Q @ Test Freq. min.	I _{rms} (mA) max.	DCR (Ω) max.	SRF (MHz) min.
SWI0805UV-2N8□	2.8	C,S	0.1V/250M	80/1500	800	0.06	7900
SWI0805UV-3N0□	3.0	C,S	0.1V/250M	65/1500	800	0.06	7900
SWI0805UV-3N3□	3.3	C,S	0.1V/250M	50/1500	600	0.08	7900
SWI0805UV-3N6□	5.6	C,S	0.1V/250M	65/1000	600	0.08	5500
SWI0805UV-6N8□	6.8	C,J	0.1V/250M	50/1000	600	0.11	5500
SWI0805UV-7N5□	7.5	C,J	0.1V/250M	50/1000	600	0.14	4500
SWI0805UV-8N2□	8.2	C,J	0.1V/250M	50/1000	600	0.12	4700
SWI0805UV-10N□	10	G,J	0.1V/250M	60/500	600	0.10	4200
SWI0805UV-12N□	12	G,J	0.1V/250M	50/500	600	0.15	4000
SWI0805UV-15N□	15	G,J	0.1V/250M	50/500	600	0.17	3400
SWI0805UV-18N□	18	G,J	0.1V/250M	50/500	600	0.20	3300
SWI0805UV-22N□	22	G,J	0.1V/250M	55/500	500	0.22	2600
SWI0805UV-24N□	24	G,J	0.1V/250M	50/500	500	0.22	2000
SWI0805UV-27N□	27	G,J	0.1V/250M	55/500	500	0.25	2500
SWI0805UV-33N□	33	G,J	0.1V/250M	60/500	500	0.27	2050
SWI0805UV-36N□	36	G,J	0.1V/250M	55/500	500	0.27	1700
SWI0805UV-39N□	39	G,J	0.1V/250M	60/500	500	0.29	2000
SWI0805UV-43N□	43	G,J	0.1V/200M	60/500	500	0.34	1650
SWI0805UV-47N□	47	G,J	0.1V/200M	60/500	500	0.31	1650
SWI0805UV-56N□	56	G,J	0.1V/200M	60/500	500	0.34	1550
SWI0805UV-68N□	68	G,J	0.1V/200M	60/500	500	0.38	1450
SWI0805UV-82N□	82	G,J	0.1V/150M	65/500	400	0.42	1300
SWI0805UV-91N□	91	G,J	0.1V/150M	65/500	400	0.48	1200
SWI0805UV-R10□	100	G,J	0.1V/150M	65/500	400	0.46	1200
SWI0805UV-R11□	110	G,J	0.1V/150M	50/250	400	0.48	1000
SWI0805UV-R12□	120	G,J	0.1V/150M	50/250	400	0.51	1100
SWI0805UV-R15□	150	G,J	0.1V/100M	50/250	400	0.56	920
SWI0805UV-R18□	180	G,J	0.1V/100M	50/250	400	0.64	870
SWI0805UV-R20□	200	G,J	0.1V/100M	50/250	400	0.68	860
SWI0805UV-R22□	220	G,J	0.1V/100M	50/250	400	0.70	850
SWI0805UV-R24□	240	G,J	0.1V/100M	44/250	350	1.00	690
SWI0805UV-R25□	250	G,J	0.1V/100M	45/250	350	1.20	660



■ Specifications

Part Number	Inductance (nH)	Tolerance	Test Frequency (Hz)	Q @ Test Freq. min.	I rms (mA) max.	DCR (Ω) max.	SRF (MHz) min.
SWI0805UV-R27□	270	G,J	0.1V/100M	48/250	350	1.00	650
SWI0805UV-R33□	330	G,J	0.1V/100M	48/250	310	1.40	600
SWI0805UV-R39□	390	G,J	0.1V/100M	48/250	290	1.50	560
SWI0805UV-R47□	470	G,J	0.1V/50M	33/100	250	1.70	375
SWI0805UV-R56□	560	G,J	0.1V/25M	23/50	230	1.90	340
SWI0805UV-R62□	620	G,J	0.1V/25M	23/50	210	2.20	220
SWI0805UV-R68□	680	G,J	0.1V/25M	23/50	190	2.20	188
SWI0805UV-R82□	820	G,J	0.1V/25M	23/50	180	2.35	215
SWI0805UV-1R0□	1000	G,J	0.1V/25M	20/50	170	2.5	100
SWI0805UV-1R2□	1200	G,J	0.1V/7.9M	18/25	170	2.5	100

□ : C=±0.2nH, S=±0.3nH, G=±2%, J=±5%, K=±10%

■ Impedance vs Frequency, DC Bias Characteristics (Typical)

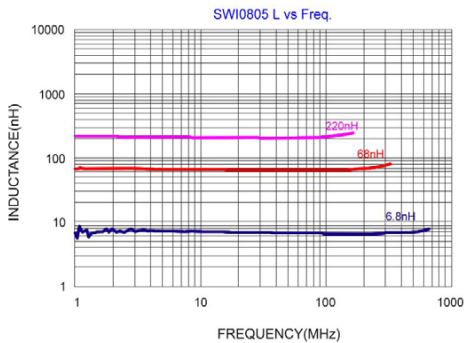
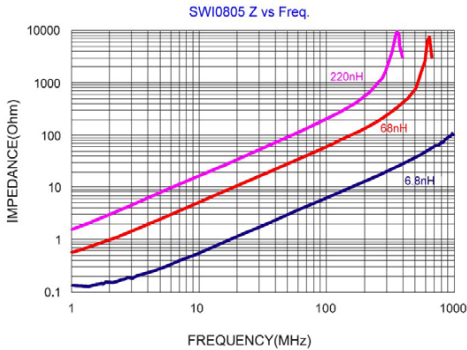

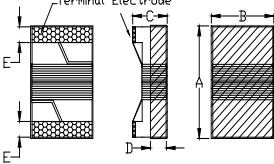

■ **Dimensions**

Chip Size	
A	2.92 max.
B	2.79 max.
C	2.20 max.
D	1.20 ref.
E	0.55±0.10

Units: mm

■ **Specifications**

Part Number	Inductance (nH)	Tolerance	Test Frequency (Hz)	Q @ Test Freq. min.	I rms (mA) max.	DCR (Ω) max.	SRF (MHz) min.
SWI1008UV-10N□	10	G, J, K	0.1V/50M	50/500	1000	0.08	4100
SWI1008UV-12N□	12	G, J, K	0.1V/50M	50/500	1000	0.09	3300
SWI1008UV-15N□	15	G, J, K	0.1V/50M	50/500	1000	0.18	2500
SWI1008UV-18N□	18	G, J, K	0.1V/50M	50/350	1000	0.11	2500
SWI1008UV-22N□	22	G, J, K	0.1V/50M	55/350	1000	0.12	2400
SWI1008UV-27N□	27	G, J, K	0.1V/50M	55/350	1000	0.13	1600
SWI1008UV-33N□	33	G, J, K	0.1V/50M	60/350	1000	0.14	1600
SWI1008UV-39N□	39	G, J, K	0.1V/50M	60/350	1000	0.15	1500
SWI1008UV-47N□	47	G, J, K	0.1V/50M	65/350	1000	0.16	1500
SWI1008UV-56N□	56	G, J, K	0.1V/50M	65/350	1000	0.18	1300
SWI1008UV-68N□	68	G, J, K	0.1V/50M	65/350	1000	0.20	1300
SWI1008UV-82N□	82	G, J, K	0.1V/50M	60/350	1000	0.22	1000
SWI1008UV-R10□	100	G, J, K	0.1V/25M	60/350	650	0.56	1000
SWI1008UV-R12□	120	G, J, K	0.1V/25M	60/350	650	0.63	950
SWI1008UV-R15□	150	G, J, K	0.1V/25M	45/100	580	0.70	850
SWI1008UV-R18□	180	G, J, K	0.1V/25M	45/100	620	0.77	750
SWI1008UV-R22□	220	G, J, K	0.1V/25M	45/100	500	0.84	700
SWI1008UV-R27□	270	G, J, K	0.1V/25M	45/100	500	0.91	600
SWI1008UV-R33□	330	G, J, K	0.1V/25M	45/100	450	1.05	570
SWI1008UV-R39□	390	G, J, K	0.1V/25M	45/100	470	1.12	500
SWI1008UV-R47□	470	G, J, K	0.1V/25M	45/100	470	1.19	450
SWI1008UV-R56□	560	G, J, K	0.1V/25M	45/100	400	1.33	415
SWI1008UV-R62□	620	G, J, K	0.1V/25M	45/100	300	1.40	375
SWI1008UV-R68□	680	G, J, K	0.1V/25M	45/100	400	1.47	375
SWI1008UV-R75□	750	G, J, K	0.1V/25M	45/100	360	1.54	360
SWI1008UV-R82□	820	G, J, K	0.1V/25M	45/100	400	1.61	350
SWI1008UV-R91□	910	G, J, K	0.1V/25M	35/50	380	1.68	320
SWI1008UV-1R0□	1000	G, J, K	0.1V/25M	35/50	370	1.75	290
SWI1008UV-1R2□	1200	G, J, K	0.1V/7.9M	35/50	310	2.00	250
SWI1008UV-1R5□	1500	G, J, K	0.1V/7.9M	28/50	330	2.23	200
SWI1008UV-1R8□	1800	G, J, K	0.1V/7.9M	28/50	300	2.60	160
SWI1008UV-2R2□	2200	G, J, K	0.1V/7.9M	28/50	280	2.80	160



■ Specifications

Part Number	Inductance (nH)	Tolerance	Test Frequency (Hz)	Q @ Test Freq. min.	I rms (mA) max.	DCR (Ω) max.	SRF (MHz) min.
SWI1008UV-2R7□	2700	G, J,K	0.1V/7.9M	22/25	290	3.20	140
SWI1008UV-3R3□	3300	G, J,K	0.1V/7.9M	22/25	290	3.40	110
SWI1008UV-3R9□	3900	G, J,K	0.1V/7.9M	20/25	260	3.6	100
SWI1008UV-4R7□	4700	G, J,K	0.1V/7.9M	18/7.9	200	4	32
SWI1008UV-5R6□	5600	G, J,K	0.1V/7.9M	18/7.9	200	4.0	25
SWI1008UV-6R8□	6800	G, J,K	0.1V/7.9M	18/7.9	200	4.9	21
SWI1008UV-8R2□	8200	G, J,K	0.1V/7.9M	16 /7.9	170	6.0	16
SWI1008UV-100□	10000	G, J,K	0.1V/2.52M	15/7.9	170	8.0	14

□ : G=±2% , J=±5% , K=±10%

■ Impedance vs Frequency, DC Bias Characteristics (Typical)

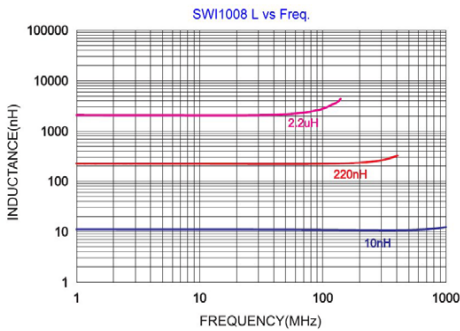
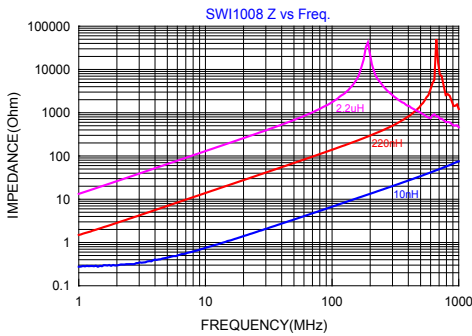



■ Dimensions

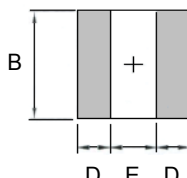
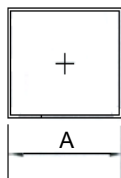

Dimensions	
A	2.00±0.20
B	1.60±0.20
C	1.50 max.
D	0.60 ref.
E	0.80 ref.

Units: mm



■ Specifications

Part Number	Inductance (uH) ±20%	Test Frequency (Hz)	SRF MHz (min)	RDC(Ω) Max.	Rated current (mA) Max.
PAS201615V-102	1000	0.1V/10K	4	38	20

Note:

1. Test frequency : Inductor(L) : 10KHz /0.1V;
2. All test data referenced to 25°C ambient.
3. Testing Instrument : L/Q: Agilent-4192A, Agilent-16334A ; I rms:CH3302,CH1320 ; SRF: Agilent-4291B ; Rdc: Agilent-34420A
4. Rated Current (I rms) will cause the coil temperature rise approximately Δt of 20°C .



■ Dimensions

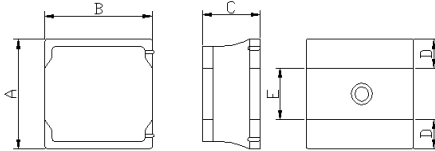

Dimensions	
A	3.00±0.20
B	3.00±0.20
C	1.00 max.
D	1.00 ref.
E	1.00 ref.

Units: mm

■ Specifications

Part Number	Inductance (uH) ±10%	Test Frequency (Hz)	SRF MHz (min)	DC Resistance (Ω) max.	Rated current (mA) max.
PAS3010EV-281K	280	10K	8.5	17.8	50

Note:

1. Test frequency : Inductor(L) : 10KHz /1V;
2. All test data referenced to 25°C ambient.
3. Testing Instrument : L/Q: Agilent-4192A, Agilent-16334A ; Irms:CH3302,CH1320 ; SRF: Agilent-4291B ; Rdc: Agilent-34420A
4. Rated Current (Irms) will cause the coil temperature rise approximately Δt of 20°C ..

■ DC Bias Characteristics (Typical)

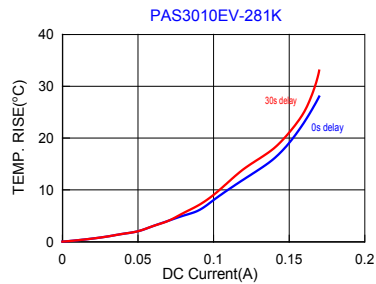
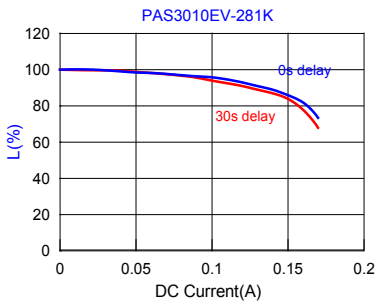



■ Dimensions

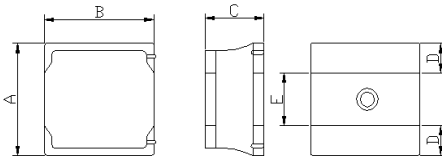

Dimensions	
A	3.00±0.20
B	3.00±0.20
C	1.20 max.
D	1.00 ref.
E	1.00 ref.

Units: mm

■ Specifications

Part Number	Inductance (uH)	Test Frequency (Hz)	SRF MHz (Typ)	DC Resistance (Ω) max.	Rated current (mA) max.
PAS3012EV-681K	680	10K	5.0	22	80

Note:

1. Test frequency : Inductor(L) : 10KHz /0.1V;
2. All test data referenced to 25°C ambient.
3. Testing Instrument : L/Q: Agilent-4192A, Agilent-16334A ; I rms:CH3302,CH1320 ; SRF: Agilent-4291B ; Rdc: Agilent-34420A
4. Rated Current (I rms) will cause the coil temperature rise approximately Δt of 20°C .

■ DC Bias Characteristics (Typical)

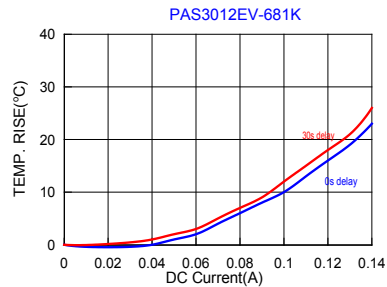
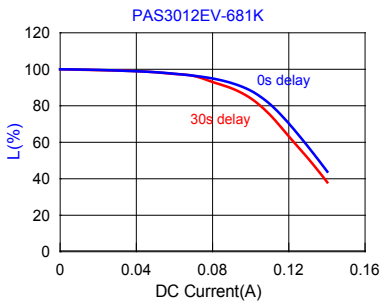



■ Dimensions

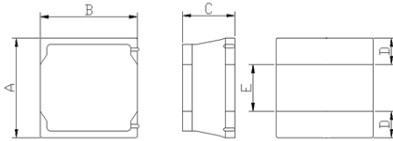

Dimensions	
A	3.00±0.20
B	3.00±0.20
C	1.50 max.
D	1.00 ref.
E	1.00 ref.

Units: mm

■ Specifications

Part Number	Inductance (uH)	Test Frequency (Hz)	SRF MHz (min)	RDC(Ω) Max.	Rated current (mA) Max.
PAS3015EV-122K	1200±10%	1V/10K	2.45	39.0	80

■ DC Bias Characteristics (Typical)

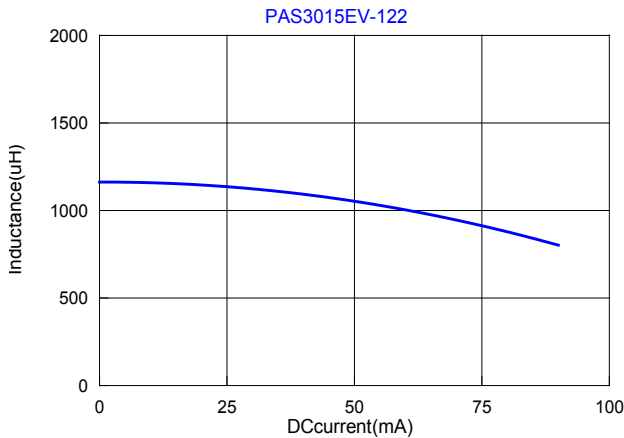



■ Dimensions

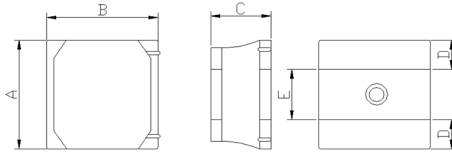

Dimensions	
A	4.00±0.20
B	4.00±0.20
C	1.80 max.
D	1.20 ref.
E	1.60 ref.

Units: mm

■ Specifications

Part Number	Inductance (uH)	Test Frequency (Hz)	SRF MHz (min)	RDC(Ω) Max.	Rated current (mA) Max.
PAS4018EV-102M	1000±20%	1V/100K	3.00	13.0	60

■ DC Bias Characteristics (Typical)

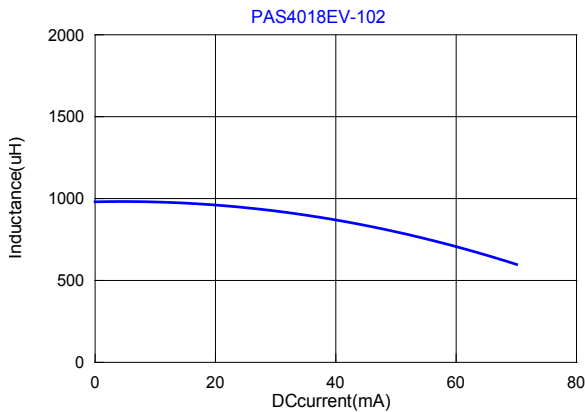



■ Dimensions

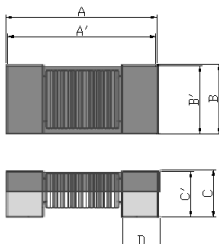

Chip Size	
A	4.55±0.25
A'	4.2±0.2
B	2.2±0.25
B'	1.80±0.2
C	2.0±0.2
C'	1.80±0.2
D	0.98 ref.

Units: mm

■ Specifications

Part Number	Inductance (uH) ±10%	f _{L0} (kHz)	SRF MHz(min)	RDC (Ω) max.	Rated Current (mA) max.
PAS4420V-352K-F10-DS	3500	10	1.00	85	20
PAS4420V-492K-F10-DS	4900	10	0.65	109	20

Note:

1. Test frequency : Inductor(L) : 10KHz /0.1V;
2. All test data referenced to 25°C ambient.
3. Testing Instrument : L/Q: Agilent-4192A, Agilent-16334A ; I rms:CH3302,CH1320 ; SRF: Agilent-4291B ; Rdc: Agilent-34420A
4. Rated Current (I rms) will cause the coil temperature rise approximately Δt of 20°C .



■ Dimensions

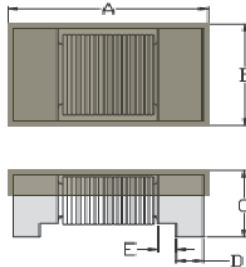

Chip Size	
A	6.40±0.30
B	2.30±0.20
C	1.80±0.20
D	0.90 ref.
E	0.50 ref.

Units: mm

■ Specifications

Part Number	Inductance (uH) ±10%	Test Frequency (KHz)	SRF Hz(min)	DC Resistance (Ω) ±10%	Rated Current (mA) max.
PAS6420V-701K-F10	700	10	2.45M	12	80
PAS6420V-532K-F10	5300	10	510K	66	30
PAS6420V-722K-F10	7200	10	450K	130	15

Note:

1. Test frequency : Inductor(L) : 10KHz /0.1V;
2. All test data referenced to 25°C ambient.
3. Testing Instrument : L/Q: Agilent-4192A, Agilent-16334A ; Irms:CH3302,CH1320 ; SRF: Agilent-4291B ; Rdc: Agilent-34420A
4. Rated Current (Irms) will cause the coil temperature rise approximately Δt of 20°C .

■ DC Bias Characteristics (Typical)

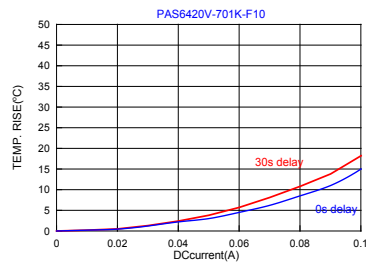
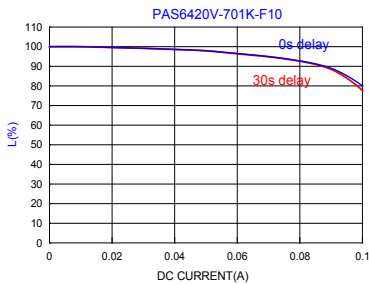



■ Dimensions

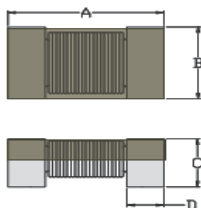

Dimensions	
A	7.85 max
B	2.70 max
C	2.70 max
D	1.15 ref.

Units: mm

■ Specifications

Part Number	Inductance (mH) ±5%	Test Frequency (Hz)	Q Typ.	RDC (Ω) max	Rated current (mA) max.
PAS8027V-452J	4.5	125K	30	80	20
PAS8027V-492J	4.9	125K	30	85	20
PAS8027V-722J	7.2	125K	35	105	20
PAS8027V-193J	18.52	125K	35	240	20

Note:

1. Test frequency : Inductor(L) : 125KHz /0.1V;
2. All test data referenced to 25°C ambient.
3. Testing Instrument : L/Q: Agilent-4192A, Agilent-16334A ; Irms:CH3302,CH1320 ; SRF: Agilent-4291B ; Rdc: Agilent-34420A
4. Rated Current (Irms) will cause the coil temperature rise approximately Δt of 20°C .



■ Dimensions

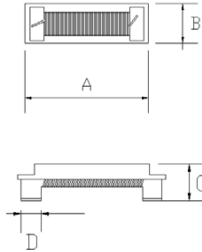

Chip Size	
A	11.60±0.30
B	3.80±0.30
C	2.50±0.30
D	1.50 ref.

Units: mm

■ Specifications

Part Number	Inductance (uH)	Test Frequency (Hz)	I rms (mA) max.	DC Resistance (Ω) max.	SRF (MHz) min.
PAS1225V-101K	100±10%	0.1V/125K	300	3.0	20
PAS1225V-232M	2300±20%	0.1V/125K	50	40	0.48
PAS1225V-492J	4900±5%	0.1V/125K	50	50	0.34
PAS1225V-722J	7200±5%	0.1V/125K	50	40	0.30

Note:

1. All test data referenced to 25°C ambient.
2. Testing Instrument : L/Q: Agilent-4192A, Agilent-16334A ; I rms:CH3302,CH1320 ; SRF: Agilent-4291B ; Rdc: Agilent-34420A
3. Rated Current (I rms) will cause the coil temperature rise approximately Δt of 20°C .

Power Inductors / Chokes



■ Power Inductors

HPC Series

UHP Series

DFP Series

FPI Series

FWP Series

AHP Series

TMPC Series

TMPF Series

TMPA Series

TMPV Series

TBMA Series



■ Dimensions

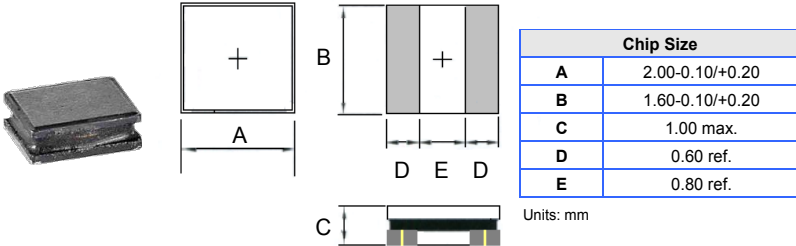

■ Specifications

Part Number	Inductance (uH)	Test Frequency (Hz)	DCR (Ω) ±20%	I sat (A) typ.	I sat (A) Max.	I rms (A) typ.	I rms (A) Max.
UHP201610NV-R47Y	0.47±30%	0.1V/1M	0.044	3.00	2.70	2.60	2.35
UHP201610NV-R68Y	0.68±30%	0.1V/1M	0.062	2.45	2.00	2.25	2.05
UHP201610NV-1R0Y	1.0±30%	0.1V/1M	0.080	1.95	1.80	1.75	1.60
UHP201610NV-1R5Y	1.5±30%	0.1V/1M	0.130	1.65	1.46	1.40	1.26
UHP201610NV-2R2M	2.2±20%	0.1V/1M	0.145	1.45	1.26	1.35	1.20
UHP201610NV-3R3M	3.3±20%	0.1V/1M	0.245	1.05	0.90	1.05	0.95
UHP201610NV-4R7M	4.7±20%	0.1V/1M	0.360	0.85	0.77	1.00	0.90
UHP201610NV-6R8M	6.8±20%	0.1V/1M	0.500	0.80	0.72	0.70	0.55
UHP201610NV-100M	10±20%	0.1V/1M	0.720	0.62	0.55	0.50	0.45
UHP201610NV-150M	15±20%	0.1V/1M	1.400	0.50	0.45	0.40	0.36
UHP201610NV-180M	18±20%	0.1V/1M	1.800	0.45	0.40	0.38	0.34
UHP201610NV-220M	22±20%	0.1V/1M	2.000	0.43	0.38	0.30	0.27

Note:

I_{sat} : Based on inductance change (ΔLL0 : ≤-30%) @ ambient temp. 25°C

I_{rms} : Based on temperature rise (ΔT : 40°C.)

■ DC Bias Characteristics (Typical)

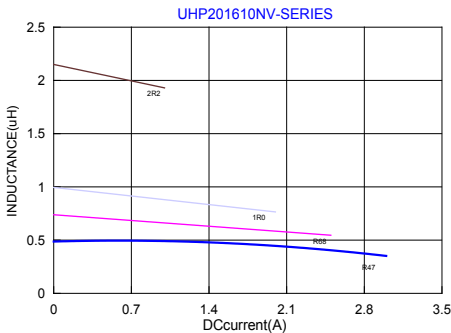



■ Dimensions

Chip Size	
A	2.00-0.10/+0.20
B	1.60-0.10/+0.20
C	1.00 max.
D	0.60 ref.
E	0.80 ref.

Units: mm

■ Specifications

Part Number	Inductance (uH)	Tolerance (%)	Test Frequency (Hz)	DCR (Ω) typ.	DCR (Ω) Max.	I sat (A) typ.	I sat (A) Max.	I rms (A) typ	I rms (A) Max.
DFP201610TV-R24M	0.24	±20%	0.1V/1M	0.023	0.028	5.10	4.50	4.40	3.90
DFP201610TV-R33M	0.33	±20%	0.1V/1M	0.031	0.040	3.90	3.50	3.50	3.10
DFP201610TV-R47M	0.47	±20%	0.1V/1M	0.035	0.042	3.85	3.40	3.30	3.00
DFP201610TV-R68M	0.68	±20%	0.1V/1M	0.046	0.055	3.25	2.80	2.80	2.50
DFP201610TV-1R0M	1.0	±20%	0.1V/1M	0.059	0.072	2.90	2.50	2.40	2.20
DFP201610TV-1R5M	1.5	±20%	0.1V/1M	0.098	0.118	2.30	1.80	2.10	1.80
DFP201610TV-2R2M	2.2	±20%	0.1V/1M	0.141	0.170	2.10	1.70	1.70	1.55

Note:

I_{sat} : Based on inductance change ($\Delta L/L_0 \leq -30\%$) @ ambient temp. 25°C

I_{rms} : Based on temperature rise ($\Delta T : 40^\circ\text{C}$) Max

■ DC Bias Characteristics (Typical)

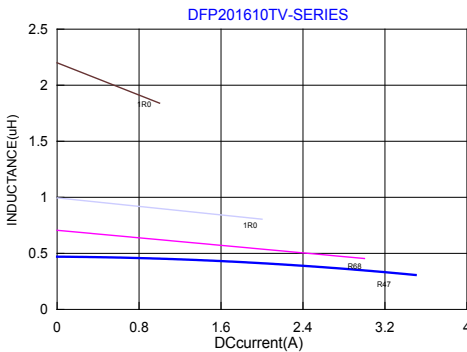



■ Dimensions

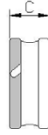
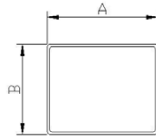

Series	A(mm)	B(mm)	C(mm)	D(mm)	E(mm)
AHP201610FV	2.0 -0.1/+0.2	1.6 -0.1/+0.2	1.0Max	0.50 ref.	1.00 ref.

Units: mm

■ Specifications

TAI-TECH Part Number	Inductance (uH)	Tolerance (%)	Test Frequency (Hz)	DCR (Ω) typ.	DCR (Ω) Max.	I sat (A) typ.	I sat (A) Max.	I rms (A) typ	I rms (A) MAX
AHP201610FV-R24M	0.24	±20	1V/1M	0.015	0.020	7.50	6.50	5.70 (1) 6.50 (2)	5.10 (1) 5.50 (2)
AHP201610FV-R33M	0.33	±20	1V/1M	0.018	0.023	5.50	5.00	5.50 (1) 5.60 (2)	5.00 (1) 5.20 (2)
AHP201610FV-R47M	0.47	±20	1V/1M	0.024	0.029	5.20	4.50	4.70 (1) 5.30 (2)	4.30 (1) 4.70 (2)
AHP201610FV-R68M	0.68	±20	1V/1M	0.036	0.044	5.10	4.40	3.90 (1) 4.20 (2)	3.50 (1) 3.80 (2)
AHP201610FV-1R0M	1.0	±20	1V/1M	0.050	0.060	4.50	4.00	3.20 (1) 3.40 (2)	2.90 (1) 3.10 (2)
AHP201610FV-1R5M	1.5	±20	1V/1M	0.068	0.082	3.20	2.80	2.90 (1) 3.10 (2)	2.50 (1) 2.70 (2)
AHP201610FV-2R2M	2.2	±20	1V/1M	0.100	0.120	2.70	2.40	2.20 (1) 2.30 (2)	2.00 (1) 2.10 (2)
AHP201610FV-4R7M	4.7	±20	1V/1M	0.180	0.216	1.60	1.40	1.60 (1) 1.80 (2)	1.40 (1) 1.60 (2)

Note:

Isat : Based on inductance change ($\Delta L/L0 : \leq 30\%$) @ ambient temp. 25°C

Irms : Based on temperature rise ($\Delta T : 40^\circ\text{C}.$) Max

Measurement board data

Irms1

Material : FR4

Board dimensions : 100 X 50 X 1.6t mm

Pattern dimensions: 45 X 30 mm (Double side board)

Pattern thickness : 50 μm

Irms2

Material: FR4

Board dimensions : 100 X 50 X 1.6t mm

Pattern dimensions: 45 X 45 mm (Double side board)

Pattern thickness : 70 μm



■ DC Bias Characteristics (Typical)

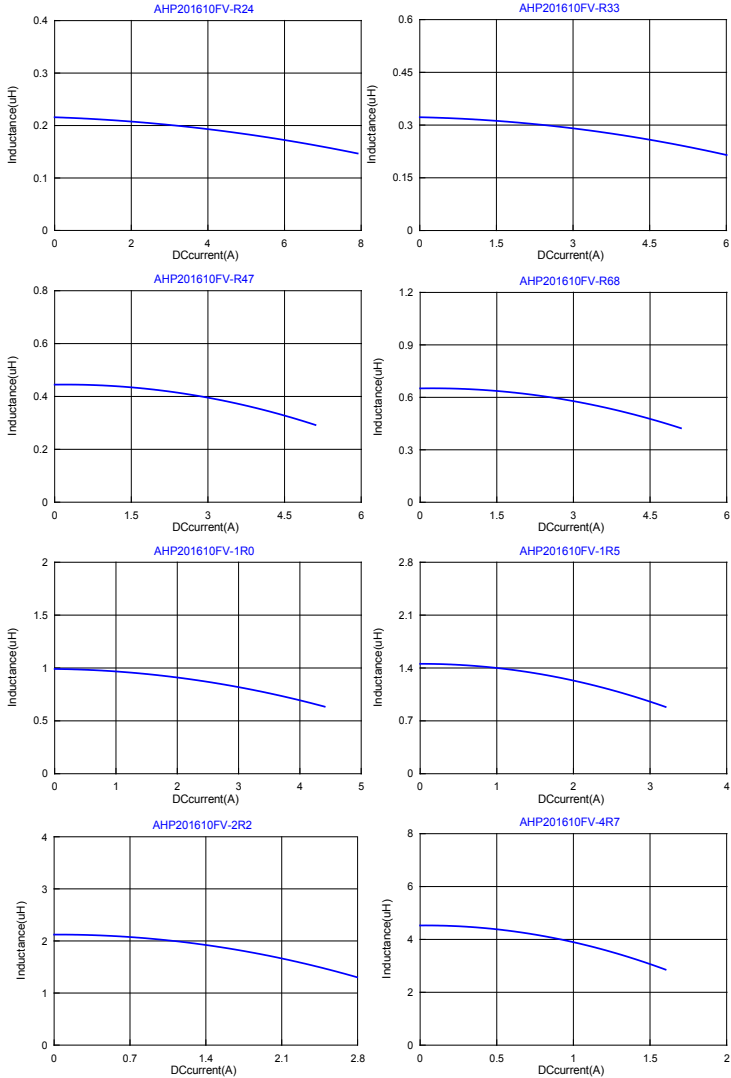



■ Dimensions

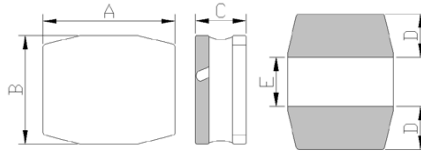

Series	A(mm)	B(mm)	C(mm)	D(mm)	E(mm)
AHP201610HV	2.0 -0.1/+0.2	1.6 -0.1/+0.2	1.0Max	0.50 ref.	1.00 ref.

Units: mm

■ Specifications

TAI-TECH Part Number	Inductance (uH)	Tolerance (%)	Test Frequency (Hz)	DCR (Ω) typ.	DCR (Ω) Max.	I sat (A) typ.	I sat (A) Max.	I rms (A) typ	I rms (A) MAX
AHP201610HV-R24M	0.24	±20	1V/1M	0.017	0.021	7.00	6.00	5.60 (1) 5.90 (2)	5.00 (1) 5.30 (2)
AHP201610HV-R33M	0.33	±20	1V/1M	0.023	0.029	5.50	5.00	5.10 (1) 5.30 (2)	4.60 (1) 4.80 (2)
AHP201610HV-R47M	0.47	±20	1V/1M	0.028	0.035	5.20	4.30	4.50 (1) 4.80 (2)	4.00 (1) 4.40 (2)
AHP201610HV-R68M	0.68	±20	1V/1M	0.040	0.050	4.30	3.70	3.80 (1) 4.00 (2)	3.40 (1) 3.60 (2)
AHP201610HV-1R0M	1.0	±20	1V/1M	0.053	0.065	3.60	3.00	3.10 (1) 3.50 (2)	2.80 (1) 3.20 (2)
AHP201610HV-1R5M	1.5	±20	1V/1M	0.100	0.120	2.60	2.30	2.40 (1) 2.70 (2)	2.10 (1) 2.30 (2)
AHP201610HV-2R2M	2.2	±20	1V/1M	0.110	0.130	2.10	1.90	2.10 (1) 2.20 (2)	1.90 (1) 2.00 (2)
AHP201610HV-4R7M	4.7	±20	1V/1M	0.190	0.230	1.10	1.00	1.10 (1) 1.20 (2)	1.00 (1) 1.10 (2)

Note:

I_{sat} : Based on inductance change (ΔL/L0 : ≤30%) @ ambient temp. 25°C

I_{rms} : Based on temperature rise (ΔT : 40°C.) Max

Measurement board data

I_{rms1}

Material : FR4

Board dimensions : 100 X 50 X 1.6t mm

Pattern dimensions: 45 X 30 mm (Double side board)

Pattern thickness : 50 μm

I_{rms2}

Material: FR4

Board dimensions : 100 X 50 X 1.6t mm

Pattern dimensions: 45 X 45 mm (Double side board)

Pattern thickness : 70 μm



■ DC Bias Characteristics (Typical)

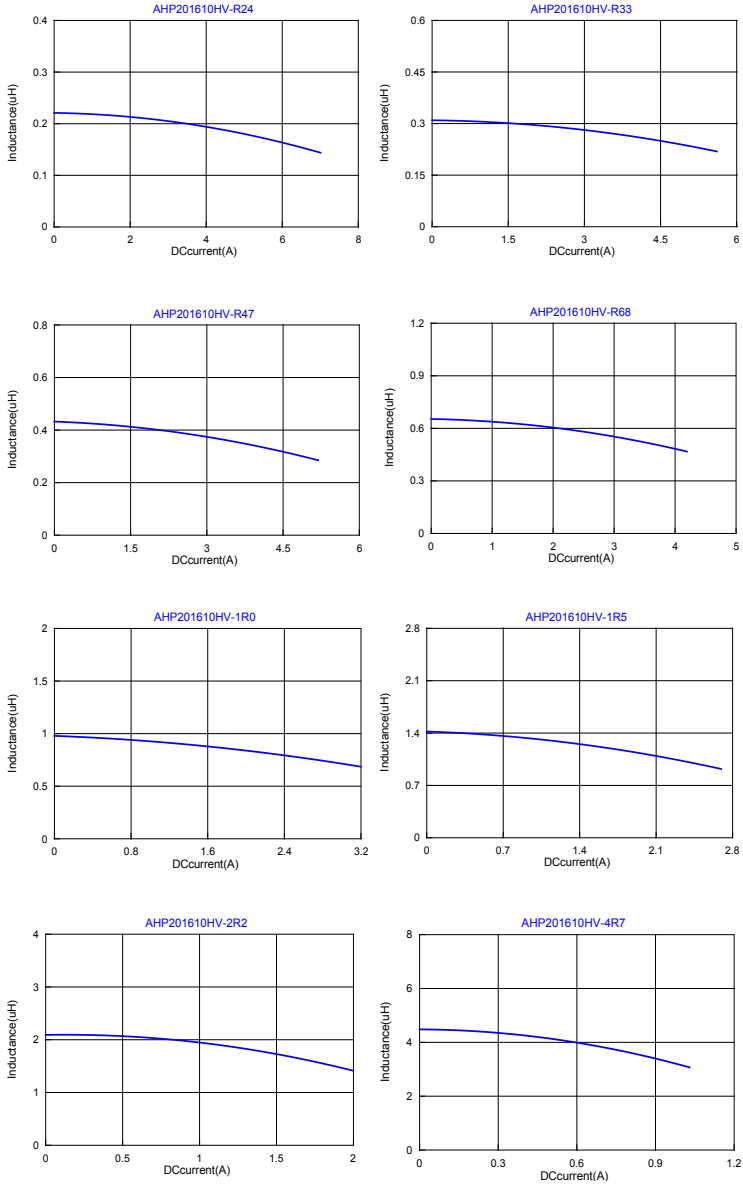



■ Dimensions

Chip Size	
A	2.00-0.10/+0.20
B	1.60-0.10/+0.20
C	1.20 max.
D	0.60 ref.
E	0.80 ref.

Units: mm

■ Specifications

Part Number	Inductance (uH)	Test Frequency (Hz)	DCR (Ω) typ.	DCR (Ω) Max.	I sat (A) typ.	I sat (A) Max.	I rms (A) typ	I rms (A) Max.
DFP201612NV-R24M	0.24±20%	0.1V/1M	0.025	0.033	5.40	4.80	4.00	3.50
DFP201612NV-R33M	0.33±20%	0.1V/1M	0.027	0.034	4.70	3.90	3.90	3.20
DFP201612NV-R47M	0.47±20%	0.1V/1M	0.035	0.046	3.90	3.50	3.30	2.90
DFP201612NV-R68M	0.68±20%	0.1V/1M	0.055	0.066	3.30	2.80	3.00	2.60
DFP201612NV-1R0M	1.0±20%	0.1V/1M	0.080	0.104	3.00	2.50	2.70	2.30
DFP201612NV-1R5M	1.5±20%	0.1V/1M	0.090	0.108	2.50	2.00	2.10	1.80
DFP201612NV-2R2M	2.2±20%	0.1V/1M	0.155	0.186	2.00	1.60	1.50	1.30

Note:

I_{sat} : Based on inductance change (ΔL/L0 : ≤-30%) @ ambient temp. 25°C

I_{rms} : Based on temperature rise (ΔT : 40°C.) Max

■ DC Bias Characteristics (Typical)

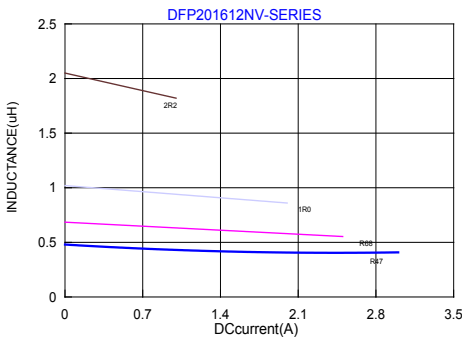



■ Dimensions

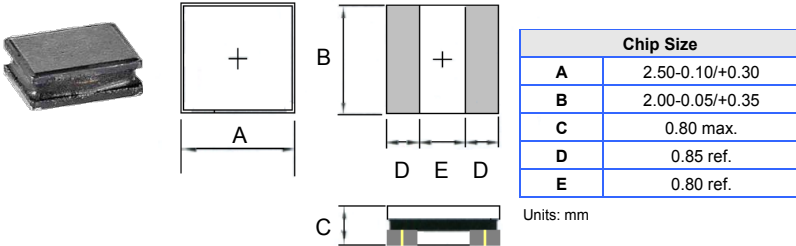

■ Specifications

Part Number	Inductance (uH)	Test Frequency (Hz)	DCR (Ω) typ.	DCR (Ω) Max.	I sat (A) typ.	I sat (A) Max.	I rms (A) typ.	I rms (A) Max.
HPC252008MV-R47	0.47±20%	0.1V/1M	0.080	0.096	2.50	2.20	1.45	1.25
HPC252008MV-R68	0.68±20%	0.1V/1M	0.100	0.120	2.05	1.80	1.35	1.15
HPC252008MV-1R0	1.0±20%	0.1V/1M	0.120	0.145	1.75	1.50	1.20	1.05
HPC252008MV-1R5	1.5±20%	0.1V/1M	0.170	0.200	1.65	1.45	1.05	0.95
HPC252008MV-2R2	2.2±20%	0.1V/1M	0.210	0.250	1.40	1.20	0.95	0.85
HPC252008MV-3R3	3.3±20%	0.1V/1M	0.300	0.360	1.10	0.95	0.85	0.75
HPC252008MV-4R7	4.7±20%	0.1V/1M	0.400	0.480	0.90	0.80	0.70	0.63
HPC252008MV-6R8	6.8±20%	0.1V/1M	0.670	0.800	0.75	0.65	0.55	0.50
HPC252008MV-100	10.0±20%	0.1V/1M	0.930	1.110	0.55	0.50	0.45	0.41

Note:

I_{sat} : Based on inductance change (ΔL/L0 : ≤-30%) @ ambient temp. 25°C

I_{rms} : Based on temperature rise (ΔT : 40°C) MAX

■ DC Bias Characteristics (Typical)

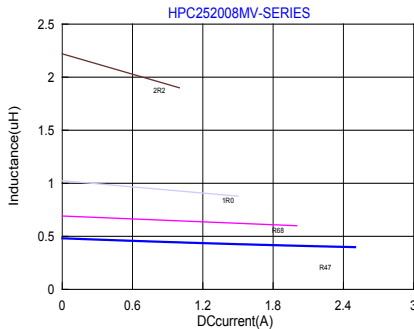



■ Dimensions

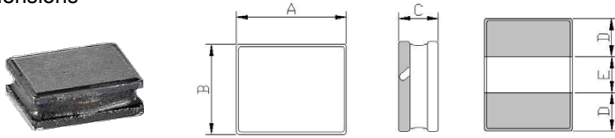

Series	A(mm)	B(mm)	C(mm)	D(mm)	E(mm)
AHP252010RV	2.5 -0.1/+0.2	2.0 -0.1/+0.2	0.8Max	0.75 ref.	1.00 ref.

Units: mm

■ Specifications

TAI-TECH Part Number	Inductance (uH)	Tolerance (%)	Test Frequency (Hz)	DCR (Ω) typ.	DCR (Ω) Max.	I sat (A) typ.	I sat (A) Max.	I rms (A) typ	I rms (A) Max
AHP252008RV-R24M	0.24	±20	1V/1M	0.035	0.042	5.30	4.80	4.50 (1) 4.70 (2)	4.00 (1) 4.20 (2)
AHP252008RV-R33M	0.33	±20	1V/1M	0.040	0.055	4.80	4.30	3.90 (1) 4.30 (2)	3.50 (1) 3.90 (2)
AHP252008RV-R47M	0.47	±20	1V/1M	0.045	0.060	4.50	4.00	3.70 (1) 4.10 (2)	3.30 (1) 3.70 (2)
AHP252008RV-R68M	0.68	±20	1V/1M	0.060	0.075	4.00	3.50	3.50 (1) 3.70 (2)	3.00 (1) 3.20 (2)
AHP252008RV-1R0M	1.0	±20	1V/1M	0.070	0.90	3.20	2.80	2.80 (1) 3.20 (2)	2.50 (1) 2.80 (2)
AHP252008RV-1R5M	1.5	±20	1V/1M	0.105	0.127	2.80	2.60	2.30 (1) 2.50 (2)	2.10 (1) 2.30 (2)
AHP252008RV-2R2M	2.2	±20	1V/1M	0.150	0.180	2.00	1.80	1.80 (1) 2.20 (2)	1.60 (1) 1.80 (2)
AHP252008RV-3R3M	3.3	±20	1V/1M	0.220	0.260	1.60	1.30	1.60 (1) 1.80 (2)	1.30 (1) 1.50 (2)
AHP252008RV-4R7M	4.7	±20	1V/1M	0.360	0.430	1.50	1.20	1.20 (1) 1.30 (2)	1.00 (1) 1.10 (2)

Note:

Isat : Based on inductance change ($\Delta L/L0 : \leq 30\%$) @ ambient temp. 25°CIrms : Based on temperature rise ($\Delta T : 40^{\circ}\text{C}.$) Max

Measurement board data

Irms1

Material : FR4

Board dimensions : 100 X 50 X 1.6t mm

Pattern dimensions: 45 X 30 mm (Double side board)

Pattern thickness : 50 μm

Irms2

Material: FR4

Board dimensions : 100 X 50 X 1.6t mm

Pattern dimensions: 45 X 45 mm (Double side board)

Pattern thickness : 70 μm



■ DC Bias Characteristics (Typical)

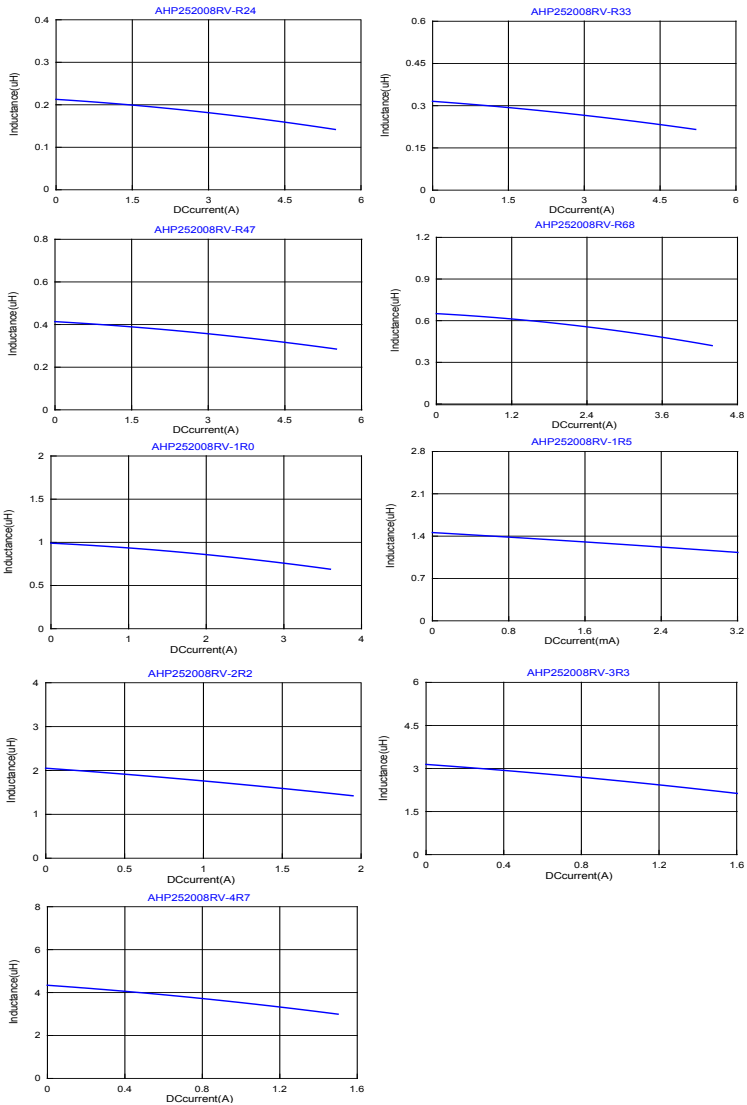



■ Dimensions

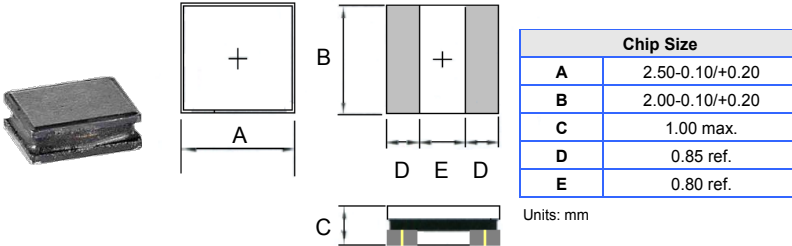

■ Specifications

Part Number	Inductance (uH)	Test Frequency (Hz)	DCR (Ω) ±20%	I sat (A) typ.	I sat (A) Max.	I rms (A) typ	I rms (A) Max.
UHP252010BV-R47Y	0.47±30%	0.1V/1M	0.030	2.85	2.57	2.80	2.50
UHP252010BV-R68Y	0.68±30%	0.1V/1M	0.039	2.70	2.45	2.45	2.20
UHP252010BV-1R0Y	1.0±30%	0.1V/1M	0.055	2.45	2.05	2.20	1.80
UHP252010BV-1R5Y	1.5±30%	0.1V/1M	0.090	1.80	1.70	1.70	1.55
UHP252010BV-2R2M	2.2±20%	0.1V/1M	0.114	1.60	1.55	1.55	1.40
UHP252010BV-3R3M	3.3±20%	0.1V/1M	0.170	1.30	1.10	1.25	1.10
UHP252010BV-4R7M	4.7±20%	0.1V/1M	0.250	1.10	0.95	1.05	0.92
UHP252010BV-6R8M	6.8±20%	0.1V/1M	0.370	0.95	0.80	0.85	0.76
UHP252010BV-100M	10±20%	0.1V/1M	0.470	0.75	0.65	0.75	0.67
UHP252010BV-150M	15±20%	0.1V/1M	0.750	0.55	0.45	0.55	0.50
UHP252010BV-220M	22±20%	0.1V/1M	1.120	0.50	0.40	0.50	0.45

Note:

I_{sat} : Based on inductance change (ΔL/L0 : ≤-30%) @ ambient temp. 25°C

I_{rms} : Based on temperature rise (ΔT : 40°C.) Max

■ DC Bias Characteristics (Typical)

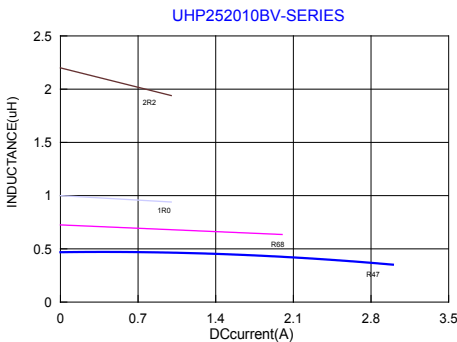



■ Dimensions

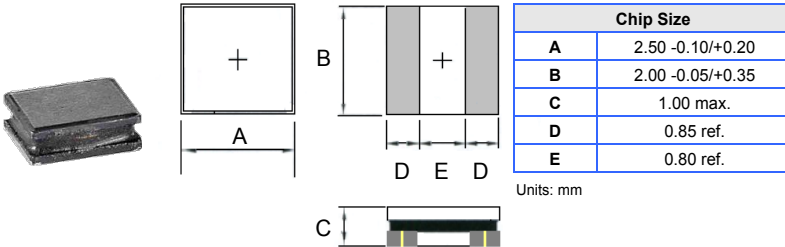

■ Specifications

Part Number	Inductance (uH)	Test Frequency (Hz)	DCR (Ω) typ.	DCR (Ω) Max.	I sat (A) typ.	I sat (A) Max.	I rms (A) typ.	I rms (A) Max.
DFP252010NV-R24M	0.24±20%	0.1V/1M	0.030	0.042	4.80	4.30	3.60	3.10
DFP252010NV-R33M	0.33±20%	0.1V/1M	0.032	0.044	4.30	3.80	3.50	3.00
DFP252010NV-R47M	0.47±20%	0.1V/1M	0.034	0.046	4.00	3.30	3.40	2.90
DFP252010NV-R56M	0.56±20%	0.1V/1M	0.045	0.054	3.80	3.00	3.30	2.80
DFP252010NV-R68M	0.68±20%	0.1V/1M	0.046	0.055	3.70	2.90	3.30	2.80
DFP252010NV-1R0M	1.0±20%	0.1V/1M	0.060	0.080	3.40	2.70	2.60	2.20
DFP252010NV-1R2M	1.2±20%	0.1V/1M	0.090	0.108	2.90	2.30	2.30	1.90
DFP252010NV-1R5M	1.5±20%	0.1V/1M	0.090	0.108	2.70	2.10	2.30	1.90
DFP252010NV-2R2M	2.2±20%	0.1V/1M	0.130	0.169	2.40	1.90	1.80	1.50

Note:

I_{sat} : Based on inductance change (ΔL/L0 : ≤-30%) @ ambient temp. 25°C

I_{rms} : Based on temperature rise (ΔT : 40°C.) Max

■ DC Bias Characteristics (Typical)

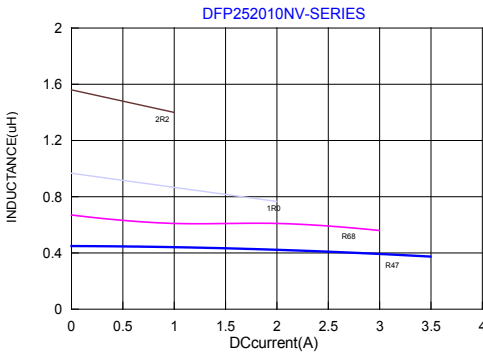



■ Dimensions

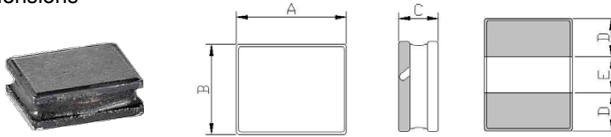

Series	A(mm)	B(mm)	C(mm)	D(mm)	E(mm)
AHP252010FV	2.5 -0.1/+0.2	2.0 -0.1/+0.2	1.0Max	0.75 ref.	1.00 ref.

Units: mm

■ Specifications

TAI-TECH Part Number	Inductance (uH)	Tolerance (%)	Test Frequency (Hz)	DCR (Ω) typ.	DCR (Ω) Max.	I sat (A) typ.	I sat (A) Max.	I rms (A) typ	I rms (A) Max
AHP252010FV-R24M	0.24	±20	1V/1M	0.018	0.022	9.50	8.00	5.50 (1) 6.00 (2)	5.00 (1) 5.50 (2)
AHP252010FV-R33M	0.33	±20	1V/1M	0.023	0.028	8.00	6.50	5.30 (1) 5.60 (2)	4.80 (1) 5.10 (2)
AHP252010FV-R47M	0.47	±20	1V/1M	0.027	0.035	7.00	5.90	4.60 (1) 5.30 (2)	4.20 (1) 4.80 (2)
AHP252010FV-R68M	0.68	±20	1V/1M	0.032	0.040	5.50	4.60	4.20 (1) 4.40 (2)	3.80 (1) 4.00 (2)
AHP252010FV-1R0M	1.0	±20	1V/1M	0.044	0.053	4.90	4.30	3.50 (1) 3.70 (2)	3.10 (1) 3.40 (2)
AHP252010FV-1R5M	1.5	±20	1V/1M	0.062	0.074	3.80	3.10	3.20 (1) 3.40 (2)	2.80 (1) 3.00 (2)
AHP252010FV-2R2M	2.2	±20	1V/1M	0.078	0.093	2.80	2.30	2.60 (1) 2.80 (2)	2.30 (1) 2.50 (2)
AHP252010FV-4R7M	4.7	±20	1V/1M	0.180	0.216	1.70	1.40	1.70 (1) 1.80 (2)	1.50 (1) 1.60 (2)

Note:

Isat : Based on inductance change ($\Delta L/L0 : \leq 30\%$) @ ambient temp. 25°C

Irms : Based on temperature rise ($\Delta T : 40^{\circ}\text{C}.$) Max

Measurement board data

Irms1

Material : FR4

Board dimensions : 100 X 50 X 1.6t mm

Pattern dimensions: 45 X 30 mm (Double side board)

Pattern thickness : 50 μm

Irms2

Material: FR4

Board dimensions : 100 X 50 X 1.6t mm

Pattern dimensions: 45 X 45 mm (Double side board)

Pattern thickness : 70 μm



■ DC Bias Characteristics (Typical)

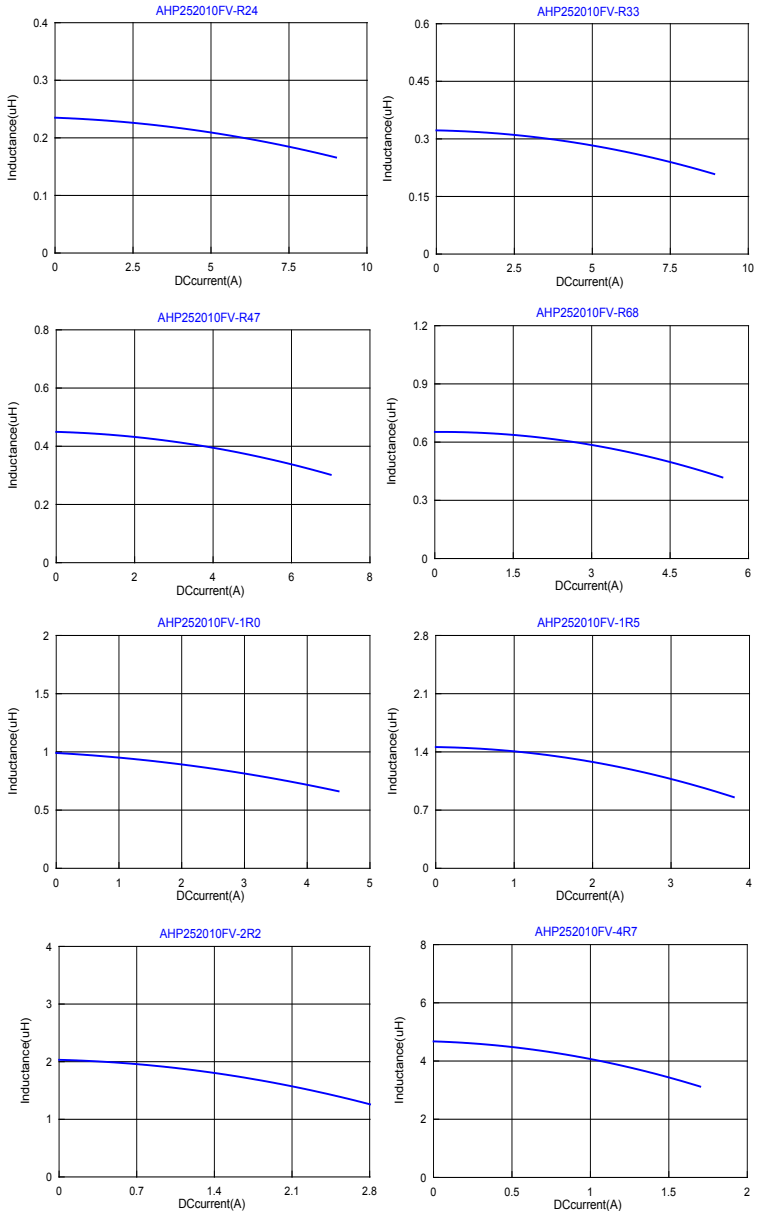



■ Dimensions

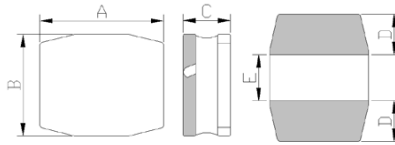

Series	A(mm)	B(mm)	C(mm)	D(mm)	E(mm)
AHP252010HV	2.5 -0.1/+0.2	2.0 -0.1/+0.2	1.0Max	0.75 ref.	1.00 ref.

Units: mm

■ Specifications

TAI-TECH Part Number	Inductance (uH)	Tolerance (%)	Test Frequency (Hz)	DCR (Ω) typ.	DCR (Ω) Max.	I sat (A) typ.	I sat (A) Max.	I rms (A) typ	I rms (A) Max
AHP252010HV-R24M	0.24	±20	1V/1M	0.022	0.028	7.20	6.70	5.50 (1) 6.00 (2)	5.00 (1) 5.50 (2)
AHP252010HV-R33M	0.33	±20	1V/1M	0.023	0.029	6.00	5.50	4.80 (1) 5.00 (2)	4.30 (1) 4.50 (2)
AHP252010HV-R47M	0.47	±20	1V/1M	0.029	0.035	5.50	4.90	4.50 (1) 4.70 (2)	3.90 (1) 4.20 (2)
AHP252010HV-R68M	0.68	±20	1V/1M	0.036	0.043	4.40	3.80	3.80 (1) 4.00 (2)	3.40 (1) 3.60 (2)
AHP252010HV-1R0M	1.0	±20	1V/1M	0.044	0.053	3.60	3.10	3.50 (1) 3.70 (2)	3.00 (1) 3.20 (2)
AHP252010HV-1R5M	1.5	±20	1V/1M	0.072	0.086	3.20	2.70	2.50 (1) 2.80 (2)	2.20 (1) 2.40 (2)
AHP252010HV-2R2M	2.2	±20	1V/1M	0.090	0.108	2.50	2.10	2.40 (1) 2.60 (2)	2.10 (1) 2.30 (2)
AHP252010HV-4R7M	4.7	±20	1V/1M	0.220	0.264	1.70	1.40	1.40 (1) 1.60 (2)	1.20 (1) 1.40 (2)

Note:

Isat : Based on inductance change ($\Delta L/L0 : \leq 30\%$) @ ambient temp. 25°C

Irms : Based on temperature rise ($\Delta T : 40^\circ\text{C}.$) Max

Measurement board data

Irms1

Material : FR4

Board dimensions : 100 X 50 X 1.6t mm

Pattern dimensions: 45 X 30 mm (Double side board)

Pattern thickness : 50 μm

Irms2

Material: FR4

Board dimensions : 100 X 50 X 1.6t mm

Pattern dimensions: 45 X 45 mm (Double side board)

Pattern thickness : 70 μm



■ DC Bias Characteristics (Typical)

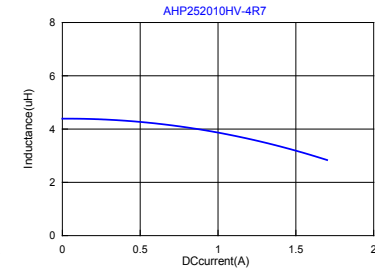
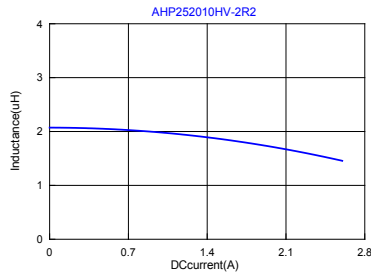
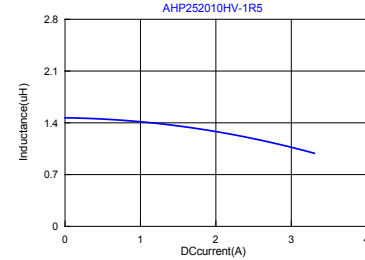
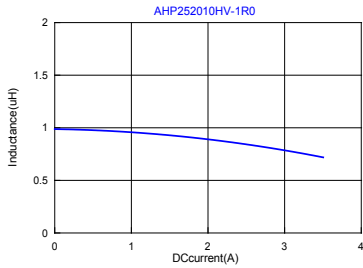
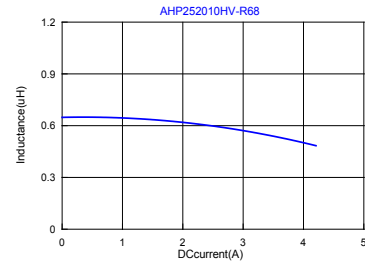
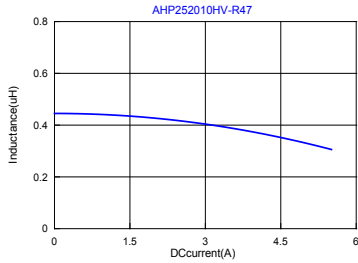
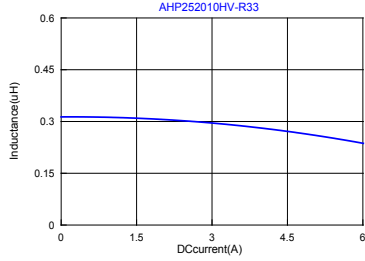
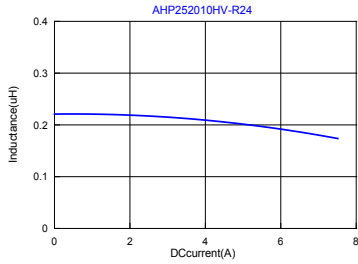



■ Dimensions

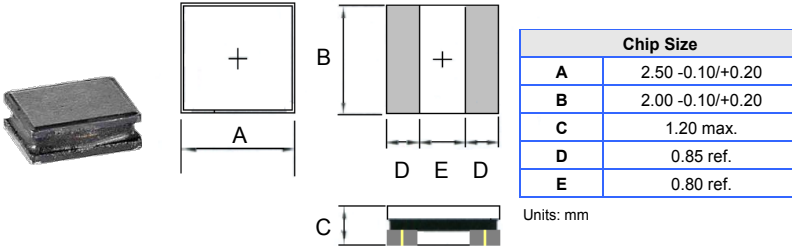

■ Specifications

Part Number	Inductance (uH)	Test Frequency (Hz)	DCR (Ω) ±20%	I sat (A) typ.	I sat (A) Max.	I rms (A) typ	I rms (A) Max.
UHP252012BV-R47Y	0.47±30%	0.1V/1M	0.028	4.00	3.60	3.70	3.35
UHP252012BV-R68Y	0.68±30%	0.1V/1M	0.036	3.00	2.70	3.30	3.00
UHP252012BV-1R0Y	1.0±30%	0.1V/1M	0.049	2.70	2.45	2.60	2.30
UHP252012BV-1R5Y	1.5±30%	0.1V/1M	0.063	2.30	2.05	2.20	1.95
UHP252012BV-2R2M	2.2±20%	0.1V/1M	0.080	2.15	1.95	1.85	1.65
UHP252012BV-3R3M	3.3±20%	0.1V/1M	0.120	1.70	1.50	1.45	1.30
UHP252012BV-4R7M	4.7±20%	0.1V/1M	0.176	1.50	1.35	1.20	1.05
UHP252012BV-6R8M	6.8±20%	0.1V/1M	0.250	1.15	1.00	1.00	0.90
UHP252012BV-100M	10±20%	0.1V/1M	0.410	0.85	0.75	0.75	0.65
UHP252012BV-150M	15±20%	0.1V/1M	0.540	0.63	0.56	0.60	0.54
UHP252012BV-220M	22±20%	0.1V/1M	0.850	0.56	0.50	0.50	0.45

Note:

I_{sat} : Based on inductance change (ΔL/L0 : ≤-30%) @ ambient temp. 25°C

I_{rms} : Based on temperature rise (ΔT : 40°C.) Max

■ DC Bias Characteristics (Typical)

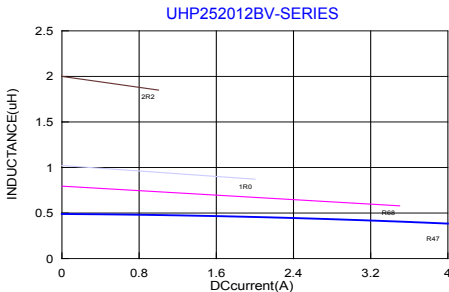



■ Dimensions

Chip Size	
A	2.50 -0.10/+0.20
B	2.00 -0.05/+0.35
C	1.20 max.
D	0.85 ref.
E	0.80 ref.

Units: mm

■ Specifications

Part Number	Inductance (uH)	Tolerance (%)	Test Frequency (Hz)	DCR (Ω) typ.	DCR (Ω) Max.	I sat (A) typ.	I sat (A) Max.	I rms (A) typ
DFP252012TV-R24M	0.24	±20%	0.1V/1M	0.024	0.028	8.00	6.50	4.70
DFP252012TV-R33M	0.33	±20%	0.1V/1M	0.027	0.032	5.70	4.60	4.50
DFP252012TV-R47M	0.47	±20%	0.1V/1M	0.027	0.032	5.50	4.50	4.40
DFP252012TV-R68M	0.68	±20%	0.1V/1M	0.036	0.043	4.50	3.80	3.60
DFP252012TV-1R0M	1.0	±20%	0.1V/1M	0.045	0.057	3.90	3.40	3.50
DFP252012TV-1R5M	1.5	±20%	0.1V/1M	0.080	0.096	3.00	2.60	2.50
DFP252012TV-2R2M	2.2	±20%	0.1V/1M	0.085	0.102	2.70	2.30	2.30

Note:

I_{sat} : Based on inductance change ($\Delta L/L_0 : \leq -30\%$) @ ambient temp. 25°C
 I_{rms} : Based on temperature rise ($\Delta T : 40^\circ\text{C}$) Max

■ DC Bias Characteristics (Typical)

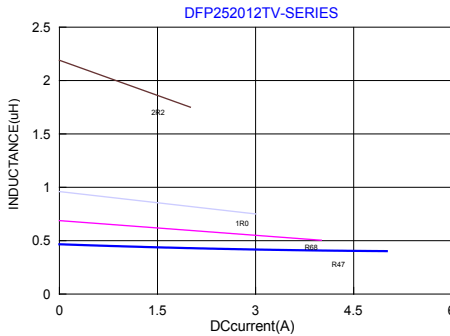



■ Dimensions

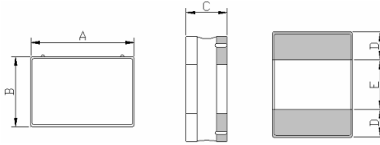

Series	A(mm)	B(mm)	C(mm)	D(mm)	E(mm)
AHP252012RV	2.5 -0.1/+0.2	2.0 -0.1/+0.2	1.2Max	0.75 ref.	1.00 ref.

Units: mm

■ Specifications

TAI-TECH Part Number	Inductance (uH)	Tolerance (%)	Test Frequency (Hz)	DCR (Ω) typ.	DCR (Ω) Max.	I sat (A) typ.	I sat (A) Max.	I rms (A) typ	I rms (A) MAX
AHP252012RV-R24M	0.24	±20	1V/1M	0.018	0.022	8.00	7.00	5.50(1) 6.00(2)	5.00(1) 5.50(2)
AHP252012RV-R33M	0.33	±20	1V/1M	0.023	0.028	7.00	6.00	5.10(1) 5.60(2)	4.60(1) 5.10(2)
AHP252012RV-R47M	0.47	±20	1V/1M	0.027	0.035	6.00	5.00	4.80(1) 5.30(2)	4.30(1) 4.80(2)
AHP252012RV-R68M	0.68	±20	1V/1M	0.036	0.045	5.00	4.50	4.00(1) 4.50(2)	3.60(1) 4.00(2)
AHP252012RV-1R0M	1.0	±20	1V/1M	0.045	0.058	4.30	3.80	3.50(1) 3.80(2)	3.20(1) 3.50(2)
AHP252012RV-1R5M	1.5	±20	1V/1M	0.060	0.072	3.50	3.00	3.10(1) 3.50(2)	2.70(1) 3.10(2)
AHP252012RV-2R2M	2.2	±20	1V/1M	0.090	0.108	3.10	2.60	2.50(1) 2.80(2)	2.20(1) 2.50(2)
AHP252012RV-3R3M	3.3	±20	1V/1M	0.125	0.150	2.20	1.90	2.10(1) 2.50(2)	1.80(1) 2.20(2)
AHP252012RV-4R7M	4.7	±20	1V/1M	0.190	0.220	2.00	1.70	1.70(1) 1.90(2)	1.40(1) 1.60(2)
AHP252012RV-6R8M	6.8	±20	1V/1M	0.300	0.360	1.80	1.50	1.20(1) 1.30(2)	1.00(1) 1.10(2)
AHP252012RV-100M	10	±20	1V/1M	0.420	0.475	1.40	1.10	1.00(1) 1.10(2)	0.90(1) 1.00(2)

Note:

Isat : Based on inductance change ($\Delta L/L0 : \leq 30\%$) @ ambient temp. 25°CI rms : Based on temperature rise ($\Delta T : 40^{\circ}\text{C}.$) Max

Measurement board data

I rms1

Material : FR4

Board dimensions : 100 X 50 X 1.6t mm

Pattern dimensions: 45 X 30 mm (Double side board)

Pattern thickness : 50 μm

I rms2

Material: FR4

Board dimensions : 100 X 50 X 1.6t mm

Pattern dimensions: 45 X 45 mm (Double side board)

Pattern thickness : 70 μm



■ DC Bias Characteristics (Typical)

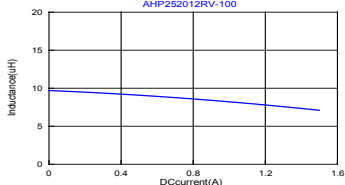
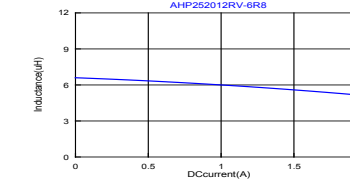
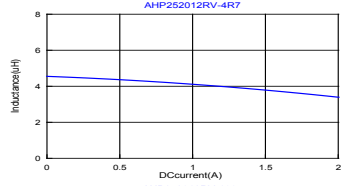
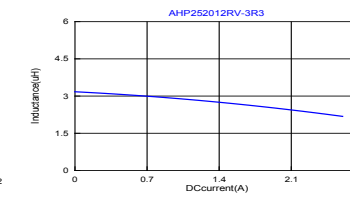
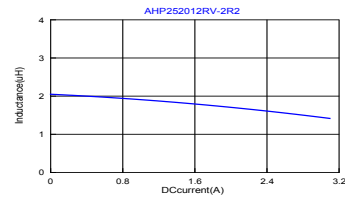
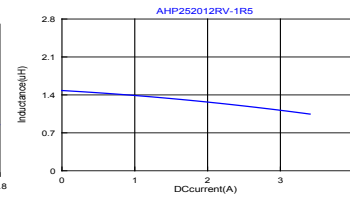
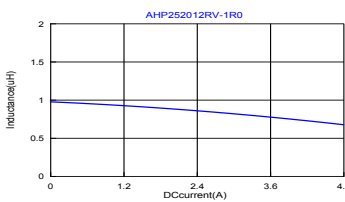
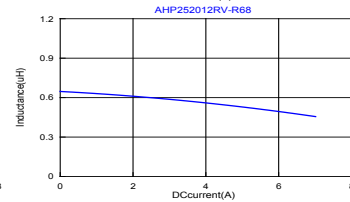
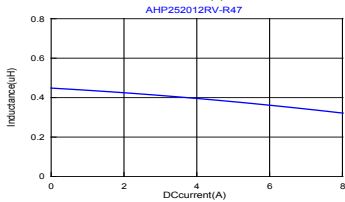
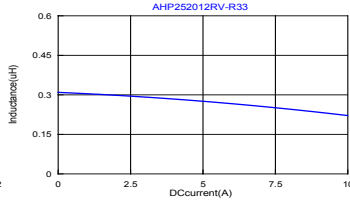
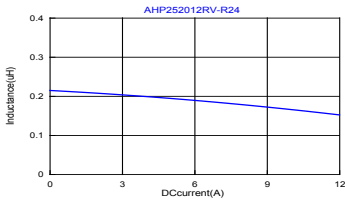



■ Dimensions

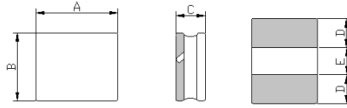

Series	A(mm)	B(mm)	C(mm)	D(mm)	E(mm)
AHP252012HV	2.5 -0.1/+0.2	2.0 -0.1/+0.2	1.2Max	0.75 ref.	1.00 ref.

Units: mm

■ Specifications

TAI-TECH Part Number	Inductance (uH)	Tolerance (%)	Test Frequency (Hz)	DCR (Ω) typ.	DCR (Ω) Max.	I sat (A) typ.	I sat (A) Max.	I rms (A) typ	I rms (A) Max
AHP252012HV-R24M	0.24	±20	1V/1M	0.011	0.015	7.80	6.50	7.00 (1) 7.50 (2)	6.00 (1) 6.50 (2)
AHP252012HV-R33M	0.33	±20	1V/1M	0.017	0.023	7.00	6.00	5.80 (1) 6.30 (2)	4.80 (1) 5.20 (2)
AHP252012HV-R47M	0.47	±20	1V/1M	0.021	0.027	6.50	5.50	5.00 (1) 5.50 (2)	4.20 (1) 4.70 (2)
AHP252012HV-R68M	0.68	±20	1V/1M	0.030	0.037	6.00	5.00	4.50 (1) 5.00 (2)	3.90 (1) 4.20 (2)

Note:

Isat : Based on inductance change ($\Delta L/L0 : \leq 30\%$) @ ambient temp. 25°C

Irms : Based on temperature rise ($\Delta T : 40^\circ\text{C}$.) Max

Measurement board data

Irms1

Material : FR4

Board dimensions : 100 X 50 X 1.6t mm

Pattern dimensions: 45 X 30 mm (Double side board)

Pattern thickness : 50 μm

Irms2

Material: FR4

Board dimensions : 100 X 50 X 1.6t mm

Pattern dimensions: 45 X 45 mm (Double side board)

Pattern thickness : 70 μm



■ DC Bias Characteristics (Typical)

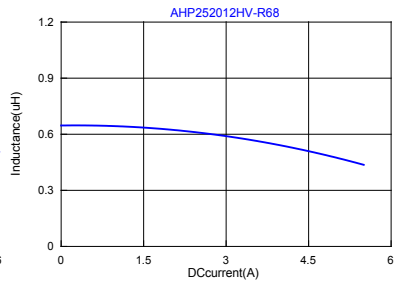
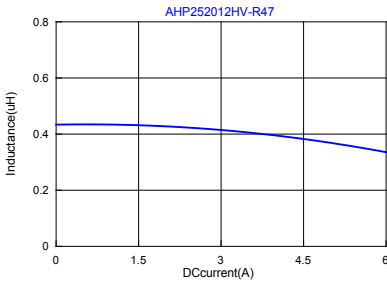
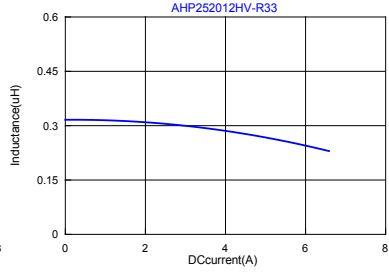
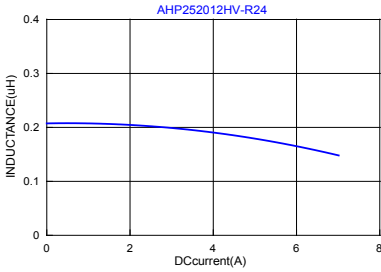



■ Dimensions

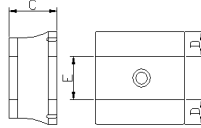
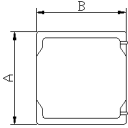

Chip Size	
A	3.00±0.20
B	3.00±0.20
C	1.00 max.
D	1.00 ref.
E	1.00 ref.

Units: mm

■ Specifications

Part Number	Inductance (uH)	Tolerance (%)	Test Frequency (Hz)	DCR (Ω) ±20%	I sat (A) typ.	I sat (A) max.	I rms (A) typ.	I rms (A) max.
HPC3010TV-1R0Y	1.0	±30%	0.1V/1M	0.055	2.20	1.80	2.50	2.10
HPC3010TV-1R5Y	1.5	±30%	0.1V/1M	0.070	2.00	1.50	2.20	1.90
HPC3010TV-2R2M	2.2	±20%	0.1V/1M	0.090	1.60	1.30	2.10	1.70
HPC3010TV-3R3M	3.3	±20%	0.1V/1M	0.130	1.30	1.10	1.70	1.50
HPC3010TV-4R7M	4.7	±20%	0.1V/1M	0.170	1.20	0.90	1.50	1.30
HPC3010TV-R68M	6.8	±20%	0.1V/1M	0.260	0.90	0.77	1.30	1.00
HPC3010TV-100M	10	±20%	0.1V/1M	0.350	0.75	0.63	1.00	0.80
HPC3010TV-150M	15	±20%	0.1V/1M	0.510	0.65	0.54	0.80	0.70
HPC3010TV-220M	22	±20%	0.1V/1M	0.750	0.55	0.43	0.75	0.60

Note:

I_{sat} : Based on inductance change (ΔL/L0 : ≤-30%) @ ambient temp. 25°C
 I_{rms} : Based on temperature rise (ΔT : 40°C typ.)

■ DC Bias Characteristics (Typical)

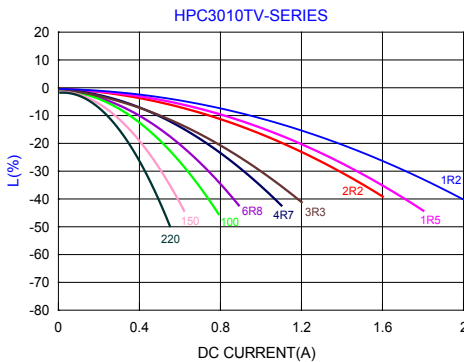



■ Dimensions

Chip Size	
A	3.00±0.20
B	3.00±0.20
C	1.20 max.
D	1.00 ref.
E	1.00 ref.

Units: mm

■ Specifications

Part Number	Inductance (uH)	Tolerance (%)	Test Frequency (Hz)	DCR (Ω) ±20%	I sat (A) typ.	I sat (A) max.	I rms (A) typ	I rms (A) max.
HPC3012TV-1R0Y	1.0	±30%	0.1V/1M	0.042	2.50	2.15	2.20	2.00
HPC3012TV-1R5Y	1.5	±30%	0.1V/1M	0.056	2.00	1.70	2.00	1.85
HPC3012TV-2R2M	2.2	±20%	0.1V/1M	0.080	1.80	1.50	1.90	1.70
HPC3012TV-3R3M	3.3	±20%	0.1V/1M	0.100	1.50	1.20	1.70	1.55
HPC3012TV-4R7M	4.7	±20%	0.1V/1M	0.130	1.30	1.05	1.50	1.30
HPC3012TV-6R8M	6.8	±20%	0.1V/1M	0.180	1.20	0.90	1.20	1.05
HPC3012TV-100M	10	±20%	0.1V/1M	0.245	0.90	0.76	1.00	0.89
HPC3012TV-150M	15	±20%	0.1V/1M	0.386	0.80	0.62	0.90	0.74
HPC3012TV-220M	22	±20%	0.1V/1M	0.580	0.60	0.49	0.70	0.61

Note:

Isat : Based on inductance change (ΔL/L0 : ≤ -30%) @ ambient temp. 25°C
 I rms : Based on temperature rise (ΔT : 40°C typ.)

■ DC Bias Characteristics (Typical)

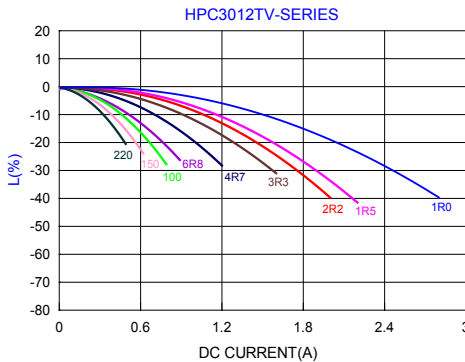



■ Dimensions

Chip Size	
A	3.50±0.20
B	3.20±0.20
C	1.00±0.20
D	0.70±0.20
E	1.20±0.20

Units: mm

■ Specifications

Part Number	Inductance L0 (uH)	I rms (A) typ.	I sat (A) typ.	DCR(mΩ) typ. @25°C	DCR(mΩ) max. @25°C
TMPC0312HV-R47MG	0.47±20%	5.00	7.20	25	30
TMPC0312HV-R56MG	0.56±20%	4.50	6.60	31	36
TMPC0312HV-R68MG	0.68±20%	4.00	6.10	34	40
TMPC0312HV-R82MG	0.82±20%	3.50	5.80	41	48
TMPC0312HV-1R0MG	1.00±20%	3.30	5.50	50	60
TMPC0312HV-1R5MG	1.50±20%	3.00	4.00	71	85
TMPC0312HV-2R2MG	2.20±20%	2.70	3.40	98	115
TMPC0312HV-3R3MG	3.30±20%	2.00	3.10	191	210
TMPC0312HV-4R7MG	4.70±20%	1.60	2.80	266	293
TMPC0312HV-5R6MG	5.60±20%	1.50	2.20	310	360
TMPC0312HV-6R8MG	6.80±20%	1.40	2.00	360	400
TMPC0312HV-8R2MG	8.20±20%	1.20	1.70	420	463
TMPC0312HV-100MG	10.0±20%	1.00	1.40	498	550

Note:

1. Test frequency : L : 100KHz /1.0V.
2. All test data referenced to 25°C ambient.
3. Heat Rated Current (Irms) will cause the coil temperature rise approximately Δt of 40°C
4. Saturation Current (Isat) will cause L0 to drop 30% typical.
5. Special inquiries besides the above common used types can be met on your requirement.

■ DC Bias Characteristics (Typical)

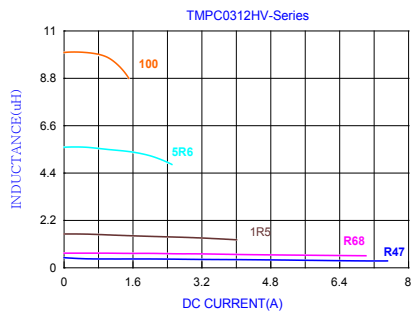
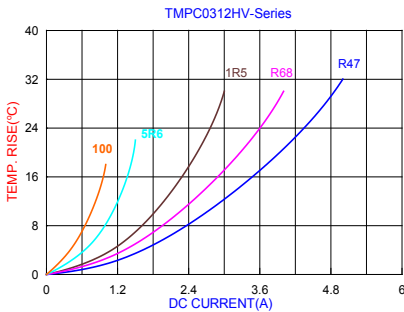



■ Dimensions

Chip Size	
A	3.00±0.20
B	3.00±0.20
C	1.50 max.
D	1.00 ref.
E	1.00 ref.

Units: mm

■ Specifications

Part Number	Inductance (uH)	Tolerance (%)	Test Frequency (Hz)	SRF (MHz) typ.	DCR (Ω) ±20%	I sat (A)typ	I sat (A)max.	I rms (A)typ	I rms (A)max.
HPC3015TV-1R0Y	1.0	±30%	1V100K	100	0.030	2.20	2.00	2.20	2.00
HPC3015TV-1R5Y	1.5	±30%	1V100K	87	0.040	2.00	1.80	2.00	1.80
HPC3015TV-2R2M	2.2	±20%	1V100K	64	0.060	1.70	1.50	1.70	1.50
HPC3015TV-3R3M	3.3	±20%	1V100K	49	0.080	1.40	1.20	1.40	1.20
HPC3015TV-4R7M	4.7	±20%	1V100K	40	0.120	1.20	1.00	1.20	1.00
HPC3015TV-6R8M	6.8	±20%	1V100K	36	0.160	1.00	0.90	1.00	0.90
HPC3015TV-100M	10	±20%	1V100K	28	0.220	0.75	0.65	0.80	0.70
HPC3015TV-150M	15	±20%	1V100K	23	0.320	0.65	0.55	0.70	0.60
HPC3015TV-220M	22	±20%	1V100K	20	0.460	0.55	0.45	0.60	0.50
HPC3015TV-330M	33	±20%	1V100K	18	0.800	0.40	0.35	0.45	0.40
HPC3015TV-470M	47	±20%	1V100K	17	1.200	0.35	0.30	0.40	0.35

Note:

I_{sat} : Based on inductance change (ΔL/L0 : ≤-30%) @ ambient temp. 25°C
 I_{rms} : Based on temperature rise (ΔT : 40°C typ.)

■ DC Bias Characteristics (Typical)

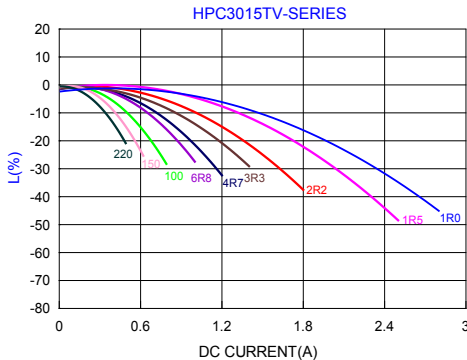

■ Dimensions

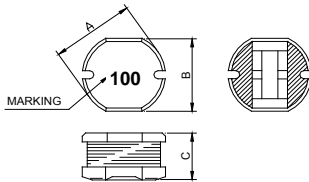

Size	A(mm)	B(mm)	C(mm)
FPI 0302	3.50±0.3	3.00±0.3	2.10±0.3

■ Specifications

TAI-TECH Part Number	Inductance (uH)	Tolerance (%)	Test Frequency (Hz)	DCR (Ω) max.	IDC (A) max.
FPI 0302BMV-1R0M	1.0	± 20%	1V/7.96M	0.04	1.50
FPI 0302BMV-2R2M	2.2	± 20%	1V/7.96M	0.08	0.75
FPI 0302BMV-3R3M	3.3	± 20%	1V/7.96M	0.15	0.60
FPI 0302BMV-4R7M	4.7	± 20%	1V/7.96M	0.20	0.50
FPI 0302BMV-5R6M	5.6	± 20%	1V/7.96M	0.23	0.45
FPI 0302BMV-6R8M	6.8	± 20%	1V/7.96M	0.25	0.40
FPI 0302BMV-8R2M	8.2	± 20%	1V/7.96M	0.30	0.40
FPI 0302BMV-100M	10	± 20%	1V/2.52M	0.35	0.35
FPI 0302BMV-120M	12	± 20%	1V/2.52M	0.40	0.35
FPI 0302BMV-150M	15	± 20%	1V/2.52M	0.50	0.30
FPI 0302BMV-180M	18	± 20%	1V/2.52M	0.55	0.30
FPI 0302BMV-220M	22	± 20%	1V/2.52M	0.60	0.30
FPI 0302BMV-270M	27	± 20%	1V/2.52M	0.70	0.30
FPI 0302BMV-330M	33	± 20%	1V/2.52M	1.00	0.25
FPI 0302BMV-390M	39	± 20%	1V/2.52M	1.20	0.25
FPI 0302BMV-470M	47	± 20%	1V/2.52M	1.50	0.20
FPI 0302BMV-560M	56	± 20%	1V/2.52M	1.80	0.20
FPI 0302BMV-680M	68	± 20%	1V/2.52M	2.00	0.18
FPI 0302BMV-820M	82	± 20%	1V/2.52M	2.50	0.16
FPI 0302BMV-101M	100	± 20%	1V/1K	3.00	0.15
FPI 0302BMV-121M	120	± 20%	1V/1K	3.50	0.14
FPI 0302BMV-151M	150	± 20%	1V/1K	4.00	0.13
FPI 0302BMV-221M	220	± 20%	1V/1K	5.50	0.10
FPI 0302BMV-331M	330	± 20%	1V/1K	7.00	0.10
FPI 0302BMV-471M	470	± 20%	1V/1K	12.0	0.09

Note:

Based on inductance change ($\Delta L/L0 : \leq -35\%$) @ ambient temp. 25°C

Based on temperature rise ($\Delta T : 40\text{°C typ.}$)



■ Dimensions

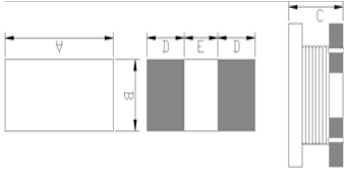

Dimensions	
A	3.20±0.30
B	1.60±0.30
C	1.80±0.30
D	1.05 ref.
E	1.05 ref.

Units: mm

■ Specifications

TAI-TECH Part Number	Inductance (uH)	Tolerance (%)	Test Frequency (Hz)	SRF (MHz) min.	DCR (Ω) ±20%	I rms (A)typ
FWP321618V-R47M	0.47	±20%	1V1M	180	0.130	0.70
FWP321618V-2R2M	2.2	±20%	1V1M	50	0.300	0.43
FWP321618V-3R3M	3.3	±20%	1V1M	55	0.350	0.38
FWP321618V-220M	22	±20%	1V1M	14	2.20	0.16

Note:

Isat : Based on inductance change ($\Delta L/L0 : \leq 30\%$) @ ambient temp. 25°C

Irms : Based on temperature rise ($\Delta T : 40^\circ\text{C}$) Max

■ DC Bias Characteristics (Typical)

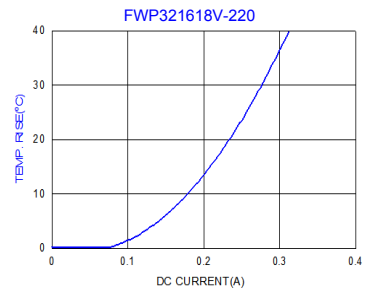
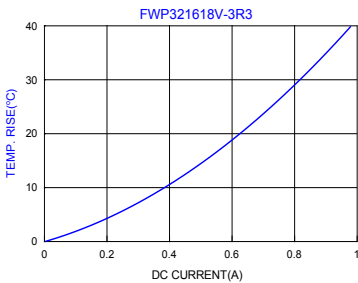
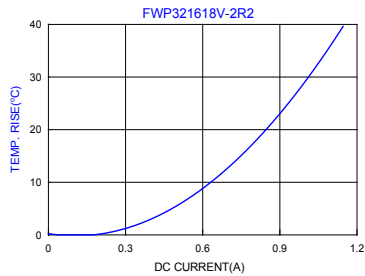
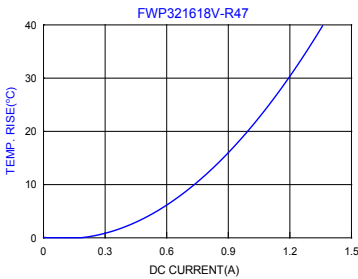



■ Dimensions

Chip Size	
A	3.50±0.20
B	3.20±0.20
C	1.80±0.20
D	0.70±0.20
E	1.20±0.20

Units: mm

■ Specifications

Part Number	Inductance L0 (uH)	I rms (A) typ.	I sat (A) typ.	DCR(mΩ) typ. @25°C	DCR(mΩ) max. @25°C
TMPC0302HV-R10YG	0.10 ± 30%	10.50	14.00	6.6	9.0
TMPC0302HV-R47MG	0.47 ± 20%	7.00	9.00	19.7	23.0
TMPC0302HV-R68MG	0.68 ± 20%	5.50	7.00	25.5	29.0
TMPC0302HV-1R0MG	1.00 ± 20%	4.00	5.00	32.0	38.0
TMPC0302HV-2R2MG	2.20 ± 20%	3.50	3.70	65.0	75.0
TMPC0302HV-3R3MG	3.30 ± 20%	3.00	3.50	125	145
TMPC0302HV-4R7MG	4.70 ± 20%	2.60	3.00	172	200
TMPC0302HV-5R6MG	5.60 ± 20%	2.20	2.60	205	238
TMPC0302HV-6R8MG	6.80 ± 20%	1.90	2.20	260	300
TMPC0302HV-100MG	10.0 ± 20%	1.40	1.60	366	422

Note:

1. Test frequency : L : 100KHz /1.0V.
2. All test data referenced to 25°C ambient.
3. Heat Rated Current (I_{rms}) will cause the coil temperature rise approximately Δt of 40°C.
4. Saturation Current (I_{sat}) will cause L0 to drop 30% typical.
5. Special inquiries besides the above common used types can be met on your requirement.

■ DC Bias Characteristics (Typical)

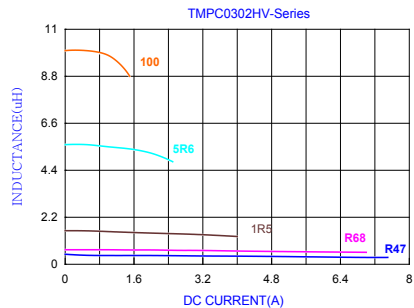
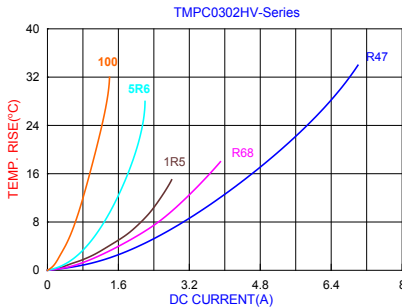



■ Dimensions

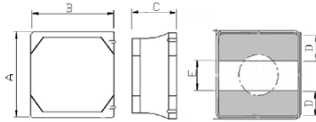

Chip Size	
A	4.00±0.20
B	4.00±0.20
C	1.00 max.
D	1.2 ref.
E	1.6 ref.

Units: mm

■ Specifications

Part Number	Inductance (uH)	Tolerance (%)	Test Frequency (Hz)	SRF (MHz) typ.	DCR (Ω) ±20%	I sat (A)typ.	I sat (A)Max.	I rms (A)typ.	I rms (A)Max.
HPC4010TV-1R0Y	1.0	±30%	1V100K	116	0.056	2.40	2.00	2.30	1.90
HPC4010TV-2R2M	2.2	±20%	1V100K	73	0.085	1.50	1.20	1.80	1.50
HPC4010TV-3R3M	3.3	±20%	1V100K	58	0.100	1.30	1.10	1.70	1.40
HPC4010TV-4R7M	4.7	±20%	1V100K	47	0.140	1.20	0.95	1.50	1.20
HPC4010TV-6R8M	6.8	±20%	1V100K	38	0.200	1.00	0.80	1.20	1.00
HPC4010TV-100M	10	±20%	1V100K	31	0.300	0.80	0.62	0.90	0.75
HPC4010TV-150M	15	±20%	1V100K	24	0.430	0.70	0.54	0.80	0.60
HPC4010TV-220M	22	±20%	1V100K	19	0.570	0.60	0.45	0.80	0.50

Note:

I_{sat} : Based on inductance change (ΔL/L0 : ≤-30%) @ ambient temp. 25°C

I_{rms} : Based on temperature rise (ΔT : 40°C typ.)

■ DC Bias Characteristics (Typical)

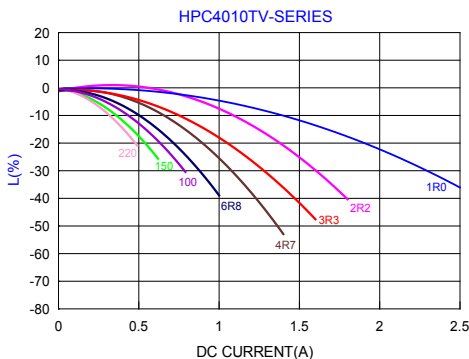



■ Dimensions

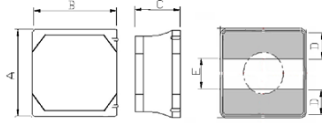

Chip Size	
A	4.00±0.20
B	4.00±0.20
C	1.20 max.
D	1.20 ref.
E	1.60 ref.

Units: mm

■ Specifications

Part Number	Inductance (uH)	Tolerance (%)	Test Frequency (Hz)	SRF (MHz) typ.	DCR (Ω) ±20%	I sat (A)typ.	I sat (A)Max.	I rms (A)typ.	I rms (A)Max.
HPC4012TV-1R0Y	1.0	±30%	1V100K	100	0.042	3.30	2.80	2.50	2.20
HPC4012TV-2R2M	2.2	±20%	1V100K	70	0.060	1.95	1.65	2.20	1.90
HPC4012TV-3R3M	3.3	±20%	1V100K	60	0.070	1.60	1.40	1.90	1.70
HPC4012TV-4R7M	4.7	±20%	1V100K	45	0.095	1.40	1.20	1.70	1.50
HPC4012TV-6R8M	6.8	±20%	1V100K	35	0.125	1.10	0.90	1.50	1.30
HPC4012TV-100M	10	±20%	1V100K	30	0.180	1.00	0.80	1.30	1.10
HPC4012TV-150M	15	±20%	1V100K	24	0.260	0.80	0.65	0.95	0.75
HPC4012TV-220M	22	±20%	1V100K	18	0.400	0.60	0.50	0.72	0.62

Note:

I_{sat} : Based on inductance change (ΔL/L0 : ≤-30%) @ ambient temp. 25°C

I_{rms} : Based on temperature rise (ΔT : 40°C typ.)

■ DC Bias Characteristics (Typical)

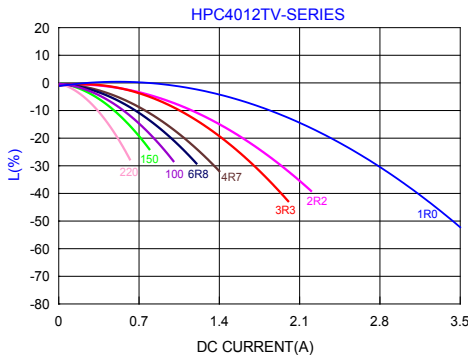



■ Dimensions

Chip Size	
A	4.45±0.25
B	4.06±0.25
C	1.00±0.20
D	0.76±0.30
E	2.00±0.20

Units: mm

■ Specifications

Part Number	Inductance L0 (uH)±20%	I rms (A)typ	I sat (A)typ	DCR (mΩ) typ. @25°C.	DCR (mΩ) max. @25°C.
TMPC0412HPV-R10YG	0.10±30%	11.50	25.0	4.30	5.50
TMPC0412HPV-R47MG	0.47±20%	6.00	6.50	18.0	20.0
TMPC0412HPV-R68MG	0.68±20%	5.00	6.00	32.0	37.0
TMPC0412HPV-1R0MG	1.00±20%	4.00	6.00	41.0	47.0
TMPC0412HPV-2R2MG	2.20±20%	2.80	3.50	69.2	80.0
TMPC0412HPV-3R3MG	3.30±20%	2.30	3.00	84.0	97.0
TMPC0412HPV-4R7MG	4.70±20%	2.00	2.50	128	145
TMPC0412HPV-5R6MG	5.60±20%	1.70	2.30	180	208
TMPC0412HPV-6R8MG	6.80±20%	1.50	1.70	300	360
TMPC0412HPV-100MG	10.0±20%	1.30	1.40	410	463

Note:

1. Test frequency : L : 100KHz /1.0V.
2. All test data referenced to 25°C ambient.
3. Heat Rated Current (Irms) will cause the coil temperature rise approximately Δt of 40°C.
4. Saturation Current (Isat) will cause L0 to drop 30% typical.
5. Special inquiries besides the above common used types can be met on your requirement.

■ DC Bias Characteristics (Typical)

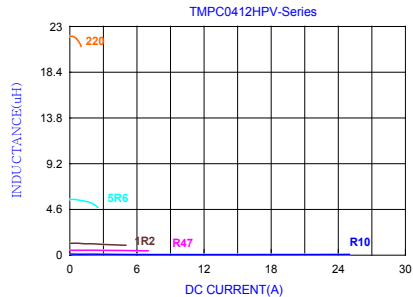
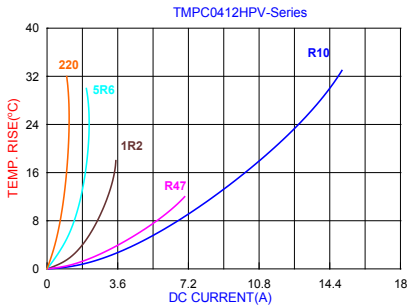

■ Dimensions

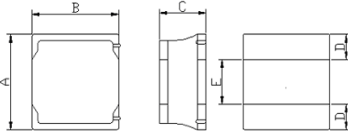

Chip Size	
A	4.00±0.20
B	4.00±0.20
C	1.80 max.
D	1.2 ref
E	1.6 ref

Units: mm

■ Specifications

Part Number	Inductance (uH)	Tolerance (%)	Test Frequency (Hz)	SRF (MHz) typ.	DCR (Ω) ±20%	I sat (A)typ.	I sat (A)Max.	I rms (A)typ.	I rms (A)Max.
HPC4018NV-1R0M	1.0	±20%	1V100K	160	0.027	4	3.6	3.7	3.6
HPC4018NV-1R5M	1.5	±20%	1V100K	110	0.032	3.3	3	3.3	3
HPC4018NV-2R2M	2.2	±20%	1V100K	70	0.042	3	2.7	2.9	2.7
HPC4018NV-3R3M	3.3	±20%	1V100K	60	0.055	2.3	2.2	2.3	2.2
HPC4018NV-4R7M	4.7	±20%	1V100K	50	0.07	2	1.9	2	1.9
HPC4018NV-6R8M	6.8	±20%	1V100K	40	0.098	1.7	1.6	1.7	1.6
HPC4018NV-100M	10	±20%	1V100K	35	0.15	1.5	1.4	1.5	1.4
HPC4018NV-150M	15	±20%	1V100K	25	0.19	1.1	1	1.1	1
HPC4018NV-220M	22	±20%	1V100K	20	0.29	0.9	0.8	0.9	0.8
HPC4018NV-330M	33	±20%	1V100K	12	0.405	0.75	0.7	0.75	0.7
HPC4018NV-470M	47	±20%	1V100K	10	0.55	0.6	0.55	0.6	0.55

Note:

Isat : Based on inductance change (ΔL/L0 : ≤-30%) @ ambient temp. 25°C

I rms : Based on temperature rise (ΔT : 40°C typ.)



■ Dimensions

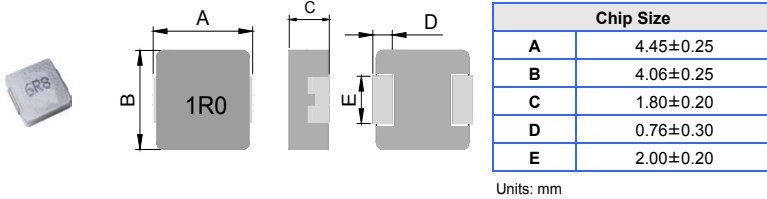

■ Specifications

Part Number	Inductance L0 (uH)±20%	I rms (A)typ	I sat (A)typ	DCR (mΩ) typ. @25°C.	DCR (mΩ) max. @25°C.
TMPC0402HPV-R33MG	0.33	10.0	18.0	7.80	8.60
TMPC0402HPV-R47MG	0.47	8.00	12.0	11.2	14.0
TMPC0402HPV-R68MG	0.68	7.00	10.0	16.0	19.0
TMPC0402HPV-1R0MG	1.00	5.00	8.50	22.0	27.0
TMPC0402HPV-2R2MG	2.20	4.00	6.00	51.0	61.0
TMPC0402HPV-3R3MG	3.30	3.50	4.00	69.0	76.0
TMPC0402HPV-4R7MG	4.70	2.60	3.50	95.0	105
TMPC0402HPV-6R8MG	6.80	2.10	2.80	150	172
TMPC0402HPV-100MG	10.0	1.80	2.30	215	243
TMPC0402HPV-220MG	22.0	1.20	1.40	470	500

Note:

1. Test frequency : L : 100KHz /1.0V.
2. All test data referenced to 25°C ambient.
3. Heat Rated Current (Irms) will cause the coil temperature rise approximately Δt of 40°C.
4. Saturation Current (Isat) will cause L0 to drop 30% typical.
5. Special inquiries besides the above common used types can be met on your requirement.

■ DC Bias Characteristics (Typical)

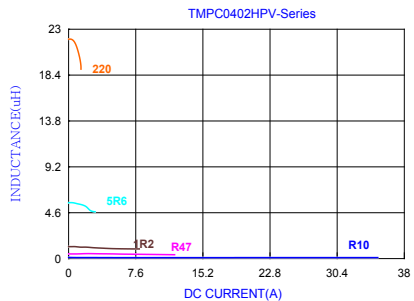
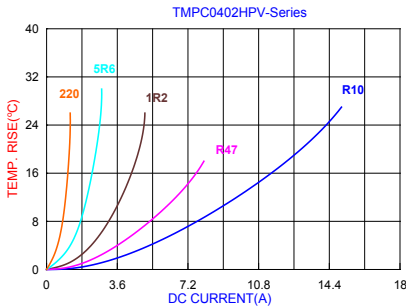



■ Dimensions

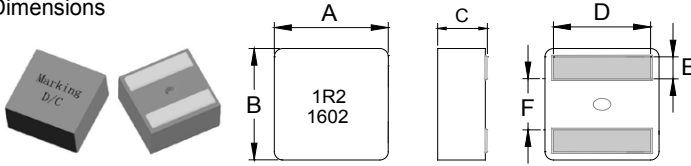

Series	A (mm)	B (mm)	C (mm)	D (mm)	E (mm)	F (mm)
TMPF0402	4.1±0.2	4.1±0.2	1.9±0.2	3.4±0.3	0.88±0.2	1.6±0.25

■ Specifications

Part Number	Inductance (uH) ±20% @ 0 A	I rms(A) Typ		I sat(A)		DCR (mΩ) Typ.	DCR (mΩ) Max.
		20°C rise	40°C rise	Typ	Max		
TMPF0402AV-R10MN	0.10	13.5	18.0	38.0	33.0	2.2	2.42
TMPF0402AV-R22MN	0.22	13.0	16.8	19.5	18.8	4.1	4.60
TMPF0402AV-R36MN	0.36	11.0	14.5	17.0	15.0	5.6	6.30
TMPF0402AV-R40MN	0.40	10.0	14.0	15.5	13.5	6.9	7.73
TMPF0402AV-R56MN	0.56	8.5	12.0	14.0	12.6	8.4	9.30
TMPF0402AV-R60MN	0.60	8.0	11.7	13.7	12.3	8.6	9.52
TMPF0402AV-R72MN	0.72	7.6	10.5	12.0	10.6	10.4	11.6
TMPF0402AV-1R0MN	1.00	6.8	9.6	9.6	8.8	13.3	14.6
TMPF0402AV-1R2MN	1.20	6.6	9.0	9.0	7.8	16.2	17.9
TMPF0402AV-1R5MN	1.50	5.8	7.6	8.0	7.4	21.0	23.5
TMPF0402AV-1R8MN	1.80	5.2	7.0	7.5	7.0	25.0	28.0
TMPF0402AV-2R2MN	2.20	4.6	5.6	6.5	6.0	35.2	38.7

Note:

1. Test frequency : L : 100KHz /0.1V.
2. All test data referenced to 25°C ambient.
3. Current that causes the specified temperature rise from 25°C ambient.
4. Saturation Current (Isat 3) will cause L0 to drop approximately 30%.



■ DC Bias Characteristics (Typical)

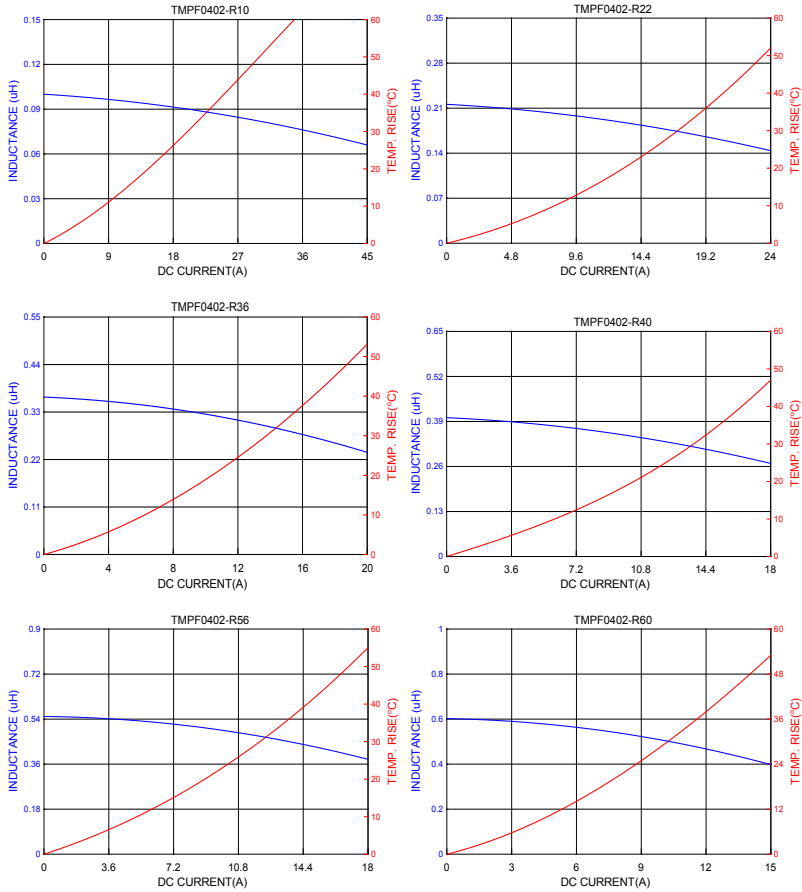



■ DC Bias Characteristics (Typical)

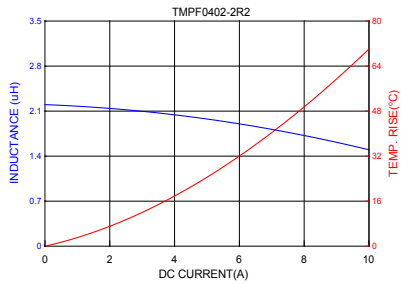
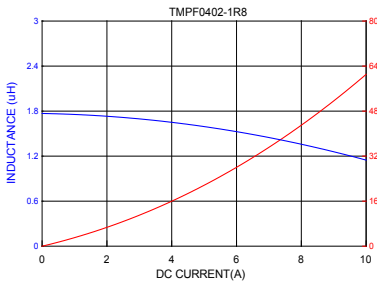
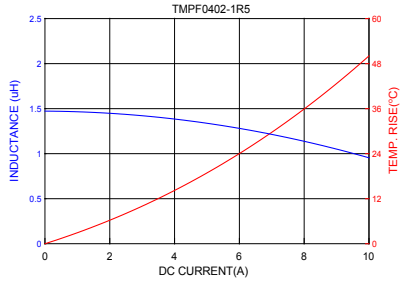
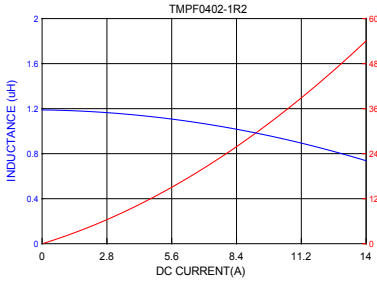
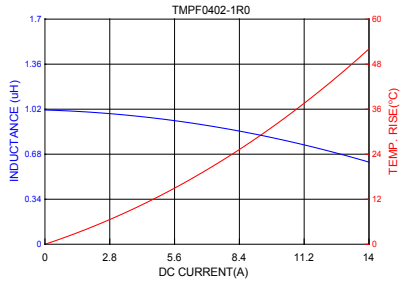
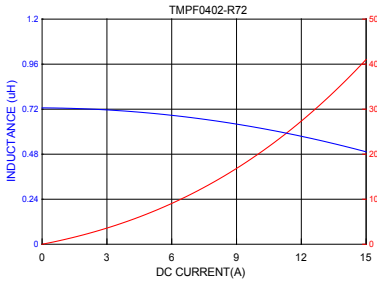



■ Dimensions

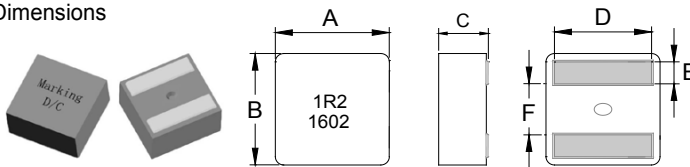

Series	A (mm)	B (mm)	C (mm)	D (mm)	E (mm)	F (mm)
TMPF0402LR	4.1±0.2	4.1±0.2	1.9±0.2	3.4±0.3	0.88±0.2	1.6±0.25

■ Specifications

Part Number	Inductance (uH) ±20% @ 0 A	I rms(A) Typ		I sat(A)				DCR(mΩ) Typ.	DCR(mΩ) Max.
		20°C rise	40°C rise	Typ			Max		
				1	2	3			
TMPF0402LRV-R47MN	0.47	9.8	13.2	7.0	10.0	14.0	12.5	6.00	6.8
TMPF0402LRV-R68MN	0.68	9.2	12.0	5.2	8.0	11.6	10.0	7.30	8.2
TMPF0402LRV-R82MN	0.82	8.5	11.5	4.8	6.5	10.2	9.0	8.60	9.5
TMPF0402LRV-1R0MN	1.00	8.0	11.0	4.5	5.4	9.2	8.0	10.60	11.7
TMPF0402LRV-1R2MN	1.20	7.2	9.5	4.3	5.0	8.6	7.5	12.20	13.4
TMPF0402LRV-1R5MN	1.50	6.7	9.1	4.1	4.5	7.5	6.7	14.40	15.8
TMPF0402LRV-2R0MN	2.00	6.2	8.2	3.2	4.0	6.2	5.0	21.15	23.3
TMPF0402LRV-2R2MN	2.20	6.0	8.0	3.1	3.8	6.0	4.8	21.35	23.5
TMPF0402LRV-3R3MN	3.30	4.4	5.5	2.7	3.4	5.3	4.4	34.2	38.3
TMPF0402LRV-4R7MN	4.70	3.8	5.1	2.0	2.7	4.0	3.5	52.0	57.2

Note:

1. Test frequency : L : 100KHz /0.1V.
2. All test data referred to 25°C ambient.
3. Testing Instrument : L : HP4284A, HP4395A, CH11025, CH3302, CH1320 ,CH1320S LCR METER / Rdc: CH16502, Agilent33420A MICRO OHMMETER, or EQU.
4. Current that causes the specified temperature rise from 25°C ambient.
5. Saturation Current (Isat 1) will cause L0 to drop approximately 10%.
Saturation Current (Isat 2) will cause L0 to drop approximately 20%.
Saturation Current (Isat 3) will cause L0 to drop approximately 30%.



■ DC Bias Characteristics (Typical)

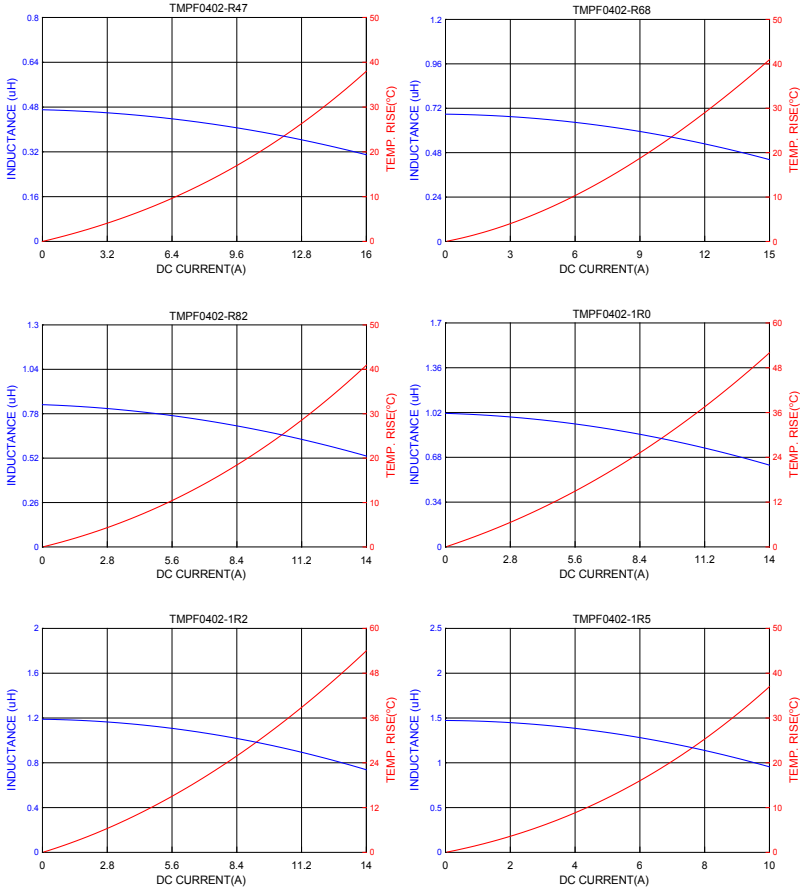



■ DC Bias Characteristics (Typical)

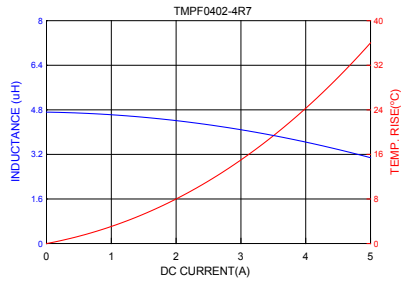
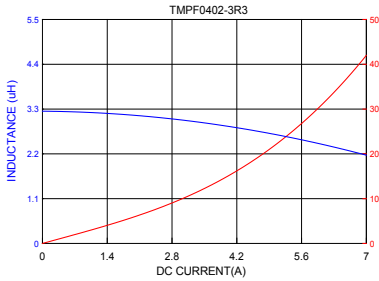
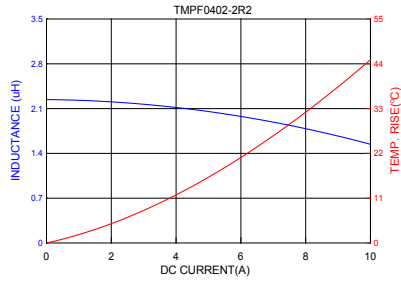
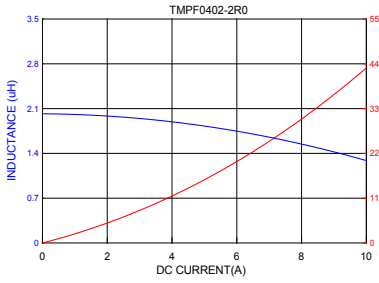



■ Dimensions

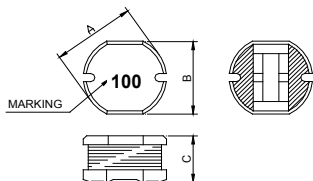

Size	A(mm)	B(mm)	C(mm)
FPI0403	4.50±0.3	4.00±0.3	3.20±0.3

■ Specifications

TAI-TECH Part Number	Inductance (uH)	Tolerance (%)	Test Frequency (Hz)	DCR (Ω) max.	IDC (A) max.
FPI 0403BMV-1R0M	1.0	± 20%	1V/7.96M	0.03	4.00
FPI 0403BMV-1R4M	1.4	± 20%	1V/7.96M	0.04	3.50
FPI 0403BMV-1R8M	1.8	± 20%	1V/7.96M	0.05	3.00
FPI 0403BMV-2R2M	2.2	± 20%	1V/7.96M	0.06	2.60
FPI 0403BMV-2R7M	2.7	± 20%	1V/7.96M	0.06	2.20
FPI 0403BMV-3R3M	3.3	± 20%	1V/7.96M	0.07	2.00
FPI 0403BMV-3R9M	3.9	± 20%	1V/7.96M	0.07	2.00
FPI 0403BMV-4R7M	4.7	± 20%	1V/7.96M	0.08	1.90
FPI 0403BMV-5R6M	5.6	± 20%	1V/7.96M	0.12	1.80
FPI 0403BMV-6R8M	6.8	± 20%	1V/7.96M	0.14	1.60
FPI 0403BMV-8R2M	8.2	± 20%	1V/7.96M	0.15	1.40
FPI 0403BMV-100M	10	± 20%	1V/2.52M	0.19	1.10
FPI 0403BMV-120M	12	± 20%	1V/2.52M	0.21	1.10
FPI 0403BMV-150M	15	± 20%	1V/2.52M	0.25	1.00
FPI 0403BMV-180M	18	± 20%	1V/2.52M	0.30	1.00
FPI 0403BMV-220M	22	± 20%	1V/2.52M	0.35	1.00
FPI 0403BMV-270M	27	± 20%	1V/2.52M	0.45	0.75
FPI 0403BMV-330M	33	± 20%	1V/2.52M	0.60	0.70
FPI 0403BMV-390M	39	± 20%	1V/2.52M	0.70	0.65
FPI 0403BMV-470M	47	± 20%	1V/2.52M	0.80	0.60
FPI 0403BMV-560M	56	± 20%	1V/2.52M	0.85	0.55
FPI 0403BMV-680M	68	± 20%	1V/2.52M	1.00	0.50
FPI 0403BMV-820M	82	± 20%	1V/2.52M	1.10	0.46
FPI 0403BMV-101M	100	± 20%	1V/1K	1.20	0.22
FPI 0403BMV-121M	120	± 20%	1V/1K	1.60	0.20



TAI-TECH Part Number	Inductance (uH)	Tolerance (%)	Test Frequency (Hz)	DCR (Ω) max.	IDC (A) max.
FPI 0403BMV-151M	150	± 20%	1V/1K	2.00	0.20
FPI 0403BMV-181M	180	± 20%	1V/1K	3.00	0.20
FPI 0403BMV-221M	220	± 20%	1V/1K	3.00	0.20
FPI 0403BMV-271M	270	± 20%	1V/1K	4.00	0.16
FPI 0403BMV-331M	330	± 20%	1V/1K	4.00	0.14
FPI 0403BMV-391M	390	± 20%	1V/1K	5.00	0.12
FPI 0403BMV-471M	470	± 20%	1V/1K	6.00	0.12
FPI 0403BMV-561M	560	± 20%	1V/1K	7.00	0.10

Note:

Based on inductance change ($\Delta L/L0 : \leq -35\%$) @ ambient temp. 25°C

Based on temperature rise ($\Delta T : 40^\circ\text{C}$ typ.)



■ Dimensions

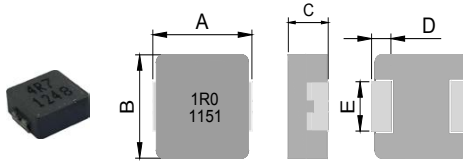

Chip Size	
A	5.70±0.30
B	5.20±0.20
C	1.00±0.20
D	1.10±0.30
E	2.50±0.30

Units: mm

■ Specifications

Part Number	Inductance L0 (uH)±20%	I rms (A)typ	I sat (A)typ	DCR (mΩ) typ. @25°C.	DCR (mΩ) max. @25°C.
TMPC0512HPV-R10YG	0.10±30%	14.0	14.5	4.30	5.20
TMPC0512HPV-R47MG	0.47	7.00	11.00	13.6	15.8
TMPC0512HPV-R68MG	0.68	6.00	9.00	21.5	24.5
TMPC0512HPV-1R0MG	1.00	5.00	6.00	26.0	30.0
TMPC0512HPV-2R2MG	2.20	3.50	4.00	65.0	75.0
TMPC0512HPV-3R3MG	3.30	3.00	3.80	75.0	86.0
TMPC0512HPV-4R7MG	4.70	2.50	3.20	100	115
TMPC0512HPV-5R6MG	5.60	2.40	3.20	175	201
TMPC0512HPV-6R8MG	6.80	2.00	3.00	193	222
TMPC0512HPV-100MG	10.0	1.50	1.80	335	385

Note:

1. Test frequency : L : 100KHz /1.0V.
2. All test data referenced to 25°C ambient.
3. Heat Rated Current (Irms) will cause the coil temperature rise approximately Δt of 40°C.
4. Saturation Current (Isat) will cause L0 to drop 30% typical.
5. Special inquiries besides the above common used types can be met on your requirement.

■ DC Bias Characteristics (Typical)

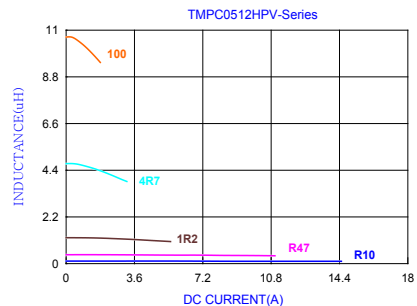
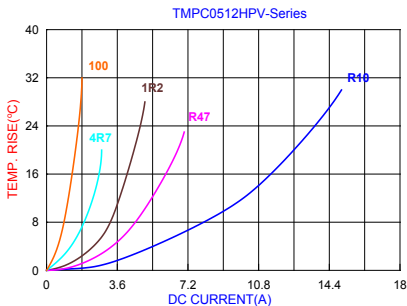



■ Dimensions

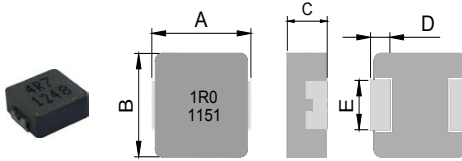

Chip Size	
A	5.70±0.30
B	5.20±0.20
C	1.30±0.20
D	1.10±0.30
E	2.50±0.30

Units: mm

■ Specifications

Part Number	Inductance L0 (uH)±20%	I rms (A)typ	I sat (A)typ	DCR (mΩ) typ. @25°C.	DCR (mΩ) max. @25°C.
TMPC0515HPV-R20YG	0.20±30%	15.0	22.5	3.80	4.20
TMPC0515HPV-R47MG	0.47	8.00	15.0	12.0	13.8
TMPC0515HPV-R68MG	0.68	7.00	13.0	14.0	16.2
TMPC0515HPV-1R0MG	1.00	6.00	9.00	22.0	25.3
TMPC0515HPV-2R2MG	2.20	4.00	6.00	45.0	52.0
TMPC0515HPV-3R3MG	3.30	3.20	4.50	78.0	90.0
TMPC0515HPV-4R7MG	4.70	2.70	4.00	103	118
TMPC0515HPV-5R6MG	5.60	2.40	3.20	126	152
TMPC0515HPV-6R8MG	6.80	2.30	3.00	142	171
TMPC0515HPV-100MG	10.0	2.00	2.30	210	235
TMPC0515HPV-220MG	22.0	1.20	1.70	405	466

Note:

1. Test frequency : L : 100KHz /1.0V.
2. All test data referenced to 25°C ambient.
3. Heat Rated Current (Irms) will cause the coil temperature rise approximately Δt of 40°C.
4. Saturation Current (Isat) will cause L0 to drop 30% typical.
5. Special inquiries besides the above common used types can be met on your requirement.

■ DC Bias Characteristics (Typical)

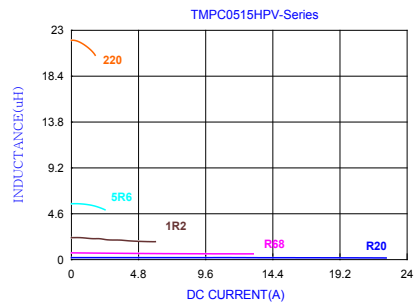
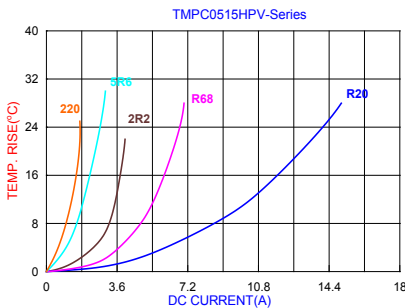



■ Dimensions

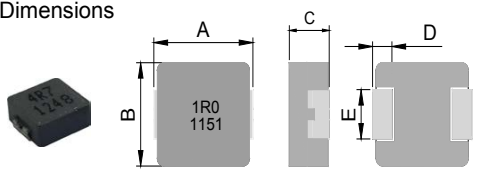

Chip Size	
A	5.70±0.30
B	5.20±0.20
C	1.60±0.20
D	1.10±0.30
E	2.50±0.30

Units: mm

■ Specifications

Part Number	Inductance L0 (uH)±20%	I rms (A)typ	I sat (A)typ	DCR (mΩ) Typ. @25°C.	DCR (mΩ) max. @25°C.
TMPC0518HPV-R33MG	0.33	11.0	15.0	7.50	8.60
TMPC0518HPV-R47MG	0.47	10.0	14.0	9.80	11.3
TMPC0518HPV-R68MG	0.68	9.00	13.0	12.4	14.3
TMPC0518HPV-1R0MG	1.0	6.80	10.0	18.2	21.0
TMPC0518HPV-2R2MG	2.2	4.50	7.50	42.0	48.3
TMPC0518HPV-3R3MG	3.3	3.50	5.00	60.0	69.0
TMPC0518HPV-4R7MG	4.7	3.00	4.50	85.0	98.0
TMPC0518HPV-5R6MG	5.6	2.50	4.00	110	127
TMPC0518HPV-6R8MG	6.8	2.40	3.50	118	137
TMPC0518HPV-100MG	10.0	2.30	2.80	165	190
TMPC0518HPV-150MG	15.0	1.70	2.30	275	318

Note:

1. Test frequency : L : 100KHz /1.0V.
2. All test data referenced to 25°C ambient.
3. Heat Rated Current (Irms) will cause the coil temperature rise approximately Δt of 40°C .
4. Saturation Current (Isat) will cause L0 to drop 30% typical.
5. Special inquiries besides the above common used types can be met on your requirement.

■ DC Bias Characteristics (Typical)

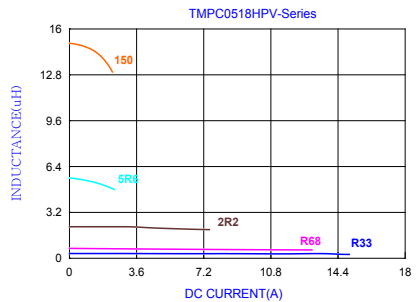
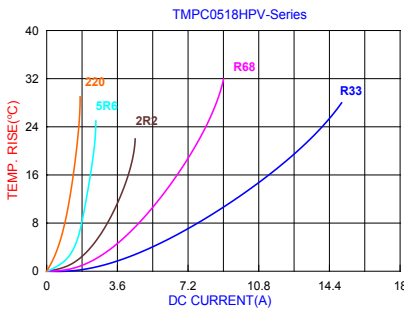

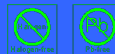

■ Dimensions

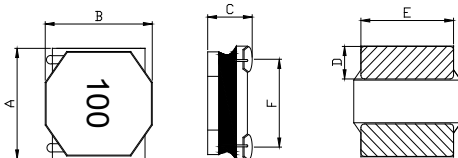

Dimensions	
A	5.00±0.20
B	5.00±0.20
C	1.80±0.20
D	1.30±0.20
E	4.70±0.20
F	3.70 ref.

Units: mm

■ Specifications

Part Number	Inductance (uH)	Tolerance	Rated current		DCR (mΩ) @25°C ±20%
			Temperature current I rms (A)	Saturation current I sat (A)	
HPC5020NV-1R0Y	1.00	±30%	4.10	5.00	20
HPC5020NV-1R2Y	1.20	±30%	3.80	4.80	20
HPC5020NV-1R5Y	1.50	±30%	3.50	4.50	25
HPC5020NV-2R2M	2.20	±20%	3.30	4.10	32
HPC5020NV-4R7M	2.70	±20%	3.00	3.80	38
HPC5020NV-3R3M	3.30	±20%	2.80	3.50	43
HPC5020NV-4R7M	4.70	±20%	2.40	2.70	60
HPC5020NV-5R6M	5.60	±20%	2.10	2.40	69
HPC5020NV-6R8M	6.80	±20%	1.90	2.10	90
HPC5020NV-8R2M	8.20	±20%	1.75	1.90	98
HPC5020NV-100M	10.0	±20%	1.60	1.70	110
HPC5020NV-120M	12.0	±20%	1.40	1.40	135
HPC5020NV-150M	15.0	±20%	1.25	1.30	165
HPC5020NV-180M	18.0	±20%	1.17	1.20	190
HPC5020NV-220M	22.0	±20%	1.10	1.10	225
HPC5020NV-330M	33.0	±20%	0.80	0.80	335
HPC5020NV-470M	47.0	±20%	0.70	0.70	460

Note:

1. All test data referenced to 25°C ambient, Ls:100KHz/1V.
2. Heat Rated Current (I rms) will cause the coil temperature rise approximately Δt of 40°C
3. Saturation Current (I sat) will cause L0 to drop approximately 30%



■ DC Bias Characteristics (Typical)

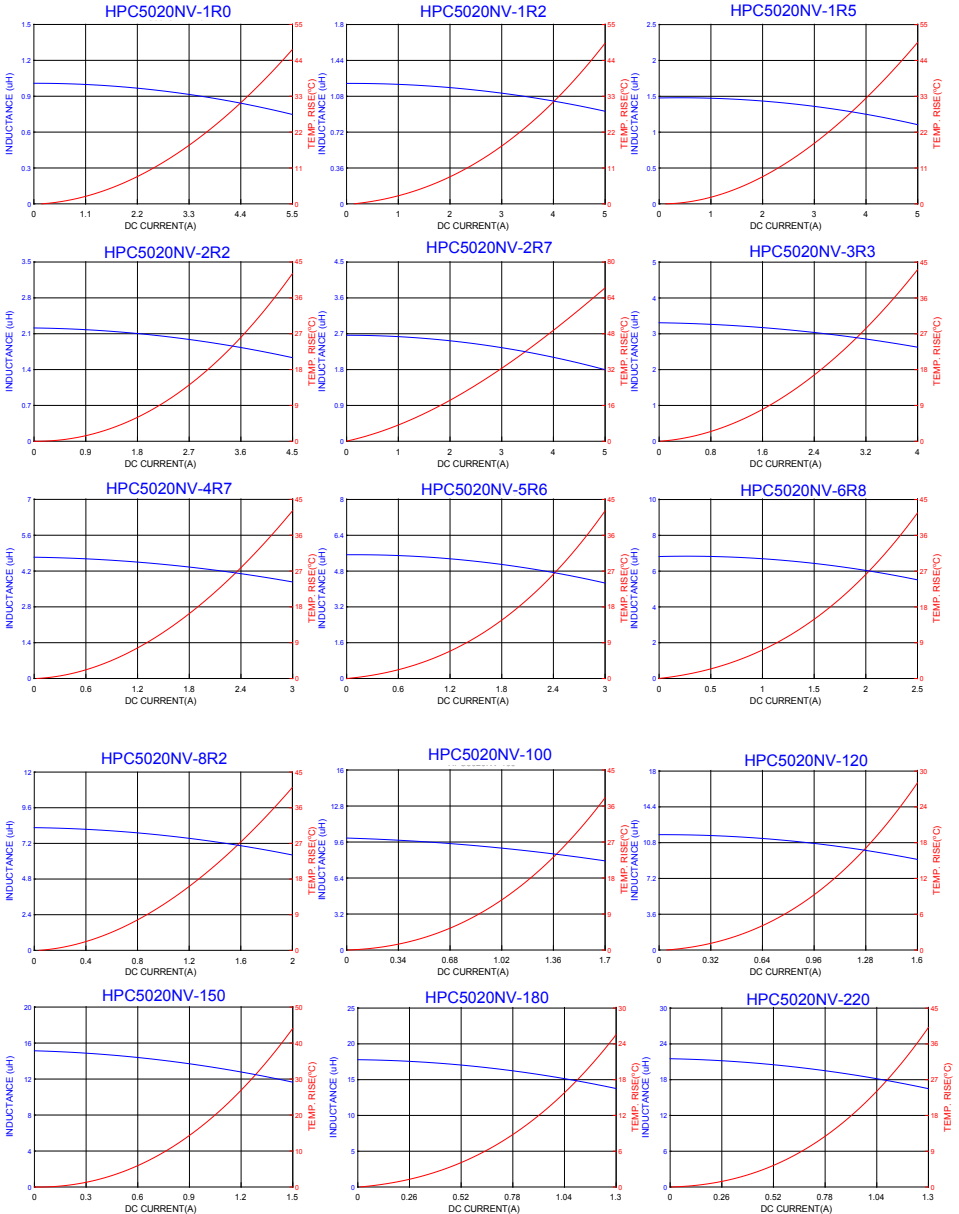



■ Dimensions

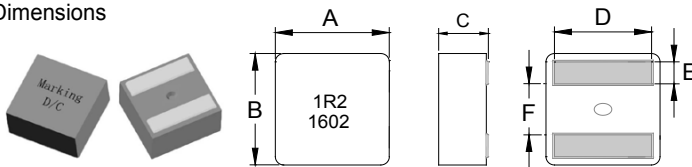

Series	A (mm)	B (mm)	C (mm)	D (mm)	E (mm)	F (mm)
TMPF0502	5.5±0.2	5.3±0.2	1.9±0.2	4.3±0.3	1.1±0.2	2.3±0.25

■ Specifications

Part Number	Inductance (uH) ±20% @ 0 A	I rms(A) Typ		I sat(A)		DCR(mΩ) Typ.	DCR(mΩ) Max.
		20°C rise	40°C rise	Typ	Max		
TMPF0502AV-R15MN	0.15	13.9	18.8	30.0	27.0	4.00	4.60
TMPF0502AV-R16MN	0.16	13.9	18.8	30.0	27.0	4.00	4.60
TMPF0502AV-R33MN	0.33	10.5	14.4	26.0	24.0	6.10	7.00
TMPF0502AV-R47MN	0.47	10.1	14.1	22.0	20.0	7.00	8.05
TMPF0502AV-R56MN	0.56	9.9	13.9	19.0	16.0	8.70	9.54
TMPF0502AV-R68MN	0.68	9.6	13.4	16.0	14.0	8.90	10.2
TMPF0502AV-R80MN	0.80	9.4	13.0	15.5	13.5	10.3	11.8
TMPF0502AV-R82MN	0.82	8.5	12.0	15.0	13.0	11.0	12.7
TMPF0502AV-1R0MN	1.00	7.5	10.5	14.5	12.8	12.0	13.8
TMPF0502AV-1R2MN	1.20	6.8	9.40	14.0	12.2	14.2	16.3
TMPF0502AV-1R5MN	1.50	6.4	8.80	13.3	11.7	16.2	18.7

Note:

1. Test frequency : L : 100KHz /0.1V.
2. All test data referenced to 25°C ambient.
3. Testing Instrument : L/Q: HP4284A,HP4395A,CH11025,CH3302,CH1320 ,CH1320S LCR METER / Rdc:CH16502,Agilent33420A MICRO OHM METER,or EQU.
4. Current that causes the specified temperature rise from 25°C ambient.
5. Saturation Current (Isat) will cause L0 to drop approximately 30%.



■ DC Bias Characteristics (Typical)

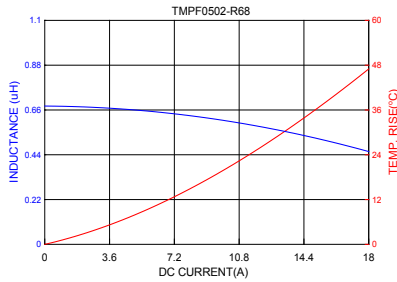
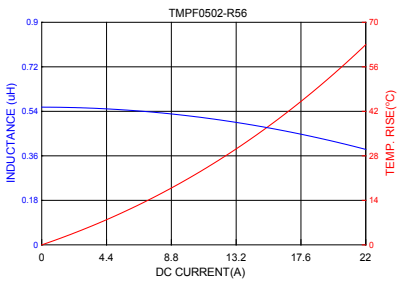
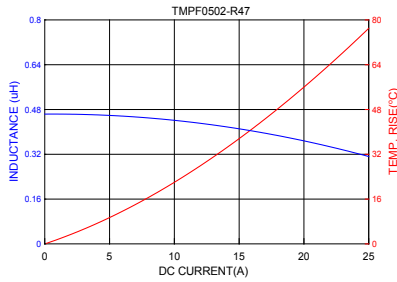
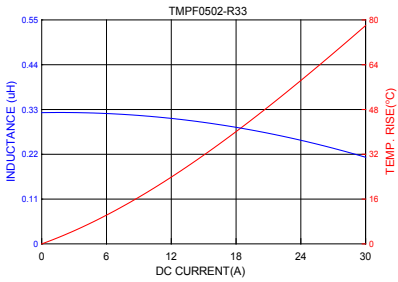
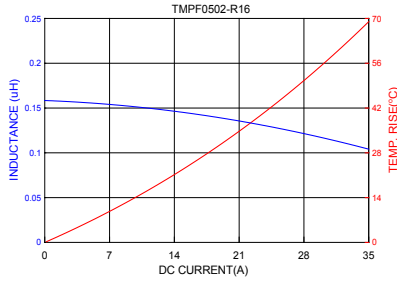
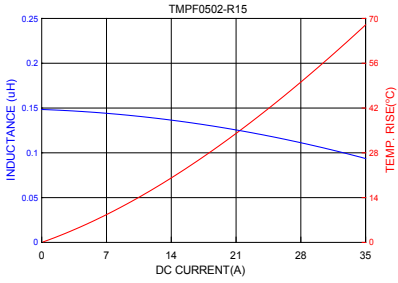



■ DC Bias Characteristics (Typical)

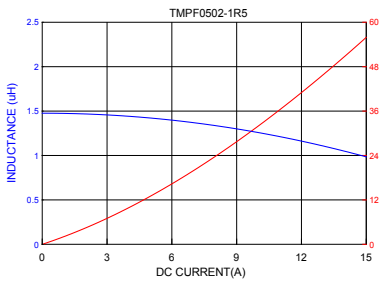
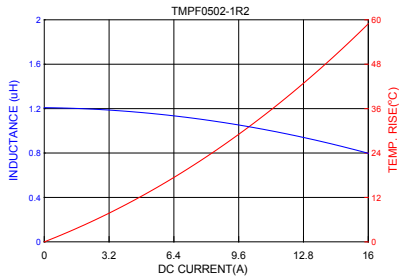
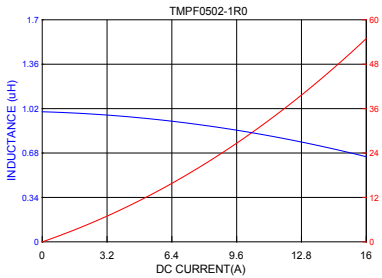
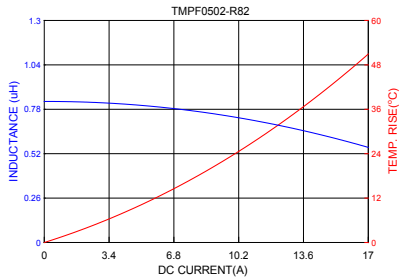
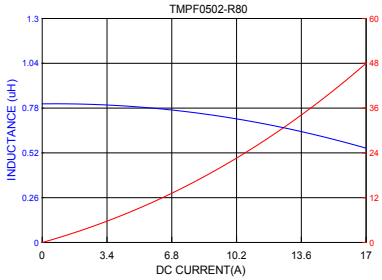



■ Dimensions

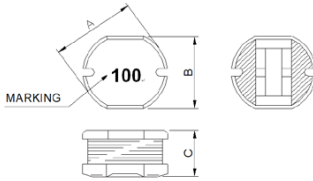

Size	A(mm)	B(mm)	C(mm)
FPI0503	5.80±0.3	5.20±0.3	3.00±0.3

■ Specifications

TAI-TECH Part Number	Inductance (uH)	Tolerance (%)	Test Frequency (Hz)	DCR (Ω) max.	I _{sat} (A) max.	I _{rms} (A) max.
FPI0503BMV-1R5M	1.50	± 20%	1V/100K	37	4.10	4.10
FPI0503BMV-1R8M	1.80	± 20%	1V/7.96M	50	4.00	2.80
FPI0503BMV-4R7M	4.70	± 20%	1V/7.96M	130	1.30	1.30
FPI0503BMV-6R8M	6.80	± 20%	1V/7.96M	71	1.87	1.87
FPI0503BMV-8R2M	8.20	± 20%	1V/7.96M	100	2.00	2.00
FPI0503BMV-100M	10.0	± 20%	1V/2.52M	200	1.90	1.90
FPI0503BMV-330M	33.0	± 20%	1V/2.52M	450	1.40	1.40

Note:

Based on inductance change ($\Delta L/L0 : \leq -35\%$) @ ambient temp. 25°C
 Based on temperature rise ($\Delta T : 40^\circ\text{C typ.}$)



■ Dimensions

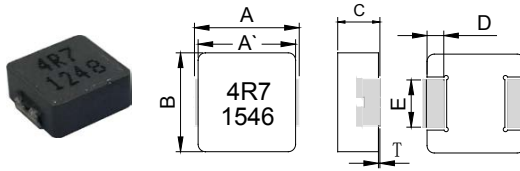

Series	A	A'	B	C	D	E	T
TMPA0503	5.7±0.3	5.2±0.3	5.2±0.2	2.8±0.2	1.0±0.3	2.0±0.2	0~0.15

Units: mm

■ Specifications

Part Number	Inductance L0 A(uH) ±20%	Heat Rating Current DC Typ (A) Irms.		Saturation Current DC Typ (A) Isat		DCR (mΩ) Typ	DCR (mΩ) Max
		Typ	Max	Typ	Max		
TMPA0503SV-R47MN	0.47	13.5	12	10	9.0	5.2	6.0
TMPA0503SV-R68MN	0.68	12.5	11	9.0	8.0	7.4	8.5
TMPA0503SV-R82MN	0.82	10	9.0	8.8	7.7	8.0	9.2
TMPA0503SV-1R0MN	1.00	9.0	8.0	8.5	7.5	10.5	12.0
TMPA0503SV-1R5MN	1.50	8.0	7.0	7.5	6.5	13.6	15.7
TMPA0503SV-2R2MN	2.20	7.0	6.5	6.5	5.8	21.6	25
TMPA0503SV-3R3MN	3.30	6.3	5.8	6.0	5.3	28	33
TMPA0503SV-4R7MN	4.70	5.5	4.8	5.3	4.6	38	44
TMPA0503SV-5R6MN	5.60	5.0	4.3	4.6	4.0	50	58
TMPA0503SV-6R8MN	6.80	4.3	3.7	3.5	3.1	57	66
TMPA0503SV-100MN	10.0	3.8	3.4	2.5	2.1	88	103

Note:

1. Test frequency : Ls : 100KHz /1.0V.
2. All test data referenced to 25°C ambient.
3. Heat Rated Current (Irms) will cause the coil temperature rise approximately ΔT of 40°C
4. Saturation Current (Isat) will cause L0 to drop approximately 30%.



■ DC Bias Characteristics (Typical)

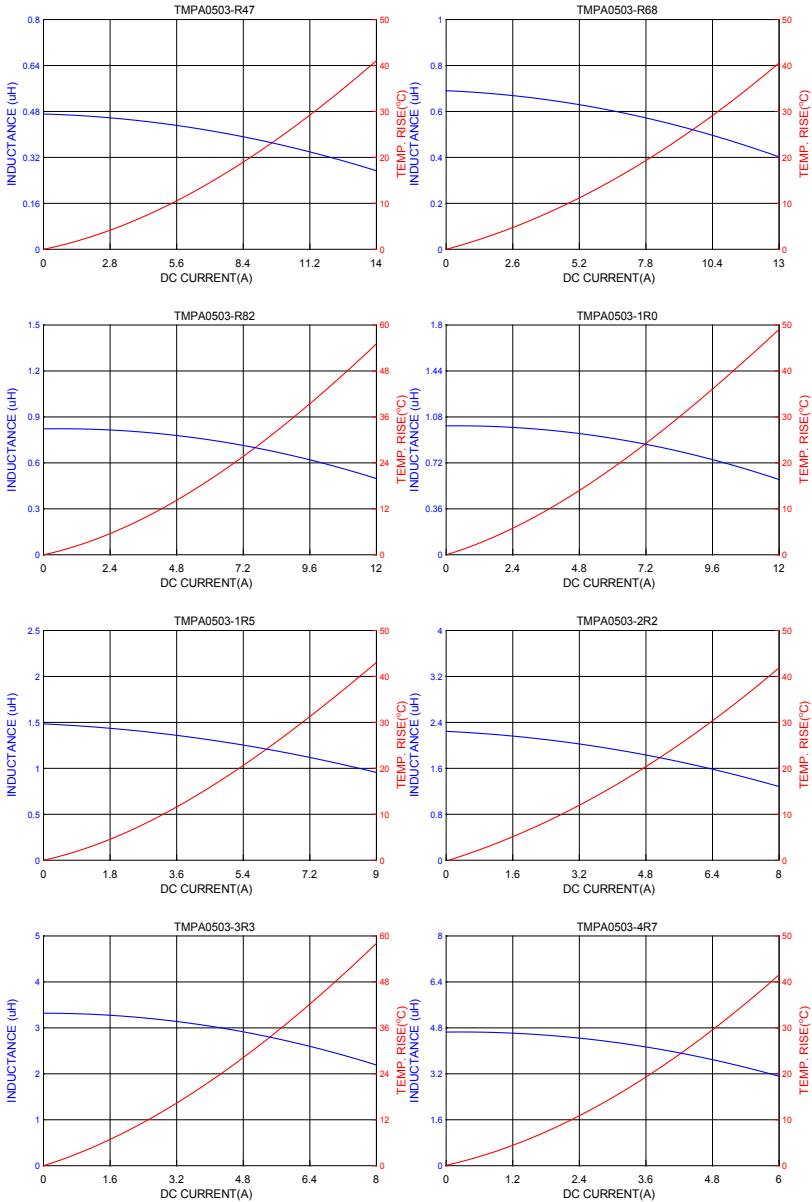



■ DC Bias Characteristics (Typical)

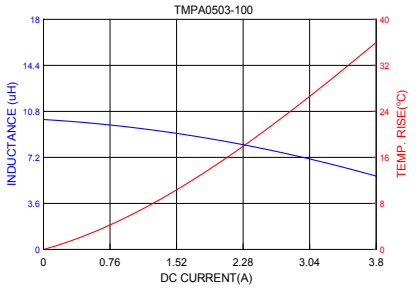
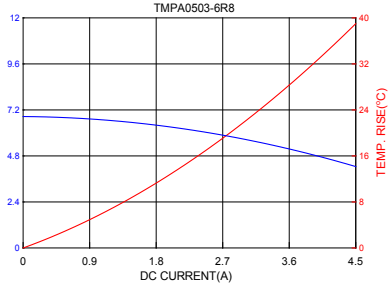
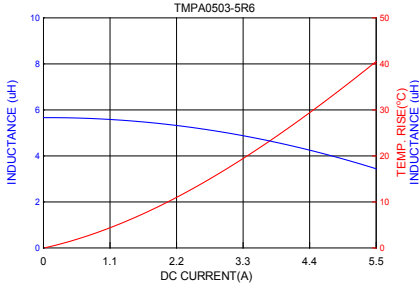



■ Dimensions

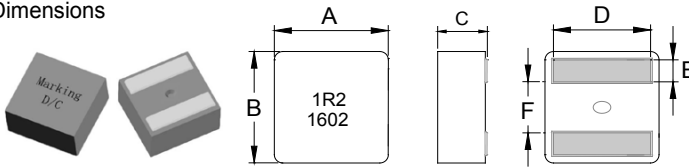

Series	A (mm)	B (mm)	C (mm)	D (mm)	E (mm)	F (mm)
TMPF0503	5.5±0.2	5.3±0.2	2.9±0.2	4.3±0.3	1.1±0.2	2.3±0.25

■ Specifications

Part Number	Inductance (uH) ±20% @ 0 A	I rms(A) Typ		I sat(A)		DCR(mΩ) Typ.	DCR(mΩ) Max.
		20°C rise	40°C rise	Typ	Max		
TMPF0503AV-R15MN	0.15	14.3	22.2	36.0	32.5	2.10	2.31
TMPF0503AV-R16MN	0.16	14.2	22.2	35.0	32.0	2.12	2.33
TMPF0503AV-R33MN	0.33	13.8	19.2	28.0	26.0	3.20	3.52
TMPF0503AV-R47MN	0.47	13.7	18.4	26.0	24.0	3.75	4.13
TMPF0503AV-R56MN	0.56	13.6	17.7	22.2	20.2	4.05	4.52
TMPF0503AV-R60MN	0.60	13.6	17.7	22.0	20.0	4.11	4.52
TMPF0503AV-R80MN	0.80	10.1	13.1	20.0	18.0	5.14	5.65
TMPF0503AV-R82MN	0.82	9.90	12.9	19.7	17.6	5.25	5.78
TMPF0503AV-1R0MN	1.00	9.00	12.2	16.5	14.3	6.90	7.60
TMPF0503AV-1R2MN	1.20	8.50	11.0	15.0	13.5	8.80	9.70
TMPF0503AV-1R5MN	1.50	8.00	10.5	14.0	12.5	10.1	11.2
TMPF0503AV-1R8MN	1.80	7.60	10.1	12.3	11.3	11.5	12.7
TMPF0503AV-2R2MN	2.20	7.20	9.70	10.0	9.0	13.2	14.5
TMPF0503AV-3R3MN	3.30	5.90	8.10	9.5	8.7	21.0	23.1
TMPF0503AV-4R7MN	4.70	4.30	5.90	8.2	7.0	33.0	36.3

Note:

1. Test frequency : L : 100KHz /0.1V.
2. All test data referenced to 25°C ambient.
3. Testing Instrument : L/Q: HP4284A, HP4395A, CH11025, CH3302, CH1320 ,CH1320S LCR METER / Rdc:CH16502, Agilent33420A MICRO OHM METER, or EQU.
4. Current that causes the specified temperature rise from 25°C ambient.
5. Saturation Current (Isat) will cause L0 to drop approximately 30%.



■ DC Bias Characteristics (Typical)

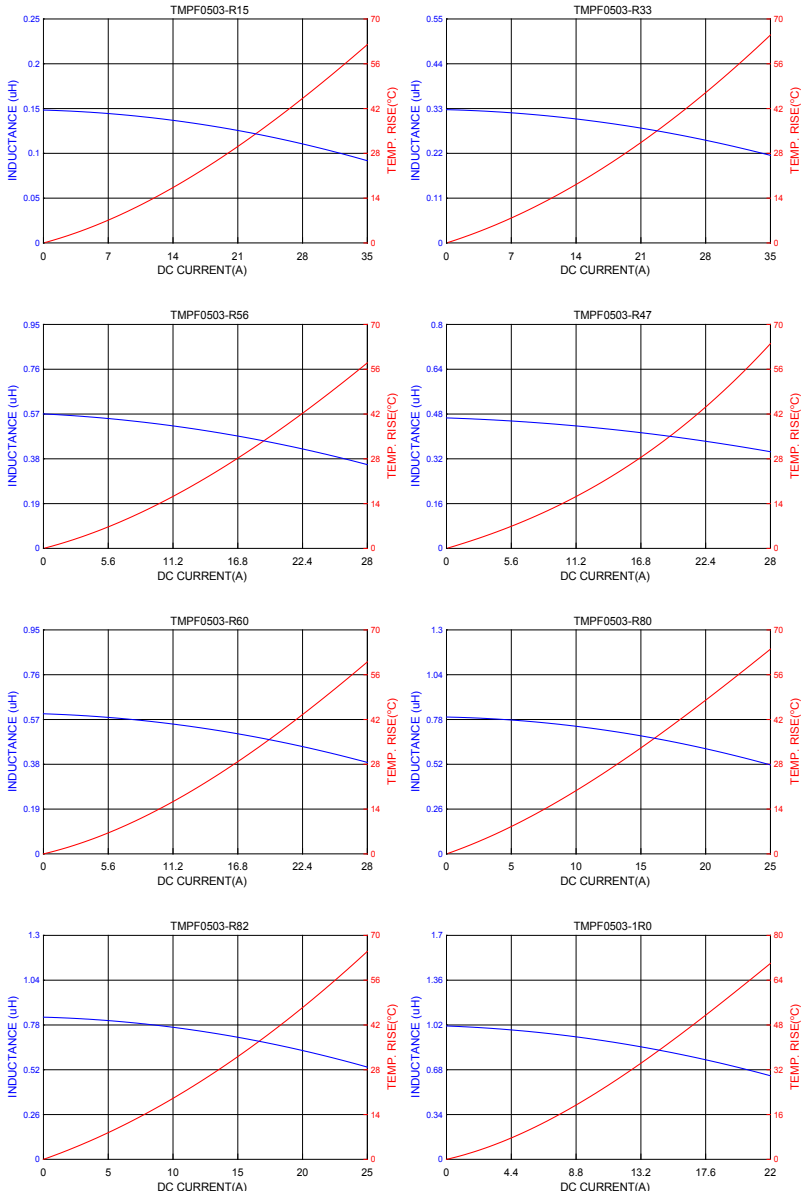



■ DC Bias Characteristics (Typical)

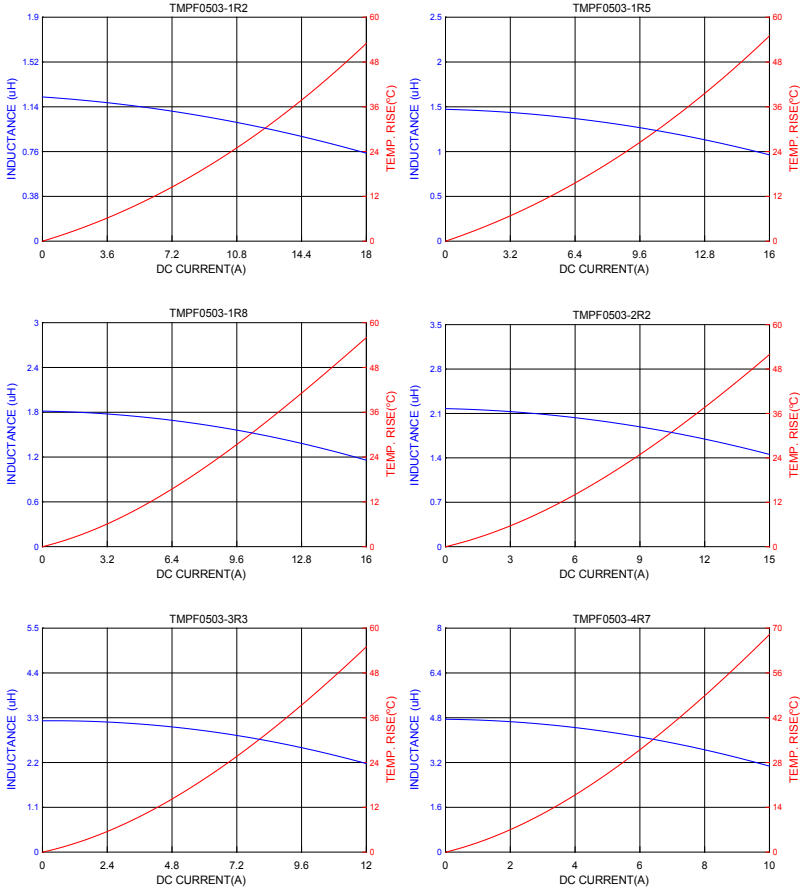



■ Dimensions

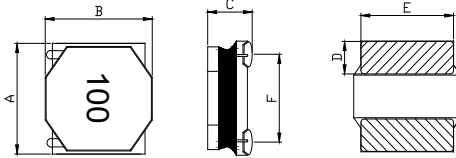

Dimensions	
A	4.95±0.20
B	4.95±0.20
C	*1. 3.90±0.20 *2. 3.80±0.20
D	1.30±0.30
E	4.20±0.20
F	3.70 ref.

Units: mm

*1 ≤ 10 uH

*2 > 10 uH

■ Specifications

Part Number	Inductance (uH)	Tolerance				Rated current		DCR (mΩ) @25°C ±20%
		K	L	M	Y	Temperature current I rms (A)	Saturation current I sat (A)	
HPC5040NV-1R0	1.00	/	/	±20%	±30%	5.00	7.50	12
HPC5040NV-1R5	1.50	/	/	±20%	±30%	4.50	6.50	15
HPC5040NV-2R2	2.20	/	/	±20%	±30%	3.80	5.70	21
HPC5040NV3R3	3.30	/	/	±20%	±30%	3.50	4.40	24
HPC5040NV-4R7	4.70	/	/	±20%	±30%	3.20	3.90	32
HPC5040NV-6R8	6.80	/	/	±20%	±30%	2.50	3.30	43
HPC5040NV-100	10.0	/	/	±20%	±30%	2.20	2.52	56
HPC5040NV-150	15.0	/	±15%	±20%	±30%	1.80	2.00	80
HPC5040NV-220	22.0	/	±15%	±20%	±30%	1.50	1.62	123
HPC5040NV-330	33.0	/	±15%	±20%	±30%	1.20	1.30	180
HPC5040NV-470	47.0	±10%	±15%	±20%	±30%	1.00	1.10	270
HPC5040NV-680	68.0	±10%	±15%	±20%	±30%	0.80	0.90	400
HPC5040NV-101	100	±10%	±15%	±20%	±30%	0.72	0.75	560

Note:

1. All test data referenced to 25°C ambient, Ls:100KHz/1V.
2. Heat Rated Current (I rms) will cause the coil temperature rise approximately Δt of 40°C
3. Saturation Current (I sat) will cause L0 to drop approximately 30%



■ DC Bias Characteristics (Typical)

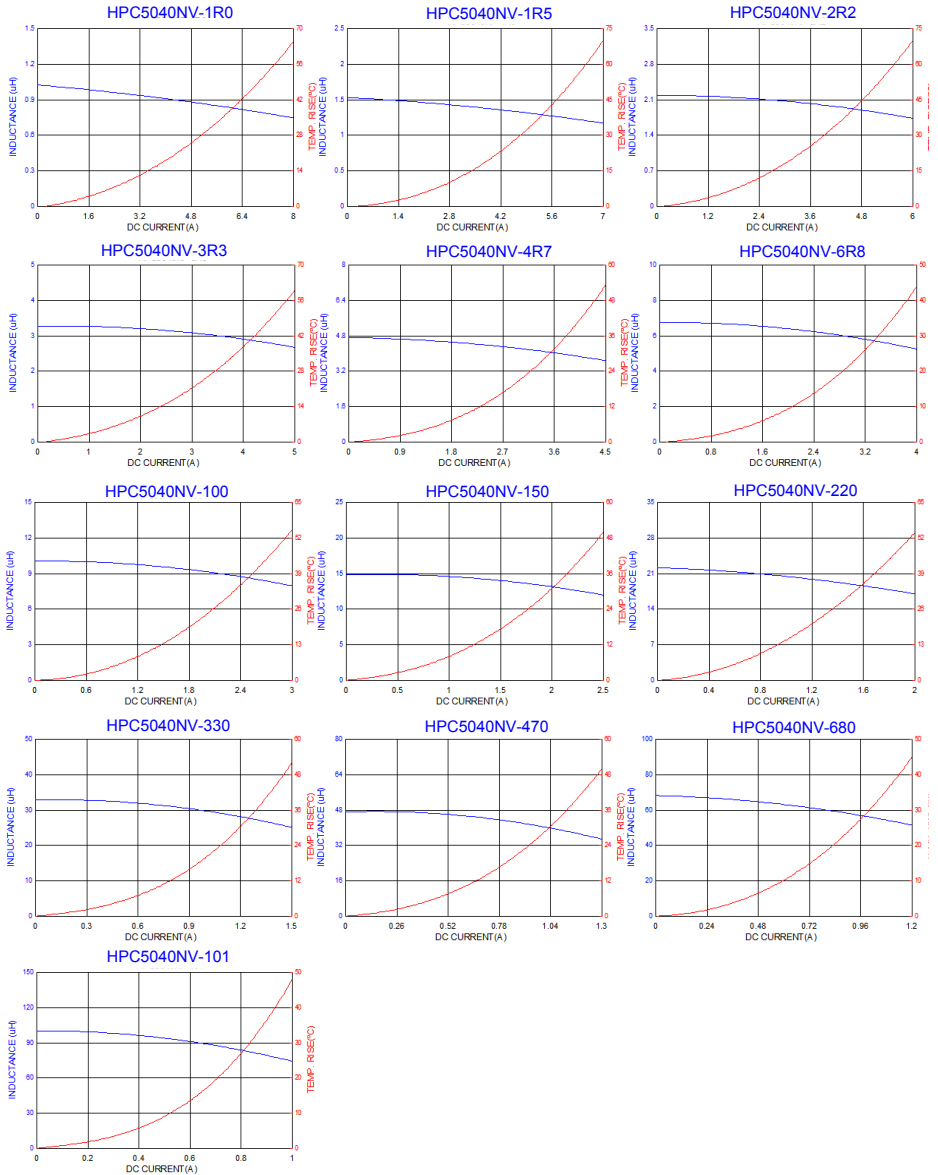



■ Dimensions

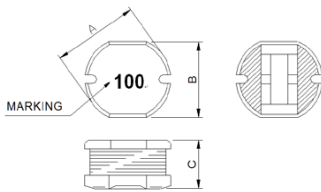

Size	A(mm)	B(mm)	C(mm)
FPI0504	5.80±0.3	5.20±0.3	4.50±0.3

■ Specifications

TAI-TECH Part Number	Inductance (uH)	Tolerance (%)	Test Frequency (Hz)	DCR (Ω) max.	IDC (A) max.
FPI 0504BMV-1R0M	1.0	± 20%	1V/7.96M	0.018	3.50
FPI 0504BMV-1R4M	1.4	± 20%	1V/7.96M	0.020	3.50
FPI 0504BMV-1R8M	1.8	± 20%	1V/7.96M	0.025	3.00
FPI 0504BMV-2R2M	2.2	± 20%	1V/7.96M	0.030	2.80
FPI 0504BMV-2R7M	2.7	± 20%	1V/7.96M	0.035	2.60
FPI 0504BMV-3R3M	3.3	± 20%	1V/7.96M	0.040	2.50
FPI 0504BMV-3R9M	3.9	± 20%	1V/7.96M	0.050	2.30
FPI 0504BMV-4R7M	4.7	± 20%	1V/7.96M	0.060	2.60
FPI 0504BMV-5R6M	5.6	± 20%	1V/7.96M	0.070	2.40
FPI 0504BMV-6R8M	6.8	± 20%	1V/7.96M	0.080	2.20
FPI 0504BMV-8R2M	8.2	± 20%	1V/7.96M	0.080	2.00
FPI 0504BMV-100M	10	± 20%	1V/2.52M	0.090	1.80
FPI 0504BMV-120M	12	± 20%	1V/2.52M	0.100	1.60
FPI 0504BMV-150M	15	± 20%	1V/2.52M	0.120	1.50
FPI 0504BMV-180M	18	± 20%	1V/2.52M	0.150	1.40
FPI 0504BMV-220M	22	± 20%	1V/2.52M	0.180	1.30
FPI 0504BMV-270M	27	± 20%	1V/2.52M	0.220	1.20
FPI 0504BMV-330M	33	± 20%	1V/2.52M	0.260	1.00
FPI 0504BMV-390M	39	± 20%	1V/2.52M	0.300	0.90
FPI 0504BMV-470M	47	± 20%	1V/2.52M	0.350	0.85
FPI 0504BMV-560M	56	± 20%	1V/2.52M	0.400	0.80
FPI 0504BMV-680M	68	± 20%	1V/2.52M	0.450	0.70
FPI 0504BMV-820M	82	± 20%	1V/2.52M	0.500	0.70
FPI 0504BMV-101M	100	± 20%	1V/1K	0.700	0.60
FPI 0504BMV-121M	120	± 20%	1V/1K	0.750	0.60



TAI-TECH Part Number	Inductance (uH)	Tolerance (%)	Test Frequency (Hz)	DCR (Ω) max.	IDC (A) max.
FPI 0504BMV-151M	150	± 20%	1V/1K	0.900	0.55
FPI 0504BMV-181M	180	± 20%	1V/1K	1.100	0.50
FPI 0504BMV-221M	220	± 20%	1V/1K	1.200	0.40
FPI 0504BMV-271M	270	± 20%	1V/1K	1.500	0.25
FPI 0504BMV-331M	330	± 20%	1V/1K	3.000	0.22
FPI 0504BMV-391M	390	± 20%	1V/1K	3.500	0.20
FPI 0504BMV-471M	470	± 20%	1V/1K	4.000	0.19
FPI 0504BMV-561M	560	± 20%	1V/1K	4.000	0.18
FPI 0504BMV-681M	680	± 20%	1V/1K	4.500	0.15

Note:

Based on inductance change ($\Delta L/L0$: $\leq -35\%$) @ ambient temp. 25°C

Based on temperature rise (ΔT : 40°C typ.)



■ Dimensions

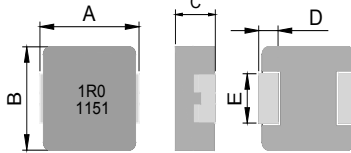

Chip Size	
A	7.00±0.30
B	6.60±0.30
C	1.00±0.20
D	1.80±0.30
E	2.50±0.30

Units: mm

■ Specifications

Part Number	Inductance L0 (uH)±20%	I rms (A)typ	I sat (A)typ	DCR (mΩ) typ. @25°C.	DCR (mΩ) max. @25°C.
TMPC0612HV-R22YG	0.22±30%	11.0	19.0	6.50	7.50
TMPC0612HV-R47MG	0.47	8.50	12.0	13.0	17.0
TMPC0612HV-R68MG	0.68	7.00	9.00	17.0	19.0
TMPC0612HV-1R0MG	1.00	6.00	7.00	27.0	30.0
TMPC0612HV-2R2MG	2.20	4.00	5.00	53.0	61.0
TMPC0612HV-3R3MG	3.30	3.20	4.00	90.0	103
TMPC0612HV-4R7MG	4.70	2.50	3.80	130	150
TMPC0612HV-6R8MG	6.80	2.10	3.00	172	198
TMPC0612HV-100MG	10.0	1.80	2.50	280	290

Note:

1. Test frequency : L : 100KHz /1.0V.
2. All test data referenced to 25°C ambient.
3. Heat Rated Current (Irms) will cause the coil temperature rise approximately Δt of 40°C.
4. Saturation Current (Isat) will cause L0 to drop 30% typical.
5. Special inquiries besides the above common used types can be met on your requirement.

■ DC Bias Characteristics (Typical)

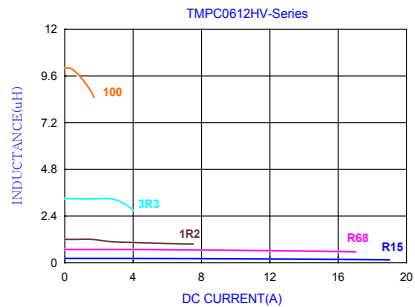
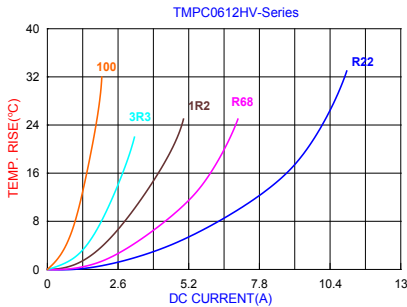



■ Dimensions

Chip Size	
A	7.00±0.30
B	6.60±0.30
C	1.30±0.20
D	1.80±0.30
E	3.00±0.30

Units: mm

■ Specification

Part Number	Inductance L ₀ (uH)±20%	I _{rms} (A)typ	I _{sat} (A)typ	DCR (mΩ) typ. @25°C.	DCR (mΩ) max. @25°C.
TMPC0615HV-R22YG	0.22±30%	14.0	22.0	4.30	5.20
TMPC0615HV-R47MG	0.47	9.50	16.0	9.00	10.3
TMPC0615HV-R68MG	0.68	7.50	15.0	13.8	15.2
TMPC0615HV-1R0MG	1.00	6.50	12.0	23.0	25.8
TMPC0615HV-2R2MG	2.20	4.50	6.50	48.0	55.0
TMPC0615HV-3R3MG	3.30	4.20	6.00	62.0	74.0
TMPC0615HV-4R7MG	4.70	3.80	5.00	96.0	111
TMPC0615HV-5R6MG	5.60	3.00	4.50	115	138
TMPC0615HV-6R8MG	6.80	2.60	3.50	128	148
TMPC0615HV-100MG	10.0	2.30	2.80	180	216
TMPC0615HV-220MG	22.0	1.50	2.50	420	504

Note:

1. Test frequency : L : 100KHz /1.0V.
2. All test data referenced to 25°C ambient.
3. Heat Rated Current (I_{rms}) will cause the coil temperature rise approximately Δt of 40°C.
4. Saturation Current (I_{sat}) will cause L₀ to drop 30% typical.
5. Special inquiries besides the above common used types can be met on your requirement.

■ DC Bias Characteristics (Typical)

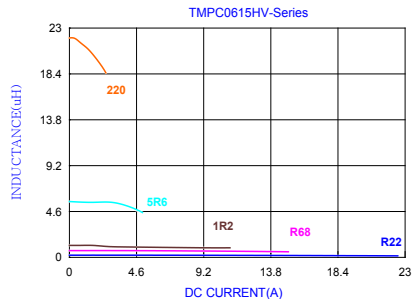
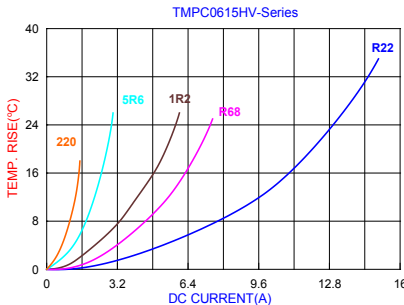

■ Dimensions

Chip Size	
A	7.00±0.30
B	6.60±0.30
C	1.60±0.20
D	1.80±0.30
E	3.00±0.30

Units: mm

■ Specification

Part Number	Inductance L0 (uH)±20%	I rms (A)typ	I sat (A)typ	DCR (mΩ) typ. @25°C.	DCR (mΩ) max. @25°C.
TMPC0618HV-R22MG	0.22	16.0	26.0	2.50	3.00
TMPC0618HV-R47MG	0.47	12.0	18.0	6.40	7.40
TMPC0618HV-R68MG	0.68	10.0	17.0	9.50	11.0
TMPC0618HV-1R0MG	1.00	7.00	14.0	14.5	17.0
TMPC0618HV-2R2MG	2.20	6.00	11.0	31.0	35.0
TMPC0618HV-3R3MG	3.30	5.00	9.00	40.0	46.0
TMPC0618HV-4R7MG	4.70	4.00	7.00	68.0	76.0
TMPC0618HV-5R6MG	5.60	3.50	6.00	78.0	86.0
TMPC0618HV-6R8MG	6.80	3.00	5.50	93.0	104
TMPC0618HV-100MG	10.0	2.30	3.50	143	160

Note:

1. Test frequency : L : 100KHz /1.0V.
2. All test data referenced to 25°C ambient.
3. Heat Rated Current (Irms) will cause the coil temperature rise approximately Δt of 40°C
4. Saturation Current (Isat) will cause L0 to drop 30% typical.
5. Special inquiries besides the above common used types can be met on your requirement.

■ DC Bias Characteristics (Typical)

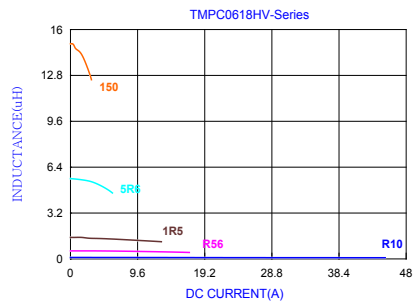
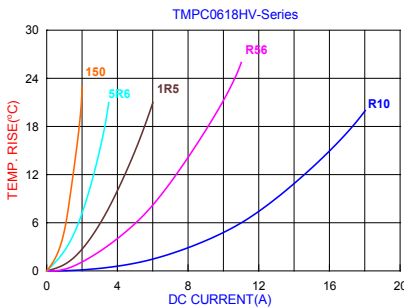



■ Dimensions

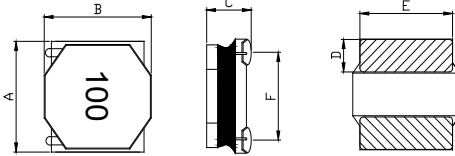

Dimensions	
A	6.00±0.20
B	6.00±0.20
C	1.80±0.20
D	1.60±0.30
E	5.80±0.30
F	4.30 ref.

Units: mm

■ Specifications

Part Number	Inductance (uH)	Tolerance				Rated current		DCR (mΩ)@25°C ±20%
		K	L	M	Y	Temperature current I rms (A)	Saturation current I sat (A)	
HPC6020NV-1R0	1.00	/	/	±20%	±30%	4.5	6.2	19
HPC6020NV-1R5	1.50	/	/	±20%	±30%	3.8	5.5	22.5
HPC6020NV-2R0	2.00	/	/	±20%	±30%	3.65	5.3	25
HPC6020NV-2R2	2.20	/	/	±20%	±30%	3.5	5	29
HPC6020NV-3R3	3.30	/	/	±20%	±30%	3.3	4	35
HPC6020NV-4R7	4.70	/	±15%	±20%	±30%	2.8	3	54
HPC6020NV-5R6	5.60	/	±15%	±20%	±30%	2.6	2.7	59
HPC6020NV-6R8	6.80	/	±15%	±20%	±30%	2.5	2.6	78
HPC6020NV-8R2	8.20	/	±15%	±20%	±30%	2.3	2.4	103
HPC6020NV-100	10.0	±10%	±15%	±20%	±30%	2.1	2.1	106
HPC6020NV-150	15.0	±10%	±15%	±20%	±30%	1.6	1.5	138
HPC6020NV-220	22.0	±10%	±15%	±20%	±30%	1.4	1.3	204

Note:

1. All test data referenced to 25°C ambient, Ls:100KHz/1V.
2. Heat Rated Current (I rms) will cause the coil temperature rise approximately Δt of 40°C
3. Saturation Current (I sat) will cause L0 to drop approximately 30%



■ DC Bias Characteristics (Typical)

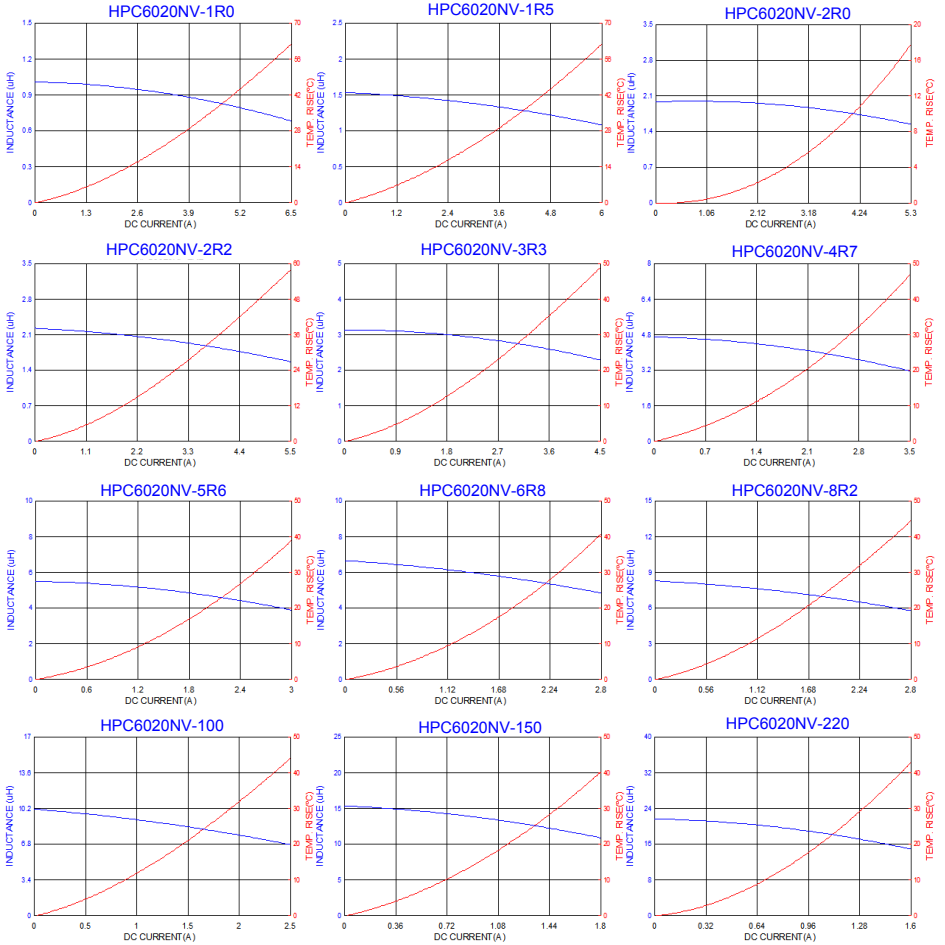

■ Dimensions

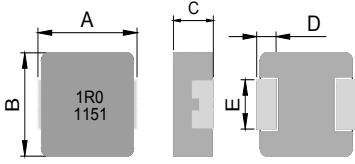
Chip Size	
A	7.00±0.30
B	6.60±0.30
C	1.80±0.20
D	1.80±0.30
E	3.00±0.30

Units: mm

■ Specification

Part Number	Inductance L0 (uH)±20%	I rms (A)typ	I sat (A)typ	DCR (mΩ) typ. @25°C.	DCR (mΩ) max. @25°C.
TMPC0602HV-R10YG	0.10±30%	21.0	40.0	2.00	2.40
TMPC0602HV-R47MG	0.47±20%	11.7	20.0	7.10	8.30
TMPC0602HV-R68MG	0.68±20%	10.5	16.0	8.30	10.0
TMPC0602HV-1R0MG	1.00±20%	8.00	14.0	16.5	18.0
TMPC0602HV-2R2MG	2.20±20%	6.00	10.0	32.0	37.0
TMPC0602HV-3R3MG	3.30±20%	5.00	8.00	43.0	48.0
TMPC0602HV-4R7MG	4.70±20%	4.50	7.00	53.0	60.0
TMPC0602HV-5R6MG	5.60±20%	4.00	6.00	59.0	68.0
TMPC0602HV-6R8MG	6.80±20%	4.00	5.50	63.0	73.0
TMPC0602HV-100MG	10.0±20%	2.80	4.00	134	154
TMPC0602HV-220MG	22.0±20%	1.50	2.50	236	280

Note:

1. Test frequency : L : 100KHz /1.0V.
2. All test data referenced to 25°C ambient.
3. Heat Rated Current (Irms) will cause the coil temperature rise approximately Δt of 40°C.
4. Saturation Current (Isat) will cause L0 to drop 30% typical.
5. Special inquiries besides the above common used types can be met on your requirement.

■ DC Bias Characteristics (Typical)

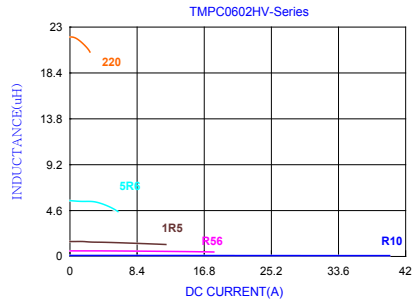
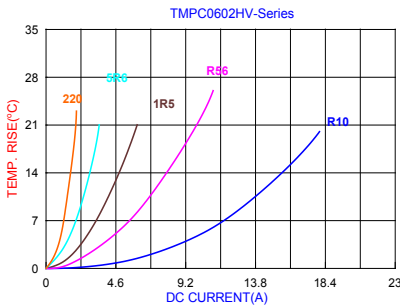

Molding Type High Current Power Inductors

TMPC 0624H Series

(2525 inch -40~+125)



■ Dimensions

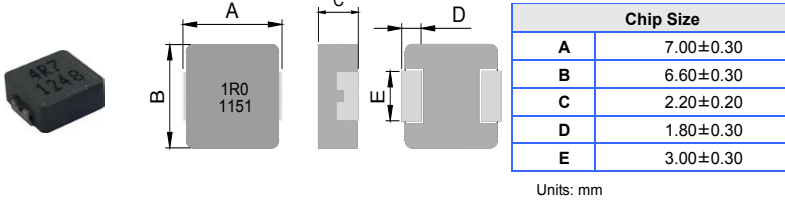

■ Specification

Part Number	Inductance L ₀ (μH)	I _{rms} (A)typ	I _{sat} (A)typ	DCR (mΩ) typ. @25°C.	DCR (mΩ) max. @25°C.
TMPC0624HV-R22MG	0.22±20%	21.0	34.0	2.00	3.20
TMPC0624HV-R47MG	0.47±20%	15.0	26.0	4.80	5.10
TMPC0624HV-R68MG	0.68±20%	13.0	21.0	6.40	7.20
TMPC0624HV-1R0MG	1.00±20%	11.0	16.0	10.5	13.5
TMPC0624HV-2R2MG	2.20±20%	7.0	14.0	23.0	28.0
TMPC0624HV-3R3MG	3.30±20%	6.0	10.0	34.0	39.0
TMPC0624HV-4R7MG	4.70±20%	5.5	9.0	41.0	50.0
TMPC0624HV-5R6MG	5.60±20%	5.0	8.0	56.0	62.0
TMPC0624HV-6R8MG	6.80±20%	4.0	7.0	65.0	72.0
TMPC0624HV-100MG	10.0±20%	3.2	5.0	92.0	101

Note:

1. Test frequency : L : 100KHz /1.0V.
2. All test data referenced to 25°C ambient.
3. Heat Rated Current (I_{rms}) will cause the coil temperature rise approximately Δt of 40°C .
4. Saturation Current (I_{sat}) will cause L₀ to drop 30% typical.
5. Special inquiries besides the above common used types can be met on your requirement.

■ DC Bias Characteristics (Typical)

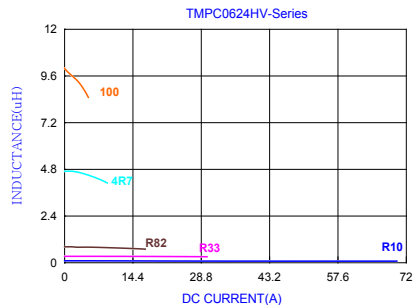
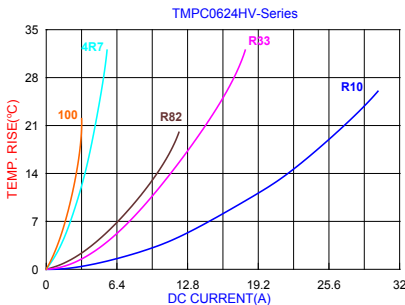



■ Dimensions

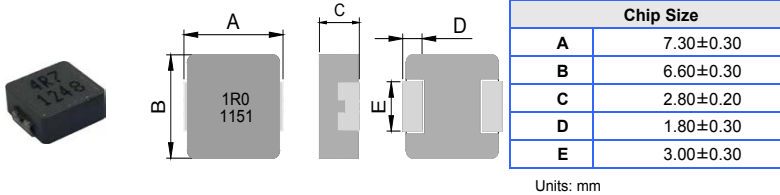

■ Specification

Part Number	Inductance L0 (uH)±20%	I rms (A)typ	I sat (A)typ	DCR (mΩ) typ. @25°C.	DCR (mΩ) max. @25°C.
TMPC0603HV-R10YG	0.10±30%	32.5	60.0	1.2	1.7
TMPC0603HV-R22YG	0.22±30%	23.0	40.0	2.1	2.8
TMPC0603HV-R47MG	0.47	17.5	26.0	4.0	4.2
TMPC0603HV-R68MG	0.68	15.5	25.0	4.8	5.5
TMPC0603HV-1R0MG	1.00	11.0	22.0	8.3	10.0
TMPC0603HV-2R2MG	2.20	8.0	14.0	18.0	20.0
TMPC0603HV-3R3MG	3.30	6.0	13.5	28.0	30.0
TMPC0603HV-4R7MG	4.70	5.5	10.0	37.0	40.0
TMPC0603HV-5R6MG	5.60	5.0	9.0	43.0	48.0
TMPC0603HV-6R8MG	6.80	4.5	8.0	54.0	60.0
TMPC0603HV-100MG	10.0	3.5	6.0	75.0	85.0

Note:

1. Test frequency : L : 100KHz /1.0V.
2. All test data referenced to 25°C ambient.
3. Heat Rated Current (Irms) will cause the coil temperature rise approximately Δt of 40°C
4. Saturation Current (Isat) will cause L0 to drop 30% typical.
5. Special inquiries besides the above common used types can be met on your requirement.

■ DC Bias Characteristics (Typical)

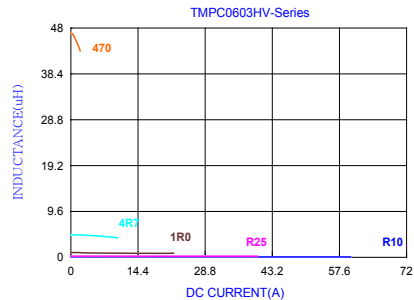
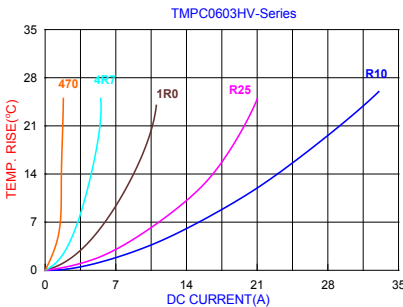



■ Dimensions

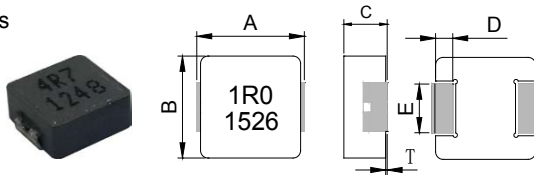

Series	A	B	C	D	E	T
TMPA0603	7.1±0.3	6.6±0.2	2.8±0.2	1.6±0.3	3.0±0.2	0~0.15

Units: mm

■ Specifications

Part Number	Inductance L0 A(μH) ±20%	Heat Rating Current DC Typ (A) Irms.	Saturation Current DC Typ (A) Isat	DCR (mΩ)Typ	DCR (mΩ)Max
TMPA0603SV-R15YN	0.15±30%	30	40	1.7	2.1
TMPA0603SV-R22MN	0.22	23	34	2.0	2.5
TMPA0603SV-R33MN	0.33	21	25	2.8	3.4
TMPA0603SV-R36MN	0.36	20	24	3.3	3.9
TMPA0603SV-R47MN	0.47	18	20	3.4	4
TMPA0603SV-R56MN	0.56	16.5	18	3.9	4.5
TMPA0603SV-R68MN	0.68	16	17	4.7	5.3
TMPA0603SV-R82MN	0.82	14	16	5.4	6.0
TMPA0603SV-1R0MN	1.00	12	15	6.7	7.4
TMPA0603SV-1R2MN	1.20	10	14	7.7	9.5
TMPA0603SV-1R5MN	1.50	10	14	10.2	12.1
TMPA0603SV-2R2MN	2.20	8	10	13.5	15
TMPA0603SV-3R3MN	3.30	6.5	9.5	19	22
TMPA0603SV-4R7MN	4.70	5.5	6.5	28	33
TMPA0603SV-5R6MN	5.60	5.5	6	39	42
TMPA0603SV-6R8MN	6.80	4.5	6	43	50
TMPA0603SV-8R2MN	8.20	4.5	6	54	60
TMPA0603SV-100MN	10.0	4	5.5	62	68
TMPA0603SV-150MN	15.0	3	4.5	110	140
TMPA0603SV-220MN	22.0	2.5	3	150	190

Note:

1. Test frequency : Ls : 100KHz /1.0V.
2. All test data referenced to 25°C ambient.
3. Heat Rated Current (Irms) will cause the coil temperature rise approximately ΔT of 40°C
4. Saturation Current (Isat) will cause L0 to drop approximately 30%.



■ DC Bias Characteristics (Typical)

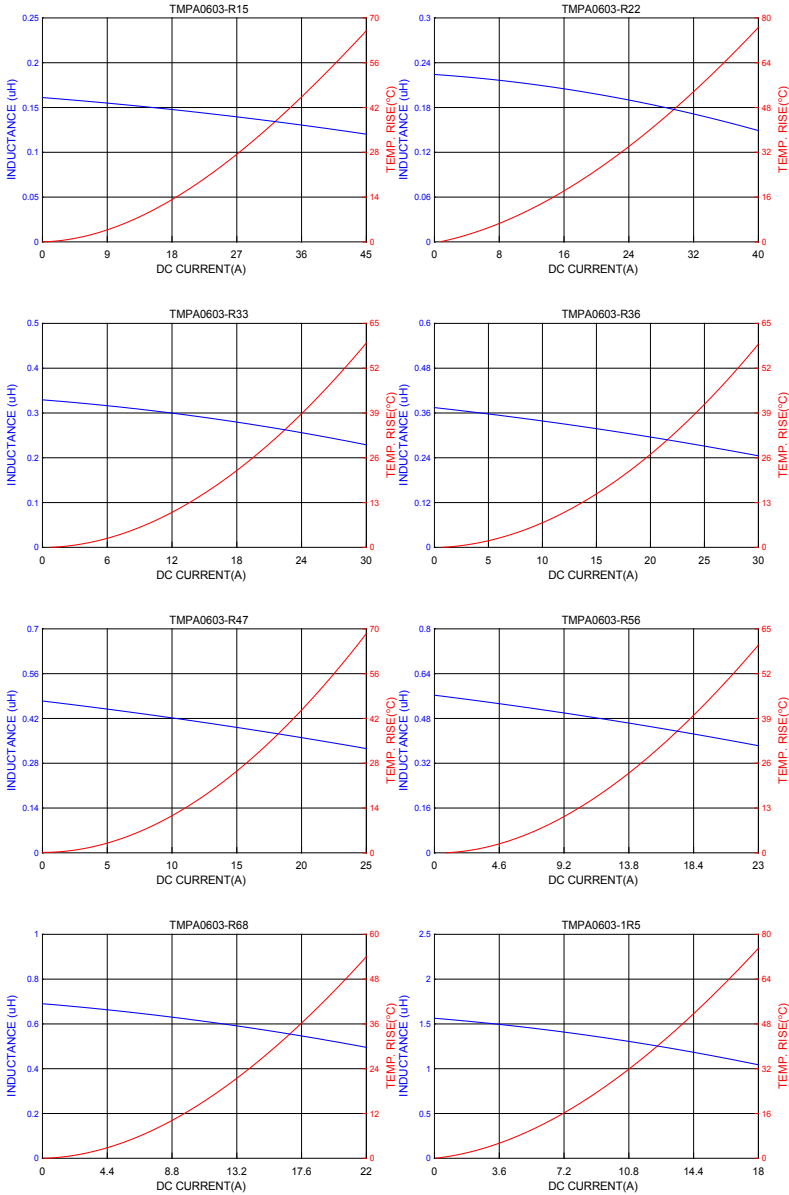



■ DC Bias Characteristics (Typical)

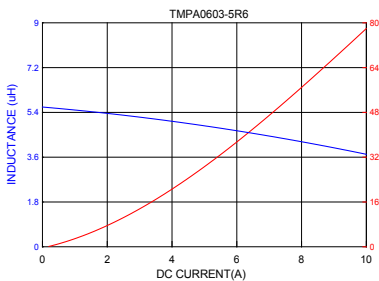
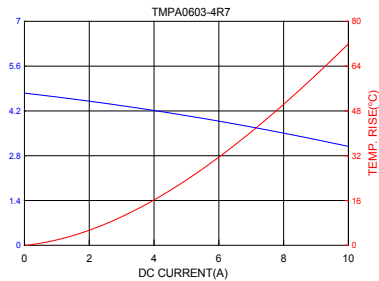
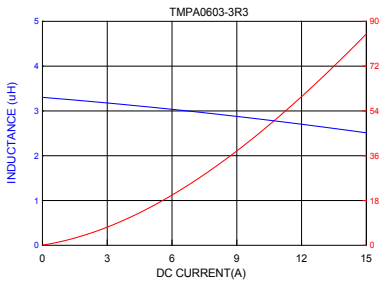
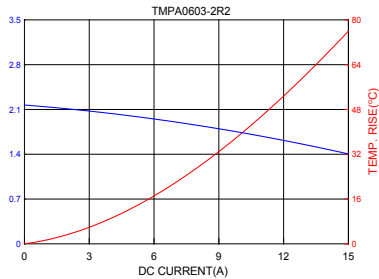
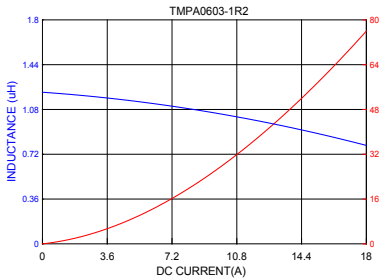
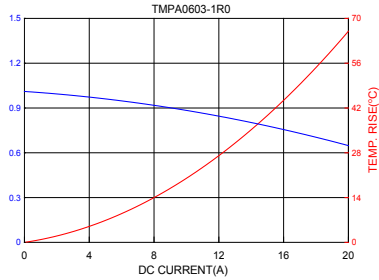
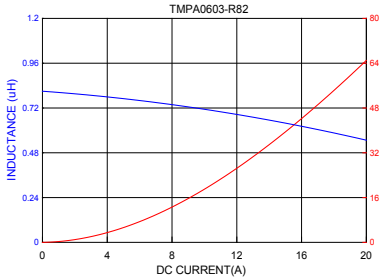



■ Dimensions

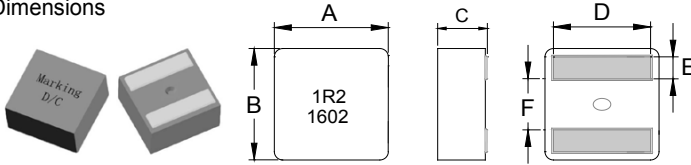

Series	Inductance Range	A (mm)	B (mm)	C (mm)	D (mm)	E (mm)	F (mm)
TMPF0603	1.2uH and below	6.6±0.2	6.4±0.2	2.8±0.2	See Spec table	1.4±0.2	2.6±0.25
	1.5uH and above			2.9±0.2			

■ Specifications

Part Number	Inductance(uH) ±20% @ 0 A	I rms(A) Typ		I sat(A)		DCR (mΩ) Typ.	DCR (mΩ) Max.	D(mm) ±0.3
		20°C rise	40°C rise	Typ	Max			
TMPF0603AV-R18MN	0.18	24.0	32.0	40.0	36.0	1.60	1.75	5.30
TMPF0603AV-R33MN	0.33	20.0	25.0	32.0	28.0	2.25	2.50	5.55
TMPF0603AV-R56MN	0.56	17.0	22.0	29.0	25.0	3.00	3.31	5.30
TMPF0603AV-1R0MN	1.00	13.0	18.0	23.0	18.0	5.50	6.05	5.20
TMPF0603AV-1R2MN	1.20	12.0	16.0	22.0	16.0	6.70	7.40	5.15
TMPF0603AV-1R8MN	1.80	10.0	14.0	18.2	13.0	9.20	10.2	5.10
TMPF0603AV-2R2MN	2.20	7.00	10.0	15.9	11.0	11.0	12.2	5.05
TMPF0603AV-3R3MN	3.30	6.00	8.00	12.2	9.00	18.8	20.8	5.00
TMPF0603AV-4R5MN	4.50	5.00	7.00	10.0	8.00	23.0	25.3	5.00

Note:

1. Test frequency : L : 100KHz /0.1V.
2. All test data referenced to 25°C ambient.
3. Testing Instrument : L: HP4284A,HP4395A,CH11025,CH3302,CH1320 ,CH1320S LCR METER / Rdc:CH16502, Agilent33420A MICRO OHM METER, or EQU.
4. Current that causes the specified temperature rise from 25°C ambient.
5. Saturation Current (Isat) will cause L0 to drop approximately 30%.



■ DC Bias Characteristics (Typical)

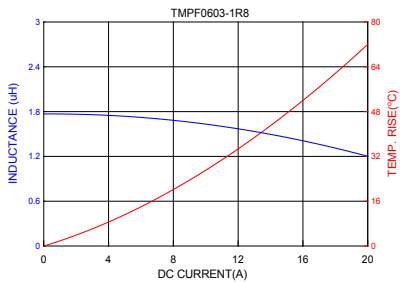
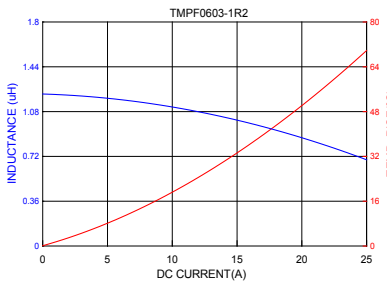
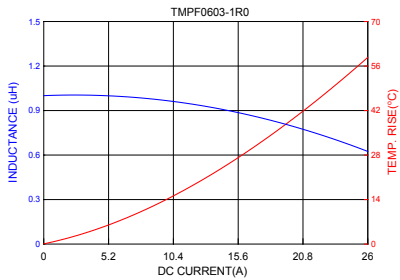
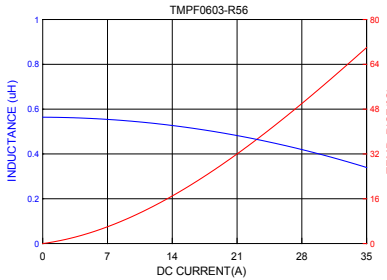
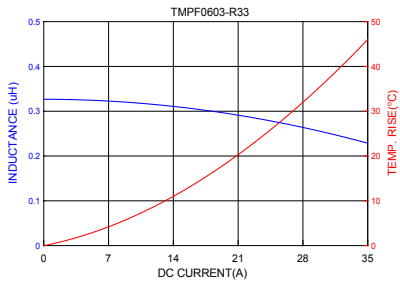
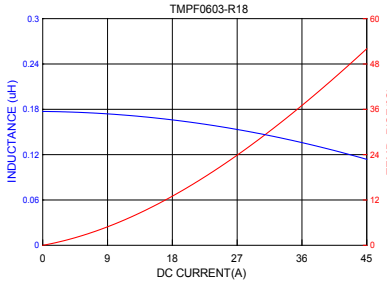



■ DC Bias Characteristics (Typical)

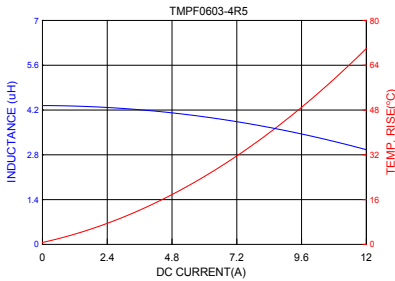
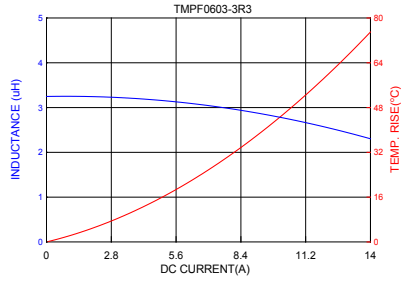
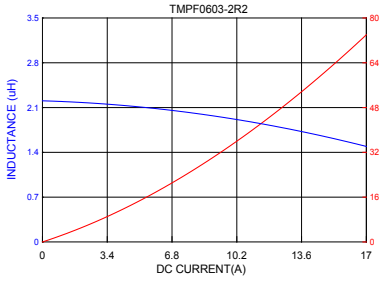



■ Dimensions

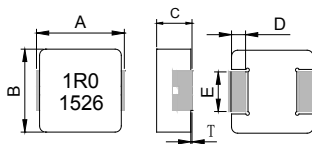

Series	A	B	C	D	E	T
TMPV0603	7.1±0.	6.6±0.	2.8±0.	1.6±	3.0±0.2	0~0.15

Units: mm

■ Specifications

Part Number	Inductance L0 A(μH) ±20%	Heat Rating Current DC Typ (A) I _{rms} .	Saturation Current DC Typ (A) I _{sat}	DCR (mΩ)Typ	DCR (mΩ)Max
TMPV0603SV-R47MN-D	0.47	20.0	14.0	3.87	4.14
TMPV0603SV-R68MN-D	0.68	16.5	17.0	5.38	5.76
TMPV0603SV-R82MN-D	0.82	13.8	16.8	6.75	7.22
TMPV0603SV-1R0MN-D	1.00	12.0	13.0	7.90	8.45
TMPV0603SV-1R5MN-D	1.50	10.6	11.6	12.3	13.2
TMPV0603SV-2R2MN-D	2.20	8.1	10.8	17.1	18.3
TMPV0603SV-3R3MN-D	3.30	6.8	8.3	26.5	28.4
TMPV0603SV-4R7MN-D	4.70	5.6	5.6	35.9	38.4
TMPV0603SV-5R6MN-D	5.60	5.3	4.8	42.6	45.6
TMPV0603SV-6R8MN-D	6.80	4.4	4.4	53.8	57.6
TMPV0603SV-100MN-D	10.0	4.0	2.9	71.9	76.9
TMPV0603SV-150MN-D	15.0	2.9	2.8	118	127
TMPV0603SV-220MN-D	22.0	2.8	2.2	163	174

Note:

1. Test frequency : Ls : 100KHz /1.0V.
2. All test data referenced to 25°C ambient.



■ Dimensions

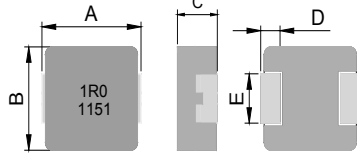

Chip Size	
A	7.30±0.30
B	6.60±0.30
C	3.80±0.20
D	1.80±0.30
E	3.00±0.30

Units: mm

■ Specification

Part Number	Inductance L0 (uH)±20%	I rms (A)typ	I sat (A)typ	DCR (mΩ) typ. @25°C.	DCR (mΩ) max. @25°C.
TMPC0604HV-R15YG	0.15	30.0	55.0	0.9	1.2
TMPC0604HV-R47MG	0.47	23.0	28.0	3.0	3.4
TMPC0604HV-R68MG	0.68	16.0	24.0	4.1	4.5
TMPC0604HV-1R0MG	1.00	14.0	22.0	6.8	8.0
TMPC0604HV-2R2MG	2.20	9.0	14.0	11.5	14.0
TMPC0604HV-3R3MG	3.30	8.0	12.0	24.0	27.0
TMPC0604HV-4R7MG	4.70	6.0	11.0	28.0	32.5
TMPC0604HV-5R6MG	5.60	5.0	9.0	33.0	38.0
TMPC0604HV-6R8MG	6.80	4.5	8.5	44.0	50.0
TMPC0604HV-100MG	10.0	4.0	7.0	64.0	72.0
TMPC0604HV-150MG	15.0	3.0	3.5	80.0	90.0

Note:

1. Test frequency : L : 100KHz /1.0V.
2. All test data referenced to 25°C ambient.
3. Heat Rated Current (Irms) will cause the coil temperature rise approximately Δt of 40°C
4. Saturation Current (Isat) will cause L0 to drop 30% typical.
5. Special inquiries besides the above common used types can be met on your requirement.

■ DC Bias Characteristics (Typical)

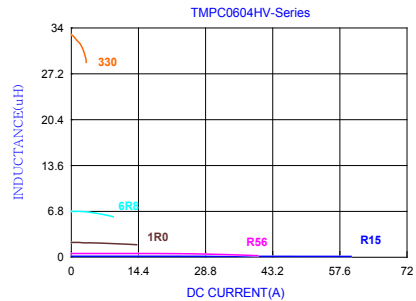
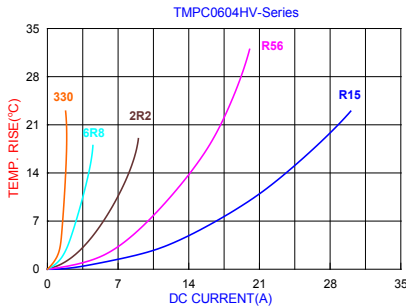



■ Dimensions

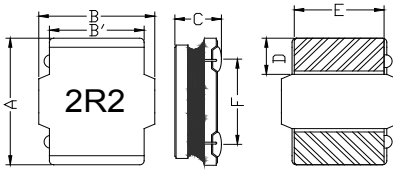

Dimensions		unit: mm
A	6.00±0.20	
B	6.00±0.20	
B'	4.80±0.20	
C	4.20±0.30	
D	1.70±0.30	
E	4.50±0.30	
F	4.25±0.30	

■ Specifications

Part Number	Inductance L0 (uH) @ 0 A	Tolerance				Rated current				DCR (mΩ) @25℃ ±20%.
						Temperature current I rms (A)		Saturation current I sat (A)		
		K	L	M	Y	Typ	Max	Typ	Max	
HPC6045NV-R36	0.36	/	/	±20%	±30%	9.00	8.50	18.00	16.50	4.80
HPC6045NV-R47	0.47	/	/	±20%	±30%	8.60	8.00	17.00	16.00	6.80
HPC6045NV-R82	0.82	/	/	±20%	±30%	8.20	7.50	14.50	13.50	8.50
HPC6045NV-1R0	1.00	/	/	±20%	±30%	8.00	7.30	13.50	12.50	10.0
HPC6045NV-1R2	1.20	/	/	±20%	±30%	7.50	7.00	12.50	11.50	10.5
HPC6045NV-1R3	1.30	/	/	±20%	±30%	7.50	7.00	12.50	11.50	10.5
HPC6045NV-1R5	1.50	/	/	±20%	±30%	7.00	6.60	12.00	11.00	11.7
HPC6045NV-1R8	1.80	/	/	±20%	±30%	6.80	6.20	11.00	10.00	12.0
HPC6045NV-2R0	2.00	/	/	±20%	±30%	6.50	5.80	10.50	9.50	13.5
HPC6045NV-2R2	2.20	/	/	±20%	±30%	6.00	5.30	9.50	8.55	15.0
HPC6045NV-2R3	2.30	/	/	±20%	±30%	5.80	5.00	9.30	8.20	16.0
HPC6045NV-3R0	3.00	/	/	±20%	±30%	5.20	4.60	8.00	7.50	20.0
HPC6045NV-3R3	3.30	/	/	±20%	±30%	5.00	4.50	7.80	7.30	21.0
HPC6045NV-3R6	3.60	/	/	±20%	±30%	4.90	4.30	7.40	6.90	22.5
HPC6045NV-4R7	4.70	/	±15%	±20%	±30%	4.50	4.00	6.80	6.20	26.0
HPC6045NV-5R6	5.60	/	±15%	±20%	±30%	4.10	3.70	6.40	5.70	31.0
HPC6045NV-6R3	6.30	/	±15%	±20%	±30%	3.80	3.50	5.90	5.30	33.0
HPC6045NV-6R8	6.80	/	±15%	±20%	±30%	3.60	3.30	5.70	5.15	34.0
HPC6045NV-8R2	8.20	/	±15%	±20%	±30%	3.40	2.90	5.10	4.50	46.0
HPC6045NV-100	10.0	±10%	±15%	±20%	±30%	3.20	2.60	4.60	4.20	52.0
HPC6045NV-150	15.0	±10%	±15%	±20%	±30%	2.80	2.20	3.80	3.30	71.0
HPC6045NV-180	18.0	±10%	±15%	±20%	±30%	2.60	2.10	3.40	2.90	80.0
HPC6045NV-220	22.0	±10%	±15%	±20%	±30%	2.30	1.90	3.30	2.70	96.0

Note:

1. All test data referenced to 25℃ ambient, Ls:1MHz/1V.
2. Heat Rated Current (I rms) will cause the coil temperature rise approximately Δt of 40℃.
3. Saturation Current (I sat) will cause L0 to drop approximately 30%.



Part Number	Inductance (uH)	Tolerance				Rated current				DCR (mΩ) @25°C ±20%.
						Temperature current I rms (A)		Saturation current I sat (A)		
		K	L	M	Y	Typ	Max	Typ	Max	
HPC6045NV-330	33.0	±10%	±15%	±20%	±30%	1.80	1.50	2.50	2.10	145
HPC6045NV-470	47.0	±10%	±15%	±20%	±30%	1.60	1.20	2.00	1.75	200
HPC6045NV-560	56.0	±10%	±15%	±20%	±30%	1.40	1.00	1.80	1.65	230
HPC6045NV-680	68.0	±10%	±15%	±20%	±30%	1.10	0.92	1.60	1.52	305
HPC6045NV-820	82.0	±10%	±15%	±20%	±30%	0.98	0.88	1.50	1.40	365
HPC6045NV-101	100	±10%	±15%	±20%	±30%	0.92	0.82	1.33	1.25	456
HPC6045NV-121	120	±10%	±15%	±20%	±30%	0.85	0.79	1.20	1.10	500
HPC6045NV-151	150	±10%	±15%	±20%	±30%	0.75	0.70	1.10	1.00	626
HPC6045NV-181	180	±10%	±15%	±20%	±30%	0.68	0.60	1.00	0.90	745
HPC6045NV-221	220	±10%	±15%	±20%	±30%	0.60	0.50	0.88	0.77	900
HPC6045NV-331	330	±10%	±15%	±20%	±30%	0.55	0.45	0.60	0.55	1400
HPC6045NV-471	470	±10%	±15%	±20%	±30%	0.40	0.35	0.50	0.45	2050

Note:

1. Heat Rated Current (Irms) will cause the coil temperature rise approximately Δt of 40°C
2. Saturation Current (Isat) will cause L0 to drop approximately 30%

■ DC Bias Characteristics (Typical)

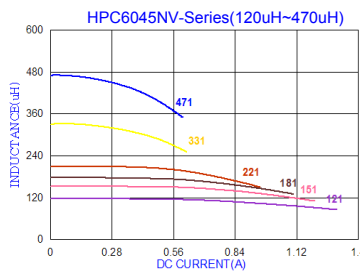
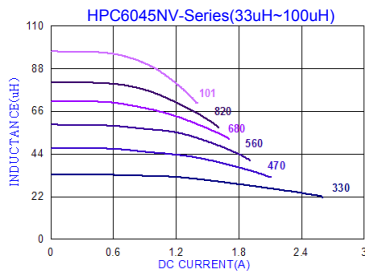
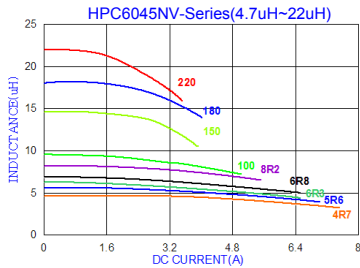
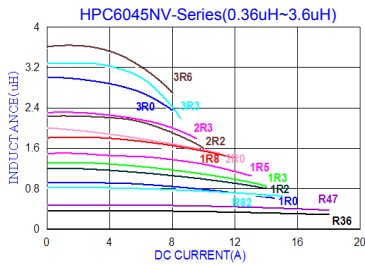

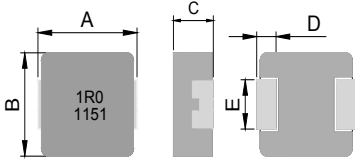

■ Dimensions

Chip Size	
A	7.30±0.30
B	6.60±0.30
C	4.80±0.20
D	1.80±0.30
E	3.00±0.30

Units: mm

■ Specification

Part Number	Inductance L0 (uH)±20%	I rms (A)typ	I sat (A)typ	DCR (mΩ) typ. @25°C.	DCR (mΩ) max. @25°C.
TMPC0605HV-R33MG	0.33	25.0	32.0	2.5	3.0
TMPC0605HV-R47MG	0.47	22.0	30.0	3.5	3.9
TMPC0605HV-R68MG	0.68	18.0	24.0	4.0	4.5
TMPC0605HV-1R0MG	1.00	15.0	20.0	6.1	6.5
TMPC0605HV-2R2MG	2.20	10.0	14.0	11.2	12.0
TMPC0605HV-3R3MG	3.30	8.0	12.0	19.0	20.9
TMPC0605HV-4R7MG	4.70	6.5	10.0	28.0	30.8
TMPC0605HV-5R6MG	5.60	6.0	9.0	43.5	49.0
TMPC0605HV-6R8MG	6.80	5.5	8.5	46.0	51.5
TMPC0605HV-100MG	10.0	4.0	7.5	60.0	69.0
TMPC0605HV-220MG	22.0	2.5	5.5	140	170

Note:

1. Test frequency : L : 100KHz /1.0V.
2. All test data referenced to 25°C ambient.
3. Heat Rated Current (Irms) will cause the coil temperature rise approximately Δt of 40°C
4. Saturation Current (Isat) will cause L0 to drop 30% typical.
5. Special inquiries besides the above common used types can be met on your requirement.

■ DC Bias Characteristics (Typical)

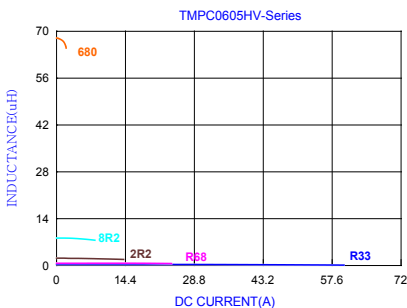
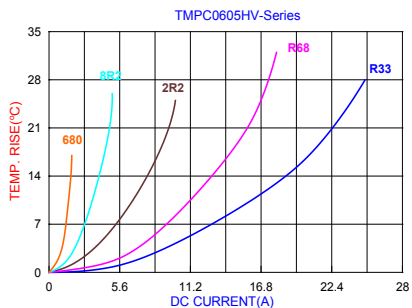



■ Dimensions

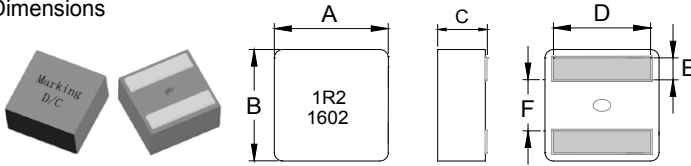

Series	A (mm)	B (mm)	C (mm)	D (mm)	E (mm)	F (mm)
TMPF0605	6.6±0.2	6.4±0.2	4.8±0.2	See Spec table	1.4±0.2	2.6±0.25

■ Specifications

Part Number	Inductance (uH) ±20% @ 0 A	I rms(A) Typ		I sat(A)		DCR (mΩ) Typ.	DCR (mΩ) Max.	D (mm) ±0.3
		20°C rise	40°C rise	Typ	Max			
TMPF0605AV-1R0MN	1.00	15	20	23.0	18.0	4.1	4.52	5.3
TMPF0605AV-1R2MN	1.20	14	18	22.0	16.0	5.3	5.83	5.3
TMPF0605AV-1R5MN	1.50	13	17	19.5	14.5	5.7	6.3	5.3
TMPF0605AV-1R8MN	1.80	12	16	18.5	13.5	6.4	7.1	5.3
TMPF0605AV-2R2MN	2.20	10	13	16.0	12.0	7.7	8.5	5.2
TMPF0605AV-3R3MN	3.30	8.5	11	12.5	10.0	11.2	12.5	5.2
TMPF0605AV-4R3MN	4.30	7.0	9.0	11.0	8.5	15.1	16.2	5.2
TMPF0605AV-4R7MN	4.70	6.5	8.5	10.5	8.0	16.7	18.4	5.2

Note:

1. Test frequency : L : 100KHz /0.1V.
2. All test data referenced to 25°C ambient.
3. Testing Instrument : L: HP4284A, HP4395A, CH11025, CH3302, CH1320 ,CH1320S LCR METER / Rdc: CH16502, Agilent33420A MICRO OHMMETER, or EQU.
4. Current that causes the specified temperature rise from 25°C ambient.
5. Saturation Current (Isat) will cause L0 to drop approximately 30%.



■ DC Bias Characteristics (Typical)

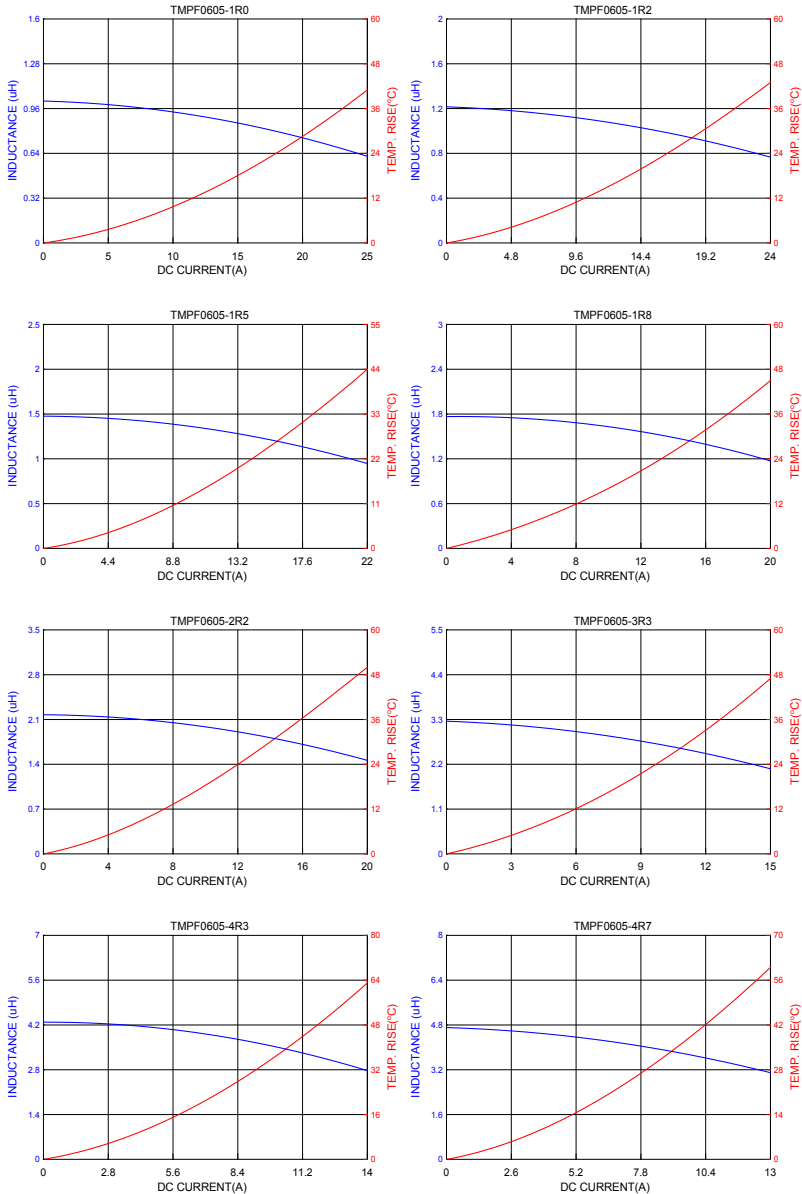



■ Dimensions

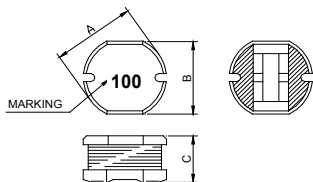

Size	A(mm)	B(mm)	C(mm)
FPI0703	7.80±0.3	7.00±0.3	3.50±0.3

■ Specifications

TAI-TECH Part Number	Inductance (uH)	Tolerance (%)	Test Frequency (Hz)	DCR (Ω) max.	IDC (A) max.
FPI 0703BMV-100M	10	± 20%	1V/2.52M	0.0803	1.44
FPI 0703BMV-120M	12	± 20%	1V/2.52M	0.0897	1.39
FPI 0703BMV-150M	15	± 20%	1V/2.52M	0.1040	1.24
FPI 0703BMV-180M	18	± 20%	1V/2.52M	0.1110	1.12
FPI 0703BMV-220M	22	± 20%	1V/2.52M	0.1290	1.07
FPI 0703BMV-270M	27	± 20%	1V/2.52M	0.1530	0.97
FPI 0703BMV-330M	33	± 20%	1V/2.52M	0.1700	0.85
FPI 0703BMV-390M	39	± 20%	1V/2.52M	0.2170	0.74
FPI 0703BMV-470M	47	± 20%	1V/2.52M	0.2520	0.68
FPI 0703BMV-560K	56	± 10%	1V/2.52M	0.2820	0.64
FPI 0703BMV-680K	68	± 10%	1V/2.52M	0.3320	0.59
FPI 0703BMV-820K	82	± 10%	1V/2.52M	0.4060	0.54
FPI 0703BMV-101K	100	± 10%	1V/1K	0.4810	0.51
FPI 0703BMV-121K	120	± 10%	1V/1K	0.5360	0.49
FPI 0703BMV-151K	150	± 10%	1V/1K	0.7550	0.40
FPI 0703BMV-181K	180	± 10%	1V/1K	1.0220	0.36
FPI 0703BMV-221K	220	± 10%	1V/1K	1.2000	0.31
FPI 0703BMV-271K	270	± 10%	1V/1K	1.3060	0.29
FPI 0703BMV-331K	330	± 10%	1V/1K	1.4950	0.28

Note:

Based on inductance change ($\Delta L/L_0 : \leq -35\%$) @ ambient temp. 25°CBased on temperature rise ($\Delta T : 40^\circ\text{C typ.}$)



■ Dimensions

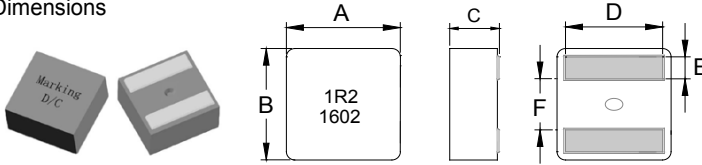

Series	A (mm)	B (mm)	C (mm)	D (mm)	E (mm)	F (mm)
TMPF0703	7.80±0.25	7.60±0.20	2.90±0.2	See Spec Table	1.75±0.2	3.15±0.25

■ Specifications

Part Number	Inductance (uH) ±20% @ 0 A	I rms(A) Typ		I sat(A)		DCR (mΩ) Typ.	DCR (mΩ) Max.	D (mm) ±0.3
		20°C rise	40°C rise	Typ	Max			
TMPF0703AV-R60MN	0.60	18.0	23.0	36.0	32.0	2.90	3.20	6.6
TMPF0703AV-1R0MN	1.00	16.1	21.8	30.0	28.0	4.55	5.00	6.6
TMPF0703AV-1R5MN	1.50	12.0	15.3	25.0	23.5	7.50	8.25	6.6
TMPF0703AV-2R2MN	2.20	10.0	13.0	19.0	17.0	12.4	13.7	6.2
TMPF0703AV-3R3MN	3.30	8.00	10.0	15.0	13.0	16.3	18.0	6.2
TMPF0703AV-4R7MN	4.70	6.90	9.00	13.5	12.2	24.2	26.7	6.2
TMPF0703AV-5R6MN	5.60	5.30	7.30	12.5	11.5	30.1	33.2	6.2
TMPF0703AV-6R8MN	6.80	4.50	6.80	12.0	11.0	38.6	42.5	6.2
TMPF0703AV-8R2MN	8.20	3.00	5.90	10.2	9.0	44.3	48.8	6.2

Note:

1. Test frequency : L : 100KHz /0.1V.
2. All test data referenced to 25°C ambient.
3. Testing Instrument : L: HP4284A,HP4395A,CH11025,CH3302,CH1320 ,CH1320S LCR METER / Rdc:CH16502,Agilent33420A MICRO OHM METER,or EQU.
4. Current that causes the specified temperature rise from 25°C ambient.
5. Saturation Current (Isat) will cause L0 to drop approximately 30%.



■ DC Bias Characteristics (Typical)

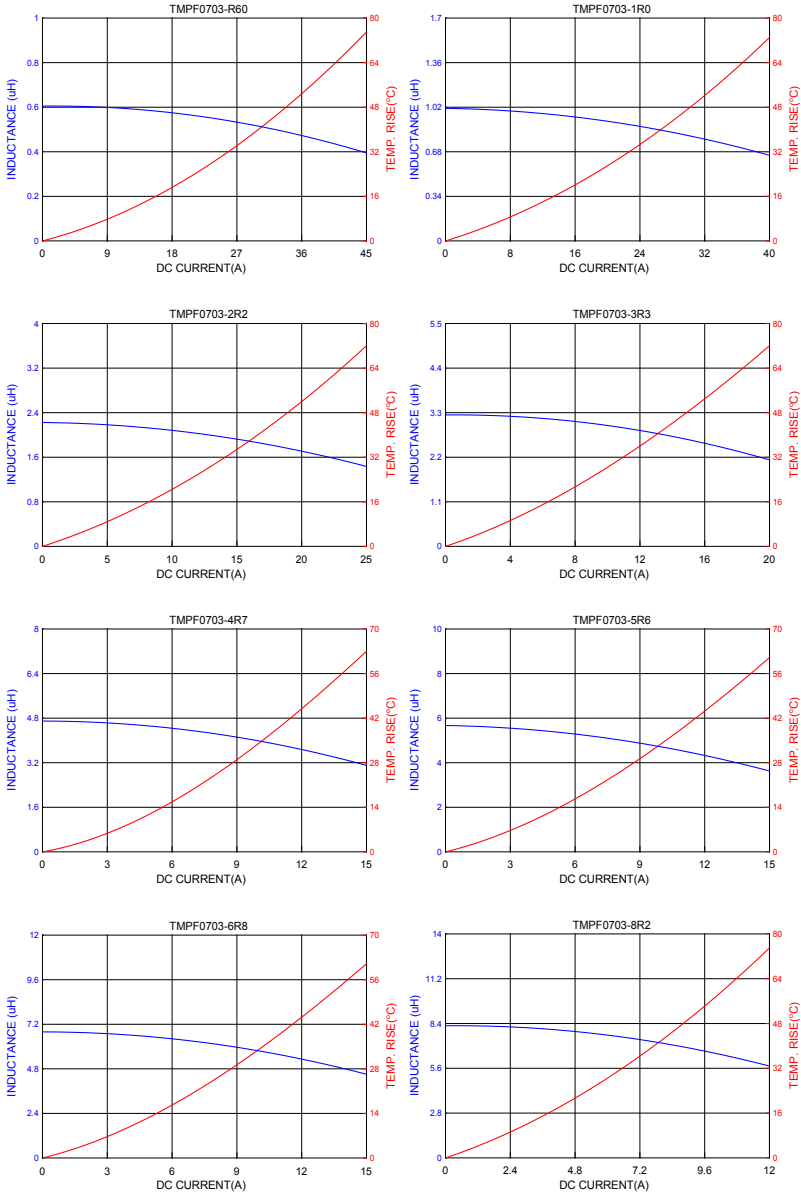



■ Dimensions

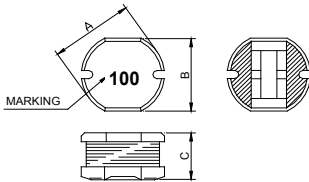

Size	A(mm)	B(mm)	C(mm)
FPI0705	7.80±0.3	7.00±0.3	5.00±0.3

■ Specifications

TAI-TECH Part Number	Inductance (uH)	Tolerance (%)	Test Frequency (Hz)	DCR (Ω) max.	IDC (A) max.
FPI 0705BMV-3R3M	3.30	± 20%	1V/7.96M	0.03	4.60
FPI 0705BMV-4R7M	4.70	± 20%	1V/7.96M	0.04	4.20
FPI 0705BMV-100M	10.0	± 20%	1V/2.52M	0.07	2.30
FPI 0705BMV-120M	12.0	± 20%	1V/2.52M	0.08	2.00
FPI 0705BMV-150M	15.0	± 20%	1V/2.52M	0.09	1.80
FPI 0705BMV-180M	18.0	± 20%	1V/2.52M	0.10	1.60
FPI 0705BMV-220M	22.0	± 20%	1V/2.52M	0.11	1.50
FPI 0705BMV-270M	27.0	± 20%	1V/2.52M	0.12	1.30
FPI 0705BMV-330M	33.0	± 20%	1V/2.52M	0.13	1.20
FPI 0705BMV-390M	39.0	± 20%	1V/2.52M	0.16	1.10
FPI 0705BMV-470K	47.0	± 10%	1V/2.52M	0.18	1.10
FPI 0705BMV-560K	56.0	± 10%	1V/2.52M	0.24	0.94
FPI 0705BMV-680K	68.0	± 10%	1V/2.52M	0.28	0.85
FPI 0705BMV-820K	82.0	± 10%	1V/2.52M	0.37	0.78
FPI 0705BMV-101K	100	± 10%	1V/1K	0.43	0.72
FPI 0705BMV-121K	120	± 10%	1V/1K	0.47	0.66
FPI 0705BMV-151K	150	± 10%	1V/1K	0.64	0.58
FPI 0705BMV-181K	180	± 10%	1V/1K	0.71	0.51
FPI 0705BMV-221K	220	± 10%	1V/1K	0.96	0.49
FPI 0705BMV-271K	270	± 10%	1V/1K	1.11	0.42
FPI 0705BMV-331K	330	± 10%	1V/1K	1.26	0.40
FPI 0705BMV-391K	390	± 10%	1V/1K	1.77	0.36
FPI 0705BMV-471K	470	± 10%	1V/1K	1.96	0.34

Note:

Based on inductance change ($\Delta L/L_0$: $\leq -35\%$) @ ambient temp. 25°C

Based on temperature rise (ΔT : 40°C typ.)



■ Dimensions

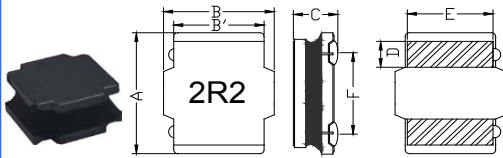

Chip Size	
A	8.00±0.30
B	8.00±0.30
B'	6.30±0.20
C	*1 3.90±0.30 *2 3.70±0.30
D	2.00±0.30
E	6.00±0.30
F	5.50±0.40

Units: mm

*1 1R0~100 Type
*2 150~471 Type

■ Specifications

Part Number	Inductance L0 (uH) @ 0 A	Tolerance				Frequency	Rated current				DCR (mΩ) @25°C ±20%
		K	L	M	Y		Temperature current I rms (A)		Saturation current I sat (A)		
							Typ	Max	Typ	Max	
HPC8040NV-1R0□-Z01	1.00	/	/	±20%	±30%	1MHz/1V	8.50	8.00	13.80	13.00	8.2
HPC8040NV-1R5□-Z01	1.50	/	/	±20%	±30%	1MHz/1V	8.00	7.70	11.50	11.00	10.0
HPC8040NV-2R2□-Z01	2.20	/	/	±20%	±30%	1MHz/1V	7.40	6.90	9.80	9.20	11.5
HPC8040NV-3R3□-Z01	3.30	/	/	±20%	±30%	1MHz/1V	6.60	6.20	8.00	7.50	15.0
HPC8040NV-4R7□-Z01	4.70	/	±15%	±20%	±30%	1MHz/1V	5.80	5.30	6.70	6.00	19.5
HPC8040NV-5R6□-Z01	5.60	/	±15%	±20%	±30%	1MHz/1V	5.40	5.20	6.20	5.80	22.0
HPC8040NV-6R8□-Z01	6.80	/	±15%	±20%	±30%	1MHz/1V	5.10	5.00	5.60	5.10	25.0
HPC8040NV-8R2□-Z01	8.20	/	±15%	±20%	±30%	1MHz/1V	4.80	4.50	5.30	4.60	30.0
HPC8040NV-100□-Z01	10.0	±10%	±15%	±20%	±30%	1MHz/1V	4.60	4.20	5.00	4.30	33.0
HPC8040NV-150□-Z01	15.0	±10%	±15%	±20%	±30%	1MHz/1V	3.60	3.20	4.00	3.60	50.0
HPC8040NV-220□-Z01	22.0	±10%	±15%	±20%	±30%	1MHz/1V	2.90	2.45	3.10	2.80	73.0
HPC8040NV-330□-Z01	33.0	±10%	±15%	±20%	±30%	1MHz/1V	2.30	2.10	2.60	2.10	100
HPC8040NV-470□-Z01	47.0	±10%	±15%	±20%	±30%	1MHz/1V	2.00	1.70	2.20	1.90	135
HPC8040NV-560□-Z01	56.0	±10%	±15%	±20%	±30%	1MHz/1V	1.75	1.60	1.90	1.60	160
HPC8040NV-680□-Z01	68.0	±10%	±15%	±20%	±30%	1MHz/1V	1.65	1.50	1.75	1.50	205
HPC8040NV-820□-Z01	82.0	±10%	±15%	±20%	±30%	1MHz/1V	1.40	1.30	1.60	1.40	230
HPC8040NV-101□-Z01	100	±10%	±15%	±20%	±30%	1MHz/1V	1.20	1.10	1.45	1.20	300
HPC8040NV-121□-Z01	120	±10%	±15%	±20%	±30%	1MHz/1V	1.10	1.00	1.30	1.10	350
HPC8040NV-151□-Z01	150	±10%	±15%	±20%	±30%	1MHz/1V	0.98	0.90	1.20	1.03	410
HPC8040NV-181□-Z01	180	±10%	±15%	±20%	±30%	1MHz/1V	0.91	0.83	1.04	0.94	490
HPC8040NV-221□-Z01	220	±10%	±15%	±20%	±30%	1MHz/1V	0.85	0.76	0.99	0.90	610
HPC8040NV-331□-Z01	330	±10%	±15%	±20%	±30%	100KHz/1V	0.70	0.66	0.75	0.70	850
HPC8040NV-471□-Z01	470	±10%	±15%	±20%	±30%	100KHz/1V	0.63	0.58	0.60	0.55	1300

Note:

- All test data referenced to 25°C ambient , Ls:1MHz/1V.
- Heat Rated Current (Irms) will cause the coil temperature rise approximately Δt of 40°C.
- Saturation Current (Isat) will cause L0 to drop approximately 30%.



■ Dimensions

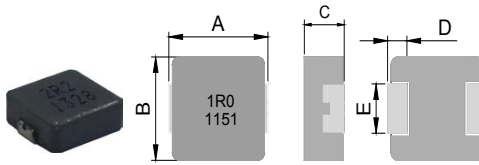

Chip Size	
A	11.00±0.50
B	10.00±0.30
C	3.80±0.20
D	2.30±0.30
E	3.00±0.30

Units: mm

■ Specifications

Part Number	Inductance L0 (uH) ±20%	I rms (A)typ	I sat (A)typ	DCR (mΩ) typ. @25°C.	DCR (mΩ) max. @25°C.
TMPC1004HV-R15YG	0.15±30%	43.0	75.0	0.5	0.6
TMPC1004HV-R47MG	0.47	28.0	43.0	1.3	1.5
TMPC1004HV-R68MG	0.68	22.0	39.0	2.4	2.7
TMPC1004HV-1R0MG	1.00	18.0	36.0	3.0	3.3
TMPC1004HV-2R2MG	2.20	12.0	27.0	6.5	7.0
TMPC1004HV-3R3MG	3.30	11.0	20.0	10.8	11.8
TMPC1004HV-4R7MG	4.70	10.0	17.0	15.0	15.5
TMPC1004HV-5R6MG	5.60	9.0	14.0	17.0	19.3
TMPC1004HV-6R8MG	6.80	8.5	13.5	17.5	23.3
TMPC1004HV-8R2MG	8.20	8.0	12.5	20.0	22.5
TMPC1004HV-100MG	10.0	7.5	12.0	27.0	30.0
TMPC1004HV-220MG	22.0	5.0	7.0	64.0	74.0

Note:

1. Test frequency : L : 100KHz /1.0V.
2. All test data referenced to 25 °C ambient.
3. Heat Rated Current (Irms) will cause the coil temperature rise approximately Δt of 40 °C
4. Saturation Current (Isat) will cause L0 to drop 30% typical.
5. Special inquiries besides the above common used types can be met on your requirement.

■ DC Bias Characteristics (Typical)

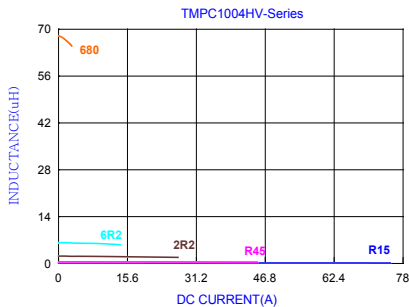
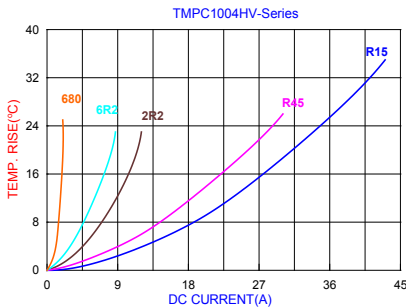

TMPA 1004S Series (4040 inch -55~+150)



■ Dimensions

The image shows a photograph of a black rectangular inductor with '2R2 1537' printed on it. To its right are two sets of dimension diagrams. The first set, labeled 'Lead Frame Type', shows a rectangular component with dimensions A, A', B, C, D, T, and W. The second set, labeled 'Non Lead Frame Type', shows a similar component with dimensions A, A', B, C, D, T, and W. The diagrams illustrate the various measurements used to define the physical size and lead placement of the inductor.

Series	Lead Frame Type		Non Lead Frame Type					Inductance
	A	A'	B	C	D	T	E	
TMPA1004	11.0±0.3	10.0±0.3	10.0±0.3	3.8±0.2	2.0±0.3	0~0.2	2.5±0.3	0.56~1.50uH
							3.0±0.3	0.47uH and below 2.00uH and above

Units: mm

■ Specifications

Part Number	Inductance L0 A(uH) ±20%	Heat Rating Current DC I rms.(A)		Saturation Current DC I sat. (A)		DCR (mΩ)Typ	DCR (mΩ)Max	Type
		Typ	Max	Typ	Max			
TMPA1004SV-R15YN	0.15±30%	44.0	38.0	82.0	75.0	0.50	0.60	non-leadframe
TMPA1004SV-R22MN	0.22	36.0	33.0	70.0	60.0	0.72	0.83	non-leadframe
TMPA1004SV-R36MN	0.36	33.0	29.0	51.0	45.0	1.05	1.18	non-leadframe
TMPA1004SV-R42MN	0.42	32.5	28.5	50.0	42.0	1.15	1.30	non-leadframe
TMPA1004SV-R47MN	0.47	32.0	28.0	46.0	40.0	1.30	1.50	non-leadframe
TMPA1004SV-R56MN	0.56	25.0	23.0	34.0	29.0	1.60	1.80	non-leadframe
TMPA1004SV-R68MN	0.68	23.0	20.0	31.0	28.0	1.90	2.20	non-leadframe
TMPA1004SV-1R0MN	1.00	20.0	18.0	29.0	26.0	2.9	3.25	non-leadframe
TMPA1004SV-1R5MN	1.50	17.5	16.0	26.0	22.0	3.7	4.2	non-leadframe
TMPA1004SV-1R8MN	1.80	16.5	15.0	23.0	20.5	5.1	5.7	leadframe
TMPA1004SV-2R0MN	2.00	16.0	14.5	21.0	18.0	5.3	6.1	leadframe
TMPA1004SV-2R2MN	2.20	15.0	13.0	20.0	16.0	5.8	6.7	leadframe
TMPA1004SV-3R3MN	3.30	11.0	10.0	17.5	14.0	10.5	11.8	leadframe
TMPA1004SV-4R7MN	4.70	8.8	8.0	15.2	13.0	15.8	19.0	leadframe
TMPA1004SV-5R6MN	5.60	8.0	7.2	14.1	11.5	19	22.8	leadframe
TMPA1004SV-6R8MN	6.80	7.8	6.8	12.2	11.0	22	24.5	leadframe
TMPA1004SV-8R2MN	8.20	7.6	6.5	9.5	8.5	25	28	leadframe
TMPA1004SV-100MN	10.0	7.5	6.1	8.6	7.5	27	30	leadframe
TMPA1004SV-150MN	15.0	6.25	5.0	7.0	6.0	41	45	leadframe
TMPA1004SV-220MN	22.0	5.0	4.1	6.2	5.5	58	66	leadframe





Part Number	Inductance L0 A(uH) ±20%	Heat Rating Current DC I rms. (A)		Saturation Current DC I sat. (A)		DCR (mΩ)Typ	DCR (mΩ)Max	Type
		Typ	Max	Typ	Max			
TMPA1004SV-330MN	33.0	4.4	3.5	5.5	5.0	84	91	leadframe
TMPA1004SV-470MN	47.0	3.5	3.0	4.0	3.7	125	143	leadframe
TMPA1004SV-680MN	68.0	2.6	2.4	3.2	3.0	184	210	leadframe
TMPA1004SV-820MN	82.0	2.3	2.1	3.0	2.8	240	270	leadframe
TMPA1004SV-101MN	100	2.0	1.8	2.7	2.4	270	310	leadframe

Note:

1. Test frequency : Ls : 100KHz /1.0V.
2. All test data referenced to 25°C ambient.
3. Heat Rated Current (Irms) will cause the coil temperature rise approximately ΔT of 40°C
4. Saturation Current (Isat) will cause L0 to drop approximately 30%.

■ DC Bias Characteristics (Typical)

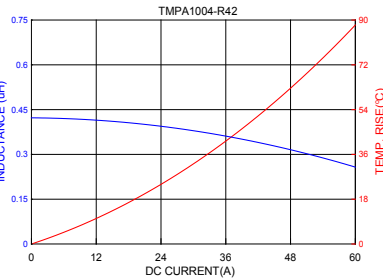
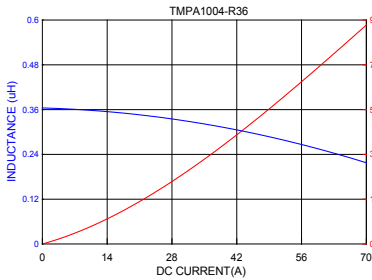
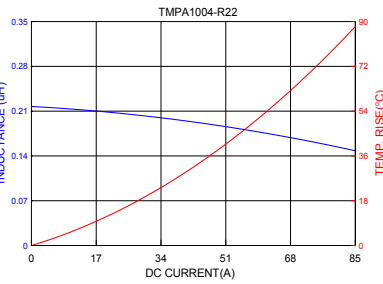
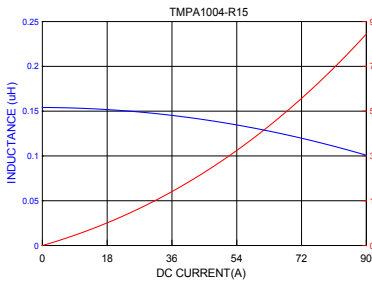

Molding Type High Current Power Inductors

TMPA 1004S Series (4040 inch -55~+150)



■ DC Bias Characteristics (Typical)

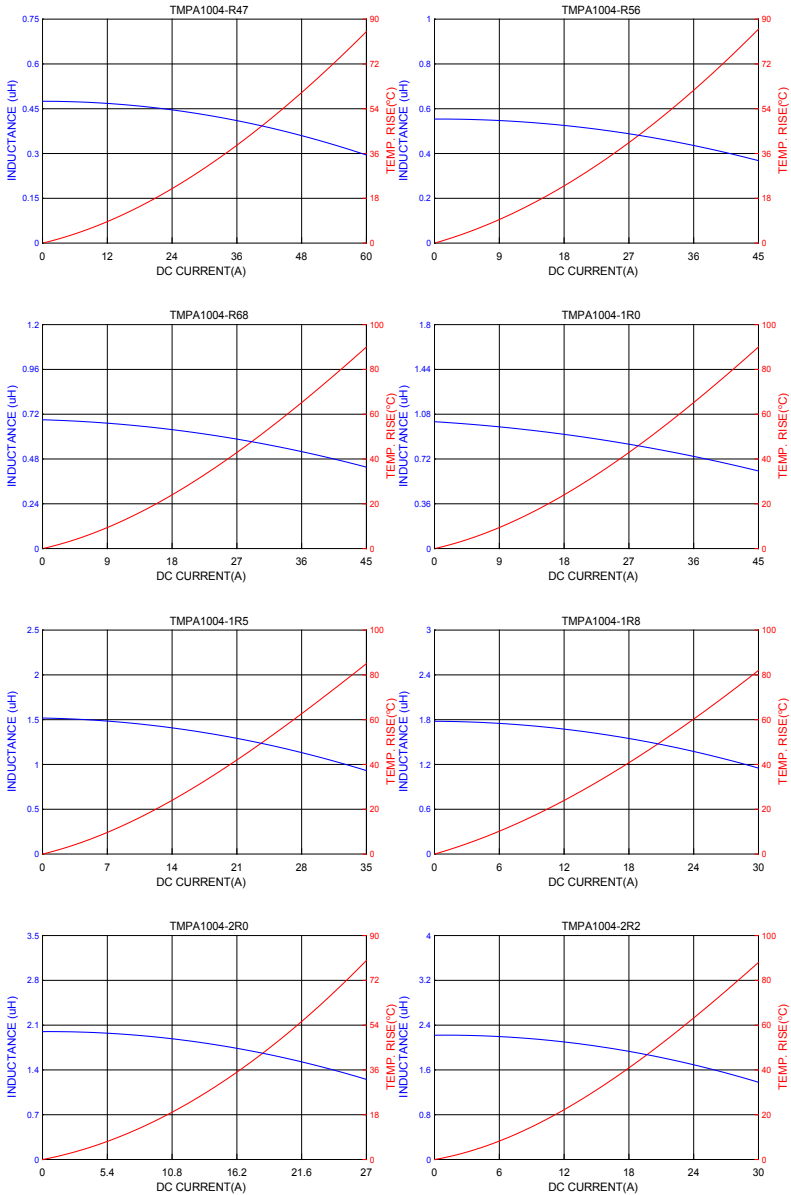

Molding Type High Current Power Inductors

TMPA 1004S Series (4040 inch -55~+150)



■ DC Bias Characteristics (Typical)

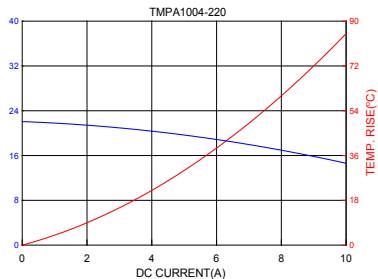
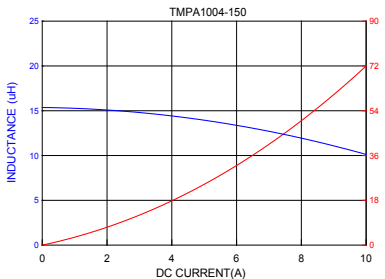
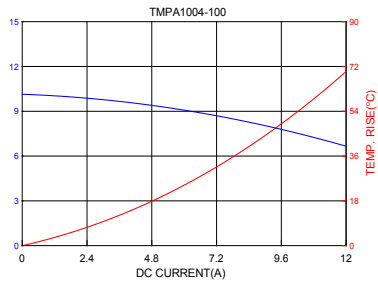
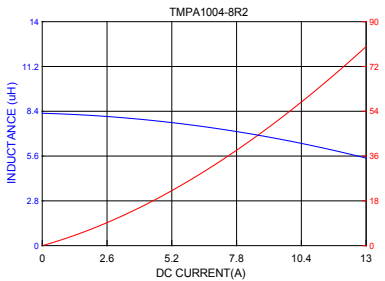
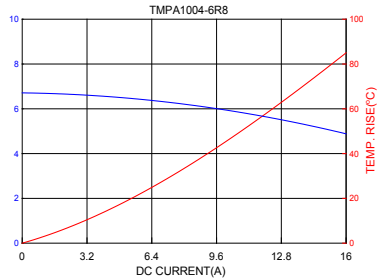
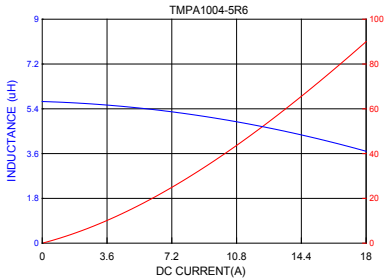
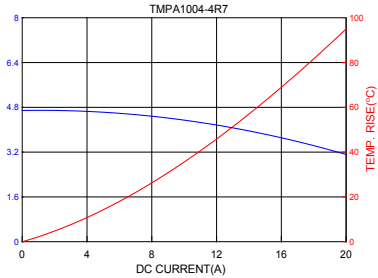
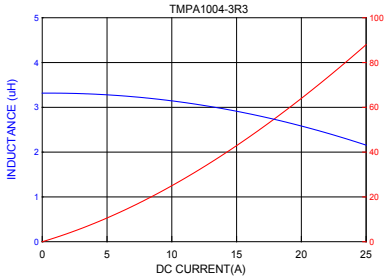



■ DC Bias Characteristics (Typical)

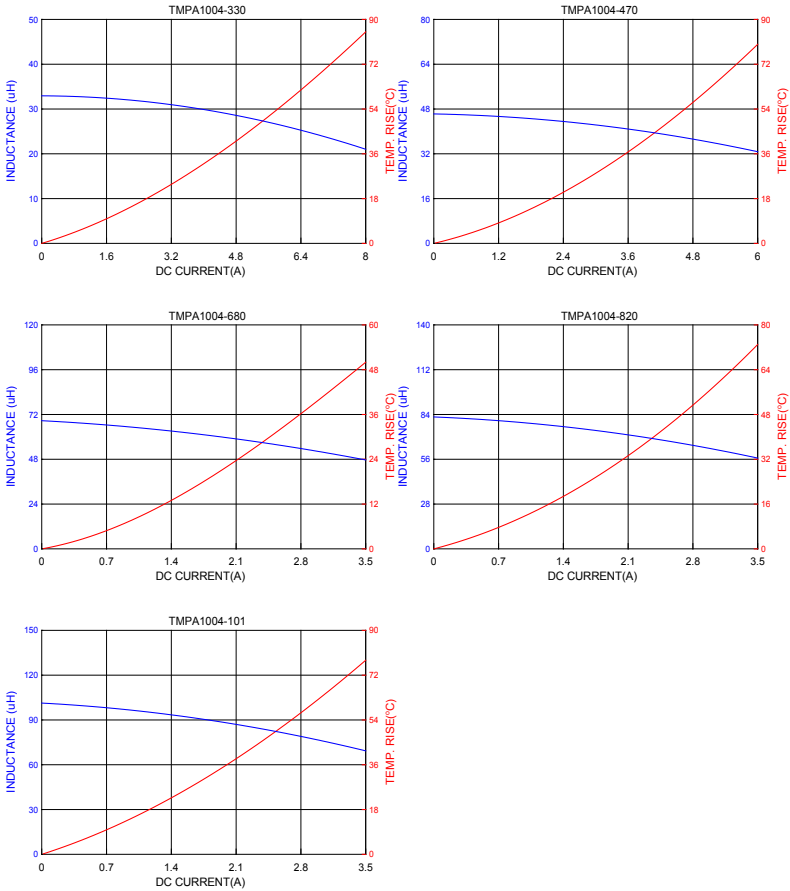



■ Dimensions

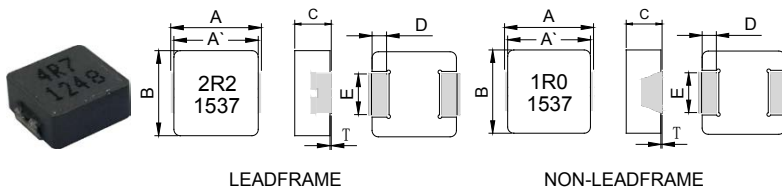

Series	A	A'	B	C	D	T	E	Inductance
TMPV1004	11.0±0.3	10.0±0.3	10.0±0.3	3.8±0.2	2.0±0.3	0~0.2	2.5±0.3	0.56~1.50uH
							3.0±0.3	0.47uH and below 2.00uH and above

Unit : mm

■ Specifications

Part Number	Inductance L0 A(uH) ±20%	Heat Rating Current DC Typ (A) Irms.	Saturation Current DC Typ (A) sat	DCR (mΩ)Typ	DCR (mΩ)Max	TYPE
TMPV1004SV-R47MN-D	0.47	30.0	28.5	1.55	1.66	non-leadframe
TMPV1004SV-1R0MN-D	1.00	23.5	24.0	2.87	3.07	non-leadframe
TMPV1004SV-1R5MN-D	1.50	22.0	17.9	4.20	4.50	non-leadframe
TMPV1004SV-2R2MN-D	2.20	15.0	12.0	8.15	8.76	leadframe
TMPV1004SV-3R3MN-D	3.30	11.0	12.0	11.0	11.8	leadframe
TMPV1004SV-4R7MN-D	4.70	9.8	9.2	14.3	15.3	leadframe
TMPV1004SV-5R6MN-D	5.60	9.3	9.0	16.5	17.6	leadframe
TMPV1004SV-6R8MN-D	6.80	8.0	9.0	20.9	22.3	leadframe
TMPV1004SV-100MN-D	10.0	6.5	8.5	30.9	33.0	leadframe
TMPV1004SV-150MN-D	15.0	5.1	7.7	47.0	50.2	leadframe
TMPV1004SV-220MN-D	22.0	4.1	6.4	70.5	75.4	leadframe
TMPV1004SV-330MN-D	33.0	3.7	4.2	110	117	leadframe
TMPV1004SV-470MN-D	47.0	2.5	4.5	167	178	leadframe
TMPV1004SV-680MN-D	68.0	2.4	3.5	240	252	leadframe

Note:

1. Test frequency : Ls : 100KHz /1.0V.
2. All test data referenced to 25°C ambient.



■ Dimensions

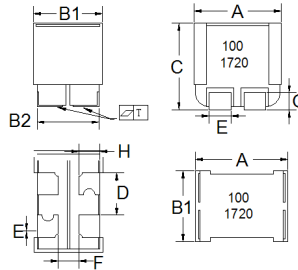

Series	A	B1	B2	C	D	E	F	G	H	T
TBMA1004	12.0±0.20	9.60±0.20	8.7±0.25	11.3±0.30	1.95±0.15	2.80±0.10	3.4 MIN	2.3±0.3	2.5±0.3	≤0.15

Unit: mm

■ Specifications

Part Number	Inductance L0 A(uH) ±20%	Heat Rating Current DC Typ (A) Irms.	Saturation Current DC Typ (A) I sat	DCR (mΩ)Typ	DCR (mΩ)Max	SRF (MHz) Ref
TBMA1004P4V-5R6MN-D	5.60	6.5	8.5	23.0	27.0	15
TBMA1004P4V-100MN-D	10.0	5.2	6.9	34.0	40.0	12
TBMA1004P4V-150MN-D	15.0	4.6	5.5	43.5	45.5	10
TBMA1004P4V-220MN-D	22.0	4.1	4.1	67.8	72.5	7
TBMA1004P4V-330MN-D	33.0	3.8	3.7	100	107	6

Note:

3. Test frequency : Ls : 100KHz /1.0V.
4. All test data referenced to 25°C ambient.



■ Dimensions

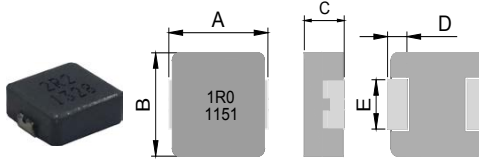

Chip Size	
A	11.00±0.50
B	10.00±0.30
C	4.80±0.20
D	2.30±0.30
E	3.00±0.30

Units: mm

■ Specifications

Part Number	Inductance L0 (uH) ±20%	I rms (A)typ	I sat (A)typ	DCR (mΩ) typ. @25°C.	DCR (mΩ) max. @25°C.
TMPC1005HV-R30MG	0.30	38.0	65.0	0.57	0.61
TMPC1005HV-R90MG	0.90	25.0	32.0	2.2	3.0
TMPC1005HV-1R0MG	1.00	22.0	30.0	2.8	3.5
TMPC1005HV-2R2MG	2.20	16.0	24.0	5.4	6.0
TMPC1005HV-3R3MG	3.30	14.0	22.0	9.0	10.4
TMPC1005HV-5R6MG	5.60	10.0	16.0	14.0	16.8
TMPC1005HV-100MG	10.0	8.0	13.5	25.0	29.0
TMPC1005HV-330MG	33.0	4.3	7.5	80.0	92.0
TMPC1005HV-470MG	47.0	3.8	6.5	125	145
TMPC1005HV-680MG	68.0	2.5	4.0	176	205

Note:

1. Test frequency : L : 100KHz /1.0V.
2. All test data referenced to 25°C ambient.
3. Heat Rated Current (I rms) will cause the coil temperature rise approximately Δt of 40°C
4. Saturation Current (I sat) will cause L0 to drop 30% typical.
5. Special inquiries besides the above common used types can be met on your requirement.

■ DC Bias Characteristics (Typical)

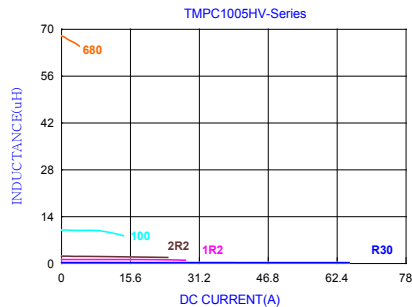
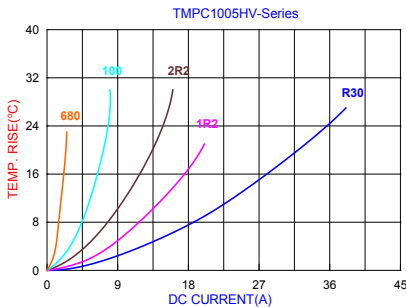



■ Dimensions

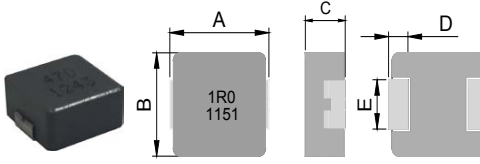

Chip Size	
A	13.5 ±0.5
B	12.5 ±0.3
C	3.3 ±0.2
D	2.3 ±0.3
E	4.7 ±0.3

Units: mm

■ Specifications

Part Number	Inductance L0 (uH) ±20%	I rms (A)typ	I sat (A)typ	DCR (mΩ) typ. @25°C.	DCR (mΩ) max. @25°C.
TMPC1235HPV-R10YG	0.10±30%	43.0	84.0	0.36	0.43
TMPC1235HPV-R47MG	0.47	32.0	55.0	1.20	1.80
TMPC1235HPV-R68MG	0.68	28.0	49.0	1.90	2.50
TMPC1235HPV-1R0MG	1.00	24.0	40.0	2.70	3.50
TMPC1235HPV-2R2MG	2.20	16.0	29.0	6.30	8.00
TMPC1235HPV-3R3MG	3.30	12.0	27.0	11.00	13.50
TMPC1235HPV-4R7MG	4.70	10.0	24.0	15.30	18.50
TMPC1235HPV-5R6MG	5.60	9.5	19.0	18.00	22.00
TMPC1235HPV-6R8MG	6.80	9.0	18.0	20.00	24.00
TMPC1235HPV-8R2MG	8.20	8.5	16.0	23.00	28.00
TMPC1235HPV-100MG	10.0	7.0	14.0	29.00	34.00

Note:

1. Test frequency : L : 100KHz /1.0V.
2. All test data referenced to 25°C ambient.
3. Heat Rated Current (I rms) will cause the coil temperature rise approximately Δt of 40°C
4. Saturation Current (Isat) will cause L0 to drop 30% typical.
5. Special inquiries besides the above common used types can be met on your requirement.

■ DC Bias Characteristics (Typical)

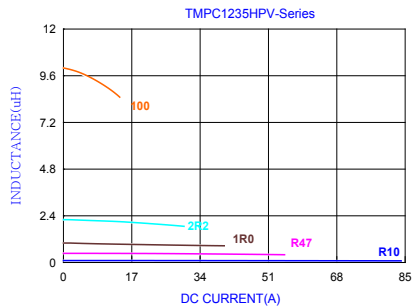
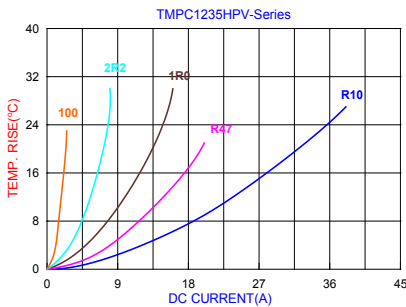



■ Dimensions

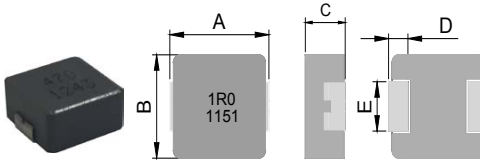

Chip Size	
A	13.50±0.50
B	12.50±0.30
C	4.80±0.20
D	2.30±0.30
E	4.70±0.30

Units: mm

■ Specifications

Part Number	Inductance L0 (uH) ±20%	I rms (A)typ	I sat (A)typ	DCR (mΩ) typ. @25°C.	DCR (mΩ) max. @25°C.
TMPC1205HPV-R20MG	0.20	52.0	110.0	0.45	0.55
TMPC1205HPV-R47MG	0.47	38.0	65.0	0.86	1.10
TMPC1205HPV-R68MG	0.68	34.0	54.0	1.40	1.70
TMPC1205HPV-1R0MG	1.00	29.0	50.0	1.85	2.50
TMPC1205HPV-2R2MG	2.20	20.0	32.0	4.20	5.50
TMPC1205HPV-3R3MG	3.30	15.0	32.0	6.80	9.20
TMPC1205HPV-4R7MG	4.70	12.0	27.0	11.40	15.00
TMPC1205HPV-6R8MG	6.80	11.0	21.0	14.50	18.50
TMPC1205HPV-8R2MG	8.20	9.5	18.0	16.80	22.50
TMPC1205HPV-100MG	10.0	9.0	16.0	21.40	25.50
TMPC1205HPV-220MG	22.0	6.5	10.0	50.00	58.00

Note:

1. Test frequency : L : 100KHz /1.0V.
2. All test data referenced to 25°C ambient.
3. Heat Rated Current (Irms) will cause the coil temperature rise approximately Δt of 40°C
4. Saturation Current (Isat) will cause L0 to drop 30% typical.
5. Special inquiries besides the above common used types can be met on your requirement.

■ DC Bias Characteristics (Typical)

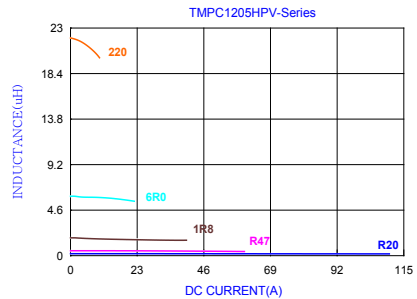
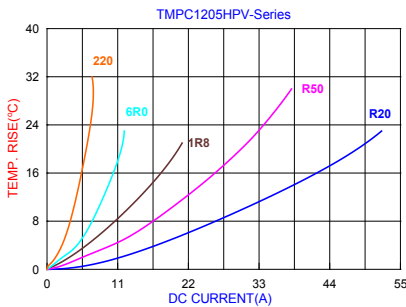



■ Dimensions

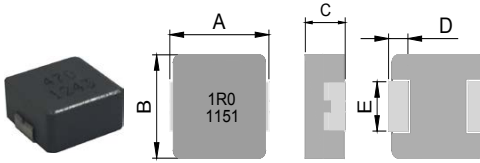

Chip Size	
A	13.50±0.50
B	12.50±0.30
C	5.70±0.30
D	2.30±0.30
E	4.70±0.30

Units: mm

■ Specifications

Part Number	Inductance L0 (uH)±20%	I rms (A)typ	I sat (A)typ	DCR (mΩ) typ. @25°C.	DCR (mΩ) max. @25°C.
TMPC1206HPV-1R0MG	1.00	29.0	45.0	1.80	2.40
TMPC1206HPV-2R2MG	2.20	21.0	34.0	4.00	4.70
TMPC1206HPV-3R3MG	3.30	17.0	28.0	5.80	7.10
TMPC1206HPV-4R7MG	4.70	16.0	25.0	9.50	11.50
TMPC1206HPV-5R6MG	5.60	15.5	22.0	10.80	12.60
TMPC1206HPV-6R8MG	6.80	15.0	19.0	12.00	13.80
TMPC1206HPV-100MG	10.0	11.0	15.5	18.00	20.70
TMPC1206HPV-220MG	22.0	8.0	11.0	34.00	39.50
TMPC1206HPV-330MG	33.0	6.0	8.0	65.00	75.00
TMPC1206HPV-470MG	47.0	5.5	7.0	80.00	90.00

Note:

1. Test frequency : L : 100KHz /1.0V.
2. All test data referenced to 25°C ambient.
3. Heat Rated Current (Irms) will cause the coil temperature rise approximately Δt of 40°C
4. Saturation Current (Isat) will cause L0 to drop 30% typical.
5. Special inquiries besides the above common used types can be met on your requirement.

■ DC Bias Characteristics (Typical)

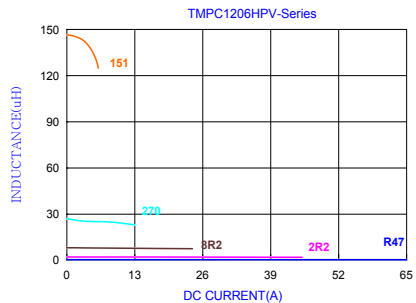
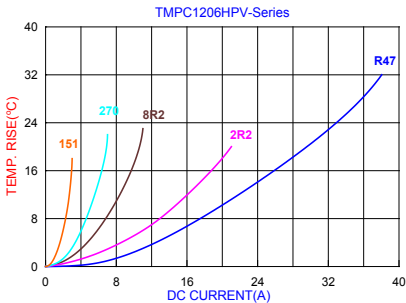



■ Dimensions

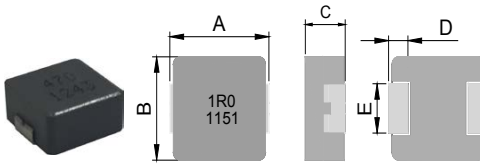

Chip Size	
A	13.50±0.50
B	12.50±0.30
C	6.20±0.30
D	2.30±0.30
E	4.70±0.30

Units: mm

■ Specifications

Part Number	Inductance L0 (uH)±20%	I rms (A)typ	I sat (A)typ	DCR (mΩ) typ. @25°C.	DCR (mΩ) max. @25°C.
TMPC1265HPV-R15MG	0.15	55.0	118.0	0.49	0.60
TMPC1265HPV-R47MG	0.47	41.0	63.0	0.90	1.20
TMPC1265HPV-1R0MG	1.00	30.0	48.0	1.70	2.30
TMPC1265HPV-2R2MG	2.20	22.0	37.0	3.80	4.20
TMPC1265HPV-3R3MG	3.30	18.0	30.0	5.70	6.80
TMPC1265HPV-4R7MG	4.70	13.5	28.0	7.00	8.40
TMPC1265HPV-5R6MG	5.60	12.5	23.0	8.50	10.00
TMPC1265HPV-6R8MG	6.80	11.5	18.0	9.50	11.50
TMPC1265HPV-100MG	10.0	10.0	15.5	13.20	16.50
TMPC1265HPV-220MG	22.0	9.0	12.0	32.50	37.00
TMPC1265HPV-330MG	33.0	8.0	11.0	48.00	58.00
TMPC1265HPV-470MG	47.0	6.5	9.5	76.00	90.00

Note:

1. Test frequency : L : 100KHz /1.0V.
2. All test data referenced to 25°C ambient.
3. Heat Rated Current (Irms) will cause the coil temperature rise approximately Δt of 40°C
4. Saturation Current (Isat) will cause L0 to drop 30% typical.
5. Special inquiries besides the above common used types can be met on your requirement.

■ DC Bias Characteristics (Typical)

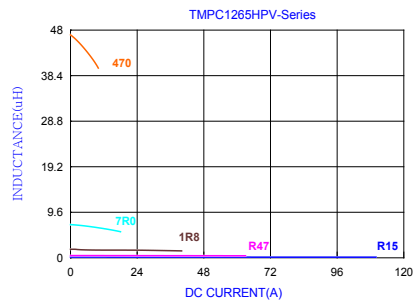
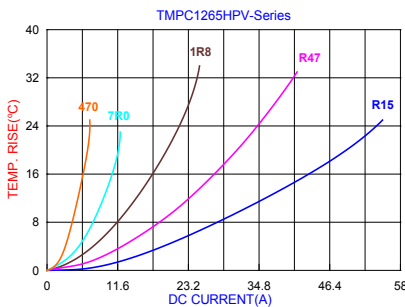



■ Dimensions

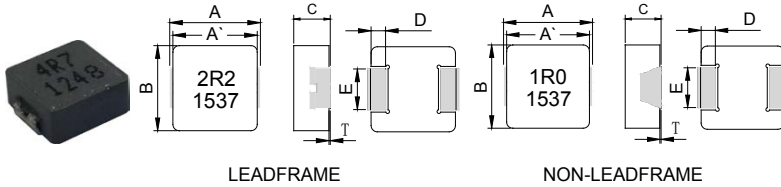

Series	A	A'	B	C	D	E	Inductance
TMPV1265	13.5±0.5	12.6±0.3	12.6±0.2	6.2±0.3	2.3±0.3	4.0±0.3	0.68~1.50uH
						4.7±0.3	0.33uH and below 1.80uH and above

Unit: mm

■ Specifications

Part Number	Inductance L0 A(uH) ±20%	Heat Rating Current DC Typ (A) Irms.	Saturation Current DC Typ (A) Isat	DCR (mΩ)Typ	DCR (mΩ)Max	TYPE
TMPV1265SPV-R22MN-D	0.22	66.0	68.0	0.73	0.81	non-leadframe
TMPV1265SPV-R33MN-D	0.33	62.0	44.0	0.83	0.92	non-leadframe
TMPV1265SPV-R47MN-D	0.47	54.0	42.0	1.05	1.16	non-leadframe
TMPV1265SPV-1R0MN-D	1.00	40.0	26.0	1.65	1.77	non-leadframe
TMPV1265SPV-1R2MN-D	1.20	29.0	24.5	1.98	2.12	non-leadframe
TMPV1265SPV-1R5MN-D	1.50	27.5	23.5	2.40	2.57	non-leadframe
TMPV1265SPV-1R8MN-D	1.80	26.0	22.5	2.75	2.94	leadframe
TMPV1265SPV-2R2MN-D	2.20	25.5	21.5	3.43	3.67	leadframe
TMPV1265SPV-3R3MN-D	3.30	20.2	16.7	5.08	5.44	leadframe
TMPV1265SPV-4R7MN-D	4.70	17.4	18.5	7.41	7.93	leadframe
TMPV1265SPV-5R6MN-D	5.60	15.7	14.2	8.51	9.11	leadframe
TMPV1265SPV-6R8MN-D	6.80	14.2	8.7	11.3	12.0	leadframe
TMPV1265SPV-7R8MN-D	7.80	13.5	8.5	12.6	13.4	leadframe
TMPV1265SPV-8R2MN-D	8.20	13.2	7.6	13.2	14.1	leadframe
TMPV1265SPV-100MN-D	10.0	10.9	7.2	16.6	17.7	leadframe
TMPV1265SPV-120MN-D	12.0	10.6	6.9	19.0	20.3	leadframe
TMPV1265SPV-150MN-D	15.0	8.7	6.8	24.0	25.6	leadframe
TMPV1265SPV-220MN-D	22.0	8.3	5.5	31.3	33.4	leadframe

Note:

1. Test frequency : Ls : 100KHz / 1.0V.
2. All test data referenced to 25°C ambient.



■ Dimensions

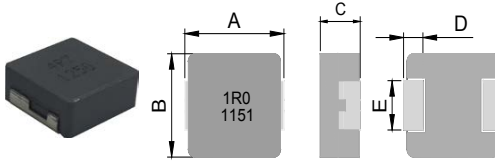

Chip Size	
A	17.60±0.40
B	16.90±0.30
C	6.70±0.30
D	2.10±0.30
E	11.90±0.30

Units: mm

■ Specifications

Part Number	Inductance L0 (uH)±20%	I rms (A)typ	I sat (A)typ	DCR (mΩ) typ. @25°C.	DCR (mΩ) max. @25°C.
TMPC1707HPV-1R0MG	1.00	52.0	60.0	1.6	2.0
TMPC1707HPV-2R2MG	2.20	43.5	47.0	2.4	2.7
TMPC1707HPV-3R3MG	3.30	28.0	45.0	3.5	3.9
TMPC1707HPV-4R7MG	4.70	25.0	41.0	4.8	5.5
TMPC1707HPV-5R6MG	5.60	21.0	40.0	5.8	7.05
TMPC1707HPV-6R8MG	6.80	19.0	32.0	8.4	9.2
TMPC1707HPV-100MG	10.0	16.5	24.0	11.8	13.0
TMPC1707HPV-220MG	22.0	12.0	18.0	25.1	26.5
TMPC1707HPV-330MG	33.0	10.7	15.0	38.0	44.0
TMPC1707HPV-470MG	47.0	8.7	9.5	48.0	55.0
TMPC1707HPV-680MG	68.0	7.0	8.0	68.0	80.0
TMPC1707HPV-101MG	100	5.3	6.5	102.0	118.0

Note:

1. Test frequency : L : 100KHz /1.0V.
2. All test data referenced to 25°C ambient.
3. Heat Rated Current (Irms) will cause the coil temperature rise approximately Δt of 40°C
4. Saturation Current (Isat) will cause L0 to drop 30% typical.
5. Special inquiries besides the above common used types can be met on your requirement.

■ DC Bias Characteristics (Typical)

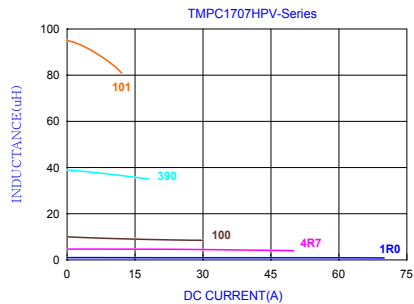
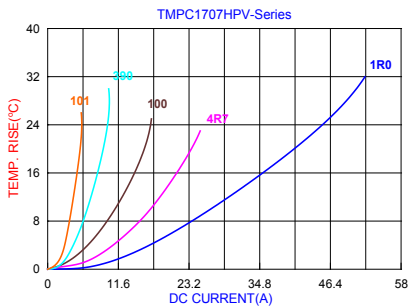



■ Dimensions

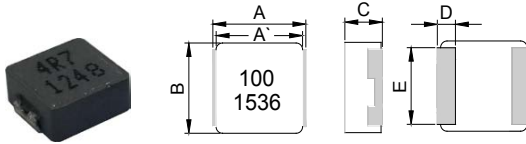

Series	A(mm)	A'(mm)	B(mm)	C(mm)	D(mm)	E(mm)
TMPA2313	23.5±0.5	22.7±0.3	22.0±0.3	12.6±0.4	5.0±0.4	19.0±0.3

Units: mm

■ Specifications

Part Number	Inductance L0 A(uH) ±20%	Heat Rating Current DC (A) Irms.		Saturation Current DC (A) Isat		DCR (mΩ) Typ	DCR (mΩ) Max
		Typ	Max	Typ	Max		
TMPA2313SPV-1R5MN	1.50	62	57	52	48	1.00	1.15
TMPA2313SPV-2R2MN	2.20	58	52	48	43	1.05	1.25
TMPA2313SPV-3R3MN	3.30	49	47	41	37	1.50	1.75
TMPA2313SPV-4R7MN	4.70	47	44	38	34	1.90	2.20
TMPA2313SPV-6R8MN	6.80	40	36	36	32	2.70	3.10
TMPA2313SPV-100MN	10.0	33	30	28	20	3.80	4.15
TMPA2313SPV-220MN	22.0	22	18	15	14	9.20	11.0
TMPA2313SPV-230MN	23.0	22	18	15	14	9.20	11.0
TMPA2313SPV-330MN	33.0	19	16	12	10.5	13.5	15.4
TMPA2313SPV-470MN	47.0	17	14	12	10.0	17.3	20.8
TMPA2313SPV-680MN	68.0	14	12	12	9.0	26.2	29.5
TMPA2313SPV-750MN	75.0	13	11	10.5	8.5	27.5	31.6
TMPA2313SPV-820MN	82.0	12	10	9.0	7.7	31.0	34.2
TMPA2313SPV-101MN	100	11	9.5	9.0	7.5	36.0	40.0

Note:

1. Test frequency : Ls : 100KHz /1.0V.
2. All test data referenced to 25°C ambient.
3. Heat Rated Current (Irms) will cause the coil temperature rise approximately ΔT of 40°C
4. Saturation Current (Isat) will cause L0 to drop approximately 30%.



■ DC Bias Characteristics (Typical)

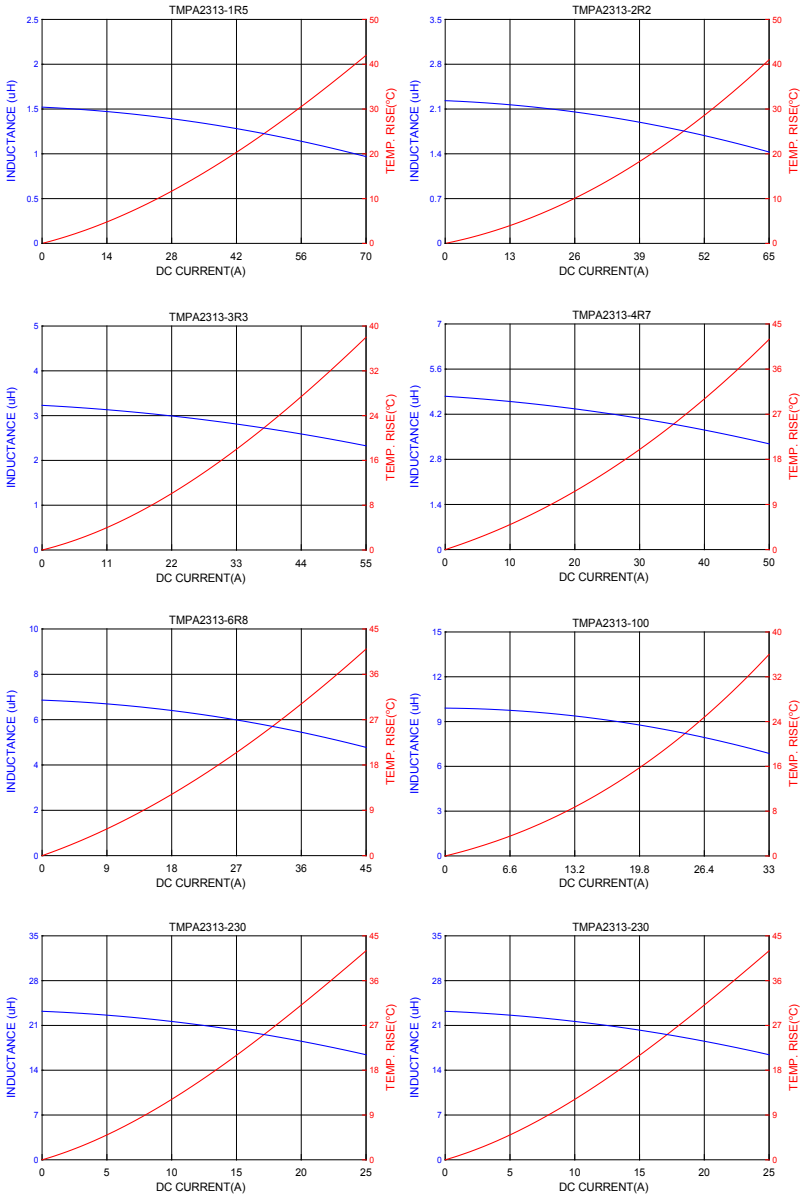



■ DC Bias Characteristics (Typical)

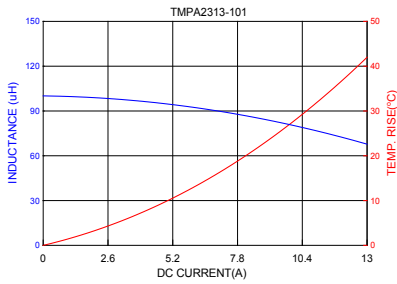
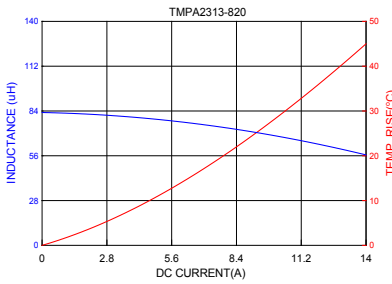
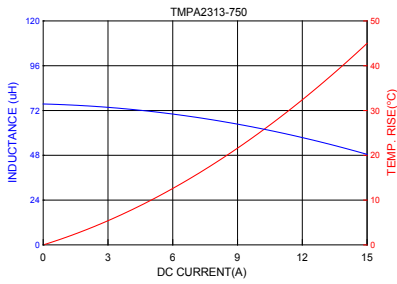
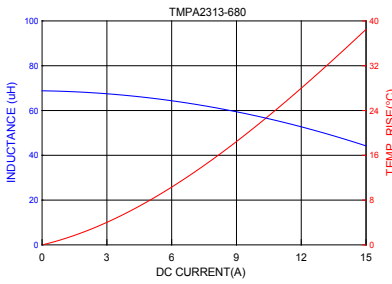
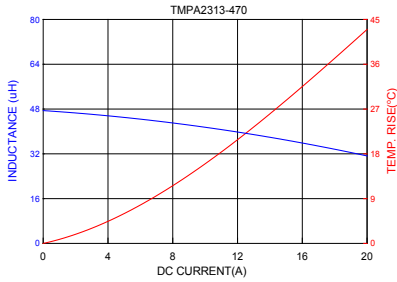
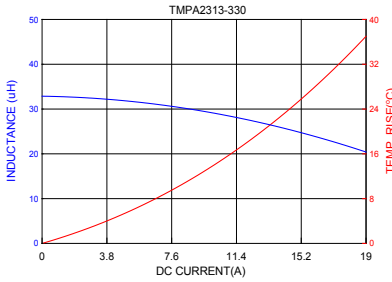

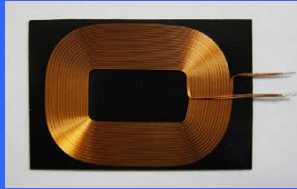

Wireless Power Charging

■ Wireless Power Charging

PTX Series

CTX Series

PRX Series



■ Dimensions

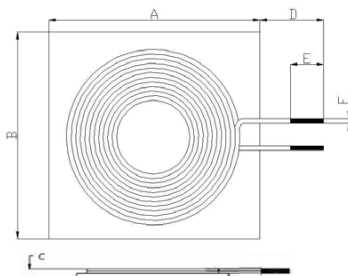
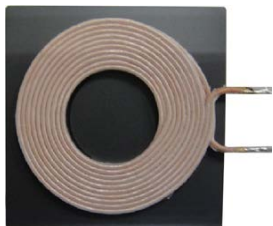

Series	A(mm)	B(mm)	C(mm)	D(mm)	E(mm)	F(mm)
PTX505035-SN	50±0.5	50±0.5	3.5 typ.	30 typ.	5.0 typ.	1.2 typ.
PTX505040-SN	50±0.5	50±0.5	4.0 typ.	30 typ.	5.0 typ.	2.4 typ.
PTX505050-SN	50±0.5	50±0.5	5.0 typ.	30 typ.	5.0 typ.	1.2 typ.
PTX505055-SN	50±0.5	50±0.5	5.5 typ.	30 typ.	5.0 typ.	2.4 typ.
PTX505055-EN	50±0.5	50±0.5	5.5 typ.	30 typ.	5.0 typ.	1.2 typ.

Units: mm

■ Specifications

Part Number	Inductance (uH)	Tolerance (%)	Test Frequency (Hz)	DCR(Ω) typ.	Q typ.	Turns
PTX505035-10W5MSN-30-00-V	6.6	±10%	100K/1V	0.037	90	10
PTX505040-10W5MSN-30-00-V	6.0	±10%	100K/1V	0.020	60	10
PTX505050-10W5MSN-30-00-V	6.6	±10%	100K/1V	0.037	90	10
PTX505055-10W5MSN-30-00-V	6.0	±10%	100K/1V	0.020	60	10
PTX505055-20W5MEN-30-00-V	24.0	±10%	100K/1V	0.056	110	20

NOTE: Efficiency was tested by T.I. Chip set.



■ Dimensions

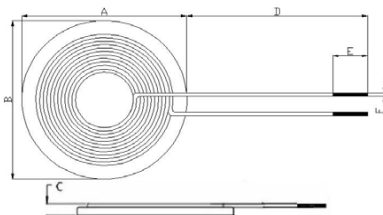

Series	A(mm)	B(mm)	C(mm)	D(mm)	E(mm)	F(mm)
CTX505028-SN	50±0.5	50±0.5	2.8 typ.	30 typ.	5.0 typ.	1.2 typ.
CTX505040-SN	50±0.5	50±0.5	4.0 typ.	30 typ.	5.0 typ.	2.4 typ.

Units: mm

■ Specifications

Part Number	Inductance (uH)	Tolerance (%)	Test Frequency (Hz)	DCR(Ω) typ.	Q typ.	Turns
CTX505028-10W5MSN-30-T0-V	6.3	±10%	100K/1V	0.037	90	10
CTX505040-10W5MSN-30-T0-V	6.0	±10%	100K/1V	0.018	80	10

NOTE: Efficiency was tested by T.I. Chip set.

■ Dimensions

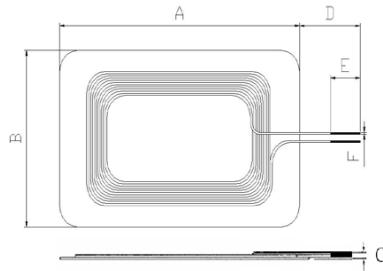

Series	A(mm)	B(mm)	C(mm)	D(mm)	E(mm)	F(mm)
PRX383109	38±0.5	31±0.5	0.9 typ.	8±1.0	3.0 typ.	0.5 typ.
PRX423809	42±0.5	38±0.5	0.9±0.3	10±1.0	5.0±0.3	0.5 typ.
PRX483209	48±0.5	32±0.5	0.9±0.3	35 typ.	10.0 typ.	0.6 typ.

Units: mm

■ Specifications

Part Number	Inductance (uH)	Tolerance (%)	Test Frequency (Hz)	DCR(Ω) typ.	Q typ.	Turns
PRX382109-14KFA-01-V	10.0	±10%	100K/1V	0.180	28	14
PRX423809-13KFA-01-V	12.5	±10%	100K/1V	0.245	30	13
PRX483209-14KFA-01-V	10.5	±10%	100K/1V	0.236	28	14

NOTE: Efficiency was tested by T.I. Chip set.

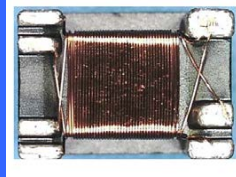

LAN Transformers & Modules

■ LAN Transformers & Modules

TXF Series

LAN Series



■ Dimensions

Series	A(mm)	B(mm)	C(mm)
453229NV-7P	4.70±0.2	3.22±0.2	2.9 Max
453222NV-7P	4.70±0.2	3.22±0.2	2.2Max

■ Specifications

TAI-TECH Part Number	Inductance (uH) (DC bias 0mA) ①to② or ③-④ short ⑥to⑦	Inductance (uH) (DC bias 8mA) ①to② or ③-④ short ⑥to⑦	Test Frequency (Hz/V)	Insertion loss	Cp Capacitance (pF) ③-④ short to ⑤	Turns ratio ①to② ③-④ short ⑥to⑦	HI-POT
TXF453229NV-351-7P	350 uH(Min)	-	100K/0.1	1-100MHZ -1.5dB Max	35pF(typ)	1:1	
TXF453229NV-381-7P	380 uH(Min)	350 uH(Min)	100K/0.1	1-100MHZ -1.5dB Max	35pF(typ)	1:1	AC 1.5KV 60SEC
TXF453222NV-351-7P	350 uH(Min)	-	100K/0.1	1-100MHZ -1.5dB Max	35pF(typ)	1:1	AC 1.5KV 60SEC

■ Schematic Diagram

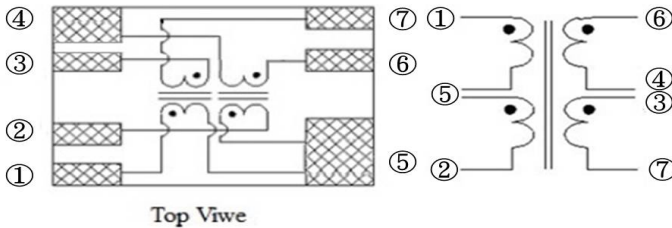



■ **Dimensions**

Series	A(mm)	B(mm)	C(mm)
535340NV-7P	5.38±0.2	5.38±0.2	4.0 Max

■ **Specifications**

TAI-TECH Part Number	Inductance (uH) (DC bias 0mA) ① to ② or ③-④ short ⑥ to ⑦	Test Frequency (Hz/V)	Cp Capacitance(pF) ③-④ short to ⑤	Turns ratio ① to ② : ③-④ short ⑥ to ⑦	HI-POT
TXF535340NV-381-7P	380 uH (min.)	100K/0.1	61pF(typ)	1:1	AC 1.5KV 60SEC

■ **Schematic Diagram**

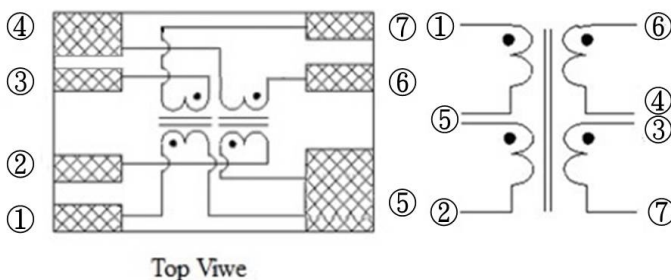

Molding Type High Current Power Inductors

LAN 12M162 S Series (-40~+85)



■ Dimensions

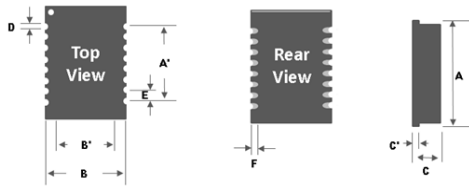

Series	A(mm)	A'(mm)	B(mm)	B'(mm)	C(mm)	C'(mm)	D(mm)	E(mm)	F(mm)
LAN-12M162S7A0	12.7±0.1	8.87±0.1	9.0±0.1	7.2±0.1	4.0±0.1	0.8±0.1	0.4±0.1	1.27±0.1	0.3±0.1
LAN-12M162S7A8	12.7±0.1	8.87±0.1	9.0±0.1	7.2±0.1	4.0±0.1	0.8±0.1	0.6±0.1	1.27±0.1	0.3±0.1

■ Specifications

Part Number	Insertion Loss (dB Max)	Return Loss (dB Min)			DCMR (dB Min)		
	1~100MHz	30MHz	60MHz	100MHz	30MHz	60MHz	100MHz
LAN-12M162S7A0	-1	-20	-15	-10	-25	-25	-25
LAN-12M162S7A8	-1	-20	-15	-10	-25	-25	-25

■ Schematic and Pin Define

LAN-12M162S7A0

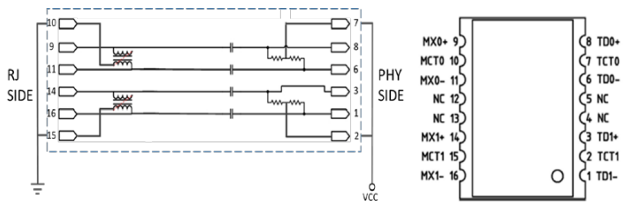

LAN-12M162S7A8

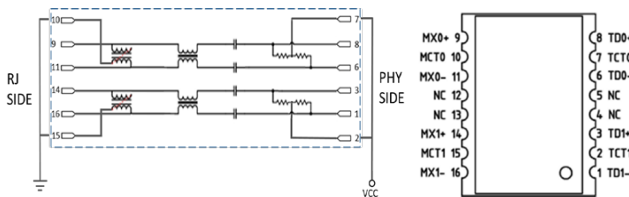



■ Dimensions

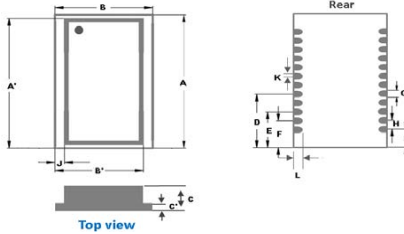

Series	units: mm	A	A'	B	B'	C	C'	D	E	F	G	H	I	J	K	L
LAN-16G241F1A8		16.5	15.99	10.0	9.5	2.3	0.6	6.75	4.75	3.75	0.4	1.0	2.75	0.65	0.2	1.0
LAN-16G241S1A8		16.5	15.99	10.0	9.5	4.15	0.8	6.75	4.75	3.75	0.4	1.0	2.75	0.65	0.2	0.3
LAN-16G241S1B8		16.5	15.99	10.0	9.5	4.15	0.8	6.75	4.75	3.75	0.6	1.0	2.75	0.65	0.2	1.0

■ Specifications

Part Number	Insertion Loss (dB Max)	Return Loss (dB Min)			DCMR (dB Min)		
		1~100MHz	30MHz	60MHz	100MHz	30MHz	60MHz
LAN-16G241F1A8	-1	-20	-15	-10	-25	-25	-25
LAN-16G241S1A8	-1	-20	-15	-10	-25	-25	-25
LAN-16G241S1B8	-1	-20	-15	-10	-25	-25	-25

■ Schematic and Pin Define

LAN-16G241F1A8

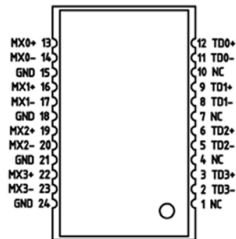
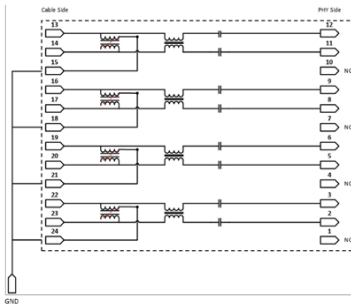

LAN 16G241 F/S Series (-40~+85)



LAN-16G241S1A8

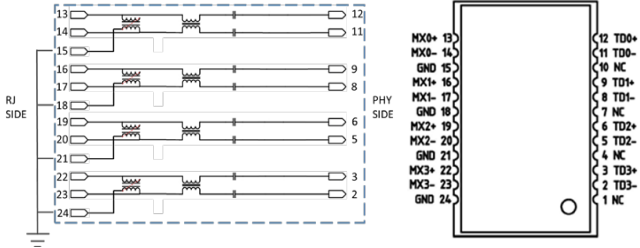

LAN-16G241S1B8

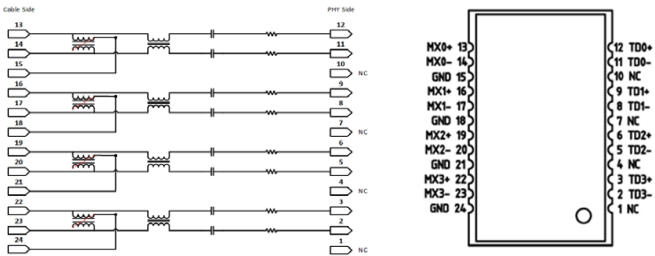

LAN 12M162 P Series (-40~+85)

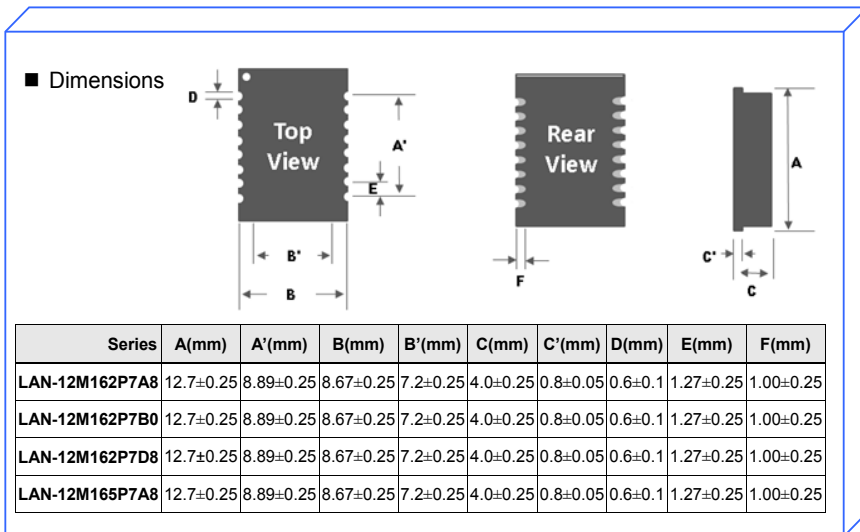

■ Specifications

Part Number	Insertion Loss (dB Max)	Return Loss (dB Min)					Cross talk (dB Min)	DCMR (dB Min)	
		1~100 MHz	1~30 MHz	40 MHz	50 MHz	60~80 MHz		1~60 MHz	60~100 MHz
LAN-12M162P7A8	-1.2	-18	-15.5	-13.5	-10	-38	-33	-26	
LAN-12M162P7B0	-1.2	-18	-15.5	-13.5	-10	-38	-33	-26	
LAN-12M162P7D8	-1.2	-18	-15.5	-13.5	-10	-38	-33	-26	
LAN-12M165P7A8	-1.2	-18	-15.5	-13.5	-10	-38	-33	-26	

Note:

1. All test data referenced to 25°C ambient
2. Hi-Pot resistance of 1500 VAC for 1 minute



■ Schematic and Pin Define

LAN-12M162P7A8

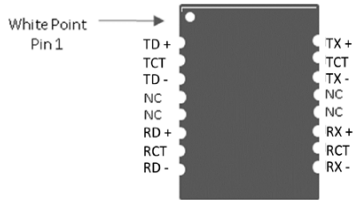
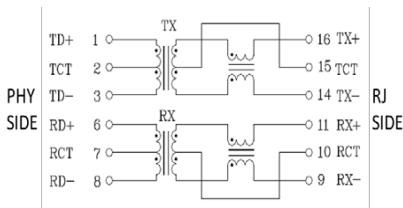

LAN-12M162P7B0

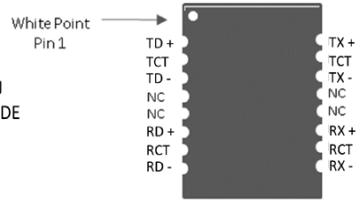
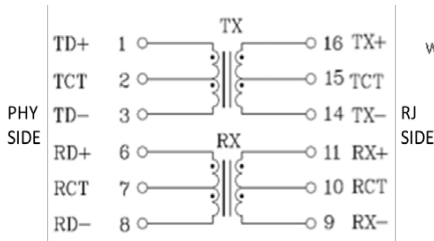

LAN-12M162P7D8

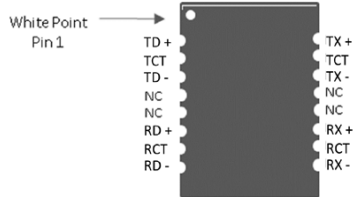
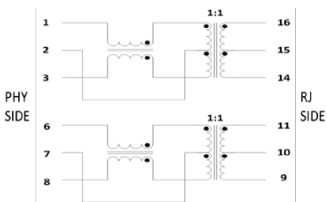

LAN-12M165P7A8

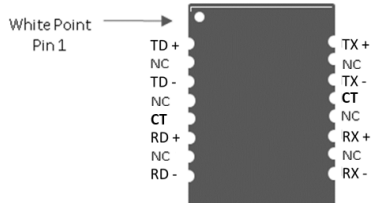
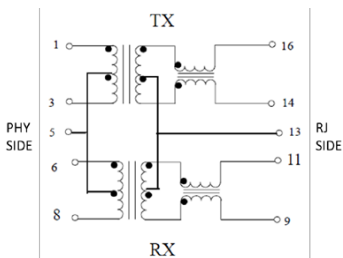



■ Dimensions

Series	units: mm	A	A'	B	B'	C	C'	D	E	F	G	H	I	J	K	L
LAN-16G241P1A8		16.5	16.0	10.3	9.65	4.1	0.8	6.75	4.75	3.75	0.4	1.0	2.75	0.65	0.2	1.0
LAN-16G241P1B8		16.5	16.0	10.3	9.65	4.1	0.8	6.75	4.75	3.75	0.4	1.0	2.75	0.65	0.2	1.0
LAN-16G242P1A8		16.5	16.0	10.3	9.65	4.1	0.8	6.75	4.75	3.75	0.4	1.0	2.75	0.65	0.2	1.0

■ Specifications

Part Number	Insertion Loss (dB Max)	Return Loss (dB Min)					Cross talk (db Min)	DCMR (dB Min)	
		1~100 Mhz	1~30 Mhz	40 Mhz	50 Mhz	60~80 Mhz		100 Mhz	1~60 Mhz
LAN-16G241P1A8	-1.1	-18	-14.4	-13.1	-12	-10	-35	-35	-30
LAN-16G241P1B8	-1.1	-18	-14.4	-13.1	-12	-10	-35	-35	-30
LAN-16G242P1A8	-1.1	-18	-14.4	-13.1	-12	-10	-35	-35	-30

Note:

1. All test data referenced to 25°C ambient
2. Hi-Pot resistance of 1500 VAC for 1 minute

LAN 16G241/242 P Series (-40~+85)

■ Schematic and Pin Define

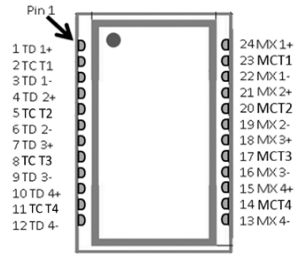
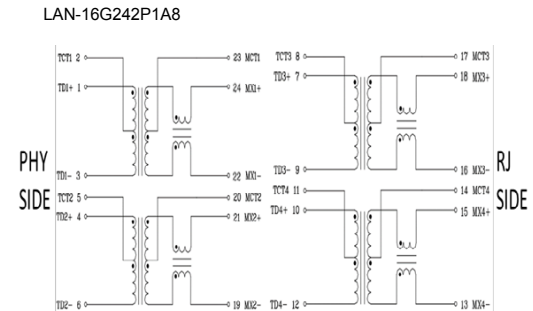
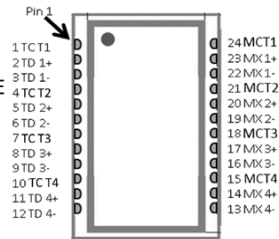
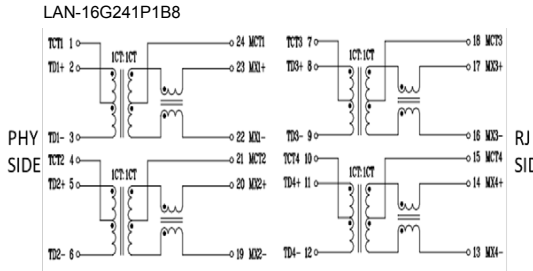
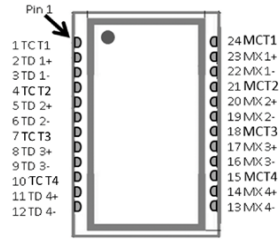
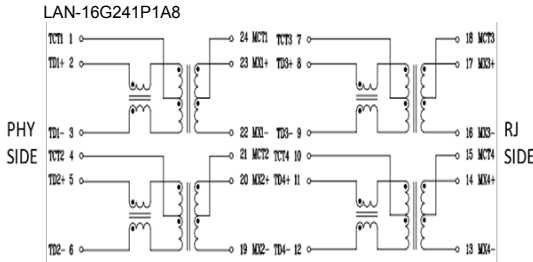



■ Dimensions

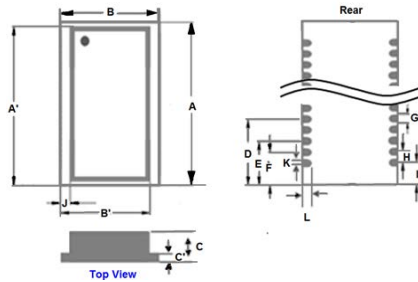

Series	units: mm	A	A'	B	B'	C	C'	D	E	F	G	H	I	J	K	L
LAN-17G241P7B8		17.53	17.03	14.6	13.9	4.5	1.0	6.86	4.32	3.05	0.8	1.27	1.78	0.67	0.3	1.1

■ Specifications

Part Number	Insertion Loss (dB Max)	Return Loss (dB Min)					Cross talk (db Min)	DCMR (dB Min)	
	1~100 MHz	1~30 MHz	40 MHz	50 MHz	60~80 MHz	100 MHz	1~100 MHz	1~60 MHz	60~100 MHz
LAN-17G241P7B8	-1.1	-18	-14.4	-13.1	-12	-10	-35	-35	-30

Note:

1. All test data referenced to 25°C ambient
2. Hi-Pot resistance of 1500 VAC for 1 minute

■ Schematic and Pin Define

LAN-17G241P7B8

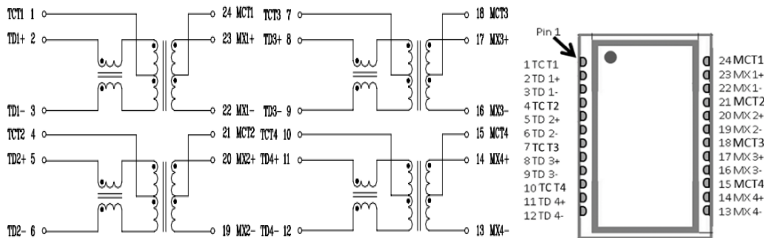

Soldering and Mounting

■ Soldering

Mildly activated rosin fluxes are preferred. TAI-TECH terminations are suitable for all wave and re-flow soldering systems. If hand soldering cannot be avoided, the preferred technique is the utilization of hot air soldering tools.

1. Solder Re-flow:

Recommended temperature profiles for re-flow soldering in Figure 1.

2. Soldering Iron (Figure 2):

Products attachment with a soldering iron is discouraged due to the inherent process control limitations. In the event that a soldering iron must be employed, the following precautions are recommended.

- Preheat circuit and products to 150°C
- Never contact the ceramic with the iron tip
- Use a 20 watt soldering iron with tip diameter of 1.0mm
- 355°C tip temperature (max)
- 1.0mm tip diameter (max)
- Limit soldering time to 4-5 sec.

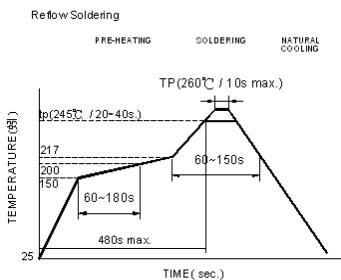

Reflow times: 3 times max.

Fig.1

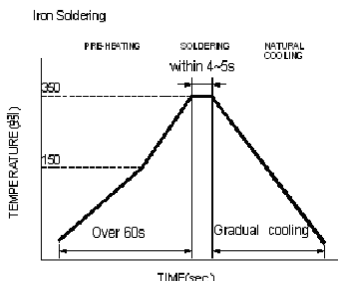

Iron Soldering times: 1 times max.

Fig.2

3. PC Board Warping:

PC Board is recommended and the on-board products are not subjected to the mechanical stress caused by warping the PC Board. The improper layout or direction might damage the on-board products.

(As Figure 3. shows, products should be located in the sideways direction (Length:L > W) to avoid the mechanical stress.)

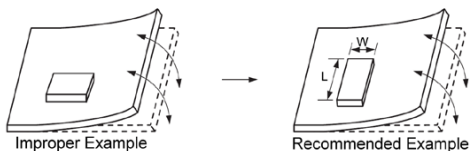
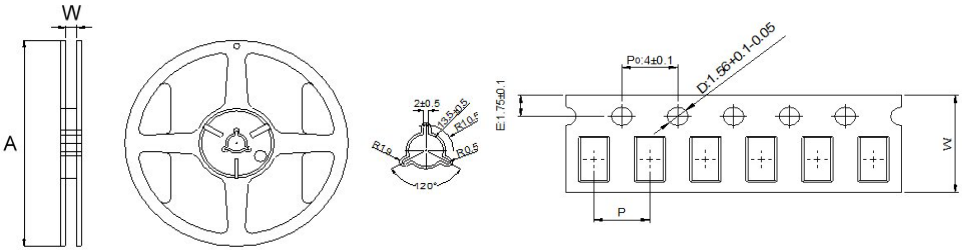

Fig. 3

■ Mounting

Please contact TAI-TECH sales representative to require the specific products "Specification for Approval" to obtain the details of Land pattern dimensions.

Packaging



Products Packaging Information

Series	A	W	P	Qty	Series	A	W	P	Qty
FCM/HCB 1005	7"	8	2	10,000	FCI 1005	7"	8	2	10,000
GHB 1005	7"	8	2	10,000	FCI 1608	7"	8	4	4,000
FCM/HCB 1608	7"	8	4	4,000	FCI 201209	7"	8	4	4,000
FCM/HCB 2012	7"	8	4	4,000	FCI 201212	7"	8	4	2,000
FCM/HCB 3216	7"	8	4	3,000	FCI 3216	7"	8	4	3,000
FCA 3216	7"	8	4	3,000	SWF 1608	7"	8	4	3,000
BPH323023	7"	8	4	1,000	SWF 2012	7"	8	4	2,000
BPH403225	7"	12	4	500	SWF 2520	7"	8	4	2,000
BPH853025	7"	16	4	500	SWF 3225	7"	8	4	2,000
HCB 4516	7"	8	4	2,000	PAS2016	7"	8	4	2,000
HCB 4532	7"	8	8	1,000	PAS 3010/3012	7"	8	4	2,000
HSF 1210	7"	8	4	3,000	PAS 3015	7"	8	4	2,000
WCM/HDMI 2012	7"	8	4	2,000	PAS 4018	13"	12	8	3,500
HSF/BCM 2012	7"	8	4	2,000	PAS 4420	7"	12	8	1,000
TCM 2520	7"	8	4	2,000	PAS 6420	7"	16	8	1,000
WCM/DCM 3216	7"	8	4	2,000	PAS 1225	13"	24	8	1,000
WCM/TCM 3225	7"	8	4	2,000					
ACM 3225	7"	8	4	2,000					
DCM3532	13"	12	8	2,000	<p>Note: For more details of packaging information, please contact TAI-TECH to acquire the Specification for Approval.</p>				
WCM/ACM4532	7"	12	8	500					
LCM 4532	7"	12	8	500					



Packaging

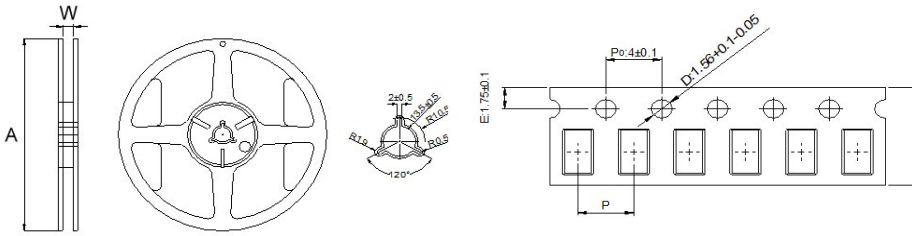

Products Packaging Information

Series	A	W	P	Qty	Series	A	W	P	Qty
UHP/DFP 201610	7"	8	4	2,000	TMPC 0312H	13"	12	8	4,000
AHP 201610	7"	8	4	2,000	TMPC 0302H	13"	12	8	3,000
DFP 201612	7"	8	4	2,000	TMPC 0412HP	13"	12	8	4,000
HPC/AHP 252008	7"	8	4	2,000	TMPC 0402HP	13"	12	8	3,000
UHP/DFP 252010	7"	8	4	2,000	TMPF 0402LR	13"	12	8	3,000
AHP 252010	7"	8	4	2,000	TMPF 0402	13"	12	8	3,000
UHP/DFP 252012	7"	8	4	2,000	TMPC 0512HP	13"	12	8	4,000
AHP 252012	7"	8	4	2,000	TMPC 0515HP	13"	12	8	3,500
HPC 3010/12/15	7"	8	4	2,000	TMPC 0518HP	13"	12	8	3,000
FWP 3216	7"	8	4	2,000	TMPF 0502	13"	12	8	3,000
HPC 4010	13"	12	8	5,000	TMPA 0503	13"	12	8	2,000
HPC 4012	13"	12	8	4,500	TMPF 0503	13"	16	8	2,000
HPC 4018	13"	12	8	3,500	TMPC 0612H	13"	16	12	3,000
HPC 5020	7"	12	8	800	TMPC 0615H	13"	16	12	2,000
HPC 5040	13"	12	8	1,500	TMPC 0618H	13"	16	12	2,000
HPC 6020	13"	16	12	2,000	TMPC 0602/24H	13"	16	12	1,500
HPC 6045	13"	12	8	1,000	TMPC 0603/04H	13"	16	12	1,000
FPI 0703	13"	16	12	1,000					
FPI 0705	13"	16	12	1,000					
HPC 8040	13"	16	12	1,000					
					Note: For more details of packaging information, please contact TAI-TECH to acquire the Specification for Approval.				

