

SANMATH_4X4-R7

Math Extensions for the HP-41C

User's Manual and Quick Reference Guide

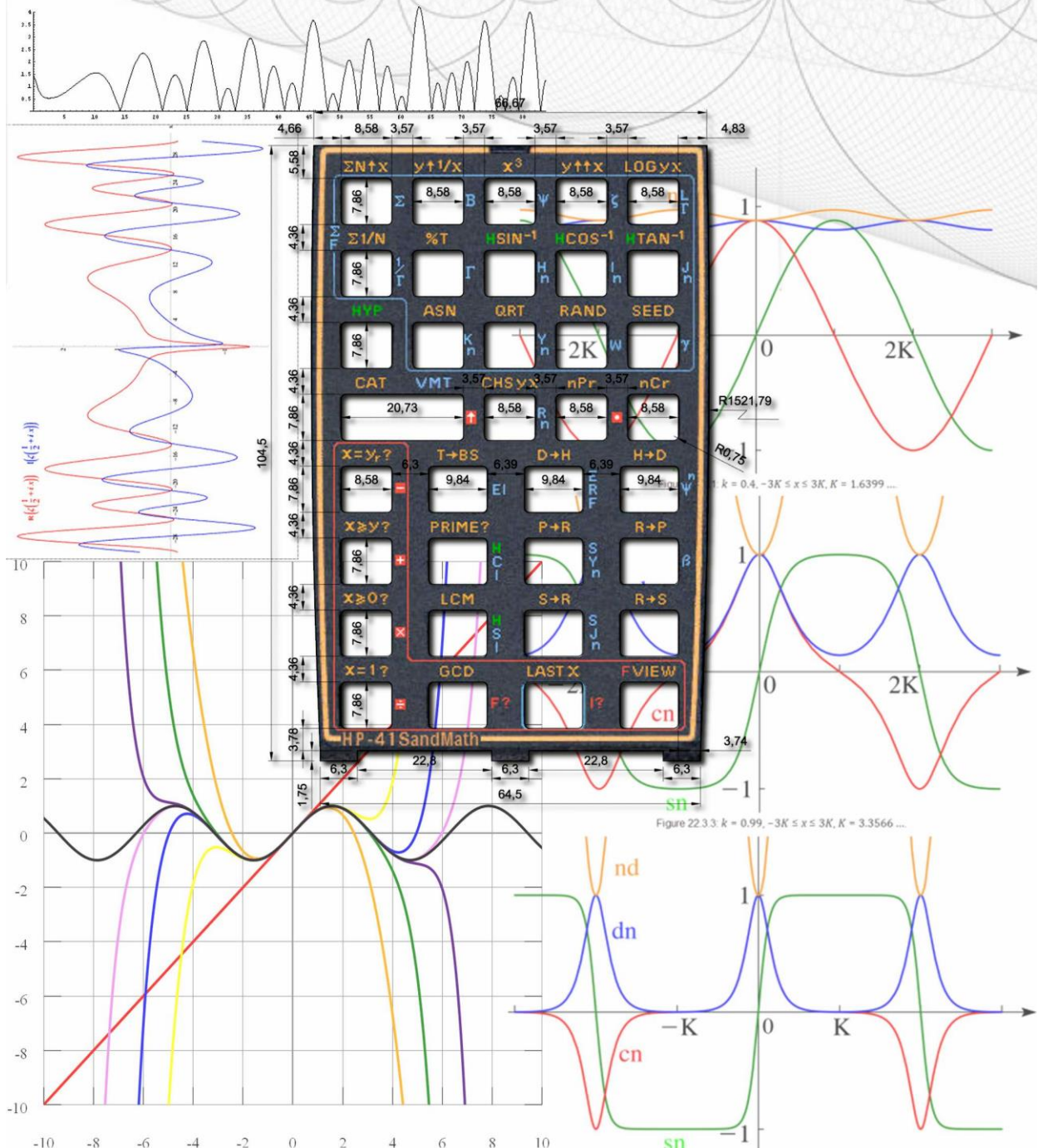

Written and programmed by Ángel M. Martín

June 2021

This compilation revision 5.88.14

Copyright © 2012 – 2021 Ángel M. Martín

Acknowledgments.-

Documentation-wise, this manual begs, steals and borrows from many other sources – in particular Jean-Marc Baillard's excellent program collection on the web. Really both the SandMath and this manual would be a much lesser product without Jean-Marc's contributions.

Thank you to Mark Fleming for his thorough reviews of this manual, which uncovered numerous typos and glitches .

There are multiple graphics and figures taken from Wikipedia and Wolfram Alpha, notably when it comes to the Special Functions sections. I'm not aware of any copyright infringement, but should that be the case I'll of course remove them and create new ones using the SandMath function definition and **PRPLOT**. Just kidding...

An important contribution comes from the AECROM (Geometric Solvers, Curve Fitting and Program Generator) and the HP-41 Advantage Pac (FROOT and FINTEG, and Number Base Conversions).

Original authors retain all copyrights, and should be mentioned in writing by any party utilizing this material. No commercial usage of any kind is allowed.

Screen captures taken from V41, Windows-based emulator developed by Warren Furlow. Its breakpoints capability and MCODE trace console are a godsend to programmers. See www.hp41.org

SandMath Overlays © 2009-2019 Luján García

Published under the GNU software licence agreement.

Table of Contents. - Version 4X4

0.- Preamble to Version 4x4+ 7

Configuring the SandMath 4x4 (revision "R7") 8

1. Introduction.

<u>Function Launchers and Mass key assignments</u>	9
<u>Used Conventions and disclaimers</u>	10
<u>Getting Started. Accessing the functions.</u>	11
<u>Main and Dedicated Launchers: the Overlay</u>	12
<u>Appendix 0.- The Hyper-shift keyboard</u>	13
<u>Appendix 1.- Last Function and Launcher Maps</u>	15
<u>Function index at a glance.</u>	16

2. Lower Page Functions in Detail

2.1. SandMath44 Group

<u>Elementary Math functions.</u>	22
<u>Number Displaying and Coordinate conversions</u>	26
<u>Number Base Conversions</u>	28
<u>First, Second and Third degree Equations</u>	31
<u>Appendix 2.- FOCAL program listing</u>	34
<u>Additional Test Functions: rounded and otherwise</u>	35

2.2. Fractions Calculator

<u>Fraction Arithmetic and displaying</u>	36
---	----

2.3. Hyperbolic Functions

<u>Direct and Indirect Hyperbolics</u>	38
<u>Errors and Examples</u>	39

2.4. Recall Math and Floating FIX mode

<u>Individual RCL Math functions</u>	40
<u>RCL Launcher – the "Total Recall"</u>	41
<u>Floating FIX mode</u>	43
<u>Appendix 3.- A trip down memory lane</u>	45

2.5. Derivatives and Continued Fractions

<u>Function first and second Derivatives</u>	49
<u>Appendix 4: DERV in Newton's and Halley's methods.</u>	51
<u>Continued Fractions Evaluation</u>	52

2.6. Geometric and TVM\$ Solvers

<u>Introduction: yet a new Launcher</u>	55
<u>Triangles, Circles and Slopes</u>	57
<u>Implementation Details</u>	58
<u>The Time Value of Money Solver</u>	61
<u>Definition and Equations</u>	62
<u>Program Information</u>	64

3. Upper Page Functions in Detail

3.1.a. Statistics and Probability

<u>Statistical Menus – Another type of Launcher</u>	65
<u>Alea jacta est...</u>	68
<u>Combinations and Permutations</u>	69
<u>Linear Regression – Let's not digress</u>	70
<u>Single and Duplex Means (to an end)</u>	71
<u>Ratios, Sorting and Register Maxima</u>	72
<u>Probability Distribution Functions</u>	73
<u>Cumulative Probability and Inverse</u>	74
<u>Poisson Standard Distribution</u>	75
<u>And what about Prime Factorization?</u>	76
<u>Appendix 5. Prime Factors decomposition</u>	77
<u>Curve Fitting: The AECROM Fitter</u>	79

3.1.b. A few more Geometry Functions

<u>3D vectors and 2D distance</u>	84
<u>Circles, Triangles and tetrahedrons</u>	86
<u>Area and radius from three points</u>	87

3.2. Factorials

<u>A timid foray into Number Theory</u>	88
<u>Pochhammer symbol: rising and falling empires</u>	89
<u>Multifactorial, Superfactorial and Hyperfactorial</u>	90
<u>Logarithm Multi-Factorial</u>	91
<u>Appendix 6.- Primorials; a primordial view.</u>	93
<u>Apery Numbers</u>	95
<u>Kaprekar Sequence</u>	96

3.3. High-Level Math

<u>The case of the Chameleon function in disguise</u>	98
<u>Gamma Function and associates</u>	99
<u>Lanczos Formula</u>	100
<u>Appendix 7. Comparison of Gamma results</u>	101
<u>Reciprocal Gamma function</u>	102
<u>Incomplete Gamma function (lower)</u>	102
<u>Logarithm Gamma function</u>	103
<u>Digamma and Polygamma functions</u>	105
<u>Inverse Gamma Function</u>	106
<u>Euler's Beta function</u>	108
<u>Incomplete Beta function</u>	108
<u>Bessel Functions and Modified</u>	109
<u>Bessel functions of the 1st Kind</u>	109
<u>Bessel functions of the 2nd Kind</u>	110
<u>Getting Spherical, are we?</u>	111
<u>Programming Remarks</u>	112
<u>Appendix 8. FOCAL program for $Y_n(x)$, $K_n(x)$</u>	115
<u>Riemann Zeta Function</u>	117
<u>Appendix 9.- Putting Zeta to work: Bernoulli numbers</u>	118
<u>Lambert W Function</u>	120

3.4. Remaining Special Functions in Main FAT

<u>The unsung Hero</u>	121
<u>Exponential Integral and associates</u>	122
<u>Generalized Exponential Integrals</u>	124
<u>Errare humanum est...</u>	125
<u>Generalized Error Functions</u>	125
<u>Appendix 10a.- Inverse Error function: coefficients galore</u>	126
<u>Appendix 10b. IERF using the CUDA Library approach</u>	127
<u>How many logarithms, did you say?</u>	128
<u>Clausen and Lobachevsky functions</u>	129

3.5. Approximations and Transforms

<u>The basics: Approximation theory</u>	131
<u>Chebyshev's Approximation</u>	132
<u>Chebyshev Polynomials</u>	134
<u>Taylor Coefficients and Approximation</u>	135
<u>Appendix 11a. Derivatives of Gamma</u>	138
<u>Fourier Series</u>	139
<u>Appendix 11b. Fourier Coefficients by brute force</u>	145
<u>Discrete Hartley (symmetrical) Transform</u>	146
<u>Discrete Fourier Transform</u>	147

3.6. More Special Functions in Secondary FAT

<u>Carlson Integrals and associates</u>	148
<u>The Elliptic Integrals</u>	149
<u>Carlson Symmetric Form</u>	151
<u>Complete and Incomplete Legendre Forms</u>	152
<u>Example: Perimeter of an Ellipse</u>	154
<u>Jacobi Elliptic Functions</u>	155
<u>JacobianTheta Functions</u>	159
<u>Airy Functions</u>	160
<u>Fresnel integrals</u>	159
<u>Weber and Anger Functions</u>	162
<u>Hankel, Struve and others.</u>	
<u>A Lambert relapse</u>	164
<u>Hankel functions – yet a Bessel 3rd. Kind</u>	165
<u>Getting Spherical, are we?</u>	166
<u>Struve Functions</u>	167
<u>Lommel functions</u>	168
<u>Lerch Trascendent function</u>	169
<u>Kelvin functions</u>	170
<u>Kummer functions</u>	174
<u>Associated Legendre functions</u>	176
<u>Generalized Laguerre Function</u>	177
<u>Whittaker functions</u>	178
<u>Toronto function</u>	179
<u>Orphans and Dispossessed.</u>	
<u>Tackle the Simple ones First</u>	180
<u>Decibel Addition</u>	181
<u>Polynomial evaluation – 1st derivative</u>	182
<u>Arithmetic-Geometric Mean (Revisited)</u>	183
<u>Example: Complete Elliptic Integral of 1st. Kind</u>	184
<u>Modified AGM and Complete Elliptic Intg.</u>	185
<u>Appendix: Mutual inductance of coaxial coils</u>	186
<u>Debye Function</u>	187
<u>Dawson Integral</u>	188
<u>Hypergeometric Functions</u>	189
<u>Regular Coulomb Wave function</u>	190
<u>Integrals of Bessel functions</u>	192
<u>Appendix 12.- Looking for Zeroes</u>	193

3.7. Solve and Integrate - Reloaded

<u>Functions Description and Examples</u>	195
<u>MCODE Cathedrals – a dissertation</u>	197
<u>Appendix 13 – His master’s voice</u>	198
<u>Appendix 14. - CUDA Rational Approximations for ierf(x).</u>	203

4. System Extensions

4.1 [AECROM Program Generator](#)

Intro and quick Example	206
A general description	207
Keying in Formulas: the Overlay	208
Details of PRGM	209

.END. **211**

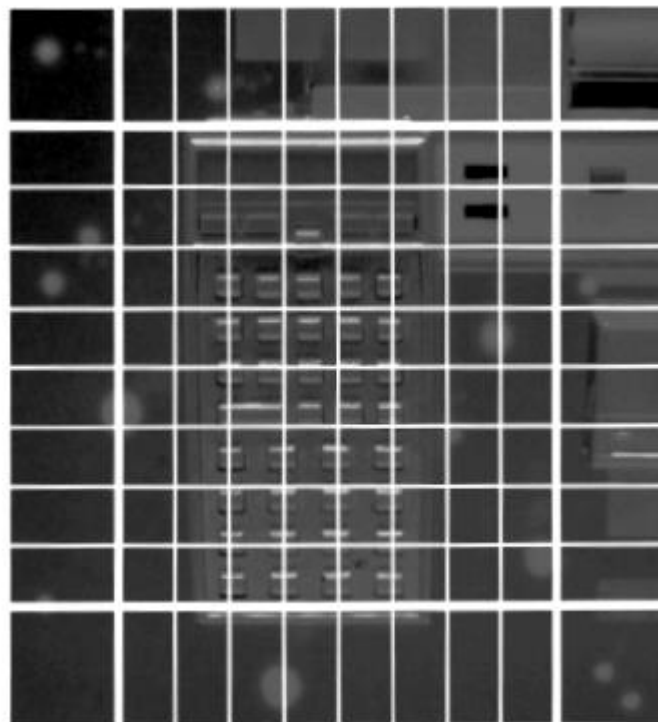

Note: Make sure that revision "R" (or higher) of the Library#4 module is installed.

Preamble – What's new in Revision "R7"

Revision "R7" is the twelfth generation of the SandMath module. It adds many important architectural changes; such as a dual bank-switched configuration for each of its two pages, and thus multiplying its initial size four-fold, to 32k in total – without changing its original 8k footprint. The benefits obtained with this layout are easy to see: more functions and programs are now available. However double storage space doesn't mean duplicating the number of functions for several reasons:

1. Because bank-switched pages are not available simultaneously, the code must be structured taking into account this limitation and other requirements imposed by the OS. For technical reasons FOCAL code can only reside in the primary bank – thus the usage of secondary banks is limited to MCODE only. Furthermore, all the menu launchers use the partial data entry technique (less demanding on battery consumption than keystroke pressing detection) which is also restricted to the main bank – as the OS will always switch back to the main bank when the CPU goes to light sleep.
2. Some of the functions are real juggernauts, with very large code streams taking up considerable space. A good example is the Curve Fitting section (about 1.5k in size in total!), but also some others fall in the same category as well (**TAYLOR**, takes about 1k, and **IERF** takes about 650 bytes by itself – to mention just two). Ideal candidates for bank-switching!
3. With over 100 functions now, the secondary FAT has received the majority of the new functions, with just a few changes made to the main FAT in the "**-HL MATH**" section to include the most important ones in a more prominent location. Two new sections "**-TRANSFORM**" and "**-/+**" were added to **CAT+**, to facilitate the navigation around this catalog.
4. Defying those reports stating that it couldn't be done, this module includes the all-time favorite Solve and Integrate functionality, first released by HP in the Advantage Module - and now available here as **FROOT** and **FINTG**. The twist has been the modification of the original code *to run in a bank-switched configuration*, located in bank-3 of the upper page. The challenge was irresistible, and the end result really is a beauty to behold.
5. Revision 3x3 also added the Geometry Solvers from the AECROM. The three solvers (TRIA, CIRC, and SARR) are consolidated into a single function, **GMSLVR** – so only one FAT entry was needed. No surprisingly it is a launcher by itself.
6. The icing on the cake is a full implementation of the Last Function functionality. Similar to LastX but applied to the last function executed, it allows repeated execution of the same function using a convenient shortcut that bypasses all the launcher paths. Very useful for sub-functions, which cannot be assigned to any key in USER mode. The LastFunction is recorded either by name or index, using **ΣFL**, **ΣF\$** and **ΣF#**.
7. Substantial enhancements were made to the main launchers and the sub-function handling, such as the automated display of the sub-function name during a single-step (SST) execution of a program. Sub-function names are also briefly shown during the execution in RUN mode, or when entering in a program using **ΣF#** - providing visual feedback to the user.
8. Revision "M" also managed to include the *Time Value of Money* functionality from the just released TVM ROM: an all-MCODE implementation of the classic functions that rivals with that in the HP-12C in speed and accuracy.
9. And last but not least, the Advantage Base Conversion functions and the AECROM program generator functionality are now included in revision 4x4 – providing more options to complement the programming choices at your disposal within the same module.

Rather than re-invent the wheel, the SandMath uses optimized versions of the best math software available for the 41' platform. The Geometric Solvers and Curve Fitting programs from the AECROM are a good example; as well as all the excellent programs developed by Jean-Marc Baillard that have found its way here. Very often I added a few enhancements to the code (like using 13-digit OS routines or other MCODE tweaks) but all credit should go to the original authors.

All in all I hope you'd agree this new incarnation of the SandMath takes good advantage of the developments made and reaches an even balance between enhancements and usability – with few compromises to speak of. Note that the changes from previous revisions caused a re-arrangement of the function entries in the upper page, the High-Level Math – both in the main and auxiliary FATs. Be advised that the individual function codes are different, in case you have written some programs using the older ones.

Configuring the SandMath_4x4 Revision "R7"

Plugging the SandMath 4x4 module requires using the bank-switching configuration options on the 41-CL (as well as on Clonix/NoVRAM, or the MLDL-2k). For the 41-CL make sure that the eight ROM images are stored in the appropriate block locations in memory (either sRAM or Flash), and that you use the "**-MAX**" control string in ALPHA for the execution of the PLUG command.

Hint.- this module is a full-house sector configuration: place the 4 lower banks in the first four blocks within a sector, and the 4 upper banks in the remaining blocks of the same sector – leaving no gaps in between.

There are only a few new functions in revision 4x4 not included before, but they alone account for two additional banks (one on each page, lower and upper). The difference is therefore substantial, despite the apparent sameness with revision 3x3. You may of course choose which one to use, depending on which one is more convenient for your hardware. The optimal setup is the 4x4 revision, benefiting the most from the bank-switching implementation - on-line code that doesn't take additional footprint.

Note for Advanced Users:

Even if the SandMath_4x4 is a 32k module, it is possible to configure only the first (lower) page as an independent bank-switched 4k-ROM. This may be helpful when you need the upper port to become available for other modules (like mapping the CL's MMU to another module temporarily); or permanently if you don't care about the High Level Math (Special Functions) and Statistics sections.

Think however that the FAT entries for the Function launchers and the sub-functions are in the upper page, so they'll be gone as well if you use the reduced foot-print version (effective 4k only) of the SandMath.

Page	Bank-1	Bank-2	Bank-3	Bank-4
<i>Upper</i>	High-Level Math, Stats	Function Launchers, Curve Fitting	HP Advantage Solve & Integrate	AEC Program Generator
<i>Lower</i>	SandMath_44	FRC, HYP, RCL# Math	TVM\$, AECROM Geometry Solvers	Derivatives, Base Conversions

Note that it is not possible to do it the other way around; that is plugging only the upper page of the module will be dysfunctional for the most part and likely to freeze the calculator– do not attempt.

Note: Make sure that revision "R" (or higher) of the Library#4 module is installed.

SandMath_44 Module – Version 4x4, rev. R7. Math Extensions for the HP-41 System

1. Introduction.

Simply put: here's the ultimate compilation of MCODE Math functions and FOCAL applications to extend the native function set of the HP-41 system. At this point in time - way over 30 years after the machine's launch - it's more than likely not realistic to expect them to be profusely employed in FOCAL programs anymore - yet they've been included for either intrinsic interest (read: challenging MCODE or difficult to realize) or because of their inherent value for those math-oriented folks.

This module is a record-breaking 32k implementation, arranged in a dual bank-switched configuration. The lower pages include more general-purpose functions, re-visiting the usual themes: Fractions, Base conversion, Hyperbolic functions, RCL Math extensions, Triangles and Circles, as well as simple-but-neat little gems to round off the page. In sum: all the usual suspects for a nice ride time.

The upper pages delve into deeper territory, touching upon the special functions, approximation theory, and Probability/Statistics. Some functions are plain "catch-up" for the 41 system (sorely lacking in its native incarnation), whilst others are a divertimento into a tad more complex math realms. All in all a mixed-and-matched collection that hopefully adds some value to the legacy of this superb machine – for many of us the best one ever.

I am especially thankful for the essential contributions from Jean-Marc Baillard: more than 3/4ths of this module are directly attributable to his original programs, one way or another.

Wherever possible the 13-digit OS routines have been used throughout the module – ensuring the optimal use of the available resources to the MCODE programmer. This prevents accuracy loss in intermediate calculations, and thus more exact results. For a limited precision CPU (certainly per today's standards) the Coconut chip still delivers a superb performance when treated nicely.

The module uses routines from the Page#4 Library (a.k.a. "Library#4"). Many routines in the library are general-purpose system extensions, but some of them are strictly math related, as auxiliary code repository to make it all fit in an 8k footprint factor - and to allow reuse with other modules. This is totally transparent to the end user, just make sure it is installed in your system and that the revisions match. See the relevant Library#4 documentation if interested.

Function Launchers and Mass key assignments.

As any good "theme" module worth its name, the SandMath has its own mass-Key assignment routine (**MKEYS**). Use it to assign the most common functions within the ROM to their dedicated keys for a convenient mapping to explore the functions. Besides that, a distinct feature of this module is the function launchers, used to access diverse functions grouped by categories. These include the Hyperbolic, the Fractions, the RCL Math, and the Special Function groups. This saves memory registers for key assignments, whilst maintaining the standard keyboard available also in USER mode for other purposes.

This is the tenth incarnation of the SandMath project, which in turn has had a fair number of revisions and iterations on its own. *One distinct addition has been a secondary Function address Table (FAT)* to provide access to many more functions, exceeding the limit imposed by the operating system (64 functions per page). Some other refinements consisted in a rationalization of the backbone architecture, as well as a more modular approach to each of pages of the module. Gone are the "8k" and "12k" distinctions of the past – as now the Matrix and Polynomial functions have an independent life of their own in separate modules, like the SandMatrix - more on that to come.

Conventions used in this manual.

This manual is a more-or-less concise document that only covers the normal use of the functions. All throughout this manual the following convention will be used in the function tables to denote the availability of each function in the different function launchers:

[*]:	assigned to the keyboard by	MKEYS
[ΣF]:	direct execution from the main launcher	ΣFL
[H]:	executed from the hyperbolic launcher	-HYP
[F]:	executed from the fractions launcher	-FRC
[RC]:	executed from the RCL# launcher,	-RCL/IO
[CR]:	executed from the Carlson Launcher	(no separate function exists)
[HK]:	executed from the Hankel launcher	(no separate function exists)
[ΣΣ]:	executed from the Statistics Menu,	-ST/PRB
[Σ\$]:	sub-function in the secondary FAT.	ΣF\$

MKEYS prompts for the assign/de-assign action; use the Y/N keys or back arrow to cancel. There are a total of 25 functions assigned, refer to the SandMath overlay for details. Note that **MKEYS** is programmable as well.

Xtra Bonus:- High Rollers Game.

There is an Easter egg included in the SandMath 3x3 – hidden somewhere there’s a rendition of the High Rollers game, so you can relax in between hard-thinking sessions of math, really! There was simply too much available space in bank 3 of the upper page to leave it unused, so this 500+ bytes MCODE rendition of the game (written by Ross Cooling, see PPCJ V14 N2 p31) was begging to be included. As to how to access it... the discovery is part of the enjoyment :-). Hint: even if it’s not geometric, it certainly is a “Solver”, of a [SHIFT]’ed type...



Choose any combination from the available digits on the right which sum matches the target on the left, repeating until there’s no more digits left (YOU WIN) or there aren’t possible combinations (YOU LOSE). Use R/S to proceed, back-arrow to delete digits. The game will ask you to try again and will keep the count of the scores.



Final Disclaimer.-

With “just” an EE background the author has had his dose of relatively special functions, from college to today. However not being a mathematician doesn’t qualify him as a field expert by any stretch of the imagination. Therefore the descriptions that follow are mainly related to the implementation details, and not to the general character of the functions. This is not a mathematical treatise but just a summary of the important aspects of the project, highlighting their applicability to the HP-41 platform.

Note: Make sure that revision “R” (or higher) of the Library#4 module is installed.

Getting Started: Accessing the Functions.

There are about 240+ functions in the SandMath Module. With each of the main two pages containing its own function table, this would only allow to index 128 functions - where are the others and how can they be accessed? The answer is called the "Multi-Function" groups.

Multi-Functions $\Sigma F\#$ and $\Sigma F\$$ provide access to an entire group of sub-functions, grouped by their affinity or similar nature. The sub-functions can be invoked either by its index within the group using $\Sigma F\#$, or by its direct name, using $\Sigma F\$$. This is implemented in such a way that they are also programmable, and can be entered into a program line using a technique called "*non-merged functions*".

You may already be familiar with this technique, originally developed by the HEPAX programmers. In the HEPAX there were two of those groups; one for the XF/M functions and another for the HEPAX/A extensions. The PowerCL Module also contains its own, and now the SandMath joins them – this time applied to the mathematical extensions, particularly for the Special Functions group.

A sub-function catalog is also available, listing the functions included within the group. Direct execution (or programming if in PRGM mode) is possible just by stopping the catalog at a certain entry and pressing the **XEQ** key. The catalog behaves very much like the native ones in the machine: you can stop them using R/S, SST/BST them, press ENTER^ to move to the next "sub-section", cancel or resume the listing at any time.

As additional bonus, the sub-function launcher $\Sigma F\$$ will also search the "main" module FAT if the sub-function name is not found within the multi-function group – so the user needn't remember where a specific function sought for was located. In fact, $\Sigma F\$$ will also "find" a function from any other plugged-in module in the system, even outside of the SandMath module.

Main Launcher and Dedicated (Secondary) Launchers.

The Module's *main* launcher is ΣFL . Think of it as the trunk from which all the other launchers stem, providing the branches for the different functions in more or less direct number of keystrokes. With a well-thought out logic in the functions arrangement then it's much easier to remember a particular function placement, even if its exact name or spelling isn't known, without having to type it or being assigned to any key.

Despite its unassuming character, the ΣFL prompt provides direct access to many functions. Just press the appropriate key to launch them, using the SandMath Overlay as visual guide: the individual functions are printed in BLUE, with their names set aside of the corresponding key. They become active when the " $\Sigma F: _$ " prompt is in the display.

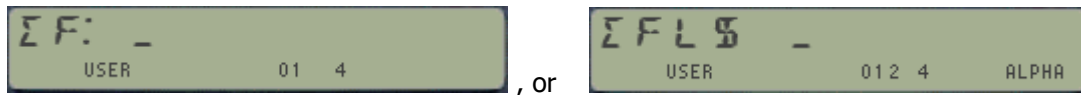

Besides providing direct access to the most common Special Functions, ΣFL will also trigger the dedicated function launchers for other groups. Think of these groupings as secondary "menus" and you'll have a good idea of their intended use. The following keys activate the secondary menus:

- [A], activates the STAT/PRB menus.
- [H] and [O], activate the Hankel and Carlson groups launchers respectively
- [0], activates the FRC (Fractions) launcher; [,] (Radix) activates the LastFunction
- [SHIFT] switches into the hyperbolic choices; pressing it twice enables the second overlay.
- [ALPHA] and [PRGM] activate the $\Sigma F\$$ and $\Sigma F\#$ sub-functions launchers respectively
- [USER] activates the **TVM\$** launcher (latest addition to the module)
- [<-], back-arrow cancels it or returns to it from a secondary menu.

As it occurs with standard functions, the name of the launched function will be shown on the display while you hold the corresponding key – and NULLED if kept pressed. This provides visual feedback on the action for additional assurance.

This is a good moment to familiarize yourself with the Σ F[L] launcher. Go ahead and try it, using it also in PRGM mode to enter the functions as program lines. Note that when activating Σ F\$ you'll NOT need to press [ALPHA] a second time to spell the sub-function name (unlike standard functions like COPY, or XEQ). This saves keystrokes as you can start spelling the function name directly. You still need to press [ALPHA] to terminate the sequence.

Direct-access function keys:

- [A]: Stat/Prob MENUS.
- [B]: Euler's Beta Function
- [C]: Digamma (PSI)
- [D]: Rieman's Zeta Function
- [E]: Gamma Natural log
- [F]: One over Gamma
- [G]: Euler's Gamma Function
- [H]: Hankel's Launcher.
- [I]: Bessel I(n,x)
- [J]: Bessel J(n,x)
- [SHIFT]: Hyperbolics Launcher.
- [K]: Bessel K(n,x)
- [L]: Bessel Y(n,x)
- [M]: Lambert's W
- [SST]: Incomplete Gamma
- [N]: Root Finder
- [O]: Carlson Launcher.
- [R]: Exponential integral
- [S]: Numeric integral
- [X]: Polygamma (PsiN)
- [V]: Cosine Integral
- [W]: Spherical Y(n,x)
- [Z]: Sine Integral
- [=]: Spherical J(n,x)
- [?]: Incomplete Beta
- [O]: Fractions Launcher
- [R/S]: View Mantissa
- [,]: Activates the Last Function
- [ALPHA]: Sub-function Alpha launcher, Σ F\$
- [ON]: Turns the calculator OFF

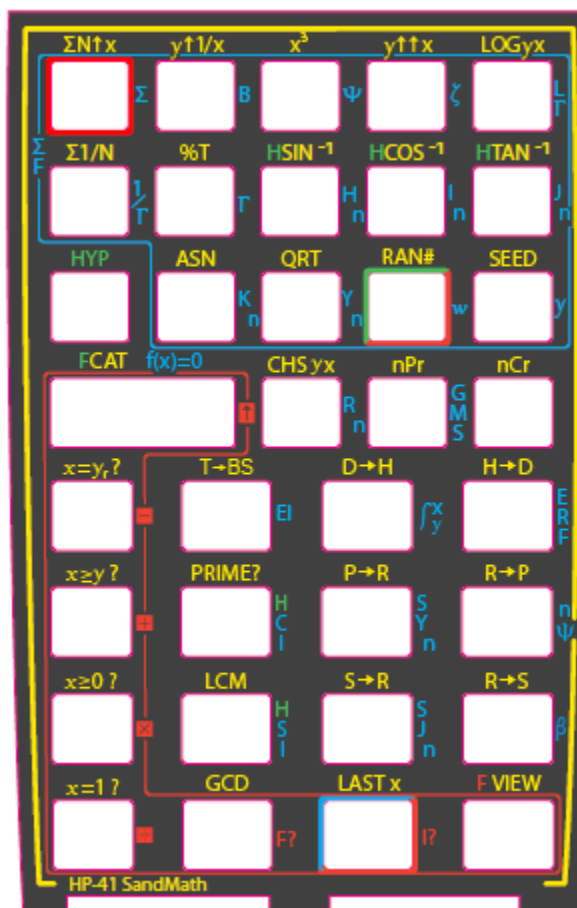

- [USER]: Time Value of Money launcher, TVM\$
- [PRGM]: Sub-function Index Launcher, Σ F#
- [<-]: Cancels out to the OS or retruns from 2nd.

A green "H" on the overlay prefixing the function name represents the Hyperbolic functions. This also includes the Hyperbolic Sine and Cosine integrals, in addition to the three "standard" ones. Using the [SHIFT] key will toggle between the direct and inverse functions. Pressing [<-] will take you back to the main Σ F: prompt.

Typically the *secondary* launchers have the possible choices in their prompt; we'll see them later on. The STAT menu differs from the others in that it consists of two line-ups toggled with the [SHIFT] key – providing access to 10 functions using the keys in the top-row directly below the function symbol. The *Fractions functions* are encircled by a red line on the overlay, at the bottom and left rows of the keyboard. They include the fraction math, plus a fraction Viewer and fraction/Integer tests. The *Hankel and Carlson* launchers present their choices in their prompts, and will be covered in a dedicated section later in the manual.

Appendix 0.- The "Hyper-SHIFT" keyboard. (HYP)

The available room in the auxiliary banks has proven useful to extend the **HYP** launcher beyond the strictly hyperbolic functions. Pressing the [SHIFT] key twice activates the "hyper-SHIFT" mode; and then repeat pressings of [SHIFT] will toggle between the normal and hyper-Shift modes:



The hyper-SHIFT extensions are mainly about adding a SHIFTED HYP mode with a full keyboard of "assignments", like those for functions assigned by **MKEYS** to the HYP prompt choices.

The picture below shows the function map for the [HYP] and [SHIFT-HYP] launchers (**HYP**). As it's now customary, the [SHIFT] key will toggle between these two, and the back arrow will return to the main **ΣFL** launcher.

Note that this arrangement includes both main- and sub-functions in the same second-layer keyboard. This is a very convenient way to circumvent the inability to directly assign sub-functions to keys. Later on in the manual we'll see dedicated launchers for other subfunctions in the CARLSON and HANKEL sections – completing the round.

- [A]: Prime Factors.
- [B]: Discrete Hartley Transform
- [C]: Curve Fitting
- [D]: Rieman's Zeta (Borwein)
- [E]: Poly-Logarithm
- [F]: Fourier Series
- [G]: Inverse Gamma
- [H]: Inverse Hyp SINE.
- [I]: Inverse Hyp COS
- [J]: Inverse Hyp TAN
- [SHIFT]: Toggles Hyp Launchers.
- [K]: Days between Dates
- [L]: Cubic Equation Roots
- [M]: Chebyshev Approximation
- [SST]: ATAN2 (Complex argument)
- [N]: INPUT data in registers
- [O]: Taylor Series.
- [P]: Arithmetic-Geometric Mean
- [←]: Cancels out to [ΣFL]
- [Q]: Probability Distribution Function
- [R]: Generalized Exponential Integral
- [S]: Generalized Error Function
- [T]: Inverse Error Function
- [U]: Cumulative Probability Function
- [V]: Hyperbolic Sine Integral
- [W]: Whittakert Function M
- [X]: Lobachesvsky function
- [Y]: Inverse Cumulative Probability
- [Z]: Hyperbolic Sine Integral
- [=]: Clausen function
- [?]: Straight Line Equation
- [:]: Reg Maximum
- [;]: Stack Sort

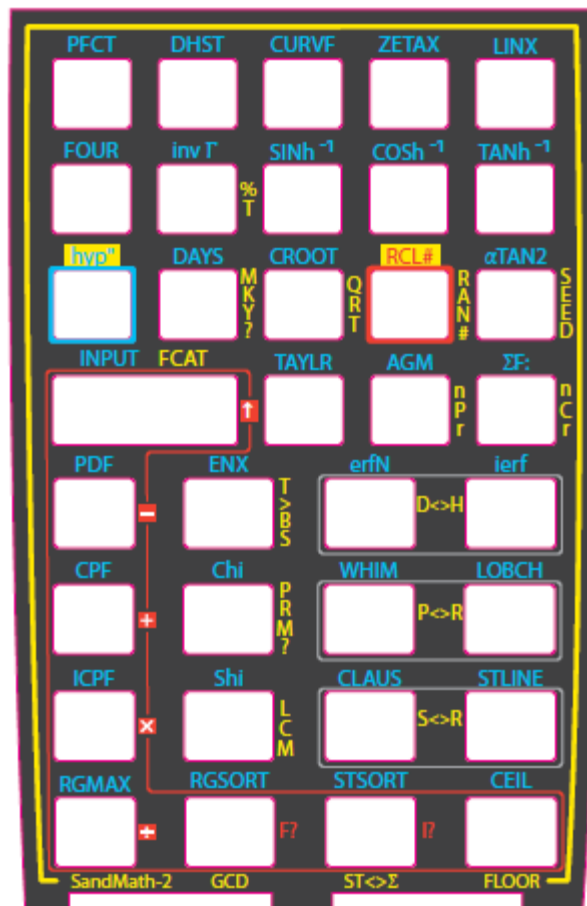

- [Spc] Register Sort
- [R/S] Ceiling function

This implementation effectively supersedes the **MKEYS** approach, respecting the default keyboard (no need to toggle USER mode) and without the extra KA registers consumption. Note also that the **HYP** keyboard is compatible with the SandMath Overlay - of which finally real-life units were made!

The "Last Function" functionality.

The latest releases of the SandMath and SandMatrix modules include support for the "LASTF" functionality. This is a handy choice for repeat executions of the same function (i.e. to execute again the last-executed function), without having to type its name or navigate the different launchers to access it.

The implementation is not universal – it only covers functions invoked using the dedicated launchers, but not those called using the mainframe XEQ function. It does however support two scenarios: (a) functions in the main FATs, as well as (b) those *sub-functions from the auxiliary FATs*. Because the latter group cannot be assigned to a key in the user keyboard, the LASTF solution is especially useful in this case. The following table summarizes the launchers that have this feature:

Module	Launchers	LASTF Method
SandMath 3x3+ revision "M"	Σ F \overline{L} , HYP, FRC, RCL#	Captures sub/fnc id#
	Σ F\$ _	Captures sub/fnc <u>NAME</u>
revision "N"	Σ F# _ _ _	Captures sub/fnc id#
	CAT+ (XEQ')	Captures sub/fnc id#

Note that the Alphabetical launcher Σ F\$ will *switch to ALPHA mode automatically*. Spelling the function name is terminated pressing ALPHA, which will either execute the function (in RUN mode) or enter it using *two* program steps in PRGM mode by means of the Σ F# function plus the corresponding index (using the so-called non-merged approach). This conversion happens entirely automatically.

The LASTF operation is also supported when executing a sub-function from within the CAT+ enumeration, using the [XEQ] hot-key - which is very handy for those with elusive spelling. Another new enhancement is the display of the sub-function names when using the index-based launcher Σ F# - which provides visual feedback that the chosen function is the intended one (or not). This feature is active in RUN mode, when entering it into a program, and when single-stepping a program execution - but obviously not so during the standard program runs.

LASTF Operating Instructions

No separate function exists - The Last Function feature is triggered by pressing the radix key (decimal point - the same key used by LastX) while the launcher prompts are up. This is consistently implemented across all launchers supporting the functionality in the three modules (SandMath, SandMatrix and PowerCL) – they all work the same way.

When this feature is invoked, it first briefly shows "LASTF" in the display, quickly followed by the last-function name. Keeping the key depressed for a while shows "NULL" and cancels the action. In RUN mode the function is executed, and in PRGM mode it's added as a program step if programmable, or directly executed if not programmable.

The functionality is a two-step process: a first one to capture the function id#, and a second that retrieves it, shows the function name, and finally parses it. All launchers have been enhanced to store the appropriate function information (either index codes or full names) in registers within a dedicated buffer (with id# = 9). The buffer is maintained automatically by the modules (created if not present when the calculator is 'switched ON'), and its contents are preserved while it is turned off (during "deep sleep"). No user interaction is required.

If no last-function information yet exists, the error message "NO LASTF" is shown. If the buffer #9 is not present, the error message is "NO BUF" instead.

Appendix 1.- Launcher Maps.

The figures below provide a better overview, illustrating the hierarchy between launchers and their interconnectivity. For the most part it is always possible to return to the main launcher pressing the back arrow key, improving so the navigation features – rather useful when you're not certain of a particular function's location.

The first one is the Main SandMath Launcher.

The first mapping doesn't show all the direct execute function keys. Use the SandMath overlay as a reference for them (names written in BLUE aside the functions).



Note that ΣFL\$ requires pressing [ALPHA] a second time in order to type the sub-function name.

And here's the Enhanced RCL MATH group:

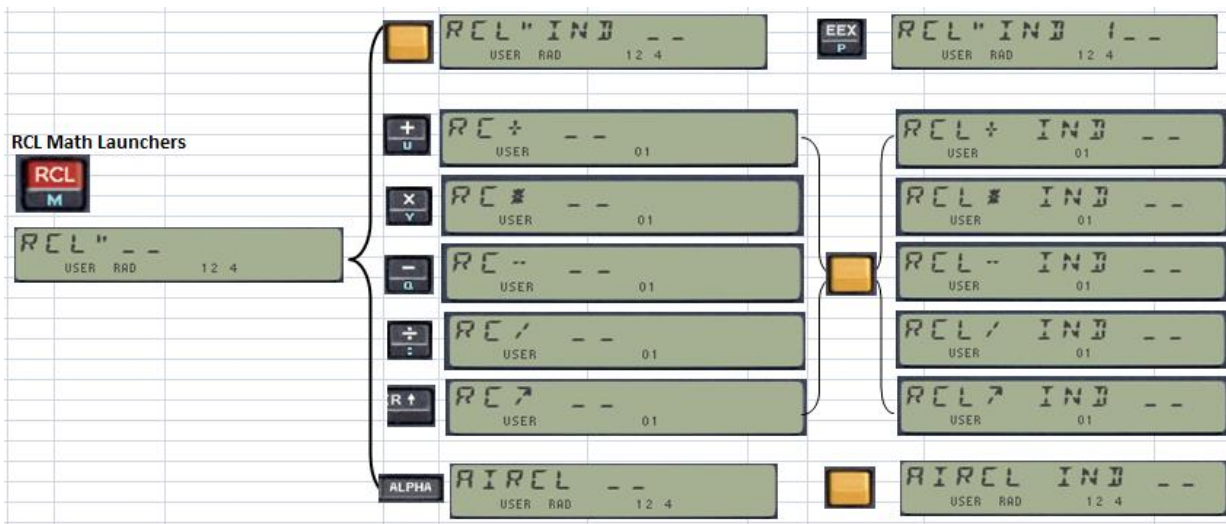

Here all the prompts expect a numeric entry. The two top rows keys can be used as shortcuts for 1-10. Note that No **STK** functionality is implemented – even if you can force the prompt at the **IND** step. Typically you'll get a "DATA ERROR" message - Rather not try it :-)

Function index at a glance.

And without further ado, here's the list of functions included in the module. First the functions in the lower page – basic extensions that will be used in more complex routines later on.

#	Name	Description	Input	Author
0	-SNDMTH 3x3	<i>TAYLOR sub-function</i>	<i>Auxiliary usage</i>	<i>Ángel Martin</i>
1	2^X-1	Powers of 2	Value in X	<i>JM Baillard</i>
2	Σ1/N	Harmonic Numbers	N in X	<i>Ángel Martin</i>
3	ΣN^X	Geometric Sums	N in Y, value in X	<i>Ángel Martin</i>
4	AGM	Arithmetic-Geometric Mean	Arguments in Y and X	<i>Ángel Martin</i>
5	AINT	Alpha Integer Part	Value in X	<i>Frits Ferwerda</i>
6	ATAN2	Dual-argument ATAN	Values in Y,X	<i>Ángel Martin</i>
7	BS>D __	Base to Decimal	Base in X, string in Alpha	<i>George Eldridge</i>
8	CBRT	Cubic Root	Value in X	<i>Ángel Martin</i>
9	CEIL	Ceil function	Value in X	<i>Ángel Martin</i>
10	CF2V _	Continued Fractions	Initial value, point in Y,X	<i>Greg McClure</i>
11	CHSYX	CHSY by X	Exp. In Y, argument in X	<i>Ángel Martin</i>
12	CROOT	Cubic Equation Roots	Coeffs. In Stack	<i>Ángel Martin</i>
13	D>BS __	Decimal to Base	Base in Y, value in X	<i>HP Co. - Ken Emery</i>
14	D>H	Dec to Hex	Decimal value in X	<i>William Graham</i>
15	DERV _	Function Derivatives	Step size, point in Y,X	<i>Greg McClure</i>
16	E3/E+	1,00X	Number in X	<i>Ángel Martin</i>
17	FLOOR	Floor Function	Argument in X	<i>Ángel Martin</i>
18	GEU	Euler's Constant	none	<i>Ángel Martin</i>
19	GMSLVR _	Geometric and TVM Solvers	Prompts for function	<i>Nelson F. Crowle</i>
20	H>D	Hex to Dec	Hex string in Alpha	<i>William Graham</i>
21	HMS*	HMS Multiply by scalar	Arguments in Y and X	<i>Tom Bruns</i>
22	LOGYX	LOG b of X	Base in Y, argument in X	<i>Ángel Martin</i>
23	MKEYS _	Mass Key Assgn.	Prompts Y/N/Cancel	<i>HP Co.</i>
24	PVL	Polynomial Evaluation	Cntl. Word in Y, point in X	<i>Ángel Martin</i>
25	QREM	Quotient Remainder	Arguments in Y and X	<i>Ken Emery</i>
26	QROOT	2nd. Degree Roots	Coeffs. In Z, Y and X	<i>Ángel Martin</i>
27	QROUT	Ouput Roots	Shows results in Stack	<i>Ángel Martin</i>
28	R>P	Complete R-P	Arguments in Y and X	<i>Tom Bruns</i>
29	R>S	Rectangular to Spherical	Arguments in Z, Y, and X	<i>Ángel Martin</i>
30	S>R	Spherical to Rectangular	Arguments in Z, Y, and X	<i>Ángel Martin</i>
31	STLINE	Straight Line from Stack	Data points in {T,Z,Y,X}	<i>Ángel Martin</i>
32	Σ^123 _	Sums of integer powers	Exponent in Y, terms in X	<i>Martin - Kaarup</i>
33	VMANT	View Mantissa	Argument in X. Hold key to see	<i>Ken Emery</i>
34	X^3	X^3	Argument in X	<i>Ángel Martin</i>
35	X=1?	Is X 1?	Argument in X	<i>Nelson F. Crowle</i>
36	X=YR?	Is X~Y? (rounded)	Arguments in Y and X	<i>Ángel Martin</i>
37	X>=0?	is X>=0?	Argument in X	<i>Ángel Martin</i>
38	X>=Y?	is X>=Y?	Arguments in Y and X	<i>Ken Emery</i>
39	Y^1/X	Xth. Root of Y	Arguments in Y and X	<i>Ángel Martin</i>
40	Y^^X	Extended Y^X	Arguments in Y and X	<i>Ángel Martin</i>
41	PRGM _	Program Generator	Formula entered in Alpha	<i>Nelson F. Crowle</i>
42	-FRC _	<i>Fraction Math Launcher</i>	<i>Prompts for function</i>	<i>Ángel Martin</i>
43	D>F	Decimal to Frac	Fractional number in X	<i>Frans de Vries</i>
44	F+	Fraction Addition	Fractions in stack	<i>Ángel Martin</i>
45	F-	Fraction Substract	Fractions in stack	<i>Ángel Martin</i>

#	Name	Description	Input	Author
46	F*	Fraction Multiply	Fractions in stack	Ángel Martin
47	F/	Fraction Divide	Fractions in stack	Ángel Martin
48	FRC?	is X fractional?	Argument in X	Ángel Martin
49	INT?	Is X Integer?	Argument in X	Ángel Martin
50	-HYP _	<i>Hyperbolics Launcher</i>	<i>Prompts for function</i>	Ángel Martin
51	HACOS	Hypebolic ACOS	Argument in X	Ángel Martin
52	HASIN	Hyperbolic ASIN	Argument in X	Ángel Martin
53	HATAN	Hyperbolic ATAN	Argument in X	JM Baillard
54	HCOS	Hyperbolic COS	Argument in X	Ángel Martin
55	HSIN	Hyperbolic SIN	Argument in X	Ángel Martin
56	HTAN	Hyperbolic TAN	Argument in X	JM Baillard
57	-RCLIO _	<i>Extended Recall</i>	<i>Prompts for function</i>	Ángel Martin
58	AIRCL _ _	ARCL Integer Part	Prompts for Reg#	Ángel Martin
59	RCL^ _ _	Recall Power	Prompts for Reg#	Ángel Martin
60	RCL+ _ _	Recall Add	Prompts for Reg#	Ángel Martin
61	RCL- _ _	Recall Subtract	Prompts for Reg#	Ángel Martin
62	RCL* _ _	Recall Multiply	Prompts for Reg#	Ángel Martin
63	RCL/ _ _	Recall Divide	Prompts for Reg#	Ángel Martin

Next are the functions in the Upper Page – a tad more involved and getting into the High Level Math fields. Some are FOCAL routines with MCODE headers, and most use functions from the lower page.

#	Name	Description	Input	Author
0	-HL MATH+	<i>Displays "RUNNING..."</i>	<i>n/a</i>	Ángel Martin
1	1/GMF	Reciprocal Gamma (Cont..Frac.)	argument in X	JM Baillard
2	ΣFL _	Function Launcher	Prompts for function	Ángel Martin
3	ΣF\$ _	Sub-function Launcher by Name	Prompts for Name	Ángel Martin
4	ΣF# _ _ _	Sub-function Launcher by index	Prompts for Index	Ángel Martin
5	BETA	Beta Function	arguments in Y and X	Ángel Martin
6	CHBAP _	Chebyshev's Approximation	Prompts for FName & Data	JM Baillard
7	CI	Cosine Integral	argument in X	JM Baillard
8	DHST	Discrete Hartley Transform	Driver for DHT	JM Baillard
9	EI	Exponential Integral	argument in X	Ángel Martin
10	ENX	Generalized Exponential Integrals	Order in Y, argument in X	JM Baillard
11	ERF	Error Function	Argument in X	JM Baillard
12	FFOUR	Fourier Series	Prompts for Data	Ángel Martin
13	FINTG _	Numerical Integration	Prompts for FName	HP Co.
14	ELIPK	Complete Elliptic intg. 1 st . Kind	Argument in X	Ángel Martin
15	FROOT _	Solution of f(x)=0	Prompts for FName	HP Co.
16	GAMMA	Gamma Function (Lanczos)	Argument in X	Ángel Martin
17	HCI	Hyperbolic Cosine Integral	Argument in X	JM Baillard
18	HGF+	Generalized Hypergeometric Funct.	Data in stack and registers	JM Baillard
19	HSI	Hyperbolic Sine Integral	Argument in X	JM Baillard
20	IBS	Bessel In Function	Order in Y, argument in X	Ángel Martin
21	ICBT	Incomplete Beta Function	Arguments in Z, Y, and X	JM Baillard
22	ICGM	Incomplete Gamma Function	Arguments in Y and X	JM Baillard
23	IERF	Inverse Error function	Argument in X	Ángel Martin
24	IGMMA	Inverse Gamma	Argument in X	Ángel Martin
25	JBS	Bessel Jn Function	Order in Y, argument in X	Ángel Martin

#	Name	Description	Input	Author
26	KBS	Bessel Kn Function	Order in Y, argument in X	Ángel Martin
27	LINX	Polylogarithm	Order in Y, argument in X	Ángel Martin
28	LNGM	Logarythm Gamma Function	Argument in X	Ángel Martin
29	LOBACH	Lobachevsky Function	Argument in X	Ángel Martin
30	PSI	Digamma Function	Argument in X	Ángel Martin
31	PSIN	Polygamma	Order in Y, argument in X	JM Baillard
32	SI	Sine Integral	Argument in X	JM Baillard
33	SJBS	Spherical J Bessel	Order in Y, argument in X	Ángel Martin
34	SYBS	Spherical Y Bessel	Order in Y, argument in X	Ángel Martin
35	TAYLOR _	Taylor Polynomial order 10	Prompts for FName	Martin-Baillard
36	WLO	Lambert W Function	Argument in X	Ángel Martin
37	YBS	Bessel Yn	Order in Y, argument in X	Ángel Martin
38	ZETA	Zeta Function (Direct method)	Argument in X	Ángel Martin
39	ZETAX	Zeta Function (Borwein)	Argument in X	JM Baillard
40	-PB/STS _	<i>Displays STAT menu choices</i>	<i>Prompts for function</i>	Ángel Martin
41	%T	Total Percentual	Arguments in Y and X	Ángel Martin
42	CORR	Correlation Coefficient	Data in ΣREG registers	JM Baillard
43	COV	Sample Covariance	Data in ΣREG registers	JM Baillard
44	"CURVE"	Curve Fitting (AECROM)	Prompts for data	Nelson F. Crowle
45	EVEN?	is X Even?	Argument in X	Ángel Martin
46	GCD	Greatest Common Divisor	Arguments in Y and X	Ángel Martin
47	LCM	Least Common Multiple	Arguments in Y and X	Ángel Martin
48	LR	Linear Regression	Data in ΣREG registers	JM Baillard
49	LRY	LR Y-value	Data in ΣREG registers	JM Baillard
50	NCR	Combinations	Arguments in Y and X	Ángel Martin
51	NPR	Permutations	Arguments in Y and X	Ángel Martin
52	ODD?	Is X Odd?	Argument in X	Ángel Martin
53	PDF	Probability Distribution Function	μ in Z, σ in Y, x in X	Ángel Martin
54	PFCT	Prime Factorization in Alpha	Argument in X	Ángel Martin
55	PRIME?	Is X Prime?	Argument in X	Jason DeLooze
56	RAND	Random Number	None / Time module	Håkan Thörgren
57	RGMAX	Block Maximun	Control word in X	JM Bailalrd
58	RGSORT	Register Sort	Control word in X	JM Baillard
59	RGSUM	Register Sum	Control word in X	JM Baillard
60	SEEDT	Stores Seed for RNDM	Argument in X	Håkan Thörgren
61	ST<>Σ	Exchange STK & ΣREG	Data in stack and ΣREG	Nelson F. Crowle
62	STSORT	Stack Sort	Data in Stack	David Phillips
63	TVM\$ _	Time Value of Money Launcher	Prompts for options	Ángel Martin

Functions in blue font are all in MCODE. Functions in black font are MCODE entries to FOCAL programs. **Pink** and **Yellow** backgrounds denote new and upgraded in latest revisions.

(*) The best way to access **FCAT** is through the main launcher [**ΣFL**] , then pressing [**SHIFT**] **ENTER** ("N")

Next come the sub-functions within the Special Functions Group – deeply indebted to Jean-Marc’s contribution (but not the only section in the module). Note that there are four sections within this auxiliary FAT – you can use the **CAT+** hot keys to navigate the groups.

Idx#	Name	Description	Input	Author
0	-SP FNC	<i>Cat header - does CAT+</i>	<i>none</i>	<i>Ángel Martin</i>
1	#BS	Aux routine, All Bessel	Under program control	<i>Ángel Martin</i>
2	#BS2	Aux routine 2nd. Order, Integers	<i>Under prgm control</i>	<i>Ángel Martin</i>
3	AIRY	Airy Functions Ai(x) & Bi(x)	Argument in X	<i>JM Baillard</i>
4	ALF	Associated Legendre fcn. 1st kind	Arguments in Z, Y, and X	<i>JM Baillard</i>
5	AWL	Inverse Lambert W	Argument in X	<i>Ángel Martin</i>
6	DAWSON	Dawson integral	Argument in X	<i>Martin-Baillard</i>
7	DEBYE	Debye functions	Order in Y, argument in X	<i>Martin-Baillard</i>
8	HGF	Hypergeometric function	Data in stack and registers	<i>JM Baillard</i>
9	HK1	Hankel1 Function	Order in Y, argument in X	<i>Ángel Martin</i>
10	HK2	Hankel2 Function	Order in Y, argument in X	<i>Ángel Martin</i>
11	HNX	Struve H Function	Order in Y, argument in X	<i>JM Baillard</i>
12	ITI	Integral of IBS	Order in Y, argument in X	<i>Ángel Martin</i>
13	ITJ	Integral of JBS	Order in Y, argument in X	<i>Ángel Martin</i>
14	JNX1	Bessel Jn for large arguments	Order in N, argument in X	<i>Keith Jarret</i>
15	KLV1	Ber & Bei functions	Order in Y, argument in X	<i>JM Baillard</i>
16	KLV2	Ker & Kei functions	Order in Y, argument in X	<i>JM Baillard</i>
17	KUMR	Kummer Function	Arguments in Z, Y, and X	<i>Ángel Martin</i>
18	LERCH	Lerch Transcendent function	Arguments in Z, Y, and X	<i>JM Baillard</i>
19	LI	Logarithmic Integral	Argument in X	<i>Ángel Martin</i>
20	LNx	Struve Ln Function	Argument in X	<i>JM Baillard</i>
21	LOMS1	Lommel s1 function	Arguments in Z, Y, and X	<i>JM Baillard</i>
22	LOMS2	Lommel s2 function	Arguments in Z, Y, and X	<i>JM Baillard</i>
23	RCWF	Regular Coulomb Wave Function	Arguments in Z, Y, and X	<i>JM Baillard</i>
24	RHGF	Regularized hypergeometric function	Data in stack and registers	<i>JM Baillard</i>
25	SHK1	Spherical Hankel1	Argument in X	<i>Ángel Martin</i>
26	SHK2	Spherical Hankel2	Argument in X	<i>Ángel Martin</i>
27	SIBS	Spherical IBS	Order in Y, argument in X	<i>Ángel Martin</i>
28	TMNR	Toronto function	Arguments in Z, Y, and X	<i>JM Baillard</i>
29	WEBAN	Weber and Anger functions	Order in Y, argument in X	<i>JM Baillard</i>
30	WHIM	Whittaker M function	Arguments in Z, Y, and X	<i>Ángel Martin</i>
31	WL1	Lambert W1	Argument in X	<i>Ángel Martin</i>
32	ZOUT	Output Complex to ALPHA	Im in Y, re in X	<i>Ángel Martin</i>
33	-ELLIPTIC	<i>Section Header</i>	<i>none</i>	<i>n/a</i>
34	AJF	Aux for JEF	Under program control	<i>JM Baillard</i>
35	BRHM	Area of cyclic quadrilateral	Four sides in stack	<i>JM Baillard</i>
36	CLAUS	Clausen Function	Argument in X	<i>JM Baillard</i>
37	CRF	Carlson Integral 1st. Kind	Arguments in Z, Y, and X	<i>JM Baillard</i>
38	CRG	Carlson Integral 2nd. Kind	Arguments in Z, Y, and X	<i>JM Baillard</i>
39	CRJ	Carlson Integral 3rd. Kind	Arguments in stack {X,Y,Z,T}	<i>JM Baillard</i>
40	CSX	Fresnel Integrals, C(x) & S(x)	Argument in X	<i>JM Baillard</i>
41	ELIPE	Complete Elliptic Intg. 2 nd . Kind	Argument in X	<i>Ángel Martin</i>
42	ELIPF	Incomplete Elliptic Integral	Arguments in Y and X	<i>Ángel Martin</i>
43	EPER	Perimeter of Ellipse	Semi-axis in Y and X	<i>Ángel Martin</i>
44	FLOOP	Aux. Function Solve/Integ	n/a	<i>HP Co.</i>
45	HERON	Area of Triangle (Heron formula)	Sides in Z, Y, X	<i>JM Baillard</i>
46	JEF	Jacobian Elliptic functions	Arguments in Y and X	<i>JM Baillard</i>
47	LEI1	Legendre Elliptic Integral 1st. Kind	Arguments in Y and X	<i>JM Baillard</i>

48	LEI2	Legendre Elliptic Integral 2nd. Kind	Arguments in Y and X	<i>JM Baillard</i>
49	LEI3	Legendre Elliptic Integral 3rd. Kind	Arguments in Y and X	<i>JM Baillard</i>
50	PP2	Point-to-Point Distance	Data points in Stack	<i>Ángel Martin</i>
51	SAE	Surface Area of an Ellipsoid	Semi-axis in Y, Y, and X	<i>JM Baillard</i>
52	THETA	Theta Functions (1,2,3,4)	Index in Z, arguments in Y,X	<i>Martin-Baillard</i>
53	THV	Tetrahedron Volume	Edges stored in {R01-R06}	<i>JM Baillard</i>

The following section groups the factorial functions, circling back from the special functions into the number theory field - a timid foray to say the most.

index#	Name	Description	Input	Author
54	-FACTORIAL	<i>Section Header</i>	<i>None</i>	<i>n/a</i>
55	ΣDGT	Sum of mantissa digits	Number in X	<i>Ángel Martin</i>
56	AGM2	Modified AGM	Arguments in Y and X	<i>Ángel Martin</i>
57	APNB	Apery Numbers	Order in X	<i>JM Baillard</i>
58	BN2	Bernouilly Numbers	Order in X	<i>Ángel Martin</i>
59	CPF	Cumulative probability (μ, σ)	μ in Z, σ in Y, x in X	<i>Ángel Martin</i>
60	ERFN	Generalized Error Function	Order in Y, argument in X	<i>JM Baillard</i>
61	FFCT	Falling Factorial	Order in Y, argument in X	<i>Ángel Martin</i>
62	ICPF	Inverse Cumulative Prob.	Argument in X	<i>Ángel Martin</i>
63	LAYX	Generalized Laguerre Functions	Arguments in Z, Y, and X	<i>Ángel Martin</i>
64	LOGHF	Logarithm Hyper-Factorial	Argument in X	<i>Ángel Martin</i>
65	LOGMF	Logarithm Multi-Factorial	Repeat in Y, argument in X	<i>JM Baillard</i>
66	MFCT	Multi-Factorial	Repeat in Y, argument in X	<i>JM Baillard</i>
67	NPRML	Number Primorials	Order in X	<i>Ángel Martin</i>
68	POCH	Pochhammer symbol	Order in Y, argument in X	<i>Ángel Martin</i>
69	PRML	Prime PrImorials	Order in X	<i>Ángel Martin</i>
70	PSD	Poisson Standard Distribution	Parameters in Y and X	<i>Ángel Martin</i>
71	QTNL	Quantile (Standard Normal ICP)	Argument in X	<i>Ángel Martin</i>
72	SFCT	Super Factorial	Argument in X	<i>JM Baillard</i>
73	XFCT	Extended Factorial	Argument in X	<i>Ángel Martin</i>

The next two sections take us into the Transforms and Approximation theory, plus several new additions related to number means and other topics:

index#	Name	Description	Input	Author
74	-TRANSFORM	<i>Section Header</i>	<i>none</i>	<i>n/a</i>
75	^LIST	Input Data in List	Control word in X	<i>Ángel Martin</i>
76	ANUMDL	ANUM with Deletion	Value in Alpha	<i>HP Co.</i>
77	b*e	Array size from cntl. word	Bbb.eee in X	<i>Ángel Martin</i>
78	b<>e	index swapping	bb.eee in X	<i>Ángel Martin</i>
79	CDAY	Calendar Day	Julian/Gregorian in X	<i>Ángel Martin</i>
80	CdT	Aux for CHBAP	Under program control	<i>JM Baillard</i>
81	CHB	Chebyshev Poyin.1st. Kind	Cntl. Word in Y, point in X	<i>Ángel Martin</i>
82	CHB2	Chebyshev Polyn. 2nd. Kind	Cntl. Word in Y, point in X	<i>Ángel Martin</i>
83	CHBCF	Chebyshev's Coefficients	Data in R11, R12 and X	<i>JM Baillard</i>
84	CRVF	Curve Fitting (AECROM)	Under program control	<i>Nelson F. Crowle</i>
85	DAYS	Days between Dates	Dates in Y and X	<i>HP Co.</i>
86	DFT	Discrete Fourier Transform	Prompts for Input data	<i>Ángel Martin</i>
87	DHT	Discrete Hartley transform	Data in X and registers	<i>JM Baillard</i>
88	dPL	First derivative of Polynomial	Cntl. Word in Y, point in X	<i>Ángel Martin</i>
89	IN	Input Data in Registers	First register in X	<i>Ángel Martin</i>

90	INPUT	Data input as ALPHA Lists	Contril word in X	Ángel Martin
91	JDAY	Julian Day Number	Date in X (MM,DDYYYY)	Ángel Martin
92	OUT	Output Data from Registers	Cntl. Word in X	Ángel Martin
93	PDEG	Polyn degree from control word	Cntl. Word in X	JM Baillard
94	-/+	Calculates (Y-X)/(Y+X)	Arguments in Y and X	Ángel Martin
95	EECC	Ellipse Eccentricity	Semi-axis in X,Y	Ángel Martin
96	EQT	Curve Equation	Curve id# in X	Ángel Martin
97	LRX	Linear Regression Abcissa	Y-Value in X	Ángel Martin
98	Y/N?	Prompts for Yes/No	none	PANAME ROM
99	CIRCL	Radius and Triangle Area	3-points data in R01-R06	Ángel Martin
100	dB+	Decibel Addition	dB values in Y and X	Ángel Martin
101	GHM	Geometric-Harmonic Mean	Values in X, Y	Greg McClure
102	AMEAN	Registers Arithmetic Mean	Control word in X	Ángel Martin
103	HMEAN	Registers Harmonic Mean	Control word in X	Ángel Martin
104	GMEAN	Registers Geometric Mean	Control word in X	Ángel Martin
105	PMEAN	Generalized p-Mean	Control word in X	Ángel Martin
106	PNEXT	Next Prime	Initial number in X	Poul Kaarup
107	PTWIN	Twin Primes	Initial number in X	Peter Platzter
108	DSP?	Display Settings	none	Ángel Martin
109	KAPR	Kaprekar Sequences	N in Y, number in X	JM Baillard
110	MTXP	Mantissa & Exponent	Argument in X	David Yerka
111	MREV	Mantissa reversal	Argument in X	Ángel Martin
112	VMOD	Vector Module	x, y,z in stack	Ángel Martin
113	VXA	Vector Cross Product	v1 in stack, V2 in alpha	Ángel Martin
114	V*A	Vector Dot Product	V1 in stack, V2 ni alpha	Ángel Martin
115	%D	Difference Percent	Arguments in Y and X	Ángel Martin
116	?DSP	Display Settingd	none	Ángel Martin
117	REV	Module Revision	none	Ángel Martin
118	CAT+ _	Sub-Function Catalog	Has hot-keys	Ángel Martin

The Sub-Function Catalog.

CAT+ provides usability enhancements for admin and housekeeping. It invokes the sub-function CATALOG, with *hot-keys for individual function launch and general navigation*. Users of the POWERCL Module will already be familiar with its features, as it's exactly the same code – which in fact resides in the Library#4 and it's reused by both modules and the SandMatrix as well.

The hot-keys and their actions are listed below:

- [R/S]:** halts the enumeration
- [SST/BST]:** moves the listing one function up/down
- [SHIFT]:** sets the direction of the listing forwards/backwards
- [XEQ]:** direct execution of the listed function – or entered in a program line
- [ENTER ^]:** moves to the next/previous section depending on SHIFT status
- [<-]:** back-arrow cancels the catalog

One limitation of the sub-functions scheme that you'll soon realize is that, contrary to the standard functions, *they cannot be assigned to a key for the USER keyboard*. Typing the full name (or entering its index at the Σ FL# prompt) is always required. This can become annoying if you want to repeatedly execute a given sub- function. The **LAST Function** implementation certainly minimizes this issue for repeat executions of the last sub-function called, without a dedicated key assignment required. Another work-around consists of writing a micro-FOCAL program with just the sub-function as a single pair of program lines, and then assign it to the key of choice. Not perfect but it works.

2. Lower-Page Functions in detail

2.1. SANDMATH GROUP



The following sections of this document describe the usage and utilization of the functions included in the SandMath_44 Module. While some are very intuitive to use, others require a little elaboration as to their input parameters or control options, which should be covered here. Reference to the original author or publication is always given, for additional information that can (and should) also be consulted.

2.1.1. Elementary Math functions

Even the most complex project has its basis – simple enough but reliable, so that it can be used as solid foundation for the more complex parts. The following functions extend the HP-41 Math function set, and many of them will be used either as MCODE subroutines or directly in FOCAL programs.

	Function	Description	Author
	2^X-1	Self-descriptive, faster and better precision than FOCAL	Ángel Martin
[*]	Σ1/N	Harmonic Number H(n)	Ángel Martin
	Σ^123 _	N in X, Prompts for exponent	Martin - Kaarup
[*]	ΣN^X	Geometric Sums	Ángel Martin
	ATAN2	Two-argument arctangent (complex argument)	Ángel Martin
[*]	CBRT	Cubic root (main branch)	Ángel Martin
[*]	CEIL	Ceiling function of a number	Ángel Martin
[*]	CHSYX	Multiple CHS by Y	Ángel Martin
	E3/E+	Index builder	Ángel Martin
[*]	FLOOR	Floor function of a number	Ángel Martin
	GEU	Euler-Mascheroni constant	Ángel Martin
[*]	LOGYX	Base-Y Natural logarithm of X	Ángel Martin
	QREM	Quotient Remainder	Ken Emery
[*]	X^3	Cube power of X	Ángel Martin
[*]	Y^1/X	x-th root of Y	Ángel Martin
[*]	Y^X	Very large powers of X (result >= 1E100)	Ángel Martin
	YX^	Modified Y^X (does 0^0=1)	JM Baillard

- **2^X-1** provides a more accurate result for smaller arguments than the FOCAL equivalents. It will be used in the ZETAX program to calculate the Zeta function using the Borwein algorithm.
- **Σ1/N** calculates the Harmonic number of the argument in X, that is the sum of the reciprocals of the natural numbers (which excludes zero) lower and equal to n. It will be used in the calculation of the Kelvin functions and the Bessel functions of the second kind, K(n,x) and Y(n,x).

$$H_n = \sum_{k=1}^n \frac{1}{k}$$

Example: calculate H(5) and H(25). Use the main **ΣFL** launcher and the LastF functionality.

```
5, ΣFL [SHIFT] [F]           => 2.283333333
25, ΣFL, [, ]                => 3.815958178
```

- **Σ^123** provides a convenient grouping for several functions that calculate the sum of integer powers directly based on the corresponding formulas. The number of terms to sum is expected to be in the X- register, and the exponent is entered as the function prompt. The exponents can be 1 (linear sum using the triangular formula), 2 (sum of squares using the pyramidal formulas) or 3 (sum of cubes also using the pyramidal formulas). Any input larger than 3 will also revert to case=3. An input of zero will calculate the sum of mantissa digits for the number in X, same as function **ΣDGT** described later on.

Example: Calculate the sum of the first 10 natural numbers and their squares and cubes:

10, **Σ^123** _ , plus "1" at the prompt quickly returns: 55.00000000
 LASTX, **Σ^123** _ , "2" => 385.00000000
 LASTX, **Σ^123** _ , "3" => 3,025.000000

Note that this function is programmable, and that in a program the value of the exponent is expected to be entered in the next program line following **Σ^123** – i.e. it also uses the "non-merged" approach.

- **ΣN^X** Calculates a generalized value of the Faulhaber's formula for integer values of x. – The few first integer values of x have explicit formulas for the result (which are used in the function **Σ^123** described above) , but that's not the case for a general value - which can also be non-integer. Obviously for x=-1 this function returns identical results than **Σ1/N**, albeit slower due to the additional complexity of the definition of the term.

Example: Check the triangular (x=1) and pyramidal (x=2) formulas for n=10 – which are particular cases of the Faulhaber's Formula, involving Binomial coefficients and Bernoulli's numbers. See the link below for details: http://en.wikipedia.org/wiki/Faulhaber%27s_formula

10, ENTER^, 1, **ΣFL** [SHIFT] [A] => 55.00000000
 10, ENTER^, 2, **ΣFL** [,] => 385.00000000

$$T_n = \sum_{k=1}^n k = 1 + 2 + 3 + \dots + n = \frac{n(n+1)}{2} = \binom{n+1}{2}$$

$$P_n = \sum_{k=1}^n k^2 = \frac{n(n+1)(2n+1)}{6} = \frac{2n^3 + 3n^2 + n}{6}.$$

And using the convention B(1) = 0.5 the formula is:

$$S_m(n) = \frac{1}{m+1} \sum_{k=0}^m \binom{m+1}{k} B_k n^{m+1-k},$$

Which could be programmed using a few of the SandMath functions, albeit it would be considerably slower due to the impact of the Zeta algorithms (part of Bernoulli's) – kicking in for n>4.

- **CHSYX** is related to the same subject, and in general relevant to the summation of alternating series – It can be regarded as an extension of **CHS** but dependent of the number in X. Its expression is:

CHS(y,x)= y*(-1)^x, and thus changing the sign of Y when the number in X is odd.

- **ATAN2** is the two-argument variant of arctangent. Its expression is given by the following definitions:

$$\text{atan2}(y, x) = \begin{cases} \arctan\left(\frac{y}{x}\right) & x > 0 \\ \pi + \arctan\left(\frac{y}{x}\right) & y \geq 0, x < 0 \\ -\pi + \arctan\left(\frac{y}{x}\right) & y < 0, x < 0 \\ \frac{\pi}{2} & y > 0, x = 0 \\ -\frac{\pi}{2} & y < 0, x = 0 \\ \text{undefined} & y = 0, x = 0 \end{cases}$$

Example: in RAD mode - Calculate ATAN2(2π, π) using the main **ΣFL** launcher.

[PI] , **[PI]** , **[2]** , **[*]** , **ΣFL** **[SHIF]** - **[SHIFT]** **[SST]** => 0.463647609

Those amongst you with a penchant for complex variable would no doubt recognize this as the principal value of the argument of a complex number.

- **E3/E+** does just what its name implies: adds one to the result of dividing the argument in x by one-thousand. Extensively used throughout this module and in countless matrix programs, to prepare the element indexes.
- **FLOOR** and **CEIL**. The floor and ceiling functions map a real number to the largest previous or the smallest following integer, respectively. More precisely, floor(x) = [x] is the largest integer not greater than x and ceiling(x) =]x[is the smallest integer not less than x.

The SandMath implementation uses the native MOD function, through the expressions:

$$\text{CEIL}(x) = [x - \text{MOD}(x, -1)]; \quad \text{and} \quad \text{FLOOR}(x) = [x - \text{MOD}(x, 1)].$$

- **GEU** is a new constant added to the HP-41: the Euler-Mascheroni constant, defined as the limiting difference between the harmonic series and the natural logarithm:

$$\gamma = \lim_{n \rightarrow \infty} \left(\sum_{k=1}^n \frac{1}{k} - \ln(n) \right)$$

The numerical value of this constant to 10 decimal places is: $\gamma = \mathbf{0.5772156649\dots}$ The stack lift is enabled, allowing for normal RPN-style calculations. It appears in formulas to calculate the Ψ (Psi) function (Digamma) and the Bessel functions of 2nd. Kind, amongst others.

- **LOGYX** is the base-b Logarithm, defined by the expression below where the base b is expected to be in register Y, and the argument in register X.

$$\log_b(x) = \frac{\log_{10}(x)}{\log_{10}(b)} = \frac{\log_e(x)}{\log_e(b)}.$$

Example: verify that 5.55 = Log[2, 2^(5.55)] using 2^X-1 and LOGYX:

5.55, **2^X-1**, 1, **[+]**, 2, **[X<>Y]**, **LOGYX** => 5.55000000

- **QREM** Calculates the Remainder "R" and the Quotient "Q" of the Euclidean division between the numbers in the Y (dividend) and X (divisor) registers. Q is returned to the Y registers and R is placed in the X register. The general equation is: $Y = Q X + R$, where both Q and R are integers. Note that if the dividend is smaller than the divisor the function will return zero for the quotient, and the remainder will be the divisor itself

Example: calculate the remainder and quotient of dividing 27 over 4.

27, ENTER^, 4, **ΣF\$** "QREM" => X=3 (remainder); Y= 6 (quotient)

Since we used the Alpha-Launcher in this example, we can take advantage of the LASTF feature to repeat the operation with swapped values:

4, ENTER^, 27, **ΣFL** [,] => X=4 ; Y=0

- **CBRT** calculates the cubic root of a number. Note that this could also be done using the mainframe function **Y^X** with $Y=1/3$ for positive values of X, but unfortunately it results in DATA ERROR when $X < 0$ – and therefore the need for a new function.

Obviously it follows that $CBRT(-x) = -CBRT(x)$, for $x > 0$

- **Y^1/X** and **X^3** are purely shortcut functions, which clearly are equivalent to $\{ 1/X, Y^X \}$, and to $\{ X^2, LASTx, * \}$ respectively - but with additional precision due to the 13-digit intermediate calculations. Besides it does away with the pesky (and totally unjustified) issue present with negative numbers as base in Y^X .

Example: verify in two different ways that the cubic root of $(-3)^3$ is indeed -3.

3, **CHS**, **X^3**, **CBRT** => -3.000000000
3, **CHS**, **X^3**, **3**, **Y^1/X** => -3.000000000

- **Y^X** is used to calculate powers exceeding the numeric range of the calculator, simply returning the base in X and the exponent in Y. The result is shown in ALPHA in RUN mode.- For instance calculate 85^{69} to obtain:

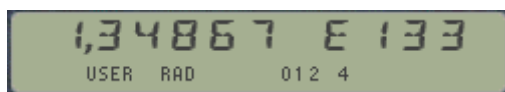

- **XFCT** is an extended-range factorial, capable of displaying results over the standard numeric range of the calculator. Like **Y^X** above, it returns the mantissa to X and the exponent to the Y-register. This function resides in the secondary FAT, and therefore needs to be called using any of the launchers. The implementation is just a particular case of the super-factorial, with the repeat factor $p=1$. This will be described in the corresponding section later on.

Example: to calculate 70! and 120! just type: (using FIX 6 for display formatting)

70, **ΣF\$** "XFCT" => 1.197857 E100
 120, **ΣFL** [,] => 6.689503 E198

The full value of the mantissa is left in the X register.

- **ΣDGT** is a small divertimento useful in pseudo-random numbers generation. It simply returns the sum of the mantissa digits of the argument – at light-blazing speed using just a few MCODE instructions. More about random numbers will be covered in the Probability/Stats section later on.

Example: calculate the sum of all digits of the HP-41's rendition of pi:

Note that **ΣDGT** is a sub-function, thus we need to use **ΣFL** to call it

PI, ΣFL "ΣDGT" => 40.00000000

- **YX^** is a modified form of the native **Y^X** function, with the only difference being its tolerance to the 0^0 case – which results in DATA ERROR with the standard function but here returns 1. This has practical applications in FOCAL programs where the all-zero case is just to be ignored and not the cause for an error.

*Note: due to not enough FAT entries being available, YX^ has been removed from the FAT as an independent entry. Its functionality is still available (and indeed used by some FOCAL routines in the module) under the "stealth" mode of launcher function **-FRC#** when used in program mode - even if in theory it is non-programmable, but certainly you know how to go around that...*

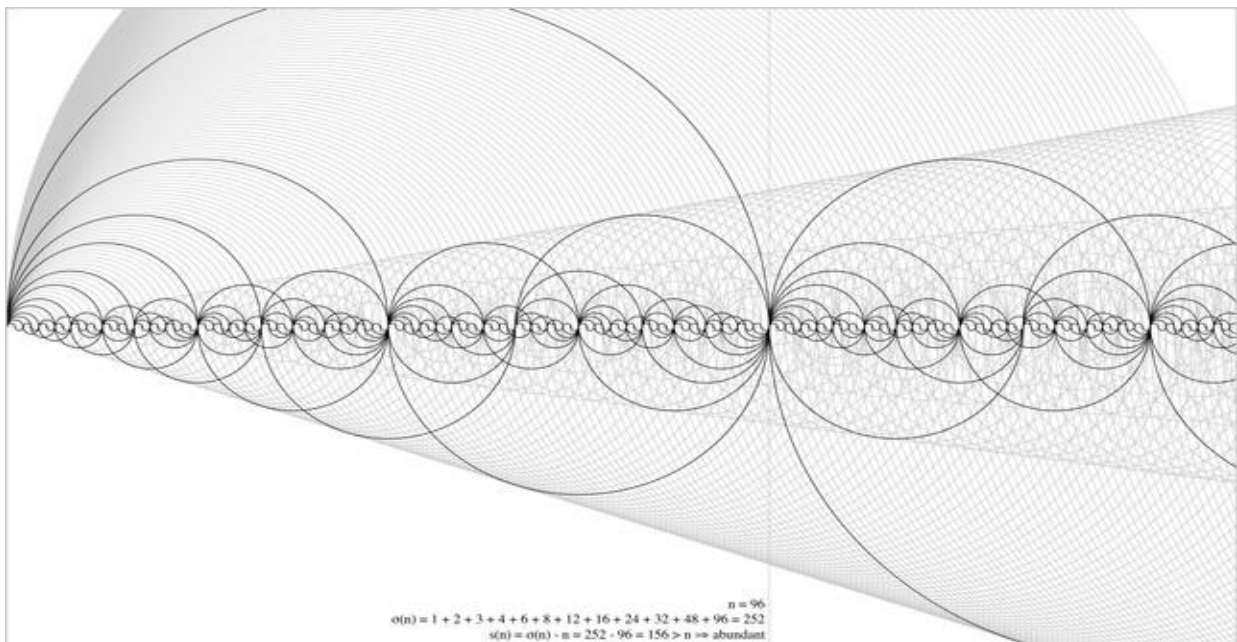

2.1.2. Number Displaying and Coordinate Conversions.

A basic set of base conversions and diverse number displaying functions round up the elementary set:

	Function	Description	Author
	AINT	A fixture: appends integer part of X to ALPHA	Frits Ferwerda
[ΣF\$]	DSP?	Shows current decimal digits setting	Ángel Martin
	HMS/	HMS Division by scalar	Tom Bruns
[ΣF\$]	HMS*	HMS Multiplication by scalar	Tom Bruns
[ΣF\$]	MTXP	Mantissa and Exponent of number	David Yerka
[ΣF\$]	MVER	Mantissa Digit Reversal	Ángel Martin
[*]	P>R	Modified Polar to Rectangular, (<) in [0, 360[Tom Bruns
[*]	R>P	Modified Rectangular to Polar, (<) in [0, 360[Tom Bruns
[*]	R>S	Rectangular to Spherical	Ángel Martin
[*]	S>R	Spherical to Rectangular	Ángel Martin
[ΣF]	VMANT	Shows full-precision (10-digit) mantissa	Ken Emery

- **DSP?** (also in the secondary FAT) returns in X the number of decimal places currently set in the display mode 0 regardless whether it's FIX, SCI, or END. Little more than a curiosity, it can be used to restore the initial settings under program control after changing them for displaying or formatting purposes.
- **AINT** elegantly solves the classic dilemma to append an index value to ALPHA without its radix and decimal part - eliminating the need for FIX 0, and CF 29 instructions, taking extra steps and losing the original calculator settings. Note that HP included function **AIP** in the Advantage module, and the CCD has **ARCLI** to do exactly the same.
- **MTXP**, **MREV** and **VMANT** are related functions that deal with the mantissa and exponent parts of a number. **MTXP** places the mantissa in X and the exponent in Y, **MVER** reverses the mantissa digits, whereas **VMANT** shows the full mantissa for a few instants before returning to the normal display form - *or permanently if any key is pressed and held during such time interval*, similar to the HP-42S implementation of "**SHOW**".
- **R>P** and **P>R** are modified versions of the mainframe functions **R-P** and **P-R**. The difference lies in the convention used for the arguments in Polar form, which here varies between 0 and 360, as opposed to the -180, 180 convention in the mainframe.

Example: convert the point [-1, -1] to the modified polar coordinates and back to rectangular:

```

DEG, 1, CHS, ENTER^, R>P    => 1.414213562
X<>Y                          => 225.0000000 (and not -135)
X<>Y, P-R                    => original point
    
```

(* Note that due to not enough FAT entries being available, the function **P>R** has been removed from revision "P". You can use the native function P-R to get the exact same results.

- **R>S** and **S>R** continue with the coordinate conversion theme. This pair of functions can be used to change between rectangular and spherical coordinates.

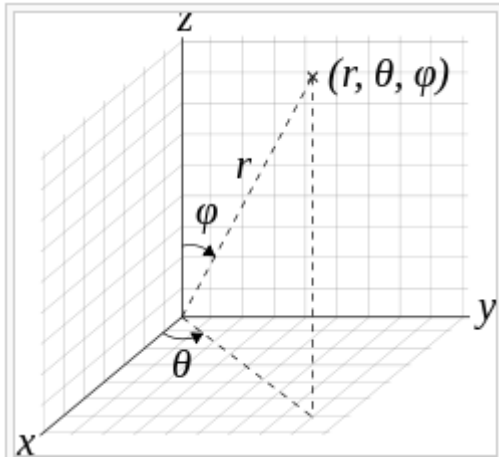

The convention used is shown in the figure below, defining the origin and direction of the azimuth and polar angles as referred to the rectangular axis: $\{ r, \text{phi}, \text{theta} \} \leftrightarrow \{ x, y, z \}$

The SandMath implementation makes use of the fact that with the appropriate selection of origins, dual P-R conversions are equivalent to Spherical, and vice-versa.

Example: convert the rectangular point [1, 2, 3] to spherical coordinates, and then back to rectangular:

```

3, ENTER^, 2, ENTER^, 1, R>S    =>  r = 3.741657386 (*)
RDN                                  =>  phi = 0.640522313
RDN                                  =>  theta = 1.107148718
RDN, RDN, S>R                    =>  original point in stack.
    
```

(*) You can also use function **VMOD** in the secondary FAT to check the modulus result. Its value should be slightly more accurate, as it uses direct math routines not based on [TOPOL].

- **HMS*** and **HMS/** complement the arithmetic handling of numbers in HMS format, adding to the native **HMS+** and **HMS-** pair. They multiply or divide the HH.MMSSSS value in Y by an scalar in X. As it's expected, the result is also put in HMS format as well.

Example: calculate the triple of 2 hours, 45 minues and 25 seconds

```

2,4525, ENTER^, 3, XEQ "HMS*"    =>  8.161499999
    
```

That is 8 hours, 16 minutes and 15 seconds almost exactly.

This function is useful in surveying calculations, as a shortcut of the standard approach involving conversion to decimal format prior to the operation. Note that to multiply or divide two numbers given in HMS format you need to convert them both to rdecimal form using **HR**, perform the operation and convert the result back to HMS format to end.

(**) Note that due to not enough FAT entries being available, the function **HMS/** has been removed from revision "P". You can use the sequence **1/X** and **HMS*** instead to get the exact same results.

Number base conversions.- The following functions are available in the SandMath:

	Function	Description	Author
	BS>D __	Base to Decimal, prompting version	Ángel Martin
02	BININ	"02" in prompt, then enter binary number	HP Co.
08	OCTIN	"08" in prompt, then enter octal number	HP Co.
16	HEXIN	"16" in prompt, then enter hex number	HP Co.
nn	BT	Any other, base in X and string in Alpha	George Eldridge
[*]	D>H	Value in X	William Graham
[*]	H>D	Hex String in Alpha	William Graham
[*]	D>BS __	Decimal to Base, prompting version.	Ángel Martin
02	BINVIEW	Value in X, "02" in prompt	HP Co.
08	OCTVIEW	Value in X, "08" in prompt	HP Co.
16	HEXVIEW	Value in X, "16" in prompt	HP Co.
nn	T>BS __	Value in X, base in prompt	Ken Emery
-nn	TB	Base in Y, value in X (with negative sign)	George Eldridge

D>BS (Decimal to Base) has become a launcher function in version 4x4. The main prompt expects the base from 2 to 36, and depending on the input value the execution will be diverted to a dedicated function: either to **BINVIEW**, **OCTVIEW** and **HEXVIEW** for binary, octal and hex cases respectively - or to the general-purpose **T>BS** itself. The prompt can be filled using the two top keys as shortcuts, from 1 to 10 (A-J), or the numeric keys 0-9.

- Note that the original argument (decimal value) is left in X unaltered, so you can use **D>BS** repeated times changing the base to see the results in multiple bases without having to re-enter the decimal value. The result is left in the display for **BINVIEW**, **OCTVIEW** and **HEXVIEW** and in both the display and ALPHA for all other bases.
- Note also that using a negative value for the input in X forces the usage of the focal routine **TB** from the PPC ROM instead; with the base placed automatically in the Y register by the function prior to the call. So here you have a choice interesting for comparison purposes and for completion sake.

BS>D has the reverse functionality, to convert the entered values to decimal. It is also a launcher function, and depending on the entered base at the prompt it will automatically trigger the dedicated functions **BININ**, **OCTIN**, and **HEXIN** for binary, octal and hex cases as above. Any other base will first input the base in X and then call the FOCAL routine **BT** (taken from the PPC ROM) – just remember that this one expects the string value *already in Alpha*.

- **BT** and **TB** are a tad slower than the MCODE alternatives but the valid data ranges are larger than with any of the other methods – which makes them interesting enough to keep them around. In all cases the result is left in the X register after the conversion. Because their results are shown in the display and also left in ALPHA, you can chain them to end with the same decimal number after the two executions.

If you enter zero or one at the prompt, the execution toggles to its counterpart function - and back to it with those prompt values again. This is a convenient way to save key assignments and access the related functionality from a single location. Note as well that there are no FAT entries for the six dedicated functions used behind the scenes; the SandMath implementation automatically uses the code borrowed from the Advantage pac, but here it is located in the fourth bank of the lower page.

Let's see an example to illustrate the usage. *Computer science student Octavius Alhexander wants to calculate the conversion of decimal number 123 into the three main bases and also base 12; and then convert the results back to decimal to check to accuracy of the results.*

In all cases we first we type 123 in X, followed by repeated executions of **D>BS**:



, then the prompt with the base value results:

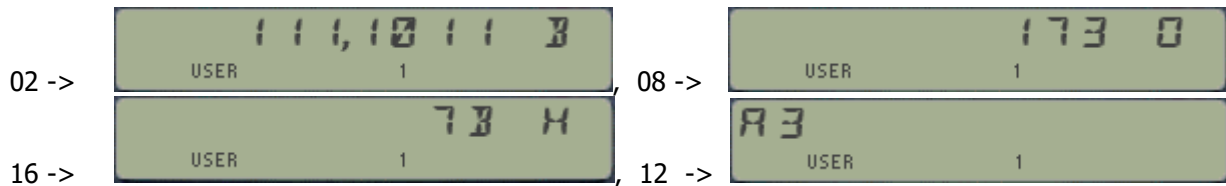

For the reverse calculation you'll need to re-enter the corresponding base value at the base prompts, once these have been triggered by the main **BS>D** function:

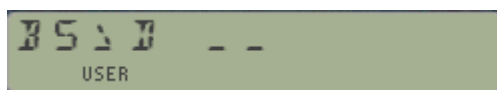

, where we fill the prompt with the desired base.

In RUN mode the maximum base allowed is 36 – and the custom error message "**BASE>36**" will be shown if exceeded (note that larger bases would require characters beyond "Z").

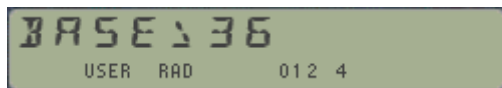

When **BINVIEW**, **OCTVIEW** and **HEXVIEW** fall short the execution is automatically transferred to **T>BS**. Then the maximum decimal value to convert depends on the destination base, since besides the math numeric factors it's also a function of the Alpha characters available (up to "Z") and the number of them in the display (length <=12). For b=16 the maximum is 99,999 E9, or 0x5AF2D4E08800

T>BS is an enhanced version of the original function, also included in Ken Emery's book "MCODE for Beginners". The author added the PRGM-compatible prompting, as well as some display trickery to eliminate the visual noise of the original implementation. Also provision for the case x=0 was added, trivially returning the character "0" for any base.

Both **D>BS** and **BS>D** are programmable. In PRGM mode the prompt is ignored and the base is expected to be in the stack, either in the Y register for **TB** to use, or in the X register for **BT**. In this case using zero or one for the base will result in "**DATA ERROR**". Additional base restrictions apply in program mode, as follows: B<=25 for **BT**, and b<=19 for **TB**.

Direct Decimal <> Hexadecimal Conversion.

Because of its importance in computer science, the decimal to hexadecimal conversions have dedicated MCODE functions in the SandMath, **D>H** and **H>D**. Use them to convert the number in X to its Hex value in Alpha, and vice-versa. Both functions are mutually reversed, and **H>D** does an stack lift as well.

The maximum number allowed is 0x2540BE3FF or 9,99999999 E9 decimal - much smaller than with **T>BS**, so there's a penalty to pay for the convenience.

These functions were written by William Graham and published in PPCJ V12N6 p19, enhancing in turn the initial versions first published by Derek Amos in PPCCJ V12N1 p3.

Details on the dedicated Number Conversions.

The following paragraphs are based on the original Advantage Manual, describing further details on the six functions embedded into the SandMath. Six functions are provided for converting numbers between decimal values and the equivalent binary, octal, and hexadecimal values, The figure below illustrates the action of these six functions.

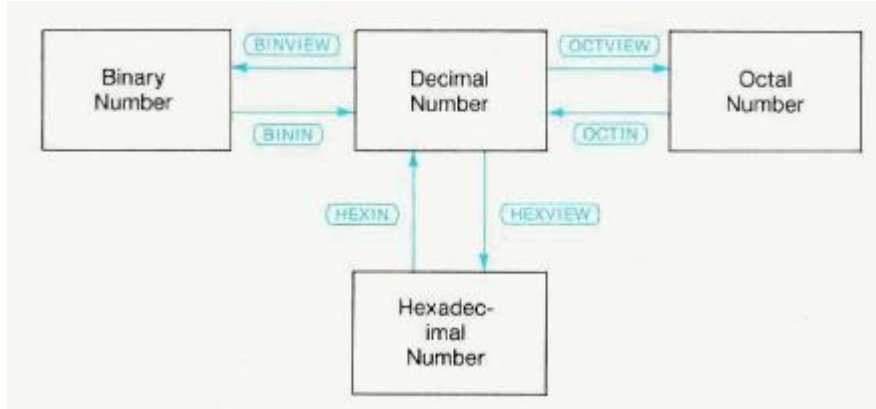

Valid Input Ranges for Data

- The binary input for BININ must be 0's and 1's; ten digits maximum. This is extended up to twelve digits max for **BS>D** in program mode (running **BT**)
- The decimal input for BINVIEW must be an integer from 0 through 1,023. Non-integers are truncated and the absolute value is used. Beyond that limit the execution is transferred to **T>BS**, which will allow integers up to 4,095.
- The octal input for OCTIN must be digits from 0 through 7; ten digits maximum. This is extended to fourteen oct chars for **BS>D** in program mode (running **BT**)
- The decimal input for OCTVIEW must be an integer from 0 through 1,073,741,823. Non-integers are truncated and the absolute value is used. Beyond that limit the execution is transferred to **T>BS**, which will allow integers up to 8,589,934,587.
- The hexadecimal input for HEXIN must be digit from 0 through 9 and letters A through F; eight digits maximum. This is extended to thirteen hex chars for **BS>D** in program mode (**BT**).
- The decimal input for HEXVIEW must be an integer from 0 through 4,294,967,295. Non-integers are truncated and the absolute value is used. Beyond that limit the execution is transferred to **T>BS**, which will allow integers up to 99,999 E9.

Instructions.

- The "VIEW" functions convert the display of the (decimal) value in the X-register, (The stack continues to hold the decimal version.) Press to display the X-register again.
- The current FIX format determines the number of digits displayed between commas of the non-decimal number.
- The "IN" functions are prefix functions: first you execute the function, then you key in your value. Press [ENTER^] to see the result.
- To abort an "IN" function press [ALPHA][ALPHA]. An "IN" function executed in a program will halt that running program.

2.1.3. First, Second and Third degree Equations.

A MCODE implementation of these offers no doubt the ultimate solution, even if it doesn't involve any high level math or sophisticated technique. The Stack is used for the coefficients as input, and for the roots as output. No data registers are used.

	Function	Description	Author
[*]	STLINE	Calculates straight line coefficients from two data points	Ángel Martín
[*]	QROOT	Calculates the two roots of the equation	Ángel Martín
	QROUT	Displays the roots in X and Y	Ángel Martín
[*]	CROOT	Calculates the three roots of the equation	Ángel Martín
	CVIETA	Driver program for CROOT	Ángel Martín

- **STLINE** is a simple function to calculate the straight line coefficients from two of its data points, $P_1(x_1,y_1)$ and $P_2(x_2,y_2)$. The formulas used are:

$$Y = ax + b, \text{ with: } a = (y_2 - y_1) / (x_2 - x_1), \text{ and } b = y_1 - a x_1$$

It is trivial to obtain the root once a and b are known, using: $x_0 = -b/a$

Example: Get the equation of the line passing through the points (1,2) and (-1,3)

3, ENTER^, -1, ENTER^, 2, ENTER^, 1, **STLINE** => Y: 2,500; X: -0,500
and its root is left in register Z: RDN, RDN => 5,000

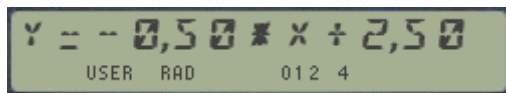

(*) will be shown in RUN mode *only*

- **QROOT**. The general forms of the Quadratic Equation is:

$$ax^2 + bx + c = 0, \text{ with } a \neq 0 .$$

Given the quadratic equation above, **QROOT** calculates its two solutions (or roots). You need to input the three coefficients into the stack registers: Z, Y, X using: a, ENTER^, b, ENTER^, c

The roots are obtained using the well-known formula: $X_{1,2} = -b/2a \pm \sqrt{(-b/2a)^2 - c/a}$

Depending on the sign of the discriminant (i.e. the argument of the square root) the result will be real or complex roots. If the discriminant is positive then the roots are real, and their values x_1 and x_2 will be left in Y and X registers upon execution. Register Z will contain a non-zero value, which can be used in program mode to determine the case.

Example: Calculate the roots of the equation: $x^2 + 2x - 3 = 0$

1, ENTER^, 2, ENTER^, 3, CHS, **QROOT** => $x_1 = 1, x_2 = -3$

In RUN mode the SandMath will show both values in the display, separated by the ampersand sign. Moreover, should the values be integers then the representation will omit the superfluous decimal places:



If the discriminant is negative, then the roots z_1 and z_2 are complex and conjugated (symmetrical over the X axis), with Real and Imaginary parts defined by:

$$\begin{aligned} \text{Re}(Z) &= -b/2a & z_1 &= \text{Re}(z) + i \text{Im}(z) \\ \text{Im}(Z) &= \sqrt{\text{abs}((-b/2a)^2 - c/a)} & z_2 &= \text{Re}(z) - i \text{Im}(z) \end{aligned}$$

Upon execution reg-Z will be zero (used in Programs), $\text{Im}(z)$ will be left in Y and $\text{Re}(z)$ will be left in X. In RUN mode the display will show the first root in a composite format showing one of the roots.

Example: Calculate the roots of the equation: $x^2 + x + 1 = 0$

1, ENTER^, ENTER^, **QROOT** => $\text{Re}(z) = -0.50000000$
 RDN => $\text{Im}(z) = 0.866025404$

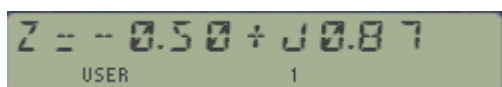

- **CROOT** The general forms of the Cubic Equation is:

$$ax^3 + bx^2 + cx + d = 0. \text{ with } a \neq 0$$

Given the cubic equation above, **CROOT** calculates the three solutions (or roots). You need to input the four coefficients in the stack registers T, Z, Y, X using:

a, ENTER^, b, ENTER^, c, ENTER^, d, ENTER^

CROOT uses the well-known Cardano-Vieta formulas to obtain the roots. The highest order coefficient doesn't need to be equal to 1, but errors will occur if the first term is zero (for obvious reasons). The SandMath implementation does reasonably well with multiple roots, but sure enough you can find corner-cases that will make it fail - yet not more so than an equivalent FOCAL program. Appendix 2 lists the code, as well as an equivalent FOCAL program to compare the sizes (much shorter, but surely much slower and with data registers requirements

Both functions can return real or complex roots. If the roots are complex, the functions will flag it in the following manners:

1. **QROOT** will clear the Z register, indicating that X and Y contain the real and imaginary parts of the two solutions. Conversely, if $Z \neq 0$ then X and Y contain the two real roots.
2. **CROOT** will leave the calculator in RAD mode, indicating that X and Y contain the real and imaginary parts of the second and third roots. The real root will always be placed in the Z register. Conversely, if the calculator is set in DEG mode then registers Z,Y, and X have the three real roots.

Example1: Calculate the three solutions of the equation: $x^3 + x^2 + x + 1 = 0$

1, ENTER^, ENTER^, ENTER^, **CROOT** → Z: -1,000; Y: 1,000; X: 1 E-10

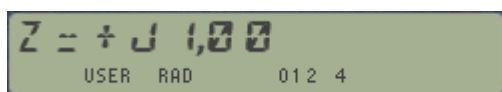

, Shown as rounded number for the real part.

Example 2:- Calculate the roots of the equation: $f(x) = 2x^3 - 3x^2 - 3x + 2$.

2, ENTER^, -3, ENTER^, ENTER^, 2, **CROOT** -> Z: 0,500; Y: -1,000; X: 2,000

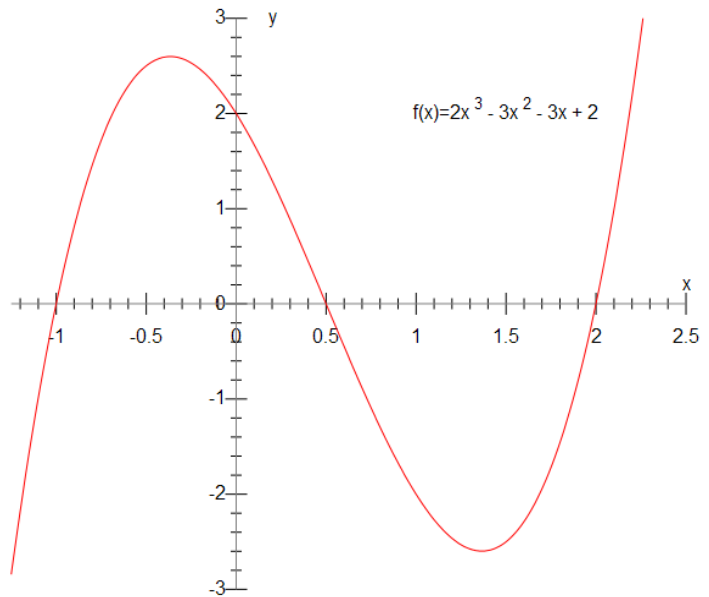

From the final prompt you know all roots are real, since the two last roots are real and the first one must always be real in a cubic equation.

The value in Z blinks briefly in the display before the final prompt above is presented; use RCL Z (or RDN, RDN) to retrieve it. No user registers are used.

QROUT outputs the contents of the X and Y registers to the display, interpreted by the value in Z to determine whether there are two real roots or the Real & Imaginary parts of the complex roots. It will be automatically invoked by **QROOT** (all cases) and by **CROOT** (real roots) when they are executed in RUN mode. Note that **CROOT** will not display the (first) real root, which will be located in Z.

CVIETA below is a driver program for **CROOT**, including the prompts for the equation coefficients. The results are placed in the stack, following the same conventions explained above. See the program listing showcasing the use of a few SandMath functions.

01	LBL "CVIETA"		16	RCL 02	<i>in stack as required</i>
02	LBL 00	<i>for new starts</i>	17	RCL 01	
03	3	<i>coeff. index</i>	18	RCL 00	
04	LBL 01		19	CROOT	
05	"a/"		20	"X="	<i>always real</i>
06	AINT		21	ARCL Z(1)	
07	" -)=?"		22	PROMPT	<i>show first root</i>
08	PROMPT		23	FS? 43	<i>is RAD mode on?</i>
09	STO IND Y(2)		24	GTO 02	<i>yes, complex roots</i>
10	RDN		25	X<> Z(1)	<i>no, clear the Z register</i>
11	DSE X(3)		26	CLX	<i>(indicates real case)</i>
12	NOP		27	X<> Z(1)	<i>restore stack</i>
13	X>=0?	<i>did them all?</i>	28	LBL 02	
14	GTO 01	<i>no, next coeff</i>	29	QROUT	<i>show other roots</i>
15	RCL 03	<i>yes, prepare data</i>	30	GTO 00	<i>new start</i>
			31	END	

Appendix 2.- CROOT equivalent FOCAL program, replaced now with an all-MCODE implementation.

01	LBL "CVIETA"		64	2	
02	-AMC MATH	"Running" message	65	/	imaginary part
03	R^		66	RCL 01	cbrt(+x-R3/2)
04	ST/ T (0)	a^2/a^3 in T	67	RCL 03	cbrt(-x-R3/2)
05	ST/ Z (1)	a^1/a^3 in Z	68	+	
06	/		69	2	
07	STO 00	$a0 = a^0 / a^3$	70	/	
08	RDN		71	CHS	
09	STO 01	$a1 = a^1 / a^3$	72	RCL 02	$a2/3$
10	RDN	$a2 = a^2 / a^3$	73	-	real part
11	3		74	,	
12	/		75	STO T (0)	flag it as Complex
13	STO 02	$a2/3$	76	RDN	Z=0 indicates it
14	X^3	$a2^3/27$	77	QROUT	
15	ST+ X (3)	$2*a2^3/27$	78	STO 01	
16	RCL 01	a1	79	X<>Y	
17	RCL 02	$a2/3$	80	STO 02	
18	*	$a1*a2/3$	81	RTN	
19	-	$2*a2^3/27 - a1*a2/3$	82	LBL 01	all real roots
20	RCL+ (00)	Showing off... :-)	83	DEG	
21	2		84	LASTX	
22	/		85	CHS	
23	STO 03	$a0/2 + a2^3/27 - a1*a2/6$	86	SQRT	
24	X^2	$(a0/2 + a2^3/27 - a1*a2/6)^2$	87	ST+ X (3)	
25	RCL 01	a1	88	X#0?	
26	RCL 02	$a2/3$	89	1/X	
27	X^2	$a2^2/9$	90	RCL 03	$a0/2 + a2^3/27 - a1*a2/6$
28	3		91	ST+ X (3)	$a0 + 2*a2^3/27 - a1*a2/3$
29	*	$a2^2/3$	92	CHS	
30	-	$a1-a2^2/3$	93	*	
31	STO 01	$a1-a2^2/3$	94	ACOS	
32	3		95	3	
33	/	$1/3 (a1 - a2^2/3)$	96	/	
34	X^3	$1/27 (a1 - a2^2/3)^3$	97	STO 03	
35	+	$1/27 (a1 - a2^2/3)^3 + (a0/2 + a2^3/27 - a1*a2/6)$	98	LASTX	
36	X<=0?		99	E3/E+	
37	GTO 01	yes, all real roots	100	STO 05	1,003
38	SQRT	complex roots	101	RCL 01	$a1-a2^2/3$
39	ENTER^		102	3	
40	ENTER^	RPLX	103	/	$a1/3-a2^2/9$
41	RCL 03	$a0/2 + a2^3/27 - a1*a2/6$	104	CHS	$a2^2/9 - a1/3$
42	-		105	SQRT	
43	CBRT		106	ST+ X (3)	
44	STO 01	$cbrt(+x-R3/2)$	107	STO 04	$2*SQR(a2^2/9 - a1/3)$
45	X<>Y		108	LBL 08	
46	CHS		109	RCL 03	
47	RCL 03	$a0/2 + a2^3/27 - a1*a2/6$	110	COS	
48	-		111	RCL 04	
49	CBRT		112	*	
50	STO 03	$cbrt(-x-R3/2)$	113	RCL 02	$a2/3$
51	+		114	-	
52	RCL 02	$a2/3$	115	"X"	
53	-		116	AIRCL	Alpha integer REG
54	"X1"		117	5	05
55	ARCL X (3)		118	"I-="	
56	AVIEW		119	ARCL X(3)	
57	STO 00	real root	120	AVIEW	
58	RCL 01	$cbrt(+x-R3/2)$	121	STO IND 05	
59	RCL 03	$cbrt(-x-R3/2)$	122	120	
60	-		123	ST+ 03	
61	3		124	ISG 05	
62	SQRT		125	GTO 08	
63	*		126	END	

2.1.4. Additional Tests: Rounded and otherwise.

Ending the first section we have the following additional test functions:

	Function	Description	Author
[*]	X=1?	Is X (exactly) equal to 1?	Nelson F. Crowle
[*]	X>=Y?	Is X equal to or greater than Y?	Ken Emery
[*]	X>=0?	Is X equal to or greater than zero?	Ángel Martin
[*]	X=YR?	Rounded Comparison	Ángel Martin
[F]	FRC?	Is X a fractional number?	Ángel Martin
[F]	INT?	Is X an integer number?	Ángel Martin
	EVEN?	Is X an even integer?	Ángel Martin
	ODD?	Is X an odd integer?	Ángel Martin
	ZOUT	Combines the values in Y and X into a complex result	Ángel Martin

They follow the general rule, returning *YES* / *NO* in RUN mode, and skipping a program line if false in a program. Their criteria are self-explanatory for the first three. These functions come very handy to reduce program steps and improve the legibility of the FOCAL programs.

- **X>=Y?** compares the values in the X and Y registers, skipping one line if false.
- **X>=0?** compares with zero the value in the X register, skipping one line if false.

These functions are arguably "missing" on the mainframe set; a fact partially corrected with the indirect comparison functions of the CX model (**X>=NN?**), but unfortunately not quite the same. On the other hand they work as two standard comparisons in series, like **X#0?** followed by **X>0?**

- **X=1?** is a quick and simple way to check whether the value in X equals one. As usual, program execution skips one step if the answer is false.
- **X=YR?** establishes the comparison of the rounded values of both X and Y, according to the current decimal digits set in the calculator. Use it to reduce the computing time (albeit at a loss of precision) when the algorithms have slow convergence or show oscillating results for larger number of decimals.
- **INT?** and **FRC?** are two more test functions which criteria is the integer or fractional nature of the number in X. Having them available comes very handy for decision branching in FOCAL programs. The Fractions section of the module is the natural placement for them.
- **EVEN?** and **ODD?** test the divisibility by 2 of the number in X, i.e. whether it is an even or an odd number. For non-integer values the fractional part will be ignored in the test.
- **ZOUT** has been used in FOCAL programs in the SandMath, - Its most interesting features are perhaps displaying integer values (in either real or imaginary parts) without any decimals; as well as omitting them when equal to zero (showing "Z=0" if both are null).

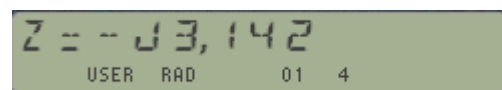
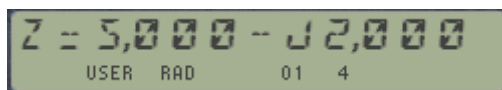

2.2. FRACTIONS

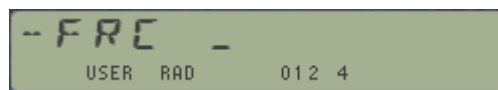

2.2.1. Fraction Arithmetic and Displaying.

A rudimentary set of fraction arithmetic functions is included in the SandMath, including the four basic operations plus a fraction viewer and two test functions.

	Function	Description	Author
[*]	-FCR	Fractions Launcher	Ángel Martin
[F]	D>F	Calculates a fraction that gives the number in X	Frans de Vries
[F]	F+	Fraction addition	Ángel Martin
[F]	F-	Fraction subtraction	Ángel Martin
[F]	F/	Fraction multiplication	Ángel Martin
[F]	F*	Fraction division	Ángel Martin
[F]	FRC?	Is X a fractional number?	Ángel Martin
[F]	INT?	Is X an integer number?	Ángel Martin

D>F is the key function within this group. Shows in the display the *smallest possible fraction* that results in the decimal number in X, for the current display precision set. Change the display precision as appropriate to adjust the accuracy of the results.

This means the fraction obtained may be different depending on the settings, returning different results. For example, the following approximations are found for π :

$$\begin{aligned} \pi &\sim 104348/33215 && \text{in FIX 9, FIX 8 and FIX 7} \\ \pi &\sim 355/113 && \text{in FIX 6, FIX 5 and FIX 4} \\ \pi &\sim 333/106 && \text{in FIX 3} \\ \pi &\sim 22/7 && \text{in FIX 2, FIX 1 and FIX 0} \end{aligned}$$

This function was written by Frans de Vries, and published in DataFile, DF V9N7 p8. It uses the same algorithm as the PPC ROM "DF" routine.

As per the fraction arithmetic functions, there's not much to say about them – apart from the fact that they use the four stack levels to enter both fractions components (the inputted values are expected to be all integers), and return the numerator and denominator of the result fraction in registers Y and X respectively. In RUN mode the execution continues to show the fraction result in ALPHA, according to the currently set number of decimals (see below).

The fraction arithmetic functions can be used in chained calculations, there's no need to re-enter the intermediate results, and the Stack enabled makes unnecessary to press ENTER^. Notice that fractions are entered using the Numerator first.

To re-calculate the fraction after changing the decimal settings just press the divide key, followed by **D>F** to re-generate the fraction values.

For example calculate 2/7 over 4/13, then add 9/17 to the result.

2, ENTER^, 7, ENTER^, 4, ENTER^, 13, **F/**, 9, ENTER^, 17, **F+** → 347/238 in FIX 6 mode.

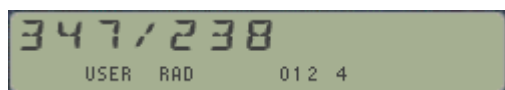

Needless to say the fractional representation display will not be produced in PRGM mode, but it'll have a silent execution instead.

Note that the fraction math functions operate on integer numbers in the stack, returning also the numerator and denominator as integers. To get the decimal number just execute $\boxed{\boxed{/}}$ to divide them.

In fact that's exactly what the functions do in RUN mode: upon completion the fraction is "converted" to a decimal number, then **D>F** presents the final output. That's why the display settings determine the accuracy of the conversions, even if it's not obviously seen.

This has the advantage that *the result is always reduced to the best possible fit*. For instance, when calculating 2/4 plus 18/24 in program mode – with the four values in the stack – the result will be 120 in Y and 96 in X (thus 120/96). However on RUN mode (or SST'ing the program) will show the reduced fraction:

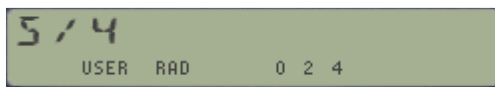

A good way to check that the result is expressed in irreducible form is pressing **GCD**, verifying that the result is indeed 1; try it out if you're curious.

If you want to see the reduced result from a program execution you'll need to add program steps to perform the division and add a conversion to fraction after the fraction-math operation step. The code snippet below describes this (see lines 10 and 11):

```

01 *LBL "TEST"
02 2
03 ENTER^
04 4
05 ENTER^
06 18
07 ENTER^
08 24
09 F+
10 /
11 D>F
12 END
    
```

$\boxed{\boxed{INT?}}$ and $\boxed{\boxed{FRC?}}$ are two more test functions which criteria is the integer or fractional nature of the number in X. Having them available comes very handy for decision branching in FOCAL programs. The Fractions section of the module is the natural placement for them.

The answer is YES / NO depending on whether the condition is true or false. In program mode the following line is skipped if the test is false.

Note: Make sure that revision "R" (or higher) of the Library#4 module is installed.

2.3. HYPERBOLICS.

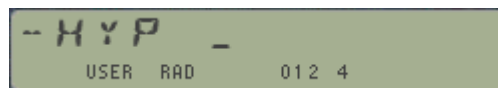

2.3.1. Hyperbolic Functions.

Yes there are many unanswered questions in the universe, but certainly one of them is why, oh why, didn't HP-MotherGoose provide a decent set of MCODE hyperbolic functions in the (otherwise pathetic) MATH-PAC, and worse yet -adding insult to injury- how come that error wasn't corrected in the Advantage ROM?

For sure we'll never know, so it's about time we move on and get on with our lives – whilst correcting this forever and ever. The first incarnation of these functions came in the AECROM module; I believe programmed by Nelson F. Crowle, a real genius behind such ground-breaking module - but it was also somehow limited to 10-digit precision. The versions in the SandMath all use internally13-digit routines.

	Function	Description	Author
[*]	-HYP	Hyperbolic Launcher	Ángel Martin
[H]	HSIN	Hyperbolic Sine	Ángel Martin
[H]	HCOS	Hyperbolic Cosine	Ángel Martin
[H]	HTAN	Hyperbolic Tangent	JM Baillard
[H]	HASIN	Inverse Hyperbolic Sine	Ángel Martin
[H]	HACOS	Inverse Hyperbolic Cosine	Ángel Martin
[H]	HATAN	Inverse Hyperbolic Tangent	JM Baillard

The use of function launchers permits convenient access to these six functions without having to assign them to any key in USER mode. Efficient usage of the keyboard, which can double up for other launchers or the standard USER mode assignment if that's also required. Combining the Σ FL and the SHIFT keys does the trick in a clean and logical way.

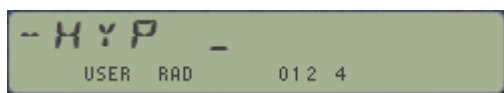

and inverses:

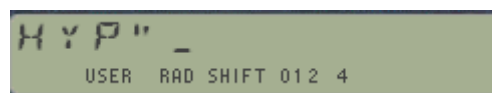

The formulas used are well known and don't require any special consideration to program.

$$\sinh x = \frac{e^x - e^{-x}}{2}$$

$$\cosh x = \frac{e^x + e^{-x}}{2}$$

$$\tanh x = \frac{e^{2x} - 1}{e^{2x} + 1}$$

The SINH code is also used as a subroutine for the Digamma function.

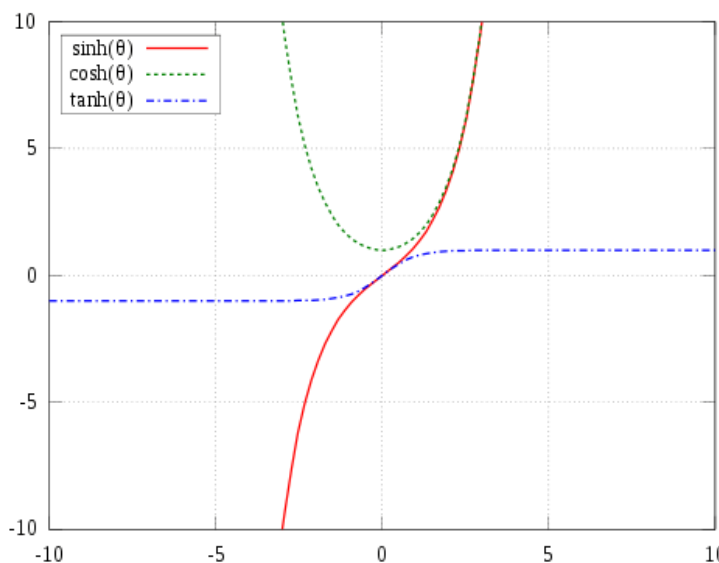

The direct functions are basically exponentials, whilst the inverses are basically logarithms.

Both cases are well covered with the mainframe internal math routines without any need to worry about singularities or special error handling.

$$\operatorname{arsinh} x = \ln \left(x + \sqrt{x^2 + 1} \right)$$

$$\operatorname{arcosh} x = \ln \left(x + \sqrt{x^2 - 1} \right); x \geq 1$$

$$\operatorname{artanh} x = \frac{1}{2} \ln \frac{1+x}{1-x}; |x| < 1$$

For all hyperbolic functions the input value is expected in X, and the return value will also be left in X. The original argument is saved in LASTx. No data registers are used.

Examples:

Complete the table below, calculating the inverses of the results to compare them with the original arguments. Use FIX 9 to see the complete decimal range.



HMKEYS assigns **-HYP** to the [SHIFT] key for convenience

x	HSIN	HASIN	HCOS	HACOS	HTAN	HATAN
1	1,175201194	1,000000000	1,543080635	1,000000000	0,761594156	0,761594156
1,001	1,176744862	1,001000000	1,544256608	1,001000000	0,762013811	1,001000000
0.01	0,010000167	0,010000000	1,000050000	0,009999958	0,009999667	0,010000000
0.0001	0,000100000	0,000100000	1,000000005	0,000100000	0,000100000	0,000100000
10	11013,23287	10,00000000	11013,23292	10,00000000	0,999999996	10,00271302

By now you've become an expert in the HYP launcher and for sure appreciate its compactness – lots of keystrokes!

With a couple of exceptions it's a100% accuracy to 10 decimal places – and really the only sore point is in the point 0.001 for **HACOS**. But don't worry, there's no bugs creating havoc here – it's just the nature of the beast, bound to occur with the limited precision (even using 13-digits) in the Coconut CPU.

No wonder you're going to repeat the same table for the trigonometric functions and see how it stacks up, right?

While you're at it, go ahead and calculate the power of two of the square root, pressing:

FIX **9** , **2** , **SQRT** , **X^2** , but don't call HP to report a bug!

For very small arguments the accuracy of **SINH** and **COSH** will also start showing incorrect digits. However **HTAN** (and **HATAN**) use an enhanced formula that will hold the accuracy regardless of how small the argument is.

Note: Make sure that revision "R" (or higher) of the Library#4 module is installed.

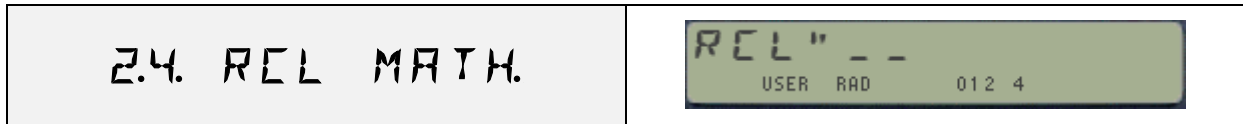

The SandMath Module includes a set of functions written to extend the native RCL functionality – mainly in the direct math operations missing when compared to the STO equivalents, but also increasing its versatility and ease of use. There are five new RCL Math functions, all connected to the native RCL function behind the scenes to access them in a convenient and useful way:

	Function	Description	Author
[*]	RCL __	RCL Math Launcher	HP Co,
[RC]	RC+ __	RCL Addition	Ángel Martin
[RC]	RC- __	RCL Subtraction	Ángel Martin
[RC]	RC* __	RCL Multiply	Ángel Martin
[RC]	RC/ __	RCL Division	Ángel Martin
[RC]	RC^ __	RCL Power	Ángel Martin
[RC]	AIRCL __	ARCL integer Part of number in Register nn	Ángel Martin

2.4.1. Individual Recall Math functions.

The new five RCL Math functions cover the range of four arithmetic operations (like STO does) plus a new one added for completion sake. The functions would recall the number in the register specified by the prompt, performing the appropriate math using the value in register X as first argument and the recalled number as the second argument.

Design criteria for these were:

1. should be prompting functions
2. should support stack registers, indirect addressing, and both combined.
3. should utilize the top 2 rows for index entry shortcut.

The first condition is easy to implement in RUN mode, as it's just a matter of selecting the appropriate prompting bits in the function MCODE name - but it gets tricky when used under program mode. This has been elegantly resolved with a method first used by Doug Wilder, by means of using the program line following the instruction as the index argument. Somewhat similar to the way the HEPAX implemented it, although here there's some advantages in that the length of the index argument doesn't need to be fixed, dropping leading zeroes and even omitting it altogether if it's zero (assuming the following line isn't a numeric one which could be misinterpreted).



The indirect addressing is actually quite simple, as it simply consists of an offset added to the register number in the index. All the function code must do is remove it from the entry data provided by the OS, and the task is done. The offset value is hex 80, or 128 decimal. We'll revisit this when discussing the RCL launcher.

For the third objective we cannot rely on the OS – just using the appropriate prompting bits in the function's name. There is an important limitation if the implementation is done using the standard prompting approach: Stack arguments are not supported – as they are more involved than the indirect addressing. The SandMath uses a custom, from-the-scratch implementation that replaces the standard one, and offers support for the Stack registers, in direct and indirect forms.

2.4.2. The Extended RCL and prompt Lengthener.



The Standard RCL has been extended to support the input of the math keys – triggering the five functions described above. Besides that, also the [EEX] key can be used for a prompt lengthener to three fields for registers over 99. This prompt extension however is effectively limited to the range R100 to R111 – because from R112 and above the index is interpreted by the OS either as stack registers (112 to 127) or as indirect register addresses (from 128 and above) instead.

The table below (borrowed from the AMC_OS/X Manual) shows the correspondence between the extended arguments and the actual registers used. Note that:

- In the range 102-111 the display is showing the conventions used for the LBL instructions, but the actual registers are correct.
- In the range 112-127 the registers used are the status registers instead of memory data registers. This is what we take advantage of to key in status registers as arguments.
- From 128 and up the instruction changes to indirect indexing. This is due to the way indirect addresses are built by the OS; adding hex 0x80 to the register number. This scheme is also applicable th the status registers!

Argument	Shown:	Argument	Shown:	Argument	Shown:
100	00	112	T	124	b
101	01	113	Z	125	c
102	A	114	Y	126	d
103	B	115	X	127	e
104	C	116	L	128	IND 00
105	D	117	M	129	IND 01
106	E	118	N	130	IND 02
107	F	119	O	131	IND 03
108	G	120	P	132	IND 04
109	H	121	Q	133	IND 05
110	I	122	-	134	IND 06
111	J	123	a	135	IND 07

The prompt lengthener is meant to be used with the following functions: STO, RCL, X<>, LBL and GTO. It however can also be invoked during other prompts (like SF, CF, FS?) which obviously have none or partial practical application for it, and that will typically generate the NONEXISTENT error message.

Example: Store 5 in register R101, and 5555,000 in register R5.

With the new prompt lengthener we can do this without indirect addressing, as follows:
5, [STO], [EEX], [0], [1] and then: 5555, STO 5

Then execute RCL" IND 101 (press [RCL], [SHIFT], [EEX], [0], [1])--> to obtain 5555,00 in X

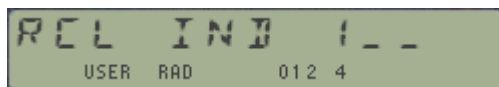

The keyboard mapping for [RCL] is as follows – nothe the standard group (first four choices) and the extensions provided by the SandMath:

- Numeric keypad (or Top rows) to perform the standard RCL
- [,] radix key for Stack arguments
- [SHIFT] for Indirect register addresses
- Back arrow to cancel out.

- [EEX] for the prompt lengthener to three places
- Math keys (+, -, /, *, and ^) to invoke the RCL Match functions
- [ALPHA] to invoke the **AIRCL** function
- [CHS] key to disable/enable the Floating FIX, described further below
- [XEQ] key to return to the main launcher **ΣFL**

Program Usage.

The Recall Math functions are fully programmable. When entered in a program the program step following it will be used to hold the register number to be used by the prompt when the program runs. This technique is known as "*non-merged*" functions, to work-around the limitation of the OS – Too bad we can't use the Byte Table locations wasted by **eGObEEP** and **W**" instead! This method is used in several functions of the SandMath module, like the RCL math functions just described.

Therefore when used in a program, the corresponding RCL# math function will prompt for a register number but (contrary to the STO math case) it won't be part of the same program step. **The argument will be added automatically by the function** as another program line following the RCL# function.

Notice also that indirect addressing is supported by this scheme: the argument will add hex 80 (that is decimal 128) to the register number as indirect register. As simple as that! So for instance "RC+ IND 25" will be entered as the following two program lines: **RC+**, followed by 153.

The same rule applies to the Stack registers – which are also usable in program mode. For instance "RC+ Z" = **RC+** followed by 113; and "RC+ IND Z" = **RC+** followed by 241 (that is: 113+128).

Pressing [ALPHA] at the RCL prompt invokes function **AIRCL _ _**. This will in turn prompt for a data register number, and once filled it'll append the integer part of the value stored in that register to the ALPHA register – thus equivalent to what **AINT** does with the x register.

The I/O_Service Interrupt

The technique used here takes advantage of the I/O_SVC interrupt (polling point). Because it uses the native RCL function it doesn't require any key assignments nor the USER mode to be active to work – **this functionality is always available with the SandMath plugged in.**

Furthermore, the prompt lengthener using the EEX shortcut is available for any prompting function, with either two-digit prompt (like STO, VIEW, X<>, etc.) or one digit prompt (like FIX, ENG, SCI, TONE). **The CAT and XEQ functions are excluded**, thus this scheme is fully compatible with the OS/X extensions from the AMC_OS/X module or the CCD Module.

Lastly, the standard 1-digit prompt for functions like FIX, SCI, ENG, TONE, etc. will automatically show two fields for a 2-digit input (or three if you press EEX at this point). Refer to the synthetic programming manuals for practical applications of the combinations above and beyond the standard.

2.4.3. The dynamic display mode: A Floating FIX.-

Later calculator models like the HP-35S offer a display mode (called FIX ALL) that automatically shows values with all the meaningful decimal places, i.e. excluding the trailing zeros. This is not only a cosmetic arrangement; its main value is to always have all needed information shown without having to adjust the FIX to see whether more decimal digits are relevant – and to not show the trailing zeros we'd get if chose the more strict FIX 9 setting required to make sure all the information was there.

The idea of a dynamic FIX mode (later coined as Floating FIX) can be implemented using the I/O_SVC interrupt as well, simply showing the number in X using a FIX setting that matches the relevant number of decimal digits – all done after the result is placed there.

So from a conceptual perspective it's relatively simple: the core is a routine to inspect the mantissa and exponent, and figure out the required FIX – which obviously needs to be confined to [0, 9] as per the numeric range of the calculator. Then we use the I/O_SVC event to display the result with that FIX – all without changing the actual display setting (FIX, ENG, SCI – and number of places will not be altered).

Under those assumptions:

- integers values are shown in FIX 0
- PI is shown in FIX 9
- Numbers between 1 E-10 and 1 E10 are dynamically shown
- Numbers equal to and smaller than 1 E-10 are displayed in SCI mode
- Numbers equal to or larger than 1 E10 are displayed in SCI mode
- Also in SCI form the mantissa will only show the relevant digits.

The Floating FIX mode is turned off by default. You need to use function **-RCLIO** and answer "Y" to its prompt to turn it on. In fact, this setting affects all functionality that uses the I/O_SVC interrupt methodology, thus the RCL math and prompt lengtheners will also be affected by the selection.



This setting is stored as a flag in the header of Buffer#9 – the SandMath buffer. It'll be remembered when you switch the calculator OFF and ON, but will be gone in case of Memory Lost or if the buffer is erased. Make sure you power-cycle the calculator when plugging the SandMath on the CL.

Formulas used – A general algorithm.

Numbers on the 41 platform are represented by the following convention, " s | abcdefghij | xyz ", with one digit for the mantissa sign, 10 digits for the mantissa, one for the exponent sign and two for the exponent. This enables a numeric range between +/- 9,999999999 E99, with a "whole" around zero defined by the interval] -1 E-99, 1 E-99 [

Let z# = number of mantissa digits equal to zero, starting from the most significant one (i.e. from PT=3 to PT=12). Then the fix setting to use is a function of the number in X , represented as follows:

1. If number ≥ 1 (or x="0") - Let XP = value of exponent (yz). Then we have:

$$\text{FIX} = \max \{ 0, [(9-z\#) + \text{XP}] \}$$

2. If number < 1 (or x="9") - Let |XP| = (100 – xyz) . Then we have:

$$\text{FIX} = \min \{ 9, [(9-z\#) + |\text{XP}|] \}$$

Implementation Details – a MCODE digression.

Here are some gory details for the MCODE-inclined folks – feel free to ignore completely if this is not your cup of tea.

Taking advantage of the I/O_SVC Interrupt is not easy to implement, even if conceptually simple. For starters, one needs to keep in mind that the event is triggered after the operations have occurred – thus is not to be mistaken with a code break during the execution.

Then there is also the fact that a constant polling of the I/O_SVC will introduce noticeable overhead on the system performance, thus one needs to carefully choose the instances and scenarios where the supplemental code is to be run. Doing it too often will cause annoying delays, but missing some will result in an inconsistent or incomplete implementation of the added functionality.

To make it more complicated, this technique is also used by other modules that the implementation here needs to be compatible with. Not an easy task; you probably know that the ZENROM and the CCD Module are not compatible, and that the AECROM takes over all the attention to maintain the results in the chosen unit (Foot, meters, inch fractions).

The criteria followed by the SandMath is full compatibility with the AMC_OS/X and CCD-style modules, regardless of the order they are plugged in the machine. That's why the criteria needs to go to lower-level conditions (like pending addresses in the RTN stack and keycodes for the pressed keys) instead of more general events, like parsing OS routines.

Here's the conditional tree used to qualify I/O events into triggering points in the SandMath.

General conditions:

1. Is Alpha ON? - Ignore if true.
2. Is the 1st. RTN address from the OS ROM_0 / ROM_1? - Ignore if False.

Conditions for the Floating FIX mode:

3. Is the message flag ON? - Ignore if true.
4. Is the 1st. RTN address = 00F0 [NFRPU], or 0CCA [STO], or 10DA [AJ]? - Ignore if False

Conditions for the RCL Math and Prompt Lengtheners

5. Is the 1st. RTN adr = 0CDE [PAR110]? - Mid term of a 2-digit prompt when True
 - a. Further check on keycode to exclude XEQ, replace it otherwise.
6. Is the 1st. RTN adr = 0D22 [PARA05]? – Mid term of a 1-digit prompt when True
 - a. Further check on keycode to exclude CAT, replace it otherwise
7. Is the 1st. RTN adr = 0DC4 [IND20] ? IND prompt situation when True
 - a. Is the 2nd. RTN adr = 122E [RCL]? – Replace the first adr when True (IND 1_ _)

Say what?, Not a Fool-Proof result !

One last word about the expected results:- This is a good example of the additional difficulty arising from the afterthought nature of a task that would be basically simple had it been done integrated into the OS. Coming from behind the OS to supplement/complement its doings is not the best way to implement this functionality, which ideally belongs to the OS displaying routines instead. Thus you'll find some instances when the Floating FIX mode won't kick in, like using STO and then numeric keys (but note that it does work using the top-two rows, A-J).

I have tested the outcome of all functions within the SandMath, modifying some of them to make sure that they provide the triggering conditions for the Floating mode to operate. With other modules the implementation may have some glitches, depending on how their functions were written.

There is currently a limitation for some functions when you execute them using the LASTFunction method, so be aware of that as well.

Appendix 3.- A trip down to Memory Lane. From the HP-41 User's Handbook.-

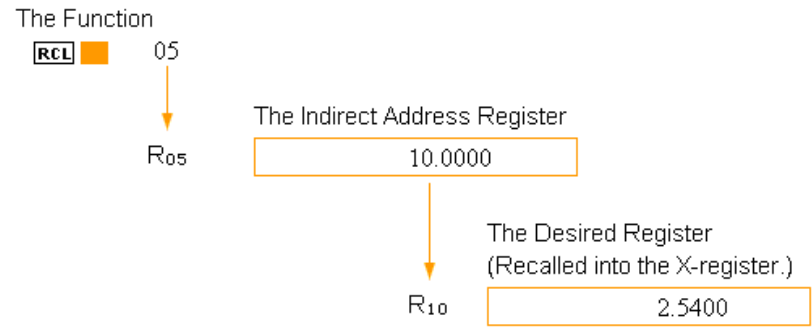
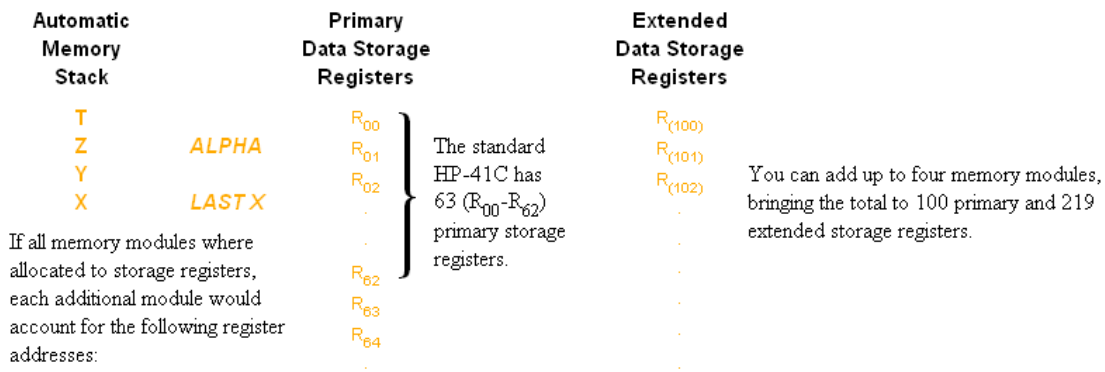

Storage Register Arithmetic

Arithmetic can be performed upon the contents of all storage registers by executing **STO** followed by the arithmetic function followed in turn by the register address. For example:

Opertion	Result
STO + 01	Number in X-register is added to the contents of register R ₀₁ , and the sum is placed into R ₀₁ . The display execution form of this is ST+ .
STO - 02	Number in X-register is subtracted from the contents of register R ₀₂ , and the difference is placed into R ₀₂ . The display execution form of this is ST- .
STO × 03	Number in X-register is multiplied by the contents of register R ₀₃ , and the product is placed into R ₀₃ . The display execution form of this is ST× .
STO ÷ 04	Number in R ₀₄ is divided by the number in the X-register, and the quotient is placed into R ₀₄ . The display execution form of this is ST÷ .

Primary Data Storage Registers

The standard HP-41C has 63 registers that can be allocated to data storage or program memory in *any* combination. As you add HP memory Modules (up to four), the total number of registers can increase to 319-64 registers for each memory module. When allocated, data storage registers numbered R_{00} through R_{99} are Primary Data Storage Registers.

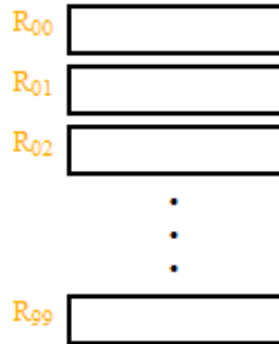

Extended Data Storage Registers

When allocated, data storage registers numbered $R_{(100)}$ through $R_{(319)}$ are extended Data Storage Registers.

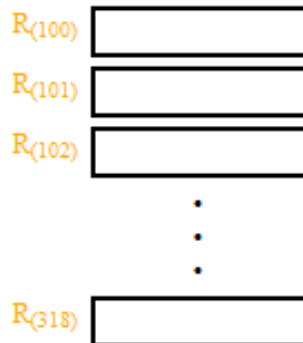

Program Memory

All registers that are not allocated as Primary or Extended data storage registers are part of program memory. When allocated as program memory, the standard HP-41C registers provide space for 200-400 fully-merged lines of programs. When allocated as program memory, each memory module adds 200-400 lines. The total can be 1000-2000 lines when all 319 registers are allocated as program memory. Variations in storage capacity depend on the kinds of functions stored in program memory.

Note: Make sure that revision "R" (or higher) of the Library#4 module is installed.

2.5. DERIVATIVES & CONTINUED FRACT.

These functions are taken from the GJM Module recently released by Greg McClure, based on the seminal work from Jean-Marc Baillard (see web pages <http://hp41programs.yolasite.com/derive.php> and <http://hp41programs.yolasite.com/contfrac.php>)

Being a full MCODE solution this new method benefits from the MCODE accuracy and speed, while still maintaining the flexibility provided by a user-defined function in the usual form of a FOCAL program. In this regard it's very similar to the SOLVE and INTEGRATE approach (more on those later in the manual), only that the implementation uses a much simplified structure – that doesn't require custom buffers or other techniques.

	Function	Description	Author
	DERV _	Function 1 st . and 2 nd . Derivatives	Greg McClure
	CF2V _	Continued Fractions Evaluation	Greg McClure
	XQRTN	Auxiliary function to Return to MCODE	Martin-McClure

2.5.1. Function Derivatives.

The **DERV** function calculates the 1st and 2nd derivatives of a global function defined by the user (and thus visible via Catalog 1). The function needs to be continuous thru the range around the value at which the derivatives of the function are desired. The program uses data registers {R00-R04} as follows: R00 and R01 to sum the term evaluations obtained by the formula used; R02 is used for the value sent to the user program, R03 is the saved step size, and R04 to contain the counter (which goes from 0 to 10).

Besides the user function name in ALPHA, the program takes two input values: the point where the derivatives are to be evaluated, and the step size to use for the derivative evaluation formula (this is the distance between points sampled). When developing this program, many formulas were available to use... this program uses the 10-point formulas developed by Jean-Marc Baillard. It takes a bit longer than the formulas used by the PPC module, but the accuracy is far better. The PPC module **FD** program does have one advantage: it finds a one-sided formula (useful in case of discontinuity at a point) - however it does not do a 2nd derivative calculation.

The formulas used are as follows: - $f(x+k.h)$ is denoted f_k to simplify these expressions -

$$df/dx = (1/2520.h).[2100.(f_1 - f_{-1}) - 600.(f_2 - f_{-2}) + 150.(f_3 - f_{-3}) - 25.(f_4 - f_{-4}) + 2.(f_5 - f_{-5})] + O(h^{10})$$

$$d^2f/dx^2 = (1/25200.h^2).[-73766 f_0 + 42000.(f_1 + f_{-1}) - 6000.(f_2 + f_{-2}) + 1000.(f_3 + f_{-3}) - 125.(f_4 + f_{-4}) + 8.(f_5 + f_{-5})] + O(h^{10})$$

These are exact for any polynomial of degree < 11

The implementation of **DERV** also makes use of an auxiliary function, **XQRTN** (described below). It is NOT designed to be used in the user function created, which only need RTN or END to terminate the FOCAL code that defines them. Why then is XQRTN needed? The operating system normally does not allow returning to MCODE from FOCAL programs. So to overcome this restriction **DERV** jumps to a mini-FOCAL program that contains **XQRTN** to execute the user function and return back to the **DERV** MCODE after doing a real RTN.

All this is transparent to the user, who needs only to provide the function name in ALPHA and the input values in the Y- and X- registers as described above. The execution ends with the first derivative value in X and R00, and the second derivative value in Y and R01.

Example 1.

Let's say we want to find the derivative of $f(x) = \sin(x)$ at $x=1$. First we need to create a Global label program to define the function (as it cannot use mainframe function names). Note that RAD can be removed if manually set before executing DERV:

```
01 LBL "AA"
02 RAD
03 SIN
04 END
```

Let's try a step value of .03 (so the points sampled will be (.85, .88, .91, ..., 1.12, 1.15).

Type: .03, ENTER^, 1, ALPHA, "AA", ALPHA, XEQ "DERV" => "RUNNING..."

On return, both R00 and X contains 0.540302302 (the actual 1st. derivative is 0.54032306) and R01 and Y contains -0.841470900 (the actual 2nd derivative is -0.841470985).

Testing the sine function for other values and step sizes is easy if you use the explicit derivatives, $f'(\sin(x)) = \cos(x)$, and $f''(\cos(x)) = -\sin(x)$, that is to say, you can test the values obtained by this program for this example by taking the $\cos(x)$ and $-\sin(x)$ for the actual 1st and 2nd derivative values.

Example 2.-

Calculate $f'(1)$ & $f''(1)$ for: $f(x) = \exp(-x^2)$

We program the function using any global LBL , 6 characters or less

```
01 LBL "T"
02 X^2
03 CHS
04 E^X
05 RTN
```

If we choose $h = 0.03$ as step-size we type:

0.03 ENTER^, 1, ALPHA "T" ALPHA, XEQ "DERV" -> "RUNNING..."

$f'(1) = -0.735758961$ the exact value is $f'(x) = -2x \cdot \exp(-x^2) = -0.735758882$

X<>Y

$f''(1) = 0.735757408$; the exact value is: $f''(x) = (4x^2 - 2) \cdot \exp(-x^2) = 0.735758882$

Choosing the best h-value is not easy but $h \sim 0.03$ "often" produces good results. Be aware that unfortunately the better step-size for the first derivative may not be a good one for the second and vice-versa.

For further information on this subject you should also refer to the **TAYLOR** approximation chapter of this manual, which includes examples of function derivatives up to order 10 as a collateral application of the TAYLOR formulas around the point of expansion.

Appendix 4.- Newton's and Halley's methods for SOLVE.

Since **DERV** calculates the first and second derivatives at the given point, it's a logical choice for the Newton and Halley's method to solve for an equation $f(x)=0$. Simply picking the results delivered by DERV and using them in the appropriate formulas:

$$x_{n+1} = x_n - \frac{f(x_n)}{f'(x_n)} \qquad x_{n+1} = x_n - \frac{2f(x_n)f'(x_n)}{2[f'(x_n)]^2 - f(x_n)f''(x_n)}$$

The routine below shows the FOCAL program to implement this idea:

01	LBL "dNWT"		22	FS? 01	Halley?
02	CF 01		23	XEQ 02	
03	GTO 01		24	RCL 06	x0
04	LBL "dHALL"		25	RCL 06	
05	SF 01		26	RC- 07	x1
06	LBL 01		27	X#Y?	x1 = x0 ?
07	ASTO 05		28	GTO 00	no, loop back
08	X<>Y		29	CLD	yes, clear LCD
09	STO 08		30	RTN	done.
10	X<>Y		31	LBL 02	
11	LBL 00		32	X^2	(f')^2
12	FS? 10	show?	33	ST+ X(3)	
13	VIEW X	yep	34	RCL 07	f
14	STO 06	x0	35	RC* 01	f*f''
15	XEQ IND 05		36	-	2.(f')^2 - f*f''
16	STO 07	f	37	1/X	
17	RCL 08		38	RC* 07	
18	RCL 06		39	RC* 00	
19	DERV		40	ST+ X(3)	
20	FC? 01	Newton?	41	STO 07	new ref. value
21	ST/ 07	f/f'	42	END	

Example: Calculate one root of $f(x) = X^3 - X^2 - X + 0.5$ near the abscissa $x_0=2$

Fist we program the function under the global label "X1":

```

01 LBL "X1"           06 +
02 X^3                07 -
03 LASTX              08 ,5
04 X^2                09 +
05 LASTX              10 END
    
```

And now, Using $h = 0.01$, we'll type: ALPHA, "X1", ALPHA

```

0.01, ENTER^, 2, XEQ "dNWET" => 1.451605963
0.01, ENTER^, 2, XEQ "dHALL" => 1.451605963
    
```

Note that the routines always work with 9-decimal places, irrespective of the display FIX settings.

As a final comment, remebber that the SandMath includes **FROOT**, the MCODE implementation of SOLVE – vastly superior to the routines covered by this appendix.

2.5.2. Continued Fractions

Continued Fractions are expressions of the form:

$$B(0) + \frac{A(1)}{B(1) + \frac{A(2)}{B(2) + \dots \frac{A(N)}{B(N) + \dots}}$$

The use of + in the denominator indicates that the remainder of the terms actually are part of that denominator. So the above expression means $B(0) + A(1) / [B(1) + A(2) / [B(2) + A(3) / [...]]]$.

This can be mathematically abbreviated as $B(0) + [A(1), A(2), A(3), \dots ; B(1), B(2), B(3), \dots]$ which will be used here. The number of expressions may or may not be infinite.

Many values are easily expressed as continued fractions. Some examples are:

$$\text{Tanh}(x) = [X, X^2, X^2, X^2, \dots ; 1, 3, 5, 7, \dots]$$

$$\text{Pi} = [4, 12, 32, 52, 72, \dots ; 1, 2, 2, 2, 2, \dots] \text{ (one of MANY representations of Pi)}$$

$$1 / (e-1) = [1, 1, 1, 1, \dots ; 2, 2, 2, 2, \dots] \text{ (again one of MANY representations of e)}$$

The simpler form of continued fractions often used are expressions with $A(n)=1$, therefore of the form: $B(0)+1/(B(1)+) 1/(B(2)+)... 1/(B(n)+)...$

mathematically abbreviated as $[B(0); B(1), B(2), B(3), \dots]$. For example:

$$e = [2; 1, 2, 1, 1, 4, 1, 1, 6, 1, 1, 8, \dots]$$

Some expressions are not so easily represented in this form. For example:

$$\text{Pi} = [3; 7, 15, 1, 292, 1, 1, 1, 2, 1, 3, 1, \dots] \text{ (there is no pattern to express the next B(N))}.$$

The **CF2V** function is designed to calculate a continued fraction value. It requires a user created subroutine that calculates $A(n)$ and $B(n)$ for $n \geq 1$. The function makes X available in R01 and n available in R02 for this program, and expects $A(n)$ in stack register X and $B(n)$ in stack register Y on completion of the user subroutine. The subroutine must be callable by a global label (of up to 7 characters). The program uses R00 thru R04.

To execute CF2V, put the value of $B(0)$ in stack register Y, and the value of evaluation point x in stack register X; then put the name of the routine that calculates both $A(N)$ and $B(N)$ into the alpha register. Execute CF2V to evaluate the continued fraction.

Here is an example of use of **CF2V**. Let's say we want to evaluate the Tanh function mentioned above. We would create the following program in memory (assume we use the label TT):

01 LBL "TT"	08 LBL 01
02 RCL 02 ; get n from R02	09 - ; (n-1) in X
03 1 ; Is it 1?	10 RCL 02 ; get n again
04 X#Y?	11 + ; (2n-1) in X
05 GTO 01 ; No, skip to LBL 01	12 RCL 01
06 RCL 01 ; B(1) = 1 in Y, A(1) = x in X	13 X^2 ; B(n) = (2n - 1) in Y,
07 RTN	14 END ; A(n) = x^2 in X

To evaluate Tanh(1) with B(0)=0 enter the following:

0 , ENTER ^, 1 , ALPHA , "TT" , ALPHA and execute **CF2V**. -> "RUNNING..."

The answer of 0.761594156 (assuming FIX 9) is displayed in a few seconds. The value returned should be accurate to at least 9 significant digits.

Try 0, ENTER ^ 2 (to evaluate Tanh(2)), execute CF2V, answer is 0.964027580.

If you want to see the estimates as they are calculated, just put a VIEW 00 statement at the beginning of routine "TT".

A more interesting example might be the Incomplete Gamma functions. As you know the following relationship applies for three Gamma functions:

$$\gamma(a, x) + \Gamma(a, x) = \Gamma(a)$$

Continued fractions exist for both lower and upper functions:

$$\Gamma(a, x) = [x^a e^{-x}, a - 1, 2(a - 2), 3(a - 3), \dots; 1 + x - a, 3 + x - a, 5 + x - a, 7 + x - a, \dots]$$

$$\gamma(a, x) = [x^a e^{-x}, -ax, x, -(a + 1)x, 2x, -(a + 2)x, 3x, \dots; a, a + 1, a + 2, a + 3, a + 4, a + 5, \dots]$$

Since this requires two variables, we need to store variable a in R05 before running each continued fraction value. Here are sample programs for calculating A(n) and B(n):

01 LBL "UIG" ;Upper Incomplete Γ	19 LBL 01
02 RCL 02 ; get counter (n)	20 X<>Y ; Calculate (n+x-1) where n=2N-1
03 1	21 ST+ X
04 X#Y? ; If not 1, skip	22 1
05 GTO 01	23 -
06 RCL 01 ; Calculate (1+x-a)	24 RCL 01
07 +	25 +
08 RCL 05	26 RCL 05
09 - ; We now have B(1)	27 - ; We now have B(N)
10 LBL 00 ; Get A(1)	28 STO Y ; Save due to next calculation
11 RCL 01 ; Calculatex ^a e ^{-x}	29 RCL 05 ; Calculate n(a-n) where n = N-1
12 RCL 05	30 RCL 02
13 Y^X	31 1
14 RCL 01	32 -
15 CHS	33 STO Z
16 E^X	34 -
17 * ; We now have A(1)	35 * ; We now have A(n)
18 RTN	36 RTN

37 LBL "LIG" ;Lower Incomplete Γ	55 LBL 03 ; Even N handling
38 RCL 02 ; Get counter (n)	56 2 ;Calculate $-(a+n) \times$
39 1	57 / ; where $n = N/2-1$
40 X#Y?	58 1
41 GTO 02	59 -
42 RCL 05 ; We now have B(1)	60 RCL 05
43 GTO 00 ; Get A(1) and exit	61 +
44 LBL 02	62 RCL 01
45 RCL 02 ; Get n	63 *
46 EVEN?	64 CHS ; We now have A(n)
47 GTO 03	65 LBL 04 ; Calculate a+n
48 1 ; Odd N handling	66 RCL 05 ;where $n = N-1$
49 - ; Calculate $n \times 50 -$	67 RCL 02
50 2 ;where $n=(N-1)/2$	68 1
51 /	69 -
52 RCL 01	70 + ; We now have B(n)
53 * ; We now have A	71 X<>Y ; B(n) in Y, A(n) in X
54 GTO 04	72 END

Let's calculate $\Gamma(3,4)$ and $\gamma(3,4)$.

Since B(0) is always 0 then we enter (for a=3 and x=4):

[ALPHA], "LIG", [ALPHA], 3, STO 05, 0, ENTER^, 4 and XEQ "CF2V". You should get 0.476206611.

Now do:

[ALPHA], "LIG", [ALPHA], 0, ENTER^, 4 and XEQ "CF2V". You should get 1.523793388

which agrees with the value we'd obtain using ICGM (described elsewhere in the manual) except for the very last decimal place.

The sum of these values should be $\Gamma(3) = 2.0$; and it is 1.999999999, which is close enough!

If for some reason the calculation takes too long to wait for (all depends on what A(n) and B(n) are) the program can be stopped by pressing R/S. It is stopped somewhere in the user created routine. Register 00 will contain the last value calculated for the continued fraction, register 02 is the number of loops performed to that point.

The idea for this program comes from Jean-Marc Baillard (in fact the TANH example is from his documentation), but usage is slightly different (he puts the name of the routine to execute in R00, here that register is used for the solution), and my routine is MCODE instead of FOCAL. I use R03 for C(n) and R04 for D(n) in using the Modified Lentz formula for continued fraction evaluation.

2.6. SOLVERS.

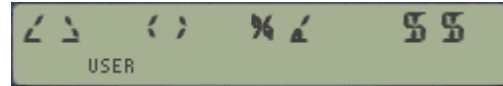

What good is a math-related module without a Triangle solver application? Never too basic to be non-important, especially if it can be tucked away in an auxiliary bank and doesn't take the customary set of FAT entries – FAT space is always at a premium. As of revision 3x3 of the SandMath the AECROM "TRIA" is included, which can arguably be considered the best Triangle solver ever written for the 41. And it is incorporated into a new single function that acts as consolidated launcher for it and the other two geometric solvers. All improved with 13-digit math routines and other usability enhancements.

2.6.1. The three geometric solvers

- CIRCLE:** different geometric properties of a circle segment.
SARR: Slope, Angle, Rise and Run – also connects to the Triangle solver.
TRIA: Knowing three elements it resolves the other 3 unknown and the area.

Notice that **GMSLVR** can be launched directly from the mail **[ΣFL]** launcher, using the **[EEX]** key as shortcut.

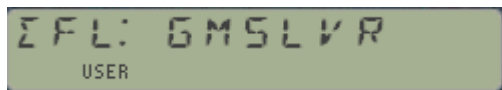

, and then:

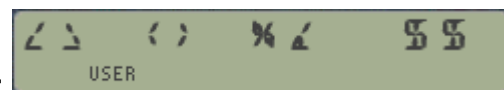

Upon selecting the desired solver, an information message is shortly shown on the display while the key is held depressed, followed by "NULL" if kept pressed to cancel the action. If not, then the initial execution of the chosen solver starts always by presenting the default menu of choices – which can always be recalled by pressing the menu option, on the **[E]** key

It's important to mention that these three are FOCAL programs (albeit quite unusual and also stealth to the FAT) triggering the different choices for these solvers as local labels; therefore the top row keys should not have any key assignments for this approach to work. Note also that the USER mode will be activated automatically by the function.

Rather than attempt to explain these functions let's refer to the original AECROM user's manual for a first-hand and inimitable description of their functionality.

1. **[%<)] = SARR- SLOPE, ANGLE, RISE & RUN SOLVER**

The SARR solver computes slopes, angles, rise and run. Your HP-41 must be in USER mode and, if you have anything assigned to the top row of keys, you need to clear those assignments.

Example: The slope of a line is 0.776. What is the angle between the line and level?

Solution: In USER mode, press [XEQ] "GMSLVR", [C] (i.e. SARR), then (assumes no keys assigned):
 0.776 [A] [B] -> 37.8115 (DEG).

When you execute SARR and switch to USER mode, the keys in the top row take on new meanings. To see these new meanings press the **[E]** key in the top row at any time. The calculator shows you the menu:

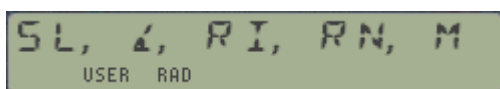

The first four keys in the top row represent the values Slope, ANgle, RIse, and RuN, and the fifth key calls the menu. Pressing one of the first four keys can mean either "take the value in the X-register as an input" or "calculate a value," depending on when you press it. When you key in a value and press one of the first four keys, the HP-41 takes it as an input. But immediately following an input, pressing one of the first four keys means "compute this value."

In the above example, the only known value was the slope, which is all you need to know to solve for the angle. You simply keyed in the slope (0.776 [A]) and solved for the angle [B]).

To solve for anyone of the four unknowns, you need to input knowns according to the following table.

<u>To Solve for:</u>	<u>You need to input:</u>
Slope	Run and Rise, or Angle
Angle	Run and Rise, or Slope
Rise	Run, and Angle or Slope
Run	Rise, and Angle or Slope

IMPORTANT RULE: Always key in your knowns *from right to left* in the menu.

Example: The center riser on a triangular roof truss is four feet high and the length from one end of the truss to the midpoint is 22 feet. What is the slope of the roof?

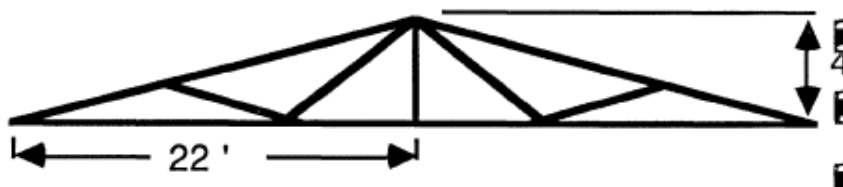

Solution: This solution assumes you have already pressed [XEQ] "GMSLVR", [C]

Now press [E] to view the menu and 22 [D], 4 [C], [A]. The answer is 0.1818.

Example: With a theodolite, you measured the angle of an imaginary line going from the top of a tree to the ground at a distance of 5.749924998 m (*) from the base of the tree to be 57 degrees. How tall is the tree?

Assuming you just completed the previous example, press (remember: you need to be in USER mode, and also in DEG mode for this example). Then 5.749924998 [D], 57 [B].

[C] will give you the answer (8.854108050 m).

In the above example, you are solving for the Rise given the Run and the angle (57 degrees). Notice that when you key in a number before you press a key in the top row, the calculator takes it as an input. But when you press one of the top row keys without first keying in a number, the HP-41 calculates that value based on the numbers you've just keyed in.

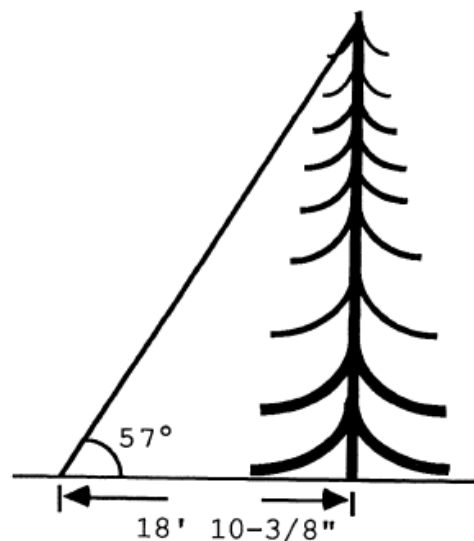

(*) Converted from the original feet value in the manual.

2. [**<>**] = TRIA - THE TRIANGLE SOLVER.

From SARR, you can press [**SHIFT**] [**d**] to execute the TRIA solver, or you can use [XEQ] "GMSLVR", [**A**] (i.e. TRIA). TRIA helps you solve all the characteristics of any triangle given three defining quantities for that triangle. Here's a picture of an arbitrary triangle with its angles and sides labeled:

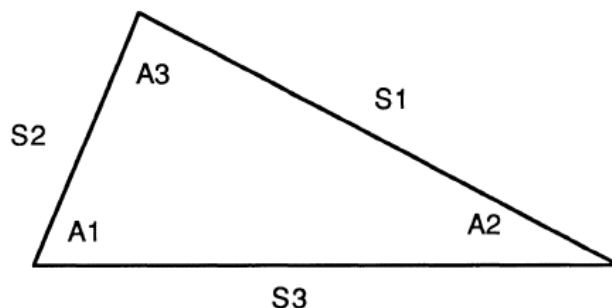

The sides are labeled in a counterclockwise order around the triangle and the angles are numbered according to the opposite side. This is the way that TRIA expects a triangle to be oriented. To call up the TRIA menu execute the function **GMSLVR**, then [**A**]. Remember, the calculator must be in USER mode. You will see the menu on the left:

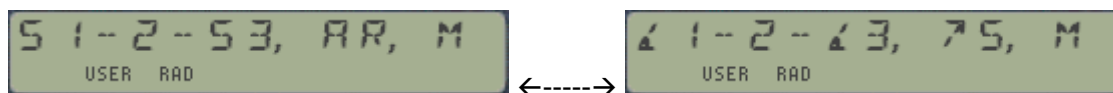

The first three keys in the left-side menu represent the three sides of the triangle, "AR" shows that using the [**D**] key you can solve for the AREA of a triangle and the "M" shows you that the [**E**] key brings up the menu at any time.

Now press [**]** [**e**]. You will see the menu on the right side. This is the shifted menu of TRIA. This menu shows you that by using the shifted top row keys ([**]** [**a**], [**]** [**b**], and [**]** [**c**]), you can input or solve for any of the three angles of a triangle. Plus, the "^S" selection executes SARR (described before),. So remember, the TRIA function has two menus. The [**E**] key calls up the unshifted menu, and [**]** [**e**] calls the shifted menu.

TRIA has fairly specific rules for inputting the three knowns that define a triangle. Once the triangle is oriented similar to the previous diagram (sides labeled counterclockwise), the known values need to be input in counterclockwise order around the triangle as follows:

<i>Knowns</i>	<i>Suggested input order</i>
SSS	S1, S2, S3
ASA	A3, S2, A1
SAS	S1, A3, S2
SAA	S1, A3, A1
SSA	S1, S2, A1

Example 1: Solve for all the unknown sides, unknown angles, and the area of the following triangle:



Solution: 5.3 [**A**], 3.1 [**B**], 83 [**]** [**c**]. Then press [**]** [**a**] to solve for A1 (64.9903), [**]** [**b**] to solve for A2 (32.0097), [**C**] to solve for S3 (5.8048), and [**D**] to solve for AREA (8.1538).

Once you have input the three defining knowns of a triangle, you can change one or two values at a time to see how the other lengths are affected.

Example 2: Given the following triangle with three known sides, calculate all the angles and the area of the triangle.



Solution: This is a S S S problem, so the input order is S1, S2, S3. With 4.24 as S1:

A1 = 20.44°, A2 = 46.25°, A3 = 113.31°, and AREA = 17.07.

Here are the keystrokes: 4.24 [A], 8.77 [B], 11.15 [C], [] [a], [] [b], [] [c], [D].

Example 3: Given the triangle below (left side) with two known angles and one known side, calculate the unknowns. Solution: This is an ASA problem, thus the input order is A3, S2, A1. With 15 as S2, press 65 [] [c], 15 [B], 75 [] [a]. Then press [A] to see S1 (22.54), [C] to see S3 (21.15), [] [b] to see A2 (40°), and [D] to see the area (153.22).

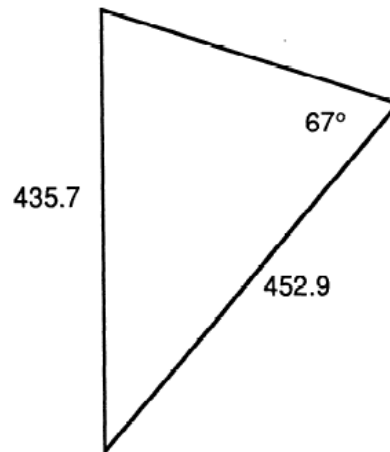
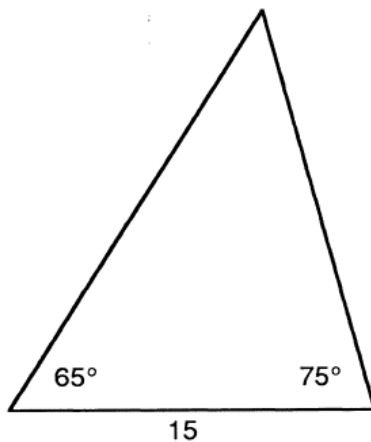

Example 4: Calculate the unknown characteristics of the triangle above (right side). Solution: This is a SSA problem, so the input order is S1, S2, A1. Once you have input this problem the calculator displays the warning "ANGL.SIDE.SIDE", indicating that this combination of inputs can result in more than one solution. The calculator solves for the case where A2 is acute.

The keystrokes to input the triangle are 435.7 [A], 452.9 [B], 67 [] [a]. After the calculator displays "ANGL.SIDE.SIDE". you can solve for the unknowns:

73.11 =A2; 39.89 =A3; 303.58 = S3; 63.280.40 = AREA

Moving between SARR and TRIA.

Pressing the [] [d] key from the TRIA menu will execute the SARR function, and pressing [] [d] from SARR will execute TRIA. Data are transferred between the two functions as follows: When going from TRIA to SARR. S1 becomes RUN and S2 becomes RISE. The slope and angle are calculated accordingly.

When going from SARR to TRIA. RUN becomes SI, RISE becomes S2, and A3 is set to 90.

If you transfer between SARR and TRIA using the [XEQ] "GMSLVR" ... process, all the data are cleared.

3. [()] = CIRC - THE CIRCLE SOLVER

The CIRC solver allows you to calculate properties of a circle and a sector of that Circle from a known radius and central angle. Like the SARR and TRIA cases, the CIRC solver is menu driven. The following diagram shows you some of the properties of a circle that can be calculated using CIRC:

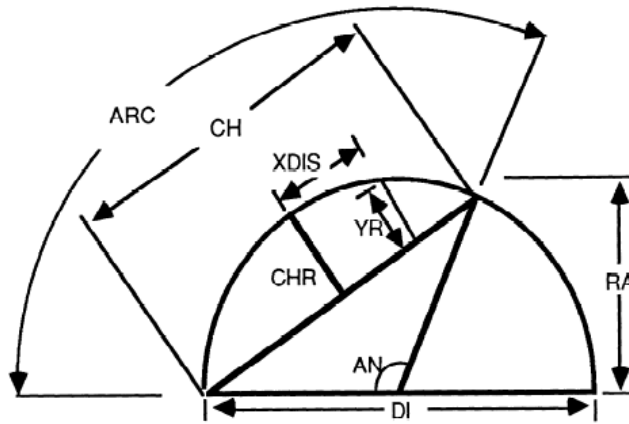

Important: The radius (Rd), the sector angle (AN<), and the X- distance (Xd) are the only allowed inputs. You can also calculate the circumference (CI) of the circle, the area (AR) of the circle, the segment area (SG), and the sector area (ST).

Three menus are available for CIRC. To view each menu, execute the function ([XEQ] "GMSOLVR" [B]) and press the [E], [e], and [J] keys.

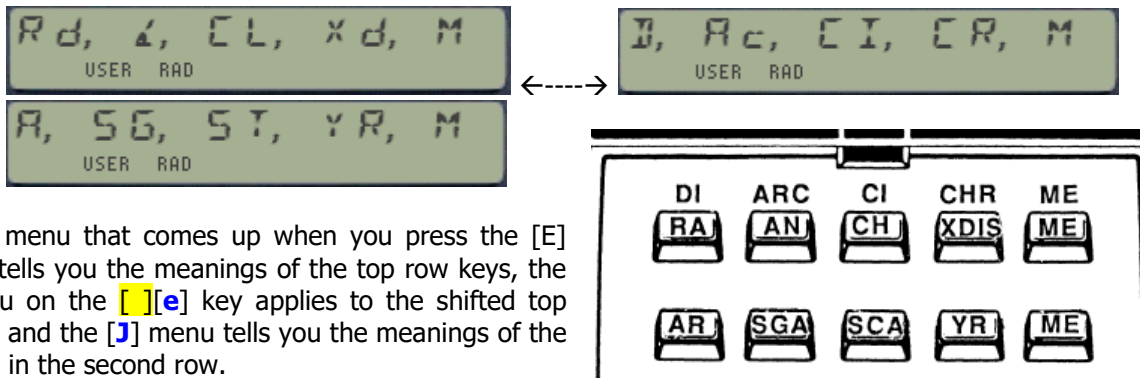

The menu that comes up when you press the [E] key tells you the meanings of the top row keys, the menu on the [e] key applies to the shifted top row, and the [J] menu tells you the meanings of the keys in the second row.

Example 1: Calculate the diameter, area, and circumference of a circle with a radius of 10.0. Also, calculate the arc length, chord length, chord rise, sector area, and segment area of a sector in that circle with a central angle of 30 degrees.

Solution: With USER mode on and the display set to FIX 4, press **GMSLVR**, [B] (i.e. CIRC), [E] 10 [A] 30 [B]. Then ...

To calculate	Press	Result:
diameter	[e][a]	20.0000
area	[F]	314.1593
circumference	[e][c]	62.8319
arc length	[e][b]	5.2360
chord length	[C]	5.1764
chord rise	[e][d]	0.3407
sector area	[H]	26.1799
segment area	[G]	1.1799

Example 2: Calculate the rise (YR) at X = 1.8. Solution: 1.8 [D] [I] (0.1774)

Notice that the only values you can input are the radius (RA on the [A] key), the central angle (AN on the [B] key), and the X-distance (XDIS on the [D] key). These values must be known if you wish to calculate any properties that depend upon them.

Geometric Solvers Implementation Details.-

This section has some comments on the integration to the SandMath - Ignore it altogether if you're not interested in what's going on under the hood.

Adding the AECROM geometric solvers to the SandMath has been an exercise of discovery and patience. The first due to the appreciation of the ingenuity used by the original developers to integrate the MCODE accuracy and speed to a basically FOCAL-driven data input process, which relies on the user flag 22 (DATA Entry flag) as trigger for known / unknown elements.

As mentioned at the beginning of this section, there are three FOCAL programs, which account for all the possible menu selections made in the three launchers – that is a total of 30 choices. The uncanny thing about those programs is that for every one and each of them, the same instruction is always executed – and that instruction is nothing less than the AECROM header function itself.

How then does the function know which option is called up for? The answer lies in the actual program pointer position of the calling step, thus *the relative location of the code was of utmost importance* – which accounts for the patience part, as I had to move and shift large sections of code to accommodate for the demanding requirements of the FOCAL newcomers.

So there were just about 180 words in the main bank in total, but what a tricky thing to adjust for on an already-packed module with interdependencies across three banks and two pages...

Fortunately the bulk of the code is the MCODE for **GMSLVR** itself, which has been conveniently located in bank-3 of the lower page – briefly "coming up" to the main bank for the partial key sequence prompts, and every time the execution exits to the FOCAL program.

I got partial vindication by consolidating the three FOCAL drivers into a single launcher, which furthermore allowed the removal of the three FAT entries (TRIA, SARR, and CIRC) – a definitive plus given that the FAT was already full. You can explore those programs switching to PRGM mode during their execution (in-between entries, standard procedure).

You probably have noticed that I changed the text presented by the different menus to a less-busy version of the same. Perhaps more importantly, I also swapped the [D] and [Y][d] actions in the TRIA solver, so now the unshifted [D] calculates the Area. This provides consistency to the [Y][d] key, as the "gate" to interconnect SARR and TRIA on both cases. Subtle differences, probably just a matter of taste.

As a side effect of the modification, only one function (**MANTXP**) was removed from the main FAT; it has been placed into the auxiliary FAT of the upper page. Hope you agree it was a small price to pay for such a rewarding addition – definitely worth the extra effort.

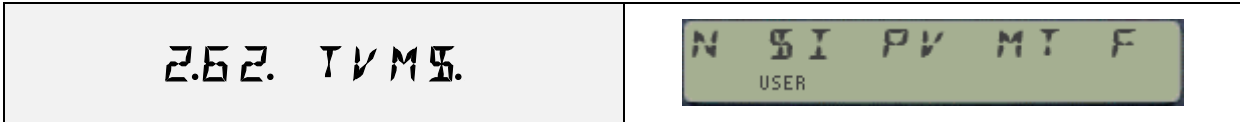

Putting a second yellow ribbon around the box, from revision "M" the SandMath also includes the new **TVM\$** solver functionality - taken from the just released TVM ROM. This is an all-MCODE implementation of the classic functions that rivals with the HP-12C implementation in speed and accuracy – use it to solve for any of the five money variables with the other four known: N, I, PV, PMT, and FV.

2.6.2. The Time Value of Money solver.-

First of all, accessing the **TMV\$** solver is also possible using a dedicated entry in the **FL** launcher – just press the [USER] key directly at its prompt; thus no need to go through the **GMSLVR** function even if for consistency reasons it's also included there. The direct way saves keystroke pressings; therefore it's the recommended approach.

Also important to know is that to input the data, **TVM\$** expects the value already in X *before* calling the corresponding menu choice. This is reversed from the geometric solvers, which first present the prompt with the menu choices for informational purposes (not a launcher).

The same option key is used to either input the variable value or to calculate it based on the other four. This duality is possible by relying on the status of the user flag 22 (the data entry flag) to determine whether it's an input or a calculation action: UF 22 set means input, whereas UF 22 clear means calculation.

Remember that to actually set the status of flag 22, you need to press a *key on the numeric pad*, i.e. the **digits 0-9**, the **Radix** or **EEX** keys. Any other key will not activate it, in particular RCL, CHS and ENTER^ - so you need to work around those cases as appropriate when a new value is to be entered.

TVM\$ will clear UF 22 upon completion of the command (either inputting or calculating) – this enables a repeat calculation of different values just by pressing each menu choice in sequence.

After the input or calculation is done, a message will show the result value for the variable chosen. If the value is an integer number then decimal settings in the calculator will be ignored for further clarity.

Not shown in the main menu are the following actions:

- **B/E** (key [J]) – use it to toggle between BEGIN / END modes. A message is displayed to inform of the selected mode, and it also toggles UF 00 annunciator in the display as a reminder of the currently selected mode.

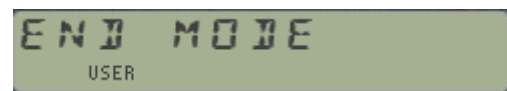

- **SHOW** (keys [F] to [I]) – use it to sequentially review the current values of each of the Money variables: N, I, PV, PMT, and FV. For additional consistency with the data entering approach, both B/E and SHOW will also clear UF 22 upon completion.

Rather than attempt to explain the usage and complete functionality let's borrow the section from the HP-41 Advantage's Pac user's manual – a superb vintage document that avoids re-inventing the wheel. Bear in mind that whereas the FOCAL version relies on the local keys within the program, the SandMath implementation uses the **TMV\$** launcher options for each value input – this is the main difference between both implementations.

The TVM program solves different problems involving time, money, and interest - the compound-interest functions. The following variables can be inputs or results.

- N = the number of compounding periods or payments. (For a 30-year loan with monthly payments, $N = 12 \times 30 = 360$.)
- I = the periodic interest rate as a percent. (For other than annual compounding, this represents the annual percentage rate divided by the number of compounding periods per year. For instance, 9% annually compounded monthly equal $9 / 12 = 0.75\%$)
- PV = the present value. (This can also be an initial cash flow or a discounted value of a series of future cash flows.) Always occurs at the beginning of the first period.
- PMT = The periodic payment,
- FV = The future value. (This can also be a final cash flow or a compounded value of a series of cash flows.) Always occurs at the end of the Nth period.

You can specify the timing of the payments to be either at the end of the compounding period (End mode) or at the beginning of the period (Begin mode). Begin mode sets flag 00. Ending payments are common in mortgages and direct-reduction loans; beginning payments are common in leasing.

Equation

$$0 = PV + (1 + ip) PMT \left[\frac{1 - (1 + i)^{-N}}{i} \right] + FV (1 + i)^{-N}$$

Where i is the periodic interest rate as a fraction ($i = I/100$),
 $p = 1$ in Begin mode or 0 in End mode.

Valid Input Values for Data

Use a cash-flow diagram to determine what your cash-flow inputs are and whether to specify them as positive or negative. The cash-flow diagram is just a time-line divided into time periods. Cash flows (transactions) are indicated by vertical arrows: an upward arrow is positive for cash received, while a downward arrow is negative for cash paid out.

For example, the six-period time line on the left shows a \$20 cash outflow initially and a \$50 cash inflow at the end of the fourth period. (Begin mode cannot be used in calculating PV or FV.) The five-period time line on the right shows a \$1,000 cash outflow initially and a \$100 inflow at the end of each period, ending with an additional \$1,000 inflow at the end of the fifth period.

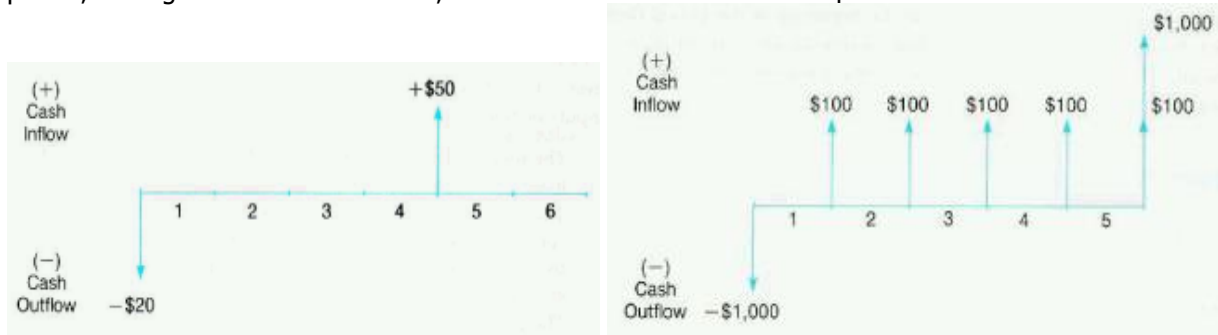

Instructions.

- The program TVM will solve for any one of the variables N, I, PV, PMT, or FV given the other three or four, which must include either N or I. The order of entry is unimportant. If you use only four variables, then the fifth must equal zero. All variables are set to zero when you first run TVM or clear the financial data, so you do not have to enter a zero in these cases.
- You should clear the financial data before beginning a completely new calculation; otherwise, previous data that is not overwritten will be used (i.e., for the fourth, unused variable),
- Remember to specify cash inflows (arrow up) as positive values and cash outflows (arrow down) as negative values. The results are also given as positive or negative, indicating inflow or outflow.
- Check that the payment mode is what you want. If you see the flag 00 annunciator (a small 0 below the main display line), then Begin mode is set. If not, End mode is set. To change the mode, press [J] (a toggle). The display will then show what you have just set: BEGIN MODE or END MODE. The default is End-mode (flag 00 clear).
- Remember that the interest rate must be consistent with the number of compounding periods. (An annual percentage rate is appropriate only if the number of compounding periods also equals the number of years.)
- You might want to set the display format for two or three decimal places (FIX 2 / 3).

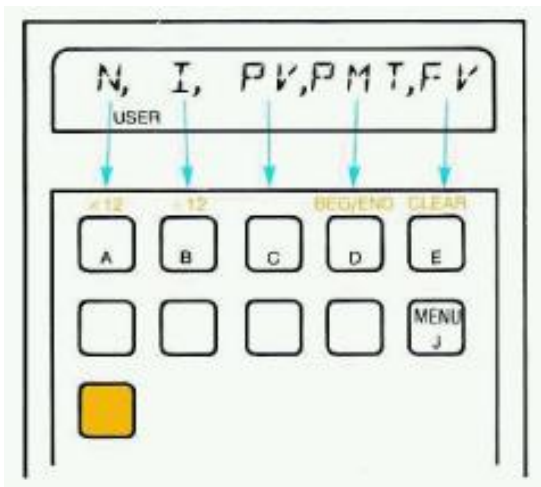

This menu will show you which key corresponds to which function in TVM. Press to recall this menu to the display at any time. This will not disturb the program in any way.

To clear the menu at any time, press [←-]. This shows you the contents of the X-register, but does not end the program. You can perform calculations, then recall the main menu by pressing 0. (However, you do not need to clear the program's display or recall the menu before performing calculations.)

Remarks

This program uses local Alpha labels (as explained in the owner's manual for the HP-41) assigned to keys [A]- [E], and their shifted counterparts (except [C] and [J]). These local assignments are overridden by any User-key assignments you might have made to these same keys, thereby defeating this program. Therefore be sure to clear any existing User-key assignments of these keys before using this program, and avoid redefining these keys in the future within possible.

The financial variable keys will only store a value if you enter it from the keyboard. If, for example, you recall a value from a register then press a variable key, the program will calculate that variable instead of storing the recalled value. To store a value that was placed in the X-register by some other means than actually keying it in, press [STO] before pressing the variable key.

Examples

Example 1.- A borrower can afford a \$650.00 monthly payment on a 30-year, 14.25% mortgage. How much can he borrow? The first payment is made one month after the money is loaned. (This requires End mode.)

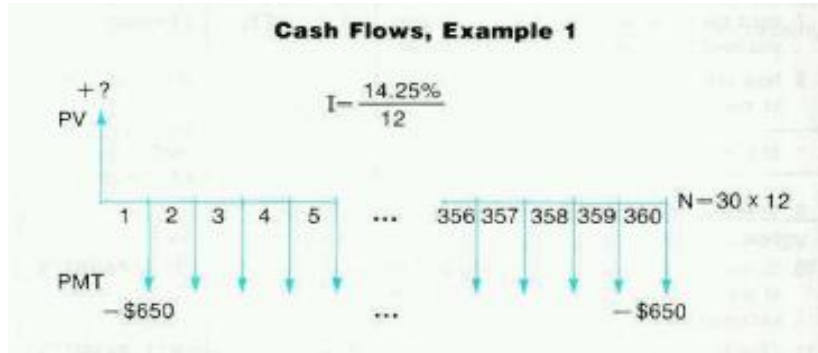

Using the **TVM\$** solver, we'll input the known variables first, and then use the unknown function key to obtain the result:

Input	Keys	Result
650, CHS	TVM\$, [D]	"PMT=-650"
14.25, ENTER^, 12, /	TVM\$, [B]	"I=1.1875"
30, ENTER^, 12, *	TVM\$, [A]	"N=360"
0	TVM\$, [E]	"FV=0"
	TVM\$, [C]	"PV=53,955.91959"

Example 2.- How much money must be set aside in a savings account each quarter in order to accumulate \$4,000 in 3 years? The account earns 11% interest, compounded quarterly and deposits begin immediately

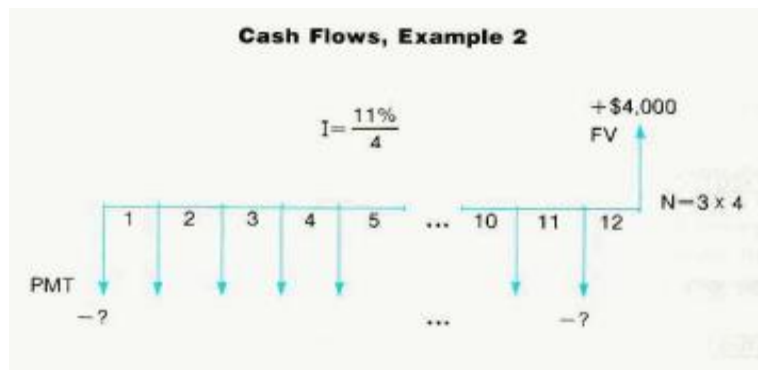

Input	Keys	Result
	TVM\$, [J]	"BEGIN MODE" (sets flag 00)
11, ENTER^, 4, /	TVM\$, [B]	"I=2.7500"
3, ENTER^, 4, *	TVM\$, [A]	"N=12"
4000	TVM\$, [E]	"FV=4,000"
0	TMV\$, [C]	"PV=0"
	TMV\$, [D]	"PMT=-278,223688"

Notice that when you press a key after keying in a value, the calculator stores that value in the indicated variable (equivalent to STO into the register). However, when you press it without first keying in a value, the calculator computes a value for the indicated variable.

Programming Information.

The calculation for N, PV, PMT and FV all use a direct formula based on the values for the other four variables. **TVM\$** uses 13-digit math routines for extended precision, thus the accuracy should in theory be better than the FOCAL programs used elsewhere (like the Advantage's own TVM).

The calculation for the interest rate uses an iterative method to solve the non-explicit equation. This is done applying Newton's formula for the successive estimations of the solution, starting with the following initial value:

$$i_0 = [\text{abs}(PV + n * \text{PMT} + \text{FV})]^{1/n}$$

The function's derivative for Newton's formula is calculated using the expression:

$$f'(i) = (\text{PMT} / i^2) * [(1+i)^{-n} - 1] + n * [\text{PMT} (1+i)^{-n} / i - \text{FV}] * (1+i)^{-(n+1)}$$

During the calculation the display shows a blinking message, shortly followed by the calculated result:

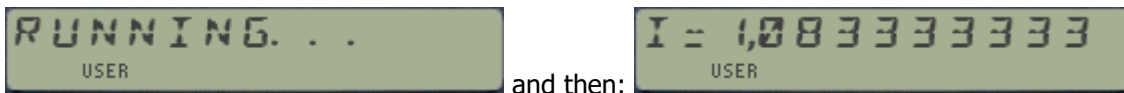

Data Registers.

The usage of data registers in **TVM\$** is compatible with the other FOCAL programs in the Advantage Pac ("**TVM**") and in the PPC ROM ("**FI**"). This is convenient if you want to use them interchangeably to compare the speed and accuracy of the different implementations. You can see the current contents with the RCL function and the top row keys as arguments, from 01 to 05 as follows:

N – R01
 I – R02
 PV – R03
 PMT – R04
 FV – R05

When you call **TVM\$** it first makes a copy of the contents of these data registers into the stack, and uses those values for the calculations. Upon completion the obtained result is stored in the corresponding register and left in the X register as well.

Using TVM\$ in Programs.

Notice that **TVM\$** is designed to be used interactively – but it can also be entered in a program utilizing the merged functions scheme, whereby the specific option is specified as an index (or argument) in the next program step following **TVM\$**. This will be taken as the "function argument of the argument in Rnn", always assuming it is a calculation action and not data input (regardless of the current status of UF 22). Simply use STO for storing the values in a program.

The valid values for this argument line are logically 0 to 10, corresponding to the same indexes used in the register allocation and local keys within the menu. Had **TVM\$** been a sub-function, and therefore already using 2 steps in a program (**ΣF#** plus index), you'd appreciate the fact that *it'd take three program lines* (and 5 bytes) to access to any of the financial sub-routines! This compounded scheme is nothing short of amazing, if you ask me...

3. Upper-Page Functions in detail.

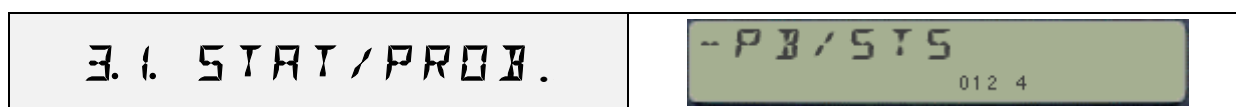

It's time now to move on to the second page within the SandMath – holding the Special Functions and the Statistical and Probability groups. Let's see first the Statistical section – easier to handle and of much less extension; and later on we'll move into high-level math, taking advantage of the extended launchers and additional functionality described in the introduction of this manual.

Statistical Menu - Another type of Launcher.

Pressing [Σ FL] twice will present the STAT/PROB functions menu, allowing access to 10 functions using the top row keys [A]-[J]. Two line-ups are available, toggled by the [SHIFT] key:

[$\Sigma\Sigma$] Default Lineup: Probability

[$\Sigma\Sigma$] Shifted Lineup: Linear Regression



Key	Function	Description	Author
[MN]	MN_	Means Launcher	Ángel Martin
[SD]	SDEV	Sample Standard Deviation	HP Co.
[CV]	COV	Sample Covariance	JM Baillard
[C]	NCR	Combinations of N elements taken in groups of R	Ángel Martin
[P]	NPR	Permutations of N elements taken in groups of R	Ángel Martin
[LR]	LR	Linear Regression a,b so that $Y = aX + b$	JM Baillard
[ab]	L1	Shows equation $Y = aX + b$	Ángel Martin
[R]	CORR	Sample Correlation Coefficient	JM Baillard
[X]	LRX	Gets estimated X-result for ordinate in X	Ángel Martin
[Y]	LRY	Gets estimated Y-result for abccisa in X	JM Baillard

Extended Register Means – Seven Means to an End.

But there's more to this menu that what meets the eye: choosing "MN:" in the first "screen" will not (yet) directly execute the mainframe MEAN function, but it'll trigger a new menu grouping the newest additions to the SandMath module – meet the seven means of the data sea...



- First of, there's the mainframe **MEAN** function, which uses the data set as defined by Σ REG.
- Then there are four additional means that use a set of data registers to hold the data. These functions take the data set control word in the X-register as input, which format is 'bbb.eee' signifying the beginning and end of the registares block. The functions are: **AMEAN**, **GMEAN**, **HMEAN**, and **PMEAN**.
- Finally there are three functions that calculate Duplex means using the values in the X and Y registers as input. These are **AGM**, **AGM2**, and **GHM**, and use the chars 1/2/3 respectively to invoke.

The "SHIFTED" screen provides a convenient launching point for several more functions, amongst them the new additions on Prime finders. See the table below for a complete review of both screens:

Key	Function	Description	Author
[A]	AMEAN	Arithmetic Mean of Rbbb - Ree	Ángel Martin
[G]	GMEAN	Geometric Mean of Rbbb - Ree	Ángel Martin
[H]	HMEAN	Harmonic Mean of Rbbb - Ree	Ángel Martin
[M]	MEAN	Sample (arithmetic) MEAN (as per ΣREG)	Hp Co.
[P]	PMEAN	Generalized p-Mean of Rbbb - Ree	Ángel Martin
[1]	AGM	Arithmetic-Geometric Mean of X,Y	Ángel Martin
[2]	AGM2	Modified AGM of X,Y	Ángel Martin
[3]	GHM	Geometric-Harmonic Mean of X,Y	Greg McClure
[0]	CIRCL	Circle Radius and Triangle Area from 3 points	Ángel Martin
[1]	Σ1/N	Harmonic Number	Ángel Martin
[N]	ΣN^X	Generalized Sum of Powers	Ángel Martin
[D]	dPL	Polynomial Derivative (Coeffs in Rbbb - Ree)	Ángel Martin
[P]	PL	Polynomial Evaluation (Coeffs. In Rbbb - Ree)	Ángel Martin
[W]	PTWIN	Next Twin Primes (after value in X)	Peter Platzer
[X]	PNEXT	Next Prime (after value in X)	Poul Kaarup
[Σ]	Σ^123_	Sum of integer powers	Martin - Kaarup

Finally, the functions listed in the following table are also in the same category – even if they're not in the dedicated launchers (although some are in the general SandMath keyboards, see the overlays for details.- Some of them are plain catch-up, with the aim to complete the set of basic functions. Some others are a little more advanced, reaching into the high level math as well.

	Function	Description	Author
[*]	%T	Compound Percent of x over y	Ángel Martin
	%D	Delta Percent	Ángel Martin
	EVEN?	Tests whether x is an even number	Ángel Martin
	ODD?	Tests whether x in an odd number	Ángel Martin
[**]	PDF	Normal Probability Density Function	Ángel Martin
	CPF	Cumulative Normal Probability Function	Ángel Martin
	ICPF	Inverse Cumulative Probability Function	Ángel Martin
	QNTL	Quantiles – particular case of ICPF for $\sigma=1, \mu=0$	Ángel Martin
[*]	PFCT	Prime Factorization	Ángel Martin
[*]	PRIME?	Primality Test – finds one factor	Jason DeLooze
[*]	RAND	Random Number from Seed (in buffer)	Håkan Thörgren
[**]	RGMAX	Maximum in a register block	JM Baillard
[**]	RGSORT	Sorts a block of registers	Hajo David
	RGSUM	Sums a block of registers	JM Baillard
[*]	SEEDT	SEED with Timer	Håkan Thörgren
[*]	ST<>Σ	ΣREG exchange with Stack	Nelson F. Crowle
[**]	STSORT	Stack Sort	David Phillips

Alea jacta est... { SEED , RAND }

It's a little known fact that the SandMath module also uses a buffer to store the current seed used for random number generation. The buffer id# is 9, and it is automatically created by SEEDT or RAND the first time any of them is executed; and subsequently upon start-up by the Module during the initialization steps using the polling points.

- **SEEDT** will take the fractional part of the number in X as seed for RNG, storing it into the buffer. If x=0 then a *new seed will taken using the Time Module* – really the only real random source within the complete system.
- **RAND** will compute a RNG using the current seed, using the same popular algorithm described in the PPC ROM - and incidentally also used in the CCD module's function RNG.

Both functions were written by Håkan Thörngren, an old-hand 41 programmer and MCODE expert - and published in PPC V13N4 p20

- **PRIME?** Determines whether the number in the X register is Prime (i.e. only divisible by itself and one). If not, *it returns the smallest divisor found and stores the original number into the LASTX register.* **PRIME?** Also acts as a test: YES or NO are shown depending of the result in RUN mode. When in a program, the execution will skip one step if the result is false (i.e. not a prime number), enabling so the conditional branching options.

This gem of a function was written by Jason DeLooze, and published in PPCCJ V11N7 p30.

Example program:- The following routine shows the prime numbers starting with 3, and using diverse Sandbox Math functions.

<pre>01 LBL "PRIMES" 02 3 03 LBL 00 04 RPLX</pre>	<pre>05 PRIME? 06 VIEW X <yes> 07 X#Y? <no> 08 LASTX</pre>	<pre>09 INCX 10 GTO 00 11 END</pre>
---	--	-------------------------------------

See other examples later in the manual, relative to prime factorization programs.

- **PNEXT** Will find the next prime number after the value in X. The original number is saved in LastX and the result is left in x.
- **PTWIN** Will find the next twin primes after the value in X, that is two prime numbers p1 and p2 such that $p2 = p1 + 2$. The initial value will be saved in LastX and the second of the twins p2 is placed in X, so you can repeat the execution for the next twin pair.
- **DSP?** (in the secondary FAT) returns in X the number of decimal places currently set in the display mode 0 regardless whether it's FIX, SCI , or END. Little more than a curiosity, it can be used to restore the initial settings after changing them for displaying or formatting purposes.

Combinations and Permutations – two must-have classics.

Nowadays it would be unconceivable to release a calculator without this pair in the function set – but back in 1979 when the 41 was designed things were a little different. So here there are, finally and for the record.

- **NPR** calculates Permutations, defined as the number of possible different arrangements of N different items taken in quantities of R items at a time. No item occurs more than once in an arrangement, and different orders of the same R items in an arrangement are counted separately. The formula is:

$$\frac{n!}{(n - k)!}$$

- **NCR** calculates Combinations, defined as the number of possible sets or N different items taken in quantities of R items at a time. No item occurs more than once in a set, and different orders of the same R items in a set are not counted separately. The formula is:

$$\frac{n!}{k!(n - k)!}$$

The general operation include the following enhanced features:

- Gets the integer part of the input values, forcing them to be positive.
- Checks that neither one is Zero, and that $n > r$
- Uses the minimum of $\{r, (n-r)\}$ to expedite the calculation time
- Checks the Out of Range condition at every multiplication, so if it occurs its determined as soon as possible
- The chain of multiplication proceeds right-to-left, with the largest quotients first.
- The algorithm works within the numeric range of the 41. Example: $nCr(335,167)$ is calculated without problems.
- It doesn't perform any rounding on the results. Partial divisions are done to calculate **NCR**, as opposed to calculating first **NPR** and dividing it by $r!$

Provision is made for those cases where $n=0$ and $r=0$, returning zero and one as respective results. This avoids DATA ERROR situations in running programs, and is consistent with the functions definitions for those singularities.

Note as well that there is no final rounding made to the result. This was the subject of heated debates in the HP Museum forum, with some good arguments for a final rounding to ensure that the result is an integer. The SandMath implementation however does not perform such final "conditioning", as the algorithm used seems to always return an integer already. Pls. Report examples of non-conformance if you run into them.

Example: Calculate the number of sets from a sample of 335 objects taken in quantities of 167:

Type: 335, ENTER^, 167, XEQ "**NCR**" -> 3,0443587 99

Example: How many different arrangements are possible of five pictures, which can be hung on the wall three at a time:

Type: 5, ENTER^, 3, XEQ "**NPR**" -> 60,00000000

The execution time for these functions may last several seconds, depending on the magnitude of the inputs. The display will show "**RUNNING...**" during this time.

Linear Regression – Let's not digress.

The following four functions deal with the Linear Regression, the simplest type of the curve fitting approximations for a set of data points. They complement the native set, which basically consists of just **MEAN** and **SDEV**.

	Function	Description	Author
[ΣΣ]	CORR	Correlation Coefficient of an X,Y sample	JM Baillard
[ΣΣ]	COV	Covariance of an X,Y sample	JM Baillard
[ΣΣ]	LR	Linear Regression of an X,Y sample	JM Baillard
[ΣΣ]	LRX	X- value for an Y point	Ángel Martin
[ΣΣ]	LRY	Y- value for an X point	JM Baillard

Linear regression is a statistical method for finding a straight line that best fits a set of two or more data pairs, thus providing a relationship between two variables. Using the well-known method of least squares, **LR** will calculate the slope A and Y-intercept B of the linear equation: $Y = Ax + B$.

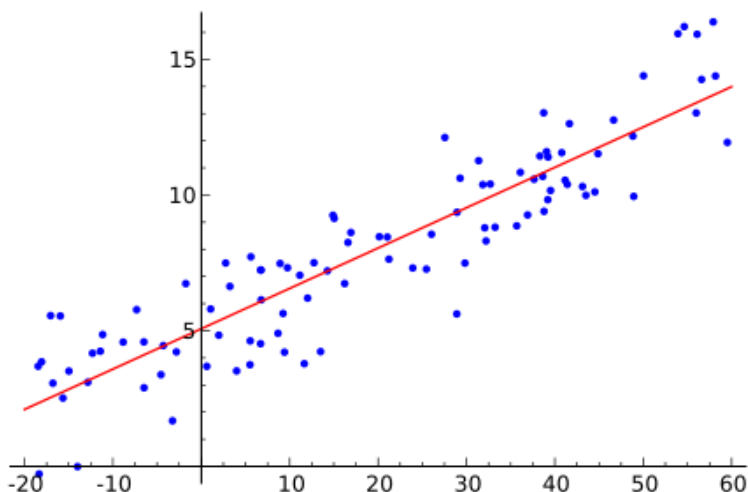

The results are placed in Y and X registers respectively. When executed in RUN mode the display will show the straight-line equation, similar to the **STLINE** function described before.

Example: find the y-intercept and slope of the linear approximation for the data set given below:

X	0	20	40	60	80
Y	4.63	5.78	6.61	7.21	7.78

Assuming all data pairs values have been entered using Y-value, ENTER, X-value, $\Sigma+$; we type: XEQ "LR" → 0,038650000 and X<>Y → 4,856000000 producing the following output in FIX 2:

As to the remaining functions, **COV** calculates the sample covariance. **CORR** returns the correlation coefficient, and **LRY**, **LRX** the linear estimates for the function at the given point or abscissa.

For the same sample still in the calculator's memory, we obtain the values:

Covariance = 38.65; CORR=0.987954828; LRY=4.894184454 (using Corr value as X)

Single and Duplex Means (to an end).

In the means department there is a very complete selection of choices: arithmetic, geometric and harmonic means are calculated on a set of data registers controlled by the control word "bbb.eee" in X – i.e. beginning and end registers, *and *not* the statistical registers as defined by ΣREG !*. Also a generalized exponential mean is available using the same syntax.

The **AMEAN**, **GMEAN**, and **HMEAN** functions calculate the means of multiple values stored in data registers. Entering the control word describing the register set in X and executing AMEAN, GMEAN, or HMEAN will result in that mean being put into X (and the control word saved in LastX). So, for example, to get one of these means for values in registers 10 thru 15, put 10.015 in X and execute the appropriate mean function.

But there is more: The **PMEAN** function is also available for a *generalized power mean* function. The power "p" is put into Y and the control word in X, and the Generalized Power Mean is calculated for the values pointed to by the control word. The PMEAN formula is:

$$M_p(x_1, \dots, x_n) = \left(\frac{1}{n} \sum_{i=1}^n x_i^p \right)^{\frac{1}{p}}$$

For p=0 this would normally lead to a problem. However the limit for this expression as p → 0 yields the Geometric Mean, so when p=0, the GMEAN function code is used.

From the above formula you can see that p=1 yields the Arithmetic mean, and p=-1 yields the Harmonic mean. However fractional and other negative values can be used, and you will notice that as p becomes infinite (positive), the mean tends to be the MAX value of the numbers. As p becomes infinite (negative), the mean tends to be the MIN value of the numbers.

With the exception of the AMEAN function, all values used in the registers must be non-zero positive values. Otherwise a "DATA ERROR" condition will occur.

Let's move now to the duplex means on a pair of numbers placed in X and Y registers: the Arithmetic-Geometric mean **AGM** and the Harmonic-Geometric mean **HGM**. An interesting definition of the mean of two values occurs when combining Arithmetic, Geometric, and Harmonic means.

- The Arithmetic-Geometric mean is a special value, defined as the common limit of A = AMean(A,B) and B = GMean(A,B) repeated until A-B = 0.
- The Geometric-Harmonic mean is defined as the limit of A = GMean(A,B) and B = HMean(A,B) repeated until A-B = 0.

AGM calculates the Arithmetic-Geometric Mean, whilst **GHM** calculates the Geometric-Harmonic mean. As an interesting note, AM(A,B) ≥ AGM(A,B) ≥ GM(A,B) ≥ GHM(A,B) ≥ HM(A,B).

What happened to the Arithmetic-Harmonic mean? That is simply the Geometric mean in disguise, thus no need for such function. Finally, note that taking p=0.5 in the PMEAN function (on two registers) will NOT yield the AGM (and -0.5 will NOT yield the GHM) unless, of course, the register values are identical! It is not that simple to get those values, and the power value required changes depending on the two values chosen for AGM or GHM.

Ratios, Sorting and Register Maxima.

- **%T** and **%D** (in the secondary FAT) are miniature functions to calculate the percent of a number relative to another one (its reference), and the delta percentual between the numbers in Y(reference) and X(new value). The formulas are:

$$\%T(y,x) = 100 \times y / x ; \quad \%D = 100 (x-y) / x$$

Example: the relative percent of 4 over 25 is 16%. - You type: 25, ENTER^, 4, XEQ "**%T**"

Example: the delta percentual of a change from 85 to 75 is -11,765%

- **GCD** and **LCM** are fundamental functions also inexplicably absent in the original function set. They are short and sweet, and certainly not complex to calculate. The algorithms for these functions are based on the PPC routines **GC** and **LM** – conveniently modified to get the most out of MCODE environment.

If a and b are not both zero, the greatest common divisor of a and b can be computed by using least common multiple (lcm) of a and b:

$$\text{gcd}(a,b) = \frac{a \cdot b}{\text{lcm}(a,b)}$$

Examples: GCD(13,17) = 1 (primes),

GCD(12,18) = 6;

GCD(15,33) = 3

Examples: LCM (13,17) = 221;

LCM(12,18) = 36;

LCM(15,33) = 165

- **RGSORT** sorts the contents of the registers specified in the control number in X, defined as: **bbb,eee**, where "**bbb**" is the begin register number and "**eee**" is the end register number. The sorting is ALWAYS done in ascending order using bbb.eee as reference i.e. you need to reverse it to eee.bbb for a descending order sort. This function was written by HaJo David, and published in PPCCJ V12N5 p44.
- **STSORT** sorts in descending order the contents of the four stack registers, X, Y, Z and T. Obviously no input parameters are required. This function was written by David Phillips, and published in PPCCJ V12N2 p13
- **RGMAX** finds the maximum within a block of consecutive registers – which will be placed in X, returning also the register number to Y. The register block is defined with the control word in X as input, with the same format as before: bbb.eee.
- **RGSUM** is a handy and super-fast way to calculate the sum of the data registers specified by the control word bbb.eee in X. It was written by Jean-Marc Baillard.
- **ST<>Σ** exchanges the contents of five statistical registers and the stack (including L). Use it as a convenient method to review their values when knowing their actual location is not required.
- **ODD?** And **EVEN?** are simple tests to check whether the number in X is odd or even. The answer is YES / NO, and in program mode the following line is skipped if the test is false. The implementation is based on the MOD function, using MOD(x,2) = 0 as criteria for evenness.

(Normal) Probability Distribution Function. { [PDF](#) }

In probability theory, the normal (or Gaussian) distribution is a continuous probability distribution that has a bell-shaped probability density function, known as the Gaussian function or informally as the bell curve:

$$f(x; \mu, \sigma^2) = \frac{1}{\sigma\sqrt{2\pi}} e^{-\frac{1}{2}\left(\frac{x-\mu}{\sigma}\right)^2}$$

The parameter μ is the mean or expectation (location of the peak) and σ^2 is the variance. σ is known as the standard deviation. The distribution with $\mu = 0$ and $\sigma^2 = 1$ is called the standard normal distribution or the unit normal distribution

PDF expects the mean and standard deviation in the Z and Y stack registers, as well as the argument x in the X register. Upon completion x will be saved in LASTx, and $f(\mu, \sigma, x)$ will be placed in X. It has an all-MCODE implementation, using 13-digit routines for increased accuracy.

PDF is a function borrowed from the Curve Fitting Module, which contains others for different distribution types. With the Normal distribution being the most common one, it was the logical choice to include in the SandMath.

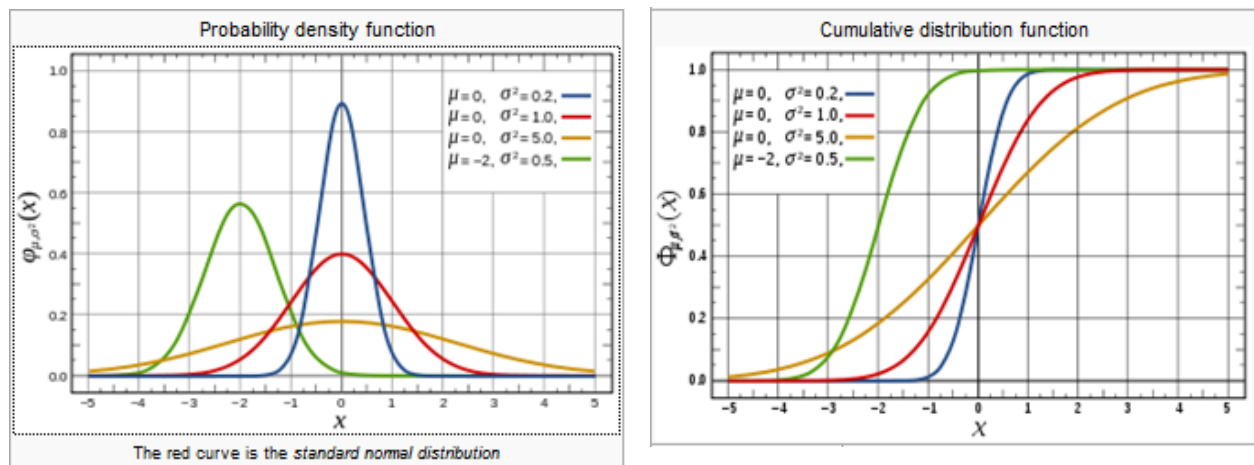

The figures above show both the density functions as well as the cumulative probability function for several cases. The Error function **ERF** in the SandMath can be used to calculate the **CPF** – no need to apply brute force and use **PDF** in an **INTEG**-like scenario, much longer to obtain or course. The relation to use is:

$$F(x; \mu, \sigma^2) = \Phi\left(\frac{x - \mu}{\sigma}\right) = \frac{1}{2} \left[1 + \operatorname{erf}\left(\frac{x - \mu}{\sigma\sqrt{2}}\right) \right], \quad x \in \mathbb{R}.$$

Example program: The routine below calculates CPF. Enter μ , σ , and x values in the stack.

```

01 LBL "CPF"      08 /
02 RCL Z          09 ERF
03 -             11 INCX
04 X<>Y          12 2
05 /             13 /
06 2             14 END
07 SQRT
    
```

Poisson Standard Distribution. { PSD }

PSD is another Statistical function, which calculates the Poisson Standard Distribution. In probability theory and statistics, the Poisson distribution is a discrete probability distribution that expresses the probability of a given number of events occurring in a fixed interval of time and/or space if these events occur with a known average rate and independently of the time since the last event

A discrete stochastic variable X is said to have a Poisson distribution with parameter $\lambda > 0$, if for $k = 0, 1, 2, \dots$ the probability mass function of X is given by:

$$f(k; \lambda) = \Pr(X = k) = \frac{\lambda^k e^{-\lambda}}{k!} :$$

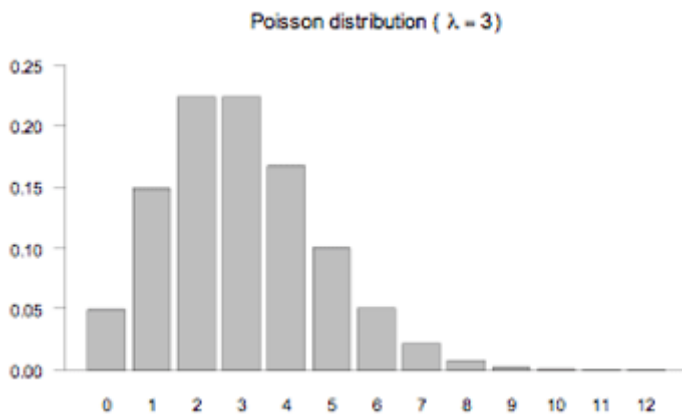

Its inputs are k and λ in stack registers X and Y. **PSD**'s result is the probability corresponding to the inputs.

Example 1.-

Calculate the probability mass function for a Poisson distribution with parameters: $\lambda=4, k=5$

4, ENTER^, 5, **ΣF\$** "PSD"
Returns: 0.156293452

Example 2: do the same for $\lambda=10$ and $k=10$

10, ENTER^, **ΣF\$** "PSD"
(or **ΣFL**, [,] - "LastF")
Returns: 0.125110036

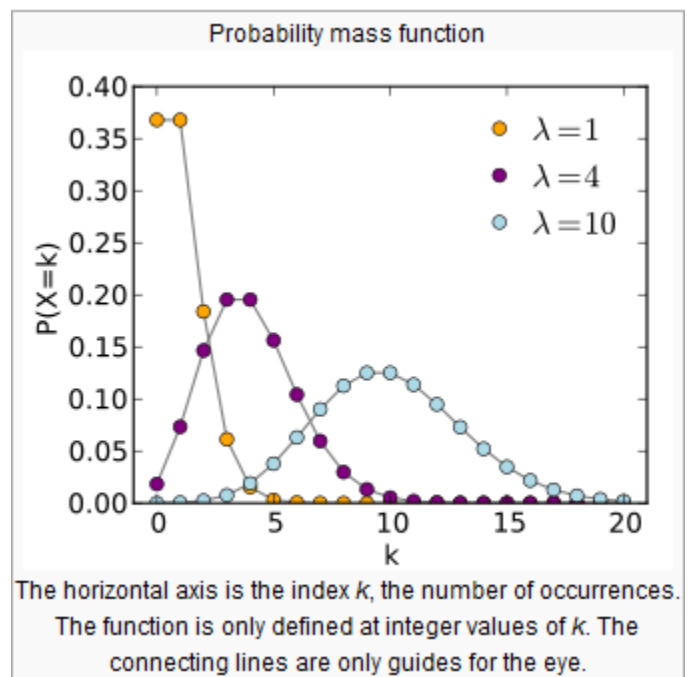

And what about prime factorization? { PFCT }

Function **PFCT** will do a very fast and simple prime factorization of the number in X, using **PRIME?** To look for the successive divisors until 1 is found. **PFCT** uses the ALPHA registers to present the results, grouping the repetitions of a given factor in its corresponding exponent.

For example, for x=126 the three prime factors are 2, 3, and 7, with 3 repeated two times:

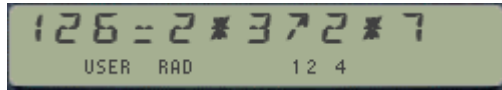

For large numbers or when many prime factors exist, the display will scroll left to a maximum length of 24 characters. This is sufficient for the majority of cases, and only runs into limiting situations in very few instances, if at all – remember that exceeding 24 characters will shift off the display the left characters first, that is the original number - which doesn't result into any data loss.

Obviously prime numbers don't have any other factors than themselves. For instance, for x=17777 PFCT will return:

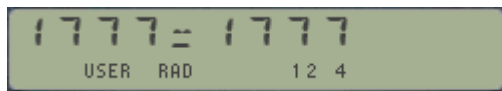

, which indeed is hardly debatable.

Note that only the last two prime factors found will be stored in Y and Z, and that the original number will remain in X after the execution terminates. A more capable prime factorization program is available in the SandMATRIX module, using the matrix functions of the Advantage and Advanced Matrix ROMs to save the solutions in a results matrix. See the appendices for a listing of the program used in the SandMath and the more comprehensive one.

1	LBL "PRMF"
2	INT
3	ABS
4	CLA
5	AINT
6	" / - "
7	X=1?
8	GTO 01
9	CF 00
10	LBL 00 ←
11	PRIME?
12	SF 00
13	AINT
14	FS?C 00
15	GTO 01 →
16	LASTX
17	X<>Y
18	/
19	" / - * "
20	GTO 00 ←
21	LBL 01 ←
22	X=1?
23	AINT
24	AVIEW
25	END

Shown on the left there's an even simpler version, that doesn't consolidate the multiple factors – which will aggravate the length limitation of the ALPHA registers of 24-chrs max. The core of the action is performed by **PRIME?**, therefore the fast execution due to the MCODE speed.

See the appendix in the next pages, with both the actual code for **PFCT** in the SandMath , and for **PRMF** - a more capable implementation using the Matrix functions from the HP Advantage to store the prime factor and their repetition indexes – really the best way to present the results.

For that second case the function **PF>X** restores the original argument from the matrix values. Also function **TOTNT** is but a simple extension, using the same approach.

Appendix 5. Enhanced Prime factor decomposition.

The FOCAL programs listed below are for **PFCT** – included in the SandMath – and **PRMF**, a more capable implementation that uses the Matrix functions from the HP Advantage (or the SandMatrix ROM). For sure a matrix is a much better place than the ALPHA register to hold that information – as is done in **PFCT**. The drawback is of course the execution speed, much faster in **PFCT**.

- **PRMF** stores all the different prime factors and their repetition indices in a (n x 2) matrix. The matrix is re-dimensioned dynamically each time a new prime factor is found, and the repetition index is incremented each time the same prime factor shows up.
- **PF>X** is the reverse function that restores the original number from the values stored in the matrix.
- **TOTNT** (Totient function) is but a simple extension, also shown in the listings below.

PRMF, **PC>X** and **TOTNT** are included in the Advanced MATRIX ROM.

Below is the program listing for PFCT, as implemented in the SandMath:

1	LBL "PRMF"		32	GTO 03	skip if Prime
2	CF 00		33	ST/ L	
3	INT		34	LASTX	reduced number
4	ABS		35	GTO 00	
5	CLA		36	LBL 03	← Prime found
6	AINT		37	RCL 00	
7	" / - "		38	X=1?	
8	PRIME?		39	GTO 01	
9	SF 00		40	" / - "	
10	AINT	first prime factor	41	AIP	
11	X=1?		42	GTO 01	→
12	GTO 01		43	LBL 02	NEW pf
13	FS?C 00	if prime, we're done	44	STO 01	
14	GTO 01		45	RCL 00	
15	STO 01	save for grouping	46	X=1?	
16	ST/ L		47	GTO 03	
17	LASTX	reduced number	48	" / - "	
18	LBL 05		49	AINT	
19	E		50	LBL 03	
20	STO 00	reset counter	51	RDN	
21	RDN		52	" / - * "	
22	LBL 00		53	AINT	
23	RCL 01	previous prime factor	54	FS?C 00	
24	X<>Y		55	GTO 01	→
25	PRIME?		56	ST/ L	
26	SF 00		57	LASTX	
27	X#Y?	different PF?	58	GTO 05	
28	GTO 02	YES	59	LBL 01	←
29	ISG 00	increase counter	60	AVIEW	
30	NOP	SAME pf	61	ANUM	
31	FS?C 00	was it prime?	62	END	

Below is the Enhanced version, allowing for any number of different prime factors and repetition indices – all stored in a (n x 2) matrix file in extended memory, "PRMF".

Note how the program structure is basically the same, despite the addition of the matrix handling. Since the Advantage module is required we've used **AIP** instead of **AINT**, totally interchangeable as they're basically the same function.

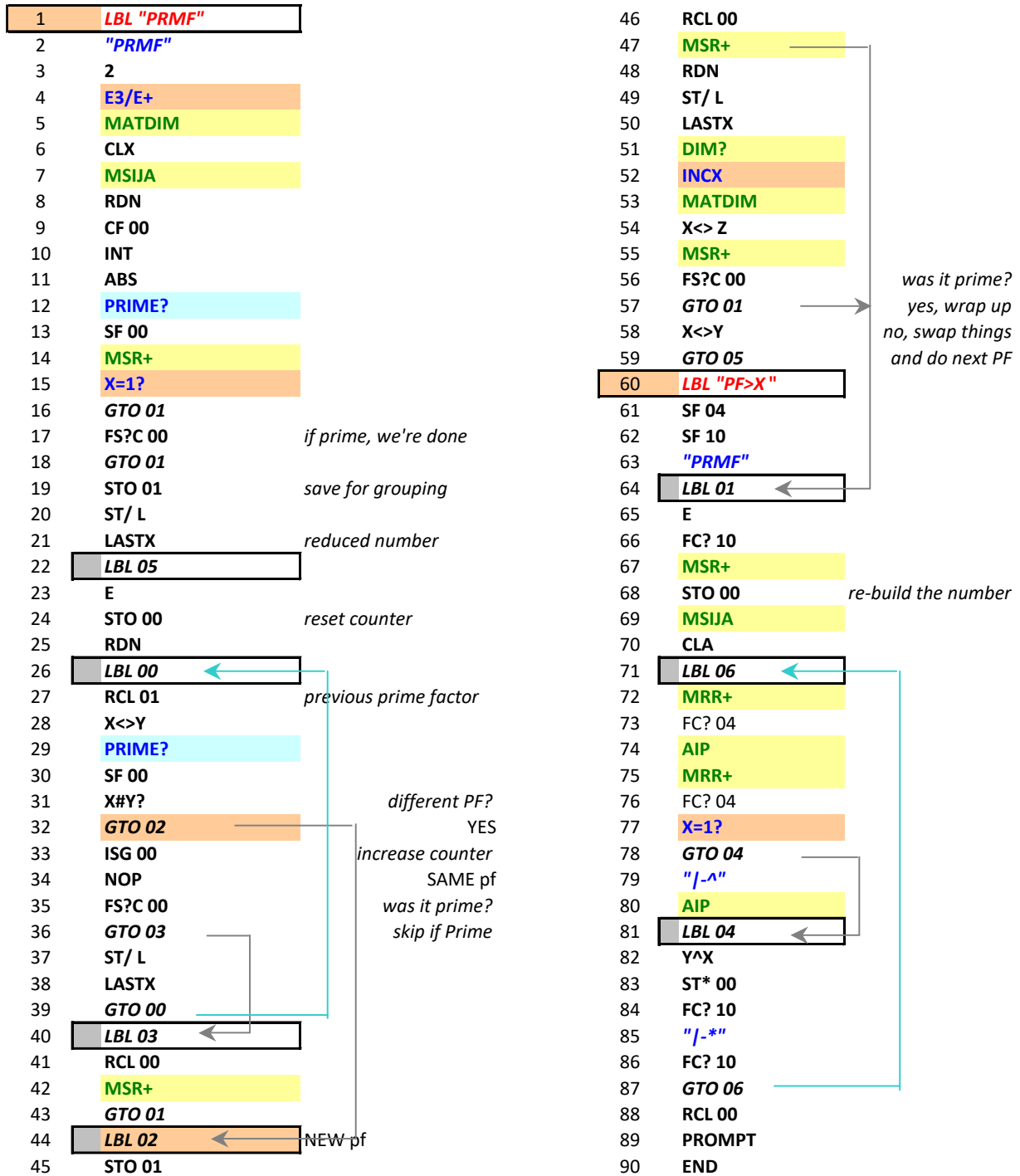

Curve Fitting at its best. { CURVE , CRVF , EQT }

Perhaps few other subjects have been so thoroughly covered and repeatedly implemented on programmable calculators as Curve Fitting. Certainly the 41 is no exception to this, see the excellent examples from the Advantage Module and the PPC ROM, or the standard-setting macro-program from W. Kolb on the same subject.

Revision 3x3 of the SandMath includes the excellent implementation of the Curve Fitting functions from the AECROM – enhanced to use 13-digit math routines. Both the **CURVE** program (in FOCAL) and the **CRVF** function (MCODE) are included in their entirety. With them you can make fast and convenient curve fitting calculations to 16 different curve types, choosing the best fit amongst them based on the correlation coefficients obtained.

The following paragraphs are extracted from the AECROM Users manual - by itself an excellent work, perfect complement to the world-class programming that went into the Module. They should provide enough information to get you going. It's only after some consideration that I decided to include them, both begging forgiveness and asking permission - you're encouraged to consult the original manual, available at: <http://www.hp41.org/LibView.cfm?Command=View&ItemID=581>

The AECROM Curve Fitter.

With the AECROM program "**CURVE**" you can fit an unlimited number of data pairs (x,y) to sixteen different curves. "CURVE" will automatically determine which of the sixteen curves best fits the supplied data or you can specify the curve to fit. Once the data has been fit to a curve, "CURVE" will return predicted y-values for x-values you supply.

A menu-driven program.

The program "CURVE" is menu driven, that is, it redefines the meanings of the top row of keys and those new meanings can be shown in the display above the keys. In order to use "CURVE," you must set your calculator to USER mode (press [USER] to turn on the word USER in the display) and you must clear any global assignments on the top row of keys.

Press XEQ "**CURVE**" and the top row of keys takes on the following meanings:

- [A] -(AD): Accumulate an (x,y) Data pair.
- [B] -(FIT): Fit the Data to the curve specified in register 00 (curve number 0 -15)
- [C] -(y=): Calculate a y-value on the current curve for an input x.
- [D] -(BST): Find the BeST fit (of the sixteen available curves) for the current data.
- [E] -(ME): Bring up this Menu.
- [SHIFT] [a]-: Remove an (x,y) Data pair (for error corrections).

The Sixteen curves

The sixteen curves available and their equations' are listed below according to curve number.

- 0. LINEAR: $y = a + bx$
- 1. RECIPRCL (reciprocal of linear): $y = 1 / (a + bx)$
- 2. HYPERBLA (hyperbola): $y = a + b/x$
- 3. RECIP HYP (reciprocal of hyperbola): $y = x / (ax+b)$
- 4. POWER: $y = ax^b$
- 5. MOD PWER (modified power): $y = a b^x$
- 6. ROOT: $y = a b^{1/x}$
- 7. EXPONENL (exponential): $y = a e^{(bx)}$

8. LOGRTHMC (logarithmic): $y = a + b \times \text{LN}x$
9. LIN HYP (linear hyperbolic): $y = a + bx + c/x$
10. 2 ORD HY (second order hyperbolic): $y = a + b/x + c/(x^2)$
11. PARABOLA: $y = a + bx + c(x^2)$
12. LIN EXPN (linear exponential): $y = ax/(b^x)$
13. NORMAL: $y = a e^{((\sim b)^2)/c}$
14. LOG NORM (log normal): $y = a e^{((b-\text{LN}x)^2)/c}$
15. CAUCHY: $y = 1/(a(x+b)^2 + c)$

Data Register usage.

In order to run the "CURVE program (or use the CRVF function), you need to have 56 registers available for data storage ([XEQ] "SIZE 056). Registers 00 to 07 (below) are the ones that contain the information pertaining to the curve fit. Registers 08 to 55 (listed on page 55) contain the accumulated data information required to fit data to the sixteen curves.

- R00 - Curve number (0 to 15)
- R01 - a
- R02 - b
- R03 - c
- R04 - RR (coefficient of determination)
- R05 - RR corrected (for comparing curves of different orders)
- R06 - Best RR corrected so far
- R07 - Rest curve number so far

Executing the CURVE program clears all data registers in the HP-41.

Example 1 : Finding the Best Fit

As a genetic engineer, you recently completed an experiment dealing with algae growth under varying levels of radiation. The experiment yielded nine data pairs, which after scaled and rounded to one significant digit, looked like this:

Radnt.	1	3	3	4	5	5	8	10	11
Growth	5	7	10	9	9	11	12	10	13

Which curve best fits these nine data pairs?

Solution: (Assumes FIX 4)

Keystrokes	Display
XEQ "CURVE"	AD,FIT,Y=,BST,ME
5, ENTER^, 1, [A]	1.0000
7, ENTER^, 3, [A]	2.0000
10, ENTER]^, 3 [A]	3.0000
9, ENTER^, 4, [A]	4.0000
9, ENTER^, 5, [A]	5.0000
11, ENTER^, 5, [A]	6.0000
12, ENTER^, 8, [A]	7.0000
10, ENTER^, 10[A]	8.0000
13, ENTER^, 11,[A]	9.0000
[E]	AD,FIT,Y=,BST,ME
[D]	LINEAR_. RECIPRCL_, HYPERBLA_, ... CAUCHY_, LIN EXPN_

By pressing the [D] key, you told the CURVE program to determine which of the sixteen curves fits this data best. The calculator displays each curve name as it is fitting the data to that curve. When the search is completed, the name LIN EXPON_ is shown in the display to indicate that the data fits best to a linear exponential curve.

The equation for the LIN EXPON curve is $y = ax/(b^x)$, and the values for "a" and "b" are stored in registers 01 and 02, respectively. If you press RCL 01, you will see 4.3859, which is the calculated value for "a." RCL 02 will show you 1.1476, which is "b."

Goodness of Fit

The coefficient of determination, [RR], is stored in register 04. As you know, this number is a score ranging from 0 to 1 that tells you how well your data fits to the specified curve. A score of 1 tells you that every data point falls exactly on the curve specified by a, b, c, and the curve's equation. If you press [RCL] 04, you should see the value 0.8767, which is RR for the previous example.

The value for RR just described is dependent upon the number of data points in your sample and upon the number of coefficients (a, b, and c) that are estimated for a given curve. For this reason, RR is not often a good tool for comparing curves. However, a corrected version of RR, one that isn't dependent upon sample size or number of coefficients, has been provided (stored in register 05) for use when comparing different curves.

Example 2: Predicting Y at a given X.

As a metallurgist, you are testing a new additive to an alloy. This additive influences the strength of the alloy and this influence varies according to the percentage of the additive in the alloy. In tensile strength experiments, you measured failure points in wires of different additive percentages. The following table of scaled data was produced:

Additive %	Failure/Scale		Additive %	Failure/Scale
0	1.00		4.0	4.165
0.5	1.131		4.5	4.629
1.0	1.079		5.0	4.811
1.5	1.354		5.5	5.577
2.0	1.382		6.0	5.391
2.5	2.350		6.5	4.735
3.0	3.767		7.0	4.618
3.5	3.945			

Input the data and find the best fit. Use the failure variables as the values of y and the percentages as the x's. Then, based on this best fit curve, find the scaled failure point for a wire with an additive percentage of 4.3.

Solution: The best fit is the NORMAL curve or NORMAL distribution (the equation is $y = a e^{((x-b)^2) + c}$). The values for a, b, and c, are: 5.173, 6.234, and -19.175 respectively. Once you have determined this to be the curve, to get the y-value at $x = 4.3$ press: 4.3 [E], [C]. That value is 4.256.

Displaying the Equations for Curve Fitting Programs { **EQT** }

As there was plenty of available space in the module, I decided to include this routine to complement the Curve Fitting program in the SandMath (**CURVE**). The routine **EQT** will write in Alpha the actual equation which reference number is in the X register, ranging from 0 to 15 as per the table below:

0. Linear	01*LBL "EQ"	30*LBL 08
1. Reciprocal	02 XEQ IND 00	31 "a+bLNx"
2. Hyperbola	03 AVIEW	32 RTH
3. Reciprocal Hyperbola	04 RTH	33*LBL 09
4. Power	05 GTO "EQ"	34 "a+bX+(c/X)"
5. Modified Power	06*LBL 08	35 RTH
6. Root	07 "a+bX"	36*LBL 10
7. Exponential	08 RTH	37 "a+(b/X)+(c/X^2)"
8. Logarithmic	09*LBL 01	38 RTH
9. Linear Hyperbolic	10 "1/(a+bX)"	39*LBL 11
10. 2 nd . Order Hyperbolic	11 RTH	40 "a+bX+cX^2"
11. Parabola	12*LBL 02	41 RTH
12. Linear Exponential	13 "a+(b/X)"	42*LBL 12
13. Normal	14 RTH	43 "aX/bX"
14. Log Normal	15*LBL 03	44 RTH
15. Cauchy	16 "X/(aX+b)"	45*LBL 13
	17 RTH	46 "ae^(((X-b)^2)/c)
	18*LBL 04	47 "t)"
	19 "aX^tb"	48 RTH
	20 RTH	49*LBL 14
	21*LBL 05	50 "ae^(((b-LNX)^2)-
	22 "ab^tX"	51 "t/c)"
	23 RTH	52 RTH
	24*LBL 06	53*LBL 15
	25 "ab^t(1/X)"	54 "1/((a(X+b)^2)+c"
	26 RTH	55 "t)"
	27*LBL 07	56 RTH
	28 "ae^t(bX)"	57 END
	29 RTH	

Note that **EQT** does not perform any calculations, thus it's just an embellishing addition to CURVE.

The original FOCAL program listing (on the right) was first published in the AECROM manual, and it's reproduced here practically unaltered.

The implementation in the SandMath is done in MCODE, much longer in size (about 350 bytes in total) but possible to tuck away in a second bank – where the space for it was available. The short FOCAL program below will show the 16 curve types sequentially:

01 LBL "CURVES"		06 PSE	<i>pause</i>
02 0.015	<i>16 types total</i>	07 ISG X	<i>next type</i>
03 LBL 00	<i>loop head</i>	08 GTO 00	<i>loop back</i>
04 EQT	<i>(ΣF# 097)</i>	09 END	<i>done</i>
05 AVIEW	<i>show text</i>		

Program listing.

01 LBL "CURVE"	08 CLRG	15 "J-E"
02 SIZE?	09 STO 55	16 AVIEW
03 56	10 GTO E	17 STOP
04 X>Y?	11 LBL 99	18 GTO 98
05 PSIZE	12 STOP	19 LBL A
06 LBL 98	13 LBL E	20 CF 00
07 CLST	14 "AD;FIT;Y=;BST;M"	21 GTO 00

22	LBL a	78	GTO 00	134	/
23	SF 00	79	LBL 03	135	+
24	LBL 00	80	ENTER^	136	GTO 01
25	CF 01	81	ENTER^	137	LBL 11
26	CRVF	82	RCL 01	138	ENTER^
27	VIEW 13	83	*	139	ENTER^
28	GTO 99	84	RCL 02	140	X^2
29	LBL B	85	+	141	RCL 03
30	STO 00	86	/	142	*
31	SF 01	87	GTO 00	143	X<>Y
32	CRVF	88	LBL 04	144	RCL 02
33	GTO 99	89	RCL 02	145	*
34	LBL D	90	GTO 01	146	+
35	0	91	LBL 06	147	LBL 01
36	STO 06	92	1/X	148	RCL 01
37	STO 07	93	LBL 05	149	+
38	,015	94	RCL 02	150	GTO 00
39	STO 00	95	X<>Y	151	LBL 12
40	LBL 97	96	LBL 01	152	ENTER^
41	RCL 00	97	Y^X	153	ENTER^
42	SF 01	98	RCL 01	154	RCL 02
43	CRVF	99	*	155	X<>Y
44	RCL 06	100	GTO 00	156	Y^X
45	RCL 05	101	LBL 07	157	/
46	X<=Y?	102	RCL 02	158	GTO 01
47	GTO 00	103	*	159	LBL 13
48	STO 06	104	E^X	160	RCL 02
49	RCL 00	105	RCL 01	161	CHS
50	STO 07	106	*	162	GTO 02
51	LBL 00	107	GTO 00	163	LBL 14
52	ISG 00	108	LBL 08	164	LN
53	GTO 97	109	LN	165	CHS
54	RCL 07	110	RCL 02	166	RCL 02
55	INT	111	*	167	LBL 02
56	GTO b	112	GTO 01	168	+
57	LBL C	113	LBL 09	169	X^2
58	GTO IND 00	114	ENTER^	170	RCL 03
59	LBL 00	115	ENTER^	171	/
60	RCL 02	116	RCL 03	172	E^X
61	*	117	X<>Y	173	LBL 01
62	RCL 01	118	/	174	RCL 01
63	+	119	X<>Y	175	*
64	GTO 00	120	RCL 02	176	GTO 00
65	LBL 01	121	*	177	LBL 15
66	RCL 02	122	+	178	RCL 02
67	*	123	GTO 01	179	+
68	RCL 01	124	LBL 10	180	X^2
69	+	125	ENTER^	181	RCL 01
70	1/X	126	ENTER^	182	*
71	GTO 00	127	RCL 03	183	RCL 03
72	LBL 02	128	X<>Y	184	+
73	RCL 02	129	X^2	185	1/X
74	X<>Y	130	/	186	LBL 00
75	/	131	X<>Y	187	GTO 99
76	RCL 01	132	RCL 02	188	END
77	+	133	X<>Y		

A few more Geometry Functions.

	Function	Description	Author
[Σ\$]	PP2	2D Distance between 2 points	Ángel Martin
[Σ\$]	VMOD	3D Vector Module	Ángel Martin
[Σ\$]	VXA	3D Cross Product	Ángel Martin
[Σ\$]	V*A	3D Dot Product	Ángel Martin
[Σ\$]	CIRCL	Radius of Circle / Area Triangle from 3 points	Ángel Martin
[Σ\$]	HERON	Area of a Triangle using its sides	JM Baillard
[Σ\$]	BRHM	Area of cyclic quadrilateral	JM Baillard
[Σ\$]	THV	Tetrahedron Volume	JM Baillard

This is the small set of geometry functions in the SandMath – just a token to glimpse at the subject, not a comprehensive implementation. The SandMatrix and Vector Analysis modules contain many more, as well as a full-featured 3D-Vector Calculator (see overlay below). The Vector Analysis ROM is just a 4k module that can be used independently from the SandMath, but sure it's a powerful complement for these specific subjects.

Distance between two points. { PP2 }

The Euclidean distance between two points p and q is the length of the line segment connecting them. In the Euclidean plane, if p = (p1, p2) and q = (q1, q2) then the distance is given by

$$d(\mathbf{p}, \mathbf{q}) = \sqrt{(p_1 - q_1)^2 + (p_2 - q_2)^2}$$

PP2 expects the coordinates of the two points stored in the stack, (y1,x1), (y2,x2) in T,Z,Y, and X (or vice-versa). The distance will be placed in X upon completion.

Example: Calculate the distance between the points a(-3,5) and b(6,-2) from the figure below:

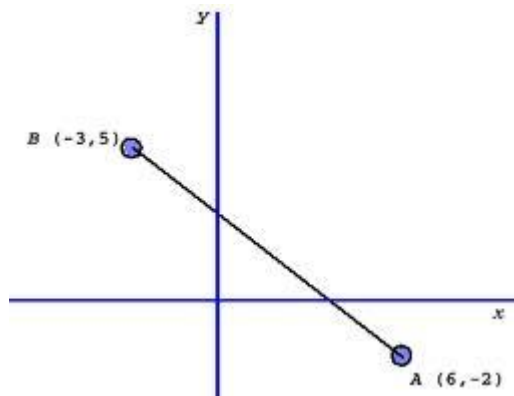

Type: 5, ENTER^, -3, ENTER^, -2, ENTER^, 6, ENTER^,

ΣF\$ "PP2" -> 11.40175425

Note: A similar function exists in the 41Z module – **ZWDIST**, which basically calculates the same thing, albeit done in a complex-number context.

3D Vector Modulus (Magnitude) { VMOD }

With the 3 coordinates stored in the stack registers Z,Y, and X, **VMOD** calculates the vector modulus. The result is returned in X, but the stack is otherwise unchanged. The initial x-coordinate is saved in LastX, so you can restore the original vector using X<> L

Example: Calculate the magnitude of vector V = [1 -3 4]

Type: 4, ENTER^, -3, ENTER^, 1, **ΣF\$ "VMOD"** -> 5.099019514

3D Dot and Cross products. { V^*A , VXA }

Here the first vector is stored in stack registers X,Y,Z, and the second in ALPHA registers M,N,O. Obviously having an auxiliary function like $ST\langle>A$ will come handy – such is available in the AMC_OS/X module. You can also use STO M, STO N, and STO O for each coordinate.

VXA returns the result coordinates in the Stack, replacing the initial values. ALPHA is unchanged.

V^*A returns the result value in X, the rest of the stack and ALPHA are unchanged.

Examples. Calculate the cross and dot products between: $V1 = [1 \ 2 \ 3]$ and $V2 = [4 \ 5 \ 6]$

Type: 6, ENTER^, 5, ENTER^, 4, ENTER^, $ST\langle>A$
 and 3, ENTER^, 2, ENTER^, 1, ENTER^, $\Sigma F\$ "V^*A"$ -> 32.00000000

Then use $X\langle>L$, to restore the initial value, and $\Sigma F\$ "VXA"$ -> -3.000000000

Use RDN twice to see the result vector is: $V1 \times V2 = [-3 \ 6 \ -3]$
 Remember also that the cross product is not commutative, thus $(V1 \times V2) = - (V2 \times V1)$.

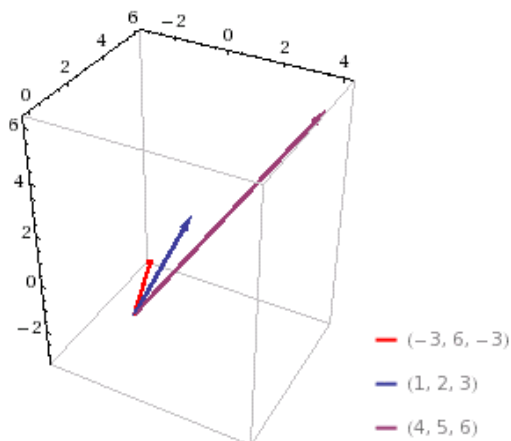
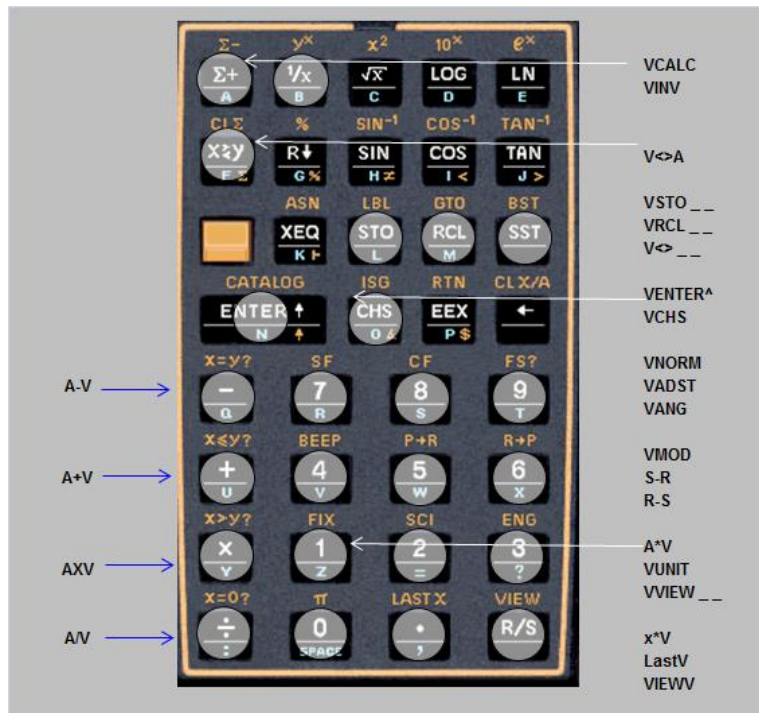

Here's a way to check your results in WolframAlpha:
<http://www.wolframalpha.com/input/?i=cross+product>

Circles, Triangles and Tetrahedrons. { CIRCL , HERON , BRHM , THV }

A short reminder section - to reflect the popularity of these topics so common in the early days of programmable calculators. See JM Baillard's pages on the subjects posted at:

<http://hp41programs.yolasite.com/polygon.php> and <http://hp41programs.yolasite.com/heron.php>

- **CIRCL** calculates the radius of a circle passing thru three data points, using the point x,y coordinates. The values are expected to be stored in R01-R07. Besides that, it'll also return in the Y-register the area of the circumscribed triangle defined by the three points.

Example: Calculate the radius of the circle passing thru P(5,1), Q(6,2), and R(5,3)

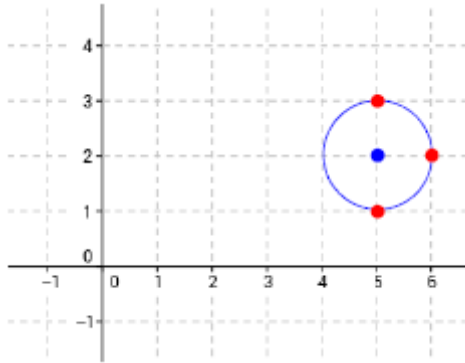

The results are:

$\Sigma F\$$ "CIRCL" $\Rightarrow r = 1,000000000$,
 $X \leftrightarrow Y \Rightarrow A = 1,000000000$

Note that you can use the routines **IN** or **INPUT** available in the auxiliary FAT to populate the registers automatically. The input sequence starts with the abccissa of P1 in R01.

- **HERON** calculates the area of a triangle knowing its three sides, using Heron's formula. Just enter the sides values in the stack, and execute the function (located in the auxiliary FAT). The result is stored in X, with the original side saved in LastX. The rest of the stack is unchanged.

Let the triangle ABC with 3 known sides { a , b , c } and $s = (a+b+c)/2$ the semi-perimeter

Heron's formula is: $Area = [s(s-a)(s-b)(s-c)]^{1/2}$

Example: a = 2, b = 3, c = 4

Type: 2, ENTER^, 3, ENTER^, 4, $\Sigma F\$$ "HERON" $\Rightarrow Area = 2.904737510$

Note: the function **CIRCL** described above makes use of the HERON formula internally after it first calculates the triangle sides from the point coordinates.

- **BRHM** is related to it, but the calculation for the area of the cyclic quadrilateral - using Brhamagupta's formula. Just enter the four values in the stack and execute the function (in the secondary FAT). The result is stored in X, with the original side saved in LastX. The rest of the stack is unchanged.

Let a, b, c, and d be its sides lengths, and the semi-perimeter $s = (a + b + c + d)/2$. The area A of the cyclic quadrilateral is:

$A = [(s-a).(s-b).(s-c).(s-d)].^{1/2}$

Example: a = 4 , b = 5 , c = 6 , d = 7

Type: 4, ENTER^, 5, ENTER^, 6, ENTER^, 7,
 $\Sigma F\$$ "BRHM" $\Rightarrow Area = 28.98275349$

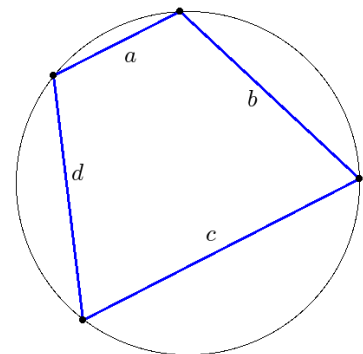

- **THV** calculates the volume of a tetrahedron using Francesca's formula - with edges values stored in registers R01 to R06. - provided that the edges a, b, c intersect at the same vertex and the edges d, e, f are respectively opposite to the edges a, b, c - thus a and d (respectively b and e, c and f) must be non-coplanar.

Here too you can use **IN** or **INPUT** to conveniently store those values in the registers, see **DHST** description section for details.

Example1: $a = 3 \quad b = 5 \quad c = 7 \quad d = 6 \quad e = 8 \quad f = 4$

Store these 6 numbers into R01 thru R06

then: $\Sigma F\$$ "THV" $\Rightarrow V = 8.426149773$ - The exact value is $\sqrt{71}$, all digits correct.

Example2: $a = 120 \quad b = 160 \quad c = 153 \quad d = 25 \quad e = 39 \quad f = 56$

Store these 6 numbers into R01 thru R06,

Then: $\Sigma F\$$ "THV" $\Rightarrow V = 8,063.999998$ - the exact result is 8,064

The second tetrahedron is a heronian tetrahedron: the edges lengths, the faces areas & the volume are all integers. So not even the 13-digit math routines return exact results in difficult cases like example2.

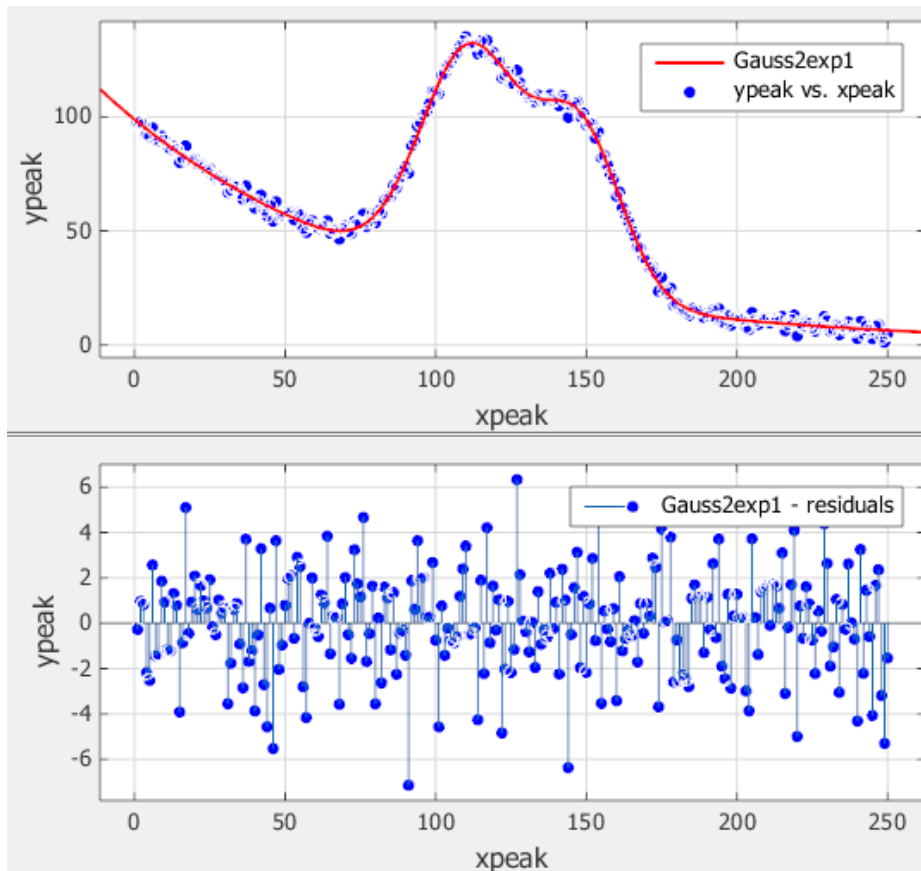

3.2 FACTORIALS



Quick recap: a summary table of the different factorial functions available in the SandMath.-

	Function	Description	Author
[Σ\$]	APNB	Apery Numbers	JM Baillard
[Σ\$]	BN2	Bernouilli Numbers	Ángel Martin
[Σ\$]	MFCT	Multifactorial	JM Baillard
[Σ\$]	LOGMF	Logarithm Multifactorial	Ángel Martin
[Σ\$]	SFCT	Superfactorial	JM Baillard
[Σ\$]	XFCT	Extended FACT	JM Baillard
[Σ\$]	POCH	Pochhammer symbol	Ángel Martin
[Σ\$]	FFCT	Falling factorial	Ángel Martin

Large numbers in a calculator like the HP-41 represent a challenge. Not only the limited numeric range becomes a problem, but also the 10-digit accuracy limits the practical application of the field. Nevertheless the few functions that follow contribute to add further examples of the ingenuity and what's possible using this venerable platform.

This was the last section added to the SandMath in revision "E". It also required compacting the few gaps available, and transferring some code to the last available space in the Library#4 module. Make sure you have matching revision of those two!

The functions in the table above *operate only on integers*, i.e. no extension to real numbers using GAMMA. Below is a 3D visualization of one of such extensions, the Hyperfactorial from WolframWorld:

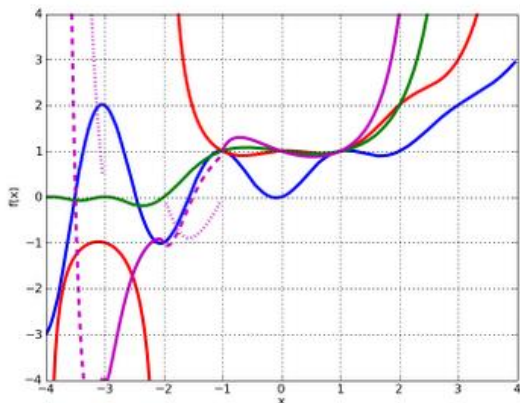
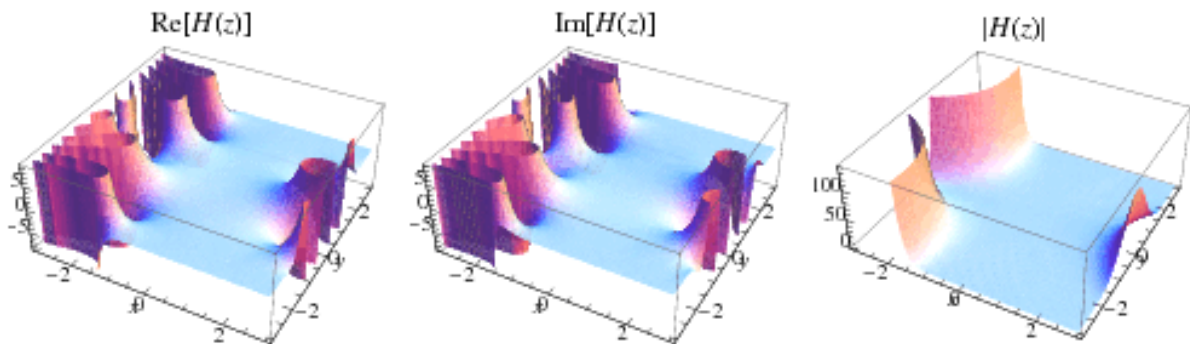

The figure on the left shows a plot of the four functions on the real line (Fibonacci in blue, double factorial in red, superfactorial in green, hyperfactorial in purple).

Don't expect quantum leaps in number theory here; it is after all one of the most difficult branches of mathematics – despite its initial unassuming appearance.

Multifactorial, Superfactorial and Hyperfactorial. { **MFCT**, **SFCT**, **HFCT** }

This section covers the main extensions and generalizations of the factorial. There are different ways to expand the definition, depending on the actual sequences of numbers used in the calculation.

The **double factorial** of a positive integer n is a generalization of the usual factorial $n!$, defined by:

$$n!! \equiv \begin{cases} n \cdot (n-2) \dots 5 \cdot 3 \cdot 1 & n > 0 \text{ odd} \\ n \cdot (n-2) \dots 6 \cdot 4 \cdot 2 & n > 0 \text{ even} \\ 1 & n = -1, 0. \end{cases}$$

Even though the formulas for the odd and even double factorials can be easily combined into:

$$n!! = \prod_{i; 0 \leq 2i < n} (n - 2i),$$

The double factorial is a special case of the multifactorial, which uses the same formula but with different "steps": subtracting "k" (instead of "2") from the original number, thus:

$$\begin{aligned} n! &= n(n-1)(n-2) \dots 2 \cdot 1 \\ n!! &= n(n-2)(n-4) \dots \\ n!!! &= n(n-3)(n-6) \dots, \end{aligned}$$

where the products run through positive integers. Obviously for $k=1$ we have the standard **FACT**. One can define the k -th factorial, denoted by $n!^{(k)}$ recursively for non-negative integers as:

$$n!^{(k)} = \begin{cases} 1, & \text{if } 0 \leq n < k, \\ n((n-k)!^{(k)}), & \text{if } n \geq k, \end{cases}$$

Another extension to the factorial is the **Superfactorial**. It doesn't use any step-size as variant, rather it follows a similar formula but using the factorial of the numbers instead of the numbers themselves:

$$sf(n) = \prod_{k=1}^n k! = \prod_{k=1}^n k^{n-k+1} = 1^n \cdot 2^{n-1} \cdot 3^{n-2} \dots (n-1)^2 \cdot n^1.$$

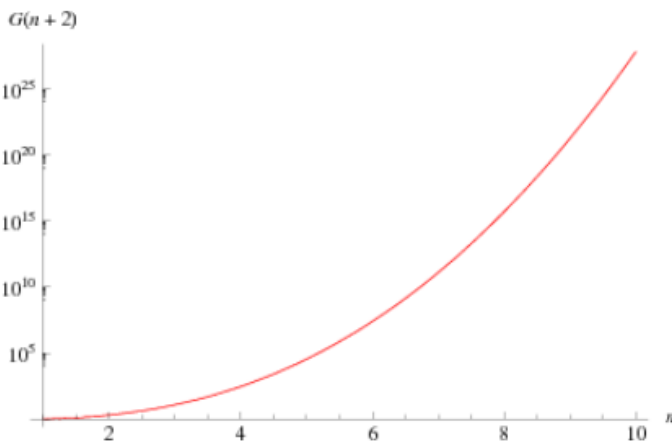

Both the multifactorial and (specially) the superfactorial will exceed the calculator numeric range rather quickly, so the SandMath functions use a separate mantissa and exponent approach, using registers X and Y respectively.

Nevertheless the functions will put up a consolidated (combined) representation in the display, using the letter "E" to separate both amounts. Make sure to adjust the FIX settings as appropriate:

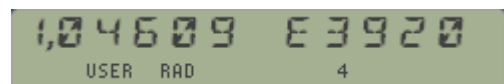

Examples: Calculate the multi- and superfactorials given below:

2345 !! !! type: 6, ENTER^, 2345, **"MFCT"** ->

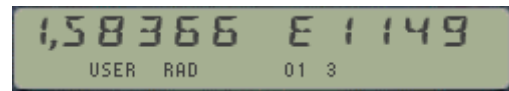

1234 !! !! type: 5, ENTER^, 1234, **"MFCT"** ->



Sf(41) type: 41, **ΣF\$ "SFCT"** ->

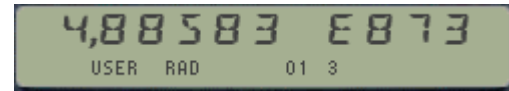

Sf(100) type: 100, **ΣFL, [,]"** ->

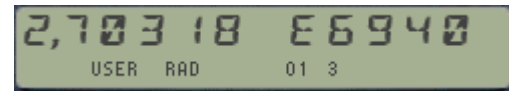

To complete this trinity of factorials – Occasionally the hyperfactorial of n is considered. It is written as H(n) and defined by:

$$H(n) = \prod_{k=1}^n k^k = 1^1 \cdot 2^2 \cdot 3^3 \dots (n-1)^{n-1} \cdot n^n.$$

The figures below show a plot for both the hyperfactorial and its logarithm – itself a convenient scale change very useful to avoid numeric range problems. Note that they're extended to all real arguments, and not only the natural numbers – also called the "K-function".

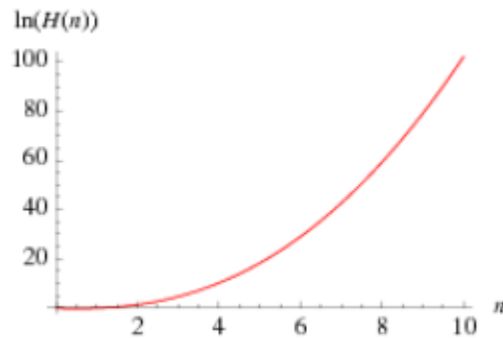
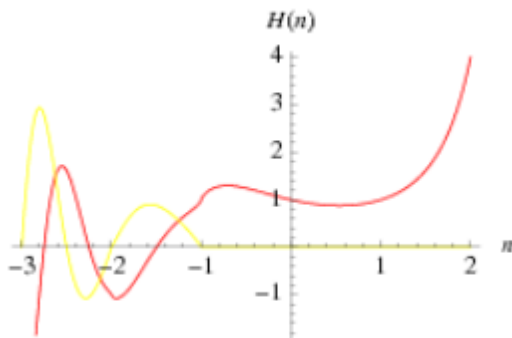

See below a couple of simple FOCAL program to calculate the hyperfactorial (which runs beyond the numeric range dramatically soon!) and its logarithm written by JM Baillard. Understandably slow and limited as these programs are, you can visit his web site for a comprehensive treatment using dedicated MCODE functions for the many different possible cases.

```
01 LBL "HFCT"      07 *
02 1              08 DSE Y
03 LBL 01         09 GTO 01
04 RCL Y         10 END
05 ENTER^
06 Y^X
```

```
01 LBL "LOGHF"    07 *
02 0              08 +
03 LBL 01         09 DSE Y
04 RCL Y         10 GTO 01
05 ENTER^        11 END
06 LOG
```

Example: calculate the Hyper-factorial of 23:

23, **ΣF\$ "LOGHF"**, 10, X<>Y, **Y^X** =>

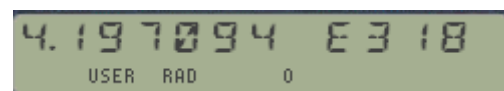

Logarithm Multi-Factorial. { LOGMF }

The product of all odd integers up to some odd positive integer n is often called the double factorial of n (even though it only involves about half the factors of the ordinary factorial, and its value is therefore closer to the square root of the factorial). It is denoted by $n!!$. For an odd positive integer $n = 2k - 1$, $k \geq 1$, it is

$$(2k - 1)!! = \prod_{i=1}^k (2i - 1)$$

A common related notation is to use multiple exclamation points to denote a multifactorial, the product of integers in steps of two ($n!!$), three ($n!!!$), or more. The double factorial is the most commonly used variant, but one can similarly define the triple factorial ($n!!!$) and so on. One can define the k -th factorial, denoted by $n!^{(k)}$, recursively for non-negative integers as:

$$n!^{(k)} = \begin{cases} 1, & \text{if } 0 \leq n < k, \\ n((n - k)!^{(k)}), & \text{if } n \geq k, \end{cases}$$

The figures below show the plots for $X!!$ (right), a comparison with $\log(\text{abs}(\text{gamma}))$ (red) versus $\log(\text{abs}(\text{doublegamma}))$ (green). - left.

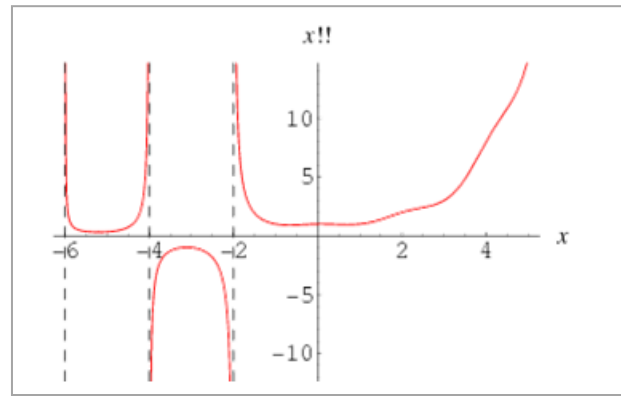
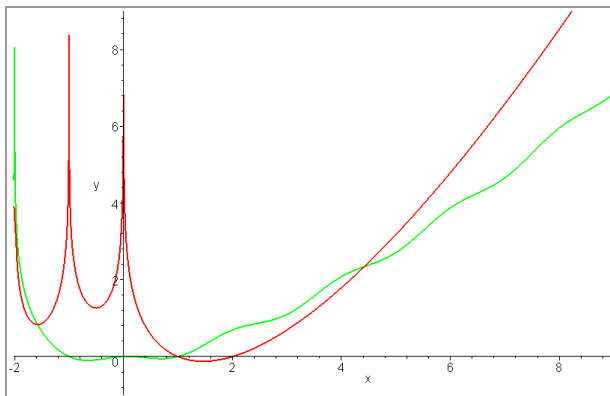

Using the Logarithm is helpful to deal with large arguments, as these functions go beyond the calculator numeric range very quickly. Also ran out of space in the module to have more than one function on this subject, thus **LOGMF** was chosen given its more general-purpose character.

The implementation is thru an all-MCODE function, yet execution times may be large depending on the arguments.

LOGMF may also be used to compute factorials, use $n=1$ and then E^X on the result. Obviously the accuracy won't be the greatest, but it's a reasonable compromise

Stack	Input	Output
Y	n	/
X	x	LGMF(x)

Examples:

```

2 ENTER^ , 100  ΣF$ "LOGMF"  -> Log ( 100 !! ) = 79.53457468
999 ENTER^ , 123456, ΣFL [ , ]  -> Log ( 123456 ! ..... ! ) = 578.0564932
    
```

Appendix 6.- Primorials – a primordial view. { NPRML , PPRML }

Welcome to the intersection between factorials and prime numbers...

In number theory primorial is a function from natural numbers to natural numbers similar to the factorial function, but rather than multiplying successive positive integers, only successive prime numbers are multiplied. The name "primorial", attributed to Harvey Dubner, draws an analogy to primes the same way the name "factorial" relates to factors.

There are two conflicting definitions that differ in the interpretation of the argument: the first interprets the argument as an *index into the sequence of prime numbers* (so that the function is strictly increasing), while the second interprets the argument as *a bound on the prime numbers to be multiplied* (so that the function value at any composite number is the same as at its predecessor).

The figures below plot both definitions, comparing their shape and slopes:-

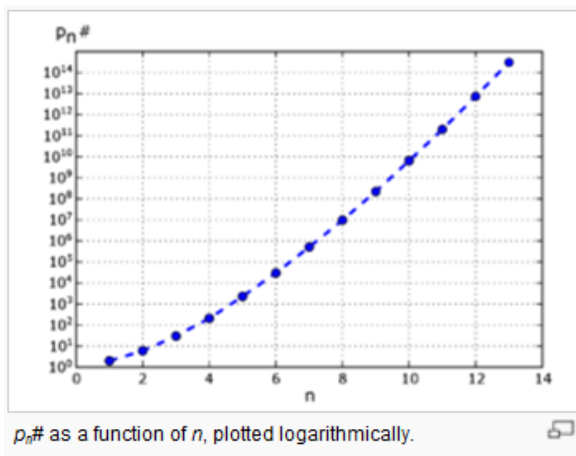

Prime primorial (left plot): For the n th prime number p_n the primorial $p_n\#$ is defined as the product of the first n primes (where p_k is the k th prime number):

$$p_n\# = \prod_{k=1}^n p_k$$

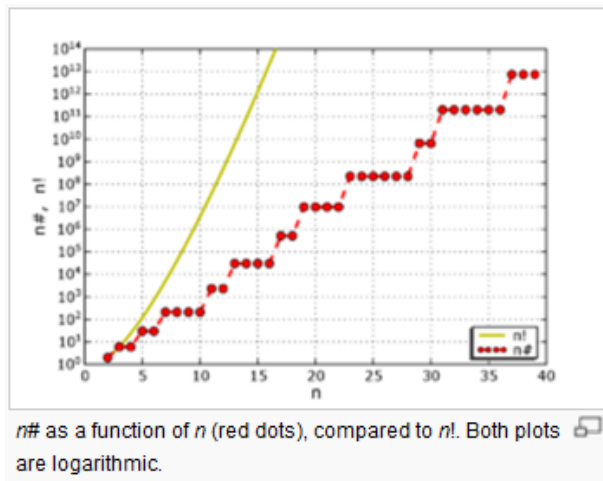

Natural primorial (right plot): In general, for a positive integer n such a primorial $n\#$ can also be defined, namely as the product of those primes $\leq n$.

$$n\# = \prod_{i=1}^{\pi(n)} p_i = p_{\pi(n)}\#$$

The FOCAL programs below can be used to calculate both flavors of primorials. Note the primordial (pun intended) role of function **PRIME?**, which effectively makes this a simple application as opposed to a full-fledged program from the scratch.

Examples: Calculate both primorials for the first 20 natural numbers.

See the solutions on the table next page.

Table of primorials

<i>n</i>	<i>n</i> #	<i>p_n</i>	<i>p_n</i> #
0	1	no prime	1
1	1	2	2
2	2	3	6
3	6	5	30
4	6	7	210
5	30	11	2310
6	30	13	30030
7	210	17	510510
8	210	19	9699690
9	210	23	223092870
10	210	29	6469693230
11	2310	31	200560490130
12	2310	37	7420738134810
13	30030	41	304250263527210
14	30030	43	13082761331670030
15	30030	47	614889782588491410
16	30030	53	32589158477190044730
17	510510	59	1922760350154212639070
18	510510	61	117288381359406970983270
19	9699690	67	7858321551080267055879090
20	9699690	71	557940830126698960967415390

01	LBL "NPRML"
02	ABS
03	INT
04	E
05	X>Y?
06	RTN
07	X<>Y
08	LBL 00 ←
09	PRIME?
10	GTO 01
11	X<> L
12	GTO 03
13	LBL 01 ←
14	ST* Y
15	LBL 03 ←
16	DSE X
17	GTO 00
18	X<>Y
19	RTN

01	LBL "PPRML"
02	ABS
03	INT
04	E
05	X>Y?
06	RTN
07	STO Z
08	LBL 00 ←
09	INCX
10	PRIME?
11	GTO 01
12	X<> L
13	GTO 00
14	LBL 01 ←
15	ST* Z
16	DSE Y
17	GTO 00
18	RCL Z
19	END

Both routines only use the stack – no data registers or user flags are used. Clearly the numeric range will again be the weakest link, reaching it for n=54 for **PPRML** and n=251 for **NPRML**.

Apéry Numbers. { **APNB** }

In mathematics Apéry's numbers were defined by Roger Apéry in his proof of irrationality of the Apéry's constant, $\zeta(3)$, and are defined by the following sums of binomial coefficients:

$$A_n = \sum_{k=0}^n \binom{n}{k}^2 \binom{n+k}{k}^2 = \sum_{k=0}^n \frac{[(n+k)!]^2}{(k!)^4 [(n-k)!]^2}$$

There's an expression based on the Generalized Hypergeometric Function (will be covered later in the manual), which is the one used in the SandMath – albeit in an independent MCODE function, thus not calling **HFG+** Said formula is:

$$A_n = {}_4F_3(-n, -n, n+1, n+1; 1, 1, 1; 1)$$

A short FOCAL program using this formula is listed below:

```

01 LBL "APNB"      07 STO 06      13 4
02 CHS            08 STO 07      14 PI
03 STO 01         09 X<>Y      15 INT
04 STO 02         10 -          16 1
05 1              11 STO 03      17 HGF+
06 STO 05         12 STO 04      18 END
    
```

They are also given by the recurrence equation:

$$A_n = \frac{(34n^3 - 51n^2 + 27n - 5)A_{n-1} - (n-1)^3 A_{n-2}}{n^3}$$

The first few are: 1, 5, 73, 1445, 33001 (see Sloane's A005259)

Their values grow very large quickly, therefore exceeding the 41 numeric range for $n \geq 67$. The technique used has been to split the result in mantissa and exponent, same as it was described for the extended factorials sections seen earlier in the manual.

The user instructions are simply to input the index n in X , and call **APNB** with the sub-function launcher **ΣF\$**. The result will be placed in stack registers Y (exponent) and X (mantissa), as well as shown as an ALPHA message in RUN mode.

Examples:

68, **ΣF\$** "APNB" -> $A_{67} = 5,08229 E100$

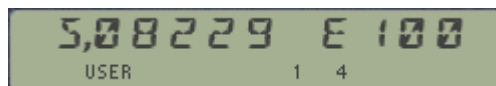

Shown as follows in RUN mode:

Other Examples:

```

41, ΣF$ "APNB" -> A41 = 4.944386782 E59
100, ΣF$ "APNB" -> A100 = 2.824655679 E149
329, ΣF$ "APNB" -> A329 = 1.990511251 E499
    
```

Kaprekar Routine. { **KAPR** }

The Kaprekar routine is an algorithm discovered in 1949 by D. R. Kaprekar for 4-digit numbers, but which can be generalized to k-digit numbers. To apply the Kaprekar routine to a number n, arrange the digits in descending (n') and ascending (n'') order. Now compute $K(n)=n'-n''$ (discarding any initial 0s) and iterate, where $K(n)$ is sometimes called the Kaprekar function. The algorithm reaches 0 (a degenerate case), a constant, or a cycle, depending on the number of digits in k and the value of n. The list of values is sometimes called a Kaprekar sequence, and the result $K(n)$ is sometimes called a Kaprekar number.

The SandMath includes a generic implementation for n digits. Simply enter the number of digits in the Y- register, and the initial number in the X- register. The program will show the partial results until a cyclic sequence is determined. The resulting elements of that sequence will be stored in data registers, and the control word is left in X so you can use **OUT** to show their values.

STACK	INPUT	OUTPUT
X	N ₀	bbb.eee

Example1: n = 6 & N₀ = 918682

6, ENTER^, 918682 ΣF\$ "KAPR" => {N₀, N₁, N₂,} and finally 24.030 (in 4 mn 02 s)

Therefore we eventually end up with a 7-number cycle in registers {R₂₄, , R₃₀} namely:

{ 851742 , 750843 , 840852 , 860832 , 862632 , 642654 , 420876 }

Example2: n = 5 & N₀ = 4 which will be read "00004" since n = 5

5, ENTER^, 4, ΣF\$ "KAPR" >>>> 15.018 (in 61 seconds)

The 4-number cycle is in registers R₁₅ thru R₁₈: { 62964 , 71973 , 83952 , 74943 }

Kaprekar Process for Three Digits

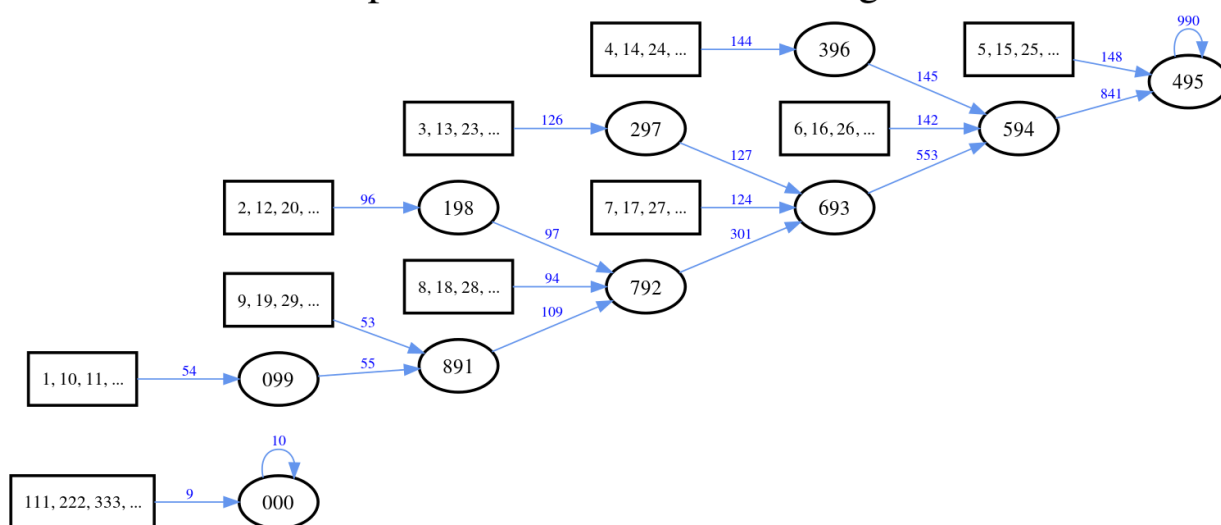

Synergy in action: A glimpse of what's ahead:

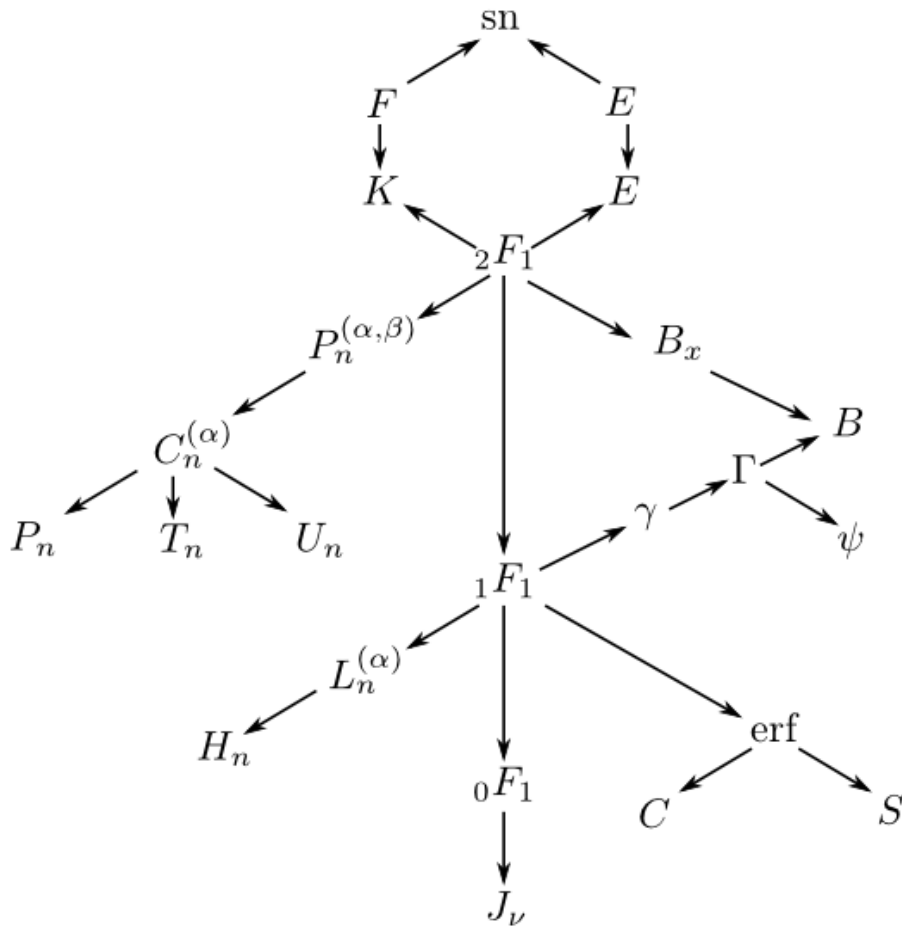

"Relationship between common special functions". Taken from John Cook's web site:
http://www.johndcook.com/special_function_diagram.html

Note: Make sure that revision "R" (or higher) of the Library#4 module is installed.

3.3. HIGH LEVEL MTH.



A word about the approach. The Hyper-Geometric Function as a generic function generator (or "*the case of the chameleon function in disguise*").

Special functions are particular mathematical functions which have more or less established names and notations due to their importance in mathematical analysis, functional analysis, physics, or other applications, frequently as solutions to differential equations. There is no general formal definition, but the list of mathematical functions contains functions which are commonly accepted as special. Some elementary functions are also considered as special functions.

The implementations described in this manual do nothing but scratching the surface (or more appropriately, "gingerly touching it") of the Special Functions field, where one can easily spend several life-times and still be just half-way through.

Implementing multiple special functions in a 41 ROM is clearly challenged by the available space in ROM, the internal accuracy and the speed of the CPU. It is therefore understandable that more commonality and re-usable components identified will make it more self-contained and powerful, overcoming some of the inherent design limitations.

The Generalized Hyper-geometric function is one of those rare instances that works in our favor, as many of the special functions can be expressed as minor variations of the general case. Indeed there are no less than 20 functions implemented as short FOCAL programs, really direct applications of the general case - saving tons of space and contributing to the general consistency and common approach in the SandMath.

We have Jean-Marc Baillard to thank for writing the original **HGF+**, the Generalized Hyper-geometric function - real cornerstone of the next two sections. The SandMath has an enhanced MCODE implementation that optimizes speed and accuracy thanks again to internal usage of 13-digit OS routines. The reuse made of it more than pays off for its lengthy code.

A few examples will illustrate this:-

$$\operatorname{erf}(x) = \frac{2x}{\sqrt{\pi}} {}_1F_1\left(\frac{1}{2}, \frac{3}{2}, -x^2\right).$$

$$J_\alpha(x) = \frac{(x/2)^\alpha}{\Gamma(\alpha + 1)} {}_0F_1(\alpha + 1; -\frac{1}{4}x^2).$$

$$H_\alpha(z) = \frac{(z/2)^{\alpha+1/2}}{\sqrt{2\pi}\Gamma(\alpha + 3/2)} {}_1F_2(1, 3/2, \alpha + 3/2, -z^2/4)$$

Naturally this is not the case for any special function, and even when there's such an expression it may be more appropriate to use the direct definition instead – or an alternative one – for the implementation. This is the case of the Bessel functions, which use the series expansion approach in the SandMath; the Gamma function using the Lanczos formula, etc.

With that said, let's delve into the individual functions comprising the High-Level Math group. First off come *those more frequently used so that they have gained their place in the ROM's main FAT*. Looking at the authorship you'll see the tight collaboration between JM and the author, as stated in the opening statements of this manual.

3.3.1. Gamma function and associates.

Let's further separate these by logical groups, depending on their similarities and applicability. The first one is the **GAMMA** and related functions: **1/GM**, **PSI**, **PSIN**, **LNGM**, **ICGM**, **BETA**, and **ICBT** – all of them a Quantum leap from the previous functions described in the manual, both in terms of the mathematical definition and as it refers to the required programming resources and techniques.

	Function	Description	Author
[ΣF]	1/GMF	Reciprocal Gamma (Continued fractions)	JM Baillard
[ΣF]	BETA	Euler's Beta function	Ángel Martin
[ΣF]	GAMMA	Euler's Gamma function (Lanczos)	Ángel Martin
[ΣF]	ICBT	Incomplete Beta function	JM Baillard
[ΣF]	ICGM	Incomplete Gamma function	JM Baillard
	IGMMA	Inverse Gamma function	Ángel Martin
[ΣF]	LNGM	Logarithm Gamma function	Ángel Martin
[ΣF]	PSI	Digamma (Psi) function	Ángel Martin
[ΣF]	PSIN	Polygamma function	JM Baillard

In mathematics, the Gamma function (represented by the capital Greek letter Γ) is an extension of the factorial function, with its argument shifted down by 1, to real and complex numbers.

If n is a positive integer, then

$$\Gamma(n) = (n - 1)!$$

showing the connection to the factorial function.

For a complex number z with positive real part, the Gamma function is defined by

$$\Gamma(z) = \int_0^\infty t^{z-1} e^{-t} dt$$

Things become much more interesting in the negative semi-plane, as can be seen in the plot on the right for real arguments.

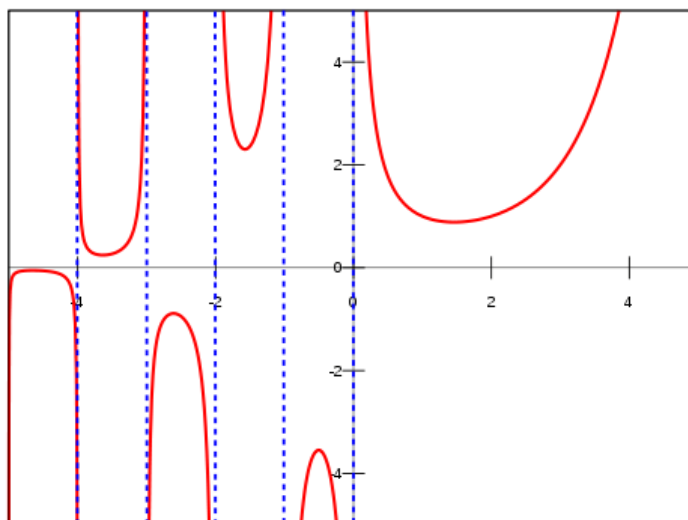

The Gamma function has become standard in pocket calculators, either as extended factorials or as proper gamma definition. It's already available in the HP-11C and of course on the 15C, and that has continued to today's models. Implementing it isn't the issue, but achieving a reasonable accuracy is the challenge.

A popular method uses the Stirling approximation to compute Gamma. This is relatively simple to program, but its precision suffers for small values of the argument. A version suitable for calculators is as follows:

$$\Gamma(z) \approx \sqrt{\frac{2\pi}{z}} \left(\frac{z}{e} \sqrt{z \sinh \frac{1}{z} + \frac{1}{810z^6}} \right)^z$$

Valid for $\text{Re}(z) > 0$, and with reasonable precision when $\text{Re}(z) > 8$.

For smaller values than that it's possible to use the recurrence functional equation, taking it to the "safe" region and back-calculating the result with the appropriate adjusting factor:

$$\Gamma(z + 1) = z \Gamma(z)$$

Incidentally, this method can be used for any approximation method, not only for Stirling's.

The method used on the SandMath is the Lanczos approximation, which lends itself better to its implementation and can be adjusted to have better precision with careful selection of the number of coefficients used. For complex numbers on the positive semi-plane [Re(z)>0], the formula used is as follows:

$$\Gamma(z) = \frac{\sum_{n=0}^{N-1} q_n z^n}{\prod_{n=0}^{N-1} (z+n)} (z+5.5)^{z+0.5} e^{-(z+5.5)}$$

$q_0 =$	75122.6331530
$q_1 =$	80916.6278952
$q_2 =$	36308.2951477
$q_3 =$	8687.24529705
$q_4 =$	1168.92649479
$q_5 =$	83.8676043424
$q_6 =$	2.5066282

Although the formula as stated here is only valid for arguments in the right complex half-plane, it can be extended to the entire complex plane by the reflection formula,

$$\Gamma(1 - z) \Gamma(z) = \frac{\pi}{\sin \pi z}$$

An excellent reference source is found under <http://www.rskey.org/gamma.htm>, written by Viktor T. Toth.

Let's mention that this method yields good enough a precision that doesn't require using the functional equation to adjust it for small values of the argument. The obvious advantage is that without the required program loop, the execution time is shorter and constant for any input. This becomes of extreme importance when Gamma is used as a subroutine of more complex cases, like the Bessel J and I functions – where the cumulative additional time is very noticeable.

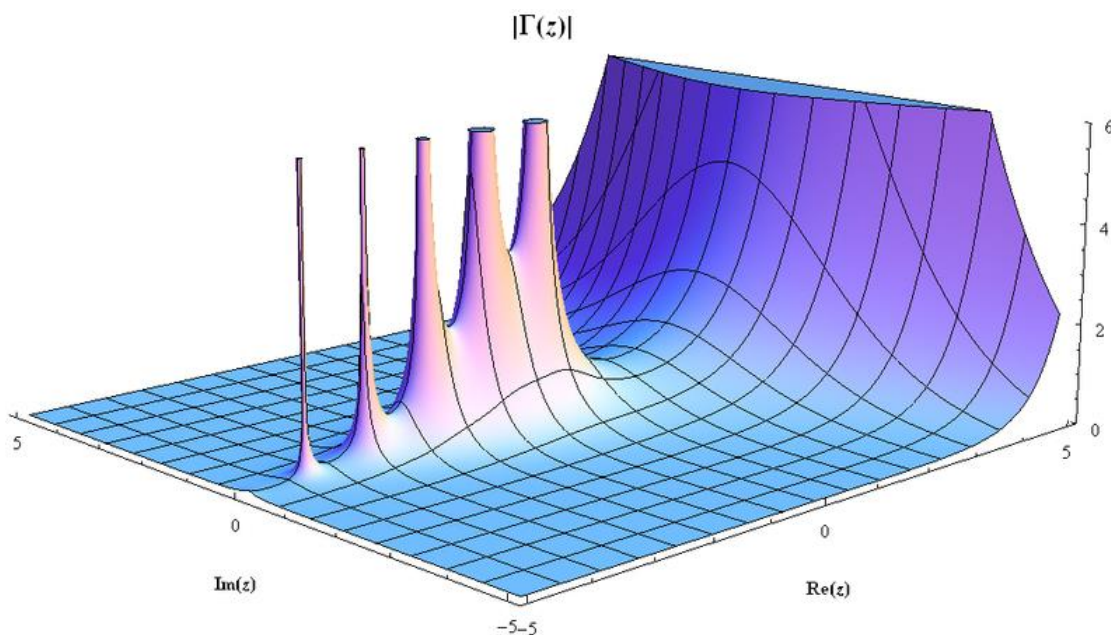

Appendix 7.- Accuracy comparison of different Gamma implementations.

The tables below provide a clear comparison between three methods used to calculate the Gamma function:

1. Lanczos formula, with k=6
2. Continued fractions, and
3. Windschitl (Stirling).

Each of them implemented using both standard 10-digit and enhanced 13-digit precision routines.

The results clearly show that the best implementation is Lanczos, and that the 13-digit routines provide a second order of magnitude improvement to the accuracy, or in other words: that it cannot compensate for the deficiencies of the used method. We're lucky in that the more accurate method is faster than the second best, albeit not as fast as Stirling's.

Obviously the extrapolation from integer case to the general case for the argument is assumed to follow the same trend, albeit not shown in the summary tables.

Standard 10-digit Implementation							
Reference (x-1) !	x	Lanczos (k=6)		Continued fractions		Windschitl (Stirling)	
		Result	error	Result	error	Result	err
1	1	1,000000001	1E-09	1,000000001	1E-09	1,000000012	1,2E-08
1	2	1	0	1,000000001	1E-09	1,000000012	1,2E-08
2	3	2	0	2,000000001	5E-10	2,000000024	1,2E-08
6	4	5,999999999	-1,66667E-10	6,000000002	3,33333E-10	6,000000071	1,18333E-08
24	5	24,00000001	4,16667E-10	24	0	24,00000028	1,16667E-08
120	6	120	0	120	0	120,0000014	1,16667E-08
720	7	720,0000008	1,11111E-09	720,0000001	1,38889E-10	720,0000087	1,20833E-08
5040	8	5040,000002	3,96825E-10	5040	0	5040,00006	1,19048E-08
40320	9	40320,00003	7,44048E-10	40319,99999	-2,4802E-10	40320,00048	1,19048E-08
362880	10	362880,0002	5,51146E-10	362879,9998	-5,5115E-10	362879,9988	-3,30688E-09
3628800	11	3628800,001	2,75573E-10	3628800,018	4,96032E-09	3628800,05	1,37787E-08
39916800	12	39916799,99	-2,50521E-10	39916800,01	2,50521E-10	39916800,9	2,25469E-08
479,001,600	13	479001599,5	-1,04384E-09	479001598,3	-3,549E-09	479001580,2	-4,1336E-08
6,227,020,800	14	6227020803	4,81771E-10	6227020798	-3,2118E-10	6227020957	2,52127E-08
Enhanced 13-digit Implementation							
Reference (x-1) !	x	Lanczos (k=6)		Continued fractions		Windschitl (Stirling)	
		Result	error	Result	error	Result	error
1	1	1	0	1	0	1	0
1	2	1	0	1,000000001	1E-09	1	0
2	3	2	0	2	0	1,999999999	-5E-10
6	4	6	0	6,000000004	6,66667E-10	5,999999997	-5E-10
24	5	24	0	24	0	23,99999999	-4,16667E-10
120	6	120	0	120	0	120,0000014	1,16667E-08
720	7	720	0	720	0	719,9999996	-5,55556E-10
5040	8	5040	0	5039,9999990	-1,9841E-10	5,039,999998	-3,96825E-10
40320	9	40320	0	40,320,00001	2,48016E-10	40,319,99998	-4,96032E-10
362880	10	362880	0	362880	0	362,880	0
3628800	11	3628800	0	3628800	0	3,628,800	0
39916800	12	39916800	0	39916800	0	39,916,799,99	-2,50521E-10
479,001,600	13	479001600	0	479001600	0	479,001,599,8	-4,17535E-10
6,227,020,800	14	6227020800	0	6227020800	0	6,227,020,800	0

3.3.2. Reciprocal Gamma function. { **1/GMF** }

The reciprocal Gamma function is the function

$$f(z) = \frac{1}{\Gamma(z)},$$

where $\Gamma(z)$ denotes the Gamma function. Since the Gamma function is meromorphic and nonzero everywhere in the complex plane, its reciprocal is an entire function. The reciprocal is sometimes used as a starting point for numerical computation of the Gamma function, and a few software libraries provide it separately from the regular Gamma function.

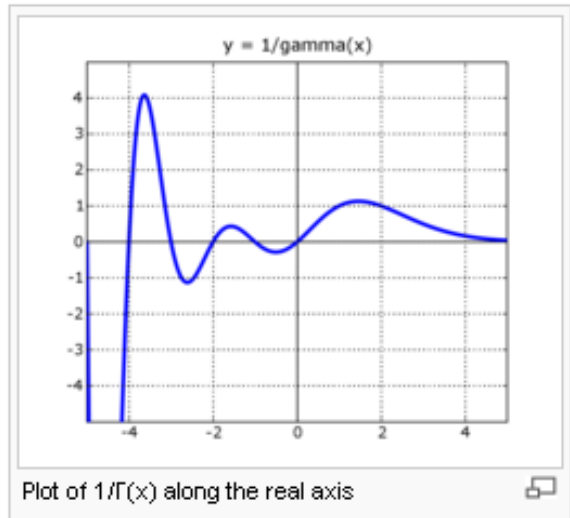

Taylor series expansion around 0 gives

$$\frac{1}{\Gamma(z)} = z + \gamma z^2 + \left(\frac{\gamma^2}{2} - \frac{\pi^2}{12} \right) z^3 + \dots$$

The SandMath however uses the expression based in continued fractions, according to which:

$$\Gamma(x) = [x^{(x-1/2)} \sqrt{2\pi} \exp [-x + (1/12)/(x + (1/30)/(x + (53/210)/(x + (195/371)/(x + \dots))))]]$$

Comparing the results obtained by GAMMA (using Lanczos) and continued fractions it appears that **the precision is generally better in the Lanczos case** – which also happens to be faster due to its polynomial-like form and the absence of loops to adjust the result for smaller arguments.

Note the special case for $x=0$, which is not a pole for this function but it is a singularity for all the others that used the common subroutines – therefore the dedicated check in the routine listing.

3.3.3. (Lower) Incomplete Gamma function. { **ICGM** }

In mathematics, the upper and the lower incomplete gamma functions are respectively as follow:

$$\Gamma(s, x) = \int_x^\infty t^{s-1} e^{-t} dt. \quad \gamma(s, x) = \int_0^x t^{s-1} e^{-t} dt.$$

There is a connection with Kummer's confluent hypergeometric function, when the real part of z is positive - which is the expression used to program it in the SandMath.

$$\gamma(s, z) = s^{-1} z^s e^{-z} M(1, s + 1, z)$$

The Upper incomplete Gamma function can be easily obtained from the relationship:

$$\gamma(s, x) + \Gamma(s, x) = \Gamma(s).$$

Examples : 3, ENTER^, 4, XEQ "**ICGM**" -> 1.523793389
 1.2, ENTER^, 1.7, XEQ "**ICGM**" -> 0.697290898

3.3.4. Log Gamma function. { **LNGM** }

Many times is easier to calculate the Logarithm of the Gamma function instead of the main Gamma value. This could be due to numeric range problems (remember that the 41 won't support numbers over E100), or due to the poles and singularities of the main definition.

The SandMath uses the Stirling approximation to compute LogGamma, as given by the following expression (directly obtained from Stirling's formula in page 95):

$$2 \ln \Gamma(z) \approx \ln(2\pi) - \ln z + z \left(2 \ln z + \ln \left(z \sinh \frac{1}{z} + \frac{1}{810z^6} \right) - 2 \right)$$

This approximation is also good to more than 8 decimal digits for z with a real part greater than 8. For smaller values we'll use the functional equation to extend it to the region where it's accurate enough and then back-calculate the result as appropriate.

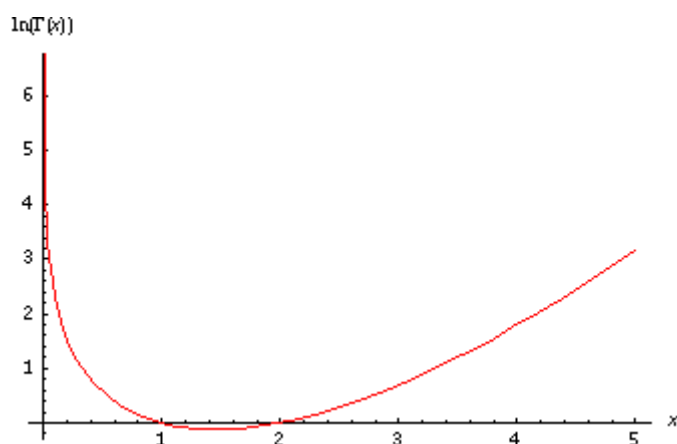

The picture on the left shows the LogGamma function for positive arguments. Interestingly it has a negative results region between 1 and 2 – so it isn't always positive.

Note also the asymptotic behavior near the origin – due to the Gamma function pole.

The implementation on the SandMath uses the analytical continuation to calculate LogGamma for arguments smaller than 9, *including negative values*. Obvious problems (like the poles at negative integer) will yield DATA ERROR messages, but outside that the approximation should hold.

since: $\Gamma(z+n) = \Gamma(z) * \prod(z+i) \mid_{i=0,2..(n-1)}$

it follows: $\ln \Gamma(z+n) = \ln \Gamma(z) + \ln [\prod(z+i) \mid_{i=0,2..(n-1)}]$

Notice also that the same error will occur when trying to calculate LogGamma when Gamma is negative, which occurs between even-negative numbers and their immediately lower (inferior) one – see the plot in page 27).

Example:

$$\begin{aligned} 1000, \text{ XEQ "LNGM" yields } \ln[\Gamma(1000)] &= 5.905,220423 \\ \text{therefore } \Gamma(1000) &= 4.02387 \cdot 10^{2564} \end{aligned}$$

See the following link for a detailed description of another implementation (using Lanczos for both cases) to calculate Gamma and LogGamma on the 41 by Steven Thomas Smith:

<http://www.hpmuseum.org/cgi-sys/cgiwrap/hpmuseum/articles.cgi?read=941>

An excellent implementation of Gamma and related functions for the 41 is available on the following link, written by Jean-Marc Baillard (very complete and detailed):

<http://www.hpmuseum.org/software/41/41gamdgm.htm>

3.3.5. Digamma and Polygamma functions. { PSI , PSIN }

In mathematics, the digamma function is defined as the logarithmic derivative of the gamma function:

$$\Psi(x) = \frac{d}{dx} \log \Gamma(x) = \frac{\Gamma'(x)}{\Gamma(x)}.$$

It is the first of the polygamma functions.

Its relationship to the harmonic numbers is shown in that for natural numbers:

$$\Psi(n) = H_{n-1} - \gamma$$

where H_n is the n 'th harmonic number, and γ is the Euler-Mascheroni constant.

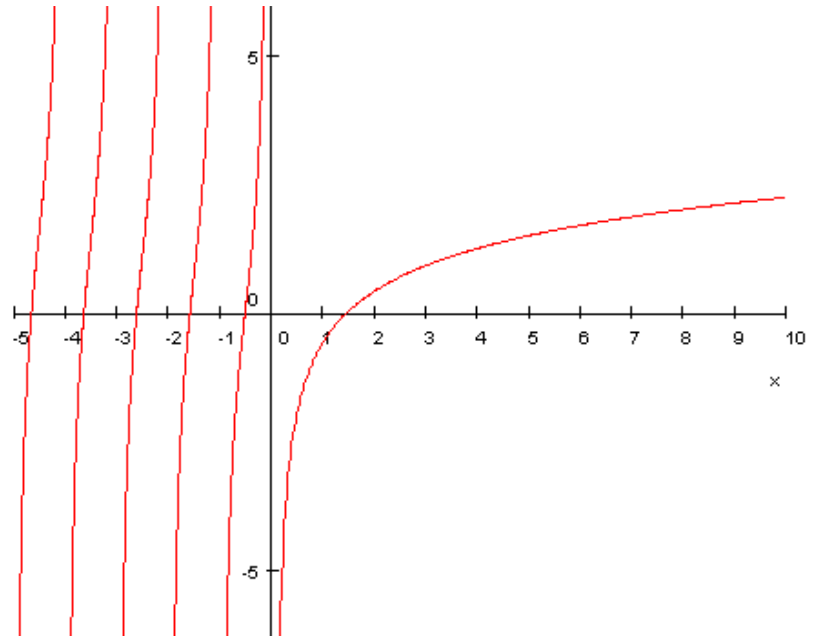

As can be seen in the figure above plotting the digamma function, it's an interesting behavior showing the same poles and other singularities to worry about. It should be possible to find an approximation valid for all the definition range of the function.

It has been implemented on the SandMath using the formulas derived from the called Gauss digamma theorem, although further simplified in the following algorithm:

$$\Psi(x) = \log(x) - \frac{1}{2x} - \frac{1}{12x^2} + \frac{1}{120x^4} - \frac{1}{252x^6} + O\left(\frac{1}{x^8}\right)$$

programmed as: $u^2\{[(u^2/20-1/21)u^2 + 1/10]u^2 -1\}/12 - [Ln u + u/2]$,

The implementation also makes use of the analytic continuation to take it to arguments greater than 9 (same as it's done for LogGamma), using the following recurrence relation to relate it to smaller values - which logically can be applied for negative arguments as well, as required.

$$\Psi(x + 1) = \Psi(x) + \frac{1}{x}.$$

Examples: PI, XEQ "PSI" -> Psi(π) = 0.977213308
 1, XEQ "PSI" -> Psi(1) = -0.577215665 (opposite of Euler's constant)
 -7.28, XEQ "PSI" -> Psi(-7.28) = 4.651194216
 -1234.5, XEQ "PSI" -> Psi(-1234.5) = 7.118826276

The Polygamma Function { **PSIN** }

In mathematics, the polygamma function of order m is a meromorphic function on \mathbf{C} and defined as the $(m+1)$ -th derivative of the logarithm of the gamma function:

$$\psi^{(m)}(z) := \frac{d^m}{dz^m} \psi(z) = \frac{d^{m+1}}{dz^{m+1}} \ln \Gamma(z).$$

For $m=0$ the expression holds, where $\psi(0) = \psi(z)$ is the digamma function and $\Gamma(z)$ is the gamma function. They are holomorph on $\mathbf{C} - \{0\}$. At all the negative integers these polygamma functions have a pole of order $m + 1$. The function $\psi(1)(z)$ is sometimes called the trigamma function.

The polygamma function satisfies the following Recurrence relation:

$$\psi^{(m)}(z + 1) = \psi^{(m)}(z) + \frac{(-1)^m m!}{z^{m+1}}$$

and the following Reflection formula:

$$\psi_n(1 - z) + (-1)^{n+1} \psi_n(z) = (-1)^n \pi \frac{d^n}{dz^n} \cot(\pi z),$$

The SandMath implements the FOCAL program written by JM Baillard. The asymptotic expansion of the Psi-function is derived n times and the recurrence relation is used for values lower then 8 to achieve a good accuracy in the result. Note also that it uses ALPHA and the stack, but no data registers.

The figure below shows the graphis for the first few values on m , color coded as follows:
Blacik: $n=0$; Red: $n=1$; Yellow $n=2$; Green: $n=3$...

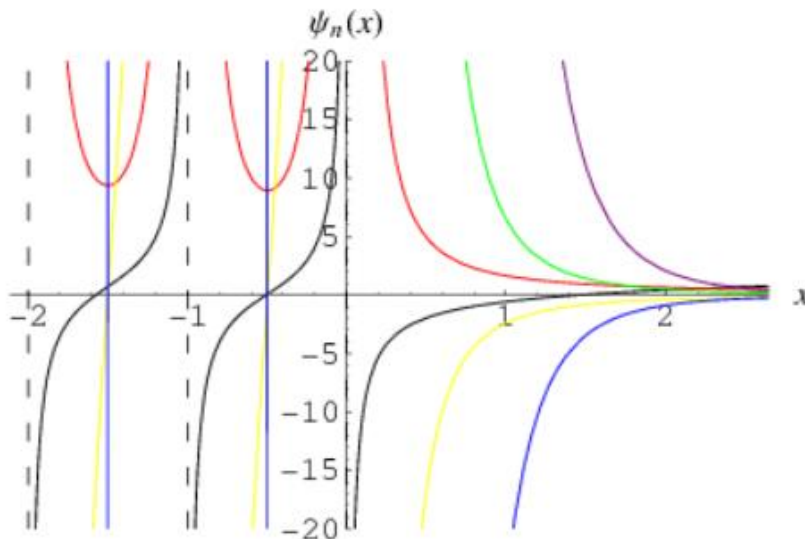

Examples- Calculate Digamma (-1.6) Trigamma (-1.6) Tetragamma (-1.6) Pentagamma (-1.6)

- | | |
|--------------------------------------|---|
| 0. ENTER^, -1.6, XEQ " PSIN " | -> Digam(-1.6) = -0.269717877 [Psi(-1.6)] |
| 1. ENTER^, -1.6, XEQ " PSIN " | -> Trigam(-1.6) = 10.44375936 |
| 2. ENTER^, -1.6, XEQ " PSIN " | -> Tetragam(-1.6) = -22.49158811 |
| 3. ENTER^, -1.6, XEQ " PSIN " | -> Pentagam(-1.6) = 283.4070827 |

3.3.6. Inverse Gamma function. { **IGMMA** }

Not to be confused with the reciprocal, the inverse gamma function is a bit of an elusive one in terms of literature and references – perhaps due to a relatively small applicability.

From a theoretical point of view however, it represents an interesting challenge, which in the SandMath has been resolved with an iterative calculation approach – making use of the Digamma function directly in the Newton method.

Let $\Gamma(x) = \text{Val}$, the value for which a suitable argument x is sought. Thus the function to find a root is $f(x) = [\Gamma(x) - \text{Val}]$, and applying Newton's method to calculate the successive approximations:

$$x_{n+1} = x_n - \frac{f(x_n)}{f'(x_n)}$$

but in this case: $f(x) / f'(x) = 1 / \Psi(x)$; which simplifies considerably the calculation.

The only remaining aspect is that of the initial approximation, x_0 . We have used that formula provided by D. Cantrell, which involves the Lambert W function as well:

$$\text{Approx Inv Gamma or AIG}(x) = L(x) / W[L(x) / e] + 1/2,$$

$$\text{Letting } L(x) = \ln[(x+c)/\text{Sqrt}(2\pi)], \text{ with } c \approx 0.036534$$

See reference: <http://mathforum.org/kb/thread.jspa?messageID=342551>

Even if this initial calculation takes longer than, say using the Logarithm or a polynomial approximation of Gamma (DataFit), the benefits of a more accurate initial value are fewer number of iterations, and therefore shorter total execution times. See below a tabulated comparison of the execution times, using the two initial approaches:

x	Direct (David Cantrell)	DataFit (Gerson Barbosa)
1.0	2.370024	2.9339976
1.5	15,4800000	17,6000040
2.0	17,96998	17.219989
2.5	11.85998	17.469972
3.0	10.98	17.66
3.5	10.36008	15.289992
4.0	10.47996	14.72004
4.5	10.179972	15.17004
5.0	10.110024	14.7900024
10	9.34992	14.230008
15	8.740008	13.86
20	9.36	14.349996

Naturally this approach requires a good implementation of both Gamma and Psi, which is the case with the SandMath. Clearly the challenging region is going to be the negative axis, where Gamma has all the singularities and thus the calculation will have some difficult times to obtain the result for values near the origin, even returning negative arguments (!).

Example: calculate the non-integer argument that yields $\Gamma(x) = 2$

Type: 2, XEQ "**IGMMA**" -> 0,442877396
 To check it simply: XEQ "**GAMMA**" -> 2,000000001

The programs below show the two versions of the implementation – very similar in the approach, but with a different initial estimation, which makes a difference as shown in the table from previous page. Note that in the SandMath case the calculation of the L(x) factor is done in MCODE – which increases accuracy and saves bytes in the main bank.

01	LBL "IGMMA"		01	LBL "IGMMA"	
02	STO 01	<i>argument to R01</i>	02	STO 01	<i>argument to R01</i>
03	2	<i>border line</i>	03	CF 01	
04	X<>Y		04	2	
05	X>Y?	<i>is x>2?</i>	05	X<>Y	
06	GTO 02	<i>yes, go over</i>	06	X<=Y?	
07	LN	<i>Ln(x)</i>	07	SF 01	
08	X=0?	<i>was x=1?</i>	08	LN	
09	E	<i>yes, replace with 1</i>	09	FS? 01	
10	STO 00	<i>store in R00</i>	10	GTO 02	
11	GTO 00	<i>go to loop</i>	11	,16	
12	LBL 02		12	X<>Y	
13	,036534	<i>magic factor</i>	13	*	
14	+	<i>add to argument</i>	14	LASTX	
15	PI		15	SQRT	
16	ST+ X	<i>2p</i>	16	2,21	
17	SQRT	<i>sqr(2p)</i>	17	*	
18	/		18	+	
19	LN		19	,194	
20	ENTER^		20	+	
21	ENTER^		21	2	
22	E		22	X<Y?	
23	E^X		23	X<>Y	
24	/		24	STO 00	
25	WLO		25	LBL 02	
26	/		26	X=0?	
27	,5		27	E	
28	+		28	STO 00	<i>initial guess</i>
29	STO 00	<i>initial guess</i>	29	LBL 00	<i>loop here</i>
30	LBL 00	<i>loop here</i>	30	RCL 01	<i>argument</i>
31	RCL 01	<i>argument</i>	31	RCL 00	<i>current guess</i>
32	RCL 00	<i>current guess</i>	32	GAMMA	
33	GAMMA		33	/	
34	/		34	CHS	
35	CHS		35	E	
36	E		36	+	
37	+		37	RCL 00	
38	RCL 00		38	PSI	
39	PSI		39	/	
40	/		40	ST- 00	<i>adjust result</i>
41	ST- 00	<i>adjust result</i>	41	VIEW 00	<i>show current</i>
42	VIEW 00	<i>show current</i>	42	ABS	
43	ABS		43	E-8	<i>tolerance</i>
44	E-8	<i>tolerance</i>	44	X<Y?	<i>less than it?</i>
45	X<Y?	<i>less than it?</i>	45	GTO 00	<i>no, next pass</i>
46	GTO 00	<i>no, next pass</i>	46	RCL 00	<i>yes. Recall result</i>
47	RCL 00	<i>yes. Recall result</i>	47	END	<i>done.</i>
48	END	<i>done.</i>			

3.3.7. Euler's Beta function. { **BETA** }

The beta function, also called the Euler integral of the first kind, is a special function defined by

$$B(x, y) = \int_0^1 t^{x-1} (1-t)^{y-1} dt \quad \text{Re}(x), \text{Re}(y) > 0.$$

The beta function was studied by Euler and Legendre and was given its name by Jacques Binet. The most common way to formulate it refers to its relation to the Gamma function, as follows:

$$B(x, y) = \frac{\Gamma(x) \Gamma(y)}{\Gamma(x + y)}$$

As a graphical example, the picture below shows B(X,0.5) for values of x between -4 and 4. As it's expected, the same Gamma problem points are inherited by the Beta function.

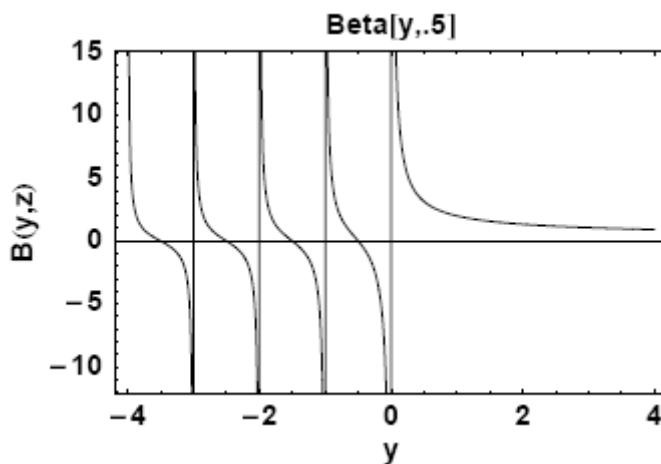

The implementation on the SandMath makes no attempt to discover new approaches or utilize any numeric equivalence: it simply applies the definition formula using the Gamma subroutine. Obvious disadvantages include the reduced numeric range – aggravated by the multiplication of gamma values in the numerator.

Execution time corresponds to three times that of the Gamma function, plus the small overhead to perform the Alpha Data checks and the arithmetic operations between the three gamma values.

3.3.8. Incomplete Beta Function. { **ICBT** }

The incomplete beta function, a generalization of the beta function, is defined as:

$$B(x; a, b) = \int_0^x t^{a-1} (1-t)^{b-1} dt.$$

For $x = 1$, the incomplete beta function coincides with the complete beta function. The relationship between the two functions is like that between the gamma function and its generalization the incomplete gamma function. And it's also given in terms of the Hypergeometric function the expression by:

$$B(z; a, b) = \frac{z^a}{a} {}_2F_1(a, 1-b; a+1; z)$$

Examples: Calculate B(0.7; π , e) and B(0.4; 21; 40)

Type: PI, 1, E^X, 0.7, XEQ "**ICBT**" -> 0.029623046
 21, ENTER^, 40, ENTER^, 0.4, XEQ "**ICBT**" -> 4.8989756-18

3.3.9. Bessel functions and Modified.

The next logical group comprises the Bessel functions – and Spherical variants.

	Function	Description	Author
[ΣF]	IBS	Bessel I(n,x) of the first kind	Ángel Martin
[ΣF]	JBS	Bessel J(n,x) of the first kind	Ángel Martin
[ΣF]	KBS	Bessel K(n,x) of the second kind	Ángel Martin
	SIBS	Spherical Bessel i(n,x)	Ángel Martin
[ΣF]	SJBS	Spherical Bessel j(n,x)	Ángel Martin
[ΣF]	SYBS	Spherical Bessel y(n,x)	Ángel Martin
[ΣF]	YBS	Bessel Y(n,x) of the second kind	Ángel Martin
[Σ\$]	JNX1	Bessel J for large arguments (integer orders only)	Keith Jarret

The SandMath Module includes a set of functions written with the harmonic analysis in mind, specifically to facilitate the calculation of the Bessel functions in their more general sense: for any real number for order and argument.

Bessel functions of the First kind – I(n,x) and J(n,x)

The formulae used are as follows:

$$J_{\alpha}(x) = \sum_{m=0}^{\infty} \frac{(-1)^m}{m! \Gamma(m + \alpha + 1)} \left(\frac{x}{2}\right)^{2m+\alpha}$$

$$I_{\alpha}(x) = i^{-\alpha} J_{\alpha}(ix) = \sum_{m=0}^{\infty} \frac{1}{m! \Gamma(m + \alpha + 1)} \left(\frac{x}{2}\right)^{2m+\alpha}$$

Where Γ denotes the Gamma function.

These expressions are valid for any real number as order, although there are issues for negative integers due to the singularities in the poles of the gamma function - as there's always a term for which (m+n+1) equals zero or negative integers, all of them being problematic.

To avoid this, we use the following expression for negative integer orders:

$$J_{-n}(x) = (-1)^n J_n(x).$$

Whilst: $I_{\alpha}(x) = I_{\alpha}(x)$, for every real number order.

This definition is also valid for negative values for X, as there's no singularity for any x value.

The SandMath implementation uses a recurrence formula instead of the one shown above. It has the clear advantage of not having to calculate Gamma for each term in the sum, contributing to a much faster and robust algorithm.

The iterative relationships are as follows:

$$J(n,x) = \sum \{U(k)|k=1,2,\dots\} * (x/2)^n / \Gamma(n+1), \text{ where:}$$

$$U(k) = - U(k-1) * (x/2)^2 / k(k+n), \text{ with } U(0) = 1.$$

The graphics below plot the Bessel functions of the first kind, $J_\alpha(x)$, and their modified, $I_\alpha(x)$, for integer orders $\alpha=0,1,2,\dots$

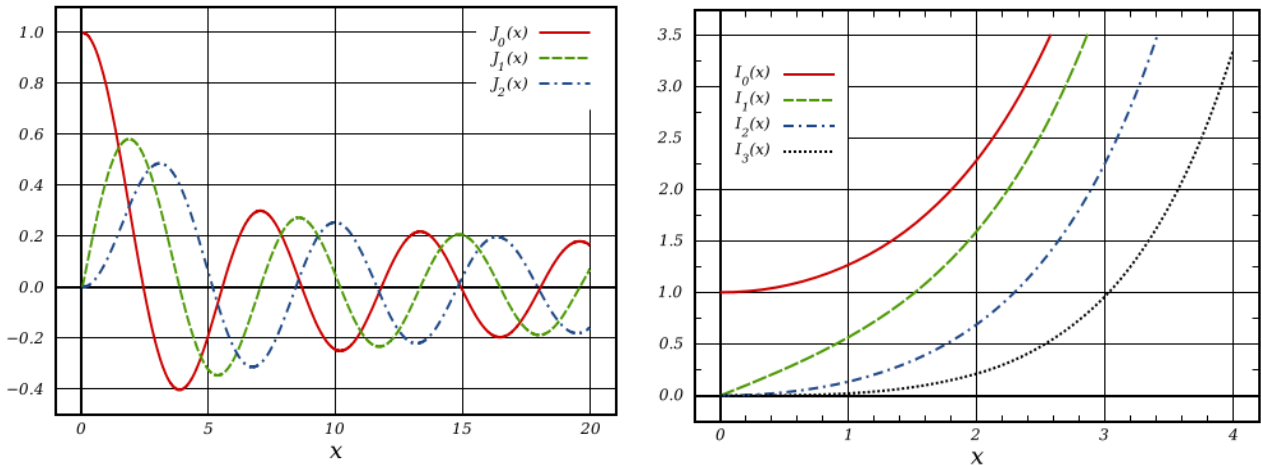

Note that *for large values of the argument, the order or both* these algorithms will return **incorrect results for J(n,x)**. This is due to the alternating character of the series, which fools the convergence criteria at premature times and fouls the intermediate results. Unfortunately there isn't an absolute criteria for validity, but a practical rule of thumb is to doubt the result if $(n+x)$ is greater than 20.

Bessel functions of the Second kind – $K(n,x)$ and $Y(n,x)$

The formulae used are as follows:

$$Y_\alpha(x) = \frac{J_\alpha(x) \cos(\alpha\pi) - J_{-\alpha}(x)}{\sin(\alpha\pi)} \quad ; \quad K_\alpha(x) = \frac{\pi I_{-\alpha}(x) - I_\alpha(x)}{2 \sin(\alpha\pi)}$$

These expressions are valid for any real number as order – with the same issues as the first kind functions above when the order is integer. To avoid the singularities and to reduce the calculation time, *the following expressions are used for integer orders:*

$$\pi Y_n(x) = 2[\gamma + \text{Ln } x/2] J_n(x) - \sum\{(-1)^k f_k(n,x)\} - \sum\{g_k(n,x)\}$$

$$2 K_n(x) = (-1)^{n+1} 2 [\gamma + \text{Ln } x/2] I_n(x) + (-1)^n \sum\{ f_k(n,x)\} + \sum\{(-1)^k g_k(n,x)\}$$

where γ is the Euler–Mascheroni constant (0.5772...), and:

$$g_k(n,x) = (x/2)^{2k-n} (n-k-1)! / k! \quad ; \quad k=0,1,2,\dots,(n-1)$$

$$f_k(n,x) = (x/2)^{2k+n} [H(k) + H(n+k)] / [k! (n+k)!] \quad ; \quad k=0,1,2,\dots$$

and $H(n)$ is the *harmonic number*, defined as: $H(n) = \sum(1/k) \mid k = 1,2,\dots, n$

Where: $Y_{-n}(x) = (-1)^n Y_n(x)$, and $K_{-n}(x) = K_n(x)$

(* note that for $x < 0$, $Y(n,x)$ and $K(n,x)$ are complex numbers.

The graphics below plot the Bessel functions of the second kind, $Y_\alpha(x)$, and their modified, $K_\alpha(x)$, for integer orders $\alpha=0,1,2,\dots$

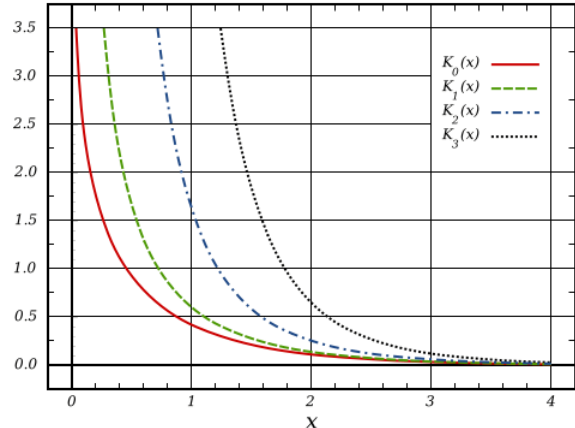
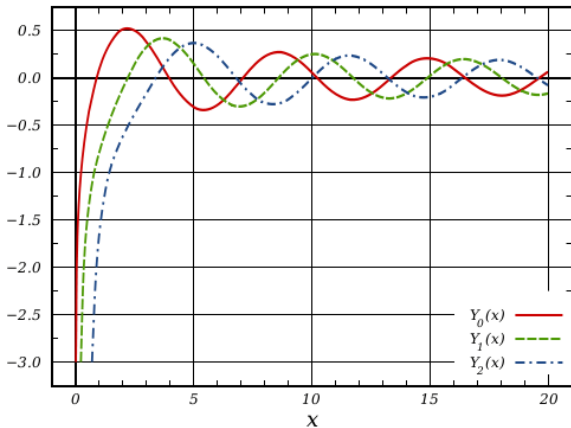

Not e that **KN BS** and **YN BS** are FO CAL pro gra ms

that use dedicated MCODE functions specially written for the calculations (**#BS** and **#BS2**). Their entries are located in the sub-functions FAT, thus won't be shown in the main CAT listings – in case you wonder about their whereabouts.

Getting Spherical, are we?

The spherical Bessel functions j_n and y_n , and are (very closely) related to the ordinary Bessel functions J_n and Y_n by:

$$j_n(x) = \sqrt{\frac{\pi}{2x}} J_{n+1/2}(x),$$

$$y_n(x) = \sqrt{\frac{\pi}{2x}} Y_{n+1/2}(x) = (-1)^{n+1} \sqrt{\frac{\pi}{2x}} J_{-n-1/2}(x).$$

Which graphical representation (naturally very JBS-ish looking) is show below:

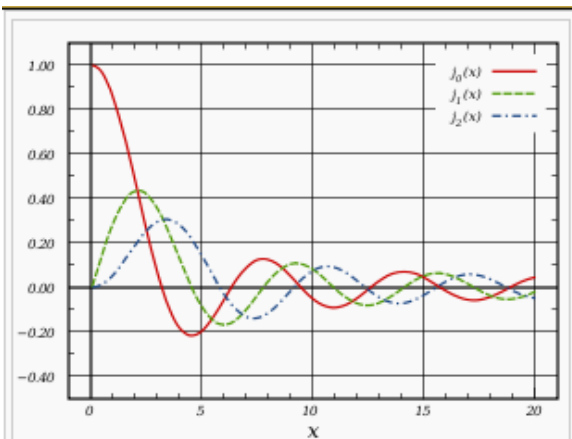

Spherical Bessel functions of 1st kind, $j_n(x)$, for $n = 0, 1,$

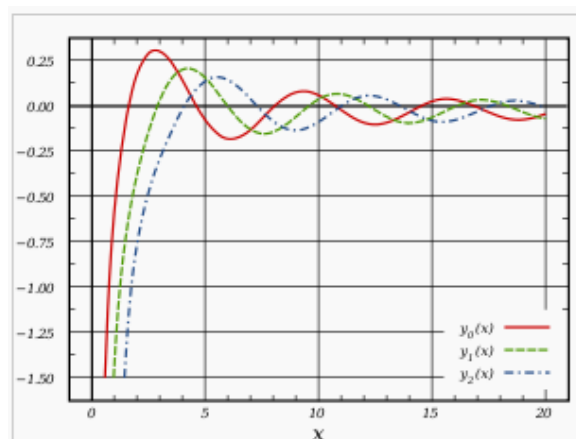

Spherical Bessel functions of 2nd kind, $y_n(x)$, for $n = 0, 1,$

Notice that there really isn't any Spherical $i(n,x)$ properly defined – but there's one in the SandMath just the same, using the same relationship as for $j(n,x)$ and $y(n,x)$.

Once again, remember than as $(n+x)$ increases the accuracy of the results decreases – specially for $J(n,x)$, $Y(n,x)$ and the spherical counterparts, where the returned value can be completely incorrect if $(n+x) > 20$ (a practical rule, not an absolute criterion).

Programming Remarks.

The basic algorithms use the summation definition of the functions, calculating the successive values of the sum until there's convergence for the maximum precision (10 decimal places on the display). Therefore the execution time can take a little long – a fact that becomes a non-issue on the CL. Or when using 41-emulator programs, like V41, setting the turbo mode on.

There are different algorithms depending on whether the order is integer or not. This speeds up the calculations and avoids running into singularities (as mentioned before).

Note that for integer indexes the gamma function changes to a factorial calculation, which benefits from faster execution on the calculator. Non-integer orders utilize the special MCODE function, **GAMMA**, with shorter execution times than equivalent FOCAL programs – but still longer than **FACT** when integers.

Besides that, for integer orders the execution time is further reduced by **calculating simultaneously the two infinite sums involved** in the first kind and the second kind terms. This assumes that the convergence occurs at comparable number of terms, which fortunately is the case - given *their relative fast convergence*.

Note that in order to obtain similar expressions for both **Yn** and **Kn** – and so getting simpler program code - we can re-write Kn as follows:

$$(-1)^{n+1} 2 K_n(x) = 2 [\gamma + \ln x/2] I_n(x) - \sum \{ f_k(n,x) \} - (-1)^n \sum \{ (-1)^k g_k(n,x) \}$$

Dedicated MCODE Functions.

To further reduce the execution time of the programs, two dedicated functions have been written, implemented as MCODE routines as follows:

Function	Flag 00 Clear	Flag 00 Set
#BS	$\sum U_k(n,x), k=0,1,2...$	where $U_k = - U_{k-1} * (x/2)^2 / k(k+n)$
#BS2	$\sum \{ f_k(n,x) \} k=0,1,2...$	or: $\sum \{ g_k(n,x) \} k=0,1,...(n-1)$

The first function **#BS** is used equally in the calculation of the first kind and the second kind of non-integer orders.

Function	Integer	Non-integer
JBS IBS	#BS	
YBS KBS	2x #BS2	#BS

As it was said before, the summation will continue until the contribution of the newer term is negligible to the total sum value. All calculations are done using the full 13-digit precision of the calculator. No rounding is made until the final comparison, which is done on 10-digit values.

From the definition above it's clear that **#BS** coincides with either Jn(x) or In(x) depending on the status of the CPU flag 9, and for positive orders. The functions **JBS** and **IBS** are just MCODE extensions of **#BS** that set up the specific settings prior to invoking it, and (depending on the signs of the orders and the arguments) possibly adjust the result after it's completed.

The second function **#BS2** is only used for second kind functions with integer orders. It's a finite sum, and not an infinite summation. Its contribution to the final result grows as the function order increases. Its main goal was to reduce execution time as much as possible, derived from the speed gains of MCODE versus FOCAL.

The definition of $f_k(n,x)$ is as follows:

$$f_k(n,x) = \{(x/2)^{2k+n} / [k! (n+k)!] \} [H(k) + H(n+k)] ; k=0,1,2...$$

The definition of $g_k(n,x)$ is as follows:

$$g_k(n,x) = (x/2)^{2k-n} (n-k-1)! / k! ; k=0,1,...(n-1)$$

Despite **GAMMA**'s execution time being reasonably fast, it is noticeably longer than that of the Factorial for integer indexes – therefore **#BS2** will use **FACT** instead for integer orders.

The Harmonic Numbers **H(n)** are obtained using another SandMath function as subroutine, **Σ1/N**. You see that the internals of **#BS2** perform quite an involved procedure, utilizing multiple resources within the SandMath module.

Furthermore, **#BS2** is called **twice** within the FOCAL program to calculate **KBS** or **YBS** – once for the first, infinite summation and a second time for the second, finite sum. The status of User Flag 00 controls the calculation made. That was done to save one FAT entry, when the limiting factor was the maximum number of functions per page (i.e. 64 functions). Now they have been pushed even further off, to the secondary FAT used for the sub-functions group.

Bessel Function	Summed Functions by #BS2	Flag 00	Flag 01
Yn(x)	$g_k(n,x)$	Set	Set
	$f_k(n,x)$	Clear	
Kn(x)	$(-1)^k * g_k(n,x)$	Set	Clear
	$(-1)^k * f_k(n,x)$	Clear	

Note also that for integer orders there are two infinite summations involved for the Bessel functions of the second kind – as calculating the 1st. kind function is also required. This is done simultaneously within #BS2 when user flag 02 is set, as both series converge in very similar conditions (i.e. with the same number of terms).

Main functions: IBS, JBS, KBS, and YBS.

The first kind pair (**IBS** and **JBS**) are entirely written in MCODE – including exception handling and special cases. This is the only version known to the author of a full-MCODE implementation on the 41 platform, and it is however a good example of the capabilities of this machine.

No data registers are used – but both the stack and the Alpha registers are used. The number of terms required for the convergence is stored in register N upon termination.

The second kind pair (**KBS** and **YBS**) is implemented using a FOCAL driver program for the auxiliary functions **#BS** and **#BS2** (in the secondary FAT). Notably more demanding than the previous two, their expressions require additional calculations that exceed the reasonable MCODE capabilities.

Although they're not normally supposed to be used outside of the Bessel program, **#BS** and **#BS2** could be called independently. Both use the same input parameters: index in Y and half of the argument in X. Pay close attention to the status of user flags 00 and 01 as they directly influence their result.

Examples: Always put "n" in Y and "x" in X:

J(1,1) = 0,440050586	I(1,1) = 0,565159104
J(-1,-1) = 0,440050586	I(-1,-1) = -0,565159104
J(0.5,0.5) = 0,540973790	I(0.5,0.5) = 0,587993086
J(-0.5, 0.5) = 0,990245881	I(-0.5,0.5) = 1,272389647
Y(1,1) = -0,781212821	K(1,1) = 0,601907230
Y(-1,2) = 0,107032431	K(-1,2) = 0,139865882
Y(0.5,0.5) = -0,990245881	K(0.5,0.5) = 1,075047604
Y(-0.5,0.5) = 0,540973790	K(-0.5,0.5) = 1,075047604

Error Messages:

Note that the functions will return a "DATA ERROR" message when the solution is a complex number, like J(-0.5, -0.5) or I(-0.5, -0.5). There's no way around that save in some particular cases of the order. You can always use the versions available in the 41Z Module for full complex range coverage.

"OUT OF RANGE", occurs when the calculator numeric range is exceeded. This typically occurs for large indexes, during the power exponentiation step.

"ALPHA DATA" indicates alphabetic data in registers X or Y. May also trigger "DATA ERROR".

Iterative Method for large arguments. { JNX1 }

The FOCAL program **JNX1** is also available in the secondary FAT for cases involving large values of the arguments and (integer) orders. It uses the relations:

$$1 = J_0(x) + 2 \sum_{k=1}^{\infty} J_{2k}(x)$$

$$J_{n-1}(x) + J_{n+1}(x) = (2n/x) J_n(x)$$

The execution time is substantially longer than the direct approach, but as an additional benefit **JNX1** will also calculate J(0,x) in addition, leaving this value in the Y-register upon completion.

Example: $J_3(100) = 7.628420178 \cdot 10^{-2}$
 $X <> Y \quad 1.998585023 \cdot 10^{-2}$

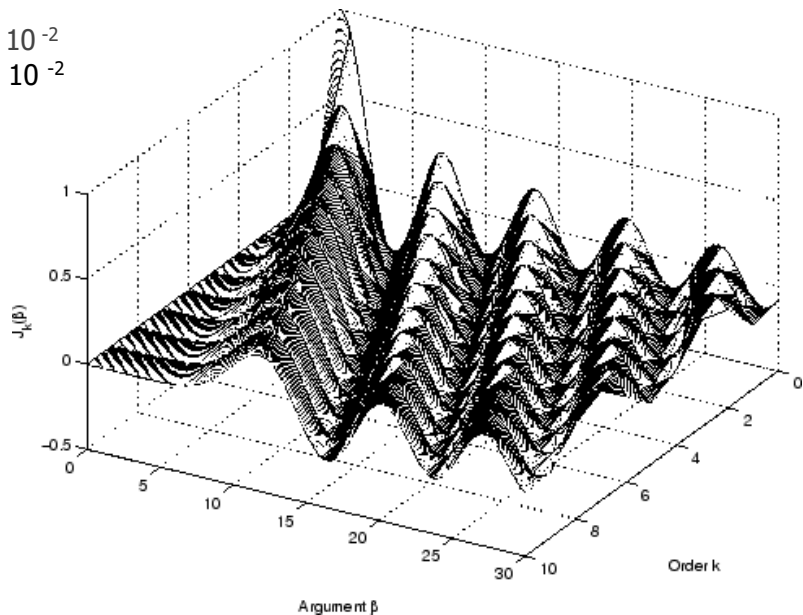

Appendix 8.- FOCAL program used to calculate the Bessel Functions of the second kind. As you can see it's just a (relatively) simple driver of the MCODE functions, with the additional task of orchestrating the logic for the different cases.

Note the usage of the sub-functions from the auxiliary FAT , as well as other SandMath functions.

01	LBL "KBS"		51	LBL:02	orden,argument swapped
02	SF 01		52	CF 02	default case
03	GTO 00		53	X<0?	is it negative?
04	LBL "YBS"		54	SF 02	negative order
05	CF 01		55	ABS	remember this fact!
06	LBL 00		56	STO 01	abs(n)
07	X=0?		57	,	
08	RTN	single case x=0	58	STO 00	reset counter
09	2		59	STO 02	and partial sum
10	/	HALFX	60	RDN	
11	STO 03	x/2	61	X=0?	skip if n=0
12	X<>Y	swap things	62	GTO 06	
13	STO 01	n	63	CF 00	selects #B2
14	INT?	is it integer order?	64	SPFC#	$\sum [gk(n,x)] k=0,1...(n-1)$
15	GTO 02	yes, divert to section	65	2	#BS2
16	CHS	-n	66	CHS	
17	X<>Y	x/2	67	STO 02	
18	RAD		68	RCL 01	abs(n)
19	SPFC#	Multi-Function Launcher	69	LBL:06	
20	1	Recurrence Sum #BS	70	RCL 03	x/2
21	CHS	-J(-n,x)	71	SF 00	selects #B1
22	STO 02	partial result	72	SPFC#	$\sum [fk(n,x)] k=0,1,2...$
23	RCL 01	n	73	2	#BS2
24	RCL 03	x/2	74	ST- 02	partial result
25	SPFC#	Multi-Function Launcher	75	RCL 03	
26	1	Recurrence Sum #BS	76	LN	
27	STO 00	save J(n,x) here - used by Hankel	77	GEU	
28	FC? 01	is KBS?	78	+	
29	GTO 01	yes, skip	79	RCL*	showing off ! :-)
30	RCL 01	n	80	ST+ X(3)	
31	PI		81	ST+ 02	partial result
32	*		82	RCL 02	
33	COS		83	FS? 01	is it YBS?
34	*		84	GTO 04	yes, cut the chase
35	LBL 01		85	RCL 01	abs(n)
36	RCL 02	partial result	86	E	
37	+		87	+	INCX
38	RCL 01	n	88	CHSYX	$(-1)^{n+1}$ * result
39	PI		89	2	
40	*		90	/	HALFX
41	SIN		91	GTO 03	
42	/		92	LBL:04	
43	FS? 01	is YBS?	93	PI	
44	GTO 03		94	/	
45	2		95	FC? 02	was negative order?
46	/	HALFX	96	GTO 03	no, skip correction
47	PI		97	RCL 01	abs(n)
48	*		98	CHSYX	
49	CHS		99	LBL:03	
50	GTO 03		100	STO 02	final result
			101	END	

3.3.9. Riemann Zeta function. { ZETA , ZETAX }

Perhaps one of the most-studied functions in mathematics, it owes its popularity to its deep-rooted connections with prime numbers theory. Not having an easy approximation to work with, its implementation on the 41 will be a bit of a challenge – mainly due to the very slow convergence of the series representation used to program it. Be assured that this numeric calculation won't help you prove the Riemann hypothesis (and collect the \$1M prize) – so adjust your expectations accordingly.

The Riemann zeta function is a function of complex argument s that analytically continues the sum of the infinite series

$$\sum_{n=1}^{\infty} \frac{1}{n^s}, \quad \Re(s) > 1. \quad \zeta(x) \equiv \frac{1}{\Gamma(x)} \int_0^{\infty} \frac{u^{x-1}}{e^u - 1} du,$$

or the integral form:

The Riemann zeta function satisfies the functional equation

$$\zeta(s) = 2^s \pi^{s-1} \sin\left(\frac{\pi s}{2}\right) \Gamma(1-s) \zeta(1-s),$$

valid for all complex numbers s (excluding 0 and 1), which relates its values at points s and $1-s$.

The plots below of the real Zeta function show the negative side with some trivial zeros, as well as the pole at $x=1$.

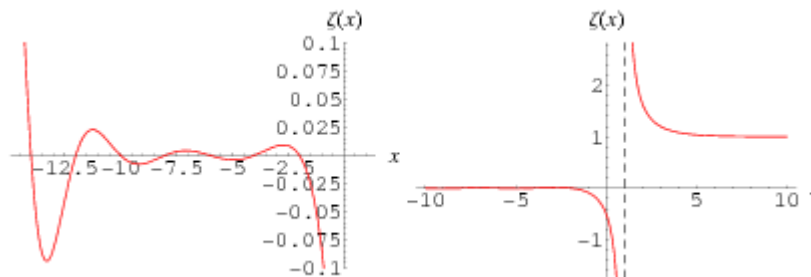

The direct implementation in the SandMath module uses the alternative definitions shown below, in a feeble attempt to get a faster convergence (which in theory it does although not very noticeably given the long execution times involved). The summations are called the Dirichlet Lambda and Eta functions respectively.

$$(1 - 2^{-x}) \zeta(x) = \sum_{n=0}^{\infty} \frac{1}{(2n+1)^x} \quad \zeta(s) = \frac{1}{1 - 2^{1-s}} \sum_{n=1}^{\infty} \frac{(-1)^{n-1}}{n^s}.$$

Go ahead and try **ZETA** with FIX 9 set in the calculator – you'll see the successive iterations being shown for each additional term, until the final result doesn't change. Be aware than MCODE or not, *it'll take a very long time for small arguments*, approaching infinite as x approaches zero.

For values lower than 1 we make use of the following relationship – a sort of "reflection formula" if you wish.

The interesting fact about this is how it has been implemented: if $x < 1$ then the MCODE function branches to a FOCAL program that (as part of the calculations) calls the MCODE function after doing the change: $x = (1-x)$, which obviously is > 1 .

$$\zeta(x) = \begin{cases} \sum_{k=1}^{\infty} k^{-x}, & \text{per } x > 1 \\ 2^x \pi^{x-1} \sin\left(\frac{x\pi}{2}\right) \Gamma(1-x) \zeta(1-x), & \text{per } x < 1 \end{cases}$$

Really the direct method isn't very useful at all, and it's more of an academic implementation without practical value except comparison purposes. The Borwein algorithm provides an iterative alternative to the direct method, with a much faster convergence even as a FOCAL program, and more comfortable treatment. It is implemented in the SandMath as a courtesy of JM Baillard, in the function **ZETAX**.

For example, using **ZETAX** to calculate $Z(1.001)$ returns the correct solution 1,005.577289 in a few seconds! See the appendices for a FOCAL listing of the program if interested.

Examples.-

Complete the table below for $\zeta(x)$, using both the direct method and the Borwein algorithm. Use the result in WolframAlfa as reference to also determine their respective errors.

x	$\zeta(x)$	Direct	error	Borwein	error
-5	-0,0039682539682	-0,003968254	8,0136E-09	-0,003968254	8,0136E-09
5	1,036927755	1,03692775	-4,96019E-09	1,036927755	-1,38255E-10
3	1,202056903	1,20205676	-1,19096E-07	1,202056903	-1,32764E-10
2	1,6449340668482	n/a	n/a	1,644934066	-5,15644E-10
1,1	10,58444846	n/a	n/a	10,58444847	4,77115E-10

We see that not only is the Borwein algorithm faster and more capable in range, but also their results are more accurate than the direct approach; MCODE or not, 13-digit internal subroutines notwithstanding.

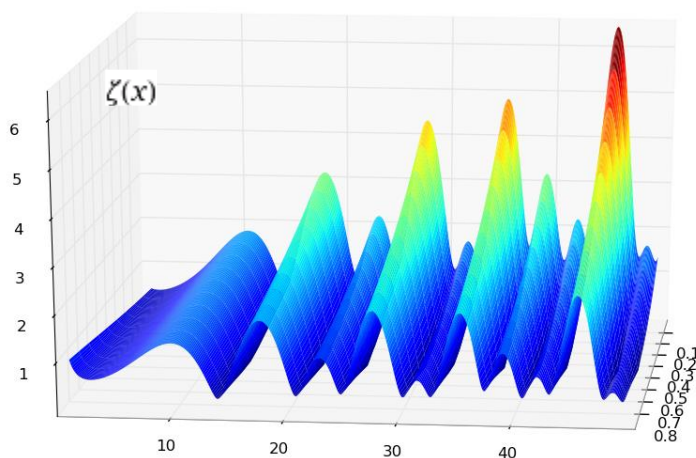

Note: The following links to the MAA and the (now defunct) Zetagrid make fascinating reading on the Zeta zeros current trends and historic perspective – make sure you don't miss them!

http://www.maa.org/editorial/mathgames/mathgames_10_18_04.html

<http://www.zetagrid.net/>



Appendix 9.- Putting Zeta to work: Bernoulli numbers. { BN2 }

In mathematics, the Bernoulli numbers B_n are a sequence of rational numbers with deep connections to number theory. The values of the first few Bernoulli numbers are

$$B_0 = 1, B_1 = \pm 1/2, B_2 = 1/6, B_3 = 0, B_4 = -1/30, B_5 = 0, B_6 = 1/42, B_7 = 0, B_8 = -1/30.$$

If the convention $B_1 = -1/2$ is used, this sequence is also known as the first Bernoulli numbers; with the convention $B_1 = +1/2$ is known as the second Bernoulli numbers. Except for this one difference, the first and second Bernoulli numbers agree. Since $B_n = 0$ for all odd $n > 1$, and many formulas only involve even-index Bernoulli numbers, some authors write B_n instead of B_{2n} .

The Bernoulli numbers were discovered around the same time by the Swiss mathematician Jakob Bernoulli, after whom they are named, and independently by Japanese mathematician Seki Kōwa. Seki's discovery was posthumously published in 1712 in his work Katsuyo Sampo; Bernoulli's, also posthumously, in his Ars Conjectandi of 1713. Ada Lovelace's note G on the analytical engine from 1842 describes an algorithm for generating Bernoulli numbers with Babbage's machine. As a result, the Bernoulli numbers have the distinction of being the subject of the first computer program.

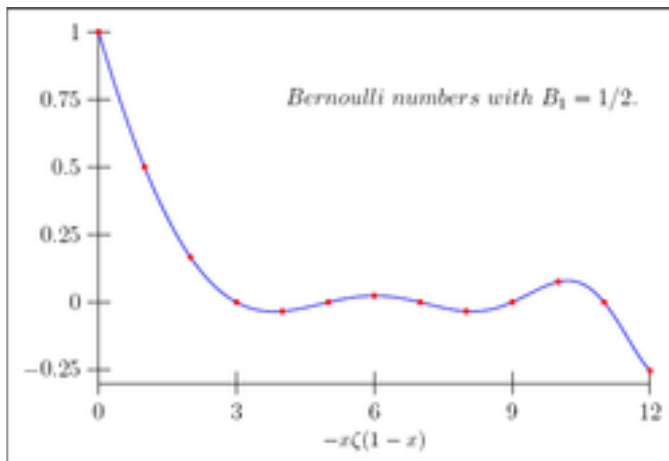

There are several (or rather many!) algorithms and approaches to the calculation of B_n . In this particular example we'll use the expression based on the Riemann's Zeta function, according to which the values of the Riemann zeta function satisfy

$$n \zeta(1 - n) = -B_n$$

for all integers $n \geq 0$. The expression $n \zeta(1 - n)$ for $n = 0$ is to be understood as the limit of $x \zeta(1 - x)$ when $x \rightarrow 0$.

The FOCAL program on the right shows the implemented SandMath code. As you can see it is a super-short application of the **ZETA** function, even if it's used for negative arguments, Obviously we've single-cased the troublesome points to avoid execution times unreasonably long, but apart from that it's quite generic in its approach. It also uses a few others SandMath functions as additional bonus.

01	LBL "BN2"
02	X=1?
03	GTO 01
04	X=0?
05	INCX
06	X=1?
07	RTN
08	ODD?
09	CLX
10	X=0?
11	RTN
12	2
13	X<Y?
14	GTO 00
15	6
16	1/X
17	RTN
18	LBL 00
19	ST+ X
20	X<Y?
21	GTO 00
22	-30
23	1/X
24	RTN
25	LBL 00
26	X<>Y
27	LBL 01
28	STO M
29	CHS
30	INCX
31	ZETA
32	RCL M
33	CHS
34	*
35	END

3.3.10. Lambert W function. { **WLO** , **WL1** , **AWL** }

This section deals with the implementation of the Lambert W function. Oddly enough its definition is typically given as the inverse of another function, as opposed to having a direct expression. This makes it a bit backwards-looking initially but in fact it is significantly easier to implement than the Riemann Zeta seen before.

The Lambert W function, named after Johann Heinrich Lambert, also called the Omega function or product log, is the inverse function of $f(w) = w \exp(w)$ where $\exp(w)$ is the natural exponential function and w is any complex number. The function is denoted here by W .

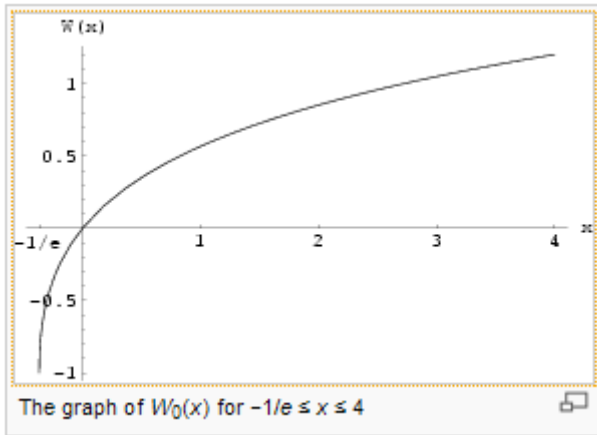

For every complex number z :

$$z = W(z)e^{W(z)}.$$

The Lambert W function cannot be expressed in terms of elementary functions. It is useful in combinatorics, for instance in the enumeration of trees.

It can be used to solve various equations involving exponentials and also occurs in the solution of delay differential equations.

The Taylor series of W_0 around 0 can be found using the Lagrange inversion theorem and is given by:

$$W_0(x) = \sum_{n=1}^{\infty} \frac{(-n)^{n-1}}{n!} x^n$$

where $n!$ is the factorial. However, this series oscillates between ever larger positive and negative values for real $z > \sim 0.4$, and so cannot be used for practical numerical computation.

The W function may be approximated using Newton's method, with successive approximations to $w = W(z)$ (so $z = w e^w$) being:

$$w_{j+1} = w_j - \frac{w_j e^{w_j} - z}{e^{w_j} + w_j e^{w_j}}.$$

The implementation in the SandMath uses this iterative method to solve for $W(z)$ the roots of its functional equation, given the function's argument z . An important consideration is the selection of the initial estimations. For that the general practice is to start with $\ln(x)$ as lower limit, and $1 + \ln(x)$ as upper value.

Another aspect of the W function is the existence of two branches. The second branch is defined for arguments between $-1/e$ and 0 , with function values between -1 and $-\infty$.

The "lower" branch is also available in the SandMath as the function **WL1**. In fact the MCODE algorithm is the same one, with just different initial estimations depending on the branch to calculate!.

Example 1: calculate W for x=5

5, **WLO** -> "RUNNING...", followed by 1,326724665

We can use the inverse Lambert function **AWL** to check the accuracy of the results, simply executing it after **WLO** and comparing with the original argument. Note the **AWL** will be seen later on, in the Secondary FAT (Sub-functions) group. This it requires **ΣF\$** to call it, not **XEQ**.

5, **WLO**, **ΣF\$** "AWL" -> 4,999999998; an error of err= 4 E-10

where **ΣF\$** can be called using the main launcher: **ΣFL**, **ALPHA**

Example 2.- calculate the Omega constant, $\Omega = W(1)$

1, **WLO** => "RUNNING..." , followed by 0,567143290

Example 3: Calculate both branches of W for $x=-1/2e$

1, E^X, CHS, ST+ X, 1/X, **WLO** -> $W_0(-1/2e) = -0,231960953$
 LASTX, **ΣF\$** "WL1" -> $W_{-1}(-1/2e) = -2,678346990$

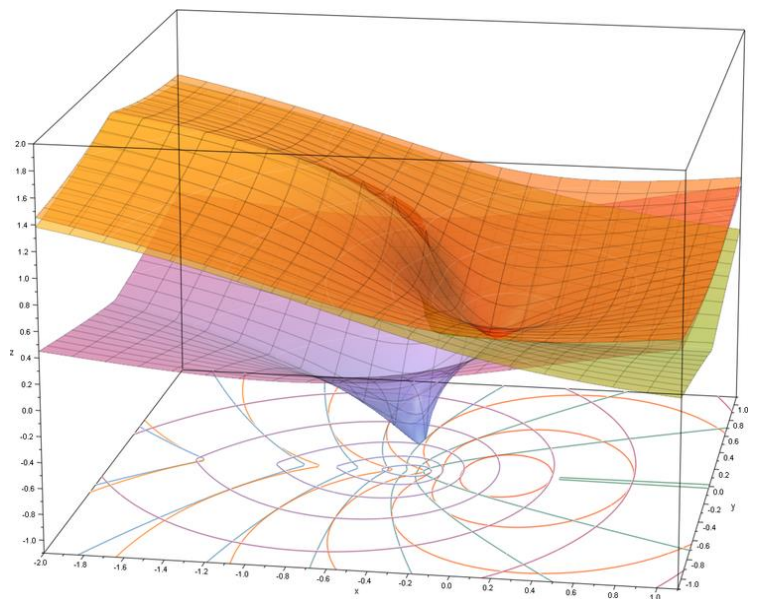
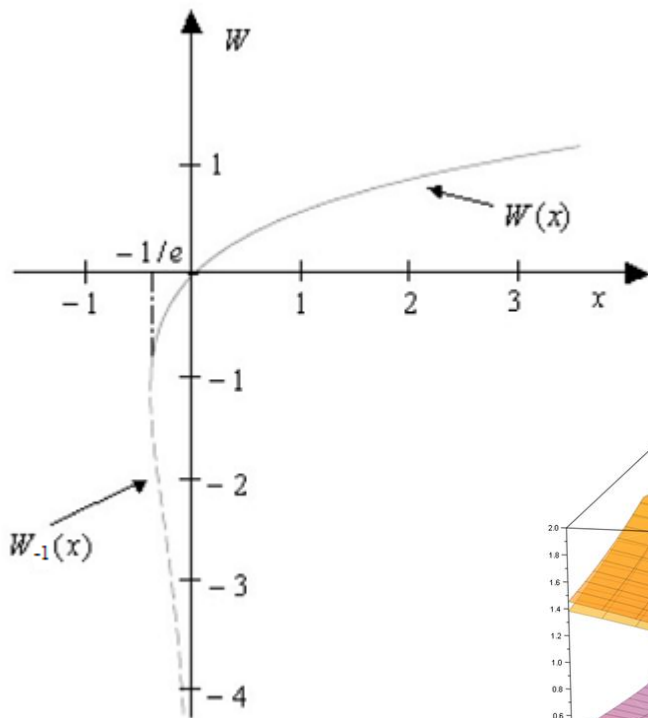

And here's a 3D representation of the complex Lambert to end this section with a graphical splash. Enough to make you want to start using your 41Z Module, isn't it?

3.4. Remaining Special Functions in the Main FAT.

The third and last chapter of the Special functions in the main FAT comprises other Hyper-geometric derived functions, plus one notable exception not easy to associate: **LINX**

	Function	Description	Author
[ΣF]	CI	Cosine Integral	JM Baillard
[ΣF]	EI	Exponential Integral	JM Baillard
[ΣF\$]	LI	Logarithmic Integral	Ángel Martin
[RF]	ELIPF	Eliptic Integral	Ángel Martin
[ΣF]	ERF	Error Function	JM Baillard
[H]	HCI	Hyperbolic Cosine Integral	JM Baillard
	HGF+	Generalized Hyper-geometric Function	JM Baillard
[H]	HSI	Hyperbolic Sine Integral	JM Baillard
	LINX	Polylogarithm function	Ángel Martin
[ΣF]	SI	Sine Integral	JM Baillard

Notable examples of "multi-purposed function" are also the Carlson Integrals, themselves a generator for several other functions like the Elliptic Integrals. More about these later on, in the corresponding sections of the manual.

The unsung hero: HGF+

If we're to believe that behind a great man there is often an even greater woman, then the greatest idea behind all these functions is the implementation of the Generalized Hyper-geometric function. A general-purpose definition requires the use of data registers for the parameters (a1... am) and (b1, ... bn) , and expects the argument x in the X register, with the number of parameters m and n stored in Z and Y, for the generic expression:

$${}_mF_p(a_1, a_2, \dots, a_m; b_1, b_2, \dots, b_p; x) = \sum_{k=0,1,2,\dots} [(a_1)_k (a_2)_k \dots (a_m)_k] / [(b_1)_k (b_2)_k \dots (b_p)_k] \cdot x^k / k!$$

- If m = p = 0 , **HGF+** returns exp(x)
- The program doesn't check if the series are convergent or not.
- Even when they are convergent, execution time may be prohibitive: press any key to stop
- Stack register T is saved and x is saved in the L-register.
- R00 is unused.
- Alpha registers {M,N,O,P} are used and then cleared.

The original **HGF+** was written by Jean-Marc Baillard. Only small changes have been made to the version in the SandMath, optimizing the code for 13-digit accuracy and checking for ALPHA DATA in all registers used, as well as for the argument x.

	Function	Description	Author
[ΣF]	WLO	Lambert's W - main branch	Ángel Martin
	WL1	Lambert's W – secondary branch	Ángel Martin
[ΣF]	ZETA	Riemann's Zeta – direct method	Ángel Martin
	ZETAX	Riemann's Zeta – Borwein algorithm	JM Baillard

3.4.1. Exponential Integral and associates. { **EI**, **CI**, **SI**, **LI** }

The first sub-section covers the Exponential, Logarithmic, Trigonometric and Hyperbolic integrals. They're all calculated using their expressions using the Generalized Hyper-geometric function, in a clear demonstration of the usefulness or the adopted approach.

For real nonzero values of x , the exponential integral $Ei(x)$ is defined as:

$$Ei(x) = \int_{-\infty}^x \frac{e^t}{t} dt.$$

Integrating the Taylor series for $\exp(t)$ and extracting the logarithmic singularity, we can derive the following series representation for real values:

$$Ei(x) = \gamma + \ln |x| + \sum_{k=1}^{\infty} \frac{x^k}{k k!} \quad x \neq 0$$

where we substitute the series by its Hyper-Geometric representation:

$$\Sigma\{ x^k / k k! \} = x * {}_2F_2(1, 1; 2, 2; x)$$

The logarithmic integral has an integral representation defined for all positive real numbers by the definite integral:

$$li(x) = \int_0^x \frac{dt}{\ln t}.$$

The function $li(x)$ is related to the exponential integral $Ei(x)$ via the equation:

$li(x) = Ei(\ln x)$, which is the one used to program it in the SandMath module.

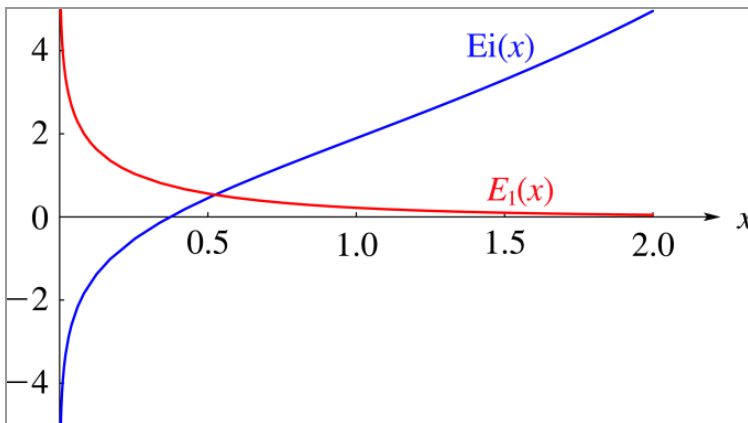

Examples:

1.4, XEQ "**EI**" -> $Ei(1.4) = 3.007207463$ or: **[ΣF]**, **[R]**
 1.4, **ΣFL\$** "**LI**" -> $Li(1.4) = -0,144991005$

LI is the Logarithm Integral, also a quick application of the **EI** function, using the formula:

$$\text{Li}(x) = \text{Ei}[(\ln(x))].$$

Note how **LI** starts as a MCODE functions that transfers into the FOCAL code calculating **EI**, so strictly speaking it's a sort of "hybrid" natured function.

The different trigonometric and hyperbolic integral definitions and their relations with the Hyper-Geometric function (for the relevant integral in the definition) are as follows:

$\text{Si}(x) = \int_0^x \frac{\sin t}{t} dt$	$\text{Shi}(x) = \int_0^x \frac{\sinh t}{t} dt$
$x * {}_1F_2(1/2; 3/2, 3/2; -x^2/4)$	$x * {}_1F_2(1/2; 3/2, 3/2; x^2/4)$
$\text{Ci}(x) = \gamma + \ln x + \int_0^x \frac{\cos t - 1}{t} dt$	$\text{Chi}(x) = \gamma + \ln x + \int_0^x \frac{\cosh t - 1}{t} dt$
$-(x^2/4) {}_2F_3(1, 1; 2, 2, 3/2; -x^2/4)$	$(x^2/4) {}_2F_3(1, 1; 2, 2, 3/2; x^2/4)$

Examples:

- 1.4, XEQ "**SI**" -> Si(1.4) = 1.256226733 - or: [ΣF], [Z]
 1.4, XEQ "**CI**" -> Ci(1.4) = 0.462006585 - or: [ΣF], [V]
 1.4, XEQ "**HSI**" -> Shi(1.4) = 1.561713390 - or: [ΣF], [SHIFT], [Z]
 1.4, XEQ "**HSI**" -> Chi(1.4) = 1.445494076 - or: [ΣF], [SHIFT], [V]

The figure below shows the function plots for Si and Ci for 0<X<15.

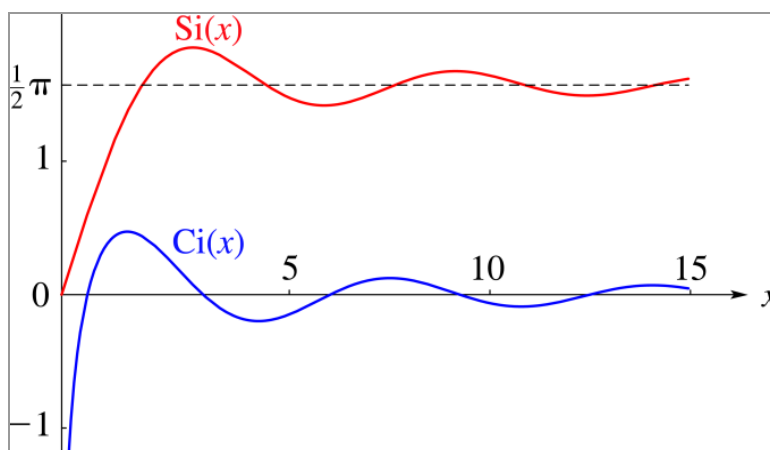

Nota also that even if support for complex arguments is not covered by the SandMath, the following relation between the Exponential and Trigonometric Integrals is available:

$$\text{E}_1(ix) = i \left(-\frac{1}{2}\pi + \text{Si}(x) \right) - \text{Ci}(x) \quad (x > 0)$$

Generalized Exponential Integrals. { **ENX** }

The exponential integral may also be generalized to

$$E_n(x) = \int_1^{\infty} \frac{e^{-xt}}{t^n} dt$$

which can be written as a special case of the (upper) incomplete gamma function:

$$E_n(x) = x^{n-1} \Gamma(1-n, x)$$

We also have:

$$E_0(x) = (1/x) \cdot \exp(-x) \text{ and} \\ E_n(0) = 1/(n-1) \text{ if } n > 1$$

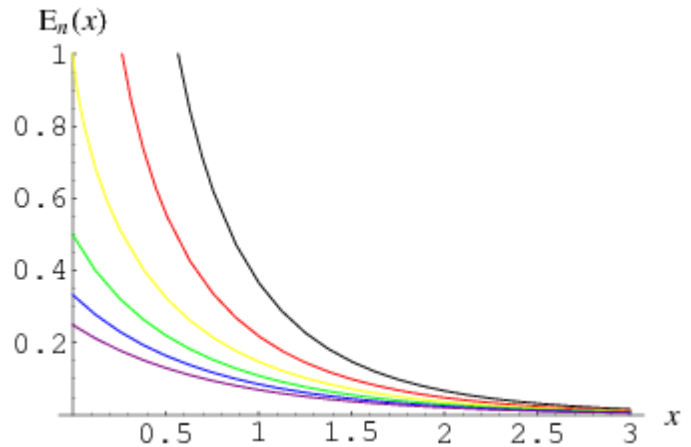

However the SandMath uses the implementation developed by JM Baillard, using a series expansion for $x < 1.5$, and continued fractions for $x > 1.5$ – as shown below:

$$E_n(z) = \frac{(-z)^{n-1}}{(n-1)!} (\psi(n) - \ln z) - \sum_{k=0}^{\infty} \frac{(-z)^k}{k!(1-n+k)}$$

and:

$$E_p(z) = e^{-z} \left(\frac{1}{z+1} \frac{p}{1+z} \frac{1}{z+1} \frac{p+1}{1+z} \frac{2}{z+1} \dots \right)$$

Examples: Calculate **ENX** for $x=1.4$ and $n=\{0,2,100\}$

0, ENTER^, 1.4 XEQ " ENX "	->	E0(1.4) = 0.176140689
2, ENTER^, 1.4 XEQ " ENX "	->	E2(1.4) = 0.0838899263
100, ENTER^, 1.4 XEQ " ENX "	->	E100(1.4) = 0.0024558006

Examples: Calculate **ENX** for $x=2$ and $n=3$, and for $x=n=100$.

3, ENTER^, 2, XEQ " ENX "	->	E3(2) = 0.03013337978
100, ENTER^, XEQ " ENX "	->	E100(100) = 1.864676429 E-46

Note that we can use **ENX** to "reverse-calculate" UICGM – the upper incomplete gamma, which obviously should satisfy the equation shown in the ICGM section: **LICGM(s,x) + UICGM(s,x) = Γ(s)**

```

01 LBL "UICGM"      10 1
02 X<>Y            11 -
03 CHS             12 CHS
04 1               13 Y^X
05 +              14 *
06 X<>Y            15 END
07 ENX
08 RCL 00          A short and simple program does it, just type:
09 RCL 01          n, ENTER^, x, XEQ "UICGM"

```

3.4.2. Errare humanum est. { **ERF** , **ERFN** }

In mathematics, the error function (also called the Gauss error function) is a special function (non-elementary) of sigmoid shape, which occurs in probability, statistics and partial differential equations. Its definition and the expression based on the Hyper-geometric function (via ascending series) are given in the table below:

$\operatorname{erf}(x) = \frac{2}{\sqrt{\pi}} \int_0^x e^{-t^2} dt.$	$\operatorname{erf} x = (2x/\pi^{1/2}) \exp(-x^2) {}_1F_1(1, 3/2; x^2)$
--	---

The complementary error function, denoted erfc, is defined as : $\operatorname{erfc} = 1 - \operatorname{erf}(x)$

Both functions are shown below for an overview.

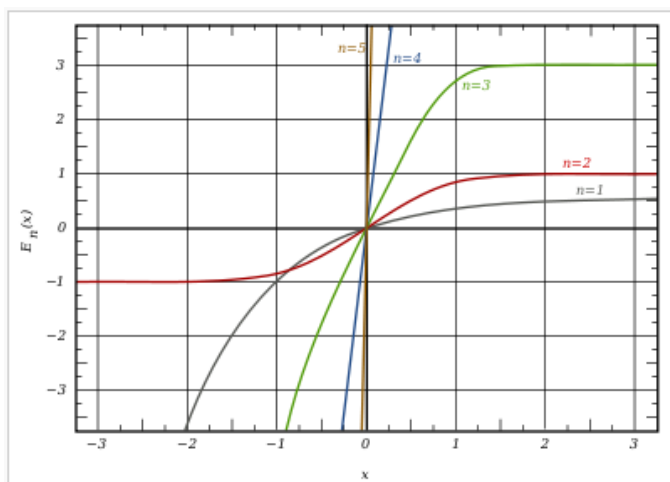
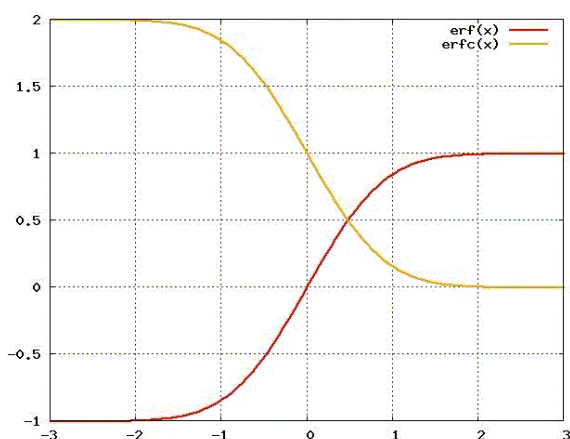

Generalized Error Functions. { **ERFN** }

Some authors discuss the more general functions:

$$E_n(x) = \frac{n!}{\sqrt{\pi}} \int_0^x e^{-t^n} dt = \frac{n!}{\sqrt{\pi}} \sum_{p=0}^{\infty} (-1)^p \frac{x^{np+1}}{(np+1)p!}.$$

Notable cases are:

- $E_0(x)$ is a straight line through the origin, $E(0,x) = x/e.\sqrt{p}$
- $E_1(x)$ is the equation $(1 - e^{-x})/\sqrt{p}$ - gray curve
- $E_2(x)$ is the error function, $\operatorname{erf}(x)$. - red curve
- green curve: $E_3(x)$; blue curve: $E_4(x)$; and gold curve: $E_5(x)$.

Examples: Calculate the first four error functions for $x=.5$ and $x=0.9$, comparing $E(2,x)$ to the results obtained by **ERF**.

x	erf1	erf2	erf3	erf4	erf	delta
0.5	0.221991303	0.520499878	1.641511206	6.687094868	0.520499878	0.000000000
0.9	0,334807217	0,796908213	2,589816366	10,839692051	0,796908213	0.000000000

Note that because **ERFN** is located in the auxiliary FAT, you need to use $\Sigma F\$$ to execute it (or alternatively $\Sigma F\#$ 061, its corresponding sub-function index).

Appendix 10.a.- Inverse Error Function.- coefficients galore...

The inverse error function can be defined in terms of the Maclaurin series

$$\operatorname{erf}^{-1}(z) = \sum_{k=0}^{\infty} \frac{c_k}{2k+1} \left(\frac{\sqrt{\pi}}{2} z \right)^{2k+1},$$

Where $c_0 = 1$ and

$$c_k = \sum_{m=0}^{k-1} \frac{c_m c_{k-1-m}}{(m+1)(2m+1)} = \left\{ 1, 1, \frac{7}{6}, \frac{127}{90}, \dots \right\}.$$

This really is a bear to handle, requiring quite a number of coefficients to be calculated for good accuracy result. Moreover, that calculation involves a lot of registers to store the values – since there isn't any iterative approach based on recursion.

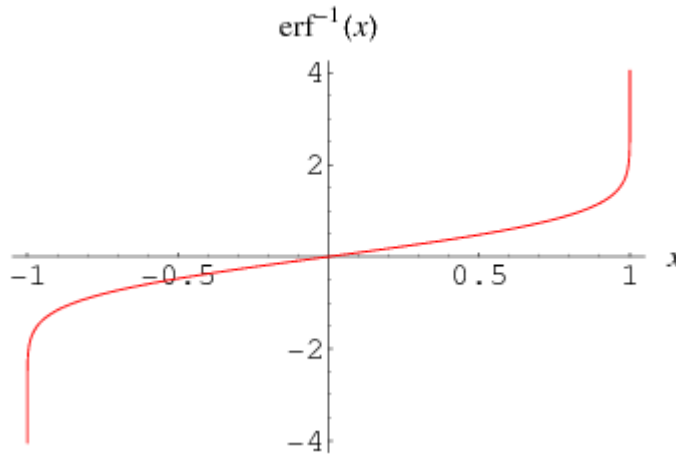

The expression below is definitely too inaccurate (only three or four digits are correct) to deserve a dedicated MCODE function:

$$\operatorname{erf}^{-1}(z) = \frac{1}{2}\sqrt{\pi} \left(z + \frac{\pi}{12}z^3 + \frac{7\pi^2}{480}z^5 + \frac{127\pi^3}{40320}z^7 + \frac{4369\pi^4}{5806080}z^9 + \frac{34807\pi^5}{182476800}z^{11} + \dots \right).$$

A paper from 1968 by A. Strecok lists the first 200 coefficients of a power series that represents the inverse error function. While using this approach it became clear that at least 30 of them are needed for a 10-digit accuracy for $0 < x < 0,85$. This only gets worse as x approaches 1, getting into a clear example of the “law of diminishing results”.

A better method for the vicinity of 1 is probably to use an asymptotic expansion, such as:

$$\operatorname{erf}^{-1}(z) \propto \frac{1}{\sqrt{2}} \sqrt{\log\left(\frac{2}{\pi(z-1)^2}\right) - \log\left(\log\left(\frac{2}{\pi(z-1)^2}\right)\right)} \quad ; (z \rightarrow 1)$$

A combination of both approaches would seem to be the best compromise, depending on the argument. . Typing the 30 coefficients is not fun however, thus the best is no doubt to use a data file in X-Memory to keep them safe.

Appendix 10.b.- ierf Revisited: CUDA Library. { **IERF }**

The author reportedly went ahead and implemented the Strecok method using the entire 200 coefficients set, both in 10-digit and 13-digit formats. Without a doubt this was an extravaganza and a bit of an insane task, which unfortunately didn't yield satisfactory results despite the resulting huge code stream – not to mention the painstakingly error-prone programming! Adding insult to injury, the 13-digit version showed **worse** accuracy than the 10-digit one, which should be explained by a coincidental benefit of the rounding – confirming that 13 digits is not enough of an improvement for the region near 1.

In case you're interested and want to see by yourself, the **IERF ROM** is available for download on request – probably a double record of both *the most boring ROM ever produced*, and the one with fewest functions (only eight in an 8k footprint!)

So for a while the only practical alternative was to use an iterative calculation (using Halley or Newton methods), which would yield acceptable accuracy (better than the failed approach above), even if the calculation time increases exponentially with the proximity to 1

Further research however uncovered the paper by Michael Giles, referring to yet another polynomial approximation - but much more tractable, and certainly suitable for implementation in the SandMath. This is known as the CUDA Library, and both a single and a double precision are published in the following references (for the paper itself and the source code):

http://people.maths.ox.ac.uk/gilesm/files/gems_erfinv.pdf
<http://gpucomputing.net/?q=node/1828>

The final SandMath implementation is entirely a MCODE function (very fast!) that uses the single precision approximation for the central region, and the double precision for the upper end region, determined by the condition: $-\ln(1-x^2) < 6.25$, that is: $x^2 > 1 - \exp(-6.25) \approx 0,998069546$

Examples.- Using **ERF** and **IERF** complete the table below. Note the relative error column (Delta), indicating the more than reasonable accuracy of both functions combined, both in the central and extreme regions equally.

x	ierf	erf	Delta
0.000100000	0.000088623	0.000100000	0.000000000E+00
0.001000000	0.000886227	0.001000000	0.000000000E+00
0.010000000	0.008862501	0.010000000	0.000000000E+00
0.100000000	0.088855991	0.100000000	0.000000000E+00
0.200000000	0.179143455	0.200000000	0.000000000E+00
0.300000000	0.272462715	0.300000000	0.000000000E+00
0.400000000	0.370807159	0.400000000	0.000000000E+00
0.500000000	0.476936276	0.500000000	0.000000000E+00
0.900000000	1.163087154	0.900000000	0.000000000E+00
0.995000000	1.984872613	0.994999999	-1.005025097E-09
0.999500000	2.461266226	0.999500001	1.000500222E-09
0.999950000	2.867761312	0.999950001	1.000049974E-09
0.999995000	3.227792264	0.999995000	0.000000000E+00
0.999999500	3.554139637	0.999999501	1.000000472E-09
0.999999950	3.854657923	0.999999951	1.000000133E-09
0.999999995	4.134484326	0.999999994	-1.000000088E-09

3.4.3. How many logarithms, did you say? { **LINX** }

LINX calculates the polylogarithm function, (also known as Jonquière's function) a special function defined by the infinite sum, or power series:

$$\text{Li}_s(z) = \sum_{k=1}^{\infty} \frac{z^k}{k^s} = z + \frac{z^2}{2^s} + \frac{z^3}{3^s} + \dots$$

Only for special values of the order s does the polylogarithm reduce to an elementary function such as the logarithm function. The above definition is valid for all complex orders s and for all complex arguments z with $|z| < 1$; it can be extended to $|z| \geq 1$ by the process of analytic continuation.

For particular cases, the polylogarithm may be expressed in terms of other functions (see below). Particular values for the polylogarithm may thus also be found as particular values of these other functions. For integer values of the polylogarithm order, the following explicit expressions are known:

$$\begin{aligned} \text{Li}_1(z) &= -\ln(1-z) \\ \text{Li}_0(z) &= \frac{z}{1-z} \\ \text{Li}_{-1}(z) &= \frac{z}{(1-z)^2} \\ \text{Li}_{-2}(z) &= \frac{z(1+z)}{(1-z)^3} \\ \text{Li}_{-3}(z) &= \frac{z(1+4z+z^2)}{(1-z)^4} \\ \text{Li}_{-4}(z) &= \frac{z(1+z)(1+10z+z^2)}{(1-z)^5} \end{aligned}$$

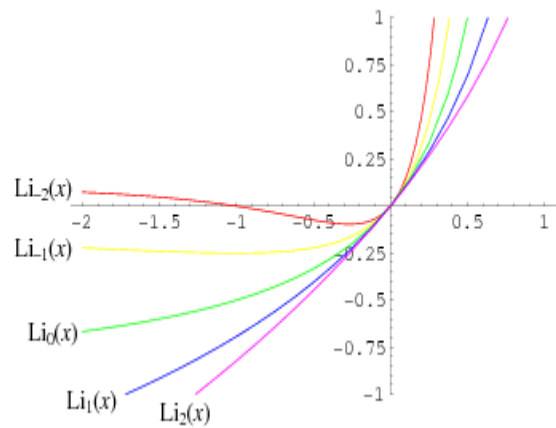

The SandMath implementation is an MCODE function that uses direct series summation, adding terms until their contribution to the sum is negligible. Convergence is very slow, especially for small arguments. Its usage expects n to be in register Y and x in register X . The result is saved in X , and X is moved to LastX.

The program below gives a FOCAL equivalent – note the clever programming done by JM Baillard to only perform Y^X once per term, which reduces the execution times significantly.

```

01   LBL "LIN"           09  LBL 01           17  RCL 02
02   STO 01              10  RCL 01           18  Y^X
03   X<>Y                11  RCL 03           19  /
04   STO 02              12  *              20  +
05   1                   13  STO 03           21  X#Y?
06   STO 03              14  ISG 00           22  GTO 01
07   CLX                 15  CLX              23  END
08   STO 00              16  RCL 00

```

Examples.- Calculate the Di- and Tri-logarithms of 0.7; $\text{Li}(2, 0.5)$ and $\text{Li}(3, 0.7)$;

```

2, ENTER^, 0.7, XEQ "LINX" => 0,889377624
3, ENTER^, 0.7, XEQ "LINX" => 0,780063934

```

3.4.4. Clausen and Lobachevsky Functions. { CLAUS , LOBACH }

Very closely related to each other by just a change of variable, but implemented in the SandMath using different approaches in independent programs, for a better coverage – allowing comparison between both.

In mathematics, **the Clausen function** was introduced by Thomas Clausen (1832), and is defined by the following integral:

$$Cl_2(\theta) = - \int_0^\theta \log |2 \sin(t/2)| dt. \quad \text{or:} \quad Cl_s(\theta) = \sum_{n=1}^{\infty} \frac{\sin(n\theta)}{n^s}$$

The expression on the right is a more general definition valid for complex s with $\text{Re } s > 1$. This definition may be extended to all of the complex plane through analytic continuation – however it's not practical for programming, as thousands of terms would be required to return accurate results if we used this formula.

Integrating by parts gives: $Cl_2(x) = -x \ln (2 \sin (x/2)) + 2 \sum_0^{x/2} (u / \tan u) du$

which using the series expansion for $[x / \tan x]$, (expressed using the Bernoulli numbers B_{2n}), can be written by a sum of the integration of the terms – a much easier approach to say the least. We'll use the **ZETA** function to calculate B_{2n} for $n > 3$, thus we have all tools required for the task.

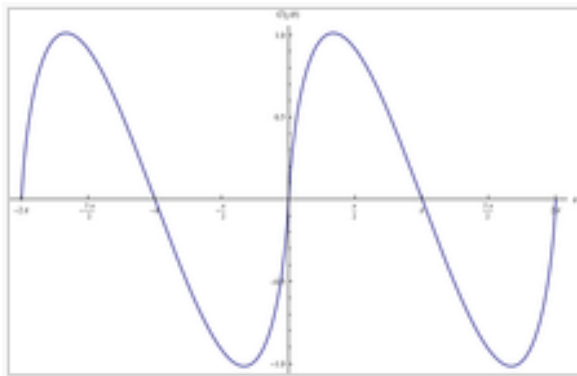

Graph of the Clausen function $Cl_2(\theta)$

Graphically we see a nice slanted shape compared to the trigonometric functions, also notice that they are periodic functions, with period = π

Some special values include $Cl_2(\pi/4) = G$ (Catalan's constant, $\sim 0.915\ 965\ 594\dots$)

The Lobachevsky function Λ or \mathcal{L} is essentially the same function with a change of variable:

$$\Lambda(\theta) = - \int_0^\theta \log |2 \sin(t)| dt = Cl_2(2\theta)/2$$

although the name "Lobachevsky function" is not quite historically accurate, as Lobachevsky's formulas for hyperbolic volume used the slightly different function:

$$\int_0^\theta \log |\sec(t)| dt = \Lambda(\theta + \pi/2) + \theta \log 2$$

We have also: $L(\mu) = (1/2) \text{Im} [\text{Li}_2 (\exp(2i.\mu))]$; where Li_2 = dilogarithm function.

Using the same method explained above, the expression to program becomes:

$$\Lambda(\mu) = -2.\mu \ln | 2.\mu | + 2.\mu + \sum_{k=1,2,\dots} (-1)^{k-1} / (2k+1)! [B_{2k} / (2k)] (2.\mu)^{2k+1}$$

LOBACH has an all-MCODE implementation – also motivated by the need to locate the code in a secondary bank, where FOCAL is not supported. This provides a fast execution, even if the M-code length more than doubles the equivalent FOCAL program (there’s a lot to say about how efficient FOCAL code is!). See JM Baillard’s page for the FOCAL code at:

<http://hp41programs.yolasite.com/lobachevsky.php>

Because the expression programmed is truncated to 8 terms, the Bernoulli numbers have been hard-coded in the code, so there’s no need to use **ZETA** as subroutine. The accuracy of this approach appears to be good enough within the 9 decimal digits resolution of the machine.

CLAUS uses a more general approach, actually calculating as many terms as needed until their contribution to the partial sum is negligible. It is however limited to arguments in the interval $[0, 2\pi]$. Note that CLAUS will read the input in the set angular mode, *but it will change it to DEG* (!).

The code is taken from JM Baillard’s page, at:

<http://hp41programs.yolasite.com/clausen.php>

Examples. Calculate both Clausen and Lobachevsky’s functions for the three arguments given in the table below, and compare their relative results. Use the **LOBACH** result as reference, obtaining the *adjusted value* for $\text{Cl}_2(2x)/2$ using **CLAUS** - i.e. $\text{Cl}_2(2x) / 2 = \Lambda(x)$

x	$\text{Cl}_2(2x) / 2$	Lobach(x)	delta
$\pi/3$	0.33831387	0.338313869	-2.95584E-09
0.15	0.330783505	0.330783505	0
6	out of range	-0.445441712	n/a

As you can see for small arguments the results are identical – this is because for those cases calculating ZETA is not required for CLAUS either, thus both programs use pretty much the same code.

Execution time tends to infinity as x tends to 2π . This routine produces DATA ERROR if $x = 0$, but $f(0) = 0$. Note also that **CLAUS** will change the angular mode to DEG, thus you need to make sure it’s set back in the appropriate mode before calling **LOBACH** (!)

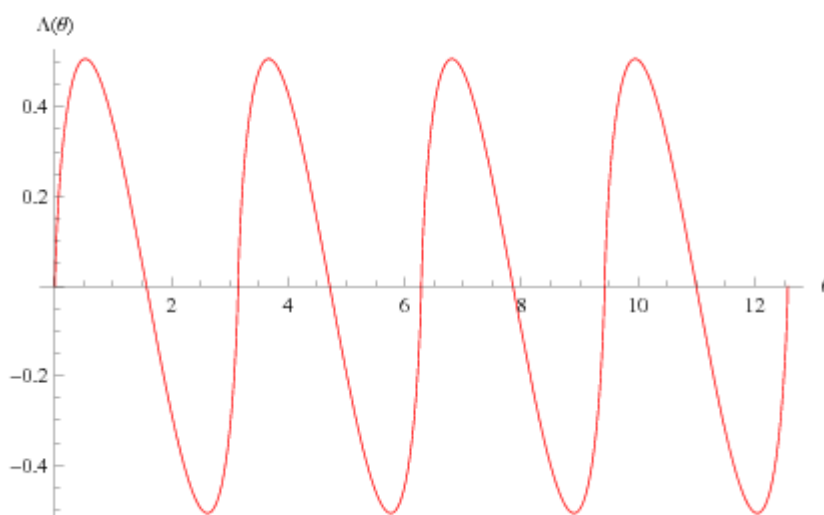

Home assignment:- Being curious about their similar shapes, calculate the differences between the Lobachevsky function and an equivalent Sine, say $f(x) = G \cdot \sin(2x)$, where $G = \text{Catalan's constant}$, so they both have the same amplitude and frequency.

Function Approximations.

	Function	Description	Author
[ΣFL\$]	CHB, CHB2	Chebyshev Polynomials Tn and Un	Ángel Martin
[ΣFL\$]	CHBCF	Chebyshev Coefficients	JM Baillard
	CHBAP _	Chebyshev's Approximation	JM Baillard
[ΣFL\$]	CdT	Auxiliary for CHBAP	JM Baillard
	TAYLOR _	Taylor Polynomial of order 10 and Approximation	Martin - Baillard
	FFOUR _	Fourier coefficients for (x)	Ángel Martin
	DHST	Discrete Hartley Symmetrical Transform	JM Baillard

In mathematics, approximation theory is concerned with how functions can best be approximated with simpler functions, and with quantitatively characterizing the errors introduced thereby. Note that what is meant by best and simpler will depend on the application. A closely related topic is the approximation of functions by generalized Fourier series, that is, approximations based upon summation of a series of terms based upon orthogonal polynomials.

One problem of particular interest is that of approximating a function in a computer mathematical library, using operations that can be performed on the computer or calculator (e.g. addition and multiplication), such that the result is as close to the actual function as possible. This is typically done with polynomial or rational (ratio of polynomials) approximations.

The objective is to make the approximation as close as possible to the actual function, typically with an accuracy close to that of the underlying computer's floating point arithmetic. This is accomplished by using a polynomial of high degree, and/or narrowing the domain over which the polynomial has to approximate the function. Narrowing the domain can often be done through the use of various addition or scaling formulas for the function being approximated. Modern mathematical libraries often reduce the domain into many tiny segments and use a low-degree polynomial for each segment.

Optimal polynomials

Once the domain and degree of the polynomial are defined, the polynomial itself is chosen in such a way as to minimize the worst-case error. That is, the goal is to minimize the maximum value of $|P(x)-f(x)|$, where $P(x)$ is the approximating polynomial and $f(x)$ is the actual function.

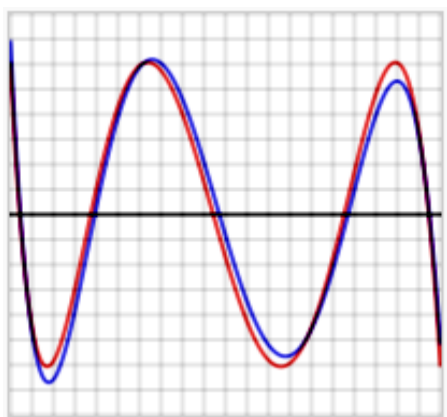

Left figure: Error between optimal polynomial and **log(x)** (red), and Chebyshev approximation and log(x) (blue) over the interval [2, 4]. Vertical divisions are 10⁻⁵. Maximum error for the optimal polynomial is 6.07 x 10⁻⁵.

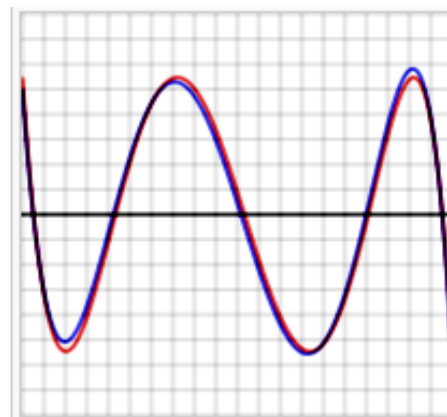

Right figure: Error between optimal polynomial and **exp(x)** (red), and Chebyshev approximation and exp(x) (blue) over the interval [-1, 1]. Vertical divisions are 10⁻⁴. Maximum error for the optimal polynomial is 5.47 x 10⁻⁴.

In the graphs above, note that the blue error function is sometimes better than (inside of) the red function, but sometimes worse, meaning that it is not quite the optimal polynomial. Note also that the discrepancy is less serious for the exp function, which has an extremely rapidly converging power series, than for the log function.

Chebyshev Approximation. { CHBAP , CHBCF , CdT }

One can obtain polynomials very close to the optimal one by expanding the given function in terms of Chebyshev polynomials and then cutting off the expansion at the desired degree. This is similar to the Fourier analysis of the function, using the Chebyshev polynomials instead of the usual trigonometric functions.

If one calculates the coefficients C_i in the Chebyshev expansion for a function:

$$f(x) \sim \sum_{i=0}^{\infty} c_i T_i(x)$$

and then cuts off the series after the T_N term, one gets an N th-degree polynomial approximating $f(x)$.

The reason this polynomial is nearly optimal is that, for functions with rapidly converging power series, if the series is cut off after some term, the total error arising from the cutoff is close to the first term after the cutoff. That is, the first term after the cutoff dominates all later terms. The same is true if the expansion is in terms of Chebyshev polynomials. If a Chebyshev expansion is cut off after T_N , the error will take a form close to a multiple of T_{N+1} . The Chebyshev polynomials have the property that they are level – they oscillate between +1 and -1 in the interval $[-1, 1]$. T_{N+1} has $N+2$ level extrema. This means that the error between $f(x)$ and its Chebyshev expansion out to T_N is close to a level function with $N+2$ extrema, so it is close to the optimal N th-degree polynomial.

After this introduction we're better equipped to use the functions and programs included in the SandMath related to approximation. The first three are related to the Chebyshev approximation:

If f is a function defined over $[-1,+1]$ and if n is a positive integer, the Chebyshev coefficients $\{c_0, c_1, \dots, c_n\}$ may be computed by the formula:

$$c_j = [2/(n+1)] \sum_{k=0,1,\dots,n} \cos [180^\circ j (k+1/2)/(n+1)] f \{ \cos [180^\circ (k+1/2)/(n+1)] \} \quad \text{if } j \neq 0$$

$$c_j = [1/(n+1)] \sum_{k=0,1,\dots,n} \cos [180^\circ j (k+1/2)/(n+1)] f \{ \cos [180^\circ (k+1/2)/(n+1)] \} \quad \text{if } j = 0$$

If f is defined over $[a,b]$, we make the change of variable $u = (2x - a - b)/(b - a)$

CHBCF expects a,b stored in R11 and R12, the function name in ALPHA, and the desired number of coefficients to calculate in X. After it's done the control word for the coefficients is returned to X (in the form bbb.eee), and the coefficients are stored in the corresponding registers. The *execution time will be very long* (recommended to use TURBO mode on V41 or the CL).

CHBAP obtains the approximation of the function using these coefficients calculated by **CHBCF**. It uses the status of flag 01 to control whether the function or its first derivative will be approximated, with all the data stored in R11, R12, the coefficients and the argument x in X.

Obviously **CHBAP** requires that the coefficients have been calculated previously, but repeated estimations can be calculated using the same coefficients with no further need to re-calculate them every time. Setting user flag 06 will allow you to call **CHBAP** directly, which will do the coefficients calculations (invoking **CHBCF** internally) saving you the additional step,

CHBCF is located in the secondary FAT, thus you need to use $\Sigma\text{FL\$}$ [or alternatively $\Sigma\text{FL\# 080}$]. You need to make sure that enough number of registers are available to store the results, setting $\text{SIZE} = 19+n$ for n coefficients.

CdT is a MCODE auxiliary function to expedite **CHBAP** execution. It is also in the secondary FAT, but typically you'll have no need to call it separately.

Example: $f(x) = 1/(x^2+x+\pi)$ and $[a,b] = [2,5]$

Which is easily programmed as follows:

```
01 LBL "FF"      05 PI
02 ENTER^       06 +
03 X^2          07 1/X
04 +           08 END
```

Store "FF" in ALPHA; 2 in R11; and 5 in R12 (interval begin and end points).
Type 10, $\Sigma\text{FL\$}$ "CHBCF" -> 18,028 (after 5 minutes! on a normal-speed 41)

This is the control word that indicates that the coefficients are stored as follows:

R18 = c0 = 0.061130486	R24 = c6 = 0.000001210
R19 = c1 = -0.038060320	R25 = c7 = 0.000000410
R20 = c2 = 0.008422922	R26 = c8 = -0.000000170
R21 = c3 = -0.001522665	R27 = c9 = 0.000000042
R22 = c4 = 0.000227407	R28 = c10 = -0.000000008
R23 = c5 = -0.000025750	

Note: you can use the program "OUT" (also included in the secondary FAT) to review and output those results. Use SF 21 if you want the display to halt after each value, resuming with R/S.

Example.- Let's now evaluate $f(3)$ & $f'(3)$ using **CHBAP** and flag 01 to select the case:

First we set flag 06 to bypass the data entry prompts, then we store the control word (bbb.eee) in R13

```
CF 01, 3, XEQ "CHBAP"    -> 0.066043252
SF 01, 3, XEQ "CHBAP"    -> -0.030531990
```

If you're missing automation you'll be glad to know there is some. Rather than a different driver program, **CHBAP** doubles as one when flag 06 is clear, triggering the data entry prompts which drive the data entry. At the prompt " $a^b^N=?$ " enter the three values separated by ENTER^, then R/S.

After a long time the coefficients are calculated and the program prompts: " $X=?$ ", your chance to input the point for the approximation. Repeat this last step as needed by entering the value, then R/S.

The accuracy of the approximation depends on the number of coefficients used - Choosing a larger n -value would give a better precision – but will also increase the calculation time.

The Chebyshev polynomials are useful to approximate $f(x)$ if f is very complicated - like the planetary positions, but it's also interesting to use these programs to evaluate the derivative $f'(x)$, where the results are often more accurate than those given by other numerical differentiation methods.

Chebyshev Polynomials. { **CHB** , **CHB2** }

Integral part of the approximation is the calculation of the Chebyshev polynomials, which is done internally in the **CdT** function. The SandMath also includes separate functions to calculate $T_n(x)$ and $U_n(x)$, the first and second kind respectively.

The Chebyshev polynomials of the first and second kinds are defined by the recurrence relations:

$$\begin{aligned} T_0(x) &= 1 & U_0(x) &= 1 \\ T_1(x) &= x & U_1(x) &= 2x \\ T_{n+1}(x) &= 2xT_n(x) - T_{n-1}(x). & U_{n+1}(x) &= 2xU_n(x) - U_{n-1}(x). \end{aligned}$$

There are also explicit expressions, based on different approaches to defining them: trigonometric, square roots, and even an expression using the Hypergeometric Function

$$T_n(x) = \begin{cases} \cos(n \arccos(x)), & x \in [-1, 1] \\ \cosh(n \operatorname{arccosh}(x)), & x \geq 1 \\ (-1)^n \cosh(n \operatorname{arccosh}(-x)), & x \leq -1 \end{cases}$$

$$T_n(x) = \frac{(x - \sqrt{x^2 - 1})^n + (x + \sqrt{x^2 - 1})^n}{2} = {}_2F_1\left(-n, n; \frac{1}{2}; \frac{1-x}{2}\right)$$

$$U_n(x) = \frac{(x + \sqrt{x^2 - 1})^{n+1} - (x - \sqrt{x^2 - 1})^{n+1}}{2\sqrt{x^2 - 1}} = (n+1) {}_2F_1\left(-n, n+2; \frac{3}{2}; \frac{1}{2}[1-x]\right)$$

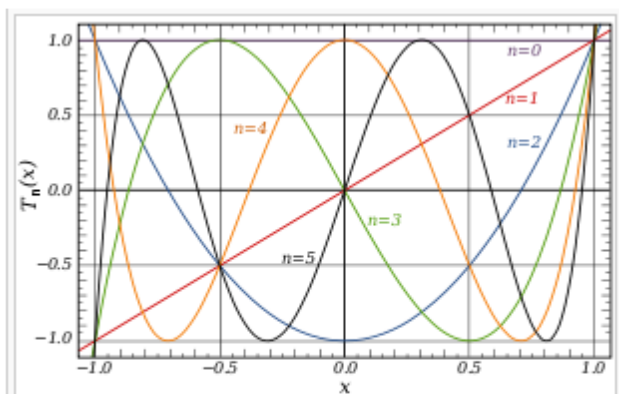

The first few Chebyshev polynomials of the first kind in the domain $-1 < x < 1$: The flat T_0, T_1, T_2, T_3, T_4 and T_5 .

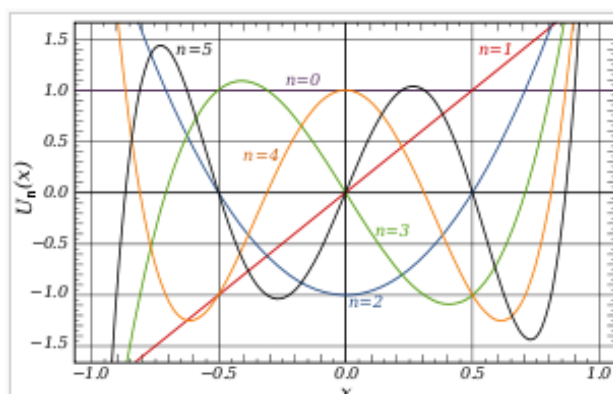

The first few Chebyshev polynomials of the second kind in the domain $-1 < x < 1$: The flat U_0, U_1, U_2, U_3, U_4 and U_5 . Although not visible in the image, $U_n(1) = n + 1$ and $U_n(-1) = (n + 1)(-1)^n$.

The MCODE functions are **CHB** for $T_n(x)$ and **CHB2** for $U_n(x)$, both are located in the secondary FAT and thus require **ΣF\$** to execute them. Note that the iterative method is used, slower but more accurate for small values of the argument – and that it also returns both $P(n,x)$ in N and $P(n-1, x)$ in M

Examples: Calculate $T_7(0,314)$ and $U_7(0.314)$

7, ENTER^, 0,314, **ΣF\$** "CHB1" -> -0.786900700 in X & N, and 0.338782777 in M
 7, ENTER^, 0,314, **ΣF\$** "CHB2" -> -0.582815681 in X & N, and 0.649952293 in M

Taylor Series and Polynomials. { TAYLOR }

In mathematics, a Taylor series is a representation of a function as an infinite sum of terms that are calculated from the values of the function's derivatives at a single point. The concept of a Taylor series was formally introduced by the English mathematician Brook Taylor in 1715. If the Taylor series is centered at zero, then that series is also called a Maclaurin series, named after the Scottish mathematician Colin Maclaurin, who made extensive use of this special case of Taylor series in the 18th century.

It is common practice to approximate a function by using a finite number of terms of its Taylor series. Taylor's theorem gives quantitative estimates on the error in this approximation. Any finite number of initial terms of the Taylor series of a function is called a **Taylor polynomial**. The Taylor series of a function is the limit of that function's Taylor polynomials, provided that the limit exists. A function may not be equal to its Taylor series, even if its Taylor series converges at every point. A function that is equal to its Taylor series in an open interval (or a disc in the complex plane) is known as an analytic function.

The Taylor series of a real or complex-valued function $f(x)$ that is infinitely differentiable in a neighborhood of a real or complex number a is the power series:

$$\sum_{n=0}^{\infty} \frac{f^{(n)}(a)}{n!} (x - a)^n$$

where $n!$ denotes the factorial of n and $f^{(n)}(a)$ denotes the n -th derivative of f evaluated at the point a . The derivative of order zero f is defined to be f itself and $(x - a)^0$ and $0!$ are both defined to be 1. In the case that $a = 0$, the series is also called a Maclaurin series.

Establishing an analogy with the Chebyshev approximation, one would notice that here the approximation is made using certain coefficients affecting the Taylor polynomials terms, which are simpler versions than Chebyshev's - basically x^n for the Maclaurin case. Thus it's intuitively understandable that a similarly good approximation (i.e. with small enough error) will require a larger number of Taylor terms to accomplish it.

Numerically however we're faced with the problem to calculate all the function derivatives of a given function. This is approached using the Taylor Expansion, using the notion of small increments of both the function and the argument *to estimate the derivatives*. Let h be that small increment, then The Taylor expansion of a function f in a point near the center is

$$f(a+h) = f(a) + h f'(a) + \frac{h^2}{2!} f''(a) + \dots + \frac{h^n}{n!} f^{(n)}(a) + \dots$$

Given a function $f(x)$, we seek approximations of $a_1 = f'(a)$, $a_2 = f''(a)/2!$, ..., $a_n = f^{(n)}(a)/n!$

The SandMath implementation is a direct application of JM Baillard's method, using a 10-degree polynomial to approximate the derivatives. This theoretically provides perfect accuracy for polynomials of degree ≤ 10 , but in practice - due to roundoff-errors - the precision decreases as k increases and the estimation of a degree >10 is often very doubtful.

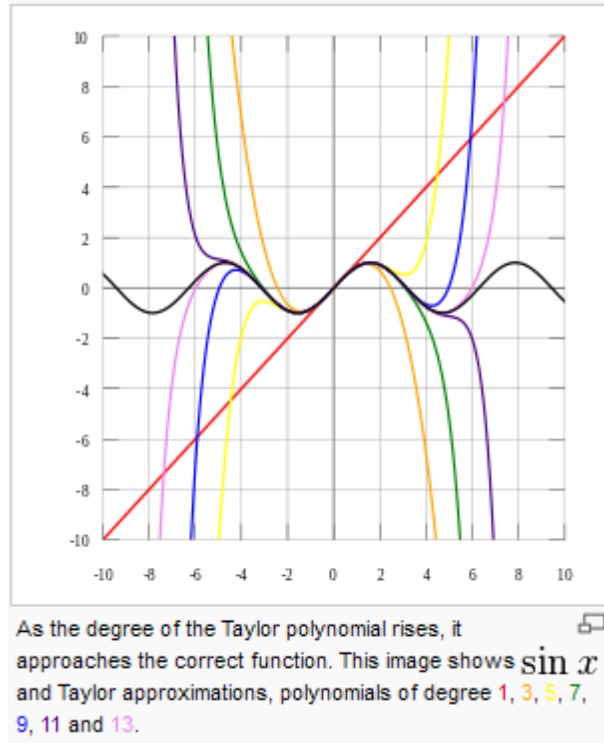

Because of the internal structure of the SandMath, **TAYLOR** was split into two distinct parts. The first part is a FOCAL program that calculates all the values for $f(a+h)$ and $f(a-h)$. The second is an MCODE version of all the remaining code. The main reason to do that was not simply to accelerate the calculation and increase the accuracy with 13-digit OS routines, - which it certainly does in both accounts - but to place the code in the second bank of the lower page, which is where the space was available.

Formulae and Methodology.

The formulas used are as follows:

Let a = center of the series; $F = f(a)$, and:

$A = f(a+h)-f(a-h)$; $B = f(a+2h)-f(a-2h)$; $C = f(a+3h)-f(a-3h)$; $D = f(a+4h)-f(a-4h)$; $E = f(a+5h)-f(a-5h)$
 $G = f(a+h)+f(a-h)$; $H = f(a+2h)+f(a-2h)$; $I = f(a+3h)+f(a-3h)$; $J = f(a+4h)+f(a-4h)$; $K = f(a+5h)+f(a-5h)$

then we have:

$$\begin{aligned} h \cdot f'(a) &\sim (2100 A - 600 B + 150 C - 25 D + 2 E) / 2520 \\ h^2 \cdot f''(a) &\sim (-73766 F + 42000 G - 6000 H + 1000 I - 125 J + 8 K) / 25200 \\ h^3 \cdot f'''(a) &\sim (-70098 A + 52428 B - 14607 C + 2522 D - 205 E) / 30240 \\ h^4 \cdot f^{(4)}(a) &\sim (192654 F - 140196 G + 52428 H - 9738 I + 1261 J - 82 K) / 15120 \\ h^5 \cdot f^{(5)}(a) &\sim (1938 A - 1872 B + 783 C - 152 D + 13 E) / 288 \\ h^6 \cdot f^{(6)}(a) &\sim (-233244 F + 184110 G - 88920 H + 24795 I - 3610 J + 247 K) / 4560 \\ h^7 \cdot f^{(7)}(a) &\sim (-378 A + 408 B - 207 C + 52 D - 5 E) / 24 \\ h^8 \cdot f^{(8)}(a) &\sim (462 F - 378 G + 204 H - 69 I + 13 J - K) / 3 \\ h^9 \cdot f^{(9)}(a) &\sim (42 A - 48 B + 27 C - 8 D + E) / 2 \\ h^{10} \cdot f^{(10)}(a) &\sim (-252 F + 210 G - 120 H + 45 I - 10 J + K) \end{aligned}$$

To understand where all this comes from, we write the polynomial $p(x) = a_0 + a_1x + \dots + a_{10}x^{10}$ so that it takes the same values as f for $x = 0$; $x = +/- 1$; $x = +/-2$, , and $x = +/-5$. With this we get a 11 x 11 linear system to solve, which requires finding the inverse of a "Vandermonde" matrix like the one shown below:

$$\begin{bmatrix} 1 & 0 & 0 & \dots & 0 \\ 1 & 1 & 1 & \dots & 1 \\ 1 & -1 & 1 & -1 & \dots & 1 \\ 1 & 2 & 4 & \dots & 1024 \\ 1 & -2 & 4 & -8 & \dots & 1024 \\ \dots & \dots & \dots & \dots & \dots & \dots \\ 1 & 5 & 25 & 125 & \dots & 5^{10} \\ 1 & -5 & 25 & -125 & \dots & (-5)^{10} \end{bmatrix}$$

Once the coefficients are calculated we can evaluate the 10-degree Taylor Polynomial as a check to verify the accuracy of the approximation. Note that this accuracy will decrease as the argument chosen to evaluate it gets further away from the "center", i.e. the value "a" used to generate them - which intuitively can be explained by the need of more terms of the polynomial, certainly more than the 10 available to us.

Let's see a couple of examples of utilization. The first one using $f(x) = e^x$, perhaps the best-behaved non-rational function. We'll use **TAYLOR** twice to obtain the coefficients around $a=0$ and $a=1$, then evaluate the resulting polynomials (T0 and T1) for $x=1$, $x=2$, and $x=3$ in each case.

After programming the function as: { 01 LBL EXP, 02 E^X, 03 RTN }, let's use $h=0.2$ as step-size for the derivative approximations. For the first case then you type:

[ALPHA], "EXP", [ALPHA] - to enter the program name in the Alpha register; followed by:
 0.2, ENTER^, 0, XEQ "TAYLOR" -> #5... #4... #3... #2... #1... "RUNNING..."

and for the second case (the program name is still in ALPHA):

0.2, ENTER^, 1, XEQ "TAYLOR" -> #5... #4... #3... #2... #1... "RUNNING..."

The display shows the progress in the calculations, with the first phase obtaining the 5 pairs of value functions, followed by the approximation of the coefficients. When it's complete (in shorter time that expected due to the MCODE speed advantage), the execution stops with the first four coefficients in the stack, and all ten of them stored in registers R01 to R10.

In these particular cases the results are summarized in the table below, together with the exact values and the accuracy of the estimations – which deteriorates as the order of the derivative increases.

RG#	T1 Approx.	T1 Exact	T1 delta	T0 Approx.	T0 Exact	T0 delta
R01	2.718281828	2.718281828	0.000000000	0.999999999	1	-0.000000001
R02	1.359140927	1.359140914	0.000000010	0.499999994	0.5	-0.000000012
R03	0.453046958	0.453046971	-0.000000029	0.166666691	0.166666667	0.000000144
R04	0.113261624	0.113261743	-0.000001051	0.041666676	0.041666667	0.000002232
R05	0.022652373	0.022652349	0.000001059	0.008333231	0.008333333	-0.000012240
R06	0.003775805	0.003775391	0.000109658	0.001388497	0.001388889	-0.000282240
R07	0.00053928	0.000539342	-0.000114955	0.000198548	0.000198413	0.000680399
R08	0.000066832	0.000067418	-0.008692041	0.000025386	0.000024802	0.023546488
R09	0.000007608	0.000007491	0.015618742	0.000002726	0.000002756	-0.010885341
R10	0.000001031	0.000000749	0.376502003	-0.000000003	0.000000276	-1.010869565

The exact values for T1 are: $a_k = e / k!$; and for T0 are: $a_k = 1/ k!$

To evaluate the resulting Taylor polynomial simple press "E" in user mode (or R/S right after the previous steps), and input the argument at the prompt "X=?" , then R/S again. Repeat as needed.

Here are the results of our example:

	Eval	Exact	delta
T1 (1)	2.718281828	2.71828183	0
T1 (2)	7.389056096	7.3890561	-4.06006E-10
T1 (3)	20.0855858	20.0855369	2.43359E-06
T0 (1)	2.718281828	2.71828183	0
T0 (2)	7.388834562	7.3890561	-2.99818E-05
T0 (3)	20.06646854	20.0855369	-0.000949359

Final Remarks.-

Choosing the increment h between 0.1 and 0.2 is "often" a good choice. The program employs the same h-value for all the derivatives, but a good choice for f'(x) may be a bad choice for f''(x), and the same issue appears for all the derivatives. See JM Baillard's FOCAL application where h is independently adjusted modified per derivative order, which achieves higher accuracy in the results.

<http://hp41programs.yolasite.com/taylor.php>

Note that registers R00 thru R09 may be used by the subroutine to program f(x).

Appendix 11.a.- Derivatives of the Gamma function. -

Let's see a practical usage of the Taylor approximation applied to the calculation of numerical derivatives of a function. Let's choose the Gamma function for the example, and attempt to calculate its first few derivatives in the point x=2

Programming the function as follows;

```
{ 01 LBL "GM", 02 GAMMA, 03 END }
```

And using a step size h=0.2 we obtain the following results for x=2 with

TAYLOR:

```
0.2, ENTER ^, 2, XEQ "TAYLOR", "GM"
```

Note: Don't forget to multiply each term by n! to obtain the value of the derivative.

h=0,2 x=2	f(x) = Γ(x)		
	TAYLOR	error %	"Exact"
R00	1.000000000	0.0000	1.000000000
R01	0.422783681	0.0000	0.422784335
R02	0.411840666	0.0000	0.411840331
R03	0.081600700	0.0003	0.081576919
R04	0.074236920		
R05	-0.000478249		
R06	0.011260925		
R07	0.001763926		
R08	0.001763926		
R09	-0.001727311		
R10	0.000897564		

But how accurate are these results? We can expect a progressive loss of accuracy as the order of the derivative increases, so let's try to check the first three derivatives for the example. Taking advantage of the Digamma (Ψ) function definition, we'll use the following relationships to verify the results obtained by TAYLOR:

$$\frac{d}{dx}(\Gamma(x)) = \Gamma(x) \psi^{(0)}(x) \quad ; \quad \frac{d^2}{dx^2}(\Gamma(x)) = \Gamma(x) (\psi^{(0)}(x)^2 + \psi^{(1)}(x))$$

$$\frac{d^3}{dx^3}(\Gamma(x)) = \Gamma(x) (\psi^{(0)}(x)^3 + 3 \psi^{(1)}(x) \psi^{(0)}(x) + \psi^{(2)}(x))$$

If you have no access to WolframAlpha, these expressions can be programmed using the SandMath functions **PSI** and **PSIN**, see the program listings on the right.

All programs take the derivative order in Y and the point in X as arguments.

Obviously the "exact" results will be affected by the inaccuracies and limitations of the functions used, but nevertheless the approach is good to see the methodology.

Setting your expectatons properly is important: this will not be the most accurate method for the calculation of the derivatives, but it is still interesting to say the least.

01	LBL "G"	01	LBL "G3"
02	GAMMA	02	STO 05
03	RTN	03	2
04	LBL "G1"	04	X<>Y
05	GAMMA	05	PSIN
06	LASTX	06	STO 06
07	PSI	07	E
08	*	08	RCL 05
09	END	09	PSIN
		10	3
01	LBL "G2"	11	*
02	STO 05	12	RCL 05
03	E	13	PSI
04	X<>Y	14	*
05	PSIN	15	LASTX
06	RCL 05	16	X^3
07	PSI	17	+
08	X^2	18	RCL 06
09	+	19	+
10	RCL 05	20	RCL 05
11	GAMMA	21	GAMMA
12	*	22	*
13	END	23	END

Fourier Series. { **FFOUR** , **FOURN** }

In mathematics, a Fourier series decomposes periodic functions or periodic signals into the sum of a (possibly infinite) set of simple oscillating functions, namely sines and cosines (or complex exponentials). The study of Fourier series is a branch of Fourier analysis.

The partial sums for f are trigonometric polynomials. One expects that the functions $\sum N f$ approximate the function f , and that the approximation improves as N tends to infinity. The infinite sum

$$\frac{a_0}{2} + \sum_{n=1}^{\infty} [a_n \cos(nx) + b_n \sin(nx)]$$

is called the Fourier series of f . The Fourier series does not always converge, and even when it does converge for a specific value x_0 of x , the sum of the series at x_0 may differ from the value $f(x_0)$ of the function. It is one of the main questions in harmonic analysis to decide when Fourier series converge, and when the sum is equal to the original function.

FFOUR Calculates the Fourier coefficients for a periodic function $F(x)$, defined as:

$$a_n = \frac{1}{L} \int_0^{2L} f(x') \cos\left(\frac{n\pi x'}{L}\right) dx'$$

$$b_n = \frac{1}{L} \int_0^{2L} f(x') \sin\left(\frac{n\pi x'}{L}\right) dx'.$$

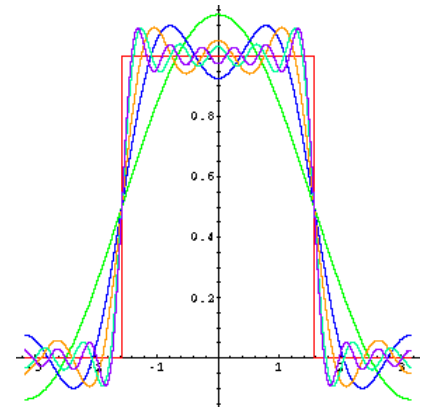

with the following characteristics:

- centered in $x = x_0$
- with period $2L$ on an interval $[x_0, x_0+2L]$
- with a given precision for calculations (significant decimal places)

FFOUR is a rather large FOCAL program, despite having a MCODE FAT entry. It calculates all integrals internally, not making use of general-purpose numeric integrators like INTEG, IG, etc – so it's totally self-contained.

The function must be programmed in main memory under its own global label. The program prompts for the function name, the first index to calculate, and the number of desired coefficients.

The program also calculates the approximate value of the function at a given argument applying the summation of the terms, using the obtained coefficients:

$$f(x') = \frac{1}{2} a_0 + \sum_{n=1}^{\infty} a_n \cos\left(\frac{n\pi x'}{L}\right) + \sum_{n=1}^{\infty} b_n \sin\left(\frac{n\pi x'}{L}\right).$$

To use it simply enter the value of x and press "E" (XEQ E) with user mode on – this assumes that no function is assigned to that key. The approximation will be more correct when a sufficient number of terms is included. The goodness is also dependent on the argument itself.

Example: calculate the first six coefficients for $f(x) = x^2$, assuming:

a period $T = 2\pi$, centered in $x_0 = 0$. As it's known,

$$x^2 = \frac{4}{3} \pi^2 + \sum \left\{ \frac{4 \cos(nx)}{n^2} - \frac{4\pi \sin(nx)}{n} \right\} | n=0,1,\dots$$

Using an accuracy of 6 decimal places the program returns the following results:

$a_0 = 13,1595$	$b_0 = 0$
$a_1 = 4$	$b_1 = -12,566$
$a_2 = 1$	$b_2 = -6,2830$
$a_3 = 0,4444$	$b_3 = -4,1888$
$a_4 = 0,250$	$b_4 = -3,1415$
$a_5 = 0,160$	$b_5 = -2.513$

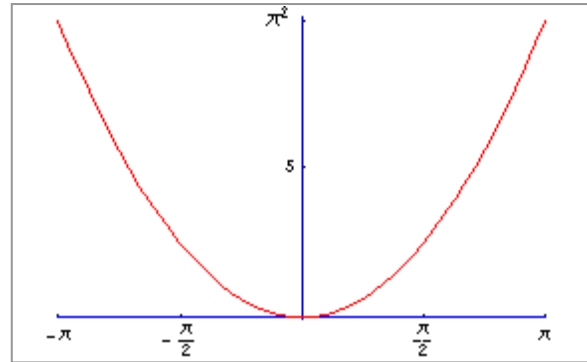

Pressing [E] will calculate an estimation of the function for the argument in X, using the fourier terms calculated previously. In this case:

$X=5$, XEQ [E] -> $f(x) = 23,254423$

$X=1$, XEQ [E] -> $f(x) = -0,154639$, which obviously misses the point.

Typically the functions used are related to the harmonic analysis though. Here's an interesting one, the "Christmas-Tree" function and its Fourier representation for different number of terms.

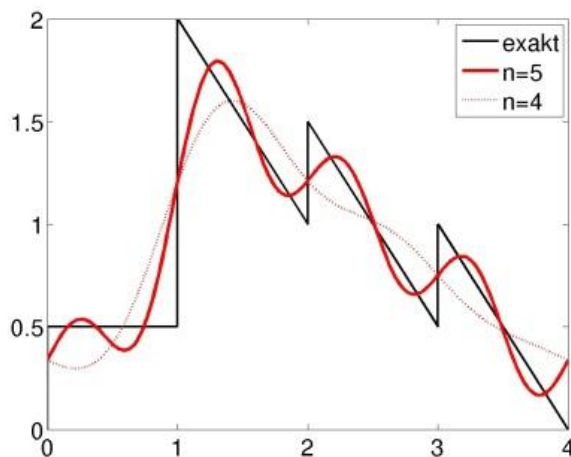

Program listings.

01	LBL "FFOUR"	56	STO 10	111	LBL 01
02	RAD	57	+	112	RCL 02
03	SIZE?	58	STO 02	113	RCL 01
04	15	59	LBL 00	114	STO 05
05	X>Y?	60	RUNNING	115	-
06	PSIZE	61	RCL 11	116	RCL 03
07	ASTO 07	62	6	117	STO 06
08	<i>"#1 IDX=?"</i>	63	*	118	/
09	PROMPT	64	RCL 08	119	STO 04
10	<i>"#TERMS=?"</i>	65	INT	120	RCL 01
11	PROMPT	66	*	121	XEQ 05
12	STO 11	67	2	122	STO 00
13	ST+ X(3)	68	+	123	X<>Y
14	14	69	STO 03	124	STO 09
15	+	70	RCL 08	125	RCL 02
16	E3/E+	71	INT	126	XEQ 05
17	14	72	ST+ X(3)	127	XEQ 08
18	+	73	PI	128	LBL 04
19	STO 13	74	*	129	XEQ 02
20	STO 14	75	RCL 10	130	XEQ 08
21	X<>Y	76	/	131	DSE 06
22	E	77	STO 12	132	DSE 06
23	E3/E+	78	XEQ 01	133	GTO 03
24	*	79	<i>"a"</i>	134	RCL 04
25	RCL 11	80	XEQ 06	135	3
26	E	81	RCL 09	136	/
27	-	82	STO 00	137	ST* 00
28	E3	83	<i>"b"</i>	138	ST* 09
29	/	84	XEQ 06	139	RTN
30	+	85	ISG 08	140	LBL 03
31	STO 08	86	GTO 00	141	XEQ 02
32	CF 00	87	RTN	142	GTO 04
33	<i>"ΣF? Y/N"</i>	88	LBL 06	143	LBL 02
34	AVIEW	89	CF 01	144	RCL 04
35	Y/N?	90	RCL 08	145	ST+ 05
36	CLX	91	INT	146	RCL 05
37	X=0?	92	X=0?	147	XEQ 05
38	GTO 11	93	SF 01	148	2
39	SF 00	94	AINT	149	ST* Z(1)
40	SIZE?	95	<i>>=""</i>	150	*
41	RCL 11	96	RCL 00	151	LBL 08
42	ST+ X(3)	97	RCL 10	152	ST+ 00
43	15	98	/	153	X<>Y
44	+	99	FC?C 01	154	ST+ 09
45	X>Y?	100	ST+ X(3)	155	X<>Y
46	PSIZE	101	RND	156	RTN
47	LBL 11	102	ARCL X(3)	157	LBL 05
48	<i>"PREC.=?"</i>	103	PROMPT	158	XEQ IND 07
49	PROMPT	104	FC?C 00	159	RCL 05
50	STO 11	105	RTN	160	RCL 12
51	<i>"X0=?"</i>	106	LASTX	161	*
52	PROMPT	107	STO IND 14	162	X<>Y
53	STO 01	108	E	163	P-R
54	<i>"T=?"</i>	109	ST+ 14	164	RTN
55	PROMPT	110	RTN		

165	LBL E	177	/	189	*
166	STO 04	178	INT	190	ISG 14
167	RCL 13	179	ST+ X(3)	191	X<>Y
168	STO 14	180	PI	192	RCL IND 14
169	,	181	*	193	*
170	STO 05	182	RCL 10	194	+
171	LBL 09	183	/	195	ST+ 05
172	RCL 14	184	RCL 04	196	ISG 14
173	INT	185	*	197	GTO 09
174	15	186	E	198	RCL 05
175	-	187	P-R	199	END
176	2	188	RCL IND 14		
01	LBL "CHBAP"	39	STO 13	78	RCL 11
02	ASTO 10	40	STO 14	79	-
03	FS? 06	41	19	80	*
04	GTO 00	42	+	81	RCL 11
05	"a^b^N=?"	43	SIZE?	82	RCL 12
06	PROMPT	44	X<>Y	83	+
07	RUNNING	45	X>Y?	84	+
08	XEQ 05	46	PSIZE	85	2
09	"X=?"	47	X<>Y	86	/
10	PROMPT	48	RDN	87	XEQ IND 10
11	LBL 00	49	E	88	RCL 14
12	ST+ X(3)	50	-	89	RCL 16
13	RCL 11	51	.017	90	*
14	RCL 12	52	+	91	COS
15	+	53	STO 17	92	*
16	-	54	RDN	93	ST+ IND 17
17	RCL 12	55	STO 12	94	DSE 15
18	RCL 11	56	RDN	95	GTO 02
19	-	57	STO 11	96	RCL 14
20	/	58	ISG 13	97	X#0?
21	RCL 13	59	LBL 01	98	SIGN
22	FS? 01	60	RCL 13	99	E
23	CHS	61	STO 15	100	+
24	X<>Y	62	CLX	101	RCL 13
25	CDT	63	STO IND 17	102	/
26	2	64	LBL 02	103	ST* IND 17
27	RCL 12	65	RCL 15	104	DSE 14
28	RCL 11	66	,	105	CLX
29	-	67	5	106	DSE 17
30	/	68	-	107	GTO 01
31	X<>Y	69	PI	108	RCL 13
32	FS? 01	70	FC? 43	109	17
33	*	71	R-D	110	+
34	RTN	72	*	111	E3/E+
35	GTO 00	73	RCL 13	112	17
36	LBL "CHBCF"	74	/	113	+
37	ASTO 10	75	STO 16	114	STO 13
38	LBL 00	76	COS	115	END
		77	RCL 12		

Appendix 11.b.- Fourier Coefficients by brute force.

Since the coefficients are basically integrals of the functions combined with trigonometric functions, nothing (besides common sense) stops us from using INTEG to calculate them. This brute force approach is just a work-around, considering the time requirements for the execution – but it can be useful to calculate a single term randomly, as opposed to the sequential approach used by FFOUR.

So here the idea is to calculate the n-th. Coefficient independently, which responds to the following defining equation:

1	LBL "FOURN"		38	LBL "*FN"
2	"F. NAME? "		39	RAD
3	AON		40	STO 03
4	PROMPT		41	XEQ IND 01
5	AOFF		42	RCL 02
6	ASTO 01		43	RCL 03
7	"PERIOD=?"		44	*
8	PROMPT		45	RCL 00
9	STO 00		46	/
10	FIX 4		47	ST+ X
11	LBL E		48	PI
12	"INDEX=?"		49	*
13	PROMPT		50	FC? 00
14	STO 02		51	COS
15	CF 00		52	FS? 00
16	XEQ 00		53	SIN
17	SF 00		54	*
18	LBL 00		55	DEG
19	"*FN"		56	END
20	0			
21	RCL 00	Example: $f(x) = x^2$		
22	INTEG			
23	RCL 00	1	LBL "X2"	
24	/	2	X^2	
25	ST+ X	3	END	
26	"a"			
27	FS? 00			
28	"b"	Example: $f(x) = x$		
29	" -"			
30	RCL 02	1	LBL "X"	
31	AINT	2	END	
32	" -)="			
33	ARCL Y			
34	PROMPT			
35	FC? 00			
36	RTN			
37	GTO E			

Notice that the module SIROM ('Solve and Integrate' ROM) contains not only **FROOT** and **FINTG**, but also the program **FOURN** in its "-APPLIED" section – so you can use that 4k rom instead of the Advantage – that'll also save you from having to type in the program.

Simply enter the information asked at the prompts, including the precision desired (number of decimal digits), function name and its chosen period (2π).

The screenshot below shows the ILPER output of the process:

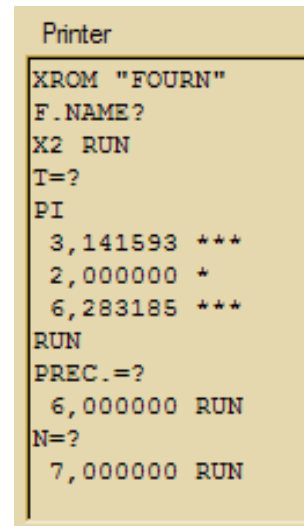

Using this program we'll calculate the coefficients for the 7th and 9th terms for $f(x) = x^2$.

a7 = 0.081633, b7 = -1,795196; and:
a9 = 0,049383, b9 = -1,396263

Discrete Hartley Transform. { DHST , DHT , INPUT }

A discrete Hartley transform (DHT) is a Fourier-related transform of discrete, periodic data similar to the discrete Fourier transform (DFT), with analogous applications in signal processing and related fields. Its main distinction from the DFT is that it transforms real inputs to real outputs, with no intrinsic involvement of complex numbers. Just as the DFT is the discrete analogue of the continuous Fourier transform, the DHT is the discrete analogue of the continuous Hartley transform, introduced by R. V. L. Hartley in 1942.

Definition and Properties.

Formally, the discrete Hartley transform is a linear, invertible function $H : \mathbf{R}^n \rightarrow \mathbf{R}^n$ (where \mathbf{R} denotes the set of real numbers). The N real numbers x_0, \dots, x_{N-1} are transformed into the N real numbers H_0, \dots, H_{N-1} according to the formula:

$$H_k = \sum_{n=0}^{N-1} x_n \left[\cos\left(\frac{2\pi}{N}nk\right) + \sin\left(\frac{2\pi}{N}nk\right) \right], \quad k=1,2,\dots,(N-1)$$

The combination $[\cos(z) + \sin(z)]$ is sometimes denoted **Cas(z)**, with the well-known expression based on the double-angle formula:

$$\cos(z) + \sin(z) = \sqrt{2} \cos\left(z - \frac{\pi}{4}\right)$$

The transform can be interpreted as the multiplication of the vector (x_0, \dots, x_{N-1}) by an $N \times N$ matrix; therefore, the discrete Hartley transform is a linear operator. The matrix is invertible; the inverse transformation, which allows one to recover the x_n from the H_k , is simply the DHT of H_k multiplied by $1/N$. That is, the DHT is its own inverse (involuntary), up to an overall scale factor.

Implementation details.

The SandMath includes **DHT**, written by JM Baillard to calculate the transform for both vectors in \mathbf{R}^n , as well as for matrices of order $(n \times m)$. **If user flag 01 is clear** the transformation is standard, but when **user flag 01 set** the transformation is strictly symmetrical, thus all coefficients are divided by $\sqrt{n \times m}$. – so $\text{DHT}[\text{DHT}(A)] = A$ – but for small round-off errors as usual.

DHT is an all-MCODE function, with the considerable speed advantage over equivalent FOCAL counterparts. The transform elements are expected to be stored in data registers before **DHT** is executed. Their existence is checked, but there's no check for Alpha Data – which will trigger a DATA ERROR condition. The transform results will be stored in a block of registers same size of the input data, and located right following the last element of the initial elements.

Input parameters for **DHT** are:

- the dimension of the vector/matrix in R00,
- the data elements stored in registers [R01 to Rm.n], and
- *the index of the result element* in X - use zero for all as a convenient shortcut.

A few auxiliary programs are also provided for the data entry and review of the results – which can be a tedious process for relatively large size vectors or matrices. These are as follows:

IN and **OUT**, to sequentially enter or review a block of registers:

- Enter the initial register index for **IN**, then proceed with all required entries and terminate with a "blank" R/S to end the sequence. Control word bbb.eee is in X upon termination.
- Input the control word in X in the form bbb.eee, and **OUT** will display all registers sequentially. Use flag 21 to control the display prompt (set) or not (clear).

INPUT / **^LIST**, to enter a set of coefficients in a List, using the ALPHA register.

- Simply type the control word in X, and **ΣF\$ "INPUT"**. Use ENTER^ to separate the list entries while you're in data entry mode, terminating with R/S.
- Entries can be negative or positive, integer or fractional – the only limitation is no "E" character (for exponents) is possible in this mode – use **IN** instead.
- Remember also the maximum length is limited to 24 characters, including the blank spaces in between the entries. Use it repeated times with smaller range if this limit is expected to be insufficient for the complete list.

Note that **INPUT** is a FOCAL program that drives its MCODE heart, i.e. **^LIST** –originally written for the Polynomial Data entry in the Polynomial ROM and later modified for Matrix Input as well.

INPUT also uses **ANUMDL** behind the scenes, to read the numeric values from the ALPHA string, deleting them in a loop repeated as many times as elements on the list. All these functions reside in the Library#4 ROM, so only FAT pointers are added to the SandMath.

Let's see a couple of examples from JM's web page: <http://hp41programs.yolasite.com/hartley.php>

Example1: One-dimensional data. Let A be the vector: $A = [1 \ 2 \ 4 \ 7]$; here, $n = 4$ & $m = 1$

Input the data elements using **INPUT** (ideally suited to this type of integer data) , and review the results using **OUT**:

```
SF 01          -> symmetrical transform
1,004, ΣF$ "INPUT"  -> "^_ " 1, ENTER^, 2, ENTER^, 4, ENTER^, 7, R/S
4, STO_00, 0, ΣF$ "DHT"  -> 7.0000 (value of b1)
5.008, ΣF$ "OUT"      -> [ R05 R06 R07 R08 ] = [ 7 -4 -2 1 ] listed sequentially
```

Example2: Two-dimensional data. Let [M] be the 2x3 matrix defined by: $\begin{bmatrix} 1 & 2 & 4 \\ 3 & 5 & 6 \end{bmatrix}$

Repeating the same process as above:- Note that for two-dimensional cases, **the elements are introduced in column order** (!).

```
1.006, ΣF$ "INPUT"  -> "^_ " 1, ENTER^, 3, ENTER^, 2, ENTER^, 5, ENTER^, 4, ENTER^, 6, R/S
2.003, STO_00, 0, ΣF$ "DHT"      -> 8.573214097 (value of b1)
7.012, ΣF$ "OUT"      -> R07 to R12 listed sequentially, as show below:
```

$B = \begin{bmatrix} 8.5732 & -2.8978 & -0.7765 \\ -2.8577 & -0.1494 & 0.5577 \end{bmatrix}$ rounded to 4 decimals.

If you copy {R07 R12} to {R01 R06} and press 0, **ΣF\$ "DHT"** again, you'll get the elements of the original matrix [M] with a mean error of about 3 E-9

A driver program for DHT. { DSHT }

Revision "N" of the SandMath includes many small enhancements and improvements in several areas, as well as **DSHT**; an all-new driver program for **DHT** – which has been moved to the secondary FAT.

With **DSHT** the data entry is automated with prompts under program control, so the user needs not to remember the parameters before hand.

The dimension can be either an integer number or a 2-column matrix. There's no need to use ",001" for the second dimension in the one-dimensional case. It's however important to remember that for 2-dimensional data the element entry and output are made in COLUMN order, as opposed to other matrix applications.

DSHT is a FOCAL program, despite its MCODE appearance in the FAT. The execution may be stopped and resumed in single-step mode if so desired. The program listing is shown below.

01	LBL "DHST"	
02	SF 01	symmetrical transform
03	"DIM=?"	sample type
04	PROMPT	dimension
05	STO 00	saved in R00
06	INT?	matrix?
07	GTO 00	no, skip
08	b*e	yes, get dimension
09	LBL 00	
10	E3/E+	normalize
11	INPUT	enter elements
12	O	all-set
13	DHT	Hartley transform
14	RCL 00	dimension
15	INT?	matrix?
16	GTO 00	no, skip
17	b*e	yes, get dimension
18	LBL 00	
19	ENTER^	
20	ST+ X	skip on set
21	E3/E+	normalize
22	+	beginning reg
23	SF 21	pause between
24	OUT	output elements
25	END	done

Note how the auxiliary functions need to be used after the **INT?** conditional tests – due to their multi-line structure. The program has the 4-byte GTO jumps pre-compiled so there are no LBL 00 steps.

The sub-function **b*e** is also available in the auxiliary FAT. It simply calculates the product of the integer part of a number by its fractional part – normalized to three decimal digits. It is therefore the matrix dimension in this case.

Note that both **b*e** and **b<>e** (which swaps the begin/end formats) have lower-case letters in their names, but despite that fact you should use upper letters when spelling them at the **SF\$** prompt.

Discrete Fourier Transform. { **DFT** }

The DHT can be used to compute the DFT, and vice versa. For **real inputs** x_n , the DFT output X_k has a real part $(H_k + H_{N-k})/2$ and an imaginary part $(H_{N-k} - H_k)/2$. Conversely, the DHT is equivalent to computing the DFT of x_n multiplied by $1+i$, then taking the real part of the result.

Using this relationship it's relatively simple to write a FOCAL routine to calculate the DFT of a set of **real values** as input. Note how the DFT is non-symmetrical for this usage.

01	LBL "DFT"		25	CHS	change sign
02	CF 01	non-symmetrical	26	RCL X	push to Y
03	"N=?"		27	CHS	undo sign change
04	PROMPT		28	RCL IND 00	second value
05	STO 00		29	ST+ Z	add for ln(z)
06	E3/E+	1,00n	30	+	add for Re(z)
07	INPUT	enter values	31	2	halve it
08	0	full set	32	ST/ Z	
09	DHT	does DHT	33	/	
10	LBL 00		34	ZOUT	show result
11	RCL 00	n	35	DSE 00	decrease index2
12	ENTER^		36	ISG Z	increase index1
13	ST+ X	2n	37	GTO 01	do next
14	STO 00		38	RDN	tidy stack
15	E3/E+	1,00(2n)	39	RDN	(2n+1),00(2n)
16	+	(n+1),00(2n)	40	b*e	2n,00(2n+1)
17	0		41	INT	2n
18	RCL IND Y		42	2	
19	ZOUT	first vresult	43	/	n
20	ISG Z	increate index1	44	STO 00	restore dim to R00
21	LBL 01		45	STOP	done,
22	RDN	tidy stack	46	GTO 00	show results
23	RDN		47	END	end.
24	RCL IND X	first value			

The results are shown sequentially until the last one is reached. Pressing R/S will repeat the result review. Note that the result values are not stored in memory, you'd need to modify the routine if that's a requirement.

Example 1. With the same input vector, $A = [1 \ 2 \ 4 \ 7]$ the results are as follows:

```
Z = 14
Z = -3.0000 + j 5
Z = -4.0000
Z = -3.0000 - j 5
```

Example 2. Using the input vector $B = [2, 4, 7, 6]$ the DFT results are as follows:

```
Z = 19
Z = -5 + j 2
Z = -1.0000
Z = -5 - j 2
```

Note how rounding errors are "flagged" by ZOUT showing zeros after the decimal point.
<https://www.easycalculation.com/engineering/mechanical/discrete-fourier-transform.php?>

3.5. MORE SPECIAL FUNCS

This section of the manual covers many other functions included in the Sub-functions group, with entries located in the secondary (hidden) FAT (go ahead and review the accessibility information from the introduction for a quick refresher if needed). Let's use the Carlson and Hankel launchers as grouping criteria.-

3.5.1. Elliptic Integrals and associates. { **RF**, **RJ**, **RG**, **ELIPE/F/K** }

The first sub-function launcher is the Carlson group. It's loosely centered on the Elliptic integrals, plus related functions. The launcher prompt is activated by pressing **[O]** at the main **ΣFL** prompt, and offers the following 14 choices – in two line-ups controlled by the **[SHIFT]** key. Note the different leadings on each screen, keeping the choices constant regardless:



The table below shows in the first column the letter used for each of the functions within this group:

[CR]	Function	Description	Author
[E]	ELIPE	Complete Elliptic intg. 2 nd . kind	Ángel Martin
[F]	ELIPF	Incomplete Elliptic Integral 1 st . kind	Ángel Martin
[K]	ELIPK	Complete Elliptic intg. 1 st . kind	Ángel Martin
[C]	CRF	Carlson Integral 1 st . Kind	JM Baillard
[J]	CRJ	Carlson Integral 3 rd . Kind	JM Baillard
[1]	LEI1	Incomplete Legendre Integral of 1 st . kind (F)	Ángel Martin
[2]	LEI2	Incomplete Legendre Integral of 2 nd . Kind (E)	Ángel Martin
[3]	LEI3	Incomplete legendre Integral of 3 rd . kind (II)	Ángel Martin
[C]	CSX	Fresnel Integrals, C(x) & S(x)	JM Baillard
[G]	CRG	Carlson Integral 2 nd . Kind	JM Baillard
[J]	JEF	Jacobi Elliptic Integrals	JM Baillard
[F]	ALF	Associated Legendre function 1 st . kind - Pnm(x)	JM Baillard
[L]	LOBACH	Lobachesvki function	Ángel Martin
[U]	CLAUS	Clausen integral	JM Baillard
[W]	WHIM	Whittaker M function	JM Baillard
[Y]	DEBYE	Deby function	Martin-Baillard
	AIRY	Airy Functions Ai(x) & Bi(x)	JM Baillard
	WEBAN	Weber and Anger functions	JM Baillard

In general the **Incomplete** Elliptic Functions are calculated using the Carlson Integrals, whereas the **Complete** Elliptic functions use the Arithmetic-Geometric approach (standard and modified). The AGM method is much faster - more about this will be discussed in this chapter.

The Elliptic Integrals.

In integral calculus, elliptic integrals originally arose in connection with the problem of giving the arc length of an ellipse. They were first studied by Giulio Fagnano and Leonhard Euler. Modern mathematics defines an "elliptic integral" as any function f which can be expressed in the form

$$f(x) = \int_c^x R\left(t, \sqrt{P(t)}\right) dt,$$

where R is a rational function of its two arguments, P is a polynomial of degree 3 or 4 with no repeated roots, and c is a constant.

The most common ones are the incomplete Elliptic Integrals of the first, second and third kinds. Besides the Legendre form given below, the elliptic integrals may also be expressed in Carlson symmetric form – which has been the basis for the implementation in the SandMath – completely based on the JMB_MATH ROM.

The incomplete elliptic integral of the first kind F is defined as:

$$F(\varphi, k) = F(\varphi | k^2) = F(\sin \varphi; k) = \int_0^\varphi \frac{d\theta}{\sqrt{1 - k^2 \sin^2 \theta}}.$$

which can also be expressed in terms of the Carlson Symmetric form R_F , resulting in:

$$F(\phi, k) = \sin \phi R_F\left(\cos^2 \phi, 1 - k^2 \sin^2 \phi, 1\right)$$

ELIPF is implemented as a MCODE function which simply calls **CRF** with the appropriate input parameters. All the heavy lifting is thus performed by **CRF**, which together with **CRJ** do all the hard work in the calculation for the Elliptic Integrals of first, second and third kinds.

The figure below shows the first and third kinds in comparison:

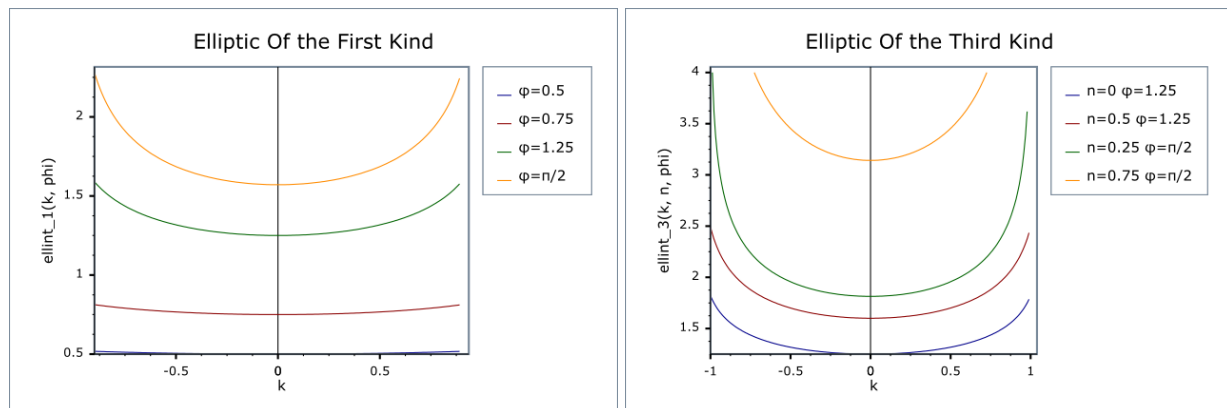

This is a perhaps a good moment to define the Carlson symmetric forms. The Carlson symmetric forms of elliptic integrals are a small canonical set of elliptic integrals to which all others may be reduced. They are a modern alternative to the Legendre forms. The Legendre forms may be expressed in terms of the Carlson forms and vice versa.

[The Carlson Symmetric Elliptic integrals of the First and Third kinds](#) are defined as:

$$R_F(x, y, z) = \frac{1}{2} \int_0^\infty \frac{dt}{\sqrt{(t+x)(t+y)(t+z)}}$$

$$R_J(x, y, z, p) = \frac{3}{2} \int_0^\infty \frac{dt}{(t+p)\sqrt{(t+x)(t+y)(t+z)}}$$

CRF and **CRJ** are the SandMath functions that calculate their values. They are located in the auxiliary FAT. Their arguments x,y,z are expected to be in the corresponding stack registers, and the result will be placed in X-Reg upon completion.

The term symmetric refers to the fact that, in contrast to the Legendre forms, these functions are unchanged by the exchange of certain of their arguments. The value of **R_F** is the same for any permutation of its arguments, and the value of **R_J** is the same for any permutation of its first three arguments.

[The Carlson Symmetric Elliptic integral of the 2nd. Kind](#) is defined as:

$$R_G(x, y, z) = \frac{1}{4} \int_0^\infty \frac{t}{\sqrt{(t+x)(t+y)(t+z)}} \left(\frac{x}{t+x} + \frac{y}{t+y} + \frac{z}{t+z} \right) dt.$$

CRG in the SandMath is calculated using the following expression involving **CRF** and **CRJ**:

$$2 \cdot R_G(x; y; z) = z \cdot R_F(x; y; z) - (x-z)(y-z)/3 R_D(x; y; z) + (x \cdot y/z)^{1/2}$$

$$\text{with } R_D(x; y; z) = R_J(x; y; z; z)$$

Examples. Calculate $R_F(2;3;4)$, and $R_G(2;3;4)$

4 ENTER^, 3 ENTER^, 2 **ΣF\$** "CRF" → $R_F(2;3;4) = 0.584082842$
 4 ENTER^, 3 ENTER^, 2 **ΣF\$** "CRG" → $R_G(2;3;4) = 1.725503028$

Examples. Calculate $R_J(1;2;3;4)$ and $R_J(1;2;4;7)$.

4 ENTER^, 3 ENTER^, 2 ENTER^, 1 **ΣF\$** "CRJ" → $R_J(1;2;3;4) = 0.239848100$
 7 ENTER^, 4 ENTER^, 2 ENTER^, 1 **ΣFL** [,] → $R_J(1,2,4,7) = 0.147854445$

Where the second call was made using the last-function shortcut.

Complete and Incomplete Legendre Forms. { LEI1 , LEI2 , LEI3 }

In mathematics, the Legendre forms of elliptic integrals are a canonical set of three elliptic integrals to which all others may be reduced. Legendre chose the name elliptic integrals because the second kind gives the arc length of an ellipse of unit semi-minor axis and eccentricity k - the ellipse being defined parametrically by $x = \sqrt{1-k^2} \cos(t)$, $y = \sin(t)$

In modern times the Legendre forms have largely been supplanted by an alternative canonical set, the Carlson symmetric forms described before. Nevertheless the SandMath also includes **LEI1**, **LEI2**, and **LEI3** - three FOCAL programs based on the Carlson formulas to calculate them. Here are the definitions again.-

The **incomplete** elliptic integral of the first kind is defined as,

$$F(\phi, k) = \int_0^\phi \frac{1}{\sqrt{1 - k^2 \sin^2(t)}} dt.$$

, calculated with **LEI1** (or with **ELIPF**)

the second kind as

$$E(\phi, k) = \int_0^\phi \sqrt{1 - k^2 \sin^2(t)} dt.$$

, calculated with **LEI2**

And the third kind as

$$\Pi(\phi, n, k) = \int_0^\phi \frac{1}{(1 - n \sin^2(t)) \sqrt{1 - k^2 \sin^2(t)}} dt.$$

, calculated with **LEI3**

Note also that the respective **complete** elliptic integrals are easily obtained by setting the value of the **amplitude**, Φ (the upper limit of the integrals), to $\pi/2$.

The formulas used to calculate them are as follows:

$$E = \sin(\Phi) \cdot \mathbf{R}_F(\cos^2(\Phi); 1 - m \cdot \sin^2(\Phi); 1) - (m/3) \sin^3(\Phi) \cdot \mathbf{R}_J(\cos^2(\Phi); 1 - m \cdot \sin^2(\Phi); 1)$$

$$P = \sin(\Phi) \cdot \mathbf{R}_F(\cos^2(\Phi); 1 - m \cdot \sin^2(\Phi); 1) - (n/3) \sin^3(\Phi) \cdot \mathbf{R}_J(\cos^2(\Phi); 1 - m \cdot \sin^2(\Phi); 1) + n \cdot \sin^2(\Phi)$$

Stack input of the three are the amplitude Φ in Y and the argument in degrees in X . - and **LEI3** also expects the characteristic n in Z. The result is always returned to X.

Examples: in **DEG mode** (!) calculate F(0.7; 84), E(0.7; 84), and P(0.9; 0.7; 84).-

```
0.7, ENTER^, 84, ΣF$ "LEI1"          -> F ( 84° | 0.7 ) = 1.884976271
0.7, ENTER^, 84, ΣF$ "LEI2"          -> E ( 84° | 0.7 ) = 1.184070048
0.9, ENTER^, 0.7, ENTER^, 84, ΣF$ "LEI3" -> P (0.9; 84° | 0.7 ) = 1.336853616
```

Obviously we could have used **ELIPF** for the first case - which has a slightly faster execution and yields the same result.

Note that LEI1 uses data registers {R00 - R03}, and LEI2/3 also use R04.

Program listings.

01	LBL "LEI1"	24	STO 00	48	RCL 00
02	SF 01	25	*	49	*
03	CF 02	26	CHS	50	E
04	GTO 00	27	E	51	ST+ Y(2)
05	LBL "LEI2"	28	+	52	FS? 02
06	CF 01	29	X=Y?	53	STO Y(2)
07	SF 02	30	X#0?	54	RCL 03
08	GTO 00	31	GTO 00	55	RCL 01
09	LBL "LEI3"	32	SIGN	56	CRJ
10	CF 01	33	FS? 02	57	RCL 02
11	CF 02	34	RTN	58	X^2
12	LBL 00	35	DEG	59	*
13	E	36	90	60	RCL 00
14	P-R	37	TAN	61	*
15	X^2	38	RTN	62	3
16	STO 01	39	LBL 00	63	/
17	X<>Y	40	STO 03	64	RCL 04
18	STO 02	41	E	65	X<>Y
19	X^2	42	CRF	66	-
20	R^	43	FS? 01	67	LBL 00
21	STO 00	44	GTO 00	68	RCL 02
22	X<> T(0)	45	STO 04	69	*
23	FS? 02	46	RCL 02	70	END
		47	X^2		

01	LBL "CRG"	14	RCL 03	28	*
02	STO 01	15	ST* Z (1)	29	RCL 02
03	RDN	16	SQRT	30	RCL 03
04	STO 02	17	/	31	-
05	X<>Y	18	+	32	*
06	STO 03	19	STO 00	33	3
07	R^	20	RCL 03	34	/
08	CRF	21	RCL 03	35	RCL 00
09	RCL 01	22	RCL 02	36	+
10	SQRT	23	RCL 01	37	2
11	RCL 02	24	CRJ	38	/
12	SQRT	25	RCL 03	39	END
13	*	26	RCL 01		
		27	-		

Application Examples. { **SAE** , **ELP** , **-/+** , **EECC** }

	Function	Description	Author
	SAE	Surface Area of an ellipsoid	Ángel Martin
	ELP	Perimeter of a ellipse	Ángel Martin
	EECC	Ellipse Eccentricity	Ángel Martin
	-/+	Calculates (Y-X)/(Y+X)	Ángel Martin

The following two examples should illustrate the applicability of these special functions in the geometry subjects related to ellipses and ellipsoids – and therefore provide some context to their origins and development.

Example 1.- Surface Area of an Ellipsoid. { **SAE** }

SAE is a direct application of the Carlson Symmetrical Integral of second kind, **CRG**, used to calculate the surface area of an scalene ellipsoid (i.e. not of revolution):

$$\frac{x^2}{a^2} + \frac{y^2}{b^2} + \frac{z^2}{c^2} = 1,$$

which formula is:

$$\text{Area} = 4\pi \cdot \mathbf{R}_G(a^2b^2, a^2c^2, b^2c^2)$$

with $c < b < a$

Example: $a=2, b=4, c=9 \rightarrow A= 283.4273843$

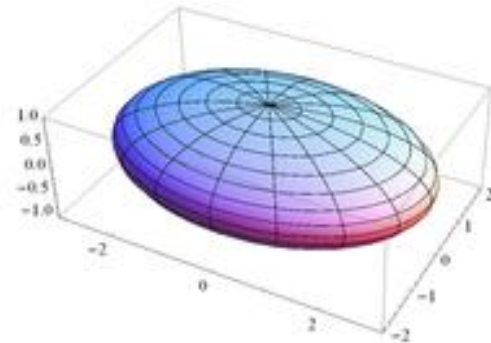

Example 2.- Ellipse parameters. { **EECC** , **-/+** }

A related magnitud appearing in formulas related to ellipses is the ratio $(a-b)/(a+b)$, sometimes squared. There's no "proper name" for this parameter (unlike eccentricity) – but regardless the sub-function **-/+** (appropriately also without a proper name) in the Auxiliary FAT (the very last one in the catalog) is available to compute it using the values in Y and X registers.

Example: for Y=1 and X=3, **-/+** returns -0.5

Using this function we will be able to re-write the **ELIPK** program from page 161 as follows:

```

01    LBL "ELIPK
02    SQRT
03    1
04    X<>Y
05    -/+ (ΣF#095)
06    RCL X
07    1
08    AGM (ΣF#056)
09    4
10    *
11    1/X
12    PI
13    *
14    X<>Y
15    1
16    +
17    *
18    END
    
```

Example 3.- Perimeter of the Ellipse. { EPER }

For an ellipse with semi-major axis a and semi-minor axis b and eccentricity e , the complete elliptic integral of the second kind is equal to one quarter of the perimeter C of the ellipse measured in units of the semi-major axis. In other words:

$$c = 4aE(e), \text{ with: } e = \sqrt{1 - b^2/a^2}.$$

or more compactly in terms of the incomplete integral of the second kind $E(\Phi, k)$, as:

$$E(k) = E\left(\frac{\pi}{2}, k\right) = E(1; k).$$

Function **EPER** is available in the auxiliary FAT. It is a FOCAL program like the one listed below, which calculates the perimeter from the semi-axis values input in Y and X stack registers – a sweet and short application of the Elliptic Integrals at work. Note how the (pesky) input conventions are observed: the parameter k needs to be squared!

1	LBL "ELP"	
2	EECC	eccentricity
3	LASTX	semi-axis a
4	X<>.Y	
5	X^2	e^2
6	ELIPE	complete elliptic 2nd. Kind
7	*	$a * E(e^2)$
8	4	
9	*	$4a * E(e^2)$
10	END	done!

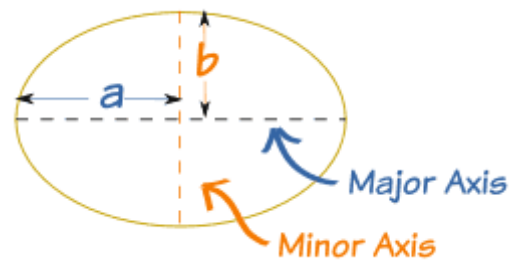

Where we have also put **EECC** to work as a nice shortcut for the calculations, and one of the nice things it does is making sure the larger semi-axis is used as denominator, regardless of its location in the stack (either X- or Y- register).

Note as well that no data registers are used with this scheme.

Example: calculate the perimeter for $a=3$ and $b=2$

3, ENTER^, 2, **ΣF\$** "EPER" -> 15.86543959

Jacobi Elliptic functions. { JEF , AJF }

In mathematics, the Jacobi elliptic functions are a set of basic elliptic functions, and auxiliary theta functions, that are of historical importance. Many of their features show up in important structures and have direct relevance to some applications (e.g. the equation of a pendulum). They also have useful analogies to the functions of trigonometry, as indicated by the matching notation sn for sin. They were introduced by Carl Gustav Jakob Jacobi (1829).

Definition as inverses of elliptic integrals

There is a simpler, but completely equivalent definition, giving the elliptic functions as inverses of the incomplete elliptic integral of the first kind. Let

$$u = \int_0^\phi \frac{d\theta}{\sqrt{1 - m \sin^2 \theta}}.$$

Then the elliptic functions sn(u,m), cn(u,m), and dn(u,m) are given by:

$$\text{sn}(u,m) = \sin(\Phi), \quad \text{cn}(u,m) = \cos(\Phi), \quad \text{and} \quad \text{dn} u = \sqrt{1 - m \sin^2 \phi}$$

Here, the angle Φ is called the amplitude. On occasion, $\text{dn}(u) = \Delta(u)$ is called the delta amplitude. In the above, the value m is a free parameter, usually taken to be real, $0 \leq m \leq 1$, and so the elliptic functions can be thought of as being given by two variables, the amplitude Φ and the parameter m .

The elliptic functions can be given in a variety of notations, which can make the subject unnecessarily confusing. Elliptic functions are functions of two variables. The first variable might be given in terms of the **amplitude** ϕ , or more commonly, in terms of u given below. The second variable might be given in terms of the **parameter** m , or as the elliptic modulus k , where $k^2 = m$, or in terms of the modular angle α , where $m = \sin^2 \alpha$.

Formulae and Methodology.

The SandMath implementation is based on the Gauss transformation, with the formulas used being:

With $m' = 1-m$, let $\mu = [(1-\text{sqrt}(m'))/(1+\text{sqrt}(m'))]^2$ and $v = u/(1+\text{sqrt}(\mu))$, we have:

$$\begin{aligned} \text{sn}(u|m) &= [(1 + \text{sqrt}(\mu)) \text{sn}(v|\mu)] / [1 + \text{sqrt}(\mu) \text{sn}^2(v|\mu)] \\ \text{cn}(u|m) &= [\text{cn}(v|\mu) \text{dn}(v|\mu)] / [1 + \text{sqrt}(\mu) \text{sn}^2(v|\mu)] \\ \text{dn}(u|m) &= [1 - \text{sqrt}(\mu) \text{sn}^2(v|\mu)] / [1 + \text{sqrt}(\mu) \text{sn}^2(v|\mu)] \end{aligned}$$

These formulas are applied recursively until μ is small enough to use.

The program calculates the three functions simultaneously, returning the result in the stack registers X [sn], Y [cn], and Z [dn]. The input parameters are the amplitude m , and the argument u – expected in Y and X respectively before calling **JEF**.

Two functions are included in the SandMath, JEF and AJF. The main program is **JEF**, which can be used to calculate the results for any value of the amplitude m (*). **AJF** is a MCODE function used to speed up the calculations, applicable when the amplitude lies between 0 and 1. You could use **AJF** directly in this case, since **JEF** does nothing but calling it in that circumstance.

(* If $m < -999999999$ the program can give wrong results.

Example 1- Evaluate $\text{sn}(0.7 | 0.3)$ $\text{cn}(0.7 | 0.3)$ $\text{dn}(0.7 | 0.3)$

0.3, ENTER^, 0.7, ΣF "JEF"	->	$\text{sn}(0.7 0.3) = 0.632304776$
RDN	->	$\text{cn}(0.7 0.3) = 0.774719736$
RDN	->	$\text{dn}(0.7 0.3) = 0.938113640$

Example 2 - Likewise for $x=0.7$ and amplitudes $\{ 1, 2, -3 \}$

$\text{sn}(0.7 1) = 0.604367777$	$\text{sn}(0.7 2) = 0.564297007$	$\text{sn}(0.7 -3) = 0.759113421$
$\text{cn}(0.7 1) = 0.796705460$	$\text{cn}(0.7 2) = 0.825571855$	$\text{cn}(0.7 -3) = 0.650958382$
$\text{dn}(0.7 1) = 0.796705460$	$\text{dn}(0.7 2) = 0.602609138$	$\text{dn}(0.7 -3) = 1.651895746$

Example 3- Let's verify the inverse relationship between the Jacobi Elliptic functions and the Elliptic Integral – for a given elliptic modulus (k) that will remain constant in both cases. The expression to verify can be written as:

$$\Phi = \text{asin}(\text{sn}[k ; F(k | \Phi)])$$

Let's use the values $\Phi = 84$ and $k = 0.7$ - We start by obtaining the value of F:

0.7, ENTER^, 84, ΣF "ELIPF" => $F(84^\circ | 0.7) = 1.884976271$

Then we use this intermediate result (and the initial parameter) as input for JEF as follows:

0.7, X<>Y, ΣF "JEF" => $\text{sn}(0.7 | F(84^\circ | 0.7)) = 0.994521895$

And finally get the arc sine of the sn value to recover the original amplitude:

ASIN => 84.00000002

Which matches the initial value with an accuracy of E-8.

Final remarks on the Jacobi Elliptic functions.

Note the interesting role of the parameter m as it moves from 0 to 1. The condition $m=0$ causes the functions to become the same as the trigonometric sin and cos, whereas in the other extreme for $m=1$ they become the hyperbolic tanh and sech. In more proper terms, these functions are doubly periodic generalizations of the trigonometric functions satisfying:

$$\begin{aligned} \text{sn}(v | 0) &= \sin v ; & \text{cn}(v | 0) &= \cos v ; & \text{and } \text{dn}(v | 0) &= 1 \\ \text{sn}(v | 1) &= \tanh v ; & \text{cn}(v | 1) &= \text{sech } v ; & \text{and } \text{dn}(v | 1) &= \text{sech } v \end{aligned}$$

The figures in next page represent three intermediate stages; observe the tendency as the elliptic modulus k varies towards both ends of the range. Quite a remarkable behavior showing how the interrelationships amongst seemingly unrelated topics appear.

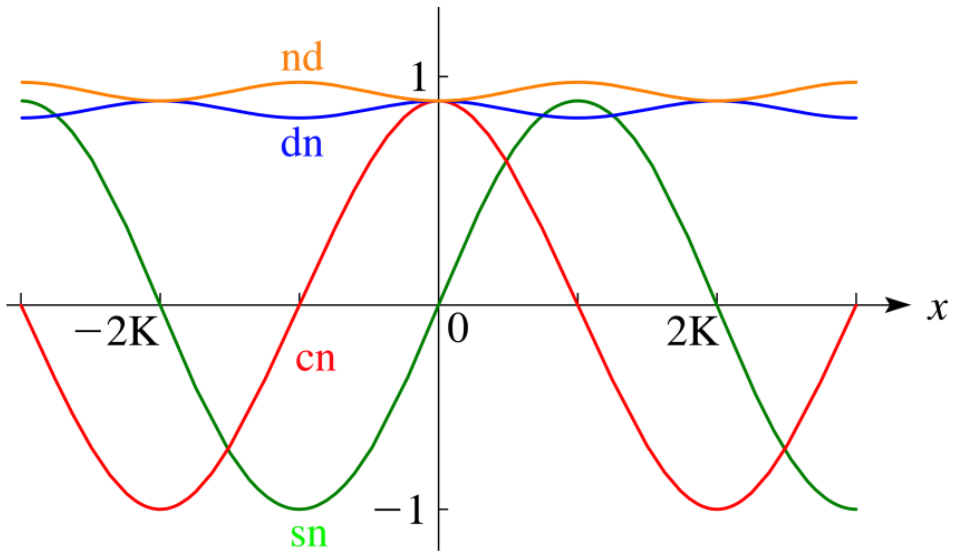

Figure 22.3.1: $k = 0.4$, $-3K \leq x \leq 3K$, $K = 1.6399 \dots$

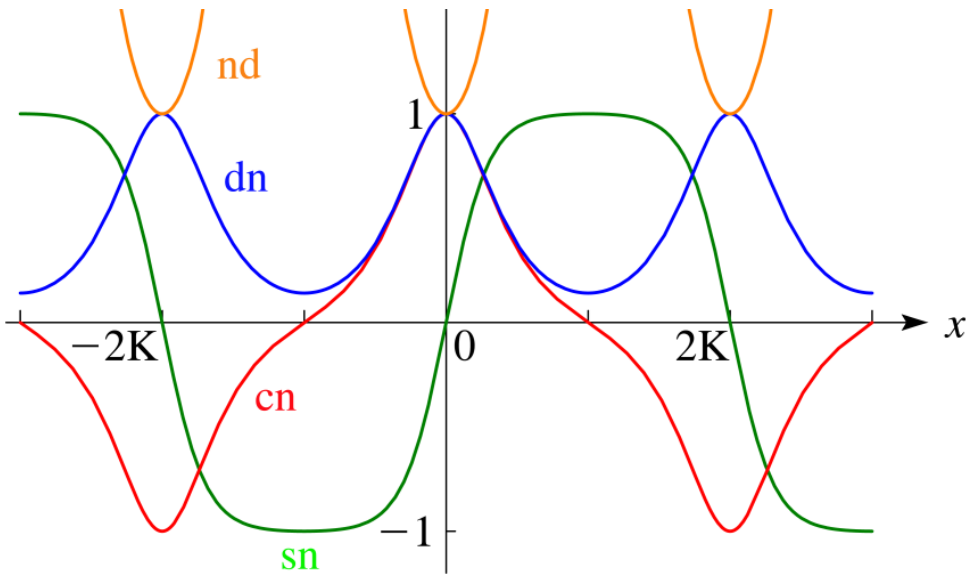

Figure 22.3.3: $k = 0.99$, $-3K \leq x \leq 3K$, $K = 3.3566 \dots$

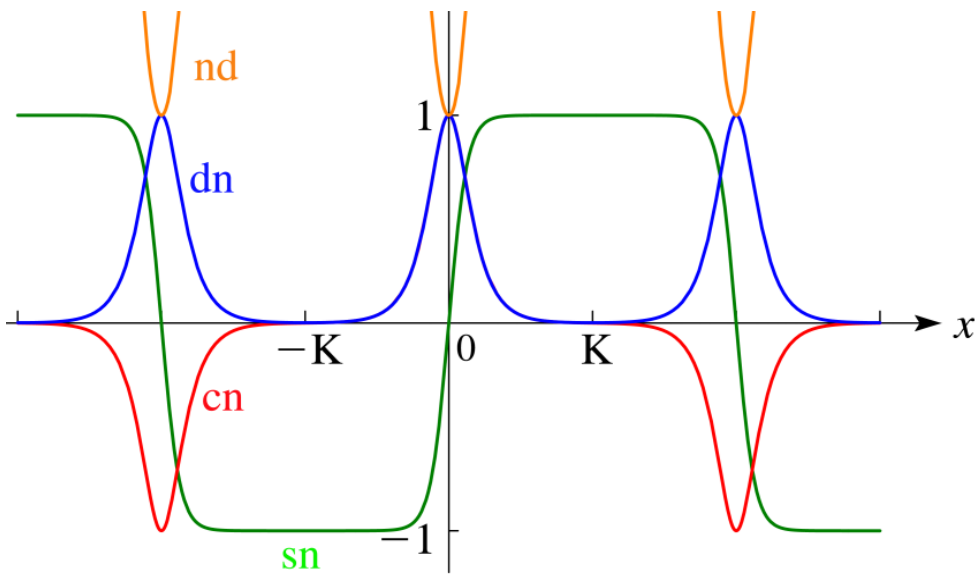

Figure 22.3.4: $k = 0.999999$, $-3K \leq x \leq 3K$, $K = 7.9474 \dots$

Program listings.

01	LBL "JEF"	24	ENTER^	47	FC?C 07
02	DEG	25	HCOS	48	GTO 02
03	CF 06	26	1/X	49	RDN
04	CF 07	27	STO Z (1)	50	X<>Y
05	X<>Y	28	X<>Y	51	R^
06	X>=0?	29	HTAN	52	RCL 00
07	GTO 00	30	GTO 02	53	SQRT
08	CHS	31	LBL 00	54	*
09	STO Z (1)	32	RDN	55	GTO 02
10	E	33	STO Z (1)	57	LBL 00
11	+	34	SQRT	58	X<> Z (1)
12	ST/ Z (1)	35	*	59	ST/ Y (2)
13	SQRT	36	X<>Y	60	ST/ Z (1)
14	*	37	1/X	61	1/X
15	X<>Y	38	ENTER^	62	X<> Z (1)
16	SF 06	39	SF 07	62	E
17	LBL 00	40	LBL 01	63	ST- 00
18	E	41	RDN	64	X<> 00
19	X>Y?	42	STO 00	65	CHS
20	GTO 01	43	X<>Y	66	SQRT
21	X#Y?	44	AJF	67	*
22	GTO 00	45	FS?C 06	68	END
23	X<> Z (1)	46	GTO 00		

01	LBL "AIRY"	17	3	34	1/X
02	STO 03	18	RCL 01	35	1/GMF
03	X^3	19	Y^X	36	/
04	9	20	/	37	/
05	/	21	RCL 01	38	ST* 03
06	2	22	1/GMF	39	RCL 02
07	ENTER^	23	*	40	RCL 03
08	3	24	STO 02	41	+
09	/	25	2	42	3
10	STO 01	26	ST* 01	43	SQRT
11	0	27	CLST	44	*
12	ENTER^	28	SIGN	45	RCL 02
13	SIGN	29	RCL 00	46	RCL 03
14	R^	30	HGF+	47	-
15	STO 00	31	3	48	END
16	HGF+	32	CBRT		
		33	LASTX		

(Jacobian) Theta Functions. { THETA }

There are several closely related functions called Jacobi theta functions, and many different and incompatible systems of notation for them. One Jacobi theta function (named after Carl Gustav Jacob Jacobi) is a function defined for two complex variables z and τ , where z can be any complex number and τ is confined to the upper half-plane, which means it has positive imaginary part. It is given by the formula:

$$\vartheta(z; \tau) = \sum_{n=-\infty}^{\infty} \exp(\pi i n^2 \tau + 2\pi i n z) = 1 + 2 \sum_{n=1}^{\infty} (e^{\pi i \tau})^{n^2} \cos(2\pi n z)$$

The SandMath uses the following definitions as per JM Baillard, with $q = e^{-\pi K'/K}$ ($0 < q < 1$)

$$\text{Theta1}(x;q) = 2 \cdot q^{1/4} \sum_{k>=0} (-1)^k q^{k(k+1)} \sin(2k+1)x$$

$$\text{Theta2}(x;q) = 2 \cdot q^{1/4} \sum_{k>=0} q^{k(k+1)} \cos(2k+1)x$$

$$\text{Theta3}(x;q) = 1 + 2 \sum_{k>=1} q^{k^2} \cos 2kx$$

$$\text{Theta4}(x;q) = 1 + 2 \sum_{k>=1} (-1)^k q^{k^2} \cos 2kx$$

Use the function **THETA** to calculate any of these, with the function index in Z, and the two arguments (q, x) in Y and X. The result is returned in X.

Stack	Input	Output
T	n#	n#
Y	q	q
X	x	Theta(n,q,x)

Example: Compute Theta1(x;q) , Theta2(x;q) , Theta3(x;q) , Theta4(x;q) for x = 2 ; q = 0.3

- 1, ENTER^, 0.3, ENTER^, 2, **ΣF\$** "THETA" -> 1.382545289
- 2, ENTER^, 0.3, ENTER^, 2, **ΣF\$** [,] (LastF) -> -0.488962527
- 3, ENTER^, 0.3, ENTER^, 2, **ΣF\$** [,] (LastF) -> 0.605489938
- 4, ENTER^, 0.3, ENTER^, 2, **ΣF\$** [,] (LastF) -> 1.389795845

The picture below shows the Theta functions 1-2 (on the left) and 3-4 (right) for a range of x between [-5,5] and a second argument y kept constant. Note the similar shapes between cn with T1,T2, as well as sn with T3,T4

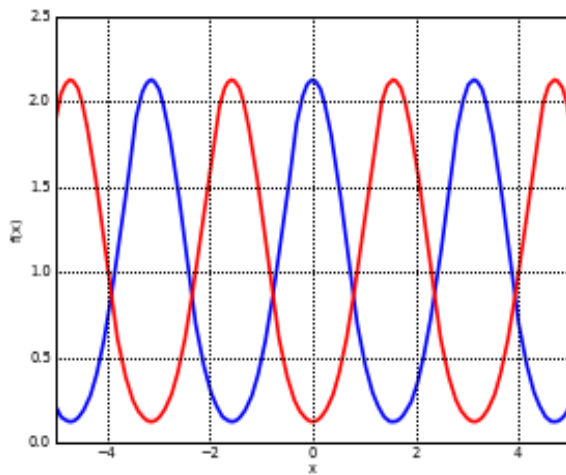
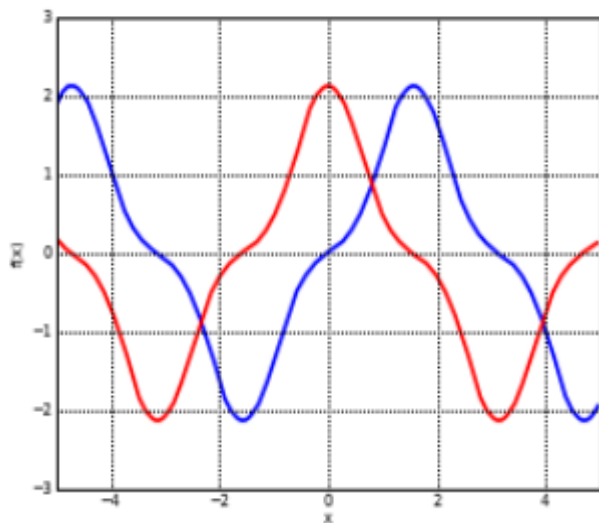

Airy Functions. { AIRY }

For real values of x, the Airy function of the first kind is defined by the improper integral

$$Ai(x) = \frac{1}{\pi} \int_0^{\infty} \cos\left(\frac{1}{3}t^3 + xt\right) dt,$$

which converges because the positive and negative parts of the rapid oscillations tend to cancel one another out (as can be checked by integration by parts).

The Airy function of the second kind, denoted Bi(x), is defined as the solution with the same amplitude of oscillation as Ai(x) as x goes to $-\infty$ which differs in phase by $\pi / 2$:

$$Bi(x) = \frac{1}{\pi} \int_0^{\infty} \left[\exp\left(-\frac{1}{3}t^3 + xt\right) + \sin\left(\frac{1}{3}t^3 + xt\right) \right] dt.$$

The expressions used to program them are again based on HGF+, as follows:

$$Ai(x) = [3^{-2/3} / \Gamma(2/3)] {}_0F_1(; 2/3; x^3/9) - x [3^{-1/3} / \Gamma(1/3)] {}_0F_1(; 4/3; x^3/9)$$

$$Bi(x) = [3^{-1/6} / \Gamma(2/3)] {}_0F_1(; 2/3; x^3/9) + x [3^{1/6} / \Gamma(1/3)] {}_0F_1(; 4/3; x^3/9)$$

The figure below shows Ai and Bi plotted for $-15 < x < 5$

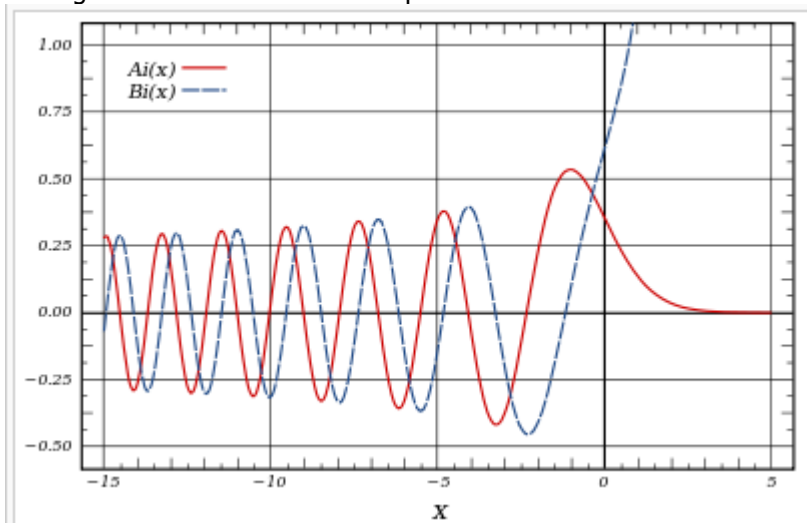

REGISTERS: R00 thru R04
 FLAGS: none

Stack	Input	Output
Y	n/a	Bi(x)
X	x	Ai(x)

Example:

0.4 $\Sigma F \$$ "AIRY" -> Ai(0.4) = 0.254742355 ; or: ΣFL , $[O]$, $[Y]$
 X<>Y -> Bi(0.4) = 0.801773001

Fresnel Integrals. { CSX }

Fresnel integrals, $S(x)$ and $C(x)$, are two transcendental functions named after Augustin-Jean Fresnel that are used in optics. They arise in the description of near field Fresnel diffraction phenomena, and are defined through the following integral representations:

$$S(x) = \int_0^x \sin(t^2) dt, \quad C(x) = \int_0^x \cos(t^2) dt.$$

The function **CSX** will calculate both $S(x)$ and $C(x)$ for the argument in X, returning the results in Y and X respectively. It is a short FOCAL program that uses (yes you guessed it) the Generalized Hypergeometric function, according to the expressions:

$$S(x) = (\pi x^3/6) {}_1F_2(3/4 ; 3/2 , 7/4 ; -\pi^2 x^4/16), \text{ and}$$

$$C(x) = x {}_1F_2(1/4 ; 1/2 , 5/4 ; -\pi^2 x^4/16)$$

The figure below shows both functions plotted for $0 < x < 5$

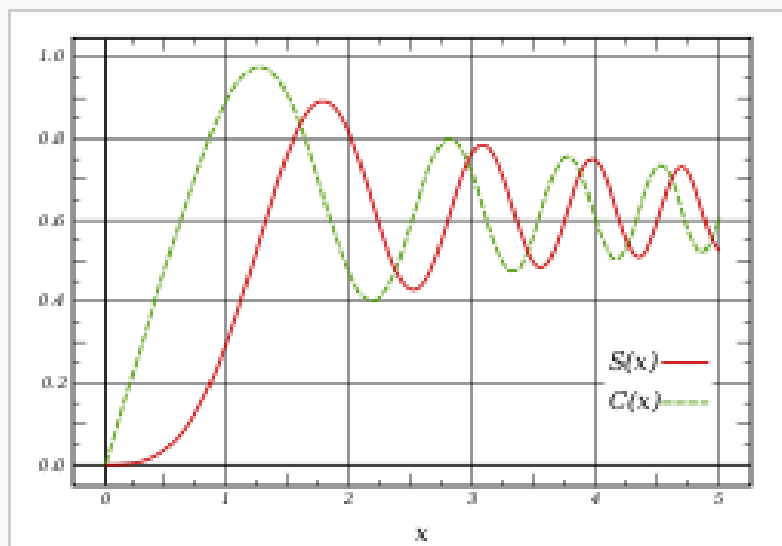

REGISTERS: R00 thru R04
 FLAGS: none

Stack	Input	Output
Y	n/a	S(x)
X	x	C(x)

Examples:

1.5 $\Sigma F\$$ "CSX" -> C(1.5) = 0.445261176 X<>Y, S(1.5) = 0.697504960
 4 $\Sigma F\$$ "CSX" -> C(4) = 0.498426033 X<>Y, S(4) = 0.420515754

Or: ΣFL , [O], [C]

Weber and Anger functions. { WEBAN }

In mathematics, the Anger function, introduced by C. T. Anger (1855), is a function defined as

$$J_\nu(z) = \frac{1}{\pi} \int_0^\pi \cos(\nu\theta - z \sin \theta) d\theta$$

The Weber function introduced by H. F. Weber (1879), is a closely related function defined by:

$$E_\nu(z) = \frac{1}{\pi} \int_0^\pi \sin(\nu\theta - z \sin \theta) d\theta$$

If ν is an integer then Anger functions J_ν are the same as Bessel functions J_ν , and Weber functions can be expressed as finite linear combinations of Struve functions (H_n and L_n).

With n and x in the stack, **WEBAN** will return both $J(n,x)$ and $E(n,x)$ in the Y and X stack registers respectively.

The figures below show four of these functions for 4 orders(0, 0.5, 1, and 1.5) – Anger on the left plots, and Weber on the right. [Check: $J(0,0) = 1$, and $E(0,0) = 1$]

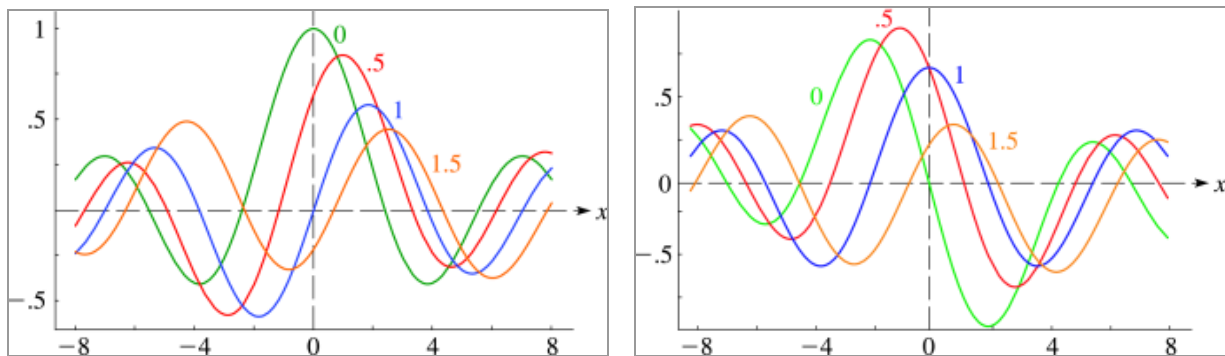

Note that **WEBAN** will return both values to the stack.

REGISTERS: R00 thru R06
 FLAGS: none

Stack	Input	Output
Y	n	$J(n,x)$
X	x	$E(n,x)$

Example:

2 , SQRT, PI, $\Sigma F\$$ "WEBAN" -> $E(\text{sqrt}(2), \pi) = -0.315594385$
 X<>Y -> $J(\text{sqrt}(2), \pi) = 0.366086559$

Alternatively: ΣFL , [O], [W] using the main launcher instead.

Program listing.

01	LBL "CSX"	35	SQRT	69	STO 04
02	ABS	36	ST/ Z(1)	70	4
03	STO 00	37	/	71	1/X
04	PI	38	R-P	72	STO 01
05	SQRT	39	E	73	5
06	X>Y?	40	ASIN	74	*
07	GTO 00	41	RCL 00	75	STO 03
08	*	42	X^2	76	SIGN
09	2	43	*	77	2
10	/	44	ST+ Z(1)	78	RCL 04
11	STO 01	45	RDN	79	HGF+
12	24	46	CHS	80	RCL 00
13	STO 02	47	P-R	81	*
14	CLST	48	E	82	3
15	GTO 14	49	+	83	ST* 01
16	LBL 06	50	RCL Y(2)	84	ST* 02
17	RCL 02	51	RCL Y(2)	85	1.4
18	2	52	+	86	ST* 03
19	/	53	X<> Z(1)	87	SIGN
20	ST* Z(1)	54	-	88	2
21	*	55	2	89	R^
22	LBL 14	56	ST/ Z(1)	90	X<> 04
23	RCL 01	57	/	91	HGF+
24	ST- Z(1)	58	RTN	92	RCL 00
25	+	59	LBL 00	93	X^3
26	R-P	60	CLX	94	*
27	X<>Y	61	.5	95	PI
28	CHS	62	STO 02	96	*
29	X<>Y	63	*	97	6
30	1/X	64	X^2	98	/
31	P-R	65	PI	99	RCL 04
32	DSE 02	66	*	100	END
33	GTO 06	67	X^2		
34	PI	68	CHS		

01	LBL "WEBAN"	17	RCL 04	34	E
02	2	18	X^2	35	CHS
03	ST/ Z(1)	19	CHS	36	ACOS
04	/	20	STO 00	37	RCL 05
05	STO 04	21	HGF+	38	*
06	X<>Y	22	STO 06	39	STO 05
07	STO 03	23	2	40	X<>Y
08	STO 05	24	1/X	41	P-R
09	CHS	25	ST+ 02	42	RCL 05
10	STO 02	26	ST+ 03	43	RCL 06
11	E	27	E	44	P-R
12	STO 01	28	LASTX	45	ST+ T(0)
13	ST+ 02	29	CHS	46	RDN
14	ST+ 03	30	RCL 00	47	X<>Y
15	LASTX	31	HGF+	48	END
16	CHS	32	RCL 04		
		33	*		

3.5.2. Hankel, Struve, and similar functions.

The second sub-function launcher is the Hankel group. It's loosely centered on the Hankel functions, plus related sort. The launcher prompt is activated by pressing [H] at the main Σ FL prompt, and offers the following 14 choices – in two line-ups controlled by the [SHIFT] key. Note the different leadings on each screen, keeping the choices constant regardless:



The table below shows in the first column the letter used for each of the functions within this group:

[HK]	Function	Description	Author
[1]	HK1	Hankel1 Function	Ángel Martin
[2]	HK2	Hankel2 Function	Ángel Martin
[W]	WLO	Lambert W0	Ángel Martin
[H]	HNX	Struve H Function	JM Baillard
[L]	LOMS1	Lommel s1 function	JM Baillard
[R]	LERCH	Lerch Transcendental function	JM Baillard
[T]	TMNR	Toronto function	JM Baillard
[K]	KLV	Kelvin Functions 1st kind	JM Baillard
[1]	SHK1	Spherical Hankel1	Ángel Martin
[2]	SHK2	Spherical Hankel2	Ángel Martin
[W]	WL1	Lambert W1	Ángel Martin
[H]	LNx	Struve Ln Function	JM Baillard
[L]	LOMS2	Lommel s2 function	JM Baillard
[R]	RCWF	Regular Coulomb Wave Function	JM Baillard
[T]	THETA	Theta functions	JM Baillard
[K]	KLV2	Kelvin Functions 2 nd . kind	JM Baillard

Here we finally find both branches of the Lambert W function, **WLO** and **WL1**, described previously in the manual, as well as a convenient selection of other (loosely) related sub-functions.

So your several choices in terms of launchers are as follows:-

a) Function **WLO** in main FAT

XEQ "WLO", the ordinary method
 Σ FL], [M], shortcut using the main launcher
 Σ F\$ "WLO", since Σ F\$ also finds functions in the main FAT
 Σ FL], [ALPHA], "WLO"

b) Functions **WOL** and **WL1** in secondary FAT

Σ FL], [H], [W]	Σ FL], [H], [SHIFT], [W]
Σ F# 031,	Σ F# 032
Σ F\$ "WLO"	Σ F\$ "WL1"
Σ FL], [ALPHA], "WLO"	Σ FL], [ALPHA], "WL1"

Now that's what I'd call both a digression and multiple ways to skin this cat.

Hankel functions – yet a Bessel third kind. { HK1, HK2 }

Another important formulation of the two linearly independent solutions to Bessel's equation are the Hankel functions $H_{\alpha}(1)(x)$ and $H_{\alpha}(2)(x)$, defined by:

$$H_{\alpha}^{(1)}(x) = J_{\alpha}(x) + iY_{\alpha}(x)$$

$$H_{\alpha}^{(2)}(x) = J_{\alpha}(x) - iY_{\alpha}(x)$$

where i is the imaginary unit. These linear combinations are also known as Bessel functions of the third kind, and it's just an association of the previous two kinds together.

This definition allows for relatively simple programming only using the real-domain Bessel programs – assuming the individual results for J and Y are not complex. The small program in the next page shows the FOCAL code to just drive the execution of both **JBS** and **YBS**, piercing them together via **ZOUT** (or **ZAWIEW** in the 41Z module).

Getting Spherical, are we? { SHK1, SHK2 }

Finally, there are also spherical analogues of the Hankel functions, as follows:

$$h_n^{(1)}(x) = j_n(x) + iy_n(x)$$

$$h_n^{(2)}(x) = j_n(x) - iy_n(x).$$

The FOCAL programs below list the simple code snippets to program the three pairs of functions just covered, as follows:

1. Hankel functions, HK1 and HK2
2. Spherical Bessel functions, SJBS and SYBS
3. Spherical Hankel functions, SHK1 and SHK2.

Note the symmetry in the code for the spherical programs, making good use of the stack efficiency derived from the utilization of the MCODE JBS function.

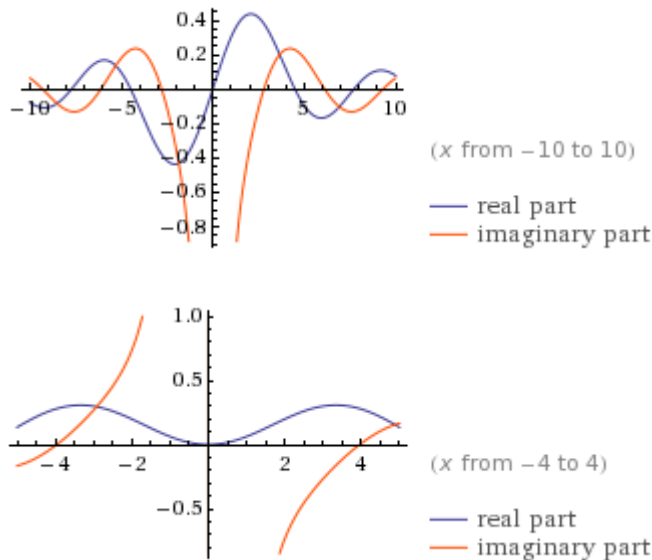

The plots on the left show the Spherical Hankel-1 function for orders 1 and 2, for a short range of the argument x . Explicitly, the first few are

$$h_0^{(1)}(z) = -i e^{jz} \frac{1}{z}$$

$$h_1^{(1)}(z) = -e^{jz} \frac{z+i}{z^2}$$

$$h_2^{(1)}(z) = i e^{jz} \frac{z^2 + 3iz - 3}{z^3}$$

$$h_3^{(1)}(z) = e^{jz} \frac{z^3 + 6iz^2 - 15z - 15i}{z^4}$$

1	LBL "HANK1"		1	LBL "SHANK1"		1	LBL "SJBS"	
2	SF 03		2	SF 04		2	SF 03	
3	GTO 00		3	GTO 00		3	GTO 00	
4	LBL "HANK2"		4	LBL "SHANK2"		4	LBL "SYBS"	
5	CF 03		5	CF 04		5	CF 03	
6	LBL 00 ←		6	LBL 00 ←		6	LBL 00 ←	
7	JBS		7	XEQ "SJBS"		7	X<>Y	
8	STO 04		8	STO 04		8	STO 00	
9	RCL Z		9	RCL 00		9	0,5	
10	RCL Z	n	10	RCL 0		10	+	n+1/2
11	ST+ X	x/2	11	ST+ X		11	FC? 03	
12	YBS		12	XEQ "SYBS"		12	CHS	-(n+1/2)
13	FC?C 03		13	FC?C 04		13	X<>Y	
14	CHS		14	CHS		14	JBS	
15	RCL 04		15	RCL 04		15	FC? 03	
16	ZAVIEW		16	ZAVIEW		16	GTO 00	
17	END		17	END		17	RCL 00	n
						18	INCX	n+1
						19	CHSYX	(-1)^(n+1) * JBS
						20	LBL 00 ←	
						21	PI	
						22	RCL 0	x/2
						23	ST+ X	
						24	ST+ X	
						25	/	
						26	SQRT	
						27	^	
						28	END	

Plot of H(1)(1,x):

Examples.-

Calculate H1, H2, SH1, and SH2 for the following values in the table:

Arguments		H1	H2	SH1	SH2
n	x				
1	1	Z=0,440-J0,781	Z=0,440+J0,781	Z=0,301-J1,382	Z=0,301+J1,382
1	-1	DATA ERROR			
0.5	1	Z=0,671-J0,431	Z=0,671+J0,431	Z=0,552-J0,979	Z=0,552+J0,979
0.5	0.5	Z=0,541-J0,990	Z=0,541+J0,990	Z=0,429-J2,608	Z=0,429+J2,608
-0.5	1	Z=0,431+J0,671	Z=0,431-J0,671	Z=0,959+J0,111	Z=0,959-J0,111
-0.5	-1	DATA ERROR			
Shortcut:		[ΣFL],[H],[1]	[ΣFL],[H],[2]	[ΣFL],[H],[SHIFT],[1]	[ΣFL],[H],[SHIFT],[2]

Where we see that *for negative arguments* (integer and non-integer orders both), the result of the Bessel function of the second kind is itself a complex number, therefore the DATA ERROR message. Note also the symmetric nature of the values for each of the function pairs, H1 with H2, and SH1 with SH2.

Struve functions. { LNX , HNX }

Struve functions are solutions $y(x)$ of the non-homogenous Bessel's differential equation:

$$x^2 \frac{d^2 y}{dx^2} + x \frac{dy}{dx} + (x^2 - \alpha^2)y = \frac{4(x/2)^{\alpha+1}}{\sqrt{\pi}\Gamma(\alpha + \frac{1}{2})}$$

Struve functions $H(n,x)$, and Modified Struve Functions $L(n,x)$, have the following power series forms:

$$H_\alpha(x) = \sum_{m=0}^{\infty} \frac{(-1)^m}{\Gamma(m + \frac{3}{2})\Gamma(m + \alpha + \frac{3}{2})} \left(\frac{x}{2}\right)^{2m+\alpha+1}$$

$$L_\nu(z) = \left(\frac{z}{2}\right)^{\nu+1} \sum_{k=0}^{\infty} \frac{1}{\Gamma(\frac{3}{2} + k)\Gamma(\frac{3}{2} + k + \nu)} \left(\frac{z}{2}\right)^{2k}$$

The figure below shows a few Struve functions of integer order, $n=1$ to 5 ; for $-10 < x < 10$

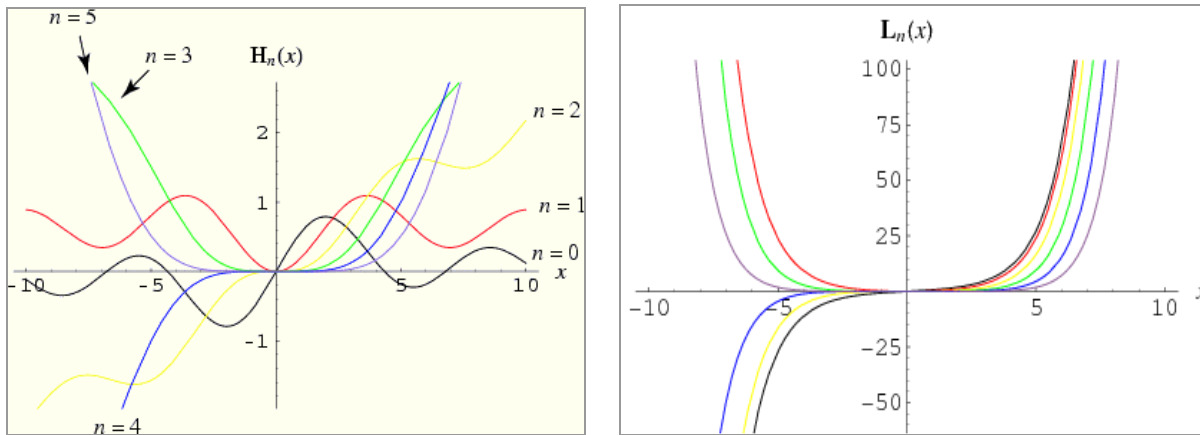

Struve functions of any order can be expressed in terms of the Generalized Hypergeometric function ${}_1F_2$ (which is not the Gauss Hypergeometric function ${}_2F_1$). – This is the expression used in the SandMath implementation:

$$H_\alpha(z) = \frac{(z/2)^{\alpha+1/2}}{\sqrt{2\pi}\Gamma(\alpha + 3/2)} {}_1F_2(1, 3/2, \alpha + 3/2, -z^2/4).$$

in other words, referred to the Rationalized Generalized Hypergeometric function (which with such a long name it definitely must be a formidable function... but it's just the same divided by Gamma)

$$H_n(x) = (x/2)^{n+1} {}_1F_2(1; 3/2, n + 3/2; -x^2/4)$$

$$L_n(x) = (x/2)^{n+1} {}_1F_2(1; 3/2, n + 3/2; x^2/4)$$

Examples: Compute **H**(1.2, 3.4) and **L**(1.2, 3.4)

1.2 ENTER ^, 3.4 ZF\$ "HNX" -> H(1.2, 3.4) = 1.113372657
 1.2 ENTER ^, 3.4 ZF\$ "LNX" -> L(1.2, 3.4) = 4.649129471

Alternatively: >FL, [H], [H] for HNX, and: >FL, [H], [SHIFT], [H] for LNX

Lommel functions. { LOMS1 , LOMS2 }

The Lommel differential equation is an inhomogeneous form of the Bessel differential equation:

$$z^2 \frac{d^2 y}{dz^2} + z \frac{dy}{dz} + (z^2 - \nu^2)y = z^{\mu+1}.$$

Two solutions are given by the Lommel functions $s_{\mu,\nu}(z)$ and $S_{\mu,\nu}(z)$, introduced by Eugen von Lommel (1880),

$$s_{\mu,\nu}(z) = \frac{1}{2}\pi \left[Y_\nu(z) \int_0^z z^\mu J_\nu(z) dz - J_\nu(z) \int_0^z z^\mu Y_\nu(z) dz \right]$$

$$S_{\mu,\nu}(z) = s_{\mu,\nu}(z) - \frac{2^{\mu-1}\Gamma(\frac{1+\mu+\nu}{2})}{\pi\Gamma(\frac{\nu-\mu}{2})} (J_\nu(z) - \cos(\pi(\mu - \nu)/2)Y_\nu(z))$$

where $J_\nu(z)$ is a Bessel function of the first kind, and $Y_\nu(z)$ a Bessel function of the second kind.

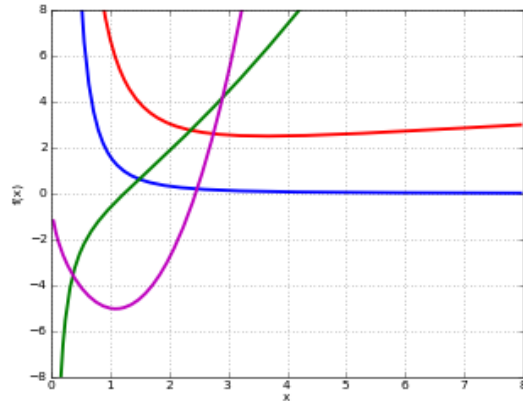
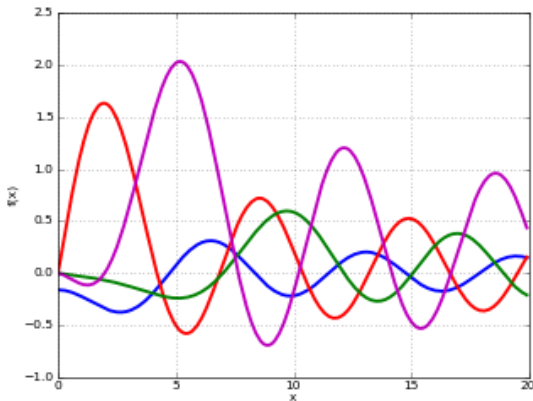

Using the Generalized Hypergeometric function the expressions for $s1(m,n,x)$ is:

$$s^{(1)}_{m,n}(x) = x^{m+1} / [(m+1)^2 - n^2] {}_1F_2 (1 ; (m-n+3)/2 , (m+n+3)/2 ; -x^2/4)$$

LOMS1 and LOMS2 calculates $s1(m,n,x)$ and $s2(m,n,x)$. Here are the specifics:

DATA REGISTERS: R00 thru R09: temp
 Flags Used: F01

Stack	Input	Output
Z	m	/
Y	n	/
X	x	s1 / s2

Example:

2 SQRT, 3 SQRT, PI **ΣF\$ "LOMS1"** -> $s1[\text{sqrt}(2), \text{sqrt}(3), \pi) = 3.003060384$
 2 SQRT, 3 SQRT, PI **ΣF\$ "LOMS2"** -> $s2[\text{sqrt}(2), \text{sqrt}(3), \pi) = 9.048798662$

alternatively: **ΣFL**, **H**, **L** for $s1$; and **ΣFL**, **H**, **SHIFT**, **L** for $s2$

Program listing.-

01 LBL "HNX"	12	STO 08	57	.
02 CF 01	13	RCL 05	58	RTN
03 GTO 00	14	CHS	59	LBL 01
04 LBL "LNX"	15	STO 05	60	STO 00
05 SF 01	16	XEQ 00	61	RDN
06 LBL 00	17	RCL 08	62	STO 03
07 2	18	+	63	STO 05
08 /	19	2	64	CHS
09 STO 00	20	ST/ Y	65	X<>Y
10 X<>Y	21	RCL 07	66	STO 04
11 STO 04	22	Y^X	67	STO 07
12 1.5	23	*	68	ST+ 03
13 STO 02	24	RCL 09	69	+
14 +	25	+	70	3
15 STO 03	26	CLD	71	ST+ 03
16 E	27	RTN	72	+
17 STO 01	28	LBL 00	73	2
18 ST+ 04	29	E	74	ST/ 03
19 2	30	RCL 05	75	/
20 CHS	31	-	76	STO 02
21 RCL 00	32	STO 01	77	E
22 X^2	33	CLST	78	STO 01
23 FC? 01	34	SIGN	79	ST+ 04
24 CHS	35	RCL 06	80	LASTX
25 HGF+	36	CHS	81	RCL 00
26 RCL 00	37 HGF+	37	82	LASTX
27 RCL 04	38	RCL 05	83	/
28 Y^X	39	E	84	X^2
29 *	40	+	85	STO 06
30 CLD	41	RCL 07	86	FS? 01
31 END	42	-	87	CHS
	43	2	88	HGF+
	44	/	89	RCL 00
	45	1/GMF	90	RCL 04
	46	*	91	YX^
	47	2	92	*
	48	RCL 05	93	RCL 04
	49	Y^X	94	X^2
	50	*	95	RCL 05
	51	RCL 05	96	X^2
	52	1/GMF	97	-
	53	/	98	/
	54	RCL 00	99	END
	55	RCL 05		
	56	YX^		

Note: **YX^** is the modified version of the power Y^X , which returns 0 when both arguments are zero.

Lerch (Transcendent) Function. { LERCH }

In mathematics, the Lerch zeta-function, sometimes called the Hurwitz–Lerch zeta-function, is a special function that generalizes the Hurwitz zeta-function and the polylogarithm. It is named after Mathias Lerch.

The Lerch zeta-function **L** and a related function, the Lerch Transcendent **Φ**, are given by:

$$L(\lambda, \alpha, s) = \sum_{n=0}^{\infty} \frac{\exp(2\pi i \lambda n)}{(n + \alpha)^s}, \quad \Phi(z, s, \alpha) = \sum_{n=0}^{\infty} \frac{z^n}{(n + \alpha)^s}.$$

Special cases.- The Lerch Transcendent generates other special functions as particular cases, as it's shown in the table below:

The Hurwitz zeta-function	$\zeta(s, \alpha) = L(0, \alpha, s) = \Phi(1, s, \alpha).$
The Legendre chi function	$\chi_n(z) = 2^{-n} z \Phi(z^2, n, 1/2).$
The Riemann zeta-function	$\zeta(s) = \Phi(1, s, 1).$
The polylogarithm	$\text{Li}_s(z) = z \Phi(z, s, 1).$
The Dirichlet eta-function	$\eta(s) = \Phi(-1, s, 1).$

The figures below depict the representation for x, given the other two constant.

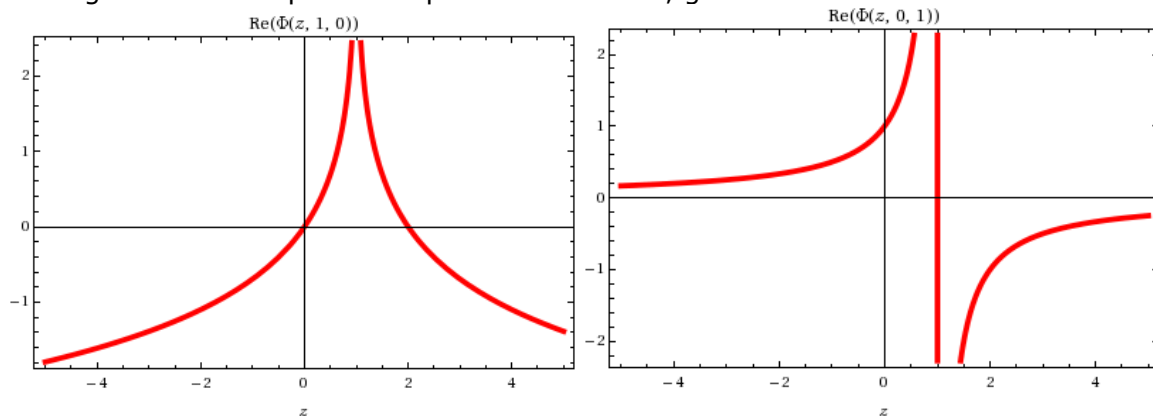

The SandMath implementation **LERCH** is for the Lerch Transcendent function. It is a short MCODE routine originally written as a FOCAL routine by Jean-Marc Baillard, which calculates the series terms and adds them until they don't have a contribution to the final result. It is a slow converging series, and therefore the execution time can be rather long (at normal CPU speeds).

Data input follows the usual conventions for the stack registers, entering x as the last parameter (in register X) – despite the written form:

Stack	Input	Output
Z	s	T
Y	a	T
X	x	Φ(x,s,a)

Examples:-

PI ENTER^, 0.6 ENTER^, 0.7 **ΣF\$ "LERCH"** -> $\Phi(0.7; \pi; 0.6) = 5.170601130$
 3 ENTER^, -4.6 ENTER^, 0.8 **ΣF\$ "LERCH"** -> $\Phi(0.8; 3; -4.6) = 3.152827048$

Alternatively: **ΣFL**, **[H]**, **[R]** using the main launcher instead.

Kelvin Functions. { KLV1 , KLV2 }

In applied mathematics, the Kelvin functions of the first kind -Ber(v,x) and Bei(v,x) - and of the Second kind - Ker(v,x) and Kei(v,x) - are the real and imaginary parts, respectively, of

$$J_\nu(xe^{3\pi i/4}), \text{ for the 1st. Kind} \qquad K_\nu(xe^{\pi i/4}) \text{ for the 2nd. Kind.}$$

These functions are named after William Thomson, 1st Baron Kelvin.

For integers n, Bern(x) and Bein(x) have the following series expansion

$$\text{Ber}_n(x) = \left(\frac{x}{2}\right)^n \sum_{k \geq 0} \frac{\cos\left[\left(\frac{3n}{4} + \frac{k}{2}\right)\pi\right]}{k! \Gamma(n+k+1)} \left(\frac{x^2}{4}\right)^k$$

and

$$\text{Bei}_n(x) = \left(\frac{x}{2}\right)^n \sum_{k \geq 0} \frac{\sin\left[\left(\frac{3n}{4} + \frac{k}{2}\right)\pi\right]}{k! \Gamma(n+k+1)} \left(\frac{x^2}{4}\right)^k$$

The figure below shows Ber(n,x) and Ker(n,x) for the first 4 integer orders and real arguments:

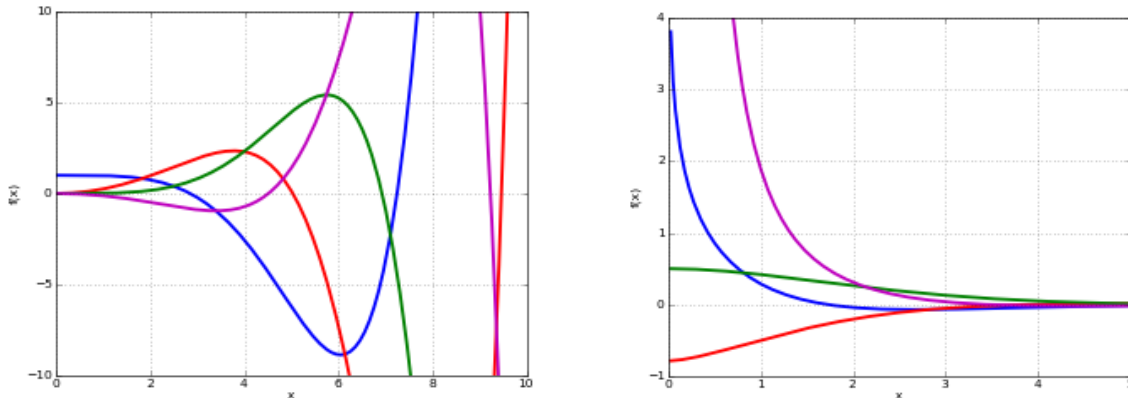

Ber(n,X), Bei(n,x), Ker(n,x) and Kei(n,x) are available in the SandMath, implemented as FOCAL programs written by JM Baillard. Both values are calculated simultaneously by **KLV(2)**, and left in X,Y registers as follows:

Stack	Input	Output	Output
Y	n	bei(n,x)	kei(n,x)
X	x	ber(n,x)	ker(n,x)

Examples:

```

2 SQR, PI, ΣF$ "KLV1"  -> ber (sqrt(2), π) = -0.674095951
X<>Y                   -> bei (sqrt(2), π) = -1.597357210

2, SQR, PI, ΣF$ "KLV2" -> ker (sqrt(2), π) = 0.025901894
X<>Y                   -> kei (sqrt(2), π) = 0.089242867
    
```

alternatively: ΣFL, H, K for KLV1 and: ΣFL, H, SHIFT, K for KLV2

Program listing.

01	LBL "KLV1"	56	135	34	-
02	DEG	57	*	35	RCL 07
03	2	58	E	36	/
04	/	59	P-R	37	RCL 08
05	STO 04	60	RCL 06	38	-
06	X<>Y	61	X<>Y	39	X<>Y
07	STO 05	62	*	40	PI
08	LASTX	63	RCL 07	41	2
09	/	64	LASTX	42	/
10	.5	65	*	43	CHS
11	STO 03	66	RCL 06	44	ST* Z (1)
12	+	67	R^	45	*
13	STO 01	68	*	46	*
14	LASTX	69	ST+ Y (2)	47	RTN
15	+	70	X<> Z(1)	48	LBL 00
16	STO 02	71	RCL 07	49	X<>Y
17	X<> L(4)	72	LASTX	50	XRROM "KLV1"
18	*	73	*	51	STO 01
19	4	74	-	52	X<>Y
20	Y^X	75	END	53	STO 02
21	CHS			54	CLX
22	3			55	STO 06
23	ENTER^	01	LBL "KLV2"	56	STO 07
24	CLX	02	X<>Y	57	RCL 05
25	X<> Z(1)	03	INT?	58	STO 03
26	STO 00	04	GTO 00	59	X=0?
27	HGF+	05	X<>Y	60	GTO 00
28	RCL 04	06	STO 10	61	LBL 02
29	RCL 05	07	XRROM "KLV1"	62	RCL 05
30	Y^X	08	STO 08	63	3
31	*	09	X<>Y	64	*
32	STO 06	10	STO 09	65	RCL 03
33	RCL 03	11	RCL 05	66	E
34	ST+ 01	12	CHS	67	-
35	ST+ 02	13	RCL 10	68	STO 00
36	ISG 03	14	XRROM "KLV1"	69	ST+ X(3)
37	CLST	15	RCL 05	70	+
38	3	16	180	71	45
39	RCL 00	17	*	72	*
40	HGF+	18	STO 07	73	RCL 05
41	RCL 04	19	COS	74	RCL 03
42	RCL 05	20	STO 06	75	-
43	2	21	RCL 08	76	FACT
44	+	22	*	77	RCL 00
45	Y^X	23	-	78	FACT
46	*	24	RCL 07	79	/
47	RCL 05	25	SIN	80	RCL 04
48	E	26	STO 07	81	X^2
49	+	27	/	82	RCL 00
50	ST/ Y(2)	28	RCL 09	83	Y^X
51	1/GMF	29	+	84	*
52	ST* 06	30	X<>Y	85	P-R
53	*	31	LASTX	86	ST+ 06
54	STO 07	32	RCL 06	87	X<>Y
55	RCL 05	33	*	88	ST+ 07

89	DSE 03	126	LASTX	163	45
90	GTO 02	127	135	164	*
91	LBL 00	128	*	165	ISG 00
92	RCL 04	129	RCL 03	166	CLX
93	RCL 05	130	P-R	167	X<>Y
94	Y^X	131	STO 08	168	P-R
95	ST+ X(3)	132	X<>Y	169	RCL 08
96	ST/ 06	133	STO 09	170	+
97	CHS	134	E	171	STO 08
98	ST/ 07	135	STO 00	172	LASTX
99	RCL 04	136	STO 10	173	-
100	LN	137	LBL 04	174	X<>Y
101	RCL 01	138	RCL 10	175	RCL 09
102	*	139	RCL 04	176	+
103	RCL 02	140	X^2	177	STO 09
104	PI	141	*	178	LASTX
105	4	142	RCL 00	179	-
106	/	143	ST/ Y(2)	180	R-P
107	STO 00	144	RCL 05	181	X#0?
108	*	145	+	182	GTO 04
109	-	146	/	183	RCL 04
110	ST- 06	147	STO 10	184	RCL 05
111	RCL 04	148	RCL 03	185	Y^X
112	LN	149	LASTX	186	LASTX
113	RCL 02	150	1/X	187	FACT
114	*	151	-	188	ST+ X(3)
115	RCL 01	152	RCL 00	189	/
116	RCL 00	153	1/X	190	ST* 08
117	*	154	-	191	ST* 09
118	+	155	STO 03	192	RCL 07
119	ST- 07	156	*	193	RCL 09
120	GEU	157	RCL 05	194	-
121	ST+ X(3)	158	3	195	RCL 06
122	STO 03	159	*	196	RCL 08
123	RCL 05	160	RCL 00	197	-
124	Σ1/N	161	ST+ X(3)	198	END
125	ST- 03	162	+		

Kummer Function. { **KUMR** }

Kummer's equation has two linearly independent solutions $M(a,b,z)$ and $U(a,b,z)$.

$$z \frac{d^2 w}{dz^2} + (b - z) \frac{dw}{dz} - aw = 0.$$

Kummer's function of the first kind M (also called Confluent Hypergeometric function) is a generalized hypergeometric series introduced in (Kummer 1837), given by

$$M(a, b, z) = \sum_{n=0}^{\infty} \frac{a^{(n)} z^n}{b^{(n)} n!} = {}_1F_1(a; b; z)$$

Where $a^{(n)}$ is the rising factorial, defined as:

$$a^{(n)} = a(a + 1)(a + 2) \cdots (a + n - 1)$$

The figures below depict two particular cases for $\{a=2, b=3\}$ and $\{a=-2, b=-3\}$

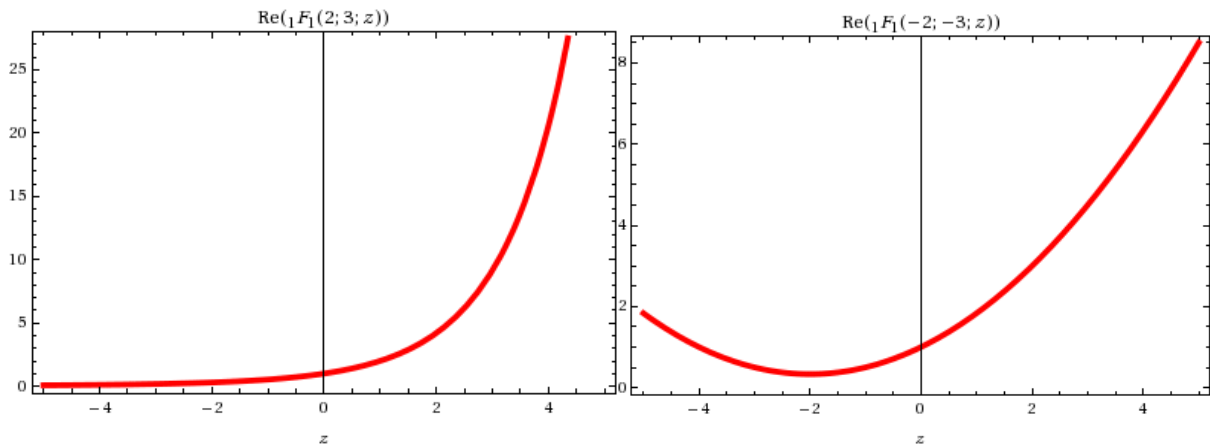

The SandMath implementation is got to be one of the simplest application of **HGF+** possible, which still renders acceptable accuracy to the results

DATA REGISTERS:

a – R00; b – R01

Stack	Input	Output
Z	a	/
Y	b	/
X	x	M(a;b;x)
L	/	x

Examples:

Compute $M(2; 3; -\pi)$ and $M(2; 3; \pi)$

2 ENTER^, 3 ENTER^, PI CHS, **ΣF\$ "KUMR"** -> $M(2;3;-\pi) = 0.166374562$
 2 ENTER^, 3 ENTER^, PI **ΣFL [,]** -> $M(2;3;\pi) = 10,24518011$

Associated Legendre Functions. { ALF }

In mathematics, the Legendre functions $P(\lambda)$, $Q(\lambda)$ and associated Legendre functions $P_\mu(\lambda)$ and $Q_\mu(\lambda)$ are generalizations of Legendre polynomials to non-integer degree. Associated Legendre functions are solutions of the Legendre equation:

$$(1 - x^2) y'' - 2xy' + \left[\lambda(\lambda + 1) - \frac{\mu^2}{1 - x^2} \right] y = 0,$$

where the complex numbers λ and μ are called the degree and order of the associated Legendre functions respectively. *Legendre polynomials are the associated Legendre functions of order $\mu=0$.*

These functions may actually be defined for general complex parameters and argument:

$$P_\lambda^\mu(z) = \frac{1}{\Gamma(1 - \mu)} \left[\frac{1 + z}{1 - z} \right]^{\mu/2} {}_2F_1\left(-\lambda, \lambda + 1; 1 - \mu; \frac{1 - z}{2}\right), \quad \text{for } |1 - z| < 2$$

The figures below give a couple of graphical plots for the Legendre Polynomials:

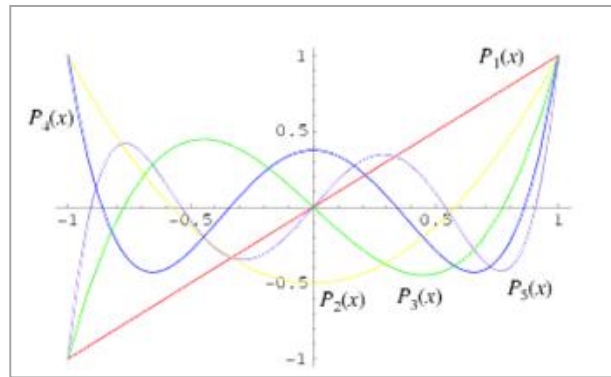
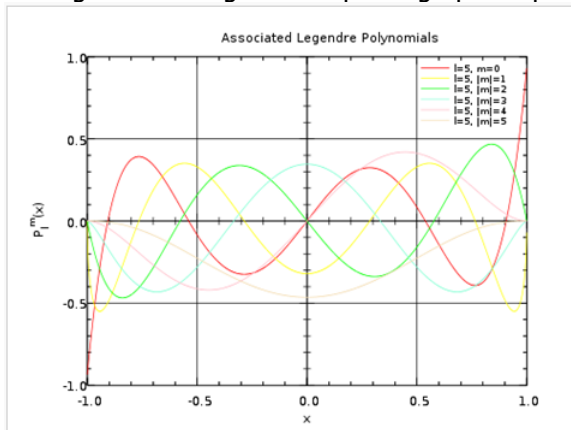

REGISTERS: R00 thru R05
 FLAGS: /

Stack	Input	Output
Z	m	/
Y	n	/
X	x	P(n,m,x)

Examples:

0.4 ENTER^, 1.3 ENTER^, 0.7 **ΣF\$ "ALF"** -> P1.3|0.4(0.7) = 0.274932821
 -0.6 ENTER^, 1.7 ENTER^, 4.8 **ΣFL** [,] -> P1.7|-0.6(4.8) = 10.67810281

Alternatively: **ΣFL**, **[O]**, **[SHIFT]**, **[L]** using the main launcher instead.

Generalized Laguerre Functions. { **LAYX** }

In mathematics, the Laguerre functions are generalizations of Associated Laguerre polynomials to non-integer degree. Generalized Laguerre functions are solutions of the generalized Laguerre differential equation:

$$xy'' + (\alpha + 1 - x)y' + ny = 0$$

In the SandMath they have been implemented as a direct application example of the Kummer function described before, through the following expression:

$$L_n^{(\alpha)}(x) = M(-n, \alpha+1, x) [\Gamma(n+\alpha+1) / \Gamma(n+1) * \Gamma(\alpha+1)]$$

The FOCAL program listig is shown on the right, note how the parameters for **KUMR** are stored in registers R01 and R02, and that **GAMMA** maintains the stack values intact.

REGISTERS: R00 thru R02
Inputs are a, n and X in the Stack

Stack	Input	Output
Z	α	/
Y	n	/
X	x	$L(a,n,x)$

01	LBL "LAYX"	
02	-E	
03	ST* Z	
04	CHS	
05	R^	
06	+	
07	X<>Y	
08	KUMR	
09	RCL 02	$\alpha+1$
10	RCL 01	-n
11	-	
12	GAMMA	
13	*	
14	E	
15	RCL 01	$n+1$
16	-	
17	GAMMA	
18	/	
19	RCL 02	$\alpha+1$
20	GAMMA	
21	/	
22	END	

Example 1: Calculate $L [\text{sqr}(7), \text{sqr}(2), \pi]$

7, SQRT, 2, SQRT, PI, $\Sigma F\$$ "LAYX" => -0.133847230

Example 2: Calculate $L [1.4, 7, \pi]$

1.4, ENTER^, 7, ENTER^, PI, $\Sigma F\$$ "LAYX" => 1.688893432

Note that this function is very closely related to the Associated Laguerre Polynomials **LANX**, available in the SandMatrix module – where n is restricted to integer values. Using the same example it returns:

1.4, ENTER^, 7, ENTER^, PI, $\Sigma V\$$ "LANX" => 1.688893513

which is closer to the WolframAlpha result:

1.688893513665350666416315753079962836789001626802753614936634...

Whittaker Function. { WHIM }

In mathematics, a Whittaker function is a special solution of Whittaker's equation, a modified form of the confluent hypergeometric equation introduced by Whittaker (1904) to make the formulas involving the solutions more symmetric.

Whittaker's equation is

$$\frac{d^2w}{dz^2} + \left(-\frac{1}{4} + \frac{\kappa}{z} + \frac{1/4 - \mu^2}{z^2} \right) w = 0$$

It has a regular singular point at 0 and an irregular singular point at ∞ . Two solutions are given by the Whittaker functions $M_{\kappa,\mu}(z)$, $W_{\kappa,\mu}(z)$, defined in terms of Kummer's confluent hypergeometric functions M and U by

$$M_{\kappa,\mu}(z) = \exp(-z/2) z^{\mu+1/2} M\left(\mu - \kappa + \frac{1}{2}, 1 + 2\mu; z\right)$$

$$W_{\kappa,\mu}(z) = \exp(-z/2) z^{\mu+1/2} U\left(\mu - \kappa + \frac{1}{2}, 1 + 2\mu; z\right).$$

The graphics below show both functions for the particular case $k=2$ and $m=0.5$

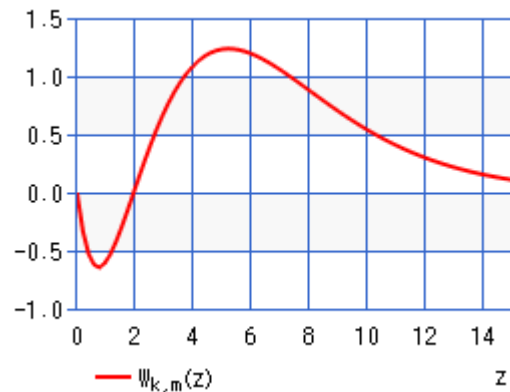
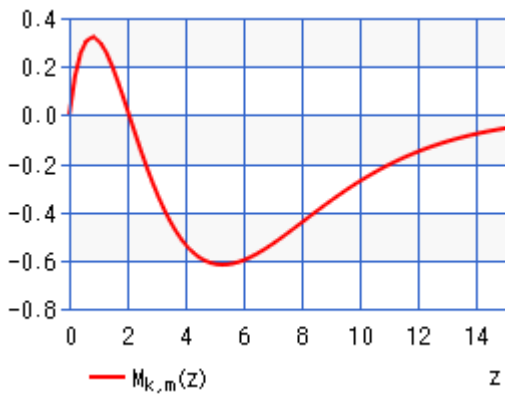

DATA REGISTERS: R00 thru R02:
Flags: none.

Stack	Input	Output
Z	K	/
Y	μ	/
X	x	W(k,m,x)

Example:

2, SQRT, 3, SQRT, PI, **SF\$** "WHIM" -> **W**(sqrt(2), sqrt(3), π) = 5.612426206

Toronto Function. { TNMR }

In mathematics, the Toronto function $T(m,n,r)$ is a modification of the confluent hypergeometric function defined by Heatley (1943) as

$$T(m, n, r) = r^{2n-m+1} e^{-r^2} \frac{\Gamma(\frac{1}{2}m + \frac{1}{2})}{\Gamma(n + 1)} {}_1F_1(\frac{1}{2}m + \frac{1}{2}; n + 1; r^2).$$

Which to untrained eyes just appears to be a twisted cocktail of the Kummer function, adding the exponential to the mix and scaling it with Gamma.

DATA REGISTERS: R00 thru R04:
Flags: none.

Stack	Input	Output
Z	m	/
Y	n	/
X	r	T (m,n,r)

Example:

2, SQRT, 3, SQRT, PI, ΣF\$ "TNMR" -> $T(\text{sqrt}(2), \text{sqrt}(3), \pi) = 0.963524225$

Alternatively: ΣFL, [H], [T] using the main launcher instead

Program listing.-

01	LBL "TNMR"	19	HGF+
02	STO 03	20	LASTX
03	X^2	21	E^X
04	STO 00	22	/
05	SIGN	23	RCL 01
06	+	24	1/GMF
07	STO 02	25	/
08	X<>Y	26	RCL 03
09	STO 04	27	RCL 02
10	LASTX	28	ST+ X(3)
11	+	29	E
12	2	30	-
13	/	31	RCL 04
14	STO 01	32	-
15	E	33	Y^X
16	ENTER^	34	*
17	CHS	35	END
18	RCL 00		

Program listings.-

```

01  LBL "ALF"
02  STO 04
03  RDN
04  STO 02
05  CHS
06  STO 01
07  E
08  ENTER^
09  ST+ 02
10  R^
11  STO 05
12  -
13  STO 03
14  CLX
15  RCL 04
16  -
17  2
18  ST/ 05
19
20  /
21  XROM "RHGF"
22  RCL 04
23  E
24  +
25  RCL 04
26  LASTX
27  -
28  X=0?
29  SIGN
30  /
31  ABS
32  RCL 05
33  Y^X
34  *
35  END
    
```

```

01  LBL "WHIM"
02  STO 00
03  RDN
04  ST+ X (3)
05  E
06  +
07  STO 02
08  2
09  /
10  X<>Y
11  -
    
```

```

12  STO 01
13  E
14  ENTER^
15  ENTER^
16  RCL 00
17  HGF+
18  RCL 00
19  2
20  /
21  E^X
22  /
23  RCL 00
24  RCL 02
25  2
26  /
27  Y^X
28  *
29  END
    
```

```

01  LBL "LAYX"
02  -
03  E
04  ST* Z (1)
05  CHS
06  R^
07  +
08  X<>Y
09  XROM "KUMR"
10  RCL 02
11  RCL 01
12  -
13  GAMMA
14  *
15  E
16  RCL 01
17  -
18  GAMMA
19  /
20  RCL 02
21  GAMMA
22  /
23  END
    
```

3.5.3. Orphans and dispossessed.

The last group of sub-functions include those not belonging to any particular launcher – for no other particular reason that there’s no more available space in the ROM. – Keep in mind that the only (dual) way to execute them is using the Σ FL# or Σ FL\$ launchers.

	Function	Description	Author
[Σ FL]	-SP FNC	Section header - does CAT+	Ángel Martin
[Σ FL]	#BS	Aux routine, All Bessel	Ángel Martin
[Σ FL]	#BS2	Aux routine - 2nd. kind, Integer orders	Ángel Martin
[Σ FL]	AMG2	Modified Arithmetic-geometric Mean	Ángel Martin
[Σ FL]	AWL	Inverse Lambert	Ángel Martin
[Σ FL]	PDEG	Polynomial Degree	JM Baillard
[Σ FL]	LI	Logarithmic Integral	Ángel Martin
[Σ FL]	PSD	Poisson Standard Distribution	Ángel Martin
[Σ FL]	dPL	Polynomial first derivative	Ángel Martin
[Σ FL]	DAYS	Days between dates (MM,DDYYYY in X,Y)	HP Co.
[Σ FL]	JDAY	Julian Day number of a Date (MM,DDYYYY in X)	Ángel Martin
[Σ FL]	CDAY	Date for a Julian day number (day number in X)	Ángel Martin

Let’s tackle the simpler ones on the list first.

- **-SPL FNS** simply provides the index-zero shortcut for **CAT+**. It invokes the sub-function CATALOG, with *hot-keys for individual function launch and general navigation*. Users of the POWERCL Module will already be familiar with its features, as it’s exactly the same code – which in fact resides in the Library#4 and it’s reused by both modules.
- **#BS** and **#BS2** are auxiliary functions used in the FOCAL programs for the Bessel functions of 2nd Kind, **KBS** and **YBS**. They were explained in more detail in the Bessel Functions paragraph. Feel free to ignore them, *as they’re not intended for stand-alone use*.
- **AWL** is the Inverse Lambert W function, an immediate application of the W definition involving just the exponential – but with additional accuracy using the MCODE 13-digit routines in the OS. $AWL = W * \exp(W)$
- **LI** is the Logarithm Integral, also a quick application of the **EI** function, using the formula: $Li(x) = Ei[(\ln(x))]$ (see description for **EI** earlier in the manual). Note how **LI** starts as a MCODE functions that transfers into the FOCAL code calculating **EI**, so strictly speaking it’s a sort of “hybrid” natured function.
- **DAYS** is taken from the HP Securities Pac. It calculates the number of days between two dates – *using a 30-day month* standard in financial calculations. The input format is MM,DDYYYY, with the later date in Y and the earlier in X. The result is returned to the X-reg.

Example: Calculate the number of days elapsed between July 21st, 1959 and May 21st, 2014:
 5.212014, ENTER^, 7.211959, Σ F\$ "DAYS" => 20,014.00000

- **JDAY** and **CDAY** are reciprocal date functions to convert a given date into the Julian day number and back to the calendar date. Use flag 00 to select either Julian or gregorian calendars in the conversions. The date format is also MM.DDYYYY regardless of the time module settings if there’s one.

Example: the date May 21st, 2014 corresponds to 2,456,799 (Gregorian calendar) or 2,456,812 (Julian calendar) day numbers.

You can also use **JDAY** to calculate the elapsed number of days between two dates – simply converting both to their Julian day numbers and subtracting them. If you do that you'll notice a small discrepancy (18 days) between this approach and the results from **DAYS** – which leads me to believe that **DAYS** uses a different convention, but unfortunately it appears to be a stealth function, as there is no documentation for it at all in the Securities Pac manual.

These two functions are based on the PPC routines **JC** and **CJ** – ported to an all-MCODE implementation to make effective use of the available ROM space in the secondary banks. The formulas used are as follows (see PPC ROM manual for details):

$$\text{JDN} = \text{int} \{ \text{int} [[D + \text{int}(367 X) - \text{int}(X)] - 0.75 * \text{int}(X)] - 0.75 * \text{int}[\text{int}(X)/100] \} + 1,721,115; \quad \text{where: } X = Y + (M-2.85) / 12$$

$$\text{Let } N = \text{JDN} - 1,721,119 \\ C = \text{int} \{ (N-0.2)/36,524.25 \}$$

if Gregorian: $N' = N + C - \text{int}(C/4)$ – or if Julian: $N' = N + 2$

$$Y' = \text{int}[(N' - 0.2) / 365.25]; \quad N'' = N' - \text{int}(365.25 * Y') \\ M' = \text{int}[(N'' - 0.5) / 30.6]; \quad D = \text{int} [N'' - 30.6 * M' + 0.5]$$

Decibel Addition. { **dB+** }

The decibel (dB) is a logarithmic unit used to express the ratio between two values of a physical quantity, often power or intensity. One of these quantities is often a reference value, and in this case the decibel can be used to express the absolute level of the physical quantity, as in the case of sound pressure. The number of decibels is ten times the logarithm to base 10 of the ratio of two power quantities,[1] or of the ratio of the squares of two field amplitude quantities [2]. One decibel is one tenth of one bel, named in honor of Alexander Graham Bell.

[1] Power quantities

When referring to measurements of power or intensity, a ratio can be expressed in decibels by evaluating ten times the base-10 logarithm of the ratio of the measured quantity to the reference level. Thus, the ratio of a power value P1 to another power value P0 is represented by LdB, that ratio expressed in decibels,[19] which is calculated using the formula below:

$$L_{\text{dB}} = 10 \log_{10} \left(\frac{P_1}{P_0} \right)$$

[2] Field quantities

When referring to measurements of field amplitude, it is usual to consider the ratio of the squares of A1 (measured amplitude) and A0 (reference amplitude). This is because in most applications power is proportional to the square of amplitude, and it is desirable for the two decibel formulations to give the same result in such typical cases. Thus, the following definition is used:

$$L_{\text{dB}} = 10 \log_{10} \left(\frac{A_1^2}{A_0^2} \right) = 20 \log_{10} \left(\frac{A_1}{A_0} \right).$$

The function **dB+** calculates the result of adding or subtracting two values in X and Y expressed in decibels. The result is also a dB value. Use a negative sign in X for subtractions.

Examples: 3 dB + 5 dB = 7.124426028 dB
 5 dB – 3 dB = 0.670765667 dB

A few polynomial functions follow next.-

You should refer to the SandMatrix module for a more comprehensive coverage of this subject.

- **PDEG** is a simple but useful routine to get the polynomial degree from the control word in X, in the form bbb.eee. It is used by **INPUT**, and obviously we have: degree = (eee – bbb). As an additional bonus, **PDEG** also leaves in LastX the address of the next free register, eee+1.
- **PVL** and **dPL** are full-fledged MCODE functions used to evaluate polynomials and to calculate the first derivative of a polynomial, which coefficients are stored in data registers. It requires the control word (bbb.eee) in Y, and the evaluation point x in X.

Example: evaluate and calculate the derivative of $P(x) = 5x^3 - 4x^2 - 3$ in $x=2$

First we input the coefficients in registers R00 to R03, using **INPUT**:

0,003, **ΣF\$** "INPUT", followed by "5, ENTER^, 4, CHS, ENTER^, 0, ENTER^, 3, CHS, R/S"

This leaves the control word in X, thus we just enter the evaluation point and call the appropriate functions, as shown below:

2, XEQ "PVL" => 21.0000
 RDN, 2 **ΣF\$** "DPL" (*) => 44.0000

(*) Note how the function name is spelled using upper-case letters, "DPL"
 Note also that **PVL** is a main function, allocated in the SandMath FAT.

The FOCAL programs shown below were written by JM Baillard. They perform the same tasks, and are provided for your sheer enjoyment – and as an example of how efficient FOCAL can be, specially with a 4-stack register pile and the capability to use indirect addressing.

Consider that the minimalistic programs below have an equivalence of about 150 bytes in MCODE, by the time you're done with the error handling and math syntax to use the OS routines. However the speed advantage - and the ability to locate the code in a secondary bank – are well worth the effort.

01	LBL "dPL"		18	GTO 00
02	RCL Y		19	LBL "PL"
03	PDEG		20	0
04	STO M(5)		21	LBL 01
05	CLX		22	RCL Y(2)
06	LBL 02		23	*
07	RCL Y(2)		24	RCL IND Z(1)
08	*		25	+
09	RCL IND Z(1)		26	ISG Z(1)
10	X<> M(5)		27	GTO 01
11	ST* M(5)		28	LBL 00
12	X<> M(5)		29	X<>Y
13	+		30	SIGN
14	ISG Z(1)		31	RDN
15	NOP		32	END
16	DSE M(5)			
17	GTO 02			

Arithmetic-Geometric Mean - Revisited { **AGM** }

In mathematics, the arithmetic–geometric mean (AGM) of two positive real numbers x and y is defined as follows: First compute the arithmetic mean of x and y and call it a_1 . Next compute the geometric mean of x and y and call it g_1 ; this is the square root of the product xy :

$$a_1 = \frac{1}{2}(x + y)$$

$$g_1 = \sqrt{xy}$$

Then iterate this operation with a_1 taking the place of x and g_1 taking the place of y . In this way, two sequences (a_n) and (g_n) are defined:

$$a_{n+1} = \frac{1}{2}(a_n + g_n)$$

$$g_{n+1} = \sqrt{a_n g_n}$$

These two sequences converge to the same number, which is the arithmetic–geometric mean of x and y ; it is denoted by $M(x, y)$, or sometimes by $\text{agm}(x, y)$.

Stack	Input	Output
Y	a0	Z
X	b0	agm(a0,b0)
L	-	b0

Note that "DATA ERROR" will be triggered when one of the arguments is negative (but not if both are).

Example 1:

To find the arithmetic–geometric mean of $a_0 = 24$ and $g_0 = 6$, simply input:

24, ENTER, ^, 6, **ΣF\$ "AGM"** → 13,45817148

Example 2. Gauss Constant.

The reciprocal of the arithmetic–geometric mean of 1 and the square root of 2 is called Gauss's constant, after Carl Friedrich Gauss. Calculate it using AGM:

2, SQRT, 1, **ΣF\$ "AGM"** → 1,198140235; 1/X → 0,834626842

A piece of trivia: the Gauss constant is a transcendental number, and appears in the calculation of several integrals such as those below:

$$\frac{1}{G} = \int_0^{\pi/2} \sqrt{\sin(x)} dx = \int_0^{\pi/2} \sqrt{\cos(x)} dx$$

$$G = \int_0^{\infty} \frac{dx}{\sqrt{\cosh(\pi x)}}$$

Example 3.- Complete Elliptic Integral of 1st Kind.

Using **AGM** it's a convenient way to calculate the Complete Elliptic Integral of the first kind, **ELIPK** (k), by means of the following relationship (where M(x,y) represents the AGM):

$$M(x, y) = \frac{\pi}{2} \bigg/ \int_0^{\pi/2} \frac{d\theta}{\sqrt{x^2 \cos^2 \theta + y^2 \sin^2 \theta}} = \frac{\pi}{4} (x + y) \bigg/ K \left(\frac{x - y}{x + y} \right)$$

where K(k) is the Complete Elliptic Integral of the first kind:

$$K(k) = \int_0^{\pi/2} \frac{d\theta}{\sqrt{1 - k^2 \sin^2 \theta}} = \int_0^1 \frac{dt}{\sqrt{(1 - t^2)(1 - k^2 t^2)}}$$

As usual the conventions used for the input parameters get in the way – so paying special attention to this, we can re-write the expression using the **In**complete Elliptic Integral instead, as follows:

ELIPF { $\pi/2$ | (a-b)/(a+b) } = $\pi (a+b) / 4 \text{ AGM}(a,b)$, which is the same as:

ELIPF { $\pi/2$, [(a-b)/(a+b)]² } = $\pi (a+b) / 4 \text{ AGM}(a,b)$

The idea is to find two values a,b derived from the argument: $x = [(a-b)/(a+b)]^2$

The easiest approach is to choose a=1, and therefore: $b = [1 - \text{sqr}(x)] / [1 + \text{sqr}(x)]$

Here's the FOCAL program used for the calculation.- Note the first step needed to get the square root of the argument, to harmonize both conventions used.

1	LBL "ELIPK"	7	E	13	4	19	E
2	SQRT	8	+	14	*	20	+
3	E	9	/	15	1/X	21	*
4	X<>Y	10	RCL X	16	PI	22	END
5	-	11	E	17	*		
6	LASTX	12	AGM	18	X<>Y		

And here are some results, compared to the values obtained using **ELIPF**. As you can expect, the execution is substantially faster using the **AGM** approach.

x	ELIPK(x)	ELIPF ($\pi/2$, x)	% Delta
0.1	1.612441348	1.612441348	0
0.2	1.659623599	1.659623598	6.02546E-10
0.3	1.713889448	1.713889447	5.83468E-10
0.4	1.777519373	1.777519371	1.12516E-09
0.5	1.854074677	1.854074677	0
0.6	1.949567749	1.949567749	0
0.7	2.075363134	2.075363135	-4.81843E-10
0.8	2.257205326	2.257205326	0
0.9	2.578092113	2.578092113	0

Modified Arithmetic-Geometric Mean { AGM2 }

We've seen the relationship between the complete Elliptic integral of first kind (ELIPK) and the AGM largely facilitates the calculation. Would it be possible to calculate the complete Elliptic of 2nd. Kind (ELIPE) using a similar approach, and if so how? As it turns out there is a way – involving the Modified AGM as described below. First we define a sequence of triples as follows:

$$x_{n+1} := \frac{x_n + y_n}{2}, \quad y_{n+1} := z_n + \sqrt{(x_n - z_n)(y_n - z_n)},$$

$$z_{n+1} := z_n - \sqrt{(x_n - z_n)(y_n - z_n)}.$$

Defining now the modified arithmetic-geometric mean (AGM2) of two positive numbers x and y as the common limit of the descending sequence {X_n} and the ascending sequence {Y_n}, with X₀ = x and y₀=y (and z₀=0)

The expressions we're interested in are those linking the Complete Elliptic integrals of first and second kind with the regular AGM and this newly defined AGM2. As it turns out both expressions exist, and are given below:

$$(1) \quad \int_0^1 \frac{dx}{\sqrt{(1-x^2)(1-y^2x^2)}} = \frac{\pi}{2M(\beta)},$$

$$(2) \quad \int_0^1 \sqrt{\frac{1-y^2x^2}{1-x^2}} dx = \frac{\pi N(\beta^2)}{2M(\beta)},$$

Where M(t) is the regular AGM(1, t) and N(t) the modified AGM2(1, t); and where {β, γ} are two positive numbers whose squares sum to one: β² + γ² = 1. In particular the equations hold if (in violation of the assumption otherwise imposed) γ² = -1 - which implies β² = 2, facilitating the calculation even more.

So there we have it, both complete integrals can be obtained using the AGM and AGM2 functions, an iterative and fast convergent algorithm that can be easily implemented on the SandMath. Once AGM and AGM2 are available it's easy to write **ELIPK** and **ELIPE** – see the method used in the example quick FOCAL program below:

01 LBL "KK"	12 *
02 CHS	13 RTN
03 1	
04 +	14 LBL "EK"
05 SQRT	15 XEQ "KK"
06 STO O	16 RCL 07
07 1	17 X^2
08 AGM	18 1
09 ST+ X	19 AGM2
10 1/X	20 *
11 PI	21 END

$$E(k) = \int_0^{\pi/2} \sqrt{1 - k^2 \sin^2 \theta} d\theta = \int_0^1 \frac{\sqrt{1 - k^2 t^2}}{\sqrt{1 - t^2}} dt$$

(*) See Article by Semjon Adlag, <http://www.ams.org/notices/201208/rtx120801094p.pdf>

Appendix.- Mutual inductance of two coaxial circular coils.

```

01 LBL "MIND"
02 "R1=?"
03 PROMPT
04 STO 06
05 "R2=?"
06 PROMPT
07 STO 07
08 LBL 00
09 "d=?"
10 PROMPT
11 LBL C
12 STO 05
13 RCL 07
14 RCL 06
15 *
16 4
17 *
18 RCL 06
19 RCL 07
20 +
21 X^2
22 RCL 05
23 X^2
24 +
25 /
26 STO 05
27 ELIPK (ΣFL# 43)
28 STO 08
29 RCL 05
30 ELIPE (ΣFL# 41)
31 STO 09
32 E
33 RCL 05
34 2
35 /
36 -
37 RCL 08
38 *
39 RCL 09
40 -
41 PI
42 *
43 8 E-7
44 *
45 RCL 06
46 RCL 07
47 *
48 RCL 05
49 /
50 SQRT
51 *
52 "MI="
53 ARCL X
54 PROMPT
55 GTO 00
56 END
    
```

This example shows a practical utilization of functions **ELIPK** and **ELIPE** to calculate the mutual inductance between two coaxial circular coils of radius r_1 and r_2 , separated a distance d . The example is taken from page# 83 of the NASA SP-42 document, "Space Resources and Space settlements".

Note the conventions used in the definition, especially for the "k" parameter – not squared!

- Test cases: with $r_1=0.2$, $r_2=0.25$
1. $d=0.1 \rightarrow MI = 2,48787E-7$
 2. $d=0.2 \rightarrow MI = 1,23957E-7$

These results are in henries.

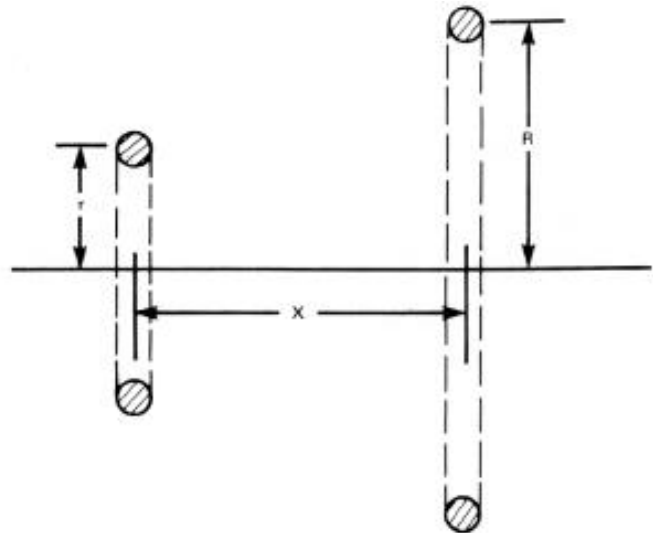

M = mutual inductance of coil pair (henries)

$$= \frac{8\pi \times 10^{-7} \sqrt{rR}}{k} \left[\left(1 - \frac{k^2}{2}\right) K - E \right]$$

where

$$k^2 = m = \frac{4rR}{[(R+r)^2 + x^2]}$$

Complete elliptic integrals of the first and second kind are

$$E(m) = \int_0^{\pi/2} \sqrt{1 - m \sin^2 \theta} \, d\theta$$

$$K(m) = \int_0^{\pi/2} \frac{d\theta}{\sqrt{1 - m \sin^2 \theta}}$$

(Second) Debye Function. { DEBYE }

The First and Second Debye functions are defined by the expressions below:

$$D_n^{(1)}(x) = \int_0^x \frac{t^n}{e^t - 1} dt \qquad D_n^{(2)}(x) = \int_x^\infty \frac{t^n}{e^t - 1} dt$$

These functions are named in honor of Peter Debye, who came across them (with $n = 3$) in 1912 when he analytically computed the heat capacity of what is now called the Debye model.

The formula used for the second function, for n positive integers and $X > 0$ is:

$$D_n^{(2)}(x) = \int_x^\infty \frac{t^n}{e^t - 1} dt = \sum_{k=1}^{\infty} e^{-kx} \left[\frac{x^n}{k} + \frac{n x^{n-1}}{k^2} + \frac{n(n-1)x^{n-2}}{k^3} + \dots + \frac{n!}{k^{n+1}} \right]$$

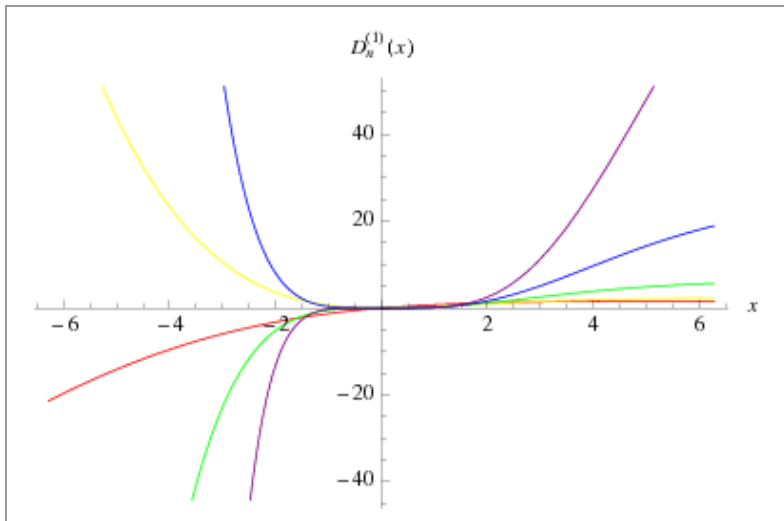

Stack	Input	Output
Y	n	n
X	x	db(n,x)
L	-	x

DEBYE is now implemented as a MCODE function that uses the same algorithm developed by JM Baillard in his FOCAL program (see: <http://hp41programs.yolasite.com/debye.php>)

Therefore no data registers are needed, but ALPHA is used for scratch. The original argument x is preserved in LASTX, and the order n is left in Y – so you can chain calculations with other arguments. Note that the convergence is relatively slow so it'll take its time to come up with the result. You can press any key at any time to abort the calculations.

Example:

3 ENTER ^, 0.7 , ΣF\$ "DEBYE" -> DB(0.7 ; 3) = 6.406833597

Alternatively: [ΣFL], [O], [SHIFT], [Y] using the main launcher instead

Note: The sum of both integrals is a possible (albeit indirect and not trivial) way to calculate the first Debye function with the aid of the Riemann Zeta function:

$$D_n^{(1)}(x) + D_n^{(2)}(x) = \int_0^\infty \frac{t^n}{e^t - 1} dt = n! \zeta(n + 1),$$

Dawson Integral. { **DAWSON** }

The Dawson function or Dawson integral (named for John M. Dawson) is either:

$$F(x) = D_+(x) = e^{-x^2} \int_0^x e^{t^2} dt$$

or:

$$D_-(x) = e^{x^2} \int_0^x e^{-t^2} dt.$$

DAWSON computes F(x) by a series expansion:

$$F(x) = e^{-x^2} [x + x^3/3 + x^5/(5*2!) + x^7/(7*3!) +]$$

The figures below show both functions in graphical form:

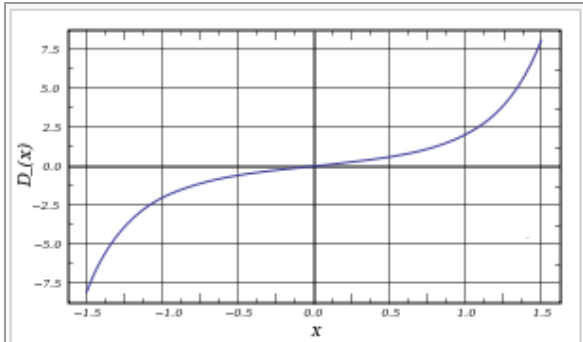
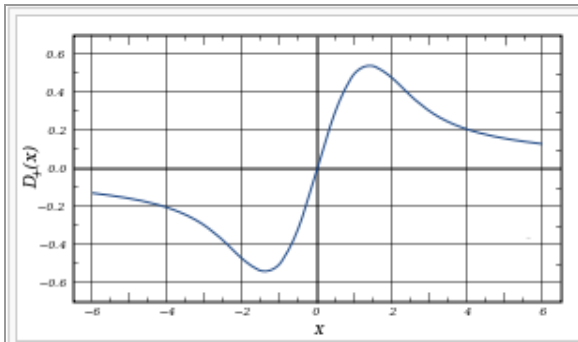

Here as well this function is fully implemented as a MCODE routine, which mimics the same algorithm used by JM Baillard in his excellent FOCAL routine (see: <http://hp41programs.yolasite.com/dawson.php>)

Stack	Input	Output
X	x	D+(x)
L	-	x

Examples:

```
1.94, ΣF$ "DAWSON" -> F(1.94 ) = 0.3140571659
10, ΣFL, [, ] -> F(10) = 0.05025384716
15, ΣFL, [, ] -> F(15) = 0.03340790676
```

For x > 15 , there will be an OUT OF RANGE condition.

For large arguments the execution is rather slow, taking a couple of seconds even with TURBO mode on V41 - so be patient! – Pressing any key will abort the execution as usual.

Regularized Generalized Hypergeometric Function { **HGF+** }

In mathematics, a generalized hypergeometric series is a power series in which the ratio of successive coefficients indexed by n is a rational function of n . The series, if convergent, defines a generalized hypergeometric function, which may then be defined over a wider domain of the argument by analytic continuation

We've already described the pivotal role of this function in the multiple ways it's used to calculate many of the special functions – but so far haven't used it by itself. Let's complete the description with a few examples, all taken from JM Baillard web pages as it's already become customary.

The first remark is about the parameter entry. Being a generalized function, *it takes a variable number of arguments*, which are to be stored in the corresponding data registers – starting with R01. The total number of arguments is specified by the function's indexes "m" and "p", as they are provided in the function's name: **mFp**. Besides those, register R00 is reserved for the principal argument "x".

The usage requires m, p, and x in the Stack – in registers Z, Y, and X respectively.

Stack	Input	Output
Z	m	Last k-val
Y	+/- p	1st. term
X	x	mFp

The second remark is the dual character of the implementation: it can compute either the standard or the regularized function (the latter has all the coefficients divided by products of the Gamma function). The option is *indicated by the sign in the second parameter "p", in the Y register*: positive for the standard, and negative for the regularized.

Example1: Calculate ${}_3F_4(1, 4, 7; 2, 3, 6, 5; \pi)$ and ${}_3F_4 \sim (1, 4, 7; 2, 3, 6, 5; \pi)$

1,007, **ΣF\$** "INPUT" -> 1, ENT[^]. 4. ENT[^], 7 ENT[^], 2 ENT[^], 3 ENT[^], 6 ENT[^], 5 ENT[^], R/S

3 ENTER[^], 4 ENTER[^], PI, XEQ "**HGF+**" -> ${}_3F_4(1, 4, 7; 2, 3, 6, 5; \pi) = 1.631019643$

3 ENTER[^], -4 ENTER[^], PI, XEQ "**HGF+**" -> ${}_3F_4 \sim (1, 4, 7; 2, 3, 6, 5; \pi) = 0.0002831631328$

Example 2: Calculate ${}_2F_2(1, 4; -2, -5; 0.1)$

1 STO 01, 4 STO 02, -2 STO 03, -5 STO 04

2 ENTER[^], -2 ENTER[^], 0.1, XEQ "**HGF+**" -> ${}_2F_2 \sim (1, 4; -2, -5; 0.1) = 0.01289656888$

Notes:

- If $m = p = 0$, **HGF+** returns $\exp(x)$
- The function code doesn't check if the series are convergent or not.
- Even when they are convergent, execution time may be prohibitive: press any key to stop
- It first checks that for register R_{m+p} existence
- The SandMath implementation of HGF+ checks for alpha data
- Contents of stack register T is preserved, and saved in register L (LastX)

Hyper-geometric Functions. { HGF , RHGF }

HGF and **RHGF** are the ordinary and the Regularized Hyler-geometric functions. They are a particular case of the Generalized version (see previous page) simply making $p=2$ and $m=1$

The Gaussian or ordinary hypergeometric function ${}_2F_1(a,b;c; z)$ is a special function represented by the hypergeometric series, that includes many other special functions as specific or limiting case. It is defined for $|z| < 1$ by the power series:

$${}_2F_1(a, b; c; z) = \sum_{n=0}^{\infty} \frac{(a)_n (b)_n}{(c)_n} \frac{z^n}{n!}$$

provided that c does not equal $0, -1, -2, \dots$. Here $(q)_n$ is the Pochhammer symbol, which is defined by:

$$(q)_n = \begin{cases} 1 & \text{if } n = 0 \\ q(q+1) \cdots (q+n-1) & \text{if } n > 0 \end{cases}$$

Many of the common mathematical functions can be expressed in terms of the hypergeometric function, or as limiting cases of it. Some typical examples are:

$$\ln(1+z) = z {}_2F_1(1, 1; 2; -z)$$

$$(1-z)^{-a} = {}_2F_1(a, 1; 1; z)$$

$$\arcsin z = z {}_2F_1\left(\frac{1}{2}, \frac{1}{2}; \frac{3}{2}; z^2\right)$$

The relation ${}_2F_1(a,b,c,x) = (1-x)^{-a} {}_2F_1(a, c-b, c; -x/(1-x))$ is used if $x < 0$

The Regularized Hypergeometric function has a similar expression for each summing term, just divided by Gamma of the corresponding Pochhammer symbol plus the index n .

REGISTERS: R01 thru R03. They are to be initialized before executing **HGF** or **RHGF**. R00 is not used.

R01 = a, R02 = b, R03 = c

Stack	Input	Output
X	X < 1	${}_2F_1(a,b,c,x)$

HGF Examples:

- 1.2 STO 01, 2.3 STO 02, 3.7 STO 03
- 0.4 $\Sigma F\$$ "HGF" -> 1.435242953
- 3 ΣFL [,] -> 0.309850661

RHGF Examples:

- 2 STO 01, 3 STO 02, -7 STO 03
- 0.4, $\Sigma F\$$ "RHGF" -> 5353330.290
- 3 ΣFL [,] -> 2128.650875

Regular Coulomb Wave Functions. { RCWF }

In mathematics, a Coulomb wave function is a solution of the Coulomb wave equation, named after Charles-Augustin de Coulomb. They are used to describe the behavior of charged particles in a Coulomb potential and can be written in terms of confluent hypergeometric functions or Whittaker functions of imaginary argument. The Coulomb wave equation is show below:

$$\frac{d^2 w}{d\rho^2} + \left(1 - \frac{2\eta}{\rho} - \frac{L(L+1)}{\rho^2} \right) w = 0$$

where L is usually a non-negative integer. The solutions are called Coulomb wave functions. Putting $x = 2i\rho$ changes the Coulomb wave equation into the Whittaker equation, so Coulomb wave functions can be expressed in terms of Whittaker functions with imaginary arguments. Two special solutions called the regular and irregular Coulomb wave functions are denoted by $F_L(\eta, \rho)$ and $G_L(\eta, \rho)$, and defined in terms of the confluent hypergeometric function by the friendly expression below:

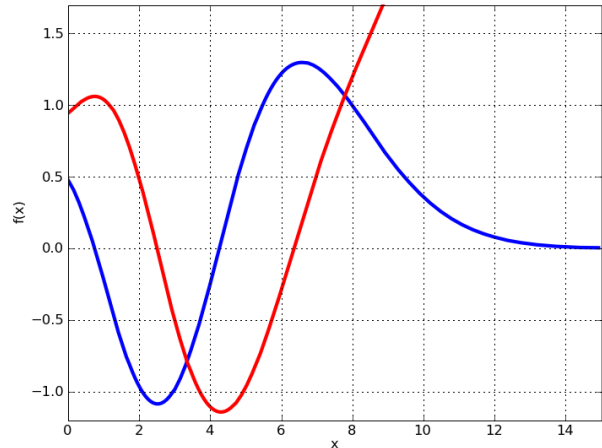

$$F_L(\eta, \rho) = \frac{2^L e^{-\pi\eta/2} |\Gamma(L+1+i\eta)|}{\Gamma(2L+2)} \rho^{L+1} e^{-i\rho} M(L+1-i\eta, 2L+2, 2i\rho)$$

where $M_{k,\mu}$ = Whittaker's function of the 1st kind – which is included in the SandMath, but without support for complex numbers and therefore can't be used for this purpose.

The formulas used instead are as follows: (as per JM Baillard's implementation as usual)

$$F_L(n,r) = C_L(n) r^{L+1} \sum A_k^L(n) r^{k-L-1} ; \text{ for } k > L, \text{ and } L \text{ integer}$$

with $C_L(n) = (1/\Gamma(2L+2)) 2^L e^{-\pi i n/2} |\Gamma(L+1+i n)|$
 and $A_{L+1}^L = 1 ; A_{L+2}^L = n/(L+1) ; (k+L)(k-L-1) A_k^L = 2n A_{k-1}^L - A_{k-2}^L \quad (k > L+2)$

further, we avoid using gamma for complex arguments by replacing the last modulus calculation with the following expressions (based on the reflection formula):

$$|\Gamma(1+iy)|^2 = (\pi \cdot y) / \sinh(\pi y); \text{ and}$$

$$|\Gamma(1+L+iy)|^2 = [L^2 + y^2] [(L-1)^2 + y^2] \dots [1 + y^2] (\pi y) / \sinh(\pi y)$$

The resulting FOCAL program is **RCWF**, which takes as inputs the values for L, n and r placed in the stack registers Z, Y, and X respectively – returning the result into X.

Example: calculate $F(2, 0.7, 1.8)$

2, ENTER^, 0.7, ENTER^, 1.8, **ΣF\$ "RCWF"** -> $F(2, 0.7, 1.8) = 0.141767746$
 or alternatively: **[ΣFL]**, **[H]**, **[SHIFT]**, **[R]** using the main launcher instead.

Note the restrictions imposed on the parameters, which are:

L is a non-negative integer, **n** is real, **r** is non-negative.

Integrals of Bessel Functions. { ITI , ITJ }

One of the usual approaches is to use the following recurrent relations for the calculation

$$\int_0^x J_\nu(t) dt = 2 \sum_{k=0}^{\infty} J_{\nu+2k+1}(x),$$

With $\text{Re}(n) > 0$. More specifically, for positive integer orders $n=1,2,\dots$ we have

$$\int_0^x J_{2n}(t) dt = \int_0^x J_0(t) dt - 2 \sum_{k=0}^{n-1} J_{2k+1}(x),$$

and also

$$\int_0^x J_{2n+1}(t) dt = 1 - J_0(x) - 2 \sum_{k=1}^n J_{2k}(x),$$

There's however another approach based (yes, here as well!) on the Generalized Hypergeometric function **HGF+**. In fact the applicability of this method extends to the Integro-Differential forms of the Bessel functions, and so could be used to calculate second primitives or derivatives as well.

The expressions used in the SandMath for functions **ITJ** and **ITI** are as follows:

$$D^\mu I_n(x) = K x^{n-\mu} \Gamma(n+1) {}_2F_3[(n+1)/2, (n+2)/2; (n+1-\mu)/2, (n+2-\mu)/2, n+1; x^2/4]$$

$$D^\mu J_n(x) = K x^{n-\mu} \Gamma(n+1) {}_2F_3[(n+1)/2, (n+2)/2; (n+1-\mu)/2, (n+2-\mu)/2, n+1; -x^2/4]$$

Where $K = 2^{\mu-2n} \text{sqrt}(\pi)$; and $\mu = -1$ for the integral (primitive)

in case you don't believe such a convenience, take a look at this WolframAlpha's link:
<http://www.wolframalpha.com/input/?i=integrate+%28besselI%28n%2Cx%29%29>

$$\int J_n(x) dx = 2^{-n-1} x^{n+1} \Gamma\left(\frac{n+1}{2}\right) {}_1\tilde{F}_2\left(\frac{n+1}{2}; n+1, \frac{n+3}{2}; -\frac{x^2}{4}\right) + \text{constant}$$

$$\int I_n(x) dx = 2^{-n-1} x^{n+1} \Gamma\left(\frac{n+1}{2}\right) {}_1\tilde{F}_2\left(\frac{n+1}{2}; n+1, \frac{n+3}{2}; \frac{x^2}{4}\right) + \text{constant}$$

Nothing short of magical if you ask me – what I'd call “going out with a bang”.

A few examples: (note the convenient usage of the LASTF feature for repeat executions of the same function.)

- 1.4 ENTER^, 3, **ΣF\$ "ITJ"** -> §|0,3 J(1.4,x).dx = 1.049262785
- 1.4 ENTER^, 3, **ΣF\$ "ITI"** -> §|0,3 I(1.4,x).dx = 2.918753200
- 1 ENTER^, 3, **ΣF\$ "ITJ"** -> §|0,3 J(1,x).dx = 1.260051955
- 0 ENTER^, 10, **ΣFL [,]** -> §|0,10 J(0,x).dx = 1.067011304
- 50 ENTER^, 30, **ΣFL [,]** -> §|0,30 J(50,x).dx = 1.478729947 E-8

Browsing the web for graphics of the integrals of Bessel functions returned no matches, so just for kicks I decided to do my own using the SandMath functions and Excel. The results are shown below for the first three integer order Bessel J functions:

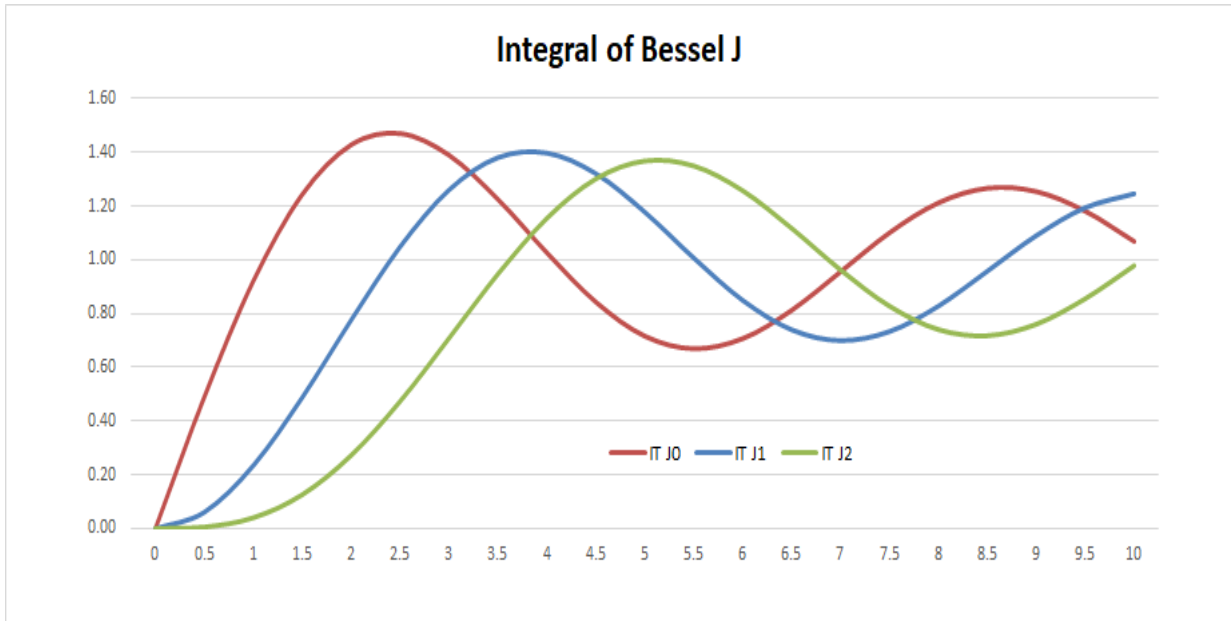

Perhaps not surprisingly we encounter the same pattern in the integrals as in the functions themselves, quite interesting to say the least...

X	IT J0	IT J1	IT J2
0	0.00000000	0.00000000	0.00000000
0.5	0.489680507	0.061530193	0.005143591
1	0.91973041	0.234802314	0.039629239
1.5	1.241449515	0.488172328	0.125576499
2	1.425770294	0.776109221	0.272320678
2.5	1.467980945	1.048383777	0.473792740
3	1.387567252	1.260051955	0.709449335
3.5	1.223305739	1.380127740	0.948550684
4	1.02473416	1.397149811	1.156820817
4.5	0.841862548	1.320542508	1.303983413
5	0.715311922	1.177596771	1.370470193
5.5	0.668914501	1.006843869	1.351790928
6	0.70622122	0.849354743	1.259588941
6.5	0.811476725	0.739905397	1.119159329
7	0.954640318	0.699920731	0.964005960
7.5	1.099171432	0.733660334	0.828674565
8	1.210746828	0.828349157	0.741474144
8.5	1.26494805	0.958060677	0.718704064
9	1.252266495	1.090333634	0.761642969
9.5	1.179441981	1.193928662	0.856912965
10	1.067011317	1.245935512	0.980065964

Appendix 12- Looking for Zeros.

Once again we're just connecting the dots: here's a brute-force crude implementation of a root finder for Bessel functions, made possible once the major task (i.e. calculating the function value) is reduced to a single MCODE function.

The following trivial-looking program (it really can't get any simpler!) uses SOLVE within the Advantage Pack (or **FROOT** in the SandMath), no less. Starting with zero, obvious guess values are the previous root and the root incremented by one. Successive repetitions will unearth all those roots; just make sure you have the "turbo" mode enabled on V41 (or equivalent emulator). Enjoy!

The first few roots $j(n,k)$ of the Bessel function $J_n(x)$ are given in the following table for small nonnegative integer values of n and k

See also: <http://cose.math.bas.bg/webMathematica/webComputing/BesselZeros.jsp>

1	LBL "ITJBS"	
2	X<>Y	
3	STO 00	
4	X<>Y	
5	0	
6	X<>Y	
7	"JB"	
8	INTEG	
9	RTN	
10	LBL "JZER"	
11	-HL MATH	"Order=?"
12	STOP	
13	STO 00	
14	0	
15	LBL 00	←
16	RPLX	
17	3	
18	+	
19	"JB"	
20	SOLVE	
21	STOP	
22	INCX	
23	GTO 00	←
24	LBL "JB"	
25	RCL 00	
26	X<>Y	
27	JBS	
28	END	

k	$J_0(x)$	$J_1(x)$	$J_2(x)$	$J_3(x)$	$J_4(x)$	$J_5(x)$
1	2.4048	3.8317	5.1356	6.3802	7.5883	8.7715
2	5.5201	7.0156	8.4172	9.7610	11.0647	12.3386
3	8.6537	10.1735	11.6198	13.0152	14.3725	15.7002
4	11.7915	13.3237	14.7960	16.2235	17.6160	18.9801
5	14.9309	16.4706	17.9598	19.4094	20.8269	22.2178

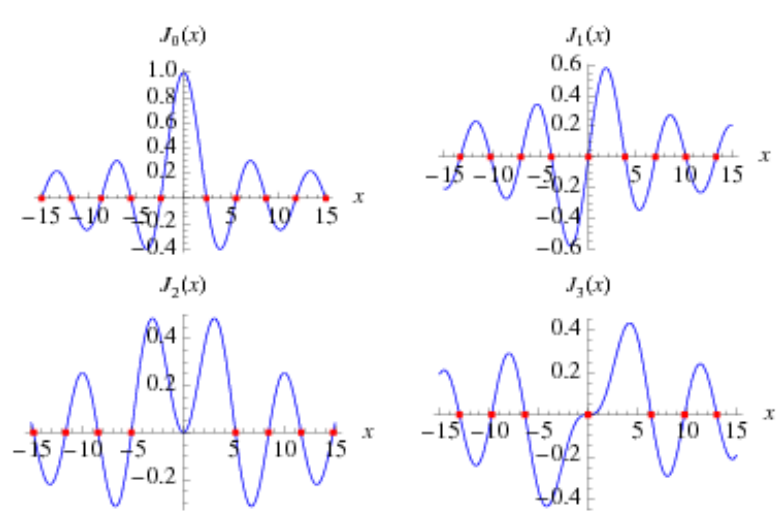

Note that the program listing also includes code to calculate the Integral of **JBS**, defined as incomplete function with the argument in the upper integration limit. Granted it isn't the fastest one in town but such isn't an issue on a modern-day emulator, and the economy of code cannot be stronger!

$$\int_0^x J_0(t) dt \qquad \int_0^x J_1(t) dt = 1 - J_0(x) \qquad \int_0^x J_n(t) dt$$

Which allegedly satisfies the equation: $\int_0^x J_n(t).dt = 2 (J_{n+1}(x) + J_{n+3}(x) + J_{n+5}(x) + \dots)$

3.7. SOLVE & INTEG

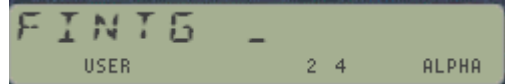

3.7.1. Functions description and examples.

Last but not least (what an understatement in this case) let's go with a bang: welcome to the bank-switched implementation of Solve and Integrate. Chances are that if you're reading this you're already familiar with SOLVE and INTEG, from the Advantage Pac module – needless to say this is about the same functions, so we won't get into a lengthy discussion on the functions methodology and attributes - both are assumed to be already known to you

	Function	Description	Comments
	FROOT	Calculates roots of $f(x)$ in an interval	Same as SOLVE
	FINTG	Calculates the integral of $f(x)$ between limits	Same as INTEG
	FLOOP	Auxiliary function for control	In Auxiliary FAT
	SIRTN	Auxiliary function for control	In hidden FAT (bank-3)

FROOT will attempt to obtain a real root for the function in an interval defined by the values in $[Y, X]$, and **FINTG** will numerically calculate the definite integral of a function $f(x)$ between the integration limits defined in registers Y (lower limit) and X (upper limit). In both cases the function needs to be programmed in a FOCAL program, and its global LBL name needs to be in ALPHA when **FROOT** or **FINTG** are executed in program mode.

Note that this means it won't work for mainframe or MCODE functions from plug-in ROMS, which will need a dummy user code program to "host" them. Also note that – contrary to the original SOLVE and INTEG -, on the SandMath implementation these functions will prompt for the program name when executed in RUN mode. ALPHA will be turned on automatically for convenience.

Let's see a couple of examples. The first one should be a repeat of the exercise from previous appendix, now using this version of the functions. Be aware that the execution time will be long, but that's an acid test for the operation – being a nested example of both.

For a second example refer to appendix in page 107 to calculate the Fourier coefficients for an explicit function, $f(x)$. Now this is what closes the circle :-)

Example. Calculate the roots of Digamma and Exponential integral functions.

Nothing can be easier than writing this trivial program:

```

01 LBL "PSI2"
02 PSI
03 RTN
04 LBL "EI2"
05 EI
06 END
    
```

Enter the values 1, ENTER^, 5, then execute **FROOT**. – typing the program name in ALPHA at the prompt: XEQ [ALPHA] "FROOT", [ALPHA], "PSI2", [ALPHA] or: XEQ "FROOT", [ALPHA], "EI2", [ALPHA]

The corresponding solutions (in FIX 9) are as follows:

X = 1.461632145 for PSI, and
X = 0.372507411 for Ei

Example. Calculate the root of the Kepler equation for $E = 0.2$ and $m=0.8$
 The equation is: $x - E \sin x = m$

Programmed as follows, assuming E is in R01 and m in R00 data registers:

```

01 LBL "KPLR"           input data: 0,2 STO 01, 0.8 STO 00
02 RAD                 input interval [0,1] in YX
03 SIN                 XEQ "FROOT" "KPLR" -> 0.964333888
04 RCL 01
05 *
06 -
07 RCL-                (subtracts R00)
08 END
    
```

Example. Write a program to calculate Bessel J using the formula:

$$J_n(x) = \frac{1}{\pi} \int_0^\pi \cos(n\tau - x \sin \tau) d\tau.$$

1	LBL "JYX"	12	LBL "*JN"
2	STO 01	13	RAD
3	X<>Y	14	RCL 00
4	STO 00	15	*
5	"*JN"	16	X<>y
6	0	17	SIN
7	PI	18	RCL 01
8	FINTG	19	*
9	PI	20	-
10	/	21	COS
11	RTN	22	END

Which won't compete for the speed award compared with the SandMath **JBS** function, but besides illustrating the example note that it returns more accurate results for large orders and arguments (as discussed in the Bessel functions section).

Example.- **J(50, 50) = 0.121409022**

Correct to the 9th decimal place as can be seen using WolframAlpha's result:
0.1214090218976150638201083836782773998739591421282135

Note that the iterative function **JNX1** can also be used for this calculation, yielding the exact same result in a comparable execution time:

50, ENTER^, **ΣFL\$** "JNX1" => 0.121409022

Note2: another approach for large arguments utilizes continued fractions, combining real and complex cases for the calculation. Refer to the "Advantage Math" Module for details on that method.

Programming Highlights: MCODE Cathedrals.

Often when visiting a landmark or a commemorative building we feel the imposing presence of something that's bigger than what any possible description could convey, and we proceed tip-toeing, speaking in whispers not to disturb the spirit of its creators... this is exactly how I felt about the addition of the **SOLVE** and **INTEG** "cathedral of MCODE" to the SandMath.

Leaving their mathematical prowess and attributes aside - as tremendous as they are - the housekeeping chores and implementation on the 41 platform are nothing short of spectacular. The original programmers - we are told - adapted the already-existing code from the HP-15C, but they had to overcome a couple of real challenges to port it smoothly into the 41 platform. Possibly the 15C also required similar trickery, but I don't know its internal architecture so I can't say.

The first striking thing is of course being able to return to an MCODE code stream after executing a user code program (FOCAL) - which calculates $f(x)$. That alone can leave you thinking - as it did to me, suspecting the hows and the abouts being explained somehow by **SIRTN** and **SILOOP**, the two auxiliary functions written for this purpose. - Yet how did they exactly work? We need to understand the buffer-14 paradigm before we can answer this.

Yes, there's the question of Buffer-14, the dedicated buffer in the Advantage that exhibits a rather idiosyncratic temperament: contrary to all other modules, the Advantage seems to be on a "search and destroy" mission, with the apparent aim to kill any previous existence of the buffer, judging by the polling events `CALC_OFF` and `IO_SRVC`.

Equally intriguing is the location of said buffer, which is situated (while it's allowed to exist) below the Key assignments area - and not above it as it's the normal way. This fact conflicts with the OS routines that manage the I/O area, like `[PKIOAS]` and others, and would create real havoc if it weren't because the Advantage manages the buffer dynamically, creating it on-the-fly just when the execution starts, and killing it upon termination. So as far as the rest of the machine is concerned (OS included), it is as if buffer-14 had never existed!

But why all that hassle, you'd ask? Couldn't they have used the normal approach to hold whatever data that needed to be stored in a standard-type buffer, like every other implementation does? I believe the reason was to have an absolute location for the buffer registers: with the starting location for buffer-14 always being `0x0C0` (192 dec) the access and retrieval of the values stored there becomes a much easier affair, just using their fixed "register numbers". This may have made using the 15C algorithms simpler, and avoids altogether the relative addressing problem present when the buffers are placed in their "regular" space (which incidentally I became very aware of while writing the 41Z complex stack buffer implementation).

However one of the implications of wedging a buffer below the key assignments area is that the code would first need to move them all - as well as all other buffers already present - up in memory, to make room for the newcomer. And conversely, this will have to be undone upon termination of the function execution.

Now you can imagine the housekeeping chores required, and the intricacies of the implementation in the code. That's why the `IO_SRVC` event is constantly checking for the presence of buffer-14, proceeding to its removal if found at a non-suitable time.

Let's add to this mounting MCODE nightmare the requirement that both **SOLVE** and **INTEG** would work in a nested way, which is something that the code will only discover having already created the buffer for the first function - so the buffer would potentially have to be resized on the fly, not losing any previous information already contained.

And adding insult to injury, welcome to the parallel dimension of bank-switching: imagine now attempting to do all that from within an auxiliary bank (say bank-3), which when activated would not know a thing about the main one (little details like the FAT, etc); so it's there to live and die by its own sword. Case in point being: what if the function $f(x)$ to solve or integrate contains functions available within the same module, how then could they be found?

Well at least this one has an easy answer: **bank-1 needs to be the active one while the FOCAL program runs**, thus obviously the main FAT is also there and all will work out. So provided we can identify the exact points in the code where the execution is transferred to the FOCAL label we'd be home free, or would we? But beware, because then not only the MCODE execution needs to be resumed (how it does it is still pending clarification), but it'll also have to re-activate bank-3 as the very first thing it does.

Buffer-14 comes to the rescue.- Say there are two auxiliary functions, one of them **SIRTN** is sought for during the initialization, and its address is placed in the RPN return stack, just above the other address for the global LBL that calculates $f(x)$. This will ensure that **SIRTN** will run after LBL $f(x)$ is finished, ok so we've got control back – what to do with it? Say now that the second auxiliary function **SILOOP** is the very first (and only) line in **SIRTN**, that'll send the execution back to our MCODE – way to go, but this is a new function that has no recollection of the past or knows nothing about whatever was done before, unless...

Unless of course **we use the buffer as data structure to do the parameter passing!** Isn't this brilliant? Yes of course, that's the answer: **SILOOP** will retrieve from buffer-14 the necessary information to resume, picking up exactly where it was left off prior to calling LBL $f(x)$. Mind you, it'll also have to make sure things are as expected when it "wakes up": is the buffer there, which function was run (SOLVE or INTEG), and react adequately if some of the information is not there. This can happen if a user programs **SILOOP** unadvertingly, of course (although they could have made it non-programmable I suspect they didn't care anyway).

The last touch of sophistication to speed up things was to also store the addresses of both LBL $f(x)$ and **SIRTN** in the buffer itself, thus there's no need to search for them in every iteration of the solution; and we know there may be from several to many depending of the difficulty of the function. Consider that the OS routine [ASRCH] is used to locate them both, and it's a sequential search: first RAM for LBL $f(x)$, then ROM – and there may be several plugged in.

You no doubt have noticed that in the SandMath there are only three functions related to this: **FROOT**, (not so fruity :-), **FINTG**, and **FLOOP** (the fluppy one :-) – which sure correspond to **SOLVE**, **INTEG**, and **SILOOP**. But what about the whereabouts of **SIRTN**? No, it's not one of the section headers - already used for other purposes- , and nor is it in the secondary FAT (that'd be impossible to pull off) – fortunately this is one of the added pluses of going bank-switched: **SIRTN** is in the FAT of bank-3 , all by itself so it'll be found while [ASRCH] is called from the MCODE... all that extra work payed off and so we saved a precious FAT entry in the main FAT.

All in all, a stroke of genius - with all the ingredients of a work of art if you ask me. So I feel especially glad to finally have cracked this nut and managed to include it in the SandMath; the yellow ribbon around the box. Hope this dissertation wasn't too boring, and that you enjoy it at least as much as I did working on it.

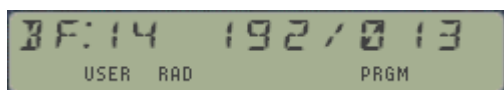

, as created by FROOT

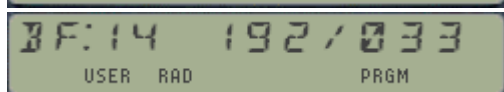

, as created by FINTG.

(*) To see this by yourself: insert function **BFCAT** in the LBL $f(x)$, then stop the enumeration.

Appendix 13.- His master's voice (or text).-

The following excerpts are taken from the Advantage Manual, pages 61-66. Just replaced SOLVE with FROOT (and INTEG with FINTG) and we're all set. Besides the Advantage Pac manual and the "HP-15C Advanced Functions Handbook" as obvious first references, most recommended reading is the description of **IG** and **SV** in the PPC_ROM users' manual – with a thorough description of the methodology and plenty of examples to try your hand and test the functions.

Finding the roots of an equation $f(x) = 0$.

The FROOT program finds the roots of an equation of the form $f(x)=0$, where x represents a real root. Note that any equation with one variable can be expressed in this form.

For example. $f(x) - a$ is equivalent to $f(x) - a = 0$. and $f(x) = g(x)$ is equivalent to $f(x) - g(x) = 0$

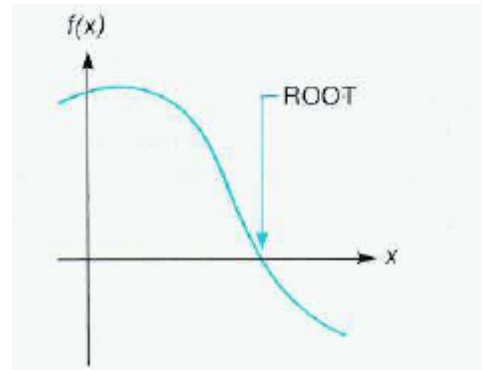

Method.

FROOT normally uses the secant method to iteratively find and test x values as potential roots. It takes the program several seconds to several minutes to do this and produce a result.

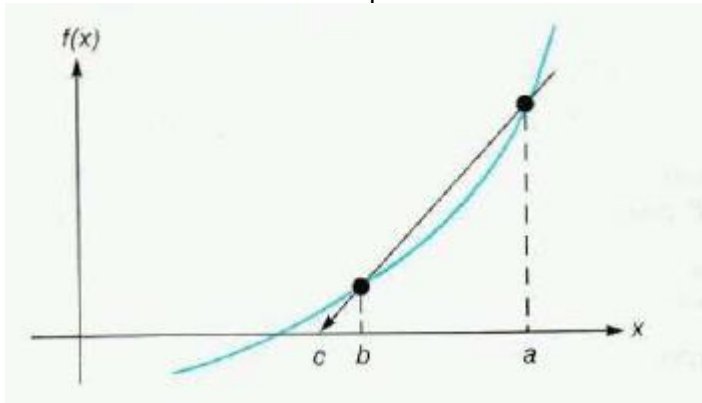

If c isn't a root, but $f(c)$ is closer to zero than $f(b)$, then b is relabeled as a , c is relabeled as b , and the prediction process is repeated. Provided the graph of $f(x)$ is smooth and provided the initial values of a and b are close to a simple root, the secant method rapidly converges to a root.

If the calculated secant is nearly horizontal, then FROOT modifies the secant method to ensure that $|c - b| \leq$

$100 |a - b|$. (This is especially important because it also reduces the tendency for the secant method to go astray when rounding error becomes significant near a root.)

If FROOT has already found values a and b such that $f(a)$ and $f(b)$ have opposite signs, it modifies the secant method to ensure that c always lies within the interval containing the sign change. This guarantees that the search interval decreases with each iteration, eventually finding a root. If this does not yield a root, FROOT fits a parabola through the function values at a , b , and c , and finds the value d at the parabola's maximum or minimum, The search continues using the secant method, replacing a with d .

If three successive parabolic fits yield no root or $d = b$, the calculator displays "NO". In the X- and Z- registers remain b and $f(b)$, respectively, with a or c in the Y -register. At this point you could: resume the search where it left off, direct the search elsewhere, decide that $f(b)$ is negligible so that $x = b$ is a root, transform the equation into another equation easier to solve, or conclude that no root exists,

Instructions.

In calculating roots, FROOT repeatedly calls up and executes a program that you write for evaluating $f(x)$. You must also provide FROOT with two initial estimates for x , providing a range for it to begin its search for the root.

Realistic estimates greatly facilitate the speedy and accurate determination of a root. If the variable x has a limited range in which it is meaningful and realistic as a solution, it is reasonable to choose initial estimates within this range. (Negative roots, for instance, are often unrealistic for physical problems.)

- FROOT requires thirteen unused program registers. If enough spare program registers are not available, FROOT will not run and the error "NO ROOM" results. Execute **PACK** in Program mode to see how many program registers are available.
- Before running FROOT you must have a program (stored in program memory or a plug-in module) that evaluates your function $f(x)$ at zero. This program must be named with a global label. FROOT then iteratively calls your program to calculate successively more accurate estimates of x . Your program can take advantage of the fact that FROOT fills the stack with its current estimate of x each time it calls your program.
- You then enter two initial estimates for the root, a and b , into the X and Y -registers. Lastly put the name of your program (that evaluates the function) into the Alpha register and then XEQ "FROOT".

When the program stops and the calculator displays a number, the contents of the stack are:

Z = the value of the function at x - root (this value should be zero!)
Y = the previous estimate of the root (should be close to the resulting root).
X = the root (this is what is shown in the display).

If the function that you are analyzing equals zero at more than one value of x , FROOT stops when it finds anyone of these values. To find additional values, key in different initial estimates and execute FROOT again.

When no root is found.

It is possible that an equation has no real roots. In this case, the calculator displays "NO" instead of a numeric result. This would happen, for example, if you tried to solve the equation $|x| = -1$, which has no solution since the absolute value function is never negative.

There are three general types of errors that stop FROOT from running:

- If repeated iterations seeking a root produce a constant nonzero value for the specified function, the calculator displays "NO".
- If numerous samples indicate that the magnitude of the function appears to have a nonzero minimum value in the area being searched, the calculator displays "NO".
- If an improper argument is used in a mathematical operation as part of your program, the calculator displays "DATA ERROR".

Programming Information.-

You can incorporate FROOT as part of a larger program you create. Be sure that your program provides initial estimates in the X- and Y-registers just before it executes. Remember also that FROOT will look in the Alpha register for the name of the program that calculates your function.

If the execution of FROOT in your program produces a root, then your program will proceed to its next line. If no root results, the next program line will be skipped. (This is the "do if true" rule of HP-41 programming). Knowing this, you can write your program to handle the case of FROOT not finding a root, such as by choosing new initial estimates or changing a function parameter.

FROOT uses one of the six pending subroutine returns that the calculator has; leaving five returns for a program that calls FROOT. Note that FROOT cannot be used recursively (calling itself). If it does, the program stops and displays "RECURSION". You *can* however use FROOT with FINTG, the integration program.

Numerical Integration

The FINTG program finds the definite integral, I , of a function $f(x)$ within the interval bounded by a and b . This is expressed mathematically and graphically as:

$$I = \int_a^b f(x) dx.$$

Executing the FINTG program employs an advanced numerical technique to find the definite integral of a function. You supply the equation for the function (in a program) and the interval of integration, and FINTG does the rest.

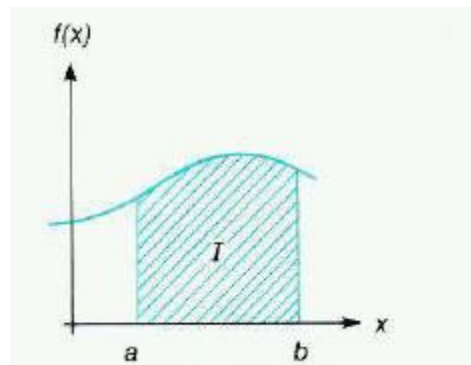

Method.

The algorithm for FINTG uses a Romberg method for accumulating the value of an integral. The algorithm evaluates $f(x)$ at many values of x between the limits of integration. It takes the program from several seconds to several minutes to do this and produce a result.

Several refinements make the algorithm more effective. For instance, instead of using uniformly spaced samples, which can induce a kind of resonance producing misleading results when the integrand is periodic, FINTG uses samples that are spaced nonuniformly. Another refinement is that FINTG uses extended precision (13 significant digits) to accumulate the internal sums. This allows thousands of samples to be accurately accumulated, if necessary.

A calculator using numerical integration can almost never calculate an integral precisely. However, there is a convenient way for you to specify how much error is tolerable. You can set the display format according to how many figures are accurate in the integrand $f(x)$. A setting of FIX 2 tells the calculator that decimal digits beyond the second one can't matter, so the calculator need not waste time estimating the integral with unwarranted precision. Refer to the heading, "Accuracy of FINTG".

Instructions.

In calculating integrals, FINTG repeatedly executes a program that you write for evaluating $f(x)$. You must also provide FINTG with two limits for x , providing an interval of integration.

- FINTG requires 32 unused program registers. If enough spare program registers are not available, FINTG will not run and the error NO ROOM results. Execute PACK in Program mode to see how many program registers are available.
- Before running FINTG you must have a program (stored in program memory or a plug-in module) that evaluates your function $f(x)$. This program must be named with a global label. * Your program can take advantage of the fact that FINTG fills the stack with its current estimate of x each time it calls your program.
- You then enter the two limits, a and b , into the X- and Y -registers. Lastly put the name of your program (that evaluates the function) into the Alpha register and then XEQ "FINTG".

When the program stops and the calculator displays the integral, the contents of the stack are:

- T** - the lower limit of the integration, a.
- Z** - the upper limit of the integration, b.
- Y** - the uncertainty of the approximation of the integral.
- X** - the approximation of the integral (this is what is shown in the display).

Accuracy of FINTG.

Since the calculator cannot compute the value of an integral exactly, it approximates it. The accuracy of this approximation depends on the accuracy of the integrand's function itself as calculated by your program. While in integrals of functions with certain characteristics such as spikes or rapid oscillations might be calculated inaccurately, these functions are rare.

This is affected by round-off error in the calculator and the accuracy of empirical constants. To specify the accuracy of the function, set the display format (FIX n, SCI n, or ENG n) so that n is no greater than the number of decimal digits that you consider accurate in the function's values. If you set n smaller, the calculator will compute the integral more quickly, but it will also presume that the function is accurate to no more than the number of digits shown in the display format. FIX and ENG determine an uncertainty in the function that is proportional to the function's magnitude, while SCI determines an uncertainty that is independent of the function's magnitude.

At the same time that the FINTG program returns the resulting integral to the X-register (the display), it returns the Uncertainty of that approximation to the Y-register. To view this uncertainty value, press X<>Y. No algorithm for numerical integration can compute the exact difference between its approximation and the actual integral. But this algorithm estimates an upper bound on this difference, which is returned as the uncertainty of the approximation.

If the uncertainty of an approximation is greater than what you choose to tolerate, you can decrease it by specifying more digits in the display format and rerunning FINTG.

Programming Information.

You can incorporate FINTG as part of a larger program you create. Be sure that your program provides upper and lower limits in the X- and Y-registers just before it executes FINTG. Remember also that INTEG will look in the Alpha register for the name of the program that calculates your function.

FINTG uses one of the six pending subroutine levels available in the calculator, leaving five returns for a program that calls FINTG. Note that FINTG cannot be used recursively (calling itself). If it is, the program stops and displays "RECURSION". You can use FINTG with FROOT. A routine that combines both FINTG and FROOT requires 32 available program registers to operate.

Appendix 14.- CUDA Rational Approximations for ierf(x).

1. Single-Precision

```

//
// auto-generated by erfinv_SP_approx.m on 21-Jun-2010 10:54:10
//

__inline__ __device__ float MBG_erfinv(float x)
{
    float w, p;

    w = -_logf((1.0f-x)*(1.0f+x));

    if ( w < 5.000000f ) {
        w = w - 2.500000f;
        p = 2.81022636e-08f;
        p = 3.43273939e-07f + p*w;
        p = -3.5233877e-06f + p*w;
        p = -4.39150654e-06f + p*w;
        p = 0.00021858087f + p*w;
        p = -0.00125372503f + p*w;
        p = -0.00417768164f + p*w;
        p = 0.246640727f + p*w;
        p = 1.50140941f + p*w;
    }

    else {

        w = sqrtf(w) - 3.000000f;
        p = -0.000200214257f;
        p = 0.000100950558f + p*w;
        p = 0.00134934322f + p*w;
        p = -0.00367342844f + p*w;
        p = 0.00573950773f + p*w;
        p = -0.0076224613f + p*w;
        p = 0.00943887047f + p*w;
        p = 1.00167406f + p*w;
        p = 2.83297682f + p*w;

    }

    return p*x;
}

```

2. Double-precision

```
//
// auto-generated by erfinv_DP_approx.m on 21-Jun-2010 11:07:08
//

    __inline__ __device__ double MBG_erfinv(double x)

{
    double w, p;

    w = - log((1.0-x)*(1.0+x));

    if ( w < 6.250000 ) {
        w = w - 3.125000;
        p = -3.6444120640178196996e-21;
        p = -1.685059138182016589e-19 + p*w;
        p = 1.2858480715256400167e-18 + p*w;
        p = 1.115787767802518096e-17 + p*w;
        p = -1.333171662854620906e-16 + p*w;
        p = 2.0972767875968561637e-17 + p*w;
        p = 6.6376381343583238325e-15 + p*w;
        p = -4.0545662729752068639e-14 + p*w;
        p = -8.1519341976054721522e-14 + p*w;
        p = 2.6335093153082322977e-12 + p*w;
        p = -1.2975133253453532498e-11 + p*w;
        p = -5.4154120542946279317e-11 + p*w;
        p = 1.051212273321532285e-09 + p*w;
        p = -4.1126339803469836976e-09 + p*w;
        p = -2.9070369957882005086e-08 + p*w;
        p = 4.2347877827932403518e-07 + p*w;
        p = -1.3654692000834678645e-06 + p*w;
        p = -1.3882523362786468719e-05 + p*w;
        p = 0.0001867342080340571352 + p*w;
        p = -0.00074070253416626697512 + p*w;
        p = -0.0060336708714301490533 + p*w;
        p = 0.24015818242558961693 + p*w;
        p = 1.6536545626831027356 + p*w;
    }

    else if ( w < 16.000000 ) {
        w = sqrt(w) - 3.250000;
        p = 2.2137376921775787049e-09;
        p = 9.0756561938885390979e-08 + p*w;
        p = -2.7517406297064545428e-07 + p*w;
        p = 1.8239629214389227755e-08 + p*w;
        p = 1.5027403968909827627e-06 + p*w;
        p = -4.013867526981545969e-06 + p*w;
        p = 2.9234449089955446044e-06 + p*w;
        p = 1.2475304481671778723e-05 + p*w;
        p = -4.7318229009055733981e-05 + p*w;
        p = 6.8284851459573175448e-05 + p*w;
        p = 2.4031110387097893999e-05 + p*w;
        p = -0.0003550375203628474796 + p*w;
        p = 0.00095328937973738049703 + p*w;
    }
}
```

```

p = -0.0016882755560235047313 + p*w;
p = 0.0024914420961078508066 + p*w;
p = -0.0037512085075692412107 + p*w;
p = 0.005370914553590063617 + p*w;
p = 1.0052589676941592334 + p*w;
p = 3.0838856104922207635 + p*w;

}

else {
w = sqrt(w) - 5.000000;
p = -2.7109920616438573243e-11;
p = -2.5556418169965252055e-10 + p*w;
p = 1.5076572693500548083e-09 + p*w;
p = -3.7894654401267369937e-09 + p*w;
p = 7.6157012080783393804e-09 + p*w;
p = -1.4960026627149240478e-08 + p*w;
p = 2.9147953450901080826e-08 + p*w;
p = -6.7711997758452339498e-08 + p*w;
p = 2.2900482228026654717e-07 + p*w;
p = -9.9298272942317002539e-07 + p*w;
p = 4.5260625972231537039e-06 + p*w;
p = -1.9681778105531670567e-05 + p*w;
p = 7.5995277030017761139e-05 + p*w;
p = -0.00021503011930044477347 + p*w;
p = -0.00013871931833623122026 + p*w;
p = 1.0103004648645343977 + p*w;
p = 4.8499064014085844221 + p*w;

}

return p*x;

}

```

4. System Extensions.

4.1. PROGRAM GENERATOR



This section of the manual is taken from the AECROM Manual, and describes the function **PRGM**.

The Program Generator will translate your algebraic formulas into HP-41 programs. The programs that it produces are normal programs that show up in your CAT 1 listing. You can write them to cards, tape. Extended memory, or any other mass storage media; and you can use these programs as subroutines in other programs. They are in every way, sense, and form a normal HP-41 program.

The only thing unique about the programs that PRGM produces is that they are created from algebraic formulas that YOU supply. With **PRGM**, writing a program to solve an algebraic formula is just a matter of keying in that formula, just like it's written! You don't even have to put your HP-41 into program mode. The PRGM function writes the program and stores it in memory for you to use.

2.8.1. A quick example of PRGM

Example: As a simple first example, use the PRGM function to write a program called "FRUIT" to solve the formula: FRUIT = APPLES + ORANGES

Solution:	Keystrokes	Display
	XEQ "PRGM"	PRGM _ (ALPHA is turned ON automatically)
	F,R,U,I,T, ALPHA	PACKING
		ENTER:FORMULA
	A, [SHIFT], +, [SHIFT], O	A+O
	R/S	ENTER:LBL,CONS.
		A. .=
	A,P,P,L,E,S	A. .=APPLES
	R/S	O. .=
	O,R,A,N,G,E,S	O. .=ORANGES
	R/S	ANS. .=
	F,R,U,I,T	ANS. .=FRUIT
	R/S	PROGRAMMING..
		PACKING
		RUN SIZE>=02

If you get the message "TRY AGAIN", you don't have enough RAM memory space for this small program. You need to either set your SIZE lower, or clear out one or more of the programs you have in your CAT 1 listing.

Running the program: Say that for this problem you have 5 apples and 6 oranges and you want to know the total amount of fruit you have. When "APPLES=?" comes up in the display, press 5, R/S. For "ORANGES=?" press 6, R/S. The calculator will temporarily display "FRUIT=" and then show you the answer: 11,000

2.8.2. A general description

The above formula was simple, to say the least, but the procedure for using the **PRGM** function will be no different when you use it for translating more complicated formulas into programs. The four steps for creating programs using the **PRGM** function are as follows:

1. Execute PRGM and, at the prompt "PRGM _", supply the name for the program that you wish to appear in CAT 1. Note that ALPHA is turned ON automatically for you.
2. Key in the formula correctly (only one side of an equation) using single letters to represent variable names. (Keying in formulas is explained in greater detail below). Press R/S when you're finished.
3. Name the variables and assign values to constants. Press [R/S] after each completed input.
4. If you want the answer to be labeled. key in a name. Press [R/S], and the function writes the program.

The key step in the above four steps is number 2. You have to know a few things about how to correctly key in a formula. What functions are available and how do you key in functions? For example, how do you key in SIN(A)? Well, here are the details of keying in a formula:

When the display shows "ENTER:FORMULA", the keyboard on the HP-41 has been redefined as follows:

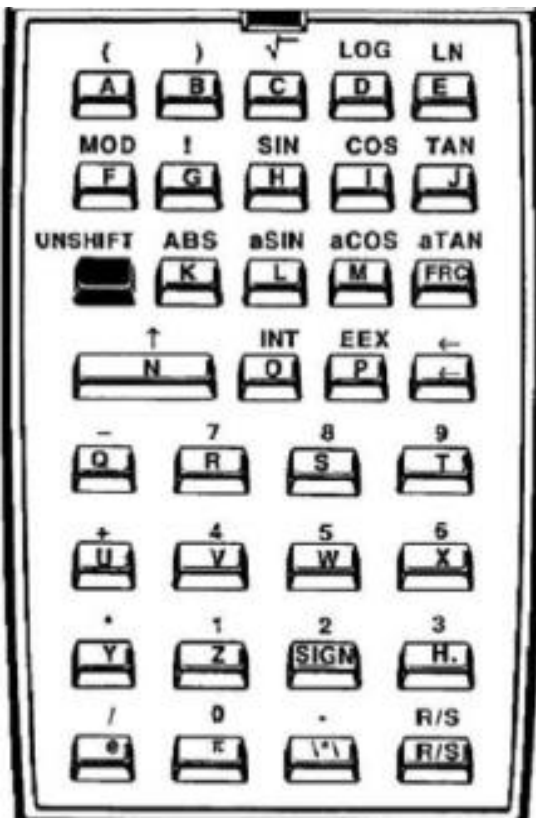

At first glance this keyboard appears very similar to the ALPHA keyboard. The letters are all each assigned to a key. The digits and arithmetic signs are available as shifted versions of the keys on which they're printed. But this keyboard is different from the ALPHA keyboard!

The best way to learn this new keyboard is to work with it. Execute PRGM and, at the prompt "PRGM _" type: T,E,S,T, [ALPHA] or any other name that you choose. The display will show: "ENTER:FORMULA".

Press the [W] key. A "W" comes up in the display. Now clear that away by pressing the back arrow key. Now press [SHIFT][W]. A "5" comes up in the display.

Press the [W] key again. Another "5" comes into the display, Notice that the SHIFT in the display hasn't cancelled. If you want the SHIFT to cancel, you have to press the shift key. This is different from the standard ALPHA keyboard, but it allows you to key in numbers like 5.775 without pressing the [SHIFT] key 5 times.

Press back arrow twice to clear those fives away, then with SHIFT on in the display press the [J] key. The

shifted J brings the TAN function into your formula.

Continue typing to complete the formula **TAN(3A) + 0.75B + C**. As you make mistakes (say what?), you can clear them away using the back arrow key. Refer to the keyboard illustrated above to locate the characters for the above formula. Remember to press the shift key when necessary.

Switching back and forth from the shifted to the un-shifted keyboard may seem a bit awkward at first, but for keying in formulas you'll find this design to be very efficient. Once you get the above formula keyed in correctly, press the back arrow key repeatedly until you cancel the function completely.

This shows you that if you respond to the enter formula prompt by pressing the back arrow you exit the PRGM function. Do not however, press R/S at that prompt - or the calculator will crash (same behavior as with the original AECROM, in case you wonder).

2.8.3. Keying in formulas.

Here are a few things you should notice when you are working through the following example.

1. PRGM accept implicit multiplication. That is, when you key in ABC it assumes you mean A x B x C. this feature reduces the keystrokes required to key in most formulas.
2. After you finish keying in a valid formula, **PRGM** will prompt you with "ENTER:LBL,CONS"; which means you need to name your variables and assign values to any constants. At this point, the keyboard is the same as above, except that any non-character keys (like TAN, SIN, LOG) will be ignored.
3. Up to eight characters can be used to name a variable.

Example: Calculate the volume of a cylinder 4 meters in diameter by 12 meters height.

Create a program that takes the height and diameter of a cylinder and returns its volume. Don't label the answer, but name the program CYLVOL. Make use of the formula for the volume of a cylinder of a known inner-diameter and height: $VOLUME = HEIGHT(\pi DIAM^2 / 4)$

Solution:	Keystrokes	Display
	XEQ "PRGM"	PRGM _
	C,Y,L,V,O,L, ALPHA	PACKING
		ENTER:FORMULA
	[H], [] [(], [], [D], [] [, ^],	H(D^2 π /4)
	2, [], [π], [], [/], 4, [)]	ENTER:LBL,CONS
	R/S	D. .=
	D,I,A,M	D. .=DIAM
	R/S	H. .=
	H,E,I,G,H,T	H. .=HEIGHT
	R/S	ANS. .=
	R/S	PROGRAMMING..
		PACKING
		RUN SIZE>=03

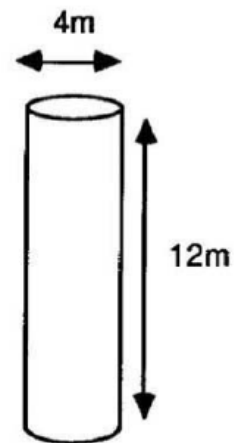

By pressing R/S when the prompt "ANS. .=" comes up in the display, you are telling **PRGM** not to label the answer. The "RUN SIZE>=" prompt tells you how many registers are required to run the program. In this case you have to have at least three data registers available when you run this program.

Applying now the numeric values for this example:

XEQ "CYLVOL" , 4, R/S, 12 R/S -> 150.7964 in FIX 4.

Below is the program listing as created by PRGM. Note the usage of the power function for the square power, more general than X^2. Each variable is internally associated with a data register which will be used in the calculations (so not based in the stack).

Note also that the final output doesn't combine the name of the answer with its value in the display – granted there's some finesse missing but the compromise is largely appropriate, and the methodology used quite impressive to say the least.

01 LBL "CYLVOL	07 STO 01	13 4
02 "DIAM=?"	08 RCL 00	14 /
03 PROMPT	09 2	15 STO 02
04 STO 00	10 Y^X	16 RCL 01
05 "HEIGHT=?"	11 PI	17 RCL 02
06 PROMPT	12 *	18 *

As the answer was left unnamed, the program doesn't include any steps to announce the final output. This would have been located at the end had a name been given to it at the "ANS. .=" step in data entry.

Low priority multiply [/*/]

There is a function located on the radix key that looks like this: /*/. This function is called "low priority multiply". It does the same thing as the multiply function [*], but it is evaluated after the [+] and [-] signs in your formula.

The purpose of low priority multiply is to reduce the number of parentheses in a formula that you key in. It can also save you from having to start all over when you get to the end of keying in a formula and realize that the whole expression needs to be multiplied by some value that otherwise would require the formula to be enclosed in parentheses. The example in the following section shows the use of the low priority multiply function.

Trigonometric and Hyperbolic functions.

The direct and inverse trigonometry functions are easy to locate on the keyboard and are just as easy to use. You simply key them in as you would write them in your formula on paper. Only one keystroke is necessary to key in a trigonometric function.

But, where are the hyperbolics? Yes, these functions (HSIN, HCOS, HTAN and their inverses) were included in the list of SandMath functions. You should be able to use them in your formulas, right? Certainly. Notice that the un-shifted version of the [3] key is the function [H.] - This key is used as a prefix to turn a trigonometric function into a hyperbolic.

Example.- Execute **PRGM**, name it "TEST", and key in the formula: "x * (sinh² a + cosh² b)"

Solution: when the display reads 'ENTER:FORMULA', key in one of the following sets of keystrokes, either will work. Notice how the low priority multiply function /*/ reduces the number of parentheses in the resulting formula.

Set-1: ; 5 times SHIFT, 22 keystrokes in total

[**2**], [(), [SIN], [**2**], [H.], [A], [**2**], [)], [^], [2], [+], [(), [COS], [**2**], [H.], [B], [**2**], [)], [^], 2, [/*/], [X]

Resulting formula: (SINH A)^2 + (COSH B)^2 /*/ X

Set-2: ; 6 times SHIFT, 24 keystrokes in total

[**2**], [(), [(), [SIN], [**2**], [H.], [A], [**2**], [)], [^], [2], [+], [(), [COS], [**2**], [H.], [B], [**2**], [)], [^], 2, [)], [**2**], [X]

Resulting formula: ((SINH A)^2 + (COSH B)^2) * X

Finally, either press R/s to have **PRGM** complete the program, or press the back arrow key repeatedly until the function cancels. Obviously the SandMath needs to be plugged in to execute it properly.

2.8.4. Details of PRGM

PRGM is non-programmable. When you key a formula at the prompt, **PRGM** insists that you follow certain rules. These rules are listed below.

1. The first character in your formula cannot be a right parentheses, MOD, FACT (!), +, *, or /. A minus sign can be used as the unary minus (for example negative 5 can be entered as -5).
2. Constants may be entered either as digits in your formula or during the 'ENTER:LBL,CONS' routine. If you wish to enter constants during the "ENTER:LBL,CONS" routine you need to include them as single letters in the formula.
3. Several functions can be followed by anything except: { +, -, *, /, FACT(!), MOD, and "" }. Those functions are: { "(, SQRT, LOG, LN, MOD, FRC, INT, EEX, ^, +, -, *, /, SIGN, and trigonometric and HYP functions}.
4. These functions (characters in your formula) can be followed by anything: the letters A through Z, e, π , low priority multiply /*/, right parentheses, factorial (!), decimal point, and the digits 1 through 9.

When "ENTER:LBL,CONS" is displayed, up to eight characters can be keyed in to name a variable or to specify the value of a constant. You can choose to leave the single letter as the prompt for the variable (by just pressing R/S), key in a name for that variable, or key in a numeric constant.

If the first character in the name is a number or a plus or minus sign, **PRGM** will take your input as a numeric constant. In a numeric constant the character "E" is used to signify the exponent in scientific notation (1.2E6 means $1,2 \times 10^6$ or 1,200,000). Also, both a comma and a dot are accepted as the radix (1.2 is the same as 1,2, which is also the same as 1,2000 so don't use commas for grouping).

When you execute **PRGM** and get the prompt 'PRGM _', you have to key in a name for the program that is going to be created. You can key in any ALPHA name up to seven characters long. **PRGM** always uses this name as the global ALPHA label at the first line of the program.

If you use the single characters "A" through "J" or "a" through "e", which are commonly used as local ALPHA labels, you will find that PRGM still makes them into global ALPHA labels. They show up in CAT 1, but because the HP-41 expects these single letters to be local ALPHA labels, you can't access them using GTO or XEQ except, perhaps, in a synthetic program line (if you're into that sort of thing). In short, don't use those single letters as program names with **PRGM** unless you enjoy the additional hassle.

Clearing programs,

The programs created by PRGM can be cleared by the same methods that you use to clear any program. The HP-41 function CLP and the extended function PCLPS are dynamite when it comes to clearing programs.

Excerpt taken from the AECROM Brochure:- you gotta love the marketing department! ☺

"Writes its own programs.- Artificial intelligence? Close to it! The AECROM, in conjunction with the HP-41, creates its own programs to solve user-supplied equations... and fast! Simply key in the desired program name and your equation. the AECROM will automatically write the program for you. Efficient, user friendly, error free programs are written for virtually any size equation in seconds. Any number and combination of most HP-41 match functions, in addition to new hyperbolic functions, may be used in your equations".

This completes this manual.

Don't forget to check Jean-Marc Baillard extensive and authoritative references on the web (despite its unassuming web site name), located at: <http://hp41programs.yolasite.com/>

A treasure chest awaits you... enjoy the ride!

