

SUPER  [®]

X9DA7
X9DAE

USER'S MANUAL

Revision 1.1a

The information in this user's manual has been carefully reviewed and is believed to be accurate. The vendor assumes no responsibility for any inaccuracies that may be contained in this document, and makes no commitment to update or to keep current the information in this manual, or to notify any person or organization of the updates. **Please Note: For the most up-to-date version of this manual, please see our Website at www.supermicro.com.**

Super Micro Computer, Inc. ("Supermicro") reserves the right to make changes to the product described in this manual at any time and without notice. This product, including software and documentation, is the property of Supermicro and/or its licensors, and is supplied only under a license. Any use or reproduction of this product is not allowed, except as expressly permitted by the terms of said license.

IN NO EVENT WILL SUPER MICRO COMPUTER, INC. BE LIABLE FOR DIRECT, INDIRECT, SPECIAL, INCIDENTAL, SPECULATIVE OR CONSEQUENTIAL DAMAGES ARISING FROM THE USE OR INABILITY TO USE THIS PRODUCT OR DOCUMENTATION, EVEN IF ADVISED OF THE POSSIBILITY OF SUCH DAMAGES. IN PARTICULAR, SUPER MICRO COMPUTER, INC. SHALL NOT HAVE LIABILITY FOR ANY HARDWARE, SOFTWARE, OR DATA STORED OR USED WITH THE PRODUCT, INCLUDING THE COSTS OF REPAIRING, REPLACING, INTEGRATING, INSTALLING OR RECOVERING SUCH HARDWARE, SOFTWARE, OR DATA.

Any disputes arising between the manufacturer and the customer shall be governed by the laws of Santa Clara County in the State of California, USA. The State of California, County of Santa Clara shall be the exclusive venue for the resolution of any such disputes. Supermicro's total liability for all claims will not exceed the price paid for the hardware product.

FCC Statement: This equipment has been tested and found to comply with the limits for a Class A digital device pursuant to Part 15 of the FCC Rules. These limits are designed to provide reasonable protection against harmful interference when the equipment is operated in a commercial environment. This equipment generates, uses, and can radiate radio frequency energy and, if not installed and used in accordance with the manufacturer's instruction manual, may cause harmful interference with radio communications. Operation of this equipment in a residential area is likely to cause harmful interference, in which case you will be required to correct the interference at your own expense.

California Best Management Practices Regulations for Perchlorate Materials: This Perchlorate warning applies only to products containing CR (Manganese Dioxide) Lithium coin cells. "Perchlorate Material-special handling may apply. See www.dtsc.ca.gov/hazardouswaste/perchlorate".

WARNING: Handling of lead solder materials used in this product may expose you to lead, a chemical known to the State of California to cause birth defects and other reproductive harm.

Manual Revision 1.1a

Release Date: April 23, 2014

Unless you request and receive written permission from Super Micro Computer, Inc., you may not copy any part of this document.

Information in this document is subject to change without notice. Other products and companies referred to herein are trademarks or registered trademarks of their respective companies or mark holders.

Copyright © 2014 by Super Micro Computer, Inc.

All rights reserved.

Printed in the United States of America

Preface

This manual is written for system integrators, PC technicians and knowledgeable PC users. It provides information for the installation and use of the X9DA7/X9DAE motherboard.

About This Motherboard

The Super X9DA7/X9DAE motherboard supports dual Intel E5-2600(v2) Series Processors (Socket R LGA 2011) that offer QPI (Intel QuickPath Interface) Technology (V.1.1), providing point-to-point connection with a transfer speed of up to 8.0 GT/s. With the C602 chipset built in, the X9DA7/X9DAE motherboard provides support for Intel® Management Engine (ME), Rapid Storage Technology, Digital Media Interface (DMI), PCI-E Gen. 3.0, and up to 1866 MHz DDR3 memory, greatly enhancing system performance for high-end workstations. Please refer to our Website (<http://www.supermicro.com>) for processor and memory support updates.



Note: E5-4600v2 processor support is available when the latest BIOS (BIOS Version 3.0 or later) is used in your system.

Manual Organization

Chapter 1 describes the features, specifications, and performance of the motherboard. It also provides detailed information about the Intel C602 chipset.

Chapter 2 provides hardware installation instructions. Read this chapter when installing the processor, memory modules, and other hardware components into the system. If you encounter any problems, see **Chapter 3**, which describes troubleshooting procedures for video, memory, and system setup stored in the CMOS.

Chapter 4 includes an introduction to the BIOS, and provides detailed information on running the CMOS Setup utility.

Appendix A provides BIOS Error Beep Codes.

Appendix B lists software installation instructions.

Conventions Used in the Manual

Pay special attention to the following symbols for proper system installation and to prevent damage to the system or injury to yourself:

Warning: Important information given to ensure proper system installation or to prevent damage to the components



Note: Additional information given to differentiate between various models or provides information for correct system setup.

Contacting Supermicro

Headquarters

Address: Super Micro Computer, Inc.
980 Rock Ave.
San Jose, CA 95131 U.S.A.

Tel: +1 (408) 503-8000

Fax: +1 (408) 503-8008

Email: marketing@supermicro.com (General Information)
support@supermicro.com (Technical Support)

Web Site: www.supermicro.com

Europe

Address: Super Micro Computer B.V.
Het Sterrenbeeld 28, 5215 ML
's-Hertogenbosch, The Netherlands

Tel: +31 (0) 73-6400390

Fax: +31 (0) 73-6416525

Email: sales@supermicro.nl (General Information)
support@supermicro.nl (Technical Support)
rma@supermicro.nl (Customer Support)

Web Site: www.supermicro.com

Asia-Pacific

Address: Super Micro Computer, Inc.
3F, No. 150, Jian 1st Rd.
Zhonghe Dist., New Taipei City 235
Taiwan (R.O.C)

Tel: +886-(2) 8226-3990

Fax: +886-(2) 8226-3992

Email: support@supermicro.com.tw

Web Site: www.supermicro.com.tw

Table of Contents

Preface

Chapter 1 Overview

| | | |
|-----|-------------------------------------|------|
| 1-1 | Overview | 1-1 |
| 1-2 | Processor and Chipset Overview..... | 1-11 |
| 1-3 | Special Features | 1-12 |
| 1-4 | PC Health Monitoring..... | 1-12 |
| 1-5 | ACPI Features..... | 1-13 |
| 1-6 | Power Supply | 1-13 |
| 1-7 | Super I/O..... | 1-14 |

Chapter 2 Installation

| | | |
|-----|---|------|
| 2-1 | Standardized Warning Statements | 2-1 |
| | Battery Handling..... | 2-1 |
| | Product Disposal | 2-3 |
| 2-2 | Static-Sensitive Devices..... | 2-4 |
| | Precautions | 2-4 |
| | Unpacking | 2-4 |
| 2-3 | Processor and Heatsink Installation..... | 2-5 |
| | Installing the LGA2011 Processor | 2-5 |
| | Installing a CPU Heatsink | 2-9 |
| | Removing the Heatsink..... | 2-10 |
| 2-4 | Installing and Removing the Memory Modules..... | 2-11 |
| | Installing & Removing DIMMs..... | 2-11 |
| | Removing Memory Modules | 2-11 |
| 2-5 | Motherboard Installation..... | 2-16 |
| | Tools Needed | 2-16 |
| | Location of Mounting Holes | 2-16 |
| | Installing the Motherboard | 2-17 |
| 2-6 | Control Panel Connectors and I/O Ports | 2-18 |
| | Back Panel Connectors and I/O Ports..... | 2-18 |
| | Back Panel I/O Port Locations and Definitions | 2-18 |
| | Serial Ports..... | 2-19 |
| | Ethernet Ports | 2-19 |
| | ATX PS/2 Keyboard/Mouse Ports..... | 2-20 |
| | Universal Serial Bus (USB)..... | 2-21 |
| | (Back_Panel) High Definition Audio (HD Audio) | 2-22 |
| | Front Accessible Audio Header..... | 2-22 |

| | |
|--|------|
| Front Control Panel..... | 2-23 |
| Front Control Panel Pin Definitions..... | 2-24 |
| NMI Button | 2-24 |
| Power LED | 2-24 |
| HDD LED..... | 2-25 |
| NIC1/NIC2 LED Indicators | 2-25 |
| Overheat (OH)/Fan Fail LED..... | 2-26 |
| Power Fail LED | 2-26 |
| Reset Button | 2-27 |
| Power Button | 2-27 |
| 2-7 Connecting Cables..... | 2-28 |
| Power Connectors | 2-28 |
| Fan Headers..... | 2-29 |
| Chassis Intrusion | 2-29 |
| Internal Speaker..... | 2-30 |
| Power LED/Speaker..... | 2-30 |
| TPM Header/Port 80 Header | 2-31 |
| Standby Power Header | 2-31 |
| Power SMB (I ² C) Connector | 2-32 |
| T-SGPIO 1/S-SGPIO 1 Headers | 2-33 |
| SPDIF_In/SPDIF_Out Headers | 2-34 |
| DOM Power Connector | 2-34 |
| Overheat/Fan Fail LED | 2-35 |
| 2-8 Jumper Settings | 2-36 |
| Explanation of Jumpers | 2-36 |
| GLAN Enable/Disable | 2-36 |
| CMOS Clear..... | 2-37 |
| Watch Dog Enable/Disable | 2-37 |
| IEEE 1394a Enable..... | 2-38 |
| I ² C Bus to PCI-Exp. Slots | 2-38 |
| Management Engine (ME) Recovery | 2-39 |
| 2-9 Onboard LED Indicators | 2-40 |
| GLAN LEDs..... | 2-40 |
| Onboard Power LED | 2-40 |
| 2-10 SATA/SAS Connections | 2-41 |
| Serial ATA Ports..... | 2-41 |
| SAS2 Ports (X9DA7 Only)..... | 2-41 |

Chapter 3 Troubleshooting

3-1 Troubleshooting Procedures 3-1
3-2 Technical Support Procedures 3-5
3-3 Battery Removal and Installation 3-6
3-4 Frequently Asked Questions 3-7
3-5 Returning Merchandise for Service..... 3-8

Chapter 4 BIOS

4-1 Introduction..... 4-1
4-2 Main Setup..... 4-2
4-3 Advanced Setup Configurations..... 4-4
4-4 Event Logs 4-24
4-5 Boot..... 4-27
4-6 Security..... 4-28
4-7 Save & Exit 4-29

Appendix A BIOS Error Beep Codes

A-1 BIOS Error Beep Codes A-1

Appendix B Software Installation Instructions

B-1 Installing Software Programs B-1
B-2 Configuring SuperDoctor® III B-2

Chapter 1

Overview

1-1 Overview

Checklist

Congratulations on purchasing your computer motherboard from an acknowledged leader in the industry. Supermicro boards are designed with the utmost attention to detail to provide you with the highest standards in quality and performance.

Please check that the following items have all been included with your motherboard. If anything listed here is damaged or missing, contact your retailer.

The following items are included in the retail box.

- One (1) Supermicro Mainboard
- Two (2) Serial ATA cables (CBL-0044Lx2)
- Two (2) I-Pass to Serial ATA cables (CBL-097L-03 x2) (for X9DR3-F)
- One (1) I-Pass to Serial ATA cables (CBL-097L-03) (for X9DRi-F)
- One (1) I/O Shield (MCP-260-00042-0N)
- One (1) Quick Reference Guide (MNL-1338-QRG)



Note: For your system to work properly, please follow the links below to download all necessary drivers/utilities and the user's manual for your motherboard.

SMCI product manuals: <http://www.supermicro.com/support/manuals/>

Product Drivers and utilities: <ftp://ftp.supermicro.com/>

If you have any questions, please contact our support team at support@supermicro.com.

SUPER Motherboard Image

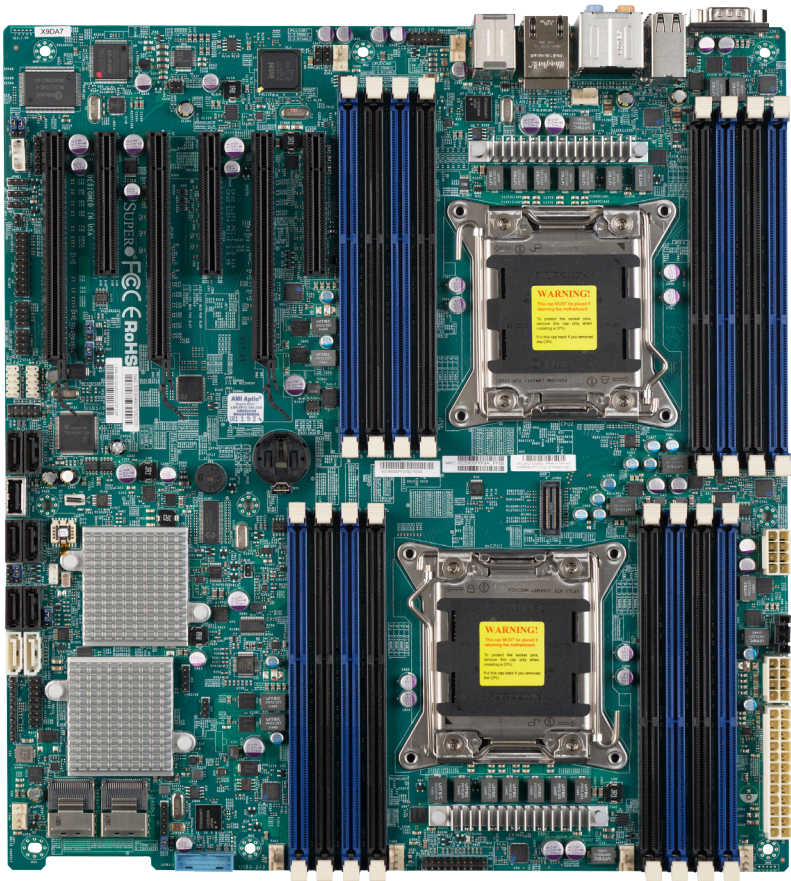

Note: All graphics shown in this manual were based upon the latest PCB Revision available at the time of publishing of the manual. The motherboard you've received may or may not look exactly the same as the graphics shown in this manual.

Motherboard Layout

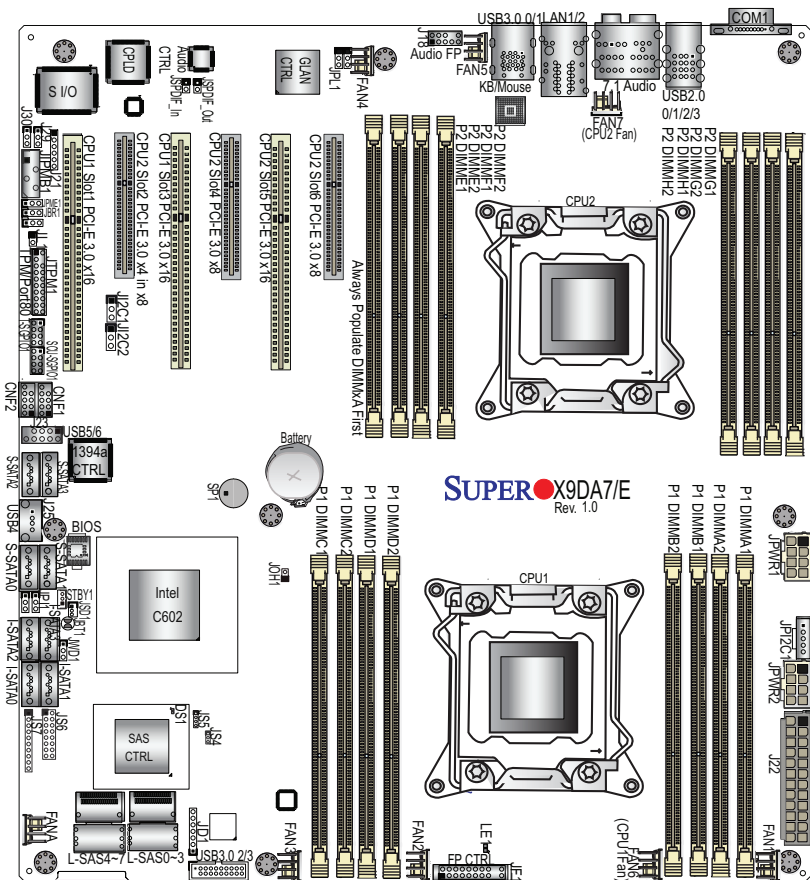

 **Note:** For the latest CPU/Memory updates, please refer to our website at <http://www.supernmicro.com/products/motherboard/> for details.

X9DA7/X9DAE Quick Reference

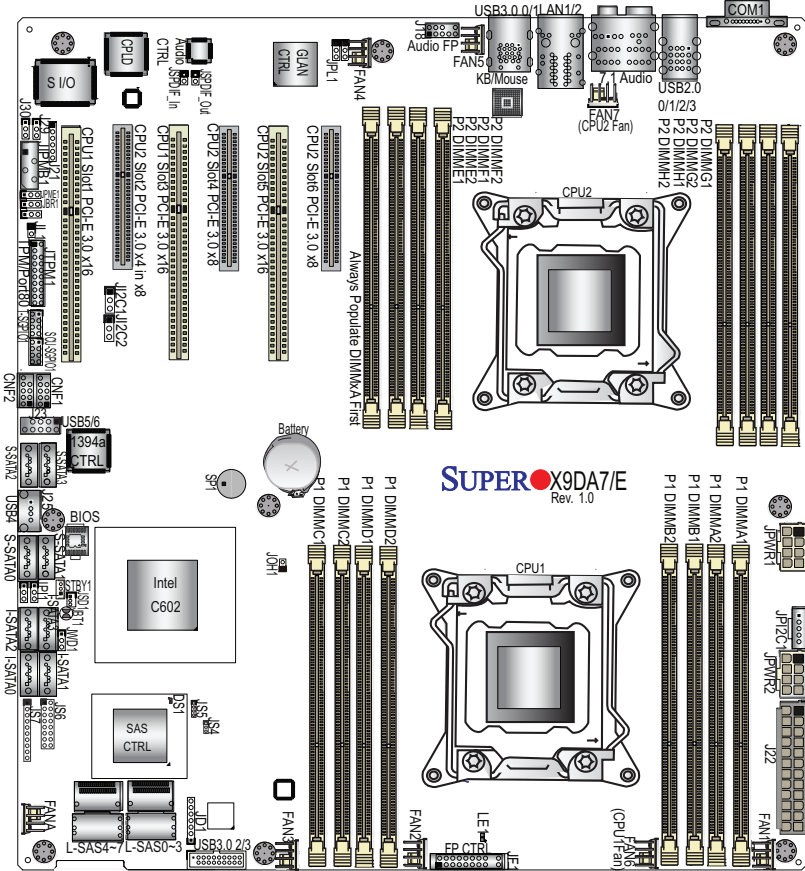

Notes:

- See Chapter 2 for detailed information on jumpers, I/O ports and JF1 front panel connections.
- "■" indicates the location of "Pin 1".
- Jumpers/LED Indicators not indicated are for testing only. Also, components that are not documented in this manual are reserved for internal use only.
- Use only the correct type of onboard CMOS battery as specified by the manufacturer. Do not install the onboard battery upside down to avoid possible explosion.

X9DA7 Jumpers

| Jumper | Description | Default Setting |
|---------------------------------------|---|------------------------|
| JBT1 | Clear CMOS | See Chapter 3 |
| JI ² C1/JI ² C2 | SMBus to PCI-E Slots | Pins 2-3 (Disabled) |
| JP11 | IEEE1394a Enable | Pins 1-2 (Enabled) |
| JPL1 | GLAN1/GLAN2 Enable | Pins 1-2 (Enabled) |
| JPME1 | Management Engine (ME) Recovery Mode Enable | Pins 1-2 (Normal) |
| JWD1 | Watch Dog Timer Enable | Pins 1-2 (Reset) |

X9DA7 Connectors

| Connectors | Description |
|--------------------|---|
| 7.1 Audio | 8 Channel (7.1) High-Definition Backplane Audio Connector |
| Battery | Onboard CMOS Battery (See Chapter 3 for Used Battery Disposal) |
| CNF1/CNF2 | IEEE 1394a 1/2 Connectors |
| COM1 | Backplane COM Port1 |
| CPU1 Slot1/Slot3 | PCI-E 3.0 x16 Slots (Available when CPU1 is installed.) |
| CPU2 Slot2 | PCI-E 3.0 x4 Slot (Available when CPU2 is installed.) |
| CPU2 Slot4 | PCI-E 3.0 x4 in x8 Slot (The slots are available when CPU2 is installed.) |
| CPU2 Slot5 | PCI-E 3.0 x16 Slot (Available when CPU2 is installed.) |
| CPU2 Slot6 | PCI-E 3.0 x8 Slot (The slots are available when CPU2 is installed.) |
| FAN1~7, FANA | CPU/System Fan Headers (Fan6/Fan7: CPU 1/2 Fans) |
| J18 | Front_Panel Audio Header |
| J22 | ATX 24-Pin Power Connector (See Warning on Pg. 1-6.) |
| JD1 | Speaker/Power LED Indicator |
| JF1 | Front Panel Control Header |
| JL1 | Chassis Intrusion |
| JOH1 | Overheat/Fan Fail LED Indicator |
| JP ² C1 | Power Supply SMBbus I ² C Header |
| JPWR1/JPWR2 | 12V 8-Pin Power Connectors (See Warning on Pg. 1-6.) |
| JSD1 | SATA DOM (Device_On_Module) Power Connector |
| JSPDIF_In | SPDIF_(Sony/Philips Digital Interface)_In Header |
| JSPDIF_Out | SPDIF_(Sony/Philips Digital Interface)_Out Header |
| JTPM1 | TPM (Trusted Platform Module)/Port 80 Header |
| KB/Mouse | (PS2) Keyboard/Mouse Connector |
| LAN1/2 | Gigabit Ethernet LAN Ports 1/2 |



| | |
|------------------|--|
| (L-)SAS 0~3, 4~7 | Serial_Attached SCSI 2.0 Connections 0~3, 4~7 from the LSI SAS Controller (X9DA7 Only) |
| (I-)SATA0~3 | Intel SB SATA Connectors 0~3 (SATA 0/1: SATA 3.0 Ports, SATA2/3: SATA 2.0 ports) |
| (S-)SATA0~3 | SATA 2.0 Connectors 0~3 from Intel SCU (Storage Control Unit) |
| SP1 | Onboard Buzzer (Internal Speaker) |
| STBY1 | Standby Power Header |
| S-SGPIO 1 | Serial-Link General_Purpose IO -Header for S-SATA Connections 0~3 |
| T-SGPIO 1 | Serial-Link General_Purpose IO Header for I-SATA Connections 0~3 |
| USB 2.0 0~3 | Back Panel USB 2.0 Ports 0/1/2/3 |
| USB 2.0 4 | Front-Panel Accessible Type A USB 2.0 Header (USB 4: J25) |
| USB 2.0 5/6 | Front-Panel Accessible USB 2.0 Connections 5/6 |
| USB 3.0 0/1 | Back Panel USB 3.0 Ports 0/1 |
| USB 3.0 2/3 | Front-Panel Accessible USB 3.0 Connections 2/3 |

X9DA7/X9DAE LED Indicators

| LED | Description | State | Status |
|-----|-----------------|-----------------------------|-------------|
| DS1 | SAS LED | (Reserved for Internal Use) | |
| LE1 | Standby PWR LED | Green: On | SB Power On |

Warning: To prevent damage to the power supply or motherboard, please use a power supply that contains a 24-pin and two 8-pin power connectors. Be sure to connect these power supply connectors to the 24-pin power connector (J22) and two 8-pin power connectors (JPWR1, JPWR2) on the motherboard. Failure in doing so will void the manufacturer warranty on your power supply and motherboard.

Motherboard Features

| | | |
|--|---|---|
| CPU | <ul style="list-style-type: none"> Dual Intel® E5-2600(v2) Series Processors (Socket R LGA 2011); each supports two full-width Intel QuickPath Interconnect (QPI) links of up to 8.0 GT/s per QPI link. <p> Note: For Intel E5-2600(v2) processor support, BIOS version 3.0 or above is required.</p> | |
| Memory | <ul style="list-style-type: none"> Integrated memory controller supports up to 1 TB of Load Reduced (LRDIMM), 512 GB of Registered (RDIMM) or 128 GB of Unbuffered (UDIMM) ECC/ Non-ECC DDR3 800/1066/1333/1600/1866 MHz 240-pin 4-channel memory modules in 16 DIMM slots. <p> Note 1: 1866 MHz memory support is dependent on Intel E5-2600v2 CPUs.</p> <p>Note 2: For the latest memory updates, please refer to the Tested Memory List posted on our website (http://www.supermicro.com/products/motherboard).</p> | |
| Chipset | <ul style="list-style-type: none"> Intel® C602 Chipset (PCH J) | |
| Expansion Slots | <ul style="list-style-type: none"> Three (3) PCI-Express 3.0 x16 slots (CPU1 Slot1/ Slot3, CPU2 Slot5), Two (2) PCI-E3.0 x8 slot (CPU2 Slot4/Slot6), One (1) PCI Express 3.0 x 4 in x8 slot (CPU2 Slot2) | |
| Network | <ul style="list-style-type: none"> One i350 Dual-Channel Gigabit (100/1000 Mb/s) Ethernet Controller for LAN 1/LAN 2 ports. LSI 2308 SAS Controller | |
| | SATA Connections | |
| | <ul style="list-style-type: none"> SATA Ports | <ul style="list-style-type: none"> Two (2) SATA 3.0 Ports: I-SATA 0/1, Two (2) SATA 2.0 Ports (I-SATA 2/3 from Intel PCH), Four (4) SATA 2.0 Ports (S-SATA 0~3) from Intel SCU |
| <ul style="list-style-type: none"> RAID | RAID 0, 1, 5, 10 (Windows/Linux latest kernel) | |

| SAS Connections (X9DA7 Only) | |
|---|---|
| <ul style="list-style-type: none"> SAS Ports | <ul style="list-style-type: none"> Eight (8) SAS 2.0 Ports: SAS 0~3, 4~7 from LSI SAS Controller |
| <ul style="list-style-type: none"> RAID | RAID 0, 1, 10 |
| Peripheral Devices | USB Devices (11 USB Connections) |
| | <ul style="list-style-type: none"> Four (4) USB 3.0 ports: USB 3.0 Ports 0/1 (on the I/O Backplane), USB 3.0 USB 2/3 (close to SAS ports for front access), Seven (7) USB 2.0 Connections: <ul style="list-style-type: none"> Four (4): Backplane USB 2.0 (Ports 0~3) Two (2): Front-Accessible USB (USB 5/6), and One (1) Type A USB Header (USB 4, located at J25) for front USB access |
| I/O Devices | Serial (COM) Port |
| | <ul style="list-style-type: none"> One (1) Fast UART 16550 Connection: 9-pin RS-232 Serial Port |
| | Keyboard/Mouse |
| | <ul style="list-style-type: none"> One PS2 Keyboard/Mouse Connector on the I/O Backpanel |
| | Audio |
| Power Connectors | <ul style="list-style-type: none"> ALC 889 Audio Controller Backpanel 7.1 High Definition Audio Front Panel Audio Header (J18) SPDIF_In/SPDIF_Out (Sony_Philips Digital Interface)_In/Out Headers |
| | ATX Power Connectors & DOM Power Connector |
| | <ul style="list-style-type: none"> One (1) 24-pin Main Power (J22) Two (2) 8-pin CPU PWR Connectors (JPWR1/2) DOM (Disk_On_Module) Power Connector for Serial_link devices (JSD1) |
| Super I/O | Super I/O |
| | <ul style="list-style-type: none"> Winbond W83627 |
| BIOS | <ul style="list-style-type: none"> 16MB AMI BIOS[®] Flash EEPROM APM 1.2, DMI 2.3, PCI 2.3, ACPI 1.0/2.0/3.0, USB Keyboard, Plug & Play (PnP) and SMBIOS 2.3 |

| | |
|-----------------------------|--|
| Power Config. | <ul style="list-style-type: none"> • ACPI/ACPM Power Management • Main switch override mechanism • Keyboard Wake-up from Soft-Off USB • Power-on mode for AC power recovery |
| PC Health Monitoring | CPU Monitoring |
| | <ul style="list-style-type: none"> • Onboard voltage monitors for 3.3V, 5V, 12V, CPU Core Voltages, Chipset Voltage, Memory Voltage, and Battery Voltage. • CPU Thermal Design Power (TDP): support up to 150W (See Note 1 below.) • CPU 6+1 -Phase switching voltage regulator • CPU/System overheat LED and control • CPU Thermal Trip support • Thermal Monitor 2 (TM2) support |
| | Fan Control |
| | <ul style="list-style-type: none"> • Fan status monitoring with firmware 4-pin (Pulse Width Modulation) fan speed control • Low noise fan speed control |
| | LED Indicators |
| System Management | System Management |
| | <ul style="list-style-type: none"> • PECL (Platform Environment Configuration Interface) 2.0 support |
| | <ul style="list-style-type: none"> • System resource alert via SuperDoctor® III |
| | <ul style="list-style-type: none"> • SuperDoctor® III, Watch Dog, NMI • Chassis Intrusion Header and Detection |
| Dimensions | <ul style="list-style-type: none"> • 12.00" (L) x 13.00" (W) (304.80 mm x 330.20 mm) |



Note 1: CPU Maximum Thermal Design Power (TDP) is subject to chassis and heatsink cooling restrictions. For proper thermal management, please check the chassis and heatsink specifications for proper CPU TDP sizing.

Note 2: For updates on CPU and memory support, please refer to our website @ <http://www.supermicro.com/support/manuals/>.

Note 3: Changing BMC log-in information is recommended during initial system power-on. The default username is ADMIN and password is ADMIN. For BMC best practices, please refer to: http://www.supermicro.com/products/nfo/files/IPMI/Best_Practices_BMC_Security.pdf

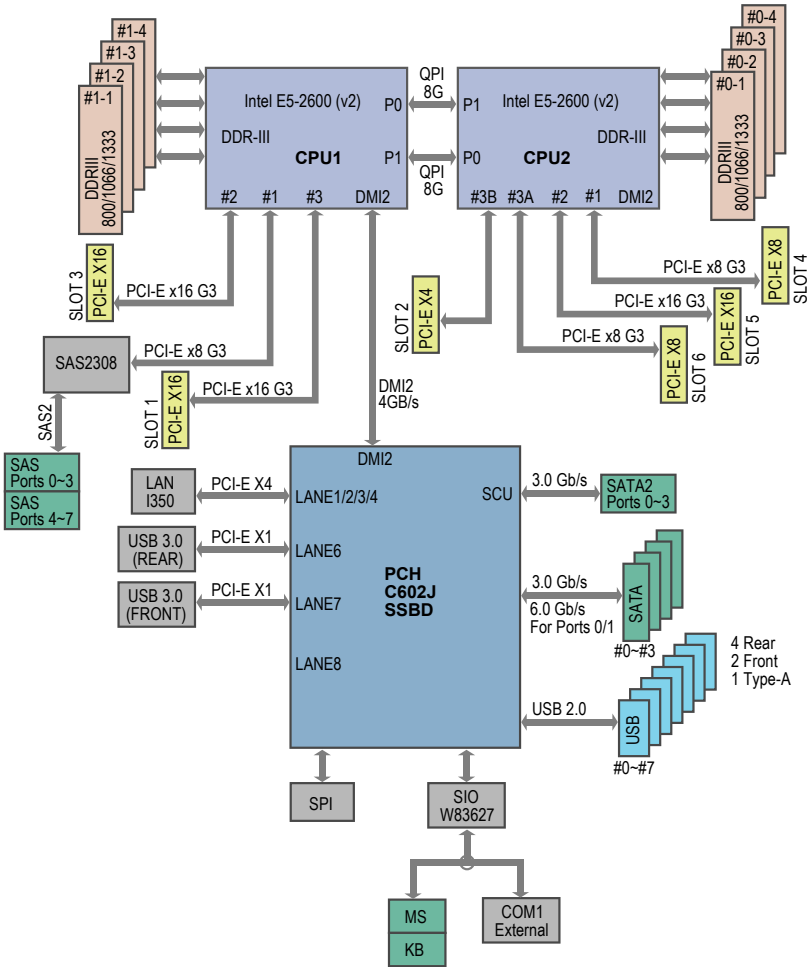

System Block Diagram

 **Note:** This is a general block diagram and may not exactly represent the features on your motherboard. See the Motherboard Features pages for the actual specifications of each motherboard. 2. This block diagram is intended for your reference only.

1-2 Processor and Chipset Overview

Built upon the functionality and the capability of the Intel E5-2600(v2) Series Processors (Socket R LGA 2011) and the C602 chipset, the X9DA7/X9DAE motherboard provides the performance and feature sets required for dual_processor-based workstation platforms. (See note below for processor support.)

With support of Intel QuickPath interconnect (QPI) Technology, the X9DA7/X9DAE offers point-to-point serial interconnect interface with a transfer speed of up to 8.0 GT/s, providing superb system performance.

The C602 chipset provides extensive IO support, including the following functions and capabilities:

- PCI-Express Rev. 2.0 support
- PCI-Express Gen. 3 support
- ACPI Power Management Logic Support Rev. 3.0b or Rev. 4.0
- USB host interface backplane and front access support
- Intel Rapid Storage Technology supported
- Intel Virtualization Technology for Directed I/O (Intel VT-d) supported
- Intel Trusted Execution Technology supported
- Serial Peripheral Interface (SPI) Supported
- Digital Media Interface (DMI) supported
- Advanced Host Controller Interface (AHCI) supported



Note: For Intel E5-2600(v2) processor support, BIOS version 3.0 or above is required.

1-3 Special Features

Recovery from AC Power Loss

The Basic I/O System (BIOS) provides a setting that determines how the system will respond when AC power is lost and then restored to the system. You can choose for the system to remain powered off (in which case you must press the power switch to turn it back on), or for it to automatically return to the power-on state. See the Advanced BIOS Setup section for this setting. The default setting is **Last State**.

1-4 PC Health Monitoring

This motherboard has an onboard System_Hardware_Monitor chip that supports PC health monitoring. An onboard voltage monitor will scan the following onboard voltages continuously: CPU Core voltages, +12V, 3.3V, 5V, battery voltage, memory voltages and chipset voltage. Once a voltage becomes unstable, a warning is given, or an error message is sent to the screen. The user can adjust the voltage thresholds to define the sensitivity of the voltage monitor.

Fan Status Monitor with Firmware Control

The PC health monitor chip can check the RPM status of a cooling fan. The onboard CPU and chassis fans are controlled via BIOS thermal management.

Environmental Temperature Control

A thermal control sensor monitors the CPU temperature in real time and will turn on the thermal control fan whenever the CPU temperature exceeds a user-defined threshold. The overheat circuitry runs independently from the CPU. Once it detects that the CPU temperature is too high, it will automatically turn on the thermal fan control to prevent the CPU from overheating. The onboard chassis thermal circuitry can monitor the overall system temperature and alert the user when the chassis temperature is too high.



Note: To avoid possible system overheating, please be sure to provide adequate airflow to your system.

System Resource Alert

This feature is available when used with SuperDoctor® III in the Windows OS environment or used with SuperDoctor II in Linux. SuperDoctor is used to notify the user of certain system events. For example, you can configure SuperDoctor to provide you with warnings when the system/CPU temperatures, CPU voltages

and fan speeds go beyond a predefined range.

1-5 ACPI Features

ACPI stands for Advanced Configuration and Power Interface. The ACPI specification defines a flexible and abstract hardware interface that provides a standard way to integrate power management features throughout a PC system, including its hardware, operating system and application software. This enables the system to automatically turn on and off peripheral devices such as CD-ROMs, network cards, hard disk drives and printers.

In addition to enabling operating system-directed power management, ACPI also provides a generic system event mechanism for Plug and Play, and an operating system-independent interface for configuration control. ACPI leverages the Plug and Play BIOS data structures, while providing a processor architecture-independent implementation that is compatible with Windows 2008, Windows 7 and Windows 8 Operating Systems.

Slow Blinking LED for Suspend-State Indicator

When the CPU goes into a suspend state, the chassis power LED will start blinking to indicate that the CPU is in suspend mode. When the user presses any key, the CPU will "wake up" and the LED will automatically stop blinking and remain on.

1-6 Power Supply

As with all computer products, a stable power source is necessary for proper and reliable operation. It is even more important for processors that have high CPU clock rates.

The X9DA7/X9DAE motherboard accommodates 24-pin ATX power supplies. Although most power supplies generally meet the specifications required by the CPU, some are inadequate. In addition, two 12V 8-pin power connections are also required to ensure adequate power supply to the system. Your power supply must also supply 1.5A for the Ethernet ports.

Warning: To prevent damage to the power supply or motherboard, please use a power supply that contains a 24-pin and two 8-pin power connectors. Be sure to connect these power supply connectors to the 24-pin (J22) and two 8-pin power connectors (JPWR1, JPWR2) on the motherboard. Failure to do so will void the manufacturer warranty on your power supply and motherboard.

It is strongly recommended that you use a high quality power supply that meets ATX power supply Specification 2.02 or above. It must also be SSI compliant. (For more information, please refer to the website at <http://www.ssiforum.org/>). Additionally, in

areas where noisy power transmission is present, you may choose to install a line filter to shield the computer from noise. It is recommended that you also install a power surge protector to help avoid problems caused by power surges.

1-7 Super I/O

The Super I/O supports one high-speed, 16550 compatible serial communication ports (UARTs). Each UART includes a 16-byte send/receive FIFO, a programmable baud rate generator, complete modem control capability and a processor interrupt system. Each UART provides legacy speed with baud rate of up to 115.2 Kbps.

The Super I/O provides functions that comply with ACPI (Advanced Configuration and Power Interface), which includes support of legacy and ACPI power management through an SMI or SCI function pin. It also features auto power management to reduce power consumption.

Chapter 2

Installation

2-1 Standardized Warning Statements

The following statements are industry-standard warnings, provided to warn the user of situations which have the potential for bodily injury. Should you have questions or experience difficulty, contact Supermicro's Technical Support department for assistance. Only certified technicians should attempt to install or configure components.

Read this section in its entirety before installing or configuring components in the Supermicro chassis.

Battery Handling



Warning!

There is a danger of explosion if the battery is replaced incorrectly. Replace the battery only with the same or equivalent type recommended by the manufacturer. Dispose of used batteries according to the manufacturer's instructions

電池の取り扱い

電池交換が正しく行われなかった場合、破裂の危険性があります。交換する電池はメーカーが推奨する型、または同等のものを使用下さい。使用済電池は製造元の指示に従って処分して下さい。

警告

電池更換不當會有爆炸危險。請只使用同類電池或製造商推薦的功能相當的電池更換原有電池。請按製造商的說明處理廢舊電池。

警告

電池更換不當會有爆炸危險。請使用製造商建議之相同或功能相當的電池更換原有電池。請按照製造商的說明指示處理廢棄舊電池。

Warnung

Bei Einsetzen einer falschen Batterie besteht Explosionsgefahr. Ersetzen Sie die Batterie nur durch den gleichen oder vom Hersteller empfohlenen Batterietyp. Entsorgen Sie die benutzten Batterien nach den Anweisungen des Herstellers.

Attention

Danger d'explosion si la pile n'est pas remplacée correctement. Ne la remplacer que par une pile de type semblable ou équivalent, recommandée par le fabricant. Jeter les piles usagées conformément aux instructions du fabricant.

¡Advertencia!

Existe peligro de explosión si la batería se reemplaza de manera incorrecta. Reemplazar la batería exclusivamente con el mismo tipo o el equivalente recomendado por el fabricante. Desechar las baterías gastadas según las instrucciones del fabricante.

אזהרה!

קיימת סכנת פיצוץ של הסוללה במידה והוחלפה בדרך לא תקינה. יש להחליף את הסוללה בסוג התואם מחברת יצרן מומלצת.

סילוק הסוללות המשומשות יש לבצע לפי הוראות היצרן.

هناك خطر من انفجار في حالة استبدال البطارية بطريقة غير صحيحة فعليك استبدال البطارية فقط بنفس النوع أو ما يعادلها كما أوصت به الشركة المصنعة تخلص من البطاريات المستعملة وفقا لتعليمات الشركة الصانعة

경고!

배터리가 올바르게 교체되지 않으면 폭발의 위험이 있습니다. 기존 배터리와 동일하거나 제조사에서 권장하는 동등한 종류의 배터리로만 교체해야 합니다. 제조사의 안내에 따라 사용된 배터리를 처리하여 주십시오.

Waarschuwing

Er is ontploffingsgevaar indien de batterij verkeerd vervangen wordt. Vervang de batterij slechts met hetzelfde of een equivalent type die door de fabrikant aanbevolen wordt. Gebruikte batterijen dienen overeenkomstig fabrieksvoorschriften afgevoerd te worden.

Product Disposal



Warning!

Ultimate disposal of this product should be handled according to all national laws and regulations.

製品の廃棄

この製品を廃棄処分する場合、国の関係する全ての法律・条例に従い処理する必要があります。

警告

本产品的废弃处理应根据所有国家的法律和规章进行。

警告

本產品的廢棄處理應根據所有國家的法律和規章進行。

Warnung

Die Entsorgung dieses Produkts sollte gemäß allen Bestimmungen und Gesetzen des Landes erfolgen.

¡Advertencia!

Al deshacerse por completo de este producto debe seguir todas las leyes y reglamentos nacionales.

Attention

La mise au rebut ou le recyclage de ce produit sont généralement soumis à des lois et/ou directives de respect de l'environnement. Renseignez-vous auprès de l'organisme compétent.

2-2 Static-Sensitive Devices

Electrostatic Discharge (ESD) can damage electronic components. To avoid damaging your system board, it is important to handle it very carefully. The following measures are generally sufficient to protect your equipment from ESD.

Precautions

- Use a grounded wrist strap designed to prevent static discharge.
- Touch a grounded metal object before removing the board from the antistatic bag.
- Handle the board by its edges only; do not touch its components, peripheral chips, memory modules or gold contacts.
- When handling chips or modules, avoid touching their pins.
- Put the motherboard and peripherals back into their antistatic bags when not in use.
- For grounding purposes, make sure that your system chassis provides excellent conductivity between the power supply, the case, the mounting fasteners and the motherboard.

Unpacking

The motherboard is shipped in antistatic packaging to avoid static damage. When unpacking the board, make sure that the person handling it is static protected.

2-3 Processor and Heatsink Installation

Warning: When handling the processor package, avoid placing direct pressure on the label area.

 **Notes:**

- Always connect the power cord last, and always remove it before adding, removing or changing any hardware components. Make sure that you install the processor into the CPU socket before you install the CPU heatsink.
- If you buy a CPU separately, make sure that you use an Intel-certified multi-directional heatsink only.
- Make sure to install the system board into the chassis before you install the CPU heatsink.
- When receiving a server board without a processor pre-installed, make sure that the plastic CPU socket cap is in place and none of the socket pins are bent; otherwise, contact your retailer immediately.
- Refer to the Supermicro website for updates on CPU support.

Installing the LGA2011 Processor

1. There are two load levers on the LGA2011 socket. To open the socket cover, first press and release the load lever labeled 'Open 1st'.

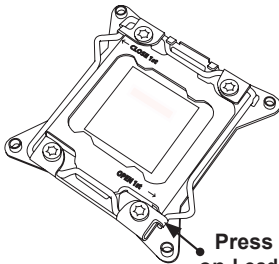
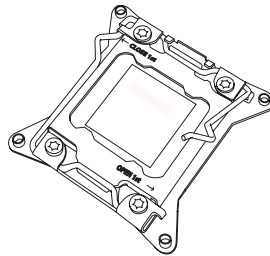
1**2**

Press down
on Load Lever
labeled 'Open 1st'.

2. Press the second load lever labeled 'Close 1st' to release the load plate that covers the CPU socket from its locking position.

1

Press down on Load
Lever 'Close 1st'

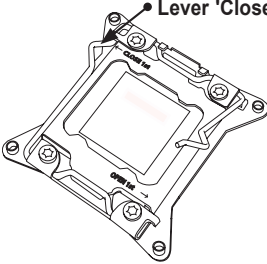

2 Pull lever away from
the socket

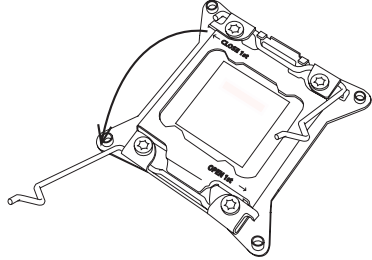

3. With the 'Close 1st' lever fully retracted, gently push down on the 'Open 1st' lever to open the load plate. Lift the load plate to open it completely.

1

Gently push
down to pop the
load plate open.

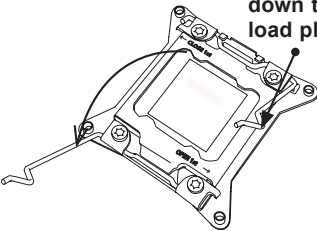

2

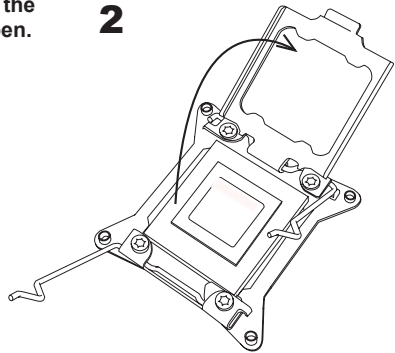

1. Using your thumb and the index finger, loosen the CPU lever and open the load plate.

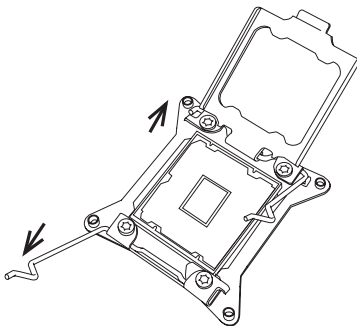

2. Use your thumb and index finger to hold the CPU on its edges. Align the CPU keys, which are semi-circle cutouts, against the socket keys.

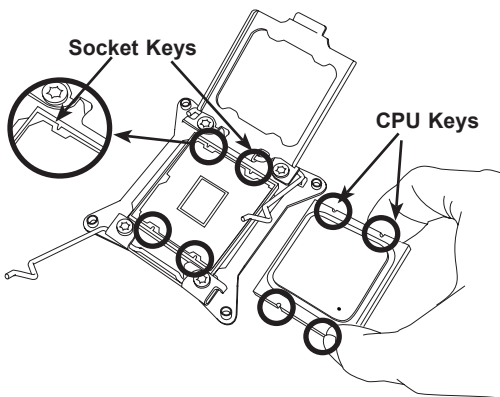

3. Once they are aligned, carefully lower the CPU straight down into the socket. (Do not drop the CPU on the socket. Do not move the CPU horizontally or vertically. Do not rub the CPU against the surface or against any pins of the socket to avoid damaging the CPU or the socket.)

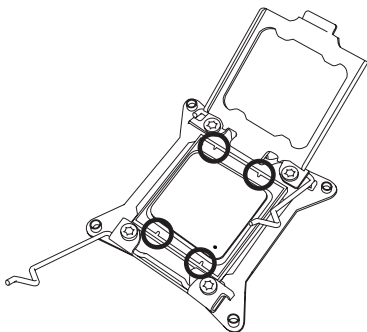

Warning: You can only install the CPU inside the socket in one direction. Make sure that it is properly inserted into the CPU socket before closing the load plate. If it doesn't close properly, do not force it as it may damage your CPU. Instead, open the load plate again and double-check that the CPU is aligned properly.

4. With the CPU inside the socket, inspect the four corners of the CPU to make sure that the CPU is properly installed.
5. Close the load plate with the CPU inside the socket. Lock the 'Close 1st' lever first, then lock the 'Open 1st' lever second. Use your thumb to gently push the load levers down to the lever locks.

1 Gently close the load plate.

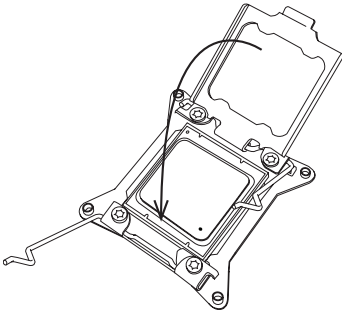

2 Push down and lock 'Close 1st' lever.

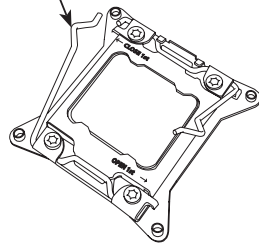

3 Push down and lock 'Open 1st' lever

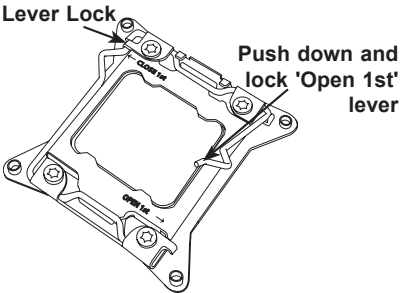

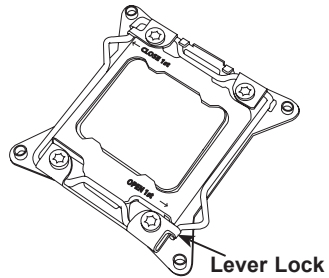

4 Lever Lock

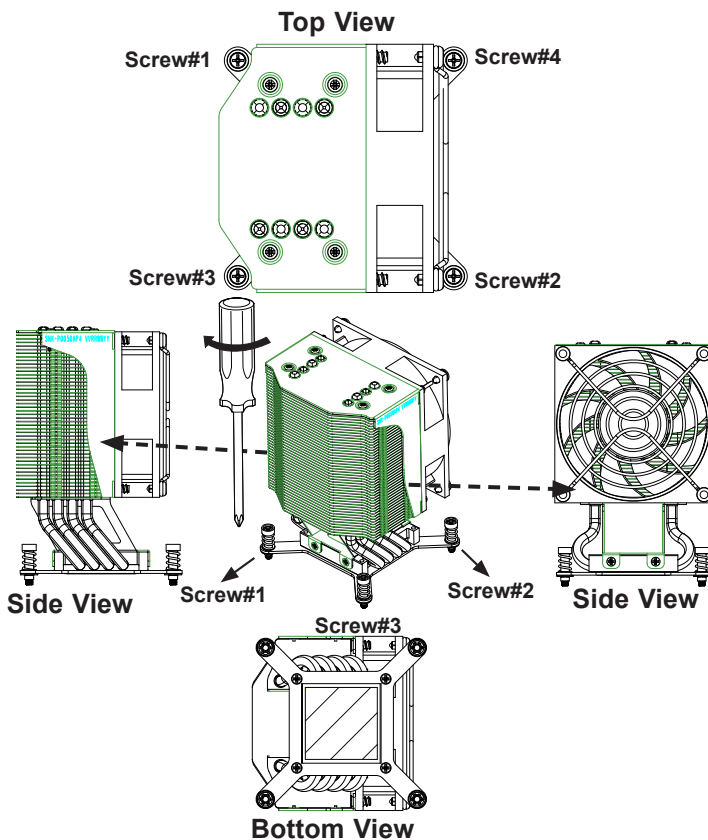

Installing a CPU Heatsink

1. Do not apply any thermal grease to the heatsink or the CPU die -- the required amount has already been applied.
2. Place the heatsink on top of the CPU so that the four mounting holes are aligned with those on the Motherboard's and the Heatsink Bracket underneath.
3. Screw in two diagonal screws (i.e., the #1 and the #2 screws) until just snug (-do not over-tighten the screws to avoid possible damage to the CPU.)
4. Finish the installation by fully tightening all four screws.



-  **Notes:** 1. For optimized airflow, please follow your chassis airflow direction to install the correct CPU heatsink direction. 2. Graphic drawings included in this manual are for reference only. They might look different from the components installed in your system.

Removing the Heatsink

Warning: We do not recommend that the CPU or the heatsink be removed. However, if you do need to uninstall the heatsink, please follow the instructions below to uninstall the heatsink to prevent damage done to the CPU or the CPU socket.

1. Unscrew the heatsink screws from the motherboard in the sequence as shown in the illustration below.
2. Gently wriggle the heatsink to loosen it from the CPU. (Do not use excessive force when wriggling the heatsink!)
3. Once the CPU is loosened, remove the CPU from the CPU socket.
4. Remove the used thermal grease and clean the surface of the CPU and the heatsink, Reapply the proper amount of thermal grease on the surface before reinstalling the CPU and the heatsink.

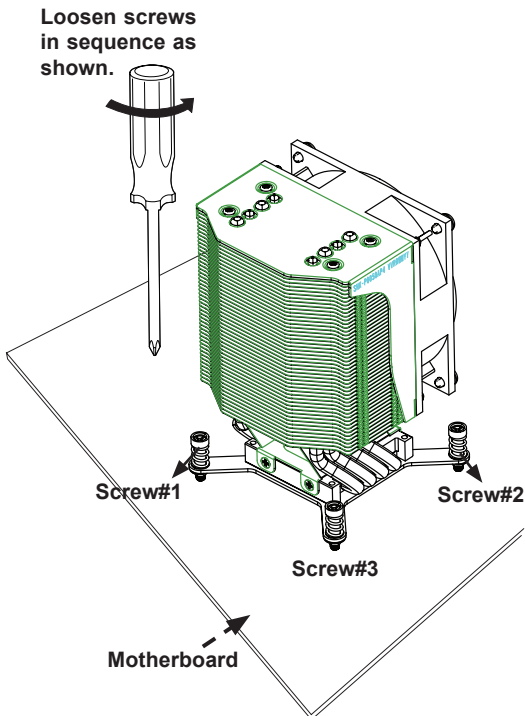

2-4 Installing and Removing the Memory Modules

 **Note:** Check Supermicro's website for recommended memory modules.

CAUTION

Exercise extreme care when installing or removing DIMM modules to prevent any possible damage.

Installing & Removing DIMMs

1. Insert the desired number of DIMMs into the memory slots, starting with P1-DIMMA1. (For best performance, please use the memory modules of the same type and the same speed.)
2. Push the release tabs outward on both ends of the DIMM slot to unlock it.

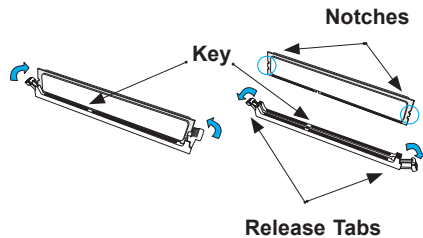
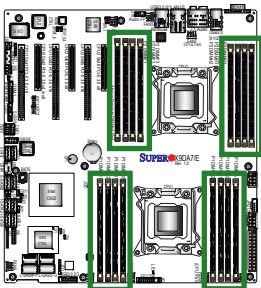

3. Align the key of the DIMM module with the receptive point on the memory slot.
4. Align the notches on both ends of the module against the receptive points on the ends of the slot.
5. Use two thumbs together to press the notches on both ends of the module straight down into the slot until the module snaps into place.
6. Press the release tabs to the locking positions to secure the DIMM module into the slot.

Press both notches straight down into the memory slot at the same time.

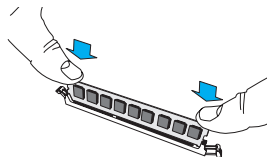

Removing Memory Modules

Press both notches on the ends of the DIMM module to unlock it. Once the DIMM module is loosened, remove it from the memory slot.

Memory Support for the X9DA7/X9DAE Motherboard

The X9DA7/X9DAE motherboard supports up to 1 TB of Load Reduced (LRDIMM), 512 GB of Registered (RDIMM) or 128 GB of Unbuffered (UDIMM) ECC/Non-ECC DDR3 800/1066/1333/1600/1866 MHz 240-pin 4-channel memory modules in 16 DIMM slots.



Note: For the latest memory updates, please refer to the Tested Memory List posted on our website (<http://www.supermicro.com/products/motherboard>).

Processor & Memory Module Population Configuration

For memory to work properly, follow the tables below for memory population.

| Processors and their Corresponding Memory Modules | | | | | | | | |
|--|---|-----------|-----------|-----------|-----------|-----------|-----------|-----------|
| CPU# | Corresponding DIMM Modules | | | | | | | |
| CPU 1 | P1-DIMMA1 | P1-DIMMB1 | P1-DIMMC1 | P1-DIMMD1 | P1-DIMMA2 | P1-DIMMB2 | P1-DIMMC2 | P1-DIMMD2 |
| CPU2 | P2-DIMME1 | P2-DIMMF1 | P2-DIMMG1 | P2-DIMMH1 | P2-DIMME2 | P2-DIMMF2 | P2-DIMMG2 | P2-DIMMH2 |
| Processor and Memory Module Population for Optimal Performance | | | | | | | | |
| Number of CPUs+DIMMs | CPU and Memory Population Configuration Table (*For memory to work properly, follow the instructions below to install DIMMs.) | | | | | | | |
| 1 CPU & 2 DIMMs | CPU1 P1-DIMMA1/P1-DIMMB1 | | | | | | | |
| 1 CPU & 4 DIMMs | CPU1 P1-DIMMA1/P1-DIMMB1, P1-DIMMC1/P1-DIMMD1 | | | | | | | |
| 1 CPU & 5-8 DIMMs | CPU1 P1-DIMMA1/P1-DIMMB1, P1-DIMMC1/P1-DIMMD1 + Any memory pairs in P1-DIMMA2/P1-DIMMB2/P1-DIMMC2/P1-DIMMD2 slots | | | | | | | |
| 2 CPUs & 4 DIMMs | CPU1 + CPU2 P1-DIMMA1/P1-DIMMB1, P2-DIMME1/P2-DIMMF1 | | | | | | | |
| 2 CPUs & 6 DIMMs | CPU1 + CPU2 P1-DIMMA1/P1-DIMMB1/P1-DIMMC1/P1-DIMMD1, P2-DIMME1/P2-DIMMF1 | | | | | | | |
| 2 CPUs & 8 DIMMs | CPU1 + CPU2 P1-DIMMA1/P1-DIMMB1/P1-DIMMC1/P1-DIMMD1, P2-DIMME1/P2-DIMMF1/P2-DIMMG1/P2-DIMMH1 | | | | | | | |
| 2 CPUs & 10-16 DIMMs | CPU1/CPU2 P1-DIMMA1/P1-DIMMB1/P1-DIMMC1/P1-DIMMD1, P2-DIMME1/P2-DIMMF1/P2-DIMMG1/P2-DIMMH1 + Any memory pairs in P1, P2 DIMM slots | | | | | | | |
| 2 CPUs & 16 DIMMs | CPU1/CPU2 P1-DIMMA1/P1-DIMMB1/P1-DIMMC1/P1-DIMMD1, P2-DIMME1/P2-DIMMF1/P2-DIMMG1/P2-DIMMH1, P1-DIMMA2/P1-DIMMB2/P1-DIMMC2/P1-DIMMD2, P2-DIMME2/P2-DIMMF2/P2-DIMMG2/P2-DIMMH2 | | | | | | | |



Notes: 1866 MHz memory support is dependent on Intel E5-2600v2 CPUs. For Intel E5-2600(v2) processor support, BIOS version 3.0 or above is required.

Populating UDIMM (ECC/Non-ECC) Memory Modules

| Intel E5-2600(v2) Series Processor UDIMM Memory Support | | | | | | | | | | | |
|--|--|------|-------|---|------------------------|------------|------------------|---------------------|------------------------|------------|------------------|
| Ranks Per DIMM & Data Width | Memory Capacity Per DIMM (See the Note below) | | | Speed (MT/s) and Voltage Validated by Slot per Channel (SPC) and DIMM Per Channel (DPC) | | | | | | | |
| | | | | 2 Slots Per Channel | | | | 3 Slots Per Channel | | | |
| | 1DPC | | 2DPC | | 1DPC | | 2DPC | | | | |
| | 1.35V | 1.5V | 1.35V | 1.5V | 1.35V | 1.5V | 1.35V | 1.5V | | | |
| SRx8 Non-ECC | 1GB | 2GB | 4GB | NA | 1066, 1333, 1600, 1866 | NA | 1066, 1333, 1600 | N/A | 1066, 1333, 1600, 1866 | N/A | 1066, 1333, 1600 |
| DRx8 Non-ECC | 2GB | 4GB | 8GB | NA | 1066, 1333, 1600, 1866 | NA | 1066, 1333, 1600 | N/A | 1066, 1333, 1600, 1866 | N/A | 1066, 1333, 1600 |
| SRx16 Non-ECC | 512MB | 1GB | 2GB | NA | 1066, 1333, 1600, 1866 | NA | 1066, 1333, 1600 | N/A | 1066, 1333, 1600, 1866 | N/A | 1066, 1333, 1600 |
| SRx8 ECC | 1GB | 2GB | 4GB | 1066, 1333 | 1066, 1333, 1600, 1866 | 1066, 1333 | 1066, 1333, 1600 | 1066, 1333 | 1066, 1333, 1600, 1866 | 1066, 1333 | 1066, 1333, 1600 |
| DRx8 ECC | 2GB | 4GB | 8GB | 1066, 1333 | 1066, 1333, 1600, 1866 | 1066, 1333 | 1066, 1333, 1600 | 1066, 1333 | 1066, 1333, 1600, 1866 | 1066, 1333 | 1066, 1333, 1600 |

Note: For detailed information on memory support and updates, please refer to the SMC Recommended Memory List posted on our website at <http://www.supermicro.com/support/resources/mem.cfm>.

Populating RDIMM (ECC) Memory Modules

| Intel E5-2600(v2) Series Processor RDIMM Memory Support | | | | | | | | | | | |
|--|--|------|-------|---|------------------------|------------|------------------|---------------------|------------------------|------------------|-----------|
| Ranks Per DIMM & Data Width | Memory Capacity Per DIMM (See the Note Below) | | | Speed (MT/s) and Voltage Validated by Slot per Channel (SPC) and DIMM Per Channel (DPC) | | | | | | | |
| | | | | 2 Slots Per Channel | | | | 3 Slots Per Channel | | | |
| | 1DPC | | 2DPC | | 1 DPC | | 2DPC | | 3DPC | | |
| | 1.35V | 1.5V | 1.35V | 1.5V | 1.35V | 1.5V | 1.35V | 1.5V | 1.35V | 1.5V | |
| SRx8 | 1GB | 2GB | 4GB | 1066, 1333 | 1066, 1333, 1600, 1866 | 1066, 1333 | 1066, 1333, 1600 | 1066, 1333 | 1066, 1333, 1600, 1866 | 1066, 1333, 1600 | 800, 1066 |
| DRx8 | 2GB | 4GB | 8GB | 1066, 1333 | 1066, 1333, 1600, 1866 | 1066, 1333 | 1066, 1333, 1600 | 1066, 1333 | 1066, 1333, 1600, 1866 | 1066, 1333, 1600 | 800, 1066 |
| SRx4 | 2GB | 4GB | 8GB | 1066, 1333 | 1066, 1333, 1600, 1866 | 1066, 1333 | 1066, 1333, 1600 | 1066, 1333 | 1066, 1333, 1600, 1866 | 1066, 1333, 1600 | 800, 1066 |
| DRx4 | 4GB | 8GB | 16GB | 1066, 1333 | 1066, 1333, 1600, 1866 | 1066, 1333 | 1066, 1333, 1600 | 1066, 1333 | 1066, 1333, 1600, 1866 | 1066, 1333, 1600 | 800, 1066 |
| QRx4 | 8GB | 16GB | 32GB | 800, 1066 | 800, 1066 | 800, 1066 | 800, 1066 | 800, 1066 | 800, 1066 | 800, 1066 | N/A, N/A |
| QRx8 | 4GB | 8GB | 16GB | 800, 1066 | 800, 1066 | 800, 1066 | 800, 1066 | 800, 1066 | 800, 1066 | 800, 1066 | N/A, N/A |

Note: For detailed information on memory support and updates, please refer to the SMC Recommended Memory List posted on our website at <http://www.supermicro.com/support/resources/mem.cfm>.

Populating UDIMM (ECC/Non-ECC) Memory Modules

| Intel E5-2600 Series Processor UDIMM Memory Support | | | | | | | | | | | |
|---|--|------|-------|---|------------|------|------------|---------------------|-------------|------------|------------|
| Ranks Per DIMM & Data Width | Memory Capacity Per DIMM (See the Note below) | | | Speed (MT/s) and Voltage Validated by Slot per Channel (SPC) and DIMM Per Channel (DPC) | | | | | | | |
| | | | | 2 Slots Per Channel | | | | 3 Slots Per Channel | | | |
| | 1DPC | | 2DPC | | 1DPC | | 2DPC | | | | |
| | 1.35V | 1.5V | 1.35V | 1.5V | 1.35V | 1.5V | 1.35V | 1.5V | | | |
| SRx8 Non-ECC | 1GB | 2GB | 4GB | NA | 1066, 1333 | NA | 1066, 1333 | N/A | 1066, 1333, | N/A | 1066, 1333 |
| DRx8 Non-ECC | 2GB | 4GB | 8GB | NA | 1066, 1333 | NA | 1066, 1333 | N/A | 1066, 1333, | N/A | 1066, 1333 |
| SRx16 Non-ECC | 512MB | 1GB | 2GB | NA | 1066, 1333 | NA | 1066, 1333 | N/A | 1066, 1333 | N/A | 1066, 1333 |
| SRx8 ECC | 1GB | 2GB | 4GB | 1066, 1333 | 1066, 1333 | 1066 | 1066, 1333 | 1066 | 1066, 1333, | 1066, 1333 | 1066, 1333 |
| DRx8 ECC | 2GB | 4GB | 8GB | 1066, 1333 | 1066, 1333 | 1066 | 1066, 1333 | 1066 | 1066, 1333, | 1066, 1333 | 1066, 1333 |

Note: For detailed information on memory support and updates, please refer to the SMC Recommended Memory List posted on our website at <http://www.supermicro.com/support/resources/mem.cfm>.

Populating RDIMM (ECC) Memory Modules

| Intel E5-2600 Series Processor RDIMM Memory Support | | | | | | | | | | | | | |
|---|--|------|-------|---|------------------|------------|------------------|---------------------|------------------|------------|------------------|-----|-----------|
| Ranks Per DIMM & Data Width | Memory Capacity Per DIMM (See the Note Below) | | | Speed (MT/s) and Voltage Validated by Slot per Channel (SPC) and DIMM Per Channel (DPC) | | | | | | | | | |
| | | | | 2 Slots Per Channel | | | | 3 Slots Per Channel | | | | | |
| | 1DPC | | 2DPC | | 1 DPC | | 2DPC | | 3DPC | | | | |
| | 1.35V | 1.5V | 1.35V | 1.5V | 1.35V | 1.5V | 1.35V | 1.5V | 1.35V | 1.5V | | | |
| SRx8 | 1GB | 2GB | 4GB | 1066, 1333 | 1066, 1333, 1600 | 1066, 1333 | 1066, 1333, 1600 | 1066, 1333 | 1066, 1333, 1600 | 1066, 1333 | 1066, 1333, 1600 | N/A | 800, 1066 |
| DRx8 | 2GB | 4GB | 8GB | 1066, 1333 | 1066, 1333, 1600 | 1066, 1333 | 1066, 1333, 1600 | 1066, 1333 | 1066, 1333, 1600 | 1066, 1333 | 1066, 1333, 1600 | N/A | 800, 1066 |
| SRx4 | 2GB | 4GB | 8GB | 1066, 1333 | 1066, 1333, 1600 | 1066, 1333 | 1066, 1333, 1600 | 1066, 1333 | 1066, 1333, 1600 | 1066, 1333 | 1066, 1333, 1600 | N/A | 800, 1066 |
| DRx4 | 4GB | 8GB | 16GB | 1066, 1333 | 1066, 1333, 1600 | 1066, 1333 | 1066, 1333, 1600 | 1066, 1333 | 1066, 1333, 1600 | 1066, 1333 | 1066, 1333, 1600 | N/A | 800, 1066 |
| QRx4 | 8GB | 16GB | 32GB | 800 | 1066 | 800 | 800 | 800 | 1066 | 800 | 800 | N/A | N/A |
| QRx8 | 4GB | 8GB | 16GB | 800 | 1066 | 800 | 800 | 800 | 1066 | 800 | 800 | N/A | N/A |

Note: For detailed information on memory support and updates, please refer to the SMC Recommended Memory List posted on our website at <http://www.supermicro.com/support/resources/mem.cfm>.

Populating LRDIMM (ECC) Memory Modules

| Intel E5-2600(v2) Series Processor LRDIMM Memory Support | | | | | | | | | | | | |
|--|--|------|---|------------------------|------------------|------------------|------------------|------------------------|------------------|------------------|-------|------|
| Ranks Per DIMM & Data Width | Memory Capacity Per DIMM (See the Note Below) | | Speed (MT/s) and Voltage Validated by Slot per Channel (SPC) and DIMM Per Channel (DPC) | | | | | | | | | |
| | | | 2 Slots Per Channel | | | | | 3 Slots Per Channel | | | | |
| | | | 1DPC | | 2DPC | | 1DPC | | 2DPC | | 3DPC | |
| | | | 1.35V | 1.5V | 1.35V | 1.5V | 1.35V | 1.5V | 1.35V | 1.5V | 1.35V | 1.5V |
| QRx4 (DDP) | 16GB | 32GB | 1066, 1333, 1600 | 1066, 1333, 1600, 1866 | 1066, 1333, 1600 | 1066, 1333, 1600 | 1066, 1333, 1600 | 1066, 1333, 1600, 1866 | 1066, 1333, 1600 | 1066, 1333, 1600 | 1066 | 1066 |
| 8Rx4 (QDP) | 32GB | 64GB | 1066 | 1066 | 1066 | 1066 | 1066 | 1066 | 1066 | 1066 | 1066 | 1066 |

Note: For detailed information on memory support and updates, please refer to the SMC Recommended Memory List posted on our website at <http://www.supermicro.com/support/resources/mem.cfm>.

| Intel E5-2600 Series Processor LRDIMM Memory Support | | | | | | | | | | | | |
|--|--|------|---|------------|-------|------------|-------|---------------------|-------|------------|-------|------|
| Ranks Per DIMM & Data Width | Memory Capacity Per DIMM (See the Note Below) | | Speed (MT/s) and Voltage Validated by Slot per Channel (SPC) and DIMM Per Channel (DPC) | | | | | | | | | |
| | | | 2 Slots Per Channel | | | | | 3 Slots Per Channel | | | | |
| | | | 1DPC | | 2DPC | | 1DPC | | 2DPC | | 3DPC | |
| | | | 1.35V | 1.5V | 1.35V | 1.5V | 1.35V | 1.5V | 1.35V | 1.5V | 1.35V | 1.5V |
| QRx4 (DDP) | 16GB | 32GB | 1066 | 1066, 1333 | 1066 | 1066, 1333 | 1066 | 1066, 1333 | 1066 | 1066, 1333 | 1066 | 1066 |
| QRx8 (QDP) | 8GB | 16GB | 1066 | 1066, 1333 | 1066 | 1066, 1333 | 1066 | 1066 | 1066 | 1066 | 1066 | 1066 |

Note: For detailed information on memory support and updates, please refer to the SMC Recommended Memory List posted on our website at <http://www.supermicro.com/support/resources/mem.cfm>.

Other Important Notes and Restrictions

- For the memory modules to work properly, please install DIMM modules of the same type, same speed and same operating frequency on the motherboard. Mixing of RDIMMs, UDIMMs or LRDIMMs is not allowed. Do not install both ECC and Non-ECC memory modules on the same motherboard.
- Using DDR3 DIMMs with different operating frequencies is not allowed. All channels in a system will run at the lowest common frequency.

2-5 Motherboard Installation

All motherboards have standard mounting holes to fit different types of chassis. Make sure that the locations of all the mounting holes for both motherboard and chassis match. Although a chassis may have both plastic and metal mounting fasteners, metal ones are highly recommended because they ground the motherboard to the chassis. Make sure that the metal standoffs click in or are screwed in tightly. Then use a screwdriver to secure the motherboard onto the motherboard tray.

Tools Needed

- Phillips Screwdriver
- Pan head screws (9 pieces)
- Standoffs (9 pieces, if needed)

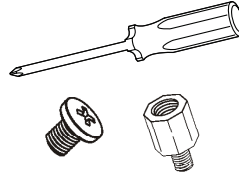

Location of Mounting Holes

There are nine (9) mounting holes on this motherboard indicated by the arrows.

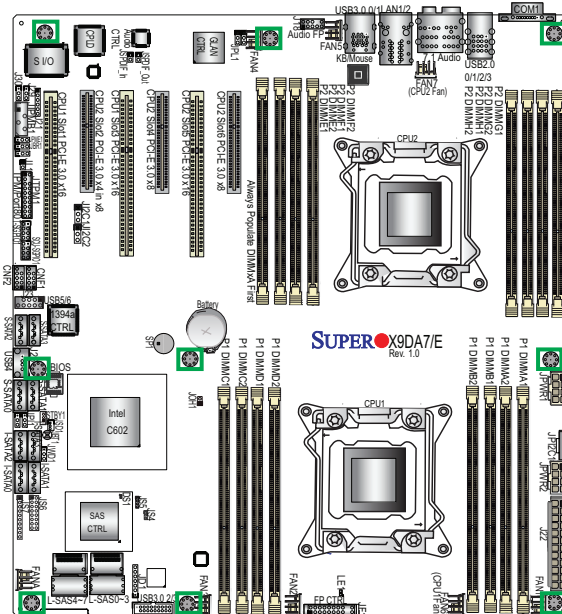

Caution: 1) To avoid damaging the motherboard and its components, please do not use a force greater than 8 lb/inch on each mounting screw during motherboard installation. 2) Some components are very close to the mounting holes. Please take precautionary measures to prevent damage to these components when installing the motherboard to the chassis.

Installing the Motherboard

1. Install the I/O shield into the chassis.

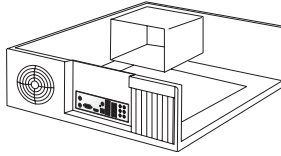

2. Locate the mounting holes on the motherboard.
3. Locate the matching mounting holes on the chassis. Align the mounting holes on the motherboard against the mounting holes on the chassis.
4. Install standoffs in the chassis as needed.

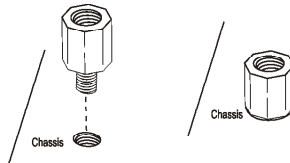

5. Install the motherboard into the chassis carefully to avoid damaging motherboard components.
6. Using the Phillips screwdriver, insert a Pan head #6 screw into a mounting hole on the motherboard and its matching mounting hole on the chassis.

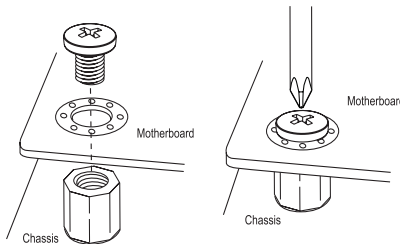

7. Repeat Step 5 to insert #6 screws into all mounting holes.
8. Make sure that the motherboard is securely placed in the chassis.

 **Note:** Images displayed are for illustration only. Your chassis or components might look different from those shown in this manual.

2-6 Control Panel Connectors and I/O Ports

The I/O ports are color coded in conformance with the PC 99 specification. See the picture below for the colors and locations of the various I/O ports.

Back Panel Connectors and I/O Ports

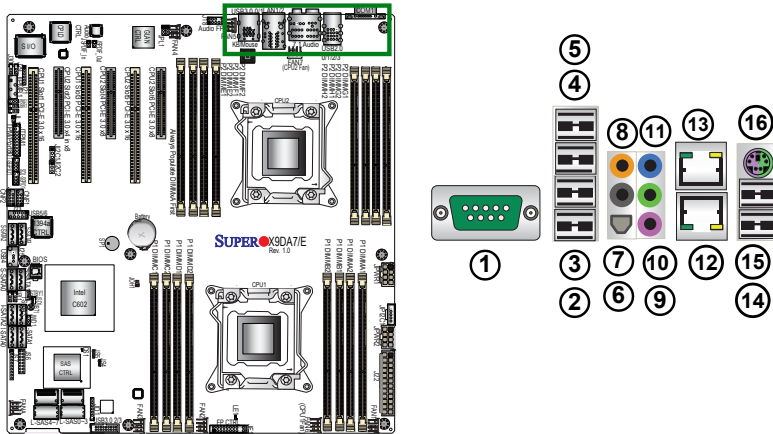

Back Panel I/O Port Locations and Definitions

| |
|-------------------------------|
| 1. COM Port 1 (Turquoise) |
| 2. Back Panel USB 2.0 Port 0 |
| 3. Back Panel USB 2.0 Port 1 |
| 4. Back Panel USB 2.0 Port 2 |
| 5. Back Panel USB 2.0 Port 3 |
| 6. SPDIF_Out |
| 7. Surround_Out |
| 8. <u>CEN/LFE_Out</u> |
| 9. <u>Mic_In</u> |
| 10. <u>Line-Out</u> |
| 11. <u>Line_In</u> |
| 12. Gigabit LAN 1 |
| 13. Gigabit LAN 2 |
| 14. Back Panel USB 3.0 Port 0 |
| 15. Back Panel USB 3.0 Port 1 |
| 16. PS/2 Keyboard or Mouse |

Serial Ports

One COM connection (COM1) is located on the Backplane I/O panel on the motherboard. See the table on the right for pin definitions.

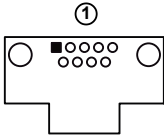

| Serial COM Port Pin Definitions | | | |
|------------------------------------|------------|-------|------------|
| Pin # | Definition | Pin # | Definition |
| 1 | DCD | 6 | DSR |
| 2 | RXD | 7 | RTS |
| 3 | TXD | 8 | CTS |
| 4 | DTR | 9 | RI |
| 5 | Ground | 10 | N/A |

Ethernet Ports

Two Gigabit Ethernet ports (LAN1/2) are located on the I/O backplane on the motherboard. All these ports accept RJ45 type cables. (**Note:** Please refer to the LED Indicator Section for LAN LED information.)

| LAN Ports Pin Definition | | | |
|-----------------------------|------------|------|--------------------------------|
| Pin# | Definition | Pin# | Definition |
| 1 | P2V5SB | 10 | SGND |
| 2 | TD0+ | 11 | Act LED |
| 3 | TD0- | 12 | P3V3SB |
| 4 | TD1+ | 13 | Link 100 LED (Yellow, +3V3SB) |
| 5 | TD1- | 14 | Link 1000 LED (Yellow, +3V3SB) |
| 6 | TD2+ | 15 | Ground |
| 7 | TD2- | 16 | Ground |
| 8 | TD3+ | 17 | Ground |
| 9 | TD3- | 18 | Ground |

(NC: No Connection)

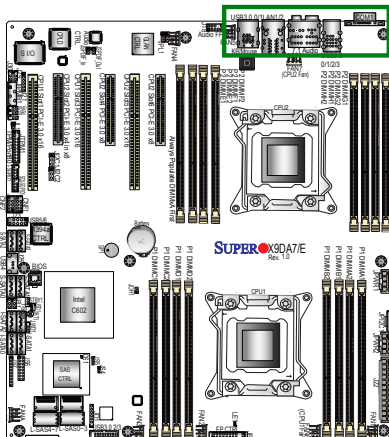

1. COM1

2. LAN1

3. LAN2

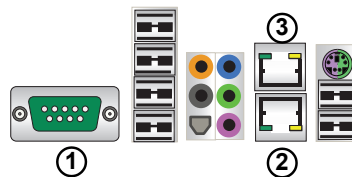

ATX PS/2 Keyboard/Mouse Ports

The ATX PS/2 keyboard and PS/2 mouse are located next to the Back Panel LAN ports 1/2 on the motherboard. See the table at right for pin definitions.

| PS/2 Keyboard/Mouse Pin Definitions | | | |
|-------------------------------------|--------------------|-----------|--------------------|
| PS2 Keyboard | | PS2 Mouse | |
| Pin# | Definition | Pin# | Definition |
| 1 | KB Data | 1 | Mouse Data |
| 2 | No Connection | 2 | No Connection |
| 3 | Ground | 3 | Ground |
| 4 | Mouse/KB VCC (+5V) | 4 | Mouse/KB VCC (+5V) |
| 5 | KB Clock | 5 | Mouse Clock |
| 6 | No Connection | 6 | No Connection |

VCC: with 1.5A PTC (current limit)

 **Note:**

This motherboard offers three Keyboard/Mouse connection options as shown in the graphic below.

- 1. Connect a keyboard cable or a mouse cable to the PS2 KB/Mouse port.
- 2. Connect an Y cable that includes a KB cable and a mouse cable to the PS2 KB/Mouse port.
- 3. Connect a KB cable and a mouse cable to any USB ports.

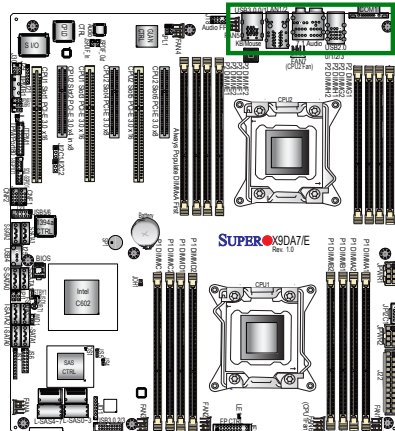
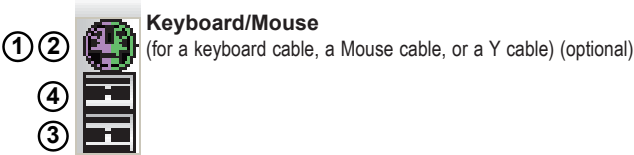

1. PS2 KB/Mouse port for a KB or a Mouse Cable
2. PS2 KB/Mouse port for an Y Cable
3. USB 3.0 Port 0
4. USB 3.0 Port 1

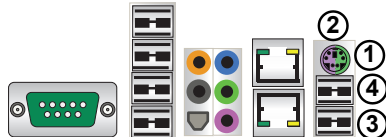

Universal Serial Bus (USB)

Four Universal Serial Bus 2.0 ports (USB 2.0 Ports 0~3), and two USB 3.0 Ports (USB 3.0 Ports 0/1) are located on the I/O backplane. In addition, two USB 2.0 ports (USB 5/6), and a Type A USB connector (USB4), located close to SATA ports, provides front USB access. Also, two USB 3.0 ports (USB 3.0 Ports 2/3) are located next to SAS ports to provide front access. USB Cables are not included. See the tables on the right for pin definitions.

| Back Panel USB (2.0) #0~3 Pin Definitions | | | |
|--|------------|------|------------|
| Pin# | Definition | Pin# | Definition |
| 1 | +5V | 5 | +5V |
| 2 | USB_PN1 | 6 | USB_PN0 |
| 3 | USB_PP1 | 7 | USB_PP0 |
| 4 | Ground | 8 | Ground |

| Front Panel USB (2.0) #4, 5/6 Pin Definitions | | | |
|--|------------|---------|------------|
| USB 5 | | USB 4/6 | |
| Pin # | Definition | Pin # | Definition |
| 1 | +5V | 2 | +5V |
| 3 | USB_PN2 | 4 | USB_PN3 |
| 5 | USB_PP2 | 6 | USB_PP3 |
| 7 | Ground | 8 | Ground |
| 9 | Key | 10 | Ground |

| Back Panel USB (3.0) #0/1, Front Accessible USB (3.0) #2/3 Pin Definitions | | | |
|---|------|-------------|---------------------------|
| Pin# | Pin# | Signal Name | Description |
| 1 | 10 | VBUS | Power |
| 2 | 11 | D- | USB 2.0 Differential Pair |
| 3 | 12 | D+ | |
| 4 | 13 | Ground | Ground of PWR Return |
| 5 | 14 | StdA_SSRX- | SuperSpeed Receiver |
| 6 | 15 | StdA_SSRX+ | Differential Pair |
| 7 | 16 | GND_DRAIN | Ground for Signal Return |
| 8 | 17 | StdA_SSTX- | SuperSpeed Transmitter |
| 9 | 18 | StdA_SSTX+ | Differential Pair |

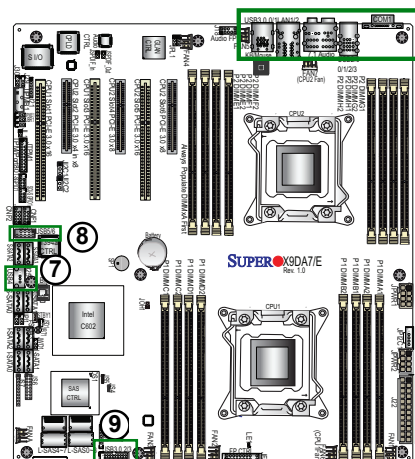

1. Backpanel USB 2.0 Port 0
2. BP USB 2.0 Port 1
3. BP USB 2.0 Port 2
4. BP USB 2.0 Port 3
5. BP USB 3.0 Port 0
6. BP USB 3.0 Port 1
7. FP USB 2.0 Port 4
8. FP USB 2.0 Port 5/6
9. FP USB 3.0 Port 2/3

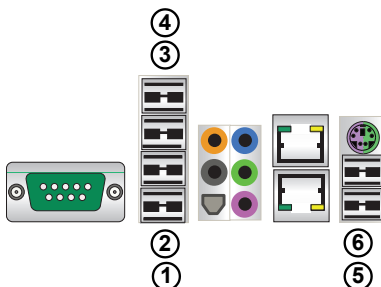

(Back_Panel) High Definition Audio (HD Audio)

This motherboard features a 7.1 Channel High Definition Audio (HDA) codec connector that provides 8 DAC channels. The HD Audio connector supports multiple-streaming 7.1 sound playback and independent stereo output through the front-panel stereo-out connection to the front, rear, center and subwoofer speakers. Use the software program included in the CD-ROM with your motherboard to enable this function.

| (BP) HD Audio | |
|----------------------|--------------|
| Conn# | Signal |
| 1 | SPDIF_Out |
| 2 | Surround_Out |
| 3 | CEN/LFE_Out |
| 4 | Mic_In |
| 5 | Line_Out |
| 6 | Line_In |

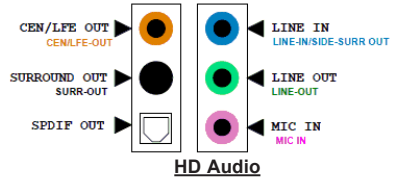

Front Accessible Audio Header

A 10-pin Audio header (J18) is also located on the motherboard. This header allows you to use the onboard sound for audio playback. Connect an audio cable to the audio header to use this feature. See the tables at right for pin definitions for these headers.

| 10-Pin Audio Pin Definitions | |
|-------------------------------------|------------------|
| Pin# | Signal |
| 1 | Microphone_Left |
| 2 | Audio_Ground |
| 3 | Microphone_Right |
| 4 | Audio_Detect |
| 5 | Line_2_Right |
| 6 | Ground |
| 7 | Jack_Detect |
| 8 | Key |
| 9 | Line_2_Left |
| 10 | Ground |

- 1. SPDIF_Out
- 2. Surround_Out
- 3. CEN/LFE_Out
- 4. Mic_In
- 5. Line-Out
- 6. Line_In
- 7. Audio Header

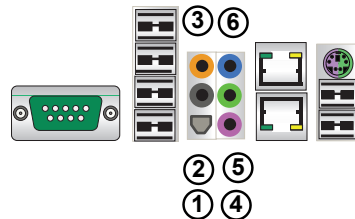
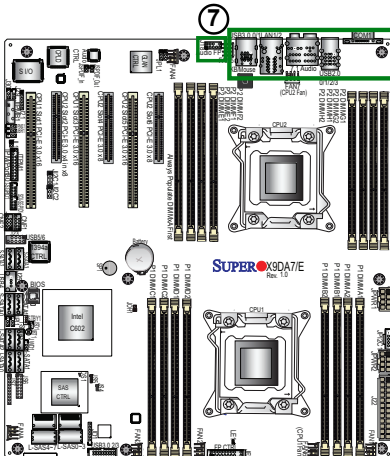

Front Control Panel

JF1 contains header pins for various buttons and indicators that are normally located on a control panel at the front of the chassis. These connectors are designed specifically for use with Supermicro's server chassis. See the figure below for the descriptions of the various control panel buttons and LED indicators. Refer to the following section for descriptions and pin definitions.

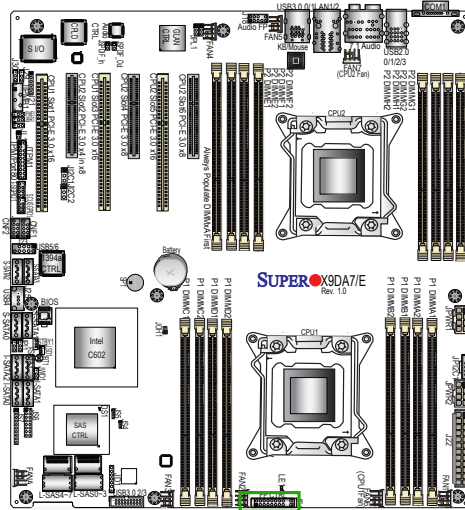

JF1 Header Pins

| | 20 | 19 | |
|-----------------|----|----|----------------------|
| Ground | ○ | ○ | NMI |
| X | ○ | ○ | X |
| Power LED | ○ | ○ | Vcc |
| HDD LED | ○ | ○ | 3.3V |
| NIC1 LINK LED | ○ | ○ | NIC1 Act LED |
| NIC2 LINK LED | ○ | ○ | NIC2 Act LED |
| OH/Fan Fail LED | ○ | ○ | Vcc |
| PWR Fail LED | ○ | ○ | 3.3V |
| Ground | ○ | ○ | Reset } Reset Button |
| Ground | ○ | ○ | PWR } Power Button |
| | 2 | 1 | |

Front Control Panel Pin Definitions

NMI Button

The non-maskable interrupt button header is located on pins 19 and 20 of JF1. Refer to the table on the right for pin definitions.

| NMI Button Pin Definitions (JF1) | |
|-------------------------------------|------------|
| Pin# | Definition |
| 19 | Control |
| 20 | Ground |

Power LED

The Power LED connection is located on pins 15 and 16 of JF1. Refer to the table on the right for pin definitions.

| Power LED Pin Definitions (JF1) | |
|------------------------------------|------------|
| Pin# | Definition |
| 15 | 3.3V |
| 16 | PWR LED |

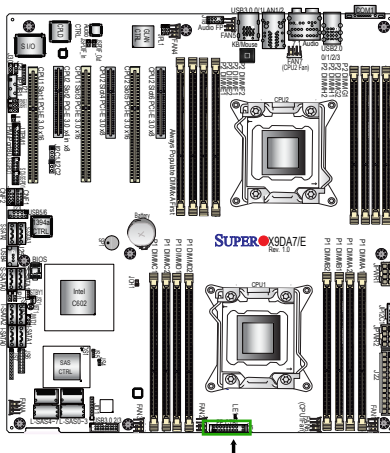

A. NMI

B. PWR LED

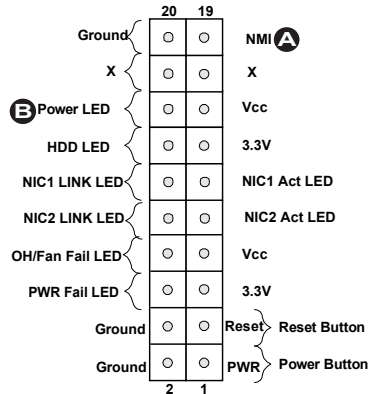

HDD LED

The HDD LED connection is located on pins 13 and 14 of JF1. Attach a cable here to indicate HDD activity. See the table on the right for pin definitions.

| HDD LED Pin Definitions (JF1) | |
|----------------------------------|--------------|
| Pin# | Definition |
| 13 | 3.3V Standby |
| 14 | HD Active |

NIC1/NIC2 LED Indicators

The NIC (Network Interface Controller) LED connection for GLAN port 1 is located on pins 11 and 12 of JF1, and the LED connection for GLAN Port 2 is on Pins 9 and 10. Attach the NIC LED cables here to display network activity. Refer to the table on the right for pin definitions.

| GLAN1/2 LED Pin Definitions (JF1) | |
|--------------------------------------|--------------------|
| Pin# | Definition |
| 9 | NIC 2 Activity LED |
| 10 | NIC 2 Link LED |
| 11 | NIC 1 Activity LED |
| 12 | NIC 1 Link LED |

A. HDD LED

B. NIC1 LED

C. NIC2 LED

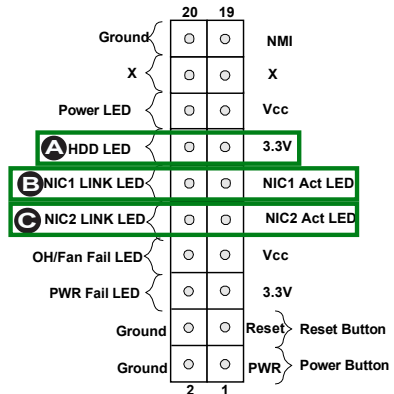
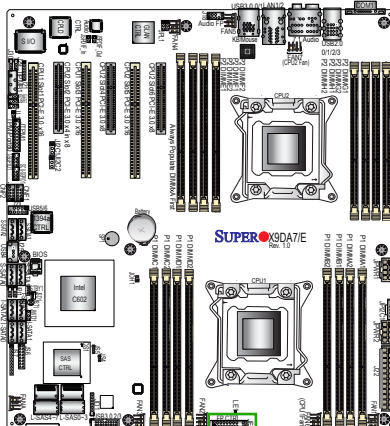

Overheat (OH)/Fan Fail LED

Connect an LED cable to pins 7 and 8 of JF1 to provide advanced warnings of chassis overheating and fan failure. Refer to the table on the right for pin definitions.

| OH/Fan Fail/PWR Fail LED Pin Definitions (JF1) | |
|--|------------------|
| Pin# | Definition |
| 7 | Vcc |
| 8 | OH/Fan Fail LED) |

| OH/Fan Fail Indicator Status | |
|------------------------------|------------|
| State | Definition |
| Off | Normal |
| On | Overheat |
| Flash-ing | Fan Fail |

Power Fail LED

The Power Fail LED connection is located on pins 5 and 6 of JF1. Refer to the table on the right for pin definitions.

| PWR Fail LED Pin Definitions (JF1) | |
|------------------------------------|-----------------|
| Pin# | Definition |
| 5 | 3.3V |
| 6 | PWR Supply Fail |

A. OH/Fail Fail LED

B. PWR Supply Fail

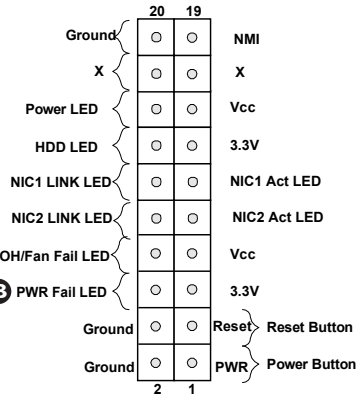
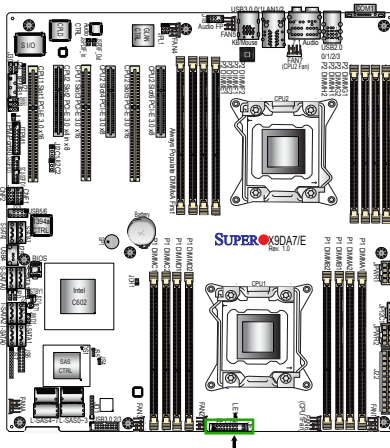

Reset Button

The Reset Button connection is located on pins 3 and 4 of JF1. Attach it to a hardware reset switch on the chassis to use this feature. Refer to the table on the right for pin definitions.

| Reset Button Pin Definitions (JF1) | |
|---------------------------------------|------------|
| Pin# | Definition |
| 3 | Reset |
| 4 | Ground |

Power Button

The Power Button connection is located on pins 1 and 2 of JF1. Momentarily contacting both pins will power on or off the system. This button can also be configured to function as a suspend button (with a setting in the BIOS - See Chapter 4). To turn off the power when the system is in suspend mode, press the button for 4 seconds or longer. Refer to the table on the right for pin definitions.

| Power Button Pin Definitions (JF1) | |
|---------------------------------------|------------|
| Pin# | Definition |
| 1 | Signal |
| 2 | Ground |

A. Reset Button

B. PWR Button

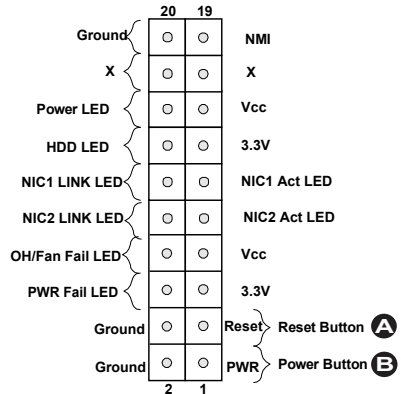
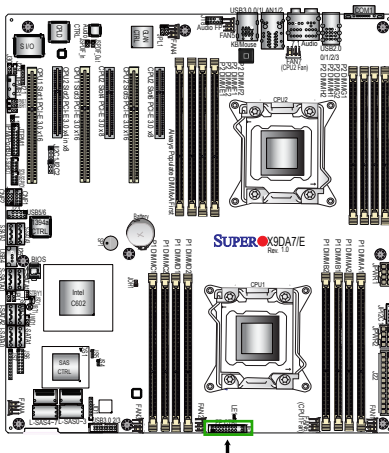

2-7 Connecting Cables

Power Connectors

A 24-pin main power supply connector(J22) and two 8-pin CPU PWR connectors (JPWR1/2) are located on the motherboard. These power connectors meet the SSI EPS 12V specification. These power connectors must also be connected to your power supply. See the table on the right for pin definitions.

Warning: To provide adequate power supply to the motherboard, be sure to connect the 24-pin ATX PWR (J22) and two 8-pin PWR connectors (JPWR1, JPWR2) to the power supply. Failure to do so will void the manufacturer warranty on your power supply and motherboard.

| Pin# | Definition | Pin # | Definition |
|------|------------|-------|------------|
| 13 | +3.3V | 1 | +3.3V |
| 14 | -12V | 2 | +3.3V |
| 15 | COM | 3 | COM |
| 16 | PS_ON | 4 | +5V |
| 17 | COM | 5 | COM |
| 18 | COM | 6 | +5V |
| 19 | COM | 7 | COM |
| 20 | Res (NC) | 8 | PWR_OK |
| 21 | +5V | 9 | 5VSB |
| 22 | +5V | 10 | +12V |
| 23 | +5V | 11 | +12V |
| 24 | COM | 12 | +3.3V |

| Pins | Definition |
|-------------|------------|
| 1 through 4 | Ground |
| 5 through 8 | +12V |

(Required)

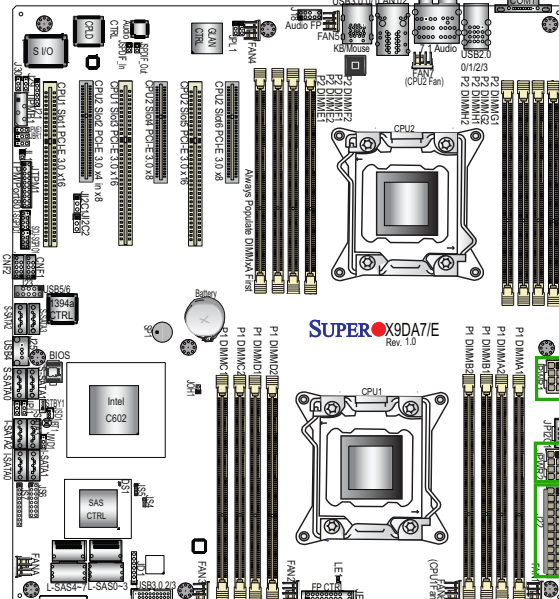

A. J22: 24-pin ATX PWR (Req'd)

B. JPWR1: 8-pin Processor PWR (Req'd)

C. JPWR2: 8-pin Processor PWR (Req'd)

Fan Headers

This motherboard has eight system/CPU fan headers (Fan 1~Fan 7, and Fan A) on the motherboard. All these 4-pin fan headers are backward compatible with the traditional 3-pin fans. The fan speeds are controlled by firmware thermal management via IPMI. (See Chapter 4 for more details.) See the table on the right for pin definitions.

| Fan Header Pin Definitions | |
|----------------------------|----------------|
| Pin# | Definition |
| 1 | Ground |
| 2 | +12V |
| 3 | Tachometer |
| 4 | PWR Modulation |

Chassis Intrusion

A Chassis Intrusion header is located at JL1 on the motherboard. Attach an appropriate cable from the chassis to inform you of a chassis intrusion when the chassis is opened.

| Chassis Intrusion Pin Definitions | |
|-----------------------------------|-----------------|
| Pin# | Definition |
| 1 | Intrusion Input |
| 2 | Ground |

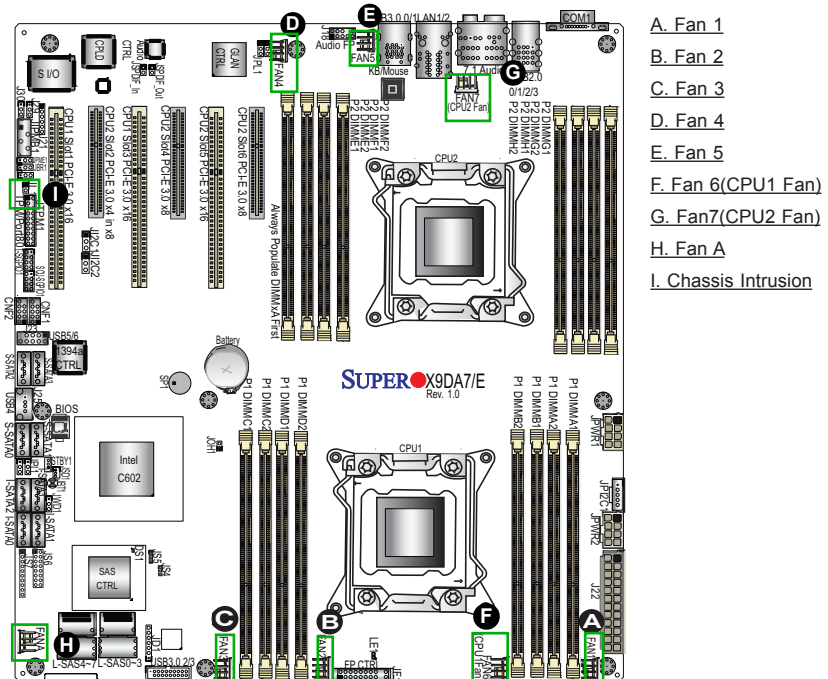

- A. Fan 1
- B. Fan 2
- C. Fan 3
- D. Fan 4
- E. Fan 5
- F. Fan 6(CPU1 Fan)
- G. Fan7(CPU2 Fan)
- H. Fan A
- I. Chassis Intrusion

Internal Speaker

The Internal Speaker, located at SP1, can be used to provide audible indications for various beep codes. See the table on the right for pin definitions. Refer to the layout below for the locations of the Internal Buzzer (SP1).

| Internal Buzzer (SP1) Pin Definition | | |
|---|-------------|---------------|
| Pin# | Definitions | |
| Pin 1 | Pos. (+) | Beep In |
| Pin 2 | Neg. (-) | Alarm Speaker |

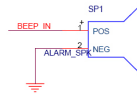

Power LED/Speaker

On JD1 header, pins 1-3 are used for power LED indication, and pins 4-7 are for the speaker. See the tables on the right for pin definitions. Please note that the speaker connector pins (4-7) are used with an external speaker. If you wish to use the on-board speaker, you should close pins 6-7 with a jumper.

| PWR LED Connector Pin Definitions | |
|--------------------------------------|-------------|
| Pin Setting | Definition |
| Pin 1 | Anode (+) |
| Pin2 | Cathode (-) |
| Pin3 | NA |

| Speaker Connector Pin Settings | |
|-----------------------------------|------------------|
| Pin Setting | Definition |
| Pins 4-7 | External Speaker |
| Pins 6-7 | Internal Speaker |

A. Internal Speaker
(Buzzer)

B. PWR LED/Speaker

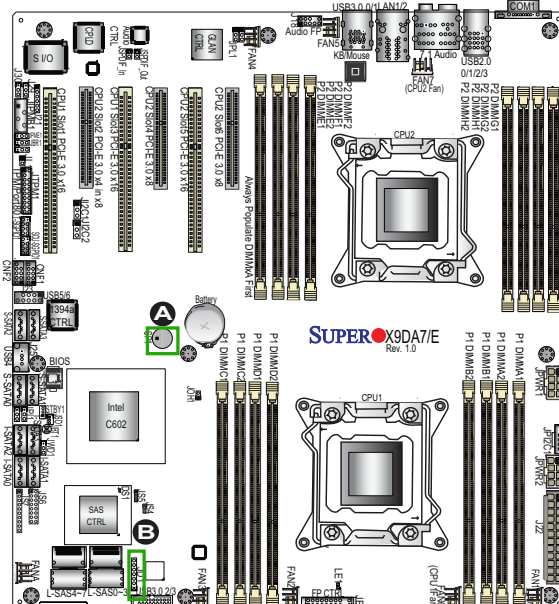

TPM Header/Port 80 Header

A Trusted Platform Module/Port 80 header is located at JTPM1 to provide TPM support and Port 80 connection. Use this header to enhance system performance and data security. See the table on the right for pin definitions.

| TPM/Port 80 Header Pin Definitions | | | |
|---------------------------------------|------------|-------|-------------|
| Pin # | Definition | Pin # | Definition |
| 1 | LCLK | 2 | GND |
| 3 | LFRAME# | 4 | <(KEY)> |
| 5 | LRESET# | 6 | +5V (X) |
| 7 | LAD 3 | 8 | LAD 2 |
| 9 | +3.3V | 10 | LAD1 |
| 11 | LAD0 | 12 | GND |
| 13 | SMB_CLK4 | 14 | SMB_DAT4 |
| 15 | +3V_DUAL | 16 | SERIRQ |
| 17 | GND | 18 | CLKRUN# (X) |
| 19 | LPCPD# | 20 | LDRQ# (X) |

Standby Power Header

The Standby Power header is located at STBY1 on the motherboard. See the table on the right for pin definitions.

| Standby Power Pin Definitions | |
|----------------------------------|-------------|
| Pin# | Definition |
| 1 | +5V Standby |
| 2 | Ground |
| 3 | Wake-up |

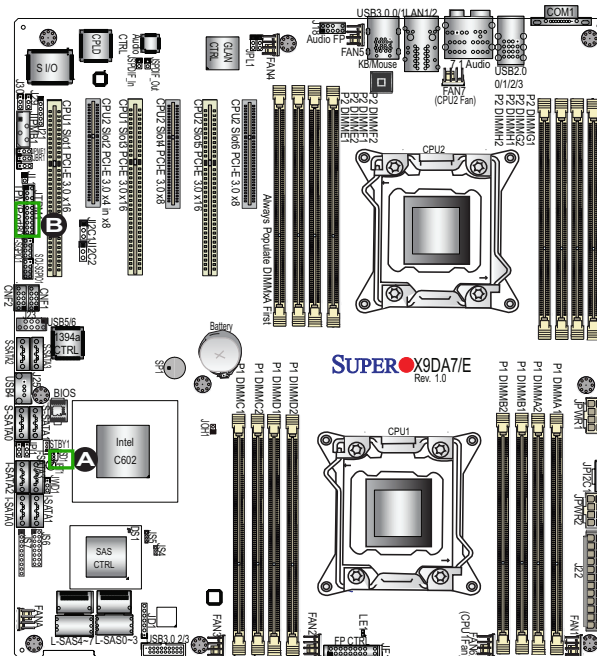

- A. TPM/Port 80 Header
- B. Standby PWR

Power SMB (I²C) Connector

Power System Management Bus (I²C) Connector (JPI²C1) monitors power supply, fan and system temperatures. See the table on the right for pin definitions.

| PWR SMB Pin Definitions | |
|----------------------------|------------|
| Pin# | Definition |
| 1 | Clock |
| 2 | Data |
| 3 | PWR Fail |
| 4 | Ground |
| 5 | +3.3V |

A. JPI²C1

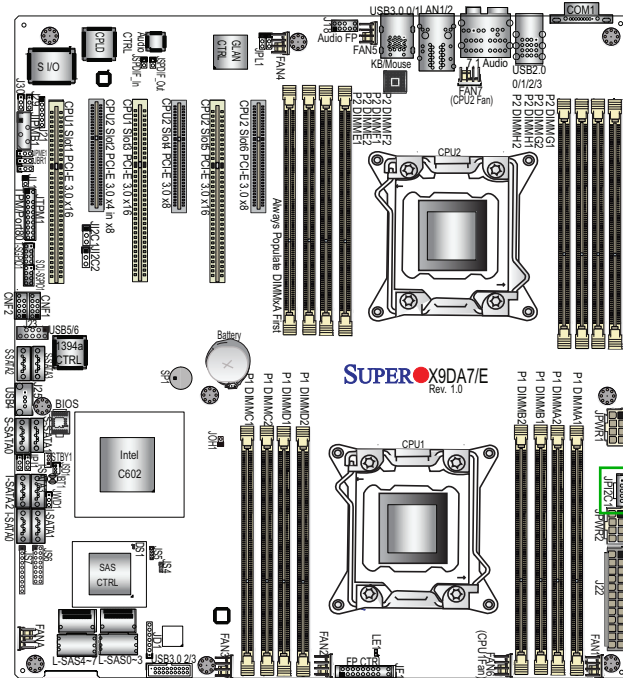

T-SGPIO 1/S-SGPIO 1 Headers

Two SGPIO (Serial-Link General Purpose Input/Output) headers are located on the motherboard. T-SGPIO supports SATA interface, and S-SGPIO 1 is for SAS interface. See the table on the right for pin definitions.

| T-SGPIO 1/S-SGPIO 1 Pin Definitions | | | |
|--|------------|-----|------------|
| Pin# | Definition | Pin | Definition |
| 1 | NC | 2 | NC |
| 3 | Ground | 4 | Data |
| 5 | Load | 6 | Ground |
| 7 | Clock | 8 | NC |

Note: NC= No Connection

IEEE 1394a_1/ 1394a_2 Connectors

1394a_1 (CNF1) and 1394a_2 (CNF2) provide IEEE 1394a connections on the motherboard. Connect IEEE 1394a cables to the connectors for IEEE 1394a support. See the tables on the right for pin definitions.

| 1394_1 Pin Definitions | | | |
|---------------------------|------------|------|------------|
| Pin# | Definition | Pin# | Definition |
| 1 | PTPA0+ | 2 | PTPA0- |
| 3 | GND | 4 | GND |
| 5 | PTPB0+ | 6 | PTPB0- |
| 7 | PWR 1394a | 8 | PWR 1394a |
| | | 10 | Shield GND |

| 1394_2 Pin Definitions | | | |
|---------------------------|------------|------|------------|
| Pin# | Definition | Pin# | Definition |
| 1 | PTPA1+ | 2 | PTPA1- |
| 3 | GND | 4 | GND |
| 5 | PTPB1+ | 6 | PTPB1- |
| 7 | PWR 1394a | 8 | PWR 1394a |
| | | 10 | Shield GND |

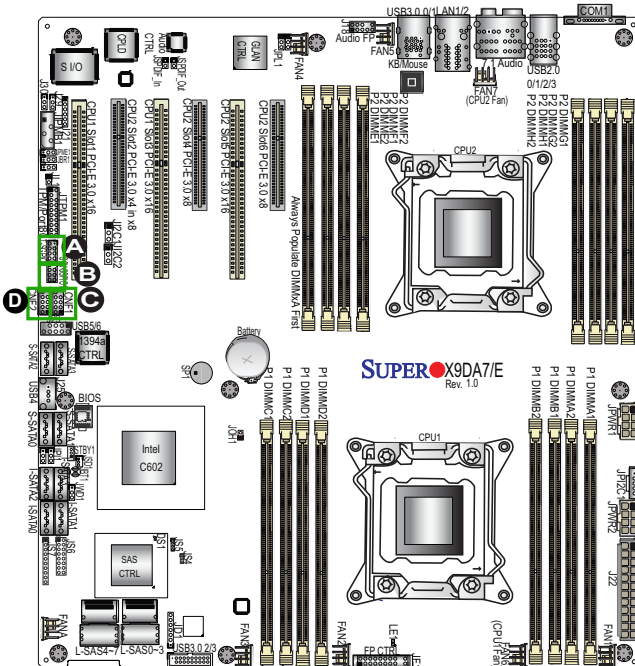

A. T-SGPIO1

B. S-SGPIO1

C. 1394a_1

C. 1394a_2

SPDIF_In/SPDIF_Out Headers

The SPDIF_In (JSPDIF_In) and SPDIF_Out (JSPDIF_Out) headers are located next to the GLAN Controller on the motherboard. Place a cap on each header for audio support. You will also need to have a cable to use each connection.

| SPDIF_In Pin Definitions | |
|-----------------------------|------------|
| Pin# | Definition |
| 1 | S/SPDIF_In |
| 2 | Ground |

| SPDIF_Out Pin Definitions | |
|------------------------------|-------------|
| Pin# | Definition |
| 1 | S/SPDIF_Out |
| 2 | Ground |

DOM Power Connector

A power connector for SATA DOM (Disk_On_Module) devices is located at JSD1. Connect an appropriate cable here to provide backup power support for your SATA DOM devices to retain cache data during power outage. See the table on the right for pin definitions..

| DOM PWR Pin Definitions | |
|----------------------------|------------|
| Pin# | Definition |
| 1 | +5V |
| 2 | Ground |
| 3 | Ground |

- A. SPDIF_In
- B. SPDIF_Out
- C. DOM PWR

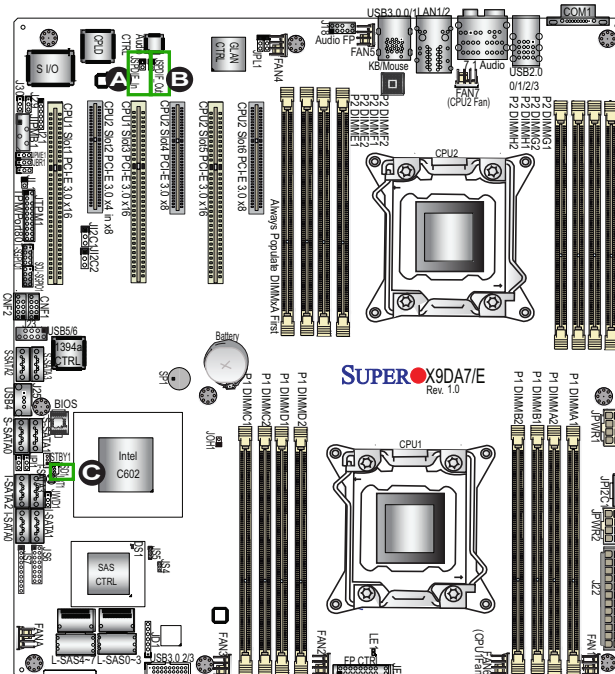

Overheat/Fan Fail LED

The JOH1 header is used to connect an LED indicator to provide warnings of chassis overheating and fan failure. This LED will blink when a fan failure occurs. Refer to the tables on right for pin definitions.

| OH/Fan Fail LED Status | |
|------------------------|----------|
| State | Message |
| Solid | Overheat |
| Blinking | Fan Fail |

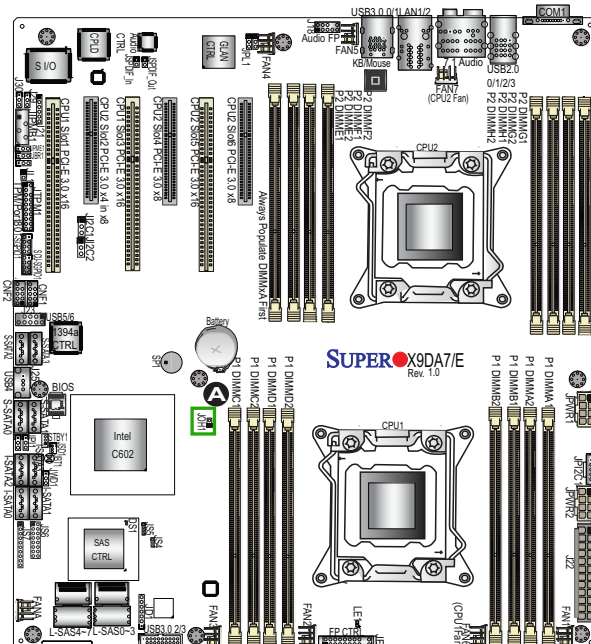

A. OH/Fan Fail LED

2-8 Jumper Settings

Explanation of Jumpers

To modify the operation of the motherboard, jumpers can be used to choose between optional settings. Jumpers create shorts between two pins to change the function of the connector. Pin 1 is identified with a square solder pad on the printed circuit board. See the motherboard layout pages for jumper locations.

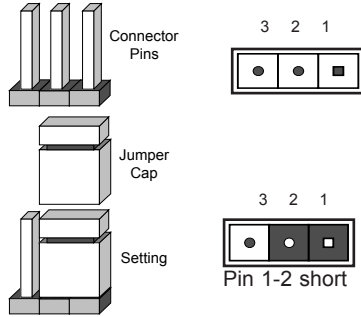

Note: On two-pin jumpers, "Closed" means the jumper is on and "Open" means the jumper is off the pins.

GLAN Enable/Disable

JPL1 enables or disables the GLAN ports on the motherboard. See the table on the right for jumper settings. The default setting is Enabled.

| GLAN Enable Jumper Settings | |
|-----------------------------|-------------------|
| Jumper Setting | Definition |
| 1-2 | Enabled (default) |
| 2-3 | Disabled |

A. GLAN1/2 Enable

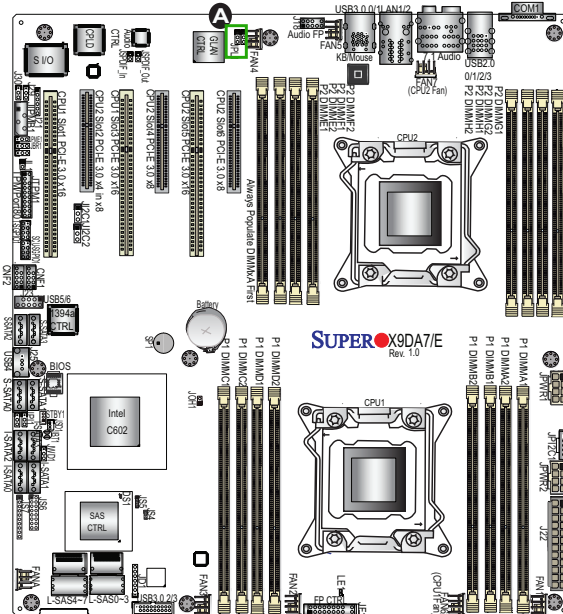

CMOS Clear

JBT1 is used to clear CMOS. Instead of pins, this "jumper" consists of contact pads to prevent accidental clearing of CMOS. To clear CMOS, use a metal object such as a small screwdriver to touch both pads at the same time to short the connection. Always remove the AC power cord from the system before clearing CMOS. (⌚)

 **Note 1:** For an ATX power supply, you must completely shut down the system, remove the AC power cord, and then short JBT1 to clear CMOS.

Note 2: Be sure to remove the onboard CMOS Battery before you short JBT1 to clear CMOS.

Note 3: Clearing CMOS will also clear all passwords.

Watch Dog Enable/Disable

Watch Dog (JWD1) is a system monitor that can reboot the system when a software application hangs. Close pins 1-2 to reset the system if an application hangs. Close pins 2-3 to generate a non-maskable interrupt signal for the application that hangs. See the table on the right for jumper settings. Watch Dog must also be enabled in the BIOS.

| Watch Dog Jumper Settings | |
|---------------------------|-----------------|
| Jumper Setting | Definition |
| Pins 1-2 | Reset (default) |
| Pins 2-3 | NMI |
| Open | Disabled |

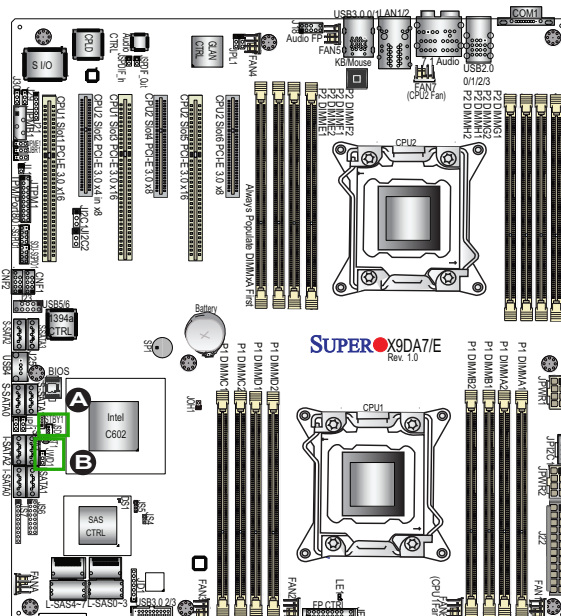

A. Clear CMOS

B. Watch Dog Enable

IEEE 1394a Enable

JPI1 allows you to enable or disable the onboard IEEE 1394a support. The default position is on pins 1 and 2 to use 1394_1 and 1394_2 connections. See the table on the right for jumper settings.

| 1394a Enable/Disable Jumper Settings | |
|--------------------------------------|------------|
| Both Jumpers | Definition |
| Pins 1-2 | Enabled |
| Pins 2-3 | Disabled |

I²C Bus to PCI-Exp. Slots

Use Jumpers JI²C1 and JI²C2 to connect the System Management Bus (I²C) to PCI-Express slots to improve PCI slot performance. These two jumpers are to be set at the same time. The default setting is Closed to enable the connections. See the table on the right for jumper settings.

| I ² C to PCI-E slots Jumper Settings | |
|---|-------------------|
| Jumper Setting | Definition |
| Closed | Enabled (Default) |
| Open | Disabled |

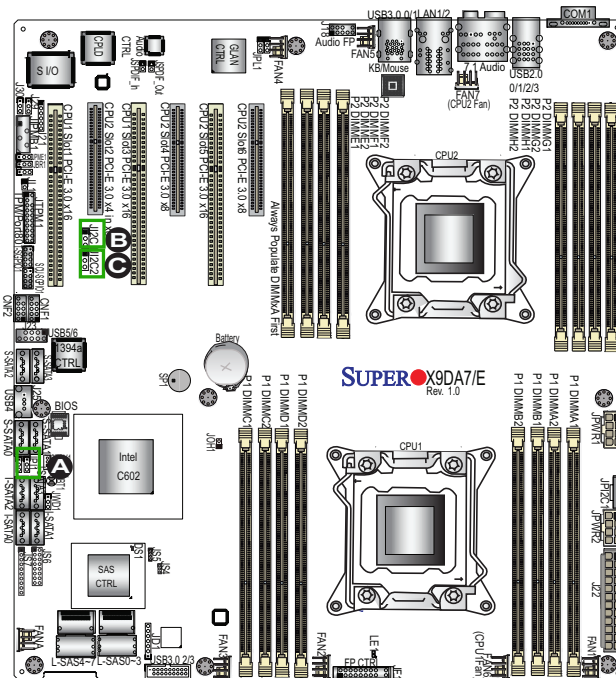

- A. 1394a Enable
- B. JI²C1
- C. JI²C2

Management Engine (ME) Recovery

Use Jumper JPME1 to select ME Firmware Recovery mode, which will limit resource allocation for essential system operation only in order to maintain normal power operation and management. In the single operation mode, online upgrade will be available via Recovery mode. See the table on the right for jumper settings.

| ME Recovery Jumper Settings | |
|-----------------------------|------------------|
| Jumper Setting | Definition |
| 1-2 | Normal (Default) |
| 2-3 | ME Recovery |

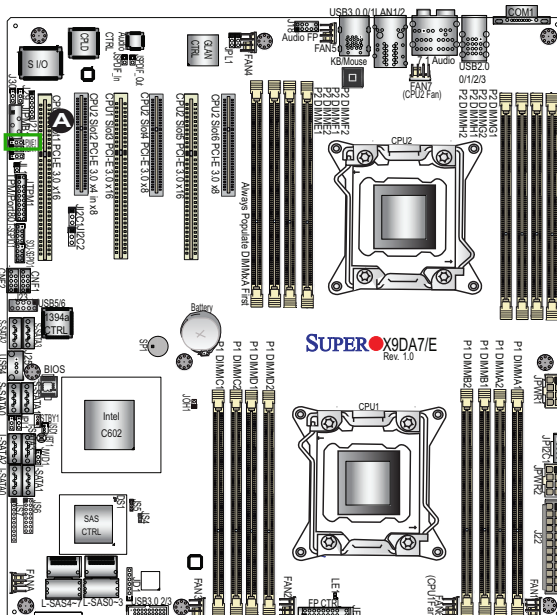

A. JPME1

2-9 Onboard LED Indicators

GLAN LEDs

Two LAN ports (LAN 1/LAN 2) are located on the IO Backplane of the motherboard. Each Ethernet LAN port has two LEDs. The green LED indicates activity, while the other Link LED may be green, amber or off to indicate the speed of the connections. See the tables at right for more information.

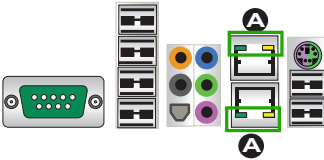

Onboard Power LED

An Onboard Power LED is located at LE1 on the motherboard. When this LED is on, the system is on. Be sure to turn off the system and unplug the power cord before removing or installing components. See the tables at right for more information.



Activity LED Link LED

Rear View (when facing the rear side of the chassis)

| LAN 1/LAN 2 Activity LED LED State | | |
|------------------------------------|----------|------------|
| Color | Status | Definition |
| Green | Flashing | Active |

| LAN 1/LAN 2 Link LED LED State | |
|--------------------------------|--------------------------|
| LED Color | Definition |
| Off | 10 Mbps or No Connection |
| Green | 100 Mbps |
| Amber | 1 Gbps |

| Onboard PWR LED Indicator (LE1) LED Settings | |
|--|--------------------------------------|
| LED Color | Status |
| Off | System Off (PWR cable not connected) |
| Green | System On |
| Green: Flashing Quickly | ACPI S1 State |

A. LAN1/2 LEDs

B. Onboard PWR LED

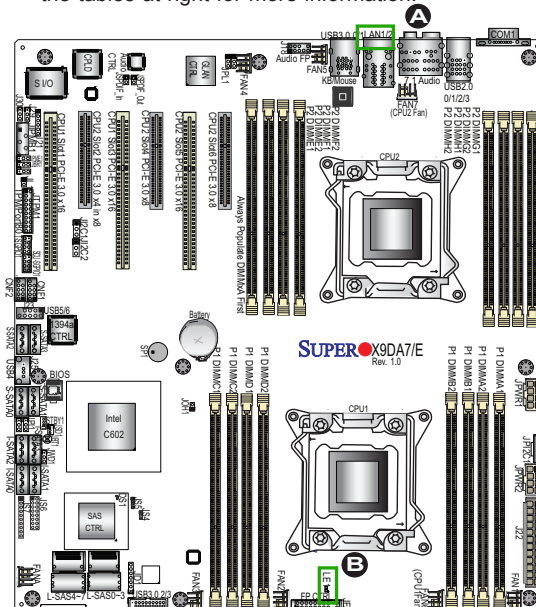

2-10 SATA/SAS Connections

Serial ATA Ports

Two SATA 3.0 Ports (I-SATA0/1), colored in white, and six SATA 2 Ports (I-SATA2/3, S-SATA0~3), colored in black, are located on the motherboard. I-SATA ports are supported by the Intel PCH chip; while S-SATA ports are supported by SCU (Storage Control Unit). These ports provide serial-link signal connections, which are faster than the connections of Parallel ATA. See the table on the right for pin definitions.

| SATA/SAS Pin Definitions | |
|--------------------------|------------|
| Pin# | Definition |
| 1 | Ground |
| 2 | TX_P |
| 3 | TX_N |
| 4 | Ground |
| 5 | RX_N |
| 6 | RX_P |
| 7 | Ground |

SAS2 Ports (X9DA7 Only)

Eight Serial_Attached_SCSI Ports (L-SAS 0~3, L-SAS 4~7) provide Serial_Attached SCSI connections on the motherboard. SAS Connections can function as SATA ports if the connectors are used with the mini-ipass cables. See the table on the right for pin definitions.

 **Note:** For more information on HostRAID configuration, please refer to the HostRAID User's Guide posted on our Website @ <http://www.supermicro.com>.

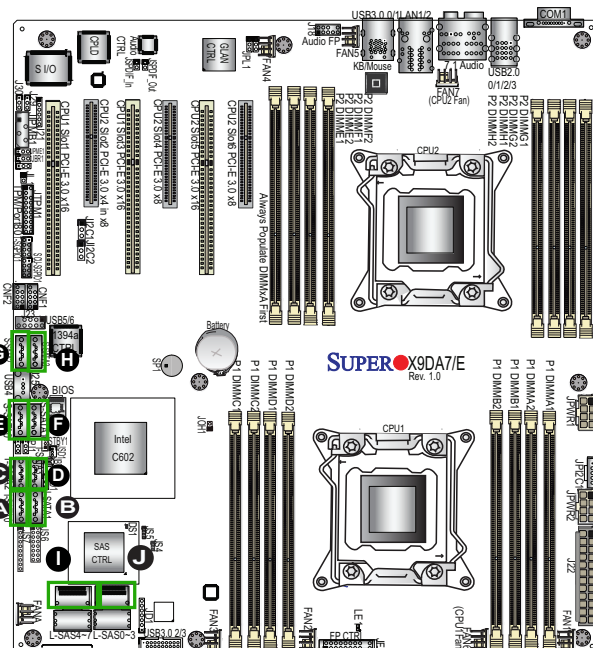

- A. I-SATA0 (SATA3.0)
- B. I-SATA1 (SATA3.0)
- C. I-SATA2 (SATA2.0)
- D. I-SATA3 (SATA2.0)
- E. S-SATA0 (SATA2.0)
- F. S-SATA1 (SATA2.0)
- G. S-SATA2 (SATA2.0)
- H. S-SATA3 (SATA2.0)
- I. L-SAS0~3 (X9DA7)
- J. L-SAS4~7 (X9DA7)

Notes

Chapter 3

Troubleshooting

3-1 Troubleshooting Procedures

Use the following procedures to troubleshoot your system. If you have followed all of the procedures below and still need assistance, refer to the 'Technical Support Procedures' and/or 'Returning Merchandise for Service' section(s) in this chapter. Note: Always disconnect the power cord before adding, changing or installing any hardware components.

Before Power On

1. Make sure that there are no short circuits between the motherboard and chassis.
2. Disconnect all ribbon/wire cables from the motherboard, including those for the keyboard and mouse.
3. Remove all add-on cards.
4. Install CPU 1 first (making sure it is fully seated) and connect the front panel connectors to the motherboard.

No Power

1. Make sure that there are no short circuits between the motherboard and the chassis.
2. Make sure that the ATX power connectors are properly connected
3. Check that the 115V/230V switch on the power supply is properly set, if available.
4. Turn the power switch on and off to test the system, if applicable.
5. The battery on your motherboard may be old. Check to verify that it still supplies ~3VDC. If it does not, replace it with a new one.

No Video

1. If the power is on, but you have no video, remove all the add-on cards and cables.
2. Use the speaker to determine if any beep codes exist. Refer to Appendix A for details on beep codes.

System Boot Failure

If the system does not display POST or does not respond after the power is turned on, check the following:

1. Check for any error beep from the motherboard speaker.
 - If there is no error beep, try to turn on the system without DIMM modules installed. If there is still no error beep, try to turn on the system again with only one processor installed in CPU Socket#1. If there is still no error beep, replace the motherboard.
 - If there are error beeps, clear the CMOS settings by unplugging the power cord and contracting both pads on the CMOS Clear Jumper (JB1). (Refer to Section 2-8 in Chapter 2.)
2. Remove all components from the motherboard, especially the DIMM modules. Make sure that the system's power is on, and memory error beeps are activated.
3. Turn on the system with only one DIMM module installed. If the system boots, check for bad DIMM modules or slots by following the Memory Errors Troubleshooting procedure in this Chapter.

Losing the System's Setup Configuration

1. Make sure that you are using a high quality power supply. A poor quality power supply may cause the system to lose the CMOS setup information. Refer to Section 2-7 for details on recommended power supplies.
2. The battery on your motherboard may be old. Check to verify that it still supplies ~3VDC. If it does not, replace it with a new one.
3. If the above steps do not fix the Setup Configuration problem, contact your vendor for repairs.

Memory Errors

When a No-Memory Beep Code is issued by the system, check the following:

1. Make sure that the memory modules are compatible with the system and that the DIMM modules are properly and fully installed. (For memory compatibility, refer to the Memory Compatibility Chart posted on our Website @ <http://www.supermicro.com>.)
2. Check if different speeds of DIMMs have been installed. It is strongly recommended that you use the same RAM speed for all DIMMs in the system.
3. Make sure that you are using the correct type of Registered/Load Reduction ECC or Unbuffered ECC/Non-ECC DDR3 DIMM modules recommended by the manufacturer.
4. Check for bad DIMM modules or slots by swapping a single module among all memory slots and check the results.
5. Make sure that all memory modules are fully seated in their slots. Follow the instructions given in Section 2-4 in Chapter 2.
6. Please follow the instructions given in the DIMM Population Tables listed in Section 2-4 to install your memory modules.

When the System Becomes Unstable

A. When the system becomes unstable during or after OS installation, check the following:

1. CPU/BIOS support: Make sure that your CPU is supported, and you have the latest BIOS installed in your system.
2. Memory support: Make sure that the memory modules are supported by testing the modules using memtest86 or a similar utility.



Note: Refer to the product page on our website <http://www.supermicro.com> for memory and CPU support and updates.

3. HDD support: Make sure that all hard disk drives (HDDs) work properly. Replace the bad HDDs with good ones.
4. System cooling: Check system cooling to make sure that all heatsink fans, and CPU/system fans, etc., work properly. Check Hardware Monitoring settings in the BIOS to make sure that the CPU and System temperatures are

within the normal range. Also check the front panel Overheat LED, and make sure that the Overheat LED is not on.

5. Adequate power supply: Make sure that the power supply provides adequate power to the system. Make sure that all power connectors are connected. Please refer to our website for more information on minimum power requirement.
6. Proper software support: Make sure that the correct drivers are used.

B. When the system becomes unstable before or during OS installation, check the following:

1. Source of installation: Make sure that the devices used for installation are working properly, including boot devices such as CD/DVD disc, CD/DVD-ROM.
2. Cable connection: Check to make sure that all cables are connected and working properly.
3. Using minimum configuration for troubleshooting: Remove all unnecessary components (starting with add-on cards first), and use minimum configuration (with a CPU and a memory module installed) to identify the trouble areas. Refer to the steps listed in Section A above for proper troubleshooting procedures.
4. Identifying bad components by isolating them: If necessary, remove a component in question from the chassis, and test it in isolation to make sure that it works properly. Replace a bad component with a good one.
5. Check and change one component at a time instead of changing several items at the same time. This will help isolate and identify the problem.
6. To find out if a component is good, swap this component with a new one to see if the system will work properly. If so, then the old component is bad. You can also install the component in question in another system. If the new system works, the component is good and the old system has problems.

3-2 Technical Support Procedures

Before contacting Technical Support, please take the following steps. Also, please note that as a motherboard manufacturer, Supermicro also sells motherboards through its channels, so it is best to first check with your distributor or reseller for troubleshooting services. They should know of any possible problem(s) with the specific system configuration that was sold to you.

1. Please go through the 'Troubleshooting Procedures' and 'Frequently Asked Question' (FAQ) sections in this chapter or see the FAQs on our website (<http://www.supermicro.com/>) before contacting Technical Support.
 2. BIOS upgrades can be downloaded from our website (<http://www.supermicro.com>).
 3. If you still cannot resolve the problem, include the following information when contacting Supermicro for technical support:
 - Motherboard model and PCB revision number
 - BIOS release date/version (This can be seen on the initial display when your system first boots up.)
 - System configuration
 4. An example of a Technical Support form is on our website at (<http://www.supermicro.com>).
- Distributors: For immediate assistance, please have your account number ready when placing a call to our technical support department. We can be reached by e-mail at support@supermicro.com.

3-3 Battery Removal and Installation

Battery Removal

To remove the onboard battery, follow the steps below:

1. Power off your system and unplug your power cable.
2. Locate the onboard battery as shown below.
3. Using a tool such as a pen or a small screwdriver, push the battery lock outwards to unlock it. Once unlocked, the battery will pop out from the holder.
4. Remove the battery.

Proper Battery Disposal

Warning: Please handle used batteries carefully. Do not damage the battery in any way; a damaged battery may release hazardous materials into the environment. Do not discard a used battery in the garbage or a public landfill. Please comply with the regulations set up by your local hazardous waste management agency to dispose of your used battery properly.

Battery Installation

1. To install an onboard battery, follow the steps 1 & 2 above and continue below:
2. Identify the battery's polarity. The positive (+) side should be facing up.
3. Insert the battery into the battery holder and push it down until you hear a click to ensure that the battery is securely locked.

Warning: When replacing a battery, be sure to only replace it with the same type.

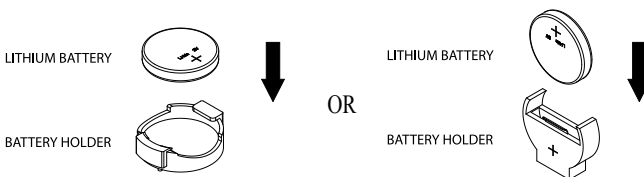

3-4 Frequently Asked Questions

Question: What are the various types of memory that my motherboard can support?

Answer: The motherboard supports Registered/Load Reduced ECC or Unbuffered ECC/Non-ECC DDR3 DIMM modules. To enhance memory performance, do not mix memory modules of different speeds and sizes. Please follow all memory installation instructions given on Section 2-4 in Chapter 2.

Question: How do I update my BIOS?

It is recommended that you **do not** upgrade your BIOS if you are not experiencing any problems with your system. Updated BIOS files are located on our website at <http://www.supermicro.com>. Please check our BIOS warning message and the information on how to update your BIOS on our website. Select your motherboard model and download the BIOS file to your computer. Also, check the current BIOS revision to make sure that it is newer than your BIOS before downloading. You can choose from the zip file and the .exe file. If you choose the zip BIOS file, please unzip the BIOS file onto a bootable USB device. Run the batch file using the format AMI.bat filename.rom from your bootable USB device to flash the BIOS. Then, your system will automatically reboot.

Warning: Do not shut down or reset the system while updating the BIOS to prevent possible system boot failure!)



Note: The SPI BIOS chip used on this motherboard cannot be removed. Send your motherboard back to our RMA Department at Supermicro for repair. For BIOS Recovery instructions, please refer to the AMI BIOS Recovery Instructions posted at <http://www.supermicro.com>.

Question: How do I handle the used battery?

Answer: Please handle used batteries carefully. Do not damage the battery in any way; a damaged battery may release hazardous materials into the environment. Do not discard a used battery in the garbage or a public landfill. Please comply with the regulations set up by your local hazardous waste management agency to dispose of your used battery properly.

3-5 Returning Merchandise for Service

A receipt or copy of your invoice marked with the date of purchase is required before any warranty service will be rendered. You can obtain service by calling your vendor for a Returned Merchandise Authorization (RMA) number. When returning the motherboard to the manufacturer, the RMA number should be prominently displayed on the outside of the shipping carton, and the shipping package is mailed prepaid or hand-carried. Shipping and handling charges will be applied for all orders that must be mailed when service is complete. For faster service, You can also request a RMA authorization online (<http://www.supermicro.com/RmaForm/>).

This warranty only covers normal consumer use and does not cover damages incurred in shipping or from failure due to the alternation, misuse, abuse or improper maintenance of products.

During the warranty period, contact your distributor first for any product problems.

Chapter 4

BIOS

4-1 Introduction

This chapter describes the AMI BIOS Setup utility for the X9DA7/X9DAE. It also provides the instructions on how to navigate the AMI BIOS Setup utility screens. The AMI ROM BIOS is stored in a Flash EEPROM and can be easily updated.

Starting BIOS Setup Utility

To enter the AMI BIOS Setup utility screens, press the key while the system is booting up.

 **Note:** In most cases, the key is used to invoke the AMI BIOS setup screen. There are a few cases when other keys are used, such as <F3>, <F4>, etc.

Each main BIOS menu option is described in this manual. The Main BIOS setup menu screen has two main frames. The left frame displays all the options that can be configured. Grayed-out options cannot be configured. Options in blue can be configured by the user. The right frame displays the key legend. Above the key legend is an area reserved for a text message. When an option is selected in the left frame, it is highlighted in white. Often a text message will accompany it.

 **Note:** The AMI BIOS has default text messages built in. The manufacturer retains the option to include, omit, or change any of these text messages.

The AMI BIOS Setup utility uses a key-based navigation system called "hot keys." Most of the AMI BIOS setup utility "hot keys" can be used at any time during setup navigation. These keys include <F3>, <F4>, <Enter>, <ESC>, arrow keys, etc.

 **Note 1:** Options printed in **Bold** are default settings.

Note 2: <F3> is used to load optimal default settings. <F4> is used to save the settings and exit the setup utility.

How To Change the Configuration Data

The configuration data that determines the system parameters may be changed by entering the AMI BIOS Setup utility. This Setup utility can be accessed by pressing <Delete> at the appropriate time during system boot.



Note: For AMI UEFI BIOS Recovery, please refer to the UEFI BIOS Recovery User Guide posted @<http://www.supermicro.com/support/manuals/>.

Starting the Setup Utility

Normally, the only visible Power-On Self-Test (POST) routine is the memory test. As the memory is being tested, press the <Delete> key to enter the main menu of the AMI BIOS Setup utility. From the main menu, you can access the other setup screens. An AMI BIOS identification string is displayed at the left bottom corner of the screen below the copyright message.

Warning: Do not upgrade the BIOS unless your system has a BIOS-related issue. Flashing the wrong BIOS can cause irreparable damage to the system. In no event shall the manufacturer be liable for direct, indirect, special, incidental, or consequential damage arising from a BIOS update. If you have to update the BIOS, do not shut down or reset the system while the BIOS is being updated to avoid possible boot failure.

4-2 Main Setup

When you first enter the AMI BIOS Setup utility, you will enter the Main setup screen. You can always return to the Main setup screen by selecting the Main tab on the top of the screen. The Main BIOS Setup screen is shown below.

The AMI BIOS main menu displays the following information:

| Main Advanced Event Logs Boot Security Save & Exit | |
|---|------------------|
| System Date | [Tue 05/06/2012] |
| System Time | [14:19:30] |
| Supramicro X9DA7 | |
| SMC Version | 1.0 |
| SMC Build Date | 5/22/2012 |
| Memory Information | |
| Total Memory | 32768 MB (DDR3) |
| Set the Date. Use tab to switch between Data elements. | |
| ← : Select Screen ↑ : Select Item Enter: Select +/- : Change Opt. F1 : General Help F2 : Previous Values F3 : Optimized Defaults F4 : Save & Exit ESC: Exit | |
| Version 2.14.1219. Copyright (C) 2011 American Megatrends, Inc. | |

System Date/System Time

Use this option to change the system time and date. Highlight *System Time* or *System Date* using the arrow keys. Enter new values through the keyboard and press <Enter>. Press the <Tab> key to move between fields. The date must be entered in Day MM/DD/YY format. The time is entered in HH:MM:SS format. (**Note:** The time is in the 24-hour format. For example, 5:30 P.M. appears as 17:30:00.).

X9DA7/X9DAE**SMC Version**

This item displays the SMC version of the BIOS ROM used in this system.

SMC Build Date

This item displays the date that the BIOS Setup utility was built.

Memory Information**Total Memory**

This displays the amount of memory that is available in the system.

4-3 Advanced Setup Configurations

Use the arrow keys to select Advanced Setup and press <Enter> to access the following submenu items.

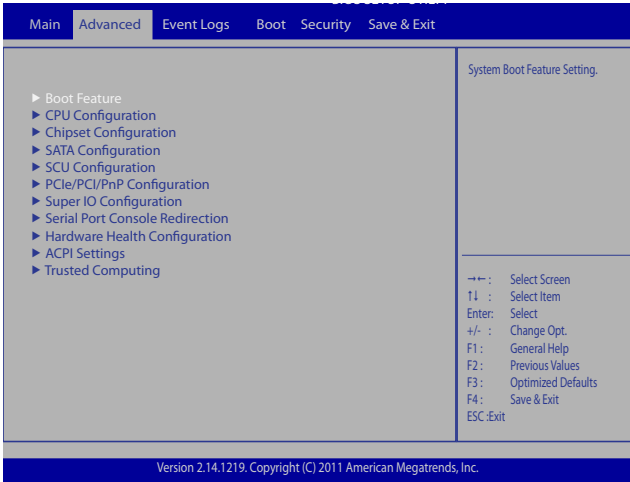

► Boot Features

Quiet Boot

This feature allows the user to select bootup screen display between POST messages and the OEM logo. Select Disabled to display the POST messages. Select Enabled to display the OEM logo instead of the normal POST messages. The options are **Enabled** and Disabled.

AddOn ROM Display Mode

Use this item to set the display mode for the Option ROM. Select Keep Current to use the current AddOn ROM Display setting. Select Force BIOS to use the Option ROM display mode set by the system BIOS. The options are **Force BIOS** and Keep Current.

Bootup Num-Lock

Use this feature to set the Power-on state for the Numlock key. The options are Off and **On**.

Wait For 'F1' If Error

Select Enabled to force the system to wait until the 'F1' key is pressed if an error occurs. The options are Disabled and **Enabled**.

Interrupt 19 Capture

Interrupt 19 is the software interrupt that handles the boot disk function. When this item is set to Enabled, the ROM BIOS of the host adaptors will "capture" Interrupt 19 at bootup and allow the drives that are attached to these host adaptors to function as bootable disks. If this item is set to Disabled, the ROM BIOS of the host adaptors will not capture Interrupt 19, and the drives attached to these adaptors will not function as bootable devices. The options are **Enabled** and Disabled.

Power Configuration

Power Button Function

If this feature is set to Instant Off, the system will power off immediately as soon as the user presses the power button. If this feature is set to 4 Seconds Override, the system will power off when the user presses the power button for 4 seconds or longer. The options are **Instant Off** and 4 Seconds Override.

Restore on AC Power Loss

Use this feature to set the power state after a power outage. Select Power-Off for the system power to remain off after a power loss. Select Power-On for the system power to be turned on after a power loss. Select Last State to allow the system to resume its last state before a power loss. The options are Power On, Stay Off and **Last State**.

CPU Configuration

This submenu displays the information of the CPU as detected by the BIOS. It also allows the user to configuration CPU settings.

►Socket 0 CPU Information/Socket 1 CPU Information

This submenu displays the following information regarding the CPU installed in Socket 0 and (or) Socket 1 as detected by the BIOS.

- Type of CPU
- CPU Signature
- Microcode Patch
- CPU Stepping
- Maximum CPU Speed

- Minimum CPU Speed
- Processor Cores
- Intel HT (Hyper-Threading) Technology
- Intel VT-x Technology
- L1 Data Cache
- L1 Code Cache
- L2 Cache
- L3 Cache

CPU Speed

This item displays the speed of the CPU installed in Socket 0.

64-bit

This item indicates if the CPU installed in Socket 0 supports 64-bit technology.

Hyper-threading

Select Enabled to support Intel Hyper-threading Technology to enhance CPU performance. The options are **Enabled** and Disabled.

Active Processor Cores

Set to Enabled to use a processor's second core and above. (Please refer to Intel's website for more information.) The options are **All**, 1, 2, 3, 4, 5, 6, 7, 8, 9, 10, and 11.

Limit CPUID Maximum

This feature allows the user to set the maximum CPU ID value. Enable this function to boot the legacy operating systems that cannot support processors with extended CPUID functions. The options are Enabled and **Disabled** (for the Windows OS).

Execute-Disable Bit Capability (Available if supported by the OS & the CPU)

Select Enabled to enable the Execute Disable Bit which will allow the processor to designate areas in the system memory where an application code can execute and where it cannot, thus preventing a worm or a virus from flooding illegal

codes to overwhelm the processor or damage the system during an attack. The default is **Enabled**. (Refer to Intel and Microsoft Web sites for more information.)

Hardware Prefetcher (Available when supported by the CPU)

If set to Enabled, the hardware prefetcher will prefetch streams of data and instructions from the main memory to the L2 cache to improve CPU performance. The options are Disabled and **Enabled**.

Adjacent Cache Line Prefetch (Available when supported by the CPU)

The CPU prefetches the cache line for 64 bytes if this feature is set to Disabled. The CPU prefetches both cache lines for 128 bytes as comprised if this feature is set to **Enabled**.

L1 Data Prefetch (Available when supported by the CPU)

Select Enabled to enable Level 1 data prefetch support to enhance system performance. For DP/MP servers, enable or disable this feature for system enhancement based on the specifications of the application running in the system at the time. The options are Disabled and **Enabled**.

DCU Streamer Prefetcher (Available when supported by the CPU)

Select Enabled to support Data Cache Unite (DCU) prefetch to speed up data accessing and processing in the DCU to enhance CPU performance. The options are Disabled and **Enabled**.

DCU IP Prefetcher

Select Enabled for DCU (Data Cache Unit) IP Prefetcher support, which will prefetch IP addresses to improve network connectivity and system performance. The options are **Enabled** and Disabled.

Intel® Virtualization Technology (Available when supported by the CPU)

Select Enabled to support Intel Virtualization Technology, which will allow one platform to run multiple operating systems and applications in independent partitions, creating multiple "virtual" systems in one physical computer. The options are **Enabled** and Disabled.



Note: If there is any change to this setting, you will need to power off and restart the system for the change to take effect. Please refer to Intel's website for detailed information.)

Clock Spread Spectrum

Select Enable to enable Clock Spectrum support, which will allow the BIOS to monitor and attempt to reduce the level of Electromagnetic Interference caused by the components whenever needed. The options are **Disabled** and Enabled.

EuP

Select Enabled to support the Low-power Compliance Mode for Energy-using Products (EuP). The options are Enable and **Disable**.

►CPU Power Management Configuration

This submenu allows the user to configure the following CPU Power Management settings.

Power Technology

Select Energy Efficiency to support power-saving mode. Select Custom to customize system power settings. Select Disabled to disable power-saving settings. The options are Disabled, **Energy Efficiency**, and Custom. If the option is set to Custom, the following items will display:

EIST

EIST (Enhanced Intel SpeedStep Technology) allows the system to automatically adjust processor voltage and core frequency in an effort to reduce power consumption and heat dissipation. **Please refer to Intel's web site for detailed information.** The options are Disabled and **Enabled**.

Turbo Mode

This feature allows processor cores to run faster than marked frequency in specific conditions. The options are Disabled and **Enabled**.

P-STATE Coordination

This feature selects the type of coordination for the P-State of the processor. P-State is a processor operational state that reduces the processor's voltage and frequency. This makes the processor more energy efficient, resulting in further gains. The options are **HW_ALL**, **SW_ALL** and **SW_ANY**.

CPU C3 Report (Available when Power Technology is set to Custom)

Select Enabled to allow the BIOS to report the CPU C3 State (ACPI C2) to the operating system. During the CPU C3 State, the CPU clock generator is turned off. The options are Enabled and **Disabled**.

CPU C6 Report (Available when Power Technology is set to Custom)

Select Enabled to allow the BIOS to report the CPU C6 State (ACPI C3) to the operating system. During the CPU C6 State, the power to all cache is turned off. The options are **Enabled** and Disabled.

CPU C7 Report (Available when Power Technology is set to Custom)

Select Enabled to allow the BIOS to report the CPU C7 State (ACPI C3) to the operating system. CPU C7 State is a processor-specific low C-State. The options are **Enabled** and Disabled.

Package C State Limit

If set to Auto, the AMI BIOS will automatically set the limit on the C-State package register. The options are C0, C2, C6, and **No Limit**.

Energy Performance

This setting allows the user to adjust the fan speed based on performance (maximum cooling) or energy efficiency (maximum energy savings). The options are Performance, **Balanced Performance**, Balanced Energy, and Energy Efficient.

Factory Long Duration Power Limit

This item displays the power limit set by the manufacturer during which long duration power is maintained.

Long Duration Power Limit

This item displays the power limit set by the user during which long duration power is maintained.

Factory Long Duration Maintained

This item displays the period of time set by the manufacturer during which long duration power is maintained.

Long Duration Maintained

This item displays the period of time during which long duration power is maintained.

Recommended Short Duration Power

This item displays the short duration power settings recommended by the manufacturer.

Short Duration Power Limit

This item displays the time period during which short duration power is maintained.

► Chipset Configuration

► North Bridge

This feature allows the user to configure the settings for the Intel North Bridge.

► IOH Configuration

Intel® VT-d

Select Enabled to enable Intel Virtualization Technology support for Direct I/O VT-d by reporting the I/O device assignments to the VWM (Virtual Working Memory) through the DMAR ACPI Tables. This feature offers fully-protected I/O resource sharing across Intel platforms, providing greater reliability, security and availability in networking and data-sharing. The options are **Enabled** and Disabled.

Intel® I/OAT

The Intel I/OAT (I/O Acceleration Technology) significantly reduces CPU overhead by leveraging CPU architectural improvements, freeing the system resource for other tasks. The options are Disabled and **Enabled**.

DCA Support

Select Enabled to use Intel's DCA (Direct Cache Access) Technology to improve data transfer efficiency. The options are **Enabled** and Disabled.

IOH 0 / IOH 1 PCIe Port Bifurcation Control

This allows the user to configure the following IO PCIe Port Bifurcation Control settings for IOH 1 PCIe port and IOH 2 PCIe port, which determine how to distribute the available PCI-Express lanes to the PCI-Exp. Root Ports.

IOU1-PCIe Port

This feature allows the user to set the PCI-Exp bus speed between IOU1 and PCIe port. The options are x4x4 and x8. The default setting for IOH 0 is **x4x4**. The default setting for IOH 1 is **x8**.

Port 1A Link Speed

Select GEN1 to enable PCI-Exp Generation 1 support for Port 1A. Select GEN2 to enable PCI-Exp Generation 2 support for Port 1A. Select GEN3 to enable PCI-Exp Generation 3 support for Port 1A. The options are GEN1, **GEN2**, and GEN3.

Port 1B Link Speed

Select GEN1 to enable PCI-Exp Generation 1 support for Port 1B. Select GEN2 to enable PCI-Exp Generation 2 support for Port 1B. Select GEN3 to enable PCI-Exp Generation 3 support for Port 1B. The options are GEN1, **GEN2**, and GEN3.

IOU2-PCIe Port

If this feature allows the user to set the bus speed between the IOU2 and the PCI-Exp port. The options are x4x4x4x4, x4x4x8, x8x4x4, x8x8, and **x16**.

Port 2A Link Speed

Select GEN1 to enable PCI-Exp Generation 1 support for Port 2A. Select GEN2 to enable PCI-Exp Generation 2 support for Port 2A. Select GEN3 to enable PCI-Exp Generation 3 support for Port 2A. The options are GEN1, **GEN2**, and GEN3.

IOU3-PCIe Port

If this feature allows the user to set the bus speed between the IOU3 and the PCI-Exp port. The options are x4x4x4x4, x4x4x8, x8x4x4, x8x8, and x16. The default for IOH 0 is **x16**. The default for IOH 1 is **x8x8**.

Port 3A Link Speed

Select GEN1 to enable PCI-Exp Generation 1 support for Port 3A. Select GEN2 to enable PCI-Exp Generation 2 support for Port 3A. Select GEN3 to enable PCI-Exp Generation 3 support for Port 3A. The options are GEN1, **GEN2**, and GEN3.

Port 3C Link Speed

Select GEN1 to enable PCI-Exp Generation 1 support for Port 3C. Select GEN2 to enable PCI-Exp Generation 2 support for Port 3C. Select GEN3 to enable PCI-Exp Generation 3 support for Port 3C. The options are GEN1, **GEN2**, and GEN3.

►QPI Configuration**Current QPI Link Speed**

This item displays the speed of the QPI Link.

Current QPI Link Frequency

This item displays the frequency of the QPI Link.

QPI (Quick Path Interconnect) Link Speed Mode

Use this feature to select data transfer speed for QPI Link connections. The options are **Fast** and Slow.

QPI Link Frequency Select

Use this feature to select the desired QPI frequency. The options are **Auto**, 6.4 GT/s, 7.2 GT/s, and 8.0 GT/s.

►DIMM Configuration

Current Memory Mode

This item displays the current memory mode.

Current Memory Speed

This item displays the current memory speed.

Mirroring

This item displays if memory mirroring is supported by the motherboard.

Sparing

This item displays if memory sparing can be supported by the motherboard.

►DIMM Information

The status of the memory modules will be displayed as detected by the BIOS.

Memory Mode

When Independent is selected, all DIMMs are available to the operating system. When Mirroring is selected, the motherboard maintains two identical copies of all data in memory for data backup. When Lockstep is selected, the motherboard uses two areas of memory to run the same set of operations in parallel. The options are **Independent**, Mirroring, Lockstep and Sparing.

Spare Err Threshold (Available if Sparing is selected for Memory Mode)

This item allows the user to determine the amount of correctable ECC errors that can accumulate before an event log is recorded. The default setting is **15**.

DRAM RAPL BWLIMIT

This item sets the limits on the average power consumption and the bandwidth of a DRAM module in operation so that the OS can manage power consumption and energy budget of hardware more effectively within a certain window of time. The options are 0, **1**, 8, and 16

Perfmon and DFX Devices

A PerfMon device monitors the activities of a remote system such as disk usage, memory consumption, and CPU load which will allow an IT administrator to maximize the performance of each computer within the network. A DFX device, usually in the form of a USB adaptor, can be used to enhance audio performance. Select Unhide to display the Perfmon and DXF devices installed in the system. The options are **HIDE** and **UNHIDE**.

DRAM RAPL Mode

RAPL which stands for Running Average Power Limit is a feature that provides mechanisms to enforce power consumption limits on supported processors. The options are **DRAM RAPL MODE0**, **DRAM RAPL MODE1**, and **Disabled**.

MPST Support

Select **Enabled** to enable the Message Processing Subscriber Terminal which is used to process short messages. The options are **Disabled** and **Enabled**.

DDR Speed

Use this feature to force a DDR3 memory module to run at a frequency other than what the system is specified in the specification. The options are **Auto**, **Force DDR3-800**, **Force DDR3-1066**, **Force DDR3-1333**, **Force DDR3-1600** and **Force SPD**.

Channel Interleaving

This feature selects from the different channel interleaving methods. The options are **Auto**, **1 Way**, **2 Way**, **3 Way**, and **4 Way**.

Rank Interleaving

This feature allows the user to select a rank memory interleaving method. The options are **Auto**, **1 Way**, **2 Way**, **4 Way**, and **8 Way**.

Patrol Scrub

Patrol Scrubbing is a process that allows the CPU to correct correctable memory errors detected on a memory module and send the correction to the requestor (the original source). When this item is set to **Enabled**, the IO hub will read and write back one cache line every 16K cycles, if there is no delay caused by internal processing. By using this method, roughly 64 GB of memory behind the IO hub will be scrubbed every day. The options are **Enabled** and **Disabled**.

Demand Scrub

Demand Scrubbing is a process that allows the CPU to correct correctable memory errors found on a memory module. When the CPU or I/O issues a demand-read command, and the read data from memory turns out to be a correctable error, the error is corrected and sent to the requestor (the original source). Memory is updated as well. Select Enabled to use Demand Scrubbing for ECC memory correction. The options are Enabled and **Disabled**.

Data Scrambling

Select Enabled to enable data scrubbing and ensure data security and integrity. The options are **Disabled** and Enabled.

DRAM RAPL (Running Average Power Limit)

This item allows the user to select the average power limit setting when a DRAM module is in operation. The options are Disabled, Mode 0, and **Mode 1**.

Device Tagging

Select Enabled to support device tagging. The options are **Disabled** and Enabled.

Thermal Throttling

Throttling improves reliability and reduces power consumption in the processor via automatic voltage control during processor idle states. The options are Disabled and **CLTT** (Closed Loop Thermal Throttling).

OLTT (Open Loop Thermal Throttling) Peak BW (Bandwidth) %

This item sets a percentage of the peak bandwidth allowed for Open Loop Thermal Throttling. The range is between 25% and 100%. The default setting is **50** (%).

► South Bridge Configuration

This feature allows the user to configure the settings for the Intel PCH chip.

PCH Information

This feature displays the following PCH information.

Name: This item displays the name of the PCH chip.

Stepping: This item displays the status of the PCH stepping.

USB Devices: This item displays the USB devices detected by the BIOS.

All USB Devices

This feature enables all USB ports/devices. The options are Disabled and **Enabled**. (If set to Enabled, EHCI Controller 1 and Controller 2 will appear.)

EHCI Controller 1/EHCI Controller 2 (Available when All USB Devices is set to Enabled)

Select Enabled to enable Enhanced Host Controller Interface (EHCI) Controller 1/ Controller 2. The options are Disabled and **Enabled**.

Legacy USB Support (Available when USB Functions is not Disabled)

Select Enabled to support legacy USB devices. Select Auto to disable legacy support if USB devices are not present. Select Disable to have USB devices available for EFI (Extensive Firmware Interface) applications only. The settings are Disabled, **Enabled** and Auto.

Port 60/64 Emulation

Select Enabled to enable I/O port 60h/64h emulation support for the legacy USB keyboard so that it can be fully supported by the operating systems that does not recognize a USB device. The options are Disabled and **Enabled**.

EHCI Hand-Off

This item is for operating systems that do not support Enhanced Host Controller Interface (EHCI) hand-off. When enabled, EHCI ownership change will be claimed by the EHCI driver. The options are **Disabled** and Enabled.

Audio Configuration

Azalia HD (High Definition) Audio

Select Enabled to enable support for Azalia High Definition Audio. The options are **Enabled** and Disabled.

Azalia Internal HDMI Decode

Select Enabled to enable support for Azalia High Definition Multi-Media Interface Decode. The options are Enabled and **Disabled**.

► SATA Configuration

When this submenu is selected, the AMI BIOS automatically detects the presence of IDE or SATA devices and displays the following items.

SATA Port0~SATA Port5: The AMI BIOS displays the status of each SATA port as detected by the BIOS.

SATA Mode

Use this feature to configure SATA mode for a selected SATA port. The options are Disabled, IDE Mode, **AHCI Mode** and RAID Mode. The following are displayed depending on your selection:

IDE Mode

The following items are displayed when IDE Mode is selected:

Serial-ATA (SATA) Controller 0~1

Use this feature to activate or deactivate the SATA controller, and set the compatibility mode. The options are Enhanced and Compatible. The default for SATA controller 0 is **Compatible**. The default for SATA controller 1 is **Enhanced**.

AHCI Mode

The following items are displayed when the AHCI Mode is selected.

Aggressive Link Power Management

Select Enabled to enable Aggressive Link Power Management support for Cougar Point B0 stepping and beyond. The options are **Enabled** and Disabled.

Port 0~5 Hot Plug

Select Enabled to enable hot-plug support for a particular port, which will allow the user to change a hardware component or device without shutting down the system. The options are Enabled and **Disabled**.

Staggered Spin Up

Select Enabled to enable Staggered Spin-up support to prevent excessive power consumption caused by multiple HDDs spinning-up simultaneously. The options are Enabled and **Disabled**.

RAID Mode

The following items are displayed when RAID Mode is selected:

PCH RAID CodeBase

Select Intel to use Intel PCH RAID settings for onboard RAID support. The default setting is **Intel**.

Port 0~5 Hot Plug

Select Enabled to enable hot-plug support for the particular port. The options are Enabled and **Disabled**.

► SCU Configuration**SCU Devices**

Select Enabled to enable support for PCH SCU (System Configuration Utility) devices. The options are Disabled and **Enabled**.

OnChip SAS Oprom

Select Enabled to support the onboard SAS Option ROM to boot up the system via a storage device. The options are Disabled and **Enabled**.

► PCIe/PCI/PnP Configuration**PCI ROM Priority**

Use this feature to select the Option ROM to boot the system when there are multiple Option ROMs available in the system. The options are EFI Compatible ROM and **Legacy ROM**.

PCI Latency Timer

Use this feature to set the latency Timer of each PCI device installed on a PCI bus. Select 64 to set the PCI latency to 64 PCI clock cycles. The options are 32, **64**, 96, 128, 160, 192, 224 and 248.

Above 4G Decoding (Available if the system supports 64-bit PCI decoding)

Select Enabled to decode a PCI device that supports 64-bit in the space above 4G Address. The options are Enabled and **Disabled**.

PERR# Generation

Select Enabled to allow a PCI device to generate a PERR number for a PCI Bus Signal Error Event. The options are **Enabled** and Disabled.

SERR# Generation

Select Enabled to allow a PCI device to generate an SERR number for a PCI Bus Signal Error Event. The options are **Enabled** and Disabled.

Maximum Payload

Select Auto to allow the system BIOS to automatically set the maximum payload value for a PCI-E device to enhance system performance. The options are **Auto**, 128 Bytes, and 256 Bytes.

Maximum Read Request

Select Auto to allow the system BIOS to automatically set the maximum Read Request size for a PCI-E device to enhance system performance. The options are **Auto**, 128 Bytes, 256 Bytes, 512 Bytes, 1024 Bytes, 2048 Bytes, and 4096 Bytes.

ASPM Support

This feature allows the user to set the Active State Power Management (ASPM) level for a PCI-E device. Select Force L0 to force all PCI-E links to operate at L0 state. Select Auto to allow the system BIOS to automatically set the ASPM level for the system. Select Disabled to disable ASPM support. The options are **Disabled**, Force L0, and Auto.

Warning: Enabling ASPM support may cause some PCI-E devices to fail!

Onboard LAN Option ROM Select

Select iSCSI to use the iSCSI Option ROM to boot the computer using a network device. Select PXE (Preboot Execution Environment) to use an PXE Option ROM to boot the computer using a network device. The options are iSCSI and **PXE**.

Load Onboard LAN1 Option ROM/Load Onboard LAN2 Option ROM

Select Enabled to enable the onboard LAN1 Option ROM~LAN4 Option ROM. This is to boot the computer using a network device. The default setting for LAN1 Option ROM is **Enabled**. The default setting for LAN2 Option ROM is **Disabled**.

VGA Priority

This feature allows the user to select the graphics adapter to be used as the primary boot device. The options are **Onboard**, and Offboard.

Network Stack

Select Enabled enable PXE (Preboot Execution Environment) or UEFI (Unified Extensible Firmware Interface) for network stack support. The options are Enabled and **Disabled**.

►Super IO Configuration

Super IO Chip

Displays the Super IO chip type.

►Serial Port 0 Configuration

The submenus allow the user to configure the following settings for Serial Port 0:

Serial Port

Select Enabled to enable a serial port specified by the user. The options are **Enabled** and Disabled.

Device Settings

This feature indicates whether or not a reset is required for a serial port specified.

Change Settings

Use this feature to set the optimal Environment Control Interface (PECI) setting for a serial port specified. The default setting is **Auto**, which will allow the AMI BIOS to automatically select the best setting for the PECI platform.

P/S 2 Connector

This option enables the selection of keyboard or mouse for the PS/2 connector. The options are **Keyboard** or Mouse.

Watch Dog Function

If enabled, the Watch Dog timer will allow the system to reboot when it is inactive for more than 5 minutes. The options are Enabled and **Disabled**.

►Serial Port Console Redirection

COM 0

Console Redirection

Select Enabled to use a COM Port selected by the user for Console Redirection. The options are Enabled and **Disabled**.

►Console Redirection Settings

This feature allows the user to specify how the host computer will exchange data with the client computer, which is the remote computer used by the user.

Terminal Type

This feature allows the user to select the target terminal emulation type for Console Redirection. Select VT100 to use the ASCII Character set. Select VT100+ to add color and function key support. Select ANSI to use the Extended ASCII Character Set. Select VT-UTF8 to use UTF8 encoding to map Unicode characters into one or more bytes. The options are ANSI, VT100, **VT100+**, and VT-UTF8.

Bits Per second

Use this feature to set the transmission speed for a serial port used in Console Redirection. Make sure that the same speed is used in the host computer and the client computer. A lower transmission speed may be required for long and busy lines. The options are 9600, 19200, 38400, 57600 and **115200** (bits per second).

Data Bits

Use this feature to set the data transmission size for Console Redirection. The options are 7 Bits and **8 Bits**.

Parity

A parity bit can be sent along with regular data bits to detect data transmission errors. Select Even if the parity bit is set to 0, and the number of 1's in data bits is even. Select Odd if the parity bit is set to 0, and the number of 1's in data bits is odd. Select None if you do not want to send a parity bit with your data bits in transmission. Select Mark to add a mark as a parity bit to be sent along with the data bits. Select Space to add a Space as a parity bit to be sent with your data bits. The options are **None**, Even, Odd, Mark and Space.

Stop Bits

A stop bit indicates the end of a serial data packet. Select 1 Stop Bit for standard serial data communication. Select 2 Stop Bits if slower devices are used. The options are **1** and 2.

Flow Control

This feature allows the user to set the flow control for Console Redirection to prevent data loss caused by buffer overflow. Send a "Stop" signal to stop sending data when the receiving buffer is full. Send a "Start" signal to start sending data when the receiving buffer is empty. The options are **None** and Hardware RTS/CTS.

VT-UTF8 Combo Key Support

Select Enabled to enable VT-UTF8 Combination Key support for ANSI/VT100 terminals. The options are **Enabled** and Disabled.

Recorder Mode

Select Enabled to capture the data displayed on a terminal and send it as text messages to a remote server. The options are **Disabled** and Enabled.

Resolution 100x31

Select Enabled for extended-terminal resolution support. The options are Disabled and **Enabled**.

Legacy OS Redirection

Use this feature to select the number of rows and columns used in Console Redirection for legacy OS support. The options are **80x24** and 80x25.

Putty Keypad

Use this feature to select function key and keypad setting on Putty. The options are **VT100**, LINUX, XTERMR6, SCO, ESCN, and VT400.

Serial Port for Out-of-Band Management/Windows Emergency Management Services (EMS)

The submenu allows the user to configure the following Console Redirection settings to support Out-of-Band Serial Port management.

Console Redirection

Select Enabled to use a COM Port selected by the user for Console Redirection. The options are Enabled and **Disabled**.

►Console Redirection Settings

This feature allows the user to specify how the host computer will exchange data with the client computer, which is the remote computer used by the user.

Out-of-Band-Mgmt Port

Use this feature to select the port for out-of-band management.

Terminal Type

This feature allows the user to select the target terminal emulation type for Console Redirection. Select VT100 to use the ASCII character set. Select VT100+ to add color and function key support. Select ANSI to use the extended ASCII character set. Select VT-UTF8 to use UTF8 encoding to map Unicode characters into one or more bytes. The options are ANSI, VT100, VT100+, and **VT-UTF8**.

Bits Per Second

This item sets the transmission speed for a serial port used in Console Redirection. Make sure that the same speed is used in the host computer and the client computer. A lower transmission speed may be required for long and busy lines. The options are 9600, 19200, 57600, and **115200** (bits per second).

Flow Control

This feature allows the user to set the flow control for Console Redirection to prevent data loss caused by buffer overflow. Send a "Stop" signal to stop sending data when the receiving buffer is full. Send a "Start" signal to start sending data when the receiving buffer is empty. The options are **None**, Hardware RTS/CTS, and Software Xon/Xoff.

► Hardware Health Configuration

This feature allows the user to monitor system health and review the status of each item as displayed.

Fan Speed Control Mode

This feature allows the user to set the fan speed mode. Select Optimal to reduce fan speed for optimal power saving. Select Full Speed for the fan to run at the full speed which will increase power consumption. The options are **Standard**, Full Speed and Optimal.

CPU Temperature Display Mode

This feature displays the CPU temperature detected by DTS (i.e., +34°C) or temperature status in text ("Low", "Medium" or "High"). The options are **Text Mode** or DTS.

If Text Mode is selected, the CPU Temperature Display Mode will show the CPU temperature status as follows:

CPU 1 Temperature/CPU 2 Temperature

The CPU Temperature feature will display the CPU temperature status as detected by the BIOS:

Low - This level is considered as the 'normal' operating state. The CPU temperature is well below the CPU 'Temperature Tolerance'. The motherboard fans and CPU will run normally as configured in the BIOS (Fan Speed Control).

Medium - The processor is running warmer. This is a 'precautionary' level and generally means that there may be factors contributing to this condition, but the CPU is still within its normal operating state and below the CPU 'Temperature Tolerance'. The motherboard fans and CPU will run normally as configured in the BIOS. The fans may adjust to a faster speed depending on the Fan Speed Control settings.

High - The processor is running hot. This is a 'caution' level since the CPU's 'Temperature Tolerance' has been reached (or has been exceeded) and may activate an overheat alarm. The system may shut down if it continues for a long period to prevent damage to the CPU. If the system buzzer and Overheat LED has activated, take action immediately by checking the system fans, chassis ventilation and room temperature to correct any problems.

System Temperature

System temperature will be displayed as detected by the BIOS.

Peripheral Temperature

Peripheral temperature will be displayed as detected by the BIOS.

Fan Speed

This feature displays the fan speed readings for all fans detected by the BIOS.

Voltage Readings

The following voltage readings will be displayed.

VTT, 1.1V, 1.5V, 5VSB, 5V, 12V, CPU1 Vcore, CPU2 Vcore, VDIMM AB, VDIMM CD, VDIMM EF, VDIMM GH, 3.3V, 3.3VSB, and VBAT.

► ACPI Setting

Use this feature to configure Advanced Configuration and Power Interface (ACPI) power management settings for your system.

ACPI Sleep State

Use this feature to select the ACPI State when the system is in sleep mode. Select S1 (CPU_Stop_Clock) to erase all CPU caches and stop executing instructions. Power to the CPU(s) and RAM is maintained, but RAM is refreshed. Select Suspend Disabled to use power-reduced mode. Power will only be supplied to limited components (such as RAMs) to maintain the most critical functions of the system. The options are S1 (CPU_Stop_Clock), Suspend Disabled, and **S3 (Suspend to RAM)**.

Numa

This feature enables the Non-Uniform Memory Access ACPI support. The options are **Enabled** and Disabled.

High Precision Timer

Select Enabled to activate the High Precision Event Timer (HPET) that produces periodic interrupts at a much higher frequency than a Real-time Clock (RTC) does in synchronizing multimedia streams, providing smooth playback, reducing the dependency on other timestamp calculation devices, such as an x86 RDTSC Instruction embedded in the CPU. The High Performance Event Timer is used to replace the 8254 Programmable Interval Timer. The options are **Enabled** and Disabled.

► Trusted Computing (Available if a TPM device is installed)

TPM Support

Select Enabled on this item and enable the TPM jumper on the motherboard to allow TPM support to improve data integrity and network security. The options are Enable and **Disable**.

Current Status Information: This item displays the information regarding the current TPM status.

TPM Enable Status

If a security device is detected by the BIOS, this item displays the status of TPM Support to indicate if TPM is currently enabled or disabled.

TPM Active Status

If a security device is detected by the BIOS, this item displays the status of TPM Support to indicate if TPM is currently active or deactivated.

TPM Owner Status

If a security device is detected by the BIOS, this item displays the status of TPM Ownership.

4-4 Event Logs

Use this feature to configure Event Log settings.

► Change SMBIOS Event Log Settings

This feature allows the user to configure SMBIOS Event settings.

Enabling/Disabling Options

SMBIOS Event Log

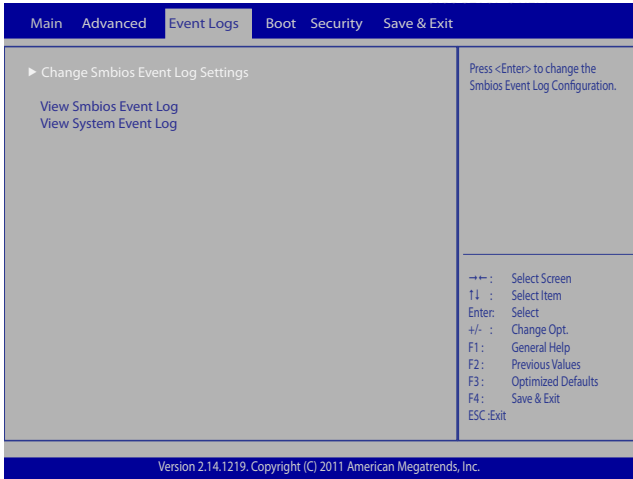

Select Enabled to enable SMBIOS (System Management BIOS) Event Logging during system boot. The options are **Enabled** and Disabled.

Runtime Error Logging Support

Select Enabled to support Runtime Error Logging. The options are **Enabled** and Disabled.

Memory Correctable Error Threshold

This feature allows the user to enter the threshold value for correctable memory errors. The default setting is **10**.

PCI Error Logging Support

Select Enabled to support error event logging for PCI slots. The options are Enabled and **Disabled**.

Erasing Settings

Erase Event Log

Select Enabled to erase the SMBIOS (System Management BIOS) Event Log, which is completed before a event logging is initialized upon system reboot. The options are **No**, Yes Next Reset, and Yes Every Reset.

When Log is Full

Select Erase Immediately to immediately erase SMBIOS error event logs that exceed the limit when the SMBIOS event log is full. Select Do Nothing for the system to do nothing when the SMBIOS event log is full. The options are **Do Nothing** and Erase Immediately.

SMBIOS Event Log Standard Settings

Log System Boot Event

Select Enabled to log system boot events. The options are **Disabled** and Enabled.

MECI (Multiple Event Count Increment)

Enter the increment value for the multiple event counter. Enter a number between 1 to 255. The default setting is **1**.

METW (Multiple Event Count Time Window)

This item allows the user to decide how long (in minutes) should the multiple event counter wait before generating a new event log. Enter a number between 0 to 99. The default setting is **60**.

View Smbios Event Log

This feature displays the contents of the SmbIOS Event Log.

View System Event Log

This feature displays the contents of the System Event Log.

4-5 Boot

This submenu allows the user to configure the following boot settings for the system.

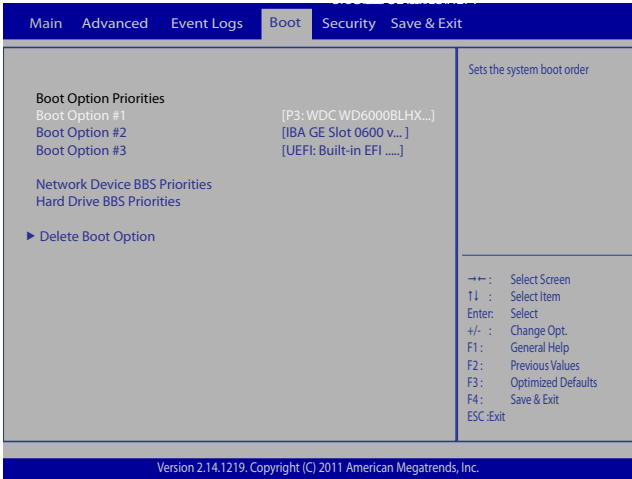

Boot Option Priorities

Boot Option #1/ Boot Option #2/ Boot Option #3

Use this feature to specify the sequence of boot device priority.

Network Device BBS Priorities, Hard Drive BBS Priorities

This option sets the order of the legacy network devices and Hard Disks detected by the motherboard.

▶ Delete Boot Option

This feature allows the user to delete a previously defined boot device from which the system boots during startup.

4-6 Security

This menu allows the user to configure the following security settings for the system.

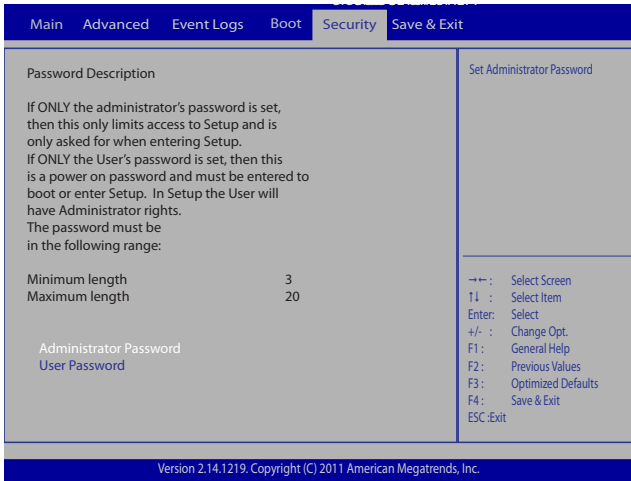

Administrator Password

Use this feature to set the Administrator Password which is required to enter the BIOS setup utility. The length of the password should be from 3 characters to 20 characters long.

User Password

Use this feature to set a User Password which is required to log into the system and to enter the BIOS setup utility. The length of the password should be from 3 characters to 20 characters long.

4-7 Save & Exit

This submenu allows the user to configure the Save and Exit settings for the system.

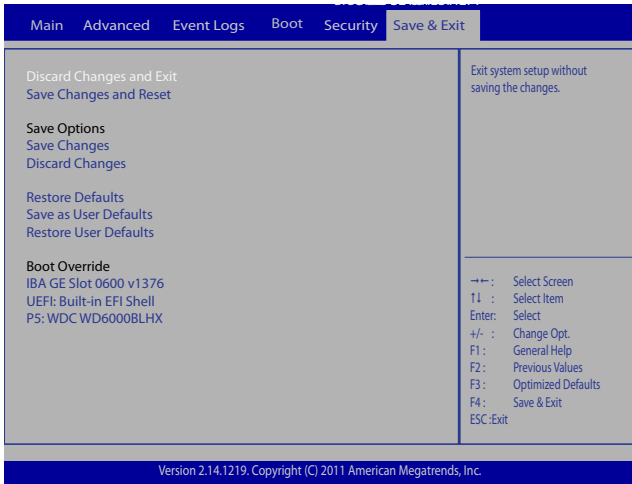

Discard Changes and Exit

Select this option to quit the BIOS Setup without making any permanent changes to the system configuration, and reboot the computer. Select Discard Changes and Exit, and press <Enter>. When the dialog box appears, asking you if you want to exit the BIOS setup without saving, click **Yes** to quit BIOS without saving the changes, or click No to quit the BIOS and save changes.

Save Changes and Reset

When you have completed the system configuration changes, select this option to save the changes and reboot the computer so that the new system configuration settings can take effect. Select Save Changes and Exit, and press <Enter>. When the dialog box appears, asking you if you want to exit the BIOS setup without saving, click **Yes** to quit BIOS without saving the changes, or click No to quit the BIOS and save changes.

Save Options

Save Changes

Select this option and press <Enter> to save all changes you've done so far and return to the AMI BIOS utility Program. When the dialog box appears, asking you if you want to save configuration, click **Yes** to save the changes, or click No to return to the BIOS without making changes.

Discard Changes

Select this feature and press <Enter> to discard all the changes and return to the BIOS setup. When the dialog box appears, asking you if you want to load previous values, click **Yes** to load the values previous saved, or click No to keep the changes you've made so far.

Restore Defaults

Select this feature and press <Enter> to load the optimized default settings that help optimize system performance. When the dialog box appears, asking you if you want to load optimized defaults, click **Yes** to load the optimized default settings, or click No to abandon optimized defaults.

Save as User Defaults

Select this feature and press <Enter> to save the current settings as the user's defaults. When the dialog box appears, asking you if you want to save values as user's defaults, click **Yes** to save the current values as user's default settings, or click No to keep the defaults previously saved as the user's defaults.

Restore User Defaults

Select this feature and press <Enter> to load the user's defaults previously saved in the system. When the dialog box appears, asking you if you want to restore user's defaults, click **Yes** to restore the user's defaults previously saved in the system, or click No to abandon the user's defaults that were previously saved.

Boot Override

This feature allows the user to enter a new setting to overwrite the original setting that was saved for the listed device.

Appendix A

BIOS Error Beep Codes

During the POST (Power-On Self-Test) routines, which are performed at each system boot, errors may occur.

Non-fatal errors are those which, in most cases, allow the system to continue to boot. The error messages normally appear on the screen.

Fatal errors will not allow the system to continue with bootup procedure. If a fatal error occurs, you should consult with your system manufacturer for possible repairs.

These fatal errors are usually communicated through a series of audible beeps. The numbers on the fatal error list correspond to the number of beeps for the corresponding error.

A-1 BIOS Error Beep Codes

| BIOS Error Beep Codes | | |
|-----------------------------|---------------------------------|--------------------------------------|
| Beep Code/LED | Error Message | Description |
| 1 beep | Refresh | Ready to boot |
| 5 short beeps + 1 long beep | Memory error | No memory detected in the system |
| 5 beeps | No Con-In or no Con-Out devices | Con-In includes USB or PS/2 keyboard |
| 1 Continuous Beep | System OH | System Overheat |

Notes

Appendix B

Software Installation Instructions

B-1 Installing Software Programs

After you've installed the operating system, a screen as shown below will appear. You are ready to install software programs and drivers that have not yet been installed. To install these programs, click the icons to the right of these items.

 **Note:** To install the Windows OS, please refer to the instructions posted on our Website at <http://www.supermicro.com/support/manuals/>.

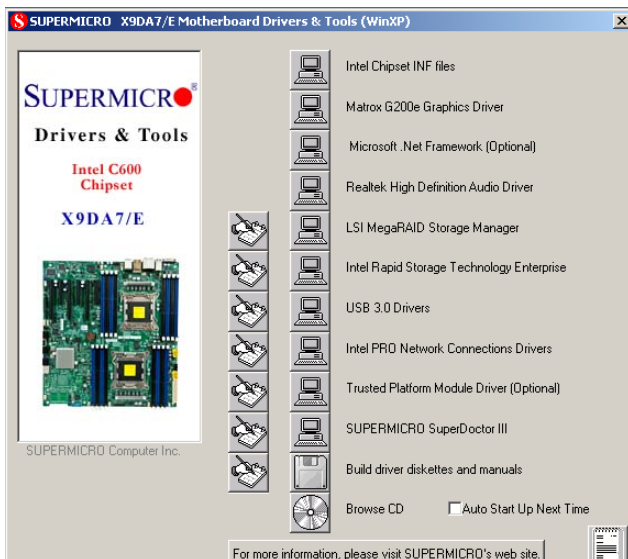

Driver/Tool Installation Display Screen

 **Note 1:** Click the icons showing a hand writing on the paper to view the readme files for each item. Click a computer icon to the right of an item to install an item (from top to the bottom) one at a time. After installing each item, you must reboot the system before proceeding with the next item on the list. The bottom icon with a CD on it allows you to view the entire contents of the CD.

Note 2: When making a storage driver diskette by booting into a Driver CD, please set the SATA Configuration to "Compatible Mode" and configure SATA as IDE in the BIOS Setup. After making the driver diskette, be sure to change the SATA settings back to your original settings.

 **Note 3:** Changing BMC log-in information is recommended during initial system power-on. The default username is ADMIN and password is ADMIN. For BMC best practices, please refer to: http://www.supermicro.com/products/info/files/IPMI/Best_Practices_BMC_Security.pdf

B-2 Configuring SuperDoctor III

The SuperDoctor[®] III program is a Web-based management tool that supports remote management capability. It includes Remote and Local Management tools. The local management is called the SD III Client. The SuperDoctor III program included on the CDROM that came with your motherboard allows you to monitor the environment and operations of your system. SuperDoctor III displays crucial system information such as CPU temperature, system voltages and fan status. See the Figure below for a display of the SuperDoctor III interface.

 **Note 1:** The default user name and password are ADMIN.

Note 2: In the Windows OS environment, the SuperDoctor III settings take precedence over the BIOS settings. When first installed, SuperDoctor III adopts the temperature threshold settings previously set in BIOS. Any subsequent changes to these thresholds must be made within SuperDoctor, since the SD III settings override the BIOS settings. For the Windows OS to adopt the BIOS temperature threshold settings, please change the SDIII settings to be the same as those set in BIOS.

SuperDoctor[®] III Interface Display Screen-I (Health Information)

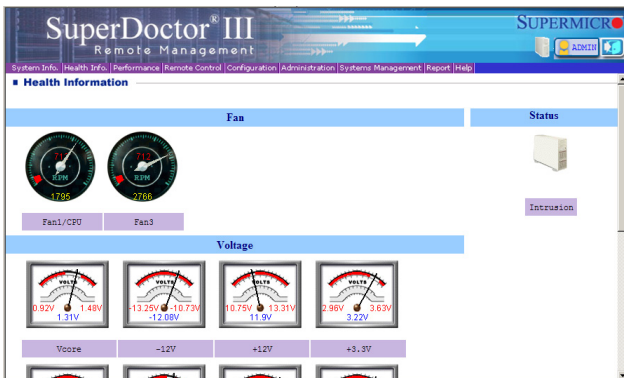

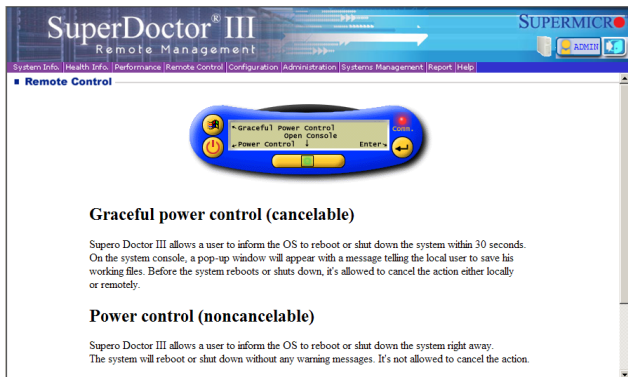
SuperDoctor® III Interface Display Screen-II (Remote Control)

 **Note:** The SD III utility and the user guide can be downloaded from our website at: <http://www.supermicro.com/products/accessories/software/SuperDoctorIII.cfm>. For Linux, we will still recommend that you use SuperDoctor II.

Notes

(Disclaimer Continued)

The products sold by Supermicro are not intended for and will not be used in life support systems, medical equipment, nuclear facilities or systems, aircraft, aircraft devices, aircraft/emergency communication devices or other critical systems whose failure to perform be reasonably expected to result in significant injury or loss of life or catastrophic property damage. Accordingly, Supermicro disclaims any and all liability, and should buyer use or sell such products for use in such ultra-hazardous applications, it does so entirely at its own risk. Furthermore, buyer agrees to fully indemnify, defend and hold Supermicro harmless for and against any and all claims, demands, actions, litigation, and proceedings of any kind arising out of or related to such ultra-hazardous use or sale.