

STAMFORD®

S5L1S-C4 Wdg.311 - Technical Data Sheet

Standards

STAMFORD industrial alternators meet the requirements of the relevant parts of the IEC EN 60034 and the relevant section of other international standards such as BS5000, VDE 0530, NEMA MG1-32, IEC34, CSA C22.2-100 and AS1359. Other standards and certifications can be considered on request.

Quality Assurance

Alternators are manufactured using production procedures having a quality assurance level to BS EN ISO 9001.

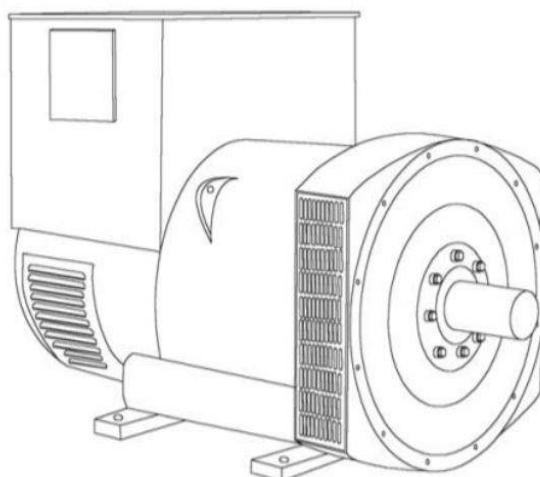

Excitation and Voltage Regulators

Excitation System					
AVR Type	AS440	MX341	MX321		
Voltage Regulation	± 1%	± 1%	± 0.5%		with 4% Engine Governing
AVR Power	Self-Excited	PMG	PMG		

No Load Excitation Voltage (V)	10.2 - 9.4
No Load Excitation Current (A)	0.6 - 0.5
Full Load Excitation Voltage (V)	44
Full Load Excitation Current (A)	2.6 - 2.4
Exciter Time Constant (seconds)	0.099

STAMFORD®

S5L1S-C4 Wdg.311

Electrical Data								
Insulation System	H							
Stator Winding	Double Layer Lap							
Winding Pitch	2/3							
Winding Leads	12							
Winding Number	311							
Number of Poles	4							
IP Rating	IP23							
RFI Suppression	BS EN 61000-6-2 & BS EN 61000-6-4, VDE 0875G, VDE 0875N. Refer to factory for others							
Waveform Distortion	NO LOAD < 1.5% NON-DISTORTING BALANCED LINEAR LOAD < 5.0%							
Short Circuit Ratio	1/Xd							
Steady State X/R Ratio	12.58							
50 Hz					60 Hz			
Telephone Interference	THF<2%				TIF<50			
Cooling Air Flow	1.035 m³/sec				1.312 m³/sec			
Voltage Star (V)	380	400	415	440	416	440	460	480
Voltage Parallel Star (V)	190	200	208	220	208	220	230	240
Voltage Series Delta (V)	220	230	240	254	240	254	266	277
kVA Base Rating (Class H) for Reactance Values (kVA)	455	500	455	450	525	550	581	594
Saturated Values in Per Unit at Base Ratings and Voltages								
Xd Dir. Axis Synchronous	3.31	3.28	2.77	2.44	3.82	3.58	3.46	3.25
X'd Dir. Axis Transient	0.18	0.18	0.15	0.13	0.21	0.20	0.19	0.18
X''d Dir. Axis Subtransient	0.13	0.13	0.11	0.10	0.15	0.14	0.14	0.13
Xq Quad. Axis Reactance	2.69	2.67	2.26	1.99	3.11	2.91	2.82	2.64
X''q Quad. Axis Subtransient	0.26	0.26	0.22	0.19	0.30	0.28	0.27	0.26
XL Stator Leakage Reactance	0.07	0.07	0.06	0.05	0.08	0.08	0.07	0.07
X2 Negative Sequence Reactance	0.19	0.19	0.16	0.14	0.22	0.21	0.20	0.19
X0 Zero Sequence Reactance	0.11	0.11	0.09	0.08	0.13	0.12	0.12	0.11
Unsaturated Values in Per Unit at Base Ratings and Voltages								
Xd Dir. Axis Synchronous	3.97	3.94	3.33	2.93	4.59	4.29	4.15	3.90
X'd Dir. Axis Transient	0.21	0.21	0.17	0.15	0.24	0.23	0.22	0.20
X''d Dir. Axis Subtransient	0.15	0.15	0.13	0.11	0.18	0.17	0.16	0.15
Xq Quad. Axis Reactance	2.77	2.75	2.32	2.05	3.20	3.00	2.90	2.72
X''q Quad. Axis Subtransient	0.31	0.31	0.26	0.23	0.36	0.34	0.33	0.31
XL Stator Leakage Reactance	0.08	0.08	0.07	0.06	0.09	0.09	0.08	0.08
Xlr Rotor Leakage Reactance	0.11	0.11	0.09	0.08	0.12	0.11	0.11	0.10
X2 Negative Sequence Reactance	0.23	0.23	0.19	0.17	0.27	0.25	0.24	0.23
X0 Zero Sequence Reactance	0.13	0.13	0.11	0.10	0.15	0.14	0.14	0.13

STAMFORD

S5L1S-C4 Wdg.311

Time Constants (Seconds)		
T'd Transient Time Const.	0.08	
T''d Sub-Transient Time Const.	0.0120	
T'do O.C. Field Time Const.	2	
Ta Armature Time Const.	0.0170	
T''q Sub-Transient Time Const.	0.0192	
Resistances in Ohms (Ω) at 22°C		
Stator Winding Resistance (Ra), per phase for series connected	0.0065	
Rotor Winding Resistance (Rf)	1.55	
Exciter Stator Winding Resistance	17	
Exciter Rotor Winding Resistance per phase	0.092	
PMG Phase Resistance (Rpmg) per phase	1.91	
Positive Sequence Resistance (R1)	0.0081	
Negative Sequence Resistance (R2)	0.0094	
Zero Sequence Resistance (R0)	0.0081	
Saturation Factors	400V	480V
SG1.0	0.311	0.273
SG1.2	1.333	1.094
Mechanical Data		
Shaft and Keys	All alternator rotors are dynamically balanced to better than BS6861: Part 1 Grade 2.5 for minimum vibration in operation. Two bearing generators are balanced with a half key.	
	1 Bearing	2 Bearing
SAE Adaptor	SAE 00, 0, 0.5, 1	SAE 00, 0, 0.5, 1
Moment of Inertia	6.8928 kgm ²	6.6149 kgm ²
Weight Wound Stator	584kg	584kg
Weight Wound Rotor	502kg	473kg
Weight Complete Alternator	1263kg	1275kg
Shipping weight in a Crate	1355kg	1395kg
Packing Crate Size	166x87x124(cm)	166x87x124(cm)
Maximum Over Speed	2250 RPM for two minutes	
Bearing Drive End	-	BALL.6220(ISO)
Bearing Non-Drive End	BALL.6314(ISO)	BALL.6314(ISO)

STAMFORD®

S5L1S-C4 Wdg.311

THREE PHASE EFFICIENCY CURVES

50Hz

60Hz

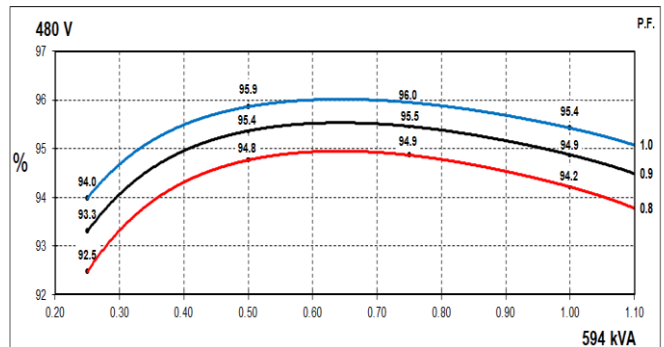
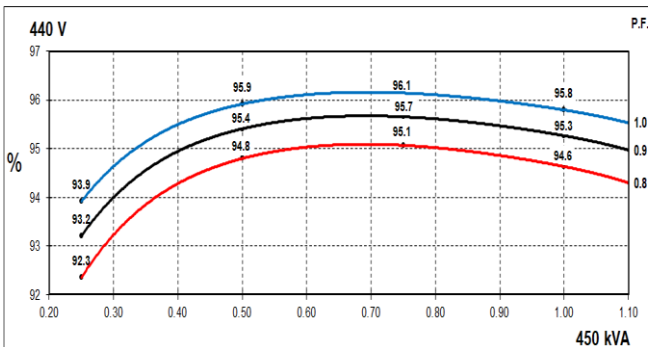
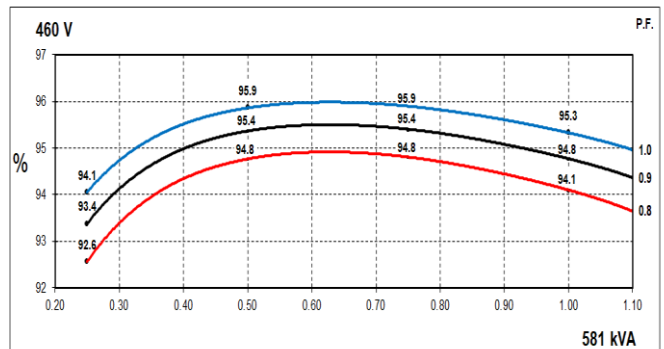
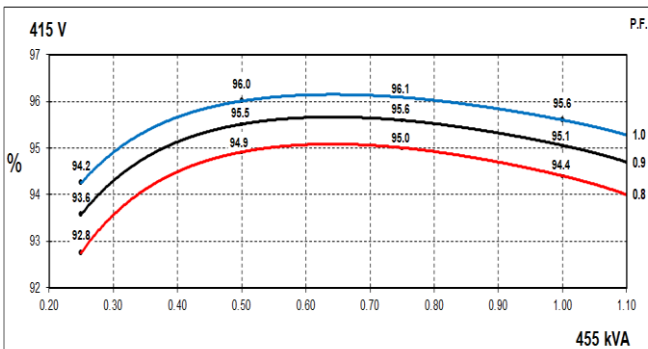
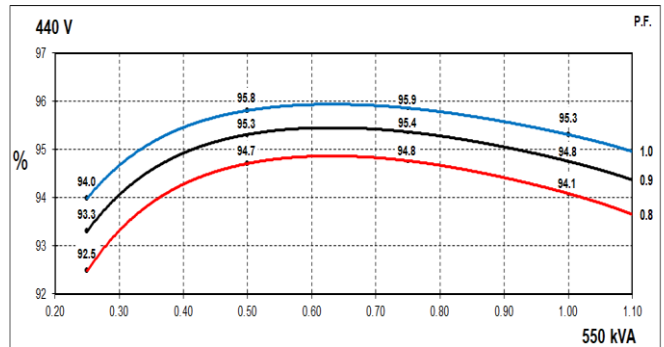
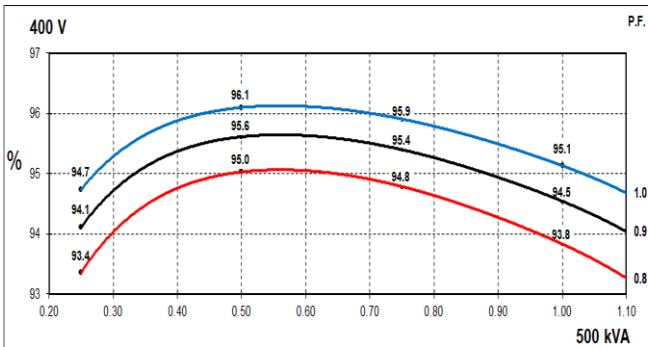
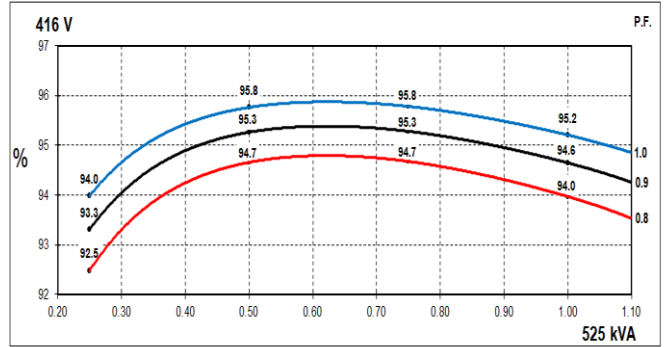
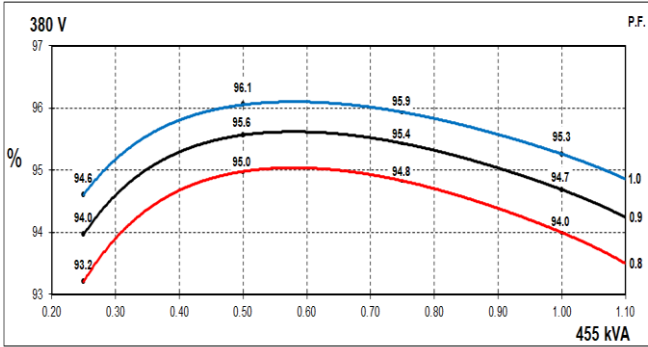

STAMFORD

S5L1S-C4 Wdg.311

Locked Rotor Motor Starting Curves - Separately Excited

50Hz

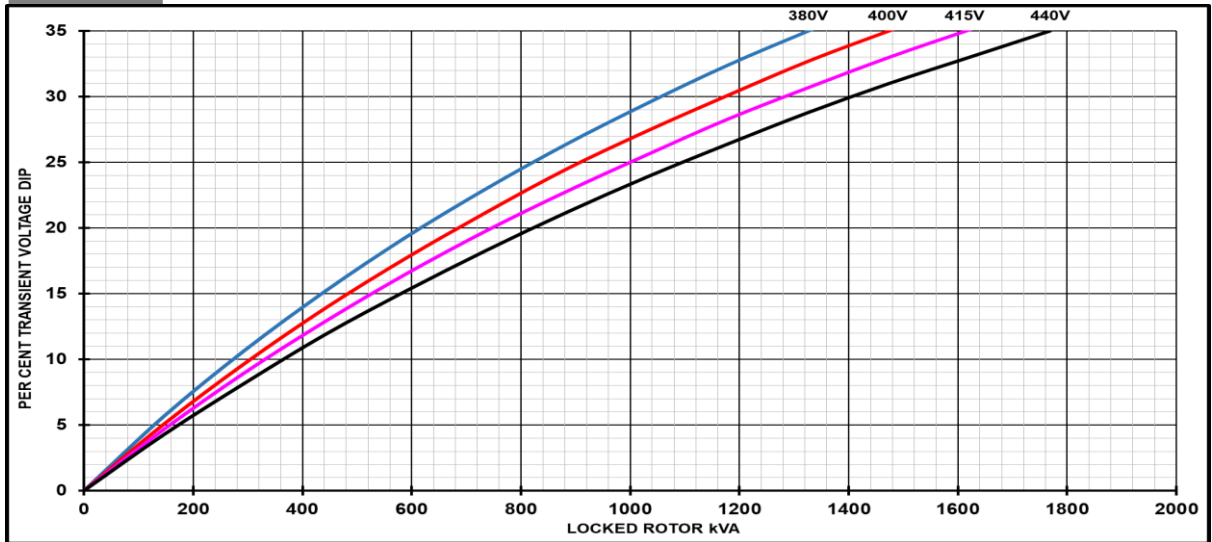

60Hz

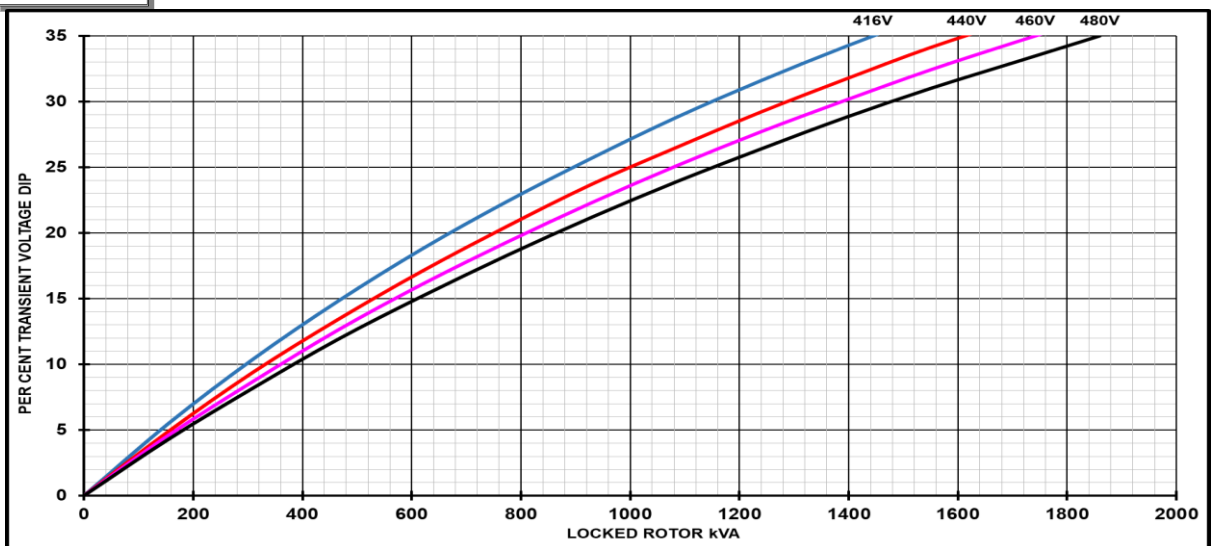

Transient Voltage Dip Scaling Factor		Transient Voltage Rise Scaling Factor
PF	Factor	For voltage rise multiply voltage dip by 1.25
< 0.5	1	
0.5	0.97	
0.6	0.93	
0.7	0.9	
0.8	0.85	
0.9	0.83	

STAMFORD

S5L1S-C4 Wdg.311

Locked Rotor Motor Starting Curves - Self Excited

50Hz

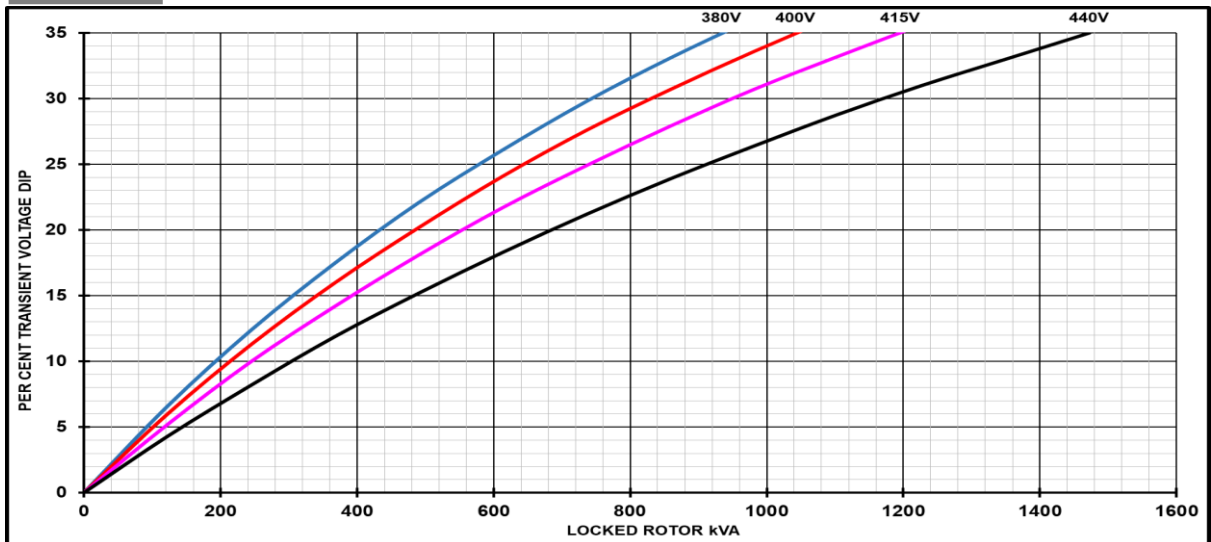

60Hz

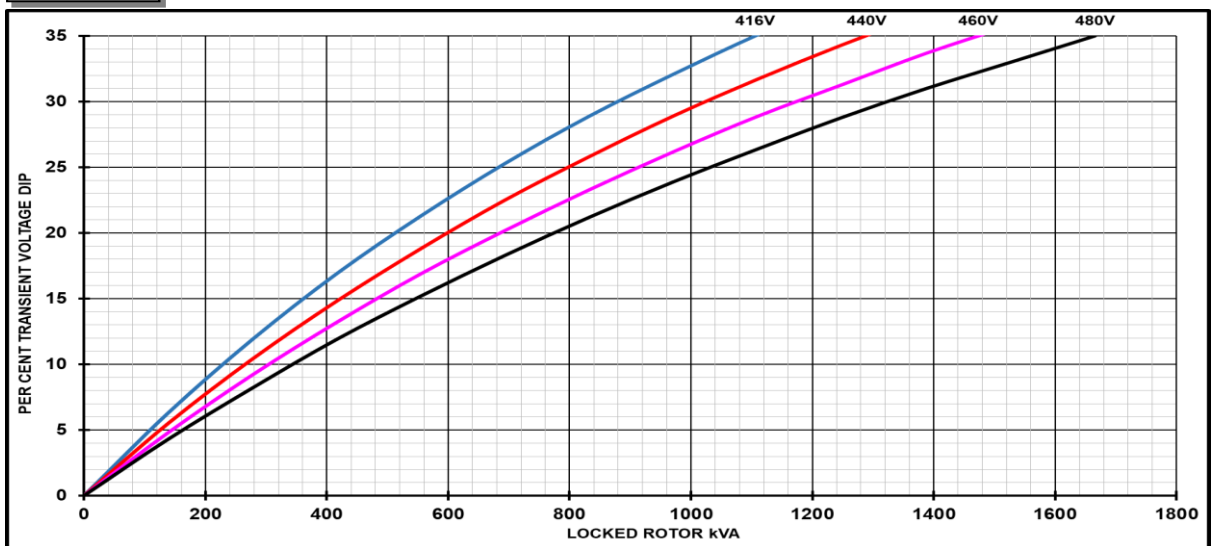

Transient Voltage Dip Scaling Factor		Transient Voltage Rise Scaling Factor	
PF	Factor	For voltage rise multiply voltage dip by 1.25	
< 0.5	1		
0.5	0.97		
0.6	0.93		
0.7	0.9		
0.8	0.85		
0.9	0.83		

STAMFORD®

S5L1S-C4 Wdg.311

Three-phase Short Circuit Decrement Curve - Separately Exited

50Hz

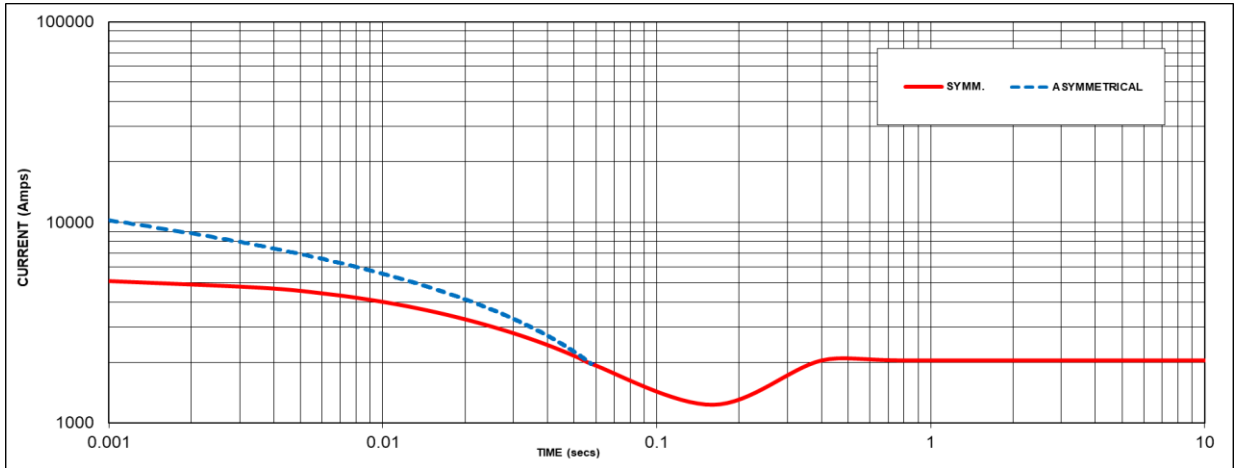

Sustained Short Circuit = 2050 Amps

60Hz

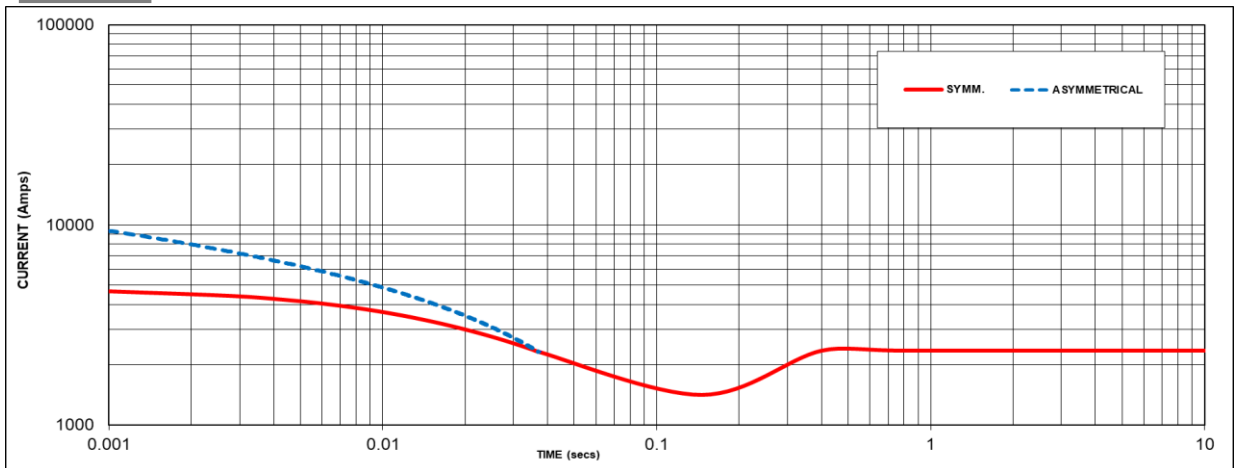

Sustained Short Circuit = 2350 Amps

Note 1

The following multiplication factors should be used to adjust the values from curve between time 0.001 seconds and the minimum current point in respect of nominal operating voltage :

50Hz		60Hz	
Voltage	Factor	Voltage	Factor
380V	X 1.00	416V	X 1.00
400V	X 1.05	440V	X 1.06
415V	X 1.09	460V	X 1.10
440V	X 1.16	480V	X 1.15

The sustained current value is constant irrespective of voltage level

Note 2

The following multiplication factor should be used to convert the values calculated in accordance with NOTE 1 to those applicable to the various types of short circuit :

	3-phase	2-phase L-L	1-phase L-N
Instantaneous	x 1.00	x 0.87	x 1.30
Minimum	x 1.00	x 1.80	x 3.20
Sustained	x 1.00	x 1.50	x 2.50
Max. sustained duration	10 sec.	5 sec.	2 sec.

Note 3

All other times are unchanged

Curves are drawn for Star connected machines under no-load excitation at rated speeds. For other connection (where applicable) the following multipliers should be applied to current values as shown :

Parallel Star = Curve current value X 2

Series Delta = Curve current value X 1.732

STAMFORD®

S5L1S-C4 Wdg.311

Typical Alternator Operating Charts

400V/50Hz

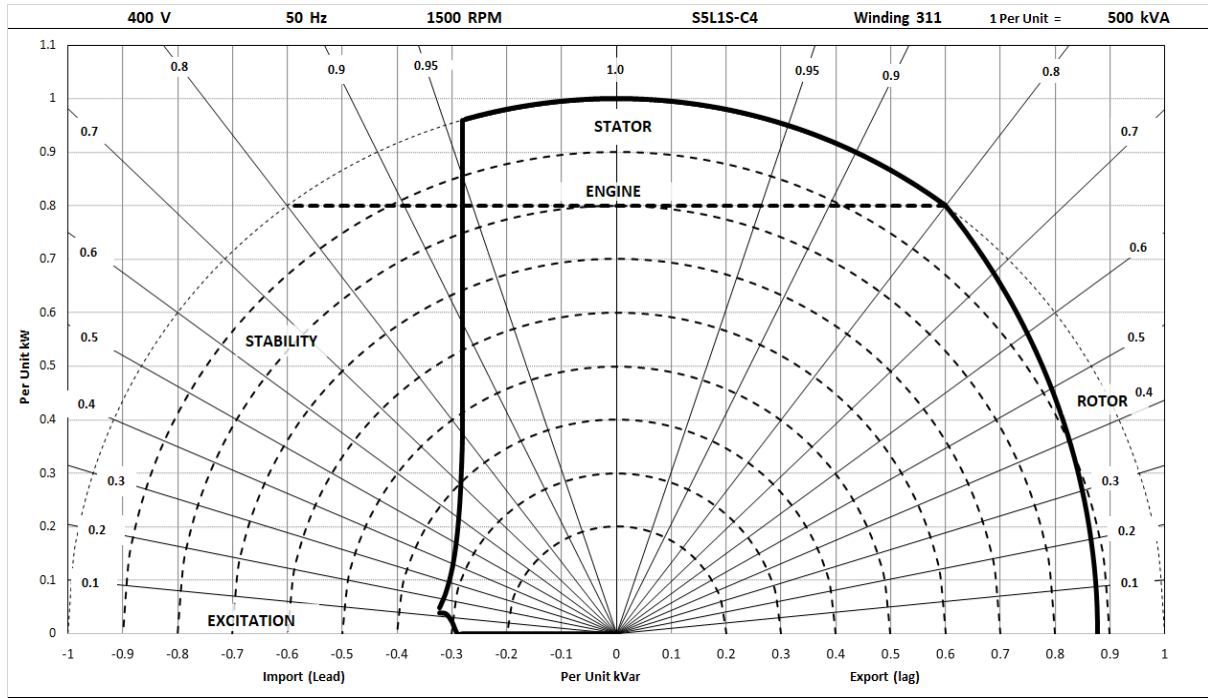

480V/60Hz

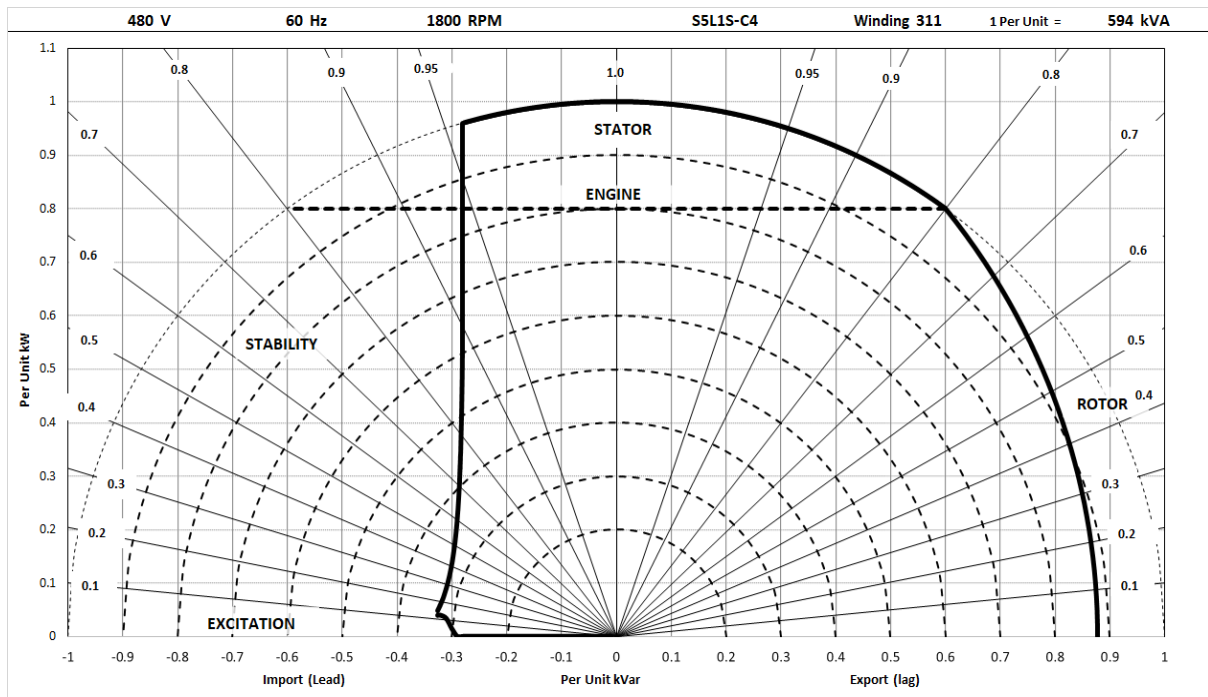

STAMFORD®

S5L1S-C4 Wdg.311

RATINGS AT 0.8 POWER FACTOR

Class - Temp Rise		Standby - 163/27°C				Standby - 150/40°C				Cont. H - 125/40°C				Cont. F - 105/40°C			
50 Hz	Series Star (V)	380	400	415	440	380	400	415	440	380	400	415	440	380	400	415	440
	Parallel Star (V)	190	200	208	220	190	200	208	220	190	200	208	220	190	200	208	220
	Series Delta (V)	220	231	240	254	220	231	240	254	220	231	240	254	220	231	240	254
	kVA	500	520	500	495	478	512	478	478	455	500	455	450	400	445	400	400
	kW	400	416	400	396	382	410	382	382	364	400	364	360	320	356	320	320
	Efficiency (%)	93.5	93.6	94.0	94.3	93.8	93.7	94.2	94.4	94.0	93.8	94.4	94.6	94.5	94.3	94.8	94.9
	kW Input	428	444	425	420	408	437	406	405	387	426	386	380	339	377	338	337

60 Hz	Series Star (V)	416	440	460	480	416	440	460	480	416	440	460	480	416	440	460	480
	Parallel Star (V)	208	220	230	240	208	220	230	240	208	220	230	240	208	220	230	240
	Series Delta (V)	240	254	266	277	240	254	266	277	240	254	266	277	240	254	266	277
	kVA	569	600	631	644	550	581	613	625	525	550	581	594	481	500	531	538
	kW	455	480	505	515	440	465	490	500	420	440	465	475	385	400	425	430
	Efficiency (%)	93.6	93.7	93.7	93.9	93.8	93.9	93.9	94.0	94.0	94.1	94.1	94.2	94.3	94.4	94.4	94.5
	kW Input	486	512	539	549	469	495	522	532	447	468	494	504	408	424	450	455

De-Rates

All values tabulated above are subject to the following reductions:

- 5% when air inlet filters are fitted
- 3% for every 500 meters by which the operating altitude exceeds 1000 meters above mean sea level
- 3% for every 5°C by which the operational ambient temperature exceeds 40°C @ Class H temperature rise (please refer to applications for ambient temperature de-rates at other temperature rise classes)
- For any other operating conditions impacting the cooling circuit please refer to applications

Note: Requirement for operating in an ambient exceeding 60°C and altitude exceeding 4000 meters (for <690V) or 1500 meters (for >690V) must be referred to applications.

Dimensional and Torsional Drawing

For dimensional and torsional information please refer to the alternator General Arrangement and rotor drawings available on our website (<http://stamford-avk.com/>)

Note: Continuous development of our products means that the information contained in our data sheets can change without notice, and specifications should always be confirmed with Cummins Generator Technologies prior to purchase.



Follow us @stamfordavk



Cummins Generator Technologies



View our videos at youtube.com/stamfordavk

news.stamford-avk.com

**For Applications Support:
applications@cummins.com**

**For Customer Service:
emea.service@cummins.com**

**For General Enquiries:
Stamford-avk@cummins.com**

Copyright 2016. Cummins Generator Technologies Ltd. All rights reserved.
Cummins and the Cummins logo are registered trade marks of Cummins Inc.
STAMFORD is a registered trade mark of Cummins Generator Technologies Ltd.

