

GROCERY STORE SOLUTIONS CATALOG

spgusa.com

SFGTM



*Check out our new and
improved website!*



Raising the bar for quality equipment, while lowering the total cost of ownership.

The SPG name has only been around since 2010, however the product lines that comprise our company have been among the most well-known and respected names in the foodservice business for nearly six decades. Individually, each of the product lines below brings unique expertise, capabilities and quality to foodservice operations. Together, they offer you a total turnkey solution.

AMCO®: The industry leader in premium shelving, equipment and accessories that utilize an ultra-strong square-post system.

ISS™: Strong, versatile wire-based shelving, wall storage systems, carts, racks, dollies, workstations and more.

ISS Contender™: The industry's workhorse in wire shelving and accessories — the ideal choice for general applications.

Freestyle®: Strong, versatile and space-efficient, Freestyle® freestanding cantilever shelving and workstations provide maximum performance for every area of your operations.

Kelmax: The gold standard in aluminum equipment — from storage and transport to specialty items for everything from produce and bakery to material handling.

Universal® Stainless: The stainless steel fabrication specialists — offering a vast array of sinks, tables, cabinets, shelves, racks, stands, counters and more.

Gillis & Jarke®: SPG's two material handling lines deliver equipment that's tough, durable, innovative, efficient and economical.

Together, the SPG product lines create unique synergies and efficiencies that enable SPG to deliver an extraordinary array of service and products to your organization. With the broadest selection of foodservice equipment available anywhere, only SPG can offer you so many choices that lead to greater productivity, profitability, performance — and the lowest cost of ownership.

Optimizing the performance and efficiency of your operation.

Nobody offers you more choices in storage equipment, or better ways to optimize the productivity and value of your space, personnel and investment.

SPG storage solutions are specifically designed to not only help you put more into every square foot, but they're also easier to access, clean and assemble. Whether it's in the food prep, drive-thru or any other area of your operation, SPG equipment is designed to fit your space, and the way you do business — reducing the time, motion and effort your staff needs to complete a task. And SPG products are built to be stronger — and last longer — by virtue of the strict manufacturing processes we employ and the quality and amount of material we put into each product.

If you want to get more out of your equipment, contact your SPG representative to see all we can do to optimize your foodservice operation.



You'll find a lot of amazing products in this catalog. But only a fraction of the amazing products we make.







As you look through these pages, bear in mind that the products shown are representative of the far greater number of solutions we offer. For any item you see, there may be dozens, hundreds — or even thousands — of additional products we can provide. SPG offers different sizes, materials, finishes, configurations and accessories to ensure you get the equipment that best fits your needs and your business.

If you don't see exactly what you want in these pages, ask your SPG representative about it. With the broadest selection of foodservice equipment, chances are we already make whatever you're looking for — and can provide it to you through your SPG representative.

For customer service and more information, contact us toll-free:

(877)503-4SPG (877-503-4774)

Email us at: customerservice@spgusa.com

	Shelving	4-17
	Wall Systems	18-19
	Workstations	20-21
	Carts	22-25
	Tables	26-29
	Sinks	30-31



SPG's foodservice products are all manufactured to meet NSF standards. For specific items, visit www.nsf.org

ISS™ SHELVING

Our most popular shelving for a lot of excellent reasons.

Versatility, innovation, strength — ISS™ brings it all together in a durable line of wire shelving that is both easy-to-assemble and competitively priced. So it's no wonder you'll find ISS™ shelving and accessories contributing to the efficiency and profitability of so many foodservice operations.



ISS™ Shelving

- Durable round post system is interchangeable with other manufacturers' shelving products
- Ideal for most any environment
- Shelves up to 60" long are rated to support 1,250 lbs. of uniformly distributed static weight
- Shelves feature extra trusses for a higher load rating, less deflection and the ability to use longer shelves
- Posts are numbered on 1" increments to speed assembly and ensure more precise shelf alignment
- Our one-piece hinged Sure-Lock™ coupler makes assembly easy and improves stability
- The marine waterfall shelf edge allows easy loading and unloading
- Shelves are available in wire (standard, wide-body, and inverted), dunnage, Series 300 solid stainless steel and plastic
- Four finishes are available — plus designer colors



Starter Unit Convenience Packs

- Convenient 4-shelf unit packed in one carton
- Each carton has 4 shelves and four 2-piece split posts to make one 70" post
- Cartons take up minimal warehouse space
- One carton each saves on shipping costs and tracking time
- Ideal for immediate storage needs
- Available in four sizes and two finishes, Gold Bond® (Y) and Plating Plus (C) add finish suffix to model number

Model No.	W x L x H (in.)	W x L x H (mm)	Weight (Lbs.) (Kg)	
1836PK	18 x 36 x 70	457 x 914 x 1778	49	22
1848PK	18 x 48 x 70	457 x 1219 x 1778	66.5	30
2436PK	24 x 36 x 70	610 x 914 x 1778	62	28
2448PK	24 x 48 x 70	610 x 1219 x 1778	78.5	35

To order, add finish suffix to model number



SPG's foodservice products are all manufactured to meet NSF standards. For specific items, visit www.nsf.org

ISS™ Wire Shelves

Model No.	W x L (In) (mm)	Weight (Lbs.) (Kg)
14-in. Wide Shelves		
1436	14 x 36 356 x 914	9 4
1448	14 x 48 356 x 1219	11.5 5
1460	14 x 60 356 x 1524	15 7
18-in. Wide Shelves		
1836	18 x 36 457 x 914	11 5
1848	18 x 48 457 x 1219	14 6
1860	18 x 60 457 x 1524	16.5 7.5
24-in. Wide Shelves		
2436	24 x 36 610 x 914	13 6
2448	24 x 48 610 x 1219	17 8
2460	24 x 60 610 x 1524	20.5 10



ISS™ Posts

Model No.	Height (In) (mm)	Weight (Lbs.) (Kg)
Digital Posts® For Stationary Shelving Units		
P74	75 1899	4 2
P86	87 2203	5 2
Digital Posts® For Use With Stem Casters		
P74N	75 1899	4 2
P86N	87 2203	5 2

Select finish and add appropriate suffix to model number

Finish	Use Suffix
Plating Plus™	C
Grey Bond®	E
Gold Bond®	Y
Stainless Steel	S

Colors (minimum order required)	
Black	ESB
Red	ESR

ISS CONTENDER™ SHELVING High-performance. Great value.

With our ISS Contender™ line, SPG has driven down the cost of wire shelving without sacrificing performance. ISS Contender™ offers impressive strength and capacity for general applications, corrosion resistance for all environments, ease of assembly — and just about everything you would expect to find on higher cost shelving.



- ISS Contender™ round post shelving is a strong, economical solution for both dry and refrigerated storage needs
- Available with Plating Plus™ finish for display and dry environments — or Contender Grey™ Epoxy finish which is warranted for seven years against naturally occurring corrosion in high-moisture, high-humidity environments
- Each 48" shelf is rated to support up to 800 lbs. (363 kgs) of uniformly distributed static load weight — longer shelves can support up to 600 lbs. (272 kgs)
- Assembles in minutes without tools or hardware
- Shelves are installed on the posts in 1" (25mm) increments — and can be changed easily as storage needs change



More Information
on our website
www.spgusa.com



Shelving Kit Convenience Packs

- Four shelves and four 70" split posts
- Available in Plating Plus™ or Contender Grey™ Epoxy finishes

Contender Grey™ Model#	Plating Plus™ Model#	(in.)	(mm.)	(lbs.)	(kg.)
IC183674KITCG	IC183674KITC	18 x 36 x 74	457 x 914 x 1880	54.00	24.50
IC184874KITCG	IC184874KITC	18 x 48 x 74	457 x 1219 x 1880	64.00	29.10
IC186074KITCG	IC186074KITC	18 x 60 x 74	457 x 1524 x 1880	84.00	38.20
IC243674KITCG	IC243674KITC	24 x 36 x 74	610 x 914 x 1880	68.00	30.90
IC244874KITCG	IC244874KITC	24 x 48 x 74	610 x 1219 x 1880	78.00	31.80
IC246074KITCG	IC246074KITC	24 x 60 x 74	610 x 1524 x 1880	92.00	41.80



SPG's foodservice products are all manufactured to meet NSF standards. For specific items, visit www.nsf.org

ISS Contender™ Wire Shelves

Model No.	W x L (in.) (mm)	Weight (Lbs.) (Kg)
18-in. Wide Shelves		
IC1836	18 x 36 457 x 914	9.5 4
IC1848	18 x 48 457 x 1219	12 5
IC1860	18 x 60 457 x 1524	17 8
24-in. Wide Shelves		
IC2436	24 x 36 610 x 914	13 6
IC2448	24 x 48 610 x 1219	16 7
IC2460	24 x 60 610 x 1524	21 9.5

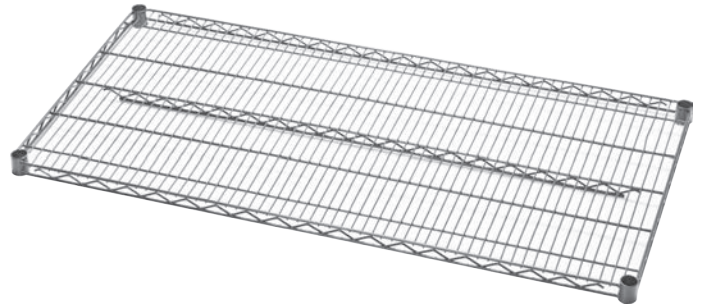

Add finish suffix to model number
 ISS Contender™ shelves are available:
 In 14", 18", 21" and 24" widths
 In 24", 30", 36", 42", 48", 54", 60" and 72" lengths
 To order other sizes: use MA + shelf width + shelf length +
 finish suffix (Example: MA1824C)

ISS Contender™ Posts For Stationary Use

Model No.	Height (In) (mm)	Weight (Lbs.) (Kg)
IC072	72 1829	4 2
IC084	84 2134	5 2

Add finish suffix to model number
 ISS Contender™ posts are also available:
 In 7", 34", 54" and 64" heights



Posts for
Stationary Use



Posts for
Stem Casters

ISS Contender™ Posts With No Foot For Use With Stem Casters

Model No.	Height (In) (mm)	Weight (Lbs.) (Kg)
IC064NF	64 1626	3.5 2
IC072NF	72 1829	4 2
IC084NF	84 2134	5 2

Add finish suffix to model number
 ISS Contender™ posts are also available:
 In 7", 34", 54" and 64" heights

Finish	Use Suffix
Plating Plus™ finish for display and dry environment applications — 1-Year Warranty against corrosion in dry environments	C
Contender Grey™ finish for moist/humid environments — 7-Year Warranty under normal use against naturally occurring corrosion	CG



ISS™ NEW ERA™ SHELVING

The same type of quality, durability and performance you'll find in our popular ISS™ wire shelving in a plastic solution — it's one more choice SPG offers, and one more reason to choose SPG as your single source for storage solutions.



- Corrosion free shelves — heavy-duty epoxy coated steel frames and grey polypropylene plastic removable panels
- Antimicrobial agent protects the shelf finishes from bacteria, mold, mildew and fungi that cause odors, stains and product degeneration — keeping shelving cleaner in between cleanings*
- Available in solid and vented styles
- Sectional panels are easy to remove and clean
- Shelves can be used with ISS™ posts and shelving components — stainless steel posts recommended
- No tools or hardware required
- Can be used in all environments from -20°F (-29°C) to 190°F (88°C)
- Load capacity of 1,000 lbs. (455kgs) per shelf of uniformly distributed static weight

* This product does not protect users or others against bacteria, viruses, germs or other disease organisms. It is for the protection of the product only. The antimicrobial product should always be thoroughly cleaned after each use.



SPG's foodservice products are all manufactured to meet NSF standards. For specific items, visit www.nsf.org

New Era™ Vented Shelves

Model No.	W x L (in.)	(mm)	Weight (Lbs.) (Kg)	
18-in. Wide Shelves				
LPS1836V	18 x 36	457 x 914	12	5
LPS1848V	18 x 48	457 x 1219	15.5	7
LPS1860V	18 x 60	457 x 1524	19.5	9
24-in. Wide Shelves				
LPS2436V	24 x 36	610 x 914	14	6
LPS2448V	24 x 48	610 x 1219	18	8
LPS2460V	24 x 60	610 x 1524	23	10

New Era™ Shelves are available:
 In 18", 21" and 24" widths
 In 24", 30", 36", 42", 48", 54" and 60" lengths



New Era™ Solid Shelves

Model No.	W x L (in.)	(mm)	Weight (Lbs.) (Kg)	
18-in. Wide Shelves				
LPS1836S	18 x 36	457 x 914	12	5
LPS1848S	18 x 48	457 x 1219	15.5	7
LPS1860S	18 x 60	457 x 1524	19.5	9
24-in. Wide Shelves				
LPS2436S	24 x 36	610 x 914	14	6
LPS2448S	24 x 48	610 x 1219	18	8
LPS2460S	24 x 60	610 x 1524	23	10

New Era™ Shelves are available:
 In 18", 21" and 24" widths
 In 24", 30", 36", 42", 48", 54" and 60" lengths

New Era™ Posts

Model No. Stationary Posts	Model No. Mobile Posts	Height (in.)	Height (mm)	Weight (Lbs.)	Weight (Kg)
Stainless Steel Posts					
P74S	P74NS	75	1899	4	2
P86S	P86NS	87	2203	5	2
Steel Posts With Grey Bond® Finish					
P74E	P74NE	75	1899	4	2
P86E	P86NE	87	2203	5	2

Stainless Steel and Grey Bond® are the optimum finishes for use with New Era™ Shelves

New Era™ Posts are also available in:
 8", 14", 34", 54" and 62" heights



PLASTIC SHELVING

AMCO® PLASTIC PLUS® & PLASTEEL® SHELVING

Two great options, one reliable source.

AMCO® Plastic Plus™ solid polypropylene plastic removable panels or Plasteel® steel-reinforced plastic shelves — both offer durable performance in any environment, are compatible with AMCO® accessories and deliver the quality and value that you expect from SPG.



AMCO® Plastic Plus® Shelving

- Grey polypropylene plastic removable panels easily snap onto heavy duty epoxy coated frames
- Sectional panels can be easily removed from frames for cleaning — no tools or hardware required
- An antimicrobial agent protects the finish from bacteria, mold, mildew and fungi that cause odors, stains and product degradation*
- For all environments from -20°F (-29°C) to 190°F (88°C)
- Strength rated to support 1,000 lbs. (455kg) of uniformly loaded static weight per shelf
- Fits standard AMCO® square posts and is compatible with other AMCO® shelving products
- Stainless steel posts recommended for a rust-free solution

* This product does not protect users or others against bacteria, viruses, germs or other disease organisms. It is for the protection of the product only. This antimicrobial product should always be thoroughly cleaned after each use.



AMCO® Plastic Plus® Vented Shelves

Model No.	W x L (in.)	W x L (mm)	Weight (Lbs.) (Kg)	
18-in. Wide Shelves				
PP1836V	17 x 36	455 x 915	12	5
PP1848V	17 x 48	455 x 1220	15.5	7
PP1860V	17 x 60	455 x 1525	19.5	9
24-in. Wide Shelves				
PP2436V	23 x 36	610 x 915	14	6
PP2448V	23 x 48	610 x 1220	18	8
PP2460V	23 x 60	610 x 1525	23	10



Plastic Plus® shelves are available:

In 18" and 24" widths

In 24", 30", 36", 42", 48", 54" and 60" lengths

Plastic Plus® Solid Shelves

Model No.	W x L (in.)	(mm)	Weight (Lbs.)	(Kg)
18-in. Wide Shelves				
PP1836S	17 x 36	455 x 915	12	5
PP1848S	17 x 48	455 x 1220	15.5	7
PP1860S	17 x 60	455 x 1525	19.5	9
24-in. Wide Shelves				
PP2436S	23 x 36	610 x 915	14	6
PP2448S	23 x 48	610 x 1220	18	8
PP2460S	23 x 60	610 x 1525	23	10



Plastic Plus® shelves are available:

In 18" and 24" widths

In 24", 30", 36", 42", 48", 54" and 60" lengths

AMCO II® Plasteel® Shelves

- Steel-reinforced plastic shelves support 1,000 lbs. each
- Available in solid or vented style — solid style has raised edge to contain liquid spills
- Grey high-impact structural foam plastic
- May be used with all other styles of Amco II® shelves
- Solid style accepted by the United States Department of Agriculture for direct food contact
- Stainless steel post recommended since it never rusts

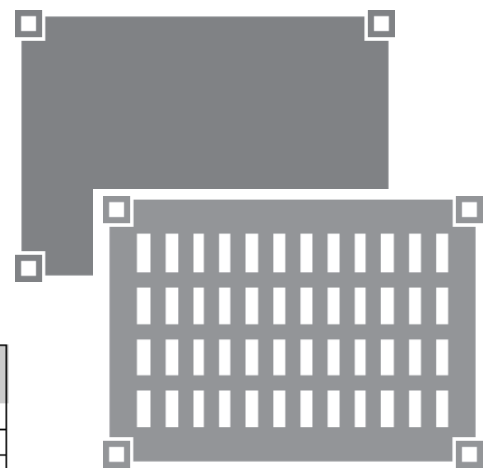

Vented Shelf Model No.	Solid Shelf Model No.	W x L (in.)	(mm)	Weight (Lbs.)	(Kg)
PS1836V	PS1836S	17 x 36.5	476 x 927	16	7
PS1842V	PS1842S	17 x 42.5	476 x 1080	17	8
PS1848V	PS1848S	17 x 48.5	476 x 1232	21	9.5
PS1860V	PS1860S	17 x 60.5	476 x 1537	29	13
PS2436V	PS2436S	25 x 36.5	629 x 927	19	9
PS2442V	PS2442S	25 x 42.5	629 x 1080	21	9.5
PS2448V	PS2448S	25 x 48.5	629 x 1232	25	11
PS2460V	PS2460S	25 x 60.5	629 x 1537	33	15

AMCO® Posts For Plastic Plus® and Plasteel® Shelving

Model No.	Height (in.)	(mm)	Weight (Lbs.)	(Kg)
Stationary Stainless Steel Posts				
P72SS	72	1830	5	2
P84SS	84	2130	5.5	2.5
Stationary Steel Posts With Grey Bond® Finish				
P72GR	72	1830	5	2
P84GR	84	2130	5.5	2.5
Mobile Stainless Steel Posts				
PC72SS	72	1830	5	2
PC84SS	84	2130	5.5	2.5
Mobile Steel Posts With Grey Bond® Finish				
PC72GR	72	1830	5	2
PC84GR	84	2130	5.5	2.5



- 16-ga. (.065") 1" O.D. square tube construction
- Notched every 2" on each corner
- Includes a top polypropylene post cap
- Stationary posts have a nylon housing on the bottom for a steel leveler



SPG's foodservice products are all manufactured to meet NSF standards. For specific items, visit www.nsf.org

AMCO® posts are available in:

8", 14", 34", 54", 64", 72" and 84" heights

Stainless steel (SS), Grey Bond® (GR) or Polygard® (PG) finishes

Freestyle® CANTILEVER SHELVING — the ultimate in freestanding cooler/freezer storage.

In real-store tests, Freestyle® shelving systems increased usable storage surface space up to 68% in coolers and up to 60% in freezers — which makes Freestyle® a proven way to get more out of every square foot of your operation and every dollar of your shelving investment.



- Each shelf has a load-bearing capacity of 600 lbs. with a unit rating of 1,800 lbs. for cantilevered shelves and 1,000 lbs. capacity on the bottom shelf — for a total unit capacity of 2,800 lbs.
- No front uprights — so it offers greater accessibility to inventory
- Increases sq. ft. and cubic volume storage capacity in existing footprint
- Adjustable shelves on 2" increments for maximum flexibility — no tools required
- Unit is fully expandable side-to-side with Add-On unit — using common uprights with dual-side adjustment
- Durable heavy-duty steel construction
- Shelving available in 5 widths and 8 lengths
- Uprights available in 5 heights
- Shelves, uprights, and frame kits have a durable grey epoxy-based finish with advanced antimicrobial protective agent
- Complete assortment of accessories including hanger rails and shelf covers in wire and stainless steel



SPG's foodservice products are all manufactured to meet NSF standards. For specific items, visit www.nsf.org

See it in action!

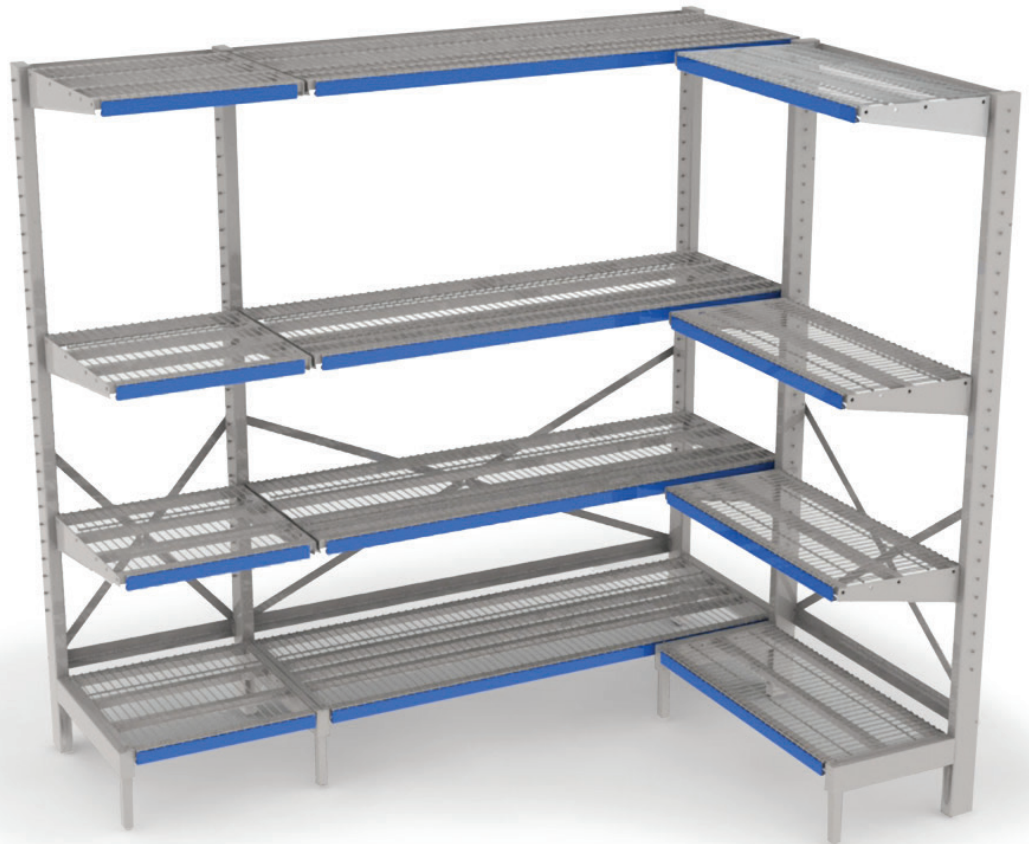

Freestyle® 4-Tier Starter Units

Includes: 1 starter frame kit, 3 standard shelves, 1 bottom shelf.
4 standard wire covers with label holders.

Model No.	W x L x H		Weight	
	(in.)	(mm)	(Lbs.)	(Kg)
FSMS741836E	18 x 36 x 74	457 x 914 x 1880	138	62
FSMS741848E	18 x 48 x 74	457 x 1219 x 1880	158	72
FSMS741860E	18 x 60 x 74	457 x 1534 x 1880	193	88
FSMS742436E	24 x 36 x 74	609 x 914 x 1880	160	72
FSMS742448E	24 x 36 x 74	609 x 1219 x 1880	185	84
FSMS742460E	24 x 36 x 74	609 x 1534 x 1880	211	96
FSMS861836E	18 x 36 x 86	457 x 914 x 2184	144	66
FSMS861848E	18 x 48 x 86	457 x 1219 x 2184	165	75
FSMS861860E	18 x 60 x 86	457 x 1534 x 2184	200	91
FSMS862436E	24 x 36 x 86	609 x 914 x 2184	166	75
FSMS862448E	24 x 48 x 86	609 x 1219 x 2184	191	87
FSMS862460E	24 x 60 x 86	609 x 1534 x 2184	217	98

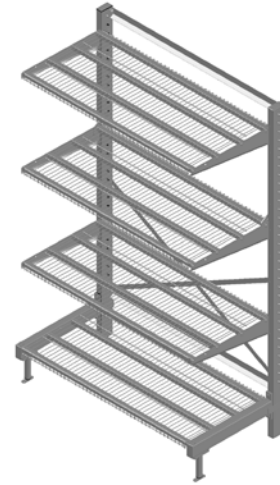

Freestyle® 4-Tier Add-On Units

Includes: 1 add-on frame kit, 3 standard shelves, 1 bottom shelf.
4 standard wire covers with label holders.

Model No.	W x L x H		Weight	
	(in.)	(mm)	(Lbs.)	(Kg)
FSMA741836E	18 x 36 x 74	457 x 914 x 1880	111	51
FSMA741848E	18 x 48 x 74	457 x 1219 x 1880	132	60
FSMA741860E	18 x 60 x 74	457 x 1534 x 1880	167	76
FSMA742436E	24 x 36 x 74	609 x 914 x 1880	132	60
FSMA742448E	24 x 48 x 74	609 x 1219 x 1880	158	72
FSMA742460E	24 x 60 x 74	609 x 1534 x 1880	183	83
FSMA861836E	18 x 36 x 86	457 x 914 x 2184	115	52
FSMA861848E	18 x 48 x 86	457 x 1219 x 2184	135	61
FSMA861860E	18 x 60 x 86	457 x 1534 x 2184	170	77
FSMA862436E	24 x 36 x 86	609 x 914 x 2184	136	62
FSMA862448E	24 x 48 x 86	609 x 1219 x 2184	161	73
FSMA862460E	24 x 60 x 86	609 x 1534 x 2184	187	85

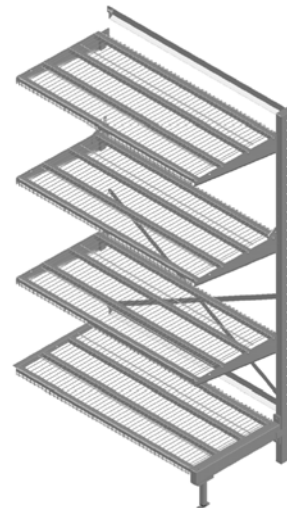

Freestyle® Reinforcement Brace

- Dramatically increases the load capacity of Freestyle® shelving:
 - by 25% on 30-in. shelves, from 600 lbs. to 800 lbs.
 - by 40% on shelves up to 24-in. deep, from 600 lbs. to 1,000 lbs.
- Provides the additional strength critical for the storage and display of heavy, high-density products
- Low-profile design and placement make it virtually invisible and will not interfere with shelf positioning
- Installation is fast, easy and requires no tools
- Significantly increases the life of your shelving
- Set includes 1 left and 1 right brace for shelf

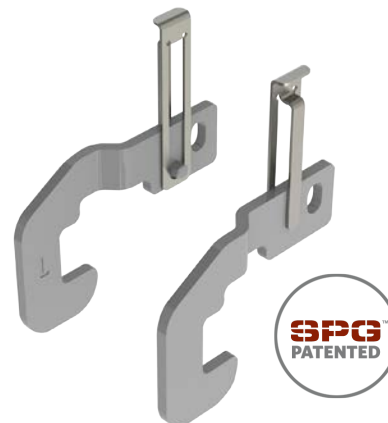

Model No.	Weight(Lbs.)
FSRBESET	0.5

CANTILEVER SHELVING

Freestyle® CANTILEVER BEER CAVE SHELVING with SWEEPING CORNER



- The Freestyle sweeping corner bridges the gap between adjacent corner Freestyle units without the use of a shared upright
- Provides easier access for product retrieval and stocking for employees
- Provides greater visibility and accessibility for customers, maximizes profit
- Introduces a new visual aesthetic to beer caves or other consumer products
- Durable heavy-duty powdercoated steel and stainless steel options, in both vented and solid models
- Powder-coated shelves have a durable gray epoxy-based finish with advanced antimicrobial protective agent
- Made to fit standard depth Freestyle shelving, simply sets in place
- Each bridge extends the load bearing surface of the shelves



QUICK ORDER KITS – 3 & 4 TIER, VENTED & SOLID, COMPLETE CORNER, GREY BOND

	Model No.	Description	Shelf Depth	Includes
- Tier	3 - Tier Solid Grey Bond Corner Kit			
	FSACS24E-3T-KIT	Angled Corner 24" Shelf Kit - 3 Tier; Solid Bridges	24	4 upper bridges; 2 bottom bridges; 4 back braces
	FSACS30E-3T-KIT	Angled Corner 30" Shelf Kit - 3 Tier; Solid Bridges	30	4 upper bridges; 2 bottom bridges; 4 back braces
	3 - Tier Vented Grey Bond Corner Kit			
	FSACV24E-3T-KIT	Angled Corner 24" Shelf Kit - 3 Tier; Vented Bridges	24	4 upper bridges; 2 bottom bridges; 4 back braces
	FSACV30E-3T-KIT	Angled Corner 30" Shelf Kit - 3 Tier; Vented Bridges	30	4 upper bridges; 2 bottom bridges; 4 back braces
- Tier	4 - Tier Solid Grey Bond Corner Kit			
	FSACS24E-4T-KIT	Angled Corner 24" Shelf Kit - 4 Tier; Solid Bridges	24	6 upper bridges; 2 bottom bridges; 4 back braces
	FSACS30E-4T-KIT	Angled Corner 30" Shelf Kit - 4 Tier; Solid Bridges	30	6 upper bridges; 2 bottom bridges; 4 back braces
	4 - Tier Vented Grey Bond Corner Kit			
	FSACV24E-4T-KIT	Angled Corner 24" Shelf Kit - 4 Tier; Vented Bridges	24	6 upper bridges; 2 bottom bridges; 4 back braces
	FSACV30E-4T-KIT	Angled Corner 30" Shelf Kit - 4 Tier; Vented Bridges	30	6 upper bridges; 2 bottom bridges; 4 back braces

SWEEPING CORNER BRACING KITS

4 braces for a 2-sided configuration

Model No.	Shelf Depth	Qty
FSACAS18*KIT4	18	4
FSACAS24*KIT4	24	4
FSACAS30*KIT4	30	4

AVAILABLE FINISHES

Finish	Suffix
Grey Bond	E

AMCO® MOD-A-FLEX® SHELVING

Get more out of your coolers & freezers

This unique, patented shelving system is supported from the walls or ceiling, eliminating front posts and increasing storage capacity by 30%. The Mod-A-Flex® system also features an impressive 400-lb. per shelf capacity, an antimicrobial grey-epoxy finish and all the features you need to store more and earn more.



Every detail of the Mod-A-Flex® system is designed to improve employee efficiency, productivity and speed of service — reducing labor and storage costs while contributing to overall operational results.

Mod-A-Flex® not only increases storage capacity up to 30% ... it also offers greater organization and higher visibility of stock... shelves can also be quickly and easily removed and repositioned...and because there are no posts, cleaning the floor is faster, easier and more thorough.

Mod-A-Flex® System

- Designed for walk-in coolers and freezers
- Ceiling mounted — no need to reinforce side walls
- Boosts capacity by up to 30% with the freedom to adjust shelves to the height of the product being stored
- No posts on the floor make cleaning easy
- Shelves can be removed without tools for cleaning
- Easy and fast adjustment of shelves; simply slide the shelf sideways to lift out of current location
- Antimicrobial grey epoxy coating for maximum cleanliness and moisture resistance



Mod-A-Flex® Shelves

Model No.	W x L		Weight	
	(In)	(mm)	(Lbs.)	(Kg)
MX1824GR	18 x 22.5	451 x 572	9	4
MX1836GR	18 x 34.5	451 x 876	12	5
MX1848GR	18 x 46.5	451 x 1181	15	7
MX2124GR	21 x 22.5	527 x 572	12	5
MX2136GR	21 x 34.5	527 x 876	17	8
MX2148GR	21 x 46.5	527 x 1181	21	9.5

Mod-A-Flex® Shelves are available:
 In 11-3/4", 17-3/4" and 20-3/4" widths
 In 22-1/2", 28-1/2", 34-1/2", 40-1/2" and 46-1/2" lengths
 Nominal shelf widths are: 12", 18" and 21"
 Nominal shelf lengths are: 24", 30", 36", 42" and 48"
 NOTE: Two support arms included with each shelf



Mod-A-Flex® Standards For Cooler Freezer

Model No.	Height		Weight	
	(In)	(mm)	(Lbs.)	(Kg)
MX68GR	68	1727	9	4
MX72GR	72	1829	12	5
MX81GR	81	2057	15	6

Mod-A-Flex® Standards For Dry Environments

Model No.	Height		Weight	
	(In)	(mm)	(Lbs.)	(Kg)
MXD72GR	72	1829	11	5
MXD85GR	85	2159	13	6

Mod-A-Flex® Standards are available:
 In 24", 36", 40", 61" 68", 72", 81" and 85" heights for installation in coolers and freezers
 18", 36" and 85" for installation in dry environments
 With Extender Kits to increase installation height

The Mod-A-Flex® Secret

The patented secret to this postless system is that standards are securely suspended from the ceiling of the walk-in cooler. This provides the strength assurance that each shelf will support 400 lbs of static weight.

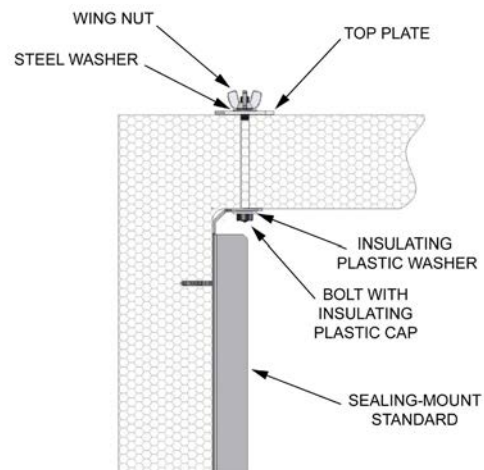

ISS™ WALL TRAX™ Wall-to-wall efficiency.

Minimize wasted time and motion of your kitchen staff — and increase productivity and service speed! Employing a channel and grid design, the ISS™ Wall Trax™ System ensures the ingredients, tools and utensils your kitchen staff needs are always within easy reach.

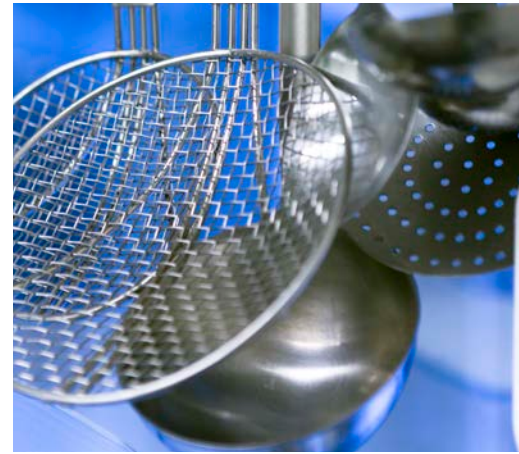

ISS™ Wall Trax™ is a complete wall mounted storage solution with specially engineered aluminum channel and grid system to increase efficiency and expand storage capacity.

- ISS™ Wall Trax™ channels and grids are easy to install
- Easily attach accessories without the need for tools or hardware
- All shelves can be moved by simply unhooking from grid or channel
- Available in three finishes, all corrosion-resistant, epoxy-based polymer coated: Grey Bond®, Gold Bond® and Polygard® (Blue)



Use this chart to select your finish

Finish	Use Suffix
Grey Bond®	E
Gold Bond®	Y
Polygard® (Blue)	PG



ISS™ Wall Trax™ Hooks

Model No.	Description	W x L x W		Weight	
		(in.)	(mm)	(Lbs.)	(Kg)
Hanging Hooks (Attach to Wall Trax channel or grid)					
HOOK24	24" hook w/seven 6" prongs	7 x 24 x 6.5	182 x 603 x 165	2	.8
HOOK12	12" hook w/four 6" prongs	7 x 12 x 6.5	182 x 305 x 165	1	.5
PHK	Pot hook				
Wall-mounted Hooks (Attach directly to wall)					
HOOK246R2	24" hook w/seven 6" prongs	6.5 x 24 x 7	182 x 603 x 165	2	.8
HOOK243R1	12" hook w/four 6" prongs	3.5 x 24 x 7	89 x 629 x 184	1	.5
HOOK20ADJ	20" hook w/seven 3" prongs	4 x 20 x 4.5	83 x 502 x 114	1.5	.7



Select finish - add suffix to model number

ISS™ Wall Trax™ Accessories

Model No.	Description	W x L x H		Weight	
		(in.)	(mm)	(Lbs.)	(Kg)
GRBTLHD	Bottle Holder	4 x 21 x 13	102 x 533 x 330	2	.1
GRSCOOP	Scoop Holder	5 x 10 x 6	127 x 254 x 150	3	.6
DISHHOLD	Monkey Dish Holder	4 x 21 x 17	102 x 533 x 432	24	11
PLATERK	Plate Rack	8 x 8 x 1	216 x 216 x 54	1.5	.7

Select finish — add suffix to model number. Additional sizes available



ISS™ Wall Trax™ Shelves

Model No.	(in.)	W x L (mm)	Weight (Lbs.) (Kg)	
Flat Shelves				
GS1436	14 x 36	356 x 914	8	4
GS1448	14 x 48	356 x 1219	11	5
GS1836	18 x 36	457 x 914	9	4
GS1848	18 x 48	457 x 1219	13	6
Flat Shelves with Lip				
GSL1436	14 x 36	356 x 914	8	4
GSL1448	14 x 48	356 x 1219	11	5
GSL1836	18 x 36	457 x 914	9	4
GSL1848	18 x 48	457 x 1219	13	6
Slanted Shelves				
GSS1436	14 x 36	356 x 914	8	4
GSS1448	14 x 48	356 x 1219	11	5
GSS1836	18 x 36	457 x 914	9	4
GSS1848	18 x 48	457 x 1219	13	6

Select finish — add suffix to model number.



ISS™ Wall Trax™ Grid

• Mounts directly to wall — brackets included

Model No.	(in.)	W x L (mm)	Weight (Lbs.) (Kg)	
GRWM2436	24 x 36	610 x 914	10	4.5
GRWM2448	24 x 48	610 x 1219	13	6
GRWM3636	36 x 36	914 x 914	15	7
GRWM3648	36 x 48	914 x 1219	19	9

Select finish — add suffix to model number.



ISS™ Wall Trax™ Offset Grid

• For use with channels

Model No.	(in.)	W x L (mm)	Weight (Lbs.) (Kg)	
GRO2436	24 x 36	610 x 914	10	4.5
GRO2448	24 x 48	610 x 1219	13	6

ISS™ Wall Trax™ Baskets

Model No.	(in.)	W x L x H (mm)	Weight (Lbs.) (Kg)	
GB12186	12 x 18 x 6	305 x 457 x 150	3	1
GB14183	14 x 18 x 3	355 x 457 x 76	3	1
GBSPRNK	5 x 12 x 4	126 x 305 x 102	1	.5
GB12106	12 x 10 x 6	254 x 305 x 150	2.5	1

Select finish — add suffix to model number. Additional sizes available



ISS™ Wall Trax™ Channel

Model No.	(in.)	W x L (mm)	Weight (Lbs.) (Kg)	
TRAX2A	4 x 24	102 x 610	3.5	1
TRAX4A	4 x 48	102 x 1219	7	3
TRAX8A	4 x 96	102 x 2438	14	6
TRAXSTOPS	Wall Trax™ Channel End Caps (1 ea.)			
TRAXTOGS	Wall Trax™ Toggle Fasteners			

FREESTYLE® WORKSTATIONS

Prepare for a higher level of productivity.

Strength and durability...speed and efficiency...storage and workspace — it's all built in to an ergonomically designed workstation that will help your staff become more efficient and your operation more profitable.



- The ergonomic design maximizes usable kitchen space and provides added storage for packaging, smallwares, menus, ingredients, utensils and more
- An impressive total load-bearing capacity of 2,800 lbs.
 - each upper shelf has a 600-lb. capacity
 - bottom shelf capacity is 1,000 lbs.
- Plug and place steamers, microwaves, food warmers and other standard equipment
- Fast, easy cleaning of food prep surfaces and overall structure
- 30" deep stainless steel work surface provides plenty of area for prep work
- Open-base design delivers adequate space for a fridge under the work surface of the 48", 54" and 60" models
- Shelf and work surface heights adjust in 2" increments
- Add components or shelves without tools
- No front uprights for an uninterrupted work surface

Before you choose a workstation, consider why so many major national foodservice operations have turned to Freestyle® to improve storage, efficiency and productivity.

Freestyle® combines the versatility and flexibility of a freestanding unit while providing rock-solid strength and stability to support steamers, microwaves and other vital equipment

From the ability to add or reconfigure shelves quickly and without tools to the wide selection of accessories available — everything about Freestyle® is customizable.

Unlike most competitive units, Freestyle® doesn't require a bottom shelf for stability — freeing up floor space underneath for a refrigerator at a prep station or a safe at the Drive-Thru.

Storage is enhanced by virtue of a 2,800-lb. unit capacity...shelves that can be positioned in 2" increments...and shelf surface areas that are uninterrupted by front uprights.



SPG's foodservice products are all manufactured to meet NSF standards. For specific items, visit www.nsf.org



Check it out on our website!

Customizable with a complete line of accessories:

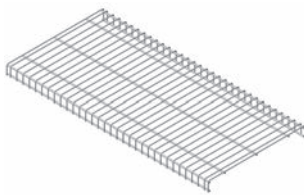

Wire Shelf Cover

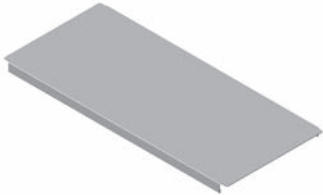

Solid Shelf Cover



Grid Basket

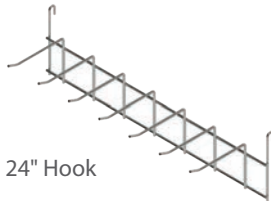

24" Hook



Spoodle Holder

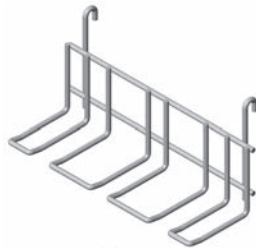

Scoop Holder



Hanger Rails

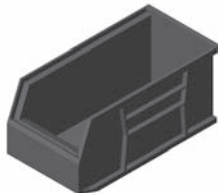

Bins



Pot Hook Grey

Model No.	Prep Surface Widths	Overhead Shelf Widths	Lengths	Inside Clearance
WST1491E	30" (762 mm)	18" (457 mm)	60" (1524 mm)	56" (1429 mm)
WST1539E	30" (762 mm)	18" (457 mm)	54" (1372 mm)	50" (1276 mm)
WST1492E	30" (762 mm)	18" (457 mm)	48" (1219 mm)	44" (11245 mm)
WST1493E	30" (762 mm)	18" (457 mm)	36" (914 mm)	32" (819 mm)

Need Even More Capacity?

The innovative Freestyle® Brace can quickly and easily increase the weight capacity of a Freestyle® by 200 lbs. or 400 lbs. per shelf.

EXCEPTIONAL ECONOMY

Throughout our extensive product line-up, SPG offers the lowest cost of ownership to help you drive out costs while driving up productivity.



ISS Contender™ Utility Carts

- Ideal for receiving, busing and general material handling
- Wire construction; 2-shelf or 3-shelf models
- Easy maneuverability with 5" diameter, swivel, resilient, non-marking casters
- Assembly requires no tools or extra hardware
- Plating Plus™ — zinc plating, chromate steel and clear lacquer form a finish that's hard, durable and attractive
- Load rating is 800 lbs.

Model No.	W x L x H (In.)	Weight
2-Shelf Utility Carts		
MUC18302C	18 x 30 x 39	37
MUC18362C	18 x 36 x 39	40
MUC24362C	24 x 36 x 39	47
3-Shelf Utility Carts		
MUC18303C	18 x 30 x 39	43
MUC18363C	18 x 16 x 39	47
MUC24363C	24 x 36 x 39	60



ISS Contender™ carts are also available with Contender Grey™ Epoxy finish for humid and moist environments. Custom handles are also available. Call your SPG representative for details.

Kelmax Heavy Duty Stainless Steel Utility Cart

- A reinforced tube adds strength under front lip of shelves
- 5" x 2" polyurethane plate casters
- 1,100 lb-rolling capacity
- Stainless steel caster hardware
- Made in 304 Series stainless steel for rust resistance



Model No.	No of Shelves	Shelf Spacing(In.)	Shelf Size	W x L x H (In.)	W x L x H (mm.)	Weight (Lbs)	Weight (Kg.)
4J0473	2	23	18 x 32	37.5 x 19.5 x 37	953 x 496 x 940	74	34
4J0407	3	11	18 x 32	37.5 x 19.5 x 37	953 x 496 x 940	90	41

Kelmax stainless steel Utility Carts are available in:
37-1/2", 38-1/2" and 54-1/2" lengths
19-1/4" and 22-1/2" widths



ISS™ Universal Staging Cart

- Provides maximum cooler storage in minimum space
- Improves thawing and storage capabilities, facilitates product rotation and includes 12 aluminum trays
- Ideal for any product that needs tempering in a walk-in cooler
- End-loading rack offers generous capacity and can hold up to 28 trays
- Assembles without tools—thanks to our Sure Lock™ coupler, numbered posts and easy instructions

Model No.	W x L x H	
	(In.)	(mm.)
WST1384Y	21 x 30 x 68.5	533 x 762 x 1740

Kelmax Aluminum Meat Lug Carts

- All welded construction
- 5" polyurethane swivel stem casters



Model No.	Lug Capacity	L x W x H		Weight	
		(In.)	(mm.)	(Lbs)	(Kg.)
4H0682	1	25 x 16 x 19	635 x 406 x 483	10	4.5
4H0690	2	25 x 16 x 33	635 x 406 x 838	18	8
4H0694	6	27 x 19 x 69	686 x 483 x 1753	30	13.5

Kelmax Meat Lug Carts are also available in 3 and 4-lug capacities
Order lugs separately - see page 76



SPG's foodservice products are all manufactured to meet NSF standards. For specific items, visit www.nsf.org

Kelmax Mixing Bowl Dolly

- Designed for the toughest conditions
- 16-ga. 304 Series stainless steel construction tubing with .25" thick ring
- 800 lb. capacity
- Mobile unit on 5" polyurethane casters

Model No.	Ring Size (In.)	L x W x H		Weight	
		(In.)	(mm.)	(Lbs)	(Kg.)
4J0274	19	28 x 21 x 30	711 x 533 x 761	45	20

Available with 19" and 30" rings, in 26" and 30" heights



MAXIMUM MOBILITY

Whether you need to maneuver in tight, busy kitchen spaces or transport meals, supplies and more — SPG has a complete selection of products to help move your operation forward.



Kelmax Aluminum Sheet Pan Dolly

- Store and transport foodservice trays with greater efficiency and convenience
- One or two tier units
- Holds 18" x 26" sheet trays
- 5" polyurethane swivel plate casters
- Heavy-duty units have 1-1/4" square tubing
- All welded aluminum construction

Model No.	Capacity (Lbs)	L x W x H		Weight	
		(In.)	(mm.)	(Lbs)	(Kg.)
4H1331	900	27 x 22 x 32	686 x 559 x 813	22	10



Tray Modules Mobile Unit

- Space saving cart for storing trays
- Each cart consists of 4 shelves, 4 posts, four 5" CM5M swivel casters, 4 donut bumpers and tray modules to fill each shelf tray
- Tray module is TM241PG, spacing is 1-9/16"
- Shelving is 24" wide, 77" high

Polygard® Model No.	Tray Cap.	Length (In.)	Length (mm.)	Weight (Lbs.) (Kg.)	
TM2448PG	96	48	1220	160	72.6
TM2460PG	112	60	1525	190	86.2
TM2472PG	144	72	1830	206	93.4



AMCO® Dishwasher Rack Dolly

- Rugged polypropylene construction
- Durable rubber 4" dia. swivel casters
- Reduces ware handling, breakage — increases staff efficiency and productivity
- Easily moves 150 to 180 glasses
- 2" deep waste well stops water from dripping onto the floor
- Sized to fit all brands of dishwasher racks
- Color: Brown

Model No.	W x L x H		Weight	
	(In.)	(mm.)	(Lbs)	(Kg.)
232	21 x 21 x 7	540 x 540 x 178	12	5
233	21 x 21 x 36	540 x 540 x 914	17	8



Model No. 232

Model No. 233



Kelmax U-Boat

- Heavy-duty dual steel channel base deck
- 6-wheel design offers maximum maneuverability
- 2 - 8" rigid center polyurethane wheels
- 4 — 4" swivel polyurethane end casters
- One U-Boat does the work of five (5) hand trucks
- 24" deck is available when a larger capacity is needed

Model No.	Capacity (Lbs)	W x D		Weight	
		(In.)	(mm.)	(Lbs)	(Kg.)
4G0251 16" Deck U-Boat	2,500	60 x 16	1524 x 407	87	39
4G0372 16" Deck U-Boat	2,500	48 x 16	1219 x 407	90	40
4G0263 18" Deck U-Boat	2,000	60 x 18	1524 x 457	105	47
4G0276 24" Deck U-Boat	2,000	60 x 24	1524 x 610	120	54
4G0722 Shelf 16 x 48	—	16 x 48	407 x 1219	26	12
4G0729 Shelf 16 x 60	—	16 x 60	407 x 1524	29	13



Kelmax Hand Trucks

- Beveled plate and heavy-duty steel construction
- Easy-to-control loop handle
- SPG's unique Kick-Off feature makes it easier to unload products

Model No.	Handle Type	Wheel Type	Capacity (Lbs)	Weight (Lbs) (Kg.)	
4K0163	Loop Handle	Semi Pneumatic	600	35	16

INSPIRED INGENUITY

We not only imagine products that create efficiencies, improve productivity, cut costs and reduce employee injuries — we build them, too.



Both the Universal® Stainless Adjustable Ergo Table and Deli Slicer are designed with a fold-away hydraulic crank — so the work surface can be raised or lowered quickly and easily. As a result, these innovative tables provide a customized fit for each employee — to improve staff comfort, increase productivity and optimize efficiency.



Universal® Stainless Adjustable Ergo Table

- Quickly, easily adjust table surface heights from 30" - 42" or from 34" - 40"
- Uses 100% food-safe hydraulic fluid in a closed-loop system
- All models feature bullet feet, and can be ordered with casters by adding the suffix C to the part number.

Tables with 12-Inch Adjustment Range (28" - 40")

PART NUMBER	L x W	WORKING SURFACE
48SLCA12-30	48" x 30"	301 Stainless Steel Tops/Pans
48MCTA12-30	48" x 30"	Poly Top & Tabs Added
60SLCA12-30	60" x 30"	301 Stainless Steel Tops/Pans
60MCTA12-30	60" x 30"	Poly Top & Tabs Added
72SLCA12-30	72" x 30"	301 Stainless Steel Tops/Pans
72MCTA12-30	72" x 30"	Poly Top & Tabs Added

Tables with 6-Inch Adjustment Range (34" - 40")

PART NUMBER	L x W	WORKING SURFACE
48SLCA6-30	48" x 30"	301 Stainless Steel Tops/Pans
48MCTA6-30	48" x 30"	Poly Top & Tabs Added
60SLCA6-30	60" x 30"	301 Stainless Steel Tops/Pans
60MCTA6-30	60" x 30"	Poly Top & Tabs Added
72SLCA6-30	72" x 30"	301 Stainless Steel Tops/Pans
72MCTA6-30	72" x 30"	Poly Top & Tabs Added

Universal® Stainless Adjustable Deli-Slicer

- Work surface adjusts from 34" to 40"
- 36" x 30" table with marine edge 16-ga. 300 Series stainless steel
- Under shelf 18-ga. 300 Series stainless steel
- 2" square stainless steel leg tubes
- Four 4-inch locking casters
- Work surface adjusts from 34" to 40"

Model Number	L x W (In.)	Working Surface
SS-3630-A6-C	36 x 30	300 Series Stainless Steel



SPG's foodservice products are all manufactured to meet NSF standards. For specific items, visit www.nsf.org



Universal® Stainless VC Counter System

SPG can customize an integrated counter system that's perfectly tailored to your space and your work processes. Seamlessly integrated top-of-the line materials combined with ergonomic design create a system that maximizes utility, optimizes workflow, improves storage and promotes a clean, organized workspace.

The modular counter system will deliver the lowest cost of ownership and drive staff productivity in every area of your operation — including:

- Drive-Thru
- Dining
- Food Prep
- Bakery
- Front Counter Operations



Among the many features we can incorporate into your system are:

- Tables, open bases, cabinets, side panels
- Wire or solid shelving
- One-piece tops — flat, marine edges or even configured for natural stone
- Integrated drip-trough and spray grommet
- Easy access to electrical, plumbing, data services
- Sectioned base that allows custom configurations of equipment and shelving
- Integrated trash section
- Sink bowls
- Backsplash receptacles
- Cut-outs for drop-ins

— or just about any other option you require.

For the ultimate in efficiency, flexibility and productivity, contact your SPG representative for more details.

TABLES

Universal® Stainless Work Table

- Choose from two series of tables:
Standard N Series: 16-gauge 300 Series stainless steel top
Spec SL Line: 14-gauge 300 Series stainless steel top
- Configurations include:
stainless steel legs and crossrails
Flat top or 6" backsplash
With or without undershelf
- Square edge design for clean abutment to other equipment
- Underbracing locations provide solid top and minimal deflection
- Legs: 1-5/8" O.D. 16-gauge stainless steel with adjustable bullet feet and stainless steel gussets
- Crossrails: 1-5/8" O.D. 16-gauge stainless steel notched to fit legs and fully welded
- Undershelves: 18-gauge stainless steel with corners notched to fit legs and fully welded
- Standard working height is 36"
- All tables 84" and longer come standard with 6 legs
- Ships welded and set up - no assembly required

Model No.	W x L	Gauge of Top	Weight(Lbs.)
Flat Top With Stainless Steel Legs & Crossrails			
4SLC-30	30 x 48	16 GA	100
4-SL-SLC-30	30 x 48	14 GA	120
Available in: 24", 30" & 36" depths, 24" – 108" lengths			
Flat Top With Stainless Steel Legs & Undershelf			
4SLS-30	30 x 48	16 GA	120
4-SL-SLS-30	30 x 48	14 GA	120
Available in: 24", 30" & 36" depths, 24" – 108" lengths			
6" Backsplash With Stainless Steel Legs & Crossrails			
4SLCB-30	30 x 48	16 GA	115
4-SL-SLCB-30	30 x 48	14 GA	135
Available in: 24", 30" & 36" depths, 24" – 108" lengths			
6" Backsplash With Stainless Steel Legs & Undershelf			
4SLSB-30	30 x 48	16 GA	130
4-SL-SLSB-30	30 x 48	14 GA	150
Available in: 24", 30" & 36" depths, 24" – 108" lengths			

Table Options

Description	Qty.
End Splash	Each
Cap & Finish for End Splash*	Each
Cap & Finish for End Splash*	Each
Splash Cut-Out	Each
Step Down in Top	Each
Urn Trough	Linear Ft.
Table Cut-Out less than 6"	Each
Table-Cut Out up to 20"	Each
Table-Cut Out over 20" x 20"	Each
Receptacle Box MTD in Splash	Each
Marine Edge	Linear Ft.
Rolled Edge	Linear Ft.
Inverted "V"	Linear Ft.

*Does not include End Splash



SPG's foodservice products are all manufactured to meet NSF standards. For specific items, visit www.nsf.org



Universal® Stainless Cabinet Base Tables

Model No.	W x L	Weight(Lbs.)
Open Front With Flat Top		
4CBT-30	30 x 48	125
Available in 24" & 30" depths, 48" – 120" lengths		
Open Front With 6" Backsplash		
4CBT-30B	30 x 48	131
Available in 24" & 30" depths, 48" – 120" lengths		
Flat Top With Sliding Doors		
4CBT-30D	30 x 48	150
Available in 24" & 30" depths, 48" – 120" lengths		
6" Backsplash With Sliding Doors		
4CBT-30BD	30 x 48	156
Available in 24" & 30" depths, 48" – 120" lengths		
Flat Top With Hinged Doors		
4CBT-30HD	30 x 48	150
Available in 24" & 30" depths, 48" – 120" lengths		
6 Backsplash With Hinged Doors		
4CBT-30BHD	30 x 48	156
Available in 24" & 30" depths, 48" – 120" lengths		

- Choose from open-front, sliding or hinged doors; flat top and 6" backsplash
- Includes one mid shelf
- Uni-body design includes die-formed rear and end panels welded to undershelves to achieve rigid one-piece unit
- Top 16-ga. 300 Series stainless steel — body and shelves are 18-ga. 300 Series stainless steel
- Legs: 6" high stainless steel with adjustable bullet feet
- Doors (if applicable) double pan, die formed and suspended with overhead track and ball bearing rollers with recessed pulls



Universal® Stainless Poly Top Tables



- Table frame fabricated from 1-1/2" square 16-ga. 300 Series stainless steel tubing
- Base fully-welded 1-5/8" stainless steel tubing legs and crossrails with stainless steel adjustable bullet feet
- 5/8" thick poly tops are sectional and removable per NSF standard No. 2 — and made of NSF and USDA approved high density polyethylene
- 6" backsplash and deck formed from one-piece stainless steel and welded
- Crossrails are 1-5/8" O.D. stainless steel tubing notched to fit legs and fully welded
- Underself is 18-ga. stainless steel with corners notched to fit legs and fully welded
- Ships fully welded and set up

Model No.	W x L	Weight(Lbs.)
Flat Top With Stainless Steel Legs & Crossrails		
4MCT-30	30 x 48	95
Available in: 30" depth, 48" – 120" lengths		
Flat Top With Stainless Steel Legs & Underself		
4MCT-30U	30 x 48	125
Available in: 30" depth, 48" – 120" lengths		
6" Backsplash With Stainless Steel Legs & Crossrails		
4MCT-B30	30 x 48	95
Available in: 30" depth, 48" – 120" lengths		
6" Backsplash With Stainless Steel Legs & Underself		
4MCT-B30U	30 x 48	125
Available in: 30" depth, 48" – 120" lengths		

UNIVERSAL UTILITY

Universal® Stainless sinks are available in a huge variety of sizes and configurations — from mobile sinks to hand sinks to compartment sinks with one to four bowls. Manufactured to fit any space ... accessories to satisfy every operational need.



Universal® Stainless Mobile Hand Sink

This is a complete, totally self-contained unit, requiring only a 110V/20-amp power source to operate.

- Promotes food safety, staff hygiene, adherence to HACCP principles
- A spacious 26" x 24" x 36" cabinet base with a 16-ga. stainless steel top and 18-ga. body
- 8" back and side splashes
- Four locking casters to provide mobility
- Powerful 115V UL listed water pump
- Mini™ 2 at 110V/15 amp tankless in-line water heater
- A faucet that blends hot and cold water
- 110° F water supplied at .32 GPM
- Paper towel holder and soap dispenser
- 5-gallon clean tank plus a 6-gallon waste tank
- 10' cord with GFI plug to wall/power source
- Optional end splashes available, contact your rep



Model No.	W x L x H		Weight	
	(In.)	(mm.)	(Lbs.)	(Kg)
K-MHS-2624-SG	26 X 24 X 36	660 X 610 X 914	190	86

Universal® Stainless Hand Sinks

- Choose from Standard Series (18-ga. deep fully fabricated bowl) or Spec Series (16-ga. 300 Series stainless steel, fully fabricated)
- 12" x 10" x 6" (305 x 254 x 152) bowl size
- 7" high integrally formed backsplash
- Inverted "V" non-drip edge on three sides
- Includes faucets, basket drains, and wall brackets



Model No.	Bowl Size L x W x D		Weight		Cubic Feet
	(In.)	(mm.)	(Lbs.)	(Kg.)	
Drop In Hand Sinks With Faucets & Basket Drain					
DI-1-5DF	10 x 14 x 5	254 x 356 x 127	8	4	0.6
DI-1-10DF	10 x 14 x 10	254 x 356 x 254	10	5	1.0
Skirted Hand Sinks					
EHS-2	12 x 10 x 6	305 x 254 x 152	20	9	2.5
Hand Sink With Soap & Towel Dispensers					
EHS-3	12 x 10 x 6	305 x 254 x 152	27	12	2.5
Hand Sink With Soap & Towel Dispensers Below					
CHS-5	12 x 10 x 6	305 x 254 x 152	36	16	4
ADA Compliant Hand Sink With Handles & Soap Dispenser					
HS-ADA	16 x 17 x 6	406 x 432 x 152	20	9	2.5

Universal® Stainless 3-Compartment Sink With 2 Drainboards

- Available in 16-ga. (N Series) or 14-ga. (SL-Series) 300 Series stainless steel construction
- Fully fabricated bowl with full metal thickness throughout for greater strength than a drawn sink
- 9" high integrally formed backsplash, with 2" return to wall at 45°
- 2-1/2" high, 180° sanitary rolled rim at all free edges
- Leg assemblies are located directly under sink bowls for greater load support
- Legs are 1-5/8" diameter tubing with adjustable bullet feet
- N-Series 16 ga: SL-Series 14 ga: features stainless steel legs and crossrails
- Where applicable, crossrails are 1-5/8" diameter — coped and fully welded for maximum durability
- All corners are covered at 5/8" radius, welded and polished to form a one-piece sanitary unit
- Comes with basket drains and 1-1/8" faucet holes punched in backsplash on 8" centers as required
- NSF listed and CSA certified



SPG's foodservice products are all manufactured to meet NSF standards. For specific items, visit www.nsf.org



Model No.	Approx. Weight			Drainboard		L x W	
	(Lbs.)	(Kg.)	(Cu. Ft.)	(In.)	(mm.)	(In.)	(mm.)
3SL1824-2D18	196	89	53	18	457	94 x 29.5	2388 x 749
3N1824-2D18	172	78	49	18	457	94 x 29.5	2388 x 749

SPG has a full range of 1, 2 and 3-compartment sinks — with bowl sizes from 16" x 18" to 30" x 30" and a variety of drainboard options. 4-compartment sinks and custom bowl sizes are available, call for details.

Universal® Stainless Standard And Anti-Splash Floor Troughs

- 14-ga. 300 Series stainless steel subway grating
- Stainless steel waste cup up to 3" waste pipe
- Includes 3 O.D. - 4" long plumbing sleeve

Universal® Stainless offers: A choice of stainless steel subway grating or Fiberglass grating — with or without anti-splash feature.

Three widths (12", 18", & 24") and lengths from two feet to five feet in six-inch increments.

Call for details.

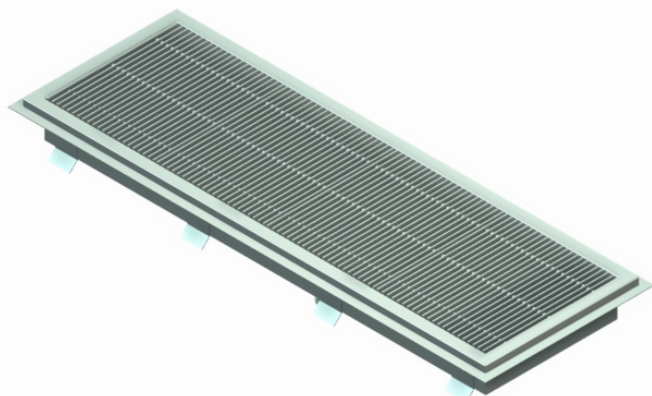



Maximizing efficiency, improving performance, getting more out of your people and your investment — it's what you must do every day to make your business more successful and more profitable. And it's what SPG helps you achieve through our extensive line of innovative food service equipment.

At SPG, our equipment is ergonomically designed to minimize the time, movement and effort of your staff— while maximizing the efficiency of every inch of your available space. We use the best materials for the job and manufacture to strict tolerances to ensure our equipment provides lasting performance and enduring value.

As a global company, we manufacture ISS, Kelmax, Freestyle and other quality storage product lines throughout North America and the Pacific. As a result, our products are delivered to businesses throughout the world every day...and every day we continue to deliver on our promise to ensure their continuing success and profitability.

Check out our new and improved website!



CONTACT SPG

For SPG's complete product menu, visit spgusa.com or contact us:

 877.503.4SPG (4774)

 info@spgusa.com

 SPG International, LLC
World Headquarters
3340 Peachtree Rd Suite 1250
Atlanta, Georgia 30326