

Remote Camera System Guide

Table of Contents

Read This First	3
<hr/>	
Chapter 1 Application	
Small Studios	5
Reality Shows	6
Houses of Worship	7
Lecture Capture	8
Event Production	9
Parliament/Congress	10
Live Sports Events	11
Video Conferences	12
Radio Booth	13
E-sports	14
<hr/>	
Chapter 2 Connection & Basic Settings	
A Auto IP address setting from RM-IP500	16
B IP address setting from RM-IP Setup Tool	18
C Serial connection setting (RS-422/RS-232C)	20
D 4K video switcher	22
E Fiber extension from BRC-H900	23
F Tally control from MCX-500	24
G Connection with AWS-750	26
H Connection with RCP-3100/1500 series	28
I Connection with MSU-1000 series	31
J NDI® HXconnection	34
<hr/>	
Chapter 3 Products	
Remote cameras	36
System camera	39
Remote controllers	40
Switchers	41
Optional items for BRC-H900	42
Edge Analytics Appliance	43
<hr/>	
Chapter 4 Edge Analytics Appliance Application	
Edge Analytics Appliance Application Configuration	45
Usage example of Handwriting Extraction in the classroom	46
Usage example of PTZ Auto Tracking in the lecture hall	47
Usage example of Close-up by Gesture in the classroom	48
Usage example of Chroma key-less CG Overlay in a small-scale studio	49
Usage example of Focus Area Cropping at an event space	50
<hr/>	
Chapter 5 Appendix	
Controller compatibility chart	52
Pin assignments	56

Read This First

About this guide

This guide contains typical examples of applications and system configurations using remote cameras, remote controllers and peripherals, as well as instructions on making connections and initial settings (as of September 2019).

For more details, see each operation manual.

Jump to related page

When viewing this guide on a computer, you can click the item showing a related page to jump to an explanation of that page. This feature makes it easy to search for related pages.

Software information

Update the software of each device to the latest version.

Devices shown in this guide

Note that the specifications of devices included in this guide may be updated without prior notice.

Services and software provided by other companies

- Separate terms and conditions of use may be applied.
- Provision of services and software updates may be interrupted or terminated without notice.
- Services and software content are subject to change without notice.
- Separate registration and/or payment may be required.

Please note that Sony Corporation is not responsible for any claim, from customers or third parties, arising from any use of services and software provided by other companies.

NewTek™ and NDI® are registered trademarks of NewTek, Inc.

Copyright information

Reproducing this guide in whole or in part without the prior consent of the copyright holder is prohibited under copyright law.

©2017 Sony Corporation

How to interpret system configuration examples in “Chapter 1 Application”

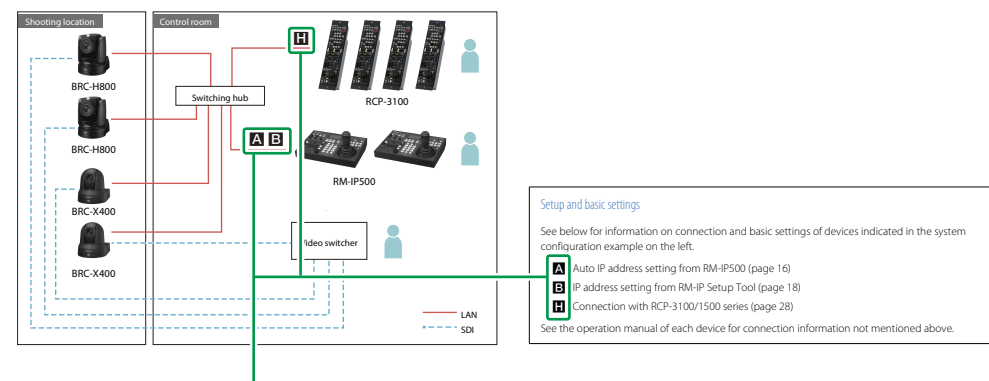

This is a reference that shows connection and setup instructions for the applicable device.

Chapter 1 Application

Small Studios

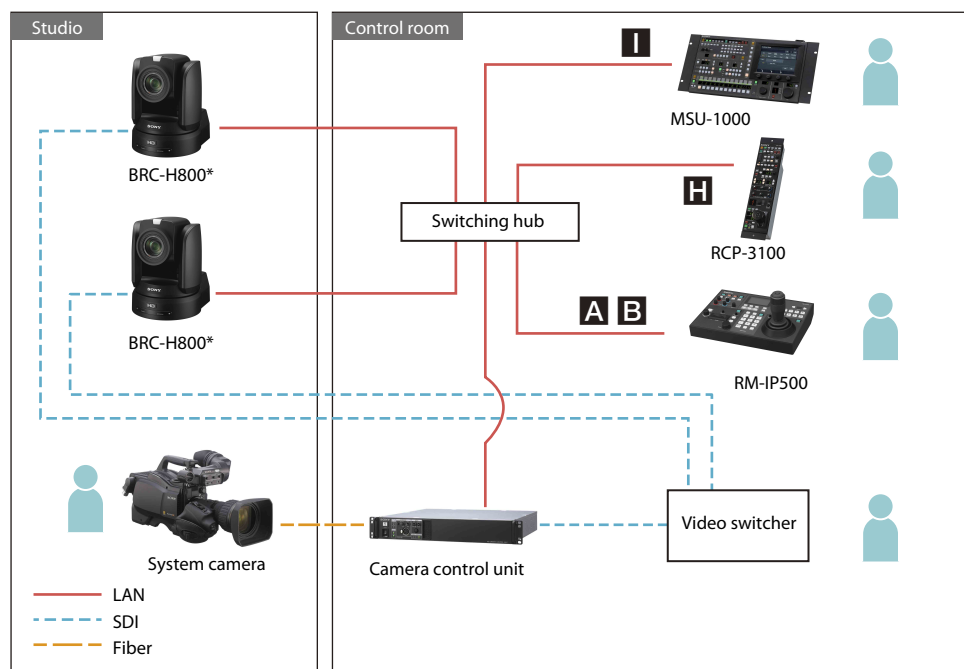

Usage

Installing remote cameras in a studio enables program production with minimal staff.

User benefits

- Multiple remote cameras attached to tripods can be controlled with a single remote controller for efficient studio recording.
 - Using preset functions you can zoom in, take head shots, and change the camera position based on the progress of the program.
 - Presets can easily be returned to their original settings using simple operations. This feature also enables quick adaptation to differing scenes and continuing with program production of a different type.
 - Smooth operations via a swivel base enable smooth camera work from low speed to quick turning.
- * BRC series and SRG-360SHE are equipped with a tally lamp required for studio cameras. However, SRG-360SHE does not support external sync signals.

Setup and basic settings

See below for information on connection and basic settings of devices shown in the system configuration example on the left.

- A** : Auto IP address setting from RM-IP500 (page 16)
- B** : IP address setting from RM-IP Setup Tool (page 18)
- H** : Connection with RCP-3100/1500 series (page 28)
- I** : Connection with MSU-1000 series (page 31)

See the operation manual of each device for connection information not mentioned above.

Reality Shows

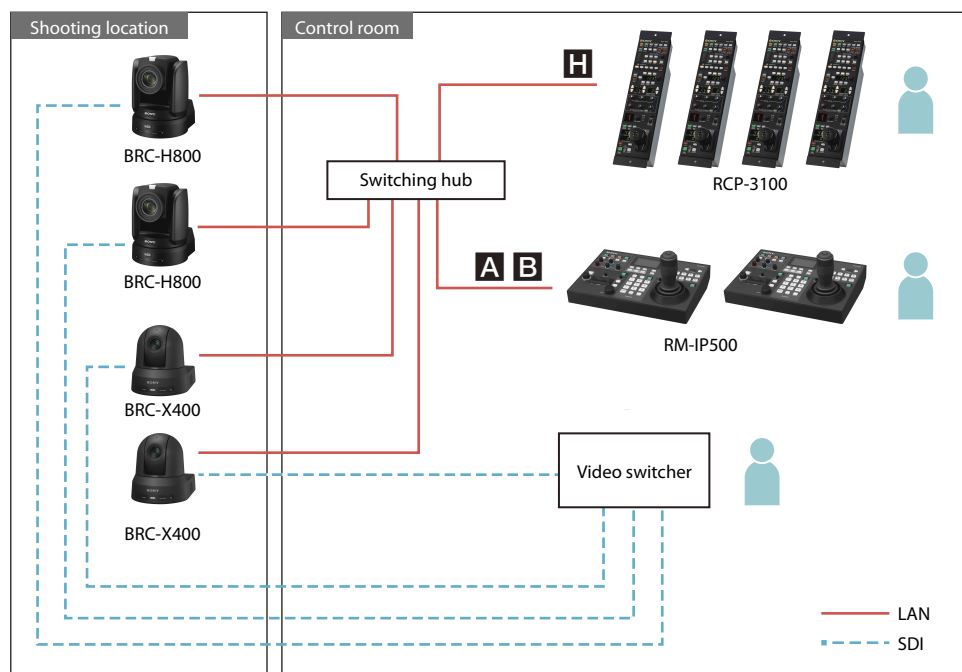

Usage

Install remote cameras in various shooting locations to capture every action and expression of the cast.

User benefits

- A smart, integrated remote camera design makes it possible to record natural actions and expressions without making the cast aware of the cameras.
- High-quality images capture detailed, realistic representations of cast expressions.
- An easy-to-operate remote controller and auto functions make shooting easy.
- Smooth operations via a swivel base enable smooth camera work to match cast actions from low speed to quick turning.
- The preset position function can be used to switch to a preset camera position with the push of a single button.
- Multiple camera control with a single remote controller enables operations with minimal crew.
- An IP remote controller makes it possible to control the camera from a remote location.

Setup and basic settings

See below for information on connection and basic settings of devices shown in the system configuration example on the left.

- A** : Auto IP address setting from RM-IP500 (page 16)
- B** : IP address setting from RM-IP Setup Tool (page 18)
- H** : Connection with RCP-3100/1500 series (page 28)

See the operation manual of each device for connection information not mentioned above.

Houses of Worship

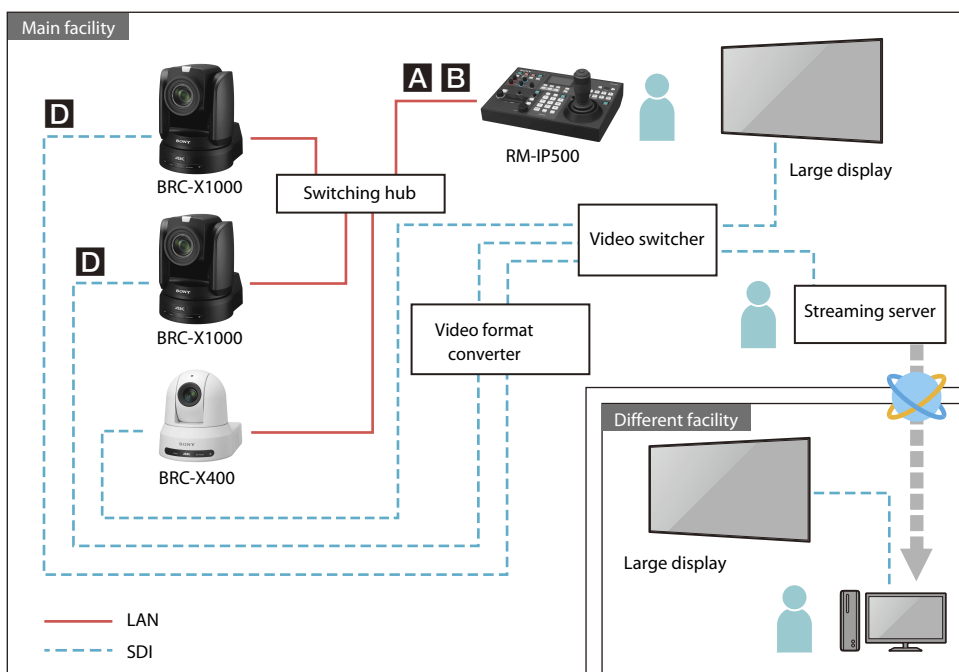

Usage

Capture events at houses of worship without disturbing the solemn atmosphere of the location.

User benefits

- Broadcast or stream the speech at houses of worship in high-definition 4K video.
- Cameras can be installed in locations that are difficult for camera operators to enter. A camera with an integrated swivel base can be installed unobtrusively in buildings such as houses of worship.
- High-quality video can be captured even in dark environments.
- A full lineup of products are available to perfectly match the scale of the house of worship, from locations with a full studio setup to smaller houses of worship.
- The tally lamp strength can be adjusted or it can be turned off as appropriate for the situation.

Setup and basic settings

See below for information on connection and basic settings of devices shown in the system configuration example on the left.

- A** : Auto IP address setting from RM-IP500 (page 16)
- B** : IP address setting from RM-IP Setup Tool (page 18)
- D** : 4K Video switcher (page 22)

See the operation manual of each device for connection information not mentioned above.

Lecture Capture

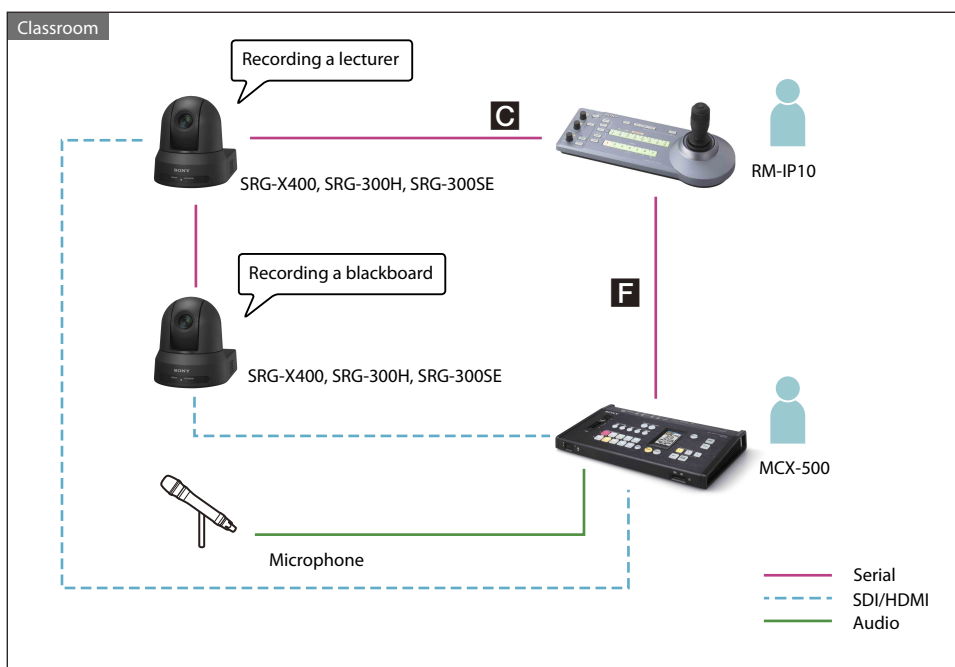

Usage

Capture and utilize video of every aspect of university classes and academic conferences.

User benefits

- High-quality images capture detailed, realistic representations of lecturer and student expressions.
- An easy-to-operate remote controller and auto functions make shooting easy with simple operations.
- Multiple cameras enable lecture recording from multiple angles.
- Multiple camera control with a single remote controller enables operations with minimal crew.
- The preset position function can be used to switch to a preset camera position, such as the lecturer or blackboard with the push of a single button.

Setup and basic settings

See below for information on connection and basic settings of devices shown in the system configuration example on the left.

C : Serial connection settings (RS-422/RS-232C) (page 20)

F : Tally control from MCX-500 (page 24)

See the operation manual of each device for connection information not mentioned above.

Event Production

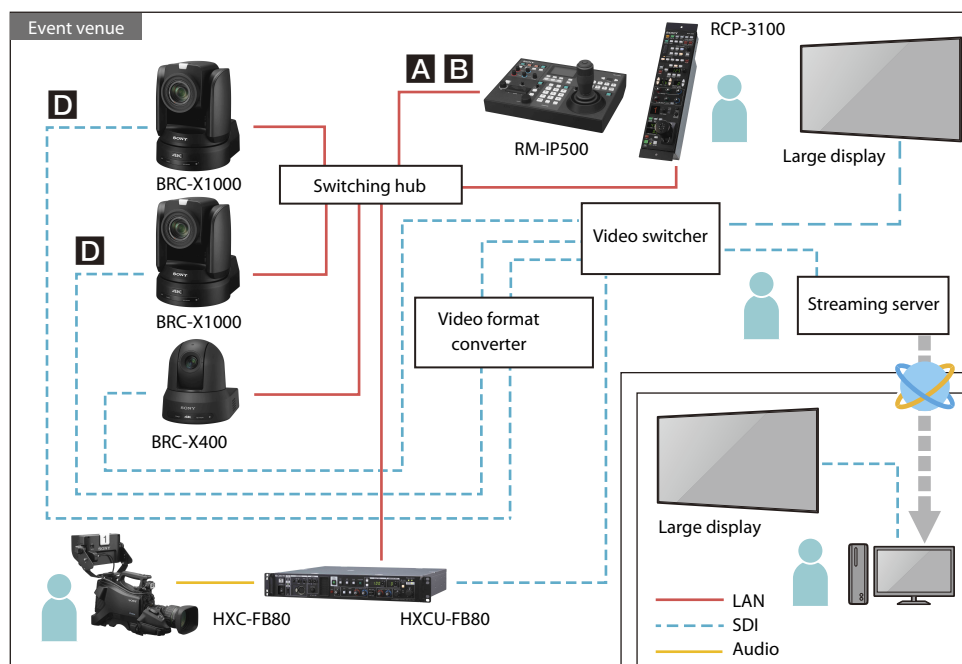

Usage

Shoot from positions where a camera operator cannot enter to fully capture the motion of performers and the audience reaction.

User benefits

- High-quality images capture realistic video of performer and audience expressions.
- An easy-to-operate remote controller and auto functions make shooting easy with simple operations.
- Using preset positions you can shoot subjects from a variety of angles with the push of a single button.
- A multi-camera system for higher image quality can be built by integration with a system camera (HXC-FB80).
- Supports HD HDR shooting to capture footage which is close to what the human eye captures in locations where there is a big difference in lighting between bright and dark areas, such as in an event venue.

Setup and basic settings

See below for information on connection and basic settings of devices shown in the system configuration example on the left.

- A**: Auto IP address setting from RM-IP500 (page 16)
- B**: IP address setting from RM-IP Setup Tool (page 18)
- D**: 4K Video switcher (page 22)

See the operation manual of each device for connection information not mentioned above.

Parliament/Congress

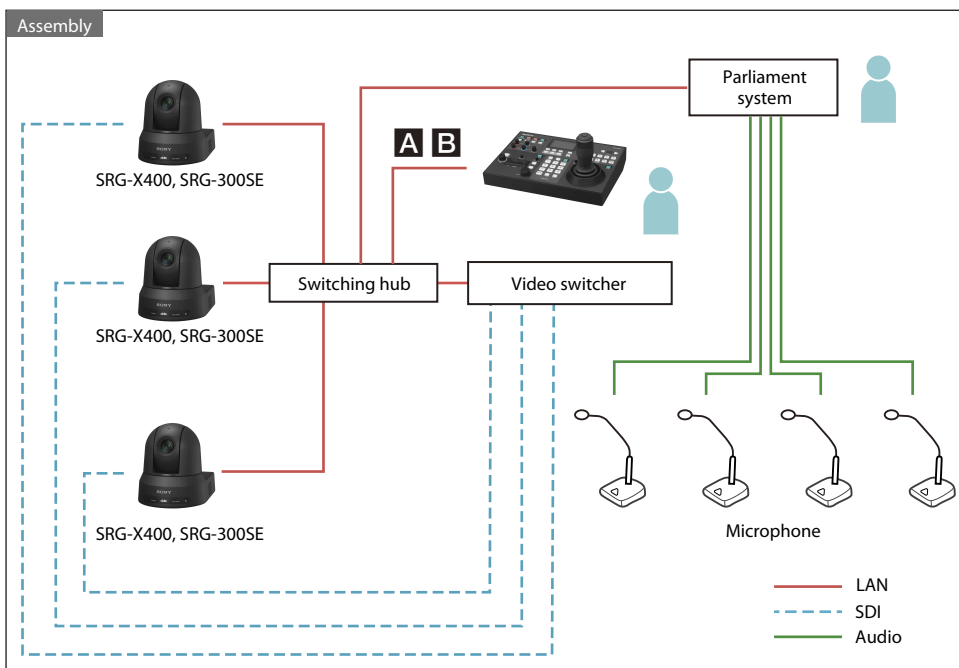
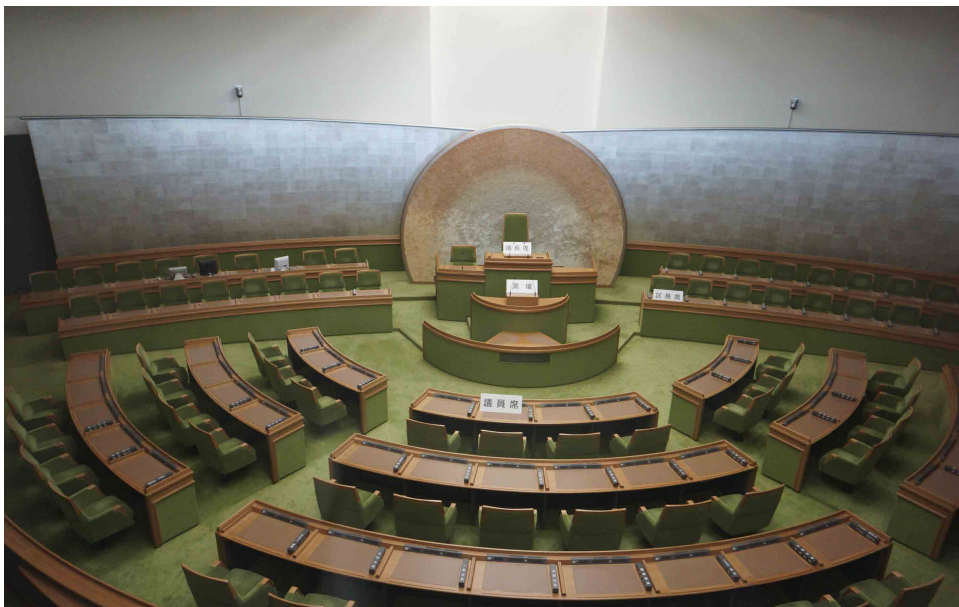

Usage

Connecting remote cameras to the existing parliament/congress system enables broadcasting while switching between video and audio using simple operations even with minimal staff.

User benefits

- A smart design ensures that the cameras will not interfere with the interior design of the parliament building, nor will they interfere with the speakers, enabling realistic recording of parliament member expressions and the atmosphere of the parliament.
- Preset functions can be used to set shooting locations such as the chairperson's seat, the podium, and parliament members' seats which can be smoothly cycled through according to the progress of the parliament session.
- Combined with the existing system at the parliament, the camera can automatically capture each speaker when the microphone speech button is linked with the preset function.

Setup and basic settings

See below for information on connection and basic settings of devices shown in the system configuration example on the left.

A : Auto IP address setting from RM-IP500 (page 16)

B : IP address setting from RM-IP Setup Tool (page 18)

See the operation manual of each device for connection information not mentioned above.

Live Sports Events

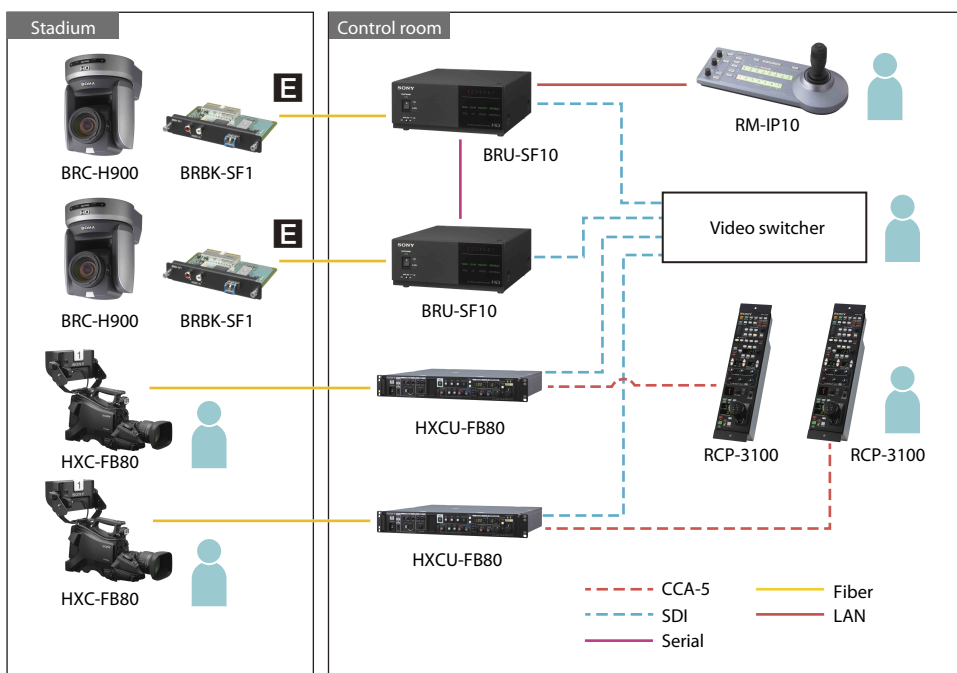
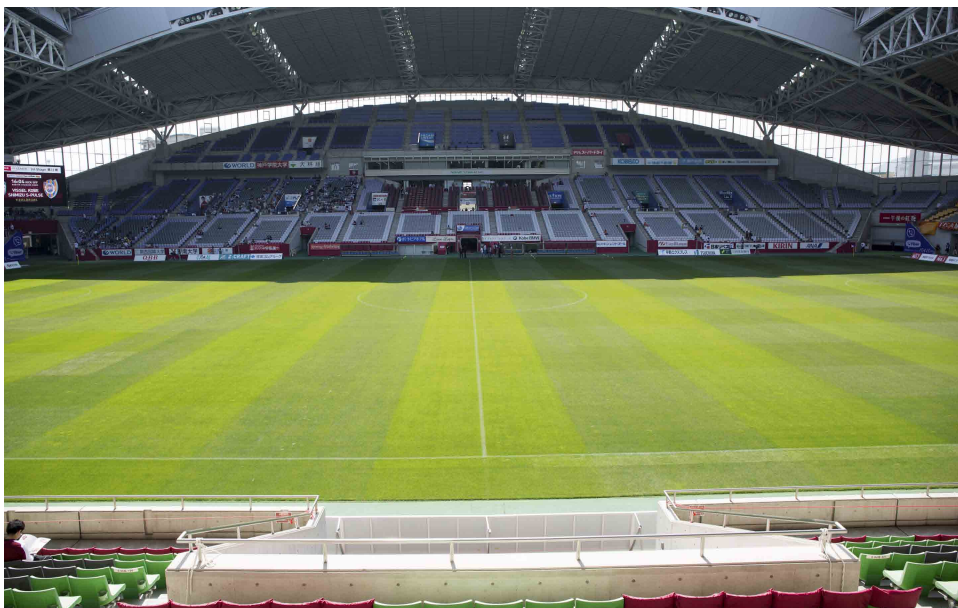

Usage

Shoot a sporting event for a sports program and record on a recorder at a remote site. PTZ cameras can be used as sub cameras to capture video from various locations, such as a position high in the stadium or near the player's bench on the field.

User benefits

- Ceiling-mounted cameras can be used to shoot from high locations where camera operators cannot usually shoot. Combined with footage recorded by camera operators, this setup enables multi-location recording for realistic video.
- Cameras can be installed so that the view of spectators in the rear is not blocked when shooting the seating area or the stage from the front row of seats.
- Combined with the optional fiber cable (BRC-H900 only) or a commercially available optical fiber converter, video can be transmitted over long distances from the stadium to a control room.
- Remote camera control lets you capture player movements and spectator reactions without missing a thing.
- Progressive signal format output from an HXC-FB80, operated by a camera operator, supports smoother video images during live broadcasts.
- Supports HD HDR shooting to capture footage which is close to what the human eye captures in locations where there is a big difference in lighting between bright and dark areas, such as in a sports stadium.

Setup and basic settings

See below for information on connection and basic settings of devices shown in the system configuration example on the left.

E : Fiber extension from BRC-H900 (page 23)

See the operation manual of each device for connection information not mentioned above.

Video Conferences



Usage

Use a network connection to link to a remote location for video conferences. A smart, integrated design that matches the TV and interior design makes it possible to unobtrusively capture conference attendees.

User benefits

- High-quality images capture detailed, realistic representations of attendee expressions.
- Multiple cameras make it possible to relay the conference from a variety of angles.
- The preset position function can be used to switch to a preset camera position, such as attendees or the whiteboard, with the push of a single button.

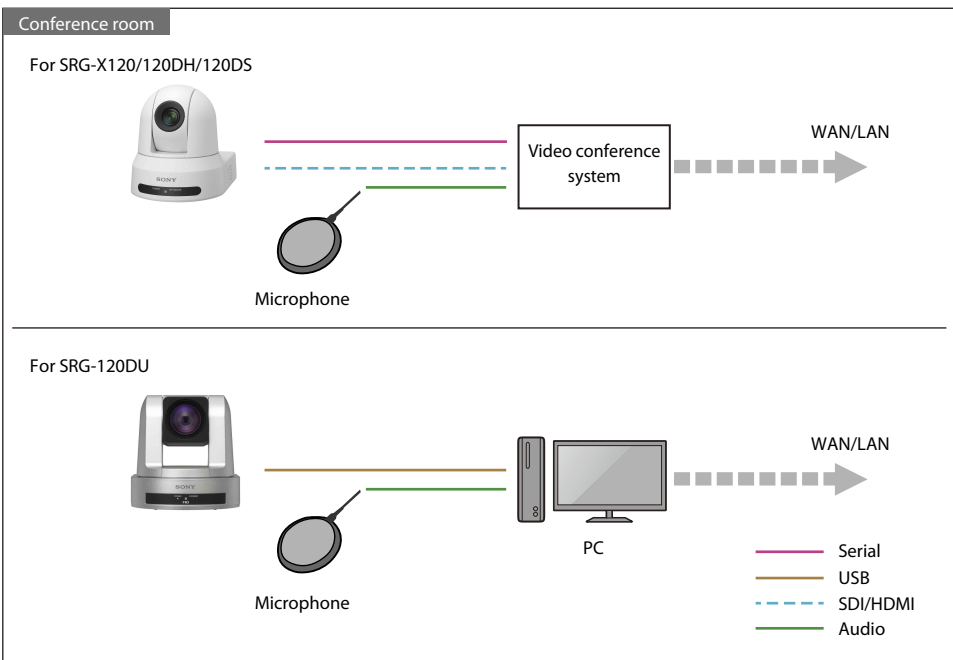

Radio Booth



Usage

Footage of happenings in a radio booth can be captured and streamed live.

User benefits

- Shooting in spaces where a camera operator usually cannot enter is now possible.
- Panning, tilting, and zooming can easily be controlled remotely.
- For single-camera setups, you can stream directly from the camera. MCX-500 can be used to easily switch between multiple cameras for streaming.

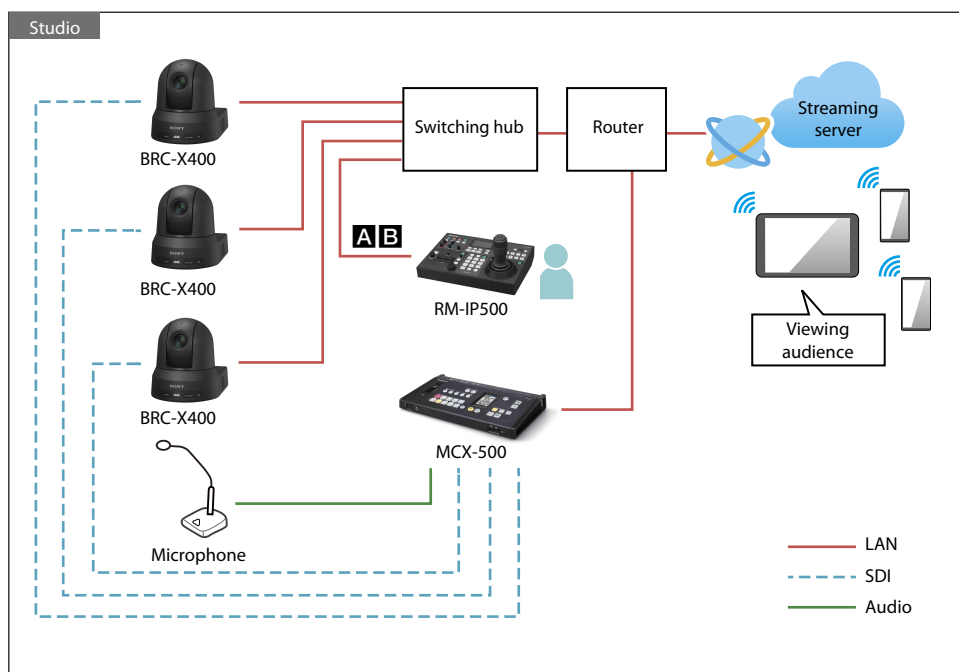

Setup and basic settings

See below for information on connection and basic settings of devices shown in the system configuration example on the left.

A : Auto IP address setting from RM-IP500 (page 16)

B : IP address setting from RM-IP Setup Tool (page 18)

See the operation manual of each device for connection information not mentioned above.

E-sports



Usage

Shoot at angles not possible for a camera operator to capture each expression on players' and spectators' faces.

User benefits

- Capture sharp images even in dark environments. Capture enhanced images of detailed expressions on players' and spectators' faces in high-definition.
- An easy-to-operate remote controller and enhanced auto functions make shooting easy with simple operations.
- Using preset positions you can shoot subjects from a variety of angles with the push of a single button.

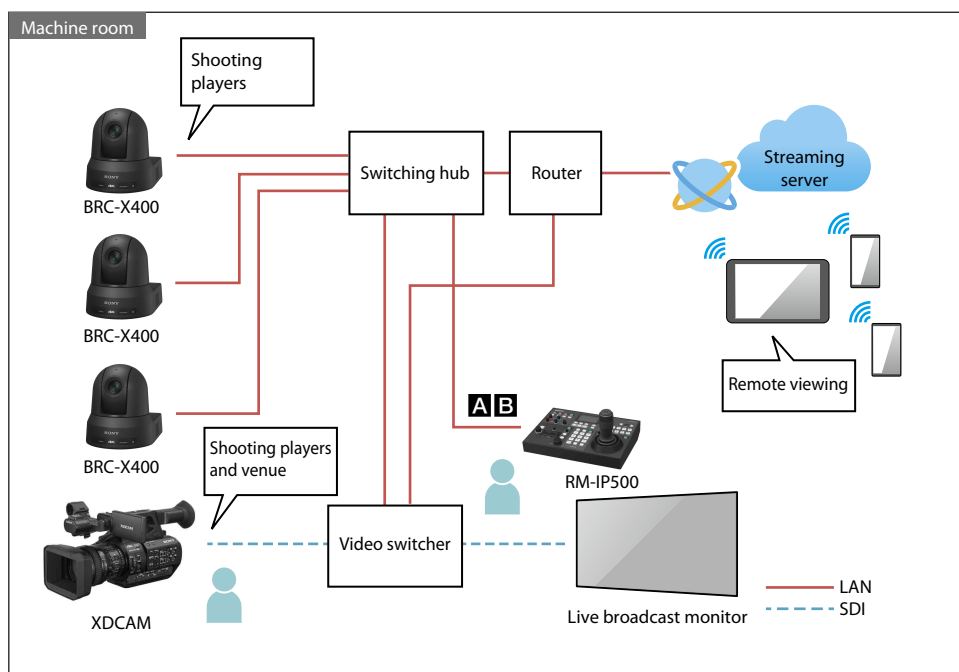

Setup and basic settings

See below for information on connection and basic settings of devices shown in the system configuration example on the left.

A : Auto IP address setting from RM-IP500 (page 16)

B : IP address setting from RM-IP Setup Tool (page 18)

See the operation manual of each device for connection information not mentioned above.

Chapter 2 Connection & Basic Settings

A Auto IP address setting from RM-IP500

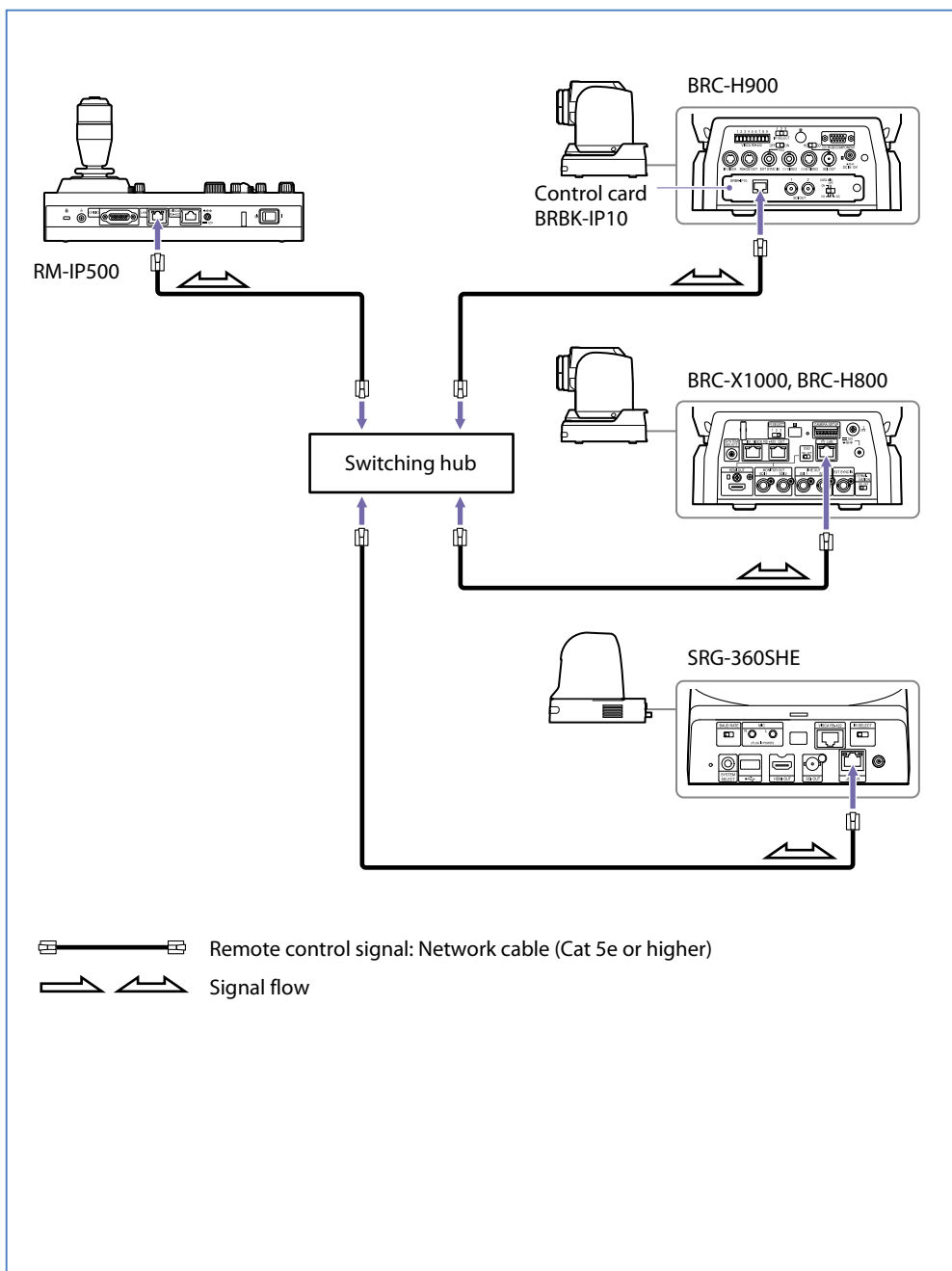

Devices

Remote camera	BRC-X1000/H800, BRC-H900, SRG-360SHE, BRC-X400, SRG-X400, SRG-X120, SRG-300SE, SRG-300H, SRG-120DH, SRG-120DS, SRG-120DU
Control card	BRBK-IP10*
Remote controller	RM-IP500
Other	Commercially available switching hubs

* When using BRC-H900

What you can do

Automatically assign the IP address and camera number of remote cameras in the same segment from the RM-IP500 remote controller.

Setup instructions

1. Connect the devices using the diagram on the left as a reference, then turn them on.
2. Press the RM-IP500 RM MENU button, then from TOP MENU select CONFIG > LAN.
The following screen appears.

```

<LAN>
IP: → 192 . 168 . 0 . 10
SM: 255 . 255 . 255 . 0
GW: 0 . 0 . 0 . 0
APPLY      : NOT EXEC

MAC : x x - x x - x x - x x - x x - x x
  
```

3. Set the RM-IP500 IP address, subnet mask, and default gateway.
4. After setting the IP address, subnet mask, and default gateway, change [APPLY] [NOT EXEC] to [EXEC], then press the VALUE button.
The RM-IP500 connection mode is set to IP connection.

5. After confirming that the camera is turned on, press the RM MENU button.

6. From TOP MENU select AUTO IP SETUP >SETUP IP.

The following screen appears.

```
<SETUP IP>
[FROM]
IP: →192. 168.   0. 100
[TO]
IP: 192. 168.   0. 199
SETUP IP   : NOT EXEC
```

7. After specifying the range of IP addresses assigned to the camera, change [SETUP IP] [NOT EXEC] to [EXEC], then press the VALUE button.

8. Change [CONFIRM: NO] displayed on the screen to [YES], then press the VALUE button.

After completing IP address settings, "COMPLETE DONE" is displayed on the screen.

The RM-IP500 camera selection block CAMERA button assigned by the camera is lit blue.

9. Press the CANCEL button to return to the TOP MENU and confirm that the selected camera can be controlled.

The set IP address can be checked in AUTO IP SETUP >CAMERA TABLE.

Precautions

- BRBK-IP10 control card (sold separately) is required to control BRC-H900 via IP.
- At factory default settings, the IP address of RM-IP500 is 192.168.0.10, and the IP address of the IP control card is 192.168.0.100. If you do not know the IP address of the camera or IP control card, press the network reset switch on the back of each device to reset network settings.
- See the RM-IP500 operation manual for other advanced settings.

B IP address setting from RM-IP Setup Tool

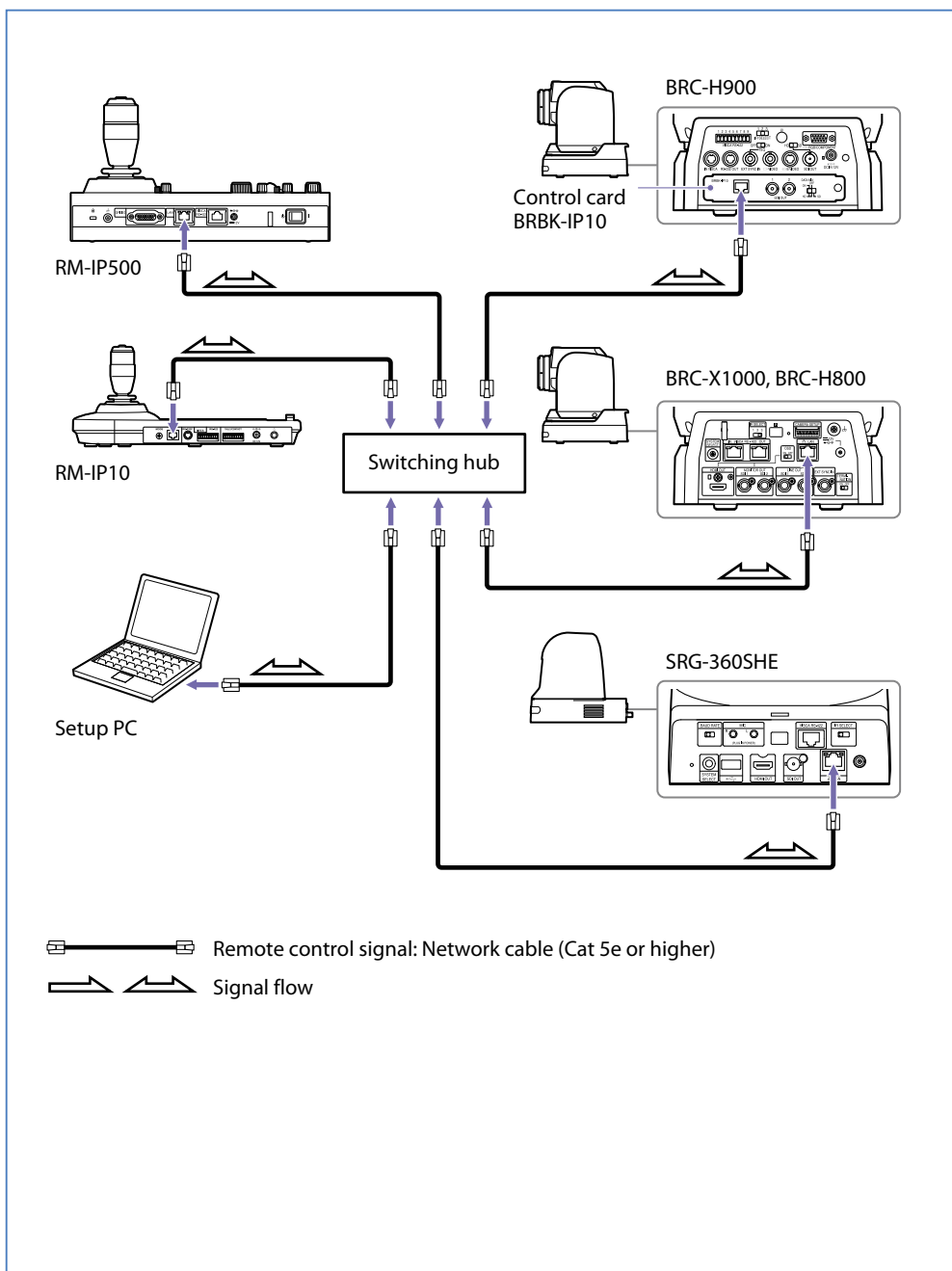

Devices

Remote camera	BRC-X1000/H800, BRC-H900, BRC-X400, SRG-X400, SRG-X120, SRG-360SHE, SRG-300SE, SRG-300H, SRG-120DU, SRG-120DH, SRG-120DS
Control card	BRBK-IP10*
Remote controller	RM-IP500, RM-IP10
Edge Analytics Appliance	REA-C1000
Other	Commercially available switching hubs, setup PC

* When using BRC-H900

What you can do

You can assign each camera to the RM-IP500 and RM-IP10 remote controller using the RM-IP Setup Tool installed on the PC.

Setup instructions

1. Connect the devices using the diagram on the left as a reference, then turn them on.
2. Set the PC IP address, subnet mask, and default gateway.
See the PC manual for details on how to set these items.
Set the IP address to the same segment as the remote camera and remote controller.
3. Enable camera registration on RM-IP500 and RM-IP10.

For RM-IP500

- ① From the RM menu select MAINTENANCE > UPDATE MODE, and the following screen appears.

```
<UPDATE MODE>
→UPDATE MODE : ON

PASSWORD : XXXXXXXX
```

② Change [UPDATE MODE] to [ON] and press the VALUE button.

* Note that a one-time password is not used when making settings from the RM-IP Setup Tool only.

For RM-IP10

① Set DIP switch 1-1 on the bottom of the device (RS-422/LAN) to OFF (LAN), and change DIP switch 2-8 (SETTING) to ENABLE, and restart RM-IP10.

After restarting the device, the control button is lit green.

4. Launch the RM-IP Setup Tool installed on the PC.

5. Set the IP address of each camera in the [Camera] tab.

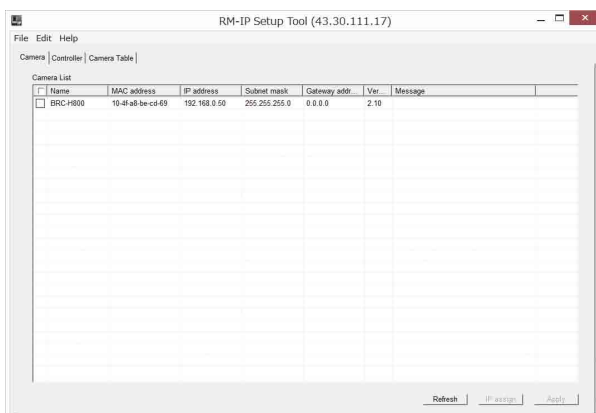

6. Set each remote controller IP address in the [Controller] tab.

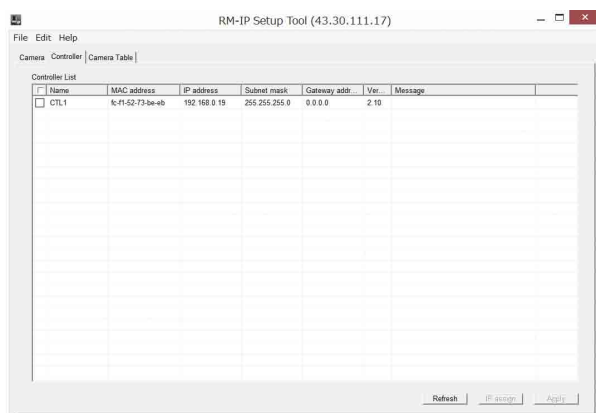

7. Select the [Camera Table] tab, then select the remote controller you want to set from the [Controller] pull-down menu.

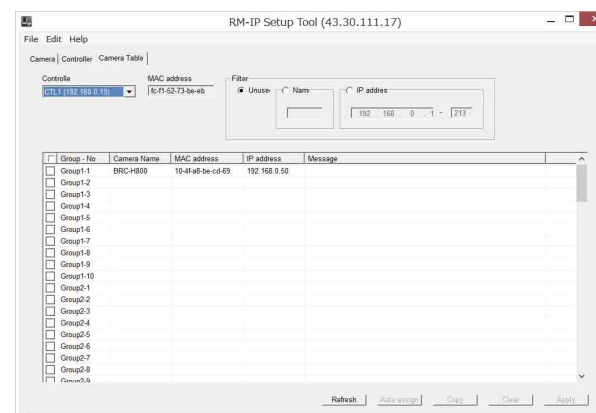

8. Click the [Camera Name] of the camera group and camera number you want to assign, then select the camera name to assign to that number from the pull-down menu.

* When making initial settings, you can assign the camera group and camera number automatically by clicking [Auto Assign].

Precautions

- BRBK-IP10 control card (sold separately) is required to control BRC-H900 via IP.
- In this operation, only remote controllers and cameras in the same segment as a computer where the RM-IP Setup Tool has been installed can be detected. For details on how to assign cameras to a different segment, see the RM-IP Setup Tool Guide.
- RM-IP Setup Tool may not operate correctly (no cameras are shown in the list even if they are connected and configured correctly), depending on the configuration of Windows Firewall. For further details check the RM-IP Setup Tool Guide.

C Serial connection setting (RS-422/RS-232C)

Connect one remote camera to one remote controller

For RM-IP500

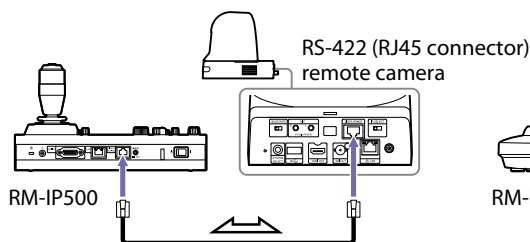

For RM-IP10

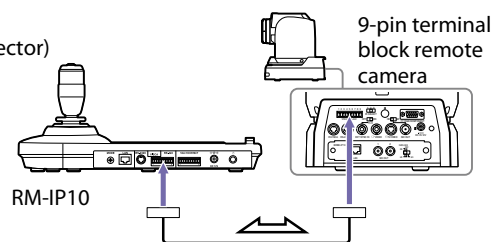

Connect multiple remote cameras to one remote controller

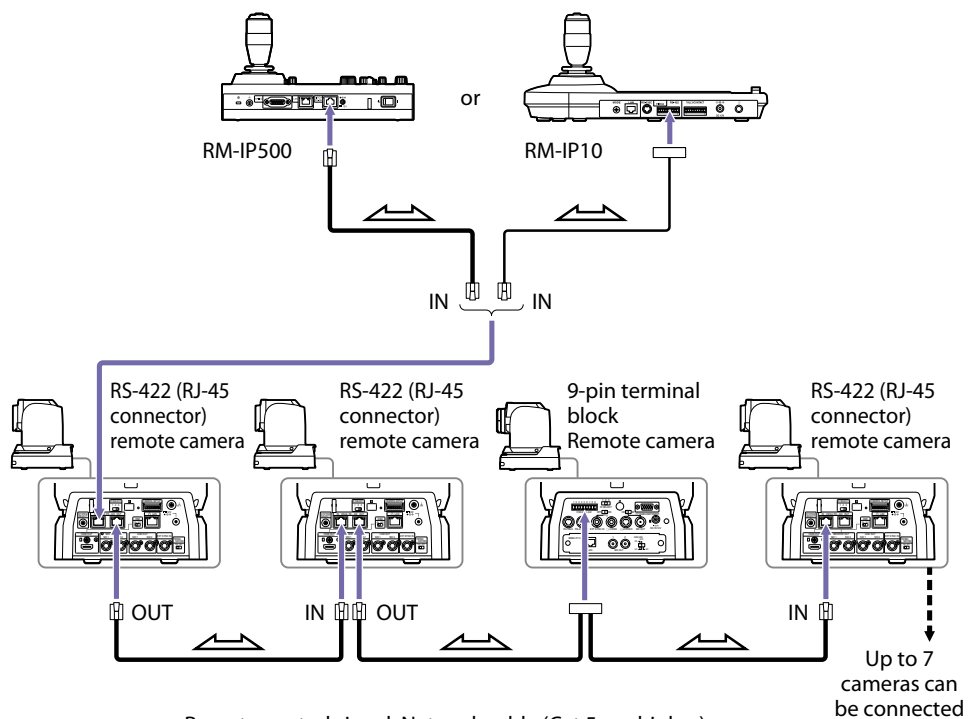

- Remote control signal: Network cable (Cat 5e or higher)
- Remote control signal: Network cable modified for terminal block connection (Cat 5e or higher)
- Signal flow

Devices

Remote camera	RS-422 connection	BRC-X1000/H800, BRC-H900, BRC-X400, SRG-X400, SRG-X120, SRG-360SHE, SRG-300SE, SRG-300H
	RS-232C connection	BRC-H900, SRG-300H, SRG-120DU, SRG-120DH, SRG-120DS
Remote controller	RM-IP10 : RS-422/232C	
	RM-IP500 : RS-422 connection only	

What you can do

Serial connection to multiple cameras is possible using VISCA RS-422 or RS-232C. Up to seven units can be assigned to a single remote controller.

* The cable can be up to 15 m long for RS-232C, and up to 1.2 km long for RS-422.

Setup instructions

1. Connect the devices using the diagram on the left as a reference, then turn them on.
For details on the RS-422/RS-232C connector of each camera, see "RS-422/RS-232C terminal of each camera" (page 57) in the appendix.
2. Set the camera address using the DIP switch on the camera bottom or rear panel. (BRC series only)
When the address is set to 0, the address is automatically set on the camera.
 - * On BRC-H900 and SRG-300H, use the DIP switch on the bottom or rear panel of the camera to select the communication system (RS-422/RS232C).
 - * Only automatic setting is available for the SRG series camera address.
3. Change the BAUD RATE (9600, 38400) using the DIP switch on the camera bottom or rear panel.
4. After using the DIP switch, restart the camera.

5. Adjust remote controller serial connection settings.

For RM-IP500

- ① From the RM menu, select CONFIG > SERIAL.

The following screen appears.

```
<SERIAL>
BAUD RATE : 9600
→APPLY    : NOT EXEC
```

- ② Select the same BAUD RATE as the camera and change [APPLY] [NOT EXEC] to [EXEC].

After settings are complete, RM-IP500 automatically restarts.

For RM-IP10

- ① Set DIP switch 1-1 on the bottom to serial connection (ON).
- ② Set the second communication system and third communication system BAUD RATE to the same as the camera.

Restart RM-IP10 after changing the settings.

Precautions

- Use the same settings for the camera and remote controller communication system and BAUD RATE.
- RS-422 and RS-232C connections cannot be mixed.
- Use a straight network cable for RS-422 connection between RJ-45 connectors.
- Serial connection on SRG-360SHE is only supported for a one-on-one communication. Use a network connection when connecting multiple units.

D 4K video switcher

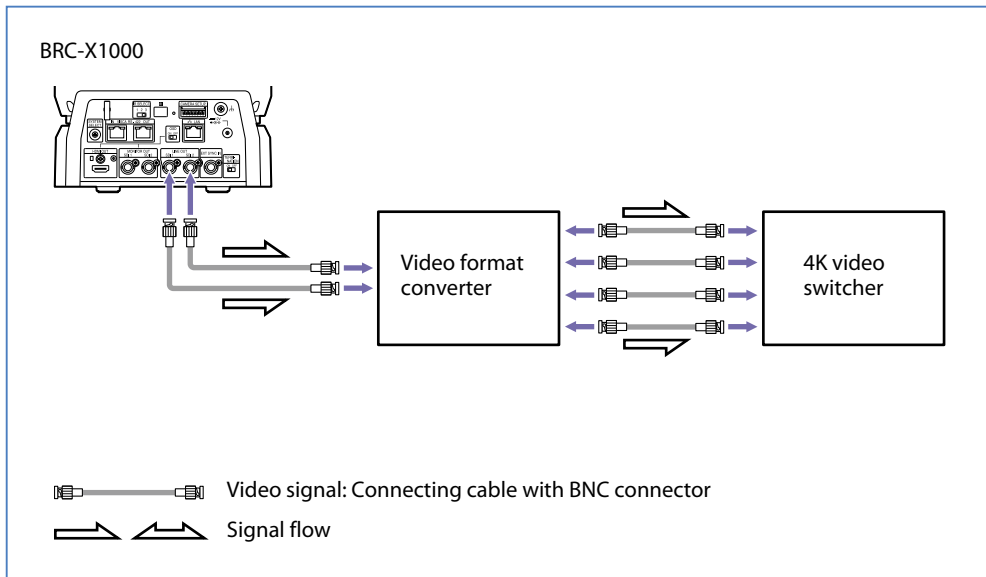

BRC-X1000 compatible format

Switch number	Image size/frame rate	Switch number	Image size/frame rate
0	3840×2160/29.97p	8	3840×2160/25p
1	1920×1080/59.94p	9	1920×1080/50p
2	1920×1080/59.94i	A	1920×1080/50i
3	No output	B	No output
4	1280×720/59.94p	C	1280×720/50p
5	No output	D	No output
6	No output	E	3840×2160/23.98p
7	HDMI: 640×480/59.94p SDI: 1280×720/59.94p	F	1920×1080/23.98p

Devices

Remote camera	BRC-X1000
Other	Commercially available 4K 29.97p compatible video switchers, video format converters

What you can do

29.97p/25p/23.98p video can be input to a video switcher.

Setup instructions

1. Referencing the table on the left, set the BRC-X1000 image format to the desired video format.
2. Connect the devices using the diagram on the left as a reference, then turn them on.

Precautions

- The BRC-X1000 SDI image output is Dual link 3G-SDI (2SI). Use a commercially available video format converter to match it to your video switcher input format.

E Fiber extension from BRC-H900

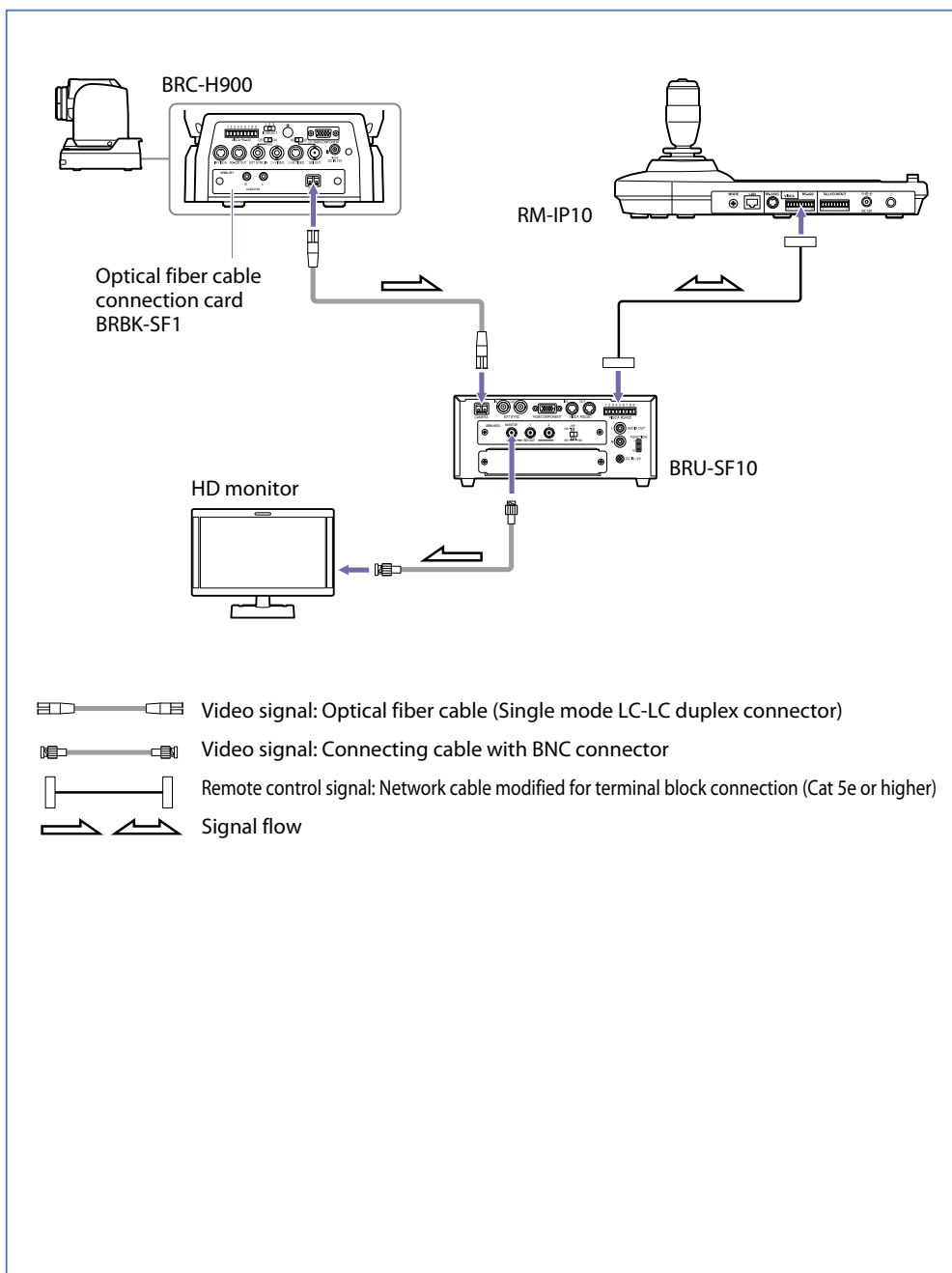

Devices

Remote camera	BRC-H900
Control card	BRBK-SF1
HD Optical Multiplex Unit	BRU-SF10
Remote controller	RM-IP500, RM-IP10

What you can do

Image/audio signals, control signals, and external synchronization signals output from the BRC-H900 with attached BRBK-SF1 can be transmitted over long distances via fiber optics.

Setup instructions

1. Connect the devices using the diagram on the left as a reference, then turn them on.
2. Set the camera communication system using BOTTOM switch 3 on the bottom of the camera and the communication BAUD RATE using switch 4.
3. Change VISCA FUNCTION switch 1 (RS-232C/RS-422) and switch 2 (communication BAUD RATE) on the back of BRU-SF10 to the same setting as the camera.
4. Set the remote controller communication system and communication BAUD RATE. See "Serial connection setting (RS-422/RS-232C)" (page 20) for details on adjusting settings.

Precautions

- The VISCA RS-232C and VISCA RS-422 connectors on the camera cannot be used during optical fiber cable connection.

F Tally control from MCX-500

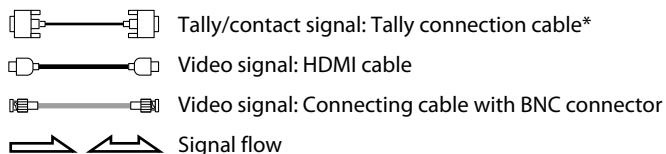
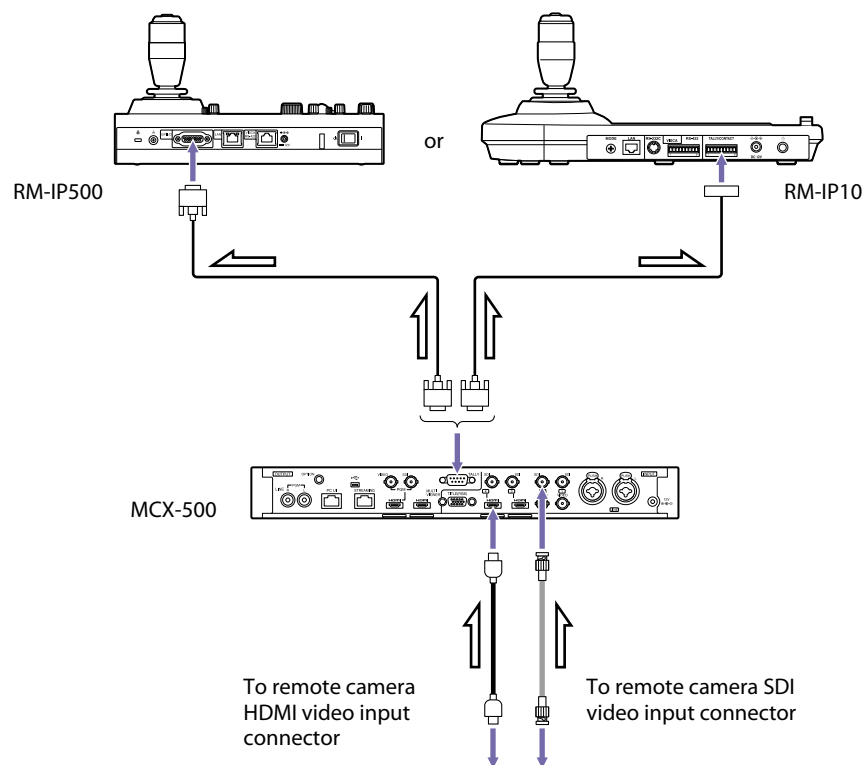

* Refer to the connector pin array in the index for further details.

Devices

Remote camera	BRC-X1000/H800, BRC-H900, SRG-360SHE, SRG-300SE, SRG-300H, SRG-120DH, SRG-120DS, BRC-X400, SRG-X400, SRG-X120
Remote controller	RM-IP500, RM-IP10
Switcher	MCX-500
Other	Commercially available switching hubs

What you can do

- You can input remote camera video to MCX-500.
- You can select the remote controller camera number and switch the remote camera tally lamp according to video switching input to MCX-500.

Setup instructions

- Connect the devices using the diagram on the left as a reference, then turn them on. For details on MCX-500 and remote controller tally connector pin arrangements, see "Chapter 5 Appendix" > "TALLY terminal (MCX-500)" (page 58).
- Press the MCX-500 ASSIGN button and select the MCX-500 video input connector number you want to use from the [VIDEO INPUT SELECT] line.
- Select [ENABLE] from the MCX-500 screen, then select the type of input connector you want to use. At default settings, the video from devices connected to SDI input connectors is assigned to inputs 1 to 4. Once assignment is complete, the video input selected in PGM output is displayed.
- Configure the remote controller and MCX-500 tally connection. RM-IP500 is used for this explanation.
- Set RM menu CONFIG > GPI I/O [SETTING] to [INPUT].

6. Select the [TALLY MODE] from the following two options.

NORMAL

When switching MCX-500 video, the RM-IP500 controlled camera switches and the RM-IP500 camera select block tally input lamp is lit.

ON AIR TALLY

When switching MCX-500 video, the RM-IP500 camera select block tally input lamp is lit. RM-IP500 controlled cameras are not changed.

When CAMERA LINK is turned ON, the camera tally lamp will switch in coordination with MCX-500 video selection.

Precautions

- Set RM-IP500 COMMAND SEL to STANDARD.
- When using MCX-500 VIDEO/HDMI video input and you select video 1 to 4, the RM-IP500 camera number changes between 5 to 8.

G Connection with AWS-750

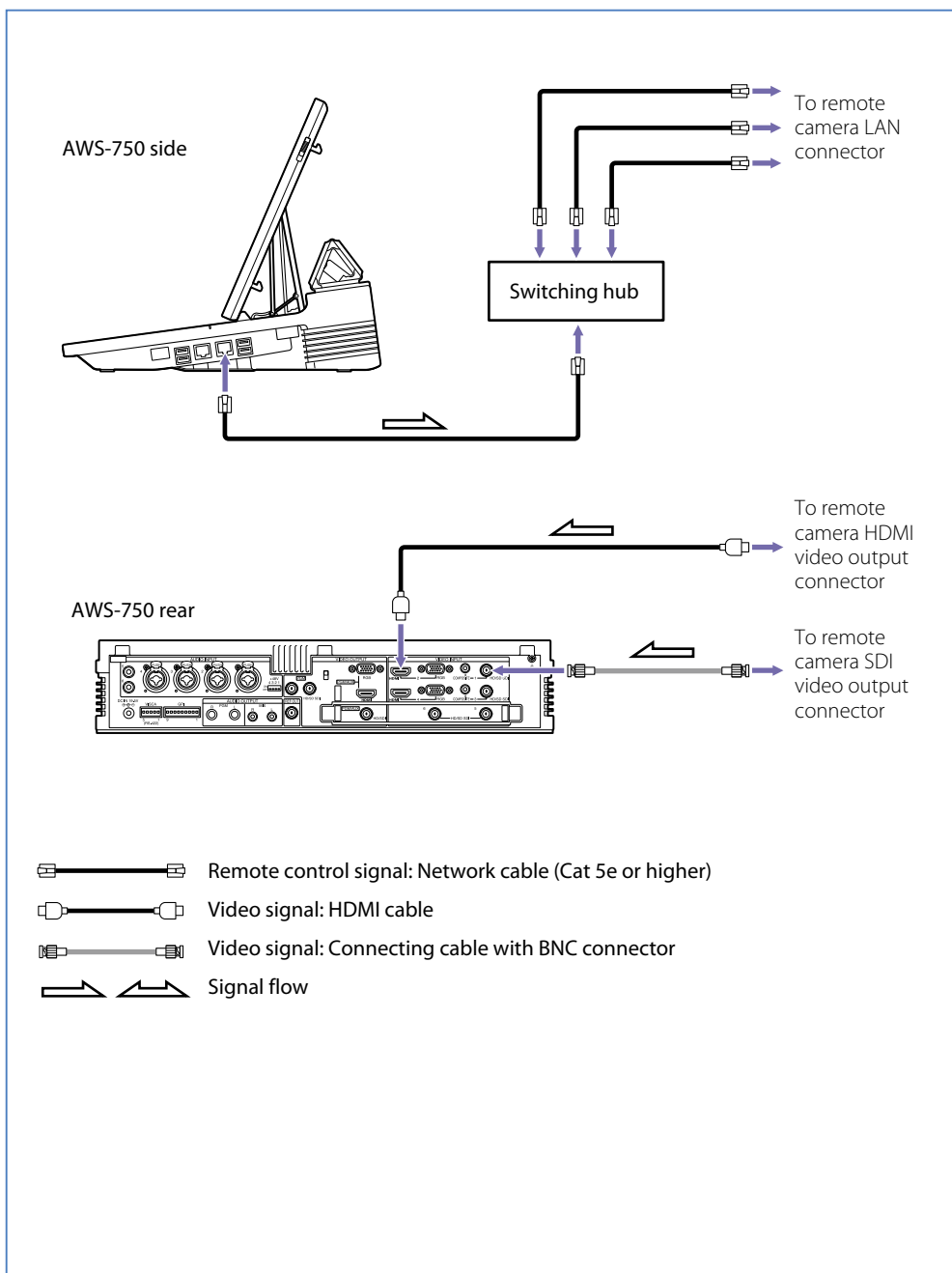

Devices

Remote camera	BRC-X1000/H800, BRC-H900, SRG-300H, SRG-300SE, SRG-120DH
Remote controller	RM-IP500, RM-IP10
Switcher	AWS-750
Other	Commercially available switching hubs

What you can do

- You can assign remote cameras compatible with AWS-750 Live Content Producer.
 - Serial connection: Up to 7 remote cameras can be connected
 - IP connection: Up to 7 remote cameras, and up to 4 remote controllers can be connected
- Verified models as of October 2017 are shown below.

Camera/Remote controller	Option board	Supported output	Connection interface
BRC-X1000/H800	–	HD SDI	Serial RS-422/LAN
BRC-H900	–	Switchable SDI (HD/SD)	Serial RS-422
	BRBK-SA1	SD analog output	
	BRBK-HSD2	Switchable SDI (HD/SD)	
SRG-300H	–	HDMI	Serial RS-422/LAN
	–	SDI	Serial RS-422/LAN
	–	HDMI	LAN
RM-IP500	–		LAN
RM-IP10	–		LAN

Setup instructions

This connection procedure uses an IP connection for explanation purposes. See the AWS-750 operation manual for serial connection configuration procedures.

1. **Connect the devices using the diagram on the previous page as a reference, then turn them on.**
2. **Start AWS-750.**
See the AWS-750 operation manual for information on how to start AWS-750.
3. **Change camera video signal to the video format you want to use.**
AWS-750 SDI video signal input is compatible with 1080/59.94i and 50i.
4. **Set the IP addresses for the remote cameras and remote controller.**
See "Auto IP address setting from RM-IP500" (page 16) and "IP address setting from RM-IP Setup Tool" (page 18) for information on procedures.
5. **Select the setting icon on the top right of the sub screen, then select [Network].**
6. **Set the AWS-750 IP address to the same as the remote camera and remote controller.**

Configuration example

[IPv4 Mode]: Manual
 [IP Address]: 192.168.0.11
 [Prefix Length]: /24

7. **After adjusting settings, press [Apply].**
8. **From the sub screen setting icon, select Others >Remote Camera, then set the connection mode to the remote camera.**
 - ① From [Connection] select [LAN].
 - ② Enter camera IP addresses in [VISCA 1] to [VISCA 7].
9. **After settings are complete, press [Apply].**
The camera is formatted.
10. **With the remote camera connected to AWS-750, select the camera video input from the [Input] list at the top of the AWS-750 main screen and check the video.**
11. **Select the sub screen setting icon then press [Video].**
12. **Select the remote camera video input from [Input 1] to [Input 6], then configure the connector and video format, etc.**
13. **From [Remote Control], select the numbers of the remote cameras to control from [VISCA 1] to [VISCA 7].**

If the camera model name does not appear in the [Remote Control] pull-down list, restart the camera.

When using auto tracking

Turn [Tracking] on. See the AWS-750 operation manual for information on how to configure the tracking function.

When steps 10 to 13 are complete, the [Camera] tab appears in the sub screen and remote cameras can be controlled.

Precautions

- Limit switching hub stacks to two levels. Further multi-level stack connections will result in longer network delays.
- We recommend connecting the remote camera and remote controller to the LAN 2 connector on AWS-750.
- Do not connect more than one AWS-750, seven remote cameras, four remote controllers, and one PC for configuration to the same network.
- IPv6 cannot be used in AWS-750 settings when connected to remote cameras and remote controllers.

H Connection with RCP-3100/1500 series

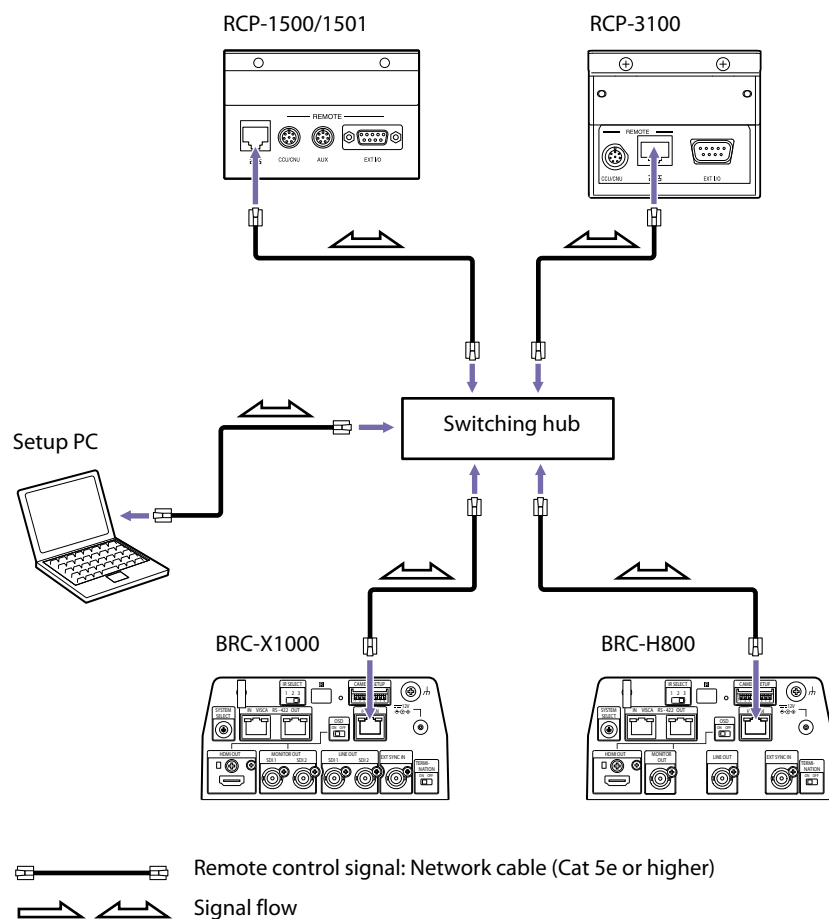

Devices

Remote camera	BRC-X1000/H800, BRC-H900, BRC-X400, SRG-360SHE
Remote control panel	RCP-3100/1500/1501/1530
Camera control network adapter	CNA-1*
Other	Commercially available switching hubs, setup PC

* When using BRC-H900

What you can do

You can connect to a network camera in Bridge Mode via network connection from a Sony-brand remote control panel. In Bridge Mode, the network camera and RCP communicate on a one-on-one basis. For information on available functions of each camera, see "Function compatibility for RCP/MSU to BRC-X1000/H800/X400" (page 55).

Setup instructions

This connection procedure uses BRC-X1000/H800 and RCP-3100/1500 for explanation purposes. See the HZC-BRCN1 operation manual for details on Bridge Mode connection when using camera control network adapter CNA-1 and BRC-H900.

1. Connect the devices using the diagram on the left as a reference, then turn them on.
2. Set the IP address of each camera to connect to.
See "Auto IP address setting from RM-IP500" (page 16) and "IP address setting from RM-IP Setup Tool" (page 18) for instructions on how to set IP addresses.

3. Configure the RCP connection.

The configuration procedure differs for the RCP-3100 and RCP-1500. See the procedures for each product.

[Connecting RCP-3100]

This description is for a connection by the following network settings.

* The following settings can also be configured in the Web menu. For information on Web menu settings and RCP-3100 details, see the RCP-3100 Operating Instructions.

RCP-3100

Camera connected to RCP-3100

IP address	: 192.168.0.20	IP address	: 192.168.0.100
Subnet mask	: 255.255.255.0	Subnet mask	: 255.255.255.0
Default gateway	: 192.168.0.254	Default gateway	: 192.168.0.254

① Press and hold the CONFIG button to start configuration mode.

The CONFIG button LED remains lit in configuration mode.

② Perform operations a. to d. for all items listed on the front.

- Set the master gain display window to the number of the item to set using the master gain selection buttons.
- Set the CC (color temperature conversion) filter display window to the number of the item to set using the CC filter selection buttons.
- Display the desired setting in the adjustment display window by turning the adjustment knob.
- Press the SAVE button to apply the setting.

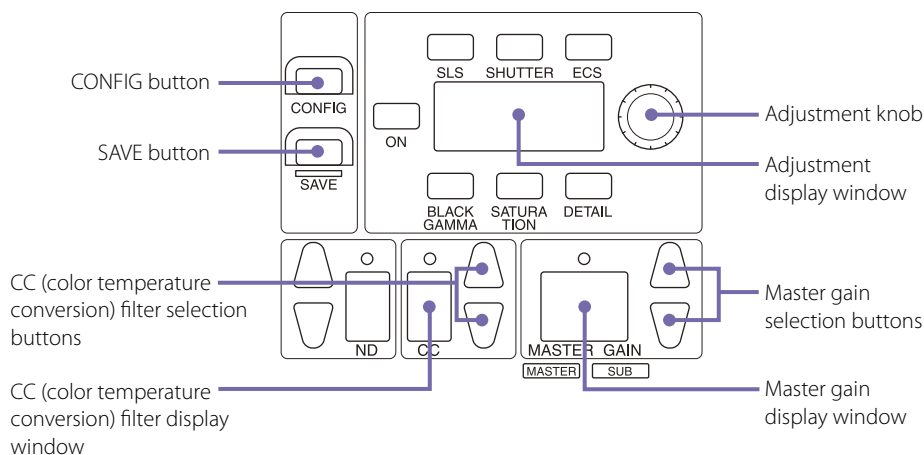

Setting item	Master gain display window number	CC (color temperature conversion) filter display window number	Adjustment display window display (sample address shown)
1 1st block of RCP IP address	02	1	192 (192.168.0.20)
2 2nd block of RCP IP address		2	168 (192.168.0.20)
3 3rd block of RCP IP address		3	0 (192.168.0.20)
4 4th block of RCP IP address		4	20 (192.168.0.20)
5 1st block of RCP subnet mask	03	1	255 (255.255.255.0)
6 2nd block of RCP subnet mask		2	255 (255.255.255.0)
7 3rd block of RCP subnet mask		3	255 (255.255.255.0)
8 4th block of RCP subnet mask		4	0 (255.255.255.0)
9 1st block of RCP default gateway	04	1	192 (192.168.0.254)
10 2nd block of RCP default gateway		2	168 (192.168.0.254)
11 3rd block of RCP default gateway		3	0 (192.168.0.254)
12 4th block of RCP default gateway		4	254 (192.168.0.254)
13 Connection mode (CNS)	01	- (Setting not required)	1 (Bridge mode)
14 1st block of IP address for camera connection	08	1	192 (192.168.0.100)
15 2nd block of IP address for camera connection		2	168 (192.168.0.100)
16 3rd block of IP address for camera connection		3	0 (192.168.0.100)
17 4th block of IP address for camera connection		4	100 (192.168.0.100)

③ When settings are complete, press and hold the CONFIG button to exit configuration mode.

Make sure to complete this operation to apply the settings.

When you exit configuration mode, the CONFIG button LED goes out.

When a successful connection is made, the shutter speed, etc., of the connected camera is displayed on the panel.

[Connecting RCP-1500]

① In the RCP-1500 MENU screen select Config >RCP >Security, then turn Engineer Mode on.

Engineer Mode is turned on and the button is lit orange.

- ② Return to the MENU TOP screen, then select Config >RCP >Network >TCP/IP and configure the necessary network settings.

Configuration example

IP address : 192.168.0.20 Subnet mask : 255.255.255.0 Default gateway : 192.168.0.254

- ③ After input is complete press [Set] to apply settings.
- ④ Return to the RCP-1500 MENU screen TOP, select Config >RCP >Network >CNS, then turn Bridge Mode on.
- ⑤ Press [Set] on the screen.
- ⑥ Next press [Edit], enter the IP address of the camera you want to operate, and finally press [Set].
If the connection is successful, the shutter speed, etc. of the connected camera appears in the panel.

Precautions

- Update the BRC-X1000/H800 software to v2.0 or later before use.
- The RCP-3100/1500 series requires a PoE power supply (IEEE802.3af) and BRC-X1000/H800 requires a PoE+ (IEEE802.3at) or DC 12 V power supply. Use a compatible switching hub.
- CNA-1 (sold separately) is required for BRC-H900 to RCP connection. See the HZC-BRCN1 operation manual for further details.

Connection with MSU-1000 series

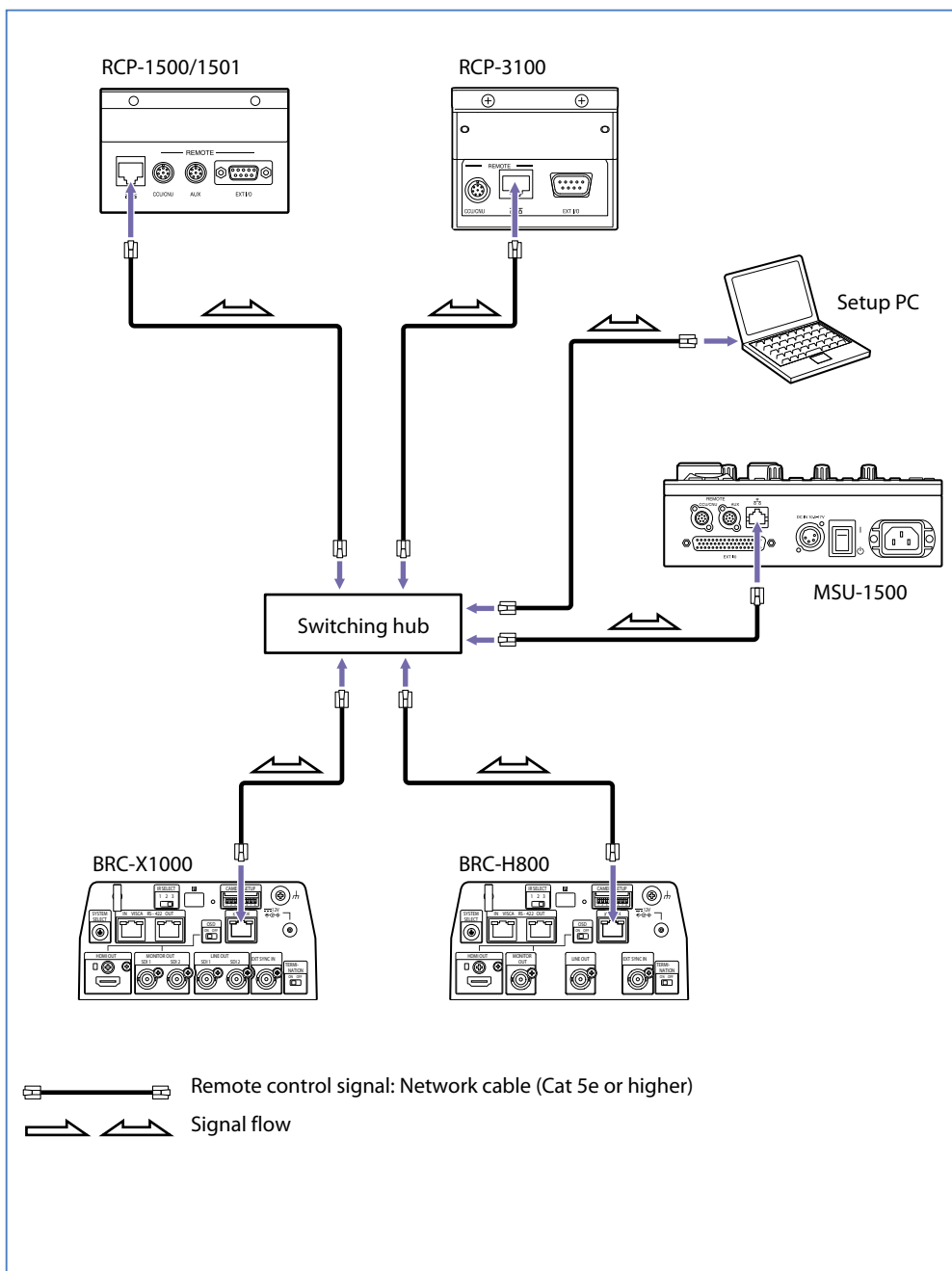

Devices

Remote camera	BRC-X1000/H800/X400
Remote control panel	RCP-3100/1500/1501/1530
Master setup unit	MSU-1000/1500
Other	Commercially available switching hubs, setup PC

What you can do

You can connect to BRC-X1000 and BRC-H800 in MCS Mode via network connection from a Sony-brand remote control panel and master setup unit. MCS Mode is used to link RCP and MSU in a multi-camera environment.

Setup instructions

This connection procedure uses BRC-X1000/H800/X400, RCP-3100/1500 and MSU-1500 for explanation purposes. See the applicable operation manuals for procedures on how to configure other devices.

1. Connect the devices using the diagram on the left as a reference, then turn them on.
2. Set the IP address of each camera to connect to.
See "Auto IP address setting from RM-IP500" (page 16) and "IP address setting from RM-IP Setup Tool" (page 18) for instructions on how to set IP addresses.
3. Configure MSU-1500 network settings.
 - ① Press the MSU-1500 menu operation block CONFIG button, then from the screen select MSU > Security, and turn Engineer Mode on.
Engineer Mode is turned on and the button is lit orange.
 - ② Return to the Config TOP screen, select MSU > Network > TCP/IP, then adjust any necessary network settings.

Configuration example

IP address	: 192.168.0.50
Subnet mask	: 255.255.255.0
Default gateway	: 192.168.0.254

- ③ After input is complete, press [Set] to apply settings.
- ④ Return to the Config TOP screen and select Config >MSU >Network >CNS.
- ⑤ Turn [MCS] on and press [Set] on the right side of the screen.
- ⑥ Next press [Edit], then select Master and enter the MSU-1500 IP address.
IP address example: 192.168.0.50
- ⑦ Press [Set].
This concludes MSU-1500 configuration.

4. Configure the RCP connection.

[Connecting RCP-3100]

This description is for a connection by the following network settings.

* The following settings can also be configured in the Web menu. For information on Web menu settings and RCP-3100 details, see the RCP-3100 Operating Instructions.

RCP-3100

IP address	: 192.168.0.20
Subnet mask	: 255.255.255.0
Default gateway	: 192.168.0.254

- ① Press and hold the CONFIG button to start configuration mode.
The CONFIG button LED remains lit in configuration mode.
- ② Perform operations a. to d. for all items listed on the front.
 - a. Set the master gain display window to the number of the item to set using the master gain selection buttons.
 - b. Set the CC (color temperature conversion) filter display window to the number of the item to set using the CC filter selection buttons.
 - c. Display the desired setting in the adjustment display window by turning the adjustment knob.
 - d. Press the SAVE button to apply the setting.

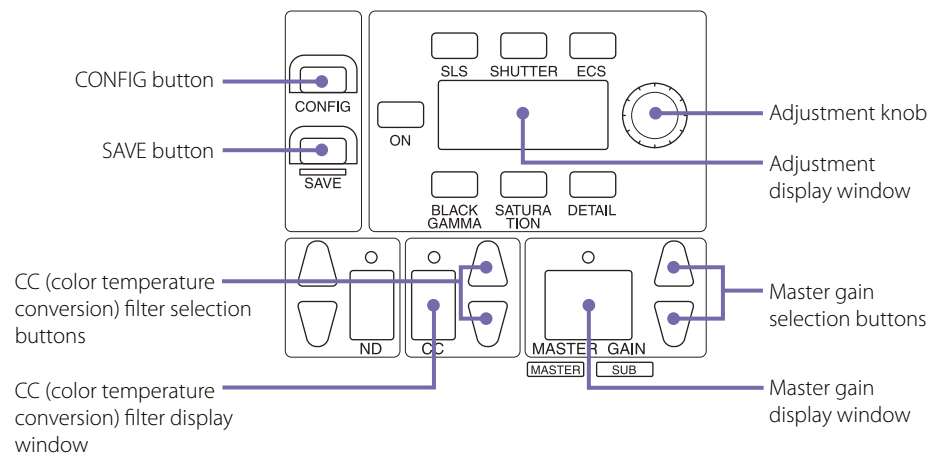

Setting item	Master gain display window number	CC (color temperature conversion) filter display window number	Adjustment display window display (sample address shown)
1 1st block of RCP IP address	02	1	192 (192.168.0.20)
2 2nd block of RCP IP address		2	168 (192.168.0.20)
3 3rd block of RCP IP address		3	0 (192.168.0.20)
4 4th block of RCP IP address		4	20 (192.168.0.20)
5 1st block of RCP subnet mask	03	1	255 (255.255.255.0)
6 2nd block of RCP subnet mask		2	255 (255.255.255.0)
7 3rd block of RCP subnet mask		3	255 (255.255.255.0)
8 4th block of RCP subnet mask		4	0 (255.255.255.0)
9 1st block of RCP default gateway	04	1	192 (192.168.0.254)
10 2nd block of RCP default gateway		2	168 (192.168.0.254)
11 3rd block of RCP default gateway		3	0 (192.168.0.254)
12 4th block of RCP default gateway		4	254 (192.168.0.254)
13 Connection mode (CNS)	01	- (Setting not required)	2 (MCS mode)

Setting item	Master gain display window number	CC (color temperature conversion) filter display window number	Adjustment display window display (sample address shown)
14 1st block of the Master MSU IP address	07	1	192 (192.168.0.50)
15 2nd block of the Master MSU IP address		2	168 (192.168.0.50)
16 3rd block of the Master MSU IP address		3	0 (192.168.0.50)
17 4th block of the Master MSU IP address		4	100 (192.168.0.50)

③ When settings are complete, press and hold the CONFIG button to exit configuration mode.

Make sure to complete this operation to apply the settings.
When you exit configuration mode, the CONFIG button LED goes out.

[Connecting RCP-1500]

- ① In the RCP-1500 MENU screen select Config >RCP >Security, then turn Engineer Mode on.
Engineer Mode is turned on and the button is lit orange.
- ② Return to the MENU TOP screen, then select Config >RCP >Network >TCP/IP and configure the necessary network settings.

Configuration example

IP address : 192.168.0.20
Subnet mask : 255.255.255.0
Default gateway : 192.168.0.254

- ③ After input is complete press [Set] to apply settings.
- ④ Return to the RCP-1500 MENU screen TOP, select Config >RCP >Network >CNS, then turn Bridge Mode on.
- ⑤ Press [Set] on the screen.
- ⑥ Next press [Edit], enter the IP address of the camera you want to operate, and finally press [Set].
If the connection is successful, the shutter speed, etc. of the connected camera appears in the panel.

5. Configure BRC-X1000/H800/BRC-X400 CNS settings.

- ① Enter the IP address of the camera you want to connect to in the web browser of the PC connected to the network.

A user name and password are required for access. Default settings are as follows.

User name: admin
Password: Admin_1234

- ② From the CNS tab select [MCS Mode], enter the Master MSU-1500 IP address and destination camera number, then press [OK].

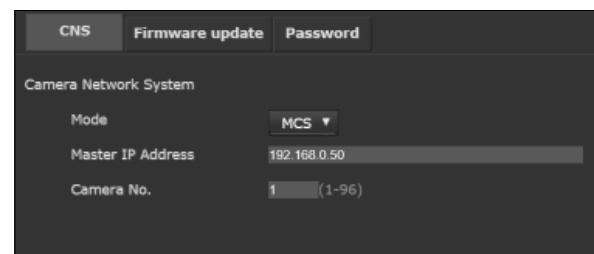

Precautions

- Update the BRC-X1000 and BRC-H800 software to v2.0 or later before use.
- RCP-3100/1500 series requires a PoE power supply (IEEE802.3af) and BRC-X1000/H800 requires PoE+ (IEEE802.3at) or 12V DC power supply. Use a compatible switching hub.
- CNA-1 (sold separately) is required for BRC-H900 to RCP and MSU connection. See the HZC-BRCN1 operation manual for further details.

J NDI® | HXconnection

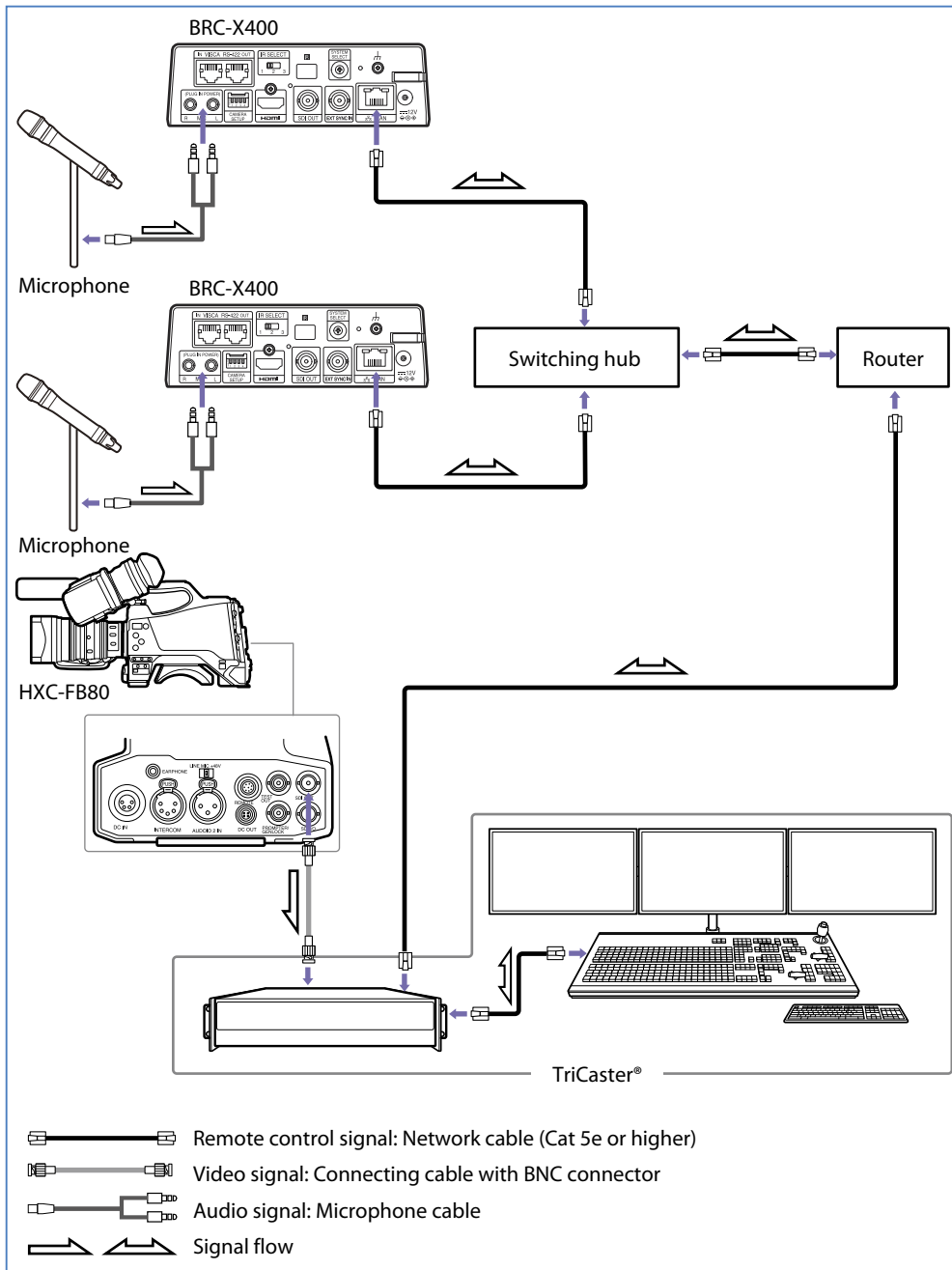

Devices

Remote camera

BRC-X400, SRG-X400, SRG-X120

What you can do

Connect to an NDI® compatible product to transfer camera footage or audio input to the camera and to control the camera.

Setup instructions

1. Purchase a license on the NewTek website.
<https://www.newtek.com/ndihx/products/upgrade/>
2. Download the NDI Tool from the NewTek website and install it on your computer.
3. Enable access to the camera from a web browser.
For details, refer to the Operating Instructions of the camera.
4. Connect the computer and camera to an external network via a LAN cable, launch the NDI Tool, and attach the license to the camera.
5. See the NewTek website for details on how to configure connection settings.

Chapter 3 Products

Remote cameras

BRC-X1000/BRC-H800



1.0-type Exmor R CMOS 4K/HD remote camera

- This camera features a 1.0-type Exmor R CMOS sensor and optical 12x zoom lens on an integrated swivel base.
- BRC-X1000 supports the 4K format.
- It comes with two SDI outputs and one HDMI output as standard equipment.
- A silent design enables unobtrusive operation sounds even at a maximum speed of 60°/s for smooth swivel operation.
- Clear Image Zoom enables 18x zoom at 4K and 24x zoom at HD. Tele Convert Mode enables a maximum equivalent of 48x telephoto zoom performance.
- PoE+ (IEEE802.3at) support enables power supply via a network cable.

See below for examples of applications where this product is used.

- Small Studios (page 5)
- Reality Shows (page 6)
- Houses of Worship (page 7)
- Event Production (page 9)

BRC-H900



1/2-type Exmor 3 CMOS HD remote camera

- This camera features a 1/2-type Exmor CMOS sensor and optical 14x zoom lens on an integrated swivel base.
- It comes with one SDI output as standard equipment. Using the option card (sold separately) enables a variety of output options including optical fiber.
- A silent design enables unobtrusive operation sounds even at a maximum speed of 60°/s for smooth swivel operation.

See below for examples of applications where this product is used.

- Live Sports Events (page 11)

BRC-X400



NDI® | HX capable 1/2.5-type Exmor R CMOS-equipped IP 4K remote camera

- This video camera features a 1/2.5-type Exmor R CMOS 4K image sensor and integrated swivel base.
- It supports 4K format.
- It comes with an SDI/HDMI/IP output as standard equipment.
- Clear Image Zoom enables 30x zoom when shooting in 4K and 40x zoom when shooting in HD. Tele Convert Mode delivers up to 80x equivalent telephoto performance when shooting in HD.
- This single camera covers a shooting range from wide angle (approx. 70°) to telephoto.
- PoE+ (IEEE802.3at) support enables power supply via a network cable.
- It is NDI® | HX capable and can be used to build live system with NDI® compatible devices.
- Equipped with Genlock and a tally light.
- Audio input to the audio input connector can be superimposed on the IP output for transmission.

See below for examples of applications where this product is used.

- Reality Shows (page 6)
- Houses of Worship (page 7)
- Event Production (page 9)
- Radio Booth (page 13)
- E-sports (page 14)

SRG-X400



NDI® | HX capable 1/2.5-type, 40 x Exmor R CMOS-equipped IP Full HD remote camera

- This video camera features a 1/2.5-type Exmor R CMOS sensor and integrated swivel base.
- Supports 4K upgrade option*.
- It comes with an SDI/HDMI/IP output as standard equipment.
- Clear Image Zoom enables 40x zoom when shooting in HD.
- This single camera covers a shooting range from wide angle (approx. 70°) to telephoto.
- PoE+ (IEEE802.3at) support enables power supply via a network cable.
- It is NDI® | HX capable* and can be used to build live system with NDI® compatible devices.
- Supports high-speed swivel Max 300°/sec during preset movement.
- Audio input to the audio input connector can be superimposed on the IP output for transmission.

* Support to be added in a version update

See below for examples of applications where this product is used.

- Lecture Capture (page 8)
- Parliament/Congress (page 10)

SRG-360SHE



HDMI/SDI/IP output, 30x optical HD remote camera

- This camera features a 1/2.8-type Exmor CMOS sensor and optical 30x zoom lens on an integrated swivel base.
- It comes with an SDI/HDMI/IP output as standard equipment.
- Audio input to the audio input connector can be superimposed on the SDI/HDMI/IP outputs for transmission.
- A high dynamic range is achieved via the View-DR function.
- PoE+ (IEEE802.3at) support enables power supply via a network cable.

See below for examples of applications where this product is used.

- Small Studios (page 5)

SRG-300SE



SDI/IP output, 30x optical HD remote camera

- This camera features a 1/2.8-type Exmor CMOS sensor and optical 30x zoom lens on an integrated swivel base.
- It comes with an SDI/IP output as standard equipment.
- Audio input to the audio input connector can be superimposed on the IP output for transmission.
- A high dynamic range is achieved via the View-DR function.

See below for examples of applications where this product is used.

- Lecture Capture (page 8)
- Parliament/Congress (page 10)

SRG-300H



HDMI output, 30x optical HD remote camera

- This camera features a 1/2.8-type Exmor CMOS sensor and optical 30x zoom lens on an integrated swivel base.
- It comes with an HDMI output as standard equipment.
- A high dynamic range is achieved via the View-DR function.

See below for examples of applications where this product is used.

- Lecture Capture (page 8)

SRG-X120



NDI® | HX capable 1/2.5-type Exmor R CMOS-equipped optical 12x IP Full HD remote camera

- This video camera features a 1/2.5-type Exmor R CMOS sensor and integrated swivel base.
- Supports 4K upgrade option*.
- It comes with an SDI/HDMI/IP output as standard equipment.
- This model is capable of 12x optical zoom.
- This single camera covers a shooting range from wide angle (approx. 70°) to telephoto.
- PoE+ (IEEE802.3at) support enables power supply via a network cable.
- It is NDI® | HX capable* and can be used to build live system with NDI® compatible devices.
- Supports high-speed swivel Max 300°/sec during preset movement.
- Audio input to the audio input connector can be superimposed on the IP output for transmission.

* Support to be added in a version update

See below for examples of applications where this product is used.

- Video Conferences (page 12)
- Lecture Capture (page 8)

SRG-120DH



HDMI output, compact HD remote camera

- This camera features a 1/2.8-type Exmor CMOS sensor and optical 12x zoom lens on an integrated swivel base.
- It comes with an HDMI output as standard equipment.
- The compact design makes it possible to unobtrusively capture video for video conferences in meeting rooms.
- A high dynamic range is achieved via the View-DR function.

See below for examples of applications where this product is used.

- Lecture Capture (page 8)
- Video Conferences (page 12)

SRG-120DS



SDI output, compact HD remote camera

- This camera features a 1/2.8-type Exmor CMOS sensor and optical 12x zoom lens on an integrated swivel base.
- It comes with an SDI output as standard equipment.
- The compact design makes it possible to unobtrusively capture video for video conferences in meeting rooms.
- A high dynamic range is achieved via the View-DR function.

See below for examples of applications where this product is used.

- Lecture Capture (page 8)
- Video Conferences (page 12)

SRG-120DU



USB output, compact HD remote camera

- This camera features a 1/2.8-type Exmor CMOS sensor and optical 12x zoom lens on an integrated swivel base.
- A USB output (based on USB Video Class 1.0a*) is included as standard equipment on this model.
- The compact design makes it possible to unobtrusively capture video for video conferences in meeting rooms.
- A high dynamic range is achieved via the View-DR function.

* Control specifications may coexist due to VISCA, so some items may not comply with part of the UVC standards.

See below for examples of applications where this product is used.

- Video Conferences (page 12)

System camera

HXC-FB80/HXCU-FB80



3G transmission capable HD portable camera and camera control unit

- Signals can be transmitted up to a distance of 600 m when connected to camera control unit HXCU-FB80 via a hybrid type optical fiber cable. 3G transmission is supported for 1080/59.94p signals and 1080/59.94i signals which can be simultaneously transmitted. HD trunk and HD prompters can also be used for transmitting HD footage separately from camera footage.
- 1080/29.97PsF and 23.98PsF formats are supported for use in various HD live production such as studios, sports, and live events. It is also possible to scale up to 3840x2160/59.94p output from the camera control unit. 12G SDI output is also supported for 4K video output from a coaxial cable.
- Supports HD HDR shooting to capture footage which is close to what the human eye captures under conditions where shooting objects have big differences in lighting between bright and dark areas, such as in an outdoor sports broadcasting and nighttime shooting.
- The connector that links the camera and camera control unit is compatible with both hybrid type optical fiber cables and single mode fiber cables. These options make it possible to create a flexible system.
- The three model lineup consists of the HXC-FB80H with the camera body only, the HXC-FB80K which includes a lens and viewfinder set, and the HXC-FB80S which includes a large viewfinder for studio use. These options make it possible to select the optimal model for your needs.
 HXC-FB80H: Camera body only
 HXC-FB80K: Camera body, 20x zoom lens, 3.5-type LCD viewfinder, microphone
 HXC-FB80S: Camera body, 20x zoom lens, 7-type LCD viewfinder

HXC-P70H



Multipurpose camera

- Equipped with three 2/3-type CMOS sensors, this model features F12 high sensitivity and 60 dB high S/N, etc. for high image quality. It also automatically adjusts the iris, gain and shutter to adapt to ambient brightness, making it useful not only as a studio camera, but also as a weather camera and for monitoring purposes.
- At a width of 86 mm and weight of approximately 1.5 kg, it is compact and lightweight, offering flexible installation in high locations and small spaces. It also has a low power consumption of approximately 17 W.
- It contains a built-in filter servo that is used to remotely operate the ND filter position.
- In addition to the maximum 64 frame accumulation slow shutter function, the camera gain can be increased to +48 dB for shooting in low light conditions.
- This model supports 1080/59.94i, 50i, 29.97PsF, 25PsF, 720/59.94p and 50p.
- Equipped with a 2x and 4x digital extender function so there is no sensitivity falloff due to electrical processing.
- Not only can the camera be used on its own, but it can be used with camera control unit HXCU-FB80 in a system configuration. Transmission is possible up to a distance of 1 km when using a hybrid type optical fiber cable and up to 10 km when using a single mode fiber cable.
- Lens sold separately.

Remote controllers

RM-IP500



- When connected via LAN, up to 100 remote cameras can be controlled using just one RM-IP500. VISCA RS-422 connection is also supported.
- An automatic IP setting function enables IP configuration on multiple cameras from the remote controller menu even without a PC. This is particularly effective for building large systems.
- High-precision pan, tilt, and zoom operations are also possible. A speed adjustment knob enables zoom, focus, pan, and tilt control at the optimal speed. A seesaw lever and joystick can also be used to control the zoom.
- This item is equipped with a wealth of camera adjustment features, including dedicated knobs for direct adjustment of whites and blacks. Six buttons are available for assigning frequently used functions which can be instantly accessed.

See below for examples of applications where this product is used.

- Small Studios (page 5)
- Reality Shows (page 6)
- Houses of Worship (page 7)
- Event Production (page 9)

RM-IP10



- When connected via LAN, up to 112 remote cameras can be controlled using just one RM-IP10. VISCA RS-422 and RS-232C connection are also supported.
- A total of 16 preset positions can be activated for camera tilt and position.

See below for examples of applications where this product is used.

- Lecture Capture (page 8)
- Live Sports Events (page 11)

RCP-3100/1500/1501/1530



- This item is equipped with a multi-function control panel with direct control switches. System camera and remote camera adjustment is possible directly via buttons.

See below for examples of applications where this product is used.

- Small Studios (page 5)
- Reality Shows (page 6)
- Event Production (page 9)
- Live Sports Events (page 11)

MSU-1000/1500



- This is a control panel mainly used for camera system maintenance and configuration. It is equipped with a 6.5-inch LCD touch panel for centralized management of multi-unit camera systems. The horizontal-type MSU-1000 and vertical-type MSU-1500 are both available.

See below for examples of applications where this product is used.

- Small Studios (page 5)

Switchers

MCX-500



- This compact, lightweight body is packed with a wealth of input/output connectors and a full range of features necessary for small events. It can handle input from up to four video feeds.
- A touch panel is included in addition to button controls, making a variety of operations simple, including assigning input signals to the input button, etc.
- You can connect remote controllers and remote cameras, switch between camera signals and output camera tally signals to remote controllers.
- The body is equipped with an SD card slot and program out video and audio can be recorded to the memory card in Full HD.
- The streaming function enables easy streaming relays with minimal equipment.

See below for examples of applications where this product is used.

- Lecture Capture (page 8)
- Radio Booth (page 13)

AWS-750



- This is an all-in-one A/V control console equipped with video switching, camera control, audio mixer, and live internet streaming functions.
- It enables simple control over video switching and audio mixing. The system supports six video inputs (HD/SD-SDI, composite, RGB, HDMI).
- It is equipped with two touch panel displays. The main screen is used for footage monitoring and switching, whereas the sub screen is designed for ease of use in audio mixing and setting adjustment.
- Remote control of panning, tilting, and zooming are possible on VISCA-compatible cameras. Panning, tilting, and zooming status can be saved as presets for instant access when needed. It is also possible to move the camera to track subjects and tap the viewer to center the camera position.

Optional items for BRC-H900

BRBK-IP10



Card for LAN connection between BRC-H900 and remote controller

- Attach to BRC-H900 to connect to IP remote controller RM-IP500, RM-IP10 via network.
- HD-SDI/SD-SDI signal output is possible. Selection of HD-SDI or SD-SDI output is possible via a switch.

BRBK-SF1



Optical fiber cable connection card

- Use this to connect BRC-H900 to multi interface unit BRU-SF10 via an optical fiber cable.

BRU-SF10



Multi interface unit for optical fiber cable connection

- Connect BRC-H900 with attached optical fiber cable connection card BRBK-SF1 to this device using an optical fiber cable (single mode LC-LC duplex connector) to transmit signals over long distances.

BRBK-HSD2

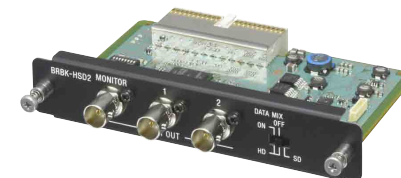

HD/SD switching SDI output card

- Attaching this to the BRC-H900 and multi interface unit BRU-SF10 makes it possible to output HD-SDI/SD-SDI signals. Selection of HD-SDI or SD-SDI output is possible via a switch.

CNA-1



Camera control network adapter for expanding a Sony camera network system

- Using this device and optional software HZC-BRCN1 makes it possible to connect BRC-H900 to RCP-3100/1500/1501/1530.

Edge Analytics Appliance

REA-C1000 Main unit



Edge Analytics Appliance (REA-C1000) uses Sony AI image analysis technology to maximize the abilities of all types of visual communication.

Image analysis and processing input from the camera is performed in real-time, delivering an unprecedented simple and efficient way to create attractive visual content.

Click here or scan QR code to view a video

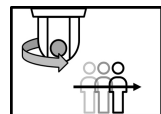

REA-L0200 PTZ Auto Tracking



This application automatically turns the PTZ camera to track the speaker's movements. Camera control is so precise that it is almost as if a camera operator is manually controlling the movement.

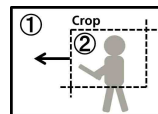

REA-L0500 Focus Area Cropping*

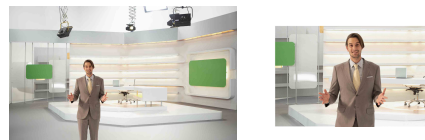

This application makes it possible to capture images with two different angles of view using just a single camera, one with a wide-angle view and another cropped to focus on a certain area. Smooth camera work that tracks the speakers movement in real-time is possible in the cropped area.

* Firmware version 2.0 is required to use this application.

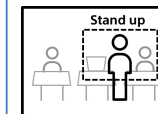

REA-L0300 Close-up by Gesture

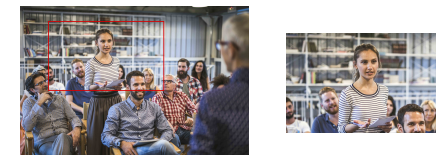

This application uses gesture recognition technology to detect scenes where a person stands, triggering automatic generation of smooth images of the person. An overall, wide-angle view image and close-up image of the person standing can be captured with a single camera.

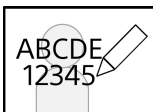

REA-L0100 Handwriting Extraction

This application automatically recognizes and extracts handwritten text and images on a whiteboard or blackboard and displays it in front of the speaker.

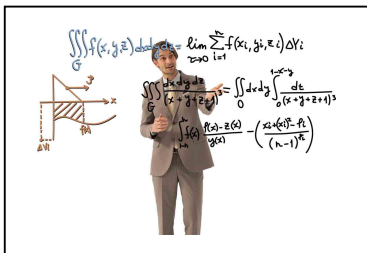

- The speaker's expressions, movement, and gestures are simultaneously captured, reading the content of the whiteboard or blackboard without blocking the speaker.
- Enhanced color and contrast processing displays images that are more vivid than the human eye.
- Superimposed video on a hanging monitor or streaming service makes it possible for students sitting in the back of the classroom or in a remote location to experience an enhanced version of the class.
- The transparency of the person can be adjusted in real-time. It is also possible to create video only of handwriting.

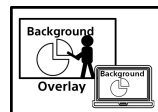

REA-L0400 Chroma key-less CG Overlay*

This application makes it easy to create composite video content that usually requires a special studio and experienced staff.



- Moving object detection technology is used to create appealing real-time composite images without any fuss.
 - The image background can be set to a video or presentation content.
- * Firmware version 2.0 is required to use this application.

Chapter 4 Edge Analytics Appliance Application

Edge Analytics Appliance Application Configuration



Edge Analytics Appliance (Main unit)
REA-C1000

[Application]



Handwriting Extraction
REA-L0100



Usage example of Handwriting Extraction in the classroom (page 46)

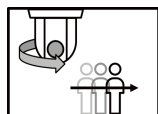

PTZ Auto Tracking
REA-L0200



Usage example of PTZ Auto Tracking in the lecture hall (page 47)

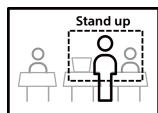

Close-up by Gesture
REA-L0300



Usage example of Close-up by Gesture in the classroom (page 48)

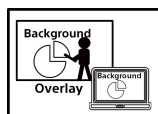

Chroma key-less CG Overlay
REA-L0400



Usage example of Chroma key-less CG Overlay in a small-scale studio (page 49)

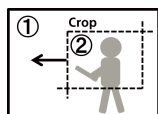

Focus Area Cropping
REA-L0500



Usage example of Focus Area Cropping at an event space (page 50)

[Usage example]

Usage example of Handwriting Extraction in the classroom

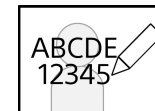

User benefits

Using the Handwriting Extraction application (REA-L0100) makes it possible to extract text and drawings from the white board or blackboard for real-time output as video. Extracted text and drawings are displayed on top of the footage of the lecturer, making it possible for the class to always view both the lecturer and what is written on the board. Students can catch every detail of the lecturer's face, gestures, and explanations, simultaneously viewing both the lecturer as they speak and the content on the board, which is usually hidden as it is being written. This leads to greater understanding of and satisfaction with lectures. The system improves real-time video viewing quality in large classrooms and remote classes, and makes it possible to easily create appealing lecture content.

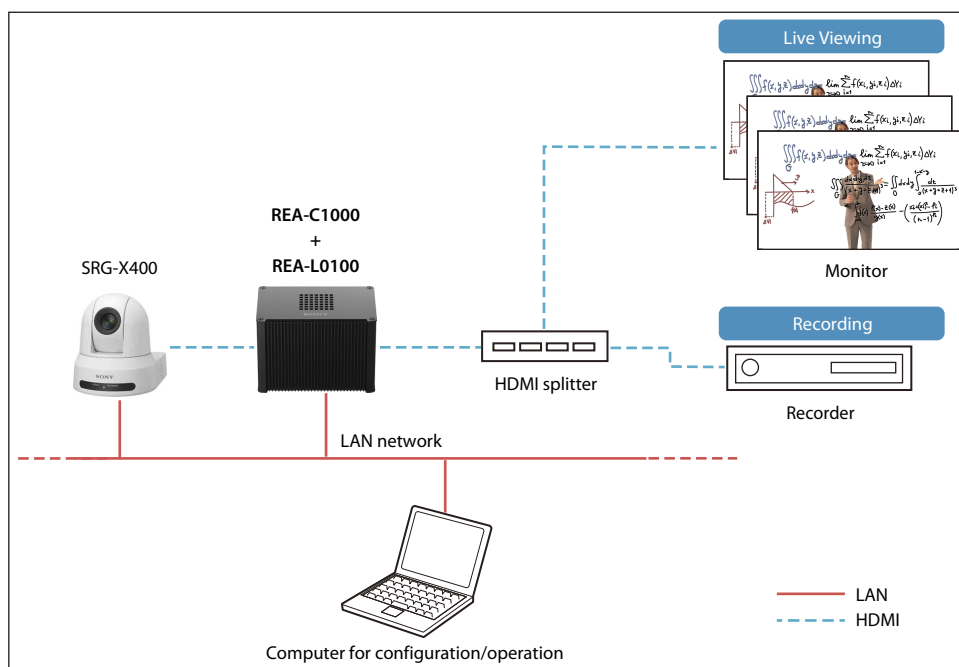

Usage example of PTZ Auto Tracking in the lecture hall

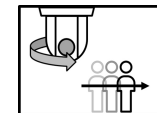

User benefits

Using the PTZ Auto Tracking application (REA-L0200) enables AI detection of multiple elements in footage, such as the faces, movement, shapes, and colors of subjects within the angle of view for smoother camera control. Having the camera pan to track the movement of subjects in the angle of view makes it possible to control and maintain the optimal angle of view. This application makes it possible to easily capture natural, enhanced footage that appears as if an operator is controlling a PTZ camera. This model is equipped with an optical zoom, which is optimal for relatively large spaces such as auditoriums, lecture halls and event spaces.

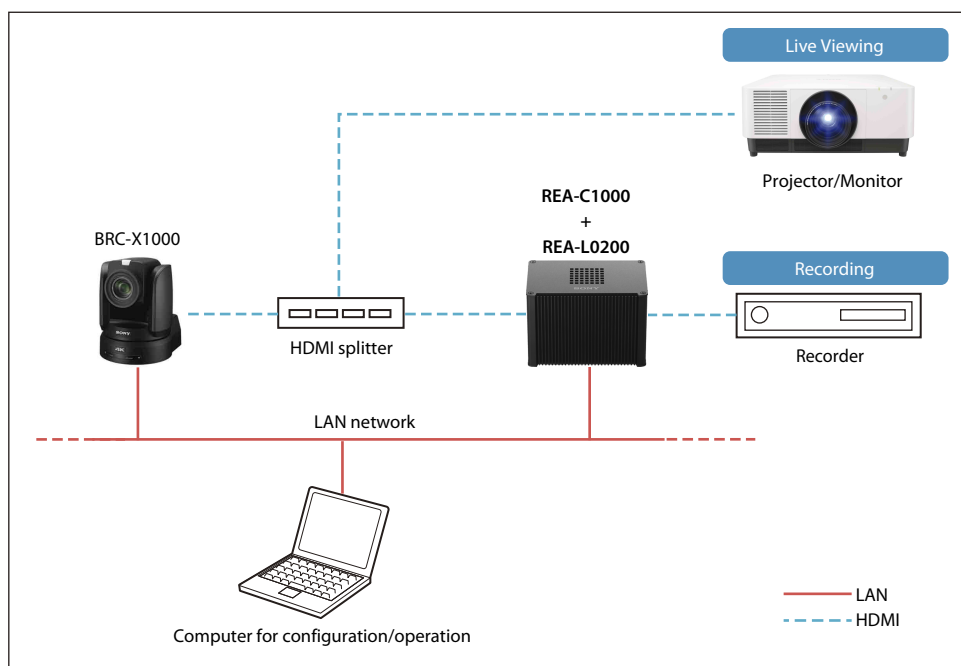

Usage example of Close-up by Gesture in the classroom

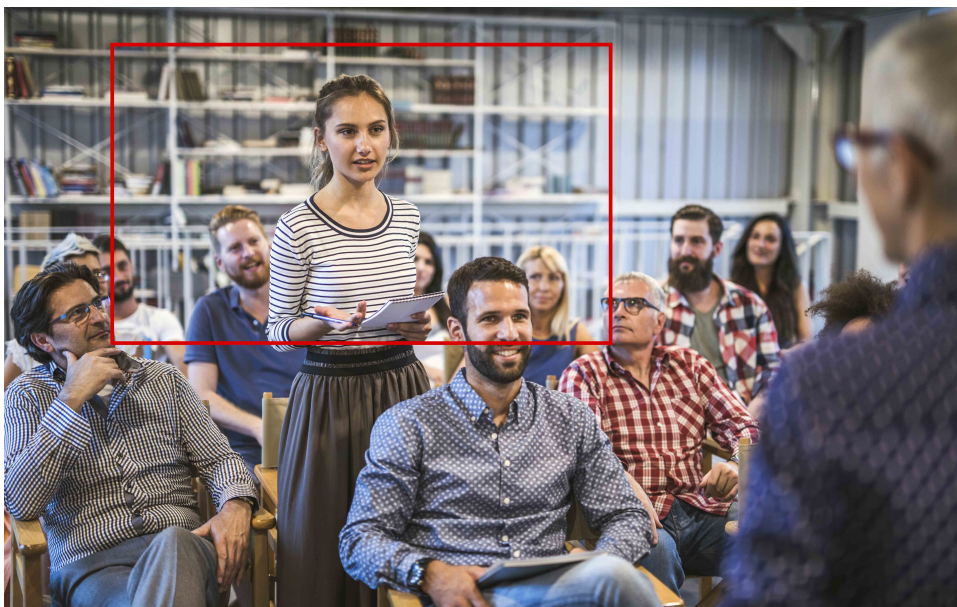
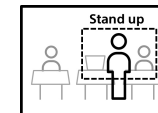

User benefits

When using the Close-up by gesture application (REA-L0300) to capture footage in the classroom, students that stand up to speak from a group of about 20 to 30 people are automatically recognized and the PTZ camera electronically zooms in on the speaker. When the student sits down, the camera automatically switches from zoomed in to a 4K bird's eye angle of view as if a camera operator is controlling the camera. When used with another application, it is possible to capture footage in the front and rear of the classroom suitable for faculty development. The REA-C1000 also supports IP output for recording the footage of multiple classrooms to recorders on a network.

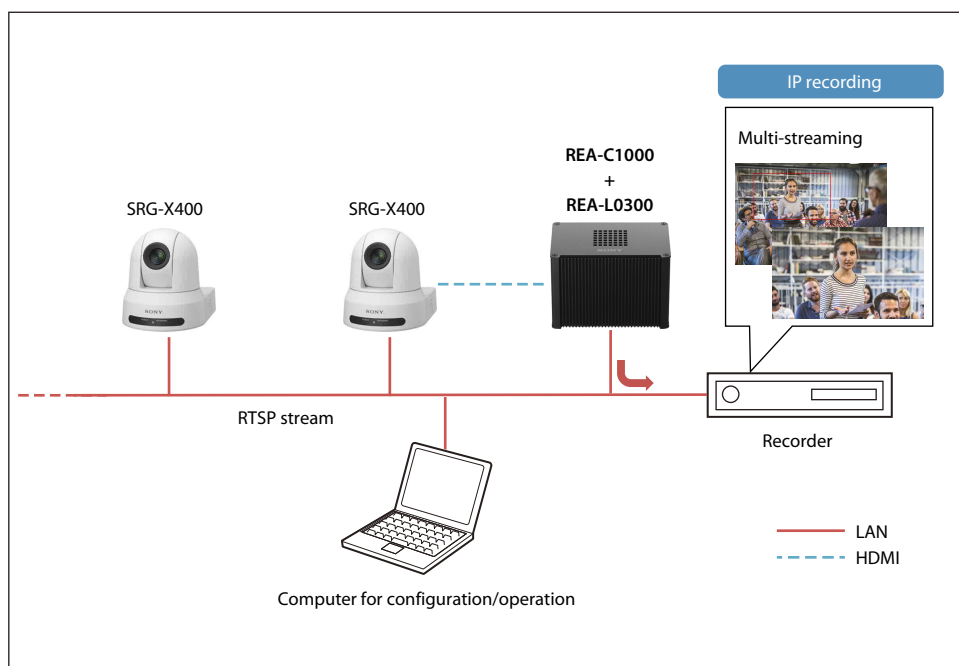

Usage example of Chroma key-less CG Overlay in a small-scale studio

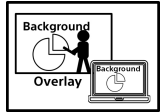

User benefits

Using the Chroma key-less CG Overlay application (REA-L0400) makes it possible to easily create composite images without a green screen studio or special staff. An office conference room or simple studio can be used to place the person being recorded into another image in real-time, making it easy to produce appealing image content. The Chroma key-less CG Overlay application is a powerful tool for producing business presentation videos, video content for streaming on the web, and e-learning content.

Hints

For better-looking composite shots, make sure to choose a shooting location without moving objects in the background. It is also a good idea to wear clothing that is a different color than the shooting environment.

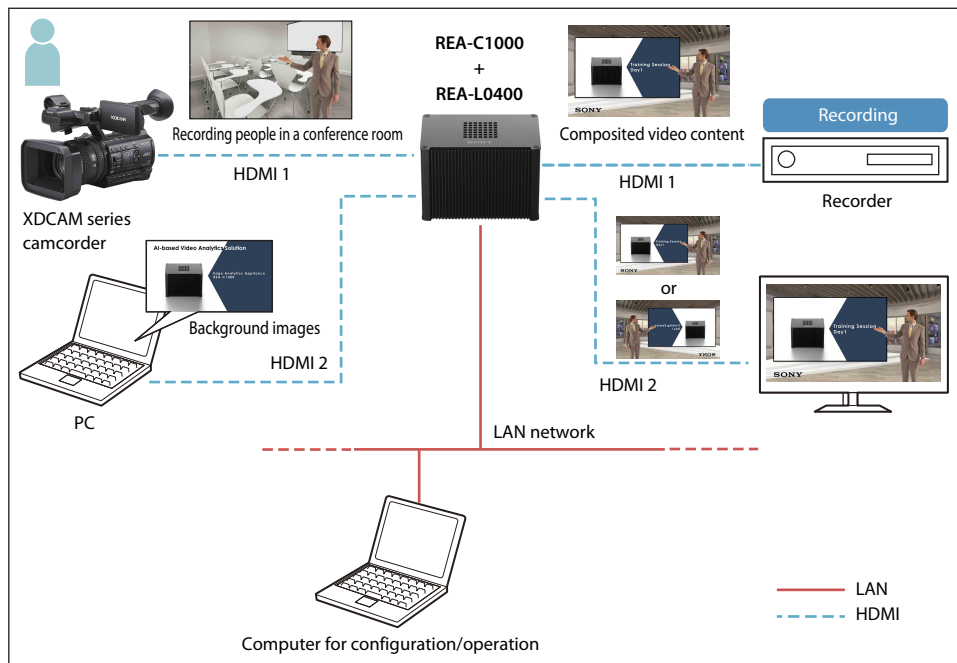

Usage example of Focus Area Cropping at an event space

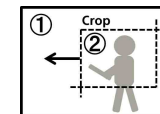

User benefits

Using the Focus Area Cropping application (REA-L0500) makes it possible to output footage in real time from different angles with a single camera, almost as if you are using a multi-camera setup. This application enables shooting with fewer cameras than usually required at a single shooting location, making it possible to allocate equipment and staff for more shooting opportunities. The Focus Area Cropping function provides electronic panning, tilting and zooming that tracks subject movement in the angle of view from a 4K bird's-eye view for continuous subject tracking that is almost as if a camera operator is controlling the camera. The Fixed Area Cropping function gives complete freedom of control over the shooting area by dragging the mouse to switch from a bird's-eye view to digital zoom. The shooting resolution is variable and can easily be changed, however, because the video is converted to Full HD (1920x1080) during output, no compatibility is lost with later stage systems.

Hints

- The Focus Area Cropping function is best for cropping subjects that move around such as speakers and actors.
- The Fixed Area Cropping function is best for cropping subjects with minimal movement, such as screens, panelists and on-stage presenters.

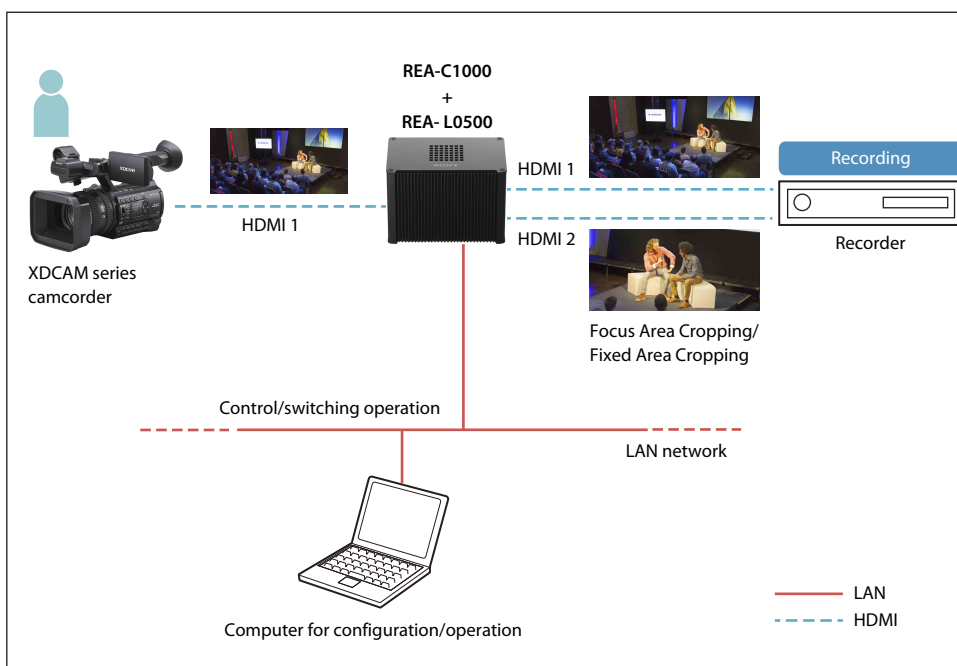

Chapter 5 Appendix

Controller compatibility chart

RM-IP500

Yes: Supported
–: Not supported

Control block	Button/knob	Function	Conditions	BRC-X1000/H800 / X400	BRC-H900	SRG series *1
Lens control block	AE button	Exposure mode selection	<ul style="list-style-type: none"> When the button is on (lit): Full auto. When the button is off (not lit): Follows CONFIG >RM SETUP >AE CONFIG setting in the RM menu. 	Yes	Yes	Yes
	FOCUS adjustment knob	Manual focus adjustment	Enabled when the AUTO FOCUS mode button is not lit.	Yes	Yes	Yes
	O.P.AF (one-push auto focus) button	One-push auto focus adjustment	Enabled when the AUTO FOCUS mode button is not lit.	Yes	Yes	Yes
	IRIS knob	Iris setting adjustment	Enabled when the AE button is not lit, and CONFIG >RM SETUP >AE CONFIG is set to MANUAL or IRIS Pri in the RM menu.	Yes	Yes	Yes
Color adjustment block	O.P.AWB (one-push auto white balance) button	One-push white balance auto adjustment	Enabled when OPERATION >WHITE >WB MODE is set to ONE PUSH in the RM menu.	Yes	Yes	Yes
	O.P.ABB (one-push auto black balance) button	One-push black balance auto adjustment	Enabled when OPERATION >BLACK >ABB MODE is set to ON in the RM menu.	–	Yes	–
	BARS button	Toggle color bars output on/off.	–	Yes *12	Yes	–
	ASSIGN 1 to ASSIGN 3	Toggle backlight compensation on/off.	Enabled when the AE button is lit.	Yes	Yes *3	Yes
		Toggle flicker compensation on/off.	–	Yes	Yes	–
		Toggle flicker compensation on/off.	–	Yes	Yes	Yes
		Display the status of the iris, gain, shutter speed, and zoom position.	–	Yes *8 *11	–	Yes *10
	Tele convert on/off switching	–	–	Yes *8 *11	–	–
	Preset mode (MOD1-TRCE and MOD2-TRCE) switching	–	–	Yes *8	–	–
	R-WHITE knob/B-WHITE knob	R gain and B gain adjustment	Enabled when OPERATION >WHITE >WB MODE is set to MANUAL in the RM menu.	Yes	Yes	Yes
R-BLACK knob/B-BLACK knob	R black and B black adjustment	Enabled when OPERATION >BLACK >ABB MODE is set to OFF in the RM menu.	–	Yes	–	
MASTERBLACK knob	Master black adjustment	–	Yes	–*2	–	

Yes: Supported
 – : Not supported

Control block	Button/knob	Function	Conditions	BRC-X1000/H800 / X400	BRC-H900	SRG series *1	
FUNCTION menu of menu control block	ASSIGN 4 to ASSIGN 5	DETAIL LEVEL display	–	Yes	Yes	Yes *5	
		Adjustment using VALUE knob after DETAIL LEVEL is displayed	On the BRC-H900, enabled if DETAIL is set to ON in the camera menu.				
		KNEE POINT display	–	Yes	Yes	–	
		Adjustment using VALUE knob after KNEE POINT is displayed	Enabled when KNEE is set to ON in the camera menu, and KNEE MODE is set to MANUAL.				
		AE level display	Enabled when the AE button is lit, or if the AE button is not lit and CONFIG >RM SETUP >AE CONFIG is not set to MANUAL in the RM menu.	Yes	Yes	Yes	
		Adjustment using VALUE knob after AE level is displayed	Enabled when OPERATION >EXPOSURE >EX-COMP is set to ON in the RM menu.				
		ND filter ND1 to 4 settings	–	Yes *8	–	–	
	IRIS button (Lit blue when enabled)	IRIS setting display	IRIS setting display	Enabled when the AE button is not lit.	Yes	Yes	Yes
			Adjustment using VALUE knob after IRIS setting is displayed	Enabled when the AE button is not lit, and CONFIG >RM SETUP >AE CONFIG is set to MANUAL or IRIS Pri in the camera menu.			
	GAIN button (lit blue when enabled)	GAIN setting display	GAIN setting display	Enabled when the AE button is not lit.	Yes *10	Yes *6	Yes *6
			Adjustment using VALUE knob after GAIN setting is displayed	Enabled when the AE button is not lit, and CONFIG >RM SETUP >AE CONFIG is set to MANUAL or GAIN Pri in the camera menu.			
	SHUTTER button (Lit blue when enabled)	Shutter speed display	Shutter speed display	Enabled when the AE button is not lit.	Yes *7	Yes *7	Yes *7
			Adjustment using VALUE knob after shutter speed is displayed	Enabled when the AE button is not lit, and CONFIG >RM SETUP >AE CONFIG is set to MANUAL or SHUTTER Pri in the camera menu.			
			Picture profile PP1 to 6 settings	–	Yes *11	–	–

*1 Applicable cameras: SRG-360SHE, SRG-300SE, SRG-300H, SRG-120DH/120DS/120DU, SRG-X400, SRG-X120

*2 If the camera menu EXPOSURE > MODE > FULL AUTO has a WIDE D (VIEW-DR) function, FULL AUTO mode cannot be turned OFF with the AE button in settings other than OFF. If you want to switch between AUTO/manual with the AE button, set WIDE D to OFF.

*3 Enabled when Exposure Mode is set to FULL AUTO or BACK LIGHT in the camera menu.

*4 Setting is enabled in the camera menu.

*5 Excluding SRG-X400 and SRG-X120, the APERTURE setting in camera PICTURE menu is applied.

*6 GAIN Pri cannot be selected.

*7 Setting changes with the frame rate (50 Hz/59.94 Hz). Set CONFIG > RM SETUP > CAMERA FREQ in the RM menu to the frame rate setting of the camera.

*8 Applicable cameras: BRC-X1000 and BRC-H800 with firmware version 2.0 and later

*9 GAIN Pri is not available on BRC-X400

*10 Applicable cameras: SRG-X400

*11 Applicable cameras: BRC-X400

RM-IP10

Yes: Supported
 -: Not supported

Button/knob	Function	Conditions	BRC-X1000/H800	BRC-H900	SRG-360SHE
VALUE/R knob	Adjustment of priority setting mode values on the camera.	Enabled when the brightness adjustment mode is selected with the MODE button and the VALUE indicator is lit.	Yes	Yes	Yes
BRIGHT/B knob	Adjusts the camera brightness value.	Enabled when the brightness adjustment mode is selected with the MODE button and the BRIGHT indicator is lit.	Yes	Yes	Yes
FOCUS knob	Adjusts the focus		Yes	Yes	Yes
AUTO/MANUAL button	Press this button to select focus mode AUTO or MANUAL.		Yes	Yes	Yes
ONE PUSH AF button	Press to activate the one-push auto focus function.	This control is enabled when MANUAL is selected with the AUTO/MANUAL button	Yes	Yes	Yes
PRESET button	Current camera settings are stored in the memory of the camera.	Enabled when holding down the PRESET button and pressing one of the GROUP/POSITION buttons.	Yes	Yes	Yes
RESET button	The memory of the camera is cleared to the factory preset condition.	Enabled when holding down the RESET button and pressing one of the GROUP/POSITION buttons.	Yes	Yes	Yes
BACK LIGHT button	Enables the backlight compensation function of the camera.		Yes	Yes	Yes
PAN-TILT RESET button	Resets the pan/tilt position of the camera to its initial condition.		Yes	Yes	Yes
ONE PUSH AWB button	Activates one-push white balance adjustment.		Yes	Yes	Yes
MENU button	Used to display the menu of the camera, return to the main menu, or turn off the menu.	Enabled when pressing the button for about one second.	Yes	Yes	Yes
Joystick	Used for pan/tilt and zoom operations.		Yes	Yes	Yes
POWER button	Used to turn the camera ON/OFF.		Yes	Yes	Yes
	Used to change the Preset Speed*.		Yes	Yes	-

* See the RM-IP10 operation manual for instructions on how to change the preset speed.

Function compatibility for RCP/MSU to BRC-X1000/H800/X400

Operation Panel	Function	Conditions
ND*1	ND filter	
IRIS*2	Iris	Enabled when AE is set to MANUAL on the camera.
SHUTTER*2	Shutter speed	
MASTER GAIN	Gain	
SCENE FILE*3	Preset Recall, preset Set	Enabled when the camera preset mode is not set to TRACE. If the camera preset mode is set to TRACE, movement recorded in TRACE is shown in playback.
WHITE R*2	R-Gain	Enabled when white balance is set to MANUAL on the camera.
WHITE B*2	B-Gain	
MASTER BLACK	Black Level Offset	
	Detail Auto/Manual	
DETAIL	Detail Level	
	Detail Crispening	
	Detail H/V Balance	
	Matrix STD/OFF	
	R-G, G-B, B-R, R-B, G-R, B-G	Enabled when Matrix is turned ON on the camera.
	Gamma Level	
	Black Gamma Level	
	Knee Setting, Knee Point, Knee Slope, Knee Mode	
	Noise Reduction	Enabled when ADVANCED is not set on the camera.
	Flicker Reduction	
BARS *4	Color Bar	

*1 Only supported on BRC-X1000/H800

*2 SRG-360SHE supports IRIS, SHUTTER, MASTER GAIN, WHITE R/B only.

*3 Scene files are supported on BRC-X400 via version update. (early 2020)

*4 Only supported on BRC-X400

Pin assignments

RS-422

RJ45 connector



IN

Pin no.	Function
1	TX-
2	TX+
3	RX-
4	GND
5	GND
6	RX+
7	N.C.
8	N.C.

OUT

Pin no.	Function
1	RX-
2	RX+
3	TX-
4	GND
5	GND
6	TX+
7	N.C.
8	N.C.

Contact terminal block

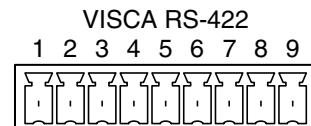

Pin no.	Function
1	RXD OUT-
2	RXD OUT+
3	TXD OUT-
4	TXD OUT+
5	GND
6	RXD IN-
7	RXD IN+
8	TXD IN-
9	TXD IN+

Connecting cable example

When connecting BRC-X1000/H800



RM-IP10

1	N.C.
2	N.C.
3	N.C.
4	N.C.
5	GND
6	RX-
7	RX+
8	TX-
9	TX+

Camera

1	TX-
2	TX+
3	RX-
4	GND
5	GND
6	RX+
7	N.C.
8	N.C.

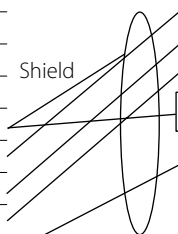

Notes

- Connect the GNDs of both devices together to stabilize the voltage level of the signal.
- When preparing cables, use network cables of category 5e or more. Use cables equivalent to or higher than shielded twisted pair cables.

RS-232C

VISCA RS-232 IN terminal

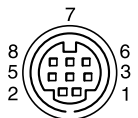

VISCA RS-232 IN

Pin no.	Function
1	DTR IN
2	DSR IN
3	TXD IN
4	GND
5	RXD IN
6	GND
7	SIRCS OUT*
8	Not used

* Pin 7 SIRCS OUT can be switched using the BOTTOM switch.

VISCA RS-232 OUT terminal

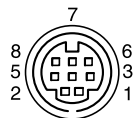

VISCA RS-232 OUT

Pin no.	Function
1	DTR OUT
2	DSR OUT
3	TXD OUT
4	GND
5	RXD OUT
6	GND
7	Not used
8	Not used

RS-422/RS-232C terminal of each camera

Camera/Remote controller	RS-422 connector	RS-232C connector
BRC-X1000, BRC-H800, BRC-X400, SRG-X400, SRG-X120, SRG-360SHE, RM-IP500	RJ45	Not supported
BRC-H900, SRG-300H, RM-IP10	9-pin contact terminal block	Mini DIN 8-pin type
SRG-300SE	9-pin contact terminal block	Not supported
SRG-120DS, SRG-120DH, SRG-120DU	Not supported	Mini DIN 8-pin type

GPI I/O terminal (RM-IP500)

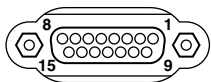

Pin no.	Signal
1	TALLY IN /CONTACT OUT 1
2	TALLY IN /CONTACT OUT 2
3	TALLY IN /CONTACT OUT 3
4	TALLY IN /CONTACT OUT 4
5	TALLY IN /CONTACT OUT 5
6	TALLY IN /CONTACT OUT 6
7	TALLY IN /CONTACT OUT 7
8	TALLY IN /CONTACT OUT 8
9	TALLY IN /CONTACT OUT 9
10	TALLY IN /CONTACT OUT 10
11	NC
12	NC
13	GND
14	GND
15	GND

TALLY/CONTACT terminal (RM-IP10)

TALLY/CONTACT

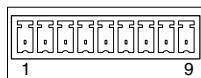

Pin no.	Function
1	CAMERA 1
2	CAMERA 2
3	CAMERA 3
4	CAMERA 4
5	CAMERA 5
6	CAMERA 6
7	CAMERA 7
8	GND
9	GND

TALLY terminal (MCX-500)

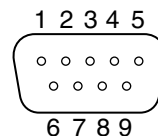

Pin no.	GPI	Description		
		Function	Target	Specs
1	OUT	PGM OUT TALLY	INPUT1 (SDI)	On: SHORT, Off: OPEN
2	OUT	PGM OUT TALLY	INPUT2 (SDI)	On: SHORT, Off: OPEN
3	OUT	PGM OUT TALLY	INPUT3 (SDI)	On: SHORT, Off: OPEN
4	OUT	PGM OUT TALLY	INPUT4 (SDI)	On: SHORT, Off: OPEN
5	OUT	PGM OUT TALLY	INPUT1 (VIDEO)	On: SHORT, Off: OPEN
6	OUT	PGM OUT TALLY	INPUT2 (VIDEO)	On: SHORT, Off: OPEN
7	OUT	PGM OUT TALLY	INPUT3 (HDMI)	On: SHORT, Off: OPEN
8	OUT	PGM OUT TALLY	INPUT4 (HDMI)	On: SHORT, Off: OPEN
9	-	GND	-	-