



Installation Guide

**Three Phase Inverter with  
Synergy Technology  
with SetApp Configuration**

For Australia

Version 1.3

# Disclaimers

## Important Notice

Copyright © SolarEdge Inc. All rights reserved.

No part of this document may be reproduced, stored in a retrieval system or transmitted, in any form or by any means, electronic, mechanical, photographic, magnetic or otherwise, without the prior written permission of SolarEdge Inc.

The material furnished in this document is believed to be accurate and reliable. However, SolarEdge assumes no responsibility for the use of this material. SolarEdge reserves the right to make changes to the material at any time and without notice. You may refer to the SolarEdge web site ([www.solaredge.com](http://www.solaredge.com)) for the most updated version.

All company and brand products and service names are trademarks or registered trademarks of their respective holders.

Patent marking notice: see <http://www.solaredge.com/patent>

The general terms and conditions of delivery of SolarEdge shall apply.

The content of these documents is continually reviewed and amended, where necessary. However, discrepancies cannot be excluded. No guarantee is made for the completeness of these documents.

The images contained in this document are for illustrative purposes only and may vary depending on product models.

## Emission Compliance

This equipment has been tested and found to comply with the limits applied by the local regulations.

These limits are designed to provide reasonable protection against harmful interference in a residential installation. This equipment generates, uses and can radiate radio frequency energy and, if not installed and used in accordance with the instructions, may cause harmful interference to radio communications. However, there is no guarantee that interference will not occur in a particular installation. If this equipment does cause harmful interference to radio or television reception, which can be determined by turning the equipment off and on, you are encouraged to try to correct the interference by one or more of the following measures:

- Reorient or relocate the receiving antenna.
- Increase the separation between the equipment and the receiver.
- Connect the equipment into an outlet on a circuit different from that to which the receiver is connected.
- Consult the dealer or an experienced radio/TV technician for help.

Changes or modifications not expressly approved by the party responsible for compliance may void the user's authority to operate the equipment.

# Contents

---

Disclaimers .....	1
Important Notice .....	1
Emission Compliance .....	2
<b>Contents</b> .....	<b>3</b>
<b>Version History</b> .....	<b>5</b>
<b>HANDLING AND SAFETY INSTRUCTIONS</b> .....	<b>6</b>
Safety Symbols Information .....	6
<b>IMPORTANT INVERTER SAFETY INSTRUCTIONS</b> .....	<b>6</b>
<b>Chapter 1: Introducing the SolarEdge Power Harvesting System</b> .....	<b>9</b>
Power Optimiser .....	9
Three Phase Inverter with Synergy Technology .....	10
Monitoring Platform .....	11
Supported AC Grids .....	11
Installation Procedure .....	12
Installation Equipment List .....	12
<b>Chapter 2: Installing the Power Optimisers</b> .....	<b>14</b>
Safety .....	14
Package Contents .....	15
Installation Guidelines .....	15
Step 1: Mounting the Power Optimisers .....	18
Step 2: Connecting a PV panel to a Power Optimiser .....	19
Step 3: Connecting Power Optimisers in Strings .....	19
Step 4: Verifying Proper Power Optimiser Connection .....	20
<b>Chapter 3: Installing the Primary and Secondary Unit(s)</b> .....	<b>21</b>
Primary Unit Package Contents .....	21
Secondary Unit Package Contents .....	21
Identifying the Units .....	21
Primary Unit Interface .....	22
Connection Unit Interface .....	25
Secondary Unit Interface .....	27
Opening Conduit Drill Guides .....	27
Mounting and Connecting the Primary and Secondary Unit(s) .....	29
<b>Chapter 4: Connecting the AC and DC Strings to the Connection Unit</b> .....	<b>37</b>
Grid Connection Guidelines .....	37
Connecting the AC Grid to the Connection Unit .....	38
Connecting the AC Grid and Grounding to the Connection Unit .....	39
Connecting the Strings to the Connection Unit .....	41
Selecting a Residual Current Device (RCD) .....	42

<b>Chapter 5: Activating, Commissioning and Configuring the System</b> .....	<b>44</b>
Step 1: Activating the Installation .....	44
Step 2: Commissioning and Configuring the Installation .....	45
Step 3: Verifying Proper Activation and Commissioning .....	47
Reporting and Monitoring Installation Data .....	48
Designer .....	49
Mapper Application .....	49
Physical Layout Editor .....	50
Using a Paper Template .....	50
<b>Chapter 6: Setting Up Communication to the Monitoring Platform</b> .....	<b>51</b>
Communication Options .....	52
Communication Connectors .....	53
Primary Unit Communication Board .....	54
Connection Unit Communication Board .....	55
Creating an Ethernet (LAN) Connection .....	56
Creating an RS485 Bus Connection .....	60
RS485 Bus Configuration .....	63
Verifying the Connection .....	64
<b>Appendix A: Errors and Troubleshooting</b> .....	<b>65</b>
Identifying Errors .....	65
Power Optimiser Troubleshooting .....	66
Troubleshooting Communication .....	68
<b>Appendix B: Mechanical Specifications</b> .....	<b>70</b>
Primary Unit and Connection Unit .....	70
Secondary Unit .....	70
<b>Appendix C: SafeDC™</b> .....	<b>71</b>
<b>Appendix D: External Fan Maintenance and Replacement</b> .....	<b>72</b>
Fan Maintenance .....	72
External Fan Replacement .....	72
<b>Appendix E: Replacing System Components</b> .....	<b>74</b>
Replacing the Primary Unit .....	74
Replacing a Secondary Unit .....	76
Replacing the Connection Unit .....	76
Replacing Power Optimisers .....	78
<b>Appendix F: Determining the Circuit Breaker Size</b> .....	<b>79</b>
Using Transformers in Commercial Three Phase Inverter Installations .....	79
Determining the Size of an Inverter Circuit Breaker .....	80
<b>Three Phase Inverter with Synergy Technology - Technical Specifications (Australia)</b> .....	<b>83</b>
<b>Support Contact Information</b> .....	<b>87</b>

# Version History

## Version 1.3 (July 2020)

- Updated *Power Optimiser Installation Guidelines* on page 15.
- Added a requirement to minimize the distance between the positive and negative DC optimiser cables in *Step 3: Connecting Power Optimisers in Strings* on page 19.
- Added the requirement for a special bracket, when installing close to the shoreline in *Mounting and Connecting the Primary and Secondary Unit(s)* on page 29.
- For inverter clearance, added a link to *Application Note - Clearance Guidelines* in *Mounting and Connecting the Primary and Secondary Unit(s)* on page 29
- Updated the lug requirements in *Connecting the AC Grid and Grounding to the Connection Unit* on page 39.
- Updated the communication board TCP details in *Creating an Ethernet (LAN) Connection* on page 56.
- Changed the cable type required for the RS485 and Ethernet connection to CAT6.
- Updated Activating, Commissioning and Configuring the System.

## Version 1.2 (February 2019)

- Added appendix 'Determining the Circuit Breaker Size' and paragraph referencing to it, in the 'Grid Connection Guidelines' section.

# HANDLING AND SAFETY INSTRUCTIONS

During installation, testing and inspection, adherence to all the handling and safety instructions is mandatory. **Failure to do so may result in injury or loss of life and damage to the equipment.**

## Safety Symbols Information

The following safety symbols are used in this document. Familiarize yourself with the symbols and their meaning before installing or operating the system.

### WARNING!



Denotes a hazard. It calls attention to a procedure that, if not correctly performed or adhered to, could result in **injury or loss of life**. Do not proceed beyond a warning note until the indicated conditions are fully understood and met.

### CAUTION!



Denotes a hazard. It calls attention to a procedure that, if not correctly performed or adhered to, could result in **damage or destruction of the product**. Do not proceed beyond a caution sign until the indicated conditions are fully understood and met.

### NOTE



Denotes additional information about the current subject.

### IMPORTANT SAFETY FEATURE



Denotes information about safety issues.

Disposal requirements under the Waste Electrical and Electronic Equipment (WEEE) regulations:



### NOTE

Discard this product according to local regulations or send it back to SolarEdge.

## IMPORTANT INVERTER SAFETY INSTRUCTIONS

SAVE THESE INSTRUCTIONS

### WARNING!



The inverter cover must be opened only after shutting off the inverter ON/OFF switch located at the bottom of the Primary Unit, above the Connection Unit. This disables the DC voltage inside the inverter and opens the AC relays. Wait five minutes before opening the cover. Otherwise, there is a risk of electric shock from energy stored in the capacitors.



P = Program/Pair  
1 = ON  
0 = OFF

**WARNING!**

Before operating the inverter, ensure that the inverter is grounded properly.

**WARNING!**

Opening the inverter and repairing or testing under power must be performed only by qualified service personnel familiar with this inverter.

**WARNING!**

Do not touch the PV panels or any rail system connected when the inverter switch is ON, unless grounded.

**WARNING!**

SafeDC complies with IEC60947-3 when installing the system with a worst case SafeDC voltage (under fault conditions) < 120V.



The worst case voltage is defined as:  $V_{oc,max} + (\text{String Length} - 1) * 1V$ , where:

- $V_{oc,max}$  = Maximum  $V_{oc}$  (at lowest temperature) of the PV panel in the string (for a string with multiple panel models, use the max value)
- String Length = number of power optimisers in the string

**CAUTION!**

This unit must be operated according to the technical specification datasheet provided with the unit.

**CAUTION!**

**HEAVY OBJECT.** To avoid muscle strain or back injury, use proper lifting techniques, and if required - a lifting aid.

**NOTE**

Use PV panels rated according to IEC 61730 class A.

**NOTE**

The symbol  appears at grounding points on the SolarEdge equipment. This symbol is also used in this manual.



## NOTE

A SolarEdge inverter may be installed in a site with a generator. SolarEdge requires installing a physical or electronic interlock, which will signal to the inverter when the grid has been disconnected. Interlock procurement, installation, maintenance and support are the responsibility of the installer.



Damage to the inverter due to incorrect interlock installation or use of an interlock that is incompatible with the SolarEdge system will render the SolarEdge warranty invalid.

For more information, refer to

<https://www.solaredge.com/sites/default/files/se-inverter-support-of-voltage-sources.pdf>.



## NOTE

The following warning symbols appear on the inverter warning label:



Risk of electric shock



5 Minutes

Risk of electric shock from energy stored in the capacitor. Do not remove cover until 5 minutes after disconnecting all sources of supply.



Hot surface – To reduce the risk of burns, do not touch.

For details refer to: [http://www.solaredge.com/files/pdfs/lightning\\_surge\\_protection.pdf](http://www.solaredge.com/files/pdfs/lightning_surge_protection.pdf)

# Chapter 1: Introducing the SolarEdge Power Harvesting System

The SolarEdge power harvesting solution is designed to maximize the power output from any type of solar Photovoltaic (PV) installation while reducing the average cost per watt. The following sections describe each of the system's components.

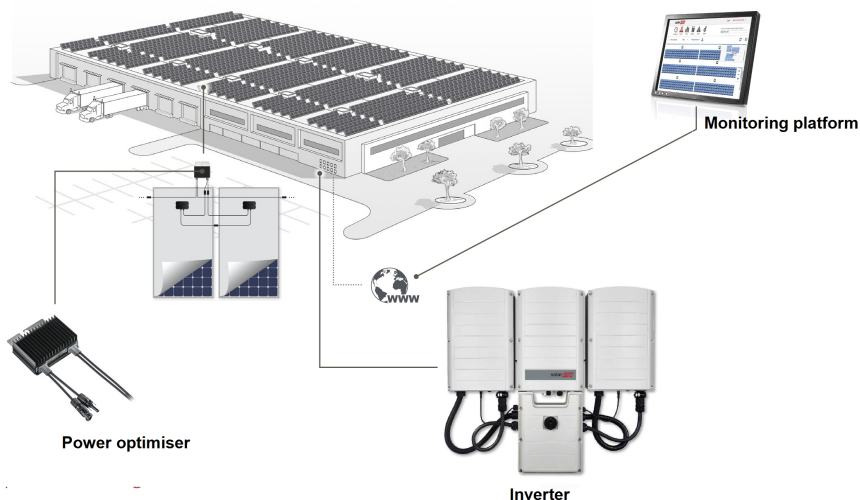

Figure 1: The SolarEdge power harvesting system components

## Power Optimiser

The power optimisers are DC-DC converters connected to PV panels in order to maximize power harvesting by performing independent Maximum Power Point Tracking (MPPT) at the panel level.

The power optimisers regulate the string voltage at a constant level, regardless of string length and environmental conditions.

The power optimisers include a safety voltage function that automatically reduces the output of each power optimiser to 1 Vdc in the following cases:

- During fault conditions
- The power optimisers are disconnected from the inverter
- The inverter ON/OFF/P switch is turned OFF

- The safety switch on the Connection Unit is turned OFF
- The inverter AC breaker is turned OFF

Each power optimiser also transmits panel performance data over the DC power line to the inverter.

Two types of power optimisers are available:

- panel add-on power optimiser – connected to one or more panels
- smart panels - the power optimiser is embedded into a panel

## Three Phase Inverter with Synergy Technology

The Three Phase Inverter with synergy technology inverter (referred to as 'inverter' in this manual ) efficiently converts DC power from the panels into AC power that can be fed into the main AC service of the site and from there to the grid. The inverter also receives the monitoring data from each power optimiser and transmits it to the SolarEdge monitoring platform (requires Internet or Cellular connection).

The inverter is comprised of one Primary Unit with an integrated Connection Unit with a DC Safety Switch (referred to as 'Connection Unit ' in this manual) for disconnecting the DC power of a SolarEdge system, and of one or two Secondary Units, depending on the inverter's capacity. The Secondary Unit(s) are connected to the primary unit with AC, DC and communication cables.

Each unit operates independently and continues to work in case the others are not operating.

You can set up a leader-follower configuration, connecting up to 31 additional inverters to one leader inverter.

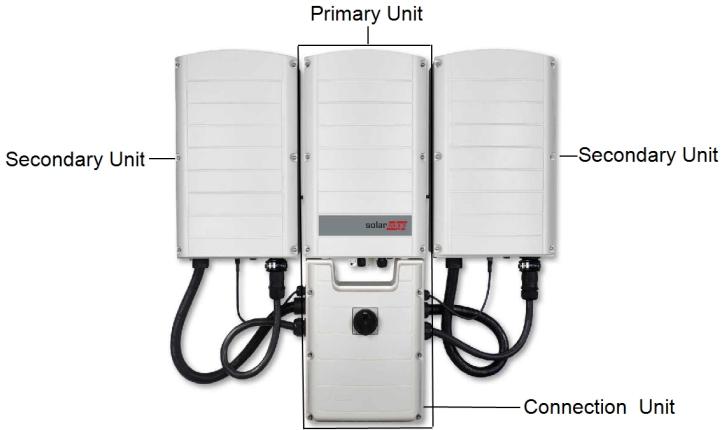

Figure 2: Primary Unit with two Secondary Units

## Monitoring Platform

The monitoring platform enables monitoring the technical and financial performance of one or more SolarEdge sites. It provides past and present information on the system performance both at the system and panel levels.

## Supported AC Grids

The following section shows the AC grids supported by the inverters (model dependent).

Ground connection is required for all grids, as described in *Connecting the AC Grid and Grounding to the Connection Unit* on page 39.

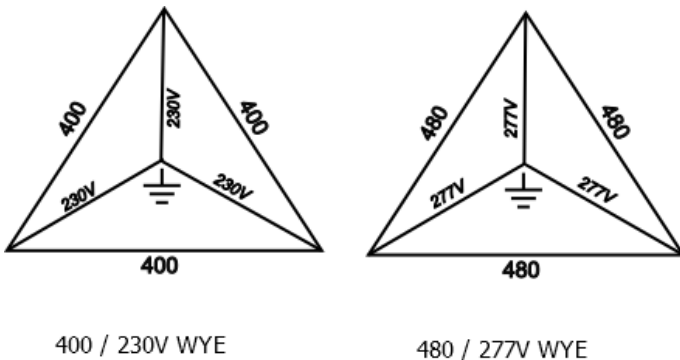

Figure 3: AC grids supported by SolarEdge three-phase inverters

## Installation Procedure

The following is the procedure for installing and setting up a new SolarEdge site. Many of these also apply to modification of an existing site.

1. [Installing the Power optimisers](#), page 14
2. [Mounting and Connecting the Primary and Secondary Unit\(s\)](#), page 29

### NOTE



It is recommended to connect communication connections (step 6 of this installation) before connecting the AC, for easier access to the communication board.

3. [Connecting the AC and the Strings to the Connection Unit](#), page 37
4. [Activating and Commissioning the System Using SetApp](#), page 44
5. [Configuring the System Using SetApp](#), page 47
6. [Setting Up Communication](#), page 51

## Installation Equipment List

Standard tools can be used during the installation of the SolarEdge system. The following is a recommendation of the equipment needed for installation:

- Allen screwdriver for 5mm screw type for the inverter cover, Connection Unit cover, and inverter side screws
- Allen screwdriver for M5/M6/M8 screw types
- 17/32 HEX Allen screwdriver for AC stud connector
- SolarEdge supplied DC / interlock conduit(s)
- Standard flat-head screwdrivers set
- Non-contact voltage detector
- Cordless drill (with a torque clutch) or screwdriver and bits suitable for the surface on which the inverter and optimisers will be installed. Use of an impact driver is *not* allowed.
- Appropriate mounting hardware (for example: stainless bolts, nuts, and washers) for attaching:
  - Primary and Secondary Unit(s) mounting brackets to the mounting surface
  - Ppower optimisers to the racking (not required for smart panels)
  - MC4 crimper

- 4xM8 ring terminals and suitable crimper
- Wire cutters
- Wire strippers
- Voltmeter

For installing the communication options, you may also need the following:

- For Ethernet:
  - CAT6 twisted pair Ethernet cable with RJ45 connector
  - If using a CAT6 cable spool: RJ45 plug and RJ45 crimper
- For RS485:
  - Four- or six-wire shielded twisted pair cable
  - Watchmaker precision screwdriver set

For secondary grounding:

- Ring terminal crimper for the AC wire
- Ring terminal
- Serrated washer
- Grounding screw
- Two washers

## Chapter 2: Installing the Power Optimisers

### Safety

The following notes and warnings apply when installing the SolarEdge power optimisers. Some of the following may not be applicable to smart panels:

**WARNING!**

When modifying an existing installation, turn OFF the inverter ON/OFF switch, the Connection Unit and the AC circuit breaker on the main AC distribution panel.

**CAUTION!**

Power optimisers are IP68/NEMA6P rated. Choose a mounting location where optimisers will not be submerged in water.

**CAUTION!**

This unit must be operated according to the operating specifications provided with the unit.

**CAUTION!**

Cutting the power optimiser input or output cable connector is prohibited and will void the warranty.

**CAUTION!**

All PV panels must be connected to a power optimiser.

**CAUTION!**

If you intend to mount the optimisers directly to the panel or panel frame, first consult the panel manufacturer for guidance regarding the mounting location and the impact, if any, on panel warranty. Drilling holes in the panel frame should be done according to the panel manufacturer instructions.

**IMPORTANT SAFETY FEATURE**

Modules with SolarEdge power optimisers are safe. They carry only a low safety voltage before the inverter is turned ON. As long as the power optimisers are not connected to the inverter or the inverter is turned OFF, each power optimiser will output a safe voltage of 1V.

**CAUTION!**

Installing a SolarEdge system without ensuring compatibility of the module connectors with the optimiser connectors may be unsafe and could cause functionality problems such as ground faults, resulting in inverter shut down. To ensure mechanical compatibility of the SolarEdge optimisers' connectors with the PV panels' connectors to which they are connected:



- Use identical connectors from the same manufacturer and of the same type on both the power optimisers and on the panels; or
- Verify that the connectors are compatible in the following way:
- The panel connector manufacturer should explicitly verify compatibility with the SolarEdge optimiser connector; and
- A third-party test report by one of the listed external labs (TUV, VDE, Bureau Veritas UL, CSA, InterTek) should be obtained, verifying the compatibility of the connectors.

## Package Contents

- Power optimisers
- Stainless steel grounding lock washers

## Installation Guidelines

- For the minimum and maximum number of power optimisers in a string (string length), see the power optimiser datasheets. Refer to the Designer for string length verification. The Designer is available on the SolarEdge website at: <https://www.solaredge.com/products/installer-tools/designer#/>.
- The length of home-run cables from the first and last power optimiser to the inverter (total cable length) may not exceed the following values:

Single Phase Inverters	Three Phase Inverters
All - 1000 ft. /300 m	SE17K and below - 1000 ft. /300 m Above SE17K - 2300 ft. /700 m



- Do not use extension cables between a panel and a power optimiser, between two panels connected to the same power optimiser, or between two power optimisers other than in the following cases:

#### **Between a power optimiser and a panel:**

- Power optimisers with the 4-type suffix in their part number (Pxxx-4xxxxxx) - extension cables of up to 16 m can be installed per power optimiser (8 m for DC+ and 8 m for DC-).
- Power optimisers manufactured starting from working week 42, 2019, as indicated in the serial number (Example: S/N SJ5019A-xxxxxxx - working week 50, 2019) - extension cables of up to 16 m can be installed per power optimiser (8 m for DC+ and 8 m for DC-).

#### **Between two power optimisers or between a power optimiser and the inverter:**

- Extension cables can be installed between power optimisers only from row to row, around obstacles or pathways within a row, and from the end of the string to the inverter, as long as the total cable length is not exceeded.
  - For connecting power optimisers to the inverter, use cables with a minimum cross-section of 11 AWG/ 4 mm<sup>2</sup> DC cables.
  - Frame-mounted power optimisers are mounted directly on the panel frame, regardless of racking system (rail-less or with rails). For installation of frame-mounted power optimisers, refer to [http://www.solaredge.com/sites/default/files/installing\\_frame\\_mounted\\_power\\_optimizers.pdf](http://www.solaredge.com/sites/default/files/installing_frame_mounted_power_optimizers.pdf).
- 
- The power optimiser can be placed in any orientation.
  - If connecting more panels than power optimiser inputs in parallel, use a branch cable. Some commercial power optimiser models have a dual input.
  - Position the power optimiser close enough to its panel so that their cables can be connected.
  - Make sure to use power optimisers that have the required output conductor length.
  - Completely shaded panels may cause their power optimisers to temporarily shut down. This will not affect the performance of the other power optimisers in the string, as long as the minimum number of unshaded power optimisers connected in a string of panels is met. If under typical conditions fewer than the minimum power optimisers are connected to unshaded panels, add more power optimisers to the string.

■ To allow for heat dissipation, maintain clearance as specified below.

All power optimisers, except for the P860 and M1600 power optimisers

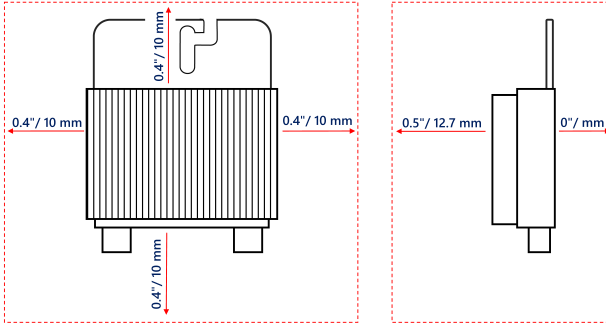

P860 and M1600 power optimisers

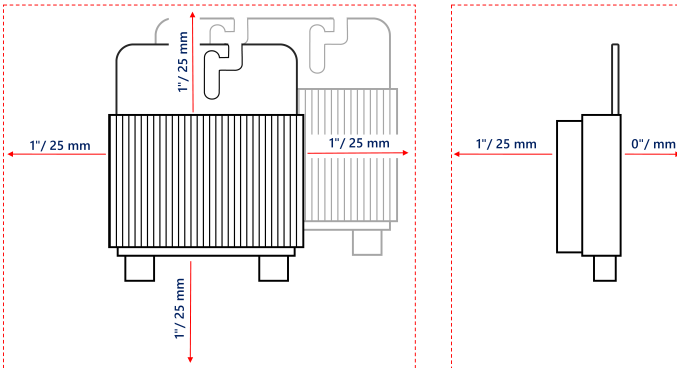

Figure 4: Power optimiser clearance

■ When installing panels in a confined space, for example, if installing Building-integrated photovoltaic (BIPV) panels, ventilation measures may be needed to ensure the power optimisers are not be exposed to temperatures outside their specifications.

## Step 1: Mounting the Power Optimisers

For each of the power optimisers<sup>(1)</sup>:

1. Determine the power optimiser mounting location and use the power optimiser mounting brackets to attach the power optimiser to the support structure. It is recommended to mount the power optimiser in a location protected from direct sunlight. For frame-mounted power optimisers follow the instructions supplied with the optimisers, or refer to [https://www.solaredge.com/sites/default/files/installing\\_frame\\_mounted\\_power\\_optimizers.pdf](https://www.solaredge.com/sites/default/files/installing_frame_mounted_power_optimizers.pdf).
2. If required, mark the mounting hole locations and drill the hole.



### CAUTION!



Drilling vibrations may damage the power optimiser and will void the warranty. Use a torque wrench or an electric drill with adjustable clutch that meets the mounting torque requirements. *Do not* use impact drivers for mounting the power optimiser.

*Do not* drill through the power optimiser or through the mounting holes.

3. Attach each power optimiser to the rack using M6 (1/4") stainless steel bolts, nuts and washers or other mounting hardware. Apply torque of 9-10 N\*m / 6.5-7 lb\*ft.
4. Verify that each power optimiser is securely attached to the panel support structure.
5. Record power optimiser serial numbers and locations, as described in *Reporting and Monitoring Installation Data* on page 48.

---

<sup>(1)</sup>Not applicable to smart panels.

## Step 2: Connecting a PV panel to a Power Optimiser



### NOTE

Images are for illustration purposes only. Refer to the label on the product to identify the plus and minus input and output connectors.

For each of the power optimisers:

- Connect the Plus (+) output connector of the panel to the Plus (+) input connector of the power optimiser.
- Connect the Minus (-) output connector of the panel to the Minus (-) input connector of the power optimiser.

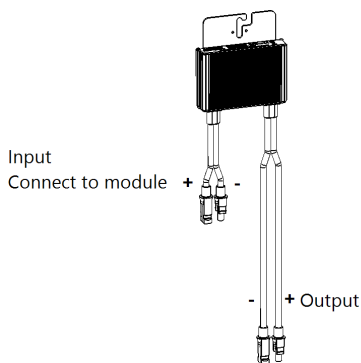

Figure 5: Power optimiser connectors

## Step 3: Connecting Power Optimisers in Strings

You can construct parallel strings of unequal length, that is, the number of power optimisers in each string does not have to be the same. The minimum and maximum string lengths are specified in the power optimiser datasheets. Refer to the SolarEdge Site Designer for string length verification.



### NOTE

The DC bus of each unit is separate and not shared for all units. Therefore, in addition to following the inverter design rules, each unit should follow the unit design rules as detailed in the Technical Specifications.

1. Connect the Minus (-) output connector of the string's first power optimiser to the Plus (+) output connector of the string's second power optimiser.
2. To minimize electromagnetic interference (EMI), make sure to minimize the distance between the positive and negative DC cables.

For detailed instructions, see:

<https://www.solaredge.com/sites/default/files/se-emi-performance-application-note.pdf>



3. Connect the rest of the power optimisers in the string in the same manner.
4. If you intend to monitor the installation using the SolarEdge monitoring platform, record the physical location of each power optimiser, as described in *Creating Logical and Physical Layout using Installation Information* on page 49.

## Step 4: Verifying Proper Power Optimiser Connection

When a panel is connected to a power optimiser, the power optimiser outputs a safe voltage of 1V ( $\pm 0.1V$ ). Therefore, the total string voltage should equal 1V times the number of power optimisers connected in series in the string. For example, if 10 power optimisers are connected in a string, then 10V should be produced.

Make sure the PV panels are exposed to sunlight during this process. The power optimiser will only turn ON if the PV panel provides at least 2W.

In SolarEdge systems, due to the introduction of power optimisers between the PV panels and the inverter, the short circuit current  $I_{SC}$  and the open circuit voltage  $V_{OC}$  hold different meanings from those in traditional systems.

For more information about the SolarEdge system's string voltage and current, refer to the  $V_{OC}$  and  $I_{SC}$  in *SolarEdge Systems Technical Note*, available on the SolarEdge website at:

[https://www.solaredge.com/sites/default/files/isc\\_and\\_voc\\_in\\_solaredge\\_systems\\_technical\\_note.pdf](https://www.solaredge.com/sites/default/files/isc_and_voc_in_solaredge_systems_technical_note.pdf)



→ To verify proper power optimiser connection:

- Measure the voltage of each string individually before connecting it to the other strings or to the inverter. Verify correct polarity by measuring the string polarity with a voltmeter. Use a voltmeter with at least 0.1V measurement accuracy.



### NOTE

Since the inverter is not yet operating, you may measure the string voltage and verify correct polarity on the DC wires inside the Connection Unit.

For troubleshooting power optimiser operation problems, refer to *Power Optimiser Troubleshooting* on page 66.

## Chapter 3: Installing the Primary and Secondary Unit(s)

Install the units either before or after the panels and power optimisers have been installed.

First install the Primary Unit, then the Secondary Unit(s) (in any order).



### CAUTION!

Do not rest the connectors at the bottom of the units on the ground, as it may damage them. To rest a unit on the ground, lay it on its back.

### Primary Unit Package Contents

- Primary Unit (comprised of an inverter and Connection Unit) and pre- assembled cables that connect to the Secondary Unit(s)
- Mounting bracket kit
- Two Allen screws for fastening the unit to the mounting bracket
- Cable lock(s)
- For built-in wireless communication: antenna and mounting bracket
- Installation guide

### Secondary Unit Package Contents

- Secondary Unit
- Mounting bracket kit
- Two Allen screws for fastening the unit to the mounting bracket
- Machine screws for connecting the interlocks
- Conduits

### Identifying the Units

The stickers on the Primary Unit and on the Connection Unit specify the inverter's **Serial Number** and **Electrical Ratings**.

When opening a site in the SolarEdge monitoring platform and when contacting SolarEdge support, provide the inverter's serial number.

## Primary Unit Interface

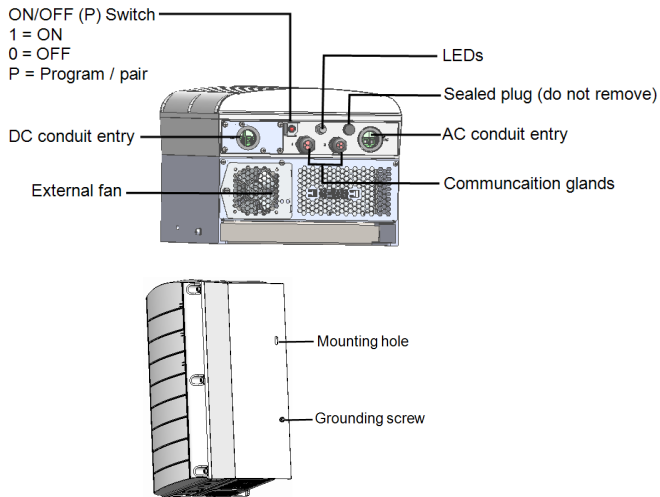

Figure 6: Primary Unit bottom and side interfaces

- **Mounting hole:** for securing the unit to the bracket and for connecting an optional secondary grounding cable.
- **Grounding screw:** for connecting an optional secondary grounding cable.
- **AC and DC conduit entries:** Connection points of the Connection Unit.
- **Two communication glands,** for connection of communication options. Each gland has three openings. Refer to *Setting Up Communication to the Monitoring Platform* on page 51 for more information.
- **ON/OFF/P Switch:**



P = Program/Pair  
1 = ON  
0 = OFF

Figure 7: ON/OFF/P switch

- **ON (1)** - Turning this switch ON (after optimiser pairing) starts the operation of the power optimisers, enables power production and allows the inverter to begin exporting power to the utility grid.
- **OFF (0)** - Turning this switch OFF reduces the power optimiser voltage to a low safety voltage and inhibits exportation of power. When this switch is OFF, the Primary and Secondary Units' control circuitry remains powered up.
- **P** - Moving and releasing the switch allows viewing system information via the LEDs and on the SolarEdgeSetApp mobile application screen and performing functions:

P Position duration	Function	Comments
Switch moved to P for <b>less than 5 seconds</b> , then released.	<ul style="list-style-type: none"> <li>• Displays production information for 5 seconds on the SetApp screen.</li> <li>• Displays error type indications (if exist) for 5 seconds.</li> <li>• Activates the Wi-Fi access point for connecting to the SolarEdge Inverter SetApp</li> </ul>	While the switch is in P, all LEDs are ON
Switch moved to P for <b>more than 5 seconds</b> , then released.	Starts pairing	

- **LEDs:** three LEDs indicate, by color and state (on/ off/ blinking<sup>(1)</sup>/ flickering<sup>(2)</sup>/alternating<sup>(3)</sup>), different system information, such as errors or performance indications.

Generally, the main LED indications are:

---

(1)Blinking = Turns ON and OFF for the same duration

(2)Flickering = Turns ON for 100 mS and turns OFF for 5 seconds

(3)Alternating = Alternate LEDs flash



- Blue ON - the inverter is communicating with the monitoring platform
- Green ON - the system is producing
- Green blinking - AC is connected but the system is not producing
- Red ON - system error

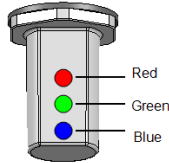

Figure 8: LEDs

The following table describes system performance information by LED color and ON/OFF/P switch position.

Indication	ON/ OFF/ P switch position	LED color			Comment
		Red	Green	Blue	
Power optimisers not paired	ON (1)	OFF	Blinking	<ul style="list-style-type: none"> <li>• S_OK: ON</li> <li>• No S_OK: OFF</li> </ul>	S_OK: ON communication with the monitoring platform is established
Pairing		Blinking	Blinking	Blinking	
Wake-up/ Grid Monitoring		OFF	Blinking	Blinking	
System Producing		OFF	ON	<ul style="list-style-type: none"> <li>• S_OK: ON</li> <li>• No S_OK: OFF</li> </ul>	
Night mode (no production)		OFF	Flickering	<ul style="list-style-type: none"> <li>• S_OK: ON</li> <li>• No S_OK: OFF</li> </ul>	
Inverter is OFF (Safe DC)	OFF (0)	OFF	Blinking	<ul style="list-style-type: none"> <li>• No S_OK: OFF</li> </ul>	
Inverter is OFF (DC not safe)		Blinking	Blinking	<ul style="list-style-type: none"> <li>• S_OK: ON</li> <li>• No S_OK: OFF</li> </ul>	
Inverter	ON / P	ON	ON	ON	

Indication	ON/ OFF/ P switch position	LED color			Comment
		Red	Green	Blue	
configuration or reboot					
Inverter firmware upgrade	ON / P	Alternating	Alternating	Alternating	The upgrade process can take up to 20 minutes
Error	Any	ON	ON/ OFF/ Blinking/ Flickering	ON/ OFF / Blinking/ Flickering	Refer to <i>Errors and Troubleshooting</i> on page 65

The following table describes production percentage of AC information by LED color and ON/OFF/P switch position.

Indication	ON/ OFF/ P switch position	LED color			Comment
		Red	Green	Blue	
Percentage of AC Production: 0 - 33 %	ON (1)	OFF	ON	OFF	This indicates power production as percentage of rated peak AC output power
Percentage of AC Production: 33 - 66 %		OFF	OFF	ON	
Percentage of AC Production: 66 - 100 %		OFF	ON	ON	

## Connection Unit Interface

The Connection Unit is part of the Primary Unit.

### NOTE



In the following figure the connections to the Secondary Unit are shown only on the left side of the Connection Unit; for an inverter that has two Secondary Units, similar connections are located on the other side of the unit as well.

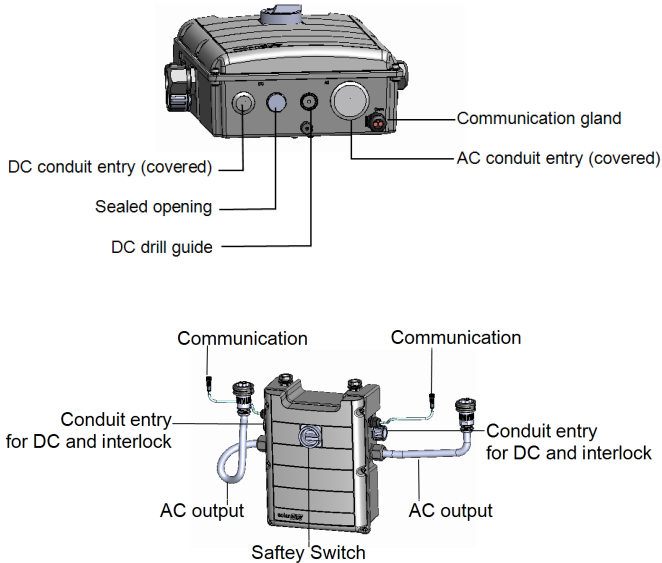

Figure 9: Connection Unit bottom, front and side interface

- **Safety switch:** a manually operated safety switch for disconnecting the DC power of the SolarEdge system.

#### NOTE

When the Connection Unit is OFF (for example during maintenance) it may be locked to prevent a safety hazard:



Lock here



1. Move the switch to the Lock position.
2. Insert the lock through the knob opening and lock.

- Cables for connection to the Secondary Unit(s):
  - Communication Cable
  - DC and interlock Cables
  - AC Cable
- **DC conduit entries:** three DC conduits for connecting the PV
- **AC drill guide entry:** AC drill guide for grid connection

- **Communication gland:** for connection of communication options. Refer to *Setting Up Communication to the Monitoring Platform* on page 51.

## Secondary Unit Interface

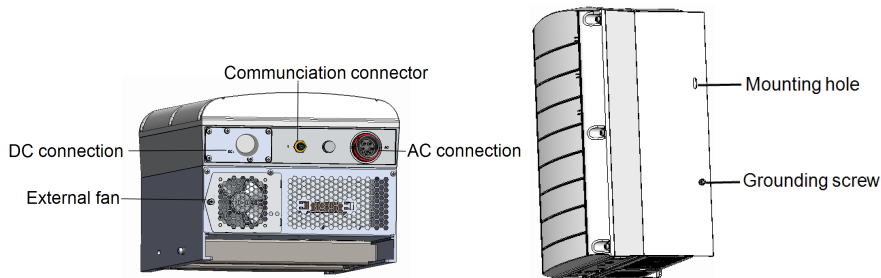

Figure 10: Secondary Unit bottom and side interfaces

- The Secondary units connectors are for connection to the Primary Unit:
  - **DC connection:** for connection of the PV installation
  - **Communication connector:** for communication options
  - **AC connector:** for connection of the AC
- **Mounting hole:** for securing the unit to the bracket and for connecting an optional secondary grounding cable.
- **Grounding screw:** for connecting an optional secondary grounding cable.

## Opening Conduit Drill Guides

This section describes how to open the AC and DC drill guides.

This step may be performed before or after mounting the inverter.

→ To open conduit drill guides:

1. Ensure that the Connection Unit and inverter ON/OFF switch are set to OFF.
2. Loosen the screws on the front cover of the Connection Unit.

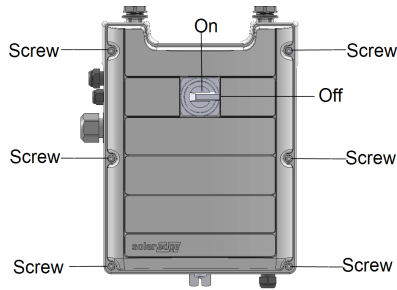

Figure 11: Opening the Connection Unit cover

3. Remove the Connection Unit cover.
4. Open the required AC and DC conduit openings according to the conduits used in the installation.  
The conduit entries (usually covered) and the drill guides are located at the bottom of the enclosure.

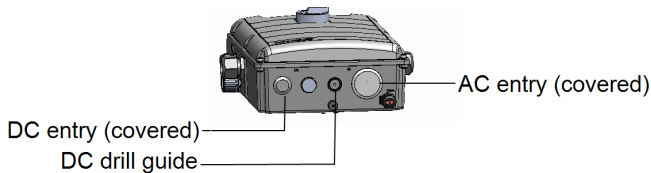

Figure 12: Connection Unit drill guides

- Open the DC entry cover. If needed, knockout the DC drill guide.

**NOTE**

The Connection Unit is provided with one open DC conduit opening and with one closed drill guide. If you require an additional conduit entry, open the drill guide.

- Open the AC conduit entry.  
If using one Secondary Unit, open the drill guide according to the smaller size marking. If using two Secondary Units you can open it to a larger diameter according to the cable size.

**NOTE**

Unused conduit openings and glands should be sealed with appropriate seals.

## Mounting and Connecting the Primary and Secondary Unit(s)

The inverter is typically mounted vertically, and the instructions in this section are applicable for vertical installation. Some SolarEdge inverters model can be installed horizontally (above 10° tilt) as well as vertically. For information and instructions for horizontal mounting refer to [http://www.solaredge.com/sites/default/files/application\\_note\\_horizontal\\_mounting\\_of\\_three\\_phase\\_inverters.pdf](http://www.solaredge.com/sites/default/files/application_note_horizontal_mounting_of_three_phase_inverters.pdf)



First mount the Primary Unit then the Secondary Unit(s).

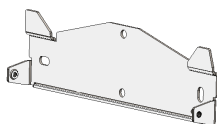

Figure 13: Mounting bracket

### NOTE



Make sure the mounting surface or structure can support the weight of the inverter and brackets, and make sure that it spans the width of the mounting brackets.

### CAUTION!



**HEAVY OBJECT.** To avoid muscle strain or back injury, use proper lifting techniques, and if required - a lifting aid.

### CAUTION!



SolarEdge inverters and power optimisers can be installed at a minimum distance of 50 m / 164 ft from the shoreline of an ocean or other saline environment, as long as there are no direct salt water splashes on the inverter or power optimiser.

For SolarEdge inverters installed at a distance of 200 m / 655 ft. or closer to the shoreline, special brackets purchased separately from SolarEdge and SS304 stainless screws are required.

1. Determine the inverter mounting location, on a wall or stud framing . It is recommended to mount the inverter in a location protected from direct sunlight.
2. To allow for proper heat dissipation, follow the guidelines specified in *Application Note - Clearance Guidelines*

<https://www.solaredge.com/sites/default/files/se-clearance-guidelines-for-multiple-inverter-mounting.pdf>



Maintaining proper clearance between the inverter and other objects prevents power reduction due to excessive temperature.

3. Position the mounting brackets against the wall and mark the required drilling holes locations.
4. Drill two holes for each bracket and mount the brackets.
5. Mount the Primary Unit bracket and put in the screws.
6. Tighten the Primary Unit screws all the way and verify that the bracket is firmly attached to the mounting surface.
7. Mount the Primary Unit:
  - a. Lift the Primary Unit from its sides.
  - b. Align the two indentations in the enclosure with the two triangular mounting tabs of the bracket, and lower the unit until it rests on the bracket evenly (see *Figure 14*).
  - c. Insert the supplied screw through the right side of the heat sink and into the bracket.

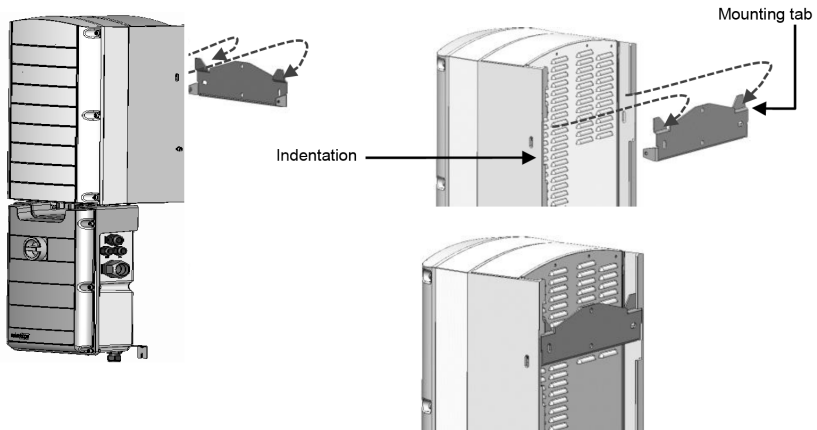

Figure 14: Hanging units

#### NOTE



If connecting secondary grounding, the grounding cable on either side of the chassis, to the upper mounting screw or to the lower grounding screw, before hanging the unit on the bracket, see *Connecting the AC Grid and Grounding to the Connection Unit* on page 39.

8. Mount the Secondary Unit(s):

- There is no specific order for hanging the Secondary Units.  
When installing a 2 unit inverter, mount the Secondary Unit to the left of the Primary Unit.
  - Lift the Secondary Unit(s) from the sides, or hold it at the top and bottom of the unit to lift into place.
  - Align the two indentations in the enclosure with the two triangular mounting tabs of the bracket, and lower the unit until it rests on the bracket evenly (see *Figure 14*).
  - Insert one of the supplied screws through the outer side of the heat sink and into the bracket. Tighten the screws with a torque of 4.0N\*m / 2.9 lb.\*ft.
9. Secure the Connection Unit to the wall:
- Mark the location of the bracket screw and drill the hole
  - Fasten the bracket using a standard bolt
  - Verify that the bracket is firmly attached to the mounting surface .

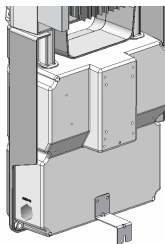

Figure 15: Connection Unit bracket

10. Connect the Connection Unit cables to the Secondary Unit(s) connectors:
- Communication cable to communication connector
  - AC cable to AC connector:
    - Position the cable so that the arrows are facing you.
    - Plug the AC cable into the Secondary Unit.
    - Rotate the cable connector clockwise to fasten it.



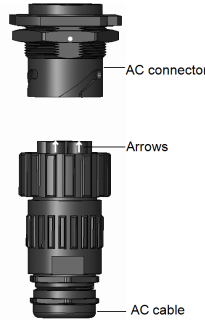

Figure 16: Connecting the AC connector to a Secondary Unit



**NOTE**

When connecting the AC cable to the left Secondary Unit, loop the cable ( see the following figure) to prevent pressure on the gland.



Figure 17: Connecting the Connection Unit to the Secondary Unit

- Assemble the two parts of the cable lock (supplied with the inverter) around the cable connector, making sure that the orientation of the printed text on the lock is correct. Push the parts together until they click to lock. To open

the lock use a flat-bladed screwdriver.

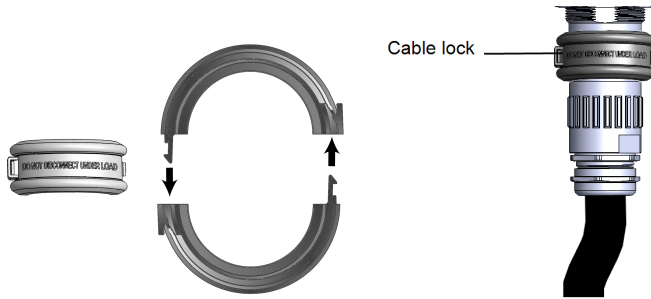

Figure 18: Cable lock

■ DC cables to DC+ and DC- connectors:

Connect the DC wires and the DC interlock trimmer lines from the Secondary Unit(s) to the Connection Unit, using the supplied conduits. The DC wires and the interlock lines are pre-connected to the Secondary Unit. The inverter interlock is used to mechanically interlock the inverter units to the Connection Unit. This allows removal of the units without risk of electrical hazards.

- Feed the two interlock trimmer lines together with the DC cables through the conduit supplied with the inverter.
- Attach the conduit connector to the conduit entry at the bottom of the Secondary Unit and push it in until it clicks into place.



Figure 19: Connecting the conduit to the Secondary Unit

- Feed the two interlock cables together with the DC cables through the conduit entry at the side of the Connection Unit.
- Attach the other end of the conduit connector to the conduit entry on the side of the Connection Unit and push it in until it clicks into place.

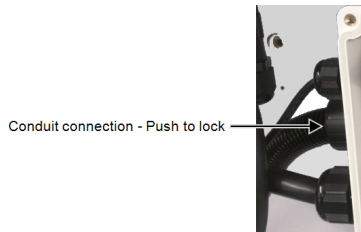

Figure 20: Connecting the conduit to the Connection Unit

**NOTE**

When connecting the right Secondary unit to the Connection Unit ,loop the conduit before connecting it to the Connection Unit.



Loop the conduit

- Connect the lugs with the supplied machine screw to one of the captive screws at the top corner of the Connection Unit .If you are using another Secondary Unit repeat this step to connect the lugs to the Connection Unit.

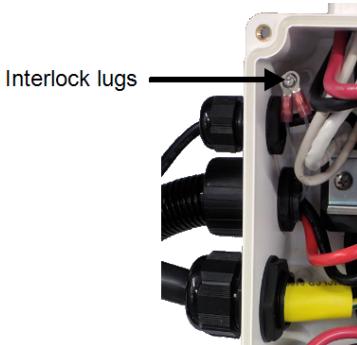

Figure 21: Connecting the interlock

- Connect the DC wires (Plus and Minus) from the Secondary Unit(s) to the terminal blocks in the Connection Unit. If you are using another Secondary Unit repeat this step to connect the DC wires to the Connection Unit.

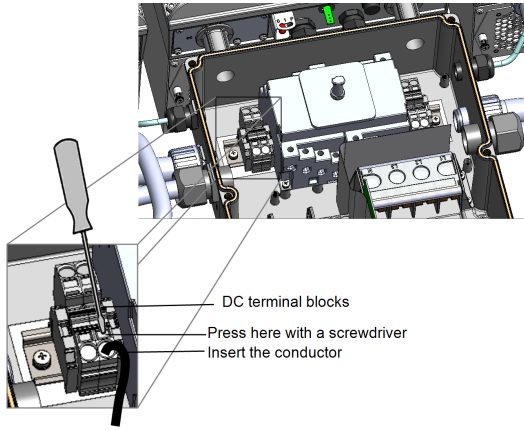

Figure 22: Connecting the DC wires

## Chapter 4: Connecting the AC and DC Strings to the Connection Unit

This section describes how to connect the inverter to the AC grid, and to the PV strings. Inverters of different models might be equipped with different sizes/ types of terminal blocks.

### Grid Connection Guidelines

#### NOTE

In most countries, SolarEdge three phase inverters require neutral connection at all times (only grids with neutral connection are supported).

In some countries, the SolarEdge three phase inverters can be connected to 220/230/480V delta grids. For more information prior to system installation refer to:

- Three Phase Inverters for Delta Grids application note



[https://www.solaredge.com/sites/default/files/se\\_three\\_phase\\_inverters\\_for\\_delta\\_grids.pdf](https://www.solaredge.com/sites/default/files/se_three_phase_inverters_for_delta_grids.pdf)



- Supported Countries application note to confirm compatibility [http://www.solaredge.com/sites/default/files/se\\_inverters\\_supported\\_countries.pdf](http://www.solaredge.com/sites/default/files/se_inverters_supported_countries.pdf); installing without confirmation may void the inverter warranty.



---

For recommended circuit breaker size per model, refer to *Determining the Circuit Breaker Size* on page 79.

For more wiring information refer to the *SolarEdge Recommended AC Wiring Application Note*, available on the SolarEdge website at <http://www.solaredge.com/files/pdfs/application-note-recommended-wiring.pdf>.



## Connecting the AC Grid to the Connection Unit

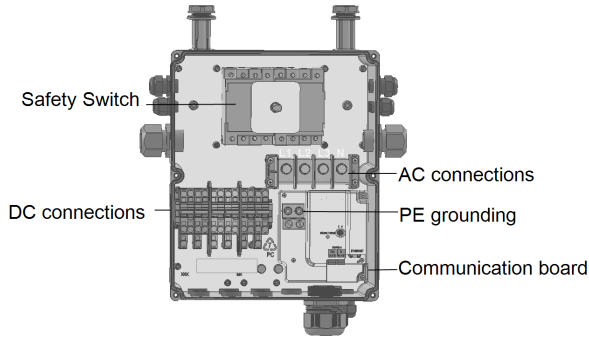

Figure 23: Inside the Connection Unit

### NOTE



Functional electrical earthing of DC-side negative or positive poles is prohibited because the inverter has no transformer. Grounding (earth ground) of panel frames and mounting equipment of the PV array panels is acceptable.

### NOTE



SolarEdge's fixed input voltage architecture enables the parallel strings to be of different lengths. Therefore, they do not need to have the same number of power optimisers, as long as the length of each string is within the permitted range.

### WARNING!



Turn OFF the AC before connecting the AC terminals. If connecting equipment grounding wire, connect it before connecting the AC Line and Neutral wires.

### NOTE



It is recommended to connect communication connections (*Setting Up Communication to the Monitoring Platform* on page 51) before connecting the AC, for easier access to the communication board.

## Connecting the AC Grid and Grounding to the Connection Unit

This section describes how to connect the AC grid and grounding to the Connection Unit.

### Grounding

For grounding the Primary unit you can:

- thread a 4 wire AC cable through the AC gland and use an additional wire/cable for PE.  
-or-
- thread a 5 wire AC cable with a PE (grounding) wire through the AC gland, see the following procedure. The AC gland supports a cable of 20-38 mm diameter, for larger cables use the previous option.

→ To connect AC and ground:

1. Turn OFF the AC circuit breaker.
2. Open the Connection Unit cover: Release the six Allen screws and carefully move the cover horizontally before lowering it.

#### CAUTION!



When removing the cover, make sure not to damage internal components. SolarEdge will not be held responsible for any components damaged as a result of incautious cover removal.

3. Remove the terminal block cover.
4. Strip the required length of the external and internal cables insulation.

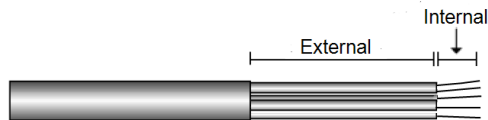

Figure 24: Insulation stripping – AC

5. Open the AC cable gland and insert the cable through the AC gland.



**WARNING!**



Turn OFF the AC before connecting the AC terminals. If connecting equipment grounding wire, connect it before connecting the AC Line and Neutral wires.

6. If using a separate wire / cable for grounding , insert the additional wire/ cable for grounding through the PE gland.
  - Strip the required length of the external and internal cables insulation.
  - Open the PE cable gland and insert the cable through the PE gland.
7. Connect the grounding wire to the grounding terminal block and tighten with a torque of 15N\*m.
8. Remove the screws from the AC terminal blocks.
9. Crimp ring terminals on the AC wires.

Lug parameters:

- Bolt hole size: M8.
- Compression lugs only (no mechanical lugs).
- Maximum wire size: 95mm<sup>2</sup>
- Maximum lug tongue thickness: 4mm
- Maximum lug tongue width: ≤24mm, must be of the narrow tongue type
- Maximum lug length: 60 mm

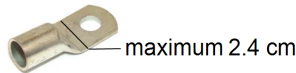

10. Apply heat shrink insulation to the lug barrels.
11. Connect the wires to the terminal blocks with a proper tool according to the labels on the terminals.

Wire type	Connect to terminal	
Line 1	L1	
Line 2	L2	
Line 3	L3	
Neutral	N	

Figure 25: Wire connections to terminal block

12. Tighten the screws of each terminal with a torque of 15.0 N\*m
13. Place the cover on the terminal block and push until you hear a click.

## Secondary Grounding

If required, ground the units as described in the following figure using a grounding cable, a grounding screw, two washers, a ring terminal and a serrated washer. You can connect the grounding cable to either side of a unit and to either the mounting hole or grounding screw. You can connect grounding to the Primary Unit and to each of the Secondary Units, as required.

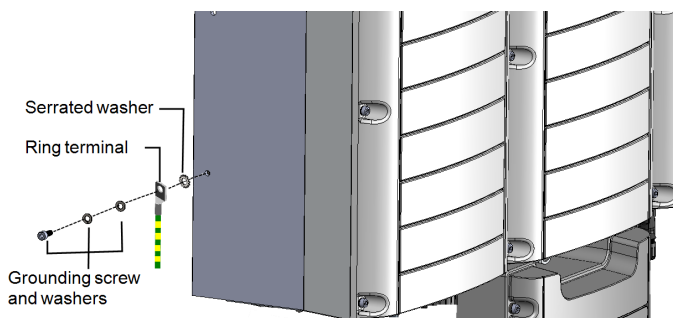

Figure 26: Secondary grounding

## Connecting the Strings to the Connection Unit

You can connect systems with multiple DC strings in parallel to the DC input terminals of the Connection Unit.

### NOTE



The DC bus of each unit is separate and not shared for all units. Therefore in addition to following the inverter design rules, each unit should follow the unit design rules as detailed in Technical Specifications.

Inverters may have a different number of pairs of DC input terminals, depending on the inverter power rating. If more strings are required, they can be connected in parallel using an external combiner box before connecting to the Connection Unit; strings connected to different units cannot be combined. When connecting multiple strings, it is recommended to run separate circuits to the Connection Unit or to position the combiner box near the Connection Unit. This simplifies commissioning by allowing testing and servicing near the inverter.

→ To connect the strings to the Connection Unit with glands/conduits:

1. Strip 5/16" (8 mm) of the DC wire insulation.
2. Insert the DC cable from the PV installation, into the DC gland on the Connection Unit.
3. Connect the DC wires to the DC+ and DC- terminal blocks, according to the labels on the terminals. or; connect two wires (DC+ and DC-) per string:
  - a. Use a standard flat-blade screwdriver to connect the wires to the spring-clamp terminals. The screwdriver blade should fit freely in the terminal opening. Too large a blade can crack the plastic housing.
  - b. Insert the screwdriver and firmly tilt it to press the release mechanism and open the clamp.
  - c. Insert the wire into the top opening (see *Figure 27*).
  - d. Remove the screwdriver – the wire is automatically clamped.

#### CAUTION!



Ensure that the Plus (+) wire is connected to the + terminal and that the Minus (-) wire is connected to the Minus (-) terminal connector.

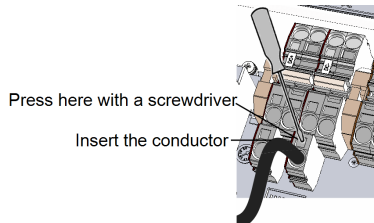

Figure 27: DC Spring-clamp terminals

Figure 28:

4. Close the Connection Unit cover: Attach the switch cover and secure it by tightening the six screws with a torque of 1.2 N\*m / 0.9 ft.\*lb.

## Selecting a Residual Current Device (RCD)

#### IMPORTANT SAFETY FEATURE



All SolarEdge inverters incorporate a certified internal Residual Current Device (RCD) in order to protect against possible electrocution and fire hazard in case of a malfunction in the PV array, cables or inverter. There are 2 trip thresholds

for the RCD as required for certification (DIN VDE 0126-1-1). The default value for electrocution protection is 30 mA per unit , and for slow rising current is 300 mA per unit.

---

If an external RCD is required by local regulations, check which type of RCD is required for the relevant electric code. Install the residual-current device (RCD) in accordance with the applicable local standards and directives. SolarEdge recommends using a type A RCD. When required by local regulations, the use of an RCD type B is permitted. Use at least 600mA RCD for a 2 unit inverter and at least 900mA RCD for a 3 unit inverter.

**NOTE**

For multiple inverters, an RCD per inverter is required.

---

You have completed installing the system, proceed to the next chapter to activate and commission it, then to *Setting Up Communication to the Monitoring Platform* on page 51, to set up required communication options and to set up leader-follower configurations, if required.

## Chapter 5: Activating, Commissioning and Configuring the System

You can connect communication options at this stage, as described in *Setting Up Communication to the Monitoring Platform* on page 51.

After completing all connections, activate and commission the system using the inverter SetApp mobile application. You can download the SetApp from the Apple App Store and Google Play before arriving at the site.



Internet connection is required for the download, one-time registration, and logging in, but not required for using the SetApp.

### Step 1: Activating the Installation

During system activation, a Wi-Fi connection is created between the mobile device and the inverter and the system firmware is upgraded.

#### Before activation

- Download, register (first time only) and log-in to SetApp on your mobile device. Verify that the application is updated with the latest version.
- If applicable, turn on all devices (battery, Energy Meter) connected to the inverter, so that the devices may be auto-detected.

#### → To activate the inverter:

1. Turn ON the AC circuit breaker on the main distribution panel.
2. Move the Connection Unit DC switch to the ON position.
3. Open SetApp and follow the on-screen instructions (scan the inverter bar-code; move the ON/OFF/P switch to P position for 2 seconds and release).

SetApp creates a Wi-Fi connection, upgrades the inverter firmware and activates the inverter.

4. When the activation is complete, do one of the following:
  - Select **Connect to Another Device** to continue activating additional inverters.
  - Select **Start Commissioning** for pairing and other system configuration.

## Step 2: Commissioning and Configuring the Installation

This section describes how to use the SetApp menus for commissioning and configuring the inverter settings.

Menus may vary in your application depending on your system type.

→ To access the Commissioning screen:

Do one of the following:

- During first time installation: Upon activation completion, in the SetApp, tap **Start Commissioning**.
- If the inverter has already been activated and commissioned:
  - If not already ON - turn ON AC to the inverter by turning ON the circuit breaker on the main distribution panel.
  - If not already ON - move the Connection Unit switch to the ON position.
  - Open SetApp and follow the on-screen instructions (scan the inverter QR code, move the ON/OFF/P switch to P position for 2 seconds and release).  
The mobile device creates a Wi-Fi connection with the inverter and displays the main Commissioning screen.

## Setting Country, Grid and Language

The inverter must be configured to the proper settings in order to ensure that it complies with the country grid code and functions.

1. From the **Commissioning** screen select **Country & Grid**.
2. From the **Country & Grid** drop-down list, select the required option and tap **Set Country & Grid**.
3. From the **Language** drop-down list, select your language and tap **Set Language**.

## Pairing

Once all connections are made, all the power optimisers must be logically paired to their inverter. The poweroptimisers do not start producing power until they are paired. This step describes how to assign each inverter to the poweroptimisers from which it

will produce power.

Perform this step when the panels are exposed to sunlight. If the string length is changed or a power optimiser is replaced, repeat the pairing process.

1. From the **Commissioning** menu, select **Pairing**.
2. Tap **Start Pairing**.
3. When **Pairing Complete** is displayed, the system startup process begins:  
Since the inverter is ON, the power optimisers start producing power and the inverter starts converting AC.

**WARNING!**

When you turn ON the inverter ON/OFF/P switch, the DC cables carry a high voltage and the power optimisers no longer output a safe output.

When the inverter starts converting power after the initial connection to the AC, the inverter enters Wake up mode until its working voltage is reached. This mode is indicated by the flickering green inverter LED.

When working voltage is reached, the inverter enters Production mode and produces power. The steadily lit green inverter LED indicates this mode.

4. Tap **OK** to return to the **Commissioning** menu.

## Communication

Communication settings can be configured only after communication connections are complete. Refer to *Setting Up Communication to the Monitoring Platform* on page 51.

- Select **Monitoring Communication** to configure communication with the monitoring platform.
- Select **Site Communication** to configure communication between multiple SolarEdge devices or external non-SolarEdge devices, such as batteries or loggers.

## Power Control

Power control options are detailed in the *Power Control Application Note*, available on the SolarEdge website at [https://www.solaredge.com/sites/default/files/application\\_note\\_power\\_control\\_configuration.pdf](https://www.solaredge.com/sites/default/files/application_note_power_control_configuration.pdf).



The Grid Control option may be disabled. Enabling it opens additional options in the menu.

The Energy Manager option is used for setting power export limitation, as described in the *Export Limitation Application Note*, available on the SolarEdge website at [https://www.solaredge.com/sites/default/files/feed-in\\_limitation\\_application\\_note.pdf](https://www.solaredge.com/sites/default/files/feed-in_limitation_application_note.pdf).



## Step 3: Verifying Proper Activation and Commissioning

1. Select **Information** and verify that the correct firmware versions are installed on each inverter.
2. Select **Status** and verify that inverter is operating and producing power.
3. Verify that the number of paired optimisers is the same as the number of physically installed power optimisers.
4. Verify that additional configurations were properly set by viewing the relevant Status screens.
5. Verify that the green inverter LED is steadily lit.

Your SolarEdge power harvesting system is now operational.



## Reporting and Monitoring Installation Data

Monitoring the site requires connecting the inverter to the monitoring platform, using any of the wired or wireless options available from SolarEdge. Refer to *Setting Up Communication to the Monitoring Platform* on page 51.

### The Monitoring Platform

The monitoring platform provides enhanced PV performance monitoring and yield assurance through immediate fault detection and alerts at the panel, string and system level.

Using the platform, you can:

- View the latest performance of specific components.
- Find under-performing components, such as panels, by comparing their performance to that of other components of the same type.
- Pinpoint the location of alerted components using the physical layout.

The monitoring platform enables accessing site information, including up-to-date information viewed in a physical or logical view:

- **Logical Layout:** Shows a schematic tree-layout of the components in the system, such as: inverters, strings, panels, meters and sensors, as well as their electrical connectivity. This view enables you to see which panels are connected in each string, which strings are connected to each inverter, and so on.
- **Physical Layout:** Provides a bird's eye view of the actual placement of panels in the site, and allows pinpoint issues to the exact location of each panel on a virtual site map.

If you do not report the mapping of the installed power optimisers, the monitoring platform will show the logical layout indicating which power optimisers are connected to which inverter, but will not show strings or the physical location of power optimisers.

The monitoring platform includes a built-in help system, that guides you through the monitoring functionality.

For more information, refer to <https://www.solaredge.com/products/pv-monitoring#/>.



## Creating Logical and Physical Layout using Installation Information

To display a logical layout, insert the inverter serial number in the new site created in the monitoring platform. When the communication between the inverter and the monitoring server is established, the logical layout is displayed.

To display a physical layout, you need to map the locations of the installed power optimisers. To map the locations, use one of the methods described in the next sections.

### Designer

Designer recommends inverter and power optimiser selection per site size and enables report generation. You can create a project in Designer and export the site design with the string layout to the monitoring platform.

For more information, refer to

<https://www.solaredge.com/products/installer-tools/designer#/>.



### Mapper Application

Use the Mapper smart phone application to scan the power optimiser and inverter 2D bar-codes and create a virtual map of a PV site for enhanced monitoring and easier maintenance.

The Mapper application is integrated with the monitoring platform and enables:

- Simple on-site registration of new systems.
- Creating, editing and verifying system physical layout.
- Scanning and assigning the power optimiser serial number to the correct panel in the system physical layout.

For detailed information, refer to the *Mapper* demo movies:

- [Creating new sites using the Mapper mobile application](#)



- [Mapping existing sites using the Mapper mobile application](#)



## Physical Layout Editor

1. If you are a registered installer, access the monitoring platform site creation page at <https://monitoring.solaredge.com/solaredge-web/p/home#createSites>. If you have not yet signed up, go to <https://monitoring.solaredge.com/solaredge-web/p/createSelfNewInstaller>.
2. Fill out all required information in the screen, which includes information about your installation, as well as details about its logical and physical mapping.



## Using a Paper Template

Fill out the Physical Layout Template (downloadable from the SolarEdge website <http://www.solaredge.com/files/pdfs/physical-layout-template.pdf>) using the detachable 2D barcode stickers on each power optimiser. Once the form is completed, use the Mapper to scan the 2D codes and create the map in the monitoring platform. Optionally, you can send the sticker sheet to SolarEdge Support for physical layout creation.



## Chapter 6: Setting Up Communication to the Monitoring Platform

The inverter sends the following information to the monitoring platform:

- Power optimiser information received via the DC power lines (the PV output circuit)
- Inverter information
- Information of any other connected devices

This chapter describes how to set up communication between:

- The inverter and the monitoring platform through the Internet (wired/ wireless)
- Multiple inverters for a leader-follower configuration

Communication setup is not required for power harvesting, however it is needed for using the monitoring platform .



### NOTE

It is recommended to connect communication connections before connecting the AC, for easier access to the communication board.

### CAUTION!



When connecting the communication cables, make sure that the ON/OFF/P switch on the Connection Unit is turned OFF, and the AC is turned OFF.

When configuring the communication parameters, make sure that the ON/OFF/P switch on the Connection Unit is OFF, and the AC is turned ON.

## Communication Options

The following types of communication can be used to transfer the monitored information from the inverter to the monitoring platform.

Only communication products offered by SolarEdge are supported.

### Ethernet

Ethernet is used for a LAN connection. For connection instructions refer to *Creating an Ethernet (LAN) Connection* on page 56

### RS485

RS485 is used for the connection of multiple SolarEdge devices on the same bus in a leader-follower configuration. RS485 can also be used as an interface to external devices, such as meters and third party data loggers.

- RS485-1: Enables the connection of multiple inverters over the same bus, such that connecting only one inverter to the Internet is sufficient to provide communication services for all the inverters on the bus. RS485-1 has built-in surge protection.
- RS485-2: Enables connection of non-SolarEdge devices.

For connection instructions refer to *Creating an RS485 Bus Connection* on page 60

### GSM

This wireless communication option (purchased separately) enables using a GSM connection to connect one or several devices (depending on the data plan used) to the monitoring platform.

The GSM Plug-in is provided with a user manual, which should be reviewed prior to connection. Refer to

[http://www.solaredge.com/sites/default/files/cellular\\_gsm\\_installation\\_guide.pdf](http://www.solaredge.com/sites/default/files/cellular_gsm_installation_guide.pdf)



## Communication Connectors

The Primary Unit has communication glands for connecting the various communication options to the inverter, as described in the following table. Unused openings should remain sealed.

	Gland#	Opening	Functionality
Primary Unit	1	two large openings 4.5-7 mm	Cellular
		one small opening 2-4 mm	external antenna cable
	2	three large openings 2.5-5 mm	power reduction and RS485-2
Connection Unit	1	three openings	Ethernet connection (CAT6) and RS485 -1

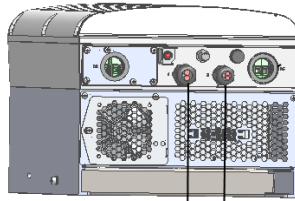

Communication glands: 1 2

Figure 29: Primary Unit

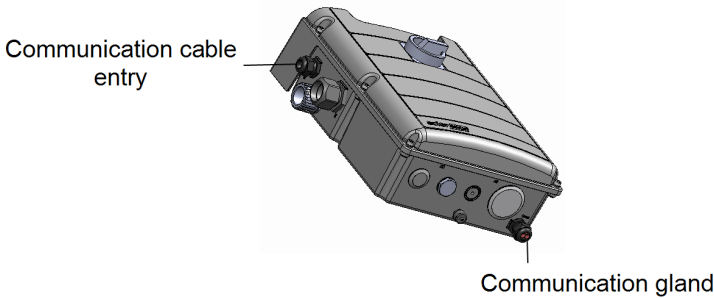

Figure 30: Connection Unit

## Communication Board

The communication board is in the Primary Unit with an extension in the Connection Unit.

### Primary Unit Communication Board

Open the Primary Unit cover to access the communication board to:

- GSM- connect a GSM modem. See *Communication Options* on page 52.
- RS485-1 - connected to the Connection Unit communication board. For connecting multiple inverters over the same bus, connect RS485 wires to the terminal blocks on the Connection Unit Communication Board. For more information see, *Connection Unit Communication Board* on page 55
- RS485-2 - connect a non-SolarEdge device, such as a meter or a third party data logger, to the RS485-2 connector. Every pair of in and out wires are connected to the same pin.
- Power Reduction Interface (PRI) - connect a power reduction device. See [application\\_note\\_power\\_control\\_configuration.pdf](#)

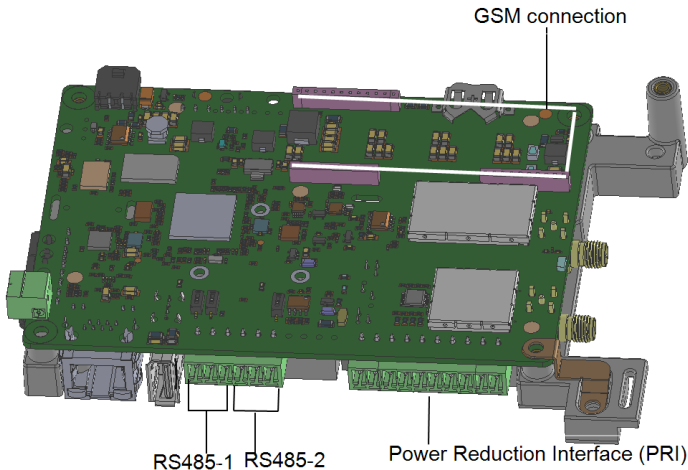

Figure 31: Primary Unit communication board

## Connection Unit Communication Board

Open the Connection Unit cover to access the communication board to:

- connect a standard RJ45 connector for Ethernet.
- connect RS485 wires to the terminal blocks for RS485 connection. There are two 3-pin terminal blocks, one for connecting the preceding device in the bus and one for connecting the following device. Additionally, the RS485 port has a built-in surge protection.

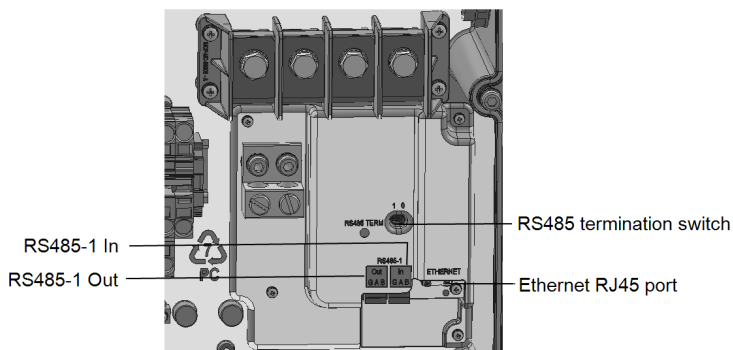

Figure 32: Connection Unit Communication board

## Removing the Connection Unit Cover

If the Connection Unit is not already removed, remove it as described in the following section.

→ To remove the Connection Unit cover:

1. Turn OFF the inverter ON/OFF switch, and wait until the green LED is blinking, indicating that the DC voltage is safe (<50V), or wait five minutes before continuing to the next step.
2. Disconnect the AC to the inverter by turning OFF the circuit breakers on the distribution panel.
3. Open the Connection Unit cover:
  - a. Release the six Allen screws of the cover.
  - b. Tilt the top of the cover towards you.
  - c. Slide the cover down and remove it.



**CAUTION!**

When removing the cover, make sure not to damage internal components. SolarEdge will not be held responsible for any components damaged as a result of incautious cover removal.

## Creating an Ethernet (LAN) Connection

This communication option enables using an Ethernet connection to connect the inverter to the monitoring platform through a LAN.

Ethernet cable specifications:

- Cable type – CAT6 and higher with shielding protection of the twisted pairs of wires and an outer foil or braided shielding
- Maximum distance between the inverter and the router – 100 m/ 330 ft.

**NOTE**

If using a cable longer than 10 m / 33 ft in areas where there is a risk of induced voltage surges by lightning, it is recommend to use external surge protection devices.



For details refer to:

[http://www.solaredge.com/files/pdfs/lightning\\_surge\\_protection.pdf](http://www.solaredge.com/files/pdfs/lightning_surge_protection.pdf).

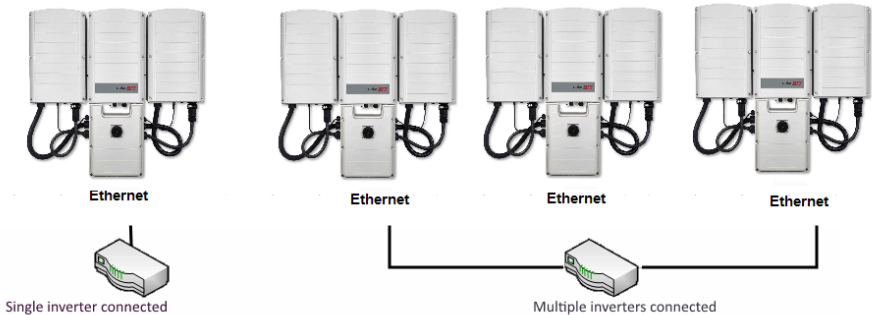

Figure 33: Example of Ethernet connection

→ To connect the Ethernet cable:

1. Open the communication gland.



**CAUTION!**

The gland includes a rubber waterproof fitting, which should be used to ensure proper sealing.

2. Remove the rubber fitting from the gland and insert the CAT6 cable through the gland and through the gland opening in the Connection Unit .
3. Remove the plastic seal from the large opening that has a cut in the rubber fitting.
4. Push the cable into the cut opening of the rubber fitting.

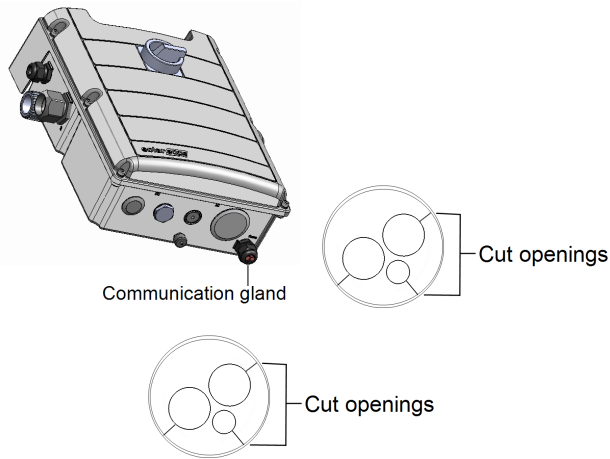

Figure 34: Communication gland and rubber fitting

CAT6 cables have eight wires (four twisted pairs), as shown in the diagram below. Wire colors may differ from one cable to another. You can use either wiring standard, as long as both sides of the cable have the same pin-out and color-coding.

RJ45 Pin #	Wire Color <sup>(1)</sup>		10Base-T Signal 100Base-TX Signal
	T568B	T568A	
1	White/Orange	White/Green	Transmit+
2	Orange	Green	Transmit-

<sup>(1)</sup>The connection does not support RX/TX polarity change. Supporting crossover Ethernet cables depends on the switch capabilities.

RJ45 Pin #	Wire Color <sup>(1)</sup>		10Base-T Signal 100Base-TX Signal
	T568B	T568A	
3	White/Green	White/Orange	Receive+
4	Blue	Blue	Reserved
5	White/Blue	White/Blue	Reserved
6	Green	Orange	Received-
7	White/Brown	White/Brown	Reserved
8	Brown	Brown	Reserved

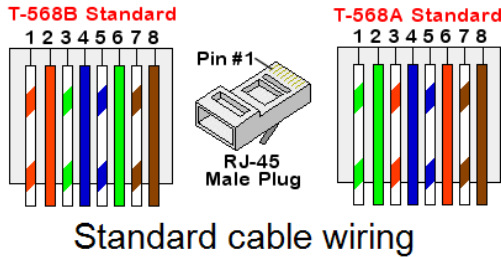

### Standard cable wiring

Figure 35: Standard cable wiring

5. Use a pre-terminated cable to connect via the gland to the RJ45 port on the inverter's communication board or, if using a spool of cable, connect as follows:
  - a. Insert the cable through the gland.

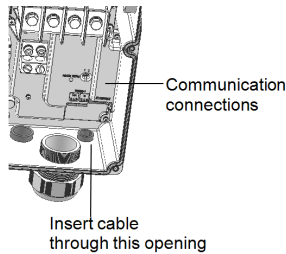

Figure 36: Inserting communication cables

- b. Remove the cable's external insulation using a crimping tool or cable cutter and expose eight wires.
  - c. Insert the eight wires into an RJ45 connector, as described *Figure 35*.

<sup>(1)</sup>The connection does not support RX/TX polarity change. Supporting crossover Ethernet cables depends on the switch capabilities.

- d. Use a crimping tool to crimp the connector.
- e. Connect the Ethernet connector to the RJ45 port on the communication board as shown in *Figure 35*.

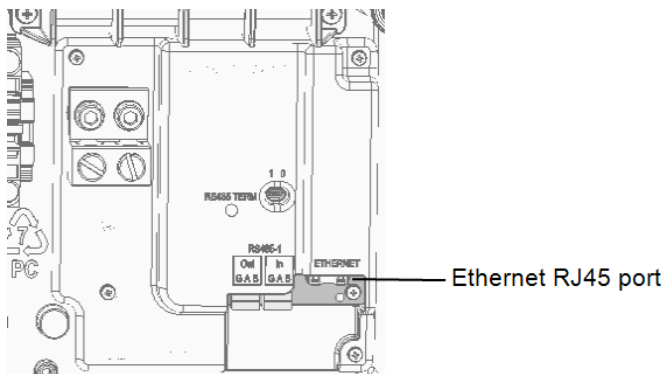

Figure 37: Connection Unit Communication board

6. For the switch/router side, use a pre-crimped cable or use a crimper to prepare an RJ45 communication connector.
7. Connect the cable RJ45 connector to the RJ45 port of the Ethernet switch or router. You can connect more than one inverter to the same switch/router or to different switches/routers, as needed. Each inverter sends its monitored data independently to the SolarEdge monitoring platform.

#### NOTE



There are no LED indicators on the Ethernet connector, if the inverter is not communicating with the monitoring platform through a LAN refer to *Troubleshooting Communication* on page 68.

8. The inverter is configured by default to LAN. If reconfiguration is required:
  1. Verify the ON/OFF/P switch is OFF.
  2. Verify the AC is on.
  3. Close the cover and turn ON the Connection Unit.

#### WARNING!



**ELECTRICAL SHOCK HAZARD.** Do not touch uninsulated wires when the Connection Unit cover is removed.

4. Use the SolarEdge SetApp to access the **Commissioning** main menu screen as described in *Communication* on page 47.

5. From the main menu tap **Monitoring Communication**.
6. Select **Configure Ethernet**, to configure the connection.
9. Verify the connection, as described in *Verifying the Connection* on page 64.

**NOTE**

The system automatically establishes communication with the monitoring platform as it is configured to LAN by default.

**NOTE**

If your network has a firewall, you may need to configure it to enable the connection to the following address:

- Destination Address: **prodssl.solarede.com**
- Modbus TCP Port: **443** (for incoming and outgoing data)

## Creating an RS485 Bus Connection

The RS485 option enables creating a bus of connected inverters, consisting of up to 31 follower inverters and 1 leader inverter. Using this option, inverters are connected to each other in a bus (chain) via their RS485 connectors, thus allowing to connect only the leader inverter to the monitoring platform. The first and last inverters in the chain must be terminated as described in *RS485 Bus Configuration* on page 63

RS485 wiring specifications:

- Cable type: CAT6 and higher with shielding protection of the twisted pairs of wires and an outer foil or braided shielding
- Wire cross-section : 0.2- 1 mm<sup>2</sup>/ 24-18 AWG
- Maximum distance between first and last devices: 1 km /3300 ft.

The following sections describe how to physically connect the RS485 bus and how to configure the bus.

→ To connect the RS485 communication bus:

1. Open the communication gland.



**CAUTION!**

The gland includes a rubber waterproof fitting, which should be used to ensure proper sealing.

2. Remove the rubber fitting from the gland and insert the CAT6 cable through the gland and through the gland opening in the Connection Unit.

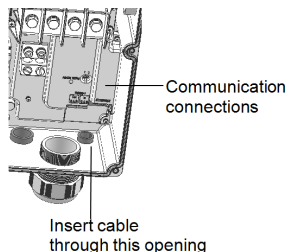

Figure 38: Inserting communication cables

3. Remove the seal from one of the openings in the communication gland and insert the wire through the opening.
4. Pull out both 3 -pin RS485 terminal blocks, as shown below:

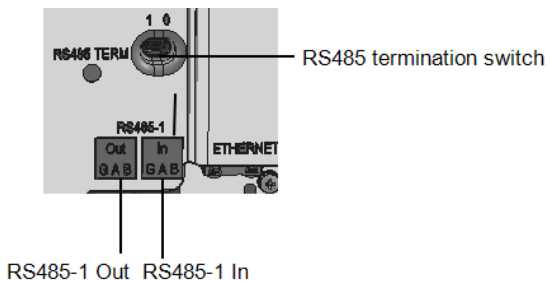

Figure 39: RS485 connectors and termination switch

- Loosen the screws of pins A(+), B(-), and G in either the 'Out' or 'In' RS485 terminal block.

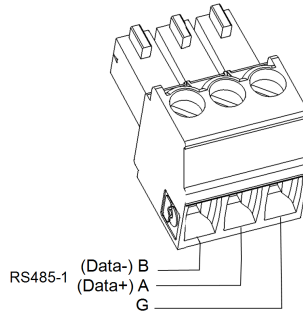

Figure 40: RS485 terminal block wire connections

- Insert the wire ends into the **G**, **A** and **B** pins shown above. Use one terminal block for the previous inverter in the bus and the other terminal block for the next inverter in the bus, as shown in *Figure 41*.

You can use any color wire for each of the **A**, **B** and **G** connections, as long as:

- The same color wire is used for all A pins the same color for all B pins and the same color for all G pins
- The wire for G is not from the same twisted pair as A or B.

- Connect all B, A and G pins in all inverters. The following figure shows this connection schema:

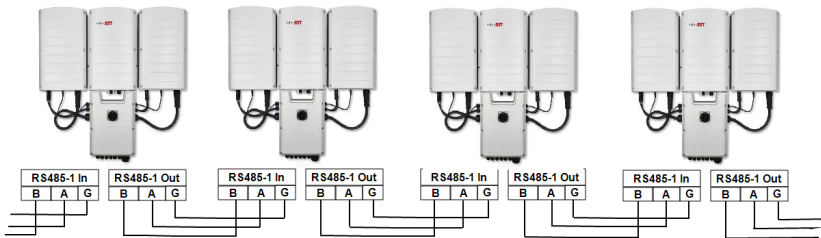

Figure 41: Connecting the inverters on a bus

- Tighten the terminal blocks screws.
- Check that the wires are fully inserted and cannot be pulled out easily.
- Push the RS485 terminal blocks firmly all the way into the connectors on the communication board, see *Figure 39*.

11. Terminate the first and last inverters on the bus by moving the termination switch to ON (left position); See *Figure 39*. The other inverters on the bus should have the termination switch OFF (right position).

## RS485 Bus Configuration

→ To connect to the monitoring platform:

1. Designate a single inverter as the connection point between the RS485 bus and the monitoring platform. This inverter will serve as the leader inverter.
2. Connect the leader to the monitoring platform via the LAN option (refer to *Creating an Ethernet (LAN) Connection* on page 56) or any of the other options.

→ To configure the RS485 bus:

All inverters are configured by default as followers. To configure the leader:

1. Verify the ON/OFF/P switch is OFF.
2. Verify that AC is on.
3. Turn ON the Connection Unit.
4. Use SetApp to access the **Commissioning** menu screen as described in *Communication* on page 47.
5. From the **Commissioning** menu tap **Site Communication**.
6. Select the following to configure the connection:
  - RS485-1 > Modbus (Multi-Device)
  - RS485-1 > SolarEdge > SolarEdge Leader
  - RS485-1 > Follower Detect

The system starts automatic detection of the follower inverters connected to the leader inverter. The inverter should report the correct number of followers. If it does not, verify the connections and terminations.

7. To check the follower IDs and last communication time, select **RS4851 > Follower List**.
8. Verify the connection of the leader to the monitoring platform, as described in the next section.



## Verifying the Connection

After connecting and configuring a communication option, perform the following steps to check that the connection to the monitoring server has been successfully established.

1. If the Connection Unit cover is not closed, close it: Attach the Connection Unit cover and secure it by tightening the screws with a torque of 10.3 N\*m/ 7.5 lb.\*ft. For proper sealing, first tighten the corner screws and then the two central screws.
2. Go to **Commissioning > Status**.
3. In the **Summary** section, under **Server Comm.**, make sure **S\_OK** is displayed together with the selected communication option.
4. Scroll down to the **Communication** section and check that the communication options are as required.

# Appendix A: Errors and Troubleshooting

This chapter describes general system problems, and how to troubleshoot them. For further assistance, contact SolarEdge Support.

## Identifying Errors

Errors may be indicated in various system interfaces: On the inverter bottom panel, a red LED indicates an error. In the monitoring platform and SetApp, errors are displayed with codes.

For more information on the codes displayed for error and warning messages, refer to <http://www.solaredge.com/sites/default/files/se-inverter-installation-guide-error-codes.pdf>. This document describes errors that appear in SetApp, monitoring platform, and LCD (for inverters with LCD). To identify the error types, use the methods described below.



→ To identify the error type using the inverter LEDs:

1. Move the ON/OFF/P switch to **P** position for **2 seconds** and release it.
2. Observe the LED lights and use the following table to identify the error type. For more information, refer to <https://www.solaredge.com/leds>.



Error type	LED color and state		
	Red	Green	Blue
Arc detected	ON	OFF	OFF
Isolation or RCD problem	Blinking	OFF	OFF
Grid error	OFF	ON	OFF
High temperature	OFF	Blinking	OFF
Pairing failed	OFF	OFF	ON
Other issue	OFF	OFF	Blinking

→ To identify the error type using the monitoring platform:

1. Open the site dashboard and click the **Layout** icon.
2. Right-click the inverter and select **Info** from the menu. The inverter details window is displayed.
3. Click the **Errors** tab. The list is displayed.

## Power Optimiser Troubleshooting

Malfunction	Possible Cause and Corrective Action
Pairing failed	<p>Power optimisers are shaded.</p> <p>If you connected the inverter to the monitoring platform, retry pairing remotely (during sunlight). Make sure to leave the inverter ON/OFF/P switch ON and that S_OK appears in the status screen.</p>
String voltage is 0V	<p>Power optimiser (s) output is disconnected.</p> <p>Connect all power optimiser outputs.</p>
String voltage not 0V but lower than number of optimisers	<p>Power optimiser(s) not connected in the string.</p> <p>Connect all power optimisers.</p>
	<p>Panel(s) not connected properly to power optimiser inputs (not applicable to smart panels).</p> <p>Connect the panels to the optimiser inputs.</p>
	<p>String reverse polarity.</p>
	<p>Check string polarity using a voltmeter and correct if needed.</p>

Malfunction	Possible Cause and Corrective Action
<p>String voltage is higher than number of optimisers</p> <p><b>WARNING!</b> If the measured voltage is too high, the installation may not have a safe low voltage. <b>PROCEED WITH CARE!</b> A deviation of <math>\pm 1\%</math> per string is reasonable.</p> 	<p>Extra power optimiser(s) connected in the string (not applicable to smart panels). Check if an extra power optimiser is connected in the string. If not – proceed to next solution.</p> <p>A panel is connected directly to the string, without a power optimiser (not applicable to smart panels). Verify that only power optimisers are connected in the string and that no panel outputs are connected without a power optimiser. If the problem persists, proceed to the next step.</p> <p>Power optimiser(s) malfunction.</p> <ol style="list-style-type: none"> <li>1. Disconnect the wires connecting the power optimisers in the string.</li> <li>2. Measure the output voltage of each power optimiser to locate the power optimiser that does not output 1V safety voltage. If a malfunctioning power optimiser is located, check its connections, polarity, panel, and voltage.</li> <li>3. Contact SolarEdge Support. Do not continue before finding the problem and replacing the malfunctioning power optimiser. If a malfunction cannot be bypassed or resolved, skip the malfunctioning power optimiser, thus connecting a shorter string.</li> </ol>

## Troubleshooting Communication

### Troubleshooting Ethernet (LAN) Communication

The possible errors and their troubleshooting are detailed in the following table:

Error Message	Possible Cause and Troubleshooting
LAN cable disconnected	Physical connection fault. Check the cable pin-out assignment and cable connection. Refer to <i>Creating an Ethernet (LAN) Connection</i> on page 56.
No DHCP Configure Static IP or set to DHCP	IP settings issue. Check the router and inverter configuration. Consult your network IT.
Gateway not responding	Ping to router failed. Check the physical connection to the switch/ router. Check that the link LED at the router /switch is lit (indicating phy-link). If OK - contact your network IT, otherwise replace the cable or change it from cross to straight connection.
No Internet connection	Ping to google.com failed. Connect a laptop and check for internet connection. If internet access is unavailable, contact your IT admin or your internet provider. For Wi-Fi networks, ensure that user-name and password are as defined in the internet provider AP/ router.

### Troubleshooting RS485 Communication

- If the message **RS485 Leader Not Found** appears in the Status screen, check the connections to the leader device and fix if required.

- If after follower detection the number of followers displayed for the leader under **RS485-1 > Follower Detect** is lower than the actual number of followers, refer to the following application note to identify missing followers and troubleshoot connectivity problems: [https://www.solaredge.com/sites/default/files/troubleshooting\\_undetected\\_RS485\\_devices.pdf](https://www.solaredge.com/sites/default/files/troubleshooting_undetected_RS485_devices.pdf)



## Additional Troubleshooting

1. Check that the modem or hub/router is functioning properly.
2. Check that the connection to the internal connector on the communication board is properly done.
3. Check that the selected communication option is properly configured.
4. Use a method independent of the SolarEdge device to check whether the network and modem are operating properly. For example, connect a laptop to the Ethernet router and connect to the Internet.
5. Check whether a firewall or another type of network filter is blocking communication.

# Appendix B: Mechanical Specifications

The following figures provide dimensions of the Primary Unit, Connection Unit and Secondary Unit.

## Primary Unit and Connection Unit

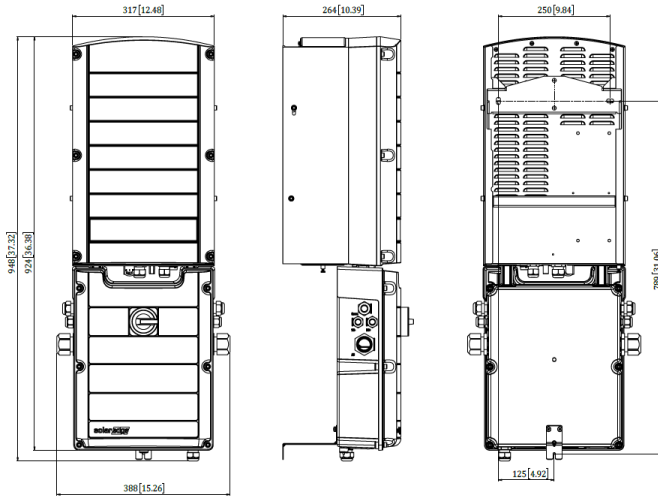

Figure 42: Primary Unit and Connection Unit - front, side and rear views

## Secondary Unit

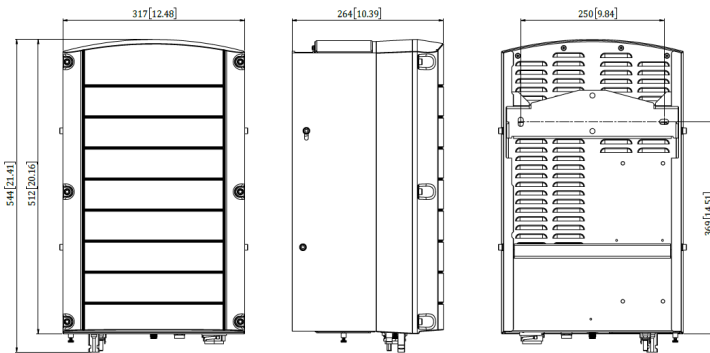

Figure 43: Secondary Unit - front, side and rear views

## Appendix C: SafeDC™

The SolarEdge inverters are certified for compliance with the following standards as disconnection devices for PV generators, meaning that they can replace a DC disconnect:

- IEC 60947-3:1999 + Corrigendum: 1999 + A1:2001 + Corrigendum 1:2001 + A2:2005;
- DIN EN 60947-3
- VDE 0660-107:2006-03
- IEC 60364-7-712:2002-05
- DIN VDE 0100-712:2006-06.

In compliance with these standards, follow the instructions below to disconnect DC power:

1. Move the inverter P/ON/OFF switch to OFF (0).
2. Disconnect the AC to the inverter by turning OFF the circuit breakers on the distribution panel.

### WARNING!

SafeDC complies with IEC60947-3 when installing the system with a worst case SafeDC voltage (under fault conditions)  $< 120V$ .

The worst case voltage is defined as:  $V_{oc,max} + (\text{String Length} - 1) * 1V$ , where:



- $V_{oc,max}$  = Maximum  $V_{oc}$  (at lowest temperature) of the PV panel in the string (for a string with multiple panel models, use the max value)
  - String Length = number of power optimisers in the string
-



## Appendix D: External Fan Maintenance and Replacement

The Primary and Secondary Units have two fans each: one is internal and the other is accessible from the outside of the unit. This appendix describes external fan replacement.

The inverter has two fans: one is internal and the other is accessible from the outside of the inverter.

A fan replacement kit is available from SolarEdge.

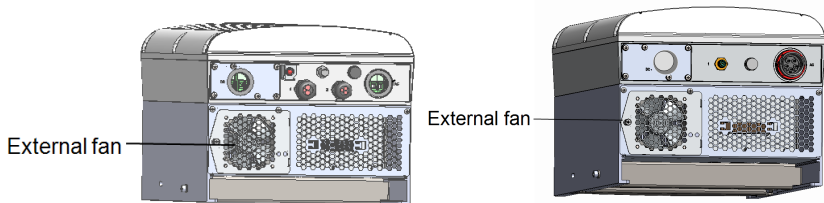

Figure 44: Primary Unit (left) and Secondary Unit (right) external fans

### Fan Maintenance

At least once a year, open the fan screen and clean the accumulated dust using a brush. If the SetApp Status screen displays the status **Not Working** for the fan, replace the fan as described in the next section.

### External Fan Replacement

1. Turn OFF the inverter ON/OFF/P switch, and wait until the green LED is blinking, indicating that the DC voltage is safe (<50V), or wait five minutes before continuing to the next step.
2. Disconnect the AC to the inverter by turning OFF the circuit breakers on the distribution panel.
3. Use a standard screwdriver to unfasten the single screw of the fan cover and open the fan door.

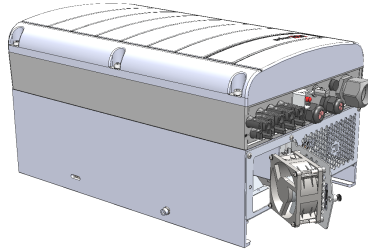

4. Disconnect the fan connector and remove the fan.

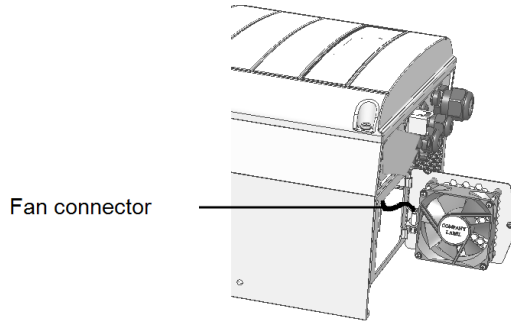

Figure 45: Fan connector

5. Connect the fan connector to the new fan.
6. Close the fan door and fasten the cover screws
7. After powering up the inverter, open SetApp and check that the Fan status is OK under **Commissioning > Status**.

## Appendix E: Replacing System Components

This appendix details replacement procedures for the SolarEdge system components.

### NOTE



If you are permanently disassembling the installation or part of it, make sure to use the disposal methods dictated by local regulations.

## Replacing the Primary Unit

1. Turn OFF the Inverter ON/OFF/P switch, and wait until the green LED is blinking , indicating that the DC voltage is safe (<50V), or wait five minutes before continuing to the next step.

### WARNING!



If you cannot see Primary Unit LEDs or you cannot connect to the Primary Unit, or if the red LED light is on indicating a malfunction , wait five minutes for the input capacitors of the inverter to discharge.

2. Disconnect the AC to the inverter by turning OFF the circuit breakers on the distribution panel.
3. For a 3-unit inverter first disconnect and remove the Secondary Unit on the right.
4. Open the Primary Unit cover:
  - a. Release the six Allen screws of the cover.
  - b. Tilt the top of the cover towards you.
  - c. Slide the cover down and remove it.

### CAUTION!



When removing the cover, make sure not to damage internal components. SolarEdge will not be held responsible for any components damaged as a result of incautious cover removal.

- Disconnect all DC, AC wires and the communication connectors from the Primary Unit.

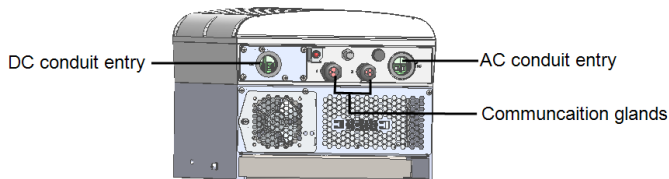

Figure 46: Primary Unit interface

- Unscrew the two conduit nuts in the Primary Unit securing it to the Connection Unit.

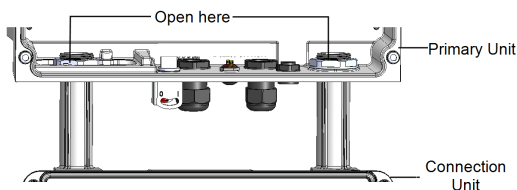

Figure 47: Conduit nuts

- Remove the screw securing the Primary Unit to the mounting bracket and remove the Primary Unit from the mounting bracket.



#### NOTE

If you remove the Primary Unit and do not immediately install a new one, use insulation tape to isolate any exposed wires.

- Place the new Primary Unit on the mounting bracket; insert the screw securing the Primary Unit through the right side of the heat sink and into the bracket.
- Connect the DC, AC wires and the communication connectors to the Primary Unit.
- For a 3 unit inverter reconnect the AC, DC and comm cables from the Connection Unit to the right Secondary Unit.
- Close the Primary Unit cover.
- Perform the commissioning steps as described in *Activating, Commissioning and Configuring the System* on page 44.
- In the monitoring platform, use the **Replace** button in the **logical layout** tab (in site Admin).

## Replacing a Secondary Unit

1. Turn OFF the Inverter ON/OFF/P switch, and wait until the green LED is blinking, indicating that the DC voltage is safe (<50V), or wait five minutes before continuing to the next step.

### WARNING!



If you cannot see Primary Unit LEDs or you cannot connect to the Primary Unit, or if the red LED light is on indicating a malfunction, wait five minutes for the input capacitors of the inverter to discharge.

2. Disconnect the AC to the inverter by turning OFF the circuit breakers on the distribution panel.
3. Disconnect all the connectors on the bottom of the Secondary Unit.
4. Remove the screw securing the Secondary Unit to the mounting bracket and remove the Secondary Unit from the mounting bracket.
5. Place the new Secondary Unit on the mounting bracket.
6. Insert one of the supplied screws through the outer side of the heat sink and into the bracket.
7. Perform pairing as described in *Activating, Commissioning and Configuring the System* on page 44.

## Replacing the Connection Unit

### Removing the Connection Unit

1. Turn OFF the Inverter ON/OFF/P switch, and wait until the green LED is blinking, indicating that the DC voltage is safe (<50V), or wait five minutes before continuing to the next step.

### WARNING!



If you cannot see Primary Unit LEDs or you cannot connect to the Primary Unit, or if the red LED light is on indicating a malfunction, wait five minutes for the input capacitors of the inverter to discharge.

2. Disconnect the AC to the inverter by turning OFF the circuit breakers on the distribution panel.
3. Open the Connection Unit cover:

- Release the six Allen screws of the cover.
- Tilt the top of the cover towards you.
- Slide the cover down and remove it.

**CAUTION!**

When removing the cover, make sure not to damage internal components. SolarEdge will not be held responsible for any components damaged as a result of incautious cover removal.

4. Disconnect the interlock and DC cables.
5. Disconnect the Secondary Unit(s) from the Connection Unit .
6. Disconnect the communication connector from the Primary Unit communication board.
7. Unscrew the two conduit nuts in the Primary Unit securing the Connection Unit to it, see *Figure 47*.
8. Open the Connection Unit cover and disconnect the DC, AC and communication wires.
9. Release the Connection Unit bracket from the wall.
10. Carefully remove the Connection Unit with its mounting bracket from the wall.

## Installing a New Connection Unit

1. Position the new Connection Unit below the inverter and from the inside of the Primary Unit grab the AC and DC wires extending from the switch conduits.
2. Securely screw the two conduit nuts onto the conduit ends in the inverter.
3. Attach the Connection Unit with its bracket to the wall and tighten its screw.

## Connecting the Connection Unit to the Primary Unit

1. Connect the DC, as follows, see *Figure 46*:
  - Connect the red wire to any of the DC+ terminals in the inverter.
  - Connect the black wire to any of the DC- terminals in the inverter.
2. Connect the communication wire to the communication board.
3. Connect the AC wires according to the labels on the AC terminal blocks, as follows:

Three Phase Inverter	
Wire type	Connect to terminal
Line 1	L1
Line 2	L2
Line 3	L3
PE (grounding)	⊕
Neutral	N

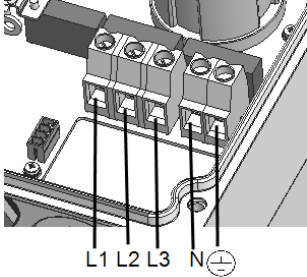

The diagram shows a close-up of the AC terminal block on the inverter. It features five terminals labeled L1, L2, L3, N, and PE. L1, L2, and L3 are the three phase lines. N is the neutral terminal. PE is the protective earth (grounding) terminal, indicated by a ground symbol. Wires are shown being inserted into the terminals.

Figure 48: Primary Unit AC terminals

4. Tighten the screws of each terminal with a torque of 1.2-1.5 N\*m / 0.88-1.1 lb.\*ft.
5. Verify that there are no unconnected wires at the output of the Connection Unit and that any unused terminal screws are tightened.
6. Connect the DC and AC wires to the Connection Unit. Refer to *Connecting the AC and DC Strings to the Connection Unit* on page 37 .
7. Ensure proper cable entry sealing; inspect the entire cable run and use standard sealants to avoid water penetration.

## Replacing Power Optimisers

1. Turn OFF the inverter ON/OFF/P switch, and wait until the LCD green light is blinking, or wait five minutes before continuing to the next step.

### WARNING!



If a malfunction is indicated by the LEDs, wait five minutes for the input capacitors of the inverter to discharge.

2. Turn OFF the AC breaker and distribution panel on the main distribution panel.
3. Disconnect and replace the necessary power optimisers.
4. Perform pairing
5. In the monitoring platform, use the **Replace** button in the **logical layout** tab (in site Admin). Replace the serial number of the removed power optimiser with the serial number of the newly installed power optimiser. Refer to <https://www.solaredge.com/sites/default/files/se-monitoring-portal-site-admin.pdf>



# Appendix F: Determining the Circuit Breaker Size

Inverters should be protected by circuit breakers. This document describes how to determine which circuit breaker to use in three phase commercial installations.

## Using Transformers in Commercial Three Phase Inverter Installations

Using transformers in a commercial installation is optional. In most cases a transformer is used to connect the installation to the medium voltage power grid. The following figure illustrates a typical transformer and commercial three phase inverter installation topology.

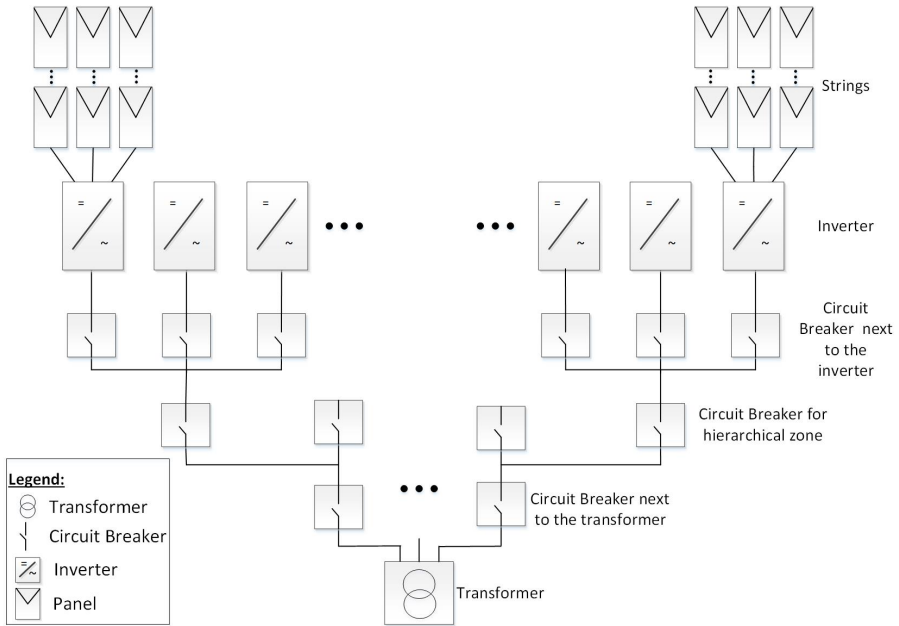

Figure 49: Typical transformer and commercial three phase inverter installation topology

There are many considerations for selecting the suitable transformer and its associated current limiting devices such as circuit breakers and fuses. The considerations must include at least the following:

- The transformer should be designed for a typical PV system production profile: high daytime loads with no loads at night.



- The current limiting devices should protect the electrical circuits and the inverters from the excess current created by an overload, or a short circuit. If a short circuit or other overcurrent occurs, the current limiting devices should block the current flow to the circuit, thus preventing damage to the electrical circuits and the inverters.

The circuit breakers and the fuses should comply with the transformer manufacturer recommendations and with the relevant sections in standards such as IEC 60909, IEC 60364, UL 508A and NEC 2017.

Some manufacturers provide detailed information about the transformer short circuit calculation procedure, and its effect on the selection of circuit breakers and fuses at the different hierarchical levels of the installation topology (see *Figure 49*). For an example of a calculation, refer to:

- [Guidelines on the Short Circuit Current Rating for Industrial Control Panels](#)
- [Short-circuit current rating \(SCCR\) of industrial control panels](#)
- To ensure that the circuit breaker and fuses trip as expected, follow their manufacturers' recommendations, especially with respect to the various de-rating considerations.

#### NOTE



Transformer procurement, installation, maintenance and support are the responsibility of the installer. Damage to the inverter due to incorrect transformer installation, or use of a transformer that is incompatible with the SolarEdge system will render the SolarEdge warranty invalid.

## Determining the Size of an Inverter Circuit Breaker

This section explains how to determine the rate of a circuit breaker next to an inverter. For an example of an inverter with a circuit breaker next to it see *Figure 49*.

Ensure you have the following parameters before determining the circuit breaker size:

- The inverter's maximum continuous output current as appears in the datasheet.
- Factor for the installation's country. This factor is dictated by regulation, applicable standards or common practice and is usually 1.25.

→ To determine the size of an inverter circuit breaker:

1. Multiply the inverter's maximum continuous output current by the factor.  
For example,  $40\text{A} \times 1.25 = 50\text{A}$
2. Round up the rated size, as calculated in step 1, to the closest standard circuit breaker size. See Circuit Breaker Criteria table below for standard sizes suitable for SolarEdge three phase inverters.

**NOTE**

If the result has a decimal fraction smaller than 0.5 round it down.

3. To ensure that the selected circuit breaker trips as expected, at minimum consider the following:
  - The circuit breaker rated voltage.
  - Temperature de-rating due to both close proximity of other circuit breakers and the effect of ambient temperature on the distribution board.
  - De-rating due to permanent load.

If the de-rated current of the selected circuit breaker is lower than the maximum output current of the inverter, consider selecting a circuit breaker that is designed for a higher rated current, or reducing the temperature de-rating effect by increasing the distance between adjacent circuit breakers.

**NOTE**

- Make sure to select cables that are suitable for the environmental conditions, the operating voltage and the selected circuit breaker.
- Three or four pole circuit breakers are required. It is recommended to use a four pole circuit breaker when applicable.
- Only use a circuit breaker with tripping characteristic B or C.

**Table 1: Circuit Breaker Criteria**

Inverter	Max. Continuous Output Current (per Phase)	Recommended Circuit Breaker
SE12.5K	20A	25A
SE14.4KUS	40A	50A
SE15K	23A	32A
SE16K	25.5A	32A
SE17K	26A	32A
SE25K	38A	50A
SE27.6K	40A	50A
SE30KUS	36.5A	50A
SE33.3K	40A	50A
SE43.2KUS	120A	150A
SE50K	76A	100A
SE55K	80A	100A
SE66.6K	80A	100A
SE66.6KUS	80A	100A
SE75K	120A	150A
SE82.8K	120A	150A
SE100K	120A	150A
SE100KUS	120A	150A

## Three Phase Inverter with Synergy Technology - Technical Specifications (Australia)

	Three Phase Inverters		Three Phase Inverters for the 480/277V Grid		
	SE50K	SE82.8K	SE66.6K	SE100K	Unit
<b>Output</b>					
Rated AC power output	49900	82800	66600	100000	VA
Maximum AC power output	49900	82800	66600	100000	VA
AC output voltage – line to line / line to neutral (nominal)	400/230		480/277		Vac
AC output voltage range line to line range: line to neutral range	318-460;184-264.5		384-552 / 244-305		Vac
AC frequency	50± 5				Hz
Maximum continuous output current (per phase) @Vac.nom	76	120	80	120	A
Grids supported – three phase	3 / N / PE (WYE with Neutral)				
Maximum Residual Current Injection	250 per unit <sup>(1)</sup>				

(1) If an external RCD is required, its trip value must be  $\geq 300\text{mA}$  per unit ( $\geq 600\text{mA}$  for SE50K/SE55K;  $\geq 900\text{mA}$  for SE82.8K)

	Three Phase Inverters		Three Phase Inverters for the 480/277V Grid		
	SE50K	SE82.8K	SE66.6K	SE100K	Unit
Utility monitoring, islanding protection, configurable Power Factor, country configurable thresholds			Yes		
<b>Input</b>					
Maximum DC power (Module STC), Inverter /Unit	67365 / 33680	11750/37250	90000/45000	135000/45000	W
Transformer-less, ungrounded	Yes				
Maximum input voltage DC to GND	415		500		
Maximum input voltage DC+ to DC-	830		1000		
Nominal DC input voltage DC to GND	375		425		Vdc
Nominal DC input voltage DC+ to DC	750		850		
Maximum input current	2x37	3x40	2x40	3x40	Adc
Reverse-polarity protection	Yes				
Ground-fault isolation detection	350kΩ Sensitivity per unit				
Maximum inverter efficiency	98.3		98.1		%
European weighted efficiency	98				%
Night-time power consumption	< 12				W

	Three Phase Inverters		Three Phase Inverters for the 480/277V Grid			
	SE50K	SE82.8K	SE66.6K	SE100K	Unit	
<b>Additional Features</b>						
Supported communication interfaces <sup>(1)</sup>	RS485, Ethernet, Cellular (optional), Wi-Fi (optional)					
RS485 Surge Protection	Built-in					
<b>DC Connection Unit</b>						
DC Disconnect	1000V / 2 x 40A	1000V /3 x 40A	1000V / 2 x 40A	1000V /3 x 40A		
<b>Standard Compliance</b>						
Safety	IEC-62109, AS3100					
Grid connection standards <sup>(2)</sup>	VDE -AR-N-4105, G59/3, AS-4777,EN50438, CE-1, VDE 0126-1-1, CEI-016,BDEW					
Emissions	IEC61000-6-2, IEC61000-6-3, IEC61000-3-11, IEC61000-3-12					
RoHS	Yes					
<b>Installation Specifications</b>						
Number of units	2	3	2	3	mm	
AC output conduit size	50					mm
AC output max. L, N cross section / max. PE cross section	70 / 35	95 / 50	70 / 35	95 / 50	mm <sup>2</sup>	
Number of DC input (One per unit)	2	3	2	3		
DC conduit size	2x25	3x25	2x25	3x25	mm	
DC terminal block cross section	6-35	6-35	6-35	6-35	mm <sup>2</sup>	

<sup>(1)</sup>Refer to Datasheets → Communications category on Downloads page for specifications of optional communication options

:<https://www.solaredge.com/downloads#/>

<sup>(2)</sup>For all standards refer to Certification category on Downlands <https://www.solaredge.com/downloads#/>

	Three Phase Inverters		Three Phase Inverters for the 480/277V Grid		
	SE50K	SE82.8K	SE66.6K	SE100K	Unit
AC output wire	Aluminum or Copper;L,N:Up to 70, PE:Up to 35	Aluminum or Copper;L,N:Up to 95, PE:Up to 50	Aluminum or Copper;L,N:Up to 70, PE:Up to 35	Aluminum or Copper;L,N:Up to 95, PE:Up to 50	
Dimensions (HxWxD)	Primary Unit:940x315x260 ; Secondary Unit:540x315x260				mm
Weight	Primary Unit:48; Secondary Unit:45				kg
Operating temperature range	-40 to + 60 <sup>(1)</sup>				°C
Cooling	Fan (user replaceable)				
Noise	< 60				dBa
Protection rating	IP65 Outdoor and indoor				
Mounting bracket Mounted	Brackets provided				

<sup>(1)</sup>For power de-rating information ,refer to the application note at the following link: <http://www.solaredge.com/files/pdfs/se-temperature-derating-note.pdf>

## Support Contact Information

If you have technical problems concerning SolarEdge products, please contact us:



<https://www.solaredge.com/service/support>

Before contact, make sure to have the following information at hand:

- Panel and serial number of the product in question.
- The error indicated on the product SetApp mobile application or on the monitoring platform or by the LEDs, if there is such an indication.
- System configuration information, including the type and number of panels connected and the number and length of strings.
- The communication method to the SolarEdge server, if the site is connected.
- The product's software version as it appears in the status screen.



**solar**edge