

PUMPING CATALOG

American-Made Pumps



Smith & Loveless Inc.

VACUUM DOMES

Check out page 8 for the relief of vacuum dome assurance.



EVERLAST™ BASEPLATE CONVERSION

We have your back with upgrading your pump stations. See page 52 for all the details.

25 YEAR
DURO-LAST®
WARRANTY

WAVESTART®

Unstoppable sensing. Check out your next quick and effective solution on page 27.



CONTENTS

Vacuum Pumps & Repair Kits	5	Solenoid Valve Repair Kits	7
4	Compare for Yourself 2-Way vs. 3-Way Solenoid Valve	6	Maintenance Video Series
The Electrode & Vacuum Dome Evolution	13	WAVESTART® Upgrade Kits	15
8	ER Relay & Electrode Probe Evolution	14	Most Recent Pump Conversions
Bubbler Air Compressors	17	Mechanical Seal	19
16	X-PELLER® Non-Clog Impeller	18	Quick Ship Control Panel
Full Body Spring-Loaded Non-Slamming Check Valves	22	Vibration Isolator & Environmental Equipment	24
20	Impeller Rotation	23	WAVESTART®
Flooded Suction Pump Seal Filter	26	Fighting Flushables	30
25	WAVESTART®	28	Wafer Check Valves



RAPIDJACK®	36	Gaskets & Quad Rings	38
32	RAPIDJACK®	37	Continuous Hinge & Hood Lift Assist Kit
Anode Test Box & Corrosion Blocker	40	Vibration Isolators	42
39	Underground Lid Locking System	41	Float Check Valve
Float Switches	44	Custom Series Pump Station Retrofit	50
43	Mechanical Seals	48	Easy Rotating Assembly
Fast & Simple Pumps	52	KCK Case Study	58
51	EVERLAST™ Baseplate Conversions	56	Submersibles to EVERLAST™



Copyright 2023 Smith & Loveless, Inc. reserves all rights. No part of this catalog, or the catalog in its entirety, may be reproduced by any means, electronics, or otherwise, without explicit prior written authorization from Smith & Loveless, Inc.

Published by: After Market Division • Smith & Loveless, Inc. • 14040 Santa Fe Trail Drive • Lenexa, KS 66215-1234, USA • Ph: (913) 888-5201 • Fax: (913) 748-0106 • Toll Free: (800) 922-9048, Option 5.

PUMP STATION TYPES KEY

		
Above Grade Pump Station	Below Grade Pump Station	Both

DARE to COMPARE

Compare Smith & Loveless' Vacuum Pump Price to Grainger's Price



\$550

8L29
Top End Single Piston Model



\$499

8L44
Standard Single Piston Model



\$900

8L32
Rugged Dual Piston Model



3/32" Orifice
1L406E (Obsolete)
Replaced by 1L406K
Old Style 3-Way
Solenoid Valve

5/16" Orifice
1L545A or 1L545B
New Style 2-Way
Solenoid Valve

OLD VS NEW

The 5/16" orifice 2-way solenoid valve reduces routine maintenance and can reduce priming time by up to 40% compared to the 3-way solenoid valve.

We encourage you to upgrade to either the 5/16" dome mounted or control panel conduit mounted solenoid valve. Check out the options below.

2-Way Solenoid Valve

PART#	DESCRIPTION
1L545A	2-Way Solenoid Valve for Bracket Mounting
87A481-STK	Din Connection Cable for the 1L545A - Connects Via Cable Solenoid Valve to Control Panel.
1L545B	2-Way Solenoid Valve Thru Backpan Mounting
1L9D	Nipple, Required for 1L545B Solenoid Valve
5L181A	Conduit Fitting Hub for 1L545B Solenoid Valve



1L545A and 1L545A-2

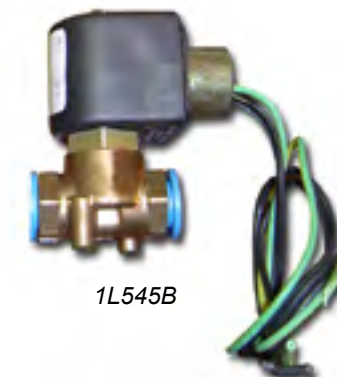

1L545B



5L181A



1L9D



*Prices expire 2/1/2024.
*Prices subject to change.



When you replace the vacuum pump, Smith & Loveless Customer Service recommends replacing the vibration isolators to keep vibration noise to a minimum. Don't forget to add a set of vibration isolators to your order.

Vacuum Pump Single & Dual Piston

PART#	STATION PIPING SIZE	TYPE
8L29	4"	Top End, Single Piston
8L44	4"	Standard, Single Piston
8L32	6"	Rugged, Dual Piston

8L29 Single Piston Vacuum Pump Repair Kit

PART#	DESCRIPTION
8L29AB	Repair Kit
8L29A1	Inlet Filter

8L32 Dual Piston Vacuum Pump Repair Kit

PART#	DESCRIPTION
8L32-1	Repair Kit





SOLENOID VALVE REPAIR KITS

One of the most common calls for S&L customer service is solenoid valves leaking. This stems from having a solenoid valve repair kit that was not manufactured by S&L. Smith & Loveless' 2-way solenoid valve is made specifically for S&L and to a rugged specification.

The 2-way solenoid valve is a critical piece in the vacuum priming system. It keeps the water from

going up the vacuum tubing, into the float check valve and sometimes the vacuum pump. When it has a good seal, the vacuum pumps turn "off" and "on" and don't run continuously potentially burning out contactors prematurely.

Buyer beware when you buy a non-OEM repair kit for the 2-way solenoid valve, it may create vacuum priming problems for you.

THE REPAIR KIT DIFFERENCES



Pictured above, the S&L OEM plunger is on the left and the plunger by others is on the right. Notice the S&L plunger has a solid black cap made of highly chemical resistant material that fully seats the full diameter of the solenoid valve orifice and prevents vacuum leaks. The plunger on the right by others, does not fully seat, causing leaking.



Pictured above, notice the center orifices are not the same. The S&L on the bottom is larger. This difference means that the smaller orifice clogs faster.



Shown above are three plungers. The S&L OEM is on the far right. The other two are plungers by others. Notice the difference in the black cap. There is no side slot in the S&L plunger and the springs are different. The two plungers on the left will leak

The next time you are ordering a repair kit for your 2-way solenoid valve (PN: 1L545A-6), make sure you are ordering a repair kit that won't create leaks.



MAINTENANCE VIDEO SERIES

All Smith & Loveless products are designed for an extended life span. However, certain things can shorten this lifespan and create problems. Smith & Loveless' maintenance video series goes through the process of using gauges to monitor your pump station, when and how to replace a single mechanical seal, changing out a float check valve or replacing the reeds in a vacuum pump.

How to Access:

1. Go to smithandloveless.com.
2. Click on "MyS&L."
3. Select "Create new account."

You will then have 24/7 access to these videos. Become a maintenance expert, sign up today!

Become a maintenance expert, sign up for MyS&L today!

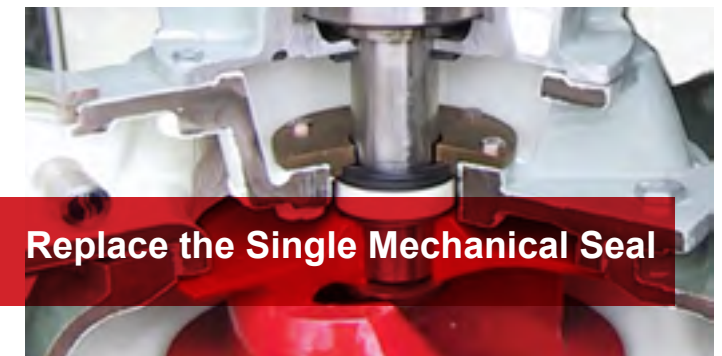

THE ELECTRODE & VACUUM DOME EVOLUTION



ORIGINAL 2-Hole Vacuum Dome Aluminum Electrode



Obsolete. Original 2-hole Vacuum Dome With Aluminum Electrode. Use PN: **H87A329A** Conversion Kit.

VERSION 2 1-Hole Vacuum Dome Hollow Electrode



Obsolete. Only Certain Components Still Available. 1-Hole Vacuum Dome With Hollow Stainless Steel Electrode. Convert to Solid Stainless Steel Electrode With PN: **87B309B & 87B309C.**

VERSION 3 1-Hole Vacuum Dome Solid Electrode



Move to WAVESTART® Still Supported in Parts. 1-Hole Vacuum Dome with Solid Stainless Steel Electrode. PN: **87B309B** - 5-1/4" Long Electrode & PN: **87B309C** - 6" Long Electrode.

VERSION 4 1-Hole Vacuum Dome SONIC START® Probe



Obsolete. 1-Hole Vacuum Dome with **No Electrode.** Use **SONIC START®** Probe. PN: **87B452A** (Dome Assembly).

VERSION 5 SONIC START® STREAMLINE™ 1-Hole Vacuum Dome, SONIC START® Probe & 2-Way Solenoid Valve



Obsolete. 1-Hole Vacuum Dome with No Electrode. Uses **SONIC START®** Probe and Relocates Larger Ported 5/16" Diameter Orifice 2-Way Solenoid Valve to Above Vacuum Dome. PN: **87B728** (Vacuum Dome Assembly with Solenoid Valve)

NEWEST VERSION 6 - WAVESTART® 1-Hole Vacuum Dome, WAVESTART® Probe & 2-Way Solenoid Valve



Current Version for all Vacuum Primed Pump Station New Equipment. 1-Hole Vacuum Dome With No Electrode. Uses **WAVESTART®** Probe. PN: **87B728** (Vacuum Dome Assembly With Solenoid Valve).

REAL TIME VIEW

Never doubt if your pump station is priming again with the Vacuum Dome! A simple window into your pump provides you with a portal for watching the wastewater pumping in real time.



Smith & Loveless Inc.



PEDAL TO THE METAL



Worry less with our noncorrosive Wafer Check Valve! The metal valve's incomparable strength works to keep the Wafer Check Valve from corroding in harsh pumping applications.



Smith & Loveless Inc.



THIS IS NOT A DRILL!

Alert yourself before flushables becomes a big problem with S&L's Pump Failure Alarm! Our alarm will alert you when the check valve doesn't open fully, keeping interruption to a minimum and allowing the redundant pump to take over while you diagnose any trouble.

FIGHT! AGAINST CHEMICALS!

CHEMICAL RESISTANT VACUUM -DOME!!-

Today record levels of chemicals are dumped into our wastewater systems. In high enough concentrations, the chemicals can attack the clear PVC vacuum dome.

Smith & Loveless now offers a new chemical resistant vacuum dome for pump stations that are under attack from chemicals in the wastewater. You'll know if your dome is under attack if the dome creates fissures or hairline cracks.

The amber vacuum dome has a very high tolerance to chemicals.

Fight back against chemical attacks. Order the chemical resistant vacuum dome today.

PN: 87B133C

1-800-922-9048

ER RELAY EVOLUTION



4L29 No longer available 4L408 No longer available 4L408H No longer available 4L408J 4L408Q 4L264S

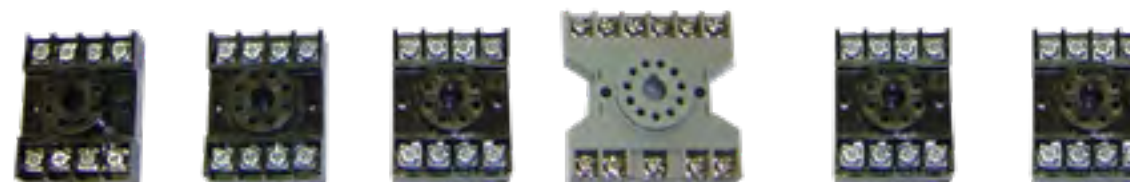

ELECTRODE PROBE EVOLUTION

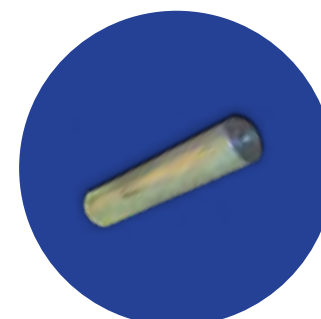

Aluminum 87A72
Obsolete

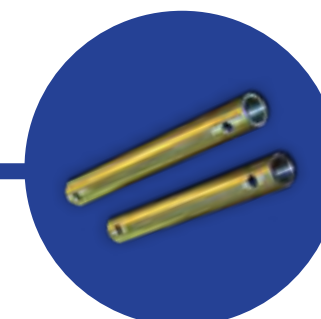

Hollow 87A229A & B
Obsolete

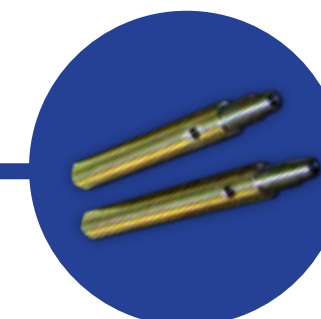

Solid 87A285 5-1/4" Long and
87A285A 6" Long
Move to **WAVESTART®**

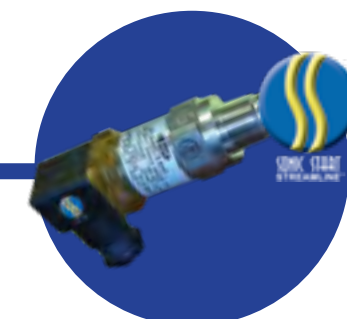

200 Millisecond
SONIC START® Probe
4L628N
Obsolete

Newest Components!

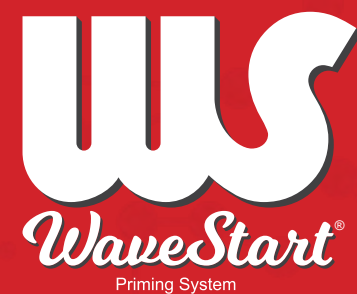

4L1178A WAVESTART® Probe

4L264E WAVESTART® Relay
and 4L406B Delay Timer



ORDER LOCALLY FROM YOUR **Smith & Loveless Representative**

UPGRADE KITS



UPGRADE FROM SONIC START®



H87A391S
(1 pump kit)

H87A391T
(2 pump kit)

The "S" and "T" kits include everything you need to upgrade your station from the **SONIC START®** system to the new and improved **WAVESTART®** Priming System. Try the S-Kit on one pump for your own side-by-side performance test. The S-Kit includes everything required for one pump while the T-Kit includes everything for two pumps.

UPGRADE FROM ELECTRODE



H87A391U

The "U" kit includes everything you need to upgrade your station from the electrode to the new and improved **WAVESTART®** Priming System for one pump.

AMERICAN-MADE SUSTAINABILITY, EVERLAST™



Most recent conversions.

Location	Years of installation
Kansas	33 Years
Wisconsin	38 years
Georgia	26 years
Kansas	29 years
Kansas	30 years
California	29 years
Virginia	25 years
Maryland	32 years
Florida	40 years
Nebraska	34 years
Maryland	32 years
West Virginia	46 years

EVERLAST™ longevity that submersibles aspire to.



Don't forget! The more you buy, the deeper your discount!

Test **WAVESTART®** at your pump station for 60 days, and experience less clogs or return it.

60-day Money Back WAVESTART® Offer:

Buyers have 60 days from shipment date to return all of the parts in the **WAVESTART®** kit, if not satisfied with its performance.*

**Smith & Loveless will refund the purchase price and the buyer will only be responsible for shipping and handling costs.*



BUBBLER AIR COMPRESSORS

Used on all Smith & Loveless Underground Pump Stations are the bubbler air compressors. We sell two replacement bubbler air compressors, the 9L25C and the 9L25. The 9L25C is the smaller of the two units. Otherwise, they perform the same way.

Bubbler Air Compressors

Includes: One bubbler air compressor.



9L25



9L25C

PART#	DESCRIPTION
9L25C	Bubbler Air Compressor
9L25	Bubbler Air Compressor



- Avoid having to redrill the mounting holes. The 9L25C has three mounting feet and the 9L25 has four mounting feet. Check to see which style you already have installed.
- When you replace the bubbler air compressor, Smith & Loveless customer service recommends replacing the vibration isolators to keep vibration noise to a minimum. Don't forget to add a set to the order.

CLEAR CLOGS, NOT YOUR OPERATIONS BUDGET!



Smith & Loveless Inc.



XPELLER®



Rid yourself of time-consuming maintenance with Smith & Loveless' X-PELLER®. Our latest technology virtually eliminates clogs from flushables, even in high volume applications, with more wipes and rags than wastewater. Get back to 24/7 pumping with the X-PELLER®.

60-day money back X-PELLER® offer: Buyers have 60 days from shipment date to return the X-PELLER® if not satisfied with its performance.*

**Smith & Loveless will refund the purchase price and the buyer will only be responsible for shipping and handling costs.*



MONEY DOESN'T GROW ON TREES



Smith & Loveless' uniquely designed Mechanical Seals are especially formulated for harsh sewage pumping environments with our undoubted excellence since 1948. S&L's formulated mechanical seal was created specifically for pumping wastewater.

YOU NEED IT BY YESTERDAY!



Order the Quick-Ship Control Panel today for your vacuum-primed Pump Station and receive it as quickly as 2 to 4 weeks! You never know when a car, flood or lightning strike will take out your pump station controls. This standard 2-pump control panel will arrive to you equipped with the latest S&L technology.



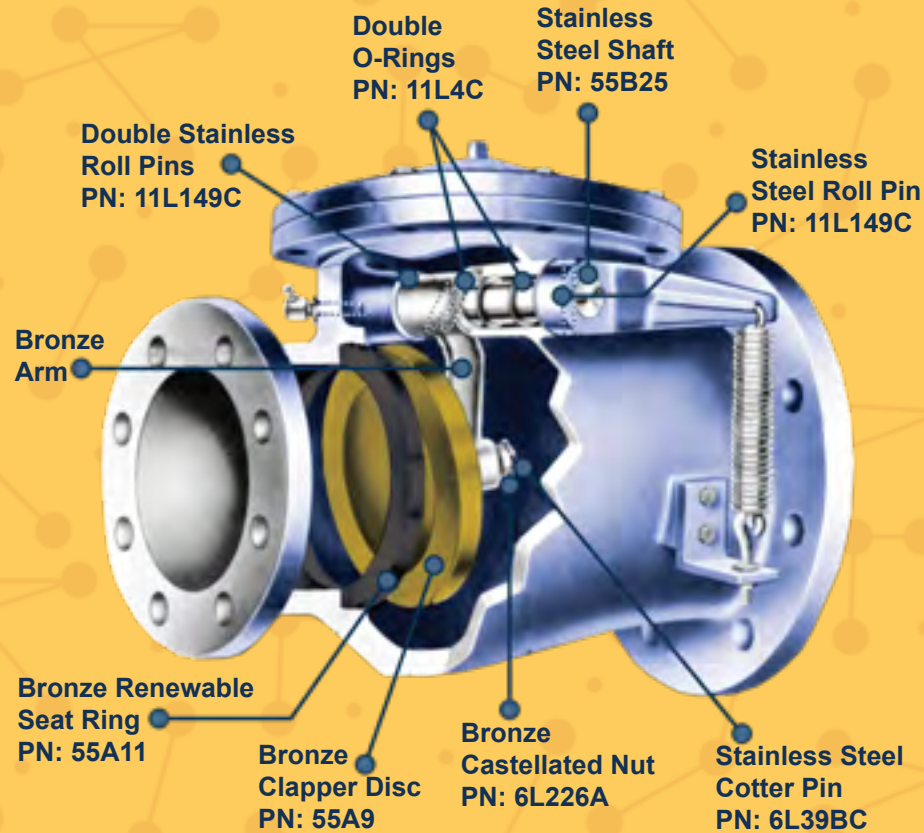
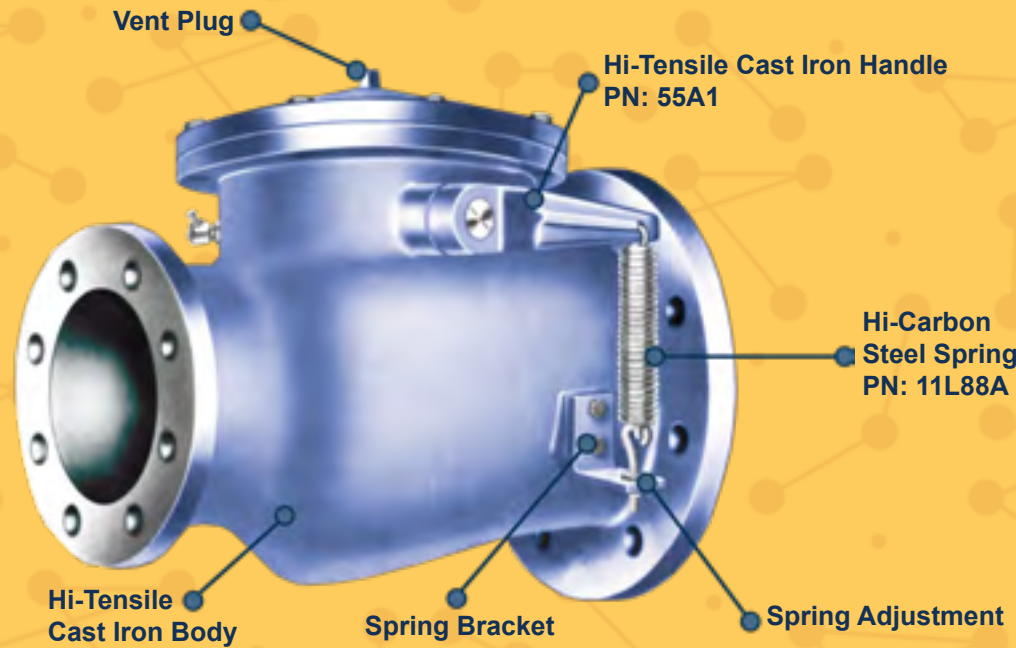

FULL BODY SPRING-LOADED NON-SLAMMING CHECK VALVES

These two 3-D drawings of the Smith & Loveless Spring-Loaded Non-Slamming Check Valves highlight some of their key features of PN: 2L34A/AA and 2L35A/AA.

FULL BODY SPRING-LOADED NON-SLAMMING CHECK VALVES DIMENSION CHART

PART#	Size of Valve	RH Vs. LH	A	B ₁	B ₂	C ₁	C ₂	D ₁	D ₂	E ₁	E ₂	F	G	H	I	Wt. In Lbs.
2L34A 2L34AA	4" x 4"	RH LH	13-5/16 13-5/16	15/16 15/16	15/16 15/16	9 9	9 9	7-1/2 7-1/2	7-1/2 7-1/2	5/8 5/8	5/8 5/8	10 10	10 10	6-1/4 6-1/4	7-3/16 7-3/16	125 125
2L35A 2L35AA	4" x 6"	RH LH	13-5/16 13-5/16	15/16 15/16	15/16 15/16	9 9	11 11	7-1/2 7-1/2	9-1/2 9-1/2	5/8 5/8	3/4 3/4	10 10	13-1/2 13-1/2	6-1/4 6-1/4	7-3/16 7-3/16	130 130
2L35B 2L35BB	4" x 8"	RH LH	18-1/4 18-1/4	15/16 15/16	1-1/8 1-1/8	9 9	13-1/2 13-1/2	7-1/2 7-1/2	11-3/4 11-3/4	5/8 5/8	3/4 3/4	13-1/2 13-1/2	13-1/2 13-1/2	8-3/4 8-3/4	9-1/2 9-1/2	225 225
2L35C 2L35CC	5" x 8"	RH LH	18-1/4 18-1/4	15/16 15/16	1-1/8 1-1/8	10 10	13-1/2 13-1/2	8-1/2 8-1/2	11-3/4 11-3/4	3/4 3/4	3/4 3/4	13-1/2 13-1/2	13-1/2 13-1/2	8-3/4 8-3/4	9-1/2 9-1/2	235 235
2L35D 2L35DD	6" x 8"	RH LH	18-1/4 18-1/4	1 1	1-1/8 1-1/8	11 11	13-1/2 13-1/2	9-1/2 9-1/2	11-3/4 11-3/4	3/4 3/4	3/4 3/4	13-1/2 13-1/2	13-1/2 13-1/2	8-3/4 8-3/4	9-1/2 9-1/2	240 240

Dimension Drawing Keys

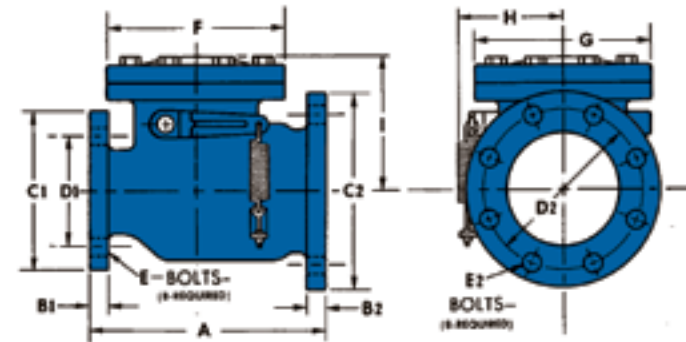

KEY ADVANTAGES

- Eliminates the need for increasing fittings — saving space, materials and labor cost.
- Spring-loaded gate and non-slamming design.
- Highest quality construction with cast iron body, bronze and stainless steel fittings.
- Lubricated dual O-ring shaft seals for easy opening and longer service life.
- Shaft extension allows right or left-hand mounting of lever and spring assembly.
- Simple design and operation — all parts accessible through cover.



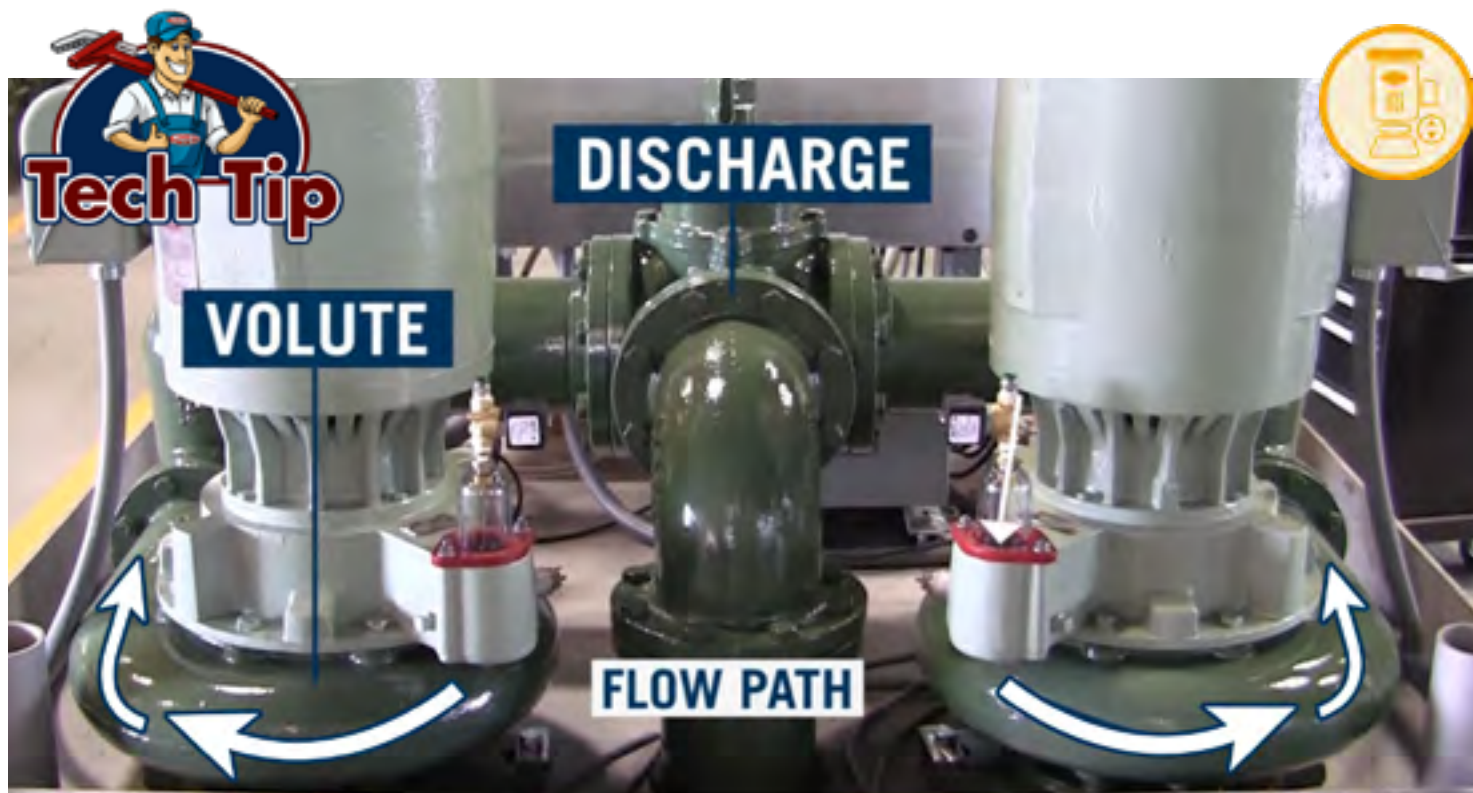

IMPELLER ROTATION

Determining impeller rotation is one of the most common questions customers ask. If you have the impeller already removed, the first thing is to make sure the “motor end” with keyway is up and the larger opening “suction end” is down.

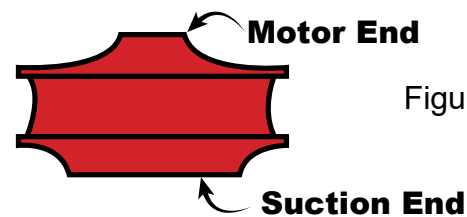
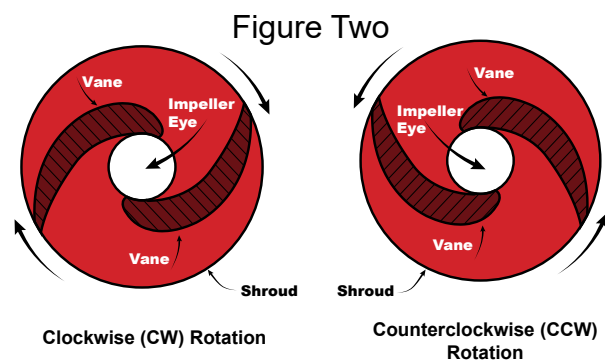

Figure One

Then looking down on the impeller with the “motor end” up, determine which way the vanes curve. The first drawing shows a clockwise rotation (CW). The second drawing shows a counterclockwise rotation (CCW).



If you haven't removed the pump yet, you can still determine the rotation of the pump and impeller by looking at the equipment and how the wastewater flows through the pump.

On all Smith & Loveless Duplex Wet Well Mounted Pump Stations, there is a CW and CCW pump. The pump draws the wastewater up from the wet well and into the volute that houses the impeller. The pump then discharges the wastewater out of the volute. This can be seen in figure two by following the arrows. By looking at the directional flow of the wastewater through the pump, the rotation can be determined.

In the diagram, the flow is pulled into the pump from the wet well that is located directly under the pump. The pump on the left in this diagram is the CW rotation. The pump on the right in this diagram is the CCW rotation. The flow always circulates around the volute first and then out through the volute discharge. Whatever rotation this flow path is will determine whether the impeller and pump are CW or CCW in rotation.

If you'd like to watch a video on determining impeller rotation, you can find it online at:

youtu.be/_V2d2DC_A40

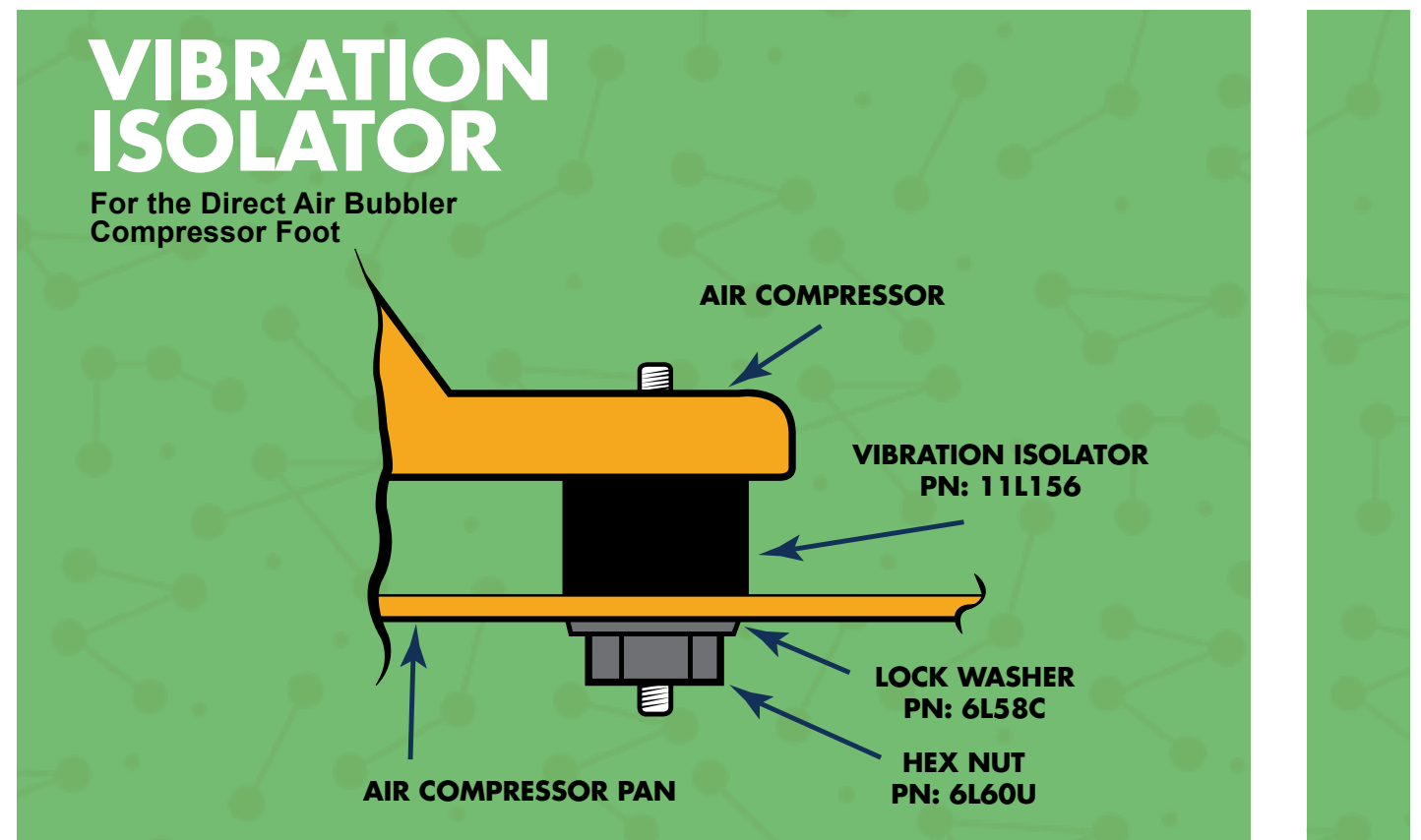

UNDERGROUND PUMP STATION HUMIDISTAT & DEHUMIDIFIER

Humidity can quickly create problems if it is not controlled. As part of your equipment review, make sure the Smith & Loveless Humidistat PN: 4L215, and Dehumidifier, PN: 11L150C are functioning correctly. You easily set the level of desired humidity with the convenient dial switch and the PN: 4L215 Humidistat will operate the dehumidifier PN: 11L150C. It handles relative humidity 0 to 70%.

Humidistat & Dehumidifier

Includes: One Humidistat and/or one Dehumidifier



PART#	DESCRIPTION
4L215	Humidistat
11L150C	Dehumidifier

WORKING HARD OR HARDLY WORKING?

You'll never have to question whether Smith & Loveless' technology is accurately checking for priming with the **WAVESTART®**. Expertly designed to recognize priming status through wipes, rags and strings, you'll feel the freedom of our seamless priming system.



TO ORDER, CALL 1-800-922-9048



PN: 1L485

The pump seal filter is the first line of defense in protecting your pump's double mechanical seal. It filters out unwanted particles to help keep your mechanical seal lubricated. Smith & Loveless' customer service recommends keeping a backup filter or two on the shelf for quick change outs. Doing this allows for specific parts to be reordered like the element, baffle and drain that wear over time so that you can rebuild the unit in the convenience of your shop.

All of Smith & Loveless' flooded suction pumps use the pump seal filter. This includes its underground pumps and its remote mounted **PISTA®** Grit Pumps. No piping changes are required to convert your pump from one of the original seal filters to the most current PN: 1L485 unit.

Don't let this critical part go unnoticed because if it gets too dirty, you'll be shortening the life of your pump's mechanical seal. Those take much longer to replace than a quick seal filter swap out. Check out your pump seal filter today. Is it ready for cleaning?

Complete Flooded Suction Pump Seal Filter Assembly

PART#	DESCRIPTION
1L485	Seal Filter Assembly

1L485, 1L371 & 1L89 PARTS

Smith & Loveless carries a full line of repair kits for the PN: 1L485. For the older style, PN: 1L371, and PN: 1L89, Smith & Loveless still carries some of the element components. The PN: 1L485 is a direct replacement to both the PN: 1L371 and PN: 1L89 so it can be put in place easily.

PN: 1L485



PN: 1L371



PN: 1L89

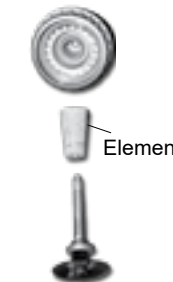

1L485, 1L371 and 1L89 Repair Kits and Spare Parts

PART#	DESCRIPTION
1L485A	Filter Element Kit: Includes Bowl O-Ring and Filter Element
1L485B	Bowl Kit: Includes Bowl, Bowl O-Ring and Drain Kit
1L485C	Drain Kit: Includes Twist Drain and Drain O-Ring
1L485D	Baffle Kit: Includes Baffle, Deflector and Bowl O-Ring

PART#	DESCRIPTION
1L371C	O-Ring
1L371E	Element
1L89E	Element

ORDER LOCALLY FROM YOUR **Smith & Loveless Representative**



GOODBYE
Flushables
HELLO
Freedom



The new patent pending **WAVESTART**® priming system by Smith & Loveless says “Hello” to freedom. The **WAVESTART**® was specifically designed to incorporate a new sensing technology that brings fast and effective pump priming in an environment containing flushables and debris. Rags, strings, wipes or other flushable debris do not prevent **WAVESTART**® from sensing the pump’s prime status, making it the best prime sensing technology on the market today.

The secret behind **WAVESTART**® is a custom and proprietary design that incorporates **MULTI-VARIABLE SENSING**™ to define the unique profile of wastewater when determining the pump’s prime status. Reaction time is decreased to provide better system response and the probe has a smaller profile. The result to you? Freedom from flushables.



SEE HOW EASY IT IS TO INSTALL!



Test **WAVESTART**® at your pump station for 60 days, and experience less false primes or return it.

60-day money back **WAVESTART**® offer: Buyers have 60 days from date of shipment to try the **WAVESTART**®. If you’re not satisfied with its performance, return all of the parts and Smith & Loveless will refund the purchase price minus shipping. We know you’re going to love it.

Order today!
1-800-922-9048



FIGHTING FLUSHABLES



The **WAVESTART**® is the newest product in Smith & Loveless' Fighting Flushables product line. With the ever-increasing number of flushables field operators face, Smith & Loveless developed the best non-clog, mono-ported pump on the market today with the **X-PELLER**® Impeller. Flushables can be so overwhelming that customers can be forced to pull their pumps three and four times a week to unclog them. With the **X-PELLER**® Impeller, customers now go six months to years without having to pull a pump due to flushables. Fighting Flushables additionally

include the **RAPIDJACK**® Wafer Check Valve that allows operators to pull the check valve, remove the rags and reinstall it in 15 minutes or less. Now, the **WAVESTART**® Priming System incorporates **MULTI-VARIABLE SENSING**™ to determine whether the pump is primed even when rags, strings or film build-up are present. You have the triple threat to fight back against flushables.



Volute Gasket

VOLUTE GASKETS

Each time the rotating assembly is taken apart, install a new volute gasket to increase the life span of your pump.

Vacuum Priming Pump Volute Gaskets

PART#	PUMP SIZE
60A26	4B2B, 4B2C, 4B2D, 4C2B, 4C2D, 4B2X and 4C2X
60A28	4B3B, 4C3B, 4D3B, 6B3B, 6C3B and 6D3B

Vacuum Priming Pump Volute Gaskets

PART#	PUMP SIZE
60A88	8C4D and 8D4D
60A106B	4D4B

EASY TO MONITOR PUMP STATION

With a quick glance at the Combination PSI Air/Vacuum Gauge, monitoring your Smith & Loveless vacuum priming system is simple. The gauge indicates whether the pump station is working in normal operating conditions. If not, you will know whether it is a vacuum leak, vacuum plug, suction plug or discharge plug with a glance at the gauge.

These glycerin filled gauges come with a diaphragm already built-in. If you have the old style gauge, no major changes are necessary to convert to the new style gauge. All you need to do is take off the existing diaphragm and thread the new gauge into place.

Save yourself time. Make sure you have a gauge installed on each of your pumps for fast feedback. Order your gauge today.



1L780C



1L780A-F Combo Air/Vac Gauge With 3 1/2" Diameter Gauge Face.

(Measures Inches of Mercury and PSI)

PART#	DESCRIPTION
1L780A	0-30" HG, 0-15 PSI, Handles up to 25' TDH
1L780B	0-30" HG, 0-30 PSI, Handles 26' - 50' TDH
1L780C	0-30" HG, 0-60 PSI, Handles 51' - 90' TDH
1L780D	0-30" HG, 0-100 PSI, Handles 91' - 150' TDH
1L780E	0-30" HG, 0-150 PSI, Handles 151' - 225' TDH
1L780F	0-30" HG, 0-300 PSI, Handles 226' - 500' TDH

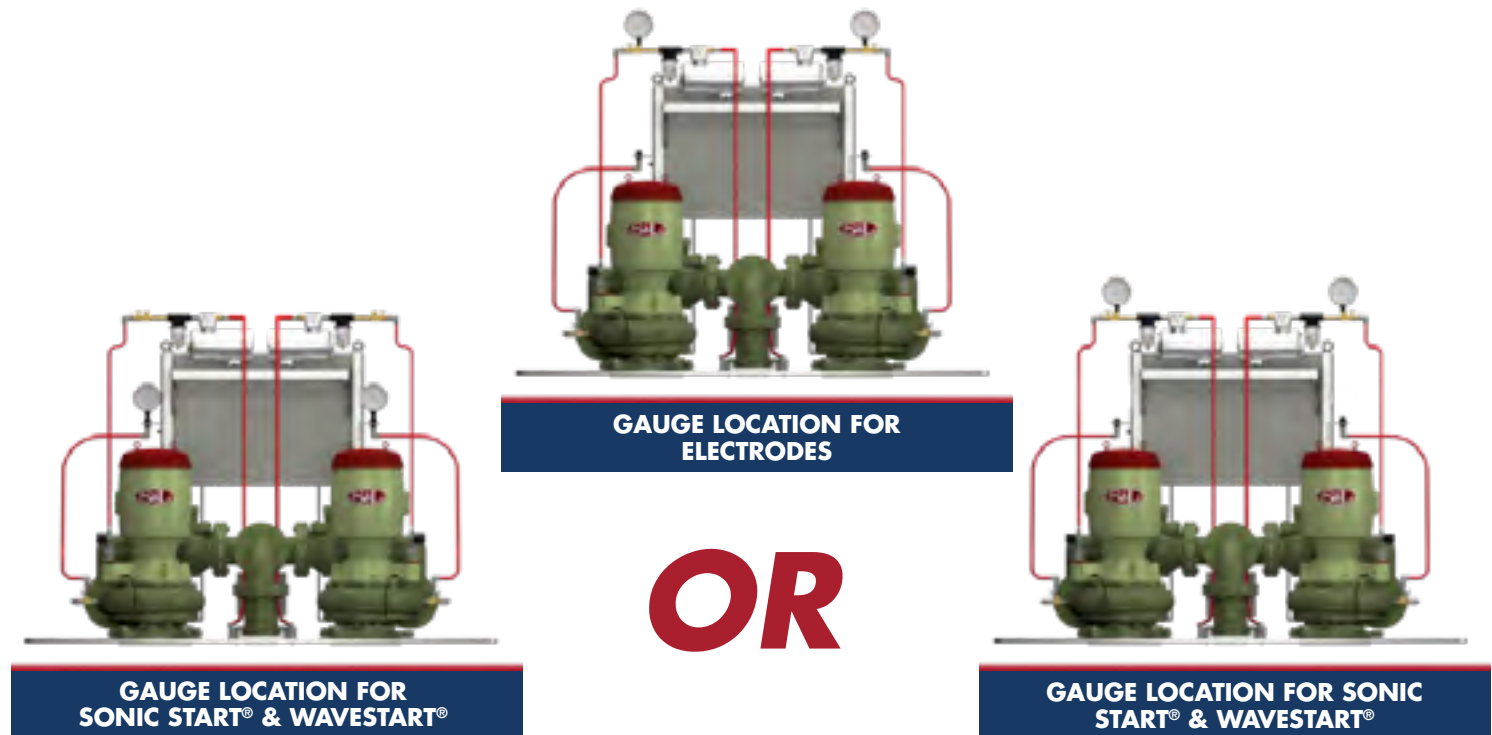

ORDER LOCALLY FROM YOUR **Smith & Loveless Representative**



WAFER CHECK VALVES



Larger diameter brass clapper provides an even larger seat area.

Arm and shaft drilled with double pin holes to securely hold the arm and shaft in place, offering more arm and shaft strength.

Double O-rings for leak protection.

Stainless steel shaft brass clapper and arm are all built from non-corrosive materials.

Double O-rings for leak protection.

New larger diameter O-ring seat.

DESIGNED TO PASS A 3" SPHERE.

New dovetail groove has a rugged gripping action that keeps the larger diameter O-ring seat securely in place without the use of adhesive.

1/4" of metal — a 200% increase of metal seat area between hole and O-Ring Seat groove for an even more effective and robust seal.

PN: 2L153NA, PA, QA & RA

Now engineered for even tougher operation, Smith & Loveless' 4" and 6" Wafer Check Valves now feature a new seat design which gives them one of the most robust seat arrangements on the market today! The 4" and 6" Wafer Check Valves are found on all of Smith & Loveless' vacuum primed pump stations.

PART#	DESCRIPTION	REPLACES
2L153NA	4" Left-Hand Wafer Check Valve	2L153N, 2L153E and 2L153A
2L153PA	4" Right-Hand Wafer Check Valve	2L153P, 2L153F and 2L153B
2L153QA	6" Left-Hand Wafer Check Valve	2L153Q, 2L153L, 2L153G and 2L153C
2L153RA	6" Right-Hand Wafer Check Valve	2L153R, 2L153M, 2L153H and 2L153D



WAFER CHECK VALVES

Extended Body Check Valves for FORMULA X® stations

- 2L153SA 4" Left-Hand Extended Body Check Valve
- 2L153TA 4" Right-Hand Extended Body Check Valve

Extended Body Check Valves for EVERLAST™ stations

- 56B20BA 4" Right-Hand Extended Body Check Valve
- 56B21AA 6" Left-Hand Extended Body Check Valve
- 56B21BA 6" Right-Hand Extended Body Check Valve
- 56B20AA 4" Left-Hand Extended Body Check Valve

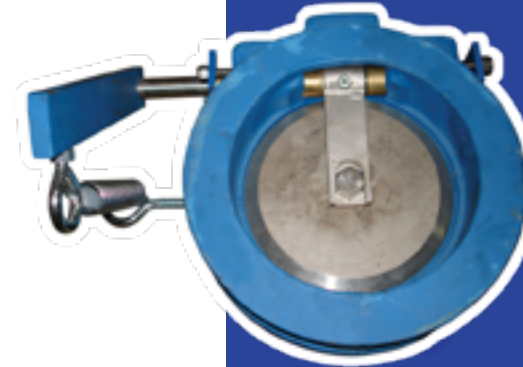

PART#	SHAFT SIZE
2L161E-300	8" Left-Hand Wafer Check Valve
2L161F-300	8" Right-Hand Wafer Check Valve
2L161G-300	10" Left-Hand Wafer Check Valve
2L161H-300	10" Right-Hand Wafer Check Valve
2L161J-300	12" Left-Hand Wafer Check Valve
2L161K-300	12" Right-Hand Wafer Check Valve



- H56A37A 4" Left-Hand **RAPIDJACK**® Check Valve
- H56A37B 4" Right-Hand **RAPIDJACK**® Check Valve
- H56A37C 6" Left-Hand **RAPIDJACK**® Check Valve
- H56A37D 6" Right-Hand **RAPIDJACK**® Check Valve



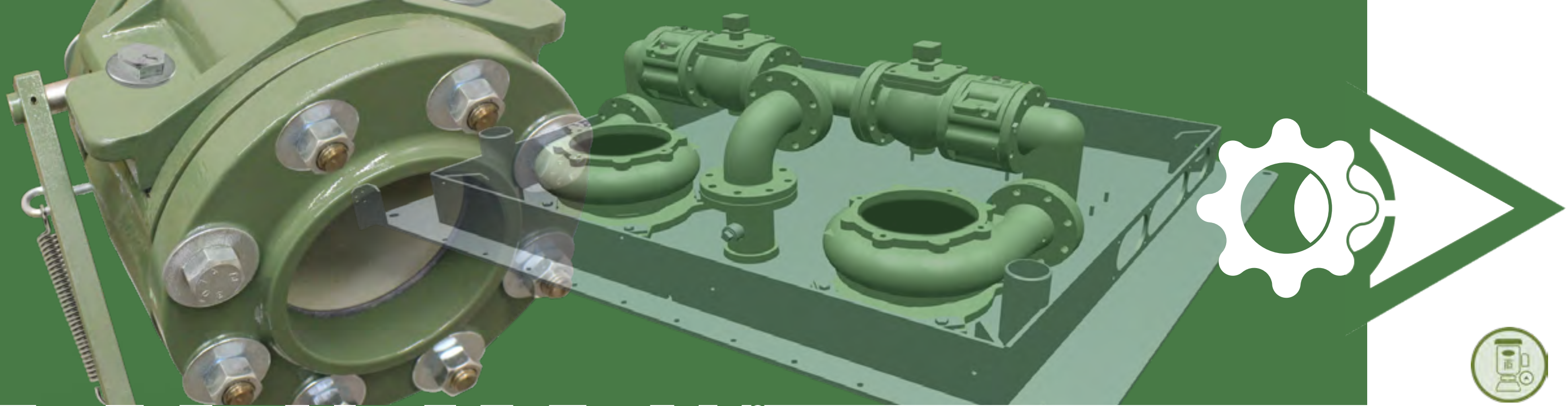

RAPIDJACK®

Unclogging a valve is normally a messy, labor-intensive process.

Clearing wafer check valves of stringy materials and obstructions will now take 15 minutes or less.

Designed for quick removal, just four bolts allow the clapper system to be removed while the **RAPIDJACK®** valve body remains in the piping. Simply remove the obstruction, reinsert the clapper system and the four bolts and go!

Smith & Loveless has done what no other company has been able to engineer, the revolutionary new **RAPIDJACK®** wafer check valve.

RAPIDJACK® 3 STEPS TO CLEAN

- 1 Remove four bolts and one spring.

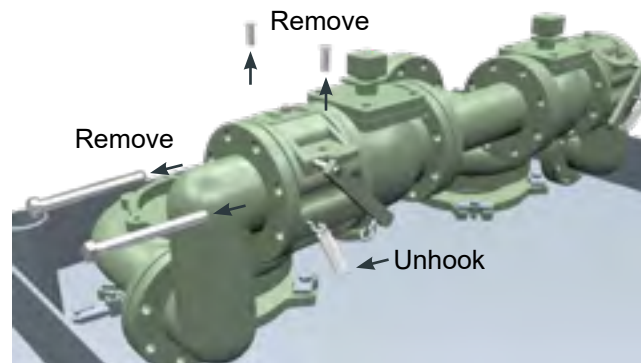

- 2 Lift the clapper system of the **RAPIDJACK®** check valve and remove debris.



- 3 Reinstall clapper system, bolts and spring.

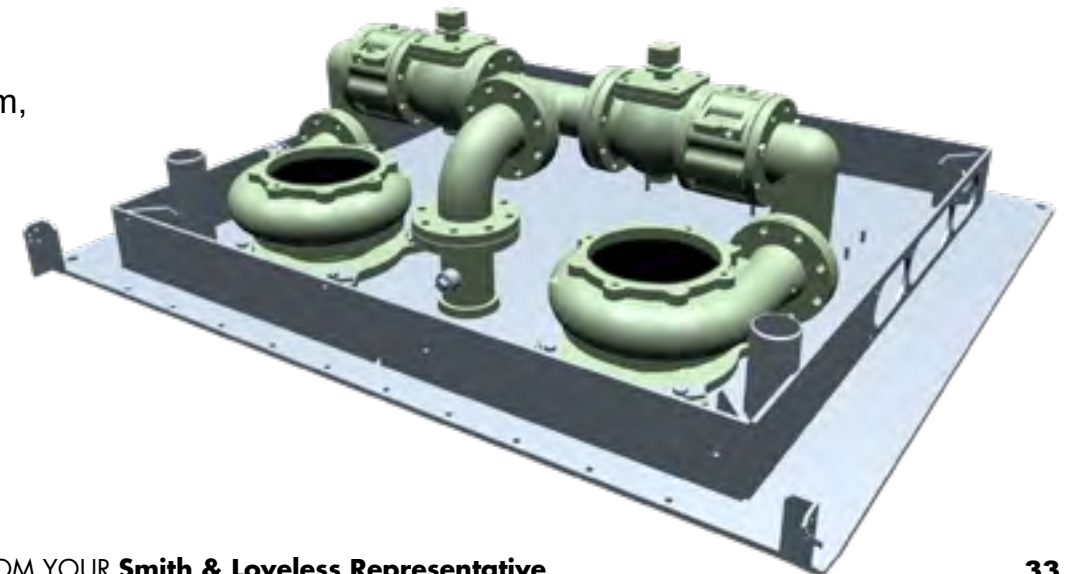

FOUR RAPIDJACK® BUYING OPTIONS



OPTION 1: PART

The **RAPIDJACK®** can be purchased as a stand-alone part that inserts into new piping layouts or can replace valves measuring five-inch lay length.

Requirement: Must have space for a five-inch lay length.



OPTION 2: PIPING SKID

Many Smith & Loveless pump stations require a new piping skid to insert the **RAPIDJACK®** because the lay length of the **RAPIDJACK®** is a little more than a standard wafer check valve. Smith & Loveless can review each pump station's piping layout and determine what piping modifications are required. In many cases two spool pieces, two **RAPIDJACK®** check valves and a 3-way plug valve will be required.



25
YEAR
WARRANTY

duro **LAST**

STAINLESS STEEL BASEPLATE

OPTION 3: SST BASEPLATE/PIPING UPGRADE

Many Smith & Loveless pump stations have been in service for more than 25 years. With time, wear occurs. By upgrading to the SST Baseplate/Piping option that features the **RAPIDJACK®** check valve, cities can reuse rotating assemblies, control panels and have an upgraded pump station with the latest features for a cost-effective price. This option features the SST **DURO-LAST®** baseplate

with a 25-year warranty. Additionally, this is available in the **EVERLAST™** one-piece and two-piece hood designs, with additional features that include the pump failure alarm, hood lift assist (if the one piece hood is selected), wet well cord manager, two new vacuum pumps on raised shelf, two-piece manway to the wet well entrance and **RAPIDJACK®**.

OPTION 4: EVERLAST™ PUMP STATION WITH RAPIDJACK®

The premier option is a new **EVERLAST™** Pump Station with the **RAPIDJACK®**. Engineered for flexibility, every **EVERLAST™** pump station's piping arrangement has the room to add the **RAPIDJACK®** when originally purchased or purchased at a later date.



EVERLAST™



YouTube



**CHECK OUT OUR
YOUTUBE VIDEO!**



JACK OF ALL TRADES



Wafer check valve headaches from flushables? We'll have your check valve back in operation within 15 minutes or less with the unique design of **RAPIDJACK®**, where the valve body stays in the piping. With only four bolts and one spring to remove, clogs are no feat for you!



Seal Housing Gasket



Quad Ring

GASKET & QUAD RING

Each time the mechanical seal is replaced, Smith & Loveless recommends the seal housing gasket or quad ring also be replaced.

PARTS TIP: The older seal housing has a flat surface and uses the flat gasket. The newer seal housing has a groove and it can use either the flat gasket or the quad ring.

GASKET PART#	QUAD RING PART#	SHAFT SIZE
60A11	60A110	B-Shaft 1-7/8"
60A17	60A111	C-Shaft 2-1/8"
60A84	60A146	D-Shaft 3" (single seal)
60A84	60A112	D-Shaft 3" (double seal)



C!@G IS A DIRTY WORD.

Never Mention Clogs Again.

Pump clogs are costly and time consuming. Now, they are a thing of the past with the X-PELLER® impeller and S&L non-clog pumps.



ORIGINAL PARTS



CONTINUOUS HINGE

If your hinges are starting to tear loose or have already torn loose from the lip of the fiberglass hood, you can now fix it without having to buy an entirely new hood. The new Continuous Hinge/Backing Bar Kit installs right over the old holes - dramatically extending the life of your hood.

Continuous Hinge/Backing Bar

49" W x 64" L 62" W x 64" L or 62" W x 70" L



HOOD LIFT ASSIST KIT

Opening your classic pump station hood just got easier with the new Hood Lift Assist by Smith & Loveless, specially designed for the insulated and non-insulated single piece Smith & Loveless above grade pump station hood.

The Hood Lift Assist Kit features two gas shocks and two patent-pending gas shock pivot assemblies that extend the hood opening to an astonishing 85 degrees* in most installations.

All you need to know are the hood, side plate dimensions and weight of your station hood. Order your hood lift assist kit today!

**In a limited number of installations, the bracket will prevent the hood from opening the full 85 degrees.*

You may also want to upgrade the hinge kit of your classic hood.

Gas Cylinder, Ball Stud & Safety Clip

PART#	DESCRIPTION
11L241AA	13MM Ball Stud
11241BB	10MM Ball Stud
11L241CC	Safety Clip



GAS SHOCK REPLACEMENT

PART#	DESCRIPTION
11L241H	Locking Replacement Gas Shock - 49" W x 64" L Hood Sizes.
11L241K	Non-Locking Replacement Gas Shock - 49" W x 64" L Hood Sizes
11L241M	Non-Lock Replacement Gas Shock- 62" W x 64" or 70" L Hood Sizes
11L241N	Locking Replacement Gas Shock - 62"W x 64" or 70" L Hood Sizes

THE ANODE TEST BOX



The Smith & Loveless Anode Test Box was designed to monitor the current flow in each sacrificial anode surrounding the buried pump station. The amount of current flowing in the anodes depends on the condition of the anode. The flow of current is also effected by the electrical ground at the service pole.

The S&L Anode Test Box provides a single measuring point to monitor the current flow and subsequent amount of anode migration. S&L's Anode Test Box works well with not only Smith & Loveless equipment, but also on all underground steel structures such as water booster pump stations, valve vaults and pump stations. See the sizing information below.

Circular Steel Structures: Recessed Wet Well Mounted Pump Stations, Custom Series and DUO-DUCT® Pump Stations.

PUMP STATION SIZE	#OF ANODES	CONDUIT SIZE
7' - 0" Diameter	2	3/4"
8' - 0" Diameter	2	3/4"
8' - 6" Diameter	2	3/4"
9' - 9" Diameter	3	3/4"
10' - 6" Diameter	3	1"
11' - 6" Diameter	3	1"

Fully Buried Steel Structures: CAPSULAR® Pump Stations

PUMP STATION SIZE	#OF ANODES	CONDUIT SIZE
9' - 9" Width X 21'-0" Length	4	1-1/4"
9' - 9" Width X 23'-0" Length	5	1-1/4"
9' - 9" Width X 27'-0" Length	6	1-1/4"
9' - 9" Width X 31'-0" Length	7	1-1/4"
9' - 9" Width X 34'-0" Length	8	1-1/4"

CORROSION BLOCKER: SACRIFICIAL ANODE PACK

Stop corrosion in its tracks with the Smith & Loveless Sacrificial Anode Pack. This magnesium-type 17-pound pack includes a 30-foot copper lead wire that attaches to an anti-corrosion structure.

This sacrificial anode pack is used for corrosion protection on all buried pump stations and recessed wet well mounted pump stations, along with any wastewater treatment plant or water treatment plant buried in the ground. The sacrificial anode significantly extends the life of the exposed metal by slowing the corrosion process.

The S&L PN: 12L8 Sacrificial Anode Pack can be tied directly into your Smith & Loveless Anode Test Box to monitor anode migration.



PART#	DESCRIPTION
12L8	Sacrificial Anode Pack

PROTECTION FROM UNAUTHORIZED ENTRY: UNDERGROUND LID LOCKING SYSTEM

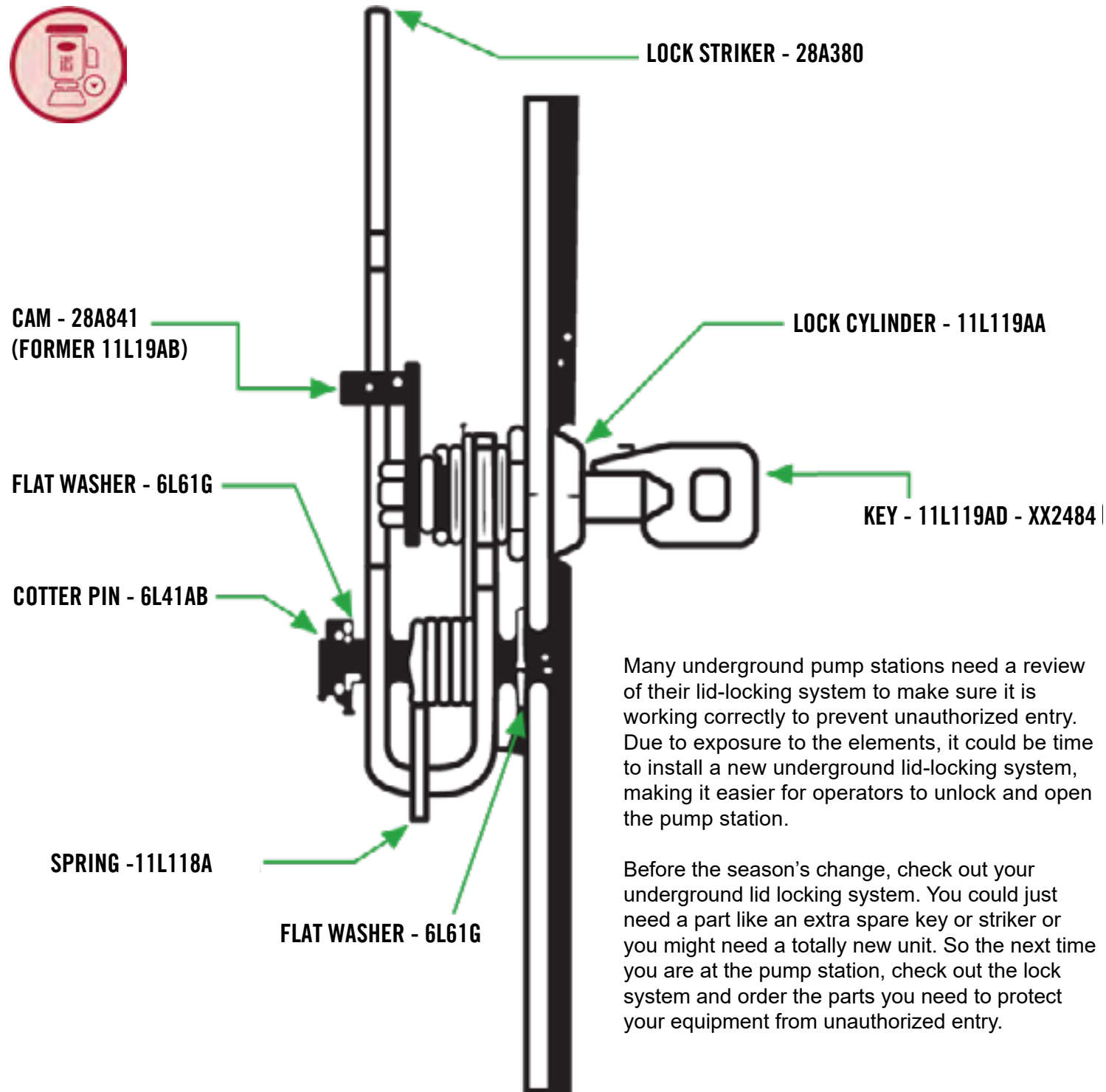

Many underground pump stations need a review of their lid-locking system to make sure it is working correctly to prevent unauthorized entry. Due to exposure to the elements, it could be time to install a new underground lid-locking system, making it easier for operators to unlock and open the pump station.

Before the season's change, check out your underground lid locking system. You could just need a part like an extra spare key or striker or you might need a totally new unit. So the next time you are at the pump station, check out the lock system and order the parts you need to protect your equipment from unauthorized entry.

VIBRATION ISOLATORS

MULTI-STRUT SHELF

Vacuum Pump Vibration Isolator Parts

ITEM#	QTY	PART#	DESCRIPTION
1	6	6L104D	Nylok Hex Nut
2	6	6L232DG	Grade B Carriage Bolt
3	20	6L61F	Washer
4	4	6L63DF	Carriage Bolt
5	4	87A291	Vibration Isolator
6	4	6L60F	Hex Nut
7	4	6L32D	Lock Nut

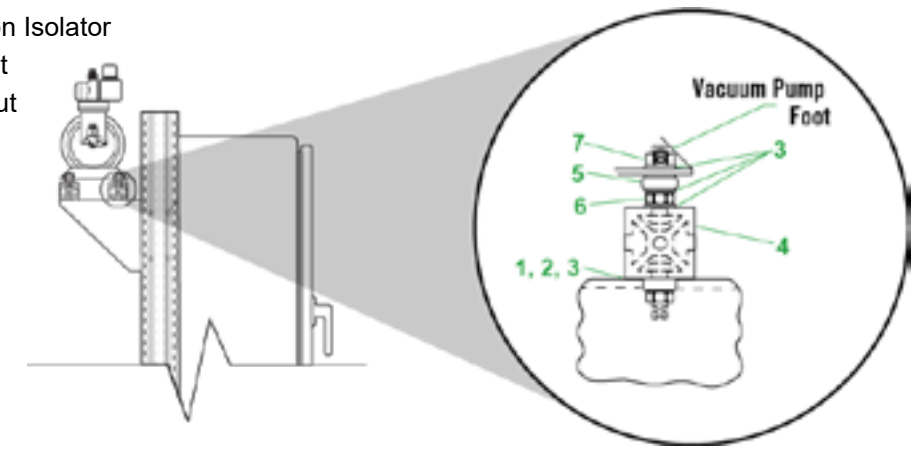

CHANNEL SHELF ON FLOOR

Vacuum Pump Vibration Isolator Parts

ITEM#	QTY	PART#	DESCRIPTION
1	4	87A291	Vibration Isolator
2	4	6L20AD	Capscrew
3	4	6L60E	Hex Nut
4	12	6L61E	Washer
5	4	6L32A	Lock Nut

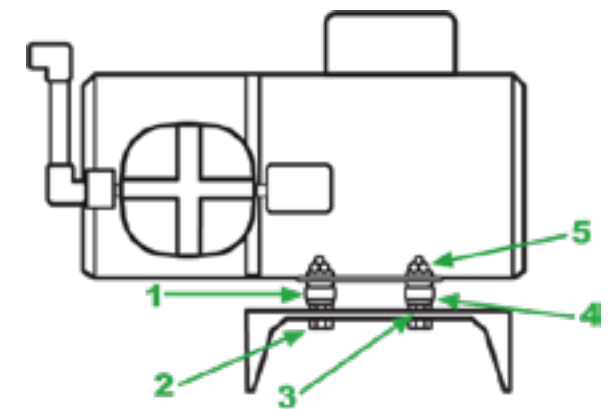

Over time, the vibration isolator located between the bottom foot of the vacuum pump and the vacuum pump shelf or floor of the wet well becomes worn and requires replacement. Updating keeps noise from vibration while the vacuum pumps works to a minimum.





ORIGINAL PARTS



1L443H

COMPLETE FLOAT CHECK VALVE ASSEMBLY

1L443H Float Check Valve Assembly

The new PN: 1L443H Smith & Loveless float check valve diameter and length were completely changed in 1999 to the new design PN: 1L443H for better overall float check valve assembly performance. The float check valve is used on all Smith & Loveless vacuum primed pumps.

1L443H SPARE PARTS

Smith & Loveless carries a full line of spare parts for the PN: 1L443H float check valve, put into use in 1999.

1L443H FLOAT CHECK VALVE SPARE PARTS

1L443HD	Body
1L443HA	Ball Seat
1L443B	1-1/2" Diameter Float Ball
1L443HB	O-Ring
1L443HC	Bowl Assembly
1L333	Check Valve (Install With Arrow Pointing Down)

1L443G SPARE PARTS

Even though this float check valve assembly was used only from 1997 to 1999, Smith & Loveless still carries a full line of spare parts for it.

1L443 Float Check Valve Spare Parts

PART#	DESCRIPTION
1L443A	Ball Seat
1L443B	1-1/2" Diameter Float Ball
1L443E	O-Ring (Goes around inside Lip of the Bowl)
1L443F	Bowl Assembly
1L333	Check Valve (Install with Arrow Pointing Down)

1L443 SPARE PARTS

Used from 1995 to 1997, Smith & Loveless Float Check Valve

PN: 1L443 still has some spare parts available for purchase.

1L443 Float Check Valve Spare Parts

PART#	DESCRIPTION
1L443B	1-1/2" Diameter Float Ball
1L443C	O-Ring (Goes Around Inside Lip of the Bowl)
1L333	Check Valve (Install with Arrow Pointing Down)

ORIGINAL PARTS



87A76 SPARE PARTS

Used from 1970 to 1995, Smith & Loveless Float Check Valve PN: 87A76 still has some spare parts available for purchase.

87A76 Float Check Valve Spare Parts

PART#	DESCRIPTION
1L443B	1-1/2" Diameter Float Ball
1L410C	O-Ring (Goes Around Inside Lip of the Bowl)
1L410D	Bowl (Not Shown)
1L410H	Bowl Insert
1L333	Check Valve (Install with Arrow Pointing Down)

NORMALLY OPEN FLOAT SWITCH

Are your floats measuring the level in your wet well consistently or is it time to replace your floats? Made of polyethylene materials, the blue normally open float switch PN: 4L291A is the most common float sold by S&L. It is typically used for high water alarms and non-alarm conditions in the wet well that signal your S&L pump to start or stop pumping.

Includes: One normally-open float switch.



Normally Open Float Switch

PART#	DESCRIPTION
4L291A	Normally-Open Float Switch

Non-Mercury Float Switch

PART#	DESCRIPTION
4L291F	Non-Mercury Float Switch



NORMALLY CLOSED FLOAT SWITCH

Made of polyethylene materials, the red normally closed float switch PN 4L291B is typically used for low water alarms.

Includes: One normally closed float switch.



Normally Closed Float Switch

PART#	DESCRIPTION
4L291B	Normally Closed Float Switch

INFLATION FIGHTERS: MECHANICAL SEALS

ASK FOR OUR NEW PRICING AT
PARTS@SMITHANDLOVELESS.COM

By securing lower supply chain prices for our customers, Smith & Loveless is fighting back against inflation with its Mechanical Seal OEM Spare Parts line. Ask for our new pricing.

The Smith & Loveless Mechanical Seal was designed to average seven years of normal sewage pumping operation.

Unfortunately, customers tell us how their purchasing department ordered “knock-off” seals and these seals fail quickly. Then they have to tear apart the entire pump to replace the “knock-off” seal.

Each component in the Smith & Loveless mechanical seal was specially designed and formulated for harsh sewage environments. S&L are pros in sewage and mechanical seals. S&L has been pumping sewage for more than 75 years.

Just because someone sells a mechanical seal doesn't mean it was formulated for sewage. Order your Smith & Loveless OEM mechanical seal today. You'll be glad you did.



SINGLE MECHANICAL SEAL REPLACEMENT PARTS KIT

The single mechanical seal was designed to have the longest seal life of any in the industry. Used on all Smith & Loveless Classics, **FORMULA X**®, Recessed WWMP and **EVERLAST**™, it comes in three sizes, depending upon the shaft size.



Single Mechanical Seal Parts Kit

Includes: One carbon, one ceramic, one spring, one O-ring and one quad ring. Does not include seal housing gasket and quad ring, impeller bolt, locking washer, impeller washer, volute gasket or bolts for the bronze seal housing.

PART#	SHAFT SIZE
H87A28	B-Shaft: 1-7/8"
H87A97	C-Shaft: 2-1/8"
H87A534	D-Shaft: 3"

SINGLE MECHANICAL SEAL PARTS KIT PLUS

Includes: One carbon, one ceramic, one spring, one O-ring and one quad ring, one Nylok impeller bolt, one locking washer and one impeller washer. Does not include volute gasket or bolts for the bronze seal housing.



MECHANICAL SEAL	QUAD RING	GASKET	IMPELLER BOLT	LOCKING WASHER	IMPELLER WASHER	SHAFT SIZE
H87A28	60A110	60A11	60A12	6L391D	60A20	B-Shaft: 1-7/8"
H87A97	60A111	60A17	60A12	6L391D	60A20	C-Shaft: 2-1/8"
H87A534	60A146	60A84	60A87	6L391D	60A86	D-Shaft: 3"

BRONZE SEAL HOUSING

Includes: One bronze seal housing. Existing bolts not included. Reuse existing bolts or order six new bolts.



HOUSING PART#	BOLT PART#	SHAFT SIZE
87B2	6L59BC	B-Shaft: 1-7/8"
87B19	6L59BC	C-Shaft: 2-1/8"
87B73	6L59EC	D-Shaft: 3"





DOUBLE MECHANICAL SEAL PARTS KIT

The double mechanical seal was designed to have the longest seal life of any in the industry. Used on all Smith & Loveless flooded suction pumps found on Custom Series and **CAPSULAR®** Underground Pump Stations, it comes in three sizes, which is dependent upon the shaft size.

Includes: Two carbons, two ceramics, one spring, two O-rings and two quad rings. Does not include seal housing gaskets and quad rings, impeller bolt, locking washer, impeller washer, volute gasket or bolts for the bronze seal housing.



PART#	SHAFT SIZE
H60A119	B-Shaft: 1-7/8"
H60A120	C-Shaft: 2-1/8"
H60A121	D-Shaft: 3"

BRONZE SEAL HOUSING

Includes: One upper bronze seal housing and/or one lower bronze seal housing. Does not include bolts. Reuse or order six new bolts for reassembly.



	B-SHAFT	C-SHAFT	D-SHAFT
	1-7/8"	2-1/8"	3"
Upper Bronze Seal Housing	60C92	60C94	60C96
Lower Bronze Seal Housing	60C93	60C95	60C97
Single Bolt (Six Required)	6L59BE	6L59BE	6L59BE

COMPLETE BRONZE SEAL HOUSING ASSEMBLY



Keep a complete bronze seal housing on the shelf for quick changeouts that allow you to rebuild the assembly in the convenience of your maintenance/parts room.

Includes fully assembled: one upper bronze seal housing, one lower bronze seal housing, two carbons, two ceramics, one spring, two O-rings, two quad rings and three bolts. Does not include volute gasket, impeller bolt, locking washer, impeller washer, seal housing, quad ring, O-ring and remaining three bolts. Reuse existing three bolts or order three additional bolts for 100% new bolts.

	B-SHAFT	C-SHAFT	D-SHAFT
	1-7/8"	2-1/8"	3"
Complete Seal & Housing Assembly	60C98	60C99	60C100

DOUBLE

DOUBLE MECHANICAL SEAL PARTS KIT PLUS

Have all the parts you need to rebuild your double mechanical seal. Don't forget to order your volute gaskets.

Includes: two carbons, two ceramics, one spring, two O-rings, two quad rings, one seal housing quad ring, one seal housing gasket, one Nylok impeller bolt, one locking washer, one impeller washer. Does not include volute gasket, bronze seal housing or bronze seal housing bolts.



MECHANICAL SEAL	QUAD RING	GASKET	IMPELLER BOLT	LOCKING WASHER	IMPELLER WASHER	SHAFT SIZE
H60A119	60A110	60A11	60A12	6L391D	60A20	B-Shaft: 1-7/8"
H60A120	60A111	60A17	60A12	6L391D	60A20	C-Shaft: 2-1/8"
H60A121	60A112	60A84	60A87	6L391D	60A86	D-Shaft: 3"



GASKET & QUAD RING

Each time the mechanical seal is replaced, Smith & Loveless recommends the seal housing gasket or quad ring also be replaced.

PARTS TIP: The older seal housing has a flat surface and uses the flat gasket. The newer seal housing has a groove and it can use either the flat gasket or the quad ring.



Volute Gasket

Vacuum Priming Pump Volute Gaskets

PART#	PUMP SIZE
60A26	4B2B, 4B2C, 4B2D, 4C2B, 4C2D, 4B2X and 4C2X
60A28	4B3B, 4C3B, 4D3B, 6B3B, 6C3B and 6D3B

Vacuum Priming Pump Volute Gaskets

PART#	PUMP SIZE
60A88	8C4D and 8D4D
60A106B	4D4B

VOLUTE GASKETS

Each time the rotating assembly is taken apart, install a new volute gasket to increase the life span of your pump.



CUSTOM SERIES PUMP STATION RETROFIT

GET MORE FROM YOUR STATION

The Smith & Loveless Custom Series is the original underground pump station made built to last. This classic established the quality features and benefits that you've come to expect from Smith & Loveless pump stations, designed for long lasting service and continuous human occupancy. Double the life of your station by retrofitting modern equipment in a proven design.

UPGRADE YOUR STATION TODAY!

Improve Operator Safety – Move the control panel to grade level, minimizing the operator from having to enter the dry well for daily maintenance.

Cost Effective – Upgrade and replace components as needed. Need just the valves or all new replacement components? We have you covered.

Changing Flow Conditions - Flow conditions change in 40+ years. There is never a better time to upgrade your pumps to meet demand.

IN PROGRESS



Eliminate Ragging – Upgrade to the **X-PELLER**® which effectively expels high volumes of consumer flushables, including wipes, rags and other stringy material. The **X-PELLER**® significantly reduces the need dismantle the pump to unbind the impeller.

Get Smart with QUICKSMART™ – Smith & Loveless offers a state-of-the art touch screen PLC that delivers an unparalleled ability to monitor and adjust all of your pump station functions.

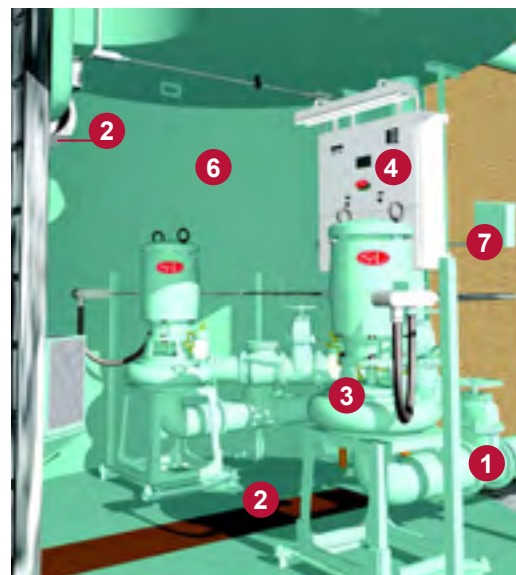

THE COMPLETE RETROFIT PACKAGE

1. Directly replace existing piping and valves with easy installation and improved factory performance.
2. Upgrade and replace the environmental equipment, including ventilation blower with 30 air changes per hour, dehumidifier and sump pump and lighting, which allows for continuous human occupancy and provides a dry, comfortable climate in which to work.
3. Directly replace the complete S&L non-clog pump with premium efficient inverter-ready motor that has a service life of decades. If needed, S&L can change flow conditions to meet your demand. Directly replace or install a new **QUICKSMART™** station control panel at the top of the station to improve operator safety and convenience. S&L can provide a local junction box in the station to make wiring a breeze and preserve local HOA controls. VFD and soft start options are available.
5. Replace the existing high strength fiberglass entrance cover, ladder extension and safety prop bar for maximum operator safety. Contact S&L for maintenance lift options.
6. Sand and re-coat the walls of the dry well with new, color matched **VERSAPOX®** epoxy coating provided by S&L to prevent rust and maximize the life of the station.
7. Replace or retrofit the sacrificial anode to prevent rust and maximize the life of the station.



XPELLER®

Mono-port impeller for heavy flushables. Available for 4" - 8" (100 mm - 200 mm) and 8" (200 mm) pumps!

S&L NON-CLOG PUMP

FEATURES

- Double Mechanical Seal
- Heavy Duty Stainless Steel Shaft
- Premium Efficient Motor
- Class F Insulation
- Explosion Proof and TEFC Options Available
- Inverter Ready



Smith & Loveless Inc.

CALIFORNIA 47 YEARS OF SERVICE



ATTENTION: Owners and Operators of Allis Chalmers, Aurora and Fairbanks-Morse Vertical Mounted Sewage Pumps!



BOLT-ON TOP PERFORMANCE BY UPGRADING TO SMITH & LOVELESS ROTATING ASSEMBLIES.

IT'S AS EASY AS 1, 2, 3

- 1 Find existing pump model from chart below
- 2 Identify Smith & Loveless drop-in replacement
- 3 Relax & reap the rewards:
 - Premium Performance
 - Low Maintenance
 - Less Energy Usage
 - Reduced Operating Costs

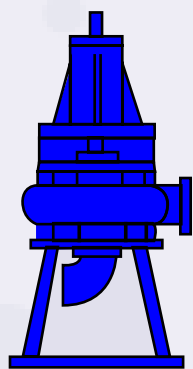

In-Line Shaft Pump

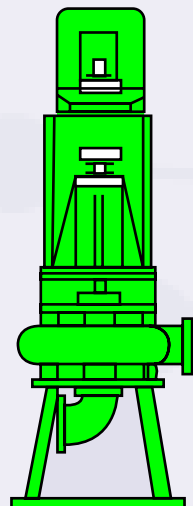

Flex-Coupled Pump

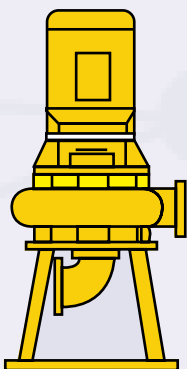

Close-Coupled Pump

TECHNICALLY ADVANCED FOR PRACTICAL PERFORMANCE.

Smith & Loveless pumps have many outstanding features which make them work *for you, not against you.*

- The oversized shaft minimizes shaft deflection, resulting in extended seal and bearing life.
- The bronze mechanical seal housing provides the best possible heat dissipation, preventing the formation of abrasive rust particles in the seal
- The non-clog impeller with a streamlined eye will pass three inch solids.
- Custom-trimmed impeller vanes are designed for maximum efficiency. The back shroud is full diameter to prevent stringy material from winding around the shaft and the front shroud is also full diameter to prevent recirculation of pumped liquid and improve efficiency.
- Smith & Loveless' compact design minimizes pump height, thus reducing vibration and extending seal and bearing life.



Replacement Pumps Available:

- Fairbanks-Morse
- Aurora
- Cornell
- Deming-Crane
- Allis-Chalmers
- Clow
- Chicago
- Hydromatic

REPLACEMENT ROTATING ASSEMBLIES AVAILABLE FOR:

S&L ROTATING ASSEMBLIES:

Allis-Chalmers	4x4x14	Type NSWV	Model 200, 300 and 400	4D4
Allis-Chalmers	8x6x17	Type NSWV	Model 200, 300 and 400	6D5
Aurora Pump Co.	8Ex10	Type KU	Series	8D5
Aurora Pump Co.	10Ex10	Type KU	Series	10D5
Aurora Pump Co.	12Ex10	Type KU	Series	12D5
Fairbanks-Morse	4"	Fig.	5412, 5432 and 5442	4B2
Fairbanks-Morse	4"	Fig.	5413, 5433 and 5443	4B3
Fairbanks-Morse	5"	Fig.	5413, 5433 and 5443	6B3

Tired of excessive maintenance costs and down-time due to limited seal life, bearing and shaft failure and frequent clogging? A simple, economic way to give new life to your wastewater pumping system is to install high-performance, energy-efficient Smith & Loveless pumps or drop-in rotating assembly.

Upgrading to Smith & Loveless quality is fast and easy whether you presently have close-coupled, flex-coupled, or in-line shaft driven pumps. The S&L rotating assembly bolts right into the existing volute casing while the Smith & Loveless complete pump bolts onto the base - no cutting; welding or piping changes! The installation takes minutes, with a few simple tools and factory supplied parts. Just bolt on, connect the motor leads and keep on pumping.

FAST AND SIMPLE: BOLT ON, TURN ON.

Call: 1-800-922-9048
smithandloveless.com



COST-EFFECTIVE UPGRADES. EVERLAST™



25 YEAR DURO-LAST® WARRANTY

Save money when you order the **EVERLAST™** Baseplate conversion by reusing rotating assemblies and controls. If you have several pump stations to upgrade, it can be a real money saver.

The **EVERLAST™** Baseplate Conversion comes standard with the features found on a complete **EVERLAST™** Pump station – except the rotating assemblies and controls. The entire swap out from the existing pump station to the new **EVERLAST™** Baseplate Conversion takes about one day.

The conversion is pretty easy and provides you with the 25-year **DURO-LAST®** warranty on the baseplate.

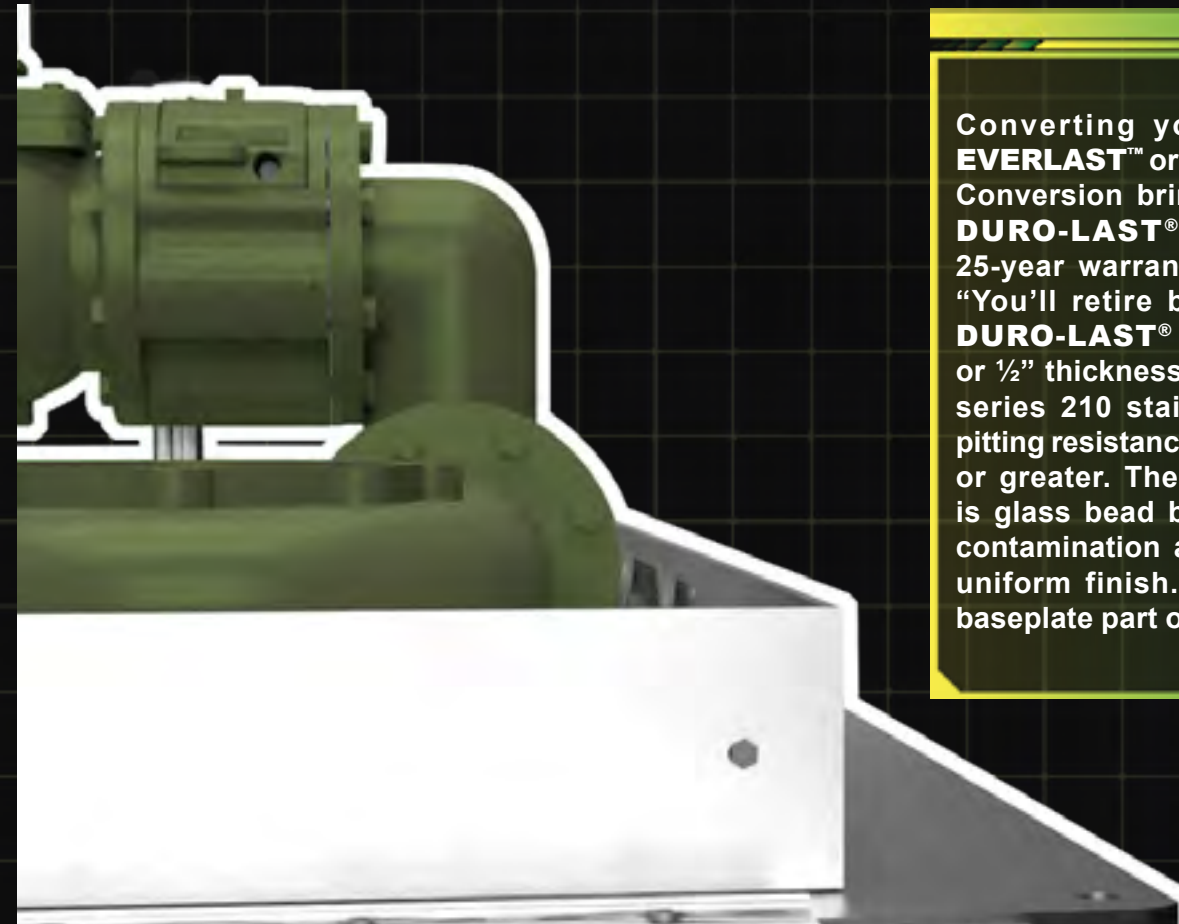

Converting your station with a new **EVERLAST™** or an **EVERLAST™** Baseplate Conversion brings the packages rugged **DURO-LAST®** baseplate with the full 25-year warranty, making the statement “You’ll retire before it does” true. The **DURO-LAST®** baseplate comes in 3/8” or 1/2” thickness in 316 and/or lean duplex series 210 stainless steel. It features a pitting resistance equivalent number of 24.0 or greater. The **DURO-LAST®** baseplate is glass bead blasted to remove surface contamination and passivated to provide uniform finish. Make the **DURO-LAST®** baseplate part of your retirement program.



CHECK OUT OUR YOUTUBE VIDEO!





1

SELECT THE STATION
THAT FITS YOUR SITE.

2

REMOVE OLD STATION;
INSTALL NEW.

3

TURN ON FOR
YEARS OF SERVICE.

NO MORE CONFINED SPACE ENTRY

Built the way every pump station should be.....above grade and out of the sewage, the **EVERLAST™** is a modern station design, free of confined space entry for routine maintenance. Submersible pumps with their old design make checking the pump an expensive, multi-person visit with a harness required. With the **EVERLAST™**, you can perform routine maintenance without entering a confined space. Every feature of the **EVERLAST™** was designed with the operator in mind. Ease of maintenance.

Smith & Loveless pump stations last 30+ years without changing out pumps. Can you say that about your submersible pumps? Save time and money with the **EVERLAST™** or **EVERLAST™** Baseplate Conversion.

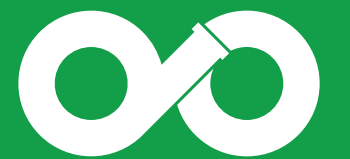
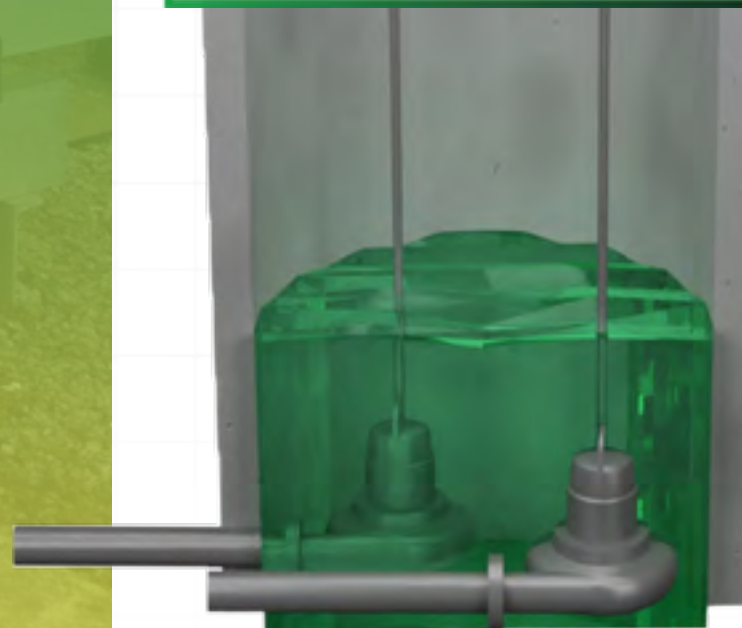
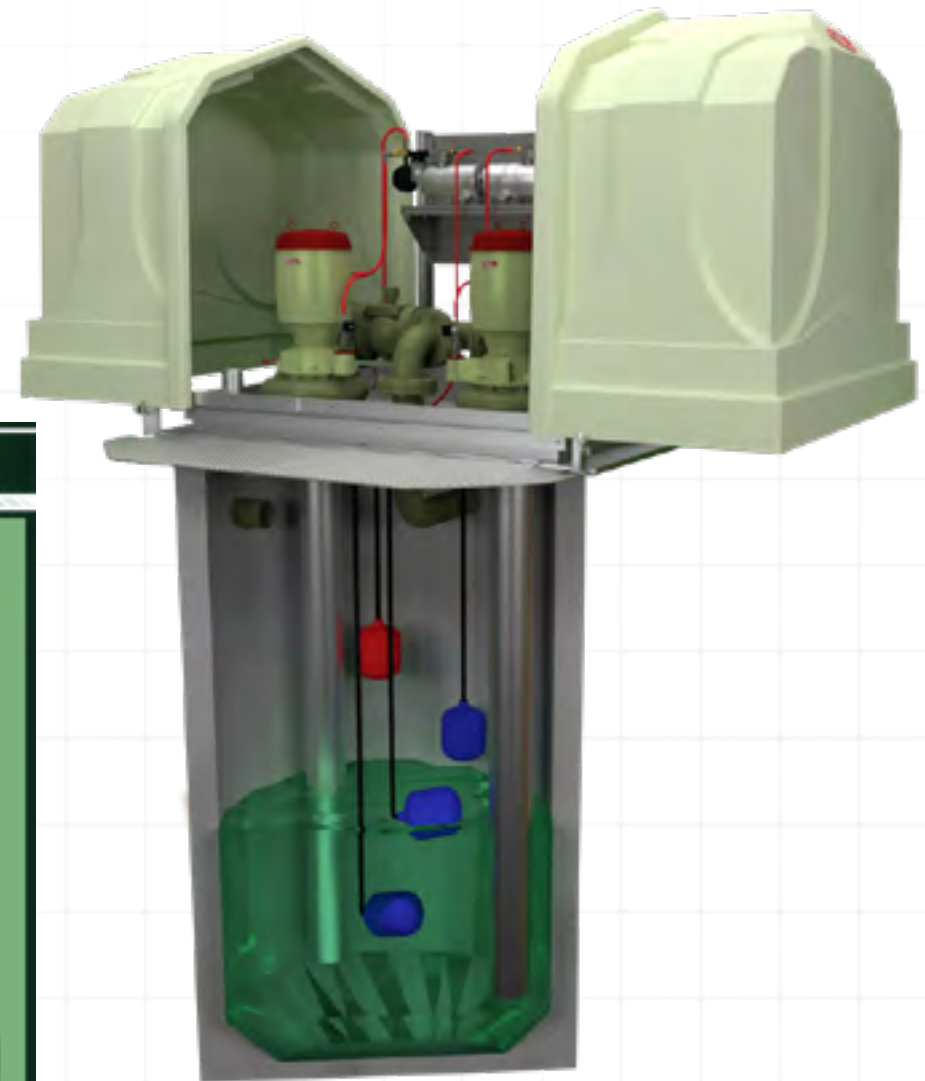

EVERLAST™
Easy Access Maintenance

ORDER LOCALLY FROM YOUR **Smith & Loveless Representative**

KCK CASE STUDY

This study measures and compares labor hours and costs, outside contractor expense, parts costs and total expenditures for these pump stations over the 12-year period.



53

Smith & Loveless

32



Submersibles

21



Of these stations with flow conditions of less than 1,000 GPM per pump and 50,000 GPD, 32 are Smith & Loveless Vacuum Primed Wet Well Mounted Pump Stations and 21 are submersible pump stations.

Labor was the most significant cost component of the study and was calculated at the actual rates of the employees used. Submersible pump stations cost an average of \$2,058 a year, while Smith & Loveless Vacuum Primed Wet Well Mounted Pump Stations only cost an average of \$1,352 in labor hours per year.



LABOR HOURS

Average Yearly Cost per Pump Station

Submersibles

\$2,058 70HRS

Smith & Loveless

\$1,352 46HRS

CONTRACTOR EXPENSE

Average Yearly Cost per Pump Station



For contractor expenses, submersible pump stations cost an average of \$1,206 a year. Smith & Loveless pump stations only cost an average of \$466 a year.

Submersibles
\$1,207

Smith & Loveless
\$466

Replacing parts on submersible pump stations cost an average of \$1,611 a year. Smith & Loveless pump stations costs an average of \$322 a year on parts.



PART COSTS & REPLACEMENT

Total Number of Pumps Replaced over 12 Year Study

Submersibles

42

Smith & Loveless

0



PARTS COST

Average Yearly Cost per Pump Station

Submersibles

\$1,611

Smith & Loveless

\$332

And throughout the 12 years of running submersible pump stations, 42 pumps were replaced. Zero Smith & Loveless pump stations were replaced during the 12-year case study period.



TOTAL EXPENDITURES

Total Cost per Pump Station

Submersibles

\$973,771

Smith & Loveless

\$576,325

For the 12-year total the cost for submersible pump stations was \$973,771 while Smith & Loveless pumps only cost \$576,325.

TOTAL SAVINGS:

\$397,446



MOVE FROM 7 YEAR SUBMERSIBLES...

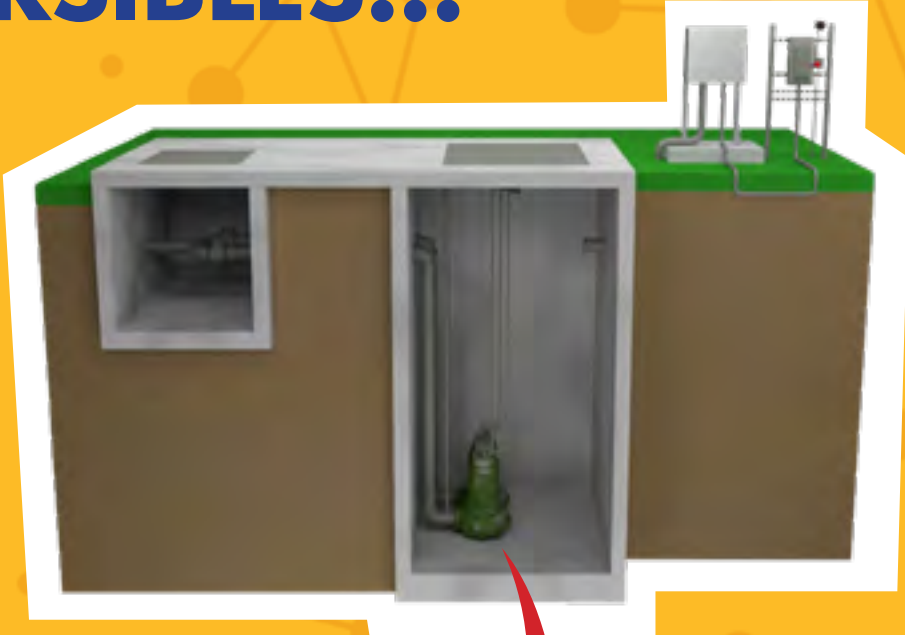

TO ABOVE GRADE 35+ YEAR EVERLAST™



Above grade pumps last 5 TIMES longer!
Call today!



GO GREEN When You GO ABOVE

S&L Pump Stations help end-users “go green” and “save your green.”

Long-lasting S&L non-clog pumps deliver decades of reliable service and cost-saving higher efficiencies. Eliminate expensive submersible pump stocking and disposal when you go above the wet well with EVERLAST™.

You Have a Better, More Sustainable Pump Station Choice.



EVERLAST™
Above Ground Pump Stations

Learn More at
smithandloveless.com



Smith & Loveless, Inc.
14040 Santa Fe Trail Drive
Lenexa, KS 66215

ARE YOU SIGNED UP FOR OUR CATALOG?

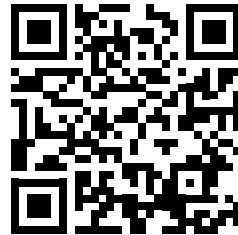

SCAN ME!

Sign up today at SmithandLoveless.com to gain access to all of our catalogs and the latest industry updates.

Phone: 1-800-922-9048

Email: parts@smithandloveless.com
answers@smithandloveless.com
retrofit@smithandloveless.com

FOLLOW US ON SOCIAL MEDIA



BEFORE

**WEST VIRGINIA
46 YEARS
OF SERVICE**

AFTER

