



**Office  
Products**

**Facility  
Maintenance**

**Packaging  
& Shipping**

**Shop  
Equipment**

**Cabinets  
& Lockers**

**Bin Storage**

**Shelving & Racks**

**Dock Equipment**

**Safety Products**

**Drums &  
Drum Equipment**

**Material Handling**

# Are you thinking Lean?

70% of manufacturers in the U.S. are either using lean manufacturing concepts or planning to in 2009.

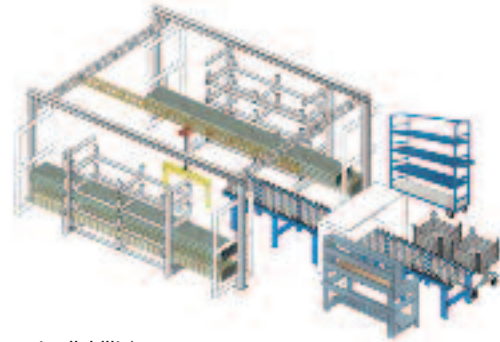

## Basic Lean Manufacturing Opportunities You Should Look For:

- ✓ Reduce waste
- ✓ Decrease cost in manufacturing
- ✓ Increase profitability
- ✓ 5S (reduce setup cycle, lower accident costs, reduce wasted labor, and increase equipment reliability)
- ✓ 6S (includes increased safety)
- ✓ Kanbans
- ✓ Communication
- ✓ TPM (Total Productive Maintenance)

In the front of our newest catalog we offer examples of lean work cells and suggested products used in the lean manufacturing process. Our selection of lean products will continue to grow.

## What is Lean Manufacturing?

A business philosophy that continuously shortens the time between a customer order and shipment by eliminating everything that increases the cost and time.

### It can address these production issues:

- ✓ Large batches
- ✓ Excessive inventory
- ✓ Long lead times
- ✓ Excessive work in progress
- ✓ Disorganized shop floor with no space
- ✓ High costs
- ✓ Low percent of on-time deliveries
- ✓ Difficulty in meeting customer needs
- ✓ Not competitive—having selling price too high

## The Benefits of a Lean Manufacturing System

A lean manufacturing system is a philosophy that was first developed by Toyota for its production system. Lots of manufacturing businesses have adopted this principle and enjoy the benefits that it offers.

### The lean manufacturing system principles are:

- 1. Value**—Customer's willingness to pay for your product.
- 2. Value Stream**—Add-ons to a product or process.
- 3. Flow**—The movement of your product through a single piece flow or work cells rather than production lines.
- 4. Pull**—Having the right amount of materials to manufacture the product, and at the same time, having a small or no inventory.
- 5. Continuous Improvement**—Getting rid of waste on a constant basis.

## Lean Manufacturing Glossary of Terms

**5S:** The principle of waste elimination through workplace organization. 5S stands for sort (red tag area, etc), sweep/shine, straighten, standardize/schedule, and sustain.

**Kanban:** a Japanese term meaning card signal. Kanban is the information signal used to indicate the need for material replenishment in a pull production process.

**Total Productive Maintenance (TPM):** Maximizing equipment effectiveness and uptime throughout the entire life of the equipment.

**Value Stream:** A series of all actions required to fulfill a customer's request, both value added and not.

**Value Stream Mapping (VSM):** This is the process of directly observing the flows of information and materials as they now occur, summarizing them visually (mapping), and then envisioning a future state with much better performance.

**Visual Factory/Control & Management:** The placement in plain view of all tools, parts, production activities, and indicators of production system performance so everyone involved can understand the status of the system at a glance. Often involves use of labeling.

**Water Bug (spider):** This is the skilled and well-trained person who makes the rounds supplying parts, assisting with changeover, providing tools and materials.

**Work Cell:** A cell is a grouping of equipment and/or people in a work environment that is dedicated to the completion of common work tasks. (Also called a Production Cell).

# Look inside for these symbols:

To help make your shopping experience easier, look for these symbols that identify what's new, in stock, and on sale!

### New:

We continue to add new and innovative products to our already vast selection.



### Stock Products:

Blue model numbers indicate products that are in stock in one of our national distribution centers ready to ship.



### Factory Quick Ship:

Green model numbers indicate products that will ship in 7 days or less directly from the manufacturer.



# SAVE on selected items.



Save on select items, with prices even lower than our everyday low prices.

Look for this symbol throughout the book to find our great deals!

## Can't find it?

We take pride in offering a wide selection of products from multiple manufacturers. However, if you don't see what you're looking for, just give us a call. We'll work with you and our vendors to get you the right product for your application.

**Call us today!**

## Quick-Reference Index



### Material Handling

8-85



### Drums & Drum Equipment

86-102



### Safety Products

103-120



### Dock Equipment

121-158



### Shelving & Racks

159-189



### Bin Storage

190-204



### Cabinets & Lockers

205-229



### Shop Equipment

230-262



### Packaging & Shipping

263-266



### Facility Maintenance

267-284



### Office Products

285-297



# LEAN MANUFACTURING!

CREATE AN EFFICIENT LEAN MANUFACTURING SYSTEM IN YOUR FACILITY. WE HAVE THE PRODUCTS THAT ALLOW YOU TO CREATE ONE-PIECE FLOW WORK CELLS FOR EVERYTHING FROM LIGHT ASSEMBLY TO HEAVY MANUFACTURING. WHEN YOU ELIMINATE: UNNECESSARY WASTE IN THE TRANSPORTING OF GOODS, EXCESS OPERATOR MOTION, AND WAITING TIMES THAT RESULT FROM NOT HAVING PARTS WHERE YOU NEED THEM, YOU WILL IMMEDIATELY REALIZE SAVINGS FROM THE REMOVAL OF NON-VALUE ADDED WORK.

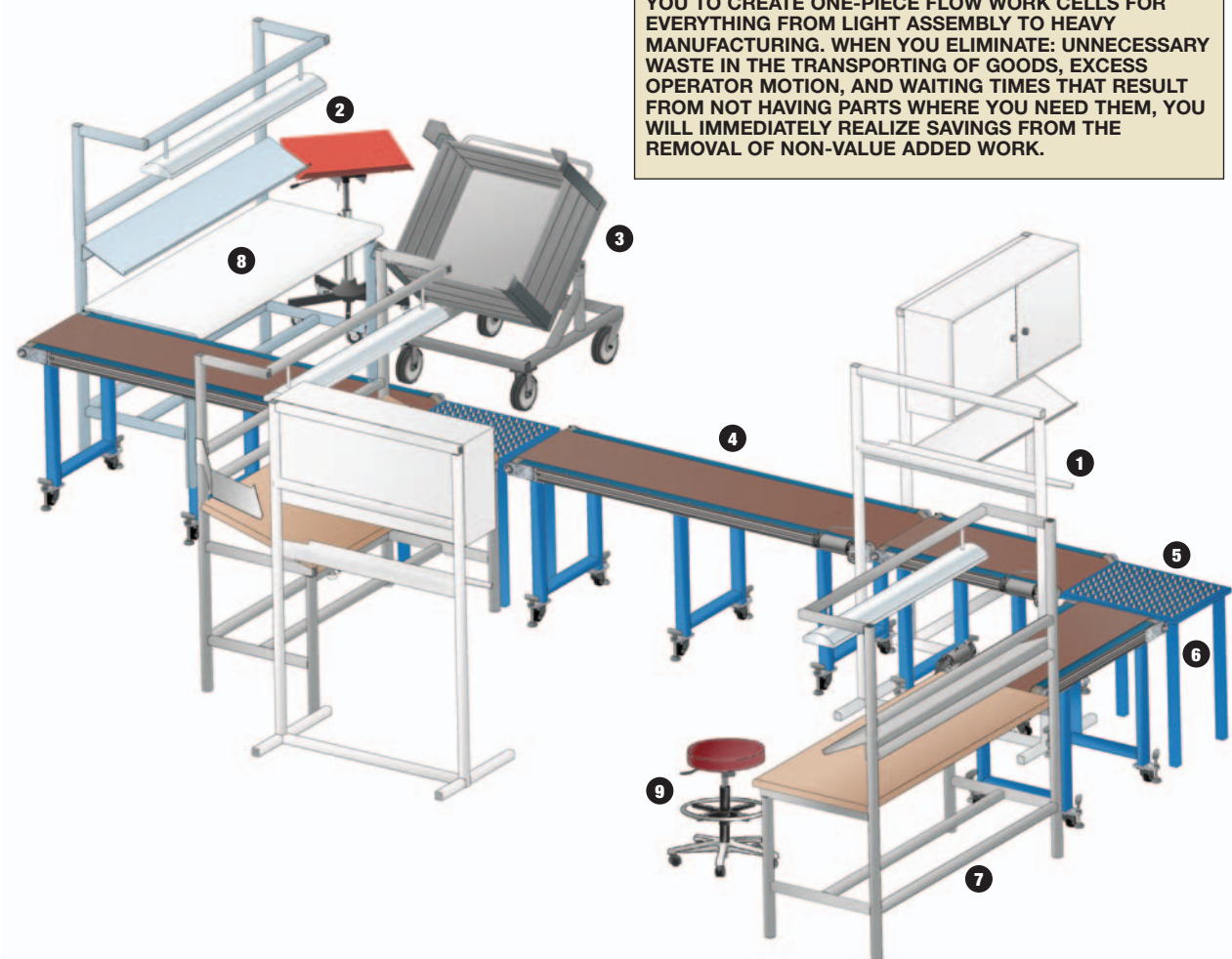

## Light-Duty Lean Manufacturing

This light-duty lean manufacturing station features configurable conveyors that allow you to easily move product from workstation to workstation and create work cells for multiple part families. Our workstations can be set up to match your process and organized to increase throughput and reduce worker fatigue and injuries.

USING LEAN MANUFACTURING TECHNIQUES CAN:

- INCREASE PRODUCTION PER EMPLOYEE
- DECREASE MANUFACTURING COSTS
- INCREASE PROFITS

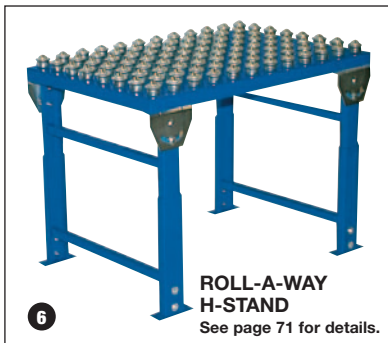
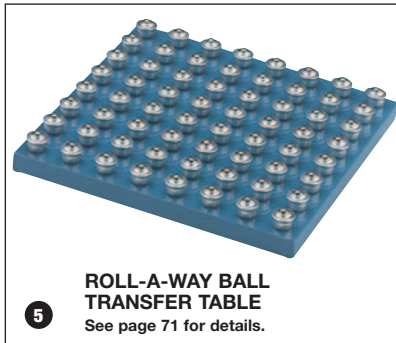



# LEAN MANUFACTURING!



1

DOES NOT INCLUDE BINS. SEE PAGE 201 TO ORDER BINS.

## SCHNEIDER INDUSTRIES Conveyor Workstation

- 160-lb. capacity
- 4" rubber casters

Can be positioned along conveyor runs for access to parts. Extruded aluminum construction. Includes 8" D shelf, 36"W x 19"H bin panel, and framework for optional light or tool balancer. FOB WISCONSIN.

Model No. **XA-1400—Conveyor Workstation.**  
Wt. 150 lbs. ....\$625.00

### ACCESSORIES

- Model No. **XA-1401—10" shelf** (replaces standard 8" shelf). Wt. 5 lbs. ....\$41.00
- Model No. **XA-1402—12" shelf** (replaces standard 8" shelf). Wt. 6 lbs. ....\$48.00
- Model No. **XA-1403—Tool balancer, 1–2 lb. capacity.** Wt. 9 lbs. ....\$111.00
- Model No. **XA-1404—Tool balancer, 2–5 lb. capacity.** Wt. 9 lbs. ....\$137.00
- Model No. **XA-1405—48"L fluorescent light.** Wt. 8 lbs. ....\$162.00



2

## SCHNEIDER INDUSTRIES ESD Work Positioner

- 220-lb. capacity
- Platform size: 19-1/2"W x 13-3/4"D
- Platform height: 24-1/2–34-1/2"
- Platform tilt: 0–40°

Features anti-static painted platform and anti-static casters. Hydraulic gas lift raises work surface. 55-lb. lifting capacity. 3" rubber casters, one with brake. FOB WISCONSIN.

Model No. **XA-1406**—Wt. 54 lbs. ....\$383.00



3

## SCHNEIDER INDUSTRIES Work Positioning Tilt Table

- 1,000-lb. capacity
- Manual hand control
- Hydraulic 0–45° tilt

All-welded tubular steel frame with 8" casters and heavy-duty floor lock. FOB WISCONSIN.

Model Number	Overall W x D	Fits Container	Wt. Lbs.	Price Each
<b>XA-1407</b>	32 x 46"	32"W x 40"D	325	<b>\$3805.00</b>
<b>XA-1408</b>	32 x 54"	36"W x 48"D	359	<b>4128.00</b>

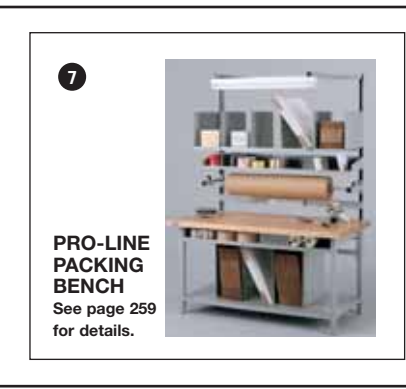

7

**PRO-LINE PACKING BENCH**  
See page 259 for details.



8

**PRO-LINE ERGO-LINE WORKSTATION**  
See page 258 for details.



9

**BREWER VINYL STOOL**  
See page 245 for details.

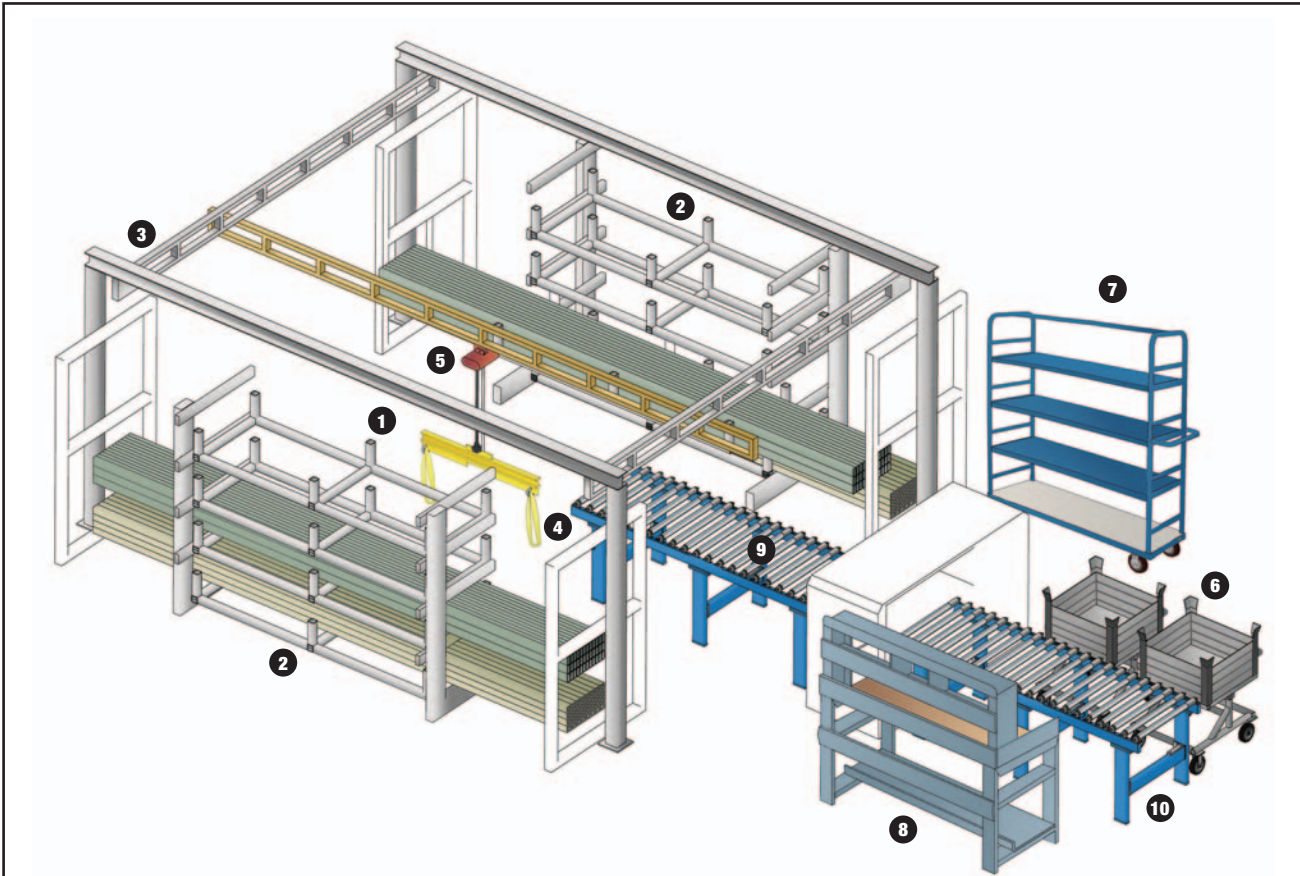

## Heavy-Duty Lean Manufacturing

Reduce the handling time needed to unload and organize incoming raw materials when you utilize this heavy-duty lean manufacturing layout. Choose rollout storage racks with shelves that can be loaded and unloaded directly from overhead then rolled back out of the way of the operator. Loading directly from overhead reduces the possibility of injury commonly seen with standard racks. In this layout you'll also find slings, a stand-alone bridge crane, lifting beams, hoists, gravity roller conveyors, and carts—all available in this catalog.

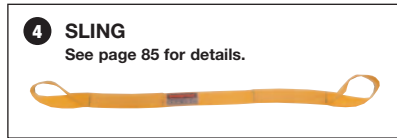



# LEAN MANUFACTURING!

## SCHNEIDER INDUSTRIES Lifting Beams

- I-beam construction
  - 2,000- and 4,000-lb. capacities
- Adjustable spreader. Welded steel construction. Includes (3) screw pin shackles. Color: safety yellow. FOB WISCONSIN.

Model Number	Overall LxWxH	Cap. Lbs.	Headroom	Spread	Wt. Lbs.	Price Each
XA-1409	72x4x11"	2,000	13-1/4"	72"	180	\$533.00
XA-1410	72x4x12"	4,000	14-1/4"	72"	208	592.00

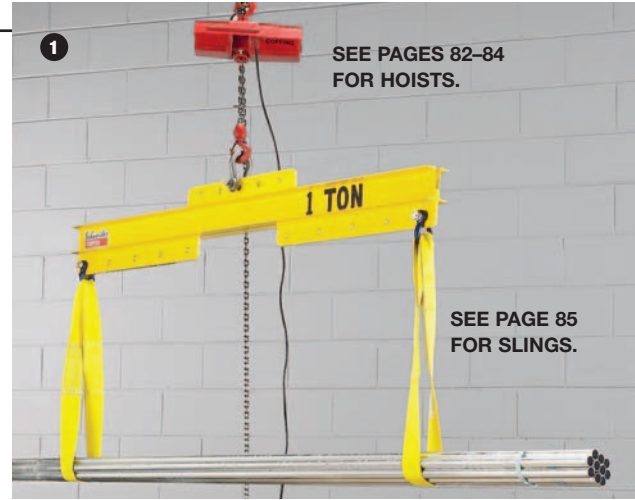

1

SEE PAGES 82-84 FOR HOISTS.

SEE PAGE 85 FOR SLINGS.

## SCHNEIDER INDUSTRIES Roll-Out Bar Storage Racks

- All-welded steel construction
  - Up to 12,000-lb. capacity
  - Roll-out shelves
- Holds up to 20'L material. 9" wide channel uprights. 24"D shelves pull out 24" for full access from overhead. 2,000-lb. capacity per shelf. Must be mounted to the floor. FOB WISCONSIN.

Model Number	Overall WxDxH	Shelf Qty.	Shelf Spacing	Cap. Lbs.	Wt. Lbs.	Price Each
XA-1411	96x66x84"	4	13.75"	8,000	2,020	\$7581.00
XA-1412	96x66x84"	5	10.19"	10,000	2,250	8382.00
XA-1413	96x66x84"	6	7.75"	12,000	2,480	9184.00

Model No. XA-1414-Removable center post.  
Wt. 12 lbs. ....\$70.30  
Model No. XA-1415-Stationary top shelf.  
Wt. 87 lbs. ....\$506.00



2

4-SHELF RACK

SEE PAGES 181-188 FOR MORE BAR



7 EUROKRAFT® SHELF TRUCK  
See page 30 for details.



8 TENNSCO WORKBENCHES  
See page 250 for details.



9 ROLL-A-WAY 10' GRAVITY CONVEYOR  
See page 70 for details.

10

ROLL-A-WAY H-STANDS  
See page 71 for details.

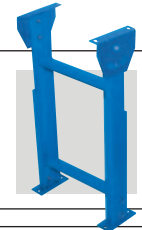

# Bulk Trucks



**ALSO AVAILABLE IN:**

- RD - RED
- YL - YELLOW
- GY - GRAY
- WH - WHITE

**WESCO® Box Trucks**

- .125" thick polyethylene
- 5" polyurethane casters

One-piece molded container with seamless walls and rounded corners. Two rigid, two swivel casters. Casters are mounted to a plywood base on 450-600-lb. cap. trucks. **SPECIFY COLOR:** BL - Blue, GY - Gray, RD - Red, WH - White, YL - Yellow. **FACTORY QUICK SHIP—FOB PENNSYLVANIA.**

Model Number	Overall WxDxH	Cap. Lbs.	Cap. Cu. Ft.	Inside Height	Wt. Lbs.	(WH) Price Ea.	(RD), (YL), (BL), (GY) Price Ea.
XF-2110	21x32x21-1/2"	350	3.4	15"	19	\$144.00	\$152.00
XF-2111	24x35-1/2x30"	450	6.1	23"	32	183.00	191.00
XF-2112	28x38x35"	550	10.2	27.8"	37	228.00	233.00
XF-2113	30x42x37"	600	14	30"	41	250.00	258.00
XF-2114	34x46x40"	600	18.7	31.7"	54	290.00	298.00

**FACTORY QUICK SHIP** 



**ALSO AVAILABLE IN:**

- BL - BLUE
- GY - GRAY
- RD - RED

**Elevated Floor Trucks** 

- Polyethylene
- 4" rubber casters

Tub and base are completely sanitary. Seamless, one-piece tub is rust-resistant and steam-cleanable. Tub can be removed from base. Two rigid, two swivel casters. Materials have been approved to meet FDA standards. Lids available, call for information. Base color: Black. **SPECIFY TUB COLOR:** BL - Blue, GY - Gray, RD - Red, WH - White. **FOB NEW YORK.**

Model Number	Overall WxDxH	Cap. Lbs.	Cap. Cu. Ft.	Inside Height	Wt. Lbs.	Price Each
YF-0154	19x28.5x28"	200	4	12"	24	\$193.00
YF-0155	22x31x33"	200	7	20.5"	34	222.00



**STOCK**

Selected Models 

**ROYAL Vinyl Basket Trucks**

- Vinyl liners
- 3" polyurethane casters

Liners are sewn and riveted for extra strength. Vinyl resists tears, punctures and abrasions. Seam-welded steel chassis, hardwood base with swivel casters. Liners have a black top rim, reinforced wear points, reinforced handles on both ends, and extra-large work order pocket. **SELECTED MODELS IN STOCK.** Others **FACTORY QUICK SHIP—FOB WISCONSIN.**

**AVAILABLE COLORS:**

- BK - BLACK
- BL - BLUE
- GN - GREEN
- GY - GRAY
- RD - RED
- WH - WHITE
- YL - YELLOW

Model Number	Cap. Bu.	Overall WxDxH	Inside Height	Wt. Lbs.	Price Each
XC-2900	6	20x30x26-1/2"	20-1/2"	25	\$149.00
XC-2901	8	22x34x29"	23"	30	167.00
XC-2902**	10	24x36x31"	25"	33	187.00
XC-2903*	12	26x36x33-1/2"	27-1/2"	36	197.00
XC-2904*	14	28x40x33-1/2"	27-1/2"	42	230.00
XC-2905	16	28x40x36"	30"	48	247.00
XC-2906	18	30x42x36"	30"	52	271.00
XC-2907**	20	32x48x36"	30"	60	275.00
XC-2908†	24	34x54x36"	30"	80	392.00

†(RD)(BK) **IN STOCK** and feature extra side and back framing with 4" casters.  
\*(RD) **IN STOCK.** \*\*(BL)(RD) **IN STOCK.**



**WK-3070**

**STOCK**

**TECHSTAR Elevated Starcarts**

- Polyethylene
- 3" rubber casters

Removable container will not dent, tear, or rust. Powder coated steel frame with threadguard swivel casters. Ships assembled. Color: gray. **IN STOCK.**

Model Number	Overall WxDxH	Cap. Lbs.	Cap. Cu. Ft.	Inside Height	Wt. Lbs.	Price Each
WK-3070	19x33x28"	200	5	16"	25	\$167.00
WK-3071	23x33x29"	200	7	20"	35	230.00



**WK-3071**



# Bulk Trucks



## ROTONICS Versa-Bin Containers

- Rotational molded polyethylene
- 2-way and 4-way fork access
- Stack and nest

ALSO AVAILABLE IN:  
GY - GRAY

Vertical ribbing adds side-wall strength. Also includes roll-over lip around top rim. Materials have been approved to meet FDA standards. NSF listed. **SPECIFY COLOR: GY - Gray, WH - White.** Other colors available, call for information. **FACTORY QUICK SHIP—FOB ILLINOIS.**

Model Number	Overall WxDxH	Cap. Lbs.	Cap. Cu. Ft.	Inside Height	Fork Entry	Wt. Lbs.	Price Each
<b>VERSA-BIN CONTAINER</b>							
YA-0190	43-1/2x43-1/2x34-1/2"	1200	28	29"	2-Way	68	\$337.00
<b>VERSA-BIN CONTAINER WITH 6" POLY CASTERS—2 SWIVEL, 2 RIGID</b>							
YA-0191	43-1/2x43-1/2x41-1/2"	1200	28	29"	2-Way	135	\$633.00
<b>VERSA-BIN CONTAINERS WITH LID</b>							
YA-0192	44-1/2x44-1/2x36"	1200	28	30-1/2"	4-Way	70	\$460.00
YA-0193	46x39x50"	1200	45	32"	4-Way	95	501.00

Model No. **YA-0194—Lid.** For YA-0190 and YA-0191. Wt. 25 lbs. **\$138.00**

## MEESE Polyethylene Trucks

- Polyethylene
- 3" hard rubber casters



Seamless .225" thick molded body with galvanized steel base. Two swivel, two rigid casters mounted in diamond pattern. **SPECIFY COLOR: BL - Blue, RD - Red, WH - White. SELECTED MODELS IN RD - RED AND BL - BLUE ARE IN STOCK.** Others FOB CALIFORNIA, INDIANA, NEW JERSEY.



ALSO AVAILABLE IN:  
BL - BLUE

Model Number	Overall WxDxH	Cap. Lbs.	Cap. Cu. Ft.	Inside Height	Wt. Lbs.	Price Each
XV-1188	24x34x25"	450	7	21"	35	\$223.00
XV-1189	25-1/2x37x28-1/2"	450	10	24"	41	235.00
XV-1190	27-1/2x39-1/2x29"	500	12	25"	46	259.00
XV-1191	29-1/2x39-1/2x32"	550	15	28"	53	269.00
XV-1192	31-1/2x43x32"	600	17	28"	57	282.00
XV-1193	31-3/4x43x34"	600	20	30"	60	323.00
XV-1194	35-1/2x51x34"	650	24	30"	72	368.00



ALSO AVAILABLE IN:  
BL - BLUE  
GN - GREEN

## TECHSTAR Easy-Access Carts

- High-density polyethylene
- 4" casters

Features ergonomic sidewall cut-out and reinforced rolled rim. Resists moisture, most chemicals and solvents—will not rust, dent, crack, splinter, or corrode. Two swivel and 2 rigid casters are attached to a 3/4" treated plywood base. **SPECIFY COLOR: BL - Blue, GN - Green, LG - Light Gray. IN STOCK.**

Model Number	Outside WxDxH	Cap. Lbs.	Cap. Cu. Ft.	Inside Height	Caster Pattern	Wt. Lbs.	Price Each
YT-1710	31x46x39"	900	21	32"	Corner	75	\$477.00
YT-1711	31x63x39"	900	24	32"	Corner	100	566.00
YT-1712	31x63x39"	900	24	32"	Diamond	100	584.00
YT-1713	31x46x48-1/2"	900	24	42"	Corner	75	576.00



ALSO AVAILABLE IN:  
BL - BLUE  
GN - GREEN  
GY - GRAY  
OR - ORANGE  
RD - RED

## ICM Double-Wall Dual-Access Tuf-Truck

- Polyurethane
- 4" Colson casters



Front and back sidewall cut-outs feature folding web doors. Double-wall body is supported by a metal base frame. Non-marking casters. Nestable. Towable frame available on request. **SPECIFY COLOR: BL - Blue, GN - Green, GY - Gray, OR - Orange, RD - Red, YL - Yellow. FACTORY QUICK SHIP—FOB WISCONSIN.**

Model Number	Overall WxDxH	Cap. Lbs.	Cap. Cu. Ft.	Inside Height	Wt. Lbs.	Price Each
YC-2110	31-3/4x48x37"	1,200	19.6	28"	97	\$415.00

# Tilt Trucks



**SELECTED TILT TRUCKS**  
WJ-452,  
WJ-314  
**AVAILABLE IN:**

**BL - DK.BLUE**

**BK - BLACK**

**RD - RED**

STOCK



MADE IN  
USA

### RUBBERMAID® Sanitary Tilt Trucks

- Rotation molded polyethylene
- Up to 2,300-lb. capacity
- Multiple caster choices available

Entire unit is counterbalanced for smooth, controlled dumping. Seamless construction resists corrosion. 1/2 and 1 cu. yd. models have inset wheels to protect walls and doorways. Standard color: black. **IN STOCK.**

Model No.	Overall WxDxH	Cap. Lbs.	Cap. Cu. Yd.	Wt. Lbs.	Price Ea.
<b>(2) SEMI-PNEUMATIC TIRES, (1) SOFT-RUBBER SWIVEL CASTER</b>					
<b>WJ-450*</b>	28x56-3/4x38-5/8"	450	1/2 Utility	63	\$484.00
<b>(2) SEMI-PNEUMATIC TIRES, (2) SOFT-RUBBER SWIVEL CASTERS</b>					
<b>WJ-452**</b>	28x60-1/2x38-5/8"	850	1/2 Standard	77	\$700.00
<b>WJ-317**</b>	28x60-1/2x38-5/8"	1,400	1/2 Heavy-Duty	88	796.00
<b>WJ-451</b>	33-1/2x72-1/4x43-3/4"	850	1 Utility	111	658.00
<b>WJ-314**</b>	33-1/2x72-1/4x43-3/4"	1,250	1 Standard	111	863.00
<b>WJ-315**</b>	33-1/2x72-1/4x43-3/4"	2,100	1 Heavy-Duty	120	985.00

\*Does not include push handle.  
\*\*Includes full-perimeter steel tubing.

**DOMED-HINGED LIDS.** Color: black.

Model No. **WJ-453BK** – Fits 1/2 cu. yd. trucks. Wt. 22 lbs. ....\$162.00  
Model No. **WJ-454BK** – Fits 1 cu. yd. trucks. Wt. 24 lbs. ....\$217.00



STOCK



MADE IN  
USA

### RUBBERMAID® Economy Tilt Trucks

- Rotationally molded polyethylene
- 300- and 600-lb. capacities
- (2) 10" rubber wheels; (1) 4" polypropylene caster

Smooth, one-piece seamless body with rounded corners. Will not rust, dent, chip, or peel. Center caster swivels. Color: black. **IN STOCK.**

Model Number	Overall WxDxH	Cap. Cu. Yd.	Cap. Lbs.	Wt. Lbs.	Price Each
<b>XC-0005</b>	28x56-3/4x38-5/8"	1/2	300	139	\$464.00
<b>XC-0006</b>	33-1/2x72-1/4x43-3/4"	1	600	260	635.00



**ALSO AVAILABLE IN:**

**GN - GREEN**

**LG - LIGHT GRAY**

STOCK

### TECHSTAR Next Generation Starcarts™

- Polyethylene
- 5" casters

Double-wall top lip and box style rim absorb impact. Molded-in handles. Steel undercarriage is bolted directly to the body. Two rear swivel casters and two axle-mounted wheels. Nestable. **SPECIFY COLOR:** BL - Blue, GN - Green, LG - Light Gray, WH - White. **IN STOCK.**

Model Number	Overall WxDxH	Cap. Lbs.	Cap. Cu. Ft.	Inside Height	Wheel Height	Wt. Lbs.	Price Each
<b>XK-1302</b>	31x48x33"	1,000	16	25-1/2"	10"	80	\$434.00
<b>XK-1303</b>	32x60x34"	1,000	24	28"	12"	100	515.00



STOCK



MADE IN  
USA

### RUBBERMAID® Structural Foam Tilt Trucks

- Structural foam
- Up to 2,100-lb. capacity
- (2) 10" or 12" rubber wheels; (2) 4" rubber casters

Upper and lower ergonomically designed handles offer optimum control with minimum effort. Smooth, rounded interior. Fits through standard doorways. Also includes two non-marking swivel casters. Color: BK - Black. **IN STOCK.**

Model Number	Overall WxDxH	Cap. Cu. Yd.	Cap. Lbs.	Wheel Height	Wt. Lbs.	Price Each
<b>XK-3080</b>	26-7/8x57-3/8x33-7/8"	1/2 Utility	450	10"	70	\$464.00
<b>XK-3081</b>	26-7/8x57-3/8x33-7/8"	1/2 Standard	850	10"	77	542.00
<b>XV-2690</b>	30-1/4x64-1/2x38"	3/4 Utility	600	12"	97	647.00
<b>XV-2691</b>	30-1/4x64-1/2x38"	3/4 Standard	1000	12"	95	760.00
<b>XK-3082</b>	33-1/2x70-3/4x42-1/4"	1 Standard	1250	12"	139	782.00
<b>XK-3083</b>	33-1/2x70-3/4x42-1/4"	1 Heavy-Duty	2100	12"	123	902.00

**DOMED-HINGED LID.** Color: black.

Model No. **XK-3084BK** – For 1/2 Cu. Yd. Tilt Trucks. Wt. 25 lbs. ....\$128.00  
Model No. **XV-2689BK** – For 3/4 Cu. Yd. Tilt Trucks. Wt. 25 lbs. ....\$194.00  
Model No. **XK-3085BK** – For 1 Cu. Yd. Tilt Trucks. Wt. 37 lbs. ....\$173.00

# Tilt Trucks

## BAYHEAD Haul-All Tilt Trucks



- Rotational molded polyethylene
- Up to 2,800-lb. capacity
- Two neoprene front wheels; two rear casters

Bodies will not dent, corrode, or absorb moisture. White trucks are constructed of resin materials that have been approved to meet FDA standards. 1/3 cu. yd. truck has one swivel caster. Conforms to OSHA spec. 1910.141 when used with hinged lids. (Lids are sold separately.) **SPECIFY COLOR:** **BL** - Blue, **GN** - Green, **GY** - Gray, **RD** - Red, **WH** - White, **YL** - Yellow. **GY - GRAY IS FACTORY QUICK SHIP.** All FOB NEW HAMPSHIRE.



XC-1058GN

XC-1059RD



Selected Models

XC-1062YL



NEOPRENE-TIRE TRUCKS						HINGED LIDS	
Model Number	Overall WxDxH	Cap. Lbs.	Cap. Cu. Yd.	Wt. Lbs.	Price Each	Model Number	Price Each
XC-1057	26x48x30"	275	1/3 Utility	49	\$229.00	XC-1071	\$107.00
XC-1058	27x56x36"	600	5/8 Utility	75	381.00	XC-1072	105.00
XC-1059*	27x56x38"	1,000	5/8 Standard	94	526.00	XC-1072	105.00
XC-1060**	27x56x38"	1,500	5/8 Heavy-Duty	117	611.00	XC-1072	105.00
XC-1061	34x69x40"	900	1.1 Utility	94	513.00	XC-1073	125.00
XC-1062*	34x69x40"	1,400	1.1 Standard	126	681.00	XC-1073	125.00
XC-1063**	34x69x42"	2,100	1.1 Heavy-Duty	162	843.00	XC-1073	125.00
XC-1064	40x74x51"	1,000	1.7 Utility	150	771.00	XC-1074	162.00
XC-1065*	40x74x54"	1,700	1.7 Standard	207	1022.00	XC-1074	162.00
XC-1066**	40x74x54"	2,200	1.7 Heavy-Duty	263	1112.00	XC-1074	162.00
XC-1067	51x74x52"	1,200	2.2 Utility	211	913.00	XC-1075	178.00
XC-1068*	51x74x54"	2,000	2.2 Standard	244	1150.00	XC-1075	178.00
XC-1069**	51x74x54"	2,500	2.2 Heavy-Duty	302	1245.00	XC-1075	178.00
XC-1070†	55x78x55"	2,800	3 Heavy-Duty	364	1485.00	XC-1076†	234.00

\*Includes front and back vertical steel tubular frame with handle.  
 \*\*Includes full-perimeter vertical and horizontal steel tubular frame with handle.  
 †Only available in GY - Gray.



XC-1065BL



XC-1069GY AND XC-1075GY



INCLUDES 5.6"W X 2.75"H STEEL FORK POCKETS.

## RUBBERMAID® Tilt Trucks with Fork Pockets

- Rotationally molded polyethylene
- Up to 1,250-lb. capacity
- (2) rubber wheels; (1) rubber caster

5.6"W x 2.75"H steel fork pockets allow you to move fully loaded trucks with a fork truck. Constant force design permits controlled dumping action. Seamless body will not corrode. Powder coated steel frame. Will work with competitive dumper systems. Color: black. **IN STOCK.**

Model Number	Overall WxDxH	Cap. Lbs.	Cap. Cu. Yd.	Wheel Height	Wt. Lbs.	Price Each
WK-4575	28x60x38-5/8"	850	1/2	3-1/2"/10"	88	\$691.00
WK-4576	33-1/2x72-1/4x43-3/4"	1,250	1	5"/12"	124	881.00
WK-4577	43x80-1/2x49-1/2"	1,200	1-1/2	4"/12"	232	1702.00



1.1 CU. YD. STANDARD TRUCK SHOWN

## TECHSTAR Tilt Trucks



- .250" polyethylene
- Up to 2,000-lb. capacity
- 10" or 12" rubber wheels; 4" rubber casters

Large recessed wheels and swivel casters. Nestable. Materials have been approved to meet FDA standards. Color: gray. **IN STOCK.**

Model Number	Overall WxDxH	Cap. Lbs.	Cap. Cu. Yd.	Wheel Height	Wt. Lbs.	Price Each
WS-1450GY	28x53x37"	400	5/8 Utility	10"	70	\$489.00
WS-1451GY	35x63x40"	500	1.1 Utility	10"	85	576.00
WS-1452GY	30x53x37"	800	5/8 Standard	12"	85	576.00
WS-1453GY	35x66x41"	1,200	1.1 Standard	10"	100	754.00
WS-1454GY	43x80x53"	1,500	1.5 Standard	10"	125	882.00
WS-1455GY	49x74x57"	2,000	2 Standard	12"	180	1321.00

# Self-Dumping Hoppers



**FACTORY QUICK SHIP**

Selected Models

## McCULLOUGH Wright Hoppers



- Steel
- Up to 7,000-lb. capacity

Perfectly balanced hoppers roll forward when loaded and unlatched; automatically return to upright locked position when empty. Features: continuous welds, 3"W rockers, strong, latch, formed smooth edge around top, and extended sides on pouring lip. Hoppers can be used with optional casters, with a forklift truck, or both. **GY - GRAY IS FACTORY QUICK SHIP.** All FOB OHIO.

**EXTRA HEAVY-DUTY HOPPERS.** 3/16" (7-gauge) sides with 1/4" base. **SPECIFY COLOR: GY - Gray Primer, YL - Safety Yellow.**

Model Number	Cu. Yd.	Cap. Lbs.	Overall LxWxH	Fork Pocket WxH	Wt. Lbs.	GY - Gray		YL - Yellow	
						Price Ea.	Price Ea.	Price Ea.	Price Ea.
WB-1577	1/4	7000	41-1/2x33x24"	18x3"	325	\$536.00	\$552.00		
WB-1578	1/3	7000	51-1/2x32x32-3/4"	18x3"	410	613.00	601.00		
WB-1579	1/2	7000	51-1/2x37-1/4x32-3/4"	26x3"	445	686.00	703.00		
WB-1580	3/4	7000	58-1/2x39-1/4x37-1/4"	28x3"	551	842.00	858.00		
WB-1581	1	7000	63x39-1/4x39"	28x3"	602	891.00	907.00		
WB-1582	1-1/2	7000	65x57-1/4x38-1/2"	28x3"	715	1054.00	1078.00		
WB-1583	2	7000	64-1/2x57-1/4x45-1/2"	28x3"	805	1193.00	1217.00		
WP-1540	2-1/2	7000	74-1/2x46x54-1/8"	28x3"	860	1364.00	1389.00		
WB-1584	2-1/2	7000	64-1/2x69x45-1/2"	28x3"	926	1364.00	1389.00		
WB-1585	3	6000	74-1/2x57-1/4x54-1/8"	28x3"	971	1438.00	1471.00		
WB-1586	4	6000	74-1/2x83x54-1/8"	42x3"	1203	1781.00	1814.00		
WP-1541	5	6000	74-1/2x103x54-1/8"	42x3"	1410	2075.00	2108.00		

**MEDIUM-DUTY HOPPERS.** 1/8" (11-gauge) sides with 3/16" (7-gauge) base. **SPECIFY COLOR: GY - Gray primer, YL - Safety yellow.**

Model Number	Cap. Lbs.	Cu. Yd.	Overall LxWxH	Fork Pocket WxH	Wt. Lbs.	GY - Gray		YL - Yellow	
						Price Ea.	Price Ea.	Price Ea.	Price Ea.
WP-1542	4000	1/2	51-1/2x37-1/4x32-3/4"	26x3"	375	\$572.00	\$588.00		
WB-1587	4000	1	63x39-1/4x39"	28x3"	487	719.00	735.00		
WB-1588	4000	1-1/2	65x57-1/4x38-1/2"	28x3"	553	817.00	842.00		
WB-1589	4000	2	64-1/2x57-1/4x45-1/2"	28x3"	620	915.00	940.00		
WP-1543	4000	3	74-1/2x57-1/4x54-1/8"	28x3"	780	1152.00	1185.00		

**TWO-PIECE HINGED LID**



**OPTIONAL CASTERS**

**PERFECTLY BALANCED—ROLLS FORWARD WHEN LOADED—RETURNS TO LATCHED POSITION WHEN EMPTY**



**HEAVY-DUTY, HINGED LIDS. SPECIFY COLOR: GY - Gray primer, YL - Safety yellow.**

Model Number	Fits Hopper Capacity	Wt. Lbs.	GY - Gray		YL - Yellow	
			Price Ea.	Price Ea.	Price Ea.	Price Ea.
WD-1675	1/4 cu. yd.	75	\$192.00	\$209.00		
WD-1676	1/3 cu. yd.	95	239.00	255.00		
WD-1677	1/2 cu. yd.	105	257.00	274.00		
WD-1678	3/4 cu. yd.	120	284.00	300.00		
WD-1679	1 cu. yd.	125	292.00	309.00		
WD-1680	1-1/2 cu. yd.	165	417.00	434.00		
WD-1681	2 cu. yd.	225	442.00	459.00		
WD-1682	2-1/2 cu. yd.	275	550.00	575.00		
WD-1683	3 cu. yd.	255	500.00	525.00		
WD-1684	4 cu. yd.	325	659.00	675.00		

**CASTERS.** 8" x 2" casters—2 swivel, 2 rigid. Sold in sets of 4.

Model No.	Construction	Wt. Lbs.	Price Each
WB-1573	Semi-steel	54	\$234.00
WB-1574	Rubber tire	50	234.00
WB-1575	Plastic	42	234.00
WB-1576	Polyurethane	54	317.00

Lift Lugs, 3-Way Entry, Stacking and Chain Pull Options Available.



1-1/2 CU. YD. MODEL WITH OPTIONAL LID.

**STOCK**  
Selected Models

## RUBBERMAID® Self-Dumping Polyethylene Hoppers

- Polyethylene
- 750- and 1000-lb. capacities

Mobile hopper has forklift capabilities for elevated dumping. Tilts a full 30° below horizontal. Pull-release safety latch operates manually with rope or stick. Color: black. **SPECIFY: A - Without casters, B - With 6" polyolefin casters. SELECTED MODELS IN B - WITH CASTERS ARE IN STOCK.** Others FOB VIRGINIA.

Model Number	Cap. Cu.	Cap. Lbs.	Overall LxWxH	Wt. Lbs.	(A)		(B)	
					Price Ea.	Price Ea.	Price Ea.	Price Ea.
WP-694	1/2	750	55x26-1/4x40"	194	\$1369.00	\$1653.00		
WP-695	1	1000	71-1/2x31-1/4x44-7/8"	230	1588.00	2088.00		
WP-696	1-1/2	1000	83-5/8x42-7/8x49-1/8"	307	2293.00	2694.00		
WP-697	2	1000	83-7/8x46x49-1/2"	303	2447.00	2879.00		
WP-698	2-1/2	1000	83-1/2x55x49-1/2"	305	2638.00	3391.00		

Model No. WK-1301—Optional Hinged Lid for 1-1/2 cu. yd. model.  
Wt. 33 lbs. ....\$447.00

# MECO Self-Dumping Hoppers

## Self-Dumping Hoppers



- All-welded steel
- Up to 6,000-lb. capacity

Tips forward completely dumping the load; automatically returns to upright position when empty. Heavy-duty construction features double-welded seams, 2" formed top lip, and extra-deep fork openings. Safety chain secures hopper to forklift mast. 1/4-2-cu. yd. units stack up to 3 high when empty. **SPECIFY COLOR: GY - Gray, OR - Orange. FACTORY QUICK SHIP—FOB NEBRASKA.**



Model Number	Cap. Lbs.	Cap. Cu. Yds.	Overall LxWxH	Fork Pocket WxH	Wt. Lbs.	Price Each
<b>HEAVY-DUTY HOPPERS—7-GAUGE STEEL</b>						
WJ-1019	6,000	1/4	49-1/2x29x26"	18-1/2x2-1/2"	347	\$589.00
WJ-1020	6,000	1/3	53x29x30-1/2"	18-1/2x2-1/2"	377	630.00
WJ-1021	6,000	1/2	53x41x30-1/2"	30-1/2x2-1/2"	453	716.00
WJ-1022	6,000	3/4	59-1/2x41x34-1/2"	30-1/2x2-1/2"	508	780.00
WJ-1023	6,000	1	63-1/2x41x38-1/2"	30-1/2x2-1/2"	570	833.00
WJ-1024	6,000	1-1/2	63-1/2x59x38-1/2"	48-1/2x2-1/2"	690	1018.00
WJ-1025	6,000	2	69-1/2x59x44"	48-1/2x2-1/2"	762	1139.00
WJ-1026	6,000	2-1/2**	69-1/2x72x44"	48-1/2x2-1/2"	895	1293.00
WJ-1027*	5,000	3**	74x64x59-1/2"	39x2-1/2"	1,063	1549.00
WJ-1028*	4,000	4**	74x84x59-1/2"	39x2-1/2"	1,212	1915.00
WJ-1029*	4,000	5**	74x100x59-1/2"	39x2-1/2"	1,354	1998.00
<b>LOW PROFILE HEAVY-DUTY HOPPERS—7-GAUGE STEEL</b>						
WJ-1059*	5,000	3**	69-1/2x98-1/2x46"	39x2-1/2"	1,105	\$1793.00
WJ-1060*	5,000	3-1/2**	69-1/2x98-1/2x46"	39x2-1/2"	1,195	1848.00
<b>MEDIUM-DUTY HOPPERS—10-GAUGE STEEL</b>						
WJ-1061	4,000	1/4	49-1/2x29x26"	18-1/2x2-1/2"	296	\$569.00
WJ-1062	4,000	1/3	53x29x30-1/2"	18-1/2x2-1/2"	316	609.00
WJ-1063	4,000	1/2	53x41x30-1/2"	30-1/2x2-1/2"	379	709.00
WJ-1064	4,000	3/4	59-1/2x41x34-1/2"	30-1/2x2-1/2"	421	744.00
WJ-1030	4,000	1	63-1/2x41x38-1/2"	30-1/2x2-1/2"	473	760.00
WJ-1065	4,000	1-1/2	63-1/2x59x38-1/2"	48-1/2x2-1/2"	568	923.00
WJ-1031	4,000	2	69-1/2x59x44"	48-1/2x2-1/2"	652	1017.00
WJ-1032	4,000	2-1/2**	69-1/2x72x44"	48-1/2x2-1/2"	760	1170.00
WJ-1066	4,000	3	74x64x59-1/2"	39x2-1/2"	848	1457.00
<b>LIGHT-DUTY HOPPERS—12-GAUGE STEEL</b>						
WJ-1067	2,000	1/4	49-1/2x29x26"	18-1/2x2-1/2"	251	\$524.00
WJ-1068	2,000	1/3	53x29x30-1/2"	18-1/2x2-1/2"	272	542.00
WJ-1033	2,000	1/2	53x41x30-1/2"	30-1/2x2-1/2"	327	624.00
WJ-1069	2,000	3/4	59-1/2x41x34-1/2"	30-1/2x2-1/2"	363	705.00
WJ-1034	2,000	1	63-1/2x41x38-1/2"	30-1/2x2-1/2"	385	719.00
WJ-1035	2,000	1-1/2	63-1/2x59x38-1/2"	48-1/2x2-1/2"	467	842.00
WJ-1036	2,000	2	69-1/2x59x44"	48-1/2x2-1/2"	516	922.00
WJ-1070	2,000	2-1/2	69-1/2x72x44"	48-1/2x2-1/2"	601	1051.00

\*Casters not available.

\*\*Not stackable. When stacking heavy-duty models, factory recommends only 3 high.

Optional lids are welded onto hoppers. They are non-returnable.

### Optional Hopper Lids Shown

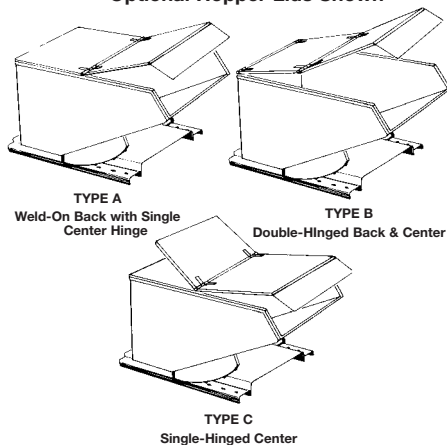

### CASTERS

Two rigid, two swivel casters. Hoppers are shipped with casters bolted to base. Sold in packs of 4. **FACTORY QUICK SHIP—FOB NEBRASKA.**

### OPTIONAL HOPPER LIDS

Hoppers with lids are not stackable. Factory-installed. **SPECIFY LID TYPE: A - Weld-on back with single center hinge, B - Double-hinged back and center, C - Single-hinged center. FACTORY QUICK SHIP—FOB NEBRASKA.**

### CASTERS (SET OF 4)

Model No.	Description	Cap. Lbs.	Wt. Lbs.	Price Each
WJ-1051	6x2" Semi Steel	4,000	59	\$171.00
WJ-1052	6x2" Mold-On Rubber	1,600	53	151.00
WJ-1053	6x2" Phenolic	4,800	46	146.00
WJ-1054	8x2" Semi Steel	4,000	72	194.00
WJ-1055	8x2" Mold-On Rubber	2,000	67	180.00
WJ-1056	8x2-1/2" Mold-On Rubber	2,700	74	345.00
WJ-1057	8x2-1/2" Phenolic	6,000	75	318.00

NOTE: 6" platform legs, 3-way entry and trip chain options are available.

### OPTIONAL HOPPER LIDS

Model No.	Fits Hopper Cap.	Wt. Lbs.	Price Each
WJ-1039	1/2 cu. yd.	75	\$171.00
WJ-1040	1/4 cu. yd.	50	128.00
WJ-1041	1/3 cu. yd.	55	133.00
WJ-1042	3/4 cu. yd.	86	184.00
WJ-1043	1 cu. yd.	96	191.00
WJ-1044	1-1/2 cu. yd.	140	270.00
WJ-1045	2 cu. yd.	145	295.00
WJ-1046	2-1/2 cu. yd.	179	371.00

# MILWAUKEE Steel Hand Trucks



SHOWN WITH OPTIONAL NOSE EXTENSION

## Steel Hand Trucks

- 15-gauge steel tubing
- 400–800-lb. capacities
- Multiple wheel choices available



A variety of styles lets you choose what best suits your needs. Welded steel with 1" tubing. Wheel types: semi-pneumatic (SP), solid rubber with polyolefin hub (SR), full-pneumatic (FP). **IN STOCK.**



### STEEL HAND TRUCKS WITH D-HANDLE/P-HANDLE

Key	Model Number	Overall WxH	Nose Plate WxD	Cap. Lbs.	Wheel		Includes	Wt. Lbs.	Price Each
					Type	Height			
A	<a href="#">XP-0636</a>	19x50"	14x7"	600	FP	10"	Wheel guards	37	<b>\$116.00</b>
B	<a href="#">XP-543</a>	19x50-1/2"	14x8"	400	SP	10"	Inset wheels	35	<b>93.70</b>

### STEEL HAND TRUCKS WITH CONTINUOUS HANDLE

Key	Model Number	Overall WxH	Nose Plate WxD	Cap. Lbs.	Wheel		Includes	Wt. Lbs.	Price Each
					Type	Height			
C	<a href="#">XP-538</a>	20x48"	14x10" beveled	700	SR	10"	Tubular stair climbers and cross brace	41	<b>\$106.00</b>
C	<a href="#">XP-539</a>	21x48"	14x10"	500	SP	10"	Tubular stair climbers and cross brace	40	<b>114.00</b>
C	<a href="#">XP-540</a>	22x48"	14x10" beveled	600	FP	10"	Tubular stair climbers and cross brace	42	<b>125.00</b>
D	<a href="#">XP-544</a>	19x46-1/2"	14x8"	800	SR	10"	—	33	<b>103.00</b>
E	<a href="#">XP-0635</a>	19x46"	14x7"	600	FP	10"	Wheel guards	32	<b>101.00</b>
F	<a href="#">XP-545</a>	18x46-3/8"	14x8"	600	SR	8"	—	27	<b>69.80</b>

Model No. [XP-549](#)—24" Nose Extension for (D) and (H) .....**\$31.80**

### STEEL HAND TRUCKS WITH TWIN HANDLE

Key	Model Number	Overall WxH	Nose Plate WxD	Cap. Lbs.	Wheel		Includes	Wt. Lbs.	Price Each
					Type	Height			
G	<a href="#">XP-0634</a>	19x45"	14x7"	600	FP	10"	Wheel guards	31	<b>\$90.52</b>
H	<a href="#">XP-541</a>	20x49"	14x10"	700	SR	10"	Tubular stair climbers and cross brace	40	<b>104.00</b>
H	<a href="#">XP-542</a>	21x49"	14x10"	500	SP	10"	Tubular stair climbers and cross brace	41	<b>118.00</b>

Model No. [XP-549](#)—24" Nose Extension for (D) and (H) .....**\$31.80**



## 2-in-1 Convertible Hand Trucks



- 15-gauge steel tubing
- 300–500-lb. hand truck capacities
- Multiple wheel choices available

Quickly converts from a two-wheel hand truck to a four-wheel platform truck. Constructed of welded steel with 1" tubing. Available with either semi-pneumatic (SP) or full-pneumatic (FP) wheels. **IN STOCK.**

Model Number	Hand Truck		Platform Truck		Nose Plate WxD	Wheel		Wt. Lbs.	Price Each
	Height	Cap. Lbs.	LxW	Cap. Lbs.		Type	Height		
<a href="#">XP-535</a>	46-1/2"	300	38x14"	400	14x8"	SP	8"	36	<b>\$104.00</b>
<a href="#">XP-536</a>	46-1/2"	400	38x14"	500	14x8"	SP	10"	42	<b>134.00</b>
<a href="#">XP-537</a>	46-1/2"	500	38x14"	600	14x8"	FP	10"	41	<b>153.00</b>

### REPLACEMENT CASTERS

Model No. [XP-546](#)—4" polyolefin swivel, fits [XP-535](#) .....**\$11.10**  
 Model No. [XP-547](#)—5" polyolefin swivel, fits [XP-536](#) & [XP-537](#)...**\$14.70**

# MAGLINER® Aluminum Hand Trucks



## REPLACEMENT CAST NOSE PLATES

Model No. <b>WP-527</b> —7-1/2" x 14" .....	\$31.70
Model No. <b>WP-528</b> —7-1/2" x 18" .....	\$40.50

## FRAME EXTENSIONS

Model No. <b>WP-529A</b> —52" .....	\$11.90
Model No. <b>WP-529B</b> —60" .....	\$18.30
Model No. <b>WP-529C</b> —68" .....	\$21.20



## NOSE EXTENSIONS. 300-lb. capacity.

Model No. <b>WP-530</b> —24" Plate Type .....	\$59.00
Model No. <b>WP-531</b> —30" Channel Type .....	\$47.30

## STAIR GLIDES

Sold in pairs.

Model No. <b>WP-532</b> —Magnesium .....	\$28.30
Model No. <b>WP-533</b> —Magnesium with Nylon Skid Bar .....	\$33.70

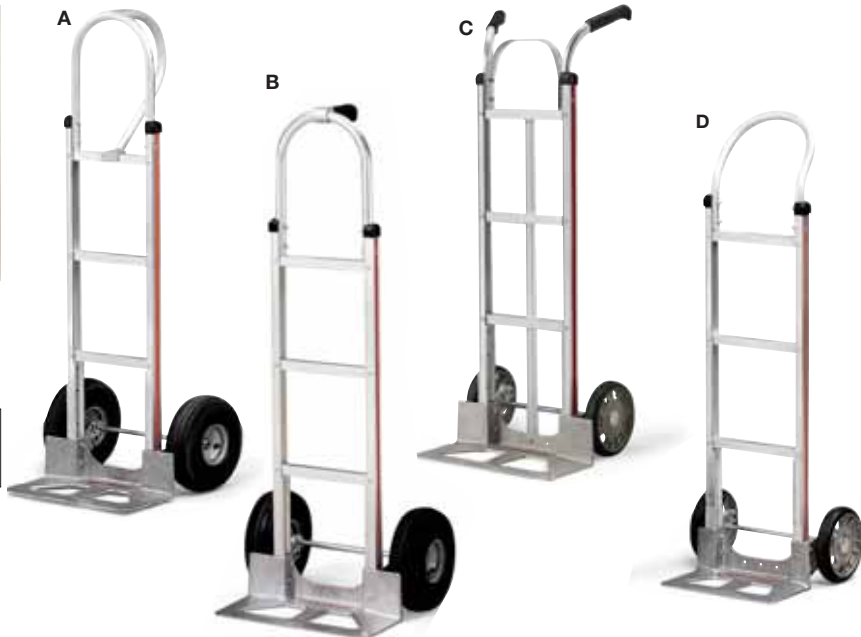

## Aluminum Hand Trucks

- Aluminum
- 500-lb. capacity
- Multiple wheel choices available



Magnesium nose plates. All parts are replaceable. Wheel types: (MR) mold-on rubber, (SR) solid rubber, (P) pneumatic. Ships via small package carrier. **IN STOCK.**

Key	Model Number	Overall WxH	Noseplate WxD	Wheel Type	Wheel Height	Frame Extension	Center Strap	Wt. Lbs.	Price Each
A	<b>XP-524</b>	21x52"	18x7-1/2"	P	10"	No	No	23	\$183.00
A	<b>XP-525</b>	18x52"	18x7-1/2"	SR	10"	No	No	23	164.00
B	<b>XP-520</b>	18x48"	18x7-1/2"	MR	8"	No	Yes	18	152.00
B	<b>XP-521*</b>	21x48"	14x7-1/2"	P	10"	No	Yes	26	185.00
C	<b>XP-522</b>	18x48"	18x7-1/2"	MR	8"	Yes	Yes	19	159.00
C	<b>XP-523</b>	21x48"	18x7-1/2"	P	10"	Yes	Yes	23	184.00
D	<b>XP-517</b>	17-1/4x48"	14x7-1/2"	MR	8"	No	No	18	133.00
D	<b>XP-518</b>	18x48"	14x7-1/2"	SR	8"	No	No	26	139.00
D	<b>XP-519</b>	21x48"	18x7-1/2"	P	10"	No	No	22	166.00

\*Model No. XP-521 has curved back for handling round objects.

## Gemini Convertible Aluminum Truck

- Aluminum
- 500-lb. hand truck capacity
- 10" full-pneumatic tires



Converts in seconds from a 4-wheel platform truck to a 2-wheel hand truck. 5" polyurethane swivel casters. Stair gliders for use with 61"H trucks. Ships unassembled and boxed via small package carrier. **IN STOCK.**

Model Number	Hand Truck Cap. Lbs.	Plat. Truck Cap. Lbs.	Overall Width	Frame Width	Hand Truck Height	Plat. Truck Height	Wt. Lbs.	Price Each
<b>WT-1852</b>	500	1,000	20-1/2"	16-5/8"	51"	40"	44	\$368.00
<b>WT-1851</b>	500	1,000	20-1/2"	16-5/8"	61"	45-1/8"	45	392.00

**SNAP-ON DECK.** Carry small tools and oddly shaped equipment as well as large loads more securely. **IN STOCK.**

Model No. <b>WT-1853</b> —Fits <b>WT-1851</b> .....	\$91.60
Model No. <b>WT-1858</b> —Fits <b>WT-1852</b> .....	\$88.10



51"H HAND TRUCK

61"H HAND TRUCK

# Hand Trucks

## MECO Shovel-Style Freight Trucks

- 1-1/4" steel pipe frame
- 1,000- and 1,200-lb. capacities
- 8" wheels

Double-welded frame. 1/4" thick steel nose plate tapers to 11" at the front. Heavy-duty wheels have 3/4" roller bearings and grease fittings. Includes stair glides. Two-year warranty. **IN STOCK.**



Model Number	Overall WxH	Nose Plate WxD	Cap. Lbs.	Wheel Type	Wt. Lbs.	Price Each
ZT-108A	19-3/4x50"	17x14"	1000	Mold-on rubber	59	\$214.00
ZT-108	19-3/4x50"	17x14"	1200	Steel	70	\$231.00



## WESCO® Folding Hand Trucks

- Aluminum/poly construction
- 110- to 550-lb. capacities
- Multiple caster choices available

Folds down in seconds for easy storage. Includes elasticized cord to secure loads. **IN STOCK.**

**WHEN FOLDED, MINI MOVER TRUCK FITS INTO AIRLINE OVERHEAD COMPARTMENT.**



**MEGA MOVER IS ONLY 23.5"W X 4.75"D X 34"H WHEN FOLDED.**

Model Number	Overall WxH	Nose Plate WxD	Cap. Lbs.	Wt. Lbs.	Price Each
<b>MINI MOVER. 5"H non-marking rubber wheels.</b>					
ZM-2314	15.6x41"	15x12.5"	110	7.5	\$99.00
<b>SUPERLITE. 7"H non-marking rubber wheels.</b>					
ZM-2313	19x42"	19x12.5"	175	9	\$155.00
<b>MEGA MOVER. 8" full-pneumatic wheels.</b>					
YM-1039	26.5x47"	23.5x18"	550	28.5	\$303.00

## DUTRO Shovel Nose Trucks with Extended Handle

- 3/4" steel pipe frame
- 900-lb. capacity
- 8" wheels

Perfect for moving large, heavy loads. Tall frame with extended handle gives more leverage. 1 year warranty. **IN STOCK.**



Model Number	Overall WxH	Nose Plate WxD	Wheel Type	Wt. Lbs.	Price Each
YM-4230	19x61-3/4"	19x14"	Balloon cushion	55	\$263.00
YM-4231	19x61-3/4"	19x14"	Solid rubber	55	\$260.00



## MILWAUKEE D-Handle Hand Trucks

- 16-gauge steel tubing
- 800-lb. capacity
- 10" wheels

D-handle offers easier one-hand operation. Extra-wide 18" nose plate. Oversized wheel guards. **IN STOCK.**



Model Number	Overall WxH	Nose Plate WxD	Wheel Type	Wt. Lbs.	Price Each
YK-3200	19-1/2x51"	18x8"	Pneumatic	30	\$77.00
YK-3201	19x50-1/2"	18x8"	Solid rubber	30	\$80.00

## High Stacker Hand Truck

- Steel tubing frame
- 400-lb. capacity
- 10" semi-pneumatic wheels

Flow-back handle design allows you to stack product to the maximum truck height. FOB WISCONSIN.



Model Number	Overall WxH	Nose Plate WxD	Wt. Lbs.	Price Each
XT-1985	20-1/4x65"	20x14"	41	\$138.00



# Hand Trucks



HEIGHT ADJUSTS FROM 41-3/4" TO 52-1/2".

YA-2498



YA-2497



## MILWAUKEE Lightweight Hand Trucks



- Polymer and 15-gauge steel tubing
- 500- or 600-lb. hand truck capacity

One-piece frame is made of rust-proof fiberglass-reinforced nylon polymer. Steel handle and noseplate. Built-in stair glides. **IN STOCK.**

### HAND TRUCK

Includes (2) 10" pneumatic wheels.

Model Number	Overall WxH	Nose Plate WxD	Cap. Lbs.	Wt. Lbs.	Price Each
YA-2497	21x51"	15x7"	500	25	\$73.80

### CONVERTIBLE HAND TRUCK

Includes (2) 5" swivel poly casters and (2) 10" pneumatic wheels.

Model Number	HAND TRUCK		PLATFORM TRUCK		Nose Plate WxD	Wt. Lbs.	Price Each
	Height	Cap Lbs.	LxW	Cap. Lbs.			
YA-2498	48-50-1/4"	600	36x12"	600	15x7"	28	\$101.00



## LITTLE GIANT Hand Trucks

- 14-gauge steel tubing
- 800-lb. capacity
- Multiple wheel choices available

Reinforced nose plate has extra-heavy-duty stair glides. Three wheel types: MR—mold-on rubber; SR—solid rubber; FP—full pneumatic. Continuous handle. Ten-year warranty. Ship via small package carrier. **IN STOCK.**



Model Number	Overall WxH	Nose Plate WxD	Wheel Type	Wheel Height	Wt. Lbs.	Price Each
YA-1750	21x47"	14x12"	MR	8"	35	\$137.00
YA-1751	21x47"	14x12"	SR	8"	36	127.00
YA-1752	21x47"	14x12"	SR	10"	41	135.00
YA-1753	21x47"	14x12"	FP	10"	38	143.00

### OPTIONAL ALUMINUM SNAP-ON DECKS

- Model No. **YA-3012**—For YA-3010. 42"L. Wt. 8 lbs. ....\$104.00
- Model No. **XA-2223**—For YA-3011. 55"L. Wt. 10 lbs. ....\$121.00



### YA-3011 IN PLATFORM TRUCK POSITION.



### OPTIONAL 30"L FOLDING NOSE.

- Model No. **YA-3013**—Wt. 5 lbs. ....\$65.20



## WESCO® Spartan Convertible Hand Trucks

- Aluminum
- 500-lb. hand truck capacity
- 10" pneumatic wheels

Includes 5" rubber casters for use in platform truck mode. Press a pedal to convert 2-wheel hand truck into a 4-wheel model. Unassembled. Ships via small package carrier. **IN STOCK.**



YA-3011

YA-3010

Model Number	HAND TRUCK		PLATFORM TRUCK		Noseplate WxD	Wt. Lbs.	Price Each
	Height	Cap. Lbs.	LxW	Cap. Lbs.			
YA-3010	51"	500	38x12"	1000	18x7-1/2"	37-1/2	\$235.00
YA-3011	61"	500	51x12"	1000	18x7-1/2"	41	252.00

# Speciality Trucks







## DUTRO EZE-OFF Steel Hand Trucks

- 14-gauge steel tubing
- 800-lb. capacity
- Multiple wheel choices available

Simply spot and level the load, step down on the EZE-OFF bar and the truck slides out from underneath the load—no bending or lifting. 1" dia. steel tube frame. 8"H wheels. 1-year warranty.

FACTORY QUICK SHIP—FOB UTAH.



Model Number	Overall WxH	Noseplate WxD	Wheel Type	Wt. Lbs.	Price Each
XA-0280	17-1/2x55"	13x7"	Mold-on rubber	32-1/2	<b>\$166.00</b>
XA-0281	17-1/2x55"	13x7"	Solid rubber	32-1/2	<b>166.00</b>
XA-0282	17-1/2x55"	13x7"	Full pneumatic	32-1/2	<b>206.00</b>





## DUTRO 3-Way Convertible Steel Trucks

- 14-gauge steel tubing
- 800-lb. capacity
- Multiple wheel choices available

Easily converts from hand truck to tilt truck to platform truck. 1" dia. steel tube frame. 8"H wheels—MR - mold-on rubber, SR - solid rubber, PN - full pneumatic. 1-year warranty.

FACTORY QUICK SHIP—FOB UTAH.





Model Number	Hand Truck		Platform Truck		Noseplate WxD	Wheel Type	Wt. Lbs.	Price Each
	Height	Cap. Lbs.	LxW	Cap. Lbs.				
XA-0283	50"	800	19x50"	800	14x7"	MR	62	<b>\$315.00</b>
XA-0284	50"	800	19x50"	800	14x7"	SR	62	<b>315.00</b>
XA-0285	50"	800	19x50"	800	14x7"	PN	62	<b>344.00</b>









PLATFORM TRUCK



TILT TRUCK



STEERABLE DOLLY

## VALLEY CRAFT® 4-Way™ Convertible Hand Truck

- Steel tubing
- 350-lb. hand truck capacity
- 2-1/2" casters and 8" semi-pneumatic wheels

Converts from a standard hand truck or four-wheeler to a tilt truck or a steerable dolly in a matter of seconds. Baked enamel finish. Color: gray. Ships via small package carrier. **IN STOCK.**

Model Number	Hand Truck		Platform Truck		Noseplate WxD	Wt. Lbs.	Price Each
	Height	Cap. Lbs.	LxW	Cap. Lbs.			
ZA-2490	55-1/2"	350	20x47"	500	14x8"	32	<b>\$145.00</b>





## WESCO 4-Wheel Appliance Trucks

- Steel
- 1200-lb. capacity
- 8" mold-on rubber wheels

Non-marking padding on all contact surfaces. Double-welded steel tube frame. Features include: caterpillar crawler stair climber with 3-1/2" flip-out rubber casters, 14' belt and ratchet tightener, and ball-bearing wheels.

IN STOCK.



Model Number	Overall WxH	Noseplate WxD	Wt. Lbs.	Price Each
XP-551	17x60"	24x5"	80	<b>\$436.00</b>
XP-552	18x72"	24x5"	95	<b>453.00</b>

# Heavy Equipment Transport

## WESCO® HeviMover™ Roller Dollies

- Steel
- Multiple capacities available
- Steel rollers

Rollers form an endless chain that revolves around a central load-bearing plate. Weight of load is transferred directly from load-bearing plate to rollers, requiring less power to start and move load. **FACTORY QUICK SHIP—FOB PENNSYLVANIA.**

### ROLLER DOLLIES

Full 360° swivel-top provides maximum maneuverability. Spring-loaded locking mechanism at 45° intervals.

Model Number	Overall WxDxH	Roller Dia.xW	Cap. Lbs.	Wt. Lbs.	Price Each
YP-3110	3-1/8x8x3-3/16"	11/16x1-7/8"	2,000	10	\$111.00
YP-3111	5-1/2x10x4-7/16"	15/16x3-1/4"	8,000	31	193.00
YP-3112	5-3/4x10-1/2x4-7/8"	1-3/16x3-1/4"	15,000	39	215.00
YP-3113	6-1/2x12-3/4x4-7/16"	1-3/16x4"	30,000	52	274.00

**ROLLER DOLLY KITS** Includes: (4) 2,000-lb. capacity Roller Dollies and (2) 29" unassembled steering handles, and steel tool box.

Model No. **YP-3119**—Wt. 55 lbs. ..\$628.00

### ACCESSORIES

Model No.	Description	Wt. Lbs.	Price Ea.
YP-3114	36" steering handle for YP-3110	6	\$26.90
YP-3115	48" steering handle for YP-3110	7	32.30
YP-3116	36" steering handle for YP-3111, YP-3112, YP-3113	6	25.10
YP-3117	48" steering handle for YP-3111, YP-3112, YP-3113	7	25.50
YP-3118	36" turning bar for YP-3111, YP-3112, YP-3113	14.5	60.70



## RELIUS SOLUTIONS Nylon Roller Dollies

- Steel
- Multiple capacities available
- Nylon wheels

For easy, safe transport of heavy equipment. Heavy-duty frame features a rubber loading pad on top. **IN STOCK.**



### ROLLER DOLLIES

Model Number	Overall WxDxH	Roller Qty.	Roller Dia.xW	Cap. Lbs.	Wt. Lbs.	Price Each
YK-1200	15-3/4x9x4-1/2"	8	4x1-3/8"	4,400	20	\$108.00
YK-1201	15-3/4x9x4"	4	3-3/8x3-3/8"	6,600	23	117.00
YK-1202	15-3/4x9x4"	6	3-3/8x3-3/8"	13,200	28	168.00

### ROLLER DOLLIES WITH STEEL HANDLE

Designed specifically for moving heavy equipment around corners. Each row of rollers turns independently left or right. Handle is 36"L.

Model Number	Overall WxDxH	Roller Qty.	Roller Dia.xW	Cap. Lbs.	Wt. Lbs.	Price Each
YK-1203	11-3/4x7-7/8x4"	4	3-3/8x3-1/2"	6,600	33	\$142.00
YK-1204	25-1/8x21x4"	8	3-3/8x3-1/2"	13,200	110	377.00
YK-1205*	25-1/8x22-1/4x4"	8	3-1/2x3-1/2"	26,400	145	454.00

\*Steel wheels.

NOTE: Handles on 13,200- and 26,400-lb. models also have a 2" eye hole at the top for towing.

## FAIRBANKS Pry Bar Lever Trucks



- Wood and steel
- Multiple capacities available
- 5" steel wheels

Selected perfect-grain oak handle has 6"W x 3"D beveled nose plate. Hardwood handle has 5"W x 3"D beveled nose plate. Nose plate is bolted to handle.

**SPECIFY HANDLE: A - Oak, B - Hardwood. IN STOCK.**

Model Number	Handle Length	Cap. Lbs.	Wt. Lbs.	(A)	(B)
				Price Ea.	Price Ea.
YP-494	60"	3,500	26	\$144.00	\$129.00
YP-495	72"	4,250	32	156.00	132.00
YP-496	84"	5,000	39	167.00	154.00



## SKARNES Hydraulic Lift Trucks

- Steel
- Up to 10,000-lb. capacity
- Phenolic or steel wheels

Insert forks under load and lift. Designed to be used in pairs unless a single unit is used in conjunction with a lift truck or other lifting device. Forks have serrated pads and are suspended on a vertical sliding frame member which is actuated by a hand hydraulic device. Swivel casters. Sold in pairs. **FACTORY QUICK SHIP—FOB MINNESOTA.**



Model Number	Cap. Lbs./Pair	Lift Height	Wheel Height	Wheel Type	Fork Height	Overall WxH	Wt. Lbs./Pair	Price Each
XH-193	2,000	5-1/8"	5"	Phenolic	7-1/4"-17-1/2"	22x47-1/2"	160	\$1226.00
XH-194	4,000	12"	6"	Phenolic	5"-19-1/2"	23x44"	325	1616.00
XH-195	6,000	6"	6"	Phenolic	6"-19-1/2"	23x42-1/2"	335	1761.00
XH-196	7,000	6"	8"	Steel	7-1/4"-19-1/2"	23-1/8x45"	400	1915.00
XH-197	10,000	6"	8"	Steel	9-1/4"-19-1/2"	24x45-1/2"	438	2197.00

NOTE: Available options include poly wheels, dual wheels for better weight distribution, swivel locks and nylon straps for securing large bulky loads. Call for quote.

Model No. **XH-198**—Nylon Side Belts .....\$150.00

# Dollies



**Set of 4 YA-1372**

### Low-Profile Triangle Dollies

- Aluminum or steel
- 880- and 1,320-lb. capacities
- 2" rubber casters

Nest into table legs or cabinet corners for secure movement around your facility. Capacity is rated per set of four dollies. 1" load height. Heavy frames are supported by three non-marking casters. Includes a plastic carrying case. Sold in sets of 4 only. **IN STOCK.**

Model Number	Frame Type	Cap. Lbs. per Set	Overall WxDxH	Wt. Lbs. per Set	Price Ea. Set
YA-1370*	Aluminum	880	7-1/2x7-1/2x3-3/8"	22	\$211.00
YA-1371	Aluminum	880	8-3/4x8-3/4x3-1/2"	24	251.00
YA-1372	Steel	1320	10-3/8x10-3/8x3-3/8"	29	178.00

\*For pianos, desks, cabinets, or other hard-to-move products. Knotted inset holds furniture leg tightly for safe transport. Cabinet has to be on top of dolly at a 3-3/8" height.



### FAIRBANKS Reversible Heavy-Duty Steel Dollies

- 11-gauge steel
- 1,000-lb. capacity
- 4" hard rubber casters

Model No.	LxW	Lbs.	Price Ea.
YA-0332	18x24"	30.5	\$91.70
YA-0333	36x24"	34.8	130.00

Solid steel top can be used with 1" lip turned up or down. Rolls on durable double-ball race swivel casters. Green epoxy finish. **IN STOCK.**

**CASTERS MOUNTED FOR LIP UP OPTION**

**OPTIONAL SOLID STEEL ROD/HANDLE**

Model No. YA-1402—37"L. 1/2" dia. Wt. 3 lbs. ....\$13.50

**CASTERS MOUNTED FOR LIP DOWN OPTION**



### AKRO-MILS® Polyethylene Dollies

- Polyethylene
- 1,200-lb. capacity
- 4" casters

One-piece plastic design eliminates splinters, splinters, nails and staples. Non-porous and will not rot, mildew, swell, or split. Steel-reinforced design. Choose between flush and black rubber padded models. **SPECIFY COLOR: BL - Blue, GY - Gray, YL - Yellow.** **IN STOCK.**

Model Number	Overall LxW	Caster Type	Wt. Lbs.	Price Each
<b>FLUSH DECK</b>				
YL-0896	30x18"	Black polyolefin	16	\$78.10
YL-0897	30x18"	Blue rubber	18	111.00
<b>PADDED DECK</b>				
YL-0898	30x18"	Black polyolefin	18	\$101.00
YL-0899	30x18"	Blue rubber	20	133.00



**MADE IN USA**

**STOCK** Selected Models

**ONE PERSON CAN EASILY MOVE PALLETS WITHOUT WAITING FOR A FORKLIFT.**

### MAGLINE® Pallet Dollies

- Aluminum channel
- 4,000- and 6,000-lb. capacities
- 3-1/2" phenolic wheels

4-1/2" high frame. Non-marking casters.

**SPECIFY ROLLERS:**  
**A** - Non-tilt for straight line movement,  
**B** - Tilt when turning is necessary.

**SELECTED MODELS IN STOCK.** Others FOB MICHIGAN.

Model Number	Overall LxW	Wt. Lbs.	Price Each
<b>4,000-LB. CAPACITY—6 WHEELS AND 2 CENTER WHEELS</b>			
XP-592	36x36"	31	\$353.00
XP-593	42x42"	35	380.00
XP-594	48x42"	37	391.00
XP-595	48x48"	38	401.00
<b>6,000-LB. CAPACITY—8 WHEELS AND 4 CENTER WHEELS</b>			
XP-596	36x36"	38	\$409.00
XP-597	42x42"	41	420.00
XP-598	48x42"	44	458.00
XP-599	48x48"	45	441.00

# Dollies

**SOLID**



**FLUSH**



**CARPET-COVERED**





**OPTIONAL TOW HANDLE & EYE.** 3/8 x 5/16" steel rod handle with 5/8" I.D. towing eye.  
Model No. **XP-600**—  
Wt. 3 lbs. ....\$17.60

STOCK

MADE IN



USA

**AKRO-MILS® Hardwood Dollies**

- Select hardwood
- 900–1,200-lb. capacities
- Multiple caster choices available

American hardwood is kiln-dried to prevent shrinking and warping. 7/8" thick. Countersunk bolts and an environmentally friendly varnish. Smooth working surface. All swivel casters. Load capacities vary based on casters selected. **SPECIFY CASTERS: A** - 3" polyolefin, **B** - 4" polyolefin, **C** - 3-1/2" non-marking rubber. **IN STOCK.**

Model Number	Overall LxW	Wt. Lbs.	(A) 3" CASTERS		(B) 4" CASTERS		(C) 3.5" CASTERS	
			Cap. Lbs.	Price Ea.	Cap. Lbs.	Price Ea.	Cap. Lbs.	Price Ea.
<b>SOLID PLATFORM SELECTED HARDWOOD. Ships unassembled.</b>								
<b>XT-1923</b>	24x16"	18	900	\$54.80	1,200	\$65.50	900	\$89.10
<b>XT-1926</b>	27x18"	22	900	65.50	1,200	76.20	900	99.90
<b>XT-1257</b>	30x18"	24	900	70.80	1,200	81.40	900	106.00
<b>XT-1259</b>	36x24"	30	900	80.40	1,200	93.50	900	120.00
<b>FLUSH PLATFORM SELECTED HARDWOOD. Ships unassembled.</b>								
<b>XT-1255</b>	24x16"	16	900	\$50.20	1,200	\$60.90	900	\$84.70
<b>XT-1256</b>	30x18"	19	900	60.80	1,200	68.40	900	92.60
<b>XT-1258</b>	36x24"	20	900	62.00	1,200	72.70	900	97.10
<b>CARPET-COVERED ENDS. Ships unassembled.</b>								
<b>XT-1254</b>	30x18"	19	900	\$71.50	1,200	\$84.20	900	\$109.00
<b>XT-1253</b>	36x24"	21	900	72.40	1,200	85.00	900	110.00
<b>ALL CARPET-COVERED. Ships assembled.</b>								
<b>XC-3020</b>	24x16"	20	900	\$61.70	1,200	\$72.40	900	\$99.00
<b>XC-3021</b>	30x18"	26	900	87.00	1,200	88.30	900	116.00
<b>XC-3022</b>	36x24"	33	900	98.80	1,200	110.00	900	137.00



**CARPETED ENDS**

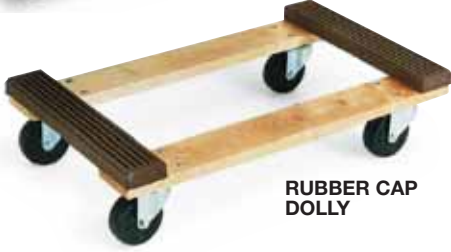

**RUBBER CAP DOLLY**

**RUBBER CAP DOLLY.** Non-skid reinforced rubber caps keep slippery loads in place without damage. Rubber cap boards are 3" wide. Rolls on four easy-glide 4" x 1-1/4" rubber swivel casters.

Model No. **XT-1947**—30"Lx18"Wx7-1/8"H.  
Wt. 16 lbs. ....\$92.60

**AKRO-MILS® Premium Oak Dollies**

- Oak
- 1,200-lb. capacity
- 4" casters

Constructed from select 5/4" thick oak lumber that's kiln-dried to prevent warping. Deck is varnished and features routed edges and countersunk bolts. Four swivel casters. **SPECIFY CASTERS: A** - 4" polyolefin, **B** - Premium 4" non-marking blue rubber. **IN STOCK.**

Model Number	Overall LxW	Wt. Lbs.	(A) 4" POLYOLEFIN	(B) 4" RUBBER
			Cap. Lbs.	Price Ea.
<b>SOLID PLATFORM</b>				
<b>WT-2000</b>	24x18"	24	\$87.80	\$117.00
<b>WT-2001</b>	30x18"	26	97.10	128.00
<b>WT-2002</b>	36x24"	40	116.00	144.00
<b>RUBBER CAP ENDS. Ships assembled</b>				
<b>WT-2003</b>	30x18"	26	\$95.30	\$125.00

**SOLID PLATFORM**



**RUBBER CAP ENDS**



STOCK

MADE IN



USA

**RELIUS SOLUTIONS Economical Hardwood Dollies**

- Hardwood
- 660-lb. capacity
- Rubber casters

Moves heavy equipment, boxes, and other bulky items. Constructed of 7/8" thick hardwood—the flat, smooth deck features countersunk bolts and is varnished to prevent splinters. Four swivel casters. Ships set up via small package carrier. **IN STOCK.**

Model Number	Overall LxW	Caster Size	Wt. Lbs.	Price Each
<b>SOLID PLATFORM</b>				
<b>YA-1500</b>	24x16"	3"	17	\$35.30
<b>YA-1501</b>	26x18"	3"	19	37.00
<b>YA-1502</b>	26x18"	4"	20	40.80
<b>YA-1503</b>	36x24"	4"	26	55.20
<b>OPEN PLATFORM</b>				
<b>YA-1504</b>	24x16"	3"	13	\$34.50
<b>YA-1505</b>	30x18"	4"	15	44.60

**SOLID PLATFORM**



**OPEN PLATFORM**



STOCK

# Casters



ZV-1246

ZV-1242

ZV-1256

ZV-1250



## FAULTLESS® Light- and Medium-Duty Casters

Among the most popular in the industry, these casters are ideal for a number of general use applications. Cold-forged raceways have hardened steel ball bearings. Use single-ball race when swiveling is infrequent, double-ball race for smoother, quieter swiveling, under harder use. Choice of semi-steel (SS), soft rubber (SR), or hard rubber (HR). **IN STOCK.**

Wheel Type	Wheel Dia. x W	Cap. Lbs.	Overall Height	Bolt Holes	Wt. Lbs.	SWIVEL		RIGID		SWIVEL w/BRAKE	
						Model No.	Price Ea.	Model No.	Price Ea.	Model No.	Price Ea.
HR	2 x 7/8"	125	2-1/2"	1 x 2-1/8"	0.8	ZV-1240	\$2.87	ZV-1249	\$2.43	ZV-1255	\$5.10
SR	3 x 3/4"	125	3-3/4"	1-3/4 x 3"	1.5	ZV-1241	8.10	—	—	—	—
SS	3 x 1-1/4"	300	3-3/4"	2-3/8 x 3-1/2"	2	ZV-1242	10.10	—	—	—	—
HR	3 x 1-1/4"	250	3-3/4"	2-3/8 x 3-1/2"	2	ZV-1243	7.20	ZV-1250**	5.60	ZV-1256	9.30
SR	4 x 1"	125	4-3/4"	1-3/4 x 3"	2.1	ZV-1244	10.30	—	—	—	—
SR	4 x 1-1/4"	200	5"	1-3/4 x 3"	2.2	ZV-1245	12.70	ZV-1251	\$8.90	ZV-1257	\$14.80
HR	4 x 1-1/4"	275	5"	1-3/4 x 3"	2.2	ZV-1246	12.70	ZV-1252	8.50	ZV-1258	14.80
SR	5 x 1-1/4"	200	6-1/8"	1-3/4 x 3"	2.8	ZV-1247	14.70	ZV-1253	12.00	—	—
HR	5 x 1-1/4"	290	6-1/8"	1-3/4 x 3"	2.8	ZV-1248	14.70	ZV-1254	12.10	ZV-1260	18.20

\*Single ball race; others double ball race. \*\*Bolt holes are 1-3/16" x 4".



## COLSON Hi-Tech Casters

Ideal for use in wet or corrosive environments, as these casters resist most chemicals, solvents, water, and acids. Polyurethane tread is mechanically bonded to a gray polyolefin core with Delrin™ bearings. 2-1/2" x 3-5/8" top plate includes 1-3/4" x 3" bolt holes. Swivel model has a double-ball raceway with dust cover. Zinc-plated finish with grease hole. Works well in temperatures from -30° to +180°F.

**IN STOCK.**

Model Number	Wheel Dia. x W	Cap. Lbs.	Overall Ht.	Wt. Lbs.	Price Each
<b>SWIVEL</b>					
ZM-2320	3-1/2 x 1-1/4"	225	4-3/4"	2	\$22.00
ZM-2321	5 x 1-1/4"	250	6-1/3"	2.6	27.70
<b>RIGID</b>					
ZM-2323	3-1/2 x 1-1/4"	225	4-3/4"	2	\$19.00
ZM-2324	5 x 1-1/4"	250	6-1/3"	2.6	23.30



ZV-1288

ZV-1275



## FAULTLESS® Polyolefin Casters

Economical, strong injection-molded wheels offer 200% more strength than standard rubber casters. Highly resistant to most solvents and chemicals, polyolefin material is impervious to water, grease, oil, and gasoline. Self-lubricating and non-flattening casters can be steam-cleaned. Feature double-ball raceways and plain bores. **IN STOCK.**

Wheel Dia. x W	Cap. Lbs.	Overall Height	Bolts Hole	Wt. Lbs.	SWIVEL		RIGID		SWIVEL W/BRAKE	
					Model No.	Price Ea.	Model No.	Price Ea.	Model No.	Price Ea.
4 x 1"	140	4-3/4"	1-3/4 x 3"	1.5	ZV-1265	\$7.70	ZV-1273	\$6.20	ZV-1281	\$10.00
3 x 1-1/4"	270	3-3/4"	1-3/4 x 3"	1.3	ZV-1267	7.90	ZV-1275	7.20	ZV-1283	11.40
4 x 1-1/4"	275	5"	1-3/4 x 3"	2.0	ZV-1268	13.60	ZV-1276	9.70	ZV-1284	18.30
5 x 1-1/4"	290	6-1/8"	1-3/4 x 3"	2.3	ZV-1269	13.30	ZV-1277	10.40	ZV-1285	17.50
3 x 1-1/4"	225	3-3/4"	2-3/8 x 3-7/16"	1.3	ZV-1270	6.10	ZV-1278*	4.50	ZV-1286	8.70
4 x 1-1/4"	275	5"	2-3/8 x 3-7/16"	2.4	ZV-1271	14.70	ZV-1279	13.70	ZV-1287	22.60
5 x 1-1/2"	290	6-1/8"	2-3/8 x 3-7/16"	2.6	ZV-1272	14.00	ZV-1280	13.40	ZV-1288	19.00

\*Bolt holes are 1-3/16" x 4".



## Mold-On Rubber Casters

Impact-resistant casters offer smooth-rolling operation in a number of applications. Rubber tire is bonded to a corrosion-resistant, lightweight cast aluminum wheel center. Swivel models have roller bearing wheels with heat-treated double-ball raceways. Top plate and legs are zinc-plated. 4" x 4-1/2" top plate with slotted holes for 2-5/8" x 3-5/8" or 3" x 3" bolt holes. 500-lb. capacity. **IN STOCK.**

Model Number	Caster Type	Wheel Dia. x W	Overall Height	Wt. Lbs.	Price Each
ZV-1289	Swivel	8 x 2"	9-1/2"	6	\$32.50
ZV-1290	Rigid	8 x 2"	9-1/2"	6	28.30



## FAIRBANKS® Medium-/Heavy-Duty Casters



Larger, hot-forged, 1-piece, king-bolt construction with lower ball raceway stands up to tough use. Heat-treated upper and lower ball raceways. Hardened roller bearings. Grease seal ring on upper ball raceway. 4" x 4-1/2" top plate includes slotted bolt holes for 2-5/8" x 3-5/8" to 3" x 3" bolt holes. ASTM test-proven epoxy powder coat meets FF-C-88-C and MIL-C-747E specifications. Wheel types: SS—semi-steel, MR—mold-on rubber, PO—polyolefin, PU—polyurethane, PH—phenolic, MR-HC—mold-on rubber, high capacity. **SELECTED MODELS IN STOCK.**

SPECIFY WHEEL SIZE: A - 4", B - 5", C - 6", D - 8".

Model No. **YV-1221**—Wheel brake \$11.50

Wheel Type	Wheel Dia. x W	Cap. Lbs.	Overall Height	Wt. Lbs.	SWIVEL		RIGID	
					Model No.	Price Ea.	Model No.	Price Ea.
SS	4 x 2"	1,000	5-5/8"	6.5	YV-1197	\$29.50	YV-1209	\$23.60
PO	4 x 2"	500	5-5/8"	3.8	YV-1198	29.10	YV-1210	17.53
PU	4 x 2"	600	5-5/8"	5.8	YV-1199	32.90	YV-1211	25.20
MR	5 x 2"	350	6-1/2"	6.5	YV-1200	34.10	YV-1212	20.60
PO	5 x 2"	650	6-1/2"	4.1	YV-1201	28.10	YV-1213	17.30
MR	6 x 2"	410	7-1/2"	7.4	YV-1203	38.40	YV-1215	26.30
PO	6 x 2"	750	7-1/2"	4.2	YV-1204	32.10	YV-1216	20.40
PH	6 x 2"	1,200	7-1/2"	5.5	YV-1205	33.00	YV-1217	24.90
MR	8 x 2"	500	9-1/2"	9.7	YV-1206	36.60	YV-1218	26.10
PU	8 x 2"	1,200	9-1/2"	10.2	YV-1207	47.30	YV-1219	47.20
MR-HC	8 x 2"	1,000	9-1/2"	10.7	YV-1208	39.60	YV-1220	34.70

# Casters

**STOCK**

**ZV-0018**

## 8" Solid Rubber Casters

Solid rubber tread surrounds a rust-proof polyolefin hub. 440-lb. capacity with 4" x 4-1/2" top plate and slanted 2-3/8" x 3-5/8" to 3" x 3" bolt holes. **IN STOCK.**

Model Number	Caster Type	Wheel Dia. x W	Overall Height	Wt. Lbs.	Price Each
ZV-0018	Swivel	8 x 2-1/2"	9-1/2"	6.5	\$41.30
ZV-0019	Rigid	8 x 2-1/2"	9-1/2"	6.5	32.80



**STOCK**

**ZV-0028A**

## E.R. WAGNER 6" Pneumatic Casters

Steel hub offers a non-marking tread. 200-lb. capacity. 7-1/2" H overall. Three-piece rim with tire and tube wheel. **IN STOCK.**

Model Number	Caster Type	Wheel Dia. x W	Wt. Lbs.	Price Each
<b>4 x 4-1/2" TOP PLATE WITH SLOTTED BOLT HOLE SPACING OF 2-5/8 x 3-5/8" OR 3 x 3"</b>				
ZV-0026A	Swivel	6 x 2"	4.8	\$34.30
ZV-0027A	Rigid	6 x 2"	4.6	27.60
ZV-0028A	Swivel with Total Lock brake	6 x 2"	5.0	41.00
<b>2-1/2 x 3-5/8" TOP PLATE WITH BOLT HOLE SPACING OF 1-3/4 x 3"</b>				
ZV-0026B	Swivel	6 x 2"	4.8	\$38.70
ZV-0027B	Rigid	6 x 2"	4.6	32.60
ZV-0028B	Swivel with Total Lock brake	6 x 2"	5.0	40.40



**ZA-1504 WITH SPRING-OPERATED SWIVEL LOCK**

**ZA-1508 WITH CAM-STYLE FOOTBRAKE**

## Medium-Duty Casters

Feature hardened roller bearings and double-ball raceway swivels; grease fittings and zinc-plated finish; 4" x 4-1/2" top plate with slotted bolt holes on 2-5/8" x 3-5/8" to 4" x 3" centers; 1/2" dia. axle; and 5/8" king pin. Wheel types: (PH) phenolic, (PU) polyurethane, (RS) rubber on steel. **FACTORY QUICK SHIP – FOB GEORGIA, ILLINOIS.**

Wheel Type	Wheel Dia. x W	Cap. Lbs.	Overall Height	Wt. Lbs.	SWIVEL		RIGID	
					Model No.	Price Ea.	Model No.	Price Ea.
PH	4 x 2"	800	5-5/8"	5.25	ZA-1500	\$16.30	ZA-1512	\$12.00
PU	4 x 2"	700	5-5/8"	6.2	ZA-1501	19.20	ZA-1513	14.70
RS	4 x 2"	300	5-5/8"	6.2	ZA-1502	16.80	ZA-1514	13.30
PH	5 x 2"	1,000	6-1/2"	5.75	ZA-1503	17.10	ZA-1515	13.30
PU	5 x 2"	900	6-1/2"	6.7	ZA-1504	20.10	ZA-1516	17.10
RS	5 x 2"	450	6-1/2"	6.2	ZA-1505	17.50	ZA-1517	16.80
PH	6 x 2"	1,200	7-1/2"	7.5	ZA-1506	18.30	ZA-1518	14.30
PU	6 x 2"	1,000	7-1/2"	8.5	ZA-1507	24.40	ZA-1519	19.80
RS	6 x 2"	500	7-1/2"	7.7	ZA-1508	18.70	ZA-1520	15.20
PH	8 x 2"	1,200	9-1/2"	7.8	ZA-1509	21.40	ZA-1521	18.70
PU	8 x 2"	1,200	9-1/2"	12.3	ZA-1510	27.60	ZA-1522	24.20
RS	8 x 2"	600	9-1/2"	7.7	ZA-1511	22.20	ZA-1523	18.60

Model No. **ZA-1524**—Cam-Style Foot Brake. SPECIFY WHEEL SIZE: (A) 4", (B) 5", (C) 6", (D) 8". .....\$4.70  
 Model No. **ZA-1525**—Spring-Operated Swivel Lock. Changes swivel caster into straight line movement. ....\$8.80



**STOCK**

## Full-Pneumatic Casters

For smooth transport over uneven surfaces. Four-ply, tire and tube pneumatics offer wobble-free movement. Other features include: 4" x 4-1/2" top plate with 2-5/8" x 3-5/8" or 3" x 3" slanted bolt holes, double ball raceway swivels, and cold forged 1/4" plated steel with zerk fittings. Colors: standard black or non-marking gray. **IN STOCK.**

Wheel Dia. x W	Cap. Lbs.	Overall Height	Color	Wt. Lbs.	SWIVEL		RIGID	
					Model No.	Price Ea.	Model No.	Price Ea.
8 x 2.5"	320	9.75"	Black	6.5	YV-1225	\$44.00	YV-1228	\$36.30
8 x 2.5"	320	9.75"	Gray	6.5	YV-1226	46.10	YV-1229	38.00
10 x 4"	450	12"	Black	6.5	YV-1227	46.40	YV-1230	39.30

Model No. **YV-1231**—Brakes for 8" swivel casters only. ....\$9.30

**FULL PNEUMATIC TIRES.**  
 Model No. **YV-1232**—8" x 2.5", 320-lb. cap. Black. Wt. 4 lbs....\$25.40  
 Model No. **YV-1233**—8" x 2.5", 320-lb. cap. Gray. Wt. 4 lbs. ....\$27.20  
 Model No. **YV-1234**—10" x 4", 450-lb. cap. Black. Wt. 5.5 lbs. ....\$27.80



**FACTORY QUICK SHIP**

## Economy Foot-Operated Floor Lock

Constructed of thick steel and large diameter tubing. Step down to engage; kick middle pedal lightly to release. 4" x 4-1/2" top plate with slotted mounting holes that have 3" x 3" and 2-5/8" x 3-5/8" slotted bolt spacing. **FACTORY QUICK SHIP – FOB GEORGIA.**

Model Number	Underside Height	Wt. Lbs.	Price Each
ZV-0013A	4-3/4"-6"	3	\$33.30
ZV-0013B	5-1/2"-6-7/8"	3	33.30
ZV-0013C	6-1/2"-7-3/4"	3	33.30
ZV-0013D	8-1/2"-9-3/4"	3	33.30



**STOCK**

## COLSON Medium-/Heavy-Duty Casters

Ideal for wet or corrosive environments—resist most chemicals, solvents, water, and acids. Tread is mechanically bonded to a gray core with roller bearings. Zinc-plated finish with zerk grease fittings. 4" x 4-1/2" top plate with slotted 3" x 3" to 3-5/8" x 2-5/8" bolt holes. Swivel models have a double ballraceway. **IN STOCK.**

**PERFORMA (RG).** Rubber polyolefin core with gray round tread wheel.  
**HI-TECH (HT-PU).** Polyolefin core with polyurethane tread.

Wheel Type	Wheel Dia. x W	Cap. Lbs.	Overall Height	Wt. Lbs.	SWIVEL		RIGID	
					Model No.	Price Ea.	Model No.	Price Ea.
RG	6 x 2"	450	7-1/2"	5	ZM-2418	\$39.30	ZM-2421	\$30.50
RG	8 x 2"	500	9-1/2"	6	ZM-2419	51.10	ZM-2422	40.50
HT-PU	8 x 2"	900	9-1/2"	11	ZM-2420	57.60	ZM-2423	46.90

**OPTIONAL TECH-LOCK BRAKES FOR SWIVEL CASTERS.**  
**ZM-2425**—For 6" .....\$16.50      **ZM-2426**—For 8" .....\$19.10



# Platform Trucks



## FAIRBANKS® Hardwood Tubular Frame Trucks

- 1,200–2,000-lb. capacities
- Poplar hardwood deck
- Multiple deck heights available

MADE IN USA

**STOCK**



**8" PNEUMATIC WHEELS AVAILABLE.**

Casters are bolted to steel channel cross members beneath the deck. 1" tubular steel frame. Varnished deck with fixed pipe pockets and removable handle. Two swivel, two rigid casters. **SPECIFY CASTERS: A - 5" mold-on rubber (MR), B - 8" mold-on rubber (MR), C - 8" full pneumatic wheels (FP).** **IN STOCK.**

Model Number	Deck LxW	(A) 5" MR			(B) 8" MR			(C) 8" FP		
		Deck Ht.	Cap. Lbs.	Price Ea.	Deck Ht.	Cap. Lbs.	Price Ea.	Deck Ht.	Cap. Lbs.	Price Ea.
XD-3075	48x24"	7"	1,400	\$300.00	10"	2,000	\$300.00	10"	1,200	\$353.00
XD-3076	60x30"	7"	1,400	\$334.00	10"	2,000	\$334.00	10"	1,200	\$391.00
XD-3077	72x36"	7"	1,400	\$417.00	10"	2,000	\$427.00	10"	1,200	\$472.00

**SHOWN WITH (A) 5" MOLD-ON RUBBER WHEELS.**



## AKRO-MILS® Wood Platform Trucks

- 1,500–2,600-lb. capacities
- Hardwood deck
- Multiple deck heights available

MADE IN USA

**STOCK**

Model Number	Deck LxW	(A)		(B)		(C)		(D)		(E)	
		Deck Ht.	Price Ea.	Deck Ht.	Price Ea.	Deck Ht.	Price Ea.	Deck Ht.	Price Ea.	Deck Ht.	Price Ea.
XP-556	48x24"	9"	\$325.00	10"	\$347.00	12"	\$333.00	11-3/4"	\$375.00	14-1/2"	\$386.00
XP-557	54x27"	9"	\$357.00	10"	\$377.00	12"	\$364.00	11-3/4"	\$406.00	14-1/2"	\$417.00
XP-558	60x30"	9"	\$419.00	10"	\$435.00	12"	\$423.00	11-3/4"	\$466.00	14-1/2"	\$476.00
XP-559	72x36"	9"	\$553.00	10"	\$562.00	12"	\$556.00	11-3/4"	\$597.00	14-1/2"	\$607.00

Corner and handle bumpers are available, call for more information.

**(D) 8" OR (E) 10" FULL PNEUMATIC CASTERS**

**AKRO-MILS® Wood Platform Trucks**

Varnished, tongue-and-grooved deck is surrounded by a 2" x 2", 1/8" thick steel frame. Removable pipe handle. **SPECIFY CASTERS: A - 5" polyolefin, 2,600-lb. cap., B - 6" gray non-marking, 1,640-lb. cap.; C - 8" mold-on rubber, 2,000-lb. cap.; D - 8" full pneumatic, 1,200-lb. cap.; E - 10" full pneumatic, 1,500-lb. cap.** **IN STOCK.**



## COLSON® Universal Rubber Corner Bumpers

Attaches to steel, aluminum, wood, or plastic surfaces. Hardware not included. **IN STOCK.**

**STOCK**

Model No. **YD-0186**—2-5/8"x1-1/8"x1" .....\$5.10



## AKRO-MILS® Steel Platform Trucks

- 1,200–2,000-lb. capacities
- 13-gauge steel deck
- Multiple deck heights available

MADE IN USA

**STOCK**

Base is formed on all sides with channel stiffeners welded underneath. 36"H, 1" dia. removable handle. Two swivel, 2 rigid weld-on casters. Durable powder coat finish. **SPECIFY WHEELS: A - 8" mold-on rubber (MR), B - 8" full pneumatic wheels (Pneu.), C - 5" mold-on rubber (MR). A - 8" WHEELS AND B - 8" WHEELS ARE IN STOCK. Others FACTORY QUICK SHIP—FOB OHIO.**

**(B) 8" PNEUMATIC WHEELS**

Model Number	Deck LxW	Wt Lbs.	(A) 8" M.R.		(B) 8" PNEU.		(C) 5" M.R.	
			Cap. Lbs.	Price Ea.	Cap. Lbs.	Price Ea.	Cap. Lbs.	Price Ea.
XV-1137	36x24"	99	2,000	\$283.00	1,200	\$372.00	1,400	\$268.00
XV-1138	48x24"	102	2,000	\$296.00	1,200	\$391.00	1,400	\$285.00
XV-1139	48x30"	118	2,000	\$307.00	1,200	\$419.00	1,400	\$308.00
XV-1140	60x30"	131	2,000	\$341.00	1,200	\$432.00	1,400	\$341.00
XV-1141	72x36"	160	2,000	\$391.00	1,200	\$469.00	1,400	\$389.00



## FAIRBANKS® Welded Steel Platform Trucks

- 3,500-lb. capacity
- 12-gauge steel deck
- 10-7/8"H deck

MADE IN USA

**STOCK**

Reinforced steel deck has integral handle holes on each end and rounded corners. 26" high, 1" dia. removable handle. 8" mold-on rubber wheels, 2 rigid and 2 swivel. Green epoxy powder finish. **IN STOCK.**

WELDED STEEL PLATFORM TRUCKS				EXTRA HANDLE	
Model No.	Deck LxW	Wt. Lbs.	Price Ea.	Model No.	Price Ea.
XP-571	48x24"	115	\$372.00	XP-575	\$37.80
XP-572	54x27"	127	\$404.00	XP-576	\$39.40
XP-573	60x30"	141	\$446.00	XP-577	\$41.50
XP-574	72x36"	172	\$536.00	XP-578	\$46.20



# Platform Trucks



## DUTRO Stocking Truck

- 1,400-lb. capacity
- Tubular steel deck
- 11"H deck

Tubular deck offers strength without the weight of a solid platform. Features (4) 5" non-marking swivel casters and (2) 8" mold-on rubber wheels. Powder coat finish. **IN STOCK.**

Model Number	Deck LxW	Wt. Lbs.	Price Each
YP-2441	53x18"	69	\$314.00



## LITTLE GIANT Shop Wagons

- 2,000-, 3,000-, and 3,500-lb. capacities
- 12-gauge steel deck
- Multiple deck heights available

Wagon trucks, with their fifth wheel steering design, provide easier maneuverability when transporting heavy loads. Double-grip T-bar handle. **SPECIFY: A - 1-1/2" retaining lip, B - Flush edges for sliding heavy objects. FACTORY QUICK SHIP—FOB ILLINOIS.**



XV-2800 SHOWN WITH (B) FLUSH EDGES.



(A) 1-1/2" RETAINING LIP.

Deck LxW	12" PNEUMATIC TIRES					16" PNEUMATIC TIRES					12" MOLD-ON RUBBER TIRES				
	Model Number	Deck Height	Cap. Lbs.	Wt. Lbs.	Price Each	Model Number	Deck Height	Cap. Lbs.	Wt. Lbs.	Price Each	Model Number	Deck Height	Cap. Lbs.	Wt. Lbs.	Price Each
48x24"	XV-2800	16"	2,000	139	\$383.00	XV-2731	18"	3,000	143	\$420.00	XV-2726	16"	3,500	185	\$401.00
48x30"	XV-2801	16"	2,000	155	401.00	XV-2733	18"	3,000	159	438.00	XV-2728	16"	3,500	201	420.00
60x30"	XV-2802	16"	2,000	170	420.00	XV-2734	18"	3,000	174	457.00	XV-2729	16"	3,500	216	438.00
60x36"	XV-2803	16"	2,000	172	447.00	XV-2737	18"	3,000	182	485.00	XV-2736	16"	3,500	224	466.00
72x36"	XV-2804	16"	2,000	205	466.00	XV-2735	18"	3,000	209	504.00	XV-2730	16"	3,500	251	485.00

## WESCO® Lightweight Aluminum Trucks

- 1,800–3,000-lb. capacities
- Aluminum deck
- Multiple deck heights available



Non-corrosive design includes an integral deck frame that wraps around entire perimeter. Heavy-duty deck is bolted to supportive girders. Rounded deck corners. Pipe pockets are located on each end of the deck. Removable crossbar handle. **SPECIFY WHEELS: A - 6" phenolic resin wheels with 3,000-lb. capacity, B - 8" mold-on rubber wheels with 2,000-lb. capacity, C - 10" full pneumatic wheels with 1,800-lb. capacity. IN STOCK.**

Model Number	Deck L x W	(A) PHENOLIC			(B) 12" MOLD-ON RUBBER			(C) PNEUMATIC		
		Deck Height	Wt. Lbs.	Price Each	Deck Height	Wt. Lbs.	Price Each	Deck Height	Wt. Lbs.	Price Each
<b>TREADPLATE DECK</b>										
XP-579	36x24"	10"	68	\$330.00	12"	69	\$353.00	14-1/2"	78	\$404.00
XP-580	48x24"	10"	73	393.00	12"	74	413.00	14-1/2"	83	465.00
XP-581	60x30"	10"	85	487.00	12"	88	509.00	14-1/2"	95	561.00
XP-582	72x36"	10"	103	634.00	12"	105	656.00	14-1/2"	112	709.00
<b>SMOOTH DECK</b>										
XP-583	36x24"	10"	67	\$349.00	12"	68	\$371.00	14-1/2"	77	\$422.00
XP-584	48x24"	10"	72	350.00	12"	73	371.00	14-1/2"	82	422.00
XP-585	60x30"	10"	83	412.00	12"	86	431.00	14-1/2"	93	482.00
XP-586	72x36"	10"	101	504.00	12"	103	525.00	14-1/2"	110	578.00



SMOOTH DECK

PNEUMATIC WHEELS

Model No. **XP-587** — Extra Handle. **SPECIFY DECK WIDTH:** A - 24", B - 30", C - 36". .....\$67.90

TREADPLATE DECK WITH MOLD-ON RUBBER WHEELS



PHENOLIC WHEELS

# Platform Trucks



**CONTROL PANEL**

## WESCO® Self-Propelled Steel Platform Trucks

- 990- and 1,100-lb. capacities
- 10-gauge steel deck
- 12" deck height

Speed control throttle features both forward and reverse power drive up to 2.6 mph. Operates on (2) 12-volt DC batteries with built-in UL-approved charger. Powerful tansaxle easily moves loads up to 5° incline. Motor can be disengaged to operate manually. Other features include: battery charge status indicator, speed limit control, emergency stop button, and motion beeper. Platform has roller bumpers at outside corners. Padded comfort grip handle is 29-1/4" above deck. Clipboard/work order holder. 8" polyurethane rubber casters, 2 swivel at the front, 2 rigid in the rear. FOB PENNSYLVANIA.

Model Number	Deck L x W	Cap. Lbs.	Wt. Lbs.	Price Each
XA-0183	36 x 24"	1100	191	\$1753.00
XA-0184	48 x 24"	1100	254	1807.00
XA-0185	48 x 30"	1100	318	1855.00
XA-0186	60 x 30"	990	397	1981.00



**MADE IN USA**

**STOCK**

## AKRO-MILS® Work-Height Trucks

- 1,800-lb. capacity
- Wood deck
- 26-1/2" deck height

Tongue-and-groove deck is strengthened with cross battens and has steel frame. Removable 15-3/4"H handle. 8" mold-on rubber casters—2 swivel and 2 rigid. Durable powder coat finish. Ships unassembled. **IN STOCK.**

Model Number	Deck LxW	Wt. Lbs.	Price Each
XA-0094A	48x24"	85	\$365.00
XA-0095A	60x30"	128	464.00

# Platform Trucks



**RUBBERMAID®  
Plastic Deck  
Platform Trucks**

- 500–2000-lb. capacities
- Structural foam deck
- Multiple deck heights available

Deck underside features tough honeycomb construction. Will not rust, dent, chip, peel, or splinter. Withstands temperatures from subzero to steam cleaning. Sealed bearing casters. Models with completely sealed bottoms are available. Call for more information. **SPECIFY WHEEL TYPE: A** - 5" hard rubber, 500-lb. capacity; **B** - 6" hard rubber, 1,000-lb. capacity; **C** - 8" polyolefin, 2,000-lb. capacity; **D** - 8" pneumatic, 1,000-lb. capacity. **IN STOCK.**



(C) 8" POLYOLEFIN



(D) 8" PNEUMATIC

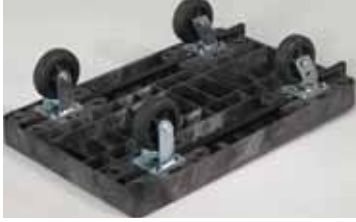

**DECK IS REINFORCED BY SOLID STEEL BARS.**



(A) 5" OR (B) 6" HARD RUBBER WHEELS SHOWN

Model Number	Deck LxW	Wt. Lbs.	(A)		(B)		(C)		(D)	
			Deck Ht.	Price Ea.	Deck Ht.	Price Ea.	Deck Ht.	Price Ea.	Deck Ht.	Price Ea.
WV-1142	36x24"	58	9-7/8"	\$467.00	10-7/8"	\$524.00	—	—	—	—
WV-1143	48x24"	76	—	—	10-7/8"	569.00	12-7/8"	\$644.00	12-7/8"	\$769.00
WV-1144	60x30"	100	9-7/8"	644.00	10-7/8"	—	12-7/8"	775.00	12-7/8"	817.00



**ALSO AVAILABLE IN:**

**BL - BLUE**   **GY - GRAY**



**TECHSTAR Plastic Platform Trucks**

- 500-lb. capacity
- Roto-molded linear low-density polyethylene deck
- Multiple deck heights available

Feature innovative molded-in storage pockets and beverage holder to keep your supplies organized. Contoured deck will not rust, dent, crack, or splinter. 48"Lx30"W overall. Powder coated steel handles. **SPECIFY CASTERS: A** - 6" mold-on rubber, **B** - 6" phenolic, **C** - 8" mold-on rubber, **D** - 8" pneumatic. **IN STOCK.**

Model Number	Deck LxW	Color	(A) 6" MOLD-ON RUBBER			(B) 6" PHENOLIC			(C) 8" MOLD-ON RUBBER			(D) 8" PNEUMATIC		
			Deck Ht.	Wt. Lbs.	Price Ea.	Deck Ht.	Wt. Lbs.	Price Ea.	Deck Ht.	Wt. Lbs.	Price Ea.	Deck Ht.	Wt. Lbs.	Price Ea.
YM-1060	41x30"	Red	12"	68	\$486.00	12"	62	\$495.00	14"	80	\$510.00	14-1/4"	80	\$507.00
YM-1061	41x30"	Blue	12"	68	486.00	12"	62	495.00	14"	80	510.00	14-1/4"	80	507.00
YM-1062	41x30"	Gray	12"	68	486.00	12"	62	495.00	14"	80	510.00	14-1/4"	80	507.00



**AKRO-MILS®  
Structural Plastic  
Platform Trucks**

- 1,200–2,700-lb. capacities
- Structural foam deck
- Multiple deck heights available

Deck is reinforced with steel bars and resists rust, chemicals, dents, and temperature changes. Durable, powder coated heavy-gauge steel handles. **SPECIFY CASTERS: A** - 5" mold-on rubber, 1,400-lb. capacity; **B** - 6" polyurethane, 2,700-lb. capacity; **C** - 8" full-pneumatic, 1,200-lb. capacity; **D** - 8" mold-on rubber, 2,000-lb. capacity. **IN STOCK.**



**SOLID STEEL REINFORCEMENTS ENSURE MAXIMUM RIGIDITY AND SUPPORT UNDER THE HEAVIEST LOADS.**



XA-1900 SHOWN WITH (B) 6" POLYURETHANE WHEELS.

Model Number	Deck LxW	Handle Type	Wt. Lbs.	(A)		(B)		(C)		(D)	
				Deck Ht.	Price Ea.	Deck Ht.	Price Ea.	Deck Ht.	Price Ea.	Deck Ht.	Price Ea.
XA-1900	48x24"	Open	74	9-1/4"	\$378.00	9-1/4"	\$479.00	11-1/4"	\$510.00	11-1/4"	\$400.00
XA-1901	48x24"	Crossbar	75	9-1/4"	392.00	9-1/4"	481.00	11-1/4"	513.00	11-1/4"	397.00
XA-1902	60x30"	Open	102	9-1/4"	404.00	9-1/4"	462.00	11-1/4"	545.00	11-1/4"	388.00
XA-1903	60x30"	Crossbar	103	9-1/4"	417.00	9-1/4"	518.00	11-1/4"	427.00	11-1/4"	391.00

# EUROKRAFT® Trucks



**THREE-SHELF TRUCK SHOWN WITH WOOD SHELVES AND MOLD-ON RUBBER CASTERS.**



**THREE-SHELF TRUCK SHOWN WITH STEEL SHELVES AND POLYURETHANE CASTERS.**



## EUROKRAFT® Premium Three-Shelf Security Trucks

- Wood doors and sides; angle iron frame
- 1,200 and 2,000-lb. capacities
- Multiple caster choices available
- Bolted-on push handle

Among the strongest in the industry, premium trucks are built entirely of close-tolerance components. Solid wood doors and sides. Deck is 3/4" thick layered wood panel mounted flush into an all-welded, 1/8" x 1-1/2" angle iron frame. Each upper shelf supports 400 lbs. Doors open on full-length piano hinges and include high-security, hardened steel padlock hasps. Padlocks not included. Color: blue. **SPECIFY CASTERS: A - 5" polyurethane, B - 8" mold-on rubber, C - 8" pneumatic. IN STOCK.**

Model Number	Overall W x D	Shelf Qty.	Shelf Clearance	(A) POLYURETHANE				(B) MOLD-ON RUBBER				(C) PNEUMATIC			
				Overall Ht.	Cap. Lbs.	Wt. Lbs.	Price Ea.	Overall Ht.	Cap. Lbs.	Wt. Lbs.	Price Ea.	Overall Ht.	Cap. Lbs.	Wt. Lbs.	Price Ea.
<b>WOOD TRUCKS WITH 3 WOOD SHELVES</b>															
YM-2985	48" x 24"	3	17-1/2"	63"	2000	315	\$1677.00	66"	2000	330	\$1715.00	66"	1200	327	\$1710.00
YM-2986	48" x 30"	3	17-1/2"	63"	2000	341	1666.00	66"	2000	356	1702.00	66"	1200	353	1731.00
YM-2987	60" x 30"	3	17-1/2"	63"	2000	389	1949.00	66"	2000	410	1981.00	66"	1200	404	2008.00
<b>WOOD TRUCKS WITH 1 WOOD AND 2 STEEL SHELVES</b>															
YM-2982	48" x 24"	3	17-1/2"	63"	2000	334	\$1714.00	66"	2000	355	\$1750.00	66"	1200	349	\$1745.00
YM-2983	48" x 30"	3	17-1/2"	63"	2000	360	1694.00	66"	2000	381	1731.00	66"	1200	375	1730.00
YM-2984	60" x 30"	3	17-1/2"	63"	2000	394	1994.00	66"	2000	415	2030.00	66"	1200	409	2026.00

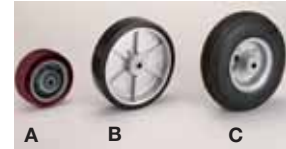

**CHOOSE FROM 3 CASTER TYPES!**

- A - Polyurethane 5" casters. 2,000-lb. capacity.**
  - B - Mold-on rubber 8" casters. 2,000-lb. capacity.**
  - C - Pneumatic 8" casters. 1,200-lb. capacity.**
- Capacities are for a set of 4 casters (per truck).



**YM-2992 SHOWN WITH STEEL SHELVES AND POLYURETHANE CASTERS.**



**YM-2989 SHOWN WITH WOOD SHELVES AND PNEUMATIC CASTERS.**



## Premium Wire Security Trucks

- Steel wire
- 1,200 and 2,000-lb. capacities
- Multiple caster choices available
- Hardened steel padlock hasp

2-1/4" square welded wire construction offers total security and see through visibility. Decks are 3/4" thick layered wood panel mounted flush into an all-welded, 1/8" x 1-1/2" angle iron frame that supports the entire perimeter. Each upper shelf supports 400 lbs., while the doors open on full-length piano hinges. Padlocks not included. Two swivel and 2 rigid casters. Color: blue. **SPECIFY CASTERS: A - 5" polyurethane, B - 8" mold-on rubber, C - 8" pneumatic. IN STOCK.**



**HARDENED STEEL HASP KEEPS ENTIRE LOCK SAFE FROM BOLT CUTTERS OR OTHER DEVICES.**

Model Number	Overall W x D	Shelf Qty.	Shelf Clearance	(A) POLYURETHANE				(B) MOLD-ON RUBBER				(C) PNEUMATIC			
				Overall Ht.	Cap. Lbs.	Wt. Lbs.	Price Ea.	Overall Ht.	Cap. Lbs.	Wt. Lbs.	Price Ea.	Overall Ht.	Cap. Lbs.	Wt. Lbs.	Price Ea.
<b>WIRE TRUCKS WITH 3 WOOD SHELVES</b>															
YM-2989	48" x 24"	3	17-1/2"	63"	2000	182	\$1442.00	66-1/2"	2000	212	\$1468.00	66-1/2"	1200	206	\$1479.00
YM-2990	48" x 30"	3	17-1/2"	63"	2000	207	1602.00	66-1/2"	2000	237	1628.00	66-1/2"	1200	231	1666.00
YM-2991	60" x 30"	3	17-1/2"	63"	2000	294	2147.00	66-1/2"	2000	315	2172.00	66-1/2"	1200	309	2207.00
<b>WIRE TRUCKS WITH 1 WOOD SHELF AND 2 STEEL SHELVES</b>															
YM-2992	48" x 24"	3	17-1/2"	63"	2000	189	\$1488.00	66-1/2"	2000	210	\$1502.00	66-1/2"	1200	204	\$1533.00
YM-2993	48" x 30"	3	17-1/2"	63"	2000	225	1679.00	66-1/2"	2000	246	1697.00	66-1/2"	1200	240	1735.00
YM-2994	60" x 30"	3	17-1/2"	63"	2000	299	2219.00	66-1/2"	2000	320	2237.00	66-1/2"	1200	314	2266.00

# Security Trucks

YL-1341 SHOWN WITH  
(B) ONE FIXED SHELF.



## LITTLE GIANT Visible Contents Security Trucks

- Mesh sides with 12-gauge steel frame
- 2,000-lb. capacity
- 6" polyurethane casters

Offers maximum security, as well as good ventilation and visibility of contents. Heavy-gauge reinforced deck. Double doors swing open 270° and include a padlock hasp for security. 48" interior height. Rolls on non-marking wheels—2 swivel, 2 rigid. Available without shelf, with fixed shelves, or with one adjustable shelf that moves up and down on 3-1/2" centers. **SPECIFY: A** - Without shelf, **B** - With one fixed shelf, **C** - With two fixed shelves, **D** - With one adjustable shelf. **FACTORY QUICK SHIP—FOB ILLINOIS.**



Model Number	Overall W x D x H	(A) WITHOUT SHELF		(B) ONE FIXED SHELF			(C) TWO FIXED SHELVES			(D) ONE ADJUSTABLE SHELF	
		Wt. Lbs.	Price Ea.	Shelf Clearance	Wt. Lbs.	Price Ea.	Shelf Clearance	Wt. Lbs.	Price Ea.	Wt. Lbs.	Price Ea.
YL-1340	48" x 24" x 56"	186	\$725.00	21-1/2"	216	\$736.00	14"	246	\$813.00	216	\$870.00
YL-1341	48" x 30" x 56"	196	769.00	21-1/2"	230	791.00	14"	267	877.00	230	925.00
YL-1342	60" x 30" x 56"	245	834.00	21-1/2"	275	878.00	14"	320	965.00	275	1014.00
YL-1343	60" x 36" x 56"	292	890.00	21-1/2"	345	971.00	14"	420	1122.00	—	—
YL-1344	72" x 36" x 56"	350	927.00	21-1/2"	392	1031.00	14"	451	1182.00	—	—



Selected Models

## METRO *qwikSLOT*<sup>™</sup> Security Trucks

- Steel wire
- 800-1,200-lb. capacity
- 5" polyurethane casters
- Patented 1/4-turn padlock hasp

Totally enclosed design and locking doors make this truck the perfect solution for reducing theft. Open-wire construction makes it easy to monitor inventory. Order *qwikSLOT*<sup>™</sup> shelves separately. Ships unassembled. **SELECTED MODELS IN STOCK.** Others FOB PENNSYLVANIA, TENNESSEE.

**STANDARD-DUTY TRUCKS.** 800-lb. capacity.

Model Number	Overall W x D x H	Wt. Lbs.	Price Each
YL-1450	40-3/4" x 27-1/4" x 68-1/2"	142	\$1103.00
YL-1451	52-3/4" x 27-1/4" x 68-1/2"	148	1247.00
YL-1452	65" x 27-1/4" x 68-1/2"	188	1413.00

**HEAVY-DUTY TRUCKS.** Wire cage is mounted on an aluminum dolly with wraparound bumper for extra strength and durability. 1,200-lb. capacity.

Model Number	Overall W x D x H	Wt. Lbs.	Price Each
YL-1453	38-1/2" x 28-1/16" x 67-7/8"	171	\$1238.00
YL-1454	50-1/2" x 28-1/16" x 67-7/8"	198	1461.00
YL-1455	63-1/8" x 28-1/16" x 67-7/8"	225	1547.00



**qwikSLOT<sup>™</sup> SHELVES.** EASILY ADJUSTABLE AND REMOVABLE WITHOUT DISMANTLING THE ENTIRE UNIT. SHELVES ARE SUPPORTED ON CLIPS THAT SNAP INTO POSTS AT 1" INTERVALS.



**HEAVY-DUTY TRUCK IS MOUNTED TO AN ALUMINUM DOLLY FOR EXTRA STRENGTH.**

**qwikSLOT<sup>™</sup> SHELVES.** 300-lb. capacity per shelf.

Model Number	Overall W x D	Wt. Lbs.	Price Each
YL-1456	36" x 24"	13	\$62.70
YL-1457	48" x 24"	16	83.30
YL-1458	60" x 24"	21	90.60

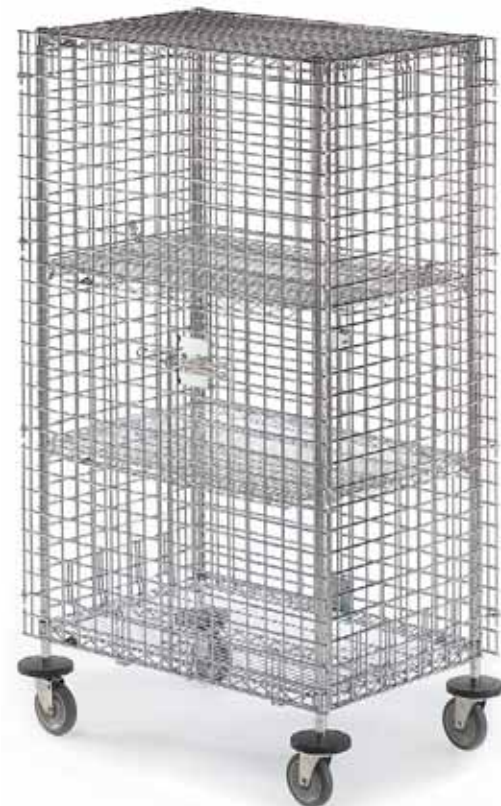

**STANDARD-DUTY TRUCK SHOWN WITH 2 OPTIONAL SHELVES.**

# EUROKRAFT® Trucks



YM-3015 SHOWN WITH MOLD-ON RUBBER CASTERS.



YM-3002 SHOWN WITH MOLD-ON-RUBBER CASTERS.



YM-3013 SHOWN WITH FULL-PNEUMATIC CASTERS.

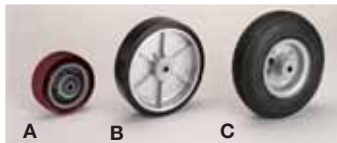

Choose from 3 caster types!

**A - Polyurethane 5" casters.**  
1,600-lb. cap.\*

**B - Mold-on rubber 8" casters.**  
1,600-lb. cap.\*

**C - Pneumatic 8" casters.**  
1,200-lb. cap.\*

\*Capacities are per truck. All include two swivel and two rigid casters.



## Premium Shelf Trucks

- Steel and wood shelves
- 1,200–1,600-lb. capacity
- Multiple caster choices available

Close-tolerance components easily assemble into the most durable trucks on the market. All-welded, 1/8" x 1-1/2" angle iron base frame supports the entire perimeter of the flush wooden bottom shelf. Choose either 3/4" layered wood shelves with a durable lacquered surface or sturdy steel shelves. **SPECIFY CASTER: A - 5" polyurethane, B - 8" mold-on rubber, C - 8" pneumatic. IN STOCK.**

Key	Model Number	Shelf W x D	Shelf Qty.	Shelf Clearance	(A) 62-1/4"H POLYURETHANE		(B) 65-1/4"H MOLD-ON RUBBER		(C) 65-1/4"H PNEUMATIC	
					Wt. Lbs.	Price Ea.	Wt. Lbs.	Price Ea.	Wt. Lbs.	Price Ea.
<b>STEEL-SHELF TRUCKS WITH WOODEN BOTTOM SHELF</b>										
A	YM-3000	48" x 24"	4	12-3/4"	202	\$677.00	202	\$710.00	202	\$741.00
A	YM-3001‡	60" x 30"	4	12-3/4"	321	926.00	321	952.00	321	981.00
B	YM-3002	48" x 24"	3	19-1/4"	142	685.00	142	716.00	142	746.00
B	YM-3003	48" x 30"	3	19-1/4"	191	742.00	191	768.00	191	798.00
B	YM-3004‡	48" x 30"	3	19-1/4"	204	814.00	204	840.00	204	871.00
B	YM-3005‡	60" x 30"	3	19-1/4"	186	830.00	186	857.00	186	886.00
<b>WOOD-SHELF TRUCKS</b>										
A	YM-3019	48" x 24"	4	12-3/4"	140	\$636.00	169	\$655.00	170	\$682.00
A	YM-3006‡	60" x 30"	4	12-3/4"	191	756.00	191	770.00	191	800.00
B	YM-3013	48" x 24"	1	—	105	542.00	134	560.00	135	588.00
B	YM-3007‡	60" x 30"	1	—	131	625.00	131	643.00	131	671.00
B	YM-3015	48" x 24"	3	19-1/4"	122	647.00	141	663.00	142	593.00
B	YM-3016	48" x 30"	3	19-1/4"	136	705.00	165	717.00	166	753.00
B	YM-3008	48" x 30"	3	19-1/4"	159	694.00	159	707.00	159	735.00
B	YM-3009‡	60" x 30"	3	19-1/4"	145	792.00	145	780.00	145	832.00

‡All welded models.

# Specialty Trucks



**SINGLE-SIDED TRUCK WITH (8) ACCESSORY TRAYS**

**DEEP TRAY WITH 3" LIP**

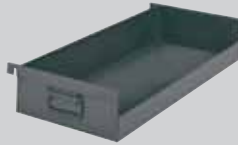

**DEEP TRAY WITH FLUSH FRONT**

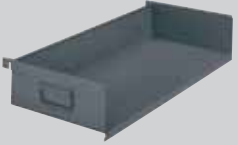

**FLUSH FRONT DEEP TRAY SHOWN WITH (2) DIVIDERS**



**HANGER BAR WITH (12) SPINDLES**



**DOUBLE-SIDED TRUCK WITH (4) DEEP TRAYS WITH FLUSH FRONTS; (4) DEEP TRAYS WITH 3" LIP AND (2) HANGER BARS WITH SPINDLES**



## Vari-Tuff™ A-Frame Shelf Trucks

- Steel
- 1,500–2,500-lb. capacity
- 5" phenolic casters



Eases storage, storing, and distribution of parts and supplies. All-welded units are available in either a single- or double-sided configuration. Single-sided trucks hold (7) 6"H trays; double-sided trucks hold (14) 3"H trays per side. All trucks roll on (2) rigid, (2) swivel casters. Add optional accessories to customize truck to fit your needs. Color: gray. **IN STOCK.**

Model Number	Description	Overall	Cap.	Wt.	Price Each
XH-4211	Single-sided	38" x 18" x 64"	1,500	172	\$318.00
XH-4212	Single-sided	38" x 24" x 64"	1,500	220	\$332.00
XH-4213	Double-sided	38" x 30" x 64"	2,500	260	\$365.00
XH-4214	Double-sided	38" x 40" x 64"	2,500	290	\$377.00

### ACCESSORIES

Model Number	Description	Size	Wt. Lbs.	Price Each
XH-4215	Deep tray/3" front lip	15"D x 6"H	23	\$63.50
XH-4216	Deep tray/flush front	15"D x 6"H	20	\$65.50
XH-4217	Shallow tray/1-1/2" front lip	9"D x 3"H	20	\$62.70
XH-4218	Shallow tray/flush front	9"D x 3"H	10	\$62.70
XH-4219	Hanger bar	38"W x 4"H	10	\$39.60
XH-4220	Spindles	15"L	1.5	\$12.10
XH-4223	Deep tray dividers	15"D x 6"H	1	\$16.90
XH-4224	Shallow tray dividers	9"D x 3"H	0.5	\$14.40



## PARENT METAL Shelf Trucks

- 13–20 gauge steel
- 1,000-lb. capacity
- 5" hard rubber casters

Ideal for transport and volume storage of parts, packages, and supplies. Shelves are bolted to heavy 13-ga., 1" x 2" hot-rolled rail steel angle posts at two points in each corner, creating a rigid 8-point suspension. Gusset angle sways, on three levels and all four sides provide extra rigidity. Shelves adjust on 1" centers. Tubular push handle for fingertip control. Two rigid, 2 swivel casters are bolted to bottom shelf. Color: gray. Ships unassembled. **SPECIFY STYLE: A - Open truck, B - Semi-open truck, C - Closed truck. FACTORY QUICK SHIP – FOB PENNSYLVANIA.**



**(A) OPEN TRUCK**



**(B) SEMI-OPEN TRUCK**



**(C) CLOSED TRUCK**

Model Number	Shelf W x D	Overall Ht.	Shelf Qty.	SHELF TRUCKS						EXTRA SHELVES	
				A. OPEN TRUCK		B. SEMI-OPEN TRUCK		C. CLOSED TRUCK		Model Number	Price Each
				Wt. Lbs.	Price Ea.	Wt. Lbs.	Price Ea.	Wt. Lbs.	Price Ea.		
XP-607	36" x 18"	57"	5	88	\$213.00	100	\$245.00	110	\$260.00	XP-611	\$17.40
XP-608	48" x 18"	57"	5	103	\$251.00	120	\$265.00	135	\$283.00	XP-612	\$20.90
XP-609	36" x 24"	57"	5	101	\$250.00	115	\$269.00	129	\$285.00	XP-613	\$19.90
XP-610	48" x 24"	57"	5	121	\$277.00	140	\$297.00	157	\$321.00	XP-614	\$27.20

# Wire Trucks



SHELF TRUCK

### EXTRA SHELVES

Model No. <b>XC-1390</b> —36" x 18". Wt. 11 lbs. ....	<b>\$33.80</b>
Model No. <b>XC-1391</b> —48" x 18". Wt. 15 lbs. ....	<b>\$41.50</b>
Model No. <b>XC-1392</b> —60" x 18". Wt. 18 lbs. ....	<b>\$49.10</b>
Model No. <b>XC-1393</b> —36" x 24". Wt. 13-1/2 lbs. ....	<b>\$55.00</b>
Model No. <b>XC-1394</b> —48" x 24". Wt. 18-1/2 lbs. ....	<b>\$51.50</b>
Model No. <b>XC-1395</b> —60" x 24". Wt. 23 lbs. ....	<b>\$67.20</b>



## RELIUS SOLUTIONS Square-Post Wire Trucks and Carts



- Steel wire shelves and steel posts
- 1,000- and 1,200-lb. capacities
- 5" casters

Three styles to choose from to meet your material handling needs. Shelves adjust in 2" increments. Durable zinc-plated finish with a clear non-toxic lacquer coating. NSF listed. **IN STOCK.**

Model Number	Shelf W x D	Overall Ht.	Shelf Qty.	Cap. Lbs.	Wt. Lbs.	Price Each
<b>UTILITY CART WITH RUBBER CASTERS</b>						
<b>XC-1355</b>	36" x 18"	40"	2	800	48-1/2	<b>\$236.00</b>
<b>XC-1356</b>	48" x 18"	40"	2	800	56-1/2	<b>249.00</b>
<b>XC-1357</b>	60" x 18"	40"	2	800	62-1/2	<b>261.00</b>
<b>XC-1358</b>	36" x 24"	40"	2	800	54-1/2	<b>256.00</b>
<b>XC-1359</b>	48" x 24"	40"	2	800	64-1/2	<b>271.00</b>
<b>XC-1360</b>	60" x 24"	40"	2	800	73-1/2	<b>298.00</b>
<b>XC-1361</b>	36" x 18"	40"	3	800	59-1/2	<b>264.00</b>
<b>XC-1362</b>	48" x 18"	40"	3	800	71-1/2	<b>284.00</b>
<b>XC-1363</b>	60" x 18"	40"	3	800	80-1/2	<b>303.00</b>
<b>XC-1364</b>	36" x 24"	40"	3	800	68	<b>291.00</b>
<b>XC-1365</b>	48" x 24"	40"	3	800	83	<b>315.00</b>
<b>XC-1366</b>	60" x 24"	40"	3	800	96-1/2	<b>354.00</b>
<b>SHELF TRUCK WITH POLYURETHANE CASTERS</b>						
<b>XC-1369</b>	36" x 18"	60"	4	900	76	<b>\$337.00</b>
<b>XC-1370</b>	48" x 18"	60"	4	900	92	<b>367.00</b>
<b>XC-1371</b>	60" x 18"	60"	4	900	104	<b>397.00</b>
<b>XC-1372</b>	72" x 18"	60"	4	900	118	<b>423.00</b>
<b>XC-1373</b>	36" x 24"	60"	4	900	86	<b>369.00</b>
<b>XC-1374</b>	48" x 24"	60"	4	900	106	<b>407.00</b>
<b>XC-1375</b>	60" x 24"	60"	4	900	124	<b>469.00</b>
<b>XC-1376</b>	72" x 24"	60"	4	900	140	<b>507.00</b>
<b>XC-1377</b>	36" x 18"	70"	4	900	76	<b>350.00</b>
<b>XC-1378</b>	48" x 18"	70"	4	900	92	<b>380.00</b>
<b>XC-1379</b>	60" x 18"	70"	4	900	104	<b>411.00</b>
<b>XC-1380</b>	72" x 18"	70"	4	900	118	<b>437.00</b>
<b>XC-1381</b>	36" x 24"	70"	4	900	86	<b>383.00</b>
<b>XC-1382</b>	48" x 24"	70"	4	900	106	<b>420.00</b>
<b>XC-1383</b>	60" x 24"	70"	4	900	124	<b>482.00</b>



OPTIONS SOLD ON PAGE 161.



ALSO AVAILABLE IN GREEN, CALL FOR INFORMATION.

## Wire Trucks

- Chrome wire shelves and chrome posts
- 800-lb. capacity
- 5" rubber casters

Open wire will not accumulate dirt and dust like solid shelves. (4) shelves adjust in 1" increments along double-notched posts. Swivel casters—2 with brakes. ISO 9002 Certified. NSF listed.

**SPECIFY HEIGHT: A - 60", B - 69", C - 80". IN STOCK.**

Model Number	Shelf W x D	Wt. Lbs.	A - 60"H	B - 69"H	C - 80"H
			Price Ea.	Price Ea.	Price Ea.
<b>ZC-1663</b>	36" x 18"	64	<b>\$373.00</b>	<b>\$383.00</b>	<b>\$389.00</b>
<b>ZC-1664</b>	36" x 24"	78	<b>411.00</b>	<b>421.00</b>	<b>429.00</b>
<b>ZC-1665</b>	48" x 18"	74	<b>408.00</b>	<b>416.00</b>	<b>423.00</b>
<b>ZC-1666</b>	48" x 24"	90	<b>456.00</b>	<b>465.00</b>	<b>473.00</b>
<b>ZC-1667</b>	60" x 18"	94	<b>446.00</b>	<b>457.00</b>	<b>464.00</b>
<b>ZC-1668</b>	60" x 24"	110	<b>513.00</b>	<b>525.00</b>	<b>531.00</b>
<b>ZC-1669</b>	72" x 18"	106	<b>495.00</b>	<b>505.00</b>	<b>512.00</b>
<b>ZC-1670</b>	72" x 24"	130	<b>602.00</b>	<b>617.00</b>	<b>622.00</b>



# Stock Trucks

TRUCKS FOLD UP AND NEST FOR SPACE-SAVING STORAGE.



## RELIUS SOLUTIONS Nesting Stock Trucks

- Mesh sides; steel frame
- 1,000-lb. capacity
- 5" polyurethane casters

When folded, six trucks nest in less than 5' of space preserving valuable floor place in the storage room. Features (2) folding shelves to accommodate large or small items, and (4) swivel non-marking casters—(1) directional, (1) with Total-Lock.

Powder coat finish.  
Ships set up. FOB ILLINOIS, WASHINGTON.

Model Number	Shelf W x D	Overall Height	Shelf Qty.	Collapsed Height	Wt. Lbs.	Price Each
YA-0395	49" x 30"	59"	3	76"	208	\$659.00
YA-0396	62" x 30"	59"	3	76"	245	795.00



## RELIUS SOLUTIONS Square-Post Wire Stock Trucks

- Steel wire shelves and steel posts
- 1,200-lb. capacity
- 5" polyurethane casters

Features corrosion-resistant zinc-plated finish, 3x3" mesh sides and back. Shelves adjust in 2" increments. Four swivel casters. NSF listed.

Model Number	Shelf W x D	Overall Height	Shelf Qty.	Wt. Lbs.	Price Each
XT-1798	36" x 18"	70"	4	108	\$496.00
XT-1799	48" x 18"	70"	4	126	555.00
XT-1800	60" x 18"	70"	4	150	612.00
XT-1801	36" x 24"	70"	4	124	551.00
XT-1802	48" x 24"	70"	4	144	618.00
XT-1803	60" x 24"	70"	4	170	708.00



FOLD-DOWN SIDES FOR EASY ACCESS.



## WESCO® Wire Cage Platform Truck

- Steel wire cage
- 1,100-lb. capacity
- 8" mold-on thermoplastic rubber casters

Prevent packages, supplies and equipment from falling during transport. Fold-down sides are removable, allowing for easy access to contents. Also features powder-coated platform and handles and a zinc-plated cage. **FACTORY QUICK SHIP**—FOB PENNSYLVANIA.

Model No. YA-0070—48"L x 30"W overall. 40" inside height.  
Wt. 124 lbs. .... \$451.00



# Stock Trucks



XA-1600 TRUCK SHOWN WITH XA-1603(A) REMOVABLE FOURTH PANEL WITH DROP GATE.



## LITTLE GIANT Catch-All Trucks

- Expanded metal
- 2,000- and 3,600-lb. capacities
- Multiple wheel choices available
- All-welded

Moves heavy cartons, mailbags, or other goods. Electric-arc welded construction. 36" interior height. Optional fourth panel secures contents during transport. **SPECIFY WHEELS: A** - 8" polyurethane, 3,600-lb. capacity; **B** - 6" mold-on rubber, 2,000-lb. capacity.

**FACTORY QUICK SHIP – FOB ILLINOIS.**

Model Number	Overall W x D x H	Wt. Lbs.	(A) 8" POLYURETHANE Cap. Lbs.	Price Ea.	(B) 6" MOLD-ON RUBBER Cap. Lbs.	Price Ea.
XA-1600	48" x 24" x 48"	150	3,600	\$459.00	2,000	\$431.00
XA-1601	48" x 30" x 48"	160	3,600	481.00	2,000	453.00
XA-1602	60" x 30" x 48"	185	3,600	513.00	2,000	487.00

REMOVABLE FOURTH PANEL WITH DROP GATE. SPECIFY PANEL WIDTH.

XA-1603 – (A) 48"W.	\$155.00.	(B) 60"W	.....	\$180.00
---------------------	-----------	----------	-------	----------



## AKRO-MILS® Welded Tray-Shelf Trucks

- 13-gauge steel shelves
- 1,800-lb. capacity
- 5" polyurethane casters
- All welded

Heavy-gauge steel stands up to tough use. Spacious 12" deep top shelf securely stores cargo. Lower shelf includes 1-1/2" lip. Two swivel, 2 fixed casters include roller bearings. Durable gray powder coat finish. **SELECTED MODELS IN STOCK.** Others FOB OHIO.

Model Number	Shelf W x D	Overall Height	Shelf Qty.	Shelf Clearance	Wt. Lbs.	Price Each
YA-1512	30" x 18"	32-1/2"	2	12-1/8"	92	\$390.00
YA-1513	36" x 18"	32-1/2"	2	12-1/8"	96	403.00
YA-1514	36" x 24"	32-1/2"	2	12-1/8"	116	450.00



6" DEEP SHELF TRUCK



Selected Models

## LITTLE GIANT Deep-Shelf Trucks

- 12-gauge steel shelves
- 1,200-lb. capacity
- 5" polyurethane casters
- All welded



12" DEEP SHELF TRUCK

Ideal for order picking, stocking, or mail room jobs. Extremely rigid and durable truck. Extra-deep shelves hold and restrain more small items. Two swivel and 2 rigid casters. **SELECTED MODELS IN STOCK.** Others FOB ILLINOIS.

Model Number	Shelf W x D	Overall Height	Shelf Qty.	Shelf Clearance	Wt. Lbs.	Price Each
<b>3" DEEP SHELVES</b>						
YA-1624	30" x 18"	35"	2	22-1/2"	71	\$226.00
YA-1625	36" x 24"	35"	2	22-1/2"	95	268.00
<b>6" DEEP SHELVES</b>						
YA-1626	30" x 18"	35"	2	16-1/2"	87	\$266.00
YA-1627	36" x 24"	35"	2	16-1/2"	116	324.00
<b>12" DEEP SHELVES*</b>						
YA-1628	30" x 18"	35"	2	15"	91	\$290.00

\*Bottom shelf is 1-1/2" deep.

# High-End Trucks



## RELIUS SOLUTIONS High-End Platform Trucks

- 1,800-lb. capacity
- Three deck materials available
- 11" and 12" deck heights

Two removable 51"H handles. Two rigid wheels and four swivel casters allow truck to turn on its own radius.

**SPECIFY DECK:**

**A** - Steel-bound wood deck, **B** - 13-ga. steel deck, **C** - Galvanized steel treadplate deck.

**IN STOCK.**



**A - STEEL BOUND WOOD DECK**



**B - 13-GA. STEEL DECK**



**C - GALVANIZED STEEL TREADPLATE DECK**

Model Number	Deck L x W	Wheel Type	Wt. Lbs.	(A)		(B)		(C)	
				Deck Ht.	Price Ea.	Deck Ht.	Price Ea.	Deck Ht.	Price Ea.
<b>XL-0690</b>	48" x 16"	Polyurethane	85	12"	<b>\$262.00</b>	11"	<b>\$198.00</b>	11"	<b>\$292.00</b>
<b>XL-0691</b>	60" x 16"	Polyurethane	101	12"	<b>277.00</b>	11"	<b>208.00</b>	11"	<b>302.00</b>
<b>XL-0693</b>	60" x 24"	Polyurethane	132	12"	<b>318.00</b>	11"	<b>299.00</b>	11"	<b>407.00</b>



## WIN-HOLT High-End Platform Trucks

- 1500-lb. capacity
- All-welded steel deck
- 9-1/2"H deck

Long narrow deck and tall end panels make this truck ideal for handling large, bulky loads. (2) 8" center stationary wheels with (4) 4" swivel end casters allows truck to swivel on its own radius.

FOB NEW YORK, GEORGIA, TEXAS AND CALIFORNIA.



Model Number	Deck L x W	Wheel Type	Wt. Lbs.	Price Each
<b>XT-327</b>	63" x 16"	Polyurethane	100	<b>\$154.00</b>
<b>XT-328</b>	51" x 16"	Polyurethane	90	<b>145.00</b>



## RUBBERMAID® StockMate® Platform Truck

- 1,500-lb. capacity
- Structural foam plastic deck
- 10-5/8"H deck

Will not rust, dent, chip, or peel.

Pivots on its own axis. Four 5" polyolefin swivel wheels on each end and (2) 6" rigid polyolefin wheels in the middle. Diamond plate deck with removable uprights. **IN STOCK.**



Model No. **YT-2029**—60x18" deck. Wt. 70 lbs. ....**\$324.00**

# Panel/Sheet Trucks



**5 YEAR WARRANTY**

**ORDER PLATFORM AND UPRIGHTS SEPARATELY.**

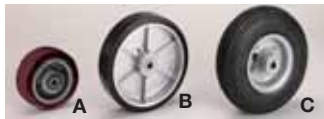

**CHOOSE FROM 3 WHEEL TYPES!**  
**A - Polyurethane 5" casters. 2,000-lb. capacity\*.**  
**B - Mold-on rubber 8" casters. 2,000-lb. capacity\*.**  
**C - Full pneumatic 8" casters. 1,200-lb. cap.\***  
 \*Capacities indicated are for a set of 4 casters (per truck).

## EUROKRAFT® Premium Panel/Sheet Trucks

- 1,200 and 2,000-lb. capacities
- Uprights are spaced 3-1/2" apart
- 12", 26", or 38" high uprights



Transports and stores multiple sizes of sheet and panel stock. Rugged 3/4" thick layered seamless wood deck is mounted into a rigid all-welded 1/8" x 1-1/2" angle iron frame. Strong base frames have rounded edges. Deck features a durable, non-mar lacquered finish. 24" model has 7 pockets, 30" has 9 pockets. Two rigid, two swivel casters. Order upright frames separately. **IN STOCK.**

PLATFORM ONLY. SPECIFY CASTERS: A - 5" polyurethane, B - 8" mold-on rubber, C - 8" pneumatic.											
Model Number	Deck L x W	(A) POLYURETHANE			(B) MOLD-ON RUBBER			(C) PNEUMATIC			
		Deck Ht.	Wt. Lbs.	Price Ea.	Deck Ht.	Wt. Lbs.	Price Ea.	Deck Ht.	Wt. Lbs.	Price Ea.	
YM-3090	48" x 24"	8"	65	\$360.00	11"	95	\$370.00	10-3/4"	95	\$407.00	
YM-3091	60" x 30"	8"	80	435.00	11"	110	450.00	10-3/4"	110	484.00	

UPRIGHTS ONLY. Sold in pairs. SPECIFY HEIGHT: 12 - 12"H, 26 - 26"H, 38 - 38"H.							
Model Number	Overall Length	(12) 12"H		(26) 26"H		(38) 38"H	
		Wt. Lbs.	Price Ea. Pr.	Wt. Lbs.	Price Ea. Pr.	Wt. Lbs.	Price Ea. Pr.
YM-3095	48"	7	\$70.50	9	\$80.40	11	\$120.00
YM-3096	60"	11	90.70	13	105.00	15	118.00



## LITTLE GIANT A-Frame Panel/Sheet Trucks

- 2,000-lb. capacity
- Uprights are spaced 12" apart at base
- 48"H uprights



Holds sheets on both sides of the A-frame. Deck is surrounded by a 1" retaining lip. 6" phenolic swivel casters. **IN STOCK.**

Model No.	Deck L x W	Deck Ht.	Wt. Lbs.	Price Ea.
YB-1025	36" x 24"	8"	108	\$264.00
YB-1026	48" x 24"	8"	122	299.00
YB-1027	48" x 30"	8"	134	308.00
YB-1028	60" x 30"	8"	150	334.00
YB-1029	72" x 36"	8"	184	389.00



**STOCK**  
Selected Models

SHOWN WITH OPTIONAL PUSHBAR HANDLE

XA-1700(A) SHOWN

## LITTLE GIANT Panel/Sheet Trucks

- 1,600- and 3,600-lb. capacities
- Uprights are spaced 6" apart (24"W decks) or 8" apart (30"W decks)
- 27"H uprights



Uprights can be placed in any of four positions to accommodate different sized loads on each trip. 12-ga. reinforced steel deck. Maneuvers on two swivel, two rigid casters. Additional uprights sold separately. **SPECIFY CASTERS: A - Polyurethane swivel with brake, 3,600-lb. cap.; B - Mold-on rubber, 1,600-lb. cap. SELECTED MODELS IN STYLE (A) ARE IN STOCK. Others FACTORY QUICK SHIP—FOB ILLINOIS.**

Model Number	Deck L x W	Wt. Lbs.	(A) 6" POLYURETHANE			(B) 6" MOLD-ON RUBBER		
			Deck Ht.	Cap. Lbs.	Price Ea.	Deck Ht.	Cap. Lbs.	Price Ea.
XA-1700	48" x 24"	117	9"	3600	\$333.00	9"	1600	\$320.00
XA-1701	60" x 24"	134	9"	3600	360.00	9"	1600	325.00
XA-1702	48" x 30"	132	9"	3600	376.00	9"	1600	344.00
XA-1703	60" x 30"	150	9"	3600	372.00	9"	1600	364.00

### ADDITIONAL UPRIGHTS

Model No. XA-1704—For 48"L Decks. Wt. 18 lbs. ....	\$45.00
Model No. XA-1705—For 60"L Decks. Wt. 21 lbs. ....	\$53.90

### OPTIONAL PUSHBAR HANDLE. SPECIFY DECK WIDTH: A - 24", B - 30".

Model No. XA-1706—Wt. 10 lbs. ....	\$27.00
------------------------------------	---------



## Premium Platform Trucks with Wire Side Panels

- 1,200- and 2,000-lb. capacities
- Premium wood deck
- Multiple deck heights available



FLOOR LOCKS AVAILABLE FOR 30" WIDE TRUCKS. PLEASE CALL FOR INFORMATION.

Close-tolerance components place these trucks among the strongest in the industry. 23"H panels are constructed of 2-1/4" square, 1/4" dia. wire mesh. 3/4" thick, noise-deadening layered wood deck is supported by a no-rattle, 1/8" x 1-1/2" angle iron base frame. Also includes rounded edges and mar-resistant, lacquered finish. 2 swivel and 2 rigid casters. Ships unassembled. **SPECIFY CASTERS: A - Polyurethane, B - Mold-on rubber, C - Pneumatic. IN STOCK.**

Key	Model Number	Deck L x W	Deck Ht.	(A) 5" POLYURETHANE			(B) 8" MOLD-ON RUBBER			(C) 8" PNEUMATIC				
				Cap. Lbs.	Wt. Lbs.	Price Ea.	Deck Ht.	Cap. Lbs.	Wt. Lbs.	Price Ea.	Deck Ht.	Cap. Lbs.	Wt. Lbs.	Price Ea.
A	YM-3062	48" x 24"	8"	2,000	98	\$432.00	10-3/4"	2,000	137	\$468.00	11"	1,200	121	\$464.00
A	YM-3063	60" x 30"	8"	2,000	126	\$515.00	10-3/4"	2,000	161	\$551.00	11"	1,200	151	\$477.00
B	YM-3066	48" x 24"	8"	2,000	90	\$478.00	10-3/4"	2,000	127	\$515.00	11"	1,200	120	\$510.00
B	YM-3067	60" x 30"	8"	2,000	118	\$557.00	10-3/4"	2,000	151	\$592.00	11"	1,200	155	\$589.00
C	YM-3064	48" x 24"	8"	2,000	82	\$361.00	10-3/4"	2,000	115	\$395.00	11"	1,200	80	\$391.00
C	YM-3065	60" x 30"	8"	2,000	110	\$480.00	10-3/4"	2,000	143	\$516.00	11"	1,200	88	\$512.00

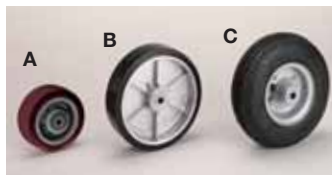

**CHOOSE FROM 3 CASTER TYPES!**  
**A - Polyurethane 5" casters.**  
**B - Mold-on rubber 8" casters.**  
**C - Full pneumatic 8" casters.**

**FOOT BRAKES FOR SWIVEL CASTERS. IN STOCK.**

Model. No. **YM-3086A** – For 5" polyurethane. ....\$7.00  
 Model. No. **YM-3086B** – For 8" mold-on rubber. ....\$7.90  
 Model. No. **YM-3086C** – For 8" pneumatic. ....\$11.90

## Premium Platform Trucks with Wood Side Panels

- 1,200- and 2,000-lb. capacities
- Premium wood deck
- Multiple deck heights available



Solid wood panels give you more load control. 18"H panels slide into steel posts. 3/4" layered wood deck is supported by a no-rattle, 1/8" x 1-1/2" angle iron base frame. Also includes rounded edges and mar-resistant, lacquered finish. Ships unassembled. **SPECIFY CASTERS: A - Polyurethane, B - Mold-On Rubber, C - Pneumatic. IN STOCK.**



FLOOR LOCKS AVAILABLE FOR 30" WIDE TRUCKS. PLEASE CALL FOR INFORMATION.

Key	Model Number	Deck L x W	Deck Ht.	(A) 5" POLYURETHANE			(B) 8" MOLD-ON RUBBER			(C) 8" PNEUMATIC				
				Cap. Lbs.	Wt. Lbs.	Price Ea.	Deck Ht.	Cap. Lbs.	Wt. Lbs.	Price Ea.	Deck Ht.	Cap. Lbs.	Wt. Lbs.	Price Ea.
D	YM-3073	48 x 24"	7-1/4"	2,000	104	\$488.00	10-1/2"	2,000	137	\$475.00	10-1/4"	1,200	134	\$550.00
D	YM-3074	60 x 30"	7-1/4"	2,000	112	\$554.00	10-1/2"	2,000	143	\$541.00	10-1/4"	1,200	142	\$619.00
E	YM-3075	48 x 24"	7-1/4"	2,000	98	\$422.00	10-1/2"	2,000	131	\$413.00	10-1/4"	1,200	128	\$488.00
E	YM-3076	60 x 30"	7-1/4"	2,000	125	\$489.00	10-1/2"	2,000	158	\$476.00	10-1/4"	1,200	155	\$551.00

# Utility Carts



SHOWN WITH (C) PNEUMATIC WHEELS.

## EUROKRAFT® Premium Utility Cart

- 12-gauge steel
- 1,200–2,000-lb. capacity
- Multiple caster choices available
- All-welded

Shelves include 2"D lips. Ergonomic handle is placed at a comfortable height for proper posture. Two swivel, two rigid casters. **SPECIFY CASTERS: A** - 5" polyurethane, **B** - 8" mold-on rubber, **C** - 8" pneumatic. **IN STOCK.**



Model Number	Shelf W x D	Shelf Qty.	Shelf Clearance	(A) 5" POLYURETHANE			(B) 8" MOLD-ON RUBBER			(C) 8" PNEUMATIC					
				Overall Ht.	Cap. Lbs.	Lbs.	Price Ea.	Overall Ht.	Cap. Lbs.	Lbs.	Price Ea.	Overall Ht.	Cap. Lbs.	Lbs.	Price Ea.
YM-3050	36" x 24"	2	22"	32"	2000	95	\$277.00	35-1/2"	1600	110	\$303.00	35-1/2"	1200	110	\$360.00



YM-3048 SHOWN WITH (B) MOLD-ON RUBBER CASTERS.

## EUROKRAFT® Premium Reversible-Shelf Utility Trucks

- 12-gauge steel
- 1,200–2,000-lb. capacity
- Multiple caster choices available
- Unassembled

Among the strongest, most dependable trucks on the market. Shelves are surrounded by a 1-1/2"H lip to keep packages and tools from rolling off. Shelves can be placed in the lip-up or lip-down position to meet your needs. Maneuver through the workplace on two rigid and two swivel casters. Ship unassembled via small package carrier. **SPECIFY CASTERS: A** - 5" polyurethane, **B** - 8" mold-on rubber, **C** - 8" pneumatic. **IN STOCK.**

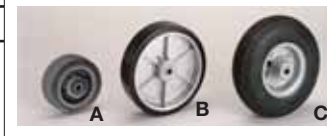

CHOOSE FROM 3 CASTER TYPES!  
**A** - Polyurethane 5" casters.  
**B** - Mold on rubber 8" casters.  
**C** - Pneumatic 8" casters.



Model Number	Shelf W x D	Shelf Qty.	Shelf Clearance	(A) 5" POLYURETHANE			(B) 8" MOLD-ON RUBBER			(C) 8" PNEUMATIC					
				Overall Ht.	Cap. Lbs.	Wt. Lbs.	Price Ea.	Overall Ht.	Cap. Lbs.	Wt. Lbs.	Price Ea.	Overall Ht.	Cap. Lbs.	Wt. Lbs.	Price Ea.
YM-3048	36" x 24"	2	26-1/2"	31-1/8"	2000	90	\$273.00	34-5/8"	2000	119	\$352.00	34-5/8"	1200	120	\$374.00
YM-3049	36" x 24"	3	12-5/8"	31-1/8"	2000	125	\$296.00	34-5/8"	2000	154	\$362.00	34-5/8"	1200	155	\$404.00



## HERCULES® Premium Flush-Shelf Shop Carts

- 1-1/2" angle steel with 12-gauge shelves
- 2,000-lb. capacity
- 5" phenolic casters
- All-welded

Offer years of trouble-free service. Lower shelves have a 2" lip that keeps items from rolling off while the top shelf features a flush design for easy loading and unloading. Welded tubular push handle maneuvers units on 2 swivel, 2 rigid casters. Enamel finish. **SPECIFY COLOR: BL** - Blue, **GY** - Gray.

SELECTED MODELS IN BL - BLUE ARE IN STOCK. Others FOB MINNESOTA.

Model Number	Shelf W x D	Overall Ht.	Shelf Qty.	Shelf Clearance	Wt. Lbs.	Price Each
XT-249	30" x 24"	32"	2	21-7/8"	100	\$471.00
XT-250	30" x 24"	32"	3	10"	124	\$461.00
XT-251	36" x 24"	32"	2	21-7/8"	107	\$448.00
XT-252	36" x 24"	32"	3	10"	132	\$75.00
XT-253	45" x 24"	32"	2	21-7/8"	124	\$462.00
XT-254	45" x 24"	32"	3	10"	170	\$598.00
XT-112	45" x 24"	40"	4	7-11/16"	213	\$774.00

ALSO AVAILABLE IN GY - GRAY



Selected Models



SHOWN WITH OPTIONAL WRITING TABLE STORAGE BOX, AND WIRE BASKET.



## VESTIL Stock Trucks

- 12-gauge steel
- 1,200-lb. capacity
- 5" polyurethane casters
- Unassembled

Popular with workers who stock shelves or pick orders, this uniquely-designed truck offers easier access to items on the bottom shelf. Three shelf support legs, rather than four, ease loading and unloading of large boxes and bulky items. Ergonomic dual chrome-plated handles. Two rigid, 2 locking swivel casters. Ships via small package carrier. Color: blue. **IN STOCK.**

Model Number	Shelf W x D	Wt. Lbs.	Price Each
XA-1800	18" x 36"	70	\$238.00
XA-1801	24" x 36"	80	\$252.00
XA-1802	24" x 48"	90	\$288.00

### OPTIONS

XA-1803—Writing Table/Storage Box Wt. 10 lbs.	\$38.60
XA-1804—Wire Basket Wt. 4 lbs.	\$28.50



# HERCULES® Utility Carts



## Premium 2,000-Lb. Capacity Low-Deck Trucks

- 12-gauge steel
- 2,000-lb. capacity
- 5" phenolic casters
- All-welded



Moves heavy loads without compromise. Stable 22"H flush top eases loading and unloading of boxes and other materials. Fixed bottom shelf adds structural integrity and is surrounded by 2"H lip. Shelves are fixed to 1-3/4" x 3/16" angle posts. 32"H tubular push bar

maneuvers truck on 2 rigid, 2 swivel casters. Blue enamel finish. **IN STOCK.**

Model Number	Shelf W x D	Overall Ht.	Shelf Qty.	Shelf Clearance	Wt. Lbs.	Price Each
XT-1907	30" x 18"	32"	2	11-3/8"	90	\$396.00
XT-1909	36" x 18"	32"	2	11-3/8"	94	449.00
XT-377	30" x 24"	32"	2	11-3/8"	95	441.00
XT-378	36" x 24"	32"	2	11-3/8"	105	438.00
XT-1914	48" x 24"	32"	2	11-3/8"	109	548.00
XT-1912	60" x 24"	32"	2	11-3/8"	131	504.00
XT-1916	42" x 30"	32"	2	11-3/8"	120	516.00
XT-1917	48" x 30"	32"	2	11-3/8"	126	522.00
XT-1918	60" x 30"	32"	2	11-3/8"	140	556.00



MOLD-ON RUBBER CASTERS SHOWN.

## Premium High-Capacity Shelf Trucks

- 12-gauge steel
- 1,300- or 2,400-lb. capacity
- Pneumatic or mold-on rubber casters



Sturdy trucks allow you to load and unload parts easily. The top shelf sits 32" above floor. Four casters—2 swivel, 2 rigid. Enamel finish. Color: blue. **IN STOCK.**

Model Number	Shelf W x D	Overall Ht.	Shelf Qty.	Shelf Clearance	Cap. Lbs.	Caster Type	Wt. Lbs.	Price Each
XT-110	45" x 24"	38"	2	19"	1,300	Pneumatic	142	\$638.00
XT-111	45" x 24"	38"	2	19"	2,400	Mold-on rubber	142	556.00



## Premium Two-Drawer Shop Cart

- 12-gauge steel
- 2,000-lb. capacity
- 5" phenolic casters
- All-welded



Stores and transports both small supplies and larger tools. Extremely rugged and durable. Welded push handle maneuvers cart. Dual locking 15"W x 19"D gray drawers. Locks sold separately. **IN STOCK.**

Model Number	Shelf W x D	Overall Ht.	Shelf Qty.	Shelf Clearance	Wt. Lbs.	Price Each
XT-1586	36" x 24"	32-1/2"	2	15-7/8"	148	\$699.00

Model No. **ZH-1000**—Cylinder Lock .....\$7.10



XT-1587

## Premium Shop Carts with Bins

- 12-gauge steel
- 2,000-lb. capacity
- 5" phenolic casters
- All-welded



Keeps small parts neat and organized during transport. Rugged, durable cart withstands heavy use. Welded push handle maneuvers cart. Features 5"W x 12"D x 3"H small parts storage bins. Gray bins include 2 adjustable dividers. **IN STOCK.**

Model Number	Shelf W x D	Overall Ht.	Shelf Qty.	Bin Qty.	Shelf Clearance	Wt. Lbs.	Price Each
XT-1587	36" x 24"	32-1/2"	2	24	7-5/8"	180	\$806.00
XT-1594	36" x 24"	32-1/2"	2	48	7-5/8"	240	1104.00

# Utility Carts



## EDSAL 800-Lb. Capacity Carts

- 18-gauge steel shelves
- 800-lb. capacity
- 5" polypropylene casters
- Unassembled

Hundreds of uses in the shop or office. 3" deep trays have mitered edges for extra rigidity. All trays except bottom can invert for flat working surfaces. Two swivel, two rigid casters. Gray powder coat finish. **IN STOCK.**

Model No. Number	Shelf W x D	Overall Height	Shelf Qty.	Shelf Clearance	Wt. Lbs.	Price Each	EXTRA SHELVES		
							Model No.	Wt. Lbs.	Price Ea.
XP-601	30" x 16"	32"	2	19-1/2"	40	\$132.00	XP-605	12	\$24.60
XP-602	36" x 24"	32"	2	19-1/2"	57	160.00	XP-606	20	36.90
XP-603	30" x 16"	60"	4	13-3/4"	75	189.00	XP-605	12	24.60
XP-604	36" x 24"	60"	4	13-3/4"	99	240.00	XP-606	20	36.90



## EDSAL Steel Utility Carts

- 14-gauge steel shelves
- 350- and 500-lb. capacities
- 5" polypropylene casters
- Unassembled

Add the extra drawer to keep pencils and small parts close at hand. 3" deep metal trays are reversible. Optional third tray adds extra versatility. Two swivel, 2 rigid casters. Gray powder coat finish. **IN STOCK.**

Model Number	Shelf W x D	Overall Height	Shelf Qty.	Shelf Clearance	Cap. Lbs.	Wt. Lbs.	Price Each	EXTRA SHELVES		
								Model No.	Wt. Lbs.	Price Ea.
XV-099	30" x 16"	32"	2	20"	350	32	\$75.90	—	—	—
XP-615	30" x 16"	32"	2	20"	500	32	85.70	XP-618	9	\$21.10
XP-616	28" x 20"	32"	2	20"	500	43	97.50	XP-619	12	23.80
XP-617	36" x 24"	32"	2	20"	500	33	115.00	XP-620	15	32.30

Model No. **XP-621**—Drawer for Model XP-617. 12"W x 20"D x 4"H.  
.....\$26.40



## MECO 1,000-Lb. Capacity Carts

- 16-gauge steel
- 1,000-lb. capacity
- Multiple caster choices available
- All-welded

Multi-purpose cart is popular in the warehouse, factory, or shop. Trays include 2"D formed edges that are double-welded for added strength and rigidity. 3/16" x 1-1/2" x 1-1/2" supports. 3/4" formed round milled steel handle. Two rigid and two swivel casters are mounted to cross channel bolsters for added support. **SELECTED MODELS IN STOCK.** Other **FACTORY QUICK SHIP**—FOB NEBRASKA.

Model Number	Shelf W x D	Overall Height	Shelf Qty.	Shelf Clearance	Caster Type	Wt. Lbs.	Price Each
XA-2271	28" x 16"	33"	2	23"	4" Rubber	60	\$252.00
XA-2272	32" x 20"	33"	2	23"	4" Rubber	77	265.00
XA-2273	28" x 16"	33"	2	23"	4" Steel	60	270.00
XA-2274	32" x 20"	33"	2	23"	4" Steel	77	286.00



# Utility Carts

## LAKESIDE Utility Carts

- 20-22-gauge stainless steel shelves
- 300 and 500-lb. capacities
- Rubber casters
- Assembled



Sound deadening panels beneath shelves restrict vibrations and noise. Sanitary, corrosion-resistant stainless steel cart transports lab equipment, dishes, or any moderate load. Shelves are electronically welded and have hemmed edges. Protective bumpers on legs and handles. Four swivel casters. **IN STOCK.**

Model Number	Shelf W x D	Overall Height	Shelf Qty.	Cap. Lbs.	Shelf Clearance	Shelf Gauge	Leg Gauge	Caster Height	Wt. Lbs.	Price Each
XT-1622	24" x 15-1/2"	32-1/8"	3	300	11-3/4"	22	20	3-1/2"	26	\$240.00
XT-1628	27" x 18"	33"	3	300	12-1/4"	22	20	3-1/2"	32	265.00
XT-1623	24" x 15-1/2"	33-3/8"	3	500	11-1/2"	20	16	4"	39	314.00
XT-1624	27" x 18"	33-3/8"	3	500	11-1/2"	20	16	4"	42	345.00
XT-1625	35" x 21"	37-1/4"	3	500	13-1/8"	20	16	5"	68	588.00



## LAKESIDE Heavy-Duty Carts

- 11-gauge stainless steel
- 700-lb. capacity
- 5" and 8" polyurethane casters
- Assembled



Angled U-shaped steel frame adds strength and support. Stainless steel construction with electronically welded shelves and hemmed shelf edges. Two swivel and two fixed casters. Protective bumpers on legs and handle. **SPECIFY MODEL: A - Standard, B - NSF listed.**

**FACTORY QUICK SHIP—FOB WISCONSIN.**

Model Number	Shelf W x D	Overall Height	Shelf Qty.	Shelf Clearance	Wt. Lbs.	(A) STANDARD	(B) NSF LISTED
						Price Each	Price Each
XT-1630	24" x 15-1/2"	34-1/4"	2	19"	49	\$729.00	\$794.00
XT-1626	27" x 18"	34-1/2"	2	19"	53	721.00	783.00
XT-1631	33" x 21"	37-1/8"	2	21"	64	876.00	937.00
XT-1627	49" x 21"	37"	2	21"	87	1268.00	1295.00



NSF LISTED TRUCKS AVAILABLE

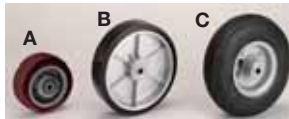

**CHOOSE FROM 3 CASTER TYPES!**  
**A - Polyurethane 5" casters.**  
**B - Mold-on rubber 8" casters.**  
**C - Pneumatic 8" casters.**

**FOOT BRAKES FOR SWIVEL CASTERS. IN STOCK.**

Model No. **YT-1016A**—For 5" polyurethane.....\$7.00  
 Model No. **YT-1016B**—For 8" mold-on rubber....\$7.80  
 Model No. **YT-1016C**—For 8" pneumatic.....\$11.80

## EUROKRAFT® Stainless Steel Trucks

- 14-gauge stainless steel
- 1,000-1,500-lb. capacity
- Multiple caster choices available
- All-welded



For use in laboratories, restaurants, anywhere sanitary conditions are required. Features a #3 satin polished finish that is completely sanitary because it will not react with food oils, resists rust, corrosion, and chemicals. Large shelves have raised retaining lips on all sides. Ergonomic handle with vertical gripping area eliminates wrist turn, reducing strain on forearms and elbows. Trucks roll on 2 swivel and 2 rigid casters. **SPECIFY CASTER: A - 5" polyurethane, B - 8" mold-on rubber, C - 8" pneumatic. IN STOCK.**



Model Number	Shelf W x D	Shelf Clearance	(A) POLYURETHANE				(B) MOLD-ON RUBBER				(C) PNEUMATIC			
			Overall Height	Cap. Lbs.	Wt. Lbs.	Price Each	Overall Height	Cap. Lbs.	Wt. Lbs.	Price Each	Overall Height	Cap. Lbs.	Wt. Lbs.	Price Each
<b>2-SHELF</b>														
YT-1010	36" x 24"	19-5/8"	31"	1000	91	\$530.00	34-1/2"	1000	112	\$561.00	34-1/2"	1000	106	\$555.00
YT-1011	48" x 24"	19-5/8"	31"	1000	105	654.00	34-1/2"	1000	126	685.00	34-1/2"	1000	120	681.00
YT-1012	48" x 30"	19-5/8"	31"	1000	111	685.00	34-1/2"	1000	132	715.00	34-1/2"	1000	126	711.00
YT-1013	60" x 30"	19-5/8"	31"	1000	126	710.00	34-1/2"	1000	147	741.00	34-1/2"	1000	141	736.00
<b>3-SHELF</b>														
YT-1014	36" x 24"	9"	31"	1500	111	\$649.00	34-1/2"	1500	132	\$679.00	34-1/2"	1200	126	\$675.00
YT-1015	48" x 30"	9"	31"	1500	141	845.00	34-1/2"	1500	162	875.00	34-1/2"	1200	156	871.00

# Utility Carts



## RUBBERMAID® Xtra™ Carts with Aluminum Uprights

- Structural web shelves and aluminum uprights
- 200- and 300-lb. capacities
- 4" polyurethane casters
- Handles include recessed storage compartments

Transport a variety of items in commercial, retail, or manufacturing industries. Textured shelves resist scratches, chips, and dents. Other features include: comfort grip handles and non-marking swivel casters. Helps in assisting with HACCP compliance in the safe handling of food and related items. **SPECIFY COLOR: BK - Black, GY - Gray, RD - Red, WH - Off-white.** Colors are available as listed by code in chart. **IN STOCK.**

SHOWN WITH OPTIONAL 4-GAL. UTILITY BASKET

Key	Model Number	Shelf W x D	Overall Ht.	Shelf Qty.	Cap. Lbs.	Shelf Clearance	Colors Available	Wt. Lbs.	Price Each
A	<b>XD-1387</b>	40-3/4" x 20"	37-13/16"	3	300	12"	BK, GY, WH	43	<b>\$255.00</b>
B	<b>XD-1386</b>	40-3/4" x 20"	51"	4	300	12"	BK, WH	43	<b>\$336.00</b>
C	<b>XD-1390</b>	33-5/8" x 18-3/8"	37-3/4"	3	200	12"	BK, GY, RD, WH	30	<b>\$218.00</b>

### HOOK-ON UTILITY BASKETS. Color: black.

Model No. <b>XC-1261</b> —4 gal. cap. 17"x12-1/8"x10-1/2". Wt. 5.4 lbs. ....	<b>\$34.80</b>
Model No. <b>XC-1262</b> —8 gal. cap. 17"x12"x22". Wt. 9 lbs. ....	<b>\$73.10</b>



## LUXOR Flush-Shelf Carts

- Polyethylene
- 300- and 400-lb. capacities
- 4" rubber casters
- Molded handle

All-plastic design offers easy maintenance and quiet operation. Shelves resist bending or buckling—will not stain, corrode or retain odors. Retaining lip on all shelves keeps items from falling off. Swivel casters, 2 with brakes. **SPECIFY COLOR: BK - Black, GY - Gray, PY - Putty.** Colors are available as listed by code in chart. **SELECTED MODELS IN GY - GRAY IN STOCK.** Others FOB ILLINOIS.

Model Number	Shelf W x D	Overall Ht.	Shelf Qty.	Cap. Lbs.	Shelf Clearance	Colors Available	Wt. Lbs.	Price Each
<b>WV-089*</b>	24" x 18"	33"	2	300	26"	BK, GY, PY	25	<b>\$103.00</b>
<b>WV-090*</b>	24" x 18"	34"	3	400	12"	BK, GY, PY	27	<b>124.00</b>
<b>WV-091</b>	24" x 18"	36"	4	400	8"	BK, GY	30	<b>148.00</b>
<b>WV-093</b>	24" x 18"	45"	6	400	6"	BK, GY	42	<b>230.00</b>
<b>WV-094*</b>	32" x 24"	33"	2	400	25"	BK, GY	37	<b>198.00</b>
<b>WV-095</b>	32" x 24"	33"	3	400	11"	BK, GY	42	<b>252.00</b>
<b>WV-096</b>	32" x 24"	36"	4	400	8"	BK, GY	54	<b>312.00</b>
<b>WV-098</b>	32" x 24"	56"	6	400	8"	BK, GY	77	<b>419.00</b>

\*BK - BLACK ALSO IN STOCK.

# Utility Carts

YA-2941 SHOWN



CENTER SHELF IS ADJUSTABLE.

## Economical Polymer Utility Carts

- Chrome posts with polymer shelves
- 400-lb. capacity
- 4" rubber casters
- Molded handle

Smooth, easy-to-clean shelves feature molded-in lips to contain spills. 150-lb. shelf capacity. Swivel casters. NSF listed. Ships unassembled. Color: gray. **IN STOCK.**

Model Number	Shelf W x D	Overall Height	Shelf Qty.	Shelf Clearance	Wt. Lbs.	Price Each
YA-2940	28" x 18"	33-1/4"	2	23"	27.5	\$127.00
YA-2941	28" x 18"	33-1/4"	3	10"	33	153.00



YA-1902



## RELIUS SOLUTIONS Economical Tray-Shelf Steel Carts

- 20-gauge steel shelves
- 220-lb. capacity
- Rubber casters
- Unassembled

Choose the style that fits your material handling needs. 3"D shelves can be placed with lips up or down. Powder coat finish. Color: red. **IN STOCK.**

Model Number	Shelf W x D	Overall Height	Shelf Qty.	Shelf Clearance	Caster Type	Wt. Lbs.	Price Each
YA-1901	30" x 16-1/8"	32-1/2"	2	22"	5" - 2 swivel, 2 rigid	33	\$88.30
YA-1902	30" x 16-1/8"	34-1/2"	2	19"	4" swivel	34	79.40



YA-1901



## METRO® Polymer Utility Carts

- Chrome posts with polymer shelves
- 400-lb. capacity
- 4" rubber casters
- Molded handle

All polymer shelves will never corrode. Smooth shelf surface resists staining and wipes clean easily. Will not chip, dent, or peel. Raised lip on all shelves keeps items from rolling off. 150-lb. capacity per shelf. Ships unassembled. NSF listed. Colors available as listed by code in chart. **SPECIFY COLOR: BK - Black, LB - Lt. Blue, LG - Lt. gray, RD - Berry. SELECTED MODELS ARE IN STOCK.** Others FOB PENNSYLVANIA, TENNESSEE.



Selected Models

### AVAILABLE COLORS:

<b>BL - BLACK</b>	<b>LB - LT. BLUE</b>
<b>RD - BERRY</b>	<b>LG - LT. GRAY</b>

Model Number	Shelf W x D	Overall Height	Shelf Qty.	Shelf Clearance	Colors Available	Wt. Lbs.	Price Each
<b>A. TWO-SHELF CART WITH CHROME-PLATED POSTS</b>							
YK-2980†	28" x 18"	33"	2	23"	LB	28	\$184.00
YK-2981	33-3/4" x 21-1/2"	33"	2	23"	BK, LB, LG, RD	34-1/2	190.00
YK-2982**	39-1/2" x 27"	33"	2	23"	BK, LB, LG, RD	40-1/2	222.00
<b>B. THREE-SHELF CART WITH CHROME-PLATED POSTS. Adjustable center shelf.</b>							
YK-2983*	33-3/4" x 21-1/2"	33"	3	10"	BK, LB, LG, RD	43	\$240.00
YK-2984**	39-1/2" x 27"	33"	3	10"	BK, LB, LG, RD	52	267.00
<b>C. THREE-SHELF/THREE-SIDE ENCLOSED CART</b>							
YK-2985†	33-3/4" x 21-1/2"	33"	3	10"	LB, LG	50	\$336.00

\*LB - LT. BLUE, LG - LT. GRAY **IN STOCK.**

\*\*LB - LT. BLUE, LG - LT. GRAY, RD - BERRY **IN STOCK.**

†LB - LT. BLUE **IN STOCK.**

# Utility Carts



## RUBBERMAID® Ladder Carts



- Structural foam shelves
- 500-lb. capacity
- 5" rubber casters
- Molded handle



One-of-a-kind cart transports everything you need to complete maintenance tasks including your 4-6' folding step ladder. Award-winning design features a middle compartment that holds ladder vertically allowing easy maneuverability through standard 79"H doorways. 42"H structural foam worksurface. Model WK-1391 includes a metal storage cabinet with perforated panels on face and sides that accept 1/4" dia. tool hooks. Powdercoat steel frame. Non-marking casters, 2 fixed, 2 swivel. Ladder, lock, and tools not included. Ships unassembled via small package carrier. **IN STOCK.**

REMOVABLE STRUCTURAL FOAM SHELVES ALLOW CART TO BE CONFIGURED TO HOLD LIGHT BULBS, CEILING PANELS, OR TUBING.



XK-1390



CABINET INCLUDES THREE 30" x 8" SHELVES.

XK-1391

Model Number	Shelf W x D	Overall Height	Shelf Qty.	Shelf Clearance	Wt. Lbs.	Price Each
<b>CART</b>						
WK-1390	25x8-1/2"	42-7/8"	4	8"	69	\$433.00
<b>CART WITH LOCKABLE CABINET</b>						
WK-1391	30" x 8"	42-7/8"	3	12"	99	\$553.00



## RUBBERMAID® TradeMaster™ Contractor's Cart



- Structural foam
- 500-lb. capacity
- 5" non-marking casters
- Unassembled

Dependable cart keeps all your tools and supplies close at hand. Features ergonomic handle with built-in storage, multi-compartment parts organizer, 4" locking steel drawer, and side hooks. Includes three-duplex outlet, surge protected power strip with a 15-amp power rating, and a 15' cord. 2 fixed casters, 2 casters with total lock brakes. **IN STOCK.**

Model Number	Shelf W x D	Overall Ht.	Shelf Qty.	Shelf Clearance	Wt. Lbs.	Price Each
XC-1240	30-5/8" x 52-1/2"	37-7/8"	2	14-1/8"	85	\$494.00



## RUBBERMAID® Xtra™ Instrument Cart



- Structural web plastic
- 300-lb. capacity
- 5" polyurethane casters
- Unassembled

All-in-one cart stores everything you need to perform job tasks. Won't dent, rust, or chip and will not conduct electricity. Each shelf is surrounded by a retaining lip that keeps items from rolling off. Other features include:

dual molded-in handles; pull-out utility tray, and 34"W x 20"D x 11-3/4"H locking cabinet. Color: gray. **IN STOCK.**

### INSTRUMENT CART

Model Number	Shelf W x D	Overall Height	Shelf Qty.	Shelf Clearance	Wt. Lbs.	Price Each
XC-1260	34" x 20"	37-13/16"	2	12"	52	\$412.00

**HOOK-ON UTILITY BASKETS.** Color: black.

Model No. **XC-1261**—4 gal. cap. 17"x12-1/8"x10-1/2". Wt. 5.4 lbs. ..... **\$34.80**  
 Model No. **XC-1262**—8 gal. cap. 17"x12"x22". Wt. 9 lbs. **\$73.10**

# Utility Carts



**XT-1021BL**  
SHOWN WITH  
OPTIONAL 8-GAL.  
UTILITY BASKET

**SAVE**



**XT-1061BE**

**STOCK**



**XT-1019GY**



**XT-1025BK SHOWN  
WITH OPTIONAL  
DRAWER**

## RUBBERMAID® Plastic Utility Carts



- Structural foam
- 500 and 750-lb. capacities
- Multiple caster choices available
- Handle includes built-in tool storage

Will not rust, dent, chip or peel. Handles both industrial or commercial loads. Leakproof top features rounded corners to protect walls, furniture, and equipment. Top shelf will accommodate hook-on utility basket (sold separately). Lightweight carts are easy to maneuver on 2 fixed and 2 swivel non-marking casters. Optional lockable center drawer is perfect for extra tools and paperwork. **SPECIFY COLOR: BE - Beige, BL - Blue, BK - Black, GY - Gray. COLORS ARE AVAILABLE AS LISTED BY CODE IN CHART. IN STOCK.**

Model Number	Shelf W x D	Overall Ht.	Shelf Qty.	Cap. Lbs.	Shelf Clearance	Colors Available	Caster Type	Wt. Lbs.	SALE EACH
<b>XT-1019</b>	30" x 16"	33-1/4"	2	500	18-7/8"	BE, BK, BL, GY	5" rubber	31	<b>\$155.00</b>
<b>XT-1060</b>	30" x 16"	33-1/4"	3	500	7-3/4"	BE, BK	5" rubber	38	<b>199.00</b>
<b>XT-1061</b>	36" x 24"	33-1/4"	2	500	18-7/8"	BE, BK, BL, GY	5" rubber	45	<b>175.00</b>
<b>XT-1061</b>	36" x 24"	33-1/4"	3	500	7-3/4"	BE, BK	5" rubber	56	<b>243.00</b>
<b>XT-1023</b>	36" x 24"	33-1/4"	2	500	18-7/8"	BE, BK, GY	8" pneumatic	66	<b>369.00</b>
<b>XT-1024</b>	46" x 24"	33-1/4"	2	750	18-7/8"	BE, BK	5" rubber	52	<b>303.00</b>
<b>XT-1025</b>	46" x 24"	33-1/4"	2	750	18-7/8"	BE, BK	8" pneumatic	74	<b>487.00</b>

### LOCKABLE CENTER DRAWERS

Model No. <b>XT-1080</b> —For 30" x 16" cart. 25" x 17". 40-lb. cap. Wt. 12 lbs. ....	<b>\$89.20</b>
Model No. <b>XT-1081</b> —For 36" x 24" and 46" x 24" carts. 25" x 17". 40-lb. cap. Wt. 12 lbs. ....	<b>\$84.90</b>

### HOOK-ON UTILITY BASKETS

Model No. <b>XT-1082</b> —4-Gal. Cap. 17"W x 12-1/8"D x 10-1/2"H. Wt. 5.4 lbs. ....	<b>\$34.80</b>
Model No. <b>XT-1083</b> —8-Gal. Cap. 17"W x 12"D x 22"H. Wt. 9 lbs. ....	<b>\$73.10</b>

## CONTINENTAL Tray-Shelf Carts

**STOCK**

- Derma-Tek® plastic
- 400-lb. capacity
- Rubber or pneumatic casters
- Handle includes pocket organizer



Practically indestructible carts will not peel, chip, crack, or fade. 200-lb. capacity per shelf. Other features include: rounded corners and a front ledge that accommodates a utility basket. Two swivel, 2 rigid casters. **SPECIFY COLOR: BE - Beige, GY - Gray. IN STOCK.**

Model Number	Shelf W x D	Overall Ht.	Shelf Qty.	Shelf Clearance	Wt. Lbs.	Price Each
<b>CARTS WITH 5" GRAY NON-MARKING CASTERS</b>						
<b>XC-2103</b>	30" x 16"	32"	2	19-1/4"	33.8	<b>\$149.00</b>
<b>XC-2104</b>	36" x 24"	32"	2	19-1/4"	45	<b>165.00</b>
<b>CARTS WITH 8" PNEUMATIC CASTERS</b>						
<b>XC-2108</b>	36" x 24"	37"	2	19-1/4"	65	<b>\$368.00</b>

### ACCESSORIES

Model No.	Description	Wt. Lbs.	Price Ea.
<b>XC-2105</b>	30"W x 16"D middle shelf	11	<b>\$51.40</b>
<b>XC-2106</b>	36"W x 24"D middle shelf	11	<b>59.50</b>
<b>XC-2107</b>	23-gal. utility basket	81	<b>32.60</b>



**XC-2108**  
SHOWN WITH OPTIONAL UTILITY  
BASKET AND MIDDLE SHELF



**XC-2108**

**CATCH-ALL  
POCKET  
ORGANIZER  
ON 24"W  
CARTS ONLY**



# Utility Carts

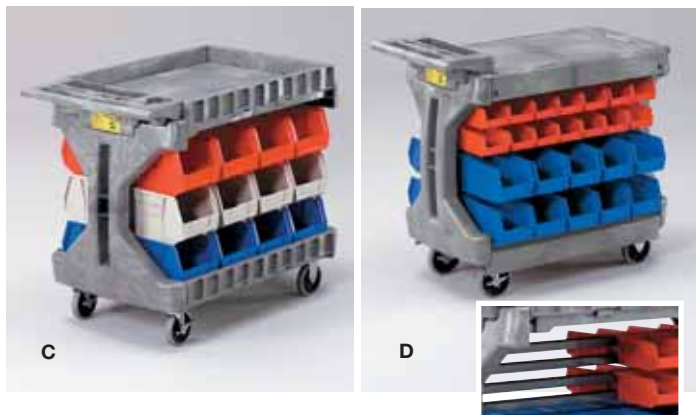

## AKRO-MILS® ProCart™ Utility Carts

- High-density polyethylene structural foam
- 400-lb. capacity
- 5" rubber casters
- Handle includes built-in tool storage



Quickly switches from box-top to flat-top cart to meet the demands of each job. Hinged shelf sides flip up or down independently—all sides down creates a smooth, flat surface or flip up to create a box-top cart. I-beam supports ease loading and unloading of oversized cartons. Choose the standard cart or cart with Akro-Bins® on each side. 2 swivel casters with brake and 2 rigid. Cart color: gray. **IN STOCK.**

Model Number	Shelf W x D*	Overall Ht.	Shelf Qty.	Shelf Clearance	Wt. Lbs.	Price Each
<b>A. CARTS WITHOUT BINS</b>						
<b>XL-0904</b>	27-3/4" x 17"	32"	2	22"	43	<b>\$201.00</b>
<b>XL-0906</b>	31-3/4" x 22"	32"	2	22"	57	<b>242.00</b>
<b>CARTS WITH (12) 10-7/8" x 11" x 5"H BINS. SPECIFY COLOR: BL - Blue, GN - Green, RD - Red, ST - Stone, YL - Yellow. Bins hang on steel rail kit, included (not shown).</b>						
<b>XL-0908</b>	27-3/4" x 17"	32"	2	22"	81	<b>361.00</b>
<b>B. CARTS WITH (36) 10-7/8" x 5-1/2" x 5"H BINS. SPECIFY COLOR: BL - Blue, GN - Green, RD - Red, ST - Stone, YL - Yellow. Bins hang on steel rail kit, included.</b>						
<b>XL-0910</b>	31-3/4" x 22"	32"	2	22"	108	<b>469.00</b>
<b>C. CARTS WITH (24) 10-3/4" x 8-1/4" x 7"H BINS. BIN COLORS: (8) red, (8) stone, and (8) blue. Bins stack freely 3 high by 4 across.</b>						
<b>XL-0912</b>	31-3/4" x 22"	32"	2	22"	93	<b>454.00</b>
<b>D. CARTS WITH (28) 7-3/8" x 4-1/8" x 3"H RED BINS AND (20) 10-7/8" x 5-1/2" x 5"H BLUE BINS. Bins hang on steel rail kit, included.</b>						
<b>XL-0914</b>	27-3/4" x 17"	32"	2	22"	87	<b>414.00</b>

\*With sides flipped up with top shelf.



## RUBBERMAID® Economical Tray-Shelf Carts

- Structural foam
- 300-lb. capacity
- 4" rubber casters
- Molded push handle



Tough, durable cart is ideal for use practically anywhere. Maintenance-free unit will not rust, dent, chip, or peel. Includes a leakproof top and rounded corners. Ergonomic flat handle has built-in tool storage. Gray non-marking casters—2 fixed, 2 swivel. Color: black. **IN STOCK.**

Model Number	Shelf W x D	Overall Ht.	Shelf Qty.	Shelf Clearance	Wt. Lbs.	Price Each
<b>XT-2400</b>	30" x 16"	31-1/4"	2	18-7/8"	28	<b>\$152.00</b>
<b>XT-2401</b>	36" x 24"	31-1/4"	2	18-7/8"	38	<b>173.00</b>



AVAILABLE IN:

BE - BEIGE

BL - BLACK

## RUBBERMAID® Flush Shelf Carts

- Structural foam
- 500-lb. capacity
- 5" rubber casters



- Wrap-around handle includes built-in tool storage

Rimless shelf design eases transfer of heavy items. Deep trench detail around top shelf catches small parts and liquids. Front plate accommodates a hanging utility basket or screwed in power strip. Non-marking casters, 2 rigid, 2 swivel. Three-shelf models are available, call for information. **SPECIFY COLOR: BE - Beige, BK - Black. IN STOCK.**

Model Number	Shelf W x D	Overall Ht.	Shelf Qty.	Shelf Clearance	Wt. Lbs.	Price Each
<b>XV-1416</b>	30" x 19"	33-5/16"	2	22-1/4"	33	<b>\$196.00</b>
<b>XV-1418*</b>	36" x 26"	33-5/16"	2	22-1/4"	43	<b>216.00</b>

\*Also available in GY - Gray.

# Audio-Visual Carts



## LUXOR Duraweld Adjustable-Height Carts

- 20-ga. steel shelves and 14-ga. steel legs
- 24-42"H top shelf
- 3-outlet power strip
- Rubber casters



Selected Models



YV-1402(B)

Colorful carts organize specific department's instrumentation, inventory and supplies. Ribbed runner mat on top shelf prevents items from sliding off, while the roll-formed shelves are surrounded by 1/2" retaining lips. Top shelf height adjusts in 4" increments. Includes 3-outlet power strip with 15' UL- and CSA-listed cord, integral push handle, and cable pass-through holes.

### STANDARD CARTS.

Ships unassembled. **SPECIFY COLOR:**

**BK** - Black, **BL** - Blue, **GN** - Green, **RD** - Red, **YL** - Yellow. **BK - BLACK AND BL - BLUE ARE IN STOCK.** Others FOB ALABAMA.

Model Number	Shelf W x D	Shelf Qty.	Wt. Lbs.	Price Each
<b>4" SWIVEL CASTERS, (2) WITH LOCKING BRAKES</b>				
<b>YR-1856</b>	24" x 18"	3	48	<b>\$164.00</b>
<b>(2) 8" WHEELS, (2) 4" CASTERS WITH BRAKE</b>				
<b>YR-1857</b>	24" x 18"	3	52	<b>\$209.00</b>

### CART WITH LOCKING CABINET.

Locking cabinet with recessed chrome handle and 2 keys. Color: black. **SPECIFY CASTERS: A** - Four 4" swivel, 2 with brakes; **B** - Two 4" swivel casters with brakes and two 8" big wheels. **IN STOCK.**

Model Number	Shelf W x D	Shelf Qty.	Wt. Lbs.	(A) Price Ea.	(B) Price Ea.
<b>YV-1402</b>	24" x 18"	2	62	<b>\$249.00</b>	<b>\$287.00</b>

### AVAILABLE COLORS:

<b>BK - BLACK</b>	<b>BL - BLUE</b>	<b>GY - GRAY</b>
<b>PY - PUTTY</b>	<b>RD - RED</b>	<b>YL - YELLOW</b>

## H. WILSON Tuffy Utility Carts

- Injection-molded thermoplastic
- 200-lb. capacity
- 4" rubber casters
- Molded handle

Will not stain, scratch, dent, or rust. Material is a natural electrical insulator. All carts (except black ones) have square almond-color posts. Swivel casters, two with brakes.

Ships unassembled. **SPECIFY SHELF COLOR:** **BK** - Black, **BL** - Blue, **GY** - Gray, **PY** - Putty, **RD** - Red, **YL** - Yellow. NOTE: when ordering **BK - Black**, the entire cart is black. **SELECTED MODELS IN BL - BLUE ARE IN STOCK.** Others FOB ILLINOIS.



Selected Models



**TWO CARTS INCLUDE 3-OUTLET, UL- AND CSA-LISTED ELECTRICAL ASSEMBLY WITH 15' CORD.**

### A. ALL-PURPOSE SHELF CARTS.

Model Number	Shelf W x D	Overall Height	Shelf Qty.	Shelf Clearance	Wt. Lbs.	(BL)(GY)(PY)(RD)(YL) Price Ea.	(BK) Price Ea.
<b>INCLUDES 3-OUTLET ELECTRIC ASSEMBLY (SHOWN)</b>							
<b>XK-3051</b>	24" x 18"	34"	3	15-1/2" & 7-1/2"	30	<b>\$167.00</b>	<b>\$154.00</b>
<b>XK-3052</b>	24" x 18"	42"	3	15-1/2" each	31	<b>179.00</b>	<b>166.00</b>
<b>CARTS ONLY (WITHOUT OUTLET ASSEMBLY)</b>							
<b>XK-3053</b>	24" x 18"	26"	2	15-1/2"	22	<b>\$108.00</b>	<b>\$101.00</b>
<b>XK-3054</b>	24" x 18"	34"	3	15-1/2" & 7-1/2"	28	<b>130.00</b>	<b>121.00</b>
<b>XK-3055</b>	24" x 18"	42"	3	15-1/2" each	29	<b>138.00</b>	<b>121.00</b>

### B. CART WITH LOCKING CABINET.

Fit 18-gauge steel panels between shelves and posts. Keys and electric assembly included.

Model No.	Shelf W x D	Overall Height	Shelf Qty.	Shelf Clearance	Wt. Lbs.	(BL)(GY)(PY)(RD)(YL) Price Ea.	(BK) Price Ea.
<b>XK-3057</b>	24" x 18"	34"	3	7-1/2"	47	<b>\$330.00</b>	<b>\$315.00</b>
<b>XK-3058</b>	24" x 18"	42"	3	15-1/2"	48	<b>329.00</b>	<b>322.00</b>

# Bulk Containers



## Bulk Pack Shipping Cartons

Perfect for shipping and storage, sturdy corrugated containers feature 350-lb. test, double wall, BC flute construction. Lift-off lid keeps contents clean and protected (lid must be stapled before use). Ships motor freight. Order in quantities of 5, priced each. **IN STOCK.**

Model No.	Overall W x D x H	Cap. Cu. Ft.	Inside Ht.	Wt. Lbs.	Price Ea.
<b>ZR-1200</b>	48 x 40 x 30"	33.3	30"	13	<b>\$37.40</b>
<b>ZR-1201</b>	48 x 40 x 36"	40.0	36"	15	<b>40.60</b>

Model No. **ZR-1202**—Lid.....**\$10.70**



**ALSO AVAILABLE IN:**  
GY - GRAY

## TECHSTAR Bulk Containers

Hefty 2,000-lb. maximum capacity makes these containers ideal for the largest loads. Polyethylene construction features 4-way entry for easy fork lift handling. Barrel type nesting prevents jamming, while the engineered side ribs offer maximum load capacity. Includes stacking lid. Materials have been approved to meet FDA standards. Rotator bars for fork lift dumping are available, call for information. **SPECIFY COLOR: BL - Blue, GY - Gray. IN STOCK.**

Model Number	Overall W x D x H	Cap. Lbs.	Cap. Cu. Ft.	Inside Height	Wt. Lbs.	Price Each
<b>WR-1410</b>	42 x 48 x 30"	1,200	24	26"	105	<b>\$418.00</b>
<b>WR-1411</b>	44 x 44 x 46"	2,000	38	42"	120	<b>517.00</b>



## ORBIS® BulkPak™ Containers

Industrial and pharmaceutical supplies as well as food and beverages are just some of the items that can be stored inside these rugged containers. Rotationally molded polyethylene construction offers maximum durability and strength. Smooth interior and exterior walls are easy to steam clean. Materials have been approved to meet FDA standards. Flat bottom allows containers to stack with lids or nest when empty. Can be moved by either a forklift or pallet jack. XB-1260 and XB-1261 feature vertical ribbing for added side wall stiffness. XA-2008 offers double-wall construction for extra strength and standard drain hole with bulk head fitting and drain plug. **IN STOCK.**

Key	Color	Model Number	Overall W x D x H	Cap. Lbs.	Cap. Cu. Ft.	Inside Height	Wt. Lbs.	Price Each	CONTAINERS		
									Model Number	Wt. Lbs.	Price Each
A	Natural	<b>XB-1260</b>	48 x 42 x 30"	1200	20	25.8"	75	<b>\$546.00</b>	<b>XB-1262</b>	23	<b>\$214.00</b>
A	Gray	<b>XB-1261</b>	48 x 42 x 30"	1200	20	25.8"	72	<b>546.00</b>	<b>XB-1263</b>	23	<b>214.00</b>
B	Natural	<b>XA-2008</b>	48 x 40 x 42"	1000	30	37"	130	<b>816.00</b>	<b>XA-2009</b>	24	<b>194.00</b>





# Bulk Containers



Selected Models

## M.O.D. Bulk Handlers

Store and transport heavy loads in these stack and nest containers. Sturdy polyethylene construction resists shock, sun and heat. Easy to clean and sanitize. 1" roll rim around top edge facilitates handling.

Transports with two-way forklift or pallet jack. Lid is included. Materials (in natural color only) have been approved to meet FDA standards. **SPECIFY COLOR: BL - Blue, DG - Forest green, RD - Red, WH - Natural.**

**SELECTED MODELS IN BL - BLUE, WH - NATURAL IN STOCK.**

Others FOB INDIANA.



Model Number	Overall W x D x H	Cap. Lbs.	Cap. Cu. Ft.	Inside Height	Wt. Lbs.	Price Each
<b>BULK HANDLERS WITH LIDS</b>						
YL-4080	45 x 45 x 33"	700	32	27"	102	\$470.00
YL-4081	45 x 45 x 44"	800	38	37"	133	495.00
YL-4082	48 x 48 x 30"	1500	32	29"	120	564.00
YL-4083	48 x 48 x 46"	1500	40	43"	150	656.00
<b>BULK HANDLERS WITH LIDS, CASTERS AND DUMPING BRACKET</b>						
YL-4084	45 x 45 x 33"	700	32	27"	112	\$565.00
YL-4085	45 x 45 x 44"	800	38	37"	143	645.00
YL-4086	48 x 48 x 30"	1500	32	29"	130	699.00
YL-4087	48 x 48 x 46"	1500	40	43"	160	785.00



**10-POINT ZIPPER LOCK SYSTEM ENSURES FAST SECURE SET-UP AND COLLAPSE.**

## MacroBin® ShuttleBin 330® Folding Container

Save money in transportation and storage costs when you use this collapsible, reusable container. Set-up bins stack up to three high in standard trailers. Practical ten-point zipper lock system ensures fast and secure set up and collapse. Constructed of high-pressure injection molded polypropylene that is UV-stabilized and crack-resistant. Materials have been approved to meet FDA standards for handling food and pharmaceuticals. Other features include: vented sidewalls, four-way forklift base, and side drop-gate. One-year warranty. Color: tan.

**IN STOCK.**



Model Number	Overall W x D x H	Cap. Lbs.	Cap. Cu. Ft.	Inside Height	Collapsed Height	Access Door Side	Wt. Lbs.	Price Each
XL-2219	48 x 40 x 33"	1500	27	26.9"	11.6"	On 48" side	112	\$346.00

Model No. **XL-2220**—Lid .....\$94.70

# Bulk Containers



## ORBIS® Bulk Containers

Strong, durable containers are ideal for shipping a variety of large, bulky or work-in-process materials. Fully collapsible and reusable units feature large, easy-to-use latches that unlock, allowing containers to be folded down for convenient storage. Interior radius corners and smooth surfaces are easy to spray out or steam clean. Stackable containers are 100% recyclable and include 4-way fork and 2-way pallet truck access. Molded area on all sides accepts optional snap-in card holders. Materials have been approved to meet FDA standards. **IN STOCK.**



**OPTIONAL SNAP-IN CARD HOLDER**

Model Number	Overall W x D x H	Cap. Lbs.	Cap. Cu. Ft.	Inside Height	Collapsed Height	Access Door	Color	Wt. Lbs.	Price Each
<a href="#">XR-1091BK</a>	32 x 30 x 25"	2,000	8.1	18.1"	13.1"	On 32" sides	Black	70	<b>\$291.00</b>
<a href="#">XR-1091BL</a>	32 x 30 x 25"	2,000	8.1	18.1"	13.1"	On 32" sides	Blue	70	<b>291.00</b>
<a href="#">XR-1095BK</a>	48 x 45 x 25"	1,500	19.3	18.1"	13.0"	On 48" sides	Black	104	<b>418.00</b>
<a href="#">XR-1095BL</a>	48 x 45 x 25"	1,500	19.3	18.1"	13.0"	On 48" sides	Blue	104	<b>418.00</b>
<a href="#">XR-1096BK</a>	48 x 45 x 34"	1,500	29.0	27.1"	13.0"	—	Black	132	<b>393.00</b>
<a href="#">XR-1097BK</a>	48 x 45 x 34"	1,500	29.0	27.1"	13.0"	On 48" sides	Black	132	<b>439.00</b>
<a href="#">XR-1097BL</a>	48 x 45 x 34"	1,500	29.0	27.1"	13.0"	On 48" sides	Blue	132	<b>439.00</b>

### ACCESSORIES.

Model No. [XR-1101](#)—**Snap-In Cardholder.** Holds a 4" x 8.3" card.....**\$0.95**  
 Model No. [XR-1102](#)—**Structural Foam Load-Bearing Covers.** Fits 32" x 30" containers.....**\$73.20**  
 Model No. [XR-1103](#)—**Structural Foam Load-Bearing Covers.** Fits 48" x 45" containers.....**\$91.00**

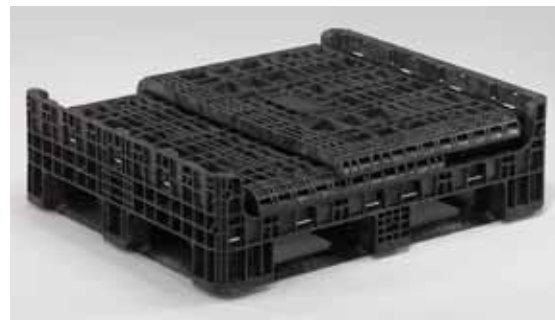

## ORBIS® Heavy-Duty Bulk Containers



Containers collapse to a fraction of their height in seconds for space saving storage and return shipment. 2000-lb. capacity units may be stacked up to 6 high with static loads and dynamic loads can stack up to 3 high. Stacking collapsed containers helps you maximize warehouse and return storage space. Include two cardholders for 4" x 6" I.D. cards. Taller models available, call for information. 3-year limited warranty. Color: black. **IN STOCK.**

### Optional Lids

Model No. [XA-1205](#)—32" x 30". Wt. 11 lbs.....**\$64.80**  
 Model No. [XA-1206](#)—48" x 40". Wt. 23 lbs.....**\$83.00**  
 Model No. [XA-1207](#)—48" x 45". Wt. 27 lbs.....**\$85.40**

Model Number	Overall W x D x H	Cap. Lbs.	Cap. Cu. Ft.	Inside Height	Collapsed Height	Access Door	Wt. Lbs.	Price Each
<a href="#">XA-1200</a>	32 x 30 x 34"	2,000	12.6	27.4"	13.1"	On 32" Sides	87	<b>\$316.00</b>
<a href="#">XA-1201</a>	48 x 40 x 34"	2,000	25.2	27.6"	13.6"	On 48" Sides	159	<b>427.00</b>
<a href="#">XA-1202</a>	48 x 40 x 39"	2,000	29.8	32.8"	13.6"	On 48" Sides	169	<b>450.00</b>
<a href="#">XA-1203</a>	48 x 45 x 25"	2,000	19.7	18.6"	13.1"	On 48" Sides	122	<b>407.00</b>
<a href="#">XA-1204</a>	48 x 45 x 34"	2,000	29.2	27.5"	13.1"	On 48" Sides	147	<b>428.00</b>

# Bulk Containers



YL-2914

MADE IN  
USA



## DECADE/DOLAV® Bulk Containers

Injection-molded high-density polyethylene boxes are stronger than plastic, sturdier than wood and better than stainless steel. Durable material resists most chemicals, corrosion, and UV rays—will not rust, rot, dent, warp, chip, or splinter. All hardware is stainless steel. Ideal for storing powders, liquids, or granular material. Stack up to 6 high with or without lid on. Four-way fork entry. Materials have been approved to meet FDA standards. **SPECIFY CONTAINER COLOR:** BL - Blue, WH - White. FOB ILLINOIS.



YL-2912 SHOWN IN BL - BLUE.

Model Number	Overall W x D x H	Inside Height	Cap. Cu. Ft.	Cap. Lbs.	Wt. Lbs.	Price Each
<b>BULK CONTAINERS</b>						
YL-2910	48 x 40 x 31"	25.5"	24.7	1500	95	\$389.00
YL-2911	48 x 40 x 50"	44.5"	42.8	1700	120	717.00
<b>CONTAINER WITH 28.5x32.5"H ACCESS DOOR ON 40" SIDE</b>						
YL-2912	48 x 40 x 50"	44.5"	42.8	1700	125	\$902.00
<b>BULK CONTAINERS WITH 5" NYLON CASTERS ON 40" ENDS</b>						
YL-2913	48 x 40 x 35"	25.5"	24.7	1500	115	\$707.00
<b>CONTAINER WITH 28.5x32.5"H ACCESS DOOR &amp; 6" POLY CASTERS ON 40" ENDS</b>						
YL-2914	48 x 40 x 53"	44.5"	42.8	1700	155	\$1075.00

### WHITE LID

Model No. YL-2915—Wt. 5 lbs.....\$92.20



SOS™ Storage Bins are sold on page 122.



STOCK

XL-0462

MADE IN  
USA

## MacroBin Poly Bulk Containers

Impact-resistant copolymer polypropylene construction resists breakage and cracking making containers ideal for numerous environments. Versatile units can be used for storing parts, work in process materials, liquids, dry powders or foods. The smooth interior walls are easy to clean and allow container to be filled to the top. Stackable with or without lids. Card holder included. Materials have been approved to meet FDA standards. 3-year warranty. **IN STOCK.**



XL-0465

XL-0463

Model Number	Overall W x D x H	Inside Height	Cap. Cu. Ft.	Cap. Lbs.	Wt. Lbs.	(IV) Price Ea.	(BL) (GY) Price Ea.
XL-0462*	47 x 47 x 28"	22-1/2"	24.3	1200	93	\$302.00	\$322.00
XK-2965	47 x 47 x 21-1/2"	15-3/4"	16	1200	83	244.00	—
XL-0463	48 x 48 x 52-1/2"	46-3/4"	54.4	3000	188	459.00	—

\*SPECIFY COLOR: BL - Blue, GY - Gray, IV - Ivory.

Model No. XL-0464—Lid for XL-0462 and XK-2965.

Color: ivory.....\$113.00

Model No. XL-0465—Lid for XL-0463. Color: ivory.....\$113.00

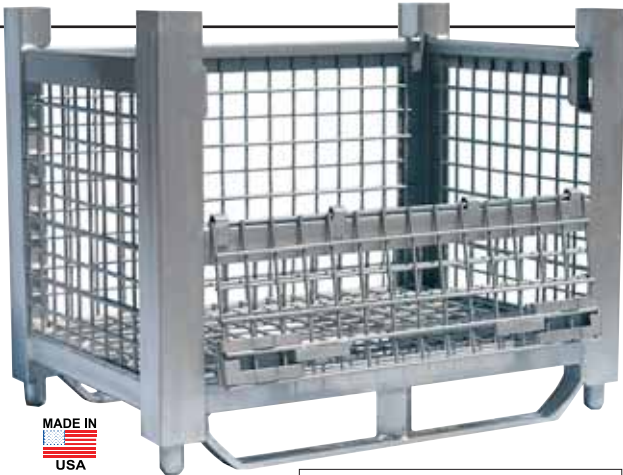

MADE IN  
USA

## CARGOTAINER Heavy-Duty Wire Containers

SPECIFY COLOR FOR XL-2334:

BL-BLUE

DG-GREEN

RD-RED

YL-YELLOW

Heavy-duty 11-ga. tubular steel base supports the 2" x 2", 2-gauge steel wire sides and deck. 1/2" x 2" runner bars on each side add stability when fully loaded. Other features include positive locking stacking plugs and caps that allow container to be stacked up to 4 high. FOB MICHIGAN.

Model Number	Overall WxDxH	Cap. Lbs.	Inside Height	Access Door	Wt. Lbs.	Price Ea.
<b>ALUMINUM PAINT FINISH</b>						
XL-2333	48 x 40 x 36"	6,000	30"	On 48" side	313	\$676.00
<b>POWDER COAT PAINT FINISH</b>						
XL-2334	48 x 40 x 36"	6,000	30"	On 48" side	313	\$857.00

# Bulk Containers



XK-3020A(BL) SHOWN

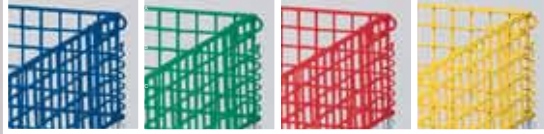

STACKABLE TO SAVE SPACE



SEE PAGE 54 FOR HERCULES® HYDRAULIC TILT TABLES

## NASHVILLE WIRE Wire Containers

Designed to give you full visibility and excellent circulation. High strength wire weighs less than solid material, making these containers more economical to ship. Welded, square mesh construction features square tubing fabricated to the base carriage. Legs won't scratch floors. Half drop side gates for easier access, less bending. 4" underclearance. Hinged lid keeps items secure during storage and transport. Phenolic casters (2 swivel, 2 rigid) allow manual movement without a fork truck. **CONTAINERS WITHOUT OPTIONS ARE IN STOCK.** Others FOB TENNESSEE.

**BAKED-ON POWDER-COAT FINISH.** Containers Available for only 3-ga., 2" mesh, 48"W x 40"D x 35-1/2"H collapsible container with drop gate on the 48" side. Inside height: 30". 4000-lb. capacity. **SPECIFY COLOR: BL** - Blue, **GN** -Green, **RD** - Red, **YL** - Yellow.

Model No. **XK-3020**—Wt. 163 lbs.....\$281.00

**STANDARD ZINC-PLATED FINISH CONTAINERS. SPECIFY: A** - Container only, **B** - Container with casters (2 swivel, 2 rigid), **C** - Container with casters and lid, **D** - Container with lid.

Model Number	Overall W x D x H	Cap. Lbs.	Cap. Cu. Ft.	Inside Height	Collapsed Height	Drop Gate	Mesh Size	Mesh Gauge	Wt. Lbs.	(A)* Price Each	(B) Price Each	(C) Price Each	(D) Price Each
<b>XK-3021</b>	32 x 20 x 21"	1000	5.2	16"	6-1/2"	32"	1-1/8"	#11	43	\$112.00	\$188.00	—	—
<b>XK-3022</b>	32 x 20 x 21"	1000	5.2	16"	6-1/2"	32"	1/2"	#11	55	125.00	201.00	—	—
<b>XK-3023</b>	40 x 32 x 33.5"	4000	19.3	28"	7-1/2"	40"	2"	#3	122	197.00	302.00	\$376.00	\$271.00
<b>XK-3024</b>	48 x 40 x 35.5"	4000	31.1	30"	7-1/2"	48"	2"	#3	163	244.00	348.00	427.00	330.00
<b>XK-3025</b>	48 x 40 x 41.5"	4000	37.4	36"	7-1/2"	48"	2"	#3	176	256.00	363.00	446.00	346.00

\*Colors available for (A) containers—call for information.

NOTE: Standard caster size is 4" x 2". XK-3021B and XK-3022B have 3" x 1-1/4" casters.



XK-3024C SHOWN



CONTAINERS FOLD DOWN FOR EASY STORAGE



## MIDWEST WIRE Baskets



Here's a convenient way to carry, clean, and store parts in the warehouse or plant. Ideal for use as a wash box, as well, because the 1/2" wire mesh design permits drainage and air flow. 18-ga. rust-resistant, zinc-plated metal construction. Integral handle runner permits stacking in tiers and movement of entire stacks. **FACTORY QUICK SHIP—FOB MICHIGAN.**

Model Number	Overall W x D x H	Wt. Lbs.	Price Each
<b>WV-1394</b>	16 x 10 x 4-1/2"	7-1/4	\$52.30
<b>WV-1395*</b>	16 x 10 x 4-1/2"	7-1/2	61.60
<b>WV-1396</b>	21 x 13-1/4 x 6"	10-3/4	64.40
<b>WV-1397*</b>	21 x 13-1/4 x 6"	11-3/4	67.90
<b>WV-1398</b>	24 x 13-1/4 x 3"	10	70.30
<b>WV-1399</b>	24 x 13-1/4 x 6"	12-3/4	70.70

\*1/4" mesh sides and bottom.

# Bulk Containers



Selected Models

## CARICO Electro-Zinc Plated Wire Containers

Ideal for warehousing, storing work in process, distribution, and picking/order operations, open containers provide fast, visual inspection of inventory, promote ventilation, and eliminate dirt buildup. Unique design enables containers to be collapsed easily in 3-4 seconds and then stacked 30 high without banding. Special electro-zinc plating prevents rust and protects products inside. Other features include: solid hinges, wire stacking feet, and half-drop gate on 48" side. **SPECIFY:** A - Without casters, B - With 5" x 2" casters. **SELECTED MODELS FACTORY QUICK SHIP.** All FOB INDIANA.



OPEN CONTAINERS



AVAILABLE CUSTOM COLORS, CALL FOR INFORMATION



CONTAINERS WITH HINGED TOP

Model Number	Overall W x D x H	Cap. Lbs.	Cap. Cu. Ft.	Inside Height	Collapsed Height*	Drop Gate Side	Mesh Size		Wt. Lbs.	(A) NO CASTERS	(B) WITH CASTERS
							Wall	Base		Price Ea.	Price Ea.
<b>OPEN WIRE CONTAINERS</b>											
XR-1035	33-3/4 x 24 x 26-1/4"	800	11.4	21-1/4"	9"	33-3/4"	2-1/2 x 3-1/2"	1 x 4"	54	\$137.00	\$186.00
XR-1036	44-1/2 x 33 x 39"	2200	25.7	33-1/2"	12"	44-1/2"	2-1/4 x 2-1/4"	1 x 6"	110	238.00	324.00
XR-1037	48 x 40 x 38"	2205	31.7	31-1/2"	12-1/2"	48"	2-1/2 x 4-1/2"	1 x 6"	115	250.00	325.00
XR-1038	48 x 40 x 45-1/2"	2200	39.9	39"	12-1/2"	48"	2-1/2 x 4-1/2"	1 x 6"	120	284.00	363.00
XA-3295	72 x 40 x 46"	1800	60.0	39-1/2"	12-1/2"	72"	2-1/2 x 4-1/2"	1 x 6"	145	449.00	520.00
<b>WIRE CONTAINERS WITH HINGED SECURITY TOP</b>											
XR-1039	33-3/4 x 24 x 28"	800	11.4	21-1/4"	11"	33-3/4"	2-1/2 x 3-1/2"	1 x 4"	59	\$211.00	\$259.00
XA-3300	44-1/2 x 33 x 40-3/4"	2200	25.7	33-1/2"	14-1/2"	44-1/2"	2-1/4 x 2-1/4"	1 x 6"	115	337.00	425.00
XR-1040	48 x 40 x 39-3/4"	2205	31.7	31-1/2"	14-1/2"	48"	2-1/2 x 4-1/2"	1 x 6"	122	332.00	407.00

NOTE: \*XR-1035 can be stacked up to 3 high when loaded. All others can stack up to 4 high when loaded.



A



C

B



## TOPPER Steel Containers

Sturdy steel containers stack up to 5 high, making them ideal for crowded areas with minimal floor space. Boxes are supported by 4 sturdy steel legs that offer 4" clearance underneath. 24" inside height. Choose either heavy-duty, 4,000-lb. capacity corrugated steel or 2,500-lb. capacity wire mesh that offers increased light and air flow. Both types are interchangeable with other standard model containers. Enamel paint finish inside and out. **SPECIFY COLOR:** BL - Dark Blue, RD - Red, TL - Teal, UP - Unpainted. **FACTORY QUICK SHIP—FOB WISCONSIN.**

Overall W x D x H	Cap. Lbs.	Cap. Cu. Ft.	Inside Height	Wt. Lbs.	(A) CORRUGATED STEEL CONTAINERS		(B) CORRUGATED STEEL CONTAINERS WITH DROP GATE		(C) WIRE MESH CONTAINERS	
					Model No.	Price Ea.*	Model No.	Price Ea.*	Model No.	Price Ea.*
30 x 24 x 29-1/2"	4,000	10	24"	120	XK-3030	\$236.00	XK-3034	\$283.00	—	—
30 x 30 x 29-1/2"	4,000	12-1/2	24"	133	XF-2120	251.00	XF-2127	296.00	—	—
35 x 30 x 29-1/2"	4,000	14-1/2	24"	144	XK-3031	253.00	XK-3035	298.00	—	—
35 x 35 x 29-1/2"	4,000	17	24"	196	XF-2121	268.00	XF-2128	314.00	XF-2134	\$301.00
42 x 30 x 29-1/2"	4,000	17-1/2	24"	160	XF-2122	280.00	XF-2129	326.00	—	—
42 x 35 x 29-1/2"	4,000	20-2/5	24"	180	XF-2123	290.00	XF-2130	335.00	XF-2135	318.00
42 x 42 x 29-1/2"	4,000	24-1/2	24"	190	XF-2124	315.00	XF-2131	364.00	XF-2136	378.00
48 x 30 x 29-1/2"	4,000	20	24"	172	XK-3032	284.00	XK-3036	331.00	—	—
48 x 35 x 29-1/2"	4,000	23	24"	192	XK-3033	306.00	XK-3037	353.00	XK-3038	338.00
48 x 42 x 29-1/2"	4,000	28	24"	216	XF-2125	340.00	XF-2132	387.00	XF-2137	393.00
48 x 48 x 29-1/2"	4,000	32	24"	231	XF-2126	359.00	XF-2133	406.00	XF-2138	402.00

\*Deduct \$35.00 from catalog prices for unpainted models.

# HERCULES® Box Dumpers & Tilt Tables



## Box Dumpers

Heavy-duty, all-welded steel dumpers are made to handle heavy loads from 2,000 to 6,000 lbs. Push-button control activates chute, lifting container to desired dump height—36", 48" or 60". Chutes have a 1/4" plate steel base with 7-ga. sides. Dumpers are fully powered up and gravity down and include an overload-protected NEMA 4 magnetic motor starter with dual voltage transformer for 120V control circuit. Dumper bolts directly to floor to ensure stability during operation. Dumps completely in less than one minute. Casters, variable speed control, stainless steel, and higher dump heights are available, call for information. **SPECIFY 3-PHASE VOLTAGE: A - 230V, B - 460V.** FOB MINNESOTA.

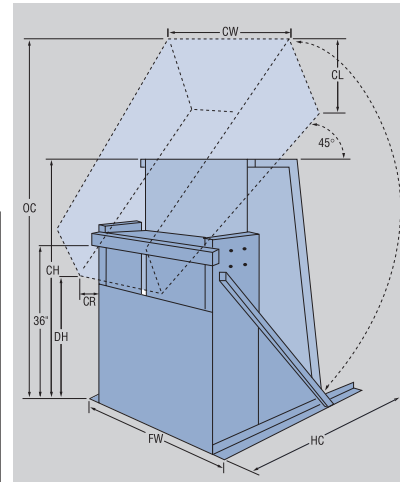

### HANDLES THESE CONTAINERS:

- BULK CONTAINERS
- CARTONS
- GAYLORDS
- TOTES
- TROUGHS
- TUBS
- POLY CONTAINERS
- VATS
- CORRUGATED STEEL CONTAINERS

Dump Height DH	Chute Length CL	Chute Width CW	Chute Reach CR	Chute Height CH	Frame Width FW	Horizontal Clearance HC	Overhead Clearance OC	2000-LB. CAPACITY		4000-LB. CAPACITY		6000-LB. CAPACITY	
								Model Number	Price Each	Model Number	Price Each	Model Number	Price Each
36"	36"	36"	12-1/2"	66"	51"	72"	111"	XH-616	\$6920.00	XH-620	\$8272.00	XH-818	\$8738.00
36"	48"	51"	12-1/2"	66"	66"	81"	119"	XH-629	7162.00	XH-633	8507.00	XH-831	8971.00
48"	36"	36"	10"	72"	51"	79"	127"	XH-618	7024.00	XH-622	8391.00	XH-820	8852.00
48"	48"	51"	10"	72"	66"	87"	135"	XH-631	7255.00	XH-635	8621.00	XH-833	9085.00
60"	36"	36"	5"	72"	51"	83"	138"	XH-814	7112.00	XH-816	8504.00	XH-822	8971.00
60"	48"	51"	5"	72"	66"	91"	146"	XH-827	7346.00	XH-829	8735.00	XH-835	9202.00

NOTE: Any application information such as material being dumped, type and size of the receptacle being dumped into, and any special concerns such as wash down environment, extreme conditions, or the number of cycles the unit will run over the course of the day, etc. is helpful in choosing the proper dumper.

**DUMP HEIGHTS OF 72" - 168" AVAILABLE. CONTACT US FOR PRICING AND COMPLETE SPECIFICATION INFORMATION.**  
No cancellations or returns on this item. Specifications are subject to change without notice.



SHOWN AT 20°

## Hydraulic Tilt Tables

Prevent back strain and fatigue from bending, lifting and reaching with these hydraulic tilt tables. One person can tilt pallets, crates, boxes and other large containers to an ideal working position. Quality-constructed tables feature all-welded heavy-duty plate steel for years of use. 1/60/120 volt, 1HP motor-driven hydraulic system tilts these tables up and down. To raise or lower them, step on the "deadman-type" foot pedal control. Tilts from 0 to 60 degrees. Deck height is 10-1/2" when unit is lowered. 12"H lip helps to hold containers in place during use. If container is tilted more than 45 degrees, bolt the table in place or brace it properly to prevent tipping. Choose from 2,000-, 4,000-, or 6,000-lb. capacities. Enamel finish. Color: blue. FOB MINNESOTA.

Platform W x D	2000-LB. CAPACITY			4000-LB. CAPACITY			6000-LB. CAPACITY		
	Model Number	Wt. Lbs.	Price Each	Model Number	Wt. Lbs.	Price Each	Model Number	Wt. Lbs.	Price Each
38 x 42"	WT-23842	957	\$5875.00	WT-43842	1,092	\$6097.00	WT-63842	1,319	\$6092.00
44 x 42"	WT-24442	971	5989.00	WT-44442	1,107	6123.00	WT-64442	1,334	6315.00
44 x 48"	WT-24448	994	6159.00	WT-44448	1,133	6166.00	WT-64448	1,371	6452.00
44 x 60"	WT-24460	1,098	6523.00	WT-44460	1,243	6521.00	WT-64460	1,406	6523.00
50 x 48"	WT-25048	1,068	6323.00	WT-45048	1,208	6321.00	WT-65048	1,346	6620.00
50 x 60"	WT-25060	1,182	6623.00	WT-45060	1,328	6621.00	WT-65060	1,590	6757.00

NOTE: 3/60/230 volt or 3/60/460 volt electrical motors available.  
CORNER TILT TABLES ALSO AVAILABLE, CALL FOR INFORMATION.

DEADMAN FOOT CONTROL WITH GUARD

ITEM NOT SUBJECT TO CANCELLATION OR RETURN.

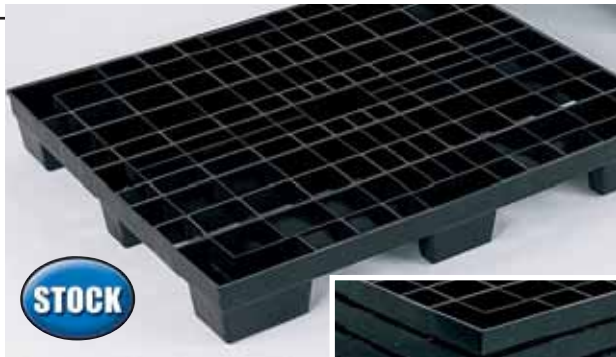

## Lightweight Nestable Pallet



NESTED

Lightweight injection-molded pallet. Leg drain holes prevent liquids from accumulating. Weather-resistant plastic is easy to steam clean. 4-way fork truck entry. **IN STOCK.**

Model No.	Overall WxDxH	Floor Cap. Lbs.	Fork Cap. Lbs.	Wt. Lbs.	Price Ea.
<b>XD-5775</b>	48 x 40 x 6"	6,000	2,000	15.5	<b>\$23.90</b>



## LEWISBINS+ Recycled Polyethylene Pallet

Single face, one-piece high-density polyethylene construction incorporates at least 20% recycled materials. 5/8" raised edge around entire deck prevents loads from sliding off. Pallets nest, giving space-saving storage—27 pallets stack to approximately 48" high. Easy-to-clean efficient drainage design. **IN STOCK.**

Model Number	Overall WxDxH	Capacity Lbs.		Wt. Lbs.	Price Each
		Floor Cap. Lbs.	Fork Cap. Lbs.		
<b>YP-0177</b>	48 x 40 x 5-1/2"	20,000	2,500	22	<b>\$83.30</b>



## ORBIS® Nestable Structural Foam Pallets

Structural foam pallets are ideal for use in many industrial and food processing applications. Will not absorb moisture, liquids or promote the growth of mold or mildew. Lightweight and easy to steam clean. Rugged design distributes loads better. Nestable to save warehouse and shipping space. **IN STOCK.**

Model Number	Overall W x D x H	Cap. Lbs.		Wt. Lbs.	Price Each
		Floor	Fork		
<b>YD-1446</b>	48 x 40 x 5"	30,000	3,000	29	<b>\$52.50</b>
<b>YD-1450</b>	48 x 48 x 5.8"	30,000	4,000	46	<b>142.00</b>



## ORBIS® Injection-Molded Pallets

Injection-molded pallets feature: flow-through design to ease steam cleaning, weather-resistant construction, and four-way entry for forklifts and hand trucks. Fully recyclable pallets nest to save space when not in use—2.5:1 nesting ratio. Choose either flat top model or pallet with 1" intermittent lip. Color: black. **IN STOCK.**

Model No.	Type	Capacity Lbs.		Overall W x D x H	Wt. Lbs.	Price Each
		Floor	Fork			
<b>XR-1660</b>	Flat	11,000	2,300	48 x 40 x 5.5"	21-1/2	<b>\$37.00</b>
<b>XR-1661</b>	With Lip	11,000	2,300	48 x 40 x 6.5"	21-1/2	<b>36.90</b>

NOTE: Exempt from ISPM15, so these pallets do not need expensive heat treatments, fumigations, or certification stamps when exporting anywhere.



## One-Way Shipping Pallets

Environmentally-friendly pallets are made of 100% regenerated plastics and are completely recyclable. Constructed of blended polyethylene and polypropylene, practical units are resistant to insects, bacteria, and fungi. Nestable pallets also include four-sided entry for forklifts. Order standard or special export size pallets in millimeter sizes that meet USA and overseas shipping per ISPM15 regulations. Standard size pallets are ISPM15 exempt. Color: black. **IN STOCK.**

Model Number	Overall W x D x H	Capacity Lbs.		Wt. Lbs.	Price Each
		Floor	Fork		
<b>YD-1383</b>	48 x 40 x 5.1"	3,500	1,500	13	<b>\$31.60</b>
<b>YD-1384</b>	48 x 40 x 5.5"	5,500	2,200	22	<b>28.40</b>



## Pallet Puller

Grab hard-to-reach loads with this handy pallet puller. Designed to access badly positioned pallets—even with overhanging loads. Cast iron construction features double scissor action to assure tight grip. One-piece curved, 2-3/4" self-cleaning heads. For stringers up to 3" thick. 5,000-lb. cap. Comes with 17' of 1/4" proof coil chain. **IN STOCK.**

Model No. <b>YD-1420</b> —Pallet Puller. Wt. 19 lbs. ....	<b>\$70.30</b>
Model No. <b>ZD-1443</b> —Optional Chain. 20' of 1/4" electro-galvanized proof coil with grab hooks. ....	<b>\$41.70</b>

# Pallets



**MADE IN USA**

**ORBIS® Rackstar II™ Pallets**

Durable pallets feature a completely encapsulated design, making them ideal for racking and conveyor applications. Internal reinforcement structure provides strength and impact-resistance. Removeable bottom stringers offer extra capacity when used on conveyors. Will not absorb moisture and is easy to steam clean. 100% recyclable. Hand holds and 4-way fork entry ease transport of fully loaded pallets. **IN STOCK.**

Model Number	Overall W x D x H	Type	Cap. Lbs.		Wt. Lbs.	Price Each
			Floor	Fork		
<b>XC-1037</b>	48 x 40 x 6.5"	Lip	30,000	6,000	57	<b>\$158.00</b>
<b>XC-1038</b>	48 x 40 x 6"	Flat*	30,000	6,000	56	<b>161.00</b>

\*Flat type models have 16 rubber grommets to prevent slipping.



**MADE IN USA**

**ORBIS® Rackstar™ Pallets**

Double deck design is ideal for use on pallet racks and conveyors. One-piece polyethylene construction features dual easy to clean, open grid decks. 1/2" interrupted lip on the top deck stabilizes the load. In an edge-supported rack, pallet will handle a 2,000-lb. evenly distributed load. Four-way fork entry. 48"W x 40"D x 6.6"H overall. **IN STOCK.**

**FLAT MODELS WILL TAKE UP TO 14 GROMMETS (SEE YS-1478).**

Model Number	Description	Overall W x D x H	Capacity Lbs.		Wt. Lbs.	Price Each
			Floor	Fork		
<b>YC-1040*</b>	Blue	48 x 40 x 6.6"	20,000	5,000	48	<b>\$166.00</b>
<b>YC-1041*</b>	Blue with lip	48 x 40 x 6.6"	20,000	5,000	45	<b>166.00</b>
<b>YC-1042</b>	Black	48 x 40 x 6.6"	20,000	5,000	49	<b>163.00</b>
<b>YC-1043</b>	Black with lip	48 x 40 x 6.6"	20,000	5,000	45	<b>163.00</b>

\*100% virgin material with colorants/pigments that have been approved to meet FDA standards.

**GROMMETS FOR RACKSTAR™ PALLETS.** Prevent slipping. Field installable. 14 per pallet.

Model No. **YS-1478**—  
.....**\$1.00**



**MADE IN USA**

**BUCKHORN™ Polyethylene Pallet**

Unique two-piece design supports heavier loads. Handles static loads of up to 20,000 lbs. and dynamic loads of up to 1,500 lbs. Top includes skid-resistant tread and is supported underneath by fork straps for added safety. 100% recyclable high-density polyethylene construction is impervious to most industrial chemicals and detergents. Will not rust, rot, or splinter. Withstands extreme temperatures from -30° to 150°F. 40" x 48" x 5-1/2". 4-way entry for transport by forks or pallet jacks. **FACTORY QUICK SHIP—FOB KENTUCKY.**

Model No. **YD-1777**—Wt. 47 lbs. ....**\$133.00**



**MADE IN USA**

**ORBIS® Drum Pallet**

Unique design prevents drum shifting and ensures secure stacking of fully loaded pallets. Four recessed 3/8" rings let you positively position standard 55-gallon drums. Ring design continues on pallet underside to ensure secure double stacking. Constructed of reusable, recyclable high-density polyethylene. Easy to clean open grid will not collect liquid or debris. Four-way entry for fork truck or pallet jacks. **IN STOCK.**

## ORBIS® Drum Pallet

Unique design prevents drum shifting and ensures secure stacking of fully loaded pallets. Four recessed 3/8" rings let you positively position standard 55-gallon drums. Ring design continues on pallet underside to ensure secure double stacking. Constructed of reusable, recyclable high-density polyethylene. Easy to clean open grid will not collect liquid or debris. Four-way entry for fork truck or pallet jacks. **IN STOCK.**

Model Number	Overall W x D x H	Drum Cap.	Capacity Lbs.		Wt. Lbs.	Price Each
			Floor	Fork		
<b>YK-1610</b>	48 x 48 x 5-1/2"	4	30,000	4,000	57	<b>\$208.00</b>

PRODUCT	PALLET RACK COMPATIBILITY CAPACITY			
	SELECTIVE	DECKING	CROSSBAR SUPPORTED	BEAM EDGE SUPPORTED
	<b>BUCKHORN</b>			
<b>YD-1777</b>	—	2000	—	—
	<b>ORBIS</b>			
<b>YC-1040</b>	2000	5000	5000	2000
<b>YC-1041</b>	2000	5000	5000	2000
<b>YC-1042</b>	2000	5000	5000	2000
<b>YC-1043</b>	2000	5000	5000	2000
<b>YC-1037</b>	3000	6000	6000	3000
<b>YC-1038</b>	3000	6000	6000	3000

NOTE: Wt. Cap. are dependent on application, environment, and evenly distributed loads. Call for assistance in choosing the right pallet for your application.



**FACTORY QUICK SHIP**

**ROTONICS Dunnage Rack**

Keep stored products off the floor with these durable dunnage racks. Structural foam, high-density polyethylene will not rot, dent, splinter, or chip. Seamless 1/4" thick wall construction with 10" underclearance. 4,000-lb. capacity. Withstands temperatures from -20° to 212°F. Stack when full and nest when empty for convenient shipping and storage. 22"W x 48"L x 12"H. NSF listed. Materials have been approved to meet FDA standards. **FACTORY QUICK SHIP—FOB ILLINOIS.**

Model No. **ZA-2285**—Wt. 16 lbs.....**\$83.00**

## ROTONICS Dunnage Rack

Keep stored products off the floor with these durable dunnage racks. Structural foam, high-density polyethylene will not rot, dent, splinter, or chip. Seamless 1/4" thick wall construction with 10" underclearance. 4,000-lb. capacity. Withstands temperatures from -20° to 212°F. Stack when full and nest when empty for convenient shipping and storage. 22"W x 48"L x 12"H. NSF listed. Materials have been approved to meet FDA standards. **FACTORY QUICK SHIP—FOB ILLINOIS.**

Model No. **ZA-2285**—Wt. 16 lbs.....**\$83.00**





YD-1054

## PROTECTA-PACK SYSTEMS™ Corrugated Pallets



Designed for one-way shipping in foreign or domestic markets. Corrugated deck is supported by high-density polyethylene legs to eliminate moisture absorption and accommodate a variety of deck material. Saves storage space—a stack of 100 pallets measures only 57"H. Sold only in multiples of 10. **IN STOCK.**

Model Number	Type	Overall W x D x H	Capacity Lbs.		Wt. Lbs.	Price Each
			Floor	Fork		
YD-1054	9-Leg	48 x 40 x 4"	1,000	800	5	\$13.30
YD-1055	12-Leg	48 x 40 x 4"	1,200	1,000	5-1/2	15.50

NOTE: 40x30" pallets also available. Call for more information.



## Nestable Presswood Pallets



60% lighter than hardwood pallets! Practical pallets are molded from a mixture of wood fiber and synthetic resins and feature a dry deck design that eliminates the need for moisture barrier sheets. Free of nails or splinters that can harm employees or damage shipments. Rounded edges also protect packaging. Stack of 50 nested pallets measures only 7"H. Four-way forklift entry. Order standard or special export size pallets in millimeter sizes that meet USA and overseas shipping per ISPM 15 regulations. **SELECTED MODELS IN STOCK.**

Model Number	Overall W x D x H	Capacity Lbs.		Wt. Lbs.	Price Each
		Floor	Fork		
<b>STANDARD PALLETS.</b> Order in quantities of 10, priced each. <b>IN STOCK.</b>					
YD-2200	42 x 42 x 5.6"	20,000	2,000	39	\$17.00
YD-2201	45 x 45 x 5.1"	25,000	2,500	42	18.10
YD-2202	48 x 40 x 5.6"	20,000	2,000	40	17.00
YD-2203	48 x 40 x 5.6"	25,000	2,500	43	18.10
<b>HALF-SIZE PALLET.</b> Minimum order quantity of 50, priced each. <b>FOB MS.</b>					
YD-2240	40 x 24 x 5.1"	15,000	1,500	22	\$11.10
<b>SPECIAL EXPORT-SIZE PALLETS.</b> Minimum order quantity of 50, priced each. <b>FOB OH.</b>					
YD-2204	600mm x 800mm x 135mm	20,000	2,000	18	\$13.00
YD-2205	1200mm x 800mm x 135mm	20,000	2,000	30	18.40



## JIFRAM Recycled Plastic Pallets

Need a pallet that lasts? Tough heavy-duty recycled plastic pallets are built to stand up to years of continuous use in all work conditions. Flame-retardant pallets are superior to standard wood—they're impervious to bug infestations and extreme climates. Also includes a slip-resistant surface. Custom sizes available, call for information. **IN STOCK.**



Model Number	Overall W x D x H	CAPACITY LBS.		Wt. Lbs.	Price Each
		Floor	Fork		
XD-2030	48 x 40 x 4-1/2"	2,500	1,250	40	\$88.00



## ATLAS® Wire Mesh Pallets

More cost-effective than wood or plastic pallets. Heavy-duty 2-gauge, 2" x 4" wire mesh surface with 13-gauge stringers. Galvanized. Nestable. Four-way fork entry. **IN STOCK.**



Model No.	Overall W x D x H	CAPACITY LBS.		Wt. Lbs.	Price Each
		Floor	Fork		
XP-0126	48 x 40 x 4"	4,000	2,500	45	\$83.40
XP-0127	48 x 48 x 4"	4,000	2,500	50	92.70

# Pallet Trucks

## JET Pallet Trucks

Move heavy loads up to 6,000 lbs. Handle includes a three-position (raise, lower, neutral) lever for fingertip control and one-hand operation. Narrow 200° turning radius eases maneuverability around pallets and dock boards. Other features include: solid steel lifting rods, polyurethane covered steer and load wheels with double sealed bearings, grease fittings and oilless bearings, and overload bypass protection valve. Two-year warranty on pump. Made in China.

**HEAVY-DUTY PREMIUM 6,000-LB. CAPACITY TRUCK.** Fork height: 2-7/8" to 7-3/4". Includes: ergonomic cushioned handle, articulating axle, special lowering valve to control rate of descent, and rounded fork tips with nylon rollers. 7" steer wheels, 2-7/8" load wheels, 6-1/4" wide forks. **SPECIFY FORK SIZE: A - 21"W x 36"L, C - 21"W x 48"L, E - 27"W x 42"L, F - 27"W x 48"L. F - 27"W x 48"L IS IN STOCK.** Others FOB WASHINGTON.

Model No. **XC-3178**—Wt. 200 lbs. ....\$545.00



XC-3178

**STOCK**  
Selected Models

**5,000-LB. CAPACITY LOW-PROFILE PALLET TRUCK.** 6"W x 48"L forks raise load from 2-1/2" to 6-1/4". Cross-welded steel plates reinforce the heavy-gauge frame. Tapered and inclined fork tips ease pallet entry/exit. 6-1/4" steer wheel, 2-1/2" load wheels. 6" wide forks. **IN STOCK.**

Model No. **XH-1066**—Wt. 195 lbs. ....\$465.00

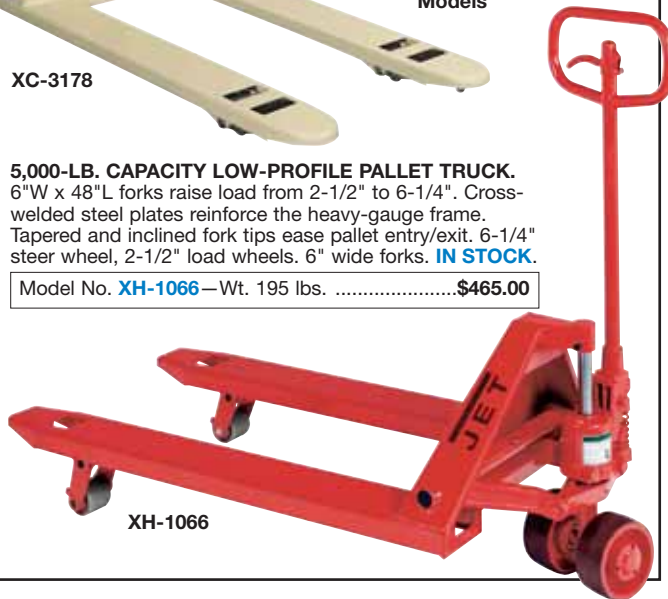

XH-1066

## E-Z Lift Pallet Truck

Reliable 5,500-lb. capacity pallet truck at an affordable price. Includes: high-quality hydraulic system with load limiter; leak-proof pump; sealed bearings throughout and three-position hand control. Fork height: 2.9 - 7.2". 6.3" wide forks. One-year warranty. **FACTORY QUICK SHIP—FOB CALIFORNIA, ILLINOIS.**

Model No. **XP-0125A**—20-1/2"W x 48"L forks. Wt. 180 lbs. ....\$346.00  
Model No. **XP-0125B**—27"W x 48"L forks. Wt. 180 lbs. ....\$346.00



**FACTORY QUICK SHIP**



**FACTORY QUICK SHIP**

**FREE ALUMINUM HAND TRUCK**

## LIFT PRODUCTS Heavy-Duty Pallet Truck

Now you can have a strong, 5,500-lb. capacity pallet truck at an affordable price. Quality construction features reinforced steel frame with gussets that prevent fork spreading and adjustable push rods that keep forks aligned even after years of use. Pallet truck also includes: fork entry/exit rollers, poly wheels with steel hubs for long service life, and 3-function handle with lift, lower and neutral. Fork height: 2.9-8". One-year warranty. **SPECIFY FORK SIZE: A - 20-1/2"W x 48"L, B - 27"W x 48"L. FACTORY QUICK SHIP—FOB WISCONSIN.**

Model No. **YH-4100**—Wt. 174 lbs. ....\$469.00

**FREE Aluminum Hand Truck with purchase of YH-4100.** An \$89.50 Value.

Model No. **HNDTRK**—200 lb. capacity. 17" x 9.5" x 43". Wt. 14 lbs.



**FACTORY QUICK SHIP**

## ZENITH Pallet Trucks

Safety loop handle is designed for fingertip control with either the left or right hand. Three-position release controls raise, neutral, and lower operations. 230° steering arc. Other features include: full-adjustable push rods on 6" wide forks, poly-nylon steering wheels and load rollers, and grease fittings with hard chrome-plated rams and pistons. Two-year pump warranty. **FACTORY QUICK SHIP—FOB ILLINOIS.**

**5,500-LB. CAP. TRUCK.** 2.9" low to 7-3/4" high fork height. **SPECIFY FORK SIZE: A - 20-1/2"W x 48"L, B - 27"W x 48"L.**

Model No. **XP-1508**—Wt. 200 lbs. ....\$332.00

**4,400-LB. CAP. TRUCK.** 2" to 5-3/4" fork height. Steel load rollers. 27"W x 48"L forks.

Model No. **XP-1509**—Wt. 200 lbs. ....\$522.00

# Pallet Trucks



**QUICK LIFT PUMP!**

## HERCULES® Premium 6000-Lb. Capacity Pallet Truck

- 5-year full replacement pump warranty
- Quick Lift pump raises 0 to 330-lb. loads off the floor with only 2 strokes
- Extra thick steel with reinforced fork bracing
- 6,000-lb. capacity
- 7" steering and 2.8" load steel hub, polyurethane tread wheels
- 6"W forks include nylon pallet entry/exit wheels
- Yellow powder coat finish

Built to last, this premium pallet truck is backed by two extensive warranties—5 years on the pump and 1 year on the frame. Bushings replace zerk fitting at all pivot points for maintenance-free use—just change hydraulic oil when necessary. Spring-loaded handle remains upright when not in use and includes rubber covered top and 3-position raise, lower, and neutral fingertip controls. 210° steering arc. **IN STOCK.**

Model No.	Lift Height	Forks WxL	Wt. Lbs.	Price Ea.
YC-3560	2-7/8-7-3/4"	27 x 48"	198	\$587.00

**STOCK**



**QUICK LIFT PUMP!**

## RELIUS SOLUTIONS 5500-Lb. Capacity Pallet Truck

- Heavy-duty truck is backed by two warranties—two years on the pump, one year on the entire unit
- Quick Lift pump raises 0 to 330-lb. loads off the floor with only 2 strokes
- 5,500-lb. capacity
- Extra-thick steel with reinforced fork bracings
- 6"W forks have nylon entry/exit rollers
- 7" nylon steering wheels and 2.8" nylon load wheels

Virtually maintenance-free truck has pivot points instead of zerk fittings. 210° steering arc. Spring-loaded handle has 3-position raise, lower, neutral fingertip control. Blue powder coat finish. **IN STOCK.**

Model No.	Lift Height	Forks WxL	Wt. Lbs.	Price Ea.
YC-3030	2-7/8-7-3/4"	27 x 48"	172	\$411.00

**STOCK**

## LIFT-RITE Titan Pallet Trucks

Improved pump performance combines with a 2-year pump warranty, making this one of the most reliable trucks on the market. Double sealed hydraulic pump has automatic pressure bypass when forks are fully raised. Fingertip loop handle control lets you raise, lower and hold forks with ease. Forks include entry and exit rollers and adjustable push rods. Load and steer wheels have sealed ball bearings for easy maneuverability. Hard chrome-plated pump piston.

**STANDARD, 5,500-LB. CAPACITY TRUCK.** 7"W forks. 3" load rollers and 8" polyurethane steer wheels include sealed ball bearings for smooth rollability. 210° steering arc. **SPECIFY FORK SIZE:** **B** - 20-1/2"W x 36"L, **C** - 20-1/2"W x 42"L, **D** - 20-1/2"W x 48"L, **F** - 27"W x 36"L, **G** - 27"W x 42"L, **H** - 27"W x 48"L. **H - 27"W X 48"L IS IN STOCK.** Others FOB WISCONSIN.

Model No.	Lift Height	Wt. Lbs.	Price Ea.
XV-1730	3-7-3/4"	170	\$564.00

NOTE: Special sizes, brakes, skid adapters, tandem rollers, and other options available.

**EXTRA HEAVY-DUTY 10,000-LB. CAPACITY TRUCK.** 7"W heavy-duty structural steel forks feature solid steel push rods for extra strength. 8" steel steer and 3-1/2" load wheels. 180° steering arc. Other custom-made sizes available, call for information. **FACTORY QUICK SHIP—FOB WISCONSIN.**

Model No.	Lift Height	Forks W x L	Wt. Lbs.	Price Ea.
XV-1732	3-1/2-8"	27 x 48"	400	\$1305.00



**FOUR-WAY ENTRY PALLET IS USUALLY 40"W x 48"L.**

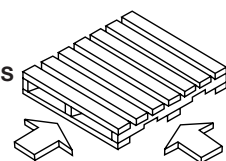

**STOCK**  
Selected Models

**WIDTH ADDER. SPECIFY EXACT WIDTH NEEDED.** (21" and 27" are standard).

Model No.	(A) 14"-26"	(B) 28"-32"
	Price Ea.	Price Ea.
WA-1736	\$265.00	\$656.00

**LENGTH ADDER. SPECIFY EXACT LENGTH NEEDED.** (36", 42" and 48" are standard).

Model No.	(A) 20"-47"	(B) 49"-72"
	Price Ea.	Price Ea.
WA-1737	\$117.00	\$313.00

**1-3/4" LOW-PROFILE, FOUR-WAY TRUCK**  
5,000-lb. capacity. 8" polyurethane steer and 1-3/4" steel load wheels. 6" wide forks. 210° steering arc. **FACTORY QUICK SHIP—FOB WISCONSIN.**

Model No.	Lift Height	Forks WxL	Wt. Lbs.	Price Ea.
XA-1733	1-3/4-6-1/2"	33 x 48"	200	\$1095.00

**LIFT-RITE CUSTOM FORK SIZES**  
For XV-1730—5,500-lb. capacity truck only. FOB WISCONSIN.

Model No. **XA-1734** .....\$611.00

# Pallet Trucks

## Low-Profile Pallet Truck

2.75–7.3" lowered fork height is 3/8" lower than other pallet trucks, permitting entry into lower height pallets. Handles 5,500-lb. capacity loads. Pumps easily and rolls smoothly on polyurethane wheels and rollers. Features fully rebuildable pump unit with overload valve and hard chrome-plated lift ram and pump piston. Low-maintenance truck has entry and exit ramps and sealed ball bearings. Strong, one-piece tapered forks. High quality seals and wipers. 1-year warranty on parts. 1-year pump exchange program. **SPECIFY FORK SIZE:** A - 20-1/2"W x 36"L, B - 20-1/2"W x 42"L, C - 20-1/2"W x 48"L, D - 27"W x 36"L, E - 27"W x 42"L, F - 27"W x 48"L. **IN STOCK.**

Model No. **YK-2380**—20-1/2" x 36".  
Reg. \$415.00. **SALE** .....\$341.00



## Little Mule Pallet Trucks

When you add together all the features, the high capacity, and the comprehensive 1-year pump warranty, you get one of the best performing pallet trucks on the market today. Fitted with a three-position, safety control handle, this pallet truck is easy to operate even during the most demanding applications. And the break-resistant switch with finger-formed grip offers good ergonomic operation. Encapsulated hydraulic system includes integral tank, mechanically protected piston, and pressure relief valve. Other quality features include: 6.9" raised height, sturdy 6" wide forks with polyurethane steer and polyamide load rollers, rounded fork tips, and durable powder coat finish. **FACTORY QUICK SHIP—FOB INDIANA.**

**STANDARD MODEL.** 5,500-lb. capacity. Fork height: 2.9–7.6". **SPECIFY FORK SIZE:** A - 21"W x 36"L, B - 21"W x 42"L, C - 21"W x 48"L, D - 27"W x 36"L, F - 27"W x 48"L.

Model No. **XS-1767**.....\$401.00

**LOW-PROFILE MODEL.** 5,000-lb. capacity. Fork height: 1.99–6.6". **SPECIFY FORK SIZE:** F - 27"W x 48"L, G - 20.5"W x 48"L, H - 33"W x 48"L.

Model No. **XR-1730**—1.99" lowered height ...\$494.00



## VESTIL All-Terrain Pallet Trucks

Transports cargo safely over rough terrain, snowy ground, or uneven surfaces. Large 17" front and 10" rear pneumatic wheels reduce effort needed to start truck on its way. Extra wide outriggers allow trucks to surround pallet for maximum load stability. Straddle inside width: 48". 4"W adjustable forks can be set anywhere between 9-1/2" and 26"W. 300° steering arc. 2,000-lb. capacity at 12" load center; 1,500-lb. capacity at 15" load center. Lightweight steel tubular frame and sealed wheel bearings offer long life. 49"L x 66"W overall. Painted yellow finish. **FOB INDIANA.**

Model No.	Lift Height	Forks W x L	Wt. Lbs.	Price Ea.
<b>WA-0030</b>	3-9"	9-1/2-26 x 32"	410	<b>\$673.00</b>



## BISHAMON Pallet Truck

Convenient safety loop handle or foot pump activates lifting mechanism, raising 5,500-lb. loads. Both mechanisms feature 3-position controls—lower, raise, and neutral. Load rolls on 7" polyurethane steering wheels and 2.8" load wheels. 6" wide forks have glides that reinforce fork tips. Also includes overload bypass valve, oilless bearings, and 210° steering arc. 1-year warranty on complete truck—labor and parts.

**SELECTED MODELS IN STOCK.** Others **FOB CALIFORNIA.**

Model No.	Lift Height	Forks WxL	Wt. Lbs.	Price Ea.
<b>XV-3535A</b>	2.9–7.65"	21 x 32"	200	<b>\$635.00</b>
<b>XV-3535B</b>	2.9–7.65"	21 x 36"	200	<b>635.00</b>
<b>XV-3535C</b>	2.9–7.65"	21 x 42"	200	<b>635.00</b>
<b>XV-3535D</b>	2.9–7.65"	21 x 48"	200	<b>635.00</b>
<b>XV-3535E</b>	2.9–7.65"	27 x 32"	200	<b>635.00</b>
<b>XV-3535F</b>	2.9–7.65"	27 x 36"	200	<b>635.00</b>
<b>XV-3535G</b>	2.9–7.65"	27 x 42"	200	<b>635.00</b>
<b>XV-3535H</b>	2.9–7.65"	27 x 48"	200	<b>635.00</b>

# Pallet Trucks



**STOCK**

## WESCO® Pallet Truck/Scale

Weighs loads on the spot. UL-approved scale operates on 6 D-cell batteries and weighs in pounds or ounces. Scale can also be calibrated for varying altitudes. 5,000-lb. capacity. Other features include: 205° turning radius, polyurethane load and steering wheels, and 3-position raise, lower, neutral hand control. Rebuildable overload bypass pump with one-year warranty. Fork height is 2.9" low to 8" high. **SPECIFY FORK SIZE: A - 22"W x 47-1/2"L, B - 27-1/2"W x 47-1/2"L. IN STOCK.**

Model No. **YA-2260**—Wt. 304 lbs. ....\$1870.00



**STOCK**  
Selected Models

## VESTIL Scale Pallet Truck

Weighs loads while en route to their location. Selectable scale adjusts to the size of your load. Scale features keyboard calibration, functional set-up with automatic zero capabilities, and digital filtering that compensates for vibration and motion. 5,000-lb. capacity. Pallet truck includes quick lift pump that requires only 12 strokes to fully raise forks. Rebuildable hydraulic pump features overload relief valve, chrome-plated hardened and polished piston rod, and top of stroke bypass. Fingertip lever controls raise, lower, and neutral operations. Polyurethane steering and load wheels, 180° steering arc, and grease zerks. One-year parts warranty. **SELECTED MODELS IN STOCK.** Other **FACTORY QUICK SHIP—FOB INDIANA.**

Model No.	Lift Height	Forks WxL	Wt. Lbs.	Price Ea.
<b>YA-2267A</b>	3-7-1/2"	23 x 48"	285	<b>\$1653.00</b>
<b>YA-2267B</b>	3-7-1/2"	27 x 48"	285	<b>1653.00</b>



**EASY ADJUSTMENT—JUST LOOSEN AND RESET ADJUSTING BOLTS.**

**STOCK**

## WESCO® Adjustable Pallet Truck

Two pallet trucks in one! Adjustable forks can be set to handle multiple size loads. Easy adjustment at once—just loosen and reset front and rear adjusting bolts. 5,500-lb. capacity truck also includes: adjustable fork tie rods, pump overload bypass valve, entry and exit rollers, and rubber coated handles. Mold-on polyurethane wheels: 3"W load, 8"W steering. 5-year pump warranty. **IN STOCK.**

Model No.	Lift Height	Forks WxL	Wt. Lbs.	Price Ea.
<b>XA-2300</b>	2-5/8-7-1/2"	21-27 x 48"	200	<b>\$539.00</b>



**FACTORY QUICK SHIP**

**HEAVILY PROTECTED 24V, BRUSHLESS DC MOTOR.**

## LIFT-RITE Self-Propelled Pallet Truck

Light-duty, self-propelled unit features a compact design that is perfect for warehouses, hospital corridors, supermarkets—anywhere loads need to be maneuvered in tight areas. 180° steering angle. All-steel construction. 24V brushless DC motor operates on (2) 12-volt, 24AH batteries with 24-volt, 3-amp charger. Provides up to 2 hours of continuous use with full 2,200-lb. load. Travel speed: 2.8 mph unloaded, 1.8 mph loaded. 7" x 2" polyurethane drive wheel; 3.3" x 4" single load rollers. **FACTORY QUICK SHIP—FOB WISCONSIN.**

Model No.	Lift Height	Forks WxL	Wt. Lbs.	Price Ea.
<b>WA-2210</b>	3-7-1/2"	27 x 48"	236	<b>\$3236.00</b>

# Lifts & Stackers



PLATFORM IS REINFORCED WITH HEAVY-DUTY, HIGH-QUALITY STEEL FOR EXTRA STRENGTH.

INCLUDES BUILT-IN VICE



### FOLDS FOR COMPACT STORAGE



MULTIPLE APPLICATIONS!

## The Mule™ Stacker

All-in-one stacker, transporter, positioner and portable workbench. Built-in vice holds unwieldy loads. Low-profile unit fits through 28"W doorways. Folds down to 13"L for compact storage. 18"W x 18-28"L expandable platform. 3-1/2" lowered height; 48" raised height. (2) 13" rubber rear wheels and (2) 2-1/2" multi-directional front casters. 350-lb. capacity. 12V battery included. Includes battery recharger. FOB CONNECTICUT.

Model No. **XL-0191-27"Lx18"Wx64"H**. Wt. 150 lbs. ....\$1751.00



1,000-LB. CAPACITY COUNTERWEIGHT MODEL SHOWN WITH POWER LIFT AND DRIVE.



EASY-FINGERTIP CONTROLS.

## WESCO® Battery-Powered Counterweight Lift Trucks

Illuminated voltmeter indicates battery status. Remote control has a magnetic backing. Maintenance-free 12V battery with 10 amp, 12V charger. May be used on AC current while charging. 1,000-lb. capacity. Power drive model also includes finger-tip controls built into the steering handle; a red emergency switch that automatically reverses direction when coming in contact with an obstacle, and two batteries. NOTE: forks are 3"W x 25"L and adjust from 6-25"W. Required counterweights are sold separately. SPECIFY: **A** - Power lift, **B** - Power lift with power drive. FOB PENNSYLVANIA.

Model Number	Lift Height	Load Center	Overall WxDxH	(A)		(B)	
				Wt. Lbs.	Price Ea.	Wt. Lbs.	Price Ea.
XL-1250	1-56"	13"	27 x 61 x 72"	522	\$2982.00	780	\$5850.00
XL-1251	1-64"	13"	27 x 61 x 80"	530	3083.00	794	5888.00
XL-1252	1-76"	13"	27 x 61 x 92"	559	3110.00	831	5919.00

### COUNTERWEIGHTS

Model No. **XL-1253**-To get 334-lb. capacity. Wt. 200 lbs. ....\$88.20  
 Model No. **XL-1254**-To get 668-lb. capacity. Wt. 450 lbs. ....\$175.00  
 Model No. **XL-1255**-To get 1000-lb. capacity. Wt. 600 lbs. ....\$317.00

# Lifts & Stackers

## BEECH Stackers

- 1,000-lb. lifting capacity
- 2-year warranty on all components except battery; 1-year warranty on battery and 5-year warranty on weldments

Hand-controlled needle valve precisely lowers the load. Safety bypass valve is set at 110% of capacity to prevent dangerous overloads and the entire unit has been factory-proof tested to 150% of capacity. Stackers roll on 5" x 2" load and 4" x 2" swivel roller-bearing phenolic wheels with grease fittings. All units are equipped with a manual floor lock. Clear acrylic safety shield provides an unobstructed view and protects operator. Choose either a foot-operated model with fold-up pump pedal or battery-operated unit with heavy-duty deep cycle battery, and 10 amp automatic built-in charger. All units exceed ASME B56.10 design standards.

**FACTORY QUICK SHIP—FOB OHIO.**

### PLATFORM STACKERS.

**SPECIFY LIFT: B - Foot Pump, C - Battery.**

Model Number	Lift Height	Platform W x D	Overall W x D x H	Load Center	Straddle Legs		(B) FOOT PUMP		(C) BATTERY	
					Inside Width	Outside Width	Wt. Lbs.	Price Ea.	Wt. Lbs.	Price Ea.
YC-3306	5-1/4-60"	24 x 24"	24 x 36 x 72"	15"	14"	22"	300	\$1567.00	400	\$2818.00
YC-3307	5-1/4-70"	24 x 24"	24 x 36 x 82"	15"	14"	22"	310	1639.00	410	2848.00
YC-3309	5-1/4-60"	30 x 32"	32 x 42 x 72"	18"	25"	33"	340	1770.00	440	2981.00
YC-3310	5-1/4-70"	30 x 32"	32 x 42 x 82"	18"	25"	33"	350	1791.00	460	3018.00

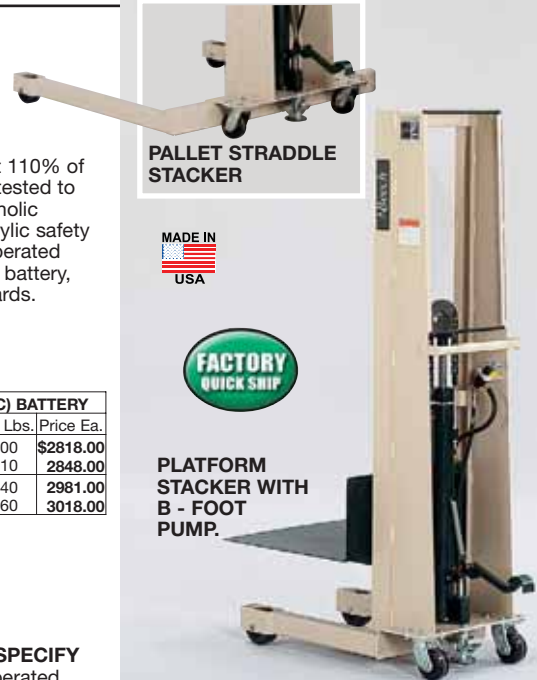

### PALLET STRADDLE STACKERS

Fork width adjusts from 8" to 26-1/2". **SPECIFY**

**LIFT: A - Foot-operated, B - Battery-operated.**

Model Number	Lift Height	Fork W x L	Overall W x D x H	Load Center	Base Legs		(A) FOOT PUMP		(B) BATTERY	
					Inside Width	Overall Width	Wt. Lbs.	Price Ea.	Wt. Lbs.	Price Ea.
WC-1135	1-66"	4 x 36"	50 x 53 x 82"	24"	42"	50"	560	\$2030.00	660	\$3124.00
WC-1136	1-76"	4 x 36"	50 x 53 x 92"	24"	42"	50"	570	2160.00	670	3238.00
WC-1137	1-66"	4 x 36"	58 x 53 x 82"	24"	50"	58"	570	2160.00	670	3256.00
WC-1138	1-76"	4 x 36"	58 x 53 x 92"	24"	50"	58"	580	2282.00	680	3355.00

## HERCULES® Lift Trucks

A safe, efficient general-purpose stacker. 660-lb. capacity. Strong, durable chromium-plated frame. Hydraulic foot pump raises load to maximum height. Maneuvers on 6" dia. steering and frame rollers. **IN STOCK.**

Model Number	Lift Ht.	Platform W x D	Overall W x D x H	Base Legs		Wt. Lbs.	Price Each
				Inside Width	Outside Width		
YA-3107	7-3/4-47-1/4"	21-1/2-25-1/2"	23-1/4 x 40 x 51-1/2"	13"	20"	157	\$658.00
YA-3108	7-3/4-59"	21-1/2-25-1/2"	23-1/4 x 40-3/4 x 51-1/2"	13"	20"	181	748.00

## JET Stackers

Lift, lower and transport heavy loads with minimal effort. Durable construction features heavy-duty welded steel frame with safety cage. Adjustable-width forks and outrigger legs handle 48 x 40" pallets. Rolls on swivel casters with brakes. Model (A) features a quick-lift hydraulic pump with safety overload bypass system, 2,200-lb. capacity, and 2-3/4-59" lift height. Model (B) has a hand-winch with automatic brake, 770-lb. capacity, and 3-59" lift height. Durable powder coat finish. **FACTORY QUICK SHIP—**

**FOB TENNESSEE, WASHINGTON.**

Key	Model Number	Fork W x L	Overall W x D x H	Load Center	Straddle Legs		Wt. Lbs.	Price Each
					Inside Width	Overall Width		
A	YD-3001	5-1/4 x 41-3/4"	42 x 62 x 78"	20"	34-1/2 - 50-1/2"	42 - 58-3/4"	568	\$1266.00
B	YD-3000	3 x 36"	39-1/2 x 52 x 73"	18"	33-1/2 - 49-1/2"	39 - 59"	268	883.00

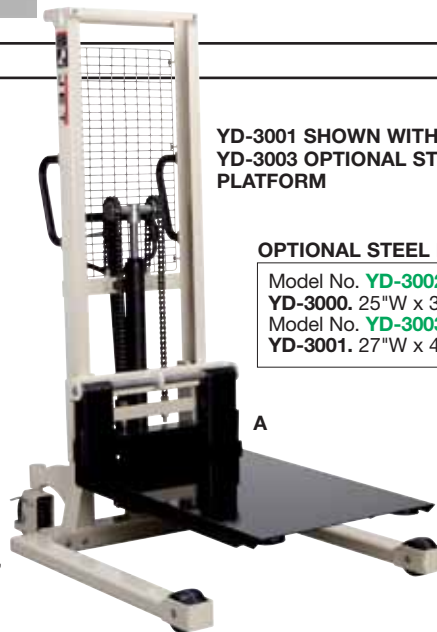

**YD-3001 SHOWN WITH YD-3003 OPTIONAL STEEL PLATFORM**

### OPTIONAL STEEL PLATFORMS

Model No. **YD-3002**—Platform for **YD-3000**. 25"W x 36"D. Wt. 43 lbs. ...\$39.00  
 Model No. **YD-3003**—Platform for **YD-3001**. 27"W x 40"D. Wt. 51 lbs. ...\$39.00



# Pallet Carousels



POSITIONER SHOWN WITH 2 CASTERS AND DOLLY HANDLE



BELLOWS GUARD OPTION



## BISHAMON® EZ Loader Pallet Positioners

Automatically adjusts pallet height as load changes. System is pressurized from 15 psig to 60 psig (depending upon desired capacity from 450–4500 lbs.) from any available air source. Includes: built-in relief system, rotating top, air gauge and air bag pneumatic lift. Platform raises from 8-3/4–30" high. Steel base frame. Blue polyester powder coat finish. **IN STOCK.**

Model Number	Capacity Lbs.	Lift Height	Platform Size	Overall W x D	Wt. Lbs.	Price Each
WH-1025	450–3,000	8-3/4–30"	43" dia.	50-1/2 x 30"	480	\$2262.00
WH-1067	1,000–4,500	8-3/4–30"	43" dia.	50-1/2 x 30"	480	2262.00

NOTE: Air gauge kit standard.

**OPTIONAL EQUIPMENT (FIELD INSTALLABLE). FOB CALIFORNIA.**

**TWO CASTERS AND TWO-WHEELED DOLLY HANDLE.** Wheels automatically lower and lock into position when one end of dolly and empty loader are raised off the floor. For use only to move unloaded EZ LOADER. Model No. **WH-1028** – Wt. 80 lbs. ....\$564.00

**BELLOWS GUARD.** Keeps feet and hands away from the scissors assembly. Four-sided, vinyl-coated polyester accordion encloses the base and scissors. Color: yellow and black.

Model No. **WH-1027** – Wt. 40 lbs. ....\$611.00



**SOLID PLATE TURNTABLE COVER.** Creates a solid surface for small pallets or plastic pallets to rest on.

Model No. **WH-1029** – Wt. 30 lbs. ....\$333.00



6-1/2" LOWERED HEIGHT

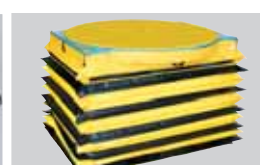

WM-2267

## LIFT PRODUCTS Roto-Max Premium Pallet Positioners

Unique design makes this pallet positioner one of the safest and easiest to use. Manual rotating top. Swivels a full 360°. Magnetic-backed hand control. Zerk grease fitting on cam rollers and all pivot points ensure long life of moving components. Load size and variations in pallet weight will not affect positioner's performance. Built-in maintenance safety bars. **FACTORY QUICK SHIP – FOB WISCONSIN.**

### OPTIONS

Model No. <b>WM-2265</b> – Foot Controls .....	\$176.00
Model No. <b>WM-2266</b> – Two casters and dolly handle .....	\$645.00
Model No. <b>WM-2267</b> – Vinyl accordion skirting .....	\$651.00
Model No. <b>XC-3041</b> – Fork pockets for easy movement. (Add 3" to low and raised heights.) Wt. 40 lbs. ....	\$446.00
Model No. <b>XC-3042</b> – Powered rotating top. For intermittent use. <b>SPECIFY CLOCKWISE ROTATION SPEED: A - 3 RPM, B - 6 RPM.</b> Wt. 10 lbs. ....	\$2427.00

Model Number	Cap. Lbs.	Lift Height	Platform Size	Overall W x D	Rise Time Seconds	Motor HP	Volts	Wt. Lbs.	Price Each
WM-2257	3,000	6-1/2–32-1/2"	43" dia.	43 x 45"	14	1-1/2	115V, 1PH, 20 amp	680	\$4134.60
WM-2264	2,500	6-1/2–32-1/2"	43" dia.	43 x 45"	10	1-1/2	115V, 1PH, 20 amp	680	4277.00
XC-3040*	3,500	6-1/2–32-1/2"	43" dia.	43 x 45"	19	2	230 or 460V, 3PH	700	5154.00

\*SPECIFY: A - 230V, B - 460V, 3 phase.



# Pallet Carousels



## SOUTHWORTH Low-Profile Disc Turntable

Pallets can be easily rotated by one person, reducing chance of muscle strain. Will fit neatly under hand pallet jack for load transfer. Equipped with long life, anti-friction bearings. 43-3/8" dia. 4,000-lb. capacity.

**FACTORY QUICK SHIP—**  
**FOB ARKANSAS.**

Model Number	Overall Height	Wt. Lbs.	Price Each
XP-662	7/8"	263	\$985.00



## VESTIL Pallet Carousels

Pallet carousel lets one person rotate heavy pallets without assistance. Ergonomic design reduces the chance of injury from straining and bending to grasp hard-to-reach boxes. Works well on any load-bearing flat surface that is larger than the carousel. Steel construction and low-friction bearings. 2-1/8" H. **SPECIFY DIAMETER: A - 30", B - 36", C - 40", D - 48", E - 60", F - 72". C-40" DIA. IS IN STOCK.** Others **FACTORY QUICK SHIP—**FOB INDIANA.

Model Number	Cap. Lbs.	(A) 30" DIA.	(B) 36" DIA.	(C) 40" DIA.	(D) 48" DIA.	(E) 60" DIA.	(F) 72" DIA.
		Wt. Lbs.	Price Each	Wt. Lbs.	Price Each	Wt. Lbs.	Price Each
YP-663	2,000	30	\$390.00	36	\$404.00	40	\$347.00
YP-664	4,000	33	440.00	39	456.00	44	397.00
YP-665	6,000	—	—	—	—	48	442.00
						55	575.00
						60	\$475.00
						63	\$515.00
						66	\$575.00
						72	\$519.00
						75	\$62.00
						79	\$679.00
							\$741.00



STATIONARY  
PALLET STAND



WN-2200D SHOWN WITH  
OPTIONAL CAROUSEL

## Pallet Stands, Pallet/Carousel Stands

Reduces back strain by raising load to a comfortable working height. Heavy-duty springs allow one person to operate. Locking mechanism keeps stand in raised position during stationary use—will not collapse during raising and lowering operations. When stand is in desired locked position and loaded, it cannot be adjusted until load is taken off. To move stands with casters they must be unloaded and collapsed. All-welded structural channel construction with heavy-gauge flux core for heavy-duty use, increased efficiency, less fatigue and safer operation. Collapsible to save space. **SELECTED MODELS IN STOCK.** Others **FACTORY QUICK SHIP—**FOB NEBRASKA.



Model Number	Cap. Lbs.	Lift Height	Overall W x D	Platform Size	Wt. Lbs.	Price Each
<b>MODELS</b>						
XP-666	4,000	24", 30-1/2", 34"	40 x 40"	40" dia.	180	\$474.00
WN-2200	4,000	20-1/4", 30-1/2", 35-1/4"	42 x 40"	40" dia.	320	\$537.00
<b>MODELS</b>						
XP-669	1,500	30-1/2", 37", 40-1/2"	40 x 40"	40" dia.	200	\$687.00
WN-2200D	1,500	27-3/4", 38", 42-1/2"	42 x 40"	40" dia.	375	\$613.00

\*WN-2200 and WN-2200D accept 40" pallet carousel YP-664

# Mobile Lift Tables



## SOUTHWORTH Mobile Lift Tables

**STOCK**

An excellent lift table for office, factory or warehouse. Heavy-duty foot-operated hydraulic pump raises load to the desired height. Easy rolling rubber casters—2 rigid, 2 swivel. Foot-operated floor lock on swivel end for stable positioning. **IN STOCK.**

Model Number	Cap. Lbs.	Lift Height	Platform W x D	Overall W x D	Wheel Height	Platform Color	Wt. Lbs.	Price Each
WH-1003	330	8.3–28.9"	17.5 x 28"	18 x 35"	4"	Blue	75	\$760.00
WH-1004	550	9.6–31.9"	19 x 31"	20 x 38"	4"	Orange	115	867.00
WH-1005	1,100	11.8–36.6"	23.5 x 36"	24 x 42"	5"	Yellow	195	1131.00
WH-1006	1,760	13–40.2"	23.5 x 39"	24 x 46"	6"	Gray	275	1417.00
WH-1007*	770	13.6–49.8"	23.5 x 36"	24 x 42"	5"	Yellow	229	1535.00

\*Double scissors model



## LIFT PRODUCTS Mobile Lift Tables

Handles a number of material handling jobs. Foot-operated pump and dependable hydraulic system raise the load to desired height. Entire unit rolls on poly wheels and swivel casters with brakes. Other features include: upper lift limit bypass and 1-year limited warranty. **FACTORY QUICK SHIP—FOB WISCONSIN.**

Model Number	Cap. Lbs.	Lift Height	Platform W x D	Price Each
XP-1548	330	10–30"	27-1/2 x 17-3/4"	\$571.00
XP-1549	550	12–36"	32-3/4 x 19-3/4"	714.00
XP-1550	1,100	17–39"	39-3/4 x 20-1/2"	775.00
XP-1551	1,650	17–39"	39-3/4 x 20-1/2"	925.00
XP-1552	2,200	17–39"	39-3/4 x 20-1/2"	991.00
XP-1553†	660	17–62"	39-3/4 x 20-1/2"	995.00
XP-1554*†	1,100	17–62"	39-3/4 x 20-1/2"	1165.00

\*Available with battery-operated lift. Call for pricing.

†Double scissors models



## HERCULES® Mobile Scissors Lift Tables

Perfect in the office or shop, this convenient table will lift, position, and transport loads up to 2,200 lbs. Steel platform with rust-resistant construction. Manually operated unit has a easy-to-operate foot pump and safety overload valve. Rolls on polyurethane casters—two rigid, two swivel with brakes. All casters have safety covers. Also includes plastic protective shields inside the handle and a maintenance stop pin that prevents platform from falling during service. **IN STOCK.**

Model Number	Cap. Lbs.	Lift Height	Platform W x D	Overall W x D	Wheel Height	Wt. Lbs.	Price Each
YC-1200	330	8.6–28.8"	17.7 x 27.6"	17.7 x 35.5"	4"	82	\$478.00
YC-1201	660	14.6–35.5"	19.7 x 32.5"	19.7" x 42.9"	5"	163	644.00
YC-1202*	770	13.6–51.2"	20.1 x 35.6"	20.1 x 45.3"	5"	249	865.00
YC-1203	1,100	14.6–35.5"	19.9 x 32.3"	19.7 x 42.2"	5"	185	746.00
YC-1204	2,200	16.4–39.4"	20.1 x 39.4"	22.9 x 53.2"	6"	262	1015.00

\*Double scissors model.



## BISHAMON® Mobile Scissors Lift Tables

Designed to easily lift, position, and transport heavy loads in the office, factory, or warehouse. Manually operated foot pedal and hydraulic cylinder raises truck bed to desired height. Two swivel, 2 rigid casters roll truck to job site while the standard wheel brake locks truck in position during operation. Lowering controls meet ANSI safety standards. **SELECTED MODELS IN STOCK.** Others FOB CALIFORNIA.

Model Number	Lift Height	Platform W x D	Overall W x D	Cap. Lbs.	Wt. Lbs.	Price Each
XB-1045	8.4–28.8"	17.7 x 27.6"	17.7 x 33.6"	330	110	\$632.00
XB-1046	11.3–34.1"	19.7 x 32.1"	19.7 x 39.7"	550	190	769.00
XB-1047*	17.1–62.1"	20.5 x 39.8"	20.5 x 49.5"	660	350	1408.00
XB-1048	17.2–39.3"	20.5 x 39.8"	20.5 x 46.9"	1,100	300	1058.00
XB-1049	17.2–39.3"	20.5 x 39.8"	20.5 x 49.5"	1,760	300	1275.00

\*Double scissors model.

# Pallet & Work Positioners



BATTERY-POWERED MODEL AVAILABLE, CALL FOR INFORMATION.

## WESCO® High Lift Pallet Positioner

Ideal for feeding conveyors, printing, or punch presses, this economical lifter raises heavy pallets. Solid steel bar scissors. 180° steering arc. Features include: inside loop handle mechanism and mold-on polyurethane wheels and load rollers. Does not work with closed pallet unless pallet is set on top of forks. **IN STOCK.**

Model No.	Cap. Lbs.	Lift Ht.	Fork W x L	Wt. Lbs.	Price Ea.
XR-1408A	2,200	3.6-31.5"	21 x 44-1/2"	242	\$806.00
XR-1408B	2,200	3.6-31.5"	27 x 44-1/2"	275	806.00

## LIFT-RITE 3,000-Lb. Cap. Lift Trucks

Designed to maneuver open pallets or skids to punch and printing presses, conveyors, etc. 3,000-lb. capacity truck features 7"W forks with 8" dia. polyurethane load wheels and 3" dia. polyurethane load rollers. Narrow 180° steering arc is ideal for compact areas. Other features include: solid steel bar scissors and loop handle with inside hand control. Will not work with closed pallets unless pallet is set on top of forks. **27" X 48" FORKS ARE FACTORY QUICK SHIP.** All FOB WISCONSIN.



Selected Models

### MANUAL MODEL

Quick Lift hydraulics require 24 strokes to lift 400-lb. loads to maximum height.

Model No.	Lift Height	Forks WxL	Wt. Lbs.	Price Ea.
WP-1512A	3-1/4-31-1/2"	20-1/2 x 48"	390	\$1510.00
WP-1512B	3-1/4-31-1/2"	27 x 48"	390	1510.00

### ELECTRIC MODEL

12V DC battery-powered lift raises loads in as little as 9 seconds. Includes battery, charger, and release valve.

Model No.	Lift Height	Forks WxL	Wt. Lbs.	Price Ea.
WP-1513A	4-31-1/2"	20-1/2 x 48"	546	\$2995.00
WP-1513B	4-31-1/2"	27 x 48"	546	2995.00

### OPTIONAL 27" x 48" PLATFORM

Model No. WP-1514	\$165.00
-------------------	----------



## LIFT PRODUCTS Maxx-Mobile Skid Lifters

FACTORY QUICK SHIP

Use anywhere lifting is required—warehouses, factories, assembly lines or tool rooms. Ergonomic design reduces chance of injury while increasing productivity. Choose between manual models with foot pump or electric models that have 12V DC battery. Electric units also feature an on-board power unit with a battery and external automatic charger that runs on 110V input. All models have 3-1/4"-32-3/4" fork height and 2,200-lb. capacity.

FACTORY QUICK SHIP—  
FOB WISCONSIN.

Model No.	Description	L x W	Wt. Lbs.	Price Ea.
XL-0500	Manual	45-1/2" x 20-3/4"	297	\$1401.00
XL-0501	Manual	45-1/2" x 27-1/2"	317	1457.00
XL-0502	Electric	45-1/2" x 20-3/4"	446	3343.00
XL-0503	Electric	45-1/2" x 27-1/2"	477	3403.00

### OPTIONS

Model No. XL-0497—Removable Platform for 45-1/2" x 20-3/4" Lifter. Wt. 15 lbs.	\$84.40
Model No. XL-0498—Removable Platform for 45-1/2" x 27-1/2" Lifter. Wt. 18 lbs.	\$96.40
Model No. XL-0499—On-Board Charger for Electric Skid Lifters. Wt. 2 lbs.	\$141.00

**FREE ALUMINUM HAND TRUCK** with purchase of XL-0500, XL-0501, XL-0502, XL-0503. An \$89.50 Value.

Model No. HNDTRK—200 lb. capacity, 17" x 9.5" x 43". Wt. 14 lbs.
--

## Adjustable Work Positioner

MADE IN USA

Ergonomically designed stand features a user-friendly platform that tilts from 0-40°. Platform height adjusts easily by releasing fixing bolt, pulling toggle upwards, adjusting height, and retightening bolt. 20" x 16" platform has 1" ledge. 12-gauge steel construction. Four 3" swivel polyurethane casters with brake. 330-lb. capacity. **SPECIFY HEIGHT: A - 20"-27-1/2", B - 28-1/4"-42". IN STOCK.**



Model No. YD-1344—Wt. 62 lbs.	\$234.00
-------------------------------	----------

# Lift Tables

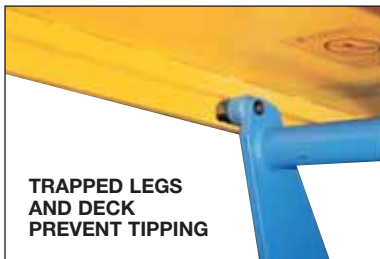

**TRAPPED LEGS AND DECK PREVENT TIPPING**



Selected Models

Model No. **WM-2278**—Optional Foot Control .....\$190.00  
 Model No. **WV-2692\***—Optional Platform Sizes. Includes any size in 1" increments up to 48" x 72" or 48" x 96". For larger sizes, call for a quote. ....\$350.00

## LIFT PRODUCTS Max-Lift Hydraulic Lift Tables

Premium quality table offers excellent stability and safety as a result of "trapping" the cam rollers in a top and bottom channel. High-quality components and greasable pivot points provide for long life under demanding conditions. Deck and legs are "trapped" to prevent accidental tipping due to unbalanced loads or accidental impact. Zerk grease fittings on camrollers and all pivot points to ensure long life of moving components. Built-in maintenance safety bars eliminate the potential for lost or misplaced safety blocks required for inspection or repairs. Magnetic backed pendant control box for operator convenience. 1-1/2 HP motor, single or three phase input. **SELECTED MODELS FACTORY QUICK SHIP.** All FOB WISCONSIN.

**STANDARD LIFT TABLES. SPECIFY VOLTAGE:** for 1 ph **A - 115V, B - 230V;** for 3 ph **C - 230V, D - 460V.**

Model Number	Cap. Lbs.	Lift Height	Platform W x D	Rise Time Seconds	Wt. Lbs.	Price Each
<b>WV-2613</b>	2,500	7-43"	24 x 48"	11	685	<b>\$3239.00</b>
<b>WV-2614</b>	3,000	7-43"	24 x 48"	12	710	<b>3684.00</b>
<b>WV-2615</b>	4,000	7-43"	24 x 48"	18	815	<b>3854.00</b>
<b>WV-2616</b>	5,000	7-43"	24 x 48"	24	915	<b>4260.00</b>
<b>WV-2617</b>	6,000	7-43"	24 x 48"	25	950	<b>4750.00</b>
<b>WV-2618</b>	2,500	7-55"	25 x 64"	21	850	<b>4514.00</b>
<b>WV-2619</b>	3,000	7-55"	25 x 64"	25	915	<b>4870.00</b>
<b>WV-2620</b>	4,000	7-55"	25 x 64"	28	1,110	<b>5043.00</b>
<b>WV-2621</b>	5,000	7.3-55"	25 x 64"	34	1,185	<b>5135.00</b>
<b>WV-2622</b>	6,000	7.3-55"	25 x 64"	42	1,220	<b>5495.00</b>

### FACTORY QUICK SHIP MODELS

FACTORY QUICK SHIP MODELS							
Model Number	Capacity Lbs.	Lift Height	Platform W x D	Rise Time Seconds	Volts	Wt. Lbs.	Price Each
<b>1-PHASE</b>							
<b>WR-1320</b>	2,500	7-43"	24 x 48"	11	115V	700	<b>\$3236.00</b>
<b>WR-1321</b>	2,500	7-43"	36 x 48"	11	115V	900	<b>3588.00</b>
<b>3-PHASE</b>							
<b>WR-1322</b>	4,000	7-43"	24 x 48"	18	460V	825	<b>\$3851.00</b>
<b>WR-1323</b>	4,000	7-43"	48 x 48"	18	460V	1,050	<b>4201.00</b>
<b>WR-1324</b>	6,000	7.3-43"	24 x 48"	25	460V	1,000	<b>4746.00</b>
<b>WR-1325</b>	6,000	7.3-43"	42 x 60"	25	460V	1,375	<b>5096.00</b>



## BISHAMON® Lift 2K® Lift Table

Economically priced unit lifts your heaviest loads up to 2,000 lbs. Increases productivity and employee safety by placing load at a comfortable working height. Hydraulically powered 1/2 HP, 115V motor. Includes hand-held push button control with 8' cord. Meets ANSI standards. **FACTORY QUICK SHIP—FOB CALIFORNIA & INDIANA.**

Model Number	Lift Height	Platform W x D	Rise Time Seconds	Wt. Lbs.	Price Each
<b>WA-2230</b>	8-3/4-39-1/4"	28 x 48"	22	500	<b>\$1702.00</b>
<b>WA-2234</b>	8-3/4-39-1/4"	36 x 48"	22	520	<b>2025.00</b>

For larger sizes call for quote.

### OPTIONS

Model No. **WA-2231**—Bellows .....\$858.00  
 Model No. **WA-2232**—Portability Package ..\$645.00  
 Model No. **WA-2233**—Foot Control .....\$180.00

# Mobile Lift Tables



HAND-ACTIVATED



FOOT-ACTIVATED



## HERCULES® Mobile Lift Tables

Elevates, transports, and positions castings, dies, or machine accessories. Heavy-duty lift table is available with either economical hand or foot-activated pump. Both models are equipped with a foot-activated table release. 2,000-lb. capacity. Heavy-duty reinforcing angles and all-welded steel construction. 1/4" thick smooth steel top. Two 4" dia, stabilizing columns. Hydraulic ram gives 18" lift. Lowered height is 30"; Raised height is 48". Lower platform is securely braced and reinforced. Rubber-bottom floor lock. Heavy-duty roller bearing casters, two rigid, two swivel, 5" x 1-1/2" phenolic casters. Blue enamel finish. **IN STOCK.**

Model No. **XH-403**—Hand pump/foot release. 24"W x 36"D.  
 Wt. 297 lbs. ....\$1487.00  
 Model No. **XH-161**—Foot pump/foot release. 24"W x 36"D.  
 Wt. 297 lbs. ....\$1452.00



12V, DC POWERED LIFTS AVAILABLE, CALL FOR INFORMATION.

## WESCO® 4-Post Mobile Lift Tables

Use this table for your biggest lifting jobs. The four posts offer stability and help reduce friction. Foot-operated floor lock keeps table in position during use. **IN STOCK.**

Model Number	Cap. Lbs.	Lift Height	Platform W x D	Caster Height	Wt. Lbs.	Price Each
<b>WC-3010</b>	2,000	30-1/2 - 47-1/2"	24" x 36"	4"	225	\$1097.00
<b>WC-3011</b>	2,000	30-1/2 - 47-1/2"	32" x 48"	4"	350	1331.00
<b>WC-3013</b>	6,000	37-59"	32" x 48"	6"	412	1396.00



## VESTIL Feed Tables

Mobile feed table is ergonomically designed to reduce the stress of handling awkward loads, making this table perfect for sheet and strip handling. Hydraulic foot pump. Other features include: structural steel base, and 5" x 2" polyurethane casters with dual floor locks that help stabilize loads. 2,000-lb. overall capacity. FOB INDIANA.

Model Number	Lift Height	Platform W x D	Wt. Lbs.	Price Each
<b>WC-3130</b>	31-48"	60 x 30"	541	\$1448.00
<b>WC-3131</b>	31-48"	72 x 30"	563	1481.00
<b>WC-3132</b>	31-48"	96 x 30"	827	1852.00
<b>WC-3133</b>	31-48"	120 x 30"	1124	1892.00



# ROLL-A-WAY Conveyors

## 1-3/8" and 1.9" Galvanized Steel Roller Conveyors

2-1/2" x 1" x 1", 12-gauge galvanized steel frames with bolted cross braces with hook and rod couplers. Spring-loaded 1/4" dia. cold drawn steel shafts. **SPECIFY SECTION SIZE: A - 10' section, B - 5' section, C - 10' section, D - 5' section. FACTORY QUICK SHIP—FOB ILLINOIS.**

**1-3/8" DIA. ROLLER.** 18-ga. galvanized steel with flange type bearings. Roller capacity: 50 lbs. ea.; frame: 90 lbs./ft. Rollers are set 3/16" above rail. Actual roller widths for 12"W conveyor are 9-3/4", or 15-3/4" for 18"W, or 21-3/4" for 24"W.

**1.9" DIA. ROLLER.** 16-ga. galvanized steel with flange type bearings. Roller capacity: 125 lbs. ea.; frame: 90 lbs./ft. Rollers are set 1/2" above rail. Actual roller widths for 12"W conveyor are 9-3/4", or 15-3/4" for 18"W, or 21-3/4" for 24"W.



O.A. Width	Between Roller Width	Roller Ctr.	Model Number	LIGHT-DUTY-1-3/8" ROLLER DIA.				MEDIUM-DUTY-1.9" ROLLER DIA.			
				(A) 10' SECTION		(B) 5' SECTION		(C) 10' SECTION		(D) 5' SECTION	
				Lbs.	Price Ea.	Lbs.	Price Ea.	Lbs.	Price Ea.	Lbs.	Price Ea.
12"	10"	1-1/2"	WV-1580	95	\$360.00	51	\$197.00	—	—	—	—
	10"	3"	WV-1581	62	218.00	33	126.00	74	\$273.00	37	\$157.00
	10"	4-1/2"	WV-1582	52	173.00	28	106.00	65	212.00	33	127.00
	10"	6"	WV-1583	46	143.00	25	90.60	55	183.00	28	114.00
18"	16"	1-1/2"	WV-1584	129	415.00	68	228.00	—	—	—	—
	16"	3"	WV-1585	82	243.00	43	141.00	95	319.00	47	181.00
	16"	4-1/2"	WV-1586	67	192.00	36	115.00	82	238.00	41	142.00
	16"	6"	WV-1587	57	159.00	28	96.50	69	203.00	35	124.00
24"	22"	1-1/2"	WV-1588	162	466.00	87	258.00	—	—	—	—
	22"	3"	WV-1589	102	272.00	54	155.00	104	368.00	52	202.00
	22"	4-1/2"	WV-1590	82	216.00	43	127.00	90	271.00	45	154.00
	22"	6"	WV-1591	72	176.00	38	107.00	76	223.00	38	132.00

## 1-3/8" and 2" Aluminum Roller Conveyors

Durable and lightweight 2-1/2" x 1" x 1", 1/8" thick aluminum frames with bolted cross braces and hook and rod couplers. Spring-loaded 1/4" dia. cold drawn steel shafts. **SPECIFY SECTION SIZE: A - 10' section, B - 5' section, C - 10' section, D - 5' section. FOB ILLINOIS.**

**1-3/8" DIA. ROLLER.** 18-gauge .049" thick steel with flange type bearings. Roller capacity: 40 lbs. ea.; frame: 60 lbs./ft. Rollers are 3/16" above rail with same actual width as 1-3/8" steel.

**2" DIA. ROLLER.** 16-gauge steel with flange type bearings. Roller capacity: 65 lbs. ea.; frame: 60 lbs./ft. Rollers are 1/2" above rail with same actual roller width as 1.9" steel.

O.A. Width	Between Roller Width	Roller Ctr.	Model Number	LIGHT-DUTY-1-3/8" ROLLER DIA.				MEDIUM-DUTY-2" ROLLER DIA.			
				(A) 10' SECTION		(B) 5' SECTION		(C) 10' SECTION		(D) 5' SECTION	
				Lbs.	Price Ea.	Lbs.	Price Ea.	Lbs.	Price Ea.	Lbs.	Price Ea.
12"	10"	1-1/2"	WV-1595	52	\$442.00	28	\$242.00	—	—	—	—
	10"	3"	WV-1596	35	269.00	20	153.00	50	\$313.00	28	\$174.00
18"	16"	1-1/2"	WV-1597	55	498.00	32	269.00	—	—	—	—
	16"	3"	WV-1598	41	309.00	34	171.00	61	363.00	34	202.00
	16"	4-1/2"	WV-1599	32	237.00	18	137.00	53	285.00	29	158.00
	16"	6"	WV-1600	29	208.00	16	126.00	45	244.00	24	140.00
24"	22"	1-1/2"	WV-1601	86	615.00	47	326.00	—	—	—	—
	22"	3"	WV-1602	55	356.00	29	198.00	73	459.00	41	243.00
	22"	4-1/2"	WV-1603	46	278.00	25	159.00	65	334.00	36	184.00
	22"	6"	WV-1604	41	231.00	22	134.00	56	277.00	31	156.00

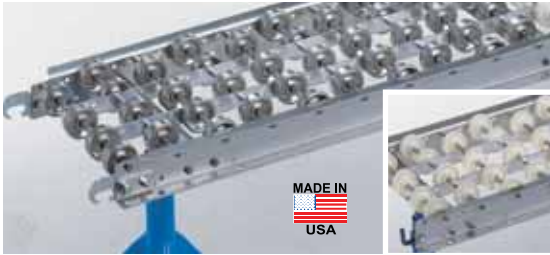

## Skatewheel Conveyors

2" dia. wheels, with 5/8" face and 1/4" bore. 1/4" dia. axles are spaced on 3" centers. Wheels are 1/2" above rail. Bolted cross braces and hook and rod couplers. **SPECIFY SECTION SIZE: A - 10' section, B - 5' section. FOB ILLINOIS.**

**STEEL WHEEL.** Zinc-plated wheels are set in a 2-1/2" x 1" x 1", 12 ga. galvanized steel frame. Wheel capacity 60 lbs. ea.; frame capacity: 90 lbs./ft.

**ALUMINUM WHEEL.** Features a lightweight 2-1/2" x 1" x 1", 1/8" thick aluminum frame. Wheel capacity: 50 lbs. ea.; frame capacity: 60 lbs./ft.

**NYLON WHEEL.** White nylon wheels are set in a 2-1/2" x 1" x 1", 12-gauge galvanized steel frame. Wheel capacity: 40 lbs. ea.; frame capacity: 90 lbs./ft.

Overall Width	Wheels Qty./Ft.	STEEL WHEELS/STEEL FRAME				ALUMINUM WHEELS/ALUMINUM FRAME				NYLON WHEELS/STEEL FRAME			
		Model Number	Wt. Lbs.	(A) 10' SECTION Price Ea.	(B) 5' SECTION Price Ea.	Model Number	Wt. Lbs.	(A) 10' SECTION Price Ea.	(B) 5' SECTION Price Ea.	Model Number	Wt. Lbs.	(A) 10' SECTION Price Ea.	(B) 5' SECTION Price Ea.
12"	10	WV-1610	65	\$194.00	\$117.00	WV-1620	35	\$216.00	\$128.00	WV-1626	45	\$194.00	\$117.00
	16	WV-1611	75	242.00	142.00	WV-1621	43	274.00	157.00	WV-1627	50	242.00	142.00
18"	12	WV-1612	76	232.00	136.00	WV-1622	46	253.00	147.00	WV-1628	54	232.00	136.00
	16	WV-1613	83	266.00	152.00	WV-1623	51	311.00	175.00	WV-1629	59	266.00	152.00
24"	18	WV-1614	83	324.00	183.00	WV-1624	56	348.00	200.00	WV-1630	63	324.00	183.00
	20	WV-1615	98	337.00	191.00	WV-1625	60	380.00	211.00	WV-1631	66	337.00	191.00



## Angle End Stops

Bolts directly to the conveyor's top channel frame. 10-ga. steel. Mounting hardware included. **FOB ILLINOIS.**

Model Number	Overall WxH	Wt. Lbs.	Price Each
XA-3535	12x1-1/2"	3	\$17.80
XA-3536	18x1-1/2"	5	19.90
XA-3537	24x1-1/2"	6	20.50



## 90° & 45° Curved Skatewheel Sections

36" I.D. radius. Add conveyor width for O.D. radius. **SPECIFY SECTION: A - 90°, B - 45°. FOB ILLINOIS.**

O.A. Width	Model Number	Wt. Lbs.	STEEL WHEELS/STEEL FRAMES		ALUM. WHEELS/ALUM. FRAME			
			(A) 90° Price Ea.	(B) 45° Price Ea.	Model Number	Wt. Lbs.		
12"	XV-1722	42	\$177.00	\$108.00	XV-1725	25	\$203.00	\$125.00
18"	XV-1723	52	230.00	146.00	XV-1726	30	234.00	151.00
24"	XV-1724	63	299.00	204.00	XV-1727	38	304.00	211.00

# Conveyor Components

## ROLL-A-WAY Tripod Stands

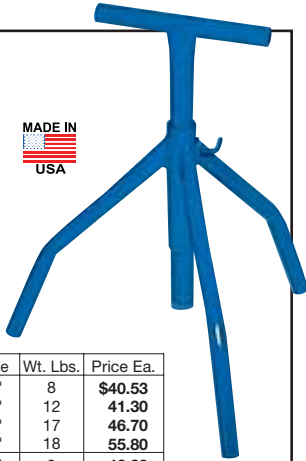

Adjustable stand, ideal for installing gravity or support lines and where portability is necessary. FOB ILLINOIS.

Model No.	Width	Ht. Range	Wt. Lbs.	Price Ea.
XV-1645	12"	18"-30"	8	\$40.53
XV-1646	12"	24"-40"	12	41.30
XV-1647	12"	30"-50"	17	46.70
XV-1648	12"	40"-70"	18	55.80
XV-1649	18"	18"-30"	9	42.30
XV-1650	18"	24"-40"	11	45.20
XV-1651	18"	30"-50"	18	49.10
XV-1652	18"	40"-70"	19	56.30
XV-1653	24"	18"-30"	10	44.60
XV-1654	24"	24"-40"	14	46.80
XV-1655	24"	30"-50"	19	49.80
XV-1656	24"	40"-70"	20	60.20



## ROLL-A-WAY V-Top Roller Stand

Ideal for maintaining control of materials when feeding chop saws, drill presses, etc. Angle iron, 4" dia. round tube rollers. Height adjusts up to 26"-38". 300-lb. capacity. FOB ILLINOIS.

Model No. **XA-3531** - 18"W.  
Wt. 17 lbs. ....\$76.20

## VESTIL Roller Stands

Ideal for feeding material into a saw, punch press, drill press, shear or other types of machinery. Height is adjusted with friction lock screw. 14" wide roller. 250-lb. capacity. **IN STOCK.**



Model No. **XA-0110** - 23-38-1/2"H.  
Wt. 66 lbs. ....\$91.70  
Model No. **XA-0111** - 27-42"H.  
Wt. 75 lbs. ....\$97.00



## ROLL-A-WAY Guard Rails



For use with 5", 10", 45° and 90° conveyors. Adjustable width guard rails are constructed of 1" pipe. Placed 3" above conveyor. **SPECIFY CONVEYOR WIDTH: A - 12", B - 18", C - 24".** FOB ILLINOIS.

Model Number	Rail Length	Rail Curve	Rail Sides	Wt. Lbs.	(A) 12"	(B) 18"	(C) 24"
					Price Ea.	Price Ea.	Price Ea.
XA-2621	5'	—	1	8	\$32.50	\$34.30	\$36.30
XA-2622	10'	—	1	18	51.90	52.50	53.20
XA-2623	—	45°	1*	8	50.70	51.90	53.00
XA-2624	—	90°	1*	18	55.20	57.50	59.20
XA-2625	—	45°	2*	16	67.60	69.10	67.60
XA-2626	—	90°	2*	36	73.60	76.60	78.90

\*When only one 45° and 90° curved guard rail is needed, that guard rail will be on the outside. When two guard rails are required, they will be on the outside and inside of conveyor.

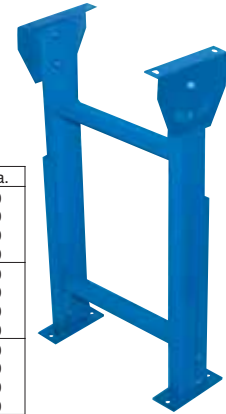

## ROLL-A-WAY H-Stands

Permanent support. FOB ILLINOIS.

Model No.	Width	Ht. Range	Wt. Lbs.	Price Ea.
XV-1630	12"	17"-23"	11	\$37.60
XV-1631	12"	24"-30"	14	42.00
XV-1632	12"	31"-37"	17	45.60
XV-1633	12"	38"-44"	20	46.30
XV-1634	18"	17"-23"	12	37.70
XV-1635	18"	24"-30"	15	44.60
XV-1636	18"	31"-37"	18	45.30
XV-1637	18"	38"-44"	20	46.70
XV-1638	24"	17"-23"	12	37.70
XV-1639	24"	24"-30"	15	44.50
XV-1640	24"	31"-37"	18	49.00
XV-1641	24"	38"-44"	21	50.40
XV-1642	36"	17"-23"	18	41.30
XV-1643	36"	24"-30"	19	50.40
XV-1644	36"	31"-37"	20	51.90
XV-1657	36"	38"-44"	23	53.30

O.A. Width	1-3/8" ROLLER DIAMETER				1.9" ROLLER DIAMETER					
	Model Number	(A) 90°	(B) 45°	Model Number	(A) 90°	(B) 40°	Model Number	(A) 90°	(B) 40°	
12"	XV-1710	55	\$176.00	30	\$115.00	XV-1713	48	\$243.00	24	\$189.00
18"	XV-1711	76	191.00	42	125.00	XV-1714	53	273.00	27	208.00
24"	XV-1712	97	208.00	54	131.00	XV-1715	62	302.00	31	237.00
12"	XV-1716	33	\$202.00	18	\$133.00	XV-1719	36	\$292.00	18	\$224.00
18"	XV-1717	46	223.00	26	148.00	XV-1720	44	338.00	23	270.00
24"	XV-1718	59	245.00	33	162.00	XV-1721	50	394.00	26	306.00



## ROLL-A-WAY 90° & 45° Curved Roller Sections

SPECIFY SECTION: A - 90°, B - 45°. FOB ILLINOIS.



## ROLL-A-WAY Ball Transfer Table



Use anywhere in a conveyor layout for multi-directional and/or turnaround of material. 50-lb. capacity, 1" dia. x 1-1/2"H balls are bolted into a 12-ga. sheet. 3" overall height. Custom sizes available.

**SPECIFY BALL CENTER:**

**A - 3":** 16 balls/sq. ft.,

**B - 4":** 9 balls sq. ft., **C - 6":**

4 balls/sq. ft. **SELECTED**

**MODELS IN (A) 3" ARE**

**IN STOCK.** Others FOB

ILLINOIS.

Model Number	Overall LxW	(A) 3" CENTER		(B) 4" CENTER		(C) 6" CENTER	
		Wt. Lbs.	Price Ea.	Wt. Lbs.	Price Ea.	Wt. Lbs.	Price Ea.
XA-1490	24x24"	54	\$304.00	48	\$231.00	35	\$153.00
XA-1491	36x24"	73	442.00	56	314.00	49	199.00
XA-1492	48x24"	100	575.00	81	391.00	67	252.00
XA-1493	36x36"	110	671.00	95	437.00	69	378.00
XA-1494	48x36"	145	789.00	115	536.00	91	353.00



# Conveyors



## NESTAFLEX® Expandable Portable Conveyors

Flexible, portable, expandable conveyor systems are ideal for all types of shipping and receiving operations. Systems set-up fast when needed and fold-away when not in use. All units bend around a 21" radius. Conveyors roll on 5" swivel antistatic rubber casters with foot brakes. High tensile, galvanized steel tie rods. There is a 4' space between each leg and 5-1/4" center to center of each axle when fully extended. Ideal for UPS and packaging lines. Supports up to 226 lbs. per ft. Legs have single cross brace with 2-point, 11-ga. connection. Side links are 11-ga. zinc plated steel. Height adjusts from 28"-44". 6-9 skatewheels per axle. **SPECIFY SELF-TRACKING SKATE WHEELS: A** - Red nylon with celcon bushings for general applications and low-to-moderate volume, **B** - Black polymer with moisture-resistant ball bearings for light to medium weight packages and ideal for long run applications, **C** - Steel with ball bearings for heavy-duty applications and high impact. **SELECTED MODELS IN (B) PLASTIC ARE IN STOCK.** Others FOB OHIO.

Model Number	Overall Width	Overall Length	Leg Set Qty.	Wheels Qty./Axle	Wt. Lbs.	(A) NYLON	(B) PLASTIC	(C) STEEL
						Price Ea.	Price Ea.	Price Ea.
WP-804	14"	2' 4"-8' 11"	3	6	130*	\$490.00	Error	\$527.00
WP-805	14"	3' 3"-12' 10"	4	6	165*	639.00	666.00	700.00
WP-806	14"	4' 3"-16' 9"	5	6	210*	858.00	876.00	904.00
WP-807	14"	6' 2"-24' 8"	7	6	280*	1180.00	1203.00	1231.00
WP-808	18"	2' 4"-8' 11"	3	6	150*	508.00	527.00	546.00
WP-809	18"	3' 3"-12' 10"	4	6	195*	695.00	714.00	746.00
WP-810	18"	4' 3"-16' 9"	5	6	250*	867.00	886.00	937.00
WP-811	18"	6' 2"-24' 8"	7	6	290*	1226.00	1259.00	1286.00
WP-812	24"	2' 4"-8' 11"	3	9	200*	564.00	597.00	639.00
WP-813	24"	3' 3"-12' 10"	4	9	255*	770.00	788.00	830.00
WP-814	24"	4' 3"-16' 9"	5	9	355*	1017.00	1045.00	1073.00
WP-815	24"	6' 2"-24' 8"	7	9	450*	1468.00	1483.00	1496.00

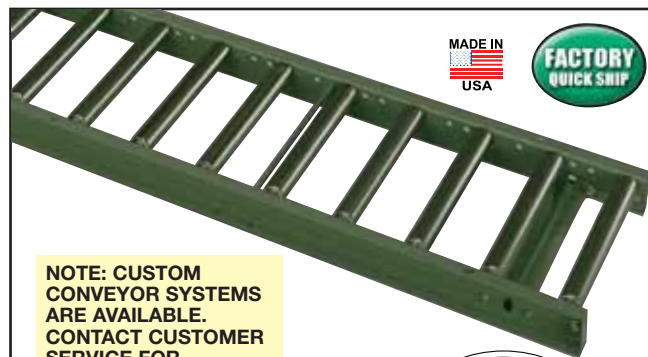

**NOTE: CUSTOM CONVEYOR SYSTEMS ARE AVAILABLE. CONTACT CUSTOMER SERVICE FOR ASSISTANCE.**

**CURVED SECTIONS SPECIFY ANGLE: A - 45° curve, B - 90° curve.**

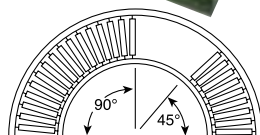

Model Number	Inside Rail Width	(A) 45° Curve		(B) 90° CURVE	
		Wt. Lbs.	Price Ea.	Wt. Lbs.	Price Ea.
<b>1.9" DIA. x 16-GAUGE WITH TAPERED ROLLERS</b>					
XV-1690	13"	46	\$310.00	83	\$527.00
XV-1691	17"	54	353.00	100	590.00
XV-1692	21"	72	396.00	136	644.00
XV-1693	25"	87	423.00	166	704.00
<b>2.5" DIA. x 11-GAUGE WITH STRAIGHT ROLLERS</b>					
XV-1694	19"	106	\$432.00	210	\$649.00
XV-1695	25"	129	491.00	255	748.00
XV-1696	31"	216	1045.00	400	1511.00

**H-STANDS.** Heavy-duty welded frame assemblies have adjustable feet and pivot plates. **SPECIFY OVERALL WIDTH OF CONVEYOR**

Model Number	Conveyor Height	Wt. Lbs.	Price Ea.
<b>FOR 1.9" ROLLERS</b>			
XV-1700	19.3" - 25.3"	13-1/2	\$57.30
XV-1701	23.3" - 29.3"	19-1/2	59.80
XV-1702	27.3" - 39.3"	22-1/2	65.80
XV-1703	37.3" - 49.3"	24	75.30
XV-1704	49.3" - 61.3"	26-1/2	89.40
<b>FOR 2.5" ROLLERS</b>			
XV-1705	18" - 21"	27	\$74.70
XV-1706	21" - 24"	28-1/2	77.40
XV-1707	24" - 30"	31-1/2	95.00



## HYTROL Heavy-Duty Gravity Roller Conveyors

Unplated labyrinth-sealed steel rollers have grease-packed bearings. Painted frames with butt couplings for easy section assembly. Two-year warranty. **FACTORY QUICK SHIP—FOB ARKANSAS.**

**1.9" DIA. x 16-GAUGE ROLLERS.** Rollers have 7/16" spring-loaded hex shaft and support up to 250 lbs. Rollers are set 1/4" above frame which provides 620-lb. capacity per ft. in 5' section; 135-lb. cap. in 10' section. 10-ga. frame is 3-1/2" x 1-1/2". **SPECIFY LENGTH: A - 10' L, B - 5' L.**

**2.5" DIA. x 11-GAUGE ROLLERS.** Rollers have 1-1/16" spring-loaded hex shaft and support up to 750 lbs. Rollers are set 3/8" above frame which provides 1,620-lb. capacity per ft. in 5' section; 350-lb. capacity in 10' section. 4-ga. frame is 4" x 1-5/8". **SPECIFY LENGTH: A - 10' L, B - 5' L.**

O.A Width	Inside Rail Width	Roller Ctr.	Model Number	(A) 10' L		(B) 5' L	
				Wt. Lbs.	Price Ea.	Wt. Lbs.	Price Ea.
<b>1.9" DIA. x 16-GAUGE ROLLERS</b>							
16"	13"	3"	XV-1660	151	\$347.00	76	\$174.00
16"	13"	4-1/2"	XV-1661	121	275.00	61	138.00
16"	13"	6"	XV-1662	103	238.00	51	119.00
16"	13"	9"	XV-1663	88	205.00	44	103.00
20"	17"	3"	XV-1664	176	382.00	88	192.00
20"	17"	4-1/2"	XV-1665	137	301.00	69	150.00
20"	17"	6"	XV-1666	115	258.00	57	129.00
20"	17"	9"	XV-1667	96	221.00	48	111.00
24"	21"	3"	XV-1668	217	417.00	101	210.00
24"	21"	4-1/2"	XV-1669	154	327.00	77	164.00
24"	21"	6"	XV-1670	127	279.00	64	140.00
24"	21"	9"	XV-1671	105	237.00	53	119.00
28"	25"	3"	XV-1672	225	455.00	113	228.00
28"	25"	4-1/2"	XV-1673	170	353.00	90	177.00
28"	25"	6"	XV-1674	140	299.00	70	150.00
28"	25"	9"	XV-1675	113	253.00	57	126.00
<b>2.5" DIA. x 11-GAUGE ROLLERS</b>							
16"	13"	4"	XV-1676	310	\$773.00	160	\$387.00
16"	13"	6"	XV-1677	250	581.00	130	291.00
16"	13"	8"	XV-1678	220	485.00	115	243.00
22"	19"	4"	XV-1679	370	882.00	190	441.00
22"	19"	6"	XV-1680	290	657.00	150	329.00
22"	19"	8"	XV-1681	250	545.00	130	273.00
28"	25"	4"	XV-1682	505	991.00	220	496.00
28"	25"	6"	XV-1683	330	733.00	170	367.00
28"	25"	8"	XV-1684	280	604.00	145	302.00
34"	25"	4"	XV-1685	500	1099.00	255	550.00
34"	31"	6"	XV-1686	380	793.00	195	405.00
34"	31"	8"	XV-1687	310	664.00	160	332.00



# Conveyors

LENGTHS UP TO 100' AND PUSH BUTTONS ALSO AVAILABLE—CALL FOR MORE INFORMATION.



## HYTROL Motorized Horizontal Belt Conveyors

Versatile unit is ideal for assembly, inspection, sorting, or packing lines. Totally enclosed 1/2 HP motor. Black friction surface belt runs one way. Features: 65 FPM belt speed, and 4"D, 12-gauge conveyor bed. 27-3/4-39-3/4" conveyor height. 300-lb. capacity. Powder coat paint finish. **SPECIFY VOLTAGE: A - 115V, 1 ph., B - 230/460V, 3 ph.** **SPECIFY ONE-WAY SPEED: between 17 and 135 FPM. FACTORY QUICK SHIP-FOB ARKANSAS.**

Belt Width	Model Number	Bed L x W	Wt. Lbs.	Price Each	Model Number	Bed L x W	Wt. Lbs.	Price Each
12"	<b>WV-2500</b>	5' x 16"	317	<b>\$2224.00</b>	<b>WV-2508</b>	15' x 16"	447.5	<b>\$2871.00</b>
14"	<b>WV-2501</b>	5' x 18"	327	<b>2275.00</b>	<b>WV-2509</b>	15' x 18"	465.5	<b>2860.00</b>
18"	<b>WV-2502</b>	5' x 22"	360	<b>2376.00</b>	<b>WV-2510</b>	15' x 22"	542.5	<b>3068.00</b>
20"	<b>WV-2503</b>	5' x 24"	388	<b>2425.00</b>	<b>WV-2511</b>	15' x 24"	561.5	<b>3172.00</b>
12"	<b>WV-2504</b>	10' x 16"	359	<b>2511.00</b>	<b>WV-2512</b>	20' x 16"	489.5	<b>3149.00</b>
14"	<b>WV-2505</b>	10' x 18"	373	<b>2538.00</b>	<b>WV-2513</b>	20' x 18"	511.5	<b>3122.00</b>
18"	<b>WV-2506</b>	10' x 22"	427	<b>2693.00</b>	<b>WV-2514</b>	20' x 22"	609.5	<b>3385.00</b>
20"	<b>WV-2507</b>	10' x 24"	442	<b>2779.00</b>	<b>WV-2515</b>	20' x 24"	632.5	<b>3515.00</b>

NOTE: Add 1' to bed length for overall length.

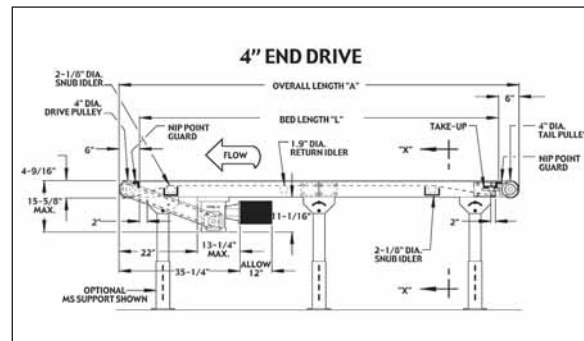

Model No. **WV-2516**—One-direction. SPECIFY: A - 1-ph, B - 3-ph. 115 V, 1 ph. Wt. 5-1/2 lbs. ....**\$137.00**  
 Model No. **WV-2517**—Reversing with center drive. Wt. 5 lbs. ....**\$976.00**



## Pallet Handling Conveyors

Designed for multiple applications such as staging fully loaded pallets in shipping departments and assembly areas or as infeed or discharge ends of weight scales and stretch wrap machines. Moving fully loaded pallets is easy when you use these large conveyors. 2" dia., 49-1/2" 12-ga. spring-loaded rollers run on 3" centers and are set low on 7/16" hex axles. 52"W overall, 50" wide between rails. All-welded, 3-1/2" x 1", 1" thick 10-ga. channel steel frame with butt couplers. 300-lb. capacity per roller, 3,500-lb. fully supported frame capacity on the floor. If H-stands are needed, 5' centers are mandatory, call for information. Ships knocked down. FOB ILLINOIS.

Model No. **YA-2393**—10' Long. Wt. 500 lbs...**\$874.00**  
 Model No. **YA-2394**—5' Long. Wt. 265 lbs....**\$490.00**

NOTE: Rollers will ship separately to prevent freight damage.



# HERCULES® Boom Attachments

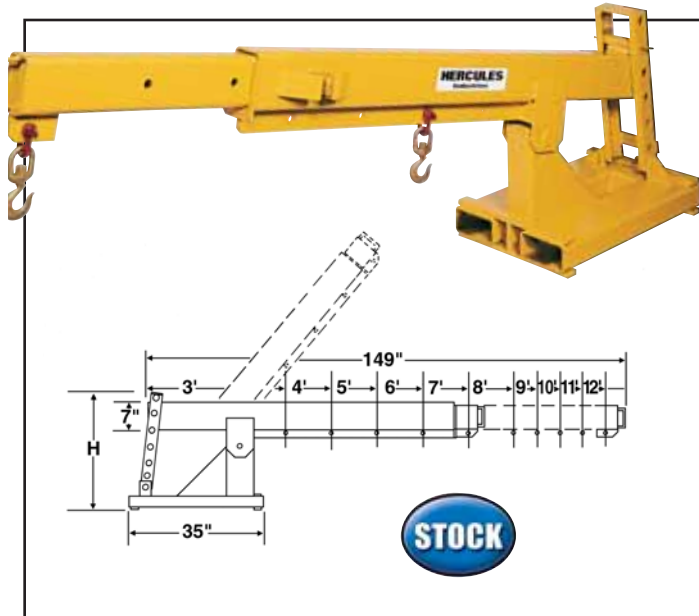

## Telescoping Pivoting Jibs

Convert your forklift into a low-cost mobile boom lift in seconds. Excellent for setting steel, erecting racks, columns, etc. Jib features 5 alternate telescoping boom adjustments from 8' to 12' on 1' increments and tilting up to 50° above horizontal. 35" L fork tubes. Clevis-type safety hooks can be placed in 10 alternate positions. Base is 21-1/2"W overall. Individual fork pockets are 2-1/2" x 7-1/2" for XC-1500 and 3-1/2" x 7-1/2" for XC-1501 and XC-1502. Also includes: welded hand pull, boom lock, and 3' restraining chain for securing to carriage. **IN STOCK.**

Model No.	Cap. Lbs.	Frame Height	Base Width	Fork Pocket W x H	Wt. Lbs.	Price Ea
<b>XC-1500</b>	4,000	28"	21-1/2"	7-1/2" x 2-1/2"	430	<b>\$3000.00</b>
<b>XC-1501</b>	6,000	28"	21-1/2"	7-1/2" x 3-1/2"	515	<b>3022.00</b>
<b>XC-1502</b>	8,000	28"	21-1/2"	7-1/2" x 3-1/2"	610	<b>3047.00</b>

Hook Position	MAXIMUM LOAD ON SINGLE HOOK		
	Capacity Lbs.		
	XC-1500	XC-1501	XC-1502
4 Feet	4,000	6,000	8,000
5 Feet	3,700	5,700	7,500
6 Feet	3,400	5,400	7,000
7 Feet	3,000	5,000	6,500
8 Feet	2,500	4,200	5,500
9 Feet	2,100	3,500	4,500
10 Feet	1,800	3,000	4,000
11 Feet	1,600	2,700	3,500
12 Feet	1,500	2,500	3,000

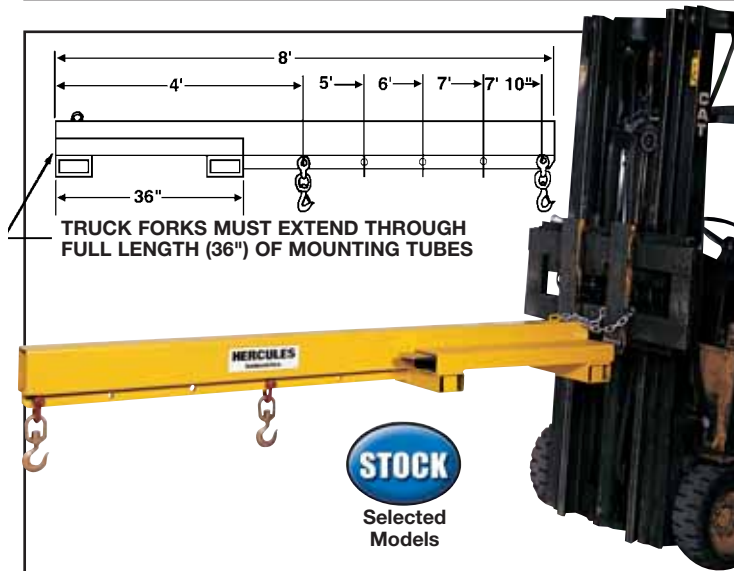

## Standard Boom Attachments

The fast, economical way to change your fork truck into a mobile jib lift. Just insert forks into 5-1/2"W x 2-1/2"H, 16"W overall fork pockets. The 3' restraining chain with clevis attaches to your forklift carriage, securing the unit onto the fork truck. Constructed of structural steel tubing for superior strength. 5 hook positions. Non-telescoping. Check with your forklift manufacturer for load capacities before using. **SELECTED MODEL IN STOCK.** Other **FACTORY QUICK SHIP—FOB MN.**

Model Number	Cap. Lbs.	Fork Pocket W x H	Forks Width	Wt. Lbs.	Price Each
<b>XC-643</b>	4,000	5-1/2" x 2-1/2"	16"	260	<b>\$941.00</b>

**YC-1490—Sling Package** consists of (one each) 3', 5', 8' and 12' endless slings rated at 4,960 lbs. choke and 6,200 lbs. vertical. Sling is 1-3/4" wide. ....**\$80.50**

Hook Position	Capacity Lbs.
4'	4,000
5'	3,500
6'	3,000
7'	2,500
7' 10"	2,000

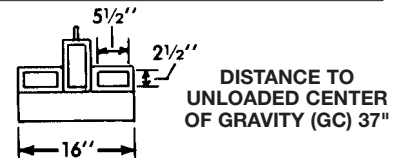

## Telescoping Hi-Lift Boom Attachments

Designed for applications involving extension booms with higher than average underclearance requirements. Easily mounts on forks to lift tall objects up to 4000 lbs. Basic construction the same as other Hercules® boom-lift attachments. Restraining chain, extension lock, welded on hand pull and dual movable safety-latch hooks standard. Each XC-1223 fork pocket is 7-1/2"L x 2-1/2"H with a 20"W base. Individual fork pockets on XC-1224 are 7-1/2"L x 2-3/4"H with 21"W base. **IN STOCK.**

Model Number	Capacity Lbs.	Frame Ht.	Base Length	Boom Length	Wt. Lbs.	Price Each
<b>XC-1223</b>	1,500-4,000	64"	30"	6-1/2'	410	<b>\$1825.00</b>
<b>XC-1224</b>	1,500-4,000	67"	30"	12'	775	<b>2282.00</b>

MODEL NO. XC-1223		MODEL NO. XC-1224	
Hook Position	Cap. Lbs.	Hook Position	Cap. Lbs.
2' - 6"	4,000	4' - 0"	4,000
3' - 0"	4,000	5' - 0"	3,700
3' - 6"	4,000	6' - 0"	3,400
*4' - 0"	4,000	*7' - 0"	3,000
4' - 6"	3,300	8' - 0"	2,500
5' - 0"	2,700	9' - 0"	2,100
5' - 6"	2,200	10' - 0"	1,800
6' - 0"	1,800	11' - 0"	1,600
6' - 6"	1,500	12' - 0"	1,500

\*Retracted Position Of Telescoping Boom.

**ALL SPECIFICATIONS SUBJECT TO MODIFICATION OR IMPROVEMENT WITHOUT PRIOR NOTICE**

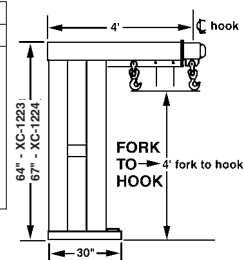

# Forklift Attachments

## HERCULES® Mobile Boom Lift Attachments

Converts your forklift into a low-cost mobile boom lift in seconds. Structural steel boom features ten alternate hook positions with clevis-type safety hooks. Telescoping boom retracts to 7'4" and extends to 12' (center line of hook). Also includes: welded hand pull, fork pockets, boom lock and 3' restraining chain. Easy-on easy-off restraining chain with grab hook attaches to forklift carriage to secure the unit onto the forks. Handles 4,000-, 6,000-, and 8,000-lb. loads. Before using, check with the manufacturer of your fork lift for load capacities. Non-telescoping models also available. Additional pocket size options available. **SELECTED MODELS IN STOCK.** Others FOB MINNESOTA.



### BASE MODELS

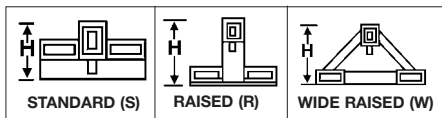

Note: Special base widths and pocket sizes are numerous. Let us know your special needs. All models available in non-telescoping design.

MAXIMUM LOAD ON SINGLE HOOK			
Hook Position	XC-1403 XC-1404 XC-1405	XC-1406 XC-1407 XC-1408	XC-1409 XC-1410 XC-1411
4'	4,000 lbs.	6,000 lbs.	8,000 lbs.
5'	3,700 lbs.	5,700 lbs.	7,500 lbs.
6'	3,400 lbs.	5,400 lbs.	7,000 lbs.
7'	3,000 lbs.	5,000 lbs.	6,500 lbs.
8'	2,500 lbs.	4,200 lbs.	5,500 lbs.
9'	2,100 lbs.	3,500 lbs.	4,500 lbs.
10'	1,800 lbs.	3,000 lbs.	4,000 lbs.
11'	1,600 lbs.	2,700 lbs.	3,500 lbs.
12'	1,500 lbs.	2,500 lbs.	3,000 lbs.

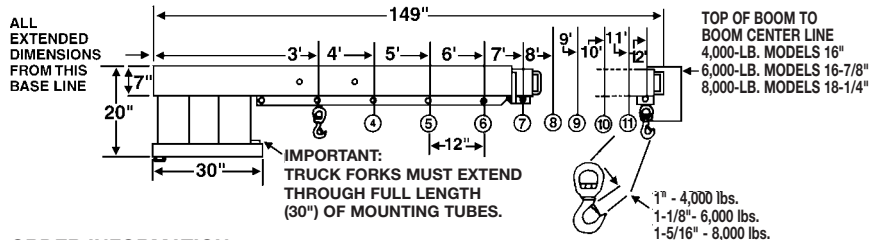

### ORDER INFORMATION

Model No.	Base Description	Cap. Lbs.	Overall Height	Base Width	Fork Pocket W x H	Wt. Lbs.	Price Ea.
<b>XC-1403</b>	Standard	4,000	10"	21"	7-1/2" x 2-1/2"	335	<b>\$1520.00</b>
<b>XC-1404</b>	Raised	4,000	20-3/4"	21"	7-1/2" x 2-1/2"	400	<b>1722.00</b>
<b>XC-1405</b>	Wide Raised	4,000	16-1/2"	32"	7-1/2" x 2-1/2"	422	<b>2222.00</b>
<b>XC-1406</b>	Standard	6,000	10"	21"	7-1/2" x 3-1/2"	513	<b>1932.00</b>
<b>XC-1407</b>	Raised	6,000	20-3/4"	21"	7-1/2" x 3-1/2"	485	<b>2025.00</b>
<b>XC-1408</b>	Wide Raised	6,000	18-1/2"	34"	7-1/2" x 3-1/2"	505	<b>2256.00</b>
<b>XC-1409</b>	Standard	8,000	10"	21"	7-1/2" x 3-1/2"	406	<b>1764.00</b>
<b>XC-1410</b>	Raised	8,000	20-3/4"	21"	7-1/2" x 3-1/2"	527	<b>2066.00</b>
<b>XC-1411</b>	Wide Raised	8,000	18-1/2"	34"	7-1/2" x 3-1/2"	565	<b>2293.00</b>

## VESTIL Steel Hopper



Move parts and bulk-in-process materials with your fork truck when you utilize this hopper. 19"H unit fits easily underneath machinery to act as a parts catch basin. May be attached to fork truck via 7-1/2"W x 2-1/2"H fork pockets and dumped 90° using the convenient pull-cable. Once material is dumped, hopper automatically returns to locked position when lowered to the ground. All-welded steel hopper measures 48-1/2"W x 58-1/2"D overall and includes a 33-1/2"H removable handle. 1,500-lb., 1/2 cu. yard capacity. Rolls on 4" x 2" phenolic casters—2 swivel, 2 rigid. Powder coat finish. Color: blue. FOB INDIANA.



Model No. **XC-8848**—  
Wt. 289 lbs. .... **\$630.00**

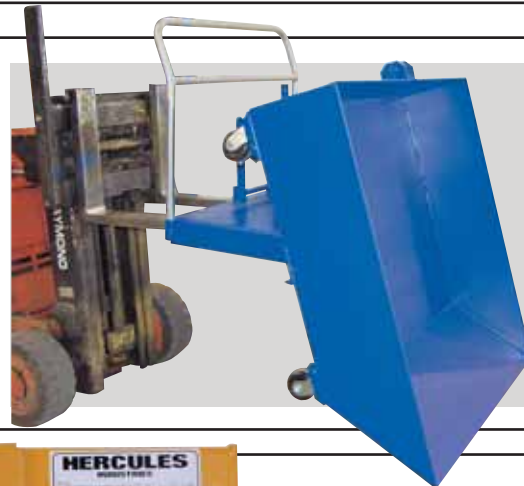

## HERCULES® Crane Hook

All-welded steel frame features a swivel hook to handle loads up to 6,000 lbs. Attaches easily by hand-tightening bottom wing nuts tightly against forks. Fits onto both forks with a 24" fork spread. 25" wide overall. Before using, check with manufacturer of your forklift for load capabilities. **IN STOCK.**

Model No. **WC-118**—Wt. 40 lbs. .... **\$280.00**



ASK US ABOUT  
SPECIAL VARIATIONS.



# Fork Truck Accessories



## Fork Extensions

Handle large or long loads with your existing fork truck when you add these economical fork extensions. User-friendly units just slide onto truck forks for quick installation. Contact your lift truck manufacturer to verify that your lift can be safely operated with fork extensions. Sold in pairs. **SPECIFY LENGTH: A - 60", B - 72".**

**IN STOCK.**

Model Number	Fits Fork Width	(A) 60"		(B) 72"	
		Wt./Pr. Lbs.	Price/Pair	Wt./Pr. Lbs.	Price/Pair
YA-1420	4"W	98	\$220.00	114	\$264.00
YA-1421	5"W	101	256.00	129	301.00
YA-1422	6"W	106	260.00	145	322.00
YA-1423	7"W	119	325.00	139	342.00

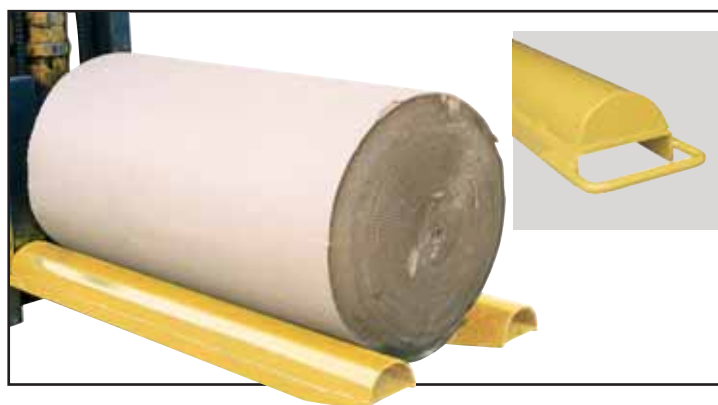

## VESTIL Round Fork Extensions

Lifts delicate long or large objects with your existing fork truck. All steel construction. Includes a non-removable loop that secures unit to fork, and warning and operating stickers. Sold in pairs. Powder coat finish. Color: safety yellow. **SPECIFY LENGTH: A - 54", B - 63".**

**IN STOCK.**

Model Number	Fits Fork Width	(A) 54"		(B) 63"	
		Wt./Pr. Lbs.	Price/Pair	Wt./Pr. Lbs.	Price/Pair
YA-1200	4"W	140	\$468.00	162	\$491.00
YA-1201	5"W	166	482.00	185	505.00



## A. Fork Extensions

Retrofit your existing truck to handle large or long loads. Welded steel. OSHA requires extensions do not exceed the length of the forks by more than 50%. **SPECIFY LENGTH: A - 54", B - 60", C - 72", D - 84", E - 96".** **FACTORY QUICK SHIP – FOB CALIFORNIA, ILLINOIS.**

Model Number	Fits Fork Width	(A) 54"L		(B) 60"L		(C) 72"L		(D) 84"L		(E) 96"L	
		Wt./Pr. Lbs.	Price/Pair	Wt./Pr. Lbs.	Price/Pair	Wt./Pr. Lbs.	Price/Pair	Wt./Pr. Lbs.	Price/Pair	Wt./Pr. Lbs.	Price/Pair
YP-0131	4"	90	\$233.00	100	\$246.00	118	\$290.00	136	\$330.00	150	\$362.00
YP-0132	5"	104	329.00	114	336.00	136	372.00	156	411.00	178	455.00
YP-0133	6"	116	518.00	132	419.00	154	444.00	180	484.00	202	558.00

## B. Replacement Forks

Welded steel forks help you lift long or large objects with your existing fork truck. Should be inspected for cracks and deformation twice a year. Wear at bottom edge will decrease the fork capacity. **SPECIFY LENGTH: A - 36", B - 42", C - 48", D - 60", E - 72".** **FACTORY QUICK SHIP – FOB CALIFORNIA, ILLINOIS.**

Model Number	Size	(A) 36"L		(B) 42"L		(C) 48"L		(D) 60"L		(E) 72"L	
		Wt. Lbs.	Price/Pair	Wt. Lbs.	Price/Pair	Wt. Lbs.	Price/Pair	Wt. Lbs.	Price/Pair	Wt. Lbs.	Price/Pair
XP-0150	1-1/4" x 4"	164	\$313.00	182	\$408.00	202	\$431.00	238	\$481.00	—	—
XP-0151	1-1/2" x 4"	184	519.00	208	406.00	228	447.00	282	515.00	312	\$573.00
XP-0152	1-3/4" x 4"	196	557.00	220	449.00	224	499.00	290	554.00	338	625.00
XP-0153	1-3/4" x 5"	270	744.00	300	583.00	330	619.00	388	722.00	448	855.00

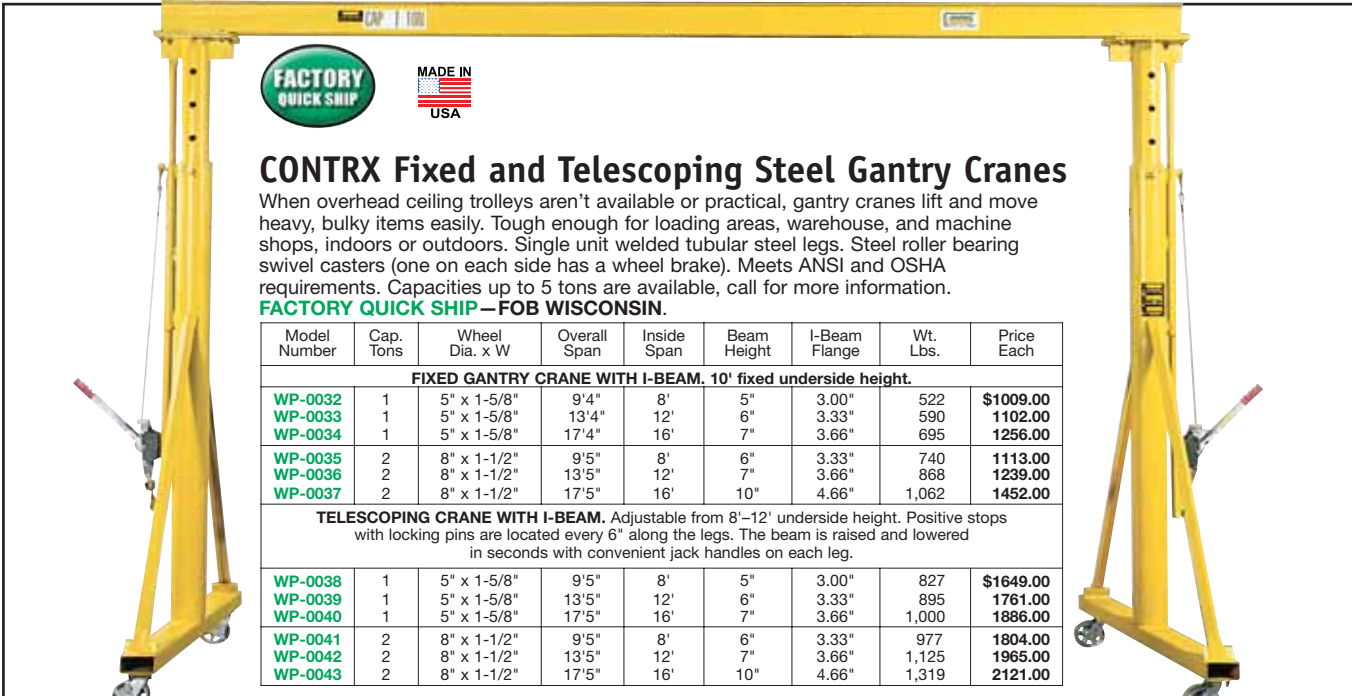

**FACTORY QUICK SHIP** **MADE IN USA**

## CONTRX Fixed and Telescoping Steel Gantry Cranes

When overhead ceiling trolleys aren't available or practical, gantry cranes lift and move heavy, bulky items easily. Tough enough for loading areas, warehouse, and machine shops, indoors or outdoors. Single unit welded tubular steel legs. Steel roller bearing swivel casters (one on each side has a wheel brake). Meets ANSI and OSHA requirements. Capacities up to 5 tons are available, call for more information.

**FACTORY QUICK SHIP – FOB WISCONSIN.**

Model Number	Cap. Tons	Wheel Dia. x W	Overall Span	Inside Span	Beam Height	I-Beam Flange	Wt. Lbs.	Price Each
<b>FIXED GANTRY CRANE WITH I-BEAM. 10' fixed underside height.</b>								
WP-0032	1	5" x 1-5/8"	9'4"	8'	5"	3.00"	522	\$1009.00
WP-0033	1	5" x 1-5/8"	13'4"	12'	6"	3.33"	590	1102.00
WP-0034	1	5" x 1-5/8"	17'4"	16'	7"	3.66"	695	1256.00
WP-0035	2	8" x 1-1/2"	9'5"	8'	6"	3.33"	740	1113.00
WP-0036	2	8" x 1-1/2"	13'5"	12'	7"	3.66"	868	1239.00
WP-0037	2	8" x 1-1/2"	17'5"	16'	10"	4.66"	1,062	1452.00
<b>TELESCOPING CRANE WITH I-BEAM.</b> Adjustable from 8'–12' underside height. Positive stops with locking pins are located every 6" along the legs. The beam is raised and lowered in seconds with convenient jack handles on each leg.								
WP-0038	1	5" x 1-5/8"	9'5"	8'	5"	3.00"	827	\$1649.00
WP-0039	1	5" x 1-5/8"	13'5"	12'	6"	3.33"	895	1761.00
WP-0040	1	5" x 1-5/8"	17'5"	16'	7"	3.66"	1,000	1886.00
WP-0041	2	8" x 1-1/2"	9'5"	8'	6"	3.33"	977	1804.00
WP-0042	2	8" x 1-1/2"	13'5"	12'	7"	3.66"	1,125	1965.00
WP-0043	2	8" x 1-1/2"	17'5"	16'	10"	4.66"	1,319	2121.00



## VESTIL Mobile Jib Cranes

Ideal for use in small shops and large plants, telescoping boom lifts the heaviest loads. Manual hand pump raises boom quickly, while the hand-adjusted release valve lowers boom. Includes rigid lifting hook. Steel construction with painted finish. Rolls on two rigid, two swivel casters. Choose either standard with adjustable 57-1/2" to 84-3/4" L legs or folding space-saver model with 48-1/2" L fixed legs.

**FACTORY QUICK SHIP – FOB INDIANA.**

Model No.	Boom Cap. Lbs.
YA-1805	2,000 @ 36-5/8"L, 20-1/2-76"H
	1,500 @ 40"L, 17-1/2-78"H
	1,000 @ 43-3/4"L, 14-1/2-80"H
	500 @ 47"L, 10-1/2-82"H
YA-1806	4,000 @ 52"L, 22-84"H
	3,000 @ 60"L, 16-3/4-88"H
	2,000 @ 68"L, 11-1/2-92-1/2"H
	1,000 @ 76-1/4"L, 6-1/4-96-3/4"H

Model No.	Description	Wt. Lbs.	Price Ea.
YA-1805	Space-saver crane	100	\$306.00
YA-1806	Standard crane	233	390.00

**FACTORY QUICK SHIP**



**MADE IN USA** **FACTORY QUICK SHIP**

## BEECH Reverse Boom Floor Cranes

Ideal for reaching over, under or around obstacles in cramped production areas. Structural steel, counterweighted design includes an adjustable boom with safety swivel hook. Load sensing, two speed double acting pump on 1,000- and 2,000-lb. models. Also includes: built-in safety overload relief valve, rear-mounted steering handle, needle valve controlled lowering, and replaceable roller-bearing phenolic wheels with grease fittings. Factory tested to 150% of capacity and exceeds ASME PALD-12 and ANSI Z 4535 standards.

**FACTORY QUICK SHIP – FOB OHIO.**

**CRANE OPTIONS**

Model No. **XK-1410**—Optional manual floor lock. ....\$167.00

Model No. **XK-1411**—Power Lift. Available on XK-1415 and XK-1416. Controls lifting operation. Includes 12V deep cycle battery, automatic charger, and pendant control with 20' cord. Wt. 75 lbs. ....\$1387.00

**CRANES**

Model Number	Boom Cap. Lbs.	Overall L x W x H	Load Wheel W x H	Steer Wheel W x H	Wt. Lbs.	Price Each
XK-1414	500 @ 41"L, 22-88"H	49-9/16" x 30-1/2" x 57-1/4"	6" x 2"	4" x 2"	980	\$2256.00
	425 @ 47"L, 17-94"H					
	375 @ 53"L, 13-99"H					
XK-1415	1,000 @ 46"L, 21-91"H	61" x 30-1/2" x 64-3/4"	8" x 2"	5" x 2"	1,735	3605.00
	800 @ 52"L, 16-95"H					
	700 @ 57-7/8"L, 12-99"H					
XK-1416	2,000 @ 52"L, 34-107"H	72" x 30-1/2" x 75-1/4"	8" x 3"	6" x 2"	3,035	5327.00
	1,600 @ 60-1/4"L, 28-114"H					
	1,400 @ 70-1/2"L, 23-120"H					
	1,200 @ 80-3/4"L, 17-128"H					
	1,000 @ 90"L, 10-136"H					

# CONTRX Jib Cranes

## Self-Supporting 360° Jib Cranes

A jib crane that's well-designed, well-constructed at an economical price! Bottom thrust rollers consist of two self-aligning, heavy-duty sealed follower-type bearings. Free-standing unit rotates 360° continuously for maximum head room application. Rolled steel I-beam boom fits most standard hoist trolleys (removable end stops furnished). The head is heavy wall pipe with roller axles and boom connection plates. To assure squareness, assembly is jig-welded. Heavy pipe mast column has top bushing and housing; welded steel base plate and gussets are provided for rigid mounting. **SPECIFY UNDERSIDE HEIGHT: A - 8', B - 10', C - 12'.** Other sizes and capacities available. Call for more information. **FACTORY QUICK SHIP—FOB WISCONSIN.**



Model Number	Capacity Lbs.	Boom Length	Beam Height	Flange Width	(A) 8' HEIGHT		(B) 10' HEIGHT		(C) 12' HEIGHT	
					Wt. Lbs.	Price Ea.	Wt. Lbs.	Price Ea.	Wt. Lbs.	Price Ea.
WP-0015	500	6'	5"	3.00"	381	\$818.00	381	\$859.00	381	\$885.00
WP-0016	500	8'	5"	3.00"	401	\$866.00	401	\$899.00	401	\$920.00
WP-0017	500	10'	5"	3.00"	421	\$891.00	421	\$920.00	421	\$954.00
WP-0018	500	12'	6"	3.33"	585	\$1119.00	585	\$1165.00	585	\$1194.00
WP-0019	500	14'	8"	4.00"	695	\$1299.00	695	\$1346.00	695	\$1501.00
WP-0020	500	16'	8"	4.00"	734	\$1382.00	734	\$1410.00	734	\$1450.00
WP-0021	1,000	6'	6"	3.33"	520	\$1083.00	520	\$1129.00	520	\$1219.00
WP-0022	1,000	8'	6"	3.33"	545	\$1137.00	545	\$1152.00	545	\$1227.00
WP-0023	1,000	10'	8"	4.00"	798	\$1425.00	798	\$1604.00	798	\$1576.00
WP-0024	1,000	12'	8"	4.00"	835	\$1415.00	835	\$1610.00	835	\$1616.00
WP-0025	1,000	14'	8"	4.00"	923	\$1538.00	923	\$1604.00	923	\$1670.00
WP-0026	1,000	16'	10"	4.66"	1,058	\$1832.00	1,058	\$1879.00	1,058	\$1915.00
WP-0027	2,000	8'	8"	4.00"	814	\$1503.00	814	\$1641.00	814	\$1674.00
WP-0028	2,000	10'	8"	4.00"	891	\$1595.00	891	\$1702.00	891	\$1834.00
WP-0029	2,000	12'	10"	4.66"	1,108	\$1985.00	1,108	\$2119.00	1,108	\$2257.00

## Heavy-Duty, Minimum Deflection 360° Jib Cranes

Rugged construction offers years of trouble-free service. Complete assembly is supported by adjustable tension bolts to permit field adjustments and ensure even pressure of the roller on pipe. Side thrust roller unit is mounted in heavy-duty machine carriage weldment. I-beam shaped rolled steel boom. Two heavy side reinforced plates balance stress. Steel pipe pillar is reinforced with heavy base plates, allowing it to withstand bending stress without undue deflection. Heavy steel capping has provision for bearing mount. Girder contains proper mount provisions for connection to jib crane and has removable end stops. **SPECIFY UNDERSIDE HEIGHT: A - 10', B - 12', C - 14'.** Other sizes available. **SELECTED MODELS FACTORY QUICK SHIP.** All FOB WISCONSIN.

Model Number	Capacity Lbs.	Boom Length	Beam Height	Flange Width	(A) 10' HEIGHT		(B) 12' HEIGHT		(C) 14' HEIGHT	
					Wt. Lbs.	Price Ea.	Wt. Lbs.	Price Ea.	Wt. Lbs.	Price Ea.
WP-834	2,000	8'	10"	4.66"	931	\$1955.00	987	\$2215.00	1,043	\$2274.00
WP-835	2,000	10'	10"	4.66"	967	\$2146.00	1,024	\$2342.00	1,442	\$2815.00
WP-836	2,000	12'	10"	4.66"	1,382	\$2538.00	1,482	\$2787.00	1,581	\$3062.00
WP-837	2,000	14'	12-3/8"	6.50"	1,505	\$2684.00	1,666	\$3139.00	1,775	\$3435.00
WP-838	2,000	16'	12-3/8"	6.50"	1,617	\$2911.00	1,726	\$3227.00	1,835	\$3725.00
WP-839	2,000	18'	16"	7.00"	2,166	\$498.00	2,218	\$3950.00	2,464	\$3862.00
WP-840	2,000	20'	16"	7.00"	2,251	\$3670.00	2,418	\$4154.00	2,544	\$4056.00
WP-841	4,000	8'	10"	4.66"	1,333	\$2360.00	1,442	\$2635.00	1,552	\$2823.00
WP-842	4,000	10'	12-3/8"	6.50"	1,437	\$2483.00	1,546	\$2775.00	1,655	\$2950.00
WP-843	4,000	12'	16"	7.00"	2,013	\$2982.00	2,178	\$3243.00	2,224	\$3584.00
WP-844	4,000	14'	16"	7.00"	2,098	\$3107.00	2,099	\$3839.00	2,304	\$3839.00
WP-845	4,000	16'	21"	6.50"	2,553	\$3435.00	2,778	\$3658.00	2,976	\$4032.00
WP-846	4,000	18'	24"	7.00"	3,124	\$4676.00	3,265	\$4875.00	3,406	\$5146.00
WP-847	4,000	20'	24"	7.00"	3,248	\$5094.00	3,388	\$5178.00	4,124	\$5733.00
WP-848	6,000	8'	12-3/8"	6.50"	1,985	\$2879.00	2,110	\$3037.00	2,236	\$3112.00
WP-849	6,000	10'	16"	7.00"	2,098	\$2966.00	2,190	\$3127.00	2,316	\$3245.00
WP-850	6,000	12'	16"	7.00"	2,749	\$4370.00	2,851	\$4515.00	2,933	\$4581.00
WP-851	6,000	14'	21"	6.50"	3,069	\$4691.00	3,210	\$4872.00	3,351	\$4975.00
WP-852	6,000	16'	24"	7.00"	3,738	\$5108.00	3,946	\$5493.00	4,154	\$5731.00
WP-853	6,000	18'	24"	9.00"	4,419	\$5643.00	4,627	\$6073.00	4,835	\$6185.00
WP-854	6,000	20'	24"	9.00"	4,963	\$6633.00	5,214	\$6989.00	5,465	\$7158.00



Selected Models

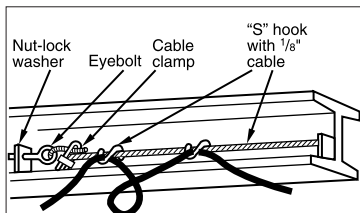

**TIGHT WIRE KIT (TAGLINE).** Keeps hoist power cord from dropping.

Model No. WP-855 .....\$61.40

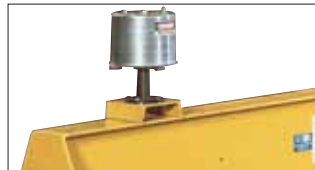

**COLLECTOR RING ASSEMBLY FOR FULL 360° ELECTRIFICATION.**

Provides power to electric hoist without twisting power cord.

Model No. WP-856 .....\$532.00

### ANCHOR BOLT KITS

Model No. XK-1085—4 bolts.  
3/4" dia. x 31"L. Wt. 24 lbs. ....\$80.60  
Model No. XK-1086—6 bolts.  
1" dia. x 31"L. Wt. 60 lbs. ....\$140.00  
Model No. XK-1087—8 bolts.  
1" dia. x 40"L. Wt. 90 lbs. ....\$197.00  
Model No. XK-1088—12 bolts.  
1" dia. x 40"L. Wt. 140 lbs. ....\$273.00

**PAPER TEMPLATE.** Assists in proper placement of anchor bolts in concrete.

Model No. XK-1089.....\$77.40

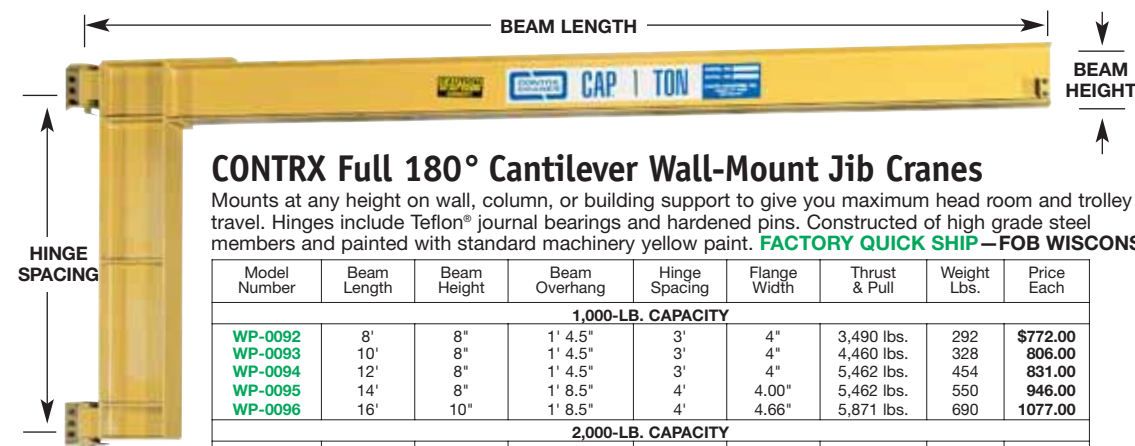

## CONTRX Full 180° Cantilever Wall-Mount Jib Cranes

Mounts at any height on wall, column, or building support to give you maximum head room and trolley travel. Hinges include Teflon® journal bearings and hardened pins. Constructed of high grade steel members and painted with standard machinery yellow paint. **FACTORY QUICK SHIP—FOB WISCONSIN.**

Model Number	Beam Length	Beam Height	Beam Overhang	Hinge Spacing	Flange Width	Thrust & Pull	Weight Lbs.	Price Each
<b>1,000-LB. CAPACITY</b>								
WP-0092	8'	8"	1' 4.5"	3'	4"	3,490 lbs.	292	\$772.00
WP-0093	10'	8"	1' 4.5"	3'	4"	4,460 lbs.	328	806.00
WP-0094	12'	8"	1' 4.5"	3'	4"	5,462 lbs.	454	831.00
WP-0095	14'	8"	1' 8.5"	4'	4.00"	5,462 lbs.	550	946.00
WP-0096	16'	10"	1' 8.5"	4'	4.66"	5,871 lbs.	690	1077.00
<b>2,000-LB. CAPACITY</b>								
WP-0097	8'	8"	1' 8.5"	4'	4.00"	4,827 lbs.	310	\$835.00
WP-0098	10'	10"	1' 8.5"	5'	4.66"	4,986 lbs.	545	988.00
WP-0099	12'	10"	1' 8.5"	5'	4.66"	6,085 lbs.	595	1041.00
WP-0100	14'	10"	1' 8.5"	5'	4.66"	7,204 lbs.	645	1119.00
WP-0101	16'	12-3/8"	1' 8.5"	6'	6.50"	7,106 lbs.	745	1308.00



Model Number	Beam Length	Beam Height	Beam Overhang	Hinge Spacing	Flange Width	Thrust & Pull	Wt. Lbs.	Price Each.
<b>1,000-LB. CAPACITY</b>								
WP-0102	8'	6"	1' 3"	2' 9"	3.33"	3,531 lbs.	190	\$710.00
WP-0103	10'	6"	1' 6"	3' 0"	3.33"	4,352 lbs.	220	739.00
WP-0104	12'	6"	2' 0"	3' 9"	3.33"	4,082 lbs.	250	769.00
WP-0105	14'	6"	2' 0"	4' 6"	3.33"	4,094 lbs.	280	799.00
WP-0106	16'	6"	2' 0"	5' 6"	3.33"	3,891 lbs.	311	825.00
<b>2,000-LB. CAPACITY</b>								
WP-0107	8'	6"	1' 3"	2' 9"	3.33"	6,591 lbs.	190	\$718.00
WP-0108	10'	6"	1' 6"	3' 0"	3.33"	8,090 lbs.	220	779.00
WP-0109	12'	6"	2' 0"	3' 9"	3.33"	7,557 lbs.	250	814.00
WP-0110	14'	8"	2' 0"	4' 6"	4"	7,692 lbs.	360	906.00
WP-0111	16'	8"	2' 3"	5' 6"	4"	7,301 lbs.	403	942.00

## CONTRX Over-Braced Wall-Mount Jib Cranes



Ideal for crowded areas because this crane mounts within inches of any overhead obstruction. Single tie rods with threaded ends allow easy field adjustment. 180° hook rotation.

Constructed of high grade steel hinges and beams with Teflon® journal bearing hinges and hardened pins. Painted one coat standard machinery yellow.

**FACTORY QUICK SHIP—FOB WISCONSIN.**

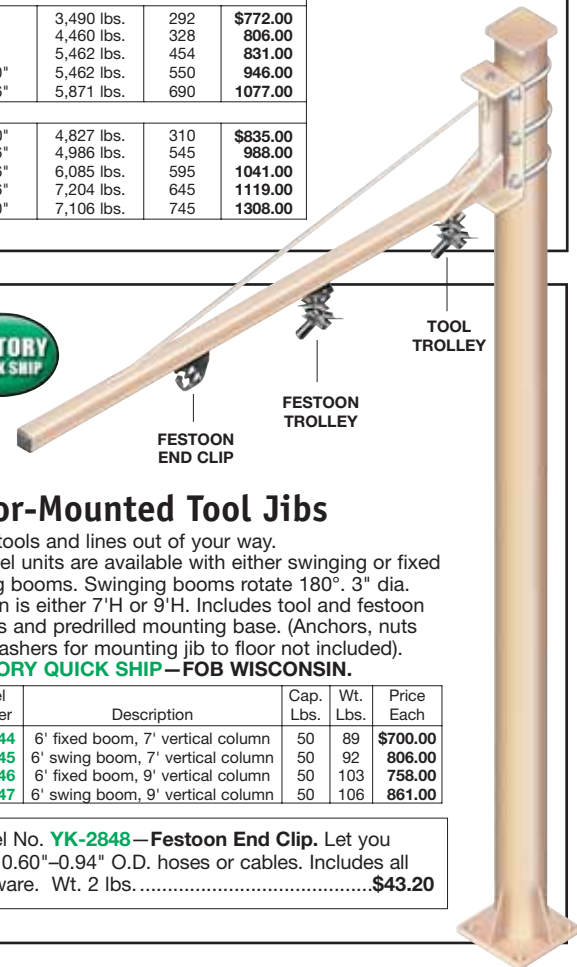
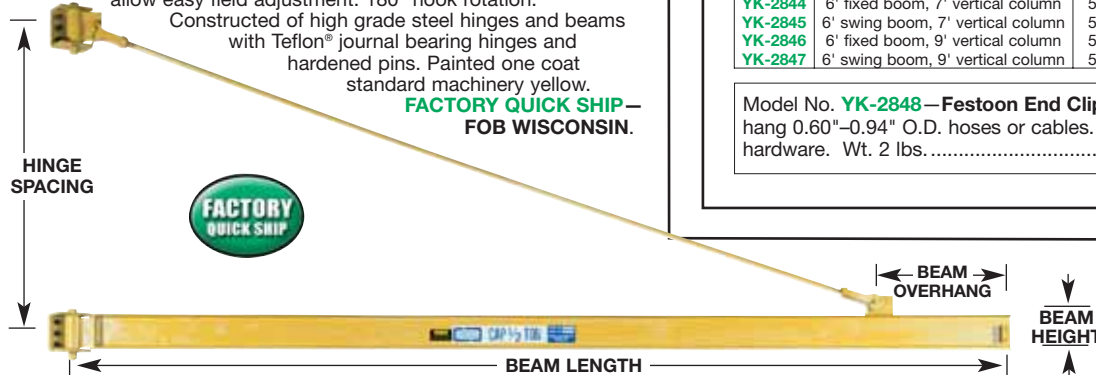

## Floor-Mounted Tool Jibs

Keep tools and lines out of your way. All-steel units are available with either swinging or fixed 6' long booms. Swinging booms rotate 180°. 3" dia. column is either 7'H or 9'H. Includes tool and festoon trolleys and predrilled mounting base. (Anchors, nuts and washers for mounting jib to floor not included).

**FACTORY QUICK SHIP—FOB WISCONSIN.**

Model Number	Description	Cap. Lbs.	Wt. Lbs.	Price Each
YK-2844	6' fixed boom, 7' vertical column	50	89	\$700.00
YK-2845	6' swing boom, 7' vertical column	50	92	806.00
YK-2846	6' fixed boom, 9' vertical column	50	103	758.00
YK-2847	6' swing boom, 9' vertical column	50	106	861.00

Model No. **YK-2848—Festoon End Clip.** Let you hang 0.60"–0.94" O.D. hoses or cables. Includes all hardware. Wt. 2 lbs. ....\$43.20

## CONTRX Do-It-Yourself Jib Crane Kits

Economical kits let you turn existing I-beams and tie bars into a working jib crane. Fittings include high-grade, structural steel top, bottom and end assemblies. Equipped with Teflon® journal bearings and lower thrust washer. (Column boom and tie bar not included). **SPECIFY OVERALL LENGTH UP TO 20' AND HEIGHT OF I-BEAM. FACTORY QUICK SHIP—FOB WISCONSIN.**

Model No.	Capacity	Wt. Lbs.	Price Ea.
<b>FOR FULL CANTILEVER (2 "B" fittings)</b>			
XP-0088	1/2 ton	65	\$333.00
XP-0089	1 ton	80	354.00
<b>FOR OVERBRACED WALL BRACKET (1 "A", 1 "B", 1 "C", fitting)</b>			
XP-0090	1/2 ton	79	\$416.00
XP-0091	1 ton	94	472.00

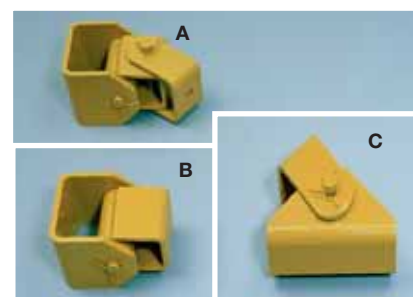

NOTE: Call for information on larger sizes.

# Cranes & Trolleys

**SPANCO Industrial Bridge Cranes**

Free-standing bridge cranes reduce operator fatigue when operating hoists, balancers, or manipulators continuously over multiple shifts. 100 to 1 weight-to-force ratio of the enclosed track provides an ergonomic weight advantage that eases movement yet ensures accurate load positioning. 23' runways have a 20' support center; 33' runways have a 17' and 13' support center. Columns meet AISC specifications. Includes bridge, runway trusses, support columns, header beams and hanger clamps, end stops, hoist trolley, end trucks, flat-wire festooning for runway and bridge, and installation instructions. Hoist and lag bolts not included. FOB PENNSYLVANIA.

**CUSTOM SIZES, LIGHT-DUTY AND MONORAIL VERSIONS AVAILABLE. CALL FOR INFORMATION.**

Bridge Length	Runway Length	Festoon Stor. Ext.	500-LB. CAPACITY				1000-LB. CAPACITY				2000-LB. CAPACITY						
			Model Number	Overall Height	Overall Width	Wt. Lbs.	Price Each	Model Number	Overall Height	Overall Width	Wt. Lbs.	Price Each	Model Number	Overall Height	Overall Width	Wt. Lbs.	Price Each
10'	23'	12"	WV-1800	13'11"	11'6"	1379	\$5199.00	WV-1806	14'3"	11'6"	1598	\$5989.00	WV-1812	14'7"	11'7"	2352	\$6939.00
10'	33'	24"	WV-1801	13'11"	11'6"	1974	6995.00	WV-1807	14'3"	11'6"	2296	7677.00	WV-1813	14'7"	11'7"	3391	9037.00
15'	23'	12"	WV-1802	13'11"	16'6"	1574	5379.00	WV-1808	14'3"	16'6"	1822	6315.00	WV-1814	14'9"	16'7"	2870	7616.00
15'	33'	24"	WV-1803	13'11"	16'6"	2229	7520.00	WV-1809	14'3"	16'6"	2585	8249.00	WV-1815	14'9"	16'7"	4073	10182.00
20'	23'	12"	WV-1804	14'1"	21'6"	2012	5706.00	WV-1810	14'3"	21'6"	2227	6598.00	WV-1816	14'9"	21'7"	3164	8030.00
20'	33'	24"	WV-1805	14'1"	21'6"	2856	7887.00	WV-1811	14'3"	21'6"	3159	8446.00	WV-1817	14'9"	21'7"	4462	11076.00

NOTE: To determine overall length, add runway length and festoon storage extension.

**COFFING® Trolleys**

Sealed, precision bearing type, for rugged use. Sizes through five tons have lifetime-lubricated ball bearings. Heavy steel sideplates reinforced by heavy castings. Alloy cast iron wheels. Fits I-Beam as noted; measured vertically through the beam. FOB NORTH CAROLINA.

Model Number	Cap. Tons	Fits Beam Height	Fits Flange Width	Wt. Lbs.	Price Each
XC-0142	2	6"-18"	3.33"-8.045"	52	\$298.00
XC-0143	3	8"-20"	4.00"-8.045"	60	482.00
XC-0145	5	10"-24"	4.60"-8.05"	96	725.00

**JET Trolleys**

Dependable trolleys are designed for various H- and I-Beams and are quickly adjustable to fit wide flange beams also. For use on straight or curved tracks and can be installed or removed at any point along the track. Constructed of heavy steel plate with built-in bumpers for added protection. Double-sealed ball bearings ensure long rolling life. Include a cast hand chain wheel, hard chain guide and operating chain (8' for 1/2-ton models, 10' for 1-10-ton units).

**SELECTED MODELS IN STOCK.** Others FOB TENNESSEE, WASHINGTON.

Model No.	Cap. (tons)	Fits Beam Ht.	Fits Flange Width	A	B	Price Ea.
XC-708	1/2	4"-19"	2-1/2"-8"	4"	8-3/8"	\$111.00
XC-709	1	4"-19"	3"-8"	4-1/2"	10"	141.00
XC-710	1-1/2	4"-19"	3-1/4"-8"	5-1/4"	11-7/8"	218.00
XC-711	2	4"-19"	3-1/4"-8"	5-1/4"	11-7/8"	234.00
XC-712	3	5"-19"	4"-8"	6-1/2"	13-5/8"	497.00
XC-713	5	5"-19"	4-5/8"-8"	7-7/8"	15"	764.00

GEARED TROLLEYS ALSO AVAILABLE. CALL FOR INFORMATION.

**STOCK**  
Selected Models



# Trolleys & Beam Clamps

**MADE IN USA**



## VESTIL Heavy-Duty Die-Lifting Tongs

Long arms lift tall objects. For use with hoists and other overhead lifting devices. Made of steel. Meets ASME B30.20 standards. FOB INDIANA.

Model Number	Cap. Lbs.	Max. Opening	Wt. Lbs.	Price Each
XL-0090	2000	20"	37	\$857.00
XL-0091	2500	28"	58	1091.00
XL-0092	3000	38"	101	1306.00

**FACTORY QUICK SHIP**





## MaxX® Magnetic Lifters

Magnetic force grabs, carries and releases flat, round or curved steel loads over 1" thick very quickly with only one operator. Tested to a safety factor of x3. On/off rotor reduces residual magnetism, making piece lifted easy to remove once rotor is turned off. Permanent magnet eliminates fear of magnetic failure in the event of a power failure. **FACTORY QUICK SHIP—FOB MICHIGAN.**

Model Number	Flat Items Cap. Lbs.	Round Items		Overall W x D x H	Wt. Lbs.	Price Each
		Cap. Lbs.	Cap. Dia.			
XD-2950	275	110	12"	3 x 4-3/4 x 5-1/2"	11	\$557.00
XD-2951	550	220	12"	3 x 7 x 5-1/2"	11	725.00
XD-2952	1100	440	15-3/4"	4 x 9-1/2 x 7-1/2"	33	1078.00
XD-2953	2200	880	17-3/4"	5 x 13-1/4 x 9"	77	1867.00
XD-2954	3300	1320	19-3/4"	6-1/2 x 16-1/4 x 11-1/2"	154	2443.00
XD-2955	4400	1760	23-3/4"	7-1/4 x 17-1/4 x 12-1/2"	209	3307.00

**MADE IN USA**

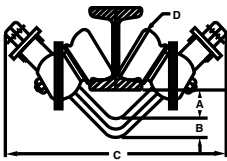
**STOCK Selected Models**

## COLUMBUS MCKINNON Low-Headroom Trolleys

High-quality rolled steel construction stands up to hard use. Compact, rugged design is 50% lighter than conventional trolleys. Ball bearing wheels provides 5 times greater wear. Is able to negotiate radius curves as tight as 7-10", depending on capacity. Dial-Fit™ die-cast aluminum collars fit a wide range of I-beams and flat or wide beams. **FOR XD-1110, SPECIFY CAPACITY: A - 1/4 ton, B - 1/2 ton. SELECTED MODELS IN STOCK.** Others FOB VIRGINIA.

Model Number	Cap. Tons	Fits Beam Height	Fits Flange Width	Mounting Clearance	Suspension Pin Dia.	Overall Depth	Wheel Dia.	Wt. Lbs.	Price Each
XD-1110	1/4 or 1/2	4"-12"	2-5/8"-5-1/8"	1-3/4"	3/4"	5-7/8"	2-3/4"	12	\$162.00
XD-1111	1	4"-12"	2-5/8"-5-1/8"	1-5/8"	7/8"	6"	2-3/4"	13	198.00
XD-1112	2	6"-15"	3-1/4"-5-5/8"	2"	1-1/8"	7-1/2"	3-1/2"	28	322.00
XD-1113	3	8"-18"	4"-6-1/4"	2-5/8"	1-1/8"	8-1/16"	3-1/2"	35	563.00

\*Dimensions given are for the minimum S-beam and will vary with larger beams.

**FACTORY QUICK SHIP**

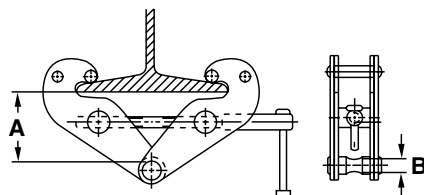
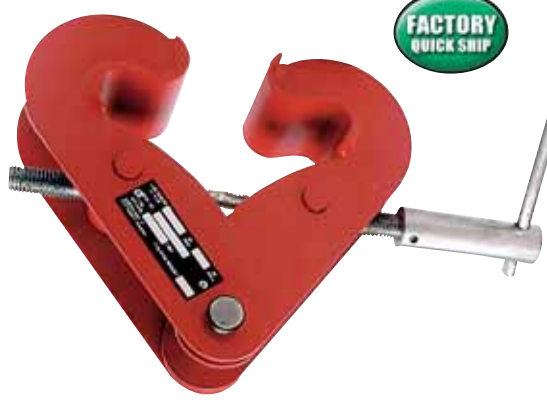
## JET Beam Clamps

To reduce flange beam stress, the stationary I-beam clamp is designed for non-moving or non-rolling loading applications. Perfect for areas with low headroom. May be used for lifting or positioning H- or I-beams. Suspension bar accepts hoist hook. Mounts easily with threaded handle. Meets ASME B-30.20 standards. **FACTORY QUICK SHIP—FOB TENNESSEE, WASHINGTON.**

Model Number	Cap. Tons	Fits Flange Width	Headroom	Suspension Pin Dia.	Price Each
ZP-0044	1	3"-9"	5.3"	.8"	\$75.00
ZP-0045	2	3"-9"	5.3"	.8"	79.50
ZP-0046	3	3.9"-9.8"	6.3"	.87"	124.50
ZP-0047	5	5"-10.6"	6.5"	1.10"	141.00

# Hoists



## COFFING® Industrial-Duty Compact Hoists



Smooth lifting hoist includes long life chain and built-in, multiple disc brake for positive load holding. Limiting clutch prevents damage caused by overload. Adjustable upper and lower limit switches regulate load travel. Also includes: 24-volt push-button control, rugged aluminum housing, 15-foot power cord, machine-hardened alloy steel gears, safety latch hooks, and chain container. Meets the industry's H3 high-duty cycle and all applicable ANSI standards. Lifetime warranty. Made in the U.S.A. **SPECIFY: A** - 115/230V, 1-phase, **B** - 230/460V, 3-phase. **FACTORY QUICK SHIP—FOB CALIFORNIA OR NORTH CAROLINA.**

Cap. Lbs.	Motor H.P.	Speed FPM	Head-room	Wt. Lbs.	10' LIFT—6' P.B. CORD		15' LIFT—11' P.B. CORD		20' LIFT—16' P.B. CORD	
					Model No.	Price Ea.	Model No.	Price Ea.	Model No.	Price Ea.
500	1/4	16	18"	60	<b>WV-3625</b>	\$1590.00	<b>WV-3631</b>	\$1745.00	<b>WV-3637</b>	\$1764.00
500	1/2	32	18"	60	—	—	<b>WV-3632</b>	1975.00	<b>WV-3638*</b>	1859.00
1,000	1/2	16	18"	74	<b>WV-3627</b>	1687.00	<b>WV-3633</b>	1975.00	<b>WV-3639</b>	1859.00
1,000	1	32	18"	87	<b>WV-3628</b>	1813.00	<b>WV-3634</b>	1899.00	<b>WV-3640*</b>	1987.00
2,000	1	16	18"	74	<b>WV-3629</b>	1882.00	<b>WV-3635</b>	1970.00	<b>WV-3641</b>	2055.00
4,000	1	8	21-3/4"	99	<b>WV-3630</b>	2232.00	<b>WV-3636</b>	2439.00	<b>WV-3642</b>	2650.00

\*Not available in A - 115/230V

## JET SS Series Single-Speed Electric Chain Hoist

Engineered to operate under tough conditions, these hoists feature totally enclosed steel plate construction with durable powder coat finish. Lifetime lubricated gear trains offer quiet operation and low maintenance without periodic oil changes. Tough, heavy-duty fan cooled motor features class E insulation for 3-phase, class B insulation for 1-phase. Reliable electromagnetic DC brake eliminates the need for gap adjustment, absorbs inertia, and holds the load even if power is interrupted. Other features include: quick connect wiring for low voltage, 24V NEMA 2-button control with strain relief, simple upper and lower limit buttons. Thermal overload protection for 1-phase; reverse phase protection for 3-phase. Drop forged safety hooks, 16-1/2' power cable with quick connects, and heavy-duty chain container. H3 rating with 25% duty cycle for 1-phase and 30% duty cycle for 3-phase. Proof tested, certified and meets OSHA and ANSI B30.16 standards. Two-year warranty. **FOB TENNESSEE, WASHINGTON.**



Cap. Lbs.	Motor H.P.	Speed FPM	Head-room	8' LIFT—8' P.B. CORD			15' LIFT—13' P.B. CORD			20' LIFT—18' P.B. CORD		
				Model No.	Wt. Lbs.	Price Ea.	Model No.	Wt. Lbs.	Price Ea.	Model No.	Wt. Lbs.	Price Ea.
<b>1-PHASE, 115/230V — PREWIRED AT 230V</b>												
1,000	7/8	19.7	20-3/16"	<b>XD-3550</b>	108	\$1675.00	<b>XD-3551</b>	112.5	\$1734.00	<b>XD-3552</b>	114.5	\$1789.00
2,000	1-3/4	19.7	24-7/16"	<b>XD-3553</b>	170	1972.00	<b>XD-3554</b>	174	2029.00	<b>XD-3555</b>	181	2417.00
4,000	1-3/4	9.8	28-1/8"	<b>XD-3556</b>	181	2414.00	<b>XD-3557</b>	196	2478.00	<b>XD-3558</b>	205	2434.00
6,000	1-3/4	6.6	31-1/2"	<b>XD-3559</b>	216	2814.00	<b>XD-3560</b>	231.5	3038.00	<b>XD-3561</b>	244.5	3162.00
10,000	1-3/4	4.9	30-11/16"	<b>XD-3562</b>	236	3621.00	<b>XD-3563</b>	235.5	3945.00	—	—	—
<b>3-PHASE, 230/460V — PREWIRED AT 230V</b>												
1,000	1-1/5	31.5	20-3/16"	<b>XD-3564</b>	99	\$1493.00	<b>XD-3565</b>	103.5	\$1548.00	<b>XD-3566</b>	106	\$1610.00
2,000	2-1/7	24.8	24-7/16"	<b>XD-3567</b>	158.5	1644.00	<b>XD-3568</b>	163	1699.00	<b>XD-3569</b>	170	1766.00
4,000	2-1/7	12.4	28-1/8"	<b>XD-3570</b>	174	2074.00	<b>XD-3571</b>	185	2179.00	<b>XD-3572</b>	194	2266.00
6,000	2-1/7	8.3	31-1/2"	<b>XD-3573</b>	205	2724.00	<b>XD-3574</b>	205	2858.00	<b>XD-3575</b>	233.5	2990.00
10,000	2-1/7	6.2	30-11/16"	<b>XD-3576</b>	225	3564.00	<b>XD-3577</b>	244.5	3766.00	<b>XD-3578</b>	264.5	3968.00



## COFFING® Heavy-Duty Dual Brake Hoists



Ideal for use in paper mills, textile, industrial and food processing plants. Meets all applicable ANSI standards with 30-minute dual voltage motor. Adjustable upper and lower limit switches. Pre-set overload clutch device protects against damage caused by reverse phasing. Dual braking system features a multiple direct acting motor disc brake and a safety mechanical load brake operates even when power is turned off. 10' standard lift. Also includes: five pocket load sheave, 24V push button station, safety latch hooks, and chain container. Lifetime warranty. Meets ANSI standards. **SPECIFY: A** - 115/230 volt, 1-phase, **B** - 230/460 volt, 3-phase. **FACTORY QUICK SHIP—FOB CALIFORNIA OR NORTH CAROLINA.**

Cap. Lbs.	Motor H.P.	Speed FPM	Head-room	Wt. Lbs.	10' LIFT—6' P.B. CORD		15' LIFT—11' P.B. CORD		20' LIFT—16' P.B. CORD	
					Model No.	Price Ea.	Model No.	Price Ea.	Model No.	Price Ea.
500	1/4	16	17"	100	<b>WV-1310</b>	\$1999.00	<b>WV-1323</b>	\$2078.00	<b>WV-1336</b>	\$2154.00
500	1/2	32	17"	108	<b>WV-1311</b>	2109.00	<b>WV-1324</b>	2187.00	<b>WV-1337</b>	2263.00
500	1	64	17"	116	<b>WV-1312</b>	2391.00	<b>WV-1325</b>	2470.00	<b>WV-1338</b>	2547.00
1,000	1/4	9	17"	110	<b>WV-1313</b>	2219.00	<b>WV-1326</b>	2296.00	<b>WV-1339</b>	2375.00
1,000	1/2	16	17"	106	<b>WV-1314</b>	2266.00	<b>WV-1327</b>	2369.00	<b>WV-1340</b>	2447.00
1,000	1	32	17"	118	<b>WV-1315</b>	2542.00	<b>WV-1328</b>	2621.00	<b>WV-1341</b>	2700.00
2,000	1/2	8	18"	116	<b>WV-1316</b>	2364.00	<b>WV-1329</b>	2568.00	<b>WV-1342</b>	2706.00
2,000	3/4	12	17"	114	<b>WV-1317</b>	2486.00	<b>WV-1330</b>	2572.00	<b>WV-1343</b>	2662.00
2,000	1	16	17"	118	<b>WV-1318</b>	2542.00	<b>WV-1331</b>	2633.00	<b>WV-1344</b>	2719.00
4,000	3/4	6	19"	127	<b>WV-1319</b>	2961.00	<b>WV-1332</b>	3121.00	<b>WV-1345</b>	3280.00
4,000	1	8	19"	133	<b>WV-1320</b>	3102.00	<b>WV-1333</b>	3263.00	<b>WV-1346</b>	3420.00
6,000	1	5	23-1/4"	200	<b>WV-1321</b>	3824.00	<b>WV-1334</b>	4056.00	<b>WV-1347</b>	4523.00
6,000	3**	*16	27-3/8"	347	<b>WV-1322</b>	4814.00	<b>WV-1335</b>	5053.00	<b>WV-1348</b>	5306.00

NOTE: P.B. - Push-button. \*Double chained units. \*\*Only available in (B) 230/460 volt, 3-phase, single speed.

**TWO SPEED OPTION (3-PHASE ONLY).** Slow speed to 1/3 of speed for all models except 3-ton, 16 FPM.

Model No. **WV-1349\***—Adder to above prices .....\$659.00

\*Not available on 3HP units.

# Hoists

## COFFING® Portable Electric Chain Hoists



With a compact hoist weighing only 20 lbs. or less you can lift up to 1,000 lbs. For a variety of light-duty lifting jobs, high-strength, lightweight aluminum housing makes hoist easy to move from one workstation to another. 115V, AC, 1/3 HP motor with low-voltage control station for safe, one-handed operation. If power is interrupted, you still have positive braking. Duty cycle: 15 secs. on, 60 secs. off (20%) at max. speed. Meets OSHA/ANSI Standards. Machine hardened alloy steel gears with lifetime lubrication. Safety latch hooks and chain container included. Made in the U.S.A. 9-3/4" L x 5-1/4"W x 4-1/4"H. **IN STOCK.**

Model Number	Rated Load	Std. Lift Height	Speed FPM	Unit Voltage	Wt. Lbs.	Price Each
<b>WP-0389</b>	500 lbs.	10'	12	115 V	16	\$1095.00
<b>WP-0390</b>	500 lbs.	20'	12	115 V	16	1181.00
<b>WP-0391</b>	1,000 lbs.	10'	6	115 V	20	1263.00

NOTE: Push-button drop is approximately 3' less than lift.



## COLUMBUS MCKINNON Portable Electric Chain Hoists

Popular chain hoists are ideal in plants where sterile, clean conditions are a must. Lifetime lubrication means there is no oil to change and no drips to clean up. Major maintenance is completed in minutes, making this one of the easiest hoists to maintain. Rigid-duty cycle meets ANSI B30.16 and has a 30-minute duty rated motor and exclusive CM hoist-alloy long life chain. Also includes: adjustable upper and lower enclosed geared limit switches, magnetic and regenerative non-asbestos dual braking system, and load protector. All operated from a Nema 4 weatherproof, 115V, snap action control station. Chain container included. **SPECIFY: A - 115V, 1-phase, B - 230/460V, 3-phase. SELECTED MODELS IN STOCK.** Others FOB VIRGINIA.

Capacity	Motor HP	Speed FPM	Head-Room	Wt. Lbs.	10' LIFT—6' P.B. CORD		15' LIFT—11' P.B. CORD		20' LIFT—16' P.B. CORD	
					Model Number	Price Each	Model Number	Price Each	Model Number	Price Each
500 lbs.	1/4	16	16-1/2"	57	<b>WK-1155</b>	\$2129.00	<b>WK-1163</b>	\$2223.00	<b>WK-1171</b>	\$2317.00
500 lbs.	1/2	32	16-1/2"	65	<b>WK-1156</b>	2238.00	<b>WK-1164</b>	2332.00	<b>WK-1172</b>	2427.00
1,000 lbs.	1/2	16	16-1/2"	64	<b>WK-1157</b>	2431.00	<b>WK-1165</b>	2525.00	<b>WK-1173</b>	2620.00
2,000 lbs.	1	16	17-5/8"	117	<b>WK-1158</b>	2717.00	<b>WK-1166</b>	2836.00	<b>WK-1174</b>	2949.00
2,000 lbs.	2	32	18-1/4"	121	<b>*WK-1159</b>	3782.00	<b>*WK-1167</b>	3902.00	<b>*WK-1175</b>	4014.00
4,000 lbs.	1	8	24-1/2"	136	<b>WK-1160</b>	3337.00	<b>WK-1168</b>	3557.00	<b>WK-1176</b>	3759.00
4,000 lbs.	2	16	25-1/8"	136	<b>*WK-1161</b>	4259.00	<b>*WK-1169</b>	4479.00	<b>*WK-1177</b>	4680.00
6,000 lbs.	1	5.5	26-1/8"	161	<b>WK-1162</b>	4096.00	<b>WK-1170</b>	4451.00	<b>WK-1178</b>	4735.00

\*Only available in 3-phase

## WAMPLER Air-Operated Hoists

Your operation will not shut down if power goes out because these strong hoists run without electricity. Air-operated rotary vane type motor runs cool, allowing continuous operation. Automatic disc brake holds loads securely. Standard models have pull chain to give operator full control over the load. Add optional pendant control for remote operation. Standard top and bottom hooks.

**SPECIFY LIFT: A - 9.8', B - 19.7'. FOB KENTUCKY.**



Model Number	Ton Capacity	Air PSI	Speed FPM	Air CFM	No. Falls	Wt. Lbs.	(A) 9.8' LIFT Price Ea.	(B) 19.7' LIFT Price Ea.
<b>XK-1666</b>	0.25	87	59	56	1	41	\$1933.00	\$2193.00
<b>XK-1667</b>	0.5	87	34	58	1	41	1993.00	2257.00
<b>XK-1668</b>	1	87	17	58	2	58	2159.00	2723.00
<b>XK-1669</b>	1	87	19	63	1	75	2972.00	3361.00

### OPTIONAL PENDANT SWITCH

Model No. <b>XK-1673</b> —For hoist (A) 9.8' lift.....	\$470.00
Model No. <b>XK-1674</b> —For hoist (B) 19.7' lift.....	\$575.00

## COFFING® Light-Duty Electric Hoists



Lightweight hoists are ideal for lifting 500 lbs. up to 10'. Built-in disc brake for positive load holding and spotting. 115V, 60 Hz, AC, 1/8 HP motor can be used anywhere without special wiring. 6 min./hr. motor rating. Upper and lower limit switches prevent accidental hook overtravel. Latch-type hooks and 6' push-button cable included. 500-lb. rated models double-chained. Limited lifetime warranty. Made in the U.S.A. **SELECTED MODELS IN STOCK.** Others FOB NORTH CAROLINA.



Model Number	Rated Load	Speed FPM	Wt. Lbs.	Price Each
<b>ELECTRIC WIRE ROPE HOIST</b>				
<b>WC-297</b>	500 lbs.	10	21	\$765.00
<b>ELECTRIC CHAIN HOISTS</b>				
<b>WC-319*</b>	300 lbs.	16	23	\$812.00
<b>WC-321</b>	500 lbs.	8	26	879.00

\*Model WC-319 includes brake.

# Hoists & Festooning



XC-1269                      XC-1024                      XC-1032

## JET Hand Chain Hoists

Compact design is ideal for close quarter, low-ceiling applications. Excellent load spotting capabilities and completely enclosed automatic brake system combine for positive load control. Wide throat safety hooks have heavy-duty latches and swivel 360° for easy rigging. Proof-tested and certified to OSHA and ANSI/ASME standards. Custom lifts available, call for information. **SPECIFY LIFT: A - 10', B - 15', C - 20'.** **SELECTED MODELS IN STOCK.** Others FOB TENNESSEE, WASHINGTON.

Model Number	Cap. Ton.	Head Room	(A) 10' LIFT		(B) 15' LIFT		(C) 20' LIFT	
			Lbs.	Price Ea.	Lbs.	Price Ea.	Lbs.	Price Ea.
XC-1267	1/2	10-3/4"	22	\$202.00	28	\$226.00	31	\$276.00
XC-1268	1	11-3/4"	27	227.00	35	253.00	38	303.00
XC-1269	1-1/2	14-3/4"	37	393.00	48	499.00	55	499.00
XC-1270	3	21"	53	654.00	57	702.00	72	793.00
XC-1271	5	24-1/2"	97	869.00	149	1071.00	149	1238.00

## JET Ratchet Pullers

Crank handle moves load up or down, keeping hands away from messy, oily chains. Pull direction is controlled with one flip of the self-locking thumb lever. Lightweight stamped steel design. Meets OSHA and ANSI/ASME HST-3M standards. **SPECIFY LIFT: A - 5', B - 10', C - 15', D - 20'. A - 5' AND C - 15' ARE IN STOCK.** Others FOB TENNESSEE, WASHINGTON.

Model Number	Cap. Tons	Wt. Lbs.	(A) 5' LIFT	(B) 10' LIFT	(C) 15' LIFT	(D) 20' LIFT
			Price Ea.	Price Ea.	Price Ea.	Price Ea.
XC-1023	1/2	11	\$169.00	\$172.00	—	—
XC-1024	3/4	16	242.00	245.00	\$287.00	\$276.00
XC-1025	1-1/2	26	306.00	308.00	353.00	353.00
XC-1026	3	44	464.00	471.00	545.00	541.00

## WESCO® Economy Hand Hoists

Here's an effective, low-cost way to maneuver loads. Lightweight, portable units lift and position loads up to 3 tons. Hoists feature steel frames and hardened load chains that offer positive load control. **SPECIFY LIFT: B - 10', D - 20'.** **SELECTED MODELS IN B - 10' ARE IN STOCK.** Others FOB PENNSYLVANIA.

Model Number	Cap. Tons	Hdmm.	(B) 10' LIFT		(D) 20' LIFT	
			Lbs.	Price Ea.	Lbs.	Price Ea.
XC-1030	1/2	9.50"	20	\$135.00	32	\$180.00
XC-1031	1	10.60"	24	157.00	36	198.00
XC-1032	2	15.00"	43	248.00	60	281.00
XC-1033	3	18.50"	52	267.00	118	330.00

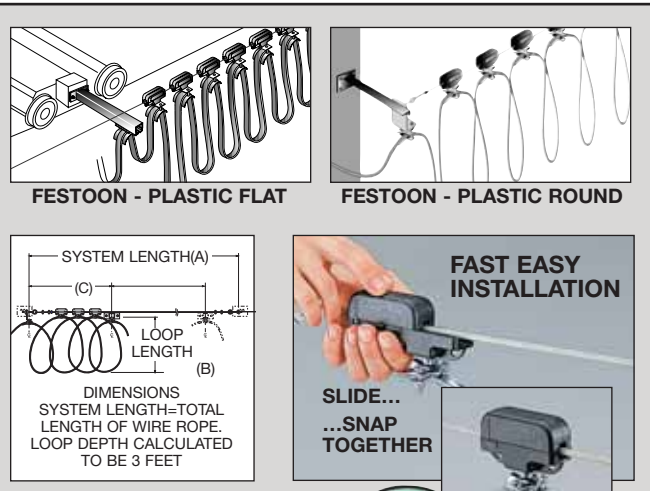

## HUBBELL Festoon Systems For Hoists



Designed for limited travel distance and speed applications. Frequently used with lighter weight cables than steel track systems. Fiberglass-reinforced nylon trolleys with zinc-plated steel cable or hose saddles are easy to install. All kits are shipped complete with all components and hardware (electrical cable & connectors not included). System must be supported at each end. **FACTORY QUICK SHIP—FOB WISCONSIN.**

Model Number	Overall Length (A)	Travel Length (B)	Minimum Storage Space (C)	Cable Length*	Intermediate Trolley Qty.	Wt. Lbs.	Price Each
<b>FLAT ELECTRICAL CABLE</b>							
YK-2863	23'	20'	25"	24'	3	21	\$266.00
YK-2864	27'	24'	28"	29'	4	22	282.00
YK-2865	33'	29'	32"	35'	5	23	297.00
YK-2866	38'	34'	35"	41'	6	24	311.00
YK-2867	43'	39'	39"	47'	7	25	288.00
YK-2868	49'	44'	42"	52'	8	26	340.00
YK-2869	54'	49'	45"	58'	9	27	354.00
YK-2870	59'	54'	51"	60'	10	28	369.00
<b>0.60"-0.94" O.D. ROUND CABLE</b>							
YK-2871	20'	17'	25"	26'	3	21	\$248.00
YK-2872	25'	22'	28"	32'	4	22	275.00
YK-2873	30'	26'	32"	38'	5	23	285.00
YK-2874	35'	31'	35"	45'	6	24	296.00
YK-2875	39'	35'	39"	51'	7	25	304.00
YK-2876	44'	39'	42"	60'	8	26	315.00
YK-2877	56'	50'	51"	72'	10	28	338.00
YK-2878	72'	65'	66"	88'	13	30	370.00
<b>0.95"-1.25" O.D. ROUND CABLE</b>							
YK-2879	20'	17'	25"	26'	3	21	\$513.00
YK-2880	25'	22'	28"	32'	4	22	570.00
YK-2881	30'	26'	32"	38'	5	23	629.00
YK-2882	35'	31'	35"	45'	6	24	684.00
YK-2883	39'	35'	39"	51'	7	25	742.00
YK-2884	44'	39'	42"	60'	8	26	830.00
YK-2885	56'	50'	51"	72'	10	28	916.00
YK-2886	72'	65'	66"	88'	13	30	1092.00

\*Length of festooned cable. If additional cable is required for hook up to machine or junction box, add to above.

MADE IN USA

## CONTRX Wire Rope Festooning

**IDEAL FOR HOIST AND JIB CRANE INSTALLATION.**

Unique method of handling your power feed cables or hoses for hoist, machinery and small cranes. Carriers handle round cables. Use on any I-beam. The power cord festoons when the hoist is in the retracted position. Complete kit includes cable, trolleys and hardware. Power cord not included. **FACTORY QUICK SHIP—FOB WISCONSIN.**

Model No.	Working Travel	Wire Dia.	Wt. Lbs.	Price Ea.
WC-822	8-12'	9/16-3/4"	11 lbs.	\$123.00
WC-823	13-16'	9/16-3/4"	14 lbs.	132.00
WC-824	17-21'	9/16-3/4"	16 lbs.	138.00

NOTE: This system is for round cables. Call us for flat cable models.

# Slings

## ROCKFORD RIGGING Nylon Web Slings



Durable, flexible slings are economical answers to your lifting problems. Shock-proof and abrasion-resistant. Strong units lift thousands of pounds. **FACTORY QUICK SHIP—FOB ILLINOIS.**

### HIGHER CAPACITY SLINGS AVAILABLE.

#### HOW TO SELECT AND ORDER

Select sling width. Determine sling length (Base 3' plus additional feet). Check capacity and type (eye and eye; endless; reversed eye or combination with hardware). Then order by Model No. — Additional Feet add Suffix "A".

#### EXAMPLE-TYPES OF HITCHES

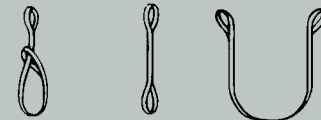

#### CHOKER VERTICAL BASKET

SAVE TIME AND EXPENSE—HANDLE BUNDLED OR PALLETED LOADS EASILY.



COMBINATION HARDWARE END TERMINALS						
SPECIFY TOTAL LENGTH: Add "A" to model for additional feet.						
Model Number	Sling Width	No. Of Plys	Capacity (Lbs.)		Base Price 3' Sling Choker Hdw.	Addtl. Per Foot
			Choker	Basket		
YC-1275	2"	1	1,760	4,400	\$52.70	\$2.04
YC-1276	2"	2	3,520	8,800	54.50	3.06
YC-1278	3"	1	2,640	6,600	107.00	2.90
YC-1279	3"	2	5,280	13,200	75.10	5.40
YC-1281	4"	1	3,520	8,800	102.00	2.63
YC-1282	4"	2	6,560	16,400	105.00	5.00
YC-1287	6"	1	5,280	13,200	287.00	4.00
YC-1288	6"	2	9,840	24,600	293.00	8.50



REVERSED EYE TYPE								
SPECIFY TOTAL LENGTH: Add "A" to model for additional feet.								
Model Number	Sling Width	Eye Lgth.	No. Of Plys	Capacity (Lbs.)			Base Price 3' Sling	Addtl. Per Foot
				Choker	Vertical	Basket		
YC-1290	2"	12"	1	2,880	3,600	7,200	\$21.80	\$3.66
YC-1291	2"	12"	2	4,640	5,800	11,600	26.80	5.10
YC-1292	2"	12"	2	6,720	8,400	16,800	36.00	5.80
YC-1293	3-1/2"	14"	1	4,640	5,800	11,600	31.50	4.32
YC-1294	3-1/2"	14"	2	6,720	8,400	16,800	37.20	7.30
YC-1295	3-1/2"	14"	3	9,600	12,000	24,000	48.00	13.70
YC-1297	6"	18"	1	8,000	10,000	20,000	48.70	8.80
YC-1298	6"	18"	2	12,800	16,000	32,000	61.20	15.80
YC-1299	6"	18"	3	17,280	21,600	43,200	125.00	23.30
YC-1300	6"	18"	2	16,000	20,000	40,000	71.30	14.00
YC-1301	6"	18"	3	21,200	26,500	53,000	176.00	21.00
YC-1302*	6"	18"	4	27,200	34,000	68,000	313.00	31.50

\*Length of sling no less than 8'.



EYE AND EYE TYPE							
SPECIFY TOTAL LENGTH: Add "A" to model for additional feet.							
Model Number	Sling Width	No. Of Plys	Capacity (Lbs.)			Base Price 3' Sling	Addtl. Per Foot
			Choker	Vertical	Basket		
YC-1303	1"	1	880	1,100	2,200	\$7.50	\$0.63
YC-1304	1"	2	1,760	2,200	4,400	8.80	0.98
YC-1305	1"	2	2,480	3,100	6,200	10.50	1.44
YC-1306	1"	4	4,960	6,200	12,400	30.80	3.11
YC-1307	1-3/4"	1	1,520	1,900	3,800	10.80	1.60
YC-1308	1-3/4"	2	3,040	3,800	7,600	11.80	2.75
YC-1309	1-3/4"	3	4,560	5,700	11,400	20.30	4.30
YC-1311	1-3/4"	4	6,080	7,600	15,200	25.50	5.50
YC-1312	2"	1	1,760	2,200	4,400	10.30	0.91
YC-1313	2"	2	3,520	4,400	8,800	12.00	1.31
YC-1314	2"	2	4,960	6,200	12,400	15.00	2.16
YC-1315	2"	4	9,920	12,400	24,800	46.70	5.40
YC-1316	3"	1	2,640	3,300	6,600	14.80	1.42
YC-1317	3"	2	5,280	6,600	13,200	17.20	2.80
YC-1318	3"	2	7,040	8,800	17,600	25.00	3.50
YC-1319	3"	4	14,080	17,600	35,200	73.50	8.23
YC-1320	4"	1	3,520	4,400	8,800	19.70	1.73
YC-1321	4"	2	6,560	8,200	16,400	23.00	3.57
YC-1322	4"	2	8,800	11,000	22,000	28.60	5.00
YC-1323	4"	3	13,200	16,500	33,000	76.60	9.30



ENDLESS TYPE							
SPECIFY TOTAL LENGTH: Add "A" to model for additional feet.							
Model Number	Sling Width	No. Of Plys	Capacity (Lbs.)			Base Price 3' Sling	Addtl. Per Foot
			Choker	Vertical	Basket		
YC-1336	1"	1	1,760	2,200	4,400	\$5.90	\$0.91
YC-1337	1"	1	2,480	3,100	6,200	7.40	1.15
YC-1338	1"	2	4,960	6,200	12,400	15.00	2.47
YC-1340	1-3/4"	1	3,040	3,800	7,600	9.50	1.75
YC-1341	1-3/4"	2	6,080	7,600	15,200	19.30	3.25
YC-1342	1-3/4"	3	9,120	11,400	22,800	40.10	6.50
YC-1343	2"	1	3,520	4,400	8,800	10.50	1.75
YC-1344	2"	1	4,960	6,200	12,400	13.30	2.25
YC-1345	2"	2	9,920	12,400	24,800	27.20	4.75
YC-1346	2"	3	14,880	18,600	37,200	44.30	7.00
YC-1347	3"	1	5,280	6,600	13,200	14.60	2.75
YC-1348	3"	1	7,440	9,300	18,600	18.50	4.00
YC-1349	3"	2	14,080	17,600	35,200	37.00	8.30
YC-1350	3"	3	21,120	26,400	52,800	63.20	12.30
YC-1351	4"	1	7,040	8,800	17,600	22.10	3.95
YC-1352	4"	1	9,920	12,400	24,800	28.00	5.30
YC-1353	4"	2	17,600	22,000	44,000	57.30	10.50
YC-1354	4"	3	27,520	34,400	68,800	78.70	15.80

## ROCKFORD RIGGING Heavy-Duty Alloy Chain Slings



Designed to withstand years of punishment and abuse. Quality, grade 80 alloy-steel assembled chain slings are proof tested and tagged per OSHA specifications. 60° angle capacity varies with angle use. 5'L chain is standard. Choose either grab or sling hook. **SPECIFY TOTAL LENGTH CHAIN DESIRED. FACTORY QUICK SHIP—FOB ILLINOIS.**

GRAB HOOK Model No.	SLING HOOK Model No.	Chain Size	Cap. Lbs.	Price Ea. 5' Lgth	Additional Foot
WF-2230	WF-2233	1/4"	5,625	\$151.00	\$8.00
WF-2231	WF-2234	3/8"	11,425	220.00	9.30
WF-2232	WF-2235	1/2"	19,475	313.00	15.10

Add AW to model number for additional feet. Also available in 5/8", 3/4" and 7/8" chain size. Call for information.

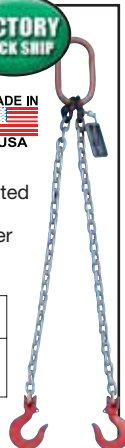

## DD SLING Independent Wire Rope Center Slings



Mechanically spliced 6" x 19" "flemish" slings give you 7-1/2% more strength than standard wire rope slings. Conform to OSHA standard 1910.184 and ANSI B30.9-1971. **SPECIFY LENGTH DESIRED. 5' minimum. FOB WISCONSIN.**



CHOKER BASKET

Model Number	Rope Dia.	Choker Hinge Cap. Lbs.	Basket Hinge Cap. Lbs.	Price Ea. 5' Base	Additional Foot
YF-2075	1/4"	900	2,200	\$9.80	\$1.14
YF-2076	3/8"	1,800	5,000	13.00	1.37
YF-2077	1/2"	3,200	8,800	17.50	1.79
YF-2078	5/8"	5,000	13,600	25.80	2.42
YF-2079	3/4"	7,200	19,400	39.20	3.26

Add AW to model number for additional feet.

# Drum Handlers



**STOCK**  
Selected Models

MADE IN USA

## MECO Drum Dollies

Moves 30-, 55-gallon or overpack drums smoothly, easily and without lifting. All-welded rigid construction stands up to tough use. Cross bars extend from caster to caster, adding stability and durability. Choose either tough steel or chemical-resistant poly wheels. Ships boxed via small package carrier. Orange enamel finish. **SELECTED MODELS IN STOCK.** Others FOB NEBRASKA.

DRUM DOLLIES							
Model Number	For Drum Cap. Gal.	Overall Height	Inside Dia.	Wheel Type	Capacity Lbs.	Wt. Lbs.	Price Each
<b>XD-105</b>	55	5-1/4"	23-1/4"	Steel	900	24	<b>\$72.40</b>
<b>XD-106</b>	55	5-1/4"	23-1/4"	Poly	700	22	<b>56.80</b>
<b>XD-210</b>	55	5-1/2"	23-1/4"	Steel	1,200	25	<b>76.50</b>
<b>XD-109</b>	55	5-1/2"	23-1/4"	Rubber	900	22	<b>54.80</b>
<b>XD-107</b>	30	5-1/4"	19-1/4"	Steel	900	21	<b>70.10</b>
<b>XD-108</b>	30	5-1/4"	19-1/4"	Poly	700	19	<b>51.00</b>

OVERPACK DRUM DOLLIES							
Model Number	Height	Inside Dia.	Wheel Type	Capacity Lbs.	Wt. Lbs.	Price Each	
<b>XD-422</b>	5-1/2"	27"	Poly	900	24	<b>\$61.80</b>	
<b>XD-423</b>	5-1/2"	27"	Steel	1,200	28	<b>80.00</b>	

DOUBLE DRUM DOLLIES							
Model Number	For Drum Cap. Gal.	Dimensions L x W x H	Wheel Type	Capacity Lbs.	Wt. Lbs.	Price Each	
<b>XD-485</b>	30	40" x 19-1/2" x 6-3/4"	4" Polyolefin	1,800	45	<b>\$162.00</b>	
<b>XD-486</b>	55	48" x 23-1/2" x 6-3/4"	4" Polyolefin	1,800	51	<b>172.00</b>	



MADE IN USA

**FACTORY QUICK SHIP**

## ENPAC Spill Control Dolly

Take your drum right to the dispensing area with this mobile dolly. Free-rolling casters ease movement of heavy 55-gallon drums. Spill dolly well is constructed of rust- and corrosion-resistant polyethylene material. Well capacity is 10 gallons. 600-lb. load-bearing capacity. 34.5" dia. x 9"H. **FACTORY QUICK SHIP—FOB OHIO.**

Model No. **WD-463**—Dolly. Wt. 25 lbs..\$**169.00**  
 Model No. **YD-464**—Optional Handle ..\$**41.00**



**STOCK**

MADE IN USA



## Plastic Drum Dollies

**A. RUBBERMAID® UNIVERSAL DRUM DOLLY.** 500-lb. capacity dolly holds 55-gallon drums and other containers. All plastic, professional-grade construction stands up to tough use. High lip surrounds the completely enclosed surface to contain any leaks or spills. 24-3/8" dia., 7-3/8"H with (5) 3" replaceable casters. Sold in multiples of 2, priced per dolly. **IN STOCK.**

Model No. **ZD-1638**—Wt. 17 lbs.....\$**120.00/ea.**

**B. DIXIE PLASTIC DRUM DOLLIES.** Heavy-duty, rust-resistant plastic dolly works well indoors or outdoors. Complete enclosed top. 600-lb. capacity. Includes (4) 3" swivel casters. **SPECIFY COLOR: BK - Black, BL - Blue, GN - Green, RD - Red, WH - White, YL - Yellow. SELECTED MODELS IN BL - BLUE AND BK - BLACK ARE IN STOCK.** Others **FACTORY QUICK SHIP—FOB SOUTH CAROLINA.**

Model Number	Overall Dia.	Cap. Gal.	Wt. Lbs.	Price Each
<b>XC-3110</b>	17"	15	4-1/2	<b>\$85.00</b>
<b>XC-3111</b>	18"	20	4-3/4	<b>87.40</b>
<b>XA-2090</b>	20"	30	11	<b>93.40</b>
<b>XC-3112</b>	21"	35	5-1/2	<b>92.30</b>
<b>XA-2091</b>	24"	55	12	<b>102.00</b>

**ALSO AVAILABLE IN:**

<b>BK- BLACK</b>	<b>BL- BLUE</b>	<b>GN- GREEN</b>
<b>WH- WHITE</b>	<b>YL- YELLOW</b>	



SHOWN WITH OPTIONAL HANDLE

**STOCK**

MADE IN USA

## DUTRO Triangular Drum Dolly

Low-profile design combines with unique triangle shape to make this dolly very easy to load and unload. No lifting or forklifts required, just tilt drum and roll the dolly underneath. 3/8" thick steel construction supports up to 700 lbs. Rolls over door thresholds and floor cracks with little effort. 3" casters are bolted on for easy replacement. Ships unassembled via small package carrier. **IN STOCK.**

Model No. **XR-1737**—Wt. 16 lbs. ....\$**78.20**  
 Model No. **XR-1738**—Optional Handle ..\$**62.70**

# Drum Handlers



**STOCK**

## VESTIL Low-Profile Drum Trucks

Handles practically any sized steel, plastic or fiber container safely and efficiently. Versatile unit features extra platform supports to hold 30- or 55-gal. drums as well as two 5-gal. pails and other smaller containers. Includes a removable handle with built-in bung nut wrench, seal remover, and manual drum tilter. 26"W x 16"D straddle. 1/2"H cradle has a beveled front edge and rolls on (2) 6" x 2" rigid wheels and (1) 3" x 1" swivel caster. All-welded steel construction with powder coat safety yellow finish.

**IN STOCK.**

Model Number	Cap. Lbs.	Caster Type	Wt. Lbs.	Price Each
YP-2001	1000	Mold-on rubber	38	\$125.00
YP-2002	1200	Steel	40	141.00
YP-2003	1200	Poly on steel	38	125.00
YP-2004	1200	Phenolic	38	152.00



**STOCK**

MADE IN  
USA

## MECO Standard Drum Trucks

Cradles and locks drums securely during movement up or down inclines. Forged steel toes slide under the drum for easy loading or unloading of pallets. Heavy-duty all-welded truck features tubular handle welded to square heavy-walled tubing. Welded cradle and axle provide extra load support. Simply remove four screws to easily replace drum hook. 1,000-lb. capacity. Equipped with 10" x 2-1/2" wheels. 24-1/2"W x 59"H overall. Model XD-151 includes unique drum chime hook to handle both steel and fiber drums.

**IN STOCK.**

Model No. XD-151—Mold-on rubber wheels. Wt. 71 lbs.....	\$274.00
Model No. XD-354—All steel wheels. Wt. 74 lbs.....	\$285.00
Model No. XD-369—Polyolefin wheels. Wt. 50 lbs.....	\$213.00



## MECO Economy Drum Truck

Economical truck features sliding chime hook that adapts for 30- and 55-gallon drums between 30" and 42"H. All double-welded construction. Toes are all steel, wedge-type and beveled for easy loading. Heavy 1-1/4" diameter steel frame. 1,000-lb. capacity. 10" x 2-1/4" polyolefin wheels. FOB NEBRASKA.

Model Number	Overall W x H	Wt. Lbs.	Price Each
XD-405	25-1/2" x 61"	50	\$159.00

## WESCO® 4-Wheel Drum Trucks

Safely load and unload drums onto or off pallets with this handy drum truck. Load rests on 4 wheels reducing operator fatigue—truck rolls without operator support. Kick stand allows unit to stand alone. 25"W x 61"H units support 1,000 lbs. 16-1/4"W at nose. All wheels have grease fittings.

**IN STOCK.**



**STOCK**

MADE IN  
USA

Model No. XP-434—Mold-on rubber 10" & 6" rigid wheels. Wt. 79 lbs.....	\$370.00
Model No. XP-435—Polyolefin 10" & 6" rigid wheels. Wt. 61 lbs.....	\$323.00
Model No. XP-436—Mold-on rubber 10" rigid & 6" swivel casters. Not recommended for loading and unloading drums from pallets. Wt. 83 lbs.....	\$445.00

**FACTORY  
QUICK SHIP**

Selected Models

## WESCO® Self-Standing Drum Trucks

Self-standing feature lets truck stay vertical when not in use. Spring-loaded, floating axle cushions the load. Also includes replaceable nose prongs and 10" x 2-1/2" wheels with 1" roller bearings and grease fittings. 1000-lb. capacity. Dimensions: 22"W x 61"H at handles. 16-1/2"W nose. **SELECTED MODELS FACTORY QUICK SHIP.** All FOB PENNSYLVANIA.

Model No. XP-431—Non-marking mold-on wheels. Wt. 74 lbs.....	\$336.00
Model No. XP-432—Polyolefin wheels. Wt. 59 lbs.....	\$293.00

### LARGER NOSE PRONGS AND BELT.

For handling any style 55- to 95-gal. plastic or steel drums.

Model No. XP-433—	Wt. 84 lbs.....	\$437.00
-------------------	-----------------	----------



# Drum Handlers



## MORSE Drum Karriers™

One person does it all! Self-locking safety stops prevent accidental handle movement. Tilt locks secure drum in vertical and horizontal position. Carry open or closed, steel, fiber or polyethylene drums up to 800 lbs. All-steel, welded construction. 8" hard poly wheels with roller bearings; 4" hard polyolefin rear swivel caster. Leverage adjusts clearance from 5-1/8" to 11-1/2". Clearances are 25-1/2" inside, 34-1/4" outside. Lower handle will not release unless operator deliberately opens safety locks. **IN STOCK.**

Model No. <b>XD-101*</b> —55- or 30-Gal. Steel. Wt. 106 lbs. ....	\$705.00
Model No. <b>XD-103</b> —21"-23" Fiber or 55-gal. Steel. Wt. 106 lbs. ....	\$753.00
Model No. <b>XD-356</b> —55-gal. Steel or 34"-36" Polyethylene. Wt. 106 lbs. ....	\$651.00
Model No. <b>XD-0020</b> —Saddle Adapter for 30-gal. steel drums. Wt. 24 lbs. ....	\$131.00

\* If purchasing a 30-gal. cap. Drum Karrier™, you must purchase the adapter (XD-0020).



## WESCO® 4-Wheel Drum Cradles

Now you can move full drums to dispensing stations safely and easily. Handles both 55- and 30-gal. standard drums. 1,000-lb. capacity. Spigot can be rotated to the bottom, allowing drum to be picked up from any side. 24"W x 56-1/2"H steel tubing frame. 10" x 2-1/2" and 6" x 2" wheels with grease fittings. **IN STOCK.**

**CRADLE WITH DISPENSING ROLLERS AND CHIME HOOK.** Chime hook fits beneath spigot, no need to disengage. Non-sparking polyolefin rollers.

Model No. <b>XP-437</b> —Mold-On Rubber Wheels. Wt. 70 lbs. ....	\$279.00
Model No. <b>XP-438</b> —Semi-Steel Wheels. Wt. 92 lbs. ....	\$280.00
Model No. <b>XP-439</b> —Polyolefin Wheels. Wt. 70 lbs. ....	\$253.00

**CRADLE WITH OVERSIZE NOSE PRONGS AND BELT SYSTEM.**

Model No. <b>XP-440</b> —Mold-On Rubber Wheels. Wt. 83 lbs. ....	\$410.00
--	----------



## MORSE Drum Spotter

Economical drum handler lifts and moves a 55-gal. drum from any 6"H pallet, skid or containment basin. Innovative design utilizes leverage and strong gas springs to lift 800-lb. rimmed steel, fiber, or plastic drums. Here's how it works: position handler so hooks are below drum rim, pull down handle to engage hooks, activate hand-operated release to raise drum handle and disengage steel hooks. Straddle legs fit into corner letting you reach a drum in any pallet location. Rolls on (2) 6" polyolefin roller-bearing load wheels and (2) 5" rear swivel casters. **IN STOCK.**

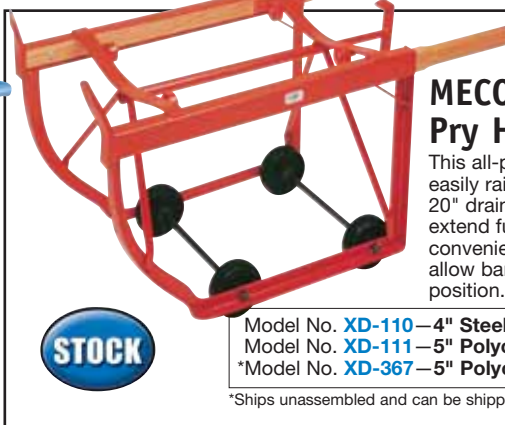

## MECO Pry Handle Drum Cradles

This all-purpose drum stand allows you to easily raise 15-, 30-, or 55-gallon drums to a 20" drain height. 1,000-lb. capacity. Handles extend fully to 64" and retract into frame for convenient storage. Rollers on top of frame allow barrel to be rotated while in a horizontal position. **IN STOCK.**

Model No. <b>XD-110</b> —4" Steel Wheels. Wt. 51 lbs. ....	\$206.00
Model No. <b>XD-111</b> —5" Polyolefin Wheels. Wt. 48 lbs. ....	\$194.00
*Model No. <b>XD-367</b> —5" Polyolefin Wheels. Wt. 56 lbs. ....	\$224.00

\*Ships unassembled and can be shipped via small package carrier (boxed).



## MECO Drum Cradles

The most economical rack for draining and storing drums. One person can load with safety and ease. Drum can be tilted from vertical to horizontal drain position without back breaking effort. Will easily handle and support 55-gallon drums up to 1,000 lbs. Available with two 4" steel support wheels and two 2-1/2" steel swivel casters or two 5" polyolefin support wheels and two 3" polyolefin swivel casters. **IN STOCK.**

*Model No. <b>XD-112</b> —19-1/2" Drain Height. Steel wheels. Wt 35 lbs. ....	\$149.00
Model No. <b>XD-424</b> —20" Drain Height. Poly wheels. Wt. 34 lbs. ....	\$138.00
Model No. <b>XD-355</b> —36" Handle. ....	\$21.60

\*Ships via small package carrier. NOTE: Cradle without wheels is available, call for information.



# Drum Handlers



CHAIN-OPERATED  
MODEL SHOWN

## MORSE Drum Kontrol-Karriers™

Efficiently dumps fully and partially loaded drums. Alloy chain tightener shields the pawl from impact and has large teeth for greater holding power. Positive tilt lock holds drum in position; release lock to control tilt when pouring load. Chain-operated unit includes 6' loop chain. FOB NEW YORK.

Drum Type	Cap. Lbs.	CHAIN OPERATED			MANUALLY OPERATED		
		Model Number	Wt. Lbs.	Price Each	Model Number	Wt. Lbs.	Price Each
55- or 30-gal. steel	800	YD-126*	71	\$628.00	YD-129	46	\$319.00
55- or 30-gal. steel & 21"-23" dia. fiber	800	YD-128*	71	628.00	YD-130	46	387.00
55-gal. steel	1500	YD-362	85	799.00	—	—	—
55-gal. steel	2000	YD-255	165	1763.00	—	—	—

\*If purchasing the 30-gallon Kontrol-Karrier™, you need to purchase the adapter (YD-0021).

Model No. YD-0021—Adapter for 30-gal. steel drums. ....\$130.00



## Drum Lifting Chains

Performs multiple operations from up-right and side angle lifting to dumping and double leg maneuvers. Heavy-duty chain with hooks on each end. Fits 15-, 30-, and 55-gallon steel drums. 1,100-lb. capacity. One-year warranty. **IN STOCK.**

Model No. YA-0240—  
Wt. 8 lbs. ....\$75.20



## MORSE Automatic Drum Mover

Built for heavy-duty handling of 55-gallon steel drums with loads up to 1,000 lbs. Lets the operator reach over a quantity of vertically stacked drums, select, lift and move the drum to any area including those with limited access. Balanced to stand vertical on top of the drum or floor for easy pick-up. Includes simple, positive grab mechanism and pads that assist in aligning while gripping the drum. FOB NEW YORK.

Model No. XD-240—  
Wt. 50 lbs. ....\$228.00



Selected Models

## Drum Lifting Hooks

Dependable hook raises drums in horizontal position. 1,100-lb. capacity steel model consists of 1/2" rods attached to malleable iron hooks. For 55-gallon steel drums only. Spark-resistant bronze model is ideal for potentially hazardous situations. **SELECTED MODELS IN STOCK.** Others FOB NEW YORK.

Model No. ZP-693—Steel. Wt. 5 lbs. ....\$40.50  
Model No. ZD-170—Bronze non-sparking. Wt. 6 lbs. ....\$88.10



Selected Models



## MECO Drum Caddies

Lets you handle drums with your lift truck quickly and easily. Quickly attaches to 30- or 55-gallon drums. Eliminate possible back injury due to manual handling of heavy drums. Features 1" dia. pivot rollers and 5" x 3" fork pockets. Painted safety orange enamel. Ships UPS boxed. **SELECTED MODEL IN STOCK.** Other FOB NEBRASKA.

Model No.	Cap. Gal.	Wt. Lbs.	Price Ea.
XD-248	30	18	\$78.00
XD-249	55	20	79.80



## Drum Lift

All-steel unit handles open- or closed-head, loaded 55-gal. steel drums. Drums remain upright during lift for easy loading into overpacks. Works with overhead hoist or forklift hook. 770-lb. capacity. **IN STOCK.**

Model No. YD-3040—  
Wt. 20 lbs. ....\$71.80

# Drum Handlers



**EAGLE-GRIP™ AUTOMATICALLY CLAMPS DRUM CHIME.**



**OPTIONAL SCALE ACCURATELY WEIGHS DRUMS.**

## Easy Lift™ Economy Drum Transporter

Ideal for placing drums on or off pallets, floor scales, or spill containment units. Eagle-Grip™ automatic clamping head attaches to any chimed drum, lifting it 20" off floor. Overall width: 39-1/2"; overall length: 35". 800-lb. capacity. 1000-lb. x 1-lb. capacity. **FACTORY QUICK SHIP—FOB DELAWARE.**

Model No. **WV-2701**—Easy Lift™ Drum Transporter. Wt. 330 lbs.....**\$2342.00**

### OPTIONS

Model No.	Description	Price Ea.
<b>WV-2696</b>	8" Locking Wheels Instead of 5" Standard	<b>\$144.00</b>
<b>WV-2699</b>	Double Clamping Mechanism Instead of Single	<b>617.00</b>
<b>WV-2700</b>	Spark Resistant Jaws and Belt Base	<b>206.00</b>
<b>WV-2693</b>	Scale with Stainless Steel Indicator	<b>2573.00</b>
<b>WV-2694</b>	Intrinsically Safe Scale w/Non-Sparking Jaws & Belt	<b>3809.00</b>



## HERCULES® Strong-Arm® Fiber/Steel Drum Handler

Let the powerful jaws on this drum handler do the work for you! Handles drums with chime and closure ring design that are strong enough to support the weight of their own contents. Works on open or closed drums, fiber or steel drums, and even plastic drums if the drum lip can support the weight of the drum's contents. Will not work on welded closed top steel drums. Choose single- or double-drum units. One person can easily install and operate this unit. Drum handler mounts quickly to forks and stays in place with turn-down bolts. 37" H overall. **SELECTED MODELS IN STOCK.** Others FOB MINNESOTA.

**STOCK**  
Selected Models



Easy 4-step operation:

- (1) Approach drum with mast of truck tilted slightly forward.
- (2) Jaws open as you lower unit onto drum.
- (3) Jaws lock on drum as you tilt back and raise mast.
- (4) Jaws automatically open and release drum as you set drum down, tilt mast forward and back away.

Model Number	Max. Drum Qty.	Cap. Lbs.	Fork Pocket W x H	Load Center	Overall Ht.	Wt. Lbs.	Price Each
<b>YD-231</b>	1	1,000	6-1/2" x 2-1/2"	15"	37"	138	<b>\$914.00</b>
<b>YD-232</b>	2	2,000	6-1/2" x 2-1/2"	28"	37"	219	<b>1236.00</b>

NOTE: Mounting brackets included in price.

Model No. **XJ-3160**—Replacement Beak Assembly. Wt. 9 lbs.....**\$255.00**

# Drum Handlers



Selected Models

## MORSE Forklift Drum Handler

One person can lift and pour heavy drums without leaving the driver's seat. Offers dependable, controlled pouring without hydraulics—20'L chain with 10' drop is used to manipulate drums. Saddle has spring-loaded pawl on hinged steel plate which snaps between drum chimes. Handles 22-1/2" dia., 55-gallon drums. Optional attachment adjusts saddle to fit 19-1/2" dia., 30-gallon drums. 6-1/2"W x 26-5/8"D x 2-1/2"H, spaced 24-1/2", attach to forklift quickly and easily. Width between forks must be a minimum of 24-1/2". **SELECTED MODELS IN STOCK.** Others FOB NEW YORK.

Model No.	Cap. Lbs.	Wt. Lbs.	Price Ea.
<b>XD-159</b>	500-800	205	<b>\$805.00</b>
<b>XD-257</b>	800-1,500	200	<b>931.00</b>
<b>XD-256</b>	1,000-2,000	310	<b>2172.00</b>

**SADDLE ADAPTER.** Converts XD-159 and XD-257 to fit 19-1/2" dia., 30-gallon drums.

Model No. <b>XD-237</b> —Wt. 25 lbs.....	<b>\$137.00</b>
--	-----------------



## VALLEY CRAFT® Manual Drum-Handling Attachment

One person can pick up, transport, and unload empty or full drums up to 1,500 lbs. Spring-and-cam actuated jaws use drum weight to maintain a constant grip until drum is set down. 6" x 15" jaws adjust manually to handle any drum from 18-28" in diameter. Grips steel 30-, 55- or 85-gallon overpack drums. Jaws are lined with bonded rubber to prevent marring. Fork-mounted unit easily attaches to a lift truck in seconds. 34"L x 33"W overall. 18-1/2" between fork tubes; 19-1/2" between forks. Safety chain included. **IN STOCK.**

Model No. <b>XK-1418</b> —Wt. 126 lbs.....	<b>\$724.00</b>
--	-----------------



## MORSE Morspeed Automatic Drum Handler

Securely grasps any 23"H or more common rimmed steel, fiber or plastic drum from 150-1,500 lbs. Positive grab and hold action is activated as you raise and lower forks. 24"D fork pockets with 6-1/2" x 2-1/8" openings spaced 16-1/2" apart. Chain and clamp secure handler to forklift truck. **FOB NEW YORK.**

Model No. <b>WK-1695</b> —Single-Drum Handler. 1,500-Lb. Capacity. Wt. 219 lbs.....	<b>\$1624.00</b>
Model No. <b>WK-1694</b> —Two-Drum Handler. 3,000-Lb. Capacity. Wt. 305 lbs.....	<b>\$2826.00</b>



# Drum Handlers



MODEL YD-176 SHOWN



JAWS ADJUST MANUALLY



WD-336 SINGLE-DRUM HANDLER SHOWN



YD-179 STANDARD FIXED DOUBLE DRUM HANDLER SHOWN

## HERCULES® Automatic Drum Handlers

Designed for the heavy-duty loading, handling, and stacking of steel drums. One person can lift, transfer and deposit steel drums without leaving the forklift. Drum handlers slide onto forks and are secured by turn-down bolts. Heavy-duty drum lifter features spring and cam actuated jaws that automatically grip when engaging the drum and release when lowering it. Strong steel shaft lets gripping arms work parallel to each other for better operator control and steady drum placement. Economical Herc-U-Grab® model is perfect for low-volume drum handling jobs. 1/2" x 2-1/2" lifting arms automatically grasp drums by utilizing a unique knuckle-gripping system and the natural pressure of a loaded drum. Also includes retaining chain. **IN STOCK.**

Model Number	Type	Fits Drum	Cap. Lbs.	Fork Pocket		Wt. Lbs.	Price Each
				Center	W x H		
<b>HEAVY-DUTY DRUM HANDLERS</b>							
YD-179	Double	55	3,500	28"	6-1/2" x 2-1/2"	236	\$980.00
YD-176*	Single	30 or 55	1,500	14"	5-5/8" x 1-5/8"	175	732.00
<b>LOW-VOLUME HERC-U-GRAB® DRUM HANDLER</b>							
WD-336	Single	55	800	14"	5-5/8" x 1-5/8"	73	\$335.00

\*U.S. Patent No. 4,318,661.

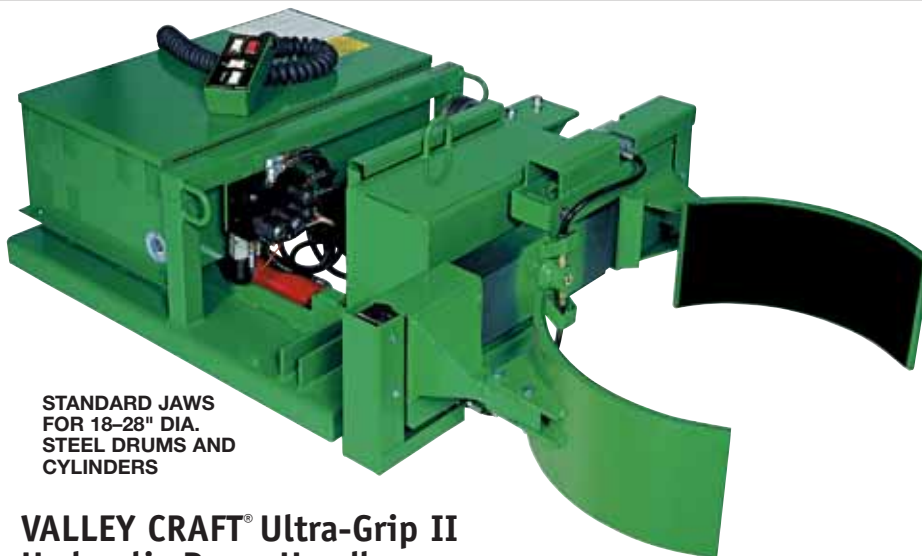

STANDARD JAWS FOR 18-28" DIA. STEEL DRUMS AND CYLINDERS

## VALLEY CRAFT® Ultra-Grip II Hydraulic Drum Handlers

One of the most versatile and durable drum handlers available. Easily-controlled handler inverts, moves and stacks 18-28" steel, plastic and fiber drums and cylinders. 360° rotation on a horizontal or vertical plane. 38"L fork pockets. 125° forward dumping. 180° inverting. Built-in 12V battery-operated Power-Pak and self-contained hydraulics. (Batteries included.) FOB MINNESOTA.



DRUM HUGGER JAWS FOR 55-GAL., 23-24" DIA. STEEL, PLASTIC AND FIBER DRUMS.



GIANT JAWS FOR 18-28" DIA. STEEL AND FIBER DRUMS. .

Model Number	Description	Cap. Lbs.	Fork Pocket		Wt. Lbs.	Price Each
			Center	W x H		
WA-0092	Standard	2000	20-1/2"	6-1/2" x 2-1/2"	881	\$7166.00
WA-0093	Drum Hugger	2000	20-1/2"	6-1/2" x 2-1/2"	948	7404.00
WA-0094	Giant	2000	20-1/2"	6-1/2" x 2-1/2"	913	7377.00

# Drum Dumpers

## MORSE Hydra-Lift Karriers™

One person can raise, move, tilt and drain a 55-gallon steel drum without back-breaking work. Efficient unit tilts 360° forward or backward, while the one-speed manual pump raises the load. Other features include: all-welded steel frame, 22-1/2" diameter saddle, two 8" roller bearing wheels, and two 4" swivel casters. A selection of power options are available, call for information. **SELECTED MODELS IN STOCK.** Others FOB NEW YORK.

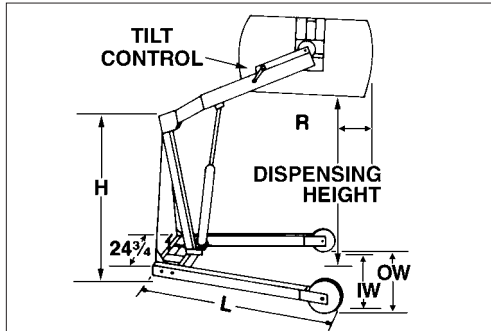

Model No. **XD-237**—30-Gal. Saddle Adaptor.  
Wt. 25 lbs. ....\$137.00



Model Number	Cap. Lbs.	Dispensing Height	Reach (R)	Overall L x H	Base Legs Overall Width (OW)	Base Legs Inside Width (IW)	Tilt Control	Wt. Lbs.	Price Each
<b>XD-236</b>	800	60"	8"	60" x 55"	44"	37"	Hand Crank	301	\$2072.00
<b>XD-310</b>	800	72"	6"	60" x 55"	44"	37"	Chain Wheel	307	2172.00
<b>XD-312</b>	750	96"	-4"	76-1/2" x 69"	50"	43"	Chain Wheel	379	2369.00

## HERCULES® Standard Drum Dumpers



Economical heavy-duty dumper for applications not requiring custom sizes or features. Lift and dump a variety of 24" dia. drums, including plastic, steel and fiber as well as other cylindrical-shaped containers up to 55-gallons, 1,000-lb. capacity. Dumpers are designed for easy one-person operation. 1 HP, 110-volt motor powers the chute up, gravity down. 45-second dump time. Posi-grip, adjustable hold-downs keep container in place during use. 1,000-lb. cap. Includes detachable pendant control. Heavy-gauge carbon steel construction with enamel finish. Choose the dump height that best meets your needs—36", 48" or 60". **SELECTED MODELS IN STOCK.** Others FOB MINNESOTA.

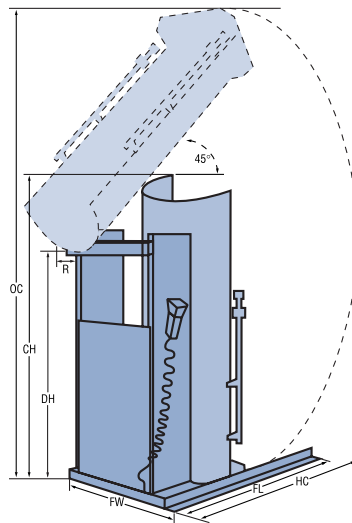

**STOCK**  
Selected Models

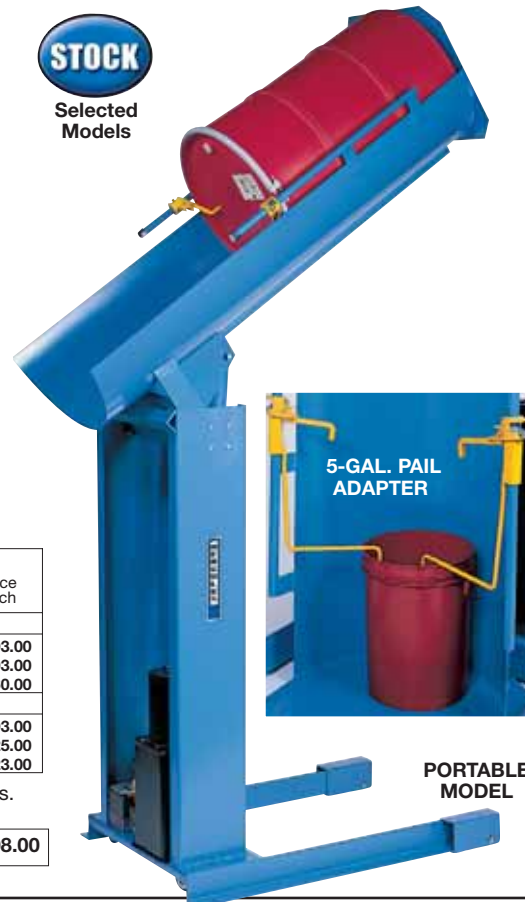

Model No.	Dump Height DH	Chute Height CH	Clearance		Chute Reach R	Frame		Wt. Lbs.	Price Each
			Overhead OC	Horizontal HC		Length FL	Width FW		
<b>STATIONARY</b>									
<b>XH-3500</b>	36"	58.25"	95.25"	62"	9.37"	53"	36"	660	\$3593.00
<b>XH-3501</b>	48"	65"	110"	67"	8.37"	53"	36"	690	3803.00
<b>XH-3502</b>	60"	72"	124"	74.5"	7"	53"	36"	720	3960.00
<b>PORTABLE</b>									
<b>XH-3505</b>	36"	58.25"	95.25"	62"	9.37"	53"	36"	750	\$4593.00
<b>XH-3506</b>	48"	65"	110"	67"	8.37"	53"	36"	770	4725.00
<b>XH-3507</b>	60"	72"	124"	74-1/2"	7"	53"	36"	809	5323.00

**5-GAL. PAIL ADAPTER.** Avoid back injuries. For safe and easy dumping of 5-gal. pails. Will work on 30-gal. drums. Attaches easily to standard dumpers.

Model No. **XH-3510**—Wt. 10 lbs. ....\$108.00

# HERCULES® Drum Dumpers



**SINGLE-STAGE  
LOW-LEVEL  
DUMPER**



**EASY-TO-  
OPERATE  
PUSHBUTTON  
CONTROL**



**DUAL-STAGE  
HIGH-LEVEL  
DUMPER**

**SHOWN WITH  
OPTIONAL  
ROLLER BASE.**

Ergonomic unit lets one person safely lift and pour plastic, steel and fiber drums. Pushbutton pendant control hydraulically powers chute up while gravity slowly lowers it. 1/60/120-volt, 2 HP, overload-protected NEMA 4 motor. Adjustable hold-downs accommodate different heights and sizes of drums or cylindrical containers up to 55 gallons. Constructed of formed 12-ga. carbon steel for durability. Includes owner's manual complete with installation, operation and maintenance instructions. Choose either stationary dumpers that are bolted to the floor or portable units with 6" x 2" wheels and floor locks. Enamel finish. Color: blue. FOB MINNESOTA.

## SINGLE-STAGE LOW-LEVEL DUMPERS.

Dump heights from 36"-60". 45° maximum dumping angle.

Model Number	Dump Height*		Clearance		Chute Reach	Frame		Dump Time (Seconds)**	Wt. Lbs.	Price Each
	DH	CH	Overhead OC	Horizontal HC		Length FL	Width FW			
<b>PORTABLE MODELS—SINGLE-STAGE LOW-LEVEL</b>										
XH-640	36"	60-1/2"	95"	62"	7-1/2"	52"	36"	30	685	\$5527.00
XH-642	48"	66-1/2"	112"	69"	7-1/2"	52"	36"	33	759	5672.00
XH-644	60"	72-1/2"	129"	76"	7"	52"	36"	38	781	5920.00
<b>STATIONARY MODELS—SINGLE-STAGE LOW-LEVEL</b>										
XH-645	36"	60-1/2"	95"	62"	7-1/2"	52"	36"	30	750	\$5149.00
XH-647	48"	66-1/2"	112"	69"	7-1/2"	52"	36"	33	770	5291.00
XH-649	60"	72-1/2"	129"	76"	7"	52"	36"	38	809	5412.00

## DUAL-STAGE HIGH-LEVEL DUMPERS.

Chute rises vertically until arms meet pivot rollers, causing chute to rotate.

Dump heights from 72"-120". 45° maximum dumping angle.

Model Number	Dump Height*		Overhead Clearance OC	Frame Dimensions				Vert. Lift Ht.	Dump Time (Seconds)**	Wt. Lbs.	Price Each
	DH	CH		Reach R	Width FW	Length FL	Height FH				
<b>PORTABLE MODELS—DUAL-STAGE HIGH-LEVEL</b>											
XH-790	72"	58"	128"	5"	36"	52"	88"	30"	27	1,125	\$9801.00
XH-792	84"	58"	140"	5"	36"	52"	100"	42"	32	2,260	10059.00
XH-794	96"	58"	152"	5"	36"	52"	112"	54"	36	1,200	10342.00
XH-796	108"	58"	164"	5"	36"	52"	124"	66"	41	1,235	10652.00
XH-798	120"	58"	176"	5"	36"	52"	136"	78"	46	1,475	10963.00
<b>STATIONARY MODELS—DUAL-STAGE HIGH-LEVEL</b>											
XH-791	72"	58"	128"	5"	36"	52"	88"	30"	27	1,125	\$9285.00
XH-793	84"	58"	140"	5"	36"	52"	100"	42"	32	2,260	9543.00
XH-795	96"	58"	152"	5"	36"	52"	112"	54"	36	2,300	9828.00
XH-797	108"	58"	164"	5"	36"	52"	124"	66"	41	1,235	10136.00
XH-799	120"	58"	176"	5"	36"	52"	136"	78"	46	1,275	10447.00

NOTE: All dimensions are in inches. Dimensions for clearance only. All specifications subject to modification or improvement without prior notification.

\*Dump height is for 45° dump angle.

\*\*Dump time is up time to 45°; down time approximately the same.

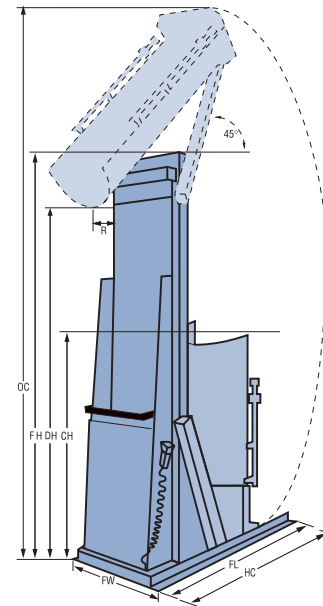

## ORDERING INSTRUCTIONS

1. Measure the size and determine the capacity of the container you are dumping. If you must dump various size containers, please specify all dimensions.

2. Measure the height of the receptacle you are dumping into. If the receptacle height does not match a standard dump height listed in chart below, see if the next dump height dimension will work for you. Pay close attention to overhead clearance (OC) required to fully dump.

3. Now that you know the capacity and dump height, select the appropriate model.

# Drum Storage

## 2- and 3-Drum Racks

### MECO 2- AND 3-DRUM RACKS.

Contoured, all-welded steel racks hold 55-gallon steel drums. Stackable up to 4 high for space-efficient, vertical drum storage. Four-way access easily accommodates fork trucks for easy portability. Do not transport more than 2 stacked racks. Ships via small package carrier stacked and banded. Color: safety orange. **IN STOCK.**

Model No.	Cap. Lbs.	Capacity	Dimensions W x D x H	Wt. Lbs.	Price Ea.
<b>XD-224</b>	1,600	2 Drums	45-1/2" x 30" x 12-1/2"	45	<b>\$126.00</b>
<b>XD-226</b>	2,400	3 Drums	71-1/2" x 30" x 12-1/2"	70	<b>189.00</b>

**JARKE® PORTABLE STAND FOR 2-DRUM RACKS.** 46"W x 30"D x 25-1/2"H stand rolls on (2) swivel, (2) rigid 5" phenolic casters. 1,800-lb. cap. Does not include drum rack or drums. **IN STOCK.**

Model No. <b>XM-2196</b> —	
Wt. 75 lbs. ....	<b>\$327.00</b>

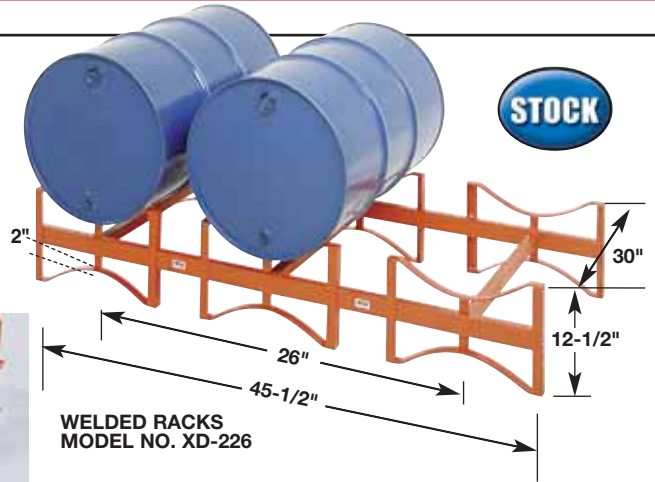

## Drum Cradle Systems

**ENPAC SINGLE POLY-RACK SYSTEM.** Ideal for dispensing drums where space is at a premium. Base module holds on 55-gallon drum. Combine it with the stacking module to add a second drum without losing valuable floor space. Constructed of rust- and corrosion-resistant polyethylene material. **FACTORY QUICK SHIP—FOB OHIO.**

Model Number	Description	Overall W x D x H	Wt. Lbs.	Price Each
<b>YK-1337</b>	Base module	53" x 31" x 32"	95	<b>\$377.00</b>
<b>YK-1338</b>	Stacking module	41" x 31" x 20"	60	<b>228.00</b>
<b>YD-436</b>	Dispensing shelf	17" x 21-1/2" x 17-1/2"	7	<b>105.00</b>

### JUSTRITE® GATOR® DRUM MANAGEMENT SYSTEM

Modular unit combines efficient drum storage and positive spill control to give you a safe liquid dispensing system for either 30- or 55-gallon drums. Chemical-, acid- and corrosive-resistant polyethylene material. Base Module holds (2) drums; dispensing well holds either 5-gal. safety cans or 5-gal. pails. Stack Module rests on top of lower drums to facilitate dispensing from two levels. Attach optional Dispensing Shelf to stack module to dispense liquids into smaller containers. EPA-compliant. **SPECIFY COLOR: GY - Gray, YL - Yellow.** **FACTORY QUICK SHIP—FOB ILLINOIS.**

Model Number	Description	Sump Cap. Gallons	Load Bearing Capacity	Overall W x D x H	Compliance	Ctn. Wt. Lbs.	Price Each
<b>ZK-3125</b>	Base module	66	3,000 lb.	49" x 59" x 26"	EPA, UFC	141	<b>\$638.00</b>
<b>ZK-3126</b>	Stack module	—	1,500 lb.	49" x 46" x 12"	—	70	<b>368.00</b>
<b>ZK-3127</b>	Dispensing shelf	—	60 lb.	19-1/2" x 18-3/4" x 16-1/2"	—	8	<b>162.00</b>



## Drum Storage Racks

### DRUM STORAGE RACKS

Racks are made of heavy-duty structural steel—front and back panels are arc-welded for strength and durability. Braces and cross members are bolted into position. Engineered for compact, orderly handling with selective removal and storage of drums. Ships semi-knocked down (in a box). Color: safety orange. **FACTORY QUICK SHIP—FOB NEBRASKA.**

Model Number	Drum Capacity	Dimensions W x D x H	Wt. Lbs.	Price Each
<b>XD-183</b>	3	33" x 34" x 70"	163	<b>\$289.00</b>
<b>XD-184</b>	4	60" x 34" x 48-1/2"	162	<b>307.00</b>
<b>XD-182</b>	6	60" x 34" x 70"	230	<b>397.00</b>
<b>XD-185</b>	9	85-1/2" x 34" x 68-1/2"	302	<b>522.00</b>

### ADJUSTABLE DRUM RACKS

Uprights punched full height on 4" centers. Cross beams bolt to uprights for rugged service. Starter Unit comes complete with 12 or 16 cradles. Add-On Unit allows for extension of drum rack. Ships knocked down. Color: gray. **XD-300 IS IN STOCK.** Others **FACTORY QUICK SHIP—FOB NEBRASKA.**

Model Number	Description	Capacity Lbs.	Wt. Lbs.	Price Each
<b>3-TIER—12 DRUM (105"W x 36"D x 84"H)</b>				
<b>XD-300</b>	Starter Unit	14,475	480	<b>\$792.00</b>
<b>XD-301</b>	Add-On Unit	14,475	417	<b>694.00</b>
<b>4-TIER—16 DRUM (105"W x 36"D x 120"H)</b>				
<b>XD-302</b>	Starter Unit	19,300	655	<b>\$1050.00</b>
<b>XD-303</b>	Add-On Unit	19,300	563	<b>917.00</b>

Model No. **XD-202**—Additional Cradle. Wt. 11 lbs. .... **\$25.60**

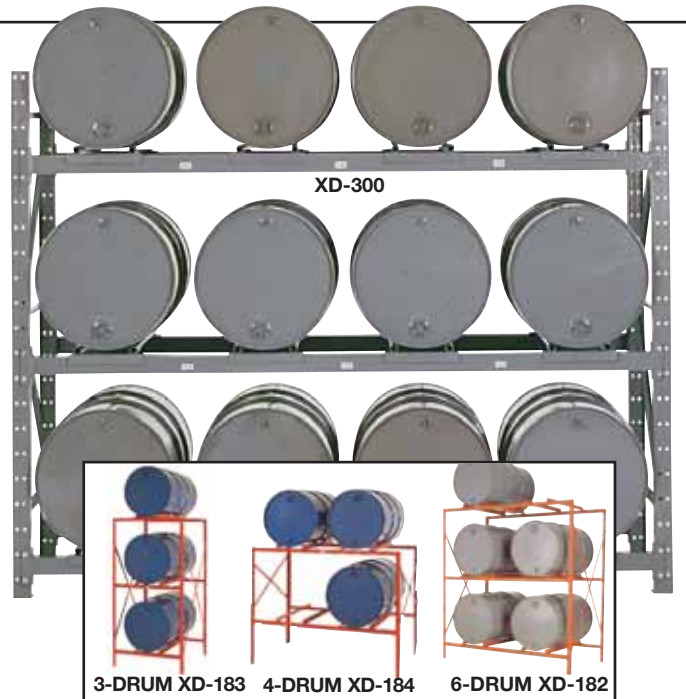

# Drum Accessories



## Plastic Faucets

Constructed of polyethylene with instant on/off—no drip. Materials have been approved to meet FDA standards. Suitable for light oils, waxes, most cleaning solutions, water-based solvents, and solutions with up to 50% sulfuric or hydrochloric acid. Liquids must not exceed 140°F.  
**IN STOCK.**

Model No. **XP-453**—3/4" NPT. Sold in multiples of 5. ....\$2.62  
Model No. **XP-454**—2" NPT. ....\$11.20

**OPTIONAL CONVERSION ADAPTER.** Changes 2-3/4" O.D. buttress threads to NPT threads.

Model No. **XP-455B**—Wt. 0.3 lbs.....\$22.10



## WESCO® Zinc Die Cast Faucets

Built-in safety features include automatic shut-off, handle that can be padlocked in closed position, and static ground hook. 3/4" NPT. Explosion-proof flame arrester. Not for use with chlorinated solvents, high acids, alkalies. FM approved for viscous liquids.  
**IN STOCK.**

Model No. **YP-459**—Wt. 1 lb.....\$44.10



## JUSTRITE® Self-Closing Drum Cover

Clamps onto 22-1/2"–22-3/4" dia., 55-gal. drum, creating a firesafe container. Cover automatically shuts if there is a fire in the drum when the replaceable, fusible link inside melts at 165°F. Ideal for storing combustible trash. Red powder coat paint finish.  
**IN STOCK.**

Model No. **WP-493**—Wt. 16 lbs. ....\$141.00



## VESTIL Quick-Open Drum Deheader

Removes drum heads in about 30 seconds. Unique tool operates similar to a household can opener, making drum deheading quick and easy. Deheader has a comfort grip handle and an inside cutting blade that won't leave sharp, jagged edges. Must use with a 1/2" manual ratchet driver (not included). Works well on all 30- and 55-gallon steel head drums.  
**IN STOCK.**



Model No. **XL-0760**—Wt. 10 Lbs. ....\$114.00



## KRUEGER SENTRY Fill Gauges

Accurate, durable unit helps prevent costly drum overfills. See-through plastic dome surrounds calibration chart. Shows gallons, liters and percent of liquid remaining. Anti-fog material makes it easy to read the red indicator and black calibrations. Resistant to oil and many chemicals. **SPECIFY DRUM SIZE: A - 55-gal., B - 30-gal., C - 15-gal. SELECTED MODELS IN STOCK.** Others FOB WISCONSIN.

Model Number	Bung Size	Wt. Lbs.	Price Each
<b>XD-410</b>	3/4"	1	\$42.40
<b>XD-411</b>	2"	1	35.50
<b>XD-412*</b>	3/4"	1	71.60
<b>XD-413*</b>	2"	1	54.90

\*316 Stainless steel.



## WESCO® Vertical Slide Drum Deheader

Quickly and easily opens any size and gauge steel drum. Sharp-edged hardened steel blade and comfortable plastic hand grip.  
**IN STOCK.**

Model No. **YP-1150**—Vertical Slide Drum Deheader. Wt. 8 lbs. ....\$71.50  
Model No. **YP-1151**—Replacement Blade. Wt. 1 lb. ....\$16.90



# Drum Accessories



## WESCO® Drum Wrenches

**NON-SPARKING PLUG WRENCH.** Three-four times stronger and harder than aluminum, and bronze alloy will not spark. **IN STOCK.**

**UNIVERSAL PLUG WRENCH.** Annealed ductile iron is guaranteed not to bend or chip. **IN STOCK.**

Model No. <b>ZM-2180</b> —Non-Sparking.	
Wt. 2 lbs. ....	\$33.80
Model No. <b>ZM-2181</b> —Ductile Iron.	
Wt. 4 lbs. ....	\$39.00



## DIXIE Bung Wrench

Lightweight aluminum wrench fits all steel and plastic hex-head type plugs. Durable and spark-resistant. **IN STOCK.**

Model No. <b>YP-1152</b> —	
Wt. 0.5 lbs. ....	\$61.80



## Drum Vents

**JUSTRITE® VERTICAL DRUM VENT.** Automatic pressure relief at 5 psi. Vacuum relief. Polyethylene body and stainless steel parts for many flammables and solvents. Vents 230 CFM at 20 psi. 2" NPT thread. **IN STOCK.**

**WESCO® HORIZONTAL DRUM VENT.** Automatic pressure relief at 5 psi. Manual vacuum relief. Vents 230 CFM at 20 psi. 2" NPT thread. **IN STOCK.**

**JUSTRITE® VERTICAL BRASS DRUM VENT.** Automatic pressure and automatic vacuum relief at 5 psi. Designed for petroleum-based applications. 2" NPT. **IN STOCK.**

Model No. <b>XP-491</b> —Vertical.	Wt. 2 lbs. ....	\$73.50
Model No. <b>XP-492</b> —Horizontal.	.....	\$74.70
Model No. <b>XR-1130</b> —Vertical Brass.	.....	\$50.80

## Grounding Wires & Clamps

**A. WESCO® BONDING & GROUNDING WIRES.** Keep static electricity from sparking when you transfer flammables. OSHA requires that you use these wires for any hazardous chemicals with a flashpoint less than 140°F. Use bond wires between containers and ground wires between drum and ground connection. All wires are 3' long. **IN STOCK.**

**BOND WIRE.**

Model No. <b>YK-2520</b> —C-Clamp and Alligator-Clip.	\$29.90
Model No. <b>YK-2521</b> —2 Alligator-Clips.	\$23.20

**GROUND WIRE.**

Model No. <b>YK-2522</b> —C-Clamp and Alligator-Clip.	\$37.80
---	---------

**B. JUSTRITE® COILED GROUNDING CLAMP.** Vinyl-coated 1/8" cable is corrosion-resistant and built to last for years. When not in use, unit self-recoils. Clamp is heavy-duty and designed like a plier. 10' long. **IN STOCK.**

Model No. <b>YK-2525</b>	\$39.70
--------------------------	---------

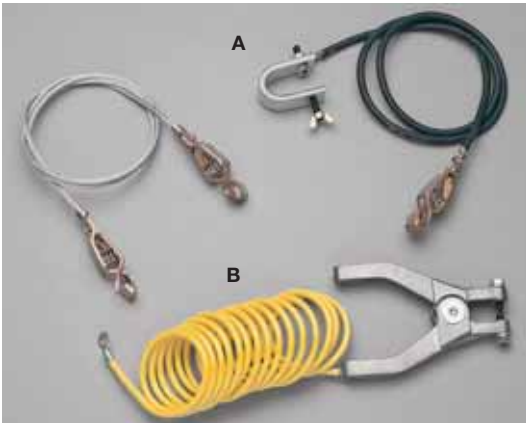

## High Volume Funnels

**DIXIE POLYETHYLENE FUNNEL.** Prevent liquids from splashing. Use these funnels with standard drums as well as small jugs and bottles. Designed for use indoors or out. Resist chemicals and corrosion. 16"H. 10-1/2" diameter. **IN STOCK.**

Model <b>YM-2035</b> —	
Wt. 2-1/4 lbs. ....	\$64.10

## JUSTRITE® FIRE-RESISTANT DRUM FUNNEL.

Dispose flammable liquids safely. 6" long brass vent with flame arrestor and screen included. Cover is hinged, lockable and has a fusible link that melts at 165°F, automatically closing the cover. Fits standard 2" NPT bung openings. FM-approved. **IN STOCK.**

Model <b>YM-2037</b> —	
Wt. 12 lbs. ....	\$209.00



## Poly Funnels

Pour liquids from cans, filters, and pails safely and easily. Poly funnels fit all 55- and 30-gal. closed-head drums and most 5-gal. pails. 18" dia. funnel allows access of 3/4" bung. Funnel spout fits any 2" NPT bung. Optional cover prevents content contamination. **IN STOCK.**

Key	Model No.	Description	Cap. Gal.	Dia. x Ht.	Wt. Lbs.	Price Ea.
C	<b>YP-0060</b>	6"H side-wall funnel	5	18" x 7"	6-1/2	\$35.70
C	<b>YP-0061</b>	Side-wall funnel with screen	5	18" x 7"	6-1/2	39.60
C	<b>YP-0062</b>	Side-wall funnel cover	—	—	6	16.60
D	<b>YP-0352</b>	Low-profile funnel	2	21" x 2"	4	42.90
D	<b>XP-461</b>	Low-profile funnel cover	—	—	4	31.00

# Drum Pumps

**CAUTION: Bond/Ground Wires Required With GASOLINE and FLAMMABLES**



Gasoline, Diesel Fuel

## QUICK-REFERENCE SYMBOLS FOR ALL PUMPS



Water Based Solutions



Acids & Corrosives



Detergents, Waxes, Disinfectants



Kerosene, Light Oils



### 316 Stainless Piston Pumps

Standard 2" IPS adapter. Teflon® packing, piston and suction tube. **SPECIFY CHEMICAL TO BE PUMPED. IN STOCK.**

#### 8-OZ. PER STROKE PISTON PUMP

Ideal for most liquids such as solvents, thinners, methyl chloride, trichlorethane and freon TE. For 5-, 15-, 30-, and 55-gal. drums.

Model No. **XP-451**—Wt. 3 lbs. ....\$130.00

#### 16-OZ. PER STROKE PISTON PUMP

Handles non-corrosives such as waxes, soaps, and mild detergents. For 15-, 30-, and 55-gal. drums.

Model No. **XP-452**—Wt. 3 lbs. ....\$111.00

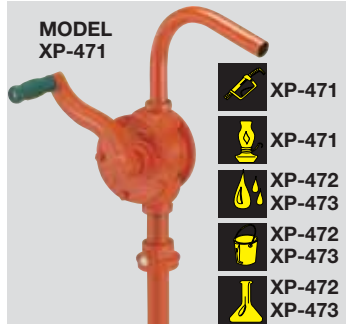

### Rotary Hand Pumps

For 15-, 30-, 55-gal. drums. **IN STOCK**

**CAST IRON PUMP.** For petroleum products. 6 GPM.

Model No. **XP-471**—Wt. 14 lbs. ....\$61.50

**POLYPROPYLENE PUMP.** For most alkalis, detergents, mild acids, waxes, and water-soluble inorganic chemicals. 6 GPM. Wetted parts: polypropylene, ryton, Teflon®, stainless steel. **SPECIFY CHEMICAL TO BE PUMPED.**

Model No. **XP-472**—Wt. 3 lbs. ....\$92.50

**RYTON PUMP.** For aggressive chemicals such as esters, alcohols, hydrocarbons. Stainless steel discharge and suction tubes, ryton vanes, Teflon®, and stainless steel seal. 7.5 GPM. **SPECIFY CHEMICAL TO BE PUMPED.**

Model No. **XP-473**—Wt. 8 lbs. ....\$135.00



### PACER Transfer Pumps

Non-corrosive thermoplastic pumps deliver 1 qt. per stroke. 1" inlet with stainless steel screen, 3/4" discharge. Up to 14' lift with 2-pc. suction tube, 8' discharge hose, 2" bung adapter. For 30- and 55-gal. drums. **IN STOCK.**

**TRANSFER PUMP FOR PETROLEUM OILS.** Also diesel fuels, leaded and unleaded fuels.

Model No. **YP-467**—Wt. 10 lbs. ...\$137.00

**TRANSFER PUMP FOR AGGRESSIVE CHEMICALS.** For alkalis, caustics, acids (pH range 2–12), also detergents, waxes, and disinfectants. **SPECIFY CHEMICAL TO BE PUMPED.**

Model No. **YP-470**—Wt. 10 lbs. ..\$292.00



### Syphon Pumps

Leakproof pump is ideal for mildly corrosive fluids, light oils, waxes, most cleaning solutions, soaps, disinfectants, antifreeze and deodorants. Fits 55-gallon steel drums with 2" female IPS opening. Can be adapted for 15- or 30-gallon drums. 3' hose. **IN STOCK.**

Model No. **ZP-463**—5 GPM max. flow. Wt. 4 lbs. ....\$11.70

Model No. **ZP-464**—Heavy-duty plastic construction with 7 GPM max. flow. Wt. 5 lbs. ....\$16.00



### All-PVC Piston Pumps

100% polyvinylchloride piston pump is the only one of its kind. Designed for rugged use and ideal for a variety of chemicals and liquids. Includes 2" NPT bung adapter and flexible 1/2" discharge hose. Handles up to 40 wt. motor oil. **IN STOCK.**

Model No. **YP-0353**—For 5-, 15-, 30-, and 55-gallon drums. 8 oz./stroke, 21" discharge hose. Wt. 3 lbs. ....\$23.00  
Model No. **YP-0354**—For 15-, 30-, and 55-gallon drums. 22 oz./stroke, 36" discharge hose. Wt. 4 lbs. ....\$38.10

PUMPS NOT RECOMMENDED FOR gasoline, diesel fuel, 80% acetic acid, acetone, aqua regia, chloric acid, hydrofluoric acid and MEK.

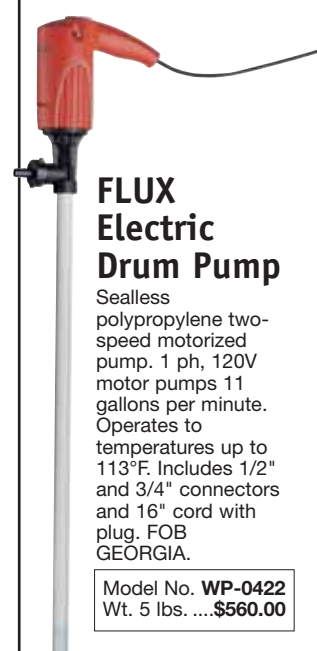

### FLUX Electric Drum Pump

Sealless polypropylene two-speed motorized pump. 1 ph, 120V motor pumps 11 gallons per minute. Operates to temperatures up to 113°F. Includes 1/2" and 3/4" connectors and 16" cord with plug. FOB GEORGIA.

Model No. **WP-0422** Wt. 5 lbs. ....\$560.00

# Drum Heaters

## Electric Drum Heaters

Speed up the flow of solid/semi-solid viscous materials in pails and drums with these handy electric heaters. Wraparound aluminized steel unit effectively spreads heat over the entire surface. Toggle clamp secures heater around drum or pail. Also includes neon pilot light and 6' power cord. Not recommended for fiber or fiber-lined drums. Units are not moisture-resistant or explosion-proof. Select from four heating controls. 1-year warranty. UL listed and CSA certified. **IN STOCK.**

**A. THERMOSTAT CONTROL WITH 3-HEAT SWITCH** for heating materials with good heat receptivity. 3-heat switch allows three wattage ratings per thermostat setting and voltage rating. Thermostat bulb senses temperature in areas away from heating element. Packed with fiberglass insulation.

**B. INFINITE (VARIABLE) CONTROL WITH 3-HEAT SWITCH** for heating materials that are subject to coking, burning, or chemical separation, like food, chocolate, honey, light oils, chemicals, and undercoating materials. Infinite control allows operator to closely control heater output within a 3-heat switch setting of high, medium, or low. Does not include a thermostat and will not automatically reach and maintain a certain temperature. Packed with fiberglass insulation.

**C. WATER BOIL-OFF WITH THERMOSTAT CONTROL** removes water from non-flammable solutions, reducing the volume of material for disposal. Includes 70–300°F thermostat with resettable cut-off switch. Automatically shuts off when water is below heater level. When metal container is refilled, boil-off process may be restarted by pressing the red reset button. Packed with fiberglass insulation.

**D. PLASTIC DRUM HEATER WITH THERMOSTAT CONTROL** for heating contents in 55-gallon plastic drums. 9" shroud does not include fiberglass insulation. As recommended for plastic drums, preset thermostat will not exceed 160°F. 5-gallon pail heaters available, call for information.

Style	Model Number	Drum Cap.	Drum Dia.	1 Ph Volt	Watts High-Med-Low	Amps.	Heat Range	Wt. Lbs.	Price Each
<b>STEEL DRUMS AND PAILS</b>									
A	WP-474	55	22-1/2"	120	1,750 - 875 - 437	14.0	60–250°F	15	\$350.00
	WP-475	55	22-1/2"	120	1,920 - 960 - 480	17.4	60–250°F	15	340.00
	WP-476	55	22-1/2"	120	1,920 - 960 - 480	17.4	200–400°F	15	340.00
	WP-477	55	22-1/2"	240	3,000 - 1,500 - 750	13.0	60–250°F	15	340.00
A	WP-479	30	18-1/2"	120	1,920 - 960 - 480	17.4	60–250°F	15	320.00
	WP-480	16	14-1/2"	120	1,500 - 750 - 375	13.0	60–250°F	8	312.00
	WP-481	5	11-1/4"	120	1,500 - 750 - 375	13.0	60–250°F	5	284.00
	WP-483	55	22-1/2"	240	3,000 - 1,500 - 750	13.0	—	15	340.00
C	WP-484	55	22-1/2"	240	3,000	13.0	70–300°F	15	436.00
<b>PLASTIC DRUMS</b>									
D	WP-485	55	22-1/2"	120	800	6.7	0–165°F	28	\$376.00

\*For Style (B) heaters, the three wattage choices of high, medium, and low also have the infinite control for each wattage for closer heat control by user.



## BH THERMAL Briskheat® Drum Heaters

Designed for freeze protection and viscosity control of stored materials.

**STANDARD AND HEAVY-DUTY DRUM HEATERS.** Totally integrated heating systems feature wraparound spring fasteners and encapsulated thermostatic controllers with adjustable settings. Standard 3"W grounded models quickly heat steel drums. Heavy-duty 4"W units have nickel-iron heating elements insulated with fiberglass and laminated between two layers of silicone rubber-impregnated fiberglass cloth with dense grounding grid. 120V units include 6' power cord and plug. 240V units do not have plugs. 1-year warranty. UL-listed. **IN STOCK.**



Selected Models



WC-3120



WD-320

WC-3121

WD-324

WC-3125

Drum Cap.	Drum Dia.	1 Ph Volt	FOR STEEL DRUMS—THERMOSTAT 50° TO 450° F							FOR PLASTIC DRUMS—THERMOSTAT 50° TO 160° F							
			STANDARD				HEAVY-DUTY			HEAVY-DUTY							
			Model No.	Watts	Amps	Wt. Lbs.	Price Ea.	Model No.	Watts	Amps	Wt. Lbs.	Price Ea.	Model No.	Watts	Amps	Wt. Lbs.	Price Ea.
55	22-1/2"	240	WD-316	1,000	8.4	3	\$158.00	WD-324	1,200	5	13	\$289.00	WD-328	300	1.25	13	\$289.00
55	22-1/2"	120	WD-317	1,000	8.4	3	158.00	WD-323	1,200	10	13	289.00	WD-327	300	1.25	13	289.00
30	18-1/2"	240	—	—	—	—	—	WC-3122	1,000	8.3	8	240.00	WC-3125	250	1.1	8	281.00
30	18-1/2"	120	WD-318	750	6.2	2.7	152.00	WD-325	1,000	8.3	8	258.00	WC-3325	250	1.1	8	281.00
15	14-1/2"	240	—	—	—	—	—	WC-3123	700	5.8	6	220.00	WC-3126	200	0.8	6	266.00
15	14-1/2"	120	WD-319	500	4.2	2.5	146.00	WD-322	700	5.8	6	234.00	WC-3326	200	0.8	6	266.00
5	11-1/4"	240	—	—	—	—	—	WC-3124	550	4.6	4	199.00	WC-3127	150	0.6	4	238.00
5	11-1/4"	120	WD-320	300	2.5	2	141.00	—	—	—	—	WC-3327	150	0.6	4	238.00	

**INSULATED BLANKET DRUM HEATERS.** Wraparound silicone-coated enclosure includes an easy-to-use digital temperature controller with audio/visual alarm that adjusts from 50–450°F with max. 1600W for steel drums; 50–160°F with max. 720W for plastic drums. Positioned within the lower one-third of blanket, knitted heating elements will not overheat when drum is partially full. Unit fits 22-1/2" dia., 55-gal. steel or plastic drums. Also includes Velcro closure and 6' cord with standard plug. **SPECIFY DRUM TYPE: A - Steel, B- Plastic. IN STOCK.**

Model No. **WC-3120**—120V, 13.3 amps. Wt. 22 lbs. ....\$843.00

**BLANKET DRUM INSULATOR ONLY.** For any silicone type heater. FOB OHIO.

Model No. **WC-3121**—  
Wt. 20 lbs. ....\$567.00

# Drums



## SKOLNIK Steel Drums

Dependable drums handle virtually any material. All drums are coated with a rust inhibitor lining. Open drums include sponge rubber gaskets, bolt rings and bolt/nuts. Closed head drums have 2" and 3/4" plugs in the top heads. UN- and D.O.T.-approved. Color: black. **IN STOCK.**

Cap. Gal.	Head Type	UN RATING		Gauge Top/Body/Bottom	Wt. Lbs.	BOLT RING		LEVER LOCK	
		Solids	Liquids			Model No.	Price Ea.	Model No.	Price Ea.
20	Closed	—	1A1/X1.2/300	16/20/16 ga.	18	XP-404BK	\$65.80	—	—
20	Open	1A2/X220/S	1A2/Y1.5/150	18/18/18 ga.	20	XP-405BK	75.20	XP-397BK	\$117.00
30	Closed	—	1A1/Y1.5/300	20/20/20 ga.	25	XP-406BK	79.50	—	—
30	Open	1A2/X235/S	1A2/Y1.5/150	16/18/18 ga.	35	XP-407BK	98.00	XP-399BK	118.00
55	Closed	—	1A1/X1.2/300	18/20/18 ga.	40	XP-408BK	116.00	—	—
55	Open	1A2/Y425/S	1A2/Y1.2/100	18/20/20 ga.	45	XP-409BK	115.00	—	—
55	Open	1A2/X400/S	1A2/Y1.5/150	16/18/18 ga.	55	XP-410BK	147.00	XP-402BK	146.00
55	Open	1A2/X430/S	1A2/Y1.6/200	16/16/16 ga.	57	XP-411BK	162.00	XP-403BK	170.00

**OPTIONAL EPOXY PHENOLIC COATING** for increased compatibility and greater rust protection. Must be factory installed.

Model No. **XP-412**.....\$13.50



Selected Models



QUICK LEVER-LOCK OPTION

## SKOLNIK Overpack/Salvage Drums

Contain hazardous materials from spilling and leaking. Overpack drums let you store and ship hazardous materials safely. Can be used with open or closed head steel, plastic and fiber drums, and composite containers. Heavy-duty steel construction with 12-ga. bolt rings and rubber gaskets. Interiors resist corrosion. Add optional epoxy phenolic coating for increased compatibility and greater rust protection. Choose either locking bolt lids or convenient lever locking lids that close in seconds. Meets UN requirements. **SELECTED MODELS IN STOCK.** Others FOB ILLINOIS.

Cap. Gal.	Inside Dia. x Ht.	UN Rating		Wt. Lbs.	BOLT RING		LEVER-LOCK	
		Liquid	Solid		Model Number	Price Each	Model Number	Price Each
8	14" x 14"	1A2/X96/S	1A2/Y1.8/150	12	XK-1035	\$54.10	XK-1041	\$54.60
20	18-1/4" x 19-1/4"	1A2/X175/S	1A2/Y1.15/150	20	XK-1036	105.00	XK-1033	106.00
30	18-1/4" x 27-1/2"	1A2/X225/S	1A2/Y1.5/150	35	XK-1037	104.00	XK-1034	105.00
55	22-1/2" x 33"	1A2/X430/S	1A2/Y1.6/200	60	XK-1038	163.00	XK-1042	165.00
85	26" x 37"	1A2/X440/S	1A2T/Y320/S	78	XK-1039	213.00	XK-1043	215.00
96	26" x 41"	1A2/X440/S	—	85	XK-1040	208.00	—	—
110	30" x 41"	1A2/Y409/S	—	100	XA-3306	476.00	—	—

NOTE: Order next largest size than drum being contained. 20- and 30-gal. fit into 55-gal, 55-gal. fits into 85-gal., 85- and 96-gal. fit into 110-gal. container.

**OPTIONAL EPOXY PHENOLIC COATING** for increased compatibility and greater rust protection. Must be factory installed.

Model No. **XP-412**.....\$13.50



## DIXIE Heavy-Duty Plastic Drums

Extremely dependable drums feature .200" wall thickness and straight sides that match those of 55-gal. steel drums. Seamless polyethylene construction. Corrosion-free for outdoor use. Tight head models have liquid drain vent molded into top chime. NPT standard 2" and 3/4" plugs. Material has been approved to meet FDA standards. **SPECIFY COLOR: BK** - Black, **BL** - Blue, **GN** - Green, **RD** - Red, **WH** - White, **YL** - Yellow. FOB NEW JERSEY, SOUTH CAROLINA.

Cap. Gal.	Dia x Ht.	Wt. Lbs.	CLOSED HEAD		OPEN HEAD WITH LEVER RING	
			Model No.	Price Ea.	Model No.	Price Ea.
15	16" x 22.75"	8	XP-421	\$52.30	XP-426	\$61.10
20	17.25" x 26.4"	10	XP-422	53.20	XP-427	71.20
30	19.4" x 29.75"	15	XP-423	76.20	XP-428	96.80
35	20.75" x 31.75"	16	XP-424	83.80	XP-429	102.00
55	23.5" x 36.25"	23	XP-425	111.00	XP-430	139.00



## DIXIE Closed-Head Plastic Drums

Holds a wide variety of liquids from hazardous chemicals to food. Impact- and crack-resistant side walls are constructed of .125" thick high molecular polyethylene. Will not rust or corrode. Choose blue drums with 2" buttress and 2" NPT with 3/4" threaded knock out or white drum with 2" and 3/4" NPT plugs. UN rated for liquids.

Materials have been approved to meet FDA standards. **IN STOCK.**

Key	Model Number	Cap. Gal.	Overall Dia. x H	UN Rating	Color	Wt. Lbs.	Price Each
A	XA-2033	15	13.75" x 26.25"	1H1/Y1.9/150	White	7	\$44.90
B	XP-419	30	19.5" x 30"	1H1/Y1.9/150	Blue	21	52.00
B	XP-418	55	23" x 35.8"	1H1/Y1.9/150	Blue	26	63.30



## DIXIE Open-Head Plastic Drums

Stores a wide variety of solid material from chemicals to food. Crack-resistant blow-molded, high-density polyethylene is .125" thick. Will not rust or corrode.

Removable polyethylene lid includes metal locking ring and a Buna-N gasket. (C) drums will nest inside each other. (D) drums include two 2" NPT plugs. UN rated for solids. Materials have been approved to meet FDA standards. Color: blue. **IN STOCK.**

Key	Model Number	Cap. Gal.	Overall Dia. x H	UN Rating	Wt. Lbs.	Price Each
C	XA-2034	14	15" x 26"	1H2/Y100/S	8	\$51.10
C	XA-2035	30	20.75" x 30.5"	1H2/Y180/S	13	83.10
C	XA-2036	55	23.5" x 38"	1H2/Y140	21	111.00
D	XP-417	55	23" x 33.5"	1H2/Y150/S	24	83.50
D	XP-416	55	23" x 36.8"	1H2/Y250	23	116.00



## Fiber Drums

Designed for economical storage of dry or solid materials. Strong fiber material will not corrode or contaminate product. Top and bottom are reinforced by steel chimes to prevent drum collapse when loaded. Locking steel band secures contents. Can be disposed of in accordance with EPA standards. Stack up to 3 high, empty or full. **IN STOCK.**

Model Number	Capacity		Dia. x Ht.	Price Each
	Gal.	Lbs.		
ZD-1505	15	400	15-1/2" x 18-1/2"	\$33.00
ZD-1506	30	550	18-1/2" x 26"	45.00
ZD-1507	55	550	21-1/2" x 34-1/2"	53.60



# Pails



## Plastic Pails

Tough, high-density polyethylene pails are ideal for storing a wide range of hazardous and non hazardous materials. Rust- and corrosion-resistant. Open head pails nest for convenient storage and have metal swing handles for easy transport. Closed head pails include lift-up plastic handles, superior neck finish, and self-draining tops for convenient stacking. Material has been approved to meet FDA standards. Order in quantities of 4, priced each. **IN STOCK.**

Key	Model Number	Style	Cap. Gal.	UN Reg.	Color	Price Ea. (4+)
A	YA-2020	Open Head Pails w/Lids	1	1H2	White	\$9.40
A	YA-2021	Open Head Pails w/Lids	2	1H2	White	12.20
A	YA-2022	Open Head Pails w/Lids	3	1H2	White	15.00
B	XA-2037	Rectangle Closed Head Pail	5	1H1	White	18.70
B	XA-2038	Rectangle Closed Head Pail	7	1H1	White	18.40
C	XA-2031	Round Closed Head Pail	5	1H1	White	17.20
C	XA-2032	Round Closed Head Pail	5	1H1	Blue	17.20

**OPEN HEAD PAIL WITH OPTIONAL COVER.** Conforms to item 258c of the NMFC and Rule 40, Sec. 7.25 of the UFC without cover, and to UN reg. 1H2 with cover.

Model No. YA-0280 — Open Head Pail. 5-gal. capacity. Color: white. Wt. 2 lbs. ....	\$8.50
Model No. YA-0281 — Lid. Color: white. Wt. 1/2 lb. ....	\$3.96



## Plastic Scoops

Dispenses dry or liquid contents quickly and easily. Available in 3 sizes. **IN STOCK.**

Model No. ZA-1040 — 6 oz. ....	\$6.50
Model No. ZA-1041 — 32 oz. ....	\$10.40
Model No. ZA-1042 — 64 oz. ....	\$12.20



## DIXIE Steel Pails

Ideal for general storage of dry or liquid materials. Closed head pail includes a metal flex spout, while the open head pail has plastic flex spout. Choose from phenolic-lined (P) pails for extra chemical resistance or pails lined with rust inhibitors (RI) for general use. 5-gallon capacity. Sold in quantities of four. **IN STOCK.**

Model Number	Head Type	Lining	UN Rating	Price Each
YP-413	Open	RI	1A2/Y1.4/70	\$18.00
YP-414	Open	P	1A2/Y1.4/70	17.80
YP-415	Closed	RI	1A1/Y1.2/90	16.50



## 5-Gallon Plastic Pails

Organize and store contents with these brightly colored pails. Tough, high-density construction is ideal for a wide range of hazardous and non-hazardous materials. Materials have been approved to meet FDA standards. Meets UN Reg. 1H2. Order pails in quantities of 4, priced each. **SPECIFY COLOR: BL - Blue, GN - Green, RD - Red, YL - Yellow. IN STOCK.**

Model No. ZA-8660 — Open Head Pails. Wt. 2.5 lbs. ....	\$8.30
Model No. ZA-8661 — Lid with Pull-Out Spout. Wt. 1 lb. ....	\$3.83
Model No. ZA-8662 — Standard Lid. Wt. 1 lb. ....	\$3.53



## Polyethylene Screw-Top Pails

Screw top lid creates a vacuum tight seal. Easy-to-operate lid threads on and secures via a tamper-evident LifeLatch®. UN-Certified for Group II and III liquid and dry shipping storage. Both lids and containers are constructed of prime virgin high-density polyethylene. Order in quantities of 4, priced each. **IN STOCK.**

Key	Model Number	Cap. Gal.	Overall Dia. x Height	UN Rating	Wt. Lbs.	Price Each
D	YA-8083	1.0	10-1/2" x 8-1/8"	1H2/Y6	1	\$9.40
E	YA-8084	2.5	11-1/4" x 12"	1H2/Y15	2	16.20
F	YA-8085	5.0	14-1/8" x 14-1/2"	1H2/Y30	3-1/2	20.90
G	YA-8086	11.3	14-1/2" x 18"	1H2/Y40	7	50.50



## Pail Openers

Will open any plastic pail in seconds with very little effort. **IN STOCK.**

Model No. ZA-8680 — "Bucket Buster". Positive spring action opener is heavy-gauge steel with a rubber-coated handle. Opening is done from side of pail, not from top. ....	\$19.90
Model No. ZA-8681 — Economical Plastic Pail Opener. ....	\$8.90

# Spill Containment



## EAGLE® Mobile Spill Basin

Safely contains liquids from leaky 30-, 55-, and 95-gallon drums. 12-gallon sump capacity; 1,375-lb. load-bearing capacity. Rust- and corrosion-resistant polyethylene construction. Include: poly push/pull handle and 5 swivel casters. 31-3/4" inside dia., 35-3/4" dia. x 9-1/2"H overall. **IN STOCK.**

Model No. **YP-0359**—  
Wt. 30 lbs. ....\$167.00



## Five-Gallon Spill Containment Pail Kit

Take everything you need to clean up hazardous materials directly to the spill site. Includes: 5 sorbent socks, 5 sorbent sheets, one pair of nitrile gloves, and polyethylene pail with cover **IN STOCK.**

Model No. **XP-0551**—Five-Gallon Pail Kit. Wt. 12 lbs. ....\$34.80  
Model No. **XP-0552**—Replacement Kit. Wt. 9 lbs. ....\$26.30



## Spill Containment Cabinet

Includes everything you need to clean up hazardous spills. Rust-resistant steel storage cabinet includes two adjustable shelves and full-length Plexiglas window. The 13-13/16" x 30-1/16" x 12-3/4" cabinet may be wall-mounted. Contains 10 sorbent socks, 6 sorbent pillows, 5 sorbent sheets, 3 pair of goggles, and 2 pairs of nitrile gloves. Meets ANSI Z87.1-1989 and CSA Z94.3-1988 standards. **IN STOCK.**

Model No. **ZP-0545**—Compact Wall/Bench Station. Wt. 50 lbs. ....\$219.00  
Model No. **ZP-0546**—Replacement Kit. Wt. 20 lbs. ....\$80.00



## ENPAC Spillpal™ Spill Control Pallets

Here's a convenient way to temporarily store 55-gallon drums. An alternative to hard plastic pallets, unique unit features 4" foam sidewalls that spring back into position after pressure is applied. Allows hand trucks to easily drive in or out without the aid of a ramp. Reusable unit folds up and stores on shelf when not in use. Add optional grates to keep drums away from spilled liquid. **FACTORY QUICK SHIP—FOB OHIO.**

Model No.	Description	Overall L x W x H	Sump Cap. Gal.	Wt. Lbs.	Price Each
<b>XP-1562</b>	1-Drum	2' x 2' x 3"	10	2	\$90.80
<b>XP-1563</b>	2-Drum	2' x 4' x 3"	20	3	163.00
<b>XP-1564</b>	4-Drum	4' x 4' x 3"	40	4-1/2	233.00
<b>XP-1565</b>	4-Drum In Line	2' x 8' x 3"	40	5-1/2	285.00
<b>XP-1566</b>	6-Drum	4' x 6' x 3"	60	6-1/2	345.00
<b>XP-1567</b>	8-Drum	4' x 8' x 3"	80	7-1/2	419.00
<b>XP-1568*</b>	Grates	48" x 23" x 1-3/4"	—	17-1/2	54.60

\*To determine the number of grates, divide the number of drums by 2. Example: 4-drum Spillpal™ requires 2 grates.



## DIXIE Polyethylene Spill Trays

These heavy-duty polyethylene spill trays help contain accidental overflows. Ideal for storing bottles, pails, drums, or any assortment of containers. Polyethylene is chemical-resistant and easy to clean. Low-profile design. **IN STOCK.**

Model No.	Inside Dia.	Height	Outside Dia.	Capacity	Wt. Lbs.	Price Ea.
<b>XP-0547</b>	12"	3"	13.5"	2 gal.	3	\$29.70
<b>XP-0548</b>	16"	3"	17.5"	3.5 gal.	4	37.40
<b>XP-0549</b>	22"	3"	23.5"	5 gal.	5	50.20
<b>XP-0550*</b>	25"	3.5"	26.5"	6 gal.	6	57.20

\*Fits most 55-gal. drums.

# Spill Containment



**STOCK** **MADE IN USA**

## EAGLE® Budget Spill Basins

Economical basin catches spills during dispensing, filling, or storage of 55-gallon drums. Constructed of high-density polyethylene, each basin is chemical-, rust-, and corrosion-resistant. Low sidewalls make the basin easy to load and unload. **IN STOCK.**

Model No. **XN-2090**—2-Drum Basin. Holds 2 drums or one drum cradle. 34-gal. cap. 51-1/2"L x 26-1/4"W x 6-1/2"H overall. Wt. 20 lbs. ....**\$76.50**  
 Model No. **XR-1600**—4-Drum Basin. Meets EPA 40 CFR 264.175. Fits on standard 48" x 48" wooden pallet. Includes 3/4" drain with plug. 66-gal. capacity. 51-1/2"L x 51-1/2"W x 7"H. Wt. 20 lbs. ....**\$161.00**



**STOCK** **MADE IN USA**

## DIXIE Two-Drum Econo Basin

This basin prevents environmental contamination by containing spills while dispensing, filling or storing hazardous liquids. 65-1/2"L x 29"W x 9"H units hold two drums. 62-gallon sump capacity. Meets EPA Secondary Containment requirements. Polyethylene material won't rust. **IN STOCK.**

Model No. **WP-0553**—  
 Wt. 15 lbs. ....**\$77.10**



**SHOWN WITH OPTIONAL COVER.**

**SHOWN WITH OPTIONAL DOLLY**

**FACTORY QUICK SHIP** **MADE IN USA** **Selected Models**

## DIXIE Containment Basins

Large polyethylene basins hold spills or leaks from 55-gallon steel drums. Durable construction resists most chemicals. Forklift base. Meets EPA 40 CFR 264.175. **SELECTED MODELS FACTORY QUICK SHIP.** All FOB SOUTH CAROLINA.

Drum Cap.	Model Number	Type	Load Cap. Lbs.	Outside Dimensions	Wt. Lbs.	Price Each
1	<b>YK-1547</b>	Base	900	31" dia. x 26"H	25	<b>\$196.00</b>
	<b>YK-1548</b>	Cover	—	33" dia. x 17"H	12	<b>101.00</b>
2	<b>YK-1549</b>	Base	1,800	56"L x 30"W x 24"H	45	<b>265.00</b>
2	<b>YK-1550</b>	Cover	—	59"L x 33"W x 27"H	30	<b>239.00</b>
4	<b>YK-1551</b>	Base	—	51"L x 51"W x 18"H	55	<b>397.00</b>
4	<b>YK-1552</b>	Cover	—	54"L x 54"W x 21"H	48	<b>343.00</b>

**BASIN DOLLIES.** Polyethylene dolly has 2-1/2"H sides.

Model No. **YK-1554**—Single-Drum basin. (4) 3" Casters. Wt. 22 lbs. ....**\$86.30**  
 Model No. **YK-1555**—Two-Drum Basin. (6) 4" Casters. Wt. 53 lbs. ....**\$231.00**

**STOCK** **MADE IN USA**



## DIXIE Polyethylene Spill Sump Basin

Constructed of molded high-density polyethylene which resists most chemicals. Collects leaks and spills during dispensing, fill or waste collection operations, preventing environmental contamination or damage. Will not corrode or deteriorate. Easy to clean. Translucent walls also aid in checking for spills. Dimensions: 31-1/2" I.D.; 35" O.D.; 14"H. **IN STOCK.**

Model No. **XP-490**—Wt. 13 lbs. ....**\$84.50**

**MADE IN USA**



## DIXIE Extra-Low Spill Decks

Optional connector strip connects spill decks in any configuration. Removable decking. Constructed of rotational molded polyethylene. FOB SOUTH CAROLINA.

Model No. **YK-2052**—Access Ramp. 22"W x 22"D x 2-1/4"H. Wt. 25 lbs. ....**\$99.60**  
 Model No. **YK-2053**—Connector Strip. 48"L x 1"W. Wt. 1 lb. ....**\$20.70**

Model Number	Overall W x D x H	Drum Capacity	Sump Capacity	Capacity Lbs.	Wt. Lbs.	Price Each
<b>YK-2050</b>	48 x 24 x 2-1/4"	2	9	1,600	24	<b>\$129.00</b>
<b>YK-2051</b>	48 x 48 x 2-1/4"	4	18	3,200	40	<b>232.00</b>



# Spill Containment

## DIXIE Spill Tray System

### SPILL TRAYS

Chemical-resistant poly trays protect surfaces from corrosive liquids. Shelves support weight of fully loaded trays. Not to be used to carry items. 36"W with 1/2"H lip. Fits most standard shelving. Materials have been approved to meet FDA standards. **SPECIFY COLOR:** GY - Gray, YL - Yellow. **IN STOCK.**



Tray Size	FLAT BOTTOM		RIBBED BOTTOM	
	Model No.	Price Ea.	Model No.	Price Ea.
12"	YK-4492	\$17.20	YK-4495	\$20.40
18"	YK-4493	27.00	YK-4496	29.50
24"	YK-4494	35.20	YK-4497	40.60

### COMPLETE SHELF UNIT.

5-shelf, 36"W x 18"D x 87"H PENCO Hi-Performance Unit, with 4 spill trays.

**SPECIFY TRAY COLOR:** GY - Gray, YL - Yellow.

Model No. YK-4498—Flat-Bottom Tray Unit. ....	\$270.00
Model No. YK-4499—Ribbed-Bottom Tray Unit. ....	\$278.00



## EAGLE® Spill Tray

Ideal for use on counters and workbenches. Hold small spills up to 5 gallons. Heavy-duty, high-density polyethylene material with ribbed bottom and 2" lip. Not sized to fit on standard shelving. 36"L x 18"W. **IN STOCK.**



Model No. YK-4500—	\$24.90
--------------------	---------



## DIXIE Modular Spill Pallets

Machinery, support posts, or other inplant obstacles in your drum storage area are not a problem when you choose these modular pallets. Units clamp together in any configuration in-line, around obstacles, or over entire floor. Lightweight, chemical-resistant polyethylene construction with removable yellow grating. 10-gallon spill capacity per module (not intended for secondary containment). Each 32"L x 32"W x 6"H pallet holds one 55-gallon drum. **IN STOCK.**

Model No. XV-3510—Wt. 25 lbs.....	\$124.00
-----------------------------------	----------



## DIXIE Big Mouth Econo Stacker

Take advantage of every inch of storage space with these stackable basins. Large basin fits over a standard 48" x 48" pallet letting you stack multiple units up to 3 or 4 high. Nestable when empty. 65-gallon sump drains through a 2" NPT plug. 49-1/8" x 49-1/8" overall. **IN STOCK.**



Model No. XK-1065—Wt. 30 lbs.....	\$179.00
-----------------------------------	----------

# EAGLE® Spill Containment



MODEL YP-448



## Polyethylene Containment Pallets

Protect against leaking, damaged 55-gallon drums with plastic secondary containment pallets. Removable deck is easy to clean. Chemical-resistant and easily handled with a standard forklift. Optional access ramp with 9° slope hooks over spill platform edge. Meets EPA requirements for secondary containment.

**IN STOCK.**



MODEL YP-0400



MODEL YK-1060 SHOWN WITH YK-1065 OPTIONAL ACCESS RAMP.

PALLET						RAMP			
Model No.	Description	W x D x H	Sump Cap	Wt. Lbs.	Price Ea.	Model No.	W x D x H	Wt. Lbs.	Price Ea.
YP-448	2-Drum	54 x 30 x 17"	68-gallon	60	\$297.00	—	—	—	—
YP-446	4-Drum	50 x 50 x 17"	85-gallon	70	389.00	—	—	—	—
YP-0400	Low-Profile 4-Drum	51-1/2 x 51-1/2 x 8"	62-gallon	58	331.00	—	—	—	—
YK-1060	Low-Profile 4-Drum	106 x 30-1/4 x 6-3/4"	63-gallon	74	361.00	YK-1065	45-1/2 x 32 x 8"	32	\$173.00



## Secondary Containment Pallets

Constructed of durable polyethylene to resist most chemical corrosion. Safely contain hazardous leaks, meeting EPA requirements. Removable open grating makes cleaning easy. Units have translucent basin for quick visual inspections. **FACTORY QUICK SHIP—FOB WEST VIRGINIA.**

Model Number	Unit Capacity	Secondary Spill Capacity	Overall L x W x H	Wt. Lbs.	Price Each
YP-449	6-drum	61-gal.	77" x 51-1/2" x 6-1/2"	88	\$570.00
YP-450	8-drum	82-gal.	102" x 51-1/2" x 6-1/2"	116	687.00

**OPTIONAL ACCESS RAMP.** 45-1/2"L x 32"W x 8"H with gentle 9° slope and non-skid surface. Hooks over platform edge to avoid movement during use. Lightweight polyethylene resists chemicals.

Model No. **YP-995** .....\$177.00



OPTIONAL ACCESS RAMP

# Spill Containment



## ENPAC Drum Workstations & Ramp

This workstation doubles as drum storage/pump station and as a waste collection center. It will hold up to eight 55-gallon drums with a static load capacity of 8,000 lbs. At 6-1/4" high, this product is one of the lowest profile compliance spill pallets on the market. It has a 60-gallon sump capacity to catch incidental spills. A ramp is also available with the workstation. It hooks onto the workstation for stability, and it also has 2 gallons of incidental spill capacity. Ramp load capacity is 1,000 lbs. **FACTORY QUICK SHIP—FOB OHIO.**

Model Number	Description	Dimensions L x W x H	Std. Cap.	Wt. Lbs.	Price Each
XK-1070	2-Drum	53" x 29" x 6"	21	37	\$211.00
XK-1071	4-Drum	53" x 53" x 6"	43.5	72	270.00
XK-1072	6-Drum	77" x 53" x 6"	62	107	326.00
XD-431	8-Drum	100" x 53" x 6"	73	149	542.00
XD-432	Ramp	27" x 48" x 6"	-	30	202.00
XK-1073*	Link-Lock™	9" x 7" x 3-3/4"	-	2.5	78.40

\*Sold in pairs



**ACID-RESISTANT POLYETHYLENE PROVIDES SAFE BATTERY STORAGE.**



## EAGLE® Modular Spill Pallets

Pallets lock together in any configuration in-line, around posts/machines, or over entire floor. Durable high-density polyethylene is chemical-resistant, leak-proof and will not crack or bend. Removable grating eases cleaning. **IN STOCK.**

Model Number	Description	Overall L x W x H	Cap. Lbs.	Sump Cap. Gal.	Wt. Lbs.	Price Each
YK-0320	1-Drum Pallet	26" x 26" x 6-1/2"	2000	12	16	\$76.20
YK-0405	2-Drum Pallet	51-1/2" x 26-1/4" x 6-1/2"	5000	30	32	139.00
YK-0406	4-Drum Pallet	51-1/2" x 51-1/2" x 6-1/2"	10,000	60	65	268.00

**ACCESS RAMP FOR 2- AND 4-DRUM SPILL PALLETS.** 45-1/2"L x 32"W x 8"H ramp hooks over platform edge and stays securely in place while drum is moved. Gradual 9° slope. Diamond tread. **IN STOCK.**

Model No. **YK-0323**—Wt. 32 lbs. ....\$173.00

# Safety Cabinets



**SINGLE-DRUM CABINET**



**DOUBLE-DRUM CABINET**

## SECURALL® Safety Cabinets

Two great ways to safely store dangerous flammable chemicals. Reinforced 18-ga. all-welded galvanized steel construction offers an iron-zinc alloy finish without spangles and premium paint adherence. Two 2" vents with flash arrestors prevent buildup of dangerous gases. Double-wall construction includes 1-1/2" air space and leakproof 2" deep sill. Doors swing on continuous piano hinges and lock via three-point self-latching devices with flush-mount handles. Large warning label spans both doors. Choose either horizontal cabinets with floor tracks that guide drum cradle into position or vertical cabinets with ball-bearing rollers for easy drum placement and a galvanized steel storage shelf for small waste containers. Meet OSHA and NFPA code 30 regulations. **FACTORY QUICK SHIP—FOB INDIANA.**

Model Number	Max. Drum Qty.	Max. Can Qty.	FM Appr.	Overall W x D x H	Door Type	Wt. Lbs.	Price Each
<b>HORIZONTAL CABINETS</b>							
YP-1290	(1) 55-gal.	(1) 5-gal.	FM	34" x 50" x 50"	Manual	384	<b>\$724.00</b>
YP-1291	(1) 55-gal.	(1) 5-gal.	—	34" x 50" x 50"	Sliding	389	<b>801.00</b>
YP-1292	(1) 55-gal.	(1) 5-gal.	FM	34" x 52" x 50"	Safety	414	<b>876.00</b>
<b>VERTICAL CABINETS</b>							
YP-1293	(1) 55-gal.	(2) 5-gal.	FM	31" x 65" x 31"	Manual	382	<b>\$796.00</b>
YP-1294	(1) 55-gal.	(2) 5-gal.	—	31" x 65" x 31"	Sliding	387	<b>864.00</b>
YP-1295	(1) 55-gal.	(2) 5-gal.	FM	31" x 67" x 31"	Safety	404	<b>932.00</b>
YP-1296	(2) 55-gal.	(2) 5-gal.	FM	56" x 65" x 31"	Manual	581	<b>1701.00</b>
YP-1297	(2) 55-gal.	(2) 5-gal.	FM	56" x 67" x 31"	Safety	610	<b>1921.00</b>
YP-1298	(1) 55-gal.	(12) 5-gal.	FM	56" x 65" x 31"	Manual	600	<b>2188.00</b>



**YK-1075 SINGLE-DRUM CABINET**



**YK-1081 DOUBLE-DRUM CABINET**

## EAGLE® Safety Cabinets

Designed for temporary on-site storage of hazardous waste containers. Double-wall, 18-ga. steel cabinet includes 2" sill and 2" screened flame arrestor vents that prevent dangerous vapor build-ups. Door features a 3-point lock to prevent unauthorized access to hazardous contents. Easy-to-read "Flammable—Keep Fire Away" stencils on both doors.

Adjustable leveler feet stabilize cabinet. Choose either single-drum cabinet or double-drum cabinets that store both 55-gallon drums and small containers. Selected cabinets have a roller bottom that eases removal of heavy drums. Both cabinets meet OSHA and NFPA standards.

**FACTORY QUICK SHIP—FOB WEST VIRGINIA.**

Model Number	Description	Max. Drum Qty.	Max. Can Qty.	Overall W x D x H	Door Type	Wt. Lbs.	Price Each
YK-1075	Horizontal	(1) 55-gal.	—	31" x 48" x 50"	Manual	410	<b>\$1036.00</b>
YK-1076	Vertical	(1) 55-gal.	—	31" x 31" x 65"	Manual	400	<b>978.00</b>
YK-1080	Vertical with Roller Bottom	(1) 55-gal.	(2) 5-gal.	32" x 32" x 65"	Manual	350	<b>1045.00</b>
YK-1081	Vertical with Roller Bottom	(2) 55-gal.	(3) 5-qt.	58" x 32" x 65"	Manual	575	<b>1689.00</b>
YK-1082	Vertical with Roller Bottom	(1) 55-gal.	(2) 5-gal.	32" x 32" x 65"	Sliding	360	<b>1131.00</b>

NOTE: NFPA Code 30 limits storage in one cabinet to 120 gal., and only 60 of the 120 gallons can be flammable liquids.

# JUSTRITE® Safety Cabinets



## Safety Cabinets with Sure-Grip® EX Handle

Store flammables safely with these double-wall 18-ga. welded steel cabinets. 1-1/2" air space prevents buildup of explosive temperatures. Self-closing doors shut automatically via fusible link that melts at 165°F (per Uniform Fire Code, UFC). Doors clearly marked with Haz-Alert™ reflective labels reading "FLAMMABLE KEEP FIRE AWAY" in three languages. U-Lock™ padlock handle includes both a keyed lock and padlock hasp (padlock not included) for maximum security. Adjustable SpillSlope™ shelves are angled to drain leaks to the back; meet ANSI standards with a 350-lb. cap. Durable chemical-resistant powder coat finish. 10-year manufacturer warranty. Meets the National Fire Protection Assoc. Flammable Combustible Liquid Code #30 and with OSHA std. 1910.106. FM-approved. **SELECTED MODELS IN STOCK. FACTORY QUICK SHIP AND FACTORY DIRECT MODELS FOB ILLINOIS.**

### DOUBLE-WALL SAFETY CABINETS

Rated to handle type I and II safety containers in sizes up to 5 gallons. 30-gal. models have (1) 15"D shelf, 45-gal. models have (2) 15"D shelves, 60- and 90-gal. models have (2) 31"D shelves. Color: yellow.

Model Number	Cap. Gal.	Shelf Qty.	Overall W x D x H	Wt. Lbs.	Price Each
<b>1-DOOR CABINETS (SELF-CLOSING SLIDING DOORS)</b>					
XS-113	30	1	43" x 18" x 44"	246	\$747.00
XS-114	45	2	43" x 18" x 65"	330	820.00
<b>2-DOOR CABINETS (MANUAL-CLOSING DOORS)</b>					
XS-115	30	1	43" x 18" x 44"	237	\$600.00
XS-116	45	2	43" x 18" x 65"	322	762.00
XS-644	60	2	34" x 34" x 65"	387	875.00
XS-646	96	2	43" x 34" x 65"	480	1260.00
<b>2-DOOR CABINETS (SELF-CLOSING DOORS)</b>					
XS-414	30	1	43" x 18" x 44"	237	\$754.00
XS-416	40	3	43" x 18" x 44"	254	741.00
XS-413	45	2	43" x 18" x 65"	313	867.00
XS-645	60	2	34" x 34" x 65"	416	993.00
XS-647	90	2	43" x 34" x 65"	480	1381.00



### EXTRA SHELVES

Model No. XS-262—Fits 30- and 45-Gal. Safety Cabinets. Wt. 12 lbs. ....	\$41.20
Model No. XS-263—Fits 60-Gal. Safety Cabinet. Wt. 18 lbs. ....	\$84.20
Model No. XS-264—Fits 90-Gal. Safety Cabinet. Wt. 18 lbs. ....	\$91.90



**SPACE-SAVING COMPACT CABINETS** Convenient cabinets store safely on or under benches and counter tops. Include (1) adjustable shelf.

Model Number	Cap. Gal.	Door Qty.	Overall W x D x H	Wt. Lbs.	Price Each
<b>MANUAL-CLOSING DOORS</b>					
XR-1020	12	1	23" x 18" x 35"	114	\$427.00
XR-1022	15	1	23" x 18" x 44"	125	504.00
XR-1024	22	2	35" x 22" x 35"	204	620.00
<b>SELF-CLOSING DOORS</b>					
XR-1021	12	1	23" x 18" x 35"	118	\$462.00
XR-1025	22	2	35" x 22" x 35"	212	724.00

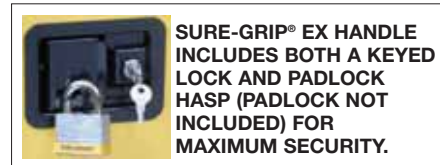

**SURE-GRIP® EX HANDLE INCLUDES BOTH A KEYED LOCK AND PADLOCK HASP (PADLOCK NOT INCLUDED) FOR MAXIMUM SECURITY.**

### PAINTS, INKS, AND CLASS III COMBUSTIBLES CABINETS

Low-profile cabinet stores 1-gallon Class III liquid cans of paints, inks, etc. in confined work areas.

Model Number	Cap. Gal.	Shelf Qty.	Overall W x D x H	Wt. Lbs.	Price Each
<b>MANUAL-CLOSING DOORS</b>					
XR-1005	40	3	43" x 18" x 44"	250	\$659.00
XR-1007	60	4	43" x 18" x 65"	340	884.00
XR-1009	120	4	34" x 34" x 65"	420	1061.00
<b>SELF-CLOSING DOORS</b>					
XR-1006	40	3	43" x 18" x 44"	250	\$741.00
XR-1008	60	4	43" x 18" x 65"	355	1017.00
XR-1010	120	4	34" x 34" x 65"	420	1219.00

NOTE: Also available in red, call for information.



## JUSTRITE® Document Storage Boxes

Weather-resistant, rust-proof polyethylene storage box keeps papers clean and dry. Mounts on cabinets, machinery, equipment, wire partitions, or wall. Includes heavy-duty double-sided tape for mounting directly on safety cabinet. Pre-drilled holes on back accept mounting hardware or zip ties.

Model Number	Description	Interior W x D x H	Exterior W x D x H	Wt. Lbs.	Price Each
YS-1440	Medium, Top-Opening	8-3/4" x 1-5/8" x 11-1/2"	10-1/4" x 2-1/4" x 12-1/2"	33	\$42.30
YS-1441	Large, Front-Opening	10-3/4" x 2-1/4" x 13-1/4"	13-3/8" x 3-9/16" x 15-3/4"	30	60.80

NOTE: To keep from voiding safety rating, you must use included double-sided tape if mounting box directly on a cabinet.

Model No. YS-1442—Label Pack. 4 yellow labels (2 blank and 2 printed MSDS and Instruction Manuals). .....\$4.20



# EAGLE® Safety Cabinets



## Double-Wall Flammable Storage Cabinets



Double-wall, 18-gauge welded steel construction with 1-1/2" air space prevents gas build-up that may occur when storing hazardous liquids. Choose either manual close doors or models with self-closing doors that shut automatically via a melting link when temperatures reach 160°F (meets Uniform Fire Code, UFC). Other protective features include: dual 2" capped vents to provide external exhaust, ground wire connection to prevent static buildup (wire not included), and leakproof 2" base sill that contains hazardous liquids. Locking 3-point handle secures contents. Shelves adjust to accept different sized containers. Labeled with large easy-to-read "Flammable Keep Fire Away" message in three languages. Complies with National Fire Protection Association Flammable Combustible Liquid Code #30 and with OSHA standard 1910.106. Color: yellow. **IN STOCK.**

Model Number	Cap. Gal.	Overall W x D x H	Shelf Qty.	Wt. Lbs.	Price Each
<b>SINGLE SLIDING DOOR CABINET (SELF-CLOSING DOOR)</b>					
<b>XD-5033</b>	30	43" x 18" x 44"	1	261	<b>\$785.00</b>
<b>XD-5034</b>	45	43" x 18" x 65"	2	361	<b>970.00</b>
<b>2-DOOR CABINET (MANUAL-CLOSING DOORS)</b>					
<b>XD-5036</b>	30	43" x 18" x 44"	1	261	<b>\$672.00</b>
<b>XD-5037</b>	45	43" x 18" x 65"	2	361	<b>841.00</b>
<b>XD-5038</b>	60	31-1/4" x 31-1/4" x 65"	2	374	<b>978.00</b>
<b>XP-1436</b>	90	43" x 34" x 65"	2	485	<b>1400.00</b>
<b>2-DOOR CABINET (SELF-CLOSING DOORS)</b>					
<b>XD-5039</b>	30	43" x 18" x 44"	1	276	<b>\$794.00</b>
<b>XD-5040</b>	45	43" x 18" x 65"	2	376	<b>955.00</b>
<b>XD-5041</b>	60	31-1/4" x 31-1/4" x 65"	2	389	<b>1103.00</b>
<b>XP-1437</b>	90	43" x 34" x 65"	2	485	<b>1507.00</b>

NOTE: Other colors available. Call for more information.

### EXTRA SHELVES

Model No. <b>XD-5042</b> —Fits 30-, 45- and 90-Gal. Safety Cabinet. Wt. 14 lbs. ....	<b>\$49.50</b>
Model No. <b>XD-5043</b> —Fits 60-Gal. Safety Cabinet. Wt. 16 lbs. ....	<b>\$94.10</b>



## Cabinets For Paints, Inks, and Class III Combustibles



Durable 18-ga. steel cabinets safely store gallon-size paint and ink cans. Choose either manual-close or self-close cabinets with doors that automatically shut at 160°F via a melting link. Other safety features include: double walls with 1-1/2" air space to prevent build-up of explosive gases, dual capped vents for external exhaust, and ground wire connection to prevent static build-up. 3-point lock secures contents. 14-3/4"D shelves. **SPECIFY COLOR: RD** - Red, **YL** - Yellow. **SELECTED MODELS ARE IN STOCK.** Others FOB WEST VIRGINIA.

Model Number	Cap. Gal.	Overall W x D x H	Shelf Qty.	Wt. Lbs.	Price Each
<b>MANUAL-CLOSE 2-DOOR</b>					
<b>XF-2215</b>	40	43" x 18" x 44"	3	310	<b>\$720.00</b>
<b>XF-2216</b>	60	43" x 18" x 65"	5	425	<b>911.00</b>
<b>XP-1438</b>	120	31-1/4" x 31-1/4" x 65"	5	412	<b>1173.00</b>
<b>SELF-CLOSE, SLIDING 1-DOOR</b>					
<b>XF-2217</b>	40	43" x 18" x 44"	3	310	<b>\$835.00</b>
<b>XF-2218</b>	60	43" x 18" x 65"	5	425	<b>1071.00</b>

### EXTRA METAL SHELVES

Model No. <b>XF-2219</b> —Fits 40- and 60-Gal. Wt. 14 lbs. ....	<b>\$49.50</b>
Model No. <b>XP-1440</b> —Fits 120-Gal. Wt. 16 lbs. ....	<b>\$93.00</b>



# SECURALL® Safety Cabinets



## Safety Cabinets

Loaded with features to safely store flammables in accordance with OSHA standards and NFPA code 30. 18-gauge all-welded galvanized steel construction for premium paint adherence and an iron-zinc alloy finish. 1-1/2" insulating air space to prevent buildup of explosive temperatures. 2" leakproof door sills help contain spills while the adjustable self-leveling legs keep cabinet stable on uneven floors. Doors feature flush-mounted locking handle for safety and 3-point self-latching system with spring latches. Choose either manual or self-closing doors that automatically shut via a fusible link that melts at 165°, closing the door. Color: yellow. **FACTORY QUICK SHIP—FOB INDIANA.**



Model No.	Cap. Gal.	Approvals	Overall W x D x H	Shelf Qty.	Wt. Lbs.	Price Each
<b>SINGLE-DOOR CABINET (SELF-CLOSING SLIDING DOOR)</b>						
XP-1370	30	FM	43" x 18" x 44"	1	252	\$610.00
XP-1371	45	FM	43" x 18" x 65"	2	342	725.00
XP-1372	60	—	31" x 31" x 65"	2	377	850.00
XP-1373	90	—	43" x 31" x 65"	2	448	1082.00
<b>2-DOOR CABINET (MANUAL-CLOSING DOORS)</b>						
XP-1374	30	FM	43" x 18" x 44"	1	247	\$540.00
XP-1375	45	FM	43" x 18" x 65"	2	337	652.00
XP-1376	60	FM	31" x 31" x 65"	2	372	779.00
XP-1377	90	FM	43" x 31" x 65"	2	443	1008.00
<b>2-DOOR CABINET (SELF-CLOSING DOORS)</b>						
XP-1378	30	FM	43" x 18" x 46"	1	267	\$685.00
XP-1379	45	FM	43" x 18" x 67"	2	357	798.00
XP-1380	60	FM	31" x 31" x 67"	2	394	922.00
XP-1381	90	FM	43" x 31" x 67"	2	472	1154.00

## Caster Assemblies

Adds mobility to either safety cabinet on this page. 12-gauge units mount at the bottom corners of the cabinet, converting stationary units to mobile ones. 2000-lb. capacity. Each set includes (2) locking caster assemblies, one with 2 swivel casters and one with 2 rigid casters. **SPECIFY COLOR: RD - Red, YL - Yellow.** **FACTORY QUICK SHIP—FOB INDIANA.**

Model No.	Description	Wt. Lbs.	Price Each
XR-1630	For 18"D cabinets	30	\$225.00
XR-1631	For 31"D cabinets	39	248.00



## Paint & Ink Cabinets



Safely store gallon-size paints and inks in these durable safety cabinets. Perfect for print shops or auto body repair shops. Strong 18-gauge all-welded steel cabinet features 1-1/2" insulating air space that prevents buildup of explosive temperatures. Flush-mounted handles offer easy access and promote worker safety. Other cabinet features include: 2" leakproof door sill, adjustable self-leveling legs, and 3-point self-latching doors with spring latches. Choose either manual or self-closing door with fusible link that melts at 165°, automatically closing the door. Color: red. **FACTORY QUICK SHIP—FOB INDIANA.**

Model No.	Cap. Gal.	Approvals	Overall W x D x H	Shelf Qty.	Wt. Lbs.	Price Each
<b>SINGLE-DOOR CABINET (SELF-CLOSING SLIDING DOOR)</b>						
XP-1385	40	FM	43" x 18" x 44"	1	276	\$642.00
XP-1386	60	FM	43" x 18" x 65"	2	378	807.00
XP-1387	120	—	31" x 31" x 65"	2	419	993.00
<b>2-DOOR CABINET (MANUAL-CLOSING DOORS)</b>						
XP-1388	40	FM	43" x 18" x 44"	1	271	\$568.00
XP-1389	60	FM	43" x 18" x 65"	2	373	735.00
XP-1390	120	FM	31" x 31" x 65"	2	414	921.00
<b>2-DOOR CABINET (SELF-CLOSING DOORS)</b>						
XP-1391	40	FM	43" x 18" x 44"	1	291	\$935.00
XP-1392	60	FM	43" x 18" x 65"	2	393	880.00
XP-1393	120	FM	31" x 31" x 65"	2	436	1065.00



# Safety Cabinets



SELF-CLOSING



MANUAL CLOSING



MANUAL CLOSING



## EDSAL Safety Cabinets

Designed to safely store flammable liquids in accordance with OSHA and NFPA standards. Double-wall, 18-gauge welded steel construction has 1-1/2" air space to prevent build-up of explosive gas. Dual 2" capped vents with flash arrestors provide external exhaust. 2"H leakproof door sill contains spills. 500-lb. capacity galvanized shelves adjust on 2-1/2" centers. Locking handle with 3-point latch secures contents. Adjustable leveling feet steady cabinet on uneven surfaces. Labeled with large easy-to-read "Flammable—Keep Fire Away" message. **IN STOCK.**



**MANUAL-CLOSING CABINETS.** Double doors close manually for dependable storage of flammable and combustible liquids. Color: yellow.

Model Number	Overall W x D x H	Cap. Gal.	Shelf Qty.	Wt. Lbs.	Price Each
XA-2240	43" x 18" x 44"	30	1	252	\$458.00
XA-2241	43" x 18" x 65"	45	2	349	679.00
XA-2242	34" x 34" x 65"	60	2	409	897.00

**SELF-CLOSING CABINETS.** Bi-fold doors close automatically after each use. Include fusible link that can latch door open when retrieving multiple items. In the event of a fire, fusible link melts at a specified temperature, automatically closing doors and protecting contents from flames. Color: yellow.

Model Number	Overall W x D x H	Cap. Gal.	Shelf Qty.	Wt. Lbs.	Price Each
XA-2243	43" x 18" x 44"	30	1	250	\$655.00
XA-2244	43" x 18" x 65"	45	2	350	812.00
XA-2245	34" x 34" x 65"	60	2	400	972.00

**PAINT AND INK CABINETS.** Securely stores gallon-size containers of paints and inks. Color: red.

Model Number	Overall W x D x H	Cap. Gal.	Shelf Qty.	Wt. Lbs.	Price Each
XA-2246	43" x 18" x 44"	60	3	269	\$678.00
XA-2247	43" x 18" x 65"	60	5	378	723.00

PAINT AND INK



## WILRAY Safety Cabinets

One of the most durable cabinets available, this model features solid welded construction, extra reinforcements, and welded top and bottom seams for extra rigidity and structural integrity. Full-welded, 18-ga. cabinet is double-walled with a 1-1/2" air space, while the solid welded 2" sill and 2" deep sump contain hazardous materials. Self-closing doors feature a rugged hinge, internal spring, and a 3-point self-latching closure. Also includes exhaust vent, 12-ga. 4" high legs, and adjustable galvanized shelves. Meets OSHA and NFPA Code 30. Color: yellow. **IN STOCK.**



Model Number	Overall W x D x H	Cap. Gal.	Shelf Qty.	Door Qty.	Wt. Lbs.	Price Each
<b>FOR 5-GALLON CONTAINERS</b>						
XR-1670	28" x 18" x 46"	20	1	1	155	\$580.00
XR-1671	42" x 20" x 44"	30	1	1	260	606.00
XR-1672	28" x 28" x 39"	40	1	1	190	629.00
XR-1673	42" x 20" x 61"	45	2	2	300	773.00
XR-1674	28" x 28" x 55"	60	2	1	270	709.00
XR-1675	28" x 40" x 55"	90	2*	1	430	941.00
XR-1676	40" x 40" x 55"	135	2*	1	500	1021.00
XR-1677	40" x 40" x 73"	180	3*	1	595	1335.00
<b>FOR 1-GALLON CONTAINERS</b>						
XR-1678	28" x 18" x 46"	20	4	1	200	\$638.00
XR-1679	42" x 20" x 60"	40	4	2	330	842.00
XR-1680	42" x 20" x 61"	60	5	1	335	862.00
XR-1681	42" x 28" x 61"	90	5	2	475	1188.00
XR-1682	56" x 30" x 66"	120	5	2	735	1309.00

\*Shelves are not adjustable.



# Cylinder Storage

## Steel Cabinets for Cylinders

Protect 20-, 30-, or 43-lb. cylinders behind tamperproof doors. Legs feature lag holes for bolting to floor. 13-gauge steel mesh sides; 16-gauge sheet steel roof. Includes red lettered signage to indicate flammable contents. Padlock hasp (lock not included). Upright storage cabinets include chains for securing cylinders. Holds up to 20 cylinders. Feature "Flammable—Keep Away From Flame" label. Meet OSHA requirements and NFPA standards. Safety yellow powder coat. **SELECTED MODELS IN STOCK.** Others FOB INDIANA.



Selected Models

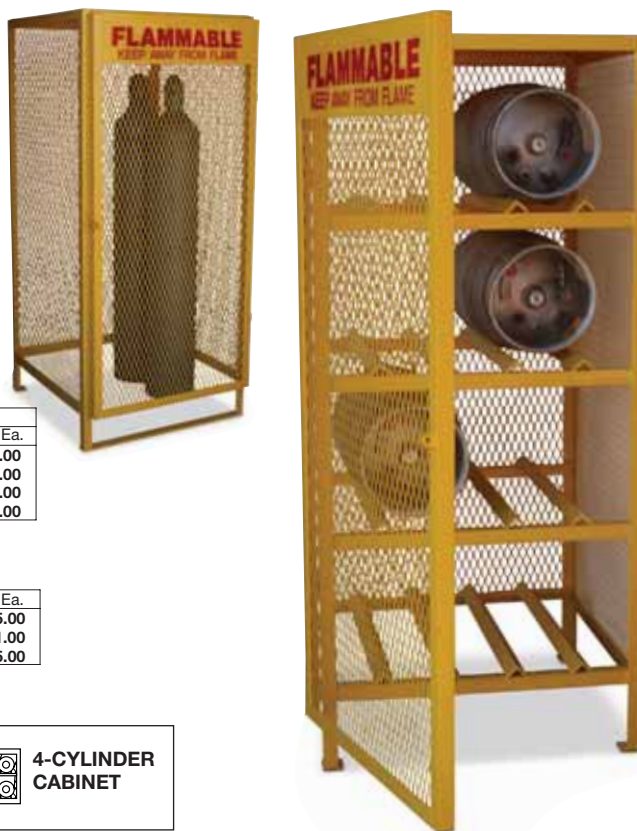

### HORIZONTAL STORAGE CABINETS

Overall W x D x H	Cylinder Capacity*	Wt. Lbs.	UNASSEMBLED		SET-UP	
			Model No.	Price Ea.	Model No.	Price Ea.
33 x 38 x 37"	4	180	ZA-5100	\$541.00	ZA-5104	\$549.00
33 x 38 x 70"	8	290	ZA-5101	821.00	ZA-5105	809.00
49 x 38 x 70"	12	350	ZA-5102	1025.00	ZA-5106	955.00
65 x 38 x 70"	16	500	ZA-5103	1389.00	ZA-5107	1335.00

\*Based on maximum 14" diameter cylinders.

### UPRIGHT STORAGE CABINETS

Model No.	Overall W x D x H	Cylinder Cap.*	Description	Wt. Lbs.	Price Ea.
ZA-5108	60 x 38 x 72"	10-20	Unassembled	215	\$1175.00
ZA-5109	33 x 37 x 72"	5-10	Set Up	215	731.00
ZA-5110	60 x 38 x 72"	10-20	Set Up	370	1135.00

\*Depending on cylinder size.

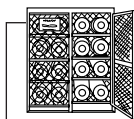

16-CYLINDER CABINET

12-CYLINDER CABINET

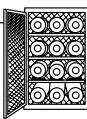

4-CYLINDER CABINET



## Stationary Cylinder Holders

Safely stores gas cylinders in compliance with OSHA and insurance company regulations. Polypropylene strap with steel cinch style buckle secures cylinders without slack. Holder (D) screw clamps directly to workbench. **IN STOCK.**

Key	Model Number	Cylinder Cap.	Cylinder Dia.	Overall Width	Wt. Lbs.	Price Each
<b>WALL-MOUNT MODEL</b>						
A	ZA-1407	1	14"	8"	3	\$30.70
B	ZA-1408	2	12-3/8"	23-3/8"	8	58.60
<b>FREE-STANDING MODEL</b>						
C	ZA-1409	2	12-3/8"	28"	48	163.00
<b>BENCH-MOUNT MODEL</b>						
D	ZA-1410	1	14"	8"	6	46.30

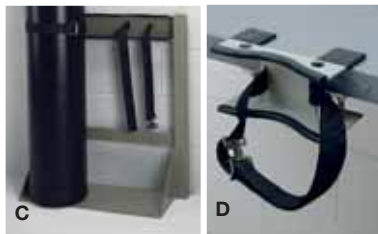

## SECURALL® Aluminum Cylinder Cabinets

Keep cylinders organized and away from theft and vandalism. All-welded aluminum construction is designed for outdoor use, making these durable cabinets ideal for all weather environments; they won't corrode or discolor with age either. See-through expanded metal sides and doors stop the accumulation of hazardous gases and permit quick, visual checks of cylinders. Most locks fit the built-in padlock hasp. Meets OSHA requirements and NFPA standards. Shipping costs are greatly reduced because aluminum is 1/3 the weight of steel. Ships fully assembled, ready for use immediately. **FACTORY QUICK SHIP – FOB INDIANA.**



Model Number	Overall W x D x H	Cylinder Capacity	Wt. Lbs.	Price Each
YK-2184	30" x 32" x 33"	4	76	\$407.00
YK-2185	30" x 32" x 65"	8	117	656.00
YK-2186	43" x 32" x 65"	12	126	887.00
YK-2187	60" x 32" x 65"	16	204	1079.00

# Cylinder Storage & Cylinders

## JUSTRITE® Aluminum Cylinder Lockers

Designed for outdoor storage of cylinders and LPG containers. Heavy-gauge mesh and extruded frames are constructed of heavy .081 non-sparking aluminum that is 58% thicker than other models. Sloped roof allows water and ice to run off and the entire locker will not rust, discolor, or corrode. Pre-drilled corners accept 1/2" anchor bolts. Includes padlock lug and information labels. Meets OSHA 1910.110 and NFPA 58 standards. Ships assembled. **FACTORY QUICK SHIP—FOB ILLINOIS.**

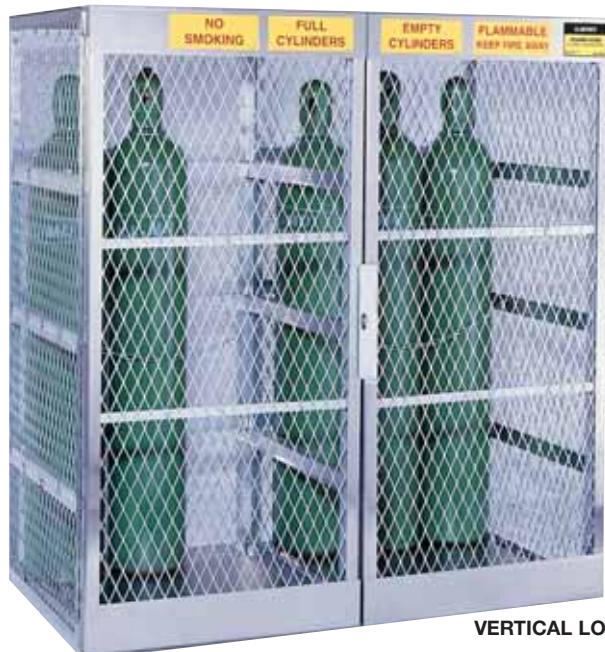

VERTICAL LOCKER



HORIZONTAL & VERTICAL COMBO LOCKER

Model Number	Max. Cylinder Qty.	Overall W x D x H	Wt. Lbs.	Price Each
<b>HORIZONTAL LOCKERS</b>				
XA-2080	4	30" x 32" x 33-1/2"	79	\$572.00
XA-2081	6	30" x 32" x 49-1/2"	97	682.00
XA-2082	8	30" x 32" x 65"	114	800.00
XA-2083	12	60" x 32" x 49-1/2"	178	1276.00
XA-2084	16	60" x 32" x 65"	211	1535.00
<b>VERTICAL LOCKERS</b>				
XA-2085	10	30" x 32" x 65"	102	\$740.00
XA-2086	20	60" x 32" x 65"	187	1315.00
<b>2-IN-1 COMBINATION CABINET LOCKER</b>				
XA-2087	8 horiz./5-10 vert.	60" x 32" x 65"	200	\$1405.00



HORIZONTAL LOCKER



## ATLAS Steel & Aluminum Cylinders



Built to the highest quality, steel or aluminum cylinders are your best choice for liquid propane fuel. Both include: service valve, safety release valve, fixed liquid level valve, safety coupler, and fast fill valve. Meet DOT 4E240 specifications. Choose either heavy steel or weather-resistant aluminum construction. **FACTORY QUICK SHIP—FOB ILLINOIS.**

Model No. XA-2380—	
Steel Cylinders	
Wt. 34-1/2 lbs. ....	\$258.00
Model No. XA-2381—	
Aluminium Cylinders	
Wt. 23-1/2 lbs. ....	\$302.00



## Cylinder Pallets

Fork liftable pallets handle 4, 6, or 8 cylinders up to 9" in diameter. Double-welded steel construction. 7-ga. steel pockets on both ends accept forks up to 6-1/4" wide. 34"W x 40"H overall. Depth varies from 23" to 43". Hinged dividers provide easy access to each cylinder from either end. Orange enamel finish. **FACTORY QUICK SHIP—FOB NEBRASKA.**



Model No.	Max. Cylinder Qty.	W x D x H	Wt. Lbs.	Price Ea.
ZC-349	4	34" x 23" x 40"	153	\$347.00
ZC-350	6	34" x 33" x 40"	200	421.00
ZC-351	8	34" x 43" x 40"	247	500.00

# Safety Cans

**TYPE I**

**TYPE II**

**STOCK**  
Selected Models

**FM**  
APPROVED

**UL**

**MADE IN USA**

## JUSTRITE® Safety Cans

Store and handle flammable liquids in accordance with the National Board of Fire Underwriters. Constructed of heavy-duty high-grade steel with double-lock seams, reinforced ribbing, and wide flanges. Include flame arrester screens to prevent fire flashback. Powder coat finish. Meets OSHA para 1910.106. Type I cans are equipped with a single pouring and filling spout that includes a spring controlled, automatic pressure-relief cover. Type II cans have separate pour and fill openings with spring loaded caps. Flexible metal hose permits smooth, accurate, spill-free dispensing. **SELECTED MODELS IN STOCK.** Others FOB ILLINOIS.

Model No.	Capacity	Dia. x Ht.	Wt. Lbs.	Price Ea.
<b>TYPE I SAFETY CANS</b>				
<b>YS-349</b>	1-pint	4-5/8" x 6-3/4"	1-1/2	<b>\$67.30</b>
<b>YS-351</b>	1-quart	4-5/8" x 8-1/4"	1-3/4	<b>58.40</b>
<b>YS-353</b>	1/2-gallon	7-1/4" x 8-3/8"	3	<b>35.90</b>
<b>YS-355</b>	1-gallon	7-1/4" x 11-1/2"	3-1/2	<b>35.70</b>
<b>YS-357</b>	2-gallon	9-3/8" x 12-5/8"	5	<b>37.10</b>
<b>YS-359</b>	3-gallon	9-3/8" x 16-1/8"	6	<b>41.90</b>
<b>YS-361</b>	5-gallon	11-1/2" x 17"	8	<b>39.70</b>
<b>TYPE II SAFETY CANS</b>				
<b>YS-916</b>	1-gallon	9-3/8" x 6-1/2"	5	<b>\$81.90</b>
<b>YS-919</b>	3-gallon	11-1/2" x 13-1/2"	8	<b>82.70</b>
<b>YS-920*</b>	3-gallon	11-1/2" x 13-1/2"	8	<b>82.70</b>
<b>YS-921</b>	5-gallon	11-1/2" x 17"	9	<b>81.30</b>
<b>YS-922*</b>	5-gallon	11-1/2" x 17"	9	<b>81.30</b>

\*1" hose O.D.

**FM**  
APPROVED

**STOCK**

**UL**

**MADE IN USA**

## EAGLE® Type I Safety Cans

Safely store and dispense flammable liquids with these Type I safety cans. Relief vent mechanism allows expanding vapors to escape. Spout includes a 4" metal mesh flame arrester screen that inhibits fire or explosion. Constructed of 24-gauge galvanized steel. UL listed, FM approved. **IN STOCK.**

Model No.	Cap.	Dia. x Ht.	Wt. Lbs.	Price Ea.
<b>YD-1473</b>	1-gal.	9" x 10"	4	<b>\$33.90</b>
<b>YD-1474</b>	2-gal.	11-1/4" x 9-1/2"	6	<b>36.20</b>
<b>YD-1475</b>	5-gal.	12-1/2" x 13-1/2"	8	<b>37.30</b>

Model No. **YD-1476** —FM approved polyethylene funnel.....**\$4.61**

**STOCK**

**MADE IN USA**

## JUSTRITE® Faucet/Dispensing Cans

Dispenses flammable liquids at a safe controlled rate. Fill opening has pressure relief cap and double-mesh metal flame arrester screen to prevent flashback. 24-gauge steel construction. Choose bottom faucet can, tilt-type with 20-ga. frame, or can with carbon steel pump that fits into 3/4" opening on can dome and pumps approximately 3-1/2 oz. per stroke. **IN STOCK.**

Model No.	Cap. Gal.	Description	Wt. Lbs.	Price Ea.
<b>YA-1440</b>	5	Tilt, 14-1/4" x 14" base	17	<b>\$147.00</b>
<b>YA-1441</b>	3	Bottom faucet for shelf	9	<b>116.00</b>
<b>YA-1442</b>	5	Bottom faucet for shelf	10	<b>116.00</b>

**UL**

**FM**  
APPROVED

**STOCK**

**MADE IN USA**

## JUSTRITE® Combustible Waste Cans

Waste cans are designed for disposing of oily rags, waste solvent cloths and surgical dressings. Units are made of 20-ga. steel and feature a foot operated cover. When can is operated by foot or hand, cover opens to a 60° angle, closing automatically when released. Chemical resistant powder coat finish. **IN STOCK.**

Model No.	Outside Dia.	Unit Ht.	Unit Cap.	Wt. Lbs.	Price Ea.
<b>ZJ-269</b>	11-7/8"	15-7/8"	6-gal.	9.6	<b>\$61.30</b>
<b>ZJ-271</b>	13-15/16"	18-1/4"	10-gal.	12.2	<b>66.00</b>
<b>ZJ-273</b>	16-1/16"	20-1/4"	14-gal.	15.1	<b>73.50</b>
<b>ZJ-281</b>	18-3/8"	23-7/16"	21-gal.	22.0	<b>123.00</b>

**STOCK**

**FM**  
APPROVED

**UL**

**MADE IN USA**

## EAGLE® Plunger Cans

Safe way to dispense flammables for sponging or cleaning. Large top pan with plunger for controlled action. Perforated flame arrester screen prevents flashback. 24-ga. terne-coated steel. FM-approved. **IN STOCK.**

Model Number	Overall Dia. x Ht.	Can Capacity	Wt. Lbs.	Price Each
<b>YA-1444</b>	6-1/4" x 8"	1-qt.	2.5	<b>\$57.30</b>
<b>YA-1445</b>	8" x 8-1/2"	2-qt.	3	<b>59.10</b>
<b>YA-1446</b>	8" x 10-3/4"	4-qt.	3.5	<b>71.80</b>

# Safety Equipment



**MODEL ZD-120**

**MODEL ZD-121**



## Heavy-Duty Gas Caddies



Steel or polyethylene caddies safely syphon or dispense a wide range of flammables with ease. 2-way rotary pump drains and fills tanks quickly and efficiently. Easy grip handles and large rear wheels roll caddies right to dispensing site.

**ALL-WELDED 30-GALLON STEEL GAS/DIESEL CADDY**  
Epoxy powder coated finish. 8' clear hose. 2" filler neck for bulk filling. Fire screened vent and gauge combination. 14"W x 22"D x 45"H overall. Ground wire and clamp included. Two semi-pneumatic tires. End stops provide secure footing. FM-approved. OSHA compliance. Color: red. FOB IOWA.

Model No. **ZD-120** –Wt. 90 lbs. ....\$**580.00**

**28-GALLON POLY CADDIES**  
UL approved 3/4" ball valve permits user to shut off liquid flow during operation. 3/4" dia. x 10'L UL-approved flexible hose. Calibrated in 2-gallon increments. 27-1/2"W x 22-1/2"D x 41"H overall. Two pneumatic tires with nylon bearings. UN/DOT-approved (UN3H1W). Ships unassembled. **IN STOCK.**



Model No. **ZD-121** – Poly Gas Caddy. Color: red. Wt. 50 lbs. ....\$**776.00**  
Model No. **YD-122** – Diesel Caddy. Color: yellow (not shown). Wt. 50 lbs. ....\$**788.00**

## Dry Chemical Fire Extinguishers

Designed to put out all 3 classes of fires. Steel cylinder filled with multipurpose monoammonium phosphate. Also includes aluminum valve, polyester epoxy finish, pressure gauges, and bracket. **IN STOCK.**



**TYPES OF FIRES & EXTINGUISHERS**

Letter	Picture	Description
<b>A</b>		Wood, paper, cloth, trash, and other materials.
<b>B</b>		Gasoline, grease, oil, paint, and other flammable liquids.
<b>C</b>		Live electrical equipment.

Model Number	Cap. Lbs.	UL Rating	Bracket Type	Dia. x Ht.	Price Each
<b>ZD-1655</b>	2-1/2	1A:10B:C	Vehicle	3" x 14-3/8"	<b>\$46.60</b>
<b>ZD-1656</b>	5	2A:10B:C	Wall	4-1/4" x 14-5/8"	<b>62.20</b>
<b>ZD-1657</b>	5	2A:10B:C	Vehicle	4-1/4" x 14-5/8"	<b>64.90</b>
<b>ZD-1658</b>	10	4A:60B:C	Wall	5" x 20"	<b>105.00</b>
<b>ZD-1659</b>	20	20A:120B:C	Wall	7" x 24"	<b>182.00</b>



**SHOWN WITH OPTIONAL PARTS BASKET**

## JUSTRITE® Floor-Standing Rinse Tanks

Generously sized unit lets you totally immerse large parts up to 35" long. Heavy-duty 18-gauge steel is coated with a tough powder coat paint finish for superior durability and chemical resistance. Foot treadle mechanism operates cover. An adjustable-rate pneumatic cylinder prevents cover from shutting quickly and catching your hand. Also includes 3/4" drain plug and 33"H stand. **FACTORY QUICK SHIP—FOB ILLINOIS.**

**RINSE TANKS**

Model Number	Table L x W x H	Overall Ht.	Cap. Lbs.	Approvals	Wt. Lbs.	Price Each
<b>YD-2050</b>	24" x 16" x 8-3/4"	33-1/4"	11	FM	60	<b>\$354.00</b>
<b>YD-2051</b>	35-1/4" x 16" x 12"	33-1/4"	22	FM	60	<b>541.00</b>

**PARTS BASKETS**

Model Number	Description	Overall L x W x H	Wt. Lbs.	Price Each
<b>YD-2052</b>	Fits 11 gal. rinse tank	16" x 13" x 4"	4	<b>\$48.50</b>
<b>YD-2053</b>	Fits 22 gal. rinse tank	28" x 13" x 4"	5	<b>59.70</b>

# Exit Signs & Emergency Lights

**Glow-In-The-Dark Safety Signs**  
 Guide the way for up to 8 hours. Reactivate automatically without power. Constructed of phosphorescent material. Choose high-impact plastic or self-stick vinyl. Meets OSHA specs. 1910.137Q. **SPECIFY:** Stock number and sign code.

**FACTORY QUICK SHIP** —  
**SHIP** —  
**FOB ILLINOIS.**

Model No.	Description	Price Ea.
ZD-1498	High-Impact Plastic	\$20.30
ZD-1499	Self-Stick Vinyl	20.30

**OSHA Compliance Signs**  
 For indoor or outdoor use. Will not rust, weather, tear, dent, scratch, etc. All are 14" x 10". .055" thick high-impact plastic has silk-screened message. Self-stick vinyl adheres to smooth surfaces. **SPECIFY:** Stock number and sign code.

**FACTORY QUICK SHIP** —  
**SHIP** —  
**FOB ILLINOIS.**

Model No.	Description	Price Ea.
ZD-1496	High-Impact Plastic	\$19.00
ZD-1497	Self-Stick Vinyl	13.20

**BIG BEAM Exit Signs.**  
**EXIT SIGNS WITH STEEL HOUSING**  
 Clearly marks exits during power failures. 20-gauge steel housing offers ceiling, end, or back mount capabilities. Other features include: canopy, universal stencil, downlight, and white powder coat finish. UL-listed. **IN STOCK.**

Model No. **XV-1811**—Standard Exit Sign. Two incandescent lamps included. 120V AC operation. Red or green letters, convertible single or double faceplate. 12.3"W x 2"D x 7.5"H. Wt. 4 lbs.....**\$37.20**

Model No. **XV-1812**—Rechargeable LED Exit Sign. Nickel cadmium battery provides 1-1/2 hours of LED illumination during power failures. Consumes 95% less power than standard sign. 120/277V AC operation. Red letters, convertible single or double faceplate. 12.3"W x 2"D x 10.5"H. Wt. 5 lbs.**\$121.00**

Model No. **XV-1813**—Rechargeable Emergency Exit Sign. Stays on for 1-1/2 hours during a power failure. Built-in 120/277V AC with automatic charger and low voltage battery disconnect. Two lamps included. Red or green letters. Convertible single or double faceplate. UL-listed. 12.3"W x 2"D x 10.5"H. Wt. 14 lbs.....**\$112.00**

**STOCK**  
**ARROW KNOCKOUTS INDICATE DIRECTION.**

**STANDARD EXIT SIGN**      **COMBO LIGHT/EXIT SIGN**

**EXIT SIGNS WITH THERMOPLASTIC HOUSING**  
 Economical units feature energy-efficient LED illumination. Flame retardant, high-impact thermoplastic housing. Red letters and directional arrow snapouts. Ceiling, end or back mount. UL-listed. **IN STOCK.**

Model No. **YV-1840**—Standard Exit Sign. 120V AC operation. 12.25"W x 2.5"D x 12.75"H. Wt. 2.6 lbs. ....**\$28.30**

Model No. **YV-1841**—Combo Emergency Light/Exit Sign. Exit sign and emergency light in one unit. 120/277V AC operation. Maintenance-free sealed lead calcium battery provides backup power. Two adjustable lamp heads. 23"W x 4.5"D x 10.25"H. Wt. 8.6 lbs.....**\$92.40**

**BIG BEAM Emergency Lights**  
 Powerful emergency lights offer 1-1/2 hours of illumination. Maintenance-free battery with low voltage cut-off. Exclusive lifetime guarantee. **IN STOCK.**

**I. LOW-PROFILE EMERGENCY LIGHT.** Compact unit fits where standard units won't. Injection-molded thermoplastic housing with two adjustable 6W high-intensity tungsten lamps. 120/277V AC operation. Wall or ceiling mount. UL-listed. 16"W x 4.5"D x 5"H.

Model No. **YV-1842**—Wt. 4.4 lbs. ....**\$42.90**

**J. HIGH-ILLUMINATION/CAPACITY LIGHTS.** Ideal for large areas. Lamps include 10AH or 20AH sealed batteries with multiple rate solid state charger that automatically recharges battery within 24 hours. 120/277V AC. New York City approved. Steel construction. 15-1/2"H x 10-1/2"W x 3-1/2"D.

Model No.	Lamps	Sq. Ft.	Wt. Lbs.	Price Ea.
<b>XC-1118</b>	(2) 12W Halogen	2880	15	<b>\$131.00</b>
<b>XC-1119</b>	(2) 20W Halogen	4560	16	<b>135.00</b>
<b>XC-1120</b>	(2) 25W Tungsten	5040	23	<b>139.00</b>

**STOCK**

**I**      **J**

# Eye Protection



**SELF-CONTAINED UNITS PROVIDE INSTANT PROTECTION IN EMERGENCY SITUATIONS. DESIGNED FOR USE NEAR POTENTIAL HAZARD AREAS LACKING WATER SUPPLIES. NO PLUMBING HOOKUP IS REQUIRED.**

**MEETS ANSI A117, 1-1986 PROVIDING ACCESSIBILITY AND USABILITY FOR PHYSICALLY HANDICAPPED PEOPLE.**

**MADE IN USA** **STOCK**

## SPEAKMAN® Gravity-Fed Eye/Face Wash

High-density polyethylene station with large, high-efficiency rubber spray heads. 21-gallon capacity. Sprays for up to 15 minutes. Wall-mounting hardware included. Meets ANSI Z358. 1. Color: blue. **IN STOCK.**

Model No. **XA-1015**— 26"Wx12"Dx24"H. Wt. 15 lbs. **\$245.00**



**MADE IN USA** **STOCK**

## GUARDIAN Faucet-Mount Eyewashes

Turns faucet into an emergency eyewash station. Pull faucet stem toward you to activate eyewash. Does not require expensive plumbing changes and will not interfere with normal faucet operation. Includes float-off dust covers. **IN STOCK.**

Model No. **XB-1010**— 3"H Unit. Heads 3" apart. Wt. 1/2 lb .....**\$70.30**  
 Model No. **XB-1011**— 5"H Unit. Heads 5" apart. Wt. 1 lb .....**\$86.10**

**XB-1011**



**STOCK**

## CREWS® Tomahawk® Wraparound Glasses

Offers maximum eye protection from all angles. Includes: one-piece polycarbonate lens with integral sideshields and lightweight frames with adjustable temples. Meets ANSI Z87.1-1989. **IN STOCK.**

Model No.	Lens	Frame	Price Ea.
<b>YM-2201</b>	Clear	Black	<b>\$2.72</b>
<b>YM-2202</b>	Clear	Blue	<b>3.19</b>
<b>YM-2203</b>	Clear	Red, white, blue	<b>3.19</b>
<b>YM-2204</b>	Gray	Black	<b>3.18</b>



**STOCK** **MADE IN USA**

## SPEAKMAN® Emergency Stations

**SAF-T-ZONE® EMERGENCY STATIONS**  
 Shower is activated via a triangular pull handle, while the eyewash activates with a steel push handle. Also includes: plastic shower head and eyewash bowl and chrome-plated full-flow stay-open ball valves. 1-1/4" NPT inlet connection. Color: safety green. **IN STOCK.**

Model No. **XA-1011**— Combo Shower/Eyewash. 38 GPM at 5 psi. Wt. 65 lbs. ....**\$622.00**  
 Model No. **XA-1012**— Combo Shower, Eye/Face Wash. 40.5 GPM at 20 psi. Wt. 43 lbs. ....**\$655.00**

**EYESAVER® PEDESTAL MOUNT EYEWASH**  
 Full-flow stay-open ball valve is activated by a stainless steel push handle. Twin spray heads have individual flow restrictors and flip-off dust covers. Delivers 3.6 gallons at 30 PSI. Plastic bowl. 1/2" inlet connection. Does not include shower. Color: safety green. **IN STOCK.**

Model No. **XA-1013**— Wt. 22 lbs.....**\$310.00**

**WEARWELL® Emergency Eyewash Mats** **MADE IN USA** **FACTORY QUICK SHIP**

Placed below eyewash station, this brightly colored mat draws attention to eyewash. 7/8" thick vinyl mat features drainage holes and a high-traction design. 6"W sloped borders. One-year warranty. **FACTORY QUICK SHIP— FOB TENNESSEE.**

Model No. **YS-2150**— 30x36". Wt. 18 lbs...**\$122.00**  
 Model No. **YS-2151**— 30x48". Wt. 24 lbs...**\$161.00**



**STOCK**

## CREWS® Yukon® Visitor Glasses

Provides easy access to protective eyewear. Wraparound style includes molded-in brow guard and vented sideshields. Fits over prescription glasses. Not a replacement for CSA approved safety glasses. **IN STOCK.**

Model No. **XD-1384**— Dispenser box includes 12 glasses .....**\$21.10**  
 Model No. **XD-1385**— Individual glasses .....**\$1.77/ea.**

# Protective Clothing

## Disposable Tyvek® Clothing

Tear-, snag-, and puncture-proof Tyvek® protects workers during asbestos removal or laboratory, industrial, and food processing applications. Includes nonwoven polyethylene fibers bonded with heat and pressure, non-absorbent, antibacterial slick surface, and serged seams. Color: white. **IN STOCK.**

### CLOTHING

**SPECIFY SIZE:** B - Medium, C - Large, D - X-large.

Model No. **YP-826**—Hooded coverall with zip front, boots, elastic wrists and hood for secure fit. ....\$6.60  
 Model No. **YP-827**—Lab coat with 3-snap front. ....\$4.20  
 Model No. **YD-1909**—Coverall with elastic cuffs. ....\$6.00  
 Model No. **YP-828**—Coverall with open cuffs and zipper front. ....\$5.30  
 Model No. **YD-1910**—Shoe cover with tight seal elastic top, 14"H. One size. ....\$1.60/ea.

### SIZING CHART FOR CLOTHING

Height	Weight (Lbs.)	Size
5'8"-5'10"	130-220	L-XL
5'6"	110-200	M-L
5'2"-5'4"	110-160	M



### APRON/SLEEVES

Model No. **YA-1463**—Apron. 36"Lx27"W. ....\$1.35  
 Model No. **YA-1464**—Sleeves. 18"L, elastic top & wrists. ....\$0.83

## Protective Aprons

Perfect for shop, warehouse, and stock rooms. This rugged denim apron takes tough wear as it protects clothing. Made of durable, blue cotton denim with two handy pockets, and one pencil pocket. Fastens easily with denim ties. Even after many washes, it wears well. **IN STOCK.**

Model No. **ZP-0126**—Denim Apron with pockets (shown). 36"L x 24"W .....\$9.40  
 Model No. **ZP-0127**—Economy Denim Apron without pockets. 36"L x 27"W .....\$4.20



## Hard Hats

Meets or exceeds all OSHA and ANSI Z89.1 1986 class A, B and C requirements. Comfortable six-point nylon suspension. Adjusts to fit sizes 6-1/2 to 8. Shell includes slots to accessories. Cushioned, removable sweat/brow pad included. **SPECIFY COLOR:** BL - Blue, RD - Red, WH - White, YL - Yellow. **IN STOCK.**

A. Model No. **YK-2324**—Ratchet Adjustment Hard Hats .....\$9.60  
 B. Model No. **YK-2325**—Economical Hard Hats. Quick-slide adjustment. ....\$6.20



## Driver's Gloves

Top-grain cowhide leather provides extensive protection against splinters, scrapes and cuts and insulates hands against hot or cold steering wheels. Also features: gunn cut and shirred elastic back. **IN STOCK.**

Model No. **ZS-1444** .....\$11.00/pr.



## Kevlar® Aramid Fiber Gloves

Comfortable Kevlar® gloves resist heat, abrasion, cuts and slashes. Hand-to-hand reversibility extends glove life. Select either heavy-weight 13-cut glove with gripping dots or fine gauge 13-cut glove with interwoven Kriss Cross coating. Size: large. **IN STOCK.**

Model No. **ZD-1803**—Dot Coated .....\$6.60/pr.  
 Model No. **ZD-1804**—Kriss-Cross Coated .....\$5.40/pr.



# Ergonomic Support



**STOCK**

**BACK-A-LINE® Lumbar Support Belts**

Orthopedically correct belt has a built-in lumbar pad that fits into the natural position of the spine, alleviating pain and fatigue associated with improper posture. Grooved 8" tall lumbar pad covers the full range of the spine. Washable, breathable fabric will not stretch, holding the lumbar pad firmly in place. OrthoWick® lining stays dry. **SPECIFY WAIST SIZE: B - Medium (31"-36"), C - Large (35"-40").** **IN STOCK.**

Model No. **ZD-1400**—Color: black.....\$54.80  
 Model No. **ZD-1401**—Color: blue.....\$54.80

**MADE IN USA**



**STOCK**

**VALEO® Heavy-Duty Elastic Support Belt**

Five rubberized back supports keep belt in place while lifting and bending. Heavy-duty breathable elastic knit wraps around waist and secures with Velcro® closure. Quick-release detachable straps with two-stage hook and loop closure adjust to fit individual user. 9" wide. Washable. **SPECIFY SIZE: B - Medium (32"-37"), C - Large (35"-40"), D - X-large (40"-45").** **IN STOCK.**

Model No. **ZF-2255**—Wt. 1.5 lbs. ....\$18.70



**STOCK**

**Wrist Supports**

**AMBIFLEX**  
 Eight flexible medical-grade stays help keep wrist in neutral position restricting flex and stress. Fits left or right wrist. Washable. **SPECIFY SIZE: A - Medium, B - Large, C - X-large.** **IN STOCK.**

Model No. **YA-1807** — .....\$14.30

**AMBIBAND**  
 3"W adjustable elastic band offers firm support to the wrist. One size. **IN STOCK.**

Model No. **YA-1808**— .....\$4.20



**STOCK**

**VALEO® VES Elastic Support Belt**

8" elastic power net belt has 4 non-conductive stays that promote proper posture when lifting or bending. Fits comfortably and stays securely in place. Other features include: adjustable two stage hook and loop closure, rubberized stay covers, and removable elastic suspenders with hook and loop tabs. Washable. **SPECIFY SIZE: A - Small (24"-34"), B - Medium (32"-42"), C - Large (42"-52"), D - X-Large (52"-62").** **IN STOCK.**

Model No. **ZR-1860**— .....\$14.20



**STOCK**

**VALEO® Back/Abdomen Support Belts**

Back and abdominal support features a thick, flexible hypoallergenic, closed cell foam core that conforms to the body. Always returns to its original shape. Designed to be worn outside clothing. Lycra® outer shell is lined with brushed tricot. Nylon mesh webbing strap with cam buckle. Softly bound edges won't pinch, scrape or cut. Color: black. **SPECIFY SIZE: A - Small (28"-33"), B - Medium (31"-36"), C - Large (34"-39"), D - X-large (38"-43").** **IN STOCK.**

Model No.	Size	Price Ea.
<b>XP-829</b>	4"W	<b>\$22.30</b>
<b>XP-830</b>	6"W	<b>28.70</b>

Model No. **XP-833**—Training Video .....\$8.50



# Floor Tapes & Striping



## Floor and Safety Tape

Premium quality tape. Self-adhesive vinyl applies quickly to most surfaces. Comes in the standard one color or hazard which uses two colors striped and is 5-mil thick.

**SPECIFY COLOR FOR STANDARD VINYL TAPE: BK - Black, GN - Green, RD - Red, WH - White, YL - Yellow. IN STOCK.**

Model No.	Roll W x L	Ctn. Qty.	Wt./Roll Lbs.	Price Ea. Roll
<b>STANDARD VINYL—SPECIFY COLOR</b>				
ZP-877	1" x 36 yd.	4	0.4	\$4.32
ZP-878	2" x 36 yd.	4	0.8	7.30
ZP-879	3" x 36 yd.	4	1.2	11.00
ZP-880	4" x 36 yd.	2	1.6	14.60
<b>STANDARD VINYL—HAZARD WARNING (BLACK/YELLOW STRIPE)</b>				
ZP-881	2" x 36 yd.	4	0.8	\$8.70
ZP-882	3" x 36 yd.	4	1.21	13.10
ZP-883	4" x 36 yd.	4	1.6	16.20
<b>LAMINATED—HAZARD WARNING (BLACK/YELLOW STRIPE)</b> For flat surfaces, floor, etc. for extended life.				
ZP-884	2" x 18 yd.	4	0.8	\$10.40
ZP-885	3" x 18 yd.	4	1.2	15.10

NOTE: specific carton quantities in chart. Only sold in quantities indicated in chart.



## Self-Adhesive Anti-Slip Tape

Brightly colored tape outlines work, danger, or off limit areas. Abrasive material provides maximum skid resistance on practically any surface. Super adhesive backing sticks to most floors. Flexible material bends over 90° angles without cracking for use on stairways or ladders. Withstands temperatures from -40° to 220° F. Resists detergents, grease, and oils. **IN STOCK.**

Model No.	Size	Wt./Roll Lbs.	Price Each
<b>SOLID BLACK</b>			
YM-2208	1" x 20 yd.	1	\$10.00
YM-2209	2" x 20 yd.	1.5	20.50
YM-2210	4" x 20 yd.	3	42.00
YM-2211	6" x 20 yd.	4	61.00
<b>SOLID COLORS—SPECIFY COLOR: RD - Red, YL - Yellow</b>			
YM-2212	2" x 20 yd.	1.5	\$27.30
<b>STRIPED. Black and Yellow</b>			
YM-2215	2" x 20 yd.	1.5	\$25.80



## MIGHTYLINE™ Aisle Striping Tape

Eliminate the time and effort it takes to stripe paint aisles and restricted areas with this durable and economical solution. Installs quickly and easily — simply release backing and apply tape to clean, dry surface. Scuff-resistant material can be easily cleaned with soap and water. **SPECIFY COLOR: BL - Blue, GN - Green, OR - Orange, RD - Red, YL - Yellow, WH - White. FACTORY QUICK SHIP—FOB OHIO.**

Model Number	Roll W x L	Thickness Mil	Wt./Roll Lbs.	Price Each
XL-0520	2" x 100'	30	6	\$135.00
XL-0521	4" x 100'	40	11	146.00



## Tape Applicator

Applies vinyl floor, aisle marking, and safety tapes with 3" cores and widths of 2", 2-1/2", 3", 3-3/8", and 3-5/8". Ships unassembled. Color: black.

Model No. ZP-5380—  
Wt. 18 lbs. ....\$116.00



## Industrial Striping Machine

Rigid wheel design gives you a straight line every time. Easy to operate—simply snap 18-oz. aerosol can into inverted compartment and start striping. Adjust the aerosol can tray to change from 2" to 4" line widths. No striping discs to change and no messy clean-up. All-metal unit has a special compartment that holds six cans for time-saving convenience. **IN STOCK.**

Model No. YP-875 .....\$144.00

**LEAD FREE STRIPING PAINT.** Produces a good looking, long lasting stripe. Each 18-oz. can will stripe a 200 ft., 4 wide line. Non-clogging inverted spray tip allows easy, upside down use. Lead-free paint is specially formulated for industrial use. **SPECIFY COLOR: BL - Blue, WH - White, YL - Yellow. IN STOCK.**

Model No. YP-876—Case of 6 .....\$50.60

# Traffic Safety



**PERSONALIZED LETTERING AVAILABLE**

## Traffic Cones

Mark hazardous areas, alert drivers, and prevent accidents with these easy-to-see cones. Fluorescent, fade-resistant orange color is highly visible on cloudy or sunny days. One-piece vinyl construction stands up to all weather conditions and traffic situations. 1,200 psi tensile strength; 250 psi tear strength. Will not melt in temperatures up to 160°F. High-density, square PVC base provides superior stability. Cones stack easily when not in use. Engineered to meet MUTCD specifications. Reflective collared models required for night time use. **SPECIFY: A** - Without collars, **B** - With collars. **IN STOCK.**

Model Number	Overall W x H	Wt. Lbs.	A. WITHOUT COLLARS	B. WITH COLLARS
			Price Ea.	Price Ea.
ZC-1100	8-1/2" x 12"	1.5	\$6.80	—
ZC-1101*	11-1/2" x 18"	3	9.10	\$13.20*
ZC-1102	13" x 28"	5	14.20	20.40
ZC-1103	15-1/4" x 28"	7	17.80	25.00

\*18" model with one 6" collar. All others have a 6" collar and 4" collar. Personalized permanent lettering available. 50-piece minimum per order—Call for pricing.



## Safety Vest

Bright fluorescent orange vest with reflector stripes stands out in full sun or under cloudy skies. Mesh allows cooling breezes to flow through. Front Velcro® closure. 48"L x 18"W. Color: orange. **IN STOCK.**

Model No. **YC-1163**— \$10.80



## Recycled Plastic Speed Bumps

Prevent speeding in driveways and parking lots with these 6'L x 10"W x 2"H speed bumps. 100% recycled plastic resists chemicals, moisture, oil, salt, and sunlight. Place end-to-end for longer lengths. Easy-to-install in either asphalt or concrete. **IN STOCK.**

Model No. <b>ZB-1292</b> —Asphalt Mount.....	\$121.00
Model No. <b>ZB-1293</b> —Concrete Mount .....	\$121.00



## Recycled Plastic Car Parking Stop

Provides extra protection against vehicle movement in parking lots or garages. Unlike concrete, plastic material won't spall, crack, or chip—resists gas, oil, salt, sunlight, and chemicals. Anchoring system is easy to install in either asphalt or concrete. Limited 5-year warranty. 72"L x 7"W x 4-1/2"H. **SPECIFY COLOR: GY** - Gray, **WH** - White, **YL** - Yellow. **IN STOCK.**

Model No. <b>YB-1290</b> —Asphalt Mount .....	\$59.20
Model No. <b>YB-1291</b> —Concrete Mount.....	\$64.10



## SOS™ Storage Bins

Built to withstand sub-zero temperatures to extreme heat, weather-proof containers prevent the outside elements from damaging stored contents. Because polyethylene containers are completely moisture-resistant and weather-proof, they are ideal for storing rock salt, sand or grit. Resist rust, dents, and corrosion. Hinged locking lid closes securely keeping out rain and snow (padlock not included). Containers nest when lid is raised. **SPECIFY COLOR: LG** - Lt. gray, **YL** - Yellow. Other colors are available, call for information. **IN STOCK.**



Model Number	Overall L x W x H	Cap. Cu. Ft.	Cap. Lbs.	Wt. Lbs.	Price Each
<b>WF-2000</b>	30" x 24" x 23"	5-1/2	500	35	\$197.00
<b>WF-2001</b>	42" x 29" x 30"	11	1000	50	\$344.00
<b>WF-2002</b>	48" x 33" x 34"	18-1/2	1750	65	454.00
<b>WF-2003</b>	72" x 36" x 36"	11	3600	50	722.00



**ACRYLIC FULL DOME**

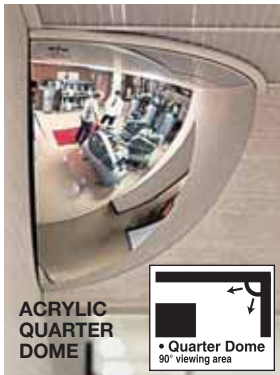
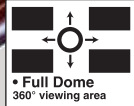

**ACRYLIC QUARTER DOME**

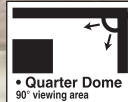

**ACRYLIC HALF DOME**

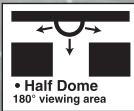

## Panoramic Dome Mirrors

Smooth coated surfaces provide bright, clear reflections that maximize safety and security. Constructed of virtually unbreakable acrylic or durable steel. Steel domes are perfect for areas where vandalism is a problem. Come complete with mounting wires and instructions. **SELECTED MODELS IN STOCK.** Others FOB ILLINOIS.

Model No.	Overall Dia.	Wt. Lbs.	Price Ea.
<b>ACRYLIC FULL DOMES.</b>			
Full 360° visibility. For 4-way intersections.			
XS-1059	18"	6	\$49.30
XS-1060	26"	10	81.10
XS-1061	32"	19	110.00
XS-1062	36"	19	148.00
XC-3032	48"	31	286.00
<b>ACRYLIC HALF DOMES. 180° visibility.</b>			
For "T" intersections and aisles.			
XS-1069	18"	3	\$39.30
XS-1070	26"	5	57.70
XS-1071	32"	8	81.50
XS-1072	36"	11	91.80
XC-3031	48"	17	186.00
<b>ACRYLIC QUARTER DOMES. 90° visibility.</b>			
For "L" intersections and aisles.			
XS-1074	18"	2	\$23.70
XS-1075	26"	4	35.00
XS-1076	32"	6	49.30
XS-1077	36"	8	61.30
XC-3030	48"	10	119.00
<b>STEEL FULL DOMES. Full 360° visibility.</b>			
For 4-way intersections.			
XC-3035	9"	5	\$136.00
XC-3036	12"	7	163.00
XC-3037	18"	10	197.00
<b>STEEL HALF DOMES. 180° visibility.</b>			
For "T" intersections and aisles.			
XC-3033	9"	2	\$92.10
XC-3034	12"	4	109.00
XS-1073	18"	10	140.00



Selected Models

## Blind Spot Mirror

Eliminate blind spots in your workstation, office or warehouse. Ideal for use where permanent mounting is not possible. Handy clip lets you attach unit to a shelf or desk while the adjustable arm positions mirror for optimum viewing. 7" convex mirror is constructed of lightweight, shatterproof plastic. **IN STOCK.**

Model No. **ZD-1331** .....\$21.10



## Wide Angle Convex Mirrors

Wide 160° angle mirrors are designed to increase surveillance, provide security, and promote safety. Units are supplied with dual mounting channels, mounting brackets and hardware. All mirrors are waterproof and rubber sealed. Outdoor mirrors include ABS backing for extreme durability. Meet OSHA requirements. **IN STOCK.**

**ABS OUTDOOR MIRROR BACKING ON PLEXIGLASS<sup>®</sup> MIRRORS.**

**GLASS.** Reflects strong, clear images, offers long life, and is easy to clean. Backed by copper using premium silver. Use to monitor cross aisles, blind corners, assembly lines or anywhere a crisp, clear view is necessary.

Model No.	Dia.	Wt. Lbs.	Price Ea.	Model No.	Dia.	Wt. Lbs.	Price Ea.
<b>INDOOR</b>				<b>OUTDOOR</b>			
XS-1049	12"	5	\$24.10	XA-2016	12"	6	\$30.70
XS-1050	18"	7	38.50	XA-2017	18"	8	47.70
XS-1051	26"	15	62.70	XS-1063	26"	17	75.30
XS-1052	30"	18	85.70	XS-1064	30"	20	94.90
XS-1053	36"	24	111.00	XS-1065	36"	27	119.00

**PLEXIGLAS<sup>®</sup>.** Virtually unbreakable mirrors work best in hospitals, nursing homes, food processing plants—anywhere glass is not permitted for safety reasons. Lightweight.

Model No.	Dia.	Wt. Lbs.	Price Ea.	Model No.	Dia.	Wt. Lbs.	Price Ea.
<b>INDOOR</b>				<b>OUTDOOR</b>			
XA-2020	12"	3	\$27.20	XA-2023	12"	4	\$33.70
XS-1056	18"	5	39.40	XS-1066	18"	6	52.50
XS-1057	26"	11	69.40	XS-1067	26"	13	94.50
XA-2021	30"	14	90.70	XA-2024	30"	16	132.00
XS-1058	36"	20	130.00	XS-1068	36"	22	155.00
XA-2022	48"	28	213.00	XA-2025	48"	28	285.00



## Magnetic Forklift Mirrors

For use as forklift back-up mirror, in elevators or in small confined areas. Heavy rubber frame and adjustable swivel mounting bracket included. Glass convex with metal back. **IN STOCK.**



Model Number	Size	Wt. Lbs.	Price Each
XA-2018	5"	2	\$25.60
XA-2015	6"	1-1/2	30.00
XA-2019	8"	3	35.00

# Chocks

## Optional #2/0 Gauge Chain

For use with molded rubber, aluminum, and plate steel chocks. 15' long straight, zinc plated link chain. Includes S-hooks. **IN STOCK.**

Model No. **YD-1917** .....\$10.40

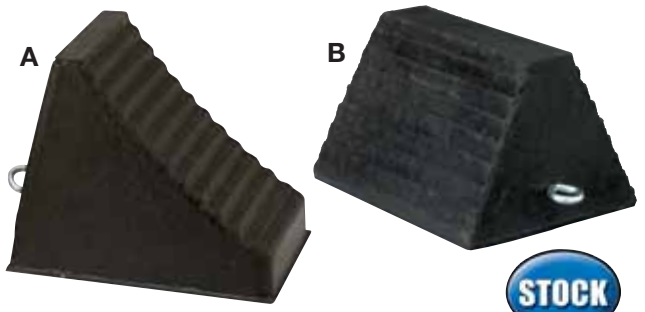

## Molded Rubber Wheel Chocks

Constructed of a tough rubber, durable chocks resist sun, salt, oil, and ozone. Fluted design gives maximum gripping power while the tire-like bottom tread prevents kickout. Cushion-core design absorbs shock. Meets OSHA requirements. Eyebolt for chain attachment. Order optional chain below. **IN STOCK.**

- A. Model No. **YD-1911**—7-1/2"W x 9-1/2"D x 8"H. Wt. 11 lbs. ....\$17.20
- B. Model No. **YD-1912**—9-3/4"W x 6"D x 8"H. Wt. 10 lbs. ....\$18.60



## Urethane Wheel Chocks

Molded urethane chocks resist oils and chemicals to assure superior gripping action on both tires and pavement. Fluted design causes downward pressure to lock chock in place. High visibility orange color. Also includes anti-theft chain hole and safety tread on face. Choose Model YD-1915 for use with small utility trucks, trailers, pickups, autos and RVs. For Over the Road trucks and trailers, select Model YD-1916. **IN STOCK.**

- Model No. **YD-1915**—8-1/2"L x 7-1/2"W x 6-1/4"H. Wt. 2 lbs. ....\$21.20
- Model No. **YD-1916**—11"L x 7-3/4"W x 8"H. Wt. 4-1/2 lbs. ....\$31.60



## Laminated Rubber Chock

Rubber and steel chock consists of curved rubber pads compressed and held together by 1/8" thick steel, triangle-shaped plates. 8"W x 8"D x 8"H. OSHA-approved and resistant to sun, moisture, salt, and oil. **IN STOCK**

Model No. **YK-1148**— Wt. 14 lbs. ....\$53.10

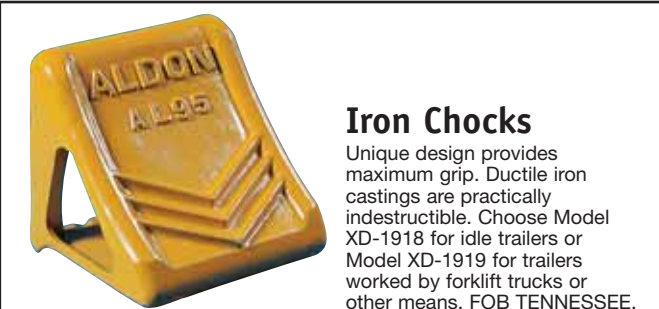

## Iron Chocks

Unique design provides maximum grip. Ductile iron castings are practically indestructible. Choose Model XD-1918 for idle trailers or Model XD-1919 for trailers worked by forklift trucks or other means. FOB TENNESSEE.

- Model No. **XD-1918**—Medium-duty. 8"L x 9-1/8"W x 8-1/2"H. Wt. 16 lbs. ....\$57.70
- Model No. **XD-1919**—Heavy-duty. 10-1/2"L x 10"W x 10-3/4"H. Wt. 27 lbs. ....\$115.00



## Aluminum Wheel Chocks

3/8" long cleats grip hard surface—provide excellent holding power. Ribbed wheel area grabs tire securely. 10-3/4"L x 7"W x 8"H. **IN STOCK.**

- Model No. **XK-1151**—Aluminum. Wt. 7-1/4 lbs. ....\$53.00
- Model No. **XK-1160**—Yellow Aluminum. Wt. 7 lbs. ....\$57.90



## Rail Chocks

Replaceable heat-treated steel spurs grab rails to prevent slipping. Use on exposed rails only. For one directional stopping choose the single rail chock. Double rail chock is needed to stop in both directions (with rubber strap and hooks for greater tension). Meet OSHA regulations. FOB ILLINOIS.

- Model No. **WS-517**—Double Chock w/Flag. Wt. 16 lbs. ....\$138.00
- Model No. **WS-518**—Double Chock. Wt. 12 lbs. ....\$127.00
- Model No. **WS-519**—Single Chock w/Flag. Wt. 13 lbs. ....\$104.00

# Stabilizing Jacks



## Truck Stabilizing Jacks

Stabilize and prevent tilting of trucks and semi-trailers during loading and unloading. Prevent supplementary running gear collapse when trailers are detached from tractor. Always use in front position to prevent collapse of trailer running gear. All-steel body. Built-in dolly has either 6" or 10" ball bearing semi-pneumatic rubber wheels. Storable handle with rubber hand grip. When model number XS-412 is placed under trailer's fifth wheel plate, the 7" diameter ball and socket mounted top pad tilts 9° for complete contact. Meets OSHA requirements. **SELECTED MODELS IN STOCK.** Others FOB TENNESSEE.

Model Number	Description	Static Cap. Lbs	Lifting Cap. Lbs	Top Pad Size	Height Range	Foot Pad Dia.	Wt. Lbs	Price Each
<b>JACK WITH 6" SEMI-PNEUMATIC RUBBER TIRES WITH OFFSET STEEL HUBS</b>								
XS-478	Standard	50,000	5,000	5" Sq.	43-1/2" - 50-1/2"	12"	54	\$292.00
<b>JACK WITH 10" BALL-BEARING SEMI-PNEUMATIC RUBBER TIRES</b>								
XS-181	Heavy-Duty Spin Top	100,000	40,000	7" Dia.	41" - 50-1/2"	14"	100	\$292.00
YS-412	Heavy-Duty Ratchet	100,000	40,000	7" Dia.	41" - 50-1/2"	14"	125	330.00
XS-479	Heavy-Duty Ratchet Beam-Type	100,000	40,000	26"L x 4"W	41" - 50-1/2"	14"	142	489.00

## VESTIL Economical Trailer Stabilizing Jacks



Low cost, yet dependable units stabilize trucks and prevent running gear collapse when trailers are detached from tractors. Always position jack in front of trailer to prevent collapse of running gear. 5" swivel top pad secures firmly to base of trailer. Raises from 44-51" high.

### TRAILER JACK

Supports static loads up to 50,000 lbs. 5" x 5" top plate lifts 5,000-lb. loads. Round base distributes load to the ground. **IN STOCK.**

Model No. **XS-1414**—  
Wt. 45 lbs. ....\$109.00

### TRAILER STABILIZING JACK WITH DOME-SHAPED BASE.

Sturdy base ensures jack stability beneath truck. 14" diameter base supports the 3" welded steel tube column. Supports up to 40,000 lbs. **IN STOCK.**

Model No. **XF-2025**—  
Wt. 35 lbs. ....\$99.40



## VESTIL Hand-Crank Stabilizing Jacks

Supports up to 80,000 lbs. 40,000 lbs. lift capacity. Oversized 16" x 21" base. 30"L x 6"W top plate is 3/8" thick. Jack extends from 41" - 55"H. Full 1-1/2" dia. roll thread acme jackscrew. Oversized 16" wheels. Meets all OSHA requirements. Made in USA. **FACTORY QUICK SHIP—FOB INDIANA.**

Model No.	Description	Wt. Lbs.	Price Ea.
XS-2900	16" dia. semi-pneumatic tires with gear box	200	\$730.00
XS-2901	16" dia. pneumatic wheels with gear box	200	698.00

# Dock Equipment

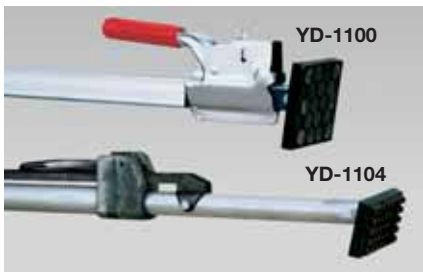

## Cargo Bars

Limit load movement and prevent costly cargo damage with these protective bars. Rubber end pads hold bars securely in place. May be positioned vertically or horizontally. Choose one-piece or two-piece construction. Two-piece enables unit to fit easily inside locked trailer cab when not in use. **IN STOCK.**

**STEEL CARGO BARS.** Mounts vertically or horizontally. 1-1/2", 14-ga. square tube. Non-slip mechanical ratchet.

Model No. **YD-1100**—1-pc. Galvanized Cargo Bar. 87-119"L. Wt. 19 lbs. ..\$66.00  
 Model No. **YD-1101**—Folding Cargo Bar. 87-119"L. Wt. 19 lbs. ....\$69.90

**CARGO BAR WITH ALUMINUM STOPS.** For use in trailers. Locking handle. Rack and pinion jack.

Model No. **YD-1104**—1-pc. Cargo Bar. 89-104"L. Wt. 12 lbs. ....\$71.80

**CARGO BAR WITH STEEL STOP AND HOOP.** All-welded construction. 19-1/2"H hoop. 70-3/4"L top loop; 78-1/2"L bottom loop.

Model No. **YD-1102**—1-pc. Cargo Bar. 87-116"L. Wt. 35 lbs. ....\$89.40

**CARGO BAR WITH E- AND A-FITTINGS.** 2-1/2" x 3-1/2" aluminum tube has a 2-3/8" x 3" steel tube that slides and locks in each end. Adjusts 92-102". E- and A-track fittings on both ends.

Model No. **YD-1768**—Wt. 22 lbs.....\$86.80



## E-Track Sections

12-gauge steel and 50,000 lbs. psi yield strength. Available in 5' sections. Accommodates YD-1768 cargo bar and YA-1134 and YA-1135 tie downs. **IN STOCK.**

Model No. **YA-1120**—Painted. ....\$16.70 ea. 5' section  
 Model No. **YA-1121**—Galvanized. ....\$20.40 ea. 5' section



CAM BUCKLE SHOWN



## Polyester Ratchet Tie Downs With E- and A-Track Fittings

Rugged polyester tie down has a fixed 4' side and an adjustable 8', 12', or 16' side. Both have E- and A-track fittings on the ends. Uses 2" wide polyester with 3,000-lb. capacity. **SPECIFY LENGTH: A - 12', B - 16', C - 20'. IN STOCK.**

Model Number	Description	(A) 12'L		(B) 16"L		(C) 20'L	
		Color	Price Ea.	Color	Price Ea.	Color	Price Ea.
YA-1134	With cam buckle	Yellow	\$16.50	Gray	\$17.70	Blue	\$19.40
YA-1135	With ratchet buckle	Yellow	21.30	Gray	23.20	Blue	25.00

# Dock Equipment



## BLUFF Edge of Dock Levelers



Innovative design dramatically reduces installation time and virtually eliminates installation errors. New flanged mount plate simply rests on top of the dock edge automatically positioning the unit at the proper height in relation to the dock surface. One person can easily move leveler into position. Handles standard trucks from 5" lower to 5" higher than dock height. 4" x 10" x 12" molded rubber bumpers are mounted on steel beams and extend 16-1/2" from dock face. Leveler extends 27-3/4" from dock face. Integrated bumper assemblies help you anchor and weld unit in place. **IN STOCK.**



### Easy four-step operation:

1. Pull handle up from stored position and pull back toward dock.
2. As you pull handle back and down, leveler moves into upright ready position.
3. Push handle back toward trailer and leveler automatically extends into trailer floor.
4. Returns to dock automatically when trailer pulls away.

Model Number	Plate Width	Overall Width	Wt. Lbs.	Price Each
WV-3519	66"	88"	505	\$923.00
WV-3520	72"	96"	545	1007.00
WV-3521	78"	102"	585	1218.00

## VESTIL Dock Bumpers

Place at intervals along your dock edge—either direct to dockface or mount on existing wooden bumper strips. Rubber impregnated pads are secured by adjustable threaded 2-1/2" x 3", 1/4" thick angle iron brackets. Mounting brackets which form the ends are drilled with two 13/16" diameter mounting holes. To order: Select appropriate length by allowing 12" clear between each rubber block. **SELECTED MODELS IN STOCK.** Others FOB INDIANA.



Selected Models

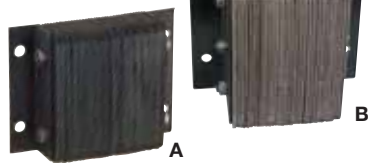

Model Number	Overall W x D x H	Wt. Lbs.	Price Each
<b>A. HORIZONTAL</b>			
YA-123	12" x 4" x 10"	24	\$51.50
YA-124	18" x 4" x 10"	35	70.10
YA-125	24" x 4" x 10"	44	88.00
YA-126	36" x 4" x 10"	76	135.00
YA-120	18" x 6" x 10"	42	88.70
YA-121	24" x 6" x 10"	50	113.00
YA-122	36" x 6" x 10"	83	162.00
<b>B. VERTICAL</b>			
YA-1208	20" x 4-1/2" x 11"	49	\$91.20
YA-1209	24" x 4-1/2" x 11"	53	110.00
YA-1210	36" x 4-1/2" x 11"	100	164.00

## GILLIS Permanent Dock Ladders

Mount ladders permanently to platforms, docks or storage areas. 29"W ladder is constructed of 1" dia. pipe with enamel finish. 18"W steps have 3/4" solid round rungs with excellent slip-resistance even in wet or oily environments. 6-1/2" inside clearance. 350-lb. capacity. Meets OSHA specifications. **FOB ILLINOIS.**



Model No.	Step Qty.	Top Step Ht.*	Wt. Lbs.	Price Ea.
YL-0450	2	1'6"	31	\$166.00
YL-0451	3	2'6"	35	187.00
YL-0452	4	3'6"	43	227.00
YL-0453	5	4'6"	47	253.00
YL-0454	6	5'6"	52	283.00
YL-0455	7	6'6"	56	306.00
YL-0456	8	7'6"	61	336.00
YL-0457	9	8'6"	66	246.00
YL-0458	10	9'6"	70	402.00

\*Distance between top of dock and bottom rung.



Selected Models



## WESCO® Dock Loading Lights

Swings easily into place to illuminate dark end dock areas. For precise positioning, lights adjust 300° horizontally. Tough steel construction with twin struts. 1-1/2" sq. tubing. Lighthead is 8-1/8" dia. Use incandescent lamps only: Par-38 up to 150W or R40 up to 300W (lamps not incl.). 120V with toggle switch. **SELECTED MODELS IN STOCK.** Others FOB PENNSYLVANIA.

Model Number	Arm Qty.	Arm Length	Overall Length	Wt. Lbs.	Price Each
XP-0058	2	21-1/2" ea.	40"	18	\$140.00
XP-0059	2	31-1/2" ea.	60"	23	141.00
XP-0060	3	31-1/2" ea.	90"	35	239.00



## Rubber Dock Bumpers

Solid fiber-reinforced rubber bumper. Abrasion-resistant and extremely durable. Countersunk holes that take 1/2" bolts with molded-in steel washers. **IN STOCK.**



Model No. XP-0051 — 10"L. 2 holes. Wt. 5 lbs.	\$10.80
Model No. XP-0052 — 20"L. 4 holes. Wt. 10 lbs.	\$20.20
Model No. XP-0053 — 30"L. 6 holes. Wt. 15 lbs.	\$29.40

# BLUFF Aluminum Dockplates & Dockboards

## SELECTION GUIDE

Choosing the correct **SIZE** and **CAPACITY** of equipment helps improve your dock operation. The following guidelines will help you determine what equipment best suits your individual needs.

### HEIGHT DIFFERENTIAL

#### Highest Truck Height T

We recommend using 55" for the T unless your customer says otherwise, since 55" is the maximum height of most trailers. On refrigerated or container trailers use 59".

T =  Inches

#### Dock Height D

(You must measure this.)

D =  Inches

#### Height Differential (Maximum) H

H is equal to T minus D.

H =  Inches

## LENGTH

To determine the proper length of a dockboard/plate, three items are required:

- Dock height (D)
- Height of highest truck (T)
- Type of loading equipment used

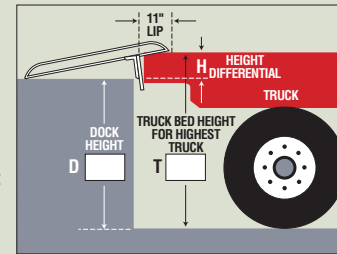

## WIDTH

Bluff recommends a minimum product width of 12" to 18" wider than the overall width of the vehicle or pallet used. For improved end loading efficiency, you may consider increasing board width, as shown in diagram.

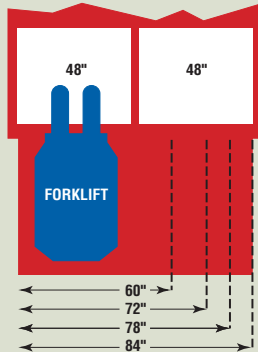

## CAPACITY NOTES

- Stackers and other narrow aisle loaders should not be used on a dockboard.
- Paper roll clamp and multi-shift loading add 5,000 pounds to the board capacity.
- Capacity rated for single-shift operation at a 3 mile per hour maximum rate of travel.
- For all railroad applications, we require a fully completed railroad worksheet.

## CAPACITY SELECTION CHART

3-Wheel Forklift	4-Wheel Forklift	Board Capacity
2,000 – 2,500		10,000
	2,000 – 3,000	10,000
3,000 – 3,500		15,000
4,000 – 5,000		20,000
	3,000 – 5,000	15,000
	5,000 – 6,000	20,000
Lifting Capacities		

## Aluminum Dockplates

Here's an economical dockplate recommended for light-activity operations and non-powered loading. Includes non-slip diamond tread surface and bolt-on steel legs to secure unit between dock and trailer. Other sizes and capacities available, call for information. **SELECTED MODELS FACTORY QUICK SHIP.** All FOB TEXAS.



Selected Models

Size L x W	Height Diff. (1)*	STANDARD 3/8" THICK PLATE				HEAVY-DUTY 1/2" THICK PLATE			
		Model No.	Cap. Lbs.	Wt. Lbs.	Price Each	Model No.	Cap. Lbs.	Wt. Lbs.	Price Each
24" x 36"	1"	ZN-2230	3,850	45	\$234.00	ZN-2246	6,950	56	\$274.00
30" x 36"	2"	ZN-2231	3,250	53	281.00	ZN-2247	5,750	68	328.00
36" x 36"	3"	ZN-2232	2,650	63	328.00	ZN-2248	4,750	80	382.00
48" x 36"	5"	ZN-2233	1,950	82	421.00	ZN-2249	3,350	105	491.00
24" x 48"	1"	ZN-2234	4,950	56	312.00	ZN-2250	8,650	71	381.00
30" x 48"	2"	ZN-2235	4,350	67	359.00	ZN-2251	7,750	86	445.00
36" x 48"	3"	ZN-2236	3,650	79	405.00	ZN-2252	6,250	102	515.00
48" x 48"	5"	ZN-2237	2,750	104	499.00	ZN-2253	4,750	134	656.00
60" x 48"	7"	ZN-2238	2,150	128	594.00	ZN-2254	3,950	166	795.00
24" x 60"	1"	ZN-2239	6,650	66	359.00	ZN-2255	11,550	85	445.00
30" x 60"	2"	ZN-2240	5,550	80	421.00	ZN-2256	9,950	104	530.00
36" x 60"	3"	ZN-2241	4,650	95	484.00	ZN-2257	7,650	124	617.00
48" x 60"	5"	ZN-2242	3,550	125	609.00	ZN-2258	5,750	163	789.00
60" x 60"	7"	ZN-2243	2,750	155	734.00	ZN-2259	4,950	203	960.00
30" x 72"	2"	ZN-2244	6,650	93	515.00	ZN-2260	11,950	122	725.00
48" x 72"	5"	ZN-2245	4,150	147	749.00	ZN-2261	7,450	193	1053.00

\*NOTE: Height Difference (1) is the maximum height difference between dock and truck for pallet jacks.



Selected Models

## Aluminum Dockboards With Bolted-On Steel Curbs

Bridge the gap between dock and truck with this strong aluminum dockboard. Full-length structural steel curbs are bolted to the dockboard for increased strength and prevention of run-off. Entire surface features a diamond tread pattern to prevent slippage and enhance safety. Includes locking legs for secure positioning. Choose either 10,000-lb. or 15,000-lb. capacity boards. Other sizes, refrigerated lip, and capacities available, call for information. **SELECTED MODELS FACTORY QUICK SHIP.** All FOB TEXAS.



Overall L x W	Height Diff. (1)*	Height Diff. (2)*	10,000-LB. CAPACITY			15,000-LB. CAPACITY		
			Model Number	Wt. Lbs.	Price Each	Model Number	Wt. Lbs.	Price Each
36" x 60"	3"	5"	ZA-2050	127	\$653.00	ZA-2057	154	\$822.00
48" x 60"	5"	7"	ZA-2051	165	837.00	ZA-2058	201	1053.00
60" x 60"	7"	9"	ZA-2052	202	1021.00	ZA-2059	247	1283.00
72" x 60"	8.5"	11"	ZA-2053	240	1206.00	ZA-2060	294	1511.00
36" x 72"	3"	5"	ZA-2054	144	730.00	ZA-2061	177	914.00
48" x 72"	5"	7"	ZA-2055	187	945.00	ZA-2062	230	1205.00
60" x 72"	7"	9"	ZA-2056	230	1160.00	ZA-2063	284	1497.00

\*NOTE: Height Difference (1) is the maximum height difference between dock and truck for pallet jacks or electric forklifts. Height Difference (2) is the maximum height difference between dock and truck for propane forklifts.

## OPTIONS

- Model No. **ZA-2064**—Lifting Chains. Allow worker to position unit with a forklift. .... **\$93.50**
- Model No. **ZA-2065**—EZ Roll Positioning Handles. Lets one person position dockboard without a forklift. .... **\$315.00**
- Model No. **ZA-5145**—Extra Leg with Fasteners. .... **\$38.50**
- Model No. **ZA-5146**—Loop Handles. Welded to each leg. .... **\$30.80**

NOTE: An 11" lip is standard, an 11° bend is standard. Leg lengths are 2" to 3" longer than maximum height difference. Useable width is overall width less 3".



# BLUFF Steel Dockboards

## Steel Dockboards With Steel Curbs

High-strength steel dockboards are essential parts of efficient dock truck operations. Welded steel curbs increase strength and prevent fork truck run-off, while the diamond tread surface enhances safety and prevents slippage. Supports loads up to 10,000 lbs. with a 3,000-lb. forklift capacity. Includes lifting chains for easy positioning between dock and truck. **SELECTED MODELS FACTORY QUICK SHIP.** All FOB TEXAS.

Model Number	Overall L x W	Height Diff. (1)*	Height Diff. (2)*	Wt. Lbs.	Price Each
<b>ZA-2066</b>	36" x 60"	3"	5"	207	<b>\$835.00</b>
<b>ZA-2067</b>	48" x 60"	5"	7"	276	<b>1034.00</b>
<b>ZA-2068</b>	60" x 60"	7"	9"	345	<b>1137.00</b>
<b>ZA-2069</b>	72" x 60"	8.5"	11"	414	<b>1283.00</b>
<b>ZA-3237</b>	36" x 72"	3"	5"	248	<b>892.00</b>
<b>ZA-3238</b>	48" x 72"	5"	7"	331	<b>1047.00</b>
<b>ZA-3239</b>	60" x 72"	7"	9"	415	<b>1209.00</b>

\*NOTE: Height Difference (1) is the maximum height difference between dock and truck for pallet jacks or electric forklifts. Height Difference (2) is the maximum height difference between dock and truck for propane forklifts.

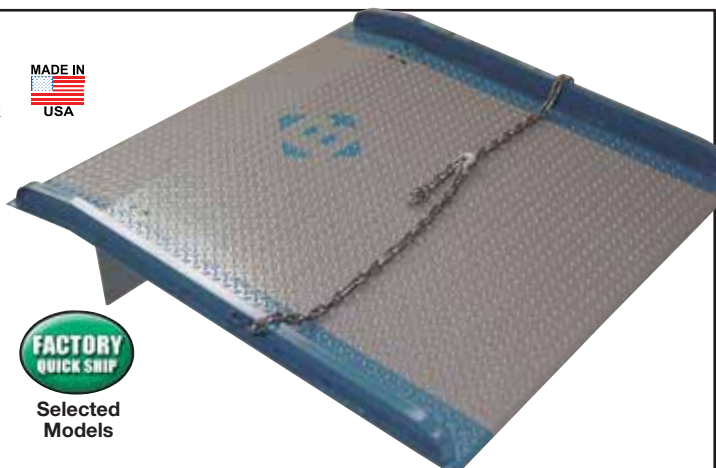

Selected Models

## Steel T-Boards

Specially designed T-board features steel pins that drop into side pockets to give you extra strength during heavy-duty applications. When pins are in side pockets, they position the board securely between trailer and dock. MIG continuously welded steel side curbs help prevent runoffs and add 6" to width in chart. Includes lift loops to ease movement of board. T-boards work well with standard or refrigerated trailers. **SELECTED MODELS FACTORY QUICK SHIP.** All FOB TEXAS.

Overall L x W	Height Difference (1)*	Height Difference (2)*	15,000-LB. CAPACITY			20,000-LB. CAPACITY		
			Model Number	Wt. Lbs.	Price Each	Model Number	Wt. Lbs.	Price Each
48" x 60"	5"	7"	<b>ZB-1073</b>	430	<b>\$1174.00</b>	<b>ZC-3250</b>	535	<b>\$1281.00</b>
60" x 60"	7"	9"	<b>ZB-1074</b>	540	<b>1384.00</b>	<b>ZB-1079</b>	675	<b>1502.00</b>
72" x 60"	8.5"	11"	<b>ZB-1075</b>	625	<b>1599.00</b>	<b>ZB-1080</b>	785	<b>1715.00</b>
48" x 72"	5"	7"	<b>ZB-1076</b>	495	<b>1291.00</b>	<b>ZB-1081</b>	610	<b>1395.00</b>
60" x 72"	7"	9"	<b>ZB-1077</b>	625	<b>1502.00</b>	<b>ZB-1082</b>	770	<b>1640.00</b>
72" x 72"	8.5"	11"	<b>ZB-1078</b>	720	<b>1715.00</b>	<b>ZB-1083</b>	895	<b>1881.00</b>

\*NOTE: Height Difference (1) is the maximum height difference between dock and truck for pallet jacks or electric forklifts. Height Difference (2) is the maximum height difference between dock and truck for propane forklifts.

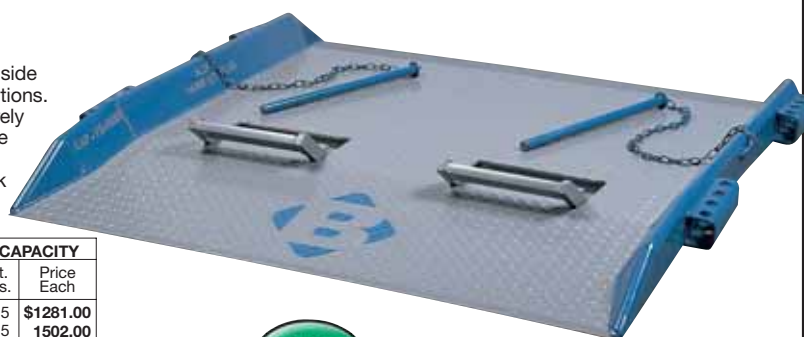

Selected Models

LIFT LOOPS ARE UNCONDITIONALLY GUARANTEED

## Red Pin Steel Dockboards



Positive pin locking system offers safety, versatility in handling conventional parking or troublesome angle park-outs. 1" steel pins slide into side holds safely securing board between trailer and dock. Other features include safety curbs with tapered ends, forklift loops, and two deck plate bends that stop kick-ups and allow plenty of bottom clearance for forklifts. All-steel construction is continuously MIG-welded for maximum strength and longer service. **SPECIFY CAPACITY: A - 15,000-lb., B - 20,000-lb. FOB TEXAS.**

RED PINS SAFELY HANDLE TROUBLESOME PARK-OUT SITUATIONS.



Model Number	Overall L x W	Height Diff. (1)*	Height Diff. (2)*	Pin Length	(A) 15,000-LB. CAP.		(B) 20,000-LB. CAP.	
					Wt. Lbs.	Price Ea.	Wt. Lbs.	Price Ea.
<b>ZB-1050</b>	48" x 60"	5"	7"	20"	485	<b>\$1022.00</b>	535	<b>\$1085.00</b>
<b>ZB-1051</b>	60" x 60"	7"	9"	20"	610	<b>1197.00</b>	675	<b>1279.00</b>
<b>ZB-1052</b>	72" x 60"	8.5"	11"	24"	710	<b>1372.00</b>	785	<b>1487.00</b>
<b>ZB-1053</b>	84" x 60"	10"	13"	30"	850	<b>1551.00</b>	940	<b>1696.00</b>
<b>ZB-1054</b>	48" x 72"	5"	7"	20"	550	<b>1166.00</b>	610	<b>1212.00</b>
<b>ZB-1055</b>	60" x 72"	7"	9"	20"	690	<b>1372.00</b>	770	<b>1453.00</b>
<b>ZB-1056</b>	72" x 72"	8.5"	11"	24"	805	<b>1580.00</b>	895	<b>1696.00</b>
<b>ZB-1057</b>	84" x 72"	10"	13"	30"	970	<b>1791.00</b>	1070	<b>1935.00</b>
<b>ZB-1058</b>	48" x 78"	5"	7"	20"	600	<b>1237.00</b>	650	<b>1285.00</b>
<b>ZB-1059</b>	60" x 78"	7"	9"	20"	735	<b>1462.00</b>	815	<b>1542.00</b>
<b>ZB-1060</b>	72" x 78"	8.5"	11"	24"	855	<b>1688.00</b>	950	<b>1799.00</b>

\*NOTE: Height Difference (1) is the maximum height difference between dock and truck for pallet jacks or electric forklifts. Height Difference (2) is the maximum height difference between dock and truck for propane forklifts.



# Ramps

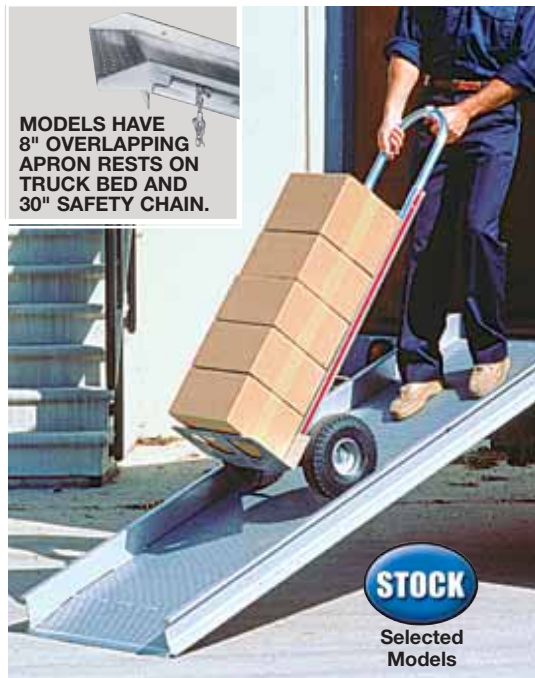

## MAGLINE® Aluminum Walk Ramps

Non-rusting aluminum walk ramps ease truck to ground loading or unloading. May also be used to cross over machinery, or in place of an entrance stairway. Level-off apron overlaps trucks bed. Lightweight aluminum construction with non-slip serrated deck and welded safety curbs to prevent runoff. Not for use with pallet jacks or any motorized equipment. **SELECTED MODELS IN STOCK AND FACTORY QUICK SHIP.** Others FOB MICHIGAN.

### Selecting a Ramp

1. Measure height from truck bed to ground or between two levels in your building.
  2. Select ramp best suited to your needs.
- Note: More than one length handles a given height. If only unloading light loads, shorter length with greater incline is satisfactory. If unloading and loading heavy loads, longer ramps with shorter inclines are recommended.

Model Number	Ramp Height	Overall Length	Capacity Lbs.	Wt. Lbs.	Price Each
<b>OVERALL WIDTH 28-3/4", USEABLE WIDTH 26-1/4"</b>					
XA-5079	10-31"	8'	2,500	78	\$496.00
XA-5080	12-37"	10'	2,200	93	580.00
XA-5081	16-46"	12'	1,900	110	668.00
XA-5082	17-52"	14'	1,600	123	705.00
XA-5083	20-61"	16'	1,000	147	802.00
<b>OVERALL WIDTH 39-1/2", USEABLE WIDTH 37"</b>					
XA-5084	10-31"	8'	2,500	98	\$583.00
XA-5085	12-37"	10'	2,200	114	683.00
XA-5086	16-46"	12'	1,900	139	751.00
XA-5087	17-52"	14'	1,600	151	831.00
XA-5088	20-61"	16'	1,000	176	941.00

NOTE: Capacities shown are for two- and four-wheeled trucks only.



## BLUFF Portable Steel Yardramps

No more waiting to unload trucks or trailers, because this portable YardRamp can be at the dock in minutes. Ramp features a tubular steel box undercarriage assembly with wide 18" solid rubber pneumatic tires that let you easily tow or reposition ramp where you need it. The self-contained, double-action hydraulic pump wheel assembly quickly places ramp at the proper height. 8" curb height. Supports 16,000 or 20,000 lbs. Other features include: open serrated steel grating for excellent traction, beveled approach for smooth transition, and safety chain. For truck- or rail car-to-ground applications, choose a 36' unit with a 6' level off. For dock-to-ground applications, choose a 30' model. Other sizes available, call for information. **FACTORY QUICK SHIP—FOB TEXAS.**

Model Number	Ramp L x W	Cap. Lbs.	Wt. Lbs.	Price Each
WS-1410	30' x 70"	16,000	4159	\$10199.00
WS-1411	36' x 70"	16,000	5102	11589.00
WS-1412	30' x 84"	16,000	4964	10940.00
WS-1413	36' x 84"	16,000	5828	12921.00
WS-1414	36' x 84"	20,000	6048	14049.00

**OPTIONAL RAMP CLAMP OR TOW BAR FREE WITH THE PURCHASE OF A YARDRAMP!**



**RAMP CLAMP.** Locks onto lift truck forks to quickly move ramp a short distance.

**TOWBAR.** Tows ramp safely over long distances. Easy, fast-locking hook-up and quick disconnect improves handling efficiency.

Model No. **WS-1415**.....\$187.00

Model No. **WS-1416**.....\$202.00

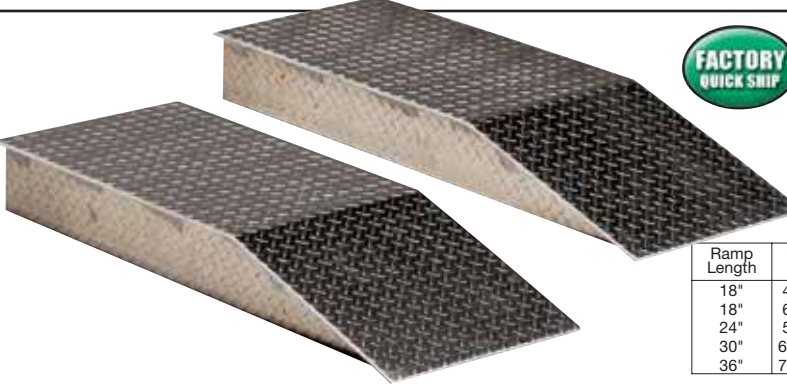

## VESTIL Truck/Trailer Wheel Ramps

Decrease the height difference between docks and trailer beds with these durable ramps. 15,000-lb. capacity per ramp. Rugged, lightweight aluminum construction features safety tread for increased traction. Ramps sold individually. **FACTORY QUICK SHIP—FOB INDIANA.**

Ramp Length	Overall L x H	18"W MODELS			24"W MODELS		
		Model No.	Wt. Lbs.	Price Ea.	Model No.	Wt. Lbs.	Price Ea.
18"	48" x 6"	XP-1457	72	\$463.00	XP-1462	89	\$538.00
18"	60" x 6"	XP-1458	97	559.00	XP-1463	120	667.00
24"	54" x 8"	XP-1459	93	528.00	XP-1464	111	648.00
30"	66" x 10"	XP-1460	133	713.00	XP-1465	158	818.00
36"	72" x 12"	XP-1461	166	805.00	XP-1466	188	950.00

# Protective Guards

**MADE IN USA** **STOCK**

## BLUFF Door Track Protectors

Prevent heavy machinery from damaging overhead door tracks with this all steel protector. 48"H columns wrap around the track so they don't interfere with door operation. Beveled edge reduces risk of hand injury when lowering the door. 3/16" thick columns. 5/8" thick base includes (3) 11/16" anchor holes. Protrudes 7" from wall. Anchors to both wall and floor (fasteners not included). **IN STOCK.**

Model Number	Description	Price Each
XA-2360	Left Side	\$111.00
XA-2361	Right Side	111.00



**MADE IN USA** **STOCK**

## DIXIE Corner Protector

Use these protectors in corners, overhead, or surround your door frames with them. Molded polyethylene material resists stress and cracking and will not rust. Mounts easily via countersunk fastener openings (fasteners not included). Performs well in cold environments. **IN STOCK.**

Model No. **XK-2198**..\$93.50/pr.



**FACTORY QUICK SHIP**

## VESTIL Guard Rail Systems

Mar-resistant, galvanized 10-ga. steel guard is ideal for outdoors and harsh environments. Black/yellow caution tape combines with bright yellow legs to give you high visibility and warning before impact. Spring steel mounting post deflects fork truck impact without damage to rail or truck. 3"W x 10-3/4"D x 24"H posts topped by 12-1/8"H rail with 3" projection. **SELECTED MODELS FACTORY QUICK SHIP.** All FOB INDIANA.

### STRAIGHT RAILS

Model Number	Overall Length	Wt. Lbs.	Price Each
XC-1467	4'	37	\$62.10
XC-1468	8'	74	132.00
XC-1469	12'	111	170.00

### 90° CURVED RAILS

Model Number	Overall Length	Mounting Post Qty. Required	Radius	Wt. Lbs.	Price Each
XL-0654	8'	3	61"	89	\$289.00
XL-0655	12'	3	92"	133	327.00

### POSTS

Model No. **XL-0656**—Tubular Post. Wt. 41 lbs. ....\$93.10  
 Model No. **XC-1470**—Spring Post. Wt. 18 lbs. ....\$107.00

### MOUNTING PLATE.

For use on asphalt. 12"L x 7-1/2"W.  
 Model No. **XC-1471**—Wt. 6 lbs. ....\$16.40

### END CAP

Model No. **XL-0659**—Wt. 10 lbs. ....\$43.80



**MADE IN USA**

## WILDECK® Safety Bollards

Place safety bollards strategically around valuable equipment to deter worker injury and product damage. 5" x 5" x 3/16" square steel tube is welded to a 10" x 10" base plate. Includes galvanized steel cap. Bolt to surface or secure in concrete (hardware not included). Color: safety yellow. FOB WISCONSIN.

Model Number	Overall Ht.	Wt. Lbs.	Price Each
XV-2503	24"	35	\$92.90
XV-2504	36"	47	122.00
XV-2505	42"	53	135.00

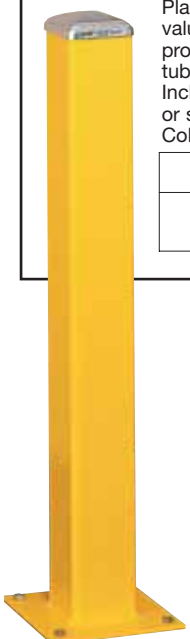

**STOCK** **MADE IN USA**

## BLUFF Heavy-Duty Bollard

Provide a physical barrier between fork trucks and valuable equipment with these safety bollards. 6" dia. steel pipe construction with welded dome top. 42"H overall. 10" x 10" x 5/8" base has 3/4" mounting holes. Bolts into position with four included 5/8" anchors. **IN STOCK.**

Model No. **XA-2362**—Wt. 90 lbs. ....\$223.00



**MADE IN USA**

## GCP Bollard Covers

Clean up the look of unsightly damaged or worn posts with these economical bollard covers; they're easy to install and reduce paint and labor costs. Ideal for use in parking lots, loading docks, building entrances, drive-thru windows, or ATMs. Constructed of 1/8" thick high-density UV-resistant polyethylene bollard covers won't chip, fade or rust over time. Reflective strips offer increased visibility at night. **SPECIFY COLOR: BL** - Blue, **RD** - Red, **WO** - Without Stripes. FOB OHIO.

Model Number	Inside Dia. x H	Wt. Lbs.	Price Each
YL-0707	4" x 52"	5	\$28.30
YL-0708	4" x 60"	5	30.20
YL-0709	7" x 52"	6	37.70
YL-0710	7" x 72"	8	41.50



# Protective Guards

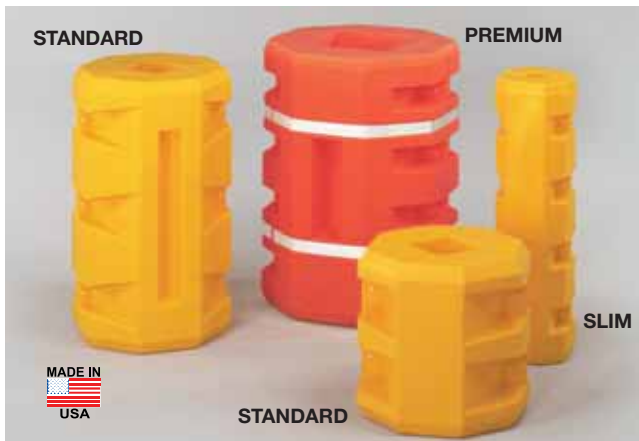

## DIXIE Column Protectors

Stress- and crack-resistant molded polyethylene guards wrap around columns, creating a protective barrier between fork truck and building structure. Units can be stacked to protect the entire column length. Bumper should fit snugly around upright. Fasteners included.

**STANDARD.** Withstands up to a 10,000-lb. forklift or hand truck impact. Color: safety yellow. **IN STOCK.**

Model No.	Overall W x H	Wt. Lbs.	Price Ea.
<b>SPECIFY SHAPE: A - D</b>			
<b>XA-1465</b>	26" x 24"	28	<b>\$130.00</b>
<b>SPECIFY SHAPE: A - F</b>			
<b>XC-1462</b>	26" x 42"	46	<b>\$218.00</b>
<b>SPECIFY SHAPE: G - I</b>			
<b>XC-1452</b>	30" x 42"	70	<b>\$366.00</b>

**PREMIUM.** Designed for areas that are prone to frequent and high speed impacts from small lift trucks, premium column protectors are 60% thicker than standard models. Withstands impact over 10,000 lbs. Color: orange with glow-in-the-dark strip.

**FACTORY QUICK SHIP - FOB SOUTH CAROLINA.**

Model No.	Overall W x H	Wt. Lbs.	Price Ea.
<b>SPECIFY SHAPE: A - F</b>			
<b>XC-3160</b>	26" x 42"	70	<b>\$402.00</b>
<b>SPECIFY SHAPE: G - I</b>			
<b>XC-3161</b>	30" x 42"	100	<b>\$574.00</b>

**SLIM.** Perfect for protecting small columns on mezzanines and pipes. Color: yellow. **IN STOCK.**

Model No.	Overall W x H	Wt. Lbs.	Price Ea.
<b>SPECIFY SHAPE: A-D</b>			
<b>XC-3162</b>	12" x 42"	18	<b>\$119.00</b>

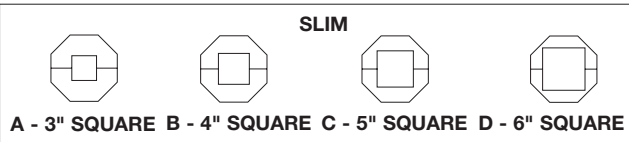
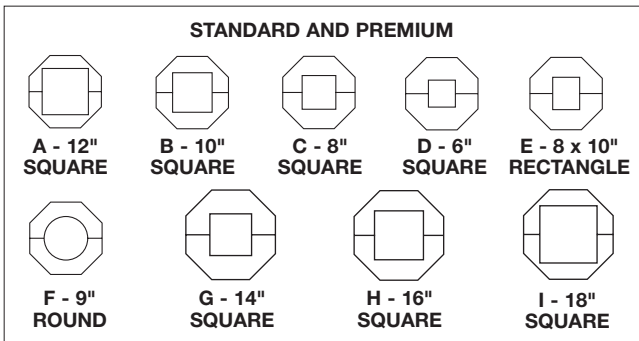

**STOCK**

**DIXIE Poly Pipe Protector**

**MADE IN USA**

Polyethylene protector keeps electrical pipes, water pipes and support beams safe from fork truck damage. C-channel unit is stress- and crack-resistant. Will cover up to 5" dia. pipe. 12"W x 6"D x 42"H. **IN STOCK.**

Model No. <b>XL-0681</b> —	Wt. 6 lbs. ....	<b>\$59.70</b>
----------------------------	-----------------	----------------



**STOCK**

**VESTIL Rack Protectors with Rubber Bumper**

Strong guard will protect racking from damaging fork truck impact. Rubber bumper is bolted to C-channel steel guard to absorb impact. Mounting hardware not included. Yellow powder coat finish. **SPECIFY OPENING: A - 4-1/2", B - 6-1/2". IN STOCK.**

Model Number	Overall Height	(A) 4-1/2" USABLE WIDTH		(B) 6-1/2" USABLE WIDTH	
		Wt. Lbs.	Price Ea.	Wt. Lbs.	Price Ea.
<b>XL-0674</b>	12"	17	<b>\$44.90</b>	28	<b>\$49.70</b>
<b>XL-0675</b>	18"	25	<b>58.60</b>	38	<b>66.40</b>
<b>XL-0676</b>	24"	34	<b>72.30</b>	51	<b>80.60</b>
<b>XL-0677</b>	36"	46	<b>107.00</b>	71	<b>120.00</b>



**STOCK**

**WILDECK Steel Rack Protector**

**MADE IN USA**

Extremely strong post protector is constructed of heavy gauge 6" channel steel making it virtually indestructible. For use with 4" beams. 8"W x 6"D x 12"H; base is 1/4" thick. **IN STOCK.**

Model No. <b>YL-0682</b> —	Wt. 10 lbs. ....	<b>\$42.10</b>
----------------------------	------------------	----------------



**STOCK**

**DIXIE Poly Rack Protector**

**MADE IN USA**

Versatile protector can be bolted to floor for permanent application or secured via Velcro® strips for temporary use. Polyethylene construction won't crack or dent and will keep posts safe from fork truck scrapes and dents. 4-1/2"W x 8"D x 18"H. **IN STOCK.**

Model No. <b>XL-0680</b> —	Wt. 3 lbs. ....	<b>\$42.70</b>
----------------------------	-----------------	----------------

# Protective Guards

## WILDECK® Pallet Rack Protectors



Extremely heavy and durable protectors absorb fork truck impact that can damage valuable racking. Curved endplates fit around rack corners while 6"H angles run along each bottom edge. Can be bolted to the floor for extra stability. Color: safety yellow. **SPECIFY CORNER: A - Left, B - Right.**  
**FACTORY QUICK SHIP—FOB WISCONSIN.**

**STANDARD PALLET RACK PROTECTORS.** Withstands abuse from fork trucks and heavy equipment in warehouses, shipping and receiving areas, and loading docks. 1/2" thick steel with 12"H endplate. Hardware not included.

Model Number	Overall L x W x H	Wt. Lbs.	Price Each
XA-2330	26" x 6" x 12"	57	\$152.00
XA-2331	36" x 6" x 12"	70	166.00
XA-2332	42" x 6" x 12"	95	179.00
XP-1450	50-1/2" x 6" x 12"	105	199.00

**"LITE" PALLET RACK PROTECTORS.** Designed for lighter-duty applications such as placement around bulk storage lockers, mesh partitions, or tool cribs. 5/16" thick steel with 8"H endplate. Hardware included.

Model Number	Overall L x W x H	Wt. Lbs.	Price Each
XA-2333	47-1/2" x 3-1/2" x 8"	70	\$127.00



## BLUFF Rack Protectors



Strong protectors place an immovable barrier between heavy machinery and support posts. 1/4" thick steel construction. Base plates have (4) 9/16" mounting holes (fasteners not included).  
**FACTORY QUICK SHIP—FOB TEXAS.**

Model Number	Overall Height	Wt. Lbs.	Price Each
XA-2340	12"	11	\$28.00
XA-2341	18"	15	33.60
XA-2342	24"	20	37.10



## RELIUS SOLUTIONS Universal Rack Protectors



Protects support posts from damaging impact that can be caused by heavy machinery. 3-1/2"D overall with 3.87" inside width. 6"W x 3-1/2"D, 1/4" thick base plate. Mounting hardware included. **IN STOCK.**

Model Number	Overall Height	Wt. Lbs.	Price Each
XA-2334	12"	8	\$32.00
XA-2335	18"	10	39.00
XA-2336	24"	12	45.00

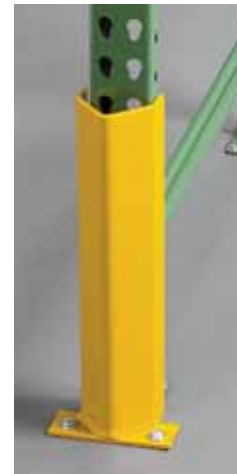

TWO 48"W UNITS SHOWN.

## DIXIE Poly Wall Protector

Protects walls and inplant offices from damaging impact by fork trucks and other powered equipment. Crack- and stress-resistant poly rail bolts to the wall for secure installation. 48"W x 2-1/4"D x 6-1/4"H.  
**IN STOCK.**

Model No. **XL-3963**—Wt. 6 lbs. ....\$51.40



## Bolt-On Column Protectors



Strong guards place immovable barriers between heavy machinery and support columns. Flush mount design eliminates catch points. Protects columns up to 24"H. Fits all 3" columns. 1/4" thick bull nose deflects outrigger column damage. All installation hardware included. Color: safety yellow. **FACTORY QUICK SHIP—FOB ILLINOIS, TEXAS.**

Model Number	Overall Height	Wt. Lbs.	Price Each
YP-0130	24"	20	\$35.20

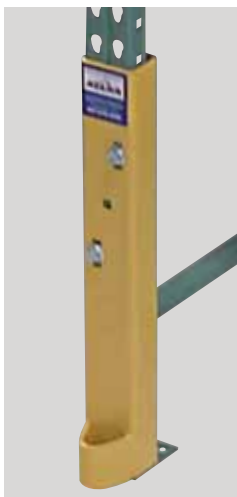

# Protective Guards



**REMOVABLE  
HIGH-CAPACITY  
ANCHORS  
INCLUDED**



## WILDECK® Wilgard® Protective Steel Guardrails

Easy-to-install barricades protect valuable equipment and workers from hazards in the workplace. Easy installation with concrete anchors. 11-ga. steel components absorb impact of a 13,000-lb. load at 4 mph. 5" x 5" x 3/16" structural tube columns support rolled top rails. 12" x 12" x 3/4" baseplate. Single post is 18"H while the double post is 44"H. Industrial yellow enamel finish. Mounting anchors included. **IN STOCK.**

**LIFT-OUT RAILS** (Shown)—Are easy to remove for servicing, repairs, cleaning, or pass-through. Rail slips into specially designed "saddle," which is bolted to post to retain structural integrity.

Components	STANDARD RAILS			LIFT-OUT RAILS		
	Model No.	Wt. Lbs.	Price Ea.	Model No.	Wt. Lbs.	Price Ea.
10' Rail	<a href="#">XV-1478</a>	69	<b>\$206.00</b>	<a href="#">XV-1484</a>	69	<b>\$275.00</b>
8' Rail	<a href="#">XV-1479</a>	56	<b>173.00</b>	<a href="#">XV-1485</a>	56	<b>252.00</b>
6' Rail	<a href="#">XV-1480</a>	43	<b>148.00</b>	<a href="#">XV-1486</a>	43	<b>226.00</b>
4' Rail	<a href="#">XV-1481</a>	30	<b>122.00</b>	<a href="#">XV-1487</a>	30	<b>193.00</b>
Single Post	<a href="#">XV-1482</a>	50	<b>162.00</b>	<a href="#">XV-1488</a>	50	<b>162.00</b>
Double Post	<a href="#">XV-1483</a>	75	<b>217.00</b>	<a href="#">XV-1489</a>	75	<b>217.00</b>



### Self-Closing Gate

Allow access to protected machinery and equipment with this self-closing gate. It's spring-loaded and closes securely with a latching mechanism. Replaces a 4' double rail section. Can be installed on right or left side of rail system.

Model No. [XL-0625](#)—  
Wt. 75 Lbs. .... **\$527.00**



**FACTORY  
QUICK SHIP**  
Selected  
Models

## BLUFF Safety Rail

When placed around machinery, steel rails protect workers from potential hazards and prevent damage that can be caused by heavy equipment. 10-ga. steel construction with rounded top rails. Open-sided posts are easy to assemble. 10" x 10", 5/8" thick base plates. Fasteners included. **SELECTED MODELS**

**FACTORY QUICK SHIP.**  
All FOB TEXAS.

Description	Model No.	Wt. Lbs.	Price Each
1' Rail	<a href="#">XA-2343</a>	12	<b>\$84.10</b>
2' Rail	<a href="#">XA-2344</a>	20	<b>90.90</b>
3' Rail	<a href="#">XA-2345</a>	27	<b>98.70</b>
4' Rail	<a href="#">XA-2346</a>	35	<b>107.00</b>
5' Rail	<a href="#">XA-2347</a>	42	<b>123.00</b>
6' Rail	<a href="#">XA-2348</a>	50	<b>129.00</b>
7' Rail	<a href="#">XA-2349</a>	57	<b>153.00</b>
8' Rail	<a href="#">XA-2350</a>	65	<b>164.00</b>
9' Rail	<a href="#">XA-2351</a>	72	<b>176.00</b>
10' Rail	<a href="#">XA-2352</a>	80	<b>185.00</b>
11' Rail	<a href="#">XA-2353</a>	87	<b>194.00</b>
12' Rail	<a href="#">XA-2354</a>	94	<b>213.00</b>
18" Post	<a href="#">XA-2356</a>	39	<b>115.00</b>
30" Post	<a href="#">XA-2357</a>	52	<b>139.00</b>
42" Post	<a href="#">XA-2358</a>	65	<b>149.00</b>
Lift-Out Attachment	<a href="#">XA-2355</a>	18	<b>35.00</b>
Corner Connector	<a href="#">XA-2359</a>	1	<b>12.90</b>



## WILDECK® Machinery and Rack Safety Guards

U-shaped guards prevent fork trucks or other powered machinery from damaging important equipment. 5" x 5" x 3/16" steel tube is welded to a 9" x 9" base plate. May be bolted or secured in concrete (hardware not included). FOB WISCONSIN.

Model No.	L x H	Wt. Lbs.	Price Ea.
<a href="#">XV-2506</a>	36" x 24"	100	<b>\$324.00</b>
<a href="#">XV-2507</a>	36" x 42"	136	<b>350.00</b>
<a href="#">XV-2508</a>	48" x 24"	112	<b>350.00</b>
<a href="#">XV-2509</a>	48" x 42"	131	<b>372.00</b>
<a href="#">XV-2510</a>	36" x 10"	72	<b>248.00</b>
<a href="#">XV-2511</a>	48" x 10"	84	<b>283.00</b>

# JARKE® Guardrails



## Steel Sentry™ Ultra Welded Protective Railing Systems

Protect valuable machinery from damage caused by heavy equipment with these protective railings. 4" square tubular 7-ga. steel construction is extremely heavy-duty and virtually indestructible. 11" x 11", 1/2" thick foot plates should be mounted to the floor for increased stability. 7/8" mounting holes. Choose either 15"H single rail, 29-1/2"H double rail, or 44"H triple-rail system. FOB ILLINOIS.

Rail Lgth.	Model Number	Wt. Lbs.	Price Each	Model Number	Wt. Lbs.	Price Each	Model Number	Wt. Lbs.	Price Each
	SINGLE-RAIL SYSTEMS			DOUBLE-RAIL SYSTEMS			TRIPLE-RAIL SYSTEMS		
4'	YC-1446	107	\$228.00	YC-1449	180	\$386.00	YC-1452	205	\$534.00
6'	YC-1447	117	253.00	YC-1450	201	427.00	YC-1453	260	631.00
8'	YC-1448	128	279.00	YC-1451	222	551.00	YC-1454	316	718.00

**CORNER GUARD RAILS.** Create protective cages around valuable machinery and equipment. 42"L per side. Fits your existing system.

Model No. <b>YC-1456—Single-Rail.</b>	Wt. 145 lbs. ....	\$365.00
Model No. <b>YC-1457—Double-Rail.</b>	Wt. 236 lbs. ....	\$604.00
Model No. <b>YC-1458—Triple-Rail.</b>	Wt. 328 lbs. ....	\$833.00

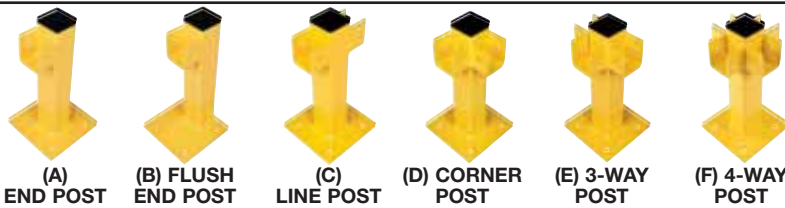

## Steel Sentry™ Impact-Resistant Railing Systems

You can have it all—a protective, immovable barrier with unobstructed access to machinery for repairs and maintenance. Removable rails bolt in place for strength and can be easily lifted out when necessary. Extremely strong posts are constructed of 4" square tubular 7-gauge steel. Rails are constructed of 3" x 4" tubular 11-gauge steel. Posts are supported by 11" x 11", 1/2" thick foot plates with 7/8" mounting holes and should be bolted to the floor for stability. Ships unassembled. **FACTORY QUICK SHIP—FOB ILLINOIS.**

### POSTS.

Model Number	Description	(A) & (B) Price Ea.	(C) & (D) Price Ea.	(E) & (F) Price Ea.
XC-3173	21" Single	\$119.00	\$132.00	\$146.00
XC-3174	45" Double	170.00	180.00	213.00

**SPECIFY:** A - End post, B - Flush end post, C - Line post, D - Corner post, E - 3-way post, F - 4-way post.

### LIFT-OUT RAILS.

Model No.	Length	Wt. Lbs.	Price Ea.
XC-3170	4'	21	\$51.30
XC-3171	6'	32	79.20
XC-3172	8'	43	90.80



## Safety Guardrails

Make overhead walkways and mezzanines safe with these easy-to-install guardrails. 1-1/2" square tube rails are welded in 4'L sections with plastic end caps on each side of top rail. May be used in a straight line or as a 90° directional change. Includes railing to base hardware. Order end base or intermediate base sockets separately. Anchoring hardware not included. **IN STOCK.**

Key	Model No.	Description	Overall W x H	Wt. Lbs.	Price Ea.
A	XS-1402	Hand Rail Assembly	48" x 42"	23-1/2	\$72.80
B	XS-1403	Intermediate Base	—	2	24.50
C	XS-1404	End Base	—	2-1/2	22.90



# Barricades & Guards



MEETS OSHA REQUIREMENTS FOR GUARDING DANGEROUS MACHINERY.



## WIREWAY/HUSKY™ EZ-Wire™ Perimeter Guards

Open wire design allows clear viewing of operations yet limits unauthorized access. Meets all OSHA requirements for guarding dangerous machinery and electrical switch gear. 4'W x 5'H swing door with padlock hasp in handle, padlock not included. 12" sweep space. Order panels, posts, and doors separately. Color: yellow. **FACTORY QUICK SHIP – FOB NORTH CAROLINA.**

5'H PANELS Order posts separately.			
Model No.	Width	Wt. Lbs.	Price Ea.
XV-2490	1'	9	\$53.20
XV-2491	2'	13	57.70
XV-2492	3'	18	82.60
XV-2493	4'	22	104.00
XV-2494	5'	26	126.00
XV-2495	6'	35	146.00
XV-2496	7'	45	162.00
XV-2497	8'	49	176.00
XV-2498	9'	53	191.00
XV-2499	10'	58	199.00

Model No. <b>XV-2500</b> —Swing Door. Wt. 30 lbs. ....	\$210.00
Model No. <b>XV-2501</b> —Posts. 2-1/2" sq. x 6' H. Wt. 20 lbs. ....	\$75.20



## DIXIE Poly-Cade Barricade

Restrict dangerous or hazardous areas with safety barricades. Modular units have interlocking joints to create a barricade specific to your needs. UV-resistant polyethylene will not fade, and is stress- and crack-resistant. 400-lb. capacity units can be filled with water or sand for extra stability. Ships empty. **SPECIFY COLOR: GT - Granite, OR - Orange, WH - White, YL - Yellow. FOB SOUTH CAROLINA.**

Model Number	Overall L x W x H	Wt. Lbs.	(OR)(WH)(YL)	(GT)
			Price Ea.	Price Ea.
XL-0630	60" x 16" x 24"	33	\$159.00	\$209.00
XL-0640	72" x 16" x 35"	70	292.00	422.00

INTERLOCKING JOINT CONNECTION



# Commercial & Industrial Sweepers

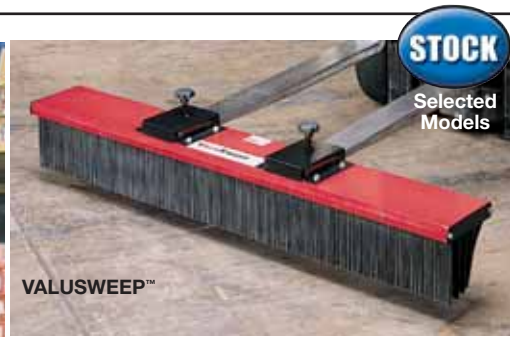

## TRYNEX Commercial Sweepers

Modular broom is designed for indoor and outdoor use. Perfect for sweeping warehouses, parking lots, construction sites and more. Handles dry or wet material. Brushes away snow and squeegees water. Easy 30-second installation—simply attach broom to forklift. Main frame is constructed of 10-ga. steel with 1/4" thick end caps. Eight brush rows feature replaceable, recyclable polypropylene bristles. Bristle wear is 1/64th of an inch per mile. Low-maintenance.

EASY-TO-REPLACE BRISTLES



**PRO SERIES HEAVY-DUTY INDOOR/OUTDOOR BROOMS.** Designed for heavy-duty applications, these brooms handle sand, gravel, and standing water with ease. Perfect for outdoors and construction sites. 11-1/2"H bristles, 10-ga. steel frame. Magnetic bar attachment picks up nails and dangerous metal debris.

**FACTORY QUICK SHIP—FOB MICHIGAN.**

**VALUSWEEP™ STANDARD-DUTY INDOOR BROOMS.** 8"H bristles sweep away light- and medium-weight debris. Lightweight, extruded aluminum mounts to lift truck using Quick-Tite fork pockets. Ships via small package carrier. **IN STOCK.**

Model Number	Overall Width	Wt. Lbs.	Price Each
<b>PRO SERIES FORKLIFT-MOUNT BROOMS</b>			
XN-2206	60"	146	\$1129.00
XN-2207	72"	173	1469.00
<b>PRO SERIES FORKLIFT REPLACEMENT BRUSH KITS</b>			
XK-2166	60"	53	\$458.00
XK-2167	72"	67	491.00
<b>PRO SERIES MAGNETIC BAR ATTACHMENTS</b>			
XK-2171	60"	64	\$570.00
XK-2172	72"	77	636.00
<b>VALUSWEEP™ FORKLIFT-MOUNT BROOMS</b>			
XJ-3110	48"	43	\$536.00
XJ-3111	60"	52	626.00
<b>VALUSWEEP™ REPLACEMENT BRUSH KITS</b>			
XJ-3112	48"	8	\$191.00
XJ-3113	60"	10	227.00

### ACCESSORIES

Model No. **XK-2169**—60" Dust Mop Kit for 60" and 72" brooms. Wt. 10 lbs.....\$114.00

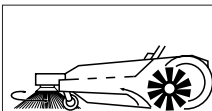

REVERSE ROTATION OF MAIN BROOM KICKS DIRT AND DEBRIS INTO HOPPER.

## Industrial Push Sweeper

Picks up dirt, debris, and litter anywhere—inside or out. 12" dia. side broom cleans along edges and corners while delivering material into the path of 19" rotating main broom. 27" total sweeping width. 8-gal. hopper is easy to empty. Broom pressure adjusts for different surfaces. Other features: 10" wheels, structural plastic body, and bumpers to prevent damage to walls. **IN STOCK.**

Model No. **XM-383**—Wt. 47 lbs.....\$614.00



# Fans



**BELT DRIVE SWIVEL MODEL**



**BELT DRIVE STANDARD MODEL**



**DIRECT DRIVE STANDARD MODEL**

### TPI® Portable Air Circulators

Now you can efficiently cool large areas with these heavy-duty air circulators. Durable, powder coat 20-gauge shroud with front and rear spiral guards protects the steel blade paddles. Front and rear roll formed embossments add strength and rigidity. Air circulators include: ball-bearing open drip proof motors, rocker-type switches, and 15', 3 conductor cords. Meet OSHA requirements and are UL listed. **DIRECT DRIVE MODEL.** 2-speed, 115V, permanent split capacitor motor. 8" hard rubber wheels. Three blades. **BELT DRIVE MODELS.** 1-speed, 115V, capacitor start motor. 10" hard rubber wheels. Four blades. Swivel model rotates 360° in 15° increments. **IN STOCK.**

Model Number	Fan Dia.	Mount Style	Motor HP	CFM	RPM	Amps	Wt. Lbs.	Price Each
<b>DIRECT DRIVE</b>								
<b>XV-1180</b>	36"	Std.	1/3	12,500*	1,100	8.6	72	<b>\$406.00</b>
<b>BELT DRIVE</b>								
<b>XV-1181</b>	36"	Std.	1/2	14,500	500	7.5	120	<b>\$550.00</b>
<b>XV-1182</b>	42"	Std.	3/4	18,200	430	9.8	135	<b>627.00</b>
<b>XV-1183</b>	48"	Std.	1	22,700	390	12.2	155	<b>704.00</b>
<b>XV-1184</b>	36"	Swivel	1/2	14,500	500	7.5	145	<b>647.00</b>
<b>XV-1185</b>	42"	Swivel	3/4	18,200	430	9.8	160	<b>744.00</b>
<b>XV-1186</b>	48"	Swivel	1	22,700	390	12.2	180	<b>838.00</b>

\*2nd speed for direct drive models is 9,000 CFM.







### TPI® Mini-Blowers

Choose either traditional floor style stand or yoke type to mount unit on wall or ceiling. Floor model is operated by rotary switch, while pull chain operates the yoke-mounted model. Two-speed, 1/4 HP, 115V totally enclosed ball bearing, permanently lubricated motor is ideal for dirty or dusty areas. Powder coat 20-ga. steel housing with front and rear spiral wire guards houses aluminum blades. SJT type, 3-conductor cord is 10' long. One-year limited warranty. CSA approved, UL listed and meets OSHA requirements. **IN STOCK.**

Model Number	Mount Style	Blade Dia.	CFM	Amps	Wt. Lbs.	Price Each
<b>XC-1149</b>	Floor	24"	5,500/7,000	2.5	52	<b>\$305.00</b>
<b>XC-1150</b>	Yoke	24"	5,500/7,000	2.5	52	<b>305.00</b>
<b>XC-1151</b>	Floor	30"	6,200/8,200	2.7	58	<b>336.00</b>
<b>XC-1152</b>	Yoke	30"	6,200/8,200	2.7	58	<b>336.00</b>

Model No. **XC-1153**—Wall/Ceiling Mount for yoke mount style.....**\$50.70**







### TPI® Oscillating Desk/Floor Fans

Designed for both the shop and office, practical fan is available in either a convenient desktop model or floor model for larger spaces. Three-speed low power consumption motor. Also includes push button controls, 3-conductor SPT cord and plug, powder coated wire mesh guards, plastic housing and plastic blades. Floor fan extends to 40"H. UL-listed. Meets OSHA requirements. Color: white. One-year warranty. **IN STOCK.**

Model Number	Blade Dia.	Fan Type	Air Flow CFM	Wt. Lbs.	Price Each
<b>YD-5200</b>	12"	Desk	1200	10	<b>\$77.60</b>
<b>YD-5201</b>	16"	Desk	2100	9	<b>91.80</b>
<b>YD-5202</b>	16"	Floor	2100	16	<b>107.00</b>





### TPI® Workstation Fans

Workbenches, walls, beams, shelving, machines, or ceilings are just a few of the surfaces you might mount this fan. Head rotates 360° to deliver air in any direction. Totally enclosed, sleeve bearing, permanently lubricated motor. Also includes: pull chain switch, 10'L, 3-conductor cord, and three aluminum blades. Meets OSHA standards and is UL-listed. **IN STOCK.**

Model Number	Blade Dia.	Motor HP	Air Flow CFM	Wt. Lbs.	Price Each
<b>YD-5235</b>	12"	1/12	2750/2200/1600	13	<b>\$88.20</b>
<b>YD-5236</b>	18"	1/8	5750/4700/3200	20	<b>103.00</b>
<b>YD-5237</b>	24"	1/8	6350/5200/3600	23	<b>196.00</b>



TABLETOP MODEL



FLOOR MODEL



## TPI® 3-Speed Fans

Dependable fans cool air in factories, warehouses—any large, open areas. Runs efficiently in temperatures up to 130°F. Includes: 3 aluminum blades with double-locking chrome-plated guard and 10', 3-conductor cord. 360° tilt, rotary switch activates the 115V, sleeve bearing motor. Meets OSHA standards, UL-listed, and CSA-approved. One-year warranty. **IN STOCK.**

### TABLETOP MODELS

Model Number	Blade Dia.	HP	CFM	Amps	Wt. Lbs.	Price Each
<b>XV-1173</b>	12"	1/15	2,750/2,200/1,600	1.3	13	<b>\$83.40</b>
<b>XV-1174</b>	18"	1/8	5,750/4,700/3,200	2.7	20	<b>\$96.80</b>

### FLOOR MODEL

Includes tilt stand, 5" plastic wheels. Stand raises fan center to 40" height.

Model Number	Blade Dia.	HP	CFM	Amps	Wt. Lbs.	Price Each
<b>XV-1175</b>	18"	1/8	5,750/4,700/3,200	2.7	27	<b>\$136.00</b>



(D) I-BEAM MOUNT. ADD YOUR OWN PIPE FOR A CUSTOM EXTENSION.

(C) AND (E) WALL-MOUNT

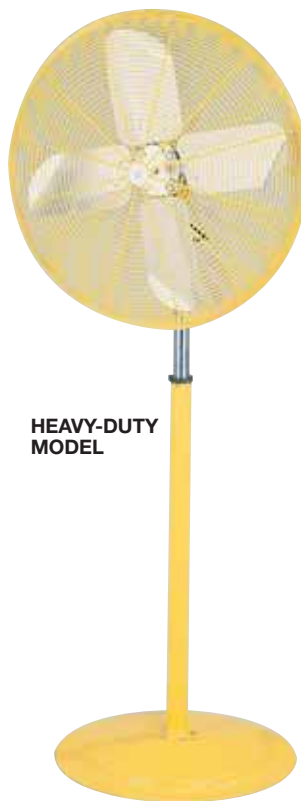

HEAVY-DUTY MODEL



HIGH PERFORMANCE INDUSTRIAL MODEL

HEAVY-DUTY MODEL

## TPI® Air Circulators

Designed to ventilate and efficiently cool large industrial areas. Pull-chain switch activates the 115V, 1ph. ball-bearing, totally enclosed motor. Also includes: steel hub, spider aluminum blades and 18'L cord with 3-conductor plug. 27" dia. base supports adjustable fan column raises from 4-1/2-7'H. Meet OSHA standards and are UL listed. **IN STOCK.**

**HIGH PERFORMANCE INDUSTRIAL:** Two-speed, 1/3 HP motor withstands temperatures up to 135°F. Includes: chrome-plated steel fan guard and 3 paddles. Three-year limited warranty. **SPECIFY:** **A** - Fixed pedestal-mount, **C** - Wall-mount fixed, **D** - I-beam-mount fixed.

Model Number	Blade Dia.	CFM	Amps	(A)		(C)		(D)	
				Wt.	Price Ea.	Wt.	Price Ea.	Wt.	Price Ea.
<b>YC-1156</b>	30"	8,200/6,200	3.4	82	<b>\$291.00</b>	82	<b>\$248.00</b>	82	<b>\$278.00</b>

**COMMERCIAL MODEL:** (Not shown) Three-speed, 1/4 HP motor withstands temperatures up to 135°F. Includes: chrome-plated steel fan guard and 3 blades. One-year limited warranty. **SPECIFY:** **A** - Fixed pedestal-mount, **B** - Oscillating pedestal-mount, **C** - Wall-mount fixed, **E** - Wall-mount oscillating.

Model Number	Blade Dia.	CFM	Amps	(A)		(B)		(C)		(E)	
				Wt.	Price Ea.	Wt.	Price Ea.	Wt.	Price Ea.	Wt.	Price Ea.
<b>YC-1157</b>	30"	7,900/6,000	2.7	71	<b>\$326.00</b>	71	<b>\$397.00</b>	71	<b>\$265.00</b>	71	<b>\$337.00</b>

**HEAVY-DUTY MODEL:** Two-speed, 1/2 HP motor with yellow powder coat fan guard with four silver blades. Post is supported by a wheeled base (not shown). Five-year limited warranty. **SPECIFY:** **A** - Fixed pedestal-mount, **C** - Wall-mount fixed.

Model Number	Blade Dia.	CFM	Amps	(A)		(C)	
				Wt. Lbs.	Price Ea.	Wt. Lbs.	Price Ea.
<b>YC-1158</b>	30"	9,850/7,500	5.6	119	<b>\$497.00</b>	119	<b>\$383.00</b>

# GOFF Curtain Walls™



Selected Models

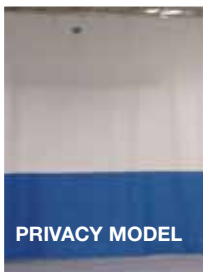

PRIVACY MODEL



WELDVIEW MODEL

STANDARD MODEL

## BUILD A WORKSTATION: STANDARD OR CUSTOM SIZES

### USE CURTAIN WALLS FOR:

- MACHINE AREA SEPARATION
- PAINT, PRIMER AND PREP AREAS
- ASSEMBLY AREAS
- METAL SHOPS
- FOOD PROCESSING AREAS
- WASH BAYS
- WELDING AREAS
- WOODWORKING AREAS
- GRINDING AREAS

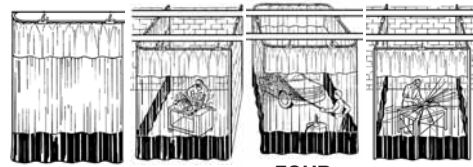

SINGLE CURTAIN

TWO-SIDED STATION

FOUR-SIDED STATION

THREE-SIDED STATION

## GOFF Curtain Walls™

Increase useable floor space while controlling contaminants, climate, and noise levels. Curtain Walls™ glide easily on steel track and dual-wheeled rollerhooks. Made from a combination of 14-oz. heavy-duty, reinforced vinyl and double-polished 20-mil clear PVC material. Reinforced hems and chain-weighted lower hems add durability. Hook and loop fasteners on side hems attach to adjacent panels. Available in standard, weldview or privacy design. Meet NFPA-701 requirements for flame retardancy. Standard model has a white vinyl top, clear PVC center, blue vinyl bottom. Privacy model has a 27"H blue vinyl bottom with white vinyl top. Weldview model has a white vinyl top, UV yellow weldview center, and black vinyl bottom. **STANDARD DESIGN IS FACTORY QUICK SHIP.** ALL FOB WISCONSIN.

### SINGLE CURTAIN.

Work well as room dividers. Include rollers, track, and mounting brackets. **SPECIFY: A - Standard, B - Privacy, C - Weldview.**

Curtain Length	Model Number	8' HIGH			Model Number	9' HIGH			Model Number	10' HIGH			Model Number	12' HIGH		
		(A) Price Ea.	(B) Price Ea.	(C) Price Ea.		(A) Price Ea.	(B) Price Ea.	(C) Price Ea.		(A) Price Ea.	(B) Price Ea.	(C) Price Ea.		(A) Price Ea.	(B) Price Ea.	(C) Price Ea.
6'	ZK-3150	\$163.00	\$163.00	\$179.00	ZK-3151	\$175.00	\$175.00	\$193.00	ZK-3152	\$185.00	\$185.00	\$185.00	ZK-3153	\$202.00	\$202.00	\$202.00
12'	ZK-3154	308.00	308.00	339.00	ZK-3155	327.00	327.00	360.00	ZK-3156	348.00	348.00	383.00	ZK-3157	385.00	385.00	424.00
24'	ZK-3158	590.00	590.00	649.00	ZK-3159	628.00	628.00	691.00	ZK-3160	669.00	669.00	736.00	ZK-3161	743.00	743.00	817.00

### 2-, 3-, AND 4-SIDED CURTAIN WALL PACKAGE.

Encloses a 12'W x 24'D working space. Includes 90° curves, rollers, track, and mounting brackets. **SPECIFY: A - Standard, B - Privacy, C - Weldview.**

Side Qty.	Model Number	8' HIGH			Model Number	9' HIGH			Model Number	10' HIGH			Model Number	12' HIGH		
		(A) Price Ea.	(B) Price Ea.	(C) Price Ea.		(A) Price Ea.	(B) Price Ea.	(C) Price Ea.		(A) Price Ea.	(B) Price Ea.	(C) Price Ea.		(A) Price Ea.	(B) Price Ea.	(C) Price Ea.
2	ZK-3163	\$903.00	\$903.00	\$993.00	ZK-3164	\$957.00	\$957.00	\$1053.00	ZK-3165	\$1015.00	\$1015.00	\$1117.00	ZK-3166	\$1118.00	\$1118.00	\$1230.00
3	ZK-3167	1508.00	1508.00	1659.00	ZK-3168	1598.00	1598.00	1758.00	ZK-3169	1695.00	1695.00	1871.00	ZK-3170	1871.00	1871.00	2058.00
4	ZK-3171	1883.00	1883.00	2071.00	ZK-3172	1995.00	1995.00	2071.00	ZK-3173	2109.00	2109.00	2320.00	ZK-3174	2314.00	2314.00	2545.00

NOTE: Custom sizes and colors are available. Call for information.

## GOFF Welding/Safety Screens

Modular screens feature lightweight 1" extruded aluminum frame that stand up to the toughest shop environments. Panels mount to frame with brass grommets and button head screws. Finished hem on all edges. **SPECIFY COLOR: BL - Blue, GN - Green, GR - Gray, RD - Red, YL - Yellow.** **FACTORY QUICK SHIP—FOB WISCONSIN.**

**SAFETY/PRIVACY SCREENS.** Ideal for areas where an opaque barrier is required. Protects from UV rays, dirt/dust, and most chemicals. Tough 14-oz. reinforced vinyl coated polyester fabric resists tears, heat, and moisture. Meets NFPA-701 flame retardancy and California Fire Marshal standards.

**WELDVIEW ROLLS AND SCREENS.** Creates safe work areas by confining harmful glare from welding arcs and dangerous welding sparks. Durable, transparent 14 mil thick PVC provides see-through visibility to welding area. Blocks 100% of UV light. Available in two styles. WELDVIEW SCREENS can be used to create welding booths by hinging frames together with optional kit. Both meet CPAI-84 and California health and safety code requirements and are weld spatter resistant and OSHA approved. WELDVIEW ROLLS are extremely cost-effective and perfect for temporary or emergency situations when frames aren't needed. Cut curtains as needed with a scissors or utility knife.



UNIQUE UNDER-OVER LEG DESIGN ALLOWS ADJACENT PANELS TO BE PLACED AT DESIRED ANGLES.



WELDVIEW ROLLS

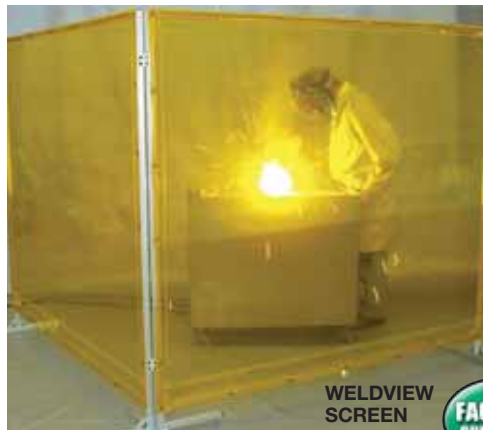

WELDVIEW SCREEN



SAFETY/PRIVACY SCREEN

### Screens

Overall W x H	Wt. Lbs.	WELDVIEW		SAFETY/PRIVACY	
		Model No.	Price Ea.	Model No.	Price Ea.
5' x 6'	20	ZK-3130	\$241.00	ZK-3131	\$241.00
5' x 7'	21	ZK-3132	257.00	ZK-3133	257.00
5' x 8'	22	ZK-3134	284.00	ZK-3135	284.00
6' x 6'	21	ZK-3136	262.00	ZK-3137	262.00
6' x 7'	22	ZK-3138	296.00	ZK-3139	296.00
6' x 8'	23	ZK-3140	319.00	ZK-3141	319.00
8' x 6'	23	ZK-3142	319.00	ZK-3143	319.00
8' x 8'	26	ZK-3144	360.00	ZK-3145	360.00

### Weldview Rolls

Model No. **ZK-3148**—66"W x 25 yd. L Wt. 33 lbs. \$268.00

### Accessories for Weldview Screens

Model No. **ZK-3146**—Casters. 4/pkg. ....\$32.30  
 Model No. **ZK-3147**—Hinges. 2/pkg. ....\$22.30



WELDING MATS NOW AVAILABLE. SEE PAGE 282.

# Replacement Strip Doors & Acoustic Screens



## TMI Rip-A-Strip™ Universal Strip Door Replacements

Replace damaged or torn strips in your doors economically with this unique system. Rip-A-Strip system reduces the cost of replacement strips up to 35% and significantly reduces installation time. Universal replacement strips arrive on a continuous roll and are pre-cut and pre-punched to specific strip lengths. Just rip off the strips you need and rehang them on your existing hardware. No tools are required for installation. **SPECIFY: A - Standard, B - Ribbed. FACTORY QUICK SHIP—FOB PENNSYLVANIA.**

Model Number	Roll W x L	Strip Length	(A) STANDARD		(B) RIBBED	
			Wt. Lbs.	Price Ea.	Wt. Lbs.	Price Ea.
<b>YS-1920</b>	8" x 70'	7'	25	<b>\$101.00</b>	27	<b>\$118.00</b>
<b>YS-1921</b>	8" x 72'	8'	25	<b>101.00</b>	27	<b>118.00</b>
<b>YS-1922</b>	12" x 70'	10'	57	<b>188.00</b>	60	<b>221.00</b>
<b>YS-1923</b>	12" x 72'	12'	57	<b>188.00</b>	60	<b>221.00</b>

### Replacement Safe-T Loc Galvanized Hardware

Model No. <b>YS-2140</b> —1'W Faceplate.....	<b>\$11.20</b>
Model No. <b>YS-2141</b> —2'W Faceplate.....	<b>\$22.40</b>
Model No. <b>YS-2142</b> —3'W Faceplate.....	<b>\$32.50</b>
Model No. <b>YS-2143</b> —4'W Faceplate.....	<b>\$42.60</b>



RIBBED ROLL



STANDARD ROLL



RIBBED ROLL SHOWN ON DISPENSING RACK

## Dispensing Rack

Eases unwind of Rip-A-Strip rolls. Solid welded construction supports up to 200 lbs. 12"L x 20"W x 19"H overall. FOB WISCONSIN.

Model No. **YS-1919**—Wt. 7 lbs. ....**\$83.70**



## SINGER SAFETY Acoustic Blanket

Lightweight easy to handle material is an excellent noise absorber. Vinyl-coated quilted fiberglass resists oil, grease, and mildew. Meets Class 1 ASTM E-84 standards for flammability. Supplied with brass grommets for easy hanging or attaching to walls. **FACTORY QUICK SHIP—FOB ILLINOIS.**

Overall W x H	1" THICK WALL/CEILING PANELS			2" THICK PARTITION PANELS		
	Model No.	Wt. Lbs.	Price Ea.	Model No.	Wt. Lbs.	Price Ea.
4' x 6'	<b>WS-1078</b>	7	<b>\$77.80</b>	<b>WS-1105</b>	13	<b>\$133.00</b>
4' x 8'	<b>WS-1088</b>	9	<b>104.00</b>	<b>WS-1106</b>	17	<b>177.00</b>
4' x 10'	<b>WS-1104</b>	11	<b>131.00</b>	<b>WS-1107</b>	21	<b>221.00</b>



EXTRA-STURDY FRAME.

## GOFF Portable Acoustic Enclosures

Designed to enclose noisy power equipment, machinery or air compressors; versatile units reduce sound by 10–12 dB. Designed for 5–10 HP vertical or horizontal compressors with tank sizes up to 120 gal. Quilted panels with a barium-loaded vinyl barrier are constructed of sound-absorbing fiberglass vinyl that is coated to resist most chemicals. Material is also waterproof and fire retardant in accordance with ASTM-E84 Class 1. Rugged aluminum frames. Order the optional casters and create movable panels that allows you to easily access machine for maintenance operations. FOB WISCONSIN.



Model Number	Screen Qty.	Overall L x W x H	Wt. Lbs.	Price Each
<b>FOR USE WITH VERTICAL COMPRESSORS</b>				
<b>YS-2160</b>	2	54" x 54" x 96"	152	<b>\$1103.00</b>
<b>YS-2161</b>	3	54" x 54" x 96"	228	<b>1680.00</b>
<b>YS-2162</b>	4	54" x 54" x 96"	304	<b>2255.00</b>
<b>FOR USE WITH HORIZONTAL COMPRESSORS</b>				
<b>YS-2163</b>	2	84" x 54" x 80"	136	<b>\$1246.00</b>
<b>YS-2164</b>	3	84" x 54" x 80"	204	<b>1750.00</b>
<b>YS-2165</b>	4	84" x 54" x 80"	272	<b>2564.00</b>

Model No. **YS-2166**—Optional caster kit for all panels. Includes 4 casters per panel. ....**\$32.90**

# ALECO® Strip Doors



## Energy-Saving Strip Doors

Reduce the loss of heated and cooled air while preventing the flow of dust and contaminants from parking or loading areas with these energy-efficient doors. With the addition of strip doors, you'll have reduced clean-up and maintenance costs as well as lower sound transmission helping you meet OSHA requirements. Constructed of fire-resistant, self-extinguishing PVC, strip doors offer 2-way visibility for safety. Clear-Flex II™ rounded edges won't cut, non-stick additive prevents clinging. Ships knocked down for easy assembly. Holes are pre-punched and all strips are cut to size. **SPECIFY VINYL STRIP:** **A** - Standard for indoor/outdoor applications and temperatures from -10° to 150°F; **B** - for interior applications only. Recommended for coolers and freezers, meets food service requirements and remains flexible in temperatures as low as -40°. **SELECTED MODELS IN STOCK.** Others **FACTORY QUICK SHIP – FOB ALABAMA.**

**CUSTOM CUT STRIPS.** Punched (3/8" dia. holes on 2" centers). Can be used on most other strip doors. Available in full-foot increments only. **SPECIFY BOTH TOTAL AND CUT LENGTH.** Example: 100 ft., Model No. YP-758, (A) Std. @ \$1.35/ft. cut and punched in (10) 10 ft. lengths.

Model Number	Strip Width	Strip Thickness	Wt. Lbs./Ft.	(A) STD.	(B) LOW TEMP.
				Price Ea.	Price Ea.
<b>SMOOTH CLEAR-FLEX II®</b>					
YP-756	4"	.060"	0.15	\$0.75	\$0.89
YP-757	6"	.060"	0.23	0.87	1.00
YP-758	8"	.080"	0.35	1.30	1.54
YP-759	12"	.120"	0.73	2.84	3.48
YP-760	16"	.160"	1.4	5.10	6.10
<b>SCRATCH-GUARD® CLEAR-FLEX II®</b>					
YR-1740	8"	.198"	0.35	\$1.38	\$1.62
YR-1741	12"	.216"	0.73	3.11	3.83

**BULK ROLLS.** For economy. Do your own cutting and hole punching. Buy in bulk. Each roll comes in a specific length. Other lengths in custom cut are available.

Model Number	Roll W x L	Strip Thickness	Wt. Lbs.	(A) STD.	(B) LOW TEMP.
				Price Ea.	Price Ea.
<b>SMOOTH CLEAR-FLEX II®</b>					
YP-764	300' x 4"	.060"	45	\$152.00	—
YP-765	150' x 6"	.060"	34	90.70	\$110.00
YP-766	300' x 6"	.060"	68	167.00	203.00
YP-767	150' x 8"	.080"	53	151.00	171.00
YP-768	300' x 8"	.080"	105	270.00	306.00
YP-770	75' x 12"	.120"	55	156.00	—
YP-771	150' x 12"	.120"	110	280.00	349.00
YP-772	100' x 16"	.160"	140	345.00	395.00
YP-773	60' x 48"	.080"	126	387.00	417.00
YP-774	60' x 48"	.120"	175	654.00	—
<b>SCRATCH-GUARD® CLEAR-FLEX II®</b>					
YR-1743	150' x 8"	.198"	53	\$159.00	\$180.00
YR-1744	150' x 12"	.216"	110	298.00	372.00
YR-1745	100' x 16"	.229"	140	364.00	—



**SMOOTH.** OFFERS EXCELLENT VISIBILITY AT AN ECONOMICAL PRICE.

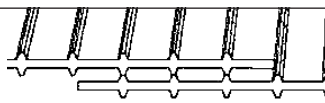

**SCRATCH-GUARD®.** FEATURES BUMPERS THAT RESIST SCRATCHES AND ABRASIONS. STAYS CLEARER LONGER.



**Under-Header Mount**

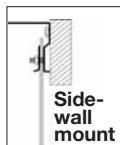

**Side-wall mount**

**MOUNTING HARDWARE MOUNTS UNDER-HEADER OR ON SIDEWALL. UNIVERSAL AIRCRAFT ALUMINUM CONSTRUCTION. KIT INCLUDES MOUNTING ANGLE WITH 3/4" DIAMETER HOLES ON 2" CENTERS, 1' FACE PLATE(S) WITH MATCHING HOLES, AND STRIP FASTENERS.**

## MaxBullet™ Mounting Hardware

Build custom regular or heavy-duty hanging strip doors with bulk rolls of material and MaxBullet™ hardware. Cuts installation and strip replacement time by over 90%. To install: snap 3/8" pre-drilled strip holes over bullet shaped locks. Choose either HTP (high tensile strength polymer) hardware in 2' interlocking sections or extra heavy aluminum hardware in 1' to 4' sections. MaxBullet™ 304 stainless steel available, call for information. Lifetime guarantee. FOB ALABAMA.



Model No.	Description	Price Ea.
YA-1180	2'W HTP	\$12.20
YA-1181	1'W Faceplate	17.50
YA-1182	2'W Faceplate	25.90
YA-1183	3'W Faceplate	37.20
YA-1184	4'W Faceplate	45.70

Strip Width	Max. Door W x H	SMOOTH CLEAR-FLEX II®				SCRATCH-GUARD® CLEAR-FLEX II®			
		Model Number	Wt. Lbs.	(A) STD.	(B) LOW TEMP.	Model Number	Wt. Lbs.	(A) STD.	(B) LOW TEMP.
				Price Ea.	Price Ea.			Price Ea.	Price Ea.
8"	3' x 7'	YR-1750	19	—	\$97.00	YR-1763	17	\$84.30	\$101.00
	4' x 7'	YR-1751	24	\$98.20	120.00	YR-1764	21	109.00	130.00
	4' x 8'	YR-1752	26	121.00	147.00	YR-1765	24	124.00	155.00
	5' x 8'	YR-1753	32	141.00	172.00	YR-1766	31	155.00	194.00
	6' x 8'	YR-1754	39	168.00	205.00	YR-1767	36	185.00	231.00
	8' x 8'	YR-1755	53	238.00	290.00	YR-1768	66	271.00	340.00
12"	8' x 8'	YR-1756	84	296.00	360.00	YR-1769	84	332.00	370.00
	8' x 10'	YR-1757	102	371.00	453.00	YR-1770	80	384.00	384.00
	9' x 9'	YR-1758	112	374.00	456.00	YR-1771	91	389.00	466.00
	10' x 10'	YR-1759	126	462.00	564.00	YR-1772	98	479.00	575.00
	10' x 12'	YR-1760	151	554.00	675.00	YR-1773	118	574.00	689.00
	11' x 11'	YR-1761	162	557.00	680.00	YR-1774	127	639.00	737.00
	12' x 12'	YR-1762	179	629.00	766.00	YR-1775	139	689.00	877.00

**MAXMAGIC™ TEMPLATE KIT FOR BULK ROLLS.** Stainless steel template eases cutting bulk rolls into individual strips. Easy-to-use cutting and marking directions are permanently etched directly on the template. Kit also includes patented Safe Start drill bit that punches a perfect mounting hole without twisting or tearing PVC material. Fits standard drill. For all strip thicknesses and widths up to 16".

Model No. **YA-1179**—Wt. 2 lbs.....**\$67.70**

**VINYL STRIP CLEANER.** For removing grease and grime from strip curtains. Biodegradable, concentrated, and may be diluted as needed for light jobs.

Model No. **YP-803**—Wt. 10 lbs. ....**\$46.80/gal.**

# Air Curtains & Doors



STAINLESS

ENAMEL



## ALECO® JetStream™ Air Curtains

Prevents loss of warm or cool air. Helps keep out flying insects, dirt, dust, and fumes. Includes 5' power cord, 3-position switch, and directional vents. UL-listed. **SPECIFY FINISH: A - Enamel, B - Stainless.** FOB ALABAMA.

Model Number	Overall WxDxH	Volts	Fits Doorway Width	(A) ENAMEL				(B) STAINLESS					
				Air Flow CFM	Amps	Motor HP	Wt. Lbs.	Price Each	Air Flow CFM	Amps	Motor HP	Wt. Lbs.	Price Each
YL-0305	36x8-1/2x10"	110	3'	740-890	3.00	0.47	35	\$601.00	990-1210	3.74	0.67	50	\$837.00
YL-0306	42x8-1/2x10"	110	3'6"	790-950	3.74	0.67	37	\$635.00	1100-1355	5.40	0.87	53	\$891.00
YL-0315	48x8-1/2x10"	110	4'	1135-1365	5.25	0.80	41	\$717.00	1515-1860	5.40	0.87	60	\$922.00
YL-0316	60x8-1/2x10"	110	5'	1385-1660	5.75	0.90	48	\$877.00	1890-2325	6.80	1.00	69	\$1239.00



## GOFF DRAW-TITE™ Powered Doors

Keep the wind out! Indoor/outdoor dock doors feature a unique tensioning system that draws doors closed, enabling wind load capability to 70 MPH (wind load tested on 10' x 12' solid vinyl roll-up door per ANSI/DASMA 108-2002). Fiberglass wind bars breakaway to prevent damage. Doors roll up and down on garage-door type rollers in an extruded aluminum side track with EPDM weather-strip seals. Operate at 36" per second with a 110V motor; up to 4,000 cycles per day. Also features a standard wall-mount 3-button control station. Optional rain cover available. NOTE: Face mount doors are incompatible with dock seals and dock shelters. Trim color matches requested color unless specially ordered. FOB WISCONSIN.

### VINYL DOORS

Save energy, reduce heating costs, and lessen noise! Constructed of 18 oz./sq. yd. vinyl coated polyester. Feature a clear window to allow light into work areas.

**SPECIFY COLOR:** AL - Almond, BK - Black, BL - Blue, GN - Green, GY - Gray, RD - Red, YL - Yellow.

Model Number	Overall W x H	Wt. Lbs.	Price Each
YA-0520	8' x 10'	74	\$4411.00
YA-0521	10' x 10'	81	4542.00
YA-0522	12' x 12'	95	4760.00
YA-0523	12' x 14'	101	4866.00
YA-0524	14' x 14'	111	5014.00

Additional sizes and controls available. Call for more information.

### OUTSIDE FACE MOUNT SELF-INSTALLATION GUIDE

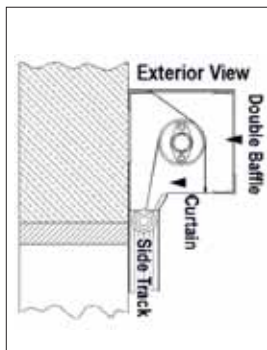

### MESH DOORS

Keep insects and pests out, while allowing fresh air in. Constructed of 11 oz./sq.yd., 17x11 pre-coated woven polyester mesh. **SPECIFY COLOR:** BK - Black, BL - Blue, GN - Green, GY - Gray, RD - Red, WH - White, YL - Yellow.

Model Number	Overall W x H	Wt. Lbs.	Price Each
YA-0525	8' x 10'	70	\$4309.00
YA-0526	10' x 10'	75	4566.00
YA-0527	12' x 12'	89	4835.00
YA-0528	12' x 14'	95	4929.00
YA-0529	14' x 14'	101	5121.00

Additional sizes and controls available. Call for more information.

### OPTIONAL WATERPROOF MOTOR COVER

Model No. YA-0530—Wt. 6.5 lbs. ....\$179.00

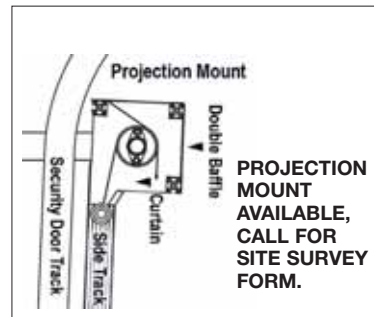

**PROJECTION MOUNT AVAILABLE, CALL FOR SITE SURVEY FORM.**

# Gates & Pipe Fittings



## WIREWAY/HUSKY™ Folding Steel Security Gates

Prevents unauthorized access to work areas. Sturdy 3/4" steel channel construction. Lift and turn locking mechanism accepts a padlock with up to 1-1/2" dia. shaft. Gates fold compactly for easy access. All pivot and fold flat to the side. Double gates roll on 2" steel swivel casters and have drop pin at center to stabilize closed doors. Can be recessed or surface mounted (brackets included). Color: gray. **SELECTED MODELS IN STOCK.** Others FOB NORTH CAROLINA.



Selected Models

(A) PIVOTING DOOR GATES				
Model Number	Retracted Width	Expanded W x H	Wt. Lbs.	Price Each
XN-2220	4.5"	33.5' x 56"	24	\$97.80
XN-2221	5.9"	47' x 74"	39	122.00
XN-2222	6.3"	46.5' x 81"	50	144.00
XN-2223	7.3"	43' x 92"	54	154.00

NOTE: Non-expanded heights shown.

(B) PIVOTING DOUBLE GATES				
Model Number	Retracted Width	Expanded W x H	Wt. Lbs.	Price Each
XP-0292	6.9"	8' x 6.5'	90	\$272.00
XP-0294	6.9"	8' x 8'	120	340.00
XP-0296	8.4"	10' x 6.5'	100	329.00
XP-0298	8.4"	10' x 8'	130	400.00
XP-0300	10.6"	12' x 6.5'	110	379.00
XP-0303	10.6"	12' x 8'	140	483.00
XP-0305	11.4"	14' x 6.5'	125	446.00
XP-0308	11.4"	14' x 8'	140	542.00
XP-0310	12.1"	16' x 6.5'	130	507.00
XP-0313	12.1"	16' x 8'	145	626.00

(C) PIVOTING SINGLE GATES				
Model Number	Retracted Width	Expanded W x H	Wt. Lbs.	Price Each
XP-0316	9.1"	5.5' x 6.5'	61	\$150.00
XP-0317	9.1"	5.5' x 7'	63	195.00
XP-0319	9.1"	5.5' x 8'	67	219.00
XP-0322	10.6"	6.5' x 6.5'	64	204.00
XP-0323	10.6"	6.5' x 7'	66	221.00
XP-0325	10.6"	6.5' x 8'	70	258.00
XP-0328	11.4"	7.5' x 6.5'	67	239.00
XP-0329	11.4"	7.5' x 7'	71	255.00
XP-0331	11.4"	7.5' x 8'	75	295.00



SINGLE-SOCKET TEE		
Model Number	Pipe Size	Price Each
XG-101	3/4"	\$5.20
XG-104	1"	6.00
XG-107	1-1/4"	8.50
XG-110	1-1/2"	10.10



STRAIGHT COUPLING		
Model Number	Pipe Size	Price Each
XS-1390	3/4"	\$7.00
XS-1391	1"	7.20
XS-1392	1-1/4"	9.70
XS-1393	1-1/2"	11.00



90° ELBOW		
Model Number	Pipe Size	Price Each
XG-118	3/4"	\$7.20
XG-119	1"	7.50
XG-120	1-1/4"	10.30
XG-121	1-1/2"	13.00



ADJ SIDE OUTLET TEE		
Model Number	Pipe Size	Price Each
XS-1394	3/4"	\$16.50
XS-1395	1"	18.20
XS-1396	1-1/4"	22.80
XS-1397	1-1/2"	23.70



SIDE OUTLET ELBOW		
Model Number	Pipe Size	Price Each
XG-123	3/4"	\$10.90
XG-124	1"	10.40
XG-125	1-1/4"	15.00
XG-126	1-1/2"	18.80



## KEE INDUSTRIAL Structural Pipe Fittings

Assemble with only an Allen wrench—no welding, threading, drilling, or bolting. Pre-cut pipe slips into pipe fitting sockets and locks securely with case-hardened, set screws. Galvanized and reusable. For standard 3/4" to 2" I.D. pipe. **IN STOCK.**



90° SIDE OUTLET TEE		
Model Number	Pipe Size	Price Each
XG-127	3/4"	\$7.90
XG-128	1"	8.20
XG-130	1-1/4"	11.80
XG-132	1-1/2"	13.40



90° THREE-SOCKET TEE		
Model Number	Pipe Size	Price Each
XG-147	3/4"	\$10.00
XG-148	1"	9.30
XG-149	1-1/4"	14.80
XG-151	1-1/2"	16.30

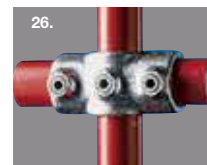

TWO-SOCKET CROSS		
Model Number	Pipe Size	Price Each
XG-153	3/4"	\$8.30
XG-154	1"	9.30
XG-156	1-1/4"	11.50
XG-158	1-1/2"	14.50



SIDE OUTLET TEE		
Model Number	Pipe Size	Price Each
XG-161	1-1/2"	\$10.30
XG-162	1"	11.60
XG-163	1-1/4"	16.70
XG-164	1-1/2"	18.10



CROSSOVER		
Model Number	Pipe Size	Price Each
XG-171	3/4"	\$8.80
XG-172	1"	8.00
XG-174	1-1/4"	11.10
XG-176	1-1/2"	13.00



SINGLE-SWIVEL SOCKET		
Model Number	Pipe Size	Price Each
XG-190	3/4"	\$11.80
XG-191	1"	11.80
XG-192	1-1/4"	14.40
XG-193	1-1/2"	16.10



DOUBLE-SWIVEL SOCKET		
Model Number	Pipe Size	Price Each
XG-2260	3/4"	\$22.90
XG-2261	1"	22.10
XG-2262	1-1/4"	25.80
XG-2263	1-1/2"	28.90



SWIVEL FLANGE		
Model Number	Pipe Size	Price Each
XG-2285	3/4"	\$14.40
XG-2286	1"	14.00
XG-2287	1-1/4"	15.80
XG-2288	1-1/2"	17.30



MEDIUM FLANGE		
Model Number	Pipe Size	Price Each
XG-208	3/4"	\$6.30
XG-209	1"	6.80
XG-210	1-1/4"	9.50
XG-211	1-1/2"	12.10

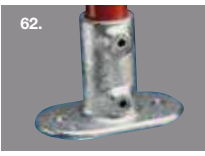

RAILING STANDARD FLANGE		
Model Number	Pipe Size	Price Each
XG-213	3/4"	\$12.70
XG-214	1"	10.80
XG-215	1-1/4"	13.40
XG-216	1-1/2"	17.30



PLASTIC PIPE PLUG		
Model Number	Pipe Size	Price Each
XG-2280	3/4"	\$1.04
XG-2281	1"	1.27
XG-2282	1-1/4"	1.41
XG-2283	1-1/2"	1.43

NOTE: Other fittings available...CONTACT US.



# FordLogan Wire Partitions



**FACTORY QUICK SHIP**  
Selected Models

## HOW TO PLAN AND ORDER

A sketch of the area to be partitioned should be prepared. (see sample line drawing). Details of the sketch should include the following :

- (1) Overall layout dimensions.
- (2) If doors and windows are to be included in the installation, the location and type of each should be indicated.
- (3) Height of partitions.
- (4) Show locations of existing walls and obstructions.

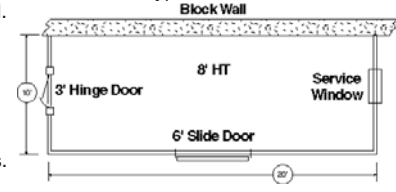

The original FordLogan heavy-gauge wire partitions are structurally strong to assure years of service with little maintenance. Constructed of 10-gauge, 1-1/2" diamond wire mesh that is securely clinched to frames. Vertical frames are 1-1/4" x 5/8" roll-formed "C" channels mortised and tenoned at the corners. Horizontal frames are 1" x 1/2" roll formed steel. Center channels provide extra reinforcement. Top cap channels are constructed of 1-1/2" x 1/2" x 14-gauge roll formed channel with bolt holes in-line with panel's top bars. 1-1/4" x 1-1/4" x 11-gauge hot roll formed angle steel makes up the corner posts. Line posts—3-1/2" x 1-1/4", 10-gauge. Die cast aluminum base shoes are 2" high. Gray polyester powder coat paint finish is standard. All necessary hardware furnished. Bronze cylinder mortise type locks are standard on sliding or hinged doors.

**SELECTED MODELS FACTORY QUICK SHIP.**  
ALL FOB INDIANA.

Panel Ht	5' WIDE		4' WIDE		3' WIDE		2' WIDE		1' WIDE	
	Model No.	Price Ea.	Model No.	Price Ea.	Model No.	Price Ea.	Model No.	Price Ea.	Model No.	Price Ea.
7'	<b>XL-507</b>	\$158.00	<b>XL-407</b>	\$142.00	<b>XL-307</b>	\$126.00	<b>XL-207</b>	\$106.00	<b>XL-107</b>	\$89.60
8'	<b>XL-508</b>	164.00	<b>XL-408</b>	151.00	<b>XL-308</b>	132.00	<b>XL-208</b>	114.00	<b>XL-108</b>	92.50
10'	<b>XL-510</b>	213.00	<b>XL-410</b>	188.00	<b>XL-310</b>	166.00	<b>XL-210</b>	141.00	<b>XL-110</b>	127.00

SINGLE HINGED DOOR				
Panel Ht.	3' WIDE STANDARD		4' WIDE STANDARD	
	Model Number	Price Each	Model Number	Price Each
7'	<b>XL-329</b>	\$379.00	<b>XL-330</b>	\$386.00
8'	<b>XL-332</b>	418.00	<b>XL-333</b>	452.00
10'	<b>XL-338</b>	466.00	<b>XL-339</b>	527.00

NOTE: Transom panels are furnished with partitions higher than 7' only. Can be purchased separately, call for information.

DOUBLE SLIDE DOOR				
Model Number	8' WIDE		10' WIDE	
	Price Each	Model Number	Price Each	Model Number
<b>XL-368</b>	\$1083.00	<b>XL-369</b>	\$1140.00	<b>XL-370</b>
<b>XL-370</b>	1138.00	<b>XL-371</b>	1226.00	<b>XL-374</b>
<b>XL-374</b>	1260.00	<b>XL-375</b>	1444.00	

Panel Height	SINGLE SLIDE DOOR							
	3' WIDE		4' WIDE		5' WIDE		6' WIDE	
	Model Number	Price Each	Model Number	Price Each	Model Number	Price Each	Model Number	Price Each
7'	<b>XL-346</b>	\$481.00	<b>XL-347</b>	\$507.00	<b>XL-348</b>	\$632.00	<b>XL-349</b>	\$780.00
8'	<b>XL-350</b>	529.00	<b>XL-351</b>	568.00	<b>XL-352</b>	605.00	<b>XL-353</b>	745.00
10'	<b>XL-358</b>	619.00	<b>XL-359</b>	660.00	<b>XL-360</b>	692.00	<b>XL-361</b>	828.00

NOTE: Transom panels are furnished with partitions higher than 7' only. Can be purchased separately, call for information.

## AVAILABLE CUSTOM COLORS, CALL FOR INFORMATION:



**BLACK**      **BLUE**      **GREEN**  
**RED**      **YELLOW**

## OPTIONS



**LINE POSTS.**  
Line posts are recommended if interior supports such as building columns, ceiling joists or other bracing is not available. Recommended to be used every 10 ft.

Model No.	Ht.	Lbs.	Price Ea.
<b>XL-380</b>	7'	19	\$44.30
<b>XL-381</b>	8'	23	47.30
<b>XL-383</b>	10'	29	57.50



**3-WAY POSTS.** Use at 90° intersections.

Model No.	Ht.	Lbs.	Price Ea.
<b>XL-439</b>	7'	12	\$62.00
<b>XL-440</b>	8'	14	67.20
<b>XL-442</b>	10'	17	73.40



**FLEX PANELS.**  
Adjustable steel panels adjust from 2-1/2" to 1'.

Model No.	Ht.	Lbs.	Price Ea.
<b>XL-443</b>	7'	38	\$103.00
<b>XL-444</b>	8'	41	109.00
<b>XL-445</b>	10'	51	122.00



**WALL CLAMPS.**  
Required for each connection.

Model No. **XL-326**—For masonry, wood and steel walls. Pkg./4 **\$10.60**



**CORNER POSTS.**  
Required for each 90° corner of partition; size 1-1/4" x 1-1/4".

Model No.	Ht.	Lbs.	Price Ea.
<b>XL-376</b>	7'	12	\$31.10
<b>XL-377</b>	8'	13	33.60
<b>XL-379</b>	10'	15	38.20



**5' WIDE PANEL WITH SERVICE WINDOW.**  
Comes with a service shelf and catches to hold the window open or closed. Window opening is 24" W x 21" H.

Model Number	Panel Height	Price Each
<b>XL-321</b>	7'	\$494.00
<b>XL-322</b>	8'	499.00
<b>XL-324</b>	10'	550.00

NOTE: Price includes service window and panel.

# Enclosures & Partitions



## HALLOWELL® Modular Storage Enclosures



Heavy-duty, open wire storage units protect valuables while allowing full visibility and unrestricted air, light and heat flow. Modular design makes enclosures easy to install and relocate. Doors include welded padlock hasps. Panels feature pre-punched holes for easy installation with nuts, bolts, and hand tools. Basic hardware included. Double-tier design features non-removable reinforced center shelf. 7'6" H overall. **FACTORY QUICK SHIP—FOB TENNESSEE.**

Overall W x D	STARTER			ADD-ON		
	Model Number	Wt. Lbs.	Price Each	Model Number	Wt. Lbs.	Price Each
<b>SINGLE-TIER ENCLOSURES</b>						
3' x 3'	YA-2100	119	\$301.00	YA-2106	88	\$226.00
3' x 4'	YA-2101	133	\$354.00	YA-2107	95	\$259.00
3' x 5'	YA-2102	147	\$407.00	YA-2108	102	\$291.00
4' x 3'	YA-2103	129	\$354.00	YA-2109	98	\$259.00
4' x 4'	YA-2104	143	\$418.00	YA-2110	105	\$304.00
4' x 5'	YA-2105	157	\$483.00	YA-2122	112	\$350.00
<b>DOUBLE-TIER ENCLOSURES</b>						
3' x 3'	YA-2123	126	\$364.00	YA-2129	93	\$301.00
3' x 4'	YA-2124	140	\$426.00	YA-2130	100	\$342.00
3' x 5'	YA-2125	154	\$488.00	YA-2131	107	\$384.00
4' x 3'	YA-2126	136	\$426.00	YA-2132	103	\$339.00
4' x 4'	YA-2127	150	\$502.00	YA-2133	110	\$399.00
4' x 5'	YA-2128	164	\$578.00	YA-2134	117	\$460.00

### OPTIONAL TOPS

Model Number	Overall W x D	Wt. Lbs.	Price Each
YA-2135	3' x 3'	9	\$37.30
YA-2136	3' x 4'	10	\$39.60
YA-2137	3' x 5'	11	\$41.80
YA-2138	4' x 3'	12	\$47.20
YA-2139	4' x 4'	13	\$51.70
YA-2140	4' x 5'	14	\$56.30

### OPTIONAL BACKS

Model Number	Overall Width	Wt. Lbs.	Price Each
YA-2141	3'	28	\$83.60
YA-2142	4'	30	\$8.80

PADLOCKS NOT INCLUDED



## WIREWAY/HUSKY™ EZ-Wire™ Partition System

Patented hook design dramatically reduces labor costs and installs in one-third the time as traditional nut and bolt or screw-type partitions. Tubular supports have a 50% thicker base plate. Hook fastener on partitions slips easily into 2-1/2" sq. tube posts. Aluminum drive pins are tapped into place above hook for permanent installation. All attachments are done on inside of enclosure. Panel orders are crated, eliminating damage during transit. A rough sketch of each enclosure is required with every order. Color: gray. **FACTORY QUICK SHIP—FOB NORTH CAROLINA.**

### STANDARD WIRE PANELS.

Model No.	Width	Lbs.	Price Ea.
<b>8' H—TWO 4' H PANELS STACKED.</b>			
WP-0342	1'	16	\$88.90
WP-0343	2'	22	101.00
WP-0344	3'	30	143.00
WP-0345	4'	38	179.00
WP-0346	5'	44	212.00
WP-0347	6'	60	249.00
WP-0348	7'	74	274.00
WP-0349	8'	80	302.00
WP-0350	9'	88	322.00
WP-0351	10'	98	333.00
<b>10' H—TWO 5' H PANELS STACKED.</b>			
WP-0352	1'	18	\$98.30
WP-0353	2'	26	109.00
WP-0354	3'	36	153.00
WP-0355	4'	44	194.00
WP-0356	5'	52	228.00
WP-0357	6'	70	270.00
WP-0358	7'	90	300.00
WP-0359	8'	98	325.00
WP-0360	9'	106	350.00
WP-0361	10'	116	370.00

**POSTS.** 2-1/2" x 2-1/2", 14-ga. tubular steel. Use one post between each panel width, on both sides of door, and at corners. Post heights ranging in size from 3–30' are available, call for information.

Model Number	Height	Lbs.	Price Each
<b>STANDARD POST</b>			
WP-0362	8'	25-1/2	\$69.40
WP-0363	10'	31	84.40
<b>CORNER POST</b>			
WP-0364	8'	25	\$71.80
WP-0365	10'	31	87.40

**FILL-A-GAP PANELS.** Sheet metal panels finish or attach a run of partitioning to a wall or post. Adjustable up to 1' wide. Panels from 1'W x 1'H to 10'W x 5'H in 1' increments each way are available, call for information.

Model No.	W x H	Lbs.	Price Ea.
WP-0368	1' x 8'	17	\$101.00
WP-0369	1' x 10'	21	122.00



**PATENTED HOOK FASTENER SLIPS INTO 2-1/2" SQ. POST.**

**ALUMINUM DRIVE PIN IS TAPPED INTO PLACE FOR PERMANENT INSTALLATION.**

**2-1/2" TUBULAR SUPPORTS HAVE A 50% THICKER BASE PLATE.**

**HINGED DOORS.** Open wire. Hinged left or right, opening in or out. Openings are 7' high with transom filling out the panel height. Cylinder locks (key included) standard. 1' transom on 8'H doors, 3' transom on 10'H doors. Hinged double-width doors available, call for information.

Model Number	W x H	Lbs.	Price Each
WP-0370	3' x 8'	55	\$312.00
WP-0371	4' x 8'	65	352.00
WP-0372	3' x 10'	63	337.00
WP-0373	4' x 10'	74	378.00

**SINGLE SLIDING DOORS.** Enclosed track comes with guide and keeper. Sliding door hangers use 4-wheel trolleys with bearings. Doors slide left or right, keyed outside. Send sketch of top view when ordering. Cylinder lock standard.

Model Number	W x H	Lbs.	Price Each
WP-0374	3' x 8'	55	\$368.00
WP-0375	4' x 8'	68	398.00
WP-0376	5' x 8'	78	486.00
WP-0377	6' x 8'	94	570.00
WP-0378	8' x 8'	127	718.00
WP-0379	10' x 8'	165	815.00
WP-0380	3' x 10'	74	396.00
WP-0381	4' x 10'	88	419.00
WP-0382	5' x 10'	101	545.00
WP-0383	6' x 10'	114	658.00
WP-0384	8' x 10'	146	814.00
WP-0385	10' x 10'	184	939.00

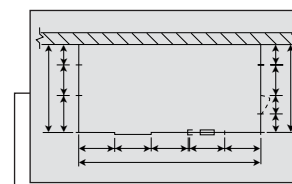

### How To Order

Make a rough floor plan of area to be enclosed. Note overall measurements. Call us to request help.

# Modular Buildings & Wire Enclosures

## Modular Buildings

Interchangeable walls are easy to replace or relocate without disturbing adjacent walls. Non-combustible 3" thick panels are built to keep sound out and heat in—1/2" vinyl-faced gypsum board is laminated to both sides of a polystyrene core. Color: khaki. Each wall is supported by two-piece aluminum posts, forming a concealed vertical raceway. Design allows electric, communication and data lines to be installed on both sides of the post. Color: khaki. Ceilings are suspended and have 2' x 4' white acoustical tiles. Door resists marring and is constructed of light oak vinyl hardboard with 1/4" tempered glass window. Door includes 18-ga. steel frame, ball bearing hinges and stainless steel key-in knob lock set. Steel roof deck is constructed of 22-ga. 1-1/2" deep ribbed painted steel for noise and dust control. Electrical package includes 2' x 4' recessed fluorescent light fixtures, light switch, duplex receptacles and load center with proper circuit breaker. Optional windows measure 4'W x 3'H, have 1/4" tempered safety glass and are assembled in the factory in extruded aluminum frames. Modular buildings ship knocked down with pre-cut components and easy instructions. Other sizes available. Call for quote. Please submit a rough floor plan of area to be enclosed. Note overall measurements and door and panel locations. Call us for help if needed. **FACTORY QUICK SHIP—FOB MISSOURI.**



Size W x D	Light Qty.	Outlet Qty.	4-WALL UNIT		3-WALL UNIT	
			Model Number	Price Each	Model Number	Price Each
8 x 8'	1	2	WK-2628	\$3881.00	WK-2645	\$3316.00
10 x 8'	1	2	WK-2629	4233.00	WK-2646	3544.00
12 x 8'	2	3	WK-2630	4732.00	WK-2647	3919.00
12 x 10'	2	3	WK-2632	5130.00	WK-2649	4319.00
12 x 12'	2	3	WK-2634	5559.00	WK-2651	4745.00
16 x 12'	3	4	WK-2635	6466.00	WK-2652	5407.00
20 x 12'	4	4	WK-2636	7379.00	WK-2653	6073.00
16 x 16'	4	5	WK-2640	7736.00	WK-2657	6674.00
20 x 16'	5	5	WK-2641	8915.00	WK-2658	7608.00
20 x 20'	6	6	WK-2642	9958.00	WK-2659	8651.00

Panels available in gray or white upon request. Base price includes 8' high khaki walls, ceiling, roof, door with window and standard electrical package. 3-wall buildings have 1 long and 2 short walls. Price assumes existing walls are load bearing. Custom sizes available.

### ACCESSORIES

Model No.	Description	Price Ea.
WK-2680	Window 1/4" Tempered Glass	\$181.00
WK-2683	4'L Baseboard Heater, 120V	195.00

**NO CANCELLATIONS OR RETURNS ON THIS ITEM.**

**WE SPECIALIZE IN CUSTOM-DESIGNED MODULAR BUILDINGS. CONTACT OUR TECHNICAL DEPARTMENT FOR COMPLETE ASSISTANCE FOR YOUR APPLICATION.**

**MODULAR BUILDINGS CAN BE USED TO CREATE A VARIETY OF SETTINGS**

## WIREWAY/HUSKY™ Wire Enclosures

Practical wire enclosures work well as tool rooms for valuable parts storage. All sliding doors are 5' x 7' with a transom above. Doors come with cylinder locks. Hardware including top cap and/or ceiling angle, floor shoes and erection nuts and bolts are included. FOB MASSACHUSETTS OR NORTH CAROLINA.

W x D x H	3 SIDES			4 SIDES		
	Model Number	Wt. Lbs.	Price Each	Model Number	Wt. Lbs.	Price Each
<b>UNITS WITH CEILINGS</b>						
10 x 10 x 10'	WL-1067	539	\$1967.00	WL-1077	655	\$2337.00
20 x 10 x 10'	WL-1068	781	2886.00	WL-1078	1,013	3610.00
20 x 15 x 10'	WL-1069	1,099	3880.00	WL-1079	1,331	4550.00
20 x 20 x 10'	WL-1070	1,359	4544.00	WL-1080	1,591	5342.00
30 x 20 x 10'	WL-1071	1,707	6240.00	WL-1081	2,169	7421.00
10 x 10 x 8'	WL-1072	480	1743.00	WL-1082	584	2044.00
20 x 10 x 8'	WL-1073	704	2457.00	WL-1083	869	2883.00
20 x 15 x 8'	WL-1074	1,004	3461.00	WL-1084	1,196	4012.00
20 x 20 x 8'	WL-1075	1,246	4169.00	WL-1085	1,438	4722.00
30 x 20 x 8'	WL-1076	1,700	5548.00	WL-1086	1,980	6357.00
<b>UNITS WITHOUT CEILINGS</b>						
10 x 10 x 10'	WL-1037	413	\$1554.00	WL-1047	549	\$1970.00
20 x 10 x 10'	WL-1038	549	2105.00	WL-1048	821	3005.00
20 x 15 x 10'	WL-1039	705	2522.00	WL-1049	977	3399.00
20 x 20 x 10'	WL-1040	821	2851.00	WL-1050	1,093	3770.00
30 x 20 x 10'	WL-1041	957	3506.00	WL-1051	1,365	4871.00
10 x 10 x 8'	WL-1042	354	1326.00	WL-1052	468	1665.00
20 x 10 x 8'	WL-1043	467	1683.00	WL-1053	694	2395.00
20 x 15 x 8'	WL-1044	595	2103.00	WL-1054	822	2817.00
20 x 20 x 8'	WL-1045	693	2401.00	WL-1055	920	3116.00
30 x 20 x 8'	WL-1046	806	2777.00	WL-1056	1,164	3864.00

**TWO-SIDED SECURITY ENCLOSURES AVAILABLE. CONTACT US FOR PRICING.**



# Mezzanines & Lifiable Work Platforms



YELLOW STAIR RAILS, HANDRAILS & KICKPLATES AVAILABLE UPON REQUEST AT NO EXTRA CHARGE.

**Custom-Size Mezzanines.** We specialize in custom-design mezzanines. Contact our technical dept. for complete assistance for any mezzanine application.

### CLOSED TREAD & OPEN RISER.

(Accessories sold only in conjunction with complete mezzanine order. **SPECIFY STAIR:** A - OSHA 36"W, B - UBC 36"W, C - BOCA/SBC 36"W, D - IBC 44"W.)

Model No.	Description	(A) OSHA 36"W		(B) UBC 36"W		(C) BOCA/SBC 36"W		(D) IBC 44"W	
		Lbs.	Price Ea.	Lbs.	Price Ea.	Lbs.	Price Ea.	Lbs.	Price Ea.
WV-2479	Closed tread & open riser 36" stair*	815	\$2358.00	1,205	\$3485.00	1,135	\$3285.00	1,265	\$3534.00

\*Closed tread and closed riser available, call for information.

**MEZZANINE OPTIONS.** (Accessories sold only in conjunction with complete mezzanine order. **SPECIFY HAND RAIL:** A - 2-Rail, B - 3-Rail, C - Expanded metal.)

Model No.	Description	(A) 2-RAIL HANDRAIL		(B) 3-RAIL HANDRAIL		(C) EXPANDED METAL	
		Lbs.	Price Ea.	Lbs.	Price Ea.	Lbs.	Price Ea.
WV-2480	42" x 42" stair landing	250	\$1016.00	275	\$1116.00	425	\$1304.00
WV-2481	Handrail/kickplate (per ft.)	10	29.00	14	37.00	24	56.10
WV-2482	Swing gate (6' wide)	180	883.00	200	883.00	220	883.00

## WILDECK® Mezzanines

Install one of these modularly designed, moderately priced pre-engineered mezzanines and you'll double your floor space. Completely fabricated steel components are ready to assemble without drilling or welding. Heavy-duty, high capacity 5" x 5" x 3/16" columns are strong enough to meet your industrial and commercial needs. Designed for 125 PSF live load and 8' clear height. Please submit approval drawings for all orders showing size and height of mezzanine, type of decking, length and number of framing members, column locations, and location and type of accessories. FOB WISCONSIN.

**PLEASE SUBMIT APPROVAL DRAWINGS FOR ALL ORDERS.**



**MEZZANINES.** 16 standard sizes. Column spacing is 11' x 15'11-1/4" for typical plan. Moisture-resistant resin board is 3/4" tongue and groove. Bar grating is 1" x 1-1/8". These mezzanines are applicable for seismic zones 1 & 2. For other zones call for information. Call for pricing on sizes not shown. **SPECIFY:** A - Roof deck and resin board, B - Bar grating.

Model Number	Overall L x W*	Overall Sq. Ft.	(A) ROOF DECK & RESIN BOARD		(B) BAR GRATING	
			Lbs.	Price Ea.	Lbs.	Price Ea.
WV-2470	16' x 11'	176	1,964	\$3665.00	2,272	\$4685.00
WV-2471	16' x 21'7"	346	3,419	\$6226.00	4,021	\$8622.00
WV-2472	16' x 32'2"	515	4,861	\$744.00	5,762	\$11709.00
WV-2473	31'6" x 21'7"	678	6,243	\$11097.00	7,430	\$15165.00
WV-2474	31'6" x 32'2"	1011	8,935	\$15805.00	10,704	\$21722.00
WV-2475	47' x 11'	517	5,096	\$9249.00	6,001	\$12236.00
WV-2476	47' x 21'7"	1015	9,071	\$16025.00	10,848	\$21999.00
WV-2477	47' x 42'9"	2010	16,986	\$29255.00	20,524	\$40960.00
WV-2478	62'6" x 42'9"	2672	22,398	\$36939.00	27,075	\$52590.00

\*Above dimensions are nominal. Exact dimensions may vary ±1".

### DOUBLE DROP GATE.

Mezzanine level personnel can access one pallet bay while a lift truck operator at level below is accessing the other. Interconnected sliding gate opens and closes each 5' x 5' bay.



Model No. **WV-2483**—Wt. 550 lbs. ....\$3585.00

Tilt gate also available, call for information.



MODEL XK-1002

NOTE: RATED TO FIT TWO PEOPLE.



SAFETY CHAIN SECURES UNIT TO FORK TRUCK

## DIXIE Lifiable Work Platforms



Heavy-gauge steel unit holds workers and their tools and supplies. Slip-resistant 11-ga. treadplate deck is surrounded by a 4"H kickplate and 1-1/4" square tube railings. 42"H rails are removable for easy storage. All-welded construction ensures long-lasting service and safety. 42"H mesh guard at the forklift mast protects personnel from moving parts. Unit attaches to truck via 3" x 6" fork pockets with screw-down bolts and double safety chains. Rolls on 3" polyolefin swivel casters. Color: safety yellow. Meets OSHA standards. FOB SOUTH CAROLINA.

Model Number	Overall W x D	Wt. Lbs.	Price Each
XK-1000	36" x 48"	210	\$571.00
XK-1001	40" x 48"	235	765.00
XK-1002*	60" x 40"	325	783.00

\*Includes hinged door as standard.

### ACCESSORIES

Model Number	Description	Wt. Lbs.	Price Each
XK-1003	Optional Hinged Door*	25	\$58.50
XK-1004	Mesh Back Panel Ext.	15	80.20
XK-1006	Metal Light Bulb Caddy	33	83.40
XK-1007	Tool Tray	9	101.00
XK-1008	Bin Panel	5	114.00

\*Factory installed only.

# Liftable Work Platforms

## HERCULES® Work Platforms

Provide safe work platforms for your employees. 42"H guardrails are constructed of 1" square tubing for superior strength. 65"H mesh safety screen protects employees from moving truck parts. 4"H toe board surrounds the platform. Platform secures to a truck via a safety chain with spring-loaded clips. 1,000-lb. capacity. Baked enamel finish. Color: safety yellow. **IN STOCK.**

### STOCK PICKER

All-welded unit includes a 29"W x 22"D slip-resistant diamond-plate platform. A safety chain in the front prevents workers from falling out. 5-1/2"W x 2-1/2"H fork pockets, set on 23" centers, easily slide onto fork truck. 42"L extended forks handle pallets and large, bulky items.

Model No. **XK-163**—Wt. 225 lbs. ...**\$1212.00**

### ACCESSORIES

#### TOOL TRAY

Model No. **XK-159**— Wt. 15 lbs. ....**\$207.00**

#### TUBE CADDY

Holds two boxes of fluorescent tubes.

Model No. **XK-157**— Wt. 40 lbs. ....**\$332.00**



MODEL XK-163

### MAINTENANCE PLATFORM

Swing gate door encloses the platform and prevents door from accidentally opening. Other features include: 36"W x 36"D slip-resistant diamond tread deck, 7"W x 2"H fork pockets with screw-down bolts, and 4" non-locking phenolic casters. Meets ANSI B56.1-1993 7.35.1 (a)-(d)(1).

Model No. **XK-160**—Wt. 175 lbs. **.\$820.00**



SHOWN WITH  
OPTIONAL  
TOOL TRAY  
AND TUBE  
CADDY.

MODEL XK-160

## DIXIE 500-Lb. Capacity Work Platforms

One-of-a-kind design features a compact 24" square platform that raises a single worker to high reaching tasks. Includes anti-slip diamond-plate deck surrounded by 4" kickplate and 42"H handrails. Attaches to truck via 2" x 6" fork pockets and double safety chains. Breaks down quickly by simply unscrewing four wing nuts for convenient storage when not in use. Available with either chain gate or swing gate. Ships via small package carrier. **IN STOCK.**

Model Number	Description	Overall WxDxH	Wt. Lbs.	Price Each
<b>YA-2200</b>	Work Platform w/Chain Gate	24x24x42"	95	<b>\$362.00</b>
<b>YA-2201</b>	Work Platform w/Swing Gate	24x24x42"	126	<b>411.00</b>

Model No. **YA-2202**—  
**Wire Mesh Back Riser.**  
Wt. 15 lbs. ....**\$82.10**



## DIXIE Universal Bulb Caddy

Shatter-resistant bulb caddy hooks over the rail of your forklift work platform. Works on any manufacturer's model. UV protected polyethylene construction will not rust, scratch, or dent and protects fragile bulbs better than metal models. FOB SOUTH CAROLINA.

Model No. **YK-0600**— Wt. 14.5 lbs. ....**\$74.80**

## DIXIE Poly Work Platform

Perfect for high-reaching electrical tasks, this unique platform is completely dielectric. Poly material will not conduct electricity. Dual chain front gate and non-skid floor keep worker safe during use. Unit secures to forklift via 7" fork pockets and a safety chain. Also includes a molded-in tool tray. 36"W x 40"D x 48-1/4"H overall. 1,000-lb. capacity. Color: yellow with black base. FOB SOUTH CAROLINA.

Model No. **XA-0700**—Wt. 99 lbs. ....**\$538.00**



# Step Stands



## EGA Adjustable One-Step Steel Work Platforms



Serrated, Grip-Strut® tread gives you safe, sure footing in wet or dry environments. Heavy-gauge steel construction stands up to the rigors of every day use. Simply twist threaded feet to adjust platform to desired height. If you need a larger stepping surface, place multiple platforms side-by-side until you reach desired length. Meets OSHA 1910.26 standards. Gray enamel finish. FOB WISCONSIN.

Model Number	Adjustment Height	Platform Size	Wt. Lbs.	Price Each
YC-1397	5-8"	24" x 24"	25	\$264.00
YC-1398	5-8"	24" x 36"	34	286.00
YC-1399	5-8"	24" x 60"	50	332.00
YC-1400	9-14"	24" x 24"	30	276.00
YC-1401	9-14"	24" x 36"	39	302.00
YC-1402	9-14"	24" x 60"	54	347.00



## Heavy-Duty Step Stands

Large, stable stands come in handy in warehouses, shipping areas, etc. High-density polyethylene construction. Anti-fatigue skid-resistant matting on each step and all bottom edges provide excellent gripping action to your shoes and the floor. Extra wide stand has a broader stepping area. 1,000-lb. capacity. Carrying handle. Stackable for convenient storage. **IN STOCK.**

- Model No. **XD-1621**—One Step. 24"W x 24"D x 15-1/2"H. Wt. 10 lbs. **\$89.10**
- Model No. **XD-1622**—Two Step. 23"W x 30"D x 24"H. Wt. 15 lbs. **\$140.00**
- Model No. **XD-1623**—Extra-Wide Two Step. 26"W x 32"D x 20"H. Wt. 20 lbs. **\$138.00**
- Model No. **XD-1624**—One Step. 27-1/2"W x 21-1/2"D x 10-1/2"H. Wt. 15 lbs. **\$83.40**
- Model No. **XD-1625**—One Step. 35"W x 35"D x 16"H. Wt. 20 lbs. **\$171.00**
- Model No. **XD-1626**—One Step. 66-1/2"W x 24-1/2"D x 10"H. Wt. 25 lbs. **\$241.00**



## DIXIE Interlocking Work Platform

Design hundreds of work platform configurations for machine areas, warehouses, or large departments. Rust-proof, food-grade polyethylene, may be used in or outside. Anti-skid deck. 18" x 18" x 10"H; 500-lb. capacity. **FACTORY QUICK SHIP—FOB SOUTH CAROLINA.**

- Model No. **YK-0981**—Wt. 12 lbs. **\$89.70**



## DIXIE Step Stands

Here's a safe, secure way to reach out-of-the-way work areas. High-density polyethylene steps have abrasive strips that offer slip-resistant footing. Rear openings on the 2- to 4-step stands store tools and supplies inside the stairs. One- to 3-step models have side handholds while the four-step model includes 31"H handrails for safety and 2 casters for easy mobility. 500-lb. capacity. **SPECIFY COLOR: GY - Gray, YL - Yellow. FACTORY QUICK SHIP—FOB SOUTH CAROLINA.**

- Model No. **XJ-3060**—One-Step. 18"W x 12"D x 12"H. Wt. 10 lbs. Reg. ~~\$50.00~~ **SALE**.....**\$41.00**
- Model No. **XJ-3061**—Two-Step. 22"W x 21"D x 20"H. Wt. 22 lbs. Reg. ~~\$87.80~~ **SALE**.....**\$71.00**
- Model No. **XJ-3062**—Three-Step. 32"W x 22"D x 30"H. Wt. 33 lbs. Reg. ~~\$137.00~~ **SALE**.....**\$111.00**
- Model No. **XJ-3063**—Four-Step w/Hand Hold. 45"W x 25"D x 70"H. Wt. 53 lbs. **\$282.00**

# Work Platforms & Ladders

## Work Platforms



Lift employees to higher heights comfortably with these plastic platforms and anti-fatigue mats. Plastic platforms stack together easily for increased height. Lock adjacent platforms together to create large work surfaces. FOB MICHIGAN.



BASE WITH TWO ADD-ONS AND MAT SHOWN.

**PLATFORMS.** Start with a base and use add-ons to create multiple levels. Stack them vertically or use optional connection clips to link them horizontally. 2-5/8" H polyethylene is lightweight and easy to move. High-density plastic resists chemicals. Grates on the surface allow fluids and small particles to drain away. Wide-stance design for comfort.

**SPECIFY UNIT:**  
A - Base,  
B - Add-on.

Model Number	L x W	PLATFORMS			
		(A) BASE		(B) ADD-ON	
		Wt. Lbs.	Price Ea.	Wt. Lbs.	Price Ea.
XK-2240	36" x 24"	12	\$46.70	12	\$46.70
XK-2241	66" x 24"	21	85.60	21	85.60
XK-2242	96" x 24"	30	99.80	30	99.80
XK-2243	96" x 36"	43	129.00	43	129.00

**PLATFORM MATS.** 7/8" thick mat relieves tired back, feet and legs and promotes circulation. Anti-skid surface prevents accidents. Plug locks secure the mat to the top of platform. **SPECIFY COLOR: BK - Black, YL - Yellow border.**

Model Number	L x W	PLATFORM MATS			
		(YL) YELLOW BRD		(BK) BLACK	
		Wt. Lbs.	Price Ea.	Wt. Lbs.	Price Ea.
XK-2245	36" x 24"	17	\$113.00	12	\$70.80
XK-2246	66" x 24"	31	209.00	21	154.00
XK-2247	96" x 24"	43	303.00	30	231.00
XK-2248	96" x 36"	64	372.00	43	290.00

Model No. **XK-2250—Connection Clips.** Link platforms together horizontally. Edges of platforms fit between clip prongs. Can be used on all sides of platform. Minimum of 2 required per side .....\$4.97/pkg. 4

**A**

**B**

**C**  
PLATFORM LADDER

**D**  
DOUBLE-STEP LADDER

**SEE PAGE 44 FOR RUBBERMAID® LADDER CART.**

### Fiberglass Ladders

**A. 250-LB. CAPACITY LADDERS**  
Economical ladders are ideal for electrical, painting and maintenance uses. Type 1, non-conductive construction. Aluminum steps include 3" traction-tread. Handy top plastic tray holds tools and supplies. Also features pinchless spreaders and shock-resistant bumper pads. FOB 20 NATIONWIDE FACTORY SHIPPING LOCATIONS.

Model Number	Size	Wt. Lbs.	Price Each
WP-0146	4'	13	\$106.00
WP-0147	5'	16	124.00
WP-0148	6'	18	136.00
WP-0149	8'	25	180.00

**B. TYPE 1A LADDERS.**  
Type 1A ladders are rated for industrial quality. Lightweight, strong, stable units are non-conductive. Include convenient Tool-Tra-Top®. Extra heavy-duty ladders include 3-1/4"D aluminum steps and reinforced fiberglass front and rear rails. **SELECTED MODELS IN STOCK.** Others FOB 20 NATIONWIDE FACTORY SHIPPING LOCATIONS.

Model Number	Size	Cap. Lbs.	Wt. Lbs.	Price Each
WP-0157*	4'	375	17	\$182.00
WP-0158*	5'	375	21	217.00
WP-0159	6'	375	25	241.00
WP-0160	7'	75	29	287.00
WP-0161	8'	375	35	343.00
WP-0162	10'	375	46	400.00
WP-0163	12'	300	53	481.00

\*Ships via small package carrier.

**C. & D. SPECIALTY LADDERS.**  
Type 1A, 300-lb. capacity units are non-conductive. Reinforced fiberglass front and rear rails are supported by non-pinch spreader bars. Aluminum steps include 3-1/4" serrated tread. Slip resistant rubber feet. Platform on (C) is 2' below top height. (D) is ideal for two-person application or two-way access. **SELECTED MODELS IN STOCK.** Others FOB 20 NATIONWIDE FACTORY SHIPPING LOCATIONS.

Overall Ht.	Model No.	Wt. Lbs.	Price Ea.
<b>300-LB. CAPACITY</b>			
10'	WP-0167	44	\$438.00
12'	WP-0168	55	522.00
<b>375-LB. CAPACITY</b>			
5'	WP-0164	21	\$230.00
6'	WP-0165	25	267.00
8'	WP-0166	33	348.00

Overall Ht.	Model No.	Wt. Lbs.	Price Ea.
<b>D. DOUBLE-STEP LADDERS</b>			
<b>300-LB. CAPACITY</b>			
16'	WP-0176	98	\$907.00
<b>375-LB. CAPACITY</b>			
4'	WP-0169*	22	\$230.00
6'	WP-0171*	31	299.00
8'	WP-0172	42	393.00
10'	WP-0173	54	491.00
12'	WP-0174	67	585.00
14'	WP-0175	73	789.00

\*Ships via small package carrier.

# Ladders



## STAPLETON® Stepping Stands

Practical stands help you access out-of-reach supplies. Large 10" x 16" steps have anti-slip surfaces. When pressure is placed on the bottom step, the spring-loaded casters retract and plastic cups with rubber rings grip the floor. Steel tube frame. Industrial-duty rated at 300 lbs. Meets or exceeds all OSHA-ANSI standards. **IN STOCK.**

Model No.	Description	Overall W x D	Top Step Ht.	Wt. Lbs.	Price Ea.
YA-1450	One-step	18-3/4" x 13"	10"	6	\$83.60
YA-1451	Two-step with rail	21" x 20"	22"	20	122.00
YA-1452	Three-step with rail	21" x 30"	29"	22	161.00



## STAPLETON® Step Ladders

One-of-a-kind ladder is perfect for painters, maintenance workers, and landscapers. Small parts tray, paper towel holder, and paint can hook places supplies within reach, rather than on the ground. Large 15"W steps provide ample room for both feet. Top platform is 13"D; steps are 8"D. All-welded frames include support cross bars for extra stability. 250-lb. capacity. **IN STOCK.**

Model Number	Description	Overall W x D	Top Step Ht.	Wt. Lbs.	Net Each
YA-1476	2-step	21-1/2" x 26-1/2"	18"	14	\$81.30
YA-1477	3-step	21-1/2" x 28-1/2"	27-1/4"	18	105.00

(01) EZY TREAD

(02) GRIP-STRUT®

EZY ANGLE

STANDARD ANGLE

Selected Models

Model No. **YL-0360**— Optional 32"H Handrails For EZY ANGLE. On 3 sides of platform for 3- and 4-step EZY Angle models.....\$107.00

Model No. **YL-0361**— Optional 32"H Handrails For Standard Angle. On 3 sides of platform for 3- and 4-step Standard Angle models.\$101.00

## EGA Mobile Steel Work Platforms

Easily pick up one end of these work platforms and roll with ease. Rubber tips grip the floor giving you a secure, steady platform. Constructed of 1" square tube frame with 5" rear casters. Choose either standard angle or 50° EZY angle that enables user to turn and descend in a forward direction. **SPECIFY STEP: A** - EZY Tread with perforated steps, **B** - Grip Strut®. **SELECTED MODELS IN (B) ARE FACTORY QUICK SHIP.** All FOB WISCONSIN.

### EZY ANGLE

Model Number	Step Qty.	Platform L x W x H	Overall Length	Wt. Lbs.	Price Ea.	
					A	B
<b>WITHOUT HANDRAIL (Optional handrails sold below)</b>						
YL-0336	3	36" x 24" x 30"	56"	81	\$434.00	\$539.00
YL-0337	3	48" x 24" x 30"	70"	93	490.00	589.00
YL-0338	3	36" x 30" x 30"	56"	105	495.00	632.00
YL-0339	3	48" x 30" x 30"	70"	121	577.00	710.00
YL-0340	4	36" x 24" x 40"	65"	97	559.00	601.00
YL-0341	4	48" x 24" x 40"	79"	109	598.00	677.00
YL-0342	4	36" x 30" x 40"	65"	124	584.00	722.00
YL-0343	4	48" x 30" x 40"	79"	140	693.00	927.00
<b>WITH HANDRAIL</b>						
YL-0344	5	36" x 24" x 50"	74"	113	\$649.00	\$848.00
YL-0345	5	48" x 24" x 50"	88"	125	700.00	878.00
YL-0346	5	36" x 30" x 50"	74"	143	733.00	945.00
YL-0347	5	48" x 30" x 50"	88"	159	850.00	1056.00

NOTE: Dimensions & weights may vary slightly depending on the tread style ordered.

### STANDARD ANGLE

Model Number	Step Qty.	Platform L x W x H	Overall Length	Wt. Lbs.	Price Ea.	
					A	B
<b>WITHOUT HANDRAIL (Optional handrails sold below)</b>						
YL-0348	3	35" x 24" x 30"	51"	75	\$394.00	\$478.00
YL-0349	3	49" x 24" x 30"	63"	86	457.00	516.00
YL-0350	3	35" x 30" x 30"	51"	86	459.00	591.00
YL-0351	3	49" x 30" x 30"	63"	100	538.00	720.00
YL-0352	4	35" x 24" x 40"	59"	90	489.00	556.00
YL-0353	4	49" x 24" x 40"	71"	101	565.00	636.00
YL-0354	4	35" x 30" x 40"	59"	103	538.00	673.00
YL-0355	4	49" x 30" x 40"	71"	116	633.00	850.00
<b>WITH HANDRAIL</b>						
YL-0356	5	35" x 24" x 50"	66"	106	\$594.00	\$775.00
YL-0357	5	49" x 24" x 50"	78"	117	668.00	842.00
YL-0358	5	35" x 30" x 50"	66"	119	665.00	846.00
YL-0359	5	49" x 30" x 50"	78"	132	808.00	902.00

NOTE: Dimensions & weights may vary slightly depending on the tread style ordered.



# EGA Ladders

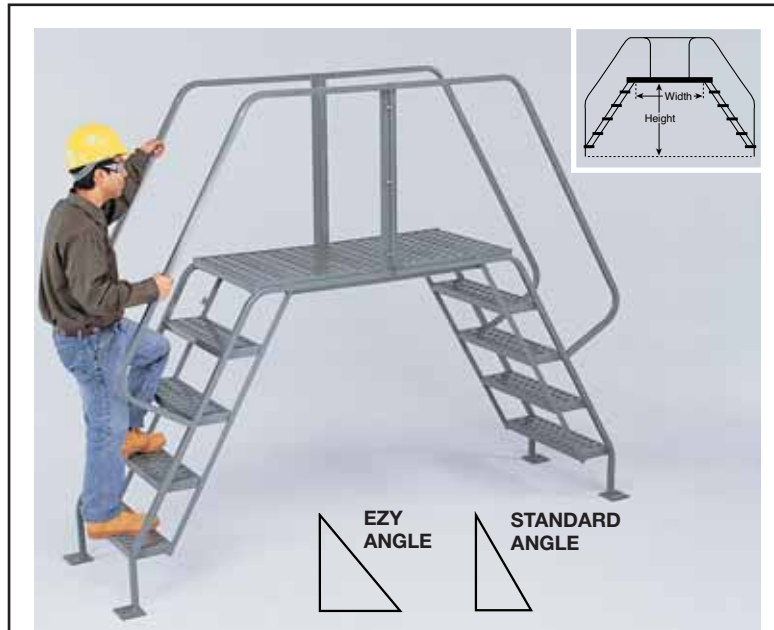

## Cross-Over Ladders

Gives users safe access over machinery, ducts and other obstacles in plants and warehouses. Can be used as conventional ladders or bolted to the ground for permanent installation. All-welded construction. First choose either a Standard Angle or EZ Y Angle ladder. Then choose step type: EZ Y Tread 1/2" perforated stair treads with a slip-resistant surface or Grip-Strut® treads which offer slip-resistance in wet environments. **SPECIFY ANGLE AND STEP: A - EZ Y Tread, B - Grip-Strut®; C - EZ Y Tread, D - Grip-Strut®.** FOB WISCONSIN.

Model Number	Step Qty.	Clearance H x W	STANDARD ANGLE		Wt. Lbs.	EZ Y ANGLE		
			(A) Price Ea.	(B) Price Ea.		(C) Price Ea.	(D) Price Ea.	
XL-0224	4	37" x 21"	84	\$639.00	\$827.00	94	\$722.00	\$946.00
XL-0225	4	37" x 28"	89	671.00	893.00	99	772.00	1031.00
XL-0226	4	37" x 35"	96	701.00	903.00	106	759.00	982.00
XL-0227	5	47" x 21"	145	689.00	893.00	155	793.00	1022.00
XL-0228	5	47" x 28"	151	765.00	984.00	161	875.00	1126.00
XL-0229	5	47" x 35"	160	802.00	1038.00	170	919.00	1179.00
XL-0230	6	57" x 21"	180	862.00	1105.00	190	978.00	1258.00
XL-0231	6	57" x 28"	186	880.00	1152.00	196	1020.00	1314.00
XL-0232	6	57" x 35"	199	903.00	1176.00	209	1043.00	1352.00



## All-Welded Industrial Stairways

Designed to provide durable, reliable access to mezzanines, platforms, etc. all-welded stairways arrive set-up and ready to use. 36"W rugged units feature 10" channel stringers for extra rigidity. 1-1/2" tube hand rails are welded 32" above the stairs. Steps feature heavy Grip-Strut® tread for slip-resistant footing. OSHA compliant. BOCA-compliant stairways available, call for information. Gray painted enamel finish. FOB WISCONSIN.

Model Number	Landing Height	Clearance H x D	Step Qty.	Wt. Lbs.	Price Each
XP-1170	42"	35" x 48"	5	223	\$892.00
XP-1171	49"	42" x 57"	6	260	945.00
XP-1172	56"	49" x 67"	7	309	1012.00
XP-1173	63"	56" x 76"	8	346	1137.00
XP-1174	70"	63" x 86"	9	382	1222.00
XP-1175	77"	70" x 95"	10	419	1332.00
XP-1176	84"	77" x 105"	11	468	1430.00
XP-1177	91"	84" x 114"	12	505	1484.00
XP-1178	98"	91" x 124"	13	541	1539.00
XP-1179	105"	98" x 133"	14	577	1698.00
XP-1180	112"	105" x 143"	15	626	1714.00
XP-1181	119"	112" x 152"	16	663	1727.00

## Custom Work Platform System

You're sure to find just what you need among these different work platform styles. Use styles A-I alone or add extensions (J) to platforms (A), (C), (D), (F), or (G) to build large work decks. To order extensions: match platform and extension heights from the charts below. If you need to reach different heights along your work deck, select higher or lower extensions for step-up or step-down levels. All work platforms feature:

39"H railings, 33"W x 9-1/2"D adjustable steps, and Grip-Strut® tread for slip-resistant footing. Platform heights adjust up or down 3" and entire units support 500 lbs. Meets OSHA standard 1910.23. Ships unassembled. Color: gray enamel. FOB NC.

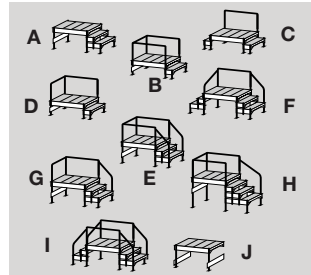

Key	Model Number	Step Qty.	Platform L x W x H	Wt. Lbs.	Price Each
A	XP-1182	2	3' x 3' x 21"	76	\$485.00
A	XP-1183	3	3' x 3' x 33"	97	638.00
B	XP-1184	2	3' x 3' x 21"	98	632.00
C	XP-1185	2	3' x 3' x 21"	100	681.00
D	XP-1186	2	3' x 3' x 21"	91	577.00
E	XP-1187	3	3' x 3' x 27"	127	857.00
E	XP-1188	3	3' x 3' x 33"	130	870.00
F	XP-1189	3	3' x 3' x 33"	148	1290.00
F	XP-1190	4	3' x 3' x 45"	190	1418.00
G	XP-1191	3	3' x 3' x 27"	116	779.00
G	XP-1192	3	3' x 3' x 33"	118	960.00
G	XP-1193	4	3' x 3' x 45"	142	974.00
G	XP-1194	4	3' x 6' x 45"	194	1471.00
H	XP-1195	4	3' x 3' x 39"	151	1041.00
H	XP-1196	4	3' x 3' x 45"	154	1048.00
H	XP-1197	4	3' x 6' x 45"	214	1520.00
I	XP-1198	3	3' x 3' x 33"	168	1197.00

\*Step quantity includes platform.



Key	Model Number	Platform Height	Wt. Lbs.	Price Each
J	XP-1199	21"	56	\$322.00
J	XP-1201	27"	69	406.00
J	XP-1202	33"	70	409.00
J	XP-1203	45"	72	418.00

# Ladders



## VESTIL Port-O-Fold Mobile Ladders

Portable, but strong, safety ladder folds for convenient transport and storage. Square steel tube framework with two 10" hard rubber wheels mounted on rear legs. 17"W x 7"D steps. Extra-deep 14" top platform. 30"H removable handrails. Complies with ANSI 14.7 and OSHA 1910.29. Color: blue. **SPECIFY ANGLE AND STEP: 58° STANDARD ANGLE A** - Perforated, **B** - Grip-Strut®, **50° ANGLE C** - Perforated, **D** - Grip-Strut®, **D** - Grip-Strut®, FOB INDIANA.

Model Number	Step Qty.	Top Step Ht.	Overall Height	Overall W x D	Wt. Lbs.	STANDARD ANGLE		EZY ANGLE	
						(A)	(B)	(C)	(D)
YL-0317	5	50"	87"	28 x 46"	90	\$364.00	\$384.00	\$410.00	\$439.00
YL-0318	6	60"	97"	29 x 53"	110	414.00	435.00	460.00	483.00
YL-0319	7	70"	107"	30 x 59"	125	470.00	494.00	535.00	565.00
YL-0320	8	80"	117"	31 x 66"	135	561.00	588.00	626.00	653.00
YL-0321	9	90"	127"	32 x 72"	140	602.00	642.00	699.00	741.00
YL-0322	10	100"	137"	33 x 79"	160	676.00	724.00	757.00	819.00
YL-0323	11	110"	147"	34 x 86"	185	716.00	769.00	809.00	881.00
YL-0324	12	120"	157"	36 x 92"	205	777.00	837.00	872.00	926.00



## EGA Rubber-Tread Rolling Ladders

Attractive colors combine with strong durable construction making this ladder ideal for both industrial and office use. Rigid 1" dia. square steel construction supports up to 300 lbs. Steps feature rubber tread for safe footing, and the gradual incline eases climbing. 3" rubber casters retract automatically when weight is applied to first step so rubber tipped legs grip the floor for stability. Meets OSHA standards. Enamel finish. **SPECIFY COLOR: BK** - Black, **BL** - Blue, **GY** - Gray, **SD** - Sandalwood. **SELECTED MODELS ARE FACTORY QUICK SHIP.** All FOB WISCONSIN.

Model Number	Step Qty.	Hand-rails	Top Step Ht.	Overall W x D x H	Wt. Lbs.	Price Each
YL-0294*	1	No	10"	22 x 20 x 10"	15	\$188.00
YL-0295*	2	No	20"	22 x 23 x 20"	28	201.00
YL-0296*	2	Yes	20"	22 x 23 x 40"	31	228.00
YL-0297*	3	No	30"	22 x 27 x 30"	34	253.00
YL-0298*	3	Yes	30"	22 x 29 x 54"	38	287.00
YL-0299	4	No	40"	22 x 29 x 54"	50	268.00
YL-0300	4	Yes	40"	22 x 35 x 40"	55	309.00
YL-0301	5	Yes	50"	22 x 36 x 64"	100	352.00
YL-0302	6	Yes	60"	32 x 57 x 90"	115	390.00

\*1-3-step ships via small package carrier.



## EGA Steel Wall-Mount Steps

Provides safe, reliable access to docks, platforms, large trucks, etc. Durable steel 18"W x 7"D steps feature Grip-Strut® tread for secure footing. 12" between steps. 350-lb. capacity. Mounting hardware not included. Color: gray. Ships via small package carrier. **IN STOCK.**

Model No. **YL-3729**.....\$136.00



## VESTIL Steel Fold-Up Step

Available when you need it, out of the way when you don't. 14"W x 9-1/2"D step features Grip-Strut® tread for slip-resistant footing. 350-lb. capacity. Mounting hardware not included. Color: blue. **IN STOCK.**

Model No. **YL-3730**.....\$80.30

# Ladders

All our ladders comply with OSHA and ANSI standards. Please note: California and portions of other areas may require special options such as higher handrails. Please check your local codes before ordering.

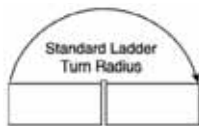

NOW, EVEN LARGE ROLLING LADDERS MANEUVER EASILY IN CONFINED AREAS!

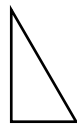

STANDARD ANGLE

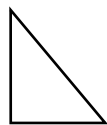

SAF-T-ANGLE

## GILLIS Saf-T-Six Wheeler Rolling Ladders

Cut turning radius in half with these six-wheeler ladders. Patented design features a set of middle wheels that allow ladder to turn on its own radius making it a great option for tight areas. 1" O.D. tube frame construction with enamel finish. Front casters are 4" swivel, middle are 6" rigid, and back are 4" rigid. As soon as you step on first step the middle casters rise and ladder feet lower so that ladder is stabilized to floor. When front bar is touched the middle casters lower, returning ladder to rolling position. 7"D steps with a 14" top platform. 350-lb. capacity. **SPECIFY ANGLE AND STEP: STANDARD ANGLE, A - Perf Step, B - Grip-Strut®; 50° SAF-T-ANGLE, C - Perf Step, D - Grip-Strut®.** FOB ILLINOIS.

Model Number	Step Qty.	Overall W x H	STANDARD LADDER				SAF-T-ANGLE LADDER			
			Total Lgth.	Wt. Lbs.	(A) Price Ea.	(B) Price Ea.	Total Lgth.	Wt. Lbs.	(C) Price Ea.	(D) Price Ea.
<b>26"W AT TOP</b>										
YL-0259	7	32" x 105"	62"	146	\$514.00	\$564.00	76"	143	\$613.00	\$654.00
YL-0260	8	32" x 115"	68"	154	603.00	707.00	90"	154	699.00	821.00
YL-0261	9	32" x 125"	76"	173	698.00	720.00	96"	172	745.00	877.00
YL-0262	10	32" x 135"	82"	185	702.00	750.00	103"	188	785.00	961.00
YL-0263	11	32" x 145"	90"	199	781.00	818.00	115"	195	838.00	986.00
YL-0264	12	32" x 155"	96"	215	854.00	840.00	121"	203	975.00	902.00
YL-0265	13	40" x 173"	103"	231	1005.00	973.00	—	—	—	—
YL-0266	14	40" x 183"	108"	245	1012.00	1084.00	—	—	—	—
YL-0267	15	40" x 193"	115"	259	1093.00	1095.00	—	—	—	—
YL-0268	16	40" x 203"	121"	278	1125.00	1150.00	—	—	—	—
<b>32"W AT TOP</b>										
YL-0269	7	32" x 105"	62"	149	\$587.00	\$645.00	76"	166	\$657.00	\$679.00
YL-0270	8	36" x 115"	68"	162	674.00	696.00	90"	181	781.00	741.00
YL-0271	9	36" x 125"	76"	170	713.00	771.00	96"	196	828.00	1005.00
YL-0272	10	36" x 135"	82"	180	796.00	825.00	103"	208	923.00	1012.00
YL-0273	11	36" x 145"	90"	201	864.00	895.00	115"	220	1005.00	1093.00
YL-0274	12	36" x 155"	96"	210	902.00	939.00	121"	229	1089.00	1125.00
YL-0275	13	40" x 173"	103"	254	1050.00	1096.00	—	—	—	—
YL-0276	14	40" x 183"	108"	262	1075.00	1451.00	—	—	—	—
YL-0277	15	40" x 193"	115"	278	1168.00	1223.00	—	—	—	—
YL-0278	16	40" x 203"	121"	298	1205.00	1257.00	—	—	—	—



5- TO 16-STEP LADDERS ARE PROTECTIVELY PACKAGED TO PREVENT DAMAGE DURING SHIPPING. PROTECTIVE PACKAGING ADDS TO PRODUCT WEIGHT. ONLY PRODUCT WEIGHT IS LISTED BELOW.



PATENTED DESIGN

SET OF MIDDLE WHEELS ALLOWS THE LADDER TO TURN ON ITS OWN RADIUS.



50° STAIRWAY SLOPE

## EGA Stock Picking Ladders

Shelving is built-in to units making stock picking efficient and easy. 1" steel tubing adds strength and durability while 30"H handrails add safety. Features EZY Lock braking system: step on first step and casters rise pushing leveling legs to the floor. Step on bottom bar and leveling legs rise and ladder returns to rolling position. 24"Wx7"D steps and 24"Wx21"D top platform. Color: industrial green. **SPECIFY STEP: A - EZY Tread, B - Grip-Strut®.** FOB WISCONSIN.

Model Number	Step Qty.	Top Step W x D x H	Wt. Lbs.	(A)	(B)
				Price Ea.	Price Ea.
YL-0287	6	24" x 21" x 60"	175	\$532.00	\$647.00
YL-0288	7	24" x 21" x 70"	185	560.00	689.00
YL-0289	8	24" x 21" x 80"	195	647.00	747.00
YL-0290	9	24" x 21" x 90"	205	718.00	795.00
YL-0291	10	24" x 21" x 100"	210	757.00	862.00
YL-0292	11	24" x 21" x 110"	230	828.00	954.00



FOLDS FOR EASY STORAGE

## VESTIL Mobile Maintenance Ladders

Goes where you need it—just tip and roll. Square steel tube frame with 4" hard rubber wheels mounted on the rear legs. 21"D top platform and removable 30"H hand rails with removable access chain. 24"W x 7"D steps. Ships unassembled. Complies with ANSI 14.7 and OSHA 1910.29. Color: blue. **SPECIFY STEP: A - Perforated, B - Grip-Strut®.** FOB INDIANA.



Model Number	Step Qty.	Overall Height	Top Step Ht.	Wt. Lbs.	(A) Price Ea.	(B) Price Ea.
YL-0329	4	70"	40"	63	\$409.00	\$462.00
YL-0330	5	80"	50"	78	467.00	537.00
YL-0331	6	90"	60"	88	497.00	601.00
YL-0332	7	100"	70"	101	556.00	652.00

# EGA Ladders



**FACTORY QUICK SHIP**  
Selected Models

ALL UNITS RATED 300-LB. CAPACITY.



**TAPERED DESIGN FOR BETTER STABILITY ON 5- OR MORE STEP LADDERS**



**SQUARE TUBE CONSTRUCTION PROVIDES EXCEPTIONAL STRENGTH AND DURABILITY.**

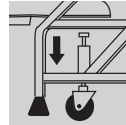

**2- THROUGH 4-STEP LADDERS HAVE SPRING-LOADED CASTERS THAT RETRACT**

**AUTOMATICALLY WHEN WEIGHT IS APPLIED, ALLOWING RUBBER TIPS TO GRIP FLOOR. REMOVE WEIGHT AND LADDER IS IN ROLLING POSITION.**



All our ladders comply with OSHA and ANSI standards. Please note: California and portions of other areas may require special options such as higher handrails. Please check your local codes before ordering.



EZY TREAD STEP GRIP-STRUT® STEP

## Safety Ladders With EZY Tread or Grip-Strut® Steps

Square tubing plus quality design is the hallmark of these safety ladders. Handrails and frames are constructed of 1" square tubular steel that is 40% stronger than round tube. Casters on the 2-4 step ladders are spring-loaded and locking. 5-16 step ladders have a heavy-duty EZY lock first step with a foot release. Choose from two stair tread types—EZY Tread or Grip-Strut®. The EZY Tread stair has 1"L x 3/8"W perforations to prevent slipping. For even more slip resistance, choose the Grip-Strut®

tread, designed for wet or oily work conditions. Both styles have 7" deep steps with a 9" top platform. Ladder legs have rubber tips that grip the floor for extra stability. Sub-assemblies are welded, making them more durable. The hand rail sits 30" above platform on 2-13 step ladders and 37" on 13-16 step ladders. All ladders meet OSHA standard 1910.29 and ANSI standard A14.7-1991 and are carefully packaged to prevent freight damage. 2-4-step ladders ship via small package carrier; 2-, 3-step without handrail ship completely assembled; 3-step with handrails ship knocked down. Easy to assemble. **SELECTED MODELS IN (A) ARE FACTORY QUICK SHIP.** All FOB WISCONSIN.

### 2-7-STEP

**SPECIFY STEP: A - EZY Tread, B - Grip-Strut®.**

No. Steps	Platform Height	Hand Rails	Overall Height	Model Number	20"W AT TOP				26"W AT TOP				32"W AT TOP					
					Base W x D	Wt. Lbs.	Price Ea.		Model Number	Base W x D	Wt. Lbs.	Price Ea.		Model Number	Base W x D	Wt. Lbs.	Price Ea.	
							(A)	(B)				(A)	(B)				(A)	(B)
2†	20"	no	20"	<b>YV-3800*</b>	22" x 25"	28	\$151.00	\$180.00	<b>YV-3822*</b>	26" x 22"	30	\$164.00	\$194.00	<b>YV-3840*</b>	32" x 22"	31	\$191.00	\$234.00
2†	20"	yes	44"	<b>YV-3801*</b>	22" x 25"	31	180.00	215.00	<b>YV-3823*</b>	26" x 22"	33	188.00	234.00	<b>YV-3841*</b>	32" x 22"	34	204.00	258.00
3†	30"	no	30"	<b>YV-3802*</b>	22" x 34"	34	183.00	226.00	<b>YV-3824*</b>	26" x 28"	37	204.00	242.00	<b>YV-3842*</b>	32" x 28"	38	231.00	285.00
3†	30"	yes	60"	<b>YV-3803*</b>	22" x 34"	38	207.00	247.00	<b>YV-3825*</b>	26" x 28"	41	231.00	279.00	<b>YV-3843*</b>	32" x 28"	43	271.00	320.00
4†	40"	no	40"	<b>YV-3804*</b>	22" x 44"	50	210.00	261.00	<b>YV-3826*</b>	26" x 33"	55	242.00	293.00	<b>YV-3844*</b>	32" x 33"	63	357.00	411.00
4†	40"	yes	70"	<b>YV-3805*</b>	22" x 44"	55	245.00	296.00	<b>YV-3827*</b>	26" x 33"	60	266.00	349.00	<b>YV-3845*</b>	32" x 33"	68	430.00	507.00
5†	50"	yes	80"	<b>YV-3806*</b>	26" x 43"	65	293.00	352.00	<b>YV-3828*</b>	32" x 42"	72	330.00	435.00	<b>YV-3846*</b>	38" x 42"	82	489.00	561.00
6†	60"	yes	90"	<b>YV-3807*</b>	27" x 50"	78	387.00	456.00	<b>YV-3829*</b>	32" x 48"	84	432.00	521.00	<b>YV-3847*</b>	38" x 48"	96	553.00	634.00
7†	70"	yes	100"	<b>YV-3808*</b>	27" x 57"	88	427.00	502.00	<b>YV-3830*</b>	32" x 55"	100	465.00	564.00	<b>YV-3848*</b>	38" x 55"	114	607.00	706.00

†Number of steps includes top platform. If all-welded required, please call.

\*Shipped via small package carrier, 2- & 3-step without handrail completely assembled. 3-step with handrail ships unassembled. Easy to assemble.

NOTE: Stated weights may vary slightly depending on stair tread.

### 8-16-STEP

**SPECIFY STEP: A - EZY Tread, B - Grip-Strut®.**

No. Steps	Platform Height	Overall Height	Model Number	26"W AT TOP				32"W AT TOP				EXTRA-DEEP TOP PLATFORMS					
				Base W x D	Wt. Lbs.	Price Ea.		Model Number	Base W x D	Wt. Lbs.	Price Ea.		Model Number	Platform Depth	Models	Price Ea.	
						(A)	(B)				(A)	(B)				(A)	(B)
8†	80"	110"	<b>YV-3809*</b>	32" x 62"	112	\$513.00	\$620.00	<b>YV-3831*</b>	38" x 62"	128	\$784.00	\$902.00	<b>YV-3849*</b>	21"	3-8 steps	\$153.00	\$153.00
9†	90"	120"	<b>YV-3810*</b>	33" x 70"	124	660.00	778.00	<b>YV-3832*</b>	38" x 69"	142	821.00	958.00	<b>YV-3850*</b>	28"	3-8 steps	212.00	212.00
10†	100"	130"	<b>YV-3811*</b>	34" x 76"	136	698.00	832.00	<b>YV-3833*</b>	38" x 76"	156	921.00	1076.00	<b>YV-3851*</b>	35"	3-8 steps	282.00	282.00
11†	110"	140"	<b>YV-3812*</b>	36" x 83"	148	789.00	937.00	<b>YV-3834*</b>	41" x 83"	170	1025.00	1183.00	<b>YV-3852*</b>	21"	9-16 steps	153.00	153.00
12†	120"	150"	<b>YV-3813*</b>	37" x 90"	160	851.00	982.00	<b>YV-3835*</b>	41" x 90"	184	1122.00	1301.00	<b>YV-3853*</b>	28"	9-16 steps	212.00	212.00
13†	130"	160"	<b>YV-3814*</b>	38" x 96"	175	921.00	1079.00	<b>YV-3836*</b>	43" x 96"	201	1299.00	1521.00	<b>YV-3854*</b>	35"	9-16 steps	282.00	282.00
14†	140"	170"	<b>YV-3815*</b>	39" x 102"	190	1133.00	1377.00	<b>YV-3837*</b>	43" x 102"	218	1471.00	1747.00					
15†	150"	180"	<b>YV-3816*</b>	40" x 109"	210	1251.00	1481.00	<b>YV-3838*</b>	45" x 108"	240	1645.00	1948.00					
16†	160"	190"	<b>YV-3817*</b>	41" x 116"	235	1320.00	1572.00	<b>YV-3839*</b>	42" x 114"	246	1792.00	2128.00					

## 60° Angle Safety Ladders

Rolls easily to and from work areas. 1" steel tube frame and handrails provide structural support. Handrail is 24" high on 2-3-step ladders, 30" high on 4-12-step ladders, and 42" high on 13-16-step ladders. 14"D top platform is standard, 21" and 28"D platforms are also available. 7"D stairs are available with perforated tread for general-duty use or Grip Strut® stair tread for oily or wet environments. Two- to five-step ladders have retractable casters while the 6-16-step ladders have four casters with floor locking mechanisms. 2-, 3-, and 4-step ladders (without handrails) ship fully assembled. All others ship unassembled to save freight. Ladders are packaged to reduce the risk of shipping damage. Assembled, welded version available on request. Meet OSHA standard 1910.29, and ANSI standard A-92.1-1971. Gray/green enamel. **SELECTED MODELS IN (A) ARE FACTORY QUICK SHIP.** All FOB ILLINOIS.

### REPLACEMENT PARTS

**FOLD DOWN TRAY.**  
10"D, 3/4"H. SPECIFY WIDTH:  
**A - 16", B - 24". IN STOCK.**  
Model No. **XP-699** .....\$22.20

**RUBBER TIPS.** Set/4.  
Model No. **XP-700** .....\$7.20

Casters: call for replacement information.



**5- TO 16-STEP LADDERS ARE PROTECTIVELY PACKAGED TO PREVENT DAMAGE DURING SHIPPING. PROTECTIVE PACKAGING ADDS TO PRODUCT WEIGHT. ONLY PRODUCT WEIGHT IS LISTED BELOW.**

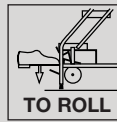

Selected Models

**POSITIVE LOCK FOR 6-16 STEP LADDERS. BOTTOM STEP RELEASES THE CASTER CARRIAGE, PUTS LEGS FIRMLY ON FLOOR. JUST ACTUATE FOOT PEDAL TO RAISE THE LADDER ONTO SWIVEL CASTERS FOR EASY ROLLING.**

All ladders meet OSHA and ANSI standards. California and other areas may require special options. Please check your local codes before ordering.



**TAPERED DESIGN FOR BETTER STABILITY (5 OR MORE STEPS).**

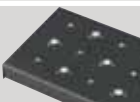

**A - PERFORATED STEP**

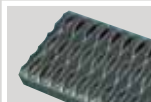

**B - GRIP STRUT® STEP**

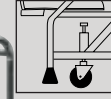
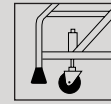

**FLOOR LOCKING MECHANISM FOR 2-5 STEP LADDERS-SPRING LOADED CASTERS RETRACT AUTOMATICALLY UNDER INDIVIDUAL'S WEIGHT. WIDE BASE AND DURABLE RUBBER TIPS GRIP FLOOR AND SECURE LADDER.**



### 2-7 STEPS. SPECIFY STEP: A - Perforated, B - Grip Strut®.

No. Steps	Plat. Ht.	Hand-rails	O.A. Height	Model Number	18" WIDE AT TOP				26" WIDE AT TOP				32" WIDE AT TOP					
					Base W x D	Wt. Lbs.	Price Ea.		Model Number	Base W x D	Wt. Lbs.	Price Ea.		Model Number	Base W x D	Wt. Lbs.	Price Ea.	
							(A)	(B)				(A)	(B)				(A)	(B)
2	20"	No	20"	<b>*XP-701</b>	22" x 24"	25	\$138.00	\$139.00	<b>*XP-710</b>	30" x 24"	30	\$155.00	\$149.00	<b>XP-719</b>	33" x 24"	34	\$177.00	\$177.00
2	20"	Yes	53"	<b>*XP-702</b>	22" x 24"	33	168.00	163.00	<b>*XP-711</b>	30" x 24"	43	181.00	172.00	<b>XP-720</b>	33" x 24"	47	197.00	185.00
3	30"	No	30"	<b>*XP-703</b>	22" x 32"	31	163.00	170.00	<b>XP-712</b>	30" x 32"	40	200.00	209.00	<b>XP-721</b>	33" x 32"	44	222.00	192.00
3	30"	Yes	63"	<b>*XP-704</b>	22" x 32"	41	191.00	191.00	<b>XP-713</b>	30" x 32"	48	230.00	229.00	<b>XP-722</b>	33" x 32"	59	241.00	245.00
4	40"	No	40"	<b>XP-705</b>	22" x 37"	37	194.00	206.00	<b>XP-714</b>	30" x 37"	50	227.00	247.00	<b>XP-723</b>	33" x 37"	54	291.00	263.00
4	40"	Yes	73"	<b>XP-706</b>	22" x 37"	53	260.00	255.00	<b>XP-715</b>	30" x 37"	62	280.00	280.00	<b>XP-724</b>	33" x 37"	67	299.00	297.00
5	50"	Yes	83"	<b>XP-707</b>	22" x 44"	62	274.00	288.00	<b>XP-716</b>	32" x 44"	70	317.00	308.00	<b>XP-725</b>	33" x 44"	75	329.00	327.00
6	60"	Yes	93"	<b>XP-708</b>	28" x 55"	95	479.00	446.00	<b>XP-717</b>	32" x 55"	109	494.00	496.00	<b>XP-726</b>	36" x 55"	119	514.00	538.00
7	70"	Yes	103"	<b>XP-709</b>	28" x 62"	104	514.00	484.00	<b>XP-718</b>	32" x 62"	121	531.00	540.00	<b>XP-727</b>	36" x 62"	130	559.00	599.00

Weights may vary slightly.

\*No. of steps includes top platform. 2-, 3-, & 4-step (without handrails) shipped fully assembled.

### 8-16 STEPS. SPECIFY STEP: A - Perforated, B - Grip Strut®.

No. Steps	Platform Ht.	O.A. Ht.	Model Number	26" WIDE AT TOP				32" WIDE AT TOP				EXTRA-DEEP TOP PLATFORMS					
				Base W x D	Wt. Lbs.	Price Ea.		Model Number	Base W x D	Wt. Lbs.	Price Ea.		Model Number	Plat. Depth	Models	Price Ea.	
						(A)	(B)				(A)	(B)				(A)	(B)
8	80"	113"	<b>XP-728</b>	32" x 68"	130	\$518.00	\$597.00	<b>XP-737</b>	36" x 68"	142	\$654.00	\$786.00	<b>XP-746</b>	21"	2-7 steps	\$109.00	\$109.00
9	90"	123"	<b>XP-729</b>	32" x 76"	148	682.00	711.00	<b>XP-738</b>	36" x 76"	164	697.00	761.00	<b>XP-747</b>	28"	2-7 steps	163.00	163.00
10	100"	133"	<b>XP-730</b>	32" x 82"	164	686.00	747.00	<b>XP-739</b>	36" x 82"	182	790.00	794.00	<b>XP-748</b>	21"	8-11 steps	109.00	109.00
11	110"	143"	<b>XP-731</b>	32" x 90"	177	773.00	818.00	<b>XP-740</b>	36" x 90"	201	865.00	862.00	<b>XP-749</b>	28"	8-11 steps	163.00	163.00
12	120"	153"	<b>XP-732</b>	32" x 96"	209	868.00	843.00	<b>XP-741</b>	36" x 96"	223	896.00	891.00	<b>XP-750</b>	21"	12-16 steps	109.00	109.00
13	130"	173"	<b>XP-733</b>	40" x 103"	220	1095.00	1313.00	<b>XP-742</b>	40" x 103"	236	1028.00	1031.00	<b>XP-751</b>	28"	12-16 steps	163.00	163.00
14	140"	183"	<b>XP-734</b>	40" x 108"	233	1029.00	1337.00	<b>XP-743</b>	40" x 108"	248	1081.00	1102.00	Consult sales when ordering in conjunction with Products For Industry stock ladders.				
15	150"	193"	<b>XP-735</b>	40" x 115"	242	1114.00	1095.00	<b>XP-744</b>	40" x 115"	264	1404.00	1684.00					
16	160"	203"	<b>XP-736</b>	40" x 121"	355	1138.00	1119.00	<b>XP-745</b>	40" x 121"	282	1172.00	1110.00					

Weights may vary slightly.\*No. of steps includes top platform. 2-, 3-, & 4-step (without handrails) shipped fully assembled.

### OUTRIGGER. Meet CAL-OSHA Requirements (10-16-step)

Model No. **XV-3821** .....\$54.40

NOTE: Cal-OSHA requires 42"H handrails. Call for our selection.

# GILLIS Ladders



All our ladders meet OSHA and ANSI standards. **NOTE:** California and portions of areas may require special options such as higher handrails. Please check your local codes before ordering.



Selected Models

## Saf-T-Angle Safety Ladders

Safe 50° climbing angle lets workers turn around at top and descend facing forward. Assures maximum safety with any load. Rugged 1" steel tubing construction provides long lasting service. Double deep top step—other steps 7" deep. 350-lb. capacity. Conforms to OSHA and ANSI standards. Color: gray/green enamel finish. **SPECIFY STEP:** **A** - Perforated, **B** - Grip-Strut®. **SELECTED MODELS FACTORY QUICK SHIP.** All FOB ILLINOIS.

**OPTIONAL 42" HANDRAIL** (Factory installed only). Model No. **WK-705**—For 5-12-step ladders. Necessary to meet California OSHA standards.....**\$83.00**



5- TO 16-STEP LADDERS ARE PROTECTIVELY PACKAGED TO PREVENT DAMAGE DURING SHIPPING. PROTECTIVE PACKAGING ADDS TO PRODUCT WEIGHT. ONLY PRODUCT WEIGHT IS LISTED BELOW.

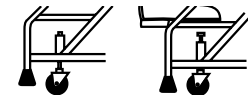

**FLOOR-GRIPPING MECHANISM FOR 2-4-STEP LADDERS—SPRING-LOADED CASTERS RETRACT AUTOMATICALLY UNDER INDIVIDUAL'S WEIGHT. WIDE BASE & DURABLE RUBBER TIPS GRIP FLOOR & SECURE THE LADDER.**

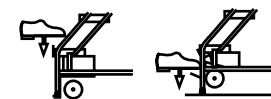

**SAF-T-LOCK IS STANDARD ON 6-12-STEP LADDERS. BOTTOM STEP RELEASES THE CASTER CARRIAGE, PUTS LEGS FIRMLY ON FLOOR. JUST ACTUATE FOOT PEDAL TO RAISE THE LADDER ONTO SWIVEL CASTERS FOR EASY ROLLING.**

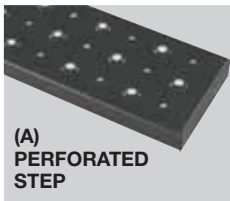

**(A) PERFORATED STEP**



**(B) GRIP-STRUT® STEP**

**50° SAF-T-ANGLE**

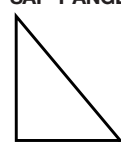

**60° STANDARD ANGLE**

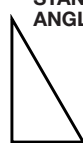

**TAPERED DESIGN FOR BETTER STABILITY.**

Step Qty.	Plat. Ht.	Rail Type	Overall Ht.	Model Number	Base W x D	Wt. Lbs.	(A)		Model Number	Base W x D	Wt. Lbs.	(B)		Model Number	Base W x D	Wt. Lbs.	(A)		(B)	
							Price Ea.	Price Ea.				Price Ea.	Price Ea.				Price Ea.	Price Ea.		
<b>2- TO 7-STEP</b>																				
<b>18" WIDE AT TOP</b>							<b>26" WIDE AT TOP</b>							<b>32" WIDE AT TOP</b>						
2	20"	None	20"	<b>XL-0196</b>	21" x 26"	24	<b>\$205.00</b>	<b>\$212.00</b>	<b>XK-693</b>	30" x 25"	32	<b>\$177.00</b>	<b>\$229.00</b>	<b>XL-0205</b>	33" x 25"	39	<b>\$220.00</b>	<b>\$264.00</b>		
2	20"	Hand	55"	<b>XL-0197</b>	22" x 25"	33	<b>210.00</b>	<b>251.00</b>	<b>XK-694</b>	30" x 25"	44	<b>227.00</b>	<b>272.00</b>	<b>XL-0206</b>	33" x 25"	58	<b>259.00</b>	<b>310.00</b>		
3	30"	None	30"	<b>XL-0198</b>	22" x 34"	36	<b>215.00</b>	<b>261.00</b>	<b>XK-695</b>	30" x 34"	40	<b>230.00</b>	<b>275.00</b>	<b>XL-0207</b>	33" x 34"	45	<b>275.00</b>	<b>330.00</b>		
3	30"	Hand	63"	<b>XL-0199</b>	22" x 35"	41	<b>238.00</b>	<b>283.00</b>	<b>XK-696</b>	30" x 34"	59	<b>258.00</b>	<b>310.00</b>	<b>XL-0208</b>	33" x 34"	64	<b>305.00</b>	<b>365.00</b>		
4	40"	None	40"	<b>XL-0200</b>	22" x 45"	45	<b>246.00</b>	<b>294.00</b>	<b>XK-697</b>	30" x 45"	55	<b>274.00</b>	<b>279.00</b>	<b>XL-0209</b>	33" x 45"	51	<b>306.00</b>	<b>431.00</b>		
4	40"	Hand	73"	<b>XL-0201</b>	22" x 45"	54	<b>255.00</b>	<b>327.00</b>	<b>XK-698</b>	30" x 45"	64	<b>322.00</b>	<b>366.00</b>	<b>XL-0210</b>	33" x 45"	68	<b>434.00</b>	<b>521.00</b>		
5	50"	Hand	85"	<b>XL-0202</b>	28" x 62"	84	<b>438.00</b>	<b>436.00</b>	<b>XK-699</b>	32" x 62"	100	<b>509.00</b>	<b>536.00</b>	<b>XL-0211</b>	36" x 62"	109	<b>484.00</b>	<b>583.00</b>		
6	60"	Hand	93"	<b>XL-0203</b>	28" x 68"	97	<b>513.00</b>	<b>548.00</b>	<b>XK-700</b>	32" x 68"	110	<b>578.00</b>	<b>620.00</b>	<b>XL-0212</b>	36" x 68"	128	<b>633.00</b>	<b>761.00</b>		
7	70"	Hand	103"	<b>XL-0204</b>	28" x 76"	107	<b>541.00</b>	<b>586.00</b>	<b>XK-701</b>	32" x 76"	131	<b>631.00</b>	<b>659.00</b>	<b>XL-0213</b>	36" x 76"	153	<b>689.00</b>	<b>830.00</b>		
<b>8- TO 12-STEP</b>																				
<b>18" WIDE AT TOP</b>							<b>26" WIDE AT TOP</b>							<b>32" WIDE AT TOP</b>						
8	80"	Hand	113"	—	—	—	—	—	<b>XK-702</b>	32" x 90"	147	<b>\$728.00</b>	<b>\$852.00</b>	<b>XL-0214</b>	36" x 90"	167	<b>\$806.00</b>	<b>\$968.00</b>		
9	90"	Hand	123"	—	—	—	—	—	<b>XK-703</b>	32" x 96"	156	<b>766.00</b>	<b>919.00</b>	<b>XL-0215</b>	36" x 96"	184	<b>862.00</b>	<b>1033.00</b>		
10	100"	Hand	133"	—	—	—	—	—	<b>XK-704</b>	32" x 103"	174	<b>846.00</b>	<b>1019.00</b>	<b>XL-0216</b>	36" x 103"	193	<b>972.00</b>	<b>1166.00</b>		
11	110"	Hand	143"	—	—	—	—	—	<b>XK-706</b>	32" x 115"	189	<b>872.00</b>	<b>1043.00</b>	<b>XL-0217</b>	36" x 115"	206	<b>1066.00</b>	<b>1278.00</b>		
12	120"	Hand	153"	—	—	—	—	—	<b>XK-707</b>	32" x 121"	201	<b>1031.00</b>	<b>1236.00</b>	<b>XL-0218</b>	36" x 121"	221	<b>1161.00</b>	<b>1395.00</b>		

NOTE: Step quantity includes top platform.

# EDSAL Bin Shelving



D



C



B



A



Key	Model Number	Overall WxDxH	Bin Qty./ Bin WxDxH	Wt. Lbs.	Price Each
<b>BIN SHELVING</b>					
A	<a href="#">XP-026</a>	36x12x85"	(14) 18x12x12"	115	<b>\$226.00</b>
A	<a href="#">XP-027</a>	36x18x85"	(14) 18x18x12"	141	<b>279.00</b>
A	<a href="#">XP-028</a>	36x24x85"	(14) 18x24x12"	179	<b>330.00</b>
B	<a href="#">XP-029</a>	36x12x85"	(21) 12x12x12"	124	<b>241.00</b>
B	<a href="#">XP-030</a>	36x18x85"	(21) 12x18x12"	154	<b>302.00</b>
B	<a href="#">XP-031</a>	36x24x85"	(21) 12x24x12"	195	<b>360.00</b>
C	<a href="#">XP-032</a>	36x12x85"	(16) 8x12x9" (16) 10x12x9" (2) 8x12x12" (2) 10x12x12"	146	<b>313.00</b>
C	<a href="#">XP-033</a>	36x18x85"	(16) 8x18x9" (16) 10x18x9" (2) 8x18x12" (2) 10x18x12"	188	<b>386.00</b>
C	<a href="#">XP-034</a>	36x24x85"	(16) 8x24x9" (16) 10x24x9" (2) 8x24x12" (2) 10x24x12"	239	<b>472.00</b>
D	<a href="#">XP-035</a>	36x12x85"	(12) 6x12x9" (66) 6x12x6"	186	<b>424.00</b>
D	<a href="#">XP-036</a>	36x18x85"	(12) 6x18x9" (66) 6x18x6"	248	<b>536.00</b>
D	<a href="#">XP-037</a>	36x24x85"	(12) 6x24x9" (66) 6x24x6"	331	<b>668.00</b>
E	<a href="#">XP-038</a>	36x12x85"	(6) 18x12x12" (3) 12x12x12" (12) 12x12x9"	126	<b>257.00</b>
E	<a href="#">XP-039</a>	36x18x85"	(6) 18x18x12" (3) 12x18x12" (12) 12x18x9"	158	<b>317.00</b>
E	<a href="#">XP-040</a>	36x24x85"	(6) 18x24x12" (3) 12x24x12" (12) 12x24x9"	201	<b>380.00</b>
F	<a href="#">XP-046</a>	36x12x85"	(6) 6x12x12" (48) 6x12x9"	165	<b>370.00</b>
<b>BIN DRAWER SHELVING. ALSO INCLUDES (18) 5-1/2"Wx4-5/8"H DRAWERS.</b>					
G	<a href="#">XP-044</a>	36x12x85"	(6) 12x12x12" (4) 18x12x9" (24) 6x12x6"	193	<b>522.00</b>
G	<a href="#">XP-045</a>	36x18x85"	(6) 12x18x12" (4) 18x18x9" (24) 6x18x6"	250	<b>635.00</b>

- Multiple bin sizes available
- Steel cabinet

Fully enclosed units can be used to build storage walls or wall partitions. Fast Kwik-Klip assembly; bin dividers adjust in 2" increments. Unassembled. Gray enamel finish. **IN STOCK.**

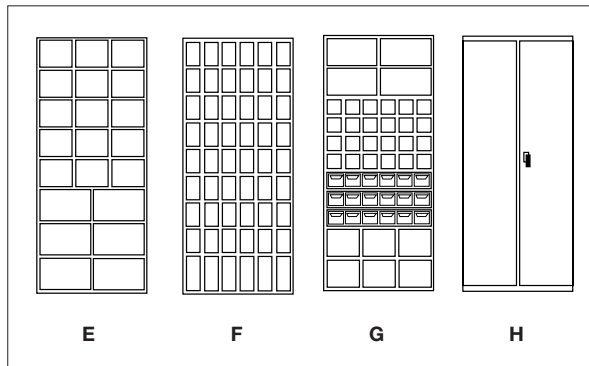

**H. DOUBLE SWING DOORS.** 180° swing, 3-point locking device. 20-gauge steel. Doors will not fit style G bin unit.

Model No. [XP-052](#)—Wt. 73 lbs.....**\$218.00**

# Square-Post Open Wire Shelving



- Shelves slide over split collets along notched posts
  - Up to 48"W shelf capacity: 1,000 lbs.  
60"W shelf capacity: 800 lbs.  
72"W shelf capacity: 500 lbs.
  - Zinc plating with lacquer coating
- 12-ga. solid steel frames.  
1" square tube posts are notched on 2" centers and dimpled every 6" to position shelves.
- IN STOCK.**



Shelf WxD	Overall Height	Shelf Cap. Lbs.	4-SHELF STARTER			4-SHELF ADD-ON		
			Model No.	Wt. Lbs.	Price Ea.	Model No.	Wt. Lbs.	Price Ea.
48x18"	64"	1,000	ZL-0364	78	\$225.00	ZL-0382	69	\$213.00
60x18"	64"	800	ZL-0365	90	257.00	ZL-0383	81	244.00
72x18"	64"	500	ZL-0366	104	285.00	ZL-0384	95	271.00
48x18"	72"	1,000	ZL-0367	80	234.00	ZL-0385	70	216.00
60x18"	72"	800	ZL-0368	92	265.00	ZL-0386	82	248.00
72x18"	72"	500	ZL-0369	106	292.00	ZL-0387	96	275.00
48x18"	84"	1,000	ZL-0370	82	246.00	ZL-0388	71	222.00
60x18"	84"	800	ZL-0371	94	276.00	ZL-0389	83	254.00
72x18"	84"	500	ZL-0372	108	304.00	ZL-0390	97	282.00
48x24"	64"	1,000	ZL-0373	92	267.00	ZL-0391	83	254.00
60x24"	64"	800	ZL-0374	110	333.00	ZL-0392	101	319.00
72x24"	64"	500	ZL-0375	126	370.00	ZL-0393	117	357.00
48x24"	72"	1,000	ZL-0376	94	274.00	ZL-0394	84	258.00
60x24"	72"	800	ZL-0377	112	340.00	ZL-0395	102	323.00
72x24"	72"	500	ZL-0378	128	377.00	ZL-0396	118	361.00
48x24"	84"	1,000	ZL-0379	96	287.00	ZL-0397	85	264.00
60x24"	84"	800	ZL-0380	114	352.00	ZL-0398	103	372.00
72x24"	84"	500	ZL-0381	130	390.00	ZL-0399	119	436.00

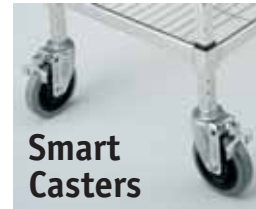

## Stem Casters

5" polyurethane casters. 300-lb. capacity.

Model No.	Type	Wt. Lbs.	Net Ea.
ZL-0427	Swivel	2-3/4"	\$37.30
ZL-0428	Rigid	2-3/4"	39.90
ZL-0429	Swivel/Brake	2-3/4"	41.00

## Smart Casters

Foot operated mechanism locks swivel caster into one of four rigid positions. Set of 4 casters—2 swivel and 2 smart.

Model No. **ZL-0431**—  
Wt. 12 lbs. ....\$165.00

## Extra Shelves

Shelf clips included. Sold in lots of 2.

Model No.	Overall W x D	Wt. Lbs.	Price Ea.
ZL-0403	36" x 18"	11	\$41.90
ZL-0405	48" x 18"	15	51.40
ZL-0407	60" x 18"	18	60.80
ZL-0408	72" x 18"	21-1/2	69.00
ZL-0411	36" x 24"	13-1/2	52.00
ZL-0413	48" x 24"	18-1/2	63.90
ZL-0415	60" x 24"	23	83.20
ZL-0416	72" x 24"	27	94.70



## Shelf Collets

Slide nylon collet down post and lock into place with a twist of the wrist. Slide shelf down post onto collets.

Model No. **ZL-0435**—  
Pkg. of 4. ....\$6.40



## 7"H Shelf Dividers

Order by shelf depth.

Model No.	Overall Depth	Wt. Lbs.	Price Ea.
ZL-0433	18"	1.5	\$6.40
ZL-0434	24"	2.0	8.00



## 6"H Shelf Ledges

Model Number	Overall Depth	Wt. Lbs.	Price Each
<b>SIDE LEDGES</b>			
ZL-0436	18"	0.5	\$4.90
ZL-0437	24"	0.75	7.70
<b>BACK/FRONT LEDGES</b>			
ZL-0441	36"	1.5	\$8.00
ZL-0443	48"	2.0	11.00
ZL-0444	60"	2.5	13.90
ZL-0445	72"	3.0	16.40



## Add-On Clip

To join adjacent shelves without posts. Two per shelf required.

Model No. **ZL-0490**.....\$1.40



# Chrome Open Wire Shelving



- Shelves slide over tapered post sleeves along double-notched 1" dia. posts
- Up to 48"W shelf capacity: 800 lbs.  
Over 48"W shelf capacity: 600 lbs.
- Chrome finish available

Shelves adjust on 1" centers. Starter units include 4 posts, 4 shelves, and 16 tapered post sleeves. Add-on units come complete with 2 posts, S-hooks, 4 shelves, and 8 tapered post sleeves. Add-on units can be attached end-to-end, back-to-back, or at right angles. **IN STOCK.**



4-SHELF STARTER AND ONE ADD-ON

### POST CLAMPS.

Joins shelving together to create large storage centers.

Model No. **ZA-3397** — ..\$4.50



### S-HOOKS

Add-on adjacent wire shelving units. Use two per shelf.

Model No. **ZC-1671** — ..\$2.90



TAPERED POST SLEEVES SNAP INTO PLACE



### FOOT PLATES.

Replaces leveling bolt. Attaches shelving to floor.

Model No. **ZA-3396** — ..\$8.60



### EXTRA TAPERED POST SLEEVES.

Snaps around post. Shelf load strengthens sleeve's grip.

Model No. **ZA-3398** — Pkg. of 4. ....\$5.40



### 4"H SHELF LEDGES.

- Model No. **ZA-3387** — 18"W Side Ledge. Wt. 1-1/2 lbs. ....\$12.10
- Model No. **ZA-3388** — 24"W Side Ledge. Wt. 2 lbs. ....\$13.50
- Model No. **ZA-3389** — 36"W Back Ledge. Wt. 2-3/4 lbs. ....\$17.50
- Model No. **ZA-3390** — 48"W Back Ledge. Wt. 3-3/4 lbs. ....\$21.90
- Model No. **ZA-3391** — 60"W Back Ledge. Wt. 4 lbs. ....\$23.40
- Model No. **ZA-3392** — 72"W Back Ledge. Wt. 5 lbs. ....\$28.10



### 7"H SHELF DIVIDERS.

- Model No. **ZA-3393** — 18"W. Wt. 2-1/4 lbs. ....\$15.00
- Model No. **ZA-3394** — 24"W. Wt. 2-3/4 lbs. ....\$32.00



Shelf WxD	Overall Height	4-SHELF STARTER			4-SHELF ADD-ON		
		Model No.	Wt. Lbs.	Net Ea.	Model No.	Wt. Lbs.	Net Ea.
36x18"	63"	<b>ZA-0280</b>	64	\$242.00	<b>ZA-0283</b>	55	\$258.00
48x18"	63"	<b>ZC-1673</b>	70	280.00	<b>ZC-1680</b>	61	295.00
60x18"	63"	<b>ZC-1674</b>	76	315.00	<b>ZC-1681</b>	67	329.00
72x18"	63"	<b>ZC-1675</b>	82	361.00	<b>ZC-1682</b>	73	377.00
36x18"	74"	<b>ZA-0281</b>	72	248.00	<b>ZA-0284</b>	59	259.00
48x18"	74"	<b>ZC-1633</b>	78	288.00	<b>ZC-1641</b>	65	297.00
60x18"	74"	<b>ZC-1635</b>	84	321.00	<b>ZC-1643</b>	71	332.00
72x18"	74"	<b>ZC-1637</b>	90	368.00	<b>ZC-1645</b>	77	379.00
36x18"	86"	<b>ZA-0282</b>	80	263.00	<b>ZA-0285</b>	63	271.00
48x18"	86"	<b>ZC-1649</b>	86	301.00	<b>ZC-1657</b>	69	306.00
60x18"	86"	<b>ZC-1651</b>	92	334.00	<b>ZC-1659</b>	74	341.00
72x18"	86"	<b>ZC-1653</b>	98	382.00	<b>ZC-1661</b>	81	387.00
36x24"	63"	<b>ZC-1676</b>	66	287.00	<b>ZC-1683</b>	57	302.00
48x24"	63"	<b>ZC-1677</b>	70	330.00	<b>ZC-1684</b>	61	345.00
60x24"	63"	<b>ZC-1678</b>	76	379.00	<b>ZC-1685</b>	67	395.00
72x24"	63"	<b>ZC-1679</b>	84	438.00	<b>ZC-1686</b>	75	453.00
36x24"	74"	<b>ZC-1632</b>	74	293.00	<b>ZC-1640</b>	61	305.00
48x24"	74"	<b>ZC-1634</b>	78	337.00	<b>ZC-1642</b>	65	350.00
60x24"	74"	<b>ZC-1636</b>	84	385.00	<b>ZC-1644</b>	71	399.00
72x24"	74"	<b>ZC-1638</b>	92	445.00	<b>ZC-1646</b>	79	456.00
36x24"	86"	<b>ZC-1648</b>	82	307.00	<b>ZC-1656</b>	65	312.00
48x24"	86"	<b>ZC-1650</b>	86	352.00	<b>ZC-1658</b>	69	356.00
60x24"	86"	<b>ZC-1652</b>	92	401.00	<b>ZC-1660</b>	75	406.00
72x24"	86"	<b>ZC-1654</b>	100	459.00	<b>ZC-1662</b>	83	463.00

EXTRA SHELVES			
Model No.	Overall WxD	Wt. Lbs.	Price Ea.
<b>ZA-0286</b>	36x18"	11	\$45.20
<b>ZA-0287</b>	48x18"	12.5	54.60
<b>ZA-0288</b>	60x18"	14	63.60
<b>ZA-0289</b>	72x18"	15.5	76.20

EXTRA SHELVES			
Model No.	Overall WxD	Wt. Lbs.	Price Ea.
<b>ZA-0290</b>	36x24"	11.5	\$56.40
<b>ZA-0291</b>	48x24"	12.5	68.10
<b>ZA-0292</b>	60x24"	14.5	80.50
<b>ZA-0293</b>	72x24"	16	95.80

# EDSAL Commercial-Grade Shelving



75" HIGH OPEN UNIT  
SHOWN IN GRAY



75" HIGH CLOSED UNIT  
SHOWN IN GRAY

KWIK-KLIP  
CONSTRUCTION  
SAVES SET-UP TIME

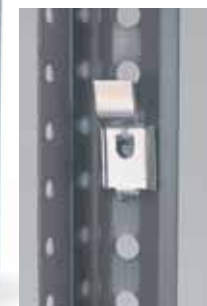

EXTRA SHELF CLIP

Model No. **XV-100**  
.....\$0.42



- Shelves attach to posts via Kwik-Klips
- Shelf capacity: 400 lbs.
- 16-24 gauge steel uprights; 22-gauge steel shelves

Rigid, box-formed shelves adjust on 1" centers. Units include shelves, four corner posts, back and side braces, back and side panels (on closed-type units), and all hardware. Ships unassembled. Baked enamel finish. **SPECIFY COLOR: GY - Gray, TN - Tan. IN STOCK.**

Shelf WxD	Shelf Qty.	75"H OPEN SHELVING			85"H OPEN SHELVING			75"H CLOSED SHELVING			85"H CLOSED SHELVING		
		Model No.	Wt. Lbs.	Price Ea.	Model No.	Wt. Lbs.	Price Ea.	Model No.	Wt. Lbs.	Price Ea.	Model No.	Wt. Lbs.	Price Ea.
36x12"	5	<a href="#">XV-029</a>	42	\$76.70	<a href="#">XV-057</a>	46	\$92.40	<a href="#">XV-045</a>	74	\$131.00	<a href="#">XV-073</a>	81	\$161.00
36x12"	6	<a href="#">XV-030</a>	47	86.50	<a href="#">XV-058</a>	51	104.00	<a href="#">XV-046</a>	79	140.00	<a href="#">XV-074</a>	87	170.00
36x12"	7	<a href="#">XV-031</a>	52	95.90	<a href="#">XV-059</a>	56	114.00	<a href="#">XV-047</a>	84	149.00	<a href="#">XV-075</a>	92	179.00
36x12"	8	<a href="#">XV-032</a>	57	108.00	<a href="#">XV-060</a>	61	124.00	<a href="#">XV-048</a>	89	159.00	<a href="#">XV-076</a>	98	189.00
36x15"	5	<a href="#">XV-033</a>	47	86.50	<a href="#">XV-061</a>	52	104.00	—	—	—	—	—	
36x15"	6	<a href="#">XV-034</a>	54	98.10	<a href="#">XV-062</a>	58	117.00	—	—	—	—	—	
36x15"	7	<a href="#">XV-035</a>	60	111.00	<a href="#">XV-063</a>	64	127.00	—	—	—	—	—	
36x15"	8	<a href="#">XV-036</a>	66	124.00	<a href="#">XV-064</a>	70	139.00	—	—	—	—	—	
36x18"	5	<a href="#">XV-037</a>	45	97.50	<a href="#">XV-065</a>	49	115.00	<a href="#">XV-049</a>	83	161.00	<a href="#">XV-077</a>	99	191.00
36x18"	6	<a href="#">XV-038</a>	50	112.00	<a href="#">XV-066</a>	54	128.00	<a href="#">XV-050</a>	88	174.00	<a href="#">XV-078</a>	107	206.00
36x18"	7	<a href="#">XV-039</a>	56	126.00	<a href="#">XV-067</a>	60	141.00	<a href="#">XV-051</a>	94	187.00	<a href="#">XV-079</a>	114	218.00
36x18"	8	<a href="#">XV-040</a>	61	139.00	<a href="#">XV-068</a>	65	155.00	<a href="#">XV-052</a>	99	202.00	<a href="#">XV-080</a>	122	232.00
36x24"	5	<a href="#">XV-041</a>	64	126.00	<a href="#">XV-069</a>	68	141.00	<a href="#">XV-053</a>	108	197.00	<a href="#">XV-081</a>	114	228.00
36x24"	6	<a href="#">XV-042</a>	73	144.00	<a href="#">XV-070</a>	77	159.00	<a href="#">XV-054</a>	117	216.00	<a href="#">XV-082</a>	123	245.00
36x24"	7	<a href="#">XV-043</a>	82	162.00	<a href="#">XV-071</a>	86	177.00	<a href="#">XV-055</a>	126	233.00	<a href="#">XV-083</a>	131	263.00
36x24"	8	<a href="#">XV-044</a>	91	179.00	<a href="#">XV-072</a>	95	194.00	<a href="#">XV-056</a>	135	250.00	<a href="#">XV-084</a>	140	280.00

EXTRA SHELVES. SPECIFY COLOR: GY - Gray, TN - Tan.

Model No. **XV-085**—  
36"Wx12"D. Wt. 5 lbs. ....\$10.20

Model No. **XV-086**—  
36"Wx15"D. Wt. 6 lbs. ....\$12.00

Model No. **XV-087**—  
36"Wx18"D. Wt. 6 lbs. ....\$13.80

Model No. **XV-088**—  
36"Wx24"D. Wt. 9 lbs. ....\$18.20

# EDSAL HeviLoad Plus II Open-Style Shelving



**EXTRA SHELF CLIPS.** with 2-point suspension. Locking feature reinforces corners to reduce lateral movement. Once the clip and shelf are in place, the corner becomes completely closed.

Model No. **XP-092** .....\$0.57



**BOX BEAM DESIGN REINFORCES THE EDGES OF EACH SHELF TO PROVIDE EXTRA CAPACITY. ADDITIONAL RIBBING ADDS SHELF STRENGTH AND REDUCES SURFACE DEFLECTION.**

**SHELF CLIPS INCLUDED WITH EACH SHELF FOR FASTER INSTALLATION AND EASIER SHELF RELOCATION.**



- Shelves connect to posts via compression-type shelf clips
- Shelf capacity: up to 1,100 lbs.
- 14-gauge steel uprights
- 18-, 20-, or 22-gauge steel shelves

Box-beam-type ribbed shelves adjust on 1" centers. L-shape posts. Includes 4 shelf clips per shelf, back braces, and side braces. Phosphatized gray enamel finish. Ships unassembled. **SPECIFY SHELVES: A** - 22-gauge shelves, **B** - 20-gauge shelves, **C** - 18-gauge shelves. **IN STOCK.**

85"H OPEN SHELVING											
Shelf WxD	Shelf Qty.	Model Number	A - 22-GAUGE SHELVES			B - 20-GAUGE SHELVES			C - 18-GAUGE SHELVES		
			Shelf Cap. Lbs.	Wt. Lbs.	Price Ea.	Shelf Cap. Lbs.	Wt. Lbs.	Price Ea.	Shelf Cap. Lbs.	Wt. Lbs.	Price Ea.
36x12"	5	XP-093	600	56	\$99.00	725	61	\$105.00	975	66	\$126.00
36x12"	6	XP-094	600	62	111.00	725	68	117.00	975	75	141.00
36x12"	7	XP-095	600	68	121.00	725	75	128.00	975	85	157.00
36x12"	8	XP-096	600	74	132.00	725	82	140.00	975	94	173.00
36x18"	5	XP-097	600	66	119.00	750	73	127.00	1,050	90	152.00
36x18"	6	XP-098	600	74	134.00	750	83	143.00	1,050	102	173.00
36x18"	7	XP-099	600	82	148.00	750	92	158.00	1,050	115	192.00
36x18"	8	XP-100	600	90	162.00	750	102	173.00	1,050	128	212.00
36x24"	5	XP-101	600	79	141.00	775	94	150.00	1,100	109	179.00
36x24"	6	XP-102	600	89	159.00	775	107	170.00	1,100	125	206.00
36x24"	7	XP-103	600	99	177.00	775	120	189.00	1,100	141	231.00
36x24"	8	XP-104	600	109	194.00	775	133	209.00	1,100	157	256.00
48x12"	5	XP-105	350	66	119.00	525	73	127.00	600	88	152.00
48x12"	6	XP-106	350	74	134.00	525	82	142.00	600	100	172.00
48x12"	7	XP-107	350	82	148.00	525	92	158.00	600	113	192.00
48x12"	8	XP-108	350	90	163.00	525	101	173.00	600	125	213.00
48x18"	5	XP-109	350	78	140.00	540	91	149.00	650	108	178.00
48x18"	6	XP-110	350	89	158.00	540	104	169.00	650	125	203.00
48x18"	7	XP-111	350	99	176.00	540	117	188.00	650	141	230.00
48x18"	8	XP-112	350	110	194.00	540	130	208.00	650	158	254.00
48x24"	5	XP-113	350	94	171.00	550	85	182.00	700	133	218.00
48x24"	6	XP-114	350	107	194.00	550	102	209.00	700	153	250.00
48x24"	7	XP-115	350	120	218.00	550	119	233.00	700	174	285.00
48x24"	8	XP-116	350	133	240.00	550	136	260.00	700	195	317.00

\*Shelf capacities are based on evenly distributed loads.

# EDSAL HeviLoad Plus II Closed-Style Shelving



**EXTRA SUPER-GRIP SHELF CLIPS.** with 2-point suspension. Locking feature reinforces corners to reduce lateral movement. Once the clip and shelf are in place, the corner becomes completely closed.

Model No. **XP-092** .....\$0.57



**BOX BEAM DESIGN REINFORCES THE EDGES OF EACH SHELF TO PROVIDE EXTRA CAPACITY. ADDITIONAL RIBBING ADDS SHELF STRENGTH AND REDUCES SURFACE DEFLECTION.**



- Shelves connect to posts via compression-type shelf clips
- Shelf capacity: up to 1,100 lbs.
- 14-gauge steel uprights
- 18-, 20-, or 22-gauge steel shelves

Box-beam-type ribbed shelves adjust on 1" centers. L-shape posts. Includes 4 shelf clips per shelf and 24-ga. side and back panels. Phosphatised gray enamel finish. Ships unassembled. **SPECIFY SHELVES: A** - 22-gauge shelves, **B** - 20-gauge shelves, **C** - 18-gauge shelves. **IN STOCK.**

Shelf WxD	Shelf Qty.	Model Number	85"H CLOSED SHELVING								
			A - 22-GAUGE SHELVES			B - 20-GAUGE SHELVES			C - 18-GAUGE SHELVES		
			Shelf Cap. Lbs.	Wt. Lbs.	Price Ea.	Shelf Cap. Lbs.	Wt. Lbs.	Price Ea.	Shelf Cap. Lbs.	Wt. Lbs.	Price Ea.
36x12"	5	XP-117	600	90	\$161.00	725	95	\$166.00	975	107	\$186.00
36x12"	6	XP-118	600	96	172.00	725	102	177.00	975	117	203.00
36x12"	7	XP-119	600	102	181.00	725	109	188.00	975	126	217.00
36x12"	8	XP-120	600	108	191.00	725	116	200.00	975	136	232.00
36x18"	5	XP-121	600	106	189.00	750	113	196.00	1,050	130	220.00
36x18"	6	XP-122	600	114	203.00	750	123	211.00	1,050	142	240.00
36x18"	7	XP-123	600	122	217.00	750	132	226.00	1,050	155	261.00
36x18"	8	XP-124	600	130	231.00	750	142	241.00	1,050	168	280.00
36x24"	5	XP-125	600	126	216.00	775	141	225.00	1,100	156	254.00
36x24"	6	XP-126	600	136	233.00	775	154	244.00	1,100	172	278.00
36x24"	7	XP-127	600	146	252.00	775	167	264.00	1,100	188	305.00
36x24"	8	XP-128	600	156	269.00	775	180	283.00	1,100	204	329.00
48x12"	5	XP-129	350	100	184.00	525	107	191.00	600	122	216.00
48x12"	6	XP-130	350	108	199.00	525	117	207.00	600	135	235.00
48x12"	7	XP-131	350	116	212.00	525	126	222.00	600	147	258.00
48x12"	8	XP-132	350	124	227.00	525	136	238.00	600	160	277.00
48x18"	5	XP-133	350	118	211.00	540	131	220.00	650	148	248.00
48x18"	6	XP-134	350	129	230.00	540	144	239.00	650	165	275.00
48x18"	7	XP-135	350	139	247.00	540	157	260.00	650	181	299.00
48x18"	8	XP-136	350	150	265.00	540	170	278.00	650	198	325.00
48x24"	5	XP-137	350	141	247.00	550	161	260.00	700	180	294.00
48x24"	6	XP-138	350	154	271.00	550	178	285.00	700	200	328.00
48x24"	7	XP-139	350	167	293.00	550	195	310.00	700	221	361.00
48x24"	8	XP-140	350	180	317.00	550	212	336.00	700	242	393.00

\*Shelf capacities are based on evenly distributed loads.

# PENCO Premium Industrial Shelving



**EXTRA SHELF CLIP**



- Shelves connect to posts via Clipper® compression clips
- Shelf capacity: up to 1,250 lbs.

Begin row with complete starter unit and connect add-on units to extend row. Shelves feature welded tubular front and rear edges with double flanged sides for extra strength. Shelves adjust on 1" centers. Common front box post cuts assembly time when connecting two or more units. Extra shelves include clips. Color: gray. **IN STOCK.**

Shelf WxD	Shelf Cap. Lbs.	87"H OPEN SHELVING						87"H CLOSED SHELVING						EXTRA SHELVES		
		5-SHELF STARTER			5-SHELF ADD-ON			5-SHELF STARTER			5-SHELF ADD-ON			Model Number	Wt. Lbs.	Price Each
		Model No.	Wt. Lbs.	Price Ea.	Model No.	Wt. Lbs.	Price Ea.	Model No.	Wt. Lbs.	Price Ea.	Model No.	Wt. Lbs.	Price Ea.			
<b>20-GAUGE SHELVES WITH 14-GAUGE POSTS. Heavy-duty high-strength steel.</b>																
36x12"	800	<a href="#">XP-053</a>	76	\$167.00	<a href="#">XP-053A</a>	62	\$145.00	<a href="#">XP-065</a>	98	\$230.00	<a href="#">XP-065A</a>	84	\$207.00	<a href="#">XP-077</a>	7	\$17.90
36x18"	850	<a href="#">XP-054</a>	88	189.00	<a href="#">XP-054A</a>	74	164.00	<a href="#">XP-066</a>	116	262.00	<a href="#">XP-066A</a>	98	234.00	<a href="#">XP-078</a>	10	21.90
36x24"	900	<a href="#">XP-055</a>	99	209.00	<a href="#">XP-055A</a>	85	184.00	<a href="#">XP-067</a>	133	292.00	<a href="#">XP-067A</a>	112	261.00	<a href="#">XP-079</a>	12	25.90
48x12"	500	<a href="#">XP-056</a>	82	192.00	<a href="#">XP-056A</a>	73	169.00	<a href="#">XP-068</a>	116	279.00	<a href="#">XP-068A</a>	102	256.00	<a href="#">XP-080</a>	9	22.80
48x18"	525	<a href="#">XP-057</a>	97	235.00	<a href="#">XP-057A</a>	88	211.00	<a href="#">XP-069</a>	138	330.00	<a href="#">XP-069A</a>	119	306.00	<a href="#">XP-081</a>	12	31.20
48x24"	550	<a href="#">XP-058</a>	112	265.00	<a href="#">XP-058A</a>	103	241.00	<a href="#">XP-070</a>	158	371.00	<a href="#">XP-070A</a>	137	344.00	<a href="#">XP-082</a>	15	37.70
<b>18-GAUGE SHELVES WITH 14-GAUGE POSTS. Extra heavy-duty high strength steel.</b>																
36x12"	1,100	<a href="#">XP-059</a>	89	\$194.00	<a href="#">XP-059A</a>	75	\$171.00	<a href="#">XP-071</a>	110	\$256.00	<a href="#">XP-071A</a>	96	\$235.00	<a href="#">XP-083</a>	10	\$22.00
36x18"	1,200	<a href="#">XP-060</a>	106	218.00	<a href="#">XP-060A</a>	92	194.00	<a href="#">XP-072</a>	133	291.00	<a href="#">XP-072A</a>	116	266.00	<a href="#">XP-084</a>	13	24.50
36x24"	1,250	<a href="#">XP-061</a>	121	247.00	<a href="#">XP-061A</a>	107	222.00	<a href="#">XP-073</a>	155	332.00	<a href="#">XP-073A</a>	134	302.00	<a href="#">XP-085</a>	16	29.20
48x12"	750	<a href="#">XP-062</a>	101	227.00	<a href="#">XP-062A</a>	91	202.00	<a href="#">XP-074</a>	134	312.00	<a href="#">XP-074A</a>	120	291.00	<a href="#">XP-086</a>	13	26.50
48x18"	900	<a href="#">XP-063</a>	103	265.00	<a href="#">XP-063A</a>	95	241.00	<a href="#">XP-075</a>	141	360.00	<a href="#">XP-075A</a>	123	340.00	<a href="#">XP-087</a>	17	29.60
48x24"	900	<a href="#">XP-064</a>	111	306.00	<a href="#">XP-064A</a>	102	281.00	<a href="#">XP-076</a>	187	410.00	<a href="#">XP-076A</a>	187	388.00	<a href="#">XP-088</a>	21	39.90

Capacities are based on evenly distributed loads with a 1.65 safety factor.

## EXTRA SHELF CLIPS.

Model No. [XP-089](#) — .....\$0.28 per clip

## OPTIONAL FRONT BASE STRIPS.

Model No. [XP-090](#) — 36" wide.....\$5.00  
 Model No. [XP-091](#) — 48" wide.....\$6.40

# PENCO Rivet-Rite™ Single-Rivet Bulk Storage Shelving



**6-SHELF SINGLE-RIVET STARTER AND ADD-ON UNIT WITH DECKING.**



**ASSEMBLY IS SIMPLE. JUST INSERT SHELF RIVETS INTO ADJACENT TEE OR ANGLE POST SLOTS. TEE POSTS ARE USED TO ADD-ON EXTRA UNITS. ANGLE POSTS FORM UNIT'S CORNERS.**



**COMPLETE SHELVING UNITS WITHOUT DECKING.** All complete units are 84"H. Starters include 4 angle posts for beginning and ending rows. Add-ons include 2 T-posts to join add-ons to starter or other add-on units.

Shelf WxD	Shelf Cap. Lbs.	Shelf Qty.	STARTER			ADD-ON		
			Model Number	Wt. Lbs.	Price Each	Model Number	Wt. Lbs.	Price Each
<b>STANDARD CAPACITY</b>								
36x12"	350	6	XV-2623	46	\$102.00	XV-2624	42	\$87.10
36x18"	350	6	XV-2625	48	105.00	XV-2626	43	88.70
36x24"	350	6	XV-2627	50	107.00	XV-2628	44	90.50
48x12"	250	6	XV-2629	53	111.00	XV-2630	48	96.90
48x18"	250	6	XV-2631	55	115.00	XV-2632	49	98.00
48x24"	250	6	XV-2633	56	119.00	XV-2634	50	100.00
<b>EXTRA CAPACITY</b>								
36x12"	600	6	XV-2649	59	\$117.00	XV-2650	55	\$108.00
36x18"	600	6	XV-2651	61	123.00	XV-2652	56	117.00
36x24"	600	6	XV-2653	63	128.00	XV-2654	57	120.00
48x12"	500	6	XV-2655	70	131.00	XV-2656	65	123.00
48x18"	500	6	XV-2657	72	138.00	XV-2658	66	131.00
48x24"	500	6	XV-2659	73	141.00	XV-2660	67	135.00

NOTE: Purchase decking separately.

**UPRIGHTS.** Combine with shelving to build your own custom storage unit.

Overall Height	ANGLE POST - 1-1/2"W			TEE POST - 3"W		
	Model No.	Wt. Lbs.	Price Ea.	Model No.	Wt. Lbs.	Price Ea.
60"	XV-2641	3.4	\$7.20	XV-2642	6.2	\$11.80
84"	XV-2643	4.8	9.80	XV-2644	8.6	15.50
96"	XV-2645	5.5	11.00	XV-2646	9.9	17.60
120"	XV-2647	6.8	13.80	XV-2648	12.3	21.30

NOTE: Purchase decking separately.

**5/8" PARTICLEBOARD DECKING.** Completes custom shelving unit. 36"W supports 350 lbs. while 48"W holds 250 lbs.

Model Number	For Shelf WxD	Wt. Lbs.	Price Each	Model Number	For Shelf WxD	Wt. Lbs.	Price Each
XV-2673	36x12"	7	\$8.30	XV-2676	48x12"	9	\$8.30
XV-2674	36x18"	10-1/2	10.20	XV-2677	48x18"	14	10.20
XV-2675	36x24"	14	13.40	XV-2678	48x24"	19	13.40

- Shelves attach to posts via a boltless single-rivet connection
  - Shelf capacity: up to 600 lbs.
  - Particleboard decking is sold separately
- Safe, economical storage for virtually any kind of hand-loaded material. Top and bottom shelves connect with double rivets. Common T-post between starters and add-ons. Shelves adjust on 1-1/2" centers. Light putty baked-on finish. Optional heavy-duty single-rivet beams available (or make your own custom units using 60", 96", or 120" high uprights). **IN STOCK.**

**SHELVES WITHOUT DECKING.** Combine with uprights to build your own custom unit. Double-rivet shelves must be used at top and bottom with single-rivet shelves in between. Can be built using all double-rivet shelves if necessary.

Model No.	Overall WxD	Wt. Lbs.	Price Each
<b>STANDARD CAPACITY SINGLE-RIVET</b>			
XV-2635	36x12"	4.4	\$10.10
XV-2636	36x18"	5.0	11.60
XV-2637	36x24"	5.4	12.00
XV-2638	48x12"	5.4	11.00
XV-2639	48x18"	6.0	12.70
XV-2640	48x24"	6.4	13.10
<b>EXTRA CAPACITY SINGLE-RIVET</b>			
XV-2661	36x12"	7	\$13.30
XV-2662	36x18"	8	14.70
XV-2663	36x24"	9	15.40
XV-2664	48x12"	10	15.40
XV-2665	48x18"	11	16.90
XV-2666	48x24"	12	17.70
<b>DOUBLE-RIVET</b>			
XV-2667	36x12"	6	\$16.30
XV-2668	36x18"	7	17.60
XV-2669	36x24"	8	18.50
XV-2670	48x12"	8	19.50
XV-2671	48x18"	9	20.80
XV-2672	48x24"	10	21.40

NOTE: Purchase decking separately.

# PENCO Rivet-Rite™ Double-Rivet Bulk Storage Shelving

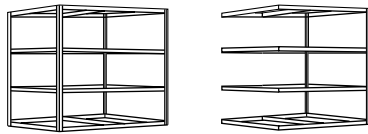

**STARTER**

**ADD-ON**

**EXAMPLE: One starter and one add-on.**  
 Starter and add-on units are combined to form rows of shelving. Each add-on unit includes a pair of tee posts which are used in common between units. Begin each row with two angle posts from the starter unit and join the desired number of add-on units to complete the row. Finish the last unit with a pair of angle posts from the starter unit.



**EASY ASSEMBLY—ALL YOU NEED IS A RUBBER Mallet.**



- Shelves attach to posts via a boltless double-rivet connection
- Shelf capacity: up to 1,400 lbs.
- Wire or particleboard decking

Stores retail, wholesale, or industrial goods. Starter and add-ons include four shelves that adjust in 1-1/2" increments. Roll-formed steel framing with chip-resistant baked enamel finish. **IN STOCK.**



**ORDER DECKING SEPARATELY**



## 84"H COMPLETE 4-SHELF UNIT

Shelf W x D	4-SHELF UNIT WITHOUT WIRE DECKING						4-SHELF UNIT WITH WIRE DECKING							
	STARTER			ADD-ON			STARTER			ADD-ON				
	Shelf Cap.	Model No.	Wt. Lbs.	Price Ea.	Model No.	Wt. Lbs.	Price Ea.	Shelf Cap.	Model No.	Wt. Lbs.	Price Ea.	Model No.	Wt. Lbs.	Price Ea.
48x24"	750 lbs.*	YP-221	63.4	\$130.00	YP-230	61.6	\$149.00	1,400 lbs.*	YM-2432	147	\$247.00	YM-2441	145	\$248.00
72x24"	500 lbs.*	YP-222	78.1	143.00	YP-231	75.3	183.00	900 lbs.*	YM-2433	186	299.00	YM-2442	184	290.00
96x24"	300 lbs.*	YP-223	91.2	172.00	YP-232	90.4	178.00	600 lbs.*	YM-2434	227	408.00	YM-2443	225	402.00
48x36"	750 lbs.*	YP-224	69.2	138.00	YP-233	67.4	150.00	1,400 lbs.*	YM-2435	201	297.00	YM-2444	199	288.00
72x36"	500 lbs.*	YP-225	83.9	173.00	YP-234	82.1	143.00	900 lbs.*	YM-2436	256	350.00	YM-2445	254	343.00
96x36"	300 lbs.*	YP-226	97.4	165.00	YP-235	95.6	163.00	600 lbs.*	YM-2437	313	476.00	YM-2446	311	467.00
48x48"	750 lbs.*	YP-227	75.6	140.00	YP-236	79.1	156.00	1,400 lbs.*	YM-2438	268	354.00	YM-2447	266	344.00
72x48"	500 lbs.*	YP-228	89.8	154.00	YP-237	88.0	192.00	900 lbs.*	YM-2439	346	410.00	YM-2448	344	401.00
96x48"	300 lbs.*	YP-229	103.3	181.00	YP-238	101.5	185.00	600 lbs.*	YM-2440	341	577.00	YM-2449	339	568.00

\*Capacities are for the steel beams without center supports and decking. To double capacity, add recommended center supports.

## COMPONENTS

**EXTRA SHELVES.** Particleboard decking sold separately.

Overall WxD	STANDARD SHELVING				SHELVING WITH HEAVY-DUTY C-CHANNEL (3"H X 1"D)			
	Model No.	Capacity	Wt. Lbs.	Price Ea.	Model No.	Capacity	Wt. Lbs.	Price Ea.
48x24"	YP-251	750 lbs.	10.8	\$21.40	—	—	—	—
72x24"	YP-252	500 lbs.	14.6	26.80	YP-261	925 lbs.	17.6	\$32.70
96x24"	YP-253	300 lbs.	18.2	33.00	YP-262	700 lbs.	22.4	40.90
48x36"	YP-254	750 lbs.	12.2	24.30	—	—	—	—
72x36"	YP-255	500 lbs.	16.0	29.60	YP-264	925 lbs.	19.0	35.40
96x36"	YP-256	300 lbs.	19.6	35.70	YP-265	700 lbs.	23.8	43.70
48x48"	YP-257	750 lbs.	13.8	27.30	—	—	—	—
72x48"	YP-258	500 lbs.	17.6	32.80	YP-267	925 lbs.	20.6	38.40
96x48"	YP-259	300 lbs.	21.2	39.00	YP-268	700 lbs.	25.4	46.90

**5/8" PARTICLEBOARD DECKING.** 45-lb. density industrial grade. 72" and 96" boards are shipped in 2 pieces.

Model No.	For Shelf WxD	Capacity	Wt. Lbs.	Price Ea.
YP-239	48x24"	700 lbs.*	19	\$22.10
YP-240	48x36"	755 lbs.*	28	24.70
YP-241	48x48"	920 lbs.*	38	31.50
YP-242	72x24"	770 lbs.*	28-1/4	25.40
YP-243	72x36"	655 lbs.*	44	40.20
YP-244	72x48"	685 lbs.*	56	43.50
YP-245	96x24"	1,000 lbs.*	38	31.00
YP-246	96x36"	710 lbs.*	56	43.50
YP-247	96x48"	650 lbs.*	76	61.70

\*With center support.

**UPRIGHTS.** Design your system (order shelves and decking separately).

Overall Height	ANGLE POSTS 1-1/2"W			TEE POSTS 3"W		
	Model No.	Wt. Lbs.	Price Ea.	Model No.	Wt. Lbs.	Price Ea.
60"	YP-269	3.4	\$7.50	YP-273	6.2	\$12.20
84"	YP-270	4.8	10.20	YP-274	8.6	16.10
96"	YP-271	5.5	11.40	YP-275	9.9	18.20
120"	YP-272	6.8	14.20	YP-276	12.3	22.00

**CENTER SUPPORTS.** Order one per pair of 48" or 72" beams. 2 for 96" beams. Sold only in pkg. of 4.

Model No.	For Shelf Depth	Wt. Lbs.	Pkg. Price
YP-248	24"	8.2	\$24.70
YP-249	36"	11.8	29.30
YP-250	48"	15	35.60

# Industrial Shelving



A



B

## A. TENNSCO Stur-D-Stor Steel Shelving



- Double-rivet boltless shelf connection
- Shelf capacity: 1,000 lbs.
- 14-gauge steel posts; 16-gauge steel shelf supports

Shelves snap easily into uprights. 5/8" thick particleboard shelves adjust in 1-1/2" increments. Can be assembled as a 5-shelf unit or as two separate units (one two-shelf and one three-shelf). Color: sand.

Ships unassembled.

Model Number	Shelf WxD	Overall Height	Shelf Qty.	Wt. Lbs.	Price Each
YP-3020	36x12"	72"	5	80	\$105.00
YP-3021	36x18"	72"	5	88	114.00
YP-3022	48x24"	84"	5	142	152.00

IN STOCK.

## B. TENNSCO Commercial Steel Shelving



- Boltless shelf connection
- Shelf capacity: 250 lbs.
- 16-gauge posts; 22-gauge shelves

End plates and back braces enhance rigidity. Includes 5 shelves that adjust in 1" increments. Medium gray powder coat finish. Ships unassembled.

### SHELVING

Model Number	Shelf WxD	Overall Height	Shelf Qty.	Wt. Lbs.	Price Each
YP-3023	36x12"	75"	5	48	\$92.90
YP-3024	36x18"	75"	5	61	114.00
YP-3025	36x24"	75"	5	73	131.00

### EXTRA SHELVES

Model Number	Overall WxD	Wt. Lbs.	Price Each
YP-3026	36x12"	6	\$12.40
YP-3027	36x18"	8	15.10
YP-3028	36x24"	11	19.20

IN STOCK.



48"Wx20"Dx60"H  
ALL-WELDED  
ALUMINUM  
SHELVING



48"Wx24"Dx76"H  
ALUMINUM SHELVING  
WITH SOLID  
ADJUSTABLE SHELVES

### ALL-WELDED ALUMINUM SHELVING

- Aluminum
- 1,500-lb. capacity per shelf
- Welded shelves

Shelves feature 1-3/4" x 1-1/2" open cross tubes. All-welded. FOB CALIFORNIA, GEORGIA, PENNSYLVANIA, TEXAS.

Model Number	Shelf WxD	Overall Height	Shelf Clearance	Shelf Qty.	Wt. Lbs.	Price Each
YA-7801	48x20"	60"	22-1/2"	3	26	\$342.00
YA-7802	48x24"	60"	22-1/2"	3	29	393.00
YA-7803	60x20"	60"	22-1/2"	3	36	388.00
YA-7804	60x24"	60"	22-1/2"	3	40	497.00

SHELVES ARE ADJUSTABLE; TIGHTEN TO POST WITH ALLEN WRENCH/HEX KEY.

SOLID SHELVES ARE REINFORCED WITH ALUMINUM CROSS MEMBERS.

ALL-WELDED FIXED SHELVING.



## WIN-HOLT Corrosion-Resistant Aluminum Shelving



### ADJUSTABLE ALUMINUM SHELVING

- Aluminum
- 800- and 2,000-lb. capacities per shelf
- Adjustable shelves
- Lifetime guarantee against rust or corrosion

Choose either shelves with 1-3/4" x 1-1/2" open cross tubes or reinforced solid shelving with cross tubing reinforcements underneath. Unassembled. FOB CALIFORNIA, GEORGIA, PENNSYLVANIA, TEXAS.

Model Number	Shelf WxD	Overall Height	Shelf Qty.	Shelf Cap. Lbs.	Wt. Lbs.	Price Each
<b>TUBULAR SHELVES</b>						
YA-7805	36x20"	76"	4	2000	44	\$546.00
YA-7806	36x24"	76"	4	2000	56	603.00
YA-7807	48x20"	76"	4	2000	56	382.00
YA-7808	48x24"	76"	4	2000	68	392.00
YA-7809	60x20"	76"	4	2000	68	587.00
YA-7810	60x24"	76"	4	2000	76	653.00
<b>REINFORCED SOLID SHELVES</b>						
YA-7811	36x20"	76"	4	800	58	\$406.00
YA-7812	36x24"	76"	4	800	60	497.00
YA-7813	48x20"	76"	4	800	68	349.00
YA-7814	48x24"	76"	4	800	72	568.00
YA-7815	60x20"	76"	4	800	76	549.00
YA-7816	60x24"	76"	4	800	84	595.00



# EDSAL Bulk Storage Shelving



- Boltless beams lock to posts via tab hook connections
- Shelf capacities: 60" wide (2200 lbs.)  
72" wide (1500 lbs.)  
96" wide (1200 lbs.)

- Steel decking
- 16-gauge steel

Designed for hand loading of bulky items. Racks without decking include front-to-back components to build 24", 36", or 48" deep uprights. Capacities are per pair of beams.

**IN STOCK.**

### BEAM CONNECTOR.

16-ga. beams offer extra stability, more load capacity. Three tab hooks engage matching key-slot openings in uprights for rigid rack assembly. Adjusts on 1-1/2" centers.



**EACH ROW OR SINGLE UNIT REQUIRES A RACK END TO FINISH ROW.**

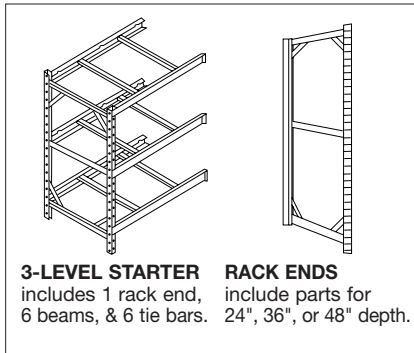

### 3-LEVEL STARTER

includes 1 rack end, 6 beams, & 6 tie bars.

### RACK ENDS

include parts for 24", 36", or 48" depth.



**ONE STARTER WITH OPTIONAL RIBBED STEEL DECKING AND ONE RACK END SHOWN**

Overall WxH	STARTER WITHOUT DECKING			STARTER WITH STEEL DECKING. SPECIFY DEPTH: A - 24", B - 36", C - 48"						RACK END		
	24", 36" & 48"D			(A) 24"D		(B) 36"D		(C) 48"D		FOR ALL UNITS		
	Model No.	Lbs.	Price Ea.	Lbs.	Price Ea.	Lbs.	Price Ea.	Lbs.	Price Ea.	Model No.	Lbs.	Price Ea.
60x72"	YR-1045	104	\$195.00	173	\$286.00	209	\$330.00	242	\$373.00	YR-1063	35	\$60.30
72x72"	YR-1046	110	214.00	194	322.00	236	373.00	275	422.00	YR-1063	35	60.30
96x72"	YR-1047	131	235.00	212	391.00	290	456.00	341	520.00	YR-1063	35	60.30
60x96"	YR-1048	109	207.00	178	298.00	214	342.00	247	383.00	YR-1064	40	71.40
72x96"	YR-1049	115	226.00	199	331.00	241	383.00	280	434.00	YR-1064	40	71.40
96x96"	YR-1050	136	259.00	217	401.00	295	467.00	346	532.00	YR-1064	40	71.40
60x120"	YR-1051	115	223.00	184	315.00	220	358.00	253	400.00	YR-1065	46	87.20
72x120"	YR-1052	121	242.00	205	348.00	247	400.00	286	450.00	YR-1065	46	87.20
96x120"	YR-1053	142	276.00	223	418.00	301	484.00	352	548.00	YR-1065	46	87.20

**EXTRA LEVELS\***. Includes one pair of beams and two tie bars. Static load stated per pair of beams, maximum evenly distributed load.

Model No.	Overall WxD	Cap. Lbs.	Wt. Lbs.	Price Ea.
YR-1066	60x24"	2,200	20	\$44.80
YR-1067	60x36"	2,200	21	44.80
YR-1068	60x48"	2,200	23	44.80
YR-1069	72x24"	1,500	22	50.80
YR-1070	72x36"	1,500	23	50.80
YR-1071	72x48"	1,500	25	50.80
YR-1072	96x24"	1,200	28	62.60
YR-1073	96x36"	1,200	30	62.60
YR-1074	96x48"	1,200	32	62.60

\*Levels will not interchange with uprights purchased prior to 1990.

**RIBBED STEEL DECKING.** 20-ga. panels have 1-7/8" wide ridges spaced 4-1/2" apart. No fasteners required. Fits into step recess of beam (beams sold separately).

Model No.	Overall WxD	Wt. Lbs.	Price Ea.
YR-1075	60x24"	35	\$30.40
YR-1076	60x36"	46	45.00
YR-1077	60x48"	46	59.10
YR-1078	72x24"	42	35.80
YR-1079	72x36"	55	53.20
YR-1080	72x48"	55	69.60
YR-1081	96x24"	55	47.20
YR-1082	96x36"	72	69.30
YR-1083	96x48"	72	90.80

**CENTER SUPPORTS.** 16-ga. formed channel supports, prepunched for attachment to beam. Two supports are included with each pair of beams. Sold only in lots of 6.

Model No.	Overall Depth	Wt. Lbs.	Price Ea.
YR-1084	24"	1-1/2	\$3.60
YR-1085	36"	2-1/2	4.90
YR-1086	48"	3	6.50

# AIGNER Shelving Labels



## Hol-Dex® Label Holders

Adheres to most any clean surface. Butyrate tubing with a non-glare finish. Side-loading. Sold in packages of 12. **SPECIFY COLOR:** **BL** - Blue, **CL** - Clear, **GN** - Green, **RD** - Red. **IN STOCK.**

Model No.	Overall WxH	Wt. Oz.	Pkg. Qty.	Price Ea. Pkg.
<b>SELF-ADHESIVE C-CHANNEL</b>				
ZK-2744	6x1/2"	3	12	\$12.90
ZK-2745	6x3/4"	4	12	14.70
ZP-1490	6x1"	5	12	17.00
ZK-2746	6x1-1/2"	6	12	17.80
ZK-2747	6x2"	9	12	22.30
<b>MAGNETIC C-CHANNEL</b>				
ZK-2748	6x3/4"	8	12	\$15.90
ZK-2749*	6x1"	8-1/2	12	18.20
ZK-2755	6x2"	16	12	34.10

\*Not available in BL - Blue.

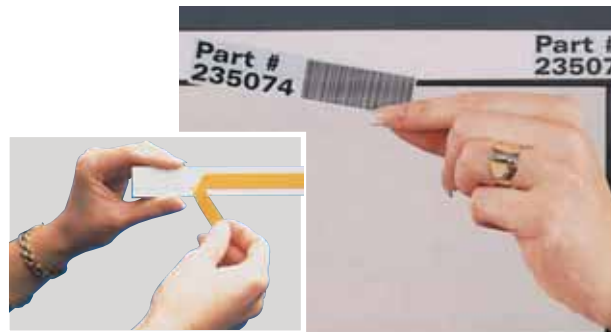

## Slip-Strip™ Self-Adhesive Label Holders

10-year adhesive "stick" life. Bottom loading. Cut to exact length with scissors. Sold in packages of 6. Ships via small package carrier. **IN STOCK.**

Model No.	Overall WxH	Price Ea. Pkg.
YK-2730	36x3/4"	\$31.50
YK-2732	36x1"	33.20
YK-2734	36x2"	41.30
YK-2736	48x1"	42.40
YP-1492	48x1-1/4"	43.80
YP-1493	48x1-1/2"	46.90
YK-2738	48x2"	52.70
YK-2740	48x3"	70.80



## EconoHolder™ Self-Adhesive Label Holders

C-channel design. Includes white inserts. **IN STOCK.**

Model No.	Overall WxH	Pkg. Qty.	Price Ea. Pkg.
ZP-1471	4x7/8"	25	\$13.10
ZP-1472	4x7/8"	25	18.10



## Magnetic Write-On Label Rolls

Write on top coat, cut to length, and apply to any metal surface. Clear-coated vinyl surface with 1/16" thick magnetic backing. Color: white. **IN STOCK.**

Model No.	Roll WxL	Pkg. Qty.	Roll Wt. Lbs.	Price Ea. Roll
ZP-1481	1"x50'	1 Roll	6	\$47.50
ZP-1482	2"x50'	1 Roll	12	62.40
ZP-1483	3"x50'	1 Roll	18	131.00



## Magnetic Label Holders

Adheres to any metal surface. Includes labels. **IN STOCK.**

Model No.	Overall WxH	Pkg. Qty.	Price Ea. Pkg.
ZP-1474	3x1"	25	\$11.20
ZP-1475	6x1"	25	19.20
ZP-1476	3x2"	25	15.30
ZP-1477	6x2"	25	27.10
ZP-1478	6x3"	25	38.10

Model No. **ZP-1479**—Extra Labels for Magnetic Label Holders. **SPECIFY LABEL SIZE: A - 1"H, B - 2"H, C - 3"H.....\$19.60**



## Label Holders for Wire Shelving

Clear, flexible plastic sleeves fit new or existing wire shelving with 1-1/4" face. Paper inserts included. **IN STOCK.**

Model No.	Overall Length	Pkg. Qty.	Pkg. Wt. Lbs.	Price Each
ZP-1485	3"	24	1/2	\$18.50
ZP-1486	6"	12	1	15.70
ZP-1487	12"	12	1	26.20
ZP-1488	24"	6	1	26.20



## Aisle Sign Kit

Snaps into upright frame holes. Soft plastic hinge flexes, without breaking, when bumped. Holds paper stock or plastic sign blanks up to .100" thick. Compatible with any laser or ink-jet printer. Kit includes 10 label holders and 12 laser/ink-jet sheets. **SPECIFY COLOR: BL** - Blue, **GN** - Green, **RD** - Red, **WH** - White, **YL** - Yellow. **IN STOCK.**

Model No. **ZP-0138**—Aisle Sign Kit. Pkg. of 10 label holders.....\$25.40  
Model No. **ZP-0139**—Additional Paper. Pkg. of 50. ....\$19.60



## Superscan® Label Holders

See-through plastic with matte finish. Paper inserts slide through either side and are compatible with laser or ink jet printers (printing instructions included). 50 labels per package. Backing packaged separately. **IN STOCK.**

Model No.	Overall WxH	Backing Description	Pkg. Wt. Lbs.	Price Ea. Pkg.
ZP-1527	3-1/2x2"	Self-Adhesive	1.0	\$21.80
ZP-1528	5x3"	Self-Adhesive	1.1	26.50
ZP-1529	6x4"	Self-Adhesive	1.3	31.30
ZP-1530	3-1/2x2"	Magnetic	1.0	34.90
ZP-1531	5x3"	Magnetic	2.7	36.50
ZP-1532	6x4"	Magnetic	3.0	45.50

# Pallet Rack Selection Guide

Are you looking for the most popular and versatile storage for large, palletized, or boxed loads? You've found it with Pallet Racks. This guide provides basic information needed to select pallet racking. However, before selecting any racking, please check local ordinances, codes, and seismic requirements.

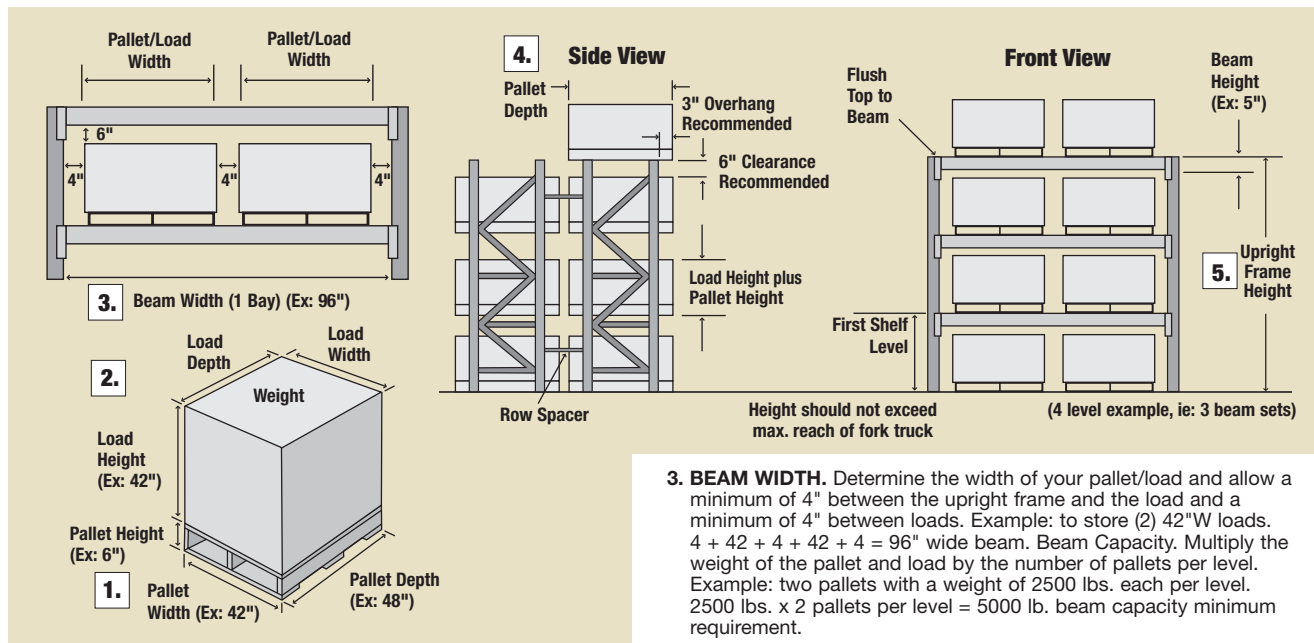

**3. BEAM WIDTH.** Determine the width of your pallet/load and allow a minimum of 4" between the upright frame and the load and a minimum of 4" between loads. Example: to store (2) 42"W loads.  $4 + 42 + 4 + 42 + 4 = 96$ " wide beam. Beam Capacity. Multiply the weight of the pallet and load by the number of pallets per level. Example: two pallets with a weight of 2500 lbs. each per level.  $2500 \text{ lbs.} \times 2 \text{ pallets per level} = 5000 \text{ lb.}$  beam capacity minimum requirement.

**4. UPRIGHT FRAME DEPTH.** The depth of the upright frames should be your pallet depth (48") minus 6" (3" overhang in the front and 3" overhang in the back). Example:  $48" - 6" = 42$ " deep upright frame.

**5. UPRIGHT FRAME HEIGHT.** Determine the overall load height. Add a minimum of 6" clearance between top of load and next level of beams. Add the beam height and multiply total by the amount of upper levels required. (do not count floor level). Example (4 shelf levels):  $48"H + 6"$  (for clearance)  $+ 5"$  (beam height)  $= 59"$ .  $3 \text{ upper levels} \times 59 = 177"$  high upright frame requirement.

## To Select Pallet Rack

### 1. DETERMINE THE SIZE OF YOUR PALLET TO BE STORED.

Example: 42"W x 48"D x 6"H.

### 2. DETERMINE THE OVERALL LOAD W X D X H.

For the overall height, add the load and pallet heights together.

Example: load height 42" + pallet height 6" = 48" overall height. Overall load: 42"W x 48"D x 48"H.

## Accessory & Component Guide

- 1. UPRIGHT FRAME:** Vertical structural support for racking system.
- 2. BEAM:** Horizontal steel supports that tie upright frames together and hold the load.
- 3. SKID SUPPORT:** Supports items smaller than the unit depth.
- 4. WIRE DECKING:** Turns area between beams into useable shelving space. Mesh promotes air flow and eases inventory checks.

- 5. SPACERS:**
  - ROW:** Connects and spaces two rows of rack back-to-back.
  - WALL:** Connects racks to wall for additional stability.
- 6. SHIM:** Levels upright frames on slopes or uneven surfaces to ensure uniform heights.
- 7. UPRIGHT FRAME PROTECTOR:** Protects upright frames from damaging impact from material handling equipment.

# Pallet Racks

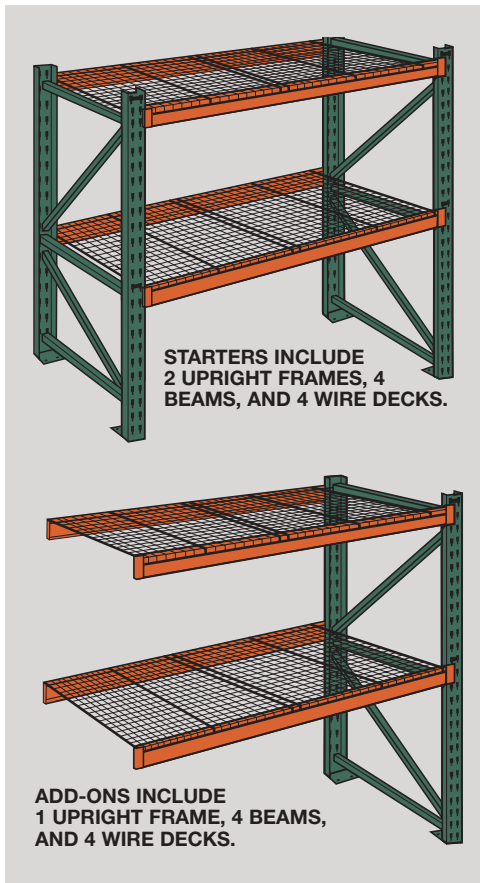

## WIREWAY/HUSKY™ Invincible™ Complete Pallet Racks

- Welded upright frames
- Pre-configured starters and add-ons
- Upright frame capacities from 10,400 to 25,000 lbs.
- Patented Bowlock® safety clip securely attaches beam to upright



Here's a vast selection of in-stock racking ready to ship immediately! Rugged, high-strength steel construction allows 2" beam adjustability. One-piece tubular beams feature a continuous seam weld. A minimum of 2 pairs of beams are required for each storage bay. Safety certified 55,000 lbs. psi minimum yield high-strength steel used throughout. Upright frames include foot plates. Complete starters include 2 upright frames, 4 solid beams, and 4 wire decks. Add-ons include 1 upright frame, 4 solid beams, and 4 wire decks. Heavy-duty foot plates are available for seismic requirements. Polyurethane paint finish on upright frames and beams. Color: orange beams and green upright frames. **IN STOCK.**

Overall W x D x H	Beam Cap./Pr.	COMPLETE RACK AND DECK SYSTEM						
		STARTER			ADD-ON			
		Model No.	Wt. Lbs.	Price Ea.	Model No.	Wt. Lbs.	Price Ea.	
96" x 36" x 96"	4,000	YP-3050	254	\$375.00	YP-3074	215	\$304.00	
96" x 36" x 96"	6,000	YP-3051	268	387.00	YP-3075	228	315.00	
96" x 42" x 96"	4,000	YP-3052	271	389.00	YP-3076	229	316.00	
96" x 42" x 96"	6,000	YP-3053	284	400.00	YP-3077	243	327.00	
96" x 48" x 96"	4,000	YP-3054	288	417.00	YP-3078	244	330.00	
96" x 48" x 96"	6,000	YP-3055	301	406.00	YP-3079	258	342.00	
120" x 36" x 96"	4,700	YP-3056	315	438.00	YP-3080	276	366.00	
120" x 42" x 96"	4,700	YP-3057	335	455.00	YP-3081	293	381.00	
120" x 48" x 96"	4,700	YP-3058	355	474.00	YP-3082	312	400.00	
96" x 36" x 120"	4,000	YP-3059	277	417.00	YP-3083	266	324.00	
96" x 36" x 120"	6,000	YP-3060	290	428.00	YP-3084	240	336.00	
96" x 42" x 120"	4,000	YP-3061	294	432.00	YP-3085	241	338.00	
96" x 42" x 120"	6,000	YP-3062	308	444.00	YP-3086	255	349.00	
120" x 36" x 120"	4,700	YP-3063	338	479.00	YP-3087	287	387.00	
120" x 42" x 120"	4,700	YP-3064	358	498.00	YP-3088	305	403.00	
96" x 36" x 144"†	4,000	YP-3065	376	557.00	YP-3089	319	452.00	
96" x 36" x 144"†	6,000	YP-3066	396	574.00	YP-3090	339	469.00	
96" x 42" x 144"†	4,000	YP-3067	403	577.00	YP-3091	342	470.00	
96" x 42" x 144"†	6,000	YP-3068	423	594.00	YP-3092	363	488.00	
96" x 48" x 144"†	4,000	YP-3069	428	602.00	YP-3093	365	493.00	
96" x 48" x 144"†	6,000	YP-3070	448	618.00	YP-3094	385	509.00	
120" x 36" x 144"†	4,700	YP-3071	466	651.00	YP-3095	443	546.00	
120" x 42" x 144"†	4,700	YP-3072	499	675.00	YP-3096	439	569.00	
120" x 48" x 144"†	4,700	YP-3073	530	705.00	YP-3097	467	596.00	

†144" units include (3) upper levels, (6) beams and (6) wire decks.

# Pallet Racks

SEE PAGE  
177 FOR  
WIRE  
DECKING.



## WIREWAY/HUSKY™ Invincible™ Pallet Rack Components



Selected Models

### STANDARD OR HEAVY LOAD UPRIGHT FRAMES

Frame D x H	STANDARD LOAD			HEAVY LOAD		
	Model Number	Wt. Lbs.	Price Each	Model Number	Wt. Lbs.	Price Each
36" x 72"	YP-907	31	\$69.00	YP-923	40	\$79.00
42" x 72"	YP-908	32	70.50	YP-924	42	81.00
48" x 72"	YP-909	33	72.20	YP-925	43	82.60
36" x 96"	YP-910	30-2/3	71.50	YP-926	47	92.50
42" x 96"	YP-911	40-1/3	73.10	YP-927	48-1/2	94.50
48" x 96"	YP-912	43	75.10	YP-928	50-1/4	96.40
36" x 120"	YP-914	50-3/4	92.60	YP-929	60	99.00
42" x 120"	YG-4072	53	94.70	YP-930	62	103.00
48" x 120"	YP-915	55-3/4	116.00	YP-931	64-1/2	105.00
36" x 144"	YG-4071	56-1/4	105.00	YP-932	69-1/4	113.00
42" x 144"	YG-4073	60-2/3	107.00	YP-933	71-1/2	115.00
48" x 144"	YP-916	63	109.00	YP-934	74	118.00
36" x 168"	YP-917	69-1/3	148.00	YP-935	82	161.00
42" x 168"	YP-918	72-1/2	151.00	YP-936	85	164.00
48" x 168"	YP-919	75-3/4	154.00	YP-937	88-1/4	168.00
36" x 192"	YP-920	77	136.00	YP-938	91-1/2	176.00
42" x 192"	YP-921	80	164.00	YG-4074	94-1/2	181.00
48" x 192"	YP-922	83	168.00	YP-939	97-1/2	184.00
36" x 240"	YP-3098	96	196.00	YP-3101	114	213.00
42" x 240"	YP-3099	99	199.00	YP-3102	118	216.00
48" x 240"	YP-3100	103	203.00	YP-3103	121	221.00

OTHER SIZES AVAILABLE. PLEASE CALL FOR INFORMATION.

### SOLID BEAMS. Two per level required.

Model Number	Beam L x H	Cap. Lbs./Pair	Step Height	Wt. Lbs.	Price Each
<b>REGULAR-DUTY</b>					
YG-4075	96" x 4"	4,048	1-1/2"	22-1/3	\$33.70
YG-4076	96" x 5"	6,054	1-1/2"	25-1/2	36.50
YP-900	108" x 4"	3,198	1-1/2"	25	36.70
YG-4077	108" x 5"	5,373	1-1/2"	28-1/2	39.90
YP-901	120" x 4"	2,590	1-1/2"	27-1/2	47.40
YP-902	120" x 5"	4,412	1-1/2"	31-1/3	48.00
<b>HEAVY-DUTY</b>					
YP-903	96" x 5-1/2"	8,701	1-1/2"	32-1/4	\$43.50
YP-904	108" x 5-1/2"	7,723	1-1/2"	36	47.60
YP-905	120" x 6"	7,979	1-1/2"	42-1/3	54.00
YP-906	144" x 6"	7,552	1-1/2"	60	70.50

### SHIMS. 12 ga. galvanized metal.

Model No. YP-0817—3-1/4"W x 4-1/4"D.	Wt. 0.38 lbs.	\$0.94
Model No. YP-0818—5"W x 7-3/4"D	Wt. 1 lb.	\$6.30

### FRAME PROTECTORS. Polyurethane paint finish.

Model No. YP-0819—12"H.	Wt. 11.1 lbs.	\$31.20
Model No. YP-0820—18"H.	Wt. 15.35 lbs.	\$40.40
Model No. YP-0821—24"H.	Wt. 19.6 lbs.	\$49.80

(calculated in accordance with RMI 1997 Standards)

Vertical Shelf Spacing	CAPACITY	
	Standard Load 3x1 1/2" Uprights	Heavy Load 3x3" Uprights
36"	19400 lbs.	25000 lbs.
42"	17400 lbs.	22600 lbs.
48"	15900 lbs.	21200 lbs.
54"	14600 lbs.	19700 lbs.
60"	13200 lbs.	18100 lbs.
66"	11800 lbs.	16500 lbs.
72"	10400 lbs.	14800 lbs.

**SAFETY LOAD LOCKS ARE ATTACHED PERMANENTLY TO EACH BEAM END.**

**STEP DEPTH 3/4"**  
**1-3/4"**

**STEP HEIGHT 1-1/2"**

**BEAM PROFILE**

**BEAMS INCLUDE BOWLOCK® SAFETY CLIP FOR A SECURE CONNECTION.**

**STEP-BEAMS ACCOMMODATE SKID SUPPORTS AND WIRE DECKING.**

### SKID SUPPORTS. Galvanized metal.

Model No. YP-277—36".	Wt. 3.7 lbs.	\$6.40
Model No. YP-278—42".	Wt. 4.4 lbs.	\$7.40
Model No. YM-2733—48".	Wt. 6.3 lbs.	\$8.40

### SPACERS. Includes mounting hardware to frame. Galvanized metal.

Overall Length	ROW SPACERS			WALL SPACERS		
	Model Number	Wt. Lbs.	Price Each	Model Number	Wt. Lbs.	Price Each
6"	YP-873	0.9	\$6.00	YP-0813	1.1	\$5.60
8"	YP-0810	1	6.40	YP-0814	1.5	5.90
12"	YP-874	1.6	7.20	YP-0815	1.7	6.60
18"	YP-0811	2.23	8.30	YP-0816	2.4	7.80
24"	YP-0812	2.89	9.40	—	—	—

### ACCESSORIES



# Pallet Racks

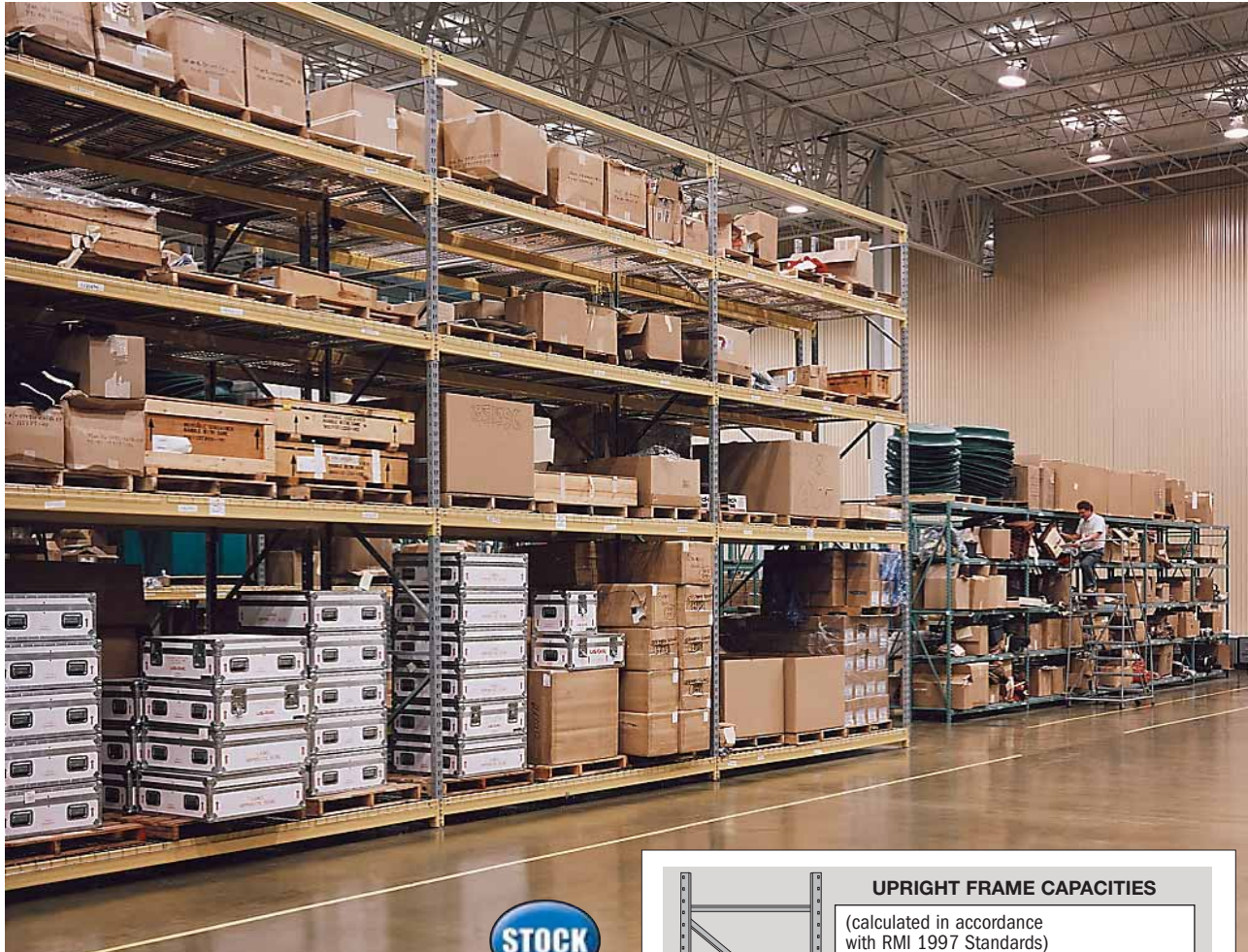

**Selected Models**

## PENCO Pallet Racks

- All-welded upright frames
- Upright frame capacities from 18,000 to 30,000 lbs.
- Three-rivet beam connection locks six ways for greater stability
- Beams are available in two step sizes: 7/8" and 1-5/8"

Beams and upright frames let you create various sized 'bays'. Unique beams assure positive beam to post alignment and uniform load distribution. Upright M-recessed frames are made from two vertical posts joined with cleanly welded horizontal and diagonal braces. End posts have support holes punched the entire length for 3" adjustability. Safety load factor is 1.92. **SELECTED MODELS IN STOCK.** Others FOB PENNSYLVANIA.

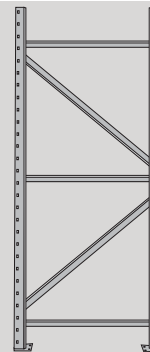

### UPRIGHT FRAME CAPACITIES

(calculated in accordance with RMI 1997 Standards)

Vertical Shelf Spacing	CAPACITY	
	Standard Load 3x1 1/2" Uprights	Heavy Load 3x3" Uprights
36"	19400 lbs.	25000 lbs.
42"	17400 lbs.	22600 lbs.
48"	15900 lbs.	21200 lbs.
54"	14600 lbs.	19700 lbs.
60"	13200 lbs.	18100 lbs.
66"	11800 lbs.	16500 lbs.
72"	10400 lbs.	14800 lbs.

**UPRIGHT FRAMES ARE SECURELY WELDED FOR MAXIMUM RIGIDITY.**

**UPRIGHT FRAMES.** 18,000–30,000-lb. capacity.

Frame D x H	STANDARD LOAD 18,000-lb. max.			HEAVY LOAD 24,000-lb. max.			EXTRA HEAVY LOAD 30,000-lb. max.		
	Model No.	Wt. Lbs.	Price Ea.	Model No.	Wt. Lbs.	Price Ea.	Model No.	Wt. Lbs.	Price Ea.
36" x 72"	<a href="#">XP-154</a>	34	\$63.40	<a href="#">XP-172</a>	37	\$68.10	<a href="#">XP-190</a>	40	\$74.30
42" x 72"	<a href="#">XP-155</a>	35	65.20	<a href="#">XP-173</a>	38	70.40	<a href="#">XP-191</a>	41	76.70
48" x 72"	<a href="#">XP-156</a>	36	66.60	<a href="#">XP-174</a>	39	72.00	<a href="#">XP-192</a>	42	78.00
36" x 96"	<a href="#">XP-157</a>	47	85.90	<a href="#">XP-175</a>	51	92.40	<a href="#">XP-193</a>	54	102.00
42" x 96"	<a href="#">XP-158</a>	50	89.50	<a href="#">XP-176</a>	54	96.80	<a href="#">XP-194</a>	57	106.00
48" x 96"	<a href="#">XP-159</a>	53	93.30	<a href="#">XP-177</a>	57	101.00	<a href="#">XP-195</a>	60	109.00
36" x 120"	<a href="#">XP-160</a>	56	100.00	<a href="#">XP-178</a>	61	108.00	<a href="#">XP-196</a>	69	121.00
42" x 120"	<a href="#">XP-161</a>	59	105.00	<a href="#">XP-179</a>	64	112.00	<a href="#">XP-197</a>	73	124.00
48" x 120"	<a href="#">XP-162</a>	60	108.00	<a href="#">XP-180</a>	65	118.00	<a href="#">XP-198</a>	74	128.00
36" x 144"	<a href="#">XP-163</a>	67	129.00	<a href="#">XP-181</a>	74	139.00	<a href="#">XP-199</a>	84	151.00
42" x 144"	<a href="#">XP-164</a>	72	133.00	<a href="#">XP-182</a>	79	145.00	<a href="#">XP-200</a>	89	156.00
48" x 144"	<a href="#">XP-165</a>	76	140.00	<a href="#">XP-183</a>	83	151.00	<a href="#">XP-201</a>	93	162.00
36" x 168"	<a href="#">XP-166</a>	76	144.00	<a href="#">XP-184</a>	85	154.00	<a href="#">XP-202</a>	94	168.00
42" x 168"	<a href="#">XP-167</a>	78	148.00	<a href="#">XP-185</a>	89	158.00	<a href="#">XP-203</a>	101	176.00
48" x 168"	<a href="#">XP-168</a>	80	153.00	<a href="#">XP-186</a>	91	165.00	<a href="#">XP-204</a>	103	179.00
36" x 192"	<a href="#">XP-169</a>	87	161.00	<a href="#">XP-187</a>	96	168.00	<a href="#">XP-205</a>	108	187.00
42" x 192"	<a href="#">XP-170</a>	90	165.00	<a href="#">XP-188</a>	100	176.00	<a href="#">XP-206</a>	113	191.00
48" x 192"	<a href="#">XP-171</a>	93	168.00	<a href="#">XP-189</a>	102	180.00	<a href="#">XP-207</a>	115	196.00

# Pallet Racks



Selected Models



## BEAMS



ROLL-FORMED ONE PIECE BEAM FEATURES THREE-PRONG CONNECTION THAT ASSURES POSITIVE BEAM TO POST ALIGNMENT AND UNIFORM LOAD DISTRIBUTION. LONG LASTING YELLOW BAKED ENAMEL FINISH.

### STEP DEPTH

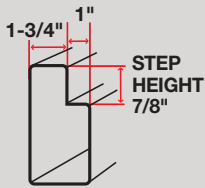

BEAM PROFILE

### STEP DEPTH

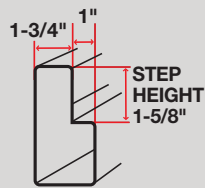

BEAM PROFILE

**SOLID BEAMS.** Available with either 7/8" or 1-5/8" step height. Two per level required.

Model Number	Beam L x H	Cap./Pr. Lbs.	Wt./Pr. Lbs.	Price Each
<b>BEAM WITH 7/8" STEP</b>				
XP-0101	48" x 3-3/4"	8,920	35	\$31.00
XP-141	60" x 3-3/4"	7,120	42	27.80
XP-142	96" x 3-3/4"	4,420	63	49.90
XP-143	108" x 3-3/4"	3,920	70	55.30
XP-144	120" x 3-3/4"	3,190	77	60.50
XP-145	144" x 3-3/4"	2,220	91	70.50
<b>BEAM WITH 1-5/8" STEP</b>				
XP-0102	48" x 3-3/8"	8,380	33	\$30.40
XP-0103	60" x 3-3/8"	6,695	40	34.70
XP-146	96" x 3-3/8"	3,990	50	49.10
XP-147	96" x 4-3/16"	5,290	66	51.90
XP-0104	108" x 3-3/4"	3,990	35	55.30
XP-149	108" x 4-3/16"	4,630	73	57.70
XP-150	120" x 3-3/4"	3,230	77	60.60
XP-151	120" x 4-11/16"	4,810	85	66.60
XP-152	144" x 3-3/4"	2,240	80	70.60
XP-153	144" x 5-3/8"	4,740	108	82.70

### SKID SUPPORTS FOR SOLID BEAMS.

All cross bars are rated equally: 36"—996-lb. capacity; 42"—830-lb. capacity; 48"—711-lb. capacity. Painted.

**A. 16-Ga. Skid Supports for Plywood.** (Plywood or particleboard depth should be upright frame depth minus 3-3/4") Center support must be securely fastened.

**B. General Duty Skid Supports.** Supports loads smaller than unit depth. Not for plywood.

**C. 16-ga. Flanged Skid Supports.** Recommended for hard-use applications.

Deep	A. PLYWOOD			B. GENERAL-DUTY			C. FLANGED		
	Model Number	Wt. Lbs.	Price Each	Model Number	Wt. Lbs.	Price Each	Model Number	Wt. Lbs.	Price Each
<b>SKID SUPPORTS FOR 7/8" STEP</b>									
36"	XP-0110	4.4	\$7.30	XP-0113	4.4	\$10.60	—	—	—
42"	XP-0111	5.3	8.40	XP-0114	5.3	12.00	—	—	—
48"	XP-0112	6.1	9.50	XP-0115	6.1	13.60	—	—	—
<b>SKID SUPPORTS FOR 1-5/8" STEP</b>									
36"	XP-212	4.4	\$10.50	XP-215	4.4	\$10.50	XP-218	5.3	\$11.90
42"	XP-213	5.3	11.90	XP-216	5.3	11.60	XP-219	6.1	13.40
48"	XP-214	6.1	14.10	XP-217	6.1	13.20	XP-220	6.9	14.90

**D. RELIUS SOLUTIONS UNIVERSAL FRAME PROTECTORS.** 6"W x 3-1/2"D, 1/4" thick baseplate. 3.5" O.D. depth; 3.87" I.D. width. Mounting hardware included.

Model No.	Ht.	Wt. Lbs.	Price Ea.
XD-1933	12"	8	\$30.50
XD-1934	18"	10	39.50
XD-1935	24"	12	50.60

**E. RELIUS SOLUTIONS FRAME PROTECTORS.** 5"W x 4-1/2"D, 1/4" thick. 8" x 6" base plate. Anchors not included.

Model No.	Ht.	Wt. Lbs.	Price Ea.
XL-0920	12"	9	\$36.10
XL-0921	18"	13	47.90
XL-0922	24"	18	48.60

**F. & G. SPACERS.** Mounting hardware included.

Overall Length	F. ROW SPACERS			G. WALL SPACERS		
	Model Number	Wt. Lbs.	Price Each	Model Number	Wt. Lbs.	Price Each
6"	XP-0105	2	\$4.83	XP-0107	2	\$4.74
8"	XP-208	2.4	5.60	XP-210	2.4	5.40
10"	XP-0106	2.8	6.20	XP-0108	2.8	5.90
12"	XP-209	3.2	6.70	XP-211	3.2	6.50

### H. SHIMS

Model No. **XP-0109**—3-1/4" x 4-1/4". 7-ga. thick. Wt. 0.8 lbs. **\$1.50**

## PENCO ACCESSORIES

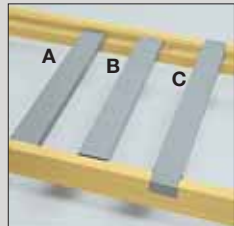

SKID SUPPORT

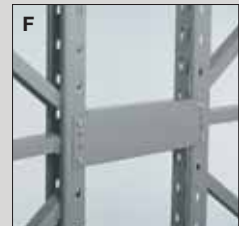

ROW SPACER

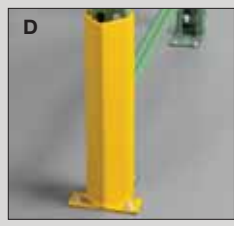

RELIUS SOLUTIONS UNIVERSAL FRAME PROTECTOR

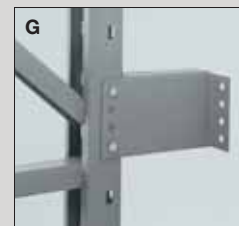

WALL SPACER



RELIUS SOLUTIONS FRAME PROTECTOR

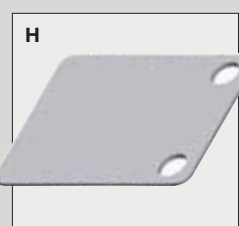

SHIM

# Pallet Rack



ALL-WELDED CONSTRUCTION

## INTERLAKE InterRack-30™ Pallet Racks

- All-welded
- Upright frame capacities from 21,600 to 35,200 lbs.
- Column-shaped stud and keyhole beam connection increase rigidity
- Piston (pull-pin) lock for secure beam attachment

One of the strongest and most flexible racking systems on the market today. Innovative beam features a patented stud and keyhole that increase rigidity and reduce stress at the connection. Choose either U-punch or teardrop keyhole beam connection. Upright frames feature a combination of narrow keyholes (punched every 2") and offset rectangular holes allowing beam to seat automatically into column, locking securely in place. High-strength steel columns have 55,000 psi min. yield strength. All-welded construction. Welds are made to AWS standards to ensure strength and long product life. Hardbaked enamel finish is corrosion and scratch resistant and meets or exceeds all environmental regulations. FOB ILLINOIS, SOUTH CAROLINA.

### UPRIGHT FRAMES. 21,600–35,200-Lb. capacity 3" x 3" frames

Frame D x H	U-PUNCH KEYHOLE			TEARDROP KEYHOLE								
	21,600-LB. MAX. CAP.			30,600-LB. MAX. CAP.		35,200-LB. MAX. CAP.						
	Model No.	Wt. Lbs.	Price Ea.	Model No.	Wt. Lbs.	Price Ea.	Model No.	Wt. Lbs.	Price Ea.	Model No.	Wt. Lbs.	Price Ea.
36" x 72"	YF-2312A	36	\$85.70	YF-2330A	47	\$97.30	YF-2348A	53	\$107.00			
42" x 72"	YF-2313A	38	88.70	YF-2331A	48	101.00	YF-2349A	54	110.00			
48" x 72"	YF-2314A	39	92.20	YF-2332A	50	105.00	YF-2350A	56	114.00			
36" x 96"	YF-2315A	50	107.00	YF-2333A	62	122.00	YF-2351A	69	133.00			
42" x 96"	YF-2316A	53	111.00	YF-2334A	64	129.00	YF-2352A	71	138.00			
48" x 96"	YF-2317A	55	116.00	YF-2335A	66	131.00	YF-2353A	73	142.00			
36" x 120"	YF-2318A	60	130.00	YF-2336A	78	148.00	YF-2354A	88	160.00			
42" x 120"	YF-2319A	62	132.00	YF-2337A	80	152.00	YF-2355A	90	164.00			
48" x 120"	YF-2320A	64	139.00	YF-2338A	83	155.00	YF-2356A	92	170.00			
36" x 144"	YF-2321A	74	149.00	YF-2339A	93	168.00	YF-2357A	104	188.00			
42" x 144"	YF-2322A	77	154.00	YF-2340A	96	175.00	YF-2358A	107	193.00			
48" x 144"	YF-2323A	80	157.00	YF-2341A	99	175.00	YF-2359A	110	198.00			
36" x 168"	YF-2324A	84	162.00	YF-2342A	109	190.00	YF-2360A	123	209.00			
42" x 168"	YF-2325A	87	167.00	YF-2343A	112	195.00	YF-2361A	126	214.00			
48" x 168"	YF-2326A	90	172.00	YF-2344A	116	201.00	YF-2362A	129	220.00			
36" x 192"	YF-2327A	98	184.00	YF-2345A	122	212.00	YF-2363A	138	226.00			
42" x 192"	YF-2328A	102	192.00	YF-2346A	126	218.00	YF-2364A	141	232.00			
48" x 192"	YF-2329A	106	196.00	YF-2347A	129	224.00	YF-2365A	144	238.00			

Note: All capacities are based on 48" beam spacing and meet RMI-97 standards.

### ACCESSORIES

**FLANGED SKID SUPPORTS.** For slotted or solid beams. Galvanized.

Model No.	Fits Frame Depth	Cap. Lbs.	Wt. Lbs.	Price Ea.
YF-2366	36"	1,050	6	\$12.90
YF-2367	42"	910	7	14.50
YF-2368	48"	780	8	16.00

**FRAME PROTECTORS.** Bolts to frame. Includes mounting hardware.

Model No.	Height	Wt. Lbs.	Price Ea.
YF-2374	12"	2	\$12.90
YF-2375	18"	2	15.40
YF-2376	24"	3	18.30

**SPACERS.** Galvanized. Includes mounting hardware.

Overall Length	ROW SPACERS			WALL SPACERS		
	Model No.	Wt. Lbs.	Price Ea.	Model No.	Wt. Lbs.	Price Ea.
6"	YF-2369	2	\$5.10	—	—	—
8"	YF-2370	2	5.60	YF-2372	2	\$5.90
12"	YF-2371	2	6.53	YF-2373	2	7.00

**SHIMS.** Use to level upright frames on uneven surfaces.

YF-0120—3-1/2"W X 5-1/4"D. 1/8" thick. Wt. 0.6 lbs.  
.....\$1.21

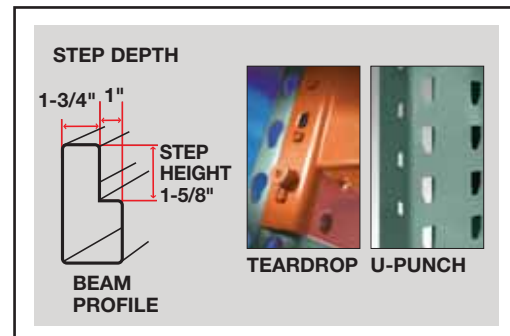

**SLOTTED BEAMS.** 14-gauge beams with 1-5/8" step height. Two per level required.

Model No.	Beam L x H	Cap./Pr. Lbs.	Wt. Lbs.	Price Ea.
YF-2300	96" x 4"	5,030	26	\$46.00
YF-2301	96" x 4-3/4"	6,670	29	49.50
YF-2302	96" x 5-1/2"	8,260	32	53.90
YF-2303	108" x 4"	4,040	29	50.40
YF-2304	108" x 4-3/4"	5,990	32	54.30
YF-2305	108" x 5-1/2"	7,400	35	59.60
YF-2306	120" x 4"	3,330	32	55.90
YF-2307	120" x 5"	5,630	36	63.30
YF-2308	120" x 5-15/16"	7,480	42	71.60
YF-2309	144" x 4-1/2"	3,080	39	67.90
YF-2310	144" x 5"	4,020	43	74.00
YF-2311	144" x 5-15/16"	5,970	50	83.50

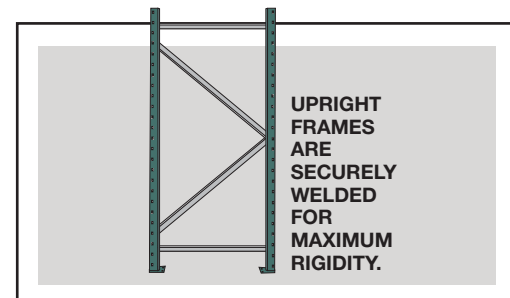



# Pallet Rack Accessories

## STEEL & WIRE DECKING REFERENCE GUIDE

CAPACITY OF DECKING IS NEVER GREATER THAN BEAM CAPACITY. HOW TO FIGURE THE NUMBER OF DECKS NEEDED FOR MOST BEAM LENGTHS:

Beam L	Use
4' (48")	One 46"
5' (60")	One 58"
8' (96")	Two 46"
9' (108")	Two 52"
10' (120")	Two 34" & One 46"
12' (144")	Three 46"

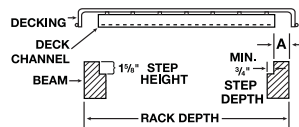

WIRE DECKING WILL ONLY WORK ON 36", 42", OR 48" PALLET RACK WITH 1-1/2" TO 1-5/8" STEP BEAMS WITH A MINIMUM 3/4" WIDE LEDGE.

MIN. 3/4" STEP DEPTH



BEAM PROFILE

BEAM TOP SURFACE (A) MUST BE BETWEEN 1-5/8" AND 1-7/8" WIDE.

DEPTH

WIDTH

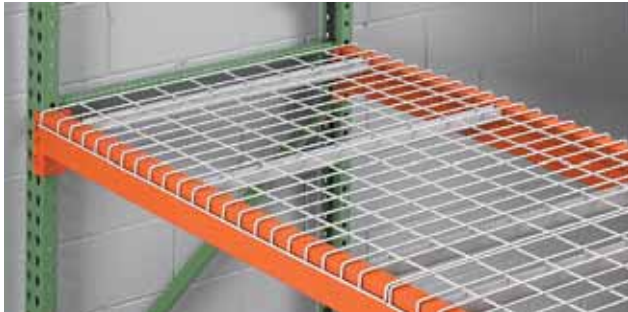

## NASHVILLE WIRE Painted Steel Wire Decking

- 2x4" steel mesh
- Instant storage—simply drop decking in place over rack beams. 1-1/2" x 1-1/8", 12-gauge channel. Gray polyester paint finish. Custom sizes available. **SPECIFY MANUFACTURER NAME AND STEP HEIGHT BEAM. FACTORY QUICK SHIP—FOB TENNESSEE.**

Model Number	Overall W x D	Cap. Lbs.	Channel Qty.	Wt. Lbs.	Price Each
<b>32-1/4" DECK CHANNEL DEPTH</b>					
YL-0805	34" x 36"	3050	3	19	\$24.80
YL-0806	46" x 36"	3450	3	22	37.80
YL-0807	52" x 36"	3600	3	23	30.00
YL-0808	58" x 36"	3750	3	25	31.70
<b>38-1/4" DECK CHANNEL DEPTH</b>					
YL-0809	34" x 42"	2950	4	21	\$27.70
YL-0810	46" x 42"	3500	4	28	33.60
YL-0811	52" x 42"	3650	4	30	36.10
YL-0812	58" x 42"	3850	4	32	37.30
<b>40-1/4" DECK CHANNEL DEPTH</b>					
YL-0813	46" x 44"	2800	4	29	\$34.30
YL-0814	52" x 44"	2950	4	31	36.00
<b>44-1/4" DECK CHANNEL DEPTH</b>					
YL-0815	34" x 48"	2250	4	27	\$31.40
YL-0816	46" x 48"	3000	4	32	36.90
YL-0817	52" x 48"	3200	4	34	39.70
YL-0818	58" x 48"	3300	4	36	41.90



## WIREWAY/HUSKY™ Galvanized Steel Wire Decking

- 2x4" mesh size
  - Available in high capacity: 2,330–3,380 lbs. and low capacity: 2,050 lbs.
- Rust- and corrosion-resistant wire decking is ideal for harsh environments. Low maintenance and easy to install—simply drop wire deck in place over rack beams. Fits EDSAL Stor-Master Pallet Racks, HUSKY Invincible Pallet Racks and Penco Pallet Storage Racks (1-1/2" and 1-5/8" step height only.) **IN STOCK.**

Model Number	Overall W x D	Cap. Lbs.	Channel Qty.	Wt. Lbs.	Price Each
<b>32-1/4" DECK CHANNEL DEPTH</b>					
YL-0821	46" x 36"	2620	3	23	\$27.00
YL-0822	52" x 36"	2620	3	26	26.80
YL-0823	58" x 36"	3380	4	29	30.80
<b>38-1/4" DECK CHANNEL DEPTH</b>					
YL-0824	46" x 42"	2520	3	27	27.50
YL-0825	52" x 42"	2520	3	32	29.50
YL-0826	58" x 42"	3300	4	34	34.40
<b>44-1/4" DECK CHANNEL DEPTH</b>					
YL-0827	46" x 48"	2330	3	30	30.80
YL-0828	52" x 48"	2330	3	37	33.00
YL-0829	58" x 48"	2720	4	39	38.60

## RELIUS SOLUTIONS Solid Steel Decking

- 14-gauge steel
- 12-gauge steel reinforcement channels
- 3,000-lb. capacity

Boxes slide easily across the smooth surface. Deck panel has 1-1/2" waterfall front and rear edges to avoid catching on items during placement. Formed channels fit 1-5/8" step beams. Gray enamel finish. **IN STOCK.**



Model Number	Overall W x D	Cap. Lbs.	Channel Qty.	Wt. Lbs.	Price Each
<b>32-1/4" DECK CHANNEL DEPTH</b>					
YL-4950	46" x 36"	3000	3	59	\$130.00
YL-4951	52" x 36"	3000	3	64	139.00
YL-4952	58" x 36"	3000	3	69	154.00
<b>38-1/4" DECK CHANNEL DEPTH</b>					
YL-4953	46" x 42"	3000	3	68	\$146.00
YL-4954	52" x 42"	3000	3	74	155.00
YL-4955	58" x 42"	3000	3	80	173.00
<b>44-1/4" DECK CHANNEL DEPTH</b>					
YL-4956	46" x 48"	3000	4	87	\$176.00
YL-4957	52" x 48"	3000	4	93	188.00
YL-4958	58" x 48"	3000	4	100	206.00



# Pallet Rack Accessories



## WIREWAY/HUSKY™ Steel Pallet Rack Guards

- 10-gauge, 1/2" diamond steel wire mesh
- Attaches with spacer slips or flush-mount clip

Keep stored items from falling off shelves. Heavy-duty mesh is welded to steel 1-1/4" x 1-1/4" x 1/8" angle frame to enclose back of pallet racking while still providing clear visibility of inventory. One panel is required for each bay. Spacer clips are sold separately. Color: safety yellow. FOB NORTH CAROLINA.

### RACK GUARDS

Model Number	Overall W x H	Wt. Lbs.	Price Each
<b>3'H PANELS</b>			
YL-2110	7' x 3'	34	<b>\$136.00</b>
YL-2111	8' x 3'	38	<b>147.00</b>
YL-2112	9' x 3'	42	<b>160.00</b>
YL-2113	10' x 3'	46	<b>176.00</b>
YL-2114	12' x 3'	54	<b>238.00</b>
<b>4'H PANELS</b>			
YL-2115	7' x 4'	40	<b>\$162.00</b>
YL-2116	8' x 4'	45	<b>173.00</b>
YL-2117	9' x 4'	50	<b>190.00</b>
YL-2118	10' x 4'	54	<b>209.00</b>
YL-2119	12' x 4'	63	<b>282.00</b>
<b>5'H PANELS</b>			
YL-2120	7' x 5'	47	<b>\$183.00</b>
YL-2121	8' x 5'	52	<b>201.00</b>
YL-2122	9' x 5'	34	<b>219.00</b>
YL-2123	10' x 5'	62	<b>241.00</b>
YL-2124	12' x 5'	72	<b>325.00</b>

### SPACER CLIPS

Model Number	Description	Wt. Lbs.	Price Each
YL-2125	Flush-Mount Clip	1	<b>\$6.30</b>
YL-2126	4" Spacer Clip	1	<b>6.50</b>
YL-2127	6" Spacer Clip	1	<b>6.60</b>
YL-2128	8" Spacer Clip	1	<b>6.70</b>
YL-2129	12" Spacer Clip	1	<b>7.00</b>

NOTE: Order 4 clips per panel.



## EUROKRAFT® Pallet Rack Mounted Shop Desk

- 16-gauge steel
- Fits 36–48"W rack ends

Convenient place to fill out paperwork, shipping labels, and other bills of material. Mounts directly to the end of pallet racking. Includes locking 19"W x 19"D x 5"H drawer. 23"W x 20"D x 20"H overall. **IN STOCK.**

Model No. **YL-2103**—Wt. 62 lbs. .... **\$392.00**



## EGA Pallet Rack Bay Dividers

- Fit any 3" pallet beam

Quick and easy installation—dividers drop right into place. No hardware required. 1" round tubing, 54"H. Pre-punched holes for permanent mounting. Safety yellow enamel finish. **FACTORY QUICK SHIP—FOB WISCONSIN.**



Model No.	D x H	Wt. Lbs.	Price Ea.
<b>WL-0725</b>	36" x 54"	9.5	<b>\$37.10</b>
<b>WL-0726</b>	42" x 54"	10.5	<b>41.00</b>
<b>WL-0727</b>	48" x 54"	11.5	<b>44.90</b>

# Pallet Rack Accessories

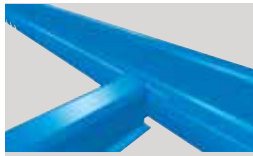

DROP-IN CROSSTIES



ADD ROLLATRAK AND GUIDE

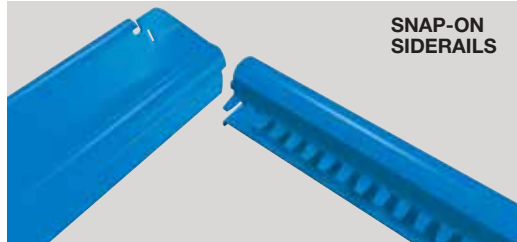

SNAP-ON SIDERAILS



YP-1111 SHOWN

## QuikPik® Gravity Flow Pallet Rack Levels

- Inverted channel adjusts every 1/2"
- Shelf capacity: 25 lbs. per square foot

QuikPik® shelves convert your pallet racks to carton flow racks. RollaTrak with guide rails conveys packages in separate lanes. Inverted channel locks firmly in place without tools. Patented clip attaches to all pallet racking with round or square side post holes that are 7/16" or larger and 2" center-to-center. Comes complete with 16 RollaTrak pieces and 7 guide rails per shelf level (uprights and beams not included). FOB KENTUCKY.

Model Number	Overall WxD	Wt. Lbs.	Price Each
YP-1110	96x48"	123	\$373.00
YP-1111	96x96"	209	599.00

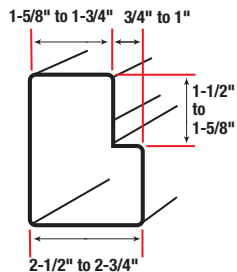

BEAMS WITH THESE SPECIFICATIONS ARE COMPATIBLE WITH DECK TRACK.



DECK TRACK DECKING DROPS INTO RACK.



## UNEX Span-Trak Gravity-Flow Deck Track Decking

- Decks install between existing 1-1/2"-1-5/8" step beams without any tools
- 50-lb. capacity per lineal foot

Easily convert your single-deep pallet racks into carton flow racks. Maintenance-free construction features galvanized steel side 2" roller center channels and 3/4" diameter aluminum rollers. To install: set front beam to desired elevation and rear beam at higher elevation. Track length must match upright (out-to-out) dimensions. Seven-year warranty. FOB NEW JERSEY.

Track Width	36" FRAME DEPTH			42" FRAME DEPTH			48" FRAME DEPTH		
	Model No.	Wt. Lbs.	Price Ea.	Model No.	Wt. Lbs.	Price Ea.	Model No.	Wt. Lbs.	Price Ea.
9"	YL-0412	9	\$40.00	YL-0415	10	\$43.80	YL-0418	11	\$46.60
12"	YL-0413	11	46.10	YL-0416	12	50.00	YL-0419	12	55.00
15"	YL-0414	12	53.10	YL-0417	13	57.00	YL-0420	13	63.30



# Heavy-Duty Shelving

## LITTLE GIANT All-Welded Shelving

- 12-gauge steel shelves
- Shelf capacity: 2,000 lbs.
- All-welded

Continuously welded shelves support the heaviest loads. 2" x 2", 3/16" thick angle iron posts. Enamel paint finish. Color: gray. **FACTORY QUICK SHIP** — **FOB ILLINOIS.**



Shelf WxD	Shelf Qty.	60"H			72"H				
		Model Number	Shelf Clearance	Wt. Lbs.	Price Each	Model Number	Shelf Clearance	Wt. Lbs.	Price Each
36x24"	4	YP-0827GY	16-1/2"	185	\$381.00	YP-0835GY	20-1/2"	195	\$401.00
48x24"	4	YP-0828GY	16-1/2"	243	486.00	YP-0836GY	20-1/2"	253	507.00
60x24"	4	YP-0829GY	16-1/2"	288	553.00	YP-0837GY	20-1/2"	298	581.00
48x30"	4	YP-0830GY	16-1/2"	283	543.00	YP-0838GY	20-1/2"	291	569.00
60x30"	4	YP-0831GY	16-1/2"	334	627.00	YP-0839GY	20-1/2"	344	658.00
72x30"	4	YP-0832GY	16-1/2"	411	759.00	YP-0840GY	20-1/2"	421	779.00
60x36"	4	YP-0833GY	16-1/2"	384	693.00	YP-0841GY	20-1/2"	394	707.00
72x36"	4	YP-0834GY	16-1/2"	468	842.00	YP-0842GY	20-1/2"	478	856.00

All shelf capacities are based on evenly distributed loads.



GALVANIZED POSTS



## DURHAM® Heavy-Duty Reinforced Shelving

- 12-gauge steel posts; 14-gauge steel shelves
- Shelf capacity: 3,000 lbs.
- Unassembled

Shelves are channel-formed on 4 sides with stiffeners underneath. 2" x 2" posts are punched on 1" centers. Comes complete with 4 galvanized posts, 5 bolt-on shelves and all hardware. Shelves have durable gray powder coat finish. **IN STOCK.**

Shelf WxD	Shelf Qty.	72" HIGH			96" HIGH			EXTRA SHELVES		
		Model No.	Wt. Lbs.	Price Ea.	Model No.	Wt. Lbs.	Price Ea.	Model No.	Wt. Lbs.	Price Ea.
48x18"	5	YP-1601	216	\$586.00	YP-1607	221	\$605.00	YP-1613	36	\$106.00
48x24"	5	YP-1604	285	644.00	YP-1610	289	663.00	YP-1616	50	118.00
60x24"	5	YP-1605	313	743.00	YP-1611	307	761.00	YP-1617	54	138.00

All shelf capacities are based on evenly distributed loads.

## EDSAL High-Capacity Racks

- 14-gauge steel
- Shelf capacity: 3,000 lbs.
- Unassembled

Channel formed shelves have welded stiffeners. Formed angle 2" x 2" uprights are punched on 1" centers. Gray finish. **IN STOCK.**



Shelf WxD	Shelf Qty.	72" HIGH			96" HIGH		
		Model Number	Wt. Lbs.	Price Each	Model Number	Wt. Lbs.	Price Each
36x18"	5	XP-279	167	\$306.00	XP-285	175	\$317.00
48x18"	5	XP-280	212	376.00	XP-286	220	392.00
60x18"	5	XP-281	252	455.00	XP-287	260	470.00
36x24"	5	XP-282	197	360.00	XP-288	205	374.00
48x24"	5	XP-283	242	431.00	XP-289	250	452.00
60x24"	5	XP-284	292	535.00	XP-290	300	549.00

All shelf capacities are based on evenly distributed loads.

EXTRA SHELVES							
Model Number	Overall	Wt.	Price Each	Model Number	Overall	Wt.	Price Each
XP-291	36x18"	27	\$52.50	XP-294	36x24"	33	\$63.90
XP-292	48x18"	36	68.70	XP-295	48x24"	42	82.50
XP-293	60x18"	44	84.90	XP-296	60x24"	52	101.00



# Cantilever Rack Selection Guide

Cantilever racks are ideal for storing long, rigid materials such as lumber, pipe, and bar stock. The racks can be front-loaded by hand or with a fork truck or can be used as side pick racks in space-conscious areas. This guide will help you through the ordering process by providing basic information needed to select cantilever rack.

## HOW TO ORDER

**A CANTILEVER RACK IS CONFIGURED PER BAY AND CONSISTS OF THREE GENERAL COMPONENTS: ARMS, COLUMNS, AND BRACE SETS.**

- 1. Determine storage needs** by taking into account the length, depth, height and weight of the product being stored.
- 2. Arms:** Choose arm style and length, along with the capacity needed to support the load. Two arms (one on each side) create a "level". Divide the weight of the load per level by two (for one bay) to give the individual arm capacity needed. (This assumes that the load is supported sufficiently by two arms to prevent load deflection).
- 3. Columns:** Determine the number of arms needed per column side and vertical space required. Adding up all of the individual arm capacities and vertical space required will determine the height and combined weight capacity needed for the two columns.
- 4. Brace:** Determine brace set width. Take into account the length of the pieces planned to be stored. Brace set widths will provide center-to-center measurements of the arms installed on columns. One brace set per bay is required.

### EXAMPLE:

- 1. Product to store:** Pipes bundled at 8' long, 10" deep, weighing 2,000 lbs.
- 2. Arm choice:** 12"L, straight, with lip. Load weight is 2,000 lbs. Divide weight by two (one level) to obtain 1,000 lbs. per arm requirement.
- 3. Column choice:** Assuming four levels of load are required, then eight arms would be needed with vertical spacing of 18" apart. Eight arms x 1,000 lbs. capacity per arm = 8,000 lbs. Combined required column capacity (4,000 lbs. per column, single sided) at 8' high would be needed.
- 4. Brace:** 8'L load with two-arm (one bay) support would require a 4' wide brace set.

## BUYING IN COMPLETE SETS

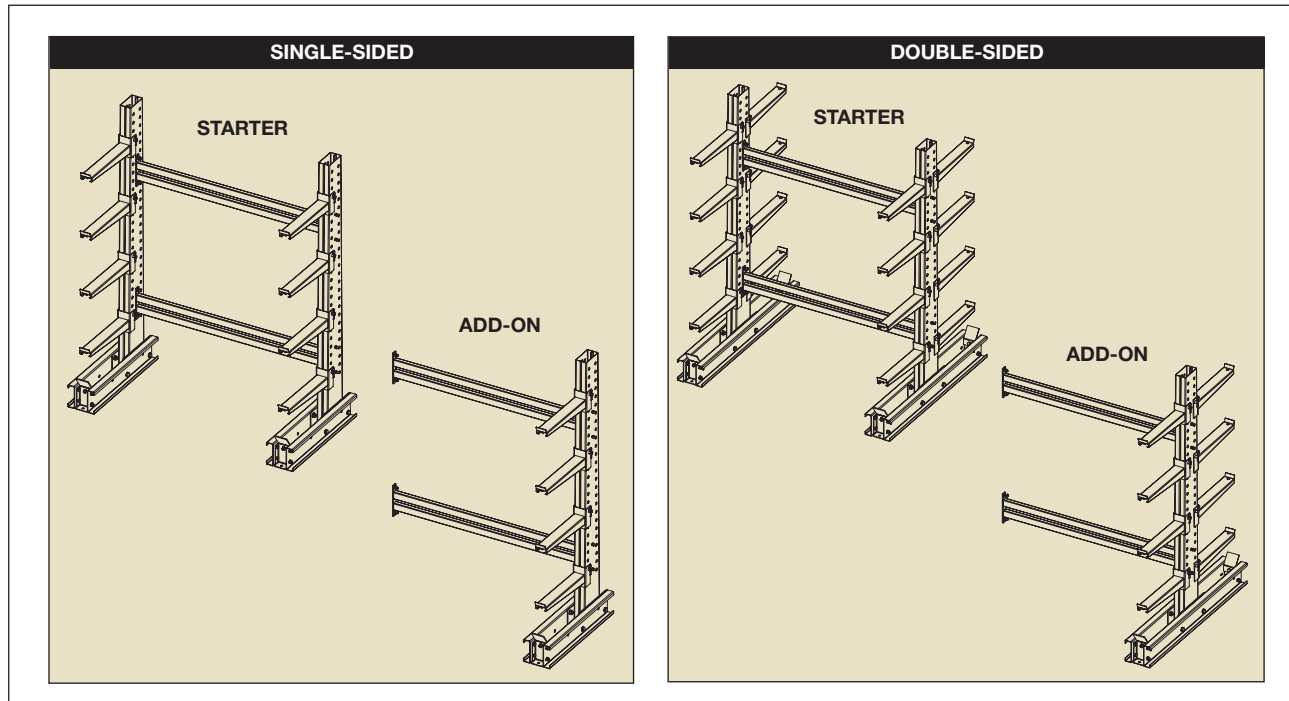

## BUYING IN COMPONENT PARTS

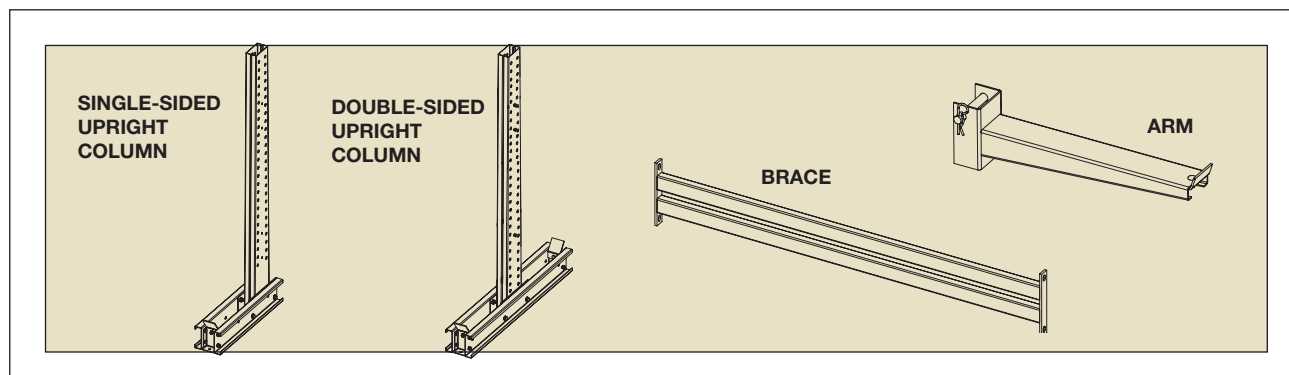

# Heavy-Industrial & Ultra-Capacity Grade Cantilever Racks



## MECO Heavy-Industrial & Ultra-Capacity Grade Cantilever Racks



- Single-sided column capacity: up to 21,900 lbs.
- Double-sided column capacity: up to 43,800 lbs.
- Arm capacity: up to 4,000 lbs.
- 12' and 16' heights

Capacities are based on evenly distributed loads. Gray enamel finish. **FACTORY QUICK SHIP – FOB NEBRASKA.**

**STRAIGHT ARMS FOR HEAVY-INDUSTRIAL GRADE COLUMNS.** Arms adjust on 3" centers. Pin assembly included. **SPECIFY: A - With lip, B - Without lip.**

Model Number	Overall Length	Cap./Arm Lbs.	Wt. Lbs.	Price Each
XP-1585	24"	2000	13	\$27.80
XP-1586	36"	1200	17	33.10
XP-1587	48"	1000	21	38.00
XP-1657	54"	800	24	64.10

**STRAIGHT ARMS FOR ULTRA-CAPACITY GRADE COLUMNS.** Arms adjust on 3" centers. Pin assembly included. **SPECIFY: A - With lip, B - Without lip.**

Model Number	Overall Length	Cap./Arm Lbs.	Wt. Lbs.	Price Each
XP-1650	36"	2175	28	\$44.50
XP-1651	36"	3400	34	57.00
XP-1652	48"	1630	34	50.50
XP-1653	48"	2000	36	54.30
XP-1654	48"	2500	40	61.80
XP-1655	48"	3000	39	78.40
XP-1656	48"	4000	51	93.10
XP-1658	54"	1490	38	64.10
XP-1659	54"	2000	44	78.80
XP-1660	60"	1300	42	65.00
XP-1661	60"	1650	46	91.80
XP-1662	60"	2000	61	116.00

**BRACE SETS FOR HEAVY-INDUSTRIAL GRADE AND ULTRA-CAPACITY GRADE COLUMNS.** Hardware included.

Brace Length	FOR 8' UPRIGHTS				FOR 10'-14' UPRIGHTS				FOR 16' UPRIGHTS			
	Model Number	Brace Qty.	Wt. Lbs.	Price Each	Model Number	Brace Qty.	Wt. Lbs.	Price Each	Model Number	Brace Qty.	Wt. Lbs.	Price Each
4"	XL-0470	Set of 2	35	\$60.70	XP-1665	Set of 3	62	\$92.60	XP-1669	Set of 4	97	\$172.00
5"	XL-0471	Set of 2	42	70.50	XP-1666	Set of 3	62	102.00	XP-1670	Set of 4	113	201.00
6"	XL-0472	Set of 2	49	78.20	XP-1667	Set of 3	73	114.00	XP-1671	Set of 4	130	228.00
8"	XL-0473	Set of 2	63	93.60	XP-1668	Set of 3	94	139.00	XP-1672	Set of 4	182	309.00

### HEAVY-INDUSTRIAL GRADE COLUMNS.

Overall Height	For Arm Length	Max. Cap./ Side Lbs.	SINGLE-SIDED COLUMNS				DOUBLE-SIDED COLUMNS*			
			Model Number	Base Depth	Wt. Lbs.	Price Each	Model Number	Base Depth	Wt. Lbs.	Price Each
8'	24"	21,500	XL-0474	37"	245	\$333.00	XL-0482	65"	290	\$389.00
	36"	16,000	XL-0475	49"	263	351.00	XL-0483	82"	315	420.00
	48"	12,800	XL-0476	61"	281	366.00	XL-0484	106"	349	453.00
	60"	10,700	XL-0477	74"	299	390.00	XL-0485	130"	384	515.00
10'	24"	21,300	XL-0478	37"	283	382.00	XL-0486	65"	328	441.00
	36"	15,800	XL-0479	49"	301	403.00	XL-0487	82"	353	470.00
	48"	12,600	XL-0480	61"	319	418.00	XL-0488	106"	387	503.00
	60"	10,600	XL-0481	74"	337	440.00	XL-0489	130"	422	565.00
12'	24"	20,900	XP-1590	37"	319	424.00	XP-1602	65"	364	482.00
	36"	15,600	XP-1591	49"	337	443.00	XP-1603	82"	389	513.00
	48"	12,500	XP-1592	61"	355	461.00	XP-1604	106"	423	547.00
	60"	10,500	XP-1593	74"	373	481.00	XP-1605	130"	458	606.00
14'	24"	20,200	XP-1594	37"	358	499.00	XP-1606	65"	402	558.00
	36"	15,400	XP-1595	49"	376	520.00	XP-1607	82"	427	586.00
	48"	12,400	XP-1596	61"	393	535.00	XP-1608	106"	462	620.00
	60"	10,400	XP-1597	74"	411	558.00	XP-1609	130"	496	682.00
16'	24"	17,600	XP-1598	37"	396	553.00	XP-1610	65"	440	609.00
	36"	14,000	XP-1599	49"	413	571.00	XP-1611	82"	465	641.00
	48"	12,000	XP-1600	61"	431	590.00	XP-1612	106"	499	672.00
	60"	10,300	XP-1601	74"	449	609.00	XP-1613	130"	534	733.00

\*Maximum capacity for double column is twice value shown.

### ULTRA-CAPACITY GRADE COLUMNS.

Overall Height	For Arm Length	Max. Cap./ Side Lbs.	SINGLE-SIDED COLUMNS				DOUBLE-SIDED COLUMNS*			
			Model Number	Base Depth	Wt. Lbs.	Price Each	Model Number	Base Depth	Wt. Lbs.	Price Each
12'	36"	21,900	XP-1626	52"	432	\$578.00	XP-1638	84"	498	\$677.00
	48"	17,700	XP-1627	64"	454	609.00	XP-1639	108"	542	723.00
	54"	16,100	XP-1625	76"	477	626.00	XP-1637	132"	586	773.00
	60"	14,900	XP-1628	76"	477	626.00	XP-1640	132"	586	774.00
14'	36"	21,000	XP-1630	52"	477	654.00	XP-1642	84"	543	748.00
	48"	17,600	XP-1631	64"	499	679.00	XP-1643	108"	587	802.00
	54"	16,000	XP-1629	76"	522	702.00	XP-1641	132"	631	849.00
	60"	14,600	XP-1632	76"	522	702.00	XP-1644	132"	631	849.00
16'	36"	20,500	XP-1634	52"	522	713.00	XP-1646	84"	588	804.00
	48"	17,200	XP-1635	64"	544	743.00	XP-1647	108"	632	858.00
	54"	15,700	XP-1633	76"	567	758.00	XP-1645	132"	676	904.00
	60"	14,400	XP-1636	76"	567	758.00	XP-1648	132"	676	904.00

\*Maximum capacity for double column is twice value shown.

# Standard-Industrial & Heavy-Industrial Grade Cantilever Racks

## MECO Standard-Industrial Grade Cantilever Racks

- Single-sided column capacity: up to 8,100 lbs.
- Double-sided column capacity: up to 16,200 lbs.
- Arm capacity: up to 1,000 lbs.
- 6', 8' and 10' heights



Straight arms have a 3/8" pitch per foot while inclined arms have a 20° pitch for deflection; all adjust on 3" centers. Ships unassembled. FOB NEBRASKA.

ARMS. SPECIFY: **A** - With Lip, **B** - Without Lip.

Model Number	Arm Length	Arm Cap. Lbs.	Wt. Lbs.	Price Each
<b>STRAIGHT ARMS</b>				
XL-0578	12"	1,000	6	\$20.00
XL-0579	24"	600	8	22.50
XL-0580	36"	400	10	27.70
XL-0581	48"	300	15	36.20
<b>INCLINED ARMS</b>				
XL-0582	12"	1,000	6	\$21.50
XL-0583	24"	600	8	24.80
XL-0584	36"	400	10	30.70
XL-0585	48"	300	15	37.40

**DOUBLE-SIDED RACK**



### COLUMNS

Overall Height	Arm Lengths	Max. Lbs. Cap. Per Side	SINGLE COLUMN				DOUBLE COLUMN*				
			Model Number	Base Depth	Wt. Lbs.	Price Each	Model Number	Base Depth	Wt. Lbs.	Price Each	
6'	12" & 24"	8,100 & 5,500	XL-0560	33"	82	\$162.00	XL-0569	54"	99	\$191.00	
	36"		4,100	XL-0561	45"	90	173.00	XL-0570	78"	115	210.00
	48"		3,300	XL-0562	57"	100	189.00	XL-0571	102"	135	253.00
8'	12" & 24"	7,600 & 5,300	XL-0563	33"	96	180.00	XL-0572	54"	113	207.00	
	36"		4,000	XL-0564	45"	104	186.00	XL-0573	78"	129	226.00
	48"		3,200	XL-0565	57"	114	206.00	XL-0574	102"	149	267.00
10'	12" & 24"	7,100 & 5,000	XL-0566	33"	110	196.00	XL-0575	54"	127	226.00	
	36"		3,800	XL-0567	45"	118	205.00	XL-0576	78"	143	244.00
	48"		3,100	XL-0568	57"	128	223.00	XL-0577	102"	163	285.00

\*Maximum capacity for double column is twice value shown.

### BRACE SETS FOR COLUMNS. Set of 2.

Model Number	Brace Length	Wt. Lbs.	Price Each Set
XL-0586	35"	28	\$54.60
XL-0587	47"	35	64.80
XL-0588	59"	42	75.00
XL-0589	71"	49	85.00



**DOUBLE-SIDED RACK**



## MECO Heavy-Industrial Grade Cantilever Racks

- Single-sided column capacity: up to 13,300 lbs.
- Double-sided column capacity: up to 26,600 lbs.
- Arm capacity: up to 2,400 lbs.
- 8', 10', 12' and 14' heights

Straight arms have a 3/8" pitch per foot while inclined arms have a 20° pitch for deflection; all adjust on 3" centers. FOB NEBRASKA.

**SINGLE-SIDED RACK**



### COLUMNS

Overall Height	Arm Lengths	Max. Lbs. Cap. Per Side	SINGLE ARM COLUMN				DOUBLE ARM COLUMN*			
			Model Number	Base Depth	Wt. Lbs.	Price Each	Model Number	Base Depth	Wt. Lbs.	Price Each
8'	24"	13,300	XL-0590	38"	188	\$263.00	XL-0602	59"	216	\$302.00
	36"	10,600	XL-0591	50"	201	279.00	XL-0603	83"	243	332.00
	48"	8,800	XL-0592	62"	215	294.00	XL-0604	107"	270	362.00
10'	24"	13,100	XL-0593	38"	217	296.00	XL-0605	59"	245	336.00
	36"	10,300	XL-0594	50"	230	312.00	XL-0606	83"	272	366.00
	48"	8,600	XL-0595	62"	244	326.00	XL-0607	107"	299	396.00
12'	24"	12,600	XL-0596	38"	245	331.00	XL-0608	59"	273	372.00
	36"	10,200	XL-0597	50"	258	347.00	XL-0609	83"	300	401.00
	48"	8,500	XL-0598	62"	272	363.00	XL-0610	107"	327	432.00
14'	24"	12,300	XL-0599	38"	272	386.00	XL-0611	59"	300	426.00
	36"	9,800	XL-0600	50"	285	400.00	XL-0612	83"	327	457.00
	48"	8,300	XL-0601	62"	299	417.00	XL-0613	107"	354	485.00

\*Maximum capacity for double column is twice value shown.

### BRACE SETS FOR COLUMNS

Model Number	Brace Length	Wt. Lbs.	Price Each Set	Model Number	Brace Length	Wt. Lbs.	Price Each Set
<b>FOR 8' COLUMNS SET OF TWO</b>				<b>FOR 10-14' COLUMNS SET OF THREE</b>			
XL-0971	35"	28	\$55.50	XL-0975	35"	41	\$83.20
XL-0972	47"	35	64.80	XL-0976	47"	52	97.10
XL-0973	59"	42	75.00	XL-0977	59"	62	112.00
XL-0974	71"	49	85.00	XL-0978	71"	79	126.00

ARMS. SPECIFY: **A** - With Lip, **B** - Without Lip.

Model Number	Arm Length	Arm Cap. Lbs.	Wt. Lbs.	Price Each
<b>STRAIGHT ARMS</b>				
XL-0614	24"	1,200	9	\$29.40
XL-0615	24"	2,400	14	36.30
XL-0616	36"	800	11	35.80
XL-0617	36"	1,500	18	40.20
XL-0618	36"	2,400	23	47.60
XL-0619	48"	600	16	40.90
XL-0620	48"	1,000	21	41.10
XL-0621	48"	1,500	24	44.00
XL-0622	48"	2,000	29	48.40
<b>INCLINED ARMS</b>				
XL-0623	24"	1,200	9	\$32.60
XL-0624	36"	800	11	37.50
XL-0970	48"	600	16	43.30

# Heavy-Industrial Grade Cantilever Racks



SHOWN WITH ONE DOUBLE-SIDED COLUMN AND ONE ADD-ON.



SHOWN WITH TWO SINGLE-ARM COLUMNS.  
THE ONLY MANUFACTURER WITH DOUBLE-TUBE BRACING FOR GREATER STABILITY.



RUGGED ARM CONSTRUCTION. RIGID COLUMNS ARE CONNECTED TO HEAVY ARM SADDLES FOR EFFICIENT LOAD SUPPORT.



SECURE PIN LOCK FOR ARMS AND BRACES. IS EASILY INSERTED OR REMOVED TO INSTANTLY ADJUST ARMS. PIN WILL NOT WORK LOOSE WHEN IT IS SECURED.

## JARKE® Steeltree® Heavy-Industrial Grade Cantilever Racks

- Single-sided column capacity: up to 16,000 lbs.
- Double-sided column capacity: up to 32,000 lbs.
- Arm capacity: up to 2,000 lbs.
- 8', 10', and 12' heights

Tapered columns have patented internal stiffeners. 10-gauge steel columns. Arms adjust on 3" centers. **SELECTED MODELS IN STOCK.** Others FOB ILLINOIS.

### COMPLETE CANTILEVER SYSTEMS

Includes hardware. Ships unassembled.

Overall Height	Base Depth	Cap. Lbs.	Arm Cap. Lbs.	Base Width	STARTER				ADD-ON			
					Model No.	Arm Lgth.	Wt. Lbs	Price Ea.	Model No.	Arm Lgth.	Wt. Lbs	Price Ea.
<b>SINGLE-SIDED COLUMN</b>												
8'	37"	16,000	2000	(Set of 2) 6'	XP-0200	(8) at 24"	564	\$1126.00	XP-0212	(4) at 24"	313	\$637.00
10'	46"	15,600	1300	(Set of 3) 6'	XP-0201	(12) at 36"	791	1569.00	XP-0213	(6) at 36"	442	897.00
12'	58"	16,000	1000	(Set of 3) 6'	XP-0202	(8) at 48"	827	1823.00	XP-0214	(4) at 48"	460	983.00
<b>DOUBLE-SIDED COLUMN</b>												
8'	65"	32,000	2000	(Set of 2) 6'	XP-0209	(16) at 24"	442	\$1515.00	XP-0215	(8) at 24"	774	\$832.00
10'	82"	31,200	1300	(Set of 3) 6'	XP-0210	(24) at 36"	1,113	2213.00	XP-0216	(12) at 36"	603	1218.00
12'	106"	20,000	1000	(Set of 3) 6'	XP-0211	(16) at 48"	1,161	2782.00	XP-0217	(8) at 48"	627	1475.00



# Heavy-Industrial Grade Cantilever Racks

## JARKE® Cantilever Rack Components

### COLUMNS

Includes hardware. Ships unassembled.

Model Number	Overall Height	Arm Lengths	Max. Lbs. Cap. Per Side	Base Depth	Wt. Lbs.	Price Each
<b>SINGLE-ARM COLUMN—Sold individually</b>						
XP-323	8'	12", 18"	18,520, 14,950	31"	183	\$321.00
XP-324	8'	24"	12,530	37"	191	332.00
XP-325	8'	30", 36"	10,780, 9,460	46"	211	347.00
XP-326	8'	42", 48"	8,430, 7,600	58"	230	363.00
XP-327	10'	12", 18"	26,650, 20,640	31"	248	389.00
XP-328	10'	24"	16,860	37"	256	399.00
XP-329	10'	30", 36"	14,250, 12,340	46"	276	414.00
XP-330	10'	42", 48"	10,880, 9,730	58"	286	430.00
XP-331	12'	12", 18"	26,300, 20,450	31"	283	443.00
XP-332	12'	24"	16,730	37"	291	455.00
XP-333	12'	30", 36"	14,160, 12,270	46"	311	467.00
XP-334	12'	42", 48"	10,830, 9,690	58"	321	484.00
XP-335	15'	24"	16,540	37"	371	625.00
XP-336	15'	30", 36"	14,020, 12,170	46"	385	638.00
XP-337	15'	42", 48"	10,750, 9,620	58"	402	656.00
<b>DOUBLE-ARM COLUMN—Sold individually</b>						
XP-338	8'	12", 18"	18,520, 14,950	53"	210	\$364.00
XP-339	8'	24"	12,530	65"	236	385.00
XP-340	8'	30", 36"	10,780, 9,460	82"	252	403.00
XP-341	8'	42", 48"	8,430, 7,600	106"	292	468.00
XP-342	10'	12", 18"	26,650, 20,640	53"	275	430.00
XP-343	10'	24"	16,860	65"	301	451.00
XP-344	10'	30", 36"	14,250, 12,340	82"	317	471.00
XP-345	10'	42", 48"	10,880, 9,730	106"	357	533.00
XP-346	12'	12", 18"	26,300, 20,450	53"	310	485.00
XP-347	12'	24"	16,730	65"	336	503.00
XP-348	12'	30", 36"	14,160, 12,270	82"	352	524.00
XP-349	12'	42", 48"	10,830, 9,690	106"	392	587.00
XP-350	15'	24"	16,540	65"	414	684.00
XP-351	15'	30", 36"	14,020, 12,170	82"	438	705.00
XP-352	15'	42", 48"	10,750, 9,620	106"	473	769.00

\*Maximum capacity for double column is twice value shown.



### STRAIGHT ARMS

Pin assembly included.

Overall Length	Arm Cap. Lbs.	Wt. Lbs.	NO LIP		WITH LIP	
			Model No.	Price Ea.	Model No.	Price Ea.
12"	3,000	11	XP-309	\$26.80	XP-316	\$29.80
18"	2,500	13	XP-310	29.80	XP-317	32.80
24"	2,000	15	XP-311	31.70	XP-318	34.60
30"	1,600	17	XP-312	37.20	XP-319	40.10
36"	1,300	20	XP-313	40.60	XP-320	43.60
42"	1,145	22	XP-314	43.40	XP-321	46.50
48"	1,000	24	XP-315	46.50	XP-322	49.40



### INCLINED ARMS

Do not have lip. Pin assembly included.

Model Number	Overall Length	Arm Cap. Lbs.	Wt. Lbs.	Price Each
XP-303	12"	3,000	12	\$29.00
XP-304	18"	2,500	14	31.80
XP-305	24"	2,000	16	34.90



### BRACE SETS FOR COLUMNS.

3-6 ft. wide column centers. Includes hardware. SPECIFY WIDTH:

A - 3', B - 4', C - 5', D - 6'.

Model Number	Column Height	Brace Quantity	A - 3' Price Ea.	B - 4' Price Ea.	C - 5' Price Ea.	D - 6' Price Ea.
XP-306	8'	Set of 2	\$79.40	\$90.30	\$97.60	\$110.00
XP-307	10' & 12'	Set of 3	119.00	137.00	148.00	166.00
XP-308	15'	Set of 4	229.00	271.00	315.00	335.00



# Standard-Industrial & Heavy-Industrial Grade Cantilever Racks



**STOCK**  
Selected Models

**UP TO 1300-LB. CAPACITY**  
Per Arm

**JARKE® Standard-Industrial Grade Cantilever Racks**

- Single-sided column capacity: up to 6,960 lbs. Double-sided column capacity: up to 13,920 lbs.
- Arm capacity: up to 1,300 lbs.
- 6', 7', 8', and 10' heights

12-gauge steel. Arms adjust on 3" centers. Assemble as either a single rack or a continuous unit consisting of any number of uprights. **SELECTED MODELS IN STOCK.** Others FOB ILLINOIS.

**COLUMNS**

Base Depth	Arm Lengths	Max. Lbs. Cap. Per Side*	Model Number	O.A. Ht.	Wt. Lbs.	Price Each	Model Number	O.A. Ht.	Wt. Lbs.	Price Each
<b>SINGLE-ARM COLUMN. Sold individually.</b>										
31"	12, 18"	9,980, 8,050	<a href="#">XD-1700</a>	6'	106	\$238.00	<a href="#">XD-1706</a>	8'	125	\$272.00
37"	24"	6,750	<a href="#">XD-1701</a>	6'	111	247.00	<a href="#">XD-1707</a>	8'	130	279.00
46"	30, 36"	5,810, 5,100	<a href="#">XD-1702</a>	6'	119	258.00	<a href="#">XD-1708</a>	8'	138	293.00
31"	12, 18"	9,980, 8,050	<a href="#">XD-1703</a>	7'	116	244.00	<a href="#">XD-1709</a>	10'	145	304.00
37"	24"	6,750	<a href="#">XD-1704</a>	7'	121	250.00	<a href="#">XD-1710</a>	10'	150	316.00
46"	30, 36"	5,810, 5,100	<a href="#">XD-1705</a>	7'	129	281.00	<a href="#">XD-1711</a>	10'	158	328.00
<b>DOUBLE-ARM COLUMN*. Sold individually.</b>										
53"	12, 18"	9,980, 8,050	<a href="#">XD-1712</a>	6'	123	\$279.00	<a href="#">XD-1718</a>	8'	142	\$312.00
65"	24"	6,750	<a href="#">XD-1713</a>	6'	133	295.00	<a href="#">XD-1719</a>	8'	152	328.00
82"	30, 36"	5,810, 5,100	<a href="#">XD-1714</a>	6'	148	317.00	<a href="#">XD-1720</a>	8'	167	326.00

\*Maximum capacity for double column is twice value shown.

**ARMS**

Arm Length	Arm Cap. Lbs.	Wt. Lbs.	NO LIP		WITH LIP	
			Model No.	Price Ea.	Model No.	Price Ea.
<b>STRAIGHT ARMS</b>						
12"	1,300	8	<a href="#">XD-1725</a>	\$23.80	<a href="#">XD-1735</a>	\$26.20
18"	870	9	<a href="#">XD-1726</a>	25.60	<a href="#">XD-1736</a>	28.20
24"	650	11	<a href="#">XD-1727</a>	27.80	<a href="#">XD-1737</a>	30.50
30"	520	12	<a href="#">XD-1728</a>	29.70	<a href="#">XD-1738</a>	32.10
36"	430	14	<a href="#">XD-1729</a>	34.10	<a href="#">XD-1739</a>	36.40
<b>INCLINED ARMS</b>						
12"	1,300	9	<a href="#">XD-1730</a>	\$23.20	<a href="#">XD-1740</a>	\$25.50
18"	870	10	<a href="#">XD-1731</a>	25.60	<a href="#">XD-1741</a>	27.80
24"	650	12	<a href="#">XD-1732</a>	28.30	<a href="#">XD-1742</a>	30.60
30"	520	13	<a href="#">XD-1733</a>	30.60	<a href="#">XD-1743</a>	32.90
36"	430	15	<a href="#">XD-1734</a>	34.30	<a href="#">XD-1744</a>	36.40

**BRACE SETS FOR COLUMNS. Set of 2.**

Model No.	Brace Width	Wt. Lbs.	Price Ea. Set
<a href="#">XD-1745</a>	3'	25	\$66.30
<a href="#">XD-1746</a>	4'	32	69.40
<a href="#">XD-1747</a>	5'	39	74.00
<a href="#">XD-1748</a>	6'	46	79.10
<a href="#">XD-1749</a>	8'	60	90.50

**DOUBLE-SIDED RACK**

**MADE IN USA**



**STOCK**

**UP TO 1600-LB. CAPACITY**  
Per Arm

**RELIUS SOLUTIONS Heavy-Industrial Grade Cantilever Racks**

- Single-sided column capacity: up to 15,900 lbs.
- Double-sided column capacity: up to 31,800 lbs.
- Arm capacity: up to 1,600 lbs.
- 8' and 12' heights

Rectangular columns have internal stiffeners at brace connecting points. Double tube braces. Arms are constructed of 3" sq. tube that is welded to a heavy steel saddle. Arms adjust on 3" centers. Accepts fork truck as well as hand loading. **IN STOCK.**

**COLUMNS**

Model Number	Overall Ht.	Arm Lengths	Max. Lbs. Cap. Per Side	Base Depth	Wt. Lbs.	Price Each
<b>SINGLE-ARM COLUMN. Sold individually.</b>						
<a href="#">XM-1130</a>	8'	24"	12,000	37"	174	\$338.00
<a href="#">XM-1131</a>	8'	36"	9,000	46"	194	353.00
<a href="#">XM-1132</a>	8'	48"	7,200	58"	204	364.00
<a href="#">XM-1133</a>	12'	24"	15,900	37"	220	429.00
<a href="#">XM-1134</a>	12'	36"	11,900	46"	240	444.00
<a href="#">XM-1135</a>	12'	48"	8,950	58"	250	456.00
<b>DOUBLE-ARM COLUMN*. Sold individually.</b>						
<a href="#">XM-1159</a>	8'	24"	12,000	65"	219	\$381.00
<a href="#">XM-1160</a>	8'	36"	9,000	82"	235	410.00
<a href="#">XM-1161</a>	8'	48"	7,200	106"	275	473.00
<a href="#">XM-1162</a>	12'	24"	15,900	65"	265	473.00
<a href="#">XM-1163</a>	12'	36"	11,900	82"	281	500.00
<a href="#">XM-1164</a>	12'	48"	8,950	106"	321	562.00

\*Maximum capacity for double column is twice value shown.

**STRAIGHT ARMS**

Arm Lgth.	Max. Lbs. Cap./Side	Wt. Lbs.	NO LIP		WITH LIP	
			Model No.	Price Ea.	Model No.	Price Ea.
24"	1,600	10-1/4	<a href="#">XM-1165</a>	\$31.60	<a href="#">XM-1168</a>	\$33.90
36"	1,150	13-1/2	<a href="#">XM-1166</a>	36.70	<a href="#">XM-1169</a>	38.90
48"	900	17	<a href="#">XM-1167</a>	42.70	<a href="#">XM-1170</a>	45.10

**BRACE SETS FOR COLUMNS. Set of 2.**  
**SPECIFY BRACE WIDTH: A - 3', B - 4', C - 6'**

Model Number	Column Ht.	Qty.	A - 3'			B - 4'			C - 6'		
			Price Ea. Set	Price Ea. Set	Price Ea. Set	Price Ea. Set	Price Ea. Set	Price Ea. Set	Price Ea. Set		
<a href="#">XM-1172</a>	8'	Set of 2	\$86.40	\$97.90	\$115.00						
<a href="#">XM-1173</a>	12'	Set of 3	130.00	150.00	174.00						

NOTE: ALSO AVAILABLE IN 12' LENGTH.

**DOUBLE-SIDED RACK**

**MADE IN USA**

# Bar Storage



## DURHAM® Vertical Bar Rack

- 3,000-lb. overall capacity
- 3 bays
- All-welded

Arms extend 8" beyond the 16-gauge steel shelves. 1-1/2" x 1/8" angle iron frame. Gray powder coat finish.

**IN STOCK.**

Model No. **YA-1786** —  
**36"Wx24"Dx84"H.**  
 Wt. 110 lbs. ....\$308.00



VERTICAL BAR RACK



HORIZONTAL BAR RACK

## DURHAM® Horizontal Bar Rack

- 2,600-lb. capacity
- 9 pairs of double-sided arms
- 143-lb. capacity per arm level, per side, evenly distributed
- Unassembled

Pyramid shape adds stability. Angled arm levels are spaced 7" on center and provide 9-1/2" L storage space. 14-gauge steel construction. Gray powder coat finish. **IN STOCK.**

Model No. **YA-1787** —  
**30"Wx30"Dx85"H.**  
 Wt. 64 lbs. ....\$373.00

## RELIUS SOLUTIONS Bar Cradle Trucks

- 4,000- and 10,000-lb. capacities
- All-welded
- Phenolic casters mounted in a diamond pattern

1/4" steel cradle includes 3" channel upright support. 8" x 2" end casters.

**FACTORY QUICK SHIP — FOB NEBRASKA.**



Model Number	Overall LxWxH	Capacity Lbs.	Cradle Qty.	Channel Size	Load Wheels WxH	Wt. Lbs.	Price Each
<b>XK-1568</b>	60x28x29"	4,000	3	C-3	12x2-1/2"	194	<b>\$498.00</b>
<b>XK-1569</b>	96x28x29"	4,000	3	C-3	12x2-1/2"	229	<b>545.00</b>
<b>XK-1570</b>	60x28x29"	10,000	3	C-3	12x3"	248	<b>564.00</b>
<b>XK-1571</b>	96x28x29"	10,000	4	C-3	12x3"	316	<b>713.00</b>
<b>XK-1572</b>	120x28x29"	10,000	4	C-4	12x3"	423	<b>798.00</b>



# Stacking Racks



## JARKE® AIRector® Portable Stacking Rack Components



- 10-13-gauge tubular steel
- 2,000- and 4,000-lb. capacities
- All-welded base

May be stacked up to 4 high. Four-way fork truck entry. 4-1/2" underclearance. Available with 1" x 6" sturdy decking or without. Build your own racks from components listed below. **FACTORY QUICK SHIP – FOB ILLINOIS.**

### 2,000-LB. CAPACITY COMPONENTS.

13-gauge, 1-1/2" square tube posts with 1-3/4" square sockets.

Overall L x W	BASE WITH DECKING (1" x 6" boards)			BASE WITHOUT DECKING		
	Model No.	Wt. Lbs.	Price Ea.	Model No.	Wt. Lbs.	Price Ea.
48" x 42"	<b>XV-2368</b>	81	\$173.00	<b>XV-2372</b>	60	\$154.00
60" x 42"	<b>XV-2369</b>	92	192.00	<b>XV-2373</b>	75	151.00
48" x 48"	<b>XV-2370</b>	92	196.00	<b>XV-2374</b>	65	161.00
60" x 48"	<b>XV-2371</b>	103	205.00	<b>XV-2375</b>	82	169.00

Model No. <b>XV-2376</b> —36"H, 13-gauge post (4/set).....	\$80.30 ea. set
Model No. <b>XV-2377</b> —42"H, 13-gauge post (4/set).....	\$92.30 ea. set
Model No. <b>XV-2378</b> —48"H, 13-gauge post (4/set).....	\$92.90 ea. set

NOTE: 60" posts available on request.

### 4,000-LB. CAPACITY COMPONENTS.

10-gauge, 2.170" sq. tube posts with 2-1/2" square sockets.

Overall L x W	BASE WITH DECKING (1 x 6" boards)			BASE WITHOUT DECKING		
	Model No.	Wt. Lbs.	Price Ea.	Model No.	Wt. Lbs.	Price Ea.
48" x 42"	<b>XV-2357</b>	91	\$200.00	<b>XV-2361</b>	97	\$181.00
60" x 42"	<b>XV-2358</b>	105	211.00	<b>XV-2362</b>	109	193.00
48" x 48"	<b>XV-2359</b>	103	217.00	<b>XV-2363</b>	104	195.00
60" x 48"	<b>XV-2360</b>	117	226.00	<b>XV-2364</b>	115	205.00

Model No. <b>XV-2365</b> —36"H, 10-gauge post (4/set).....	\$81.80 ea. set
Model No. <b>XV-2366</b> —42"H, 10-gauge post (4/set).....	\$84.00 ea. set
Model No. <b>XV-2367</b> —48"H, 10-gauge post (4/set).....	\$93.00 ea. set



## JARKE® Mini Modules®

- 14-gauge steel posts; 7-gauge steel supports
- Up to 7,500-lb. capacity
- All-welded

Strong welded steel construction—no bolts, fittings or tools required. Stack up to 6 modules high. Optional shelves divide modules for extra storage. **IN STOCK.**

Model Number	Overall L x W x H	Cap. Lbs.	Wt. Lbs.	Price Each
<b>YP-297</b>	16" x 12" x 13-1/2"	2,500	17	\$66.10
<b>YP-298</b>	19" x 14" x 17"	3,700	29	68.70
<b>YP-299</b>	22" x 15" x 20-1/2"	5,600	35	77.20
<b>YP-300</b>	26" x 16" x 23-1/2"	7,500	60	95.00

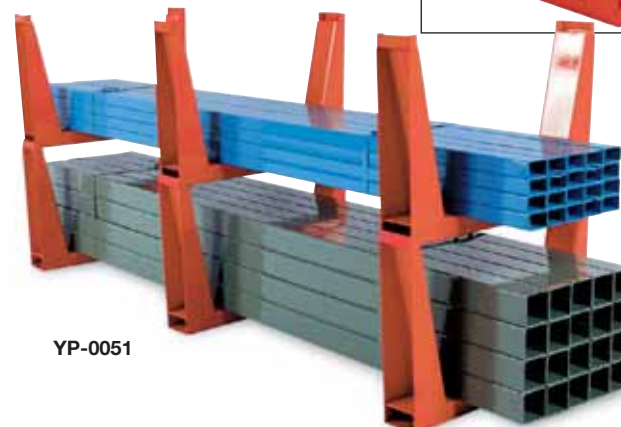

YP-0051

## MECO Stacking U-Racks

- 10-12-gauge steel sides; 7-gauge steel supports
- 6,000- and 10,000-lb. capacities
- All-welded

Interlocking steel frames stack up to 4 high. Load capacities can be varied by moving racks closer together or farther apart. Clearance height: 15-3/4". Orange enamel finish. **IN STOCK.**

Model No.	Overall L x W x H	Cap. Lbs./Pr.	Wt. Lbs.	Price Ea.
<b>YP-0050</b>	25" x 4" x 20"	6,000	23	\$68.80
<b>YP-0051</b>	25" x 4" x 19"	10,000	27	75.30

# Reel Dispensers

## WIREWAY/HUSKY Cable Reel Racks

- Includes three sets of axle brackets
- 2,000-lb. capacity per pair of axle brackets
- 10,000-lb. overall capacity



All-welded steel upright braces with 2-1/2" dia. spindle brackets. You provide the bars that hold the reels in place. Handles reel sizes up to 5' diameter. Begin with a starter and secure add-ons as needed to make a row. **SELECTED MODELS IN STOCK.** Others FOB NORTH CAROLINA.

Overall W x D x H	STARTER			ADD-ON		
	Model No.	Wt. Lbs.	Price Ea.	Model No.	Wt. Lbs.	Price Ea.
24" x 24" x 96"	<b>XS-865</b>	140	<b>\$611.00</b>	<b>XS-871</b>	91	<b>\$419.00</b>
36" x 24" x 96"	<b>XS-866</b>	146	<b>581.00</b>	<b>XS-872</b>	97	<b>390.00</b>
48" x 24" x 96"	<b>XS-867</b>	152	<b>571.00</b>	<b>XS-873</b>	103	<b>380.00</b>
24" x 36" x 96"	<b>XS-868</b>	150	<b>623.00</b>	<b>XS-874</b>	96	<b>425.00</b>
36" x 36" x 96"	<b>XS-869</b>	156	<b>594.00</b>	<b>XS-875</b>	102	<b>396.00</b>
48" x 36" x 96"	<b>XS-870</b>	162	<b>584.00</b>	<b>XS-876</b>	108	<b>387.00</b>
24" x 24" x 120"	<b>XS-877</b>	168	<b>734.00</b>	<b>XS-883</b>	108	<b>519.00</b>
36" x 24" x 120"	<b>XS-878</b>	176	<b>757.00</b>	<b>XS-884</b>	116	<b>542.00</b>
48" x 24" x 120"	<b>XS-879</b>	184	<b>740.00</b>	<b>XS-885</b>	124	<b>523.00</b>
24" x 36" x 120"	<b>XS-880</b>	174	<b>745.00</b>	<b>XS-886</b>	111	<b>524.00</b>
36" x 36" x 120"	<b>XS-881</b>	182	<b>767.00</b>	<b>XS-887</b>	119	<b>546.00</b>
48" x 36" x 120"	<b>XS-882</b>	190	<b>749.00</b>	<b>XS-888</b>	137	<b>528.00</b>

Model No. **YS-889**— Axle brackets.....\$38.00 per pair

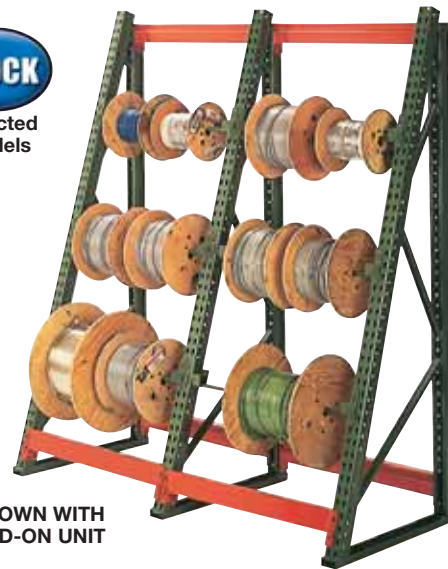

SHOWN WITH  
ADD-ON UNIT

## Three-Spool Rack

- Includes 1 axle
- 150-lbs. overall capacity



Stores any diameter spool. Solid welded construction. FOB WISCONSIN.

Model No. **YV-2353**— 12"Lx20"Wx19"H. Wt. 7 lbs. ....\$87.50

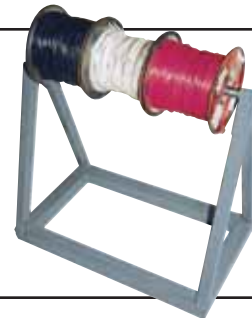

## DURHAM® Spool Racks

- Includes one, two, or four sets of axle brackets
- 15-lb. capacity per axle
- 15-, 30-, and 60-lb. capacities



Stores wire spools up to 10" diameter. Plated 5/8" diameter steel axles. Heavy-gauge steel frame is painted with a rust-resistant powder coat finish. Choose single-axle rack with carrying handle, double-axle rack or four-axle rack that holds 20 or more spools. Ships

unassembled. Color: gray. **FACTORY QUICK SHIP**— FOB CONNECTICUT.

Model Number	Description	Cap. Lbs.	Overall W x D x H	Wt. Lbs.	Price Each
<b>YM-2502</b>	1 axle	15	26-1/8 x 6" x 10-3/8"	9	<b>\$52.30</b>
<b>YM-2503</b>	2 axles	30	26-1/8 x 6" x 17-7/8"	11	<b>62.60</b>
<b>YM-2504</b>	4 axles	60	26-1/8 x 6" x 37-1/8"	18	<b>93.50</b>



## Reel Winders

Heavy-gauge steel frame includes ball bearing rollers with hex axle that lock into end channels. Side rollers are standard. Handles reels from 28" to 48" wide. Color: orange. FOB NEBRASKA.

Model Number	Reel Qty.	Overall W x D x H	Cap. Lbs.	Wt. Lbs.	Price Each
<b>YS-124</b>	(1) 28"W	31-1/2" x 28" x 4"	1,500	73	<b>\$310.00</b>
<b>YS-125</b>	(1) 48"W or (2) 24"W	31-1/2" x 28" x 4"	3,000	114	<b>478.00</b>
<b>YS-128*</b>	(1) Any Width	9-1/4" x 28" x 4"	3,000	79	<b>528.00/pair</b>

\*5-1/2" max. flange width. One single unit can be purchased to expand use of Model No. YS-124 and YS-125.

# Small Parts Storage



## EDSAL Drawer Shelving

- Multiple drawer sizes available
- Steel cabinet

Hanglock catches above shelf act as drawer stop and allow drawer with rear lip to suspend from shelf above. Removable 22-ga. welded steel drawers feature hemmed edges, extra large full grip handle, label slots, and divider slots. Optional dividers adjust in 1" increments. Unassembled. **IN STOCK.**

OPTIONAL DIVIDERS		
Model No.	Width	Price Ea.
WA-2100	5-9/16"	\$0.90
WA-2101	8-3/8"	1.75
WA-2102	11-1/4"	2.29

WP-369

Model Number	Overall WxDxH	Drawer Qty./ Drawer WxDxH	Wt. Lbs.	Price Each
WP-365	36x12x75"	(48) 8-3/8x12x4-5/8"	296	\$863.00
WP-366	36x18x75"	(48) 8-3/8x18x4-5/8"	384	1044.00
WP-367	36x12x75"	(72) 5-9/16x12x4-5/8"	296	886.00
WP-368	36x18x75"	(72) 5-9/16x18x4-5/8"	408	1062.00
WP-369	36x12x75"	(36) 5-9/16x12x4-5/8" (24) 8-3/8x12x4-5/8"	296	874.00
WP-370	36x18x75"	(36) 5-9/16x18x4-5/8" (24) 8-3/8x18x4-5/8"	396	1053.00



## DURHAM® Modular Drawer Cabinets

- Multiple drawer sizes available
- Steel cabinet

Stackable steel cabinets. Drawers have full width handles and positive stops. Two dividers per drawer—adjust on 1" centers. Rust and acid resistant gray powder coat finish. **IN STOCK.**

Model Number	Overall WxDxH	Drawer Qty.	Drawer WxDxH	Wt. Lbs.	Price Each
XG-4185	33-3/4x11-5/8x4"	6	5-3/8x11-1/4x2-3/4"	18	\$72.10
XG-4183	33-3/4x11-5/8x10-7/8"	18	5-3/8x11-1/4x2-3/4"	50	146.00
XG-4187	33-3/4x11-3/4x12-7/8"	18	5-3/8x11-1/4x3-1/2"	54	179.00
XG-4189	33-3/4x17-1/4x12-7/8"	18	5-3/8x17x3-1/2"	75	276.00
XG-4184	33-3/4x11-5/8x14-3/8"	24	5-3/8x11-1/4x2-3/4"	62	204.00
XG-4188	33-3/4x11-3/4x17"	24	5-3/8x11-1/4x3-1/2"	71	247.00
XG-4190	33-3/4x17-1/4x17"	24	5-3/8x17x3-1/2"	96	350.00



Selected Models

## DURHAM® Drawer Cabinet Systems

- 5-1/4"W x 11-1/8"D x 2-3/4"H drawers
- Steel cabinet



Arrive set up, ready to be filled. Each drawer has two dividers, full-width handles, positive stops, and open on two embossed runners. Rust- and acid-resistant gray powder coat finish. **SELECTED MODELS IN STOCK.** Others **FACTORY QUICK SHIP—FOB CONNECTICUT.**

Model Number	Drawer Qty.	Overall WxDxH	Wt. Lbs.	Net Each
XJ-3201	48	34-1/8x12-1/4x33-3/4"	161	\$555.00
XJ-3202	72	34-1/8x12-1/4x48-1/8"	216	762.00
XJ-3203	96	34-1/8x12-1/4x62-1/2"	300	969.00



## DURHAM® All-Welded Bin Cabinets



- Multiple bin sizes available
- Steel cabinet

Stack cabinets to save floor space and increase storage, or use alone on benches and assembly areas. All welded. Fully hemmed safety bin ledges. Gray powder coat finish. Ships set up. **IN STOCK.**

Model Number	Overall WxDxH	Bin Qty.	Bin WxDxH	Wt. Lbs.	Price Each
XS-1531	33-3/4x12x24"	40	4x11-7/8x4-1/2"	50	\$125.00
XS-1530	33-3/4x12x42"	20	8x11-7/8x8-1/2"	55	169.00
XS-1532	33-3/4x12x42"	42	5-3/8x11-7/8x5-1/2"	71	203.00
XS-1533	33-3/4x12x42"	56	4-1/2x11-7/8x5-1/2"	75	204.00
XS-1534	33-3/4x12x42"	72	4x11-7/8x4-1/2"	80	203.00

**OPEN BASE FOR BIN CABINETS. 5-3/4"H.**

Model No. **XS-1535**—Wt. 13 lbs. .... **\$24.20**

# Small Parts Storage

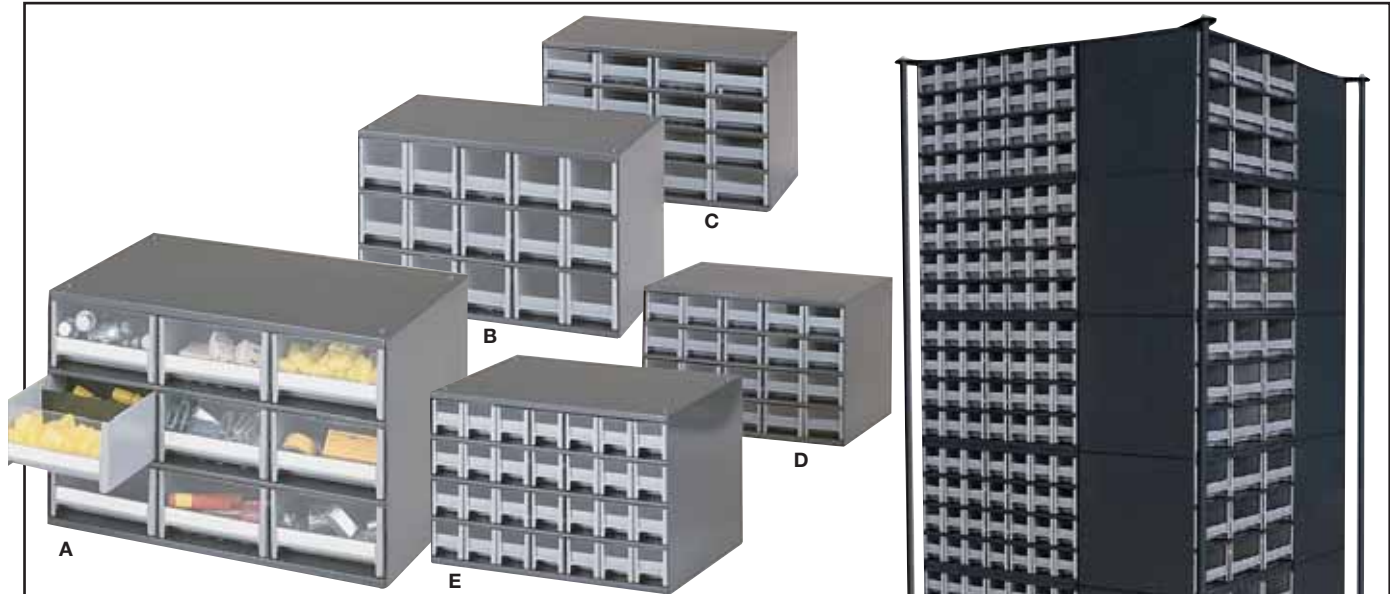

## AKRO-MILS® Industrial Parts Cabinets

- Multiple drawer sizes available
- Steel cabinet

Molded polystyrene plastic drawers are virtually unbreakable, rust and corrosion proof, and guaranteed for life. Half-clear drawer fronts. I.D. labels, label holders, and dividers also included. Cabinet has powder coat finish. **IN STOCK.**



CABINETS						DIVIDERS (pkg. of 25)			
Key	Model Number	Overall WxDxH	Drawer Qty.	Drawer WxDxH	Wt. Lbs.	Price Each	Model Number	Price Pkg.	
A	<b>XG-3182</b>	17x11x11"	9	5-1/4x10-1/2x3"	21	\$93.50	<b>XG-3188</b>	\$13.00	
B	<b>XG-3183</b>	17x11x11"	15	3-1/8x10-1/2x3"	23	93.50	<b>XG-3189</b>	11.10	
C	<b>XG-3184</b>	17x11x11"	16	4x10-1/2x2-1/8"	23	93.50	<b>XG-3190</b>	10.10	
D	<b>XG-3185</b>	17x11x11"	20	3-1/4x10-1/2x2-1/8"	25	93.50	<b>XG-3191</b>	8.60	
E	<b>XG-3186</b>	17x11x11"	28	2-1/4x10-1/2x2"	27	93.50	<b>XG-3192</b>	10.80	

### F. STORAGE-GO-ROUND

Add any combination of up to 20 parts cabinets to build a storage center. Includes: inset turntable base with stationary base, center stabilizing plate, metal top cap, and assembly hardware. 1/2-ton total storage capacity. Powder coat finish. Unassembled. **IN STOCK.**

Model No. **XA-3110**—31"Wx31"Dx60"H.  
Wt. 109 lbs. ....\$628.00

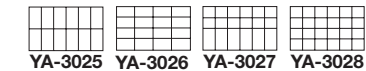
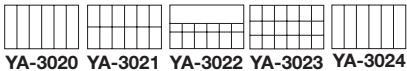

## DURHAM® Plastic Divider Boxes

- Polypropylene case
- Clear bin front

Reinforced hinges allow case cover to stand up in open position. Steel cabinet with durable powder coat finish holds five divider boxes. May be wall-mounted. Optional locking hinge secures boxes. **IN STOCK.**

Model Number	Cmpt. Qty.	Drawer Qty.	Wt. Lbs.	Price Each
<b>SMALL COMPARTMENT BOXES. 11"Wx6-3/4"Dx1-3/4"H.</b>				
<b>YA-3020</b>	6	5	1	\$5.60
<b>YA-3021</b>	12	5	1	5.60
<b>YA-3022</b>	13	5	1	5.60
<b>YA-3023</b>	18	5	1	5.60
<b>LARGE COMPARTMENT BOXES. 13-1/8"Wx9"Dx2-5/16"H.</b>				
<b>YA-3024</b>	6	5	2	\$7.10
<b>YA-3025</b>	12	5	2	7.10
<b>YA-3026</b>	16	5	2	7.10
<b>YA-3027</b>	18	5	2	7.10
<b>YA-3028</b>	24	5	2	7.10



### ACCESSORIES

Model No.	Description	Overall WxDxH	Wt. Lbs.	Price Ea.
<b>YA-3029</b>	Cabinet for 5 small boxes	11-1/4x6-3/4x10-3/4"	7	\$37.80
<b>YA-3030</b>	Cabinet for 5 large boxes	13-1/2x9-1/8x13-1/4"	11	45.50
<b>YA-3031</b>	Locking hinge (small & large)	—	1	9.00

# Small Parts Storage



MODEL XG-501

## DURHAM® Rotabin® Revolving Shelves

Steel shelves rotate independently on ball thrust bearings. Welded-in dividers.

Removable compartment fronts serve as label holders. 28" dia. compartments are 14"W at face, 12"D x 6"H with 1-5/8"H bin fronts. 34" dia. compartments are 15"D x 7"H with 2-3/8"H bin fronts. Gray powder coat finish. **IN STOCK.**



Model Number	Overall Height	Cap. Lbs.	Shelf Qty.	Shelf Cap. Lbs.	Wt. Lbs.	Price Each
<b>28" DIA., 6 COMPARTMENTS PER SHELF</b>						
XG-3847	34-1/8"	2500	5	500	125	\$541.00
XG-3848	40-3/8"	3000	6	500	144	\$617.00
XG-3849	46-5/8"	3500	7	500	163	\$693.00
XG-3850	52-7/8"	4000	8	500	182	\$769.00
XG-3851	59-1/8"	4500	9	500	201	\$845.00
XG-499	65-3/4"	5000	10	500	220	\$916.00
<b>34" DIA., 5 COMPARTMENTS PER SHELF</b>						
XG-3852	34-1/4"	2000	4	500	135	\$540.00
XG-488	42"	2500	5	500	162	\$634.00
XG-3853	49-3/4"	3000	6	500	188	\$728.00
XG-3854	65-3/4"	3500	7	500	215	\$819.00
XG-501	65-3/4"	4000	8	500	240	\$912.00

### EXTRA BIN DIVIDERS

Model No. **XG-672**—For use with 28" diameter units. Plastic dividers are 12"L x 4-3/4"H. Adjust on 1" centers. Bolts for fastening dividers to shelf bottom furnished. Pkg. of 20. Wt. 4 lbs. ....\$78.60 per pkg.  
 Model No. **XG-671**—For use with 34" diameter units. Plastic dividers measure 14-7/8"L x 4-3/4"H. Adjust on 1" centers. Bolts for fastening dividers to shelf bottom furnished. Pkg. of 20. Wt. 5 lbs. ....\$98.00 per pkg.



## DURHAM® "Scoop" Drawers and Slide Cabinets

- Steel case
- Solid drawer fronts

Steel drawers, piano hinge lids, and handles. Drawer layout diagrams to the right. Order drawers and cabinet separately. Gray powder coat finish. **IN STOCK.**

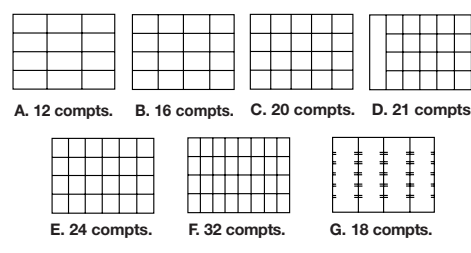

SCOOP DRAWERS				
Key	Model Number	Compartment Qty.	Wt. Lbs.	Price Each
A	WG-5394	12	32	\$25.00
B	WG-5393	16	32	25.00
C	WG-5392	20	32	25.00
D	WG-5391	21	32	25.00
E	WG-5390	24	32	25.00
F	WG-5389	32	32	25.00
G	WG-5398	18 Adjustable	32	26.20

### SLIDE CABINET AND BASE

Model No. **WG-5401**—4-Drawer Cabinet. 20"W x 15-3/4"D x 14-1/2"H. Wt. 37 lbs. ....\$86.10  
 Model No. **WG-5400**—4-Drawer Cabinet Base. Wt. 13 lbs. \$49.40



60 DRAWERS    48 DRAWERS    30 DRAWERS    24 DRAWERS    16 DRAWERS    8 DRAWERS

## Modular Small Parts Storage Cabinets



- Multiple drawer sizes available
- Steel cabinet

Cabinets have spot-welded steel frames, steel shelves, and opaque drawers with dividers and label holders. Also include: built-in drawer guides, no-spill drawer stops. **IN STOCK.**

Model Number	Overall WxDxH	Drawer Quantity/Drawer WxDxH	Wt. Lbs.	Price Each	DIVIDERS		
					Model No.	Pkg. Qty.	Fits Model No. / Pkg. Price
YN-2020	12-1/8x5-3/4x21-7/8"	(8) 11"Wx5-1/4"Dx2-1/4"H	10	\$38.30	YN-2026	12	YN-2020 \$4.02
YN-2021	12-1/8x5-3/4x21-7/8"	(16) 5-1/4"Wx5-1/4"Dx2-1/4"H	10	38.30	YN-2027	12	YN-2021 4.02
YN-2022	12-1/8x5-3/4x21-7/8"	(24) 3-1/8"Wx5-1/4"Dx2-1/4"H	11	38.30	YN-2028	24	YN-2022 4.02
YN-2023	12-1/8x5-3/4x21-7/8"	(24) 2-1/2"Wx5-1/4"Dx1-3/8"H, (4) 5-1/4"Wx5-1/4"Dx2-1/4"H, (2) 11"Wx5-1/4"Dx2-1/4"H	11	38.30	—	—	—
YN-2024	12-1/8x5-3/4x21-7/8"	(48) 2-1/2"Wx5-1/4"Dx1-3/8"H	12	38.30	YN-2029	48	YN-2024 4.02
YN-2025	12-1/8x5-3/4x21-7/8"	(60) 2"Wx5-1/4"Dx1-3/8"H	12	38.30	YN-2030	20	YN-2025 4.02



## All-Welded Steel Bins & Boxes

Combine any of these bins, boxes and racks to create a customized storage system. Heavy-gauge, all-welded steel construction withstands hard use. Stores assembly or in-process materials. Order steel boxes, steel bins and 12" double width base separately below. FOB RHODE ISLAND.

**STACKBINS®.** One-piece steel construction features sturdy stacking rim. Stacking capacity is 4,000 lbs. Large hopper front permits easy access to contents. **SPECIFY COLOR:** BE - Beige, BL - Blue, GN - Green, GY - Gray.

**STACKRACKS®.** Individual racks easily interstack to form any height or width racking system. Each rack is designed to house a corresponding bin or box. Rack weight capacity is 6,000 lbs. without deflection. Easy assembly. Sold individually.

**ADAPTOR COVER.** Used to adjust for the difference in depth between a larger and smaller Stackrack®.



STACKRACKS®



ADAPTOR COVERS

Model No. **XM-2026**—Single-Wide.  
Wt. 10 lbs. ....\$26.10

STACKBINS®					SINGLE FRAME STACKRACKS®			DOUBLE FRAME STACKRACKS®			12"H DOUBLE WIDTH BASE		
Model Number	Overall W x D x H	Ga.	Wt. Lbs.	Price Each	Model Number	Fits Model Number	Price Each	Model Number	Fits Model Number	Price Each	Model Number	Fits Model Number	Price Each
XG-3917	8 x 4-1/2 x 4-1/2"	20	1-3/4	\$15.90	—	—	—	—	—	—	—	—	—
XG-3918	12 x 5-1/2 x 4-1/2"	20	3	19.00	XG-3930	XG-3918	\$23.50	XM-2015	XG-3918	\$30.20	—	—	—
XG-3919	15-1/2 x 7-1/2 x 6"	18	5-1/2	22.20	XG-3931	XG-3919	23.50	XM-2016	XG-3919	33.80	XK-1540	XG-3919	\$79.80
XG-3920	18-3/4 x 9 x 7-1/2"	17	9	28.20	XG-3932	XG-3920	25.90	XM-2017	XG-3920	40.40	XK-1541	XG-3920	\$4.30
XG-3921	20-1/2 x 12 x 9-1/2"	16	12-1/2	37.20	XG-3933	XG-3921	30.40	XM-2018	XG-3921	40.40	XK-1542	XG-3921	90.80
XG-3922	24 x 15 x 11"	16	20-1/2	51.60	XG-3934	XG-3922	34.80	—	—	—	XK-1543	XG-3922	93.70
XG-3923	30 x 18 x 12"	16	30	90.60	XG-3935	XG-3923	45.10	—	—	—	XK-1544	XG-3923	96.90
XG-3924	24 x 10 x 8"	16	12	34.30	XG-3936	XG-3924	31.10	XM-2019	XG-3924	49.80	XK-1545	XG-3924	90.80



## SUNCAST® Giant Stacking Bin

Holds practically anything from loose parts or components to packaged goods and recyclables. Lid with "stay-open" front flap eases access to stored contents. Stacks with or without lid. Durable resin construction. 18-1/4"W x 24-3/8"D x 17"H. **SPECIFY COLOR:** BE - Beige with blue lid, LG - Lt. gray with black lid. **IN STOCK.**

Model No. **YG-3909**—Wt. 5.6 lbs. ....\$20.60



**STANDARD RACKING**  
SHOWN: (2) XK-1543,  
(4) XG-3922, (4) XG-3934, (5) XG-3921,  
(5) XG-3933, (6) XG-3920, (6) XG-3932,  
(7) XG-3919, (7) XG-3931, (9) XG-3918,  
(9) XG-3930, (22) XM-2026

**STEEL BOXES AND LIDS.** Heavy-gauge steel boxes hold practically anything. Easy-pull drop handles on both ends. Stackboxes can be readily stacked with corresponding size steel bins. They can also be used with Stackrack® systems. **SPECIFY COLOR:** BE - Beige, BL - Blue, GN - Green, GY - Gray.



BOXES					LIDS		
Model Number	Overall L x W x H	Ga.	Wt. Lbs.	Price Each	Model Number	Wt. Lbs.	Price Each
XG-3925	13" x 7-1/2 x 6"	18	5-1/2	\$27.80	YG-1611	1	\$10.40
XG-3927	16-1/2" x 12" x 9-1/2"	16	12.5	36.90	YG-1612	3	13.00
XG-3928	19-1/4" x 15" x 11"	16	20	51.40	YG-1613	4	17.00
XG-3929	20" x 10" x 8"	16	12	35.90	YG-1614	6	14.10

# Stacking Containers



**STOCK**

## SCHAEFER Stacking Containers

Ideal for storing, transporting food, packaged goods or loose parts. Uniform walls permit stacking and cross stacking. Polyethylene containers will not corrode or rot. 5-year guarantee. Impervious to most industrial solvents. Select sizes include label holders. **SPECIFY COLOR: BL - Blue, GN - Green, RD - Red, YL - Yellow. IN STOCK.**

Model Number	Overall L x W x H	Cap. Cu. Ft.	Wt. Lbs.	Price Each
<b>XV-1076</b>	8" x 6" x 5"	.1	.7	<b>\$6.90</b>
<b>XV-1077</b>	12" x 8" x 6"	.3	1.3	<b>12.90</b>
<b>XV-1078*</b>	18" x 12" x 3"	.4	2.5	<b>13.20</b>
<b>XV-1079*</b>	18" x 12" x 5"	.53	3.0	<b>16.80</b>
<b>XV-1080*</b>	18" x 12" x 8"	.9	3.5	<b>20.40</b>
<b>XV-1081*</b>	18" x 12" x 12"	1.2	5.0	<b>27.90</b>
<b>XV-1082*</b>	25" x 18" x 12"	2.8	10.0	<b>57.40</b>

\*Includes label holders



**STOCK**

## SCHAEFER Stack And Nest Containers

These versatile containers are made of high-density polyethylene and stack when filled; nest when empty. Easy to clean with no sharp corners, the containers are designed to resist most industrial solvents. Excellent for use in shop and manufacturing environments. **SPECIFY COLORS: BL - Blue, GN - Green, RD - Red, YL - Yellow. IN STOCK.**

Model Number	Overall L x W x H	Wt. Lbs.	Price Each
<b>CONTAINER WITH CLOSED HANDLES</b>			
<b>XJ-904</b>	23" x 15" x 8"	4	<b>\$19.50</b>
<b>CONTAINER WITH CLOSED HANDLES AND LABEL HOLDER*</b>			
<b>XJ-905</b>	24" x 16" x 10"	5	<b>\$37.00</b>
<b>CONTAINER WITH OPEN HANDLES</b>			
<b>XJ-906</b>	23" x 15" x 12"	6	<b>\$27.40</b>
<b>XJ-908</b>	24" x 16" x 14"	5	<b>42.70</b>

\*Units have corners at one end indented and rounded off.



**STOCK**

## AIGNER Bin Buddy™ Self-Adhesive Label Holders

Universal label holder has a self-adhesive backing that sticks to any plastic or metal container and protective clear plastic window. Includes laser/ink jet compatible paper labels with printing instructions. **IN STOCK.**

**SELF-ADHESIVE LABEL HOLDERS**

Model No. **ZP-0254**—3" x 5". Pkg. of 25. Wt. 4 oz. ...**\$16.00**  
 Model No. **ZP-0255**—4" x 6". Pkg. of 25. Wt. 5 oz. ...**\$19.00**

**PAPER REFILLS. 50/pkg. SPECIFY SIZE: A - 3" x 5", B - 4" x 6".**

Model No. **ZP-0256**—Wt. 3 oz. ....**\$19.30**



**STOCK**

## AKRO-MILS® Stack And Nest Boxes

Containers are made from high-density injection-molded polyethylene. This material is resistant to solvents and chemicals as well as stress cracks. Stack for safe shipping of contents or nest when empty when turned 180°. Totes won't rust, corrode or bend out of shape. Ridges under lip prevent jamming. The container lip is designed to form comfortable grab handles for easily carrying loaded totes. Gray has been approved to meet FDA standards. Sold in carton quantities only. **SPECIFY COLORS: BL - Blue, GY - Gray, RD - Red. IN STOCK.**

TOTES						LIDS	
Model Number	Overall L x W x H	Cap. Cu. Ft.	Ctn. Qty.	Wt. Lbs.	Net Each	Model Number	Price Each
<b>XJ-718</b>	18 x 11 x 6"	0.50	6	12	<b>\$9.20</b>	<b>XJ-719</b>	<b>\$6.90</b>
<b>XJ-720</b>	18 x 11 x 9"	0.76	6	24	<b>18.10</b>	<b>XJ-721</b>	<b>9.20</b>
<b>XJ-722</b>	23-1/2 x 19-1/2 x 13"	2.60	3	21	<b>27.00</b>	<b>XJ-723</b>	<b>13.10</b>
<b>XJ-949</b>	20 x 13-1/2 x 8"	0.82	6	18	<b>15.10</b>	<b>XJ-950</b>	<b>9.70</b>
<b>XJ-951</b>	24 x 16 x 12"	1.74	3	21	<b>29.10</b>	<b>XJ-952</b>	<b>13.80</b>
<b>XJ-953</b>	30 x 20 x 15"	3.67	3	33	<b>46.10</b>	<b>XJ-954</b>	<b>19.60</b>



**STOCK**

## BUCKHORN™ Stack And Nest Boxes

Tough, durable polyethylene containers will not collapse when filled to capacity. 1/4" thick walls support fully loaded stacked containers without bending. 150-lb. capacity. 100% recyclable material resists most industrial chemicals and detergents. Will not rust, dent, or splinter. Withstands extreme temperatures from -30° to 150°F. Nest when empty for convenient storage. Sold in carton quantities only. **SPECIFY COLOR: BL - Blue, BK - Black. IN STOCK.**

Model Number	Overall L x W x H	Ctn. Qty.	Wt. Lbs.	Price Each
<b>YK-1498</b>	22 x 13 x 5-3/4"	10	5-1/4	<b>\$30.20</b>
<b>YK-1499</b>	24 x 16 x 9"	6	19	<b>42.30</b>
<b>YK-1500</b>	28 x 16-3/4 x 8-3/4"	6	10	<b>52.90</b>

# Totes & Containers



## SCHAEFER Universal Containers

These polyethylene containers are suitable for manufacturing and food processing environments, as well as transportation and storage needs. Strong stacking rims provide security when stacking. All sizes can be interstacked. The smooth structure of the inside walls eliminate awkward corners, reducing areas for bacteria build-up when used for food processing. **SPECIFY COLOR: GY - Gray, RD - Red. IN STOCK.**

Model Number	Overall LxWxH	Inside LxWxH	Wt. Lbs.	Price Each
<b>YJ-861</b>	32x24x13"	30x22x12"	14	<b>\$76.50</b>
<b>YJ-863</b>	24x16x17"	22x15x16"	8	<b>50.40</b>
<b>YJ-866</b>	24x16x13"	22x15x12"	7	<b>40.70</b>
<b>YJ-869</b>	24x16x9-1/2"	22x15x9"	6	<b>37.50</b>
<b>YJ-872</b>	24x16x9"	22x15x8-1/2"	5.5	<b>35.80</b>
<b>YJ-875</b>	24x16x7"	22x15x6"	5	<b>28.00</b>
<b>YJ-878</b>	24x16x5"	22x15x4"	3.5	<b>25.60</b>
<b>YJ-884</b>	16x12x9"	15x11x8"	2.5	<b>21.20</b>



## LEWISBins+ Polyethylene Totes

Stack when full, nest when empty to save storage space. Smooth interior walls are easy to clean. Will not shrink or warp over time. Gray and blue pans can be used in direct contact with food. Materials have been approved to meet FDA standards. Sold in lots of 5 only. **SPECIFY COLOR: BL - Blue, GY - Gray, RD - Red. IN STOCK.**

TOTES					LIDS	
Model Number	Overall LxWxH	Cu. Ft. Cap.	Wt. Lbs.	Price Each	Model Number	Price Each
<b>WP-371</b>	20x13x6-1/4"	0.6	2-1/2	<b>\$16.00</b>	<b>WP-379</b>	<b>\$9.70</b>
<b>WP-372</b>	24-1/8x14x8"	1.0	4	<b>21.90</b>	<b>WP-380</b>	<b>10.40</b>
<b>WP-373</b>	19-1/2x13x12-3/8"	1.3	4	<b>21.70</b>	<b>WP-381</b>	<b>10.20</b>
<b>WP-374</b>	21x17x12"	1.7	5-1/4	<b>26.20</b>	<b>WP-382</b>	<b>11.10</b>
<b>WP-375</b>	26-1/2x18-3/4x10-1/2"	2.0	6-1/2	<b>32.10</b>	<b>WP-383</b>	<b>13.30</b>
<b>WP-376</b>	29-5/8x22-3/8x6"	2.0	5-1/4	<b>25.70</b>	—	—
<b>WP-377</b>	24x20x13"	2.6	6-1/2	<b>29.30</b>	<b>WP-384</b>	<b>14.30</b>
<b>*WP-378</b>	30x24x15"	4.7	10-1/4	<b>53.10</b>	—	—

\*Available in gray only.



## AKRO-MILS® Straight Wall Containers

Unique shipping, storage, and work-in-progress containers maximize your space. High-density polyethylene construction features straight walls for orderly storage and palletizing during shipping. Strong stacking rims and external ribbing provide added strength. All container sizes stack together. Hand holes on all four sides ease lifting and carrying. Available in three styles. Sold in carton quantities only. Color: gray. **IN STOCK.**

Model Number	Description	Overall LxWxH	Ctn. Qty.	Ctn. Wt. Lbs.	Price Each
<b>XJ-996</b>	Mesh Side/Base	16x12x8"	12	29	<b>\$11.00</b>
<b>XJ-997</b>	Mesh Side/Solid Base	16x12x8"	12	35	<b>12.40</b>
<b>XJ-998</b>	Solid Side/Base	16x12x8"	12	40	<b>11.90</b>
<b>XJ-1000</b>	Mesh Side/Base	24x16x8"	4	16	<b>16.20</b>
<b>XJ-1001</b>	Mesh Side/Solid Base	24x16x8"	4	19	<b>21.40</b>
<b>XJ-1002</b>	Solid Side/Base	24x16x8"	4	21	<b>19.10</b>
<b>XJ-1004</b>	Mesh Side/Base	24x16x12"	3	15	<b>17.50</b>
<b>XJ-1005</b>	Mesh Side/Solid Base	24x16x12"	3	17	<b>24.80</b>
<b>XJ-1006</b>	Solid Side/Base	24x16x12"	3	21	<b>25.20</b>
<b>XJ-1008</b>	Mesh Side/Base	24x16x16"	2	13	<b>20.40</b>
<b>XJ-1009</b>	Mesh Side/Solid Base	24x16x16"	2	14	<b>27.90</b>
<b>XJ-1010</b>	Solid Side/Base	24x16x16"	2	18	<b>35.00</b>



## RUBBERMAID® Palletote® Shipping Boxes

Returnable, reusable containers work well for shipping parts, supplies, even foodstuffs. Injection-molded, high-density polyethylene containers nest when empty and stack when loaded. Tight fitting lids. Materials have been approved to meet FDA standards. Fits 48" x 40" pallets. **IN STOCK.**

Model Number	Description	Overall LxWxH	Wt. Lbs.	Price Each
400-LB. MAX CAP. on bottom container stacked 6 high (200-lb. load cap. in transit)				
<b>XK-1505</b>	Box	19-1/2x15-1/2x10"	4-1/2	<b>\$28.00</b>
<b>XK-1506</b>	Box	19-1/2x15-1/2x13"	6-1/2	<b>34.50</b>
<b>XK-1507</b>	Lid	19-5/8x15-5/8x1"	2-1/2	<b>13.20</b>
500-LB. MAX CAP. on bottom container stacked 6 high (250-lb. load cap. in transit)				
<b>XK-1508</b>	Box	23-1/2x19-1/2x10"	6-1/2	<b>\$37.20</b>
<b>XK-1509</b>	Box	23-1/2x19-1/2x13"	8-1/2	<b>45.70</b>
<b>XK-1510</b>	Lid	23-3/4x19-3/4x1"	2-1/2	<b>14.80</b>

# Totes



## ORBIS® Flipak® Totes

Reusable containers let you optimize space on pallets and in trucks, trailers, and warehouses. Containers with attached covers are constructed of injection-molded polyolefin. They stack with lids closed and nest with lids open. Designed to offer maximum product protection from impact, chemicals, moisture, etc.

\*SPECIFY COLOR: **BL** - Blue, **GY** - Gray, **RD** - Red. Others gray only. **IN STOCK.**

Model Number	Overall L x W x H	Cap. Cu. Ft.	Wt. Lbs.	Price Each
<b>WP-385</b>	11-4/5 x 9-4/5 x 7-7/10"	0.3	1-4/5	<b>\$14.70</b>
<b>WP-386</b>	19-7/10 x 11-4/5 x 7-3/10"	0.7	3-1/5	<b>15.80</b>
<b>WP-387</b>	21-4/5 x 15-1/10 x 5-1/2"	0.7	5	<b>28.20</b>
<b>WP-388</b>	20-3/5 x 13-1/2 x 6-1/2"	0.8	5-1/4	<b>30.40</b>
<b>WP-389</b>	20-3/5 x 13-1/5 x 11-3/5"	1.3	6	<b>29.10</b>
<b>WP-390*</b>	21-4/5 x 15-1/5 x 9-4/5"	1.4	6-1/4	<b>19.20</b>
<b>WP-391*†</b>	22-3/10 x 13 x 12-4/5"	1.5	7	<b>20.50</b>
<b>WP-392*</b>	21-4/5 x 15-1/5 x 12-9/10"	1.8	6-1/2	<b>20.80</b>
<b>WP-393*</b>	26-9/10 x 17-1/10 x 12-3/5"	2.4	8-1/2	<b>27.00</b>
<b>WP-394*</b>	23-9/10 x 19-3/5 x 12-3/5"	2.6	9-1/2	<b>29.00</b>
<b>WP-395</b>	39 x 14 x 13"	3.2	13-1/2	<b>51.60</b>
<b>WP-396*</b>	27-3/5 x 20-3/5 x 15-3/5"	4.0	14-1/4	<b>51.60</b>
<b>WP-397</b>	30 x 22 x 20-1/2"	6.0	18-1/4	<b>98.10</b>

†Not available in RD - Red.



## UNITED VISUAL Corrugated Plastic Totes

Color-code your inventory for quick reference and easy identification with these durable, lightweight totes. Constructed entirely of tough polyethylene, corrugated totes feature sonic welded seams and steel rod reinforcements for extra strength. Cutout handles ease transport. 18-1/2"L x 13-1/4"W x 11-3/8"H overall. **SPECIFY COLOR: BL** - Blue, **RD** - Red, **WH** - White, **YL** - Yellow. **IN STOCK.**

Model No. **YA-3301** - Wt. 2 lbs. .... \$16.20



## AKRO-MILS® Totes

Not only are these versatile containers exceptionally strong, they include attached lids for secure parts storage. Tight-fitting flip lids swing open on stainless steel hinge pins. Molded from high-density polyethylene, containers feature anti-jamming ribs for extra durability. Also include textured bottoms to grip conveyor belt, ergonomic handle grips, and padlock eyes. Choose either (A) totes with full-length lid closure or (B) tote with full-width closure. Sold in carton quantity only. **SPECIFY COLOR: BL** - Blue, **GY** - Gray. **IN STOCK.**

Key	Model No.	Overall L x W x H	Capacity Cu. Ft.	Ctn. Qty.	Ctn. Wt. Lbs.	Price Each
A	<b>XS-1555</b>	21-1/2 x 15 x 9"	1.12	6	7-1/2	<b>\$18.80</b>
A	<b>XS-1556</b>	21-1/2 x 15 x 12-1/2"	1.62	6	8	<b>21.20</b>
A	<b>XS-1557</b>	21-1/2 x 15 x 17"	2.28	3	13-1/2	<b>23.40</b>
A	<b>XS-1558*</b>	27 x 16-9/10 x 12-1/2"	2.25	1	8-1/2	<b>30.10</b>
A	<b>XS-1559*</b>	24 x 19-1/2 x 12-1/2"	2.30	1	12-1/2	<b>31.70</b>
A	<b>XS-1560*</b>	28 x 21 x 15-1/2"	3.82	1	12-1/2	<b>55.70</b>
B	<b>XS-1561*</b>	34 x 24 x 19-7/10"	6.62	1	19	<b>144.00</b>

\*Available in GY - Gray only.



## ORBIS® Polyethylene Nesting Boxes with Stacking Lids

Durable boxes can be shipped up to 250 times before they will show signs of wear. Returnable and reusable containers are constructed of tough polyethylene that resists cracks, dents, and most chemicals, as well as temperatures from 0-120°F. Stack with lids to optimize shipping space and nest when empty to save on return freight. Pebble grain bottom surface provides traction for conveyors. Materials have been approved to meet FDA standards. **IN STOCK.**

NESTING BOXES				LIDS	
Model No.	Overall L x W x H	Wt. Lbs.	Price Each	Model No.	Price Each
<b>XK-2950</b>	21 x 15 x 5"	2-1/4	<b>\$15.80</b>	<b>XK-2955</b>	<b>\$7.10</b>
<b>XK-2951</b>	21-3/4 x 15-1/4 x 9-1/4"	3-3/4	<b>16.70</b>	<b>XK-2955</b>	<b>7.10</b>
<b>XK-2952</b>	21-1/2 x 15-1/4 x 12-1/4"	6-1/4	<b>17.70</b>	<b>XK-2957</b>	<b>7.10</b>
<b>XK-2954</b>	24 x 19-1/2 x 12"	5-1/2	<b>25.00</b>	<b>XK-2958</b>	<b>9.20</b>

# Divider Boxes

## LEWISBins+ Modular Divider Boxes

Ideal for storing anything from large bulk items to small, fragile parts. Can be sub-divided into compartments as small as 1-1/8" square. Molded, durable polyethylene construction resists water, oil, most chemicals, and solvents. Reinforced stacking edge and uniform wall thickness. Bottom container will support 250 lbs. when stacked. Individual load capacity up to 60 lbs. Sold in carton quantities—priced per box. **SPECIFY BOX COLOR: LB - Light Blue, GY - Gray, RD - Red.** Divider color: gray. **IN STOCK.**



DIVIDER BOXES						GRAY VERTICAL DIVIDERS						CLEAR SNAP-ON LIDS		
Model Number	Overall L x W x H	Cap. Cu. Ft.	Ctn. Qty.	Ctn. Lbs.	Price Each	LONG DIVIDERS			SHORT DIVIDERS			Model Number	Wt. Lbs.	Price Each
						Model Number	Slot Qty.	Price Each	Model Number	Slot Qty.	Price Each			
XV-1083	10-7/8 x 8-1/2 x 2-1/2"	0.07	24	12	\$5.10	XV-1096	5	\$1.11	XV-1109	7	\$1.00	XV-1122	0.3	\$6.30
XV-1084	10-7/8 x 8-1/2 x 3-1/2"	0.11	16	14	5.30	XV-1097	5	1.11	XV-1110	7	1.00	XV-1123	0.3	6.30
XV-1085	10-7/8 x 8-1/2 x 5"	0.16	16	9	6.30	XV-1098	5	1.11	XV-1111	7	1.00	XV-1124	0.3	6.30
XV-1086	16-1/2 x 10-7/8 x 2-1/2"	0.16	12	12	6.90	XV-1099	7	1.62	XV-1112	11	1.13	XV-1125	0.6	8.10
XV-1087	16-1/2 x 10-7/8 x 3-1/2"	0.24	8	12	7.70	XV-1100	7	2.20	XV-1113	11	1.13	XV-1126	0.6	8.10
XV-1088	16-1/2 x 10-7/8 x 5"	0.36	8	8	9.10	XV-1101	7	2.20	XV-1114	11	1.13	XV-1127	0.6	8.10
XV-1089	16-1/2 x 10-7/8 x 6"	0.43	8	8	9.50	XV-1102	7	2.60	XV-1115	11	2.19	XV-1128	0.6	8.10
XV-1090	16-1/2 x 10-7/8 x 7"	0.51	6	8	11.00	XV-1103	7	2.60	XV-1116	11	2.55	XV-1129	0.6	8.10
XV-1091	16-1/2 x 10-7/8 x 8"	0.59	6	10	11.00	XV-1104	7	2.60	XV-1117	11	2.65	XV-1130	0.6	8.10
XV-1092	22-3/8 x 17-3/8 x 5"	0.79	4	10	14.60	XV-1105	11	2.60	XV-1118	15	2.33	XV-1131	1.5	15.90
XV-1093	22-3/8 x 17-3/8 x 6"	0.97	4	14	15.00	XV-1106	11	3.08	XV-1119	15	2.52	XV-1132	1.5	15.90
XV-1094	22-3/8 x 17-3/8 x 8"	1.32	4	9	18.00	XV-1107	11	3.61	XV-1120	15	2.90	XV-1133	1.5	15.90
XV-1095	22-3/8 x 17-3/8 x 12"	2.00	3	10	24.40	XV-1108	11	7.40	XV-1121	15	7.16	XV-1134	1.5	15.90



**CARD HOLDERS WITH SNAPS.** Sold in lots of 12.

Model No. XV-1135—7-3/8"L x 3-1/4"W.....	\$1.31
Model No. XV-1136—6-3/8"L x 1-1/3"W.....	\$1.31

## QUANTUM™ Dividable Grid Containers

Versatile containers can be sub-divided into compartments as small as 1-1/8" square to meet your needs. Molded high-density polyethylene material resists most solvents and chemicals. Multi-ribbed external sides provide high-impact strength. Stackable to save space. Compatible with most racks, shelving, and automated material handling equipment. Container, lid, dividers, and label holders sold separately. **IN STOCK.**



### VELCRO® LABEL HOLDERS

Model No.	Fits Container	Pkg. Qty.	Wt. Lbs.	Price E.
YA-1275	YA-1230, YA-1232, YA-1235	6	0.1	\$14.30
YA-1276	YA-1231, YA-1233, YA-1236	6	0.1	15.20
YA-1277	YA-1234, YA-1237, YA-1238	6	0.1	15.90

### DIVIDABLE GRID CONTAINERS

**SPECIFY CONTAINER AND COVER COLOR: BL - Blue, GY - Gray, RD - Red.**

Model Number	Overall L x W x H	Cap. Cu. Ft.	Ctn. Qty.	Ctn. Lbs.	Price Each	Model Number	Ctn. Qty.	Price Each
<b>CONTAINERS</b>					<b>COVERS</b>			
YA-1230	10-7/8 x 8-1/4 x 3-1/2"	0.10	20	18	\$5.30	YA-1239	10	\$2.75
YA-1231	10-7/8 x 8-1/4 x 5"	0.19	20	24	5.50	YA-1239	10	2.75
YA-1232	16-1/2 x 10-7/8 x 3-1/2"	0.24	12	17	7.40	YA-1240	4	4.07
YA-1233	16-1/2 x 10-7/8 x 6"	0.44	8	15	8.80	YA-1240	4	4.07
YA-1234	16-1/2 x 10-7/8 x 8"	0.60	8	20	11.50	YA-1240	4	4.07
YA-1235	22-1/2 x 17-1/2 x 3"	0.44	6	15	10.90	YA-1241	3	7.40
YA-1236	22-1/2 x 17-1/2 x 6"	0.97	3	14	14.70	YA-1241	3	7.40
YA-1237	22-1/2 x 17-1/2 x 8"	1.32	3	12	18.00	YA-1241	3	7.40
YA-1238	22-1/2 x 17-1/2 x 12"	2.03	3	17	21.20	YA-1241	3	7.40

### VERTICAL DIVIDERS

Fits Bin Number	LONG		Pkg. Qty.	Price Ea. Pkg.	SHORT		Pkg. Qty.	Price Ea. Pkg.
	Model No.	Model No.			Model No.	Model No.		
YA-1230	YA-1242	YA-1251	6	\$5.20	YA-1251	6	6	\$4.64
YA-1231	YA-1243	YA-1252	6	5.60	YA-1252	6	6	5.20
YA-1232	YA-1244	YA-1253	6	6.50	YA-1253	6	6	5.00
YA-1233	YA-1245	YA-1254	6	11.70	YA-1254	6	6	7.50
YA-1234	YA-1246	YA-1255	6	11.50	YA-1255	6	6	9.50
YA-1235	YA-1247	YA-1256	6	12.00	YA-1256	6	6	10.40
YA-1236	YA-1248	YA-1257	6	12.70	YA-1257	6	6	11.60
YA-1237	YA-1249	YA-1258	6	13.60	YA-1258	6	6	12.40
YA-1238	YA-1250	YA-1259	6	28.90	YA-1259	6	6	26.10

## AKRO-MILS® Divider Boxes

Molded-in vertical divider slots on all sides allow you to create 1-1/4" compartments for protecting fragile parts. Recessed ledges permit stacking fully loaded containers without damaging contents. Injection molded of polyethylene construction. Compatible with most racks and shelving. Vertical divider color: black. **SPECIFY BOX COLOR: BL - Blue, GY - Gray, RD - Red.** **IN STOCK.**

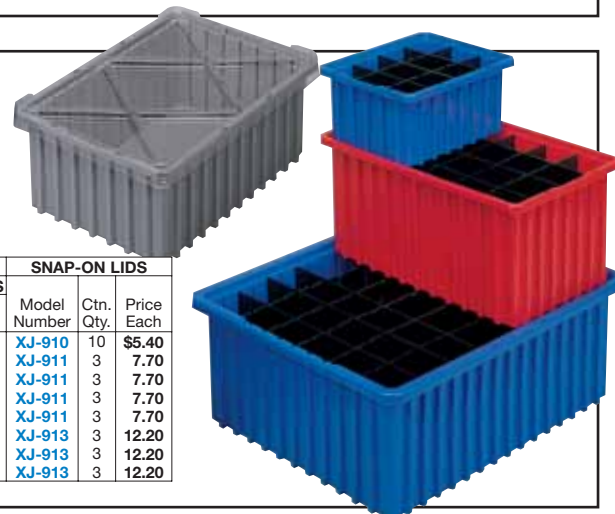

DIVIDER BOXES						VERTICAL DIVIDERS				SNAP-ON LIDS		
Model Number	Overall L x W x H	Cap. Cu. Ft.	Ctn. Qty.	Ctn. Lbs.	Price Each	LONG DIVIDERS		SHORT DIVIDERS		Model Number	Ctn. Qty.	Price Each
						Model Number	Price Each	Model Number	Price Each			
XJ-914	10-7/8 x 8-1/4 x 5"	0.16	20	18	\$6.40	XJ-919	\$6.30	XJ-918	\$6.60	XJ-910	10	\$5.40
XJ-934	16-1/2 x 10-7/8 x 4"	0.29	12	14	8.00	XJ-938	12.20	XJ-942	12.20	XJ-911	3	7.70
XJ-915	16-1/2 x 10-7/8 x 6"	0.44	8	13	11.20	XJ-921	11.90	XJ-920	9.90	XJ-911	3	7.70
XJ-916	16-1/2 x 10-7/8 x 8"	0.59	6	16	13.30	XJ-923	14.30	XJ-922	10.80	XJ-911	3	7.70
XJ-935	22-3/4 x 17-3/8 x 4"	0.61	6	22	13.90	XJ-939	15.10	XJ-943	12.20	XJ-911	3	7.70
XJ-936	22-3/4 x 17-3/8 x 6"	0.96	4	17	16.70	XJ-940	16.60	XJ-944	12.20	XJ-913	3	12.20
XJ-917	22-3/4 x 17-3/8 x 8"	1.30	3	14	21.50	XJ-925	21.00	XJ-924	20.60	XJ-913	3	12.20
XJ-937	22-3/4 x 17-3/8 x 10"	1.66	2	12	23.50	XJ-941	28.00	XJ-945	12.20	XJ-913	3	12.20

# Storage Containers



## BUCKHORN™ Structural Foam Tote Boxes



1/4" wall thickness gives extra strength. Won't rust, rot or splinter as a result of rough handling. Non-stick, seamless surface is impervious to most industrial chemicals and detergents. Easily hold over 150 lbs. Choose either ventilated totes that promote air circulation or solid models with smooth interior walls. 100% recyclable high density polyethylene. Boxes do not contain fiberglass that can cause skin irritation. ISO 9001 certified. Sold in carton quantities only. **SPECIFY COLOR: BL - Blue, BK - Black. IN STOCK.**

Model Number	Overall L x W x H	Ctn. Qty.	Price Each
<b>VENTILATED</b>			
<b>YJ-676</b>	15 x 10 x 6"	10	<b>\$28.40</b>
<b>YJ-678</b>	19 x 10 x 3-1/2"	10	<b>27.40</b>
<b>YJ-674</b>	22 x 13-1/4 x 6"	5	<b>31.50</b>
<b>SOLID</b>			
<b>YJ-677</b>	15 x 10 x 6"	10	<b>\$31.70</b>
<b>YJ-679</b>	19 x 10 x 3-1/2"	10	<b>27.40</b>
<b>YJ-675</b>	22 x 13-1/4 x 6"	5	<b>37.20</b>



## LEWISBins+ Plexton® Stack-N-Nest Fiberglass Containers

Durable containers are constructed of high-strength fiberglass and reinforced with polyester resin. Conveniently stack and nest. Withstand temperatures of -60°F to 250°F. Resist wear, oil, and most chemicals and are non-conducting. Single containers carry up to 500 lbs., while the bottom container in a stack supports up to 3,000 lbs. Other features include: smooth outer surface and seamless body, permanent, molded-in colors, and built-in hand grips. Order containers in quantities specified, priced each. **IN STOCK.**

### FIBERGLASS CONTAINERS WITH WIRE-REINFORCED RIM

Wire reinforcement around the rim adds strength, rigidity, and maximum support when carrying loaded containers. **SPECIFY COLOR: BL - Blue, GN - Green, GY - Gray, RD - Red, YL - Yellow.**

CONTAINERS						COVERS	
Model Number	Overall L x W x H	Cap. Cu. Ft.	Ctn. Qty.	Wt. Lbs.	Price Each	Model Number	Price Each
<b>XD-1267</b>	25.3 x 18.1 x 6.1"	1.62	10	7.25	<b>\$31.70</b>	<b>XD-1278</b>	<b>\$19.40</b>
<b>XD-1268</b>	25.3 x 18.1 x 10.1"	2.68	5	8	<b>34.10</b>	<b>XD-1278</b>	<b>19.40</b>
<b>XD-1270</b>	30.6 x 16.9 x 11.1"	3.32	5	13	<b>45.20</b>	<b>XD-1280</b>	<b>23.40</b>
<b>XD-1269</b>	27.5 x 19.9 x 14.1"	4.47	5	11	<b>49.70</b>	<b>XD-1279</b>	<b>21.90</b>
<b>XD-1271</b>	34.1 x 24.0 x 8.1"	3.84	5	14	<b>56.20</b>	-	-
<b>XD-1272</b>	42.5 x 20.1 x 14.1"	6.97	2	20	<b>62.50</b>	<b>XD-1281</b>	<b>31.00</b>

### FIBERGLASS CONTAINERS

**SPECIFY COLOR: GN - Green, GY - Gray, RD - Red.**

CONTAINERS						COVERS	
Model Number	Overall L x W x H	Cap. Cu. Ft.	Ctn. Qty.	Wt. Lbs.	Price Each	Model Number	Price Each
<b>XD-1440</b>	17.9 x 10.8 x 5.0"	0.56	10	4.65	<b>\$15.00</b>	<b>XD-1448</b>	<b>\$12.50</b>
<b>XD-1441</b>	19.8 x 12.8 x 6.0"	0.88	10	3.75	<b>19.00</b>	<b>XD-1449</b>	<b>13.40</b>
<b>XD-1442</b>	20.6 x 13.0 x 8.0"	1.24	10	4.5	<b>21.60</b>	<b>XD-1450</b>	<b>18.60</b>
<b>XD-1443</b>	24.1 x 11.4 x 6.9"	1.10	10	4.5	<b>24.10</b>	<b>XD-1451</b>	<b>15.80</b>
<b>XD-1444</b>	24.1 x 11.4 x 9.0"	1.43	10	4.5	<b>24.50</b>	<b>XD-1451</b>	<b>15.80</b>
<b>XD-1445</b>	24.3 x 14.8 x 5.1"	1.06	8	4.5	<b>24.50</b>	<b>XD-1452</b>	<b>16.70</b>
<b>XD-1446</b>	24.3 x 14.8 x 8.0"	1.67	8	6	<b>25.80</b>	<b>XD-1452</b>	<b>16.70</b>



## AIGNER Bin Buddy™ Self-Adhesive Label Holders



Universal label holder has a self-adhesive backing that sticks to any plastic or metal container and protective clear plastic window. Includes laser/ink jet compatible paper labels with printing instructions. **IN STOCK.**

### SELF-ADHESIVE LABEL HOLDERS

Model No. <b>ZP-0206</b> —3" x 5", Pkg. of 25. Wt. 4 oz. ....	<b>\$18.50</b>
Model No. <b>ZP-0207</b> —4" x 6", Pkg. of 25. Wt. 5 oz. ....	<b>\$22.30</b>

### PAPER REFILLS. 50/pkg. SPECIFY SIZE: A - 3" x 5", B - 4" x 6".

Model No. <b>ZP-0208</b> —Wt. 3 oz. ....	<b>\$22.50</b>
--	----------------

# Stack & Nest Containers

## LEWISBins+ Fiberglass Nesting Boxes with Stack-On Lids

Store and ship small parts in these molded fiberglass boxes. Made of fiberglass-reinforced polyester, these containers will support heavy loads up to 500 lbs. Thin wall design is durable yet lightweight. Will withstand extreme temperatures from -40° to 300°F. **SPECIFY COLOR: GN** - Green, **GY** - Gray, **LB** - Lt. Blue, **RD** - Red, **YL** - Yellow. **IN STOCK.**



CONTAINERS					LIDS		
Model No.	Overall L x W x H	Cap. Cu. Ft.	Wt. Lbs.	Price Each	Model No.	Wt. Lbs.	Price Each
<b>XR-1650</b>	6.3 x 4.9 x 2.1"	0.03	0.5	<b>\$5.40</b>	<b>XR-1655</b>	0.15	<b>\$4.65</b>
<b>XR-1651</b>	9.8 x 6.2 x 2.1"	0.06	0.5	<b>7.60</b>	<b>XR-1656</b>	0.25	<b>6.20</b>
<b>XR-1652</b>	9.8 x 6.2 x 4.5"	0.12	1.3	<b>10.50</b>	<b>XR-1656</b>	0.25	<b>6.20</b>
<b>XR-1653</b>	12.4 x 9.8 x 2.1"	0.12	1.3	<b>10.50</b>	<b>XR-1657</b>	0.55	<b>7.90</b>
<b>XR-1654</b>	11.9 x 8.8 x 4.1"	0.19	1.7	<b>11.30</b>	<b>XR-1658</b>	0.55	<b>8.00</b>

## MFG Fiberglass Nesting Boxes

Store and transport small parts and tools inside these molded fiberglass boxes. Heavy-duty construction is lightweight for easy transport. Resist oil, solvents, moisture, most chemicals, and irradiation. Withstand temperatures up to 300°F and cryogenic temperatures to -190°F. **SPECIFY COLOR: BE** - Beige, **GY** - Gray, **WH** - White. FOB PENNSYLVANIA.



Model Number	Outside L x W x H	Cap. Cu. Ft.	Wt. Lbs.	Price Each
<b>YA-1830</b>	13-1/4 x 12-1/2 x 3-1/2"	0.34	4	<b>\$12.50</b>
<b>YA-1831</b>	19 x 7-1/2 x 4"	0.33	4.2	<b>12.40</b>
<b>YA-1832</b>	19-1/2 x 13-1/2 x 4"	0.61	4.4	<b>15.30</b>
<b>YA-1833</b>	19-1/2 x 7-1/2 x 4-1/8"	0.35	4.2	<b>12.20</b>
<b>YA-1834</b>	19-1/2 x 9-1/2 x 4-1/8"	0.44	4.3	<b>12.40</b>
<b>YA-1835</b>	19-1/2 x 12-1/2 x 4-1/8"	0.58	4.4	<b>13.50</b>
<b>YA-1836</b>	19-1/2 x 13-1/2 x 4-1/8"	0.63	4.5	<b>17.00</b>
<b>YA-1837</b>	19-1/2 x 13-1/2 x 4-1/2"	0.69	4.4	<b>16.10</b>
<b>YA-1838</b>	20 x 15-7/8 x 4-1/2"	0.83	4.7	<b>18.50</b>



## MFG Stacking Fiberglass Bins

Heavy-duty reinforced fiberglass containers are perfect for storing industrial machinery, hardware, or tools. Bins offer excellent dimensional stability and load carrying capacity without creep or distortion at temperatures from -60° to +250°F (continuous) or +300°F (intermittent). Open front design gives you easy access to stored contents. 10"W x 24"D x 8"H. **SPECIFY COLOR: BL** - Blue, **GN** - Green, **GY** - Gray, **WH** - White. **IN STOCK.**

Model No. **YA-1839**—Wt. 3 lbs. ....\$36.60



## LEWISBins+ Stack and Nest Fiberglass Bins

Space-saving bins stack and nest within the floor area of a single box. Can be stacked with bottom on a 15° incline for easier access to stored parts. 500-lb. load carrying capacity per bin; bottom hopper in stack supports up to 3,000 lbs. Withstands temperatures of -40° to 240°F. Reinforced fiberglass is molded in one piece with overhang at the back and rolled front lip. Order bins in quantities specified, priced each. **SPECIFY COLOR: GN** - Green, **GY** - Gray, **RD** - Red. **IN STOCK.**



Model Number	Overall W x D x H	Carton Qty.	Wt. Lbs.	Price Each
<b>YA-1700</b>	11-3/8 x 18-1/8 x 7-5/8"	10	3-1/2	<b>\$28.20</b>
<b>YA-1701</b>	11-3/8 x 24 x 7-7/8"	10	5	<b>31.00</b>
<b>YA-1702</b>	16-1/4 x 24 x 8"	5	5	<b>39.70</b>

# Bins



**STOCK**

Model No. **XV-1151**—Removable Inner Bin. 2-1/2"W x 3-1/2"D x 4"H. Sold in packages of 50. Wt. 5 lbs. per pkg/50...**\$37.80** pkg.

## Corrugated Bin Boxes

Heavy-test corrugated bin boxes come in a variety of sizes to store a multitude of items practically anywhere. To assemble, simply fold together—they will not come apart. No tape or staples required. Index front for labeling contents. Open top design promotes visibility and accessibility. 4-1/2" rear lip hangs from shelf above. To store the smallest parts, take advantage of our handy removable inner bins. Economical pricing allows you to stock up and save. Sold in lots of 25 only. **IN STOCK.**

Overall W x D x H	REGULAR FINISH			WHITE FINISH BINS		
	Stock Number	Wt. Lbs.	Net Ea. (25+)	Stock Number	Wt. Lbs.	Net Ea. (25+)
2 x 12 x 4-1/2"	<b>XV-1046</b>	15	<b>0.73</b>	<b>XV-1061</b>	15	<b>0.75</b>
4 x 12 x 4-1/2"	<b>XV-1047</b>	20	<b>0.99</b>	<b>XV-1062</b>	20	<b>1.18</b>
6 x 12 x 4-1/2"	<b>XV-1048</b>	25	<b>1.15</b>	<b>XV-1063</b>	25	<b>1.22</b>
8 x 12 x 4-1/2"	<b>XV-1049</b>	30	<b>1.37</b>	<b>XV-1064</b>	30	<b>1.55</b>
10 x 12 x 4-1/2"	<b>XV-1050</b>	35	<b>1.41</b>	<b>XV-1065</b>	35	<b>1.88</b>
12 x 12 x 4-1/2"	<b>XV-1051</b>	40	<b>1.60</b>	<b>XV-1066</b>	40	<b>1.85</b>
2 x 18 x 4-1/2"	<b>XV-1052</b>	25	<b>1.15</b>	<b>XV-1067</b>	25	<b>1.35</b>
4 x 18 x 4-1/2"	<b>XV-1053</b>	30	<b>1.21</b>	<b>XV-1068</b>	30	<b>1.44</b>
6 x 18 x 4-1/2"	<b>XV-1054</b>	35	<b>1.46</b>	<b>XV-1069</b>	35	<b>1.73</b>
8 x 18 x 4-1/2"	<b>XV-1055</b>	40	<b>1.95</b>	<b>XV-1070</b>	40	<b>2.03</b>
10 x 18 x 4-1/2"	<b>XV-1056</b>	45	<b>1.58</b>	<b>XV-1071</b>	45	<b>2.20</b>
12 x 18 x 4-1/2"	<b>XV-1057</b>	52	<b>1.62</b>	<b>XV-1072</b>	52	<b>2.23</b>
4 x 24 x 4-1/2"	<b>XV-1058</b>	34	<b>1.97</b>	<b>XV-1073</b>	34	<b>2.82</b>
6 x 24 x 4-1/2"	<b>XV-1059</b>	40	<b>2.52</b>	<b>XV-1074</b>	40	<b>3.46</b>
8 x 24 x 4-1/2"	<b>XV-1060</b>	60	<b>2.24</b>	<b>XV-1075</b>	60	<b>3.97</b>



**STOCK**

## BUCKHORN™ Structural Foam Hoppers

Extremely strong and durable containers increase storage space in the warehouse, shop, or office. Rigid 1/4" wall thickness gives extra strength. Easily holds over 150 lbs., but withstands even greater handling stresses and pressures. 100% recyclable high-density polyethylene. won't rust, rot or splinter and the seamless surface is impervious to most industrial chemicals and detergents. Boxes do not contain fiberglass that can cause skin irritation. Sold in ctn. qty. only. **SPECIFY COLOR:**  
**BK** - Black,  
**BL** - Blue.  
**IN STOCK.**

Model Number	Overall W x D x H	Ctn. Qty.	Wt. Lbs.	Price Each
<b>YJ-680</b>	11 x 19-1/4 x 6-3/4"	5	5-1/2	<b>\$23.90</b>
<b>YJ-681</b>	11 x 23-1/2 x 9"	6	8	<b>\$0.50</b>



**STOCK**

## AIGNER Universal Label Holder Kits

Self-adhesive 1" x 3" clear plastic sleeves stick to any flat clean surface on bins or totes. Includes laser/inkjet printer compatible sheets and printing instructions. Sold in packages of 50. **IN STOCK.**

Model No. **ZP-0178**—Slip-Strip™ top loading. **\$20.50**  
 Model No. **ZP-0179**—Hol-Dex® side loading. **\$26.90**

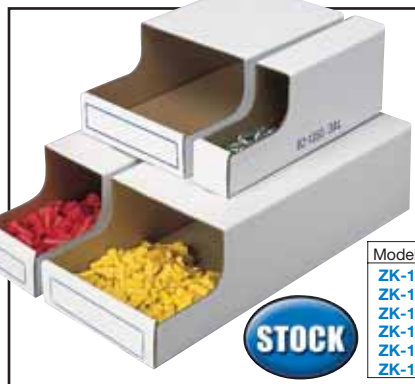

**STOCK**

## Stack-On Bin Boxes

Here's an economical way to increase your storage without buying expensive shelving. Boxes stack on shelving or benches creating small storage compartments. 200-lb. test white corrugated board has 1-piece top and sides. Sold only in lots of 25, order in multiples of 25. **IN STOCK.**

Model No.	Overall W x D	Wt. Lbs./100	Price Ea.
<b>ZK-1645</b>	2 x 12 x 4-1/2"	24	<b>\$1.02</b>
<b>ZK-1646</b>	4 x 12 x 4-1/2"	32	<b>1.20</b>
<b>ZK-1647</b>	7 x 12 x 4-1/2"	48	<b>1.69</b>
<b>ZK-1648</b>	12 x 12 x 4-1/2"	68	<b>3.21</b>
<b>ZK-1649</b>	4 x 18 x 4-1/2"	44	<b>1.77</b>
<b>ZK-1650</b>	7 x 18 x 4-1/2"	60	<b>2.37</b>



**STOCK**

## QUANTUM™ QuickPick Bins

Access items from either end of these practical bins. Stack vertically, cross-stack, and nest when empty for convenient storage. Fits standard shelving. Optional black dividers fit front-to-back, side-to-side, or both directions at the same time to create four storage compartments. **SPECIFY BIN COLOR:**  
**BL** - Blue, **RD** - Red, **YL** - Yellow. **IN STOCK.**

BINS				VERTICAL DIVIDERS (Pkg./10)		HORIZONTAL DIVIDERS (Pkg./10)	
Model No.	Overall W x D x H	Ctn. Qty.	Price Each	Model No.	Price Ea.	Model No.	Price Ea.
<b>YA-1000</b>	6-5/8 x 9-1/2 x 5"	20	<b>\$3.45</b>	<b>YA-1006</b>	<b>\$7.80</b>	<b>YA-1011</b>	<b>\$9.10</b>
<b>YA-1001</b>	6-5/8 x 12-1/2 x 5"	20	<b>3.70</b>	<b>YA-1006</b>	<b>7.80</b>	<b>YA-1012</b>	<b>15.60</b>
<b>YA-1002</b>	8-3/8 x 12-1/2 x 5"	20	<b>6.70</b>	<b>YA-1007</b>	<b>8.50</b>	<b>YA-1012</b>	<b>15.60</b>
<b>YA-1003</b>	9-1/4 x 14 x 6-1/2"	20	<b>5.30</b>	<b>YA-1008</b>	<b>9.90</b>	<b>YA-1013</b>	<b>17.50</b>
<b>YA-1004</b>	6-5/8 x 18-1/2 x 7"	10	<b>6.50</b>	<b>YA-1009</b>	<b>9.00</b>	<b>YA-1014</b>	<b>20.20</b>
<b>YA-1005</b>	8-3/8 x 18-1/2 x 7"	10	<b>8.00</b>	<b>YA-1010</b>	<b>9.10</b>	<b>YA-1014</b>	<b>20.20</b>



## QUANTUM™ Stack and Hang Poly Bins



Strong, versatile containers store and organize inventory. Constructed of heavy-duty polypropylene that will not rust or corrode. Waterproof bins are unaffected by most alkalis and weak acids. Easy-to-handle front, back and side grips with built-in hanger for suspension from louvered panel listed below. Will stack on one another and can be used on most standard shelving. Order optional windows and dividers to maximize storage capacity, prevent spillage, and keep contents organized. Order in carton quantities specified, priced each. **SPECIFY BIN COLOR: BL - Blue, GN - Green, IV - Ivory, RD - Red, YL - Yellow. IN STOCK.**



STACKING/HANGING BINS					CLEAR WINDOWS. Sold in pkg. quantities.			DIVIDERS. Sold in pkg. quantities.		
Model Number	Overall W x D x H	Ctn. Qty.	Ctn. Wt. Lbs.	Price Each	Model Number	Pkg. Qty.	Price Each	Model Number	Pkg. Qty.	Price Each
YG-5333	4-1/8 x 4-1/2 x 3"	24	9	\$1.16	—	—	—	YG-5354	6	\$4.90
YG-5334	4-1/8 x 5-1/2 x 3"	24	11	1.22	—	—	—	YG-5355	6	5.10
YG-5335	4-1/8 x 7-1/2 x 3"	24	13	1.75	—	—	—	YG-5356	6	5.30
YG-5402	4-1/8 x 10-7/8 x 4"	12	10	3.00	YG-5409	12	\$9.50	YG-5416	6	5.60
YG-5336	5-1/2 x 11 x 5"	12	11	4.87	YG-5345	12	11.10	YG-5357	6	6.30
YG-5337	5-1/2 x 13-1/2 x 5"	12	13	5.40	YG-5346	12	11.10	YG-5358	6	8.00
YG-5300	5-1/2 x 14-3/4 x 5"	12	14	6.50	YG-5305	12	11.10	YG-5310	6	11.20
YG-5338	11 x 11 x 5"	6	14	7.50	YG-5347	6	8.30	YG-5359	6	6.80
YG-5301	16-1/2 x 11 x 5"	6	18	10.50	YG-5306	6	18.40	YG-5311	6	9.20
YG-5302**	12-3/8 x 19-3/4 x 5-7/8"	6	17	19.30	YG-5307	6	15.10	YG-5312	6	20.40
YG-5303	8-1/4 x 11 x 7"	6	12	7.70	YG-5308	6	14.80	YG-5313	6	12.50
YG-5340	8-1/4 x 14-3/4 x 7"	12	14	7.90	YG-5349	12	14.80	YG-5361	6	14.00
YG-5341	16-1/2 x 14-3/4 x 7"	6	21	13.80	YG-5350	6	18.20	YG-5362	6	14.00
YG-5342	11 x 16 x 8"	4	13	13.70	YG-5351	4	8.60	YG-5363	6	26.30
YG-5304	8-1/4 x 18 x 9"	6	17	15.90	YG-5309	6	15.10	YG-5314	6	27.30
YG-5343	11 x 18 x 10"	4	15	19.10	YG-5352	4	9.00	YG-5364	6	27.40
YG-5344†	16-1/2 x 18 x 11"	3	23	24.50	YG-5353	3	10.30	YG-5365	6	43.40
YG-5403*	8-1/4 x 23-7/8 x 7"	6	19	29.10	YG-5410	6	39.40	YG-5417	6	38.90
YG-5404*	8-1/4 x 23-7/8 x 7"	6	22	29.10	YG-5411	6	39.70	YG-5418	6	39.90
YG-5405*	11 x 23-7/8 x 7"	4	15	32.50	YG-5412	4	27.70	YG-5419	6	41.60
YG-5406*	11 x 23-7/8 x 10"	4	19	36.50	YG-5413	4	28.30	YG-5420	6	45.90
YG-5407*	16 x 23-7/8 x 11"	1	7	39.80	YG-5414	1	8.20	YG-5421	6	49.50
YG-5408*	18-1/4 x 23-7/8 x 12"	1	8	42.40	YG-5415	1	8.40	YG-5422	6	61.60

\*Available in BL - Blue, RD - Red, and YL - Yellow only  
 \*\*Not available in IV - Ivory.  
 † Not designed to fit louvered panels due to large weight capacities.

## AKRO-MILS® Poly Bins

Extra wide ledge assures stability when stacked. Anti-slide stop prevents loaded bins from shifting forward when being transported. Rear grip allows bins to be suspended from louvered panels. Made of tough polypropylene with reinforcing ribs that prevent spreading when fully loaded and stacked. Rust-, corrosion-proof bins are impervious to chemicals and oils. Large label card slot. Finger grips for easy handling of larger bins. Molded-in color. Meets ISO 9001/9002. Order bins in carton quantities specified, priced each. **SPECIFY COLOR: BL - Blue, GN - Green, RD - Red, ST - Stone, YL - Yellow. IN STOCK.**

Model Number	Overall W x D x H	Ctn. Qty.	Ctn. Wt. Lbs.	Price Each	DIVIDERS (6/pkg)	
					Model No.	Price Ea. Pkg.
XG-1957	4-1/8 x 5-3/8 x 3"	7	24	\$1.39	XV-4030	\$6.30
XG-1958	4-1/8 x 7-3/8 x 3"	8	24	2.21	XV-4031	6.70
XG-4342	4-1/8 x 10-7/8 x 4"	7	12	3.43	—	—
XG-1959	5-1/2 x 10-7/8 x 5"	12	12	5.30	XV-4032	11.30
XG-1932	8-1/4 x 10-3/4 x 7"	9	6	9.00	XV-4034	15.90
XG-1931	11 x 10-7/8 x 5"	9	6	8.40	XV-4032	11.30
XG-4340	16-1/2 x 10-7/8 x 5"	12	6	13.10	—	—
XG-4341	5-1/2 x 14-3/4 x 5"	13	12	6.40	—	—
XG-1960	8-1/4 x 14-3/4 x 7"	27	12	10.90	XV-4035	17.20
XG-1961	16-1/2 x 14-3/4 x 7"	27	6	15.20	XV-4035	17.20
XG-4338	8-1/4 x 18 x 9"	20	6	17.90	XV-4037	29.20
XG-4339	16-1/2 x 18 x 11"	24	3	27.40	XV-4038	30.20



## LEWISBins+ Polypropylene Bins

Holds practically anything from small parts and nuts and bolts to health care or office supplies. Durable polypropylene bins resist water, rust, and corrosion and have large hinged fronts that permit easy access to stored contents. Will stack on one another. Other features include: label/bar code insert area and rear lip that permits hanging from louvered panels. Order bins in quantities specified, priced each. **SPECIFY BIN COLOR: BL - Blue, GN - Green, RD - Red, SD - Sandstone, YL - Yellow. IN STOCK.**

POLYPROPYLENE BINS					DIVIDERS. Sold in pkg. of 6.	
Model No.	Overall W x D x H	Ctn. Qty.	Ctn. Wt. Lbs.	Price Ea.	Model No.	Price Each Pkg.
YA-3440	4.1 x 5.4 x 3"	48	10	\$0.90	YA-3447	\$4.86
YA-3441	4.1 x 7.4 x 3"	48	14	1.48	YA-3448	4.81
YA-3442	5.5 x 10.9 x 5"	12	10	3.82	YA-3449	8.70
YA-3443	8.3 x 10.8 x 7"	8	9	6.40	YA-3450	10.50
YA-3444	11 x 10.9 x 5"	8	9	6.20	YA-3449	8.70
YA-3470	8.25 x 14.75 x 7"	12	18	8.60	YA-3451	12.90
YA-3445	16.5 x 14.8 x 7"	6	7	10.80	—	—



# Bins & Bin Panels



## AKRO-MILS® Poly Shelf Bins

Replace worn out cardboard containers with these virtually unbreakable poly bins. One-piece molded seamless bins are waterproof and unaffected by grease or oil. Special built-in hang lock allows each bin to be tilted for easy complete access. Bins are sold in carton quantity only.

**SPECIFY COLOR:**  
**BL** - Blue, **RD** - Red,  
**YL** - Yellow. **IN STOCK.**



**A 36"W SHELF WILL HOLD THE FOLLOWING BIN QTY:**

Model No.	Qty. Ea.
XG-3193	13
XG-3194	8
XG-3195	5
XG-3196	8
XG-3197	5
XG-3687	4
XG-3688	4
XG-3689	5

Model No.	Overall W x D x H	Inner Bin Cap.	Ctn. Qty.	Ctn. Wt. Lbs.	Price Each	DIVIDERS (pkg./24)
XG-3193	2-3/4 x 11-5/8 x 4"	3	24	7	\$1.60	—
XG-3194	4-1/8 x 11-5/8 x 4"	5	24	10	1.70	XG-3572 \$11.00
XG-3195	6-5/8 x 11-5/8 x 4"	9	12	8	2.80	XG-3573 11.90
XG-3687	8-3/8 x 11-5/8 x 4"	11	12	9	2.90	XG-3691 27.50
XG-4645	11-1/8 x 11-5/8 x 4"	15	12	11	4.40	XG-4650 34.10
XG-3196	4-1/8 x 17-7/8 x 4"	8	12	8	\$2.40	XG-3572 \$11.00
XG-3197	6-5/8 x 17-7/8 x 4"	15	12	10	3.30	XG-3573 11.90
XG-3688	8-1/4 x 17-7/8 x 4"	18	12	11	4.60	XG-3691 27.50
XG-4646	11-1/8 x 17-7/8 x 4"	25	12	15	7.80	XG-4650 34.10
XG-4647	4-1/8 x 23-3/8 x 4"	11	12	13	\$4.70	XG-3572 \$11.00
XG-3689	6-5/8 x 23-3/8 x 4"	21	6	8	7.10	XG-3573 11.90
XG-4648	8-1/4 x 23-3/8 x 4"	25	6	10	9.20	XG-3691 27.50
XG-4649	11-1/2 x 23-3/8 x 4"	35	6	20	10.00	XG-4650 34.10

\*Bins are sold in carton quantity only.

Model No. **XG-3690**—3" x 2" x 3-1/4"H Bin Cups. Fit all shelf bins. Ctn. qty. 48. Ctn. wt. 2-1/2 lbs. ....\$0.47



**FREE-STANDING MODEL SHOWN.**



## AKRO-MILS® Louvered Wall-Mount Panel

These versatile panels can be mounted on walls, shelving, benches, carts and cabinets. They are formed from 16-gauge cold-rolled steel with a gray baked enamel finish. Allows unlimited relocation of bin sizes. Panels must be securely fastened to assure adequate load bearing strength. **IN STOCK.**

Model No. **XG-1864**—35-3/4"W x 19"H. Wt. 12 lbs. ....\$45.80

BIN CAPACITY AND QUANTITY TO FIT XG-1864						
Panel Qty.	Overall W x D x H	XG-1957 10-lb. cap.	XG-1958 10-lb. cap.	XG-1959 30-lb. cap.	XG-1960 60-lb. cap.	XG-1960 75-lb. cap.
1	35-3/4 x 19"	32	32	18	9	4
2	35-3/4 x 37"	72	72	36	18	8
3	35-3/4 x 55"	104	104	54	27	14
4	35-3/4 x 73"	144	144	72	36	18

NOTE: Must order bins in ctn. qty., see page 201 for bins.

## AKRO-MILS® Extra-Long Poly Bins



Now you can store a higher volume of inventory in one location with these extra-long bins. Constructed of heavy-duty copolymer with reinforced ribs for sure stacking. Molded finger grips. Includes a divider. Designed to fit 18" shelving. Bins sold only in cartons of 6. Color: beige.

**IN STOCK.**

BINS					DIVIDERS (Pkg./6)	
Model Number	Overall W x D x H	Ctn. Qty.	Ctn. Wt. Lbs.	Price Each	Model Number	Price Each
ZD-3230	8-1/4 x 20-1/2 x 7"	6	21	\$18.60	ZD-3231	\$12.50
ZD-3232	11 x 20-1/2 x 7"	6	26	22.20	ZD-3233	15.80

## EDSAL Louvered Panels

Add bins listed above to create a customized storage system. Choose either wall-mount or free-standing single-sided panel with louvers to create a customized storage system. 16-ga. steel construction with tough powder coat finish. **IN STOCK.**

Model Numbers	Description	Size W x H	Louvers Down Qty.	Louvers Across Qty.	Price Each
<b>YD-1310</b>	Wall Mount	36 x 19"	9	12	<b>\$33.90</b>
<b>YD-1311</b>	Free-Standing	36 x 50"	24	12	<b>122.00</b>

NOTE: Number of rows per panel depends on the height of each bin. Figure the number of rows by how many louvers are used vertically. See photo or chart for the number of bins that will fit each panel.

Model Number	Bins Per Row	Bins Per Carton	Vertical Louvers
YG-5333	8	48	2
YG-5334	8	48	2
YG-5335	8	48	2
YG-5336	6	12	3
YG-5337	6	12	3
YG-5338	3	8	3
YG-5340	4	8	4

NOTE: Must order bins in ctn. qty., see page 201 for bins.

# Bins & Bin Racks

## QUANTUM™ Poly Shelf Bins

**SHELF BINS.** Here's a strong durable alternative to corrugated bins. Constructed of tough polypropylene, these bins are waterproof, impervious to most chemicals, and unaffected by grease or oil. Resist chipping and cracking under normal use. Slotted label holders are built into dividers. Shelf bins accept 5 dividers. Order dividers in pkg. qty. of 50 only. **SPECIFY BIN COLOR: BL - Blue, GN - Green, IV - Ivory, RD - Red, YL - Yellow. IN STOCK.**

BINS					DIVIDERS		
Model Number	Overall W x D x H	Inner Bin Cap.	Ctn. Qty.	Ctn. Wt. Lbs.	Price Each	Model Number	Price Per Pkg.
YG-5366	2-3/4 x 11-5/8 x 4"	3/0	36	14	\$1.71	—	—
YG-5367	4-1/8 x 11-5/8 x 4"	6/2	36	15	1.86	YG-5377	\$24.60
YG-5368	6-5/8 x 11-5/8 x 4"	9/4	30	16	2.20	YG-5378	28.60
YG-5373	8-3/8 x 11-5/8 x 4"	12/4	20	14	3.30	YG-5383	46.20
YG-5375	11-1/8 x 11-5/8 x 4"	18/6	8	15	4.75	YG-5385	67.90
YG-5369	4-1/8 x 17-5/8 x 4"	9/3	20	14	2.80	YG-5379	24.60
YG-5370	6-5/8 x 17-5/8 x 4"	15/6	20	17	3.60	YG-5380	28.60
YG-5374	8-1/8 x 17-5/8 x 4"	19/6	10	22	4.37	YG-5384	46.20
YG-5376	11-1/8 x 17-5/8 x 4"	29/8	8	21	7.60	YG-5386	67.90
YG-5371	4-1/8 x 23-5/8 x 4"	13/4	16	15	4.36	YG-5381	24.60
YG-5372	6-5/8 x 23-5/8 x 4"	12/8	8	20	5.10	YG-5382	28.60
YG-5389	8-3/8 x 23-5/8 x 4"	24/8	6	9	9.80	YG-5390	46.20
YG-5391	11-1/8 x 23-5/8 x 4"	35/16	6	9	9.90	—	—



**BIN CUPS.** Sold in carton quantities of 48 only. **SPECIFY COLOR: BL - Blue, YL - Yellow.**

Model No. **YG-5387**—3-1/4"L x 1-3/4"W x 3"H. Ctn. wt. 4 lbs. ....**\$22.20**  
 Model No. **YG-5388**—5-1/4" x 2-3/4" x 3"H. Ctn. wt. 7 lbs. ....**\$36.20**



## QUANTUM™ Bin Racks

Streamline your operations with these practical racks. Steel racks come complete with removable polypropylene bins that are easy to clean and resist most chemicals. **SPECIFY BIN COLOR: BL - Blue, GN - Green, RD - Red, YL - Yellow. IN STOCK.**

Model No.	Overall WxDxH	Bin Qty. 1/WxDxH	Wt. Lbs.	Price
<b>BENCH RACKS</b>				
YG-1600	36 x 8 x 19"	(32) 4-1/8 x 7-1/2 x 3"	37	\$118.00
YG-1601	36 x 8 x 19"	(18) 5-1/2 x 11 x 5"	35	148.00
YG-1602	36 x 8 x 19"	(18) 5-1/2 x 14-3/4 x 5"	39	167.00
<b>STATIONARY BIN RACKS</b>				
YG-1603	36 x 15 x 53"	(32) 4-1/8 x 7-1/2 x 3" (12) 5-1/2 x 11 x 5" (8) 8-1/4 x 14-3/4 x 7"	98	\$397.00
YG-1604	36 x 15 x 53"	(96) 4-1/8 x 7-1/2 x 3"	96	346.00
YG-1605	36 x 15 x 53"	(16) 4-1/8 x 7-1/2 x 3" (18) 5-1/2 x 11 x 5" (18) 5-1/2 x 14-3/4 x 5"	98	441.00
YG-1606	36 x 15 x 53"	(48) 4-1/8 x 7-1/2 x 3" (18) 5-1/2 x 11 x 5"	97	348.00
<b>MOBILE BIN RACKS</b>				
YG-1607	36 x 25 x 64"	(192) 4-1/8 x 7-1/2 x 3"	165	\$615.00
YG-1608	36 x 25 x 64"	(64) 4-1/8 x 7-1/2 x 3" (24) 5-1/2 x 11 x 5" (16) 8-1/2 x 11 x 7"	135	675.00
YG-1609	36 x 25 x 64"	(96) 5-1/2 x 11 x 5"	150	770.00
YG-1610	36 x 25 x 64"	(48) 8-1/4 x 14-3/4 x 7"	208	650.00



**ALSO AVAILABLE IN:**

- GN - GREEN**
- RD - RED**
- YL - YELLOW**

## AKRO-MILS® System Bins

**SIX-COMPARTMENT SYSTEM BINS**  
 Uniquely-designed bin offers the same storage capacity as six individual bins without the troublesome bin shift. One-piece high-strength double-wall copolymer plastic unit features six molded compartments for individual storage. Other features include: large label area and easy finger grip. 33"W x 5"H overall. Fits standard 36"W shelving, racks, and benches. Order in lots of 5, priced each. **SPECIFY COLOR: BL - Blue, GN - Green, RD - Red, YL - Yellow. IN STOCK.**

Model No. **YG-1030**—12"D Bins.....**\$20.30**  
 Model No. **YG-1031**—18"D Bins .....**\$33.90**

**SHELVING WITH SYSTEM BINS**  
 Sturdy steel shelving comes complete with 10 system bins. 36"W x 75"H overall. 400-lb. capacity adjustable shelves. **SPECIFY COLOR: BL - Blue, GN - Green, RD - Red, YL - Yellow. IN STOCK.**

Model No. **YG-1032**—12"D Shelves.  
 Wt. 155 lbs. ....**\$388.00**  
 Model No. **YG-1033**—18"D Shelves.  
 Wt. 198 lbs.....**\$579.00**

# Bin Shelving

## Poly Bin Shelving

Add efficiency to your storage areas with these high quality, low cost bin systems. Racks are 36" wide with (10) or (13) shelves that are adjustable on 1" centers. Constructed of 16-gauge steel uprights and side braces, with 13-gauge steel back braces. Polypropylene bins have front label slots, finger grip, and reinforced ribs to prevent spreading. Bins are resistant to chemicals and oils, and will not rust or corrode.

Units are 75" high with 400-lb. shelf capacity. **SPECIFY BIN COLOR FOR 10-SHELF UNITS:** BL - Blue, GN - Green, RD - Red, YL - Yellow. **SPECIFY BIN COLOR FOR 13-SHELF UNITS:** BL - Blue, YL - Yellow. **IN STOCK.**



Model Number	Overall W x D x H	Bin Qty./ Bin W x D x H	Wt. Lbs.	Price Each
<b>10-SHELF UNIT</b>				
XP-353	36 x 12 x 75"	(60) 5-1/2 x 10-7/8 x 5"	118	\$444.00
XP-354	36 x 12 x 75"	(12) 8-1/2 x 14-3/4 x 7"	120	447.00
XP-355	36 x 12 x 75"	(36) 5-1/2 x 10-7/8 x 5"	119	412.00
XP-356	36 x 12 x 75"	(6) 16-1/2 x 14-3/4 x 7"	118	367.00
XP-357	36 x 12 x 75"	(32) 8-1/2 x 14-3/4 x 7"	125	457.00
<b>13-SHELF UNIT</b>				
YD-1075	36 x 12 x 75"	(60) 12 x 6 x 4"	125	\$284.00
YD-1076	36 x 12 x 75"	(96) 12 x 4-1/8 x 4"	133	315.00



## Shelving With Extra-Long Poly Bins

Extra-long bins offer more storage capacity than other standard-sized bins. Each bin includes one divider and hopper front for access to stored contents. 625-lb. capacity per shelf. Ships unassembled. Bin color: beige. **IN STOCK.**

Model Number	Overall W x D x H	Bin Qty./ Bin W x D x H	Wt. Lbs.	Price Each
XD-1080	36 x 18 x 85"	(36) 8-1/4 x 20-1/2 x 7"	205	\$865.00

## AIGNER Universal Label Holder Kits

Self-adhesive 1" x 3" clear plastic sleeves stick to any flat clean surface on bins or totes. Includes laser/inkjet printer compatible sheets and printing instructions. Sold in packages of 50. **IN STOCK.**

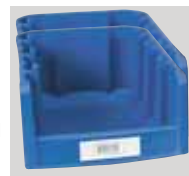

Model No. ZP-0366—Slip-Strip™ top loading.	\$20.50
Model No. ZP-0367—Hol-Dex® side loading.	\$26.90

## Corrugated Bin Shelving

Dependable steel shelving unit features economical, 200-lb. corrugated fiberboard bins. Holds up to 105 bins per shelving unit. Supports 400 lbs. per shelf (evenly distributed). Bins hang from above shelf lip for easy access and visual inspection of contents. Choose either standard brown or white bin finish. Ships unassembled. **IN STOCK.**



Overall W x D x H	Bin Qty./ Bin W x D x H	Wt. Lbs.	BROWN BINS		WHITE BINS	
			Model No.	Price Ea.	Model No.	Price Ea.
36 x 12 x 75"	(48) 4 x 12 x 4"	105	XV-1790	\$198.00	XV-1797	\$205.00
	(24) 8 x 12 x 4"		XV-1791	268.00	XV-1798	269.00
36 x 18 x 75"	(48) 4 x 18 x 4"	145	XV-1792	208.00	XV-1799	218.00
	(24) 8 x 18 x 4"		XV-1793	254.00	XV-1800	274.00
36 x 12 x 75"	(96) 4 x 12 x 4"	111	XV-1794	239.00	XV-1801	261.00
	(48) 8 x 18 x 4"		XV-1795	217.00	XV-1802	258.00
36 x 18 x 75"	(45) 2 x 12 x 4"	120	XV-1796	270.00	XV-1803	301.00
	(40) 4 x 12 x 4"					
36 x 12 x 75"	(20) 6 x 12 x 4"	145				
	(45) 2 x 18 x 4"					
36 x 18 x 75"	(40) 4 x 18 x 4"	178				
	(20) 6 x 18 x 4"					



## Steel Shelving

Maximize your storage space with this strong steel shelving. Each shelf supports up to 400 lbs. of inventory—13 shelves included. Shelves are bent and crimped on each side for added strength—adjust on 1" centers. Rear sway braces add structural support and rigidity. Accepts any plastic or corrugated bin up to 4-1/2" H. Ships knocked down. **IN STOCK.**

Model No.	Overall W x D x H	Wt. Lbs.	Price Ea.
XG-5140	36 x 12 x 75"	91	\$162.00
XG-5141	36 x 18 x 75"	120	214.00
XG-5142	36 x 24 x 75"	139	279.00

# Storage Cabinets

## Cabinet Selection Guide

With so many cabinet choices, it can be a challenge to pick the best manufacturer, style, size and color that best fits your needs. This guide will help you through the process by providing you with the basic information needed to select a cabinet, including details on construction, shelf capacities, and locking systems.

### CABINET STYLE GUIDE

**Ultra-Capacity:** 1,000+ lbs. capacity per shelf. Cabinets are constructed of the thickest (12–16 gauge) steel and are well-suited for the most demanding applications.

#### GAUGE RANGE



**Heavy-Industrial:** 400–999 lbs. capacity per shelf. Cabinets are constructed with thick (14–20 gauge) steel and are designed for long-term use in harsh environments.

#### GAUGE RANGE



**Standard-Industrial:** 200–399 lbs. capacity per shelf. Cabinets are constructed with lighter (16–22 gauge) steel for moderately harsh work environments.

#### GAUGE RANGE



**Light-Industrial:** 125–199 lbs. capacity per shelf. Cabinets are constructed with the lightest (20–24 gauge) steel and are for use in non-abusive environments or for office storage.

#### GAUGE RANGE



### GLOSSARY OF TERMS

**Shelf Capacity:** Rated by manufacturer, this is the maximum evenly distributed weight a shelf can safely hold.

**Gauge of Steel:** Each gauge number relates to a standard minimum thickness. As the gauge number goes down, the steel becomes thicker. Example: 18 gauge is at minimum 0.428" thick (43 mils); 12 gauge is at minimum .0966" thick (97 mils).

**Shelf Openings:** The number of openings between shelves, including the space at the bottom of the cabinet.

**Single-Point Lock:** Secures the door at the center point only.

**Two-Point Lock:** Secures the doors at the top and bottom of the cabinet.

**Three-Point Lock:** Secures the doors at the top, center, and bottom of the cabinet.

**Piano Hinge:** The door hinge runs continuously from the top to the bottom providing more security and strength.

**Leaf Hinge:** A standard door hinge consisting of two leaves that are joined together by a pin or metal rod.

### ASSEMBLY

**Unassembled:** Assembly is required. Hardware is provided by the manufacturer. Unassembled cabinets may cost less and are less expensive to ship.

**Set-Up:** The cabinet is either bolted or riveted together at the factory. No assembly is required.

**All-Welded:** The cabinet is put together using various welding techniques. No assembly is required.

### GAUGE RANGE Details above.



### ULTRA-CAPACITY GRADE



**3-POINT LOCKING MECHANISM WITH MALLEABLE CAST IRON ZINC PLATED HANDLE.**



**DOORS OPEN 180° ON WELDED LEAF HINGES WITH BRASS PINS.**



## EDSAL Vault Cabinets

- 1500–1800-lb. capacity per shelf
- 14-gauge steel
- All-welded
- Padlock handle with three-point lock

Superior strength and durability. Shelves adjust on 2" centers. Doors open 180° on 9-ga. welded leaf hinges with brass pins. Bolt holes in legs allow cabinet to be secured to floor. Malleable cast iron zinc plated handle accepts 7/16" dia. padlock (not included). Powder coat gray finish. **IN STOCK.**



Model Number	Overall W x D x H	Shelf Cap. Lbs.*	Shelf Openings	Wt. Lbs.	Price Each
YA-1520	36 x 24 x 78"	1800	5	363	\$989.00
YA-1521	48 x 24 x 78"	1600	5	445	1081.00
YA-1522	60 x 24 x 78"	1500	5	526	1176.00

\*Shelf capacities based on evenly distributed loads.

# Storage Cabinets



## STRONG HOLD Lifetime Cabinets

- 1,000–1,900-lb. capacity per shelf
- 12-gauge steel cabinet; 14-gauge steel shelves
- All-welded
- Padlock handle with three-point lock

The strongest cabinet available today! Handles your most demanding storage requirements. Doors swing open a full 180°. Adjustable shelves on 2" centers. **SPECIFY COLOR:** CM - Camel, DG - Dark gray. **SELECTED MODELS IN STOCK.** Others FOB KENTUCKY.

**GAUGE RANGE** Details on pg. 205.

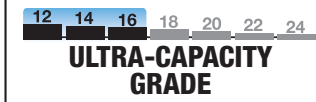

**ULTRA-CAPACITY  
GRADE**



**Selected  
Models**

**AVAILABLE  
COLORS:**

- CM - CAMEL
- DG - DARK GRAY

Model No.	Overall W x D x H	Shelf Openings	Shelf Cap. Lbs.	Wt. Lbs.	Price Each
<b>COUNTER-HEIGHT MODELS (without legs)</b>					
WG-4728	24" x 20" x 36"	3	1,000	170	\$582.00
WG-4729	36" x 20" x 36"	3	1,600	235	719.00
WG-4730	36" x 20" x 42"	3	1,600	260	762.00
<b>FLOOR MODELS</b>					
WG-4731	48" x 24" x 66"	4	1,275	472	\$994.00
WG-4725	36" x 24" x 78"	4	1,900	459	877.00
WG-4726	48" x 24" x 78"	5	1,200	557	1080.00
WG-4727	60" x 24" x 78"	5	1,650	685	1169.00

WG-4725



**GAUGE RANGE** Details on pg. 205.



**HEAVY-INDUSTRIAL  
GRADE**

**AVAILABLE  
COLORS:**

- BE - BEIGE
- GY - GRAY



**FLUSH  
MOUNTED  
HANDLE**



## SECURALL® Industrial Storage Cabinets

XR-1452

- 500-lb. capacity per shelf
- 18-gauge steel
- All-welded
- Three-point lock

Features sturdy double walls and shelf-bracing reinforcements for years of trouble-free service. Shelves adjust on 5" centers. Doors swing on full-length piano hinges. Snag-free flush mounted handle offers convenient fingertip operation. **SPECIFY COLOR:** BE - Beige, GY - Gray. FOB INDIANA.

Model No.	Overall W x D x H	Shelf Openings	Wt. Lbs.	Price Each
<b>STATIONARY MODELS</b>				
XR-1450	36" x 18" x 42"	3	151	\$549.00
XR-1451	36" x 18" x 72"	5	264	796.00
XR-1452	36" x 18" x 84"	5	300	852.00
XR-1453	36" x 24" x 42"	3	200	588.00
XR-1454	36" x 24" x 72"	5	353	861.00
XR-1455	36" x 24" x 84"	5	401	928.00
<b>MOBILE MODEL</b>				
XR-1456	36" x 24" x 47"	3	200	\$747.00

## EDSAL All-Welded Cabinets

- 400-lb. capacity per shelf
- 18- and 20-gauge steel
- All-welded
- Three-point lock



Arrives assembled and ready to load. Top-of-the-line construction will provide years of trouble-free service. Reinforced doors with dual handles swing open on full-length piano hinges. Shelves adjust on 2" centers.

**SPECIFY COLOR:** GY - Gray, PY - Putty, GY - GRAY **IN STOCK.** Others FOB ILLINOIS.

Model Number	Overall W x D x H	Shelf Openings	Wt. Lbs.	Price Each
XA-1470	36" x 18" x 78"	5	186	\$491.00
XA-1471*	36" x 24" x 78"	5	217	540.00
XA-1472	48" x 18" x 78"	5	233	636.00
XA-1473*	48" x 24" x 78"	5	271	703.00

\*PY - Putty **IN STOCK.**

# Storage Cabinets

**GAUGE RANGE** Details on pg. 205.

12 14 16 18 20 22 24

**HEAVY-INDUSTRIAL GRADE**

**AVAILABLE COLORS:**

LG - LT. GRAY

PY - PUTTY



**DUAL HANDLES MAKE OPENING AND CLOSING EASY.**



Selected Models

## PARENT METAL Premium Storage Cabinets

- 400-lb. capacity per shelf
- 18- and 20-gauge steel
- All-welded
- Three-point lock

Chemical-adhesion/weld process eliminates spot welds giving this cabinet a smooth, clean appearance. Shelves adjust on 2" centers. 1" deep pan-reinforced doors swing on full-height piano hinges. Also includes dual handles (1 fixed, 1 locking with 2 keys). **SPECIFY COLOR: LG - Lt. Gray, PY - Putty.**

**SELECTED MODELS IN STOCK. OTHERS FACTORY QUICK SHIP—FOB PENNSYLVANIA.**

Model Number	Overall W x D x H	Shelf Openings	Wt. Lbs.	Price Each
<b>STORAGE CABINET</b>				
XB-1590	36" x 18" x 78"	5	192	\$505.00
XB-1591	36" x 24" x 78"	5	220	\$73.00
XB-1592	48" x 24" x 78"	5	290	\$73.00
<b>EXTRA SHELVES—BLACK ONLY</b>				
XB-1597	36" x 18"	—	11	\$23.00
XB-1598	36" x 24"	—	14	\$25.10
XB-1599	48" x 24"	—	20	\$33.60



## DURHAM Clear-View Cabinets

- 800- and 900-lb. capacity per shelf
- 14-gauge steel
- All-welded
- Three-point lock



Keep an eye on all your supplies, from small parts and components to large tools and equipment. Strong cabinet offers secure visible storage. Punched diamond pattern doors include chrome handle and keys for complete security. Shelves adjust in 2" increments. 5-1/2"W x 11"D x 5"H yellow plastic bins hang from louvered panels and are removable for easy access to stored items. Durable powdercoat finish. **FACTORY QUICK SHIP—FOB MASSACHUSETTS.**

Model Number	Overall W x D x H	Shelf Openings	Shelf Cap. Lbs.	Wt. Lbs.	Price Each
YC-3244	36" x 18" x 72"	5	900	330	\$671.00
YC-3245	36" x 24" x 72"	5	800	370	\$736.00
YC-3246	36" x 18" x 72"	3	900	325	\$736.00
YC-3247	36" x 24" x 72"	3	800	365	\$760.00
YC-3248	36" x 18" x 72"	—	900	325	\$118.00

NOTE: Shelf capacity is based on evenly distributed loads.

## PARENT METAL XHD Series Galvanized-Shelf Cabinets



- 800-lb. capacity per shelf
- 14- and 16-gauge steel
- All-welded
- Three-point lock

Galvanized shelves offer excellent scratch-, corrosion-, and chemical-resistance—adjust on 2" centers. Doors include dual handles and full-length piano hinges.

Optional forklift base allows you to move cabinet even when fully loaded. Blue powder-coat finish. **IN STOCK.**

Model Number	Overall W x D x H	Shelf Openings	Wt. Lbs.	Price Each
WB-1850	36" x 18" x 42"	3	187	\$517.00
WB-1851	36" x 24" x 42"	3	218	\$70.00
WB-1852	36" x 18" x 78"	5	278	\$782.00
WB-1853	36" x 24" x 78"	5	370	\$879.00

**OPTIONAL BASES** allow forklift movement.

WB-1854—36" x 18". Wt. 31 lbs.	\$106.00
WB-1855—36" x 24". Wt. 38 lbs.	\$114.00

**EXTRA SHELVES**

WB-1847—36" x 18". Wt. 17 lbs.	\$33.30
WB-1848—36" x 18". Wt. 17 lbs.	\$37.70



**DUAL HANDLES MAKE OPENING AND CLOSING EASY.**



SHOWN WITH OPTIONAL BASE



# Storage Cabinets

**GAUGE RANGE** Details on pg. 205.

12 14 16 18 20 22 24

**STANDARD-INDUSTRIAL GRADE**



**STOCK**  
Selected Models

## PENCO Storage Cabinets

- 250- and 400-lb. shelf capacity
- 22-24-gauge steel cabinet;
- 22-gauge steel shelves
- Unassembled and set-up
- Three-point lock



**RECESSED HANDLE**

These durable cabinets are perfect for warehouses, plants, or offices. Quality features include adjustable shelves (every 2"), three leaf hinges on each 78"H cabinet's door, and locking L-handle or contemporary recessed handle with 2 keys. Durable baked enamel finish. **SPECIFY COLOR: GY - Gray, PY - Putty.** **SELECTED MODELS IN STOCK.** Others FOB UTAH.

Overall W x D x H	Shelf Openings	Shelf Cap. Lbs.	Wt. Lbs.	UNASSEMBLED CABINETS		SET-UP CABINETS	
				Model No.	Price Ea.	Model No.	Price Ea.
<b>CABINET WITH L-HANDLE</b>							
36" x 18" x 42"	3	250	91	<b>XM-2614</b>	\$273.00	<b>XM-2618</b>	\$328.00
36" x 21" x 42"	3	250	96	<b>XM-2615</b>	281.00	<b>XM-2619</b>	340.00
36" x 24" x 42"	3	250	103	<b>XM-2616</b>	290.00	<b>XM-2620</b>	373.00
48" x 24" x 42"	3	400	131	<b>XM-2617</b>	448.00	<b>XM-2621</b>	538.00
36" x 18" x 78"	5	250	138	<b>XD-1000</b>	297.00	<b>XD-1004</b>	371.00
36" x 21" x 78"	5	250	147	<b>XD-1001</b>	306.00	<b>XD-1005</b>	396.00
36" x 24" x 78"	5	250	156	<b>XD-1002</b>	335.00	<b>XD-1006</b>	417.00
48" x 24" x 78"	5	400	200	<b>XD-1003</b>	552.00	<b>XD-1007</b>	611.00
<b>EZ-BILT CABINET WITH RECESSED HANDLE</b>							
36" x 18" x 78"	5	250	138	<b>XM-2593</b>	\$297.00	<b>XM-2596</b>	\$413.00
36" x 21" x 78"	5	250	147	<b>XM-2594</b>	306.00	<b>XM-2597</b>	425.00
36" x 24" x 78"	5	250	156	<b>XM-2595</b>	335.00	<b>XM-2598</b>	467.00

**AVAILABLE COLORS:**

**GY - GRAY**    **PY - PUTTY**



### EXTRA SHELVES

Model No. <b>XM-2599</b> —36"W x 18"D. Wt. 7 lbs. ....	\$14.10
Model No. <b>XM-2600</b> —36"W x 21"D. Wt. 8 lbs. ....	\$15.60
Model No. <b>XM-2601</b> —36"W x 24"D. Wt. 9 lbs. ....	\$17.30
Model No. <b>XM-2602</b> —48"W x 24"D. Wt. 17 lbs. ....	\$41.50



**DUAL HANDLES MAKE OPENING AND CLOSING EASY.**



**FULL LENGTH PIANO HINGES.**

**AVAILABLE COLORS:**

**LG - LT. GRAY**    **PY - PUTTY**



**STOCK**  
Selected Models

## PARENT METAL Storage Cabinets

- 200-lb. capacity per shelf
- 22-gauge steel
- All-welded
- Three-point lock

High-quality with a functional design. Unique adhesion/welding process combines a clean appearance without unsightly spot welds. Shelves adjust on 2" centers. 1" deep pan reinforced doors swing on full-height piano hinges. Dual handles (1 fixed, 1 locking) include 2 keys. **SPECIFY COLOR: LG - Lt. Gray, PY - Putty. SELECTED MODELS IN LG - LT. GRAY IN STOCK.** Others FOB PENNSYLVANIA.

Model Number	Overall W x D x H	Shelf Openings	Wt. Lbs.	Price Each
<b>XB-1600</b>	36" x 18" x 42"	3	80	\$269.00
<b>XB-1601</b>	36" x 24" x 42"	3	100	307.00
<b>XB-1602</b>	36" x 18" x 72"	5	145	\$324.00
<b>XB-1603</b>	36" x 24" x 72"	5	165	413.00
<b>XB-1604</b>	36" x 18" x 78"	5	155	369.00
<b>XB-1605</b>	36" x 24" x 78"	5	175	426.00

### EXTRA SHELVES—BLACK ONLY

Model No. <b>XB-1608</b> —36"W x 18"D. Wt. 7 lbs. ....	\$20.30
Model No. <b>XB-1609</b> —36"W x 24"D. Wt. 9 lbs. ....	\$24.50



**GAUGE RANGE** Details on pg. 205.

12 14 **16 18 20 22 24**

**STANDARD-INDUSTRIAL GRADE**

**COLORS AVAILABLE:**

TN - TAN

GY - GRAY

BK - BLACK

**EDSAL Storage Cabinets**

- 225-lb. capacity per shelf
- 16-22-gauge cabinet;
- 20-gauge steel shelves
- Unassembled and set-up
- Three-point lock

Plenty of storage for larger or small tools, supplies or equipment. Welded frames prevent doors from sagging; concealed hinges offer a clean look. Other features include adjustable shelves (2" centers), chrome handles, and enclosed bases.

Tough powder coat finish. **SPECIFY COLOR: BK - Black, GY - Gray, TN - Tan.** **SELECTED MODELS IN STOCK.** Others FOB ILLINOIS.



YP-0017 SHOWN



Selected Models



YP-0015 SHOWN



YP-0019 SHOWN

Model Number	Overall W x D x H	Shelf Openings	Wt. Lbs.	Price Each
<b>UNASSEMBLED</b>				
YP-0015	36" x 18" x 42"	3	90	\$250.00
YP-0016	36" x 24" x 42"	3	102	279.00
YP-0017	36" x 18" x 78"	5	135	348.00
YP-0018	36" x 24" x 78"	5	172.5	365.00
YP-0019*	48" x 18" x 78"	5	196	425.00
YP-0020*	48" x 24" x 78"	5	215	470.00
<b>SET-UP</b>				
YP-0021	36" x 18" x 78"	3	135	\$411.00
YP-0022	36" x 24" x 78"	5	161	455.00

\*Not available in BK - Black.

**EXTRA SHELVES**

Model No. <b>YP-0023</b> —36"W x 18"D. Wt. 8 lbs.....	\$20.00
Model No. <b>YP-0024</b> —36"W x 24"D. Wt. 11 lbs.....	\$23.30
Model No. <b>YP-0025*</b> —48"W x 18"D. Wt. 10 lbs.....	\$31.90
Model No. <b>YP-0026*</b> —48"W x 24"D. Wt. 13 lbs.....	\$37.60

\*Not available in BK - Black.

**EDSAL Premier Radius Storage Cabinets**

- 250-lb. capacity per shelf
- 22-gauge steel
- Unassembled
- Three-point lock

These economical storage cabinets give you the same top-of-the-line engineering, materials, and design as the more expensive models. Doors open a full 180° and feature a pan-type reinforcement that prevents sagging. Other features include adjustable shelves, radius corners and easy assembly. **SPECIFY COLOR: GR - Pearl Gray, PY - Putty. IN STOCK.**



Model Number	Overall W x D x H	Shelf Openings	Wt. Lbs.	Price Each
YV-1886	36" x 24" x 78"	5	154	\$421.00
YV-1887	48" x 18" x 78"	5	175	473.00
YV-1888*	48" x 24" x 78"	5	198	580.00

\*Only available in GR - Pearl Gray.

RADIUS EDGE SHOWN



**Storage Cabinets**

# Storage Cabinets

**GAUGE RANGE** Details on pg. 205.

12 14 **16** 18 20 22 24

**STANDARD-INDUSTRIAL GRADE**

**AVAILABLE COLORS:**

**GY - DK. GRAY**

**LG - LT. GRAY**

**PY - PUTTY**



**RECESSED HANDLE**



## SANDUSKY/LEE Storage Cabinets

- 200- and 230-lb. capacity per shelf
- 22-gauge steel
- All-welded
- Three-point lock

Stores practically anything in the shop or office. Shelves adjust on 2" centers. Recessed handle. Meets ANSI/BIFMA shelf standards. Durable finish.

**SPECIFY COLOR:** LG - Light gray, GY - Dark gray, PY - Putty. **FACTORY QUICK SHIP**—FOB CALIFORNIA, PENNSYLVANIA, TENNESSEE.

Model Number	Overall W x D x H	Shelf Openings	Shelf Cap. Lbs.	Wt. Lbs.	Price Each
<b>XR-1707</b>	36" x 18" x 42"	3	200	84	<b>\$249.00</b>
<b>XR-1708</b>	46" x 24" x 42"	3	230	130	<b>376.00</b>
<b>XR-1702</b>	36" x 18" x 72"	5	200	131	<b>309.00</b>
<b>XR-1704</b>	36" x 24" x 72"	5	200	151	<b>422.00</b>
<b>XR-1706</b>	46" x 24" x 72"	5	230	210	<b>494.00</b>
<b>XR-1703</b>	36" x 18" x 78"	5	200	137	<b>397.00</b>
<b>XR-1705</b>	36" x 24" x 78"	5	200	160	<b>439.00</b>



**CHROME PUSH BUTTON LOCKING HANDLE.**



**Selected Models**

**AVAILABLE COLORS:**

**LG - LT. GRAY**

**PY - PUTTY**



## ATLANTIC METAL Storage Cabinets

- 200-lb. capacity per shelf
- 22-gauge steel
- All-welded
- Single-point lock

Choose either full-height cabinets or models with 150-lb. capacity lateral file drawer with cam lock. 72" and 78"H full-height cabinets have three adjustable shelves and two fixed shelves; lateral file models include two adjustable and two fixed shelves (all adjust on 2" centers). All 42"H cabinets have fixed shelves. Textured powder-coat finish. **SPECIFY COLOR:** LG - Lt. gray, PY - Putty. **SELECTED MODELS IN STOCK.** Others FOB TENNESSEE.



Model Number	Overall W x D x H	Shelf Opening	Wt. Lbs.	Price Each
<b>FULL-LENGTH CABINET WITH SHELVES ONLY</b>				
<b>XM-2551</b>	36" x 18" x 42"	3	85	<b>\$290.00</b>
<b>XM-2552</b>	36" x 18" x 72"	5	140	<b>373.00</b>
<b>XM-2553</b>	36" x 18" x 78"	5	160	<b>430.00</b>
<b>CABINET WITH LATERAL FILE DRAWER AT BOTTOM</b>				
<b>XM-2554</b>	36" x 18" x 42"	2	90	<b>\$410.00</b>
<b>XM-2555</b>	36" x 18" x 72"	4	145	<b>504.00</b>
<b>XM-2556</b>	36" x 18" x 78"	4	165	<b>599.00</b>

# Storage Cabinets

**GAUGE RANGE** Details on pg. 205.



**LIGHT-INDUSTRIAL GRADE**



## EDSAL Compact Cabinets

- 175-lb. capacity per shelf
- 20-24-gauge steel cabinet; 24-gauge steel shelves
- Unassembled
- Single-point lock (A & B); three-point lock (C)

Ideal for crowded or confined storage areas. Shelves adjust in 2" increments. Tough powder coat finish. Color: tan. **IN STOCK.**

Key	Model Number	Overall W x D x H	Shelf Openings	Wt. Lbs.	Price Each
A	XA-1453	18" x 18" x 42"	3	41	\$127.00
B	XA-1454	18" x 18" x 66"	5	65	175.00
C	XA-1456	30" x 15" x 66"	5	90	205.00



**GAUGE RANGE** Details on pg. 201.



**LIGHT-INDUSTRIAL GRADE**

AVAILABLE COLORS:

BK - BLACK

GY - GRAY

TN - TAN

## EDSAL Storage Cabinets

- 175-lb. capacity per shelf
- 20 to 24-gauge steel cabinets; 22-gauge steel shelves
- Unassembled and set-up
- Three-point lock

Four heights to choose from! Houses office products, maintenance and janitorial supplies, and other lightweight items. Shelves adjust on 2" centers. Welded door frame ensures proper door alignment. Doors swing open a full 180° and include a locking handle with 2 keys. Tough powder coat finish. **IN STOCK.**



**UNASSEMBLED CABINETS.**

**SPECIFY COLOR: GY - Gray, TN - Tan.**

Model Number	Overall W x D x H	Shelf Openings	Wt. Lbs.	Price Each
XP-0160	36" x 18" x 42"	3	75	\$179.00
XP-0161	30" x 15" x 66"	4	83	200.00
XP-0162	36" x 18" x 72"	5	110	229.00
XP-0163	36" x 24" x 72"	5	130	254.00
XP-0164	36" x 18" x 78"	5	80	234.00
XP-0165	36" x 24" x 78"	5	83	260.00
XP-0166	48" x 18" x 78"	5	83	297.00
XP-0167	48" x 24" x 78"	5	85	325.00

**SET-UP CABINETS.**

**SPECIFY COLOR: BK - Black, GY - Gray, TN - Tan.**

Model Number	Overall W x D x H	Shelf Openings	Wt. Lbs.	Price Each
XP-0168	18" x 18" x 42"	3	75	\$243.00
XP-0169	36" x 18" x 72"	5	110	304.00
XP-0170	36" x 24" x 72"	5	130	361.00

**EXTRA SHELVES.**

Model No. XP-015—36"W x 18"D. Wt. 7.5 lbs.....	\$17.70
Model No. XP-016—36"W x 24"D. Wt. 9 lbs. ....	\$22.70



# Wall-Hung Storage Cabinets



## EDSAL Wall-Mount Tool Cabinet

- 250-lb. capacity
- 24-gauge steel
- All-welded
- Single-point lock



Includes all-steel peg board and hooks, as well as built-in tool rack and small parts tray. Doors have magnetic catch and hasps to accommodate a standard padlock. 30"W x 11-1/2"D x 24"H when closed, 60"W x 6"D x 24"H when opened. Color: gray. **IN STOCK.**

Model No. **YA-0690**—Wt. 55 lbs. ....\$115.00



## SANDUSKY/LEE Wall-Hung Cabinets

- 50-lb. capacity per shelf
- 22-gauge steel
- Set-up
- Three-point lock

AVAILABLE COLORS:

PY - PUTTY

CH - DK. GRAY



Include adjustable shelves perfect for spray cans, first aid supplies, cleaners, or other light-duty supplies. Key lock handles secure stored items. Some assembly required for handle. Durable finish. **SPECIFY COLOR: CH - Dk. gray, PY - Putty. IN STOCK.**

Model No. **YA-1760**—Single-Door Cabinet. 18"W x 12"D x 26"H  
Wt. 46 lbs. ....\$142.00  
Model No. **YA-1761**—Two-Door Cabinet. 30"W x 12"D x 30"H  
Wt. 55 lbs. ....\$183.00



## PARENT METAL Wall Cabinets

- 50-lb. capacity per shelf
- 20- to 22-gauge steel
- All-welded
- Single-point lock



Angled top prevents dust and dirt from accumulating. Two adjustable shelves hold all your tools and supplies. Full-height piano hinges keep doors from sagging. Chrome-plated locking handle secures items when not in use. **SPECIFY COLOR: CM - Champagne, LG - Lt. gray. FACTORY QUICK SHIP—FOB PENNSYLVANIA.**

Model No. **XA-1461**—24"W x 12"D x 30"H\*. Wt. 43 lbs. ....\$239.00  
Model No. **XA-1462**—36"W x 12"D x 30"H\*. Wt. 48 lbs. ....\$256.00

\*Add 3" to height for back-of-cabinet height.



## DURHAM® Wall-Hung Utility Cabinets

- 40-lb. capacity per shelf
- 20-gauge steel
- All-welded
- Single-point lock



An economical solution for storing commercial and industrial supplies. Features two adjustable shelves and hinged single door with two friction catches. Padlock latch. Acid/rust-resistant powder coat finish. Color: gray. **IN STOCK.**

Model No. **XL-0522**—13-3/4"W x 12-3/4"D x 30"H. Wt. 31 Lbs. ....\$111.00  
Model No. **XL-0523**—19-7/8"W x 14-1/4"D x 32-3/4"H. Wt. 41 Lbs. ....\$126.00

**GAUGE RANGE** Details on pg. 205.

12 14 **16** 18 20 22 24  
**STANDARD-INDUSTRIAL GRADE**

# Mobile Storage Cabinets

XA-2115



## ATLANTIC METAL Mobile Storage Cabinets

- 200-lb. capacity per shelf
- 22-gauge steel
- All-welded and set-up
- Three-point lock

Roll job supplies where you need them. 5" rubber swivel casters (2 with brake) offer easy transport around the job site. Shelves adjust on 2" centers. Dual chrome handles include two keys. All-welded cabinets include side handles to ease maneuverability. Durable electrostatic textured powder-coat finish.

**SPECIFY COLOR:** CH - Dk. gray, LG - Lt. gray, PY - Putty. FOB TENNESSEE.

Shelf Openings	SET-UP CABINETS				ALL-WELDED CABINETS			
	Model Number	Overall W x D x H	Wt. Lbs.	Price Each	Model Number	Overall W x D x H	Wt. Lbs.	Price Each
2	XA-1300	36" x 24" x 36"	70	\$362.00	—	—	—	—
3	XA-1301	36" x 24" x 48"	105	494.00	XA-2115	46" x 24" x 48"	122	\$629.00
4	XA-1302	36" x 24" x 66"	125	553.00	XA-2116	46" x 24" x 66"	142	718.00

XA-1304—Extra Shelf. 36"W x 24"D. Wt. 13 lbs. ....\$36.80

AVAILABLE COLORS:

CH - DK. GRAY

LG - LT. GRAY

PY - PUTTY



XA-1300

AVAILABLE COLORS:

CH - DK. GRAY

LG - LT. GRAY

PY - PUTTY

## SANDUSKY/LEE Mobile Storage Cabinets

- 200- to 230-lb. capacity per shelf
- 22-gauge steel
- All-welded
- Single-point lock (35"H); three-point lock (66-78"H)

Multi-function cabinets help you transport supplies from room to room or building to building. Roll on (4) 5" swivel polypropylene casters (2 with brake). Shelves adjust on 2" centers. Storage cabinet includes recessed handle; 35"H counter-height cabinet has chrome handles. Add the optional push handle for easier maneuverability. Durable finish. Casters and handles require some assembly.

**SPECIFY COLOR:** CH - Dk. gray, LG - Light gray, PY - Putty. **SELECTED MODELS IN LG - LIGHT GRAY IN STOCK.** Others FOB CALIFORNIA, ILLINOIS, PENNSYLVANIA, TENNESSEE.

Model Number	Overall W x D x H	Shelf Openings	Wt. Lbs.	Price Each
YR-1386*	36" x 24" x 35"	2	94	\$309.00
YR-1387*	36" x 24" x 66"	4	165	465.00
YR-1389	46" x 24" x 66"	4	234	665.00
YR-1390	30" x 24" x 72"	5	181	530.00
YR-1391	36" x 24" x 78"	5	205	570.00
YR-1392	46" x 24" x 78"	5	280	714.00

\*Not available in CH - Dark gray.

YR-1393—Optional Push Handle. Wt. 9 lbs. ....\$53.70



Selected Models



YR-1386 SHOWN



YR-1392 SHOWN

# Combination Cabinets

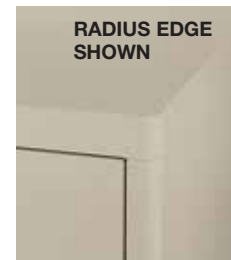

## EDSAL Premier Radius Combination Cabinets

- 250-lb. capacity per shelf
- 22-gauge steel
- Unassembled
- Three-point lock

These economical storage cabinets give you the same top-of-the-line engineering, materials, and design as the more expensive models. Doors open a full 180° and feature a pan-type reinforcement to prevent sagging. Other features include hanging rod, full-length top shelf, (4) 18"W adjustable storage shelves, radius corners and easy assembly. **SPECIFY COLOR: GR - Pearl Gray, PY - Putty. IN STOCK.**

Model Number	Overall W x D x H	Shelf Openings	Wt. Lbs.	Price Each
YV-1889	36" x 18" x 78"	5 half/1 full	142	\$419.00
YV-1890	36" x 24" x 78"	5 half/1 full	147	467.00



AVAILABLE COLORS:

CH - DK.  
GRAY

LG - LT.  
GRAY

PY -  
PUTTY

## SANDUSKY/LEE Mobile Combination Cabinets

- 85-lb. capacity per side shelves;
- 180-lb. capacity per top shelf
- 24-gauge steel
- All-welded
- Three-point lock

Great for areas where supplies are needed in multiple locations. Includes recessed locking handle, (3) adjustable half shelves and open section with wardrobe bar. Rolls on 5" swivel polypropylene casters (2 with brake). Durable finish. Casters and handles require some assembly. **SPECIFY COLOR: CH - Dk. gray, LG - Lt. gray, PY - Putty. FOB CALIFORNIA, PENNSYLVANIA, TENNESSEE.**



RECESSED  
HANDLE

Model Number	Overall W x D x H	Shelf Openings	Wt. Lbs.	Price Each
XR-1388*	36 x 24 x 66"	4 half	165	\$476.00
XR-1389	36 x 24 x 77"	4 half/1 full	201.5	583.00
XR-1390	46 x 24 x 77"	4 half/1 full	252	714.00

\* Not available in CH - Dark gray.

Model No. XR-1391 – Optional Push Handle. Wt. 9 lbs. .... \$48.20

# Combination Cabinets

**GAUGE RANGE** Details on pg. 201.

12 14 16 18 **20** 22 24

**LIGHT-INDUSTRIAL GRADE**

**AVAILABLE COLORS:**

**GY - GRAY**

**LG - LT. GRAY**

**PY - PUTTY**

## SANDUSKY/LEE Wardrobe and Combination Cabinets

- 85-lb. capacity side shelves;
- 180-lb. capacity top shelf
- 22-gauge steel
- All-welded
- Three-point lock



Stores both garments and supplies. Shelves adjust on 2" centers. Contemporary recessed handle creates a sleek, clean look. Meets ANSI/BIFMA shelf standards. Durable finish. **SPECIFY COLOR:** GY - Gray, LG - Light gray, PY - Putty. FOB CALIFORNIA, PENNSYLVANIA, TENNESSEE.

### WARDROBE CABINETS.

Includes full width adjustable shelf with wardrobe bar.

### COMBINATION CABINETS.

Includes full top shelf, three adjustable side shelves, fixed bottom shelf, and open section with wardrobe bar.



XR-1709



RECESSED HANDLE



XR-1715

Overall W x D x H	WARDROBE CABINETS				COMBINATION CABINETS			
	Model Number	Shelf Openings	Wt. Lbs.	Price Each	Model Number	Half-/Full Shelf Openings	Wt. Lbs.	Price Each
36" x 18" x 72"	XR-1709	1	112	\$338.00	XR-1714	4/1	132	\$417.00
36" x 24" x 72"	XR-1711	1	127	403.00	XR-1716	4/1	156	473.00
46" x 24" x 72"	XR-1713	1	240	469.00	XR-1718	4/1	210	546.00
36" x 18" x 78"	XR-1710	1	119	384.00	XR-1715	4/1	138	450.00
36" x 24" x 78"	XR-1712	1	134	414.00	XR-1717	4/1	164	490.00

**AVAILABLE COLORS:**

**BK - BLACK**

**GY - GRAY**

**TN - TAN**



## EDSAL Combination and Wardrobe Cabinets



- 20-24-gauge steel cabinet; 20-gauge steel shelves
- Unassembled
- Three-point lock

Store office supplies and employee clothes securely and neatly. Quality construction features welded door frames, enclosed bases, and chromium plated die cast handles. Include coat rod and full-width shelf opening at the top. Baked enamel finish. Ships unassembled. **IN STOCK.**



XP-0501



XA-1457

### COMBINATION CABINETS.

Model Number	Overall W x D x H	Half-/Full-Shelf Openings	Wt. Lbs.	Price Each
<b>225-LB. SHELF CAPACITY. SPECIFY COLOR: BK - Black, GY - Gray, TN - Tan.</b>				
XP-0501	36" x 18" x 78"	5/1	159	\$365.00
XP-0502	36" x 24" x 78"	5/1	187	394.00
<b>175-LB. SHELF CAPACITY. SPECIFY COLOR: GY - Gray, TN - Tan.</b>				
XP-010	36" x 18" x 72"	5/1	110	\$261.00

### WARDROBE CABINETS. Color: tan.

Model Number	Overall W x D x H	Wt. Lbs.	Price Each
XA-1455	18" x 18" x 66"	53	\$165.00
XA-1457	30" x 18" x 66"	77	205.00

# Plastic Storage Cabinets



**STOCK**



## RUBBERMAID® Storage Cabinets

- 150-lb. capacity per shelf
- Unassembled

Quick, easy assembly—simply snap together. Contemporary design is ideal for home or office. Moisture- and rust-resistant poly material is easy to clean and will not crack, dent or rust. All cabinets lock for secure storage (lock not included). **IN STOCK.**

Model No. **XR-1690**—36"W x 18"D x 37"H. 2 shelf openings. Wt. 28 lbs. ....\$109.00  
 Model No. **XR-1692**—36"W x 18"D x 37"H. 4 shelf openings. Wt. 55 lbs. ....\$179.00



## SUNCAST® Vertical Utility Shed

- 20 cu. ft. capacity
- Unassembled

Stores long-handled tools like brooms, mops, shovels or rakes. Constructed of durable resin material, versatile cabinet can be placed indoors or out. Features include lockable doors with padlock hasp and built-in supports for wood shelves (not included). 31"Wx23"Dx72"H overall. **IN STOCK.**

Model No. **YR-1015**—Wt. 52 lbs. ....\$203.00

**STOCK**



**STOCK**



XR-5040BE

XR-5041LG

## SUNCAST® Storage Cabinets

- 75-lb. capacity per shelf
- Unassembled

Perfect for storing items inside or out. Constructed of durable resin material, practical cabinets snap-together in minutes without tools. Adjustable shelves. Doors will accommodate a lock (lock not included). **SPECIFY COLOR: BE - Beige, LG - Light gray. IN STOCK.**

Model No. **XR-5041**—30"W x 20"D x 72"H. 5 shelf openings. Wt. 62 lbs. ....\$184.00  
 Model No. **XR-5040**—28"W x 13-1/4"D x 28"H. 3 shelf openings. Wt. 14 lbs. ...\$80.30



# Outdoor Storage

**STOCK**



## SUNCAST® Utility Sheds

- 30- and 60- cu. ft. capacity
- Unassembled

Perfect for storing groundskeeping supplies. Both styles include an easy-access ramp, lockable doors with padlock hasp, and built-in supports for wood shelves (not included). **IN STOCK.**

Model No. <b>YA-0360</b> —60 Cu. Ft. Capacity. 55"W x 37"D x 72-1/2"H. Wt. 136 lbs. ....	<b>\$471.00</b>
Model No. <b>YA-0361</b> —30 Cu. Ft. Capacity. 55"W x 37"D x 39"H. Includes lift-up locking lid. Wt. 95 lbs. ....	<b>\$292.00</b>



YA-0363 Shown

## SUNCAST® Storage Sheds

- 138- and 208-cu. ft. capacity
- Unassembled

Extra-wide doorway eases removal of large equipment. Sheds have built-in supports for wood shelves (not included). Quick assembly. Doors include a padlock hasp and upper and lower door sliding latches to secure valuable contents. FOB ILLINOIS.

Model No. <b>YA-0362</b> —138 Cu. Ft. Capacity. 66"W x 60"D x 83"H. Wt. 180 lbs. ....	<b>\$636.00</b>
Model No. <b>YA-0363</b> —208 Cu. Ft. Capacity. 66"W x 93"D x 83"H. Wt. 240 lbs. ....	<b>\$851.00</b>

**STOCK**

## RUBBERMAID® Indoor/Outdoor Storage Sheds

- 32- and 52-cu. ft. capacity
- Unassembled

Ideal for housing tools, maintenance or industrial supplies. Unique resin construction will not rust or corrode in all weather conditions. Interlocking panels assemble quickly and easily without tools. Swinging doors feature padlock hasp to secure stored items. Sheds will accept 2" wood shelves, not included. Color: sandstone shed/olive lid. **IN STOCK.**

Model No. <b>YA-0370</b> —32 Cu. Ft. Capacity. 60"W x 31.9"D x 47"H. Wt. 98 lbs. ....	<b>\$282.00</b>
Model No. <b>YA-0371</b> —52 Cu. Ft. Capacity. 51.8"W x 31.8"D x 77"H. Wt. 130 lbs. ....	<b>\$366.00</b>



# Bin Cabinets



YL-0882



YL-0883

## VALLEY CRAFT® Vari-Tuff™ High-Capacity Bin Cabinets



- 14-gauge steel
- All-welded
- Padlock handle with three-point lock

Extra-large cabinets increase your storage capacity. Flush doors feature padlock hasp to secure stored items (lock not included). Also may include adjustable 18"D shelves. Bins hang from welded-on louvered panels. Gray baked enamel finish. **SELECTED MODELS IN STOCK.** Others FOB MINNESOTA.

**48"W BIN CABINETS.** 48"W x 24"D x 78"H overall.

Model No. **YL-0882**—Cabinet with 171 Yellow Bins (shown). Includes the following bins: (64) 5"L x 4"W x 3"H, (64) 7"L x 4"W x 3"H, (24) 11"L x 6"W x 5"H, (13) 15"L x 8"W x 7"H, (6) 15"L x 16"W x 7"H. Wt. 525 lbs. ....\$1512.00

Model No. **YL-0883**—Cabinet with 137 Multi-Colored Bins and 3 adj. shelves (shown). Includes the following bins: (64) 5"L x 4"W x 3"H, (64) 7"L x 4"W x 3"H, (3) 15"L x 8"W x 7"H, (6) 15"L x 16"W x 7"H. Wt. 535 lbs. ....\$1388.00

Model No. **YL-0884**—Cabinet with 137 Yellow Bins and 3 adj. shelves. Includes the following bins: (64) 5"L x 4"W x 3"H, (64) 7"L x 4"W x 3"H, (3) 15"L x 8"W x 7"H, (6) 15"L x 16"W x 7"H. Wt. 535 lbs. ....\$1280.00

Model No. **YL-0885**—Cabinet with Louvered Panels only. Wt. 410 lbs. ....\$936.00

**60"W BIN CABINETS.** 60"W x 24"D x 84"H cabinet includes 6"H legs for maximum stability.

Model No. **YL-0889**—Cabinet with 185 Bins and 3 adj. shelves. Includes the following bins: (80) 5-1/2"L x 4-1/8"W x 3"H, (90) 7-1/2"L x 4-1/8"W x 3"H, (6) 14-3/4"L x 8-1/4"W x 7"H, (9) 14-3/4"L x 16-1/2"W x 7"H. Wt. 860 lbs. ....\$1979.00

Model No. **YL-0890**—Cabinet with 227 Bins (shown). Includes the following bins: (80) 5-1/2"L x 4-1/8"W x 3"H, (90) 7-1/2"L x 4-1/8"W x 3"H, (30) 11"L x 5-1/2"W x 5"H, (18) 14-3/4"L x 8-1/4"W x 7"H, (9) 14-3/4"L x 16-1/2"W x 7"H. Wt. 875 lbs. ....\$2088.00

Model No. **YL-0891**—Cabinet with Louvered Panels only. Wt. 700 lbs. ....\$1064.00



YL-0890



YL-3300

**72"W BIN CABINETS.** 72"W x 24"D x 84"H cabinet has 6"H legs.

Model No. **YL-3300**—Cabinet with 212 bins and 3 shelves. Includes the following bins: (96) 5-1/2"L x 4-1/8"W x 3"H, (96) 7-1/2"L x 4-1/8"W x 3"H, (8) 14-3/4"L x 8-1/4"W x 7"H, (12) 14-3/4"L x 16-1/2"W x 7"H. Wt. 845 lbs. ....\$1898.00

Model No. **YL-3301**—Cabinet with 264 bins. Includes the following bins: (96) 5-1/2"L x 4-1/8"W x 3"H, (96) 7-1/2"L x 4-1/8"W x 3"H, (36) 11"L x 5-1/2"W x 5"H, (24) 14-3/4"L x 8-1/4"W x 7"H, (12) 14-3/4"L x 16-1/2"W x 7"H. Wt. 830 lbs. ....\$1930.00

Model No. **YL-3302**—Cabinet with Louvered Panels only. Wt. 765 lbs. ....\$1089.00

Model No. **YL-3303**—Extra shelves. Wt. 30 lbs. ....\$99.00

# EDSAL Storage Cabinets

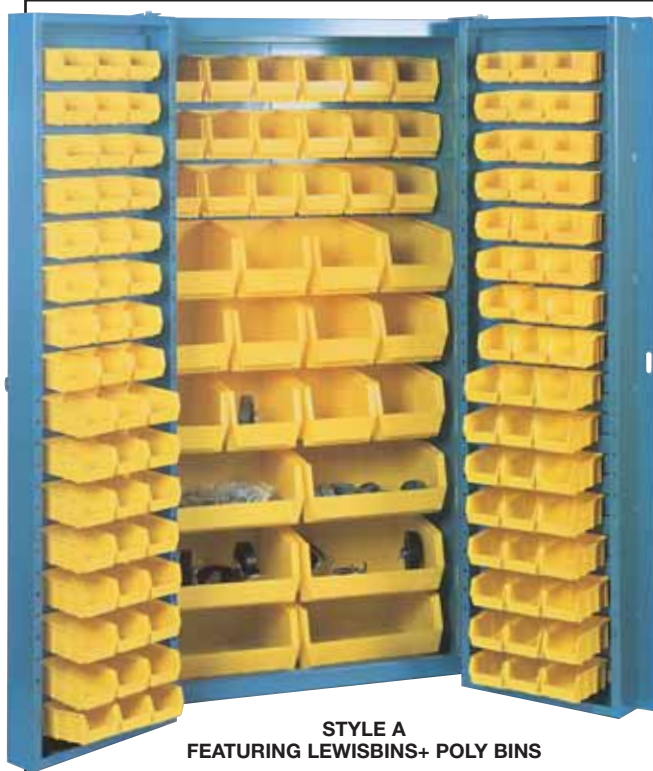

**STYLE A**  
FEATURING LEWISBINS+ POLY BINS

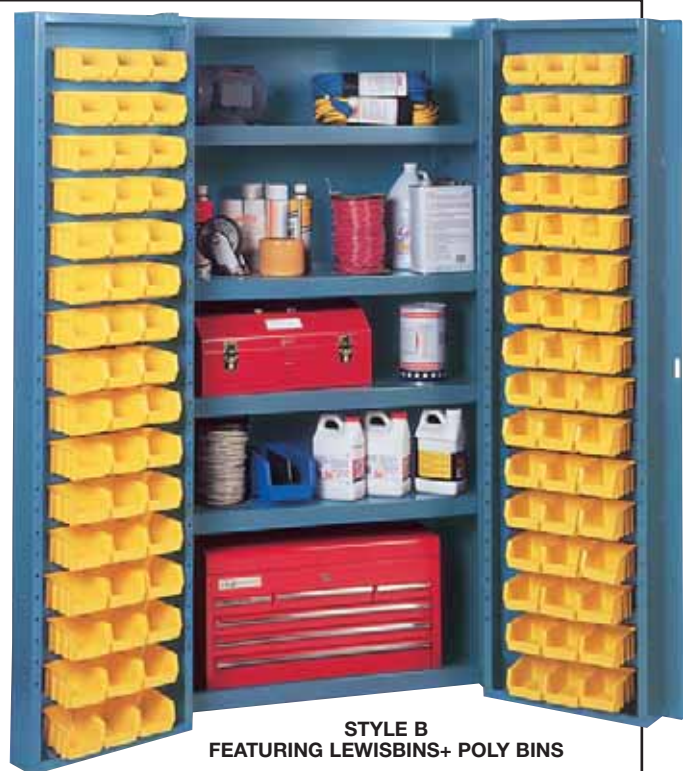

**STYLE B**  
FEATURING LEWISBINS+ POLY BINS



**STYLE C**  
FEATURING LEWISBINS+ POLY BINS



**STYLE D**

- 800-lb. capacity per shelf
- 16-gauge steel
- All-welded
- Padlock hasp with single-point lock



Securely stores tools and supplies. Choose from 4 styles. 4" deep box doors—30-lb. capacity door shelves adjust at 2" intervals. Interior, full-width shelves adjust every 4". Removable polypropylene bins suspend from louvered panels. All interior cabinet sections are 38"W x 20"D x 72"H. Also includes adjustable leveling feet. Some panel assembly required on bin models. 38"W x 24"D x 72"H overall. **IN STOCK.**

Style	Model Number	Bin Qty.	Wt. Lbs.	Price Each
A	WP-358	(48) 5-3/8" x 4-1/8" x 3" (48) 7-3/8" x 4-1/8" x 3" (12) 14-3/4" x 8-1/4" x 7" (18) 10-7/8" x 5-1/2" x 5" (6) 14-3/4" x 16-1/2" x 7"	365	\$1095.00
B	WP-359	(96) 5-3/8" x 4-1/8" x 3"	315	1085.00
C	WP-360	(16) 14-3/4" x 8-1/4" x 7" (48) 7-3/8" x 4-1/8" x 3"	334	1067.00

D. Model No. **WP-361**—Wt. 318 lbs. ....\$986.00

# Lockers

## Locker Selection Guide

Lockers come in a variety of styles and sizes, ranging from a single box locker cube to a larger gear locker. This guide will provide the basic information to help identify the different parts of a locker and detail to consider when searching through the section. For further assistance please call.

### SELECTING A LOCKER

- 1. HOW MANY LOCKER OPENINGS ARE REQUIRED.** Determine the number of people that need a locker. Single- and three-wide models are available. Some manufacturers offer a starter and add-on style of locker. Also, consider the amount of space available for installation.
- 2. LOCKER OPENING SIZE NEEDED.** Consider what will be stored in the lockers. 1-tier through 6-tier offer a variety of overall opening dimensions for storage space. A 1-tier locker may be used for full-length uniforms and coats; a 6-tier may be used to secure purses and lunch boxes.
- 3. STYLE OF LOCKER.** Once the size needed is determined, other factors may influence your decision. Do the lockers need to be ventilated for visibility or air circulation? (Ventilated Lockers) Is corrosion-resistance needed? (Plastic or Galvanized lockers) Various handles are available in some styles, most offer the ability to use your own padlock, but a mounted combination lock, or keyed lock may be preferred.
- 4. INSTALLATION.** Lockers are available as unassembled, set-up and all-welded. Time and ease of installation may determine what is best for you.

**HELPFUL ICONS IN THE LOCKER SECTION:** Each page offers different manufacturers and styles of lockers. Icons and information boxes will be on most pages to help as a quick identifier on what you are looking for, along with other details about the lockers.

**EXAMPLE:** Offers a quick reference to locker details on the chart.

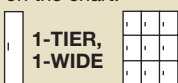

1-TIER,  
1-WIDE



3-TIER,  
3-WIDE

**EXAMPLE:** Details number plate information.



### A. VARIOUS HANDLE/LOCK TYPES



**PADLOCK HASP/PULL WITH PADLOCK.**



**RECESSED HANDLE WITH MOUNTED COMBINATION LOCK.**



**PADLOCK HASP/PULL WITH KEYED LOCK.**

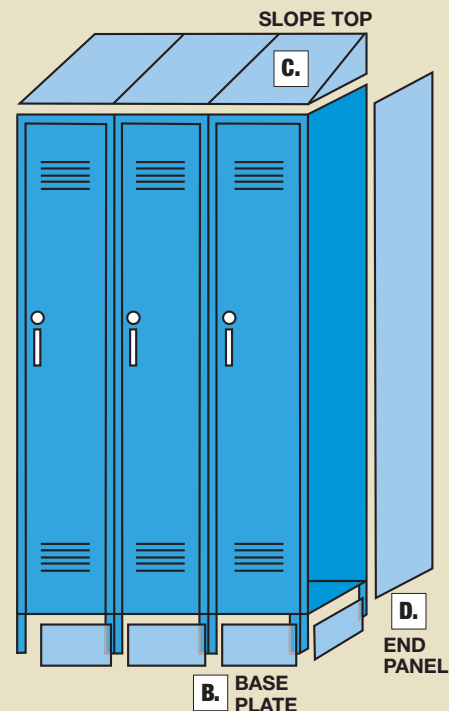

**A.** Insets will show the **types of handles** available and reference where locks can be found.

**B.** Accessories available can be quickly located, such as: **Base Plates**—for enclosing the opening between legs of lockers. Various pages list, if not noted call for details.

**C.** **Slope Tops**—for keeping items off tops of lockers. Various pages list, if not noted, call for details.

**D.** **End Panels**—some styles require end panels to finish off sections of lockers, will be noted on pages.



SHOWN WITH DECORATIVE END PANELS.

### AVAILABLE COLORS



SEE PAGE 221 FOR DECORATIVE END PANELS.



Selected Models

## HALLOWELL® Premium 3-Tier Steel Lockers

- 16-gauge steel door and frame, 24-gauge steel body
- Unassembled and set-up
- Recessed handle
- Piano hinge

Includes 6"H legs and ceiling hook. NOTE: blue, green and maroon lockers have neutral side(s) and back panels. Purchase decorative end panels for exposed row ends (see page 221). **SPECIFY COLOR: BL - Blue, GN - Green, GY - Gray, MN - Maroon, PY - Putty.** **SELECTED MODELS IN STOCK.** Others **FACTORY QUICK SHIP**—FOB CALIFORNIA, FLORIDA, PENNSYLVANIA, TENNESSEE.

**NUMBER PLATES ARE INCLUDED; SPECIFY NUMBER AT TIME OF ORDER, OTHERWISE WILL START WITH #1.**

**SET-UP LOCKERS ARE NOT RETURNABLE.**

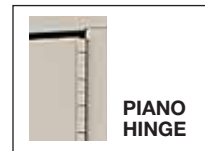

PIANO HINGE

Opening WxDxH	Overall Height	Wt. Lbs.	UNASSEMBLED		SET-UP		
			Model No.	Price Ea.	Model No.	Price Ea.	
<b>1 LOCKER WIDE (3 openings per unit, priced per unit)</b>							
	12x12x24"	78"	55	<b>XN-2199</b>	<b>\$165.00</b>	<b>XA-3506</b>	<b>\$206.00</b>
	12x15x24"	78"	59	<b>XN-2200</b>	<b>170.00</b>	<b>XA-3507</b>	<b>210.00</b>
	12x18x24"	78"	66	<b>XN-2201</b>	<b>200.00</b>	<b>XA-3508</b>	<b>235.00</b>
<b>3 LOCKERS WIDE (9 openings per unit, priced per unit)</b>							
	12x12x24"	78"	153	<b>XN-2214</b>	<b>\$410.00</b>	<b>XA-3518</b>	<b>\$512.00</b>
	12x15x24"	78"	162	<b>XN-2215</b>	<b>421.00</b>	<b>XA-3519</b>	<b>523.00</b>
	12x18x24"	78"	180	<b>XN-2216</b>	<b>499.00</b>	<b>XA-3520</b>	<b>582.00</b>

# Lockers



Selected Models

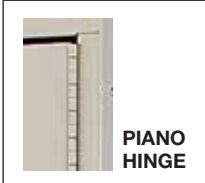

PIANO HINGE

## HALLOWELL® 1- and 2-Tier Premium Steel Lockers

- 16-gauge steel door and frame; 24-gauge steel body
- Unassembled and set-up
- Recessed handle: one-tier with 3-point lock; two-tier with 2-point lock
- Piano hinge

Doors open via a stainless steel recessed handle with gravity lift-type latching mechanism. Includes 6"H legs. Available either set up and ready-to-use or as unassembled units. NOTE: blue, burgundy, and green lockers have neutral side(s) and back panels. Purchase decorative end panels for exposed row ends.

**SELECTED MODELS ARE IN STOCK.** Others are **FACTORY QUICK SHIP**—FOB CALIFORNIA, FLORIDA, PENNSYLVANIA, TENNESSEE.



SET-UP LOCKERS ARE NOT RETURNABLE.

### AVAILABLE COLORS:



### 1-TIER LOCKERS

Includes upper hat shelf.

**SPECIFY LOCKER FRONT COLOR:**

**BL** - Blue,  
**GN** - Green,  
**GY** - Gray,  
**MN** - Maroon,  
**PY** - Putty.

Opening WxDxH	Overall Height	Wt. Lbs.	UNASSEMBLED		SET-UP	
			Model No.	Price Ea.	Model No.	Price Ea.
<b>1 LOCKER WIDE</b> (1 opening per unit, priced per unit)						
12x12x60"	66"	47	<b>XN-2270*</b>	\$112.00	<b>XN-1900*</b>	\$112.00
12x15x60"	66"	51	<b>XN-2271*</b>	120.00	<b>XN-1901*</b>	148.00
12x18x60"	66"	54	<b>XN-2272*</b>	130.00	<b>XN-1902*</b>	158.00
12x12x72"	78"	55	<b>XN-2193</b>	132.00	<b>XA-3500</b>	167.00
12x15x72"	78"	59	<b>XN-2194</b>	141.00	<b>XA-3501</b>	171.00
12x18x72"	78"	62	<b>XN-2195</b>	149.00	<b>XA-3502</b>	182.00
<b>3 LOCKERS WIDE</b> (3 openings per unit, priced per unit)						
12x12x60"	66"	131	<b>XN-2273*</b>	\$309.00	<b>XN-1903*</b>	\$375.00
12x15x60"	66"	139	<b>XN-2274*</b>	325.00	<b>XN-1904*</b>	396.00
12x18x60"	66"	146	<b>XN-2275*</b>	347.00	<b>XN-1905*</b>	422.00
12x12x72"	78"	153	<b>XN-2208</b>	319.00	<b>XA-3512</b>	411.00
12x15x72"	78"	162	<b>XN-2209</b>	349.00	<b>XA-3513</b>	423.00
12x18x72"	78"	168	<b>XN-2210</b>	370.00	<b>XA-3514</b>	451.00

\*Available in putty only.

**DECORATIVE SIDE PANELS.** Attach 18-ga. finished end panels over exposed row ends for a smooth finished look. **SPECIFY COLOR:** **BL** - Blue, **GN** - Green, **GY** - Gray, **MN** - Maroon, **PY** - Putty. **BL - BLUE, GY - GRAY, PY - PUTTY ARE IN STOCK.**

Model Number	Overall D x H	Wt. Lbs.	Price Each
<b>XK-3110</b>	12" x 72"	12	\$36.40
<b>XK-3111</b>	15" x 72"	15	42.20
<b>XK-3112</b>	18" x 72"	18	49.80

### 2-TIER LOCKERS

Includes ceiling hook and two wall hooks.

**SPECIFY LOCKER FRONT COLOR:**

**BL** - Blue,  
**GN** - Green,  
**GY** - Gray,  
**MN** - Maroon,  
**PY** - Putty.

Opening WxDxH	Overall Height	Wt. Lbs.	UNASSEMBLED		SET-UP	
			Model No.	Price Ea.	Model No.	Price Ea.
<b>1 LOCKER WIDE</b> (2 openings per unit, priced per unit)						
12x12x30"	66"	49	<b>XN-2276*</b>	\$138.00	<b>XN-1906*</b>	\$167.00
12x15x30"	66"	52	<b>XN-2277*</b>	144.00	<b>XN-1907*</b>	167.00
12x18x30"	66"	55	<b>XN-2278*</b>	148.00	<b>XN-1908*</b>	180.00
12x12x36"	78"	56	<b>XN-2196</b>	158.00	<b>XA-3503</b>	195.00
12x15x36"	78"	61	<b>XN-2197</b>	167.00	<b>XA-3504</b>	203.00
12x18x36"	78"	64	<b>XN-2198</b>	172.00	<b>XA-3505</b>	209.00
<b>3 LOCKERS WIDE</b> (6 openings per unit, priced per unit)						
12x12x30"	66"	137	<b>XN-2279*</b>	\$342.00	<b>XN-1909*</b>	\$416.00
12x15x30"	66"	144	<b>XN-2280*</b>	351.00	<b>XN-1910*</b>	426.00
12x18x30"	66"	149	<b>XN-2281*</b>	361.00	<b>XN-1911*</b>	439.00
12x12x36"	78"	156	<b>XN-2211</b>	387.00	<b>XA-3515</b>	463.00
12x15x36"	78"	168	<b>XN-2212</b>	407.00	<b>XA-3516</b>	485.00
12x18x36"	78"	174	<b>XN-2213</b>	418.00	<b>XA-3517</b>	495.00

\*Available in putty only.

**RECESSED HANDLE SHOWN WITH OPTIONAL MOUNTED COMBINATION LOCK. ACCEPTS PADLOCKS AND KEYED LOCKS. SEE PAGE 229 FOR LOCKS.**



**NUMBER PLATES ARE INCLUDED. SPECIFY NUMBER AT TIME OF ORDER, OTHERWISE WILL START WITH #1.**



# Lockers



**5-TIER LOCKERS SHOWN WITH OPTIONAL NUMBER PLATES.**

**6-TIER LOCKERS SHOWN WITH OPTIONAL NUMBER PLATES.**

## PENCO 5- and 6-Tier Lockers

- 12"W lockers have an 18-gauge steel door and 24-gauge steel body; 15"W lockers have 16-gauge steel door and 24-gauge steel body
- Unassembled and set-up
- Single-point locking padlock hasp/pull
- Double-strength hinge



Ventilated louvered doors. 13-gauge steel latch hooks. Friction catch keeps door closed. Include 6"H legs standard. **SELECTED MODELS IN BLUE, BURGUNDY, CHAMPAGNE, GRAY, PUTTY AND TAN ARE IN STOCK.** Others FOB NORTH CAROLINA, UTAH.

**NUMBER PLATES** (not included). Etched black letters on aluminum plate. Specify number(s) between 1-1,000.



Model No. **XA-0039** .....\$0.90

### 5-TIER LOCKERS

Model Number	Opening WxDxH	Overall Height	Wt. Lbs.	UNASSEMBLED Price Ea.	SET-UP Price Ea.
<b>1 LOCKER WIDE</b> (5 openings per unit, priced per unit)					
XL-0050	12x12x12"	78"	40	\$189.00	\$222.00
XL-0051	12x15x12"	78"	50	200.00	225.00
XL-0052	15x15x12"	78"	60	225.00	257.00
<b>3 LOCKERS WIDE</b> (15 openings per unit, priced per unit)					
XL-0047	12x12x12"	78"	120	\$487.00	\$540.00
XL-0048	12x15x12"	78"	150	494.00	550.00
XL-0049	15x15x12"	78"	165	517.00	629.00

### 6-TIER LOCKERS

Model Number	Opening WxDxH	Overall Height	Wt. Lbs.	UNASSEMBLED Price Ea.	SET-UP Price Ea.
<b>1 LOCKER WIDE</b> (6 openings per unit, priced per unit)					
XL-0056	12x12x12"	78"	54	\$228.00	\$260.00
XL-0057	12x15x12"	78"	60	234.00	265.00
XL-0058	12x18x12"	78"	72	240.00	275.00
<b>3 LOCKERS WIDE</b> (18 openings per unit, priced per unit)					
XL-0053	12x12x12"	78"	144	\$568.00	\$644.00
XL-0054	12x15x12"	78"	180	583.00	660.00
XL-0055	12x18x12"	78"	216	614.00	697.00

**6"H BASE PLATE**  
For fronts and sides. SPECIFY COLOR: BL - Blue, PY - Putty, TN - Tan, GY - Gray. **IN STOCK.**

Model Number	Overall Width	Wt. Lbs.	Price Each
XL-0040	12"	1	\$5.80
XL-0041	15"	2	6.30
XL-0042	18"	2	6.80

**SET-UP LOCKERS ARE NOT RETURNABLE.**

**SPECIFY COLOR:**

UNASSEMBLED:	BL1	BU1	CM1	DB1	DG1	GN1	GY1	PY1	TL1	TN1
	BLUE	BURGUNDY	CHAMPAGNE	DARK BLUE	DARK GREEN	GREEN	GRAY	PUTTY	TEAL	TAN
SET-UP:	BL2	BU2	CM2	DB2	DG2	GN2	GY2	PY2	TL2	TN2



## HALLOWELL® Premium 6-Tier Steel Lockers

- 18-gauge steel door and frame, 24-gauge steel body
- Unassembled and set-up
- Single-point locking padlock hasp/pull
- Piano hinge



Includes 6"H legs. NOTE: burgundy, green, and blue lockers have neutral side(s) and back panels. Purchase decorative end panels for exposed row ends. **SELECTED 3 LOCKERS WIDE ARE IN STOCK.** Others **FACTORY QUICK SHIP**—FOB CALIFORNIA, FLORIDA, PENNSYLVANIA, TENNESSEE.

**NUMBER PLATES ARE INCLUDED; SPECIFY NUMBER AT TIME OF ORDER, OTHERWISE WILL START WITH #1.**



DECORATIVE END PANELS SOLD ON PAGE 221.

Opening WxDxH	Overall Height	Wt. Lbs.	UNASSEMBLED Model No.	Price Ea.	SET-UP Model No.	Price Ea.
<b>1 LOCKER WIDE</b> (6 openings per unit, priced per unit)						
12x12x12"	78"	64	XN-2202	\$196.00	XA-3509	\$237.00
12x15x12"	78"	67	XN-2203	200.00	XA-3510	242.00
12x18x12"	78"	70	XN-2204	209.00	XA-3511	255.00
<b>3 LOCKERS WIDE</b> (18 openings per unit, priced per unit)						
12x12x12"	78"	180	XN-2217	\$482.00	XA-3521	\$591.00
12x15x12"	78"	186	XN-2218	496.00	XA-3522	605.00
12x18x12"	78"	192	XN-2219	520.00	XA-3523	635.00

### SPECIFY COLOR:

BL - Blue	GN - Green	GY - Gray	MN - Maroon	PY - Putty
-----------	------------	-----------	-------------	------------

OTHER SIZES AND COLORS AVAILABLE, CALL FOR INFORMATION.

SET-UP LOCKERS ARE NOT RETURNABLE.

# Lockers

## PENCO Lockers



Selected Models

- 16-gauge steel door and frame;
- 24-gauge steel body
- Unassembled and set-up
- Vanguard or recessed handle: 1-tier with 3-point lock; 2-tier with 2-point lock
- Double-strength hinge

Ventilated louvered doors. 13-gauge steel latch hooks. Includes 6"H legs. Choose lockers with either vanguard handle that pulls out with natural easy action or lift control that is recessed into door face. **SELECTED MODELS IN BLUE, BURGUNDY, CHAMPAGNE, GRAY, PUTTY, TAN ARE IN STOCK.** Others FOB NORTH CAROLINA, UTAH.



**VANGUARD HANDLE ACCEPTS PADLOCKS, MOUNTED COMBINATION LOCKS, OR KEYED LOCKS. ALL LOCKS ARE SOLD ON PAGE 229.**



**RECESSED HANDLE ACCEPTS MOUNTED COMBINATION LOCKS, PADLOCKS AND KEYED LOCKS. ALL LOCKS ARE SOLD ON PAGE 229.**



SHOWN WITH OPTIONAL BASES AND NUMBER PLATES.

SEE PAGE 229 FOR LOCKER ROOM BENCHES.

### AVAILABLE COLORS

UNASSEMBLED: BL1	BU1	CM1	DB1	DG1	GN1	GY1	PY1	TL1	TN1
<b>BLUE</b>	<b>BURGUNDY</b>	<b>CHAMPAGNE</b>	<b>DARK BLUE</b>	<b>DARK GREEN</b>	<b>GREEN</b>	<b>GRAY</b>	<b>PUTTY</b>	<b>TEAL</b>	<b>TAN</b>
SET-UP: BL2	BU2	CM2	DB2	DG2	GN2	GY2	PY2	TL2	TN2

**1-TIER LOCKERS WITH VANGUARD HANDLE.** Includes coat hooks, hanger rod (18" only), top shelf.

Model Number	Opening WxDxH	Overall Height	Wt. Lbs.	UNASSEMBLED Price Ea.	SET-UP Price Ea.
<b>1 LOCKER WIDE (1 opening per unit, priced per unit)</b>					
XL-0017	12x12x60"	66"	44	\$144.00	\$166.00
XL-0018	12x15x60"	66"	52	151.00	173.00
XL-0019	12x18x60"	66"	57	159.00	186.00
XL-0020	12x12x72"	78"	50	158.00	185.00
XL-0021	12x15x72"	78"	65	165.00	192.00
XL-0022	12x18x72"	78"	69	174.00	203.00
XL-0023	15x18x72"	78"	62	190.00	223.00
XL-0024	18x18x72"	78"	74	202.00	239.00
<b>3 LOCKERS WIDE (3 openings per unit, priced per unit)</b>					
XL-0001	12x12x60"	66"	126	\$357.00	\$407.00
XL-0002	12x15x60"	66"	135	371.00	446.00
XL-0003	12x18x60"	66"	141	394.00	454.00
XL-0004	12x12x72"	78"	150	393.00	452.00
XL-0005	12x15x72"	78"	156	407.00	467.00
XL-0006	12x18x72"	78"	165	344.00	499.00
XL-0007	15x18x72"	78"	195	376.00	546.00
XL-0008	18x18x72"	78"	219	387.00	588.00

**1-TIER LOCKERS WITH RECESSED HANDLE.** Includes coat hooks, hanger rod (18" only), top shelf.

Model Number	Opening WxDxH	Overall Height	Wt. Lbs.	UNASSEMBLED Price Ea.	SET-UP Price Ea.
<b>3 LOCKERS WIDE (3 openings per unit, priced per unit)</b>					
XL-0009	12x12x60"	66"	126	\$356.00	\$407.00
XL-0010	12x15x60"	66"	135	372.00	426.00
XL-0011	12x18x60"	66"	141	394.00	454.00
XL-0012	12x12x72"	78"	150	393.00	452.00
XL-0013	12x15x72"	78"	156	407.00	467.00
XL-0014	12x18x72"	78"	165	432.00	499.00
XL-0015	15x18x72"	78"	195	471.00	546.00
XL-0016	18x18x72"	78"	219	505.00	588.00

**2-TIER LOCKERS WITH VANGUARD HANDLE.** Horizontal reinforcing channels between doors. Includes coat hooks.

Model Number	Opening WxDxH	Overall Height	Wt. Lbs.	UNASSEMBLED Price Ea.	SET-UP Price Ea.
<b>1 LOCKER WIDE (2 openings per unit, priced per unit)</b>					
XL-0035	12x12x30"	66"	52	\$172.00	\$200.00
XL-0036	12x12x36"	78"	56	183.00	213.00
XL-0037	12x15x36"	78"	58	191.00	224.00
XL-0038	12x18x36"	78"	66	201.00	233.00
XL-0039	15x15x36"	78"	74	205.00	242.00
<b>3 LOCKERS WIDE (6 openings per unit, priced per unit)</b>					
XL-0025	12x12x30"	66"	126	\$427.00	\$493.00
XL-0026	12x12x36"	78"	150	452.00	533.00
XL-0027	12x15x36"	78"	156	472.00	550.00
XL-0028	12x18x36"	78"	168	494.00	576.00
XL-0029	15x15x36"	78"	180	503.00	596.00

**2-TIER LOCKERS WITH RECESSED HANDLE.** Horizontal reinforcing channels between doors. Includes coat hooks.

Model Number	Opening WxDxH	Overall Height	Wt. Lbs.	UNASSEMBLED Price Ea.	SET-UP Price Ea.
<b>3 LOCKERS WIDE (6 openings per unit, priced per unit)</b>					
XL-0030	12x12x30"	66"	126	\$427.00	\$492.00
XL-0031	12x12x36"	78"	150	452.00	523.00
XL-0032	12x15x36"	78"	156	472.00	550.00
XL-0033	12x18x36"	78"	168	494.00	576.00
XL-0034	15x15x36"	78"	180	510.00	596.00

**6"H FRONT BASE. SPECIFY COLOR: BL - Lake Blue, GY - Gray, PY - Lt. Putty, TN - Tan.**

Model Number	Overall Width	Wt. Lbs.	Price Each
XL-0040	12"	1	\$5.80
XL-0041	15"	2	6.30
XL-0042	18"	2	6.80

SET-UP LOCKERS ARE NOT RETURNABLE.



**NUMBER PLATES (not included).** Etched black letters on aluminum plate. Specify number(s) between 1-1,000.

Model No. XA-0039 .....\$0.90

# Lockers



1-TIER LOCKERS

SHOWN WITH OPTIONAL NUMBER PLATES.



2-TIER LOCKERS

SET-UP LOCKERS ARE NOT RETURNABLE.



Selected Models

## EDSAL 1- and 2-Tier Lockers

- 16-gauge steel door and frame; 24-gauge body
- Unassembled and set-up
- Alliance or recessed handle: 1-tier with 3-point lock; 2-tier with 2-point lock
- 4-knuckle hinge: 1-tier at 3 points; 2-tier at 2 points

Includes louvered doors, (3) single-prong wall hooks, and a double-prong ceiling hook. 1-tier has upper shelf. Electrically welded door and frame form a rigid structure. Alliance handle pulls out with a natural easy action. On recessed handle, fingerlift control is recessed neatly into door face. **GY - GRAY AND TN - TAN ARE FACTORY QUICK SHIP.** All FOB ILLINOIS.



**ALLIANCE HANDLE ACCEPTS MOUNTED COMBINATION LOCKS, PADLOCKS OR KEYED LOCKS. SEE PAGE 229 FOR LOCKS.**



**RECESSED HANDLE ACCEPTS MOUNTED COMBINATION LOCKS, PADLOCKS OR KEYED LOCKS. SEE PAGE 229 FOR LOCKS.**

### SPECIFY COLOR:

UNASSEMBLED: BL1	GY1	TN1
BLUE	GRAY	TAN
SET-UP: BL2	GY2	TN2

### 1-TIER LOCKERS WITH ALLIANCE HANDLE

Model Number	Opening WxDxH	Overall Height	Wt. Lbs.	UNASSEMBLED Price Ea.	SET-UP Price Ea.
<b>1 LOCKER WIDE (1 opening per unit, priced per unit)</b>					
XL-0121	12x12x60"	66"	45	\$130.00	\$168.00
XL-0122	12x15x60"	66"	48	135.00	176.00
XL-0123	12x18x60"	66"	51	145.00	185.00
XL-0124	12x12x72"	78"	51	143.00	184.00
XL-0125	12x15x72"	78"	55	147.00	191.00
XL-0126	12x18x72"	78"	59	157.00	202.00
XL-0127	15x18x72"	78"	66	171.00	221.00
<b>3 LOCKERS WIDE (3 openings per unit, priced per unit)</b>					
XL-0107	12x12x60"	66"	135	\$320.00	\$414.00
XL-0108	12x15x60"	66"	144	335.00	433.00
XL-0109	12x18x60"	66"	153	356.00	459.00
XL-0110	12x12x72"	78"	153	353.00	457.00
XL-0111	12x15x72"	78"	165	367.00	473.00
XL-0112	12x18x72"	78"	177	387.00	500.00
XL-0113	15x18x72"	78"	198	424.00	547.00

### 1-TIER LOCKERS WITH RECESSED HANDLE

Model Number	Opening WxDxH	Overall Height	Wt. Lbs.	UNASSEMBLED Price Ea.	SET-UP Price Ea.
<b>1 LOCKER WIDE (1 opening per unit, priced per unit)</b>					
XL-0114	12x12x60"	66"	45	\$126.00	\$163.00
XL-0115	12x15x60"	66"	48	132.00	170.00
XL-0116	12x18x60"	66"	51	140.00	180.00
XL-0117	12x12x72"	78"	51	139.00	179.00
XL-0118	12x15x72"	78"	55	145.00	186.00
XL-0119	12x18x72"	78"	59	154.00	196.00
XL-0120	15x18x72"	78"	66	168.00	216.00
<b>3 LOCKERS WIDE (3 openings per unit, priced per unit)</b>					
XL-0100	12x12x60"	66"	135	\$314.00	\$404.00
XL-0101	12x15x60"	66"	144	327.00	423.00
XL-0102	12x18x60"	66"	153	345.00	446.00
XL-0103	12x12x72"	78"	153	344.00	444.00
XL-0104	12x15x72"	78"	165	358.00	463.00
XL-0105	12x18x72"	78"	177	379.00	489.00
XL-0106	15x18x72"	78"	198	412.00	534.00

### 2-TIER LOCKERS WITH ALLIANCE HANDLE

Model Number	Opening W x D x H	Overall Height	Wt. Lbs.	UNASSEMBLED Price Ea.	SET-UP Price Ea.
<b>1 LOCKER WIDE (2 openings per unit, priced per unit)</b>					
XL-0137	12x12x36"	78"	52	\$164.00	\$211.00
XL-0138	12x15x36"	78"	56	172.00	222.00
XL-0139	12x18x36"	78"	59	179.00	231.00
<b>3 LOCKERS WIDE (6 openings per unit, priced per unit)</b>					
XL-0131	12x12x36"	78"	156	\$406.00	\$524.00
XL-0132	12x15x36"	78"	168	426.00	550.00
XL-0133	12x18x36"	78"	177	442.00	574.00

### 2-TIER LOCKERS WITH RECESSED HANDLE

Model Number	Opening W x D x H	Overall Height	Wt. Lbs.	UNASSEMBLED Price Ea.	SET-UP Price Ea.
<b>1 LOCKER WIDE (2 openings per unit, priced per unit)</b>					
XL-0134	12x12x36"	78"	52	\$159.00	\$207.00
XL-0135	12x15x36"	78"	56	168.00	217.00
XL-0136	12x18x36"	78"	59	175.00	224.00
<b>3 LOCKERS WIDE (6 openings per unit, priced per unit)</b>					
XL-0128	12x12x36"	78"	156	\$396.00	\$512.00
XL-0129	12x15x36"	78"	168	415.00	537.00
XL-0130	12x18x36"	78"	177	433.00	560.00

**NUMBER PLATES (not included).** Etched black letters on aluminum plate. Specify number(s) between 1-1,000.



Model No. **XA-0040A**—For unassembled lockers. ....\$0.99  
 Model No. **XA-0040B**—For set-up lockers. ....\$0.99



# Lockers

## EDSAL 16-Person Locker System

- 16-gauge steel door, 18-gauge steel frame, and 24-gauge steel body
- Unassembled
- Single point locking padlock hasp/pull
- 4-knuckle hinge at 2 points



Four-compartment horizontal section needs to be attached to two upright sections upon arrival. **SPECIFY COLOR: BL - Blue, GY - Gray, TN - Tan. GY - GRAY AND TN - TAN ARE IN STOCK.** Others FOB ILLINOIS.

Model Number	Opening WxDxH	Overall WxDxH	Wt. Lbs.	Price Each
(16 openings per unit, priced per unit)				
XL-0220	12x18x12"	72x18x78"	172	\$564.00



SHOWN WITH OPTIONAL NUMBER PLATES.

**NUMBER PLATE (not included).** Etched black letters on aluminum plate. Specify number(s) between 1-1,000.

Model No. **XA-0040A** - For unassembled lockers \$0.99  
 Model No. **XA-0040B** - For set-up lockers .....\$0.99



### AVAILABLE COLORS:

BLUE

GRAY

TAN

## EDSAL 5- and 6-Tier Lockers

- 16-gauge steel door, 18-gauge steel frame, and 24-gauge steel body
- Unassembled and set-up
- Single point locking padlock hasp/pull
- 4-knuckle hinge at 2 points



**FOR UNASSEMBLED LOCKERS, SPECIFY COLOR:**  
**BL1** - Blue,  
**GY1** - Gray,  
**TN1** - Tan. **FOR SET-UP LOCKERS, SPECIFY COLOR:**  
**BL2** - Blue,  
**GY2** - Gray,  
**TN2** - Tan.  
**SELECTED UNASSEMBLED MODELS IN GY1 - GRAY AND TN1 - TAN ARE IN STOCK.** Others FOB ILLINOIS.

### 5-TIER LOCKERS

Model Number	Opening WxDxH	Overall Height	Wt. Lbs.	UNASSEMBLED Price Ea.	SET-UP Price Ea.
1 LOCKER WIDE (5 openings per unit, priced per unit)					
XL-0145	12x12x12"	66"	47	\$173.00	\$224.00
XL-0146	12x15x12"	66"	52	177.00	229.00
3 LOCKERS WIDE (15 openings per unit, priced per unit)					
XL-0140	12x12x12"	66"	142	\$432.00	\$559.00
XL-0141	12x15x12"	66"	150	439.00	570.00

### 6-TIER LOCKERS

Model Number	Opening WxDxH	Overall Height	Wt. Lbs.	UNASSEMBLED Price Ea.	SET-UP Price Ea.
1 LOCKER WIDE (6 openings per unit, priced per unit)					
XL-0147	12x12x12"	78"	54	\$203.00	\$263.00
XL-0148	12x15x12"	78"	60	209.00	267.00
XL-0149	12x18x12"	78"	63	269.00	284.00
3 LOCKERS WIDE (18 openings per unit, priced per unit)					
XL-0142	12x12x12"	78"	162	\$507.00	\$653.00
XL-0143	12x15x12"	78"	180	517.00	669.00
XL-0144	12x18x12"	78"	189	545.00	706.00



Selected Models

SET-UP LOCKERS ARE NOT RETURNABLE.



SHOWN WITH OPTIONAL NUMBER PLATES.

**NUMBER PLATES (not included).** Etched black letters on aluminum plate. Specify number(s) between 1-1,000.

Model No. **XA-0039** \$0.90



### AVAILABLE COLORS:

BL - LAKE BLUE BU - BURGUNDY GN - HUNTER GREEN GY - GRAY PY - LT. PUTTY TN - TAN

## PENCO 16-Person Lockers

- 18-gauge steel door; 24-gauge steel body
- Unassembled
- Single-point locking padlock hasp/pull
- Double-strength hinge



Selected Models

Ventilated louvered doors. Includes hanger rod and 6"H legs. **SPECIFY COLOR: BL - Lake Blue, BU - Burgundy, GN - Hunter Green, GY - Gray, PY - Lt. Putty, TN - Tan. BL - LAKE BLUE, GY - GRAY, PY - LT. PUTTY, TN-TAN IN STOCK.** Others FOB

PENNSYLVANIA.

Model No.	Opening WxDxH	Overall WxDxH	Wt. Lbs.	Price Ea.
(16 openings per unit, priced per unit)				
XV-1994	12x18x12"	69-1/4x18x72"	180	\$638.00

# HALLOWELL® Lockers



## Maintenance-Free Quiet™ Lockers

- 14-gauge steel door; 18-gauge steel door frame; 24-gauge steel body
- Unassembled and set-up
- Recessed handle: 1-tier has 3-point lock; 2- and 3-tier have 2-point lock
- Piano hinge



1-TIER

2-TIER

3-TIER



ACCEPTS PADLOCKS, MOUNTED COMBINATION LOCKS, AND KEYED LOCKS. SEE PAGE 229 FOR LOCKS.

Full-height door panel is welded to the hinge side and includes a 3" door stiffener. Include 6"H legs. 1- and 2-tier lockers have a double ceiling hook and (3) single wall hooks. 1-tier locker also has an upper shelf. **Specify color: Unassembled: PY1 - Putty, GY1 - Gray; Set-Up: PY2 - Putty, GY2 - Gray. FACTORY QUICK SHIP – FOB FLORIDA.**

Model Number	Opening WxDxH	Overall Height	Wt. Lbs.	UNASSEMBLED Price Ea.	SET-UP Price Ea.
<b>1-TIER LOCKERS. 1 Locker Wide (1 opening per unit, priced per unit)</b>					
XA-1130	12x12x72"	78"	59	\$140.00	\$175.00
XA-1131	12x15x72"	78"	63	145.00	177.00
XA-1132	12x18x72"	78"	66	150.00	188.00
XA-1133	15x18x72"	78"	73	156.00	207.00
XA-1134	18x18x72"	78"	79	175.00	218.00
<b>1-TIER LOCKERS. 3 Lockers Wide (3 openings per unit, priced per unit)</b>					
XA-1135	12x12x72"	78"	165	\$273.00	\$468.00
XA-1136	12x15x72"	78"	174	385.00	479.00
XA-1137	12x18x72"	78"	180	406.00	507.00
XA-1138	15x18x72"	78"	201	449.00	560.00
XA-1139	18x18x72"	78"	219	472.00	592.00
<b>2-TIER LOCKERS. 1 Locker Wide (2 openings per unit, priced per unit)</b>					
XA-1140	12x12x36"	78"	64	\$159.00	\$202.00
XA-1141	12x15x36"	78"	67	166.00	208.00
XA-1142	12x18x36"	78"	70	172.00	214.00
XA-1143	15x18x36"	78"	78	187.00	232.00
XA-1144	18x18x36"	78"	86	217.00	271.00
<b>2-TIER LOCKERS. 3 Locker Wide (6 opening per unit, priced per unit)</b>					
XA-1145	12x12x36"	78"	180	\$436.00	\$543.00
XA-1146	12x15x36"	78"	186	449.00	563.00
XA-1147	12x18x36"	78"	192	466.00	581.00
XA-1148	15x18x36"	78"	216	499.00	624.00
XA-1149	18x18x36"	78"	240	607.00	731.00
<b>3-TIER LOCKERS. 1 Locker Wide (3 openings per unit, priced per unit)</b>					
XA-1150	12x12x24"	78"	61	\$190.00	\$235.00
XA-1151	12x15x24"	78"	65	192.00	239.00
XA-1152	12x18x24"	78"	69	203.00	253.00
<b>3-TIER LOCKERS. 3 Locker Wide (9 openings per unit, priced per unit)</b>					
XA-1153	12x12x24"	78"	171	\$511.00	\$638.00
XA-1154	12x15x24"	78"	180	519.00	649.00
XA-1155	12x18x24"	78"	189	547.00	683.00



**4-PERSON LOCKER**  
PADLOCK HASP/PULL SHOWN. ACCEPTS PADLOCKS, MOUNTED COMBINATION LOCKS AND KEYED LOCKS. SEE PAGE 229 FOR LOCKS.



ALL DOORS FEATURE FULL PIANO HINGES.

16-PERSON LOCKER

SHOWN WITH OPTIONAL CLOSED BASE. CALL FOR INFORMATION.



6-TIER LOCKER



SET-UP LOCKERS ARE NON RETURNABLE. NUMBER PLATES ARE INCLUDED. SPECIFY NUMBER AT TIME OF ORDER, OTHERWISE WILL START WITH #1.

## Safety-View Plus Lockers

- Polycarbonate door; 18-gauge steel door frame; 24-gauge steel body
- Unassembled and set-up
- Single point locking padlock hasp/pull
- Full piano hinge



Includes 6"H legs (except on wall mount units). Polycarbonate material is approved by the Consumer Product Safety Commission CPSC 16CFR 1201. Meets UL flammability standards. **SPECIFY TYPE: A - Unassembled, B - Assembled. FACTORY QUICK SHIP – FOB TENNESSEE.**

**6-TIER LOCKERS.** Includes padlock hasp/pull.

Model Number	Opening WxDxH	Overall Height	Wt. Lbs.	(A) UNASSEMBLED Price Ea.	(B) ASSEMBLED Price Ea.
<b>1 LOCKER WIDE (6 openings per unit, priced per unit)</b>					
XP-1050	12x12x12"	78"	55	\$291.00	\$362.00
XP-1051	12x15x12"	78"	59	296.00	371.00
XP-1052	12x18x12"	78"	66	308.00	385.00
<b>3 LOCKERS WIDE (18 openings per unit, priced per unit)</b>					
XP-1053	12x12x12"	78"	153	\$751.00	\$937.00
XP-1054	12x15x12"	78"	162	782.00	955.00
XP-1055	12x18x12"	78"	180	795.00	995.00

NOTE: Closed bases and sloped top accessories available upon request.

**16-PERSON LOCKERS.** Includes padlock hasp/pull.

Model Number	Opening WxDxH	Overall WxDxH	Wt. Lbs.	(A) UNASSEMBLED Price Ea.	(B) ASSEMBLED Price Ea.
<b>(16 openings per unit, priced per unit)</b>					
XP-1056	12x18x12"	12x18x78"	180	\$800.00	\$1012.00

**4-WIDE LOCKERS.** Includes padlock hasp/pull.

Model Number	Opening WxDxH	Overall Width	Wt. Lbs.	(A) UNASSEMBLED Price Ea.	(B) ASSEMBLED Price Ea.
<b>(4 openings per unit, priced per unit)</b>					
XP-1057	12x18x12"	48"	50	\$376.00	\$457.00

# Ventilated Lockers

## HALLOWELL® Heavy-Duty Ventilated Lockers



- 14-gauge steel door; 16-gauge steel sides and top; 18-gauge steel back
- Unassembled and set-up
- Recessed handle on 1-tier with 3-point lock; recessed handle on 2-tier with 2-point lock; 6-tier has single-point locking padlock hasp/pull
- Piano hinge

Rubber bumpers on door frame ensure quiet operation. 6"H legs. 1-tier lockers include upper shelf, (3) single hooks, and a double hook. 2-tier lockers include (3) single hooks, and a double hook. Baked enamel finish. **SPECIFY COLOR: GY - Gray, PY - Putty.**

**FACTORY QUICK SHIP – FOB PENNSYLVANIA.**

Opening WxDxH	Overall Height	Wt. Lbs.	UNASSEMBLED		ASSEMBLED		
			Model No.	Price Ea.	Model No.	Price Ea.	
<b>1-TIER LOCKERS. 1 locker wide (1 opening per unit, priced per unit)</b>							
	12x12x72"	78"	80	<b>XN-2130</b>	\$175.00	<b>XN-2173</b>	\$225.00
	12x18x72"	78"	97	<b>XN-2132</b>	208.00	<b>XN-2174</b>	246.00
	15x18x72"	78"	107	<b>XN-2134</b>	220.00	<b>XN-2175</b>	263.00
	18x18x72"	78"	120	<b>XN-2135</b>	241.00	<b>XN-2176</b>	283.00
<b>1-TIER LOCKERS. 3 lockers wide (3 openings per unit, priced per unit)</b>							
	12x12x72"	78"	210	<b>XN-2136</b>	\$506.00	<b>XN-2183</b>	\$610.00
	12x18x72"	78"	246	<b>XN-2138</b>	561.00	<b>XN-2184</b>	671.00
	15x18x72"	78"	276	<b>XN-2140</b>	601.00	<b>XN-2185</b>	711.00
	18x18x72"	78"	315	<b>XN-2141</b>	656.00	<b>XN-2186</b>	775.00
<b>2-TIER LOCKERS. 1 locker wide (2 openings per unit, priced per unit)</b>							
	12x12x36"	78"	82	<b>XN-2142</b>	\$210.00	<b>XN-2177</b>	\$264.00
	12x18x36"	78"	99	<b>XN-2144</b>	240.00	<b>XN-2178</b>	308.00
	15x18x36"	78"	109	<b>XN-2146</b>	264.00	<b>XN-2179</b>	293.00
	18x18x36"	78"	123	<b>XN-2147</b>	281.00	<b>XN-2180</b>	310.00
<b>2-TIER LOCKERS. 3 lockers wide (6 openings per unit, priced per unit)</b>							
	12x12x36"	78"	216	<b>XN-2148</b>	\$633.00	<b>XN-2187</b>	\$715.00
	12x18x36"	78"	252	<b>XN-2150</b>	684.00	<b>XN-2188</b>	771.00
	15x18x36"	78"	282	<b>XN-2152</b>	718.00	<b>XN-2189</b>	810.00
	18x18x36"	78"	324	<b>XN-2153</b>	762.00	<b>XN-2190</b>	839.00
<b>6-TIER LOCKERS. 1 locker wide (6 openings per unit, priced per unit)</b>							
	12x12x12"	78"	94	<b>XN-2164</b>	254.00	<b>XN-2181</b>	\$299.00
	12x18x12"	78"	117	<b>XN-2166</b>	283.00	<b>XN-2182</b>	324.00
<b>6-TIER LOCKERS. 3 lockers wide (18 openings per unit, priced per unit)</b>							
	12x12x12"	78"	252	<b>XN-2170</b>	732.00	<b>XN-2191</b>	\$810.00
	12x18x12"	78"	306	<b>XN-2172</b>	799.00	<b>XN-2192</b>	877.00



6-TIER

2-TIER

1-TIER



PIANO HINGE



NUMBER PLATES ARE INCLUDED. SPECIFY NUMBER AT TIME OF ORDER, OTHERWISE WILL START WITH #1.

## EDSAL Ventilated Lockers



SET-UP LOCKERS ARE NON RETURNABLE.

- 16-gauge steel door; 16-gauge steel sides; 18-gauge steel back; 24-gauge steel top
- Unassembled and set-up
- Recessed handle on 1-tier with 3-point lock; recessed handle on 2-tier with 2-point lock; 6-tier single-point locking padlock hasp/pull
- Four-knuckle hinge

Includes 6"H legs. 1-tier lockers include platform shelf and coat rod on 18"D units only. 1- and 2-tier models have (3) single-prong wall hooks, and a double ceiling hook. **FOR UNASSEMBLED LOCKERS, SPECIFY COLOR: BL1 - Blue, GY1 - Gray, TN1 - Tan. FOR SET-UP LOCKERS, SPECIFY COLOR: BL2 - Blue, GY2 - Gray, TN2 - Tan. FOB ILLINOIS.**

Model Number	Opening WxDxH	Overall Height	Wt. Lbs.	UNASSEMBLED	SET-UP	
				Price Ea.	Price Ea.	
<b>1-TIER LOCKERS. 3 lockers wide (3 openings per unit, priced per unit)</b>						
	XL-0150	12x12x72"	78"	153	\$458.00	\$592.00
	XL-0151	12x18x72"	78"	165	510.00	659.00
	XL-0152	15x18x72"	78"	177	526.00	680.00
<b>2-TIER LOCKERS. 3 lockers wide (6 openings per unit, priced per unit)</b>						
	XL-0153	12x12x36"	78"	156	\$500.00	\$648.00
	XL-0154	12x15x36"	78"	168	530.00	685.00
	XL-0155	12x18x36"	78"	192	556.00	719.00
<b>6-TIER LOCKERS. 3 lockers wide (18 openings per unit, priced per unit)</b>						
	XL-0156	12x12x12"	78"	162	\$640.00	\$828.00
	XL-0157	12x15x12"	78"	180	663.00	857.00
	XL-0158	12x18x12"	78"	198	698.00	906.00



SHOWN WITH OPTIONAL NUMBER PLATES SOLD BELOW.

NUMBER PLATE (not included). Etched black letters on aluminum plate. Specify number(s) between 1-1,000.

Model No. XA-0040A – For unassembled lockers...\$1.00  
Model No. XA-0040B – For set-up lockers.....\$1.00



# Corrosion-Resistant Lockers



**SPECIFY DOOR COLOR:**  
**UNASSEMBLED:** BL1 GY1  
**SET-UP:** BL2 GY2

**BLUE**      **GLACIER GRAY**

## HALLOWELL® DuraTech™ Corrosion-Resistant Lockers

- High-density polyethylene
- Unassembled and set-up
- Padlock hasp
- Continuous aluminum door hinge



Doors and frames are 1/2" thick; all body components are 3/8" thick. 1-, 2-, and 3-tier lockers feature a surface mounted solid plastic handle. Six-tier lockers include a single-point finger pull. Locker sides and back are glacier gray. **SPECIFY DOOR COLOR. FACTORY QUICK SHIP—FOB PENNSYLVANIA.**

**NUMBER PLATES ARE INCLUDED; SPECIFY NUMBER AT TIME OF ORDER, OTHERWISE WILL START WITH #1.**

	Model Number	Opening WxDxH	Overall Height	Wt. Lbs.	UNASSEMBLED Price Ea.	SET-UP Price Ea.
<b>1-TIER LOCKERS. 1 locker wide (1 opening per unit, priced per unit)</b>						
1	YA-0700	12x18x60"	60"	76	\$387.00	\$422.00
	YA-0701	15x18x60"	60"	86	412.00	448.00
	YA-0702	12x18x72"	72"	85	415.00	450.00
	YA-0703	15x18x72"	72"	99	456.00	492.00
	YA-0704	18x18x72"	72"	110	605.00	641.00
<b>1-TIER LOCKERS. 3 lockers wide (3 openings per unit, priced per unit)</b>						
1	YA-0705	12x18x60"	60"	228	\$1115.00	\$1194.00
	YA-0706	15x18x60"	60"	258	1201.00	1278.00
	YA-0707	12x18x72"	72"	255	1213.00	1290.00
	YA-0708	15x18x72"	72"	297	1355.00	1432.00
	YA-0709	18x18x72"	72"	330	1593.00	1670.00
<b>2-TIER LOCKERS. 1 locker wide (2 openings per unit, priced per unit)</b>						
2	YA-0710	12x18x36"	72"	86	\$442.00	\$479.00
	YA-0711	15x18x36"	72"	99	495.00	530.00
<b>2-TIER LOCKERS. 3 lockers wide (6 openings per unit, priced per unit)</b>						
2	YA-0712	12x18x36"	72"	258	1312.00	1389.00
	YA-0713	15x18x36"	72"	297	1445.00	1521.00
<b>3-TIER LOCKERS. 1 locker wide (3 openings per unit, priced per unit)</b>						
3	YA-0714	12x18x24"	72"	88	\$464.00	\$499.00
	<b>3-TIER LOCKERS. 3 lockers wide (9 openings per unit, priced per unit)</b>					
3	YA-0715	12x18x24"	72"	264	\$1381.00	\$1457.00
	<b>6-TIER LOCKERS. 1 locker wide (6 openings per unit, priced per unit)</b>					
6	YA-0716	12x18x12"	72"	115	\$651.00	\$687.00
	<b>6-TIER LOCKERS. 3 lockers wide (18 openings per unit, priced per unit)</b>					
6	YA-0717	12x18x12"	72"	345	\$1849.00	\$1925.00

Model Number	Overall WxDxH	Wt. Lbs.	Price Each
<b>SLOPING TOP, 1 WIDE</b>			
YA-0718	12x18x6"	5	\$35.00
YA-0719	15x18x6"	6	46.70
YA-0720	18x18x6"	7	62.20
<b>SLOPING TOP, 3 WIDE</b>			
YA-0721	36x18x6"	15	\$105.00
YA-0722	45x18x6"	18	141.00
YA-0723	54x18x6"	21	188.00

Model Number	Overall WxDxH	Wt. Lbs.	Price Each
<b>BASE, 1 WIDE. Color: black. (not shown)</b>			
YA-0724	12x18x6"	5	\$50.50
YA-0725	15x18x6"	6	62.20
YA-0726	18x18x6"	7	70.00
<b>BASE, 3 WIDE. Color: black. (not shown)</b>			
YA-0727	36x18x6"	15	\$152.00
YA-0728	45x18x6"	18	188.00
YA-0729	54x18x6"	21	200.00



## REMCON Rust-Proof Plastic Lockers

- Non-corrosive molded plastic
- Set-up
- Single point locking padlock hasp/pull
- Plastic hinge



**ALL LOCKERS ARE RETURNABLE.**

**BLANK ALUMINUM ID PLATE INCLUDED.**

Feature seamless walls, double-wall doors, drain holes, and louvers. 36"H, 47"H, and 73"H include a double coat hook. 12"H and 23"H box lockers are also available with a durable, clear polycarbonate door. Mount together side-to-side or attach to wall with optional mounting kit. Color: gray. **IN STOCK.**

Model Number	Opening WxDxH	Overall Height	Price Each
<b>1-TIER FLAT TOP LOCKERS</b>			
XA-0020GY	12x15x12"	12"	\$66.80
XA-0021GY*	12x15x12"	12"	94.00
XA-0024GY	15x15x18"	18"	95.00
XA-0026GY	12x15x36"	36"	118.00
<b>1-TIER SLOPE TOP LOCKERS</b>			
XA-0022GY	12x15x12"	23"	\$85.80
XA-0023GY*	12x15x12"	23"	106.00
XA-0025GY	15x15x18"	29"	108.00
XA-0027GY	12x15x36"	47"	133.00
XA-0028GY	15x15x62"	73"	304.00

\*Features clear polycarbonate door.

### EXTRA SHELVES

Model No. **XA-0029GY** — For 15" x 18" lockers.....\$18.60  
 Model No. **XA-0030GY** — For 12" x 15" lockers.....\$18.60

### INSTALLATION KIT

Model No. **XA-0031** — Includes: mounting bars, wall anchors, screws, and rivets. One kit installs: (4) 12"/23"H, (3) 18"/29"H, (4) 36"/47"H, or (3) 73"H.....\$51.00

# Locker Accessories

## Pedestal Benches

Butcher block hardwood seats have a clear varnish seal. Widths vary from 48–144". All hardwood seats are 9-1/2"D and 1-1/4" thick. Multiple pedestal styles to choose from. 48–96" wide benches utilize 2 pedestals; 120" and 144" wide benches utilize 3 pedestals. Hardware for securing bench seat to pedestals is included. **IN STOCK.**



### A. HARDWOOD PEDESTAL BENCHES

- 8" dia. x 16"H pedestals
- Rigid painted steel pedestals

Pedestal bases must be anchored to floor (hardware not included). Pedestal color: dove gray.

Model Number	Overall Width	Overall Height	Pedestal Base Qty.	Wt. Lbs.	Price Each
<a href="#">XV-2443</a>	72"	17-1/2"	2	39	\$146.00
<a href="#">XV-2444</a>	96"	17-1/2"	2	48	173.00
<a href="#">XV-2445</a>	120"	17-1/2"	3	63	235.00
<a href="#">XV-2446</a>	144"	17-1/2"	3	71	260.00

**XV-2447—  
Pedestal Only.**  
Wt. 6-1/2 lbs.  
.....\$38.30/ea.

A

### B. LOCKER ROOM PEDESTAL BENCHES

- 6"W x 6"D x 16-3/4" pedestals
- 16-gauge boxed, painted steel pedestals

No exposed hardware.

**SPECIFY PEDESTAL COLOR:** GY - Lt. Gray, PY - Putty.

Model Number	Overall Width	Overall Height	Pedestal Base Qty.	Wt. Lbs.	Price Each
<a href="#">XV-2454</a>	48"	18"	2	34	\$123.00
<a href="#">XV-2455</a>	72"	18"	2	40	146.00
<a href="#">XV-2456</a>	96"	18"	2	51	175.00
<a href="#">XV-2457</a>	120"	18"	3	67-1/2	258.00
<a href="#">XV-2458</a>	144"	18"	3	68-1/2	310.00

**XV-2459—  
Pedestal Only.**  
Wt. 8-1/2 lbs.  
.....\$46.90/ea.

B

### C. INDUSTRIAL PEDESTAL BENCHES

- 8" dia.x16-3/4"H pedestals
- Solid cast iron pedestals

Extremely durable. Pedestal bases must be anchored to floor (hardware not included). Pedestal color: parchment.

Model Number	Overall Width	Overall Height	Pedestal Quantity	Wt. Lbs.	Price Each
<a href="#">YD-1841</a>	48"	18"	2	47	\$207.00
<a href="#">YD-1842</a>	72"	18"	2	55	230.00
<a href="#">YD-1843</a>	96"	18"	2	64	254.00
<a href="#">YD-1844</a>	120"	18"	3	87	359.00
<a href="#">YD-1845</a>	144"	18"	3	88	384.00

C

**YD-1839—Pedestal Only.** Wt. 13 lbs.  
.....\$77.90/ea.

### D. STAINLESS STEEL PEDESTAL BENCHES

- 3"W x 14-1/2"D x 16-1/4"H pedestals
- Stainless steel pedestal base

Corrosion-resistant. Use free-standing or fasten to floor.

Model Number	Overall Width	Overall Height	Pedestal Base Qty.	Wt. Lbs.	Price Each
<a href="#">XV-2460</a>	48"	17-1/2"	2	31	\$185.00
<a href="#">XV-2461</a>	72"	17-1/2"	2	39	206.00
<a href="#">XV-2462</a>	96"	17-1/2"	2	48	230.00
<a href="#">XV-2463</a>	120"	17-1/2"	3	63	324.00
<a href="#">XV-2464</a>	144"	17-1/2"	3	74	346.00

D

**XV-2465—  
Pedestal Only.**  
Wt. 15 lbs.  
.....\$69.10/ea.



## Locks and Padlocks

### E. MASTER LOCK® BUILT-IN COMBINATION LOCKS

Master key controlled with 5 sequential combinations. For lockers with standard or recessed handles. Minimum order of 12 each. FOB ARIZONA.

Model No. **YN-2010—For Right Hinge Doors**.....\$14.70  
Model No. **YN-2011—Optional Control Key (std.)** \$3.45  
Model No. **YN-2012—For Box Lockers.** (Will not work on EDSAL box lockers.).....\$16.50  
Model No. **YN-2013—Optional Control Key (box)** \$3.45



### F. ZEPHYR COMBINATION LOCKS WITH KEY CONTROL

3-number combination. 1-7/8"W with 9/32" thick shackles. Supervisor can override combination using a key. FOB CONNECTICUT.

Model No. **XG-2023—Combination Lock**.....\$8.10  
Model No. **XG-2024—Control Key**.....\$3.73

### G. BUILT-IN KEY LOCKS

Lock mounts inside door. Reversible for left or right hand operation. FOB PENNSYLVANIA.

Model No. **YT-2020** .....\$6.50

# ROUSSEAU® Pedestal Workbenches



Suitable for demanding environments such as laboratories, the aeronautical industry or the pharmaceutical industry. Modular 18"W x 21"D, 32"H factory welded storage pedestals are extremely durable. Strong, high calibre steel construction features a baked-on enamel finish. Each 100-lb. capacity drawer extends fully on smooth gliding ball bearings. Inside

drawer dimensions: 14-1/4"W x 19-1/2"D. Full-width aluminum drawer handles have black beveled safety endcaps. 30"D, 1-3/4" thick tops. Overall height of workstations is 34". Gray frames/blue doors. **SPECIFY TOP:** **A** - Maple, **B** - Shop-Mate, **C** - Plastic laminate, **D** - Static dissipative, **E** - Steel. **IN STOCK.**



Key	Top WxD	Model Number	(A) MAPLE	(B) SHOP-MATE	(C) PLASTIC LAMINATE	(D) STATIC DISSIPATIVE	(E) STEEL
			Price Ea.	Price Ea.	Price Ea.	Price Ea.	Price Ea.
A	60" x 30"	<a href="#">XM-2292</a>	\$892.00	\$808.00	\$835.00	\$822.00	\$856.00
A	72" x 30"	<a href="#">XM-2293</a>	930.00	834.00	869.00	879.00	879.00
B	60" x 30"	<a href="#">XM-2294</a>	1042.00	1000.00	1045.00	1048.00	1054.00
B	72" x 30"	<a href="#">XM-2295</a>	1078.00	1026.00	1079.00	1074.00	1070.00
C	60" x 30"	<a href="#">XM-2296</a>	919.00	847.00	876.00	867.00	881.00
C	72" x 30"	<a href="#">XM-2297</a>	958.00	874.00	910.00	905.00	903.00
D	60" x 30"	<a href="#">XM-2298</a>	862.00	793.00	822.00	820.00	826.00
D	72" x 30"	<a href="#">XM-2299</a>	900.00	820.00	857.00	849.00	851.00
E	60" x 30"	<a href="#">XM-2300</a>	1051.00	964.00	1011.00	1012.00	1013.00
E	72" x 30"	<a href="#">XM-2301</a>	1092.00	993.00	1046.00	1039.00	1035.00
F	60" x 30"	<a href="#">XM-2302</a>	894.00	871.00	899.00	916.00	921.00
F	72" x 30"	<a href="#">XM-2303</a>	1009.00	899.00	951.00	941.00	940.00
G	60" x 30"	<a href="#">XM-2304</a>	750.00	672.00	702.00	689.00	718.00
G	72" x 30"	<a href="#">XM-2305</a>	791.00	700.00	720.00	720.00	743.00
H	60" x 30"	<a href="#">XM-2306</a>	690.00	613.00	644.00	651.00	660.00
H	72" x 30"	<a href="#">XM-2307</a>	729.00	641.00	684.00	680.00	680.00
I	60" x 30"	<a href="#">XM-2308</a>	492.00	415.00	452.00	446.00	462.00
I	72" x 30"	<a href="#">XM-2309</a>	531.00	443.00	487.00	474.00	488.00

# Workbench Components & Benches

## Workbench Components

**SPECIFY TOP:** **A** - Maple, **B** - Shop-Mate, **C** - Laminate, **D** - ESD, **E** - Steel. **IN STOCK.**



### INDIVIDUAL PEDESTALS

**CABINET.** 16-3/4"W x 20"D x 23"H usable interior space with internal adjustable shelf. 18"W x 21"D x 32"H overall.

Model No. **XV-2576**—Wt. 45 lbs. ....\$250.00

**TWO-DRAWER CABINET WITH ONE DOOR.** (2) 15"W x 20"D x 5"H drawers, (1) 16-3/4"W x 20"D x 11"H cabinet.

Model No. **XV-2612**—Wt. 56 lbs. ....\$343.00

### THREE-DRAWER CABINET INCLUDING FILE DRAWER.

(2) 15"W x 20"D x 5"H drawers, (1) 15"W x 20"D x 11"H file drawer.

Model No. **XV-2579**—Wt. 64 lbs. ....\$413.00

### FOUR-DRAWER CABINET.

(4) 15"W x 20"D x 5"H drawers.

Model No. **XV-2578**—Wt. 70 lbs. ....\$446.00

**FOUR-DRAWER CABINET INCLUDING FILE DRAWER.** (2) 15"W x 20"D, 2"H drawers, (1) 15"W x 20"D x 5"H drawer and (1) 15"W x 20"D x 11"H file drawer.

Model No. **XV-2610**—Wt. 67 lbs. ....\$469.00

**FIVE-DRAWER CABINET.** (2) 15"W x 20"D x 2"H drawers, (3) 15"W x 20"D x 5"H drawers.

Model No. **XV-2680**—Wt. 74 lbs. ....\$509.00

### OPTIONAL LOCKS

Model No. **XV-2577**—Cabinet Door Lock. ....\$8.50  
Model No. **XV-2611**—Drawer Lock. ....\$10.10



### WORKBENCH TOPS

**A. 1-3/4" "BUTCHER BLOCK" MAPLE TOP.** Electronically thermobonded with wear-resistant "varnique" finish.

**B. 1-3/4" SHOP-MATE TOP.** Strong, smooth phenolic resincore top and bottom with industrial-grade particleboard core.

**C. 1-3/4" LAMINATE TOP.** Clean white leather laminate surface with strong edge-glued lumber core.

**D. 1-1/4" ESD TOP.** Protects delicate components from static electricity. Core is made of industrial-grade particleboard.

**E. 1-3/4" STEEL TOP.** Strong and long-lasting 12-ga. painted steel.

Top W x D	Model No.	(A) MAPLE 1-3/4"	(B) SHOP-MATE 1-3/4"	(C) LAMINATE 1-3/4"	(D) ESD 1-1/4"	(E) STEEL 1-3/4"
		Price Ea.	Price Ea.	Price Ea.	Price Ea.	Price Ea.
60" x 30"	<b>YM-2311</b>	\$236.00	\$153.00	\$182.00	\$190.00	\$202.00
72" x 30"	<b>YM-2312</b>	279.00	182.00	217.00	230.00	217.00

## 10' Wide Assembly Benches

Ideal for production and assembly operations. One-piece top is made of virtually indestructible butcher block maple that stands up to heavy wear and tear. 1-3/4" surface is laminated clear through and coated with wear-resistant "Varnique" finish. Bench height adjusts from 32-38". Leveling glides. Lower half shelf holds tools and supplies. Choose one of three 18"W x 21"D x 28"H all-welded pedestals: 16-3/4"W x 20"D x 23"H cabinet with adjustable shelf; 4-drawer unit with 5"H drawers; or 5-drawer unit with (2) 2"H and (3) 5"H drawers. All 100-lb. capacity drawers are 15"W x 20"D and extend fully on roller bearing slides. **SPECIFY PEDESTAL:** **A** - Hanging cabinet pedestal, **B** - Hanging 4-drawer pedestal, **C** - Hanging 5-drawer pedestal. **IN STOCK.**



### OPTIONAL LOCK

Model No. **XM-2484**—Cabinet door lock. Wt. 1 lb. ....\$7.50  
Model No. **XM-2485**—Drawer lock. Wt. 1 lb. ....\$8.80

Model Number	Top Depth	(A) HANGING CABINET PEDESTAL		(B) HANGING 4-DRAWER PEDESTAL		(C) HANGING 5-DRAWER PEDESTAL	
		Wt. Lbs.	Price Ea.	Wt. Lbs.	Price Ea.	Wt. Lbs.	Price Ea.
<b>XM-2481</b>	30"	334	\$1044.00	359	\$1258.00	363	\$1320.00
<b>XM-2482</b>	36"	354	1141.00	379	1354.00	383	1418.00



**CABINET PEDESTAL**



**5-DRAWER PEDESTAL**

# LISTA Modular Drawer Cabinets



XV-010BE



XC-3055GY



XV-012BL

Unmatched in the industry for durability, ease of use, and safety. Heavy-gauge, welded 28-1/4"W x 28-1/2"D cabinets have fork truck base that lets them stack up to 5 high or units can be bolted side-by-side to create a storage system. All drawers have 4 slotted sidewalls and perforated grids at the bottom for positioning flexibility. Drawer walls are the same height all around for complete filling and space utilization. 24" x 24" interior dimension. Each drawer supports 440 lbs. and includes full-width drawer pulls with label holders and end caps. Drawers extend fully on smooth-operating precision ball bearings. Automatic locking system permits only one drawer to be open at a time. Wear-resistant baked-on enamel finish. **SPECIFY COLOR: BB - Bright Blue, BE - Beige, BL - Classic Blue, GR - Pearl (Light) Gray, GY - Gray. SELECTED MODELS IN BL - CLASSIC BLUE AND GR - PEARL GRAY ARE IN STOCK.** Others FOB MASSACHUSETTS.

FULL LISTA PRODUCT LINE AVAILABLE. CALL FOR PRICING.



Selected Models



XC-3056BB



XV-014BL



XV-015BE



XV-016BE



XV-017BL

DRAWER CABINETS—28-1/4"W x 28-1/2"D						
Model No.	Drawer Qty.	Front Drawer Height	Overall Height*	Wt. Lbs.	Price Each	
XV-010	9	All 5-7/8"H	59-1/2"	533	\$1841.00	
XV-012	13	(2) 2-7/8"H; (9) 3-7/8"H; (2) 5-7/8"H	59-1/2"	513	2196.00	
XC-3055	8	(2) 3-7/8"H; (3) 5-7/8"H; (1) 7-3/4"H; (2) 9"H	59-1/2"	565	1720.00	
XV-014	9	(4) 2-7/8"H; (3) 3-7/8"H; (2) 5-7/8"H	41-3/4"	455	1602.00	
XV-015	8	(6) 3-7/8"H; (2) 5-7/8"H	41-3/4"	431	1510.00	
XV-016	7	(4) 3-7/8"H; (2) 5-7/8"H; (1) 7-3/4"H	41-3/4"	401	1419.00	
XV-017	7	(6) 3-7/8"H; (1) 5-7/8"H	35-7/8"	351	1359.00	
XC-3056	5	(2) 3-7/8"H; (2) 5-7/8"H; (1) 9"H	35-7/8"	395	1168.00	

\*Height includes fork truck base (2-3/8").



A



B



C

DRAWER DIVIDERS						
Style	Model Number	Front Drawer Ht.	Usable Drawer Ht.	Drawer Body Ht.	Wt. Lbs.	Price Each
A	XV-018	2-7/8"	2-1/8"	2"	12	\$38.40
B	XV-019	2-7/8"	2-1/8"	2"	10	30.30
C	XV-020	2-7/8"	2-1/8"	2"	9	18.20
A	XV-021	3-7/8"	3-1/8"	3"	14	53.70
B	XV-022	3-7/8"	3-1/8"	3"	12	40.80
C	XV-023	3-7/8"	3-1/8"	3"	10	25.10

DRAWER DIVIDERS						
Style	Model Number	Front Drawer Ht.	Usable Drawer Ht.	Drawer Body Ht.	Wt. Lbs.	Price Each
A	XV-024	5-7/8"	5-1/16"	5"	15	\$65.90
B	XV-025	5-7/8"	5-1/16"	5"	14	52.70
C	XV-026	5-7/8"	5-1/16"	5"	10	31.80
A	XV-027	7-3/4"	7-1/32"	7"	16	67.80
C	XV-028	7-3/4"	7-1/32"	7"	12	40.40



# ROUSSEAU® Drawer Cabinets



Selected Models

Engineered to be one of the most dependable and longest lasting cabinets on the market today. Ideal for narrow aisle applications. Flexible configurations let you choose from three heights, two widths, and two depths, as well as five drawer heights. All drawers have full side heights to provide maximum storage volume and 400-lb. capacity for strength and durability. Large handle has additional finger recess for easy opening. Other standard features include: cabinet lock, forklift base with cover, and anchor hardware for wood or concrete floors. **SPECIFY CABINET/DRAWER COLOR:** BE - Beige, BL - Everest blue GY - Gray, RD - Red.

**SELECTED MODELS IN BL - EVEREST BLUE ARE IN STOCK.** Others FOB VERMONT.

Key	36"W x 24"D Model No.	30"W x 27"D Model No.	Drawer Quantity	Overall Height	Wt. Lbs.	Price Each
A	XA-1020	XA-1022	5	32"	300.4	\$1037.00
B	XA-0967*	XA-1023	7	46"	428	1310.00
C	XA-0968*	XA-1024	9	46"	507	1518.00
D	XA-0969*	XA-1025	8	60"	531.5	1521.00
E	XA-0970*	XA-1026	10	60"	531.5	1698.00
F	XA-1021	XA-1027	11	60"	557.3	1790.00

\*Available in BL - Blue only.



**A. 5-DRAWER UNIT—32"H. DRAWER QUANTITIES AND FRONT HEIGHTS: (4) 5", (1) 6". BL - EVEREST BLUE SHOWN.**



**B. 7-DRAWER UNIT—46"H. DRAWER QUANTITIES AND FRONT HEIGHTS: (3) 4", (2) 6", (2) 8". BE - BEIGE SHOWN.**



**C. 9-DRAWER UNIT—46"H. DRAWER QUANTITIES AND FRONT HEIGHTS: (1) 3", (5) 4", (1) 5", (2) 6". GY - GRAY SHOWN.**



**D. 8-DRAWER UNIT—60"H. DRAWER QUANTITIES AND FRONT HEIGHTS: (5) 6", (3) 8". BE - BEIGE SHOWN.**



**E. 10-DRAWER UNIT—60"H. DRAWER QUANTITIES AND FRONT HEIGHTS: (2) 4", (6) 5", (2) 8". RD - RED SHOWN.**



**F. 11-DRAWER UNIT—60"H. DRAWER QUANTITIES AND FRONT HEIGHTS: (2) 3", (4) 4", (4) 6", (1) 8". BL - EVEREST BLUE SHOWN.**

## DRAWER PARTITION KITS

**SPECIFY CABINET SIZE: A - 30"W x 27"D, B - 36"W x 24"D. B - 36"W X 24"D IS**

**IN STOCK.** Others **FACTORY QUICK SHIP—FOB VERMONT.**

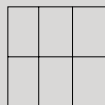

**G. 6-COMPT.**

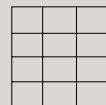

**H. 12-COMPT.**

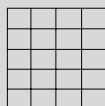

**I. 20 COMPT.**

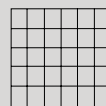

**J. 30-COMPT.**

Key	Model Number	Front Drawer Height	Usable Drawer Height	Drawer Body Height	Price Each
G	XA-0977	3"	2"	1-7/8"	\$15.40
H	XA-0978	3"	2"	1-7/8"	21.90
I	XA-0979	3"	2"	1-7/8"	34.30
J	XA-0980	3"	2"	1-7/8"	52.50
G	XA-0981	4"	3"	2-7/8"	15.80
H	XA-0982	4"	3"	2-7/8"	23.40
I	XA-0983	4"	3"	2-7/8"	36.40
J	XA-0984	4"	3"	2-7/8"	55.00
G	XA-0985	5"	4"	3-7/8"	\$18.60
H	XA-0986	5"	4"	3-7/8"	27.50
I	XA-0987	5"	4"	3-7/8"	41.90
J	XA-0988	5"	4"	3-7/8"	61.20
G	XA-0989	6"	5"	4-7/8"	21.20
H	XA-0990	6"	5"	4-7/8"	32.90
I	XA-0991	6"	5"	4-7/8"	48.90
J	XA-0992	6"	5"	4-7/8"	69.50
G	XA-0993	8"	7"	6-7/8"	24.90
H	XA-0994	8"	7"	6-7/8"	39.50
I	XA-0995	8"	7"	6-7/8"	58.70
J	XA-0996	8"	7"	6-7/8"	80.70

# Mobile Workstations



**MODEL XV-1437**                      **MODEL XV-1436**

**MODEL XV-1435**                      **MODEL XV-1438**



### EDSAL Mobile Benches

Roll these work benches right to the job site for easy access to tools and supplies. Hard pressed particle board top provides a strong, on-site work surface. Top is surrounded by a steel back and end stop to keep items from rolling off during transport. Welded steel construction. Flush front 18"W x 20"D x 5"H drawers have recessed handles and roll formed slides. Locking solid steel door conceals storage compartment with one stationary shelf. 42"W x 24"D, 28"H units roll on two rigid and two swivel with brake, 5" x 1-1/4" casters. **IN STOCK.**

Model No. <b>XV-1437</b> —2-Door Unit.	
Wt. 181 lbs .....	\$497.00
Model No. <b>XV-1436</b> —1-Door, 1-Drawer Unit.	
Wt. 150 lbs .....	\$505.00
Model No. <b>XV-1435</b> —1-Door, 5-Drawer Unit.	
Wt. 220 lbs .....	\$790.00
Model No. <b>XV-1438</b> —10-Drawer Unit.	
Wt. 259 lbs .....	\$1081.00



**YL-0550**



**YL-0551**



### VALLEY CRAFT® Vari-Tuff™ Mini Cabinets

Wobble-free carts are ideal for transporting tools and supplies. Heavy-gauge construction with 5" hard rubber casters that are welded to base. 20"W x 19-3/4"D x 5"H drawers are keyed-alike and feature ball-bearing slides. 1/2" lip on 3 sides. Gray enamel finish and 800-lb. capacity. 23"W x 20"D x 34"H overall. Color: **GY** - Gray. **IN STOCK.**

Model No. <b>YL-0550</b> —2 Drawers and Cabinet. 23"W x 20"D x 34"H.	
Wt. 132 lbs.....	\$416.00
Model No. <b>YL-0551</b> —4-Drawer Cart. 23"W x 20"D x 34"H.	
Wt. 170 lbs.....	\$416.00





### DURHAM® Mobile Bin Cabinet

Take tools, supplies and small parts right to the jobsite with this heavy-gauge steel combination cabinet. Drawers have ball-bearing slides and keyed alike locks. Ten 4"W x 5"D x 3"H storage bins are removable and the full-length piano hinges on the doors won't sag when fully loaded. 3"H backstop and 6" rubber casters (2 swivel/2 rigid) feature quick release keyslot brackets. Also includes push handle and non-slip rubber mat on top surface. Color: Gray. **FACTORY QUICK SHIP—FOB MASSACHUSETTES.**

Model No. <b>YL-0601GY</b> —Bin Cabinet.	
36"W x 21"D x 35"H. Wt. 240 lbs. ....	\$559.00

# Mobile Work Stations



**OPPOSITE BIN SIDE**

**STOCK**

**CABINET SIDE**

### DURHAM® 2-Sided Mobile Work Center

Two-sided work center features (12) 8"W x 6-5/8"H x 12"D storage bins, and (6) 5-3/8"W x 2-3/4"H x 11-1/4"D drawers on one side and a 4-compartment locking storage cabinet and (6) 5-3/8"W x 2-3/4"H x 11-1/4"D drawers on the other. Worksurface includes a non-skid rubber mat. Heavy-duty casters, (2) rigid, (2) swivel with brakes. 1,000-lb. capacity. 34"W x 24"D x 29"H overall. Includes fasteners. Durable gray powder coat finish. Ships unassembled. **IN STOCK.**

Model No. **XA-1014**—Wt. 180 lbs. ....\$**683.00**



**FACTORY QUICK SHIP**

### LITTLE GIANT Mobile Work Center

Transports your heaviest supplies. 250-lb. capacity, 26"W x 20"D x 6"H drawer features a full-width recessed handle and a padlock hasp. Heavy-duty gauge steel. 36"W x 24"D shelves. Enclosed bottom shelf has a 1-1/2" front lip. Non-marking 5" polyurethane casters, 2 rigid and 2 swivel with brakes. 1,200-lb. capacity. **FACTORY QUICK SHIP—FOB ILLINOIS.**

Model No. **YA-1768**—Wt. 180 lbs. .... \$**521.00**



**LOCKING CENTER-HINGED DRAWER COVER FOLDS TOGETHER AND SLIDES BETWEEN DRAWERS WHEN NOT IN USE.**

**MOBILE BENCH WITH LOCKABLE SIDE CABINET.**

**REAR VIEW OF BOTH BENCHES**

**MOBILE BENCH WITH LOCKABLE SIDE DRAWERS.**

### PUCEL/GRIZZLY® Mobile Cabinet Benches

All-welded steel mobile workbench stands up to heavy use. Features locking tool box with (9) drawers: (2) 21-1/2"W x 3-1/2"H, (2) 21-1/2"W x 1-3/4"H, (4) 6-1/2"W x 1-3/4"H, and (1) 6-1/2"W x 3-1/2"H. Also includes (3) 52"W x 8"D rear utility shelves, 14-ga. work surface, and 5" polyurethane casters—2 rigid, 2 swivel. 52"W x 24"D x 36-1/2"H overall. FOB OHIO.

Model No. **YA-1015**—Mobile bench with (4) 14-1/2"W x 23-1/2"D x 5"H lockable side drawers. Wt. 369 lbs. ....\$**1132.00**

Model No. **YA-1016**—Mobile bench with 18"W x 24"D lockable side cabinet with adjustable shelf. Wt. 314 lbs. ....\$**938.00**

DRAWER QTY.	FRONT DRAWER HT.	COMPARTMENT QTY.
2	2"	(10) 3-1/2" (5) 5-1/2" (2) 7-1/2"
2	2"	(10) 3-1/2" (2) 5-1/2"
1	3"	(18) 5-1/2"
2	5"	(6) 7-1/2" (6) 9-1/2"
1	7"	(3) 7-1/2" (3) 9-1/2"



### LISTA Mobile Drawer Cabinet

Durable cabinets go where you need them. 100% full extension drawers have individual latches and hold 440 lbs. each. Tubular steel handles run entire length of drawer for easy opening. Rolls on 6" casters—2 fixed, 2 swivel with brakes. FOB MASSACHUSETTS.

Model No. **XA-0312**—40-1/2"W x 22-1/2"D x 41-1/2"H overall. Wt. 500 lbs. ....\$**2011.00**

# Mobile Workstations



**RUBBERMAID® TradeMaster™ Work Centers**

Take tools and supplies to the job site inside this dependable work center. Three-duplex outlet, surge protected power strip with a 15-amp power rating and a 15' cord allows you to plug in tools when you get there. Constructed of rust-, dent, and chip-resistant structural foam. Lock secures all storage compartments. 36"W x 24"D cabinet has two adjustable 25-lb. cap. shelves. 40-lb. capacity drawers are 24"L x 13.25"W x 4.12"H. Non-marking 5" casters, 2 fixed, 2 with total lock brakes. **IN STOCK.**

Model Number	Description	Overall W x D x H	Cap. Lbs.	Wt. Lbs.	Price Each
<b>XA-5220</b>	Two doors	18-1/4" x 41-5/8" x 38-3/8"	500	57	<b>\$430.00</b>
<b>XA-5221</b>	Four drawers	18-3/8" x 40-5/8" x 38-3/8"	500	87	<b>\$94.00</b>
<b>XA-5222</b>	Two doors	26-1/4" x 49" x 38-1/4"	750	84	<b>\$91.00</b>
<b>XA-5223</b>	Four drawers/one door	26-1/4" x 49" x 38"	750	123	<b>\$72.00</b>



**WATERLOO® Project Centers**

All-in-one unit houses all your tools and supplies. Wide, smooth bench top allows plenty of room for job tasks. Project centers feature: versatile MDF worksurface surrounded by molded storage compartments, pegboard sides with hooks, full-extension drawers with smooth-action slides, external lock bar system, and 4" x 2" casters. Base includes wrap-around bumpers at each corner to protect doorways, walls, and other surfaces. Ships via small package carrier. **IN STOCK.**

**A. 3-DRAWER PROJECT CENTER**  
Includes locking storage cabinet with flip-up door. Drawers: 22.1"W x 16.75"D, (1) 2"H, (2) 4"H. Panel area: 24"W x 12"H. Overall: 34"W x 20"D x 34.5"H with casters.

Model No. **XA-5219**—Wt. 75 lbs. .... **\$191.00**

**B. 5-DRAWER DELUXE PROJECT CENTER**  
Drawers: 22.1"W x 16.75"D (1) 2"H, (2) 4"H, (2) 6.1"H. Overall: 34"W x 20"D x 34.5"H with casters.

Model No. **XA-5225**—Wt. 89 lbs. .... **\$225.00**



**EDSAL Mobile Work Center**

Store all your tools and supplies in one convenient location when you choose this practical cart. 75-lb. capacity drawers extend completely giving you full access to hammers, socket sets, wire cutters, tape measures, etc. Inside drawer dimensions are 22-7/8"W x 11-3/4"D x 1-5/8"H, and drawers have a padlock hasp for security (lock not included). Other features include: tool carrier in the push handle, (4) hanging plastic bins, and 5" x 1" casters—2 rigid, 2 swivel with brakes. 500-lb. overall capacity. Ships unassembled. **IN STOCK.**

Model No. **YD-1099**—28"W x 16"D x 34"H. Wt. 47 lbs..... **\$202.00**



**RUBBERMAID® Mobile Work Center**

Designed to house all your tools and supplies. 32-5/8"L x 19-15/16"W x 33-1/2"H work center includes (5) 22-1/4"W x 17"D drawers: (1) 2"H, (2) 4"H, (2) 6"H. Each drawer supports up to 50 lbs. and extends fully on steel suspension slides. To secure drawers, simply slide steel security bar along drawer fronts and attach padlock (not included) at bottom. Accepts #2, #3, or #4 locks. Work center top supports up to 250 lbs. Other features include: peg board on sides, molded-in storage trays and tool slots, and cord wrap. Rolls on 4" casters—(2) swivel, (2) with brake. **IN STOCK.**

Model No. **XD-5117**—Wt. 69 lbs. .... **\$410.00**

# Shop Desks



## EDSAL Premier Shop Desks

Heavy-gauge steel construction makes these desks ideal for use in warehouses, shipping rooms or on loading docks. Dual shelf riser stores pencils, forms, note pads, and other supplies. Pull-out drawer with recessed handle locks to secure contents. 34"W x 30-1/4"D sloped writing surface is 42-1/2"H at the front. 34"W x 30-1/4"D x 55-1/2"H overall. Color: tan.

**OPEN SHOP DESK.** Open lower shelf gives you easy access from all sides. Leg levelers stabilize entire unit on uneven surfaces. **IN STOCK.**

Model No. **XK-1585**—Wt. 106 lbs.....**\$321.00**

**CLOSED SHOP DESK.** Offers complete security. 30"W x 23"D x 26"H locking lower cabinet includes one adjustable shelf. Secures with a 3-point locking device. **IN STOCK.**

Model No. **XK-1586**—Wt. 155 lbs.....**\$514.00**



OPEN SHOP DESK



CLOSED SHOP DESK



## WIN-HOLT® Shop Desks

Shipping/receiving clerks and inventory control managers find these desks practical places to perform their paperwork. Both models include solid desk top that lifts up for access to locking storage compartment below and 3-compartment riser. Mobile desks roll on four 5" heavy-duty poly swivel casters, 2 with brakes. Powder coat finish. **IN STOCK.**

### OPEN SHOP DESK

Heavy-duty steel construction with lower storage shelf.

Model Number	Overall L x W x H	Type	Wt. Lbs.	Price Each
<b>XA-5226</b>	24 x 22 x 49"	Mobile	50	<b>\$269.00</b>
<b>XA-5227</b>	24" x 22" x 45"	Stationary	45	<b>234.00</b>

**MOBILE SHOP DESK WITH WIRE MESH CABINET**  
Includes locking lower wire mesh cabinet with adjustable shelf. **SPECIFY COLOR: GY - Gray, OR - Orange.**

Model No. **XA-5228**—22-1/2"L x 27"W x 49"H.  
Wt. 89 lbs. ....**\$411.00**



## VALLEY CRAFT® Vari-Tuff™ All-Welded Steel Mobile Shop Desks

Sloped writing surface includes a front lip to prevent paper and pencils from sliding off, while the two-shelf riser has multiple compartments for storing small items. Heavy 16-gauge steel construction. Color: GY - gray. **IN STOCK.**

### SINGLE-DRAWER SHOP DESK

All-welded portable desk features a large 20"W x 19-1/2"D x 5"H locking drawer, 10" x 3" welded bottom shelf, and 3" rubber swivel casters. 23"W x 20"D x 51"H overall.

Model No. **YK-1018**—Wt. 120 lbs.....**\$392.00**

### DRAWER/CABINET COMBINATION SHOP DESK

Completely secure desk includes a 19"D x 20"H locking storage cabinet with one fixed shelf, two 5"H locking drawers, and 5" swivel casters. 23"W x 20"D x 52"H overall.

Model No. **YK-1019**—Wt. 165 lbs.....**\$462.00**

**OPTIONAL COLORS AVAILABLE ON REQUEST. CALL FOR INFORMATION.**



# Shop Furniture



**STOCK**

## RELIUS SOLUTIONS Shop/Warehouse Receiving Desks

High-quality desks are priced to fit any budget. Perfect for receiving/shipping clerks, guards, or checkers, all units feature dependable steel construction. Sturdy, locking cabinet and drawers with keys offer greater security, while the storage compartments organize important papers. Drawers glide quietly on nylon rollers. Durable gray powder coat finish. **IN STOCK.**

**A. CABINET-STYLE DESK.** Located on top of the 43"H writing surface are three pigeon holes and full length compartments. Large 24" x 28" x 3-1/2"H drawer and double door cabinet. 34-1/2" x 30" x 53" overall.

Model No. **XP-0065**—Wt. 153 lbs. ....\$429.00

**B. DELUXE SHOP DESK.** Includes two double-deep file drawers, an all-purpose drawer, and tray drawer. Eight-compartment sorter holds pencils, note pads, stamps, etc. Lower shelf/footrest.

Model No. **XG-758**—39"W x 28-3/4"D x 55-1/2"H. Wt. 163 lbs.....\$736.00

**C. FOREMAN'S DESK.** Sloped writing surface includes pencil and paper compartments. 24" x 28" x 3-1/2"H locking drawer. 34-1/2" x 30" x 50" overall. Ships knocked down.

Model No. **XP-0066**—Wt. 87 lbs. ....\$229.00



**D. WALL HUNG DESK.** Includes large 34-1/2" x 30" writing surface, locking 24" x 28" x 3-1/2"H drawer, and three storage compartments. Mounting brackets and drawer key included.

Model No. **XP-0067**—Wt. 71 lbs. ....\$220.00



**STOCK**

## EDSAL Shop Cabinets. **IN STOCK.**

**E. TWO-SHELF TABLE-CABINET.** 36" x 24" top with 2" lip doubles as a handy worksurface. Cylinder door lock. 34"H. Ships knocked down.

Model No. **XK-1421**—Wt. 101 lbs.....\$285.00

**F. FOUR-SHELF CABINET.** Heavy-gauge steel cabinet with cylinder locking door provides secure storage. Reversible 15-1/2" x 21" top has flat surface on one side or tray with 2" lip on the other. 34"H. Ships knocked down.

Model No. **XK-1423**—Wt. 49 lbs.....\$132.00

**G. TWO-SHELF CABINET.** Interior shelves store tools and supplies. One shelf adjusts on 1-1/2" center. Cylinder locking door secures stored items. Smooth, flat 24" x 24" top, includes 2" lip on three sides. 34"H. Ships knocked down.

Model No. **XK-1422**—Wt. 75 lbs.....\$222.00

# Shop Furniture

## MECO Heavy-Duty Work Tables

If your machining and production areas need more space for drill presses, table saws, belt sanders or other heavy equipment, this table will fit your needs. All-welded tables feature solid steel angle legs that will not buckle under demanding conditions. 12-ga. steel shelves have rugged steel X-bracing that increases strength and rigidity. Low-maintenance—will not crack, splinter or absorb liquids. 3,000-lb. capacity tables feature heavier angle legs and steel angle reinforcements beneath shelves. Ships assembled. Gray enamel finish. **2,000-LB. CAP. SELECTED MODELS IN STOCK.** Others FOB NEBRASKA.

Model Number	Overall L x W x H	Wt. Lbs.	Price Each
<b>2,000-LB. CAP. 2-SHELVES-ALL FLUSH</b>			
WM-1217	24" x 18" x 30"	73	\$115.00
WM-1218	36" x 18" x 30"	93	123.00
WM-1219	24" x 24" x 30"	85	123.00
WM-1220	36" x 24" x 30"	109	138.00
WM-1221	48" x 24" x 30"	132	161.00
<b>2,000-LB. CAP. TOP SHELF FLUSH &amp; BOTTOM TURNED UP</b>			
WM-2210	36" x 18" x 32"	88	\$125.00
WM-2211	36" x 24" x 32"	103	133.00
WM-2212	48" x 24" x 32"	128	165.00
WM-2213	60" x 24" x 32"	153	200.00
<b>3,000-LB. CAP. 2-SHELVES-ALL FLUSH</b>			
WM-2214	48" x 24" x 36"	147	\$205.00
WM-2215	48" x 28" x 36"	160	217.00
WM-2216	48" x 34" x 36"	179	248.00
WM-2217	72" x 34" x 36"	263	362.00



## BUILT-RITE 3,000-Lb. Capacity Shop Stands



Durable, sturdy stands give you extra work space in your production area or shop. 1-1/2" square tube frame supports either a 1-3/4" thick Shop Mate® or 1-5/8" thick white leather-texture plastic laminate top. Both have smooth edges to seal out moisture and prevent warpage. Support 3,000-lb. evenly distributed loads. Flat feet can be bolted to the floor for extra stability. Other sizes available, call for information. Ships fully assembled. **SPECIFY FRAME COLOR: BE - Beige, BL - Blue, BK - Black, GY - Gray. FACTORY QUICK SHIP—** FOB WISCONSIN.



Top W x D	Overall Height	SHOP MATE®		PLASTIC LAMINATE	
		Model Number	Price Each	Model Number	Price Each
18" x 24"	24"	WA-2170	\$175.00	WA-2176	\$175.00
18" x 24"	30"	WA-2171	181.00	WA-2177	178.00
18" x 24"	36"	WA-2172	184.00	WA-2178	185.00
24" x 36"	24"	WA-2173	230.00	WA-2179	233.00
24" x 36"	30"	WA-2174	234.00	WA-2180	237.00
24" x 36"	36"	WA-2175	240.00	WA-2181	243.00



## LYON® Combination Storage Cabinets and Work Tables

Heavy-duty construction stands up to tough use. Mount vises, grinders etc. on the heavy 14-gauge top. Large 36"W x 24"D work surface has 2" high back and end stops. Interior shelf adjusts on 1-1/2" centers. Built-in lock secures stored items. 34"H. **SPECIFY COLOR: BL - Wedgewood blue, GY - Dove gray, PY - Putty.** FOB ILLINOIS, PENNSYLVANIA, CALIFORNIA OR TEXAS.

Model No. **WG-4961**—Stationary Model. Wt. 107 lbs. **\$346.00**  
 Model No. **WG-4962**—Portable Model. 3-1/2" casters; 2 swivel with locks, 2 rigid. Wt. 129 lbs. **\$436.00**

## EDSAL 1500-Lb. Capacity Adjustable-Height Tables



Factories, machine shops, and laboratories are just a few of the places you might find this multi-purpose table. 1500-lb. capacity unit features "tension" frame construction that offers unequalled rigidity and strength. Rather than crossbracing, heavy-gauge channel frame members interlock with steel legs. May also be used as a machine stand. Durable gray powder coat finish. Ships unassembled. **IN STOCK.**

Model Number	Top W x D	Overall Height	Wt. Lbs.	Price Each
XA-2160	24" x 18"	18"-24"	30	\$75.20
XA-2161	24" x 18"	30"-36"	36	82.10
XA-2162	36" x 24"	18"-24"	53	104.00
XA-2163	36" x 24"	30"-36"	51	111.00

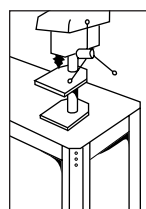

# Stools



CHOOSE WITH OR WITHOUT BACKREST AND WITH OR WITHOUT ADJUSTABLE-HEIGHT LEGS

## NPS Shop Stools

Ruggedly built for lasting applications in shop and industrial settings. 18-ga. electrically seam welded frame is constructed from 7/8" O.D. tubular steel. Legs are cross-braced and welded into a single unit for added support. Tubular footrest has four spot-welds at each connection for extra rigidity. Self leveling steel feet. Choose between stools with backrest that adjusts 2" horizontally or without. Also choose from recessed Masonite® or thick polyfoam vinyl seat. Color: gray enamel. 5-year warranty. **IN STOCK.**

### ADJUSTABLE-HEIGHT STOOLS

Model Number	Seat Height	Wt. Lbs.	Price Each
<b>MASONITE® SEAT/WITHOUT BACKREST</b>			
XL-0770	18-27"	11	\$41.40
XL-0771	24-33"	12	46.10
XL-0772	30-39"	14	49.00
<b>MASONITE® SEAT/STEEL BACKREST</b>			
XL-0773	18-27"	17	\$55.40
XL-0774	24-33"	18	57.50
XL-0775	30-39"	19	64.60
<b>PADDED VINYL SEAT/WITHOUT BACKREST</b>			
XL-0776	18-27"	11	\$47.10
XL-0777	24-33"	12	50.30
XL-0778	30-39"	14	55.70
<b>PADDED VINYL SEAT &amp; BACKREST</b>			
XL-0779	18-27"	17	\$64.60
XL-0780	24-33"	18	67.90
XL-0781	30-39"	19	72.90

### FIXED-HEIGHT STOOLS

Model Number	Seat Height	Wt. Lbs.	Price Each
<b>MASONITE® SEAT/WITHOUT BACKREST</b>			
XL-0785	18"	8	\$32.50
XL-0786	24"	10	34.20
XL-0787	30"	11	37.90
<b>MASONITE® SEAT/STEEL BACKREST</b>			
XL-0788	18"	15	\$52.90
XL-0789	24"	16	48.00
XL-0790	30"	17	51.90
<b>PADDED VINYL SEAT/WITHOUT BACKREST</b>			
XL-0791	18"	11	\$39.00
XL-0792	24"	11	40.70
XL-0793	30"	13	45.90
<b>PADDED VINYL SEAT &amp; BACKREST</b>			
XL-0794	18"	17-1/2	\$54.40
XL-0795	24"	18	56.30
XL-0796	30"	19	61.10

## NPS Masonite® Square Seat Shop Stools

Durable stools have back and legs that adjust to fit each user. Form-fitting metal back adjusts to offer proper support and legs adjust with an easy screw-lock in 1" increments. Seat is constructed of heavy-gauge cold rolled steel with a 15" x 14-1/2" x 1-1/8" recessed Masonite® panel. Telescoping welded steel legs are cross-braced and have tubular footrest with four spot-welds at each connection for added durability. Color: gray. 5-year warranty. **IN STOCK.**

Model Number	Seat Height	Wt. Lbs.	Price Each
XL-0782	18-27"	17	\$69.80
XL-0783	24-33"	18	74.90
XL-0784	30-39"	19	93.00

## NPS Deluxe Swivel Shop Stools

Unique flared-leg design offers a more stable stool. 14" dia. seat swivels 360° and adjusts 24-28"H for mobility and comfort. Seat and back are fully upholstered with polyfoam cushion underneath. Backrest adjusts 2" horizontally for added comfort. Tubular footrest has four spot-welds at each connection for extra stability. Azure gray metallic frame. **IN STOCK.**

Model No.	Description	Wt. Lbs.	Price Ea.
XL-0950	Stool without backrest	27	\$82.00
XL-0951	Stool with backrest	34	99.90



## BEVCO® Seating

Engineered to promote comfort and reduce fatigue. Fully adjustable. Contoured 5-ply plywood seat and back are contoured. Horizontal back adjustment, and 20" to 28" seat height adjustment. Seat swivels 360°. Circular footrest reduces fatigue. Plastic glides protect floors. Black baked enamel frame, plywood seat and back with durable clear lacquer finish. **IN STOCK.**

Model No. **YP-0291** — Wt. 19 lbs. ....\$111.00





## A. Teardrop Footrest Stools

Ideal for all-day comfort when sitting at your workbench, drafting table, or assembly station. Teardrop footrest supports feet at a gentle angle, keeping pressure off lower back. Seat and back features improved extra soft-form molded polyurethane over a steel understructure. Easy to clean and maintain poly material won't crack under heavy use. 18"W x 17"D seat adjusts pneumatically from 22–32"H. 17"W x 12"H backrest adjusts manually. 27" dia. base. Lifetime guarantee on pneumatic cylinders. Ships via small package carrier. Color: black. **SPECIFY: A** - Pods, **B** - Hard floor casters, **C** - Carpet casters. **IN STOCK.**

Model No. <b>YA-1540</b> —Stool. Wt. 31 lbs.....	<b>\$193.00</b>
Model No. <b>YA-1543</b> —Adjustable Arms. Wt. 7 lbs. ....	<b>\$34.30</b>



## B. Spider Base Stools

Offers proper back and leg support when sitting for eight-hour shifts. Improved extra soft-form molded polyurethane ensures comfort while the steel understructure provides firm support. 18"W x 17"D seat adjusts pneumatically, while the 17"W x 12"H backrest adjusts manually. Lifetime guarantee on pneumatic cylinders. Ships via small package carrier. Color: black. **SPECIFY: A** - Pods, **B** - Hard floor casters, **C** - Carpet casters. **IN STOCK.**

Model No. <b>YA-1541</b> —Stool. 23–31"H. Wt. 31 lbs.....	<b>\$245.00</b>
Model No. <b>YA-1542</b> —Stool. 23–38"H. Wt. 31 lbs.....	<b>\$256.00</b>
Model No. <b>YA-1543</b> —Adjustable Arms. Wt. 7 lbs. ....	<b>\$34.30</b>

### AVAILABLE COLORS:

<b>BK - BLACK</b>	<b>BU - BURGUNDY</b>	<b>LG - LT. GRAY</b>	<b>NY - NAVY</b>	<b>TL - TEAL</b>
-------------------	----------------------	----------------------	------------------	------------------

## Vinyl Stools

Everything adjusts to fit you—footring slides up and down base, seat height pneumatically adjusts from 22–32"H. 16-1/2"W x 15-1/2"H, 2-1/2" thick padded back and 18"W x 17"D, 3" thick seat with waterfall edge. 27" dia. high-impact molded black plastic base. Black vinyl. Lifetime guarantee on pneumatic cylinders. Ships via small package carrier. **SPECIFY COLOR: BK** - Black, **BU** - Burgundy, **LG** - Lt. Gray, **NY** - Navy, **TL** - Teal. **BK - BLACK IS IN STOCK.** Others FOB CALIFORNIA.



### ADJUSTABLE FOOTRING STOOLS

Model No. <b>YA-1544</b> —With carpet casters. Wt. 34 lbs. ....	<b>\$198.00</b>
Model No. <b>YA-1545</b> —With hard floor casters. Wt. 34 lbs. ....	<b>\$209.00</b>

### MULTI-ADJUSTMENT STOOLS

Fingertip levers instantly change the seat and backrest angle. Hard floor casters. 15-year guarantee.

Model No. <b>YA-1546</b> —Stool. Wt. 35 lbs. ....	<b>\$280.00</b>
Model No. <b>YA-1547</b> —Adjustable Arms. Wt. 7 lbs. ....	<b>\$34.30</b>

## BEVCO® Quality Industrial Seating

Economically priced seating offers dependable service backed by a 12-Year Intensive Use Guarantee against defects in material and workmanship. Floating action back with 5" horizontal, 3" vertical adjustment range. 6 x 13-1/2" spring mounted contoured 7-ply hardwood back is mounted on 7/16" wire support. Top grade baked enamel makes metal parts scratch and chip resistant. 15-3/8" x 13-5/8" double lacquer dipped 7-ply wooden seat. **IN STOCK.**

Model No.	Seat Height	Foot Ring	Wt. Lbs.	Price Ea.
<b>XG-3500</b>	16"–24"	No	16-1/2	<b>\$99.90</b>
<b>XG-3501</b>	20"–28"	Yes	19	<b>116.00</b>
<b>XG-3502</b>	26"–34"	Yes	21	<b>123.00</b>



## BEVCO® Industrial Seating

Believe it—these stools are backed by an unconditional 12-year guarantee (lifetime guarantee on the cylinder). Built to last with scuff-resistant, glass-reinforced plastic bases and durable black vinyl upholstery over fire-retardant foam that meets California Technical Bulletin #117. Pneumatic height adjustment raises the 18"W x 17"D, 2-3/4" thick seat. 16"W x 10"H back adjusts 3" vertically and 1-1/2" horizontally. 360° swivel. **IN STOCK.**

Model No.	Seat Height	Wt. Lbs.	Price Each
<b>WITH OVERSIZED GLIDES</b>			
<b>YP-1220</b>	17" – 22" Chair*	27	<b>\$184.00</b>
<b>YP-1221</b>	23" – 33" Stool	31	<b>\$236.00</b>
<b>WITH HARD SURFACE CASTERS</b>			
<b>YP-1222</b>	18" – 23" Chair*	29	<b>\$176.00</b>
<b>YP-1223</b>	24" – 34" Stool	33	<b>247.00</b>

\*Does not include footing.

### OPTIONAL SEAT AND BACK CUSHIONS



**OPTIONAL SEAT AND BACK CUSHION.** 1" thick back, 1-1/2" bottom. **SPECIFY COLOR: BK** - Black, **BL** - Blue, **BR** - Brown, **GY** - Gray.

Model <b>XG-3503</b> .....	<b>\$23.10</b>
----------------------------	----------------



# Stools



**STOCK**  
Selected Models

## Multi-Use Seating

Everything adjusts to fit you. Seat raises pneumatically while the backrest height and depth adjust manually. 18"W x 16"D, 2" thick seat, 16"W x 13-1/2"H backrest. High-impact molded black plastic base. Includes dual wheel carpet casters (order hard floor casters or pods separately). Ships via small package carrier. **IN STOCK.**

Model No. <b>YA-1548</b> —Stool (shown). 26" – 30" seat height. Wt. 31 lbs.....	<b>\$166.00</b>
Model No. <b>YA-1549</b> —Chair (less footring). 18" – 22" seat height. Wt. 24 lbs. ....	<b>\$116.00</b>
Model No. <b>YA-1550</b> —Set of 5 Floor Pods.....	<b>\$8.70</b>
Model No. <b>YA-1551</b> —Set of 5 Hard Floor Casters.....	<b>\$20.50</b>

YA-1548



## Polyurethane Threaded Post Lift Stools

**STOCK**

Designed for comfort and support, this ergonomic stool's seat and back feature improved extra soft form-molded polyurethane over a steel understructure. 18"W x 17"D seat height adjusts mechanically via a threaded post mechanism, while the 17"W x 12"H backrest height and angle adjust manually. Also includes fixed foot ring and five-star chrome base. Ships via small package carrier. Color: black. **SPECIFY: A** - Floor pods, **B** - Hard floor casters, **C** - Carpet casters. **IN STOCK.**

Model No. <b>YA-1552</b> —23" – 27"H. Wt. 35 lbs. ....	<b>\$179.00</b>
Model No. <b>YA-1553</b> —29" – 33"H. Wt. 35 lbs. ....	<b>\$191.00</b>
Model No. <b>YA-1554</b> —Adjustable Arm Kit.	
Sold per pair. Wt. 7 lbs.....	<b>\$34.30</b>

## BEVCO® Value-Line® Seating

Built to BEVCO's high-quality standards, this well-made chair is priced to fit even the tightest budget. Ergonomic design includes: back tilt, 360° swivel, pneumatic seat height adjustment, black reinforced plastic base, and 18" chrome footring. 18"W x 18"H seat; 16"W x 15"H back. Upholstery is coated with a rubber fabric protector for extra durability. Meet ANSI/BIFMA standards. Ships unassembled. **SPECIFY COLOR: BK** - Black, **BL** - Blue, **GY** - Gray, . **IN STOCK.**

Model No.	Base Type	Seat Ht.	Wt. Lbs.	Price Ea.
<b>YA-1430</b>	Glides	23" – 33"	34	<b>\$148.00</b>
<b>YA-1431</b>	Carpet casters	24" – 34"	34	<b>148.00</b>
<b>YA-1432</b>	Hard floor casters	24" – 34"	34	<b>149.00</b>



**FACTORY QUICK SHIP**

## OFM Anti-Microbial Vinyl Seating

Perfect for clean rooms, labs, hospitality areas or anywhere you want to remain germ free. Anti-bacterial vinyl upholstery resists germs and other disease-causing microbes. 17-1/2"W x 20"D seat. 17-1/2"W x 19"H backrest is upholstered on the front and back and includes a lumbar support, as well as back support and height adjustment controls. Other features include: pneumatic seat height adjustment and adjustable height arms. 250-lb. capacity. **SPECIFY VINYL: BK** - Black, **BU** - Burgundy, **CH** - Charcoal, **NY** - Navy, **TL** - Teal. **FACTORY QUICK SHIP – FOB NORTH CAROLINA.**



Model Number	Description	Seat Height	Wt. Lbs.	Price Each
<b>YS-2700</b>	Chair	18"-22"	35	<b>\$140.00</b>
<b>YS-2701</b>	Chair with arms	18"-22"	42	<b>180.00</b>
<b>YS-2702</b>	Stool	27"-31"	42	<b>180.00</b>
<b>YS-2703</b>	Stool with arms	27"-31"	49	<b>207.00</b>

Model No. **YS-2704**—Set of 5 optional glides. Priced per set. .... **\$14.20**

**FOR WEARWELL® CLEAN ROOM MATS, SEE PAGE 284.**



YA-1430

# Stools



## MILAGON Ergonomic Task Stools

High-quality seating at an affordable price. Soft polyurethane foam seat and back feature shock absorbing rubber grommet seat mounts for comfort and durability. Ribbed air cushion seat and back give users relief from the humidity while seated. Sturdy black composite base ships with casters and glides. Exceeds ANSI and BIFMA Ergonomic standards for seat and backrest height adjustability. One-year manufacturer warranty. **SELECTED MODELS IN STOCK.** Others **FACTORY QUICK SHIP – FOB OHIO.**

**LOW PROFILE STOOLS.** Seat adjusts from 16–21" H.

Model No. <b>YL-0505</b> —Cita Model. Single lever adjustable height. Back adjusts manually 4" up or out. Wt. 35 lbs. ....	<b>\$234.00</b>
Model No. <b>YL-0513</b> —Dura Model. Double lever for height and/or back adjustment. Wt. 35 lbs. ....	<b>\$285.00</b>

**HIGH PROFILE STOOLS.** Seat adjusts from 23–33" H.

Model No. <b>YL-0514</b> —Cita Model. Single lever adjustable height. Back adjusts manually 4" up or out. Wt. 33 lbs. ....	<b>\$304.00</b>
Model No. <b>YL-0504</b> —Dura Model. Double lever for height and synchronized seat and back tilt. Wt. 40 lbs. ....	<b>\$333.00</b>



## BEVCO® Continuous-Use Industrial Stools

Comfortable enough to sit in all day. Contoured, self-skinned polyurethane seat and back provide maximum support while promoting proper posture. 19-1/4"W x 17-3/4"D seat height adjusts pneumatically from 24" to 34" with casters or 23" to 33" with glides. 15-1/2"W x 14-1/2"H backrest and footring height adjust manually. 27" dia. reinforced plastic base. 12-year guarantee (lifetime on cylinder). **IN STOCK.**



Model No.	Description	Wt. Lbs.	Price ea.
<b>STANDARD STOOL</b>			
<b>YS-1494</b>	With glides.	36.5	<b>\$225.00</b>
<b>YS-1495</b>	With hard floor casters.	37.5	<b>236.00</b>
<b>DELUXE STOOL</b>			
Includes independent adjusting seat and backrest angle.			
<b>YS-1496</b>	With floor pods.	38.5	<b>\$278.00</b>
<b>YS-1497</b>	With hard floor casters.	39.5	<b>289.00</b>

## THE BREWER CO. Continuous-Use Polyurethane Stools

Not only is this durable stool built to last, it's available in contemporary colors. Contoured seat is constructed of puncture-, grease-, water-, and chemical-resistant polyurethane material that is self-skinned for extra durability. Waterfall front, fully adjustable contoured back, and 20" dia. footring offer full body support. Stool also includes: pneumatic seat height adjustment and five-star reinforced plastic base with floor glides. Add the optional dual wheel polyurethane hard floor casters to ease mobility.

**SPECIFY SEAT AND BACK**

**COLOR:** BK - Black, BL - Blue, BU - Burgundy, GY - Gray, YL - Yellow.

**IN STOCK.**



**ALSO AVAILABLE IN:**

- BL - BLUE**
- BK - BLACK**
- BU - BURGUNDY**
- GY - GRAY**

Model No.	Seat Height	Wt. Lbs.	Price Ea.
<b>STANDARD STOOL</b>			
<b>YC-3190</b>	16–21"	28	<b>\$238.00</b>
<b>YC-3191</b>	22–32"	34	<b>286.00</b>
<b>DELUXE STOOL.</b> Includes extra tilt lever for ergonomic seat and back rest angle.			
<b>YC-3192</b>	16–21"	32	<b>\$298.00</b>
<b>YC-3193</b>	22–32"	38	<b>356.00</b>
<b>OPTIONAL HARD FLOOR CASTERS.</b> Set of 5.			
<b>YC-3194</b>	—	2	<b>\$17.40</b>

## BEVCO® Polyurethane Static-Control Seating

Ergonomically designed chairs feature advanced static discharge control. Self-skinned polyurethane material has a surface resistance of 10<sup>9</sup> ohms or less. Three bases to choose from to fit you: heavy-duty polished aluminum 5-star base, 16-ga. chrome-plated tubular steel with 19" welded chrome footing, or heavy-duty polished aluminum 5-legged base with 18" adjustable chrome footing. All chairs feature pneumatic seat height adjustment, adjustable backs with lumbar support, and full 360° swivel. Drop chain ensures conductivity. 12-year guarantee, lifetime on the cylinder. **SPECIFY: A - ESD glides, B - ESD hard floor casters. IN STOCK.**



YA-1267B



Model No.	Base	Seat Ht.*	Wt. Lbs.	Price Ea.
<b>YA-1267</b>	5-Star Base	16–21"	30	<b>\$378.00</b>
<b>YA-1268</b>	Tubular Steel	19–24"	33	<b>387.00</b>
<b>YA-1269</b>	Tubular Steel	24–29"	33	<b>392.00</b>
<b>YA-1270</b>	5-Star Base**	22–32"	36	<b>415.00</b>

\*Add 1" to seat height for caster option (B).  
\*\*Includes adjustable footrest.



# Stools



## RELIUS SOLUTIONS Contemporary Polyurethane Seating

Economical seating is specifically designed for all-day comfort. Both contoured seat and back are upholstered with extra soft form-molded polyurethane that ensures durability and long life. Handles on either side of the 14-1/4"W x 9"H back help you maneuver chair between workstations. 16"W x 15"D seat adjusts pneumatically. Add the optional arms for even more ergonomic support. Choose the best base for you. **IN STOCK.**

- A. FOUR-LEG CHROME BASE SEATING.** Available with floor pods only.
- B. FIVE-LEG BLACK BASE SEATING.**  
SPECIFY: A - Floor pods, B - Hard floor casters, C - Carpet casters.
- C. FIVE-STAR BLACK BASE SEATING.**  
SPECIFY: A - Floor pods, B - Hard floor casters, C - Carpet casters.

Key	Model Number	Description	Seat Height	Wt. Lbs.	Net Each
A	YA-1555	Chair	23-1/2"-27"	21	\$169.00
A	YA-1556	Stool	28"-36"	22	182.00
B	YA-1557	Chair	21"-26"	28	174.00
B	YA-1558	Stool	26"-34"	29	185.00
C	YA-1559	Chair	16"-21"	30	141.00
C	YA-1560	Stool	23"-33"	33	196.00

Model No. **YA-1561**—Optional Arms. Adjust both vertically and horizontally. Sold in pairs.....\$37.00



**STOCK**  
Selected Models

ALSO AVAILABLE IN:

BK - BLACK	GY - GRAY
GN - GREEN	YL - YELLOW
BU - BURGUNDY	

### BEVCO® Ergonomic Stools

Colorful stools are specifically designed for comfort and long-lasting service even in the most demanding work environments. Durable, contoured polyurethane seat and back have ventilated ribs for total body comfort and lasting support. Pneumatic adjustment raises seat from 22" to 32" high, while the back height adjusts manually. Reinforced plastic 5-star base features an 18" dia. adjustable chrome footring. Choose either standard or deluxe stool with tilting seat and back. **SPECIFY COLOR: BL - Blue, BK - Black, BU - Burgundy, GY - Gray, GN - Green, YL - Yellow. BK - BLACK IS IN STOCK.** Others FOB WISCONSIN.

Model No.	Description	Wt. Lbs.	Price Each
<b>STANDARD STOOLS</b>			
YP-1225	Hard Floor Casters	34	\$201.00
YP-1226	Glides	34	191.00
<b>DELUXE STOOLS</b>			
YP-1227	Hard Floor Casters	36	\$251.00
YP-1228	Glides	36	241.00



**STOCK**

SHOWN WITH CASTERS

### BEVCO® Pneumatic Task Stools

Guaranteed to give you years of trouble-free service. Built for long life, each stool comes with a 12-year guarantee—lifetime on cylinder. Durable, 16-ga. tubular steel 5-leg frame supports the 18"W x 17"D, 2-3/4" thick seat. 17"W x 10"H, 2" thick back adjusts 3" vertically and 1-1/2" horizontally. Other features include: durable olefin fabric with Dupont Teflon® protector, pneumatic seat adjustment, and chrome footring. **SPECIFY COLOR: BK - Black, BL - Blue, GY - Gray. IN STOCK.**

Model No.	Seat Height	Wt. Lbs.	Price Each
<b>WITH OVERSIZED GLIDES</b>			
XD-1095	20" - 25"	26	\$209.00
XD-1097	25" - 30"	27	213.00
<b>WITH HARD SURFACE CASTERS</b>			
XD-1096	21" - 26"	27	\$246.00
XD-1098	26" - 31"	28	250.00

# Stools



## Sit/Stand Stool

Reduces worker fatigue where permanent seating isn't practical. Tilt adjustment mechanism allows user to adjust seat for maximum comfort. 13"W x 13"D soft form-molded poly seat. Adjusts with gas lift, 23" to 33"H. Ships unassembled via small package carrier. **IN STOCK.**

Model No. **YA-1310**—Wt. 19 lbs. ....\$171.00

## Polyurethane Ergonomic Stools

Comfortable, supportive seat and back are made of improved extra soft form-molded polyurethane backed by a sturdy steel understructure. High impact, molded plastic 27" dia. 5-star base adds stability. Seat height adjusts pneumatically 22" – 32". 20" dia. pre-assembled footring, backrest depth, and backrest height adjust manually for maximum comfort. 18"W x 17"D seat, 17"W x 12"D backrest. Lifetime guarantee on pneumatic cylinders. Ships via small package carrier. **SPECIFY: A** - Floor pods, **B** - Hard floor casters, **C** - Carpet casters. **IN STOCK.**



Model No. **YA-1562**—Wt. 33 lbs. ...\$231.00

### CONTINUOUS-USE STOOL.

Heavy-duty mechanism with additional seat and angle adjustments. Recommended for 24-hour continuous use with 15-yr. guarantee.

Model No. **YA-1563**—Wt. 33 lbs. ....\$296.00

### OPTIONAL ARMS. Adjust vertically and horizontally.

Model No. **YA-1564**—Sold in pairs. Wt. 7 lbs. ....\$36.70



## STAPLETON® Crawler Mechanic's Roller Seat



Practical stool allows you to comfortably reach low repair jobs. Features include: 14"W x 8"D x 2"H padded seat, 15-3/4" x 14" tool and parts tray, powder coated steel frame and (4) 2-1/2" casters. **IN STOCK.**

Model No. **YA-1300**—Wt. 15 lbs. ....\$51.00



## BEVCO® Shop Stools

Machine shops, warehouses, and industrial work areas are just a few of the places you'll find this stool. Convenient tray keeps tools and supplies close at hand. 15" dia. polyurethane seat adjusts pneumatically from 15" to 20"H. Five-legged base features locking 3" polyurethane casters. 12-year guarantee (lifetime on cylinder). **IN STOCK.**

Model No. **XF-2240**—Wt. 19 lbs. ....\$179.00

### UTILITY STOOL

Assembly lines, drafting tables, and workbenches are just a few of the places you'll find this industrial-quality stool. Pneumatic adjustment raises the 15" dia. polyurethane seat from 15-3/4" to 20-3/4"H. Stool is supported by a five-star reinforced plastic base with dual wheel hard floor casters. 12-year guarantee (lifetime on cylinder). **IN STOCK.**

Model No. **YD-1124**—Wt. 15 lbs. ....\$121.00



YC-2204BU



## BREWER Vinyl Stools

Vinyl seat is 3-1/2" thick. Polished aluminum base. Stools have 18" dia. footring. Pneumatic seat height adjustment. Meets or exceeds ANSI/BIFMA standards, up to 250 lbs. capacity. Lifetime warranty on cylinder. **SPECIFY COLOR: BK** - Black, **BL** - Blue, **BU** - Burgundy, **GY** - Gray, **YL** - Yellow. FOB WISCONSIN.

Model No.	Seat Ht.	Wt. Lbs.	Price Ea.
<b>INCLUDING PODS</b>			
<b>YC-2201</b>	16-1/2-21-1/2"	17	<b>\$186.00</b>
<b>YC-2202</b>	23-1/2-33-1/2"	27	<b>224.00</b>
<b>INCLUDING HARD FLOOR CASTERS</b>			
<b>YC-2203</b>	17-1/2-22-1/2"	18	<b>\$188.00</b>
<b>YC-2204</b>	24-1/2-34-1/2"	28	<b>222.00</b>

# Workbenches



FIXED-HEIGHT LEGS SHOWN



## 1-3/4" Butcher Block Maple Top Workbenches

Edge-grained 1-3/4" thick top is laminated clear through and entirely warp-resistant. Virtually indestructible maple can be sanded many times to blend in gouges and scrapes. Ideal for machine and wood working, tool and die, assembly, electrical, etc. Maple top is supported by braced steel legs. **SPECIFY LEG HEIGHT: A - 32"H fixed, B - 29-33"H adjustable.** **IN STOCK.**

Top W x D	Wt. Lbs.	SQUARE EDGE TOPS		COMFORT EDGE TOPS	
		Model No.	Price Ea.	Model No.	Price Ea.
48" x 30"	97	<a href="#">XV-2512</a>	\$261.00	<a href="#">XV-2516</a>	\$292.00
60" x 30"	102	<a href="#">XV-2513</a>	308.00	<a href="#">XV-2517</a>	327.00
72" x 30"	127	<a href="#">XV-2514</a>	356.00	<a href="#">XV-2518</a>	386.00
72" x 36"	138	<a href="#">XV-2515</a>	402.00	<a href="#">XV-2519</a>	420.00



COMFORT-EDGE



SQUARE-EDGE



ADJUSTABLE-HEIGHT LEGS SHOWN



1-3/4" THICK LAYERED TOP

## 1-3/4" Thick Dyna-Top® Workbenches

Unique construction means a longer wearing and impact-resistant surface. 1-3/4" thick tops are constructed of edge-glued lumber core with 70-lb. density phenolic board surfaces. Finished and sealed to withstand conventional liquids and diluted acids. Completely urea-formaldehyde free! **SPECIFY LEG HEIGHT: A - 32"H fixed, B - 29-33"H adjustable.** **IN STOCK.**

Model No.	Top W x D	Wt. Lbs.	Price Ea.
<a href="#">XV-1470</a>	48" x 30"	100	\$202.00
<a href="#">XV-1471</a>	60" x 30"	117	218.00
<a href="#">XV-1472</a>	72" x 30"	139	250.00
<a href="#">XV-1473*</a>	96" x 30"	180	352.00
<a href="#">XV-1474*</a>	120" x 30"	222	430.00
<a href="#">XV-1475</a>	72" x 36"	155	297.00
<a href="#">XV-1476*</a>	96" x 36"	218	419.00
<a href="#">XV-1477*</a>	120" x 36"	259	513.00

\*96" & 120" models have 3 legs.



1-1/2" THICK SQUARE EDGE



## 1-1/2" Thick Butcher Block Maple Top Workbenches

If you're looking for a virtually indestructible worksurface for your workshop or maintenance room, this maple top bench is your answer. Warp-resistant and electronically Thermobonded maple is laminated all the way through and finished with a penetrating oil comprised of pure mineral oil, raw linseed oil, and melted paraffin to seal out liquids. Entire surface can be sanded down many times to reveal a smooth working area. Will not harm sharp tools or delicate machine parts. Entire unit is supported by stringer-braced heavy-duty 14-ga. welded legs. **SPECIFY LEG HEIGHT: A - 32" fixed, B - 29-33" adjustable.** **IN STOCK.**

Model No.	Top W x D	Wt. Lbs.	Price Ea.
<a href="#">XC-1496</a>	60" x 30"	91	\$220.00
<a href="#">XC-1497</a>	72" x 30"	123	253.00
<a href="#">XC-1498</a>	72" x 36"	150	292.00

# Workbenches



## PUCEL/GRIZZLY® Pro Welding Benches

Durable benches accommodate all welding processes. Feature convenient pull out tray for easy debris removal and completely removable steel grating top for quick clean-up. All-welded 12-gauge steel top; 10-gauge steel legs. Height adjusts from 30–42". Ships assembled and ready to use. FOB OHIO.

Model No. **WA-0360**—36"W x 24"D.  
Wt. 185 lbs. ....\$385.00  
Model No. **WA-0361**—60"W x 36"D.  
Wt. 370 lbs. ....\$649.00

## LITTLE GIANT Heavy-Duty Steel Workbenches



Extremely strong workbench is built to withstand heavy loads. Angle iron legs have extra large corner gussets for added strength and stability and foot pads with mounting holes to bolt to the floor. Reinforced steel top will not splinter or absorb liquids. **FACTORY QUICK SHIP—FOB ILLINOIS.**

### 10,000-LB. CAPACITY WORKBENCHES

7-gauge steel top and lower shelf; 2x2" 1/4" angle iron legs. 3" square footpads have 5/8" mounting holes. 500-lb. capacity lower centered shelf. All-welded. Enamel paint finish. Color: gray. Choose fixed or adjustable height benches with legs that adjust on 1" centers.

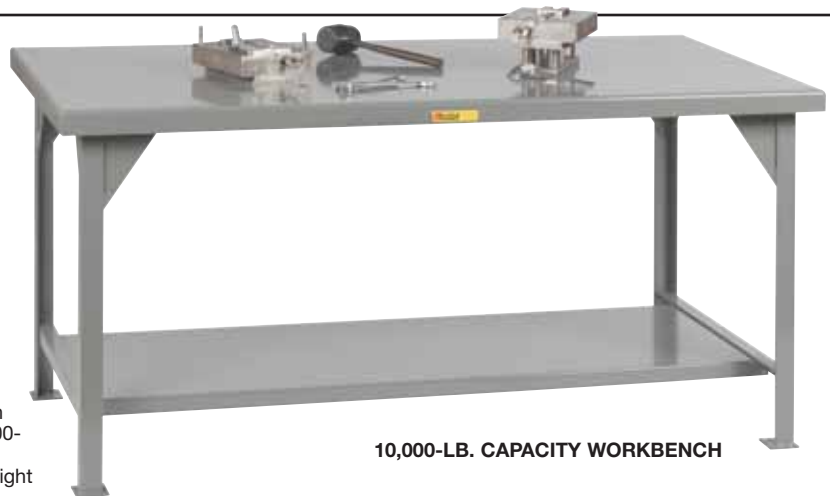

Top W x D	FIXED-HEIGHT BENCHES				ADJUSTABLE-HEIGHT BENCHES			
	Model No.	Bench Ht.	Wt. Lbs.	Price Ea.	Model No.	Bench Ht.	Wt. Lbs.	Price Ea.
36 x 30"	<b>YK-3100A</b>	34-3/16"	151	<b>\$372.00</b>	<b>YK-3100B</b>	28-3/16-38-3/16"	176	<b>\$478.00</b>
48 x 30"	<b>YK-3101A</b>	34-3/16"	187	<b>433.00</b>	<b>YK-3101B</b>	28-3/16-38-3/16"	212	<b>537.00</b>
60 x 36"	<b>YK-3102A</b>	34-3/16"	343	<b>533.00</b>	<b>YK-3102B</b>	28-3/16-38-3/16"	343	<b>639.00</b>
72 x 36"	<b>YK-3103A</b>	34-3/16"	287	<b>577.00</b>	<b>YK-3103B</b>	28-3/16-38-3/16"	350	<b>689.00</b>
84 x 42"	<b>YK-3104A</b>	34-3/16"	421	<b>745.00</b>	<b>YK-3104B</b>	28-3/16-38-3/16"	446	<b>851.00</b>

### 3000-LB. CAPACITY WORKBENCHES WITH STEEL TOP

12-gauge steel top; 1-1/2" x 1-1/2", 3/16" angle iron legs. Available with 500-lb. capacity lower half-shelf with 3" rear lip or without. All-welded. Enamel paint. Choose fixed or adjustable height benches with legs that adjust on 2" centers.

Top W x D	FIXED-HEIGHT BENCHES				ADJUSTABLE-HEIGHT BENCHES			
	Model No.	Bench Ht.	Wt. Lbs.	Price Ea.	Model No.	Bench Ht.	Wt. Lbs.	Price Ea.
48 x 30"	<b>YK-3096A</b>	36-1/8"	124	<b>\$289.00</b>	<b>YK-3096B</b>	27-1/8-41-1/8"	126	<b>\$355.00</b>
60 x 30"	<b>YK-3097A</b>	36-1/8"	153	<b>321.00</b>	<b>YK-3097B</b>	27-1/8-41-1/8"	155	<b>382.00</b>
72 x 30"	<b>YK-3105A</b>	36-1/8"	201	<b>371.00</b>	<b>YK-3105B</b>	27-1/8-41-1/8"	188	<b>433.00</b>
60 x 36"	<b>YK-3098A</b>	36-1/8"	174	<b>359.00</b>	<b>YK-3098B</b>	27-1/8-41-1/8"	176	<b>423.00</b>
72 x 36"	<b>YK-3099A</b>	36-1/8"	201	<b>405.00</b>	<b>YK-3099B</b>	27-1/8-41-1/8"	203	<b>467.00</b>
84 x 36"	<b>YK-3106A</b>	36-1/8"	224	<b>453.00</b>	<b>YK-3106B</b>	27-1/8-41-1/8"	225	<b>515.00</b>



# Workbenches



## Type 304 Stainless Steel Worktables

Extremely sanitary, rust-resistant tables promote cleanliness. Type 304 stainless steel top resists harsh chemicals. Unique 1-1/2" thick stallion front edge features a 45° taper that will not trap dirt or food and doesn't have sharp edges to snag clothing or injure workers. Entire length of work surface is supported by reinforced 1" x 2" tubing for extra rigidity. Standard 18-ga. lower shelf is fixed 12" from floor. 36"H overall. 1-5/8" diameter, 16-ga. legs include adjustable bullet feet. Ships knocked down. **IN STOCK.**

### PREMIUM STAINLESS STEEL TOP, LOWER SHELF & LEGS

Top WxD	16-GAUGE TOP			14-GAUGE TOP		
	Model No.	Wt. Lbs.	Price Ea.	Model No.	Wt. Lbs.	Price Ea.
48" x 30"	<b>YB-1610</b>	73	\$524.00	<b>YB-1614</b>	80	\$551.00
60" x 30"	<b>YB-1611</b>	83	621.00	<b>YB-1615</b>	96	649.00
72" x 30"	<b>YB-1612</b>	101	725.00	<b>YB-1616</b>	112	763.00
96" x 30"	<b>YB-1613</b>	137	894.00	<b>YB-1617</b>	151	939.00

### ECONOMICAL STAINLESS STEEL TOP, GALVANIZED LOWER SHELF & LEGS

Top WxD	16-GAUGE TOP			14-GAUGE TOP		
	Model No.	Wt. Lbs.	Price Ea.	Model No.	Wt. Lbs.	Price Ea.
48" x 30"	<b>YB-1618</b>	74	\$351.00	<b>YB-1622</b>	82	\$410.00
60" x 30"	<b>YB-1619</b>	88	409.00	<b>YB-1623</b>	98	472.00
72" x 30"	<b>YB-1620</b>	113	471.00	<b>YB-1624</b>	121	543.00
96" x 30"	<b>YB-1621</b>	139	605.00	<b>YB-1625</b>	154	695.00

### CASTERS

Model No. **YB-1627**—5" Polyolefin Casters. 4 swivel, all with brakes. Set of 4. Price each set.....**\$69.00**  
 Model No. **YB-1628**—5" Polyolefin Casters. For 96"L tables. 4-swivel, 2 with brakes. Set of 6. Price each set.....**\$105.00**

### STAINLESS STEEL DRAWER

Model No. **YB-1626**—Stainless Steel Drawer.....**\$124.00**

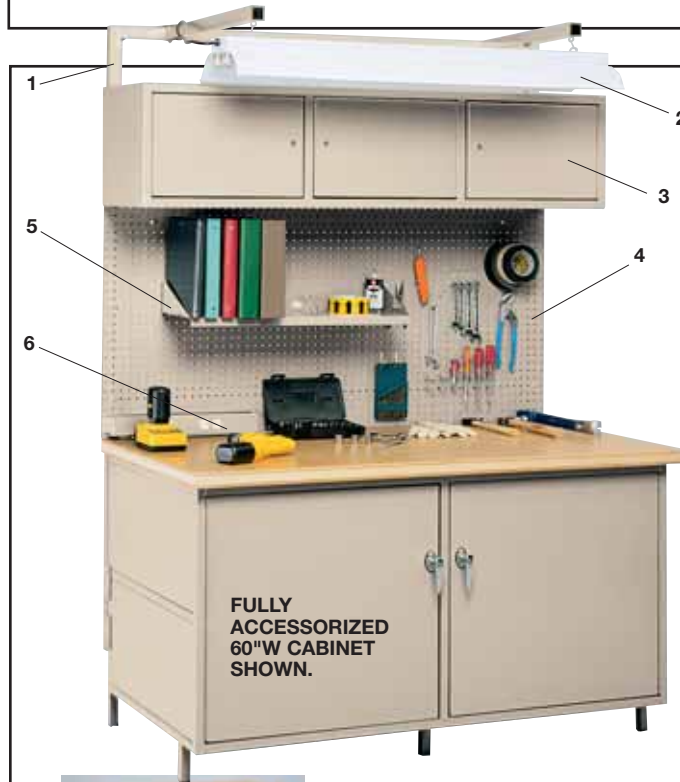

## Cabinet-Style Workbenches

Versatile workstations store everything you need to perform job tasks. All-welded 1" square tube frame construction features locking cabinet doors with two keys and adjustable shelves. Workbench with 15"W x 20"D x 6"H drawers for extra storage is also available. Choose either 1-3/4" thick layered resincore Shop-Mate top or 1-1/4" thick plastic laminate top that matches door color choice. FOB WISCONSIN.

### ACCESSORIES.

Add these accessories to either a 60"W or 72"W cabinet-style workbench to create a customized workstation. Your workbench will have to be retrofitted to add these accessories. Overhead frame is required for all accessories. Separate overhead cabinet compartments are keyed differently. Cabinets can be opened inside to each other and keyed alike, upon request. **SPECIFY COLOR:** **BE** - Beige, **BL** - Blue, **BK** - Black, **GY** - Gray.

Key	Model No.	Description	Wt. Lbs.	Price Each
1	<b>XM-2516</b>	60" Overhead Frame	48	<b>\$117.00</b>
1	<b>XM-2517</b>	72" Overhead Frame	48	<b>120.00</b>
2	<b>XM-2518*</b>	48" Shop Light (w/o bulbs)	15	<b>71.80</b>
3	<b>XM-2519*</b>	60" Overhead Cabinets (3 doors)	61	<b>272.00</b>
3	<b>XM-2520*</b>	72" Overhead Cabinets (4 doors)	85	<b>324.00</b>
4	<b>XM-2521*</b>	60" Pegboard (1/4" holes, hooks not incl.)	18	<b>54.90</b>
4	<b>XM-2522*</b>	72" Pegboard (1/4" holes, hooks not incl.)	22	<b>64.00</b>
5	<b>XM-2523**</b>	Pegboard Mounted Shelf (28"W x 9"D)	7	<b>38.30</b>
6	<b>XM-2524**</b>	Power Strip	4	<b>58.10</b>

\*Requires an overhead frame.

\*\*Requires both overhead frame and pegboard.

**SPECIFY FRAME/DOOR COLORS:** **BA** - Beige/Almond, **BE** - Beige/Beige, **BG** - Black/Gray, **BK** - Black/Almond, **BL** - Blue/Almond, **GA** - Gray/Almond, **GY** - Gray/Gray.



Description	Overall W x D x H	Model Number	Wt. Lbs.	Price Each	1-3/4" THICK SHOP-MATE TOP		1-1/4" THICK PLASTIC LAMINATE TOP	
					Model Number	Wt. Lbs.	Price Each	Model Number
2 sliding doors	60" x 30" x 34"	<b>XA-2190</b>	224	<b>\$837.00</b>	<b>XA-2202</b>	201	<b>\$842.00</b>	
2 sliding doors	72" x 30" x 34"	<b>XA-2191</b>	269	<b>945.00</b>	<b>XA-2203</b>	230	<b>944.00</b>	
2 sliding doors	96" x 30" x 34"	<b>XA-2192</b>	351	<b>1079.00</b>	<b>XA-2204</b>	383	<b>1072.00</b>	
2 doors	60" x 30" x 34"	<b>XA-2193</b>	330	<b>819.00</b>	<b>XA-2205</b>	306	<b>831.00</b>	
3 doors	72" x 30" x 34"	<b>XA-2194</b>	358	<b>905.00</b>	<b>XA-2206</b>	328	<b>912.00</b>	
4 doors	96" x 30" x 34"	<b>XA-2195</b>	403	<b>1086.00</b>	<b>XA-2207</b>	383	<b>1089.00</b>	
4 vertical drs., 2 doors	60" x 30" x 34"	<b>XA-2196</b>	364	<b>1051.00</b>	<b>XA-2208</b>	379	<b>1065.00</b>	
4 vertical drs., 2 doors	72" x 30" x 34"	<b>XA-2197</b>	402	<b>1088.00</b>	<b>XA-2209</b>	420	<b>1097.00</b>	
8 vertical drs., 2 doors	96" x 30" x 34"	<b>XA-2198</b>	490	<b>1478.00</b>	<b>XA-2210</b>	514	<b>1485.00</b>	
3 horizontal drs., 2 doors	60" x 30" x 34"	<b>XA-2199</b>	353	<b>967.00</b>	<b>XA-2211</b>	368	<b>980.00</b>	
4 horizontal drs., 3 doors	72" x 30" x 34"	<b>XA-2200</b>	402	<b>1132.00</b>	<b>XA-2212</b>	405	<b>1141.00</b>	
6 horizontal drs., 3 doors	96" x 30" x 34"	<b>XA-2201</b>	469	<b>1361.00</b>	<b>XA-2213</b>	493	<b>1367.00</b>	



# TENNSCO Pedestal Workbenches

**XG-4822 SHOWN WITH XG-4844 ELECTRICAL RISER AND XG-4809 OUTLET PANEL.**



**Selected Models**

Create a flexible, high-quality workbench to fit your specific needs. Choose from any bench configuration of pedestals and tops, then add risers (electrical or non-electrical). 34" overall work height. All parts except the wood tops come in medium gray or sand color. **SPECIFY COLOR: GY - Gray, SD - Sand. GY - GRAY IS IN STOCK.** Other FOB TENNESSEE.

**COMPONENT INFO:**

**BENCH TOPS.** Described in chart.

**BENCH PEDESTALS.** 15"W x 24"D x 32"H. Ships assembled. Door cabinet has a shelf that adjusts on 3" centers, a 3-point lock, and key-lockable recessed handle. Drawers are removable and have nylon rollers for easy operation.

**RISERS.** Attach to all tops. 60" or 72"W, 10-1/2"D x 12"H. Electronic riser has four sets of electrical knockouts. (Must order wiring kit separately.)

**ELECTRICAL OUTLET PANEL.** Mounts underneath 72"W bench top and has four knockouts for four duplex receptacles. (Must order wiring kit separately.)



**ELECTRICAL WIRING KIT**

W x D	2-PEDESTAL/4-DRAWER, 1-CABINET WORKBENCH			2-PEDESTAL/8-DRAWER WORKBENCH			2-PEDESTAL/2-CABINET WORKBENCH		
	Model No.	Wt. Lbs.	Price Ea.	Model No.	Wt. Lbs.	Price Ea.	Model No.	Wt. Lbs.	Price Ea.
<b>STEEL TOP – 12-GAUGE – 1-1/2" THICK</b>									
60" x 30"	<a href="#">XG-4802</a>	204	\$609.00	<a href="#">XG-4804</a>	228	\$730.00	<a href="#">XG-4806</a>	180	\$467.00
72" x 30"	<a href="#">XG-4803</a>	221	626.00	<a href="#">XG-4805</a>	245	750.00	<a href="#">XG-4807</a>	197	495.00
<b>SHOP TOP – BONDED PARTICLEBOARD WITH HARD MAPLE EDGES – 1-3/4" THICK</b>									
60" x 30"	<a href="#">XG-4812</a>	231	\$635.00	<a href="#">XG-4814</a>	257	\$765.00	<a href="#">XG-4816</a>	206	\$506.00
72" x 30"	<a href="#">XG-4813</a>	252	677.00	<a href="#">XG-4815</a>	272	807.00	<a href="#">XG-4817</a>	226	544.00
<b>LAMINATED PLASTIC – LAMINATED NON-CONDUCTIVE SURFACE – GRAY COLOR – 1-1/2" THICK</b>									
60" x 30"	<a href="#">XG-4822</a>	224	\$617.00	<a href="#">XG-4824</a>	250	\$751.00	<a href="#">XG-4826</a>	198	\$469.00
72" x 30"	<a href="#">XG-4823</a>	243	654.00	<a href="#">XG-4825</a>	268	784.00	<a href="#">XG-4827</a>	217	521.00
<b>MAPLE – TOP QUALITY KILN-DRIED MAPLE STRIPS – 1-3/4" THICK</b>									
60" x 30"	<a href="#">XG-4832</a>	226	\$698.00	<a href="#">XG-4834</a>	251	\$818.00	<a href="#">XG-4836</a>	200	\$563.00
72" x 30"	<a href="#">XG-4833</a>	245	746.00	<a href="#">XG-4835</a>	270	848.00	<a href="#">XG-4837</a>	219	607.00

**OPTIONS**

Model No. [XG-4809](#) – Outlet Panel for 60"W tops (order wiring kit separately).  
**SPECIFY COLOR: GY - Gray, SD - Sand. ....\$27.00**  
 Model No. [XG-4843](#) – Outlet Panel for 72"W tops (order wiring kit separately).  
**SPECIFY COLOR: GY - Gray, SD - Sand. ....\$24.90**  
 Model No. [XG-4848](#) – Electrical Wiring Kit for wiring electrical risers and outlet panels. Wt. 2.5 lbs. ....\$54.40

RISERS				
Model No.	Type	Length	Wt. Lbs.	Price Ea.
<a href="#">XG-4846</a>	Standard	60"	20	\$41.20
<a href="#">XG-4847</a>	Standard	72"	24-1/2	48.70
<a href="#">XG-4844*</a>	Electrical	60"	29	52.90
<a href="#">XG-4845*</a>	Electrical	72"	33	58.90

\*Order wiring kit separately.

# TENNSCO Workbenches



High-quality workbenches offer durability at an affordable price. Welded 13-gauge steel legs support 4,000 lbs. per pair while the large worksurface in your choice of material gives you plenty of room to complete job tasks. Choose either 32"H fixed legs or adjustable legs that raise from 27-7/8" to 35-3/8"H in 1-1/2" increments. Color: gray. **IN STOCK.**

**WORKBENCHES.** Includes top, legs, and stringer. **SPECIFY LEG HEIGHT: A** - 32" fixed, **B** - 27-7/8" to 35-3/8" adjustable.

Model Number	Top W x D	Wt. Lbs.	Price Each	
			A	B
<b>STEEL TOPS.</b> 1-1/2" thick 12-gauge steel with 14-gauge reinforcement channels at each end.				
YG-4702	48" x 30"	102	\$174.00	\$185.00
YG-4704	60" x 30"	114	188.00	201.00
YG-4706	72" x 30"	129	207.00	222.00
YG-4707	72" x 36"	146	230.00	249.00
<b>PLASTIC LAMINATE TOP.</b> 1-3/4" thick high-pressure plastic laminate with a non-conductive smooth surface.				
YG-4708	60" x 30"	130	\$210.00	\$223.00
YG-4709	72" x 30"	149	232.00	250.00
YG-4710	72" x 36"	171	269.00	286.00
<b>"BUTCHER BLOCK" MAPLE TOP.</b> 1-3/4" thick solid laminated maple that can be sanded smooth.				
YG-4711	60" x 30"	132	\$299.00	\$312.00
YG-4712	72" x 30"	151	337.00	356.00
YG-4713	72" x 36"	173	385.00	402.00
<b>DURATOP II.</b> 1-3/4" thick phenolic tempered hardboard over a MDF core. Phenolic resin core surface resists conventional liquids.				
YC-3080	60" x 30"	112	\$186.00	\$201.00
YC-3081	72" x 30"	132	213.00	227.00
YC-3082	72" x 36"	112	249.00	266.00
<b>PLASTIC LAMINATE W/BULLNOSE TOP.</b> High-strength lumber core with high-pressure laminate surface. 180° radius front edge.				
YC-3083	60" x 30"	130	\$300.00	\$299.00
YC-3084	72" x 30"	150	341.00	342.00
YC-3085	72" x 36"	168	384.00	405.00



**LOWER SHELF.** Used for extra storage 16-gauge construction. 14" deep.

Model No.	Width	Wt. Lbs.	Price Ea.
YG-4693	48"	18	\$34.60
YG-4694	60"	20	39.60
YG-4695	72"	24	46.40

**RISER.** Adds extra storage at a convenient height. Riser is 12" high and 10-1/2" deep.

Model No.	Width	Wt. Lbs.	Price Ea.
YG-4690	48"	21	\$44.90
YG-4691	60"	23	48.80
YG-4692	72"	26	54.20

**STACKABLE DRAWER.** Self-contained unit may be stacked on top of bench or mounted underneath. Nylon roller bearings for ease of operation. Includes padlock hasp, drawer divider, and removable tray.

Model No. **YG-4689**—Wt. 23 lbs...**\$62.30**

**STRINGERS.** Stabilizes bench legs. 14-ga. units bolt to legs.

Model No. <b>YC-3086</b> —48" Wide.	Wt. 7 lbs. ....	\$19.60
Model No. <b>YC-3087</b> —60" Wide.	Wt. 9 lbs. ....	\$21.50
Model No. <b>YC-3088</b> —72" Wide.	Wt. 11 lbs. ....	\$22.30



#### FIXED-HEIGHT LEGS.

32"H. All-welded 13-ga. steel with 14-ga. cross members and pre-punched flared feet that can be bolted to floor. Priced per leg.

Model No. <b>YC-3089</b> —28"D.	Wt. 15.2 lbs.	\$32.40
Model No. <b>YC-3090</b> —30"D.	Wt. 15.4 lbs.	\$27.20
Model No. <b>YC-3091</b> —34"D.	Wt. 15.8 lbs.	\$29.30
Model No. <b>YC-3092</b> —36"D.	Wt. 16 lbs.	\$28.60



#### ADJUSTABLE-HEIGHT LEGS.

Adjusts from 27-7/8" to 35-3/8" high in 1" increments. 14-ga. steel uprights with 13-ga. top members. Priced per leg.

Model No. <b>YC-3093</b> —28"D.	Wt. 17.3 lbs.	\$38.90
Model No. <b>YC-3094</b> —30"D.	Wt. 17.5 lbs.	\$36.00
Model No. <b>YC-3095</b> —34"D.	Wt. 18.5 lbs.	\$42.20
Model No. <b>YC-3096</b> —36"D.	Wt. 18.7 lbs.	\$38.80

**SIDE AND BACK RAIL KITS.** 3" height prevents parts and small objects from falling off the sides and backs.

Model No.	For Top W x D	Wt. Lbs.	Price Ea.
YG-4696	30" x 48"	12	\$29.90
YG-4698	30" x 60"	14	31.80
YG-4700	30" x 72"	15-1/2	33.00
YG-4701	36" x 72"	16-1/2	34.80

# Workbenches



Designed for heavy-duty applications because their rugged construction will stand up to tough use. Constructed of double-braced, heavy gauge steel for extra rigidity and support. 14-gauge double braced legs with leveling feet stabilize bench on uneven surfaces. Legs adjust from 30–34" in 1" increments to accommodate sitting or standing operations. Deluxe bench includes: rugged, stacking drawer, lower shelf, riser, back and end stops, and stringers. All benches are painted blue. Benches ship knocked down to save freight. **SPECIFY TOP: A - Hardwood, B - Maple, C - Shop-Mate, D - Duratop II, E - Plastic. IN STOCK.**



**STANDARD BENCH**

**COMBINE COMPONENTS TO CREATE A CUSTOM BENCH.**



**DELUXE BENCH**

**CHOOSE ONE OF THESE FIVE, 1-3/4" THICK SOLID TOPS.**



**HARDWOOD.** Natural Appalachian red oak with "Varnique" semi-gloss finish. Bull-nose front edge.



**MAPLE.** Virtually indestructible. Laminated throughout, warp-resistant and electronically thermobonded. "Varnique" wear-resistant finish.



**SHOP-MATE.** High strength lumber core with super hard, phenolic resincore surface. Continuous edges resist warping and moisture.

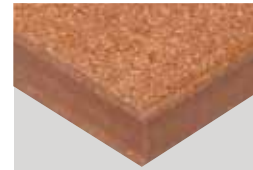

**DURATOP® II.** High strength MDF core with sealed hardwood bands. Phenolic resincore surface.



**PLASTIC.** White leather-textured .050" pressure laminated-plastic face on 3/16" hardboard with selected, edge-glued lumber core.

Top WxD	Model Number	(A) HARDWOOD		(B) MAPLE		(C) SHOP-MATE		(D) DURATOP II		(E) PLASTIC	
		Wt. Lbs.	Price Each	Wt. Lbs.	Price Each	Wt. Lbs.	Price Each	Wt. Lbs.	Price Each	Wt. Lbs.	Price Each
<b>STANDARD BENCH—INCLUDES TOP, LEGS, AND STRINGER.</b>											
60" x 30"	<a href="#">XB-1645</a>	121	\$390.00	121	\$365.00	122	\$269.00	119	\$320.00	137	\$350.00
72" x 30"	<a href="#">XB-1646</a>	144	435.00	146	414.00	175	318.00	139	379.00	157	400.00
72" x 36"	<a href="#">XB-1647</a>	158	500.00	164	469.00	205	377.00	155	445.00	181	475.00
<b>DELUXE BENCH—FULLY ACCESSORIZED AS SHOWN</b>											
60" x 30"	<a href="#">XV-1410</a>	213	\$646.00	215	\$670.00	244	\$549.00	211	\$603.00	229	\$570.00
72" x 30"	<a href="#">XV-1411</a>	246	732.00	248	742.00	277	632.00	241	672.00	259	629.00
72" x 36"	<a href="#">XV-1412</a>	261	808.00	265	814.00	308	714.00	257	759.00	284	680.00

## BENCH ACCESSORIES



**SHOWN WITH OPTIONAL CYLINDER LOCK (NOT INCLUDED).**

**DRAWER.** Reinforcing embossed detail. 20-ga. drawer with 18-ga. front. Removable padlock attachment and provision for cylinder lock. 17-1/4"W x 20"D x 6-5/8"H. **SPECIFY COLOR: BL - Blue, TN - Tan.**

Model No. [XB-1648](#)—Wt. 20 lbs. **\$124.00**

**LOCK FOR STACKABLE DRAWER. SPECIFY: A - Keyed alike, B - Keyed differently.**

Model No. [ZA-0330](#)—Wt. 0.2 lbs.....**\$7.30**

**LOWER SHELF.** 16-ga. construction, 15" deep. Workbench accepts two lower shelves. **SPECIFY COLOR: BL - Blue, TN - Tan.**

Model No. [XB-1649](#)—60"L. Wt. 22 lbs. ....**\$61.00**  
Model No. [XB-1650](#)—72"L. Wt. 27 lbs. ....**\$66.10**

**RISER.** Two shelves with dividers make up 3 equal compartments. 16-ga., 10-1/2"D riser with 2" backstop that extends 12" above top. **SPECIFY COLOR: BL - Blue, TN - Tan.**

Model No. [XB-1651](#)—60"L. Wt. 36 lbs....**\$97.60**  
Model No. [XB-1652](#)—72"L. Wt. 42 lbs....**\$112.00**

**BACK & END STOPS.** Extend 3" above top. 16-ga. **SPECIFY COLOR: BL - Blue, TN - Tan.**

Model No. [XB-1653](#)—60"W x 30"D. Wt. 12 lbs.....**\$45.90**  
Model No. [XB-1654](#)—72"W x 30"D. Wt. 13 lbs.....**\$49.40**  
Model No. [XB-1655](#)—72"W x 36"D. Wt. 14 lbs.....**\$56.30**

**STRINGERS.** 15-ga. stringers keep bench from spreading. **SPECIFY COLOR: BL - Blue, TN - Tan.**

Model No. [XB-1656](#)—60"L. Wt. 10 lbs. ....**\$21.70**  
Model No. [XB-1657](#)—72"L. Wt. 10 lbs. ....**\$28.80**

**HEAVY-DUTY LEGS.** 14-gauge steel legs have additional horizontal brace. Adjust from 30–34" in 1" increments. **SPECIFY COLOR: BL - Blue, TN - Tan.**

Model No. [XB-1658](#)—30"D. Wt. 21 lbs. ....**\$56.60**  
Model No. [XB-1659](#)—36"D. Wt. 24 lbs. ....**\$62.20**

# Workbenches



**VALLEY CRAFT® Vari-Tuff™  
10' Wide Assembly Benches**

Keep everything from tools and supplies needed for production to cleaning products for tidying at the end of the day right where you need them with these 10'W assembly benches. Durable bench is channel-formed on all sides and has stringer, shelf and legs made from 13-ga. steel. Welded channel legs adjust from 28-42"H on 2" centers. 12"D shelf is ideal for extra supply storage. Color: Gray. Optional colors available upon request, call for information. **SELECTED MODELS IN STOCK.** OTHERS FOB MINNESOTA.

**STOCK**  
Selected Models

Model No.	Depth	Wt. Lbs.	Price Ea.
<b>13-GAUGE STEEL TOP</b>			
<b>XL-0750GY</b>	28"	250	<b>\$606.00</b>
<b>XL-0751GY</b>	34"	278	<b>669.00</b>
<b>XL-0752GY</b>	48"	355	<b>809.00</b>
<b>HARDBOARD OVER STEEL TOP</b>			
<b>XL-0753GY</b>	28"	260	<b>\$660.00</b>
<b>XL-0754GY</b>	34"	310	<b>819.00</b>
<b>XL-0755GY</b>	48"	365	<b>969.00</b>



**EDSAL 10' Steel Top  
Production Benches**

Extra large, one-piece work surface gives you the room you need to complete assembly and production tasks. 120"W plywood/steel top spans entire surface area. 14-ga. double-braced legs with leveling feet provide rigidity and support. Adjust from 30-34"H in 1" increments. 16-ga. lower shelf and full width stringer support and stabilize bench. Ships knocked down. **IN STOCK.**

**STOCK**

Model No.	Top W x D	Wt. Lbs.	Price Ea.
<b>XB-1635</b>	120" x 30"	223	<b>\$689.00</b>
<b>XB-1636</b>	120" x 36"	237	<b>776.00</b>
<b>XB-1637</b>	120" x 48"	251	<b>973.00</b>



**PHILLOCRAFT  
Modular Production Tables**

Start with basic 8'W table and add on as your workspace needs grow. 1" thick invisible steel spline clamping bars connect starter and add-on tops to form a smooth continuous surface. Durable 12-ga. steel interlocking frame with smooth rolled edges supports the entire table top. Legs adjust from 33-37"H. Parallel apron rails form a permanent top and track edge. Choose either an Atomite hardboard top or an Atomica plastic-laminate top over a high-density flake core. **SPECIFY TOP: A - Hardboard, B - Plastic laminate.** FOB TENNESSEE.

(1) 8' STARTER AND  
(1) 4' ADD-ON SHOWN.

Top Depth	8'W TABLE STARTER				4'W TABLE ADD-ONS			
	Model Number	Wt. Lbs.	(A) Price Ea.	(B) Price Ea.	Model Number	Wt. Lbs.	(A) Price Ea.	(B) Price Ea.
36"	<b>XK-1351</b>	168	<b>\$648.00</b>	<b>\$728.00</b>	<b>XK-1359</b>	84	<b>\$324.00</b>	<b>\$364.00</b>
42"	<b>XK-1352</b>	196	<b>671.00</b>	<b>764.00</b>	<b>XK-1360</b>	98	<b>336.00</b>	<b>382.00</b>
48"	<b>XK-1353</b>	224	<b>756.00</b>	<b>862.00</b>	<b>XK-1361</b>	112	<b>378.00</b>	<b>431.00</b>
54"	<b>XK-1354</b>	252	<b>783.00</b>	<b>903.00</b>	<b>XK-1362</b>	126	<b>380.00</b>	<b>452.00</b>
60"	<b>XK-1355</b>	280	<b>810.00</b>	<b>943.00</b>	<b>XK-1363</b>	140	<b>405.00</b>	<b>472.00</b>
66"	<b>XK-1356</b>	308	<b>871.00</b>	<b>1018.00</b>	<b>XK-1364</b>	154	<b>436.00</b>	<b>485.00</b>
72"	<b>XK-1357</b>	336	<b>902.00</b>	<b>1062.00</b>	<b>XK-1365</b>	168	<b>451.00</b>	<b>531.00</b>
78"	<b>XK-1358</b>	364	<b>941.00</b>	<b>1114.00</b>	<b>XK-1366</b>	182	<b>471.00</b>	<b>557.00</b>

# Workbench Components

Build your own personalized workbench system. Select a bench top from opposite page and add legs and stringer. Then finish the bench by attaching the components that fit your specific needs. **IN STOCK.**

**BACK & END STOPS** prevent items from sliding off. Stops extend 3" above table top on three sides. End stop corners are rounded. **SPECIFY COLOR: GY - Gray, TN - Tan.**

Model No.	Top WxD	Wt. Lbs.	Price Ea.
<b>XB-1674*</b>	48" x 30"	11	<b>\$32.50</b>
<b>XB-1675</b>	60" x 30"	12	<b>35.40</b>
<b>XB-1676</b>	72" x 30"	13	<b>37.70</b>
<b>XB-1677</b>	72" x 36"	15	<b>40.30</b>

\*48" available in gray only.

**BENCH RISER** doubles back-of-bench storage space. Riser is 10-1/2"D with 2" back stop and extends 12" above the bench. Uprights bolt right on bench top. **SPECIFY COLOR: GY - Gray, TN - Tan.**

Model No.	Top Width	Wt. Lbs.	Price Ea.
<b>XB-1668*</b>	48"	20	<b>\$51.10</b>
<b>XB-1669</b>	60"	21	<b>53.60</b>
<b>XB-1670</b>	72"	24	<b>66.80</b>

\*48" available in gray only.

**LOWER SHELF** provides extra storage space. 15"D with 1" rear flange that keeps items from falling off. **SPECIFY COLOR: GY - Gray, TN - Tan.**

Model No.	Top Width	Wt. Lbs.	Price Ea.
<b>XB-1671*</b>	48"	17	<b>\$37.20</b>
<b>XB-1672</b>	60"	20	<b>43.60</b>
<b>XB-1673</b>	72"	22	<b>48.10</b>

\*48" available in gray only.



**STRINGERS** add rigidity. Constructed of 14-gauge steel. **SPECIFY COLOR: GY - Gray, TN - Tan.**

Model No.	Top Width	Wt. Lbs.	Price Ea.
<b>XB-1678*</b>	48"	5	<b>\$17.90</b>
<b>XB-1679</b>	60"	7	<b>19.70</b>
<b>XB-1680</b>	72"	8	<b>21.20</b>

\*48" available in gray only.



**INDUSTRIAL-DUTY ADJUSTABLE-HEIGHT BENCH LEGS.** Legs adjust in height from 29-33" in 1" increments. Construction features 14-ga. steel top support and foot assembly with 16-ga. ribbed steel legs. Punched holes allow easy attachment of stringer and top and bottom shelves. 2-3/4" wide feet bolt directly to floor. Priced per leg. **SPECIFY COLOR: GY - Gray, TN - Tan.**

Model No.	Width	Wt. Lbs.	Price Ea.
<b>XB-1664</b>	30"	14	<b>\$35.00</b>
<b>XB-1665</b>	36"	14	<b>38.00</b>

**WELDED 14-GAUGE STEEL INDUSTRIAL BENCH LEGS.** Fixed 32" height. Punched holes allow easy attachment of permit stringer and top and bottom shelves. Flanged feet bolt directly to floor. **SPECIFY COLOR: GY - Gray, TN - Tan.**

Model No.	Width	Wt. Lbs.	Price Ea.
<b>XB-1660</b>	30"	13	<b>\$28.30</b>
<b>XB-1661</b>	36"	13	<b>30.60</b>

### STACKABLE STEEL DRAWERS

Case type frame attaches underneath bench. 17-1/4" x 20" x 6-1/2"H. Includes removable padlock attachment and provision for cylinder lock. **SPECIFY COLOR: GY - Gray, TN - Tan.**

Model No. **XB-1681**—Wt. 18 lbs.....**\$61.00**

Model No. **ZB-1683**—Cylinder Lock.....**\$7.90**

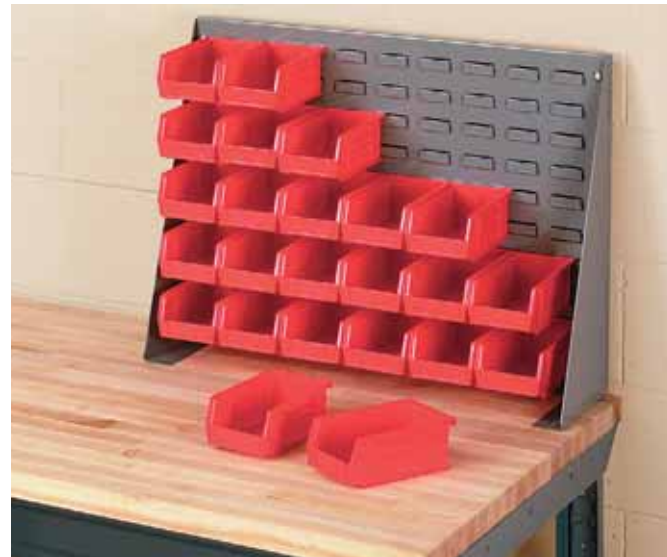

**BENCH-MOUNT PANEL.** Provides quick access to each bin. Heavy-duty 16-gauge steel bench rack measures 27-3/4" x 21" and supports up to 24 bins. Assembles in seconds. 120-lb. capacity. Available with 3 sizes of bins in five different colors for coding. Bins suspend from special louvers for quick removal, refilling or relocation. **SPECIFY COLOR: BL - Blue, GN - Green, RD - Red, ST - Stone, YL - Yellow.**

Model Number	Description	Bin W x D x H	Wt. Lbs.	Price Each
<b>XG-1934</b>	Rack with 24 No. XG-1957 Bins	4-1/8" x 5-3/8" x 3"	18	<b>\$93.50</b>
<b>XG-1935</b>	Rack with 24 No. XG-1958 Bins	4-1/8" x 7-3/8" x 3"	19	<b>120.00</b>
<b>XG-1936</b>	Rack with 12 No. XG-1959 Bins	5-1/2" x 10-7/8" x 5"	23	<b>132.00</b>

Model No. **XG-1937**—Rack only. 27-3/4" x 8" x 21". Wt. 11 lbs..**\$64.30**



**SHOWN WITH PADLOCK ATTACHMENT (PADLOCK NOT INCLUDED) AND OPTIONAL CYLINDER LOCK (SOLD SEPARATELY).**

# Bench System Tops



**1-3/4" MAPLE TOPS.** Edge-grained laminated butcher block top is virtually indestructible. Warp-resistant materials are laminated throughout and electronically thermobonded. Non-toxic Varnique wear-resistant finish repels liquids.

**2-1/4" MAPLE TOPS.** Same durable construction as other 1-3/4" maple top but thicker for maximum strength and long life. Laminated clear through, warp-resistant and electronically thermobonded.

**SHOP-MATE TOPS.** Smooth surface offers strength and durability. 3/8" thick, 62-lb. density phenolic resincore surface with a compressed wood core. Resists moisture and warpage. 1-3/4" top has a high strength lumber core over sealed hardwood bands. 2-1/4" top features an edge-glued lumber core with clear bands.

**DYNA-TOP® TOPS.** Resists impact and wears well. Features an edge-glued lumber core sandwiched between 3/8", 60-lb. phenolic resincore board. Beveled front edge. Entire top is finished and vinyl sealed to resist conventional liquids. Urea-formaldehyde free.

Size WxD	1-3/4" MAPLE				2-1/4" MAPLE		1-3/4" & 2-1/4" SHOP-MATE				1-3/4" DYNA-TOP®	
	Square Edge - 1-3/4"		Comfort Edge - 1-3/4"		Square Edge - 2-1/4"		Comfort Edge - 1-3/4"		Comfort Edge - 2-1/4"		Beveled Edge - 1-3/4"	
	Model No.	Price Ea.	Model No.	Price Ea.	Model No.	Price Ea.	Model No.	Price Ea.	Model No.	Price Ea.	Model No.	Price Ea.
48" x 30"	YB-1770	\$208.00	YB-1778	\$223.00	—	—	—	—	—	—	YB-1810	\$136.00
60" x 30"	YB-1771	258.00	YB-1779	270.00	—	—	YB-1787	\$153.00	YB-1795	\$171.00	YB-1811	151.00
72" x 30"	YB-1772	306.00	YB-1780	319.00	—	—	YB-1788	182.00	YB-1796	204.00	YB-1812	180.00
96" x 30**	—	—	YB-1781	470.00	YB-1805	\$539.00	—	—	YB-1797	270.00	YB-1813	251.00
120" x 30**	YB-1774	537.00	—	—	—	—	—	—	—	—	—	—
72" x 36"	YB-1775	361.00	YB-1783	378.00	—	—	YB-1791	220.00	YB-1799	243.00	YB-1815	225.00
96" x 36**	—	—	YB-1784	542.00	YB-1808	649.00	—	—	YB-1800	319.00	YB-1816	312.00
120" x 36**	YB-1777	644.00	—	—	—	—	—	—	—	—	—	—

\*96" & 120" tops require 3 legs and 2 stringers.

ALL BENCH TOPS ARE IN STOCK



**1-1/2" BUTCHER BLOCK MAPLE TOPS.** Completely sealed surface features a special combination of pure mineral oil, raw linseed oil, and melted paraffin. Periodic applications of penetrating oil will help preserve top's original composition. Virtually indestructible, warp-resistant and laminated throughout.

**1-3/4" BUTCHER BLOCK OAK HARDWOOD TOPS.** Tough, durable Appalachian red oak tops feature a Varnique semi-gloss finish. Bull-nose rounded comfort edge.

**1-3/4" BUTCHER BLOCK BIRCH TOPS.** An economical alternative to maple. Kiln dried wood fibers are protected with penetrating oil while internal butt joints and full-length exterior rails enhance top's tough, wear-resistant construction. Periodic applications of NSF-approved oil (listed below) help preserve composition.

**1-3/4" DURATOP® II TOPS.** Comfort edge on both top and bottom increase safety. 3/8" thick 62-lb. density phenolic resincore top and bottom are coated with a catalyzed finish to resist conventional liquids. MDF core offers extra strength. 1-1/4" thick top has 1/2" thick core; 1-3/4" thick top has a 1" thick core.

Size WxD	1-1/2" MAPLE				1-3/4" OAK HARDWOOD		1-3/4" BIRCH		1-1/4" & 1-3/4" DURATOP II			
	Square Edge - 1-1/2"		Comfort Edge - 1-1/2"		Comfort Edge - 1-3/4"		Square Edge - 1-3/4"		Comfort Edge - 1-1/4"		Comfort Edge - 1-3/4"	
	Model No.	Price Ea.	Model No.	Price Ea.	Model No.	Price Ea.	Model No.	Price Ea.	Model No.	Price Ea.	Model No.	Price Ea.
48" x 30"	—	—	—	—	YA-2156	\$206.00	—	—	YA-2111	\$104.00	—	—
60" x 30"	YA-2150	\$170.00	YA-2153	\$179.00	YA-2157	260.00	XC-3070	\$174.00	YA-2112	119.00	YA-2117	\$129.00
72" x 30"	YA-2151	201.00	YA-2154	213.00	YA-2158	299.00	XC-3071	206.00	YA-2113	137.00	YA-2118	159.00
96" x 30"	—	—	—	—	—	—	—	—	YA-2114	195.00	YA-2119	218.00
72" x 36"	YA-2152	241.00	YA-2155	254.00	YA-2159	355.00	XC-3072	247.00	YA-2115	174.00	YA-2120	197.00
96" x 36"	—	—	—	—	—	—	—	—	YA-2116	241.00	YA-2121	271.00

Model No. **XB-1818**—Hardware for securing tops to bench legs. 14x1 hex washer head tapping screws, slotted. Pkg. of 8 .....\$1.00  
 Model No. **XB-1819**—Penetrating Oil. All ingredients meet NSF formulation review for use on food preparation surfaces. Specially designed for 1-1/2" butcher block maple and 1-3/4" butcher block birch oil finished tops. ....\$6.20

# Bench System Tops



**1-1/4" PLASTIC LAMINATE TOP.**  
Now you can have a tough, stable work surface at an economical price. High-pressure laminate top and sides are supported by a phenolic backer sheet. 1-1/8" thick core is constructed of 45-lb. density particleboard.



**1-3/4" PARTICLEBOARD CORE PLASTIC LAMINATE TOPS**  
Ideal work surface for delicate precision jobs. Core is constructed of two 7/8" thick pieces of industrial-grade 45-lb. density particleboard. Self-edged high-pressure plastic laminate top and sides are balanced by a Resobak backer sheet.



**1-5/8" ARMOR EDGE TOP.**  
Resists moisture and rough treatment. High pressure plastic laminate top covers the 45-lb. density particleboard core. "Armor Edge" surrounds entire top perimeter.

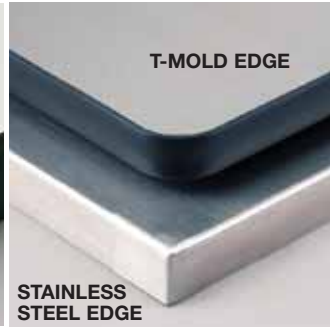

**TYPE 304 STAINLESS STEEL TOPS**  
Choose either 1-1/4" thick top with industrial strength particle board core topped by 16-ga. Type 304 stainless steel with #4 finish and hard rubber T-mold edge and backer sheet; or 1-1/2" thick top with 1-7/16" thick MDF core topped by 16-ga. Type 304 stainless steel with #3 finish and welded, polished smooth stainless steel edge and melamine backer sheet.

Size W x D	1-1/4" PLASTIC LAMINATE		1-3/4" PLASTIC LAMINATE				ARMOR EDGE		1-1/4" & 1-1/2" STAINLESS STEEL			
	White Leather Finish - 1-1/4" Square Edge		White Leather Finish - 1-3/4" Square Edge		White Leather Finish - 1-3/4" Comfort Edge		White Leather Finish - 1-5/8" Comfort Edge		Type 304 #4 Finish - 1-1/4" T-Mold Edge		Type 304 #3 Finish - 1-1/2" Stainless Steel Edge	
	Model No.	Price Ea.	Model No.	Price Ea.	Model No.	Price Ea.	Model No.	Price Ea.	Model No.	Price Ea.	Model No.	Price Ea.
48" x 30"	YB-1820	\$97.90	—	—	—	—	—	—	—	—	—	—
60" x 30"	YB-1821	110.00	YS-1635	\$140.00	YS-1990	\$151.00	YB-1846	\$166.00	YS-1890	\$305.00	YS-1893	\$313.00
72" x 30"	YB-1822	131.00	YS-1636	161.00	YS-1991	178.00	YB-1847	196.00	YS-1891	326.00	YS-1894	381.00
96" x 30"	—	—	YS-1637	217.00	YS-1992	241.00	—	—	YS-1892	492.00	YS-1895	440.00
72" x 36"	YB-1824	162.00	YS-1638	195.00	YS-1993	212.00	YB-1849	234.00	—	—	—	—

\*96" tops require 3 legs and 2 stringers.

ALL BENCH TOPS ARE **IN STOCK**



**1-3/4" LUMBER CORE PLASTIC LAMINATE TOP.**  
Dependable, stable work surface for use where cleanliness is a must. Layered 1-3/4" thick core features high-strength lumber sandwiched between two 3/8" thick particleboard sheets. Plastic laminate face on top and edges with backer sheet on bottom. Square edge or 180° comfort edge. White leather finish.



**1-1/4" & 1-3/4" ESD TOPS**  
Prevents static electricity from damaging delicate components. Industrial-grade 45-lb. density particleboard core is surrounded by static-dissipating laminate face and self-edged sides. Choose one of two sizes: square 1-1/4" thick top with 1-1/8" thick core and phenolic backer sheet or "comfort" edged 1-3/4" thick top with two-piece 7/8" thick core and Resobak backer sheet.



**1-1/2" PLASTIC LAMINATE HARDWOOD EDGE TOPS**  
Hardwood beveled front edge gives this top a distinctive flair. High-pressure plastic laminate top and Resobak backer sheet surround the two 3/4" thick pieces of industrial-grade 45-lb. density particleboard.



**1-3/4" PLASTIC LAMINATE T-MOLD EDGE TOPS**  
Designed for strength and stability. High-pressure gray plastic laminate top and phenolic backer sheet surround the two 3/4" thick pieces of industrial-grade particleboard. Black vinyl T-mold edging with radius corners.

Size W x D	1-3/4" PLASTIC LAMINATE				1-1/4" & 1-3/4" ESD TOPS				1-1/2" PLASTIC LAMINATE		1-3/4" PLASTIC LAMINATE	
	White Leather Finish - 1-3/4" Square Edge		White Leather Finish - 1-3/4" Comfort Edge		Almond Finish - 1-1/4" Square Edge		Almond Finish - 1-3/4" Comfort Edge		White Leather Finish - 1-1/2" Beveled Edge		Gray Finish - 1-3/4" T-Mold Edge	
	Model No.	Price Ea.	Model No.	Price Ea.	Model No.	Price Ea.	Model No.	Price Ea.	Model No.	Price Ea.	Model No.	Price Ea.
60" x 30"	YB-1831	\$182.00	YB-1841	212.00	YS-1643	\$188.00	YS-1648	\$261.00	YS-1653	\$161.00	YS-1658	\$171.00
72" x 30"	YB-1832	217.00	YB-1842	253.00	YS-1644	226.00	YS-1649	303.00	YS-1654	192.00	YS-1659	192.00
96" x 30"	YB-1833	302.00	—	—	YS-1645	312.00	—	—	YS-1655	268.00	YS-1660	267.00
72" x 36"	YB-1834	256.00	YB-1844	310.00	YS-1646	279.00	—	—	YS-1656	231.00	YS-1661	237.00
96" x 36"	—	—	—	—	YS-1647	389.00	—	—	YS-1657	321.00	YS-1662	330.00

\*96" tops require 3 legs and 2 stringers.

# Workbench Accessories

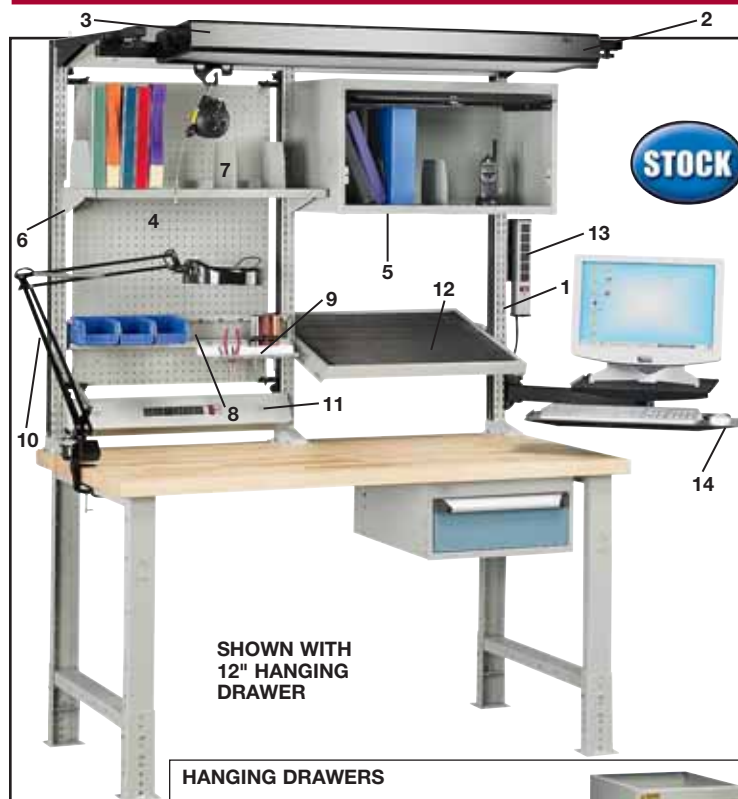

SHOWN WITH  
12" HANGING  
DRAWER

## ROUSSEAU® Workbench Accessories

Customize your existing workstation with these practical accessories. Accessory supports screw directly into either 60" or 72" workbench top. OVERHEAD CABINET has a locking roll-down door. MAGNIFIER LIGHT is a clamp style for placement anywhere along bench top. Precision 45" balanced reach light has 5", 5-diopter lens and includes 22-watt fluorescent tube. MONITOR ARM includes 13-3/4" x 13-3/4" monitor platform, 19-1/4" x 8" keyboard tray and left- or right-hand side pull-out mouse tray. **IN STOCK.**

Key	Model No.	Description	Lbs.	Price Ea.
1	YA-2800*	Accessory Supports (1 set)	46.6	\$216.00
2	YA-2801	Overhead Light & Support Arms	37.9	375.00
3	YA-2802†	Tool Rail and Trolley	8.2	150.00
4	YA-2803	Perforated Steel Panel 1/4" holes (hooks not included)	13.9	90.60
5	YA-2804	Locking Overhead Storage Cabinet	28.2	286.00
6	YA-2805	Tiltable Shelf, 0-15° (div. not incl.)	5.5	36.70
7	YA-2806	Divider, for Tiltable Shelf & Cabinet (1 ea.)	0.6	8.60
8	YA-2807	Bin Rail (bins not included)	4.5	22.50
9	YA-2808	Tool Tray (hangs from bin rail)	0.7	19.00
10	YA-2809	Clamp Style Magnifier Light	9.7	73.00
11	YA-2818	Power Channel, 6 outlets, 15 amp	6.6	136.00
12	YA-2810	Tiltable Pan Shelf, 0-30° in 5 positions, incl. rubber mat	11.0	114.00
13	YA-2819	Vertical Power Channel, 5 outlets, 15 amp	2.2	89.80
14	YA-2811	Monitor Arm with Keyboard and Mouse Tray, 50-lb. cap.	17.5	231.00

\*Accessory support is required for all other options.  
† (#2) overhead light and support arms are required.

### HANGING DRAWERS

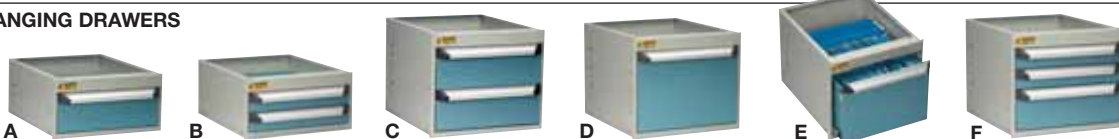

Key	Model No.	Drawer Description	W x D x H	Lbs.	Price Ea.
A	YA-2812	One 6" drawer and two dividers	18" x 21" x 9"	27	\$141.00
B	YA-2813	Two 3" drawers and four dividers	18" x 21" x 9"	32	214.00
C	YA-2814	Two 6" drawers and four dividers	18" x 21" x 15"	44	260.00
D	YA-2815	One 12" drawer	18" x 21" x 15"	30	191.00
E	YA-2816	One 12" drawer and folder hanger bars	18" x 21" x 15"	31	201.00
F	YA-2817	Two 3", one 6" drawer and 12 dividers	18" x 21" x 15"	48	353.00

**FACTORY QUICK SHIP**

## Bench-Mounted Tool Jibs

Easily mounts to any bench to keep tools within your reach. Choose the fixed or swing boom, which swings 180°. Columns are 48"H with a 24" or 36"L boom. Boom and bracket are height-adjustable. Includes tool hook or rolling tool trolley and balancer trolley. Rated 30 lbs. maximum capacity. Constructed of all steel with a baked polyester finish. All hardware included (except hardware for mounting to bench). **FACTORY QUICK SHIP—FOB WISCONSIN.**

Model No.	Description	Cap.	Wt.	Lbs.	Price Ea.
YK-2835	Jib Kit, 24" Fixed Boom w/Fixed Hook	30	10		\$187.00
YK-2836	Jib Kit, 36" Fixed Boom w/Trolley	30	11		235.00
YK-2837	Jib Kit, 36" Swing Boom w/Trolley	30	12		333.00

Model No. **YK-2838—Adjustable Utility Bracket.** Lets you attach power cords, air hose, peg board, clip board, etc. Includes hardware. Wt. 2 lbs. ....\$12.10  
 Model No. **YK-2839—Optional Backing Plate.** Fits beneath bench surface. Aids in mounting tool jib to base. ....\$31.70

## Tool Balancers



Balances and holds tools in position while you work. When properly adjusted, these balancers make tools weightless. Ideal for assembly, quality control and maintenance operations.

### STANDARD-DUTY BALANCERS.

Include adjustable tension and drag brake. Housing is made of molded ABS plastic. Smooth exterior and rounded edges won't cut you or snag clothes. Features 6' galvanized steel aircraft cable, steel hanging eye and tool hook and adjustable cable stop. 4"W x 2.88" thick x 9-1/4"H.

**FACTORY QUICK SHIP—FOB INDIANA.**

Model No.	Cap. Lbs.	Wt. Lbs.	Price Ea.
YK-2849	1/2-1-1/2	1.3	\$53.70
YK-2850	1-1/2-3	1.3	53.70
YK-2851	3-5	1.3	53.70

### HEAVY-DUTY BALANCERS.

Features an 8'L galvanized steel aircraft cable that is 920-lb. test and nylon covered. Spring is permanently lubricated for long-term use. Built-in ratchet lock easily released with slight pull on cable. Ratchet lock may be disengaged externally for constant pull operation. All-steel construction with a baked polyester finish. Includes safety tool clip and adjustable cable stop. 8-3/4"W x 3.35" thick x 13.88"H. **FACTORY QUICK SHIP—FOB WISCONSIN.**

Model No.	Cap. Lbs.	Wt. Lbs.	Price Ea.
YK-2856	3-7	6	\$185.00
YK-2857	5-10	6	256.00
YK-2858	8-12	7	277.00
YK-2859	10-15	8	310.00
YK-2860	16-23	8	312.00



# Workbench Accessories

## WILTON Precision Vise

Strong, durable vise is a must where precision is important. Vise includes keyed round slide bar, sealed lubrication, and "straight line" pull for nut and spindle. Movable section is lathe turned, stationary segment is bored for precision fit. Replaceable powdered metal pipe jaws and top jaws offer a strong, hard bite. Extra deep throat for extra holding capacity. **IN STOCK.**



Model No.	Jaw Width	Max. Opening	Pipe Cap.	Wt. Lbs.	Price Ea.
XP-0531	4-1/2"	4"	1/4" - 2-1/2"	33	\$416.00
XP-0532	5-1/2"	5"	1/4" - 3"	49	495.00
XP-0533	6-1/2"	6-1/2"	1/4" - 3-1/2"	70	634.00

## WILTON Utility Vise

Heavier body accepts the toughest work loads. Vise includes: replaceable steel top jaws, locking swivel base, and extra large anvil with polished non-mar surface that won't damage work pieces. 3/16" steel box frame slide insures long lasting performance. 1/8"-3" dia. pipe jaws. **IN STOCK.**



Model No.	Jaw Width	Max. Opening	Pipe Cap.	Wt. Lbs.	Price Ea.
XP-0534	4"	5"	1/8" - 2-1/2"	36	\$115.00
XP-0535	5"	5-1/2"	1/8" - 2-1/2"	45	137.00
XP-0536	6"	7"	1/8" - 3"	65	219.00

## Multiple Item Outlet Strips

Feature grounded three-prong outlets and cords, as well as master switches for central on/off convenience (except 4 outlet standard strips). 15 amp, 125V AC rating. Mounts easily on wall or bench. **IN STOCK.**

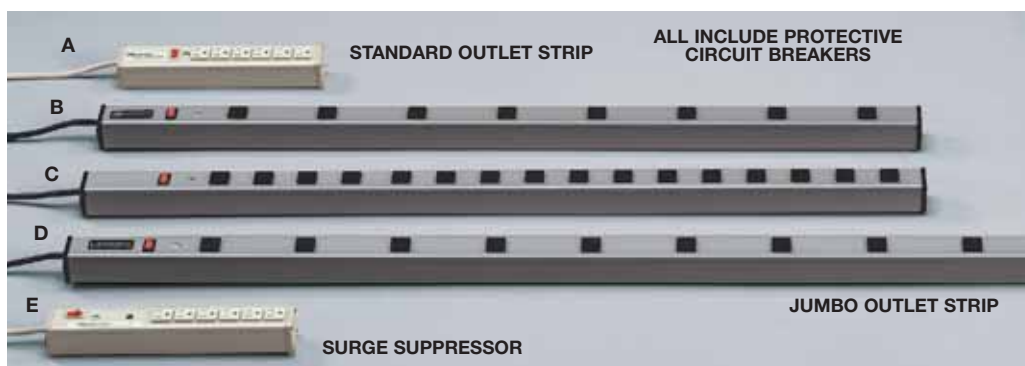

**JUMBO STRIPS.** Heavy-duty, housing is constructed of lightweight aluminum. UL listed.

**SURGE PROTECTORS.** Maximum surge protection of 6000V. 325V clamping surge, 10 nanosecond response time. 10 to 40 dB (V ratio). Frequency range 100 KHZ to 30 MHZ. Suppressor indicator light and lighted power switch.

Key Letter	Model No.	Quantity	Cord Length	Wt. Lbs.	Price Each
<b>STANDARD OUTLET STRIPS</b>					
A	YP-0522	6 outlets	6 ft.	2	\$25.80
A	YP-0523	6 outlets	15 ft.	2-1/2	30.10
<b>JUMBO, 4-FT. LONG OUTLET STRIPS</b>					
B	YP-0524	8 outlets	6 ft.	6	\$73.30
B	YP-0525	8 outlets	15 ft.	7	79.20
C	YP-0526	16 outlets	6 ft.	6	88.50

Key Letter	Model No.	Quantity	Cord Length	Wt. Lbs.	Price Each
<b>JUMBO, 6-FT. LONG OUTLET STRIPS</b>					
D	YP-0527	12 outlets	6 ft.	6	\$69.90
<b>SURGE SUPPRESSOR OUTLET STRIPS</b>					
E	YP-0529	6 outlets	6 ft.	4	\$51.10
E	YP-0530	6 outlets	5 ft.	4-1/2	55.70

## BOTT® Steel Toolboards

Practical panels add tool storage to your workbench. Constructed of reinforced steel, each 39"W x 18"H panel holds up to 160 lbs. Choose either the perfo panel that accepts lock-on hooks, clips, and accessories or the louvered panel that holds plastic bins. Two panels per pack. Includes workbench mounting brackets. Order accessories and bins separately. Color: blue. **IN STOCK.**

Model Number	Description	Wt. Lbs.	Price Each
XP-1020	Perfo-Panels	20	\$137.00
XP-1021	Louvered-Panels	20	141.00

NOTE: Bins for louvered panels sold on page 201.

### LOCK-ON TOOLHOLDER SETS

Handy kits hold all the hooks, holders, and clips you'll need to store items on your perfo panel. Industrial-grade, zinc-plated heavy steel units lock on to panels and will not come out when tools are removed. Hook ends are protected with plastic caps. **IN STOCK.**

Model No.	Description	Wt. Lbs.	Price Ea.	Pkg.
XP-1022	10-Piece Set includes: (2) Plier hooks, (2) Ring hooks, (2) Cable loop hooks, (2) Tool flex clamps, & (2) Single-spring clips.	1.6	\$46.40	
XP-1023	38-Piece Set includes: (15) Assorted single hooks, (5) Double hooks, (1) Seven-wrench rack, (4) Assorted plier hooks, (2) Hack saw holders, (1) Screwdriver rack, (5) Single-spring clips, & (5) Double-spring clips.	6	117.00	
XP-1024	68-Piece Set includes: (30) Assorted single hooks, (20) Double hooks, (1) Seven wrench rack, (1) Drill holder, (1) Screwdriver rack, (15) Assorted spring clips.	10.5	179.00	

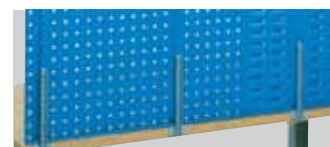

WORKBENCH MOUNTING BRACKETS SHOWN.

# Workstations

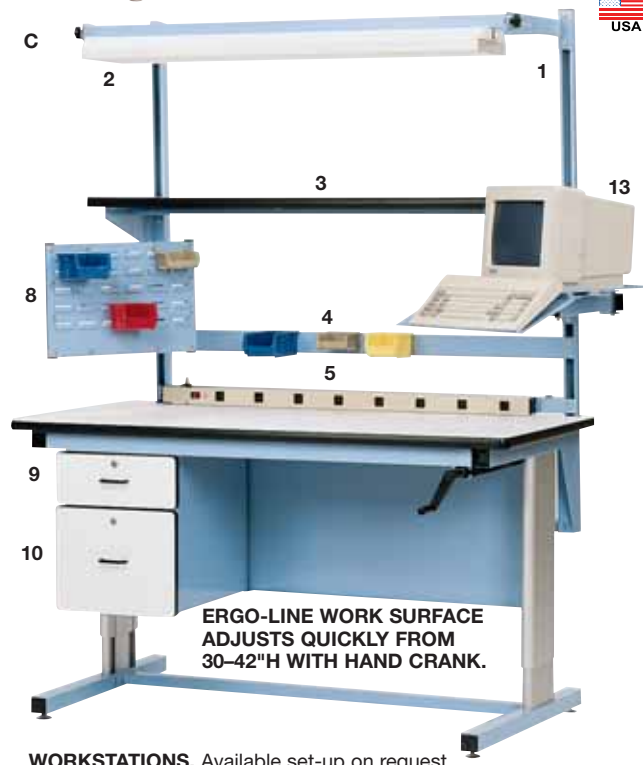
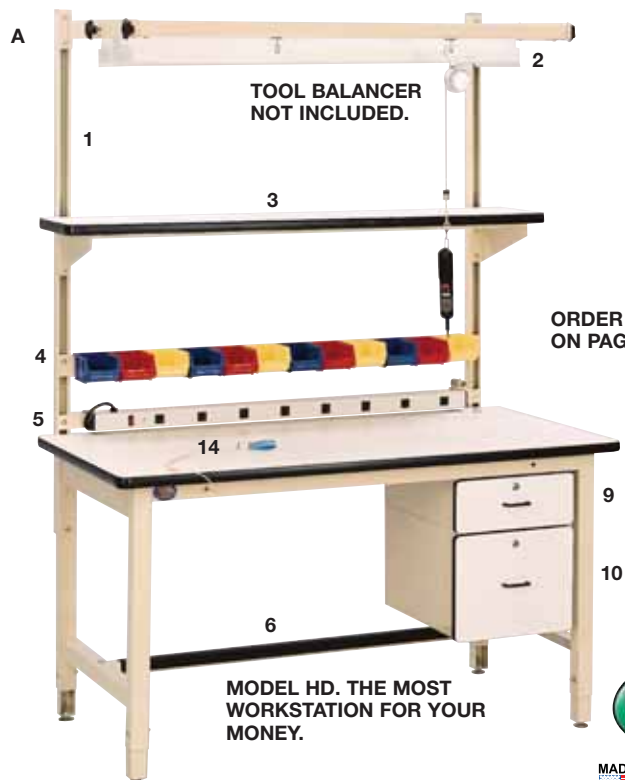

## PRO-LINE Workstations

Perfect for labs or clean rooms, versatile workstations provide the rugged strength for demanding jobs, the ergonomics for comfortable working positions, and the aesthetics for a more pleasant environment – all at an affordable price! Whatever your job, you'll appreciate the high-quality features incorporated in these workstations. Top-grade construction, for instance, includes 16-ga., 2" sq. tubular legs that provide no-wobble stability and plastic laminated tops with T-mold edging to eliminate sharp corners. Benches are 30"H. Choose from a variety of options including modular drawers with laminated faces for a high-tech look. Ships unassembled. **SPECIFY STEEL FRAME COLOR: BE - Light beige, BL - Sky Blue, GY - Gray. FACTORY QUICK SHIP – FOB MASSACHUSETTS.**

### A. HD WORKSTATIONS

Incorporate modular design, strength, and aesthetics into a basic workstation with every accessory available. Independent four-leg design for maximum stability with plenty of leg room. Workstation surface adjusts from 30–36"H.

### B. CHD WORKSTATIONS WITH RECESSED LEGS

For those who want the versatility of an independent workstation, but also need the front legs recessed for additional leg clearance. Comes standard with modesty panel.

### C. ERGO-LINE WORKSTATIONS

Repetitive motion injuries can be greatly reduced and productivity increased by using this ergonomically designed workstation. Ergo-Line allows operators of all sizes to change their work surface height with an easy-to-use, hand-operated crank. Adjusts height from 30–42"

**WORKSTATIONS.** Available set-up on request.

Top	60x30" BASIC BENCHES			72x30" BASIC BENCHES		
	Model Number	Wt. Lbs.	Price Each	Model Number	Wt. Lbs.	Price Each
<b>HD WORKSTATIONS</b>						
Plastic	WG-4345	115	\$457.00	WG-4347	130	\$498.00
ESD	WG-4346	115	629.00	WG-4348	130	699.00
<b>CHD WORKSTATIONS</b>						
Plastic	WG-3010	138	\$492.00	WG-3012	158	\$541.00
ESD	WG-3011	138	665.00	WG-3013	158	740.00
<b>ERGO-LINE WORKSTATIONS</b>						
Plastic	WG-3014	175	\$1438.00	WG-3016	155	\$1517.00
ESD	WG-3015	140	1608.00	WG-3017	155	1715.00

### ACCESSORIES

Key	Description	FOR 60x30" BENCH			FOR 72x30" BENCH		
		Model Number	Wt. Lbs.	Price Each	Model Number	Wt. Lbs.	Price Each
1.	Accessory Supports (pr.)	WG-4353	20	\$66.90	WG-4353	20	\$66.90
2.	Light & Frame*	WG-4354	27	240.00	WG-4369	38	253.00
3.	12" Shelf*	WG-4355	28	138.00	WG-4370	34	154.00
4.	Bin Holder†*	WG-4356	6	33.50	WG-4371	7	36.70
5.	Power Strip*	WG-4359	1	108.00	WG-4376	1	116.00
6.	Footrest & Guard	WG-4358	7	57.00	WG-4372	7	63.00
7.	Air Supply*	WG-4357	1	61.90	WG-4375	1	68.00
8.	Louvered Panel on Arm*	WG-5634	19	276.00	WG-5634	19	276.00
9.	6"H Drawer	WG-4361	26	193.00	WG-4361	26	193.00
10.	12"H Drawer	WG-4362	28	235.00	WG-4362	28	235.00
11.	Pullout Writing Shelf	WG-3018	12	170.00	WG-3018	12	170.00
12.	Tool Suspension Frame‡	WG-3019	13	96.20	WG-3020	14	109.00
13.	Monitor Support On Arm*	WG-4368	32	160.00	WG-4368	32	160.00
14.	Wrist Strap	WG-4363	.5	64.00	WG-4363	.5	64.00
—	Magnifier Light**	WG-3023	10	248.00	WG-3023	10	248.00

†Bins sold separately. \*Requires Accessory Supports. ‡Requires Light & Frame. \*\*Specify color for bracket only. Light and arm are black.

# Packing Benches



## BUILT-RITE Packing Benches

Everything you need to organize and speed packing operations is right here. High-pressure laminate top supports up to 200 lbs. per square foot. Double stringer keeps legs from collapsing when fully loaded. Customize your own bench by starting with basic bench and adding accessories below; or order the complete bench which includes: light standard and shop light (bulbs not included), overhead carton storage rack, adjustable catalog shelf, bin rail for plastic bins, power strip, and under bench tissue shelf. Color: gray. **IN STOCK.**

### COMPLETE PACKING BENCHES (as shown).

<b>XV-1833</b> —60" x 30". Wt. 365 lbs. ....	<b>\$1127.00</b>
<b>XV-1834</b> —72" x 30". Wt. 411 lbs. ....	<b>\$1201.00</b>

### BASIC BENCHES

<b>XV-1835</b> —60" x 30". Wt. 155 lbs. ....	<b>\$306.00</b>
<b>XV-1836</b> —72" x 30". Wt. 171 lbs. ....	<b>\$330.00</b>

### OPTIONS FOR PACKING BENCHES

Key	Description	Model No.	Wt. Lbs.	Price Ea.
<b>FOR 60"W BENCHES</b>				
1	Overhead Frame	<b>XV-1837</b>	48	<b>\$131.00</b>
2	48"L Shop Light (w/o bulbs)*	<b>XV-1851</b>	15	<b>77.00</b>
3	15"D Overhead Carton Storage*	<b>XV-1840</b>	62	<b>152.00</b>
4	12"D Adjustable Catalog Shelf*	<b>XV-1842</b>	22	<b>85.50</b>
5	Bin Rail*	<b>XV-1844</b>	15	<b>38.10</b>
6	Power Strip*†	<b>XV-1846</b>	4	<b>64.90</b>
7	Under Bench Tissue Shelf	<b>XV-1847</b>	44	<b>153.00</b>
8	Under Bench Carton Storage	<b>XV-1849</b>	70	<b>203.00</b>
<b>FOR 72" WIDE BENCHES</b>				
1	Overhead Frame	<b>XV-1838</b>	48	<b>\$136.00</b>
2	48"L Shop Light (w/o bulbs)*	<b>XV-1851</b>	15	<b>77.00</b>
3	Overhead Carton Storage*	<b>XV-1841</b>	79	<b>162.00</b>
4	Adjustable Catalog Shelf*	<b>XV-1843</b>	24	<b>94.20</b>
5	Bin Rail*	<b>XV-1845</b>	18	<b>40.30</b>
6	Power Strip*†	<b>XV-1846</b>	4	<b>64.90</b>
7	Under Bench Tissue Shelf	<b>XV-1848</b>	52	<b>167.00</b>
8	Under Bench Carton Storage	<b>XV-1850</b>	78	<b>224.00</b>

\*Requires one overhead frame †Requires one bin rail



## PRO-LINE Packing Benches

Sturdy packing benches store everything you need to complete mail room tasks. Choose either the fully accessorized complete bench or add accessories to the basic bench that includes top, adjustable legs and rear support. Both benches include 30" deep worksurfaces and strong 16-ga. square tubular legs with extenders that raise or lower tops from 30-36" in 1" increments. Choose either: plastic laminate top with T-mold edging or sturdy, hardwood maple top. Light bulbs and paper roll not included. Color: gray. **FACTORY QUICK SHIP—FOB MASSACHUSETTS.**

W x D	PLASTIC LAMINATE			MAPLE		
	Model No.	Wt. Lbs.	Price Ea.	Model No.	Wt. Lbs.	Price Ea.
<b>COMPLETE BENCHES (AS SHOWN)</b>						
60" x 30"	<b>XC-1191</b>	242	<b>\$1535.00</b>	<b>XC-1192</b>	267	<b>\$1666.00</b>
72" x 30"	<b>XC-1193</b>	295	<b>1606.00</b>	<b>XC-1194</b>	315	<b>1775.00</b>
<b>BASIC BENCHES</b>						
60" x 30"	<b>XC-1195</b>	110	<b>\$381.00</b>	<b>XC-1196</b>	135	<b>\$520.00</b>
72" x 30"	<b>XC-1197</b>	125	<b>401.00</b>	<b>XC-1198</b>	145	<b>558.00</b>

### OPTIONS FOR PACKING BENCHES

Key	Description	FOR 60"W BENCHES			FOR 72"W BENCHES		
		Model No.	Wt. Lbs.	Price Ea.	Model No.	Wt. Lbs.	Price Ea.
1	Accessory Upright Supports/pr.	<b>XC-1199</b>	25	<b>\$94.30</b>	<b>XC-1199</b>	25	<b>\$94.30</b>
2	Overhead Light Fixture & Frame*	<b>XC-1200</b>	15	<b>128.00</b>	<b>XC-1201</b>	18	<b>134.00</b>
3	Top Shelf	<b>XC-1202</b>	22	<b>157.00</b>	<b>XC-1203</b>	28	<b>169.00</b>
4	Shelf Dividers for Top Shelf/pk. 4	<b>XC-1204</b>	8	<b>101.00</b>	<b>XC-1204</b>	8	<b>101.00</b>
5	Cantilever Shelf*	<b>XC-1205</b>	15	<b>117.00</b>	<b>XC-1206</b>	20	<b>128.00</b>
6	Shelf Dividers for Cantilever Shelf/pk. 4	<b>XC-1207</b>	4	<b>54.00</b>	<b>XC-1207</b>	4	<b>54.00</b>
7	Paper Spool Holder*	<b>XC-1208</b>	6	<b>74.80</b>	<b>XC-1209</b>	13	<b>81.80</b>
8	Bin Holder*	<b>XC-1210</b>	2.5	<b>35.70</b>	<b>XC-1211</b>	3	<b>39.30</b>
9	Electrical Supply/6 Outlets†	<b>XC-1212</b>	3	<b>73.60</b>	<b>XC-1212</b>	3	<b>73.60</b>
10	Storage Shelf	<b>XC-1213</b>	12	<b>148.00</b>	<b>XC-1214</b>	18	<b>167.00</b>
11	Bottom Shelf	<b>XC-1215</b>	12	<b>123.00</b>	<b>XC-1216</b>	18	<b>138.00</b>
12	Shelf Dividers for Bottom Shelf/pk. 4	<b>XC-1217</b>	12	<b>111.00</b>	<b>XC-1217</b>	12	<b>111.00</b>

\*Requires 1 pr. accessory upright supports. †Requires one bin holder.



# Computer Workstations



**OTHER COLORS AVAILABLE:**

<b>BL - BLUE</b>	<b>BK - BLACK</b>	<b>GY - GRAY</b>
<b>LG - LT. GRAY</b>	<b>PY - PUTTY</b>	

**STOCK**  
Selected Models

**ATLANTIC METAL Computer Cabinet**

Designed to protect your entire computer system from damage or theft. Quality 20-22-ga. construction features a 26"W x 24"D x 25"H monitor cabinet and 37"H pull-out keyboard tray. 26"W x 24"D x 32"H lower cabinet includes an adjustable shelf for your CPU, printer, and supplies. All cabinets and drawers lock for extra security. 26"W x 24"D x 63"H overall. Ships assembled. Electrostatic powder coat textured finish. **SPECIFY COLOR: BK - Black, BL - Blue, GY - Gray, LG - Light gray, PY - Putty, RD - Red. BL - BLUE AND GY - GRAY ARE IN STOCK.** Others FOB PENNSYLVANIA.

Model No. **XA-2290**—Wt. 125 lbs. ....\$471.00



**OTHER COLORS AVAILABLE:**

<b>PY - PUTTY</b>
<b>LG - LT. GRAY</b>
<b>BK - BLACK</b>

**STOCK**  
Selected Models

**EDSAL Computer Cabinet**

All-welded 24-ga. steel cabinet secures and protects your entire computer system. 20-3/4"W x 21-3/4"D x 19-1/4"H top cabinet includes a protective plexiglas® window that offers full view of enclosed monitor. 19-1/2"W x 18"D x 2-1/8"H pull-out drawer houses keyboard, mouse, and small items. 20-3/4"W x 21-1/4"D x 23-1/2"H lower cabinet includes one adjustable shelf to store tower or desktop CPUs, printer, paper, or other supplies. Four 5" casters—2 rigid, 2 swivel with brake. 24-1/2"W x 22-1/2"D x 59-1/2"H overall. Ships unassembled in 2 pieces. Durable powder coat finish. **SPECIFY COLOR: BK - Black, BL - Blue, LG - Light gray, PY - Putty. BL - BLUE, LG - LIGHT GRAY AND PY - PUTTY ARE IN STOCK.** Others FOB ILLINOIS.

Model No. **XA-2295**—Wt. 100 lbs. ....\$457.00



**EDSAL Mobile Security Computer Workstation**

Durable 26"W x 24"D x 62-1/2"H all-steel cabinet protects your valuable computer investment from theft, sabotage, or harmful dust. 26"W x 24"D x 25"H top cabinet has a 19" monitor storage shelf and pull-out keyboard tray. Pull-down door locks for secure storage. 26"W x 24"D x 32"H locking bottom cabinet has three shelves to hold printer, CPU, and other supplies. Other features include: built-in surge suppressor with 6 outlets, 4" rubber wheel swivel casters—2 with brakes, and scratch resistant blue and gray enamel finish. **IN STOCK.**

**STOCK**

Model No. **XV-2687**—Wt. 135 lbs. ....\$807.00



**STOCK**

**Mobile Computer Stand**

All-in-one workcenter is ideal for areas where public access to computer files is necessary. Top shelf offers plenty of room for monitor and mouse pad. End and back stops prevent items from sliding off during transport. Pull-out keyboard tray features an ergonomic wrist rest. Fixed shelf accommodates sheet-fed or laser printers. House CPU, hard drive, paper, etc. in the locking lower cabinet. Interior shelf adjusts to fit tower CPUs. Rolls on 5" polyolefin casters—2 rigid, 2 swivel with brakes. 27"W x 24"D x 49-1/4"H overall. Ships knocked down. **SPECIFY COLOR: BL - Blue, GY - Gray. IN STOCK.**

Model No. **XC-1086**—Wt. 125 lbs. ....\$465.00

# Computer Workstations

OTHER COLORS AVAILABLE:

BL - BLUE

BK - BLACK

GY - GRAY

PY - PUTTY



## ATLANTIC METAL Countertop Computer Cabinet

Protect your computer from unauthorized access inside this security cabinet. Countertop unit features a locking compartment with 1/8" thick Plexiglas® window and locking keyboard drawer that slides out when needed. Cabinet also includes louvered back for ventilation, wire management system, and adjustable chrome leveling glides. All-welded unit ships assembled. **SPECIFY COLOR: BK - Black, BL - Blue, GY - Gray, LG - Light Gray, PY - Putty.** FOB PENNSYLVANIA.

Model No. **XA-2235**—Wt. 86 lbs.....\$300.00



## EDSAL Premier Computer Enclosure

Practical cabinet houses your entire computer system as well as files and other supplies. 33"W x 18"D x 18-1/4"H top compartment has enough room to store most monitors and CPUs. Slide-out tray holds both keyboard and mouse, while the center compartment features a pull-out shelf that adjusts to accommodate different sized printers. Also includes a lower drawer for hanging files. Everything locks separately. 35"W x 30"D x 62"H overall. Tough, powder coat finish. Color: light gray. Ships set-up. **IN STOCK.**

Model No. **XA-1030**—Wt. 196 lbs. ....\$976.00



## EDSAL Mobile Extra-Wide Computer Workstation

Double-wide design offers plenty of room to house two complete computer workstations. 50"W x 24"D x 64"H unit features all-welded construction and locking doors for complete security. Keyboard shelf slides out beneath the 18-3/4"H upper monitor cabinet while the lower 30"H cabinet includes two shelves that adjust to fit any size equipment. Top and bottom cabinets measure 46-1/2"W x 23"D. Also includes vented back to permit air flow, 6-outlet power strip with built-in surge protection, and 5" polypropylene casters—2 rigid, 2 swivel with brakes. Ships assembled. Color: blue. **IN STOCK.**

Model No. **XS-1529**—Wt. 285 lbs. ....\$1125.00



# Computer Workstations

**FACTORY QUICK SHIP**

**OFM LAN Stations**

Sturdy, computer-friendly unit organizes servers and LAN systems in one convenient location. Open wire construction permits cooling air flow and will not collect dust and dirt like solid shelves. 300-lb. capacity shelves are supported by 1" dia. steel posts with 3" casters. Other features include: keyboard tray, side manuals basket, and paper basket. **SPECIFY COLOR: BK - Black, SV - Silver. FACTORY QUICK SHIP—FOB NORTH CAROLINA.**

Model No. <b>YA-2236</b> —36" x 18" LAN Unit. Wt. 75 lbs. ....	\$184.70
Model No. <b>YA-2237</b> —48" x 18" LAN Unit. Wt. 85 lbs. ....	\$201.00

**YA-2340 SHOWN WITH YA-2341 OPTIONAL UTILITY BASKET AND YA-2342 CASTERS.**

**RELIUS SOLUTIONS Wire Computer Workstation**

Low-profile 72"H shelving takes advantage of unused vertical space to house your entire computer system. Computer-friendly open wire design maximizes air flow between components and eliminates build up of dust and dirt. Includes 650-lb. capacity shelves and fixed keyboard tray. Shelves and keyboard tray adjust in 1" increments. 30"W x 18"D overall. Ships unassembled. Metallic gray powder coat finish. **IN STOCK.**

**STOCK**

Model No. <b>YA-2340</b> —Wire Computer Center. Wt. 55 lbs..	\$288.00
Model No. <b>YA-2341</b> —Utility Basket. 13-1/2"W x 5-1/2"D x 8-1/2"H. Wt. 2 lbs.....	\$27.20
Model No. <b>YA-2342</b> —5" Hard Floor Casters and Bumpers. All swivel, 2 with brakes. Pkg. of 4. Wt. 12 lbs.....	\$92.40

**STOCK**

**Stand-Up Workstation**

Keep computer equipment in one convenient location. 27-5/8"W x 15-3/4"D top shelf holds monitor. 23-5/8"W x 13-3/4"D keyboard shelf features a side tray for mouse and mouse pad. Printer or CPU rest on the 23-5/8"W x 16-1/2"D lower shelf. 27-5/8"W x 19-5/8"D x 44"H overall. Dual wheel casters for easy mobility. Color: gray. Ships via small package carrier. **IN STOCK.**

Model No. <b>XC-1093</b> —Wt. 60 lbs. ....	\$251.00
--	----------

**YA-2343 SHOWN WITH ONE OPTIONAL SHELF YA-2345.**

**STOCK**

**RELIUS SOLUTIONS Mobile Wire Computer Workstations**

Designed to house your entire system, this functional workstation features a computer-friendly open wire construction. Wire shelves permit cooling air flow and will not collect dust and dirt like solid shelves. Includes 9"W x 18"D tower CPU shelf, 9-1/2"W x 9-1/2"D swing-out mouse shelf with mouse pad, and pull-out keyboard tray. Shelves adjust in 1" increments. Rolls on 3" x 1" hard floor swivel casters, 2 with brakes. Ships unassembled. Color: chrome. **IN STOCK.**

Model No. <b>YA-2343</b> —30"W x 18"D x 42"H. Wt. 43 lbs.....	\$216.00
Model No. <b>YA-2344</b> —30"W x 18"D x 32"H. Wt. 43 lbs.....	\$194.00
Model No. <b>YA-2345</b> —Extra Shelf. 29-1/2"W x 18"D. Wt. 8 lbs. ....	\$43.90



CONTROL PANEL AND PLATFORM CAN BE PLACED UP TO 9 FEET APART.

## DO GAIN High-Capacity Digital Weighing Scales

Accurate and rugged. Large bright red LED display. Tare and pound/kg functions. Runs on AC (adapter included) or batteries. **IN STOCK.**

Model Number	Weighing Increments*	Cap. Lbs.	Platform W x D	Wt. Lbs.	Price Each
WP-0074	0.1 lbs.	100	12" x 12-1/2"	14	\$155.00
WP-0075	0.2 lbs.	200	12" x 12-1/2"	14	165.00
WP-0076	0.5 lbs.	500	12" x 12-1/2"	14	191.00
WP-0077	0.2 lbs.	200	15" x 15"	27	205.00
WP-0078	0.5 lbs.	500	15" x 15"	27	210.00

\*Scale weighs load only in the listed increments. For example, 100-lb. capacity scale weighs in 0.1-lb. increments.



DETACHABLE CONTROL PANEL ENABLES YOU TO PUT THE PLATFORM AND CONTROL PANEL UP TO 9 FEET AWAY.



## Pelouze® by RUBBERMAID® Digital Weighing Scales

Durable all-steel platform holds up to heavy use. Wall-mountable control includes digital display on a 9' cord. Tare function. Not legal-for-trade. Operates on AC (adapter included) or 9V battery (not included). **IN STOCK.**



Model Number	Weighing Increments*	Cap. Lbs.	Platform W x D	Wt. Lbs.	Price Each
XP-0116	0.2 lbs.	150	12" x 12-1/2"	11	\$173.00
XP-0118	0.5 lbs.	400	12" x 12-1/2"	12	202.00

\*Scale weighs load only in the listed increments. For example, 150-lb. capacity scale weighs in 0.2-lb. increments.



EASY-TO-READ LED DISPLAY



## FAIRBANKS® Platform Scale

General-use scale has an easy-to-read display. Includes a digital indicator with numeric keypad and LED with adjustable display angle. Uses six D-cell batteries and has an AC power cord. Includes cast iron platform and cast iron wheels. 21"W x 36"D x 48-1/2"H overall. NTEP Certificate. **IN STOCK.**

Model Number	Weighing Increments*	Cap. Lbs.	Platform W x D	Wt. Lbs.	Price Each
XA-0160	0.2 lbs.	1000	23-1/2" x 17-3/4"	175	\$1498.00

\*Scale weighs load only in the listed increments.

## Pelouze® by RUBBERMAID® Economical Weighing Scales with Memory Lock™

Portable scale goes where you need it. Spring-activated weighing function. Other features include: zero tare knob, ribbed platform, and built-in carrying handle. Durable steel construction. **IN STOCK.**



Model Number	Weight Increments*	Cap. Lbs.	Platform W x D	Wt. Lbs.	Price Each
XP-0119	1 lb.	100	13-1/2" x 12-1/2"	36	\$96.50
XP-0120	1 lb.	250	13-1/2" x 12-1/2"	36	104.00

\*Scale weighs load only in the listed increments. For example, 100-lb. capacity scale weighs in 1-lb. increments.



STAINLESS STEEL

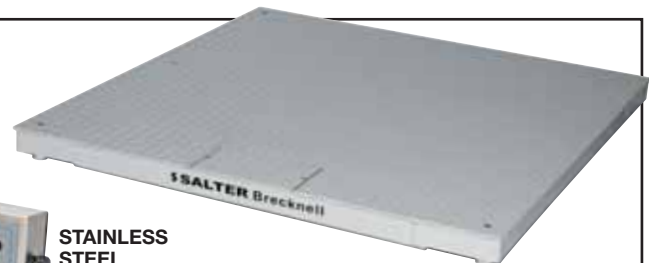

PLASTIC



## SALTER BRECKNELL Floor Scales

Heavy-duty scale offers superior strength. Constructed of 5" channel steel supports. Allows for up to 300% safe overload. Engineered for floor or in-ground applications indoors or outdoors. Platform is 3.75" off the floor and features 3/16" thick safety diamond treadplate. LED display indicator.

**FACTORY QUICK SHIP— FOB MINNESOTA.**

Model No. **YP-7404—**  
Optional Ramp. 48" x 36".  
Wt. 220 lbs.....**\$483.00**

Model Number	Weighing Increment*	Cap. Lbs.	Platform W x D	Wt. Lbs.	Price Each
<b>FLOOR SCALE WITH PLASTIC INDICATOR</b>					
YP-7400	0.5 lbs.	2500	48" x 48"	335	\$1514.00
YP-7401	1.0 lbs.	5000	48" x 48"	335	1514.00
<b>FLOOR SCALE WITH STAINLESS STEEL INDICATOR</b>					
YP-7402	0.5 lbs.	2500	48" x 48"	340	\$1684.00
YP-7403	1.0 lbs.	5000	48" x 48"	340	1684.00

\*Scale weighs loads only in the listed increments. For example, 2500-lb. capacity scale weighs in 0.5-lb. increments.

# Boxes & Accessories

**STOCK**



SEE BACK COVER FOR HERCULES® VERTICAL BALER.

## 200-Lb. Test Corrugated Containers

Puncture-resistant corrugated boxes are approved for shipping via parcel post, truck, rails, express, and UPS. 100% biodegradable. All cartons meet or exceed the standards set forth in Section 222 of the National Motor Freight Classification. Boxes are unmarked so you can add your own labels and stamps. Ships flat to save shipping costs. **IN STOCK.**

Model Number	Overall L x W x H	Bundle Quantity	Wt. Lbs. Per Bundle	Price Ea. †-100
XP-0554	4" x 4" x 4"	25	5	\$0.32
XP-0555	5" x 5" x 5"	25	5	0.39
XP-0556	6" x 6" x 4"	25	6	0.29
XP-0557	6" x 6" x 6"	25	8	0.29
XP-0558	7" x 5" x 5"	25	7	0.56
XP-0559	7" x 7" x 5"	25	16	0.50
XP-0560	7" x 7" x 7"	25	10	0.44
XP-0561	8" x 6" x 4"	25	15	0.32
XP-0562	8" x 6" x 6"	25	10	0.49
XP-0563	8" x 8" x 4"	25	16	0.40
XP-0564	8" x 8" x 6"	25	16	0.53
XP-0565	8" x 8" x 8"	25	13	0.37
XP-0566	8" x 8" x 10"	25	15	0.74
XP-0567	9" x 7" x 5"	25	10	0.84
XP-0568	9" x 9" x 9"	25	12	0.50
XP-0569	10" x 6" x 4"	25	16	0.56
XP-0570	10" x 6" x 6"	25	18	0.58
XP-0571	10" x 8" x 4-1/2"	25	21	1.68
XP-0572	10" x 8" x 6"	25	17	0.40
XP-0573	10" x 10" x 3"	25	10	0.79
XP-0575	10" x 10" x 10"	25	18	0.46
XP-0576	11-3/4" x 8-3/4" x 4-3/4"	25	14	0.71
XP-0577	11-3/4" x 8-3/4" x 8-3/4"	25	17	0.85
XP-0578	12" x 6" x 6"	25	11	0.65
XP-0579	12" x 8" x 6"	25	18	0.67
XP-0580	12" x 8" x 8"	25	21	0.56
XP-0581	12" x 9" x 4"	25	14	0.83
XP-0582	12" x 9" x 5"	25	14	0.54
XP-0583	12" x 9" x 6"	25	21	0.63
XP-0584	12" x 9" x 9"	25	19	0.94
XP-0586	12" x 10" x 10"	25	19	0.74
XP-0587	12" x 12" x 4"	25	19	1.08
XP-0588	12" x 12" x 6"	25	19	0.62
XP-0589	12" x 12" x 8"	25	18	1.12

Model Number	Overall L x W x H	Bundle Quantity	Wt. Lbs. Per Bundle	Price Ea. †-100
XP-0590	12" x 12" x 10"	25	19	\$1.22
XP-0591	12" x 12" x 12"	25	27	0.63
XP-0592	13-1/2" x 13-1/2" x 7-1/2"	20	27	1.31
XP-0593	14" x 8" x 6"	25	20	0.82
XP-0594	14" x 10" x 8"	25	17	1.02
XP-0595	14" x 12" x 10"	25	28	0.91
XP-0596	14" x 12" x 12"	25	31	1.34
XP-0597	14" x 14" x 14"	20	29	1.04
XP-0600	15" x 12" x 6"	25	23	1.17
XP-0602	16" x 12" x 4"	25	21	1.11
XP-0603	16" x 12" x 10"	25	29	1.31
XP-0604	16" x 12" x 12"	25	31	1.12
XP-0605	16" x 16" x 16"	20	38	1.17
XP-0606	17" x 11-1/4" x 11-1/2"	20	24	1.83
XP-0608	18" x 12" x 10"	25	30	1.10
XP-0609	18" x 12" x 12"	25	38	1.65
XP-0610	18" x 14" x 12"	25	38	1.39
XP-0613	18" x 18" x 12"	25	29	2.96
XP-0614	18" x 18" x 14"	25	44	1.93
XP-0616	20" x 12" x 12"	25	20	1.61
XP-0617	20" x 16" x 14"	25	29	1.80
XP-0618	20" x 20" x 20"	15	20	2.67
XP-0620	24" x 12" x 12"	20	32	1.56
XP-0621	24" x 15" x 8"	25	40	3.76
XP-0623	24" x 18" x 12"	10	22	4.15
XP-0624	24" x 18" x 18"	10	26	3.91
XP-0625	24" x 24" x 24"	30	120	5.20
XP-0627	29-1/2" x 15" x 12"	25	55	5.70



XR-1612

XP-0628

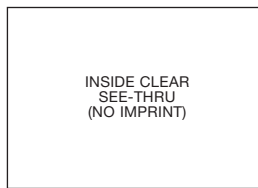

XP-0631

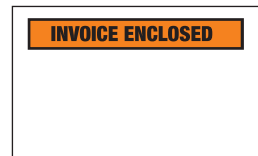

XR-1611



XR-1614



XP-0630

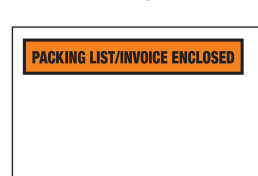

XR-1613

## Pressure-Sensitive Packing List Envelopes

**STOCK**

• 2.5 mil thick  
100% waterproof envelopes won't come off in transit. Polyethylene envelopes are backload or topload style. Clear see-thru. Sold in packages of 1,000. **IN STOCK.**

Model Number	Style	Overall L x W	Price Each
<b>PACKING LIST ENVELOPES</b>			
XP-0628	Backloading	5-1/2" x 4-1/2"	\$30.00
XP-0630	Backloading	5-1/2" x 4-1/2"	30.00
XR-1610	Top loading	7-1/2" x 5-1/2"	65.30
XP-0629	Backloading	10" x 5-1/2"	93.70
<b>INVOICE ENVELOPES</b>			
XR-1611	Backloading	5-1/2" x 4-1/2"	\$28.70
XR-1612	Backloading	5-1/2" x 4-1/2"	28.70
<b>PACKING/INVOICE ENVELOPES</b>			
XR-1613	Backloading	5-1/2" x 4-1/2"	\$28.70
XR-1614	Backloading	5-1/2" x 4-1/2"	28.70
<b>CLEAR ENVELOPES</b>			
XP-0631*	Backloading	12" x 9-1/2"	\$106.00
XP-0633	Backloading	5-1/2" x 4-1/2"	30.00
XR-1617	Top loading	6-3/4" x 10-3/4"	141.00

\*Priced per carton of 500.



# Packaging & Shipping Supplies



## Recycled Bubble Cushioning

Bubble cushioning provides advanced protection for whatever you package and ship. Because it uses air to cushion your products, your shipments will weigh less and cost less to ship. Color: green.

**IN STOCK.**

Model Number	Bubble Size	Roll W x L	Price Each Roll
<a href="#">XP-0194</a>	3/16"	12" x 300'	<b>\$25.50</b>
<a href="#">XP-0195</a>	5/16"	12" x 188'	<b>21.00</b>
<a href="#">XP-0196</a>	1/2"	12" x 125'	<b>19.60</b>
<a href="#">XP-0197*</a>	3/16"	24" x 300'	<b>50.70</b>
<a href="#">XP-0198*</a>	5/16"	24" x 188'	<b>41.00</b>
<a href="#">XP-0199*</a>	1/2"	24" x 125'	<b>37.30</b>

\*Ships via small package carrier.



## INTERTAPE Reinforced Gummed Tape

- Biodegradable kraft or mottled white

Reinforced tapes feature heavy-duty, non-asphaltic gum with tri-directional threads. Order in carton quantities specified.

**IN STOCK.**

Model Number	Roll W x L	Color	Mfg. Code	Tensile Strength	Ctn. Qty.	Wt. Lbs.	Price Per Roll
<a href="#">XP-0139</a>	3" x 375'	Kraft	265	70-75 lbs./in.	8	23	<b>\$71.90</b>
<a href="#">XV-1003</a>	3" x 375'	White	265	70-75 lbs./in.	8	23	<b>93.80</b>



## 3M Tapes

- Polypropylene
- Synthetic rubber adhesive
- Performs in temperatures from -10-120°F

**Economy Grade Tartan #369**™ is ideal for light- to moderate-duty packages. **Standard Grade Scotch® #371** is good for sealing utility boxes. **High Performance Grade #372** is perfect for sealing boxes over 40 lbs. **Heavy-Duty Grade #373** provides a more durable, single strip closure that protects against edge tearing. **Scotch® #375** has superior strength for the most demanding jobs. All meet UPS and US Postal regulations. Order in case quantities specified, priced each.

**SPECIFY COLOR: CL - Clear, TN - Tan.** **IN STOCK.**

Model Number	Roll W x L	Mfg. Code	Tensile Strength	Thickness Mil	Case Qty.	Wt./Case Lbs.	Price Per Roll
<a href="#">XP-0140*</a>	2" x 165'	#369	19 lbs./in.	1.6	36	11	<b>\$2.67</b>
<a href="#">XP-0142</a>	2" x 165'	#371	22 lbs./in.	1.9	36	11	<b>3.01</b>
<a href="#">XP-0143</a>	2" x 165'	#372	26 lbs./in.	2.2	36	16	<b>5.70</b>
<a href="#">XP-0144</a>	2" x 165'	#373	30 lbs./in.	2.5	36	16	<b>7.70</b>
<a href="#">XP-0145</a>	2" x 165'	#375	35 lbs./in.	3.1	36	20	<b>8.40</b>

\*Available in clear only.

### TAPE DISPENSER

- Holds up to 2"W rolls of tape

Side loading with adjustable brake. Stainless steel blade with protector.

Model No. [YL-0930](#) ....**\$23.90**

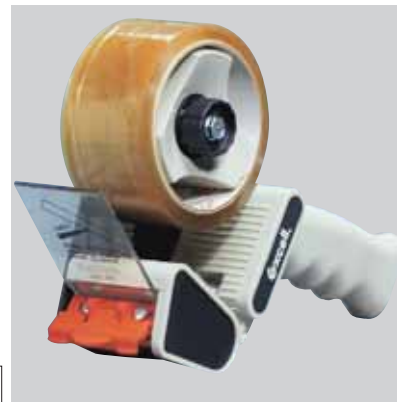

## PAC Steel Strapping Kits

Completely self-contained system is ideal for occasional to moderate strapping operations. Features a 9-1/2"W x 12"D x 12"H heavy-duty steel strapping dispenser with compartments for tools and supplies. Includes heavy-duty feedwheel tensioner, crimper, 500

open seals, strap cutter, and two 200' ribbon wound coils of U.S.-made steel strapping. Ships via small package carrier.

**IN STOCK.**

Model Number	Strap Width	Thickness Mil	Break Strength	Coil Length	Wt. Lbs.	Price Each
<b>STRAPPING KIT</b>						
<a href="#">YP-0390</a>	1/2"	.020"	1175 lbs.	200'	41	<b>\$498.00</b>
<a href="#">YP-0391</a>	5/8"	.020"	1470 lbs.	200'	43	<b>540.00</b>
<a href="#">YP-0392</a>	3/4"	.020"	1765 lbs.	200'	45	<b>540.00</b>
<b>REPLACEMENT STRAPPING, SOLD IN QUANTITIES OF 2, PRICED EACH.</b>						
<a href="#">YP-0393</a>	1/2"	.020"	1175 lbs.	200'	7	<b>\$47.81</b>
<a href="#">YP-0394</a>	5/8"	.020"	1470 lbs.	200'	8	<b>61.00</b>
<a href="#">YP-0395</a>	3/4"	.020"	1765 lbs.	200'	11	<b>68.00</b>



# Stretch Wrap



## Stretch Wrap Dispensers

Heavy-duty dispenser features flexible rubber grips, ball-bearing wrap tension, slotted spool for quick roll changes, and lower spindle. Lightweight dispenser holds rolls up to 18". **IN STOCK.**

Key	Model Number	Description	Wt. Lbs.	Price Each
A	<a href="#">XP-0179</a>	Heavy-duty dispenser	Wt. 4 lbs.	<b>\$94.00</b>
B	<a href="#">XP-0186</a>	Lightweight dispenser	Wt. 3-1/2 lbs.	<b>88.50</b>



## Banding Stretch Wrap

Self-adhesive cast wrap sticks only to itself without harming products or leaving sticky residues. Order in case quantities specified, priced each. Includes one dispenser per case. **IN STOCK.**

Model No.	Roll WxL	Gauge	Case Qty.	Price Ea.
<a href="#">XP-0230</a>	2"x1000'	80	24	<b>\$4.39</b>
<a href="#">XP-0231</a>	2"x700'	120	24	<b>4.73</b>
<a href="#">XP-0232</a>	3"x1000'	80	18	<b>6.70</b>
<a href="#">XP-0233</a>	3"x700'	120	18	<b>6.90</b>
<a href="#">XP-0234</a>	3"x650'	135	18	<b>7.20</b>
<a href="#">XP-0235</a>	3"x600'	150	18	<b>6.10</b>
<a href="#">XP-0236</a>	5"x1000'	60	12	<b>9.30</b>
<a href="#">XP-0237</a>	5"x1000'	80	12	<b>11.30</b>
<a href="#">XP-0238</a>	5"x700'	120	12	<b>11.60</b>
<a href="#">XP-0239</a>	5"x650'	135	12	<b>11.30</b>
<a href="#">XP-0240</a>	5"x600'	150	12	<b>12.60</b>



## Plastic Stretch Wrap

Superior stretchability secures and protects any size or shape pallet load. Clings to itself, eliminating the need for tapes, heat or ties. Puncture- and tear-resistant blown wrap stretches tightly to prevent load shifting. Performs well in deep freezers and is stiffer than cast film. Features exceptional long-term holding power and is ideal for irregular-shaped loads. Available in your choice of 80- or 90-gauge low-density wrap.

Order in quantities of 4, priced each. **IN STOCK.**



Model No.	Roll W x L	Gauge	Price Per Roll
<a href="#">XP-0203</a>	12" x 1,500'	80	<b>\$17.50</b>
<a href="#">XP-0205</a>	18" x 1,500'	80	<b>25.90</b>
<a href="#">XP-0206</a>	12" x 1,500'	90	<b>19.60</b>
<a href="#">XP-0208</a>	18" x 1,500'	90	<b>29.90</b>



## GOODWRAPPER® Extended Core Stretch Wrap



The fingertip control and flexible hand brakes in Goodwrapper's unique disposable handle make tighter and neater pallets in less time. The stretch wrap is tear- and puncture-resistant. During the manufacturing of blown stretch wrap, special additives are included that give wrap its exceptional cling. Keeps on working through temperature changes from -20° to 120° F.

Order 80-gauge for standard loads and 70-gauge for lighter tasks. Order in quantities of 4. **IN STOCK.**

Model No.	Roll W x L	Gauge	Price Per Roll
<a href="#">XP-0180</a>	10" x 1,000'	70	<b>\$19.20</b>
<a href="#">XP-0181</a>	15" x 1,000'	70	<b>25.60</b>
<a href="#">XP-0182</a>	20" x 1,000'	70	<b>32.50</b>
<a href="#">XP-0183</a>	15" x 1,000'	80	<b>29.50</b>
<a href="#">XP-0184</a>	20" x 1,000'	80	<b>33.90</b>

# HERCULES® Vertical Baler

**NOTE: AN ELECTRICIAN WILL NEED TO HAVE ELECTRIC SERVICE PREPARED FOR THE BALER UPON DELIVERY. ELECTRICAL REQUIREMENTS—3-PHASE SERVICE. PLEASE LET US KNOW THE INPUT VOLTAGE AVAILABLE IN YOUR BUILDING.**

**THESE UNITS CAN BALE:  
STRETCH WRAP  
CARDBOARD  
CANS  
TRASH**  
NOTE: TO PROPERLY RECYCLE, EACH BALE MUST BE SAME MATERIAL.

**FREIGHT CHARGE WILL INCLUDE DELIVERY, INSTALLATION AND SAFE OPERATION TRAINING WITH NEEDED PERSONNEL.**

**EASILY REDUCE FACTORY WASTE INTO ORGANIZED BALES.**



**SELL BALED CARDBOARD PRODUCT AND CREATE A NEW CONTINUAL REVENUE STREAM! THERE ARE SEVERAL COMPANIES THAT WILL PAY FOR THE BALED CARDBOARD. PLEASE CONTACT US TO HELP LOCATE ONE THAT WILL SERVE YOUR NEEDS.**



- 73,502 lbs. of crushing force
- 30" x 48" x 60" bale
- 2,600-psi hydraulic system
- 15 hp, 208/230/460V, 3ph motor

Empty your dumpster less and save money! Environmentally friendly vertical balers can produce dense bales up to 1,100 lbs. Easy-to-operate—after waste is loaded into baler, a down stroke ram is activated which holds the waste in place until a light alerts you that there is enough to make a bale. After the bale has been tied, a door opens and ejects the bale onto a pallet for storage until pick-up. 78"W x 143"H overall. 48-second cycle time. Meets or exceeds all ANSI Z245.5 standards for bailing equipment. Two-year warranty on parts and labor plus a 5-year warranty on structure. FOB ALABAMA.

Model No. **WR-3750** — Wt. 5,000 lbs. .... **\$12,030.00**

# Creepers & Jacks



CREEPER

TOOL TABLE



## STAPLETON Topside Creeper®

Reduces back, leg, and knee stress during maintenance jobs. Locking angle adjustment can be set in one of three positions. Slip-resistant steps. 3" locking casters. Heavy-gauge steel frame with powder coat finish. 400-lb. capacity. Ships unassembled. **IN STOCK.**

Model No. <b>YD-3275</b> —Topside Creeper®. 55"L x 30-1/4"W x 48-64"H. Wt. 72 lbs.....	<b>\$326.00</b>
Model No. <b>YD-3276</b> —Topside Tool Table. 34"L x 22-1/4"W x 54"H. Wt. 49 lbs.....	<b>\$165.00</b>



YA-0373



## JET Heavy-Duty Industrial Toe Jacks

Lifts very low-clearance or high-clearance loads. Heat-treated steel ram. Electrically welded base and cylinders. Not affected by extreme temperatures. Overload safety valve. Includes pump handle. 5- and 10-ton models have a 200° swivel socket. Complies with ANSI/ASME B30.1 standards.

**FACTORY QUICK SHIP—FOB TENNESSEE.**

Model Number	Overall L x W x H	Cap. Tons	Wt. Lbs.	Price Each
<b>YA-0373</b>	5" x 7" x 13-3/4"	2	19	<b>\$232.00</b>
<b>YA-0374</b>	10-5/8" x 7-1/4" x 16-1/8"	5	48	<b>399.00</b>
<b>YA-0375</b>	11-1/4" x 9-1/2" x 18-1/2"	10	85	<b>603.00</b>

# Canopies & Storage Garages

**HEAVY-DUTY TRUSSES PROVIDE EXTRA SUPPORT.**

**KING CANOPY**  
**Goliath Canopies**

From trade shows to company events, this instant canopy is great for outdoor activities. Canopy top is 500 denier Oxford polyester with PVC coating. All-aluminum frame includes 1-1/4" x 5/8" trusses and 2" dia. legs. Side height: 68-80". Center height: 69-81". 10'L x 10'W overall. Includes heavy-duty roller bag and (4) ground spikes with rope. Color: White. FOB NORTH CAROLINA.

Model No. **WA-0080WH—Instant Canopy.** Wt. 73 lbs. ....**\$586.00**  
 Model No. **WA-0081WH—Instant Canopy with Sidewalls.** Wt. 78 lbs. ....**\$647.00**

10' x 20' INSTANT CANOPY      10' x 10' FULLY ENCLOSED

**KING CANOPY**  
**Insta-King Instant Shelters**

Sturdy enough for any outdoor event. Rugged, white 500 denier polyester top is water-, flame- and mildew-resistant and includes corner pockets to easily insert a banner. Heavy-duty, 1-3/8" powder-coated steel frame with straight legs provides a stable, solid peak and support for all sides. Center clearance: 5'11"-6'11". Peak height: 9'10"-10'10". Side height: 5'11"-6'11". Height adjusts in 4" increments. Optional side walls are available. All canopies include heavy-duty carrying bag with wheels, storage pouch and stake kit. FOB NORTH CAROLINA.

Model No. **WA-0082—10' x 10' Instant Canopy.** Wt. 72 lbs. **\$310.00**  
 Model No. **WA-0083—10' x 20' Instant Canopy.** Wt. 128 lbs. **\$561.00**  
 Model No. **WA-0084—Sidewall Pack** (contains 2 side walls). Wt. 16 lbs. ....**\$88.20**

NOTE: 10' x 10' base needs (2) sets of sidewalls; 10' x 20' base needs (4) sets of sidewalls to fully enclose the unit.

10' x 10' INSTANT CANOPY

**KING CANOPY**  
**Storage Garages**

Durable, non-permanent storage garage protects your merchandise or equipment from the outside elements. Dome-framed garages are easy to assemble and feature extra-long sides that can be buried for added resistance against wind and other elements. Heavy-duty polyethylene construction. Sturdy 1-3/8" galvanized poles support heavy-duty 9-oz. cover. Door opening is 8'W x 7'4"H and has a zippered door. 10' x 20' x 8' overall. FOB NORTH CAROLINA.

Model No. **WA-0085—Wt. 276 lbs.** .....**\$836.00**

# Janitorial Supply Storage



**COLORS AVAILABLE:**

- PY-PUTTY
- LG-LIGHT GRAY
- DG-DARK GRAY

## LEE METAL Janitorial Supplies Cabinet

Keep all your building maintenance and cleaning supplies in one handy location. Divided cabinet has three shelves on one side and storage area for mops and vacuums on the other. Ships set-up and ready to use. 30"W x 15"D x 66"H overall. **SPECIFY COLOR:** GY - Gray, LG - Lt. Gray, PY - Putty. FOB PENNSYLVANIA.



Model No. **YD-1669**—Wt. 81 lbs.....\$229.00

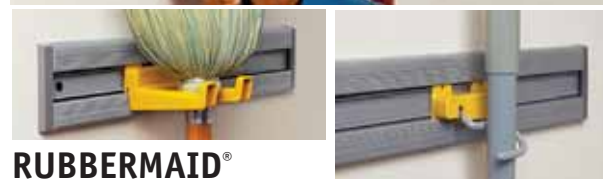

## RUBBERMAID® Closet Organizers

34"L tool storage system includes S-hooks for mop sticks/brooms, deep double hooks and carrying sling for hoses, extension cords, and a clip note holder. **IN STOCK.**

Model No. **YA-1620**—18"L.....\$31.00  
 Model No. **YA-1621**—34"L.....\$49.20  
 Model No. **YA-1622**—Value Kit. Two S-hooks, one double hook.  
 .....\$16.90



**FLIP-UP DOOR SLIDES INTO CABINET AND OUT OF THE WAY.**



## SUNCAST® Wall-Hung Cabinet

Keep floor space clear by storing all your cleaning supplies inside this practical wall cabinet. Recessed flip-up door offers easy access to stored contents. Constructed entirely of resin and completely maintenance free. Assembles quickly without tools. 30"W x 17"D x 18"H. 100-lb. capacity. Mounting brackets included. Color: beige. **IN STOCK.**

Model No. **YA-1600**—Wt. 14 lbs. ....\$55.00



## EX-CELL The Clincher Cleaning Tool Organizer

Durable steel organizer has six spring-activated rubber cams to hold mops, brushes, or brooms, a 4"D upper shelf, and five lower hooks. 34"L x 5"D x 7"H overall. Powder-coat finish. Materials have been approved to meet FDA standards. Color: white. **IN STOCK.**

Model No. **YA-1630**—Wt. 8 lbs. Reg. ~~\$55.40~~ **SALE .....\$49.90**

# Floor Maintenance

## RUBBERMAID® Mops & Handle



- Launderable: yes
- Absorption: 5 times dry wt.
- Fiber: cotton blend
- Compact packaging: yes
- Life expectancy: 5 weeks with daily laundering

Handles all your general-purpose cleaning. Constructed of tightly twisted 4-ply blended yarn. Looped ends will not fray or unravel. 1" synthetic mesh headband. Sold in pkg. of 6. **IN STOCK.**

Model Number	Mop	Wt. Lbs.	Price/Pkg.
XV-3710	Small/12-oz.	9	\$33.60
XV-3711	Medium/16-oz.	13	44.50
XV-3712	Large/24-oz.	17	53.80



**EASY-RELEASE MOP HANDLE.** Plastic mop head with hardwood handle. 1" dia. x 54" long handle.

Model No. **XV-3713**—  
Wt. 1 lb. ....\$11.90



## O-CEDAR® Maxi-Lok® Brooms

Patented E-clip lock keeps handle from turning, while the screw-on clamp prevents handle from pulling out while sweeping. Structural foam plastic block will not crack, warp, or mildew. 24"W broom head. **IN STOCK.**

**FOR SMOOTH SURFACES.** Soft, gray PVC Feather Tip® bristles sweep fine dust. 3" trim.

**FOR ROUGH SURFACES.** Extra-firm red polypropylene bristles handle heavy debris outdoors. Resists mild acids, oil, and grease. 3-1/2" trim.

**FOR MULTIPLE SURFACES.** Flagged PVC gray outer bristles sweep fine dust while the firm inner black polypropylene bristles handle heavy debris. 3" trim.

Model No. **YA-1661**—For smooth surfaces.....\$19.90  
Model No. **YA-1662**—For rough surfaces.....\$19.90  
Model No. **YA-1663**—For multiple surfaces.....\$19.90

**60"L METAL HANDLE FOR MAXI-LOK® PUSH BROOM.** Extra thick gauge steel center is coated with tough, durable plastic. Will not crack, warp or splinter. Firm-Grip™ ribbed handle.

Model No. **YA-1664**—.....\$7.50

## POLY TANKS

## STAINLESS STEEL TANKS



Selected Models

## SHOP-VAC® QSP Series Wet/Dry Vacs

Here's a great tool for industrial-sized messes. Large tank and heavy-duty 2-1/2" diameter hose pick up wet or dry spills. High-efficiency drywall collection bag and cartridge filter handle dust and fine materials. Quiet-running motor operates at 120V, 60 hz. Includes: 6' x 2-1/2" dia. heavy-duty hose, (2) 2-1/2" dia. extension wands, 6" utility nozzle, 14" floor nozzle with squeegee, crevice tool, and 18' cord.

**SELECTED MODELS IN STOCK.** Others FOB PENNSYLVANIA.

Model Number	Tank Type	Cap. Gal.	Motor HP	Air Flow CFM	Wt. Lbs.	Price Each
YA-1680	Poly	10	4.0	130	18	\$147.00
YA-1681	Poly	12	5.0	165	19	164.00
YA-1682	Poly	16	6.25	170	26	178.00
YA-1683	Poly	18	6.50	175	27	213.00
YA-1684	Poly	22	6.50	175	30	220.00
YA-1685	Stainless steel	10	6.50	175	30	261.00



## DUSTLESS TECHNOLOGIES H.E.P.A. Wet/Dry Vacs

Popular in industrial settings, wet/dry vacs are perfect for building maintenance crews. Choose either the Quiet vac or the H.E.P.A. vac to recover hazardous materials like asbestos, lead dust, and other airborne pollutants. Both models change from wet to dry pickup without removing filters, and offer static pressure/air flow: 72"/116 CFM; HP/amp: 5/11.5 (1324 watts); capacity: 16 gal. Includes: 2 extension wands, crevice tool, 6" utility nozzle, 1 micro prefilter bag, 1 1/2" dia. x 12' crushproof hose, and 15' cord. Quiet vac has a patented filtration system that is 99.5% efficient at .5 microns. H.E.P.A. vac filtration effectively removes 99.97% of all particles to 0.3 microns. **IN STOCK.**

Model No. **YA-1686**—H.E.P.A. Vacuum. Wt. 29 lbs. ....\$536.00  
Model No. **YA-1687**—Replacement H.E.P.A. Filter. ....\$178.00  
Model No. **YA-1688**—Quiet Vacuum. Wt. 29 lbs. ....\$354.00  
Model No. **YA-1689**—Replacement Micro Prefilter Bag for YA-1686 & YA-1688. Pkg./2.....\$23.50

# Janitorial Supplies



**STOCK**

## RUBBERMAID® Floor Signs

Large, easy-to-see floor signs alert patrons of hazardous areas up to 30' away. Constructed of polyethylene material with maintenance-free hinges. Caution message is hot stamped—won't chip, peel or fade. Choose English or multi-lingual message printed in English, Spanish, French, and German. Color: yellow with black message. **SPECIFY MULTI-LINGUAL MESSAGE: A - Caution, B - Closed. IN STOCK.**

Message	Model Number	Price Each	Model Number	Price Each
	<b>25"H SIGN</b>		<b>37"H SIGN</b>	
English-Caution Wet Floor	<b>XT-1983</b>	<b>\$18.30</b>	<b>XM-2705</b>	<b>\$44.30</b>
Multi-Lingual	<b>XM-2704</b>	<b>18.30</b>	<b>XM-2706</b>	<b>44.30</b>



**SEE ALL® Plastic Floor Stand Signs**

Easy-to-see signs warn approaching pedestrians of potential hazards. Bright yellow sign has a black message on both the front and back making it easy to read from each direction. 12"W x 20"H overall. Durable plastic material. **SPECIFY MESSAGE: A - Caution Wet Floor, B - Caution Men Working, C - Restrooms Being Cleaned. IN STOCK.**

Model No. **YA-1640**—.....**\$13.30**

**STOCK**

**ALSO AVAILABLE IN:**

- BL - BLUE**
- GN - GREEN**
- RD - RED**



**STOCK**

## CONTINENTAL Unibody Mopping System

Innovative system eases the strain associated with mopping floors. Ergonomic 90° angle handle reduces wrist strain and provides excellent torque and wringing power. Bucket empties easily, thanks to the large, wide-mouth pour spout and self-draining spigot. Quart and liter marks on the bucket interior allow for easy measuring and mixing of cleaning fluids. An internal screen traps dirt, so water stays cleaner longer. System includes bucket, built-in mop stick holder, caution sign holders and tool slot. Non-marking ball-bearing casters provide mobility. **SPECIFY COLOR: BL - Blue, GN - Green, RD - Red, YL - Yellow. IN STOCK.**

Model No. **XC-2130**—.....**\$98.30**



**STOCK**

## RUBBERMAID® Folding Barrier

16 articulating panels can be placed in any number of configurations: stretch them straight for a 13'L blockade or in circle around a hazardous area. Includes (2) 5" non-marking wheels and (4) locking straps. Open dimensions: 13'L x 1"W x 40"H; closed dimensions: 2'L x 13"W x 40"H. Color: safety yellow. **IN STOCK.**

Model No. **YA-1623**—Wt. 32 lbs. ....**\$510.00**



**STOCK**

## RUBBERMAID® Mop Buckets and Wringers

Molded-in wave baffles reduce water motion as well as splashing and spilling. Side and down press wringer, zinc-plated handle, and (4) 3" non-marking casters. Optional dirty water bucket decreases the chance for cross contamination. Red bucket sits inside main bucket. **SPECIFY COLOR: BZ - Bronze, YL - Yellow. IN STOCK.**

Model Number	Description	Wt. Lbs.	Price Each
<b>YA-0320</b>	35-qt. bucket/side wringer	24.5	<b>\$91.30</b>
<b>YA-0321</b>	35-qt. bucket/downward wringer	28.0	<b>138.00</b>
<b>YA-0322</b>	35-qt. mop bucket only	13.4	<b>63.70</b>
<b>YA-0323</b>	Side press wringer only	12.0	<b>82.20</b>
<b>YA-0324</b>	Down press wringer only	12.0	<b>114.00</b>

Model No. **YA-0325**—Dirty Water Bucket Only. ....**\$22.00**

**CLEANING SUPPLIES AND MOP BUCKET NOT INCLUDED.**



**STOCK**

## RUBBERMAID® Janitor Cart

Made of tough structural plastic. Resists rust and corrosion. Large leakproof bucket compartment holds spills. 8" rear wheels and front casters for easily controlled movement. Unit comes with large vinyl trash bag. 46"L x 21-3/4"W x 38-3/8"H. Color: Black. **IN STOCK.**

Model No. **XT-1598BK**—Wt. 38 lbs.....**\$224.00**



# Waste Receptacles

ALSO AVAILABLE IN:

BL - BLUE

YL - YELLOW

**SAVE**

**STOCK**



## RUBBERMAID® BRUTE® Rollout Containers

Versatile, wheeled container is built for strength and durability. 50-gal. cap. unit features a wide base that increases stability and a domed, hinged lid that locks in the open position for better access. Molded-in lift bar allows semi- and automatic dumping. Other features include: molded-in, non-slip handles and heavy-duty 8" non-marking wheels. **SPECIFY COLOR: BL - Blue, GY - Gray, YL - Yellow. IN STOCK.**

Model No. **YP-0170**—Wt. 27 lbs. Reg. ~~\$132.00~~ **SALE..\$121.00**

MADE IN USA

**STOCK**



## ROTO 4-Wheel Mobile Waste Cart

Moves easily without tipping. Molded polyethylene construction. Includes hinged lid. 3" swivel casters and 10" fixed rear wheels. Color: gray. **IN STOCK.**

Model No.	Overall W x D x H	Cap. Gal.	Wt. Lbs.	Price Ea.
<b>YP-2794</b>	28 x 35 x 42"	65	32	<b>\$257.00</b>
<b>YP-2793</b>	31 x 37 x 47-1/2"	96	52	<b>282.00</b>



AC ELECTRIC POWERED MODEL

MANUAL MODEL



HAND-HELD CONTROLLER FOR POWERED MODELS.

ADJUSTABLE HOLD-DOWNS SECURE CONTAINER FOR DUMPING.

## VESTIL Universal Trash Can Dumpers

Square chute with adjustable hold-downs. Dumps 20-1/2-37"L x 17-1/2-36"W x 22-48"H containers. 400-lb. capacity. 135° maximum dump angle. 48" maximum dump height. Choose either manual foot pump or AC or DC power hand control. DC powered dumpers include battery charger. Rolls on two rigid and two swivel casters. Set-up. FOB INDIANA.

Model No.	Description	Overall L x W x H	Wt. Lbs.	Price Ea.
<b>WA-4745</b>	Manual Trash Can Dumper	74 x 45 x 65"	426	<b>\$2615.00</b>
<b>WA-4746</b>	AC-Powered Trash Can Dumper	74 x 45 x 65"	460	<b>3636.00</b>
<b>WA-4747</b>	DC-Powered Trash Can Dumper	74 x 45 x 65"	460	<b>3636.00</b>
<b>WA-4743</b>	Bench-Top Style Battery Charger	9 x 7 x 5"	8	<b>135.00</b>
<b>WA-4744</b>	Battery Charge Indicator	2 x 2 x 2"	1	<b>80.40</b>

# Waste Receptacles



**ACCOMMODATES 23-GALLON SLIM JIM® CONTAINERS, SEE PAGE 276.**



**HINGED LID**



**RUBBERMAID® Mega BRUTE® Mobile Waste Container**

Shorten your cleaning time with this efficient container! 120-gal., 400-lb. capacity container has onboard storage to keep your cleaning necessities close-at-hand and includes two rear access doors for easy emptying. Also accommodates a 23-gal. Slim Jim® container to separate recyclables from refuse. Other features include: 55-gal. bag retainer hoop and bottle and tool storage. 12" wheels and 5" non-marking, locking casters are placed in a diamond pattern for better maneuverability. Color: black. **IN STOCK.**

Model No. **WA-0177**—Mega BRUTE® Mobile Waste Container.....\$448.00  
 Model No. **WA-0178**—Mega BRUTE® Lid.....\$158.00

**REAR ACCESS DOORS EASE EMPTYING.**





**YP-3403BL**



**YP-3408DG (DARK GREEN)**



**YP-3400GY (GRAY)**



**Larger Capacities & Improved Design**

## ROTONICS Mobile Containers

State-of-the-art rotational molding combines with uniform wall thickness for superior strength and resiliency. Scuff-resistant textured surface. 10" wheels are made from 100% post industrial recycled material. FOB CALIFORNIA.

### AUTOMATIC MOBILE CONTAINERS

Multi-purpose containers are available with standard lid or lid with can slot or paper slot. Standard lids feature a double-wall that fits into convex edge of containers for a positive seal that reduces odors and improves strength. Recycle logo included on both can and paper slot models. **SPECIFY COLOR: BL** - Recycle blue, **GY** - Gray.

### MOBILE CONTAINERS WITH STANDARD LID

Model No.	Description	Overall W x D x H	Color	Wt. Lbs.	Price Ea.
YP-3400BL	64-Gal.	25-1/2" x 32-1/2" x 44"	Recycle blue	35	\$140.00
YP-3400GY	68-Gal.	25-1/2" x 32-1/2" x 44"	Gray	35	140.00
YP-3403BL	95-Gal.	29-3/4" x 36-3/4" x 48"	Recycle blue	42	159.00
YP-3403GY	98-Gal.	29-3/4" x 36-3/4" x 48"	Gray	42	159.00

### MOBILE CONTAINERS WITH CAN SLOT OF PAPER SLOT LID

Model No.	Description	Overall W x D x H	Wt. Lbs.	Price Ea.
YP-3401	64-Gal. w/Can Slot	26-3/4" x 31" x 43"	35	\$191.00
YP-3402	64-Gal. w/Paper Slot	26-3/4" x 31" x 43"	35	171.00
YP-3404	95-Gal. w/Can Slot	29-1/2" x 37" x 43-1/2"	42	207.00
YP-3405	95-Gal. w/Paper Slot	29-1/2" x 37" x 43-1/2"	42	188.00

Model No. **YP-3406**—Locking Hasp Kit. Wt. 1 lb. ....\$23.80

**MOBILE CONTAINER WITH CAN SLOT LID AND OPTIONAL HASP KIT.**



**MOBILE CONTAINER WITH PAPER SLOT LID AND OPTIONAL HASP KIT.**



### UNIVERSAL CONTAINERS

Container body features a gusseted lifting slot for extra rigidity and a steel tubular lift bar. Double-wall lid fits into convex edge of containers for a positive seal that reduces odors and improves strength. **SPECIFY COLOR: BL** - Blue, **DG** - Dark green, **GY** - Gray.

Model Number	Description	Overall W x D x H	Wt. Lbs.	Price Each
YP-3407	38-Gal.	23-1/2" x 28" x 39"	26	\$122.00
YP-3408	68-Gal.	25-1/2" x 32-1/2" x 44"	35	140.00
YP-3409	98-Gal.	29-3/4" x 36-3/4" x 48"	40	159.00

# Waste Receptacles



## RUBBERMAID® BRUTE® Containers

One of the strongest receptacles on the market today. Rugged plastic construction resists most acids and chemicals. Withstands temperatures from sub-zero freezers to steam cleaners. Seamless construction includes reinforced bottom for added strength and stability. Molded-in handles ease emptying. Flat lids seal in odors and refuse while the dome top turns Round BRUTE® containers into a rugged outdoor container. Containers with flat lids are stackable even when filled. Optional dolly provides mobility. **SPECIFY COLOR: BK - Black, GN - Green, GY - Gray, RD - Red, YL - Yellow, WH - White.** Colors available as listed in price charts. **IN STOCK.**

**BRUTE® ROUND CONTAINERS.** Available in 5 sizes for versatile storage options. Non-slip grip handles.

Model No.	Description	Colors Available	Wt. Lbs.	Reg. Ea.	SALE EA.
<b>XC-3150</b>	10-gal. container	GY, WH	3	<del>\$16.90</del>	<b>\$15.80</b>
<b>XC-3151</b>	10-gal. lid	GY, WH	1	<b>6.30</b>	—
<b>XJ-575</b>	20-gal. container	GY, WH, YL	6-1/4	<del>\$27.50</del>	<b>\$25.00</b>
<b>XJ-579</b>	20-gal. lid	GY, WH, YL	2-1/4	<b>8.00</b>	—
<b>XJ-576</b>	32-gal. container	GN, GY, RD, WH, YL	9	<del>\$36.70</del>	<b>\$32.00</b>
<b>XJ-580</b>	32-gal. lid	GN, GY, RD, WH, YL	2-3/8	<b>11.60</b>	—
<b>XJ-583</b>	32-gal. dome top	GY, RD	5	<b>85.00</b>	—
<b>XJ-577</b>	44-gal. container	GN, GY, RD, WH, YL	13-1/2	<del>\$55.00</del>	<b>47.00</b>
<b>XJ-581</b>	44-gal. lid	BK	3-1/2	<b>19.00</b>	—
<b>XJ-584</b>	44-gal. dome top	GY, RD	10-1/4	<b>89.00</b>	—
<b>XJ-578</b>	55-gal. container	GY	18-1/4	<del>\$85.00</del>	<b>69.00</b>
<b>XJ-582</b>	55-gal. lid	GY	4	<b>28.50</b>	—
<b>XJ-585</b>	55-gal. dome top	GY, RD	13	<b>114.00</b>	—

**BRUTE® SQUARE CONTAINERS.** Interlocking handles lock several containers together side by side to conserve space. Flat sides allow containers to be stored up against the wall.

Model No.	Description	Colors Available	Wt. Lbs.	Price Ea.
<b>XJ-928</b>	28-gal. container	GY, WH	9	<b>\$41.00</b>
<b>XJ-932</b>	28-gal. lid	GY, WH	3	<b>13.70</b>
<b>XJ-929</b>	40-gal. container	GY, WH	13	<b>57.90</b>
<b>XJ-933</b>	40-gal. lid	GY, WH	4	<b>18.80</b>

### BRUTE® ROUND CONTAINER DOLLY

Fits 20-, 32-, 44- and 55-gal. round containers. Color: black.

Model No. **XJ-588**—  
Wt. 9-1/2 lbs. .... **\$56.00**



### BRUTE® VENTED CONTAINER

Designed with channel venting for easy polyliner removal. Ergonomic comfort grip handles.

Model No.	Description	Colors Avail.	Wt. Lbs.	Price Ea.
<b>XC-1140</b>	44-gal. container	BK, BL, GY, YL	12	<b>\$53.00</b>
<b>XC-1141</b>	44-gal. lid	BK	3	<b>19.00</b>



## CONTINENTAL Superkan™

This ergonomic waste can is a real back saver. The interior is lined with "lift vents", allowing you to remove a filled trash bag with ease. Extra heavy-duty containers feature reinforced handles and rims, and approximately 15% thicker walls. **IN STOCK.**

Model No.	Cap. Gal.	Color	Price Ea.
<b>XC-2124</b>	44	Dark Gray	<b>\$41.80</b>
<b>XC-2125</b>	44	Black	<b>41.80</b>

Model No. **XC-2126**—Dolly w/Casters ..... **\$40.70**

**VENTED CHANNELS AND REINFORCED INTERNAL RIBBING MAKE IT EASY TO REMOVE FULL GARBAGE BAGS.**



**BAG CLINCH AVAILABLE ON XC-2124 ONLY.**



# Waste Receptacles



**MADE IN USA**

**RUBBERMAID® Wastebaskets and Tops**

Perfect for the office or shop, low-profile wastebaskets sit beneath your workstation for handy refuse disposal. All plastic—will not chip, dent, or rust. Removable tops have swing doors for hygienic, no-touch waste disposal. **IN STOCK.**

**WASTEBASKETS. SPECIFY COLOR: BE - Beige, BK - Black, LG - Lt. gray.**

Model Number	Capacity	Overall L x W x H	Price Each
<b>YV-2500</b>	13-5/8-Qt.	11-3/8" x 8-1/4" x 12-1/8"	<b>\$8.40</b>
<b>YV-2501</b>	28-1/8-Qt.	14-3/8" x 10-1/4" x 15"	<b>9.20</b>
<b>YV-2502</b>	41-1/4-Qt.	15-1/4" x 11" x 19-7/8"	<b>16.90</b>

**TOPS. SPECIFY COLOR: BE - Beige, BK - Black.**

Model No. <b>YV-2503</b> —For 28-1/8-qt. container.	Wt. 2 lbs.....	<b>\$13.50</b>
Model No. <b>YV-2504</b> —For 41-1/4-qt. container.	Wt. 2 lbs.....	<b>\$14.10</b>

**STOCK**

**BASES & TOPS SOLD SEPARATELY.**

**MADE IN USA**

**OPEN FUNNEL TOP**      **SPRING-LOADED TOP**      **FREE-SWINGING TOP**

**ROUND BASE**      **HALF-ROUND BASE**      **SQUARE BASE**

**STOCK**

**RUBBERMAID® Untouchable® Containers**

Mix and match containers and lids to customize a refuse system for your specific needs. Leakproof bases in space-saving shapes and sizes. Durable colorfast construction. **SPECIFY COLOR: BE - Beige, GY - Gray.** **IN STOCK.**

Model No.	Description	Size	Color	Wt. Lbs.	Price Ea.
<b>SQUARE BASE &amp; TOP</b>					
<b>XV-3330</b>	23-Gal. Base	16-1/2"L x 15-1/2"W x 30-9/10"H	BE, BK, BR, GY	21.2	<b>\$63.00</b>
<b>XV-3331</b>	Free-Swinging Top	16"L x 4"W x 16"H	BE, BK	8	<b>30.00</b>
<b>ROUND BASE &amp; TOPS</b>					
<b>XV-3725</b>	22-Gal. Base	15-3/4" dia. x 30-1/8"H	BE, GY	12.5	<b>\$66.80</b>
<b>XV-3726</b>	Open Funnel Top	16-1/4" dia.	GY	2.6	<b>28.50</b>
<b>XV-3730</b>	Free-Swinging Top	16-1/8" dia.	BE, GY	2.6	<b>35.20</b>
<b>HALF-ROUND BASE &amp; TOP</b>					
<b>XV-3728</b>	21-Gal. Base	21"L x 11"W x 28"H	BE, GY	13	<b>\$91.70</b>
<b>XV-3729</b>	Spring-Loaded Top	21-5/16"L x 12-5/16"W x 9-1/2"H	Black	15	<b>134.00</b>



**MADE IN USA**

**RUBBERMAID® Slim Jim® Containers**

Combine strong, durable containers with color-coded tops and innovative linking dollies to create a customized recycling/refuse center. Slotted top accepts paper, round-hole top handles glass bottles, jars, and cans. Low-profile design fits in tight, narrow locations. Durable plastic material resists rust, liquids and is easy to clean. Vented base has molded-in venting channels that ease liner removal, liner cinches that hold waste bag in place, and molded-in base grips and side handles. 23-1/8"L x 11"W x 30"H base. **SPECIFY CONTAINER & LID COLOR: BE - Beige, BK - Black, BL - Blue, BR - Brown, GN - Green, LG - Light Gray.** Colors are available as listed by code in price chart. **IN STOCK.**

**BASE & TOPS SOLD SEPARATELY.**

Key	Model No.	Description	Colors	Wt. Lbs.	Price Ea.
<b>23-GAL. CONTAINERS</b>					
A	<b>XK-1400</b>	Standard Base	BE, BK, BR, LG	8	<b>\$57.00</b>
B	<b>XR-1414</b>	Vented Channel Base	BE, BK, LG	8	<b>61.00</b>
<b>TOPS</b>					
C	<b>XK-1402</b>	Slotted Recycled Top	BL	2	<b>\$44.30</b>
D	<b>XK-1407</b>	Handle Top	LG	2	<b>41.10</b>
E	<b>XK-1403</b>	Bottle and Can Top	BL, BR, GN	2	<b>42.90</b>
F	<b>XR-1415</b>	Swing Top Lid	BK	2.5	<b>39.30</b>
G	<b>XR-1416</b>	Hinged Top Lid	BK	2	<b>47.00</b>

**Model No. XK-1408—Trolley.** Locks together for efficient collection and ganged transport. Wt. 8 lbs. .... **\$76.30**

# Waste Receptacles

**STOCK**

## Dome Tops

Fits expanded steel wastebasket or standard 55-gallon drums. Choose polyethylene, steel, or galvanized construction. **IN STOCK.**

**STRUCTURAL FOAM.**  
Won't dent, rust, or scratch.  
**SPECIFY COLOR: BK - Black, GY - Gray, RD - Red.**

Model No. **YD-3078**—  
Wt. 32.5 lbs. ....\$73.50

Plastic dome top available in:

**RD - Red**   **BK - Black**   **GY - Gray**



**POLYETHYLENE TOP.** Will not dent, rust, or scratch. Sold in multiples of 3. **SPECIFY COLOR: BL - Blue, GY - Gray, RD - Red.**

Model No. **XA-2284**—  
Wt. 11 lbs. ....\$70.10

Polyethylene top available in:

**RD - Red**   **BL - Blue**   **GY - Gray**



**STEEL TOP.** Finished in rust-resistant enamel. **SPECIFY COLOR: BK - Black, GN - Green, RD - Red.**

Model No. **XA-2286**—  
Wt. 12 lbs. ....\$121.00



**GALVANIZED TOP.** Weather-resistant 22-ga. construction. Self-closing door offers complete fire protection.

Model No. **XA-2285**—  
Wt. 12 lbs. ....\$92.00



**STOCK**

## SUNCAST® Outdoor Trash Hideaway™

Update your outdoor eating area with this attractive trash receptacle. Weatherproof resin unit accepts 30- to 33-gal. garbage bags. Latching lid keeps unsightly waste out of site. 15-3/4"W x 16"D x 31-5/8"H. Sets up easily without tools. Color: Beige. **IN STOCK.**

Model No. **YD-3090BE**—  
Wt. 13 lbs. ....\$56.50



**STOCK**

## RELIUS SOLUTIONS Expanded Metal Container

Keep outdoor areas clean and free of litter with these weather-resistant receptacles. 48-gallon containers include expanded metal sides welded to vertical support ribs for increased rigidity. The bottom is also welded to the metal basket for increased support. Drain holes in the base prevent fluid build up, and the edges around the top are curled for safe handling. Choose either colored containers with powder-coat finish or hot-dipped galvanized units that resist rust and corrosion. 24-1/2" dia. x 32"H overall. **SPECIFY COLOR: BK - Black, BL - Blue, GL - Galvanized, GN - Green, RD - Red. IN STOCK.**

MAY BE USED WITH DOME TOPS XA-2284, XA-2286, AND XA-2285. SHOWN WITH STEEL TOP XA-2286BK.

OTHER COLORS AVAILABLE:

**BL - BLUE**   **GN - GREEN**   **RD - RED**

Model No.	Wt. Lbs.	(GL)	(BK), (BL), (GN), (RD)
		GALVANIZED	POWDER COAT
		Price Ea.	Price Ea.
<b>XK-3045</b>	31	\$193.00	\$191.00



**STOCK**

## RUBBERMAID® Stone Panel Receptacles

Unobtrusive stone receptacles blend with their natural surroundings. Feature natural aggregate side panels supported by steel channels. Will not deteriorate under constant exposure to the elements. Sand tops remove for easy waste disposal. XV-3741 has hinged top. UL listed/FM approved. Complies with ADA. XV-3741, XV-3742 include germ fighter plastic liner. **SPECIFY COLOR: BR - Brown frame/desert brown panels, GY - Gray frame/dove gray panels. IN STOCK.**

**SILICA SAND**  
For sand urns. 5-lb. bags. **SPECIFY COLOR: BK - Black, WH - White.**

Model No. **XV-3746**—Wt. 25 lbs. **\$27.70**



Key	Model No.	Cap. Gal.	Overall Sq. x H	Wt. Lbs.	Price Ea.
<b>COMBINATION TRASH RECEPTACLE/SAND URN</b>					
A	<b>XV-3741</b>	24	18 x 32"	70	\$537.00
B	<b>XV-3743</b>	12	13-1/2 x 32"	54	442.00
<b>TRASH RECEPTACLES</b>					
C	<b>XV-3742</b>	38	26 x 40"	130	\$895.00
D	<b>XV-3744</b>	12	13-1/2 x 32"	52	343.00

# Ash Receptacles



**STOCK**

MADE IN USA

OTHER COLORS AVAILABLE:

**BK - BLACK**

**GN - GREEN**

**TC - TERRA COTTA**

## JUSTRITE® Cease-Fire™ Cigarette Butt Receptacle

The practical place for disposal of smoking materials indoors or out. Cigarettes are extinguished as they travel down the long neck into the galvanized steel liner pail. To empty, just twist off lid, pull out pail, and pour out contents. Flame-resistant, polyethylene container is also UV-protected—will not rust, dent, crack, or peel. 16-1/2" dia. x 38"H. FM-approved. **SPECIFY COLOR: BE - Beige, BK - Black, GN - Green, GY - Gray, TC - Terra Cotta. IN STOCK.**

Model No. **XA-2288**—Wt. 12 lbs. ....\$47.20



**STOCK**

MADE IN USA

## RUBBERMAID® Infinity™ Smoking Receptacles

Sleek, contemporary receptacles are perfect for any decor. Practical design features a large snuff ring with stainless steel snuff plates and funnel feed for easy cigarette extinguishing and disposal. Includes stainless steel canister that twists off for efficient emptying. Base-mount unit has a weighted base for stability. Both models may be bolted down. **IN STOCK.**

**YP-2607—Base-Mount.** 1.33 gal. cap./approx. 1,500 cigarettes. 15-1/2" dia. x 39-5/8"H. ....\$269.00  
**YP-2608—Wall-Mount.** 0.60 gal. cap./approx. 700 cigarettes. 11-5/8" dia. x 18-5/8"H. ....\$166.00



## EAGLE® Butt Cans

Practical containers offer safe disposal for cigarette or cigar butts and matches. Self-extinguishing design restricts oxygen putting out cigarettes before they hit the bottom. (A) The Original Butt Can is constructed entirely of galvanized steel and has a removable top and protective powder-coat finish. (B) (C) SafeSmoker™ Cigarette Butt Receptacle features flame-resistant polyethylene construction, twist off top, and large galvanized steel collection bucket. (D) (E) Indoor/Outdoor Butt Can combines a galvanized steel receptacle with a removable all-weather polyethylene tube. **SPECIFY COLOR: BE - Beige, BK - Black, BL - Blue, BR - Brown, GN - Green, GY - Gray. SELECTED MODELS IN STOCK.** Others FOB WEST VIRGINIA.

ALSO AVAILABLE IN:

**BE - BEIGE**

**BK - BLACK**

**BL - BLUE**

**BR - BROWN**

**GN - GREEN**

**GY - GRAY**

AS LISTED IN CHART

MADE IN USA



**STOCK**

Key	Model Number	Description	Overall Dia. x H	Cap. Gal.	Colors Available	Wt. Lbs.	Price Each
A	<b>YT-2133</b>	Galv. Steel	12" x 33"	5	BE, YL	7	<b>\$68.40</b>
B	<b>YT-2134</b>	Poly w/Galv. Liner	15" x 38"	1	BE, BK, BL, BR, GN, GY	7	<b>53.60</b>
C	<b>YT-2135</b>	Poly w/Galv. Liner	17" x 43"	4	BE, BK, BL, BR, GN, GY	10	<b>66.60</b>
D	<b>YT-2136</b>	Galv. Steel/Poly	12" x 32"	2.5	BE, YL	5	<b>59.70</b>
E	<b>YT-2137</b>	Galv. Steel/Poly	12" x 40"	5	BE, YL	7	<b>74.00</b>



- BU - BURGUNDY
- GY - GRAY
- BL - BLUE
- BR - BROWN
- BK - BLACK

## Notrax® Stages™ Entrance Matting

This proven floor system puts an end to messy, wet floors that can be hazardous to your patrons. **SPECIFY COLOR:** BK - Black, BL - Blue, BR - Brown, BU - Burgundy, GY - Gray. **FACTORY QUICK SHIP—FOB ILLINOIS.**

### PRELUDE SCRAPE CLEAN™

- Place outside entrances or office and warehouse passageways
- Non-absorbent polypropylene ribbon construction
- 1/4" thick

Offers vigorous scraping action; holds dirt below surface. Yarn fibers won't stain, fade and are easy to clean. Vinyl back.

### ENCORE SCRAPE AND DRY™

- For use inside entrances or passageways with medium traffic
- Nylon and ribbon polypropylene construction
- 5/16" thick

Loop-twist polypropylene ribbon is alternated in rows with loop pile nylon yarn to provide excellent scraping action and moisture absorption. Backed by 80 mil solid vinyl.

### OVATION PREMIUM NYLON™

- Place indoors in areas with medium traffic or heavy moisture
- Nylon construction
- 5/16" thick

Dense loop pile surface outperforms olefin and polyester yarns. Vinyl backing.

Size	SCRAPE CLEAN			SCRAPE AND DRY			PREMIUM NYLON		
	Model Number	Wt. Lbs.	Price Each	Model Number	Wt. Lbs.	Net Each	Model Number	Wt. Lbs.	Price Each
3' x 4'	XV-1764	14	\$41.70	XV-1772	7	\$49.80	XV-1780	16	\$46.00
3' x 5'	XV-1765	16	52.00	XV-1773	8	61.80	XV-1781	17	57.60
3' x 6'	XV-1766	17	62.50	XV-1774	9	74.00	XV-1782	18	69.20
4' x 6'	XV-1767	18	83.40	XV-1775	11	99.40	XV-1783	19	92.20
4' x 8'	XV-1768	19	112.00	XV-1776	15	133.00	XV-1784	20	123.00
3' x 60'	XV-1769	162	593.00	XV-1777	155	709.00	XV-1785	180	619.00
4' x 60'	XV-1770	216	791.00	XV-1778	205	946.00	XV-1786	240	825.00
6' x 60'	XV-1771	324	1184.00	XV-1779	310	1417.00	XV-1787	360	1236.00

## WaterHog™ Waffle Design Mats

- Place inside entrances with heavy traffic
- Polypropylene construction
- 1/4" thick

Each mat is surrounded by a water dam that prevents water from spreading to floors.

Non-slip surface features a grid-patterned pile molded onto rubber nubs to prevent crushing. Non-skid, rubber backing will not crack in extreme temperatures. Stays in place on most carpet types and on all hard surfaces. During snowfall, ice melt may be used on mat surface. **SPECIFY COLOR:**

BL - Blue, BR - Med. Brown, LB - Bluestone, BU - Burgundy, CH - Char. Gray, GN - Evergreen, RD - Red/Black. **BL - BLUE AND CH - CHARCOAL GRAY ARE**

**FACTORY QUICK SHIP.** All FOB GEORGIA.

Model Number	Size	Wt. Lbs.	Price Each
XV-1735	2' x 3'	5	\$32.60
XV-1736	3' x 4'	10	65.20
XV-1737	3' x 5'	11	81.30
XV-1738	3' x 10'	21	138.00
XV-1739	4' x 6'	17	131.00
XV-1740	4' x 10'	29	194.00



Selected Models

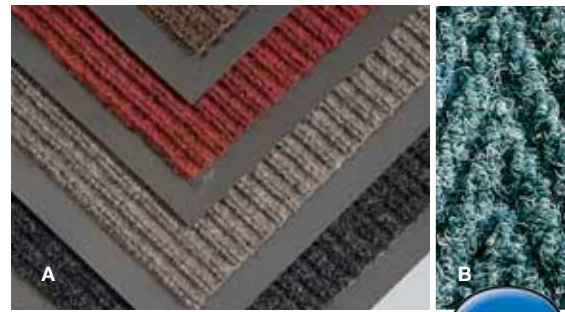
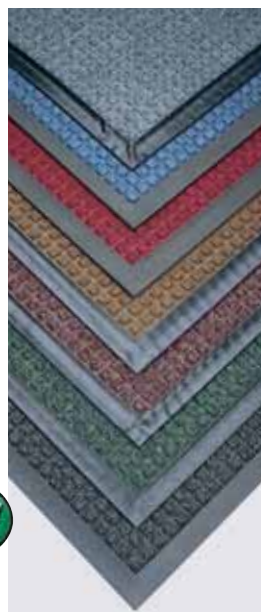

## Ribbed Carpet Mats

- For indoor entrances and foyers
- Polypropylene surface with vinyl backing
- Cavalier: 3/8" thick • Crown: 5/16" thick



Selected Models

Excellent water absorption and dirt-concealing properties. Extra coarse, 100% solution-dyed polypropylene yarns have strong brushing action. Pile is formed into ribs that deflect and trap dirt into channels beneath mat surface. 1" vinyl border on all 4 sides. Flame-resistant, easy to clean.

**(A) WEARWELL CAVALIER MATS** have longitudinal rib pattern. **SPECIFY COLOR:** BR - Brown, CH - Charcoal, GY - Gray, RD - Red. **SELECTED MODELS IN STOCK.** Others FOB TENNESSEE.

**(B) RELIUS SOLUTIONS MATS** have herringbone pattern with matching vinyl backing. **SPECIFY COLOR:** BL - Slate Blue, BR - Dark Brown, BU - Burgundy, CH - Charcoal. **SELECTED MODELS FACTORY QUICK SHIP—FOB OHIO.**

Size	A. WEARWELL CAVALIER			B. CROWN CHEVRON		
	Model No.	Wt. Lbs.	Price Ea.	Model No.	Wt. Lbs.	Price Ea.
3' x 4'	XV-1744	9	\$36.80	XV-1752	9	\$34.90
3' x 5'	XV-1745	11	45.70	XV-1753	10	43.50
3' x 6'	XV-1746	14	53.30	XV-1754	12	52.20
4' x 6'	XV-1747	18	72.80	XV-1755	20	69.50
4' x 8'	XV-1748	24	91.30	XV-1756	23	92.70
3' x 60'	XV-1749	135	513.00	XV-1757	162.5	523.00
4' x 60'	XV-1750	180	684.00	XV-1758	183	697.00
6' x 60'	XV-1751	290	1027.00	XV-1759	258	1044.00

### CAVALIER CUSTOM CUT LENGTHS TO 60 FT.\*

Longitudinal rib pattern.

Model No. XV-1760—36"W. Wt. 2-1/4 lbs./ft. ....	\$9.60/ft.
Model No. XV-1761—48"W. Wt. 3 lbs./ft. ....	\$13.90/ft.
Model No. XV-1762—72"W. Wt. 4-3/4 lbs./ft. ....	\$18.90/ft.

\*No returns on custom-cut matting.



Selected Models

## WEARWELL® Elite Super Olefin Mats

- Effective in indoor entrances with heavy traffic
- Olefin construction
- 3/8" thick

Soaks up water like a sponge! 18 oz. per sq. yard plush cut pile. Vinyl backing is impervious to dampness and will not shrink. **SPECIFY COLOR:** BK - Black, BL - Med.

Blue, BR - Med. Brown, CH - Charcoal RD - Red. **SELECTED MODELS IN STOCK.** Others FOB TENNESSEE.

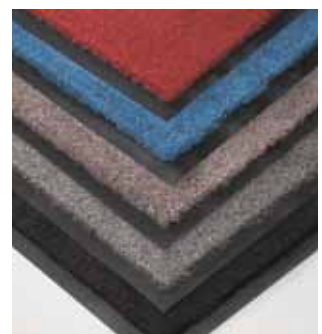

Model Number	Size	Wt. Lbs.	Price Each
<b>PRE-CUT SIZES</b>			
YK-2970	2' x 3'	6	\$17.30
YK-2971	3' x 4'	11	34.50
YK-2972	3' x 5'	14	43.20
YK-2973	3' x 6'	16	51.80
YK-2974	4' x 6'	21	69.10
YK-2975	4' x 8'	28	92.00
<b>CUSTOM-CUT SIZES*. SPECIFY LENGTH UP TO 60'—priced per foot.</b>			
YK-2976	3'W	2.7	\$9.10
YK-2977	4'W	3.6	12.10

\*No returns on custom-cut mats. NOTE: 60' mats do not have finished ends.

# Mats



Selected Models

### AVAILABLE COLORS

BK - BLACK

BL - BLUE

GY - GRAY

## WEARWELL® Ergo-Stance® Mats

- For all dry work areas
- Rubber top with low- and high-density rubber sponge strips that alternate every 12"
- 1/2" thick

Two-density sponge base subtly shifts worker's weight from leg to leg. Beveled safety edges.

**SPECIFY COLOR:** BK - Black, BL - Blue, GY - Gray. **SELECTED MODELS IN BK - BLACK OR BL - BLUE ARE IN STOCK.** Others FOB TENNESSEE.



Model No.	Size	Wt. Lbs.	Price Ea.
<b>PRE-CUT</b>			
YA-0084	2 x 3'	12	\$59.00
YA-0085	3 x 4'	24	120.00
YA-0086	3 x 5'	30	148.00
<b>CUSTOM-CUT*</b> . Specify length up to 30'—priced/ft.			
YA-0087	2'W	4/ft.	\$22.60
YA-0088	3'W	6/ft.	33.80
YA-0089	4'W	8/ft.	44.70

\*No returns on custom-cut mats.

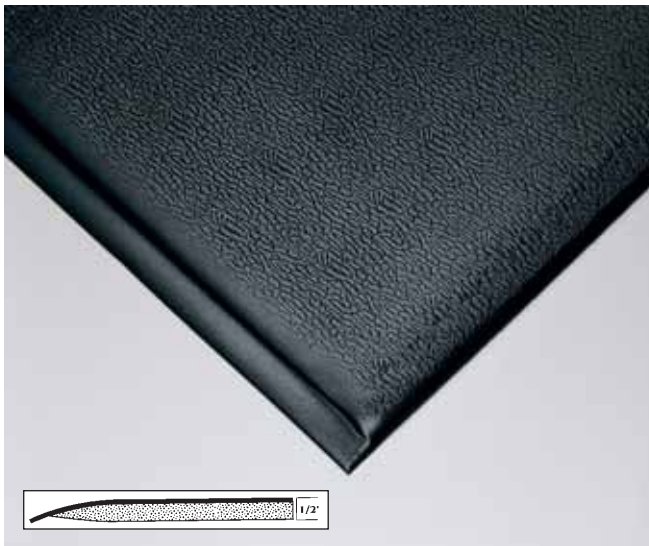

## WEARWELL® Endur-able Slip-Resistant Mats



Selected Models

- Place in dry work areas or where chemicals are present
- Vinyl sponge construction
- 1/2" thick

Unique construction integrates a durable, slip-resistant surface with a cushioning, sponge base. Guaranteed not to split apart under normal conditions. Beveled safety edges on all sides. Color: black. **SELECTED MODELS IN STOCK.** Others FOB TENNESSEE.

PRE-CUT				FULL ROLLS			
Model No.	Size	Lbs.	Price Ea.	Model No.	Size	Lbs.	Price Ea.
YF-1350	2' x 3'	4.5	\$28.00	YF-1353	2' x 60'	90	\$489.00
YF-1351	3' x 5'	11	69.70	YF-1354	3' x 60'	136	733.00
YF-1352	3' x 12'	27	169.00	YF-1355	4' x 60'	180	976.00

**CUSTOM-CUT\***. Specify length up to 60'—priced/ft.

Model No.	Size	Wt. Lbs.	Price Ea.
YF-1356	2'W	1.5/ft.	\$9.80
YF-1357	3'W	2.5/ft.	14.70
YF-1358	4'W	3.0/ft.	19.60

\*No returns on custom-cut mats.

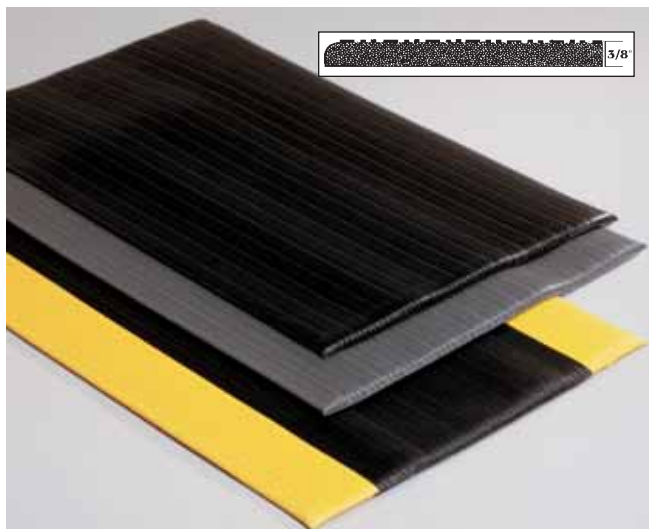

## WEARWELL® Tuf Sponge Mats



Selected Models

- Designed for any dry work area
- Closed cell vinyl sponge construction
- 3/8" thick

Relieves tired, aching feet and back and leg fatigue when standing for long periods of time. For use in dry areas only. Non-porous surface and base offer quick, easy cleaning. Includes beveled edges on full rolls and cut lengths. **SPECIFY COLOR:** BK - Black, GY - Gray. **SELECTED MODELS IN STOCK OR FACTORY QUICK SHIP—FOB TENNESSEE.** Others FOB TENNESSEE.

STANDARD SIZES				FULL ROLLS			
Model No.	Size	Wt. Lbs.	Price Ea.	Model No.	Size	Wt. Lbs.	Price Ea.
XV-1520	2' x 3'	3	\$14.90	XV-1522	3' x 60'	135	\$385.00
XP-891	3' x 5'	12	36.70	XV-1523	4' x 60'	180	499.00
XV-1521	3' x 12'	27	87.70				

**CUSTOM-CUT.** Specify length up to 60'—priced/ft.

Model Number	Size	Wt. Lbs.	Price Ea. Foot
XV-1524	3'W	2-1/4/ft.	\$7.90/ft
XV-1525	4'W	3/ft.	10.50/ft

\*No returns on custom-cut mats.





## Notrax® Comfort-Eze™ Mats

- For mostly dry work areas with light- to medium-duty soiling conditions
- Rubber construction
- 3/8" thick



Molded single-piece construction is tough and durable— withstands continuous use and abuse. Resilient rubber compound provides superb cushioning to relieve fatigue. Unique 5/16" knob pattern allows air to circulate beneath feet. Double-sided design extends the mat service life. Edges are beveled on all four sides for extra safety. Color: black. **IN STOCK.**

Model Number	Size	Wt. Lbs.	Price Each
XF-517	18" x 24"	3-1/2	\$20.10
XF-518	24" x 36"	9	28.90
XF-519	30" x 60"	20	59.70



## WEARWELL® Ortho Stand® Mats

- Ideal for both wet and dry work areas
- Natural flexible rubber construction
- 1/2" thick



Anti-fatigue design encourages frequent changes in posture, promoting improved circulation. Unique air-filled domes support back and leg muscles conserving workers' energy up to 50%. Liquid and debris settle between raised domes providing safe, dry footing. **SPECIFY COLOR: BK - Black, YL - Black with yellow border. IN STOCK.**

Model No.	Size	Wt. Lbs.	BK-Price Ea.	YL-Price Ea.
XF-536	24" x 36"	10	\$28.50	\$36.70
XF-537	36" x 48"	20	43.70	51.50

## RELIUS SOLUTIONS Waffle-Base Anti-Fatigue Mats



- Designed for use around chemicals and in wet or dry work areas
- Rubber construction
- 1/2" or 3/4" thick

Popular in machine shops, assembly lines, checkout counters, or toll booths. Cushioned mat reduces leg and back fatigue. Resilient waffle base with skid-resistant surface. Beveled edges on 3 sides unless noted. Flame-resistant. Color: black. **IN STOCK.**

Model No.	Size	Wt. Lbs.	Price Ea.
<b>3/4" THICK</b>			
XF-1000	24" x 72"	40	\$48.30
XF-1001	36" x 48"	40	48.30
XF-1002*	48" x 72"	80	90.00
<b>1/2" THICK</b>			
XF-1003	24" x 72"	27	\$38.50
XF-1004	36" x 48"	27	38.50
XF-1005*	48" x 72"	55	73.20

\*Beveled on 4 sides.

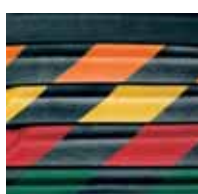

CHOOSE SOLID BLACK OR OSHA COLOR-CODED BORDERS: YELLOW FOR CAUTION, ORANGE FOR WARNING, RED FOR DANGER OR GREEN FOR SAFETY.



TEXTURE TOP



GRIP TOP



## ANDERSON Heavy-Duty Nitrile Rubber Mats

- Textured Surface—For dry or damp work areas
- Grip Surface—Provides superior traction and scraping action in wet work areas
- Polyurethane foam encapsulated within Nitrile rubber
- 3/8" thick



Unique construction makes these mats safe to use in both wet and dry areas. Resists chemicals, animal fats and petroleum products. Rubber backing grips the floor, preventing mat movement and increasing safety. Beveled safety edges on all sides. **SPECIFY BORDER: BK - Black, GN - Green, OR - Orange, RD - Red, YL - Yellow. FACTORY QUICK SHIP—FOB GEORGIA.**

Size	Wt. Lbs.	Model Number	BLACK BORDER Price Each	COLORED BORDER Price Each
<b>TEXTURE TOP</b>				
24" x 36"	10	XK-1379	\$54.90	\$58.80
36" x 60"	25	XK-1380	138.00	148.00
36" x 120"	49	XK-1381	275.00	280.00
<b>GRIP TOP</b>				
24" x 36"	10	XK-1385	\$55.00	\$58.90
36" x 60"	25	XK-1386	139.00	148.00
36" x 120"	49	XK-1387	277.00	295.00

# Mats





## WEARWELL® WeldSafe® Mats

- For welding areas
- Rubber surface with natural rubber sponge base
- 1/2" thick

Repels sparks and hot metal shards from spot-welding jobs. Very resilient sponge base provides comfort and support when standing for long periods of time. Safety beveled edges. Three-year warranty. **FACTORY QUICK SHIP—FOB TENNESSEE.**



PRE-CUT SIZES			
Model Number	Size	Wt. Lbs.	Price Each
XF-1300	2' x 3'	9	\$40.80
XF-1301	3' x 5'	23	102.00

CUSTOM CUT. SPECIFY LENGTH UP TO 75'			
Model Number	Overall Width	Wt. Lbs./Sq. Ft.	Price Ea. Ft.
XF-1302	3'	4.5	\$22.60

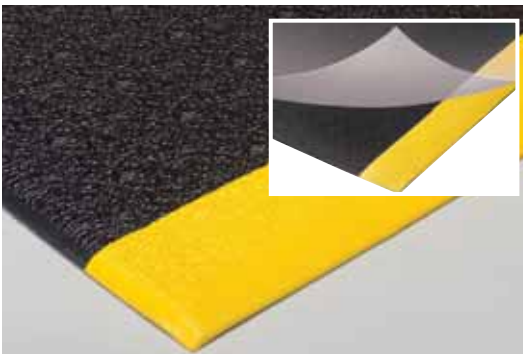

## WEARWELL® Dura Step Mats

- For mostly dry work areas or where chemicals are present
- Closed-cell PVC sponge with double urethane top coat
- 3/8" thick

Perfect for use in labs, pharmacies, factories, hospitals and industry. Comfortable materials reduce back and leg fatigue. Charcoal color combines with 4" safety yellow border with beveled edges. Color: black with yellow borders. **SELECTED MODELS IN STOCK.** Others FOB TENNESSEE.



Model No.	Size	Wt. Lbs.	Price Ea.
<b>PRE-CUT</b>			
XV-1526	2' x 3'	4	\$20.70
<b>FULL ROLLS</b>			
XV-1528	2' x 60'	75	\$356.00
XV-1529	3' x 60'	112	530.00
XV-1530	4' x 60'	149	692.00

CUT LENGTHS UP TO 60'			
Model Number	Size	Wt. Lbs./Sq. Ft.	Price Ea. Ft.
XV-1531	2'W	1-1/4	\$7.30
XV-1532	3'W	2	11.10
XV-1533	4'W	2-1/2	14.60





## WEARWELL® UltraSoft Diamond-Plate Mats

- For all dry work areas
- Koroseal vinyl top with 3/4" Nitricell® sponge base
- 15/16" thick

Eliminate the stress and pain from standing long-term by using this ultra-soft mat. Diamond-plate surface offers excellent traction and is three times more abrasion-resistant than similar mats. Beveled safety borders. 3-year warranty. **SPECIFY COLOR: BK - Black, BY - Black/yellow chevron, GY - Gray, YL - Black/yellow border. SELECTED MODELS IN STOCK or FACTORY QUICK SHIP—FOB TN.**



**FREE!**  
20-000(02)A—  
Free 14"Lx5-3/4"W mat sample available. Call for yours today!

Model Number	Size	Wt. Lbs.	SOLID COLORS		BLACK W/BORDER	
			Reg. Ea.	SALE EA.	Reg. Ea.	SALE EA.
<b>PRE-CUT</b>						
YK-5500	2' x 3'	9	\$55.80	\$47.00	\$61.10	\$51.00
YK-5501	3' x 5'	23	133.00	111.00	145.00	121.00
YK-5502	2' x 75'	225	1272.00	1069.00	1390.00	1167.00
YK-5503	3' x 75'	338	1909.00	1602.00	2084.00	1749.00
YK-5504	4' x 75'	450	2546.00	2137.00	2779.00	2332.00
<b>CUSTOM-CUT*. SPECIFY LENGTH UP TO 75'—PRICED/FT.</b>						
Custom-cut mats up to 12' wide by up to 150'L are available. FOB TN.						
YK-5505	24"W	3/ft.	\$19.00	\$15.30	\$20.70	\$17.30
YK-5506	36"W	4.5/ft.	28.20	23.50	30.30	25.50
YK-5507	48"W	5/ft.	38.00	32.00	41.20	39.90



## WEARWELL® Diamond-Plate SpongeCote™ Mats

- Place in any dry work area
- Koroseal vinyl top with 3/8" Nitricell™ sponge base
- 9/16" thick

Exceptionally buoyant mat features raised deck-plate surface providing exceptional slip-resistance. Cushions legs and spine increasing employee productivity, morale and physical well being. Grease- and chemical-resistant. Beveled safety borders. 3-year guarantee. **SPECIFY COLOR: BC - Black with Chevron Borders, BK - Solid Black, BY - Black with Yellow Borders. BK - SOLID BLACK AND BY - BLACK W/YELLOW BORDERS ARE IN STOCK IN STANDARD SIZES.** Others FOB TENNESSEE.



**FREE!**  
20-000(01)A—  
Free 14"L x 5-3/4"W mat sample available. Call for yours today!



STANDARD SIZES				
Model Number	Size	Wt. Lbs.	Price Each	
			Solid	Borders
XF-466	24" x 36"	12	\$37.70	\$44.50
XF-467	36" x 60"	30	91.40	108.00

CUSTOM-CUT MATS. SPECIFY LENGTH UP TO 75'				
Model Number	Size	Wt. Lbs./Sq. Ft.	Price Ea. Ft.	
			Solid	Borders
XF-468	24"W	3	\$13.30	\$15.50
XF-469	36"W	4-1/2	20.10	23.70

NOTE: No returns on custom-cut mats.



## WEARWELL® Industrial WorkSafe® Mats



- Effective in wet areas
- Grease-proof rubber construction
- 7/8" thick



Textured surface offers extra traction. Constructed of a unique CFR compound that is resistant to mineral oil based cutting fluids as well as most chemicals. Drainage holes and underside knobs allow liquid and debris to fall through. Molded-in safety borders in OSHA-approved safety

orange or yellow for high visibility. **SPECIFY BORDER COLOR: OR - Orange, YL - Yellow. IN STOCK.**

Model Number	Size	Wt. Lbs.	Price Each
XF-416	40" x 28"	16	\$85.80
XF-417	52" x 40"	32	153.00
XF-418	64" x 40"	49	164.00
XF-419	124" x 40"	80	323.00



## Notrax® Cushion-Tred™ Mats

- Perfect for areas with wet floors
- SBR rubber construction
- 7/8" thick

Specially designed for food preparation areas, this durable mat is very resistant to animal fats. Alternating large and small drain holes allows water to instantly drain through enhancing worker comfort and safety. Cushioning properties relieve back and leg fatigue when standing all day. 1-year warranty. Color: black. **FACTORY QUICK SHIP—FOB ILLINOIS.**

### MAT

Model No.	Size	Wt. Lbs.	Price Ea.
XF-1200	2' x 3'	19	\$44.60
XF-1201	3' x 3'	29	54.20
XF-1202	3' x 5'	49	90.40

### BEVELED EDGING

Model No.	Size	Price Ea.
XF-1204	2'	\$7.30
XF-1205	3'	10.90
XF-1206	5'	18.10

Model No. **XF-1207** – 1' Connectors.....\$3.07



## WEARWELL® Comfort Deck® Mats

- Standard: for wet or dry areas
- Grit-Top: for wet, dry, or greasy areas
- Recycled PVC construction
- 7/8" thick



Designed to reduce accidents in the workplace. Elevated, studded surface ribs and drainage holes combine to enhance traction in wet or dry areas. Includes 6" wide ramps on three sides for added safety. **SPECIFY BORDER COLOR: OR - Orange, YL - Yellow. STANDARD MAT IN YL - YELLOW IS IN STOCK.** Others FOB TENNESSEE.

Size	Wt. Lbs.	STANDARD		GRIP-TOP	
		Model Number	Price Each	Model Number	Price Each
30" x 36"	13	XF-538	\$68.80	XF-543	\$96.90
30" x 48"	19	XF-539	88.10	XF-544	120.00
30" x 60"	25	XF-540	111.00	XF-545	145.00
30" x 72"	31	XF-541	129.00	XF-546	174.00
42" x 72"	43.5	XF-542	179.00	XF-547	234.00

NOTE: Custom sizes available in 12" increments. No return on custom sizes.

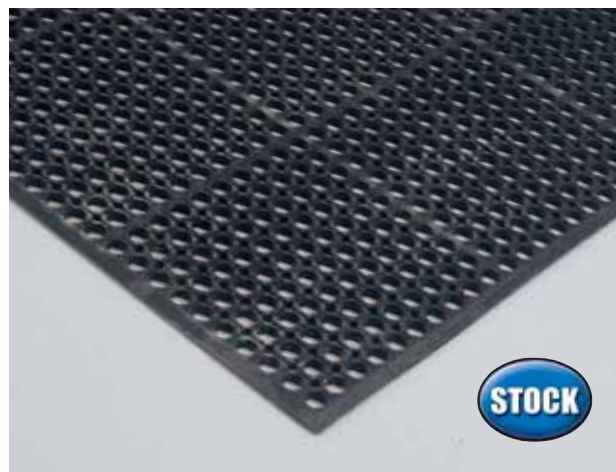

## WEARWELL® Drainage Mats

- Perfect for wet, dry or moderately greasy areas
- All-purpose rubber construction
- 1/2" thick

Workers' feet stay dry because liquids pass through drainage holes. For use in dry areas too. Rubber material cushions legs and back when standing for long periods of time. Beveled edges all around promote safety. Lightweight mats are easy to handle and spray clean. **IN STOCK.**

Model Number	Size	Wt. Lbs.	Price Each
YK-1392*	2' x 3'	9	\$29.10
YK-1391*	3' x 3'	13	46.10
YK-1390	3' x 5'	22	46.70

\*Beveled on 3 sides only.

# Mats



## WEARWELL® ErgoDeck™ 18" x 18" Modular Deck Mats

- Place solid tiles in dry areas and open tiles in wet, non-greasy areas
  - PVC construction
  - 7/8" thick interlocking tiles
- Easy-to-install mats feature 18" x 18" tiles that lock together to seamlessly cover large areas or create custom configurations. Professional-grade tiles have slightly textured surface that provides excellent traction. Flex-points on the underside are spaced to support workers weight and provide flexibility underfoot. Patented LockSafe® interlocking system securely connects tiles for a seamless installation. **FACTORY QUICK SHIP—FOB TENNESSEE.**



**CORNERS AND EDGING**  
Safety ramps feature countersunk holes for permanent installations. Color: yellow.

Model No. **YD-3106**—Ramp Edge. 6" x 18". Case of 10. Wt. 20 lbs.....**\$90.70**  
Model No. **YD-3107**—Corner. 6". Case of 4. Wt. 11 lbs....**\$113.00**

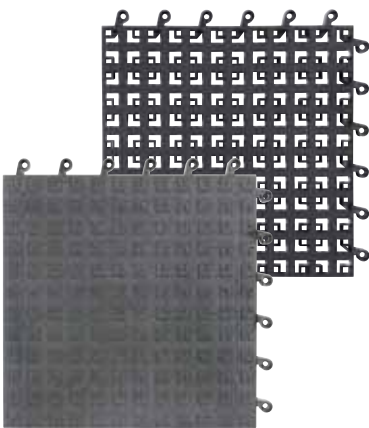

### OPEN GRID TILES

Larger openings offer better flow-through.

Model No. **YD-3100**—Single Tile. Wt. 5 lbs. ....**\$32.00**  
Model No. **YD-3101**—Case of 10 Tiles. Wt. 50 lbs..**\$229.00**

### SOLID TILES

Ideal in areas where small parts may fall to the floor. Easy to maintain. Choose either solid tiles that withstand heavy use including cart traffic or SOFT™ solid tiles that are designed for standing worker's comfort. Not for use with wheeled traffic.

### HEAVY USE TILES

Model No. **YD-3102**—Single Tile. Wt. 6 lbs. ....**\$32.00**  
Model No. **YD-3103**—Case of 10 Tiles. Wt. 56 lbs..**\$229.00**

### SOFT™ TILES

Model No. **YD-3104**—Single Tile. Wt. 6 lbs.....**\$32.00**  
Model No. **YD-3105**—Case of 10 Tiles. Wt. 56 lbs..**\$229.00**



Selected Models

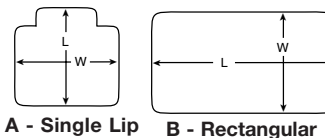

## ALECO™ Chair Mats

Ultra clear vinyl mats include a lifetime guarantee. (Guarantee is void if metal casters are used). 3/16" grippers on underside of all mats. **SPECIFY STYLE: A - Single Lip, B - Rectangular** (see diagrams). **SELECTED MODELS IN STOCK.** Others FOB ALABAMA.

### BEVELED EDGE VINYL ANCHORMATS.

Anti-skid textured surface is surrounded with safe beveled edge.

### TEXTURED STRAIGHT EDGE VINYL CHAIRMATS.

For non-carpeted surfaces, tile and hardwood floors. Textured on both sides.

### ANTISTATIC ANCHORMATS.

Trans-Stat meets Federal Test Method Standards for electrostatic properties of materials. Surrounded by a safety beveled edge except where noted.

Size	Model No.	Wt. Lbs.	(A) Price Ea.	(B) Price Ea.
<b>BEVELED EDGE VINYL ANCHORMATS</b>				
36" x 48"	<b>YD-1565</b>	12	\$55.70	\$62.70
45" x 53"	<b>YD-1566</b>	17	62.70	74.50
46" x 60"	<b>YD-1567</b>	19	78.60	86.50
60" x 60"	<b>YD-1568*</b>	26	—	131.00
60" x 72"	<b>YD-1569*</b>	31	—	141.00
<b>TEXTURED STRAIGHT EDGE VINYL CHAIRMATS</b>				
36" x 48"	<b>YD-1570</b>	12	—	\$55.30
45" x 53"	<b>YD-1571</b>	17	\$64.50	75.30
46" x 60"	<b>YD-1572</b>	20	79.50	85.00
60" x 60"	<b>YD-1573*</b>	26	—	119.00
60" x 72"	<b>YD-1574*</b>	31	—	129.00
<b>BEVELED EDGE ANTISTATIC ANCHORMATS</b>				
36" x 48"	<b>YD-1575*</b>	12	—	\$91.60
45" x 53"	<b>YD-1576</b>	17	\$111.00	117.00
46" x 60"	<b>YD-1577</b>	20	159.00	165.00
60" x 60"	<b>YD-1578*</b>	26	—	181.00
60" x 72"	<b>YD-1579**</b>	31	—	206.00

\*Rectangular only.

\*\*Rectangular with straight edge, only.



## WEARWELL® Clean Room Mats

- Place outside rooms that must remain free from dirt and other contaminants
- Tacky polyethylene film
- 1/8" thick

Tacky surface pulls dirt and dust off shoes before you enter a clean room. 30 layers of tough film are laminated together in a stack. Once top film is dirty, simply pull off and throw away. 30 sheets to a mat; 4 mats in a package. Sold in package quantities. Color: white.

**FACTORY QUICK SHIP—FOB TENNESSEE.**

Model Number	Size	Wt. Lbs.	Price Each
<b>XF-1400</b>	18" x 36"	8	\$99.80
<b>XF-1401</b>	18" x 45"	10	117.00
<b>XF-1402</b>	24" x 45"	13	173.00

## Polyurethane Task Chairs

**STOCK**

Improved extra-soft form-molded polyurethane seat and back provide maximum comfort and ergonomic support. Easy to clean and maintain. Seat height adjusts pneumatically from 17-25"H. 18"W x 17"D seat. 17"W x 12"H backrest adjusts manually. 25" dia. base. Ships via small package carrier. Color: black. **SPECIFY: A** - Pods, **B** - Hard floor casters, **C** - Carpet casters. **IN STOCK.**

SHOWN WITH OPTIONAL ARMS AND PODS.



Model No. **YA-1509**—Task Chairs. Wt. 27 lbs. ....\$196.00  
 Model No. **YA-1510**—Multi-Adjustment Task Chairs. Seat and backrest angles adjust at the touch of a lever. Wt. 34 lbs. ....\$221.00  
 Model No. **YA-1511**—Adjustable Arms. Wt. 7 lbs. ....\$34.30

## PHOENIX Ergonomic Office Seating

Provides ergonomic support all day. Waterfall front seat relieves knee pressure and promotes circulation. Both seat and back are constructed of high-density foam and contoured for comfort. Epoxy coated injection molded base. Upholstered armrests. **SPECIFY FABRIC COLOR: BK** - Black, **BR** - Brown, **GY** - Gray, **NY** - Navy, **TL** - Teal, **WN** - Wine. **SPECIFY FRAME COLOR: BK** - Black, **GY** - Gray. **FACTORY QUICK SHIP—FOB MICHIGAN.**



### FABRIC COLORS:

<b>BK - BLACK</b>	<b>BR - BROWN</b>	<b>GY - GRAY</b>
<b>NY - NAVY</b>	<b>TL - TEAL</b>	<b>WN - WINE</b>

**FACTORY QUICK SHIP**

Model No. **YD-1560**—Mid-Back Swivel Tilter. 23-1/2"W x 19"D x 31-35"H. Seat adjusts 17" - 21"H. Wt. 46 lbs. ....\$233.00  
 Model No. **YD-1562**—Super Steno. 21"W x 32"D x 36"H. Seat adjusts 16" - 20"H. Wt. 18 lbs. ....\$179.00  
 Model No. **YD-1561**—Guest Chair. 23"W x 26"D x 35"H. Wt. 20 lbs. ....\$233.00

## Poly/Steel Folding Chair

Meeting rooms, worship centers, and classrooms are just a few of the places you'll find this popular chair. Molded, contoured polypropylene seat and back will not rust or fade and are supported by a 7/8" round steel tube frame with two U-shaped cross braces. Non-mar polyethylene glides. 15"W x 16"D seat; 18-3/4"W x 7-1/2"H back. 18"W x 20"D x 29"H overall. **SPECIFY POLY/FRAME COLOR: BK** - Black/black, **NY** - Blue/gray, **BU** - Burgundy/black, **WH** - Bright/white. **FOB NEW JERSEY.**



**SAVE**

Model No. **YA-1447**—Reg. ~~\$29.80~~ **SALE ...\$26.80**

## All-Steel Folding Chair

A popular choice for meeting rooms and conference centers. 15-1/4"W x 16"D x 16-1/2"H seat is supported by a 19-ga., round tube frame with double-ripped U-shape braces. Contoured back has curled safety edges. Non-mar polyethylene leg glides. 18-3/4"W x 20-3/4"D x 29-1/2"H overall. Sold in lots of 4 only. **SPECIFY COLOR: BE** - Beige, **BK** - Black, **BL** - Blue, **GY** - Gray. **FACTORY QUICK SHIP—FOB NEW JERSEY.**



**SAVE**

**FACTORY QUICK SHIP**

Model No. **XK-3090**—Wt. 6 lbs. Reg. ~~\$22.40~~ **SALE.....\$20.20**

## Upholstered Folding Chairs

A great chair for meeting areas, auditoriums, and conference centers. 1-1/4" thick foam seat and back are upholstered with Scotch Guard™-treated fabric. Double hinge on each side prevents legs from buckling, while the double-ripped U-Brace offers extra strength and rigidity. 18-gauge tubular steel frame. 16-3/4" seat height. 18-3/4"W x 20-3/4"D x 29-1/2"H overall. Sold in lots of 4 only. **FACTORY QUICK SHIP—FOB NEW JERSEY.**



**FACTORY QUICK SHIP**

**SAVE**

**XK-3092BR SHOWN**

**FABRIC. SPECIFY COLOR: BE** - Beige with beige frame, **BL** - Blue with blue frame, **BG** - Blue with gray frame, **BR** - Dk. brown with brown frame, **BU** - Burgundy with gray frame, **GY** - Gray with gray frame.

Model No. **XK-3093**—Wt. 12 lbs. Reg. ~~\$35.10~~ **SALE.....\$31.60**

**VINYL. SPECIFY COLOR: BE** - Beige with beige frame, **BK** - Black with black frame, **BG** - Black with gray frame, **BL** - Blue with blue frame, **BR** - Brown with beige frame, **GY** - Gray with gray frame.

Model No. **XK-3092**—Wt. 12 lbs. Reg. ~~\$33.90~~ **SALE.....\$30.50**

## KI All-Steel Folding Chairs

Economical chairs feature seam-welded tubular steel frames, 3" frame strengtheners and a wallsaver design. Non-marring polypropylene feet protect floors. Scratch and chip-resistant baked enamel finish. Sold in lots of 4.

**100 SERIES FOLDING CHAIR.** Single brace. Features front and back welded crossbraces. Color: Beige. **IN STOCK.**

Model No. **XV-1387BE**—Wt. 10 lbs. ....\$24.40/ea.

**700 SERIES FOLDING CHAIR.** Double brace. Features 3 welded crossbraces. **SPECIFY COLOR: BE** - Beige, **BK** - Black, **BR** - Brown, **GY** - Azure gray metallic, **LG** - Gray, **SD** - Sand. **BE - BEIGE LG - GRAY, AND GY - AZURE GRAY METALLIC ARE IN STOCK.** Others **FOB MISSISSIPPI.**

Model No. **XV-1389**—Wt. 11 lbs. ....\$42.10/ea.



**STOCK**

Selected Models

**XV-1389**

**XV-1387**

# Seating



## BEVCO Adjustable Stools

Top quality seating is priced right for any budget. Features a 12-year guarantee against defects in material and workmanship. Attractive styling features upholstered 3" thick foam pad seat and 1" foam back. Back adjusts 5" horizontally and 3" vertically for added comfort. 1/4" x 2-1/4" solid steel support. Seat adjusts 5" vertically and swivels a full 360°. Chrome footring and sturdy 5-leg base. **IN STOCK.**

MODEL XG-3566CF

Model No. **XG-3569**—Casters (Set of 5) **\$48.00**

Model Number	Seat Height	Color	Wt. Lbs.	Price Each
<b>XG-3566CF</b>	19" - 24"	Black	27-1/2	<b>\$180.00</b>
<b>XG-3567CF</b>	24" - 29"	Black	28-1/2	<b>189.00</b>
<b>XG-3570CF</b>	19" - 24"	Brown	27-1/2	<b>180.00</b>
<b>XG-3571CF</b>	24" - 29"	Brown	28-1/2	<b>189.00</b>



## Industrial Stool

Selected Models

Built for long life and backed by a 15-year limited warranty! Comfortable stool features a 18"W x 16"D seat that adjusts from 22–32"H at the touch of a lever. Both seat and 16"W x 13"H backrest are 2" thick for added comfort. 40–50"H overall. Includes teardrop carpet footrest and dual wheel carpet casters (order hard floor casters or pods separately). **SPECIFY COLOR:** BK - Black fabric, BV - Black vinyl, GY - Gray fabric, NY - Navy fabric. **BV - BLACK VINYL IS IN STOCK.** Others **FACTORY QUICK SHIP—FOB CALIFORNIA.**

### STOOL

Model No. **YK-3206**—Wt. 30 lbs. .... **\$128.00**

### ACCESSORIES

Model No. **YK-3208**—Pods. Pkg. of 5. Wt. 2 lbs. .... **\$9.20**  
 Model No. **YK-3209**—Hard Floor Casters. Pkg. of 5. Wt. 2 lbs. .... **\$20.70**



Selected Models

### SPECIFY CUSHION COLOR:



## BEVCO Seating with Replaceable Cushions

Versatile seating allows you to remove the back and seat cushions for cleaning or replacement. Durable black plastic 18"W x 16"D seat and 18"W x 11"H back. Pneumatic seat height adjustment. All models include 5-leg reinforced plastic base with standard mushroom glides. Stools include an 18" adjustable chrome footring. 12-year guarantee. Removable cushions sold separately. Exceeds ANSI/BIFMA standards. **SELECTED MODELS IN STOCK.** Others **FOB WISCONSIN.**



OPTIONAL UPHOLSTERED CUSHIONS ARE EASY TO REMOVE.



YA-3063 SHOWN WITH OPTIONAL UPHOLSTERED SEAT AND BACK CUSHIONS.

Model Number	Description	Seat Height	Base Dia.	Wt. Lbs.	Price Each
<b>YA-3061</b>	Chair	15" - 22"	23"	120	<b>\$120.00</b>
<b>YA-3062</b>	Mid-Height Stool	19" - 27"	27"	145	<b>145.00</b>
<b>YA-3063</b>	Bench-Height Stool	22" - 32"	27"	145	<b>145.00</b>

### UPHOLSTERED CUSHIONS

Model No. **YA-3065**—Seat cushion. Wt. 24 lbs. .... **\$24.00**  
 Model No. **YA-3066**—Back cushion. Wt. 24 lbs. .... **\$24.00**

### ACCESSORIES

Model No. **YA-3064**—Loop Arm Set. Wt. 31 lbs. .... **\$31.00**  
 Model No. **YA-3067**—Hard floor casters. Set of 5. Wt. 21.9 lbs. .... **\$21.90**

## Stack Chair

Designed for strength and durability. Injection-molded polypropylene shell with rounded edges is supported by an 18-ga. steel square leg frame with 14-ga. cross braces. Legs and braces have an attractive chrome finish. Plastic glides with nylon bumper protect floors. Stack vertically up to 12 high for 6'8" door clearance. Sold in lots of 4. **SPECIFY SHELL COLOR: BK - Black, BL - Blue, BU - Burgundy, SD - Sand. IN STOCK.**



Model No. **XV-1390**  
.....\$51.90/ea.

## Deluxe Stack Chair

Textured, molded plastic shell dissipates static electricity. Heavy-gauge, tapered, tubular steel legs are sigma welded to leg brackets and to the round continuous back support for extra strength. Non-marring, nylon cushioned steel glides protect floors. Attractive chrome frame. Sold in lots of 5. **SPECIFY COLOR: BK - Black, BL - Blue, YL - Yellow. IN STOCK.**



Model No. **XF-1067** —  
Wt. 12 lbs. ....\$61.50/ea.



## KI Table Dolly

Heavy-gauge steel dolly transports and stores large, bulky tables. Uni-welded 16-ga. steel unit has 18-ga. tubular removable end and side posts. Holds (9) 72" or 96" tables, on edge. 78"L x 26-5/8"W. Color: beige. FOB MISSISSIPPI.

Model No. **XV-1519** — Wt. 70 lbs. ....\$285.00



## Chair Dolly

Safely transports 10 to 12 stacked chairs weighing a total of 280 lbs. 22-1/2"W x 22-1/2"D x 3/4"H platform is supported by four 2" smooth-rolling swivel casters. Color: black. Ships via small package carrier. **IN STOCK.**

Model No. **YP-1120** — Wt. 12 lbs. ....\$44.50



**SPACE-SAVER CADDY**

**PLATFORM CADDY**

## KI Chair Caddies

### PLATFORM CADDY

Stores and transports up to 50 chairs. Rolls smoothly on four rubber, ball-bearing casters—2 swivel, 2 fixed. 50-chair caddy has fifth swivel wheel under center of bed. Steel construction with enamel finish. FOB MISSISSIPPI.

Model No.	Overall L x W	Chair Capacity	Wt. Lbs.	Price Each
<b>XM-2066</b>	53-1/2" x 20-7/8"	25	45	<b>\$171.00</b>
<b>XM-2067</b>	80-1/2" x 20-7/8"	35	57	<b>211.00</b>
<b>XM-2068</b>	106-1/2" x 20-7/8"	50	69	<b>239.00</b>

### SPACE-SAVER CADDY

Two-tier design lets you safely move and store up to 84 chairs. Chairs hang upside down from both levels. 61-1/2"L x 33-3/4"W overall. 67-5/8"H without chairs; 79-7/8"H with chairs. FOB MISSISSIPPI.

Model No. **XM-2065** — Wt. 95 lbs. ....\$525.00

# Tables



**STOCK**  
Selected Models

**CORNERS RESIST DAMAGE UPON IMPACT FROM 2-FT. VERTICAL CORNER DROPS. RUBBER BUMPERS PROTECT TABLES FROM DAMAGE WHEN STACKED.**



## KI Lightweight Folding Tables

These tables are so lightweight that one person can easily carry them. Yet they handle an evenly distributed 2,000-lb. load. Top and bottom surfaces are made of super tough ABS plastic, which will not melt under temperatures up to 210 degrees. A honeycomb core provides strength and makes these tables lightweight. Top and bottom shells are ultrasonically welded around the perimeter to seal out moisture. Wide-mouth welds anchor the frame and leg tubing for extra strength. Feet are capped to protect the legs. 10 yr. warranty. **SPECIFY TOP COLOR: GY - Gray, SD - Sand, WL - Walnut. GY - GRAY IS IN STOCK.** Others FOB MISSISSIPPI.

Model No.	Dimensions	Wt. Lbs.	Price Ea.
<b>ROUND TABLES</b>			
<b>XP-1241†</b>	60" Dia.	47	<b>\$358.00</b>
<b>XP-1242†</b>	72" Dia.	64	<b>471.00</b>
<b>RECTANGULAR TABLES</b>			
<b>XK-2347</b>	60" x 30"	35	<b>\$272.00</b>
<b>XK-2348*</b>	72" x 30"	39	<b>295.00</b>
<b>XK-2349*</b>	96" x 30"	49	<b>315.00</b>

\*SD - Sand is **FACTORY QUICK SHIP**—FOB MISSISSIPPI.  
†Not available in WL - Walnut.



**STOCK**  
Selected Models

## CORRELL Plastic Resin Folding Tables

Tough, durable table top stands up to practically anything, yet is lightweight for easy handling. Resists damage from all types of substances from food or paint to battery acid and gasoline. Molded heavy-duty plastic resin will not chip or crack, and if dented, returns to normal within 24 hours. Entire surface is supported by a strong steel frame with five crossbars for extra strength. Folds down for easy storage. Choose standard or adjustable-height table. 5-year limited warranty. **SPECIFY COLOR: BR - Brown nebula, LG - Lt. gray nebula.**

Model Number	Overall L x W	Wt. Lbs.	Price Each
<b>STANDARD 29" FIXED HEIGHT—IN STOCK</b>			
<b>YP-1160</b>	72" x 30"	42	<b>\$173.00</b>
<b>YP-1161</b>	96" x 30"	54	<b>235.00</b>
<b>ADJUSTABLE HEIGHT 22"-32" IN 1" INCREMENTS LG-LIGHT GRAY NEBULA IS IN STOCK. BR-BROWN NEBULA IS <b>FACTORY QUICK SHIP</b>—FOB ARKANSAS.</b>			
<b>YP-1162</b>	48" x 24"	32	<b>\$172.00</b>
<b>YP-1163</b>	72" x 30"	44	<b>216.00</b>
<b>YP-1164</b>	96" x 30"	56	<b>279.00</b>



**STOCK**  
Selected Models

## BARRICKS Lunchroom Cafeteria Tables

Comfortable seating for 6 or 8 people with glass smooth textured walnut high pressure laminate over 3/4" flakeboard on bench and table tops. Plastic molding. 1-1/4" square tubular steel bases in beige enamel. Adjustable glides. Ships knocked down. **SELECTED MODELS IN STOCK.** Others FOB ALABAMA.

Model No.	Overall L x W	Wt. Lbs.	Price Ea.
<b>CAFETERIA TABLE</b>			
<b>XF-5077</b>	30" x 72"	155	<b>\$603.00</b>
<b>XF-5078</b>	30" x 96"	187	<b>684.00</b>
<b>CAFETERIA TABLE WITH BACKREST</b>			
<b>XF-5085</b>	30" x 72" w/backrest	187	<b>\$634.00</b>
<b>XF-5086</b>	30" x 96" w/backrest	240	<b>791.00</b>



## Steel Frame Folding Tables

Built to last! Double welded ribbed construction stands up to tough use. 18-gauge one-piece welded channel steel apron and understructure fastened to the top every 12". Warp-resistant Novoply™ core. Rounded corners and bullnose vinyl edging all around provide extra protection. Table surface is supported by 1-1/8" O.D., 29"H nonchipping enamel steel tube legs. 9-gauge gravity lock linkage folds legs flush within apron bottom. Walnut top/black edge/beige frame. **SELECTED MODELS IN STOCK.** Others FOB MISSISSIPPI.



**SOLID CORE STANDARD FOLDING TABLES.** 3/4" thick, high-density, high-strength solid core top with .022" burn- and mar-resistant high-pressure laminate surface.

Model No.	L x W	Wt. Lbs.	Price Ea.
<a href="#">XV-1454</a>	60" x 30"	59	<b>\$134.00</b>
<a href="#">XV-1455</a>	72" x 30"	69	<b>141.00</b>
<a href="#">XV-1456</a>	96" x 30"	91	<b>149.00</b>
<a href="#">XV-1457</a>	72" x 36"	77	<b>155.00</b>
<a href="#">XV-1458</a>	96" x 36"	105	<b>180.00</b>



Selected Models



**HONEYCOMB CORE TABLES.** 30% lighter than solid top tables. .083" thick burn- and mar-resistant high-pressure laminate top.

Model No.	L x W	Wt. Lbs.	Price Ea.
<a href="#">XV-1459</a>	60" x 30"	44	<b>\$169.00</b>
<a href="#">XV-1460</a>	72" x 30"	50	<b>170.00</b>
<a href="#">XV-1461</a>	96" x 30"	65	<b>192.00</b>
<a href="#">XV-1462</a>	72" x 36"	55	<b>211.00</b>
<a href="#">XV-1463</a>	96" x 36"	68	<b>238.00</b>



**VALUE SERIES TABLES.** 5/8" thick particleboard, Decolam low-pressure laminate top.

Model No.	L x W	Wt. Lbs.	Price Ea.
<a href="#">XV-1449</a>	60" x 30"	53	<b>\$118.00</b>
<a href="#">XV-1450</a>	72" x 30"	62	<b>124.00</b>
<a href="#">XV-1451</a>	96" x 30"	81	<b>136.00</b>
<a href="#">XV-1452</a>	72" x 36"	68	<b>160.00</b>
<a href="#">XV-1453</a>	96" x 36"	93	<b>168.00</b>

## KI Rectangular Folding Tables

Safe operation, enhanced mobility, and easy storage are just a few of the reasons why these tables are perfect for businesses, schools, or conference centers. Pneumatic lift system features torsion bars that offer easy, controlled folding and unfolding. Carefree high-pressure laminate surface is surrounded by a unique Perfect Edge that seals out moisture, bacteria, and dirt. Wide high-pressure laminate benches are supported by uniform diameter tubes with gussets for strength and durability. Unitized all-steel frames with 4" swivel casters and non-marring nylon glides. UL-listed. **SPECIFY COLOR: CH - Charcoal, GY - Gray, OK - Oak, RD - Brushed Red, WL - Walnut.** FOB WISCONSIN.

Model Number	Overall Length	Seating Capacity	Wt. Lbs.	Price Each
<a href="#">YS-1760</a>	10'	8-12 adults	250	<b>\$1049.00</b>
<a href="#">YS-1761</a>	12'	12-16 adults	290	<b>1160.00</b>



**LARGE, INTEGRATED STORAGE LOCK** AUTOMATICALLY ENGAGES WHEN TABLE IS CLOSED. RELEASE IS EASILY ACCESSIBLE FROM BOTH SIDES.



**GRAVITY LOCK** AUTOMATICALLY ENGAGES APRON SLOTS SO TABLE WON'T CLOSE UNEXPECTEDLY.



**PINCH-FREE CENTER HINGES** AND SUFFICIENT SPACE BETWEEN TABLE HALVES KEEP FINGERS FROM GETTING CAUGHT.

CH- CHARCOAL

GY- GRAY

OK- OAK

RD- BRUSHED RED

WL- WALNUT

# Cafeteria Seating & Desks



CAFETERIA SEATING IN NON-STOCK COLORS IS CUSTOM-MADE AND NOT RETURNABLE OR MAY BE SUBJECT TO A RESTOCKING FEE.

XF-5030 SHOWN IN RED WITH BUTCHER BLOCK TOP



## Lunchroom Booths



Selected Models

Here's a great way to provide cafeteria seating for up to 4 people. Bench and table faces and edges are high-pressure plastic laminate for mar-, burn-, stain-resistance and good looks that last. Damp-wipe for easy daily upkeep. Units have adjustable levelers and fasten securely to the floor. Two-piece steel frame bolts together quickly and easily. Average product life - 10 years. Choose between wall or island style that allows entry from both sides. **SPECIFY TABLE TOP AND BENCH COLOR: TABLE TOP:** Red, Navy, Butcher Block, Oak, White Nebula, Hunter Green, Black, Gray Nebula, Burgundy. **BENCH FRONT:** Red, Oak, Navy, Black, Hunter Green. **RED BENCH WITH BUTCHER BLOCK TOP IS IN STOCK.** Others FOB MINNESOTA.

- Model No. **XF-5030**—4-Person Wall-Style Unit. 24" x 40" top, 42" x 63" floor space. 1-sided entry. Wt. 188 lbs. Reg. \$872.00. **SALE** .....\$785.00
- Model No. **XF-5031**—4-Person Island-Style Unit. 24" x 40" top, 42" x 63" floor space. 2-sided entry. Wt. 183 lbs. Reg. \$961.00. **SALE** .....\$865.00
- Model No. **XF-5087**—2-Person Wall-Style Unit. 24" x 23" top, 23" x 63" floor space. 1-sided entry. Wt. 131 lbs. Reg. \$684.00. **SALE** .....\$616.00



48" ROUND TABLE SHOWN IN RD - HOLLYBERRY RED



48" SQUARE TABLE SHOWN IN BL - BLUE



## BARRICKS Round and Square Cafeteria Tables

Functional and sturdy tables are lasting solutions to your cafeteria or breakroom needs. Bench and table combination offers comfortable seating for up to 8 people. **SPECIFY COLOR: BL** - Blue, **RD** - Hollyberry Red, **WL** - Walnut, **WS** - White Sand, **YL** - Yellow. FOB ALABAMA. **TOPS.** 3/4" flakeboard with stain and scratch resistant high pressure laminate, with backer sheet and black edging. **BENCH SEATS.** 1-1/8" flakeboard with stain and scratch resistant high pressure laminate, with backer sheet and black edging. **APRONS.** 2-1/4" semi-box type with square corners. Black baked enamel paint. **BASES.** 1-1/4" x 18-ga. square tubular steel with reinforced steel bracing and adjustable glides. 30" overall height. Black baked enamel paint.

ALSO AVAILABLE IN:

- WL - WALNUT**
- YL - YELLOW**
- WS - WHITE SAND**

48" SQUARE TABLE SEATS 4-6 PEOPLE.

Model No. **WF-5134**— Wt. 207 lbs. ....\$664.00

ROUND TABLES.

- Model No. **WF-5132**—48". Seats 4-6 people. Wt. 172 lbs. ....\$650.00
- Model No. **WF-5133**—60". Seats 6-8 people. Wt. 214 lbs. ....\$742.00



Selected Models



## MBI Standard Desks

Sturdy, durable desks are perfect for the industrial office. Electronically welded cold-rolled steel construction features a 1-1/8" self-edged thermal fused laminate desk top. 29"H units are supported by 1" sq. tubular chrome-plated legs. Also includes full-size rollers on all drawers and cam locks on box and file drawers. **SPECIFY DESK/LAMINATE TOP COLORS: BK** - Black/walnut, **LG** - Lt. gray/lt. gray, **PY** - Putty/oak. **SELECTED MODELS ARE IN STOCK.** Others FOB ILLINOIS.

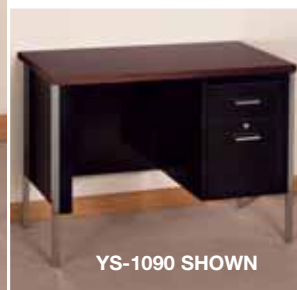

YS-1090 SHOWN

Model Number	Pedestal Style	Overall W x D	Wt. Lbs.	Price Each
<b>YS-1090</b>	Single	40" x 24"	70	<b>\$330.00</b>
<b>YS-1091</b>	Double	60" x 30"	145	<b>467.00</b>
<b>YS-1092</b>	Double	72" x 36"	192	<b>546.00</b>

# Key Cabinets & Bulletin Boards

## MMF Key Control Systems

Ideal for apartment complexes, car repair shops—anywhere you need to store a lot of keys. Keys attach to ABS plastic, numbered tags that hang securely from wide-angled slots. Plated snap hook accommodates up to 3 keys. Comes complete with numerical and alphabetical index cards. 20-ga. steel cabinet with precision spot welded end caps includes a double-reinforced 18-ga. steel door that swings open on full-length piano hinges. Paracentric key lock with 2 keys secures door to prevent theft. Sits on counter-top or hangs on the wall. Color: sand. **IN STOCK.**

**STOCK**

Model Number	Key Capacity	Overall W x D x H	Wt. Lbs.	Price Each
<b>XG-5686</b>	10	6-3/4" x 2" x 6-7/8"	3	<b>\$37.30</b>
<b>XG-5687</b>	30	12-1/8" x 2-5/8" x 8"	4	<b>66.40</b>
<b>XG-5688</b>	40	12-1/8" x 2-5/8" x 8"	4	<b>70.10</b>
<b>XG-5689</b>	60	17-1/8" x 3-1/8" x 14"	10	<b>106.00</b>
<b>XG-5690</b>	80	17-1/8" x 3-1/8" x 14"	11	<b>141.00</b>
<b>XG-5691</b>	110	17-1/8" x 3-1/8" x 14"	11	<b>160.00</b>
<b>XG-5692</b>	160	20-1/8" x 4-7/8" x 16-1/2"	15	<b>195.00</b>
<b>XG-5693</b>	240	20-1/8" x 4-7/8" x 16-1/2"	20	<b>286.00</b>
<b>XG-5694</b>	320	20-1/8" x 4-7/8" x 16-1/2"	21	<b>323.00</b>

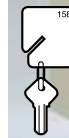

**WHITE KEY TAGS WITH NUMBERS**



### EXTRA TAGS

Model No. **XG-5695**—Plain Tags.....**\$8.00**/pkg. of 20  
 \*Model No. **XG-5696**—Numbered Tags.....**\$10.20**/pkg. of 20

\*SPECIFY TAG NUMBERS: A - 1-20, B - 21-40.

## Ghent® Enclosed Bulletin Boards

Self-sealing tan cork, acrylic enclosed bulletin boards are attractive display and message centers. Choose either satin anodized aluminum frame with doors that swing open on full-length piano hinges or walnut finished wood frame with doors that open on 2" hinges. Both boards feature 1-1/2" wide door frames that surround large acrylic windows, 1"W x 2"D overall frame size, 3/4" space between windows and corkboard, and locking doors with 2 keys. **SELECTED MODELS IN STOCK. OTHER FOB OHIO.**

**STOCK**



Description	Overall W x H	ALUMINUM			WOOD		
		Model Number	Wt. Lbs.	Price Each	Model Number	Wt. Lbs.	Price Each
*One Door	18" x 24"	<b>XG-3633</b>	15	<b>\$158.00</b>	<b>XV-1391</b>	14	<b>\$155.00</b>
*One Door	24" x 36"	<b>XG-2115</b>	25	<b>224.00</b>	<b>XG-3635</b>	24	<b>198.00</b>
Two Door	48" x 36"	<b>XG-2117</b>	50	<b>356.00</b>	<b>XG-3636</b>	47	<b>337.00</b>
Two Door	60" x 36"	<b>XG-2118</b>	63	<b>426.00</b>	<b>XG-3637</b>	57	<b>385.00</b>
Three Door	72" x 36"	<b>XG-2119</b>	77	<b>524.00</b>	<b>XG-3638</b>	70	<b>528.00</b>

\*Ships via small package carrier.



## Ghent® Cork Boards

Ideal for posting information or messages. Quality satin anodized aluminum frames surround cork board. **IN STOCK.**



**STOCK**

Model No.	Overall W x H	Wt. Lbs.	Price Ea.
<b>YD-1750*</b>	24" x 18"	4	<b>\$18.20</b>
<b>YD-1751*</b>	36" x 24"	7	<b>27.20</b>
<b>YD-1752*</b>	48" x 36"	13	<b>56.10</b>
<b>YD-1753</b>	60" x 36"	14	<b>96.30</b>

\*Ships via small package carrier.

# Office Panels & Clocks



**STOCK**  
Selected Models



## MAXON Office Panels

Now you can create individual offices in minutes with these free-standing panels. Set-up quickly because each panel arrives ready to connect and put in position. Sturdy semi-tackable panels are covered with easy-care Olefin® fabric. 1" steel frame. **SPECIFY FABRIC/FRAME COLOR:**

**BL** -Blue/Gray, **CH** - Charcoal/Charcoal, **GY** - Gray/Gray, **MV** - Mauve/Charcoal. **CH - CHARCOAL/CHARCOAL IS IN STOCK.** Others FOB NORTH CAROLINA.

Model Number	Panel H x W	Wt. Lbs.	Price Each
<b>XS-1540</b>	60" x 24"	30	<b>\$147.00</b>
<b>XS-1541</b>	60" x 30"	33	<b>150.00</b>
<b>XS-1542</b>	60" x 36"	35	<b>150.00</b>
<b>XS-1543</b>	60" x 48"	42	<b>159.00</b>
<b>XS-1544</b>	60" x 60"	54	<b>165.00</b>
<b>XS-1545</b>	60" x 72"	60	<b>195.00</b>
<b>XS-1546</b>	72" x 36"	44	<b>178.00</b>
<b>XS-1547</b>	72" x 48"	50	<b>188.00</b>
<b>XS-1548</b>	72" x 60"	62	<b>208.00</b>

NOTE: All custom-ordered products are made to order and not returnable. Changes to orders are not accepted after production starts.

### ACCESSORIES.

**SPECIFY COLOR: CH - Charcoal, GY - Gray.**

Model No.	Description	Price Ea.
<b>XS-1549</b>	Straight Connector	<b>\$10.40</b>
<b>XS-1550</b>	90° Connector	<b>10.40</b>
<b>XS-1551</b>	3-Way Connector	<b>17.70</b>
<b>XS-1552</b>	4-Way Connector	<b>21.30</b>
<b>XS-1553</b>	Stabilizing Foot	<b>18.80</b>



A



## INFINITY/ITC Wall Clocks

**A. 12" DIA. STANDARD CLOCK**  
12" dia. high-impact plastic case. **SPECIFY COLOR: BK - Black, BR - Brown. IN STOCK.**

Model No. **YL-0941** —  
Wt. 3-1/2 lbs. ....\$18.00



B

**B. MESSAGE CLOCK**  
Think Safety dial message. 12" dia. black high-impact plastic case. **IN STOCK.**

Model No. **YS-1671** —  
Wt. 3-1/2 lbs. ....\$22.00



C

**C. 19" WALL CLOCK**  
19" dia. black plastic case. Does not have a second hand. **IN STOCK.**

Model No. **YS-1670** —  
Wt. 5 lbs. ....\$153.00



### Specify Print Wheels

- (A)  
**M154**  
*(Day of Week, Hrs. & Min.)*
- (B)  
**OCT 2 154**  
*(Month, Date, Hrs. & Min.)*
- (C)  
**M1390**  
*(Day of Week, 0-23 Hrs. & 100ths of Hrs.)*



Selected Models

## ACROPRINT® Time Clocks

Ensure accurate payroll records with card-actuated time clocks. Stamps cards with accurate, consistent information, including date and time, etc. Right print edge. Choose electric, manual push bar, or battery operated units. Portable.

**SELECTED MODELS IN (B) STYLE ARE IN STOCK.** Others FOB NORTH CAROLINA.

Model No. <b>YM-2509*</b> —Manual electric .....	<b>\$373.00</b>
Model No. <b>YM-2510*</b> —Auto electric.....	<b>\$426.00</b>
Model No. <b>YM-2511*</b> —Battery model .....	<b>\$532.00</b>

### BOX/1000 ACROPRINT® TIME CARDS

Model No. <b>YM-2512</b> —Weekly Payroll, right print edge...	<b>\$41.80</b>
Model No. <b>YM-2513</b> —2-Week Payroll, right print edge...	<b>\$41.80</b>
Model No. <b>YM-2514</b> —Replacement Ribbon. <b>SPECIFY COLOR: BL - Blue, RD - Red/blue combo.</b> ....	<b>\$13.10</b>

\*SPECIFY PRINT WHEEL NUMBER AND TYPE. (Shown in box above.)



## PENCO Record Storage System

This system makes storing and locating files and records quick and easy. Records can be retrieved from both sides. This storage system assembles quickly with no special tools. Particleboard decking comes standard for each shelf on both starter and add-on units. The record storage boxes are 12-1/2"W x 16-1/2"D x 10-1/2"H. **IN STOCK.**

Overall W x D x H	Shelf Qty.	Box Qty.	STARTER			ADD-ON		
			Model Number	Wt. Lbs.	Price Each	Model Number	Wt. Lbs.	Price Each
<b>WITHOUT BOXES</b>								
69" x 15" x 60"	3	—	ZG-5064	99.4	\$180.00	ZG-5068	98.2	\$173.00
69" x 30" x 60"	3	—	ZG-5065	159.1	247.00	ZG-5069	157.9	242.00
69" x 15" x 84"	4	—	ZG-5066	133.6	235.00	ZG-5070	131.6	226.00
69" x 30" x 84"	4	—	ZG-5067	213.2	327.00	ZG-5071	211.2	318.00
<b>WITH BOXES</b>								
69" x 15" x 60"	3	30	ZG-5064A	105.4	\$264.00	ZG-5068A	104.2	\$258.00
69" x 30" x 60"	3	60	ZG-5065A	171.7	421.00	ZG-5069A	169.9	416.00
69" x 15" x 84"	4	40	ZG-5066A	141.6	350.00	ZG-5070A	139.6	343.00
69" x 30" x 84"	4	80	ZG-5067A	229.2	557.00	ZG-5071A	227.2	548.00



## HALLOWELL® Rivetwell™ 84"H Single-Rivet Boltless Shelving

Rivet-type lock engages into keyhole slot. Common T-posts between starter and add-on. Starter includes (4) angle posts, (4) left-to-right double rivet angle beams, (4) front-to-back double rivet angle beams, (2) left-to-right single rivet beams per shelf level, and (2) front-to-back single rivet beams at the intermediate level. (30"D and 36"D units include (2) front-to-back single rivet beams at each shelf level). Adder includes (2) T-posts, (4) left-to-right double rivet angle beams, (2) front-to-back double rivet angle beams, (2) left-to-right single rivet beams per shelf level, and (1) front-to-back single rivet beam at the intermediate level. (30"D and 36"D units include (1) front-to-back single rivet beam at each shelf level). Order particleboard decking separately. Color: putty. **SELECTED MODELS IN STOCK.** Others FOB PENNSYLVANIA, TENNESSEE.

Shelf WxD	Shelf Cap. Lbs.	84"H STARTER			84"H ADD-ON			EXTRA LEVELS		
		Model No.	Wt. Lbs.	Price Ea.	Model No.	Wt. Lbs.	Price Ea.	Model No.	Wt. Lbs.	Price Ea.
<b>350 LB. CAPACITY PER SHELF</b>										
36x12"	350	ZP-3020	43	\$92.80	ZP-3030	39	\$77.60	ZP-3040	3.5	\$8.10
36x18"	350	ZP-3021	45	96.20	ZP-3031	40	79.20	ZP-3041	4	8.50
36x24"	350	ZP-3022	47	99.50	ZP-3032	41	80.30	ZP-3042	4	8.90
36x30"	350	ZP-3023	54	115.00	ZP-3033	44	87.70	ZP-3043	7.5	9.30
36x36"	350	ZP-3024	57	121.00	ZP-3034	46	90.20	ZP-3044	8.5	9.60
<b>250 LB. CAPACITY PER SHELF</b>										
48x12"	250	ZP-3025	49	\$103.00	ZP-3035	45	\$87.70	ZP-3045	4.5	\$9.20
48x18"	250	ZP-3026	51	108.00	ZP-3036	46	88.50	ZP-3046	5	9.80
48x24"	250	ZP-3027	53	111.00	ZP-3037	47	90.20	ZP-3047	5	10.00
48x30"	250	ZP-3028	60	123.00	ZP-3038	51	97.00	ZP-3048	8.5	10.30
48x36"	250	ZP-3029	63	130.00	ZP-3039	52	101.00	ZP-3049	9.5	10.70

**5/8" INDUSTRIAL-GRADE PARTICLEBOARD DECKING**  
SPECIFY WIDTH: A - 36"W, B - 48"W.

Model Number	Shelf WxD	(A) 36"W	(B) 48"W
		Price Ea.	Price Ea.
ZP-3050	36x12"	\$7.00	\$9.30
ZP-3051	36x18"	10.50	14.10
ZP-3052	36x24"	15.20	18.40
ZP-3053	36x30"	19.10	25.20
ZP-3054	36x36"	22.70	27.40



# Literature Organizers



## DURHAM® Literature Racks

Tiered pocket design exposes the top 2-1/2" of each 8-1/2" x 11" magazine/brochure, letting readers quickly scan titles and make their selection. Mount rack flush against the wall or create a free-standing unit by adding pre-assembled optional legs. Constructed of cold-rolled steel, racks are finished with a baked enamel powder coat finish. Ship via small package carrier. **SPECIFY COLOR: BK - Black, GY - Gray, TN - Tan. IN STOCK.**

Model Number	Pocket Qty.	Pocket W x D x H	Overall W x D x H	Wt. Lbs.	Price Each
YD-1404	5	8-13/16" x 3/4" x 8-1/2"	9-3/4" x 4-1/8" x 20-1/4"	9	\$38.10
YD-1405	10	12-1/4" x 5/16" x 5-3/4"	13-1/4" x 1-15/16" x 26-1/4"	13	59.90
YD-1406	11	8-13/16" x 3/4" x 8-1/2"	9-3/4" x 4-1/8" x 36"	16	55.70
YD-1407	11	12-1/4" x 3/4" x 8-3/8"	13-1/4" x 4-1/8" x 36"	20	97.30
YD-1409	23	8-13/16" x 3/4" x 8-1/2"	9-3/4" x 4-1/8" x 65-1/2"	31	90.90
YD-1408	20	8-13/16" x 3/4" x 8-1/2"	13-1/4" x 4-1/8" x 58"	30	139.00

### OPTIONAL LEGS

Model No. YD-1410	— For 9-3/4"W racks. ....	\$18.90/set
Model No. YD-1411	— For 13-1/4"W racks. ....	\$22.80/set



## SAFCO Reveal™ Literature Racks

Clear racks show entire cover of pamphlets, magazines, booklets, etc. Made of see-through, break-resistant impact acrylic for ultimate durability. Each pocket holds up to 1-7/8" thick material. Single-piece, thermo-formed units do not require assembly. Come complete with screws and anchors for fast, easy set-up. Table top and free-standing floor displays also available, call for information. **FACTORY QUICK SHIP—FOB CALIFORNIA, GEORGIA.**

Model No.	Pocket (Qty.) W x D	Overall W x H	Wt. Lbs.	Price Ea.
YP-2860	(8) 4" x 9"	20-5/8" x 20-1/2"	10	\$131.00
YP-2858	(4) 4" x 9" & (2) 9-1/2" x 11"	21" x 22-5/8"	10	139.00
YP-2857	(4) 9-1/2" x 11"	20-1/2" x 24-5/8"	10	141.00
YP-2856	(6) 9-1/2" x 11"	30" x 24-5/8"	21	153.00
YP-2855	(9) 9-1/2" x 11"	30" x 36-7/8"	21	206.00
YP-2859	(6) 4" x 9" & (6) 9-1/2" x 11"	30" x 34-3/4"	21	198.00



## SAFCO Value Sorter® Organizers

Here's a low-cost solution for storing forms, literature, catalogs, etc. Strong steel shell surrounds 9-3/4"W x 12-1/2"D x 2-1/2"H corrugated fiberboard compartments. Large enough to hold letter-size file folders, each compartment will store up to 550 sheets of paper, as well. Wide shelf fronts feature label holders for quick identification of contents (labels included). Easy assembly via quick-lock fasteners. **SPECIFY COLOR: BK - Black, GY - Gray, SD - Sand. IN STOCK.**



Model No.	Compartment Qty.	Overall WxDxH	Wt. Lbs.	Price Ea.
YL-0460	24	32-1/4x13-1/2x25-3/4"	26	\$155.00
YL-0461	36	32-1/4x13-1/2x38"	36	180.00
YL-0462	75	32-1/4x13-1/2x75"	61	308.00



## DURHAM® Steel Literature Organizers

Keep files, literature and other paperwork organized with these modular racks. 11"W x 11-5/8"D x 3"H extra-wide openings offer enough room for full-size file folders. Rigid racks won't bend or sag and can be vertically stacked with provided bolts. Ships via small package carrier fully assembled, ready to use immediately. **SPECIFY COLOR: BK - Black, TN - Tan. FACTORY QUICK SHIP—FOB CONNECTICUT.**

Model Number	Description	Ctn. Qty.	Wt. Lbs.	Price Each
XL-0530	9-Compartment	1	25	\$59.50
XL-0531	12-Compartment	1	34	90.90
XL-0532	15-Compartment	1	39	96.40
XL-0533	30-Compartment	2	78	193.00
XL-0534	45-Compartment	3	108	289.00
XL-0535	Optional Base	1	13	46.90



## SAFCO 5-Drawer Steel Flat Files

Protect blueprints, tracings, maps or any large sheets from dust and damage with these file cabinets. Superior quality construction features heavy-gauge welded steel cabinets, reinforced with steel channels. All identical models may be stacked to give you more storage capacity. Drawers slide smoothly on welded ball bearing rollers while safety stops prevent drawers from pulling out too far. **SPECIFY COLOR:** BK - Black, GY - Gray, LG - Lt. Gray, TN - Tan, TS - Tropic Sand, WH - White. **LG - LIGHT GRAY, TN - TAN, TS - TROPIC SAND ARE IN STOCK.** Others FOB CALIFORNIA, MINNESOTA.



Model Number	Description	Overall W x D x H	Drawer W x D x H	Wt. Lbs.	Price Each
XV-2160	Flat File	40-3/8" x 29-3/8" x 16-1/2"	37" x 26" x 2-1/8"	169	\$803.00
XV-2161	Closed Base	40-3/8" x 26-3/8" x 6"	—	25	145.00
XV-2162	Storage Base	40-3/8" x 29-3/8" x 20"	—	40	318.00
XV-2163	Flat File	46-3/8" x 35-3/8" x 16-1/2"	43" x 32" x 2-1/8"	208	930.00
XV-2164	Closed base	46-3/8" x 32-3/8" x 6"	—	30	156.00
XV-2165	Storage base	46-3/8" x 35-3/8" x 20"	—	41	337.00
XV-2166	Flat File	53-3/8" x 41-3/8" x 16-1/2"	50" x 38" x 2-1/8"	254	1102.00
XV-2167	Closed base	53-3/8" x 38-3/8" x 6"	—	35	195.00
XV-2168	Storage base	53-3/8" x 41-3/8" x 20"	—	47	351.00

## Steel Flat Files



Blueprints, maps, posters, and other large flat materials remain free from damage when they're housed in this heavy-duty file. Heavy-gauge steel reinforced cabinet provides extra protection and durability. Rugged drawers have brushed aluminum handles that give them a contemporary, finished look. Order cabinet and base separately. **SPECIFY COLOR:** LG - Lt. Gray, LT - Lt. Tan. **IN STOCK.**



### STEEL FLAT FILES

Model Number	Overall W x D x H	Drawer W x D x H	Drawer Qty.	Wt. Lbs.	Price Each
XK-3001	46-3/8" x 35-1/4" x 25"	43-1/8" x 31-1/2" x 2-1/2"	8	277	\$707.00

### BASE

Model No. **XK-3002**— 46-3/8"W x 32-1/2"D x 6"H. Wt. 31 lbs. ....\$104.00

**OPTIONAL TOP.** Add this 3/4" thick wood laminate top to create a convenient work surfaces.

Model No. **XK-3003**— Wt. 46 lbs. ....\$214.00

## SAFCO Wire Roll File

Here's an efficient way to store large rolled materials. File is constructed of heavy gauge plastic coated steel rod. Rolls easily to any point of use on 2" casters. Four large 8" x 8" compartments hold any size document. Assembles quickly and easily. Color: white. **FACTORY QUICK SHIP— FOB CALIFORNIA, MINNESOTA.**



Model No. **ZG-4149**— 30-1/4"H x 16-1/4"W x 16-1/2"D. Wt. 16 lbs. ....\$102.00

## SAFCO Roll Files



Keep valuable documents clean and free of wrinkles with these roll files. Stores large documents up to 43". Heavy-duty pigeon holes hold dozens of sheets. Includes door file reference grid. **IN STOCK.**

**STEEL ROLL FILES.** Steel construction for storing heavier rolls. Reversible dust-tight door for left or right opening. Corner dimples on top permits stacking. 15-1/4" square cabinets.

**CORRUGATED ROLL FILES.** Economical, 200-lb. test construction with reinforced steel frame for added rigidity.

Dust-tight door. Stackable cabinets are 15-3/4" square.

Model No.	Compt. Qty.	Compt. Size	Length.	Wt. Lbs.	Price Ea.
<b>STEEL ROLL FILES</b>					
YD-1598	16	3-1/4" sq.	37"	43	\$464.00
YD-1599	36	2-1/4" sq.	37"	42	469.00
<b>CORRUGATED ROLL FILES</b>					
YD-1600	16	3-3/4" sq.	25"	14	\$190.00
YD-1601	16	3-3/4" sq.	37"	19	196.00
YD-1602	16	3-3/4" sq.	43"	20	214.00
YD-1603	25	3" sq.	25"	15	209.00
YD-1604	25	3" sq.	37"	21	219.00
YD-1605	25	3" sq.	43"	22	232.00



CORRUGATED

STEEL

# Files & Bookcases



## KI Lateral File Cabinets

These files feature clean, smooth lines and a contemporary look. 18"D files include 11"H drawers with hanging folder bars that accept both letter or legal size files. Drawers extend fully on heavy-duty ball-bearing suspensions while the safety interlock system prevents more than one drawer from opening at a time. Direct drive lock with removable core and tamper-proof security bars along both cabinet sides protect stored contents from theft or damage. Other features include adjustable glides for stability on uneven floors and full-width drawer pulls. Five-high units include a top cabinet with receding door and reinforced fixed shelf to store binders or catalogs. **SELECTED MODELS IN BK - BLACK, GY - MEDIUM GRAY AND ST - STONE ARE FACTORY QUICK SHIP.**



Selected Models

Model No.	Drawer Qty.	Overall Height	Wt. Lbs.	Price Each
<b>30"W CABINETS</b>				
XR-1460	2	27-1/8"	110	\$343.00
XR-1461	3	38-1/4"	150	440.00
XR-1462	4	49-3/8"	187	543.00
XR-1463	5	64-1/8"	228	625.00
<b>36"W CABINETS</b>				
XR-1464	2	27-1/8"	120	\$370.00
XR-1465	3	38-1/4"	160	500.00
XR-1466	4	49-3/8"	200	615.00
XR-1467	5	64-1/8"	250	838.00
<b>42"W CABINETS</b>				
XR-1468	2	27-1/8"	138	\$383.00
XR-1469	3	38-1/4"	178	527.00
XR-1470	4	49-3/8"	218	696.00
XR-1471	5	64-1/8"	284	915.00

### OTHER COLORS AVAILABLE:

TN - TAN

GY - MEDIUM GRAY

CH - CHARCOAL

BK - BLACK

ST - STONE



## HON Vertical Files

Designed to give you trouble-free service for years to come. Backed by a lifetime warranty, these cabinets meet or exceed ANSI/BIFMA and ISTA performance standards. Drawers have full-cradle suspension with 10 nylon rollers for smooth operation. High sides eliminate the need for hang rails. Drawer fronts include attractive aluminum drawer pulls, label holders and thumb latches. Interchangeable locks with one-key system are standard. **SPECIFY COLOR: BK - Black, LG - Light Gray, PY - Putty. FACTORY QUICK SHIP—FOB ILLINOIS.**

Model No.	Drawer Qty.	Overall W x H	Type	Wt. Lbs.	Price Each
<b>26-1/2"D WITH 25" OF FRONT-TO-BACK FILING SPACE</b>					
XM-2453	2	15" x 29"	Letter	62	\$254.00
XM-2454	2	18" x 29"	Legal	68	301.00
XM-2457	4	15" x 52"	Letter	113	345.00
XM-2458	4	18" x 52"	Legal	122	395.00
XM-2459	5	15" x 60"	Letter	135	507.00
<b>25"D WITH 23-1/2" OF FRONT-TO-BACK FILING SPACE</b>					
XM-2461	2	15" x 29"	Letter	60	220.00
XM-2462	2	18" x 29"	Legal	66	261.00
XM-2463	4	15" x 52"	Letter	107	295.00
XM-2464	4	18" x 52"	Legal	118	343.00



## EDSAL Welded Steel Bookcases

Durable construction will not sag when fully loaded. All welded frames support heavy 24-ga. steel shelves. Each shelf adjusts in 1" increments (except bottom shelf). 36"W x 12"D overall. Choose one of four attractive colors to fit your office decor. **SPECIFY COLOR: BK - Black, GY - Gray, PY - Putty, TN - Tan. IN STOCK.**

Model No.	Shelves	Height	Wt. Lbs.	Price Ea.
XV-3540	2	29"	46	\$127.00
XV-3541	3	40"	58	139.00
XV-3542	4	52-1/2"	76	188.00
XV-3543	5	66"	89	226.00
XV-3544	6	78"	102	278.00



# Office Equipment



## SAFCO Mail Room Furniture

**STOCK**

Position modular units in any combination to give you the space you need to complete mail room tasks. Heavy-gauge steel construction. Color: gray. **IN STOCK.**

**SORTING TABLE.** 1-1/8" thick wood laminate top surrounded by tough T-mold edges is supported by extra-thick 1-1/2" steel legs. Worksurface adjusts from 28-36"H. Includes 14"H shelf. 500-lb. overall capacity.

**SORTER MODULE.** Insert mail trays in any configuration to create up to 25 mail slots. Includes (20) 11"W trays with finger cut-outs and label holders.

**RISER.** Add to system to support other modules or for extra storage.

Model No.	Description	W x D x H	Wt. Lbs.	Price Ea.
YF-2280	Sorting Table with Shelf	60" x 30" x 28" to 36"	100	\$678.00
YF-2281	Sorting Module (2 shown)	58-1/8" x 12-1/2" x 14"	60	308.00
YF-2282	Riser for Sorting Module	58-1/8" x 12-1/2" x 14"	30	180.00

## RELIUS SOLUTIONS Fold-Away Truck

**STOCK**

Ideal for sales, service and delivery people, this full-size platform truck folds to the size of a briefcase. Strong, lightweight aluminum frame supports up to 300 lbs. 38"H handle maneuvers truck on 4" non-mar blue rubber wheels—2 swivel, 2 rigid. Protective, vinyl corner bumpers. Dual platform sizes: 20" or 28"L x 16"W. Folded size: 9-1/2" x 16" x 20". Ships via small package carrier.



**IN STOCK.**

YA-0644—Wt. 17 lbs.  
.....\$99.50

## RELIUS SOLUTIONS Lightweight Folding Platform Truck



Great for transporting inventory from the backroom to the showroom. Injection-molded polyethylene platform resists damaging impact, is easy to clean, and has a slip-resistant textured deck that prevents items from sliding off. Also includes: chrome-plated posts and handle and 5" gray non-marking casters—2 swivel, 2 rigid. 440-lb. capacity. 32"L x 20"W x 34"H overall. **IN STOCK.**

**STOCK**



YA-0645—  
Wt. 28-1/2 lbs.....\$161.00

## RELIUS SOLUTIONS Fold-Down Platform Trucks

Perfect trucks for moving forms, files, and light equipment around office or shop. For easy storage or moving handles fold flat. Heavy-gauge steel construction. Plastic bumpers protect doorways, walls, and furniture. Beige color with blue, nonskid platforms. Ships via small package carrier. **IN STOCK.**



Model No. YP-590—29"L x 19"W. 4" casters. 330-lb. cap. Wt. 31 lbs.....\$71.50

Model No. YP-591—35"L x 24"W. 5" casters. 660-lb. cap. Wt. 44 lbs. ....\$102.00

**STOCK**



**A-B**

**A-FRAME TRUCKS**.....31

**AIR, DOORS**.....143

**BARRICADES, TRAFFIC**.....136, 272

**BASKETS, WIRE**.....52

**BEAM LIFTERS**.....7

**BENCH**

Accessories & Components.....230, 231

Locker Room.....248-251, 253, 254, 257

Tops.....231, 254, 255

**BENCHES**

Assembly.....231, 252

Cabinet-Style.....248

Locker Room.....229

Mobile.....234-236

Packing.....258, 259

Pedestal.....230, 231, 249

Stainless Steel.....248

Welding.....247

**BIN**

Cabinets.....190, 207, 218, 219

Shelving & Racks.....159, 202-204

Trucks.....46, 299

**BINS**.....193, 199-203

**BOLLARDS**.....131

**BOXES**

Bulk.....48-53, 122

Corrugated.....48, 264

Divider.....197

Fiberglass.....198, 199

Poly.....48-51, 122, 194-198

Shipping.....195, 196, 199

Stacking.....48-51, 194-200

Ventilated.....195, 198

**BROOMS**.....271

**BUBBLE CUSHIONING**.....265

**BULK CONTAINERS & DUMPERS/HOPPERS**.....8, 12, 13

48-54, 75, 122

**BULK STORAGE RACKS**.....166-169

**BUMPERS**

Dock.....127

Rubber.....24

**C**

**CABINETS**

All-Welded.....205-208, 210, 213, 214

Bin.....190, 207, 218, 219

Computer.....260-262

Cylinder.....113, 114

Drawer & Small Parts.....190-192, 232, 233

Drum.....108

File.....210, 295, 296

Flammable Liquid.....108-112

Janitorial.....270

Key.....291

Mobile.....213, 214, 234-236

Shop Equipment.....234-236, 238, 239

Storage/Supply.....205-209, 211-217, 270

Visible Storage.....207

Wall-Hung.....212, 270

Wardrobe.....211, 214, 215

**CANOPIES & STORAGE GARAGES**.....269

**CANTILEVER, BAR & PANEL RACKS**.....182-188

**CARGO CONTROL**.....126

**CAROUSELS/TURNABLES, LIFT TABLES & TILTERS**.....64-69

**CARTS/TRUCKS**

Appliance.....18

Audio-Visual.....47

Bar Stock.....187

Basket.....8

Bin.....46, 299

Bulk Handling.....8-11

Convertible.....17, 18

Drum.....87

Hand.....14-18

Instrument.....39, 44, 47

Janitorial.....272

Maintenance.....44

Plastic.....8-11, 42-47

Platform.....18, 24-27, 35, 37, 297

Security.....29

Sheet & Panel.....36

Shelf.....30, 32

Stainless Steel.....41

Stock.....25, 28, 33, 34

Tilt.....10, 11, 18

Tool & Storage.....44, 46

Tray-Shelf.....31, 34

Utility.....30, 31, 34, 38-47

Wire.....28-30, 32-34, 37

**CASTERS**.....22, 23

**CHAIRS**.....285-287

**CHOCKS, WHEEL CLAMPS, FESTOONING & TROLLEYS**.....80, 81, 84

**CLOCKS, WALL**.....292

**CLOTHING, PROTECTIVE**.....119

**COLUMN PROTECTORS**.....132, 133

**COMPUTER FURNITURE**.....261

**CONTAINMENT, LEAK/SPILL CONVEYORS & ACCESSORIES**.....70-73

**CORNER, MACHINERY & RACK PROTECTORS**.....131-136, 175

**CRANES**.....74, 75, 77-79, 256

**CREEPERS**.....268

**CURTAIN WALLS**.....140

**CYLINDER**

Storage.....113, 114

Tanks.....114

**PRICING & SPECIFICATIONS:** All prices in the PFI catalog reflect Buyer's net cost in U.S. currency. The prices do not include freight, applicable federal, state, and local taxes, charges and duties, or special crating requirements for export shipment. Buyer shall pay all such costs, taxes, charges, and duties. Prices, colors, and specifications are subject to change without notice.

**D-E**

**DECKING**

Particleboard.....166, 167

Steel.....177

Wire.....177

**DESKS**.....290

Office.....178

Pallet Rack.....178

Shop.....178, 237, 238

**DOCKPLATES & BOARDS**.....127-129

**DOCUMENT STORAGE BOXES**.....109

**DOLLIES & ROLLER SKIDS**.....19-21, 86

**DOORS**

Air.....143

Dock Seal.....142, 143

Vinyl Strip.....141, 142

**DRUM ACCESSORIES**

Covers/Lids.....96

Deheaders.....96, 102

Dollies.....86

Faucets/Vents.....96, 97

Funnels.....97

Grounding Wires/Clamps.....97

Heaters.....99

Pumps.....98

Racks & Dispensers.....95

Salvage/Overpack.....100

Wrenches.....97

**DRUM HANDLERS**

Cradles.....88

Dumpers.....91-94

Lifters.....88-93

Trucks.....87, 88

**DRUMS**

Fiber.....101

Plastic.....100, 101

Steel.....100

**DUMPERS/HOPPERS & BULK CONTAINERS**.....12, 13, 48, 50-54, 75, 122

Trash Can.....273

**ELECTRIC PLATFORM TRUCKS**.....26

**EMERGENCY, LIGHTS**.....117

**EYEWASHES & SHOWERS**.....118

**F-G**

**FANS**.....138, 139

**FESTOONING, TROLLEYS, & CLAMPS**.....80, 81, 84

**FIRE EXTINGUISHERS**.....116

**FLAMMABLE STORAGE**

Cabinets.....108-112

Cans.....115, 116

**FORKLIFT ATTACHMENTS**.....74-76

**FURNITURE**

Cafeteria.....288-290

Chairs.....285, 287

Computer.....260-262

Desks.....290

Mail Room.....297

Office.....241, 285

Shop.....237-245, 261, 286

Stools.....240-245, 286

Tables.....288-290

**GUARDS & RAILINGS**.....131-136

**H-J**

**HAND TRUCKS**.....14-18

**HOISTS**.....82-84

**INSTRUMENT CARTS/TRUCKS**.....47

**JACKS**

Maintenance.....268

Stabilizing.....125

**JANITORIAL SUPPLIES**.....271

Brooms.....270

Cabinets.....270

Carts.....272

Cigarette Disposal Receptacles.....278

Closet Organizers.....270

Floor Signs.....272

Mops & Buckets.....271, 272

Recycling Containers.....273, 274, 276

Vacuums.....271

Waste Receptacles.....273-277

Wheelbarrows.....267

**JIB CRANES**.....77-79, 256

**K-L**

**KEY CABINETS/RACKS**.....291

**LABEL HOLDERS**.....170, 194, 198

200, 204

**LADDERS/STOOLS/PLATFORMS**

Cross-Over.....153

Fiberglass.....151

Fixed Access.....127, 153, 154

Mobile.....154-158

Step.....150-152

**LEAN MANUFACTURING**

A-Frame Trucks.....31

Bin Carts.....39, 46

Bin Racks.....202-204

Bulk Containers.....48-53

Conveyors.....4, 6, 70-73

Gravity Flow Shelving.....7, 179

Lift Tables.....5, 66-69

Lifting Beams.....7, 81

Packing Benches.....258, 259

Roll-Out Shelving.....7, 179

Seating.....240-245, 285-287

Storage Containers.....193-203

Work Positioners.....5, 299

Workbenches 230, 231, 234-236, 246-256

**LEVERS, PRY**.....19

**LIFT TABLES**.....5, 66-69

**LIFT/PALLET TRUCKS**

Manual.....58-60, 63, 67

Powered.....62, 63, 67

Specialty.....60, 61

**LIFTERS**

Beam.....7, 81

Drum.....88-93

Magnetic.....81

Tongs.....81

**LIGHTING, DOCK LOCKERS**.....220-228

**M-O**

**MACHINE, MOVERS, MACHINERY, CORNER & POST PROTECTORS**.....131-136, 175

**MAGNETIC LIFTERS**.....81

**MAIL ROOM FURNITURE**.....297

**MATS**

Anti-Fatigue.....280-284

Carpet & Entrance.....279, 284

Chair.....284

Drainage.....118, 283, 284

Eyewash.....118

Sponge.....280, 282

**MEZZANINES**.....148

**MIRRORS, CONVEX**.....123

**MOPS & BUCKETS**.....272

**MOTORIZED PLATFORM TRUCKS**.....26

**OFFICE PRODUCTS**

Bookcases.....296

Chairs.....285-287

Desks.....290

Files.....295, 296

Information Boards.....291

Literature Racks/Organizers.....294

Mail Room Furniture.....297

Panels & Accessories.....292

Stools.....240-245, 286

Tables.....288-290

Time Recorders & Card Racks.....292

**OFFICES, PREFAB.**.....147

**OVERPACK/SALVAGE DRUMS**.....100

**P-R**

**PACKING LIST ENVELOPES**.....264

**PADLOCKS**.....229

**PAISLS**.....102

**PAINT STRIPING MACHINE**.....121

**PALLET RACKS & ACCESSORIES**.....171-179

**PALLET/LIFT TRUCKS**

Manual.....58-60, 63, 67

Powered.....63, 67

Specialty.....60, 61

**PALLETS & ACCESSORIES**.....55-57

**PANEL, TRUCKS**.....36

**PARTITIONS/ENCLOSURES**.....136, 144-147, 269

**PIPE, FITTINGS**.....144

**PLASTIC, CARTS/TRUCKS**.....8-11, 42-47

**PLATFORM TRUCKS**.....24-27, 35, 37, 297

**POWERED PLATFORM TRUCKS**.....26

**PROTECTIVE CLOTHING**.....119

**RACKS & SHELVING**

Accessories.....170

Bin.....159, 190-193, 202-204, 253, 297

Bulk Storage.....166-169

Cantilever, Bar & Panel.....7, 182-188

Drum.....95

High-Capacity.....180

Literature Organizer.....294

Pallet Racks & Accessories.....171-179

Reel & Cable.....189

Rivet-Type.....166, 167, 293

Spool.....189

Steel.....162-165, 168, 180, 293

Wire.....160, 161

**RAILINGS & GUARDS**.....131-136

**RAMPS, TRUCK**.....130

**RECORD STORAGE**.....293

**RINSE TANKS**.....116

**ROLLER SKIDS & DOLLIES**.....19-21

**S**

**SAFETY PRODUCTS**

Back Belts.....120

Cabinets.....103, 108-112

Cylinder Storage.....113, 114

Drum Cabinets.....108

Eyewashes.....118

Fire Extinguishers.....116

Glasses/Goggles.....118

Gloves.....119

Hard Hats.....119

Hazardous Waste Storage/Disposal

Matting.....100, 105, 108, 113-116

280, 281

Mirrors.....123

Noise Control.....141

Overpack/Salvage Drums.....100

Rinse Tanks.....116

Safety Cans.....115, 116

Signs.....117

Spill Containment.....86, 95, 100, 103-108

Tapes.....121

Traffic Control.....122

Wrist Supports.....120

263

**SCALES**.....263

**SEATING**

Dollies & Caddies.....287

Office Chairs.....285, 286

Stools.....240-245, 286

Task Chairs.....285

**SHEDS, STORAGE**.....217

**SHELF TRUCKS**.....32

**SHELVING & RACKS**

Accessories.....170

Aluminum.....168

Bin.....159, 190-193, 202-204, 253

Bulk Storage.....7, 166-169

Cantilever, Bar & Panel.....182-188

Drawer.....190-192

High-Capacity.....7, 180

Pallet Racks & Accessories.....171-179

Reel & Cable.....189

Rivet-Type.....166, 167, 293

Steel.....162-165, 168, 180, 293

Wire.....160, 161

**SHOP EQUIPMENT**

Cabinets.....234-236, 238, 239

Desks.....237, 238

Outlet Strips.....257

Stools.....240-245, 286

Tables.....230, 231, 238, 239, 246-253

Vises.....257

Workbenches.....230, 231, 235

246-253, 258, 259

Workstations.....258, 259

**SIGNS**

Floor.....272

Safety.....117

**SLINGS**.....74, 85

**SPILL CONTAINMENT**

Dispensers.....86, 95

Pallets & Basins.....103-107

**SPOOL RACKS**.....189

**STABILIZING JACKS**.....125

**STACKERS & LIFTS**.....54, 62-69

**STAIRS**.....154

**STOCK CARTS/TRUCKS**.....25

**STOOLS**.....240-245, 286

**STRAPPING & SUPPLIES**.....265

**STRETCH WRAP & DISPENSERS**.....266

**STRIPING MACHINE**.....121

**SWEEPERS, FORKLIFT-MOUNT**.....137

**T-Y**

**TABLES**

Cafeteria.....288-290

Folding Tables, Benches & Caddies.....287-289

Lift.....5, 54, 66, 68, 69

Shop.....230, 231, 238, 239, 246-253

Tilt.....5, 54

**TAPE DISPENSERS**.....121, 265

**TAPES**

Box-Sealing.....265

Paper.....265

Safety.....121

**TENTS**.....269

**TILT**

Tables.....5, 55

Trucks.....10, 11

**TIME CLOCKS/CARDS**.....292

**TOOL BALANCERS**.....256

**TOTES, STACK & NEST**.....195, 196, 198, 199

**TRAFFIC, BARRICADES**.....122, 272

**TROLLEYS, FESTOONING & CLAMPS**.....80, 81, 84

**TRUCKS/CARTS**

Appliance.....18

Audio Visual.....47

Bar Stock.....187

Basket.....8

Bin.....46, 299

Bulk Handling.....8-11

Convertible.....17, 18

Drum.....87, 88

Hand.....14-18

Heavy Equipment.....19

Instrument.....39, 44, 47

Lift.....62, 63, 66, 67

Pallet.....58-61, 63

plastic.....8-11, 42-47

Platform.....18, 24-27, 35, 37, 297

Security.....29

Service.....32

Sheet.....36

Stainless Steel.....41

Stock.....25, 28, 33, 34

Tilt.....5, 10, 11, 18

Tool & Storage.....44, 46

Tray-Shelf.....31, 34

Utility.....30, 31, 34, 38-47

Wire.....28-30, 32-34, 37

**TURNABLES/CAROUSELS**.....64-69

**VACUUMS**.....271

**WASTE RECEPTACLES**.....273-277

**WELDING SCREENS**.....140

**WHEELBARROWS**.....267

**WORK PLATFORMS**

Forklift.....148, 149

Mobile.....152

Stationary.....150, 151, 153

**WORK POSITIONERS**

Bin.....299

ESD.....5

**WORKBENCH**

Accessories & Components.....230, 231

248-251, 253-257

Tops.....231, 254, 255

**WORKBENCHES**

Assembly.....231, 252

Cabinet-Style.....248

Mobile.....234-236

Pedestal.....230, 231, 249

Stainless Steel.....248

Standard.....246-248, 250, 251, 253

Welding.....247

**WORKSTATIONS**

Assembly.....258

Computer.....260-262

Packing.....258, 259

Stand-Up.....5, 237, 238, 260-262

**YARDRAMPS**.....130

# Parts Organizers

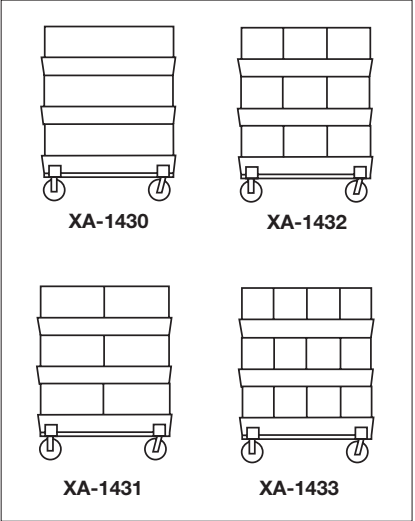

## LITTLE GIANT Mobile Storage Bins

Three-tier cart moves parts to the jobsite. Steel compartments have wide hopper fronts. 6" phenolic swivel casters. 12-ga. welded steel. FOB ILLINOIS.

Model Number	Overall W x D x H	Quantity	Compartment	Wt. Lbs.	Price Each
			W x D x H		
XA-1430	32 x 20 x 45-1/2"	3	32 x 15 x 12-1/2"	210	\$597.00
XA-1431	32 x 20 x 45-1/2"	6	16 x 15 x 12-1/2"	217	645.00
XA-1432	32 x 20 x 45-1/2"	9	10-1/2 x 15 x 12-1/2"	235	706.00
XA-1433	32 x 20 x 45-1/2"	12	8 x 15 x 12-1/2"	252	767.00



## AKRO-MILS® Cross-Stack Tub Racks

Tilted tubs ease stock picking operations. 12-gauge steel frame with solid bottom shelf. 1,000-lb. capacity. 5" mold-on rubber casters. Includes Cross-Stack Tubs. Powder coat finish. **IN STOCK.**

Model No. <b>ZA-2360</b> —Includes (32) 17-1/4"L x 11"W x 8"H bins. 49"W x 28-1/2"D x 59"H overall.	
Wt. 256 lbs.....	\$1050.00
Model No. <b>ZA-2361</b> —Includes (16) 23-3/4"L x 17-1/4"W x 8"H bins. 49"W x 28-1/2"D x 59"H overall.	
Wt. 248 lbs.....	\$979.00

