

EFR32BG22 Direction Finding Radio Board

BRD4185A Reference Manual



The BRD4185A Wireless Gecko Radio Board enables developers to develop RF-based Real-Time Locationing Systems and applications, utilizing the protocol level support of Angle of Arrival (AoA) and Angle of Departure (AoD) in Bluetooth 5. The board contains a 2.4 GHz Wireless Gecko Wireless System-on-Chip, and an antenna array optimized for accurate direction finding performance.

The BRD4185A Wireless Gecko Radio Board plugs into the Wireless Starter Kit Main-board, which is included with the Wireless Gecko Starter Kit and gives access to debug interface, Virtual COM port, packet trace, display, buttons, LEDs, and additional features from expansion boards. With the supporting Simplicity Studio suite of tools, developers can take advantage of graphical wireless application development and visual energy profiling and optimization. The board also serves as an RF reference design for applications targeting Bluetooth 2.4 GHz AoA-based direction finding.

This document contains a brief introduction and description of the BRD4185A Radio Board features, focusing on the RF sections and basic performance.

RADIO BOARD FEATURES

- Wireless SoC:
EFR32BG22C224F512IM40
 - CPU core: ARM[®] Cortex[®]-M33
 - Flash memory: 512 kB
 - RAM: 32 kB
- Operation frequency: 2.4 GHz
- Transmit power: 6 dBm
- Antenna array with PCB antennas
- UFL connector (optional)
- Crystals for LFXO and HFXO: 32.768 kHz and 38.4 MHz
- 8 Mbit low-power serial flash for over-the-air updates

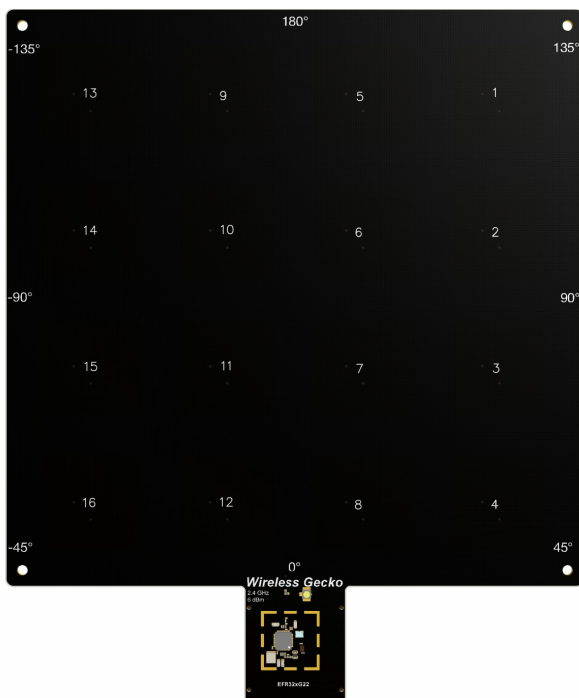

Table of Contents

1. Introduction	4
2. Radio Board Connector	5
2.1 Introduction	5
2.2 Radio Board Connector Pin Associations	5
3. Radio Board Block Summary	6
3.1 Introduction	6
3.2 Radio Board Block Diagram	6
3.3 Radio Board Block Description	6
3.3.1 Wireless MCU	6
3.3.2 LF Crystal Oscillator (LFXO)	6
3.3.3 HF Crystal Oscillator (HFXO)	6
3.3.4 Matching Network for 2.4 GHz	6
3.3.5 UFL Connector	7
3.3.6 Radio Board Connectors	7
3.3.7 2.4 GHz Antenna Array	7
3.3.8 Serial EEPROM	7
4. RF Section	8
4.1 Introduction	8
4.2 Schematic of the RF Matching Network	8
4.2.1 Description of the 2.4 GHz RF Matching	8
4.3 Bill of Materials for the 2.4 GHz Matching	8
4.4 Antenna Array	8
5. Mechanical Details	10
6. EMC Compliance	11
6.1 Introduction	11
6.2 EMC Regulations for 2.4 GHz	11
6.2.1 ETSI EN 300-328 Emission Limits for the 2400-2483.5 MHz Band	11
6.2.2 FCC15.247 Emission Limits for the 2400-2483.5 MHz Band	11
6.2.3 Applied Emission Limits for the 2.4 GHz Band	11
7. RF Performance	12
7.1 Conducted Power Measurements	12
7.1.1 Conducted Power Measurements with Unmodulated Carrier	12
7.1.2 Conducted Power Measurements with Modulated Carrier	13
7.2 Radiated Power Measurements	14
7.2.1 Maximum Radiated Power Measurements	15
7.2.2 Antenna Pattern Measurements	15
8. EMC Compliance Recommendations	16
8.1 Recommendations for 2.4 GHz ETSI EN 300-328 Compliance	16

8.2 Recommendations for 2.4 GHz FCC 15.247 Compliance 16

9. Board Revision History 17

10. Errata. 18

11. Document Revision History 19

1. Introduction

The EFR32™ Wireless Gecko Radio Boards provide a development platform (together with the Wireless Starter Kit Mainboard) for the Silicon Labs EFR32 Wireless Gecko Wireless System-on-Chips and serve as reference designs for the matching network of the RF interface.

The BRD4185A Radio Board is designed to operate in the 2400-2483.5 MHz band with the RF matching network optimized for operating at 6 dBm output power, and the on-board antenna array optimized for accurate direction finding performance.

To develop and/or evaluate the EFR32 Wireless Gecko, the BRD4185A Radio Board can be connected to the Wireless Starter Kit Mainboard to get access to debug interface, Virtual COM port, packet trace, display, buttons, LEDs, and additional features from expansion boards, and also to evaluate the performance of the RF interface and the direction finding accuracy.

2. Radio Board Connector

2.1 Introduction

The board-to-board connector scheme allows access to all EFR32BG22 GPIO pins as well as the RESETn signal. For more information on the functions of the available pins, see the EFR32BG22 data sheet.

2.2 Radio Board Connector Pin Associations

The figure below shows the mapping between the connector and the EFR32BG22 pins and their function on the Wireless Starter Kit Mainboard.

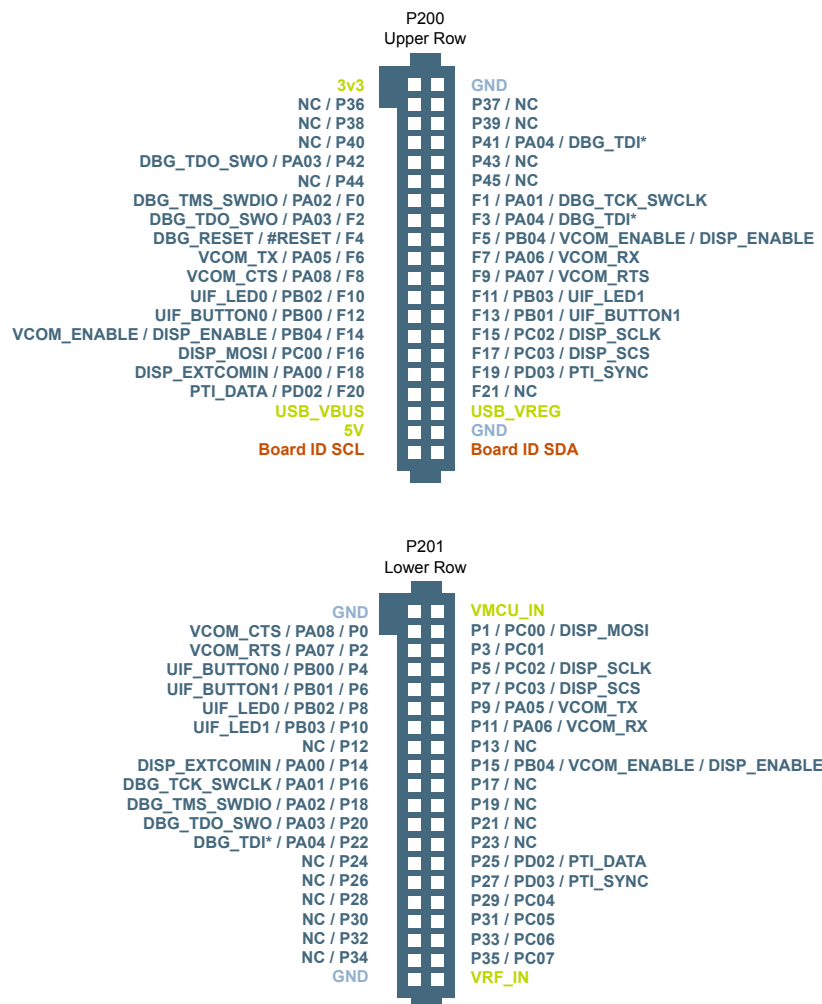

*Optional 0R resistor should be mounted to enable this connection. (Mutually exclusive with FLASH_SCS.)

Figure 2.1. BRD4185A Radio Board Connector Pin Mapping

3. Radio Board Block Summary

3.1 Introduction

This section introduces the blocks of the BRD4185A Radio Board.

3.2 Radio Board Block Diagram

The block diagram of the BRD4185A Radio Board is shown in the figure below.

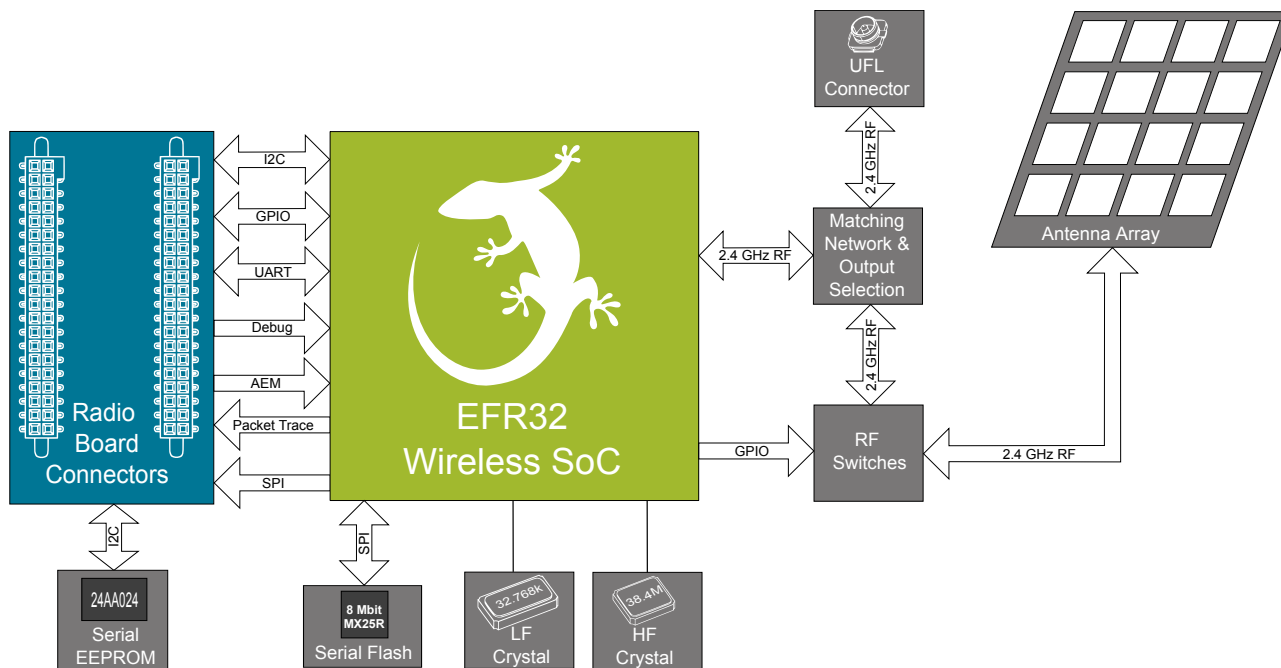

Figure 3.1. BRD4185A Block Diagram

3.3 Radio Board Block Description

3.3.1 Wireless MCU

The BRD4185A Wireless Gecko Radio Board incorporates an EFR32BG22C224F512IM40 Wireless System-on-Chip featuring 32-bit Cortex[®]-M33 core, 512 kB of flash memory, 32 kB of RAM and a 2.4 GHz band transceiver with output power up to 6 dBm. For additional information on the EFR32BG22C224F512IM40, refer to the EFR32BG22 Data Sheet.

3.3.2 LF Crystal Oscillator (LFXO)

The BRD4185A Radio Board has a 32.768 kHz crystal mounted. For details regarding the crystal configuration, refer to application note [AN0016.2: Oscillator Design Considerations](#).

3.3.3 HF Crystal Oscillator (HFXO)

The BRD4185A Radio Board has a 38.4 MHz crystal mounted. For details regarding the crystal configuration, refer to application note [AN0016.2: Oscillator Design Considerations](#).

3.3.4 Matching Network for 2.4 GHz

The BRD4185A Radio Board incorporates a 2.4 GHz matching network which connects the 2.4 GHz RF input/output of the EFR32BG22 to the one on-board printed Inverted-F antenna. The component values were optimized for the 2.4 GHz band RF performance and current consumption with 6 dBm output power.

For detailed description of the matching network, see section [4.2.1 Description of the 2.4 GHz RF Matching](#).

3.3.5 UFL Connector

To be able to perform conducted measurements, Silicon Labs added a UFL connector to the Radio Board. The connector allows an external 50 Ohm cable or antenna to be connected during design verification or testing.

Note: By default, the output of the matching network is connected to the printed inverted-F antenna by a series 0 Ohm resistor. To support conducted measurements, or the connection of an external antenna, there is option to connect the output to the UFL connector. For this, the series 0 Ohm resistor to the antenna should be moved to the position of the series resistor to the UFL connector (see section [4.2.1 Description of the 2.4 GHz RF Matching](#) for further details). On the layout, the footprints of these two resistors have overlapping pads to prevent simultaneous connection of the antenna and the UFL connector.

3.3.6 Radio Board Connectors

Two dual-row, 0.05" pitch polarized connectors make up the BRD4185A Radio Board interface to the Wireless Starter Kit Mainboard.

For more information on the pin mapping between the EFR32BG22C224F512IM40 and the Radio Board Connector, refer to section [2.2 Radio Board Connector Pin Associations](#).

3.3.7 2.4 GHz Antenna Array

The BRD4185A Radio Board incorporates an antenna array, that is optimized for the accurate direction finding performance. For detailed description of the antenna matrix, see section [4.4 Antenna Array](#)

3.3.8 Serial EEPROM

The BRD4185A Radio Board is equipped with a serial I²C EEPROM for board identification and to store additional board-related information.

4. RF Section

4.1 Introduction

This section gives a short introduction to the RF section of the BRD4185A Radio Board.

4.2 Schematic of the RF Matching Network

The schematic of the RF section of the BRD4185A Radio Board is shown in the following figure.

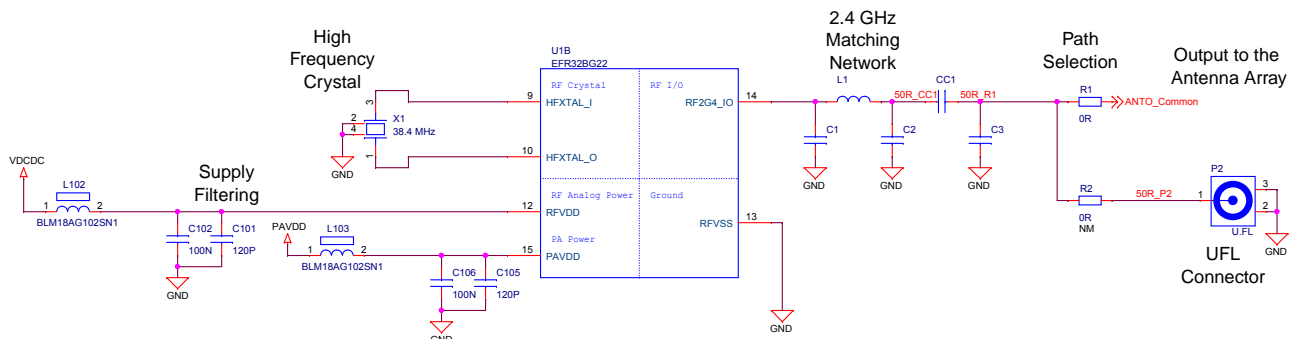

Figure 4.1. Schematic of the RF Section of the BRD4185A

4.2.1 Description of the 2.4 GHz RF Matching

The 2.4 GHz RF matching connects the RF2G4_IO pin to the on-board printed Inverted-F Antenna. The component values were optimized for the 2.4 GHz band RF performance and current consumption with the targeted 6 dBm output power.

The matching network consists of a three-element impedance matching and harmonic filter circuitry and a DC blocking capacitor.

For conducted measurements the output of the matching network can also be connected to the UFL connector by removing the series R1 resistor between the antenna and the output of the matching and adding a 0 Ohm resistor to the R2 resistor position between the output of the matching and the UFL connector.

4.3 Bill of Materials for the 2.4 GHz Matching

The Bill of Materials of the 2.4 GHz matching network of the BRD4185A Radio Board is shown in the following table.

Table 4.1. Bill of Materials for the BRD4185A 2.4GHz RF Matching Network

Component Name	Value	Manufacturer	Part Number
L1	2.6 nH	Murata	LQP03HQ2N6B02
C1	1.2 pF	Murata	GRM0335C1H1R2WA01D
C2	1.3 pF	Murata	GRM0335C1H1R3BA01D
CC1	18 pF	Murata	GJM0335C1E180GB01D
C3	Not Mounted	-	-

4.4 Antenna Array

The BRD4185A Radio Board includes an on-board antenna array, which consists of 16 rectangular patch antennas in a 4x4 matrix. The antennas are optimized for the 2.4 GHz band. The dimensions, the feeding structure (50 Ohm transmission lines, printed hybrid couplers), and the arrangement of the antennas, together with the PCB stackup, are carefully designed to occupy relatively small PCB area, while achieving accurate direction finding performance.

For detailed description of the antenna array, and its direction finding performance, refer to application note AN1195: Antenna Array Design Guidelines for Direction Finding.

On the BRD4185A Radio Board the antennas are selected through five Single Pole Quad Through RF switches, that are controlled by the GPIOs of the EFR32BG22 as shown in the figure below.

Antenna	PC04	PC05	PC06	PC07
ANT1	L	L	L	L
ANT2	H	L	L	L
ANT3	L	H	L	L
ANT4	H	H	L	L
ANT5	L	L	H	L
ANT6	H	L	H	L
ANT7	L	H	H	L
ANT8	H	H	H	L
ANT9	L	L	L	H
ANT10	H	L	L	H
ANT11	L	H	L	H
ANT12	H	H	L	H
ANT13	L	L	H	H
ANT14	H	L	H	H
ANT15	L	H	H	H
ANT16	H	H	H	H

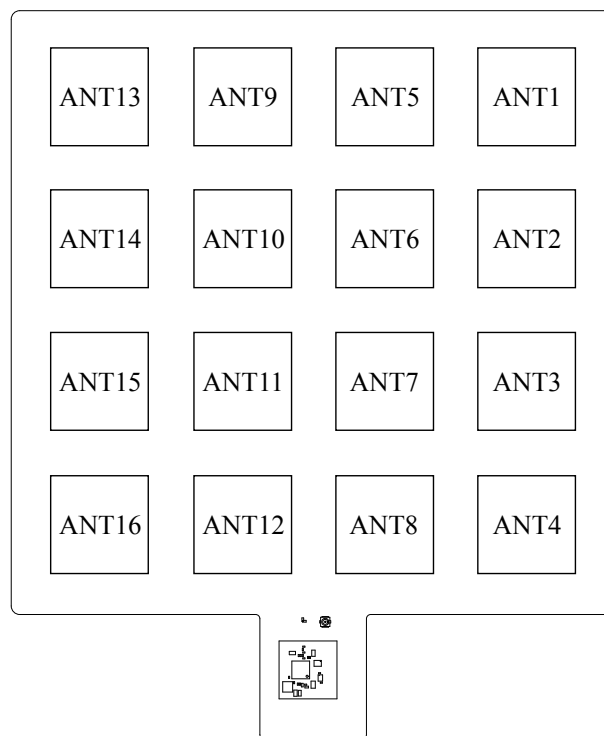

Figure 4.2. Antenna Selection

5. Mechanical Details

The BRD4185A Radio Board is illustrated in the figures below.

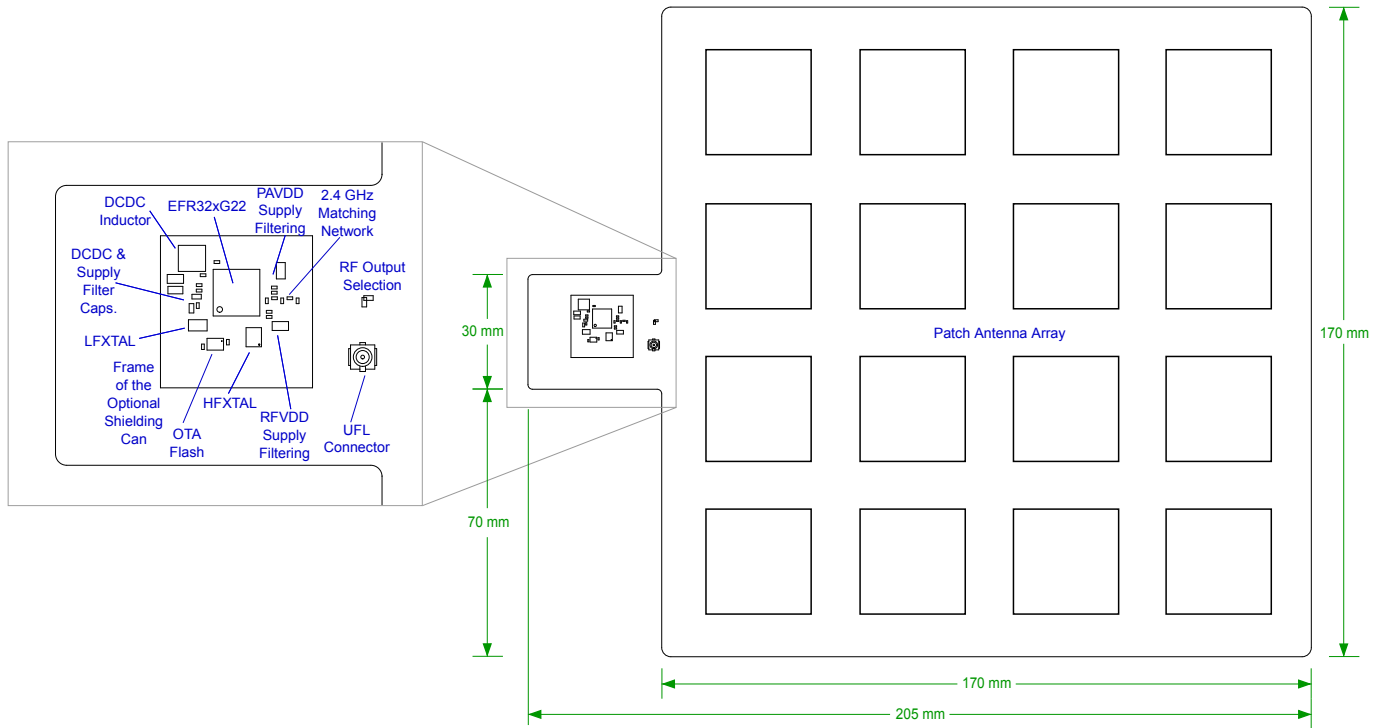

Figure 5.1. BRD4185A Top View

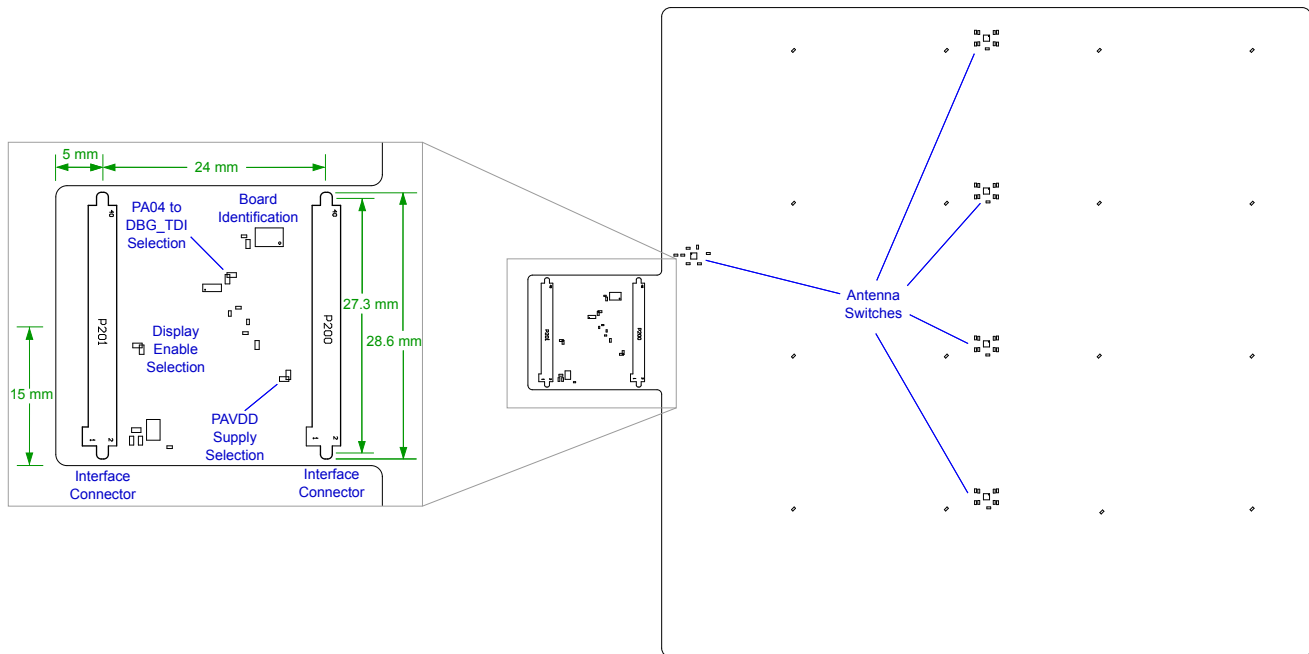

Figure 5.2. BRD4185A Bottom View

6. EMC Compliance

6.1 Introduction

Compliance of the fundamental and harmonic levels of the BRD4185A Radio Board is tested against the following standards:

- 2.4 GHz:
 - ETSI EN 300-328
 - FCC 15.247

6.2 EMC Regulations for 2.4 GHz

6.2.1 ETSI EN 300-328 Emission Limits for the 2400-2483.5 MHz Band

Based on ETSI EN 300-328, the allowed maximum fundamental power for the 2400-2483.5 MHz band is 20 dBm EIRP. For the unwanted emissions in the 1 GHz to 12.75 GHz domain, the specific limit is -30 dBm EIRP.

6.2.2 FCC15.247 Emission Limits for the 2400-2483.5 MHz Band

FCC 15.247 allows conducted output power up to 1 W (30 dBm) in the 2400-2483.5 MHz band. For spurious emissions, the limit is -20 dBc based on either conducted or radiated measurement, if the emission is not in a restricted band. The restricted bands are specified in FCC 15.205. In these bands, the spurious emission levels must meet the levels set out in FCC 15.209. In the range from 960 MHz to the frequency of the 5th harmonic, it is defined as 0.5 mV/m at 3 m distance which equals to -41.2 dBm in EIRP.

If operating in the 2400-2483.5 MHz band, the 2nd, 3rd, and 5th harmonics can fall into restricted bands. As a result, for those harmonics the -41.2 dBm limit should be applied. For the 4th harmonic the -20 dBc limit should be applied.

6.2.3 Applied Emission Limits for the 2.4 GHz Band

The above ETSI limits are applied both for conducted and radiated measurements.

The FCC restricted band limits are radiated limits only. In addition, Silicon Labs applies the same restrictions to the conducted spectrum. By doing so, compliance with the radiated limits can be estimated based on the conducted measurement, by assuming the use of an antenna with 0 dB gain at the fundamental and the harmonic frequencies.

The overall applied limits are shown in the table below. For the harmonics that fall into the FCC restricted bands, the FCC 15.209 limit is applied. ETSI EN 300-328 limit is applied for the rest.

Table 6.1. Applied Limits for Spurious Emissions for the 2.4 GHz Band

Harmonic	Frequency	Limit
2nd	4800~4967 MHz	-41.2 dBm
3rd	7200~7450.5 MHz	-41.2 dBm
4th	9600~9934 MHz	-30.0 dBm
5th	12000~12417.5 MHz	-41.2 dBm

7. RF Performance

7.1 Conducted Power Measurements

During measurements, the BRD4185A Radio Board was attached to a Wireless Starter Kit Mainboard which was supplied by USB. The voltage supply for the Radio Board was 3.3 V.

7.1.1 Conducted Power Measurements with Unmodulated Carrier

The transceiver was operated in unmodulated carrier transmission mode. The output power of the radio was set to 6 dBm. The typical output spectrums are shown in the following figures.

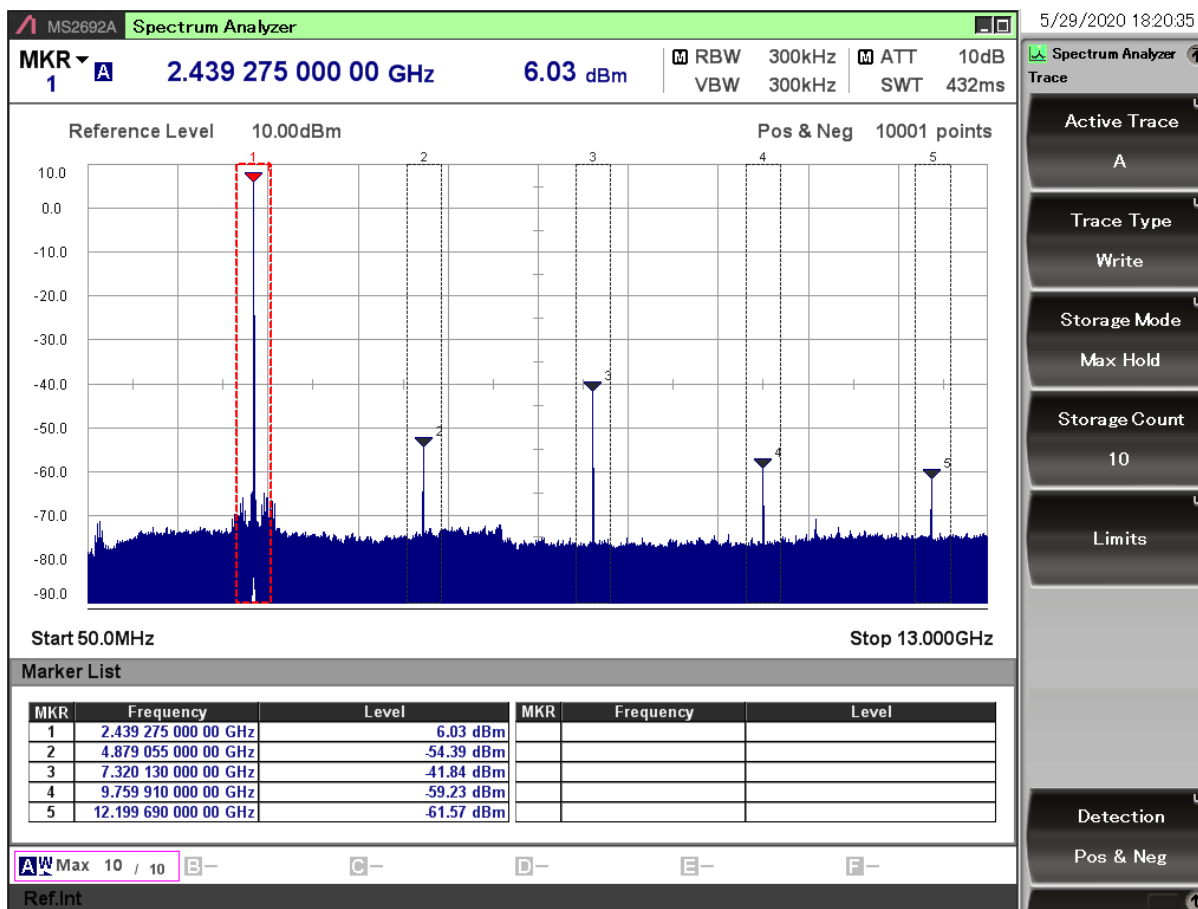

Figure 7.1. Typical Output Spectrum of the BRD4185A; PAVDD = 3.3 V

As shown in the figure, the fundamental is close to 6 dBm and all of the unwanted emissions are under the -41.2 dBm limit.

Note: The conducted measurement is performed by connecting the on-board UFL connector to a Spectrum Analyzer through an SMA Conversion Adapter (P/N: HRMJ-U.FLP(40)). This connection itself introduces approximately 0.3 dB insertion loss.

7.1.2 Conducted Power Measurements with Modulated Carrier

Depending on the applied modulation scheme, and the Spectrum Analyzer settings specified by the relevant EMC regulations, the measured power levels are usually lower compared to the results with unmodulated carrier. These differences will be measured and used as relaxation factors on the results of the radiated measurement performed with unmodulated carrier. This way, the radiated compliance with modulated transmission can be evaluated.

In this case, both the ETSI EN 300-328 and the FCC 15.247 regulations define the following Spectrum Analyzer settings for measuring the unwanted emissions above 1 GHz:

- Detector: Average
- RBW: 1 MHz

The table below shows the measured differences in case of the supported modulation schemes.

Table 7.1. Measured Relaxation Factors for the Supported Modulation Schemes

Applied Modulation (Packet Length: 255 bytes)	BLE Coded PHY: 125 Kb/s (PRBS9) [dB]	BLE Coded PHY: 500 Kb/s (PRBS9) [dB]	BLE 1M PHY: 1 Mb/s (PRBS9) [dB]	BLE 2M PHY: 2 Mb/s (PRBS9) [dB]
2nd harmonic	-2.7	-3.1	-3.3	-9.1
3rd harmonic	-4.8	-5.2	-5.2	-10.7
4th harmonic	-5.5	-6.5	-6.7	-11.9
5th harmonic	-6.3	-6.5	-6.7	-11.4

As it can be observed, the BLE 125 Kb/s coded modulation scheme has the lowest relaxation factors. These values will be used as the worst case relaxation factors for the radiated measurements.

7.2 Radiated Power Measurements

During measurements, the BRD4185A Radio Board was attached to a Wireless Starter Kit Mainboard which was supplied by USB. The voltage supply for the Radio Board was 3.3 V.

The Bluetooth stack uses ANT1 for transmission, therefore the radiated tests have also been performed by using that antenna.

The radiated power was measured in an antenna chamber by rotating the board 360 degrees with horizontal and vertical reference antenna polarizations in the XY, XZ, and YZ cuts. The measurement planes are illustrated in the figure below.

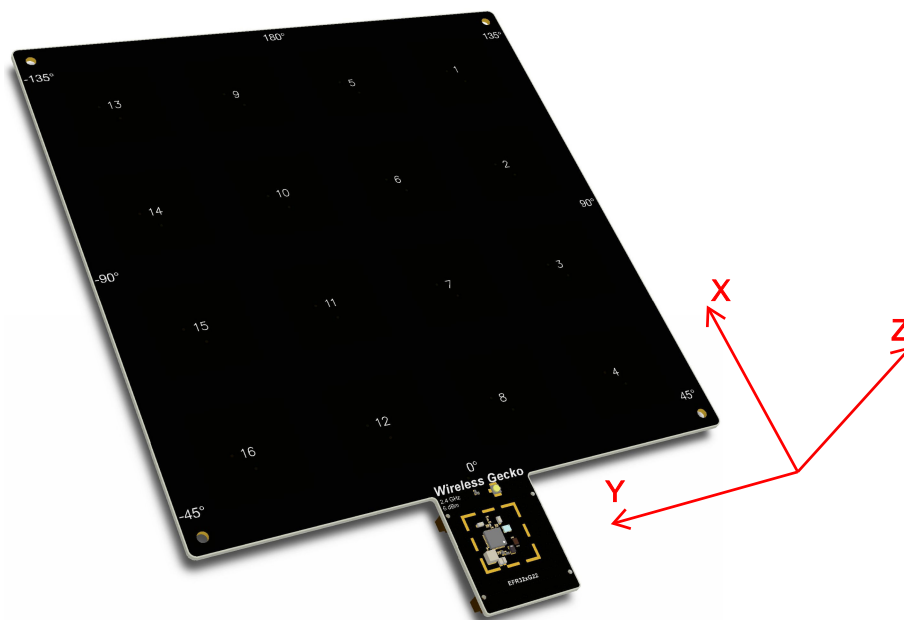

Figure 7.2. Illustration of Reference Planes with a Radio Board Plugged into the Wireless Starter Kit Mainboard

Note: The radiated measurement results presented in this document were recorded in an unlicensed antenna chamber. Also, the radiated power levels may change depending on the actual application (PCB size, used antenna, and so on). Therefore, the absolute levels and margins of the final application are recommended to be verified in a licensed EMC testhouse.

7.2.1 Maximum Radiated Power Measurements

For the transmitter antenna, the on-board printed inverted-F antenna of the BRD4185A Radio Board was used (the R1 resistor was mounted). The supply for the RF section (RFVDD) and the 2.4 GHz power amplifier (PAVDD) was 1.8 V provided by the on-chip DC-DC converter; for details, see the schematic of the BRD4185A. The transceiver was operated in unmodulated carrier transmission mode. The output power of the radio was set to 6 dBm based on the conducted measurement.

The results are shown in the tables below. The correction factors are applied based on the BLE 125 Kb/s coded modulation, showed in section 7.1.2 [Conducted Power Measurements with Modulated Carrier](#). For the rest of the supported modulation schemes the correction factors are larger, thus the related calculated margins would be higher compared to the ones shown in the table below. Thus the below margins can be considered as worst case margins.

Table 7.2. Maximums of the Measured Radiated Powers in EIRP [dBm] and the Calculated Modulated Margins in [dB] with the Wireless Starter Kit Mainboard; PAVDD = 1.8 V

Frequency (2450 MHz)	Measured Un-modulated EIRP [dBm]	Orientation	BLE 125 Kb/s Coded Modulation			Limit in EIRP [dBm]
			Correction Factor [dB]	Calculated Modulated EIRP [dBm]	Modulated Margin [dB]	
Fund	2.4	YZ/V	NA (0 is used)	2.4	27.6	30.0
2nd	-57.0	XZ/V	-2.7	-59.7	18.5	-41.2
3rd	-38.8	YZ/H	-4.8	-43.6	2.4	-41.2
4th	<-50*	-/-	-5.5	-	>10	-30.0
5th	-37.9	XZ/H	-6.3	-44.2	3.0	-41.2

* Signal level is below the Spectrum Analyzer noise floor.

As it is shown in the table above, with 6 dBm output power, the radiated power of the fundamental is lower than 6 dBm due to the low antenna gain. The 3rd and 5th harmonics are above the limit in case of the unmodulated carrier transmission. But with the relaxation of the supported modulation schemes, the margin is at least 2.4 dB and 3.0 dB, respectively.

7.2.2 Antenna Pattern Measurements

The measured normalized antenna patterns are shown in the following figures.

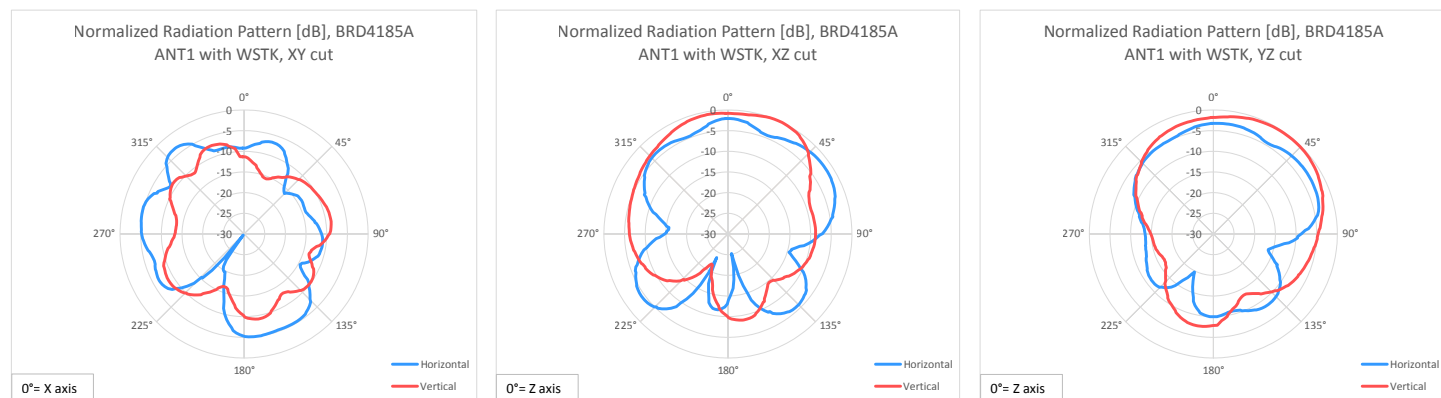

Figure 7.3. Normalized Antenna Pattern of the BRD4185A with the Wireless Starter Kit Mainboard

8. EMC Compliance Recommendations

8.1 Recommendations for 2.4 GHz ETSI EN 300-328 Compliance

As shown in section , the power of the fundamental of the BRD4185A Wireless Gecko Radio Board with 6 dBm output is compliant with the 20 dBm limit of the ETSI EN 300-328 regulation. With the supported modulation schemes, the harmonics are also compliant with the relevant limits. Although the BRD4185A Radio Board has an option for mounting a shielding can, it is not required for the compliance.

8.2 Recommendations for 2.4 GHz FCC 15.247 Compliance

As shown in section , the power of the fundamental of the BRD4185A Wireless Gecko Radio Board with 6 dBm output is compliant with the 30 dBm limit of the FCC 15.247 regulation. With the supported modulation schemes, the harmonics are also compliant with the relevant limits. Although the BRD4185A Radio Board has an option for mounting a shielding can, it is not required for the compliance.

9. Board Revision History

The board revision is laser engraved in the Board Info field on the bottom side of the PCB, as outlined in the figure below. The revision printed on the silkscreen is the PCB revision.

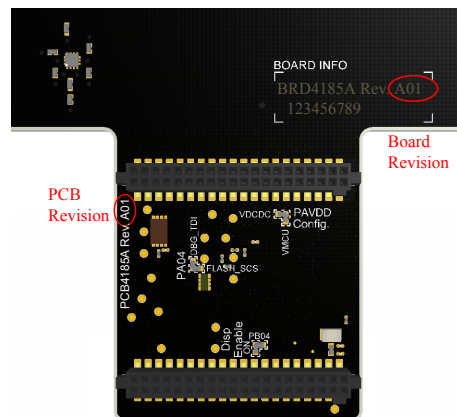

Figure 9.1. Revision Info

Table 9.1. BRD4185A Radio Board Revision History

Board Revision	Description
A01	Updated PCB prod. panel frame. No change on the board area.
A00	Initial production release.

10. Errata

There are no known errata at present.

11. Document Revision History

Revision 1.0

June, 2020

- Initial document release.

Silicon Labs

Simplicity Studio™4



Simplicity Studio

One-click access to MCU and wireless tools, documentation, software, source code libraries & more. Available for Windows, Mac and Linux!



IoT Portfolio
www.silabs.com/IoT



SW/HW
www.silabs.com/simplicity



Quality
www.silabs.com/quality



Support and Community
community.silabs.com

Disclaimer

Silicon Labs intends to provide customers with the latest, accurate, and in-depth documentation of all peripherals and modules available for system and software implementers using or intending to use the Silicon Labs products. Characterization data, available modules and peripherals, memory sizes and memory addresses refer to each specific device, and "Typical" parameters provided can and do vary in different applications. Application examples described herein are for illustrative purposes only. Silicon Labs reserves the right to make changes without further notice to the product information, specifications, and descriptions herein, and does not give warranties as to the accuracy or completeness of the included information. Without prior notification, Silicon Labs may update product firmware during the manufacturing process for security or reliability reasons. Such changes will not alter the specifications or the performance of the product. Silicon Labs shall have no liability for the consequences of use of the information supplied in this document. This document does not imply or expressly grant any license to design or fabricate any integrated circuits. The products are not designed or authorized to be used within any FDA Class III devices, applications for which FDA premarket approval is required or Life Support Systems without the specific written consent of Silicon Labs. A "Life Support System" is any product or system intended to support or sustain life and/or health, which, if it fails, can be reasonably expected to result in significant personal injury or death. Silicon Labs products are not designed or authorized for military applications. Silicon Labs products shall under no circumstances be used in weapons of mass destruction including (but not limited to) nuclear, biological or chemical weapons, or missiles capable of delivering such weapons. Silicon Labs disclaims all express and implied warranties and shall not be responsible or liable for any injuries or damages related to use of a Silicon Labs product in such unauthorized applications.

Trademark Information

Silicon Laboratories Inc.®, Silicon Laboratories®, Silicon Labs®, SiLabs® and the Silicon Labs logo®, Bluegiga®, Bluegiga Logo®, ClockBuilder®, CMEMS®, DSPLL®, EFM®, EFM32®, EFR, Ember®, Energy Micro, Energy Micro logo and combinations thereof, "the world's most energy friendly microcontrollers", Ember®, EZLink®, EZRadio®, EZRadioPRO®, Gecko®, Gecko OS, Gecko OS Studio, ISOModem®, Precision32®, ProSLIC®, Simplicity Studio®, SiPHY®, Telegesis, the Telegesis Logo®, USBXpress®, Zentri, the Zentri logo and Zentri DMS, Z-Wave®, and others are trademarks or registered trademarks of Silicon Labs. ARM, CORTEX, Cortex-M3 and THUMB are trademarks or registered trademarks of ARM Holdings. Keil is a registered trademark of ARM Limited. Wi-Fi is a registered trademark of the Wi-Fi Alliance. All other products or brand names mentioned herein are trademarks of their respective holders.



Silicon Laboratories Inc.
400 West Cesar Chavez
Austin, TX 78701
USA

<http://www.silabs.com>