

Carrier Connect™ Wi-Fi Thermostat 33CONNECTSTAT43FX

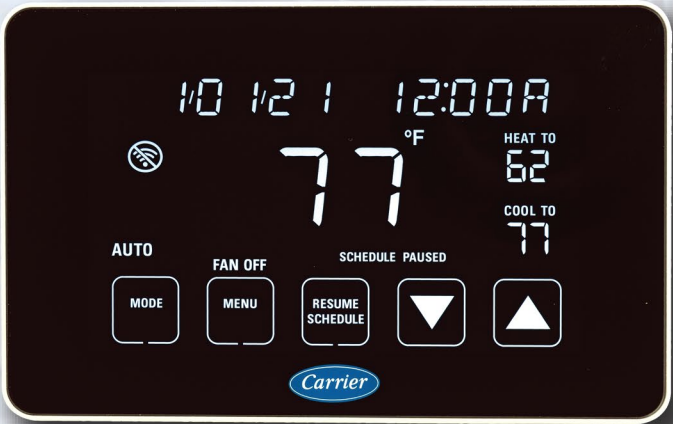

Installation Guide





Verify that you have the most current version of this document from www.hvacpartners.com, the **Carrier Partner Community** website, or your local Carrier office.

Important changes are listed in **Document revision history** at the end of this document.

©2024 Carrier. All rights reserved.



Contents

What is the Carrier Connect™ 33CONNECTSTAT43FX Thermostat?	1
Specifications	2
Programmable and non-programmable installations	3
Inputs.....	5
Outputs.....	6
Wiring the Carrier® Connect™ WI-FI Thermostat	8
To wire dual fuel systems and furnace / AC systems	8
To wire an air handler with heat pump or with AC	10
To wire hotel systems	12
To connect a remote input (sensor or contacts).....	12
To wire for BACnet communication.....	14
Registering and setting up a mobile device for enhanced access	15
Using the Connect website or app	16
Getting to know the user interface	19
Dormant screen.....	19
Home screen.....	19
Occupancy/Enter PIN screen.....	20
Changing the setpoints	21
Changing the fan.....	22
Changing the mode.....	22
Using the menu for advanced features	23
To adjust date and time.....	24
To adjust occupancy settings	25
To adjust the display settings.....	27
To adjust the banner text.....	29
Using installer settings	31
To set up BACnet	43
To test the HVAC system.....	49
To restore factory default settings	50
Setting up WI-FI	53
Timers, memory, and deadband	55
Faults and system events	56
Appendix A: BACnet Points List	58
Appendix B: BACnet Functionality	64
Appendix C: BACnet Constraints	65
Appendix D: BACnet Object Instance Ranges	66
Appendix E: BACnet Object Notes	67
Document revision history	69



What is the Carrier Connect™ 33CONNECTSTAT43FX Thermostat?

The Carrier Connect 33CONNECTSTAT43FX thermostat has:

- Space and remote temperature sensing
- Space and remote humidity sensing
- BACnet MS/TP communications
- Wi-Fi connectivity

The Carrier® Connect™ Wi-Fi Thermostat package includes:

- Thermostat
- Mounting Hardware - two screws with drywall anchors and one security screw
- Quick Start Guide - Catalog No. 11-808-873-01

Some of the features:

- Control of heating, cooling, and fan solid state 24 Vac outputs
- Space temperature sensing (> 0.5 °F accuracy from 60 °F to 90 °F)
- Outdoor temperature sensing using a 10K @ 25 °C J Curve (type II) thermistor connected to **T** and **C** terminals or Wi-Fi outdoor temperature, available by GPS location services, determined when the thermostat is installed
- Humidity sensing and control
- Remote humidity sensing from a 33ZCSENRH-02 Humidity Duct Sensor or 33ZCSENSRH-02 wall sensor
- Remote CO2 sensing from a 0-10 vdc or 4-20 mA sensor
- Wi-Fi connectivity (supports 802.11 a/b/g/n standards and utilizes a Broadcom chipset)
- Cloud Connectivity using the Carrier Connect mobile app (iOS and Android).
- Optimized installation (“finger friendly” spring-loaded connectors that accept 16 to 24 AWG wire and NO screwdriver required for wire insertion and removal)
- Optimized boot time (5 seconds total boot time until temperature displays and thermostat is fully operational)
- 4.3” segment display
- Thirteen touch points for display buttons
- OTA functionality (reprogrammable via Wi-Fi)

Specifications

Power requirements	24 Vac +/- 10% @ 3VA
Network Requirements	Wi-Fi connectivity supports Wi-Fi: 802.11 a/b/g/n standards on 2.4 GHz networks
Environmental temperature range	Operating: 32° to 104°F (0° to 40°C) Storage: -40° to 135°F (-40° to 57°C)
Humidity range	Operating: 10% to 95%, non-condensing, 32° to 104°F (0° to +40°C) Storage: 10% to 95%, non-condensing
Connections	Connectors P104 and P105. 2 banks of “finger friendly” spring type terminal blocks intended to be wired by the end-user or installer
Inputs	<ul style="list-style-type: none">• C - connection• R - connection• H - 0-10 Volt input• T - remote thermistor
Outputs	Connections: Y3, O/B, Y2, Y1, G, W1, and W2
Communications	485 signal: A+ and B
Mounting	Standard 4 x 2 in. electrical box using the 6-32 x 1/2 in. mounting screws and plastic wall anchors provided
Overall dimensions	Width: 5.15 in. (13.1 cm) Height: 3.25 in. (8.2 cm) Depth: 0.95 in. (2.4 cm)
BACnet Support	Conforms to the BACnet Application Specific Controller (B-ASC) Device Profile as defined in ANSI/ ASHRAE Standard 135-2012 (BACnet) Annex L, Protocol Revision 14
Listed by	FCC Part 15, Subpart J compliant

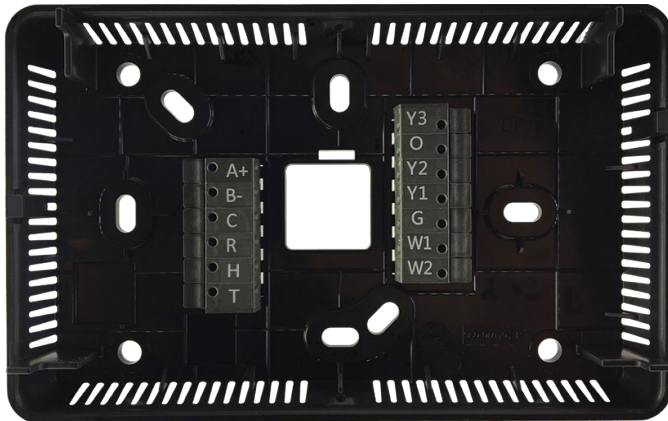

Programmable and non-programmable installations

The thermostat combines all 24 Vac output demand control functions needed for the following types of thermostat programmable and non-programmable installations:

Cool only (up to 3 stages of cooling)

- Cooling
 - **Y1** - first stage cooling
 - **Y2** - second stage cooling
 - **Y3** - third stage cooling

Heat only with gas heat (up to 2 stages of heating)

- Heating
 - **W1** - first stage heat
 - **W1 + W2** - second stage heat

Heat only with electric heat (up to 3 stages of heating)

- Heating
 - **W1** - first stage heat
 - **W2** - second stage heat
 - **W1 + W2** - third stage heat

What is the Carrier Connect™ 33CONNECTSTAT43FX Thermostat?

AC with gas heat (up to 3 stages of cooling and 2 stages heating)

- Cooling
 - **Y1** - first stage cooling
 - **Y2** - second stage cooling
 - **Y3** - third stage cooling
- Heating
 - **W1** - first stage heat
 - **W1 + W2** - second stage heat

AC with electric heat (up to 3 stages of cooling and 3 stages heating)

- Cooling
 - **Y1** - first stage cooling
 - **Y2** - second stage cooling
 - **Y3** - third stage cooling
- Heating
 - **W1** - first stage heat
 - **W2** - second stage heat
 - **W1 + W2** - third stage heat

HP with electric heat (up to 2 stages of cooling and 5 stages of heating with 3 stages auxiliary)

- Cooling
 - **Y1 + O/B** - first stage cooling
 - **Y1 + Y2 + O/B** - second stage cooling
- Heating
 - **Y1** - first stage HP heating
 - **Y1 + Y2** - second stage HP heating
 - **Y1 + Y2 + W1** - HP heating + first stage aux heat
 - **Y1 + Y2 + W2** - HP heating + second stage aux heat
 - **Y1 + Y2 + W1 + W2** - HP heating + third stage aux heat

HP with gas heat (up to 2 stages of cooling and 4 stages of heating with 2 stages auxiliary)

- This system is known as a dual fuel system.
- When gas heat turns on, the HP heat turns off unless defrost is active.
- Once the gas is turned on, the heating demand is satisfied with gas heat. The thermostat does not stage down from gas to heat pump heat.
- Cooling
 - **Y1 + O/B** - first stage cooling
 - **Y1 + Y2 + O/B** - second stage cooling

- Heating
 - **Y1** - first stage HP heating
 - **Y1 + Y2** - second stage HP heating
 - **W1** - first stage aux heat
 - **W1 + W2** - second stage aux heat

Definitions	
Heat demand	The space temperature is less than the heat setpoint (HEAT TO setting).
Cool demand	The space temperature is greater than the cool setpoint (COOL TO setting).
Heat demand satisfied	The space temperature is greater than the heat setpoint (HEAT TO setting).
Cool demand satisfied	The space temperature is less than the cool setpoint (COOL TO setting).
Heating equipment	If the Y1, W1, or W2 (W2 in electric heat systems only) outputs are energized when the mode is set to HEAT, EHEAT, or AUTO, operating in Heat, then the heating equipment is on. When all of these outputs are off, the heating equipment is off.
Cooling equipment	If the Y1 output is energized when the mode is set to COOL or AUTO operating in Cool, then the cooling equipment is on. When Y1 is off, the cooling equipment is off.

Inputs

Power supply

Class II transformer secondary voltage supplied to the thermostat is 18.0 to 30.0 Vac, 50/60 Hz. Voltage is applied between **R** and **C** connector.

Space air temperature

The space air temperature measurement is supplied by an NTC "J" curve (type II) thermistor. The resistance of the thermistor is 10K ohm nominal at +25 °C with an accuracy of ±0.20 °C from +15.6 °C to +32.2 °C (approximately 0.5 °F accuracy from 60 °F to 90 °F).

If the thermistor reading is invalid, the space temperature is measured by the Sensirion SHT21 humidity and temperature sensor.

Remote temperature sensor

The remote temperature measurement is supplied by a NTC "J" curve (type II) thermistor connected between **T** and **C**. This thermistor is supplied by the installer to use for Space, Outdoor, Supply Air, or an average with the space air temperature. When used for the space temperature sensor, up to 9 remote space sensors can be averaged (1, or multiples of 4, or 9). The **T** input allows for remote occupancy override with T55 style sensor.

- If the **Occupancy Input** installer setting is set to **OCCUPIED**, when a short in the circuit from 2 up to 5 seconds in duration is sensed, a change is made from the unoccupied heating and cooling setpoints to the occupied heating and cooling setpoints for the current time period, for the configured allowable time.
- If the **Occupancy Input** installer setting is set to **UNOCCUPIED**, when a short in the circuits sensed for more than 2 seconds, the occupied heating and cooling setpoints change to the unoccupied heating and cooling setpoints for the current time period.
- Alternatively, you can use the remote temperature sensor input as a remote occupied/unoccupied selection as well as an indicator of economizer fault or Filter Reminder.
- Alternatively, Wi-Fi outdoor temperature is available by GPS location services – determined when the thermostat is installed and registered through a Wi-Fi connection.

Remote humidity or CO2 sensor (0-10 volt or 4-20 mA)

The remote measurement is calculated from the 0-10 volt or the 4-20 mA signal applied between **H** and **C**. When the output of the sensor is the 4-20 mA signal, a 500 ohm load resistor must be connected between **H** and **C**.

Space humidity sensor

The humidity is read via synchronous communications from a Sensirion SHT21 Humidity and Temperature Sensor. The Sensirion humidity is accurate to +/- 2 % relative humidity between 20 and 80 % relative humidity.

Outputs

Connections are made via a compact and robust single pole, “finger friendly” spring-type terminal block. All outputs have a max rating of 1.25 Amp @ 24 Vac.

Terminal	Output for...	Is energized when the thermostat has a...
G	Fan	fan demand
W1	First Stage Heat or AUX Heat	first stage heat or aux heat demand
W2	Second stage heat or AUX heat	second stage heat or aux heat demand
Y1	First stage cooling or HP heating output	first stage cooling or HP heating output

Terminal	Output for...	is energized when the thermostat has a...
Y2	Second Stage Cooling or HP Heating Output	second stage cooling or HP heating demand
O	Reversing Valve Output	reversing valve demand
Y3	Third Stage AC Cooling	third stage AC cooling demand
O or Y3 or W2	Humidifier Output	humidification demand NOTE You can connect to any of these 3 outputs that are unused and select it in the system settings menu.
O, Y3, and W2	HumidiMiZer™	HumidiMiZer™ demand NOTE You can connect to any of these 3 terminals that are unused and select it in the system settings menu.
O, Y3, and W2	Economizer or Occupancy	the thermostat is running in occupied mode, as determined by the program, the occupancy input, BMS occupancy, or an override condition NOTE You can connect to any of these 3 terminals that are unused and select it in the system settings menu.

Wiring the Carrier® Connect™ Wi-Fi Thermostat

To wire duel fuel systems and furnace / AC systems

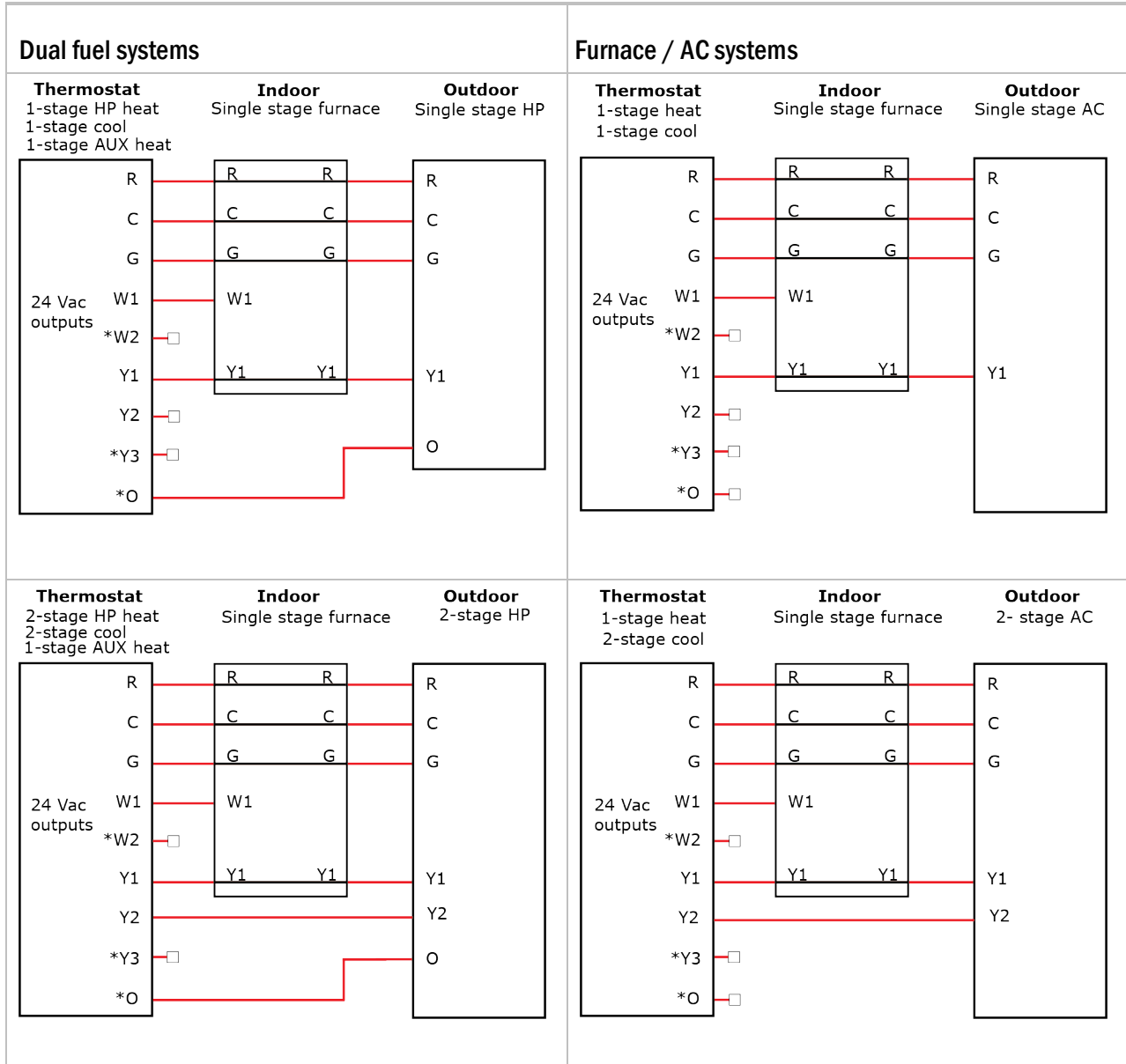

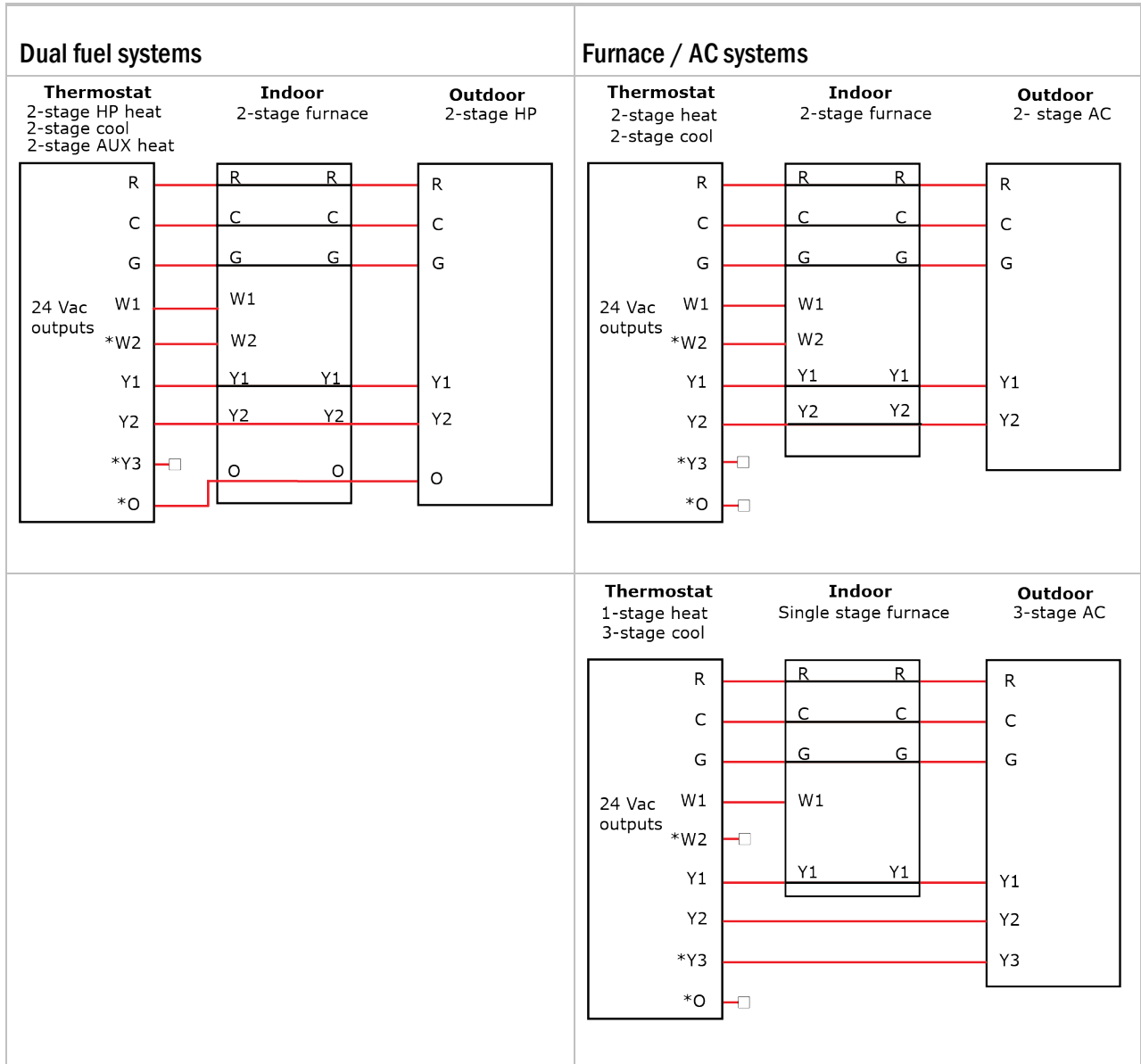

To wire an air handler with heat pump or with AC

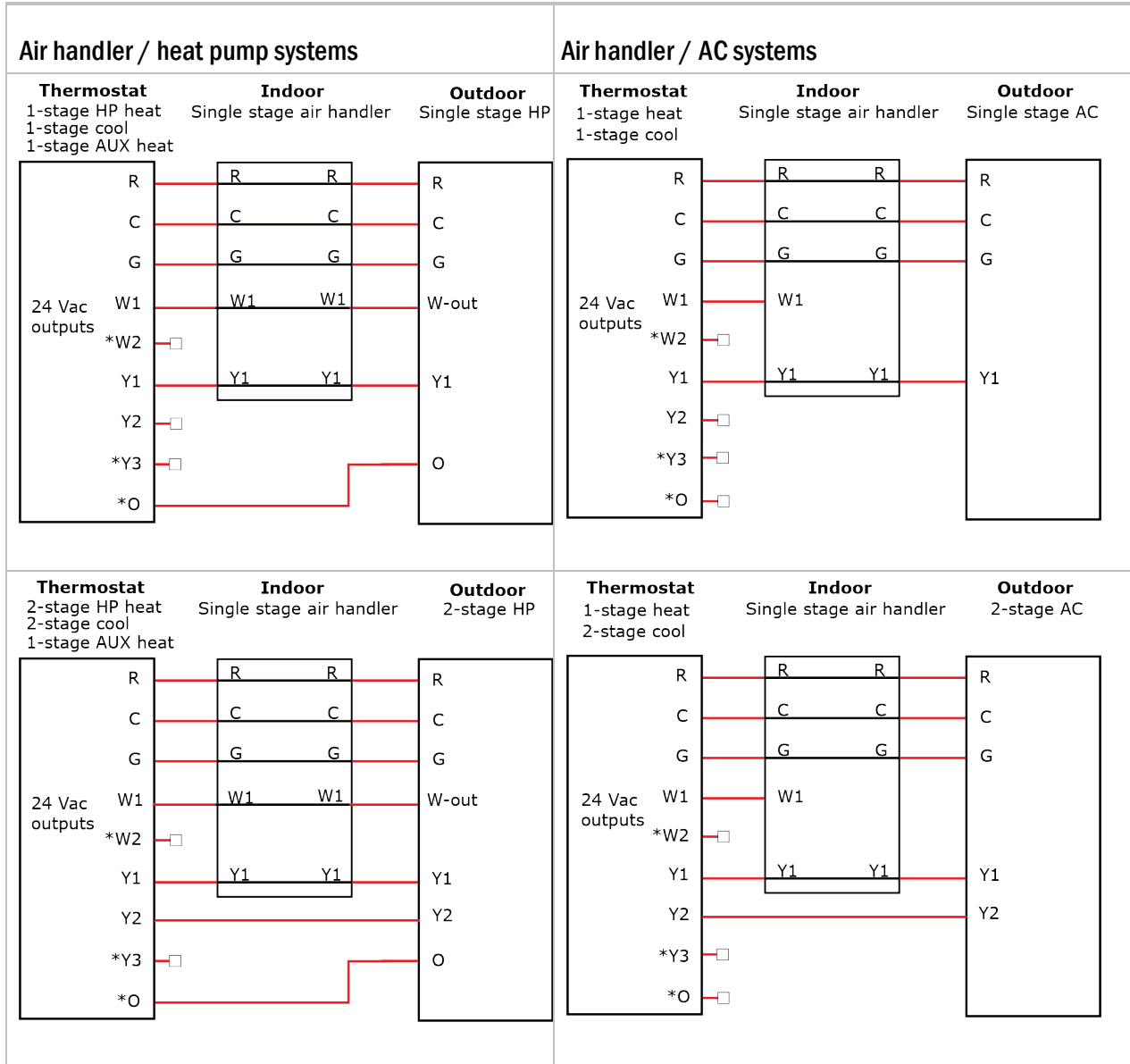

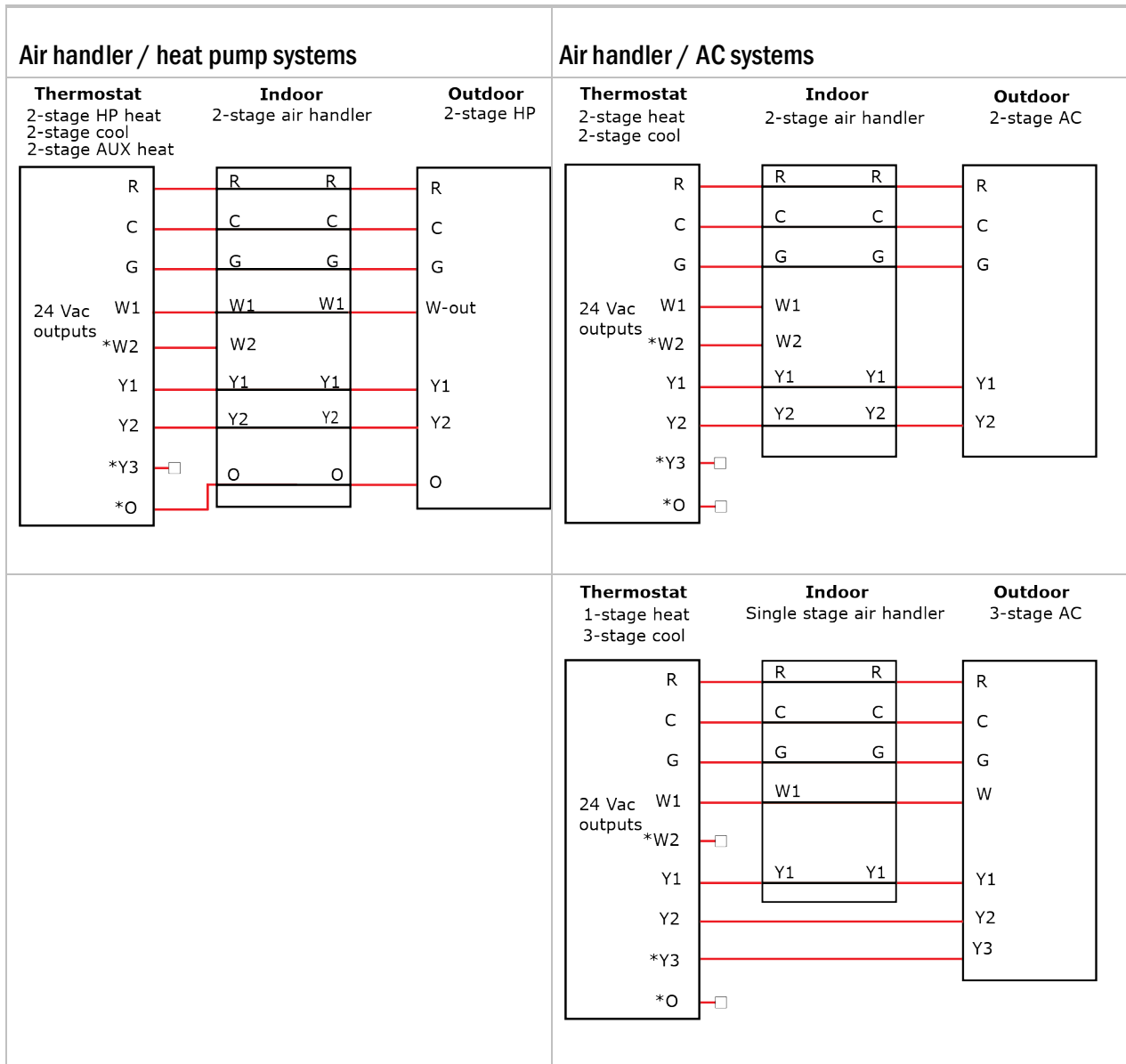

To wire hotel systems

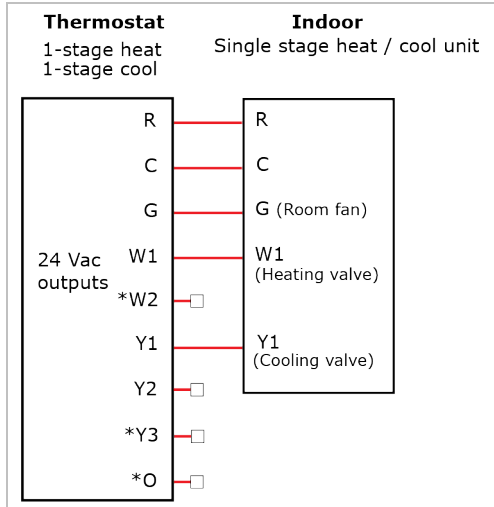

To connect a remote input (sensor or contacts)

NOTE Use the specified type of wire and cable for maximum signal integrity.

Power	N/A
Description	Stranded, twisted pair
Conductor	If < 100 ft (30.5 meters) 22 AWG, unshielded If > 100 ft (30.5 meters) 22 AWG, shielded
Maximum length	500 feet (152 meters)
Insulation	Plenum rated
Thermistor	10K Type II (CP/MCI)



Use Remote Sensor input terminals S1 and S2 for the following inputs:

- OAT
- T55
- SAT
- Occupancy contacts
- Econ Fault

Wiring for space temperature sensor averaging

4 sensors

Connect
Thermostat

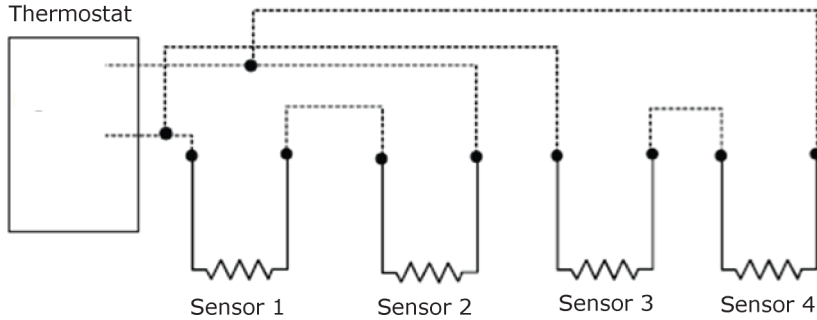

9 sensors

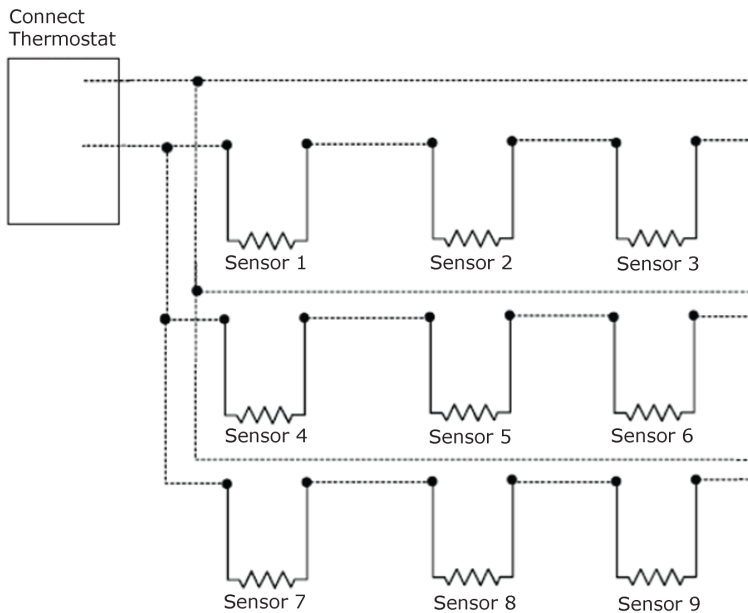

To wire for BACnet communication

NOTE Use the specified type of wire and cable for maximum signal integrity.

Cable	22 or 24 AWG, low-capacitance, twisted, stranded, shielded copper wire
Maximum length	2000 feet (610 meters) per segment
Baud rate	9600 bps, 19.2 kbps, 38.4 kbps, or 76.8 kbps, 115.2 kbps



Connect communication wiring to terminals **A+** and **B-**. Do not terminate shield at the thermostat.



CAUTION Maintain the same polarity.

NOTE For more networking details, see the *Open Controller Network Wiring Installation Guide*

Registering and setting up a mobile device for enhanced access

Downloading the Connect™ App provides enhanced access to your device. The Connect™ App is available for Apple iOS® at App Store® or at Google Play® for Android devices. Search for **Carrier Connect™ Thermostat**.

NOTE Device compatibility: Apple iOS® 7.0 or later or Android 4.2 or later

- 1 After downloading Connect™ App, select **USER SETUP** and **Register New Account**.

NOTE You can also register new accounts using the website connectstat.carrier.com.

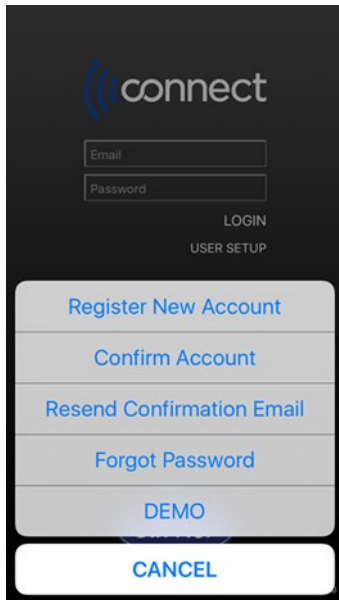

- 2 Enter an email address that you can access on your mobile device and receive the confirmation email to complete the registration process.
- 3 Select **SETUP NEW THERMOSTAT** and follow the Connect™ App instructions.
- 4 After registering the thermostat, enter servicing contractor's name and phone number on the **SERVICE INFO** screen.
- 5 On the **THERMOSTATS** screen, select the thermostat from list and the mobile app's **HOME** screen appears.



Using the Connect website or app

After you register for an account, you can access the thermostat by using the app directly or through the Web at connectstat.carrier.com.

You can:

- Monitor the thermostat operation
- Set up occupied and unoccupied (holiday) schedules
- Adjust setpoints
- Share thermostat access with other users
- Create groups of thermostats that you have registered
- Create groups of thermostats that other owners have shared with you
- Get online product information
- Find local dealer support

To navigate

- On a touchscreen device, use any of the following:
 - swipe the screen
 - tap the arrow on the side
 - tap a dot on the bottom of the screen on either side of the HOME button
 - On a non-touchscreen device, click on the gray arrow  on either the side of the screen.
 - You can press or click  to access the following drop-down list:
 - **My Systems**
 - **My Account**
 - **Shared Systems**
 - **Product Information**
 - **Find and Expert**
 - **Logout**
- 1 After logging in, a list appears of thermostats that you have registered and that have been shared with you.
 - 2 Click .

- 3 Swipe or click to navigate to the **SETTINGS** screen.

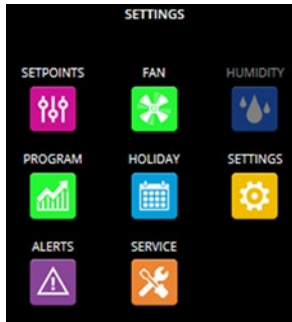

NOTES

- Navigate by clicking or pressing the buttons such as **SETPOINTS, FAN, PROGRAM**, etc...
- Grayed out function buttons indicate that feature is not being used on the thermostat.

Screens	Use to...
SETPOINTS	Adjust the occupied and unoccupied setpoints by selecting each temperature.
FAN	View and modify fan settings. <ul style="list-style-type: none"> ● The default setting for fan operation is AUTO for both Occupied and Unoccupied periods. When operating in AUTO MODE, the fan only runs when there is an active heating or cooling demand. ● When you select ON, the fan runs continuously, except during the Blower On Delay when a heat cycle is starting. There is a 30-second minimum on/off timer when changing the FAN MODE.
NOTE The following selections are not available if the thermostat has been configured for non-programmable operation.	
HUMIDITY	Adjust the thermostat's humidify and dehumidify setpoints.
PROGRAM	You can: <ul style="list-style-type: none"> ● Set Occupied and Unoccupied start times, depending on the configured number of periods and the user's security level. ● Select the time at the bottom of the screen to adjust the start or stop time of each period in 15 minute increments. ● Select Copy to apply that schedule to other days of the week. ● Adjust the setpoints for each period.

Screens	Use to...
HOLIDAY	<p>Set HOLIDAY (same as unoccupied) periods with the following options:</p> <ul style="list-style-type: none"> • Length of time from 1 to 365 days • Same day of each week of the month • Specific day of specific week(s) of the month <p>NOTE Requires advanced security level to edit these settings</p> <ul style="list-style-type: none"> • Select +ADD HOLIDAY to add start month, day, and number of days. • Select ADVANCED to configure same day of each week(s) of that month. • To delete a holiday on the: <ul style="list-style-type: none"> ○ Mobile app - swipe the selected holiday to the left and select Delete ○ Web app - select x on right side of the holiday
SETTINGS	<p>Enter the name and location of the thermostat for the user's reference. The user can enter an email address for alerts and a mobile phone number to receive text alert messages.</p> <p>NOTE Requires advanced security level to edit these settings.</p>
ALERTS	<p>Displays a list of alerts that have been flagged in the thermostat.</p>
SERVICE	<p>Displays the name and phone number of the service company or individual who is responsible for servicing the system.</p> <p>NOTE Requires advanced security level to edit these settings.</p>
CO2	<p>Displays the graph for up to 30 days of CO2 history. Presents the high and average for today as well as the last 30 days.</p>

Getting to know the user interface

Dormant screen

The dormant screen is displayed when not interacting with the thermostat.



The banner scrolls through date and time, humidity, outdoor air temperature, if configured, and any active faults or system events. The room temperature is prominently displayed.

There are no buttons on this screen, but the 13 touch locations are active, so when the display is touched, the thermostat transitions to the **LOCK** screen, if lockout is enabled, or the home screen, if lockout is disabled.



Home screen

You interact with the thermostat primarily from the Home screen.



The center portion of the screen displays the current space temperature in whole degrees. The default temperature scale is °F, but can be changed to °C in the *Installer settings* (page 31).

The top of the screen displays a banner that cycles system information every 3 seconds. To see the scrolling messages faster than 3 seconds, press the banner area of the screen to advance to the next message.

The  icon indicates the current Wi-Fi signal strength by the number of bars. A strong signal has 3 arched bars.  indicates the thermostat is not connected to a router.

Above the space temperature, the current state of occupied or unoccupied displays, unless you have temporarily overridden the program schedule settings. When overridden, the banner displays **PAUSED** and shows the time remaining in the override.

From the home screen, you can:

- *change the mode* (page 22)
- *force an occupied or unoccupied override* (page 21)
- *change the setpoints* (page 21)
- *set the filter reminder* (page 39)
- *enter the menu for more advanced functionality* (page 23)

You access the program schedule by holding the bottom middle button (labeled **OCC, UNOCC**, or **RESUME SCHEDULE**) for 3 seconds.

Access the installer configurations by setting the **MODE** to **OFF** and holding the **MENU** button for 5 seconds.

Occupancy/Enter PIN screen

The Occupancy/ENTER PIN screen is displayed when you touch the dormant screen with lockout enabled.

To enter the PIN that unlocks the thermostat, press 1 of the 3 digits in the center of the display and then use the up or down arrows to adjust to the correct value. Repeat with the remaining 2 digits. When the 3-digit PIN is correct, press **SAVE**.



This screen has an **OCC/UNOCC** button to temporarily override the program schedule settings without knowing the PIN. The PIN must be entered for all other thermostat changes. Pressing the **OCC/UNOCC** button temporarily overrides the program schedule settings with the occupied or unoccupied settings. This override remains active until the next time range in the program schedule or until the **MAX HOLD** time expires.

If the correct PIN is entered, the thermostat displays the home screen. The thermostat remains unlocked until no interaction results in the dormant screen. When the dormant screen displays, the thermostat is locked.

If the correct PIN is not entered, an **INVALID PIN** message displays for 3 seconds and the thermostat transitions to the dormant screen.

If an invalid PIN is entered 5 consecutive times, the thermostat is completely locked out for 15 minutes. The top banner displays **LOCKOUT** and shows the time remaining until another unlock can be attempted.

Changing the setpoints

You can change the setpoints from the home screen using the up and down arrows.

If the mode is:

- **OFF**—the setpoints, occupancy button, and the up and down arrows do not display
- **HEAT** or **EHEAT**—only the heat setpoint displays
- **COOL**—only the cool setpoint displays
- **AUTO**—both setpoints display



When changing the setpoints in **AUTO** mode, the setpoint modified by the up and down arrows is the last setpoint that was changed. To adjust the opposite mode setpoint, touch the setpoint value on the display. **HEAT TO** or **COOL TO** flashes above the setpoint and can be changed by using the up and down arrows. The setpoints enforce a 2-degree deadband. Setpoints in °F are displayed in whole degrees. Setpoints in °C are displayed with half degree resolution.

Pressing once on the center button at the bottom of the display changes the setpoints to either the program schedule's occupied or unoccupied settings. The label on this button shows the opposite of the word above the space temperature.

Example If the thermostat is in an occupied program period, the middle button displays **UNOCC** so you can change the thermostat settings to the unoccupied values. Overriding the program schedule using the **OCC/UNOCC** button modifies both the setpoint values and the fan setting.

A program schedule override is treated the same whether you manually change the setpoints or use the **OCC/UNOCC** button. When an override is active, the center button label changes to **RESUME SCHEDULE**, the period icon above the space temperature is not displayed, and the amount of time remaining in the override is displayed in the banner. The thermostat returns to the program schedule value at the next programmed period, when the max hold timer expires or if you press the **RESUME SCHEDULE** button.

NOTE If the thermostat is setup as a non-programmable thermostat or them **MAX HOLD** time is set to **OFF**, then the bottom middle button is not displayed.

The installer designates and clamps setpoints within a range.

Changing the fan

The fan's current state is displayed on the home screen above the **MENU** button.



You can change the fan setting by pressing **MENU** and then the current fan setting is displays.

To change the fan setting, press **SELECT** and then use the up and down arrows to toggle the fan setting between **AUTO** and **ON** and then press **SAVE**.

- **ON** specifies continuous fan that is always running.
- **AUTO** specifies that the fan only runs while actively heating or cooling.

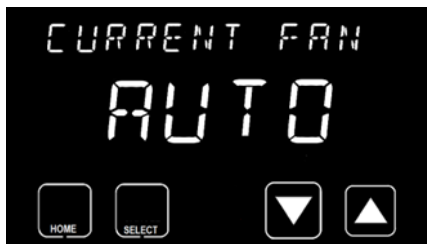

When the fan setting differs from the program schedule setting for the current period, the banner displays **FAN OVERRIDE**. The override remains active for the rest of the current program schedule.

Changing the mode

You can change the mode from the home screen by pressing the **MODE** button.

Changing from one mode to another does not affect the thermostat's operation until the mode selection has remained constant for at least 5 seconds. Changing from one mode to another (e.g. **HEAT** mode to **COOL** mode) requires the thermostat to first satisfy any **MINIMUM ON** timer requirements and then restarts the **MINIMUM OFF** timer that must expire before equipment is turned on in the new mode.

Going from any heating or cooling mode to **OFF** mode immediately shuts off any equipment that is active (after the 5-second mode button). See *Timers* (page 55) for additional descriptions of the **MINIMUM OFF** timer and the **MINIMUM ON** timer.

NOTE Some modes may not be available, based on the **INDOOR EQUIPMENT TYPE** or the **COMPRESSOR TYPE** selections made in Installer Settings.

Using the menu for advanced features

The menu allows the user to access more advanced features of the thermostat.

- 1 When you press the **MENU** button, the first menu option is **CURRENT FAN**.



- 2 Press **SELECT** to activate the up and down arrows.

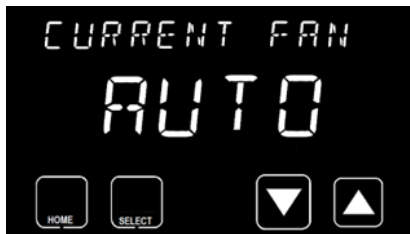

- 3 Press the up or down arrows to advance through the menu options to view or change the value for each setting.



- You must **SAVE** to store the current value and return to the **SELECT** screen.
- Press **CANCEL** to revert the value to the last saved value and return to the **SELECT** screen.

NOTES

- Press **DEFAULT** to set the value to the factory default and press **SAVE** to store the value.



To adjust date and time

Screen settings	Default/Range
SET YEAR —The current year	D: 2020 R: 2020 to 2099
SET MONTH —The current month	D: Jan R: Jan to Dec
SET DAY OF MONTH —The current day of the month	D: 1 R: 1 to 31
SET HOUR —The hour of the day using 12 hour a.m. (A) / p.m. (P) format	D: 12 A R: 12 A - 11 P
SET MINUTE —The current minute	D: 0 R: 0 to 59
SYNC TIME TO SERVER —When the thermostat is first registered and connected to a Wi-Fi router, both the date and time are synced with the server, based on the geographic location of the phone or tablet connecting the thermostat to a router or based on the ISP location if a PC is used. The time and date are updated/synced automatically at the top of each hour, unless SYNC TIME TO SERVER is set to NO .	D: YES R: YES NO
DST ENABLE —Enable or disable automatic Daylight Saving Time change in the thermostat	D: YES R: YES NO

To adjust occupancy settings

Setting	Default/Range
<p>SET OCC FAN—Operates the fan in AUTO or ON during occupied periods</p> <p>NOTE If the installer configured the thermostat for non-programmable operation and remote occupancy is disabled, this setting is not available.</p> <p>REMINDER! The AUTO setting is a violation of ASHRAE 90.1 and Title 24 but is a feature of the thermostat for building owners that mandate auto fan operation during occupied periods for energy conservation purposes.</p>	<p>D: AUTO</p> <p>R: AUTO ON</p>
<p>SET UNOCC FAN—Operates the fan in AUTO or ON during unoccupied periods</p> <p>NOTE If the installer has configured the thermostat for non-programmable operation and remote occupancy is disabled, this setting is not available.</p>	<p>D: AUTO</p> <p>R: AUTO ON</p>
<p>UNOCC COOL—The cool setpoint during unoccupied periods</p> <p>NOTES</p> <ul style="list-style-type: none"> The minimum value you can set is limited by the unoccupied heat setpoint (cool setpoint cannot be less than the heat setpoint) and the installer setting for MIN COOL SETPOINT. If the installer has configured the thermostat for non-programmable operation and remote occupancy is disabled, this setting is not available. 	<p>D: 85 °F</p> <p>R: 52 to 90 °F</p>
<p>UNOCC HEAT—The heat setpoint during unoccupied periods</p> <p>NOTES</p> <ul style="list-style-type: none"> The maximum value is limited by the unoccupied cool setpoint (heat setpoint cannot be greater than the cool setpoint) and the installer setting for MAX HEAT SETPOINT. If the installer has configured the thermostat for non-programmable operation and remote occupancy is disabled, this setting is not available. 	<p>D: 62 °F</p> <p>R: 50 to 88 °F</p>
<p>OCC COOL—The cool setpoint during occupied periods</p> <p>NOTES</p> <ul style="list-style-type: none"> The minimum value is limited by the occupied heat setpoint (cool setpoint cannot be less than the heat setpoint) and the installer setting for MIN COOL SETPOINT. If the installer has configured the thermostat for non-programmable operation and remote occupancy is disabled, this setting is not available. 	<p>D: 75 °F</p> <p>R: 52 to 90 °F</p>
<p>OCC HEAT—The heat setpoint during occupied periods</p> <p>NOTES</p> <ul style="list-style-type: none"> The maximum value is limited by the occupied cool setpoint (heat setpoint cannot be greater than the cool setpoint) and the installer setting for MAX HEAT SETPOINT. If the installer has configured the thermostat for non-programmable operation and remote occupancy is disabled, this setting is not available. 	<p>D: 70 °F</p> <p>R: 50 to 88 °F</p>

Setting	Default/Range
<p>DAY PARTS—The number of programmable periods in a single day. The setting is adjustable as either 2 (default) or 4 periods in a day. Typically, commercial or light commercial products use 2.</p> <p>NOTE If the installer has configured the thermostat for non-programmable operation and remote occupancy is disabled, this setting is not available.</p>	<p>D: 2</p> <p>R: 2 or 4</p>
<p>PROGRAM SCHEDULE—The program schedule specifies the programmed start times for the thermostat to control the space to the occupied or unoccupied fan and setpoint values.</p> <p>1 From the SET PROGRAM screen, press SELECT to view the program schedule for SUNDAY P1.</p> <div data-bbox="237 575 631 800" data-label="Image"> </div> <p>2 From the SUNDAY P1 screen, use the up and down arrows to advance through the program schedule to the next period (SUNDAY P2), or press SELECT again to change the start time or occupancy setting.</p> <p>NOTE</p> <div data-bbox="237 926 631 1150" data-label="Image"> </div> <p>NOTES</p> <ul style="list-style-type: none"> ○ BACK returns to the menu ○ Use up and down arrows to change start time ○ Use OCC/UNOCC to change occupancy ○ The bottom middle button is labeled the opposite of the current occupancy selection 	

To adjust the display settings

Setting	Default/Range
<p>SOUND EFFECT—Select the sound feedback when you press a button.</p>	<p>D: CLCK (Click)</p> <p>R: OFF CLCK (Click) BEEP</p>
<p>BACKLIGHT—There are two backlight settings, one for interacting with the thermostat and another for the dormant screen.</p>	
<p>BACKLIGHT ACTIVE—Set the active backlight to 10% to 100% of the full backlight capability.</p>	<p>D: 75%</p> <p>R: 10 to 100% (5% increments)</p>
<p>BACKLIGHT SLEEP—Set the inactive backlight for the dormant screen to 0% to 25% of the full backlight capability.</p>	<p>D: 25%</p> <p>R: to 25% (5% increments)</p>
<p>LOCKOUT ENABLE—Enable or disable adjustments to prevent unauthorized changes from the touchscreen interface. When LOCKOUT is changed from NO to YES, the user must enter a 3-digit PIN. After setting the LOCKOUT to YES and entering a PIN, the thermostat locks when the user returns to the home or the dormant screen.</p> <p>When LOCKOUT is enabled:</p> <ul style="list-style-type: none"> The user must enter the 3-digit PIN after pressing any button on the home screen. If the PIN is entered successfully, the thermostat is unlocked until the dormant screen displays. After 5 failed attempts to unlock the thermostat, a notification (fault) is sent through the Wi-Fi to the registered owner of the thermostat. Additional unlock attempts are not allowed for 15 minutes. <p>NOTE If the user enables LOCKOUT but does not save a PIN, LOCKOUT automatically disables (sets back to NO).</p>	<p>D: NO</p> <p>R: YES NO</p>
<p>SET LOCK PIN—The end user can choose or modify their own 3-digit lock PIN for the thermostat.</p> <p>One digit of the 3-digit PIN flashes to indicate which digit is changeable using the up and down arrows. To change which digit is adjustable, touch the digit on the display.</p> <p>NOTE If LOCKOUT ENABLE is set to NO, the SET LOCK PIN screen does not appear.</p>	<p>D: N/A - no default</p> <p>R: 000 - 999</p>
<p>CLEAN SCREEN—Completely disables touch functionality for 10 seconds so the screen can be cleaned with a dry nonabrasive cloth. During this time, a 10-second countdown value shows and then normal touchscreen function resumes.</p> <p>Two screens display the thermostat software versions. They are for informational purposes only.</p> <ul style="list-style-type: none"> APP VERSION displays the application. BOOT VERSION displays the bootloader. 	

Setting	Default/Range
<p>HUMIDIFY SETPOINT—Sets the humidify setpoint. When the heating equipment is energized and the humidity level is more than 2% below the humidify setpoint, the humidifier turns on.</p> <p>When the heating equipment turns off or the humidity level is more than 2% above the humidify setpoint, the humidifier turns off.</p> <p>NOTES</p> <ul style="list-style-type: none"> • If the installer set HUMIDIFIER to NO, this setting is not available. • If the installer did not set the HUM OUTPUT to 1 of the 3 configurable outputs, this setting is not available. 	<p>D: 15%rh R: 15 - 5%rh</p>
<p>DEHUMIDIFY SETPOINT—Sets the dehumidify setpoint. When the humidity level is greater than the dehumidify setpoint, dehumidification operates according to the installer configuration for the dehumidifier.</p> <p>NOTE If cooling equipment is not available (based on the OUTDOOR EQUIPMENT TYPE selection, then dehumidification is not available in the thermostat.</p>	<p>D: 65%rh R: 35 to 65%rh</p>
<p>HOLIDAYS—View or edit all holidays for the current year. When the current date in the thermostat is the same as a day in the holiday list, the setpoints for the first UNOCCUPIED time range are used for the entire day unless you later change them.</p> <p>When the HOLIDAYS screen displays, press SELECT to view the holidays. The up and down arrows scroll through the holidays, displaying one per screen.</p> <p>Maximum number of holidays in the holiday list is 24.</p> <p>There are two different holiday formats.</p> <ul style="list-style-type: none"> • Standard holidays are the same every year, such as Jan 1st and Dec 25th. • Special holidays are occurrences of a day of the week such as Memorial Day, Labor Day, and Thanksgiving. The day of the week is shown in the heat setpoint location. • For both types of holidays, the duration of the holiday is shown in the cool setpoint location. • The top banner scrolls the holiday details. <p>To program holidays:</p> <ul style="list-style-type: none"> • Press SELECT to display the SAVE and CANCEL buttons • When the month flashes, use the up and down arrows to change it. • To change the day of the month, touch the screen location that shows the day of the month and it flashes. • To change the duration, touch the duration value and it flashes. • To delete a holiday, set the duration field to zero and press SAVE. The banner scrolls DELETE HOLIDAY. • To add a holiday, scroll through the list of holidays to the end. The last entry is the ADD HOLIDAY screen. Press SELECT to add a new holiday. The new holiday is initialized to 1/01 with a duration of one day. • The day of the month advances from 1 to the last day of the month and then Su, Mo, Tu, We, Th, Fr and Sa, and then back to 1. When the days of the week are displayed, an occurrence value is shown in the heat setpoint. This allows the user to enter a special holiday. <p>NOTE If the thermostat has been configured for non-programmable operation, the HOLIDAY screen is not available in the Menu settings.</p>	

Setting	Default/Range
<p>SCREEN TIMEOUT—Set the number of seconds you want the home screen to stay active without any user interactions before transitioning to the dormant screen.</p> <p>Banner displays SCREEN TIMEOUT.</p>	<p>D: 15 seconds</p> <p>R: 5 to 30 seconds (5 second increments)</p>
<p>WI-FI ENABLE—Enable (yes) or disable (no) the Wi-Fi functionality for the thermostat. If disabled, the Wi-Fi radio in this product is turned off and Wi-Fi functionality is unavailable, including SYNC TIME TO SERVER, OUTDOOR TEMPERATURE via Wi-Fi geolocation, SERVER & WI-FI ERRORS and REMOTE ACCESS SERVICES via APP or WEB.</p>	<p>D: YES</p> <p>R: YES NO</p>
<p>FLTR HRS LEFT xxx—The number of hours left before the filter reminder displays</p> <p>RESET FILTER—Reset the filter hours to the installer-specified number if the filter is changed prior to the timer counting down to zero. Press SELECT, use up and down arrows to display YES, and press SAVE.</p> <p>NOTE Decrements to the timer happen each hour of total equipment runtime. The accumulated run time hours are stored to non-volatile memory, but the minutes are not, so a power cycle does not retain partial hour runtime.</p> <p>FILTER REMINDER displays on the home screen and dormant screen banners when the filter timer counts down to zero.</p> <p>If you touch the home screen banner when the FILTER REMINDER message displays, the thermostat transitions directly to FLT HRS LEFT screen. The banner message button is a shortcut to the FLT HRS LEFT screen when the filter timer has expired. You can access the FLT HRS LEFT screen at any time through the menu.</p>	<p>D: NO</p> <p>R: YES NO</p>

To adjust the banner text

These settings allow you to customize the information shown on the top banners of the home and dormant screens.

The **FAN STATUS**, **HEAT SETPOINT**, and **COOL SETPOINT** selections only apply to the dormant screen banner because this information is already displayed in other areas of the home screen.

Setting	Default/Range
<p>DATE AND TIME</p> <ul style="list-style-type: none"> When the date and time setting is NO, the date and time information are not displayed on the home or dormant screen banners. When the date and time setting is YES, the date, in month/day/year format, and the time, in 12 hour AM/PM format, display in both the home and dormant screen banners. 	<p>R: YES NO</p>
<p>FAN STATUS</p> <ul style="list-style-type: none"> When set to NO, the state of the fan output (the G relay) is not displayed on the dormant screen banner. When set to YES, the dormant screen banner displays either FAN OFF or FAN ON, based on the state of the fan output. 	<p>R: YES NO</p>

Setting	Default/Range
<p>OUTDOOR TEMP</p> <ul style="list-style-type: none"> When set to NO, the outdoor temperature is not displayed on the home and dormant screen banners. When set to YES, the home and dormant screen banners display the outdoor air temperature. If there is not a source for the outdoor air temperature, OUTDOOR N/A shows. 	<p>R: YES NO</p>
<p>COOL SETPT</p> <p>When set to:</p> <ul style="list-style-type: none"> NO - The cool setpoint is not displayed on the dormant screen banner. YES - The cool setpoint is displayed on the dormant screen banner. <p>NOTES</p> <ul style="list-style-type: none"> The cool setpoint is not displayed on the home screen banner. The cool setpoint is displayed on the dormant screen when the mode is set to COOL or AUTO. 	<p>R: YES NO</p>
<p>HEAT SETPT</p> <ul style="list-style-type: none"> When set to NO, the heat setpoint is not displayed on the dormant screen banner. When set to YES, the heat setpoint is displayed on the dormant screen banner. <p>NOTES</p> <ul style="list-style-type: none"> The heat setpoint is not displayed on the home screen banner. The heat setpoint is displayed on the dormant screen when the mode is set to HEAT, EHEAT or AUTO. 	<p>R: YES NO</p>
<p>HUMIDITY</p> <ul style="list-style-type: none"> When set to NO, the humidity level is not displayed on the home and dormant screen banners. When set to YES, the home and dormant screen banners display the relative humidity percent. 	<p>R: YES NO</p>
<p>SAT TEMP (Supply Air Temperature)</p> <ul style="list-style-type: none"> When set to NO, the supply air temperature is not displayed on the home and dormant screen banners. When set to YES, the home and dormant screen banners display the supply air temperature. SAT TEMP setting is only displayed if the REMOTE SENSOR (Installer Settings) is set to SAT 	<p>R: YES NO</p>
<p>CO2</p> <ul style="list-style-type: none"> When set to NO, the CO2 value is not displayed on the home and dormant banners. When set to YES, the home and dormant screen banners will display the CO2 value. This option is only available if the CO2 sensor input is enabled. 	

Using installer settings

To reach the Installer Settings screens, set the mode to **OFF** and press and hold the **MENU** button for 5 seconds.

Scrolling through the installer settings:

- The **HOME** button returns the installer to the home screen.
- The **UP** and **DOWN** arrows scroll through the settings.
- The **SELECT** button allows the installer to change the value of the setting.
- Press **DEFAULT** to set the value to the factory default. Press **SAVE** to store the value.
- Press **SAVE** to store the current value and return to the **SELECT** screen.
- Press **CANCEL** to return the setting value to the last saved value and then return to the **SELECT** screen.

Setting	Default/Range
<p>HEAT EQUIP—Set the type of heating equipment being used.</p> <p>If you set the COMPRESSOR to HP, the heading of this screen is EHEAT EQUIP instead HEAT EQUIP.</p>	<p>D: GAS</p> <p>R: GAS ELEC (Electric Heat)</p>
<p>HEAT STAGES</p> <ul style="list-style-type: none"> • If the COMPRESSOR EQUIPMENT TYPE is set to HP, the heading of this screen is EHEAT STAGES. • The option of 0 heat stages is only available if the HEATING EQUIPMENT is set to electric heat (ELEC). • If set to 2, the W2 RELAY OUTPUT is not available for optional functions such as HUMIDIFIER, DEHUMIDIFICATION, and OCCUPANCY OUTPUT 	<p>D: 1</p> <p>R: 0 to 2</p>
<p>COMPRESSOR</p> <p>When set to NONE:</p> <ul style="list-style-type: none"> • COOL mode is disabled • DEHUMIDIFY setting is not available • COOL STAGES setting is not available • AUTO ALLOWED setting is not available <p>When set to HP, the 0 output is not available for optional functions such as HUMIDIFIER, DEHUMIDIFICATION, and OCCUPANCY OUTPUT.</p>	<p>D: AC</p> <p>R: NONE AC HP</p>

Setting	Default/Range
<p>COOL STAGES—The numbers of stages define the number of HP or AC cooling stages that are present in the compressor equipment. The numbers of stages chosen also define the number of HP heating stages that are present in the compressor equipment if the COMPRESSOR selection is HP.</p> <p>NOTES</p> <ul style="list-style-type: none"> • This setting is not available to the installer if the COMPRESSOR is set to NONE. • The maximum number of stages is 2 if HP is selected. • The maximum number of stages is 3 if AC is selected. <p>If COOL STAGES is set to 3, the Y3 relay output is used for the third-stage compressor cooling and is not available for optional functions such as HUMIDIFIER, DEHUMIDIFICATION, and OCCUPANCY OUTPUT.</p>	<p>D: 1 R: 1 to 3</p>
<p>AUTO ALLOWED—Enable or disable the selection of AUTO mode when the mode button is pressed. AUTO mode allows the thermostat to automatically switch from heating to cooling to maintain the conditioned temperature between the heating and cooling setpoints.</p> <p>NOTE AUTO ALLOWED is only available if both a heating source and a cooling source are available (HEAT STAGES greater than 0 and COMPRESSOR equal to AC or HP).</p>	<p>D: YES R: YES (Auto mode is available) NO (Auto mode is not available)</p>
<p>AUTO CHANGEOVER—Defines an auto changeover of the minimum number of minutes of equipment off-time before switching from heat-to-cool or from cool-to-heat, when operating in AUTO Mode.</p> <p>This setting is only available if AUTO ALLOWED is set to YES. The top line in this screen scrolls to display AUTO CHANGEOVER.</p> <p>If the setpoint or the mode is changed, the auto changeover time is bypassed to provide a timely response to the user’s request. The auto changeover time becomes active the next time the system is operating in heat and there is a cool demand, or the system is operating in cooling and there is a heating demand.</p>	<p>D: 30 minutes R: 5 to 30 minutes</p>

Setting	Default/Range																				
<p>PROGRAMMABLE OR NON-PROGRAMMABLE—Set the thermostat to operate as a non-programmable (simplified) thermostat or a programmable thermostat.</p> <p>Operating the thermostat in a programmable mode allows the end user to setup heating and cooling setpoints for 2 or 4 periods of each day of the seven days of the week.</p> <p>The thermostat has default heating and cooling setpoints outlined in the Default Setpoint Times and Temperature Settings table shown below.</p> <p>The program heating and cooling setpoints and transition times for the 2 or 4 periods can be viewed or modified in <i>PROGRAM SCHEDULE</i> (page 25) on the thermostat.</p> <p>Choosing the non-programmable mode for the thermostat allows it to run in a simplified mode that will satisfy heating or cooling setpoints based on the setpoint value and mode.</p> <p>When the thermostat is set to NP (non-programmable):</p> <ul style="list-style-type: none"> • OCC/UNOCC/RESUME SCHEDULE button is not displayed on the home screen. • OCCUPIED, UNOCCUPIED, and SCHEDULE PAUSED icons are not displayed on the home screen. • The program schedule cannot be viewed. <p>When the REMOTE SENSOR setting is set to OCC (Occupancy), this setting is forced to NP and is not displayed to the installer.</p> <p>Default setpoint times and temperature settings</p> <table border="1"> <thead> <tr> <th>Setting</th> <th>Start time</th> <th>Heat setpoint</th> <th>Cool setpoint</th> </tr> </thead> <tbody> <tr> <td>1st Period</td> <td>7 AM</td> <td>70°F</td> <td>75°F</td> </tr> <tr> <td>2nd Period</td> <td>5 PM.</td> <td>62°F</td> <td>85°F</td> </tr> <tr> <td>3rd Period</td> <td>10 PM</td> <td>70°F</td> <td>75°F</td> </tr> <tr> <td>4th Period</td> <td>11 PM</td> <td>62°F</td> <td>85°F</td> </tr> </tbody> </table>	Setting	Start time	Heat setpoint	Cool setpoint	1st Period	7 AM	70°F	75°F	2nd Period	5 PM.	62°F	85°F	3rd Period	10 PM	70°F	75°F	4th Period	11 PM	62°F	85°F	<p>D: PROG</p> <p>R: PROG (programmable thermostat) NP [non-programmable (simplified) thermostat]</p>
Setting	Start time	Heat setpoint	Cool setpoint																		
1st Period	7 AM	70°F	75°F																		
2nd Period	5 PM.	62°F	85°F																		
3rd Period	10 PM	70°F	75°F																		
4th Period	11 PM	62°F	85°F																		
<p>MAXIMUM HOLD HOURS—Set the amount of time, in hours, that a setpoint change overrides the program schedule.</p> <p>Range</p> <ul style="list-style-type: none"> • OFF - When set to OFF, the setpoints cannot be changed from their program schedule values. • 1 to 6 - User setpoint change remains active for this number of hours and then the setpoint returns to the PROGRAM SCHEDULE setpoints. <p>NOTE This selection is not available if the thermostat has been configured as non-programmable.</p>	<p>D: 2 Hours</p> <p>R: OFF 1 - 6</p>																				
<p>F OR C UNITS—Sets the temperature units to either F (Fahrenheit) or C (Celsius).</p>	<p>D: F</p> <p>R: F/C</p>																				

Setting	Default/Range
<p>SMART RECOVERY – Transitions the conditioned space from one programmable temperature period to the next with 1°F increments of the heating setpoint or 1°F decrements of the cooling setpoint, so that by the time the next period starts, the setpoints are at the desired temperature. The purpose of the gradual transition is to use less energy by preventing staging up (because of a higher demand) to higher stages. The transitions occur in a linear fashion over the smart recovery time period.</p> <ul style="list-style-type: none"> • If you start a temporary hold in the middle of a smart recovery, the setpoints of the temporary hold are used. • If a temporary hold is already active during the time that smart recovery would have been started, a smart recovery does not start. <p>If the temporary hold ends in the middle of what would have been a smart recovery, the smart recovery starts where it would have been in the linear progression at the same time as when the temporary hold was not active.</p> <p>NOTE The smart recovery setting is only available if the thermostat is configured as a programmable thermostat.</p>	<p>D: 30</p> <p>R: NO 30 minutes 60 minutes 90 minutes</p>
<p>FAN ON WITH W—Sets the fan to turn on with any W output when the fan is set to AUTO.</p> <p>Range</p> <ul style="list-style-type: none"> • YES - The G output is turned on by the thermostat when the W1 or W2 outputs are energized. • NO - The G output is not turned on by the thermostat when the W1 or W2 outputs are energized. 	<p>D: YES</p> <p>R: YES NO</p>
<p>REVERSING VALVE – Defines whether the ON state of the reversing valve (O/B) is used for heat pump heating or heat pump cooling if OUTDOOR EQUIPMENT TYPE is set to HP.</p> <ul style="list-style-type: none"> • When the ON state of the reversing valve is used for cooling, the signal is typically referred to as a O. • When the ON state of the reversing valve is used for heating, the signal is typically referred to as a B demand. 	<p>R: HEAT COOL</p>
<p>SPACE TEMP OFFSET—Sets an offset to the displayed space temperature, which gives the end user the convenience of matching the actual sensed temperature to a different perceived temperature or a different temperature measuring device.</p>	<p>D: OFF</p> <p>R: -5 to -1 OFF 1 to 5 °F -2.7 to -0.5 OFF 0.5 to 2.7 °C</p>

Setting	Default/Range
<p>REMOTE SENSOR—Set the functionality of the remote sensor input that is connected to the T and C terminals.</p> <p>Range</p> <ul style="list-style-type: none"> • NONE - Any input on the remote sensor is ignored by the thermostat. • ID - The remote sensor input is used for the space temperature. • ODT - The remote sensor input is used for the outdoor air temperature. • AVG - The space temperature is calculated as the average of the local thermistor and the remote thermistor. • OCC - The remote sensor input determines if the occupied or unoccupied setpoints are used. When a short is detected, the occupied settings are used. • SAT - The remote sensor input determines the supply air temperature as displayed in the BACnet SAT Analog Value object. • ECFL - The remote sensor input is used to detect an Economizer fault. When the input is shorted, the home screen banner indicates an alarm is detected by displaying the words ECONOMIZER FAULT. This fault is logged into the fault history as well. • FLTR - The remote input can be configured to detect a dirty filter. When the input is shorted, the message FILTER REMINDER is displayed on the home screen banner. The message is cleared when the remote input is not shorted. This selection disables the timed air filter reminder. <p>NOTES</p> <ul style="list-style-type: none"> • If the remote sensor is set to NONE or ID, the outdoor temperature is acquired via Wi-Fi through the server (based on the geolocation of the phone/tablet used to connect the thermostat to a router). • The outdoor temperature is available if the thermostat is not connected to Wi-Fi and the ODT option is not selected for the REMOTE SENSOR. • If you select OCC, the non-programmable (NP) setting is set automatically and not displayed in the installer settings until this setting is changed. 	<p>D: NONE</p> <p>R: NONE ID ODT AVG OCC SAT ECFL FLTR</p>
<p>SAT OFFSET—Sets an offset to the supply air temperature, which allows the value read from the SAT_TEMP BACnet object to be calibrated to match other presentations of this measurement.</p> <p>This setting is only available if the REMOTE SENSOR is set to SAT.</p>	<p>D: OFF</p> <p>R: -5 to 1, OFF, 1° - 5°F -2.7 to -0.5, OFF, 0.5° - 2.7°C</p>
<p>COOL LOCKOUT—Sets an outdoor air temperature below which the cooling equipment is held off.</p> <p>NOTE If the REMOTE SENSOR is set to something other than ODT, there is no outdoor air temperature being provided by the server and the COOL LOCKOUT is set to a temperature, the message OUTDOOR N/A is displayed on the home and dormant screen banners to indicate an outdoor sensor is required but there is no outdoor temperature information available.</p> <p>If there is no valid outdoor temperature in the system, the cooling is not inhibited.</p>	<p>D: OFF</p> <p>R: OFF 0°F - 80°F (in 5°F increments)</p>

Setting	Default/Range
<p>LOW COOL LOCKOUT TEMPERATURE</p> <p>Range</p> <ul style="list-style-type: none"> OFF - Functionality disabled. Cooling always starts with first stage compressor (Y1) and stages up to second stage (Y1 and Y/Y2) when the demand is sufficient and staging and cycle timer constraints have been satisfied. 80° – 110° F - (5° F increments) Outdoor temperature above which both the first and second stages of the compressor are energized to satisfy all cooling demands. This check is performed when the first stage of the compressor is energized. If at the time the compressor is energized the outdoor air temperature is greater than or equal to the low cool lockout temperature, then the second stage of the compressor is energized also. When a cycle starts under a low cool lockout condition, it finishes the cooling cycle on high speed. If the cooling equipment is energized to satisfy a dehumidify demand only (no cooling demand), the low cool lockout is not applied. ON - The Y1 and Y/Y2 outputs are simultaneously energized to satisfy all cooling demands. <p>NOTES</p> <ul style="list-style-type: none"> If there is no valid outdoor temperature and the LOW COOL LOCKOUT is set to a temperature (not OFF or ON), the message OUTDOOR N/A is displayed in the banner and the low cool lockout setting is ignored (acts as if the setting is OFF). If the system does not have a 2-stage heat pump, this selection is not available. 	<p>D: OFF</p> <p>R: OFF 80° - 110°F (5° F increments) ON</p>
<p>LOW HEAT LOCKOUT TEMPERATURE—Sets an outdoor air temperature below which low speed compressor heating is locked out. Below the specified air temperature, all heating demands that use the compressor use high speed compressor heating.</p> <p>Range</p> <ul style="list-style-type: none"> OFF - Functionality disabled. Compressor heating always starts with first stage compressor Y1 and stages up to second stage Y1 and Y/Y2 when the demand is sufficient and staging and cycle timer constraints have been satisfied. 20° – 50° F - Outdoor temperature below which both the first and second stages of the compressor are energized to satisfy all heating demands. This check is performed when the first stage of the compressor is energized. If at the time the compressor is energized, the outdoor air temperature is less than or equal to the LOW HEAT LOCKOUT TEMPERATURE, then the second stage of the compressor is energized also. When a cycle starts under a low heat lockout condition, it will finish the heating cycle on high speed. ON - The Y1 and Y/Y2 outputs are simultaneously energized to satisfy all compressor heating demands, regardless of outdoor air temperature. <p>NOTES</p> <ul style="list-style-type: none"> If there is no valid outdoor temperature and the LOW HEAT LOCKOUT is set to a temperature (not OFF or ON), the message OUTDOOR N/A displays in the banner and the low heat lockout setting is ignored (acts as if the setting is OFF). If the system does not have a 2-stage heat pump, this selection is not available. 	<p>D: OFF</p> <p>R: OFF 20° – 50° F ON</p>

Setting	Default/Range
<p>TIME BETWEEN FUEL TYPES (ELECTRIC TO GAS)—Sets a minimum amount of time that the system runs on compressor heat before transitioning to the furnace.</p> <p>Range - The minimum number of minutes the compressor is energized to satisfy a heating demand before transitioning to gas heat.</p> <p>NOTES</p> <ul style="list-style-type: none"> This selection is only available if the HEATING EQUIPMENT is set to GAS and the COMPRESSOR is set to HP. The minimum number of minutes the compressor runs in heating before staging up to gas heat is the larger of this setting and the STAGE DELAY setting. 	<p>D: 15 minutes</p> <p>R: 10, 15, 20, 25 minutes</p>
<p>CYCLES PER HOUR—Sets a maximum number of equipment cycles per hour. Based on selecting 2, 4, 6 or 8 cycles per hour, this timer is set to 30, 15, 10 or 8 minutes. This time must elapse from the start of one cycle before another cycle can start.</p> <p>The Range - The maximum number of times the equipment can turn on per hour.</p> <p>NOTE When the equipment is off and the user changes the setpoint to create a heating or cooling demand, the cycles per hour requirement is ignored to provide a timely response to the user's request. The cycles per hour limitation become active again when the Y1, Y2, W1 or W2 outputs transition from ON to OFF.</p>	<p>D: 4</p> <p>R: 2, 4, 6, or 8</p>
<p>MAX HEAT SETPOINT—Sets a maximum heating setpoint. This is the maximum heat setpoint value that can be used in the program schedule or when the user adjusts the setpoint to temporarily override the program schedule.</p> <p>NOTE This setting is not available if HEATING EQUIPMENT is set to NONE. (HEAT EQUIP = ELEC and HEAT STAGES = 0)</p>	<p>D: 88 °F</p> <p>R: 50° – 88°F (1°F increments)</p>
<p>MIN COOL SETPOINT—Sets a minimum cooling setpoint that can be used in the program schedule or when the user adjusts the setpoint to temporarily override the program schedule.</p> <p>NOTE This setting is not available if the COMPRESSOR is set to NONE.</p>	<p>D: 52 °F</p> <p>R: 52 – 90 °F (1°F increments)</p>

Setting	Default/Range
<p>AUX HEAT LOCKOUT—Sets an outdoor temperature above which the AUX HEAT (W1 and W2) outputs are not energized in HEAT mode.</p> <p>If the selected mode is EMERGENCY HEAT, the auxiliary heat is allowed to turn on.</p> <p>The auxiliary heat lockout is checked when there is sufficient demand to energize W1, but the output has not been turned on. Once the output has been energized, it remains energized until the demand algorithm no longer requires the capacity of the auxiliary heat, regardless of the value of the outdoor air temperature.</p> <p>NOTES</p> <ul style="list-style-type: none"> • The AUX HEAT LOCKOUT functionality is not available (and is set to the OFF setting) with the OUTDOOR EQUIPMENT TYPE of NONE or AC selected, because the AUX HEAT LOCKOUT functionality needs HP heating to operate. • If the REMOTE SENSOR is set to something other than ODT, there is no outdoor air temperature being provided by the server and AUX HEAT LOCKOUT is set to a temperature, the message OUTDOOR N/A is displayed in the home and dormant screen banners to indicate an outdoor sensor is required but there is no outdoor temperature information available. • In a dual fuel unit, the auxiliary heat lockout temperature is set to a value less than the heat pump lockout temperature. This is to prevent the condition where the range of outdoor air temperatures between the auxiliary heat lockout and the heat pump lockout temperature result in no equipment operation. Below the heat pump lockout temperature, the air source attempts to turn on but the auxiliary heat lockout temperature prevents it from doing so. If the auxiliary heat lockout temperature is changed so that it is less than the heat pump lockout temperature, the heat pump lockout temperature is set equal to auxiliary heat lockout temperature value. This change to the heat pump lockout temperature is not visible to the user while the auxiliary heat lockout temperature is being changed. 	<p>D: OFF</p> <p>R: OFF 5° - 55 °F (5° F increments)</p>

Setting	Default/Range
<p>HP LOCKOUT—Sets an outdoor temperature below which the heat pump does not operate. If set to OFF, the heating equipment cycle always starts with the heat pump, regardless of the outdoor air temperature. If a lockout temperature is selected and the outdoor air temperature is less than the selected temperature, the heating cycle is started with the AUX HEAT SOURCE. If the outdoor air temperature is equal to or greater than the selected temperature, the heating cycle is started with the heat pump. If the outdoor temperature is not available, all heating cycles with compressor heat.</p> <p>When the heat pump is not energized but there is demand sufficient to request heat pump heating, the heat pump lockout temperature is checked against the outdoor air temperature and if the outdoor air temperature is greater than the heat pump lockout temperature the heat pump is energized. Once the heat pump is energized, it remains energized until the heating demand no longer requires heat pump heating, regardless of the outdoor air temperature.</p> <p>NOTES</p> <ul style="list-style-type: none"> • The HP LOCKOUT functionality is not available if the OUTDOOR EQUIPMENT TYPE is set to NONE or AC, because the AUX HEAT LOCKOUT functionality is only applicable to heat pump systems. • If the REMOTE SENSOR is set to something other than ODT, there is no outdoor air temperature is provided by the server and the HP LOCKOUT is set to a temperature, the message OUTDOOR N/A is displayed in the home screen and dormant screen banners to indicate an outdoor sensor is required but there is no outdoor temperature information available. • Do not set the heat pump lockout temperature to a value greater than the auxiliary heat lockout temperature unless the auxiliary heat lockout temperature setting is OFF. This prevents the condition where the range of outdoor air temperatures between the auxiliary heat lockout and the heat pump lockout temperature result in no equipment operation. Below the heat pump lockout temperature, the AUX heat source attempts to turn on, but the auxiliary heat lockout temperature prevents it from doing so. If the heat pump lockout temperature is changed so that it is greater than the auxiliary heat lockout temperature, the auxiliary heat lockout temperature value is set equal to the heat pump lockout temperature. 	<p>D: OFF</p> <p>R: OFF 5° - 55° F (5° F increments)</p>
<p>STAGE DELAY—Sets the minimum amount of time the current stage must be energized before staging up to the next stage of capacity.</p> <p>NOTE Multiple heating stages or multiple cooling stages must exist to use this feature.</p>	<p>D: 10 minutes</p> <p>R: 2 to 15 minutes (1 minute decrements)</p>

Setting	Default/Range
<p>FORCED STAGE UP—Sets the maximum number of minutes that the equipment runs at the current stage before forcing the equipment to stage up. The forced stage up occurs even if the differential demand is not met.</p> <p>NOTE Multiple heating stages or multiple cooling stages must exist to use this feature.</p>	<p>D: 30 minutes</p> <p>R: OFF 10 to 120 minutes (10 minute decrements)</p>
<p>DIFFERENTIAL—Sets a value that specifies the required difference between the current space temperature and the setpoint that results in the equipment being energized to satisfy the demand. This value is additive for each additional stage of equipment being demanded.</p> <p>(e.g. A chosen differential value of 0.5° F requires 0.5° difference between setpoint and space temperature before first stage is turned on. Then a value of 1.0 degree of difference between setpoint and space temperature before second stage is turned on.)</p>	<p>D: 1° F</p> <p>R: 0.3° to 2.0° F (0.1° F increments)</p>
<p>AIR FILTER REMINDER—Sets a value that specifies the number of equipment run hours before a FILTER REMINDER message is displayed on the home and dormant screen banners to remind the user to change the indoor air filter.</p> <p>No message is displayed to the user if the setting is OFF. Decrements to the timer occur each hour total equipment runtime is accumulated. Minute counts within each hour are not stored in non-volatile memory, so a power reset clears out the minutes within each hour of run time. The filter reset reminder hour timer value is stored in non-volatile memory.</p> <p>The top line in this screen scrolls to display AIR FILTER REMINDER HRS x 100</p> <p>NOTE If the REMOTE SENSOR is set to FLTR to detect a dirty filter, this setting is disabled and not available to the installer.</p>	<p>D: 3000 hours</p> <p>R: OFF 500 to 15,000 hours (100 hour increments)</p>
<p>OCCUPANCY OUTPUT—Select which output relay to use for the Occupancy Output. The choices only include outputs that are not already assigned to another function.</p> <p>The output that you select (Y3, O/B, or W2) is energized when in the occupied state and de-energized when in the unoccupied state.</p> <p>NOTE The occupancy output option is not available if the Y3, O/B, and W2 relays are already being used for other functions. The Y3 output is used for 3 stages of cooling, the humidifier, and the dehumidifier setting of HumidiMiZer™. The O/B output is used for heat pump equipment, the humidifier, and the dehumidifier setting of HumidiMiZer™. The W2 output is used for 2 stages of heating, the humidifier, and the dehumidifier setting of HumidiMiZer™.</p> <p>Any output that is already being used is not shown in the OCCUPANCY OUTPUT selections.</p>	<p>D: OFF</p> <p>R: OFF Y3 O/B W2</p>
<p>OCCUPANCY INPUT—Select what to do when a short on the remote temperature sensor is detected.</p> <p>The OCC (occupied) setting changes the current heat and cool setpoints to the occupied setpoints for the current time range for the maximum hold time when a short is detected on the remote temperature sensor for the duration of 2 to 5 seconds.</p> <p>The UNOCC (unoccupied) setting changes the current heat and cool setpoints to the unoccupied setpoints for the current time range for the maximum hold time when a short is detected on the remote temperature sensor for the duration of 2 to 5 seconds.</p>	<p>D: OCC</p> <p>R: OCC UNOCC</p>

Setting	Default/Range
<p>ANALOG INPUT—This setting allows the installer to specify the sensor that is connected to the Analog Input terminals (H and C)</p> <p>Range</p> <ul style="list-style-type: none"> • NONE - no sensor is connected • RH - a remote humidity sensor is connected • CO2 - A remote CO2 sensor is connected <p>Default</p> <ul style="list-style-type: none"> • NONE 	<p>D: STAT</p> <p>R: STAT RMT</p>
<p>ANALOG INPUT SCALING—Specify the type of electrical signal that is output by the remote sensor configured for use in the ANALOG INPUT setting. This setting is not available if the ANALOG INPUT is set to NONE.</p> <p>Range</p> <ul style="list-style-type: none"> • 0 to 10 - When using a 0-10 V signal from sensor • 2 to 10 - When using a 4-20ma signal with 500 ohm resistor <p>Default</p> <ul style="list-style-type: none"> • 2 to 10 	<p>D: 2 to 10</p> <p>R: 0 to 10 2 to 10</p>
<p>HUMIDITY OFFSET—Set an offset to the displayed humidity. This functionality offers the end user the convenience of matching the actual sensed humidity to a different perceived humidity or a different humidity measuring device.</p>	<p>D: OFF</p> <p>R: OFF -9 to 9%rh</p>
<p>HUMIDIFIER—Enables humidifier control functionality. When humidifier control is enabled, the humidifier is energized if there is humidity demand and any heating equipment is energized.</p> <p>The output (Y3, O/B or W2) is a 24 Vac output only (sourced from R) and must be isolated with a relay at the indoor equipment if 120 Vac is needed to interface to a humidifier unit.</p> <p>NOTE Humidifier functionality is not available if HEATING STAGES is set to NONE.</p>	<p>D: NO</p> <p>R: NO YES</p>
<p>HUM OUTPUT—Select which output relay to use for the humidifier. The choices only include outputs that are not already assigned to another function.</p> <p>The output that is selected (Y3, O/B or W2) is used to control the humidifier equipment.</p> <p>NOTE HUM OUTPUT is only available if the HUMIDIFIER setting is YES.</p> <p>The HUM OUTPUT option is not available if the Y3, O/B and W2 relays are already being used for other functions.</p> <ul style="list-style-type: none"> • The Y3 output is used for 3 stages of cooling, the humidifier, and the dehumidifier setting of HumidiMiZer™. • The O/B output is used for heat pump equipment, the humidifier, and the dehumidifier setting of the HumidiMiZer™. • The W2 output is used for 2 stages of heating, the humidifier, and the dehumidifier setting of HumidiMiZer™. 	<p>D: OFF</p> <p>R: OFF Y3 O/B W2</p>

Setting	Default/Range								
<p>DEHUMIDIFIER—Enable the dehumidification functionality.</p> <p>Range:</p> <ul style="list-style-type: none"> NO – Dehumidification is disabled YES – When the humidity is above the dehumidify target, the cooling setpoint is adjusted downward, increasing the cooling demand according to the following equations. The system uses the first stage of cooling to satisfy the dehumidify demand. <table border="1" data-bbox="188 590 1073 852"> <thead> <tr> <th>Cooling setpoint</th> <th>Algorithm</th> </tr> </thead> <tbody> <tr> <td><= 70 °F</td> <td>Use the cooling setpoint only</td> </tr> <tr> <td>70.1 °F - 74.9 °F</td> <td>Cooling setpoint = Cooling Setpoint - (Cooling Setpoint - 70 °F) x (Dehumidify Error / 10) with maximum dehumidify Error of 6% (i.e. use 6% if >6%)</td> </tr> <tr> <td>>= 75 °F</td> <td>Cooling setpoint = Cooling Setpoint - (Dehumidify Error / 2) with maximum dehumidify Error of 6%</td> </tr> </tbody> </table> <ul style="list-style-type: none"> OVCL - Commands the system to operate the compressor, within limits, when there is a dehumidification demand, even if there is no cooling demand. The system uses first stage of cooling to overcool up to 2 °F and no more, when satisfying a dehumidification demand. HMZR - When configured as a HumidiMiZer™ output, and the humidity level is above the dehumidify target, 24V is output at the selected terminal. When the humidity level is below the dehumidify target, 0 Vac is output on the selected terminal. There is a +1/-4% hysteresis around the dehumidify target to prevent rapid on/off cycling of the selected output. <p>This output may be connected to compressor outputs on commercial equipment. If the selected output is energized without any compressors being energized, the 5-minute time guard must be enforced.</p> <p>NOTE If the COMPRESSOR TYPE is set to NONE, dehumidification is not available.</p>	Cooling setpoint	Algorithm	<= 70 °F	Use the cooling setpoint only	70.1 °F - 74.9 °F	Cooling setpoint = Cooling Setpoint - (Cooling Setpoint - 70 °F) x (Dehumidify Error / 10) with maximum dehumidify Error of 6% (i.e. use 6% if >6%)	>= 75 °F	Cooling setpoint = Cooling Setpoint - (Dehumidify Error / 2) with maximum dehumidify Error of 6%	<p>D: NO</p> <p>R: NO YES OVCL HMZR</p>
Cooling setpoint	Algorithm								
<= 70 °F	Use the cooling setpoint only								
70.1 °F - 74.9 °F	Cooling setpoint = Cooling Setpoint - (Cooling Setpoint - 70 °F) x (Dehumidify Error / 10) with maximum dehumidify Error of 6% (i.e. use 6% if >6%)								
>= 75 °F	Cooling setpoint = Cooling Setpoint - (Dehumidify Error / 2) with maximum dehumidify Error of 6%								
<p>DEHUM OUTPUT— Select which output relay to use for the HumidiMiZer™ function of the dehumidifier. The choices only include outputs that aren't already assigned to another function and is only available if the dehumidifier selection is set to HumidiMiZer™.</p> <p>When dehumidifier setting is HumidiMiZer™, the selected relay controls the HumidiMiZer™ equipment.</p> <p>This setting is not available if the configurable outputs (Y3, O/B, and W2) are already assigned to other functions.</p> <p>Any configurable output that is already assigned to another function is not shown in the DEHUM OUTPUT selections.</p>	<p>D: OFF</p> <p>R: OFF Y3 O/B W2</p>								

Setting	Default/Range
<p>CO2 FAULT THRESHOLD - Allows the installer to specify the threshold for the High CO2 fault. The ANALOG INPUT parameters must be set to CO2 for this setting to be available.</p> <p>Range</p> <ul style="list-style-type: none"> • 900 to 1600 PPM <p>Default</p> <ul style="list-style-type: none"> • 1100 PPM 	
<p>CO2 CALIBRATION - The CO2 CALIBRATION screen can be used to compensate for the variability of the components in the analog input circuitry. If the CO2 level is known from a reference or by measuring the DC voltage out of the sensor ($PPM=200 \times VDC$), the calibration screen can be used to increase or decrease the value until it matches the reference. The Analog Input parameter must be set to CO2 for this setting to be available.</p> <p>Range</p> <ul style="list-style-type: none"> • +/- 30% of uncalibrated value <p>Default</p> <ul style="list-style-type: none"> • Raw, uncalibrated value 	

To set up BACnet

Setting	Default/Range
<p>BACNET ENABLE—Enable or disable the BACnet communications. After restoring factory defaults, the user is prompted to decide whether or not to enable BACnet. Until this choice is made, the installer menu loads after every restart and the installer menu goes directly to the BACNET ENABLE setting where ? is displayed.</p> <p>NOTE Changing the BACNET ENABLE requires the thermostat to be restarted. When the installer exits the configuration settings after making changes to the BACnet settings, there is a prompt to either cancel those settings or save the new settings which force a thermostat reset.</p>	<p>D: NO (disabled)</p> <p>R: YES (enabled) NO (disabled)</p>

Setting	Default/Range
<p>MSTP MAX MASTER—Set the maximum MAC address for BACnet MS/TP master devices. BACnet MS/TP MAC addresses for master devices exist in the range from 0 to 127. Each BACnet MS/TP device periodically looks for other devices (sends Poll for Master message) with addresses from its own address, plus one, to the next known address (wrapping to 0 after 127).</p> <p>Performance gains can be made on a BACnet MS/TP network by not leaving any gaps in MAC address and setting the MS/TP Max Master parameter of the device with the highest MAC address to a value equal to its MAC address. The downside to setting the MS/TP Max Master to a value less than 127 is, if new devices are added to the network with addresses above the Max Master value, they won't be discovered or added to the network.</p> <p>NOTES</p> <ul style="list-style-type: none"> • Changing the MS/TP Max Master requires restarting the thermostat. When the installer exits the configuration settings after making changes to the BACnet settings, there is a prompt to either cancel those settings or save the new settings, which forces a thermostat reset • The Max Master parameter should be set to a value equal to or greater than the MS/TP MAC Address. <p>This setting is not displayed if BACnet is disabled</p>	<p>D: 127</p> <p>R: 1 to 127</p>
<p>MSTP BAUD RATE—Set the baud rate for the BACnet MS/TP communications to one of the following values: 9600, 19.2K (19200), 38.4K (38400), 76.8K (76800) or 115k (115200). The BACnet MS/TP baud rate must be set to match the other devices on the BACnet MS/TP network.</p> <p>NOTE Changing the MS/TP baud rate requires restarting the thermostat. When the installer exits the configuration settings after making changes to the BACnet settings, there is a prompt to either cancel those settings or save the new setting, which forces a thermostat reset.</p> <p>This setting is not be displayed if BACnet is disabled.</p>	<p>D: 76.8K</p> <p>R: 9600 19.2K (19200) 38.4K (38400) 76.8K (76800) 115k (115200).</p>
<p>MSTP MAC—Set the BACnet MS/TP MAC addresses for master devices. Each BACnet MS/TP device on a MS/TP segment, must have a unique MAC address. Performance gains can be made on a BACnet MS/TP network by not leaving any gaps in MAC addresses, eliminating the need for each device to continuously check the addresses above its address and up to the next known device for new devices. Although the BACnet standard does not limit the use of MAC address zero, it is often reserved for an MS/TP router.</p> <p>NOTES</p> <ul style="list-style-type: none"> • Changing the MS/TP baud rate requires the thermostat to be restarted. When the installer exits the configuration settings after making changes to the BACnet settings, there is a prompt to either cancel those settings or save the new settings, which forces a thermostat reset. • The MSTP MAC is set to a value less than or equal to the MSTP Max Master setting. <p>This setting is not displayed if BACnet is disabled.</p>	<p>D: 1</p> <p>R: 0-127 (increments of 1)</p>

Setting	Default/Range
<p>BACNET UTC OFFSET—Specify a UTC offset to be set from -13 to +13 hours in increments of 15 minutes.</p> <p>When a BACnet UTC Time synchronization message is received by the device, the value in UTC Offset is subtracted from the UTC Time to determine the local standard time. The Daylight Saving time logic is then applied to the standard time to get the local time with Daylight Saving.</p> <p>NOTE For reception of the UTC Time synchronization service to be enabled (and UTC offset used) on the device, the SYNCH TIME TO SERVER option has to be set to NO and DST must be set to ENABLED.</p> <p>This setting is not displayed if BACnet is disabled.</p>	<p>D: 5:00 (5 hours 0 minutes)</p> <p>R: -13:00 to 13:00 (15 minute increments)</p>
<p>DEVICE ID—Specify a Device ID from 0 to 4194302. The Device ID can also be updated over BACnet when the BACNET CONFIG WRITE configuration is set to YES.</p> <p>Device IDs on BACnet devices must not only be unique on MS/TP segment like the MAC address, but must also be unique internetnetwork-wide. Each device broadcasts its Device ID using the I-Am service upon power up and in response to the Who-Is service. Changing the Device ID triggers a new I-Am message to be sent including the new Device ID.</p> <p>The top line in this screen scrolls to display the DEVICE ID and the ID value.</p> <p>The SELECT button changes the screen to the Device ID editor. Initially the first non-zero is flashing, indicating that it can be changed by the up and down arrows. There are left and right arrows in the middle row of the screen that can be pressed to move the cursor left and right to change each digit individually. Changing the Device ID triggers an I-Am message to be sent over BACnet and will increment the Database Revision property in the Device object.</p> <p>This setting is not displayed if BACnet is disabled.</p>	<p>D: 16xxxx where xxxx is the last four digits of the thermostat serial number.</p> <p>R: 0 to 4,194,302 (increments of 1)</p>
<p>DEVICE NAME</p> <p>This setting can be viewed but not modified from the display. The DEVICE NAME can be updated over BACnet when the BACNET CONFIG WRITE is set to YES.</p> <p>Device Object Names on BACnet devices must not only be unique on MS/TP segment like the MAC address, but must also be unique internetnetwork-wide.</p> <p>The top line in this screen scrolls to display DEVICE NAME and the name.</p> <p>NOTE Changing the Device Object Name causes the Database Revision property of the Device to be incremented.</p> <p>This setting is not be displayed if BACnet is disabled.</p>	<p>D: DEVICE 16xxxx (last 4 digits of the serial number)</p> <p>R: Any printable string with a maximum length of 16 characters</p>
<p>DEVICE LOCATION—To view, but not modify from the display, the Device Location, which is an optional property used to describe the physical location of the BACnet device.</p> <p>The DEVICE LOCATION can be updated over BACnet when the BACNET CONFIG WRITE configuration is set to YES.</p> <p>The top line in this screen scrolls to display the DEVICE LOC and the location.</p> <p>This setting is not displayed if BACnet is disabled.</p>	<p>D: LOCATION</p> <p>R: The display is limited to showing only the first 28 characters of the maximum 32 characters allowed.</p>

Setting	Default/Range
<p>DEVICE DESCRIPTION—To view, but not modify from the display, the Device Description. Description is an optional property used to add descriptive information about the BACnet device.</p> <p>The Device Description can be updated over BACnet when the BACNET CONFIG WRITE configuration is set to YES.</p> <p>The top line in this screen scrolls to display the DEVICE DES and the description.</p> <p>NOTE This setting is not displayed if BACnet is disabled.</p>	<p>D: DESCRIPTION</p> <p>R: The display is limited to showing only the first 28 characters of the maximum 32 characters allowed.</p>
<p>BACnet BMS OCC—Enable or disable occupancy scheduling through the BACnet BMS by enabling or disabling the connection between the Present Value of the BACnet Binary Object Value named BMS_OCC and the occupancy state of the controller.</p> <p>NOTE Occupancy is determined using 1 of 3 methods. BACnet BMS OCC is mutually exclusive with both PROGRAMMABLE MODE and REMOTE SENSOR set to OCCUPANCY. Setting BACnet BMS OCC to Yes forces PROG or NON-PROG to NON-PROG and switches REMOTE SENSOR to None if set to OCCUPANCY.</p> <p>This setting is not displayed if BACnet is disabled.</p>	<p>D: YES (enabled)</p> <p>R: YES (enabled) NO (disabled)</p>
<p>BACNET CONFIG WRITE—Allow (YES) or disallow (NO) BACnet writes to modify system settings. Many of the configuration items are exposed as BACnet objects. These BACnet objects can be read to verify the thermostat's configuration. If BACnet Config Write is set to YES, these objects can also be written to change the thermostat's configuration. If set to NO, these objects are read-only. NOTE This setting is not displayed if BACnet is disabled.</p>	<p>D: YES</p> <p>R: YES NO</p>
<p>NET GP OUT TIMEOUT—Set the timeout associated within network general purpose outputs. If this value is set to 2 minutes, 20 minutes, or 60 minutes, this number represents the maximum time that can lapse between writes to the Present Value property of the output object before the value returns to the inactive state.</p> <p>NOTE This setting is not displayed if BACnet is disabled.</p>	<p>D: 2 minutes</p> <p>R: 2 – 2 minutes 20 – 20 minutes 60 – 60 minutes UNLM - Unlimited</p>

Setting	Default/Range
<p>NET GP Y3 MODE—Select Network General Purpose Output Y3 for control over the BACnet network.</p> <p>Setting the mode to:</p> <ul style="list-style-type: none"> • OFF (disabled) sets the Present Value of the BACnet object to inactive and read-only and the corresponding output relay will be in a de-energized state. • ACTV (energized active) allows BACnet writes to the Present Value and energizes the output relay when the Present Value is active • INAC (energized inactive) allows BACnet writes to the Present Value and energizes the output relay when the Present Value is inactive. If a Network General Purpose Output timeout occurs, the Present Value goes to the inactive state and the relay is either energized ACTV or de-energized INAC depending on the mode. <p>The outputs have primary assignments:</p> <ul style="list-style-type: none"> • Y3 - 3rd stage cooling • W2 - 2nd stage heating • OB - Heat pump reversing valve <p>If any of these outputs are required by the system configuration for their primary function, they are available for optional equipment (humidifier, dehumidifier, and occupancy output). Any output that is still available after configuring primary and optional equipment can be made available as a BACnet network-controlled output.</p> <p>This setting is not displayed if BACnet is disabled.</p>	<p>D: OFF (disabled)</p> <p>R: OFF (disabled) ACTV (energized active) INAC (energized inactive)</p>
<p>NET GP W2 MODE—Select the Network General Purpose Output W2 mode for control over the BACnet network. Setting the mode to OFF (disabled) sets the Present Value of the BACnet object to Inactive and read-only and the corresponding output relay will be in a de-energized state.</p> <p>Setting the mode to:</p> <ul style="list-style-type: none"> • OFF (disabled) sets the Present Value of the BACnet object to inactive and read-only and the corresponding output relay will be in a de-energized state. • ACTV (energized active) allows BACnet writes to the Present Value and will energize the output relay when the Present Value is active. • INAC (energized inactive) allows BACnet writes to the Present Value and will energize the output relay when the Present Value is inactive. If a Network General Purpose Output timeout occurs, the Present Value goes to the inactive state and the relay is either energized ACTV or de-energized INAC depending on the mode. <p>The outputs have primary assignments:</p> <ul style="list-style-type: none"> • Y3 - 3rd Stage cooling • W2 - 2nd Stage heating • OB - Heat Pump reversing valve <p>If any of these outputs are required by the system configuration for their primary function, they are available for optional equipment (humidifier, dehumidifier and occupancy output). Any output that is still available after configuring primary and optional equipment can be made available as a BACnet network-controlled output.</p> <p>This setting is not displayed if BACnet is disabled.</p>	<p>D: OFF (disabled)</p> <p>R: OFF (disabled) ACTV (energized active) INAC (energized inactive)</p>

Setting	Default/Range
<p>NET GP OB MODE—Select the Network General Purpose Output OB mode for control over the BACnet network. Setting the mode to OFF (disabled) sets the Present Value of the BACnet object.</p> <p>Setting the mode to:</p> <ul style="list-style-type: none"> • OFF (disabled) sets the Present Value of the BACnet object to inactive and read-only and the corresponding output relay will be in a de-energized state. • ACTV (energized active) allows BACnet writes to the Present Value and energizes the output relay when the Present Value is active. • INAC (energized inactive) allows BACnet writes to the Present Value and energizes the output relay when the Present Value is inactive. If a Network General Purpose Output timeout occurs, the Present Value goes to the inactive state and the relay is either energized ACTV or de-energized INAC depending on the mode. <p>The outputs have primary assignments:</p> <ul style="list-style-type: none"> • Y3 - 3rd stage cooling • W2 - 2nd stage heating • OB - Heat pump reversing valve <p>If any of these outputs are required by the system configuration for their primary function, they are available for optional equipment (humidifier, dehumidifier, and occupancy output). Any output that is still available after configuring primary and optional equipment can be made available as a BACnet network-controlled output.</p> <p>This setting is not displayed if BACnet is disabled.</p>	<p>D: OFF (disabled)</p> <p>R: OFF (disabled) ACTV (energized active) INAC (energized inactive)</p>
<p>DISCONNECT WI-FI—Allows the installer to disconnect from the Wi-Fi network.</p> <p>NOTE This setting is not displayed if the thermostat is already disconnected from the Wi-Fi network.</p> <p>If the user chooses to disconnect the Wi-Fi, the control advances to the next setting since this one should not be displayed anymore.</p>	<p>D: NO</p> <p>R: YES NO</p>
<p>MAXIMUM SETPOINT ERROR—Select the number of degrees that cause an ID TEMP RANGE HIGH or ID TEMP RANGE LOW fault between the space temperature and the heat setpoint, if heating, or the cool setpoint, if cooling.</p> <p>NOTE This value is added to the cooling setpoint or subtracted from the heating setpoint.</p>	<p>D: 10° F</p> <p>R: 2 to 30° F</p>
<p>INDOOR TEMP FAULT INHIBIT—Select the time delay applied to the ID TEMP RANGE HIGH and ID TEMP RANGE LOW faults. The fault condition must be present for the selected number of minutes for the fault to become active. This allows for recovery time when transitioning from unoccupied to occupied periods</p> <p>The top line in this screen scrolls to display ID TEMP FLT INHIBIT.</p>	<p>D: 60 minutes</p> <p>R: 10 to 240 minutes (10 minute increments)</p>

To test the HVAC system

The installer uses this setting to test the HVAC system.

- 1 Press **SELECT** to open **INSTALLER TEST**.

NOTE The **HOME** and **SELECT** buttons are replaced with **MODE** and **CANCEL** buttons.



- 2 Press **MODE** to cycle through **OFF**, **COOL**, **HEAT**, and **EHEAT**.

NOTES

- The availability of the modes are based on the installer configuration settings.
 - The selected **MODE** operates each equipment stage for 3 minutes.
 - The center of the display counts down the number of seconds remaining for the current stage of equipment operation.
 - When the countdown reaches zero, if another stage exists, the banner text changes to **2ND STAGE** and a new 180-second countdown timer starts. If no other stage exists, the test cycle ends and the **MODE** is set to **OFF**.
 - When **HEAT** or **EHEAT** modes are running and there is a configured humidifier, the output that controls the humidifier is energized.
 - When **COOL** mode is running and a dehumidifier has been configured for operating a HumidiMiZer™, the output configured for the dehumidifier output is energized.
- 3 Press **CANCEL** to turn off the currently running equipment and transition the screen to the installer menu selections.

After 20 minutes of inactivity (no button presses by the installer), **INSTALLER TEST** terminates, and the home screen displays.

NOTES

- **EHEAT** is only a choice when a heat pump is selected in the configuration.
- **HEAT** is not available in a cooling-only configuration.
- **COOL** is not available in a heating-only configuration.

To restore factory default settings

This setting allows the installer to reset all system settings back to factory default values.

From the **RESTORE DEFAULTS** screen, press and hold the **DEFAULT** button to start a 5-second countdown.

NOTES

- At the end of 5 seconds, the factory settings are restored.
- Release the **DEFAULT** button to cancel the countdown at any time before the 5 seconds elapse.
- After the factory settings are restored, the control returns to **BACNET ENABLE** to allow the installer to properly configure the thermostat.



Screen	Factory defaults
HEATING EQUIP TYPE	GAS
HEATING EQUIP STAGES	1
COMPRESSOR EQUIP TYPE	A/C
COMPRESSOR EQUIP STAGES	1
AUTO ALLOWED?	YES
AUTO CHANGEOVER	30 MIN
PROG OR NON-PROG	PROG
MAX TEMP HOLD TIME	2
FAHRENHEIT OR CELSIUS	°F
SMART RECOVERY	30
FAN ON WITH W	YES
REVERSING VALVE	COOL
SPACE TEMP OFFSET	OFF
SPACE HUM OFFSET	0%
HUM SOURCE	STAT
REMOTE HUM SCALING	2-10
REMOTE SENSOR	NONE
COOL LOCKOUT	OFF
LOW COOL LOCKOUT TEMP	OFF

Screen	Factory defaults
LOW HEAT LOCKOUT TEMP	OFF
TIME B/W FUEL TYPES	15 MIN
CYCLES PER HOUR	4
HUMIDIFIER	NO
DEHUMIDIFIER	NO
MAX HEAT SETPOINT -	88 °F
MIN COOL SETPOINT	52 °F
AUX HEAT LOCKOUT	OFF
HP LOCKOUT	OFF
STAGE DELAY	10 MIN
FORCED STAGE UP	30 MIN
DIFFERENTIAL	1.0 °F
AIR FILTER REMINDER	3000 HRS
OCCUPANCY OUTPUT	OFF
OCCUPANCY INPUT	OCCUPIED
BACNET ENABLE	NO
MSTP BAUD RATE	76.8k
MSTP MAC	1
BACNET UTC OFFSET	5h, 0min (EST)
MSTP MAX MASTER	127
DEVICE ID	160000 + last 4 of S/N
DEVICE NAME	DEVICE16 + last 4 of S/N
DEVICE LOCATION -	LOCATION
DEVICE DESCRIPTION	DESCRIPTION
BACNET BMS OCCUPANCY	NO
BACNET CONFIG WRITE ENABLE	NO

Screen	Factory defaults
NETWORK GP OUT TIMEOUT	2 MIN
NETWORK GP Y3 MODE	OFF
NETWORK GP W2 MODE	OFF
NETWORK GP OB MODE	OFF

Setting up Wi-Fi

To display the **SETUP WI-FI** screen, press:

-  if the thermostat is connected to a Wi-Fi network
-  if the thermostat is not connected to a Wi-Fi network

Except for the **SETUP WI-FI** screen, which can be changed from **NO** to **YES**, the information in the Wi-Fi settings screens is read-only and cannot be changed.

The Wi-Fi screens have a fixed timeout of 60 seconds.

Connect to a network

If the thermostat is not connected to a Wi-Fi network and **NO** is displayed on the **SETUP WIFI** screen, follow these steps to connect the thermostat to a network:

- 1 Press the **SELECT** button.
- 2 Change **NO** to **YES**.
- 3 Press **SAVE**.

NOTE This puts the thermostat into the setup mode and ready to receive Wi-Fi join commands.

The thermostat is already in the setup mode if **SETUP WI-FI** was changed from **NO** to **YES** in the past 2 minutes or if the installer disconnected from a Wi-Fi network in the past 2 minutes.

The following screen indicates that the thermostat is ready to join a Wi-Fi network. If the thermostat is connected to a Wi-Fi network, the **SETUP WI-FI** screen is not displayed.



NOTE The **SELECT** button is not displayed because the thermostat is already in the setup mode.

SSID

When the thermostat is not connected to a Wi-Fi network, the SSID is a factory-configured value that starts with **CMML** followed by 12 numbers. The SSID scrolls across the top of the display for 5 seconds and then displays only the 12 digits for the remainder of the screen timeout time. The user needs these 12 digits to connect to the Carrier Connect Mobile App.

SSID - Scrolls for the first 5 seconds

CMML - Scrolls after 5 seconds

When the thermostat is connected to a Wi-Fi network, the network SSID is displayed.

MAC address

The MAC address is a unique 12-digit identifier associated with the Wi-Fi radio chip that contains the letters A through F and the numbers 0 through 9.

DSN

The DSN is the name used to identify the thermostat in the Carrier Connect Mobile App. The name starts with the letters **AC** followed by 13 letters and numbers. The DSN scrolls across the top of the display.

Registration

When the thermostat has been successfully registered to a user account with the Carrier Connect mobile app, the registered status displays **YES**.

When the thermostat is not registered to a Carrier Connect user account, the status is **NO**.

Timers, memory, and deadband

MINIMUM OFF timer

Once a heating or cooling demand is satisfied on the thermostat, the **MINIMUM OFF** timer is set to a 300-second value (5 minutes) and then begins to count down each second. Heating and cooling outputs are de-energized the entire time that this timer has a value greater than 0.

MINIMUM ON timer

Once a heating or cooling output becomes active, the 5-minute **MINIMUM ON** timer begins to count down. The output will not de-energize until the timer reaches zero and the demand is satisfied. If the user changes the setpoint to satisfy the demand, the 5 minute minimum on time is ignored and the heating or cooling equipment turns off.

Non-volatile memory

The thermostat can store settings in non-volatile memory to ensure that settings remain the same after a power outage (either intentional or unintentional). Items stored in non-volatile memory include:

- Installer settings
- Menu settings
- Program schedule
- Date and time
- Software information
- Dealer information
- Fault and system event information

Deadband

The thermostat controls the number of degrees (°F or °C) between the heating and cooling setpoints. If the user changes a setpoint that violates the deadband requirement, the opposite mode setpoint is “pushed” to enforce the deadband. The deadband setting is fixed at 2°F.

Faults and system events

The faults and system events are displayed in the home and dormant screen banners. Faults and system events include:

- Startup
- Software Update Events
- Power Cycle Events
- Parameter Out-of-Range Events
- Server Connectivity Events
- Non-Volatile Memory Faults
- Temperature Faults

The Faults and System events display in the banner while fault condition exists. You can see a history of the faults and system events in Carrier Connect mobile app under **Alerts**. The history is comprised of the 5 most recent logged items, with the most recent event being listed at the top.

Faults	
ID TEMP SENSOR HIGH	<p>Fault becomes active when main thermistor (P102 or RT1) reads > 100° F. Fault is cleared when temperature <= 99° F.</p> <p>When this fault occurs, the thermostat uses the temperature reading from the temperature/humidity sensor as the space temperature.</p>
ID TEMP SENSOR LOW	<p>Fault becomes active when main thermistor (P102 or RT1) reads < 39° F. Fault is cleared when temperature >= 40° F.</p> <p>When this fault occurs, the thermostat uses the temperature reading from the temperature/humidity sensor as the space temperature.</p>
REMOTE SENSOR HIGH	Remote temperature > 122° F; only flagged if remote sensor set to use as indoor temperature (REMOTE SENSOR setting set to INDOOR or AVERAGE)
REMOTE SENSOR LOW	Remote temperature = 0° F; only flagged if remote sensor set to use as indoor temperature (REMOTE SENSOR setting set to INDOOR or AVERAGE)
ID TEMP RANGE HIGH	If the mode is cooling (Cool or Auto operating in Cool), the space temperature is greater than the cool setpoint plus the Maximum Setpoint Error and this condition exists for the number of minutes specified by the INDOOR TEMP FAULT INHIBIT time.
ID TEMP RANGE LOW	If the mode is heating (HEAT, EHEAT or AUTO operating in HEAT), the space temperature is less than the heat setpoint minus the Maximum Setpoint Error and this condition exists for the number of minutes specified by the INDOOR TEMP FAULT INHIBIT time.
HUM SENSOR FAILURE	<p>Humidity sensor timed out</p> <ul style="list-style-type: none"> • humidity reading is > 99% • humidity reading is 0%.
HUMIDITY RANGE HIGH	Humidity reading is > 90%

Faults	
HUMIDITY RANGE LOW	Humidity reading is < 10%
OUTDOOR TEMP FAILURE	OD temp > 127 °F or < -60 °F
NO WI-FI SERVER	Not connected to Ayla server
NO WI-FI ROUTER	Router signal strength is  (not connected)
WI-FI HARDWARE FAULT	Communications error occurred with Wi-Fi module (resets after valid message received)
LOCKOUT 5 WRONG PINS	An incorrect PIN was entered consecutive times.
ECONOMIZER FAULT	Remote sensor is set to ECFL and there is a short between terminals T and C.
HIGH CO2	CO2 is above the programmed threshold (default 1100 PPM).
System Events	
FILTER REMINDER	Filter change reminder is active (run hours have expired or remote input shorted).

Appendix A: BACnet Points List

Point Name	Point Access	Units	BACnet Point Name	BACnet Object ID
Indoor Space Temperature	WRITE_WHEN_OOS	DEGREES_FAHRENHEIT	ID_SPACE_TEMP	AI:100
Indoor Space Humidity	WRITE_WHEN_OOS	PERCENT_RELATIVE_HUMIDITY	ID_SPACE_HUM	AI:101
Indoor Space CO2	WRITE_WHEN_OOS	PARTS_PER_MILLION	ID_SPACE_CO2	AI: 102
Remote Space Temperature	READ_ONLY	DEGREES_FAHRENHEIT	REM_SPACE_TEMP	AV:100
Outdoor Temperature	READ_ONLY	DEGREES_FAHRENHEIT	OD_TEMP	AV:101
Supply Air Temperature	READ_ONLY	DEGREES_FAHRENHEIT	SAT	AV:102
Network Space Temperature	READ_WRITE	DEGREES_FAHRENHEIT	NET_SP_TEMP	AV:103
Space Temperature for Control	READ_ONLY	DEGREES_FAHRENHEIT	SP_TEMP_CTRL	AV:104
Network Space Humidity	READ_WRITE	PERCENT_RELATIVE_HUMIDITY	NET_SP_HUM	AV:105
Space Humidity for Control	READ_ONLY	PERCENT_RELATIVE_HUMIDITY	SP_HUM_CTRL	AV:106
Air Filter Hours Left	READ_ONLY	HOURS	AIR_FLTR_HRS_LFT	AV:300
Override Time Remaining	READ_ONLY	HOURS	OVRD_TIME	AV:301
Occupied Heat Setpoint	READ_WRITE	DEGREES_FAHRENHEIT	OCC_HT_SP	AV:400
Occupied Cool Setpoint	READ_WRITE	DEGREES_FAHRENHEIT	OCC_CL_SP	AV:401
Unoccupied Heat Setpoint	READ_WRITE	DEGREES_FAHRENHEIT	UNOCC_HT_SP	AV:402
Unoccupied Cool Setpoint	READ_WRITE	DEGREES_FAHRENHEIT	UNOCC_CL_SP	AV:403
Dehumidification Setpoint	READ_WRITE	PERCENT_RELATIVE_HUMIDITY	DEHUM_SP	AV:406
Humidification Setpoint	READ_WRITE	PERCENT_RELATIVE_HUMIDITY	HUM_SP	AV:407
Screen Timeout	READ_WRITE	SECONDS	SCRN_TMT	AV:408
Heat Setpoint	READ_WRITE	DEGREES_FAHRENHEIT	HEAT_SP	AV:409
Cool Setpoint	READ_WRITE	DEGREES_FAHRENHEIT	COOL_SP	AV:410
Active Backlight	READ_WRITE	PERCENT	ACTV_BCKLT	AV:411
Dormant Backlight	READ_WRITE	PERCENT	DRMNT_BCKLT	AV:412
Indoor Equip Stages	GATED_WRITE		ID_STAGES	AV:500
Outdoor Equip Stages	GATED_WRITE		OD_STAGES	AV:501
Max Temperature Hold Time	GATED_WRITE	HOURS	MAX_HOLD_TIME	AV:502
Auto Changeover Delay	GATED_WRITE	MINUTES	AUTO_XOVR	AV:503
Cool Lockout Temperature	GATED_WRITE	DEGREES_FAHRENHEIT	COOL_LOCKOUT	AV:504
Low Cool Lockout (HP only)	GATED_WRITE	DEGREES_FAHRENHEIT	LO_CL_LCKOUT	AV:505
Low Heat Lockout (HP only)	GATED_WRITE	DEGREES_FAHRENHEIT	LO_HT_LCKOUT	AV:506
Delay Between Fuel (HP only)	GATED_WRITE	MINUTES	DLY_BW_FUEL	AV:507
Cycles Per Hour	GATED_WRITE	CYCLES_PER_HOUR	CYCLES_HR	AV:508
Max Heat Setpoint	GATED_WRITE	DEGREES_FAHRENHEIT	MAX_HT_SP	AV:509
Min Cool Setpoint	GATED_WRITE	DEGREES_FAHRENHEIT	MIN_CL_SP	AV:510

Point Name	Point Access	Units	BACnet Point Name	BACnet Object ID
Aux Heat Lockout (HP only)	GATED_WRITE	DEGREES_FAHRENHEIT	AUX_HT_LCKOUT	AV:511
Heat Pump Lockout	GATED_WRITE	DEGREES_FAHRENHEIT	HP_LCKOUT	AV:512
Stage Delay	GATED_WRITE	MINUTES	STG_DELAY	AV:513
Forced Stage Up Delay	GATED_WRITE	MINUTES	FRCD_STG_UP	AV:514
Stage Change Temp Differential	GATED_WRITE	DELTA_DEGREES_FAHRENHEIT	DIFFERENTIAL	AV:515
Indoor Temperature Offset	GATED_WRITE	DELTA_DEGREES_FAHRENHEIT	ID_TEMP_OFF	AV:517
Indoor Humidity Offset	GATED_WRITE	PERCENT_RELATIVE_HUMIDITY	ID_HUM_OFF	AV:518
SAT Temp Offset	GATED_WRITE	DELTA_DEGREES_FAHRENHEIT	SAT_OFFSET	AV:519
Air Filter Hours	READ_ONLY	HOURS	AIR_FLT_HRS	AV:520
Max Setpoint Error	GATED_WRITE	DELTA_DEGREES_FAHRENHEIT	MAX_SP_ERR	AV:521
Indoor Temp Fault Inhibit	GATED_WRITE	MINUTES	ID_TMP_FLT_INHBT	AV:522
CO2 Fault Threshold	GATED_WRITE	BACNET_UNITS_PPM	CO2_FLT_THRESHOLD	AV:523
1st Stage Cooling Out Status	READ_ONLY	0=OFF 1=ON	Y1_OUT	BV:200
2nd Stage Cooling Out Status	READ_ONLY	0=OFF 1=ON	Y2_OUT	BV:201
3rd Stage Cooling Out Status	READ_ONLY	0=OFF 1=ON	Y3_OUT	BV:202
1st Stage Heating Out Status	READ_ONLY	0=OFF 1=ON	W1_OUT	BV:203
2nd Stage Heating Out Status	READ_ONLY	0=OFF 1=ON	W2_OUT	BV:204
Fan Out Status	READ_ONLY	0=OFF 1=ON	G_OUT	BV:205
Reversing Valve Out Status	READ_ONLY	0=OFF 1=ON	OB_OUT	BV:206
Occupancy Out Status	READ_ONLY	0=OFF 1=ON	OCC_OUT	BV:208
Humidifier Out Status	READ_ONLY	0=OFF 1=ON	HUM_OUT	BV:209
Dehumidifier Out Status	READ_ONLY	0=OFF 1=ON	DEHUM_OUT	BV:210
Network General Purpose Out Y3	READ_WRITE	0=OFF 1=ON	NET_GP_Y3_OUT	BV:211
Network General Purpose Out W2	READ_WRITE	0=OFF 1=ON	NET_GP_W2_OUT	BV:212
Network General Purpose Out OB	READ_WRITE	0=OFF 1=ON	NET_GP_OB_OUT	BV:213
Wi-Fi Time Synchronization	READ_WRITE	0=DISABLED 1=ENABLED	WIFI_TIME_SYNC	BV:400
Auto DST Time Shift	READ_WRITE	0=DISABLED 1=ENABLED	AUTO_DST	BV:402

Appendix A: BACnet Points List

Point Name	Point Access	Units	BACnet Point Name	BACnet Object ID
Wi-Fi Enable	READ_WRITE	0=DISABLED 1=ENABLED	WIFI_ENABLE	BV:403
Setpoint Override	READ_WRITE	0=DISABLED 1=ENABLED	SETPT_OVERRIDE	BV:404
BACnet BMS Occupancy	GATED_WRITE	0=UNOCCUPIED 1=OCCUPIED	BMS_OCC	BV:405
Filter Timer Reset	READ_WRITE	0=INACTIVE 1=ACTIVE	FLTR_TMR_RST	BV:406
Network Space Temp Enable	READ_WRITE	0=DISABLED 1=ENABLED	NET_SP_TEMP_EN	BV:407
Network Space Humidity Enable	READ_WRITE	0=DISABLED 1=ENABLED	NET_SP_HUM_EN	BV:408
Occupancy Input Polarity	GATED_WRITE	0=OCCUPIED 1=UNOCCUPIED	OCC_IN_POL	BV:500
Auto Mode Allowed	GATED_WRITE	0=NO 1=YES	ALLOW_AUTO	BV:501
Prog Mode Allowed	GATED_WRITE	0=NO 1=YES	ALLOW_PROG	BV:502
Celsius Display	GATED_WRITE	0=F° 1=C°	CELSIUS_DISP	BV:503
Fan On with W	GATED_WRITE	0=NO 1=YES	FAN_WITH_W	BV:504
Rvs Vlv Energized Ht	GATED_WRITE	0=ENERGIZED FOR COOL 1=ENERGIZED FOR HEAT	RVS_VLV_DIR	BV:505
Humidifier Installed	GATED_WRITE	0=NO 1=YES	HUM_INST	BV:506
BMS Occupancy Enable	GATED_WRITE	0=DISABLED 1=ENABLED	BMS_OCC_EN	BV:507
BACnet Config Write Enable	GATED_WRITE	0=DISABLED 1=ENABLED	CFG_WR_EN	BV:511
CO2 Sensor Connected	GATED_WRITE	0=DISABLED 1=ENABLED	CO2_CONNECTED	BV:512
ID TEMP SENSOR HIGH	READ_ONLY	0=DISABLED 1=ENABLED	ID_TEMP_SENS_HI	BV:900
ID TEMP SENSOR LOW	READ_ONLY	0=INACTIVE 1=ACTIVE	ID_TEMP_SENS_LO	BV:901
REMOTE SENSOR HIGH	READ_ONLY	0=INACTIVE 1=ACTIVE	REM_TEMP_HI	BV:902
REMOTE SENSOR LOW	READ_ONLY	0=INACTIVE 1=ACTIVE	REM_TEMP_LO	BV:903
HUM TEMP SENSOR HIGH	READ_ONLY	0=INACTIVE 1=ACTIVE	HUM_TEMP_HI	BV:904
HUM TEMP SENSOR LOW	READ_ONLY	0=INACTIVE 1=ACTIVE	HUM_TEMP_LO	BV:905
ID TEMP RANGE HIGH	READ_ONLY	0=INACTIVE 1=ACTIVE	ID_TEMP_RNG_HI	BV:906

Point Name	Point Access	Units	BACnet Point Name	BACnet Object ID
ID TEMP RANGE LOW	READ_ONLY	0=INACTIVE 1=ACTIVE	ID_TEMP_RNG_LO	BV:907
HUM SENSOR FAILURE	READ_ONLY	0=INACTIVE 1=ACTIVE	HUM_SENS_FAIL	BV:908
HUMIDITY RANGE HIGH	READ_ONLY	0=INACTIVE 1=ACTIVE	HUM_TOO_HI	BV:909
HUMIDITY RANGE LOW	READ_ONLY	0=INACTIVE 1=ACTIVE	HUM_TOO_LO	BV:910
OUTDOOR SENSOR FAILURE	READ_ONLY	0=INACTIVE 1=ACTIVE	OD_TEMP_FAIL	BV:911
NOT CONNECTED TO SERVER	READ_ONLY	0=INACTIVE 1=ACTIVE	SRVR_CONN_FAIL	BV:912
NOT CONNECTED TO ROUTER	READ_ONLY	0=INACTIVE 1=ACTIVE	RTR_CONN_FAIL	BV:913
WIFI HARDWARE FAULT	READ_ONLY	0=INACTIVE 1=ACTIVE	WIFI_CONF_FAIL	BV:914
ECONOMIZER FAULT	READ_ONLY	0=INACTIVE 1=ACTIVE	ECON_FAULT	BV:915
LOCKOUT-5 BAD PIN ENTRIES	READ_ONLY	0=INACTIVE 1=ACTIVE	LOCKOUT_FAIL	BV:916
HIGH CO2	READ_ONLY	0=INACTIVE 1=ACTIVE	HIGH_CO2	BV:917
Current Mode Status	READ_ONLY	1=OFF 2=HEAT 3=COOL	CURRENT_MODE	MSV:300
User Mode	READ_WRITE	1=OFF 2=HEAT 3=COOL 4=AUTO 5=E-HEAT	USER_MODE	MSV:400
IR Proximity Sensitivity	READ_WRITE	1=HIGH 2=MEDIUM 3=LOW	PROX_SENS	MSV:401
Sound Effect	READ_WRITE	1=OFF 2=CLICK 3=BEEP	SOUND	MSV:402
Number of Parts in Schedule Day	READ_WRITE	1=2 PARTS 2=4 PARTS	SCHED_DAY_PARTS	MSV:403
Occupied Fan Mode	READ_WRITE	1=AUTO 2=ON	OCC_FAN	MSV:404
Unoccupied Fan Mode	READ_WRITE	1=AUTO 2=ON	UNOCC_FAN	MSV:405

Appendix A: BACnet Points List

Point Name	Point Access	Units	BACnet Point Name	BACnet Object ID
Current Fan Mode	READ_WRITE	1=AUTO 2=ON 3=OVERRIDE AUTO 4=OVERRIDE ON	FAN MODE	MSV:406
Indoor Equipment Type	READ_ONLY	1=NO INDOOR 2=FURNACE 3=AIR HANDLER	ID_EQUIP_TYPE	MSV:500
Outdoor Equipment Type	GATED_WRITE	1=NO OUTDOOR 2=A/C 3=HEAT PUMP	OD_EQUIP_TYPE	MSV:501
Remote Sensor Type	GATED_WRITE	1=NONE 2=OUTDOOR 3=SPACE 4=AVERAGE 5=OCCUPANCY 6=FAULT_INPUT 7=SAT	REMOTE_SENSOR	MSV:502
Dehumidification Type	GATED_WRITE	1=NO 2=YES 3=OVRCL(2F) 4=HUMIDIMIZER	DEHUM_TYPE	MSV:503
Occupancy Output Terminal	GATED_WRITE	1=OFF 2=Y3 3=O/B 4=W2	OCC_OUTPUT	MSV:504
Humidification Output Terminal	GATED_WRITE	1=OFF 2=Y3 3=O/B 4=W2	HUM_OUTPUT	MSV:505
Dehumidification Output Terminal	GATED_WRITE	1=OFF 2=Y3 3=O/B 4=W2	DEHUM_OUTPUT	MSV:506
Smart Recovery	GATED_WRITE	1=NO 2=30 MIN 3=60 MIN 4=90 MIN	SMART_RECVRY	MSV:507
Network GP W2 Mode	GATED_WRITE	1=DISABLED 2=ENERGIZED_ACTIVE 3=ENERGIZED_INACTIVE	NET_GP_W2_MODE	MSV:510
Network GP OB Mode	GATED_WRITE	1=DISABLED 2=ENERGIZED_ACTIVE 3=ENERGIZED_INACTIVE	NET_GP_OB_MODE	MSV:511
Analog Input	GATED_WRITE	NONE 1=HUMIDITY 2=CO2	ANALOG_INPUT	MSV:512

Point Name	Point Access	Units	BACnet Point Name	BACnet Object ID
Analog Input Scaling	GATED_WRITE	1=2-10V (4-20mA w/ext 500 Ohm)	ANALOG_IN_SCALE	MSV:513

Appendix B: BACnet Functionality

BACnet Communication

BACnet MS/TP

Baud Rates: 9600, 19200, 38400, 76800, 115200

BACnet Objects

Device Object

Analog Input Objects

Analog Value Objects

Binary Value Objects

Multistate Value Objects

BACnet Interoperability Building Blocks (BIBBs)

Data Sharing BIBBs

Execute Read Property (DS-RP-B)

Execute Read Property Multiple (DS-RPM-B)

Execute Write Property (DS-WP-B)

Execute Write Property Multiple (DS-WPM-B)

Device Management BIBBs

Execute Who-Is and Initiate I-Am (DM-DDB-B)

Execute Who-Has and Initiate I-Have (DM-DOB-B)

Execute TimeSynchronization (DM-TS-B)

Execute UTCTimeSynchronization (DM-UTC-B)

Execute ReinitializeDevice (DM-RD-B)

Execute DeviceCommunicationControl (DM-DCC-B)

Appendix C: BACnet Constraints

UTC Time Synchronization

If the device is to support UTCTimeSynchronization, time syncs with Local Time is disabled to avoid ambiguity, Daylight Saving calculations are enabled and the UTC_Offset is set according to the local time zone.

The following settings are in the Advanced menu:

SYNCH TIME TO SERVER—NO

DST—ENABLED

The following setting is in the installer settings menu:

BACNET UTC OFFSET—Xh Xm (5h 0m – U.S. Eastern Time Zone)

BACnet Reliability Property

In addition to indicating sensor issues, the BACnet Reliability property of the BACnet Objects conveys when the configuration does not support a given point.

Reliability Value	Meaning
No-fault-detected	Configuration matches the object description and value is in range.
Shorted-loop	The Present_Value of this object indicates a shorted sensor.
Open-loop	The Present_Value of this object indicates an open sensor.
Under-range	The Present_Value of this object is below normal.
Over-range	The Present_Value of this object is above normal.
No-output	The output is not used in the current configuration.
Unreliable-other	This object is not relevant with the current configuration.
No-sensor	The sensor is not used in the current configuration.

Appendix D: BACnet Object Instance Ranges

Instance Range	Object Type
1XX	Device Inputs
2XX	Device Outputs
3XX	Status
4XX	User Configuration
5XX	Installer Configuration
9XX	Faults

Appendix E: BACnet Object Notes

Gated Installer Configuration

After the installer enables BACnet in the installer menu, they will have the opportunity to also select BACNET CONFIG WRITE. Enabling BACNET CONFIG WRITE allows the installer to write to all the installer configuration BACnet Objects (AV5XX, BV5XX and MSVXX) remotely over the BACnet network. When the installer has completed configuring the device, they may write Inactive to CFG_WR_EN (BV5.11) to disable writes to installer configuration objects.

NOTE Re-enabling BACNET CONFIG WRITE must be done from the installer menu at the thermostat.

Multiplexed Inputs

Each analog input has a corresponding multiplexer that is used to select between the measured input value (AI1 in the figure below) and a network object value (AV1 in the figure below). The output of the multiplexer (AV2 in the figure below) is used in the equipment control algorithms. When the gate object (BV1 in the figure below) is active the network object's value is passed on to the output of the multiplexer, when the gate object is inactive the measured input value is passed on to the output of the multiplexer. The gate object value is a configuration object and is backed up to non-volatile memory. If the network object's value has not been written to within 5 minutes, the output of the multiplexer defaults to the measured input value.

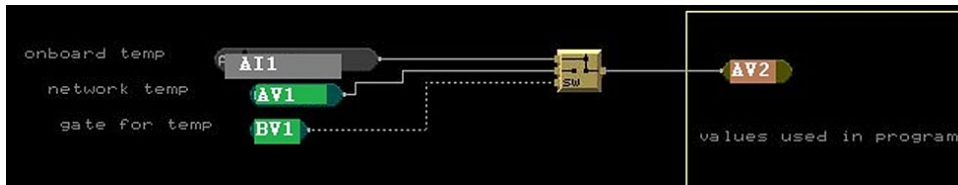

Input	Meas. Input Object	Network Object	Object Used for Equip. Control
Space Temp	ID_SPACE_TEMP (AI100)	NET_SP_TEMP (AV103)	SP_TEMP_CTRL (AV104)
Space Humidity	ID_SPACE_HUM (AI101)	NET_SP_HUM (AV105)	SP_HUM_CTRL (AV106)

Network Controlled Outputs

The thermostat has 3 outputs (**Y3**, **W2**, and **OB**) that can be assigned to optional equipment when the default assignment is not required for the equipment configuration. When any of these 3 outputs are left unassigned, they can be configured to be network controlled outputs by changing their mode from **DISABLED/OFF** to **ENERGIZED_ACTIVE** or **ENERGIZED_INACTIVE** in the installer menu or through the network configuration objects. There are 3 BV objects that control whether an output is active or inactive. These objects must be repeatedly written to over the network within the time configured in the GP_OUT_TIMEOUT (MSV508) configuration object or the output goes to the configured inactive state. The following truth table describes the action of the physical outputs as they relate to the controlling object, Mode Object, and the timeout status.

Controlling Object Value	Mode Object Value	Timed out?	Physical Output State
*	DISABLED	*	De-energized
*	ENERGIZED_ACTIVE	Yes	De-energized

Controlling Object Value	Mode Object Value	Timed out?	Physical Output State
*	ENERGIZED_INACTIVE	Yes	Energized
Inactive	ENERGIZED_ACTIVE	No	De-energized
Inactive	ENERGIZED_INACTIVE	No	Energized
Active	ENERGIZED_ACTIVE	No	Energized
Active	ENERGIZED_INACTIVE	No	De-energized

The following table shows the three outputs and the objects that configure and control them.

Controlling Object	Mode Object	Physical Output
NET_GP_Y3_OUT (BV211)	NET_GP_Y3_MODE (MSV509)	Y3
NET_GP_W2_OUT (BV212)	NET_GP_W2_MODE (MSV510)	W2
NET_GP_OB_OUT (BV213)	NET_GP_OB_MODE (MSV511)	OB

Document revision history

Important changes to this document are listed below. Minor changes such as typographical or formatting errors are not listed.

Date	Topic	Change description	Code*
		No changes yet.	

* For internal use only

