



**Sensata**  
Technologies

## **PreView Sentry®**

ST82, ST87 and ST97

Sensor Operating Manual



[sensata.com](http://sensata.com)

This page left blank intentionally

## FCC STATEMENT

This device complies with Part 15 of the FCC Rules. Operation is subject to the following two conditions: (1) this device may not cause harmful interference, and (2) this device must accept any interference received, including interference that may cause undesired operation.

**Warning:** Changes or modifications to this unit not expressly approved by the party responsible for compliance could void the user's authority to operate the equipment.

**NOTE:** This equipment has been tested and found to comply with the limits of a Class B digital device, pursuant to Part 15 of the FCC Rules. These limits are designed to provide reasonable protection against harmful interference in a residential installation. This equipment generates, uses, and can radiate radio frequency energy and, if not installed and used in accordance with the instructions, may cause harmful interference to radio communications. However, there is no guarantee that interference will not occur in a particular installation. If this equipment does cause harmful interference to radio or television reception, which can be determined by turning the equipment off and on, the user is encouraged to try and correct the interference.

## INDUSTRY CANADA STATEMENT

Per RSS-Gen, Section 8.4 This device complies with Industry Canada license-exempt RSS standard(s). Operation is subject to the following two conditions: (1) this device may not cause interference, and (2) this device must accept any interference, including interference that may cause undesired operation of the device.

Per RSS - Gen, Section 8.4 Cet appareil est conforme à Industrie Canada exempts de licence standards RSS. Le fonctionnement est soumis aux deux conditions suivantes : (1) ce dispositif ne peut pas provoquer d'interférences et (2) cet appareil doit accepter toute interférence, y compris les interférences qui peuvent causer un mauvais fonctionnement de l'appareil.

## REGULATORY COMPLIANCE

The PreView Sentry® is compliant with the following countries/regions and their regulations as of the published date of this manual. The sensor may be compliant in other countries/regions. Please check your local regulations.

- **United States** - FCC- Part 15.249
  - FCCID: **ST82/87:** OXZJCKP2016 **ST97:** OXZTHUN2019
- **Canada** - RSS-210 Radio Standards Specification
  - IC ID: **ST82/87:** 20379-PREVIEW24 **ST97:** 20379-PREVIEWTH
- **European Union** - E-Mark: E13 10R-05 15458
- **Australia/New Zealand** - AS/NZ 4268:2017 Radio Equipment and Services – Short Range Devices
- **Japan MIC:** **ST97:** R005-101717

**UK  
CA**

## PATENTS:

US patents; 7088284, 7215278, 7324278 and additional foreign patent family members. This document may be amended, corrected, and enhanced in keeping with the sensor development progress. The most recent version can be found at [sensata.com](http://sensata.com)

## TRADEMARKS

The names of actual companies and products mentioned herein may be the trademarks of their respective owners. Any rights not expressly granted herein are reserved.

# Contents

Safety .....	1
Storage and Location of These Instructions .....	1
Warning and Safety Instructions in This Operating Manual.....	1
Sensor Models .....	2
Product Description .....	3
Sensor Description.....	3
Sensor Operation .....	4
Adjustable Detection Zone .....	4
Other Sensor Features.....	5
Object Detection Capability .....	6
Sensor Installation .....	7
Before you Begin .....	7
Sensor Location .....	7
Keep Out/Interference Zones .....	7
Mounting Tolerances .....	8
Sensor Mounting.....	9
Sensor Interfaces and Configuration.....	9
System Connections .....	10
Maintenance and Testing.....	11
Safety Message.....	12
Troubleshooting .....	13
Sensor Pinout.....	14
Sensor Specifications .....	15
Warranty Information.....	16
More PreView® Safety Products.....	17



# Safety

## NOTICE

### Storage and Location of These Instructions

This operating manual should be stored in a safe place and be referred to when maintaining and/or reinstalling the system.

### Warning and Safety Instructions in This Operating Manual

 <b>WARNING</b>	Indicates a hazardous situation that, if not avoided, could result in death or serious injury
 <b>CAUTION</b>	Indicates a hazardous situation that, if not avoided, could result in minor or moderate injury
<b>NOTICE</b>	Indicates information considered important, but not hazard-related

 <b>WARNING</b>	<p><i>Installation, mounting and electrical connection may only be carried out by a trained specialist in accordance with information in this operating manual.</i></p> <p><i>The PreView® system is intended as an Object Detection System and should not be relied upon as the first line of defense for the safe operation of the equipment. The system does not apply braking, steering or any other vehicle control. It should be used in conjunction with established safety programs and procedures to augment the safe operation of the equipment, ground personnel, and adjacent property.</i></p> <p><i>The driver must have the authorization to drive the vehicle and have read and understood this manual. They must also be fit to drive, i.e., not be under the Influence of alcohol, drugs and/or narcotics or exceed the statutory driving times.</i></p>
---	--

# Sensor Models

The sensor has multiple models with preconfigured detection zones: both range and width.

The Sentry® model numbering system is as follows:

Model STABXXY-ZR, where:

A defines the bandwidth used – 8: 250 MHz / 9: 200 MHz

B defines the connector type – 7: is for Deutsch / 2: is for Conxall

XX defines the sensor's detection range in meters (0 to 30)

Y defines the detection width in meters

Z defines the CAN ID (Source Address) of the sensor

R defines how the system is powered – R: rear sensor is powered by the reverse signal / no R: rear sensor is powered by ignition

**Example:** Model ST87063-6 describes a sensor using 250 MHz with a Deutsch connector, a 20 ft (6 m) detection range and a 10 ft (3 m) detection width with a CAN ID of 6 that is powered by ignition.

Sentry® ST87/ ST97 Series radar sensors use an 8-pin Deutsch connector on a 10 in pigtail.

Sentry® ST82 Series radar sensors use an 8-pin Conxall connector on the back of the sensor.

**Note:** visit [sensata.com/products/blind-spot-monitoring-systems](https://sensata.com/products/blind-spot-monitoring-systems) for the most current data on radar sensor models.

**The frequency band used is legal throughout most of the world but check with Sensata Technologies or your country's regulations before purchasing.**

# Product Description

The PreView Sentry® is a FMCW (Frequency Modulated Continuous Waveform) radar object detection sensor designed to alert equipment (vehicle, truck, machine) operators to the presence of obstacles. The sensor detects both moving and stationary objects in a pre-defined coverage area and can report the distance of the closest object via a J1939 CAN bus message to the chosen HMI (Human Machine Interface).



**Figure 1 - PreView Sentry® Radar Sensor**

## Sensor Description

The PreView Sentry® is a small, rugged, short-range radar sensor designed by Sensata Technologies in the USA for use in heavy duty applications, such as busses, construction, mining, trucking, waste, utilities, and other applications requiring a robust, high-performance radar.

The sensor transmits and receives low power 24 GHz (narrow band) radar signals. Using FMCW technology the sensor processes the returned signals to determine if an object has reflected any energy back to the sensor. From this reflected energy it can measure radial range, speed, angle, reflectivity and other parameters of multiple stationary and moving objects, simultaneously. The sensor is designed to process and report detections within 240 milliseconds (ms) allowing the operator to quickly respond.

## Sensor Operation

The sensor has a wide horizontal field of view up to  $150^\circ$  ( $\pm 75^\circ$ ) and a configurable detection zone providing coverage flexibility to be a solution for virtually any application. The detection zone can be configured from 1 - 98 ft (30 m) in length and from 2 - 196 ft (60 m) in width. The sensor also provides five zones of detection giving the operator proximity to the object.

## Adjustable Detection Zone

Figure 2 illustrates the five proximity zones. By default, all five zones are divided equally from the detection zone length. Zone 1 is the only configurable zone and if adjusted from default, Zones 2-5 will divide equally from the remainder of the detection zone length.

**Example:** Detection length = 20 ft (6 m) and Zone 1 = 8 ft (2.4 m), Zones 2-5 each = 3 ft (0.9 m) in length.

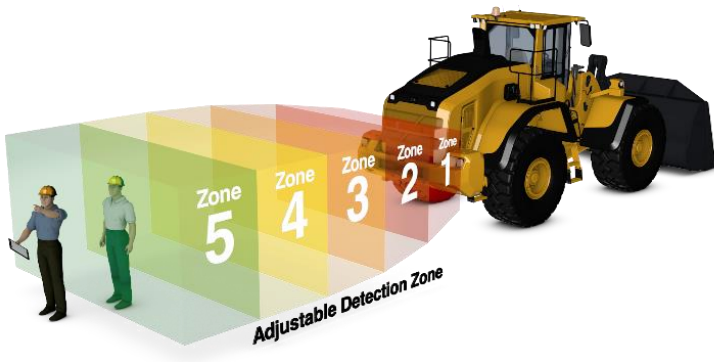

Figure 2 - Proximity Zones

Figure 3 illustrates a truck backing application with the radar detection zone set to a range of 20 ft (6 m) and a width of 10 ft (3 m) giving each proximity zone approx. 4 ft (1.2 m) in length.

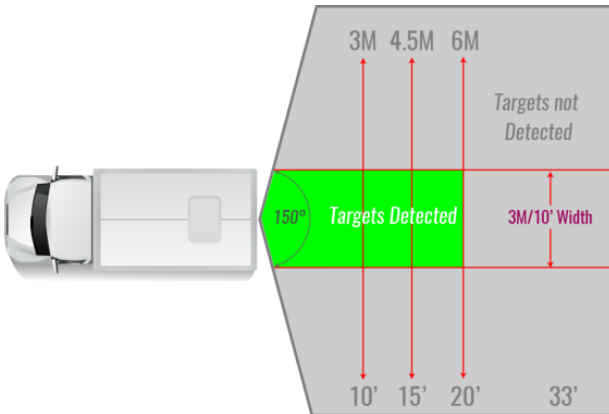
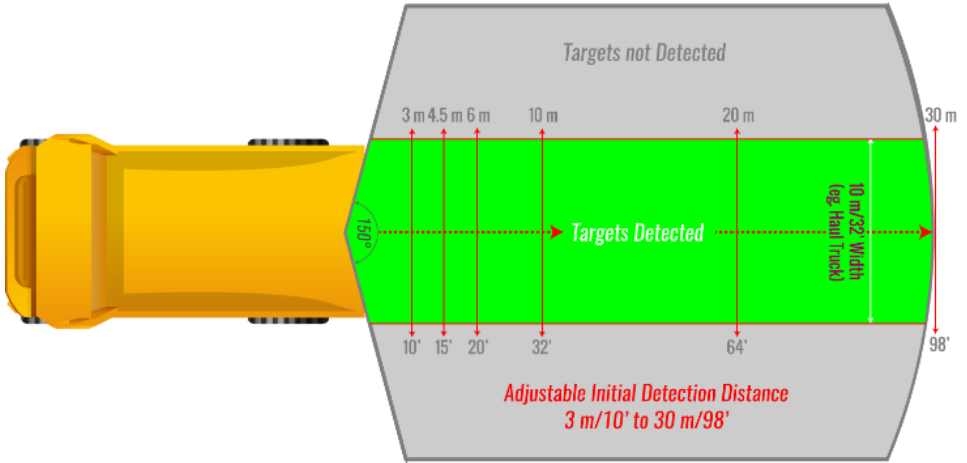

Figure 3 - Detection Zone, 6 m x 3 m



Figure 4 illustrates a mining haul truck backing application with the radar detection zone set to a range of 98 ft (30 m) and a width of 32 ft (10 m) giving each proximity zone approx. 20 ft (6 m) in length.



**Figure 4 - Detection Zone, 30 m x 10 m**

### Other Sensor Features

The sensor has a continuous Built-In-Self-Test (BIST) that notifies the operator via the in-cab display of sensor failure within a fraction of a second. This test functions by monitoring the transmit and receive performance as well as other internal operations.

The sensor can also determine if the face of the sensor is blocked with excessive ice, mud, or snow that is impeding proper operation. This blockage is then reported to the operator via the display.

The self-test and blockage detection features are important to a fail-safe operation.

# Object Detection Capability

A certain amount of the sensor's transmitted RF energy that strikes an object will reflect back to the sensor. If the returned energy is of sufficient magnitude, it is used to indicate the presence of an object. The sensor can detect most objects within the detection zone. However, there are some instances where objects can go undetected. Object composition, orientation, relative location, shape and size are all factors determining if, when, and where an object is detected.

The amount of energy returned is based on a few factors:

**Angle** – an object flat side perpendicular to the sensor will reflect more energy than an object at an angle. See Figure 5 for an example of how angle can affect return energy.

**Composition** – a metal object typically reflects more energy than a non-metallic object.

**Scattering** – a solid object reflects more energy than a non-solid object such as tree branches, gravel, bushes, etc.

**Shape** – complex shapes cause energy to be returned in a very non-uniform way. Small variations or movement can change detection status.

**Size** – a larger object usually reflects more energy than a smaller object.

## Minimal Reflection

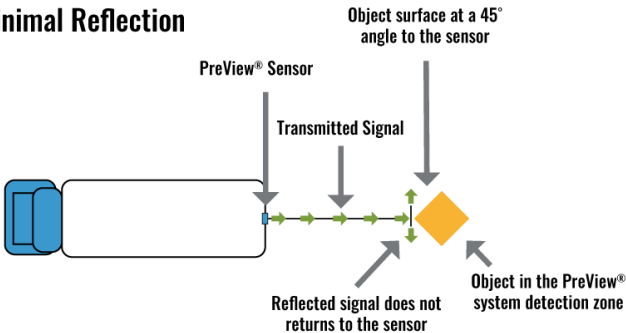

## Full Reflection

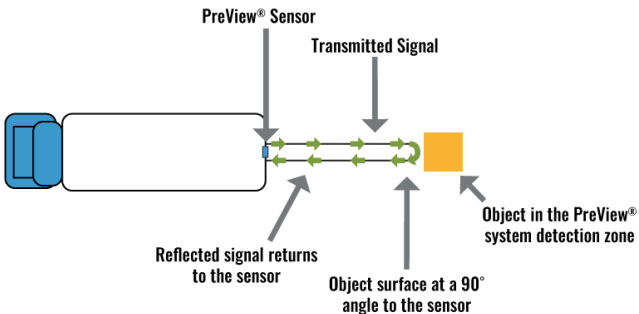

Figure 5 - Object Reflection

# Sensor Installation



If the PreView® system is not installed properly, it may not operate as intended, which could result in a failure to warn the operator of a hazardous situation.

## Before you Begin

Prior to installing the PreView® Object Detection System take time to familiarize yourself with all documentation, theory of operation, and system components.

## Sensor Location

The sensor mounting location is integral to proper system operation. The sensor's detection zone must cover the blind spot you wish to monitor, and the sensor must be mounted at the appropriate height. For example, to monitor a blind spot directly behind your equipment, the sensor should be mounted on the rear as close to the center of the equipment as possible with the sensor face perpendicular to the ground. Select a location that will provide some protection from impact and debris while allowing an unobstructed field of view covering the targeted blind spot.

## Keep Out/Interference Zones



For optimal performance, the sensor should protrude beyond any other portion of the vehicle. Metallic and other strong radar reflecting objects must remain outside of the Keep Out Zones defined in Figure 6 . Radar reflecting objects within these areas may affect operation. If those objects cannot be removed, testing must be performed to determine the influence on the system's performance.

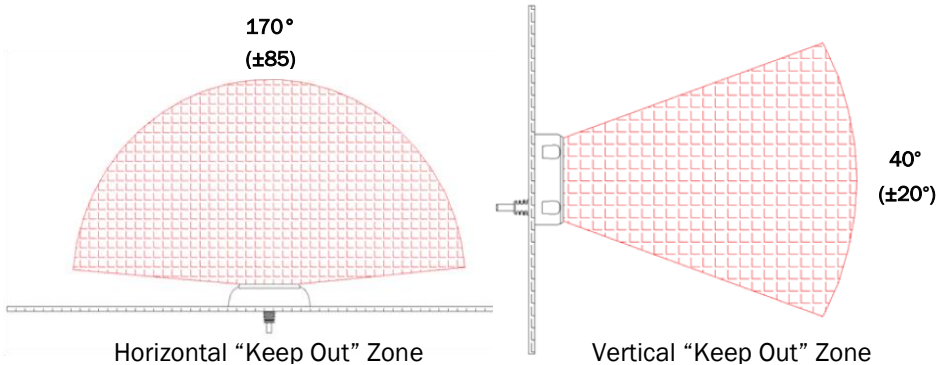

Figure 6 - Keep Out Zones



Before the sensor is permanently installed on the equipment, verify the selected location provides a clear detection zone. Move the equipment to an open field with no objects in the sensor's field of view, temporarily attach the sensor to the equipment in the proposed location, apply power and activate the system. Verify that nothing is being detected.

The sensor's performance is not affected by other PreView® Sensors or similar sensors operating in close proximity with each other.

## Mounting Tolerances



Mounting height tolerance at 36 in (1 m) is  $\pm 12$  in (0.3 m). For optimal performance at 36 in (1 m), the horizontal angle tolerance is  $\pm 5^\circ$  and the vertical angle (Up/Down) tolerances are  $+5^\circ$  (up) and  $-2^\circ$  (down).

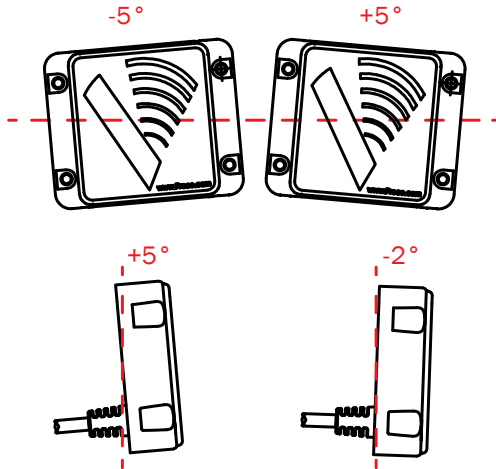

Figure 7 - Vertical and Horizontal Angle Mounting Tolerances

**Exceptions:** if mounting higher than 4 ft (1.3 m), the sensor can be angled down a few degrees as necessary (less than  $5^\circ$  in most applications).

The performance of the sensor can be negatively impacted if the sensor is angled down, causing nuisance detections from the ground. Any time the sensor must be mounted outside the mounting tolerances, the performance should be tested. In some instances, mainly with longer range models, the sensor may need to be angled upward to reduce nuisance detections from the ground.

# Sensor Mounting

1. Select the appropriate location to mount the sensor.
2. The standard mounting configuration is with the 'V' logo upright. See Figure 1 for sensor orientation.
3. Use the included sensor mounting bracket to scribe position marks through the holes. Drill four 0.25 in (6 mm) holes centered on the marks.  
**Note:** the bracket has eight holes for sensor mounting, only four will be used and which holes are used depends on bracket orientation.
4. Use the same bracket to scribe a position mark for the sensor's connector. For Deutsch models, drill one 1.5 in (38 mm) hole. For Conxall models, drill a 1 in (24 mm) hole for the connecting cable.
5. Secure the sensor to the equipment using the supplied hardware, with a maximum 22 in-lbs. (2.5N-m) torque.

# Sensor Interfaces and Configuration

## Communication

The sensor communicates with the in-cab display using a CAN interface as specified in ISO 11898-2. The CAN bus operates at a baud rate of 250 Kbits/second and is not terminated in the sensor. Since CAN is a standard communication interface, the sensor can be connected to other CAN controllers, telematics interfaces, displays, etc.

The sensor is most commonly bought in a kit that includes the needed cabling and display. The display normally included in the kit is the D2002 version of the PreView® v2.

Contact Sensata Technologies for further details.

## Sensor Input

The sensor has a trigger input that, if configured can be used to determine when and what alerts are provided by the HMI and/or activate the auxiliary output.

For backing applications, it can be used to trigger the sensor when the equipment is in reverse so the HMI may only provide detection alerts when backing.

## Auxiliary Output

The sensor provides an auxiliary output that becomes active whenever the sensor detects an object. The output is switched from a high impedance state to ground when active and is protected against an over-current or electrical short condition.

This output can be used to activate an external backup alarm or other devices as desired.

# System Connections



*If the PreView® system is not wired properly, it may not operate as intended, which may result in a failure to warn the operator of a hazardous situation.*

In backing only applications where there is only a rear sensor(s), the sensor is typically powered by the reverse signal such as the backup alarm or reverse light. See Figure 8 for a common connection diagram for a system powered by reverse.

Locate the vehicle's reverse power to connect the red wire on the body harness (WS61xxT), connect the black wire to ground.

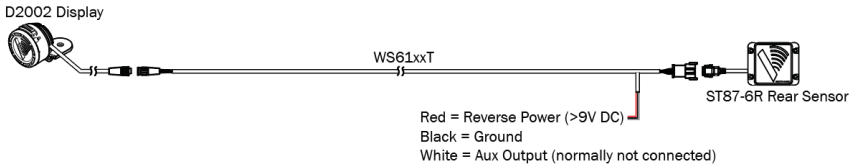
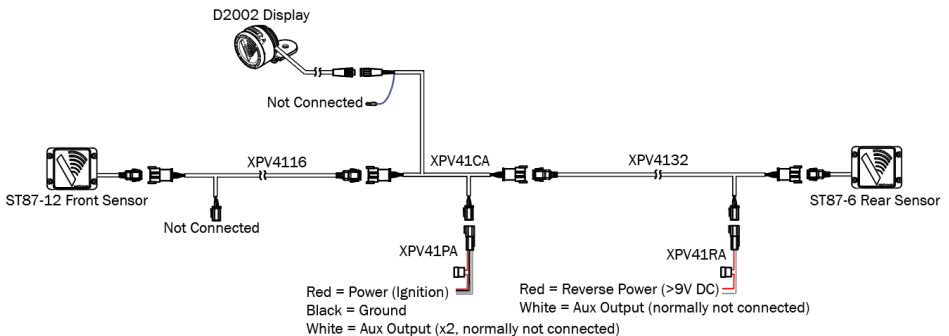

**Figure 8 - System Wiring Connections (Powered by Reverse)**

In other applications, especially when connected to other PreView® Sensors, the rear sensor(s) is powered by ignition and triggered by the reverse signal such as the backup alarm or reverse light. See Figure 9 for a common connection diagram of a front-rear application that is powered by ignition and triggered by reverse.

Locate the vehicle's ignition power to connect the red wire on the power adapter (XPV41PA) and connect the black wire to ground.

Locate the vehicles reverse power to connect the red wire on the rear adapter (XPV41RA).



**Figure 9 - System Wiring Connections (Powered by Ignition, Triggered by Reverse)**

# Maintenance and Testing



*If the PreView® system is not maintained properly, it may not operate as intended, which may result in a failure to warn the operator of a hazardous situation.*

*A walk around test shall be performed every day to verify proper function of the system and to familiarize the operator with the zone of detection. More frequent inspections should be performed when:*

- The equipment is operating in a particularly dirty or harsh environment.*
- The operator has reason to suspect the system has been damaged.*

Although the sensor performs well in harsh environments (high temperature, fog, rain, snow, etc.) it is still recommended that the sensor face be cleaned periodically as you would your equipment lights. The sensor is sealed to meet IP69K, withstands high vibration and shock levels, and is virtually maintenance free.

This test should be performed with two people, the operator who remains in the cab, and the assistant who walks through the sensor's detection zone.

1. Move the equipment to an open field larger than the detection zone to test.
2. Clean the sensor face of any accumulation of dirt, mud, snow, ice, or debris.
3. Visually inspect the attached wiring and cable and verify that they are properly secured, not chafing or dangling free where they could become snagged and damaged. Inspect the Sensor and Operator Display and verify that they are securely attached to the equipment.
4. Place the sensor in active mode. Make sure the equipment has been secured and remains stationary. For backing applications this may require placing the vehicle in reverse.
5. Verify the sensor is operational. Depending on the HMI, this may be green LED (for display), green icon (in-cab video monitor), or beep (buzzer or SAS).
6. Assure the detection zone has been cleared of all objects. Any object in the detection zone will interfere with the test.
7. The assistant should start straight out from the sensor outside of the detection zone and walk in towards the sensor. When the warning activates the operator should signal to the assistant so the location of detection can be marked/noted.
8. The assistant should continue to walk to the sensor and the operator signal when the alert increases (visually and/or audibly) indicating detection in a closer proximity zone, mark/note the proximity zone change.
9. The assistant should walk the complete sensor field while the operator notes the detection edges of the entire coverage area.
10. Finally, after the test the operator and the assistant need to communicate the details about the detection zone.

# Safety Message

## Safety Message to Equipment Operators with PreView® Systems

1. Failure to follow all safety precautions and instructions may result in property damage, serious injury, or death. It is necessary to read, understand and follow all instructions shipped with the product.
2. The equipment operator must check for proper operation at the beginning of every shift or safety inspection period.
3. The PreView® system is intended as an Object Detection System and should not be relied upon as your first line of defense for the safe operation of the equipment. It should be used in conjunction with established safety programs/procedures to augment the safe operation of the equipment and to protect ground personnel and adjacent property.
4. People's lives depend on the proper installation of this product in conformance with these instructions. Should the system become inoperative, it could jeopardize the safety or lives of those who utilize the system.
5. The PreView® Object Detection System is intended for commercial use. Proper installation of the object detection system requires a good understanding of equipment electrical systems and procedures, along with proficiency in the installation.
6. Store these instructions in a safe place and refer to them when maintaining and/or reinstalling the system.

For questions, call +1.866.977.7326 toll free in the USA. Call +1.208.323.1000 or send a fax request to +1.208.323.1034 for outside the USA, or submit an online request at [sensata.com/contact-us-technical-support](https://sensata.com/contact-us-technical-support)



# Troubleshooting

## **NOTICE**

For troubleshooting assistance, please reference your specific display manual.

Visit us online at:

[sensata.com/blindspotmonitoring/manuals](https://sensata.com/blindspotmonitoring/manuals)

**Or**

Scan the code below for quick access



# Sensor Pinout

**CONNECTOR END VIEW**  
**DEUTSCH DT06-08SA-E008**

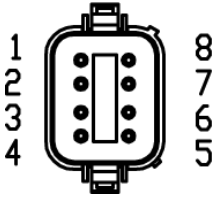

CONNECTOR PIN OUT	
PIN	SIGNAL NAME
1	INPUT POWER (+)
2	GROUND
3	CAN HIGH
4	CAN LOW
5	DISPLAY POWER OUTPUT (+)
6	DISPLAY GROUND
7	AUXILIARY OUTPUT (ACTIVE LOW)
8	TRIGGER INPUT

**Figure 10 - Deutsch Connector Pin Out (ST87/ST97 Series)**

**CONNECTOR END VIEW**  
**CONXALL 7291-8PG-300**

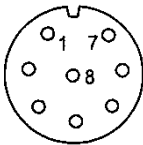

CONNECTOR PIN OUT	
PIN	SIGNAL NAME
1	CAN HIGH
2	CAN LOW
3	INPUT POWER (+)
4	GROUND
5	DISPLAY POWER OUTPUT (+)
6	DISPLAY GROUND
7	AUXILIARY OUTPUT (ACTIVE LOW)
8	TRIGGER INPUT

**Figure 11 - Conxall Connector Pin Out (ST82 Series)**

# Sensor Specifications

## NOTICE

Transmitter Connector:	FMCW Radar - 24 GHz Narrow Band Deutsch DT06-08SA-E008, see Figure 10 Conxall 7291-8PG-300, see Figure 11
Protection Rating:	IP69K
Housing Material:	Polycarbonate radome
Dimensions:	4.90" (w) x 4.06" (h) x 1.28" (d) (12.4 cm x 10.3 cm x 3.25 cm)
Weight:	ST87/ST97: 1.15 lb. (0.52 kg), ST82: 1.05 lb. (0.48 kg)
Operating Temperature:	-40 °F to +185F (-40 °C to +85 °C)
Storage Temperature:	-67 °F to +221 °F (-55 °C to +105 °C)
Vibration:	25 G, random, all three axis
Shock:	50 G
Mounting:	Four 0.22" (5.6 mm) diameter mounting holes.

### Operating Characteristics

Range:	0 – 30 m (10 dBsm target) depending on model number
Range Accuracy:	0.3 m
Azimuth Field of View:	±75° (10 dBsm target)
Elevation Field of View:	±10° (10 dBsm target)
Angle Accuracy:	±2° @ ±10° FOV, ±5° @ ±30° FOV, ±10° @ ±75° FOV
Velocity Range:	± 9 m/sec (± 20 mph)
Velocity Accuracy:	0.2 m/sec (0.5 mph)
Target Resolution:	1.4 m for static targets, approaching 0.3 m for dynamic targets
Cycle Time:	80 ms (a CAN bus target message is provided in every cycle)
Detection Pattern:	Fixed based on model
Target Detection Time:	240 ms
Power On to Active Time:	240 ms

### Electrical Specifications

Frequency:	ST82/ST87: 24.00 – 24.25 GHz ST97: 24.05 – 24.25 GHz
Power Supply:	9 – 33 VDC, Reverse polarity and over-voltage protected
Current:	<0.5 A
Fuse Requirements:	Fuse System using 3A fuse



### Communications Interface

J1939 CAN Bus Baud Rate:	250 Kbits/sec, not terminated
Alarm Output	Active - Switch to ground, sink up to 1 A, over current protected Inactive State – High Impedance

### Regulatory Compliance

Compliant with FCC Part 15.249

ST82/ST87:

**UK  
CA**

FCC ID: OXZJCKP2016  
IC: 20379-PREVIEW24  
'CE' 'E' mark: E13 10R05-15387  
AS/NZ: 4268 2017

ST97:

FCCID: OXZTHUN2019  
IC: 20379-PREVIEWTH  
'CE' 'E' mark: E13 10R05-15387  
Japan MIC: R005-101717

PRODUCT MANUFACTURED IN THE USA

+1.866.977.7326

sensata.com

3702008F  
Copyright 2022

# Warranty Information

## MANUFACTURER STANDARD LIMITED WARRANTY AND LIMITATION OF LIABILITY

Manufacturer warrants that on the Date of Purchase this Product will conform to Manufacturer's published specifications for the product, which are available from Manufacturer on request, and Manufacturer warrants that the product is free from defects in materials and workmanship. This Limited Warranty for the sensor extends for sixty (60) months from the date of shipment. Manufacturer will, at its option, repair or replace any product found by Manufacturer to be defective and subject to this Limited Warranty.

This Limited Warranty does not apply to parts or products that are misused; abused; modified; damaged by accident, fire or other hazard; improperly installed or operated; or not maintained in accordance with the maintenance procedures set forth in Manufacturer's Installation and Operating Instructions.

To obtain warranty service, you must ship the product(s) to the specified Manufacturer location within thirty (30) days from expiration of the warranty period. To obtain warranty service, call Customer Service at +1.866.977.7236 or +1.208.323.1000, or fax your request to +1.208.323.1034. Customer Service will issue warranty authorization and further instructions. You must prepay shipping charges and use the original shipping container or equivalent.

**EXCLUSION OF OTHER WARRANTIES:** MANUFACTURER MAKES NO OTHER WARRANTIES, EXPRESSED, IMPLIED OR STATUTORY. THE IMPLIED WARRANTIES FOR MERCHANTABILITY AND FITNESS FOR A PARTICULAR PURPOSE ARE HEREBY EXCLUDED AND SHALL NOT APPLY TO THE PRODUCT. BUYER'S SOLE AND EXCLUSIVE REMEDY IN CONTRACT, TORT OR UNDER ANY OTHER THEORY AGAINST MANUFACTURER RESPECTING THE PRODUCT AND ITS USE SHALL BE THE REPLACEMENT OR REPAIR OF THE PRODUCT AS DESCRIBED ABOVE.

**LIMITATION OF LIABILITY:** IN THE EVENT OF LIABILITY FOR DAMAGES ARISING OUT OF THIS LIMITED WARRANTY OR ANY OTHER CLAIM RELATED TO MANUFACTURER'S PRODUCTS, MANUFACTURER'S LIABILITY FOR DAMAGES SHALL BE LIMITED TO THE AMOUNT PAID FOR THE PRODUCT AT THE TIME OF ORIGINAL PURCHASE. IN NO EVENT SHALL MANUFACTURER BE LIABLE FOR LOST PROFITS, THE COST OF SUBSTITUTE EQUIPMENT OR LABOR, PROPERTY DAMAGE, OR OTHER SPECIAL, CONSEQUENTIAL OR INCIDENTAL DAMAGES BASED UPON ANY CLAIM FOR BREACH OF CONTRACT, NEGLIGENCE OR OTHER CLAIM, EVEN IF MANUFACTURER OR A MANUFACTURER'S REPRESENTATIVE HAS BEEN ADVISED OF THE POSSIBILITY OF SUCH DAMAGES.

Manufacturer shall have no further obligation or liability with respect to the product or its sale, operation and use, and Manufacturer neither assumes nor authorizes the assumption of any other obligation or liability in connection with such product.

This Limited Warranty gives you specific legal rights, and you may also have other legal rights, which vary, from state to state. Some states do not allow the exclusion or limitation of incidental or consequential damages, so the above exclusion or limitation may not apply to you.

Any oral statements or representations about the product, which may have been made by salesmen or Manufacturer representatives, do not constitute warranties. This Limited Warranty may not be amended, modified or enlarged, except by a written agreement signed by an authorized official of Manufacturer that expressly refers to this Limited Warranty.

## More PreView® Safety Products

### PreView® Radar Blind Spot Monitoring

- **Side Defender®** – 150° intelligent side object detection radar. Ignores stationary objects while warning of other vehicles in your side blind spots when traveling > 10 mph (16 km/h) and warns of stationary and moving objects when traveling < 10 mph (16 km/h).
- **Side Defender®II** – 150° intelligent side object detection radar with VRU protection. Ignores stationary objects while warning of bicycles, vehicles and people in your side blind spots at all vehicle speeds.
- **Sentry®X** – Designed with a narrower FOV than the Sentry®, Sentry®X supports installations that must be inset, such as large haul trucks.

### PreView® Camera Monitor Solutions

- **PreView® Plus** – 7” IP67 monitor supports 1 to 4 cameras with 1 to 24 radar sensors providing combined camera and radar technologies to deliver the most complete active blind spot monitoring solution available.
- **Monitor 5 HD** – 5” heavy-duty IP67 monitor supports up to 3 cameras.
- **Monitor 5 LD** – 5” monitor for closed cabs. Supports a single camera.
- **Mini Cam** – Compact cameras with 120°, 150°, or 180° field of view.
- **Heavy-Duty Cam** – IP67 Heavy-Duty camera with 118° field of view, IR LEDs, and built-in heater.

**PreView® VideoLink** – Make your existing camera system an active safety resource by adding visual and audible alerts from a PreView® Radar sensor to your in-cab monitor.

**PreView® PRECOLink** – Wirelessly connects your PreView® Radar sensor(s) to your in-cab display, providing versatility and ease of installation for a wide range of applications.

### PreView® Software

**Configuration Tool** – Allows the end user to configure various settings for the Sentry®, Sentry®X, Side Defender®, Side Defender®II, v2 Displays, and CD6102 and SOD displays.

This page left blank intentionally

This page left blank intentionally

**Proudly developed by**



10335 W. Emerald St.

Boise, Idaho 83704

[sensata.com](http://sensata.com)

+1.866.977.7326

**3702008F**