

DEFINING EMI SOLUTIONS SINCE 1987
www.schlegelemi.com

NORTH AMERICA

Schlegel Electronic Materials, Inc.

1600 Lexington Ave
Suite 236A Rochester NY 14606
Tel No: +1 585-643 2000
Fax No: +1 585-427 7216
Email: schlegelemi.na@schlegelemi.com

EUROPE

Schlegel Electronic Materials, bv

Slijpesteenweg 28
8432 Middelkerke (Leffinge)
Belgium
Tel No: +32 59 560 270
Fax No: +32 59 560 271
Email: schlegelbe@schlegelemi.com

ASIA

Schlegel Electronic Materials Asia Limited

Unit 3, 3/F., Block A, New Trade Plaza,
6 On Ping Street, Shatin, N.T., Hong Kong
Tel No: +852-2686 9872
Fax No: +852-2686 9728
Email: schlegelemi@emeigroup.com

Schlegel (Dongguan) Electronics Limited

No. 8 Qiaoxin Road, Qiaotou, Dongguan,
Guangdong, China
Postal Code: 523525
Tel No: +86-769-8356 5686
Fax No: +86-769-8334 5656
Email: schlegelemi@emeigroup.com

Schlegel (Shanghai) Electronics Limited

4/F., 79 Parts, 111 Meisheng Road,
F.T.Z., Pudong, Shanghai, China
Postal Code: 200131
Tel No: +86-21-5868 3383
Fax No: +86-21-5868 3386
Email: schlegelemi@emeigroup.com

Taiwan Schlegel Electronics Limited

No. 99, Alley 3, Lane 182, Section 2 Wenhua Road,
Banqiao District
Postal Code: 22044
Tel No: +886-2-8258 5148
Fax No: +886-2-8258 5149
Email: schlegelemi@emeigroup.com

Fabric Over Foam

Profile Selection Guide

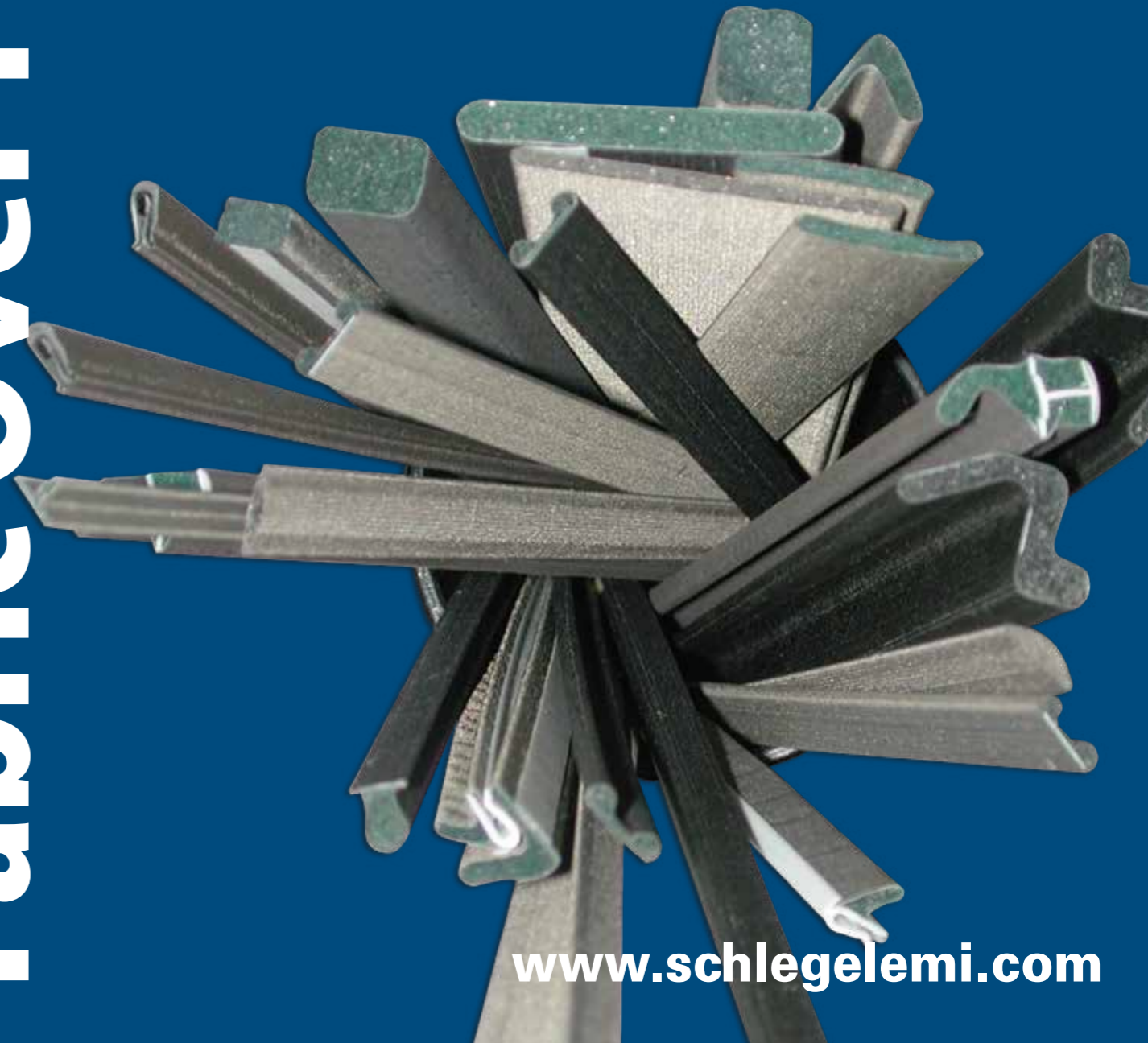
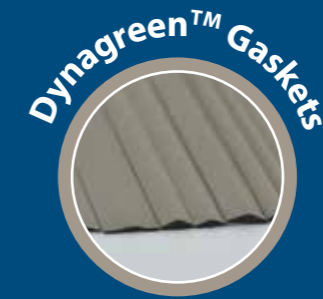

www.schlegelemi.com



As the inventor of conductive fabrics over foam shielding gaskets in 1987, Schlegel Electronic Materials (SEM) has always set the industry standard for highly flexible conductive fabrics. Over 20 years of continuous research and development on substrates, plating process and protective coatings confer today to our conductive fabrics improved shielding effectiveness, excellent environmental durability and abrasion resistance. References on the market, SEM's fabrics are used from grounding pads in consumer products to high frequency shielding gaskets in supercomputers. Fabric Over Foam technology provides continuous contact with applications which ensures consistent shielding efficiency at very high frequencies and is non-abrasive to plated and painted surfaces.

Fabric Over Foam

Reference Guide **1-3**

Conductive Materials Specifications **4**

Conductive Fabric

NiCu-C70 **5**

NiCu-C12 **6**

AgRs-C2 **7**

SnCu-C50 **8**

NiCu-C22 **9**

Characterization of EMI Shielding Gaskets **10-11**

Part Number Guide **12**

Profiles **13-22**

Finishing Information **23-26**

DynaShear/DynaGreen® **27-29**

Fabric Over Silicone EMI Gasket **30-31**

Conductive Foam (CF) **32**

ORS-II **33-34**

Environmental and EMI Hybrid EEH Series **35-38**

Conductive Tapes **39-41**

D-Sub Connectors **42-43**

Applications

Influence of Conductive (D) and Non Conductive (R) Adhesive on Shielding Effectiveness for Fabric Over Foam Gaskets **44**

SEM's Gaskets Attachment Options **45-47**

Clip Profiles Selection Guide **48**

Reference Guide: Cross - Reference Guide to EMI Shielding Gaskets

The listing below is a numerical listing of the fabric over foam profiles. For additional product and / or ordering information, please contact a SEM representative.

Profile	Complex Shape	Dimensions	Page#
E4B	D-Shape	5.08mm x 12.2mm	21
E4C	C-Fold	12.42mm x 15.06mm	22
E4D	Rectangle	5.0mm x 7.6mm	16
E4E	Rectangle	6.6mm x 6.6mm	16
E4F	Rectangle	8.5mm x 8.5mm	16
E4H	D-Shape	2.3mm x 3.8mm	19
E4J	D-Shape	2.74mm x 3.8mm	19
E4K	D-Shape	1.8mm x 6.0mm	18
E4L	D-Shape	1.78mm x 6.35mm	18
E4M	C-Fold	16.5mm x 14.7mm	22
E4N	C-Fold	20.9mm x 14.7mm	22
E4P	T-Shape	3.8mm x 4.8mm	22
E4Q	T-Shape	9.53mm x 4.83mm	22
E4R	T-Shape	6.4mm x 6.9mm	22
E4S	T-Shape	5.7mm x 4.8mm	22
E4T	T-Shape	5.1mm x 6.9mm	22
E4U	Rectangle	2.54mm x 6.6mm	14
E4V	C-Fold	8.79mm x 11.3mm	21
E4W	C-Fold	16.5mm x 14.7mm	22
E4X	Rectangle	6.4mm x 8.3mm	16
E4Y	L-Shape	9.68mm x 24.0mm	18
E5A	C-Fold	19.5mm x 16.6mm	22
E5B	Wedge	5.54mm x 42.9mm	17
E5C	Rectangle	2.0mm x 5.08mm	14
E5G	Rectangle	2.5mm x 12.7 mm	14
E5J	Wedge	5.54mm x 33.4mm	17
E5K	T-Shape	7.0mm x 6.9mm	22
E5M	D-Shape	1.0mm x 2.5mm	18
E5N	T-Shape	7.6mm x 4.8mm	22
E5R	D-Shape	2.03mm x 2.03mm	19
E5S	D-Shape	3.94mm x 6.35mm	20
E5T	Rectangle	5.08mm x 12.7mm	16
E5U	D-Shape	1.5mm x 2.5mm	18
E5V	Rectangle	8.0mm x 10.0mm	16
E5W	D-Shape	2.0mm x 4.6mm	18
E5Y	C-Fold	16.51mm x 14.73mm	22
E6B	Rectangle	7.0mm x 20.0mm	16
E6C	L-Shape	3.3mm x 3.3mm	18
E6G	Rectangle	2.5mm x 6.0mm	14
E6H	Rectangle	1.0mm x 8.0mm	13

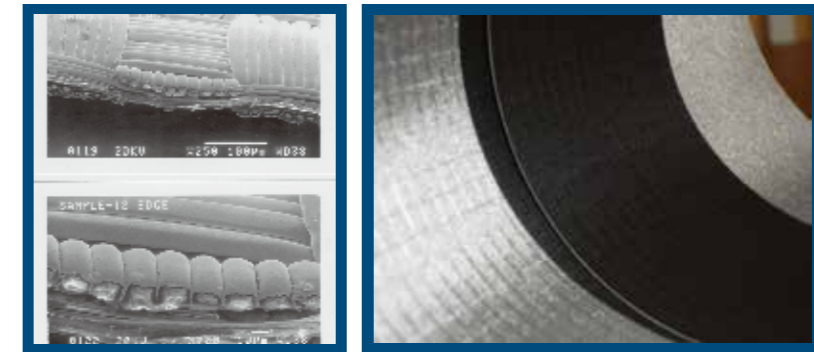

Schlegel Electronic Materials (SEM) has always been on the forefront of fabric over foam technology. And today fabric over foam continues to be at the core of our product lines. We offer a variety of fabrics including:

- 1: NiCu-C22: Nickel-Copper plated polyester ripstop fabric with Schlegel protective top coating.
- 3: NiCu-C70: Nickel-Copper plated polyester ripstop fabric with Schlegel protective top coating.
- 4: NiCu-C12: Nickel-Copper plated polyester plain weave fabric with Schlegel protective top coating.
- 7: SnCu-C50: Tin Copper plated nylon plain weave fabric with Schlegel protective top coating.
- 9: Ag-C2: Silver plated nylon ripstop fabric with Schlegel carbon coating.

	NiCu-C70	NiCu-C12	Ag-C2	SnCu-C50	NiCu-C22
Color	Grey	Grey	Black	Dark Grey	Black
Fabric Type	PET Rip-stop	PET Plain Weave	PA 6 Rip-stop	PA 6 Plain Weave	PET Rip-stop
Top Coating-Basis	Acrylic	Acrylic	Urethane	Acrylic	Urethane
Surface Resistivity	<=0.066 Ω/sq.	<=0.024 Ω/sq.	<=0.5 Ω/sq.	<=0.020 Ω/sq.	<=0.08 Ω/sq.
Shielding Effectiveness (AVG.)	96 dB MIL DTL 83528C	97.4 dB MIL DTL 83528C	95 dB MIL DTL 83528C	95.3 dB MIL DTL 83528C	95.76 dB MIL DTL 83528C
Contact Resistance (@1kg load)	0.11 Ω-inch SEM LP 3001	0.08 Ω-inch SEM LP 3001	< 1.00 Ω-inch SEM LP 3001	0.09 Ω-inch SEM LP 3001	0.2 Ω-inch SEM LP 3001
Abrasion Resistance (cycles)	1,000 ASTM D3884	1,000 ASTM D3884	800 ASTM D3884	1,000 ASTM D3884	1,000 ASTM D3884
Core	All types	All types	All types	All types	All types
Compliances	2015/863/EU (RoHS 2.0)	2015/863/EU (RoHS 2.0)	2015/863/EU (RoHS 2.0)	2015/863/EU (RoHS 2.0)	2015/863/EU (RoHS 2.0)
Galvanic Compatibility (Ni, Tin, Al, Zn)	SAE ARP 1481 classB	SAE ARP 1481 classB	SAE ARP 1481 classB	SAE ARP 1481 classB	SAE ARP 1481 classB

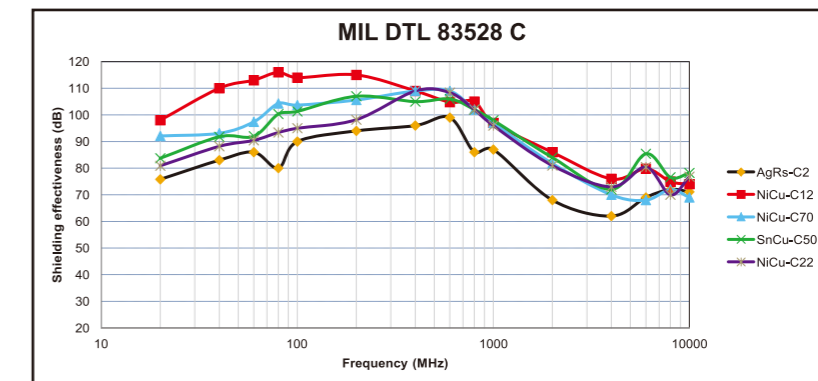

These profiles are also recognized under CSA C (Canada) and IEC 707, ISO 1210, and ISO 9773 Classifications.
* Contact your sales or customer service representative for details, special minimum order quantity may apply.

Schlegel Electronic Materials (SEM) C70 EMI gaskets provide outstanding value and performance for demanding telecommunication, server, and mainframe applications. SEM C70 gaskets are designed with Nickel-Copper cladding. These metals, when plated to our polyester rip-stop fabric, are non-abrasive to plated and painted surfaces, and maintain galvanic compatibility with a wide range of surfaces.



Specifications - Nickel-Copper C70

NiCu C70 gaskets consist of a layer of copper topped by a layer of nickel, plated to a polyester rip-stop fabric and sealed with our exclusive acrylic-based C70 coating. This fabric is non-abrasive to plated and painted surfaces. It is also quite versatile, maintaining galvanic compatibility with a wide range of surfaces. This design allows SEM to meet the design requirements of value-conscious OEMs, with no compromise to performance.

Material Specifications:

Cladding: Nickel/Copper C70 (polyester rip-stop)

Surface Resistivity: $\leq 0.066 \text{ ohm/}\square$ and $\text{CpK} \geq 2.0$

Shielding Effectiveness:

Shielding performance of 1/4" x 3/8" gasket per MIL-G-83528B in frequencies of 20 MHz to 10 GHz: 96dB (average)

Note: Gasket geometry and application determine actual shielding effectiveness

Contact Resistance (SEM LP-3001): 0.11 ohm-inch at 1kg load/inch

Abrasion Resistance (ASTM D3884): No change in surface resistivity: 1,000 cycles

Compliance: 2015/863/EU (RoHS 2.0)

Foam Specifications

All C70 products are constructed with SEM's unsurpassed, industry leading polyurethane foam core technology.

Within the C70 cladding you can select from the following options:

- Standard, highly resilient UL 94-HB recognized foam

- Bromine-free flame retardant UL 94-V0 recognized foam

Compression Set:

The core of SEM shielding gaskets is open-celled polyether polyurethane foam in a high-resiliency (HB) formula. Compression set of foam that is encapsulated is 1% at ambient temperature, and < 5% at 70°C (158°F) when compressed 50% for 22 hours.

Shielding Effectiveness: NiCu-C70 EMI Gaskets

MIL-G-83528B Test Method

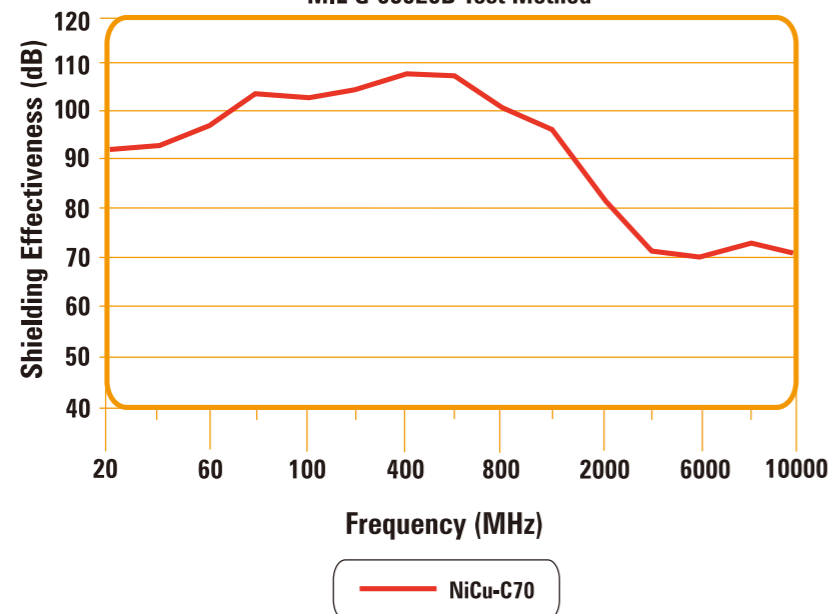

Schlegel Electronic Materials (SEM) C12 EMI gaskets provide premium performance for demanding telecommunication, optical, mainframe, and supercomputer applications. SEM C12 gaskets are designed with Nickel-Copper cladding. SEM C12 cladding resists fracturing, thus providing reliable high-frequency shielding performance. SEM C12 gaskets are designed for high temperature applications and offer superior current-carrying performance for improved ESD and EMP protection.

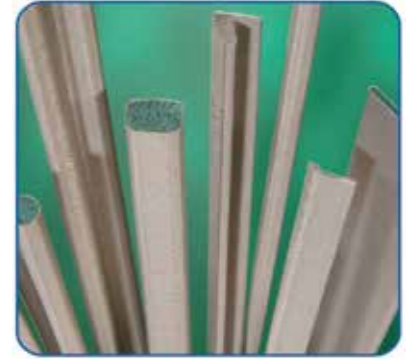

Specifications - Nickel-Copper C12

Nickel-Copper C12 Specifications

SEM's uniquely designed NiCu C12 gaskets are designed to provide maximum shielding effectiveness, environmental durability, and abrasion resistance. C12 cladding is ideal for high-frequency shielding, due to its unique design: copper topped by nickel, plated to a polyester woven substrate. Because they experience significantly less fracturing than other nickel-plated gaskets, SEM C12 gaskets maintain high-frequency performance in situations where shielding above 97 dB is required. The exclusive acrylic-based C12 coating provides improved galvanic compatibility with a wide range of materials.

Material Specifications:

Cladding: Nickel/Copper C12 (polyester plain weave)

Surface Resistivity: $\leq 0.024 \text{ ohm/}\square$ and $\text{CpK} \geq 2.0$

Shielding Effectiveness:

Shielding performance of gasket per SAE ARP 6248 in frequencies of 1 GHz to 40 GHz.

Note: Gasket geometry and application determine actual shielding effectiveness

Contact Resistance (SEM LP-3001): 0.08 ohm-inch at 1 kg load/inch

Abrasion Resistance (ASTM D3884): No change in surface resistivity: 1,000 cycles

Compliance: 2015/863/EU (RoHS 2.0)

Foam Specifications

All C12 products are constructed with SEM's unsurpassed, industry leading polyurethane foam core technology. Within the C12 cladding you can select from the following options:

- Standard, highly resilient UL 94-HB recognized foam

- Bromine-free flame retardant UL 94-V0 recognized foam

Compression Set:

The core of SEM shielding gaskets is open-celled polyether polyurethane foam in a high-resiliency (HB) formula. Compression set of foam that is encapsulated is 1% at ambient temperature, and <5% at 70°C (158°F) when compressed 50% for 22 hours.

Stripline Method -SAE ARP 6248 - AVG.

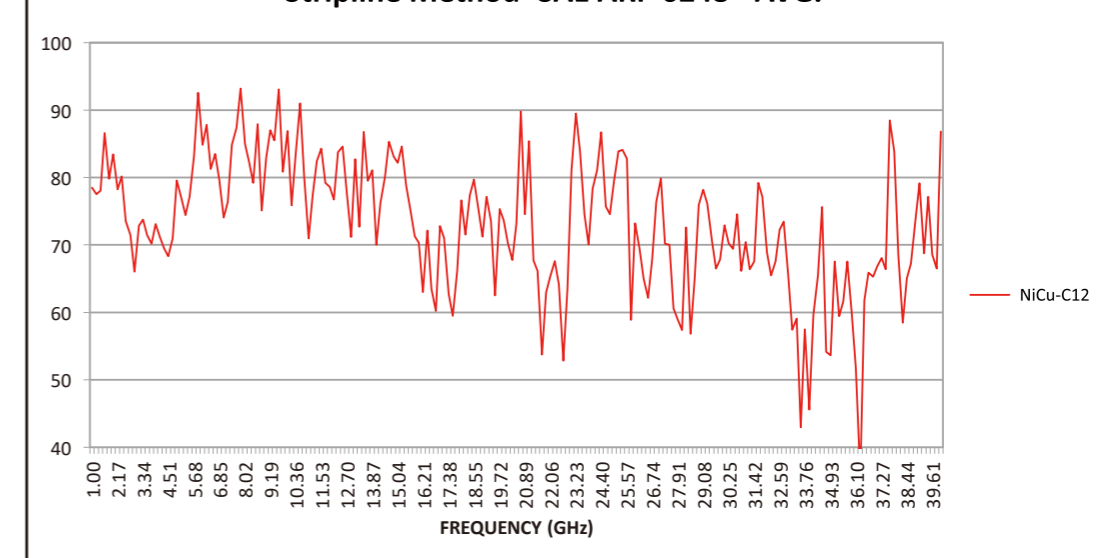

Schlegel Electronic Materials (SEM) invented the first fabric-over-foam gasket in 1987. At that time the very first conductive cladding used was the, now very famous, blackened silver Ripstop fabric AgRs-C2. A silver plated nylon 6/6 fiber woven in a Ripstop fabric with a urethane based anti-corrosion top coating with Schlegel Electronic Materials proprietary fillers formulated to improve abrasion resistance and galvanic compatibility. AgRs-C2 did serve later on as a reference to the all shielding market. This highly flexible conductive fabric is still available today because of its unique characteristics linked to the silver such as high conductivity of silver oxides, anti-bacterial properties for medical applications, and good adhesion properties on PA 6.6.

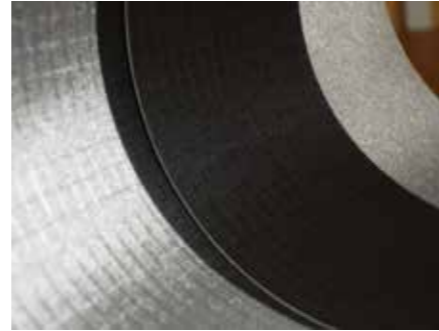

Schlegel Electronic Materials is pro-actively proposing a Halogen Free (IEC61249-2-21) EMI shielding range of products as we believe that these substances will be considered for inclusion in future RoHS legislation .

Schlegel Electronic Materials is also in compliance with the 4 new restricted substances which should be added in annex II of the Directive before 2018 (Flame retardant HBCDD and phthalates DEHP, BBP and DBP).

Technical Specifications

Silver plated woven Nylon 6/6, 30 denier Light Ripstop fabric.

Nominal fabric thickness: 0.003 in.

Top coat: urethane based anti-corrosion coating with Schlegel Electronic Materials, Inc. proprietary fillers.

Nominal thickness of C2 coating is .25 oz/yd²

Material Specifications:

Cladding: Silver C2 (PA66, Ripstop)

Surface Resistivity: $\leq 0.5 \text{ ohm}/\square$ and $CpK \geq 2.0$

Shielding Effectiveness:

Shielding performance of 1/4" x 3/8" gasket per MIL-G-83528 F in frequencies of 20 MHz to 10 GHz: 95 dB avg.

– See graph here below

Note: Gasket geometry and application determine actual shielding effectiveness

Contact Resistance (SEM LP-3001): < 1.0 ohms-inch at 1 Kg load/inch

Abrasion Resistance (ASTM D3886): No change in surface resistivity: 800 cycles

Compliance: 2015/863/EU (RoHS 2.0)

Foam Specifications

All C2 products are constructed with SEM's unsurpassed, industry leading polyurethane foam core technology.

Within the C2 cladding you can select from the following options:

- Standard, highly resilient UL 94-HB recognized foam

- UL 94-V0 recognized foams

Compression Set:

The core of SEM shielding gaskets is open-celled polyether polyurethane foam in a high-resiliency (HB) formula.

Compression set of foam that is encapsulated is 1% at ambient temperature, and <5% at 70°C (158°F) when compressed 50% for 22 hours.

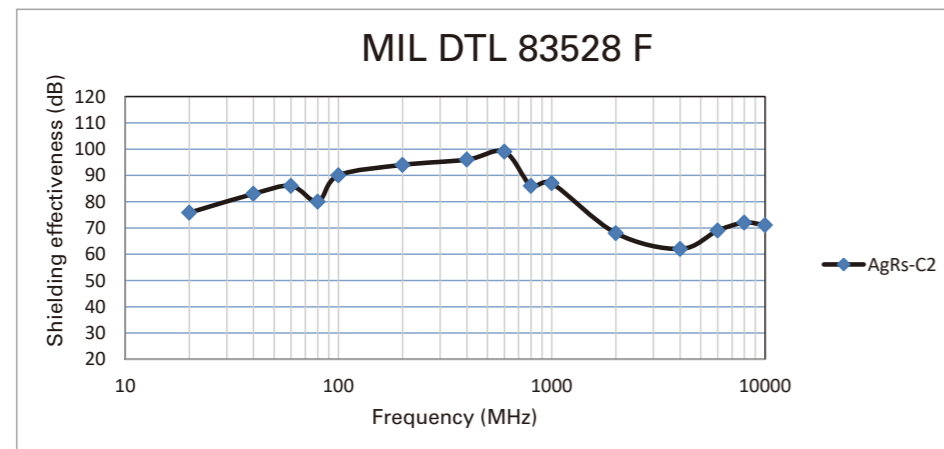

Schlegel Electronic Materials (SEM) SnCu-C50 EMI Gaskets provide excellent performance for outdoor cabinet applications. SEM SnCu-C50 gaskets are designed with Tin-Copper cladding over woven fabric. This provides good galvanic compatibility for most common frame materials. This also yields one of the lowest surface resistances available.

Schlegel Electronic Materials SnCu-C50 fabric is available in a variety of outdoor cabinet sealing shapes over closed cell foam cores including EPDM and Poron.

Rectangular shapes are available utilizing SnCu-C50 fabric and Poron cores.

SnCu-C50 is also available over our type 7 open cell foam with UL94-V0 rating in D shapes.

Specifications - SnCu-C50

Tin-Copper SnCu-C50 Specifications

SEM's SnCu-C50 gaskets are designed to provide improved

galvanic compatibility with outdoor cabinet applications while maintaining maximum shielding effectiveness.

Material Specifications:

Cladding : Tin/Copper with C50 acrylic coating (polyester plain weave)

Surface Resistivity: 0.016 ohm/ \square

Shielding Effectiveness:

Shielding performance of 1/4" x 3/8" gasket per MIL-Dtl-83528C, frequency of 20MHz to 10 GHz: 95.3 dB (average)

Note: Gasket geometry and application determine actual shielding effectiveness.

Contact Resistance (SEM LP-3001): 0.09 ohm-inch at 1 Kg load/inch

Abrasion Resistance (ASTM D3884): No change resistivity: 1,000 cycles

Compliance: 2015/863/EU (RoHS 2.0)

Color Variation:

A tin oxy-hydroxide passive layer is formed on the top of the metal which may induce light color variations in time. This layer provides a more effective corrosion protection than nickel and doesn't affect the electrical characteristics of the fabric.

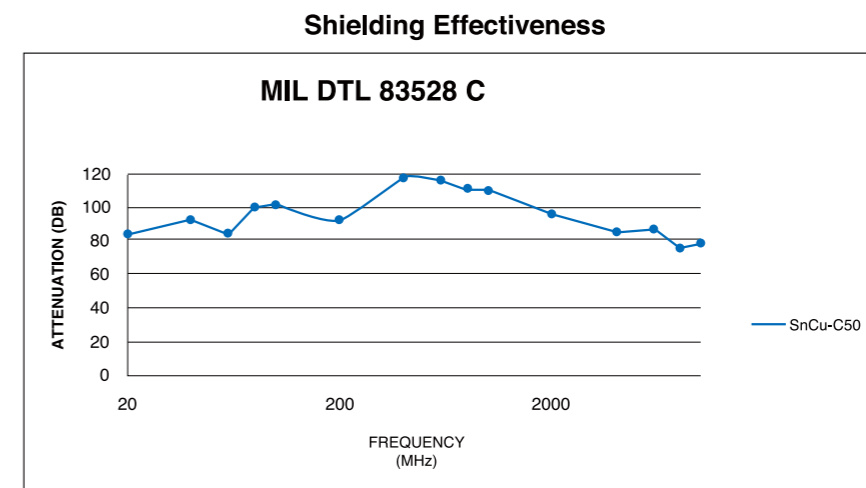

NiCu-C22: REVITALIZING THE PAST!

Schlegel Electronic Materials (SEM) invented the first Fabric-Over-Foam gasket in 1987. At that time, the first conductive cladding used was the now famous blackened Silver Rip-Stop fabric AgRs-C2. AgRs-C2 would later serve as a reference for the entire shielding market. This highly flexible conductive fabric is still available today with unique characteristics linked to the silver.



After 25 years of continuous research and development in the efficiency of flexible substrates and coatings, Schlegel Electronic Materials is now proud to complete its offering of blackened EMI shielding gaskets with the introduction of its new cost-effective NiCu-C22 fabric. While NiCu-C22 is visually inspired by its silver-made precursor, the new materials utilized for its construction feature low surface resistivity, high abrasion resistance and enhanced shielding effectiveness. NiCu-C22 is available with most of SEM's profiles and foams.

Nickel-Copper NiCu-C22 Specifications

Material:

Cladding: Ni/Cu with urethane coating (Polyester Ripstop Fabric)

Shielding Effectiveness:

Shielding Performance of 1/4" x 3/8" gasket per MIL-Dtl-83528C, frequency of 20MHz to 10GHz: 95.76 dB (average)
Note: Gasket geometry and application determine actual shielding effectiveness

Surface Resistivity: $\leq 0.08 \text{ ohm}/\blacksquare$

Contact Resistance (SEM LP-3001): $\leq 0.2 \text{ ohm-inch}$ at 1 Kg load/inch

Abrasion Resistance (ASTM D3884): No change resistivity after 1,000 cycles

Compliance: 2015/863/EU (RoHS 2.0)

Galvanic Compatibility (Ni,Sn,Al,Zn): SAE ARP 1481 Class B

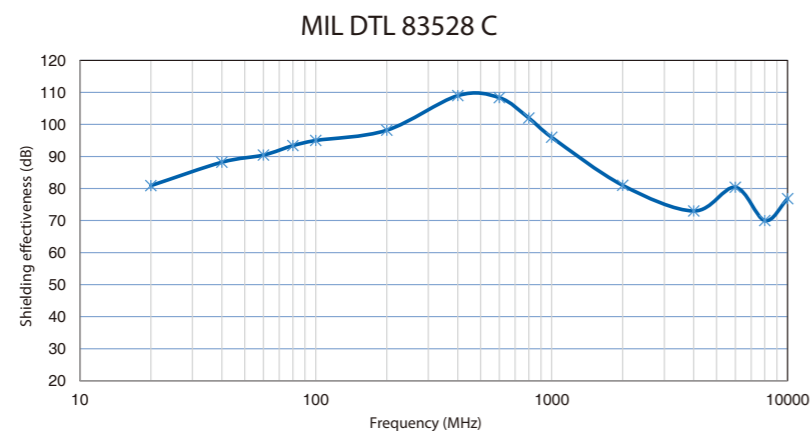

Schlegel Electronic Materials (SEM) is an active member of the IEEE P1302 Committee. This working group is in charge of the review of the methods to characterize Conductive gasket from DC to 40 GHz. Hereafter is a brief description of the main methods in use at SEM.

Mil DTL 83528 C.

This aperture attenuation method derived from the former Mil Std 285/IEEE 299 characterizes the shielding effectiveness (SE) of the gasket from 20 MHz to 10 GHz. The test set-up consist of a shielded room with an opening of 610/610 mm (24"/24") with one emitting antenna outside and a receiving antenna inside the room and two meters distance between antennas.

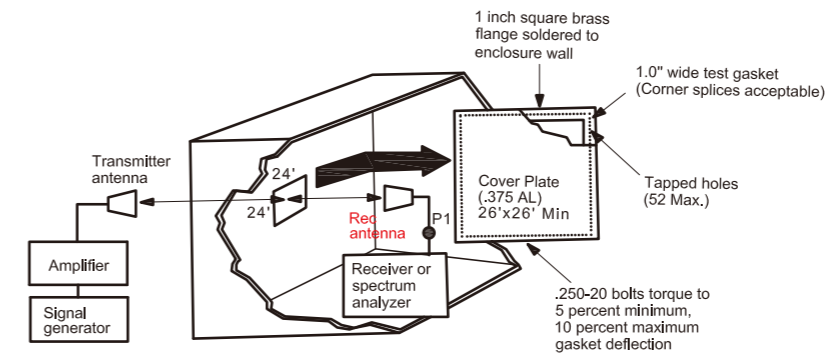

A first measurement is made from one antenna to the other through the opening and a second is made when the opening is closed by means of a metal plate with the gasket to be tested mounted around and compressed. The method measures the field before and after the metal / gasket and the shielding effectiveness of the gasket is: $20 \log E1/E2$ (H1/H2) or the difference between both measurements in dB from 20 MHz to 10 GHz. Measurements according to Mil DTL 83528C can be compared and especially if testing are carried out by an independent laboratory. The specification requires a minimum of 5 measurements per decade and SEM provide in its technical documentation the average value of the 15 measurements.

TEM-T and Ht cells

For the measurement of Shielding Effectiveness for small size gaskets, SEM is using TEM-T and Ht Cells. This is a non-standardized test method described in IEEE Std 1302 and used in R&D because of its good repeatability (1-3 dB). TEM-t is a TEM mode transmission line device simulating far field conditions. The square coaxial fixture of the TEM-t is cut in the middle so that a gasket holder compressing the gasket under test can be inserted between the two halves of the measuring equipment. The H-t cell is made by a set of two small loop antennas simulating the magnetic near field.

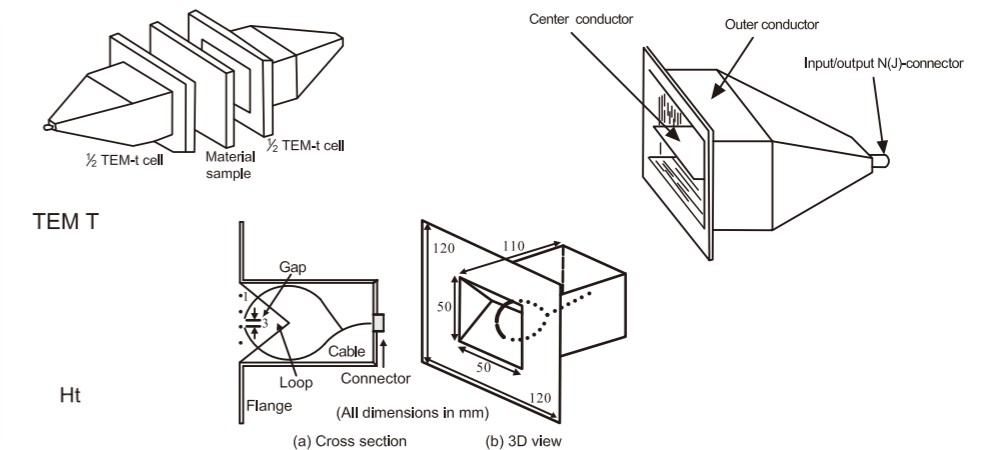

STRIPLINE METHOD (0.1-40 GHz)

Schlegel Electronic Materials (SEM), in partnership with the KULab REMI research group of the KULeuven (University of Leuven-Belgium), developed a new testing fixture to characterize the shielding effectiveness of conductive gaskets up to 40 GHz. The principle of this fixture is based on a method that was first introduced by Prof. B. Koerber to measure the radiated emission and susceptibility of Integrated Circuits (IEC 61967-8 and IEC 62132-8). The method utilizes a stripline antenna which closes over a PC-Board.

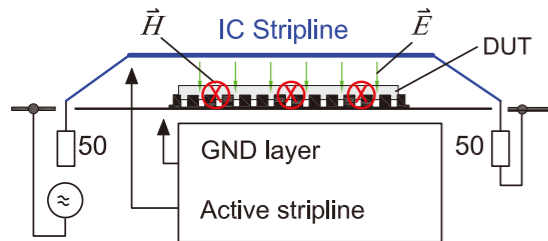

Stripline Fixture

In the new stripline fixture, the PC board with the IC under test is replaced by a small microstrip antenna embedded into a cavity within the ground plane. The cavity can be closed by means of a thick plate which compresses the gasket under test. A stripline antenna covers the set-up.

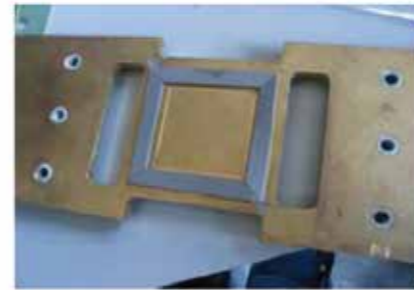
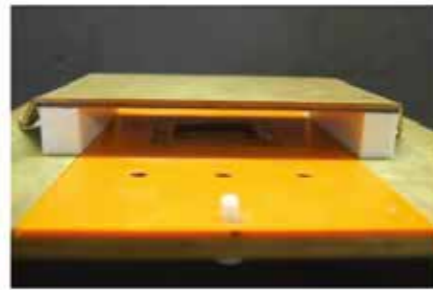
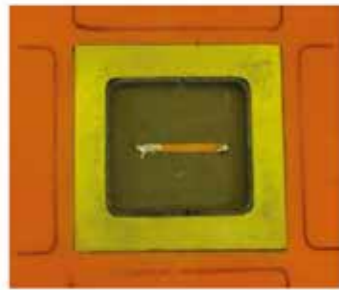

The testing procedure similar to IEEE 299 is as follows:

- a direct measurement from microstrip to stripline (signal before the shield).
- measurement of the closed cavity with the gasket under test (signal after the shield).
- Difference between both measurements in dB is the Shielding Effectiveness of the gasket .

The test method has been supported by a standard from SAE (Society of Automotive and Aerospace Engineers) under the reference SAE ARP 6248.

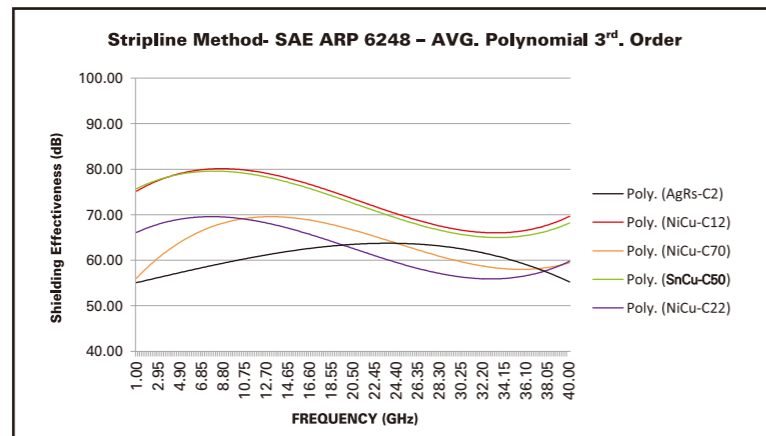

Part Number Guide

E = EMI Shielding

PROFILE SHAPE

FOAM TYPE

- 1 = UL 94 - HB recognized (*)
- 5 = Bromine free, UL 94 - V0 recognized (*)
- 7 = Ultra Soft Foam, UL 94 - V0 recognized (*)
- 9 = Closed Cell Polyurethane Foam UL 94 - HB recognized (*)
- S = High Temperature Resistance Halogen free (IEC 61249-2-21) Silicone Foam, UL 94 - V0 recognized (*)

CONDUCTIVE FABRIC CLADDINGS

- 1 = C22 Nickel / Copper Fabric, Black Color
- 3 = C70 Nickel / Copper Fabric
- 4 = C12 Nickel / Copper Fabric, Best in Shielding
- 7 = C50 Tin / Copper Fabric, Special Galvanic Compatibility
- 9 = C2 Silver Fabric

FINISHING / ATTACHMENT SYSTEM

- = No Pressure Sensitive Adhesive (PSA)
- R = High Shearing Strength Tape
- H = High Temperature Resistance Tape
- Z = Wide Release Liner Tape
- J = Rivets Mount
- E = Die Cut
- K = Kiss Cut + PSA
- 2Z / 2R = 2 rows of PSA on the bottom side (If specifying 2Z or 2R, drop the first digit of the length field. i.e. 2R4800)

- T = PSA
- W = Wide PSA
- N = Narrow PSA
- C = PSA in Center
- P = PSA on Inside Leg
- A = PSA on Adjacent Side
- B = PSA on Backside
- L = PSA on Lead Edge or Opposite Seam Side
- D = Conductive Adhesive (SEM recommends direct fabric contact over conductive adhesive.)

LENGTH IN INCHES

(all 0's if continuous)

- Examples: 04800 cut-to-length 48.00" [1219.2mm]
- 00138 cut-to-length 1.38" [35.1mm]
- 00152 cut-to-length 1.52" [38.6mm]

Some foam and fabric options may not be available with certain profiles. Please consult your SEM representative for details.

UL is a registered trademark of Underwriters Laboratories, Inc. UL tests are under the component program of Underwriters Laboratories, Inc. in specified claddings and thickness.

*Flame Rating UL 94 - V0, UL 94 - HB is a characteristic of the complete gasket; the foam component is not tested separately.

We may modify our Part No. structure for special custom made parts.

The preceding information is believed accurate by SEM. In no event, however, shall SEM have any liability whatsoever for inaccuracies or omissions contained therein. In all cases, details and values should be verified by the customer. These products are covered by various U.S. and foreign patents.

HF



































Halogen free, IEC 61249-2-21, part number ends with HF. Non-halogen free part number ends without HF. (HF, option is recommended.)

Think SEM For Shielding.



































www.schlegelemi.com

© Schlegel Electronic Materials, Inc.

Rectangle	E83	E59	ES1	E88	E91	Rectangle
	 0.5mm x 4.0mm .020" x .157"	 0.5mm x 5.0mm .020" x .197"	 0.5mm x 6.0mm .020" x .236"	 0.5mm x 7.0mm .020" x .276"	 0.5mm x 10.0mm .020" x .394"	
Rectangle	EU1	ES2	ET8	EW5	E1B	Rectangle
	 0.5mm x 15.0mm .020" x .591"	 0.5mm x 17.0mm .020" x .669"	 0.5mm x 22.5mm .020" x .886"	 0.7mm x 7.0mm .028" x .276"	 0.8mm x 6.0mm .031" x .236"	
Rectangle	E37	E03	E12	E06	E6H	Rectangle
	 1.0mm x 3.0mm .039" x .118"	 1.0mm x 4.0mm .039" x .157"	 1.0mm x 5.0mm .039" x .197"	 1.0mm x 7.0mm .039" x .276"	 1.0mm x 8.0mm .039" x .315"	
Rectangle	E11	ET3	E99	ET4	EJ6[†]	Rectangle
	 1.0mm x 10.0mm .039" x .394"	 1.0mm x 11.0mm .039" x .433"	 1.0mm x 13.0mm .039" x .512"	 1.0mm x 13.6mm .039" x .535"	 1.0mm x 15.0mm .039" x .591"	
Rectangle	ET5	E39	E2C	E2E	EX3	Rectangle
	 1.0mm x 16.0mm .039" x .630"	 1.0mm x 18.0mm .039" x .710"	 1.0mm x 19.05mm .039" x .750"	 1.0mm x 21.84mm .039" x .860"	 1.0mm x 22.8mm .039" x .898"	
Rectangle	E1K	E29	EC5[†]		E97[†]	Rectangle
	 1.0mm x 22.9mm .039" x .902"	 1.0mm x 25.4mm .039" x 1.000"	 1.0mm x 41.3mm .039" x 1.627"		 1.2mm x 8.0mm .049" x .315"	
Rectangle	EW6	ER3	EN6	ED9	E61	Rectangle
	 1.3mm x 2.3mm .051" x .090"	 1.5mm x 3.18mm .059" x .125"	 1.5mm x 3.8mm .059" x .150"	 1.5mm x 5.0mm .059" x .197"	 1.5mm x 7.0mm .059" x .275"	

















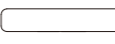

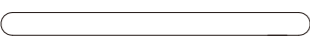
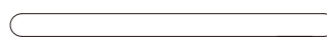



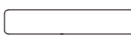
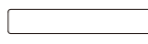

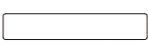
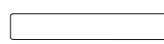

† Contact your sales or customer service representative for details, special minimum order quantity may apply.

Rectangle	EG2	EB5	ET7	E1M	EW4	Rectangle
	 1.5mm x 10.0mm .059" x .390"	 1.5mm x 14.0mm .059" x .551"	 1.5mm x 16.2mm .059" x .638"	 1.5mm x 19.1mm .059" x .752"	 1.5mm x 25.4mm .059" x 1.000"	
Rectangle	EA8[†]	E3L	EU2	EU4	E81	Rectangle
	 1.5mm x 27.0mm .059" x 1.063"	 1.78mm x 6.35mm .070" x .250"	 2.0mm x 2.5mm .079" x .098"	 2.0mm x 3.0mm .079" x .118"	 2.0mm x 4.0mm .079" x .157"	
Rectangle	E5C	EW9	E77	EC7[†]	E2N	Rectangle
	 2.0mm x 5.08mm .079" x .200"	 2.0mm x 6.0mm .079" x .236"	 2.0mm x 7.0mm .079" x .275"	 2.0mm x 7.5mm .079" x .295"	 2.0mm x 8.0mm .079" x .315"	
Rectangle	E08	E24	E2L	ED3	EN8	Rectangle
	 2.0mm x 10.0mm .079" x .394"	 2.0mm x 12.7mm .079" x .500"	 2.0mm x 15.3mm .079" x .602"	 2.0mm x 17.5mm .079" x .689"	 2.0mm x 18.0mm .079" x .710"	
Rectangle	EG7[†]	E58	EH4[†]	E09[†]		Rectangle
	 2.0mm x 19.0mm .079" x .750"	 2.0mm x 21.0mm .079" x .827"	 2.0mm x 22.0mm .079" x .866"	 2.0mm x 28.6mm .079" x 1.125"		
Rectangle	E07[†]		E30[†]		E2D	Rectangle
	 2.0mm x 41.3mm .079" x 1.625"		 2.0mm x 60.0mm .079" x 2.362"		 2.3mm x 19.05mm .091" x .750"	
Rectangle	E2F	E6G	ER6	E5G	E4U	Rectangle
	 2.3mm x 21.84mm .091" x .860"	 2.5mm x 6.0mm .098" x .236"	 2.5mm x 9.5mm .098" x .374"	 2.5mm x 12.7mm .098" x .500"	 2.54mm x 6.6mm .100" x .260"	

















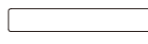











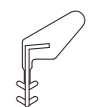

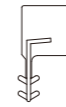

† Contact your sales or customer service representative for details, special minimum order quantity may apply.

Profiles

Profiles

Rectangle	EU5	E18	E01	EM8[†]	ES5	Rectangle
	 3.0mm x 2.0mm .118" x .079"	 3.0mm x 3.0mm .118" x .118"	 3.0mm x 4.0mm .118" x .157"	 3.0mm x 5.0mm .118" x .197"	 3.0mm x 7.0mm .118" x .275"	
Rectangle	EW8	E1Q	ES6	E44[†]		Rectangle
	 3.0mm x 9.0mm .118" x .354"	 3.0mm x 10.0mm .118" x .394"	 3.0mm x 16.0mm .118" x .630"	 3.0mm x 25.4mm .118" x 1.000"		
Rectangle	EC6[†]		ED5[†]		E70	Rectangle
	 3.0mm x 40.9mm .118" x 1.610"		 3.0mm x 43.0mm .118" x 1.693"		 3.2mm x 6.4mm .125" x .250"	
Rectangle	E62	E28	EM7[†]	EN9[†]	EM9[†]	Rectangle
	 3.2mm x 9.5mm .125" x .375"	 3.2mm x 12.7mm .125" x .500"	 3.2mm x 17.5mm .125" x .689"	 3.2mm x 19.0mm .125" x .750"	 3.2mm x 20.2mm .125" x .794"	
Rectangle	E74	E2G	E2J	E1J	E2B	Rectangle
	 3.3mm x 4.8mm .130" x .190"	 3.4mm x 19.05mm .134" x .750"	 3.4mm x 21.84mm .134" x .860"	 3.5mm x 3.5mm .138" x .138"	 3.5mm x 5.0mm .138" x .197"	
Rectangle	E3E	E65	EB4	EW2	EP6	Rectangle
	 3.5mm x 7.0mm .138" x .276"	 3.7mm x 21.0mm .146" x .827"	 4.0mm x 4.0mm .157" x .157"	 4.0mm x 6.0mm .157" x .236"	 4.0mm x 8.0mm .157" x .315"	
Rectangle	EN1[†]	E78	E47[†]		EN2	Rectangle
	 4.0mm x 10.0mm .157" x .394"	 4.0mm x 15.0mm .157" x .591"	 4.6mm x 41.3mm .180" x 1.625"		 5.0mm x 5.5mm .197" x .217"	

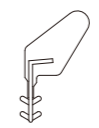









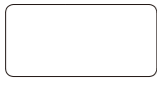





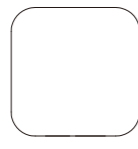
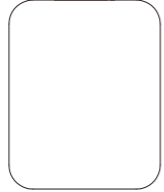

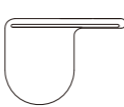
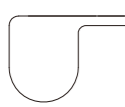



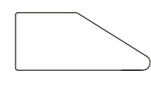
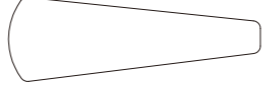





[†] Contact your sales or customer service representative for details, special minimum order quantity may apply.

Rectangle	E4D	E73	EJ7	ER7	ES7	Rectangle
	 5.0mm x 7.6mm .197" x .300"	 5.0mm x 8.0mm .197" x .315"	 5.0mm x 9.0mm .197" x .354"	 5.0mm x 10.0mm .197" x .394"	 5.0mm x 12.0mm .197" x .472"	
Rectangle	EP2	E2H	E2K	E5T	E14	Rectangle
	 5.0mm x 14.5mm .197" x .571"	 5.0mm x 19.05mm .197" x .750"	 5.0mm x 21.84mm .197" x .860"	 5.08mm x 12.7mm .200" x .500"	 5.1mm x 5.1mm .200" x .200"	
Rectangle	EP8	EN3	E79	EN4	EJ4	Rectangle
	 5.1mm x 6.4mm .200" x .250"	 5.5mm x 10.0mm .217" x .394"	 6.0mm x 6.0mm .236" x .236"	 6.0mm x 6.5mm .236" x .256"	 6.0mm x 8.0mm .236" x .315"	
Rectangle	ES8	ES9	ET1	E3A	E4X	Rectangle
	 6.0mm x 25.4mm .236" x 1.000"	 6.2mm x 22.0mm .244" x .866"	 6.2mm x 28.5mm .244" x 1.122"	 6.35mm x 6.35mm .250" x .250"	 6.4mm x 8.3mm .252" x .327"	
Rectangle	E66	E25	EG9[†]		EN5	Rectangle
	 6.4mm x 9.5mm .250" x .375"	 6.4mm x 12.7mm .250" x .500"	 6.4mm x 41.3mm .250" x 1.625"		 6.5mm x 10.0mm .256" x .394"	
Rectangle	EP3	E4E	EP9[†]	E6B	E05[†]	Rectangle
	 6.5mm x 14.5mm .256" x .571"	 6.6mm x 6.6mm .260" x .260"	 7.0mm x 7.0mm .275" x .275"	 7.0mm x 20.0mm .276" x .787"	 7.5mm x 15.0mm .295" x .591"	
Rectangle	EG8	E5V	E4F	E63	E68	Rectangle
	 8.0mm x 8.0mm .315" x .315"	 8.0mm x 10.0mm .315" x .394"	 8.5mm x 8.5mm .335" x .335"	 9.5mm x 9.5mm .375" x .375"	 9.5mm x 12.7mm .375" x .500"	



































[†] Contact your sales or customer service representative for details, special minimum order quantity may apply.

Profiles

Profiles

Rectangle	E84[†]  9.5mm x 20.0mm .375" x .787"	E20[†]  9.5mm x 25.4mm .375" x 1.000"	EP5  10.0mm x 10.0mm .394" x .394"	E80  11.5mm x 10.5mm .453" x .414"	EW7  12.7mm x 12.7mm .500" x .500"	Rectangle
	E75[†]  15.9mm x 25.4mm .625" x 1.000"	E49[†]  17.0mm x 17.0mm .669" x .669"	E36[†]  25.0mm x 20.0mm .984" x .787"	E60  3.3mm x 13.2mm .130" x .520"	EA7[†]  11.4mm x 16.0mm .448" x .630"	
EQ4  11.4mm x 16.0mm .448" x .630"	E52[†]  4.0mm x 8.2mm .157" x .324"	E5J  5.54mm x 33.4mm .218" x 1.315"			Wedge	
E5B  5.54mm x 42.9mm .218" x 1.689"		EX8  7.6mm x 17.8mm .299" x .701"	UC301612[†]  11.1mm x 33.3mm .436" x 1.313"			
ER1  1.0mm x 7.0mm .039" x .276"	E96  2.7mm x 8.0mm .106" x .315"	E67  2.7mm x 11.3mm .106" x .445"	EH6[†]  2.7mm x 11.3mm .106" x .445"	E31  2.7mm x 11.3mm .106" x .445"	Knife-Edge	
EV9  2.7mm x 17.5mm .106" x .689"	E1P  3.0mm x 16.5mm .118" x .650"	ER2  5.5mm x 10.0mm .217" x .394"	E19[†]  6.4mm x 19.1mm .250" x .750"	E3S  6.4mm x 19.1mm .250" x .750"		
E93[†]  3.05mm x 8.4mm .120" x .330"	EB9  3.7mm x 6.5mm .145" x .256"	E3M  4.15mm x 7.3mm .163" x .287"	E27[†]  16.2mm x 5.8mm .638" x .230"	E86[†]  18.8mm x 9.7mm .740" x .380"	Self-Mounting	



































[†] Contact your sales or customer service representative for details, special minimum order quantity may apply.

Bell-shape	E1H  1.8mm x 4.6mm .071" x .181"	EU7  2.5mm x 7.6mm .098" x .300"	E3F  2.54mm x 10.0mm .100" x .394"	ET2  3.0mm x 8.0mm .118" x .315"	E1R  3.0mm x 10.1mm .118" x .398"	Bell-shape
	E1U  3.0mm x 15.0mm .118" x .591"	E3G  3.05mm x 10.2mm .120" x .402"	E3H  3.6mm x 12.7mm .142" x .500"	E1T  4.0mm x 15.0mm .157" x .591"	ER8  5.5mm x 15.0mm .217" x .591"	
L-Shape	E6C  3.3mm x 3.3mm .130" x .130"	E1C[†]  3.3mm x 5.3mm .130" x .209"	ED2[†]  5.0mm x 8.5mm .197" x .335"	E3P  5.3mm x 5.3mm .209" x .209"	E13[†]  5.5mm x 12.0mm .217" x .472"	L-Shape
	E4Y  9.68mm x 24.0mm .381" x .945"	E5M  1.0mm x 2.5mm .039" x .098"	EW1  1.0mm x 3.8mm .039" x .150"	E1V  1.2mm x 10.0mm .047" x .394"	E5U  1.5mm x 2.5mm .059" x .098"	
D-Shape	E1W  1.3mm x 3.6mm .051" x .142"	E17  1.5mm x 3.8mm .060" x .150"	EY3  1.5mm x 6.0mm .059" x .236"	ET6  1.5mm x 6.4mm .059" x .250"	EY4  1.5mm x 8.0mm .059" x .315"	D-Shape
	EY5  1.5mm x 10.0mm .059" x .394"	EY2  1.5mm x 12.7mm .059" x .500"	EY6  1.5mm x 17.0mm .059" x .669"	E4L  1.78mm x 6.35mm .070" x .250"	EG6[†]  1.8mm x 4.6mm .070" x .180"	
D-Shape	E1F  1.8mm x 4.6mm .071" x .181"	E4K  1.8mm x 6.0mm .071" x .236"	E1Y  2.0mm x 4.0mm .079" x .157"	E5W  2.0mm x 4.6mm .079" x .181"	EK9  2.0mm x 6.0mm .078" x .236"	D-Shape

































[†] Contact your sales or customer service representative for details, special minimum order quantity may apply.

Profiles

Profiles

D-Shape	ES3	EV3	EJ8	EK4	ED7	D-Shape
						
	2.0mm x 6.0mm .079" x .236"	2.0mm x 8.0mm .079" x .315"	2.0mm x 10.0mm .079" x .394"	2.0mm x 12.7mm .079" x .500"	2.0mm x 12.7mm .080" x .500"	
	EY7	E51	EH2	E5R	E57	
						
2.0mm x 17.0mm .079" x .669"	2.0mm x 17.1mm .080" x .675"	2.0mm x 17.2mm .080" x .675"	2.03mm x 2.03mm .080" x .080"	2.3mm x 2.3mm .090" x .090"		
E4H	E45	EQ6	EP1	EJ9	D-Shape	
						
2.3mm x 3.8mm .090" x .150"	2.3mm x 3.9mm .090" x .155"	2.3mm x 6.0mm .090" x .236"	2.3mm x 8.0mm .090" x .315"	2.3mm x 10.0mm .090" x .394"		
EK5	EV8	ES4	ET9	EX6		
						
2.3mm x 12.7mm .090" x .500"	2.3mm x 17.1mm .091" x .673"	2.5mm x 6.4mm .100" x .250"	2.5mm x 7.6mm .100" x .300"	2.5mm x 10.0mm .100" x .394"		
EQ7	EU8	EK1	EK6	EY8	D-Shape	
						
2.7mm x 6.0mm .106" x .236"	2.7mm x 8.0mm .106" x .315"	2.7mm x 10.0mm .106" x .394"	2.7mm x 12.7mm .106" x .500"	2.7mm x 17.0mm .106" x .669"		
E4J	E87	EY1	E2S	E2M		
						
2.74mm x 3.8mm .108" x .150"	2.8mm x 9.7mm .110" x .380"	2.9mm x 2.7mm .114" x .106"	3.0mm x 6.0mm .118" x .236"	3.0mm x 8.0mm .118" x .315"		
E2T	E2P	ER9	E2U	E2V	D-Shape	
						
3.0mm x 8.0mm .118" x .315"	3.0mm x 10.0mm .118" x .394"	3.0mm x 12.7mm .118" x .500"	3.0mm x 12.7mm .118" x .500"	3.0mm x 17.0mm .118" x .669"		

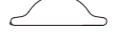

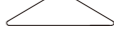
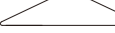































♦ Contact your sales or customer service representative for details, special minimum order quantity may apply.

D-Shape	EA3	EA1	E26	EX7	EJ5	D-Shape
						
	3.1mm x 3.8mm .120" x .150"	3.1mm x 6.4mm .120" x .250"	3.1mm x 9.1mm .120" x .360"	3.1mm x 12.7mm .122" x .500"	3.18mm x 12.7mm .125" x .500"	
	EV1	EQ8	EV6	EK2	EK7	
						
3.3mm x 4.8mm .130" x .189"	3.3mm x 6.0mm .130" x .236"	3.3mm x 8.0mm .130" x .315"	3.3mm x 10.0mm .130" x .394"	3.3mm x 12.7mm .130" x .500"		
EY9	E2W	E2X	EM6	E2R	D-Shape	
						
3.3mm x 17.0mm .130" x .669"	3.5mm x 6.0mm .138" x .236"	3.5mm x 8.0mm .138" x .315"	3.5mm x 9.5mm .140" x .375"	3.5mm x 10.0mm .138" x .394"		
E2Y	E3B	E90	EG4	EQ9		
						
3.5mm x 12.7mm .138" x .500"	3.5mm x 17.0mm .138" x .669"	3.6mm x 6.4mm .140" x .250"	3.8mm x 3.8mm .150" x .150"	3.8mm x 6.0mm .149" x .236"		
EV7	EK3	EK8	E1A	E5S	D-Shape	
						
3.8mm x 8.0mm .150" x .315"	3.8mm x 10.0mm .150" x .394"	3.8mm x 12.7mm .150" x .500"	3.8mm x 17.0mm .149" x .669"	3.94mm x 6.35mm .155" x .250"		
E4A	EA5	E35	E43[†]	E1D		
						
4.0mm x 3.8mm .157" x .150"	4.0mm x 6.0mm .156" x .236"	4.0mm x 7.4mm .156" x .292"	4.0mm x 7.4mm .156" x .292"	4.0mm x 11.0mm .157" x .433"		
EH1	EH7	E3C	EX5	E1E	D-Shape	
						
4.0mm x 12.7mm .157" x .500"	4.0mm x 12.7mm .157" x .500"	4.06mm x 14.22mm .160" x .560"	4.1mm x 14.2mm .161" x .559"	4.1mm x 18.3mm .161" x .720"		



































♦ Contact your sales or customer service representative for details, special minimum order quantity may apply.

Profiles

Profiles

D-Shape	E3Q	E2A	EM5	EM3[†]	E1N	D-Shape
						
	4.3mm x 6.0mm .169" x .236"	4.3mm x 6.4mm .169" x .252"	4.3mm x 9.7mm .170" x .380"	4.3mm x 12.7mm .169" x .500"	4.5mm x 10.0mm .177" x .394"	
	EV2	E64[†]	EB1[†]	E04	EC9	
						
4.6mm x 10.2mm .181" x .402"	4.7mm x 12.2mm .185" x .480"	4.7mm x 12.2mm .185" x .480"	4.8mm x 7.6mm .189" x .300"	5.0mm x 17.2mm .197" x .675"		
ER4	E4B	E3D	EM2[†]	EJ1	C-Fold	
						
5.08mm x 6.35mm .200" x .250"	5.08mm x 12.2mm .200" x .480"	5.25mm x 17.15mm .207" x .675"	5.25mm x 17.2mm .207" x .675"	5.5mm x 12.7mm .217" x .500"		
EW3	E1G	EU9	E10	ER5		
						
5.8mm x 12.7mm .228" x .500"	6.0mm x 17.0mm .236" x .669"	6.4mm x 6.4mm .252" x .252"	6.4mm x 9.5mm .250" x .375"	7.6mm x 6.9mm .299" x .272"		
EP4	EH5	EX4	E56[†]	E21	C-Fold	
						
8.5mm x 10.0mm .335" x .394"	9.53mm x 12.7mm .375" x .500"	12.7mm x 12.7mm .500" x .500"	6.1mm x 7.4mm .240" x .292"	6.4mm x 5.9mm .250" x .234"		
EC3	EH3	E4V	EG3[†]	EM4[†]		
						
6.4mm x 7.1mm .250" x .280"	8.0mm x 8.0mm .315" x .315"	8.79mm x 11.3mm .346" x .445"	9.8mm x 10.7mm .385" x .420"	9.8mm x 10.7mm .385" x .420"		
E98	E98 Riveted[†]	EH9[†]	E55[†]	E40	C-Fold	
						
9.8mm x 10.7mm .385" x .420"	9.8mm x 10.7mm .385" x .420"	9.8mm x 10.7mm .385" x .420"	9.8mm x 12.2mm .385" x .480"	10.0mm x 10.9mm .395" x .430"		

† Contact your sales or customer service representative for details, special minimum order quantity may apply.

C-Fold	ED8[†]	EQ3	E85	E4C	E4M	C-Fold
						
	11.4mm x 16.0mm .448" x .630"	11.8mm x 10.7mm .465" x .420"	11.8mm x 10.7mm .465" x .420"	12.42mm x 15.06mm .489" x .593"	16.5mm x 14.7mm .650" x .579"	
	E4W	E5Y	E32	E16[†]	E3X	
						
16.5mm x 14.7mm .650" x .579"	16.51mm x 14.73mm .650" x .580"	17.1mm x 14.7mm .675" x .580"	18.0mm x 14.2mm .710" x .560"	18.79mm x 15.62mm .740" x .615"		
E5A	E4N	E3Y	E02[†]	E4P	T-Shape	
						
19.5mm x 16.6mm .768" x .654"	20.9mm x 14.7mm .823" x .579"	23.52mm x 15.77mm .926" x .621"	23.9mm x 14.0mm .940" x .550"	3.8mm x 4.8mm .150" x .189"		
ED4[†]	ED1[†]	EA9	EJ2	E3V		
						
3.9mm x 6.0mm .152" x .235"	4.0mm x 6.2mm .157" x .244"	4.0mm x 6.2mm .157" x .244"	4.0mm x 6.2mm .157" x .244"	4.93mm x 8.26mm .194" x .325"		
E41[†]	E4T	E4S	EQ2[†]	E4R	T-Shape	
						
5.1mm x 4.8mm .200" x .190"	5.1mm x 6.9mm .201" x .272"	5.7mm x 4.8mm .224" x .189"	6.4mm x 4.8mm .250" x .190"	6.4mm x 6.9mm .252" x .272"		
E5K	E5N	E53[†]	E4Q	E3W		
						
7.0mm x 6.9mm .276" x .272"	7.6mm x 4.8mm .299" x .189"	7.6mm x 6.9mm .300" x .272"	9.53mm x 4.83mm .375" x .190"	9.53mm x 6.86mm .375" x .270"		
EH8[†]	EG5	E3J	E3K		Round Shape	
						
10.0mm x 10.0mm .395" x .395"	9.5mm x 12.7mm .374" x .500"	3.0mm diameter .118" diameter	4.0mm diameter .157" diameter			

† Contact your sales or customer service representative for details, special minimum order quantity may apply.

PSA WIDTH

Part	Inches	mm	Inches [mm]
ER5	.299 x .272	7.6 x 6.9	.125 [3.2]
ER9	.118 x .500	3.0 x 12.7	.160 [4.1]
ES3	.079 x .236	2.0 x 6.0	.125 [3.2]
ES4	.100 x .250	2.5 x 6.4	.125 [3.2]
ET6	.059 x .250	1.5 x 6.4	.125 [3.2]
ET9	.100 x .300	2.5 x 7.6	.070 [1.8]
EU8	.106 x .315	2.7 x 8.0	.070 [1.8]
EU9	.252 x .252	6.4 x 6.4	.125 [3.2]
EV1	.130 x .189	3.3 x 4.8	.070 [1.8]
EV2	.181 x .402	4.6 x 10.2	.188 [4.8]
EV3	.079 x .315	2.0 x 8.0	.070 [1.8]
EV6	.130 x .315	3.3 x 8.0	.070 [1.8]
EV7	.150 x .315	3.8 x 8.0	.070 [1.8]
EV8	.091 x .673	2.3 x 17.1	.160 [4.1]
EW1	.039 x .150	1.0 x 3.8	.070 [1.8]
EW3	.228 x .500	5.8 x 12.7	.100 [2.5]
EX4	.500 x .500	12.7 x 12.7	.250 [6.4]
EX5	.161 x .559	4.1 x 14.2	.100 [2.5]
EX6	.100 x .394	2.5 x 10.0	.100 [2.5]
EX7	.122 x .500	3.1 x 12.7	.100 [2.5]
EY1	.114 x .106	2.9 x 2.7	.050 [1.3]
EY2	.059 x .500	1.5 x 12.7	.100 [2.5]
EY3	.059 x .236	1.5 x 6.0	.050 [1.3]
EY4	.059 x .315	1.5 x 8.0	.070 [1.8]
EY5	.059 x .394	1.5 x 10.0	.098 [2.5]
EY6	.059 x .669	1.5 x 17.0	.160 [4.1]
EY7	.079 x .669	2.0 x 17.0	.160 [4.1]
EY8	.106 x .669	2.7 x 17.0	.160 [4.1]
EY9	.130 x .669	3.3 x 17.0	.160 [4.1]
E1A	.149 x .669	3.8 x 17.0	.160 [4.1]
E1D	.157 x .433	4.0 x 11.0	.188 [4.8]
E1E	.161 x .720	4.1 x 18.3	.188 [4.8]

PSA WIDTH

Part	Inches	mm	Inches [mm]
E1F	.071 x .181	1.8 x 4.6	.070 [1.8]
E1G	.236 x .669	6.0 x 17.0	.161 [4.1]
E1N	.177 x .394	4.5 x 10.0	.188 [4.8]
E1V	.047 x .394	1.2 x 10.0	.100 [2.5]
E1W	.051 x .142	1.3 x 3.6	.075 [1.9]
E1Y	.079 x .157	2.0 x 4.0	.071 [1.8]
E2A	.169 x .252	4.3 x 6.4	.125 [3.2]
E2M	.118 x .315	3.0 x 8.0	.126 [3.2]
E2P	.118 x .394	3.0 x 10.0	.100 [2.5]
E2R	.138 x .394	3.5 x 10.0	.100 [2.5]
E2S	.118 x .236	3.0 x 6.0	.050 [1.3]
E2T	.118 x .315	3.0 x 8.0	.070 [1.8]
E2U	.118 x .500	3.0 x 12.7	.100 [2.5]
E2V	.118 x .669	3.0 x 17.0	.160 [4.1]
E2W	.138 x .236	3.5 x 6.0	.050 [1.3]
E2X	.138 x .315	3.5 x 8.0	.070 [1.8]
E2Y	.138 x .500	3.5 x 12.7	.100 [2.5]
E3B	.138 x .669	3.5 x 17.0	.160 [4.1]
E3C	.160 x .560	4.06 x 14.22	.100 [2.5]
E3D	.207 x .675	5.25 x 17.15	.161 [4.1]
E3Q	.169 x .236	4.3 x 6.0	.051 [1.3]
E4A	.157 x .150	4.0 x 3.8	.070 [1.8]
E4B	.200 x .480	5.08 x 12.2	.250 [6.4]
E4H	.090 x .150	2.3 x 3.8	.070 [1.8]
E4J	.108 x .150	2.74 x 3.8	.070 [1.8]
E4K	.071 x .236	1.8 x 6.0	.050 [1.3]
E4L	.070 x .250	1.78 x 6.35	.126 [3.2]
E5M	.039 x .098	1.0 x 2.5	.051 [1.3]
E5R	.080 x .080	2.03 x 2.03	.051 [1.3]
E5S	.155 x .250	3.94 x 6.35	.125 [3.2]
E5U	.059 x .098	1.5 x 2.5	.071 [1.8]
E5W	.079 x .181	2.0 x 4.6	.098 [2.5]

Bell Shape

ER8	.217 x .591	5.5 x 15.0	.160 [4.1]
ET2	.118 x .315	3.0 x 8.0	.125 [3.2]
EU7	.098 x .300	2.5 x 7.6	.070 [1.8]
E1H	.071 x .181	1.8 x 4.6	.050 [1.3]
E1R	.118 x .398	3.0 x 10.1	.079 [2.0]

Bell Shape

E1T	.157 x .591	4.0 x 15.0	.125 [3.2]
E1U	.118 x .591	3.0 x 15.0	.125 [3.2]
E3F	.100 x .394	2.54 x 10.0	.098 [2.5]
E3G	.120 x .402	3.05 x 10.2	.071 [1.8]
E3H	.142 x .500	3.6 x 12.7	.098 [2.5]

Wedge

E52	.157 x .324	4.0 x 8.2	.125 [3.2]
UC301612	.436 x 1.313	11.1 x 33.3	none
EX8	.299 x .701	7.6 x 17.8	.100 [2.5]
E5B	.218 x 1.689	5.54 x 42.9	1.516 [38.5]
E5J	.218 x 1.315	5.54 x 33.4	1.102 [28.0]

Round Shape

E3J	.118 dia	3.0 dia	none
E3K	.157 dia	4.0 dia	none

L-Shape

E13	.217 x .472	5.5 x 12.0	.188 [4.8]
ED2	.197 x .335	5.0 x 8.5	.160 [4.1]
E1C	.130 x .209	3.3 x 5.3	.100 [2.5]
E3P	.209 x .209	5.3 x 5.3	.100 [2.5]
E4Y	.381 x .945	9.68 x 24.0	.375 [9.5]
E6C	.130 x .130	3.3 x 3.3	.048 [1.2]

T-Shape

E41	.200 x .190	5.1 x 4.8	.125 [3.2]
E53	.300 x .272	7.6 x 6.9	.125 [3.2]
EA9	.157 x .244	4.0 x 6.2	.125 [3.2]
ED1	.157 x .244	4.0 x 6.2	.125 [3.2]
EQ2	.250 x .190	6.4 x 4.8	.100 [2.5]
ED4	.152 x .235	3.9 x 6.0	.125 [3.2]
EH8	.395 x .395	10.0 x 10.0	.188 [4.8]
EJ2	.157 x .244	4.0 x 6.2	.100 [2.5]
E3V	.194 x .325	4.93 x 8.26	.126 [3.2]

T-Shape

E3W	.375 x .270	9.53 x 6.86	.188 [4.8]
E4P	.150 x .189	3.8 x 4.8	self-mounting
E4Q	.375 x .190	9.53 x 4.83	self-mounting
E4R	.252 x .272	6.4 x 6.9	self-mounting
E4S	.224 x .189	5.7 x 4.8	self-mounting
E4T	.201 x .272	5.1 x 6.9	self-mounting
E5K	.276 x .272	7.0 x 6.9	self-mounting
E5N	.299 x .189	7.6 x 4.8	self-mounting

Knife-Edge

E19	.250 x .750	6.4 x 19.1	.250 [6.4]
E31	.106 x .445	2.7 x 11.3	.188 [4.8]
E67	.106 x .445	2.7 x 11.3	.250 [6.4]
E96	.106 x .315	2.7 x 8.0	.100 [2.5]
EH6	.106 x .445	2.7 x 11.3	.250 [6.4]

Knife-Edge

ER1	.039 x .276	1.0 x 7.0	.125 [3.2]
ER2	.217 x .394	5.5 x 10.0	.188 [4.8]
EV9	.106 x .689	2.7 x 17.5	.250 [6.4]
E1P	.118 x .650	3.0 x 16.5	.188 [4.8]
E3S	.250 x .750	6.4 x 19.1	none

P-Shape

E60	.130 x .520	3.3 x 13.2	.250 [6.4]
EA7	.448 x .630	11.4 x 16.0	.312 [7.9]
EQ4	.448 x .630	11.4 x 16.0	.500 [12.7]

Self-Mounting

E27	.638 x .230	16.2 x 5.8	self-mounting
E86	.740 x .380	18.8 x 9.7	self-mounting

Mini-Clip

E93	.120 x .330	3.05 x 8.4	self-mounting
EB9	.145 x .256	3.7 x 6.5	self-mounting
E3M	.163 x .287	4.15 x 7.3	self-mounting

U-Shape

EG5	.374 x .500	9.5 x 12.7	.250 [6.4]
-----	-------------	------------	------------

Schlegel Electronic Materials (SEM) introduces **DynaShear** and **DynaGreen®** an innovative EMI shielding gasket family for the shielding of modules in card/cages environment that is able to offer superior features over metal fingerstocks and current Fabric Over Foam gaskets. **DynaShear** and **DynaGreen®** utilize the bump technology that result from a three axis development program:

- SEM famous special flat D-Profiles with bump
- Low memory ultra soft foam type 7
- Abrasion resistant conductive fabrics

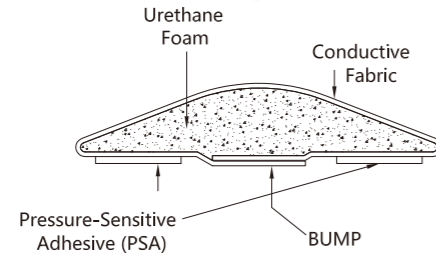
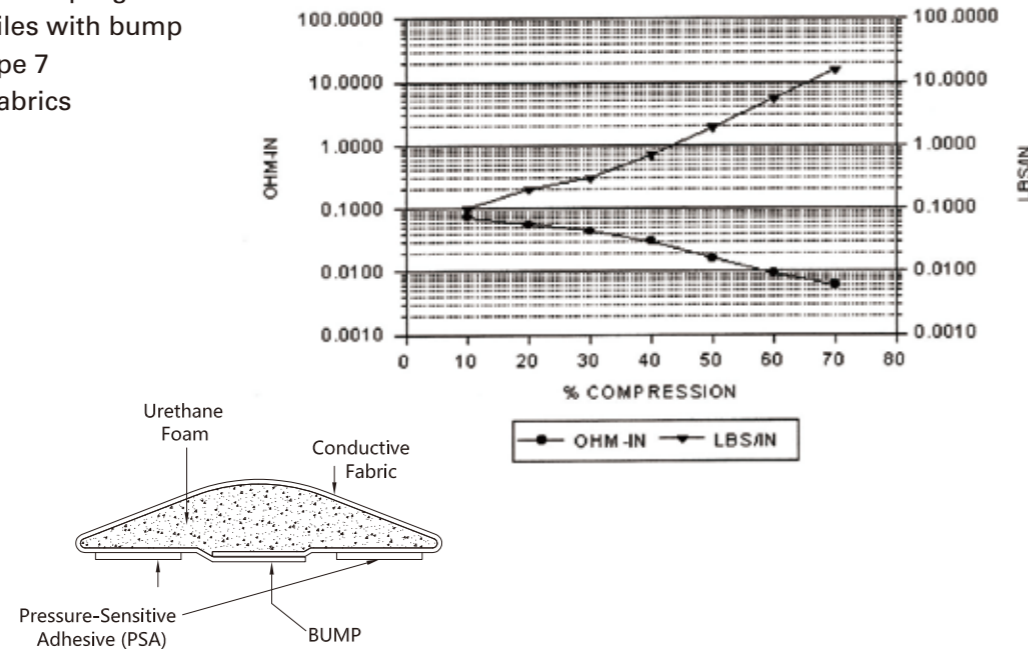

Both programs **DynaShear** and **DynaGreen®** are supplied with a flammability UL94-V0 rating but **DynaGreen®** utilizes a special SEM's formulation for the retardants making that series **Halogen Free** according to IEC 61249-2-21 (900 ppm max. bromine, 900 ppm max chlorine max. with a total of max. 1500 ppm). **DynaGreen®** is supplied with a special blue liner with a clear printed identification.

Height Width	1.5mm	2.0mm	2.3mm	2.7mm	3.0mm	3.3mm	3.5mm	3.8mm
6mm	EY37n2Zxxxx(HF)	EK97n2Zxxxx(HF)	EQ67n2Zxxxx(HF)	EQ77n2Zxxxx(HF)	E2S7n2Zxxxx(HF)	EQ87n2Zxxxx(HF)	E2W7n2Zxxxx(HF)	EQ97n2Zxxxx(HF)
8mm	EY47n2Zxxxx(HF)	EV37n2Zxxxx(HF)	EP17n2Zxxxx(HF)	EU87n2Zxxxx(HF)	E2T7n2Zxxxx(HF)	EV67n2Zxxxx(HF)	E2X7n2Zxxxx(HF)	EV77n2Zxxxx(HF)
10mm	EY57n2Zxxxx(HF)	EJ87n2Zxxxx(HF)	EJ97n2Zxxxx(HF)	EK17n2Zxxxx(HF)	E2P7n2Zxxxx(HF)	EK27n2Zxxxx(HF)	E2R7n2Zxxxx(HF)	EK37n2Zxxxx(HF)
12.7mm	EY27n2Zxxxx(HF)	EK47n2Zxxxx(HF)	EK57n2Zxxxx(HF)	EK67n2Zxxxx(HF)	E2U7n2Zxxxx(HF)	EK77n2Zxxxx(HF)	E2Y7n2Zxxxx(HF)	EK87n2Zxxxx(HF)
17mm	EY67n2Zxxxx(HF)	EY77n2Zxxxx(HF)	EV87n2Zxxxx(HF)	EY87n2Zxxxx(HF)	E2V7n2Zxxxx(HF)	EY97n2Zxxxx(HF)	E3B7n2Zxxxx(HF)	E1A7n2Zxxxx(HF)

n: specifies the fabric type (3: NiCu-C70 and 4: NiCu-C12).
xxxx: specifies the length in the form of xx.xx".
HF: specifies Halogen Free. **DynaGreen®** has suffix "HF".
 Standard parts supplied with wide release liner and 2 strips of adhesive.
 Height given for untapped and uncompressed parts.

DynaShear / DynaGreen®: Technical Features

- Compression force:** 0.70 lbs.-inch at 40% compression (*)
- Contact resistance:** 0.012 Ohms-inch at 40% compression (*)
- Compression set:** 15.4% when compressed 50% for 22 hrs. at 70°C (*)
- Recommended compression for max. shielding:** See table in the "gasket selection" section.
- Abrasion resistance:** No change in surface resistivity 1,000 cycles (NiCu-C70)
- General Service Temperature:** -40°C (-40°F), 70°C (158°F)
- Flammability:** UL94-V0 certified (under the component program of Underwriters Laboratories Inc. in specified claddings and thicknesses)
- Shielding Effectiveness:** 96 dB (average) 20 MHz-10 GHz - Mil DTL 83528 C (NiCu-C70)
- 3M Adhesive 90° peel strength on stainless steel:** 128/142 Oz./in after 72 hours -ASTM D3330

(*) : measured on EJ9732ZXXXX

DynaShear / DynaGreen®: Gasket selection

These series of D-shape gaskets are characterized by the presence of a bump at the bottom surface so to preserve a substantial shielding effectiveness even when compression is low. RF measurement shows that below 20% and down to almost 0% compression, Shielding Effectiveness is about the value measured at 20% compression. The thickness of the bump is typically 0.3 mm. The specific adhesive used on this series has been selected for its high shear strength and has a nominal thickness of 0.17 mm.

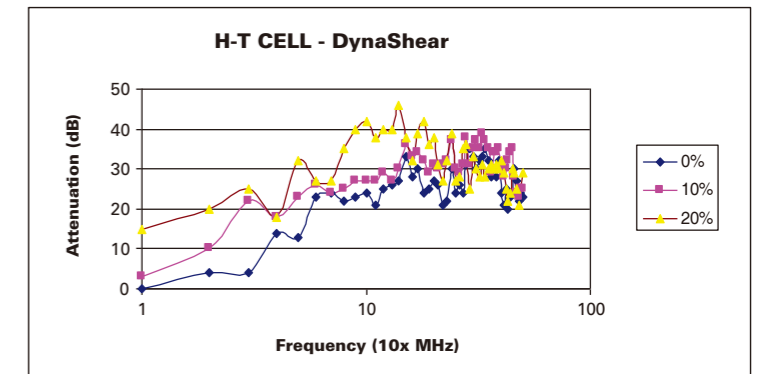

Attenuation as a function of the compression measured on EJ9732ZXXXX.

The dimensions provided in this catalog are the dimensions for the parts un-taped and in an uncompressed state. When the part is taped, the bump is slightly compressed. Therefore, the following values and table are provided to help the selection of the right profile versus the nominal gap between modules. The compression values for the gasket (% from free height) are given in black and the corresponding values of the gap between modules are provided in blue (in mm).

- Minimum Compression (mC):** mC = 1%
- Maximum Gap (MG):** MG (mm) = 0.99 * h with h (mm) = [(H - 0.3) + 0.17].
- Nominal Compression (NC):** SEM recommend to compress 50% of the free height h
NC (%) = 50
- Nominal Gap (NG):**
NG (mm) = h * 0.5
- Max. Compression (MC):**
MC (%) = (h-S)/h* 100 with S(mm)= s + 0.17
- Minimum Gap (mG) :** mG = S

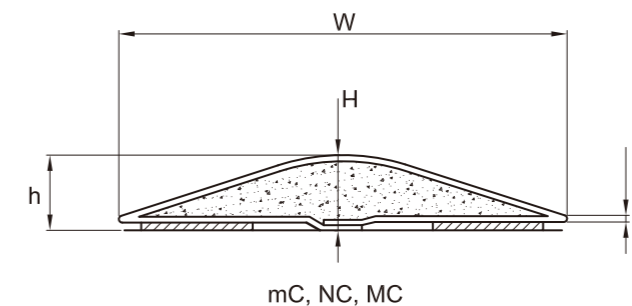

MG, NG, mG

DynaShear / DynaGreen® Profile Selection Versus Nominal Gap

P/N	H(mm)	W(mm)	s(mm)	h(mm)	mC(%)	MG(mm)	NC(%)	NG(mm)	MC(%)	mG(mm)
EY3	1.5	6.0	0.36	1.37	1	1.36	50	0.69	61.31	0.53
EY4	1.5	8.0	0.39	1.37	1	1.36	50	0.69	59.12	0.56
EY5	1.5	10.0	0.39	1.37	1	1.36	50	0.69	59.12	0.56
EY2	1.5	12.7	0.40	1.37	1	1.36	50	0.69	58.39	0.57
EY6	1.5	17.0	0.41	1.37	1	1.36	50	0.69	57.66	0.58
EK9	2.0	6.0	0.35	1.87	1	1.85	50	0.94	72.19	0.52
EV3	2.0	8.0	0.42	1.87	1	1.85	50	0.94	68.45	0.59
EJ8	2.0	10.0	0.48	1.87	1	1.85	50	0.94	65.24	0.65
EK4	2.0	12.7	0.39	1.87	1	1.85	50	0.94	70.05	0.56
EY7	2.0	17.0	0.54	1.87	1	1.85	50	0.94	62.03	0.71
EQ6	2.3	6.0	0.36	2.17	1	2.15	50	1.09	75.58	0.53
EP1	2.3	8.0	0.39	2.17	1	2.15	50	1.09	74.19	0.56
EJ9	2.3	10.0	0.39	2.17	1	2.15	50	1.09	74.19	0.56
EK5	2.3	12.7	0.60	2.17	1	2.15	50	1.09	64.52	0.77
EV8	2.3	17.0	0.75	2.17	1	2.15	50	1.09	57.60	0.92
EQ7	2.7	6.0	0.36	2.57	1	2.54	50	1.29	79.38	0.53
EU8	2.7	8.0	0.37	2.57	1	2.54	50	1.29	78.99	0.54
EK1	2.7	10.0	0.39	2.57	1	2.54	50	1.29	78.21	0.56
EK6	2.7	12.7	0.57	2.57	1	2.54	50	1.29	71.21	0.74
EY8	2.7	17.0	0.80	2.57	1	2.54	50	1.29	62.26	0.97
E2S	3.0	6.0	0.34	2.87	1	2.84	50	1.44	82.23	0.51
E2T	3.0	8.0	0.37	2.87	1	2.84	50	1.44	81.18	0.54
E2P	3.0	10.0	0.54	2.87	1	2.84	50	1.44	75.26	0.71
E2U	3.0	12.7	0.58	2.87	1	2.84	50	1.44	73.87	0.75
E2V	3.0	17.0	0.79	2.87	1	2.84	50	1.44	66.55	0.96
EQ8	3.3	6.0	0.34	3.17	1	3.14	50	1.59	83.91	0.51
EV6	3.3	8.0	0.37	3.17	1	3.14	50	1.59	82.97	0.54
EK2	3.3	10.0	0.57	3.17	1	3.14	50	1.59	76.66	0.74
EK7	3.3	12.7	0.57	3.17	1	3.14	50	1.59	76.66	0.74
EY9	3.3	17.0	0.80	3.17	1	3.14	50	1.59	69.40	0.97
E2W	3.5	6.0	0.32	3.37	1	3.34	50	1.69	85.46	0.49
E2X	3.5	8.0	0.35	3.37	1	3.34	50	1.69	84.57	0.52
E2R	3.5	10.0	0.39	3.37	1	3.34	50	1.69	83.38	0.56
E2Y	3.5	12.7	0.29	3.37	1	3.34	50	1.69	86.35	0.46
E3B	3.5	17.0	0.79	3.37	1	3.34	50	1.69	71.51	0.96
EQ9	3.8	6.0	0.33	3.67	1	3.63	50	1.84	86.38	0.50
EV7	3.8	8.0	0.39	3.67	1	3.63	50	1.84	84.74	0.56
EK3	3.8	10.0	0.35	3.67	1	3.63	50	1.84	85.83	0.52
EK8	3.8	12.7	0.57	3.67	1	3.63	50	1.84	79.84	0.74
E1A	3.8	17.0	0.78	3.67	1	3.63	50	1.84	74.11	0.95

Using the table

1. Pick in the table the nominal gap **NG(mm)** the closest to the actual one in your application.
2. Select the height H (mm) in order to fill the gap as much as possible.
3. Verify that **mG** and **MG** values are within the tolerances of the nominal gap **NG**.

Schlegel Electronic Materials (SEM), a well-respected leader in the EMI Shielding industry, introduces Fabric Over Silicone EMI Gaskets (FOS) for high temperature applications. FOS has been developed with a new flame retardant formulation providing EMI shielding gaskets with UL94-V0 grade (Underwriters Laboratories Inc.) and Halogen Free according to IEC 61249-2-21 (<=900 ppm chlorine, <=900 ppm bromine and 1500 ppm max. halogens). Fabric Over Silicone EMI gaskets provide low compression forces, low compression set and an operating temperature that can be up to 125°C (257°F). Combined with Highly flexible SEM fabrics NiCu-C12 or NiCu-C70, Fabric Over Silicone gaskets still feature over 70 dB attenuation at 40 GHz (SEM Stripline method) making this product ideal for on-board shielding or high temperature environment. Fabric Over Silicone is currently available for all the SEM rectangular profiles.



Fig 1. Contact Resistance and Compression Load Deflection Testing result of ED9 (1.5 x 5.0 mm) Gasket

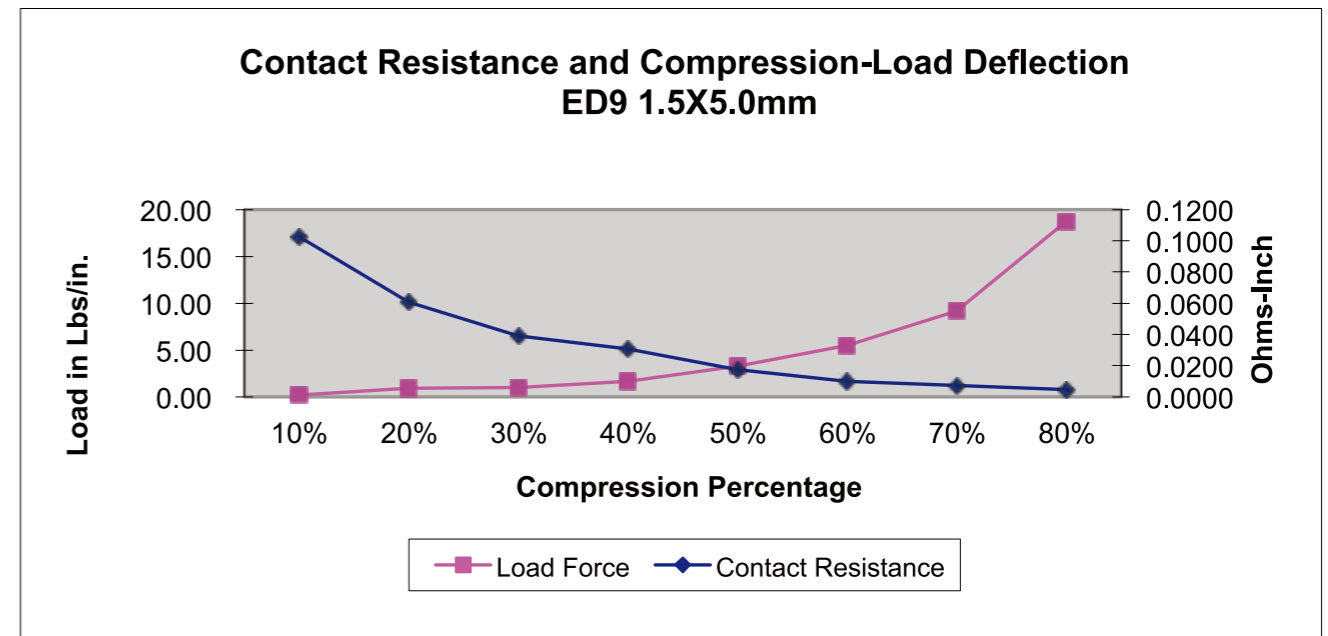

Technical Specifications

CHARACTERISTICS	SPECIFICATIONS	TEST METHODS
Shielding Effectiveness	96 dB average (20MHz-10GHz) : NiCu-C70 97.4 dB average (20MHz-10GHz): NiCu-C12	MIL DTL 83528 C
Compression Force	1.70 lbs/inch @ 40%*	SEM LP-3001
Contact Resistance	0.031 ohms-inch @ 40%*	SEM LP-3001
Compression Set	5% (compressed 50% for 22 hrs at 70°C) * *	ASTM D 3574
Compression Range	30 – 70 %	
Surface Resistance	<=0.066 Ohms/sq. : NiCu-C70 <=0.024 Ohms/sq. : NiCu-C12	ASTM F390
Contact Resistance at 1Kg load	< 0.11 ohms-in < 0.08 ohms-in	SEM LP-3001
Operating Temperature	-40°C , +125°C	ASTM D3574
Abrasion Resistance	>= 1,000 cycles: NiCu-C70 >= 1,000 cycles: NiCu-C12	ASTM D3884
Flame Retardant	UL94 V0	UL94 (Underwriters Laboratories, Inc)
Compliance	2015/863/EU (RoHS 2.0) Compliant REACH SVHC Compliance	
Halogen Content	<=900 ppm chlorine & <=900 ppm bromine & 1500 ppm max for both	IEC 61249-2-21 / EN 14852 B

* Result is measured on the ED9 Resulted measured => Result was measured ED9 (1.5 x 5.0 mm) profiles

**Result measured on the 5 mm x 25.4 mm x 25.4 mm silicone foam

The technical specification data is based on SEM tests and analysis that we believe to be reliable. However, in no event, shall SEM be liable for the inaccuracies or omissions contained therein. In all cases, details and values should be verified by the customer.

Part Number Guideline

EXXSNMXXXXHF

S: specifies Silicone foam.

N: specifies the fabric type (3: NiCu-C70 Ripstop Fabric, 4: NiCu-C12 Plain Weave Fabric).

M: specifies the finishing/attachment system (refer to page 12 Part Number Guide).

XXXXX: specifies length in the form XXX.XX".

Schlegel Electronic Materials (SEM) introduces NEW Conductive Foam (CF). SEM conductive foam, a highly resilient Nickel-Copper plated polyurethane foam, is sandwiched between SEM's knitted and non-woven conductive fabrics to form industry leading substrate for die-cut gaskets. CF material is ideal for applications that require surface conformity with excellent cavity-to-cavity EMI shielding, superior conductivity under low compression forces and better shielding effectiveness at very high frequencies. CF gaskets are precision die-cut with a back-layer of either conductive or non-conductive pressure-sensitive-adhesive (PSA).

Schlegel's manufacturing and metal plating processes enhance the material integrity of the SEM Conductive Foam and ensure excellent galvanic compatibility even for large surface applications like I/O gaskets. The through-conductivity achieved with Schlegel CF increases the shielding effectiveness at high frequencies by shortening the return current path between the flanges.

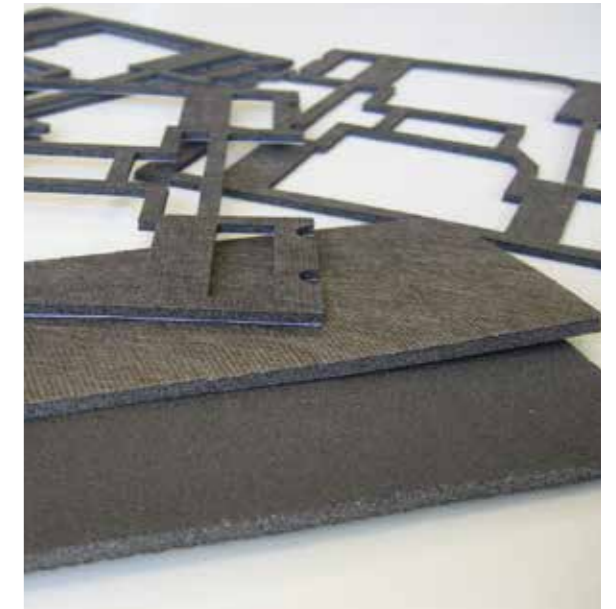

Conductive fabrics over Nickel-Copper plated polyurethane foam

Dimensions	Maximum Width: 22" (560mm) Thicknesses: 0.02", 0.04", 0.06", 0.09", 0.13", 0.20" (0.45mm, 1.00mm, 1.5mm, 2.3mm, 3.4mm, 5.0mm) Other thicknesses may be available. Please contact your SEM Representative.
Operating Temperatures	-40°F - 156°F (-40°C - +70°C) in accordance with ASTM D3374 (Standard test methods for flexible cellular materials)
Surface Resistivity	<0.08 Ohm/sq.
Compression set	<15% (compressed at 50% during 22 Hrs. @70°C)
Tensile Strength	15 kg/inch (CF-78-30FR)
Flammability	UL94-V0/V1 – See details at www.UL.com (SEM FE – Plastic component QMFZ2. E313523)
Aging	No change in surface resistivity after exposure to 60°C - 90%RH – 300 hrs
Shielding Effectiveness	>90 dB AVG. 10-1000 MHz (Tem-T Cells-Method described in IEEE Std 1302)
Compliance	2015/863/EU (RoHS 2.0) compliant

Thickness	Tolerance	UL Fire Rated	Part #
0.45mm	± 0.2mm	-	CF-78-05NR
1.00mm	± 0.2mm	UL94-V0	CF-78-10FR
1.50mm	± 0.2mm	UL94-V0	CF-78-14FR
1.50mm	± 0.2mm	-	CF-78-14NR
2.30mm	± 0.3mm	UL94-V0	CF-78-20FR
2.30mm	± 0.3mm	-	CF-78-20NR
3.40mm	± 0.3mm	UL94-V1	CF-78-30FR
3.40mm	± 0.3mm	-	CF-78-30NR
5.00mm	± 0.5mm	-	CF-78-50NR

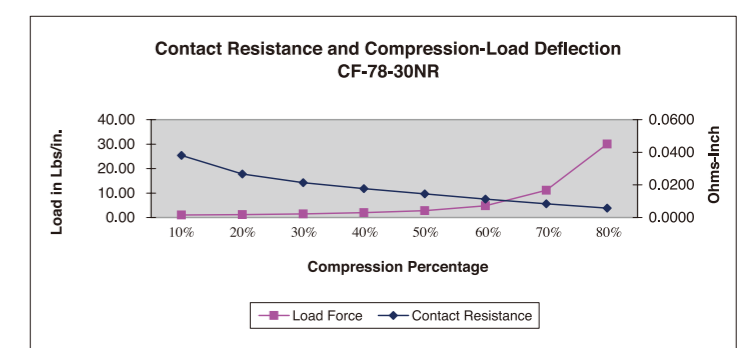

THE RIGHT SHIELDING PRODUCT FOR DIE-CUT I/O APPLICATIONS

Information Technology Equipment and other electronic devices must comply with various international radiated emissions and susceptibility requirements. Under specific conditions, FCC part 15 (US) requires such equipment to pass stringent regulations up to 40 GHz. Most unintentionally-radiated emissions are from field leakage at various chassis external interfaces, or from unbalanced differential signals; containment of both require shielding materials to provide a low impedance path despite the broadband and/or high frequency operation of such devices. Simultaneously, these electronic devices are sensitive to various susceptibility requirements, including electrostatic discharge (ESD, e.g., IEC 61000-4-2), and, in some cases, must resist to applied voltages as high as 15 kV. In this instance, the same shielding materials must also feature a very low impedance/resistance at very low frequencies to ensure a harmless discharge path exists to allow the charge to flow from the I/O connectors to the exterior of the chassis, and then safely away from the devices.

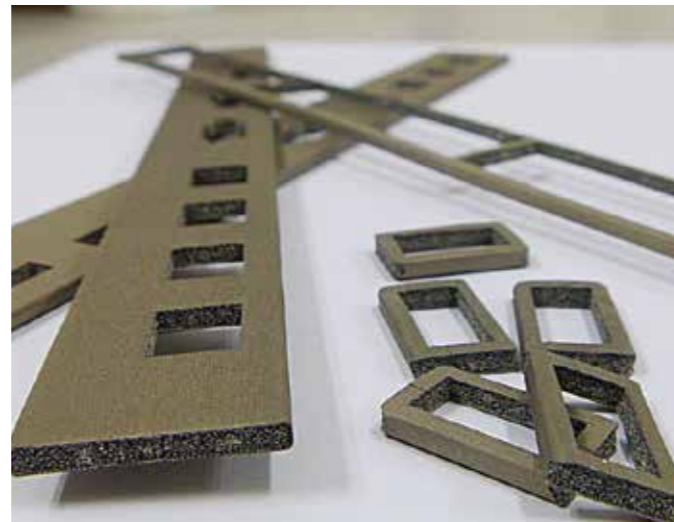

Schlegel Electronic Materials (SEM) introduces ORS-II, a new series of gaskets specially designed for broadband applications. By combining its famous nickel copper plated conductive foam and its high-end nickel copper C12 flexible fabric cladding, ORS-II offers minimal surface resistance to achieve superior grounding and shielding results at low frequencies. By offering excellent Z-conductivity to close the cavities in the chassis openings, ORS-II also ensures substantial shielding performance at high frequencies.

ORS-II is available in a variety of thicknesses, which are die-cut to customer specifications, for a durable highly conductive product in all X-Y-Z axes. In addition, shielding efficiency is achieved with less sensitivity to compression variances than other traditional shielding products. ORS-II is available with a UL94-V0 flammability rating and complies with RoHS 2.0 European Directive and SVHC Policy (REACH).

All these features combined in one product makes ORS-II a great engineering solution when addressing all types of shielding challenges which are present in broadband and high-speed applications.

ORS-II is available in a multitude of geometries and in varying thicknesses. ORS-II is recommended for all combinations of I/O connectors, is particularly effective when broadband emissions and/or susceptibility are of concern, and is far more effective than standard conductive foam when superior grounding is important.

TECHNICAL SPECIFICATIONS

Shielding Effectiveness 0.1 – 40GHZ	See Graph	Stripline method (IEEE std 1302)
Operation Temperature	-40°F +156°F (-40°C +70°C)	
Flammability	UL94 V0	UL94
Surface Resistivity	<= 0.024 Ohm/sq.:NiCu-C12 <= 0.08 Ohm/sq.: NiCu-C22	SEM LP 3004
Contact Resistance (@ 1Kg load)	<0.08 Ohm-inch : NiCu-C12 <0.2 Ohm-inch : NiCu-C22	SEM LP 3001
Abrasion Resistance	1,000 cycles	ASTM D 3884
Thicknesses (mm)	1.00, 1.50, 2.30, 3.40, 5.00	

Shielding effectiveness of ORS-II versus current shielding materials

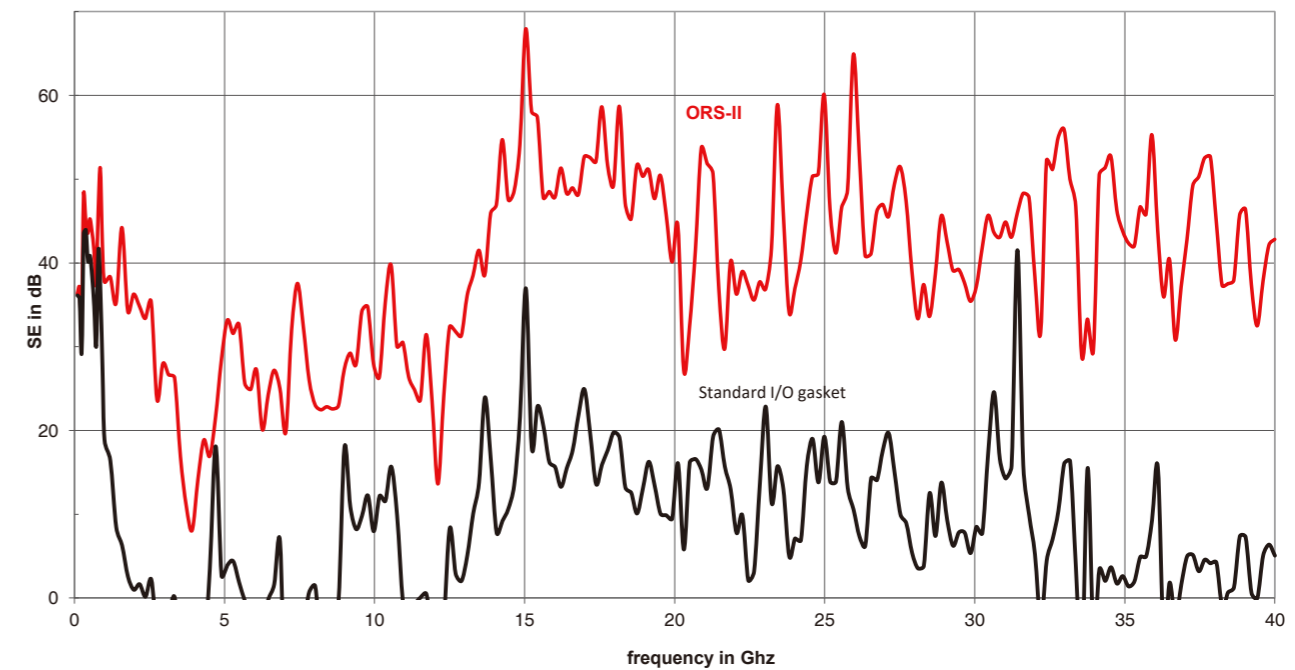

Schlegel Electronic Materials (SEM) EEH Series' gaskets have been specially designed to provide environmental sealing as well as EMI shielding for outdoor electronic cabinets. EEH gaskets are Fabric over EPDM (Ethylene Propylene Diene Monomer) sponge rubber cores extruded over a galvanized wire core for flange mounting. This product provides cost savings to manufacturers assembly lines, as labor costs are substantially reduced as they are able to use one EEH gasket instead of two different gaskets.

EEH series' gaskets are designed to ease mounting through special reinforced clips which can accommodate a wide variety of metal thicknesses. The gasket can be picture framed to ensure continuously environmental sealing in the corners. EEH profiles and materials excel in dynamic or high cycling applications such as front doors or access panels with low compression rates and very limited compression set. An operating temperature range of EPDM starts from -40°C to 100°C, and the material has good resistance to UV, water and acids etc.

SEM recommends half-wrapped EPDM for environmental and EMI protection using our corrosion resistant SnCu-C50 fabric. We also offer a full range of alternative combinations, please contact your local office for design help and advice.



Part Number	FW: Full Wrap HW: Half Wrap N: None	Fabric	Type	Flange Thickness
EW10.00019	FW	SnCu-C50	A	1-3.3
EW10.00020	FW	SnCu-C50	B	1-4.8
EW10.00021	FW	SnCu-C50	C	1.5-3.6
EW10.00022	FW	SnCu-C50	D	1-4.8
EW10.00001	FW	NiCu-C12	A	1-3.3
EW10.00013	FW	NiCu-C12	B	1-4.8
EW10.00005	FW	NiCu-C12	C	1.5-3.6
EW10.00009	FW	NiCu-C12	D	1-4.8
EW10.00002	FW	NiCu-C70	A	1-3.3
EW10.00014	FW	NiCu-C70	B	1-4.8
EW10.00006	FW	NiCu-C70	C	1.5-3.6
EW10.00010	FW	NiCu-C70	D	1-4.8
EW10.00015	FW	AgRs-C2	A	1-3.3
EW10.00016	FW	AgRs-C2	B	1-4.8
EW10.00017	FW	AgRs-C2	C	1.5-3.6
EW10.00018	FW	AgRs-C2	D	1-4.8
EW10.00023	FW	NiCu-C22	A	1-3.3
EW10.00024	FW	NiCu-C22	B	1-4.8
EW10.00025	FW	NiCu-C22	C	1.5-3.6
EW10.00026	FW	NiCu-C22	D	1-4.8
EW20.00026	HW	SnCu-C50	A	1-3.3
EW20.00027	HW	SnCu-C50	B	1-4.8
EW20.00028	HW	SnCu-C50	C	1.5-3.6
EW20.00029	HW	SnCu-C50	D	1-4.8
EW20.00003	HW	NiCu-C12	A	1-3.3
EW20.00015	HW	NiCu-C12	B	1-4.8
EW20.00007	HW	NiCu-C12	C	1.5-3.6
EW20.00011	HW	NiCu-C12	D	1-4.8
EW20.00004	HW	NiCu-C70	A	1-3.3
EW20.00016	HW	NiCu-C70	B	1-4.8
EW20.00008	HW	NiCu-C70	C	1.5-3.6
EW20.00012	HW	NiCu-C70	D	1-4.8
EW20.00018	HW	AgRs-C2	A	1-3.3
EW20.00019	HW	AgRs-C2	B	1-4.8
EW20.00020	HW	AgRs-C2	C	1.5-3.6
EW20.00021	HW	AgRs-C2	D	1-4.8
EW20.00022	HW	NiCu-C22	A	1-3.3
EW20.00023	HW	NiCu-C22	B	1-4.8
EW20.00024	HW	NiCu-C22	C	1.5-3.6
EW20.00025	HW	NiCu-C22	D	1-4.8
EW00.00001	N	EPDM ONLY	A	1-3.3
EW00.00002	N	EPDM ONLY	B	1-4.8
EW00.00003	N	EPDM ONLY	C	1.5-3.6
EW00.00004	N	EPDM ONLY	D	1-4.8

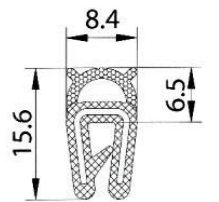

A

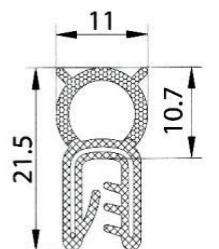

B

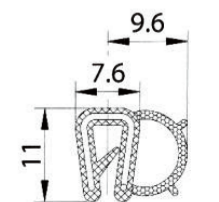

C

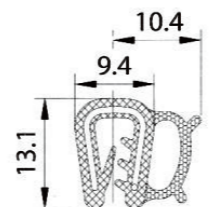

D

Material Properties

Material Properties	Testing Method /Standards	EPDM Rubber Sponge-PG61	EPDM Rubber Solid-PG281
Density	DIN 53479 /DIN 63505 (PG281)	0.60 g/m ³	1.26±0.02 g/cm ³
Hardness	DIN 53519-1,2, ISO 1183 (PG281)	-	60±5
Tensile Strength	ISO 37, DIN 53504	>1.5 N/mm ²	>8 N/mm ²
Elongation off	ISO 37, DIN 53504	>300%	>400%
Air Ageing- 72 hours / 100°C	ISO 188:1998, ISO 188:2006	CHANGED VALUES	
Hardness Shore A - (Changed values)	DIN 53519-1,2, ISO 1183 (PG281)	-	±5
Tensile Strength (Changed values)	DIN ISO 34	3.1 N/mm ²	9.0 N/mm ²
Elongation off (Changed values)	DIN ISO 34	>100%	100%
Temperature Range (application)	-40°C To + 100°C		
Flash Point	250°C		
Clamping range	Flange thickness from 1.5mm to 4.8mm		
Sealing suitability	Level of IP according to design		
Length of supply	25 mts per roll		
Resistance to Chemical & Weather Conditions	Alcohol, ozone, mild acids, acetone & Alkali		

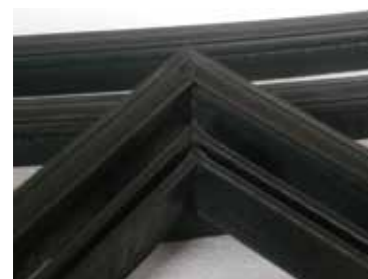

EEH serie can be supplied in frames with 90° angles and bonded with thermo plastic elastomer. This process preserves the environmental sealing properties of the gasket in the corners.

EW XX YZ F LLLLL / WWWWW (*)

XX: HW / FW

Y: Type of profile (A-B-C-D)

Z: 1: SnCu-C50 / 2: NiCu-C70 / 3: NiCu-C12 / 4: AgRs-C2 / 5: NiCu-C22

LLLLL**: Length in inches (LLL,LL")

WWWWW**: Width in inches (WWW,WW")

(*): Please consult SEM representative to confirm availability of any combination

(**): External dimensions of the frame

SEM ENVIRONMENTAL EMI HYBRID GASKET FOR RAILWAYS APPLICATIONS EUROPE

In order to guarantee the same level of security in railways vehicles in the European Union in the event of a fire on board, the CENELEC (TC 256) has released a standard EN 45545 which has become a national standard for all member states. The standard specifies the level of safety (HLx: Hazard Level) according to the requirements (location, application) and the type of vehicles (OC: Operation Category). The level of safety (HL1, HL2 or HL3) will depend on the results obtained by the materials on specific test for level of oxygen index, smoke emanation and toxicity. For further information on the subject, please refer to the standard. For EN 45545-2, Schlegel Electronic Materials EEH gasket's materials are to comply with R22/ R23 requirements (longitudinal seals such as window seals, door joints and panel connections) and is rated HL2 (see details on the following table).

By the combination of EN 45545 rated EPDM core material and a wide choice of very conductive claddings, Schlegel Electronic Materials provide a cost effective solution to meet the EMC requirements for Railways applications according to EN 50121.

Part Number

EWXX.XXXXX R for the standard profiles

EW XX YZ F LLLLL/WWWWW R for frames (See details on page 37)

SPECIFICATIONS

EW20.00026R					
RAILWAYS				Sponge Solid	
Environmental EMI Hybrid Gasket					
EPDM EXTRUSION COMPOUND	SPECIFICATION	UNIT	Requirement	HexFlame 45-1000	HexFlame 45-7000
Elastomer/Polymer				EPDM SOLID	EPDM SPONGE
Curing				Sulphur	Sulphur
Color			Black	Black	Black
Specific Gravity	DIN 53479	g/cm ³		+/- 1.51	+/- 0.8
Hardness	DIN 53505	shore A		64	N/A
Tensile strength	DIN 53504	N/mm ²		ca.5	-
Elongation at break	DIN 53504	%		>400	-
Tear Strength	DIN 53507-A	N/mm		ca.5	-
Ozon resistance	DIN 53509			Resistant	Resistant
Nitrosamine		ppm		none	none
Halogens		ppm		none	none
Flammability	EN 45545-2		Class	R22/23,HL3	R22/23,HL2
Smoke density/Gas analysis	EN ISO 5659-2	Max.	<=150 (HL3), <300 (HL2)	54	102.35
Oxygen index	ISO 4589-2	%	>=32 (HL3), >28 (HL2)	33.8	31.1
Toxicity	NF X70-100-1&2	CIT NLP	<=0.75 (HL3), <0.9 (HL2)	0.64	0.54
Test results determined on vulcanized (10 min./180°C) 2 and 6 mm thick sheets					
Identification : ' SEM EN 45545' printed in yellow on the clip area					

MORE FLEXIBILITY, HIGHER CONDUCTIVITY, AND EASIER INSTALLATION

SEM's expanded line of Conductive Tapes meets the customer needs for flexibility, higher conductivity, and easier installation. SEM Conductive Tapes feature superior shear strength, 7.6 kPa (72+ hours @ 1.1 psi) in accordance to (PSTC #7) ASTM D 3654, and peel strength, from 10.2 N/2.5 cm (36.07 oz/inch width) to 20.3 N/2.5cm (71.8 oz/inch width) in accordance to (PSTC #1) ASTM D 3330 when compared to other EMI shielding tapes. This is made possible by a unique, cross-linking acrylic based, conductive Pressure Sensitive Adhesive (PSA) that also allows the tapes to be designed into higher temperature applications. Low temp application is possible down to 10°F (-12°C), and excessive pressure is not required for application to the end unit. There is now an easy-to-apply tape to fit most every EMI shielding design need.

Conductive Silver Tapes (CST)

HIGHER CONDUCTIVITY WITHOUT THE SHARP EDGES

The foundation of SEM's tape products is Conductive Silver Fabric Tape. CST offers superb conductivity and ease of installation for a wide range of applications. The smooth, soft-edged tape will not crack after repeated flexing, or cause injuries. SEM CST achieves total coverage, even on irregular surfaces and experiences no significant shrinkage at temperatures up to 180°C (356°F). A unique, conductive Pressure Sensitive Adhesive (PSA) allows the tapes to be designed into higher temperature applications. The PSA is fire rate to UL 510, and excessive pressure is not required for application to the end unit.

CST tape has an average shielding effectiveness of 70 dB in the range of 20 MHz to 10 GHz. CST's protective C2 coating lowers the cathodic potential of the silver to make it galvanically compatible with a variety of EMI gaskets and cabinet surfaces. A superior alternative to sharp, non-conforming foil tapes, SEM's lightweight Conductive Silver Tape is ideal for grounding and for sealing small apertures in frames.

For assemblers, the CST's soft fabric is safe and easy to work with, and it stays firmly in place with SEM's strong, high-tack conductive adhesive. The conductive fabric base also allows the tape to be custom-cut in virtually any unique shape with simple, inexpensive tooling.



Sizes		
Tape Width	Tape Length	Part Number
0.315" (8mm)	18 yard (16.45m) roll	5941-0031-0
0.500" (12.7mm)	18 yard (16.45m) roll	5941-0050-6
0.788" (20mm)	18 yard (16.45m) roll	5941-0079-8
1.000" (25.4mm)	18 yard (16.45m) roll	5941-0100-3
1.180" (30mm)	18 yard (16.45m) roll	5941-0118-2
2.000" (50.8mm)	18 yard (16.45m) roll	5941-0200-5

Specifications

- Fabric: Silver woven nylon ripstop fabric with C2 anti-corrosion coating.
- Adhesive: High-tack, conductive adhesive system.
- Surface Resistivity: $\leq 0.5\Omega/\text{sq}$. Test Method: ASTM F390 modified.
- Resistivity through adhesive: ≤ 120 milliohms/square inch.
- Low Temperature Application: -40°F (-40°C).
- Abrasion Resistance: No change in surface resistivity and no fabric degradation after more than 800 wear cycles. Test Method: ASTM D3884.
- Peel Strength Test Method ASTM D3330:
45.80 oz per inch (1.62g per mm) @ 1 hour dwell initial.
47.47 oz per inch (1.67g per mm) @ 24 hour dwell initial.
- Shielding Effectiveness: 95dB. Test method: Mil DTL 83528C.

Conductive Mask & Peel Tape (CMP)

SHIELD ENCLOSURES SAFELY AND EFFICIENTLY

SEM's Conductive Mask & Peel (CMP) tape simplifies the manufacture of painted enclosures. CMP is constructed of impenetrable, heat-release mask, highly conductive nickel copper fabric and strong high-tack, conductive adhesive, which secures the tape to the metal for superior EMI shielding. The tape employs Press, Paint, and Peel application and provides total coverage. The CMP tape's volume resistance is in the range of 0.8 - cm [average]. When CMP is used with SEM shielding gaskets, a highly conductive pathway is obtained, and provides excellent galvanic capability between mating surfaces. Typical applications include large cabinets, factory automation equipment and data storage units.

Press, Paint and Peel application is simple, safe, and secure. The operator removes the release liner from the back of the fabric tape and applies it to the prepared bare metal surface. No sharp edges exist that could lead to injuries. The 2-mil polyimide mask prevents infiltration of paint during the spraying or powder-coat process. Enclosures with CMP can be baked at temperatures up to 180°C (356°F) for up to 30 minutes. The low-tack mask releases during baking so it can be easily be removed to reveal the highly conductive fabric surface.



Sizes		
Tape Width	Tape Length	Part Number
0.315" (8.0 mm)	36 yard (33m) rolls	5935-0031-4
0.500" (12.7 mm)	36 yard (33m) rolls	5935-0050-0
0.788" (20.0 mm)	36 yard (33m) rolls	5935-0079-4
1.000" (25.4 mm)	36 yard (33m) rolls	5935-0100-7
1.180" (30.0 mm)	36 yard (33m) rolls	5935-0118-8
1.570" (40.0 mm)	36 yard (33m) rolls	5935-0157-6
2.000" (50.8 mm)	36 yard (33m) rolls	5935-0200-9
2.500" (63.5 mm)	36 yard (33m) rolls	5935-0250-4

Specifications

- Fabric: Woven copper nickel fabric.
- Adhesive: High-tack, aggressive conductive adhesive system.
- Surface Resistivity: $\leq 0.024\Omega/\text{sq}$.
- Resistivity through adhesive: ≤ 10 milliohms/square inch.
- Low Temperature Application: -40°F (-40°C).
- Abrasion Resistance: No change in surface resistivity after more than 1,000 wear cycles. Test method: ASTM D3884.
- Shrinkage: $< 1\%$ @ 180°C (356°F) for 30 minutes. Test Method: LP-3012.
- Peel Strength: 50 oz. Per inch minimum initial. Test Method: ASTM D3330.
- Shielding Effectiveness: 97.4dB. Test method: Mil DTL 83528C.

Conductive NiCu Fabric Tape (CFT)

SEM's CFT is made from the same woven copper nickel fabric as its CMP and has the same conductive and galvanic capabilities. The nickel copper fabric, along with SEM's aggressive high temperature resistant conductive PSA, is designed specifically for applications that do not require a mask, i.e., cabinets that are not going to be painted or powder coated.

Sizes		
Tape Width	Tape Length	Part Number
0.315" (8.0 mm)	36 yard (33m) rolls	5927-0031-0
0.500" (12.7 mm)	36 yard (33m) rolls	5927-0050-6
0.788" (20.0 mm)	36 yard (33m) rolls	5927-0079-2
1.000" (25.4 mm)	36 yard (33m) rolls	5927-0100-3
1.180" (30.0 mm)	36 yard (33m) rolls	5927-0118-8
1.570" (40.0 mm)	36 yard (33m) rolls	5927-0157-2
2.000" (50.8 mm)	36 yard (33m) rolls	5927-0200-5

Specifications

- Fabric: Woven copper nickel fabric.
- Adhesive: High-tack, aggressive conductive adhesive system.
- Surface Resistivity: $\leq 0.024\Omega/\text{sq}$.
- Resistivity through adhesive: ≤ 10 milliohms/square inch.
- Low Temperature Application: -40°F (-40°C).
- Abrasion Resistance: No change in surface resistivity after more than 1,000 wear cycles. Test method: ASTM D3884.
- Shrinkage: $< 4\%$ @ 180°C (356°F) temperature.
- Peel Strength: 50 oz. Per inch minimum initial. Test Method: ASTM D3330.
- Shielding Effectiveness: 97.4dB. Test method: Mil DTL 83528C.

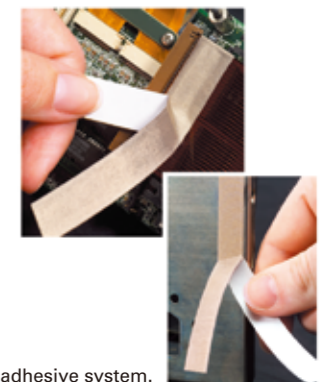

Conductive NiCu-C70 Rip-stop Fabric Tape (CFTII)

Schlegel Electronic Materials (SEM)'s CFT(II) is made of using polyester rip-stop copper nickel fabric with high conductivity PSA. CFT (II) have an average shielding effectiveness over 96 dB in the frequency ranges from 20 MHz to 10 GHz. In addition to the easy-to-apply properties to fit the most EMI shielding design, it is also ideal for grounding and sealing purpose. And it is the most economical by comparing to other SEM Conductive Tapes.

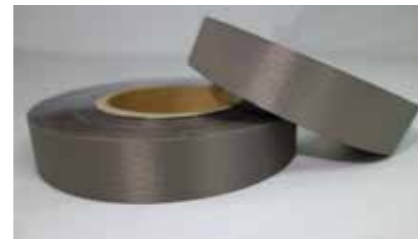

Specifications

- Fabric: Nickel-Copper plated polyester ripstop fabric.
- Adhesive: High-tack, conductive adhesive system.
- Surface Resistivity: $\leq 0.066\Omega/\text{sq}$.
- Resistivity through adhesive: ≤ 80 milliohms/square inch.
- Low Temperature Application: -40°F (-40°C).
- Abrasion Resistance: No change in surface resistivity after more than 1,000 wear cycles. Test method: ASTM D3884.
- Shrinkage: $<4\%$ @ 180°C (356°F) temperature.
- Peel Strength: 50 oz. Per inch minimum initial. Test Method: ASTM D3330.
- Shielding Effectiveness: 96dB. Test method: Mil DTL 83528C.

Sizes		
Tape Width	Tape Length	Part Number
0.315" (8.0 mm)	36 yard (33m) rolls	5923-0031-0
0.500" (12.7 mm)	36 yard (33m) rolls	5923-0050-6
0.788" (20.0 mm)	36 yard (33m) rolls	5923-0079-2
1.000" (25.4 mm)	36 yard (33m) rolls	5923-0100-3
1.180" (30.0 mm)	36 yard (33m) rolls	5923-0118-8
1.570" (40.0 mm)	36 yard (33m) rolls	5923-0157-2
2.000" (50.8 mm)	36 yard (33m) rolls	5923-0200-5

Black Conductive NiCu-C22 Fabric Tape



Schlegel Electronic Materials (SEM) offers the Black Conductive NiCu Fabric Tape which is similar to CFT(II) but blackened for the cosmetic purposes. The blackened conductive fabric was in rip-stop pattern with surface resistivity lower than 0.08 ohm/sq. The average shielding effectiveness over 95.76 dB in the frequency ranges from 20 MHz to 10 GHz. It provides the alternative to customer who prefer the black color conductive tape for the appearance design but not necessary to have silver content inside as Conductive Silver Tape (CST).

Specifications

- Fabric: Nickel-Copper plated polyester ripstop fabric.
- Adhesive: High-tack, conductive adhesive system.
- Surface Resistivity: $\leq 0.08\Omega/\text{sq}$.
- Resistivity through adhesive: ≤ 20 milliohms/square inch.
- Low Temperature Application: -40°F (-40°C).
- Abrasion Resistance: No change in surface resistivity and no fabric degradation after more than 1,000 wear cycles. Test method: ASTM D3884.
- Shrinkage: $<4\%$ @ 180°C (356°F) temperature.
- Peel Strength: 50 oz. Per inch minimum initial. Test Method: ASTM D3330.
- Shielding Effectiveness: 95.76dB. Test method: Mil DTL 83528C.

Sizes		
Tape Width	Tape Length	Part Number
0.315" (8.0 mm)	36 yard (33m) rolls	5921-0031-0
0.500" (12.7 mm)	36 yard (33m) rolls	5921-0050-6
0.788" (20.0 mm)	36 yard (33m) rolls	5921-0079-2
1.000" (25.4 mm)	36 yard (33m) rolls	5921-0100-3
1.180" (30.0 mm)	36 yard (33m) rolls	5921-0118-8
1.570" (40.0 mm)	36 yard (33m) rolls	5921-0157-2
2.000" (50.8 mm)	36 yard (33m) rolls	5921-0200-5

Conductive SnCu-C50 Fabric Tape

Schlegel Electronic Materials (SEM) offers the Conductive SnCu Fabric Tape which is made of Tin copper plain weave woven fabric with high conductivity PSA. This provides the good galvanic compatibility for most common materials and higher corrosion resistance which target for outdoor application. The average shielding effectiveness of conductive SnCu fabric tape is over 95.3 dB in the frequency ranges from 20 MHz to 10 GHz and the surface resistivity is less than 0.02 ohm/sq.



Sizes		
Tape Width	Tape Length	Part Number
0.315" (8.0 mm)	36 yard (33m) rolls	5926-0031-0
0.500" (12.7 mm)	36 yard (33m) rolls	5926-0050-6
0.788" (20.0 mm)	36 yard (33m) rolls	5926-0079-2
1.000" (25.4 mm)	36 yard (33m) rolls	5926-0100-3
1.180" (30.0 mm)	36 yard (33m) rolls	5926-0118-8
1.570" (40.0 mm)	36 yard (33m) rolls	5926-0157-2
2.000" (50.8 mm)	36 yard (33m) rolls	5926-0200-5

Specifications

- Fabric: Tin Copper plated nylon plain weave fabric.
- Adhesive: High-tack, conductive adhesive system.
- Surface Resistivity: $\leq 0.020\Omega/\text{sq}$.
- Resistivity through adhesive: ≤ 40 milliohms/square inch.
- Low Temperature Application: -40°F (-40°C).
- Abrasion Resistance: No change in surface resistivity and no fabric degradation after more than 1,000 wear cycles. Test method: ASTM D3884.
- Shrinkage: $<4\%$ @ 180°C (356°F) temperature.
- Peel Strength: 50 oz. Per inch minimum initial. Test Method: ASTM D3330.
- Shielding Effectiveness: 95.3dB. Test method: Mil DTL 83528C.

I/O SHIELDING FOR ALL STANDARD SIZES

Sized to fit standard D-Subminiature connectors, installation-friendly SEM shielding gaskets enhance the performance of EMI shielding for I/O backplanes. Made of highly conductive fabric clad foam, SEM's I/O shielding gaskets provide multiple contact points to maintain conductivity and compensate for tolerance stackup. Pressure-sensitive adhesive is available, but not usually required for installation. There is no need to contend with shard-edged metal shields- simply slip the gaskets over the connector and secure.

With no tooling costs, easy installation, and off-the-shelf availability, these gaskets are a simple and efficient solution to I/O EMI shielding.

Available D-SUB connector to EMI shielding gaskets include:

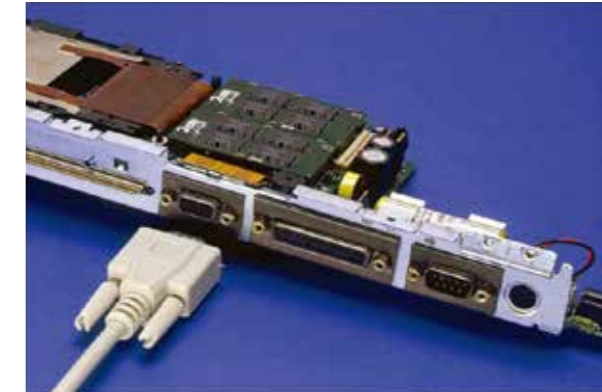

P/N	TYPE	Pin	Thickness
E29XYG-0131	D-SUB	9	0.04" (1 mm)
E58XYG-0131	D-SUB	9	0.08" (2 mm)
E29XYG-0164	D-SUB	15	0.04" (1 mm)
E58XYG-0164	D-SUB	15	0.08" (2 mm)
E29XYG-0219	D-SUB	25	0.04" (1 mm)
E58XYG-0219	D-SUB	25	0.08" (2 mm)
E29XYG-0283	D-SUB	37	0.04" (1 mm)
E58XYG-0283	D-SUB	37	0.08" (2 mm)
E29XYG-0274	D-SUB	50	0.04" (1 mm)
E58XYG-0274	D-SUB	50	0.08" (2 mm)
X: Foam type (1: UL 94-HB, 5: UL-94V0, 7: UL94-V0 Ultrasoft)			
Y: Fabric (3: NiCu-C70, 4: NiCu-C12, 9: AgC2)			

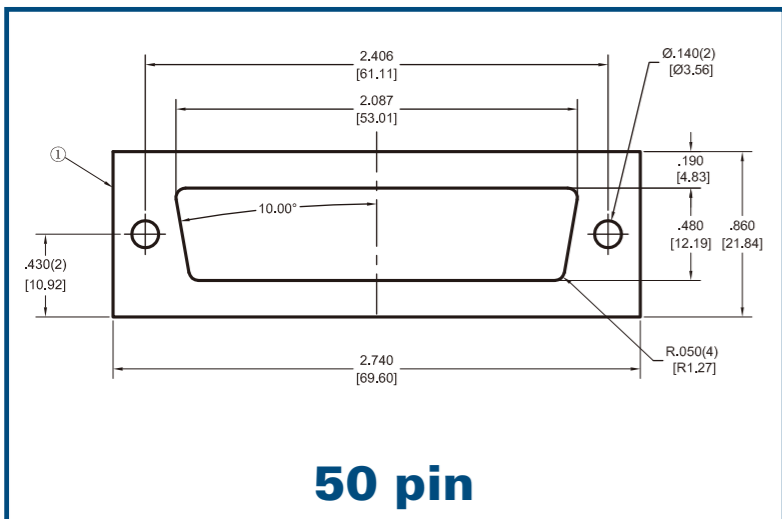
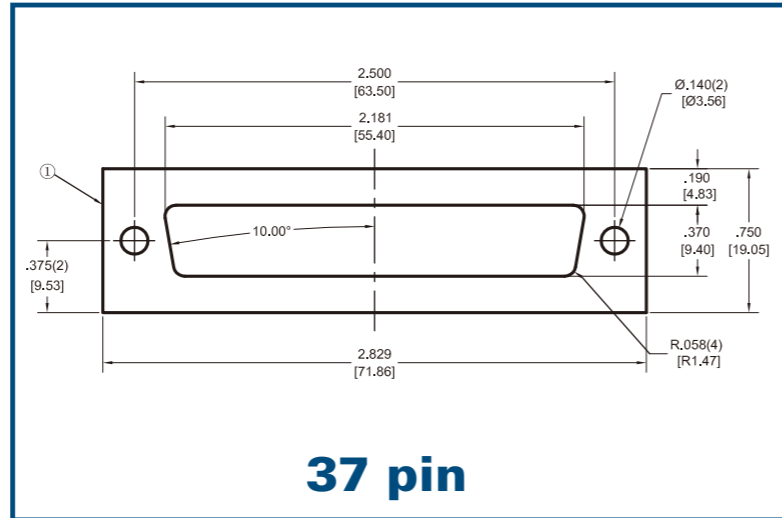
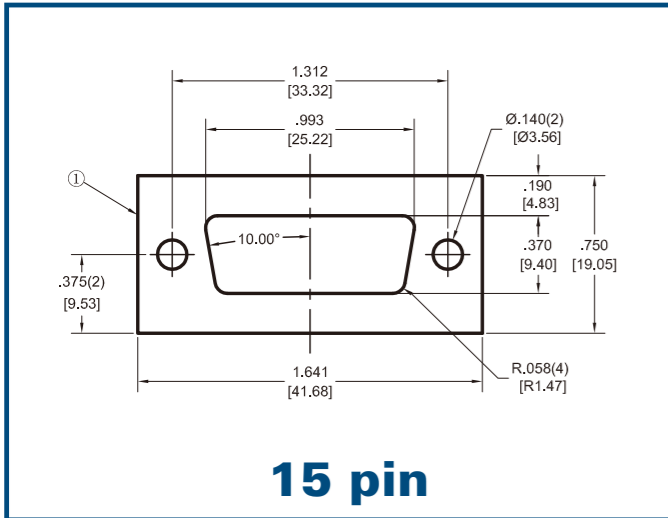
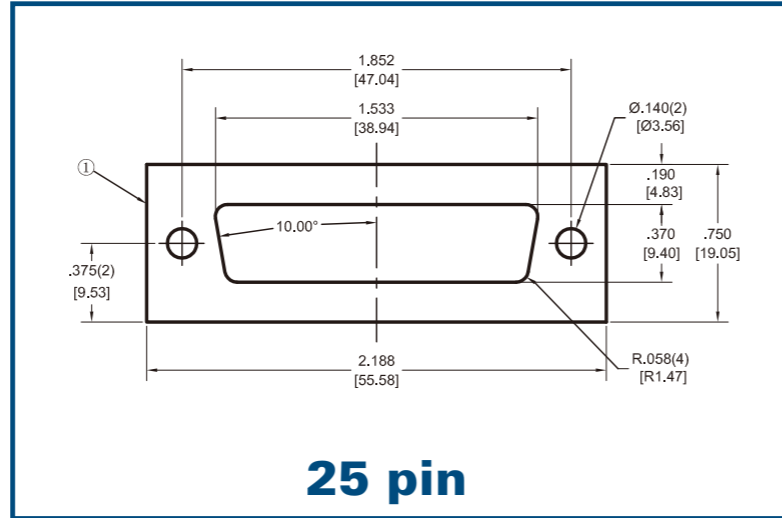
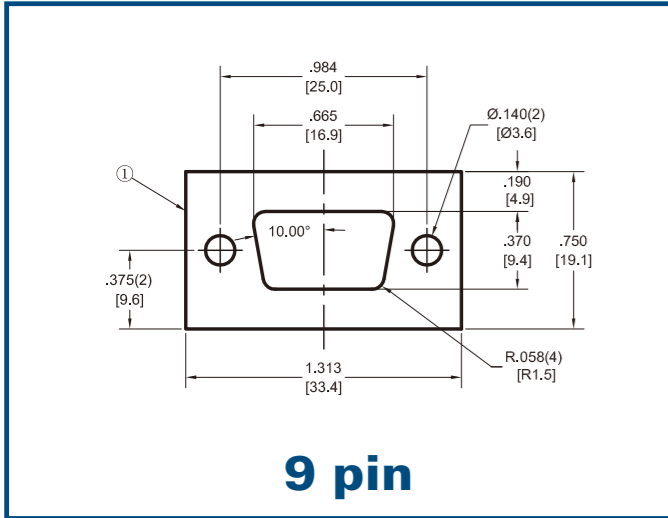

Schlegel Electronic Materials (SEM) recommends the use of non conductive adhesives in most cases (type R). All gaskets have a PSA width recommended according to the width of the profile to ensure sufficient direct contact at the bottom of the gasket with the application. Test was carried out according to SAE ARP 6248 (stripline method) on EW8 (9/3 mm) in order to measure the influence of non conductive PSA (2.5 mm and 4.5 mm wide) and conductive PSA (8 mm wide). Three profiles were tested compressed at 50% up to 40 GHz:

- EW873 + 2.5 mm R tape
- EW873 + 4.5 mm R tape
- EW873 + 8 mm D tape

Conductive PSA are usually a tradeoff between electrical conductivity and tackiness. In fact the more conductive particles embedded into the adhesive, the less tackiness and vice versa. Test results show clearly the influence of the width of the non conductive adhesive on the shielding characteristics and the poor results when the bottom surface is almost completely covered by conductive adhesive. The use of conductive adhesive should therefore be restricted to very small profiles where limited width prevent from the use of non conductive adhesive. Even for Z conductive foam, Schlegel Electronic Materials recommends the mounting of strips of non conductive adhesives.

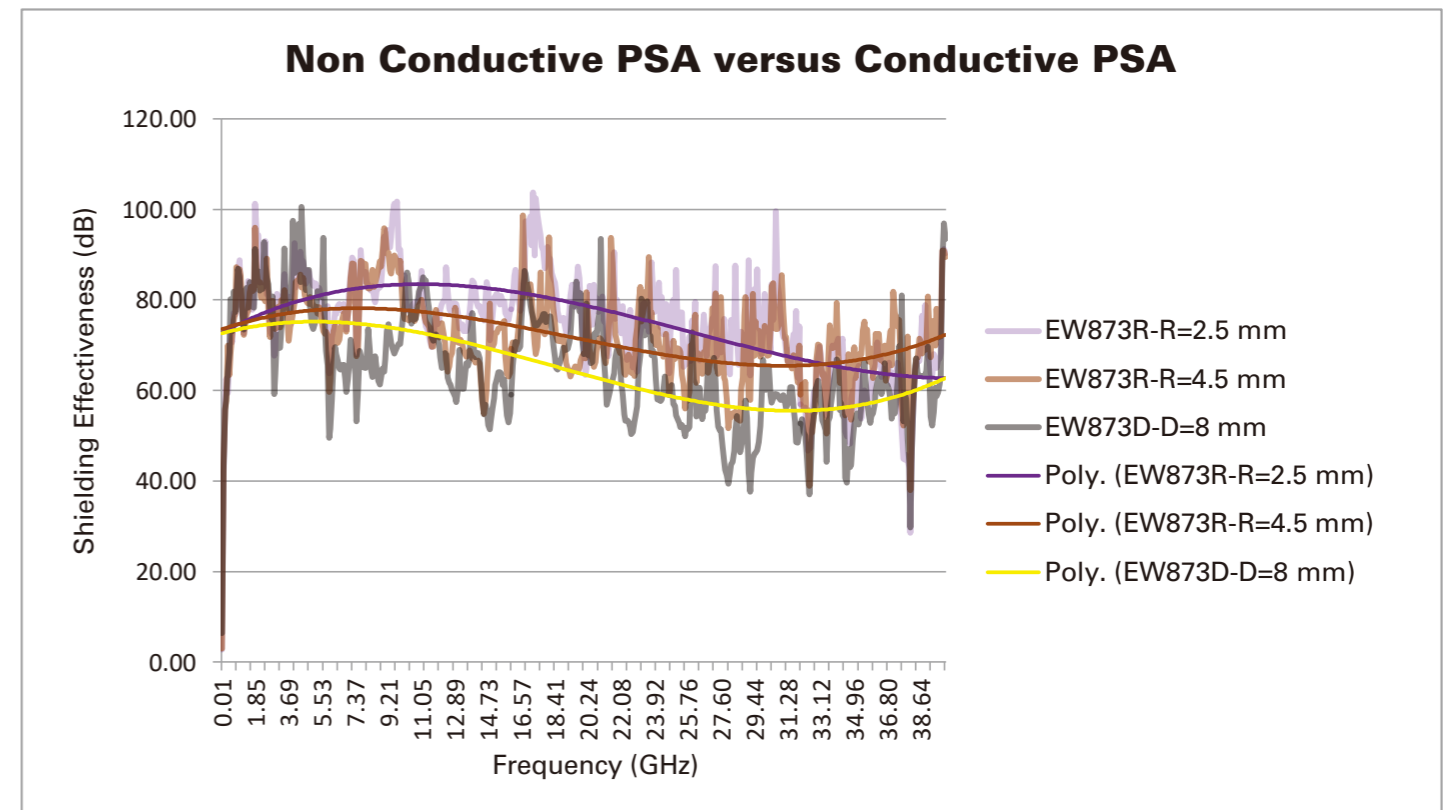

1. Pressure Sensitive Adhesive (PSA)

The most popular attachment method is the Pressure Sensitive Adhesive (PSA). Standard PSA are non conductive and are dimensioned to not cover the entire gasket surface to ensure direct electrical contact. The constraints applied on the adhesive vary in large proportions depending on the type of application. There are limited constraints for static applications because the adhesive is just there to hold the gasket the time before it will be compressed. At the contrary, for dynamic applications, constraints increase and especially when forces are exerted in the horizontal axis (for ex. during blade or module insertion) which tends to push the gasket. Schlegel Electronic Materials has selected 3M acrylic based adhesives with high shear strength values* to guarantee adhesions even in the most challenging dynamic applications.

To ensure the maximum bond strength from the adhesive, please follow the taping procedure.

	T Tape			RTape			HTape		
Adhesive	Acrylic			Acrylic			Acrylic		
Liner	Extensible polycoated kraft			Polycoated kraft			Extensible polycoated Kraft		
Adhesive thickness	5 mils (0.1270 mm)			6.7 mils (0.17 mm)			5 mils (0.1270 mm)		
Substrate	No carrier			Polyester carrier			No carrier		
Application	Pressure			Pressure			Pressure		
LT operating temp.	180°F(82.3°C)			200°F(93.4°C)			250°F(121°C)		
ST operating temp.	250°F(121°C)			300°F(149°C)			350°F(177°C)		
Elongation	8%			3%			8%		
Shear/Stainless steel	Immediate	24hrs	72hrs	Immediate	24hrs	72hrs	Immediate	24hrs	72hrs
PSI	14.7	34.8	47	17.4	45.7	50.7	17	39.4	48.3

Detailed 3M technical datasheet available on www.3M.com

Conductive adhesive can also be proposed and are recommended in specific instances (eg. very small profiles).

A) Taping procedure

Clean the metal surface with typical surface cleaner solvent. For example, use isopropyl alcohol or a heptane.

Wait until the bond surface is clean and dry because grease, oil or mold release chemicals could create a barrier between the adhesive and the substrate and hence affect the bond strength.

Wearing finger cots is suggested as a finger print is one of the contamination sources.



Remove release liner slowly and carefully. Do not allow the release liner to tear during removal. Confirm that no release liner remains on the adhesive. If the release liner tears and the remaining release liner cannot be easily removed, discard gasket and use a new gasket. Bond strength is dependent upon the amount of adhesive-to-surface contact developed. Dust, fiber or particle contamination will affect the tackiness of the adhesive and reduce the contact surface area.

Apply finger or hand pressure along the full length of gasket to completely bond to the metal surface. Confirm that pressure has been applied to both ends of the gasket to bond the adhesive to metal surface. Firm application pressure can develop a better adhesive contact and improve bond strength. The gasket and the tape can be used ONCE only. The gasket should not be peeled off and re-used again because the tape will lose its bond strength and will have adhesive issues.

The ideal tape application temperature range is 21°C to 38°C. Initial tape application to surfaces at temperatures below 10°C is not recommended as the adhesive will become too firm to adhere readily.

The bonding strength increases as a function of time. Time allows the adhesive flow on the substrate. In theory 72 hours dwell time is requested however about 2/3rd. of total adhesion strength is reached after 24 hours.

B) Adhesive removal

3M has developed a Citrus based Cleaner especially to ease the removal of adhesive residues. Further information can be found at www.3M.com



2. Rivets

Some profiles can be mounted using rivets. Plastic inserts are therefore positioned to reinforce the holes and ensure a good partition of the forces.

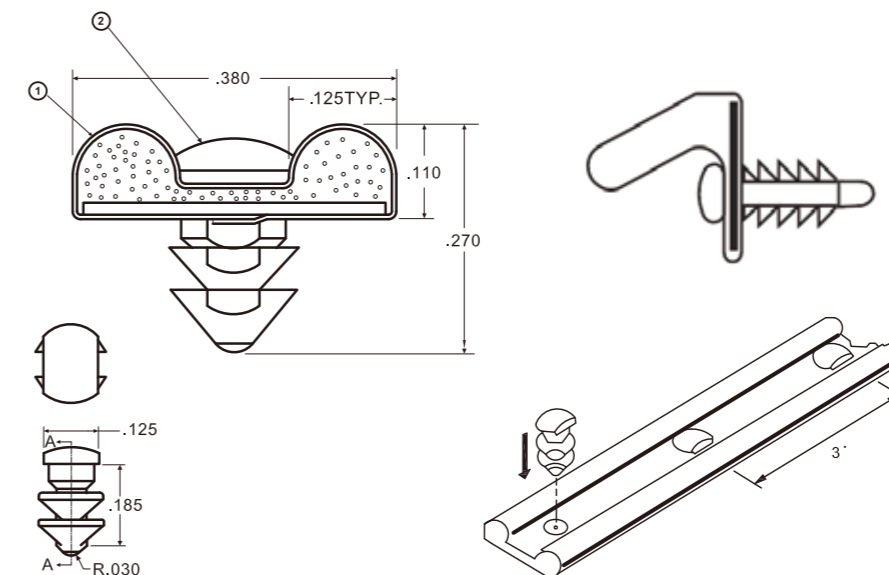

3. Clips

Several profiles with plastic clips are currently available. The conductive fabric is therefore positioned in the clip area to ensure electrical path.

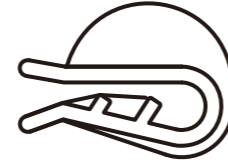
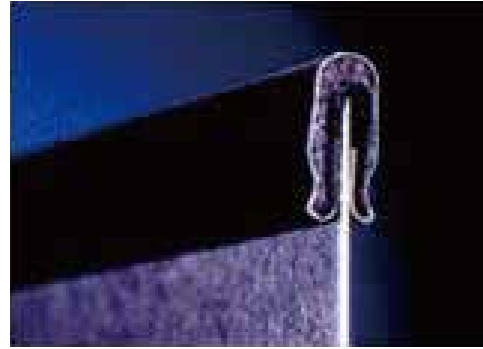

4. Self-mounting



5. Kiss cut



Schlegel PN	the widest size of the clip inside	Min. flange thickness (mm)	Max. flange thickness (mm)
E93	0.95	0.4	0.9
EB9	1.4	0.5	1.0
E64/ EB1	2.4	1.2	2.0
E56/ E43/ E35	1.5	0.6	1.2
E55	2.0	0.8	1.7

Note: The above size range can be concluded according to the actual assembly. Unit: mm