

ExCam[®] XF M3016

User Manual



Table of contents

1	Introduction	4
2	Technical Data	4
2.1	Parameters of the explosion protection	4
2.2	Electrical parameters of the camera	5
2.3	System cable SKD02-T	5
2.4	Technical specification of the camera module	6
2.5	Other technical data	6
3	Safety Instructions	7
4	Commissioning	8
5	Electrical connection	10
5.1	Potential equalization	10
5.2	Connection and Fusing	11
5.2.1	Network interface / plug assignment (RJ45)	12
5.2.2	Connection to a terminal box (alternatively)	12
5.3	Example: external connection and fusing via the terminal box	15
5.3.1	Example: direct routing from the ExTB-3 to the safe area	15
5.3.2	Example: Routing via ExConnection Rail (optional accessories)	16
5.3.3	Appropriate cables & cable glands	17
5.3.4	Cable kits - "plug and play" connection packages	18
5.3.5	Tests prior to switching on the voltage	19
6	Hardware Reset	20
6.1	Work preparation	20
6.2	Opening the pressure-resistant housing	20
6.3	Closing of the pressure-resistant housing	23
7	Network access and visualization	23
7.1	Browser Support	23
7.2	Assigning the IP address	24
7.3	Password / identification	24
8	Maintenance / Servicing / Alterations	25
9	Repairs and Maintenance	25
10	Disposal / Recycling	25
11	Drawings & 3D models	26
12	Certificates and further documentation	27

Table of Figures

Fig. 2-1 Sectional view of SKD02-T	5
Tab. 4-1 Mounting Accessories	9
Fig. 5-1 ExCam XF M3016 Equipotential Bonding	10
Tab. 5-1 Equipotential Bonding	11
Fig. 5-2 Cable gland and Ethernet cable	11
Fig. 5-3 ExCam XF M3016 T08-VA1.2.K1.BOR-N.N-005.N-P-090	11
Tab. 5-2 Electrical connection	13
Fig. 5-4 Video Tutorial ExTB-3	14
Fig 5-5 Connection to a terminal box.....	14
Fig 5-6 ExTB-3 -> Safe area.....	15
Fig. 5-7 ExTB-3 -> ExConnection Rail.....	16
Fig. 5-8 Ex-d cable selection	17
Fig. 5-9 Barrier gland.....	17
Fig. 5-10 Cable kit – plug & play connection package	18
Tab. 5-3 Available cable kits.....	19
Fig. 6-1 Opening the ExCam XF M3016.....	21
Fig. 6-2 Location of the control button	21
Fig. 6-3 Disconnecting the mounting adapter	22
Fig. 7-1 Axis IP Utility	24
Fig. 11-1 – Dimensions of the T08 ExCam XF M3016	27

Revision history

Product: ExCam® XF M3016
 Title: User manual ExCam® XF M3016
 Doc. -Id. 190917-PT08BA-ES-ExCam XF M3016_en_rev.03.docx
 Author: Eva Schneider
 Date: September 24, 2019
 Latest update: February 09, 2023

Rev.- Index	Date	Name	Remarks	Authorization of the EX Supervisor
0	Sep. 24, 2019	E. Schneider	Compilation of the document	
1	Nov. 19, 2019	E. Schneider	Adjustment of certain values (temperature, wall mount)	
2	Jan. 17, 2023	E. Schneider	Conversion of the non-armoured cable from SKD04-T.flex to SKD02-T, new certificates	
3	Feb. 09, 2023	E. Schneider	Correction of the information on the cable gland	

1 Introduction



The ExCam XF M3016 is an ultra-compact and powerful IP-Megapixel-camera which can be used within hazardous areas. Despite its ultra-compact design, it offers Full HDTV resolution (1080p) in combination with a wide-angle lens.

The ExCam series is certified both in accordance with the European (ATEX) and international (IECEx) directive. The explosion-protected housing is approved for ATEX group II for zones 1, 2, 21 and 22 including the explosion groups IIC / IIIC. The T08 ExCam certification allows not only stationary device installation but also mobile applications (hand-held use, etc.). To see other approvals, please visit our website at www.samcon.eu.

When designing the ExCam XF M3016, we focused very much on safety, mechanical precision and a high quality stainless steel.

2 Technical Data

2.1 Parameters of the explosion protection

Model key:	T08-VA1.2.K1.BOR-N.N-005.N-P-090
Identification marks according to Directive RL 2014/34/EU:	 II 2G (Zone 1 and 2)  II 2D (Zone 21 and 22)
Explosion protection (gas):	Ex db IIC T6 Gb
Explosion protection (dust):	Ex tb IIIC T80°C Db
Protection level:	IP 68 (IEC/ EN 60529)
Transportation / storage temperature:	-5°C ... +50°C
Ambient temperature (EX):	-5°C ... +50°C* (Type ...N.N...) *intermittent (24/7 T _{amb} < 40°C)
Noticed body:	TÜV Rheinland (number 0035)
EU Type Examination:	TÜV 18 ATEX 8218 X (2018)
IECEx certificate:	IECEx TUR 18.0023X (2018)
EAC-Ex TUR Report:	TC RU C-DE.HA65.B.01652/22
Other certificates:	siehe https://www.samcon.eu/en/products/network/excam-xf-m3016/

2.2 Electrical parameters of the camera

Power supply of the camera over Ethernet (PoE):

Voltage supply:	PoE, IEEE 802.3af/802.3at type 1 class 1
Reference voltage:	+48 V DC (44...54 V DC)
Maximum power consumption:	3.8 W
Typical power consumption:	2.9 W

2.3 System cable SKD02-T

Description:	Data transfer and power supply of the camera module
Jacket colour:	Green (GN), similar to RAL 6018
Outside diameter:	8.9 ± 0.3 mm
Bending radius:	8 x D _a when installed and 4 x D _a after relocation
Data line:	4 x 2 x AWG23/1 CAT.6
Properties:	PUR halogen-free, flame-retardant, UV-resistant, chemical resistance, shielded

Quick link:

https://www.samcon.eu/fileadmin/documents/en/60-Assembling%26mounting/SKD02-T_Datasheet.pdf

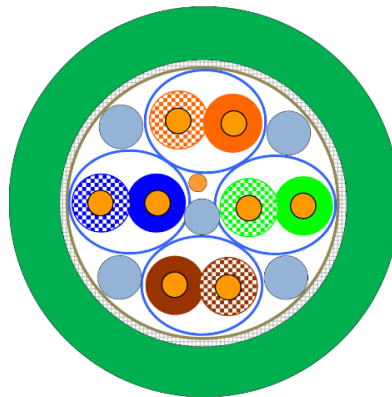

Fig. 2-1 Sectional view of SKD02-T



Attention!

For wiring and connection of the camera, DIN/EN/IEC 60079-14 has to be observed. Especially for cross zone installation, measures against zone entrainment have to be taken.

2.4 Technical specification of the camera module

We use the AXIS M3016 network camera in a pressure-resistant enclosure. For details, please refer to the Product Documentation, video-technical data of AXIS®:

<https://www.axis.com/products/axis-m3016/>



2.5 Other technical data

	Kamera (Ex-d)
Permissible ambient temperature	-5°C ... +50°C (intermitted; 24/7 T _{amb} < 40°C)
Protection class as per EN 60529/IEC 529	IP68 (test conditions: 24h/3m water column 5°C)
Housing material	Stainless steel, mat. no.: 1.4404
Weight	About. 3.0 kg
Dimensions	D79mm x 158mm

3 Safety Instructions

Please absolutely observe the safety directions stated in the Ex-installation instructions of the T08 ExCam series!



Quick link:

<https://www.samcon.eu/fileadmin/documents/en/22-Ex-Network-Cameras/ExCam-Series-T08-EX-Installation-Manual-2020.pdf>

It is absolutely mandatory to observe the national safety regulations and regulations for prevention of accidents, as well as the safety instructions given below in this User Manual!



Attention!

Cameras of the type T08 ExCam are not suitable for use in zone 0 and zone 20. The ambient temperature, temperature class and explosion group as stated on type plate must be observed! Alterations are not permitted! The camera is to be operated in sound conditions and in the intended way.



Attention!

Only original parts of SAMCON Prozessleittechnik GmbH may be used for repairs. Repairs concerning the explosion protection may only be carried out in accordance with the nationally applied regulations and by SAMCON Prozessleittechnik GmbH.



Attention!

Prior to installation, take external sources of heat or cold into account! The temperature ranges prescribed for storage, transportation, and operating must be adhered to!



Attention!

Observe the warnings given on the type plate:

“WARNING – DO NOT OPEN IN HAZARD AREAS“

“WARNING – DO NOT OPEN WHILE ENERGIZED“



The use in hazardous areas with regard to temperature and dust layers is defined in the respective national regulations.



When installing the ExCam, adhere to the requirements of the EN/IEC 60079-14.

4 Commissioning

For the camera's installation and operation, the relevant national regulations, as well as the generally accepted rules of technology shall prevail. Before mounting the camera, thoroughly check it for any transportation damages, especially at the housing and cable. Installation, electrical connection, and the first commissioning must only be carried out by qualified personnel.

Work preparation:



Attention!

Prepare your work carefully and in accordance with the relevant regulations.



Attention!

Depending on classification of hazard areas, a work approval has to be obtained!

When you open the pressure-resistant enclosure under voltage, it is absolutely necessary to prevent potentially explosive atmosphere!

To ensure the best image quality delivered by the network camera, plan the installation site carefully (consider light conditions, object distance or size, angle and minimum object distance to the focus).

- Use appropriate tools and aids.
- When working, ensure a safe stand.
- Make sure that any static charge is avoided



Attention!

Please observe the national regulations regarding security, installation, and accident prevention (e.g. DIN EN 60079-14) and the safety guidelines described in the user and in the EX installation manual!



Attention!

Adhere to the provisions of the IECEx, ATEX and EX installation instructions for mounting and commissioning!

The ExCam® XF M3016 is manufactured with a 5 m cable pigtail. The ending of the camera's cable connection is furnished with a plug. Install the ExCam® XF M3016 at the desired location. Mounting options and conditions, accessories, as well as safety guidelines are described in the EX installation manual of the T08 ExCam® Series.

Attention!

Prior to the camera installation, take external sources of heat or cold into account! Observe the permissible temperature range!

Attention!

Please pay attention to the national and local regulations for mounting heavy loads. If in doubt, take appropriate security measures.

Drawings for drill hole patterns and further information can be viewed on our product page:

Quick link:

<https://www.samcon.eu/en/products/network/excam-xf-m3016/>

Option mounting accessories

Wall mount bracket WMB-...		WALL MOUNT EXCAM XF M30 (02028-001) Wall bracket for devices of T08-VA1.2-series Suitable for hanging the camera on walls. Material: stainless steel 1.4404 Weight: 0.68 kg Dimensions: 80 x 100 x 205 mm
Pole mount adapter PMB-...		POLE MOUNT EXCAM VA1.x (-) Pole adapter for VA wall mount Material: stainless steel 1.4404 Suitable for pole diameters between 50 and 105 mm Load-bearing capacity: 45 kg Dimensions: 120 x 180 (x 130 at masts of Ø 60 mm)
Weather Protection Roof WPR-...		WEATHERSHIELD EXCAM XF M30 (02033-001) Weather shield for devices of the T08-VA1.2-series

Tab. 4-1 Mounting Accessories

5 Electrical connection



Attention!

The electrical connection of the equipment must be executed by qualified personnel only!



Attention!

It is mandatory that the housing of the ExCam[®] Series has to be grounded via a PE-connection!



Attention!

Please observe the national regulations regarding security, installation, and accident prevention (e.g. DIN EN 60079-14), as well as the safety guidelines described in this user manual and the EX installation manual!

The T08 ExCam[®] XF M3016 is delivered with an electrical connection. The maximum cable length (PD to PSE) is 95 m (depending on electromagnetic tolerance/ EMC environment) and can be determined individually to reflect the particular customer specifications.

The delivered ExCam[®] XF M3016 is equipped with a 5 m electrical connection cable. The user is NOT authorised to do electrical connection procedures inside the pressure-resistant enclosure. The ending of the camera's cable connection is furnished with a plug.

5.1 Potential equalization

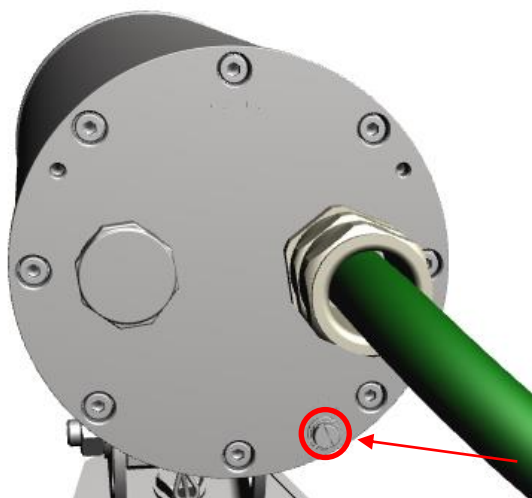

Fig. 5-1 ExCam XF M3016 Equipotential Bonding

The potential equalization/grounding of the camera body is absolutely necessary, in order to avoid static charges and thus formation of sparks. For this purpose, a screw terminal is provided at the rear side, at the bottom (right) (see Figure 5.1). The cross-section of the equipotential bonding should comply with the National Ground Rules (at least 4 mm²).

Wiring table:

Potential	Colour (IEC 60757)	Cross-section	Comment
PA	GN/YE	4 mm ² (rigid)	Terminal: slotted screw M4x0.7 (DIN 84) with washer Ø9mm (DIN 125A), Keep 3Nm tightening torque!

Tab. 5-1 Equipotential Bonding

5.2 Connection and Fusing

Ex d cable gland:
 ADE 1F2 Typ5 - M20 (Neopren);
 7-12mm

Ex-cable

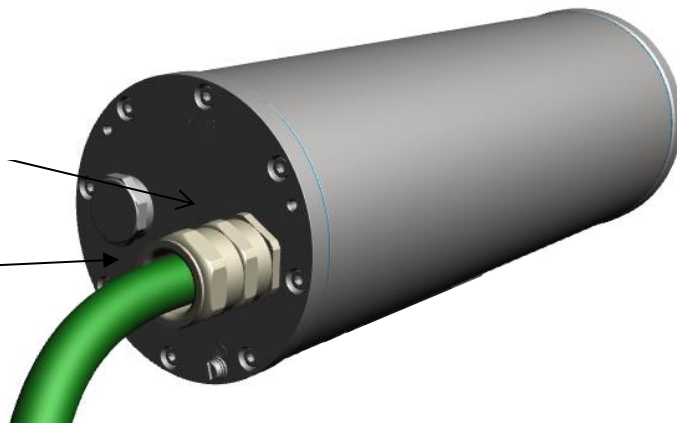

Fig. 5-2 Cable gland and Ethernet cable

Figure 5-3 illustrates the cable termination for the ExCam XF M3016 (RJ45 plug).



Fig. 5-3 ExCam XF M3016 T08-VA1.2.K1.BOR-N.N-005.N-P-090

Via the 8 (+1) wire green patch cable the digital video stream is transferred via IP/ TCP/ RTSP protocol levels and the camera module is controlled and/or parametrized via the web interface or the video management software.

The power supply of the PoE camera is conducted via this cable. In order to guarantee the power supply of the T08 ExCam XF M3016 (*Powered Device/ PD*), a Power-over-Ethernet component (Power Sourcing Equipment, PSE) has to be available at the connecting side (e.g. a PoE Switch, a PoE Injector, or Midspan) which meets the IEEE 802.3af or 802.3at type 1 class 1 specification¹. The interface of the ExCam XF M3016 uses a 100 Mbit/s „Fast Ethernet“ connection for the data transfer (100BASE-TX).

5.2.1 Network interface / plug assignment (RJ45)

Standardly, the camera's cable end is furnished with an RJ45 Ethernet plug with Power over Ethernet (PoE). This plug (Fig. 5-3) should be coupled with the RJ45 PoE socket of the network device (PSE). Prior to connecting it to the camera, the network device can already be supplied with power, hence you do not need to observe any “power ON” priority.

5.2.2 Connection to a terminal box (alternatively)

If you have to connect the camera to a terminal box, please remove the plug properly, according to good professional practice. In this case it is imperative to ensure a correct routing of the individual wires according to the EIA/TIA-568B (see Tab. 5.3). As a rule of thumb, the core wires of the same colour coding (IEC60757) should be connected.

Especially in EMC-critical environments, it is important to make sure that the cable shield is properly grounded at the terminal box side.



Attention!
Never open the Ex-e terminal box under voltage!



Attention!
Please observe the international installation regulations for connection chambers with increased safety (Ex-e).



Attention!
Please observe the separate Usual Manual for the Ex-e connection chamber attached in the annex.

Attention: The general specification for PoE allows different operation modes for PDs: Mode A (end span): This is usually used by switches; the supply voltage is executed as phantom power on the data lines. Both polarities are possible.

¹ Classification power: 9-12 mA, nominal voltage 48 V DC (44...54 V DC), maximum feed power PSE: 4.0 W, removal performance PD: 0.44 W – 3.84 W

Mode B (mid span): This is usually used by PoE injectors; the power supply and protocol transfer is executed on separate pins (plug / pin contact 4.5 is the positive pole and 7.8 is the negative pole). The T08 ExCam Series supports both modes and the used power source (PSE) determines the mode.

The pin assignment for the cable SKDP04-T.flex is in accordance with the standard EIA/TIA-568B for 100BaseTX with PoE (IEEE 802.3af/at):

Camera side / Internal wiring			System cable		Junction Box		
Pin/ Potential 100BaseTx/PoE		Color (IEC60757)	Plug contact (TIA-568B)	Profile AWG23/1		Terminal	Comments
Mode A	Mode B			Area [mm ²]	Diameter [mm]		
-	-	PE (enclosure)	SHD.	-	-	PE	SHD
Tx+ / PoE ±48 VDC	Tx+	WH / OG	1	0.26	0.57	1	
Tx- / PoE ±48 VDC	Tx-	OG	2	0.26	0.57	2	
Rx+ / PoE GND	Rx+	WH / GN	3	0.26	0.57	3	
Rx- / PoE GND	Rx-	GN	6	0.26	0.57	4	
n.a.	PoE +48 VDC	WH / BU	5	0.26	0.57	5	
n.a.	PoE +48 VDC	BU	4	0.26	0.57	6	
n.a.	PoE GND	WH / BN	7	0.26	0.57	7	
n.a.	PoE GND	BN	8	0.26	0.57	8	
Shield A/ GND (twisted pair)		-	GND (Plug)	-	-	PE.	PE
n.c.	n.c.	n.c.	n.c.	n.c.	n.c.	9	
n.c.	n.c.	n.c.	n.c.	n.c.	n.c.	10	
		-		-	-	PE	

Tab. 5-2 Electrical connection

Particularly in EMC critical environments, it is necessary to make sure that the cable shield is grounded on side of the terminal block.

The maximum cable length between camera and Ex-e terminal box is 95 m.

Video Tutorial:

Please view our video tutorial:

“SAMCON 01 Wiring the cable SKDP03-T to the junction box ExTB-3”

<https://go.samcon.eu/v01>



Fig. 5-4 Video Tutorial ExTB-3

It is allowed to separate and re-connect the ExCam XF M3016 from the network when in operation and/or when interacting with the visualization software (hot plug-in), or, if necessary, to reboot it for carrying out a re-parametrization or set it back to default.

Attention: „Hot plug-in“ as well as the connection and separation of the data and power cable from/of network devices and terminal blocks under power is only allowed within the safe area (non-hazardous atmosphere)!

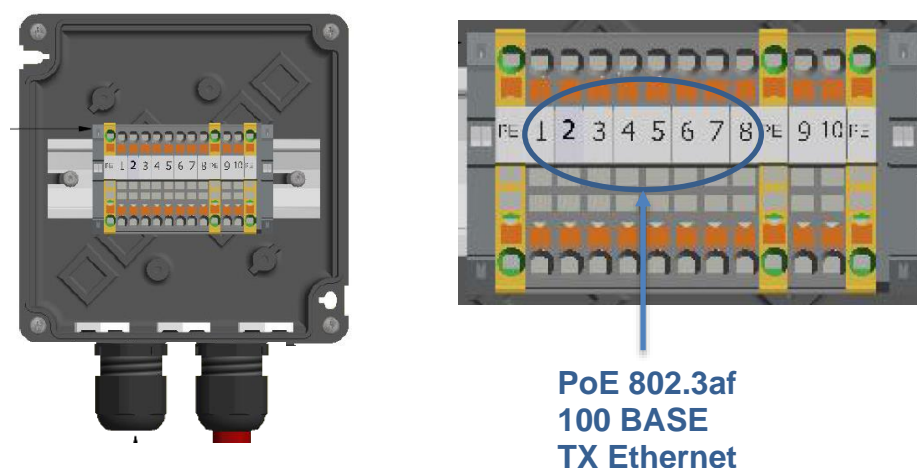

Fig 5-5 Connection to a terminal box



Attention!

Introduce the foiling up to about 15 mm to the terminals, in order to prevent alien crosstalk. Make sure that the foiling cannot cause any short circuit of the data pairs!



Attention!

Bring the twisted pair composite approximately 10mm close to the terminals, in order to ensure the interference immunity.



Attention!

Use only terminals approved by SAMCON.



Attention!

Finally, check your network installation by per Class-D Link Test.

5.3 Example: external connection and fusing via the terminal box

There are several options of routing the ExTB-3 terminal box in a safe area:

5.3.1 Example: direct routing from the ExTB-3 to the safe area

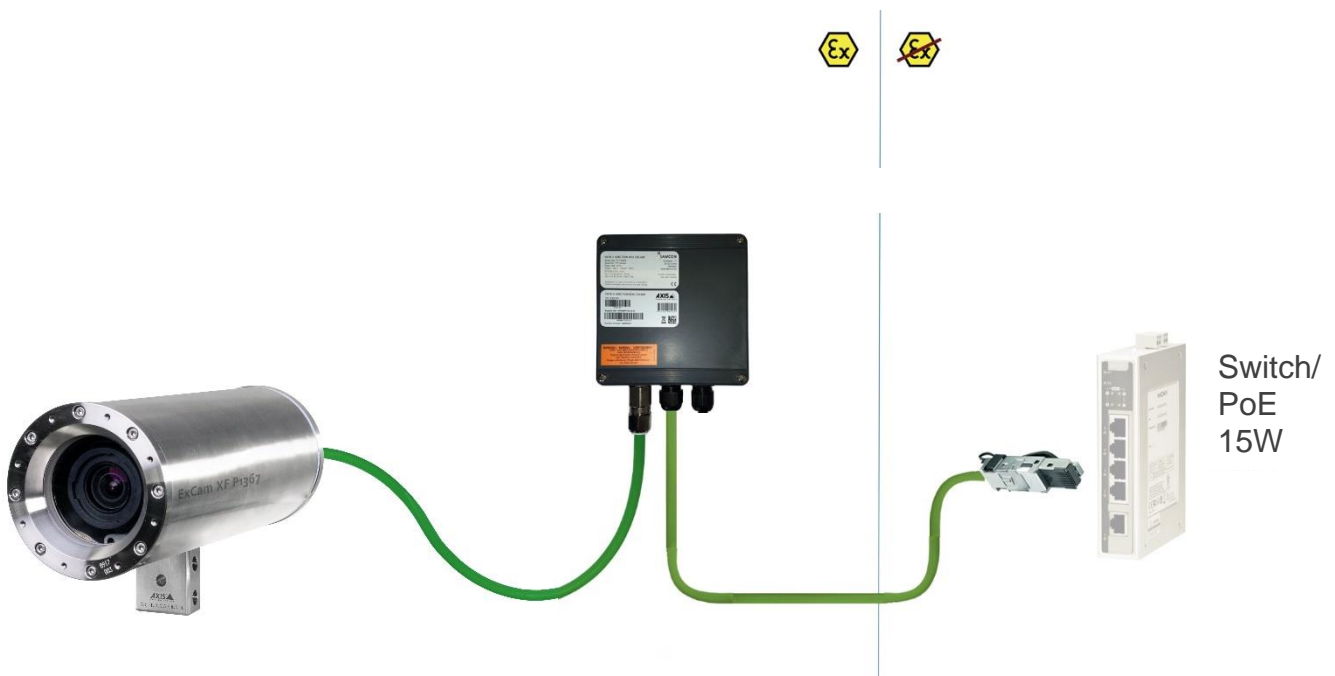

Fig 5-6 ExTB-3 -> Safe area

In the case of direct routing from ExTB-3 to the safe area, the power supply and the voltage signal are led from the safe area to the terminal box. Please observe the terminal box assignment, as described above.



Attention!
 Cables and wires must comply with the requirements of the IEC 60079-0/1/7 & 14.



Attention!
 The supply line must have a sufficient cross-section. The cable protection must comply with national and international regulations.



Attention!
 Cable glands which are not fitted with a cable have to be closed with the red blind plug.

5.3.2 Example: Routing via ExConnection Rail (optional accessories)

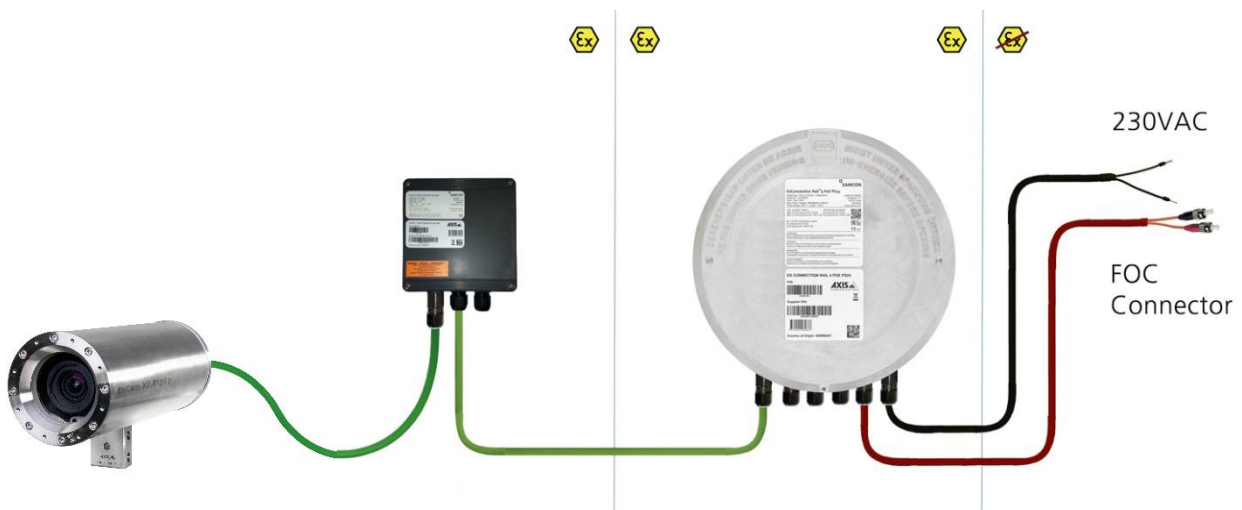

Fig. 5-7 ExTB-3 -> ExConnection Rail

In the case of routing the ExTB-3 into an ExConnection Rail, larger installation distances can be covered.

Please note:

In hazardous areas, the ExConnection Rail (optional accessories) acts as a PoE+ switch, a media converter from copper to fibre-optic cable, as well as a power supply for the cameras.

5.3.3 Appropriate cables & cable glands

An integral part of the device safety is the correct selection of the cables, wires and cable glands.



Attention!
Cables and wires must comply with the requirements of the IEC 60079-0/1/7 & 14.



Attention!
The supply line must have a sufficient cross-section. The cable protection must comply with national and international regulations.

To view non-binding configuration and planning guidelines, please visit our website:



Perhaps our video will help you: "Cables for flameproof devices in potentially explosive atmospheres"

<http://go.samcon.eu/video-cable-ex>



Fig. 5-8 Ex-d cable selection

Particularly for installations requiring a suitable barrier gland, make sure that you handle them correctly and observe the rules and notes given in the respective mounting and assembly instructions.

We show the basic procedures in the following video tutorial:

"SAMCON 02 Mounting and installing Ex-d barrier glands to ExConnection Rails"

<https://go.samcon.eu/v02>



Fig. 5-9 Barrier gland

5.3.4 Cable kits - "plug and play" connection packages

As an option, there are various cable kits for different cables are available in different lengths. The connection packages include everything you need for a professional system installation:



- ✓ 10/25/95 m SKDP03-T system cable, digital (a)
- ✓ 1 barrier gland with sealing compound (b)
- ✓ 5 ml of Loctite thread locking (c)
- ✓ One CAT6 RJ45 industrial connectors (5.5 - 10.5 mm) (d)
- ✓ Heat-shrinkable tube 40 cm, yellow-green (e)
- ✓ Heat-shrinkable tube 10 cm, black (e)
- ✓ 8 cable end sleeves (e)
- ✓ 1 set of documents

Fig. 5-10 Cable kit – plug & play connection package

Available connection packages:

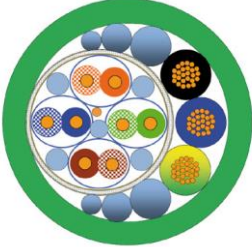
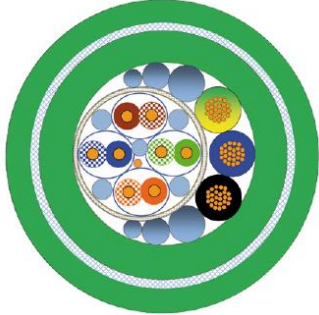
Length	Non-reinforced cable SKDP03-T	Reinforced cable ASKDP03-T
		
10 meters	SKDP03-T CABLE EXCAM 10M (01540-001) This cable set includes: 10 meters SKDP03-T system cable, digital 1 barrier gland Ex-d 5 ml Loctite 243 screw locking 1 x CAT6 RJ45 industrial plug 1 set of documents	ASKDP03-T CABLE EXCAM 10M (01543-001) This cable set includes: 10 meters ASKDP03-T system cable, digital 1 bolted connection Ex-d 1 bolted connection Ex-e 5 ml Loctite 243 screw locking 1 x CAT6 RJ45 industrial plug 1 set of documents

25 meters	SKDP03-T CABLE EXCAM 25M (01541-001) This cable set includes: 25 meters SKDP03-T system cable, digital 1 barrier gland Ex-d 5 ml Loctite 243 screw locking 1 x CAT6 RJ45 industrial plug 1 set of documents	ASKDP03-T CABLE EXCAM 25M (01545-001) This cable set includes: 25 meters ASKDP03-T system cable, digital 1 bolted connection Ex-d 1 bolted connection Ex-e 5 ml Loctite 243 screw locking 1 x CAT6 RJ45 industrial plug 1 set of documents
95 meters	SKDP03-T CABLE EXCAM 95M (01542-001) This cable set includes: 95 meters SKDP03-T system cable, digital 1 barrier gland Ex-d 5 ml Loctite 243 screw locking 1 x CAT6 RJ45 industrial plug 1 set of documents	ASKDP03-T CABLE EXCAM 95M (01542-001) This cable set includes: 95 meters ASKDP03-T system cable, digital 1 bolted connection Ex-d 1 bolted connection Ex-e 5 ml Loctite 243 screw locking 1 x CAT6 RJ45 industrial plug 1 set of documents

Tab. 5-3 Available cable kits

5.3.5 Tests prior to switching on the voltage



Attention!

Prior to starting the device, perform all tests as indicated by the national regulations. Furthermore, check the correct function and installation of the device in accordance with this User Manual and other applicable regulations.



Attention!

Incorrect installation and operation of the camera may lead to a loss of warranty!



Attention!

Do not switch on the camera at temperatures below 0°C!

6 Hardware Reset

A hardware reset should only be carried out under the following conditions: The camera is not accessible within the network after it has been disconnected from power in order to carry out a restart, after a failed firmware update, or a factory reset has been explicitly asked for. For carrying out a hardware reset it is allowed and necessary to open the Ex d housing.

6.1 Work preparation



Attention!

Please carry out any pre-operational work carefully and in accordance with the applicable regulations.



Attention:

Note: Depending on the zone classification, it might be necessary to obtain a work permit/clearance! When adjusting the camera settings potentially explosive atmosphere must be avoided by any means!

- Use appropriate tools
- Make sure you have a secure foothold
- Avoid static charge

6.2 Opening the pressure-resistant housing

Opening the pressure-resistant camera housing is only allowed to carry out the hardware reset of the M3016 camera module. Afterwards, the housing has to be closed explosion-proof again! The steps below have to be followed very carefully:



„WARNING – DO NOT OPEN IN HAZARDOUS AREA“

Attention:

For opening the ExCam XF M3016's pressure-resistant stainless steel housing T07 VA1.2.K1.BOR, it is mandatory to follow the step-by-step instructions as stated in the T08 Ex installation manual!

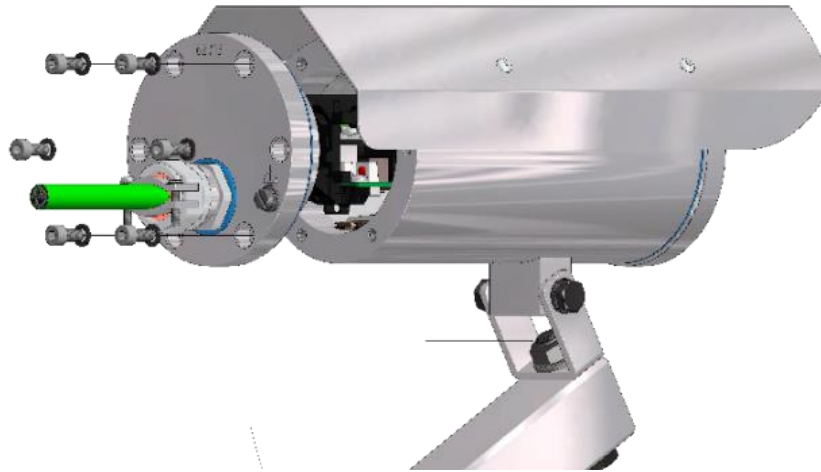

Fig. 6-1 Opening the ExCam XF M3016



Attention!

Beware not to damage the surface of bore hole and shaft (fit) at the flame proof gap preventing the transmission of ignition.



Attention!

Please make sure not to damage housing sealings and to keep them clean.

The two control buttons are located on the Axis modules main board (q.v. Figure 6-2); the outer push button is used for carrying out the hardware reset.

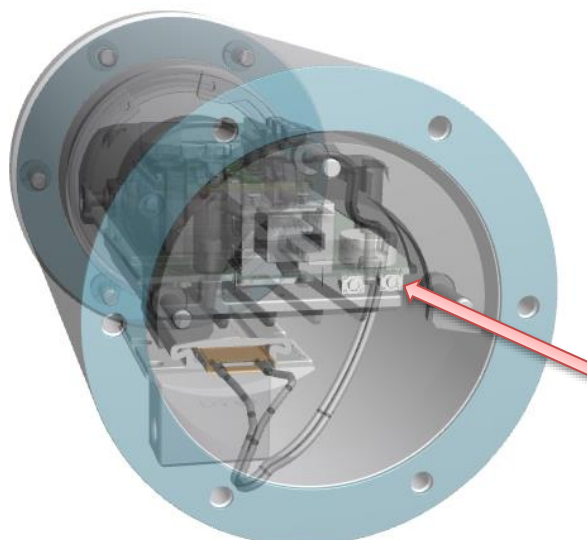

Fig. 6-2 Location of the control button

In order to be able to press the control button, the black mounting adapter has to be disconnected from the stainless steel flange. To do so, please take off the M3*0.5 16 mm cylinder head screws (DIN 912) with the associated washers (DIN 127 A) (q.v. figure 6-3)

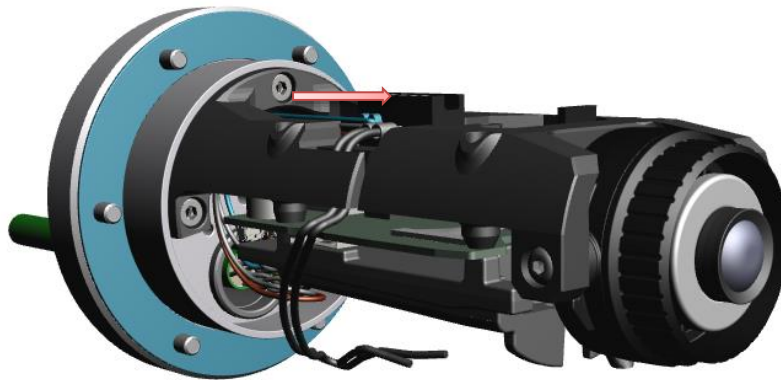

Fig. 6-3 Disconnecting the mounting adapter

Attention: Via a „heavy duty“ RJ45 network plug, the hardware is connected to the system cable. For low temperature models, there are also two further wires (BK) and an additional plug connection (WH) to the heating module. It is not mandatory to unplug the RJ45 plug but it might facilitate the handling. If the cable is unplugged, please make sure to re-loop it later on.

Carefully tilt the mounting adapter so that through the opening, the right push button can be pressed to carry out the hardware reset (q.v. Figure 6-2).

Please make sure not to damage any electrical installations, cable interfaces, the lens, or the mounting components. Also, please do not exert mechanical strain on the aforementioned components. Please be aware that the measures run a risk of distorting the optical axis which leads to a reduction in the picture quality!



When touching electrical components, potential equalization (grounding of the body) has to be observed (ESD clothing, PE wristband etc.)!

For carrying out the hardware reset, please refer to the Axis user manual (page 15) which describes the individual steps:

https://help.axis.com/api/download/um_m30_series_t10104241_de_2103.pdf

After the successful hardware reset, the mounting adapter has to be fixed again with the three M3*0.5 original screws and the associated washers. A tightening torque of 2.5 Nm is recommended!

When closing the housing, the cable routing has to be observed! In order to avoid collisions and mechanical strain within the closed housing as well as to observe the necessary bending radius, the cable has to be looped.

6.3 Closing of the pressure-resistant housing

Attention:

For closing the pressure-tight stainless steel T07 VA1.2.K1.BOR housing of the ExCam XF M3016, the instructions of the T08 Ex installation manual have to be followed step by step!



ATTENTION:

In case of any mechanical damages that happened to the flameproof joint, the housing must not be used anymore!



ATTENTION!

Do not lock-in any foreign objects in the housing



Cylinder head screws used for explosion-proof connection of the housing body with the flanges, always have to be tightened evenly and crosswise with a tightening torque of 3.0 Nm

7 Network access and visualization

For a comprehensive user manual of the web surface, please refer to the to the Axis user manual: <https://help.axis.com/axis-m3016>
https://help.axis.com/api/download/um_m30_series_t10104241_en_2103.pdf

At delivery, the ExCam XF M3016 is set to the applicable net frequency (50Hz or 60Hz). If the camera is used at a location with a differing net frequency, a flickering of the picture might be noticeable, particularly in surroundings with fluorescent tubes. In such a case, the applicable settings have to be carried out within the menu “System Options > Advanced > Plain Config”, requiring a system restart.

7.1 Browser Support

A list with the currently supported web browsers, operating systems, and required add-ons can be viewed at:

<https://help.axis.com/access-your-device>

<https://www.axis.com/support>

7.2 Assigning the IP address

The ExCam XF M3016 is intended for use in an Ethernet network and requires an IP address to access and control it. In most of today's networks, a DHCP server is integrated which automatically assigns an IP address. If there is no DHCP server available in the network, the IP default address of ExCam XF M3016 is "**192.168.0.90**" (**subnet masking 255.255.255.0**). With the "AXIS IP Utility" tool it is possible to determine the IP address with Windows; the software as well as additional useful tools can be downloaded for free from the axis homepage.

<https://www.axis.com/support/tools/axis-ip-utility>



If it is not possible to assign the IP address, it might be necessary to change the firewall settings!

The "AXIS IP Utility" tool automatically recognizes all ExCam devices and visualises them in the device list. It can also be used to manually assign a static IP address. For this purpose, the ExCam XF M3016 network camera should be installed in the same physical network segment (physical subnet) as the computer on which the AXIS IP Utility is running. The network signature of ExCam XF M3016 is "AXIS M3016" (see Fig. 8-1). MAC address and serial number for clear device identification are also detected and displayed.

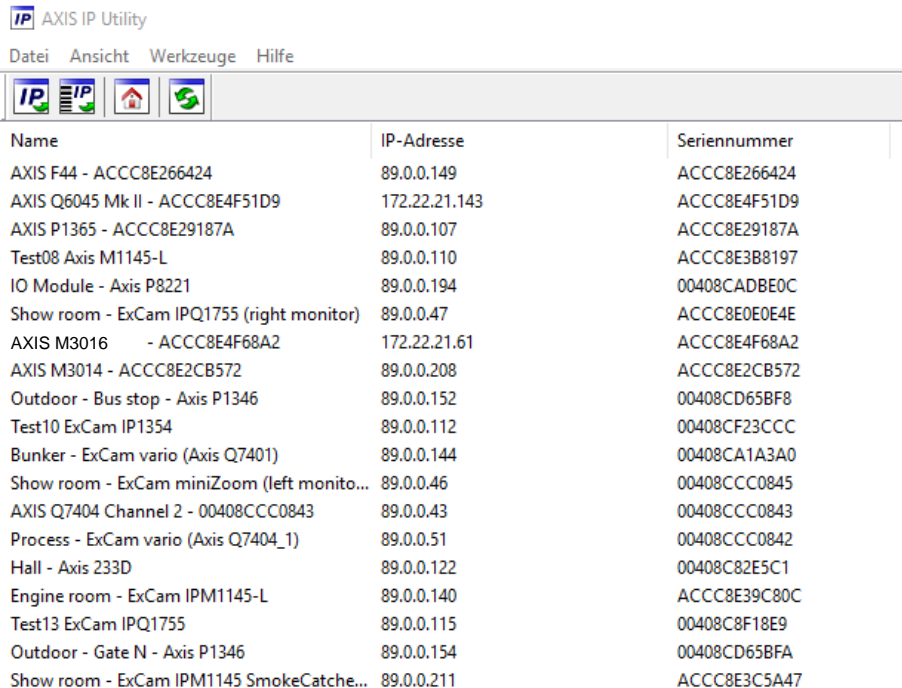

Name	IP-Adresse	Seriennummer
AXIS F44 - ACCC8E266424	89.0.0.149	ACCC8E266424
AXIS Q6045 Mk II - ACCC8E4F51D9	172.22.21.143	ACCC8E4F51D9
ExCam IP1365 → AXIS P1365 - ACCC8E29187A	89.0.0.107	ACCC8E29187A
Test08 Axis M1145-L	89.0.0.110	ACCC8E3B8197
IO Module - Axis P8221	89.0.0.194	00408CADBE0C
Show room - ExCam IPQ1755 (right monitor)	89.0.0.47	ACCC8E0E0E4E
ExCam XF M3016 → AXIS M3016 - ACCC8E4F68A2	172.22.21.61	ACCC8E4F68A2
AXIS M3014 - ACCC8E2CB572	89.0.0.208	ACCC8E2CB572
Outdoor - Bus stop - Axis P1346	89.0.0.152	00408CD65BF8
Test10 ExCam IP1354	89.0.0.112	00408CF23CCC
Bunker - ExCam vario (Axis Q7401)	89.0.0.144	00408CA1A3A0
Show room - ExCam miniZoom (left monito...	89.0.0.46	00408CCC0845
AXIS Q7404 Channel 2 - 00408CCC0843	89.0.0.43	00408CCC0843
Process - ExCam vario (Axis Q7404_1)	89.0.0.51	00408CCC0842
Hall - Axis 233D	89.0.0.122	00408C82E5C1
Engine room - ExCam IPM1145-L	89.0.0.140	ACCC8E39C80C
Test13 ExCam IPQ1755	89.0.0.115	00408C8F18E9
Outdoor - Gate N - Axis P1346	89.0.0.154	00408CD65BFA
Show room - ExCam IPM1145 SmokeCatche...	89.0.0.211	ACCC8E3C5A47

Fig. 7-1 Axis IP Utility

7.3 Password / identification

The following user name is set at the factory: **root**

The following password is set at the factory: **root**

8 Maintenance / Servicing / Alterations

The national regulations concerning the maintenance and servicing of electrical devices within hazardous areas are to be observed.

The required maintenance intervals are specific to the individual devices. The operating company has to determine these intervals depending on the application parameters. During maintenance, focus has to be put on checking parts concerning the ignition protection category such as the integrity of the housing, the sealings and the cable glands. If maintenance measures are necessary they have to be initiated and/or executed.

9 Repairs and Maintenance

Repairs must only be carried out with original parts of SAMCON Prozessleittechnik GmbH. Damaged pressure-resistant housings have to be replaced completely. If in doubt, return the applicable part to SAMCON Prozessleittechnik GmbH.

Repairs concerning the explosion protection must only be carried out by SAMCON Prozessleittechnik GmbH or a qualified electrical technician authorized by SAMCON Prozessleittechnik GmbH in accordance with nationally applied regulations. Rebuilding of or alterations to the devices are not permitted.

10 Disposal / Recycling

When disposing of the device, nationally applicable regulations must be observed.

This document is subject to alterations and additions.

11 Drawings & 3D models

The drawings below are technical drawings of the T08 ExCam XF M3016. Further drawings also for additional accessories, 3D models, STEP files and DXF shapes are available on the SAMCON homepage:

<https://www.samcon.eu/en/products/network/excam-xf-m3016/>

Analog Ex Cameras (CVBS)
Network Ex Cameras (TCP/IP)
ExCam IPM3016
ExCam IPM114x
ExCam IP1365
ExCam IPQ1645
ExCam IPQ1785
ExCam IPP5635
ExCam IPQ6055
Robust Cameras (non-ex)
Ex-d Camera Enclosures
Connection Systems
Accessories
Software
Downloads:
- Datasheet
- 3D-Model
- Users manual
- CAD-files (DXF)
- Ex Installation Manual
- ATEX Type Examination
- IECEX Cert.-of-Conformity
- EAC-Ex-Certification
- MASC (Southafrica-Certification)
- EU Dec. of Conformity

powered by 

ExCam[®] XF M3016



THIS.
2005:
35kg, -20°C, IP54...

IS.
2010:
15kg, -40°C, IP66

EVOLUTION.
2019:
3kg, -60°C, IP68...

With our ExCam XF M3016, an ultra-compact network camera is available for hazardous areas and explosion risk zones!

The **ExCam XF M3016** is an efficient IP megapixel camera which can be used in the **hazardous area**. Despite its **ultra-compact design**, it offers **Full HDTV resolution (1080p) in combination with a wide-angle lens**. In addition, the camera is certified according to **ATEX, IECEx, and EAC-Ex** suitable for hazardous areas in risk of gas and dust explosions.

If you wish additional technical information, please contact us at:
support@samcon.eu

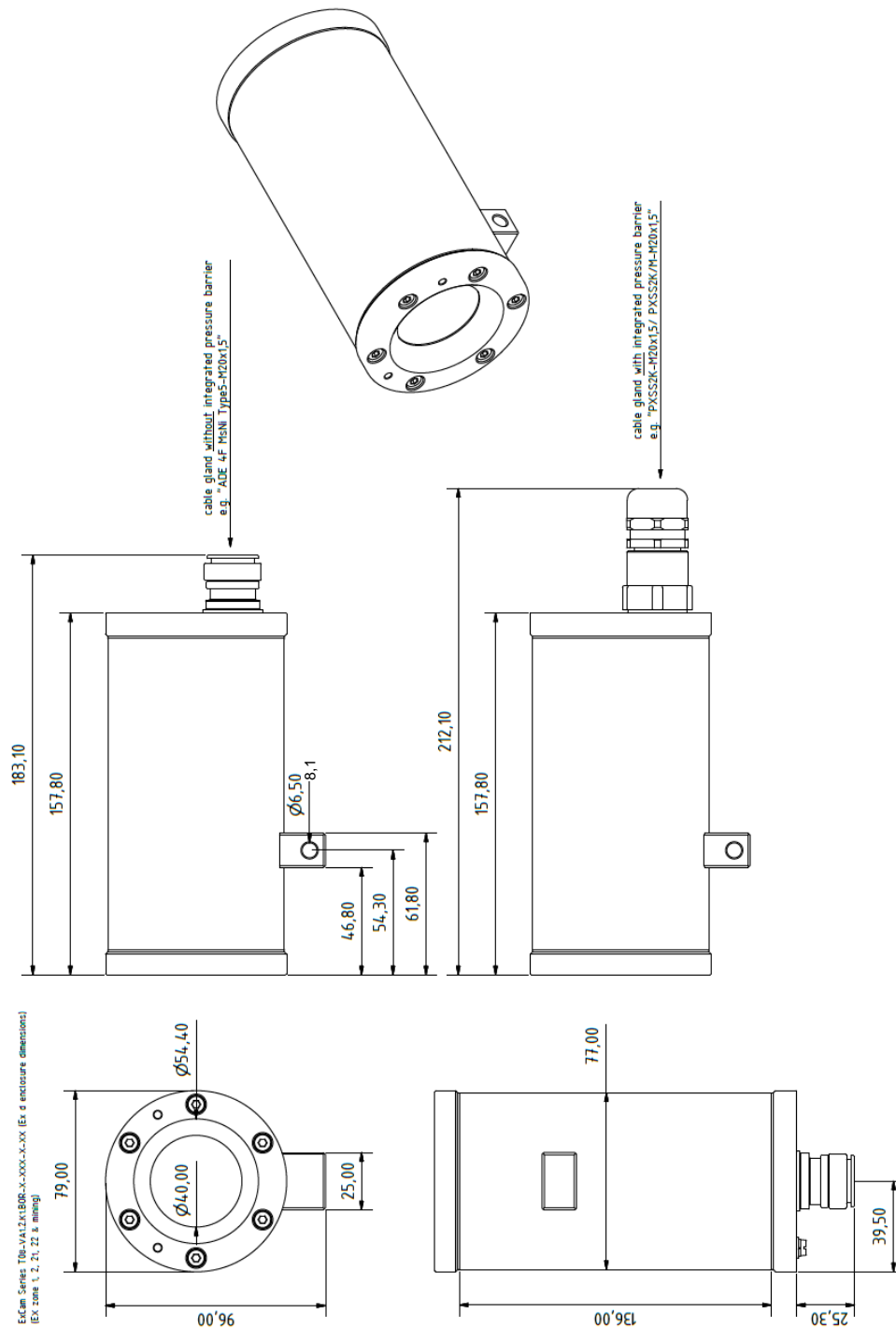

Fig. 11-1 – Dimensions of the T08 ExCam XF M3016

12 Certificates and further documentation

Certificates and further technical documents can be found on our homepage:

<https://www.samcon.eu/en/products/network/excam-xf-m3016/>



SAMCON

Schillerstrasse 17, 35102 Lohra-Altenvers
www.samcon.eu, info@samcon.eu
fon: +49 6426 9231-0, fax: - 31

