

RADIO'S LIVEST MAGAZINE

OVER 175 ILLUSTRATIONS

# Radio-Craft

★

HUGO GERNSBACK EDITOR

SPECIAL  
TEST  
EQUIPMENT  
NUMBER

October

25 Cents

In United States  
and Canada



THE  
AIRCRAFT  
RADIO  
SERVICE MAN

See Page 202

Cathode-Ray Test Equipment — New "Blind Landing" System — 60-W. Amplifier  
New Department: "Learn-by-Experimenting" Beginners' Practical Radio Course

OVER 50,000 RADIO MEN READ RADIO-CRAFT MONTHLY

A Full-Size 3"  
Laboratory Oscilloscope

# SUPREME

for Only \$59.95

## Special SUPREME FEATURES

**RETURN SELECTOR SWITCH.** This important exclusive SUPREME Floating Filament circuit allows the tester's filament supply to be connected to any two or even three filament terminations regardless of their positionings.

**25,000 OHMS PER VOLT METER.** This Super-Sensitive meter is available on Models 531, 541 and 502 at \$5.00 extra cost.

**BRONZE PANELS—OAK CASES.** Each SUPREME instrument is housed in the distinctive Oak "lifetime" case with genuine bronze panel.

**WESTINGHOUSE—SUPREME METERS.** Each meter is built to laboratory standards by Westinghouse.

**"ISO—GRAD" METER CIRCUIT.** Supreme uses a patented circuit which makes possible evenly divided A.C. voltage readings.

**FREE REFERENCE POINT SYSTEM.** Makes possible circuit readings from top of the chassis.

### MODEL 546

Combines laboratory efficiency with the greatest value ever offered in full-size oscilloscopes! Complete with built-in horizontal and vertical amplifiers. Utilizes the full-size 3" screen cathode ray tube. Used for measurements of A.C. Wave forms, frequency, phase, tube characteristics, hysteresis, hum distortion, A.C. peak volts, overload of A.F. or I.F. amplifiers, vibrators, transmitters, etc. Use with R.F. Signal Generator for visual alignment work.

Dealer's Net Cash \$59.95  
Wholesale Price .....  
Or, \$6.50 cash and 10 monthly payments of \$5.95

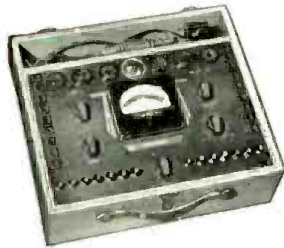

### MODEL 502 Tube and Radio Tester

When we say that this model is a serviceman's dream come true, we mean just that. Imagine having five tests for every tube PLUS nineteen additional ranges and function of .2 to 1400 A.C. volts in four ranges; .1 ohms to 20 megohms in five ranges; .2 to 1400 A.C. volts in four ranges; .2 to 1400 A.C. volts in four output ranges PLUS an Electrostatic capacity leakage test on a neon bulb and PLUS an Electrolytic filter capacity leakage test on a "Good-Bad" English reading scale. A complete, quality tube tester and set tester in a space 10½ in. x 5 in., weighing only 16 lbs. at this new low price!

Dealer's Net Cash Price ..... \$49.95  
Or, \$5.50 cash and 10 monthly payments of \$4.95

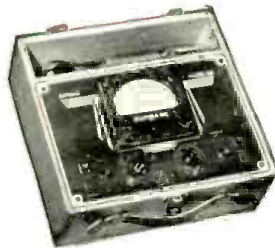

### MODEL 551 Analyzer

This extraordinary new model is not only a 'set tester' but provides a method of making voltage, current and resistance readings directly from the tube socket without removing the chassis from the cabinet! Analyzes all voltages from 0.2 to 1400 volts A.C. in 4 ranges and 0.2 to 1400 D.C. volts in 4 ranges at 1000 ohms per volt. Three D.C. current ranges of 0.2 to 1400 volts A.C. Self-contained ohmmeter circuit measures 0.1 to 20 megohms in 5 ranges. 20 functions and ranges in all!

Dealer's Net Cash Price ..... \$38.95  
Or, \$4.25 cash and 10 monthly payments of \$3.86

Sold on Supreme S. I. C. Terms—The World's Easiest Installment Terms  
Write for Literature Describing Complete Line

**SUPREME INSTRUMENTS CORP., Greenwood, Miss., U. S. A.**  
Export Dept., Associated Exporters Co., 145 W. 45th St., New York City, N. Y. Cable Address, LOPREH, N. Y.

# How a "Tip" got Tom a Good Job

Panel 1: THERE'S D.J.C. IN BERLIN, THE TENTH FOREIGN STATION TONIGHT. RADIO'S CERTAINLY FUN.

Panel 2: HELLO, TOM, HOW'S EVERYTHING? NOT SO GOOD, BILL, BUT I'M STILL PLAYING WITH RADIO. HAD D.J.C. LAST NIGHT, IS RADIO STILL YOUR HOBBY TOO?

Panel 3: NO, TOM, I'VE BEEN TOO BUSY MAKING GOOD MONEY OUT OF RADIO LATELY TO PLAY WITH IT.

Panel 4: YOU'RE SURE LUCKY, BILL. I NOTICED YOUR NEW CLOTHES AND SNAPPY CAR. I THOUGHT YOU HAD INHERITED A MILLION.

Panel 5: YOU HAVE THE SAME CHANCE TOM. ABOUT A YEAR AGO I SHOWED YOU A BOOK FROM NATIONAL RADIO INSTITUTE TELLING ABOUT THE OPPORTUNITIES AND FUTURE IN RADIO, AND NOW OTHERS HAD SUCCEEDED THROUGH THEIR HOME TRAINING. WELL I ENROLLED.

Panel 6: I'M DOING SWELL IN RADIO. MARY AND I ARE TO BE MARRIED NEXT MONTH. RADIO IS MORE THAN A PASTIME. IT'S A BIG BUSINESS AND GROWING FAST. TAKE MY TIP AND GET INTO RADIO NOW, TOM!

Panel 7: IF BILL SUCCEEDED I CAN TOO! THEN I CAN MAKE REAL MONEY SERVICING RADIO SETS. OR GET A JOB IN A BROADCASTING STATION. OR INSTALL AND SERVICE LOUD SPEAKER SYSTEMS. OR MAKE GOOD MONEY IN ANY ONE OF THE MANY OTHER NEW AND GROWING BRANCHES OF RADIO. I'M GOING TO SEND FOR THAT FREE BOOK RIGHT NOW!

Panel 8: YOU CERTAINLY KNOW RADIO. MINE NEVER SOUNDED BETTER. N.R.I. TRAINING CERTAINLY PAYS. I JUST STARTED A FEW MONTHS AGO AND I'M ALREADY MAKING GOOD MONEY IN MY SPARE TIME.

Panel 9: THANKS!

Panel 10: OH, TOM, IT'S WONDERFUL HOW FAST YOU'VE GONE AHEAD IN RADIO. WE NEVER COULD HAVE GOTTEN MARRIED ON WHAT YOU WERE GETTING BEFORE. OUR WORRIES ARE OVER, I'M MAKING GOOD MONEY NOW, AND THERE'S A FUTURE AHEAD FOR US IN RADIO.

... I will train you to start a spare time or full time **Radio service business Without Capital**

**Many Radio Experts Make \$30, \$50, \$75 a Week**



J. E. Smith, President National Radio Institute Established 1914

Do you want to make more money? The world-wide use of Radio sets has made many opportunities for you to have a spare time or full time Radio service business of your own. Three out of every four homes in the United States have Radio sets which regularly require repairs, servicing, new tubes, etc. Many sets are old and will soon be replaced by new models. I will train you to sell, install, service all types of Radio sets—to start your own Radio service business and build it up on money made in spare time while learning. Mail coupon for my 64-page book. It's FREE.

**Get Ready Now for a Business of Your Own and for Jobs Like These**

Broadcasting stations employ engineers, operators, station managers and pay to \$5,000 a year. Spare time Radio set servicing pays as much as \$200 to \$500 a year—full time Radio servicing jobs as much as \$30, \$50, \$75 a week. Many Radio Experts own and operate their own full time or part time Radio sales and service businesses. Radio manufacturers and jobbers employ testers, inspectors, foremen, engineers, servicemen, paying up to \$6,000 a year. Radio operators on ships get good pay and see the world besides. Automobile, police, aviation, commercial Radio, and loud speaker systems offer good opportunities now and for the future. Television promises many good jobs soon. Men I trained at home have good jobs in all these branches of Radio. Read their letters in my 64-page book. Mail the coupon.

**Many Make \$5, \$10, \$15 a Week Extra in Spare Time While Learning**

Practically every neighborhood needs a good spare time serviceman. The day you enroll I start sending you Extra Money Job Sheets. They show you how to do Radio repair jobs—how to cash in quickly. Throughout your training, I send you plans and ideas that have made good spare time money for hundreds of fellows. I give you special Radio equipment for conducting experiments and building circuits which illustrate important Radio principles. My Training gives you practical Radio experience while learning.

**Find Out What Radio Offers You—Mail Coupon Now**

Mail the coupon now for my Free Lesson and my book "Rich Rewards in Radio." Both are free to anyone over 16 years old. My book points out Radio's spare time and full time opportunities, and those coming in Television; shows my Training in Radio and Television; tells about my Honey-Bark Agreement; shows you letters from men I trained, telling what they are doing and earning. Find out what Radio offers YOU! MAIL THE COUPON in an envelope, or paste it on a penny postcard—NOW!

J. E. SMITH, President  
NATIONAL RADIO INSTITUTE  
Dept. 7KX, Washington, D. C.

**HERE'S PROOF THAT N.R.I. MEN MAKE GOOD MONEY**



**\$3,500 a Year in Own Business**

"After completing the N. R. I. Course I became Radio Editor of the Buffalo Courier. Later I started a Radio service business of my own, and averaged over \$3,500 a year."—T. J. TELAAK, 657 Broadway, Buffalo, N. Y.

**\$10 to \$25 a Week in Spare Time**

"I am making from \$10 to \$25 a week in spare time while still holding my regular job as a machinist. I owe my success to N. R. I."—WM. F. RUPP, 203 Front St., Conshohocken, Pa.



**GET MY FREE LESSON on Radio Servicing Tips**



I will prove that my training is practical, money-making information, that it is easy to understand—that it is just what you need to master Radio. My lesson text, "Radio Receiver Troubles—Their Cause and Remedy" covers a long list of Radio receiver troubles in A.C., D.C., battery, universal, auto, E. H. F., superheterodyne, all-wave and other types of sets. A cross reference system gives you the probable cause and a quick way to locate and remedy these set troubles. A special section is devoted to receiver check-up, alignment, balancing, neutralizing and testing. Get the lesson Free. No obligation. Just mail coupon.

**MAIL THIS. Get a lesson and 64 page book FREE**

Please Say That You Saw It in RADIO-CRAFT

Dear Mr. Smith: I want to take advantage of your offer. Without obligating me, send me your Free Lesson and your book, "Rich Rewards in Radio." (Please wr. & plainly.)

NAME.....  
ADDRESS.....  
CITY.....  
STATE.....  
ZIP.....

J. E. SMITH, President  
National Radio Institute, Department 7KX  
Washington, D. C.

AGF.



HUGO GERNSBACK, Editor-in-Chief  
 N. H. LESSEM Associate Editor  
 C. P. MASON Associate Editor  
 R. D. WASHBURNE, Managing Editor

**CONTENTS — OCT. 1937, ISSUE**  
 Volume IX Number 4

Editorial: Marconi.....Hugo Gernsback 197  
 The Radio Month in Review..... 198  
 The "Resonoscope"—New Electronic Device Detects "Off-Key" Notes ..... 200  
 New "Resolution Tester" for Cathode-Ray Tubes..... 201  
 The "Air-Track" System of "Blind Landing" .....Charles E. Planck 202  
 The Aircraft-Radio Service Man.....N. H. Lessem 202  
 Guglielmo Marconi—1874-1937 ..... 203  
 New U. S. Coast Guard Aviation Radio..... 203  
 New Tubes for the Radio Experimenter—Part I .....R. D. Washburne 204  
 New Set Tester Features Low-Ohm Scale .....B. O. Burlingame 205  
 What Size Oscilloscope?.....G. M. Buchard 205  
 Importance of Modern Test Equipment .....Glenn H. Browning 206  
 How to Make "The Seafarer" Loop-Type Boat Radio Set—Part II.....Raymond P. Adams 208  
 Build This "Optimum-Test" Tube Checker .....Milton J. Reiner 209  
 Business-Like "Silent" Servicing.....J. P. Kennedy 209  
 Bigger Service Profits from Better Tools! .....O. J. Morelock 210  
 New Circuits in Modern Radio Receivers—No. 1 .....F. L. Sprayberry 211  
 How Dependable Are Your Meter Readings?—Part I .....A. A. Ghirardi 212  
 How to Make a Class A1 Push-Pull Negative-Feedback 60-W. Amplifier.....Walter J. Bronson 214

Latest in Test Apparatus for the Service Man..... 216  
 "Learn-by-Experimenting" Beginners' Practical Radio Course—Experiment No. 1 (The "Radio Whistle") .....Sol D. Prensky 218  
 ABC of Modern Vibrator Servicing.....F. E. Wenger 220  
 The Latest Radio Equipment..... 221  
 Modern Servicing Oscilloscopes..... 222  
 Business Problems of the Service Man.....Jack Grand 223  
 RADIO SERVICE DATA SHEET:  
 No. 212—Crosley Model A-157 (Fiver Roamio) Auto Radio ..... 224  
 Build This "Intermittent Open" Condenser Tester .....Joseph Mosio 225  
 New Instrument Speeds Free-Point Testing .....G. H. Koch 225  
 Correct Playback of Spot Recordings—Part I .....Ralph L. Power 226  
 Radio Wittiquiz ..... 226  
 Operating Notes ..... 227  
 Servicing Questions and Answers..... 227  
 Book Reviews ..... 256

**NOVEMBER RADIO-CRAFT—  
 RADIO  
 VOCATION NUMBER!**

Facts and figures show that radio facilities are rapidly being expanded into numerous fields. Radio program reception and transmission, public address, and electronics all have been put to new uses. The innumerable money-making possibilities of these 3 major fields will be evident to the radio man who reads the technical and semi-technical articles in the forthcoming November issue of RADIO-CRAFT—

—on the newsstands October 1.

Published by Radcraft Publications, Inc. Publication office: 29 Worthington Street, Springfield, Mass. Editorial and Advertising Offices: 99 Hudson Street, New York City. Chicago Advertising Office: L. F. McClure, 919 North Michigan Avenue, Chicago, Ill. Western Advertising Office: Loyd B. Chappell, 530 West Sixth St., Los Angeles, Calif.

Foreign Agents:

London—Gorrings American News Agency, 9A Green St., Leicester Square, W. C. 2, England.  
 Paris—Messageries Dawson, 4 Rue Faubourg, Poissonniere, France.  
 Melbourne—McGill's Agency, 179 Elizabeth St., Australia.  
 Dunedin—James Johnston, Ltd., New Zealand.

RADIO-CRAFT is published monthly, on the first of the month preceding that of date; subscription price is \$2.50 per year in U. S. and Canada. (In foreign countries, \$3.00 a year to cover additional postage.) Entered at the post office at Springfield as second-class matter under the act of March 3, 1879.

Text and illustrations of this magazine are copyright and must not be reproduced without permission of the copyright owners.

Copyright 1937. Radcraft Publications, Inc.

# MANY OPPORTUNITIES FOR THE COYNE TRAINED RADIO MAN

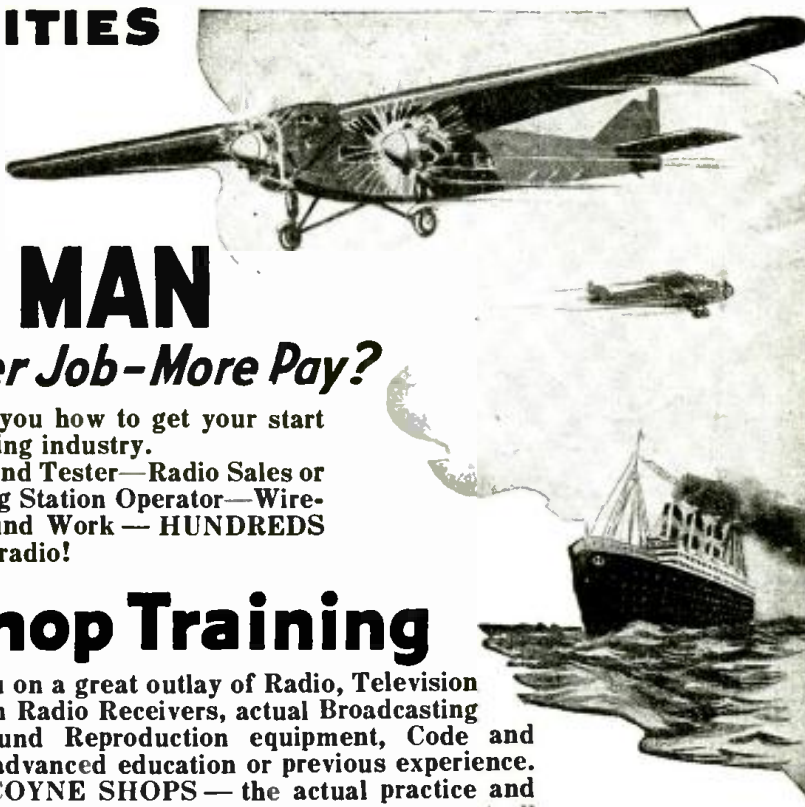

*Are You Ready for a Better Job—More Pay?*

Don't be an untrained man. Let me show you how to get your start in Radio — a fast growing, live money-making industry.

Prepare for jobs as Assembler, Inspector and Tester—Radio Sales or Service and Installation Work—Broadcasting Station Operator—Wireless Operator on a Ship or Airplane or Sound Work — HUNDREDS OF OPPORTUNITIES for a real future in radio!

## 12 Weeks of Shop Training

We don't teach by book study. We train you on a great outlay of Radio, Television and Sound equipment—on scores of modern Radio Receivers, actual Broadcasting equipment, Television apparatus and Sound Reproduction equipment, Code and Telegraph equipment, etc. You don't need advanced education or previous experience. We give you — RIGHT HERE IN THE COYNE SHOPS — the actual practice and experience you'll need for your start in this great field. And because we cut out all useless theory and only give that which is necessary you get a practical training in 12 weeks. Mail coupon for all facts about my school and training methods.

# TELEVISION *and* PUBLIC ADDRESS

Television is sure to come as a commercial industry. Rapid progress is now being made in developing this new field. It will offer opportunities to the man who is trained in Radio. Here at Coyne you learn Television principles, and work on actual Television equipment. Public Address Systems offer opportunities to the Trained Radio Man. Here is a great new Radio field which is rapidly expanding. Prepare NOW for these wonderful opportunities! Learn Radio Sound Work at COYNE on actual Sound Reproduction equipment. Not a home study course.

## SEND FOR DETAILS OF MY "PAY AFTER GRADUATION" PLAN

Mail the Coupon below and I'll tell you about my "Pay After Graduation" Plan which has enabled hundreds of others to get Coyne training with very little money. On this plan you can get your training first, then take 18 months to complete your small monthly tuition payments starting 5 months after you begin training. Not a home study course.

Mail the coupon for all details of this "Tuition Payment Plan."

### PRACTICAL WORK at COYNE in Chicago

ACTUAL, PRACTICAL WORK. You build and service radio sets. You get training on real Broadcasting equipment. You construct Television Receiving Sets and actually transmit your own Television images over our Television equipment. You work on real Sound equipment. You learn Wireless Operating on Actual Code Practice apparatus. We don't waste time on useless theory. We give you the practical training you'll need for your start in Radio—in 12 short weeks. If you desire code, this requires additional time for which there is no extra charge.

**Mail Coupon Today for All the Facts**

H. C. LEWIS, Pres. RADIO DIVISION Founded 1899

**Coyne Electrical School**  
500 S. Paulina St., Dept. 77-8H, Chicago, Ill.

### ELECTRIC REFRIGERATION AIR CONDITIONING AUTOMOBILE ELECTRICAL WORK

Instruction now included at no extra cost. Here is your opportunity to learn these valuable allied lines without extra tuition charge.

### PART TIME EMPLOYMENT TO HELP YOU "EARN WHILE LEARNING"

If you are short of money and need part time employment to help pay for your room and board while training, my Employment Department will help you get a part time job.



### GET THE FACTS

Don't let lack of money prevent your sending in the Coupon. Mail the Coupon today and I Will send you the Big FREE Coyne Book full of FACTS.

H. C. LEWIS, Pres.

**Radio Division, Coyne Electrical School**  
500 S. Paulina St., Dept. 77-8H, Chicago, Ill.

Dear Mr. Lewis:—Send me your Big Free Radio Book, and all details of your "Pay After Graduation" Plan including valuable instruction in Electric Refrigeration, Air Conditioning and Automobile Electrical Work.

Name.....

Address.....

City.....State.....

# Announcing

## THE NEW RIDER MANUAL



### Greatest ADVANCE SALE EVER GIVEN A RIDER MANUAL

Never has a Rider Manual had the enthusiastic reception which Volume VIII enjoys—even before its publication. Never have the advance orders been so great. This is the result of, **FIRST**: The tremendous and ever-increasing popularity of Rider Manuals. **SECOND**: Technicians' recognition of the thorough planning which has gone into this latest volume. For, this is **NOT** just another volume; **RATHER** it is so complete and so well laid out that it actually represents a great *forward stride toward the perfect Manual*.

To deliver the same degree of completeness which has characterized other Rider Manuals it was necessary to make Volume VIII over 1600 pages. Think of it, over 1600 pages chock-full of *dependable* information which will make the radio serviceman's work easier and more profitable—and at no increase over the price of Volume VIII! And—in spite of today's rising costs of publishing, each copy of Volume VIII will be supplemented with an *additional*

invaluable section entitled "How It Works." This separate section meets the current need for special technical information on the modern radio set—*outside* as well as within the actual radio circuit. Motorized tuning—special automatic frequency circuits—these and other *mechanical* as well as electrical kinks and innovations of the modern set must be understood if the serviceman is to work on the better sets—which pay the bigger profits.

Of course, you need all the preceding volumes of Rider Manuals which cover receivers issued between 1920 and 1937. Check your Rider Manuals with the list below and order any missing volumes when you order your Volume VIII covering the 1937-1938 models.

Vol. VIII . \$10.00 . . . 1937-38	Vol. IV . 7.50 . . . 1933-34
Vol. VII . 10.00 . . . 1936-37	Vol. III . 7.50 . . . 1932-33
Vol. VI . 7.50 . . . 1935-36	Vol. II . 7.50 . . . 1931-32
Vol. V . 7.50 . . . 1934-35	Vol. I . 7.50 . . . 1920-31

## VOLUME VIII IN TWO SECTIONS

### "HOW IT WORKS"

A new "plus" service for Rider Manual users. A separate section which goes with every copy of Volume VIII and describes the Technical Features, both *mechanical* and *electrical*, that servicemen must know to repair the modern set with Automatic Frequency Control systems and motorized tuning devices. You will find this section of great value.

### MANUAL

Volume VIII contains more than 1600 pages of circuit information on receivers produced by over a hundred different manufacturers. Auto-radio receivers, home receivers, inter-communicating systems, public address amplifiers, electronic musical instruments, etc., are all covered. As to the completeness of the information and the models represented, we suggest your comparing it with any other service now offered. Compare the replacement parts list, the alignment instructions. Compare it for convenience in use, or anything else which would have a bearing on its value to you.

### INDEX

Check this easy to follow Index. See the tremendous number of sets and models covered. Note, too, that this Index proves what we say—"that information on every set is instantly found." A time saver and a convenience for you. This Index of about 118 pages covers all eight Rider Manuals and goes with every copy of Volume VIII.

**JOHN F. RIDER, Publisher, 1440 BROADWAY, NEW YORK**

**PLACE YOUR ORDER TODAY**

VOLUME VIII  
*Rider*  
MANUAL  
OUT NOVEMBER 10TH



**OVER 1600 PAGES**

PLUS A SUPPLEMENTARY  
BOOK



"Takes the Resistance out of Radio"

Editorial Offices: 99 Hudson St., New York, N. Y.

HUGO GERNSBACK, Editor

Vol. IX, No. 4, October 1937

## MARCONI

An Editorial by HUGO GERNSBACK

**O**N JULY 20th, there died in Rome, Guglielmo Marconi who may turn out to be the greatest radio figure the world has ever seen.

Marconi . . . wireless . . . radio, all are used synonymously and you cannot very well think of wireless or radio without the accomplishments of that indefatigable genius who was the first to capture the public's imagination by an accomplishment, which in the early years of wireless well nigh bordered on the miraculous.

Marconi no doubt will go down in history as one of the race's great benefactors, as great or greater than any other benefactor who ever lived. The debt which the world owes to Marconi is staggering—if you figure only one single result of his accomplishments—the saving of tens of thousands of lives which would have perished in the sea and otherwise, if it had not been for Marconi.

But the saving of untold lives is only one of the things that the world is indebted for to Marconi. The wireless, later the radio age, has brought to life not only a huge industry, but has brought all humans closer together, has made rapid communication, particularly between fixed and mobile stations, a possibility and lately in broadcasting has given the human voice wings such as it never before dreamt of having.

Yet great as Marconi's accomplishments are, he was not the pure inventor type of man, although his name is frequently linked with the word "inventor." Without trying to detract from Marconi's greatness—there could be nothing further from my mind—Marconi was really not the man who invented wireless or radio. He admitted this freely in his own lectures. The credit for the original invention belongs to Heinrich Hertz, who, long before Marconi, investigated in pure scientific terms the electro-magnetic waves, and indeed to Hertz belongs the honor of being the real Father of Radio.

Hertz it was who in his laboratory actually transmitted and received wireless signals. By means of a spark coil he let loose into free space wireless waves. For a receiver he merely used a small loop of copper wire and observed a small spark which appeared between the two open ends of the loop every time the key of the transmitter was depressed. These experiments were made by Hertz while Marconi still was a boy, but, Hertz was a pure physicist and had little imagination. Marconi, reading of Hertz's experiments, promptly started to experiment on his own behalf, and soon he had a wireless transmitter and receiver going on his father's estate in Bologna, Italy. Even Marconi's "coherer" was not his own invention, but Branley's. Others before had noted that loose metallic filings in a glass tube became conductive to the electric current when exposed near the wave effect of a spark coil or high-power induction coil.

As for the elevated aerial used by Marconi, this also was not an invention of his own as Nikola Tesla had already patented a wireless system years before the youthful Marconi began his own experiments. It was Tesla too, who seems to be the first to show the use of an elevated conductor for inter-communication purposes without wires.

All of this should not detract anymore from the glory of Marconi's accomplishments than the parallel facts that Edison was not the original inventor of either the electric light,

motion picture or other inventions usually accredited to him. Neither Marconi nor Edison were pure research men who discovered new principles and used them.

Why then Marconi's greatness? It is one thing to discover an important and record-making discovery, but it is quite another thing to find a practical use for it. The two, as a rule, have little relation, and it is usually the man with the imagination, and the hard-working experimenter who, knowing certain principles, applies them to practical use. If it had not been for Marconi, Hertz's discovery might have lain dormant for decades, but the highly original experimenter and the terrifically hard work coupled with boundless enthusiasm which Marconi applied to a well-known principle, gave him the credit which rightfully belongs to him.

And let no one think that it was all easy and that wireless communication sprang into life overnight. It was always hard work in the face of an incredulous world. Indeed, after his first experiments in Italy were successful, the Italian government in their shortsightedness would have nothing to do with Marconi's "contraption" as they termed it. This made it necessary for Marconi to go to England and continue his experiments there. Soon his signals had reached across the English channel to France, and from then on wireless communication required no further proofs of its practicability.

But still wireless in those days was very crude and far from universal. In the meanwhile Marconi surrounded himself with good technical talent; he also knew where to get needed finances, and finally he availed himself of every new invention that came along to make his system more practical. While he devised many radio circuits, he did not himself discover the fundamental tuning principle, yet he improved existing methods of tuning—*syntonny*—as it was then called, and soon it became possible to operate many wireless stations without too much interference from each other.

But Marconi was not content. He never rested on his laurels. He always was a modest worker who gave credit to whom credit was due, and the honors for dreaming about trans-Atlantic wireless and the courage to actually start experimenting with it in the face of an incredulous world, certainly belong to Marconi. It should not be forgotten that it took a tremendous amount of courage and belief in himself to think that a new and untried system of transmitting electromagnetic waves over almost 2,000 miles of curved ocean surface was within the realm of even a remote possibility. That took more than courage. It was really a supreme heroic gesture, and it is probably for this one outstanding accomplishment, more than any other, that the world is paying homage to the dead inventor today.

In his later years, Marconi again was responsible for great improvements in radio communication, particularly in the shortwave range and his final researches in the microwave field which hold great promise, were cut short by his untimely death.

Marconi was truly an international figure, and if there is one man who ever trod the earth, who is entitled to have a monument erected in his honor in every civilized country on the globe, that man without a shadow of a doubt is the illustrious Marconi.



Photo—Consulate General, Kingdom of Yugoslavia  
Nikola Tesla, wizard of high-frequency electricity and prophet of radio, was honored on his 80th birthday by his native land, Yugoslavia, with the stamp reproduced above. (The characters in the right vertical column spell his name in the Serbian alphabet.)

## RADIO PROVED AIR NECESSITY

**B**Y its use, as well as by its absence, radio last month again showed strikingly its paramount importance in the development of modern travel. Again a flight was made over the Pole, with continual ground communication; two great boats (both illustrated at the bottom of page 199) made the first trip of what will develop into regular commercial transatlantic schedules, with radio as their safeguard—and a famous aviatrix disappeared into the silence.

Amelia Earhart and her navigator, Capt. Noonan, may have met some disaster in which radio could not have helped; we do not know. But they did wilfully discard a standard ship set which, if they had been living, and known the code, could have brought relief straight to them from the Navy, equipped with directional finders operating on this frequency. It seems still doubtful whether any messages were actually received from them; and on July 19 the search was abandoned after 17 days of feverish excitement.



America's Ladybird No. 1 shown at the controls of her famous "flying laboratory" in which (minus the 500 kc. radio installation, after leaving Miami) she and her navigator Captain Noonan flew into the great mysterious silence of the unknown.

# THE RADIO MONTH

It may be that short-wave apparatus will be developed, and generally adopted, to facilitate distress calls; but its very range militates against its being heard by the nearby relievers—and, in that waste of water around the islands lately visited only by eclipse observers, the most powerful of apparatus would have been none too strong for a call for help.

## WAR ON "GYP" MIDGET SALES

**R**AIDS were made, simultaneously, last month by the District Attorney of New York, on a group of dealers, charged with selling midget sets to which well-known nameplates had been attached. A New York law specially prohibits the practice. During the preceding weeks, the Federal Trade Commission also had issued orders to stop imitation of radio set makes.

## A HUNDRED YEARS OF RADIO?

**I**N estimating the period between first conceptions of famous inventions and their reduction to practice, a recently-publicized report from Washington gave the average period as 176 years, and that for radio as 70 years. It is true that communication at a distance is a very old idea. (At one time, it was supposed that 2 needles magnetized together would be "sympathetic" and that one would turn as the other did, at any distance. This was disproved by Sir Thomas Browne, who showed that the effect could not be obtained, even in the next room.) It is also true that inductive effects were observed during the early 19th Century, but not explained. However, the first conception of radio, as such, came with Hertz' experiments; and within 10 years, Marconi had made

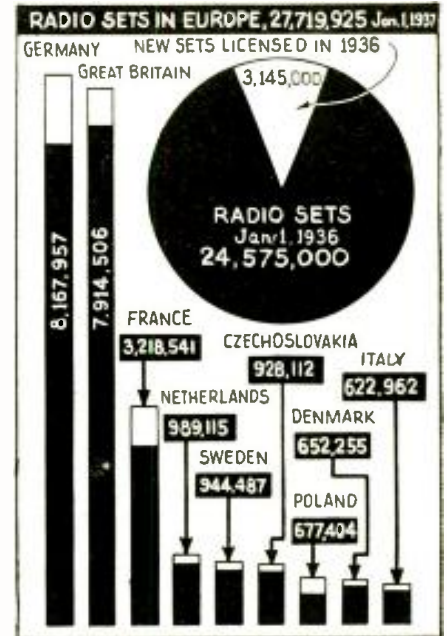

Figures of International Broadcasting Union, Geneva, show Europe Licensed 3,000,000 new radio sets last year. The proportionate growth was greatest in countries like Greece, which more than doubled the number. (Spain and U.S.S.R. omitted, and some colonies included in the total.)

the first practical demonstrations. Television (by wire) as a concept preceded radio some years.

## LOWER RATES FOR CHEAPER TUBES

**S**INCE the freight rates on radio tubes were fixed in 1934, there has been a "reduction in the value per pound of glass tube shipments, while the value per pound of metal tubes has also gradually reduced since their introduction", the R.M.A. announced last month; and for that reason it has applied for a reduction in rates on this classification of goods.

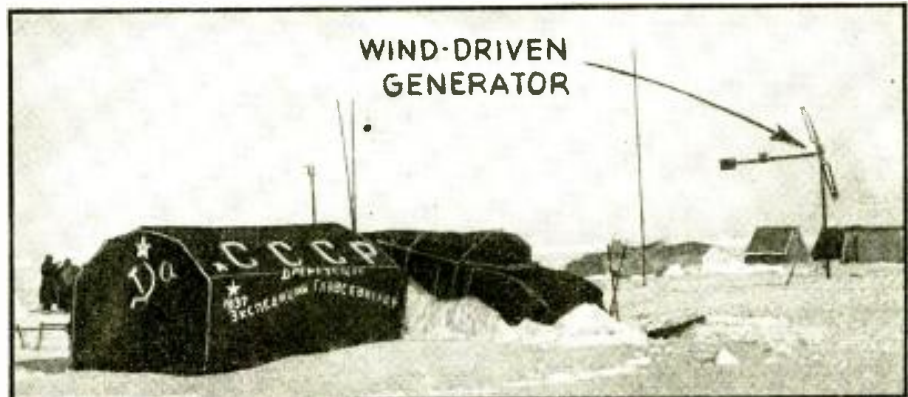

Photograph of the northernmost radio station in the world, UPOL, Lat. 90 deg. North. It was established exactly at the North Pole but, since it is based on ice drifting in the Arctic Ocean, it changes position slightly from day to day. Behind the black (to pass the heat rays, and afford best visibility to airplanes) station tent with Soviet emblems can be seen aerial masts, wind-driven generator, and other tents of the party. The station operates on amateur 20- and 40-meter bands at 1900 and 2130 GMT (which is also NPT).



# IN REVIEW

Radio is now such a vast and diversified art it becomes necessary to make a general survey of important monthly developments. RADIO-CRAFT analyzes these developments and presents a review of those items which interest all.

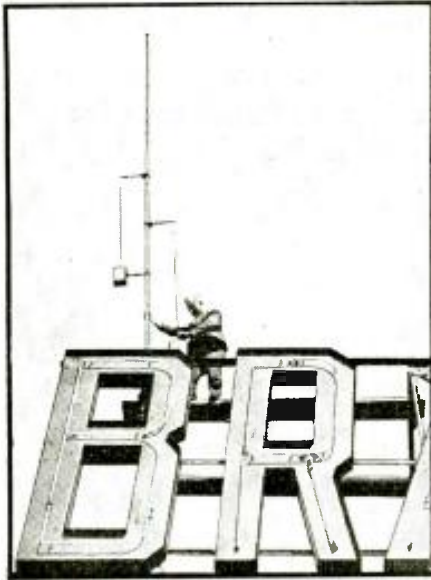

Photo—Westinghouse Co.  
The new antenna of WIXKA (Boston) is unique in being used simultaneously for receiving, while broadcasting on ultra-short waves. It is grounded to the Bradford Hotel sign, as a lightning surge protector.

## RADIO ALARM WORKS

FIRST instance in which RCA's new automatic radio alarm served an American vessel in distress occurred last month when an emergency signal was received by the Ensey City from the Sandgate Castle's newly-installed automatic alarm. Charles J. Pannill, president of Radiomarine Corp., was in-

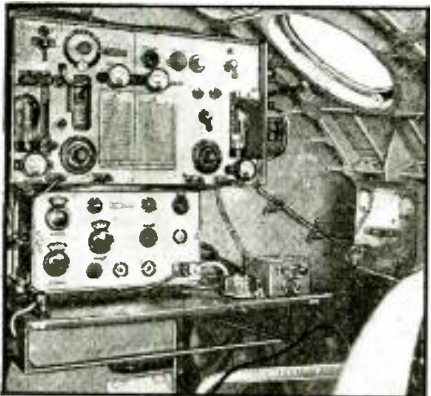
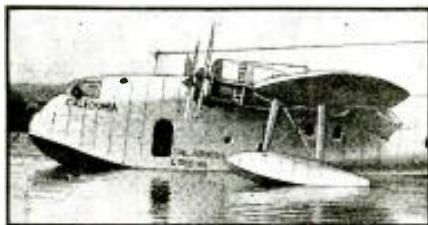

Photos—The Aeroplane (London) and Marconi's Wireless Telegraph Co., Ltd.

formed the alarm had worked perfectly.

As previously stated in *Radio-Craft* (April 1937, "SOS Robot Threatens Radio Operators"), commercial operators have not taken very kindly to the new idea.

## SOVIET INSTITUTE FOR TELEVISION

TELEVISION in the Soviet Union is somewhat behind the stage reached in the United States, Germany and Great Britain, it would seem from an announcement, last month, that its transmissions are with 120-line mechanical lens-discs; but with the setting up of an Institute of Television officially, and the dispatch of engineers to study foreign methods, considerable advance can be expected soon. It is estimated that the Soviet Union has now 3½ million receiving sets, typically of the 4-tube variety; and 400 amateur transmitters.

## MUSICIANS AGAINST DISCS AND PICKUPS

ANOTHER "headache", of the kind so common, is promised to the radio industry by the ultimatum issued last month by the American Federation of Musicians that it will strike against the "indiscriminate" use of phonograph records or transcriptions at broadcast stations, and also to prohibit its members from furnishing music to be picked up for broadcast by radio from places outside the studios. The deadline for action was set at Aug. 14. The action is stated to be the reaction of musicians to increasing unemployment, and their blaming "canned" music for the condition.

## RADIO PLAYS IMPORTANT ROLE IN PIONEER TRANS-ATLANTIC FLIGHTS

THE two great flying ships "Pan-American Clipper III", eastbound, and the "Caledonia" of English Imperial Airways, westbound—on July 6 crossed the Atlantic simultaneously, preparing the course for commercial 1-day travel between Europe and America. They passed, midway in flight, and exchanged radio greetings and weather information, while invisible to each other. Right, the "Clipper"; and an operator at the radio equipment; left, the "Caledonia", and her radio equipment, more fully shown.



Photo—S. Moto  
Transpolar flights are now becoming the regular thing. Radio communication, maintained over the course, adds greatly to their certainty. Radio apparatus being set up in the cabin of the "ANT-27"—the radio compass loop is seen ahead.

## DRAMATIC PROGRAM CAUSES ERRORS

WHILE the ingenuity of program directors is of great interest when applied to current events in a realistic manner (Shakespeare did it on the stage), it nevertheless causes much misapprehension from listeners who hear but a bit of it. Such a program, last  
(Continued on page 247)





Singer testing pitch of her voice by observing waveform on cathode-ray screen of resonoscope.

# THE "RESONOSCOPE" NEW ELECTRONIC DEVICE DETECTS "OFF-KEY" NOTES

Vocalists and instrumentalists now have available an inexpensive instrument that far outstrips human skill in detecting deviations in the pitch of a musical note.

ALLEN B. DuMONT

## SOME OF THE USES OF THE NEW "ELECTRONIC MUSIC ROBOT"

- (1) Facilitates tuning reed and string instruments not only for fundamental notes but for all octaves.
- (2) Each instrument in a band may be tuned to produce new ensemble effects.
- (3) Singers may actually "see" and quickly correct errors in pitch.
- (4) Broadcast stations use this "robot" to quickly pitch musical groups.
- (5) Music teachers now may "demonstrate" a student's tone-quality and pitch.

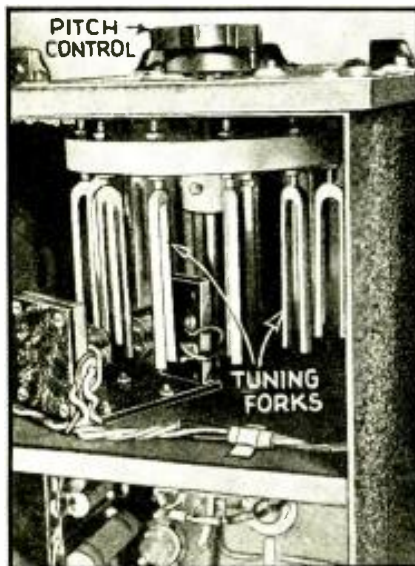

Underneath side of resonoscope chassis, showing master tuning forks and driving solenoids.

**A**N INGENIOUS electronic "robot" is now available which not only sounds the Simon-pure tone for guidance, but also checks a voice or musical instrument and indicates its pitch and its quality! In other words, the note under examination is made to write its own harmonics on the cathode-ray screen, in direct comparison with the pure note. The eye, far more critically than the most musical of ears, determines the musical quality at a glance.

### OBTAINING HORIZONTAL- AND VERTICAL-SWEEP FREQUENCIES

The "resonoscope," as this new electronic instrument is called, is a development of the Allen B. DuMont Laboratories. It comprises a special cathode-ray oscilloscope used in conjunction with a standard set of musical frequencies representing the 12 notes of the chromatic musical scale. These standard frequencies, produced by 12 electrically-driven tuning forks (see Fig. B), are utilized to synchronize a sawtooth oscillator in step with them. The oscillator is employed to provide a *horizontal-sweep frequency* for the C-R tube.

Meanwhile, a voltage amplifier is employed to pick up the music of any single musical tone by means of a sensitive microphone. The amplifier output, which constitutes the *vertical-sweep frequency*, is placed on the vertical plates of the cathode-ray tube.

These horizontal- and vertical-sweep frequencies combine to provide a visual image of the waveform of the musical note under observation. See Fig. A. If that musical note is of the same "pitch" or *frequency* as the standard being

used, or any harmonic of same, the waveform will appear to stand still on the screen. If the note is "flat" or lower in pitch than the horizontal-sweep standard, the waveform will appear to be moving to the *left*. If higher in pitch or "sharp," it will move to the *right*. The speed with which the waveform moves across the screen is a direct indication of the extent to which the instrument or voice is off-pitch.

### OBTAINING FREQUENCY "STANDARDS"

Any of the 12 standard frequencies in this new "robot" may be selected one at a time by the turn of the large control knob on the front panel. The positions are marked C, C#, D, D#, and so-on. These 12 frequencies represent the 12 notes of the chromatic scale. Each setting of the control accommodates all octaves of the particular note. The middle-octave notes appear as simple waveforms on the cathode-ray screen. The higher octaves appear as multiple waves, while lower octaves are simply portions of the waves. See Fig. 2.

One of the special features of the circuit of this oscilloscope is that the horizontal-sweep circuit is automatically changed in frequency to compensate for the change in frequency in going from one note to another. See Fig. 1. This allows the sweep circuit to be readily synchronized at all times by the standard frequency of the tuning forks, and assures the observer that the number of waveforms on the screen is a direct indication of the octave to which he or she is playing or tuning.

The frequencies of the standard  
(Continued on page 245)

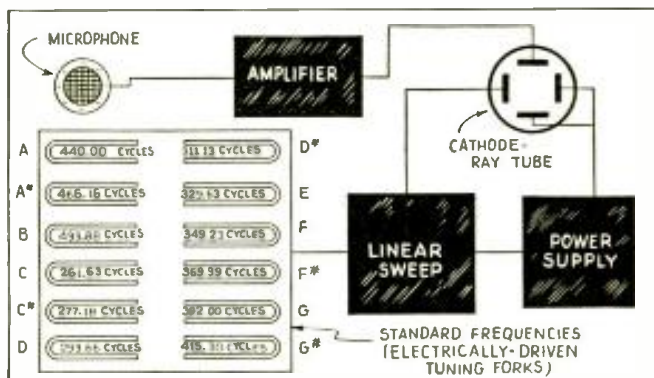

Fig. 1. Tuning forks determine the horizontal-sweep-circuit frequencies.

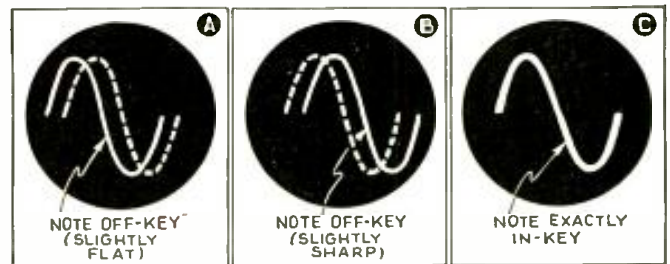

Fig. 2. The vocalist (or instrumentalist) provides vertical-sweep-circuit frequencies by singing (or playing) into the microphone; which is connected through an amplifier to the "resonoscope." "Drifting" of the waveform left or right from a central position indicates, respectively, "flat" or "sharp." *Radio-Craft* editors have witnessed demonstrations of this amazing device which prove quite definitely that even professional singers and musicians seldom realize when they are off-key. In fact, other tests show, skilled instrument tuners may vary 1/3-cycle from fundamental notes; but this new, uncanny, "electronic robot" is precise to about 0.002 per cent!

# NEW "RESOLUTION TESTER" FOR CATHODE-RAY TUBES

Here is a simplified description of "the initial nucleus of the instrument which the Service Man of the future who intends to do television work will require." Its complicated pattern facilitates testing television receiving tubes.

W. E. SHRAGE

ONE WHO GLANCES superficially over the column-full of patterns, Fig. B, shown at right probably will not hesitate to assume that the summer's heat has caused the editors to go "haywire." Nevertheless these illustrations do belong in *Radio-Craft*. The patterns concern every progressive Service Man and amateur who in a few years hence intends to be as much up to date as he is today with modern principles of radio.

## "A CIRCUIT FOR STUDYING KINESCOPE RESOLUTIONS"

Those among us who are familiar with the operation of the Service Man's cathode-ray oscilloscope will probably recognize some waveform designs as

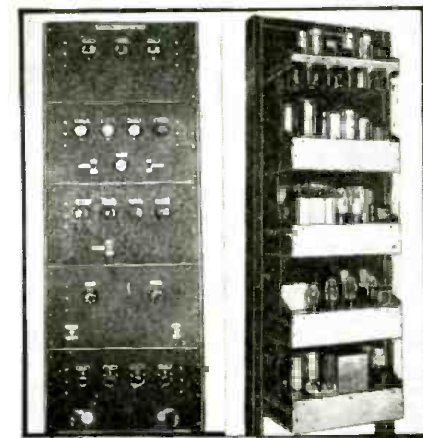

Fig. A. Front and rear views of the master-oscillator equipment used.

those resembling somehow a number of the complex figures which, once in a while, appear on the screen of their "magic box"; especially when voltages having odd frequency relations are applied to the terminals of the oscilloscope.

But one glance at Figs. A and C, showing, respectively, a complicated block diagram, and the inside and outside views of an obviously complicated master oscillator, will immediately exclude the thought that these patterns are the incidental product of work performed with a cathode-ray tube.

Mr. C. E. Burnett (of RCA's television laboratory), the originator of these patterns, and the designer of the master oscillator illustrated in Fig. A, calls it: "a circuit for studying Kinescope resolutions" which makes the issue by no means clearer.

However, the same facts, when presented in simplified language resolve themselves into something which, after all is not so very complicated; in fact it is not hard to foresee that a considerably simplified form of this elaborate master-oscillator equipment will, in the near future grace the Service Man's workbench just as the tube tester and cathode-ray oscilloscope do today!

## THE "FLYING SPOT" HAS "STREAMLINE" SHAPE!

Now here are the actual reasons for this odd experiment! Television engineers observed that Kinescope (a type of cathode-ray tube designed especially

*(Continued on page 252)*

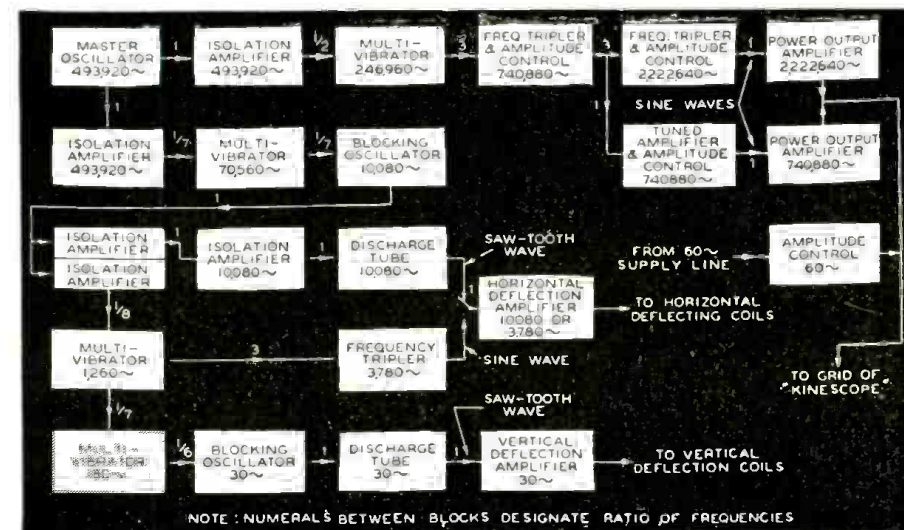

Fig. C. Block diagram of the "resolution tester" showing the various frequency relationships.

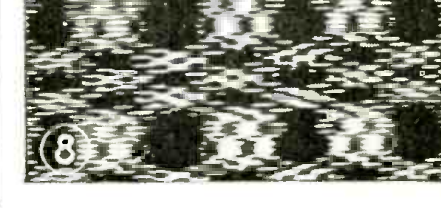
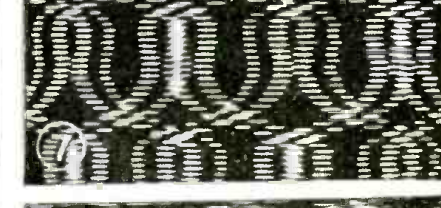
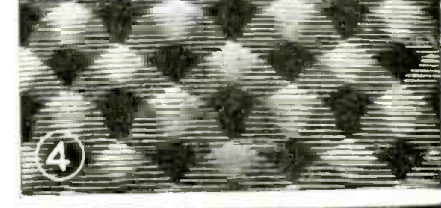
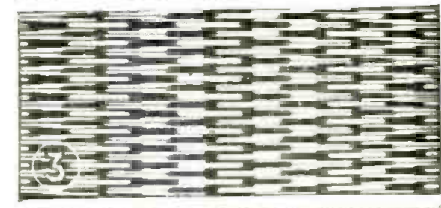
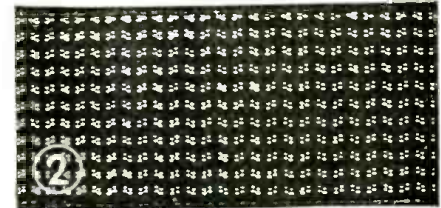
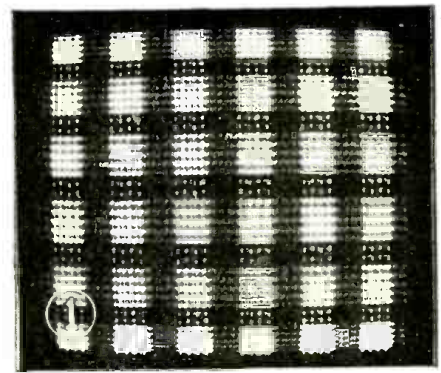

Fig. B. Patterns obtained with tester (see Table I).

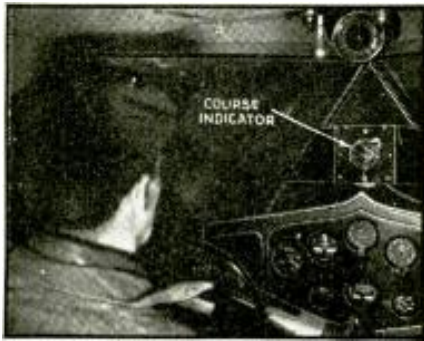

Fig. A. Note "cross-pointer" (course indicator) meter on instrument board.

# "AIR-TRACK" SYSTEM OF BLIND LANDING

CHARLES E. PLANCK

**T**HE FAMILIAR "curved beam" radio safe landing system has been developed by the Washington Institute of Technology to the point where it is now ready for commercial use on

any airport. Figure A is an action view of the system shown in Fig. B. (Figure B is a phantom diagram prepared by staff artist T. D. Pentz.)

(Continued on page 248)

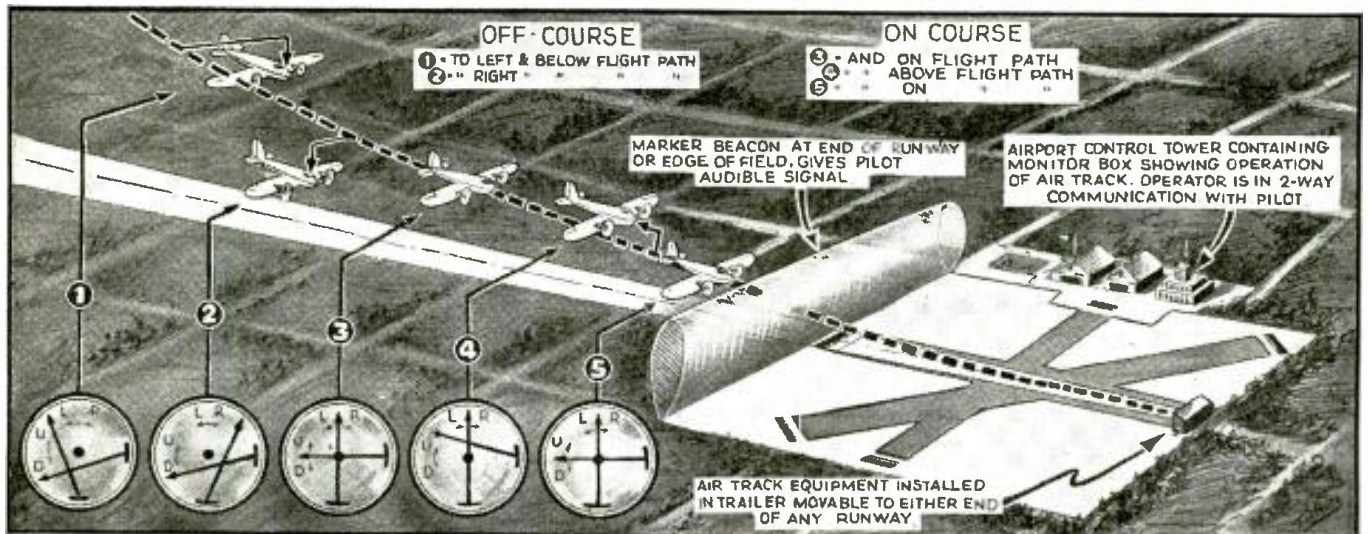

Fig. B. Any deviation of the plane from the sloping "air track" while landing is instantly recorded on the "cross-pointer" meter on instrument board.

# THE AIRCRAFT-RADIO SERVICE MAN

N. H. LESSEM

Most radio Service Men fail to realize the excellent business prospects that lie in "private" aviation—per the author's Table I.

**M**ILLIONS of dollars have been spent and are being spent in developing aviation; radio facilities constitute one of the major factors in dependable aircraft operation that has received more than its share of financial backing.

As a result, intensive work by "flying laboratories" and land crews connected with the larger transport companies has produced discoveries and equipment of great importance. Radio has greatly increased the dependability of commercial air travel, and the basic new developments of the large aviation companies are gradually being adapted to the needs of the private flyer.



## THE AIRCRAFT-RADIO SERVICE MAN

At left is reproduced a suggestion, by *Radio-Craft*, that appears in colors on the cover of this month's issue, which portrays only one activity of the aircraft-radio Service Man. (See Table I—"Sources of Revenue for the Aviation-Radio Service Man"—for a more representative visualization of the subject.)

We wish to point out at this time that, merely because the number of aviation-radio receivers in use is small compared with the number of home-radio sets, it should not be presupposed an excellent living cannot be made servicing aviation-radio equipment. In the first place it is almost a matter of life and death to maintain the radio equipment in perfect operation; regardless of the cost, within reasonable limits, this apparatus *must* be kept in perfect shape, and therefore since the servicing demands are relatively limited it becomes evident that this type of radio servicing *commands* considerably better prices.

(Continued on page 230)

# Guglielmo Marconi

## 1874 - 1937



Photo—Wide World via the Macmillan Co. The late Guglielmo Marconi, "Father of Radio," who died of a heart attack at his Rome estate early Tuesday morning July 20th, 1937 at the age of 63. The entire world mourns his loss.

**N**EVER before has the lifetime of a single man been so identified with a change in the conditions of life on the globe, of which he was the most conspicuous creator, as that of Marconi. Five centuries since the discovery of printing have been required to spread its efficacy over the globe. The electric light had been known 50 years before Edison made it a commercial success; the steamboat had been demonstrated 250 years before Fulton found a backer for his dream. But the mathematical conception of radio waves had hardly been published before Marconi was born; he was a growing boy, active in the study of science, when they were first definitely discovered. He was still young in years when he converted their possibilities into demonstrable fact. On the anniversary of the organization of his company to exploit the invention of practical "wireless"—40 years to a day—he died. And his invention carried the news of his passing to discoverers seated on the Pole, to nomads in the

desert, to ships on remote seas, to aviators flying above the clouds, and into a myriad homes in every city in the land. The monument of Guglielmo Marconi, for all time, is the "ether" vibrant about us—even within us—with the messages of all humanity.

Of the man's personality, little need be said: he was modest, self-effacing in his work; maintaining the spirit of scientific inquiry until his last moments. The first and most characteristic thought in his mind, as triumphs and honors were showered upon him, was that he was able to make his genius helpful to others, as no other man had done upon so wide a scale. His internationalism was joined with a pride in his country, which had initiated modern science with Galileo, and for whom he could speak with a voice that was heard and inspired confidence throughout the inhabited globe.

The Father of Radio has ended his share of the great work. But, as Pupin said, a quarter of a century ago: "Mar-

coni could die, and wireless development would inevitably and continuously continue. His work lives on and grows, whether he lives or not. And that means that his work is immortal. His genius gave the idea to the world; and the further perfecting of his idea needs no genius."

New radio "homing device" and inter-cockpit communication help U. S. Coast Guard answer distress calls.

## NEW U. S. COAST GUARD AVIATION RADIO

**O**NE OF THE NEWEST additions to the radio equipment of the U.S. Coast Guard airplanes is the installation here illustrated of the equipment aboard the amphibian "Dolphin" of the Coast Guard base at Floyd Bennett Airport.

This equipment resolves itself into 2 major divisions. One is the "homing device" or *direction-finding loop antenna* which may be rotated, by the radio operator, by remote control. In emergencies where minutes are precious this  
(Continued on page 234)

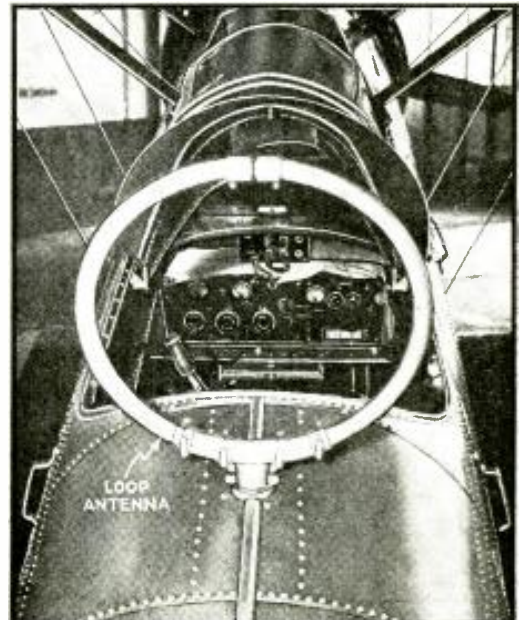
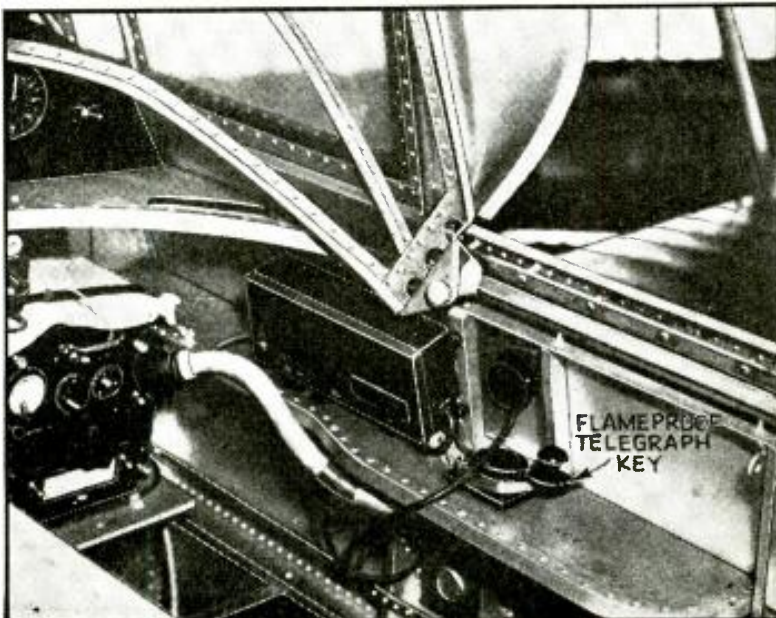

# NEW TUBES FOR THE RADIO EXPERIMENTER

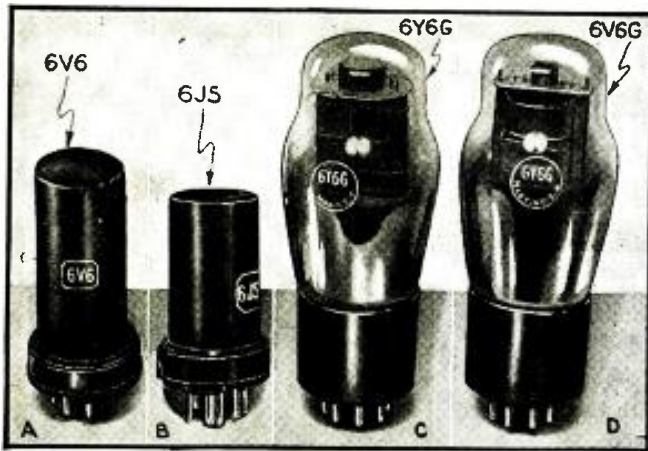

Fig. A. Four of 6 new tubes described in this article are illustrated.

All the tubes described this month, oddly enough, are amplifiers. Filament voltage range is from 2 V. to 25. One of the most interesting developments is the use of suppressor grids, in place of deflector plates, in a beam power tube.

## PART II R. D. WASHBURNE

**L**AST MONTH we told you about the types 6C8G, 6W5G, 6G5/6H5, 6T5, 2-RA-6 and WL-461 tubes. This month we add to the list the following types: 6V6, 6J5, 6Y6G, 6V6G, 1G5A, and 25L6G. Next month we'll have some more tube types to discuss with you but at the moment let us see what sort of devices have most recently been added to the "electronic family."

### AMPLIFIERS

**6V6 Unipotential-Cathode Tetrode Power Amplifier.** The 6V6 and 6V6G (the latter is described elsewhere in this article) tubes were designed by one company primarily for use in the output stage of auto-radio receivers. Both have similar characteristics, the chief advantages being (1) use of the beam principle introduced first in the 6L6 and (2) a relatively low heater drain of only 450 milliamperes. Its features permit high output power to be realized in the automobile-type radio receiver without any appreciable increase in the drain from the storage battery. In fact, some manufacturers of deluxe auto sets are using two 6V6G tubes in push-pull in the output stage of their receivers. (See Fig. 1A.)

The 6V6 is similar to the 6F6 in size (and the 6V6G compares with the 6F6G and 42 in size and general appearance).

(Data courtesy Raytheon)

**6J5 Detector and Amplifier Triode.** Except for its higher transconductance this tube is similar to the type 6C5 tube. More detailed data follow. See Fig. 1B.

The 6J5 is a new addition to the line of metal receiving tubes. This new tube, a detector-amplifier triode, has an exceptionally high value of transconductance—2,600 micromhos. The other characteristics of the tube are similar to those of the 6C5. Because of the high transconductance of the 6J5, the tube makes an excellent oscillator for superheterodyne receivers. The high transconductance also gives the tube advantages for use as the frequency-control tube in A.F.C. circuits.

Characteristics	
Heater voltage (A.C. or D.C.)	6.3 V.
Heater current	0.3-A.
Direct interelectrode capacities* (approx.)—grid-plate	3.4 mmf.
grid-cathode	3.4 mmf.
plate-cathode	3.6 mmf.
*With shell connected to cathode.	
As Class A <sup>1</sup> Amplifier	
Plate voltage (max.)	250 V.
Control-grid voltage	-8 V.
Plate current	9 ma.
Plate resistance	7,700 ohms
Amplification factor	20
Transconductance	2,600 mmhos.

(Data courtesy RCA Radiotron)

**6Y6G Heater-Type Tetrode Power Amplifier.** The usual A.C. radio receiver operates with fairly high plate voltages. The A.C.-D.C. receivers operate at considerably lower voltages. The recent introduction of 2 tubes, the 25B6G and 25L6, for A.C.-D.C. receivers has made possible receivers giving approximately 2 W. output at about the same cost as the previous A.C.-D.C. receivers which gave about 0.9-W. output.

The 2 W. A.C.-D.C. receivers are thus giving about the same performance as the small A.C. receivers using a 42-type output tube with about 220 V. available for plate and bias voltages. It would be necessary, using conventional tubes, to increase the cost of the small A.C. receivers considerably to make them give appreciably better performance than the 2 W. output A.C.-D.C. receivers.

The performance of the small A.C. receivers may be improved in economy as well as power output by using an output tube similar to the 25B6G or 25L6 at lower voltages and larger currents than would be the case with the 42-type output tube.

The 6Y6G tube is being introduced to fill the need for an output tube which will give even more output at 135 V. on the plate and screen-grid than the type 42 with 250 V. on plate and screen-grid. The high mutual conductance of the 6Y6G results in a fairly low input voltage requirement for full power output, and permits some degeneration to be used where desired. See Fig. 1C.

Characteristics	
Heater voltage (A.C. or D.C.)	6.3 V.
Heater current	1.25 A.
Plate voltage (max.)	135 V.
Screen-grid voltage (max.)	135 V.
As Class A <sup>1</sup> Amplifier	
Plate voltage	135 V.
Screen-grid voltage	135 V.
Control-grid bias	-13.5 V.
Transconductance	7,000 mmhos.
No-signal plate current	58 ma.

(Continued on page 240)

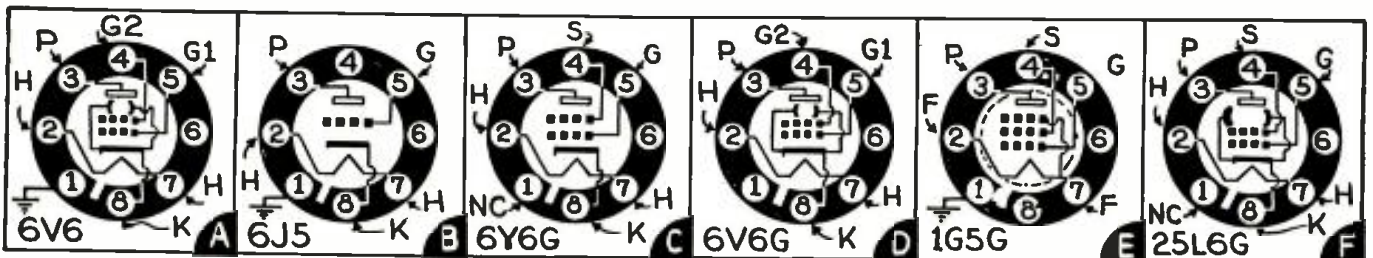

Fig. 1. The tube symbols and socket connections of the entire group of 6 new tubes are given.

# NEW SET TESTER FEATURES LOW-OHM SCALE

This instrument will measure resistance as low as 0.01-ohm and with comparatively little current drain. It also has other interesting features you should know about.



B. O. BURLINGAME

**A** COMPACT, businesslike set-tester with a clean, "professional" appearance has been designed to meet the modern requirements of fast, convenient, accurate test procedure on all types of radio receivers, P.A. and theatre amplifiers, television receivers and industrial vacuum-tube devices.

The new 5-in.-square meter with long-scale, dead-beat,

high-accuracy, solid forged steel magnet, and real sapphire bearings is critically designed, adequately to meet the severe demands of portable service and the maintenance of high accuracy over a long period of time. A high ratio of normal to overload capacity is provided to minimize the possibilities of accidental damage in this very sensitive instrument. Sensitivity: 1,000 ohms/volt.

Any of the 20 ranges is chosen with an indexed selector switch. A "zero-ohms" adjuster is provided. Ranges: 0/7/140/350/1,400 V., D.C.; 0/7/140/350/1,400 V., A.C.; 4 output-meter ranges; and, 0/200/2,000/20,000 ohms.

### IMPORTANCE OF THE LOW-OHM RANGE

The 200-ohm range of the ohmmeter is of especial interest to the Service Man and electrical trouble shooter as many difficulties are experienced in circuits of such low resistance that the problem will not yield to ordinary types of ohm-meters wherein the low end of the scale is badly cramped.

One-half of the scale of this instrument is used to read from 0 to 3.5 ohms, with the first division reading 0.1-ohm. It is very easy to read resistance values to an accuracy of 0.01-ohm as the divisions are large and clear. It is recommended that resistance values over 10 ohms be read on the

(Continued on page 244)

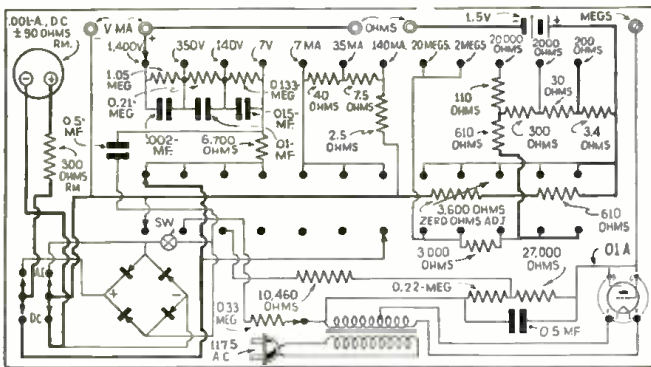

Fig. 1. Circuit diagram of the new tester illustrated above.

## WHAT SIZE OSCILLOSCOPE?

What with 3 sizes of cathode-ray tubes being used in oscilloscopes, the question is—which one to choose? The facts are in this article.

G. M. BUCHARD

**O** SCILLOSCOPE equipment for service work has now become fairly well standardized into 3 distinct sizes. These are—(1) oscilloscopes having tubes with 1-in. screen; and large-size equipment with tubes of (2) 2-in., or (3) 3-in. screen size.

Similarity. It is well at this point to consider the actual construction of the instrument and lay aside for the moment the matter of tube size.

Regardless of tube size the complete oscilloscope contains at least the following elements: (1) Vertical amplifier, (2) Horizontal amplifier, (3) Linear time sweep, (4) Spot and focus controls, (5) Adequate power supply.

Now notice that regardless of tube size the oscilloscope instrument must have the above 5 features. In fact,

with the exception of power supply the 3 sizes of oscilloscopes are almost identical in construction insofar as features 1, 2, 3 and 4 are concerned.

It is true that a certain amount of economy in power supply is possible when the oscilloscope is designed for the 1-in. tube (as compared to 3-in. tube), however it can readily be seen that this economy is of a minor order

(Continued on page 243)

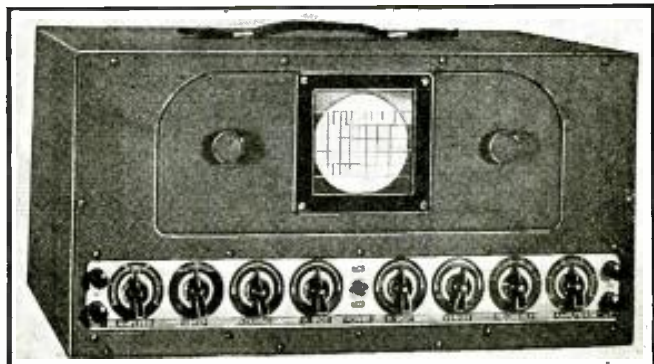

<b>A</b>	
1-INCH TUBE VISIBILITY FACTOR ---- 8.35 EFFECTIVE AREA * ---- .52sq.in. PATTERN HEIGHT * ---- .79-in. (* DOTTED LINES)	
<b>B</b>	
2-INCH TUBE VISIBILITY FACTOR ---- 33.2 EFFECTIVE AREA * ---- 2.07sq.ins. PATTERN HEIGHT * ---- 1.44 ins. (* DOTTED LINES)	
<b>C</b>	
3-INCH TUBE VISIBILITY FACTOR ---- 74.656 EFFECTIVE AREA 4.666sq.ins. PATTERN HEIGHT 2.16 ins.	

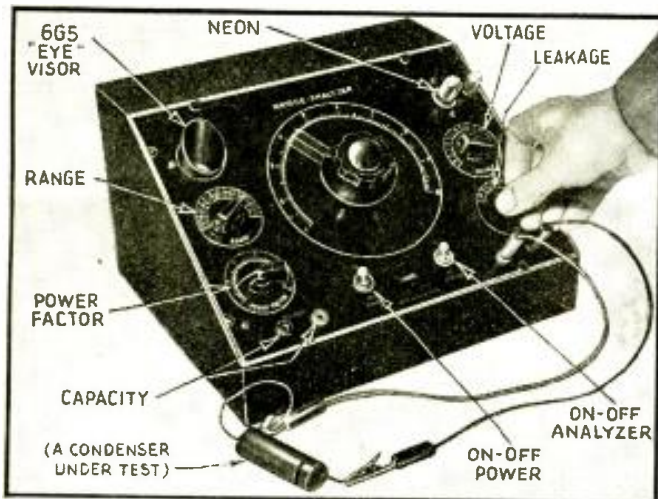

Fig. A. A typical condenser analyzer using a bridge-balance circuit.

IN THE SERVICE industry, as well as in many other lines of engineering, there has been great advancement in the tools employed. It was only some 10 years ago that the cathode-ray oscilloscope was more or less a luxury and only to be found in the exceptionally-equipped laboratory. Today, however, many wide-awake Service Men employ this method of analysis which, in many cases, saves time and is capable of rendering a real service in the precise analysis of receiver performance.

A few years ago, most Service Men had little more than a speaking acquaintance with vacuum-tube voltmeters, but in recent years this apparatus has become an almost everyday piece of test equipment. New types of testing apparatus are appearing on the market almost every month, with the result that some of the less-informed are in a quandary as to what pieces of service equipment (1) are most valuable from the standpoint of customer satisfaction and what pieces of equipment (2) are capable of producing real income from the standpoint of time saved.

It is not within the scope of this article to go into a detailed analysis regarding the uses of all the various pieces of equipment which the modern Service Man could employ to advantage if his finances were ample. However, it is the purpose of this article to discuss some of the complexities of modern radio receivers and the test equipment best adapted to render customer service at reasonable cost, and to point out various types of apparatus which will produce a return

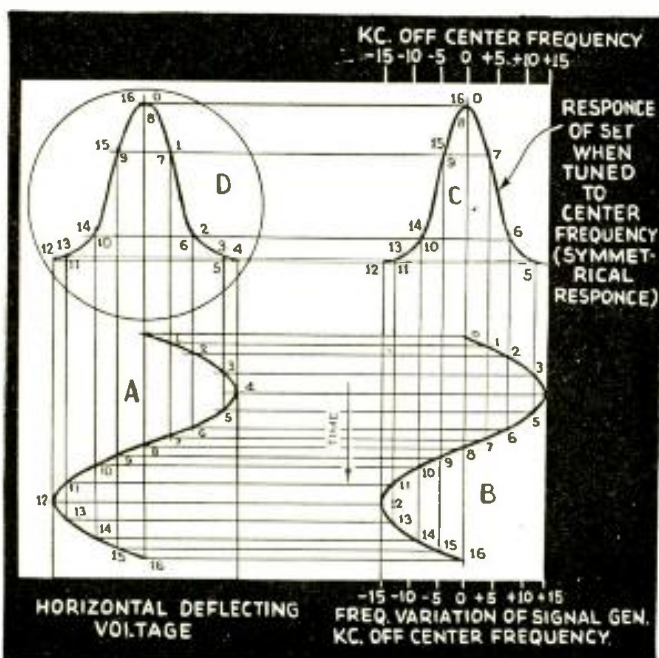

Fig. 1. Analysis of resonance curves of a set obtained on an oscilloscope.

# IMPORTANCE OF MODERN TEST EQUIPMENT

In this pithy article Mr. Browning (remember? —the famous "Browning-Drake" receiver?) relegates "screwdriver and plier" radio repair men to the discard, and shows WHY modern test equipment and procedure are essential.

GLENN H. BROWNING

more than comparable with the cost of the equipment—provided the the volume of business is sufficient.

In a recent radio service class the writer, as a part of the examination, asked each member of the class what equipment he deemed absolutely essential for the servicing of modern radio receivers. Naturally, a good *volt-ohmmeter* of wide range was the first selection. The second selection was almost a toss-up between an *all-wave signal generator* and a *tube tester*. The next choice was a device for testing accurately the condition of condensers. The writer certainly agrees that no modern service work can be done without the aid of the first 3 pieces of equipment. Consequently, we will pass on to other, more specified equipment.

## USES OF THE CONDENSER ANALYZER

It is generally agreed that condensers cause as many service calls as any other single component part entering into the radio set, though resistors will run a close second. Consequently, a good *condenser analyzer* will save the Service Man a great deal of time and trouble. Many make the practice of testing all the condensers in the radio receiver to determine their condition, for as most work is guaranteed, this may save a return call at the expense of the Service Man.

Paper condensers of small capacity have a somewhat prevalent fault of becoming open-circuited, though actual breakdowns are far from unknown. Electrolytic condensers, on the other hand, either fail or increase in power factor to such an extent that their filtering efficiency is impaired. Intermittent reception in the radio receiver, which is the general bugaboo, is usually due to paper or electrolytic condensers becoming intermittently open.

A *bridge analyzer*, such as the one manufactured by the Tobe Deutschmann Corp., is a typical condenser analyzer which gives a rather complete analysis of the condition of the condensers, for not only does it check the leakage of electrolytic and paper condensers at operating voltages ranging from 50 to 550, but also measures their power factors and capacity by means of a suitable bridge network. Intermittent condensers may readily be determined by obtaining a bridge balance and manipulating leads, whereupon an intermittent condenser will cause the electron-ray tube or "eye", used as a null indicator, to give a definite indication of such defect. Practically every Service Man will find such a device for obtaining the complete characteristics of condensers a time saver and a financial asset to his business.

## USES OF THE FREE POINT TESTER

*Free point testers* (which permit making tests of any two tube elements) are many times a great convenience, especially where work is being done at the customer's residence, which is, by the way, not recommended as general procedure when any major troubles are involved. Even in the shop, however, the free point tester in many cases will weed out defective tubes which no tube tester is able to definitely indicate.

By means of free point testers, plate, cathode, and other currents may be measured and, consequently, biases cal-



culated on resistance-coupled amplifier tubes, etc. When free point testers are used in conjunction with the radio-frequency amplifier or intermediate-frequency amplifier, erroneous indications may result due to the fact that the capacity introduced in the cord leading from the tube socket to the free point tester may start spurious oscillations in tuned circuits and thus the currents at which the tubes actually operate will differ markedly from the normal values.

In receivers having automatic volume control it is sometimes essential to measure the bias on the various R.F. and I.F. tubes which are being controlled. Poor quality in a radio receiver will often result from some part of the automatic volume control circuit being inoperative. The writer has known of cases where the automatic bias, although obtained satisfactorily in the diode detector tube (when measured across the timing condenser) was not delivered to an I.F. amplifier tube, causing faulty operation of the receiver.

#### USES OF THE INFINITE-RESISTANCE D.C. VOLTMETER

Recently there has been introduced on the market by the Hickok Company an *infinite-resistance D.C. voltmeter* which seems to answer a long-felt need, for by its means the D.C. bias on any tube can be readily determined without introducing resistance in the circuit which would materially vary the bias and thus the operating conditions.

The *potentiometer-type* infinite-resistance voltmeter operates on a well-known principle of obtaining a balance between two voltages, one the voltage developed in the apparatus itself, and the other the unknown voltage. After the 2 voltages have been adjusted so as to be equal (this adjustment is made by means of a balancing system), the unknown voltage is measured by actually placing a voltmeter across the balancing voltage developed in the apparatus itself.

This may sound somewhat complicated but in actual practice it is very simple, for the leads to the voltmeter are placed across the unknown D.C. voltage and a knob is adjusted until a meter reads zero, whereupon a button is pressed which throws the voltmeter into the circuit and the unknown voltage is read directly from this meter. The A.V.C. voltages may thus be measured (on each tube controlled) with various inputs from the signal generator. The actual bias on resistance-coupled amplifiers may be determined with accuracy. A faulty bias resistance, of course, may cause distortion. It may be necessary to unsolder one end of this resistor to measure its value accurately with a volt-ohmmeter since an electrolytic condenser is usually connected in parallel which will have some leakage, and this leakage may be sufficient to give incorrect resistance values. By means of a very high-resistance voltmeter these biases may be measured directly. Of course it probably will be necessary to disconnect the condensers for test purposes anyway, so that the above argument for a high-resistance voltmeter as a time-saving device does not always hold true.

#### USES OF THE VACUUM-TUBE VOLTMETER

In receivers embodying automatic frequency control, it is almost essential to have an infinite-resistance voltmeter or a *vacuum-tube voltmeter* which will measure D.C. voltages, as well as A.C., in order to align the tuned circuit of the discriminator with sufficient accuracy. This adjustment in most receivers is extremely critical and it is necessary, after aligning the I.F. amplifier by means of a signal generator and an output meter, to accurately set the tuned circuit which is an input into the diode plates. This circuit should be so adjusted that the voltage appearing across the 2 resistors connected in the cathode circuits of the diodes will be equal; otherwise the A.F.C. discriminator circuit will not function as it should.

While we are on the subject of vacuum-tube voltmeters, it might be pointed out that there are good, bad, and indifferent types on the market, and a considerable amount of discrimination should be exercised by the Service Man in purchasing this equipment. The Service Man can readily check up to see whether a vacuum-tube voltmeter is suitable for general work by the following procedure: If the vacuum tube voltmeter measures both D.C. and A.C., it should be able to measure the voltage of, for instance, an ordinary drycell, and give the correct value (1.5 V.) with a resistance of 2

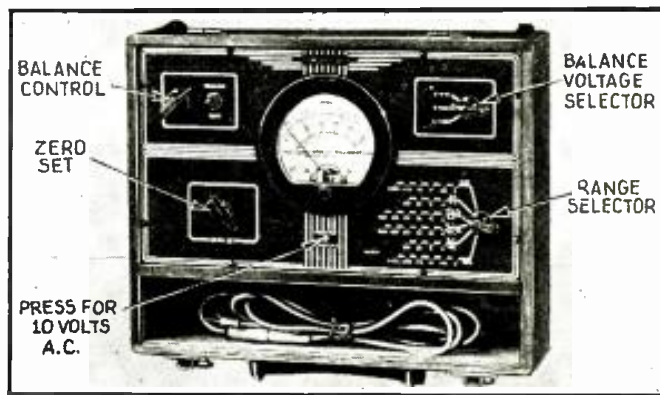

Fig. B. Representative type of infinite-resistance, bridge-circuit voltmeter.

or 3 megohms in series with the drycell. When used on A.C., it should have a sufficiently high resistance so that it may be placed across oscillator circuits without stopping oscillation. It should have an input capacity at least as low as 25 mmf., and preferably much lower.

It would be very advantageous if a reasonably-priced vacuum-tube voltmeter could be built for the Service Man which would be sufficiently sensitive so that by placing the prod near to but not touching the oscillatory circuit in a superheterodyne, a reasonable meter reading could be obtained. By means of this instrument the oscillations could be checked in a superheterodyne without de-tuning the circuit to any appreciable extent.

Many times it is difficult to determine the trouble in a superheterodyne where the oscillatory circuit has either developed a high-resistance connection or has been shorted, causing the oscillations to cease. Of course by carefully checking the circuits with a volt-ohmmeter (using the low-ohm scale) the resistance of the oscillator coil can usually be detected on the broadcast and some of the short-wave bands on an all-wave superheterodyne. However, when a short occurs in the very-high frequency oscillator coils, this condition is difficult to detect since the normal resistance of these coils is extremely low. Superheterodynes which use a 6A7, 6A8, etc., sometimes refuse to oscillate in specific regions of the bands, causing the receiver to "go dead" throughout these regions. Tube tests do not in general indicate that the tube is defective. However, replacing the faulty tube with another usually remedies the trouble. For these reasons a quick method of checking oscillations through all bands is certainly a time saver.

#### USES OF THE CATHODE-RAY OSCILLOSCOPE

The *cathode-ray oscilloscope*, especially one of those containing a *frequency-modulated signal generator* as an integral part of the apparatus, is desirable if the clientele served by the Service Man is of a very high-grade type that is willing to pay for meticulous alignment of their high-fidelity receivers. This applies particularly to sets having band-pass I.F. transformers. Of course the cathode-ray oscilloscope can be, and is, used as a very handy tool around the service laboratory and the ownership of such an instrument places the Service Man in a favorable position as regards customer acceptance.

#### USES OF THE SIGNAL GENERATOR

There are many customers who could be very readily sold the idea of having their high-priced sets checked frequently for alignment, quality, etc. Checking for quality throughout the receiver and loudspeaker requires elaborate equipment. In fact, an automatic recording device has only recently been placed on the market. This device puts into the radio receiver a signal which is modulated at various audio frequencies, and records automatically on a chart the sound pressure delivered from the loudspeaker at these audio frequencies. Undoubtedly future signal generators designed and manufactured for the Service Man will have their signal modulated not only by a fixed 400-cycle note, but will be so designed that the carrier from the signal generator may be modulated by various frequencies over the complete

(Continued on page 253)

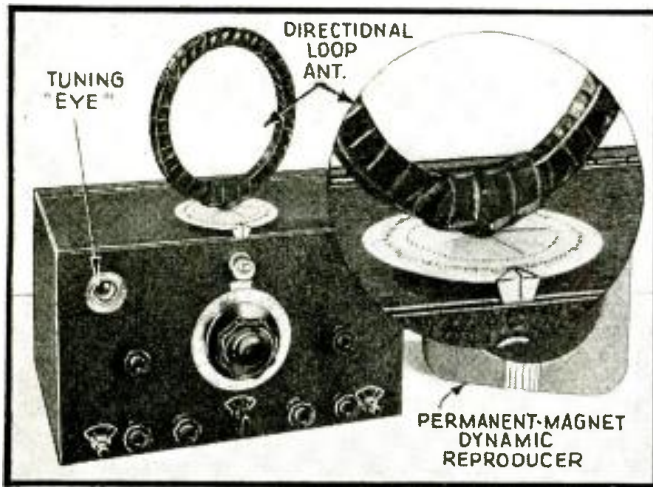

Fig. A. The Boat Radio Set and (inset) relationship of loop to scale.

**L** OOP-ANTENNA building is a matter of trial and error. We have used a very small one for general broadcast—one which works very well. Some builders may prefer to experiment somewhat before deciding upon definite jobs for service—but we shall describe the construction of the one shown in Figs. A, 1 and 2, with the comment that it will do a very good job as a *direction finder*.

#### LOOP CONSTRUCTION DETAILS

Secure 2 ordinary embroidery hoops, one about 8 ins. and one about 7½ ins. in dia. To the larger, securely affix a phone plug. Around the entire rim of the smaller one, drill a series of size No. 27 holes ½-in. apart. Insert small, round matches in these holes, with an inch or so of each match protruding outwardly, and then stagger-wind about 50 ft. of No. 24 D.S.C. wire around the loop—working back and forth between the sticks (as shown in Fig. 2) and in one direction until the winding is completed. Cut off the ends of the matches so that the smaller loop will fit tightly into the larger, tie the 2 hoops securely together, connect the leads to the phone plug.

See that the jack on the lift cover (described in Part I of this article) is connected to the input control-grid—ground binding posts. Plug in the loop and tune in a signal somewhere around 1,400 kc. using the tuning dial control. Vary the setting of the auxiliary loop trimmer and note whether or not resonance for the R.F. circuit is obtained and where it is obtained. If not enough capacity is had to tune the loop circuit to resonance with the signal, add wire to the loop itself until a “hit” is made with the trimmer set for approximately minimum setting. If too much capacity is indicated—then reduce the number of turns until a proper condition obtains.

Now tune to a 550 kc. signal. Nearly maximum trimmer capacity should be required for resonance here. If the tuning will NOT go up to resonance—your trimmer is too small, and a larger capacity will be required. Much depends, of course, upon loopsize and number of turns.

#### OBTAINING DIRECTIONAL OPERATION

With the loop built and found tunable to broadcast band limits, tape it securely together and give it a couple coats of protective lacquer. Try it out on weak signals.

When pointed *directly* at such signals—that is, *endwise*—the broadcast signal will come in at maximum level. With the loop *broadside* to the signals, the signal level should be noticeably less, at times inaudible and unreadable on the 6E5 “eye”. Even on strong locals—loop turning should afford a definite point of maximum and minimum reading on the tuning “eye”—with the point of minimum pick-up being the more easily and accurately defined.

Build a loop for the long-wave band—making it somewhat larger in size and of such inductance that with available trimmer capacity input resonance with the detector circuit is obtained. Sometimes it is good policy—and easy construction—to simply work out a job with a minimum number of

# HOW TO MAKE “THE SEAFARER” LOOP-TYPE BOAT RADIO SET

Part I described the construction of this marine direction-finder and broadcast set. Here are the loop details and operating data.

## PART II RAYMOND P. ADAMS

turns and load it up to high-frequency resonance with the trimmer at zero setting by means of fixed capacities bridged across it. Build a loop for the selected short-wave band or bands—or, if you prefer, add antenna coils for these bands and a chassis binding post to which an antenna may be connected.

(Continued on page 240)

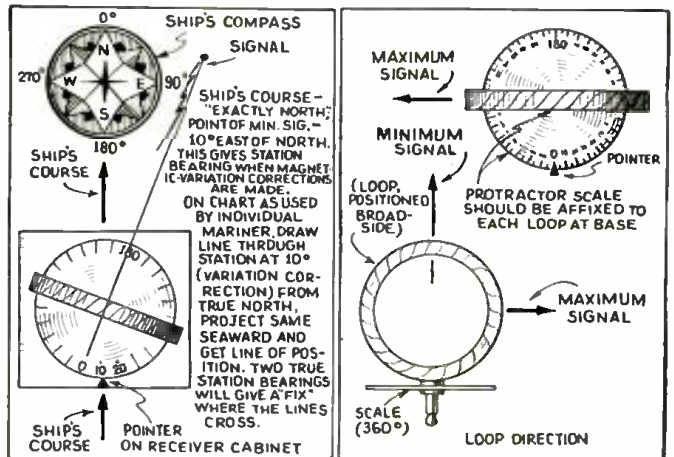

Fig. 1. Details of how the direction-finding loop antenna operates.

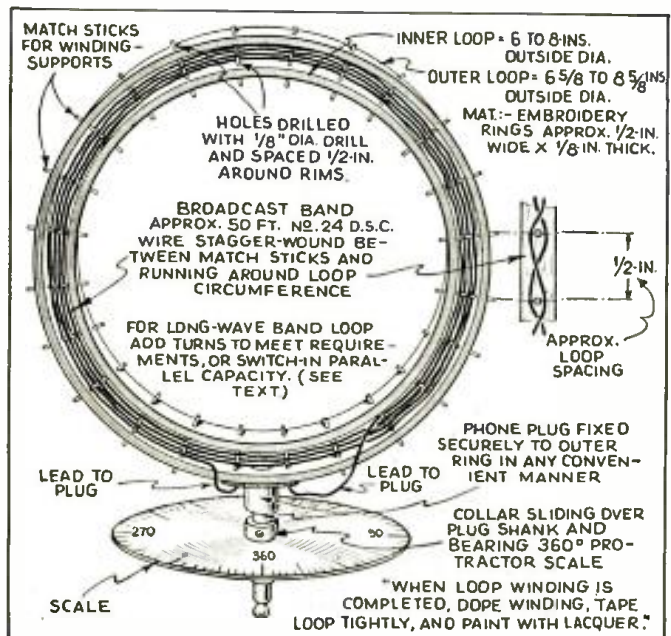

Fig. 2. Detailed specifications on the construction of the loop.

# BUILD THIS "OPTIMUM TEST" TUBE CHECKER

Service Men—A pioneer in the design and construction of radio test equipment tells you how to make an ultra-modern tube, resistance and capacity tester at low cost.

MILTON REINER

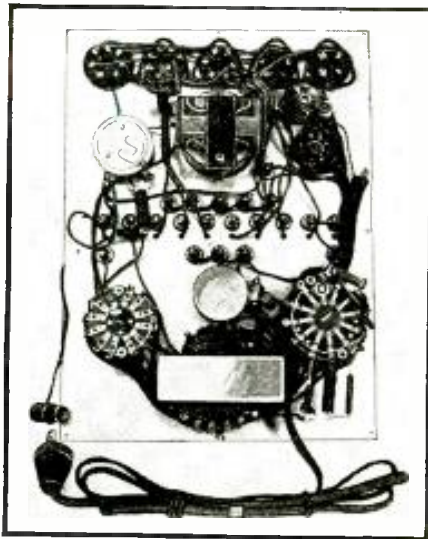

Fig. B. Underside view of the tube checker.

**T**HE MOST important instrument for the radio dealer and one of the most important for the Service Man is a Tube Tester. The design and construction details of an improved type will be described and illustrated, incidentally, the same components are utilized to make several types of tests other than those of tubes.

This tube tester (which incidentally is commercially available as the Dependable model 306 instrument) has finally passed with flying colors all requirements for an "optimum" (best all-around) test unit that would quickly and accurately test all the present-day tubes; and in addition provide for forthcoming types! The same unit also makes *resistance* and *capacity* tests!!

The general appearance of the completed device, in a counter-type case, is shown in Fig. A (underside, Fig. B); the wiring diagram is given in Fig. 1. (Continued on page 242)

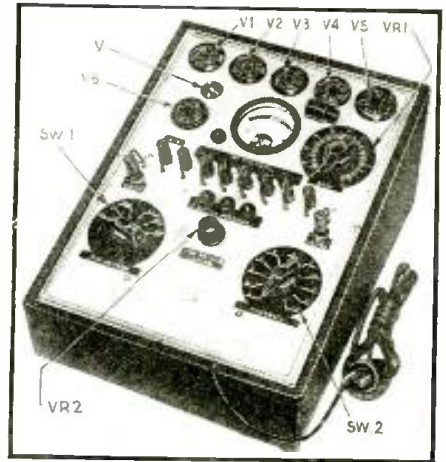

Fig. A. The "optimum-test" tube checker.

TABLE I  
FEATURES OF THE  
"OPTIMUM-TEST" TUBE CHECKER

- (1) Accuracy (circuit error is held to optimum value).
- (2) Protection against obsolescence.
- (3) Ability to test all tubes (emission test; and improved type of hot interelement short and leakage tests).
- (4) Optimum-quality parts.
- (5) Simplicity of operation.
- (6) Low cost (\$18).
- (7) Ohmmeter ranges (low-ohms: 0/10,000 ohms; high-ohms scale: 0/1 meg.).
- (8) Capacity-meter ranges (0.001-mf. to 10 mf.).

# BUSINESS-LIKE "SILENT" SERVICING

**B**ACK WHEN the daily papers carried radio circuits and you could buy all the parts at a "dime store," whistles, howls, snaps, and buzzes disclosed many of the ordinary faults of a radio receiver. Several million people became extremely clever in analyzing radio trouble by ear—and repairing radio sets with a screw-driver. Service Men found it hard to command "respectable" service fees.

## MODERN "SILENT SERVICING" TECHNIQUE

As circuits became more complex, and test instruments were designed to probe the mysteries of automatic volume control, band expansion circuits, dual I.F. channels and phase inversion systems, customers still recalled their old familiarity with the noises emanating from the speaker and protested against reasonable service fees.

"Let the customer see you work, but don't let him hear you!" is the advice of Mr. J. P. Kennedy, who introduced himself to RADIO-CRAFT readers in September 1931 as a business-getting Service Man.

J. P. KENNEDY

Now instrument manufacturers have eliminated the last psychological barrier to good service fees. With an oscilloscope and frequency modulator or "wobbulator", a good signal generator, and a multirange volt-ohm-milliammeter, every circuit of a receiver may be analyzed without a sound emanating from the loudspeaker! These instruments, plus a good tube tester, will (Continued on page 251)

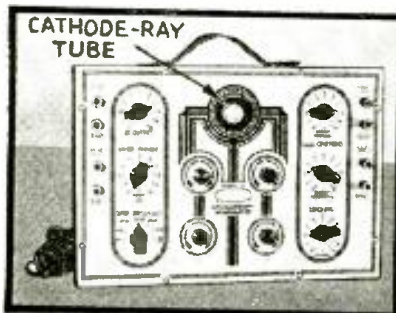

Oscilloscope wobbulator.

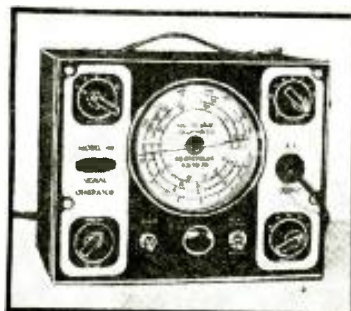

Signal generator.

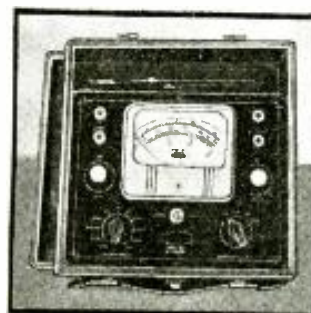

20,000-ohms/volt meter.



Tube checker.

# BIGGER SERVICE PROFITS FROM BETTER TOOLS!

Locating and correcting radio receiver faults in the minimum amount of time results in proportionately increased profits. The author describes in detail the manner in which proper servicing technique and tools make this result possible.

O. J. MORELOCK

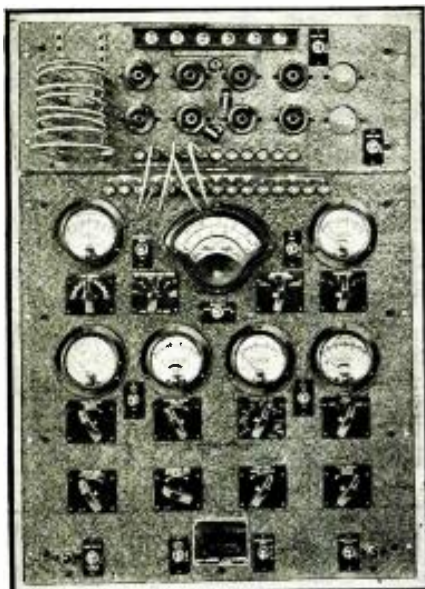

Fig. A. A high-grade set analyzer designed against obsolescence. Note the replaceable selector block. Built-in current jacks automatically place the instrument in series with any tube element. The exceptional usefulness of the series-connected meter is discussed by Mr. Morelock in detail.



Fig. B. The total-emission method of testing tubes, used in this specially-designed tube tester, is recommended by R.M.A. as the most economical, flexible and best method of testing tubes.

IN THE RADIO repair business, irrespective of the individual or company, the profits accrued or the salaries paid depend on the number of sets correctly repaired that leave the service bench for delivery each day.

Salaries and profits are a direct interest in any business, especially in service work and, therefore, an increase in turnover of receivers is vital to any radio repair man. Of course, in attempting to increase the turnover, no change in quality of repair work is suggested, as this must be kept of the first class in order to continue a satisfactory business. From the standpoint of turnover, what factors govern the Service Man's ability to accomplish an increase?

There are, generally speaking, 2 factors: (1) a simplified procedure for locating the trouble and correcting it in the minimum elapsed time; and, (2) the use of simplified and accurate service tools of known quality and dependability.

## 2 SERVICING PROCEDURES

As to procedure in locating trouble 2 methods appear best from the standpoint of quick results, preference being entirely open to argument in each case.

(1) Stage Analysis. The first of these is the locating of the defective stage by making use of an oscillator and a vacuum-tube voltmeter or, possibly an output meter. This procedure calls for measurement of "gain" (amplification), working through the receiver stage by stage, from antenna to speaker. This can be carried out with an oscillator and a vacuum-tube voltmeter, of low-input-capacity design, making connections to the grid caps of the tubes all the way through to the 1st-detector and carried

on through the receiver by connecting under the chassis to the socket grid terminals. Location of a defective stage or one supplying incorrect gain calls for a further examination of the tube and component parts in the circuit surrounding that tube.

(2) Free-Reference Analysis. The other general method, involves *analyzer* or "point-to-point" ("free point") measurement. Voltages and currents at each tube socket followed by resistance readings where incorrect potentials or currents appear, will segregate the defective part. There are other methods employed by some Service Men or organizations, but these are, in general, modifications of these two procedures and may be classed under one or the other.

There is no argument more strongly in favor of the Service Man than the use of simple, direct-reading, compact service instruments. A multiplicity of gadgets on test units is not only conducive to confusion but often causes incorrect interpretation of readings, and considerable delay. Many such "gadget units" appear spasmodically on the market to attract attention in advertisements, but if purchased are usually found to be confusing or of no value. The money used in construction of test units should be concentrated on the basic needs for accuracy, dependability through all kinds of weather and working conditions, durability and avoidance of obsolescence instead of on useless controls and devices. What then should Service Men look for in each test instrument needed for direct receiver analysis?

(Continued on page 228)

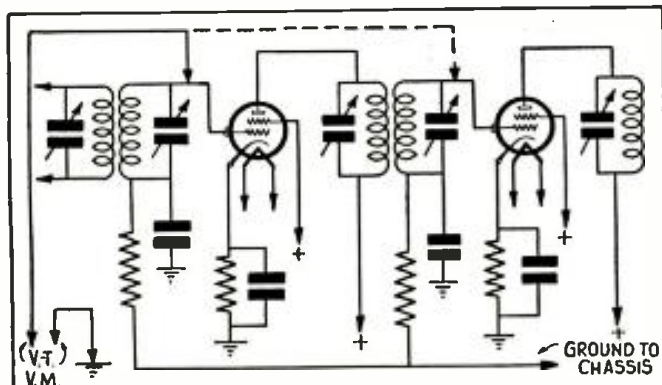

Fig. 1. Circuit for measuring gain-per-stage in radio equipment by means of a conventional vacuum-tube voltmeter.

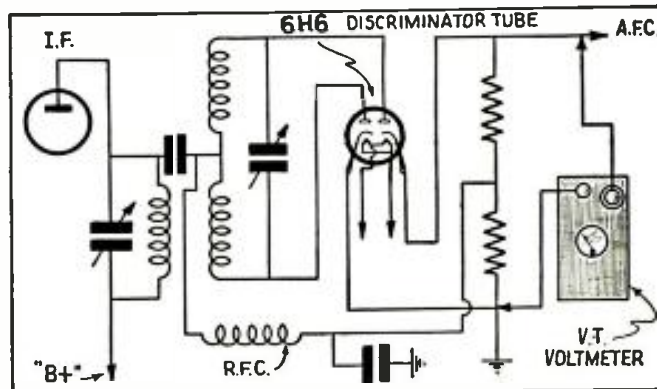

Fig. 2. Circuit for measuring automatic frequency control discriminator voltages with a conventional vacuum-tube voltmeter.

# NEW CIRCUITS IN MODERN RADIO RECEIVERS

The details of the modern radio receiver circuits that make them "different" from previous designs are illustrated and described by a well-known technician.

Watch for this department as an exclusive feature in forthcoming issues of *RADIO-CRAFT*.

F. L. SPRAYBERRY ..... No. 1

## (1) Improved Transrectification.

Zenith Chassis No. 5521. Zenith has used the circuit of Fig. 1A in many late models to improve 1st-detector action at high signal levels where the A.V.C. tends to bias the converter tube near cut-off.

A lead is brought from the control-grid end of the oscillator coil to the converter signal-grid lead, around which it is wrapped thus coupling the oscillator signal into the signal control-grid. On high bias values where the signal control-grid is near the cut-off point, the oscillator shifts the control-grid's operating point closer to the region on the grid-voltage—plate-current curve which produces detection.

## (2) Separate Discriminator 2nd-Detector Circuit.

Fairbanks-Morse 12A Chassis. As per Fig. 1B, the last I.F. primary is coupled to 2 secondaries, and each in turn is connected to diodes. One actuates the A.F.C. discriminator while the other acts as a conventional detector. The benefit of this arrangement lies in the resulting circuit simplification.

## (3) Self-Inverter Circuit.

Philco Models 38-4, 38-5 Code 121. Philco has found a practical way around using a phase-inverter tube which adds no gain to the amplifier. The result is shown in Fig. 1C. To one screen-grid is added a small load resistor (57) and a signal-coupling capacity to the control-grid of the other push-pull tube. Operating as an amplifier, but having no gain the screen-grid duplicates the control-grid voltage of the tube in which they both are, in reverse phase, and feeds this voltage to the control-grid of the other tube.

In this way, a signal is fed to only one grid of the push-pull tube and this tube feeds the other push-pull tube; thus, the need for an extra phase-inverter is eliminated.

## (4) Tuning-Indicator Sensitivity Adjustment.

General Electric Models E-91 and E-95. The General Electric models E-91 and E-95, Fig. 1D, have 2 A.V.C. levels, one high level for the R.F. amplifier and a lower level for the converter and I.F. amplifier. For the 2 high-frequency bands, where DX of low signal intensity is most likely, the colorama tuning sensitivity is fixed at maximum by the 2 connected lugs at the bottom of band switch Sw.2. For the broadcast band, where much higher signal intensities are available, as a rule switch Sw.4 provides a choice of lowering the colorama sensitivity corresponding to the lower level A.V.C. supplied to the converter and 1st I.F. tubes, or using it on maximum as usual. This provides more selective tuning, while the A.V.C. voltages are undisturbed.

## (5) Novel A.V.C. Signal Delay.

Philco Model 38-3. One diode plate of the 6Q7G 2nd-detector—1st audio amplifier (Fig. 1E) is used without bias for signal rectification, while the other diode is used to supply 2 separate A.V.C. voltages. It is biased through a 0.33-meg.—0.1-mf. filter at -3 V. by the drop across the 19-ohm (section) power resistor (87). This also biases all foregoing signal control-grids for proper tube operation and the R.F. and I.F. suppressor-grids for better tube efficiency.

(Continued on page 235)

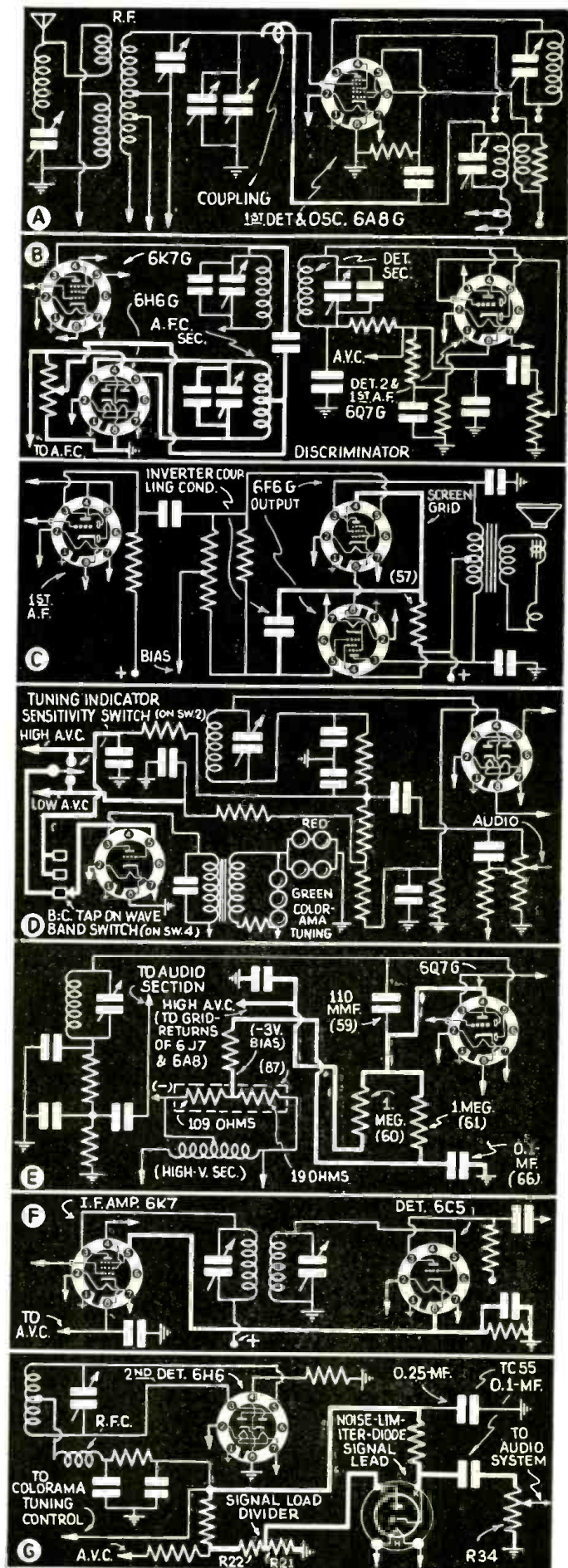

Fig. 1. Heavy lines in circuits are those discussed in text.

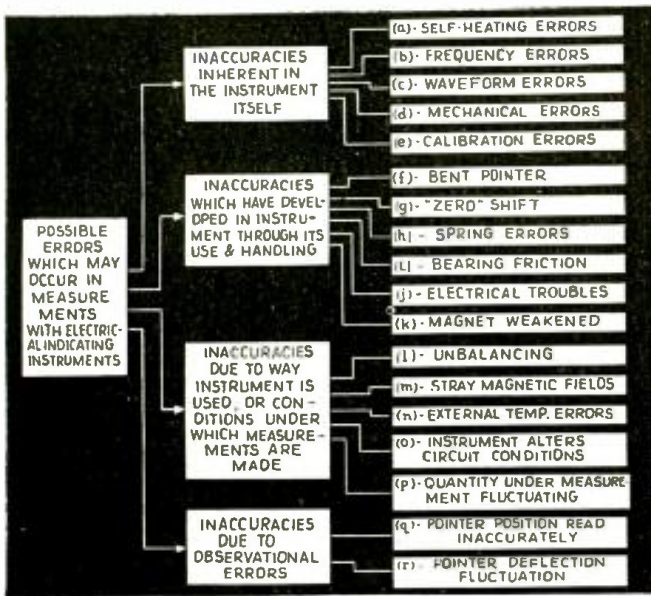

Fig. 1. Breakdown chart of the various causes of errors in test meters.

**H**OW ACCURATE is the voltage reading you just took on that receiver? How accurate are the meters you are using in your service work, anyway?

Are you one of those trusting Service Men who think that just because a meter is fairly new or expensive, it will give readings that are 100 per cent accurate at any point on the scale? Or, on the other hand, are you one of the suspicious but disillusioned type who has tried to check the accuracy of the meters in his test instruments, only to find that no two readings agree exactly? In either case, you (in common with most radio Service Men) are the victim of an incomplete, or inaccurate knowledge of electrical instrument construction and operating characteristics, for, anyone closely associated with electrical instrument design and manufacture is well aware that errors exist in all instruments, and will admit it freely. Fortunately, the entire subject of meter accuracy is fairly simple—and interesting. Perhaps we can clear up, in this series of articles, some of the more troublesome difficulties.

#### NO METER IS 100 PER CENT ACCURATE

First of all, get this fundamental fact firmly in your mind: **no commercial type electrical indicating instruments are guaranteed to read 100 per cent correctly at every point on the scale—only very expensive laboratory-type instruments approach such perfection.**

That means that you cannot, and should not, expect the readings you take on your servicing meters to be 100 per cent accurate. They really don't have to be—but that's another part of our story. What you should know is, how large the errors are, what their origin is, how you can minimize them, and whether they will seriously affect the usefulness of your measurements.

The accuracy, sensitivity, and reliability of an electrical instrument are determined by its *design*, the quality of the materials used in it, the *care* taken in its construction, the *accuracy* with which it has been assembled and calibrated at the factory, and how *roughly* it has been handled since made. In order to make meters that can be priced within the reach of the average user, accuracy has to be sacrificed somewhat.

Meters can be purchased for from less than a dollar up to several hundred dollars. Naturally, the more one pays for an instrument, the better the quality of materials used in it and the more accuracy and care exercised in its workmanship and calibration. The general run of meters used in present-day high-grade servicing instruments represent a good common-sense compromise between accuracy and price—they provide sufficient accuracy (around 98 per cent for D.C. instruments and 95 per cent for rectifier type A.C. instruments) for the general run of servicing measurements to be made, and are priced within the limits of the Service Man's pocketbook. Their manufacturers deserve unstinted

# HOW DEPENDABLE ARE YOUR METER READINGS?

Rare indeed is the Service Man who realizes just *how, why, and to what extent* his service meter readings may be inaccurate—and how much it really matters! This article explains, simply and expertly, the entire subject of meter accuracy. The author's published works include his well-known "Radio Physics Course," "Modern Radio Servicing," etc.

ALFRED A. GHIRARDI PART I

praise, for by working out clever designs, careful selection of materials, and taking advantage of every technical advance and possible manufacturing economy, they have succeeded in making really fine, rugged, instruments available to the Service Man at reasonable cost.

But the Service Man should realize that these instruments are not *perfect*—no manufacturer claims them to be! Practical construction difficulties make absolutely precise instruments unobtainable. A knowledge of the errors likely to occur, the origin of these errors, and the means used to make them negligible (or as small as possible) is of value in enabling one to use electrical instruments intelligently and obtain the best results from them under working conditions.

#### WHAT CAUSES THE ERRORS?

Now that we are reconciled to the fact that errors *do* exist in measurements made with electrical instruments, let us see what they are and what may cause them.

All of the common inaccuracies have been grouped and arranged for quick reference in a convenient chart in Fig. 1. Notice that there are 4 main sources of inaccuracy: (1) those which are inherent in the instrument itself due to its design and construction, and which may be present even in brand new instruments; (2) those which have developed in the instrument as a result of its constant usage, rough handling, etc.; (3) those which occur because of the particular way the instrument is used, or the conditions under which the measurement is made; and, (4) those which occur through inaccurate reading of the pointer position by the observer. In the chart, each of these is further broken down into its contributing causes.

Let us review these contributing causes of error briefly, so that we may understand why they may be present and what effects they have on the readings.

#### (1) Inaccuracies Inherent in the Instrument Itself

(A) **Temperature errors due to self-heating.** Most instruments contain sources of heat, such as moving coils of fine wire, springs, shunts, multiplier resistors, rectifiers, etc., through which the currents flow. This heat tends to cause a rise in the temperature of the various parts of the instrument—resulting in a change in the resistance of these parts, a consequent change in the current flowing, and a change in the deflection of the pointer. ("Carbon" resistors have a *negative coefficient* and hence *decrease* in resistance value.)

Naturally, the error which may result depends upon the value of the current or voltage under measurement and upon the length of time that the instrument is kept in the circuit. Fortunately, since the currents involved in the measurements made in radio service work are fairly small and the instruments are kept in the circuit only for a very short time, this source of error is not a very great problem.

By making the shunts and multiplier resistors of resistance materials which have a very low temperature coefficient of resistance, their resistance change due to heating is minimized. The increase in resistance of the copper movable

coil is compensated-for by using a control-spring material which produces a restraining spring that *weakens* just the right amount with change of temperature so as to offset the effect of the resistance *increase* of the movable coil. By employing these refinements in design, the actual error due to self-heating in commercial instruments is kept so low that it is negligible.

(B) and (C) **Frequency and waveform errors.** Errors due to variation of frequency (A.C. measurements), seldom bother the Service Man, because these errors are negligible for the frequencies of the A.C. circuits he has occasion to make measurements on. The same is true of waveform variation, which is, to a certain extent, analogous to variation of frequency.

(D) **Mechanical errors.** The quality of the control springs used in an electrical instrument has a very important bearing on its permanency and accuracy. The springs are such important items in the meter, that the rigid inspection they undergo before the meter leaves the factory of any reliable manufacturer makes them almost certain to be in perfect condition. What may happen to them later will be discussed.

Another mechanical error may be caused by friction in the jeweled bearings. This trouble also, has been reduced to insignificant proportions by proper inspection at the factories. However, as we shall see presently, rough handling, or excessive wear may cause this trouble later.

(E) **Calibration errors.** The scales for very inexpensive instruments are engraved or printed all in one batch, on the assumption of a particular deflection law for a given type instrument; generally the individual instruments are then adjusted by trial to make their deflections fit the scales as closely as possible. Naturally, such meters do not give accurate readings; but since the sale price is so low, the cost of individually calibrating each instrument would be prohibitive, and there is no other alternative.

For the better grade instruments, it is common practice to calibrate the scale of each instrument individually. It is not necessary, of course, to determine every scale division by test, especially on direct-current instruments with nearly uniform scales. It is usually considered sufficient to check at only a few points on the scale of a D.C. instrument by actual test. The intermediate points are filled-in, sometimes by hand, preferably by a mechanical method. Of course, if the shunts, multiplier resistors, or condensers used in the instrument are not accurate in value, this will affect the accuracy of the entire instrument. Any subsequent changes in these values due to "aging" of the resistors, condensers, control-springs or magnets, will also affect the accuracy. (Scales, even, are preferably of metal, for permanence.)

## (2) Inaccuracies Developed Through Use and Handling of the Instrument

A good electrical instrument is as fine and delicate a piece of mechanism as a fine jeweled watch. It should be handled with just as much care as such a watch, if its original accuracy is to be maintained; for many things may happen to it at any time, impairing its accuracy and reliability. Such a simple thing as a bump, or a fall, always possible with portable instruments, may have serious consequences. With permanently-installed instruments, a knock or a blow, continual vibration, effect of powerful nearby magnetic fields, overloads or other disturbances—any of these may affect instruments to such an extent as to make their readings unreliable.

(F) **Bent pointer and overload.** If too great a voltage is applied across the meter terminals (or stated in another way, too much current is allowed to flow through the meter coil), the pointer may strike against the end stop with sufficient violence to bend it. See Fig. 2A. If this occurs, *never* bring the pointer back to zero by means of the zero-adjusting screw, for this will not bring the indications into even approximate agreement with the scale markings. It will bring the moving coil into an initial position far different from that which it occupied when the initial calibration was made. See Fig. 2B. The correct thing to do is to straighten the pointer itself, in order to bring it back to zero. (Fig. 2C.) Errors due to bent pointers are quickly detected (in most instruments) by a lack of parallelism between the pointer

(Continued on page 236)

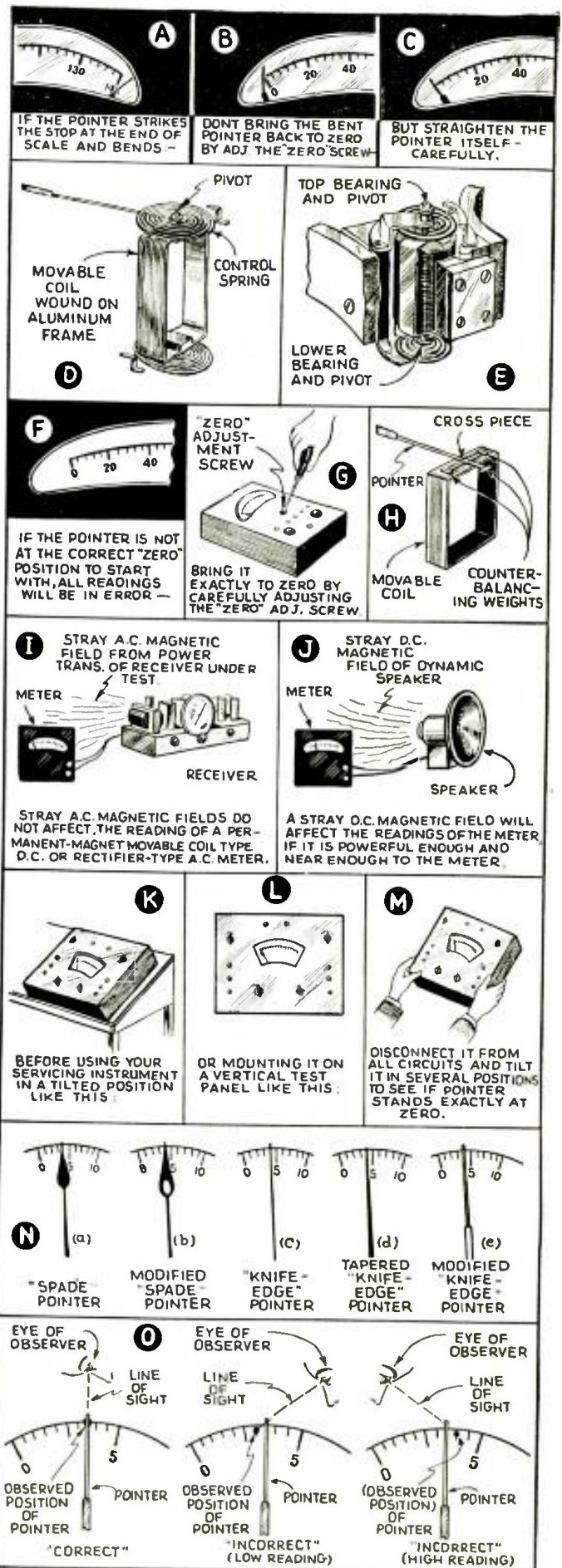

Fig. 2. Illustrations detailing the points discussed in the text.

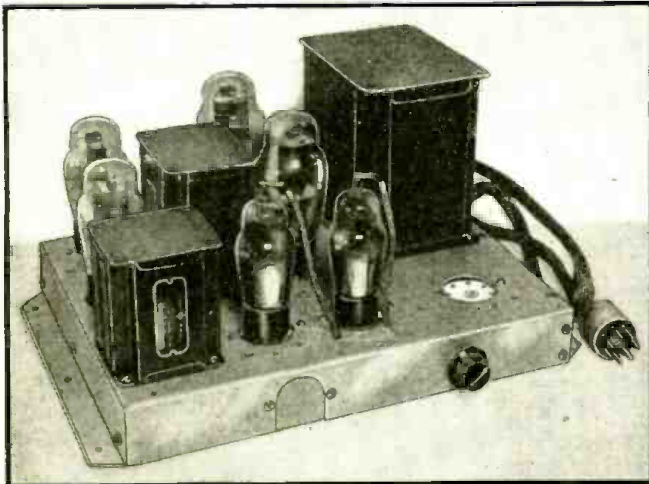

Fig. A. Appearance of the 60-W. push-pull negative-feedback amplifier.

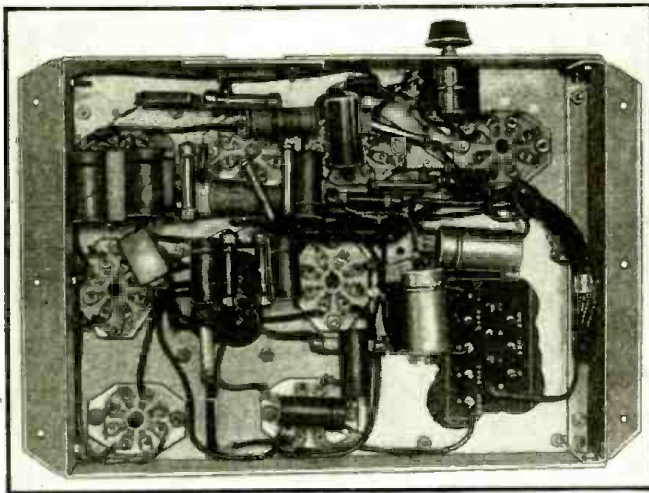

Fig. B. Under chassis view of the amplifier showing wiring and small parts.

# HOW TO MAKE A CLASS A<sup>1</sup> PUSH-PULL NEGATIVE-FEEDBACK 60-W. AMPLIFIER

Unlike previous types of negative-feedback amplifiers described in RADIO-CRAFT this new unit incorporates 3 stages utilizing this circuit arrangement. New tubes are featured.

WALTER J. BRONSON

(Continued from page 210 of *Radio-Craft* magazine.) Let us now see how these requirements are met.

## CIRCUIT DETAILS

First, a portion of the signal is fed back from the control-grids of the 6F6 push-pull A-prime stage to the cathode of the 6C8 push-pull voltage amplifier tube V2. (See Fig. 1.) This tube is the driver stage in push-pull combination to the 6F6 grids.

Second, feedback is accomplished in the following stage by taking part of the signal from the control-grids of the 6L6s through C13 and C14 including R15 and R16 which are connected to the grid-returns of the 6F6 input transformer T1.

*It is well to mention at this point that T1 is especially designed where feedback was a prime factor in the design of the amplifier.* The secondary is constructed with 2 separate windings making this an ideal component for this particular type of audio work. Although, this transformer can be used for the more straightforward audio systems by simply making a jumper connection from one secondary section to the other.

Third, negative feedback is again fed through a resistance-capacity network from the plates of the 6L6s to the negative grid-returns of the same stage. This not only compensates for certain deficiencies in the "B" voltage supply regulation, but also aids in the correction of 3rd harmonic distortion of the 6L6s.

## NOTES ON CONSTRUCTION

In constructing the amplifier and power supply for this system, care should be exercised in closely following the original layout of components. It is imperative, however, if preamplifiers are to be used in conjunction with this amplifier, that they should be perfectly shielded. Although ample gain is available at the 2 primary stages driving the inter-stage driving tubes.

To simplify construction and wiring the system is incorporated into separate units, that is, all audio parts and tubes

**T**HE BEAM-TUBE high-fidelity dual amplifier to be described incorporates 3 well-worked out stages of *negative feedback*.

Distortion, due to incorrect plate and screen-grid voltage regulation, is a very serious condition—particularly, in high-power amplifiers that incorporate negative feedbacks. Proper methods and carefully-designed feedback systems with well-designed power supplies will correct this fault and ward off all possible troubles generally encountered in this type of audio amplifier design. (A more detailed discussion of feedback amplifiers in general covering their operation and construction will not be taken up in this article, since much has been published in previous issues

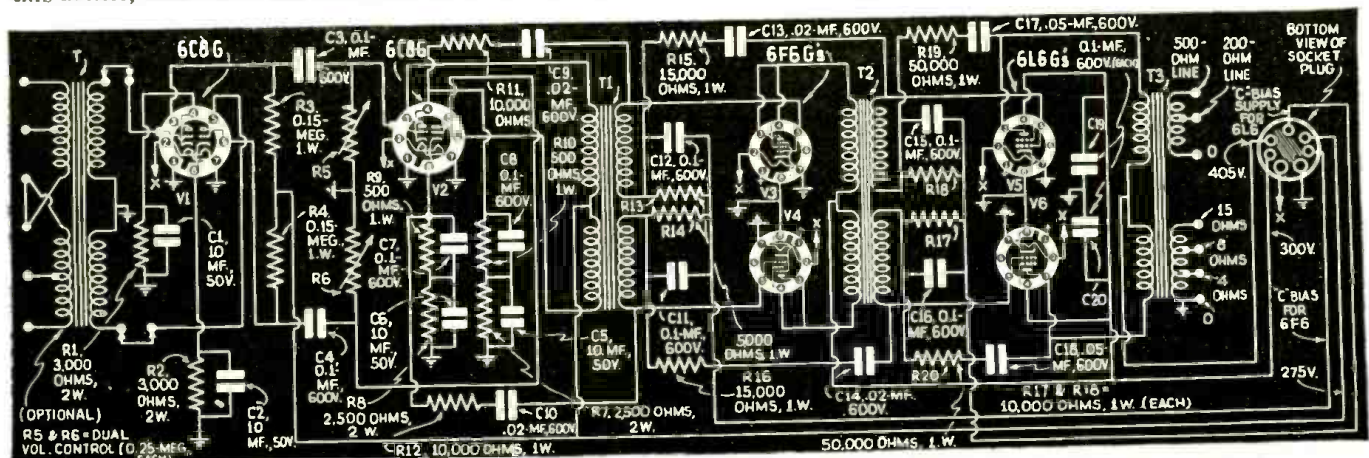

Fig. 1. Schematic diagram of the 60-W. push-pull negative-feedback amplifier. The tubes are hooked up in class A-prime arrangement.



are on one chassis; and power transformers, including their filter systems and rectifier tubes, are on a separate chassis. The dimensions of foundation chassis are as follows, 9 x 14 x 1 1/2 ins. deep; 3/32-in.-thick aluminum is used. This material was selected for the foundations to minimize weight and for its inherent qualities in the effect of shielding all possible stray hums from audio components and wiring.

### TUBE SEQUENCE

**The 6C8s.** The primary input stages are comprised of two 6C8Gs, V1 and V2. These tubes are classified as *double triodes* with the exception of having a separate cathode for each triode section of the tube. Due to the development of this new tube, voltage amplifier circuits are greatly simplified, and especially suited where push-pull operation throughout the entire audio system is desired. In the arrangement on the schematic diagram, the reader will note that 1 tube is equivalent to 2 tubes in a straightforward class A push-pull arrangement.

Improvement in quality reproduction of the 2 input stages is obtained by employing separate bias resistors and filter networks to each individual cathode.

Tube V1 is shown in the schematic diagram with an open-circuited input: this increases the possibilities of varied types of input couplings and multiple mixer stages. By having a throw-over switch special detector combinations of the phase-inverter type can easily be directly coupled to the input of this amplifier. Simplification of volume control is procured by using a dual 0.25-meg. volume control having an audio taper operating in tandem. The location of this control is in the control-grid circuit of the following 6C8 which is V2.

**The 6F6s.** Driver voltage for the 6F6 control-grids is accomplished by utilizing the 2 plates of V2 connected at the interstage transformer in push-pull class A. Ample driving power is obtained at this point when the 6C8 plates are operated at approximately 275 V. The grid-returns of the 6F6s operated in class A-prime are taken out with a lead to the negative return of the power transformer P.T.2 having the proper dropping resistor to ground. Bias voltage for the two 6F6s should be approximately 28 V. negative. However, it is best recommended to use a semi-variable resistor at this point for obtaining "C"-bias in cases where the bias voltages are apt to be abnormal; this also simplifies the adjustments and insures correct tube operation.

V3 and V4 6F6s are triode-connected (plate and screen grid tied together at socket). For V3 and V4, "B" voltage is 300 from mid-tap of driver transformer to ground. This voltage is taken from a 300-V. point at the P.T.2 power supply. These tubes are operated at strictly class A-prime driving the control-grids of the final stage.

**The 6L6.** This output stage utilizes 6L6s operated in class A-prime. Negative "C"-bias voltage for the 6L6 stage is approximately 36 V. for both tubes. A semi-variable resistor similar to the one used in the 6F6 stage is also employed at this point for correcting bias voltage and simplifying adjustments. Supply voltage for the screen-grids of the 6L6s is secured from a 300-V. point of the P.T.2 power supply. Supplying the plates of the 6L6s is "B" voltage, taken directly from P.T.1, having exactly 405 V. D.C. from mid-tap of output transformer to ground. Unit P.T.1 is solely the power supply including filament supply for the 6L6 plates and filament.

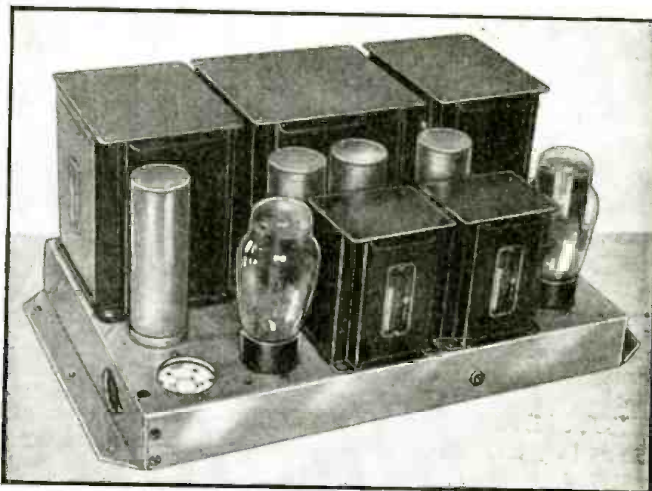

Fig. C. Appearance of the heavy-duty power supply of the 60-W. amplifier.

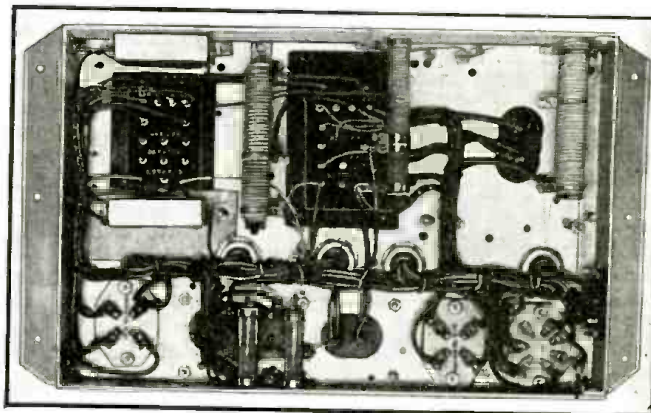

Fig. D. Under chassis view of the power supply showing wiring.

### "B"-POWER SOURCE

A glance at the schematic diagram, Fig. 2, will reveal an unusual method in securing plate and screen-grid voltages for all tubes. Two heavy-duty power transformers are effectively put to use, each transformer having its own individual rectifier and "B" filter networks insuring against possible current over-loading when the operation of the amplifier is susceptible to long hours of grueling work.

Rectifier tubes consist of an 83 for plate rectification of P.T.1 supplying plate voltage and current only to the 6L6 plates.

It is not necessary to use a high-current-delivering rectifying tube for P.T.2 since only the plates of the smaller tubes including screen-grid supply for 6L6s is being drawn from this source; a 5Z3 affords ample output. The total current drain from this power supply is approximately 125 ma. Transformer P.T.2 is rated at 200 ma., therefore, "B" voltage and filament supply for a large-size radio tuner can be easily drawn from this source. Due to the fact that the "B" voltage supply is taken from P.T.2 supplying the input

(Continued on page 251)

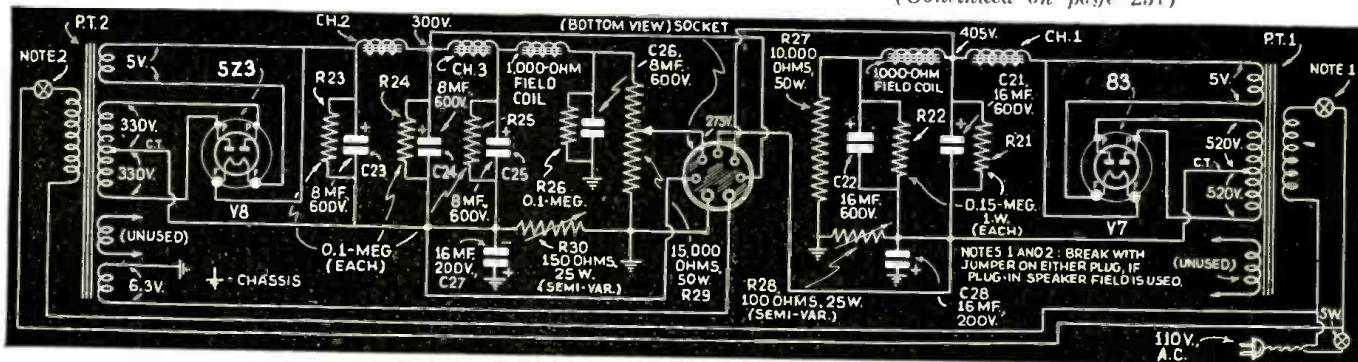

Fig. 2. Schematic diagram of the heavy-duty power supply. Actually there are 2 separate supplies, each with its own filter network.



Fig. A. The "Cyclops" 9-in. volt-ohmmeter in use.

# LATEST TEST APPARATUS FOR THE SERVICE MAN

## "CYCLOPS" VOLT-OHM-METER IS 9 INS. IN DIAMETER!

THE AVERAGE shop Service Man with his array of tools, hot soldering iron, test equipment, etc., spread before him and with test prods in his hands probing at certain voltage sources, must crane his neck and squint his eyes in order to get a reading on his small volt-ohmmeter; and while he does this one of the prods very often slips and he loses contact. Follows "cuss words", etc.

All this fuss and bother can be eliminated, according to the manufacturer of the new 9-inch "Cyclops" Volt-Ohmmeter shown in Fig. A. It has a scale which is more than 6½ ins. long, enabling accurate readings from a distance of 3 or 4 ft.

Furthermore, because of its special construction, only a 4-in. hole is required for mounting. It has a good "business-like" appearance, which will impress most set owners. Its main job, however, which it does very nicely, is to afford quick, accurate meter indications, easily readable. In this sense it is a real time saver and will be appreciated in every service shop.

(1303)

## AN R.F. SIGNAL GENERATOR WITH AN ACCURACY OF ½%

KNOWN AS the model 110, this direct-reading, silver-finish dial may be estimated to ¼ of 1 per cent. See Fig. B. Its accuracy is claimed to be ½ of 1 per cent and its frequency range is 100 kc. to 31 mc.

The radio-frequency output is continuously variable through vernier control and a 4-step ladder attenuation from minimum to 100,000 microvolts



Fig. B. This signal generator has 0.5% accuracy.

(0.1-volt) on all bands. (There is no uncontrollable, high-output tap.) A uni-selector switch provides 400-cycle internally-modulated R.F., unmodulated R.F., externally-modulated R.F., and 400-cycle push-pull sinusoidal audio voltage for amplifier tests that is adjustable 0-1.2 V. The rotor-inductor switching is done by making all coil contacts direct to the oscillating circuit.

To exclude strays, the entire R.F. circuit is enclosed in a separate, copper-shielded box. Power supply and modulator circuits are independently shielded, and the power chassis, power supply cord, and R.F. units are completely isolated by shielded, multi-section filters. The outer interlocking case is unwelded and finished in a rich, dark green baked crystalac trimmed with etched silver designation plates. The tube complement is one 76 oscillator, one 6X5 rectifier, and one 6N7 modulator.

(The Clough-Brengle Co.)

## ENGLISH-READING COMPACT VIBRATOR CHECKER

KNOWN AS the model 4100, this newly-developed instrument checks all types of auto or 6-V. household vibrators, regardless of whether they are half-wave, full-wave, synchronous, non-synchronous, etc., and regardless of what the prong arrangement might be. A universal adapter takes care of the latter.

The meter used is of the direct-reading type, indicating "good", "weak" or "bad" vibrators. It tests for shorts, sticking contacts, unsteady output, low output and poor starting. Only 2 switches and a meter compensator need be "wiggled", affording simplicity of operation. See dia. Fig. 3 (pg. 217).



Fig. C. This new vibrator checker tests all types of auto or 6 V. household vibrators. Can be used on counter, in the service shop, or carried around. Weighs but 5½ lbs.

It is furnished in a portable case with overall dimensions of 7½ x 8½ x 2½ ins. Its total carrying weight is 5½ lbs. See illustration at Fig. C.

(1304)

## HIGH-SPEED FUSES PROTECT METERS IN NEW PRACTICAL WAY

A SIMPLE METHOD of protecting commercial or home-made volt-ohm-milliammeters is suggested by a laboratory that has long specialized on this subject. It consists merely of the substitution of a double-pole selector switch for the commonly used single-pole type; in conjunction with special meter-type fuses.

The one pole is connected to various shunts as in the original hook-up and the other arm is connected to various meter fuses of a limited range. Usually, the range from 1/100- to ¼-A. can be split up most effectively by 4 types of fuses: the 1/100-, the 1/32-, the ¼- and the ¼-A. ratings. This covers the range from 1 ma. to 100 ma. which is the commonly-used scale. See Fig. 1.

By using the method described and illustrated in Fig. 1, the Service Man can speed up the time used in checking by quick insertion of the test prod. If, by accident, a damaging potential is contacted it merely means the blowing of inexpensive meter fuses, thereby saving the cost of replacing expensive shunts and delicate meter movements.

(1305)

## MUTUAL-CONDUCTANCE TUBE AND MULTI-TEST METER

THIS TUBE TESTER not only tests all tubes but also indicates volts, ohms, milliamperes, output, microfarads, ca-

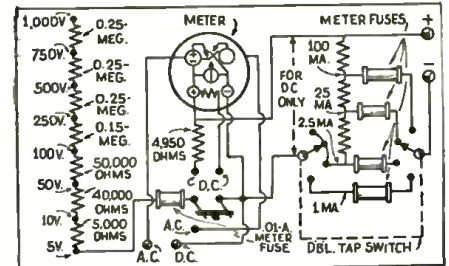

Fig. 1. The simple but very practical method of protecting expensive volt-ohm-milliammeters utilizes a 2-deck switch and fast-acting "meter" fuses. Extra deck carries the fuses.

Name and address of any manufacturer will be sent on receipt of self-addressed, stamped envelope. Kindly give (number) in above description of device.



# "LEARN-BY-EXPERIMENTING" BEGINNERS' PRACTICAL RADIO COURSE



Fig. A. The parts needed for Experiment No. 1.

## EXPERIMENT NO. 1.

### AUDIBLE TONE GENERATOR

("RADIO WHISTLE")

Here is an entirely new way of learning radio! You learn basic principles while building useful radio units!

CONDUCTED BY  
**SOL D. PRENSKY**



Fig. B. The audible tone generator for code work.

IT IS THE AIM of these Experiments to show fundamental principles of Radio in their practical applications, with the additional thought in mind of using commercially-available parts, selected and adapted, so that they will serve as general-purpose construction material. In this way, much of the apparatus used in one Experiment may be used again and again for other Experiments, thus keeping the cost of the apparatus within reasonable limits.

#### VOCATIONAL POSSIBILITIES

As radio develops, the need for well-trained men becomes much greater. The lack of proper training has become all the more pronounced with the many new developments like automatic frequency control and the like. Many, who are sincere in their desire to follow new developments, find themselves badly handicapped by the fact that no amount of practical experience can make up for the gap left in

their training by poor grounding in the basic principles of their field.

In a recent talk, Mr. J. K. Whitteker, Chief Instructor at R.C.A. Institutes, said, "Opportunities for Service Men and other radio workers are increasing considerably as a large number of those in the field drop out because of their inadequate training in the fundamentals of the science of radio."

It therefore is a matter of first importance to beginners and experienced men alike to bend every effort to master fundamental principles. These Experiments will go far to answer that purpose if the reader actually performs them, and in addition, consults a standard text book on principles of radio\* for explanations of the many topics and terms encountered in the Experiments. It is to be emphasized that any explanations given here in the course of the Experiment, are not to be regarded as complete, but simply as guides to the principles involved.

The material to be covered by these Experiments will be presented in a sequence of individual Experiments, each of which will be a unit in itself, and will assume no previous knowledge of radio to any extent, except that which can be obtained directly from a text book. Generous use will be made of pictorial aids in the beginning. The wood chassis in the first Experiment, which can be any *cigar box*, will be found very convenient at first, before it is replaced by work with a metal chassis in later Experiments.

#### \*Suggestions for Texts

"Radio Physics Course" by A. A. Ghirardi—very comprehensive in the fundamentals and quite a large book.

"Elementary Principles of Radio" by Burns—a much smaller book than above.

"Principles of Radio" by Henney—a general text.

"Practical Radio Communication" by Nilson and Hornung—a good reference book.

"How to Become a Radio Service Man" by Louis Martin—a *Radio-Craft* Red Book for those interested in service work and a good start to get an idea of what is to be done, and how.

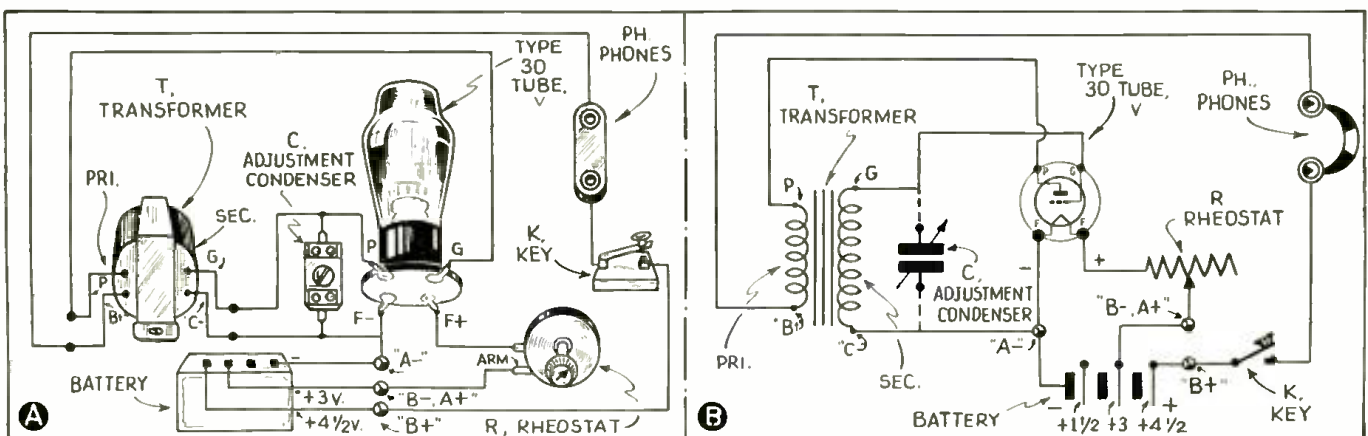

Fig. 2. The wiring diagram in section A is for the convenience of those who cannot easily follow the schematic diagram in section B.

## GENERAL PRINCIPLES—THE VACUUM TUBE

Since practically all radio work centers about the *vacuum tube*, it is necessary that we start with a simple picture of how this exceedingly versatile device works.

A *radio tube* (or "vacuum tube") is inherently an amplifier or booster device which can increase the strength of any given *signal* (radio program, static, dots and dashes, etc.), which is passed through it properly. It can also easily be modified to produce its own signal, which can be translated by *headphones* into sound, as will be seen in this experiment. However, no matter to what use the tube is put, its fundamental operation is the same, and it will be exceedingly helpful, therefore, to carefully consider this basic operation.

The vacuum tube, used in radio, is shown (see Fig. 1B and C) to consist of 3 elements, which are labeled according to their physical appearance as follows:

**Filament**—a thin wire which is heated by an *electric current* (from a battery or other source) to a point where it gives off small particles of electricity called *electrons*, which (when in motion) constitute an electric current.

**Plate**—a small sheet of metal which is connected externally to the *positive side* of a *battery* (or other source of electric current) and thus made to attract the electrons from the filament, which have a *negative charge*. The similarity of this electric attraction to the well-known magnetic attraction between magnets is shown in Fig. 1D and E.

Here it is seen that when a magnet is presented to another magnet suspended by a string, the first magnet when held in one position will cause the suspended one to be *attracted* to it (since then, the "unlike poles" [North-South, North-South] face each other). When the first magnet, however, is turned over so that it is reversed, right to left, it will be found to *repel* the suspended magnet (since now the "like poles" [North-North, South-South] are facing each other).

**Grid**—a mesh or open lattice-work of wire (placed between the filament and plate) with spaces between the wire, through which the electrons must travel on their path to the plate. When this grid is connected to the positive side of a battery, or other source of electrical supply, it will increase the flow of electrons since, being positive, it will also attract the negative electrons because of their "opposite charge." However, the same grid, if connected to the negative side of an electrical source, will now repel the negative electrons back to the filament, since "like charges of electricity repel each other." In this case the number of electrons available to flow to the plate becomes smaller.

Thus, as shown in Fig. 1B, when the grid is positive, the total number of electrons flowing to the plate becomes greater, since the grid is now *helping* the current (electrons).

When the grid is negative (see Fig. 1C), the total number of electrons flowing to the plate becomes less, since the grid now *retards* the flow of current (electrons) to the plate.

In this manner, the grid acts as a "control valve" or "trigger" so that a small change in the electrical charge of the grid controls a large change in the flow of electrons (which is the current) to the plate.

The *vacuum tube*, in operation, consists of 3 complete electrical paths, each a completely closed "loop", called *circuits*, as shown dotted in Fig. 1F.

(A) The *filament loop* is fed by the "A" battery or other form of (low or filament) *voltage* supply which heats the filament, causing it to give off electrons.

(B) The *grid loop (input circuit)* contains the signal which is to be amplified. The electric charge (or available energy) from a battery which is applied to this circuit is called the "C" (low, to medium, grid) voltage.

(C) The *plate loop (output circuit)* contains the signal, which has been amplified. The voltage supplied to this circuit is called the "B" (high or plate) voltage and the positive side of it is connected to the plate to furnish "plate voltage."

The tube operates in the following manner: The *input signal*, by means of the electric charge it gives to the grid, is able to control the large stream of electrons which travel from the filament to the positive plate. By means of such a "trigger action" the tube acts as an amplifier.

The tube and the other radio parts which will be used in the first Experiment are shown in photographic form in  
(Continued on page 232)

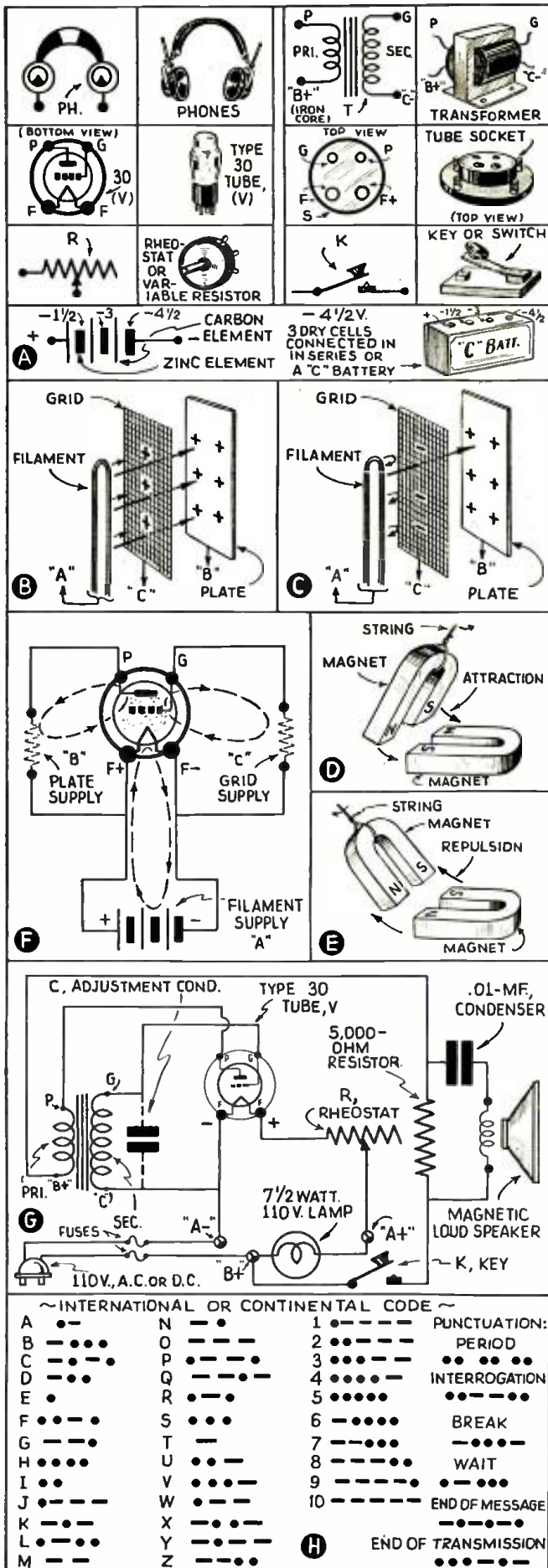

Fig. 1. A, Symbols of parts used in this experiment; B and C, The action of the grid in a radio tube; D and E, Illustrating attraction and repulsion; F, Fundamental circuits of a radio tube; G, See text; H, The code.

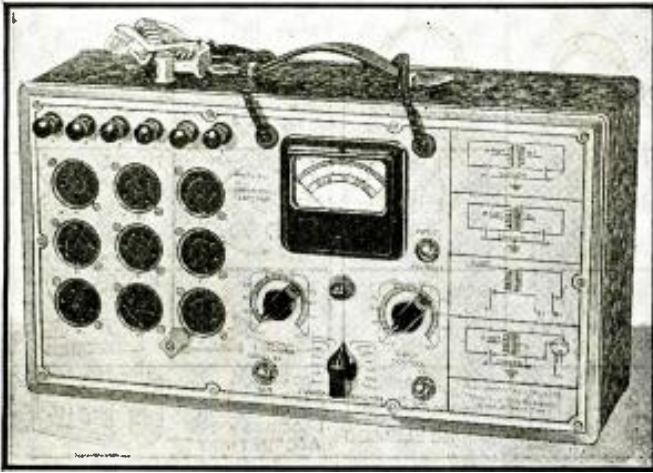

Fig. A. New modern tester designed to test all types of vibrators.

# ABC OF MODERN VIBRATOR SERVICING

Fundamental theory concerning the operation of the interrupter-type and synchronous-type vibrators, and the construction of suitable test units, are discussed.

F. E. WENGER

**A**UTOMOBILE-RADIO servicing today, can be greatly speeded up by the use of a Vibrator Tester. Before describing the testing of vibrators, I believe it is well to take the "mystery" out of the operation of vibrators. Successful servicing of auto-radio sets is entirely dependent upon the Service Man's understanding of the fundamentals of vibrators and their associated circuits.

Vibrators should be called automatic switches whose time constants are governed largely by the mechanical construction of the vibrator or switch.

## INTERRUPTER-TYPE VIBRATOR

Figure 1A shows the *interrupter-type vibrator* connected in full-wave circuit.

Current from the "A" battery flows through the center-tap of the transformer in the lead marked "A HOT," and with the reed in the upper position, the current flows with the arrows. The reed remains momentarily in the upper position until the electromagnet draws the reed to the lower position and current is interrupted through the upper section and starts flowing in the lower section of the transformer. The contact with the reed is made momentarily until the electromagnet again returns the reed to the top position. (The electromagnet is not shown in the circuit as this can be either a series or a shunt type coil.) It is easily seen how the speed of the reed and the dwell of the contacts will produce pulsating D.C. voltage in the primary of the transformer. This pulsating current is reflected as A.C. voltage on the secondary. The transformer ratio is generally 40-to-1. Thus, we have an alternating voltage in the secondary of the transformer 40 times that of the battery.

After we have A.C. in the secondary, this is rectified the same as A.C. is rectified in the conventional A.C. power pack. Filtering is substantially the same as that for home-type radio receivers and is designed for the frequency of the vibrator.

## SYNCHRONOUS-TYPE VIBRATOR

Figure 1B shows the *synchronous-type vibrator*. Note that the current in the primary takes the same path as it did in the interrupter-type vibrator. However, the reflected voltage in the secondary is rectified somewhat differently, inasmuch as it does not use a tube, but uses the same reed to interrupt the current in the primary and to pass current only in one direction.

During the first part of the cycle one-half of the secondary is delivering current to the reed, and during the second half of the cycle, the other half of the secondary is delivering current to the reed. Thus, we have accomplished the purpose of rectification and passing current in one direction only, without the use of a tube. The center-tap of the secondary in this instance becomes "B+." The 2 reeds can be electrically insulated from each other as is necessary in some radio sets where the negative return is below (less than) ground potential. However, the reed works in synchronism with the primary, hence, we have self-rectification.

By the foregoing description and a study of the action of the vibrator and a study of the circuits, it will be noted that the transformer and filter systems are separate parts of the vibrator proper and should be tested and analyzed the same as similar circuits are in conventional home-radio sets.

(Continued on page 247)

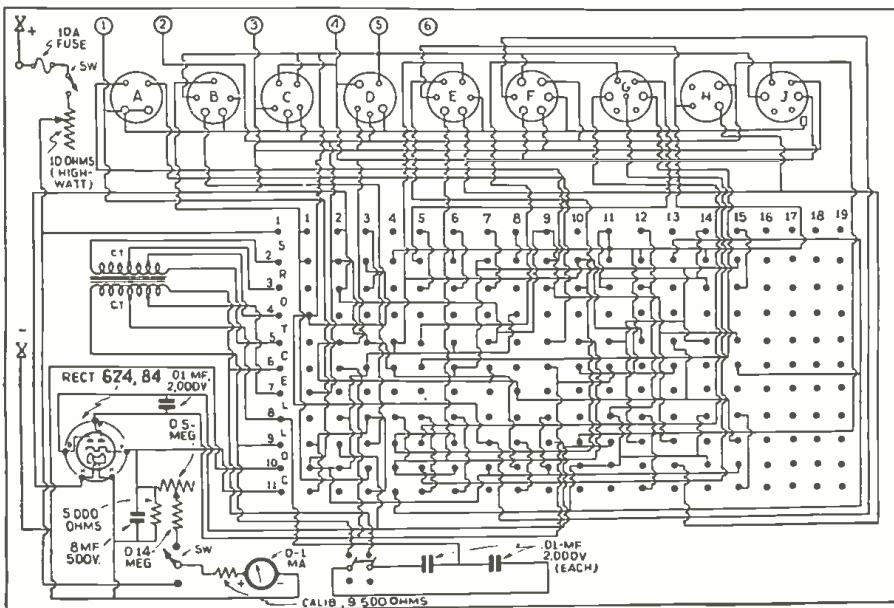

Fig. 2. Schematic circuit of the vibrator tester illustrated in Fig. A.

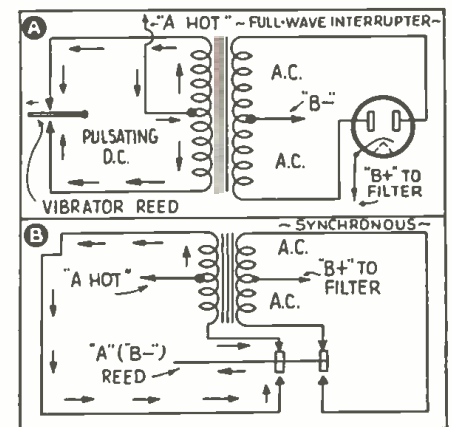
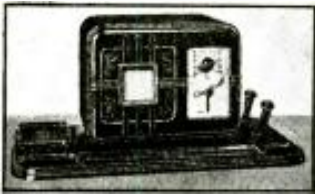

Fig. 1. Section A shows the *interrupter-type vibrator* working "full-wave." The pulsating D.C. in the primary is transformed into A.C. in the secondary at a voltage 40 times greater than that in the primary. A rectifier tube is then required to obtain D.C. Section B shows the *synchronous-type vibrator*, also working "full-wave." Here, however, the A.C. in the secondary is rectified through the medium of contacts on the vibrator reed. A separate rectifier tube is not required.

This department brings to you each month the newest developments in electronic, radio and public-address equipment. Aggressive technicians use this department to keep posted on the newer and better ways of doing things.

# THE LATEST RADIO EQUIPMENT



The newest in office intercommunicating units includes, in this all-bakelite apparatus, 2 pen-wells and 4 ashtrays. (1286)



A cleverly-designed socket that will appeal to the radio man is here illustrated. The isolantite top rotates on a metal baseplate to any desired position in order to facilitate wiring. (1287)



A dynamic microphone in a bullet-shape housing; a volume control is built-on. Frequency response, 20 to 9,000 cycles, it is said. (1288)



The earphone supplied in addition to the loudspeaker affords, in this unusually fine-appearing interphone, the facility of privacy. (1289)

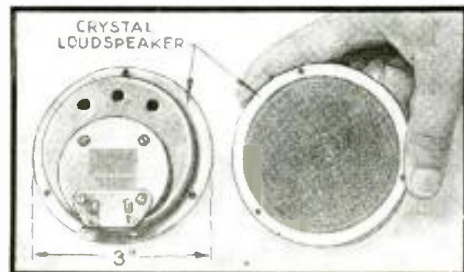

Crystal "interphone" transducer has good fidelity. (1290)

## ULTRA-MODERN DESK-SET INTERPHONE (1286)

(The Webster Company)

FOR THE BUSY business man there is now available a combination desk set and wire-type inter-office communication system. The desk set incorporates 4 nested ashtrays, 2 fountain-pen funnels, and troughs for pens, erasers, pencils and clips. Like this desk equipment the A.C.-D.C. "Amplical" interphone is made of molded black bakelite. Both 2-way and multiple-station systems are available in apparatus having the same general appearance.

## IMPROVED TUBE SOCKETS (1287)

MADE PARTLY of isolantite these new sockets feature in addition a prong-grip that extends the whole length of the tube prong. The face of the socket is electrically "dead"—no metal extends through it. Still another feature is the design which permits rotation of the isolantite body to any one of 6 positions on a metal holder, to facilitate wiring. An isolantite stand-off pillar is provided; except for the octal socket which is supplied with 2 metal pillars.

## NEW BULLET-SHAPE MICROPHONE (1288)

THE NEWEST in bullet-shape dynamic microphones features the use of a built-on volume control. The response characteristic is said to be from 20 to 9,000 cycles. Particularly recommended for use with a "guitar" amplifier. The bakelite case is available in black, Chinese-red or ivory.

## FAST-ACTION ARTISTIC INTERPHONE (1289)

(United Sound Engineering Co.)

IN THE "personal call-phone" system illustrated an earphone provides comparative privacy; raising the earphone from its rest makes conversation confidential by bringing the remote party's voice over the earphone instead of the loudspeaker. A busy signal is provided. Every station is a master. The finish is black with aluminum trim.

## 3-IN. INTERPHONE CRYSTAL SPEAKER-MIKE (1290)

(The Brush Development Co.)

ALTHOUGH somewhat greater amplification is required, the new crystal-type speaker-mike here illustrated affords a greater frequency response range than is available from the ordinary run of magnetic and dynamic transducers designed for interphone service.

As a microphone, its output level is approximately -40 db. (0 ref. equals 1 V. per dyne per sq. cm.) and it is worked directly into the control-grid of the first tube with a grid resistor of 1 meg. When switching the unit to loudspeaker position, it is not necessary to use an output transformer between the last stage and the speaker. It is common practice to shunt-feed the last tube plate through a typical load resistor; and to couple the speaker to the plate by means of a 0.05-mf. condenser (to shunt a 1/2-meg. resistor across the speaker).

## RACK-PANEL COORDINATED SOUND SYSTEM (1291)

(Wholesale Radio Service Co., Inc.)

SCHOOLS, offices, factories, churches, community centers, etc., will be particularly interested in the self-contained sound system here illustrated. It permits personal calling, mass announcements and the rebroadcasting of radio programs or phonograph records. All components are carefully coordinated with each other. Includes an all-wave radio receiver.

## MICROPHONE HANDSET FOR TRANSCEIVERS, ETC. (1292)

IMPROVEMENTS in earphones and microphones have been combined in a new handset for communicating systems, radiophone equipment, monitoring set-ups, etc.

Earphone is modernistic type. 2,000 ohms D.C. resistance (for plate circuit of a type 56, 76, etc.).

Microphone is a crystal unit that peaks at 3,500 cycles for improved speech intelligibility. Damping prevents blasting in close-talking.

(Continued on page 23\*)



Compact audio rack-panel. (1291)

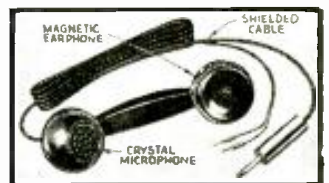

Handset has crystal microphone and magnetic earphone. (1292)

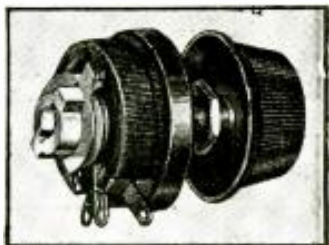

A.C. filament rheostat. (1293)

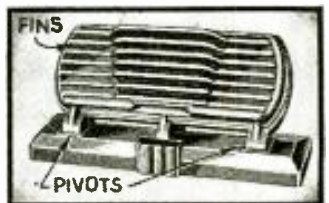

Pulpit-type velocity mike. (1294)

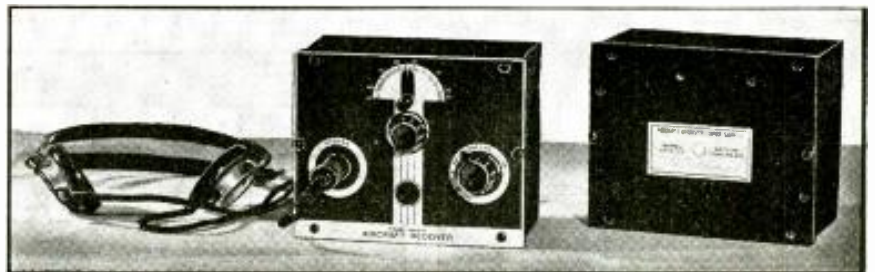

An aircraft radio receiver that obtains 4-tube efficiency with only 2 tubes. (1295)

# MODERN SERVICING OSCILLOSCOPES

Increase in oscilloscope sales prove that they are becoming more and more popular as regular servicing instruments. Outlined in this article are the features of some of the latest commercial units.



Fig. A



Fig. B

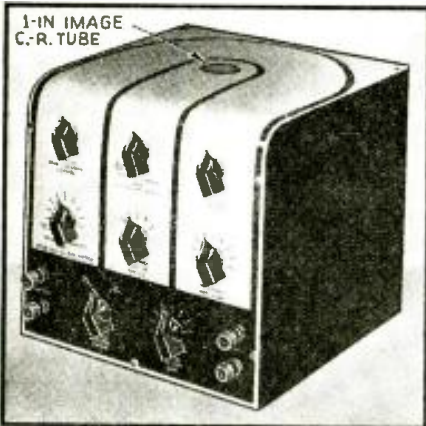

Fig. C

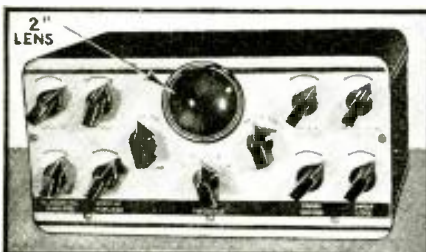

Fig. D

## CATHODE-RAY "ANALYZER" IS NEWEST SERVICE TOOL

**T**HIS INSTRUMENT contains the following sections: a 2-in. oscilloscope (cathode-ray tube and its power supply), separate amplifiers for the horizontal and vertical deflecting plates, an electronic "wobbler" (frequency modulator) of improved design, a linear-sweep circuit, and a group of variable and fixed alignment capacities.

An all-wave signal generator, either external or built-in, is a necessity when using any cathode-ray equipment for radio receiver alignment. In order to prevent obsolescence of modern equipment which the engineer might already own, this instrument was designed to operate with an external signal generator.

All the sections of the block diagram (Fig. 1) enclosed by the dotted lines are contained in the single attractive metal case shown in Fig. A. The controls have been divided into 4 groups—(1) Horizontal, (2) Vertical, (3) Linear Sweep, and (4) Alignment Capacities—so that the analyzer is easily operated and the necessary adjustments may be quickly made.

The fixed oscillator (A, in Fig. 1) which operates at a frequency of 800 kc., is frequency modulated  $\pm 15$  kc. by the "wobbler" (B), thus producing a bandwidth of 30 kc.

This frequency-modulated wave is mixed with the unmodulated output of the signal generator (C) in the frequency changer (D), the output of which has a contact bandwidth (30 kc.) regardless of the signal-generator frequency. The signal generator must be adjusted to a frequency which is either 800 kc. higher or lower than that desired. For example, to align a receiver at 1,000 kc. the generator must be set for either 1,800 kc. (1,000 + 800) or 200 kc. (1,000 - 800).

The output of the frequency changer is fed into the attenuator (E) which in turn feeds into the alignment capacities (F). The variable capacity has a range

of 125-950 mmf. (it is calibrated with the special shielded coaxial cable [G] which connects the instrument to the receiver being tested), and is used to align the antenna and R.F. stages of both home- and car-radio sets. This feature enables the engineer to correctly align car-radio receivers which require a variety of accurate "dummy antenna" values for best results. Fixed condensers of 0.1- and 0.5-mf. are included for I.F. alignment. Spare switch positions are available should other values be needed.

The coaxial cable is connected to the control-grid of an I.F. tube or to the antenna of the receiver (H) (the correct alignment capacity being used), and the "high" side of the diode-load resistor of the receiver 2nd-detector is connected to the vertical amplifier (I), as shown. The horizontal amplifier (J) is internally connected to a source of 60-cycle voltage.

A few of the many applications in which this model 96 instrument will save the service engineer time and trouble are: aligning R.F. or I.F. stages of home- and car-radio sets, adjusting low-frequency padders without the necessity of rocking the receiver gang condenser, aligning A.F.C. circuits (virtually impossible any other way), and correctly aligning "flat-topped" high-fidelity circuits. Hum and distortion may be easily located and corrected when using the linear sweep (K).

## COMPACT FOUNDATION OSCILLOSCOPE USES 1-INCH C.-R. TUBE

**W**ITH PROPER external addition, this basic oscilloscope offers facilities for the study and adjustment of numerous circuit problems. It may be adapted for R.F. and I.F. alignment, resistor, condenser, vibrator and many other tests. See Fig. B.

The oscilloscope incorporates an RCA type 913 cathode-ray tube with 1-in. fluorescent screen; has vertical and horizontal deflector-plate terminals on the front panel, as well as controls for intensity, focus, and sweep amplitude; incorporates a built-in 60-cycle sweep circuit. The instrument is housed in a metal case with black "electro-enamel" finish and measures only  $5\frac{1}{2}$  x  $7\frac{1}{2}$  x  $4\frac{1}{2}$  ins. deep. The front panel of this model 840 Ranger Examiner is finished in silver and black.

READRITE METER WORKS  
(Continued on page 234)

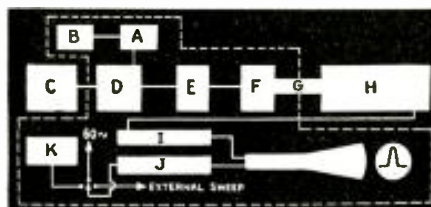

Fig. 1. Block diagram of the oscilloscope illustrated in Fig. A showing circuit sequence.



# BUSINESS PROBLEMS OF THE SERVICE MAN

The problems confronting a Service Man just branching out "on his own" are many and oft-times unforeseen. This series of articles treat of these problems in a thorough-going, practical and personal manner. Don't miss them!

Conducted by JACK GRAND

**A**LL IS not gold that glitters," nor is every idea a howling success! We humans have a great weakness, we get an idea and build it up in our imaginations until it is beyond reasonable attainment. Data is collected from all sources. We argue the possibilities of the idea from all angles trying to convince anyone who will listen that the idea is fundamentally sound.

Should anyone disagree, then in our opinion, they just don't get the right slant. Criticism, even if sound, is disregarded because of the extreme enthusiasm on our part.

It is just too bad—in fact, brutal—what a pencil and a piece of paper will do. Putting an idea on paper allows scrutiny and study. It is surprising how things change when imagination is eliminated.

When two or more men get together, invariably, discussions arise. Qualifications and abilities are discussed, opportunities and the success of various enterprises are the topics of conversations. Ofttimes the desire for a business career and a partnership is the outcome.

The type of discussion just described was instrumental in the creation of an idea whereby a partnership arrangement was created. The "idea" which these two men built up in their imagination will be our topic for discussion this month.

The names used are, of course, fictitious. We shall call these men Mr. Jerod and Mr. Holtz.

Mr. Jerod, a young, unmarried man, is employed by a large chain organization at a fair salary as a refrigeration engineer. During his spare time he had taken a resident course in radio servicing and had graduated. Upon completing the course, he continued working for the chain, and after working hours, he would study and experiment further on radio subjects and servicing.

Mr. Holtz, middle-aged and married, is employed by the same chain organization as an electrician. He had been with this concern for 12 years. Previous to this time his home had been in one of the north-western states.

## THE PROBLEM

As mentioned in the beginning of the text with reference to group conversations, these two men had ideas in common. They both wanted to go into business for themselves. Mr. Jerod was a

"knock-out" at electrical refrigeration and radio servicing, while Mr. Holtz considered himself a "cracker-jack" as an electrical contractor. Mr. Holtz also stressed his popularity and large acquaintance in his home town. He felt that better opportunities presented themselves in the North-West than here in the East.

The seed was there and the idea grew. They decided on a partnership and proceeded to make plans accordingly.

No sooner said than done. They went to the superintendent, presented their case and tendered their resignations. The superintendent had known these men for a long time and thought well of them. He offered his good wishes and at the same time, in a spirit of friendship, offered them the following proposition.

If Mr. Jerod and Mr. Holtz would take care of the refrigeration plant in the chain branch of that city he would secure for them space in the basement of that store, rent free. They could also put a sign in one corner of the window. The only stipulation being that one of them had to be on duty all the time. To this Mr. Jerod and Mr. Holtz agreed.

The picture described is beautiful—prospects looked bright. Combining refrigeration and radio servicing with electrical contracting as an all-year-round business was a master stroke—and on top of it all—rent free!

In summation—the following points are outstanding:

(1) Mr. Jerod is a good man on radio and refrigeration service.

(2) Mr. Holtz is a good electrician.

(3) Both men are good workers, they are congenial and have worked together for a number of years.

(4) A place of business has been provided—rent free.

(5) Mr. Jerod has a circle of friends and acquaintances as prospective customers.

(6) The combined financial resources are over \$1,000.

Again I repeat—the picture is good. Now let us analyze their problem.

## ANALYZING THE PROBLEM

What in your opinion are the possibilities of success for Mr. Jerod and Mr. Holtz?



## SERVICE BENCH OF SUCCESSFUL SERVICE MAN

The service bench illustrated above is that of a successful Service Man, F. C. Weckman, of Pittsburgh, Pa., who started on a small scale and gradually expanded until now he occupies a total floor space of 6,500 sq. ft.

The picture shows a very small portion of the 6,500 sq. ft. of floor space, which is used for auto-radio installation and service, quite a bit of which is sent in by dealers who do not install or service their radio sets. On the extreme left is a display board which speaks for itself. This board partially hides from view the tube shelves. The analyzer shown at left of the bench is the new Triplett 4-unit case made up of (1) point-to-point tester, (2) tube

(Continued on page 246)

After you have formed your opinion, put it down on paper, and see how it compares with the following (illustrated) analysis.

First—neither has had any business experience.

Mr. Holtz has not been in his home town for 12 years, and is depending upon friends and acquaintances that he has not seen for years.

I learned that neither one knew how many electrical contractors were in that town, nor could they inform me as to the number of radio service shops located there. They did not know the type or number of industries in the vicinity nor did they know whether the homes were in congested or scattered areas. They made no effort to determine the competitive conditions.

From this point on, lack of business experience becomes noticeable.

By studying the sketch (Fig. 1) of the store and the space allocated to these men, it became apparent that in order for a customer to get to the service department they would have to go through the store, downstairs and to the rear. True, the space is large, but not readily accessible.

Although a sign is permitted in the window, no merchandise could be displayed, therefore, possible sales of

(Continued on page 246)

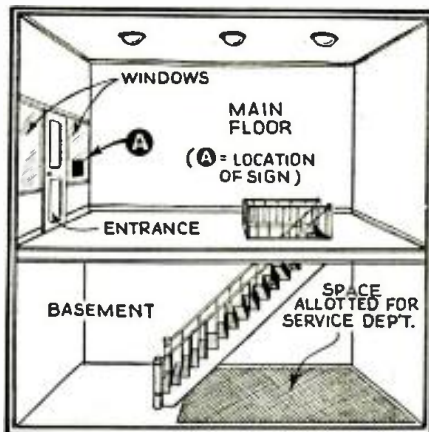
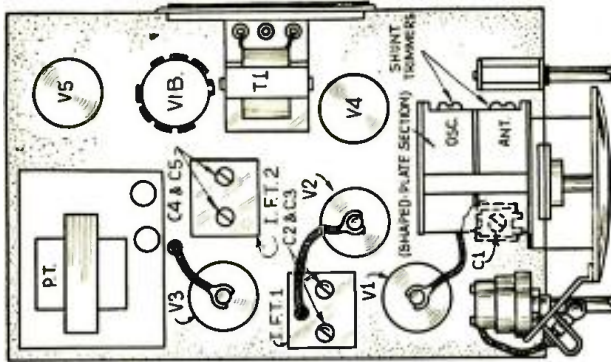

Fig. 1. The rent-free space offered as "fair exchange" for one man's full-time services.

## CROSLY MODEL A-157 (FIVER ROAMIO) AUTO RADIO

5-Tube Superheterodyne; Automatic Volume Control; Direct Tuning



The Fiver Roamio direct-tuning, auto-radio superheterodyne. The power supply and speaker are self-contained, the latter being mounted on the left side of the housing.



The Crosley Model A-157 auto-radio set is a single unit, 5-tube superheterodyne receiver, incorporating A.V.C. and many advanced features in circuit design. The power supply unit is an integral part of the receiver chassis and uses a primary-type vibrator.

**Tubes and Voltage Limits.** The following table gives the functions of the tubes used, together with the voltage readings between the tube socket contacts and the receiver chassis. Voltage readings taken with a 1,000 ohms/volt, 500-V. voltmeter (except filaments) with receiver in operating condition and no signal input.

		TUBE SOCKET VOLTAGE READINGS						
Tube	Function	H	P	S	Su	K	Ga	Go
6A8G	Osc.-Mod.	6.0	220	90	—	0	90	0
6Z7G	I.F. Amplifier	6.0	220	90	0	0	—	—
6Q7G	Diode Det. & A.F. Amp.	6.0	110	—	—	0	—	—
6K6G	Output	6.0	200	220	—	0	—	—
6X5G	Rectifier	6.0	—	—	—	220	—	—

Power Output approx. 4 W.  
Battery Drain approx. 5.7 A. at 6 V.

Connect the output meter to 3 and 4 of the 6K6G output tube socket. Be sure the meter is protected from D.C. by connecting a condenser (0.1-mf. or larger—not electrolytic) in series with one of the leads.

- Tuning I.F. Amplifier to 455 kc.**
    - Connect the output of the signal generator through a 0.02-mf. or larger, condenser to the top cap of the 6A8G Osc.-Mod. tube, leaving the tube's control-grid clip in place. Connect the ground lead from the signal generator to the receiver chassis frame. *Keep the generator leads as far as possible from the control-grid leads of the other screen-grid tubes.*
    - Adjust the station selector so that the rotor plates of the tuning condenser are completely disengaged and turn volume control to max.
    - Set the signal generator to 455 kc.
    - Adjust both trimmers located on the 2nd I.F. transformer for maximum output.
    - Adjust both trimmers located on the 1st I.F. transformer for maximum output.
    - Repeat operations (d) and (e) for more accurate adjustments.
  - In order to prevent A.V.C. action always use the lowest signal generator output that will give a reasonable output meter reading.**
  - Aligning R.F. Amplifier.**
    - Connect the output lead from the signal generator through a 250 mmf. condenser to the "ANT." connection of the receiver.
    - Set the signal generator to 1,400 kc.
    - Adjust the station selector to 140 on the dial.
    - Adjust the trimmer on the "OSC." section of the tuning condenser for maximum output.
    - Adjust the trimmer on the "ANT." section of the tuning condenser for maximum output.
    - Readjust the station selector for maximum output. *Do not readjust the OSC. trimmer.*
    - Repeat operation (e) for more accurate adjustment.
  - Adjusting Antenna Compensating Condenser.**
    - Set the signal generator to 600 kc.
    - Tune in a 600 kc. signal with the station selector for maximum output.
    - Adjust the antenna compensating condenser, C1.
    - Repeat operations (b) and (c) alternately until no further improvement can be obtained.
    - Set the signal generator to 1,400 kc. again.
    - Tune-in the 1,400 kc. signal with the station selector for maximum output.
    - Readjust the trimmer on the "ANT." section of the tuning condenser for maximum output.
- It will be necessary to adjust the antenna compensating condenser to the car antenna after the receiver has been installed in the car.
- After the installation is complete, tune-in a WEAK station between 55 and 65 on the dial.
  - Adjust the antenna compensating condenser for maximum volume in the speaker.

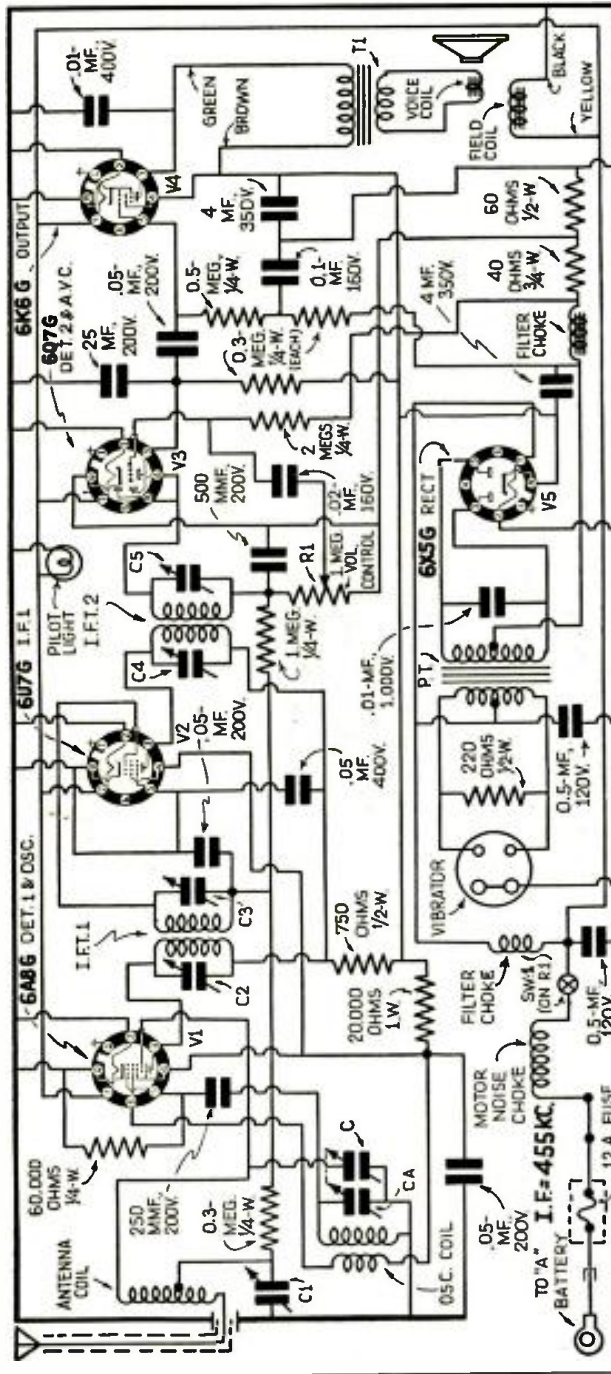

# BUILD THIS "INTERMITTENT OPEN" CONDENSER TESTER

A factory-type "breakdown-test oscillator" is described.

JOSEPH MOSIO

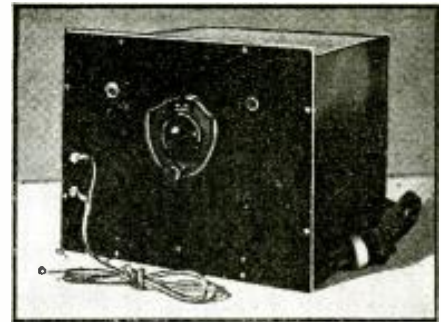

Fig. A. Appearance of the "intermittent open" condenser tester.

ONE OF THE MOST difficult condenser troubles to detect is the problem of open, or "intermittent open" paper condensers. To detect these conditions quickly and efficiently a special type of tester has been designed and is in use in a well-known condenser factory. Service Men may wish to duplicate it. See Fig. A.

The tester consists of a push-pull oscillator circuit that will deliver approximately 8 watts of R.F. power. This current is sufficient to tend to break down any intermittent contact between the condenser terminal, or wire, and the condenser foil. In some cases this break-down will occur

immediately, and in others it may be necessary to allow the condenser to "cook" for 5 or 10 minutes. If such a weak contact is present it is certain that the heavy R.F. current, which passes through the condenser, will produce the desired permanent open and thereby the faulty condensers can be eliminated. See Fig. 1 for schematic circuit.

## HOW TO USE THE INTERMITTENT-OPEN CONDENSER TESTER

The circuit is so arranged that the condenser under test is placed in a series resonant circuit with the variable condenser of the tester. By varying the capacity of the variable condenser, CV, with the test condenser in the circuit at terminals TEST, resonance is indicated by maximum glow of the pilot light, V. Also, it is possible to have a capacity indicator by calibrating the variable condenser with standard condensers of known capacitance. Intermittent-open condensers can be detected by the flicker of the pilot light; and no-glow indicates a completely-open condition.

In construction of the tester, it may be necessary to adjust the coupling of the coils in the resonant circuit to obtain maximum glow of the pilot light, however, after a few trials this condition can be obtained satisfactorily. Use

(Continued on page 241)

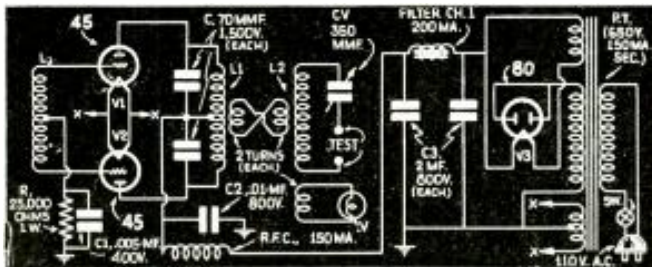

Fig. 1. Schematic circuit of the condenser tester shown above.

# NEW INSTRUMENT SPEEDS FREE-POINT TESTING

A new device permits breaking various tube circuits to obtain *current* instead of *voltage* measurements.

G. H. KOCH

A NEW INSTRUMENT has made it possible to quickly and conveniently make the very important current measurements and point-to-point voltage and resistance tests through the cord-and-plug method of analysis. Also, it eliminates the confusion caused by the great number of tube types now in use, in new and old receivers.

Through the use of machined cards (see Fig. A), placed over the jack switches, covering the internal connections and designations of all types of tubes, the operator has an ideal set-up for making a complete analysis without interruption of his trend of thought. Tube manufacturers can arrange the elements in any sequence they see fit for it is no longer necessary to refer to a complicated chart or to try to remember the connections or numerology of the various elements.

This instrument, which has been given the name of "Anal-O-Scope," when used with any volt-ohm-milliammeter is a practical and convenient device for taking current readings. Due to the complexity of the present-day receiver with its complicated and high-value resistance networks, the current method of analysis is becoming a very practical

(Continued on page 249)

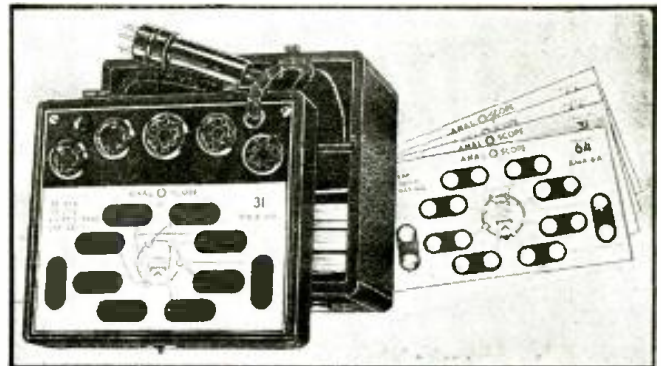

Fig. A. The new instrument which facilitates free-point testing. Its "series-circuit" jacks permit current readings of any circuit.

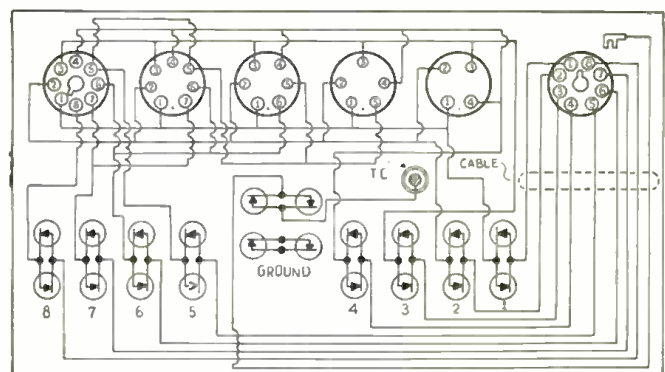

Fig. 1. Schematic diagram of the instrument illustrated above. Note the "series-circuit" jacks for insertion of a current-reading meter.

# CORRECT PLAYBACK OF SPOT RECORDINGS

Proper playback of spot recordings is equally if not more important than the actual recording. Here are some interesting facts.

RALPH L. POWER.....PART I

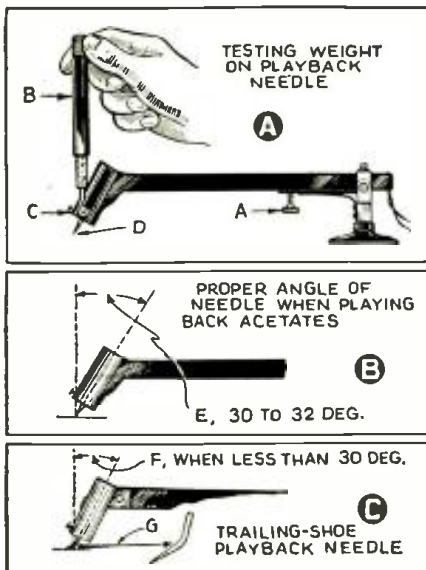

Fig. 1. A, Adjustments of the phono pickup; B and C, Proper playback angle of needle and head.

**N**UMEROUS articles have been written in the matter of exact recording procedure for the making or cutting of instantaneous records on both aluminum and the so-called acetates. But articles covering the subject of *correct playback* have been rare.

## WAX, ACETATE AND ALUMINUM RECORDINGS

Close examination of recordings on *wax*, *acetates* and *aluminum* show that

the ordinary playback pickup totally fails to reproduce many of the recorded frequencies!

The average playback set-up is entirely unsuitable for use on instantaneous recordings, for the following reasons:

(1) Excessive head weight results in excessive needle pressure (which causes tearing of the groove bottom and sides);

(2) Too-short an arm results in excessive side-wall pressure at the extreme end of the arc in the swing of the arm across the record.

While not so serious on cellulose-coated material, its most aggravated form shows up on aluminum, where there is of necessity, a very shallow groove together with a soft, pliable playback needle which quickly wears its point out of the groove and onto

the record space, or lands between the grooves when there is any appreciable side pressure. Naturally, the remedy is to use an arm the greatest longest possible length, together with a frictionless pivot bearing.

Further examination discloses that a great number of pieces of equipment used to playback instantaneous records not only fail to reproduce for the listener the frequencies and quality recorded on the discs, but very often the modulated groove in a single playing is not only seriously deteriorated but in many cases completely ruined.

## ACETATE RECORDS VS. COMMERCIAL PRESSINGS

It must be borne in mind that there is a vast difference between *acetate records* and *commercial pressings*.

(Continued on page 244)



**FREE** — A 1-year subscription to RADIO-CRAFT to each person who submits a WITTIQUIZ that in the opinion of the Editors is suitable for publication in RADIO-CRAFT. Read the following WITTIQUIZZES; can you spot the correct answers? Now send in YOUR idea of one or more good WITTIQUIZZES based on some term used in radio, and win an award. (Contest rules appear on page 235.)

(10) Did you ever know that *ampere-hour* is—

(a) A popular radio program. (b) A quantity of electricity. (c) A fractional part of an hour. (d) A particular kind of time. (e) An astronomical expression of distance. (f) The speed of an electric current.

(11) *Radio-frequency currents* travel along the surface of a wire because—

(a) The shortest distance between 2 points is a straight line. (b)  $2\pi R$  is the circumference of a conductor. (c) Centrifugal force drives it there. (d) "Skin-effect" is characteristic of high-frequency currents in a solid conductor. (e) Skip-distance effects arise at high-frequencies.

(12) You may not know offhand, but *E. M. F.* means—

(a) Equipment Manufacturers Fraternity. (b) Electromagnetic force. (c) Electrical motor friction. (d) Electromotive force. (e) Electrical microfarad.

(13) Did it ever occur to you that *grid bias* is—

(a) A grid, cut on the diagonal. (b) A direct component of the grid voltage. (c) A neutral voltage on the grid of a tube. (d) An intermediate component of the grid voltage.

(14) A *haywire hookup* necessarily must be—

(a) A circuit wired carelessly. (b) A cross-connected radio network program. (c) A farm-type radio set. (d) A radio set connected by means of wire from a bale of hay.

(15) *Volume control*. Are you thoroughly familiar with these words? Would you say that they referred to—

(a) A device for reducing signal intensity. (b) A dietician. (c) A weak radio tube. (d) A low-loss potentiometer.

(16) If you overheard a conversation in which you caught only the words *power factor* would you know this was a reference to—

(a) An electricity generating station. (b) The ratio of true to apparent power. (c) The nomograph crossover

point of amplification versus percentage curves. (d) The amplification factor of a power tube.

(17) Most radio fans know that a *voltage divider* is—

(a) An official appointed by the F.C.C. to see that radio voltages are evenly divided among licensed broadcast stations. (b) A voltage-measuring instrument. (c) An electrical mathematician. (d) A resistor provided with contacts for obtaining desired voltages when a voltage exists across the entire resistor. (e) A resistor which generates various voltages.

(18) It is now definitely established that the *Luxemburg Effect* is:

(a) The peculiar property of microwaves hastening the "souring" of a particular cheese. (b) Cross-modulation of radio waves in the ether. (c) A frequency drift of the transmitter due to a high cheese content in the casein insulating parts.

(Continued on page 235)

# OPERATING NOTES

## ANALYSES of

### RADIO RECEIVER SYMPTOMS

# SERVICING

## QUESTIONS & ANSWERS

Service Men may write, requesting answers to specific service questions. Address inquiries to Service Editor. For questions answered by mail, a service fee of 25c per question is made. Only questions of wide interest can be published.

Note: An effort is being made to maintain 48-hour service on mail inquiries, from Service Men, addressed to "Servicing Questions & Answers." Let us help you on that rush job.

Pilot 114, 115. When the complaint of fading, intermittent reception or oscillator drift is received on these models, determine whether the fading exists on all bands or only over the low-frequency portion of the broadcast band.

Since an inter-station noise suppressor stage is employed, a shift or frequency drift of only 4 or 5 kc. will produce an inoperative condition when the silencing stage is switched on and being used. Reception can again be obtained by re-tuning to the carrier. An intermittent oscillator plate coupling condenser, a 0.01-mf. unit (see Fig. 1E), has been found at fault in this case. This condenser connects between the type 76 oscillator tube plate, and the arm contact of the rear section of the wave-band switch. Upon replacement mount the unit firmly to remove the possibility of vibration and consequently microphonics.

RCA Victor RAE-79, RE-81. Although these two models use entirely different chassis, they are both radio-phonograph combinations wherein the phonograph pickup is employed for home and radio recording as well as record reproduction.

After some period of use, in every case where the home recorded records are produced, it will be found that not only will record reproduction become weak and distorted but that home or radio recordings cannot be made with the same volume and clarity as before. Since an additional weight is placed upon the phonograph pickup when producing home recorded records, the pickup device is subjected to a good deal of strain, inasmuch as it is not especially manufactured for this purpose, and generates an unusual amount of heat when used for any length of time. This causes the wax with which the pickup coil is impregnated, to melt and run down between the pole pieces and armature, and upon the rubber damping blocks. Of course, this action does not take place until several months of operation when the loss in phono output becomes markedly apparent.

The only method of effecting a repair is that of dismantling the entire pickup unit, being sure to place a keeper across the magnet before its removal and noting its polarity in relation to the pole-pieces. The armature and pole-pieces should be carefully cleaned so as to be entirely free from the impregnating compound. In some instances, it is necessary to replace the rubber dampers, which have become well "soaked," so to speak, before satisfactory operation can be obtained. These rubber dampers may be made from the rubber of an ordinary baby bottle nipple.

After all parts have been cleaned and the rubber dampers installed, the pickup should be re-assembled, the magnet remagnetized, if possible, and the armature adjusted so that it is equi-distant between the pole-pieces. This ad-

justment must be made with the permanent magnet in place, although the latter may be turned down in order to gain access to the adjusting screws. It should be remembered that the keeper bar must not be removed until after the magnet has been returned to its position across the pole-pieces.

BERTRAM M. FREED

Majestic 130. Fading on these models is usually traced to the grid-return bypass condensers. These condensers are in small metal cans located under the gang condenser shield. See Fig. 1A.

Majestic 90. Fading on these models is caused by cathode bypass condensers in the R.F. and detector stages. Another complaint on this model is inability to get stations on portion of dial caused by shorted gang condensers.

Majestic 70. Weak and distorted reception on the Majestic 70, which clears up when putting the aerial on the grid of the 2nd or 3rd R.F., but gets weak and distorted when putting the aerial back to the aerial post, is caused by an "open" in the volume control. See Fig. 1B.

IRVING ISKOWITZ

Philco 54 A.C.-D.C. Distortion. Check wire-wound resistor on rear-right of chassis. The lower portion of this unit develops high resistance (contact), and gives the type 75 tube triode-grid an incorrect bias. Remedy—clean the terminals and wire thoroughly, and resolder or replace unit. Distortion can also be caused by gradual increase in volume control resistance, due to wear, which changes the diode load. See Fig. 1C.

RCA Model R-10. When noise, similar to a noisy tube or loose connection, is encountered on this model, it may be caused by the metal grommet through which passes the control-grid wire to the 1st-detector being loosely fastened to chassis. A minute potential, which shorts intermittently to chassis, due to mechanical vibration, is developed in this small metal loop. This results in a varying voltage being superimposed on the signal voltage going to the control-grid of the tube. As there is a great deal of amplification present, the noise resulting is very objectionable. See Fig. 1D.

ALEX PLAKADIS

Wet Electrolytic Condensers. It has been called to our attention that occasionally, the electrolyte from wet electrolytic condensers will leak out of the container, run down the side and harden, leaving an unpleasant deposit. This is entirely natural due to the chemical action in condensers of this type.

In the manufacture of these condensers, sev-

(Continued on page 249)

### P.A. FADER

(26) D. J. Fink, Long Beach, L. I.

(Q.) What is meant by a "fader" as applied to a P.A. system? How is same used and why?

(A.) A fader system that is usually associated with P.A. work is a means of regulating the intensity of the input signals (voice or music) by the operator of the system in order to permit a mixing of voices, or phonograph recordings, or both.

A series of potentiometers, connected to the various inputs, is so arranged that, by rotating the controls, mixing is accomplished.

### BURNED-OUT AUDIO TRANSFORMER

(27) H. C. Johnson, Springfield, Mass.

(Q.) I have a Silver-Marshall model 730 "Round-the-World 4," battery operated. In the schematic circuit of this receiver a No. 255 Silver-Marshall unit is used in the 1st audio stage, and a potential between 45 V. and 135 V. is specified. I am using a "B" eliminator in place of the "B" batteries. On the 90-V. tap of the "B" eliminator I get a voltage reading of 135 at the plate prong of the UX 222 socket. In an effort to improve reception, I stepped up the voltage regulator on the "B" eliminator, and as a result burned-out the primary side of the No. 255 transformer. I replaced it with a straight audio transformer having a ratio of 3-to-1 and it works, but not very satisfactorily. Please advise me how I can correct this trouble.

(A.) The reason that the voltage reading on the plate of the type 222 R.F. tube seems to be excessive is primarily due to a minimum drain of your set; in other words, the "B" eliminator was designed to supply more plate current—approximately from 60 to 100 Ma.

Therefore, you can readily understand why, with very little plate current being drawn by

(Continued on page 254)

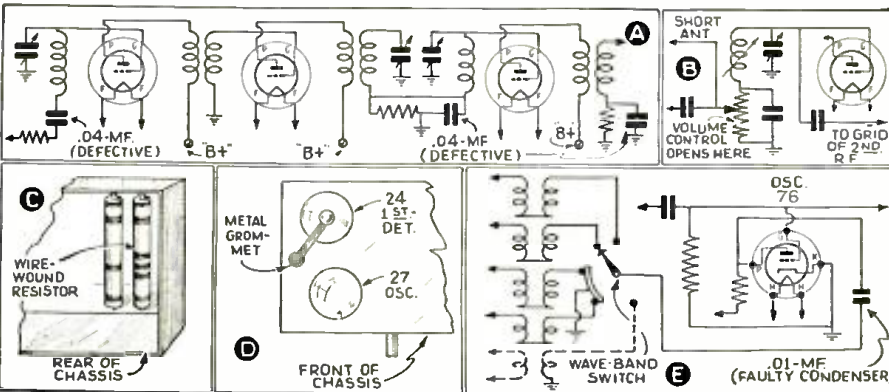

Fig. 1. Operating notes on: A, Majestic 130; B, Majestic 70; C, Philco 54; D, RCA R-10; E, Pilot 114-15.

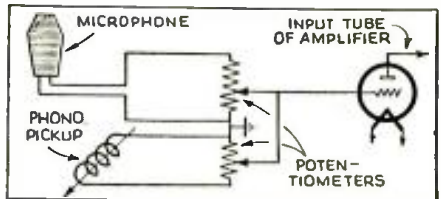

Fig. Q26. Fader-mixer for P.A. systems.

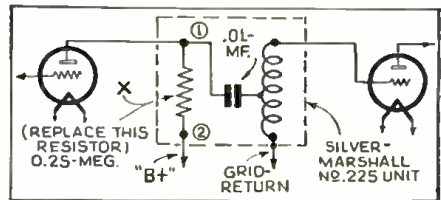

Fig. Q27. Open resistor in S-M model 730 set.

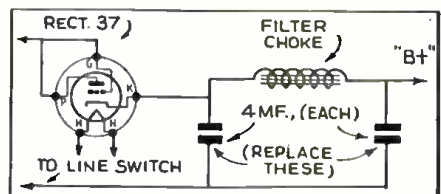

Fig. Q28. Defective electrolytics in RCA 4-17-M.

## BIGGER SERVICE PROFITS FROM BETTER TOOLS

(Continued from page 210)

### IN ANALYZERS

Devices of this type are and probably always will be the most important dollar earners of the radio service business. These devices when fundamentally built depend on the basic units of the radio industry, namely—volts, ohms and amperes. An analyzer should be built around a high-grade meter incorporating a properly-treated magnet, sapphire jewels and the hardest pivots obtainable. Poor treatment of magnet steels may cause a drop of 10 per cent or more in an instrument sensitivity after a period of weeks or months; soft jewels will soon wear sloppy and cause errors when the analyzer is used in different positions such as at 45 deg. angles or when mounted upright in a test panel; and blunt pivots result in bad friction. Any one of these defects may not just make the meter inaccurate but may render it entirely useless and \$1 or \$2 more spent on the instrument can be entered in the "well assigned cost" column.

Since all voltmeters are *adjusted milli- or micro-ammeters* with accurate series resistors and, therefore, the accuracy of a voltmeter is directly dependent upon the construction and tolerance of the resistor used. No voltmeter can ever be better than the grade of resistance unit incorporated with the instrument. Accordingly, manganin-wire-wound spools or other types of high-grade precision resistors are vital if any reasonable accuracy is expected from the device.

Commercial carbon resistors will function all right in receivers where 10 per cent tolerances are sufficiently accurate for general receiver operation, but in voltmeters they add considerably to the overall tolerance in the form of inaccurate adjustment and differences in resistance with temperature and humidity. These resistors are commonly made up of carbon particles held together with a binder of glue, or some similar substance which is in itself hygroscopic, attracting and holding moisture under wet weather conditions. This substance will also expand and contract, changing the position of the carbon particles in contact and, therefore, it is very difficult to expect any sustained accuracy for meter work on resistors of this type. For a few cents more per resistor,  $\frac{1}{2}$ -per cent-adjusted precision resistors can be used with the instruments and maintain the basic meter accuracy over each of the voltage scales.

Rectifiers for A.C. ranges should always be of the full-wave type if uniform results on various waveforms and frequencies are expected. These units depend upon the current density used in the discs for accuracy over wide temperature and humidity limits, and therefore, where 1 milliampere or lower sensitivities are used, the discs should be as small as possible. In addition, all of these full-wave meter rectifiers come under the Weston Instrument Company's patents and a great deal of research has been done by this company on the method of construction of the discs for meter work.

High sensitivities in analyzers are becoming more important daily due to the high impedance and resistance circuits used in many of the modern receivers. Analyzers of 20,000 ohms/volt type have been placed on the market by the Weston Company and these analyzers have a great many advantages over the former 1,000 ohms/volt types. Not only are high-sensitivity voltage ranges available for accurate direct-reading measurements of plate, screen-grid and control-grid voltages with minimum instrument drain, but current readings down to 0.5-micro-ampere can easily be measured with these new instruments. The current readings thus obtainable are just as important as the high-sensitivity voltage ranges in measuring detector diode currents, oscillator grid currents, high-mu triode plate currents, and output pentode distortion grid currents. The Service Man in purchasing his equipment should not afford to overlook these extended advantages in the advancement of the radio instrument art.

Current readings are as vital as they ever were in servicing the modern receivers. Analyzers with attached cord and plug, and built-in sockets are, however, not obsolescence-proof and it is highly advisable to purchase an analyzer with a detachable selector block. Instruments of this kind have been on the market 4 years with no change whatsoever in the analyzer proper; a small skirted adapter unit being the only purchase required to carry through a complete gamut of octal tubes announced during the last

2 years. This in itself is an enviable record for any piece of equipment and should point out the advisability of purchasing an analyzer unit dependent only on volts, ohms and milliamperes, and mechanically independent of all tube base connections.

For accurate service work, current readings are indispensable and should always accompany point-to-point analyses to protect all parts in receivers from overload. Tubes may draw excessive currents under conditions not directly obvious such as incorrect grid bias potentials, and these in turn may cause excessive currents to be drawn through output transformers or other parts that may not stand the overload. Where well-regulated power supplies are incorporated in the receiver, these overloads may be overlooked without a direct-current measurement being made directly at the plate; excessive current often causes a transformer failure to occur a week or two after delivery of the receiver. A photograph of the selector block detachable from an analyzer with built-in current jacks which automatically put the instrument in series with any of the tube electrodes, is shown in Fig. A. Plate currents, control-grid currents, screen-grid currents, diode A.V.C. and A.F.C. currents can all be measured quickly and effectively with such a device.

### IN TUBE CHECKERS

In tube testers the method of standard measurement, the flexibility of circuit, the construction of the instrument and the grade of other parts used are primarily important.

With the large number of tubes on the market today the *total emission* method of measurement as worked out by the sub-committee on tube testers of the Radio Manufacturers Association has proved to be the most economical, most flexible and best method of testing tubes both for the Service Man and the dealer.

There was always argument with regard to *mutual conductance* versus *emission* readings and, in general, mutual conductance readings are best where they can be measured accurately. To make correct measurements, however, requires most definitely a patch-cord system of jacks and plugs to handle the multitude of tubes encountered today. Potentials directly proportional to the ratings as released by the R.C.A. License Bureau must be applied to each of the electrodes and this in turn requires several instruments for the electrode potentials in addition to a direct-reading mutual conductance meter. Testers such as this are available on the market and are continually sold to certain organizations and to some of the larger service concerns, but at prices in the order of \$300 or \$400, and in general, the margin of profit on tubes handled by the Service Man will not warrant an expenditure of this amount. Furthermore, in testing a large number of tubes patch cords are rather complicated to handle and the average Service Man or dealer could not take the time to set up each tube base for test while the customer waited. This R.M.A. circuit as mentioned above, with maximum flexibility of switching for the tube bases incorporated in a tester of high grade construction, is the best answer for the tube tester problem as far as Service Men are concerned. A typical tester of this calibre is illustrated in Fig. B.

Accurate measurement of transformer potential is vital as read directly on the tester instrument; coupled with a method of line voltage control that will afford good regulation and complete adjustment all the way from the lowest to the highest line voltages encountered. Sockets that do not grip the tube too tightly and thus wear out easily should be used, this requirement being very different from that found in the average radio set where tubes must be gripped tightly and inserted only 3 or 4 times during the lifetime of the receiver. A single tube tester contact may have to outwear 100,000 tube pins inserted during the life of the tube checker and this requires special design.

### IN VACUUM-TUBE VOLTMETERS

These are basically radio-frequency and audio-frequency tubes, and should in general be considered, except where actual A.V.C. direct-current potentials are to be measured. A vacuum-tube voltmeter is the type of R.F. voltmeter needed for gain-per-stage measurements right at the control-grids of the tubes, audio measurements across grid windings and bypass conden-

(Continued on page 230)

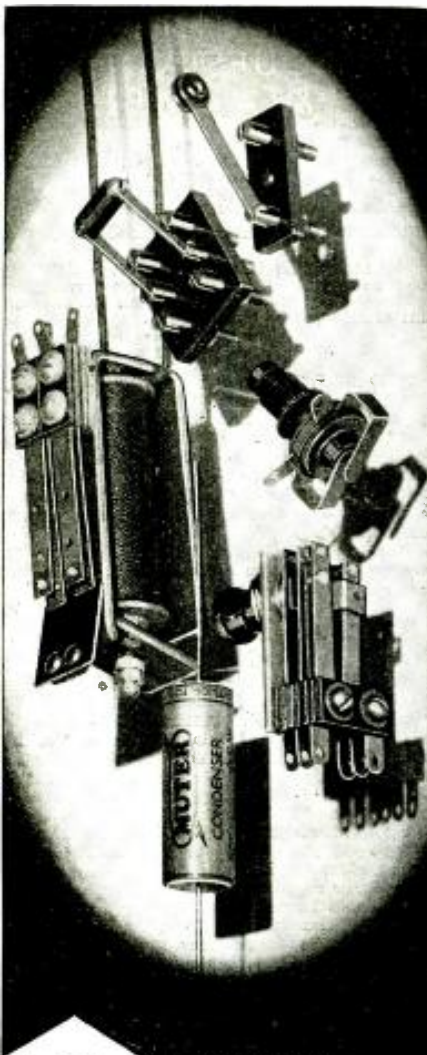

# WHEN YOU BUY THESE PARTS

SAY "MUTER" TO YOUR JOBBER AND YOU'LL GET—

**BY-PASS CONDENSERS** non-inductively wound to full capacities plus liberal voltage safety factors. Doubly enclosed in vacuum impregnated containers—moisture-proof and free from leakage. Leads are  $2\frac{1}{2}$ " long, and easily soldered. Each unit factory tested. Best quality materials used. Be sure to specify MUTER By-Pass condensers.

**RELAYS** built for hard usage. Entirely new, with many applications. Well suited to rapid switching from receiving to transmitting, for amplifying circuits and for photo-electric cell equipment. Both the 110 volt, A.C. Double Pole Double Throw, and the Single Pole Single Throw Relay, are  $3\frac{1}{8}$ " long and  $\frac{3}{4}$ " wide. See your jobber.

**SWITCHES** with unique features eliminating trouble from loose parts. Thoroughly practical for countless applications in general radio and electrical work. Ideal for switching from long to short aerial or radio to phonograph test panel and sound equipment uses, actuating relays, etc. See them at your jobber, or write direct.

**THE MUTER COMPANY 1255 S. Michigan Ave., CHICAGO, ILL.**

Please Say That You Saw It in RADIO-CRAFT

# EVERYTHING IN RADIO *at Lowest Prices*

FOR DEALERS · SERVICEMEN · SOUNDMEN · AMATEURS · EXPERIMENTERS

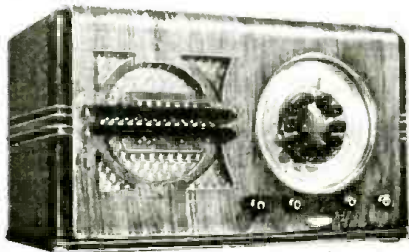

**65 GREAT NEW KNIGHT RADIOS!**

Automatic Tuning, powerful performance and rich tone are the features of the new KNIGHT Radios. Models for every taste and purse, from 5 to 16 tubes, for AC, AC-DC, 6 Volt, 32 Volt, Battery and Auto operation. Beautiful Console, Chairside, Phono-radio, Table and Chassis models—at unbeatably low prices. See all 65 models in your 1938 ALLIED Catalog!

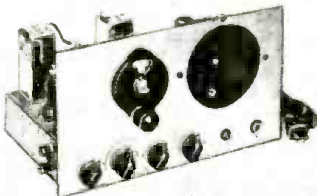

**32 TESTED AND APPROVED KITS!**

Radio Builders—here's an assortment of kits ranging from a 1 Tube set to a 14 Tube All Wave Superhet—kits for every purse and purpose! Write for Free Parts Lists—for any kit described in any radio publication.

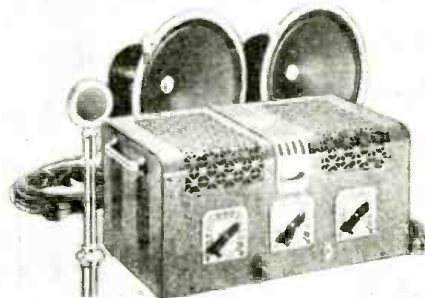

**26 MODERN P.A. SYSTEMS!**

KNIGHT "Integrated" Sound Systems from 8 to 60 watts—portable, permanent and mobile—for 110 Volt, 6 Volt and Universal operation. Also—new 2-Way, Selective and Superselective KNIGHT Intercom Systems.

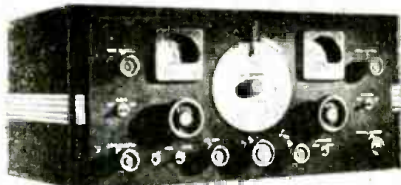

**26 LATEST AMATEUR RECEIVERS!**

See the most complete line of Amateur receivers in Radio—beginning on page 114 of your 1938 ALLIED Catalog! Radio's leading makes—National, Hallicrafters, RCA, Sargent, Hammarlund, etc. Also latest RCA, Utoh, and All-Star Transmitters; books, parts, tools. Everything from a grid cop to a 15 KW X-mitter!

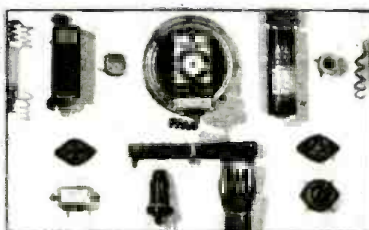

**MORE THAN 12,000 RADIO PARTS!**

Listing more than 12,000 exact duplicate and replacement parts, the 1938 ALLIED Catalog offers a tremendous assortment for repairing or building any radio circuit. This great book enables you to spot the part you want—conveniently, quickly, "exactly!"

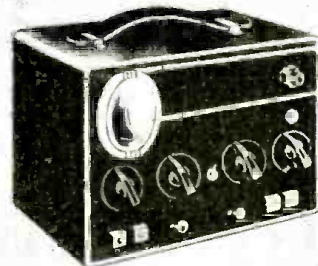

**68 NEWEST TEST INSTRUMENTS!**

Radio's most extensive line of test instruments—new 2" Cathode Ray Oscilloscope, Oscillographs, Analyzers, Tube-Checkers, Set-Testers, Signal Generators, Meters, etc. Also, new Build-Your-Own Kit; and 20,000 ohms-per-volt equipment.

*Allied's 1938 Catalog*  
**BRINGS YOU THESE**  
**AMAZING *New* DEVELOPMENTS**

*New  
Different  
Complete*

164 PAGES PACKED WITH SETS · PARTS · KITS · AMATEUR GEAR · P.A. SYSTEMS · TEST EQUIPMENT

*Free*

SEND COUPON

**WRITE FOR ALLIED'S NEW 1938 CATALOG—RADIO'S LEADING SUPPLY GUIDE!**

Send for this great book today—164 big pages packed with Everything in Radio! Thousands of parts, dozens of radio sets, kits, Public Address Systems, Test Instruments, Amateur Receivers, books, tools, etc.—at prices that will save you money on every purchase. See the separate P.A., Amateur, Service and Radio Set sections—see the revised, extended parts sections—see 1938's latest radio developments—all in your 1938 ALLIED Catalog! It's new, complete, and different from any other radio book ever published—a book written by and for radio men. Every page has been planned to make your radio buying easier and more profitable. Write for your FREE copy now—it's radio's easy-to-read, easy-to-shop, easy-to-order-from catalog!

**EVERYTHING IN RADIO — AT LOWEST PRICES!**

ALLIED carries in regular stock all leading radio lines at lowest prices. We can obtain for you special or "hard-to-get" equipment on short notice—our central location under one great roof means foster service for you. Consolidate your purchases—fill all your radio needs from one single dependable source—ALLIED—Radio's Leading Supply House!

**ALLIED RADIO**  
 CORPORATION  
 833 WEST JACKSON BLVD., CHICAGO, ILL.

**ALLIED RADIO CORPORATION**  
*1938*  
*Everything in Radio*  
 RADIO'S LEADING SUPPLY GUIDE

Allied Radio Corp.,  
 Dept. 2-RB,  
 833 W. Jackson Blvd.,  
 Chicago, Ill.

Send me your 1938 Catalog—Radio's Leading Supply Guide.

Name .....

Address .....

City ..... State .....

**CINAUDAGRAPH**

Speaker

**CINAUDAGRAPH  
Magic Magnet Speakers**

—extensively utilized by all leading radio receiver and P. A. equipment manufacturers—are available in a complete range of sizes from 5½ to 18 inches, to meet your every radio requirement.

If you demand utmost dependability and fidelity of reproduction from your equipment—in-ist on Cinaudagraph P. M. speakers. Carried in stock by all progressive distributors. Free descriptive literature on request.



**CINAUDAGRAPH  
CORPORATION**  
Speaker Division • Stamford, Conn.

**600 V.  
ELECTROLYTICS**

- ★ Your choice of either metal-can or cardboard-case general-utility electrolytics. Compact. Fit anywhere. Inexpensive.
- ★ 600 v. D.C. working. Provide extra safety margin. Use them to meet high surge voltages.
- ★ Metal-can type inverted-screw mounted. Cardboard type has Adjustimount universal metal flanges.

**New CATALOG:** 15th Anniversary Edition. 32 pages. Many new items. Ask your jobber—or write us direct.

**BIGGER SERVICE PROFITS FROM BETTER TOOLS**

(Continued from page 228)

sers, R.F. potentials in superheterodyne oscillator circuits, in trap circuit adjustments and in response-curve measurements.

Copper-oxide rectifier instruments cannot be used to advantage on R.F. resonant circuits because of frequency limitations and due to the fact that any loading of these circuits tends to pull them out of resonance. The direct insertion of a vacuum tube is about the only other method of measuring the potentials across these circuits. In this regard, a well-designed voltmeter should have a minimum input capacity, connections being made directly to the tube with no voltage divider or selector switch being used in the circuit. Such component parts will shift the capacity a few micro-microfarads each time a new section of the voltage divider or a new position on the rotary switch is used, thus shifting the resonant frequency of the circuit on which the measurement is being made. This will, of course, cause a direct error in the readings as the voltage thus read will differ on each range.

**IN OSCILLATORS**

Accuracy of calibration, frequency stability and shielding should be looked-for. Accuracy of frequency calibration is important in alignment work both at intermediate frequencies where it is vital and on the various wave bands where specific alignment points are mentioned by the manufacturer. No oscillator regardless of how well it is calibrated will maintain sustained accuracy without good coil construction and air-dielectric condensers. Trimmer or compression-type padders have very poor humidity coefficients and are, in general, the very parts that cause drift in alignment of receivers. They, therefore, should be eliminated in oscillator construction and air condensers used throughout. Carefully-constructed coils, preferably on molded bakelite forms, should be used to assist in maintaining good accuracy. The Service Man should expect individual calibration of each oscillator that he purchases if such a unit is worthy at all of maintaining any kind of a frequency tolerance throughout its useful life.

Battery operation has several advantages coupled with some disadvantages, but allows very complete shielding as the energy source is completely enclosed within the shielded case. A.C. operation can be used but must be very carefully

filtered so that signals will not feed back through the line into the receiver under test thus making it impossible to attenuate the signal in the receiver to a point where it later can be aligned. In any event shielding must be completely incorporated so that alignment below the A.V.C. level on all receivers can be carried out in case it is difficult or impractical to eliminate A.V.C. action during the alignment procedure.

Input impedance must be as high as possible and should be limited only by the measuring tube itself, as this impedance will load the circuit under measurement. Stability of readings is essential as devices, especially line-operated types, will fluctuate with line voltage potentials and cause incorrect meter readings unless some form of regulation is used. Without regulation on the lower ranges the instrument pointer will vibrate with small line potential surges and make it extremely difficult to obtain any kind of a reading.

The vacuum-tube voltmeter will be sold continually in parallel with the oscilloscope as there are definite advantages in each type of instrument. For service work the vacuum-tube voltmeter with its direct readings in volts is much easier to understand and simpler to operate and, in general, will handle all the measurements required of the Service Man. The A.V.C. or any direct-current potentials cannot be read on the oscilloscope, as, an axis shift only will result and in turn, actual gain-per-stage readings in volts cannot be taken. Furthermore, the resistance-coupled amplifiers used in oscilloscopes are notoriously poor on radio frequencies, some of them completely distorting the waveform; direct connection to the tube plates appears to be the only answer where R.F. measurements are concerned. Sensitivity, however, directly at the plates is not sufficient for many operations and here again vacuum-tube voltmeters can be built with much higher sensitivities.

The oscilloscope will, however, be used where an image of the waveform is required but this in general, is not a definite requirement for Service Men in regular repair work. In any event, the operator should be quite familiar with the oscilloscope before attempting to make a large number of measurements with it.

Two circuits showing methods of measuring automatic frequency control discriminator voltage, and gain per stage, appear in Figs. 1 and 2.

**THE AIRCRAFT-RADIO SERVICE MAN**

(Continued from page 202)

**EQUIPMENT REQUIRING SERVICE**

The itinerant flyer may have in his plane only the simplest of radio equipment—perhaps only an aviation weather broadcast receiver and not even a transmitter. On the other hand, his equipment may be so comprehensive as to include a beacon receiver, aviation weather receiver, and a so-called auxiliary beacon receiver capable of all-wave reception and thus permitting reception of broadcast programs; and, a directional-loop antenna that in conjunction with one or another receiving sets permits taking cross-bearings from either beacons or broadcast-station signals. This receiving equipment plus a 1- or 2-way transmitter for both code and telephone operation may comprise the more inclusive radio set-up.

The Department of Commerce reports that there are approximately 1,000 private and public landing fields (soon, many more—including emergency landing fields—will dot the land); and approximately 4,750 privately-operated airplanes. Since all the commercial airplanes have their own radio service crews it is unlikely that the average aviation-radio Service Man will have much opportunity to make repairs to the radio equipment of such installations—except, perhaps, in a case of extreme emergency.

Space does not permit the lengthy discussion that would be necessary to completely analyze the faults and remedial measures connected with private-aviation radio servicing—books have been written on this subject alone—suffice it to say that antenna and counterpoise systems, battery and generator-operated radio transmitters and receivers and their respective types of current-supply systems; and even in the more modern installations, private communication systems between pilot and co-pilot or passenger, all come

within the range of equipment that must be kept in top-notch condition, regardless of (reasonable) expense, by competent radio Service Men.

**TABLE I  
SOURCES OF REVENUE FOR THE AVIATION-  
RADIO SERVICE MAN**

- (1) Servicing existing radio receiving and transmitting equipment, including the power supplies and antenna systems.
- (2) Modernizing existing radio equipment to include additional services, such as pilot-to-copilot (or passenger) communication system, directional-loop antenna, extended frequency range, etc.
- (3) Locating and minimizing or eliminating ignition interference.
- (4) Sale of replacement components.
- (5) Sale of new transmitting and receiving equipment.
- (6) Custom construction of radio transmitting and receiving equipment.

**NEW TRANSMITTER AND  
PUBLIC ADDRESS MANUAL**

Not only radio amateurs and public address men (to whom it is dedicated) but anyone at all interested in radio will welcome this excellently-prepared manual. It is chock-full of theory, diagrams and practical data on transmitters and P.A. Some of its chapter headings are: R.F. Circuits; Audio Circuits; High-Fidelity Audio Circuits; Controlled-Carrier Modulation; Plate-Supply Design; Typical Rectifier Circuits; Power Supply Filters, and others. The book is available from United Transformer Co. for 25c.

Please Say That You Saw It in RADIO-CRAFT



# FULL 2 VOLTS OUTPUT



0-10,000  
Cycle B. F. O.  
**\$14.40**

Our instruments, expertly designed, carefully manufactured, are sold only by us, the manufacturer, only to you, the consumer. Our no-middleman policy SAVES YOU UP TO 50%.

## AUDIO BEAT OSCILLATOR

Based on Developments of  
**H. J. BERNARD**

INCORPORATING the original developments of H. J. BERNARD, managing editor of "Radio World," this Audio Beat Frequency Oscillator, our AUDIO-METER, combines stability with enormity of output voltage. Direct-reading in audio frequencies, 0-10,000 cycles, and also direct reading in output volts, 0-2 volts. Other beat frequency oscillators cost twice as much or more, yet provide only 1/4 volt output or less.

The audio beat frequency oscillator heretofore has been restricted largely to laboratory use, due to prohibitive prices. However, we specialize in producing precision equipment at a price servicemen can afford. So for the first time servicemen can check the fidelity of audio amplifiers in receivers, of public address systems, of speakers and other acoustic devices. Also, because of the high output, dead amplifiers can be tracked right down to their offending short or open.

The AUDIOMETER is provided with dial scale 7.5 inches in diameter (extraordinary size), 8-1 vernier dial and costly planetary drive, also closely calibrated scale, so that even the necessary frequencies for tuning musical instruments may be read exactly.

The instrument is equipped with an adjuster, so generated frequencies are always right. Works on line a.c. of any commercial frequency (25, 40, 50 or 60 cycle-) and also on d.c. (90-130 V.). Complete with five tubes and test cords. Shipping weight 8 lbs. Net price.....\$14.40

## INFINITE IMPEDANCE A-C and D-C VOLTMETER

INFINITE resistance voltmeters enable very accurate d-c measurements of circuits in which hardly any current flows, such as diode loads and a-v-c supplies. Infinite impedance volt-meters permit a-c measurements of tuned circuits or any other networks. Here is a remarkable answer to the serviceman's crying need for such an instrument. Not only does the INFINOMETER draw absolutely no current in making d-c measurements, but it is also a vacuum tube voltmeter that duplicates the same feat on a.c., measuring voltage of any frequency. Despite this double service—measurement of both a.c. and d.c. without loading—the price is less than half that of most current-drawing instruments that measure only d.c.



JUST to show what an astonishing instrument this is, we have a 0-500 microammeter of d'Arsonval movement. Moreover, the meter has nearly five inches of spread clear across—enormous visibility. Then there are six scales, 0-1.5-5-15-50-150 volts, a.c. or d.c.

The INFINOMETER has a bucking circuit for zero meter reading, two input tip jacks, and a six-position range switch. It works on any frequency a.c., also on d.c., 90-130 v., shpg. wt. 10 lbs. Complete with three tubes, low-capacity test prod cable, net price.....**\$14.40**

### GENEMETER WITH VARIABLE AUDIO FREQUENCIES

Our superlative signal generator, direct reading fundamental frequencies, 100 kc. to 23 mc., and direct reading also to 100 mc., has modulation on-off service, with bandspread audio frequencies 25-10,000 cycles. Audio, in three bands, is saw-tooth wave and useful also for oscilloscope sweep. Complete with four tubes. Shipping weight, 10 lbs. **\$14.40**



### TUBE TESTER

Emission type perfected tube tester for any and all types receiver tubes, including metal and metal-glass. Tests shorts and leakage. Accurate, simple, sturdy, direct — English — reading **\$10.40** (Bad-?-Good). Ship- ping weight, 9 lbs.



### ALLMETER 20 INSTRUMENTS ALL IN ONE

The Allmeter, a 1,000-ohms-per-volt d'Arsonval instrument, instead of being just a volt-ohm-ammeter, is such an instrument, plus a.c. readings for voltages and currents, also accurately measuring very low resistance, from below one ohm, also high resistance, capacity, henries and decibels, comprising twenty instruments in one. For a.c. 60 cycles for all 20 uses. Shipping weight 6 lbs. 40 cy. \$2 extra; 25 cy. \$3 extra. 0-15-150-750-volts and milliamperes, a.c. and d.c. -12 to + 30 decibels. .03-500 ohms. 500-500,000 ohms. 5-1,000 henries .01-50 mfd. **\$10.40** Continuity Tester.



# SUPERIOR INSTRUMENTS COMPANY

Dept. RC-10

136 LIBERTY STREET

N. Y. CITY

Send for Our Catalogue PV in Colors — It's FREE!

# Infinite Ohms Per Volt

with

# HICKOK

MODEL 4900

## ZERO CURRENT VOLTMETER



This instrument may be connected to grids in any circuit without disturbing operation of set, built-in power supply furnishes balancing voltage,—adequately filtered.

This instrument indicates:

- D.C. Volts at infinite ohms per volt
- A.C.-D.C. Volts at 1000 ohms per volt
- A.C.-D.C. Milliamperes
- Ohms and Megohms
- Microfarads, Leakage
- Decibels
- Henries

Wide ranges assure complete coverage for radio testing.



Model 4955  
Universal Volt  
Ohm Milliammeter  
Larger Meter —  
More Ranges

For Quality, Accuracy  
and Dependability use

**HICKOK TEST INSTRUMENTS**

ZERO CURRENT VOLTMETERS  
VOLT OHM MILLIAMMETERS  
SET TESTERS  
TUBE TESTERS  
OSCILLATORS  
OSCILLOGRAPH  
MODULATORS  
APPLIANCE TESTERS  
PANEL METERS

Write for literature on the complete HICKOK line.

**HICKOK**  
ELECTRICAL INSTRUMENT CO.,  
10413 Dupont Ave.,  
CLEVELAND, OHIO

## "LEARN-BY-EXPERIMENTING" BEGINNERS' PRACTICAL RADIO COURSE AUDIBLE TONE GENERATOR

(Continued from page 219)

Fig. A; and the corresponding symbols for these parts, in Fig. 1A.

### EXPERIMENT—AUDIBLE TONE GENERATOR ("RADIO WHISTLE")

**OBJECT:** To study the Operation of the Vacuum Tube in Producing Audible Tones, known as *audio frequency oscillations*.

#### PRINCIPLES INVOLVED

In this Experiment, the operation of the vacuum tube as an amplifier of an input signal is modified so as to have the tube produce its own signal which can be heard in the phones. Such a "generator of tones" which can be heard may be called a "Radio Whistle" or more correctly an Audible Tone Generator.

The purpose for which each part, other than the tube, is used in this Experiment is explained in the following listing:

**Rheostat (R).** A moving arm making contact with *resistance wire*, that is, wire which opposes the passage of the electric current through it. By turning the rheostat knob to the right, we include less and less of this resistance in the circuit, and thus allow more current to flow.

**Transformer (T).** A unit consisting of 2 coils of many turns per layer and many layers of *insulated wire* wound around an *iron core*. Current is sent through the first coil, called the *primary* (marked p and b in diagram, Fig. 2A and B). When this current is caused to change in any way, such as by electrical vibrations, these changes are transferred by the iron core to the second coil wound on it, called the *secondary* (marked c and g, in diagrams). Although these 2 coils are in no way electrically connected, the fact that they are wound on the same core gives the result that any changing current in the primary winding produces corresponding changes in the secondary winding. When, as in this case, the number of turns of the secondary is much greater than the number of turns in the primary, the changes produced in the secondary are also much greater than the original changes in the primary. This accounts for the name "step-up" transformer, and, since it is used here in connection with audible sounds, it is technically known as an *audio transformer*.

**Variable Condenser (C adj.).** A condenser consists, in general, of 2 conducting plates (usually, of brass or aluminum) separated by an *insulator* (mica, air, etc.). Its effectiveness in any circuit is judged by the amount of its *capacity*, which means its ability to store an electric charge. In this case we can make the capacity greater by turning the adjustment screw to the right, which brings the 2 metal plates closer together, though they are still separated by the insulator which is a sheet of mica. Its use here is optional, since its effect of making the pitch lower, which is obtained by increasing the capacity, can be obtained without it, to a smaller degree, by using the rheostat to increase the filament current which (by indirectly effecting the "tube capacity") has the same effect.

**Key (K).** Has the same action as a pushbutton switch in closing a break in the circuit thus forming a complete path (a *closed circuit*) and allowing the current to flow.

**Phones (Ph.).** A device for converting the varying flow of electricity into audible sounds. This device will be considered in detail in the next Experiment.

**Battery (4½ V.).** A unit composed of a number of cells which generate electricity by chemical action. Each cell contains a *zinc* and *carbon element* operating in a chemical paste. Since this paste, though always moist, is not in liquid form, the cell is called a *drycell*. Such a drycell could, for example, light a small flashlight bulb, since each cell is rated at 1½ volts, which signifies its effectiveness in applying the "electric pressure" required to force the current through the circuit against the opposition or resistance of the wire in the bulb. By connecting 3 such cells, as shown in the diagram, we have a *series* connection and the *voltage* of the entire battery is then 4½ V. (or volts). A "C" battery of 4½ V. is simply a unit containing 3

small cells already connected internally, and thus is equivalent to 3 individual drycells of the same small size. Although larger cells will last longer, this size is sufficient, in this Experiment, for operation over a few months.

#### ANALYZING THE CIRCUITS OF A TUBE

Referring to Fig. 2B, let us trace the 3 circuits of the tube in this arrangement. We will start with the "filament circuit" (or "loop"). The filament current which heats the tube is controlled by the rheostat. Turning the knob to the right decreases the amount of resistance of the rheostat being used, and so the current in the filament becomes greater, heating the filament more.

The "grid circuit" contains the secondary winding of the transformer in which "electrical vibrations" (or *oscillations*) will be produced.

In the "plate circuit," when the key is pressed, plate current flows through the primary winding of the transformer setting up the electrical vibrations. These vibrations are transferred to the secondary winding in the grid circuit, because—as previously stated—both primary and secondary coils are wound on the same iron core. These vibrations, in the grid circuit appear in turn, in amplified form, in the plate circuit. Since the plate circuit is continually feeding back energy to the grid circuit the electric vibrations do not die out but are sustained so as to be continuous at a certain rate (or *frequency*). For this reason this device may be called an "audible tone generator" or more technically an *audio-frequency oscillator*.

The sound in the headphones caused by these continuous vibrations can be controlled by the key to send signals in the International (or Continental, as it is also called) Code, which is shown in Fig. 1H.

We can also change the *pitch* of this tone by adjusting either the rheostat or the optional adjustable condenser. For example, by turning the rheostat knob to the right, the increased filament current causes a lower pitch; this same effect can be obtained to a greater degree by adding the greater capacity of the condenser to the circuit. This lower pitch indicates that the vibrations are taking place at a lower frequency. The principle involved in this case is that in any such "oscillating circuit," if the characteristics of the coil (its *inductance*) are kept constant, the frequency of oscillation will then depend upon the amount of capacity (condenser effect) in the circuit; the frequency, and therefore the pitch, becoming lower as the amount of capacity is increased.

#### PROCEDURE AND RESULTS

##### A—Code Signaling

(1) *Assembling.* The appearance of the parts, before and after mounting, is shown in the photographs, Figs. A and B. The wiring between these parts is shown pictorially in Fig. 2A and in symbol form (schematically) in Fig. 2B.

(2) *Wiring.* In making connections by soldering (The reader is referred to the article "How to Solder" which appeared in the July, 1937, issue of *Radio-Craft*.) the order in which the connections are made should follow the plan, shown in Fig. 2A and B, as made up of the following 3 "loops" or circuits:

**Filament Circuit**—The wiring, starting from the *binding post* or connection terminal marked "A+", will include the 2 terminals of the rheostat: "f+" and "f-" terminals of the socket into which the tube is later to be plugged; and back to the "A-" binding post.

**Grid Circuit**—The wiring, starting from the G terminal of the socket includes the g and c terminal: of the transformer secondary; and back to the "A-" binding post. If condenser C adj., is used across the transformer secondary, leave one wire unconnected until later. After the set-up has been worked without it, it can then be connected to determine its effect on the circuit.

**Plate Circuit**—The wiring, starting from the p terminal of the socket includes the transformer primary p and b terminals; (NOTE: If any

Please Say That You Saw It in RADIO-CRAFT

transformer, other than the one suggested, is used, it may be necessary to reverse these p and b terminals to get the device to work. To allow for this possibility, use long leads on these 2 terminals.) The circuit also includes the phone (that is, headphone) binding posts; the key (or pushbutton); and the "B+" binding post. The circuit is completed by the "B-" terminal joining the "A+" terminal; if a "C" battery is used, it is connected as in Fig. 2A in which case the "B-" is already connected within the battery to the "A+", thus completing the circuit. Notice that when using a "C" battery, which has the terminal designation shown in Fig. 1A, use the (-1½) terminal for minus (-); the (-1½) terminal for +3 V., and the (+) terminal for +1½ V.

(3) Operation. Turn the rheostat to the right up to about the first of the 10 divisions indicated on the dial plate. (CAUTION: When the filament of the type 30 tube is operating at its correct temperature, there is no perceptible glow visible. Be sure to keep the rheostat turned well down [to the left] to avoid a bright glow on the filament, since this is injurious to the life of this type of battery tube.)

Pressing the key should cause a note to be heard in the phones. If nothing, or only a "click" is heard, the circuit connections must be checked, before anything else is done, since the primary of the transformer may have to be reversed, as explained before. Practice sending a short word, such as some name, by the code signals shown in Fig. 1H.

**B—Changing the Pitch of the Note**

(1) Increase the filament current, noting precaution mentioned above. A change in the frequency of oscillation will be indicated by a change in the pitch of the note. Determine whether the filament current must be increased or decreased in order to give a lower pitch.

(2) Connect the adjustable condenser, as shown in the diagram and determine the effect (of introducing this condenser) on the pitch; then note the effect of increasing its capacity (by turning the adjusting screw to the right), on the pitch of the tone.

**OPTIONAL ADDITION**

An additional diagram, Fig. 1G, is given for using this device from the A.C. or D.C. socket power. Although it may be found convenient to use this method in some practical applications, where it is desired to operate a *loudspeaker* without the use of more batteries, it is not as suitable as the battery-operated outfit for the purpose of this Experiment, because, in the power-operated case, a strong "hum" (humming sound) from the commercial power lines is superimposed on (added to) the pure note of the generator. However, for any who wish to use it, the diagram is given in a self-explanatory form, so that it may be considered separately from the List of Parts for the battery-operated unit.

**CONCLUSION**

*Statement of Fundamental Principle.* An audible note is produced in the phones by the electrical vibration of the vacuum tube at an audible rate (that is, at a rate or frequency which is within the range of hearing). This device, therefore, is called an *audio-frequency oscillator*.

*Questions on Principles of Experiment No. 1*  
 Ques. 1. When the rheostat is turned to the right to decrease its resistance, the filament current becomes (greater) (less).

Ques. 2. Increasing the filament current causes the tone to become (higher) (lower) in pitch, and therefore, indicates a (greater) (less) frequency.

Ques. 3. Increasing the capacity of the condenser causes the pitch to become (higher) (lower) and therefore indicates a (greater) (less) frequency.

Ques. 4. Producing signals by interrupting the note is accomplished in this Experiment by breaking the (grid) (plate) (filament) circuit.

Ques. 5. The pitch, and therefore the frequency of oscillation depends on both the coil effect (amount of inductance), and the condenser effect (amount of filament) in the grid circuit.

\*Answers to these questions appear on page 241 of this issue.

School Radio Clubs are invited to write to *Radio-Craft*, attention of this department, concerning the use of these Experiments for club groups.

(Continued on page 241)

# JUST TOUCH BUTTON

## LATEST 18-TUBE MIDWEST TUNES ITSELF BY ELECTRIC MOTOR!

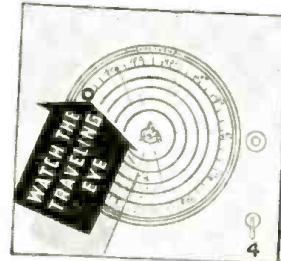
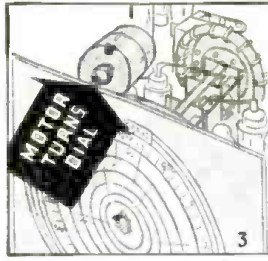
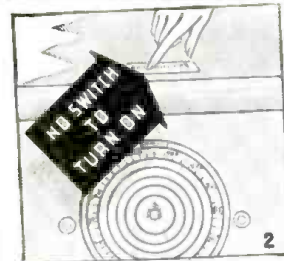

**Only Midwest's Direct - From - Factory Policy Makes This and Other Sensational Features Possible at Amazingly Low Prices!**

"The sensation of the radio world"—that's what experts said when they saw the amazing new 1938 **MOTORIZED** Midwest. You'll be astounded at the lightning-like motorized action—just touch a button (on top of the radio) . . . and its corresponding station zips in. The famous Midwest factory-to-you plan (proven by 18 years of success) is just as exciting! It enables you to buy at wholesale prices—to save up to 50%—to make your radio dollar go twice as far—to enjoy 30 days **FREE** trial in your own home—to pay as little as 50 cents a week.

Now, you can enjoy the luxury of radio at its best—**No More Dial Twiddling!** you can tune your Midwest by merely touching a button! Zip . . . Zip . . . Zip . . . you can bring in 9 perfectly tuned stations in 3 seconds. *All this happens in 1/2 second with Midwest Perfected MOTORIZED Tuning!* (See above illustrations). (1-2) You touch button; (3) Electric motor speeds dial towards corresponding station; (4) Colorful Bull's Eye darts across dial and locates itself behind station; (5) Dial stops itself at station's exact center of resonance and eye "winks" as program comes in perfectly tuned.

**30 DAYS FREE TRIAL—**  
**Enjoy the World's Most Advanced Radio For 30 Days In Your Own Home! Don't Risk A Penny!**

Act at once on this unusual factory-to-you offer. We send any Midwest radio you desire to your home. You use it 30 days, and compare it with other radios you have owned or heard. Then, you can return it to the factory, if you wish, without risking a penny. You have a year to pay, if you decide to keep it. We trust you to give the Midwest a fair trial. You are triply protected with Foreign Reception Guarantee, One-Year Warranty and Money-Back Guarantee.

**18 TUBES for PRICE of 10**  
 Why be content with an ordinary 10, 12 or 14-tube set when you can buy an 18-tube Super DeLuxe 101-feature Motorized Midwest for the same money. It will surprise and delight you with its brilliant world-wide reception on 6 bands, and range of 12,000 and more miles! It will thrill you with its marvelous 6-continent overseas reception. Secures American, Canadian, Police, Amateur, Airplane, Ship broadcasts . . . and the finest foreign programs.

Send for **FREE 1938 Catalog**

**MIDWEST**  
**WORLD-WIDE RADIOS**  
 Dept. EE-12 CINCINNATI, OHIO

**18 TUBES**  
**6 WAVE BANDS**  
*only*  
**\$39.95**  
**FACTORY-TO-YOU**  
 NEW LOW BASE PRICE  
 CHASSIS  
 (LESS TUBES)

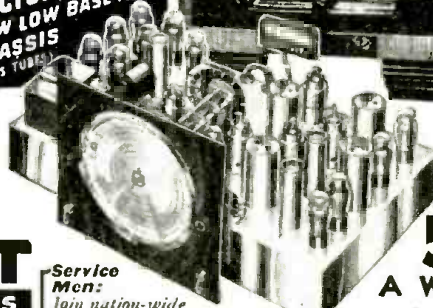
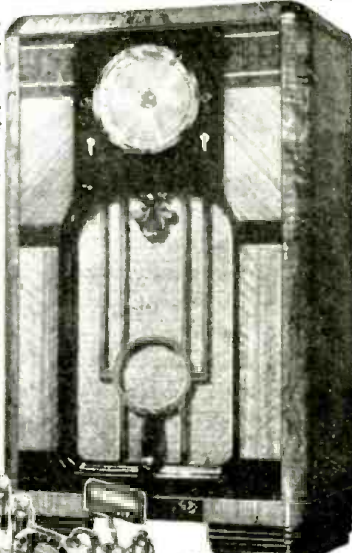

**TERMS**  
 As Low As  
**50c**  
**A WEEK!**

Send No Money Now!

**PASTE COUPON ON 1¢ POSTCARD...OR WRITE TODAY!**

**MIDWEST RADIO CORPORATION** Name \_\_\_\_\_  
 Dept. EE-12 Cincinnati, Ohio Address \_\_\_\_\_  
 Send me your new **FREE** catalog and complete details of your liberal 30-day **FREE** trial offer. Town \_\_\_\_\_ State \_\_\_\_\_  
 (Special offer and prices prevail only when dealing direct with factory by mail.) User-Agents Make Easy Extra Money. Check Here  for details  
 Check Here for 1938 **BATTERY** Catalog

Please Say That You Saw It in RADIO-CRAFT

# DEMAND OHMITE RESISTORS

★ for QUALITY—  
ECONOMY—SERVICE

It's more profitable to use Ohmite Resistors. Built to last, they do a better job, and you get no profitless "call-backs". Use Ohmite, it means "more money in the pant's pocket." Your Jobber has them.



Built like Ohmite's big industrial units, with porcelain core protected by a special acid and moisture proof vitreous enamel. All standard values!

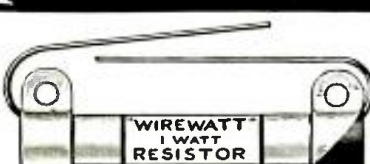

A real wire wound unit rated at 1 Watt, compact in size and permanently noiseless. All standard values!



The "standard" replacement resistor, with high overload capacity and freedom from deterioration. Wire-wound porcelain core covered with special high temperature refractory cement.

**OHMITE**  
MANUFACTURING COMPANY  
4847 Flournoy St. Chicago, Ill.

Manufacturers of  
RHEOSTATS — RESISTORS  
TAP SWITCHES

## ADVANCED HOME STUDY TRAINING FOR "SERVICE MECHANICS" WHO WANT TO BECOME EXPERT SPECIALISTS

Actually it is not a case of WANTING to become a "Service Specialist"—it is a NECESSITY! New developments and changes in circuit designs make it urgent for you to keep pace with the progress of Radio. The serviceman who lacks the necessary training is eliminating himself from a better position and better pay.

**START TRAINING NOW FOR THE FUTURE**  
RSI training in Radio Service and Public Address work gives you thorough, basic knowledge of just complex circuits work and what goes into modern receivers. Write today and learn all the facts.

**FREE!** Write today for FREE illustrated booklet: "The Key to Successful Servicing." Get all the facts now!

**RADIO SERVICE INSTITUTE**  
SUBSIDIARY OF CREI  
Dept. RC 10, 3308 14th St., N. W., Wash., D. C.

Turn to Page 249 of this issue and read about the RADIO-CRAFT Special Offer!

## MODERN SERVICING OSCILLOSCOPES

(Continued from page 222)

### KIT-TYPE SERVICING OSCILLOSCOPE UTILIZES A 2-IN. LENS (1500-A)

THE INSTRUMENT, back and front views of which are illustrated in Figs. D and E, is a servicing oscilloscope available in kit form.

The design, it is claimed, incorporates every feature of the larger 3-in. oscilloscopes, such as vertical and horizontal beam centering controls, built-in linear and 60-cycle sweeps, provision for external sweep for alignment, both vertical and horizontal amplifiers and an efficient sweep lock circuit for perfect synchronization. See Fig. 2 for circuit. (Component values are given in Table I at the end of this department.)

An outstanding feature of this kit is the use of a 2-in. magnifying lens. This increases the size of the image on the 913 screen to a full 2 ins. with unusually good definition.

The arrangement of parts of this model T-11K16 kit oscilloscope has resulted in an ideal shape and size—6 3/4 x 10 1/2 x 5 3/16 ins., just right for rack and panel mounting or easy portability. The use of an etched panel and crackle-finish case give the completed unit a truly professional appearance.

### NEW KIT-TYPE OSCILLOSCOPE HAS VERTICAL C.-R. TUBE (1500-B)

BUILDING the oscilloscope from the kit of its parts naturally affords a keener insight into its possibilities, and the details of its operation, at the same time cutting its cost to a minimum.

The oscilloscope shown in Fig. C was particularly designed for radio servicing. It uses the Dumont 2 in. cathode-ray tube. A feature of particular importance, seldom included in low-cost oscilloscopes, is the internal amplifier for increasing the sensitivity of the instrument to minute voltages. The saw-tooth sweep frequency (60 cycle line A.C., for example) substituted at will. Eight external controls are provided: vertical beam centering control; intensity control (and A.C. on-off switch); focusing control; frequency vernier (and sweep oscillator on-off switch); frequency selector switch; frequency amplitude control; vertical amplifier on-off switch, and vertical amplifier gain control.

Greater familiarity with his instrument, and very much lower cost, are the advantages the Service Man derives from buying his cathode-ray oscilloscope in kit form and assembling it himself.

TABLE I (1500A)

#### Cathode-Ray Oscilloscope Controls

- R1, R22, 0.5-meg.;
- R2, 1 meg.;
- R10, R11, 0.1-meg.;
- R12, 50,000 ohms;
- R13, 25,000 ohms;
- R14, 3 meg.;
- S1, 2-pole, 2-position switch;
- S2, 2-pole, 3-position switch;
- S3, 1-pole, 5-position switch.

#### Resistors

- R3, R4, R20, 5,000 ohms;
- R5, R6, 0.5-meg.;
- R7, R8, 2 meg.;
- R9, 75,000 ohms;
- R15, 50,000 ohms;
- R16, 0.75-meg.;
- R17, 40,000 ohms;
- R18, 8,000 ohms;
- R19, 800 ohms;
- R21, 200 ohms.

#### Condensers

- C1, C4, C5, C6, C18, 0.1-mf.;
- C2, C3, 0.003-mf.;
- C7, C8, C9, C10, 8 mf.;
- C11, 25 mf.;
- C12, C13, 0.5-mf.;
- C14, 0.13-mf.;
- C15, 0.04-mf.;
- C16, 0.007-mf.;
- C17, 0.0014-mf.

Names of manufacturers will be supplied upon receipt of a stamped and self-addressed envelope. Kindly give (number) in above description of device.

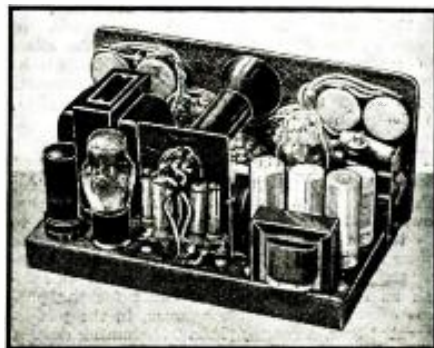

Fig. E

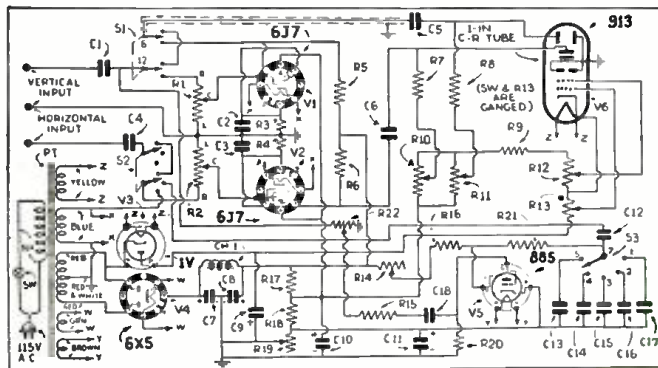

Fig. 2

Schematic diagram of the new oscilloscope rear view of which is shown in the illustration above, right. Figure D on page 222 illustrates its front appearance. A 2-inch C.-R. tube is used.

## NEW U. S. COAST GUARD AVIATION RADIO

(Continued from page 203)

homing device has and is proving itself of inestimable value in bad weather out at sea, etc.; since no time is lost in taking complicated bearings the plane for instance can proceed quickly to the aid of a ship in distress.

The radio operator aboard the plane wants to locate a freighter sending distress signals, let us say. The loop is turned until it points at the source of the signals; though unlike a compass needle which due to the earth's magnetism operates automatically the radio compass must be operated manually to maintain this directional indication. However from then on as in the instance of using a magnetic compass the plane

has only to follow the direction indicated by the radio compass.

Most of the equipment involved in the Coast Guard's new direction-finding loop antenna equipment appears in one of the views which shows the directional loop in the foreground.

The second development of interest is the *intercommunicating* feature; the radio operator is able to utilize the audio system of the radio set for voice amplification in a "private" telephone connection to the pilot. The earphone that is used for both the radio receiver and intercommunication services is shown in the second photograph in its mounting directly above the transmitter's flameproof telegraph key.

Please Say That You Saw It in RADIO-CRAFT

## NEW CIRCUITS IN MODERN RADIO RECEIVERS

(Continued from page 211)

Up to 3 V. peak signal across the last I.F. secondary (51) the receiver operates normally without A.V.C. at maximum sensitivity. When a peak exceeding +3 V. reaches the lower diode plate through the coupling capacity (50), this diode will start drawing current, building an A.V.C. voltage across the 1-meg. diode load resistor (61) and the 0.33-meg. filter resistor. At the junction of these (61 and 58) about 1/4 of the total A.V.C. developed is conveyed to the control-grid of the 6K7G I.F. amplifier. The total is conducted to the other grids through resistance-capacity filters.

### (6) Suppressor Volume Expander

**General Electric Model F-53.** Making use of an ordinary triode power detector as the 2nd-detector as shown in Fig. 1F, advantage is taken of the fact that the cathode becomes positive in proportion to the average modulation intensity of the signal. The cathode is, therefore, connected to the suppressor-grid of the I.F. amplifier and as it becomes more positive, the signal is given additional amplification. When the signal is lower, the amplification is decreased and volume expansion is accomplished by varying the amplification in proportion to the signal strength.

### (7) Noise-Limiter Circuit

**General Electric Model E-155.** This receiver makes use of an additional 6H6 tube to function for delay bias in A.V.C. and a noise-limiter circuit. See Fig. 1G. The signal voltage is taken from the 2nd-detector diode load at the junction of R21 and R22, the drop across R21 being the desired signal. This is fed to the first audio amplifier through a diode plate circuit (11-13), coupling condenser TC-55 and volume control R31.

The cathode of section (11-13) of the 6H6 noise limiter is maintained somewhat more negative than the plate of the same section due to its connection at a more negative point in the 2nd-detector load and hence a constant current flows in this diode circuit as soon as any signal is tuned-in. This current may rise to a predetermined maximum allowing full volume output, but at this point the diode is drawing near-saturation current. A noise impulse or any signal disturbance having greater amplitude will drive the diode into saturation. Above this point to reasonable limits, all additional signal drop will occur across the diode and hence be diverted from the A.F. system as the saturation current tends to remain constant in spite of increased plate voltage.

In this way any noise which is above the desired signal level is effectively eliminated.

Well, fellows, how do you like this new department in *Radio-Craft*? Constructive criticisms will be mutually advantageous.

## RADIO WITTIQUIZ

(Continued from page 226)

Answers		
(10b)	(13b)	(16b)
(11d)	(14a)	(17d)
(12d)	(15a)	(18b)

### Contest Rules

(1) An award of a 1-year subscription to *Radio-Craft* will be given to each person who submits a WITTIQUIZ that the Editors consider suitable for publication in *Radio-Craft*.

(2) WITTIQUIZZES must be typed; use only one side of paper.

(3) Submit as many WITTIQUIZZES as you care to—the more you submit the more chance you have of winning—but each should be good.

(4) Each WITTIQUIZ must incorporate humorous elements, and must be based on some term used in radio, public address or electronics.

(5) All answers must be grouped, by question number and correct-answer letter, on a separate sheet of paper.

(6) All contributions become the property of *Radio-Craft*. No contributions can be returned.

(7) This contest is not open to *Radio-Craft* employees or their relatives.

(8) The contest for a given month closes on the 15th of the 3rd month preceding magazine-issue date. (For instance, contributions to December, 1937, *Radio-Craft*, on the newsstands about Nov. 1, must be received at *Radio-Craft* editorial offices not later than Sept. 15th, 1937.)

# \$1,000.00 IN PRIZES

## OPEN TO EVERYONE!



**FREE**



Enter THE \$1,000 CONTEST Now

LET THIS New Free 1938 WHOLESALE RADIO CATALOG show you how TO WIN ONE OF THE PRIZES

FIRST PRIZE . . . \$250  
SECOND PRIZE . . . \$150  
THIRD PRIZE . . . \$100  
Fifty other prizes of \$10.00 each . . . \$500

Open to everyone . . . servicemen . . . amateurs . . . engineers . . . experimenters. So simple anyone can win! Complete details on how to obtain these valuable prizes found on Page ONE of the BIGGEST CATALOG IN RADIO HISTORY. Send for it immediately and get your slice of the generous awards. You can't afford to miss this wonderful opportunity! Be one of the winners . . . clip the convenient coupon now! The following well known people in the radio industry will act as judges: Dr. O. H. Caldwell . . . Editor, Radio Today; Mr. Lawrence Cockaday . . . Editor, Radio News; Mr. Joseph Reiss . . . President, Reiss Advertising Agency.

**EVERYONE!! HURRY!!** Here's your lucky chance to win one of the valuable prizes we are offering! Here's your opportunity to obtain our wonderful catalog. It's FREE!! And its contents will prove invaluable to you!

**for the SERVICER** . . . The greatest collection of up-to-date test equipment . . . over 10,000 bargains in parts, tubes, hardware . . . at prices that cannot be beaten! See this catalog . . . learn why thousands of successful servicemen buy the WHOLESALE way.

**for the SOUND ENGINEER** . . . Lafayette P.A. systems are made in all sizes for every possible requirement and specification . . . at prices that allow a handsome margin of profit. Complete beautiful NEW line described in detail in BIG P.A. section.

**for the AMATEUR** . . . Thousands of "Hams" buy the WHOLESALE way! It's the easiest . . . the swiftest . . . most reliable . . . and economical way. WHOLESALE maintains the biggest complete stocks of standard equipment to be found anywhere.



## HERE'S THE GREATEST CATALOG IN RADIO!

. . . it's the biggest . . . the best . . . and it has more radio bargains packed between its covers than ever before! Imagine . . . more than 10,000 real radio "Buys" . . . at amazingly low prices! Thousands of radio parts . . . at lowest listings . . . offered by the World's Largest Radio Supply House! And NOW you can make your purchases by the WHOLESALE Easy Payment Plan. Use your equipment as you pay for it.

**Remember!!** . . . THIS CATALOG is 180 pages BIG . . . and it's FREE! Send for it today . . . get the details of the \$1,000.00 contest. See the new EASY-TO-PAY Plan now available.

**SEND THE COUPON NOW**

**WHOLESALE RADIO SERVICE CO.**  
NEW YORK, N.Y. CHICAGO, ILL. ATLANTA, GA.  
100 SIXTH AVENUE 901 W. JACKSON BLVD. 430 W. PEACHTREE ST., N.W.  
BOSTON, MASS. BRONX, N.Y. NEWARK, N.J. JAMAICA, L.I.

WHOLESALE RADIO SERVICE CO., Inc.  
100 Sixth Avenue, New York, N. Y.

Rush FREE 1938 Catalog No. 69-3K7.

Name \_\_\_\_\_  
Address \_\_\_\_\_  
State \_\_\_\_\_ City \_\_\_\_\_

**FREE**

**YES...**  
Rush my copy

**MILLIAMMETERS-TO OSCILLOSCOPES!**

**METERS**

**MODERN RADIO SERVICING**

Everything You Need To Know  
in Ghirardi's  
**MODERN RADIO SERVICING**

Ghirardi's great servicing book gives you over 400 pages of solid data on all kinds of radio test instruments—ammeters, milliammeters, voltmeters, ohmmeters, volt-ohm-milliammeters, Wheatstone Bridges, output meters, vacuum-tube voltmeters, condenser testers and capacity meters, tube checkers, set analyzers, test oscillators, Cathode-Ray oscilloscopes, etc. For each type of instrument you get (a) a detailed explanation of the whole theory of operation, design and construction; (b) description of latest commercial models, with circuit diagrams and electrical constants, and explanation and illustration of special features; (c) full details on building many practical, up-to-date testing instruments yourself—diagrams, constants, etc., included.

This great 400-page instrument section forms only one-third of whole 1300-page volume. The other two-thirds explains how to use these instruments in service work—how to do servicing! You've got to get this book sometime—GET IT NOW!

Over 1300 Pages

706 Illus.

**CLIP OUT! MAIL NOW!**

**RADIO & TECHNICAL PUBL. CO.**  
45 Astor Place, New York Dept. RC-107

Encl. find \$4 for MODERN RADIO SERVICING postpaid. (Foreign \$4.50)

Encl. find \$4 for MODERN RADIO SERVICING and RADIO FIELD SERVICE DATA, incl. Jan. & June '37 Supplements to latter. (For. \$6.50)

Send free circular describing both books.

Name .....

Address .....

**MONEY-BACK GUARANTEE**

**MILLION TUBE TESTER**

**FEATURES**

- Emission
- Metal Tubes
- Shorts Hot
- Leakage Hot
- Resistance
- Electrolytics
- By-Pass
- Condensers
- D'Arsonval Meter

**MODEL CP**  
**\$13.95**  
NET

MODEL TM \$16.95 Has 3" square meter and continuous line voltage adjustment.

Direct orders require deposit and name of your jobber.

**MILLION RADIO AND TELEVISION LABORATORIES**  
559 N. UNION ST., CHICAGO, ILL.

**BE SURE TO READ THE  
ANNOUNCEMENT WHICH APPEARS  
ON PAGE 250 OF THIS ISSUE**

## HOW DEPENDABLE ARE YOUR METER READINGS?

(Continued from page 213)

shaft and the scale markings.

How much overload a given meter will stand depends upon its design, and how the overload is applied. Overloads of reasonable magnitudes will not harm properly-designed instruments. If the overload is applied for only a short time, and gradually, so there is no violent movement of the pointer, the instrument will most likely stand considerable overload without damage. (The meters of at least one prominent test instrument manufacturer are designed to stand overloads as high as 10 times the normal value.) However, if the overload is applied suddenly, so the movement is violent, a much smaller amount of overload will surely bend the pointer and also possibly dull the pivots or pit the jeweled bearings with resultant lagging and sticky action.

Incidentally, an overload of the wrong polarity, forcing the meter needle BACKWARD off-scale is very hard on meters and should be cautioned against. It is always good policy to start measuring an unknown quantity with the range selector of the instrument in the HIGHEST range position, gradually backing it down until a range is reached where the needle defects without going off-scale to the right. This, of course, is the range where the user will receive his most accurate results, and this policy of working down to the proper range will save many a meter from a burn-out due either to too much deflection forward or, a disastrously high voltage or current of the wrong polarity (as far as the meter connections are concerned).

(G) "Zero" shift. If accurate readings are desired, it is apparent that the pointer must stand exactly at the "zero" point on the scale when no current or voltage is applied to the instrument.

If the pointer is not at the zero position to start with, it is evident that all indications at other points on the scale will be in error. Practically all commercial-type meters are provided with a zero-adjustment screw (see Fig. 2G), which varies the tension of one of the control springs, allowing the meter pointer's "at rest" position to be adjusted over several scale divisions, so that it may be centered exactly over the position marked "zero" on the meter scale.

Always make sure that the pointers on your instruments are in the correct "zero" position before taking readings! If the zero error is found to be beyond the range of the adjusting screw, or if a sudden zero error of considerable magnitude is observed, it is safe to assume that the instrument needs checking and possible repair.

When "zero"-adjusting a meter be careful to avoid "parallax error" (explained later). This is particularly important when "zero"-adjusting most ohmmeters, for in these instruments the "zero"-adjustment screw does not adjust the meter pointer position directly but usually adjusts a resistor which compensates for variations in the potential of the battery supplied with the instrument. A fresh battery will, of course, apply a higher voltage to the instrument circuits than after it is partially discharged. Furthermore, because the resistors used in these meter circuits are not absolutely precise in value, there is some variation between the accuracy of the various ranges of the instrument. Therefore, each range of the instrument should be "zero"-adjusted separately—just before using.

The Megohm ranges of ohmmeters are usually powered by a miniature power supply working from the house or shop line voltage. Variations in this line voltage can be, and should be compensated-for by means of the Ohms Zero Adjuster, or whatever the manufacturer calls the "zero"-adjusting control.

Do not confuse simple "zero error" with that due to a bent pointer. If the pointer is very much off-zero because it is bent, it should not be brought back to zero by manipulating the zero-adjusting screw; for such an adjustment brings the moving coil into an initial position far different from that which it occupied when the initial calibration was made. The bent pointer itself should be straightened!

(H) Spring errors. The springs play one of the most important parts in maintaining the accuracy of the instrument; for they not only conduct the current to the movable coil, but also supply the "restoring" torque (or twist)

which resists the "actuating" torque of the movable coil, and then returns the coil and pointer to the "zero" position when the current is shut off. Any change in the "restoring" torque produced by the springs will cause a change in the position of the movable coil and pointer—causing an error in the readings.

Within the past few years, phenomenal metallurgical advances have been made in spring design which almost eliminate the "fatigue" and "aging" of springs which manifested themselves in a "drift" of calibration in older instruments. The improved springs used in instruments of reliable manufacture render negligible any probable error from this source, so long as they are not subjected to mechanical or electrical abuse.

Of course, if the springs have become overheated by prolonged abnormal current flow, they will lose some of their "temper". This will decrease their "restoring torque", and make the instrument more sensitive. (See Fig. 2, D and E.) Consequently, its readings become inaccurate insofar as its original scale calibration is concerned—and such errors may often be of considerable magnitude. This abuse of the springs by prolonged overload is difficult to detect because, as a rule, the meter seems to operate in a perfectly normal manner, no sluggishness or stickiness being evident.

The springs may also become "kinked". This fault will frequently manifest itself by the fact that the reading at a certain point of the scale will be different on "increasing" from "decreasing" values. Another error may creep in from "softened" springs which sag. These cause uneven torque, and an abnormal "zero error" of the pointer.

In general, the control springs of an instrument should be maintained in as nearly perfect a mechanical condition as possible by not abusing the instrument by serious overload, rough handling, etc. If the springs of an instrument have received any form of damage, it should be returned to the manufacturer, or an authorized repair shop, for repair, if accurate measurements are to be made with it.

(I) Bearing friction. The hardened and highly-polished steel pivots and the almost-frictionless sapphire jewel bearings which support the movable coil are subject to wear and damage. (See Fig. 2E.) They are finely shaped and polished, and accurately adjusted before the instrument leaves the factory; but friction may develop, due to excessively worn or damaged jewels or pivots. Rough handling of the instrument, overloading, dropping and tampering are all common causes of damage to the bearings.

Friction in the bearings usually manifests itself in a stickiness and lag of pointer movement, and a noticeable uncertainty in its zero position. Bearing friction will not usually cause errors in the readings, provided the instrument is gently tapped when the readings are being taken; but since its causes are likely to be productive of more serious results, they should be eliminated whenever possible.

Friction may also be caused by rubbing of the pointer on the scale, or on fine fibres loosening from the substance of a paper scale and projecting out so the pointer touches them. This trouble may become evident only during certain atmospheric conditions, and usually at certain parts of the scale; and it may be difficult to discover.

Small particles of foreign matter which have worked their way into the short air gaps of the magnet generally cause "sticky" operation and make the pointer indications erratic.

It is interesting to note that "sticky" meters due to foreign substances lodging themselves in the movement seem to rank highest among the most frequent meter repairs not due to owner negligence or carelessness. Sticky action is apt to occur even in new instruments, due to the jarring and shaking received during shipment. Although manufacturers take extreme care to insure receipt of the instrument in perfect condition and despite the care taken in assembling the meters, "trash" in the form of minute metal filings and bits of insulation or fibre may work into the movement. A meter service station should remedy this because the average radio Service Man is not capable of handling the delicate job

of cleaning out and adjusting the movement. Anyway, the usual manufacturer's guarantee will generally cover the cost of the adjustment, if it becomes necessary, within about 90 days of the purchase date.

A "sticky" meter may be detected immediately. Sticky or defective meters should be repaired at once rather than "borne with" as a man who uses an instrument which is not in 100% working order will subconsciously build up a psychological "mad" at the instrument's manufacturer. If it is repaired, he soon forgets that there was anything wrong with it.

"Backlash" in the moving parts is due primarily to loose fits in them. This trouble is not common, nor serious, since errors due to it may be materially reduced by gently tapping the instrument while taking the readings.

(J) Electrical troubles. Under this classification are those troubles which may develop in the electrical circuits of the instrument after it has been assembled, tested and calibrated. Poorly-soldered joints, loose or broken conductors, and partial or complete "short-circuits" or "grounds" are some of them. It is surprising how many loose or badly-soldered joints develop in supposedly well-made instruments, unless the manufacturers are careful to inspect them rigidly at the factory.

"Opens" due to breakage of the fine wire comprising the movable coil or that employed for the multiplier resistors in voltmeters, have given trouble in some models of instruments. Of course, in such cases, the meter fails to operate either on one or more ranges—or altogether, so the trouble quickly makes itself evident. These electrical troubles can usually be detected by observation of the instrument for erratic action. When they are detected, they usually require a careful and complete repair before the instrument can again be considered reliable for service.

The copper-oxide rectifiers used in rectifier type A.C. instruments can cause an increase in meter inaccuracy. These copper-oxide rectifiers are inherently delicate and can be easily overloaded. The average rectifier of this type will pass a maximum of but a few milliamperes, above which the rectifier "breaks down." This condition appears to be present in any A.C. measuring-meter circuit whether it be strictly a series-dropping resistor type or one in which condensers and resistors are used. Care should therefore be exercised in the application of A.C. voltages to these meters, for overload often results in a damaged rectifier and lowered A.C. voltage readings. The rectifiers cannot be repaired and are never guaranteed by the original manufacturer. Therefore, damaged rectifiers should be replaced by the instrument manufacturer, or by some reliable meter repair firm, for they sometimes go bad even while being placed in the instrument. The copper-oxide rectifiers should never be touched with the hands as chemicals in one's perspiration will usually cause early rectifier failure.

The ratio of the rectified current to the applied current may change for a given rectifier. Troubles such as the above cause this ratio to drop to sometimes half the original ratio. Variations are also possible due to variations of temperature, humidity and the amount of current applied to the rectifier each time it is used for a measurement. In other words, the rectifier will have one ratio when say 0.1-ma. is applied, another when 0.5-ma. is applied, etc.

(K) Magnet weakened. Properly-designed permanent magnets of the types which are being used in recent high-grade instruments will stand a surprisingly large amount of rough handling before their magnetic strength will change sufficiently to result in incorrect readings. Other parts, such as the jewels and pivots, springs, etc., which are more susceptible to damage by mechanical shock, are more troublesome in this respect. However, the safe rule is to handle your instruments carefully and avoid all mechanical jolts and shocks.

(3) Inaccuracies Due to Way Instrument Is Used, Or Conditions Under Which Measurements Are Made

There are several inaccuracies which are apt to creep into measurements made with electrical instruments simply because of the way the instrument is used, or the conditions under which the measurements are made. Errors which may be present when a particular instrument is used for one measurement may not occur when it is used again under different operating conditions—and vice versa! Some things to watch for will be pointed out in Part II.

(Continued on page 247)

# ..... Endorsed By Leading Service Organizations

- ★ ★
- HIGHEST QUALITY
- ★ ★
- HIGHEST PROFIT
- ★ ★
- FREE EQUIPMENT

## NATIONAL UNION RADIO TUBES

National Union manufactures a complete line of radio tubes—glass, metal and G-type. National Union's high quality has made them outstanding favorites in the radio service profession. All sales policies have been formulated with the idea of making National Union radio tubes the ideal replacement tube for the radio dealer. This has been backed up with a selling program that means real support and help to the wide-awake dealer. Dealers and jobbers handling National Union radio tubes are the leaders in repair parts and service.

### Free Equipment Includes:

Tube testers, set analyzers, oscillographs, signal generators, modulators, meters and other servicing instruments. In shop equipment items available include stock cabinets, coats, display signs, electric clocks, etc. All items absolutely free the National Union Way.

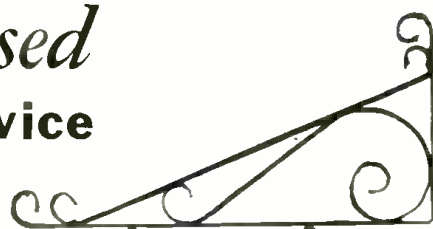

This "Sign of Efficiency"  
Can Help You, Too.  
Get It —  
**FREE from N. U.**

### The NATIONAL UNION WAY . . .

Through National Union's help, radio service dealers everywhere have been able to set up better equipped shops to do better work; also to obtain merchandise helps that produce more customers. National Union has constantly put the latest advances in scientific equipment as well as modern selling aids within reach of the service dealer. The National Union Deal calls for a dealer deposit which is rebated when the specified number of tubes has been purchased. Over 70,000 completed deals. Every service dealer should investigate.

**THE ROAD TO  
BETTER BUSINESS**

NATIONAL UNION

1. Full guarantee on highest quality radio tubes.
2. Cut price business not solicited.
3. Price Protection.
4. N. U. jobber stocks are complete...No hunting for odd types.
5. Timely business building aids.

**Clip! Mail Now! RC-1037**

**NATIONAL UNION RADIO CORPORATION**  
570 Lexington Ave., New York City

—Tell me how to get the Sign of Efficiency Free.  
—I am also interested in the following equipment:

Name .....

Address .....

City ..... State .....

**NOW-GREATER SAVINGS THAN EVER**

**IN NEW RADIOS AND EQUIPMENT**

**We Carry Almost Every Radio Set Made  
TREMENDOUS DISCOUNTS**

On Tubes, Amplifying Equipment, Public Address Systems, Auto, Home, and Farm Radios in all Styles, Types, and Voltages. We can supply you with any Manufactured Set.

**ALL MERCHANDISE GUARANTEED**  
Factory Sealed Cartons. No Seconds  
**CHOICE EXCLUSIVE TERRITORY**  
AVAILABLE TO LIVE REPRESENTATIVES

**FREE!**  
New  
**LATEST CATALOG**

CONTAINING HUNDREDS OF AMAZING RADIO VALUES

AT NEW LOW PRICES

**67M1**  
1938  
**AUTO SET**  
LIST \$54.95  
**50% OFF**

**POST RADIO CORP.** 72 CORTLANDT ST. DEPT. G NEW YORK, N.Y.

Please Say That You Saw It in RADIO-CRAFT

THE LATEST RADIO EQUIPMENT

(Continued from page 221)

RHEOSTAT FOR PRIMARY CONTROL ON SECONDARY VOLTAGE (1293)

(Ohmite Mfg. Company)

A PARTICULARLY convenient control of filament-transformer secondary voltages, in order to obtain maximum tube life (as in transmitters, etc.), is afforded by means of a power rheostat connected in series in the primary circuit. An improved vitreous enamel heavy-duty rheostat suitable for this purpose is illustrated. It is constructed entirely of porcelain and metals and thus contains nothing which can char or burn.

ORATOR-TYPE VELOCITY MICROPHONE (1294)

A VELOCITY microphone which has been especially designed for pulpit and "desk work", or for all those applications where the orator generally assumes a fixed position, is illustrated. By an ingenious application of the directional "fans" developed for an earlier-type microphone of the same make (Radio-Craft, item No. 1438, August 1937, page 93), and by placing the motor unit horizontally, an extremely wide angle of pick-up is obtained; this allows complete freedom of motion on the part of the speaker—within a radius of 3 ft.

This design is more sightly than the earlier "banquet" stand type of mounting. The base may be tilted to obtain best sound pick-up. Available with a noiseless rotary switch. Output level is -65 db.; impedance either to grid or 200 ohms (latter-type unit is equipped with a 25-ft. length of cable); frequency response 50 to 12,000 cycles; weight, 3 lbs.; finish, gunmetal.

NEWEST RADIO SET FOR AVIATORS (1295)

(RCA Manufacturing Co., Inc.)

AVAILABLE for both 6-V. and 12-V. operation, the new aviation radio receiver here illustrated features sensitivity and light weight. Only two type 6F7 tubes are used in the receiver to afford the services of (1) R.F. amplification, (2) detection, and (3) A.F. amplification in 2 stages, in a T.R.F. circuit.

Frequency range of 200 to 400 kc. permits coverage of airport traffic control, and radio beacon-weather broadcasts. White dots spot the primary weather broadcast frequency of 236 kc., and the airport traffic control frequency of 278 kc. Feather-weight headphones are utilized. Weight of complete receiver, power supply, cable and phones is 8.5 lbs. Dimensions for both receiver and power supply—6½ x 5¼ x 3½ ins. deep for each unit.

AIRCRAFT MICROPHONE (1296)

(Universal Microphone Co.)

ANNOUNCED as being "100-per cent directional and all extraneous noises excluded" is the aircraft-type microphone here illustrated. A thumb-operated pushbutton is installed on the periphery. This is a double-contact switch, one side of which closes the circuit for microphone current, and the other side operates the relay for throwing the transmitter into action.

NEW WIDE-RANGE SERVICE OSCILLATOR (1297)

(Radio City Products Co.)

ONE OF the latest in signal generator (or "service oscillators") developments is the portable, A.C. operated instrument here illustrated (size, 8 x 11¼ x 5 ins. deep; weight, 11½ lbs.).

Five bands afford a continuous range of fundamental frequencies from 125 kc. to 15 mc.; harmonics extend the high-frequency range to 16 megacycles.

Of importance to the Service Man is the means—a full-vision direct-reading 4½-in. vernier-type airplane dial with multicolor calibration—provided for speeding the reading of frequencies without recourse to charts or tables. Another interesting feature that facilitates the alignment of supersensitive radio receivers, as for instance car-radio receivers, is the use of special lead-coated steel for the case and chassis; plus separate shielding of the coil assembly, attenuator and R.F. circuits.

The possibilities of dead-spot effects are reduced through automatic shorting of unused coils; and electrostatic shielding of the power transformer prevents R.F. feedback through the power line.

Audio modulation of 30% at 400 cycles, sine-wave, is also available externally; also, other, external frequencies may be applied to the R.F. circuit. Sweep and "wobbler" circuits of cathode-ray equipment may utilize the A.F. modulation from this signal generator.

Panel and fittings are finished in chromium, aluminum and black. The cabinet is gray.

14-26 WATT PORTABLE AMPLIFIER (1298)

BRIEFED, the features of this amplifier are: electronic mixing of 2 microphones; provisions for mixing 2 microphones and 1 phonograph; includes velotron microphone (on banquet stand); has two 10-in. dust-proofed dynamic reproducers (said to be especially designed for P.A. work); tone control; beam power tubes.

Unit furnishes field supply; P.M. dynamics also may be used. Speaker No. 1 plugs into the amplifier. Speaker No. 2 plugs into speaker No. 1. This permits placing the second reproducer a maximum of 50 ft. from the amplifier.



Latest emission-type tube tester makes hot emission tests of all types of tubes. (1299)

CENTRALAB VOLUME CONTROLS cannot be Equalled!



says Mr. Owen O. Tressler of Elmira Heights



"Sir," says Old Man Centralab, "I am overcome with pride at this overwhelming vote of confidence. But, (ahem) I cannot feel but that my long years of smooth service to the radio industry merit this recognition."

Yes . . . Mr. Tressler is but one of the thousands of radio men from coast to coast who takes his hat off to OLD MAN CENTRALAB . . . and who is doing a better and more satisfactory service job because of the smooth performance of these world famous volume controls.

**Centralab**

MILWAUKEE WISCONSIN  
BRITISH CENTRALAB, LTD.  
Canterbury Rd., Kilbourn  
London N.W. 6, England  
CENTRALAB  
118 Avenue Ledru-Rollin  
Paris XI, France

**RADIO**

biggest opportunities still ahead

In a decade radio has become a giant industry. The opportunities created are being enjoyed by trained men. The International Correspondence Schools Radio Course, prepared by leading authorities and constantly revised, WILL MAKE YOU A TRAINED MAN! A fascinating book — FREE.

INTERNATIONAL CORRESPONDENCE SCHOOLS

Box 6680-C, Scranton, Penna.  
Send me—free—information on subject checked:  
 Radio  Radio Service Man  
 Radio Operator  Electrical Engineer

Name .....

Address .....



New aircraft mike. (1296)



A wide-range oscillator with continuous range of fundamentals from 125 kc. to 16 mc. (1297)



New 14-26 W. portable amplifier uses velotron microphone and 2 10-inch dynamic speakers. Input uses electronic mixing. (1298)

Please Say That You Saw It in RADIO-CRAFT





The new "etched-foil" electrolytics. (1301)

**EMISSION-TYPE TUBE TESTER (1299)**

(Million Radio & Television Laboratories)

THE TUBE TESTER illustrated on page 238 makes hot emission test of all types of tubes. English-reading indications appear on the scale of a large meter. Neon test of shorts and leakage is available up to 2 megs. Jacks provide external use of the leakage test; as well as measurements of resistance in continuity test. Operates on 110 V. A.C. The power circuit is fused; and all test circuits are insulated from the power line.

**INEXPENSIVE PRIVATE PHONE (1300)**

CARRYING the trade name of "Privaphone," this intercommunication system requires only a built-in battery to operate it. Consequently, unlike most previous types of such systems, it may be applied in many services that do not have available a 110 V. supply.

The unit comprises a microphone and earphone, and a buzzer—all battery operated. May be used in connection with dictating, detective work, temporary point-to-point communication, etc.

**COMPLETE RANGE OF ETCHED-FOIL ELECTROLYTICS (1301)**  
(Cornell-Dubilier Corp.)

BOTH THE types Kit metal container and JR silvered cardboard container small-space etched-foil condensers are now available in a complete capacity range from 4 to 16 mf. at 200 to 525 V. rating. As a protection against excessive humidity and abnormal temperatures these units are triple-sealed.

**NEW LINE OF REPLACEMENT CONDENSERS (1302)**

IN ADDITION to the number of special universal-service condensers one manufacturer (Continued on page 247)

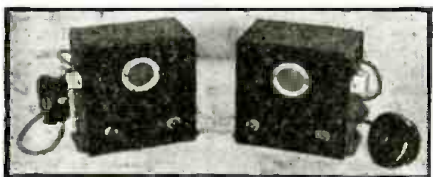

Private interphone system. (1300)

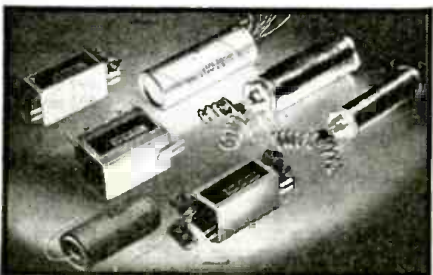

New line of replacement condensers. (1302)

**DEVELOPED for HIGH FIDELITY!**

AND ONLY

**\$17<sup>45</sup>**

FROM FACTORY

TO

**YOU!**

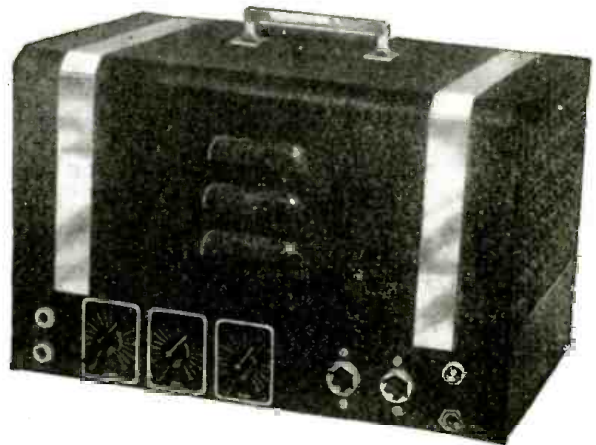

**A 30 WATT AMPLIFIER**

COMPLETELY ASSEMBLED BUT NOT WIRED

USES the new 1221 Sylvania non-microphonic input pentode which permits you to use full gain of this powerful FOUR STAGE AMPLIFIER. Push-pull 6L6 beam power output with two input channels and faders for any type of microphone, radio or phonograph pick-up.

**A RARE OPPORTUNITY FOR THE SERVICE MAN**

Just what you need for rentals; delivering anything from a whisper to full auditorium volume and handles from one to four speakers, maintaining its perfect clarity at full volume.

**K-30 HIGH FIDELITY AMPLIFIER**; assembled complete with wiring diagram & instructions less only wiring, chassis cover and tubes ..... \$17.45  
Ventilated heavy gauge chassis cover, as illustrated ..... 3.25  
Complete set of matched Sylvania tubes: 1—1221, 1—6C5, 2—6L6G, 2—6J5G, 1—5Z3 ..... 4.10

**EASTERN RADIO & TELEVISION CO.** 136 LIBERTY ST. NEW YORK, N. Y.

**FOUNDATION OSCILLOSCOPE WITH BUILT-IN 60 CYCLE SWEEP**

**PRECISION BUILT \$11.40 LESS TUBES**

- Uses No. 913 Tube with 1" Fluorescent Screen for Sharp Images
- Controls for Intensity, Focus and Sweep Amplitude
- Vertical and Horizontal Deflector Plates
- A.C. Operated



A practical foundation unit for amateurs, engineers, sound and radio servicemen. With proper external additions it offers facilities for the study and adjustment of countless circuit problems. May be adapted for R-F and I-F alignment, resistor, condenser, vibrator and many other tests.

SEE YOUR JOBBER WRITE FOR CATALOGUE

READRITE METER WORKS  
1016 College Dr., Bluffton, Ohio  
Without obligation please send me more information on Model 810. I am also interested in .....

Name .....

Address .....

City ..... State .....

MODEL 840

*Readrite*  
**RANGER**

Now—a high-powered—



## Radio Engineering Library

**New**  
The Library now comprises a revised selection of books culled from latest McGraw-Hill publications in the radio field.

—especially selected by radio specialists of McGraw-Hill publications

—to give most complete, dependable coverage of facts needed by all whose fields are grounded on radio fundamentals

—available at a special price and terms.

These books cover circuit phenomena, tube theory, networks, measurements, and other subjects—give specialized treatment of all fields of practical design and application. They are books of recognized position in the literature—books you will refer to and be referred to often. If you are practical designer, researcher or engineer in any field based on radio, you want these books for the help they give in hundreds of problems throughout the whole field of radio engineering.

**5 volumes, 3064 pages, 2000 illustrations**

1. Glasgow's PRINCIPLES OF RADIO ENGINEERING
2. Hund's PHENOMENA IN HIGH-FREQUENCY SYSTEMS
3. Chaffee's THEORY OF THERMIONIC VACUUM TUBES
4. Terman's MEASUREMENTS IN RADIO ENGINEERING
5. Henney's RADIO ENGINEERING HANDBOOK

10 days' examination. Special Price. Monthly payments. \$25.00 worth of books cost you only \$23.50 under this offer. Add these standard works to your library now; pay small monthly installments, while you use the books.

### SEND THIS ON-APPROVAL COUPON

McGraw-Hill Book Co., Inc.  
330 W. 42nd St., New York, N. Y.

Send me Radio Engineering Library, 5 vols., for 10 days' examination on approval. In 10 days I will send \$23.50, plus few cents postage, and \$3.00 monthly till \$23.50 is paid, or return books postpaid. (We pay postage on orders accompanied by remittance of first installment.)

Name .....

Address .....

City and State .....

Position .....

Company ..... RC-10-37

## IF IT'S TOUGH - DON'T CUSS Turn To RADIO-KINK-AIDS

Practical Repairs For Over  
3000 Hard-To-Fix Radios.

Just pull out the card corresponding to the name and model of the set you are repairing, and there you have listed the service troubles found in that radio and how to fix them. Yes it's so simple as that.



ONLY  
**\$1.95**

COMPLETE WITH  
METAL CABINET

FREE WRITE FOR BULLETIN  
AND SAMPLE CARD 6C-10

**AKRAD PRODUCTS CO.**  
362 WOOSTER AVE Akron, O.

Tear out this ad, write your Name and Address in the margin, send \$1.95 and we will send outfit at once.

# RADIOS WHOLESALE

Our complete NEW line of FAMOUS ZEPHYR RADIOS open for your selection, at 50% discount. Send for FREE catalog showing A.C.-D.C., All Electric or Battery sets and Auto Radios. All latest models with newest features—World-Wide reception, 5 to 15 tubes, 30 days Trial—Money back GUARANTEE. Earn EXTRA MONEY ask about our Agent-User Plan.

**ZEPHYR RADIO COMPANY**  
13141 Hamilton Ave., Detroit, Michigan

## HOW TO MAKE "THE SEAFARER" LOOP-TYPE BOAT RADIO SET

(Continued from page 208)

### LOOP-POSITION INDICATION

For each loop, secure or accurately draw a 360-degree protractor of convenient size. (See Fig. 1.) Cardboard affairs will do nicely. Center the protractor on the loop plug and fix it in position in such a way that its 0- and 180-degree markings are broadside to the loop (90 and 270 deg. markings therefore in line with the endwise plane of the loop antenna). Make definitely sure that the scale will not slip and will turn only when loop and plug are turned.

Place a pointer on the front of the cabinet's cover so that it will record against the scale. Adjust the position carefully, making sure that when the loop is turned to read zero (deg.) or 360 (deg.) against the pointer, the finder is exactly parallel—endwise—to the length, left to right, of the cabinet.

### OPERATION

In operation, the radio-direction finder is positioned in direct line with the course of the vessel. That is, the instrument heads directly toward the ship and the pointer indicates this line of direction of travel.

A chart of local waters will be required—a knowledge of magnetic variation figures for these particular waters, and a ship's compass. These, of course, are common enough to any mariner's store of seafaring apparatus and intelligence.

All bearings and positions are taken with reference to a ship's course.

**Bearing-station on-course.** Is station ZZZZ, which is coming in strongly, known to be exactly in line with a desired course? Is its position

right where we want to go? Then we simply take a bearing on it with our finder, adjusting the loop for minimum reading or inaudibility. (The maximum-response reading is not as accurate.) Our pointer will read against the scale and indicate the number of degrees this station lies away from our present line of direction. We note our course on the ship's compass and then simply correct our heading until course and signal are in line. We may now "ride the signal" into port without "much of any" trouble.

**Bearing-station off-course.** Is the bearing of station ZZZZ unknown and do we wish this bearing? Then we note our course of direction, as shown by our ship's compass, correct it for magnetic variation, get a direction reading on the signal with our finder, find out its bearing from our present course by noting the degrees difference between the 2 lines of direction, add our own bearing from true-North to this difference—and get an actual true bearing on the signal. By extending this line seaward on our chart we will have something to work on, for we'll at least know we are on this line!

Do we want a "true position"? Then we take a bearing on 2 stations, if such bearings are not known, "triangulate" or extend both lines seaward, and note on our chart where they cross. That cross or "fix" is our true position and we know exactly where we are!

But these are matters for mariners. Your job as a radio builder will be to construct a model receiver, get it into proper working order, and scamper down to the nearest yacht club for an exhibition. When you do—if you do—make such a trip, you may take along plenty of advance assurance of an immediate sale and some profitable orders for the season.

## NEW TUBES FOR THE RADIO EXPERIMENTER

(Continued from page 204)

Max.-signal plate current	60 ma.
No-signal screen-grid current	3 ma.
Load resistance	2,000 ohms
Power output	3.6 W.
2nd-harmonic	2.5%
3rd-harmonic	9%

(Data courtesy Raytheon)

Screen-grid current (no signal)	5	5 ma.
Screen-grid current (max. signal)	12	13.5 ma.
Load resistance (plate-to-plate)	10,000	8,000 ohms
Power output	8.5	13 W.
3rd-harmonic	3.5	3.5%
Total harmonic	4	4%

(Data courtesy Raytheon)

**6V6G (glass) Unipotential-cathode Tetrode Power Amplifier.** Transformed or impedance input are recommended for use with this tube. If resistance-capacity coupling is used the D.C. resistance in the control-grid circuit must not exceed 0.5-meg. with self-bias, or 0.1-meg. with fixed-bias. Note that the voltage between heater and cathode should be kept as low as possible. A direct connection is recommended. See Fig. 1D.

<b>Characteristics</b>	
Heater voltage	6.3 V.
Heater current	0.45-A.
Plate voltage (max.)	300 V.
Screen-grid voltage (max.)	300 V.
Plate and screen-grid dissipation (total)	12.5 W.
Control-grid voltage	-12.5 V.
Amplification factor	218
Plate resistance	52,000 ohms
Mutual conductance	4,100
Plate current	45 ma.
Screen-grid current	4.5 ma.
<b>Operating Conditions, Class A Amplifier</b>	
Plate voltage	250 V.
Screen-grid voltage	250 V.
Control-grid voltage	-12.5 V.
Peak signal	12.5 V.
Plate current (no signal)	45 ma.
Plate current (max. signal)	47 ma.
Screen-grid current (no signal)	4.5 ma.
Screen-grid current (max. signal)	6.5 ma.
Load resistance	5,000 ohms
Power output	4.25 W.
2nd-harmonic	4.5%
3rd-harmonic	3.5%
<b>Operating Conditions, Class AB (2 tubes)</b>	
Plate voltage	250 300 V.
Screen-grid voltage	250 300 V.
Control-grid (see item in text concerning input systems)	-15 -20 V.
Peak signal (grid-to-grid)	30 40 pk. V.
Plate current (no signal)	70 78 ma.
Plate current (max. signal)	79 90 ma.

**1G5G Low-Plate-Voltage Power Output Pentode.** This tube is designed especially for operation from a 90 V. "B" supply and will be used mainly in battery receivers, particularly where current limitations are a factor.

Resistance coupling may be employed and the rated output obtained under class A operation. Larger power output is available by employing 2 tubes in push-pull service. (See Fig. 1E.)

<b>Characteristics</b>	
Filament voltage	2 V.
Filament current	0.12-A.
Over-all length (max.)	4 11/16 ins.
Diameter (max.)	1 13/16 ins.
Bulb	ST-14
Base	Medium G Type Octal No. 6-X
<b>Operating Conditions and Characteristics</b>	
Filament voltage	2 V.
Filament current	0.12-A.
Plate voltage	90 V. max.
Screen-grid voltage	90 V. max.
Control-grid voltage	-6 V.
Plate current	8.5 ma.
Screen-grid current	2.7 ma.
Plate resistance	0.135-meg.
Mutual conductance	1,500 umhos
Amplification factor	200
Load resistance	8,500 ohms
Power output	300 mw.
Total harmonic distortion	9%

(Data courtesy Hygrade-Sylvania Corp.)

**25L6G (Glass) Beam Power Tube.** This tube has electrical characteristics that are identical to those of its metal counterpart the 25L6 described in the April, 1937, issue of *Radio-Craft*. However unlike the 25L6 which uses beam deflector plates the newer tube incorporates suppressor grids. (See Fig. 1F.)

(Tube is now available from RCA Radiotron, Raytheon, Sylvania, etc.)

**CRYSTAL HEAD PHONES**  
**SOUND CELL MICROPHONES**  
 Information on request  
**THE BRUSH DEVELOPMENT CO.**  
 3312 PERKINS AVE. - CLEVELAND, OHIO

**RADIO COURSES**  
 RADIO OPERATING: Prepare for Gov't License Exam. ● RADIO SERVICING: Including Short Wave ● AMATEUR CODE ● ELECTRONICS ● TELEVISION ●  
 Day and Evening Classes—Booklet Upon Request  
**New York YMCA Schools**  
 4 W. 64th Street, New York City

**BUILD IT YOURSELF**  
 You can build this Trailer with ordinary tools easily from our step-by-step constructional sheets and large sized blueprints. Finest decked trailer in existence, sleeps 4. Toilet, Shower, Electric Light, etc.  
 Save 75% of the cost by building it yourself. Send 25c for plans sheet, illustrations and details.  
**THE PLAN SHOP, 910 Palmolive Bldg. Chicago, Ill.**

**MODERNIZE YOUR OBSOLETE TUBE CHECKER OR SET ANALYZER with "PRECISION"**  
 Write for details. Mention make and model number of your old instrument.  
**PRECISION APPARATUS CORP.**  
 821 EAST NEW YORK AVE. BROOKLYN, N. Y.

**RADIOS..SAVE UP TO 50%**  
 DEAL DIRECT...FACTORY PRICES! Many models to select from: AC, DC, All-Wave, armchair models, automatic tuning, car radios, Farmettes that operate like city radios! Send postcard for NEW Bargain Catalog FREE. 30 DAY TRIAL plan and agent-user proposition!  
**GOLDENWAVE RADIO CO.**  
 DEPT. 810, DEARBORN, MICHIGAN

**PATENTS—TRADE MARKS**  
 All cases submitted given personal attention by members of the firm.  
 Form "Evidence of Conception" and instructions  
 "How to Establish Your Rights"—Free  
**LANCASTER, ALLWINE & ROMMEL**  
 PATENT LAW OFFICES  
 436 Bowen Bldg. Washington, D. C.

**\$500,000 GENUINE MAJESTIC-GRIGSBY GRUNOW REFRIGERATOR & RADIO PARTS.**  
 2000 REFRIG. ERATOR UNITS  
 GUARANTEE 18 MONTHS  
 SEND FOR PRICE LIST  
**G & G GENUINE MAJESTIC REFRIGERATOR & RADIO PARTS SERVICE**  
 5801 W. DICKENS AVE. CHICAGO, ILL.

**5 TUBE SUPER KIT**  
 456 K.C. 15 to 50 Meters 200 to 550 Meters  
 Kit consists of: I.F. Trans., Var. Condenser, Chassis Pan., Coils, Sockets, Paddling, Filter and By Pass Condensers, Resistors, Power Trans. and Schematic Drawing.  
 All above parts with 6 1/2" speaker ..... \$5.95  
 All above parts with 8" speaker ..... 6.95  
**25% Deposit Required With Order**  
 WRITE FOR OUR NEW 6 PAGE FLYER  
**ARROW SALES COMPANY** Dept. 5  
 631 WASHINGTON BLVD., CHICAGO, ILLINOIS

**"LEARN-BY-EXPERIMENTING" BEGINNERS' PRACTICAL RADIO COURSE**

(Continued from page 233)

- LIST OF PARTS FOR EXPERIMENT NO. 1**  
 \*One general purpose, audio microphone transformer, T;  
 \*One adjustable condenser (optional), 0.0003- to 0.001-mf. (equivalent to 300 to 1,000 mmf.);  
 One rheostat, 20 ohms, R;  
 \*One 4-prong socket, with screw terminals for type 30 tube;  
 \*One knob and dial-plate;  
 Five binding posts;  
 One type 30 tube; or, type 01A tube may be used, with rheostat advanced to full, since this tube requires a greater operating current;  
 Three drycells, or one 4 1/2 V. "C" battery;  
 One pair of standard headphones, 2,000 ohms resistance, Ph.;  
 One key, may be home-made, as shown, or push-button, K.  
 \*Names of manufacturers will be supplied upon receipt of a stamped and self-addressed envelope.

The author of this course has been identified with the teaching of radio for many years in both private and public schools, and at present is an Instructor in Radio in a New York City High School. His experience qualifies him admirably for presenting the technical material of radio from the learner's viewpoint.

**ANSWERS TO PROBLEMS ON EXPERIMENT No. 1**

(See page 233)

- (1) Filament current becomes greater.
- (2) Tone becomes lower in pitch indicating a slower or lower frequency.
- (3) Pitch becomes lower indicating slower or lower frequency.
- (4) Breaking the plate circuit.
- (5) The amount of capacity in the grid circuit.

**BUILD THIS "INTERMITTENT OPEN" CONDENSER TESTER**

(Continued from page 225)

will-insulated test prods and keep safely away from the R.F. output of this "breakdown-test oscillator" in order to avoid high-frequency burns.

Coil L consists of 76 turns of No. 24 enam. wire wound on a form (preferably, air-core) 1 1/2 ins. in dia. Coils L1 and L2 each consist of 50 turns of No. 14 enam. wire wound on a form 1 1/2 ins. in dia.

The following List of Parts is suggested to builders who may want to try out this idea in a lab. set-up. Substitutions may be made by the experienced radio man as necessary to suit individual convenience.

- LIST OF PARTS**  
 One Standard Transformer Corp. power transformer, 650 V., 150 ma. sec. and a 2.5 V. sec., T;  
 One Standard Transformer Corp. filter choke, 200 ma., Ch.1;  
 One Hammarlund R.F. choke, 150 ma., Ch.;  
 One Hammarlund variable condenser, 350 mmf., CV;  
 Two Tung-Sol type 45 tubes, V1, V2;  
 One Tung-Sol type #0 tube, V3;  
 Two Sprague condensers, No. TX-24-70, 70 mmf., 1,500 V., C;  
 One I.R.C. resistor, 25,000 ohms, 5 W. (no less), R;  
 One Sprague condenser, No. TC-25, 0.005-mf., 400 V., C1;  
 One Sprague condenser, No. TR-11, 0.01-mf., 800 V., C2;  
 Two Sprague condensers, No. OT-21, 2 mf., #00 V., C3;  
 One R.F. coil unit (see text for construction data) L, L1, L2;  
 One S.P.S.T. toggle switch, X;  
 One bulb (and socket), 2.5 V. filament, V.;  
 Three 4-prong sockets.  
 This article has been prepared from data supplied by courtesy of Sprague Products Co.

**SELL BEFORE YOU BUY**

How would you like to have a good stock of nationally advertised radio tubes on your shelves — without paying a nickel until they're sold?

That's how the Tung-Sol Consignment Plan works for radio dealers who can qualify. You don't pay for the tubes until you've collected your cost and profit. That's worth looking into — to see if you are eligible for this unique plan.

More than 8,000 dealers have qualified—and are going places in the tube business.

Full profit—no investment—no dead numbers to write off at a loss. Easy to sell, because your trade knows that Tung-Sol means top flight tube efficiency.

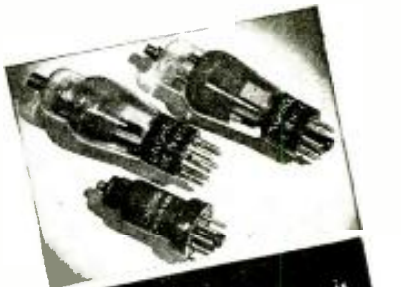

The Tung-Sol franchise is still available to a limited number of dealers who can qualify. Write for the name of your nearest wholesaler.

**TUNG-SOL**  
 Tone-flow Radio Tubes

**TUNG-SOL LAMP WORKS, INC.**  
 Dept. F Radio Tube Division  
**SALES OFFICES:** Atlanta, Boston, Chicago, Charlotte, Dallas, Detroit, Kansas City, Los Angeles, New York, General Office, Newark, N. J.

# EFFECTIVE IMMEDIATELY...



## Metallized TYPE CONTROLS

... are available in a complete line of exact duplicate replacement types.

... also, hot off the press comes the new IRC Control Guide listing replacements for almost every receiver.

Ask your jobber—or write direct to us—for a free copy of the Guide. Prepare to use the finest proved controls on EVERY job!

INTERNATIONAL RESISTANCE CO.  
401 N. Broad Street • Philadelphia, Pa.



"The Name Tells You It's a Masterpiece"

## "LET ME TRAIN YOU at home FOR A GOOD RADIO JOB"

**Get in Line for Big Money**  
A. G. Mohaupt, Director, Engineer. Radio is growing fast. Modern receivers require thoroughly trained experts for service and maintenance. You can become such an expert right at home... through R.T.A. methods and begin earning money almost from the start of your course. In a very short time you will

**Be the ONE Man in 1,000**

who understands everything there is to know in order to give quick "sure-fire" service to all kinds of receivers. You can be the one man who can take the service business away from the old-time radio "tinker."

**No Experience Needed**

Even though you know nothing about Radio now, you can quickly qualify the R.T.A. way to step right into a well-paying position—or start your own profitable business. Use your spare time and

**LEARN AT HOME**

Most R.T.A. members start making money right from the beginning. The special servicing equipment which is supplied without extra cost makes this possible. Don't wait—get started now. Write today for our interesting Radio Book FREE.

Don't Put It Off—Send Coupon Now

**RADIO TRAINING ASSOCIATION OF AMERICA**  
4525 Ravenswood Ave., Dept. RC-80, Chicago, Ill.

RADIO TRAINING ASSN. OF AMERICA  
Dept. RC-80, 4525 Ravenswood Ave., Chicago, Ill.  
Gentlemen: Send me details of your Enrollment Plan and information on how to learn to make real money in Radio quick.

Name \_\_\_\_\_  
Address \_\_\_\_\_  
City \_\_\_\_\_ State \_\_\_\_\_

**INCLUDED WITH OUR TRAINING**



This efficient time-saving, trouble-finding Circuit Analyzer and Resistance Tester helps you to make money without delay. Our Free Book tells you how.

## BUILD THIS "OPTIMUM TEST" TUBE CHECKER

(Continued from page 209)

The features incorporated in this unit are grouped in Table I. The reasons as to just WHY these various elements were considered essential in the design of this new tube-resistance-capacity tester make interesting and instructive reading.

### DESIGN FEATURES

(1) Accuracy. This is determined by the type of test circuit used, as well as the accuracy of the component parts which comprise the circuit.

A review of the R.M.A. recommendations and consultation with the engineering departments of the largest and most progressive tube manufacturers emphatically concludes that the most accurate test which can be made in a practical commercial instrument is the emission-type test under applied voltages and loads as recommended by the R.M.A. This circuit was therefore adopted after investigating power output and medium-price transconductance circuits. It is true that a finer, more elaborate transconductance tester could be built but it would be a very costly laboratory instrument, difficult to operate, and impractical for a dealer or Service Man.

The meter selected is a d'Arsonval moving-coil type with an accuracy guaranteed within 2%. The tolerance of each of the resistors as well as the regulation of the transformer must be guaranteed within 5%. Even under extreme circumstances the total circuit error will not be as much as 5% as the tube under test has a relatively high resistance compared to the other circuit constants. With all that, we would feel highly flattered if any commercial tube tester (including this one) could achieve an accuracy of 5% in grading tubes.

The accuracy of line-voltage indication is important and here a time-tested circuit is employed utilizing the 6H6 tube as a rectifier. This special circuit (described in detail in past issues of Radio-Craft) was developed by the writer and to-day is in use in many fine measuring instruments.

Hot interelement short and leakage tests and hot cathode leakage tests are fundamental requirements, yet, most instruments use only the neon lamp indication for both measurements! It is essential to note that interelement leakages—differentiated from cathode leakage—have very high resistance values which necessitate the use of a highly-sensitive neon lamp. However, there is always a permissible limit of cathode leakage which would cause a sensitive neon lamp to glow and erroneously indicate that a good tube should be discarded!

The usual practice, in order to overcome this defect of the "neon test," is to decrease the sensitivity of the lamp indication so as to be safe on cathode leakage indication; but this automatically would show as OK some tubes having troublesome high-resistance interelement leakage!

This fault is overcome by keeping the neon indication highly sensitive and then making an additional cathode leakage meter test; this procedure is considered by the tube manufacturers to be far more desirable.

(2) Protection against obsolescence. Some assurance that the apparatus will not be out-of-date in a short time is essential when considering the construction or purchase of a modern tube tester.

During the past 5 years there has been a great deal of ballyhoo in the claims of tube-tester manufacturers as to their designs providing for future changes and additions. With an occasional exception it was necessary for the manufacturer to bring out one new model, and sometimes two, every year as the previous model would be obsolete. It would not meet all of the requirements that were necessary for properly testing the tubes of the following year.

One of the primary factors is the complete free-point, free-reference of both filament leads to all sockets without being tied into any active circuit bus at the same time. This design as can readily be seen from the wiring diagram enables the complete isolation of the filament supply to any 2 desired terminals of the tube including shell and cap. (There is not my knowledge another tube tester regardless of price that has this feature.)

Furthermore any other individual element can be isolated, as desired, so that it need not be tied to the cathode or plate bus; which is not the case with all other emission-type testers. The flexible plug in connectors A, B, C, etc., provide this unusual and comprehensive protection and are operated the same as the conventional method for toggle switches.

There is provided a spare circuit (see diagram) with full switching capacity as for any present element so that an additional element or a 9-prong tube presents no problem. (No commercial emission tester on the market seemingly has such provision.) Space is also available on the panel for the addition of several new sockets should future tubes require new types of sockets.

(3) Tests all tubes. A good tube tester must be sufficiently comprehensive to test all types of tubes that are now in use including metal, glass, M.G. (metal-glass), obsolete battery and A.C. types, as well as cold-cathode rectifiers. Very few modern testers if any will test cold-cathode

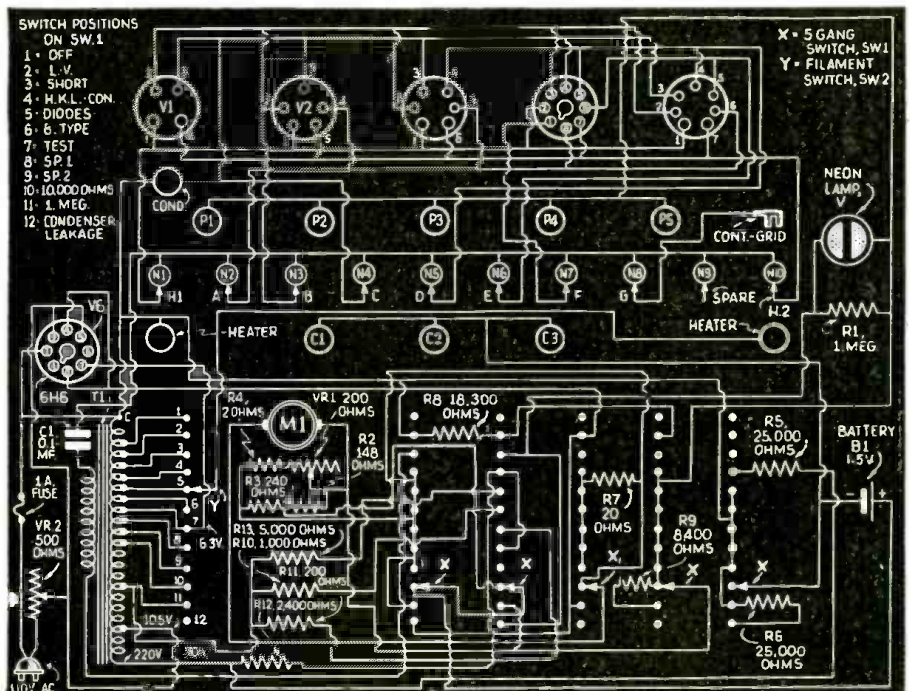

Fig. 1. Schematic diagram of the "optimum-test" tube checker.

Please Say That You Saw It in RADIO-CRAFT

rectifiers although there are a number of these tubes in use.

This design provides suitable voltage and load for proper test of such tubes at position "special No. 1" as seen in the diagram. An additional spare switch position is provided for some future special voltage and load requirement.

"Comprehensiveness" must also include the complete number of tests for properly determining the worth of a tube. This involves the quality emission test and sensitive inter-element leakage indication with a less-sensitive cathode leakage indication. Shorts, opens and loose elements should be readily detected as is easily done with this instrument because of the feature of isolating any element at will.

In addition the instrument also serves as an accurate ohmmeter and capacity meter, and also as a condenser leakage indicator. These extra features have been incorporated because they are so necessary in service work and on the dealer's counter, and involve very little in additional cost and no additional space to the tube tester.

(4) **Optimum-quality parts.** It is just as much of a fallacy to follow the assumption that "the best is cheapest in the long run" as it is to believe that "the cheapest price is the most economical." Here is where the optimum value plays the important role.

Only high-quality parts have been used in this instrument but not necessarily the most expensive ones. Molded wire-wound resistors are used in values below 2,500 ohms, and insulated and molded carbon resistors of ample watts rating are used for high-resistance units. The line-voltage power rheostat, rated to carry 25 W., is of the vitreous enamel type. Panel layout and design is very pleasing; etched to give a 2-color effect. Construction is sturdy so that the instrument should be good for at least 5 years' service if it is not abused.

(5) **Simplicity of operation.** This factor is realized in that there are only 2 selector switches. The operation is similar to the conventional emission-type tester only there are no special sockets or precautions that are necessary with so many other testers.

(6) **Economical in Design.** Economy is veritably the shining light that has automatically resulted from simplicity and efficiency in design. Just think—this unusual tester with its splendid features and high-quality parts can be constructed with little effort and at a cost to the Service Man of only about \$18.

(7) **Ohmmeter Tests.** Resistance-test facilities, with 2 direct-reading ranges, are included. Low range: 0-10,000 ohms, with self-contained 1½ V. flashlight cell. High range, 0-1 meg., self-contained power supply.

(8) **Capacity-meter operation.** Condenser-capacity tests may be made over 2 ranges from approximately 0.001-mf. to 10 mmf.

**LIST OF PARTS**

- One Dependable milliammeter, 0-5 ma., with combination scale dial, M1;
- One Dependable etched and fabricated panel;
- One Dependable special tube-testing transformer, T1;
- One wire-wound shunt rheostat, 200 ohms, VR1;
- One Dependable vitreous enamel rheostat, 25 W., 500 ohms, VR2;
- One Dependable selector switch, 6-pole 12-position, Sw.1;
- One Dependable filament switch, Sw.2;
- Six sockets, V1, V2, V3, V4, V5, V6;
- One insulated, double control-grid cap with lead, C.G.;
- Eleven insulated tip-jacks, Red—P1, P2, P3, P4, P5, CP, Heater-Heater, Black—K1, K2, K3;
- Ten metal shell tip-jacks, N1, N2, N3, N4, N5, N6, N7, N8, N9, N10;
- Ten flexible lead connectors with insulation;
- One line-cord and plug;
- One Westinghouse neon lamp, ¼-W., NI.;
- One socket for neon lamp;
- Three Dependable indicating knobs with insulated tips, H1, A, B, C, D, E, F, G, Spare H2;
- One Dependable round knob;
- One fuse holder and fuse;
- One insulated carbon resistor, ¼-W., 1 meg., R1;
- One molded wire-wound resistor, 1 W., 148 ohms, R2;
- One molded wire-wound resistor, 1 W., 240 ohms, R3;

- One molded wire-wound resistor, 1 W., 2 ohms, R4;
- One molded wire-wound resistor, 1 W., 1,000 ohms, R10;
- One molded wire-wound resistor, 1 W., 200 ohms, R11;
- One molded wire-wound resistor, 1 W., 2,400 ohms, R12;
- One molded wire-wound resistor, 1 W., 5,000 ohms, R13;
- One Dependable wire-wound rheostat, 200 ohms, VR1;
- Two molded carbon resistors, ¼-W., 25,000 ohms, R5, R6;
- One molded carbon resistor, ¼-W., 18,500 ohms, R8;
- On wire-wound resistor, 1 W., 20 ohms, R7;
- One insulated carbon resistor, 1 W., 8,400 ohms, R9;
- One flashlight monocrystal, 1½ V., B1.

This article has been prepared from data supplied by courtesy of Radio City Products Co., Inc.

**WHAT SIZE OSCILLOSCOPE?**

(Continued from page 205)

as compared to the total value and cost of the finished instrument. The same comment in general might be applied to a comparison between the 2-in. screen size and the 3-in. screen size.

**OTHER DIFFERENCES**

Although we have shown by the foregoing that the oscilloscope instrument proper (less tubes) costs nearly the same regardless of tube size, the performance of the several sizes may differ considerably.

**Visibility Factor.** The Visibility Factor may be defined as "the ratio of the smallest-size image useful for practical examination to the largest-size pattern which the area of the screen will permit." A pattern ¼-in. wide by ¼-in. high is considered the smallest useful for examination, while the largest pattern is governed solely by the size of the cathode ray tube screen.

It can be compared to band-spread on a radio receiver which permits micrometer adjustment of frequency for fine tuning. Likewise, the visibility factor determines the extent to which an oscilloscope pattern can be enlarged to allow precise examination of its waveform.

Figures A, B and C (on page 205) give comparative visibility factors for the several tube sizes. It is worthy of note that a "visibility factor" of 75 is obtained with the 3-in. tube, whereas a factor of only about 8 and 23, respectively, are obtainable from the 1- and 2-in. tubes. From an examination of these figures it can be seen that the 3-in. tube benefits greatly by comparison with the smaller sizes.

**Effective Area.** Figure 1 compares the area of the 3 tube sizes. The actual figures of effective area are given, at A, B, and C, page 205. It is well to consider a cathode ray tube screen from the angle of effective usable area, because in this way the true proportions of the image can be anticipated.

**SUMMARY**

It is entirely possible that servicing work in the near future will require more extensive use of full-size oscilloscope equipment. Ultra-modern receivers and the possibility of servicing work to be done on television equipment make it necessary for the wide-awake Service Man to carefully consider the type of cathode ray equipment to be purchased. Using the method outlined in this article to judge tube screen sizes will assist in making this decision.

This article has been prepared from data supplied by courtesy of The Jackson Electrical Instrument Co.

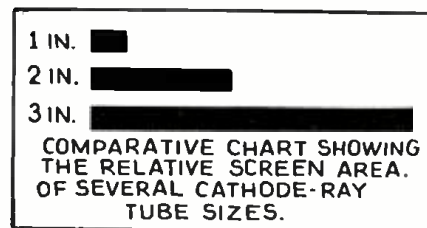

Fig. 1. Comparative C.-R. tube screen areas.

Please Say That You Saw It in RADIO-CRAFT

*Handy...and  
for 1000 Uses*

Size:  
3-1/16" x  
5-7/8" x  
2-3/8"



Completely Insulated

MODEL 666

Dealer Price **\$15.00**

AC - DC

*Pocket Volt-Ohm-Milliammeter*

For laboratory, shop or field use. Handy pocket size yet sturdy and precision built.

Uses Large 3" Sq. Triplet Instrument.

AC-DC Voltage Scales Read: 10-50-250-500-1000-volts at 1000 Ohms per volt.

DC Milliamper Scale Reads: 1-10-50-250.

Ohms Scales Read: Low ½-300; High 250,000.

Black Molded Case and Panel.

Low Loss Selector Switch.

Complete with Alligator Clips, Battery and Test Leads.

**DEALER PRICE . . . . . \$15.00**

A Complete Instrument for all servicing needs. Can be used for all AC-DC voltage, current and resistance analyses.

Leather Carrying Case, Model 669, supplied extra. Of attractive black, heavy leather with finished edges and strap. Dealer

Price . . . . . \$3.00

SEE YOUR JOBBER

WRITE FOR CATALOG

**TRIPL**  
*Precision*  
**ELECTRICAL INSTRUMENTS**

The Triplet Electrical Instrument Co.  
1610 Harmon Ave., Bluffton, Ohio

Without obligation please send me

\_\_\_\_\_ More information on Model 666.

\_\_\_\_\_ I am also interested in \_\_\_\_\_

Name \_\_\_\_\_

Address \_\_\_\_\_

City \_\_\_\_\_ State \_\_\_\_\_



## Quiet Your Razor to Quiet Your Radio!

Filternoys Suppressor F01DH is an approved plug-in device to be attached to any electric razor and plugged into the electric fixture. It takes the noise of an electric razor's motor out of your radio programs.

**CONTINENTAL** Filternoys F01DH, list price \$1.00, offers radio servicemen a handy profitable item to sell on many service calls. Carry a few in your kit. Any **CONTINENTAL CARBON** distributor can supply you.



13914 LORAIN AVE., Cleveland, Ohio  
Also, Toronto, Canada

Makers of Carbon Resistors, Paper Condensers, and Noise Suppression Filters

Enclosed find 10c in coin or stamps for my copy of Handy Pocket Data on Radio Interference Elimination.

Name ..... Address .....

City ..... State .....

## BUILT FOR PERFORMANCE



### TRANSFORMERS FOR EVERY APPLICATION

LABORATORY STANDARD

Portable Broadcast

General Purpose

Replacements

Separate Catalogs Describing The Various Kenyon Lines Of Audio and Power Units Are Obtainable From Your

**KENYON TRANSFORMER CO., Inc.**  
840 Barry St., New York, N. Y.  
Export Dept., 25 Warren St., New York, N. Y.

## NEW SET TESTER FEATURES LOW-OHM SCALE

(Continued from page 205)

2,000-ohm scale, again to take advantage of the very open scale distribution from zero to center scale, with each division representing 1.0 ohm.

These low-resistance readings give very accurate checks of the resistance of transformer filament windings, resin joints, etc.; shorted turns in speaker voice coils; contact resistance on variable-condenser shafts; shorts and grounds in 6-V. genemotor (motor-generator) armatures used on mobile P.A. systems, also armatures of rotary converters, etc.; and many other places in electrical and radio circuits.

It is also interesting to know that the current drain from the battery on the 200-ohm range is very low, in the order of 60 to 70 ma., instead of several hundred milliamperes in the usual circuit. This low current drain is accomplished by a special combination shunt-series circuit of high accuracy, as shown in the schematic diagram of Fig. 1. It requires only a single 1.5-V. battery for operation.

The high-resistance range of this instrument provides for every ordinary contingency; the scales are: 0/2/20 megs. Requisite high voltages are obtained from an internal power pack. The D.C. scales are: 0/1/7/35/140 ma.

(For those technicians who require dimensions, etc., in order to determine whether the equipment will properly match existing apparatus, and so-on, we add the following data:

(The bronze panel assembly is mounted in a quartered oak carrying case with a slip-hinge cover, ample tool compartment and leather handle. Size 7 1/4 x 10 1/2 x 4 1/2 ins. deep. Weight, only 9 lbs., complete.)

For the Service Men who require a high-sensitivity instrument (for laboratory work, etc.) there is available the type 542 set tester. This unit is similar in all respects to the model 541, except that it employs a forged, cobalt-steel magnet, and a dead-beat, microammeter with a sensitivity of 40 microamperes at 25,000 ohms/volt; and will measure current values as low as 40 microamperes.

This article has been prepared from data supplied by courtesy of Supreme Instruments Corp.

## CORRECT PLAYBACK OF SPOT RECORDINGS

(Continued from page 226)

The record's acetate coating is a tough, but only a semi-hard substance, while the pressing is what might safely be said to be flint-hard. The latter is formulated in a press under several tons pressure and is cured by the application of heat, thus producing a very hard, firm, inflexible disc with a highly glossy surface.

With the advent and use of a greater number of instantaneous records, it is essential that the user acquaint himself with, and fully recognize not only the advantages but as well, the special and very necessary requirements for proper playback. We will discuss these in the order of importance, giving in each instance, reasons for construction in the pickup to bring about maximum results both in the matter of quality of reproduction and in the life of the instantaneous record itself.

(1) Freedom of Armature Movement. Of first importance is the freedom of movement of armature of the pickup. Aside from the fact that it should be as small as it is possible to construct and likewise as light in weight, it also must be damped in the very lightest manner. The damping adjustment (point C in Fig. 1A) therefore should permit free sideward movement of the armature and should require only the very slightest pressure on the needle.

As a test, when the finger is applied to the pickup needle, D, the physical movement of the armature should be very easily and readily seen with the naked eye. The armature should be short (as stated above) and under no instances should it exceed in length that of the pickup needle itself. In other words, the damping, using the pivot of the armature as the center of a lever, would resist the side effort in the groove to move the armature between the pole pieces.

## PUT YOUR TEST EQUIPMENT TO BETTER USE! READ

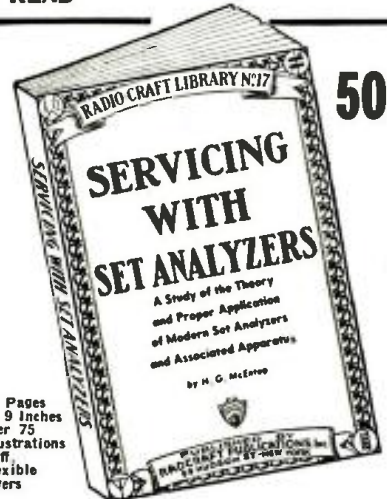

64 Pages  
6 x 9 inches  
Over 75  
Illustrations  
Stiff  
Flexible  
Covers

Become intimate with your set analyzer and other test equipment! Know how they work... how to apply them PROPERLY and quickly... and they will earn more money for you by doing more jobs. Business TURNOVER is the key to successful servicing. There's everything in SERVICING WITH SET ANALYZERS you need to know.

Here Are The Chapter Titles:  
INTRODUCTION—Relationship between Analyzers and Manufacturers—Receiver Specifications—Vacuum Tubes, The Focal Point of Set Analyzing—What Is An Analyzer?—Limitations of the Analyzer in Receiver Servicing.  
FUNDAMENTAL ANALYZER PRINCIPLES—Switches, the Various Types and Their Uses—Meters, the More Commonly Used Types—Elementary Set Analyzer Circuits.  
TROUBLE SHOOTING WITH THE SET ANALYZER—Preliminary Checking—Testing Tubes Under Operating Conditions—Isolating Trouble by the Process of Elimination—Point-to-Point Testing—Checking Individual Components.  
ASSOCIATE TESTING EQUIPMENT—The Vacuum Tube Voltmeter—The Test Oscillator—The Output Meter—The Oscilloscope.  
COMMERCIAL TESTING EQUIPMENT  
THE RMA SOCKET NUMBERING SYSTEM

Send fifty cents in stamps, money order or coin for a copy of SERVICING WITH SET ANALYZERS. It is mailed postpaid upon receipt of your remittance.

**RADCRAFT PUBLICATIONS, Inc.**  
99-R HUDSON STREET NEW YORK, N. Y.

## FACTORY TO YOU

NEW REMINGTON NOISELESS PORTABLE!



**10¢ A DAY**  
Famous Remington Noiseless Portable that speaks in a whisper, only 10c a day, direct from factory. Standard keyboard. Automatic ribbon reverse. Variable line spacer and all the conveniences of the finest portable ever built. PLUS the NOISELESS feature. Act now. Send coupon TODAY for details.

You don't RISK a Penny  
We send you Remington Noiseless Portable for 10 days' free trial. If not satisfied, send it back. We pay all shipping charges.

**FREE Typing Course and Carrying Case**  
You will receive FREE a complete simplified home course in Touch Typing. Also FREE, a handsome, sturdy carrying case. No obligation. Mail coupon for full details—NOW

Remington Rand Inc., Dept. 189-10  
315 Fourth Ave., New York, N. Y.

Tell me, without obligation, how to get a new Remington Noiseless Portable, plus Free Typing Course and Carrying Case, for 10c a day. Send Catalogue.

Name .....  
Address .....  
City ..... State .....

## Vest Pocket Adding Machine

Sturdy Steel Construction. Lifetime Pocket Companion. Adds, Subtracts, Multiplies, Divides. Capacity 999,999.99. A real machine—guaranteed 5 years. Send name and address. We ship immediately on delivery, pay postman \$2.50 (plus few cents post-charge). (Foreign countries send cash.)  
**Free Trial \$2.50**  
Your money back after 10 days trial if not satisfied. Thousands of satisfied users.  
Total Send for Special Offer to agents.  
Send no money.  
TAVELLA SALES CO., 21 West Broadway, New York, N. Y.

**Save Money**  
on everything you buy ...



**The New BARGAIN BULLETIN**  
Your Guide to Hundreds of Outstanding Values.

**FREE** Write today for this outstanding new BARGAIN BULLETIN—there is no obligation on your part. High quality merchandise at sensationally low prices! Radio Sets, Parts, Sporting Goods, Watches, Clocks, Typewriters, Cameras, Novelties and many other items at real savings to you. Fair Dealing—Prompt and Courteous Service, always. Send for your Free BARGAIN BULLETIN now, try us, and be convinced of our superior values and service.

**RADIO CIRCULAR CO., INC.**  
DEPARTMENT RC  
915 Broadway New York, N. Y.

**To Readers of RADIO-CRAFT**  
FREE POSTCARDS MAY BE HAD UPON WRITING TO THE PUBLISHERS

These post cards make it easy to answer advertisements which appear in RADIO-CRAFT, without cutting valuable data which you may wish to save.

Many times manufacturers request you to "clip the coupon" when answering their ads. Often this means destroying part of an article on the reverse page you may need later for reference. Save your RADIO-CRAFT issues complete. If you should ever want to sell bound volumes, or certain copies of RADIO-CRAFT, the resale value of uncut issues is very much higher than that of mutilated ones. So send for a supply of these free post cards and use them in answering all RADIO-CRAFT advertisers.

**WANTED - MEN**

to cast Christmas Goods, 5 and 10c Novelties, Toy Autos, Ashtrays, etc. Can be done in any spare room, basement or garage and no experience necessary. A rare opportunity to devote spare or full time to profitable work. WRITE DEPT. 26.

**METAL CAST PRODUCTS CO.**  
1696 Boston Road New York City

**Learn SOUND RECORDING**  
**TALKING PICTURE PROJECTION**  
**TELEVISION-RADIO**

Master training courses qualify you for good jobs. Practical, easy to learn. Newest equipment. Established 1905. Earn room and board while learning. Coach R. H. fare allowed to 1. A. Write for FREE BOOK. Address Dept. 10-RC, 4000 S. Figueroa St.

**NATIONAL SCHOOLS - Los Angeles**



**"HAM" SPECIAL** Standard Teleplex

A highly efficient code teacher using heavy specially prepared waxed paper tape, having two rows of perforations. Write for Free folder A10. We are the originators of this type instrument.

Instrument with tapes prepared by expert and complete course all for \$11.95. Without cost of shipping, 72-76 Cortlandt St., N. Y. C.

**TELEPLEX CO.**

**COMING SOON!**

New RCA Commercial Sound Catalog. Watch for it!

**COMMERCIAL SOUND**  
RCA Manufacturing Co., Inc., Camden, N. J.  
A Service of the Radio Corporation of America

If the needle were short and the armature long, the damping would have to be lighter and far more delicate than is possible to obtain in a practical assembly, therefore the armature is made shorter from the damper to the pivot than it is from the pivot to the end of the needle. Any pickup with a stiff or over-damped armature will destroy frequencies (on a record) directly in ratio to the excess of damping used.

(2) **Needle Pressure on Disc.** The next point of importance is the matter of weight on the needle which should be in all cases as light as possible—never over 3 ozs., and preferably less. A pickup having a heavily-damped armature of course will require more weight on the needle to make sure that the lateral movement in the groove will actuate the armature before causing the head to jump out of the groove.

(3) **Needle Angularity.** The third point that must be followed for maximum reproduction and life of acetate discs is *needle angularity*. Exhaustive experiments have proven that 30° brings about longer life without affecting reproduction (point E in Fig. 1B).

In the case of certain pickups mounted at an angle of less than 30° to the vertical, a bent needle such as is shown at point G in Fig. 1C is resorted-to in order to correct the angle of the needle at its point of contact with the record.

(4) **Length of Pickup Arm.** The next point of importance is the arm length which should be maximum at all times. Longer arms create less side pressure on the groove, eliminating distortion in the pickup; and, in describing the arc over the record being played, are less liable to side-wall wear because the needle has greater leverage (due to the longer arm) against any friction in the pivot.

Part II will discuss many problems in selecting the correct needle for playback of spot recordings. This article has been prepared from data supplied by courtesy of Universal Microphone Company.

**THE "RESONOSCOPE"**  
**NEW ELECTRONIC DEVICE**  
**DETECTS "OFF-KEY" NOTES**

(Continued from page 200)

chromatic scale are calculated for a true tempered scale, which has the most practical use for all types of tuning. The pitch of the scale is 440 cycles-per-second for A, this being the "International pitch"—musical reference point—for tuning. (This standard of pitch is the one used in the present models of the resonoscope, but any other pitch can be had by substituting a new set of tuning forks.)

**UTILITY**

The resonoscope seems definitely destined to become an indispensable aid to every branch of the musical art, especially so when it is noted that skilled musical instrument tuners will be off at least by 1/3-cycle on their fundamental notes, and more on the higher and lower octaves, in usual ear tuning! While such discrepancies may not be noticed in the individual notes, they produce a general discordant effect which is displeasing to critical musical ears.

The new "electronic robot", on the other hand, permits tuning to within a very minute part of a cycle. Its tuning forks are tuned to an accuracy of 0.002-per cent!

It facilitates the tuning of such musical instruments as pianos, accordion reeds, harmonic reeds, organs, and so-on, not only for fundamental notes but for all octaves. Each instrument of an orchestra or band may be so accurately tuned that an entirely new ensemble effect is obtained. Likewise a singer can determine precise pitch and adjust his or her voice accordingly. In busy broadcasting stations where musicians and artists hurriedly form various groups in various studios, the device is already being used to obtain correct pitch for individual instruments and vocalists, so that no time may be lost.

Because the resonoscope permits the vocalist to actually see just how his or her voice sounds, and to analyze its pitch and quality in the most critical manner, this instrument is being hailed as a great aid in voice culture. The singer can adjust his or her voice, while watching the screen pattern, until it matches that of a great singer who is to be emulated. Because the instrument indicates pitch, character of note and volume, in a visual manner, it becomes the first electronic music master for music lovers everywhere.

**NOW READY**

**THE NEW SYLVANIA CHARACTERISTICS SHEET!**



**Let It Solve Your Tube Characteristics Problems!**

No radio service man should be without this complete tube characteristics chart. It contains the very latest tube characteristics information available—information that can be found nowhere else.

**COVERS MORE THAN 180 TYPES**

The Sylvania Tube Characteristics Sheet suits service men to a "T." It covers more than 180 types . . . tube types are numerically listed . . . characteristics are tabulated . . . all characteristics and base diagrams are arranged on one side of the paper—*instantly available*. Also contains full information on the latest types of glass, metal and "G" tubes. Folds to pocket size—swell for your service kit!

Best of all, it's FREE! Just fill in the coupon below, and send it to us. You'll get your Characteristics Sheet . . . pronto!

**SYLVANIA**  
**SET-TESTED RADIO TUBES**

**HYGRADE SYLVANIA CORP.** HIC 107  
Emporium, Penna.

Please send me a FREE copy of the latest Sylvania Tube Characteristics Sheet.

Name .....

Address .....

City ..... State .....

Dealer  Service Man  
 Amateur  Experimenter

# No. 1 ON THE HIT PARADE



## Meissner TUNING ASSEMBLY

The Meissner All-Wave Tuning Assembly is the entire "front end" of the radio receiver. Each unit is completely wired and accurately balanced and aligned, READY FOR USE. Only six wires to be connected to any 456 kc. I.F. channel.

### FEATURES

1. Meissner Multi-Wave 5-Band Coil assembly; individual coils for each band; Meissner Align-Aire trimmers thru out, six-gang shorting switch; fully shielded.
2. Meissner three-gang tuning condenser; low minimum capacity.
3. Modern 8-in. oval dial; two-speed control; calibrated 5-band scale; scale for Band Spread.
4. Compactly mounted on rigid cadmium-plated steel chassis.
5. All components including all resistors, by-pass condensers, coupling condensers and AVC network.
6. Every unit laboratory tested and completely aligned and padded.
7. Available in two ranges. Model 7512—5 to 555 meters (540 kc.-60 mc.). Model 7511—7.5 to 2140 meters (140 kc.-40 mc.).

List Price  
**\$38<sup>50</sup>**

NOTE: See your dealer or write direct to Dept I for our New 32-page descriptive catalog

# MEISSNER MFG. CO.

## Mt. Carmel Illinois

## LATEST IN TEST APPARATUS FOR THE SERVICE MAN

(Continued from page 217)

brated, direct-reading decibel scale is also incorporated on the scale plate enabling db. readings from -10 to +63 db. in 5 ranges.

The instrument incorporated in this unit has a base sensitivity of 400 microamperes at 100 millivolts and is of the modern, wide-open square type, size 4 x 1 1/2 ins., allowing all scales to be easily read. The A.C. correction scale is printed in red to readily differentiate between A.C. and D.C. voltage readings.

RANGES: A.C. voltage (at 1,000 ohms/volt), 0 10/50/250/1,000/2,500; V. D.C. voltage (at 1,000 ohms/volt), 0/10 50 250/1,000/2,500. V. D.C., 0/10/50/250/1,000 ma. Resistance, 0/400 ohms/1/10 megs. Decibel meter -10 to +63 in 5 ranges of 0/+14/+24/+40/+48 db. Output meter indications.

As noted in Fig. F and circuit diagram, Fig. 2, all A.C. and D.C. voltages (except 2,500 V.), D.C. and resistance measurements are available at only one set of polarized tip-jacks through the use of the master range selector. This rotary range selector permits speedy range change without the necessity of removing and re-inserting test leads.

The Low-Ohms circuit makes use of the Shunt Method (back-up scale) for low-resistance measurements. Referring to the circuit diagram, Fig. 2, it will be noted that when the range selector is rotated to the low-ohms position, a shunt is placed across the meter posts, and at the same time a section of the current-limiting resistor is shorted out, enabling full-scale adjustment to be made through the use of the Adjust Ohms control. The combined resistance value of meter and shunt is exactly 20 ohms. The current drain of the low-ohms circuit is approximately 5 ma. It therefore can readily be seen that any low value of resistance placed across the test tip-jacks of the multimeter, will cause the current flowing through the meter to drop accordingly. An individually-calibrated and direct-reading low-ohms scale is incorporated on the meter scale plate for this low-ohms range. Resistance values as low as 1/2-ohm can readily be measured. The 20-ohms indication is located at the center of this scale.

(Precision Apparatus Corp.)

## FREE!! New 1938 Radio Catalog



Service men—Radio Salesmen and Agents—become a MODEL representative in your community without any investment. Earn up to \$100 a week in commissions selling Nationally Known Radios. Take orders from the largest and most complete catalog ever published, describing and illustrating the following 1938 makes: RCA—Philco—General Electric—Zenith—Motorola—DeLo—Grunow—Crosley—Stromberg—Carlson—Kadette—Emerson—Fada—Halsen—Garod. Join this nation wide organization by writing for particulars. Territory is now being allotted to live wire men who are anxious to earn extra money in their spare time. Write for this big catalog today.

Since 1889  
**Modell's**  
AGENCY DIVISION

Write to Dept. D-5 and mail to address nearest you.  
CHICAGO, ILL. | ATLANTA, GA. | NEW YORK, N.Y.  
56 W. Washington St. | 57 Forsyth St. | 158 Cortlandt St.

## FREE!

### HAMMARLUND 25th YEAR RADIO CATALOG

The most complete catalog ever published with special illustrations, drawings, curves and a complete description of the famous 16 tube "Super-Pro." Write Dept. RC-10-37.

HAMMARLUND MFG. CO., INC.  
424-438 West 33rd Street, New York

QUALITY recommends

# Condensers by SOLAR

WET... DRY  
PAPER  
MICA... TRIMMER



SOLAR MFG. CORP. 595-601 Broadway New York City

## RADIO ENGINEERING

RCA Institutes offer an intensive course of high standard embracing all phases of Radio. Practical training with modern equipment at New York and Chicago schools. Also specialized course, and Home Study Courses under "No obligation" plan. Catalog Dept. RT-37.

**RCA INSTITUTES, Inc.**  
A Radio Corporation of America Service  
75 Varick St., New York 1154 Merchandise Mart, Chicago

## BUSINESS PROBLEMS OF THE SERVICE MAN

(Continued from page 223)

accessories, tubes and whatever else could be sold is limited to those who would actually come down to the service department.

The next point to be covered is, how much is the space worth? If offered the equivalent in cash, would they service the store refrigerator for this amount? The answer was decidedly—NO! The rent was not worth over \$40 a month and upon examination it was determined that they could not afford to tie up one man for that amount.

It readily becomes apparent that "something for nothing is no bargain." Free rent in this case was of no advantage, in fact it becomes a great disadvantage.

The store, of necessity, must be non-competitive, therefore, it does not attract the type of

customer desired by Mr. Jerod and Mr. Holtz.

### A SOLUTION

The better arrangement for Mr. Jerod and Mr. Holtz in the event that they insist on the North-West location, is to obtain the best store available for around \$50 a month. This amount usually is sufficient in smaller towns for a reasonably good location. Then, use about \$750 of their capital for modest store fixtures and for putting in a reasonable stock of tubes, small radio sets, replacement parts, electrical appliances, etc. The balance of their reserve is to be used as a surplus fund for emergencies. If the friends and acquaintances of Mr. Holtz come through as expected their chances of success are indeed promising.

## SERVICE BENCH OF SUCCESSFUL SERVICE MAN

(Continued from page 223)

checker, (3) volt-milliammeter, and (1) signal generator. The tools shown are mounted to hinged doors opening to a cabinet about 3 ins. deep and 18 ins. high, which forms the back of the bench. This cabinet is used to hold condensers, resistors, spools of wire, screws, nuts, bolts, washers, etc. The top of the bench is set off with an aerial made up of about 30 ft. of wire mounted on two stand-off insulators. To this aerial is clipped the antenna leads of the sets being tested or repaired.

The machine to the right of the bench is a small air compressor and tank which is used to blow out the dirt from condenser plates, speakers and the house sets. (There are other pieces of equipment, not shown, such as bench drill, lathe, emery wheels and portable drills.)

Directly under the antenna is the rack for spare tubes used for testing. The center of the back of the bench is built up from the Confidence

tube, vibrator and condenser checker. Under this is a panel composed of jacks, which are connected to all instruments, and these, with the use of short wires and plugs as jumpers, will make most any test necessary.

The 2 meters to the left of the center are in the 6 V. D.C. circuit, one a voltmeter, the other an ammeter, showing current consumed by a given set while being tested. The meters to the right are first an A.C.-D.C. meter and second, an ohmmeter. Beneath these meters are 6 small lamps which are pilot lights, one of which lights with any equipment being used.

This prevents the soldering iron or tube checker from being left turned on when not in use. Also to the left-center is a neon lamp which can be plugged in any circuit for continuity or short tests. The two lower openings contain slides on which are mounted punches and chisels and socket wrenches of all sizes.

Please Say That You Saw It in RADIO-CRAFT



## THE RADIO MONTH IN REVIEW

(Continued from page 199)

month, and heard in part over long distances, had much to do with the confusion attending the search for the lost Amelia Earhart, and caused reports to be sent in by listeners on short waves that they had heard signals of distress from the missing flyers. It is difficult to imagine any precaution which could guard against such a misunderstanding, unless such interpretative programs are to be delayed until the excitement of the search has died down.

### ANNING S. PRALL, HEAD OF F.C.C., DEAD

CHAIRMAN Anning S. Prall of the Federal Communications Commission died at his summer home, Boothbay Harbor, Maine, last month, at the age of 66 years. In memoriam, practically every radio broadcast station in the United States and its territories, at the suggestion of the National Association of Broadcasters observed a 1-minute quiet period, on noon, Monday, July 26. Mr. Prall was appointed a member of the Radio Commission in 1934 by President Roosevelt. After the Radio Commission was merged with the Federal Communications Commission, Mr. Prall was made Chairman of the Radio Division of the Commission.



ANNING S. PRALL

### THE LATEST RADIO EQUIPMENT

(Continued from page 239)

has added to his new line of condensers a series of 21 replacement units. Capacities range from 1/2-mf. to 65 mf. Representative styles are shown in the illustration on page 239.

### HOW DEPENDABLE ARE YOUR METER READINGS?

(Continued from page 237)

Figure 2, on pg. 213, includes illustrations of important elements in meter construction, which the Service Man may be interested to note, as to a limited extent, they are self-explanatory. However, the detailed analysis of these elements (Figs. H to O, inclusive) constitutes important, basic knowledge which every technician should possess. This information, and considerably more, will appear in Part II of this useful article.

Read Part II of this article; it will discuss Inherent Meter Accuracy (or inaccuracy). The author of this vital article is also author of "Radio Physics Course," "Modern Radio Servicing," and "Radio Field Service Data"—all of them valuable contributions to the field of literature for the practicing radio Service Man.

**FREE**

**RADIO TRAINING!**

**SLASH COSTS  
EARN MORE  
SAVE TIME**



See your parts distributor or write us about the new C-B free instruction course.

## DEMAND CLOUGH-BRENGLE QUALITY

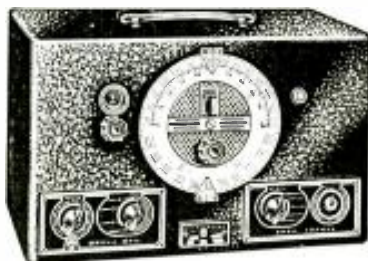

Model 110 Signal Generator

Finest engineering—Best materials—Fault free. For I F and RF alignment. Also 400 cycle audio amplifier test. Model 110 **\$13.50**  
\$5.00 down, 10 months to pay.



Model 120 Super Analyzer

Sensitivity; 20,000 Ohms per Volt. Makes all voltage, current and resistance measurements for analyzing receivers, amplifiers, etc. Model 120 **\$13.50**  
\$5.00 down, 10 months to pay.

Look  
Inside—  
Then  
Decide

Send for Catalog or see your parts dealer

The CLOUGH-BRENGLE CO.

2809 W. 19th St., Chicago, Ill.

## ABC OF MODERN VIBRATOR SERVICING

(Continued from page 220)

### PURPOSE OF THE BUFFER CONDENSERS

Not shown in the drawings, but an important part of the vibrator function, are the 2 small *buffer condensers* which are either incorporated as a part of the vibrator or incorporated in the power pack of the complete unit.

These condensers form a very useful service in limiting and suppressing the arc across the contacts due to the making and breaking of the current on the primary side. These condensers are placed in the secondary instead of the primary circuit since although the voltage must be very much higher, the capacity can be very much lower as their action is reflected in the primary circuit.

The capacity of this condenser whether incorporated as an integral part of the vibrator, or in the power pack proper, should never be changed as the *entire vibrator has been designed for this particular capacity.*

In the preliminary check of the vibrator and the power pack, much guess work can be eliminated by knowing the circuit and understanding a few of the troubles, such as the following, which can occur to vibrators and their power packs.

### NO "B" VOLTAGE

Shorted filter systems, shorted huffer condensers, grounded filter systems, shorted transformers, shorted wiring or shorted rectifier tubes may cause no "B" voltage. Also, no battery voltage may be delivered to the vibrator, which can be caused by a blown fuse, a burned-out switch, a broken "A" lead or any one of the numerous other suggestions which will come to mind.

After the cause for the absence of "B" voltage has been discovered, correct same and proceed to test the vibrator in a good vibrator tester, as a shorted filter system and other shorts, such as huffer condensers, rectifier tube, transformer secondaries, etc., can damage the vibrator by overloading the contacts. It might be stated here

that rarely, if ever, do the power transformers give trouble.

### LOW "B" VOLTAGES

If the "B"-battery voltages are low, the battery voltage must be checked, as well as the resistance of all leads from the battery to the vibrator.

Check for high-resistance shorts in the rectifier circuit. Check the rectifier tube and buffer condensers for worth, and for troubles which cause low voltage in the usual home-radio set. The vibrator should then be checked in a vibrator checker.

### HASH

Hash is a problem of circuit design, shielding—both magnetic and electrostatic, proper radio-frequency filtering, proper ground, mechanical arrangement of the receiver, and the sensitiveness of the receiver. Engineers have taken care of the hash problem in the design of the receivers and if hash is present it should be traced to its source. Do not attempt to eliminate hash by "doctoring" the vibrator. In severe cases, manufacturers of the vibrators do furnish hash eliminators.

### INTERMITTENT OPERATION

Intermittent operation can be caused by defective vibrators due to sticking contacts, loose connections in the power pack and other symptoms the same as in a conventional A.C. receiver. Eliminate these by checking the vibrator in a vibrator checker.

### OTHER VIBRATOR TROUBLES

Vibrators with unusual mechanical noise are caused by the vibrator touching other parts of the housing, the internal assembly, or by loose parts which vibrate with the operation of the vibrator.

(Continued on page 255)

Please Say That You Saw It in RADIO-CRAFT

## "AIR-TRACK" SYSTEM OF BLIND LANDING

(Continued from page 202)



### Triumph 1", 2", and 3" OSCILLOGRAPH WOBBLATORS

Buy your oscillograph and wobbulator together! Only with this combination can you accomplish true visual alignment of r-f, i-f, a-fc, and a-v-c circuits. Model 77, 1" Oscillograph Wobb. \$49.95. Model 77, 2" Oscillograph Wobb. \$59.95. Model 180-800, 3" Oscillograph Wobbulator with built-in signal generator \$100.00.

#### TRIUMPH MFG. CO.

4021 W. Lake St. Chicago, Ill.  
Please send Triumph catalogs

Name ..... Address .....  
City ..... State .....

### TALK-BAK\*

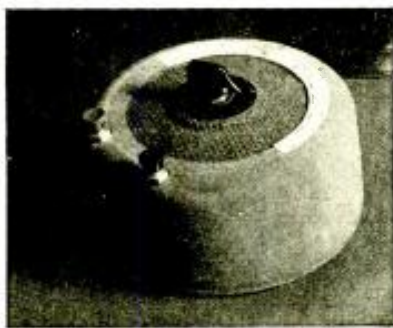

Model TRU 1700  
Size—6 1/2" diameter, 3" high

#### Lasting Wear, Perfect Operation, Attractive Appearance

The most complete, best-looking Talk-Bak\* Unit manufactured. A steel cabinet with a taupé suede finish so soft as to protect the finest furniture.

### FREE New Technical and Sales Pamphlet

gives complete information regarding all known inter-communication systems. Method of connecting different Talk-Bak\* Units and full detail information on what they will accomplish. Write for it and be sure to include your distributor's name.

Wright-DeCoster Distributors are always anxious to cooperate.

#### WRIGHT-DECOSTER, Inc.

2251 University Ave., St. Paul, Minnesota  
Export Dept.—M. Simons & Son Co., New York  
Cable Address: "Simonrice."

Canadian Representatives:  
Wm. F. Kelly Co., 1207 Bay St., Toronto, Ontario  
Taylor & Pearson, Ltd., Edmonton, Alberta

\*Copyrighted

Six important improvements have been incorporated in the Air-Track. Foremost among these are the facts that (1) the equipment has been so simplified and the design made so compact, that it is portable, making it possible to land a pilot in to a safe landing from either end of any runway on the field; (2) the radio signals, at first liable to deviation and instability, have been made reliable, and a monitoring system installed which indicates to the operator whether accurate signals are being broadcast; (3) both the localizer and the glide path are quickly adjustable and, (4) the equipment required in the plane has been made lighter and more efficient.

The principles embodied in this system were originally worked out by an Aeronautics Research Division established by the Department of Commerce at the Bureau of Standards. A number of the radio scientists who developed the system at the Bureau have been at work in a laboratory at College Park Airport near Washington developing the system from its early experimental stages to the point where it is now practical for air transport. Three years of such development and improvement work have resulted in hundreds of successful landings "under the hood" and landings in fog conditions which interrupted scheduled flying.

Three experimental installations of this curved beam type of landing system have been tested by Department of Commerce pilots, airline pilots and others. These are at College Park, Newark airport, and the municipal airport at Oakland, California. In all, upwards of 1,000 safe instrument landings have been made on these installations.

#### ELEMENTS OF THE AIR-TRACK SYSTEM

Briefly, the Air-Track system consists of two radio beams: (1) a runway localizer which lies down the center of the runway to be used, and (2) a curved glide path which leads the plane down a sloping "track" to a gentle landing on the runway. A single "cross-pointer" instrument (2 D.C. meter movements, one operating horizontally and the other vertically, mounted in one case) on the panel (see Fig. A) indicates the plane's position, the vertical needle pointing to the right or left if the plane veers from the center of the runway localizer, and the horizontal needle rising or falling if the plane gets above or below the proper glide path.

At a distance of 10 or 15 miles from the airport (see Fig. B), the pilot picks up the runway localizer signal through his regular communications receiver, over which he still receives voice communication, perhaps from the operator in the airport control tower. Linking up his flight along this localizer, which can be made as wide or as narrow as comfortable flying dictates, he approaches the curved beam down which he will glide to the runway. (The receiver for this glide path is adjusted to the best "gliding angle" of that type of plane.)

Having reached this point, the pilot flies his plane so that the 2 needles cross at right-angles, and this indicates that he is approaching over the exact center of the runway and coming down at the proper, safe gliding angle.

At the edge of the field a marker beacon gives him a signal in his earphones which tells him he is crossing the edge of the field. At this time he is approximately 20 to 30 feet above the runway, and the balance of the landing consists merely of leveling off and letting the plane settle.

Hundreds of times, planes with landing speeds as high as 75 miles an hour have been brought down to a spot on the field a few yards square! James L. Kinney, Department of Commerce pilot, as far back as 1933, took off from Washington under the hood (that is, he could not see outside the plane, had only his instruments to guide him, and hence was flying "blind"), flew by instrument to Newark airport, and landed by instrument on the experimental installation of this system, on a day when scheduled air transport planes were grounded by impossible flying weather.

Transmitting equipment is housed in an ordinary automobile trailer which is quickly movable to concrete platforms at either end of any runway, where the wheels fit into slots to insure proper location of the apparatus. The transmitters are plugged in to a power outlet and the control tower attendant throws a switch which puts them into operation.

#### USEFULNESS OF "AIR-TRACK" AT CROWDED AIRPORTS

Usefulness of the apparatus for control of traffic at crowded airports has been stressed by pilots who have flown the system. Airline officials, have pointed out that if all landings of air transport planes were made on this system, even in fine weather, a pilot would never make an unusual landing, no matter what the weather might be.

Despite the thoughtful and serious work of airline operations managers and traffic managers in "staggering" schedules to avoid simultaneous arrival of several airliners at one airport at the same time, the airports at large municipalities are already dangerously crowded at certain times. At one airport today, there are 18 transport planes arriving within the space of an hour. Increasing patronage will only aggravate this problem, and bad weather complicates it to the point of deadly hazard.

It is as if the engineers of a large number of trains were instructed to choose their own track and bring their trains in to a huge station with only the admonition to "be careful and not run into other trains." The airline pilot has two-way voice communication with the airport control tower, and receives all the information available, but he does not have a definite "track" or path to follow which will keep him clear of other approaching aircraft.

A correct blind landing system may have a number of duplicate "tracks", properly identified, just as are the tracks in a railroad yard, and the approaching pilot's orders will indicate the track he is to use. Eventually, these engineers believe, the "switches" may be set for the approaching pilot, and his plane may be taken over by radio when he is distant from the field, and brought in mechanically to a full instrument landing. This dream is not very nebulous, even today.

#### COMPARISON OF VARIOUS BLIND-LANDING SYSTEMS

There are no "preceding types" of landing systems prior to the Air-Track. It is based definitely upon the original experiments at the Bureau of Standards, which began in 1927 and 1928. An Aeronautical Development Section of the Department of Commerce, Aeronautics Branch, conducted those experiments, and carried them up through various stages of development to the demonstrations held at Newark in 1933.

As for other landing systems (Most of these systems have been described in past issues of Radio-Craft.—Editor), this is the story. In 1931 or 1932, visitors from Germany were shown the Bureau's developments and after their return to Germany the Lorenz system appeared. This is a refinement and development of one of the phases of the Bureau development.

At Newark, the Bureau installation was fixed in position, giving indication in only one direction. The Lorenz system today is also fixed in one position. If it is desired to give landing guidance on more than one runway, or in more than one direction, the installation must be duplicated. This means that under certain conditions, the pilot will be coming in to land over the antenna structure and transmitter houses. These form a positive obstacle, much disliked by pilots. There is also the consideration of the added expense necessary to duplicate these transmitters and antenna arrays and structures.

The Lorenz system also uses a European type of indication, with a kicking needle indicating off-course position. This is strange to American pilot practice and preference, and it requires an appreciable time for interpretation. There is no time available for interpretation in the job of blind landing.

The Lorenz system holds to the fundamental principles of the Bureau system, i.e. the "curved beam", localizer and marker beacons. It gives the pilot an indication of his position throughout the approach and landing. However, it is not all contained on the airport, and it has not been developed as far as Air-Track.

The success of the Bureau demonstrations at Newark prompted the duplication of the system at Oakland airport in California. Here, United Airlines, later joined by TWA and American Airlines, and still later by Bendix, have continued

(Continued on page 255)

GET THIS *new* BOOK—  
**FREE!**

Every Radio Man Can Use  
It to Advantage!



THE Editors of RADIO-CRAFT have prepared a special book for you. The new book—1937 RADIO REFERENCE ANNUAL—is not for sale, but available only to subscribers, both new and old, with a Seven Months' Subscription to RADIO-CRAFT. The price of this Special Offer is only One Dollar (\$1.00)—and as an additional saving the book is mailed to you postpaid as well as is the magazine each month. Carefully outlined below is the contents of this new book; it contains information which every radio man needs. The book contains 64 pages, size 6 x 9, and is replete with illustrations.

Read these Interesting Chapter Headings of  
**1937 RADIO REFERENCE ANNUAL**

**Receiver Construction**

Building a 12-tube All-Wave DX receiver—How to make a modern 6-tube Car Radio set—building up a 2-tube Bekinner's Set, with several different power supplies for various uses—Constructing a 2-tube midset set for portable use—How to build a "talking" briefcase—no aerial or ground needed.

**Test Equipment—Construction**

How to make an "Electronic Eye" output meter—How to construct an ultra-compact universal Volt-Ohm-Milliammeter—How to make a Resistance-Capacity tester—How to build a Pocket Adapter for set testing—Building a Portable Capacity bridge—Construction of a V.T. Voltmeter in compact form—How to Make a Modern Set Analyzer.

**Audio and P. A. Equipment**

Making an Audio Bass Booster, using direct coupling—How to build and add a Dual-Channel Amplifier to your receiver—Constructing a High-Fidelity Amplifier—Construction of a 3-tube A.C.-operated Preamplifier—Fundamentals of "Decibel Level" and "Decibel Gain."

**Articles for the Service Man**

Servicing with the Oscilloscope—Servicing with a Single Meter—"What's Wrong With Your Radio" chart—Tapers of Volume Controls, and use of various types—Ideas for the Service Shop—Aligning All-Wave receivers.

**Time and Money-Saving Kinks**

In this section you profit by the experience of other radio men. These kinks are really valuable "short-cuts" which save much time and, very often, money. They are "pet" ideas put into practice.

**Important Articles Which Have Appeared in  
RADIO-CRAFT**

**General Interest Articles**

Design of Transformers for Class "AB" and "B" operation—A table of Inter-Electrode Capacities for 30 different tube types—How to make a Floating-Grid Relay—Construction of a modern Treasure Locator—How to get DX on your All-Wave Radio—Making a 5-meter Transceiver for use in car or boat.

**New Tubes Developed in 1936**

Characteristics of the Newest Rectifying Tubes of all manufacturers, giving uses, characteristics, present equivalents (if any) and all pertinent data.

**RADIO-CRAFT**

99 Hudson Street New York, N. Y.

RADIO-CRAFT, 99 Hudson St., New York, N. Y.

Gentlemen: Enclosed you will find my remittance of One Dollar (\$1.00) for which enter my subscription to RADIO-CRAFT Magazine for Seven Months. Send me ABSOLUTELY FREE, and POSTPAID, my copy of 1937 RADIO REFERENCE ANNUAL.

Name .....

Address .....

City .. State ..  
(Send remittance by check or money order. Register your letter if you send cash or unused U. S. Postage Stamps.)

**NEW INSTRUMENT SPEEDS  
FREE-POINT TESTING**

(Continued from page 225)

means of determining circuit conditions accurately since no current is drawn from the circuit under test. Current ranges on present-day testers have been used rather infrequently because of the time and trouble required in making a series connection in the circuit.

**THE "CURRENT MEASUREMENT" SYSTEM  
OF TESTING**

One of the most difficult parts of a radio set to test and one that has become the bug-a-boo for Service Men is the A.V.C. and Q.A.V.C. circuits. Most voltmeters placed across these circuits, in order to make a voltage measurement, draw current from them and more or less upset the high-resistance networks present. The purpose of these circuits is to control the current in the tubes to which they connect. A current measurement is logical therefore, since it does not upset the A.V.C. and Q.A.V.C. networks whatsoever.

By (1) using an oscillator input at the antenna posts of the receiver, (2) plugging this new instrument into the sockets of the tubes controlled by the A.V.C. and Q.A.V.C. and (3) varying the signal strength put out by the oscillator, the plate current variation will give an absolute indication of the condition of the A.V.C. or Q.A.V.C. system.

This method can be used for testing diode 2nd-detector circuits no matter how complicated the resistance networks connected to the diode may be. Fixed minimum bias, A.F.C. or any other similar circuit may be tested by this method of current testing also. Service Men who do not have an oscillator can make these tests by tuning on and off a powerful local station. In the audio end of the set, grid bias may be checked very accurately by taking plate current readings. An overloaded condition of the rectifier tube can be checked easily by the current method for the power pack circuit need not be considered. As an example, it is the usual thing to check rectifier overload conditions by voltmeter readings from chassis to rectifier filament or cathode but this does not necessarily give a correct indication for it does not take into consideration whether the negative lead from the power transformer goes directly to chassis or through a filter or resistor network before connecting to the chassis. This especially applies in A.C.-D.C. sets.

A couple of examples where current readings come in handy are first, where an audio bias resistor has been so badly burned up that its resistance value can no longer be read. A quick estimate using Ohm's Law will give the approximate value but only by taking current readings of the tube controlled by this bias resistor is it possible to be sure that the resistor value is correct. Another example is in replacing a volume control in an orphan set. By taking current readings of the tube controlled it is possible to check very quickly whether or not the taper of the new control is correct.

To sum up, by the use of the current method of making tests, analyses of radio receiver faults are very much simplified. By use of this instrument current readings can be taken simply and without the cutting or unsoldering of wires. (Incidentally, this device also may be used in taking the "usual" tests such as voltage and resistance.)

Our Information Bureau will gladly supply manufacturers' names and addresses of any items mentioned in RADIO-CRAFT. Please enclose a stamped and self-addressed envelope.

**OPERATING NOTES**

(Continued from page 227)

eral small holes are provided in the top of the container to act as safety valves. In case this action takes place. This small leakage does not affect the efficiency or change the value of the condenser in any way.

STROMBERG-CARLSON SOLDER NUGGETS

Fada KA and U. S. Radio Model 10. Gassy 27s cause trouble in different sets in different ways. In a Fada KA, 2 of these tubes in the A.F. stage caused very poor quality of reproduction. In a U. S. Radio model 10, a gassy 27 in the 1st audio stage may cause a "jumpy" volume control.

PAUL WELAND

Please Say That You Saw It in RADIO-CRAFT

*the New*  
**LAFAYETTE**  
**CO-ORDINATED**  
**SOUND SYSTEMS**



The LAFAYETTE line, one of the oldest, most complete lines in the industry, has always meant progress . . . but never so much as in these NEW 1938 models. New colors . . . stream-lined designs . . . lightweight, sturdy, non-corrosive steel cabinets . . . special illuminated control dials . . . here are sales features that make for EASY SELLING.

**LAFAYETTE** for a wider margin of profit  
byword of satisfied users

**EASY TIME PAYMENT PLAN**

NOW . . . LAFAYETTE'S Easy Payment Plan, tailored to the needs of your business, will help you finance the "big" jobs.



HERE IT IS! **FREE!**

The Biggest Radio Catalog

over assembled! 180 pages, with large separate P.A. section, 50,000 parts, 50 LAFAYETTE Radio models, test equipment . . . and all at lowest prices in history.

**DID YOU JOIN** the \$1,000.00 free prize contest? Details will be found on page one of this big FREE RADIO CATALOG. Get your share of the prizes.

**WHOLESALE RADIO SERVICE CO., INC.**

NEW YORK, N. Y. CHICAGO, ILL. ATLANTA, GA.  
100 SIXTH AVENUE 901 W. JACKSON BLVD. 430 W. PRITCHETT ST., N. W.

BOSTON, MASS. BRONX, N. Y.

NEWARK, N. J. JAMAICA, L. I.

**WHOLESALE RADIO SERVICE CO., INC.**  
100 Sixth Avenue New York, N. Y.

Rush FREE 1938 catalog No. 69-3KA

NAME .....

ADDRESS .....

CITY .. STATE ..

One of Radio's Prominent Manufacturer's  
Writes

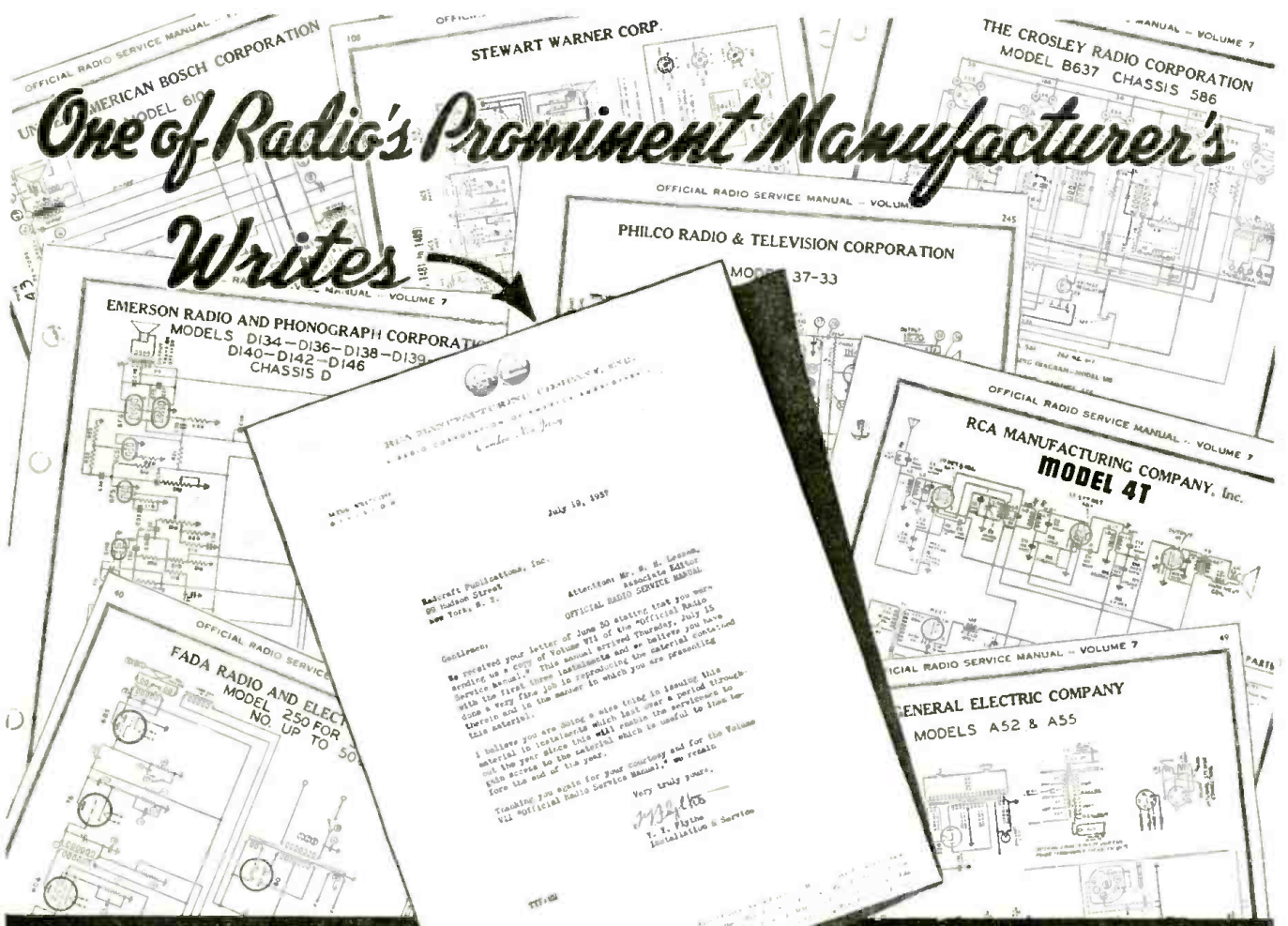

**150 PAGES... OF VOLUME 7  
TO THE OFFICIAL RADIO SERVICE MANUAL  
ARE MAILED TO SUBSCRIBERS EACH MONTH**



THIS MANUAL  
WILL CONTAIN  
**OVER  
1,800  
PAGES**

Compare other service manuals with the *new* GERNSBACK OFFICIAL RADIO SERVICE MANUAL (Volume 7) as it is published today. You'll find the GERNSBACK MANUAL, by far more complete in service information—more up-to-the-minute with present-day receiver diagrams—and published entirely differently than in previous years.

Most important of many innovations are the month-to-month installment method of publishing Volume 7—and the deferred payment plan which makes it convenient for every Service Man to own radio's *greatest of service manuals*.

Write today for descriptive literature which gives complete information about Volume 7 of the OFFICIAL RADIO SERVICE MANUAL—and the plan which tells how to pay-as-you-compile your Manual. *Mail the coupon below—TODAY!*

**RADCRAFT PUBLICATIONS, Inc., 99 Hudson Street, NEW YORK, N. Y.**

**RADCRAFT PUBLICATIONS, Inc.  
99 Hudson Street, New York, N. Y.**

RC-1037

Gentlemen: Please send me descriptive literature on Volume 7 of the GERNSBACK OFFICIAL RADIO SERVICE MANUAL—and details for buying this edition on the deferred payment plan.

Name .....

Address .....

City ..... State .....

Please Say That You Saw It in RADIO-CRAFT

## HOW TO MAKE A CLASS A1 PUSH-PULL NEGATIVE-FEEDBACK 60-W. AMPLIFIER

(Continued from page 215)

stages, more adequate filtering is therefore necessary in the filter network of this transformer. The output of the 5Z3 employs condenser input, whereas, P.T.1 employs the choke input method of filtering the rectifier system. Filtering of P.T.1 only need be sufficient to supply "B" voltage for the plates of the 6L6s; regulation should therefore be better.

Sockets for the 6L6s and the 6F6s should have high heat resistance insulation such as, isolantite. Great care should be exercised in the wiring of the plate and screen-grid supply of the 6L6s. A heavier than usual or "normal" type of insulation should be used to prevent possible arc-over between leads.

### LIST OF PARTS

Two I.R.C. resistors, 3,000 ohms, 2 W., R1, R2;  
Two I.R.C. resistors, 0.15-meg., 1 W., R3, R4;  
One Centralab dual volume control, 0.25-meg., R5, R6;  
Two I.R.C. resistors, 2,500 ohms, 2 W., R7, R8;  
Two I.R.C. resistors, 500 ohms, 1 W., R9, R10;  
Two I.R.C. resistors, 10,000 ohms, 1 W., R11, R12;  
Two I.R.C. resistors, 5,000 ohms, 1 W., R13, R14;  
Two I.R.C. resistors, 15,000 ohms, 1 W., R15, R16;  
Two I.R.C. resistors, 10,000 ohms, 1 W., R17, R18;  
Two I.R.C. resistors, 50,000 ohms, 1 W., R19, R20;  
Two I.R.C. resistors, 0.15-meg., 1 W., R21, R22;  
Four I.R.C. resistors, 0.1-meg., 1 W., R23, R24, R25, R26;  
One Electrad resistor, 10,000 ohms, 50 W., R27;

One Electrad resistor, 100 ohms, 25 W., R28;  
One Electrad resistor, 15,000 ohms, 50 W., R29;  
One Electrad resistor, 150 ohms, 25 W., R30;  
Six Hammarlund 8-prong isolantite sockets;  
Two Hammarlund 4-prong isolantite sockets;  
One Hammarlund 7-prong isolantite socket;  
\*One 7-prong special shielded plug and cable;  
One Kenyon transformer, type T255, T1;  
One Kenyon transformer, type T271, T2;  
One Kenyon transformer, type T319, T3;  
One Kenyon power transformer, type T215, T4;  
One Kenyon power transformer, type T216, T5;  
One Kenyon choke, type T166, Ch.1;  
Two Kenyon chokes, type T152, Ch.2, Ch.3;  
Four Cornell-Dubilier condensers, type ED3-100, 10 mf., 50 V., C1, C2, C5, C6;  
Ten Cornell-Dubilier condensers, type DT-6P1, 0.1-mf., 600 V., C3, C4, C7, C8, C11, C12, C15, C16, C19, C20;  
Four Cornell-Dubilier condensers, 0.02-mf., 600 V., C9, C10, C13, C14;  
Two Cornell-Dubilier condensers, 0.05-mf., 600 V., C17, C18;  
Three Cornell-Dubilier dual condensers, type PEB-6\*08, 8 mf., 600 V., C21, C22, C23, C24, C25, C26;  
One Cornell-Dubilier dual condenser, type JR-216, 16 mf., 200 V., C27, C28;  
Two Sylvania type 6C8 glass tubes;  
Two Sylvania type 6F6 glass tubes;  
Two Sylvania type 6L6 glass tubes;  
One Sylvania type 83 glass tube;  
One Sylvania type 5Z3 glass tube.

\*Names of manufacturers will be supplied upon receipt of a stamped and self-addressed envelope.

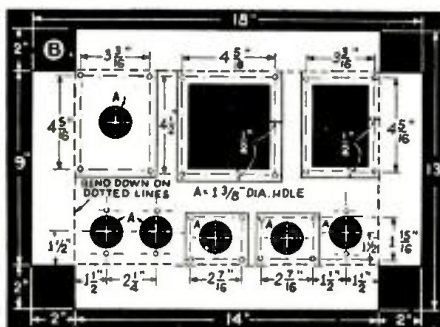
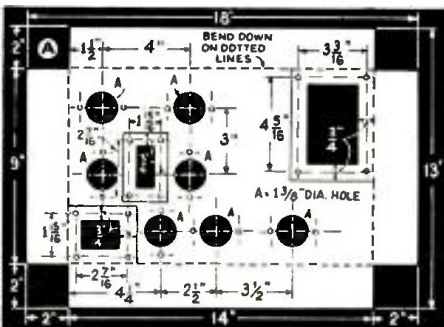

Exact physical specifications for making the amplifier (left) and power pack chassis.

## BUSINESS-LIKE "SILENT" SERVICING

(Continued from page 209)

perform every essential test required on a modern radio receiver.

The technique of using these instruments is fundamentally simple. With the speaker voice coil open and preferable a dummy load resistance equal to the speaker impedance substituted for the voice coil, a Service Man may first make a voltage analysis of the receiver using a modern 20,000 ohms/volt instrument.

Assuming that the power is properly distributed, he next attaches the vertical plates of the oscilloscope to the diode load resistor in the 2nd-detector circuit. With the signal generator feeding through the frequency wobbler in the oscilloscope and then to the control-grid of the last I.F. tube, that stage can be aligned as indicated by the resonance curve on the oscilloscope. Each preceding stage can easily be adjusted to the same frequency.

Without mechanically "rocking" the condenser, the oscillator or mixer padder can be tracked at 600 kc. or any other frequency designated in the instructions for the particular receiver. It is then quite simple to align the R.F. circuit at the high-frequency end of the dial. If the set has A.F.C., it is only necessary to change one connection of the oscilloscope from the top of the diode load resistor to the cathode of the A.F.C. diode.

Audio circuits, even with phase inverting

stages and tone compensation can be quickly analyzed with the oscilloscope across the output circuit and the audio modulation from the signal generator supplying the steady sine wave. Regeneration, phase distortion, overload, hum, or "hash" from the power pack, all may be easily identified on the oscilloscope pattern. Throughout all of these tests, not a sound is heard from the speaker!

### PSYCHOLOGICAL VALUE OF "SILENT SERVICING"

To the customer who wants to see this work done, this procedure is as marvelous as a major operation in a surgeon's clinic. The Service Man has no need to fear that the customer will learn the tricks of the trade because the instruments alone are more expensive than most radio sets and the technique is quite beyond comprehension.

Like the surgeon, the Service Man may charge a rate commensurate with his work. The flashy instruments serve as indication that his work is truly above the screwdriver mechanic's class. "Silent servicing" has raised the work of Radio Service Men to professional levels; which means a decent living from a heretofore much abused and underpaid occupation. Furthermore the customer is assured of a first-class repair job.

This article has been prepared from data supplied by courtesy of Triumph Mfg. Co.

Please Say That You Saw It in RADIO-CRAFT

## The Best "BUYS" Are Made for Cash!\*



\* By "CASH" we mean your jobber's regular terms.

During the years when "sinking-or-swimming" was an everyday problem, a lot of business men, pressed for cash, got into "no investment" merchandise deals. One by one, most of them have fought their way back to sound business principles. And only by buying the finest quality merchandise at lowest possible cash prices have they been able to prosper.

In the tube field, RAYTHEON offers the highest quality tube made—at cash\* prices that save money for dealers every time they buy RAYTHEONS! That is why RAYTHEON business has more than tripled in the last two years... why RAYTHEON dealers are prosperous business men! Ask your RAYTHEON jobber.



445 LAKE SHORE DRIVE, CHICAGO, ILL.  
555 HOWARD STREET, SAN FRANCISCO, CAL.  
420 LEXINGTON AVENUE, NEW YORK, N. Y.  
55 CHAPEL STREET, NEWTON, MASS.  
415 PEACHTREE STREET, N. E., ATLANTA, GA.

**NEW** A COMPLETE ADVANCED DESIGN LINE OF **MICRO-BEAM POWER AMPLIFIERS** NOW AVAILABLE FOR ALL P. A. APPLICATIONS

ENGINEERED BY **A. C. SHANEY**  
**GUARANTEED FOR FIVE YEARS**  
**FULL-TIME DAY FREE TRIAL**



Write For Complete Details and Attractive Proposition  
**AMPLIFIER COMPANY of AMERICA**  
 35-45 WEST 20TH STREET NEW YORK CITY NEW YORK

**NEW 10 CENTS**  
 "how-to-make-it" PUBLICATIONS for Experimenters



WE list below a large number of radio, short-wave, and mechanical "how-to-make-it" designs. Each is a special publication originated by masters in their respective fields. For the first time, at the low price of TEN CENTS, you are now enabled to buy a complete design with photographic reproductions, complete mechanical layout, and full description to make it possible for anyone to build the project in question.

The name of "Radio Publications" has become a household word because this company has for many years specialized in radio and other literature of special interest to the experimenter. PLEASE ORDER EACH PROJECT BY ITS PUBLICATION NUMBER, and use the special coupon below. We accept money-orders, cash, checks or new U. S. stamps. (No foreign stamps or currency can be accepted.) If you send cash or stamps, register your letter to safeguard against loss. Money refunded if you are not satisfied!

**ANY TWELVE PUBLICATIONS FOR ONE DOLLAR**

**PARTIAL LIST OF NEW 10 CENT PUBLICATIONS**

**SHORT-WAVE RECEIVER PUBLICATIONS**

- HOW TO MAKE THE 2 TO 5 METER TWO-TUBE LOUD-SPEAKER SET. This receiver may be used with batteries or with an A.C. power pack. Packs a big wallop... No. 107
- HOW TO BUILD THE CIGAR-BOX 1-TUBE "CATCH ALL" RECEIVER. An effective short-wave battery set which fits into a small cigar-box, assuring high portability and great efficiency... No. 111
- HOW TO BUILD THE PORTABLE MINIOYNE SHORT-WAVE BATTERY SET. Uses no aerial, no ground. The total weight is 3 1/2 lbs. and measures 5x5x6 inches. Self-contained batteries, tube, condensers, and loop. Highly sensitive circuit... No. 114
- HOW TO BUILD THE HAM-BAND "PEE-WEE" 2-TUBER. A dandy receiver with high efficiency and handsread tuning. Works a loudspeaker, yet the entire receiver is no larger than your hand. Works with either batteries or an A.C. power pack... No. 118
- HOW TO BUILD THE DUO-AMPLIDYNE. The ideal 1-tube set for the beginner. One of the finest 1-tube sets; it really gives 2-tube performance. Made for battery operation. With only ten-foot antenna brings in the good European stations... No. 116

**RADIO BROADCAST RECEIVER AND SPECIAL RADIO PUBLICATIONS**

- HOW TO BUILD A SUPER-SENSITIVE ALL-WAVE CRYSTAL SET. Just the thing for beginners who wish to have an easy-to-operate crystal set on all-waves and which will separate all the stations. Can be made for less than \$2.00. Uses no tubes or batteries... No. 121
- HOW TO BUILD THE 2-TUBE "PENTODE PORTABLE" BROADCAST SET. The lightest, smallest set giving loud-speaker volume on batteries. Weighs less than 12 pounds. Built in a small, portable case... No. 122
- HOW TO BUILD THE RADIO "TREASURE" FINDER. This is a really sensitive and practical "Treasure" No. 126
- HOW TO BUILD THE GERNSBACK ONE-TUBE PENTODE LOUD-SPEAKER SET. It works on batteries, and is for broadcast reception. Extremely sensitive... No. 124
- HOW TO BUILD THE WORLD'S SMALLEST ONE TUBE BATTERY RADIO. So small that it is actually built in a cigarette case. The wonder set of the last New York radio show... No. 125
- HOW TO BUILD A PEE-WEE AUTOMOBILE. An ultra-small automobile that can be built for less than 10 dollars. Will carry two 17-year-old boys. Runs 35 miles per hour and 100 to 125 miles on one gallon of gas... No. 132
- HOW TO MAKE A BAND SAW FROM OLD AUTO PARTS. Made from old Ford and Chevrolet parts. Capable of performing delicate and satisfactory work. Uses 25-ounce 10 and 12-inch band saw. Assembly is easy for each part fits its allotted place perfectly... No. 135
- HOW TO BUILD A REAL LATHE FOR \$5.00. Requires a few hand tools, about \$5.00 worth of raw material and patience to build. The lathe is capable of drilling, milling, trimming, boring and thread cutting... No. 136
- HOW TO BUILD A SIMPLE PORTABLE REFRIGERATOR. A real refrigerator. Does not use ice. The cooling unit operates from an alcohol flame, oil burner or open fire. Easy and inexpensive to build. Excellent for boats, camps, picnics, etc... No. 138
- HOW TO BUILD LARGE TESLA AND OUDIN COILS GIVING 18-INCH SPARKS. Interesting high-frequency apparatus with which many experiments and x-ray experiments can be performed. Capable of producing 15,000 volts... No. 141
- HOW TO MAKE AN ARC WELDER. A real arc welder capable of doing commercial jobs satisfactorily. Uses a heavy duty transformer which operates from the 110-volt A.C. main. The output of the machine ranges from 15 to 100 amperes... No. 142
- HOW TO USE AN A.C. ARC WELDER. Companion publication to the one listed directly before. Very informative; especially to the garage man or mechanic who has had little or no experience with an arc welder. Contains many important diagrams and photographs of actual work done with an arc welder... No. 143
- HOW TO MAKE YOUR OWN MICROSCOPE. A microscope which the home mechanic can easily build in his shop. The lenses are obtained from the finders of a camera. Although simple and easy to build, it is a thoroughly practical and efficient instrument... No. 144
- HOW TO MAKE A WIMSHURST ELECTROSTATIC MACHINE. An easily constructed generator of static electricity capable of discharging a fat three-inch spark. Used in schools where electricity is taught. Can be built for less than \$2.00... No. 145
- HOW TO MAKE A POWER DRILL PRESS FROM SCRAP PARTS. An excellent practical drill press that will make work easier for the mechanic. About \$2.00 worth of raw material and scrap iron are the only requirements... No. 146
- HOW TO MAKE AND EXPERIMENT WITH AN ELECTROPHORUS. With this device numerous interesting experiments with static electricity can be performed. Many of these experiments are thoroughly explained and illustrated... No. 148
- HOW TO MAKE AN ARC WELDER FROM AN AUTOMOBILE GENERATOR... No. 149

**NEW "RESOLUTION TESTER" FOR CATHODE-RAY TUBES**

(Continued from page 201)

for television reception) images quite frequently appeared to be entirely out of focus. All previous efforts to correct this misbehavior were fruitless! Exhaustive tests revealed that nothing was wrong with the "electron optics" of the cathode-ray tubes.

Finally, they hit upon the basic trouble. Those spots of light, or picture elements, which "build" the television image did not assume the circular form they had presumed, but were partly of streamline shape.

But how to verify this was the problem. To understand the difficulties involved one must consider that it takes only (see note) 1/13,230-second to "paint" one line of a television image over the full width of a fluorescent screen, and every line consists of thousands of closely arranged light dots each with a diameter of approximately 1/50,000-in.!

Mr. Burnett solved the problem in a very ingenious manner. He omitted 2/3 of the light dots by sending "blocking" impulses into the tube. The main trick to produce the patterns was done by sending 2, 5 or even 10 frequencies varying between 30 cycles and 2,000 megacycles into the tube. Since a constantly changing mixture of frequencies between 30 cycles and 3,000 megacycles (as used in actual television transmission) produces complicated images with a wealth of little details, one will readily understand that a cathode-ray tube must produce specific patterns when specified frequencies are sent into the terminals.

The main difficulties to be conquered did not lay in the actual production of the patterns shown on this page, but rather in the problem to design a master oscillator which was able to produce exactly all the specific frequencies desired, and a great number of them at one time.

How the master oscillator of this system looks is shown in Fig. A. In short it is a nice, but complicated, piece of test equipment, but as mentioned before, it is merely the initial nucleus of the instruments which the Service Man of the future who intends to do television work will require.

Note—This addition to the tools of the electronic specialist is a most important one. Regardless of whether a television program is "on the air," transmitting and receiving equipment may now be tested by means of the "synthetic" video program afforded by this resolution tester. The one here illustrated was designed several years ago; when 343-line fidelity was being employed. It is described on the basis of operation "on the air" at approximately this image-line frequency; that is, with a resolution-meter frequency of 336 lines or 10,080 c.p.s. (The frequency of 13,230 c.p.s. mentioned by the author is apparently based on 441-line operation for which the resolution meter has not as yet been redesigned. In general, however, the actual points discussed are relatively similar.)

Although, as the author states, up to 10 frequencies, constituting in the aggregate a complex "A.C. voltage mesh" which appears on the end of the cathode-ray tube as an intricate frequency pattern, may be used the practical application of the resolution meter does not require such an extensive design. The more complex mosaic is of use mostly for demonstration purposes; for ordinary, practical work it usually is sufficient to utilize only a 2 megacycle frequency, its 3rd-harmonic of about 6 megacycles and a frequency of about 700 kc. The pattern thus produced is a checkerboard.

Editor

(Continued on page 255)

**RADIO PUBLICATIONS 99A HUDSON STREET NEW YORK, N. Y.**

**RADIO PUBLICATIONS, 99A Hudson Street, New York, N. Y. RC-1037**

I enclose \$..... for the publications listed by number, at right, at 10c a copy (ONE DOLLAR FOR ANY TWELVE PUBLICATIONS.) These publications are to be sent to me postpaid. I have placed a circle around each number which I want.

Send me also your list of 27 other 10c publications.

Name .....	Address .....	107	111	114	115	116
City .....	State .....	121	122	123	124	125
		126	127	128	129	132
		135	136	138	141	142
		143	144	145	146	148
						149

**"R.-C." STAFF CHANGE**

Bert Nussbaum, formerly Assistant Advertising Manager of Radio-Craft magazine, has joined the staff of Reiss Advertising (agency). His former associates on "R.-C." feel sure that the ability he exhibited during his tenure of almost 8 yrs. will be a valuable contribution to his new position.

## G.E. PHONOGRAPH MOTOR

Formerly Sold for \$15.00



Only \$4.95

**VARIABLE speed induction type self-starting, 110 volt, 25 to 60 cycle, AC, with speed control. Plug and cord. Speed range from 5 to 240 R.P.M. Can be installed in place of old-fashioned, hand-winding speed motor. (Outside Diam. 11". Height 4 1/2". Shaft 1/2". (Diam. 1/4").**

G.E. Electric Phonograph motor as described ..... **\$4.95**  
Shipping Weight—12 lbs.

## WESTINGHOUSE UNIVERSAL MOTOR

**\$2.55** 110 Volts AC and DC

Shipping Weight 9 lbs.



Specifications: 1/30 H.P., operates on either A.C. or D.C., 110 volts, 5000 R.P.M. Rheostat can be used to vary speed. Height 3 1/4". Length, 3 3/4". Width 1 1/4". Shaft 1/2" and 1/4" inch long. Can be used to drive Sewing Machines, Models, Buffing Lathes, Polishing Head, Drills, Grindstones, etc., etc.

MOTOR only ..... **\$2.55**  
MOTOR with Arbor and 1/2" Chuck ..... **\$3.55**

Add 25c for special packing and mailing anywhere in U. S. A.

## MICROPHONE and RECEIVER

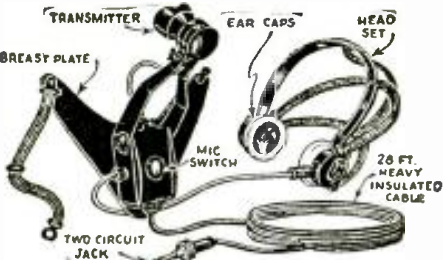

**THIS** Microphone and telephone headset outfit was built especially for the U. S. Navy Aviation Corps.

The outfit consists of a low-impedance carbon microphone (transmitter) securely fastened to a metal breast-plate, and a set of heavy-duty, low-impedance earphones. A specially constructed switch on the back of the breast-plate controls the microphone circuit. The earphones are U. S. N. "Utah" type, attached to adjustable headband.

Twenty-eight feet of very heavy weather and waterproof conductor cable is furnished. Current of not more than 10 volts should be used. A storage battery is the most satisfactory current supply.

U. S. Navy Airplane-type Microphone and Receiver as described ..... **\$4.98**  
The shipping weight is 9 lbs.

## WESTINGHOUSE POWER GENERATOR

Manufactured for U. S. Signal Corps  
A.C. Electrical 200 Watt 110V. AC Power

from a Windmill, from available Waterpower, from your Automobile, from your Motorcycle, from your Bicycle, Foot-pedals or Handcrank for portable Radio Transmitters, Street or Floodlights, Advertising Signs; do you want to operate AC Radio sets from 32 V. DC farm light systems; operate two generators in series to get 200 V. AC; obtain two phase and three phase AC, etc., etc. 1/4 to 1/2 H.P. needed to run generator.

There Are Over 25 Applications, such as: A.C. Dynamo light from eight to ten 20 Watt 110 Volt lamps. Short Wave Transmitter supplying 110 Volts A.C. for operating "Ham" transmitter. Operating 110 V. AC 60 Cycle Radio Receiver in DC districts. Motor Generator, Public Address Systems. Electric sirens on motor boats, yachts, etc. Camp Lighting, etc., etc. Blue-Print 22 x 28 in. and Four-Page 8 1/2 x 12 in. Instruction Sheets. Generator, as described including four replacement carbon brushes ..... **\$7.90**  
Shipping weight 18 lbs.

All merchandise in original packages—never used. Money-back guarantee.

We will forward Shipments by Express Collect if sufficient postage is not included.

## WELLWORTH TRADING CO.

560 W. Washington Blvd., Dept. RC-1037, Chicago, Ill.

## IMPORTANCE OF MODERN TEST EQUIPMENT

(Continued from page 207)

audible range. This type of equipment will allow the Service Man to check the response characteristics of the receiver from the antenna terminal to the input of the loudspeaker, giving indications of the quality which may be expected.

New opportunities are periodically being presented to the Service Man due to the fact that developments are continuously being made, and the public is becoming more aware of what it may expect in the way of radio reception. At the present time the set owner is beginning to realize that much of the radio interference which he was formerly led to believe was a necessary evil may be mitigated or entirely eliminated by filtering apparatus which causes radio noise. The Service Man who has made some study of this type of man-made static is in a good position to pick up much profitable business.

Public-address systems have long been more or less neglected by the average Service Man as an added source of income. A thorough acquaintance with the circuits commonly employed as well as the ordinary troubles encountered in this type of apparatus is well worthwhile.

### THE ABC OF A RESONANCE CURVE

To return to the cathode-ray oscilloscope as a means of obtaining a visualization of the resonance curve, it might be of interest to show the manner in which a curve is actually traced on the screen. In order to obtain such a curve it is necessary to have a frequency-modulated signal generator.

Frequency modulation of a signal generator as opposed to ordinary amplitude modulation, where the amplitude of the radio frequency output of the signal generator varies at an audible (say 400 cycle) rate, consists of varying the frequency of the signal produced by the signal generator at a given rate, usually 60 cycles. It should be noted that in frequency modulation the amplitude of the signal does not vary with time but the frequency does. Curve B of Fig. 1 shows the manner in which the frequency produced by the signal generator varies over a complete cycle of its frequency range.

The mode in which the radio receiver responds to a frequency modulated signal must be thoroughly understood. Assume for example that an unmodulated, single-frequency signal were fed into the input of the receiver. When the receiver is tuned to this frequency the R.F. amplifier and I.F. amplifier, if the receiver has one, will amplify this un-modulated single frequency and a voltage will be built up across the diode detector circuit which is proportional to the amplitude or intensity of the input signal. However, if frequencies other than the frequency to which the set was tuned were fed into the receiver, the voltage developed in the diode detector circuit would be smaller in value because of the selectivity of the receiver. The sharper the receiver the more variation in voltage developed in the diode circuit between the resonant frequency and other frequencies higher and lower than the resonant frequency. Curve C of Fig. 1 shows the magnitude of the voltage in the diode circuit as the frequency varies about the frequency to which the set is tuned, which is indicated by point O on the curve.

It will be noted that the frequency modulation of the signal generator as indicated by curve B varies about a mid-point to 15 kc. higher and 15 kc. lower than the middle frequency. For instance, if the mid-frequency is 600 kc., the frequency produced by the frequency-modulated signal generator will vary from 585 kc. to 615 kc., a range of 15 kc. either side of the mid-frequency.

If a connection is made so that the voltage in the diode circuit is fed to the vertical deflecting plates of the oscilloscope and the beam is swept horizontally back and forth across the screen at the same rate as the frequency modulation (which in this case is 60 cycles) then a resonance curve may be depicted on the cathode-ray screen. The 60-cycle sweep voltage is shown in curve A of Fig. 1. In order that the pattern on the screen of the cathode-ray oscilloscope will be stationary, the resonance curve must be plotted by the inertialess cathode-ray beam over and over again, falling in the same position on the screen for each successive cycle. Curve D

(Continued on following page)

## The LAST WORD in PERFORMANCE . . . .

The Last Word in Long Life!

MODEL 321

TUBE TESTER MULTITESTER

**\$49.50**



Whatever you pay for a tube tester-multi-tester, you can't duplicate comprehensiveness, engineering, performance, of Radio City's new Model 321. Consider these features:

Tube tester provides most modern R.M.A. load, separate function, open, short, leakage tests. Absolutely free reference to full floating filaments. Hum and noise tests. Double fuse protection for meter and tester.

Multitester tests condenser leakage, opens and shorts, electrolytic paper, mica types. 5 range AC voltmeter 9-5-25-125-500-1250. 5 range DC voltmeter—0-5-25-125-500-1250. 5 range ohmmeter—low 1/20th ohm to high 30 meg-ohms. Current—6 ranges—low 10 microamps, high 25 amps for vibrator testing. D.B. measurements from down 15 to up 40. 5 output ranges. Protected against burn out—and obsolescence.

## A TUBE TESTER

Set Tester combination that can't get out of date

MODEL 306

**\$21.95**



The most flexible instrument of its kind ever produced. Tests all glass and metal tubes now in use, has spare capacity for future new types. Tests each section of Multi-Purpose Tubes and individual plates of all rectifiers. Double test of hot cathode leakage by neon lamp as well as by meter. 250,000 ohms leakage sensitivity. Tests cold cathode rectifiers which cannot be tested on many higher priced checkers. Full floating filaments. In addition to all these features, measures resistance, capacity and condenser leakage. Attractive design—sturdy construction. Guaranteed for 5 years against getting out of date.

Also available in kit form \$17.95

See your jobber. Write to Dept. C for Catalog

## RADIO CITY PRODUCTS CO.

88 PARK PLACE NEW YORK CITY

"DEPEND ON DEPENDABLE"

Hot off the press!



Ghirardi's POCKET TROUBLE SHOOTERS

SPEED UP YOUR SERVICE WORK with these amazing wonder work like gadgets. Just the flip of a card and you get the test and remedy for any trouble in any receiver. One Gadget for HOME, one for AUTO radios—each one spots over 400 troubles with lightning speed. The handiest, simplest, quickest service aid you ever saw. 178 A DOLLAR TO THIS AD AND MAIL AT ONCE TO DEPT. RC-107.

Send in Your FOR \$1 BOTH GADGETS—MONEY-BACK GUARANTEE I (51.20 foreign)

RADIO & TECHNICAL PUBL. CO. 45 Astor Place, New York

# STANCOR TRANSFORMERS

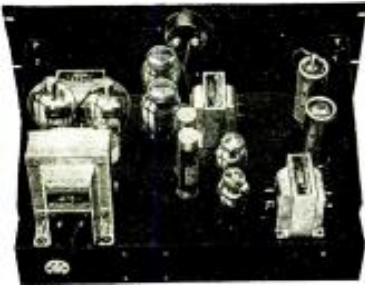

FOR THIS **\$12<sup>21</sup>**  
100 WATT  
MODULATOR

THIS inexpensive but efficient modulator delivers 100 clean watts of audio with 800 volts on the plates of the modulator tubes. Built on standard Relay Rack and Panel.

TUBES: 6C6 Pre-amplifier; 76 voltage amplifier; Push-Pull 76's; 6A3 Drivers; TZ-20 Class B Modulators.

STANCOR TRANSFORMERS: Push-Pull Input, XA4206; Push-Pull Interstage, XA4208; Push-Pull Driver, XA4212; Output, XA2908.

FREE BLUEPRINT AND LAYOUT TEMPLATE

STANDARD  
TRANSFORMER  
CORPORATION  
850 BLACKHAWK ST., CHICAGO

New! **CATALOG OF AMPLIFIERS**

All types, embodying latest principles of design and construction. Superior quality. Many new features and advantages. Superb values, remarkably low-priced. Used by leading P.A. Men. Write for free catalog now! **AMPLITONE PRODUCTS CO., 135 Liberty St. N.Y.**

**AMPLITONE**

LE'S **Correspondence Courses in RADIO and ELECTRICAL ENGINEERING**

**ELECTRICAL ENGINEERING** Get good grasp of electrical field. Prepare yourself at Low Cost, for wide future. Modern, simplified, you can understand quickly.

**RADIO ENGINEERING** Extra fine course in radio, public address, photo-electric work. Trains you to be super-service man, real vacuum tube technician. Exper. kits furnished. Diploma on completion. Tuition, \$25, either course. Deferred payment plan.

**FREE** Get copies of school catalogs, student magazines, complete details. **SEND NOW!**

**LINCOLN ENGINEERING SCHOOL, Box 931-43, LINCOLN, NEBR.**

**R M C RELAYS**

Sensitive D.C. type for general use including P.E. Cell work, signal and alarm circuits, etc. Pure silver contacts. 1 ampere rating. Operates on 3 to 4 M.A. horizontal or 6 M.A. vertical. Standard resistance 1000 ohms—other values available.

Dealer Net Price... **\$2.85** Postpaid  
25% Deposit Required on C.O.D. Shipments

**REGAL MANUFACTURING CO.**  
1406 S. Grand Ave. Los Angeles, Calif.

**RADIO CHASSIS CRADLE**

For more profitable and quicker servicing, testing and repairing of receivers or amplifiers, every radio service shop needs the **RADIO GIMBAL** (chassis cradle). Equipment clamps to cradle which can be adjusted to any desired angle. Conveniently accommodates any chassis up to 13 x 21 inches. Excellent for displaying receivers to customers.

Write for illustrated circular RC7  
**WM. A. THOMAS CO. 321 CAROLINE ST., NEENAH, WISCONSIN**

(Continued from preceding page)

represents the picture which actually appears on the screen under the above conditions.

### HOW A CYCLE "PAINTS" ITS IMAGE

The intersection of horizontal lines drawn through points of curve C representing various points in the cycle, with vertical lines drawn through the corresponding points of curve A, determine the pattern which is traced on the screen of the 'scope during a complete cycle.

The reader can readily follow these points as they are numbered consecutively. For instance, at point O the moving spot is in the center of the screen as regards its horizontal position; at this same instant of time the frequency-modulated signal generator is producing the frequency to which the set is tuned so that the response of the set (applied to the vertical deflecting plates) is a maximum. At point I on curve A the spot has moved slightly to the right as regards to its horizontal position. At this instant of time the frequency produced by the signal generator is slightly higher than the frequency to which the set is tuned and the response is correspondingly lower. The remainder of the picture traced on the screen may be understood by following the consecutive points indicated on the drawing.

### THE "SERVICE TECHNICIAN"

The Service Man is becoming more and more, as the years go on, a technician. In the successful pursuit of his work he must have a fundamental understanding of the various principles underlying each and every individual circuit which goes to make up the radio receiver. These circuits, when individually analyzed, are not extremely difficult. However, they do require a thorough understanding of the operation of each of the component parts entering into the circuit. Not only must the Service Man have a good physical picture of circuit operation, but he must also be thoroughly acquainted with the various types of test equipment which he uses in analyzing receiver faults. He must know the applicability and limitations of this equipment and, as a consequence, he must understand the principles on which it operates.

The standards for efficient Service Men are being constantly raised. Their professional services should demand increased remuneration. Radio service racketeers are finding that it is becoming increasingly difficult to hoodwink the public. Probably the day will arrive when no Service Man not having a diploma from a creditable school will be allowed to practice.

### SERVICING QUESTIONS AND ANSWERS

(Continued from page 227)

your 4-tube set, the plate voltage is generally much higher, and this is responsible for the resistor on the primary side of the No. 255 audio transformer burning out.

You ask what the correct voltage should be on the plate-return of the 1st audio stage. It is advisable to "juggle" the voltages from 45 to 135 in order to determine the best results.

Remove the 3-to-1 audio transformer and reconnect the Silver-Marshall No. 255 unit, for since you only burned-out the primary resistor, it is merely necessary to replace this resistor with one having a value of 0.2-meg. See Fig. Q27. It is not necessary to open the transformer, to get at the resistor; merely shunt this resistor across taps 1 and 2, and this unit will be as good as new.

### LOUD HUM AND WEAK SIGNALS

(28) Floyd Coomber, Walworth, N. Y.

(Q.) I have an RCA model 4-17-M set. It has a loud hum and only faint reception of the nearby, powerful, local stations. Tubes were checked and found to be OK.

(A.) The reason for a loud hum and only faint reception of nearby local stations of your RCA model 4-17-M 4-tube receiver is due to the filter condensers capacities being below their designated rating. The only remedy is to replace these filter condensers, and in doing so, make sure that the correct polarity of the replacement condensers is maintained. Voltages will read from 60 to 100 V. on all sockets.

# GERNSBACK OFFICIAL RADIO SERVICE MANUALS AND HANDIBOOK

ARE AVAILABLE AT

★ **JOBBERS**  
★ **DISTRIBUTORS**  
★ **MAIL ORDER  
HOUSES**

Here they are:

**1936 Official Radio Service Manual**  
1,200 PAGES • OVER 2,500 ILLUSTRATIONS  
Looseleaf Binder—Stiff, Hard Covers  
Size 9 x 12 Inches • Price \$7.00

**1935 Official Radio Service Manual**  
OVER 1,000 PAGES • OVER 3,000 ILLUSTRATIONS  
Looseleaf Binder—Flexible, Leatherette Covers  
Size 9 x 12 Inches • Price \$7.00

**1934 Official Radio Service Manual**  
OVER 400 PAGES • OVER 2,000 ILLUSTRATIONS  
Looseleaf Binder—Flexible, Leatherette Covers  
Size 9 x 12 Inches • Price \$3.50

**1933 Official Radio Service Manual**  
OVER 700 PAGES • OVER 2,000 ILLUSTRATIONS  
Looseleaf Binder—Flexible, Leatherette Covers  
Size 9 x 12 Inches • Price \$5.00

**1932 Official Radio Service Manual**  
OVER 1,000 PAGES • OVER 2,000 ILLUSTRATIONS  
Looseleaf Binder, Flexible Covers  
Size 9 x 12 Inches • Price \$5.00

**1931 Official Radio Service Manual**  
OVER 650 PAGES (Including Supplements)  
OVER 1,500 ILLUSTRATIONS  
Looseleaf Binder—Flexible, Leatherette Covers  
Size 9 x 12 Inches • Price \$4.50

**1935 Official Auto-Radio Service Manual**  
OVER 240 PAGES • OVER 500 ILLUSTRATIONS  
Looseleaf Binder—Flexible, Leatherette Covers  
Size 9 x 12 Inches • Price \$2.50

**1933 Official Auto-Radio Service Manual**  
OVER 250 PAGES • OVER 500 ILLUSTRATIONS  
Looseleaf Binder—Flexible, Leatherette Covers  
Size 9 x 12 Inches • Price \$2.50

**Official Radio Service Handbook**  
OVER 1,000 PAGES • OVER 1,000 ILLUSTRATIONS  
Beautiful Linen, Gold-Stamped Cover  
Size 6 x 9 Inches • Price \$4.00

If your jobber or mail order house cannot supply you, order any of the **OFFICIAL RADIO SERVICE MANUALS** or the **OFFICIAL RADIO SERVICE HANDBOOK** from the publishers. Send your remittance in form of check or money order—or, if you send cash or unused U. S. Postage Stamps, be sure to register your letter. **ALL ORDERS ARE FILLED PROMPTLY. BOOKS ARE SENT TO YOU POSTAGE PREPAID.** Address Dept. RC-1037.

**RADCRAFT PUBLICATIONS, INC.**  
99 Hudson Street, New York, N. Y.

Please Say That You Saw It in RADIO-CRAFT



# NEW "RESOLUTION TESTER" FOR CATHODE-RAY TUBES

(Continued from page 252)

**TABLE I**  
**HOW THE PATTERNS OF FIG. 8**  
**WERE OBTAINED**

No. 1—Deflection: Vertically, 30 c.p.s. sawtooth; horizontally, 10,080 c.p.s. sawtooth. Grid: 1. 30 c.p.s. square-wave, negative portion the width of the vertical-deflection return-line time; 2. 10,080 c.p.s. square-wave, negative portion the width of the horizontal-deflection return-line time; 3. 2,222,640 c.p.s. sine-wave; 4. 740,880 c.p.s. sine-wave; 5. 246,960 c.p.s. square-wave; 6. 70,560 c.p.s. square-wave; 7. 1,260 c.p.s. square-wave; 8. 180 c.p.s. square-wave.

No. 2—Deflection: Vertically, 30 c.p.s. sawtooth; horizontally, 10,080 c.p.s. sawtooth. Grid: 1. 30 c.p.s. square-wave, negative portion the width of vertical deflection return-line time; 2. 10,080 c.p.s. square-wave, negative portion the width of horizontal-deflection return-line time; 3. 740,880 c.p.s. sine-wave; 4. 246,960 c.p.s. square-wave; 5. 1,260 c.p.s. square-wave.

No. 3—Deflection: Vertically, 30 c.p.s. sawtooth; horizontally, 3,780 c.p.s. sine-wave plus small component of 1,260 c.p.s. Grid: 1. 30 c.p.s. square-wave, negative portion the width of the vertical-deflection return-line time; 2. 70,560 c.p.s. square-wave.

No. 4—Deflection: Vertically, 30 c.p.s. sawtooth; horizontally, 3,780 c.p.s. sine-wave plus small components of 1,260 c.p.s. and 180 c.p.s. Phase of horizontal deflection is changed from that in No. 3. Grid: 1. 30 c.p.s. square-wave, negative portion the width of the vertical-deflection return-line time; 2. 70,560 c.p.s. square-wave.

No. 5—Deflection: Vertically, 30 c.p.s. sawtooth; horizontally, 3,780 c.p.s. sine-wave plus small components of 1,260 c.p.s. and 180 c.p.s. Phase is shifted slightly from No. 4. Grid: 1. 30 c.p.s. square-wave, negative portion the width of the vertical-deflection return-line time; 2. 3,780 c.p.s. sine-wave; 3. 70,560 c.p.s. square-wave.

No. 6—Deflection: Vertically, 30 c.p.s. sawtooth; horizontally, 3,780 c.p.s. sine-wave plus small components of 1,260 c.p.s. and 180 c.p.s. Phase is shifted slightly from No. 4. Grid: 1. 30 c.p.s. square-wave, negative portion and width of the vertical-deflection return-line time; 2. 3,780 c.p.s. sine-wave; 3. 70,560 c.p.s. square-wave.

No. 7—Deflection: Vertically, 30 c.p.s. sawtooth; horizontally, 3,780 c.p.s. sine-wave plus small components of 1,260 c.p.s. and 180 c.p.s. Phase is shifted some from No. 4, is almost same as that for No. 5. Grid: 1. 30 c.p.s. square-wave, negative portion the width of the vertical-deflection return-line time; 2. 70,560 c.p.s. square-wave; 3. 246,960 c.p.s. square-wave.

No. 8—Deflection: Vertically 30 c.p.s. sawtooth; horizontally 3,780 c.p.s. sine-wave plus small components of 1,260 c.p.s. and 180 c.p.s. Phase is shifted considerably from No. 4. Grid: 1. 30 c.p.s. square-wave, negative portion the width of the vertical-deflection return-line time; 2. 70,560 c.p.s. square-wave; 3. 246,960 c.p.s. square-wave.

Note—All patterns were made on a 9-in. cathode-ray tube using full magnetic deflection and a second-anode potential of 6,000 volts. All frequencies are synchronized.

## ABC OF MODERN VIBRATOR SERVICING

(Continued from page 247)

A vibrator tester's primary purpose is to detect defective vibrators which will no longer function or operate properly with their associated circuits. The Triplett Laboratory in working out the design of their Vibrator Tester Model 1670, secured a number of vibrators in various stages of deterioration and worked closely with the manufacturers of vibrators so a tester could be designed which would enable Service Men to make every needed test.

In the analysis of vibrator trouble, it was found that defective vibrators had two distinct characteristics.

- (1) The vibrators would fail to start properly on very low voltage such as 5.5 V. on a 6-V. battery.
- (2) The vibrators would operate unevenly, thus causing a variation in the output voltage.

### REQUISITE TEST FACILITIES

In the design of the Triplett tester, these facts were carefully taken into consideration and the unit was designed to:

- (1) Accurately measure the input voltage.
- (2) Control the input voltage to the vibrator.
- (3) Accurately measure the output of the vibrator on a GOOD-BAD scale.
- (4) Accurately check the regularity of the vibrator on the meter.
- (5) Check the output voltage in per cent with an increase, of the input voltage, of 0.5-V.
- (6) Place a 5,000-ohm load across the filtering system so the vibrator would work into the approximate load it works into in normal operation. This was found to give a vibrator test approximating the actual condition under which the vibrator would operate.

The tester has been designed for extreme simplicity using a minimum number of sockets and a rotary switch to select the proper circuits for the vibrators under test. A D.P.D.T. toggle switch is used to switch the measuring instrument in either the input or output circuits. A potentiometer is used to control the input voltage, and a second switch is used to place buffer condensers in the circuit of the vibrator when they are not a definite part of the vibrator.

Most Service Men seem not to realize the tremendous progress that has been made in vibrator-type power supply systems. It is hoped that this article, therefore, will be useful to these men.

## "AIR-TRACK" SYSTEM OF BLIND LANDING

(Continued from page 248)

their development. They have not released much on their development, but we understand that it is still fixed in position, although it retains the fundamental principles of the Bureau system.

The 4 major Airlines, AA, TWA, UAL and EAL, meeting with Bureau of Commerce and Federal Communications Commission representatives recently set forth recommended specifications for instrument landing to be adopted on a national scale.

It is interesting to note that Air-Track exceeds the operating requirements of these specifications, meets all the requirements described as "practicable," and most of those which are called "projected developments." For example, the specifications suggest that glide path and localizer indications should be separate. The Bureau started with separate transmitters and we regard them as essential to safety and proper operation.

We believe this instrument landing situation has implications which make it the biggest story in radio or aviation at this time. Entirely aside from the safety angle, its economic angle is sure to have a tremendous effect on the history of air transportation.

### CREDITS

When a curtailment of funds necessitated a discontinuance of Department of Commerce activities on radio aids to flying in 1933, scientists who had been employed at the Bureau were set up in a new laboratory at College Park where they continued their research and experiments.

Among these men were Gomer L. Davies, Dr. Frank G. Kear, Gerald H. Wintermute, and the late William H. Orton, who are largely responsible for the improvement of the Air-Track and its adaptation to commercial needs.

The first job of instrument landing is to save lives. Its second job is to make possible the completion of every trip interrupted or cancelled because the terminal airport is "closed in," and thus to guarantee flying on an announced schedule. The story of its contributions will be the first chapter in an entirely new epoch of human flight.

Airlines of the country took a big step toward 100% in safety and regularity of scheduled operation when they recently agreed upon specifications for an acceptable instrument landing system.

As a result, it appears that a workable system will have been tested and accepted before the arrival of bad flying weather this winter.

# IT'S BONUS TIME IN RADIO

## Are You Getting YOURS?



THIS year—Radio's banner year—ought to pay you a handsome BONUS—\$25, \$50, \$100 EXTRA every month. But is it? Hundreds of Sprayberry trained men are making that much extra out of increased salaries, increased profits from their own businesses from spare-time earnings. So can you.

**\$175 A MONTH**  
Meet my student Joseph Arizabalo who says: "Now I'm in charge of the repair department of a big distributor—a permanent job. Thanks to your course, which was interesting and easy to understand, I'm making \$175 a month. You can do it too! Write today, get the facts!"

## BIG OUTFIT SENT

The Sprayberry course is complete. ADVANCED. Includes latest circuits and special series of spare-time BUSINESS BUILDINGS. Also big PROFESSIONAL OUTFIT OF REAL RADIO TOOLS, TRIPLETT TESTER, 7-RIDER MANUALS, EBV ELECTRIC EYE, ETC.

## EASY TO START

My terms, as low as \$3 a month, make it easy to start, easy to keep on, easy to collect big dividends as you go. New FREE BOOK, "More Money in Radio" fully explains. Get your copy. Write me, or use the handy coupon.

## SPECIAL COURSE FOR SERVICEMEN

Servicemen!—ask about my Special Course for YOU! Also fully explained in my big book, "More Money in Radio". Send for a copy—get complete facts.

## MAIL NOW FOR FREE BOOK

F. L. SPRAYBERRY, Pres.,  
SPRAYBERRY ACADEMY OF RADIO,  
20-L University Place, N. W.,  
Washington, D. C.

Send me a FREE copy of "More Money in Radio," and facts about your new type of training.

Name ..... ARE.....

Address .....

City ..... State .....

Paste Coupon on Penny Postcard, Mail TODAY

**Everything NEW in Radio**

- RADIO TUBES
- PUBLIC ADDRESS
- 12,000 RADIO PARTS
- NEWEST TEST EQUIPMENT
- TOOLS - BOOKS
- RADIO RECEIVERS
- AUTO SETS

**Profit Guide!**

**NEWEST BOOK** The Radolek 1937 Profit Guide is the most complete and up-to-date radio parts book ever published. 164 pages of radio buying information, TECHNICAL information and helps for servicemen are featured throughout the book.

**12,000 PARTS** The Right replacement items for every radio that you will service. A complete new selection of Receivers, Amplifiers, Test Equipment, Tubes, Tools, and Books—always in stock—ready for prompt shipment.

**FASTER SERVICE** Radolek SPECIALIZES in servicing the radioman. Our organization is geared-up to serve you best—to give you what you want when you want it and at the RIGHT PRICES. This BIG new book is FREE! Send for your copy NOW!

## RADOLEK

601 W. Randolph, Chicago, Dept. C-10  
Send me the Radolek Radio Profit Guide FREE.

Name .....

Address .....

Serviceman?  Dealer?  Experimenter?

Please Say That You Saw It in RADIO-CRAFT

# CORNELL-DUBILIER DRY ELECTROLYTIC CAPACITORS



## TYPE JR.

- Convenient mounting feet.
- Long color-coded insulated terminal leads.
- Smallest size ... made possible by etched foil process of manufacture.
- Available in a complete capacity range at 250 and 525 volts Peak.
- Dual and multiple section units in popular capacity combinations.

Compactly designed for maximum utility, the Type JR capacitor will fill the majority of servicing requirements. Expensive delays and costly shopping tours are entirely eliminated by standardizing on C-D capacitors.

Have you received your copy of the New Catalog No. 151A? Many new innovations in condenser design, and the full C-D line of capacitors illustrated in complete detail.

WORLD'S LARGEST EXCLUSIVE MANUFACTURER OF CAPACITORS • MICA...DYKANOL...PAPER... WET AND DRY ELECTROLYTICS.

**CORNELL-DUBILIER**  
ELECTRIC CORPORATION  
South Plainfield, New Jersey

## The U.S.E. Type 20-C AMPLIFIER

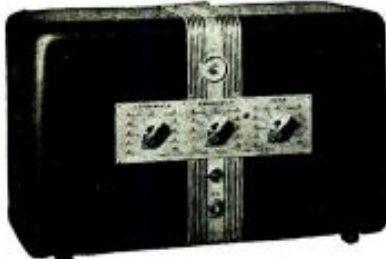

- 20 Watts output
- Dual mike input
- Electric Eye Monitor

Modern in appearance and performance

A complete line of sound systems for every application illustrated in U.S.E.'s new 16-page catalog.

Write for new catalog No. 107 and proposition

## United Sound Engineering Company

Manufacturers of Electronic Equipment  
2239 UNIVERSITY AVENUE  
St. Paul Minn.

Licensed by arrangement with E.R.P.I. under patents owned and controlled by A. T. & T. and Western Elec. Co., Inc.

## BOOK REVIEWS

**MARCONI—THE MAN AND HIS WIRELESS.** by Orrin E. Dunlap, Jr. Published by The Macmillan Company. Size, 6 x 9 ins.. 360 pages, 16 illustrations. Price, \$3.50.

This is the life story of Marconi; the emphasis is on the man's work and on his personality.

Starting with the birth of Marconi, Mr. Dunlap, Jr., portrays in a technically-accurate and most vivid narrative manner the entire history-making sequence of Marconi's life to within several short months of his death.

The author very ably interprets, with historical accuracy and scientific acumen, the role that Marconi played and the significant steps in the epic of "wireless" (radio).

The book touches on many historic events—the heroic and dramatic role of Marconi wireless in the *Republic* disaster and the *Titanic's* mid-ocean tragedy. The period of the World War which started the hectic rush to develop new radio devices and led to the development of short waves (on which Marconi was working when death claimed him) is fully and most interestingly covered.

Incidentally, Marconi himself thoroughly checked the final proofs so that the book would be accurate in facts about radio and historically correct in personal details.

**AUTOMATIC FREQUENCY CONTROL SYSTEMS.** by John F. Rider. Published by John F. Rider, Publisher. Size, 5 1/4 x 7 1/2 ins., hard cloth cover, 144 pages, profusely illustrated. Price, \$1.

Automatic Frequency Control is radio's biggest development—and, the Service Man's latest headache, unless he knows what it's all about.

The author evidently had this thought well in mind for A.F.C. is explained from its fundamentals, through its various developments up to the final forms which the circuits assume in various commercial receivers. A review chapter covers that part of the theory of inductance and phase relations upon which A.F.C. depends.

Automatic Frequency Control Systems is another Rider book that should be on every Service Man's bookshelf.

**JONES ANTENNA HANDBOOK.** by Frank C. Jones. Published by Frank C. Jones. Size, 6 x 9 ins., 64 pages. Price, 50c.

If it serves no other purpose than to clarify in the mind of the reader conflicting opinions as to relative merits of various arrangements of antennas the *Jones Antenna Handbook* will have effected a worthwhile achievement. Merely to list the chapter headings—which is all that space permits in this column—is hardly to do justice to this valuable reference work. Contents: Antenna Theory; Antennas for Transmitting; Directional Antennas; Antennas for Receiving; Antennas for Ultra-High Frequencies; Special Purpose Antennas; 160-Meter Antennas; Antenna Coupling Systems; Antenna Charts; Measuring Equipment.

**AIR CONDITIONING IN THE HOME.** by Elmer Torok, M. E. Published by The Industrial Press. Size, 6 x 9 ins.. 296 pages, 50 illustrations. 39 tables. Price, \$3.

We find upon reviewing this book that no better cross-section concerning its makeup can be prepared than is contained in the author's preface, from which we quote:

"The first 2 chapters deal with the benefits, effects and functions of air conditioning. Chapters III and IV describe in detail various types of air-conditioning equipment and systems. Chapter V is devoted exclusively to the subject of installation and operating costs. If the reader wished to go into the matter more in detail, Chapter VI, written in question and answer form, will enlighten him on the principles of air conditioning. If one finds simple calculations more fascinating than solving crossword puzzles, Chapters VII to XII will give him a generous amount of material in the form of tables, examples, and solutions."

Service Men can well use this book as a guide to work in the new, profitable field.

## ADVERTISERS' INDEX

<b>A</b>	
Aerovox Corporation.....	230
Akrad Products Company.....	210
Allied Radio Corporation.....	229
American Television Institute, Inc. Inside Back Cover	
Amplifier Co. of America.....	22
Amplitude Products Company.....	251
Arrow Sales Corporation.....	241
<b>B</b>	
The Brush Development Co.....	241
<b>C</b>	
Central Radio Laboratories.....	238
Cinadagraph Corporation.....	233
Cough-Itrengle Company.....	217
Continental Carbon, Inc.....	211
Cornell-Dubilier Corp.....	256
Coyne Electrical School.....	195
<b>E</b>	
Eastern Radio & Television Co.....	230
<b>G</b>	
G & G Genuine Majestic Refrigerator and Radio Parts Service.....	211
Gadgets Magazine.....	248
Goldentone Radio Company.....	241
<b>H</b>	
Hammamund Mfg. Company.....	216
Husok Elec. Instrument Co.....	232
Hygradeylvania Corporation.....	245
<b>I</b>	
International Correspondence Schools.....	238
International Resistance Company.....	242
<b>K</b>	
Kenyon Transformer Company, Inc.....	244
<b>L</b>	
Lancaster, Alwine & Rommel.....	241
Lincoln Engineering School.....	251
<b>M</b>	
McGraw-Hill Book Company.....	240
Melssner Mfg. Company.....	246
Metal Cast Products Company.....	245
Midwest Radio Corporation.....	233
Million Radio & Television Labs.....	236
Missett.....	246
The Muter Company.....	228
<b>N</b>	
National Radio Institute.....	193
National Schools.....	245
National Union Radio Corp.....	237
New York YMCA Schools.....	241
<b>O</b>	
Ohmite Manufacturing Company.....	234
<b>P</b>	
The Plan Shop.....	241
Post Radio Corporation.....	237
Precision Apparatus Corporation.....	241
<b>R</b>	
RCA Institutes, Inc.....	216
RCA Manufacturing Company, Inc.....	245
Radio & Technical Publishing Co.....	236
Radio Circular Company.....	245
Radio City Products Company.....	252
Radio Publications.....	231
Radio Service Institute.....	231
Radio Training Association of America, Inc.....	242
Radolek Company.....	251
Raytheon Production Corporation.....	220
Readrite Meter Works.....	251
Regal Manufacturing Company.....	254
Remington Rand, Inc.....	244
John F. Rider.....	196
<b>S</b>	
Solar Manufacturing Company.....	216
Spayberry Academy of Radio.....	255
Standard Transformer Corporation.....	244
Superior Instrument Company.....	231
Supreme Instruments Corporation.....	Inside Front Cover
<b>T</b>	
Tarela Sales Company.....	241
Teleplex Company.....	245
William A. Thomas Company.....	241
Tri-jett Electrical Instrument Co.....	243
Triumph Manufacturing Company.....	248
Tung Sol Lamp Works, Inc.....	241
<b>U</b>	
United Sound Engineering Co.....	256
<b>W</b>	
Wellworth Trading Company.....	253
Weston Electrical Instrument Corp.....	Back Cover
Wholesale Radio Service Company.....	253, 249
Wright-Decoster, Inc.....	248
<b>Z</b>	
Zephyr Radio Company.....	240

(While every precaution is taken to insure accuracy, we cannot guarantee against the possibility of an occasional change or omission in the preparation of this index.)

NO GREATER OPPORTUNITY THAN THIS

# The GROUND FLOOR

# of TELEVISION



Every student receives this giant television cathode ray tube as part of his equipment.

## TRAINED TELEVISION MEN WILL BE NEEDED SOON!

### Already Commercial in England!

Television engineering will be the next high salaried profession. Will you be ready to cash in with this new industry? Leaders of radio recognized their opportunity some fifteen years ago, and they as engineers have since earned millions! Now the future of television is assured. Are you going to make it *your* opportunity for success? Trained men will make from \$2,500 to \$20,000 per year.

## THE AMERICAN TELEVISION INSTITUTE

was established in 1935, to provide skilled men for television development in the United States. A. T. I. was founded by U. A. Sanabria, internationally famous inventor of the interlaced scanning system, now universally used. The Institute possesses one of the best equipped television experimental laboratories in the world, and it is here that students complete their courses under the personal supervision of Mr. Sanabria.

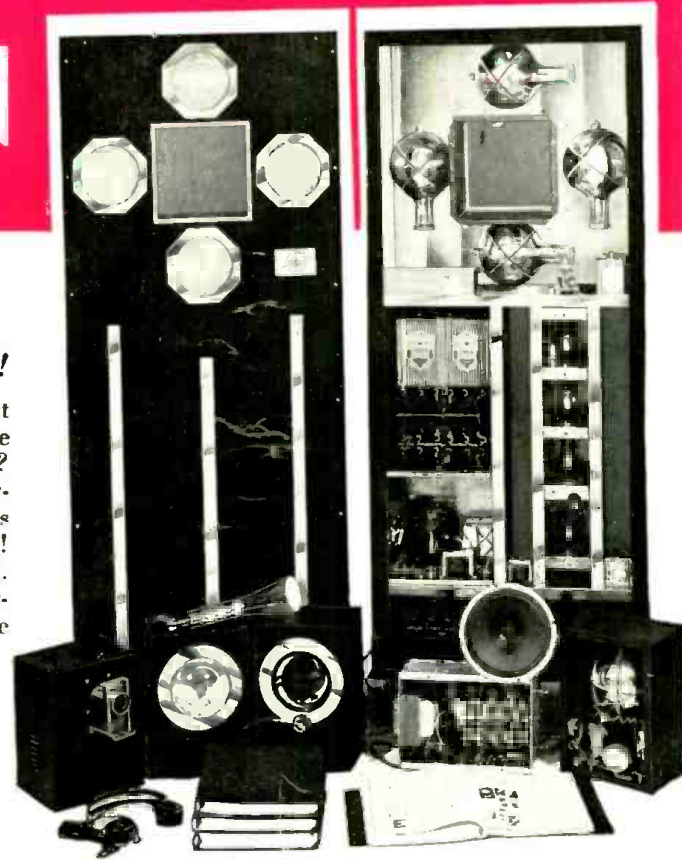

## A. T. I. TELEVISION TRAINING

qualifies you during the first few months to take your **RADIO TELEPHONE FIRST CLASS GOVERNMENT LICENSE EXAMINATION** and get into a good paying job in the radio field while completing your television instruction. Many of our graduates are successful in radio and sound motion pictures.



M. B. Foster of Prairie Du Chien, Wis., writes: "As a graduate of the class of 1936, I can highly recommend A. T. I. training with practical equipment. Since graduating, I am a technician with the Ampro Motion Picture Corp., making a good salary. I feel secure in knowing that I am able to do nearly anything in sound motion pictures or radio now, and that I am ready for television."



E. D. Carter of Bethany, Ohio, writes: "I spent two years in college and have investigated other training in radio and the allied arts, and I have yet to find anything nearly so comprehensive as the A. T. I. training in television, which includes all any practical man needs to know about radio. I have earned an average of \$2,500 per year since studying with Mr. Sanabria doing television and telephone work."

## ★ Bulletin! ★

7/17/37. The National Resources Committee reported to President Roosevelt that the most important development work in television was completed, and that only the commercial arrangements remain to be made to provide national television service.

**This means trained men must be ready.**

## AN UNPARALLELED VALUE AMAZING OFFER

### Equipment You Receive From American Television Institute

Is not small, ordinary instruction equipment, but a full sized professional television laboratory used for public exhibitions with a steel rack and panels nearly six feet high, two feet wide and eight inches deep mounted on rubber tired casters; R.C.A. amplifier and modulator tubes throughout with A.T.I.'s giant photo-electric cells and 7" x 21" cathode ray receiving tube, together with all other parts to make a complete television transmitter and receiver worth a thousand dollars to one taking this training. All of this is included with the A.T.I. course and is yours to keep. It is all amazingly low in price and on terms arranged to suit you. It costs you nothing to thoroughly investigate this opportunity. You cannot afford to pass it up if you want to get in to television. **Send Coupon Now.**

## 4 Lessons FREE!

### The Man of Ability Will Succeed

We accept only applicants who can pass the examinations on the first four lessons. We will actually send four lessons without cost or obligation, so you may determine how A. T. I. training will benefit you, and equip you for a future in radio and television. Clip coupon at right, now, and mail it to us without delay!

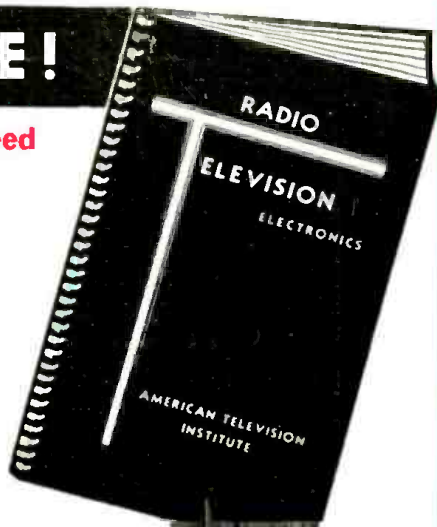

## THIS MAY MEAN YOUR FUTURE IN TELEVISION — MAIL COUPON Today!

AMERICAN TELEVISION INSTITUTE  
433 E. Erie St., Chicago, Ill. RC-1037

Gentlemen: Please send me your free book, and first four lessons, with which I would like to be tested. It is understood that all this is free.

Name ..... Age .....

Street .....

City ..... State .....

**WESTON  
MODEL 775 SERVISSET**  
A complete tester . . .  
really portable! Con-  
tains all the features  
of Models 772 Ana-  
lyzer and 773 Tube-  
checker.



**WESTON  
MODEL 772 ANALYZER**  
20,000 ohms per volt . . .  
actually measures 50  
microamperes full scale  
. . . proper condenser  
leakage test on 30 meg-  
ohm scale.



**FIRST  
IN THE FIELD!**

**WESTON  
MODEL 773 TUBE-CHECKER**  
Special, approved Mas-  
ter circuit . . . tests all  
present tubes . . . spare  
socket . . . noise test.



**1<sup>st</sup>**

**WESTON  
MODEL 773 TUBE SELLER**  
Contains all the fea-  
tures of 773 portable,  
plus built in, rapid re-  
ference rotator tube  
chart. Handsome pol-  
ished-wood case.



- in dependable accuracy
- in engineering and design
- in wide range of usefulness
- in operating simplicity
- in low obsolescence features
- in profit possibilities for service men

**WESTON  
MODEL 771 CHECKMASTER**  
Ideal field estimator  
. . . tube checker, volt-  
meter, ohmmeter,  
continuity tester.



— and remember, all WESTON Radio Instruments can  
be purchased under the convenient WESTON Invest-  
ment Plan.

**WESTON**

GET ALL THE FACTS — RETURN COUPON TODAY

Weston Electrical Instrument Corp.,  
599 Frelinghuysen Ave., Newark, N. J.  
Send full data on all Radio Instruments.

Name .....

Address .....

City ..... State .....